

# RB079 NEUTRON ACER TENDL-2024 LIBRARY; T=0.K

## Principal cross sections

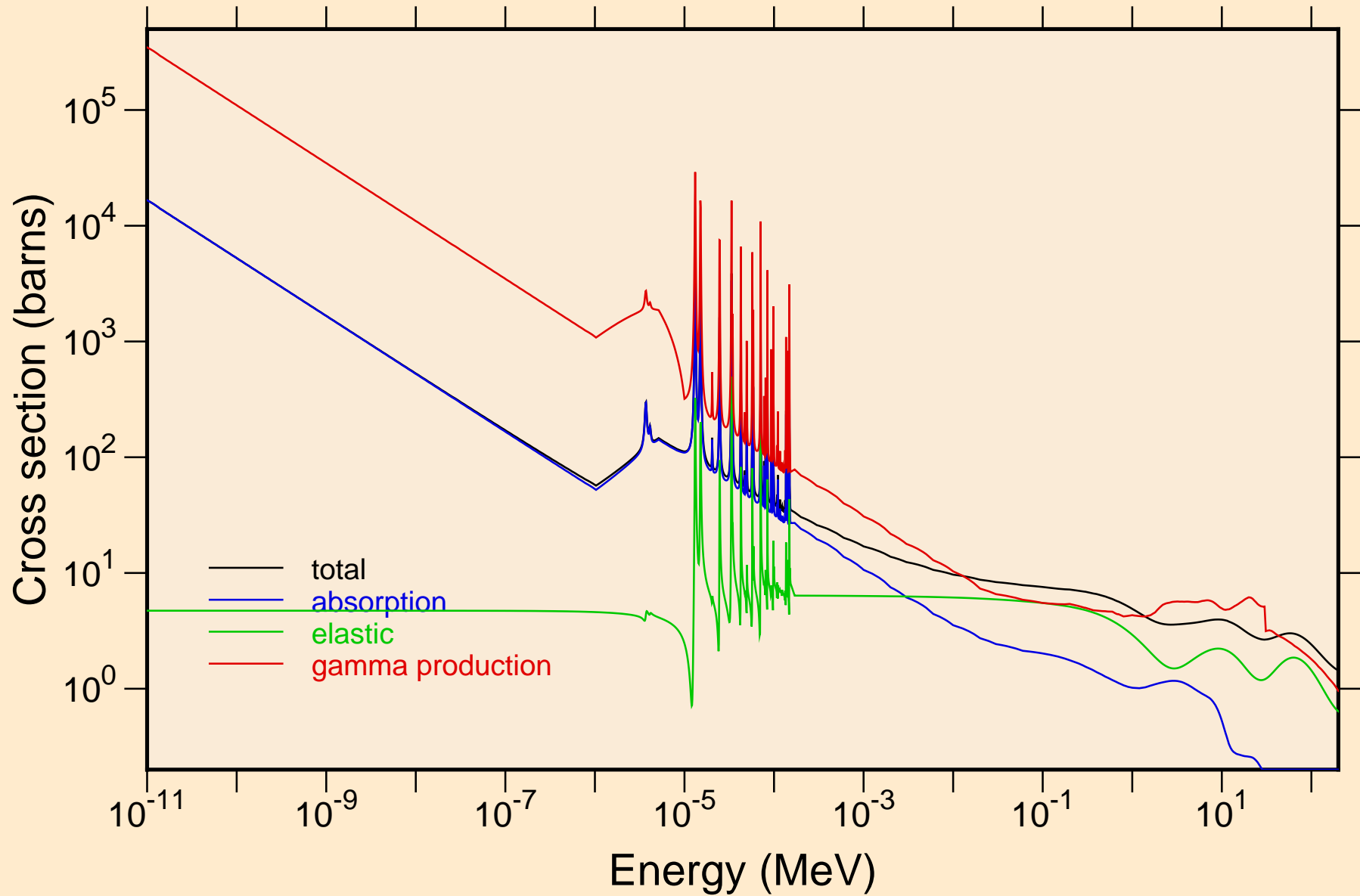

RB079 NEUTRON ACER TENDL-2024 LIBRARY; T=0.K  
resonance total cross section

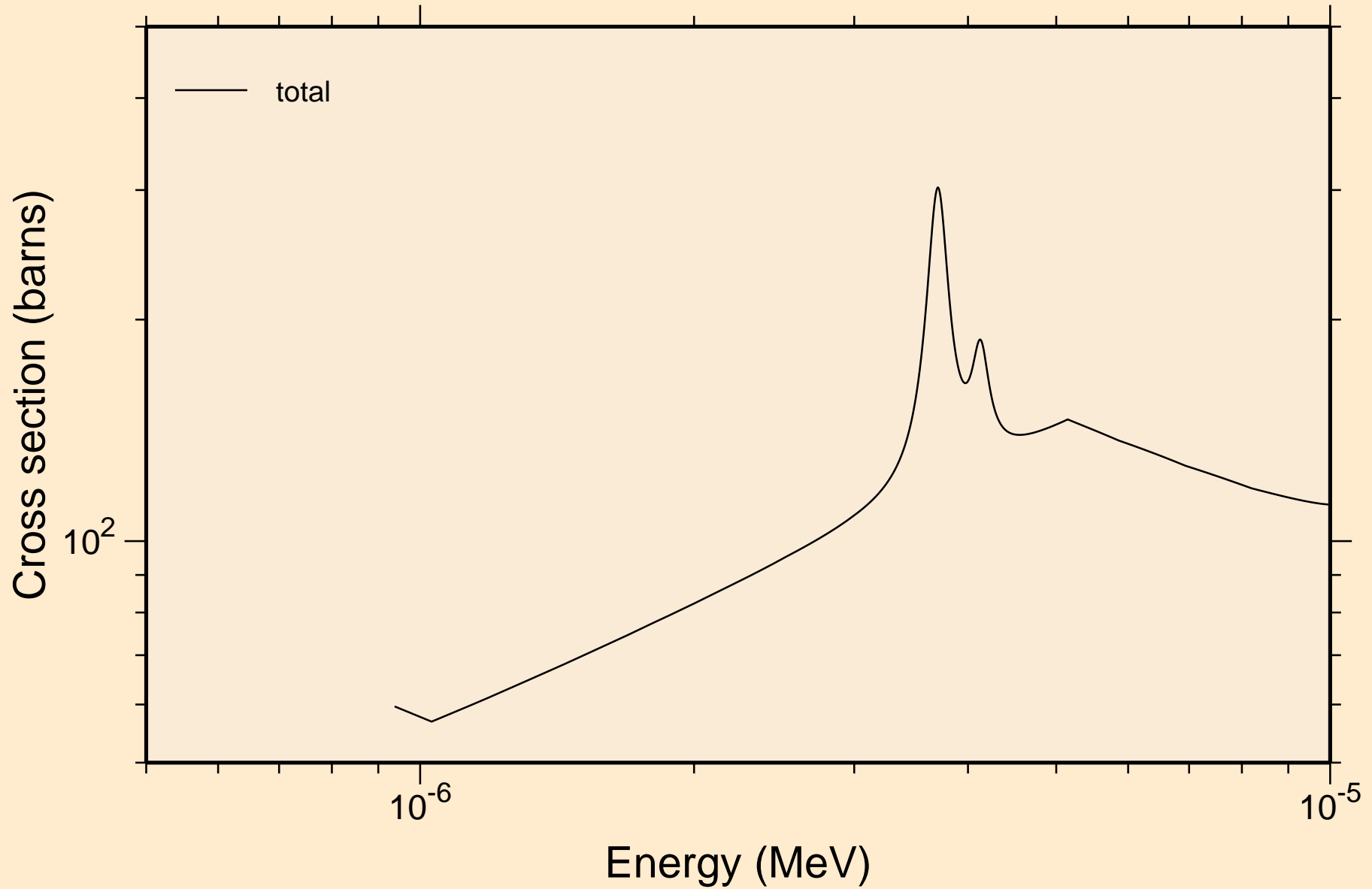

RB079 NEUTRON ACER TENDL-2024 LIBRARY; T=0.K  
resonance total cross section

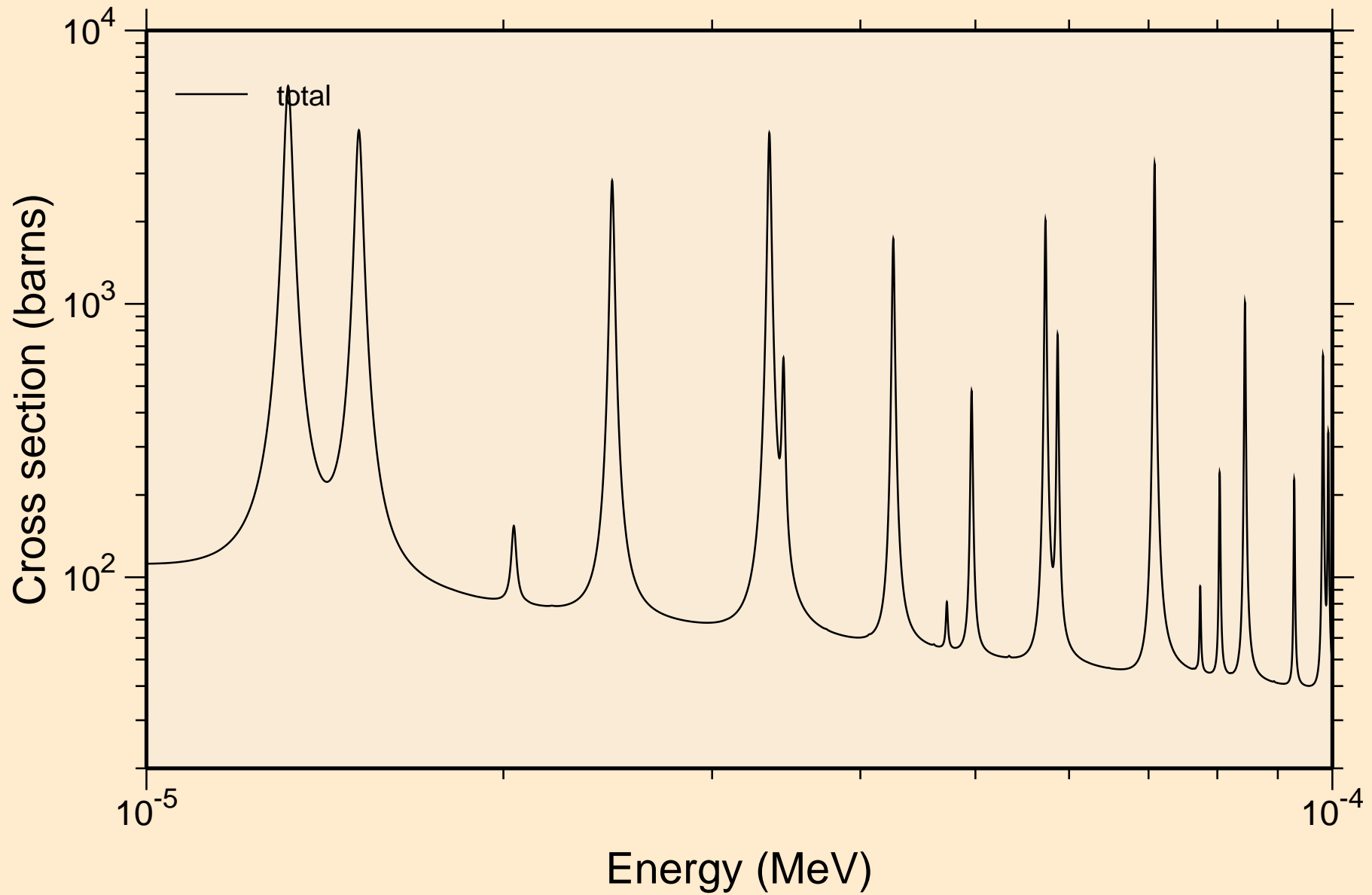

RB079 NEUTRON ACER TENDL-2024 LIBRARY; T=0.K  
resonance total cross section

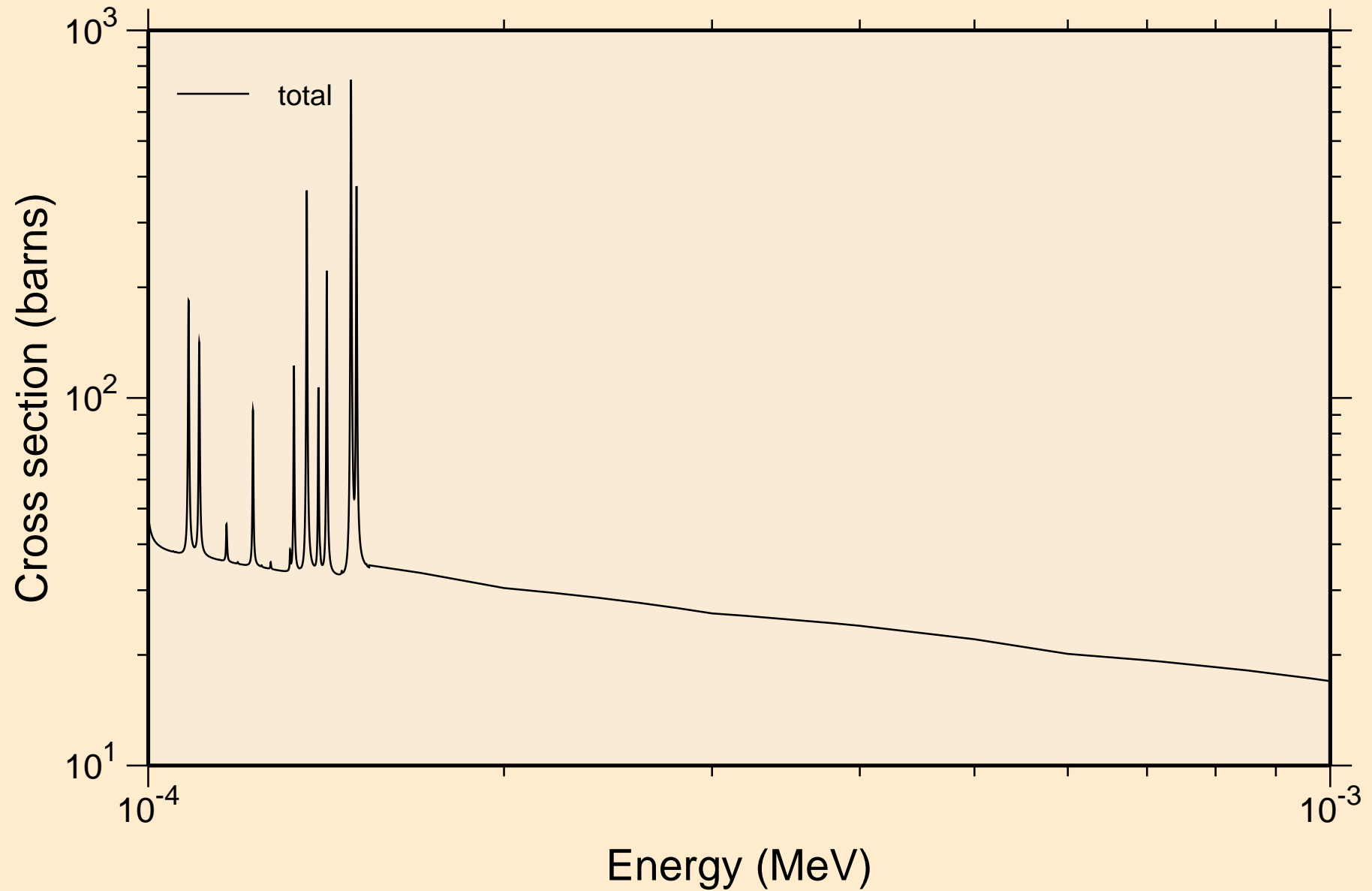

R̄B079 NEUTRON ACER TENDL-2024 LIBRARY; T=0.K  
resonance total cross section

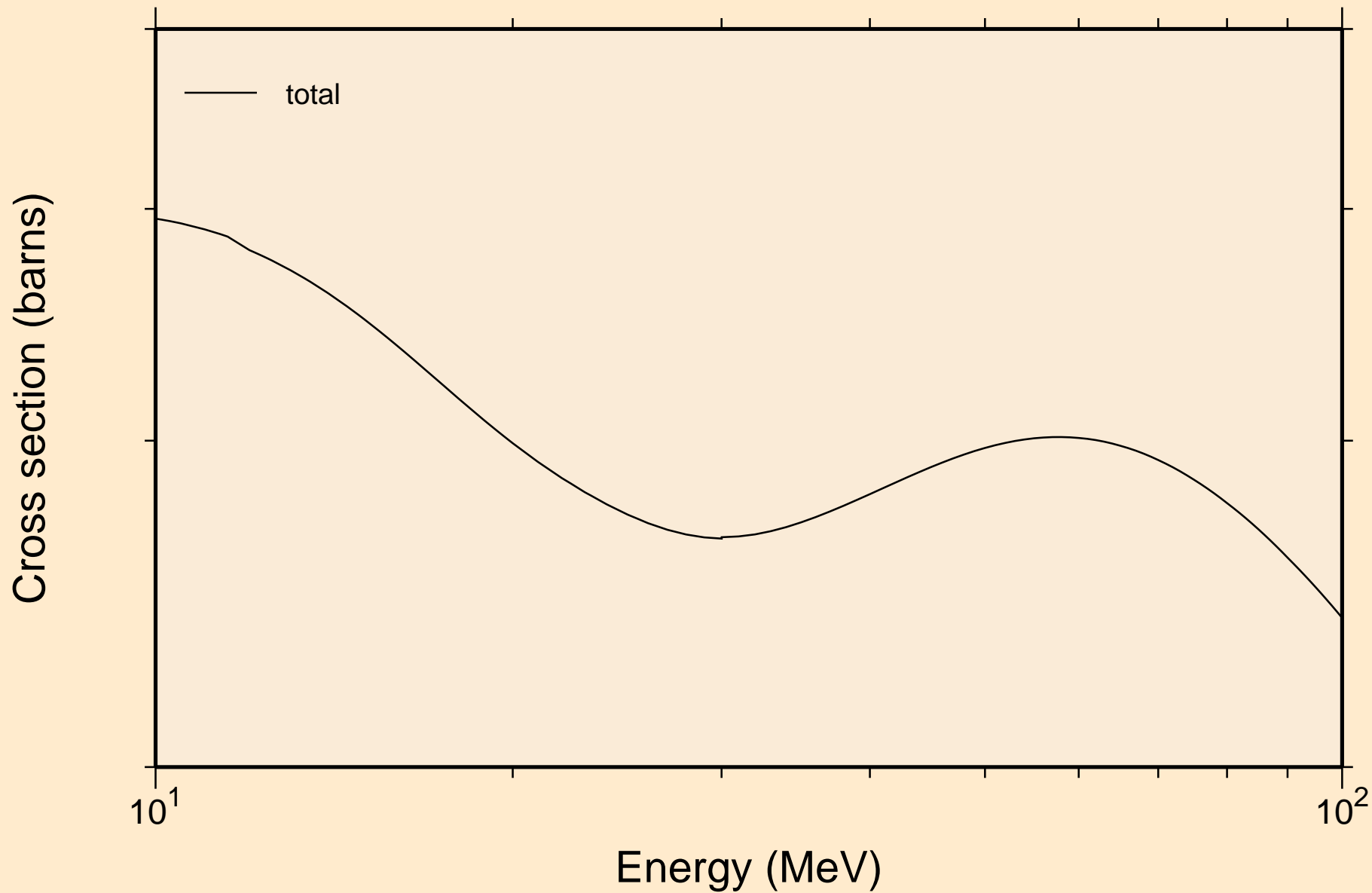

RB079 NEUTRON ACER TENDL-2024 LIBRARY; T=0.K  
resonance absorption cross sections

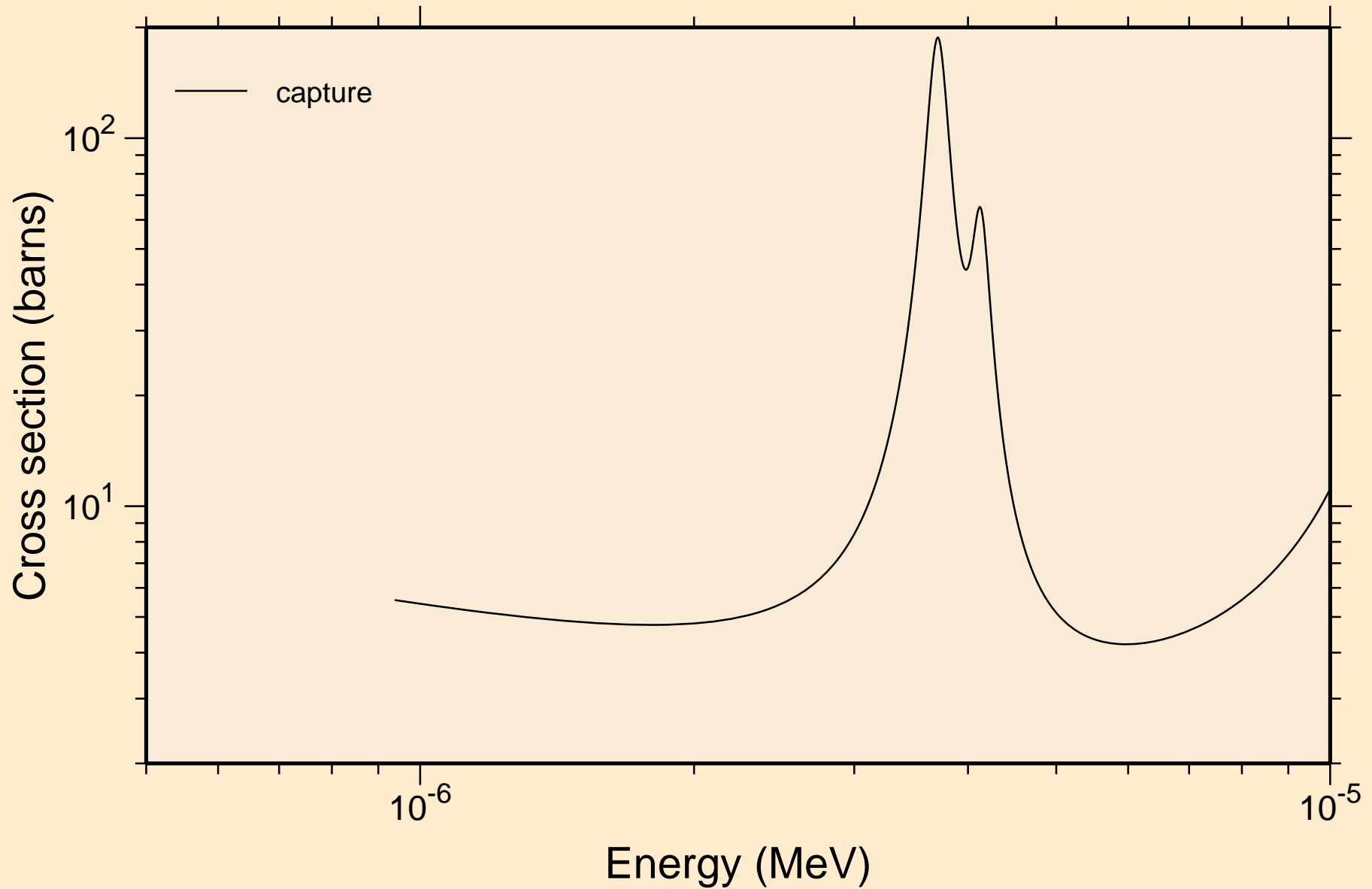

RB079 NEUTRON ACER TENDL-2024 LIBRARY; T=0.K  
resonance absorption cross sections

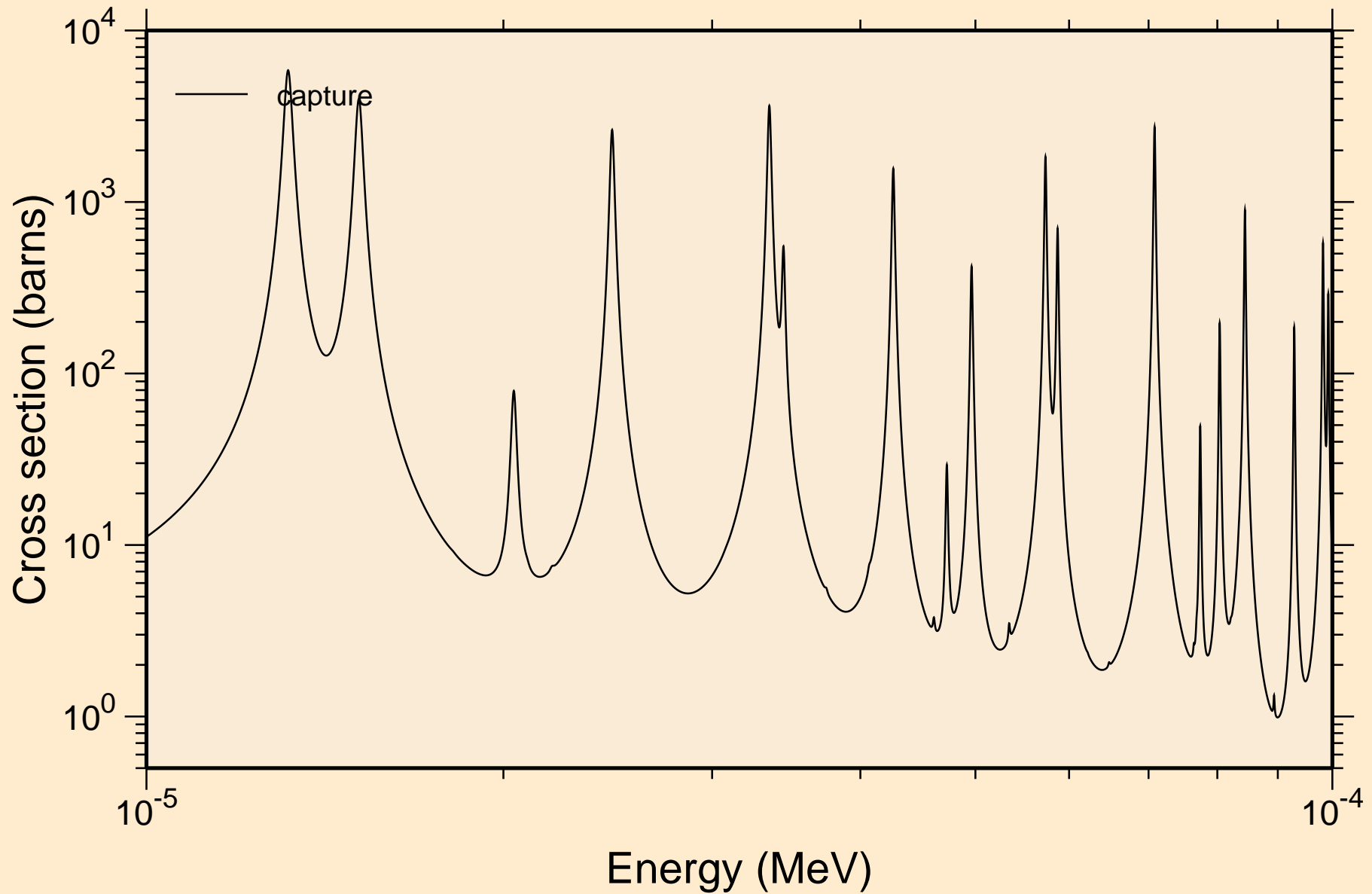

RB079 NEUTRON ACER TENDL-2024 LIBRARY; T=0.K  
resonance absorption cross sections

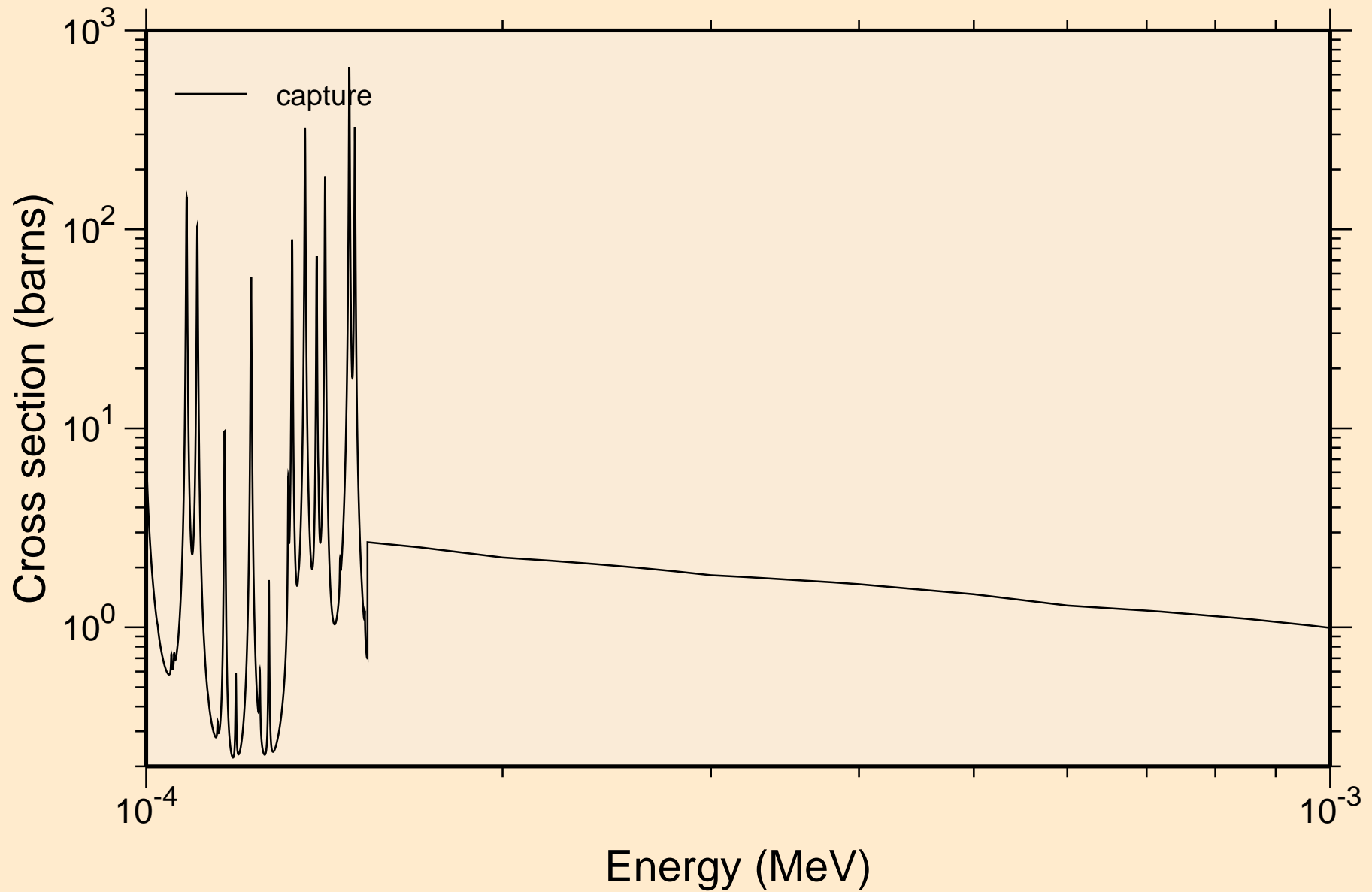



RB079 NEUTRON ACER TENDL-2024 LIBRARY; T=0.K  
resonance absorption cross sections

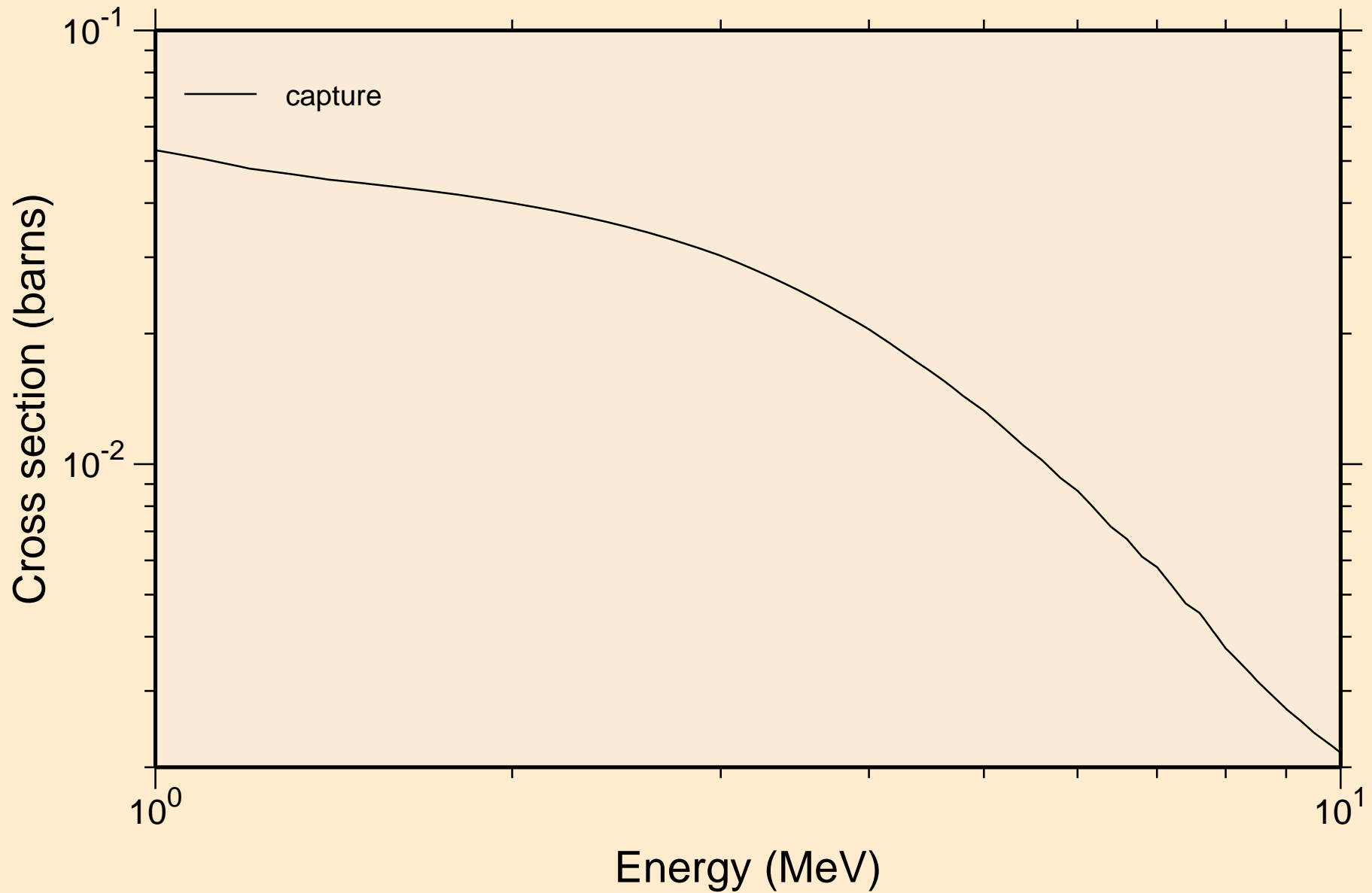

RB079 NEUTRON ACER TENDL-2024 LIBRARY; T=0.K  
Heating

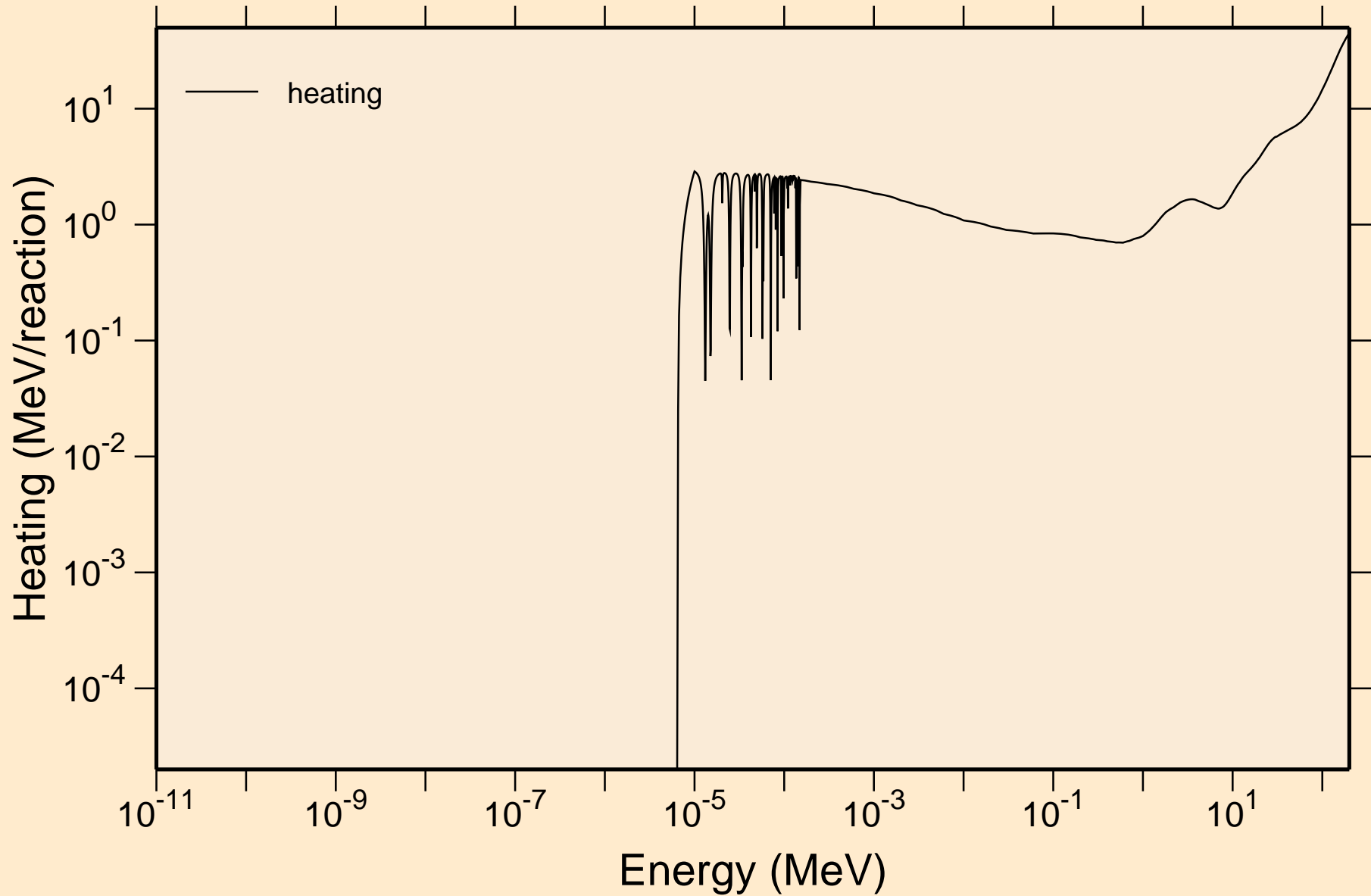

RB079 NEUTRON ACER TENDL-2024 LIBRARY; T=0.K  
Damage

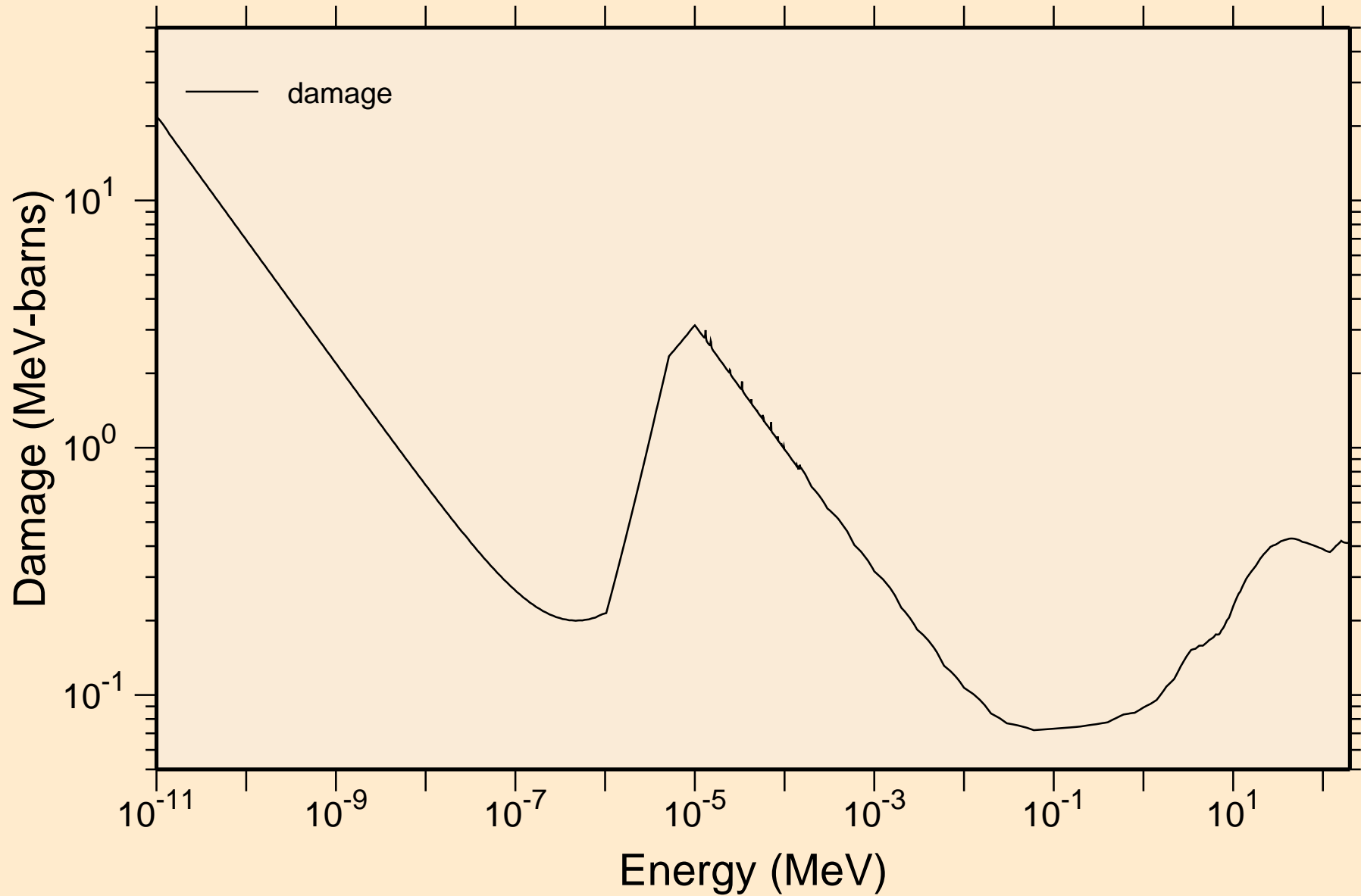

RB079 NEUTRON ACER TENDL-2024 LIBRARY; T=0.K  
Non-threshold reactions

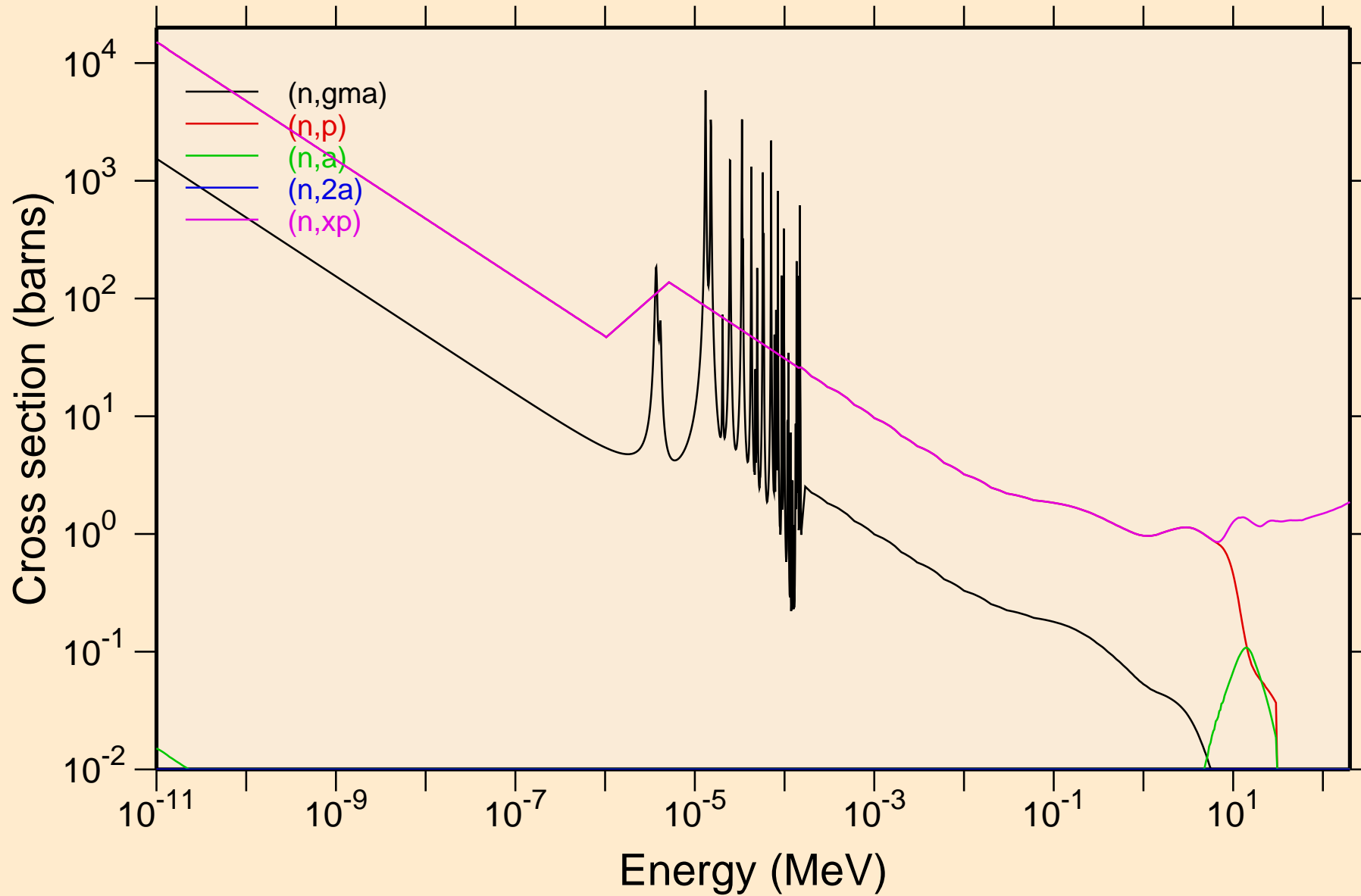

RB079 NEUTRON ACER TENDL-2024 LIBRARY; T=0.K  
Non-threshold reactions

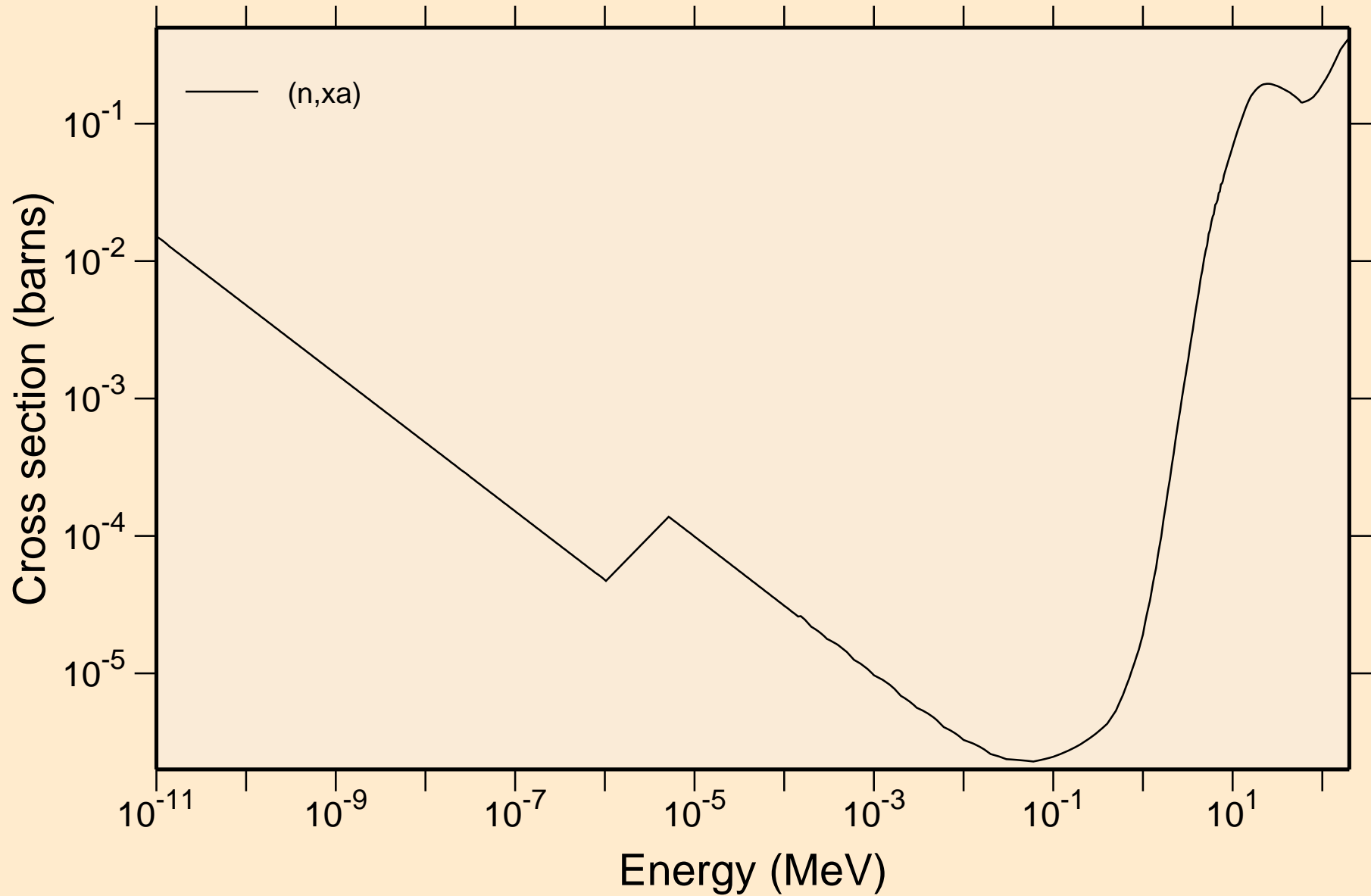

# RB079 NEUTRON ACER TENDL-2024 LIBRARY; T=0.K

## Principal cross sections

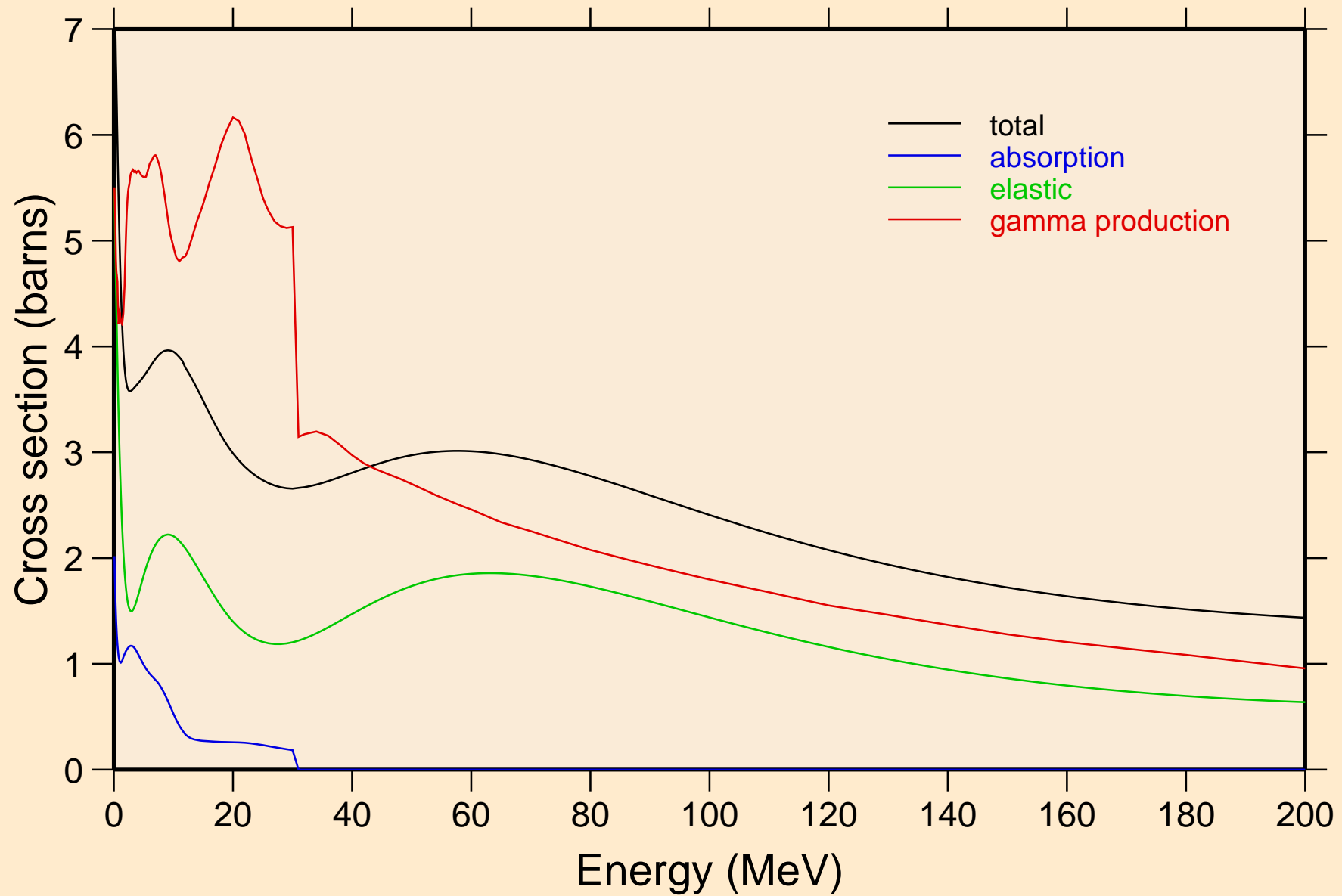

# RB079 NEUTRON ACER TENDL-2024 LIBRARY; T=0.K

## Heating

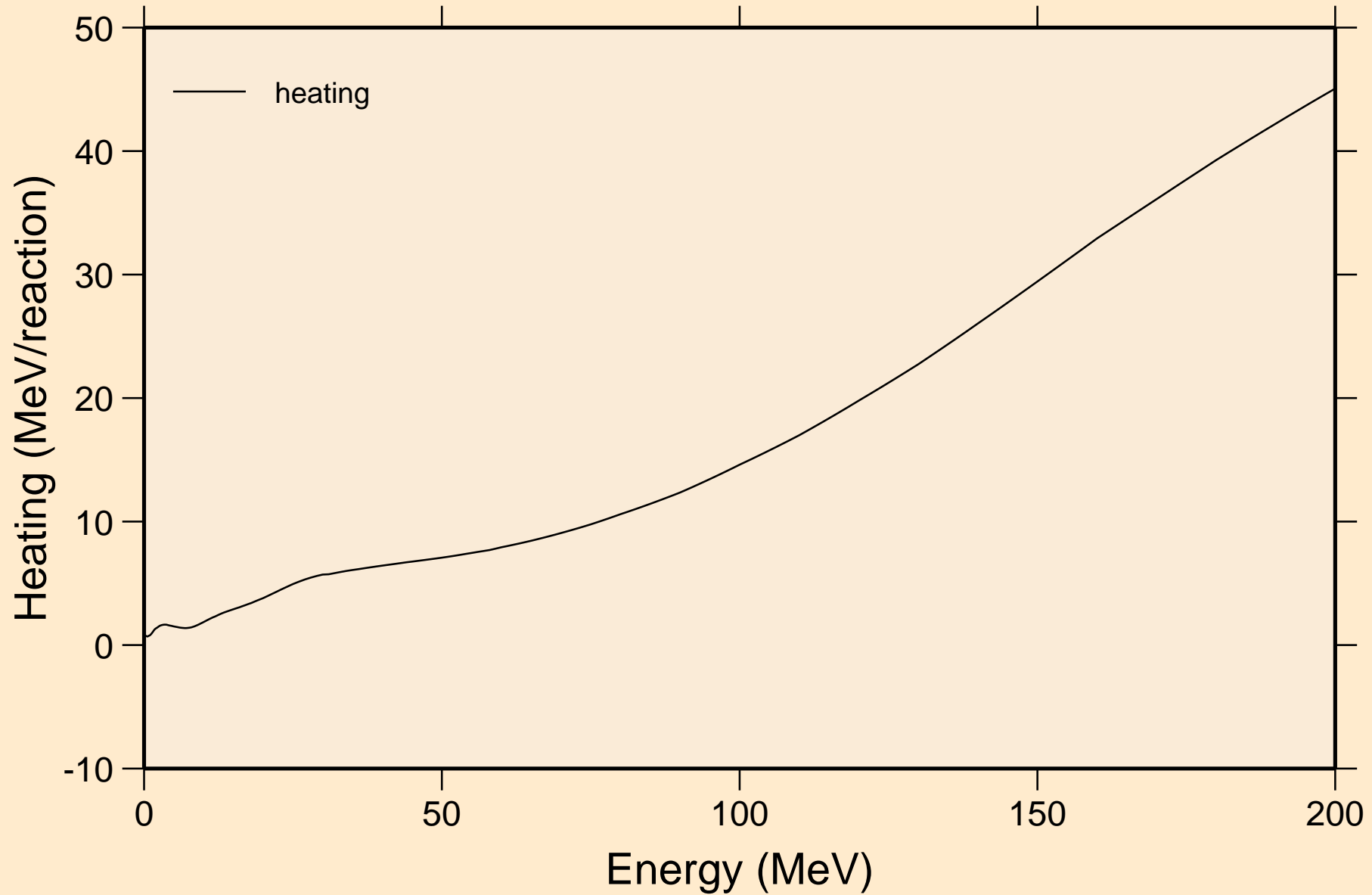

# RB079 NEUTRON ACER TENDL-2024 LIBRARY; T=0.K

## Damage

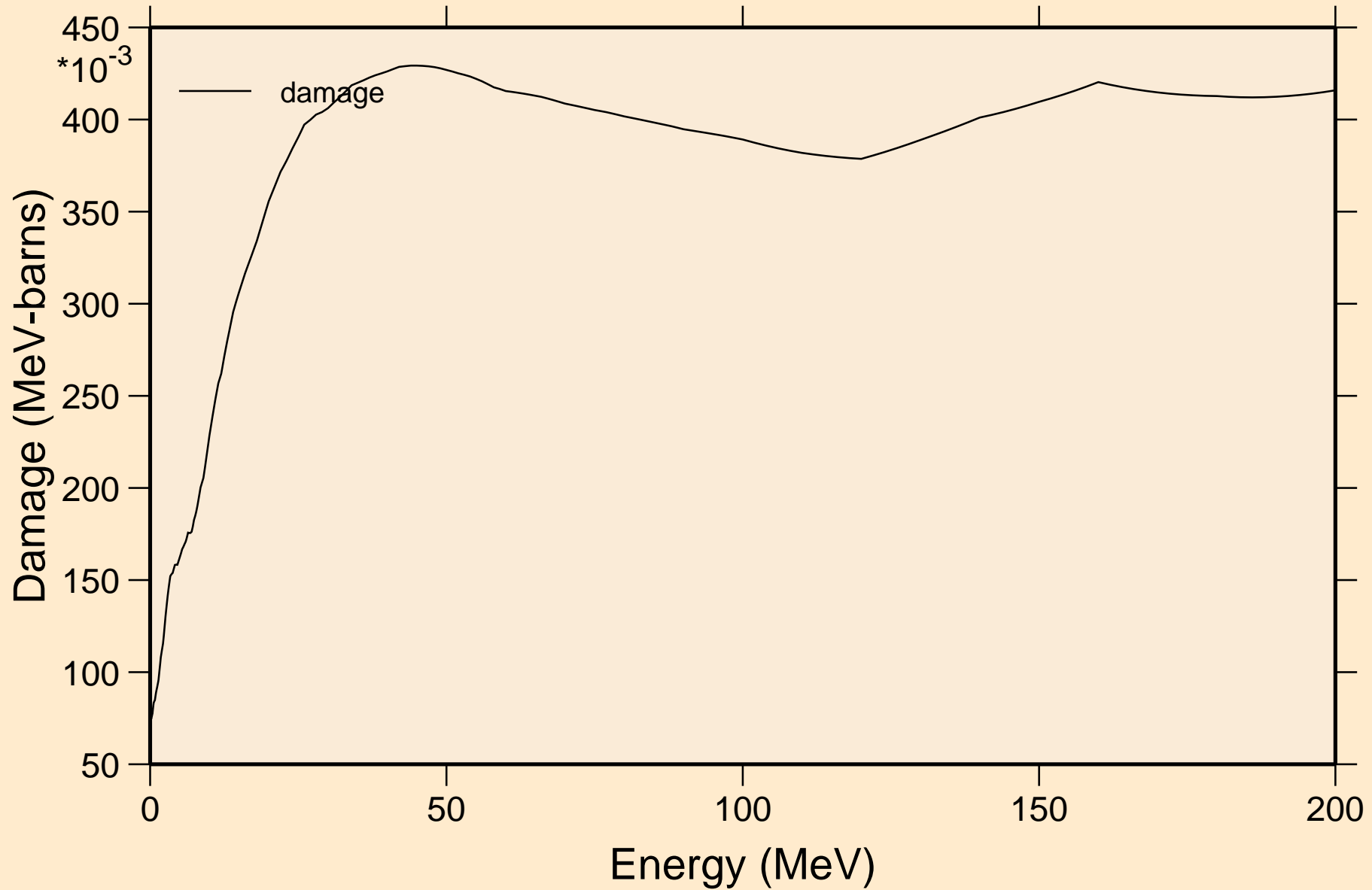



RB079 NEUTRON ACER TENDL-2024 LIBRARY; T=0.K  
Non-threshold reactions

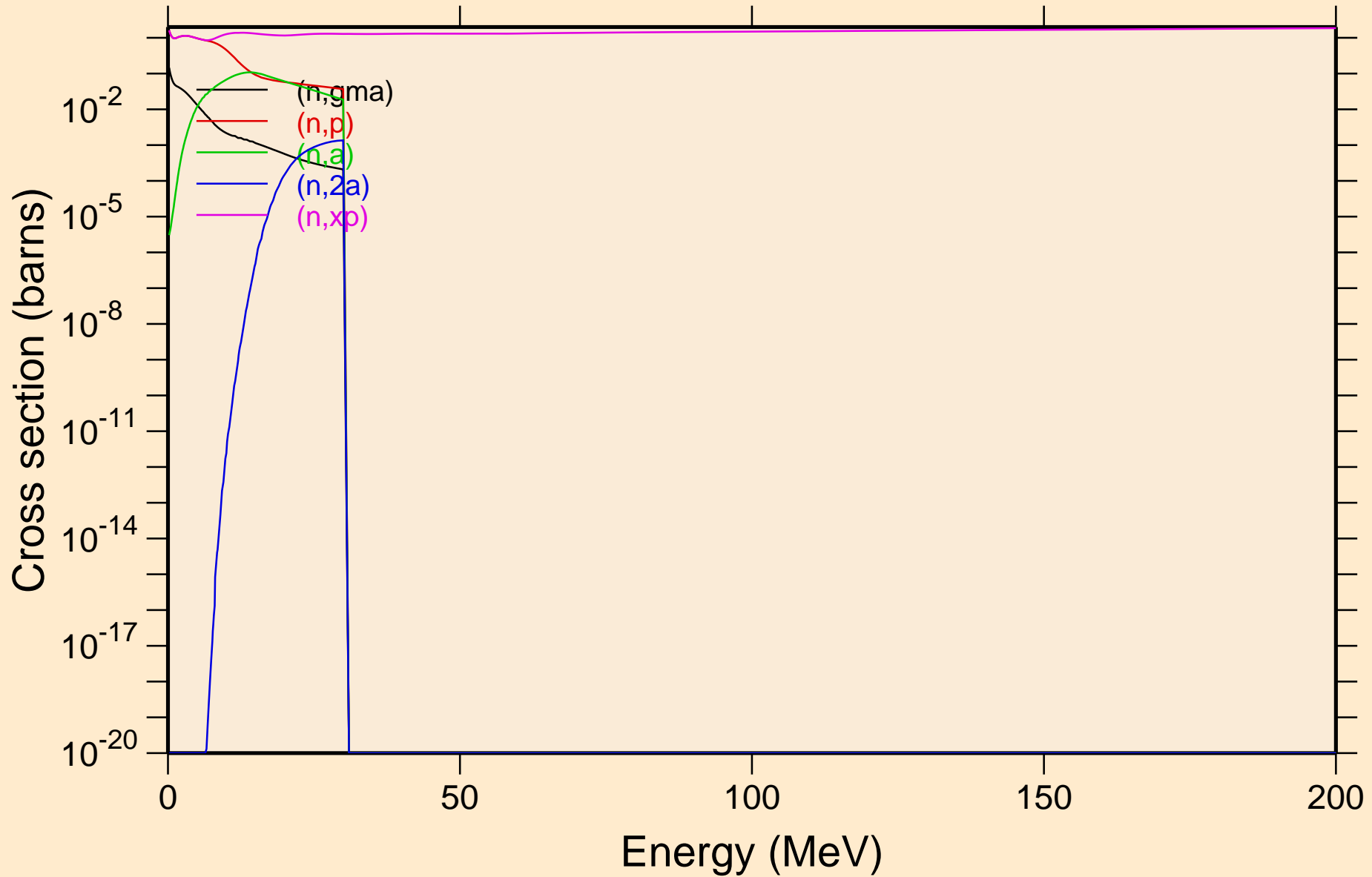

RB079 NEUTRON ACER TENDL-2024 LIBRARY; T=0.K  
Non-threshold reactions

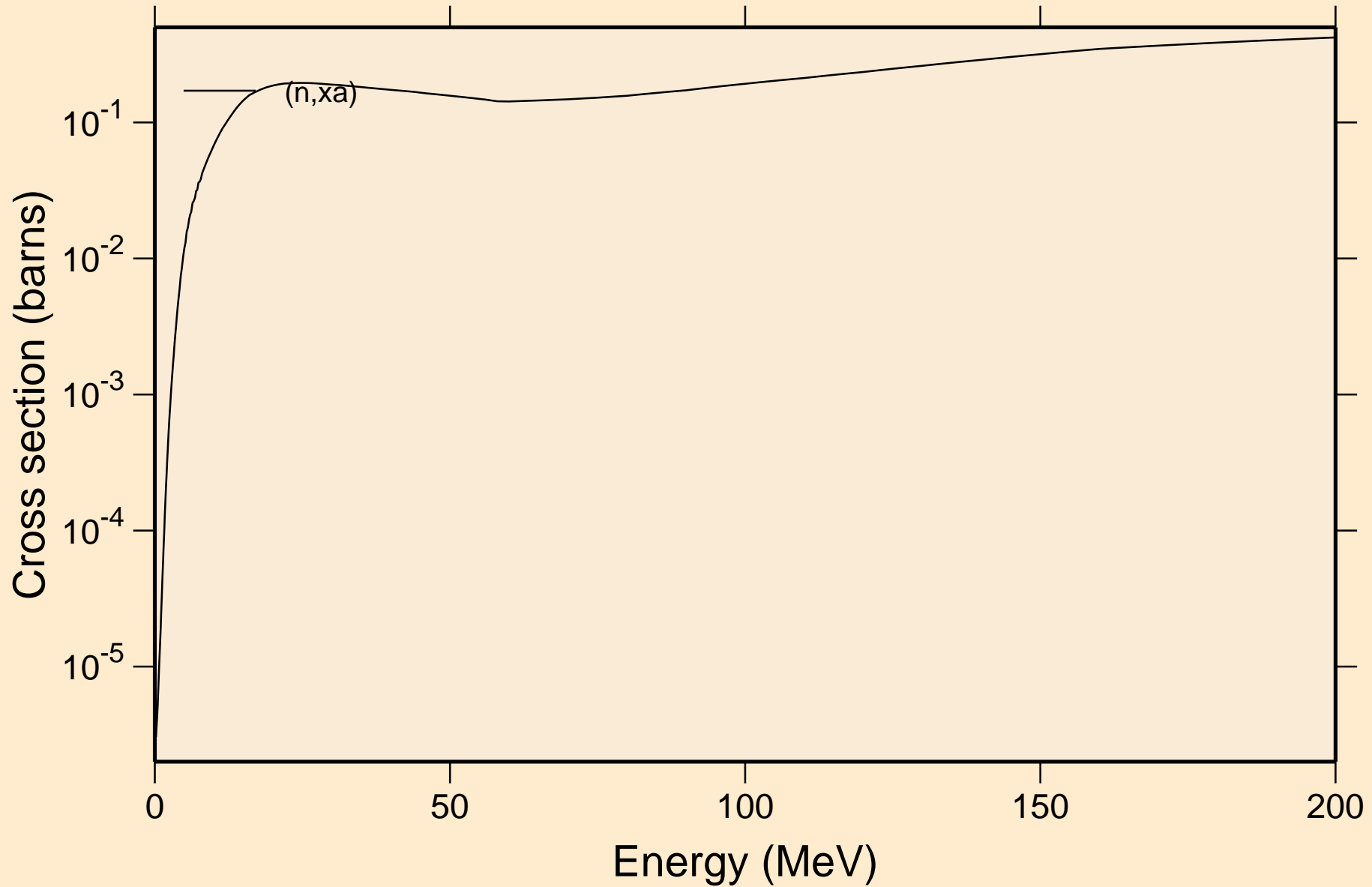

RB079 NEUTRON ACER TENDL-2024 LIBRARY; T=0.K  
Inelastic levels

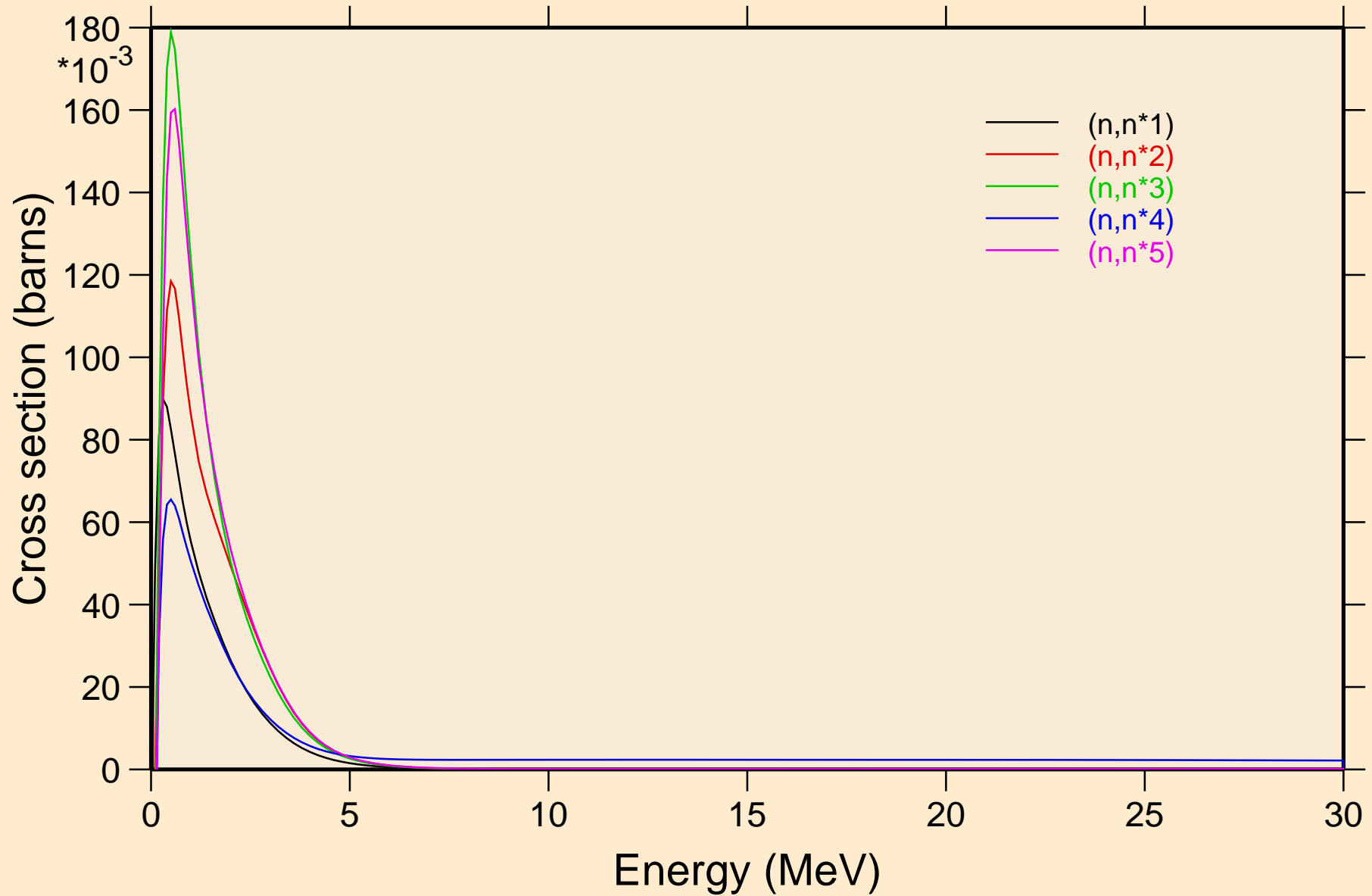

RB079 NEUTRON ACER TENDL-2024 LIBRARY; T=0.K  
Inelastic levels

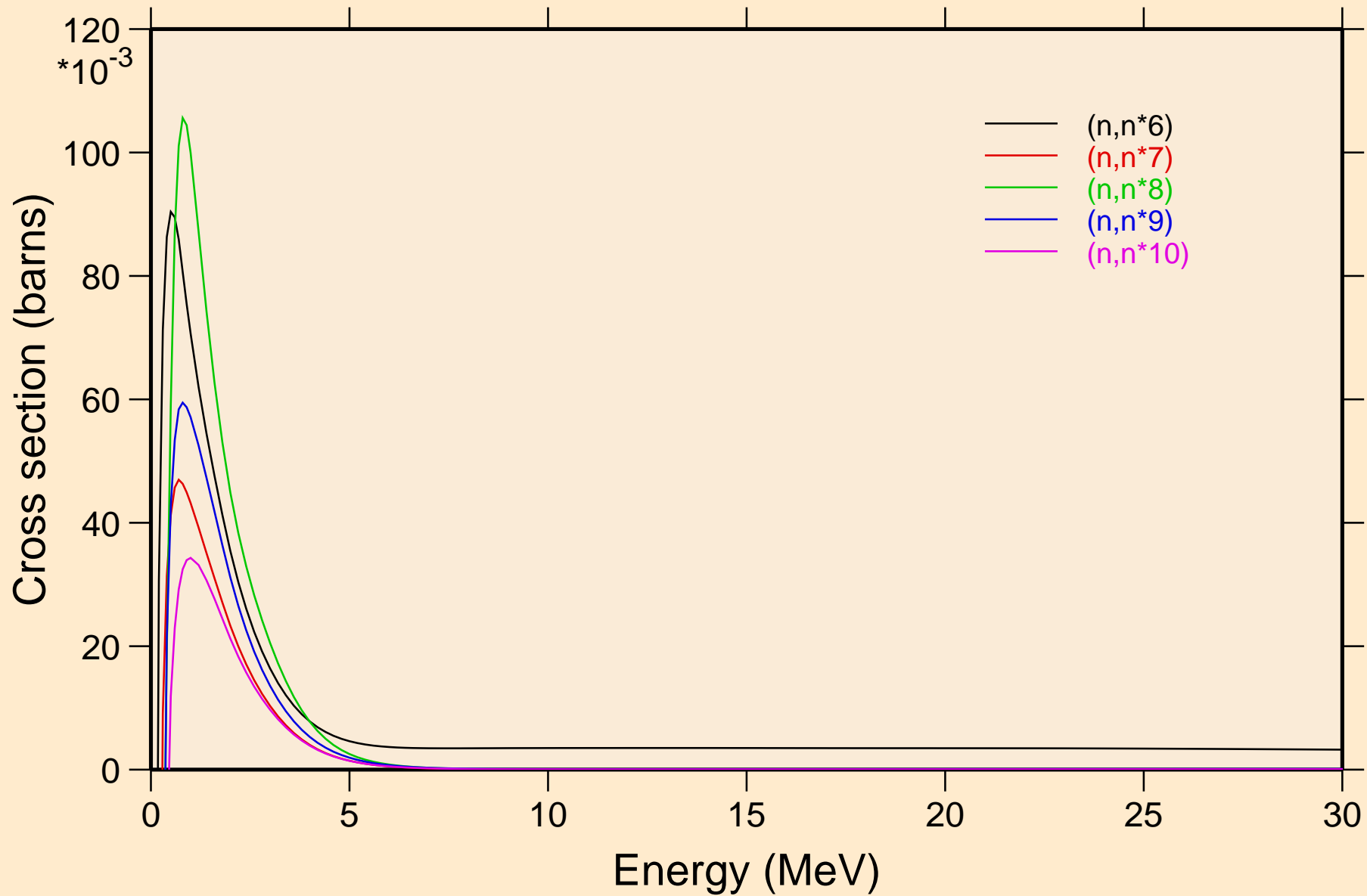

RB079 NEUTRON ACER TENDL-2024 LIBRARY; T=0.K  
Inelastic levels

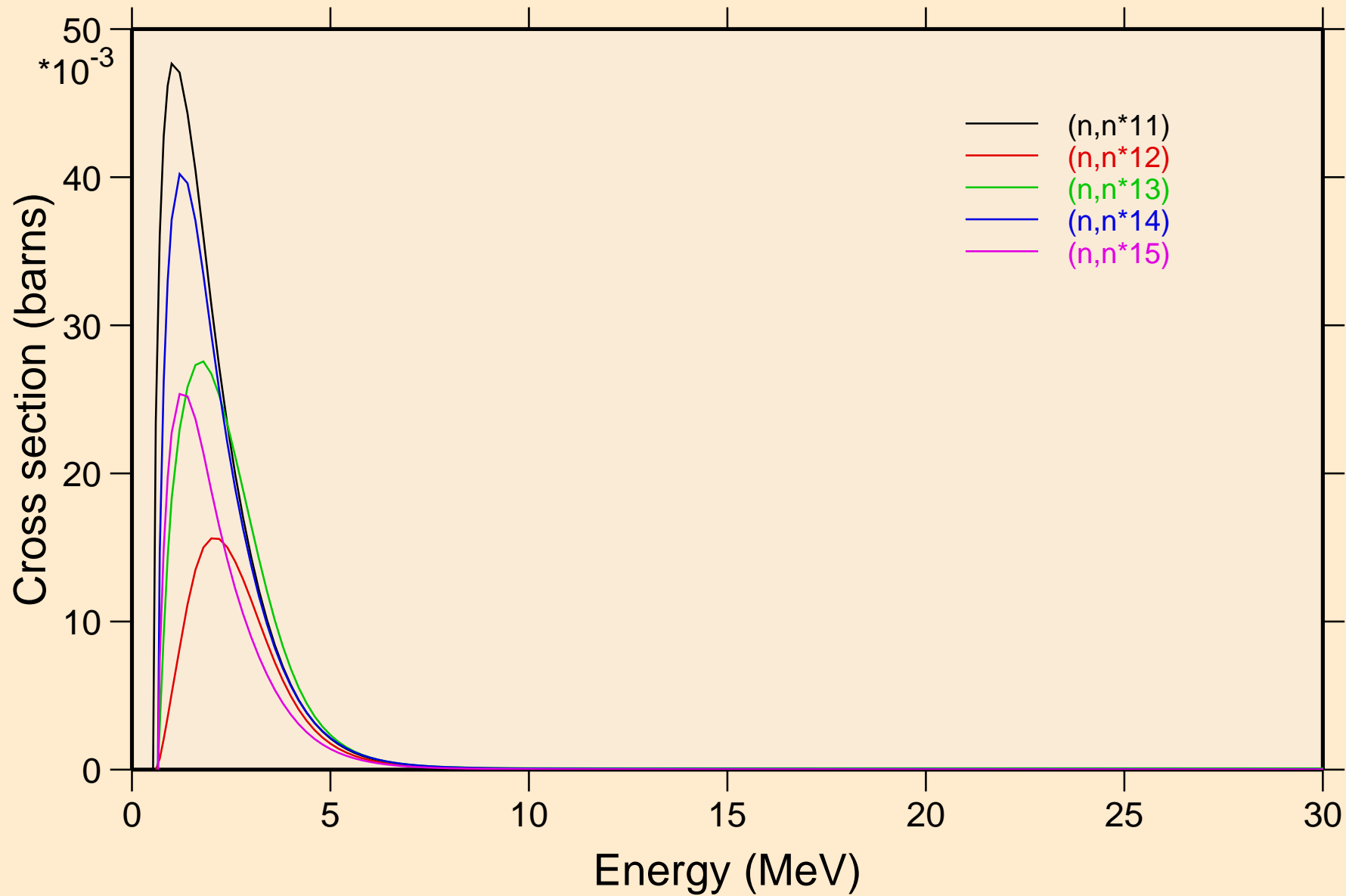

RB079 NEUTRON ACER TENDL-2024 LIBRARY; T=0.K  
Inelastic levels

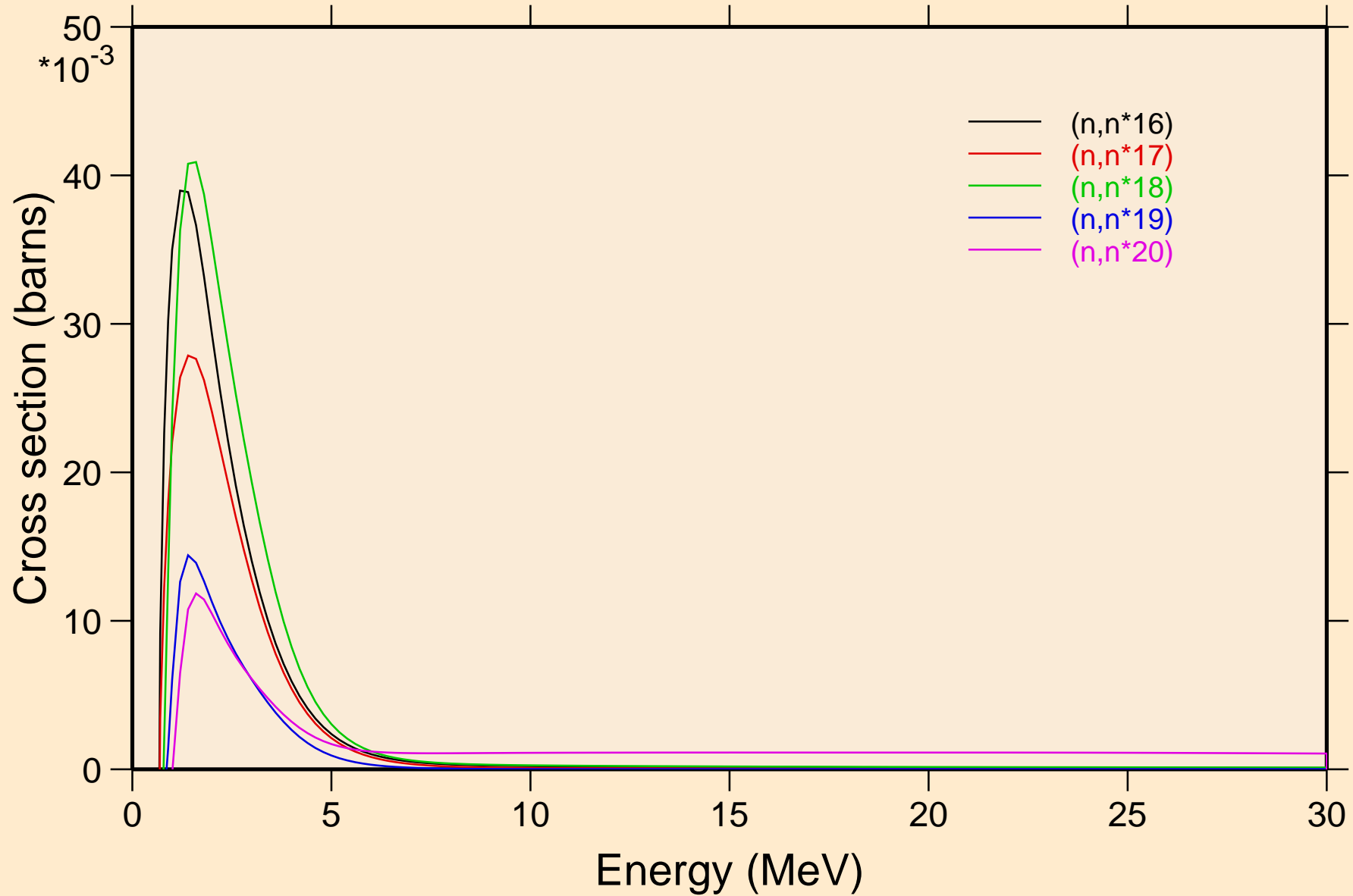

RB079 NEUTRON ACER TENDL-2024 LIBRARY; T=0.K  
Inelastic levels

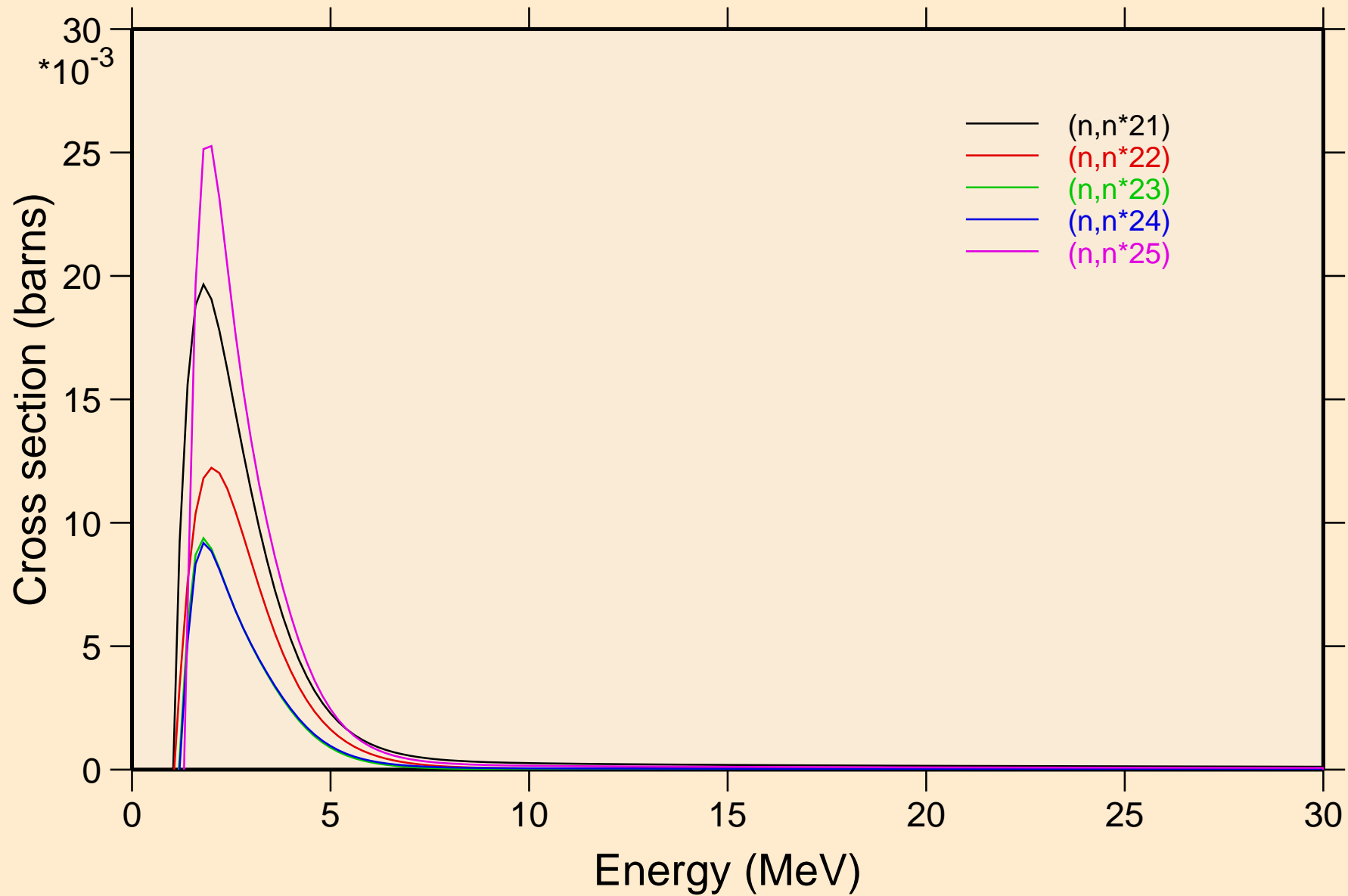

RB079 NEUTRON ACER TENDL-2024 LIBRARY; T=0.K  
Threshold reactions

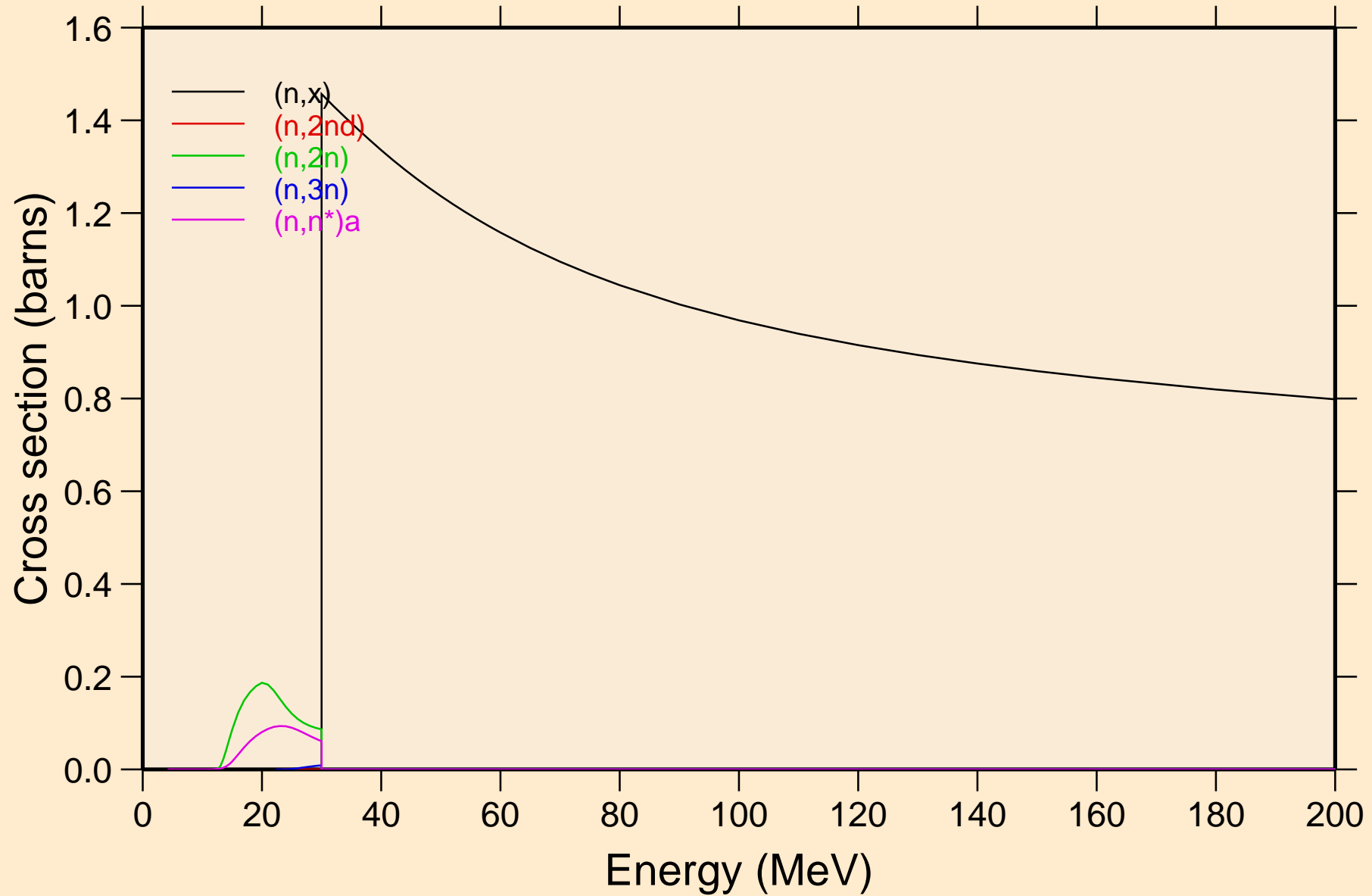



RB079 NEUTRON ACER TENDL-2024 LIBRARY; T=0.K  
Threshold reactions

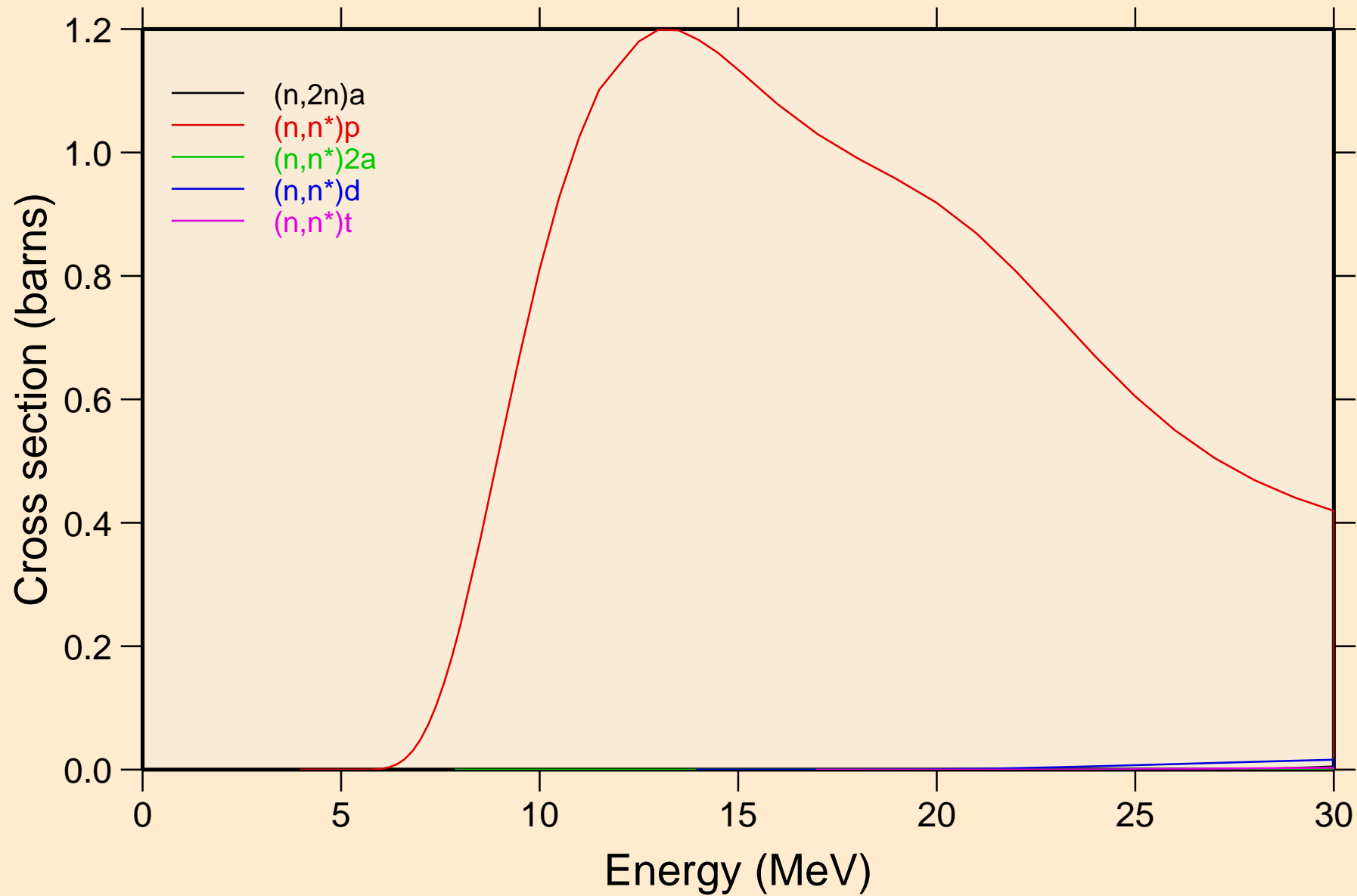

RB079 NEUTRON ACER TENDL-2024 LIBRARY; T=0.K  
Threshold reactions

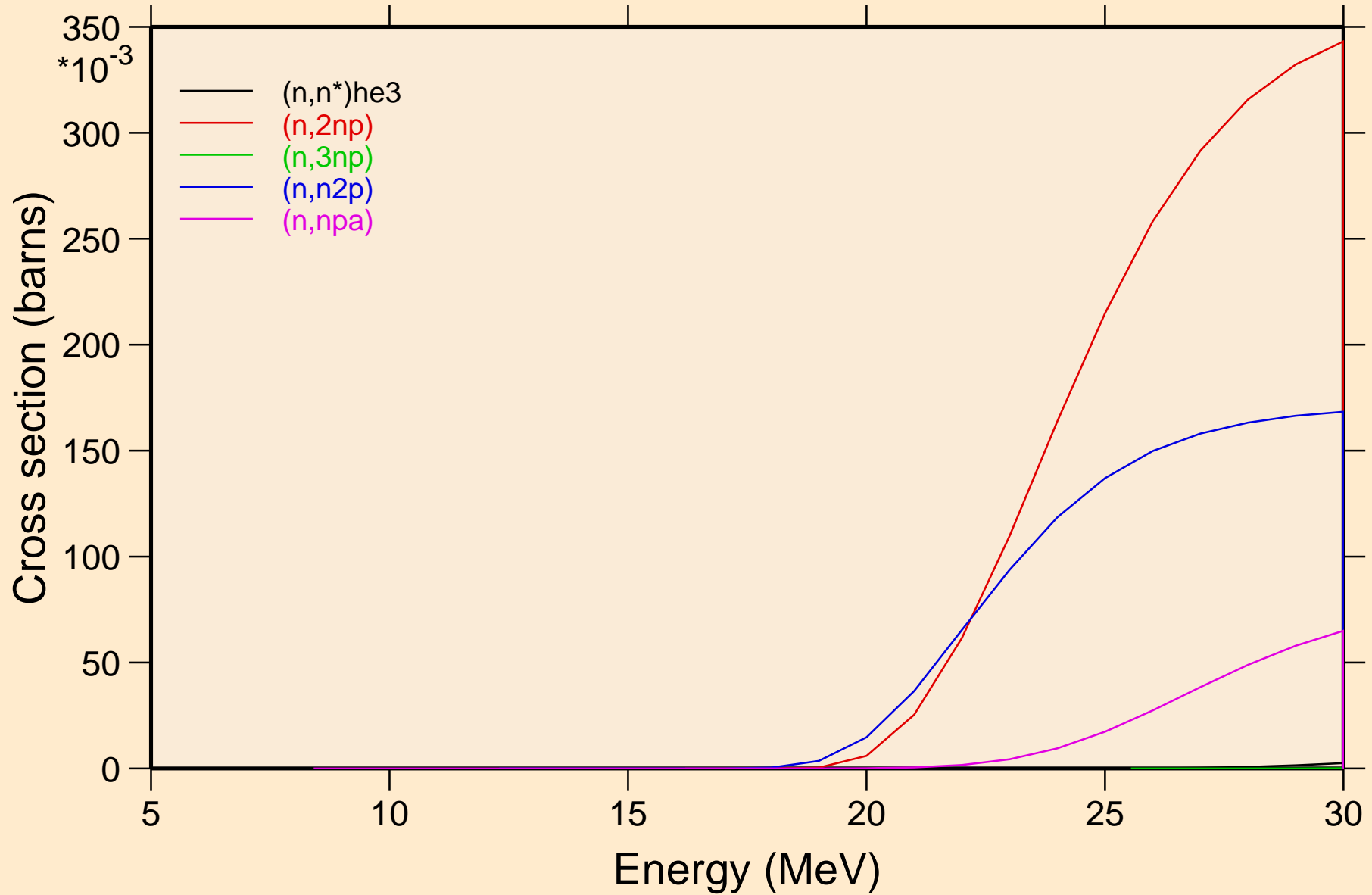

RB079 NEUTRON ACER TENDL-2024 LIBRARY; T=0.K  
Threshold reactions

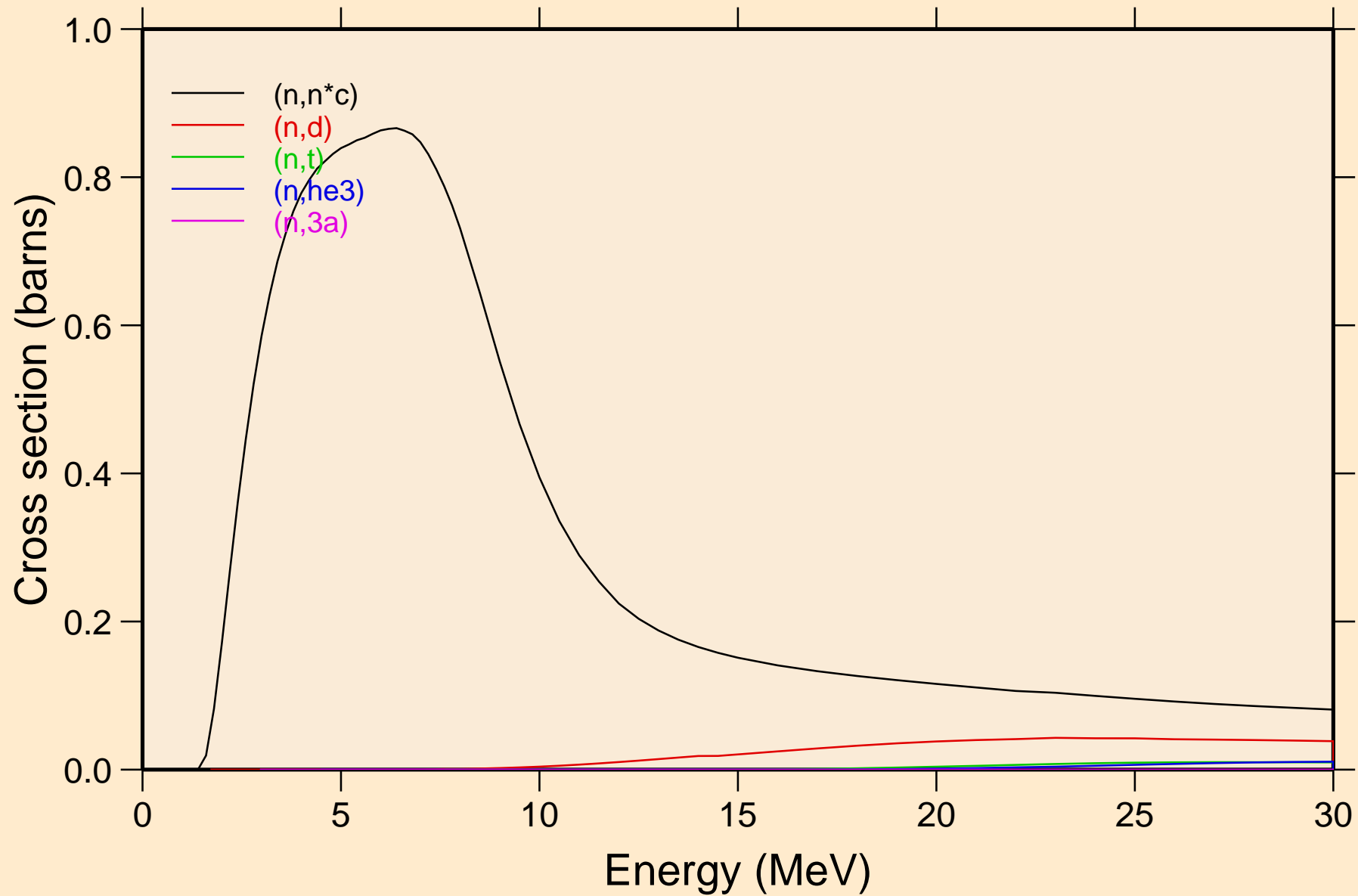

# RB079 NEUTRON ACER TENDL-2024 LIBRARY; T=0.K

## Threshold reactions

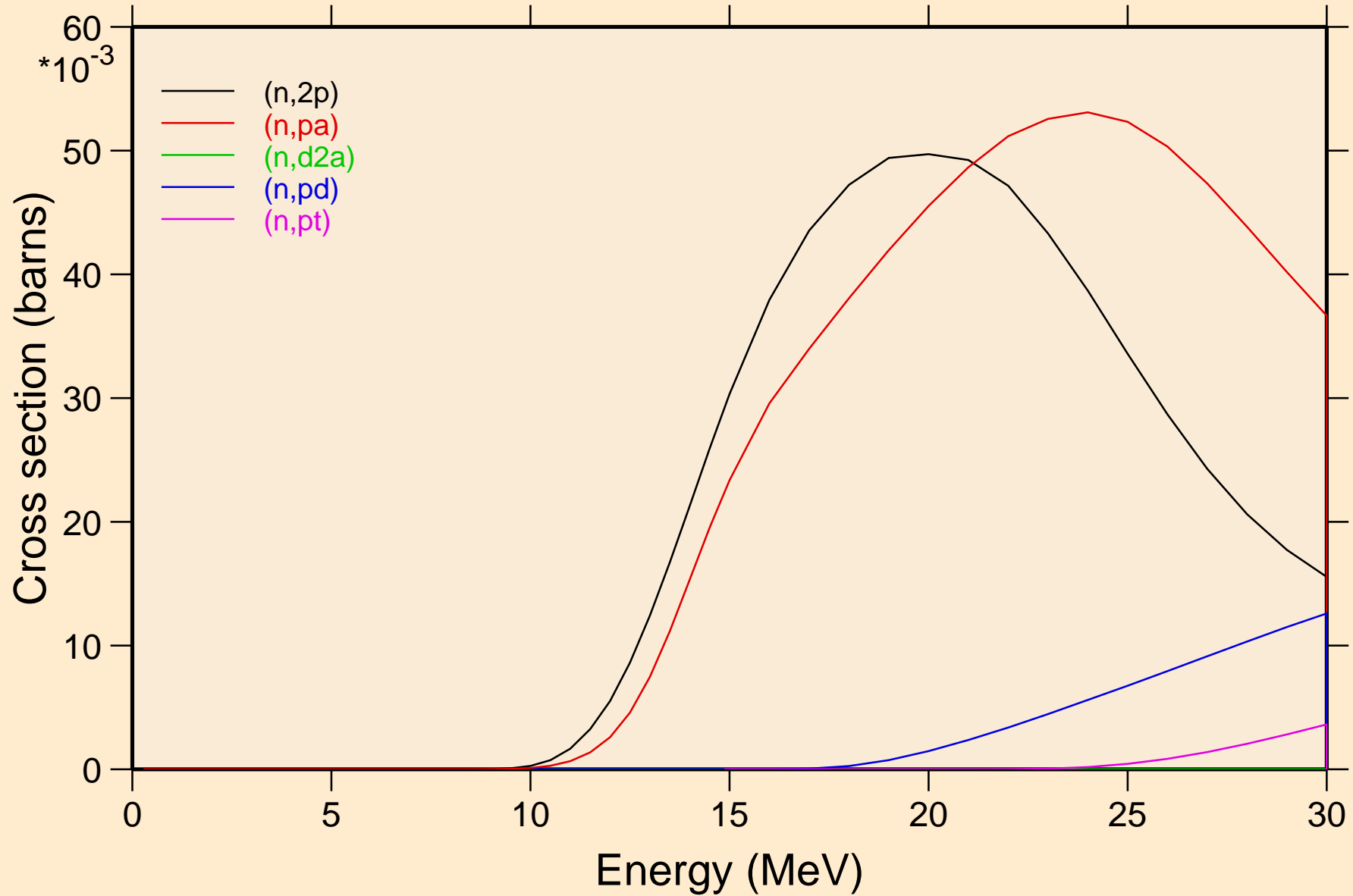

RB079 NEUTRON ACER TENDL-2024 LIBRARY; T=0.K  
Threshold reactions

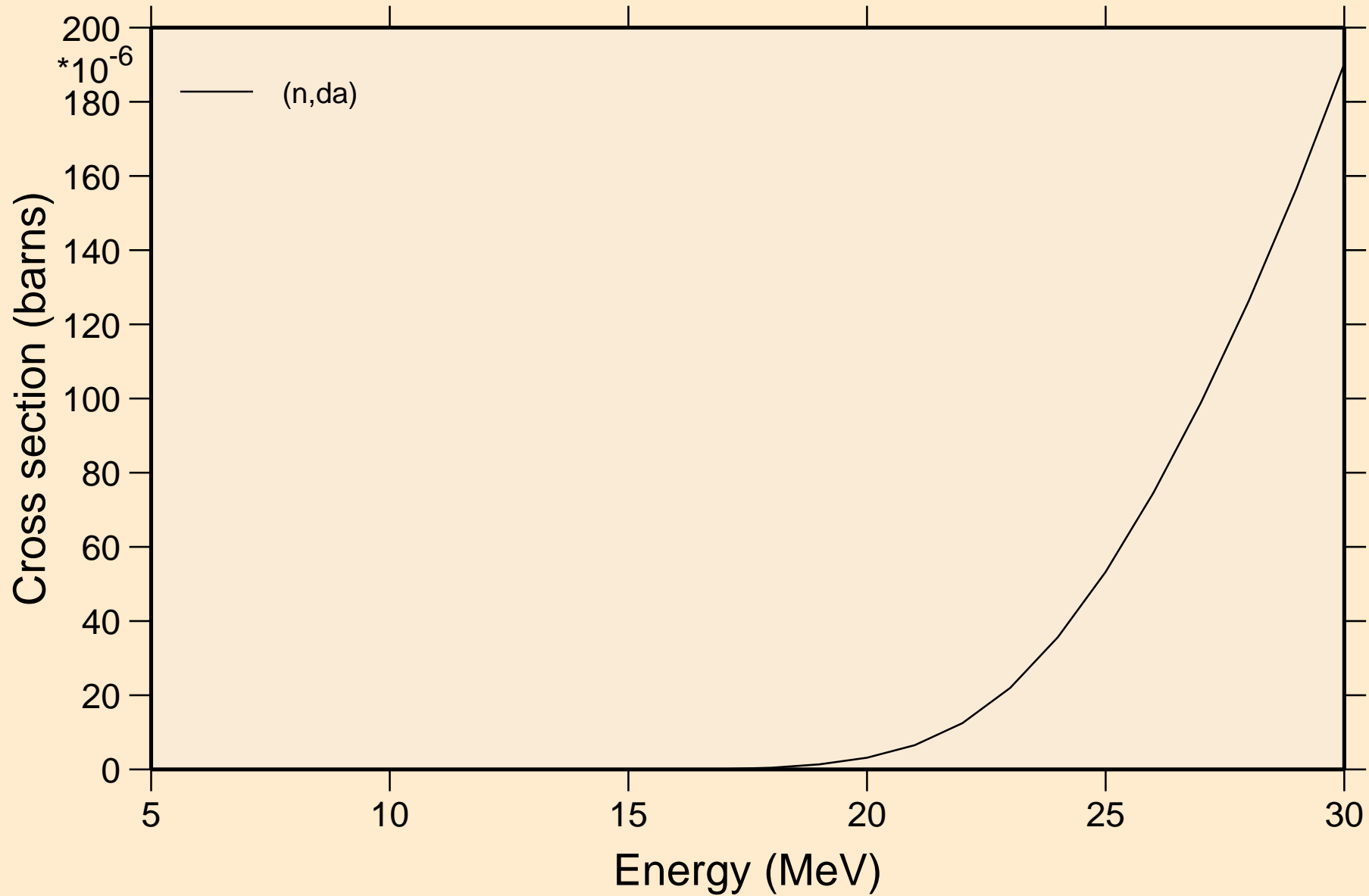

RB079 NEUTRON ACER TENDL-2024 LIBRARY; T=0.K  
Threshold reactions

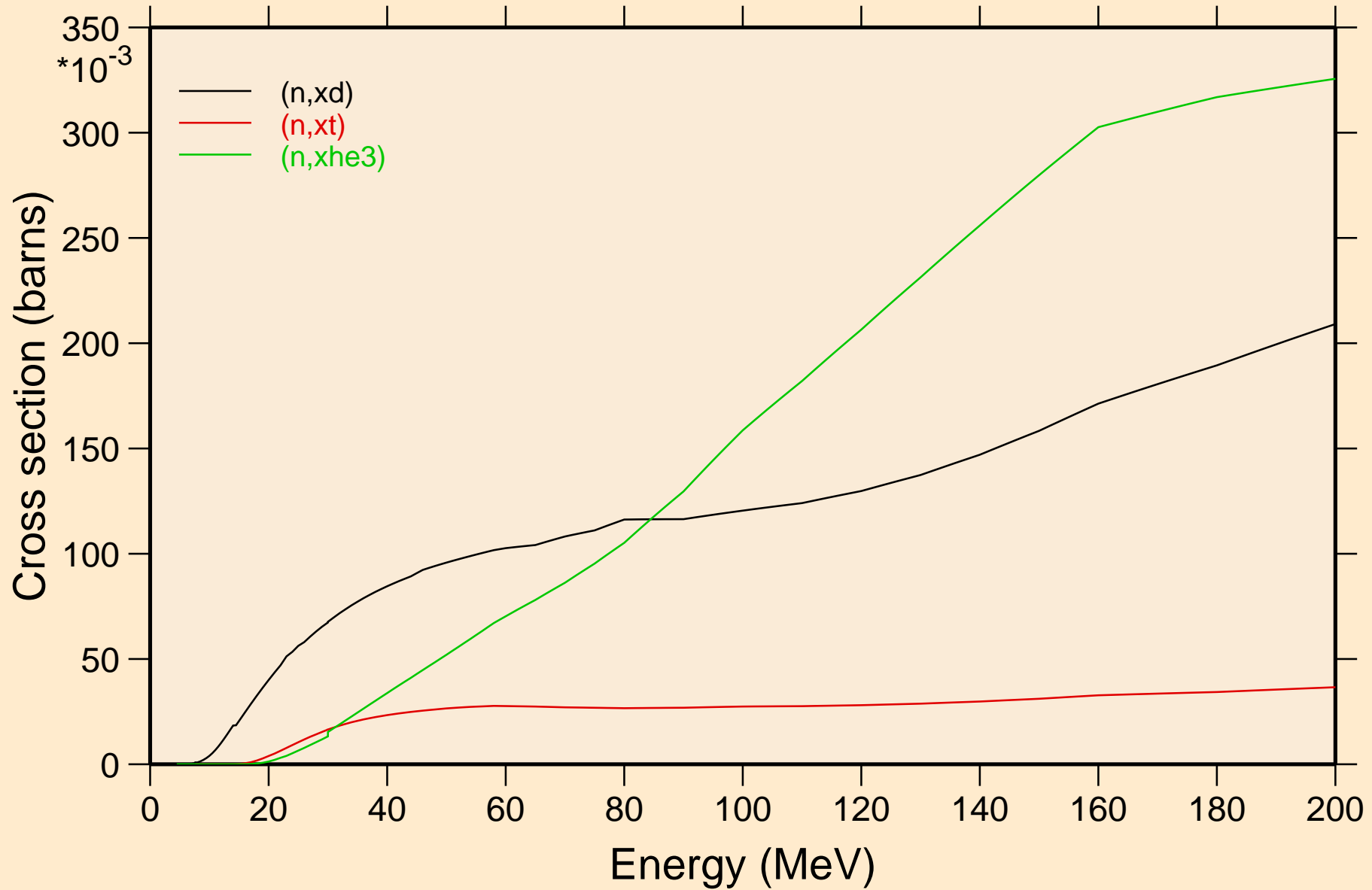

RB079 NEUTRON ACER TENDL-2024 LIBRARY; T=0.K  
angular distribution for elastic

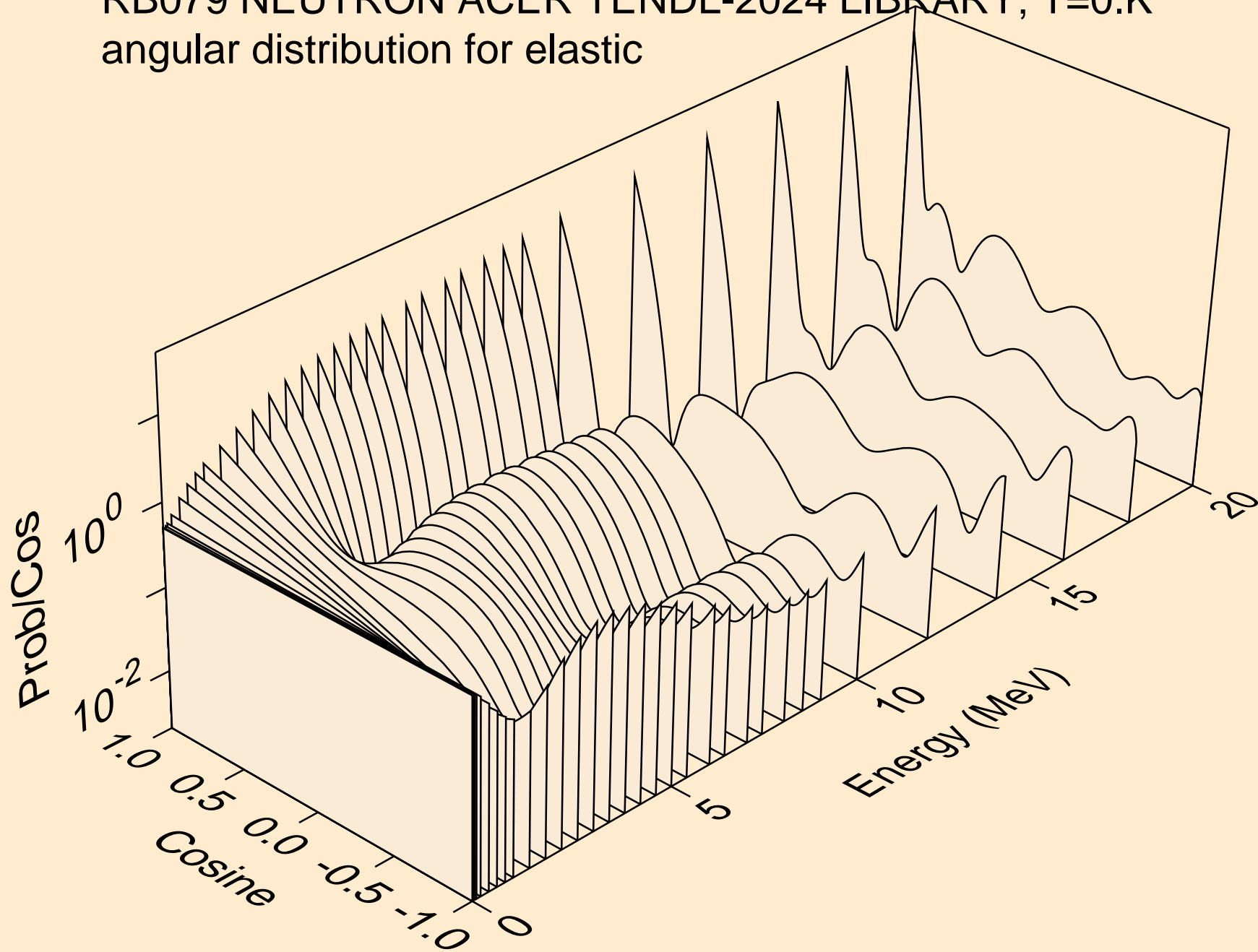

RB079 NEUTRON ACER TENDL-2024 LIBRARY; T=0.K  
angular distribution for elastic

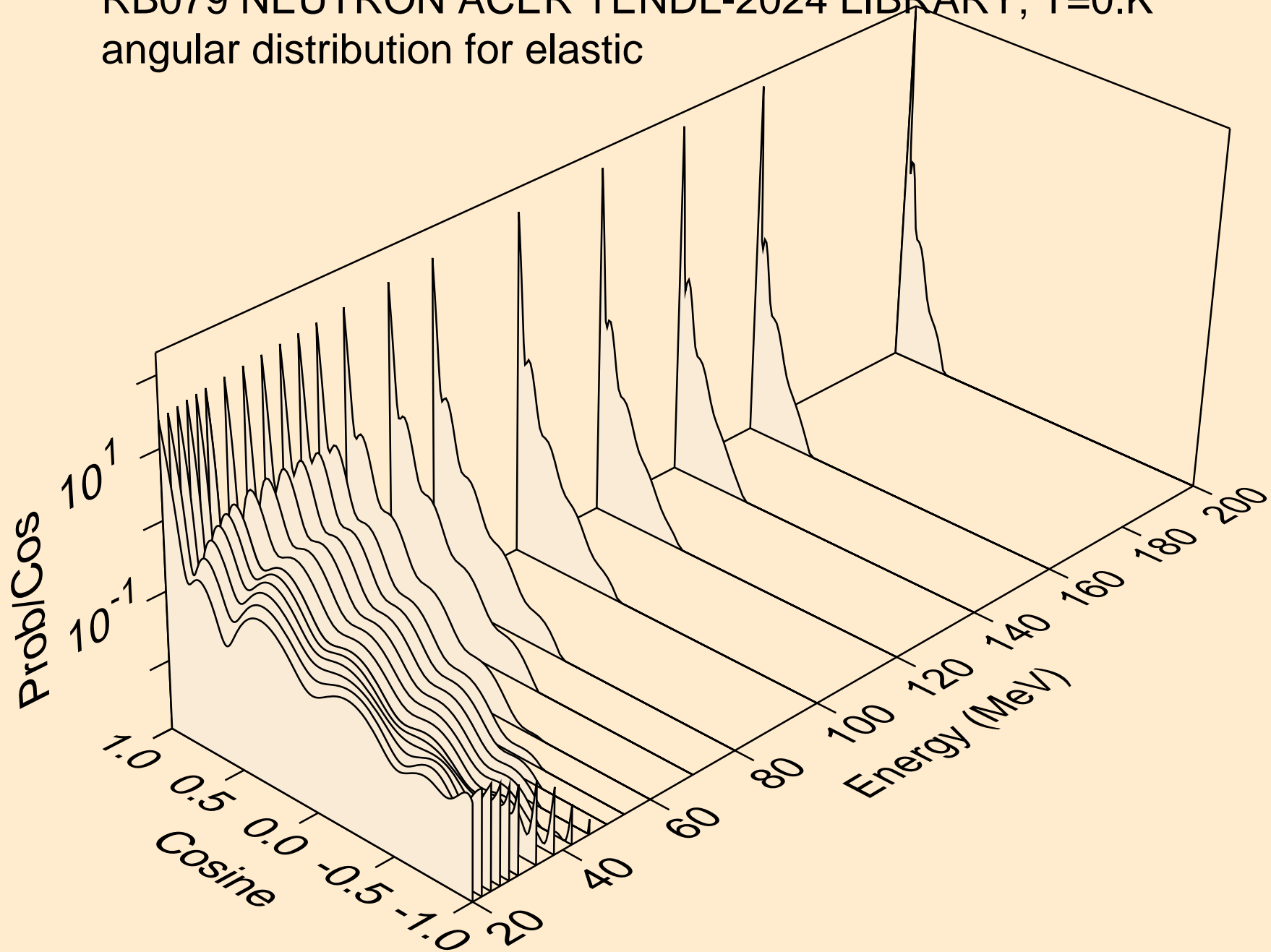



RB079 NEUTRON ACER TENDL-2024 LIBRARY; T=0.K  
angular distribution for (n,n\*1)

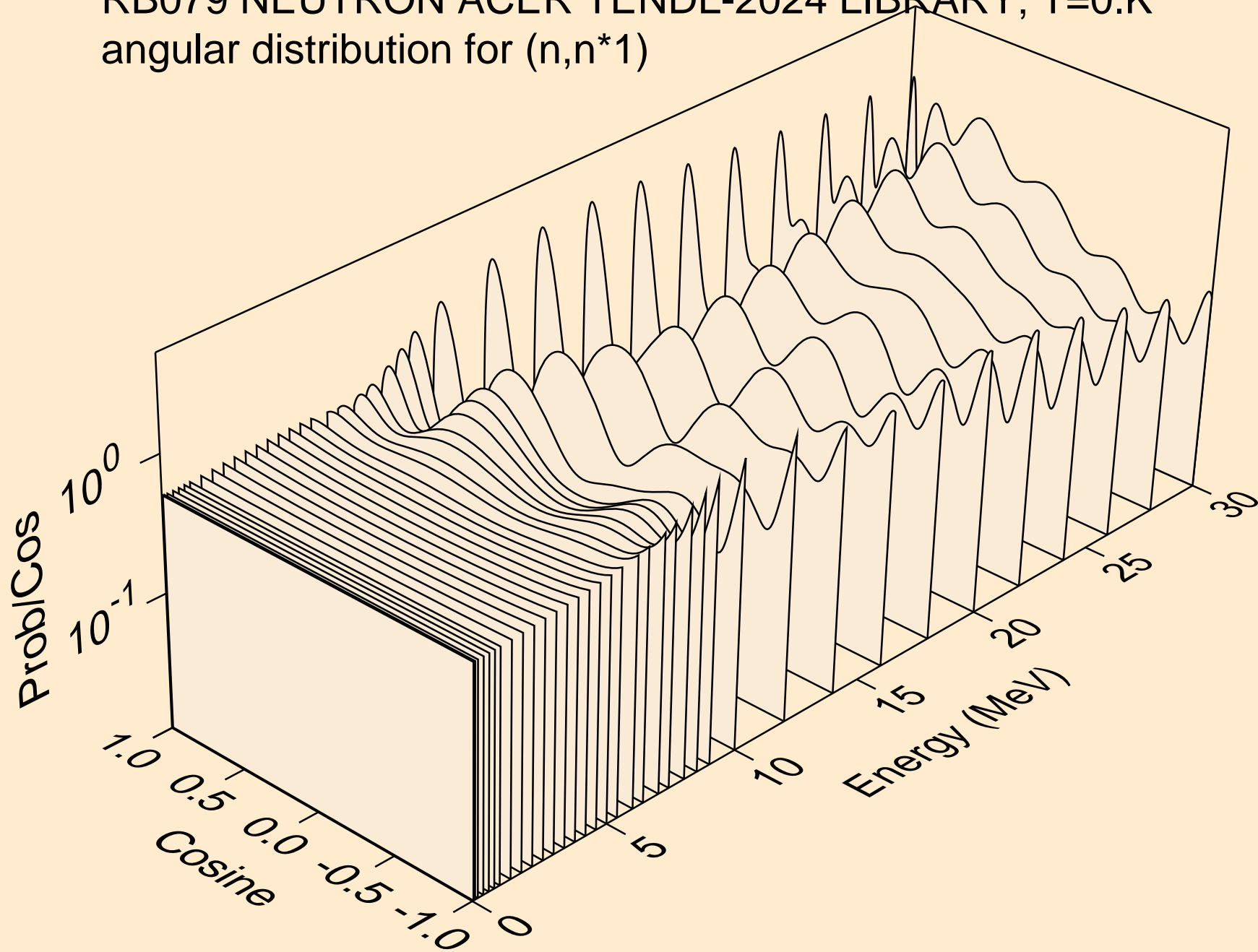

RB079 NEUTRON ACER TENDL-2024 LIBRARY; T=0.K  
angular distribution for (n,n\*2)

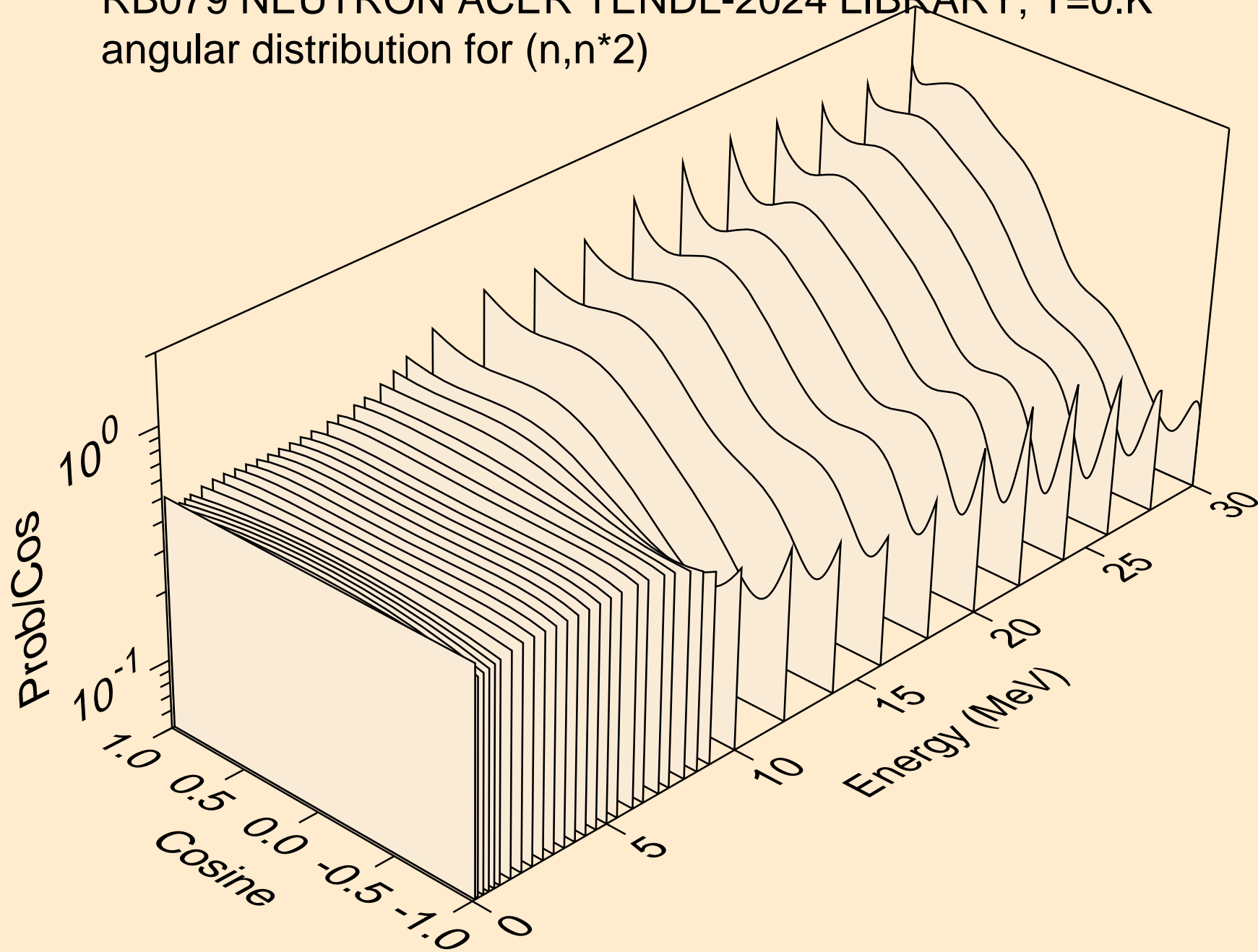

RB079 NEUTRON ACER TENDL-2024 LIBRARY; T=0.K  
angular distribution for (n,n\*3)

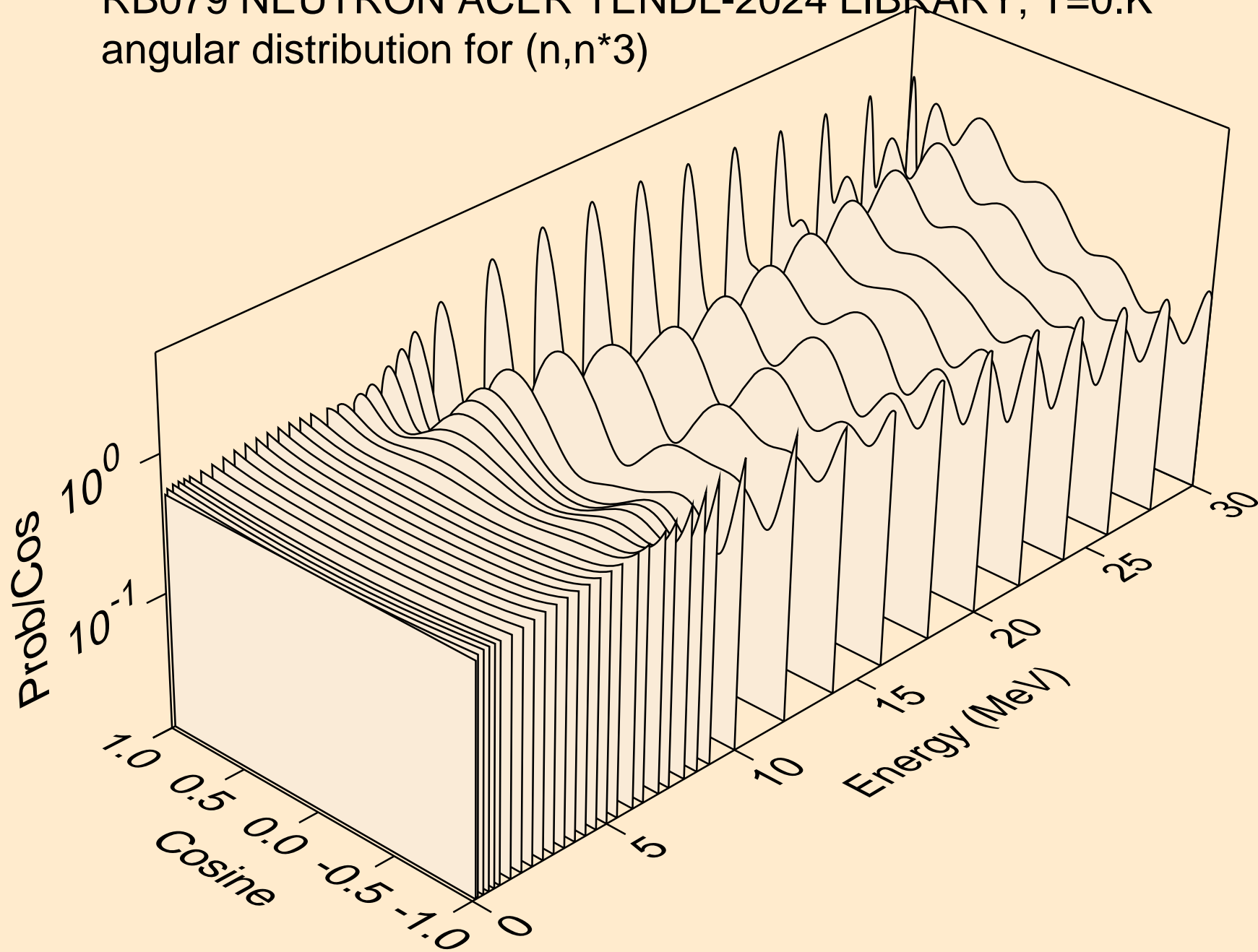

RB079 NEUTRON ACER TENDL-2024 LIBRARY; T=0.K  
angular distribution for (n,n\*4)

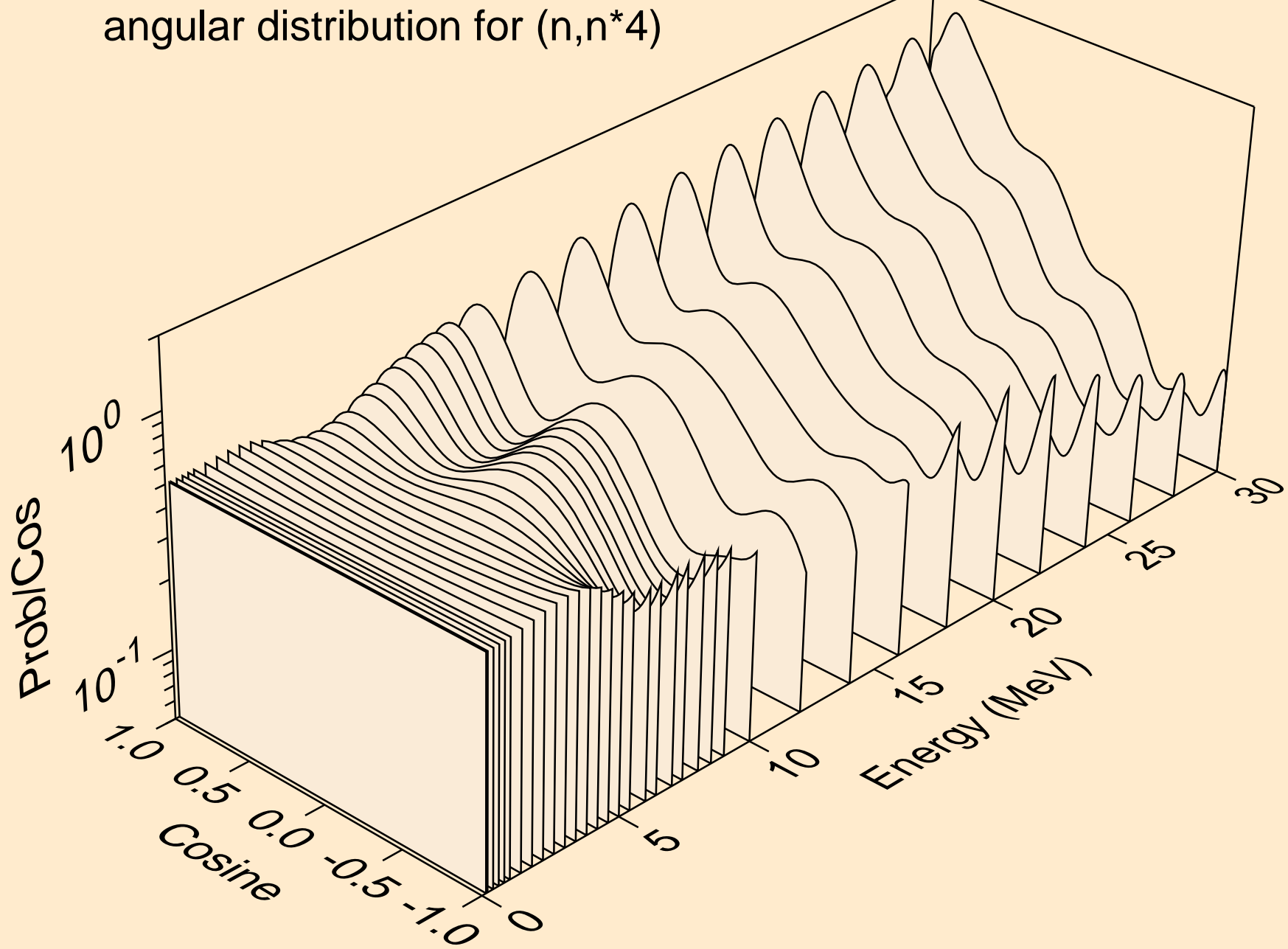

RB079 NEUTRON ACER TENDL-2024 LIBRARY; T=0.K  
angular distribution for (n,n\*5)

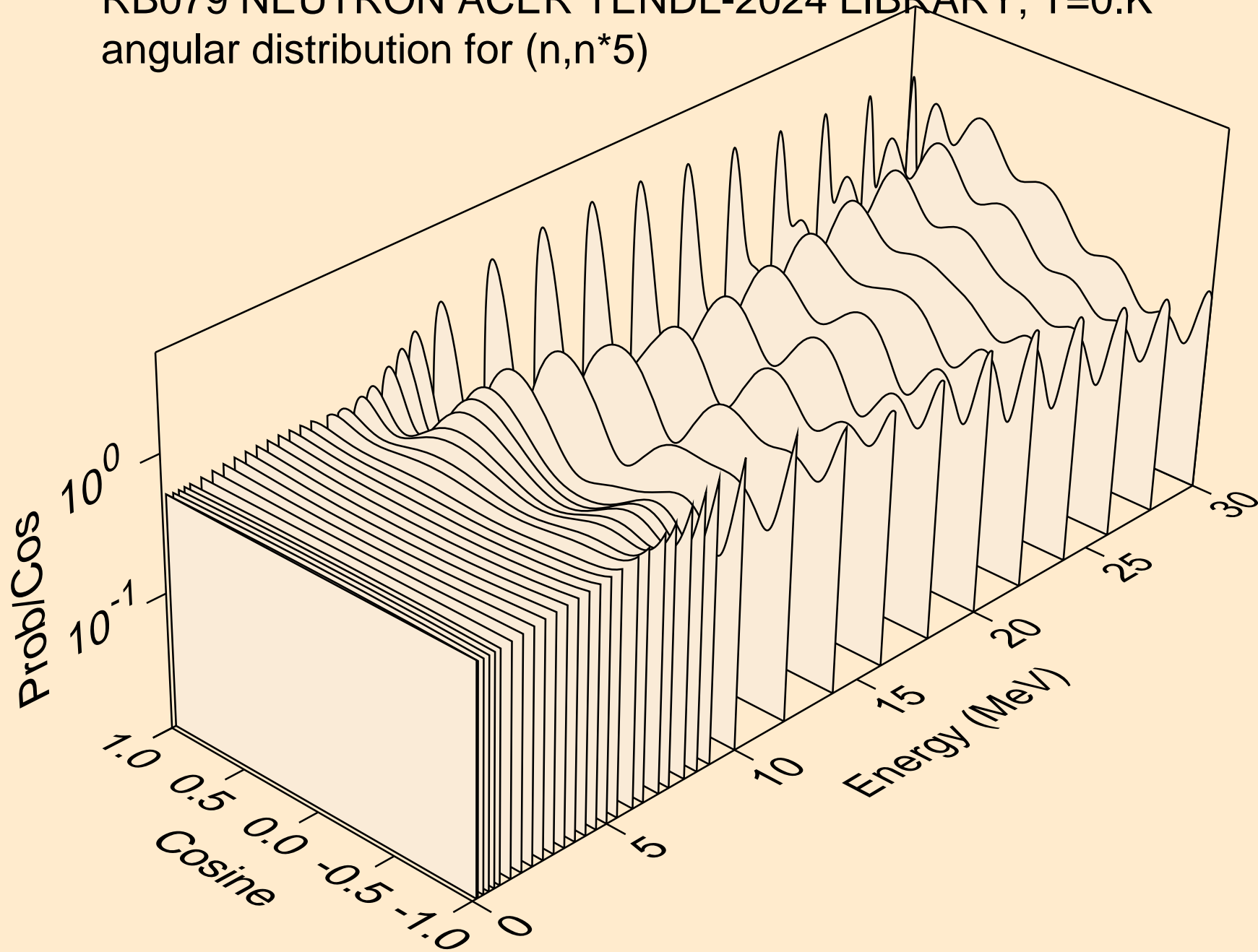

RB079 NEUTRON ACER TENDL-2024 LIBRARY; T=0.K  
angular distribution for (n,n\*6)

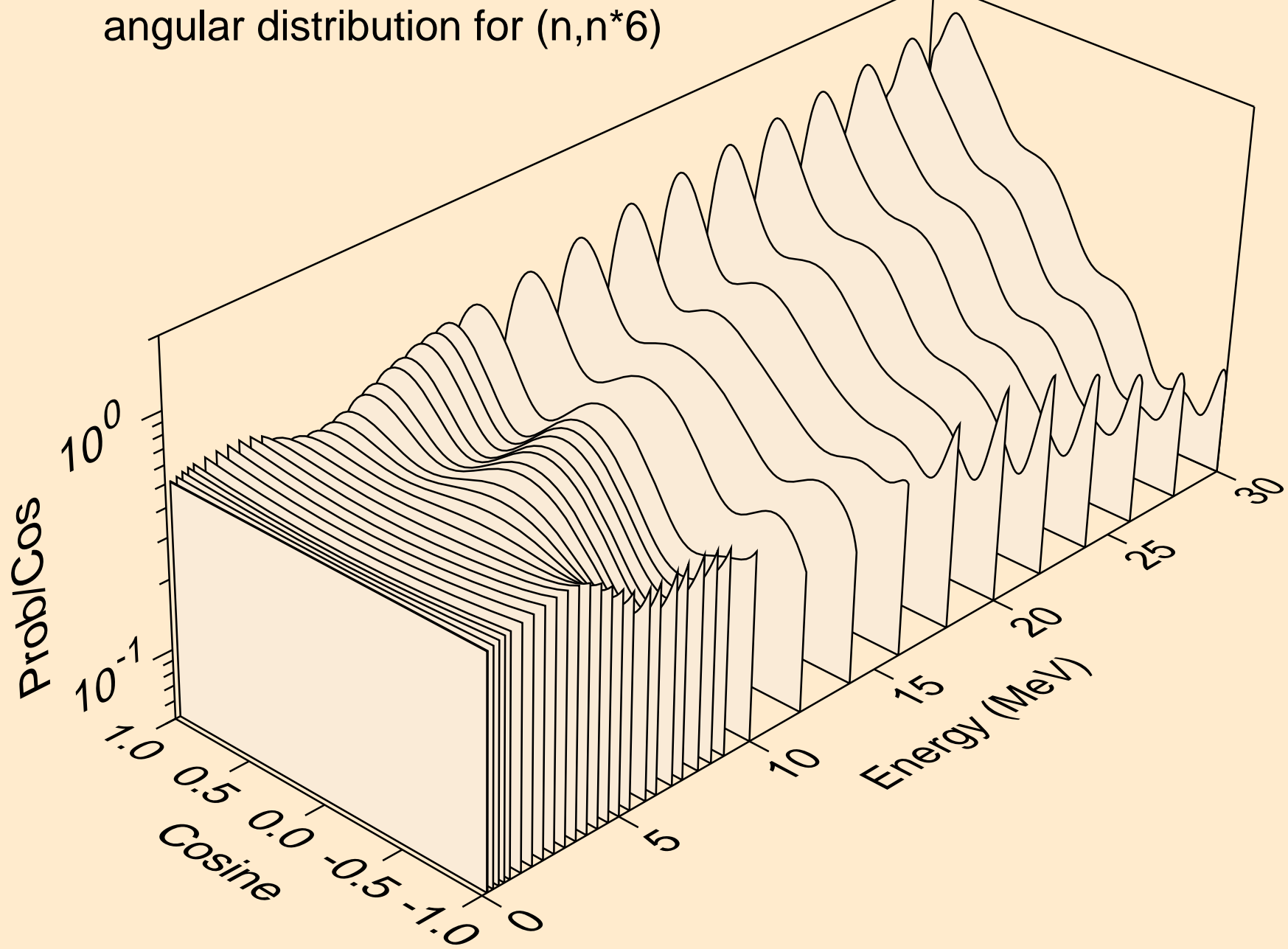

RB079 NEUTRON ACER TENDL-2024 LIBRARY; T=0.K  
angular distribution for (n,n\*7)

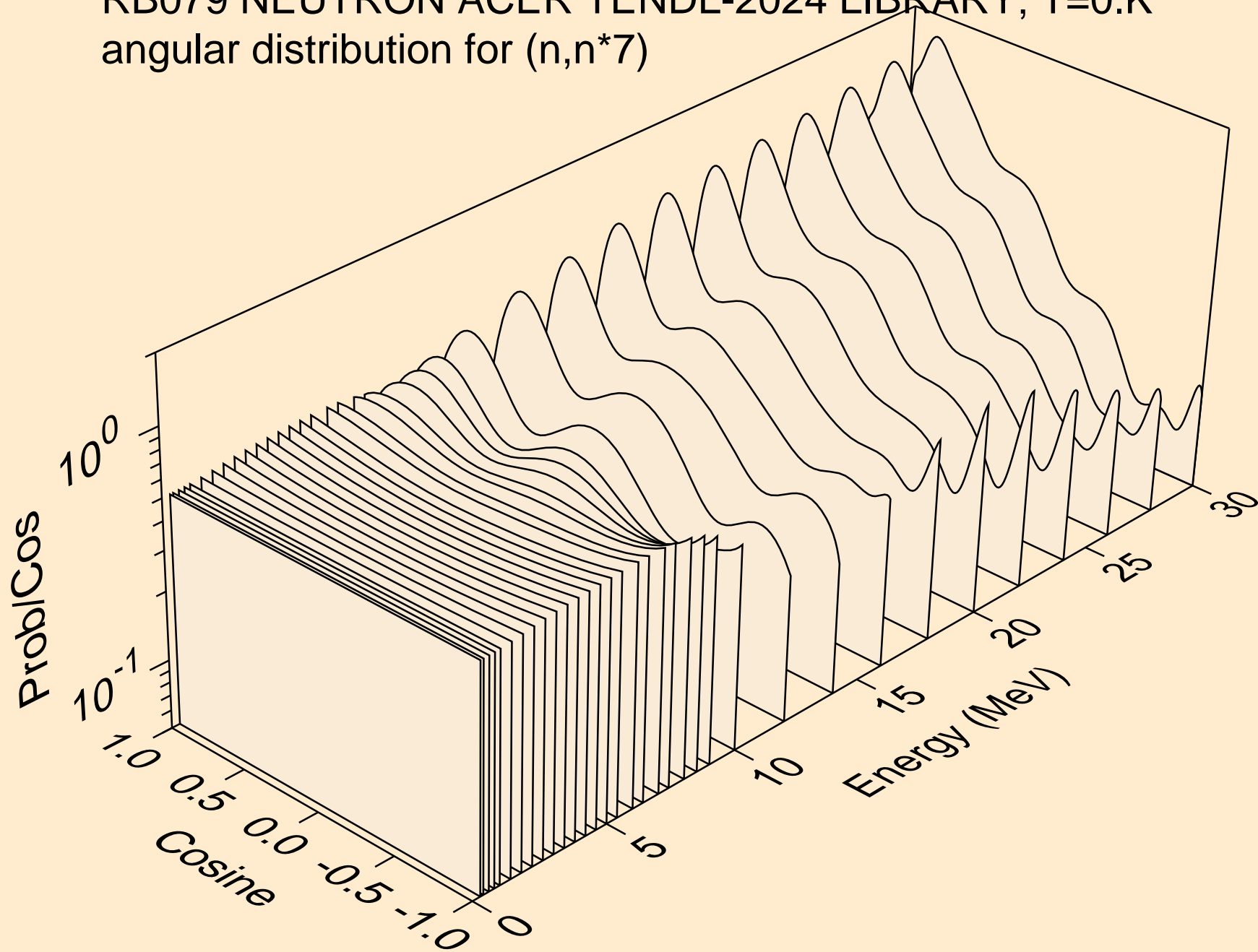



RB079 NEUTRON ACER TENDL-2024 LIBRARY; T=0.K  
angular distribution for (n,n\*8)

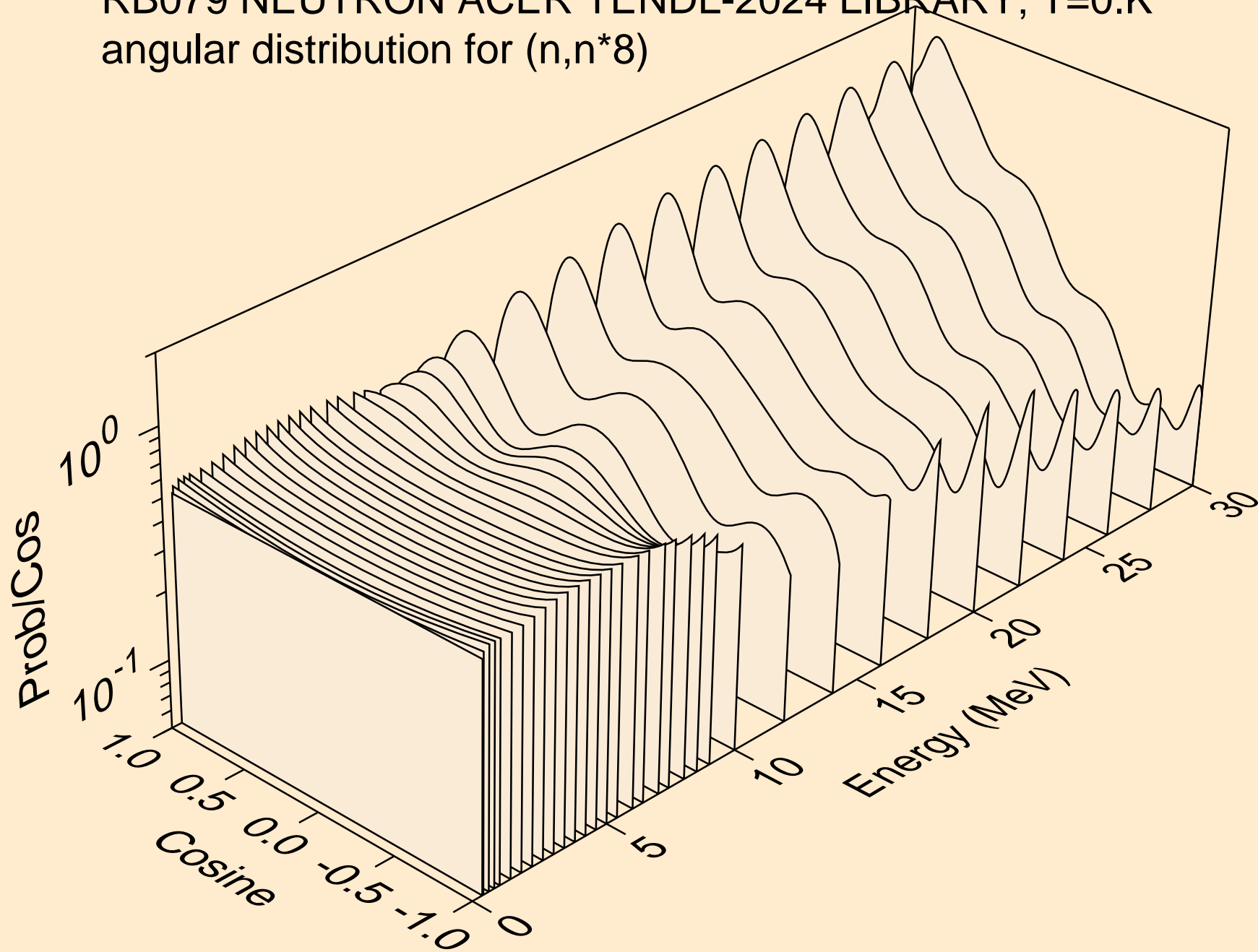



RB079 NEUTRON ACER TENDL-2024 LIBRARY; T=0.K  
angular distribution for (n,n\*9)

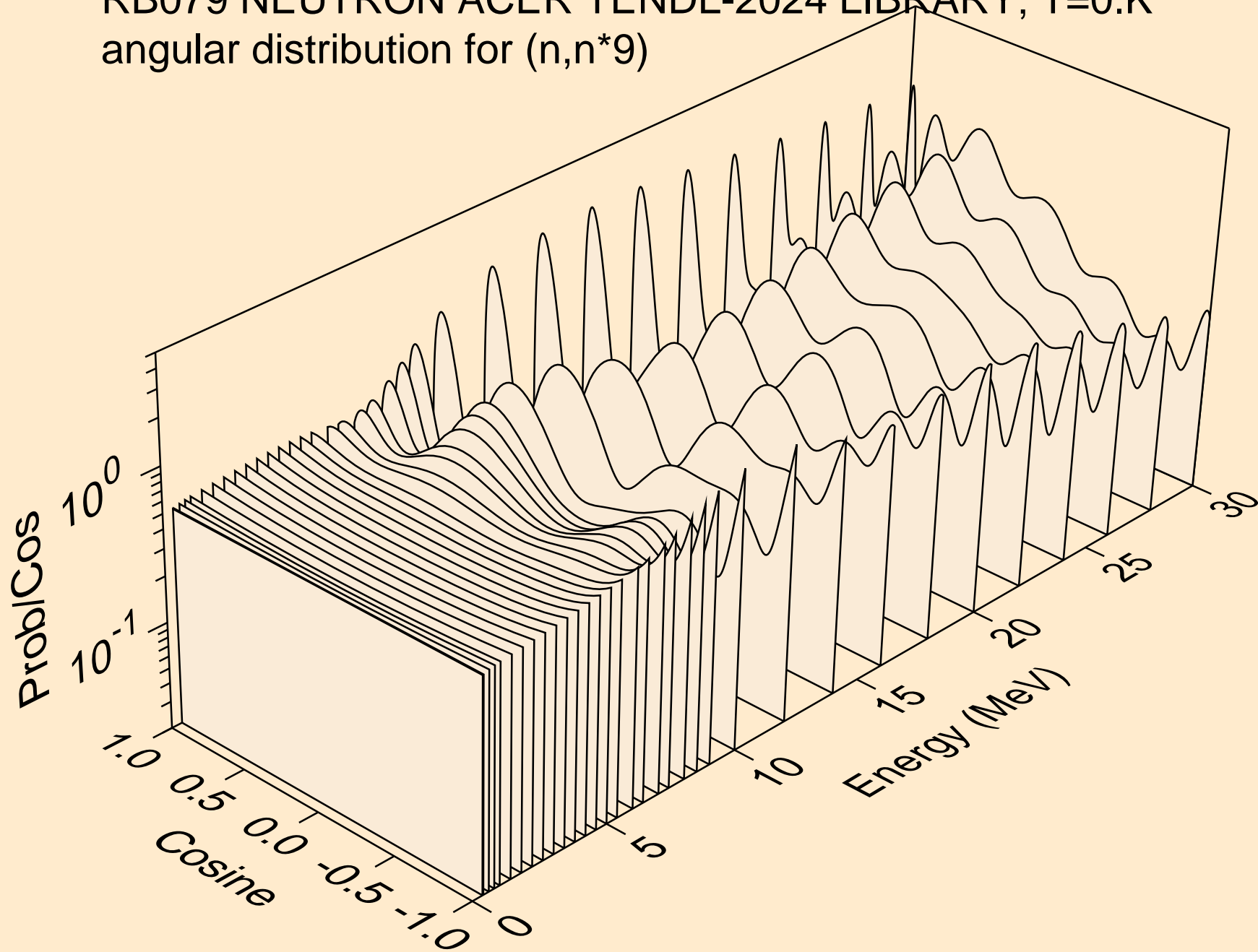

RB079 NEUTRON ACER TENDL-2024 LIBRARY; T=0.K  
angular distribution for (n,n\*10)

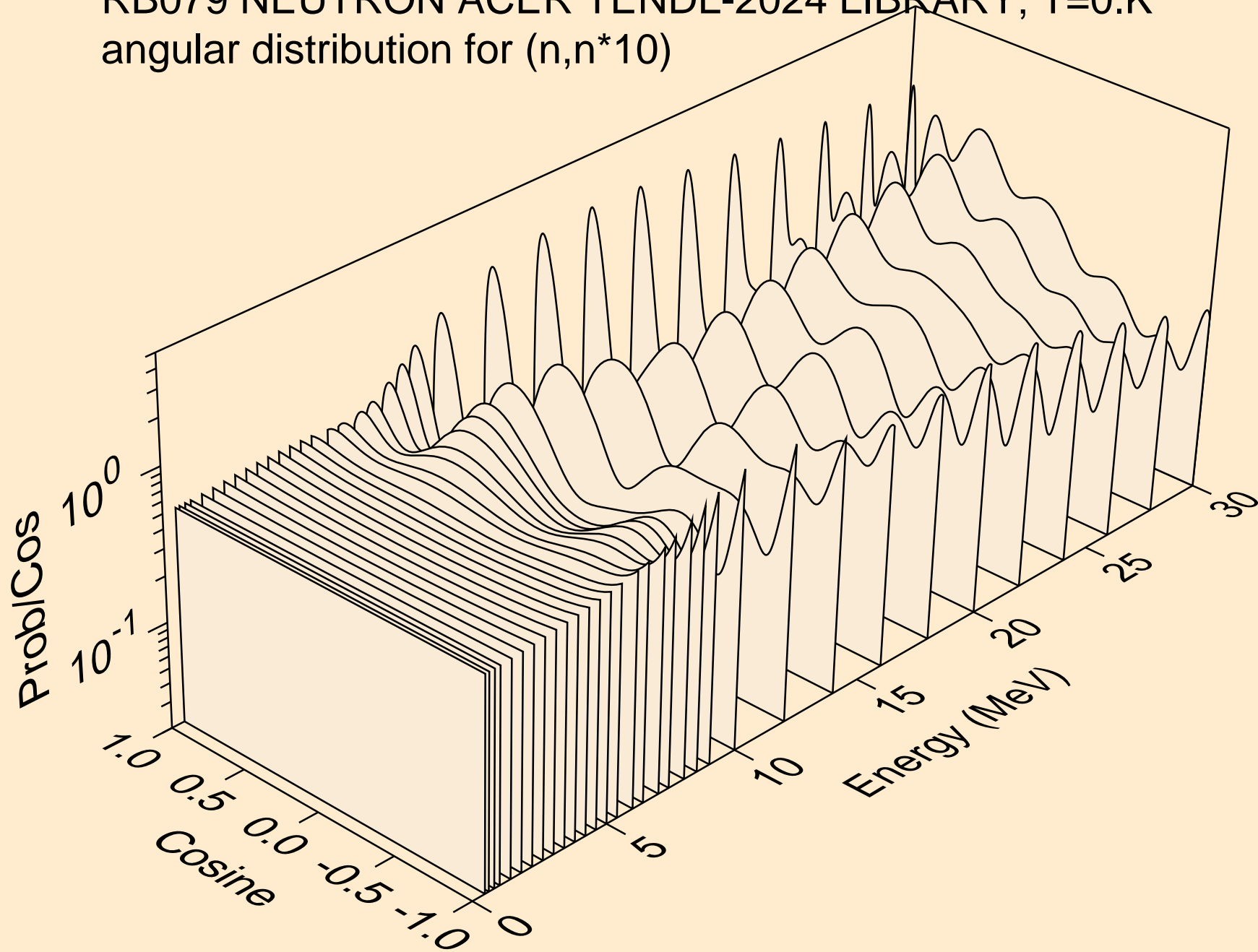

RB079 NEUTRON ACER TENDL-2024 LIBRARY; T=0.K  
angular distribution for (n,n\*11)

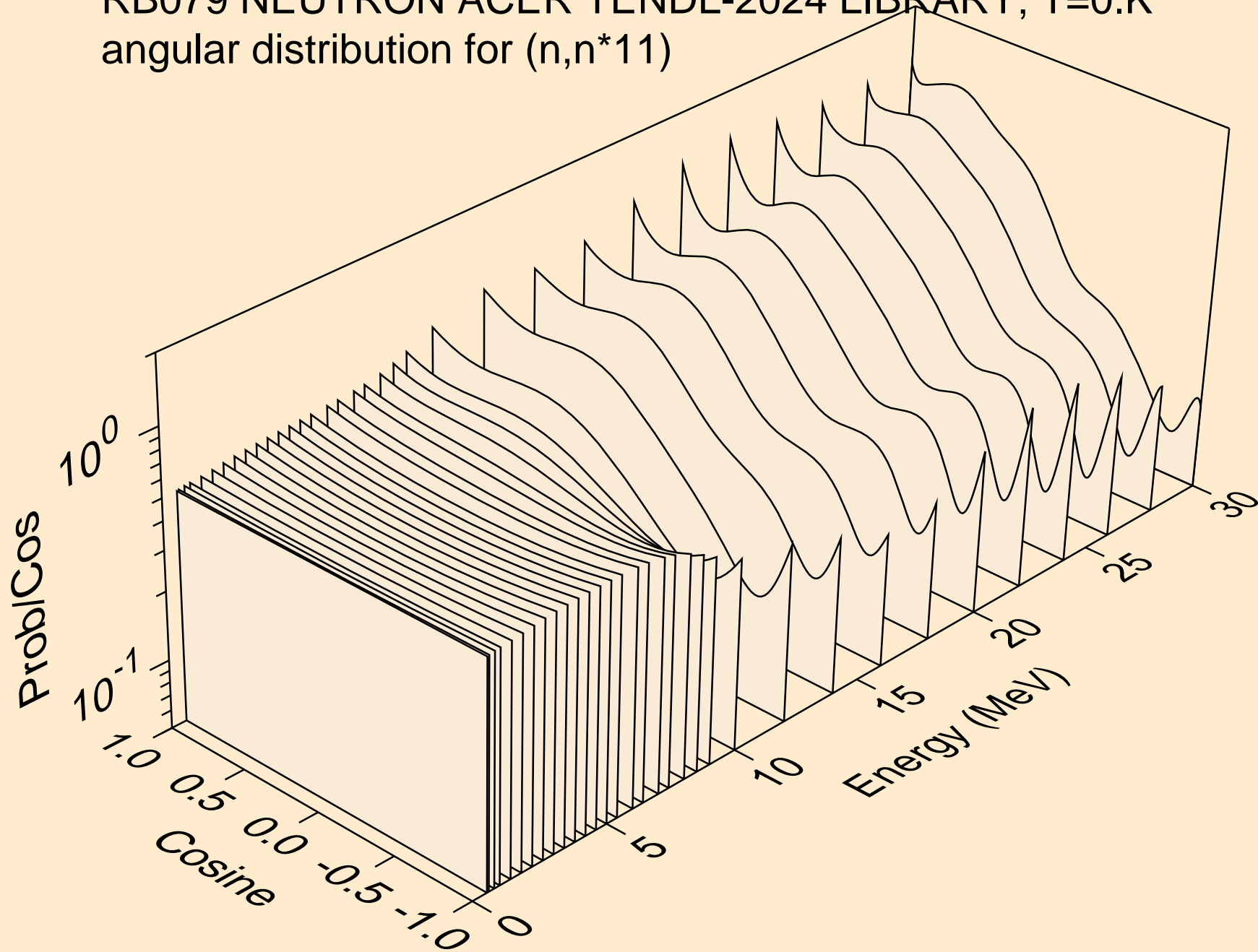

RB079 NEUTRON ACER TENDL-2024 LIBRARY; T=0.K  
angular distribution for (n,n\*12)

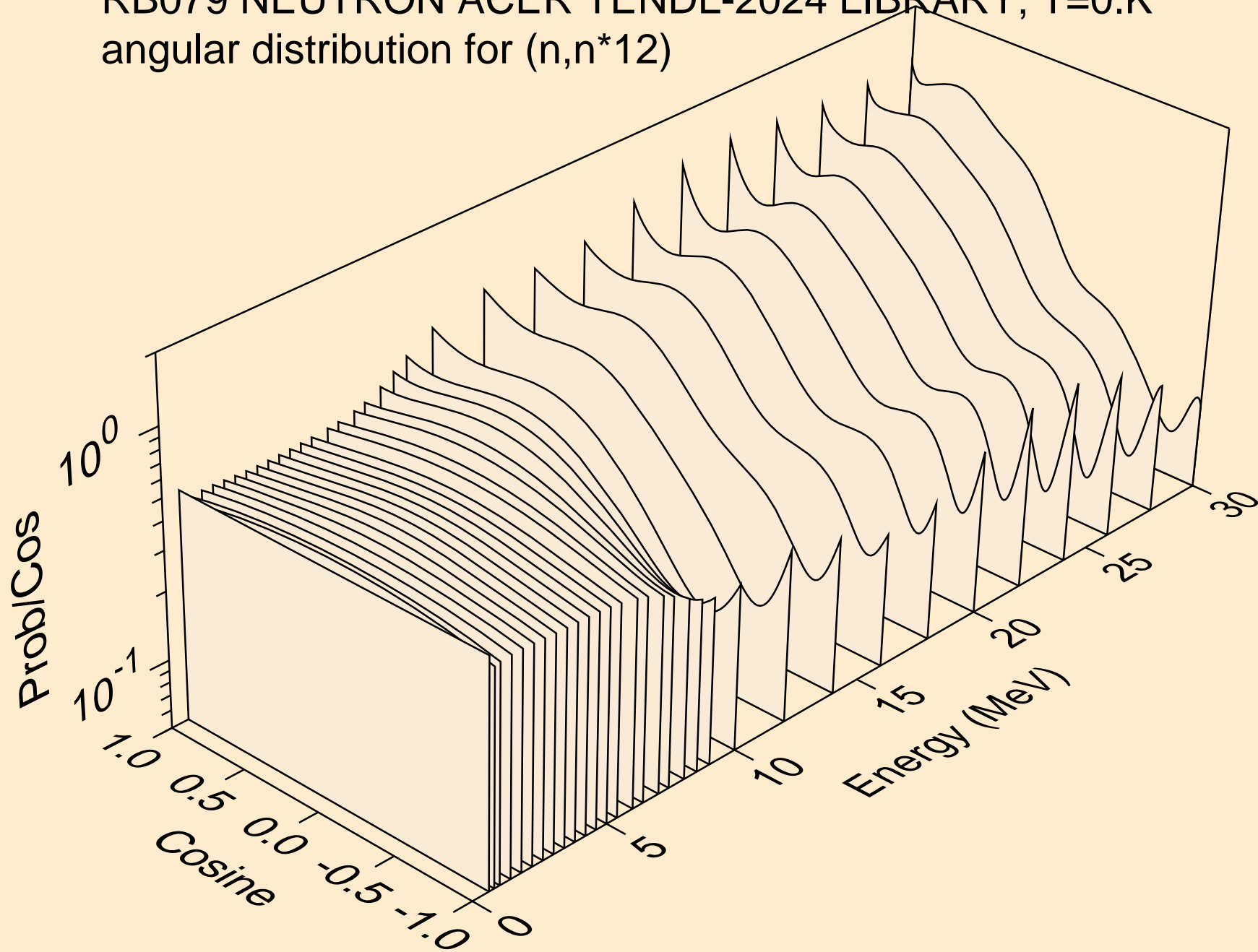

RB079 NEUTRON ACER TENDL-2024 LIBRARY; T=0.K  
angular distribution for (n,n\*13)

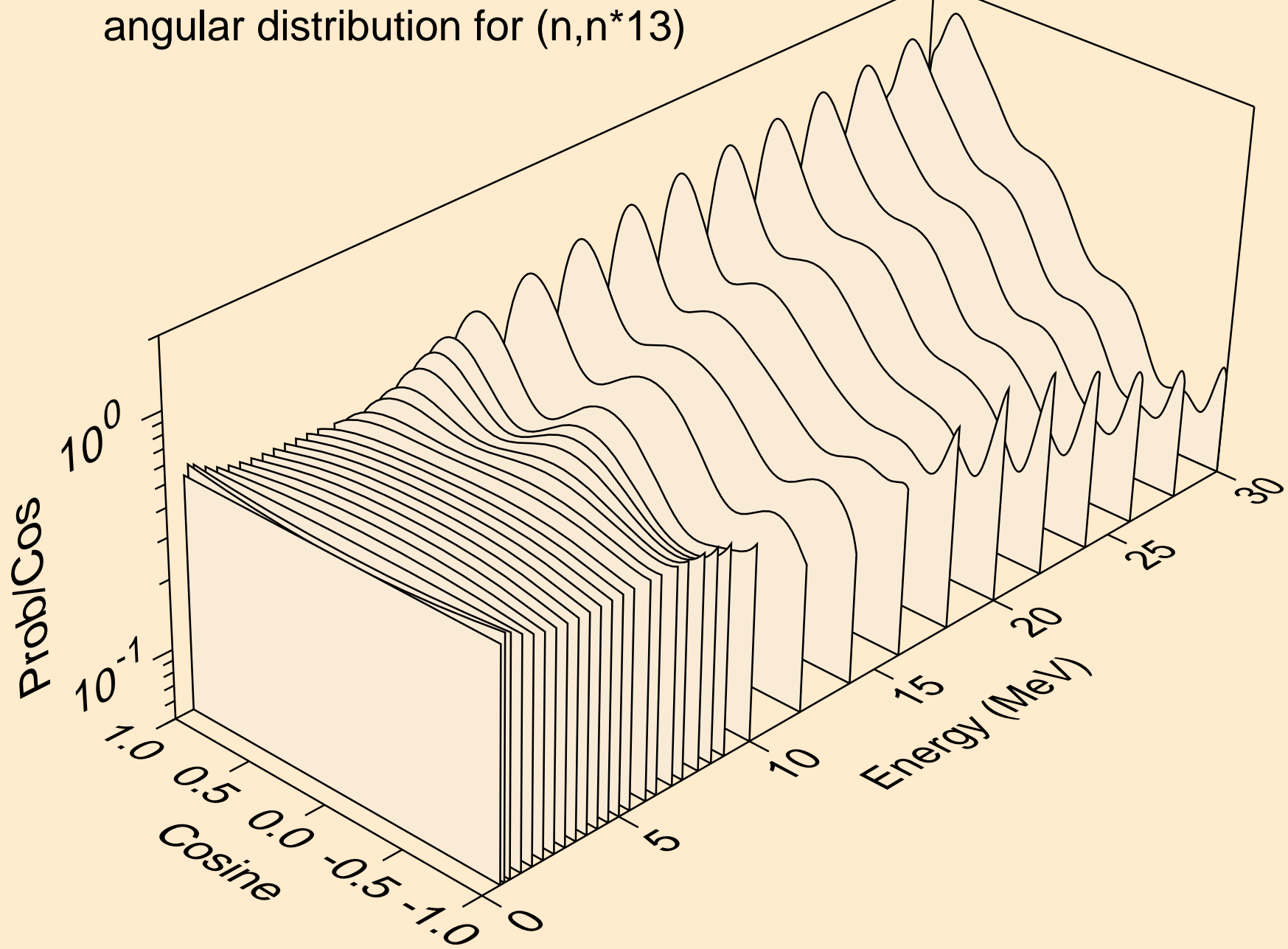

RB079 NEUTRON ACER TENDL-2024 LIBRARY; T=0.K  
angular distribution for (n,n\*14)

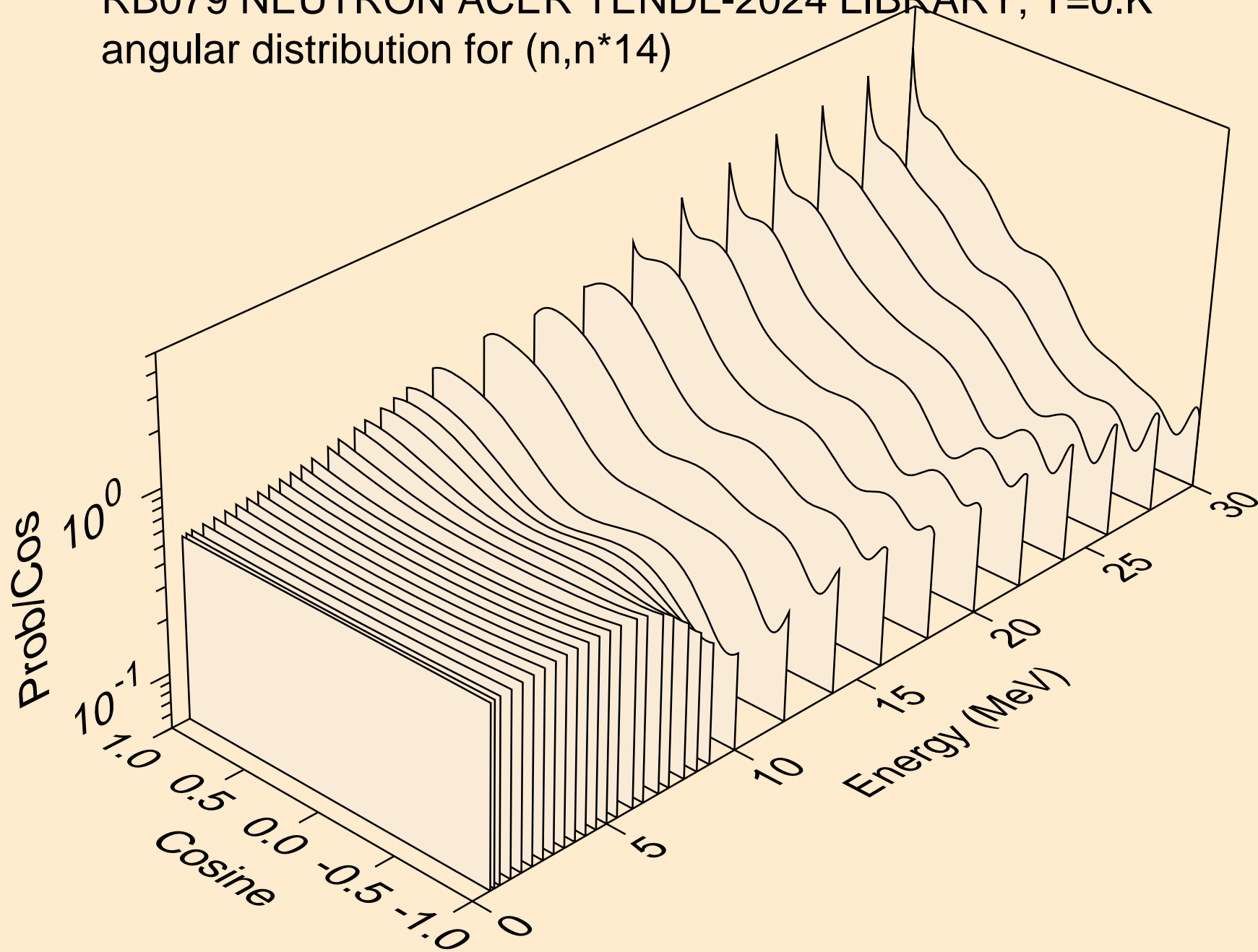

RB079 NEUTRON ACER TENDL-2024 LIBRARY; T=0.K  
angular distribution for (n,n\*15)

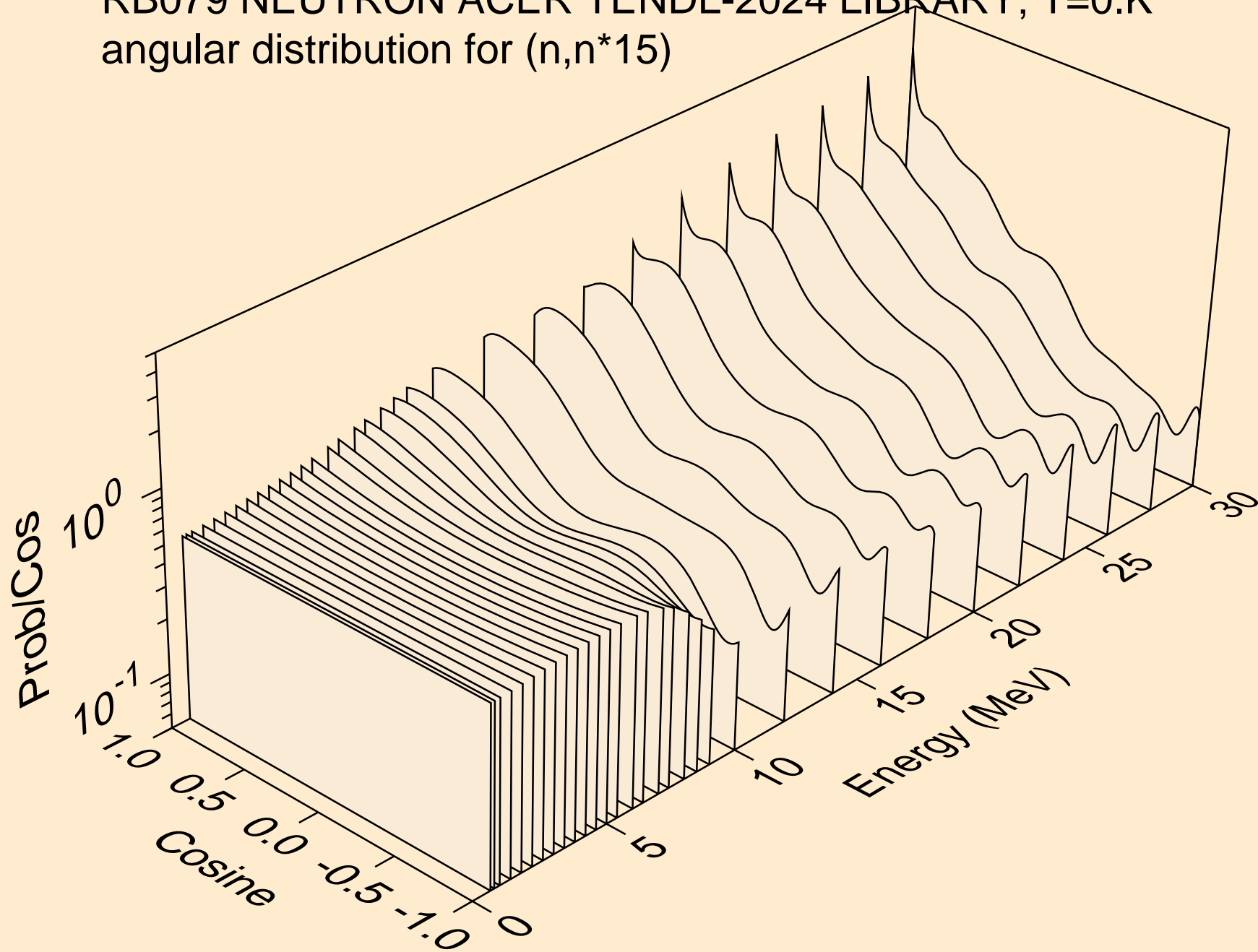

RB079 NEUTRON ACER TENDL-2024 LIBRARY; T=0.K  
angular distribution for (n,n\*16)

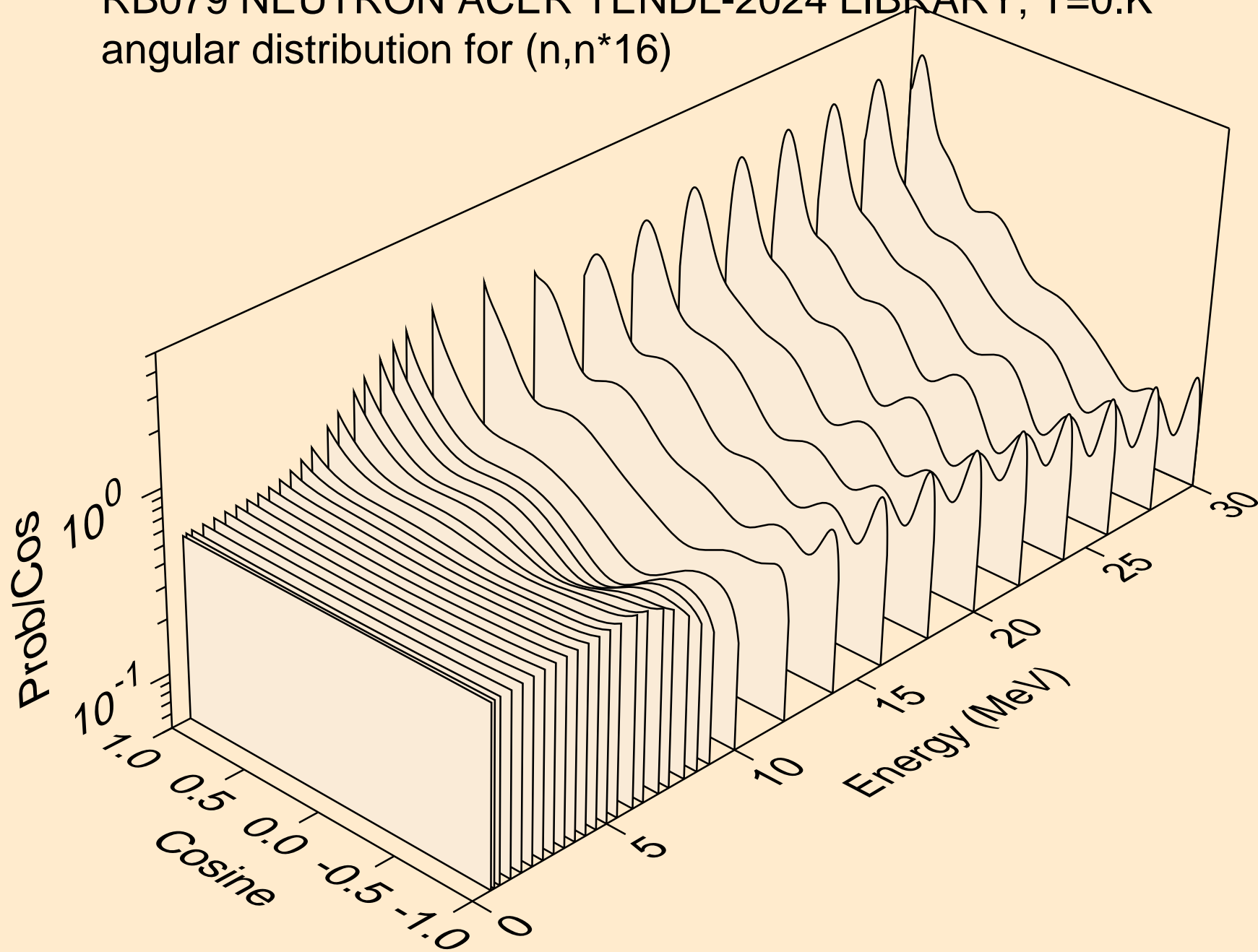



RB079 NEUTRON ACER TENDL-2024 LIBRARY; T=0.K  
angular distribution for (n,n\*17)

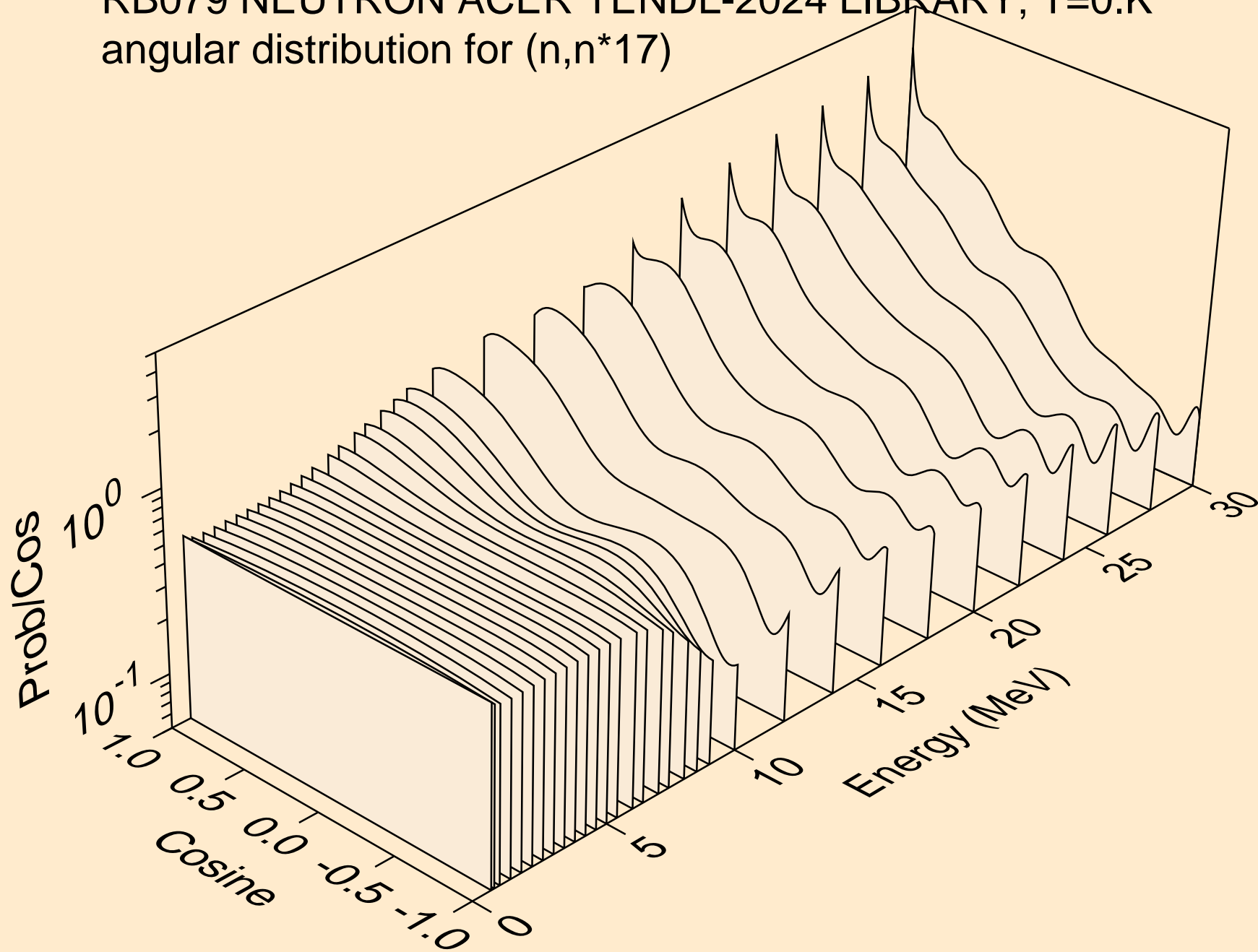

RB079 NEUTRON ACER TENDL-2024 LIBRARY; T=0.K  
angular distribution for (n,n\*18)

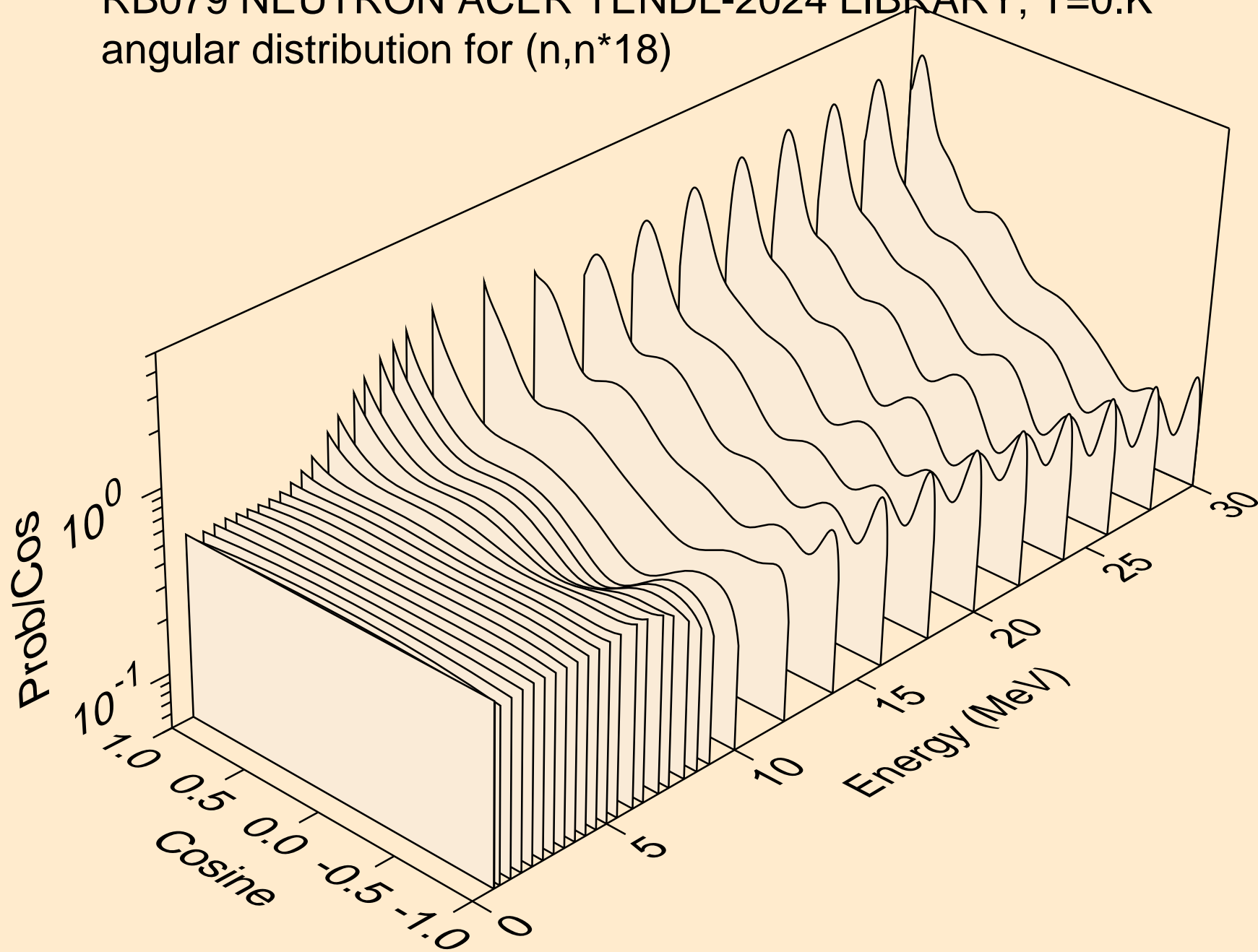

RB079 NEUTRON ACER TENDL-2024 LIBRARY; T=0.K  
angular distribution for (n,n\*19)

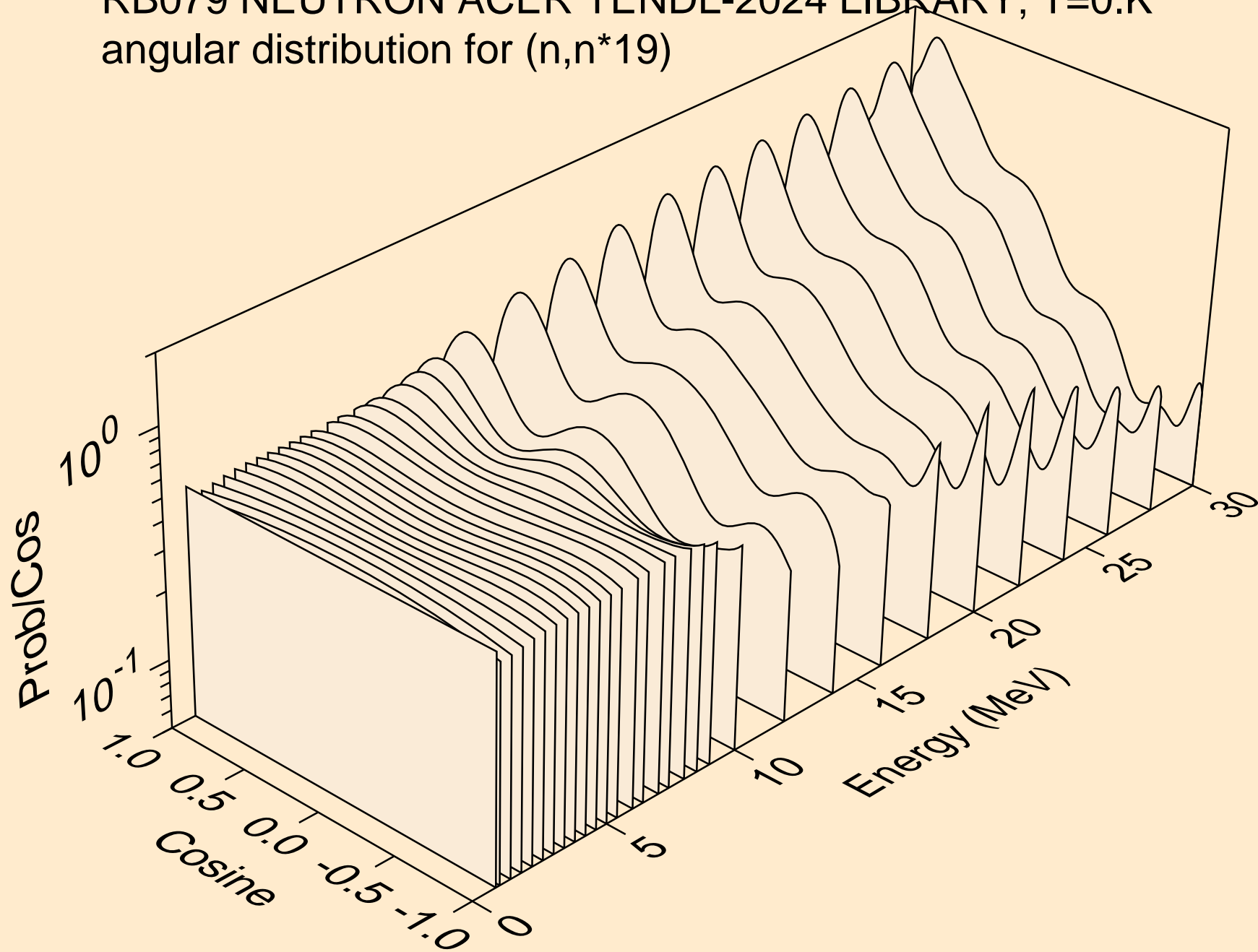

RB079 NEUTRON ACER TENDL-2024 LIBRARY; T=0.K  
angular distribution for (n,n\*20)

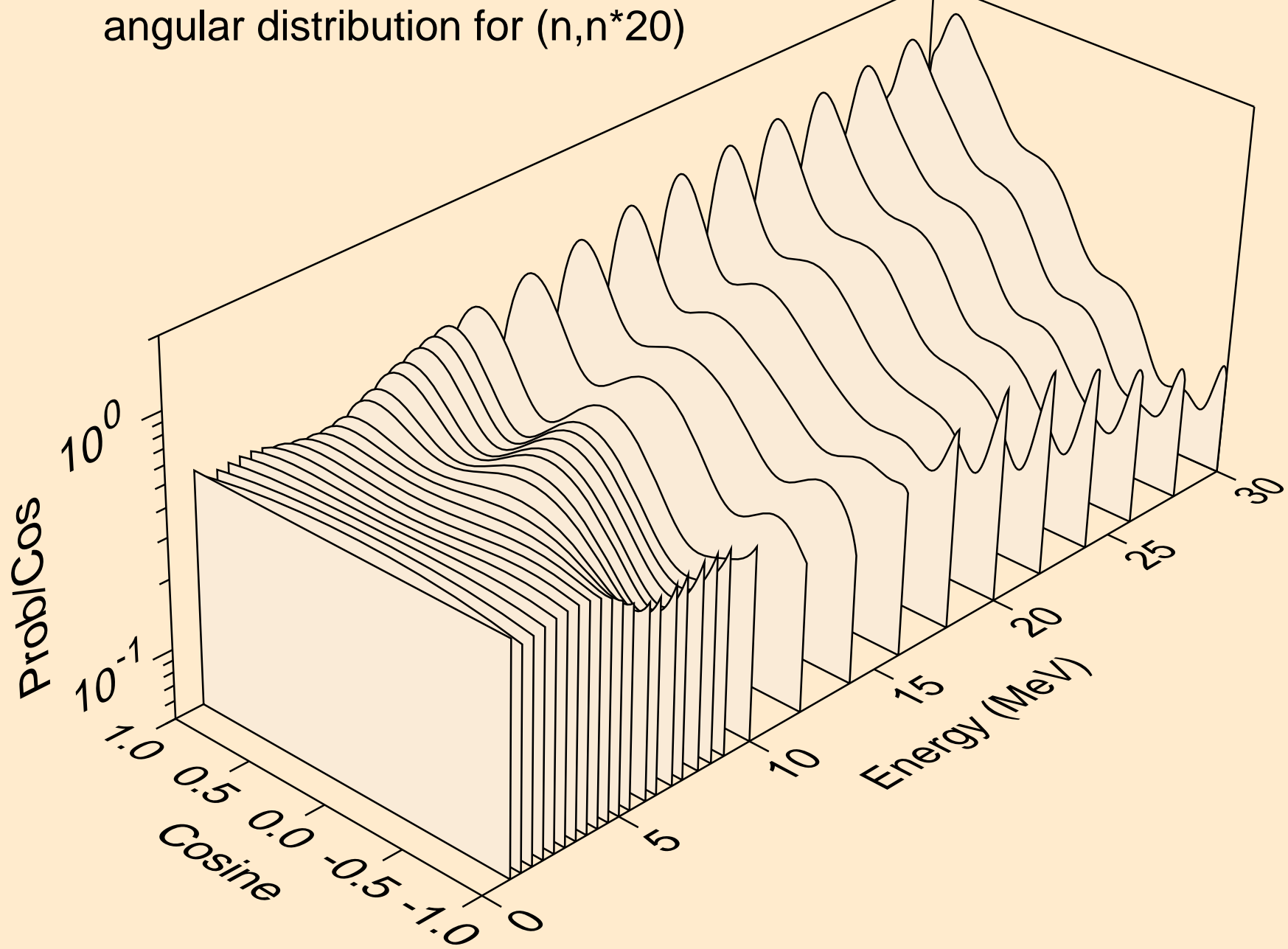

RB079 NEUTRON ACER TENDL-2024 LIBRARY; T=0.K  
angular distribution for (n,n\*21)

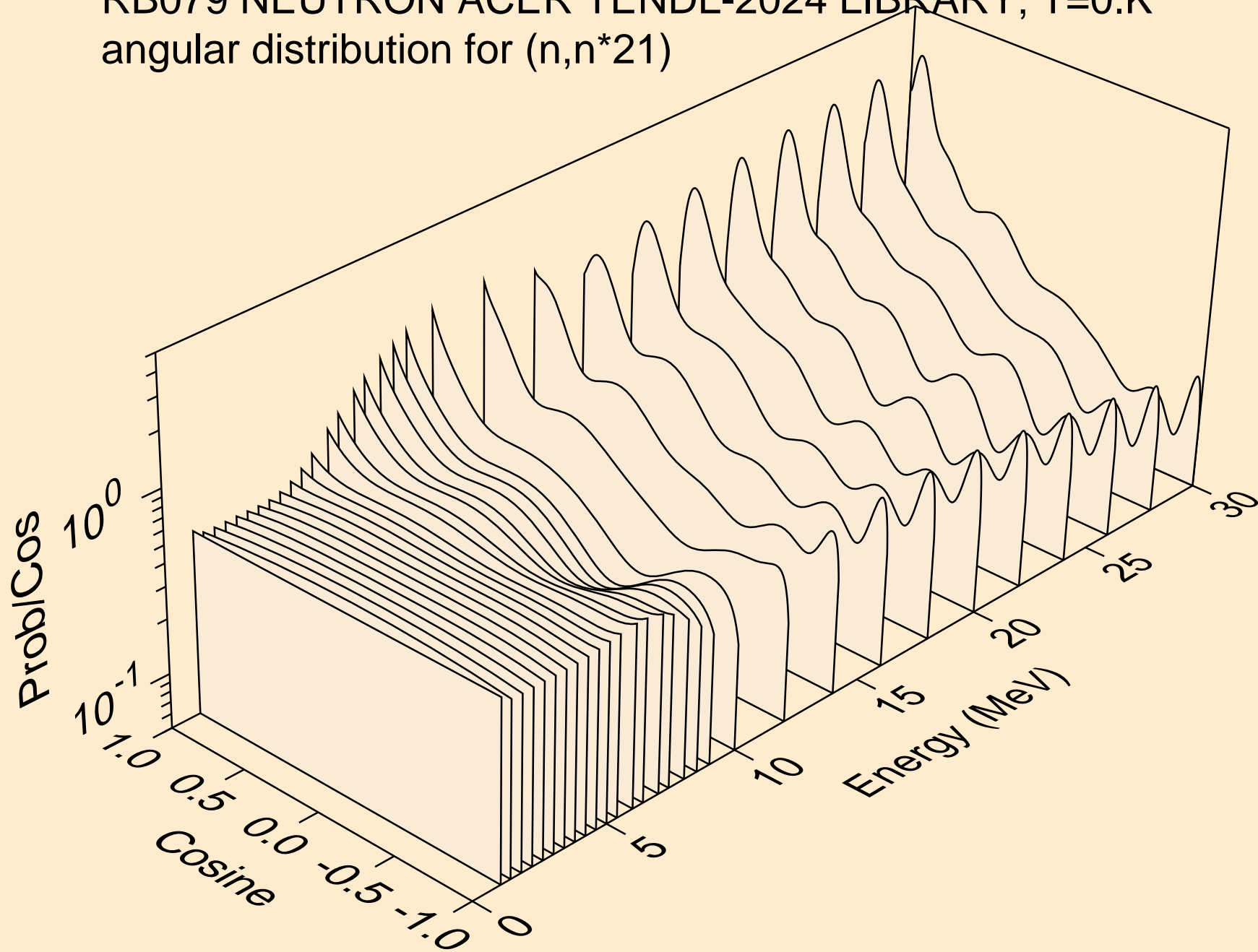

RB079 NEUTRON ACER TENDL-2024 LIBRARY; T=0.K  
angular distribution for (n,n\*22)

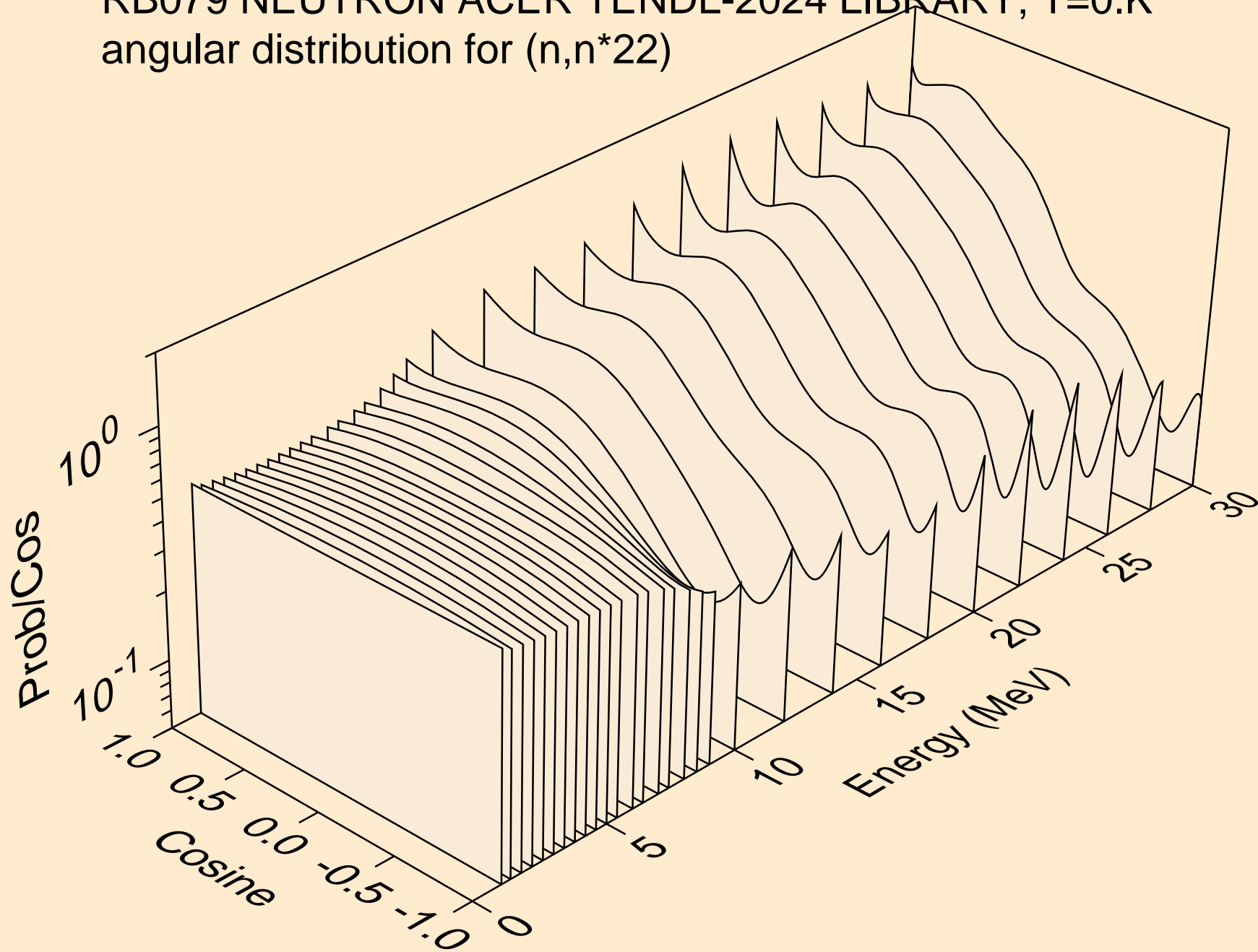

RB079 NEUTRON ACER TENDL-2024 LIBRARY; T=0.K  
angular distribution for (n,n\*23)

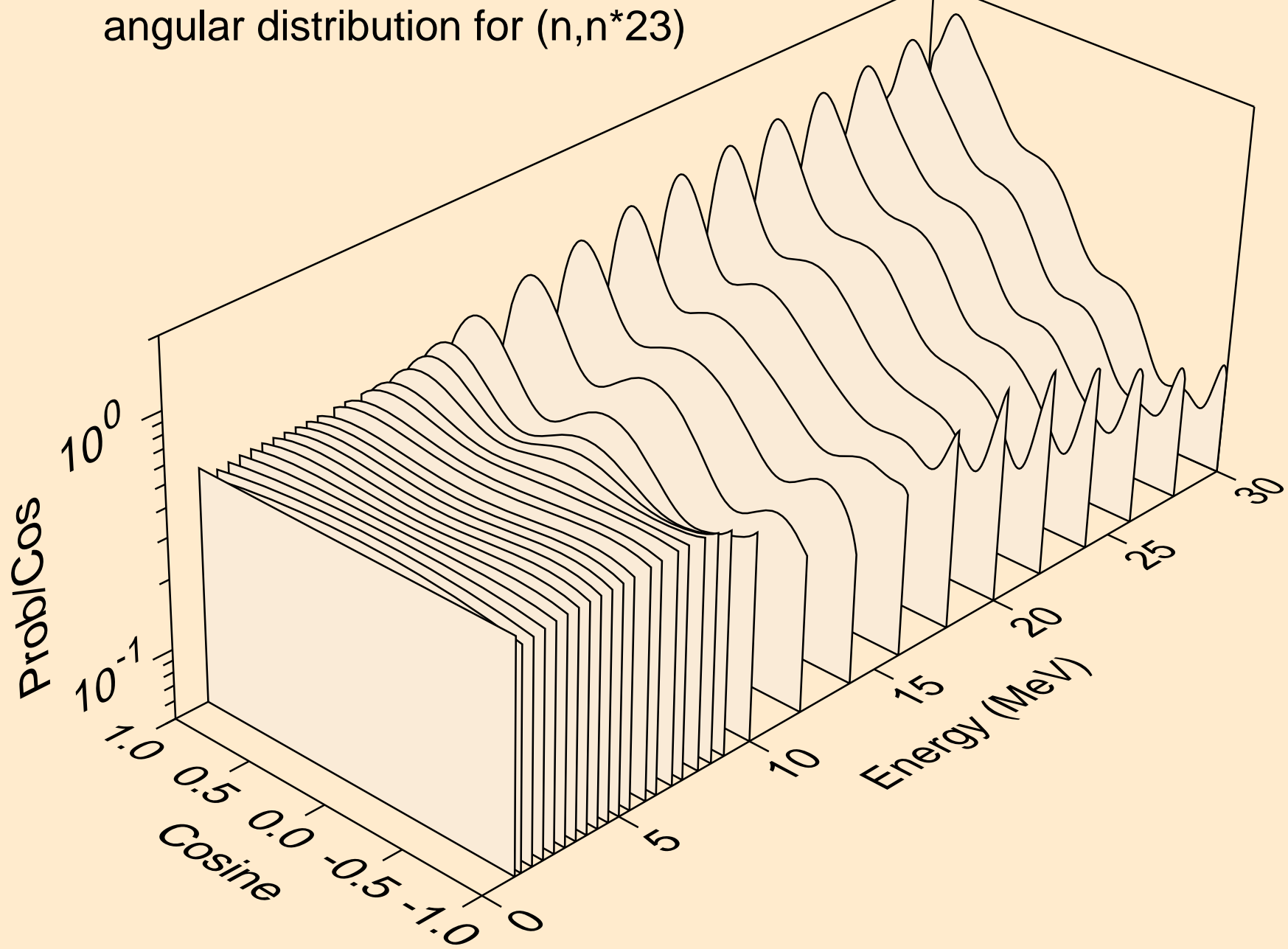

RB079 NEUTRON ACER TENDL-2024 LIBRARY; T=0.K  
angular distribution for (n,n\*24)

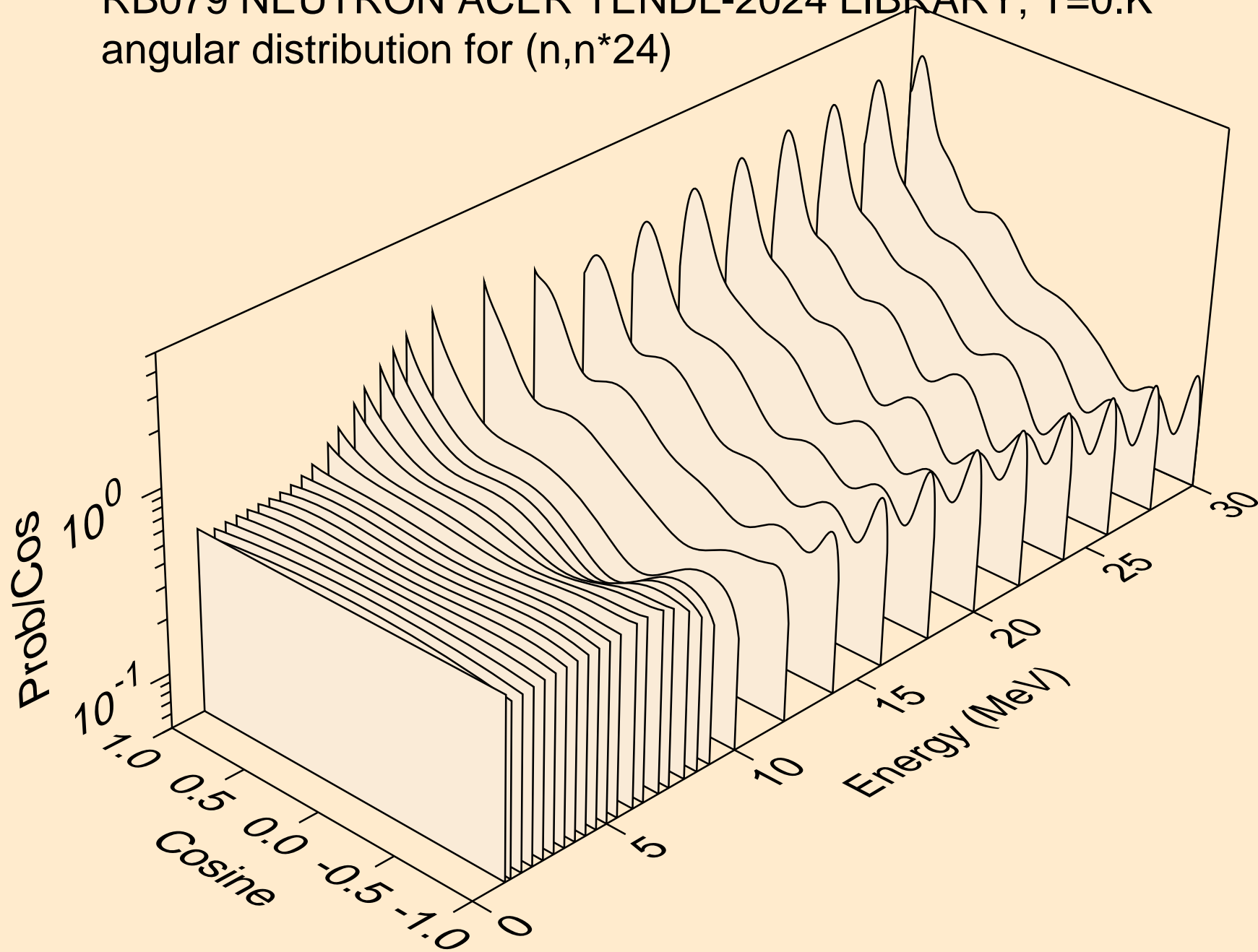



RB079 NEUTRON ACER TENDL-2024 LIBRARY; T=0.K  
angular distribution for (n,n\*25)

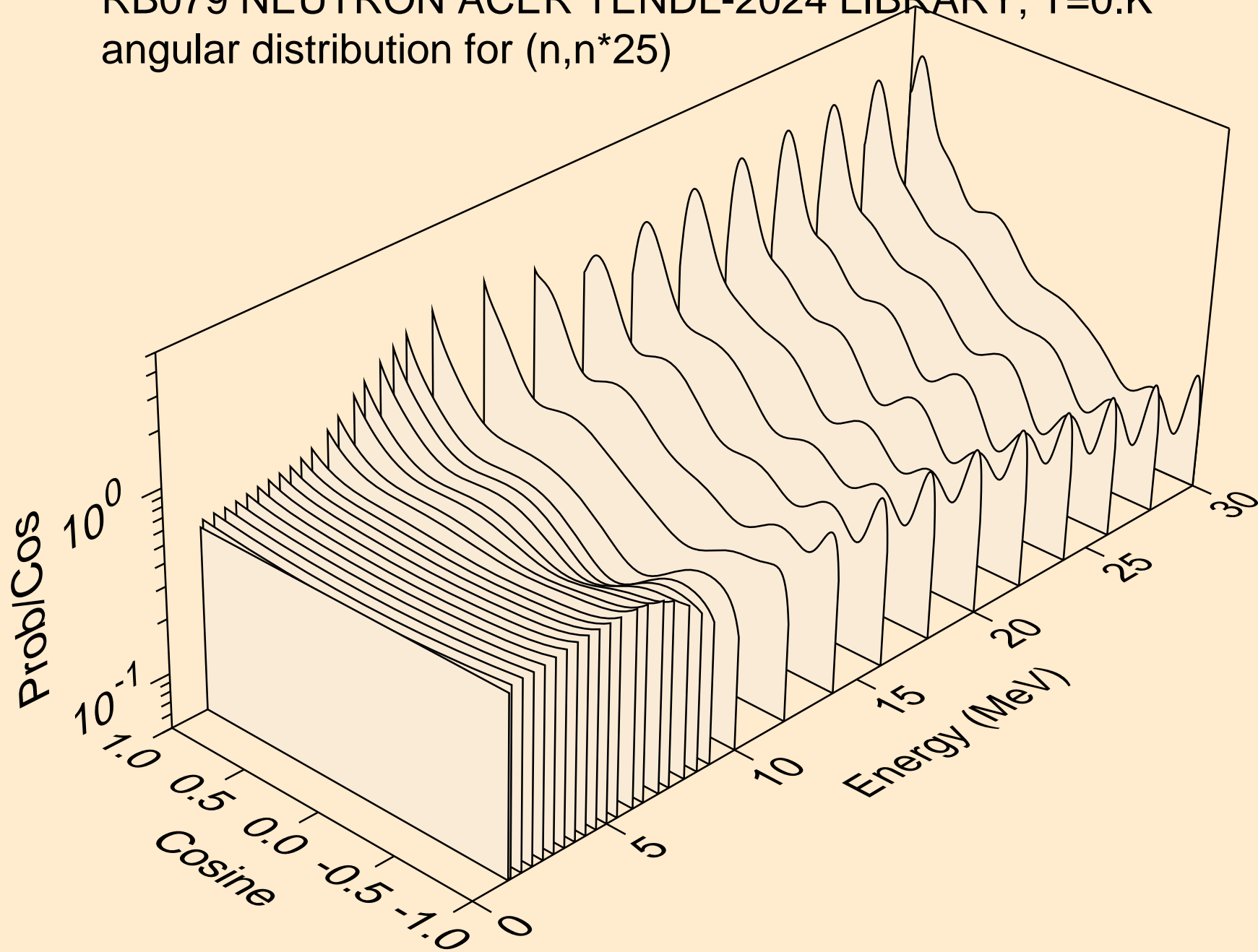

RB079 NEUTRON ACER TENDL-2024 LIBRARY; T=0.K  
Neutron emission for (n,x)

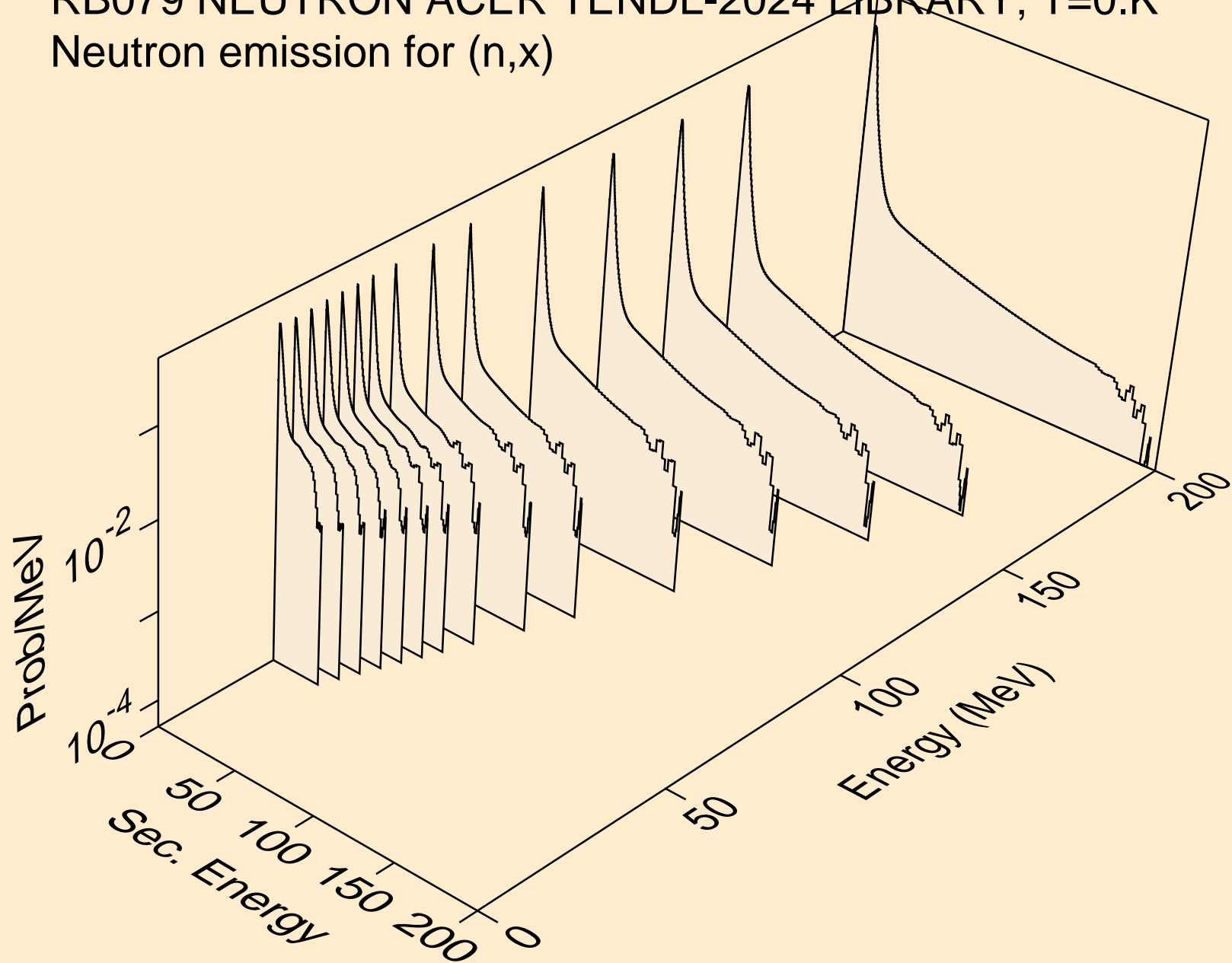

RB079 NEUTRON ACER TENDL-2024 LIBRARY; T=0.K  
Neutron emission for (n,2nd)

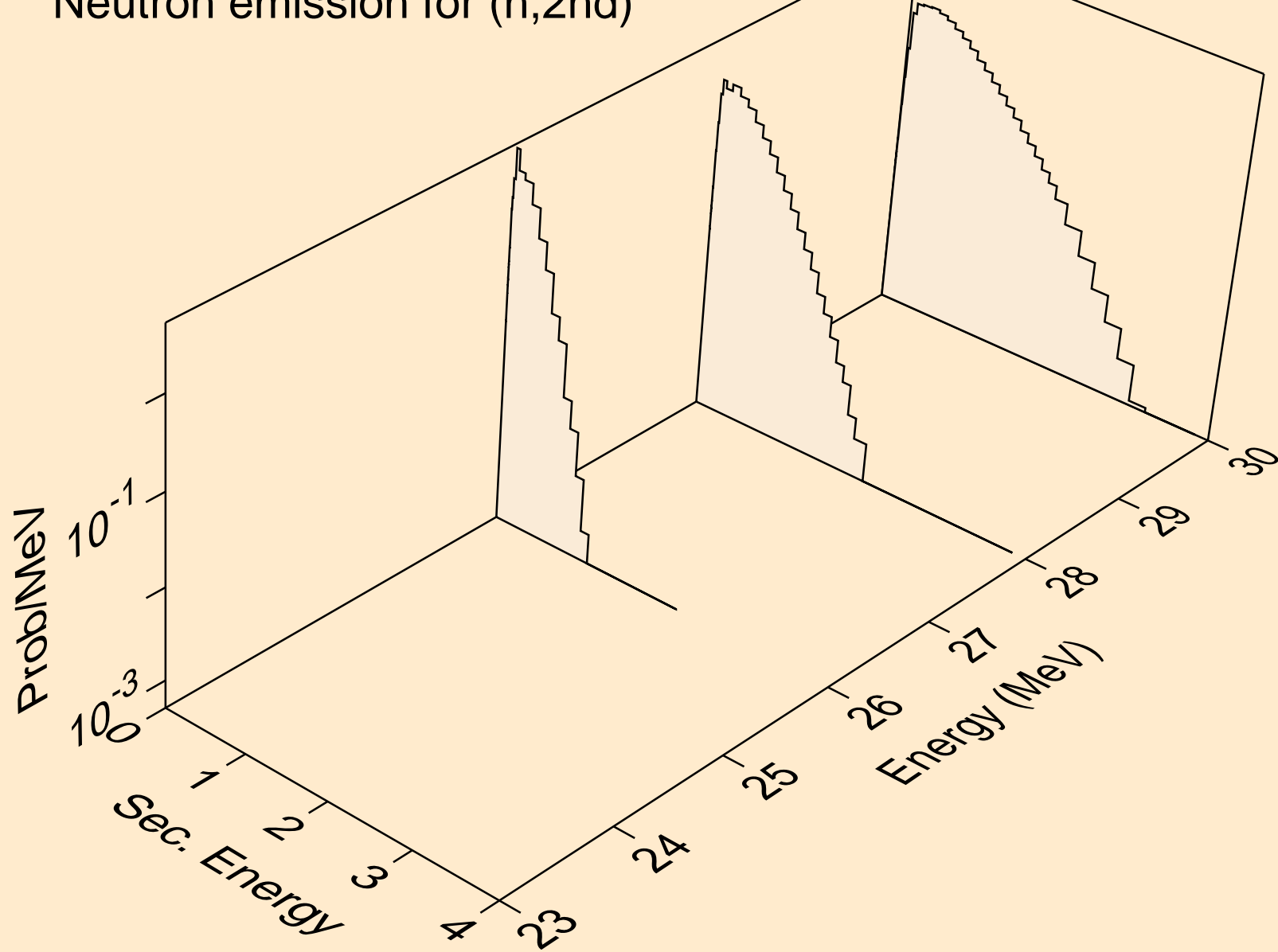

RB079 NEUTRON ACER TENDL-2024 LIBRARY; T=0.K  
Neutron emission for (n,2n)

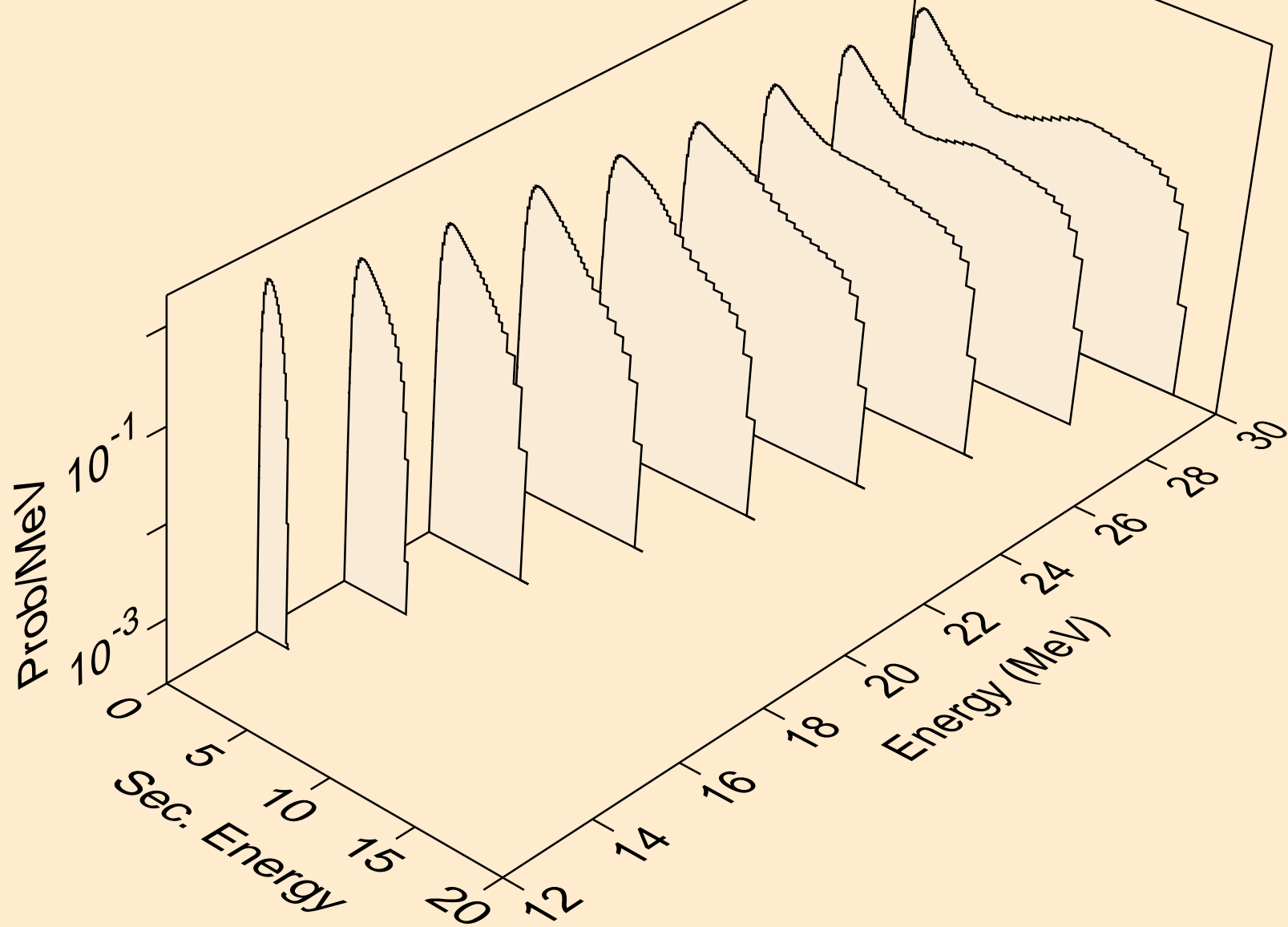

RB079 NEUTRON ACER TENDL-2024 LIBRARY; T=0.K  
Neutron emission for (n,3n)

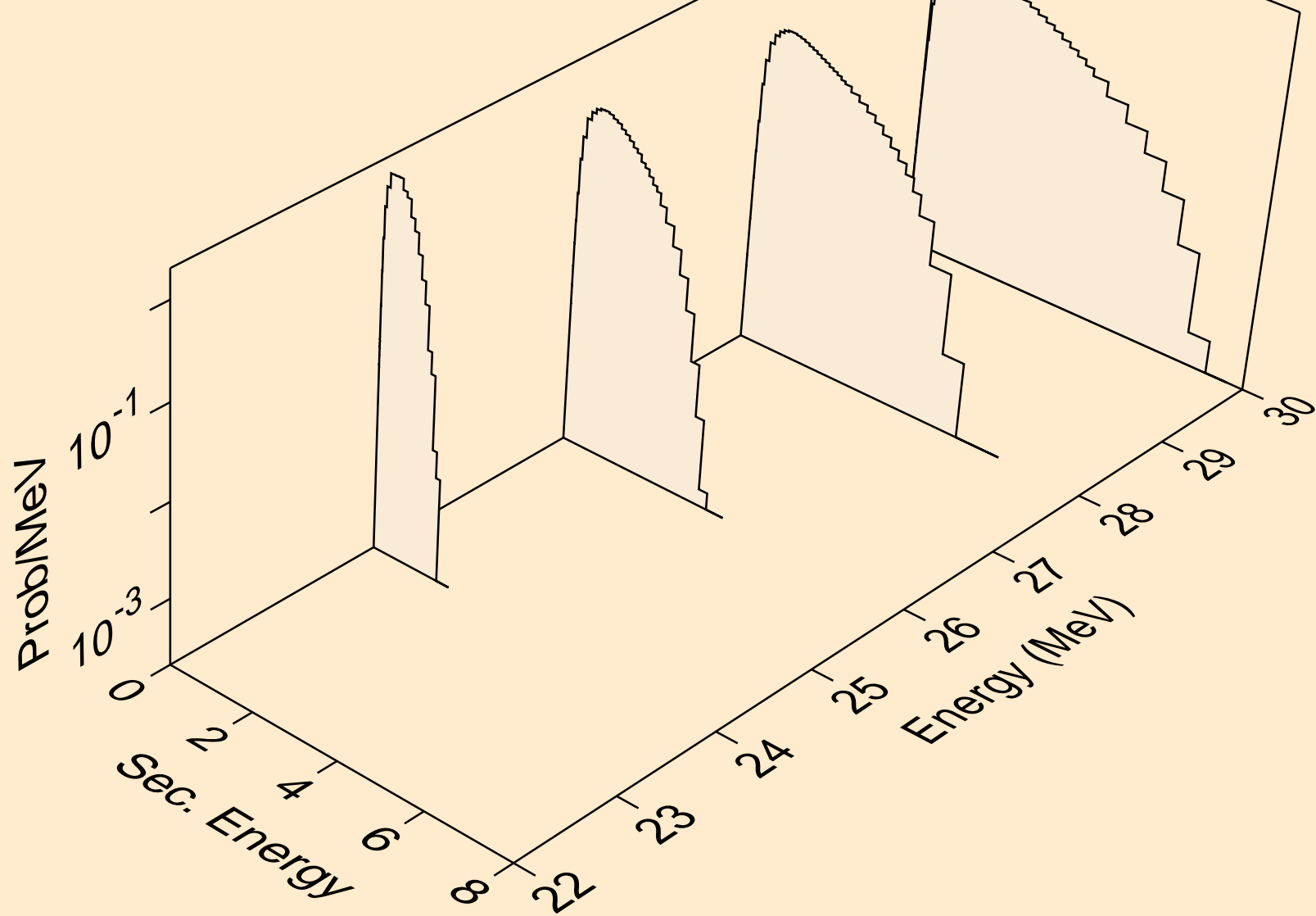

RB079 NEUTRON ACER TENDL-2024 LIBRARY; T=0.K  
Neutron emission for (n,n\*)a

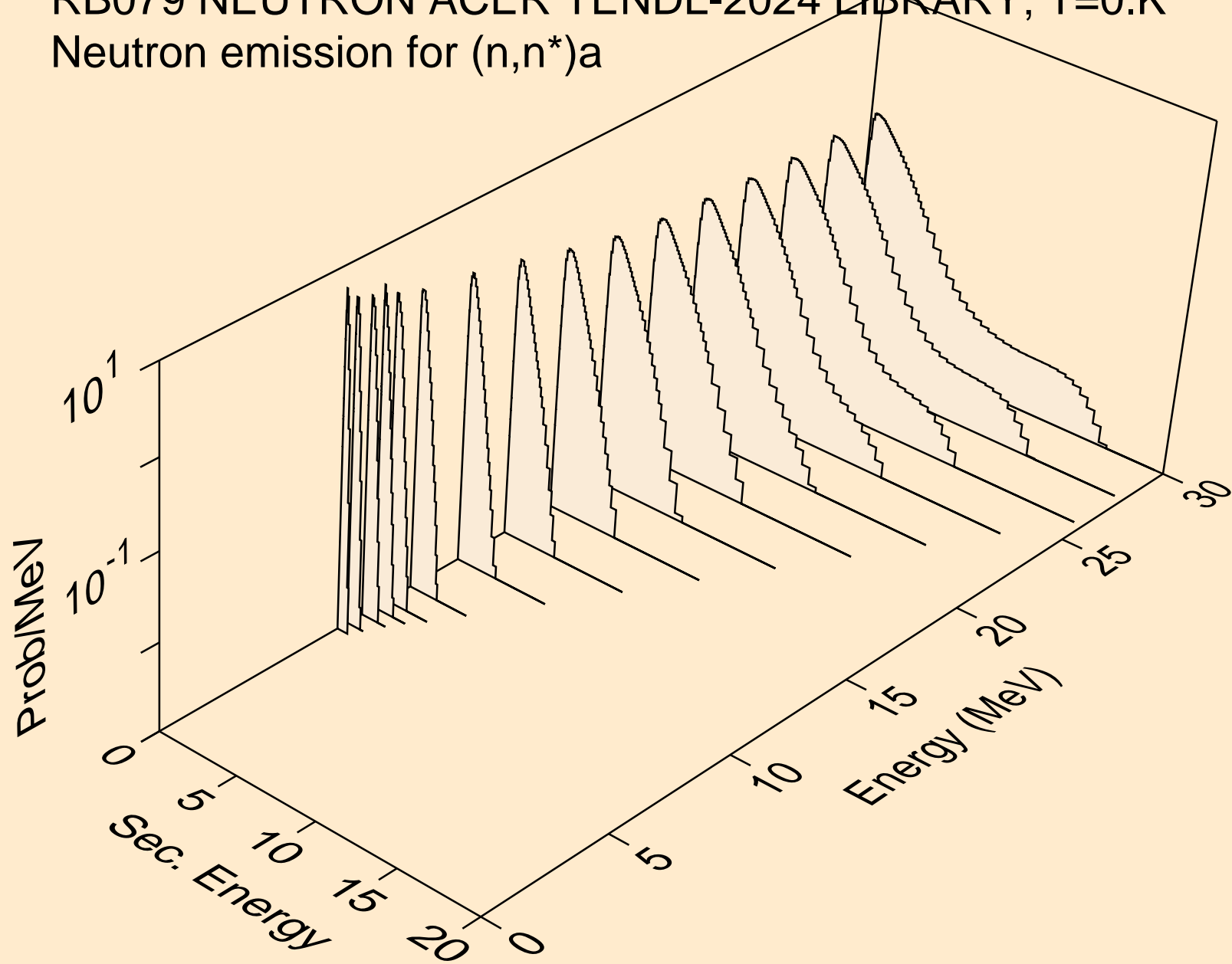

RB079 NEUTRON ACER TENDL-2024 LIBRARY; T=0.K  
Neutron emission for (n,2n)a

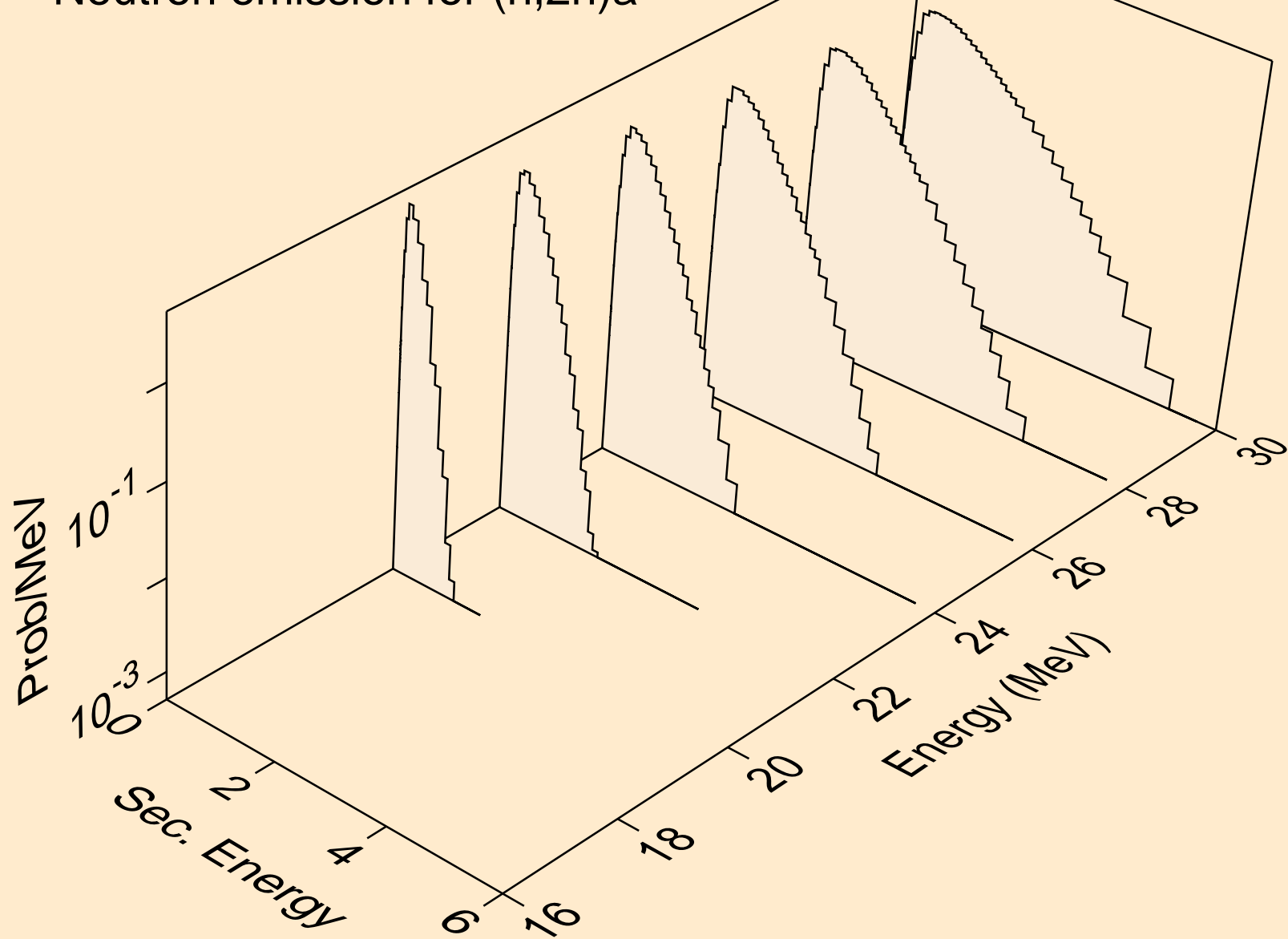

RB079 NEUTRON ACER TENDL-2024 LIBRARY; T=0.K  
Neutron emission for (n,n\*)p

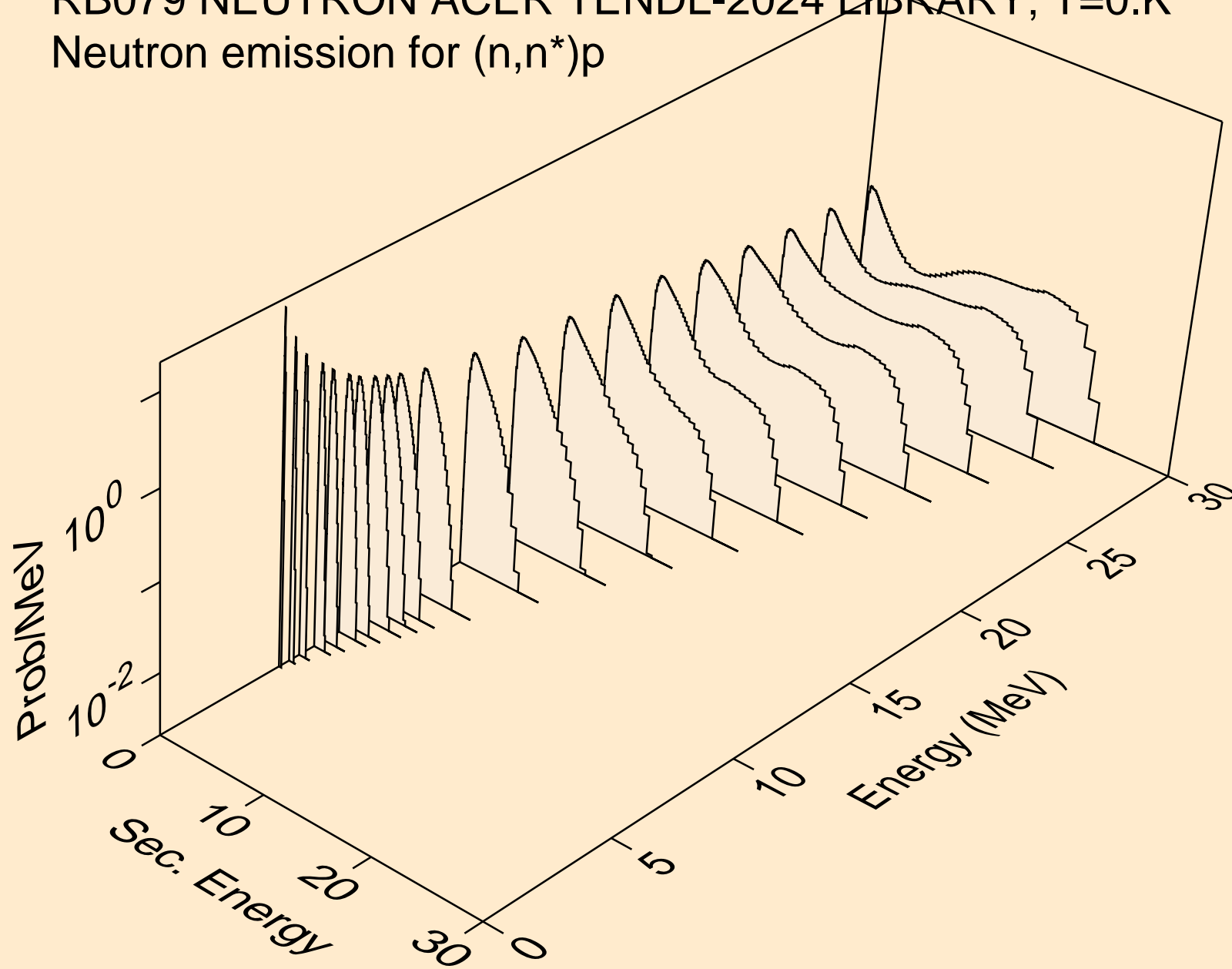



RB079 NEUTRON ACER TENDL-2024 LIBRARY; T=0.K  
Neutron emission for (n,n\*)2a

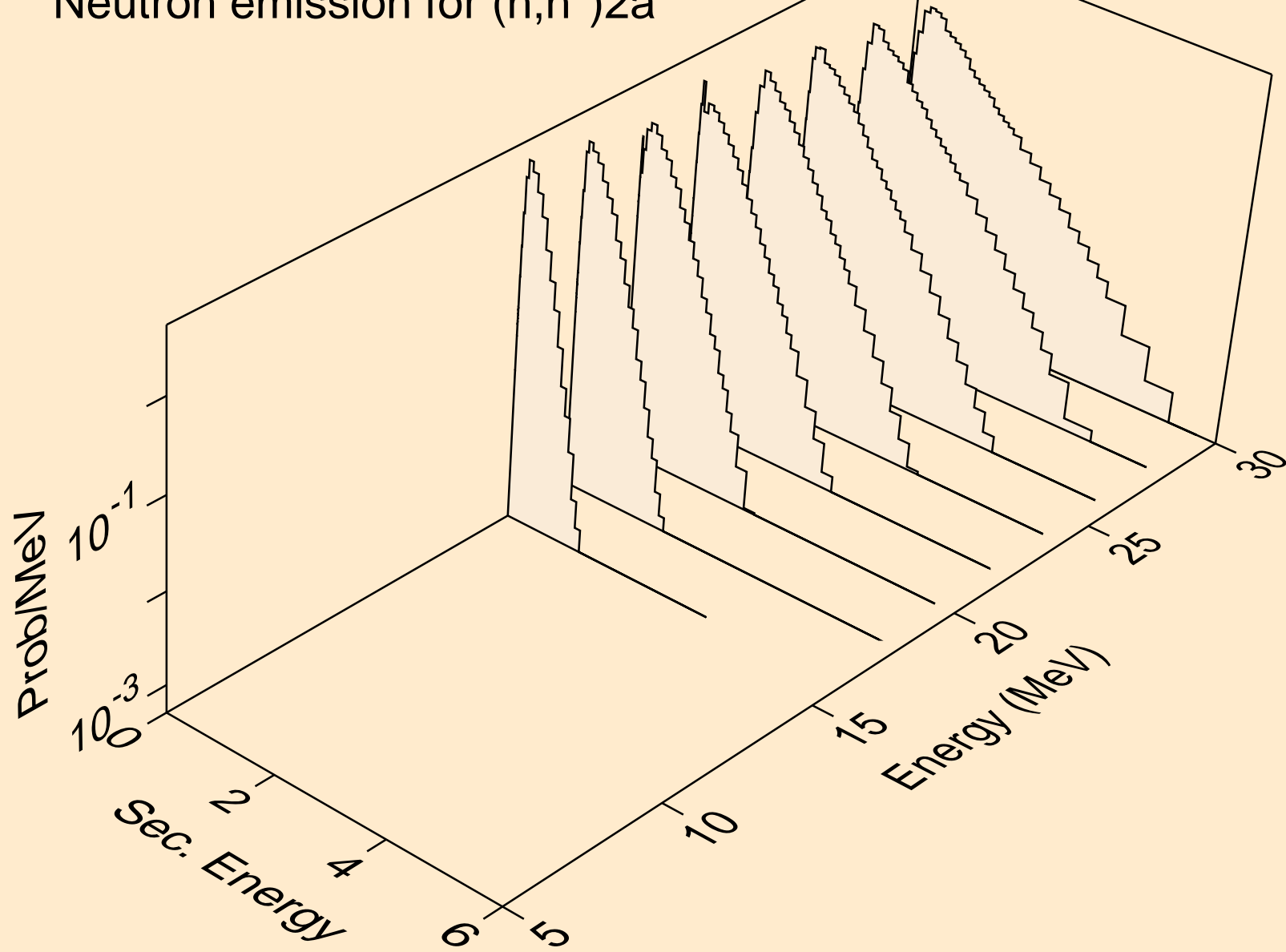

RB079 NEUTRON ACER TENDL-2024 LIBRARY; T=0.K  
Neutron emission for (n,n\*)d

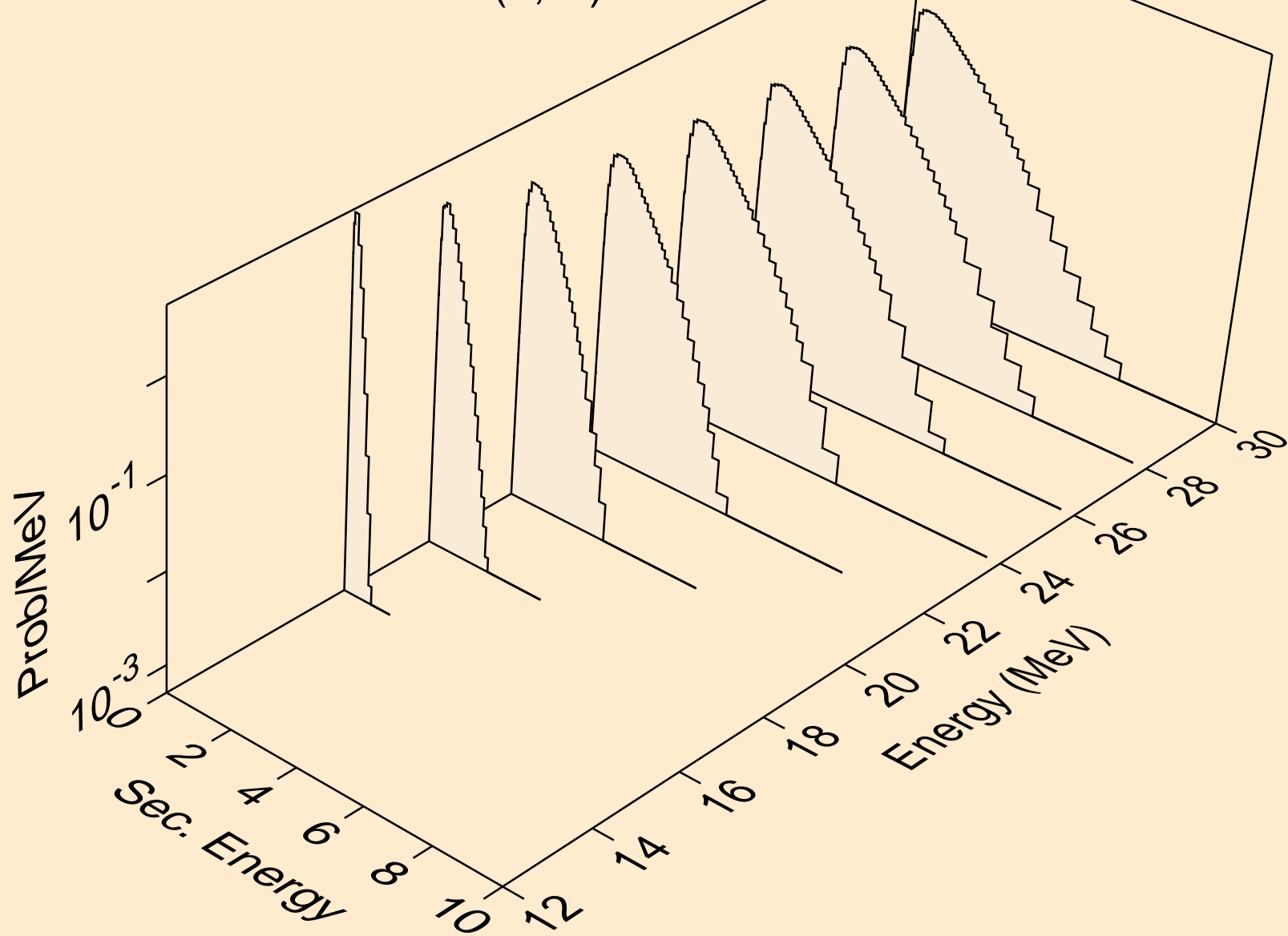

RB079 NEUTRON ACER TENDL-2024 LIBRARY; T=0.K  
Neutron emission for (n,n\*)t

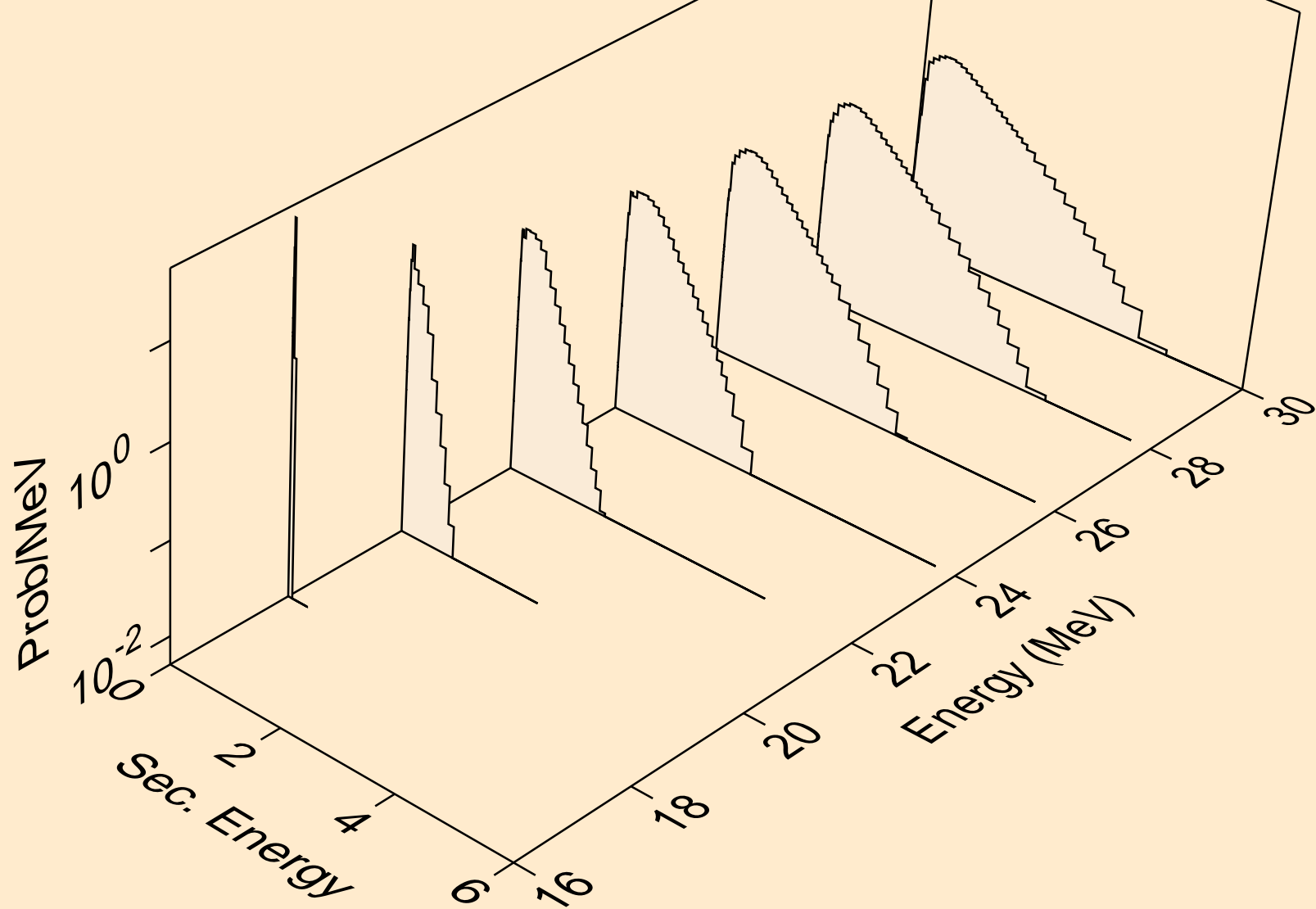

RB079 NEUTRON ACER TENDL-2024 LIBRARY; T=0.K  
Neutron emission for (n,n\*)he3

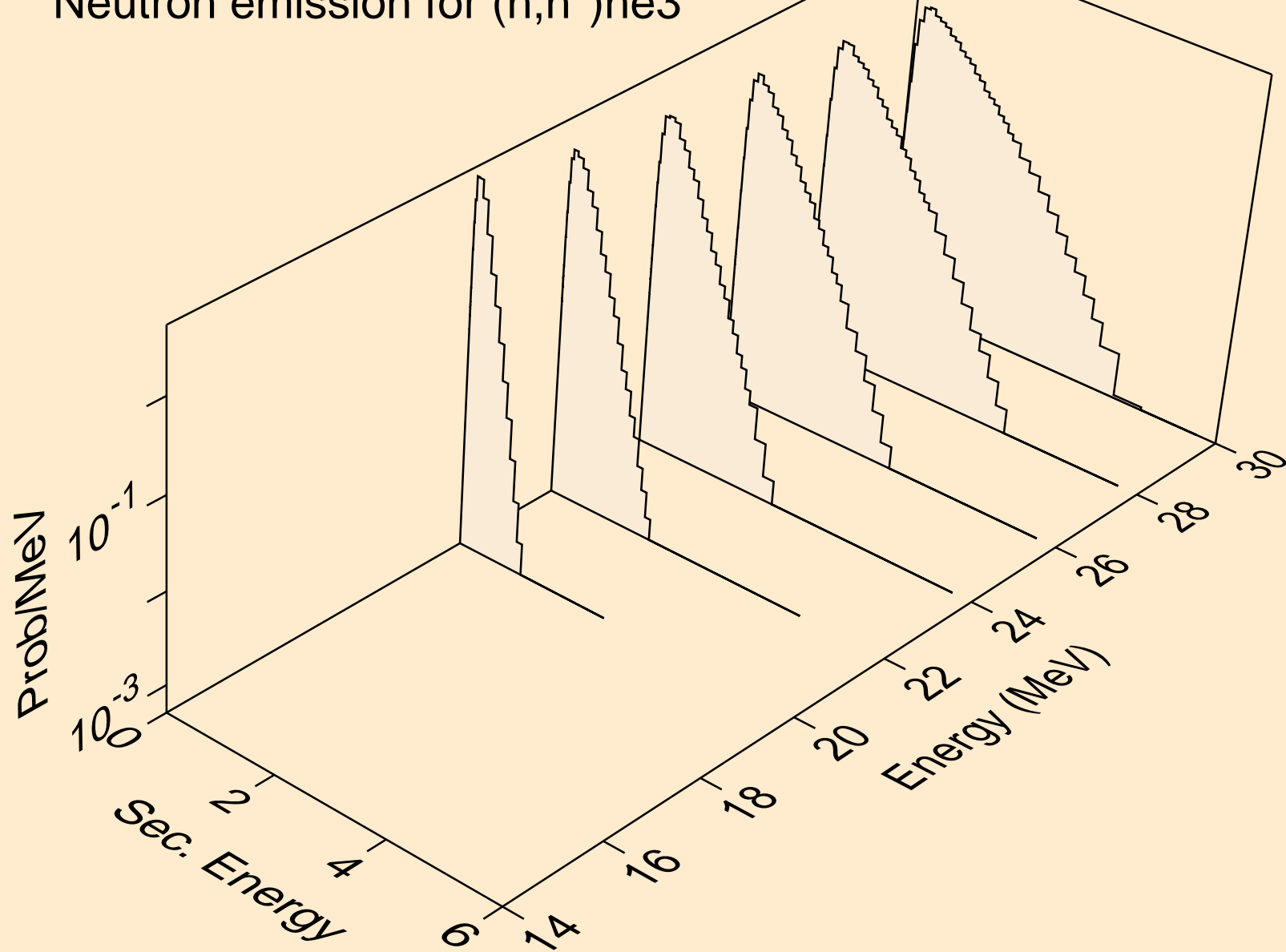

RB079 NEUTRON ACER TENDL-2024 LIBRARY; T=0.K  
Neutron emission for (n,2np)

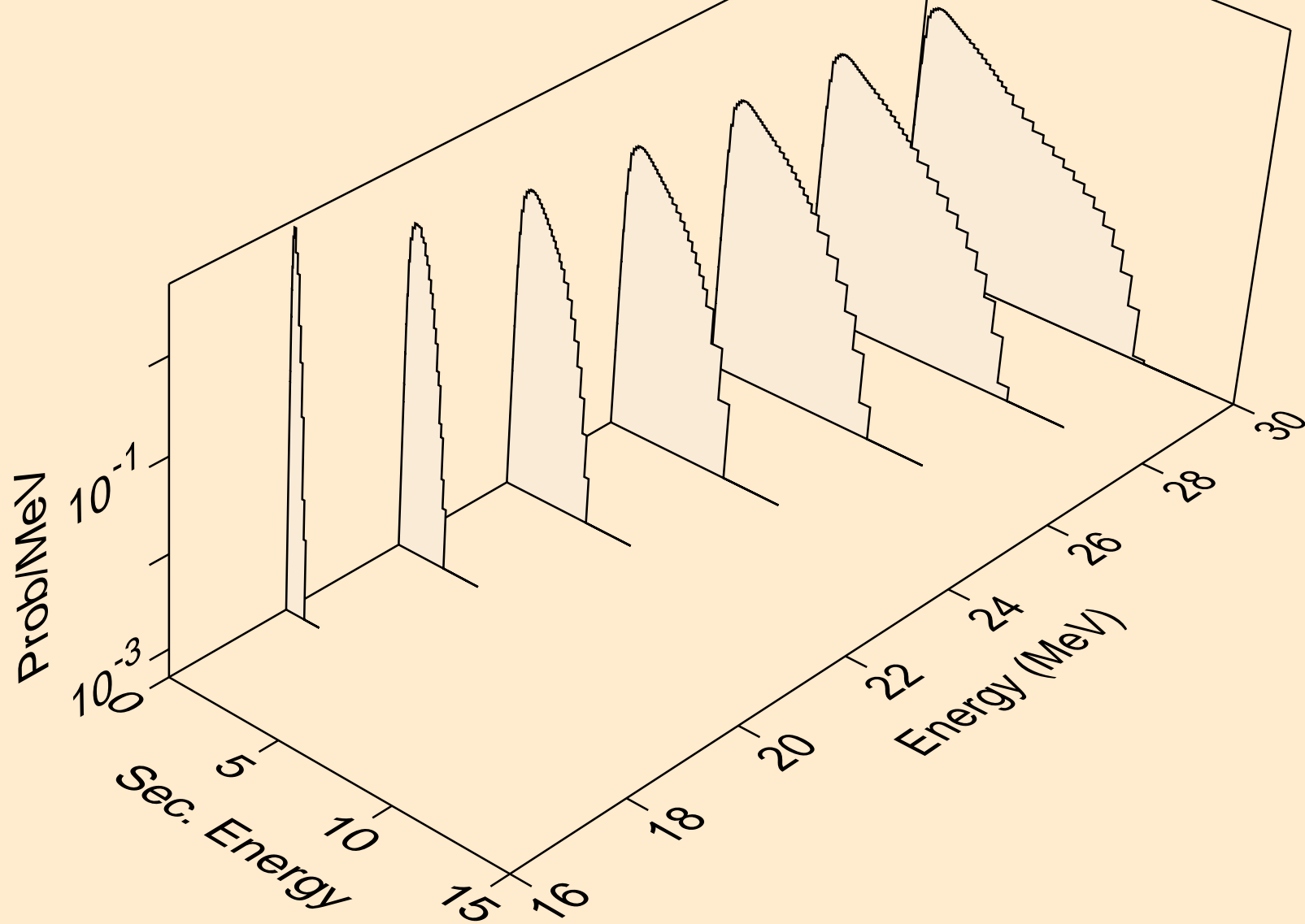

RB079 NEUTRON ACER TENDL-2024 LIBRARY; T=0.K  
Neutron emission for (n,3np)

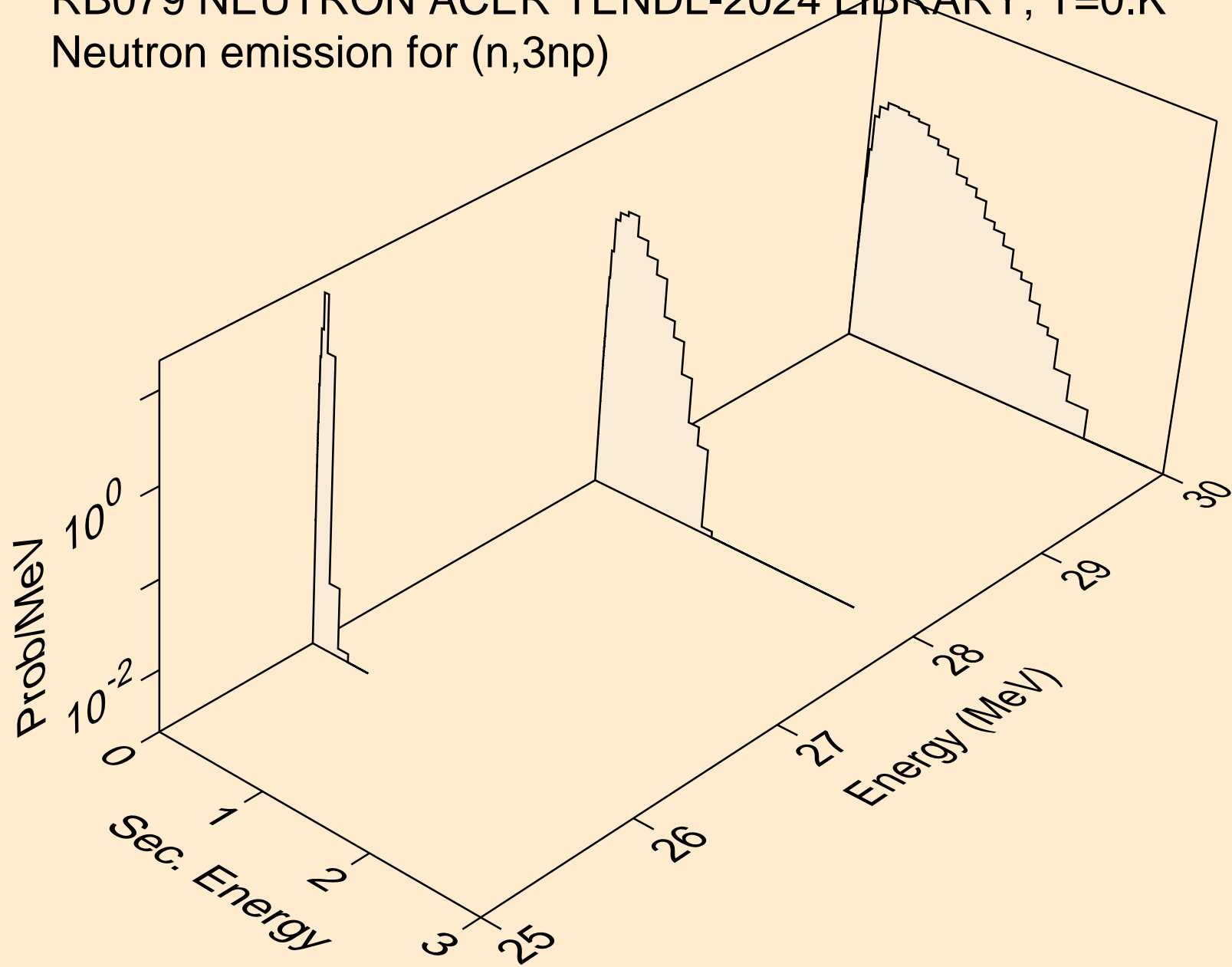

RB079 NEUTRON ACER TENDL-2024 LIBRARY; T=0.K  
Neutron emission for (n,n2p)

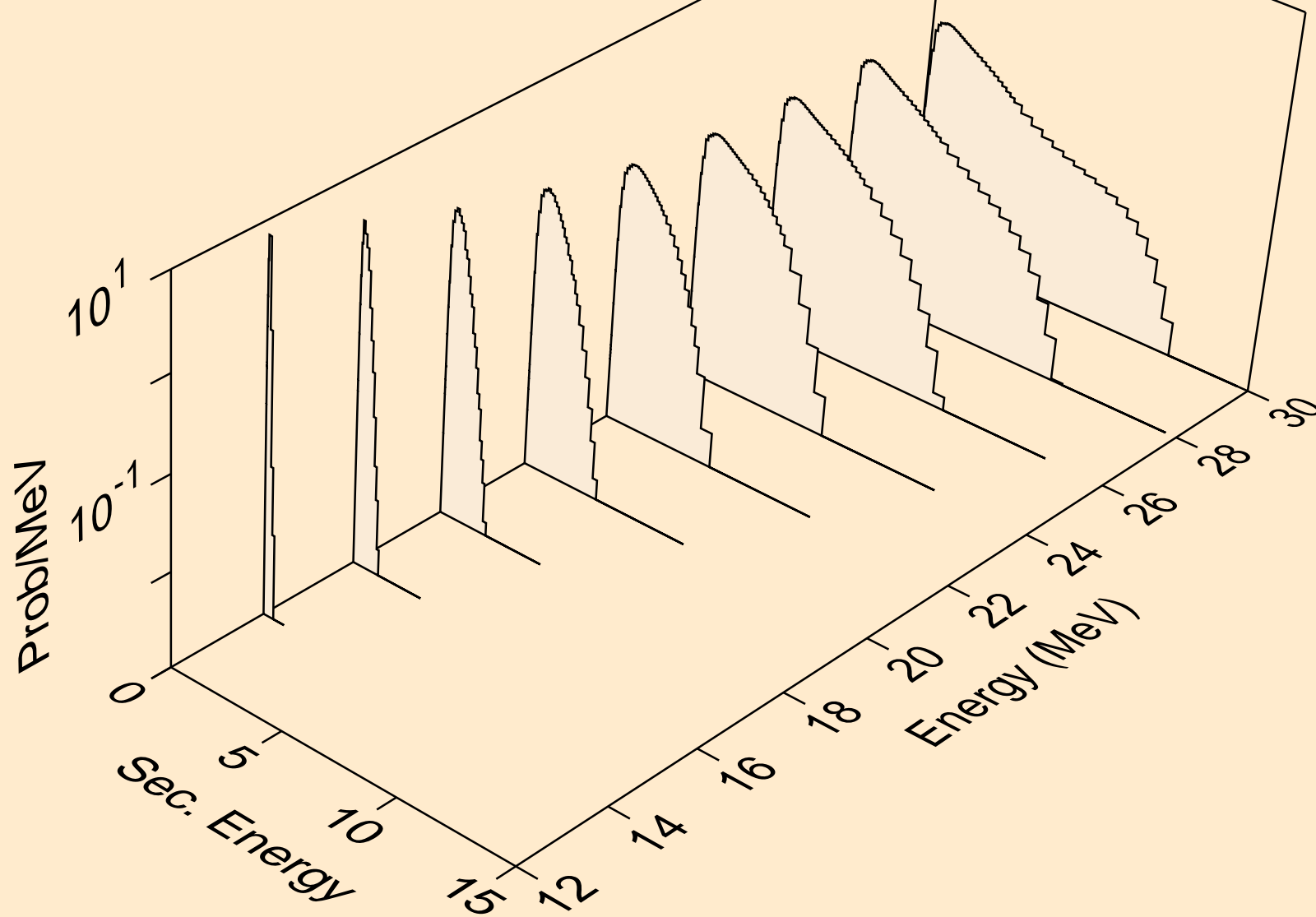

RB079 NEUTRON ACER TENDL-2024 LIBRARY; T=0.K  
Neutron emission for (n,npa)

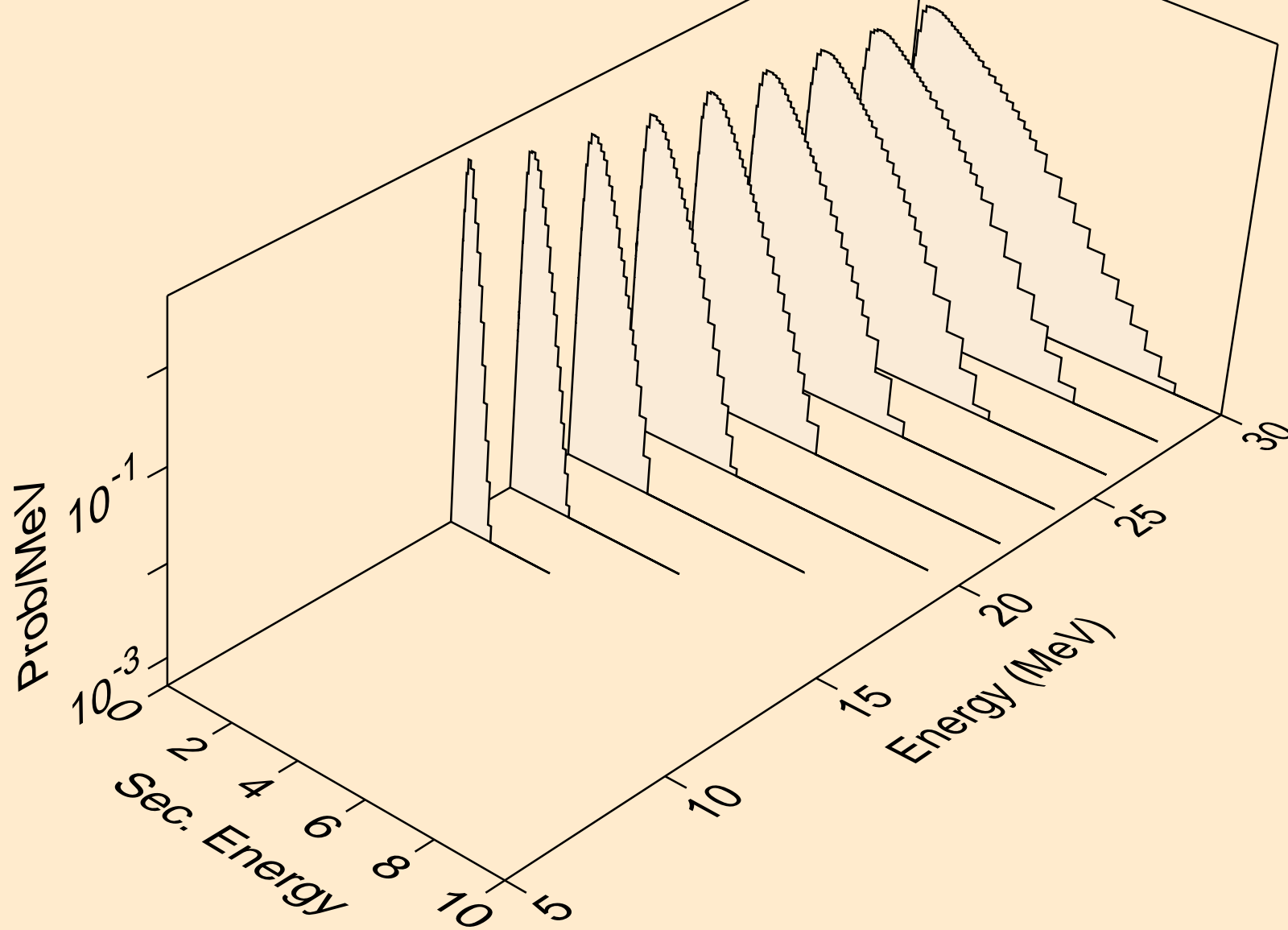



RB079 NEUTRON ACER TENDL-2024 LIBRARY; T=0.K  
Neutron emission for (n,n\*c)

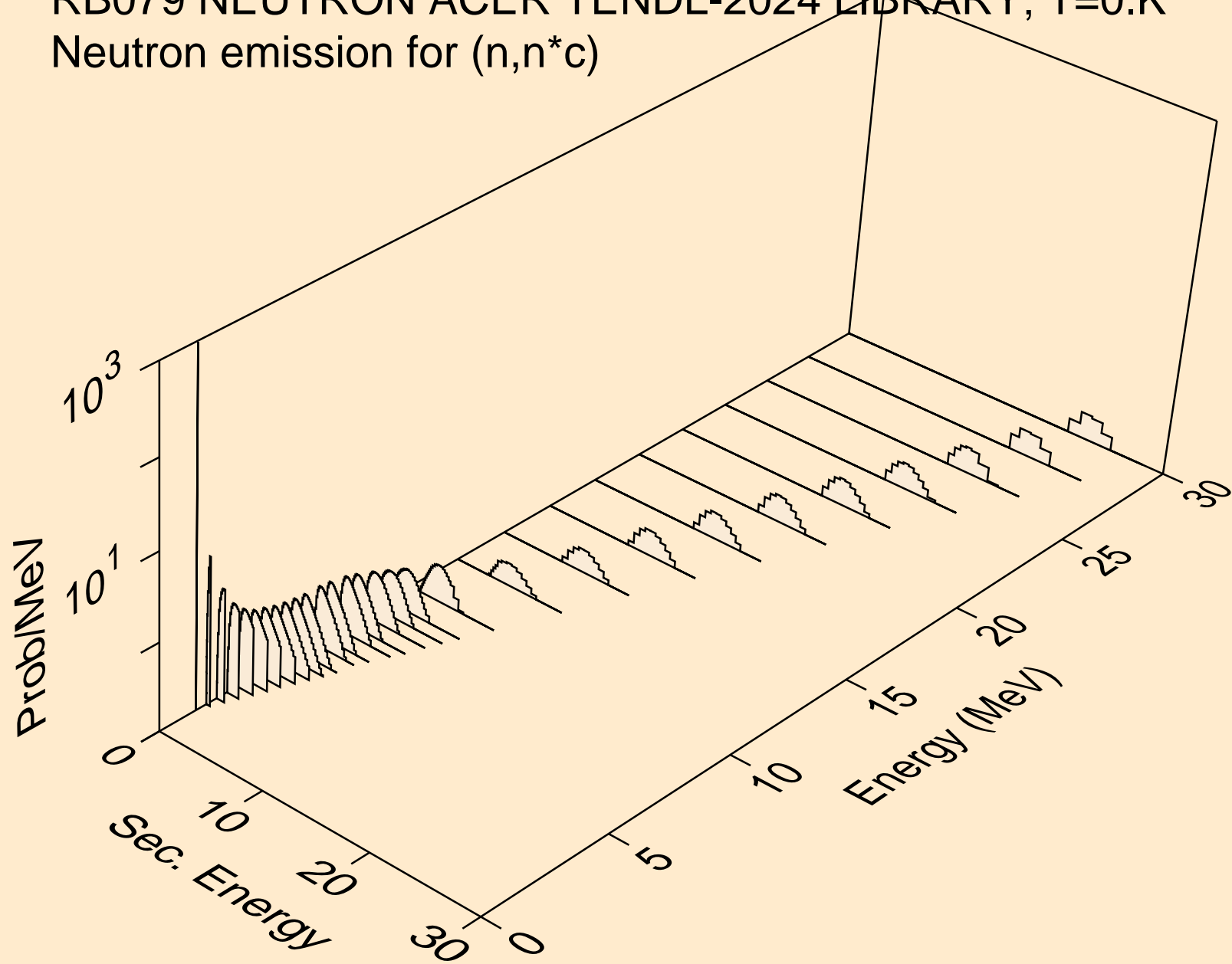

RB079 NEUTRON ACER TENDL-2024 LIBRARY; T=0.K  
Photon emission for (n,x)

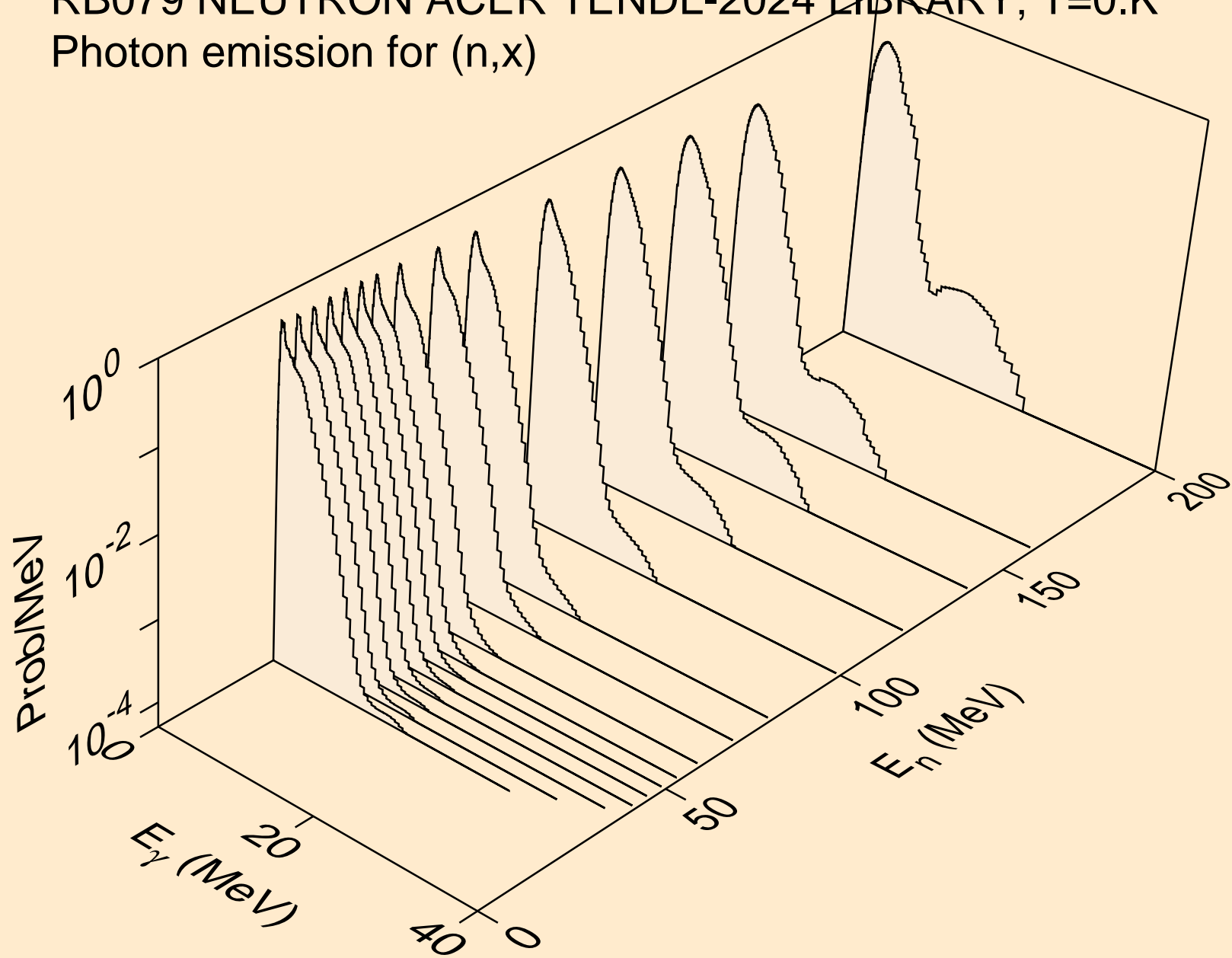

RB079 NEUTRON ACER TENDL-2024 LIBRARY; T=0.K  
Photon emission for (n,2nd)

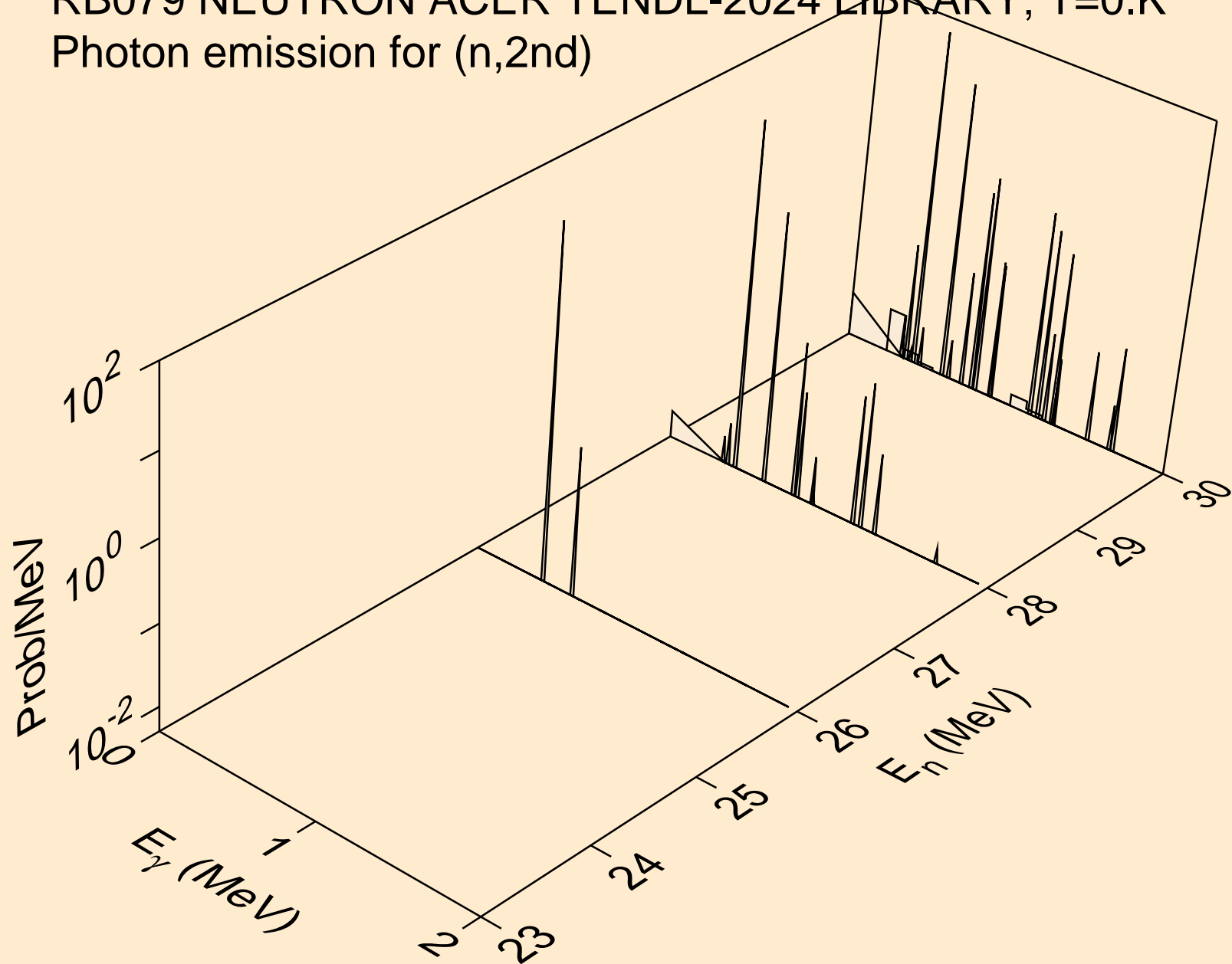

RB079 NEUTRON ACER TENDL-2024 LIBRARY; T=0.K  
Photon emission for (n,2n)

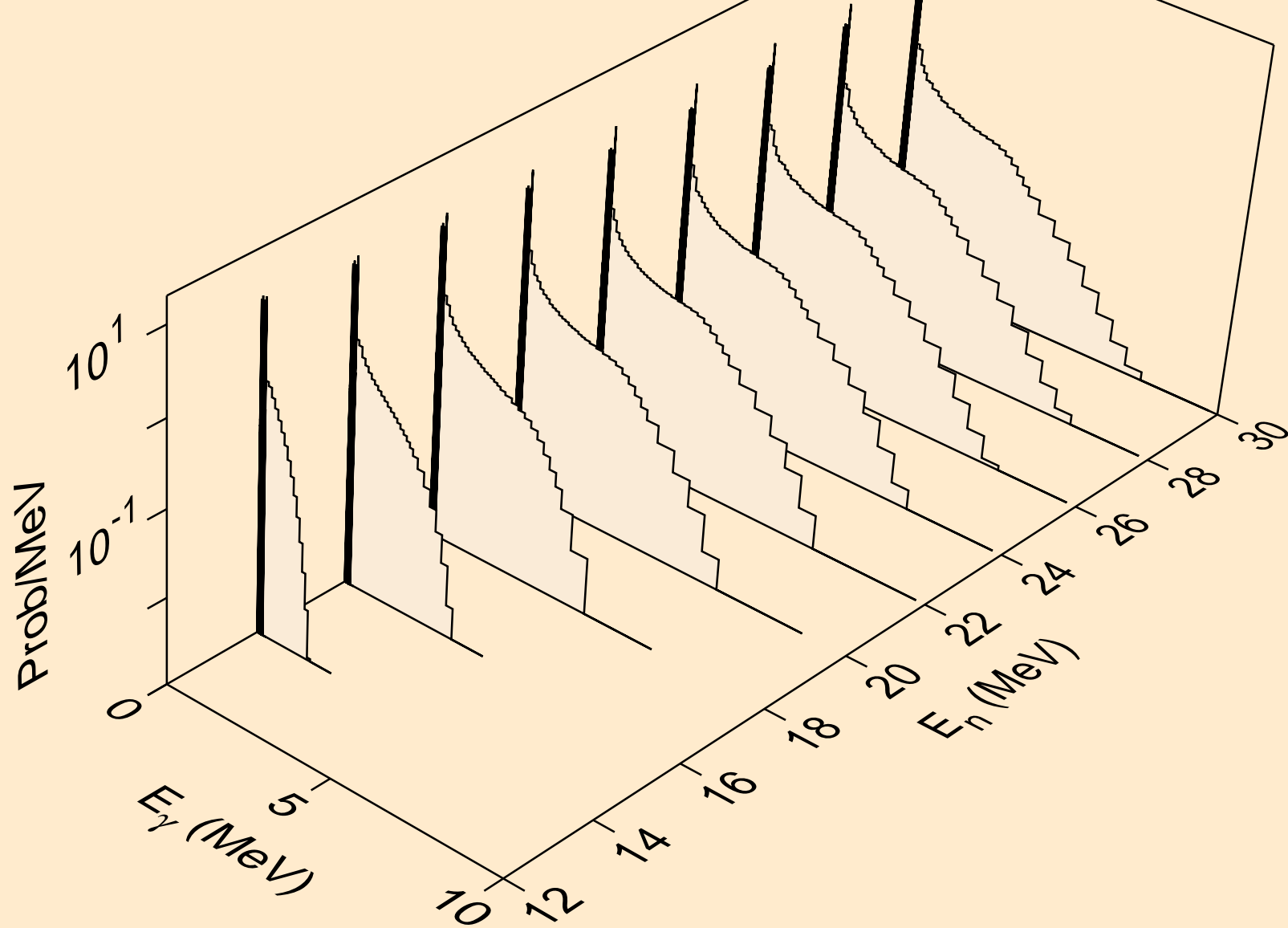

RB079 NEUTRON ACER TENDL-2024 LIBRARY; T=0.K  
Photon emission for (n,3n)

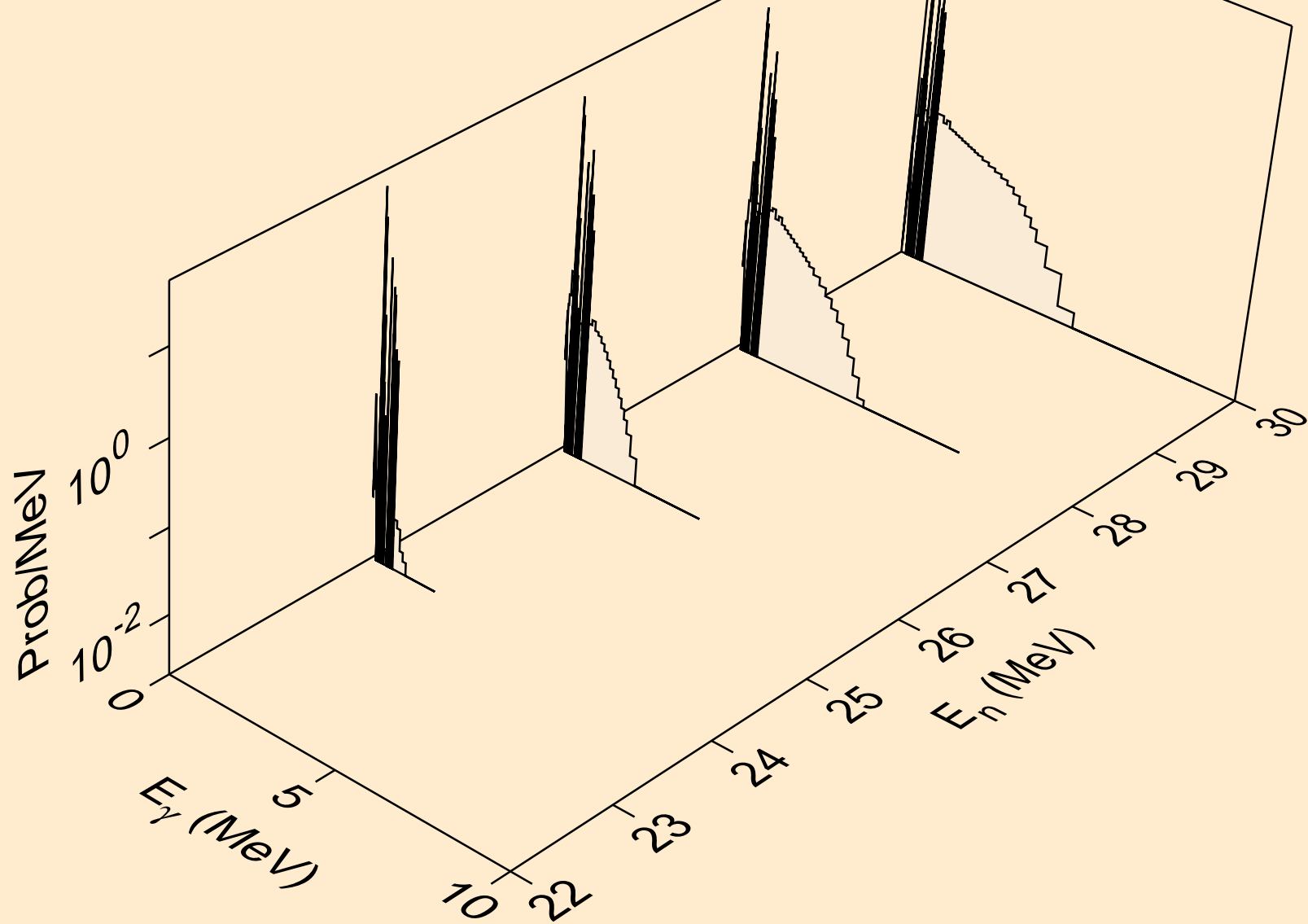

RB079 NEUTRON ACER TENDL-2024 LIBRARY; T=0.K  
Photon emission for (n,n\*)a

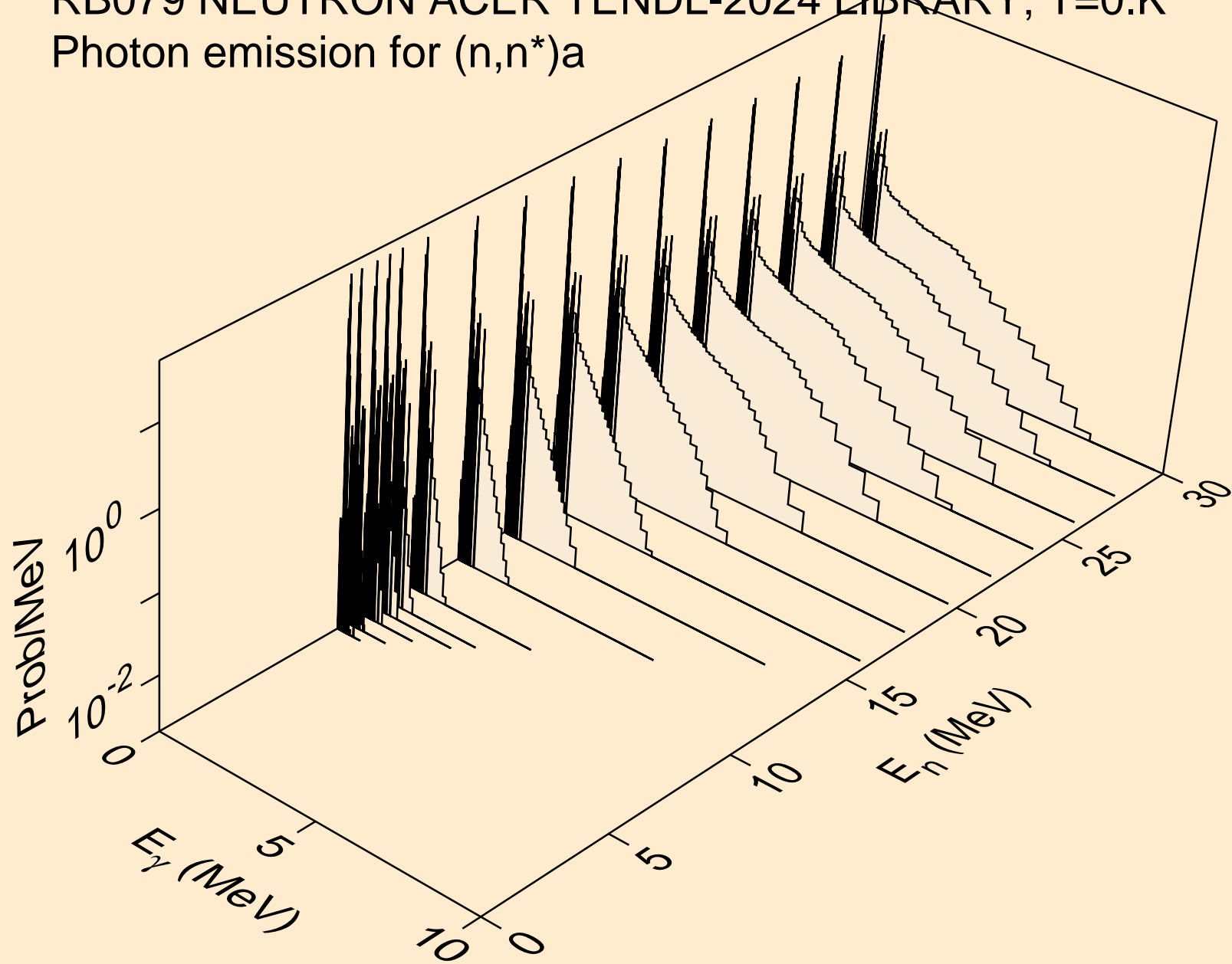

RB079 NEUTRON ACER TENDL-2024 LIBRARY; T=0.K  
Photon emission for (n,2n)a

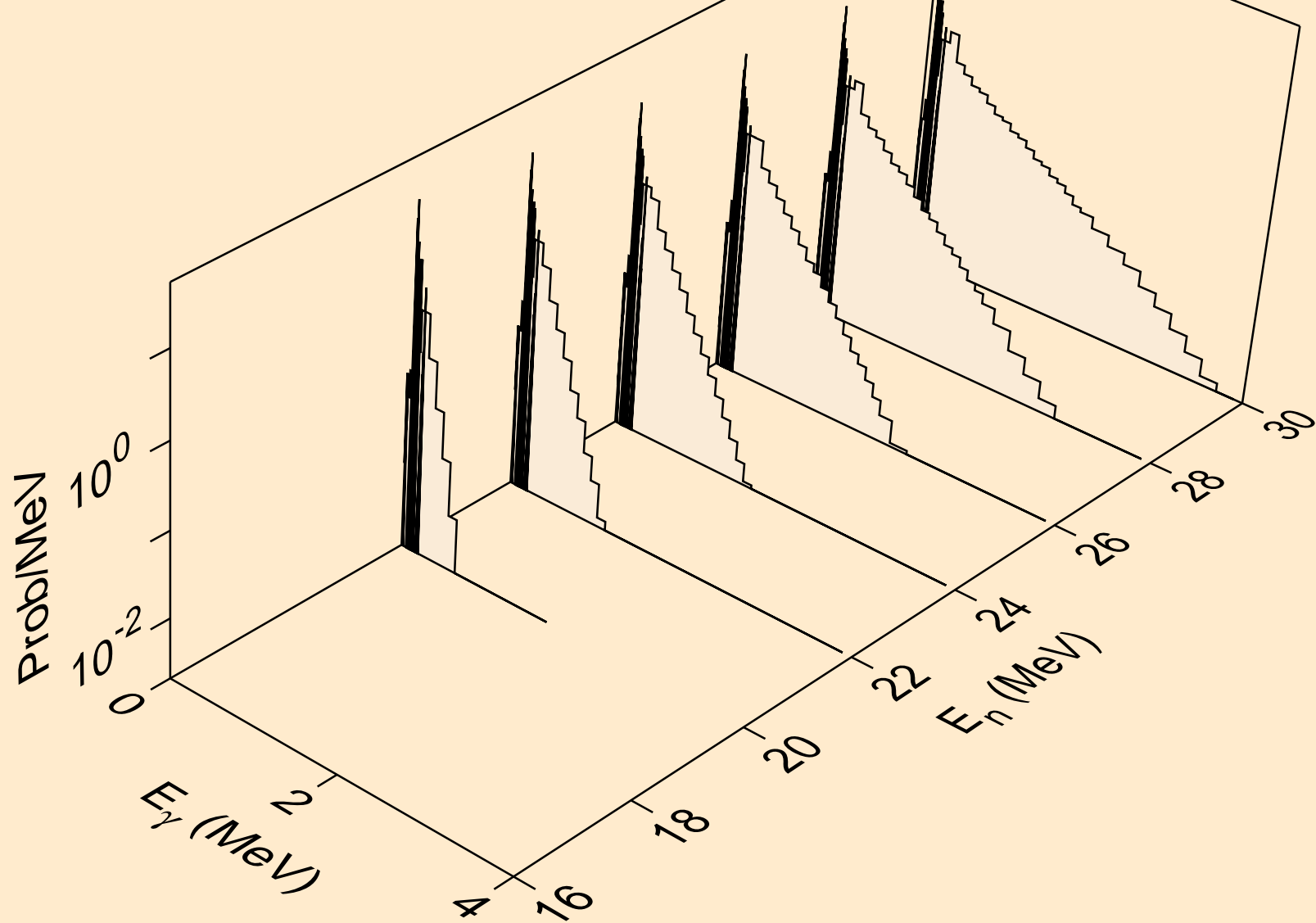

RB079 NEUTRON ACER TENDL-2024 LIBRARY; T=0.K  
Photon emission for (n,n\*)p

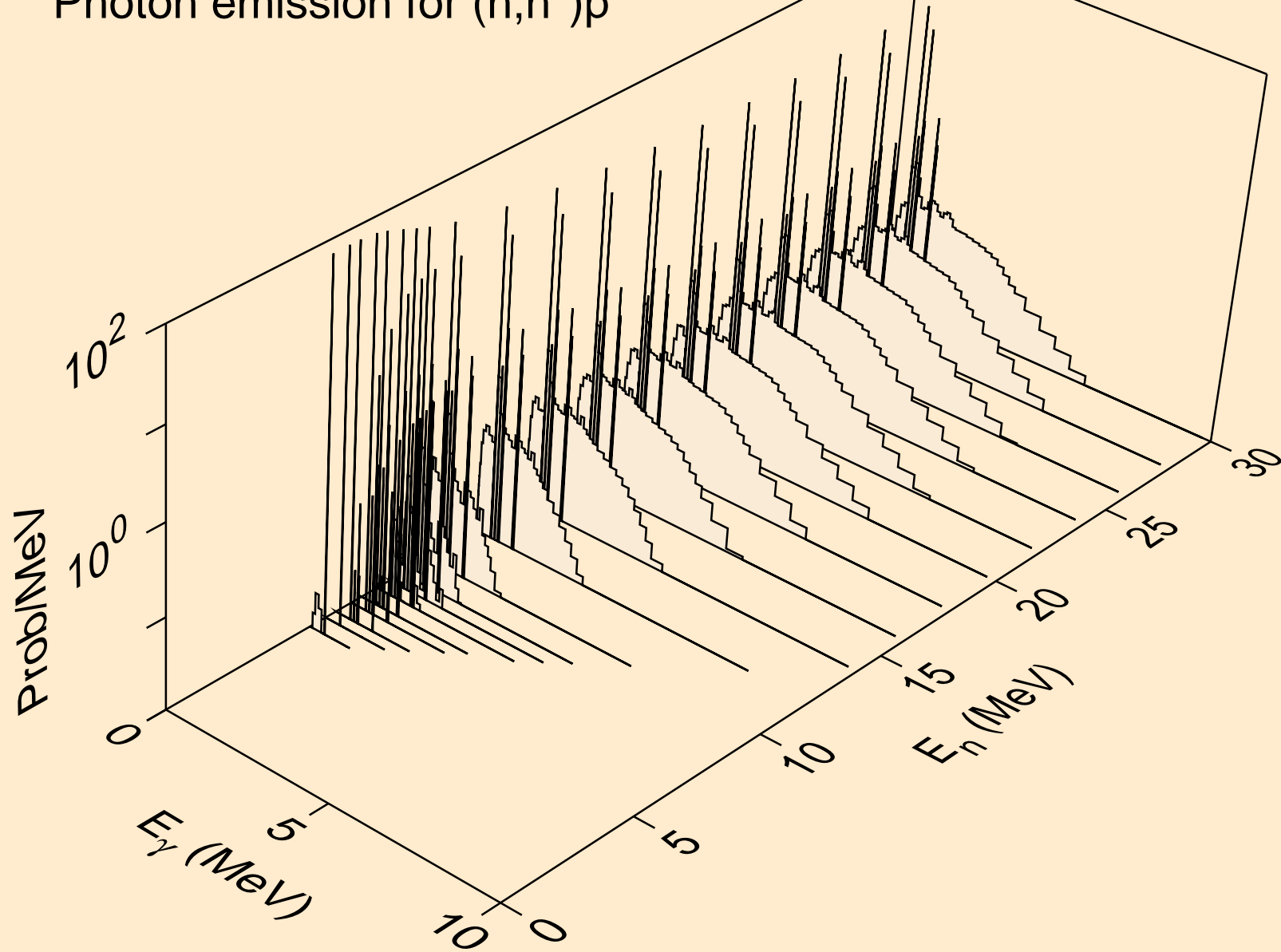



RB079 NEUTRON ACER TENDL-2024 LIBRARY; T=0.K  
Photon emission for (n,n\*)2a

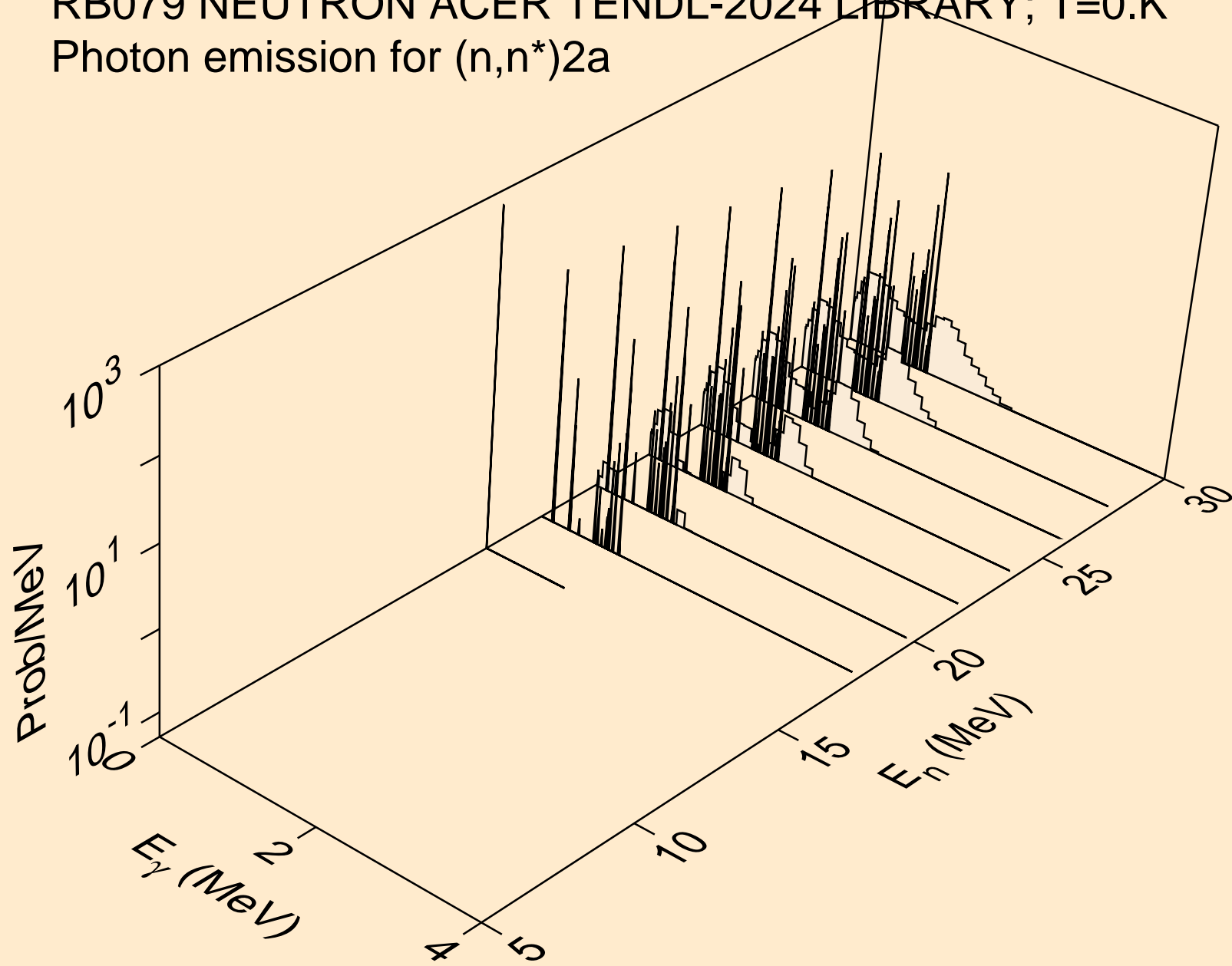

RB079 NEUTRON ACER TENDL-2024 LIBRARY; T=0.K  
Photon emission for (n,n\*)d

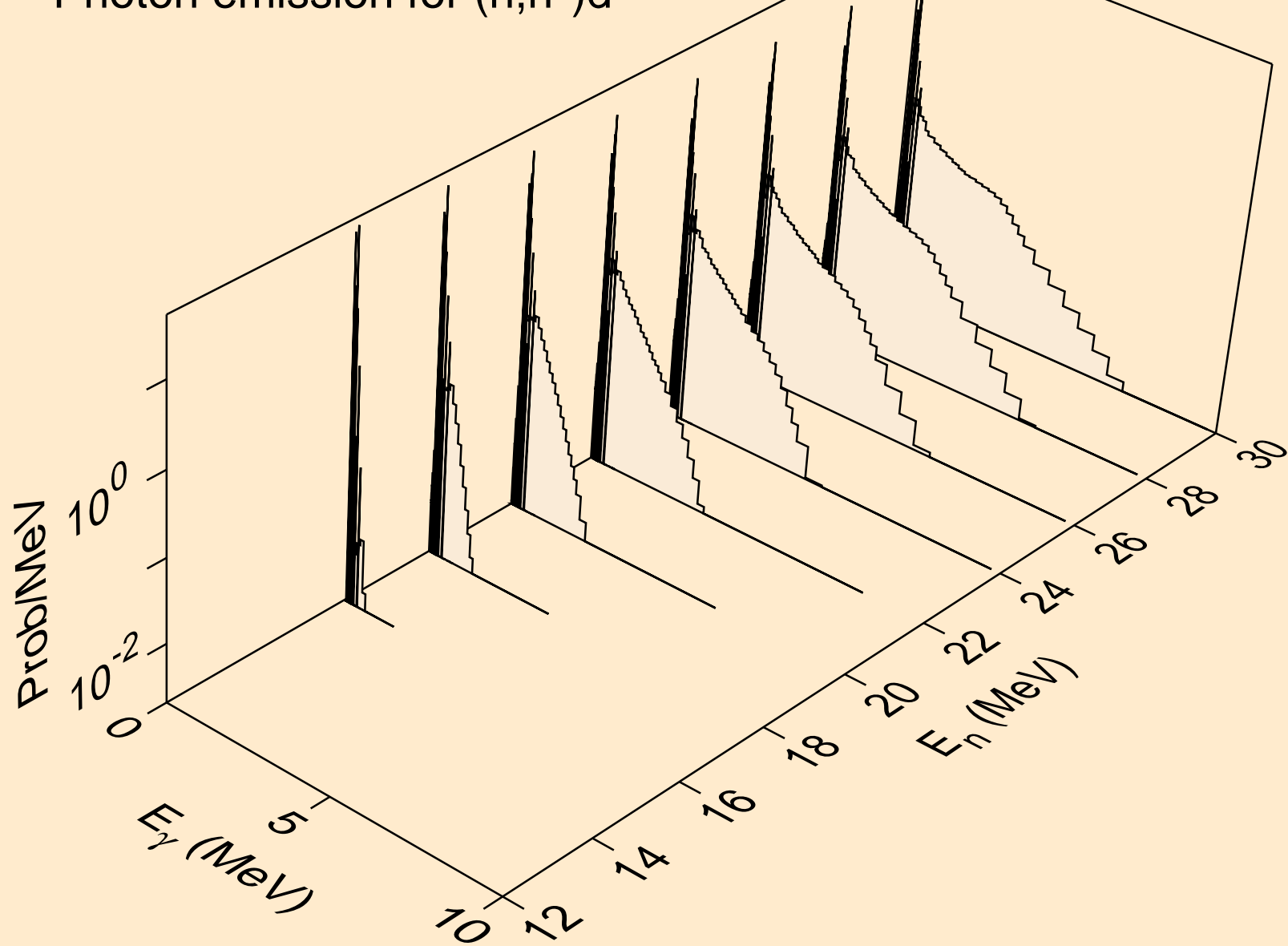

RB079 NEUTRON ACER TENDL-2024 LIBRARY; T=0.K  
Photon emission for (n,n\*)t

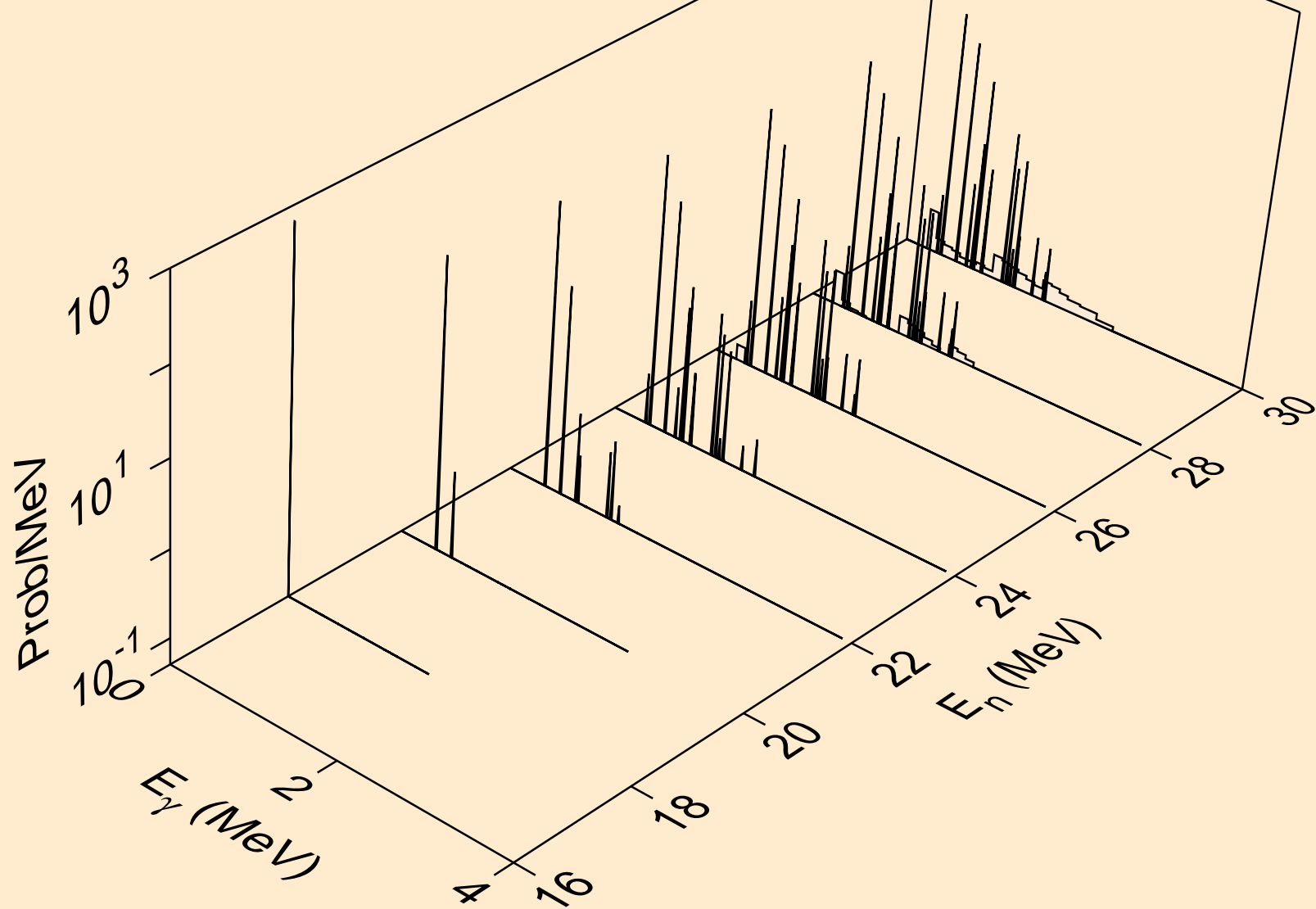

RB079 NEUTRON ACER TENDL-2024 LIBRARY; T=0.K  
Photon emission for (n,n\*)he3

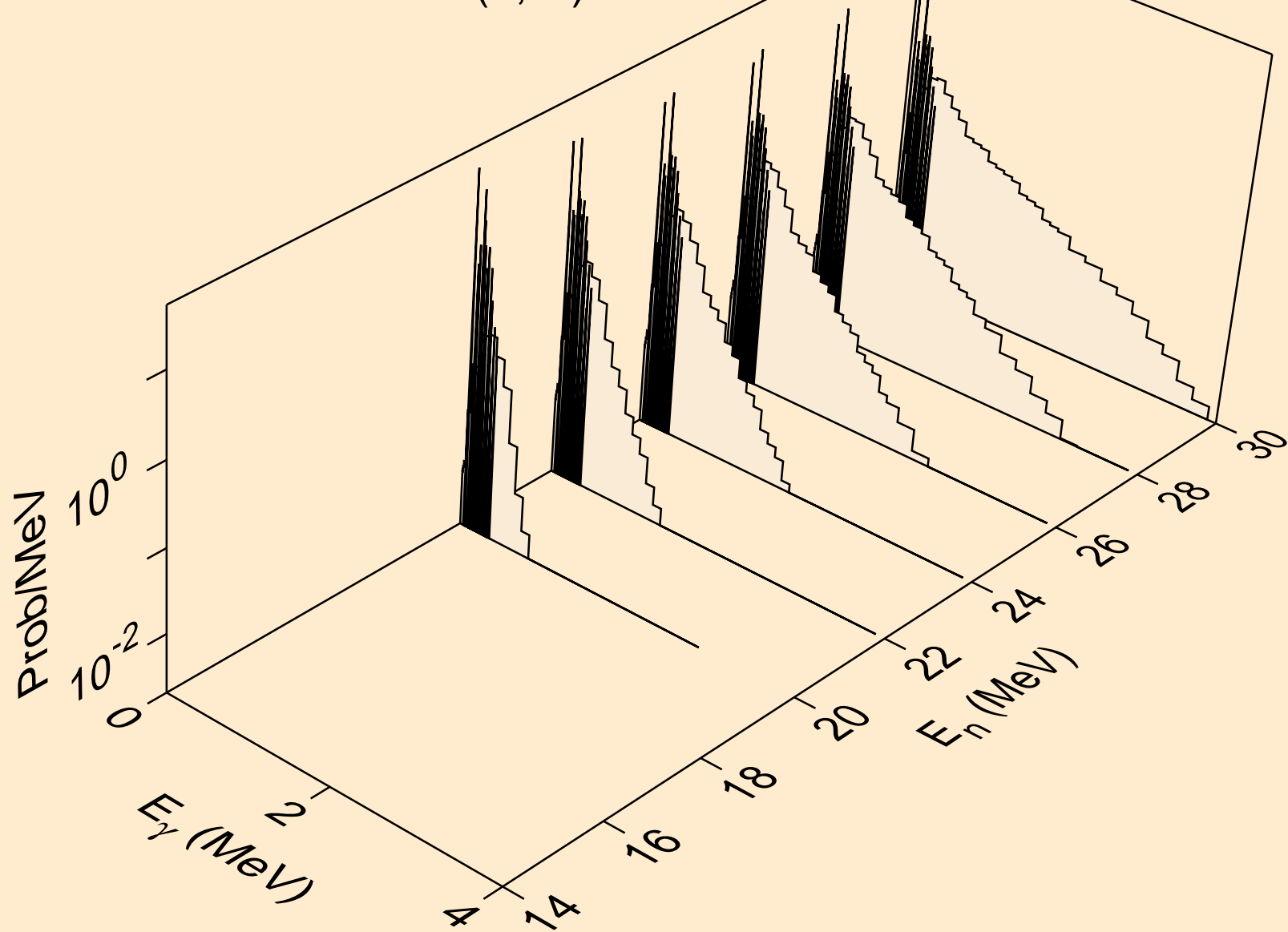

RB079 NEUTRON ACER TENDL-2024 LIBRARY; T=0.K  
Photon emission for (n,2np)

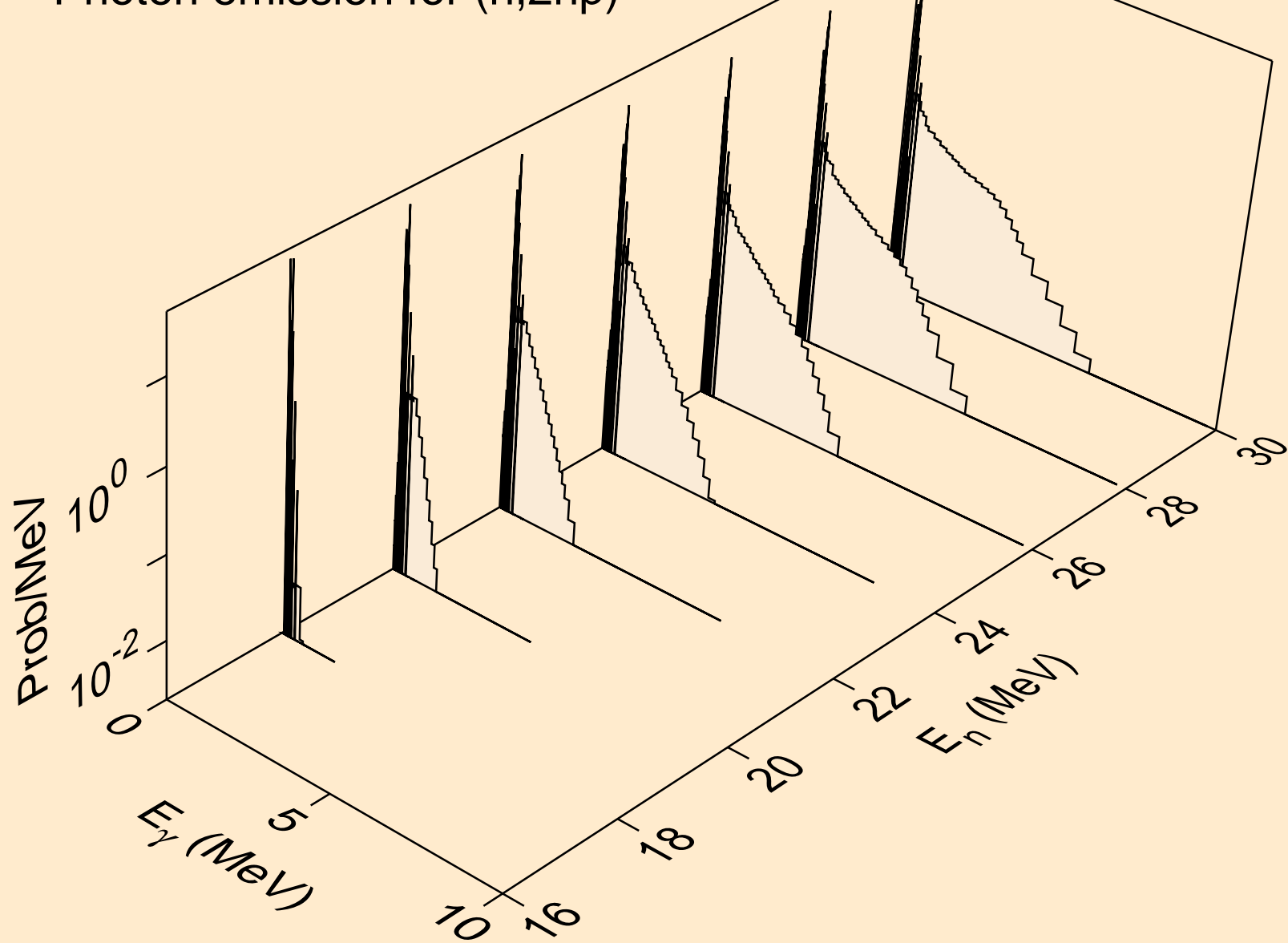

RB079 NEUTRON ACER TENDL-2024 LIBRARY; T=0.K  
Photon emission for (n,3np)

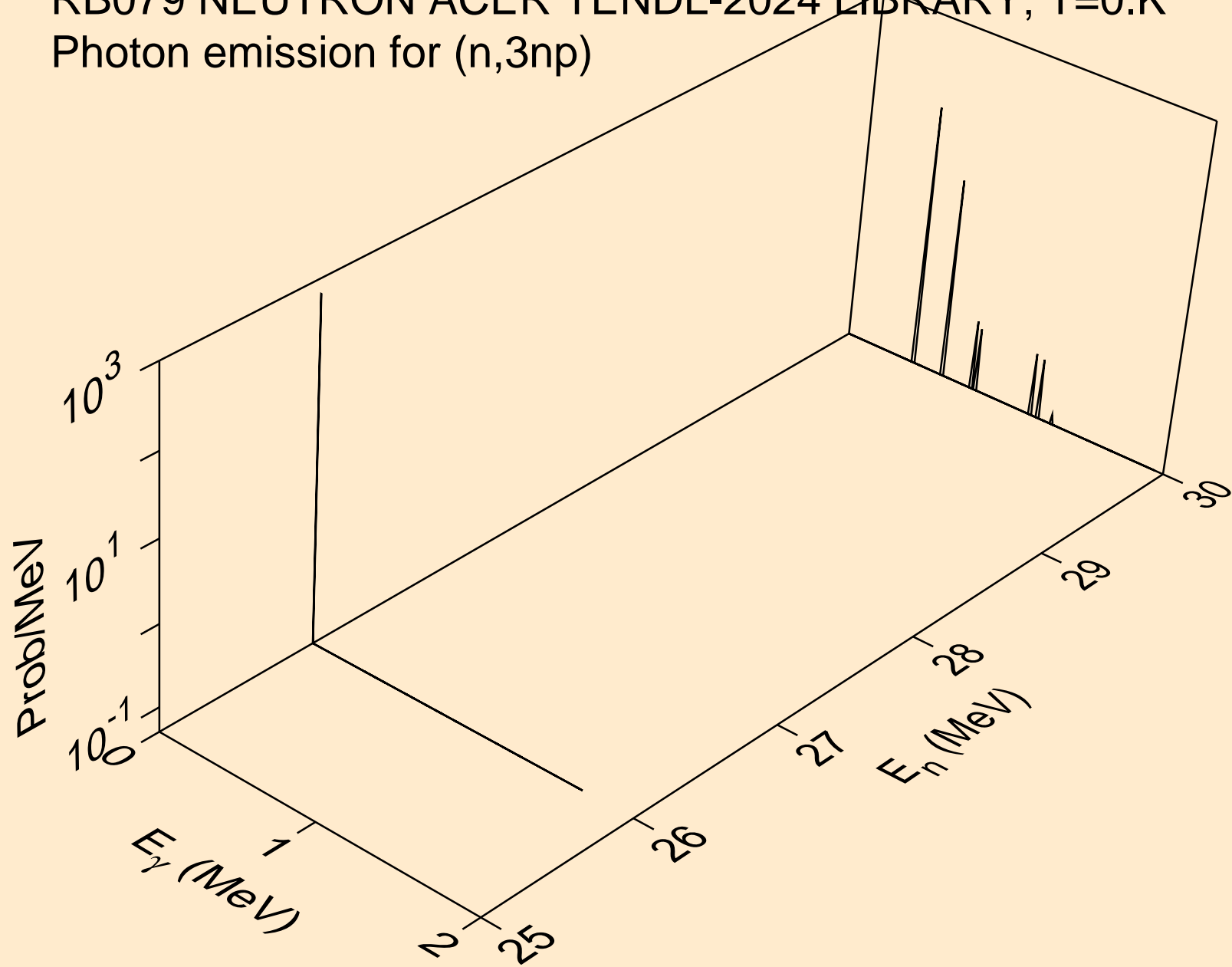

RB079 NEUTRON ACER TENDL-2024 LIBRARY; T=0.K  
Photon emission for (n,n2p)

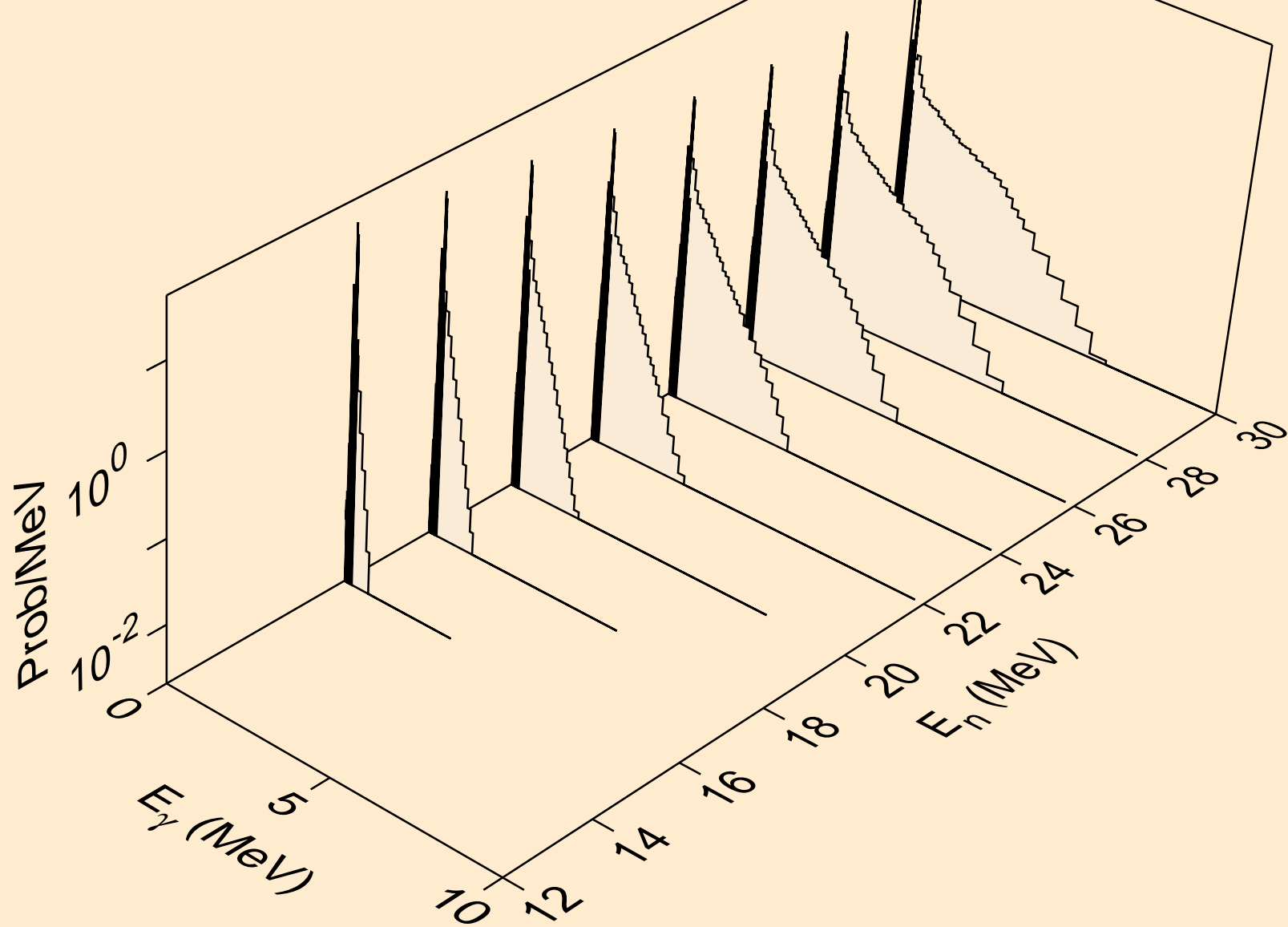

RB079 NEUTRON ACER TENDL-2024 LIBRARY; T=0.K  
Photon emission for (n,npa)

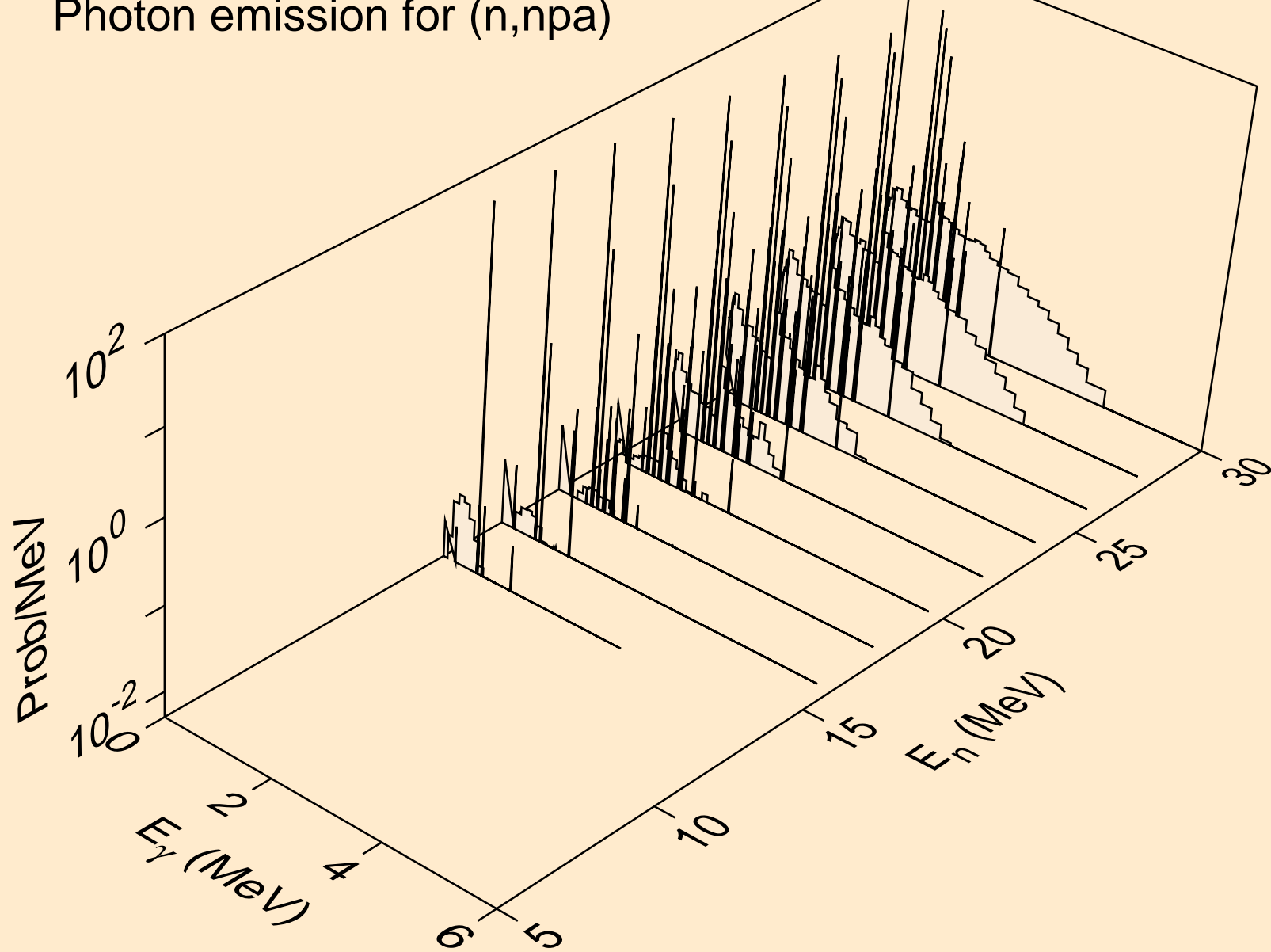



RB079 NEUTRON ACER TENDL-2024 LIBRARY; T=0.K  
Photon emission for (n,n\*c)

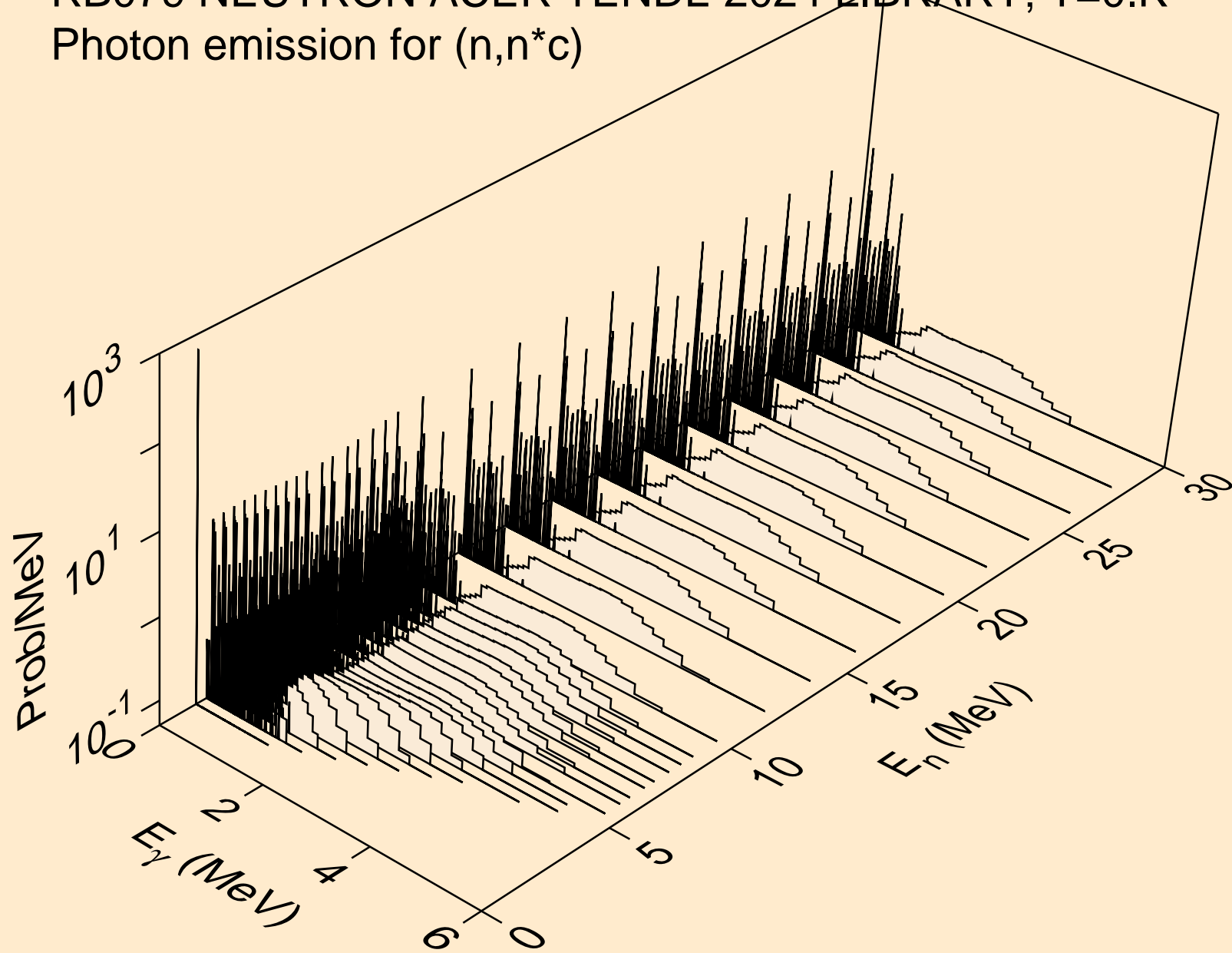

RB079 NEUTRON ACER TENDL-2024 LIBRARY; T=0.K  
Photon emission for (n,gma)

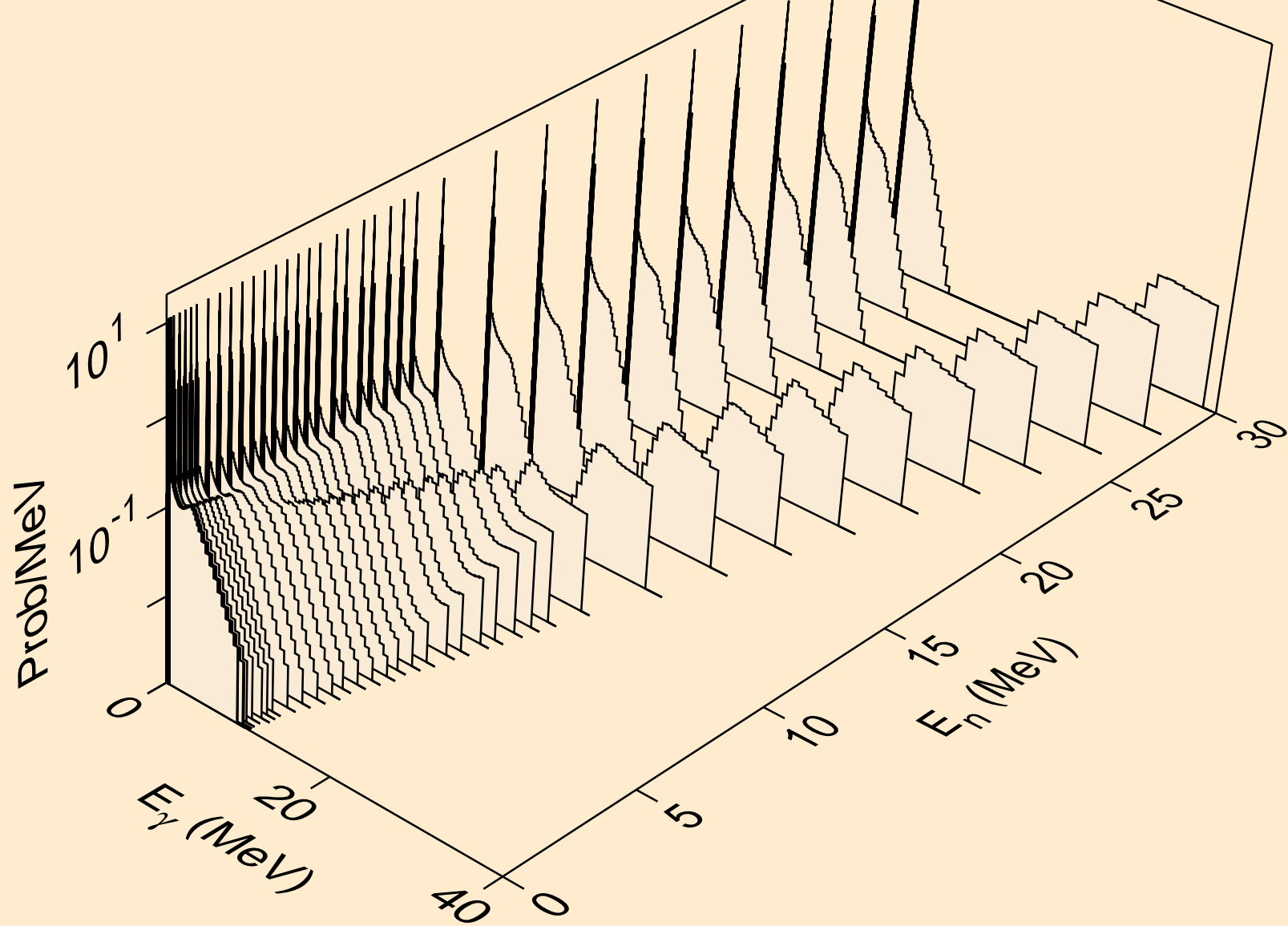

RB079 NEUTRON ACER TENDL-2024 LIBRARY; T=0.K  
Photon emission for (n,p)

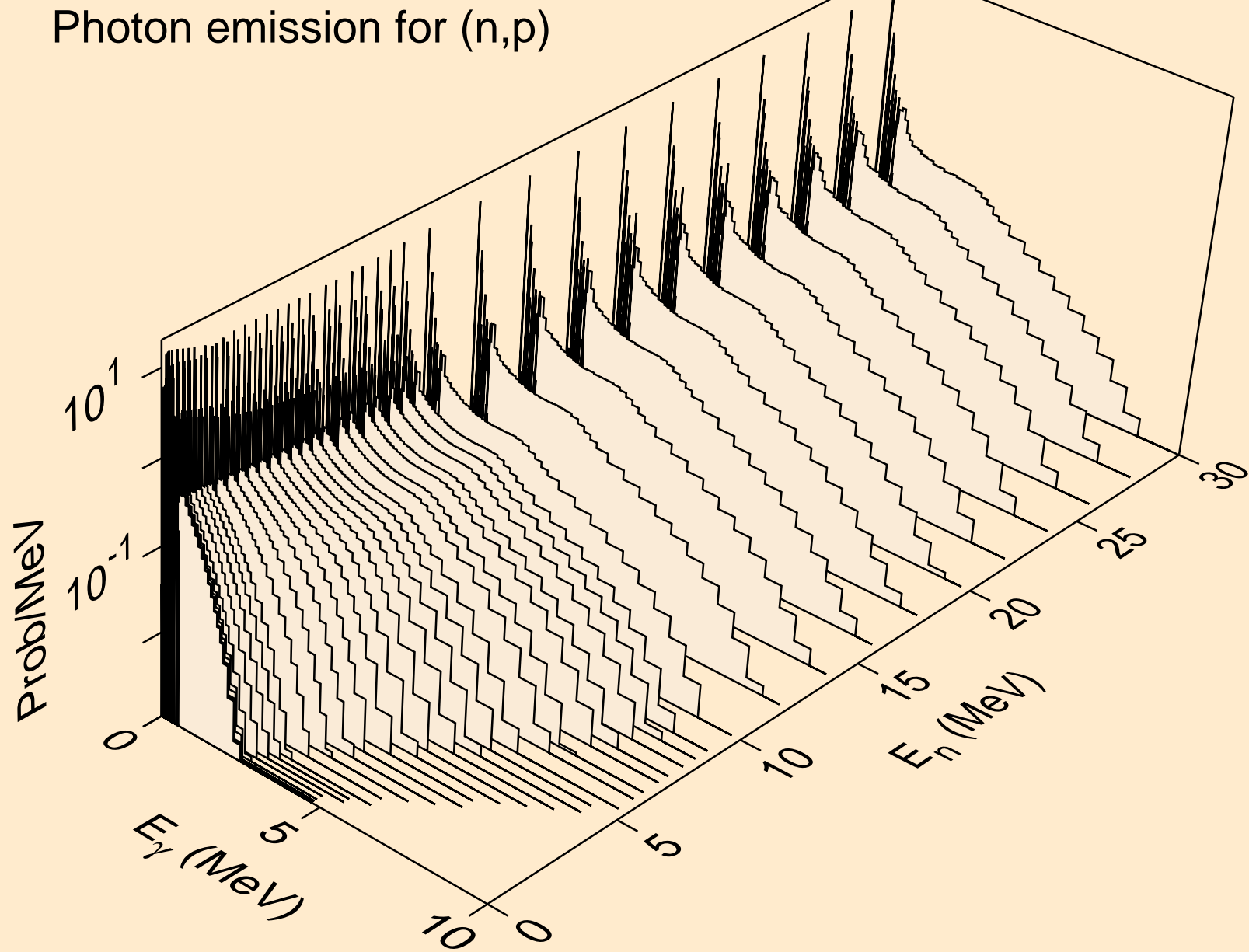

RB079 NEUTRON ACER TENDL-2024 LIBRARY; T=0.K  
Photon emission for (n,d)

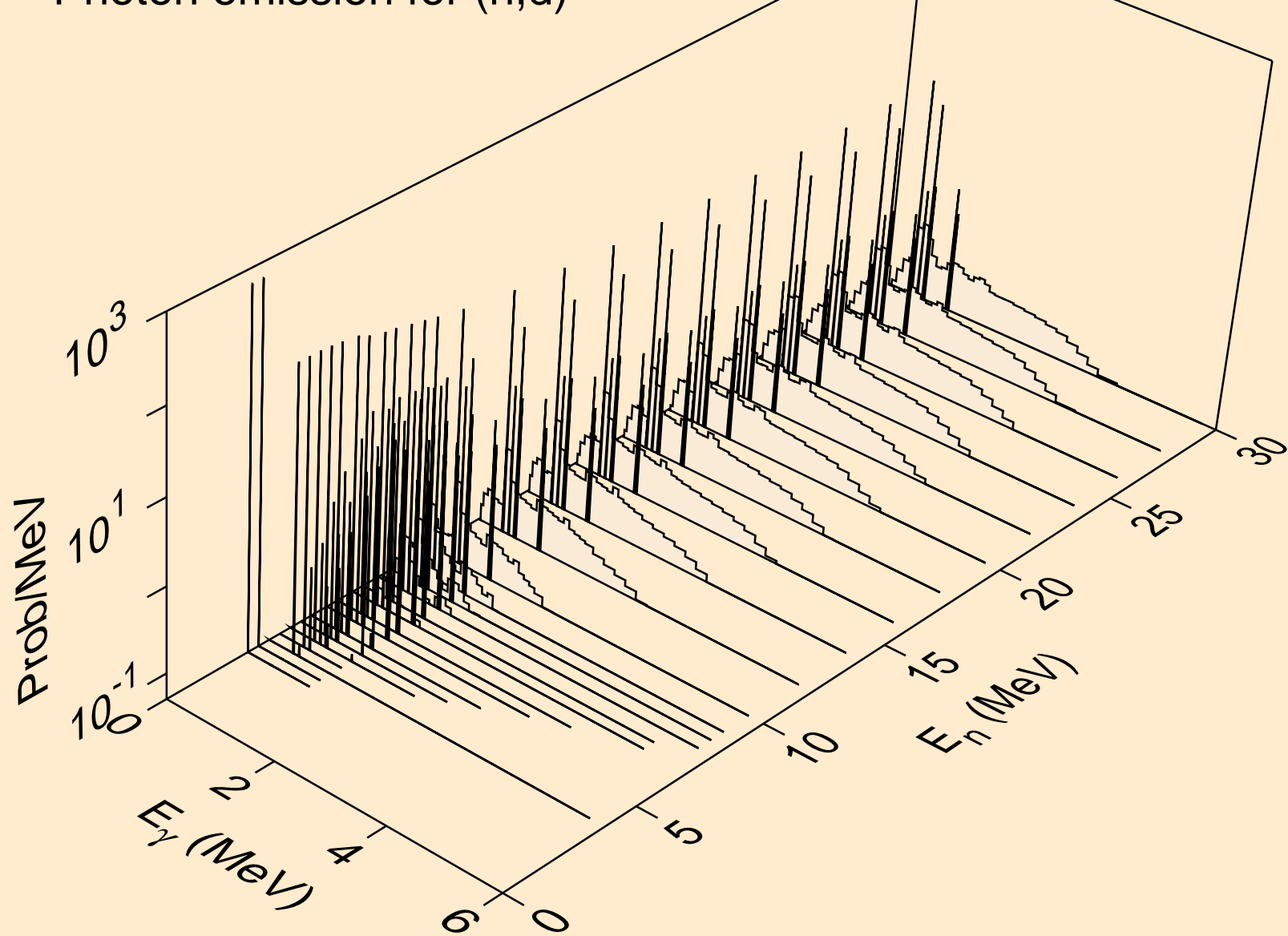

RB079 NEUTRON ACER TENDL-2024 LIBRARY; T=0.K  
Photon emission for (n,t)

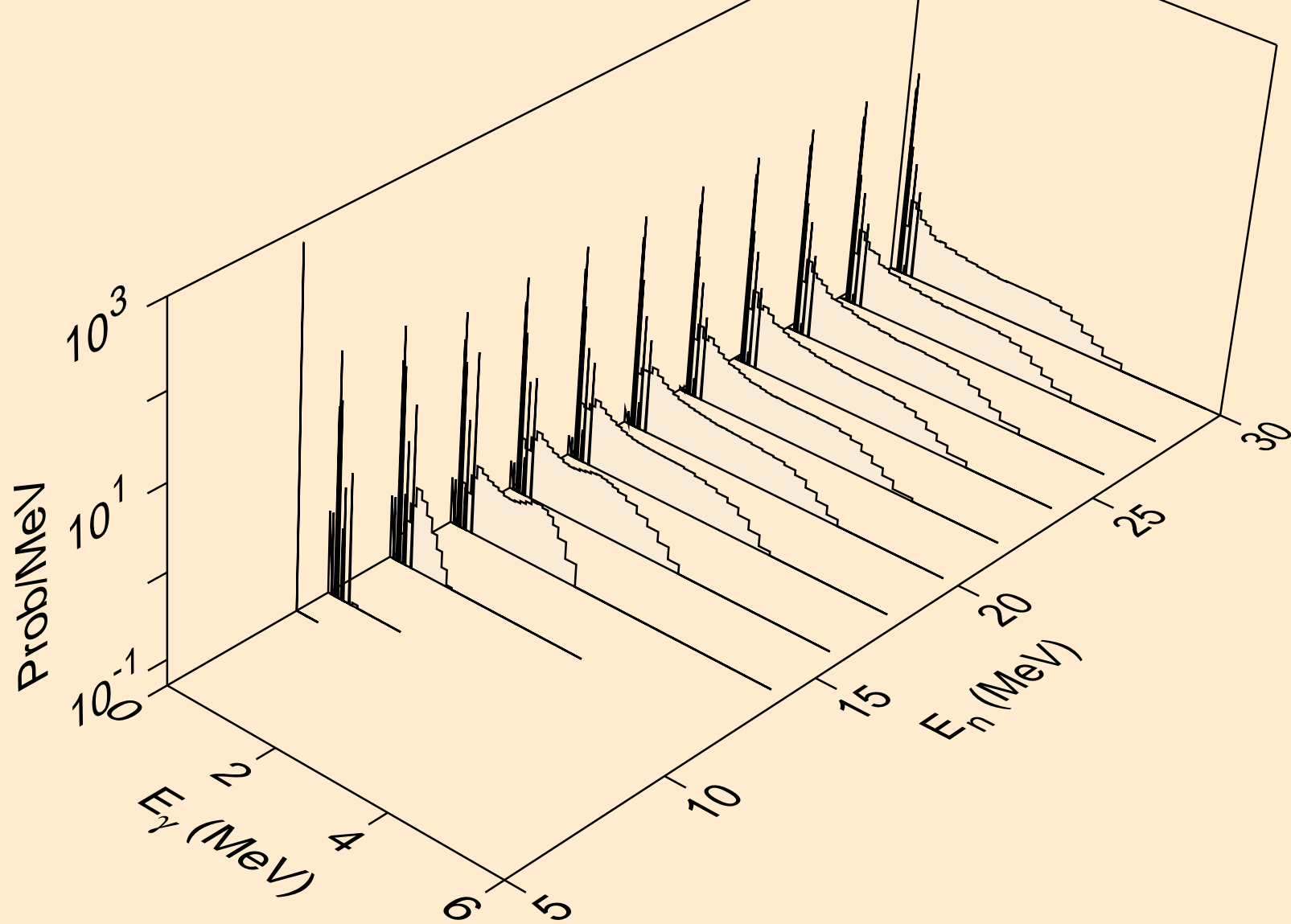

RB079 NEUTRON ACER TENDL-2024 LIBRARY; T=0.K  
Photon emission for (n,he3)

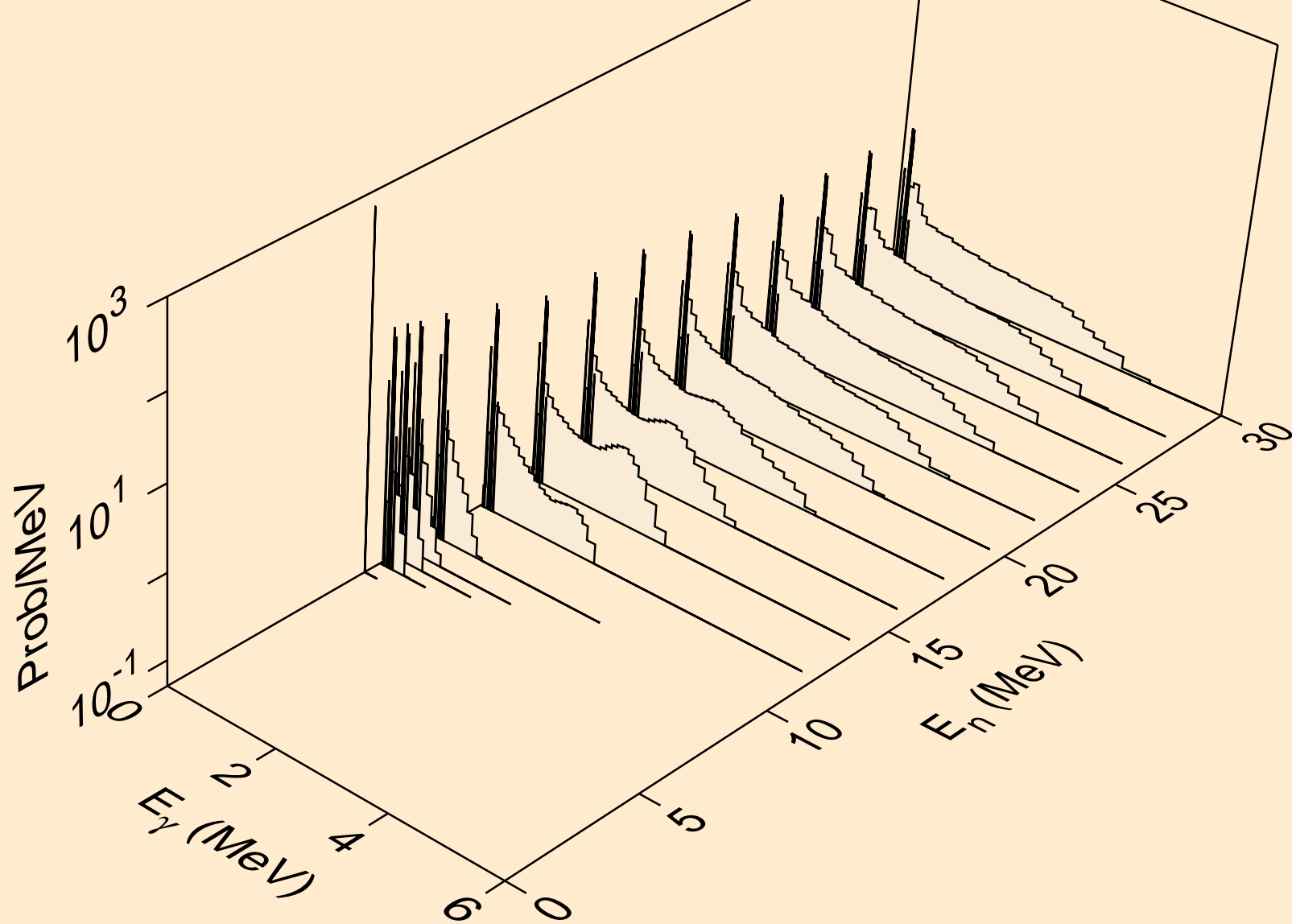

RB079 NEUTRON ACER TENDL-2024 LIBRARY; T=0.K  
Photon emission for (n,a)

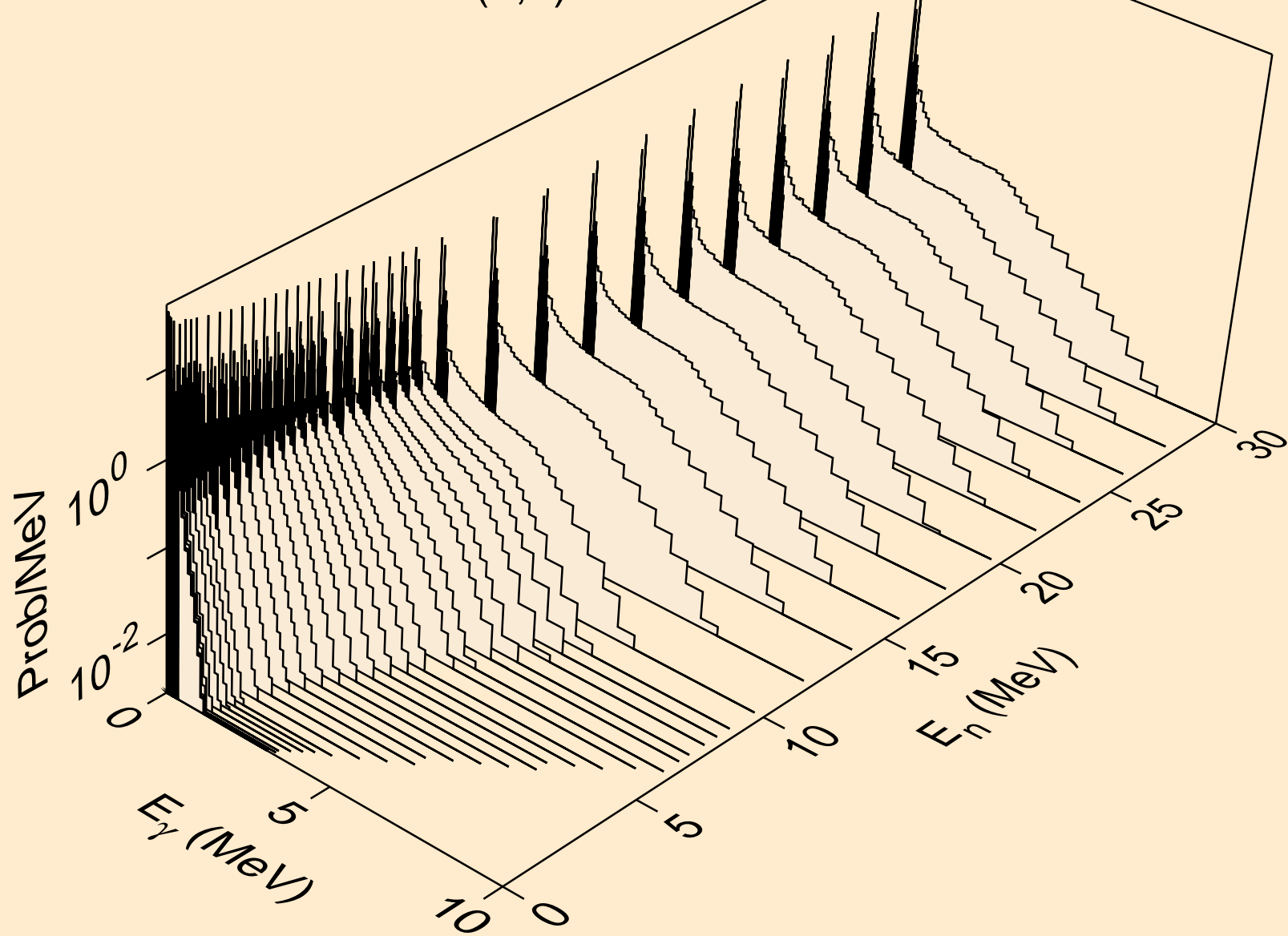

RB079 NEUTRON ACER TENDL-2024 LIBRARY; T=0.K  
Photon emission for (n,2a)

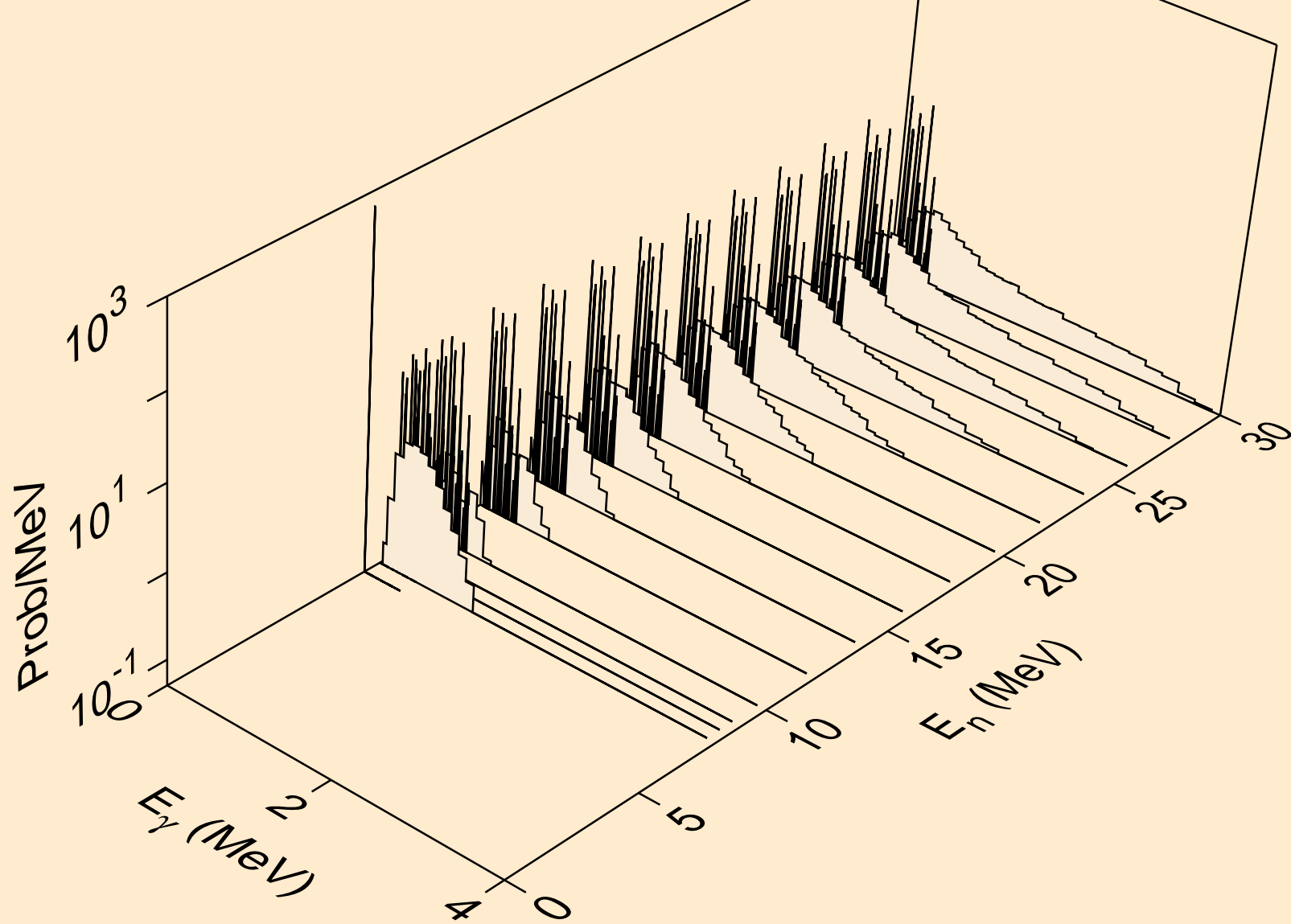



RB079 NEUTRON ACER TENDL-2024 LIBRARY; T=0.K  
Photon emission for (n,3a)

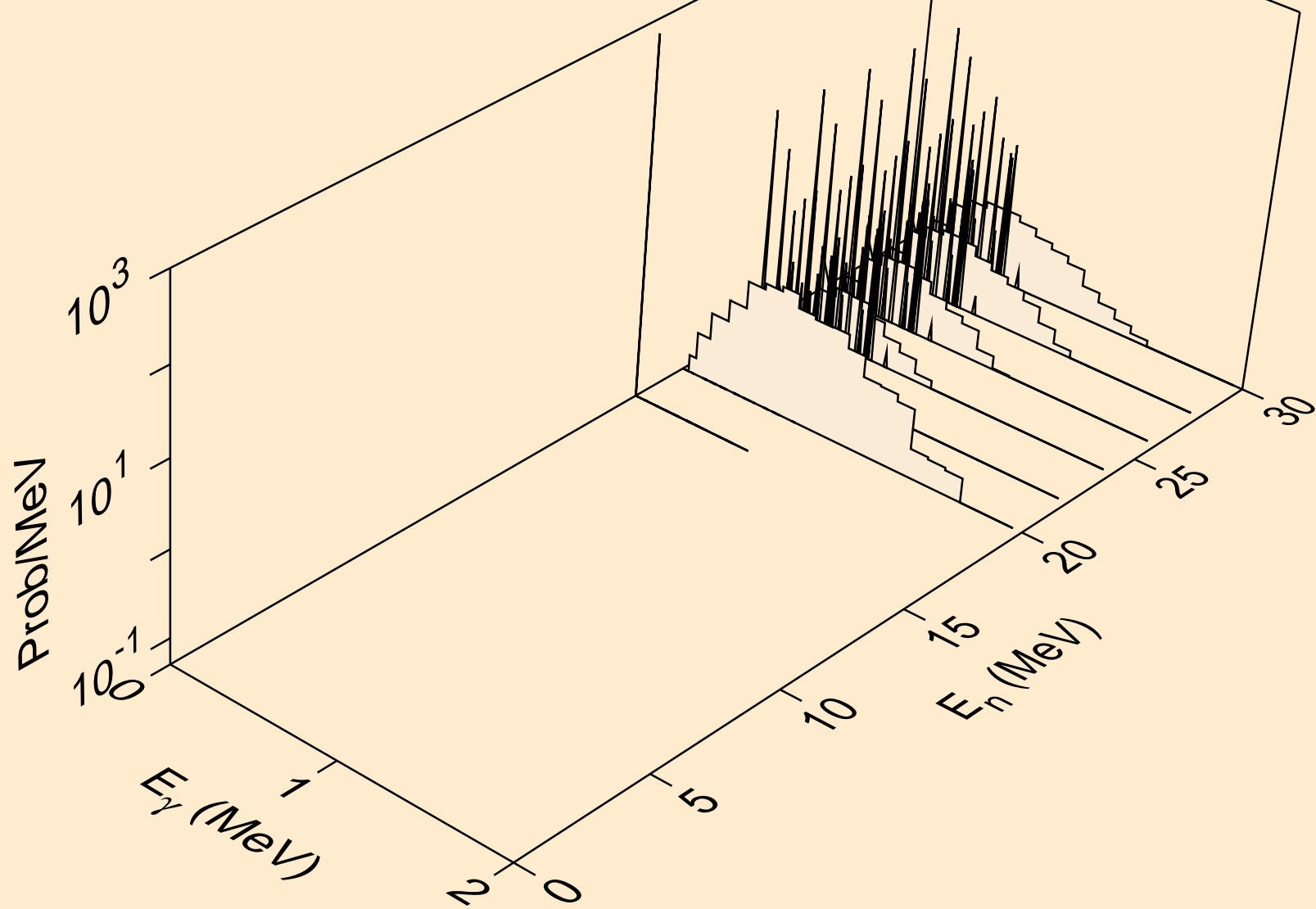

RB079 NEUTRON ACER TENDL-2024 LIBRARY; T=0.K  
Photon emission for (n,2p)

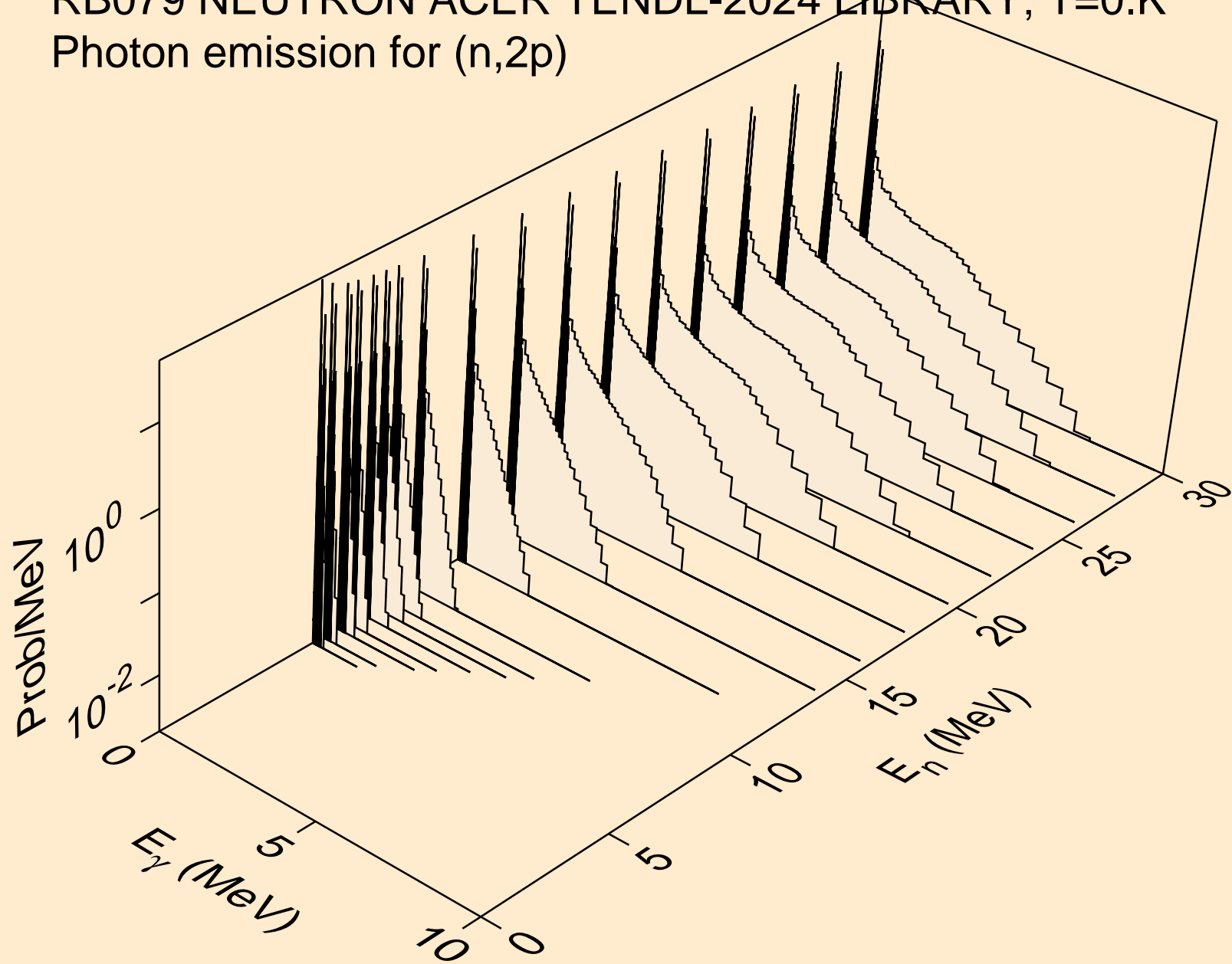

RB079 NEUTRON ACER TENDL-2024 LIBRARY; T=0.K  
Photon emission for (n,p $\alpha$ )

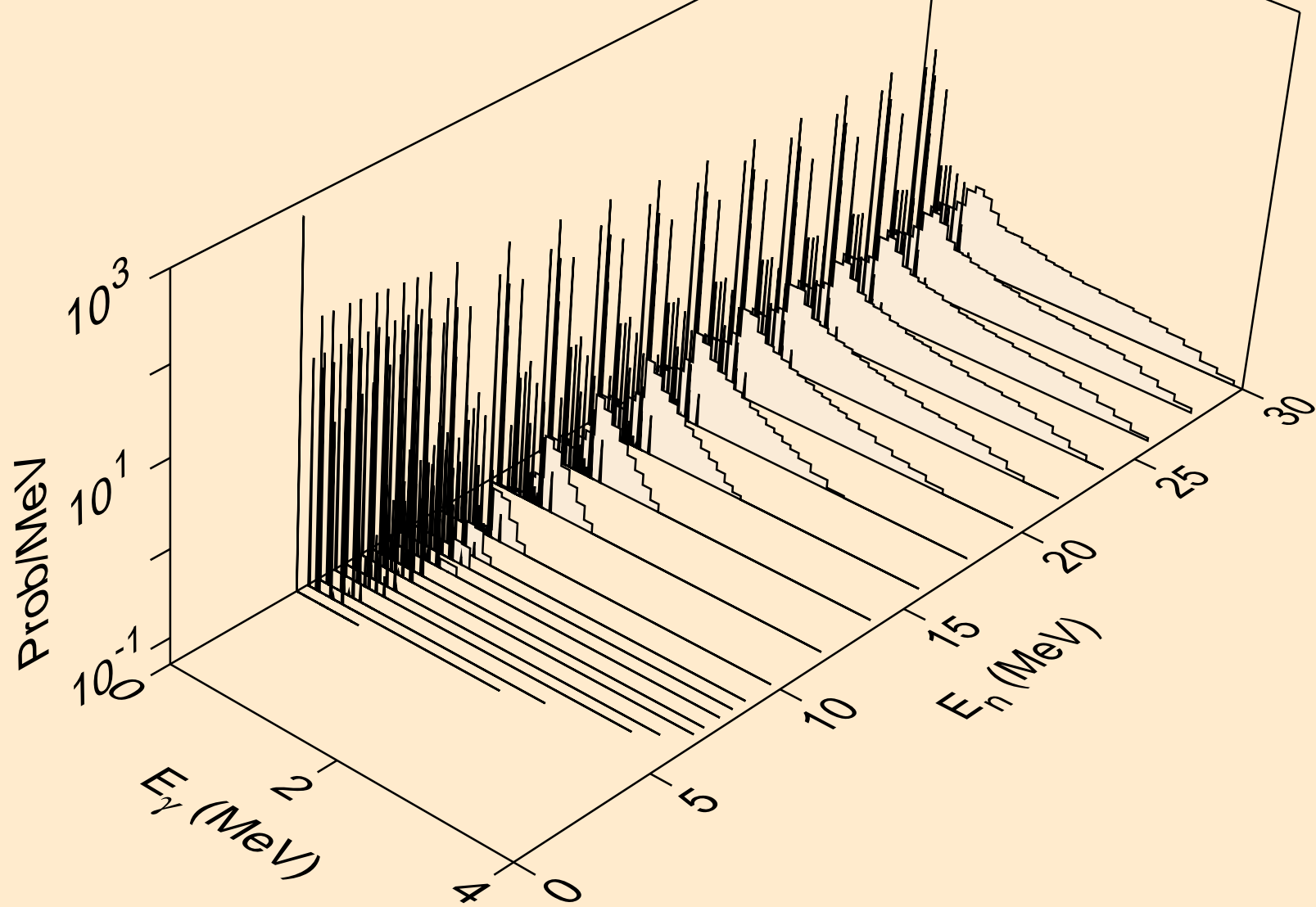

RB079 NEUTRON ACER TENDL-2024 LIBRARY; T=0.K  
Photon emission for (n,d2a)

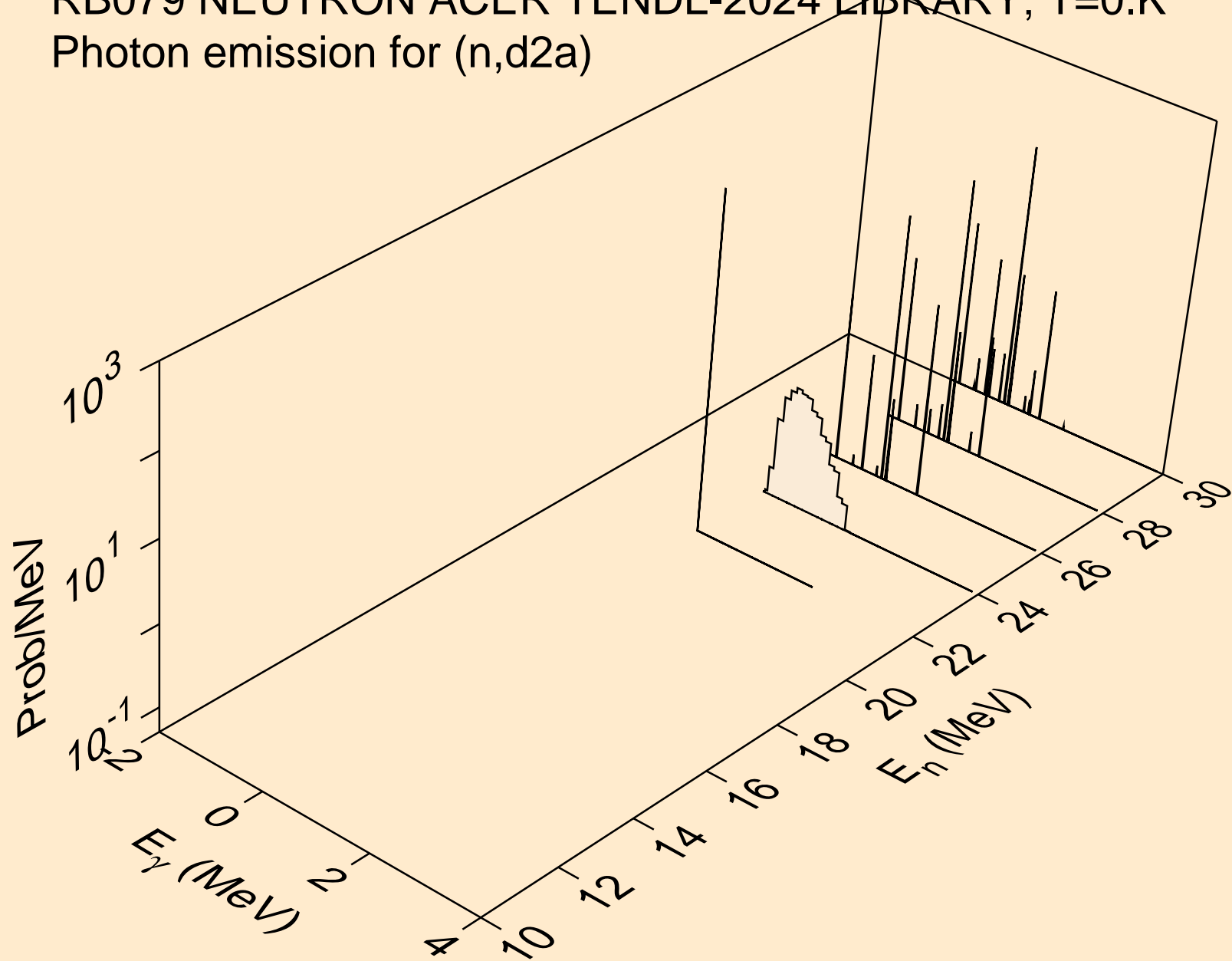

RB079 NEUTRON ACER TENDL-2024 LIBRARY; T=0.K  
Photon emission for (n,pd)

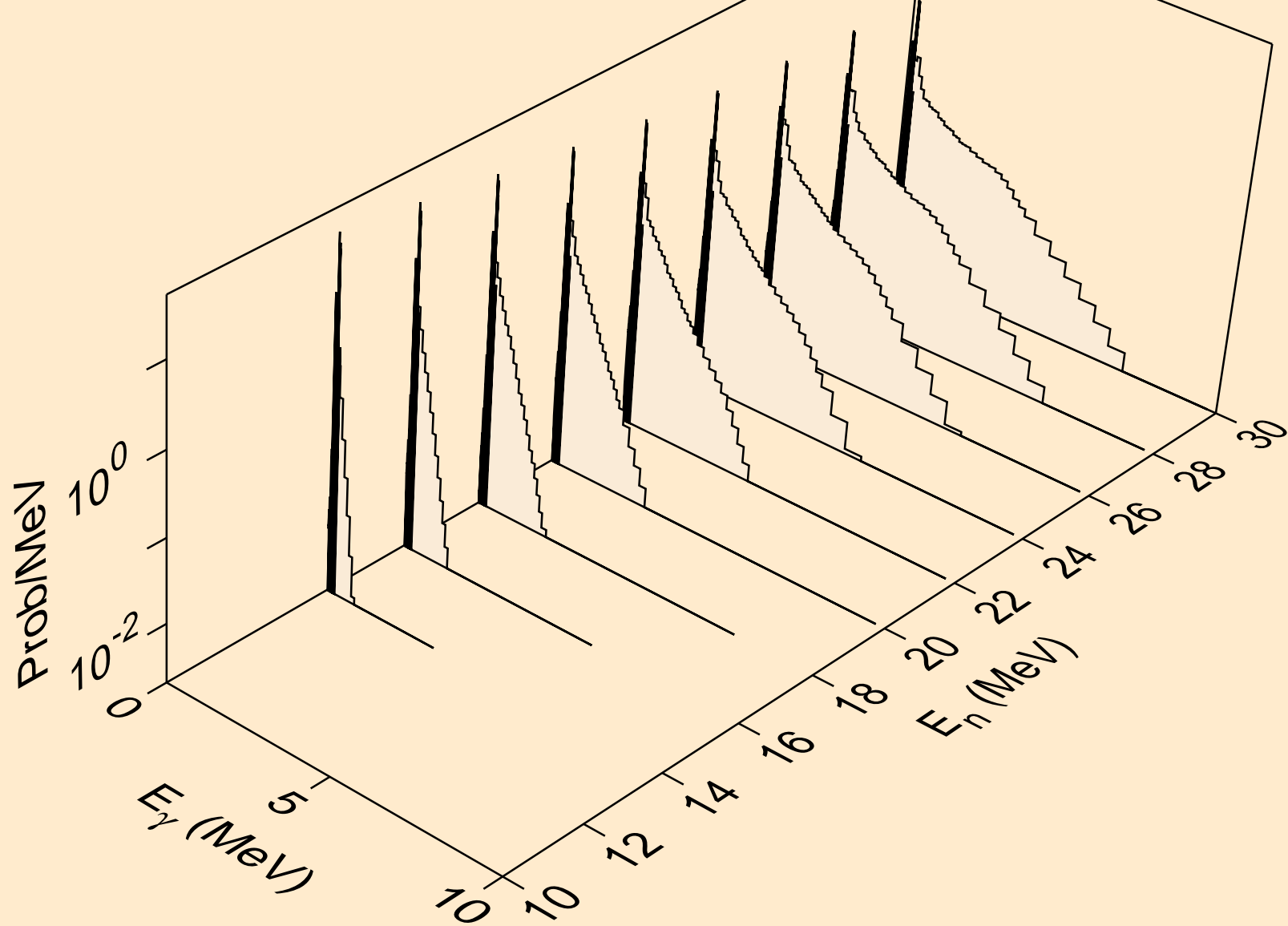

RB079 NEUTRON ACER TENDL-2024 LIBRARY; T=0.K  
Photon emission for (n,pt)

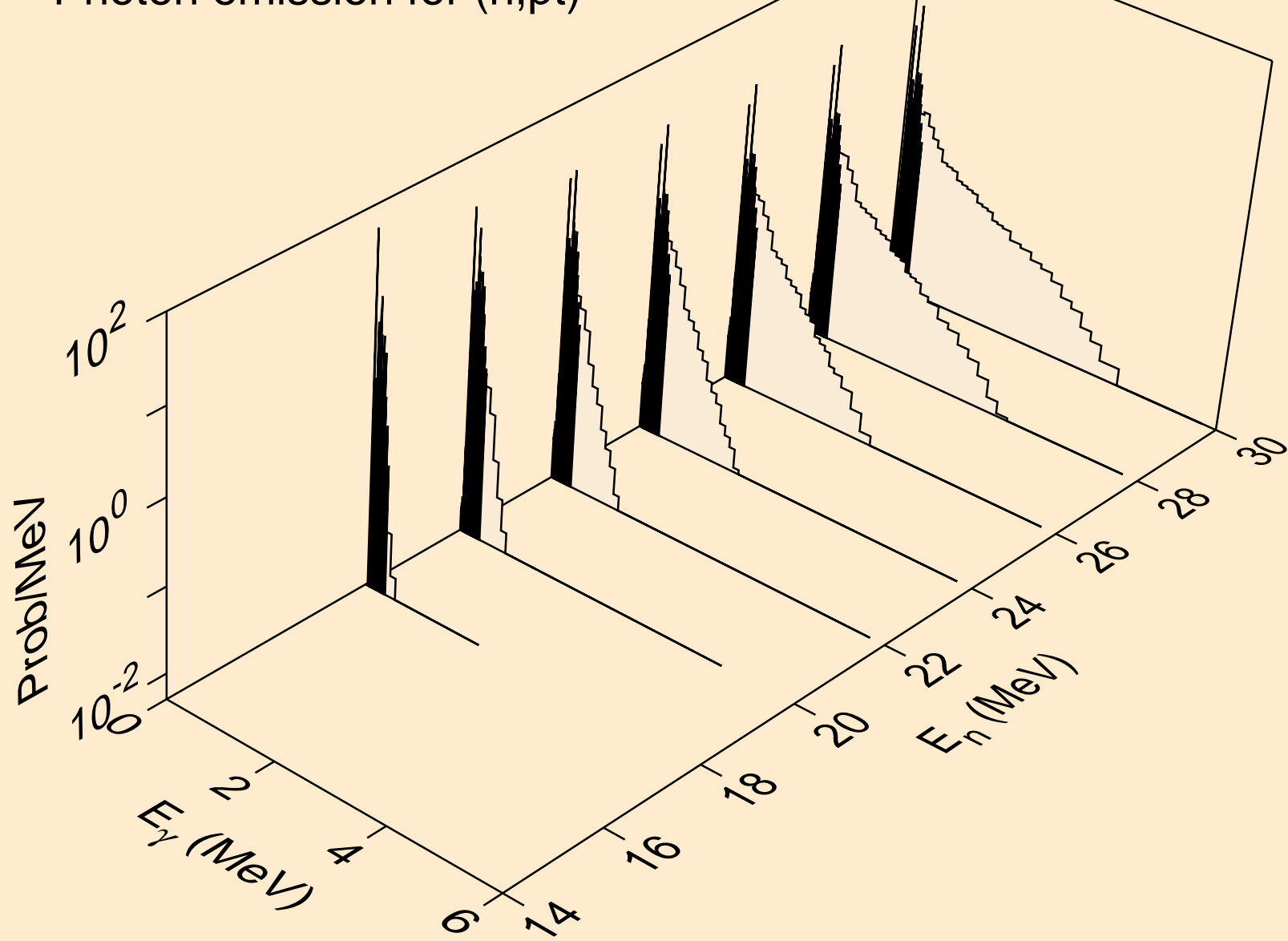

RB079 NEUTRON ACER TENDL-2024 LIBRARY; T=0.K  
Photon emission for (n,da)

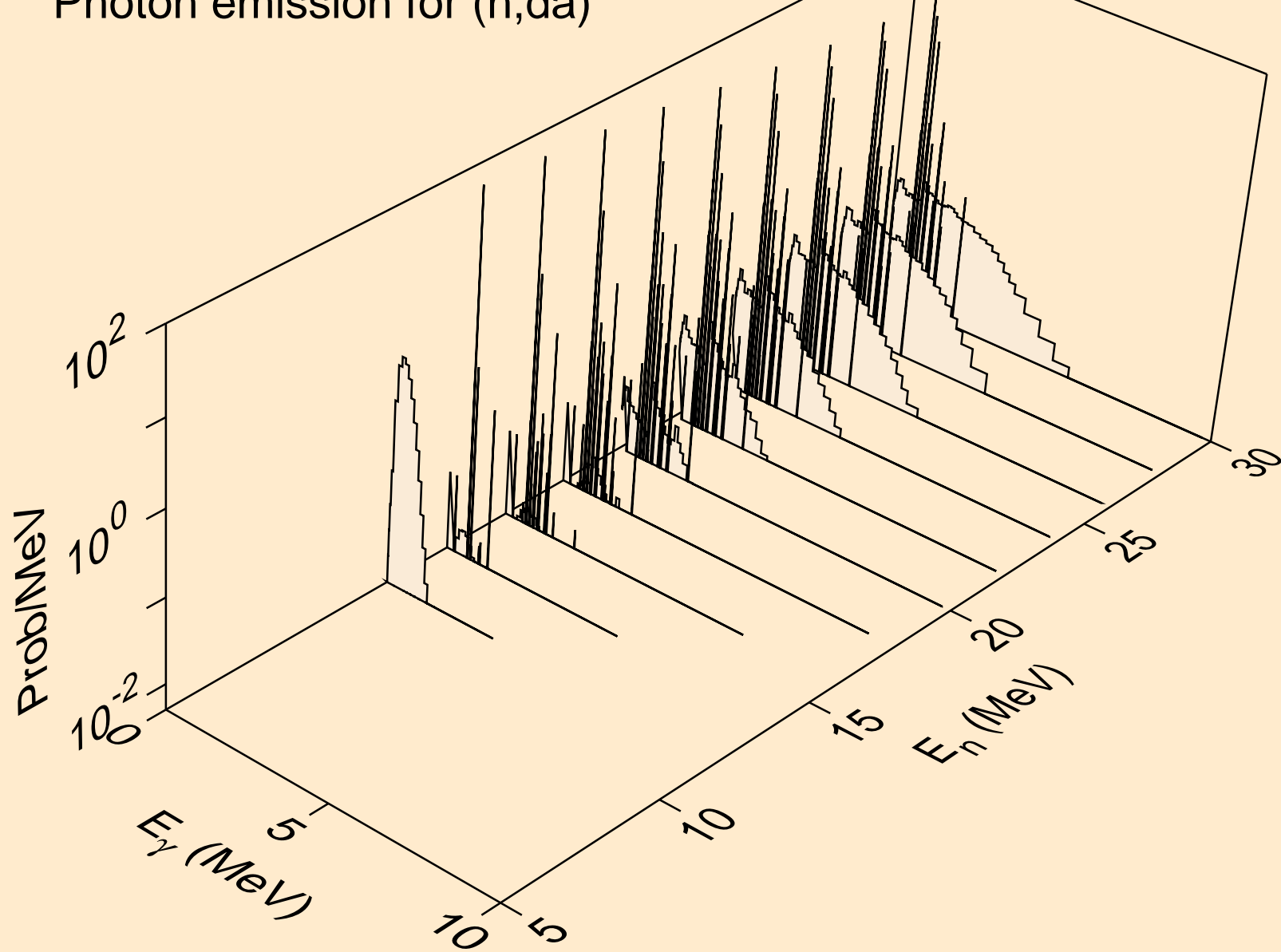

RB079 NEUTRON ACER TENDL-2024 LIBRARY; T=0.K  
thermal capture photon spectrum

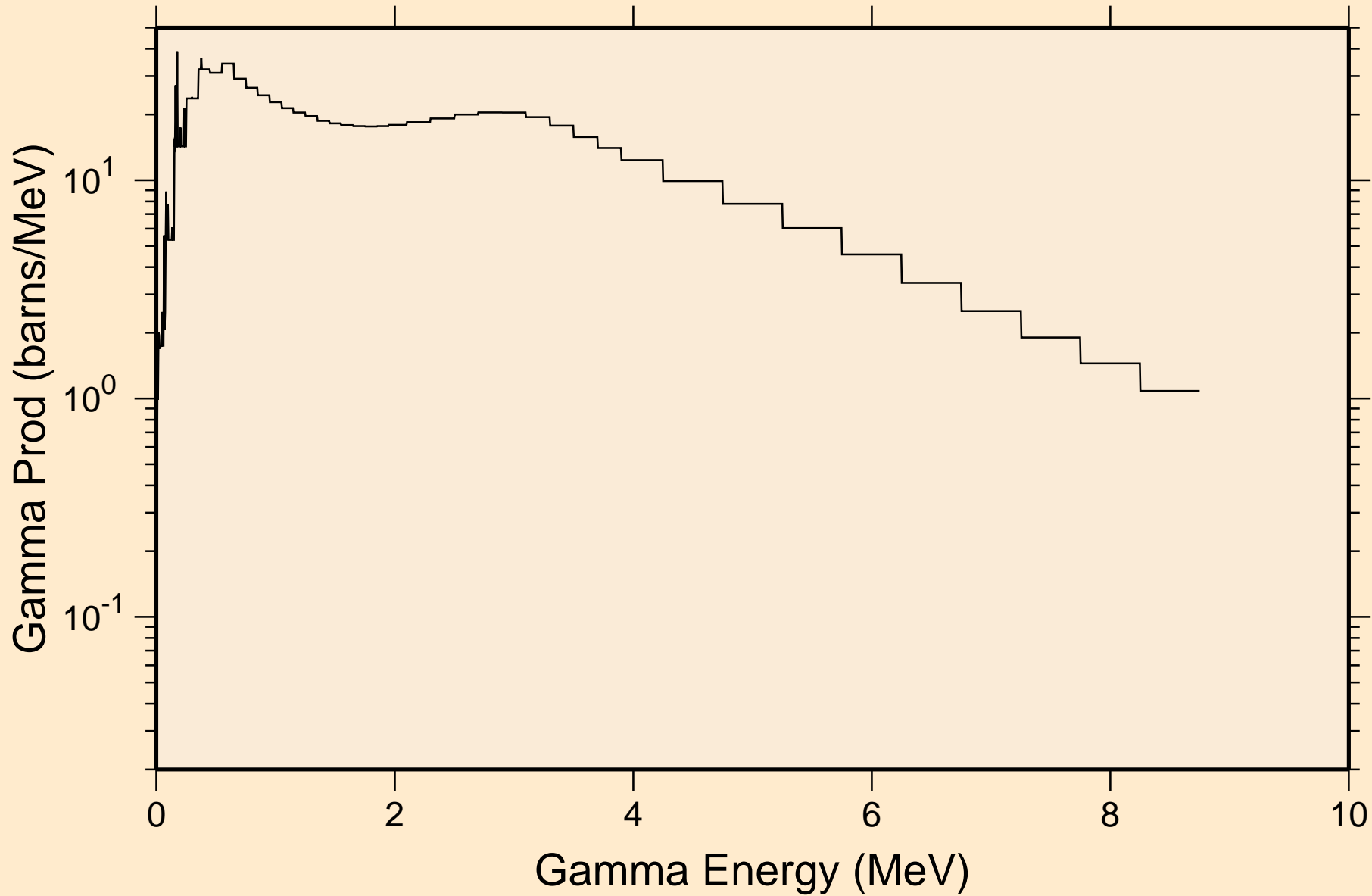



RB079 NEUTRON ACER TENDL-2024 LIBRARY; T=0.K  
14 MeV photon spectrum

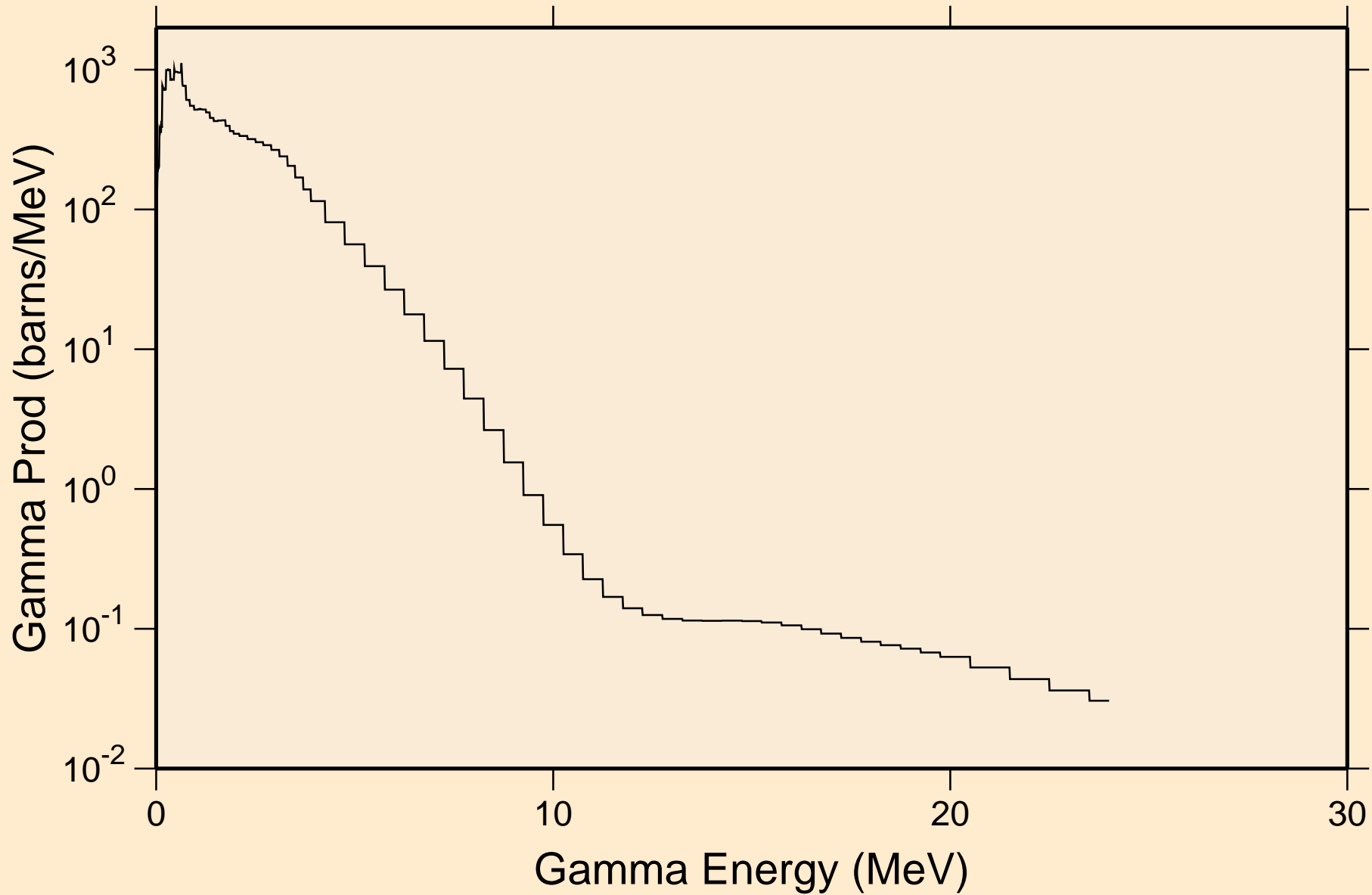

# RB079 NEUTRON ACER TENDL-2024 LIBRARY; T=0.K

## Particle heating contributions

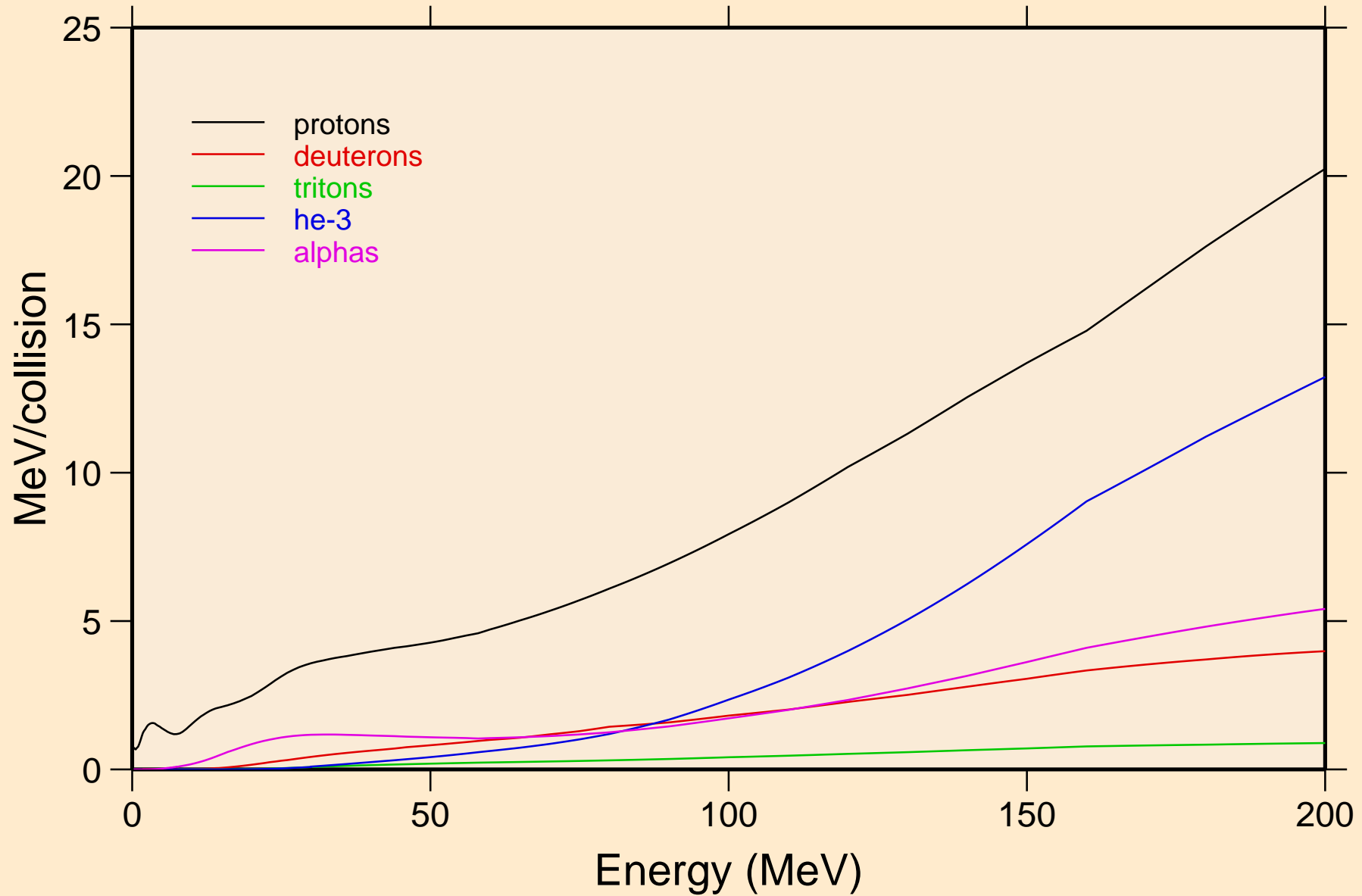

# RB079 NEUTRON ACER TENDL-2024 LIBRARY; T=0.K

## Recoil Heating

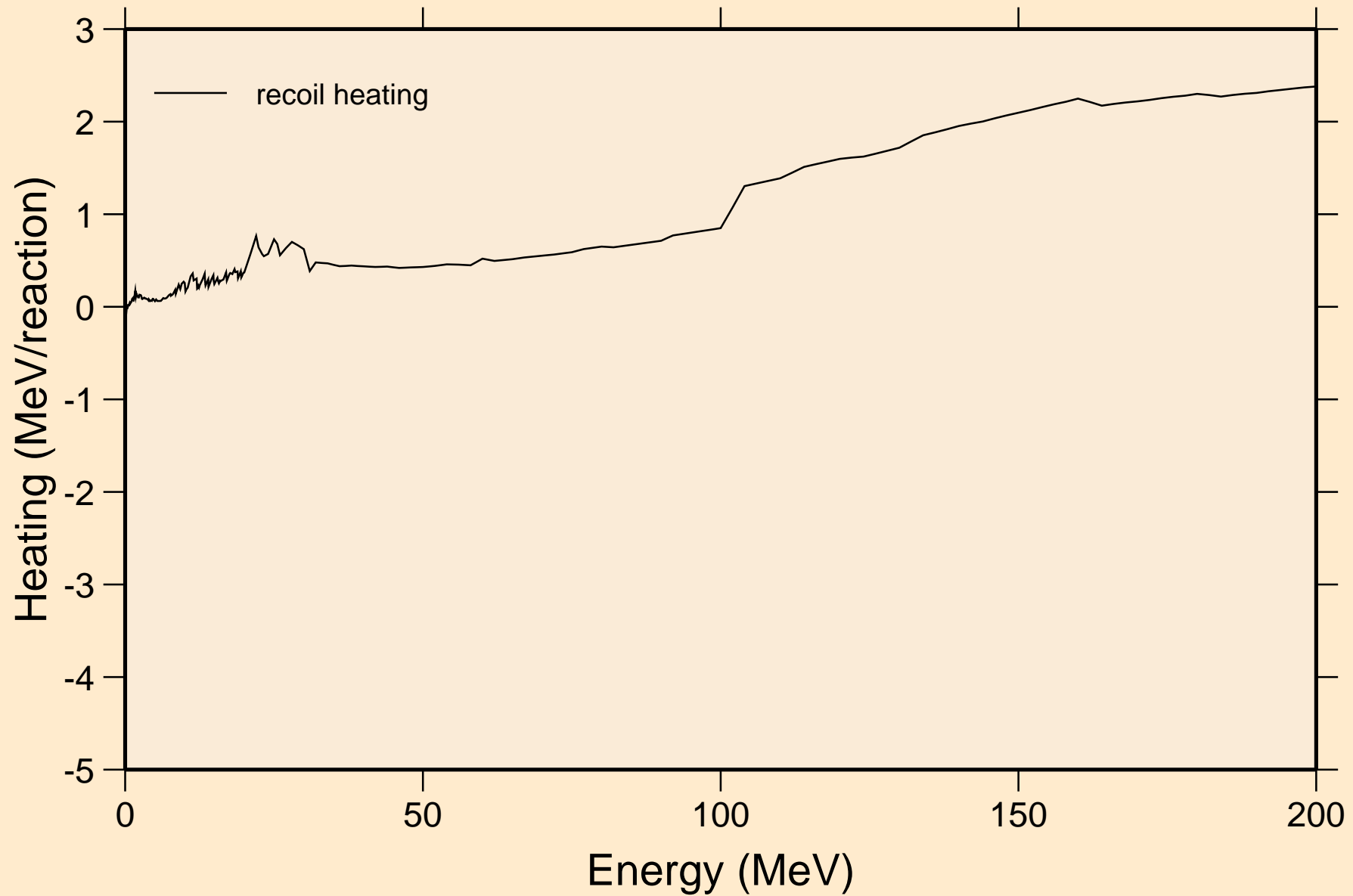

# RB079 NEUTRON ACER TENDL-2024 LIBRARY; T=0.K

## Particle production cross sections

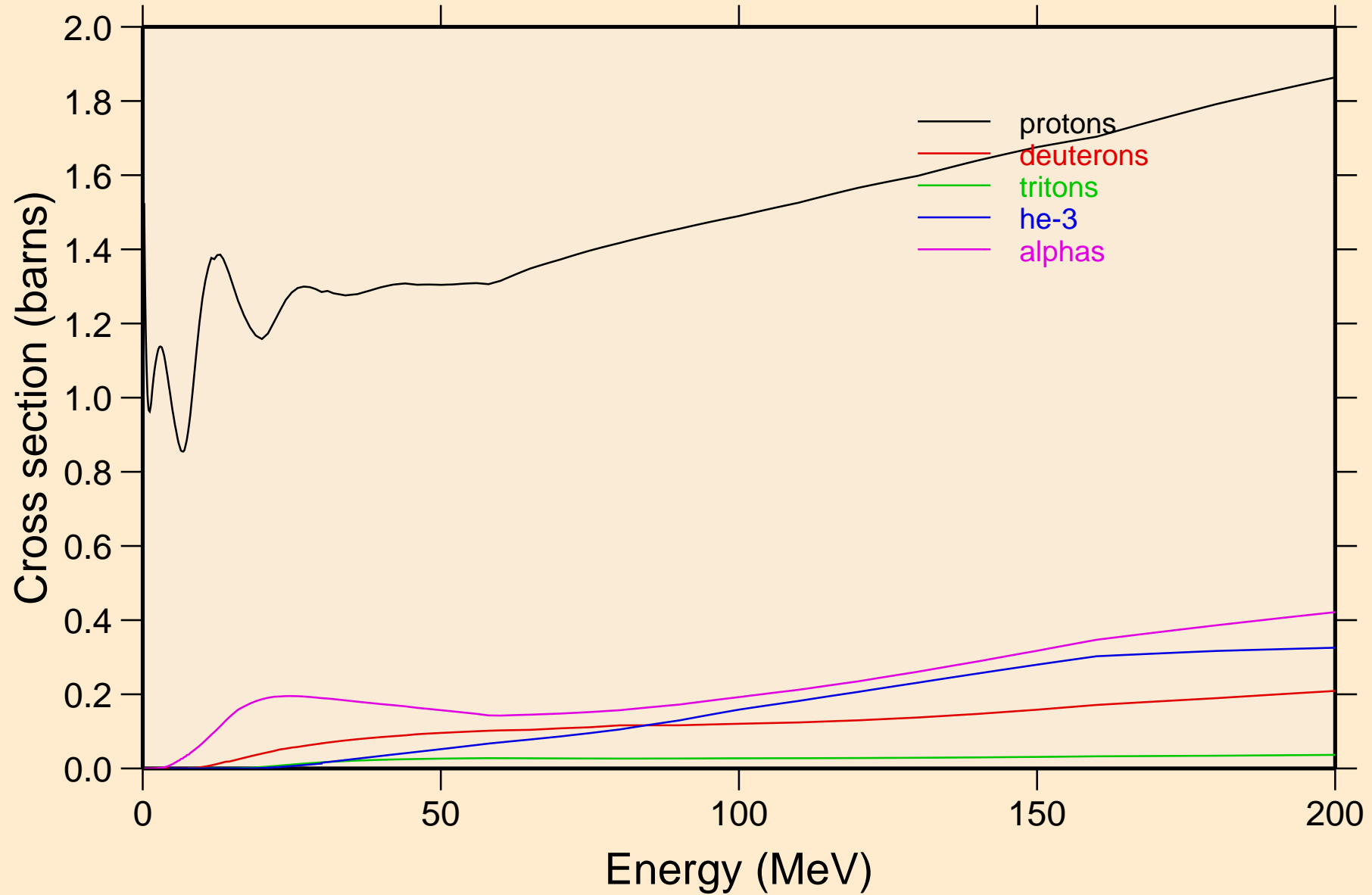

RB079 NEUTRON ACER TENDL-2024 LIBRARY; T=0.K  
protons from (n,x)

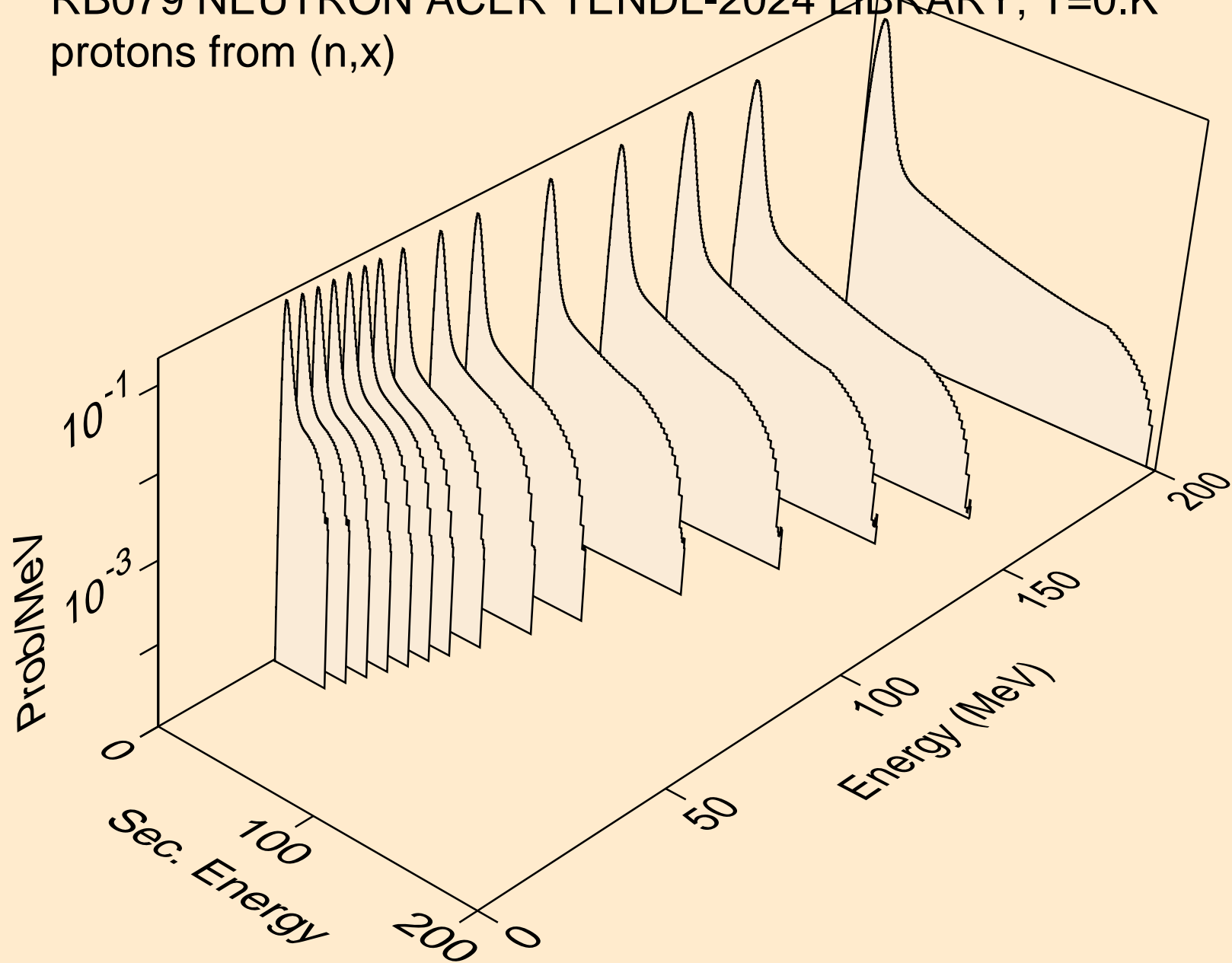

RB079 NEUTRON ACER TENDL-2024 LIBRARY; T=0.K  
protons from (n,n\*)p

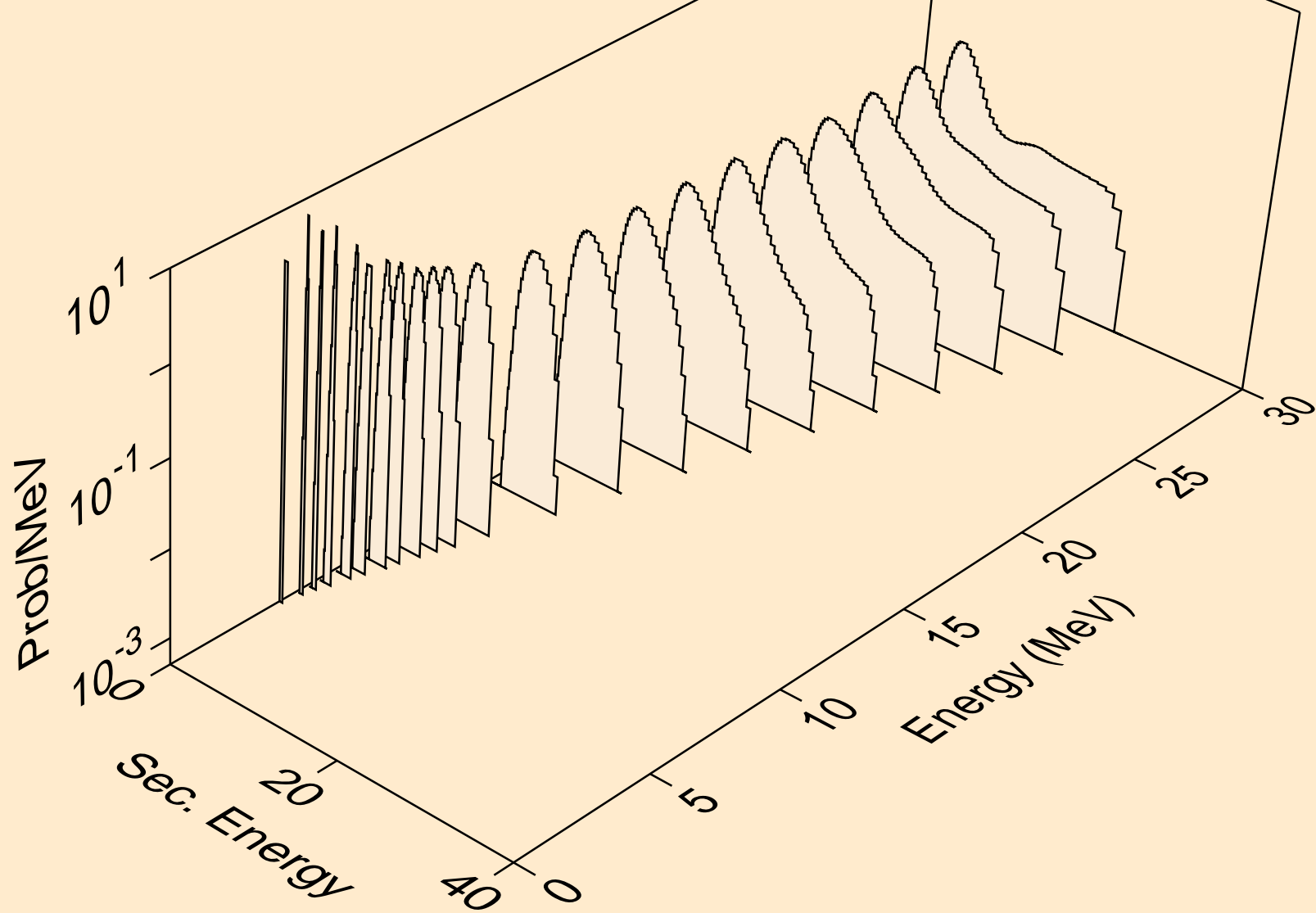

RB079 NEUTRON ACER TENDL-2024 LIBRARY; T=0.K  
protons from (n,2np)

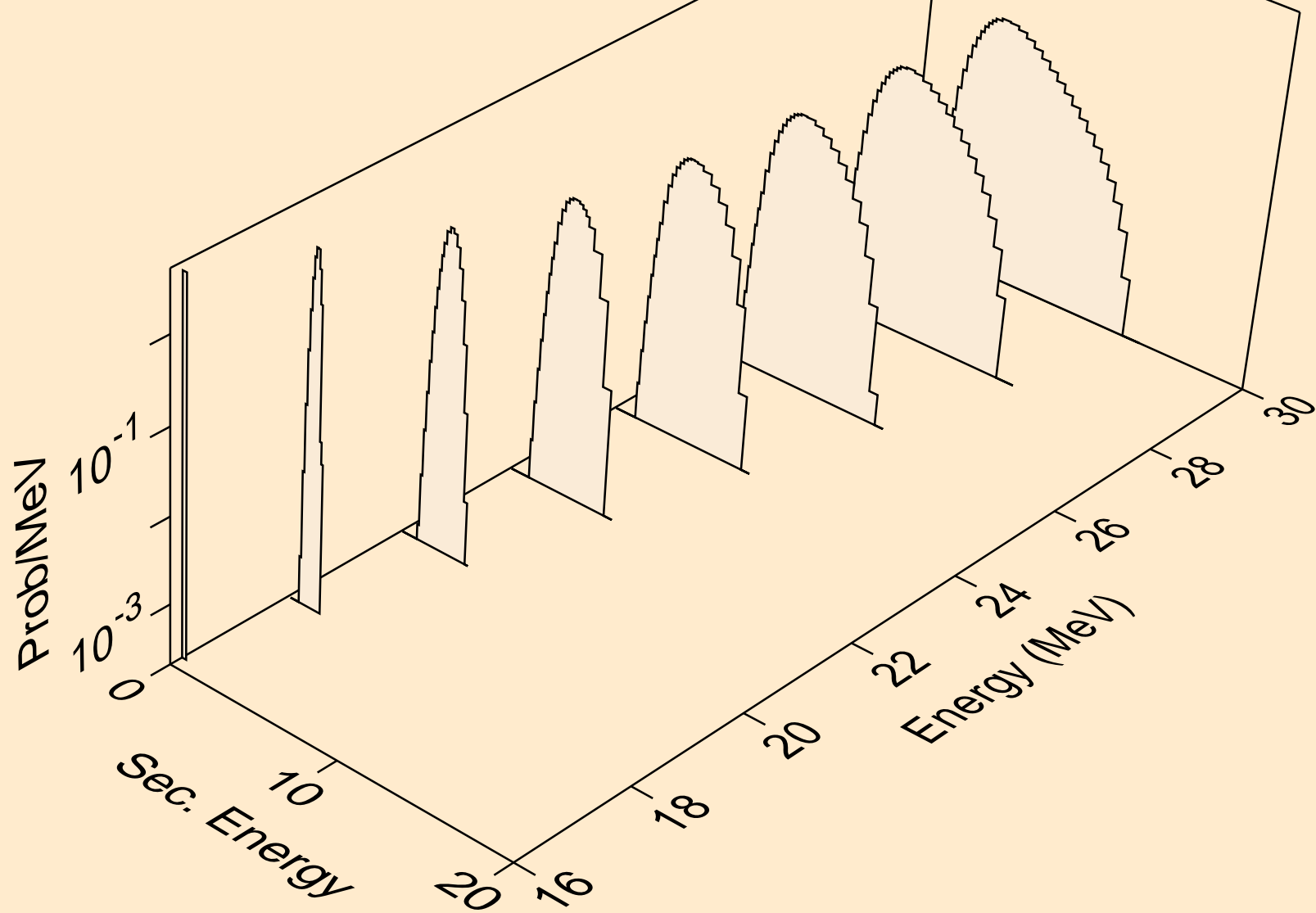

RB079 NEUTRON ACER TENDL-2024 LIBRARY; T=0.K  
protons from (n,3np)

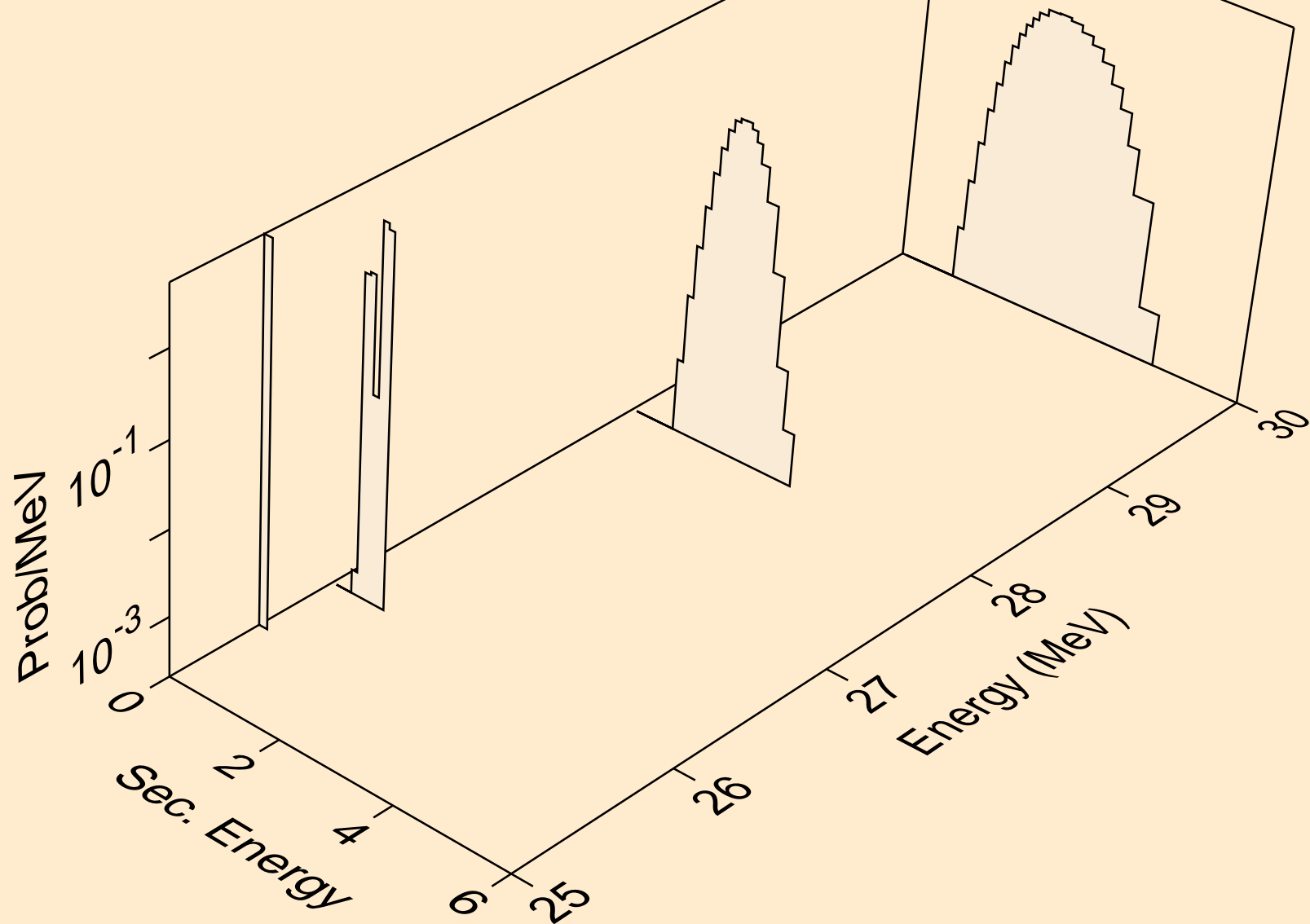



RB079 NEUTRON ACER TENDL-2024 LIBRARY; T=0.K  
protons from (n,n2p)

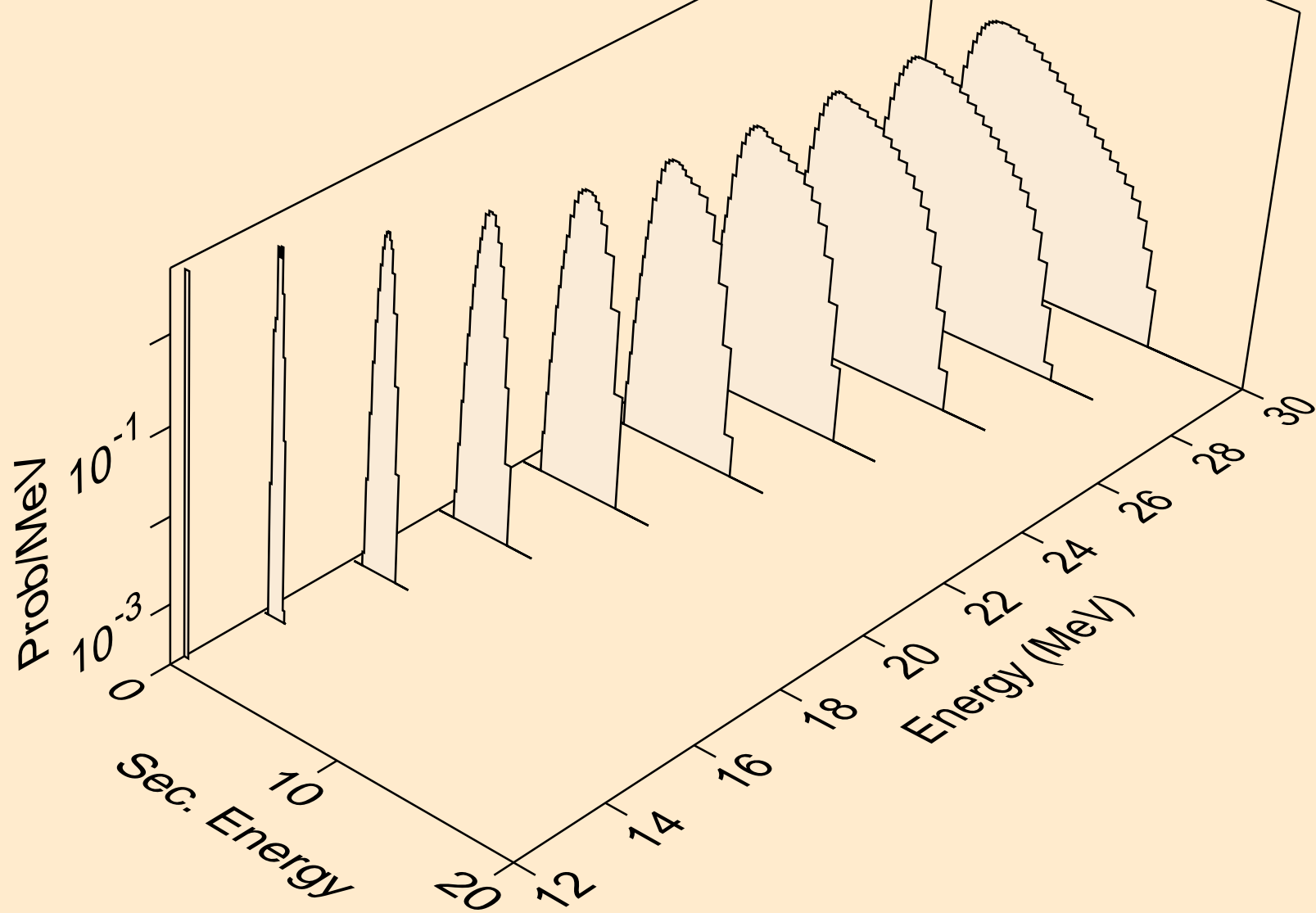

RB079 NEUTRON ACER TENDL-2024 LIBRARY; T=0.K  
protons from (n,npa)

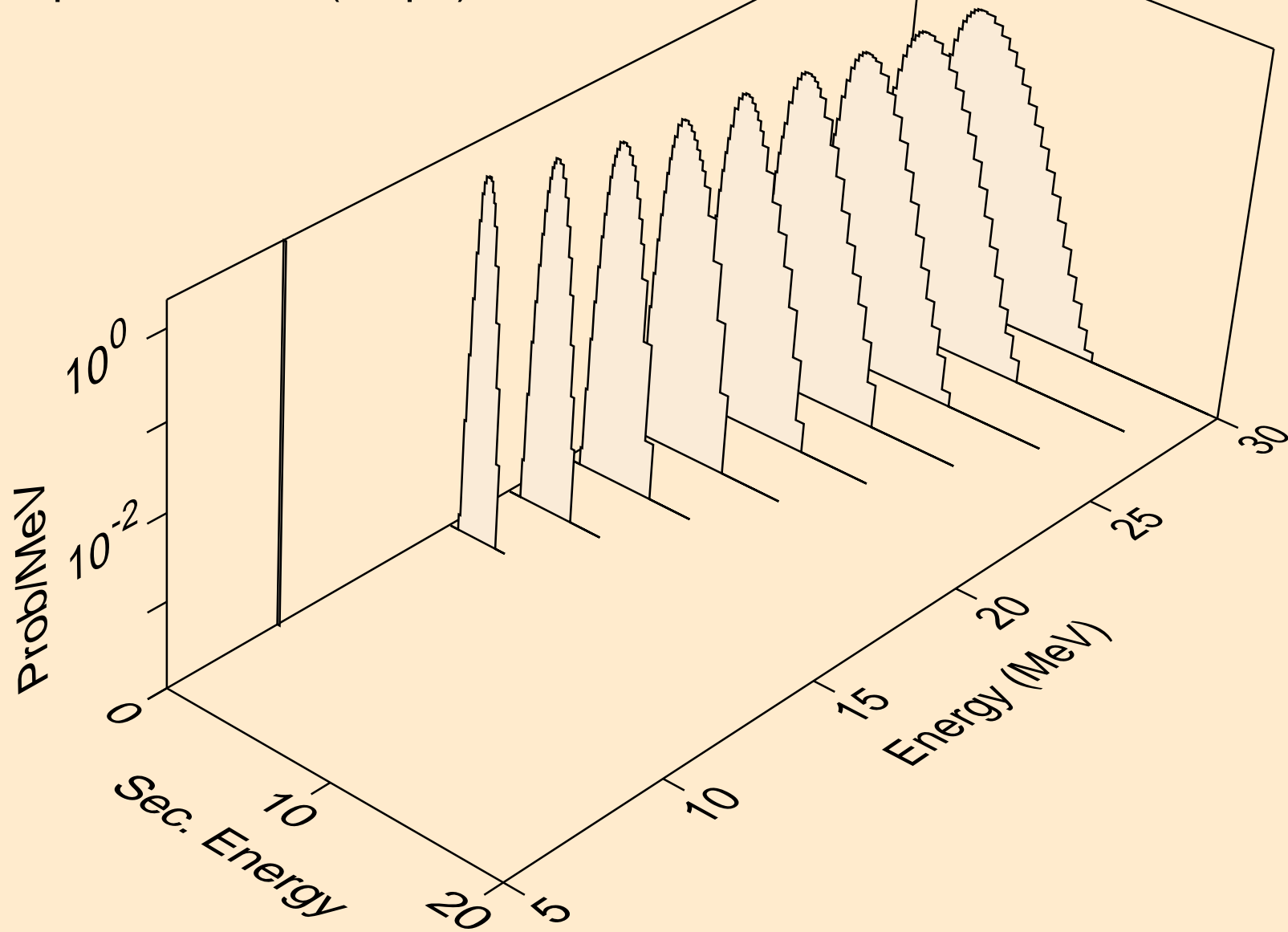

RB079 NEUTRON ACER TENDL-2024 LIBRARY; T=0.K  
protons from (n,p)

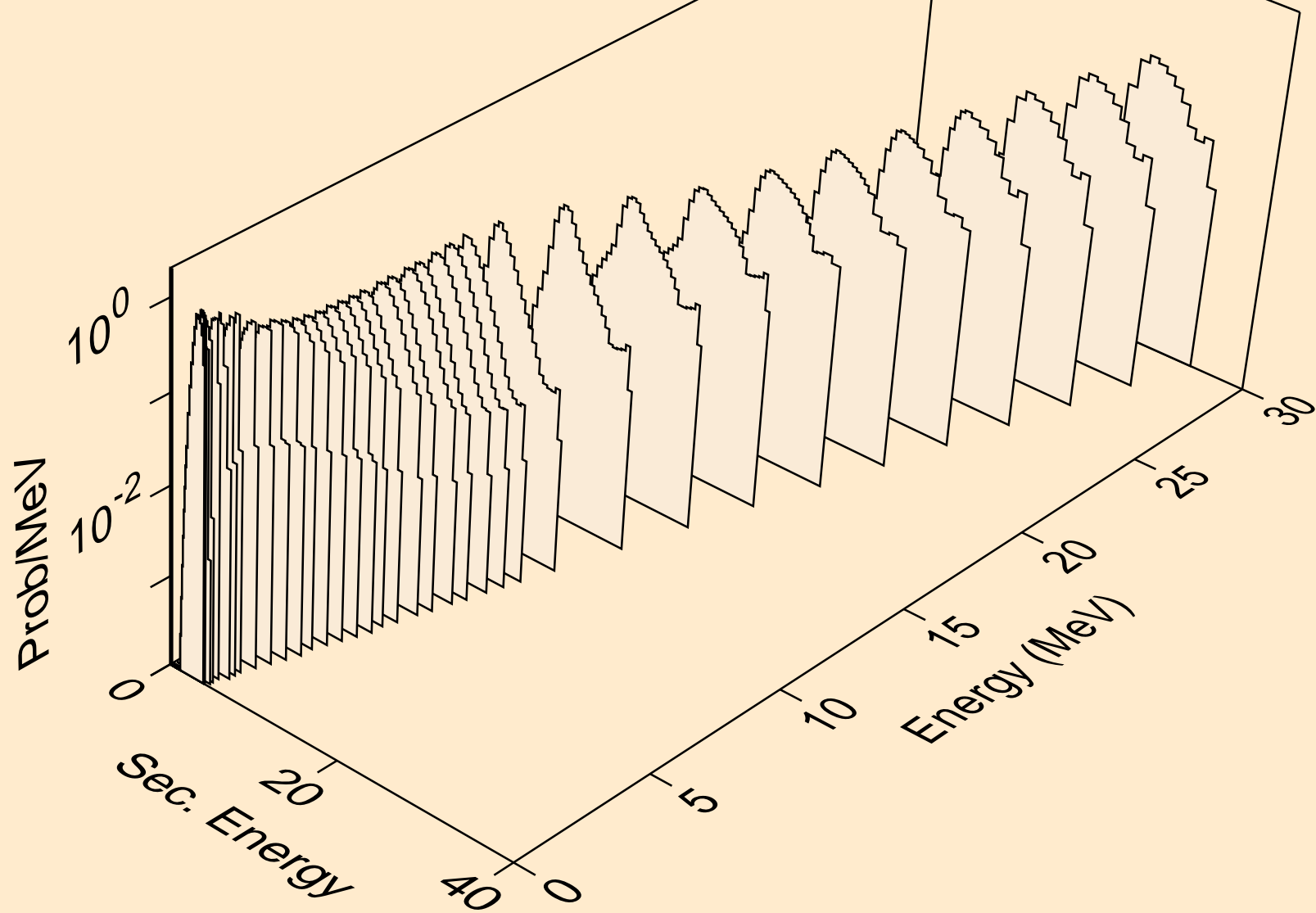

RB079 NEUTRON ACER TENDL-2024 LIBRARY; T=0.K  
protons from (n,2p)

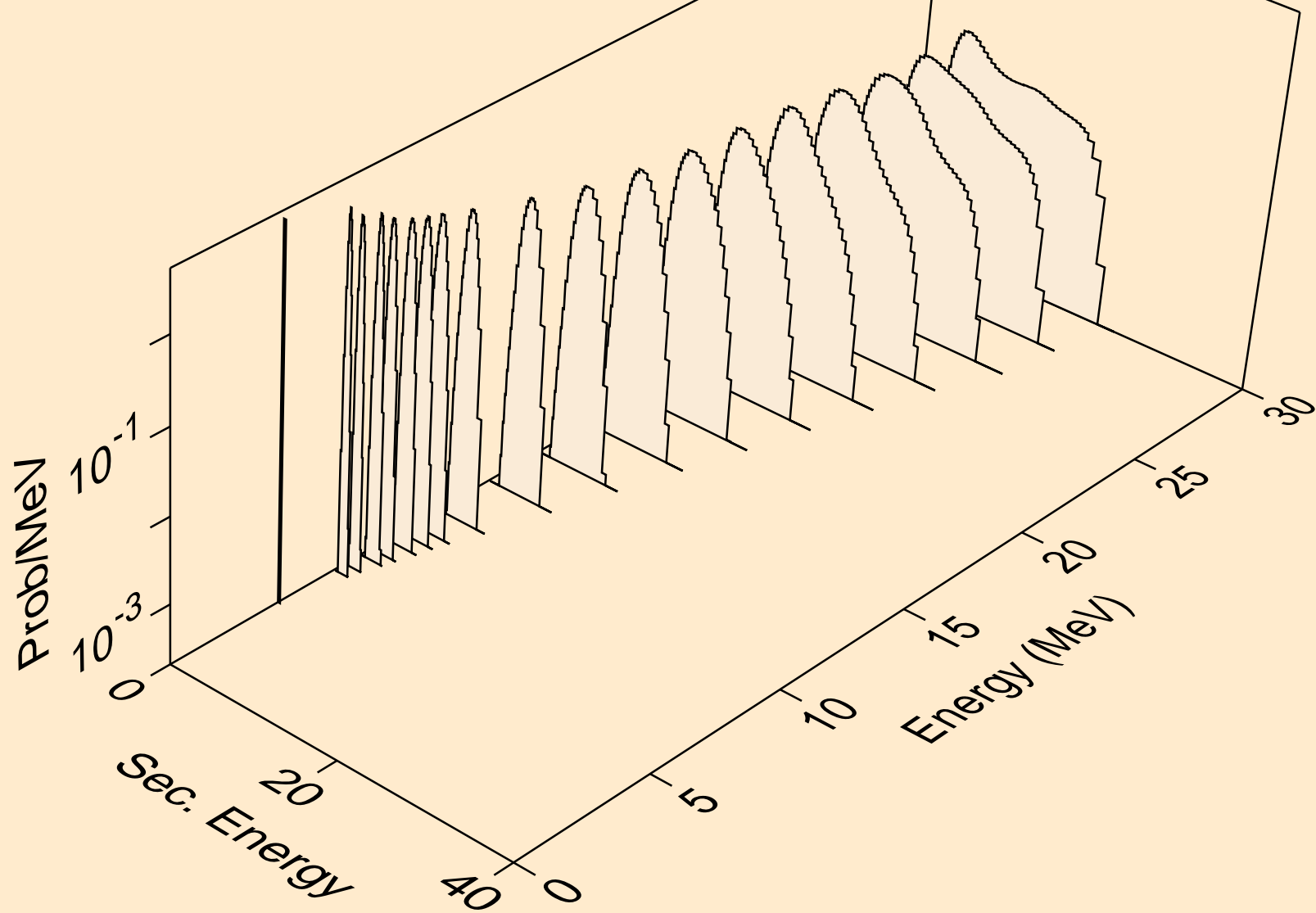

RB079 NEUTRON ACER TENDL-2024 LIBRARY; T=0.K  
protons from (n,p)

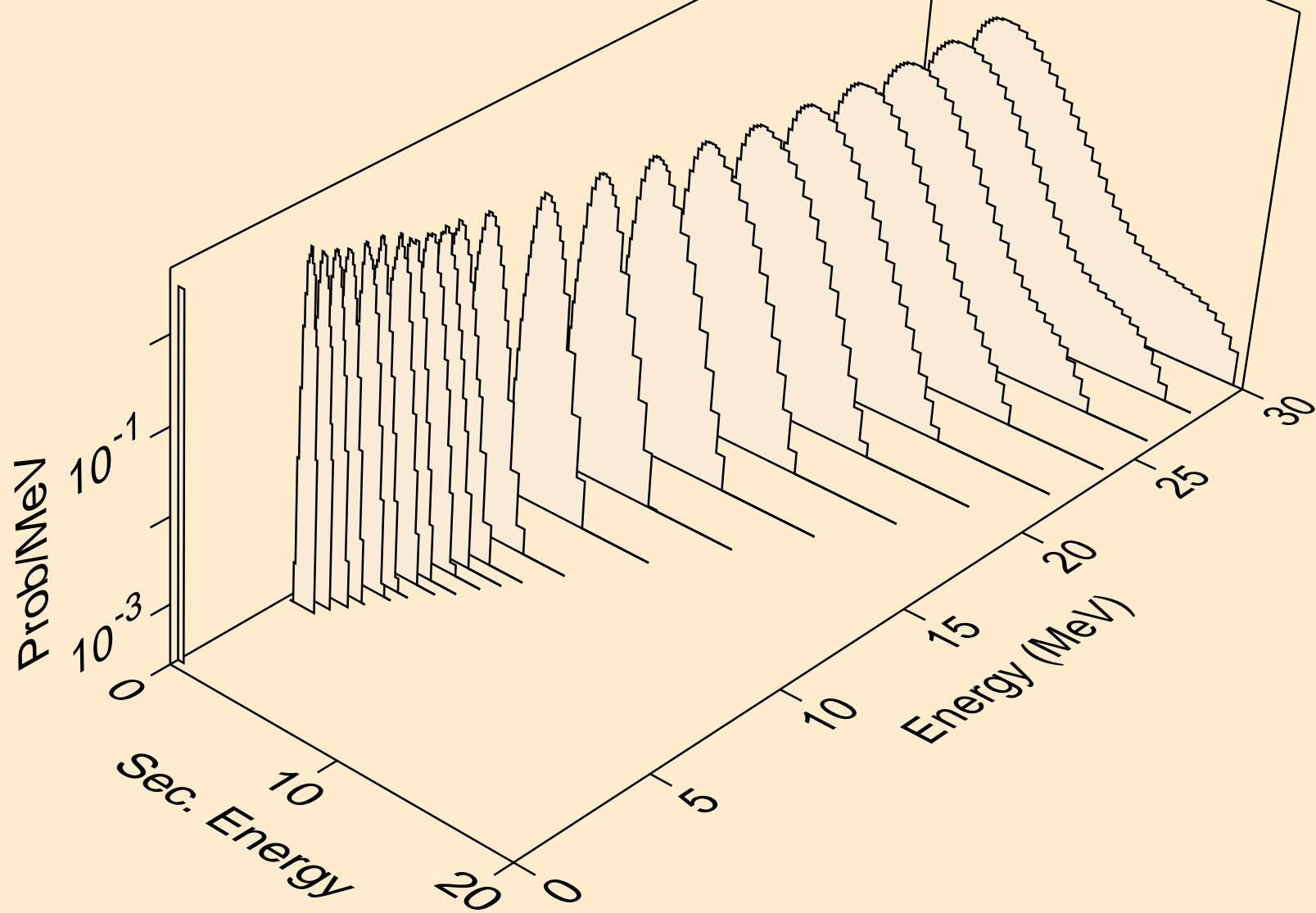

RB079 NEUTRON ACER TENDL-2024 LIBRARY; T=0.K  
protons from (n,pd)

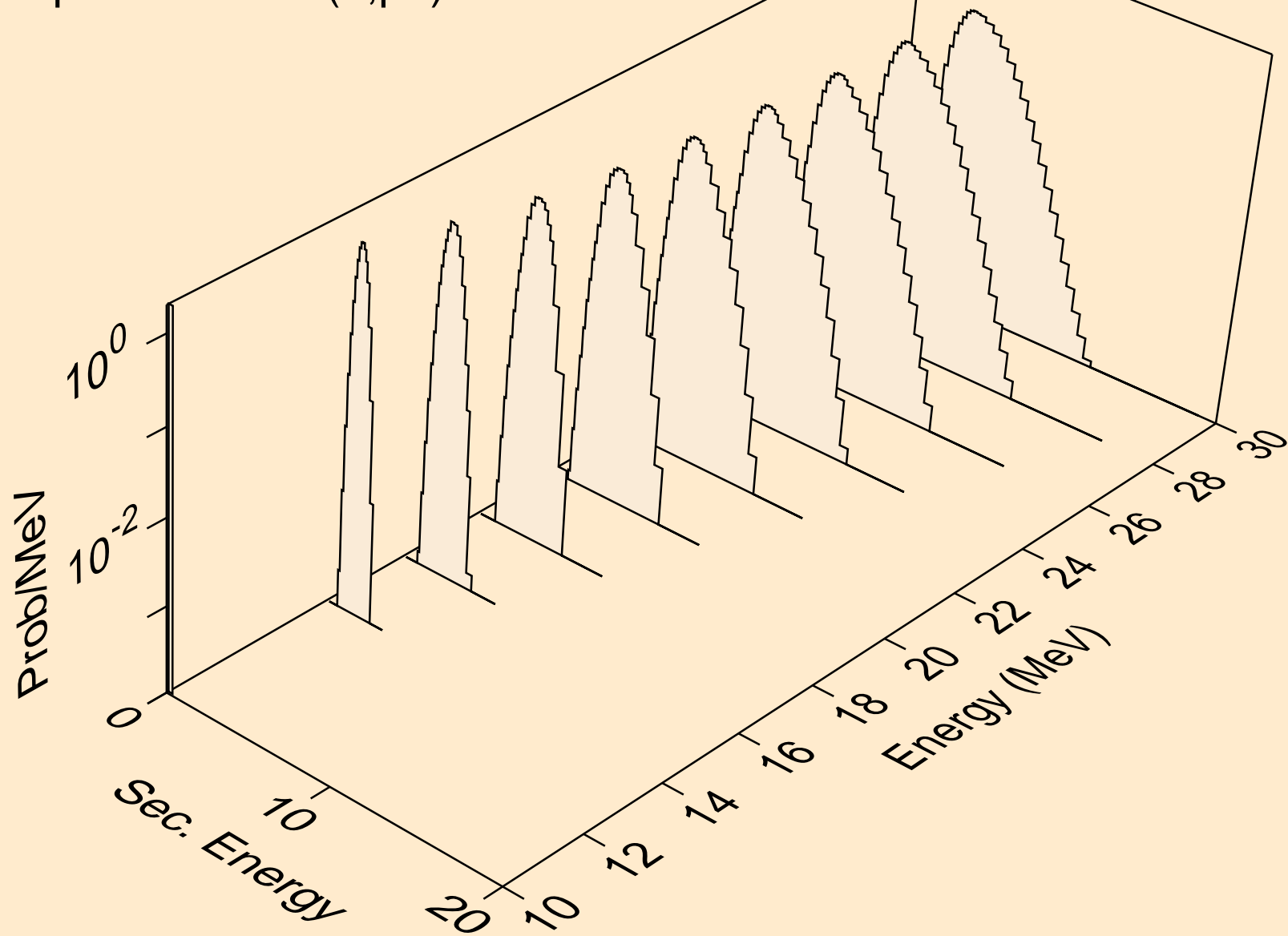

RB079 NEUTRON ACER TENDL-2024 LIBRARY; T=0.K  
protons from (n,pt)

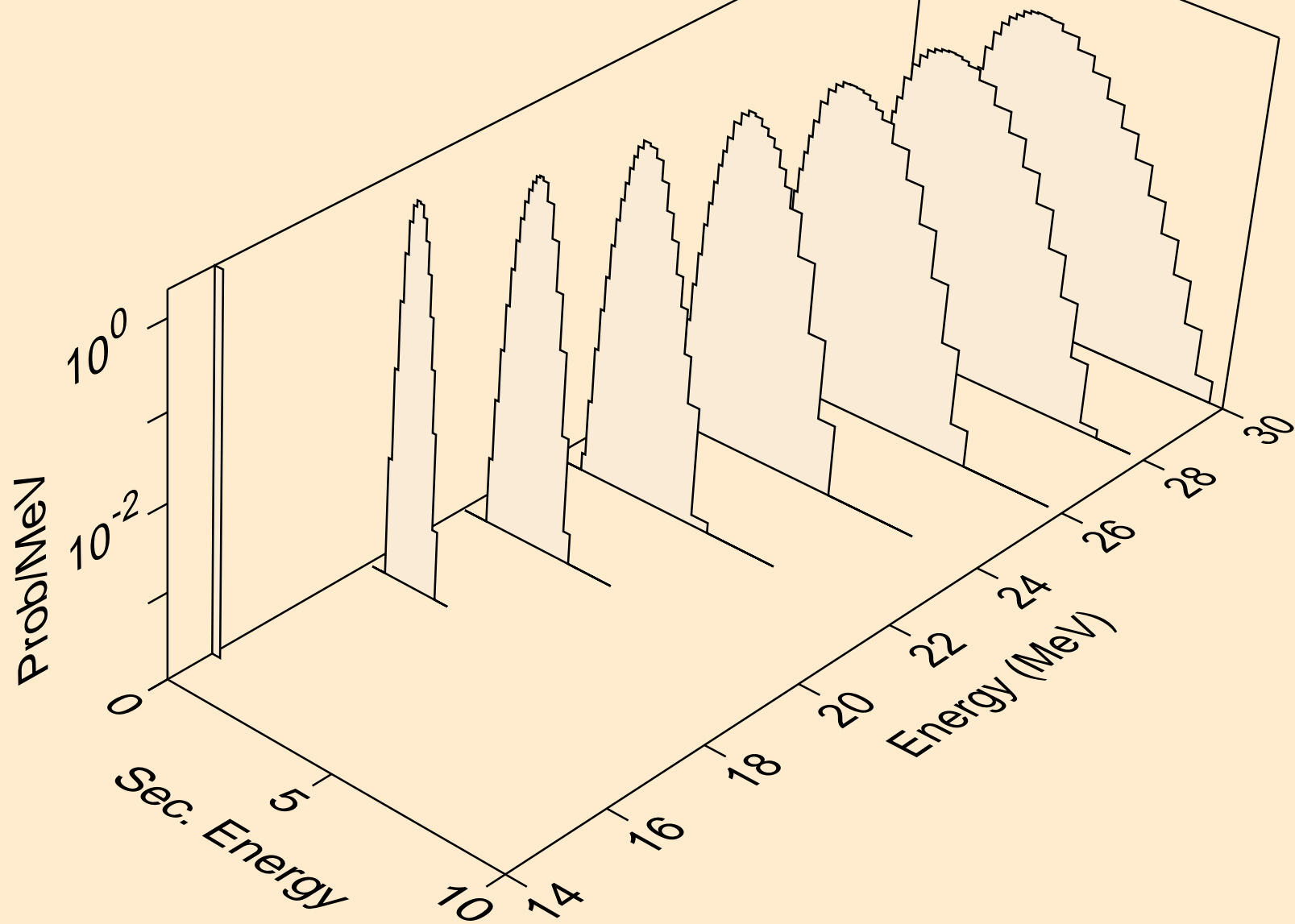

RB079 NEUTRON ACER TENDL-2024 LIBRARY; T=0.K  
deuterons from (n,x)

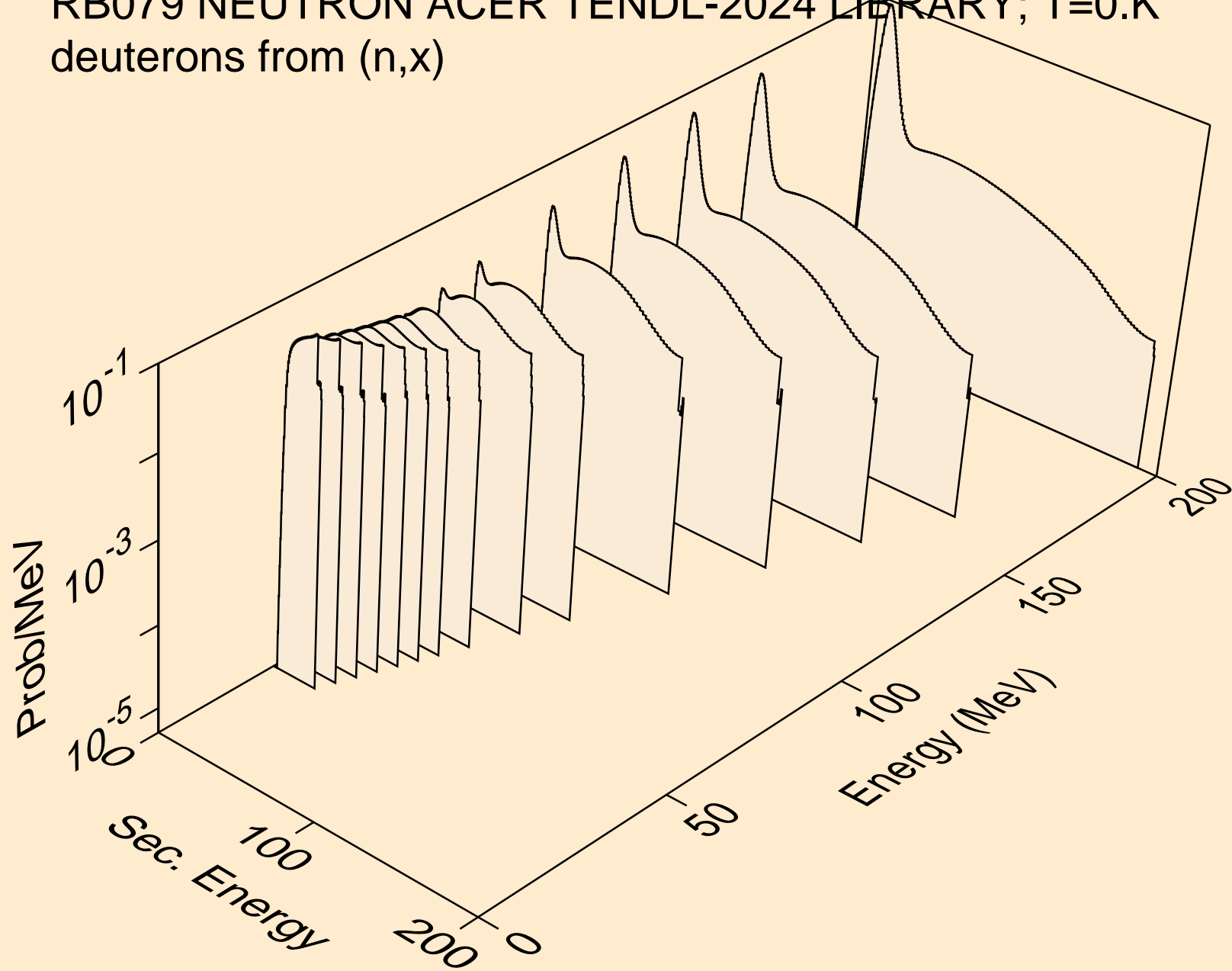



RB079 NEUTRON ACER TENDL-2024 LIBRARY; T=0.K  
deuterons from (n,2nd)

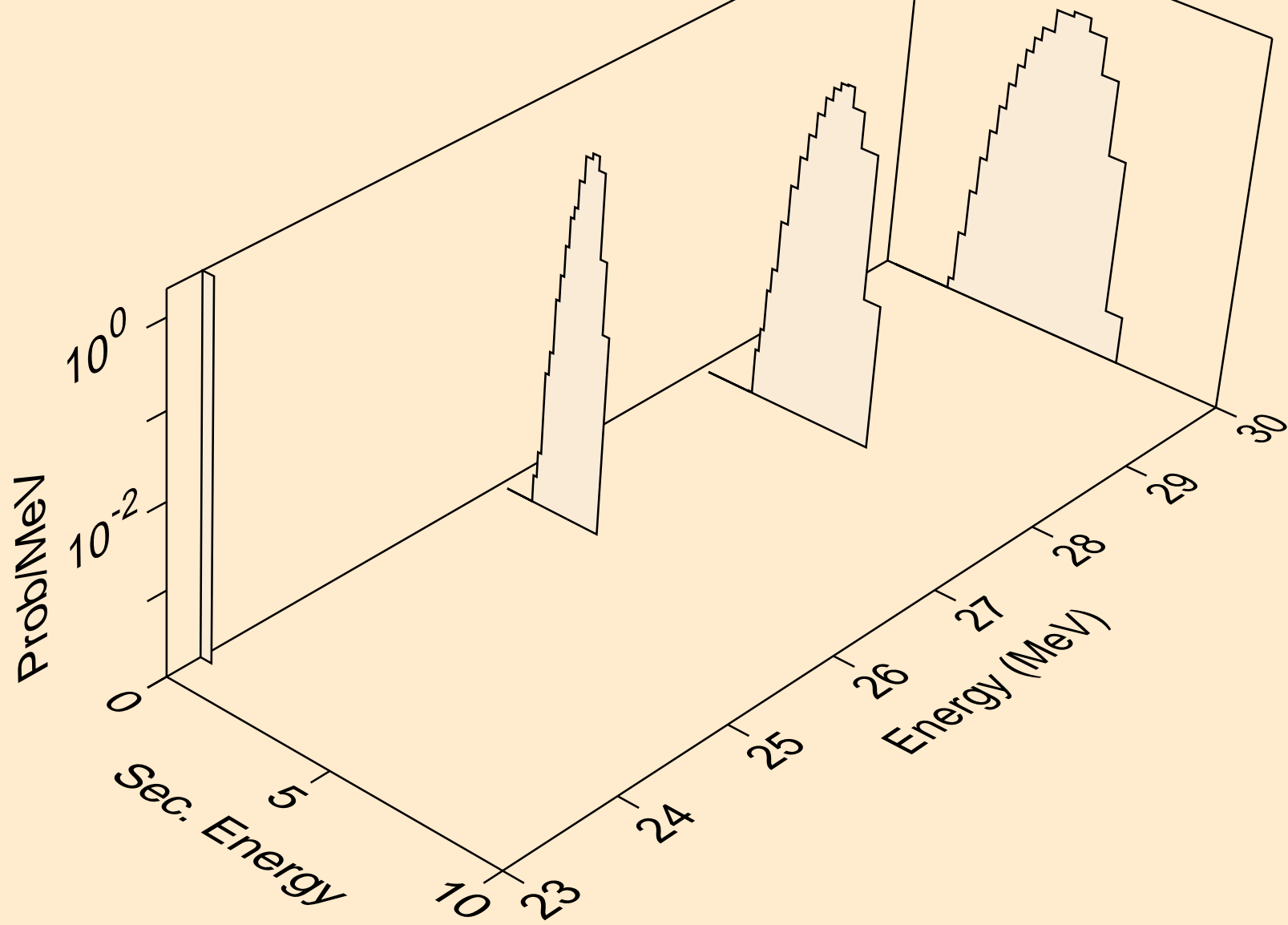

RB079 NEUTRON ACER TENDL-2024 LIBRARY; T=0.K  
deuterons from (n,n\*)d

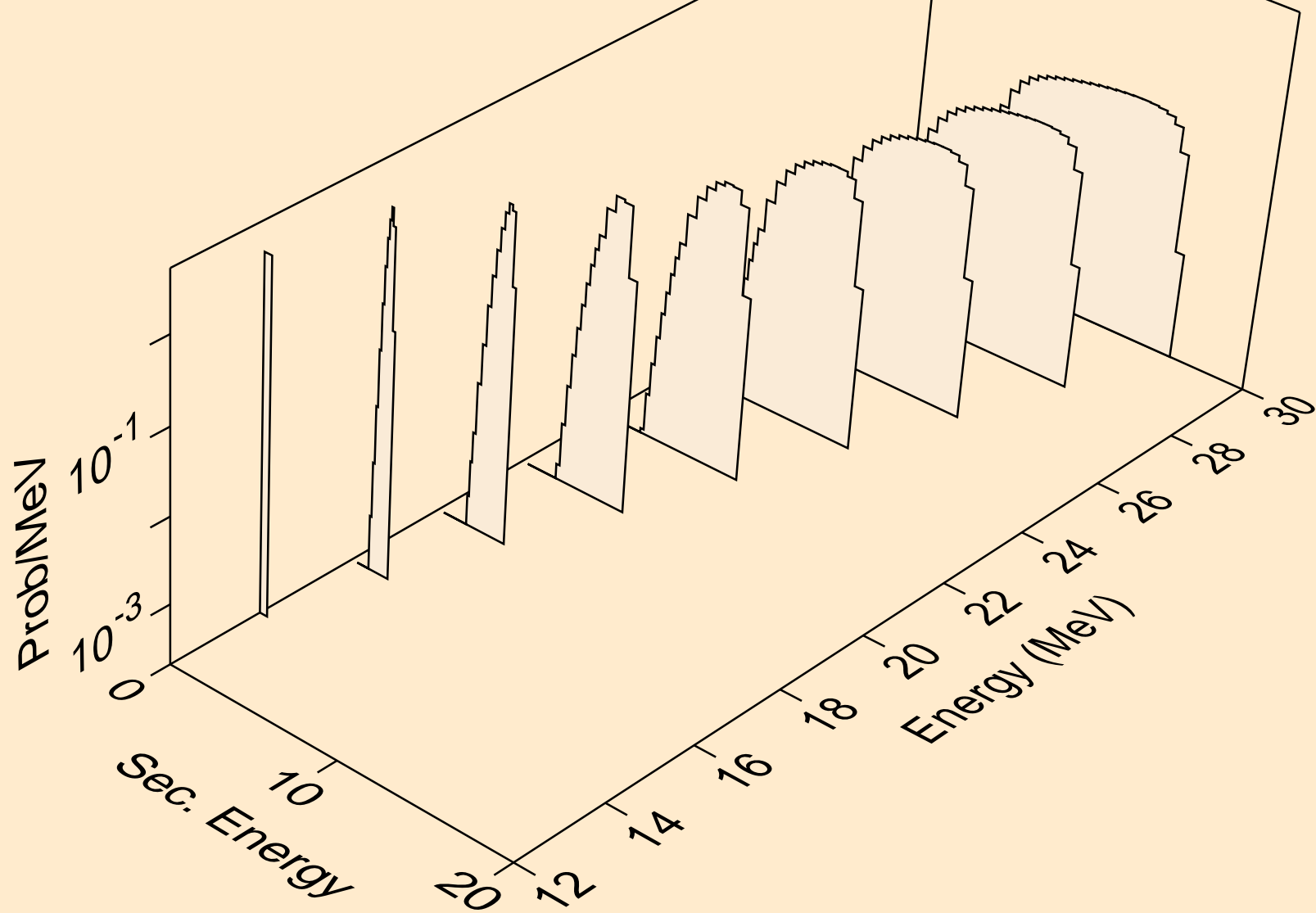

RB079 NEUTRON ACER TENDL-2024 LIBRARY; T=0.K  
deuterons from (n,d)

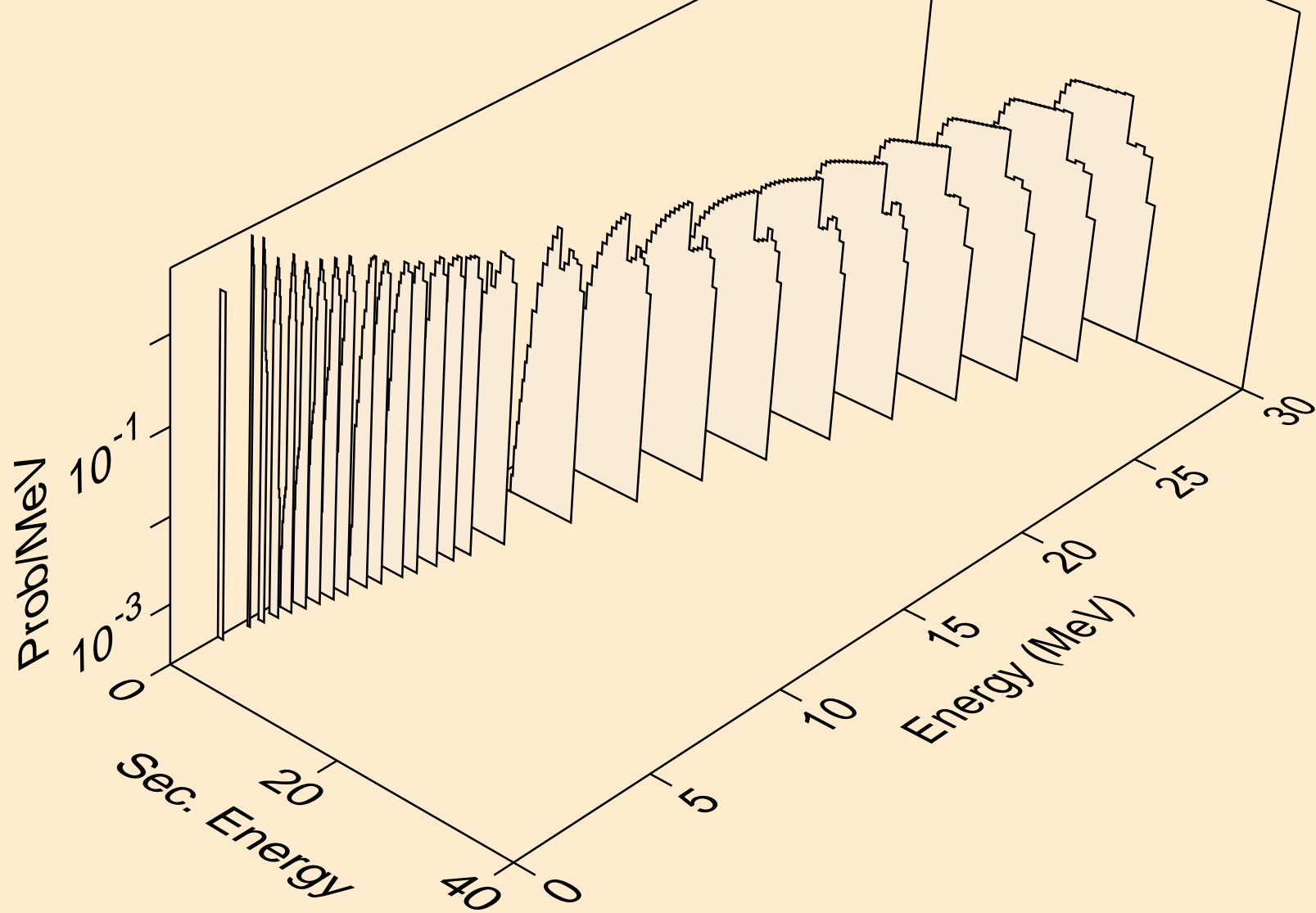

RB079 NEUTRON ACER TENDL-2024 LIBRARY; T=0.K  
deuterons from (n,d2a)

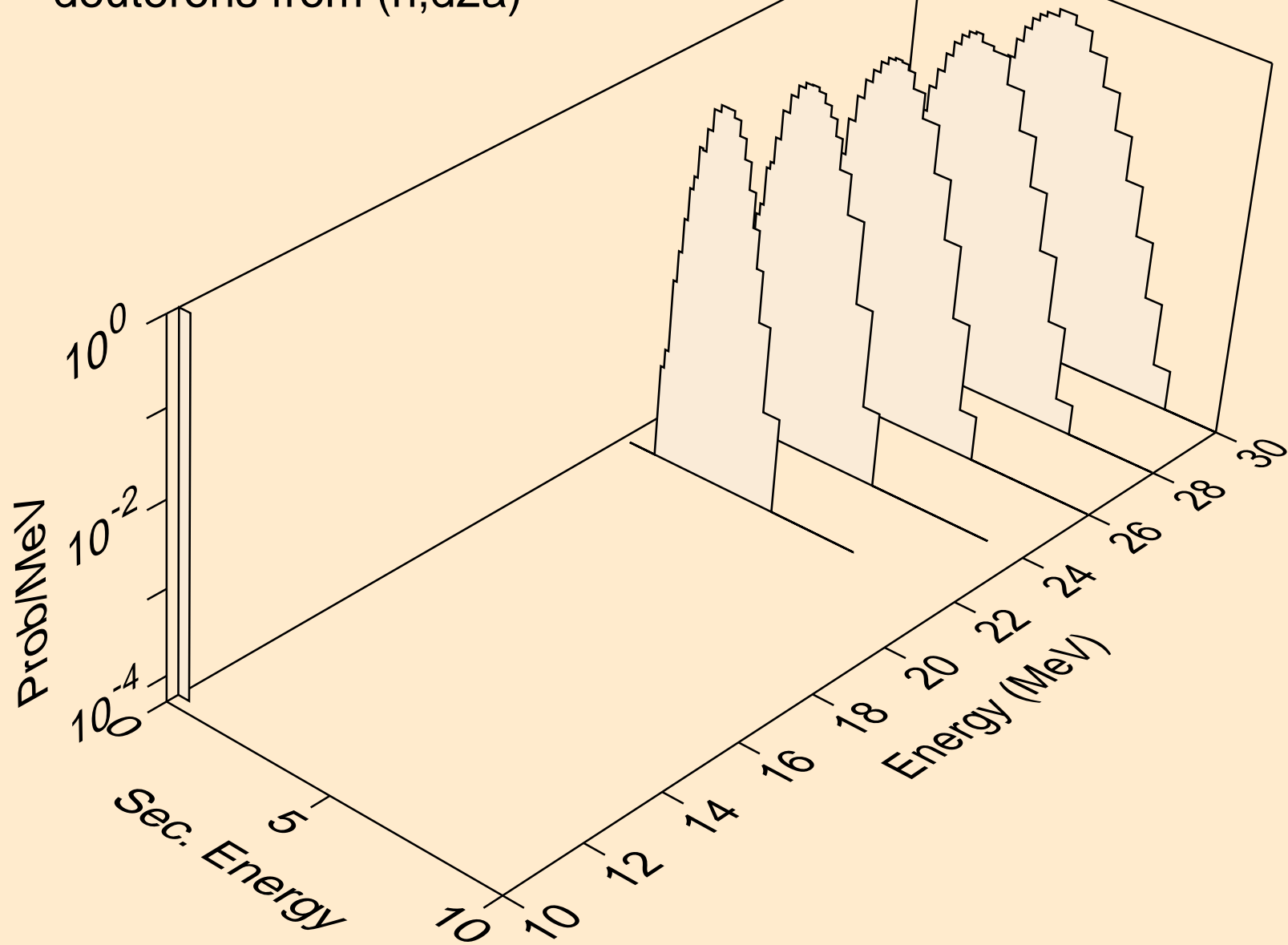

RB079 NEUTRON ACER TENDL-2024 LIBRARY; T=0.K  
deuterons from (n,pd)

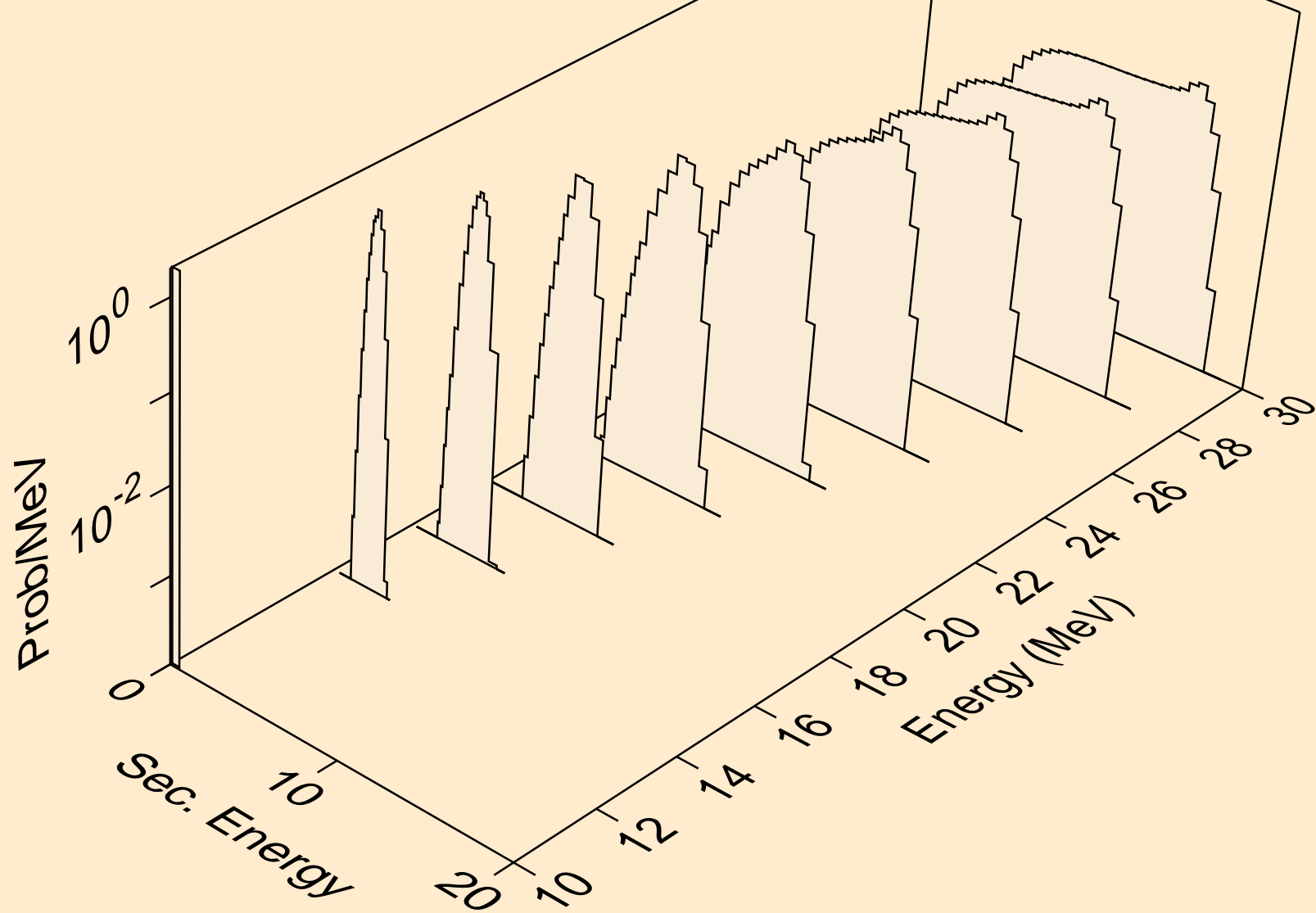

RB079 NEUTRON ACER TENDL-2024 LIBRARY; T=0.K  
deuterons from (n,da)

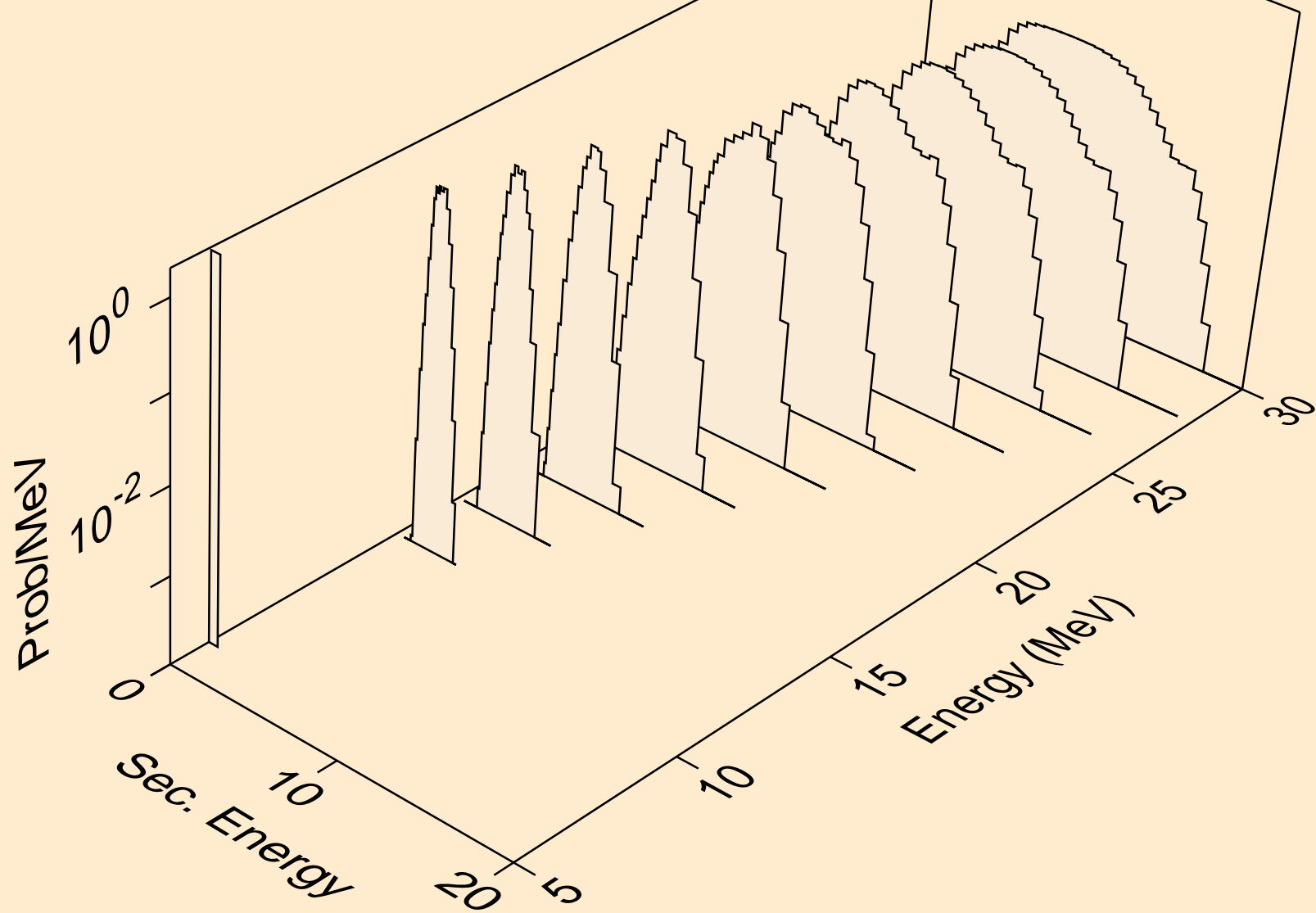

RB079 NEUTRON ACER TENDL-2024 LIBRARY; T=0.K  
tritons from (n,x)

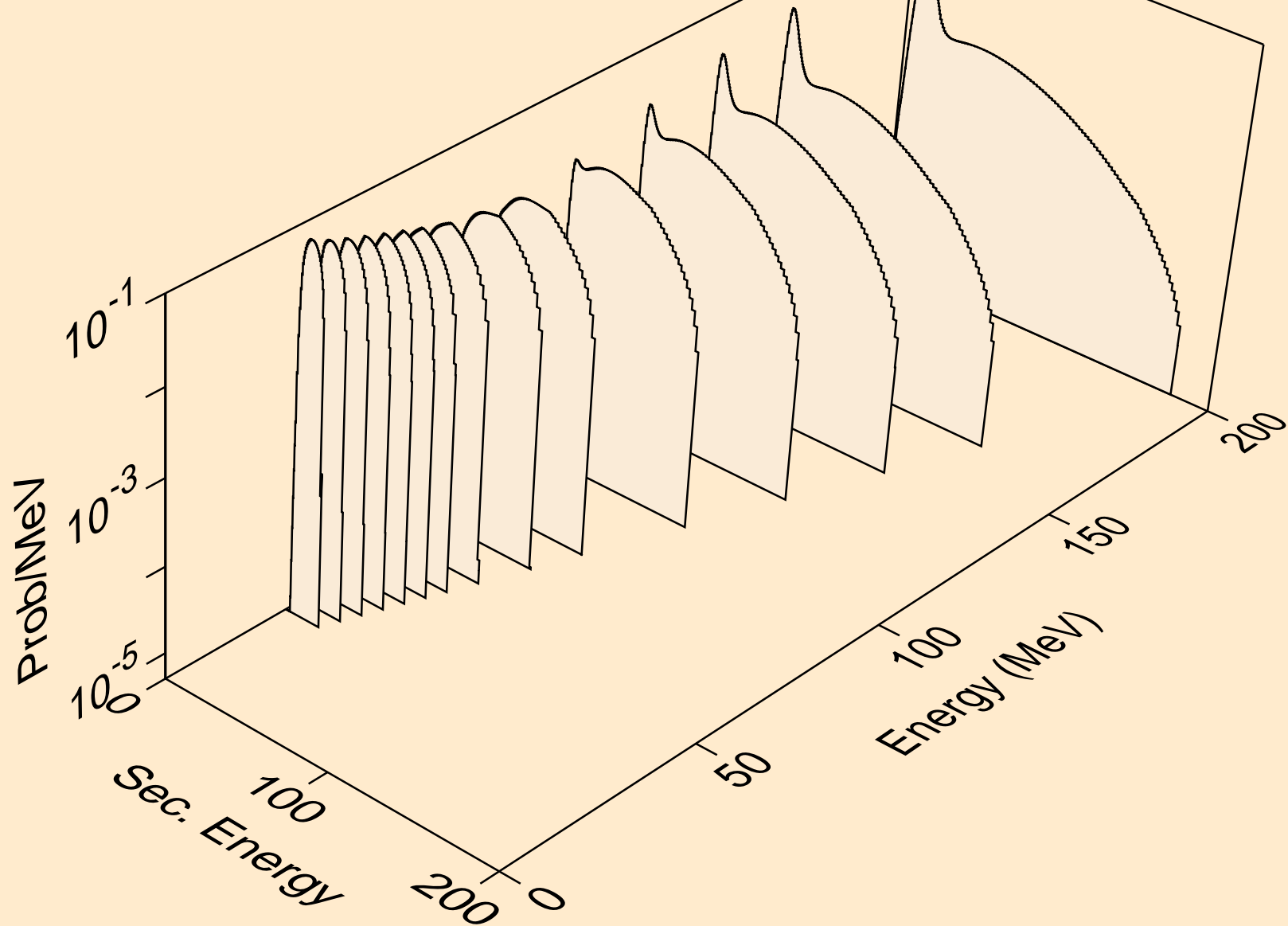

RB079 NEUTRON ACER TENDL-2024 LIBRARY; T=0.K  
tritons from (n,n\*)t

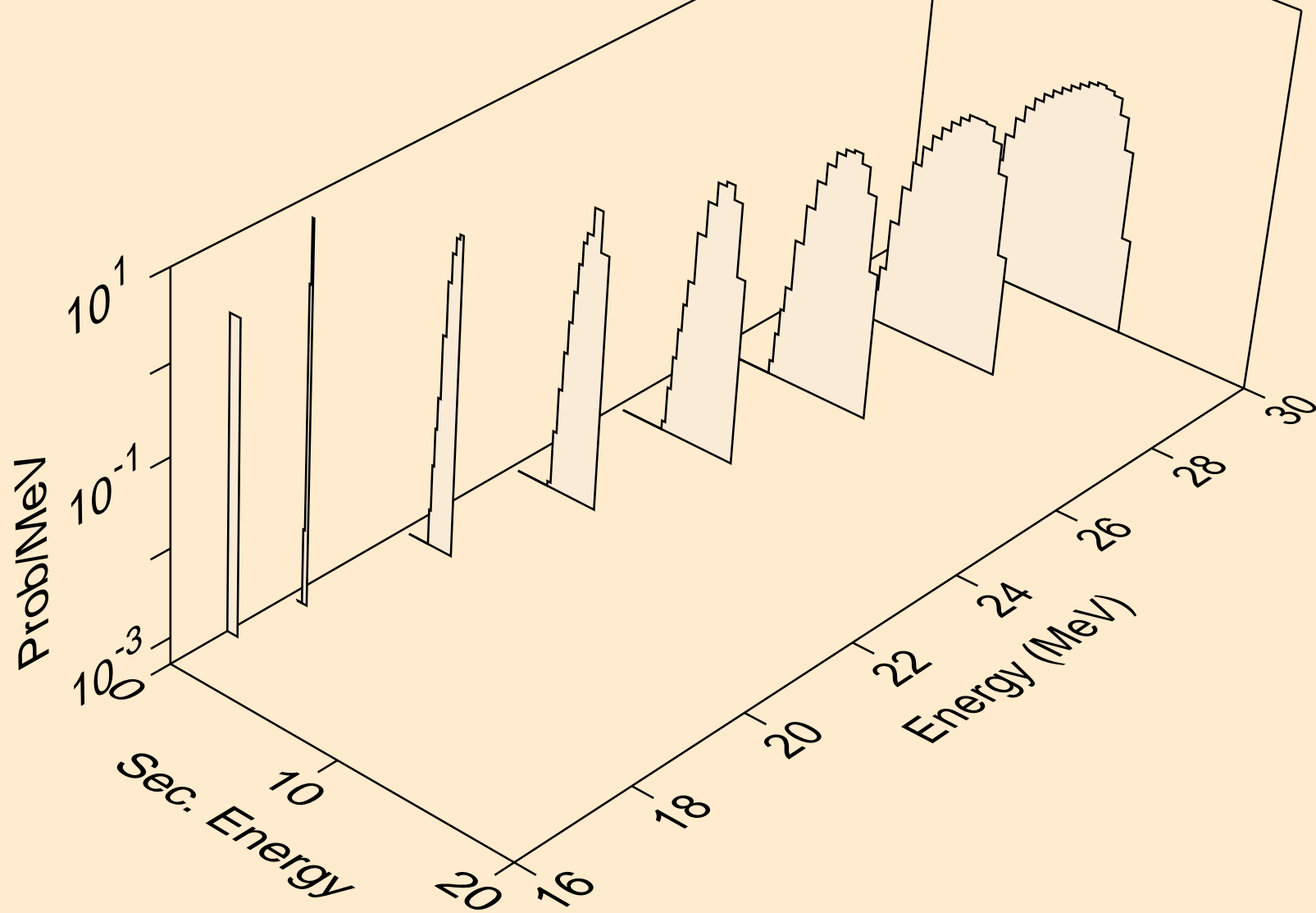



RB079 NEUTRON ACER TENDL-2024 LIBRARY; T=0.K  
tritons from (n,t)

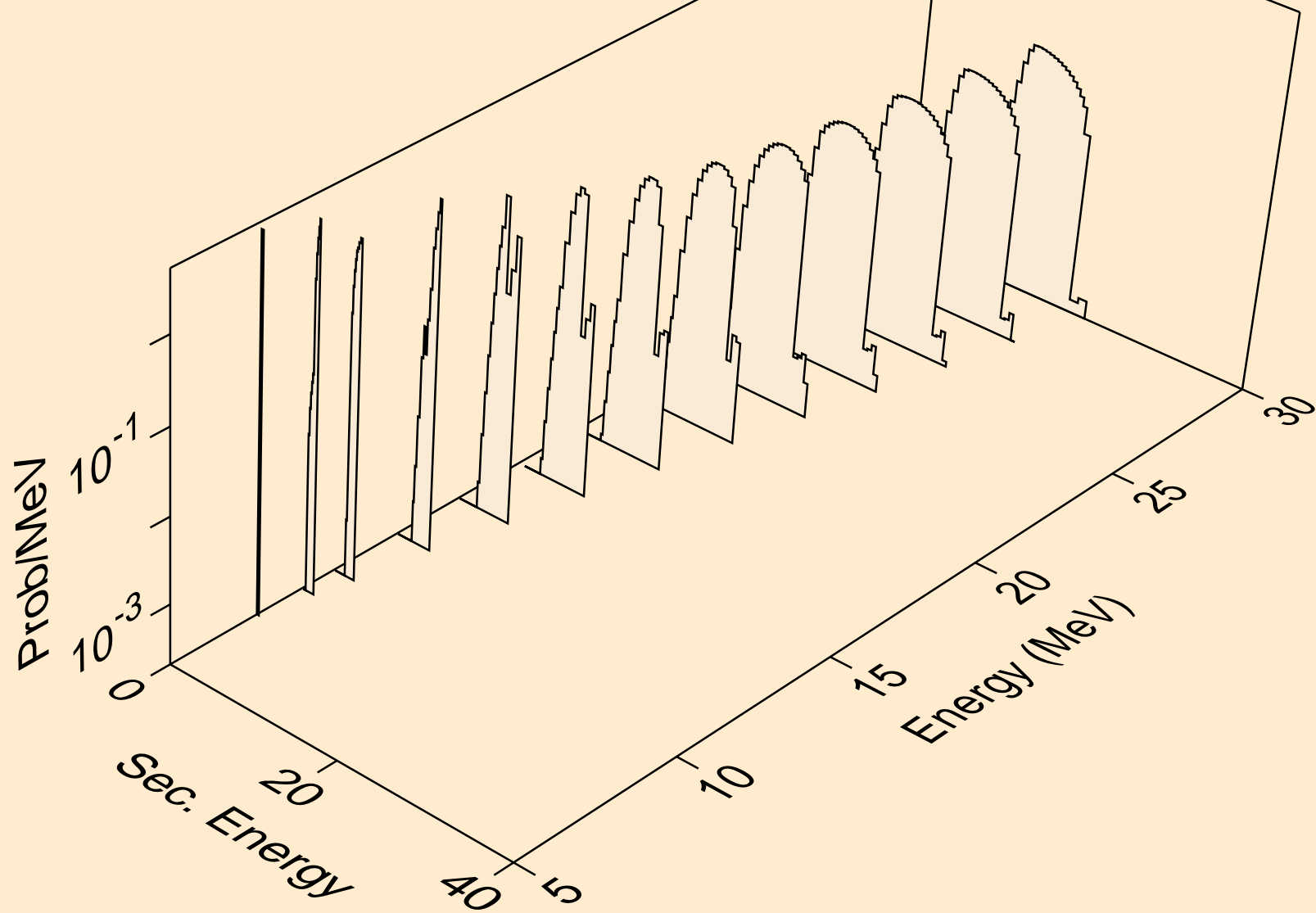

RB079 NEUTRON ACER TENDL-2024 LIBRARY; T=0.K  
tritons from (n,pt)

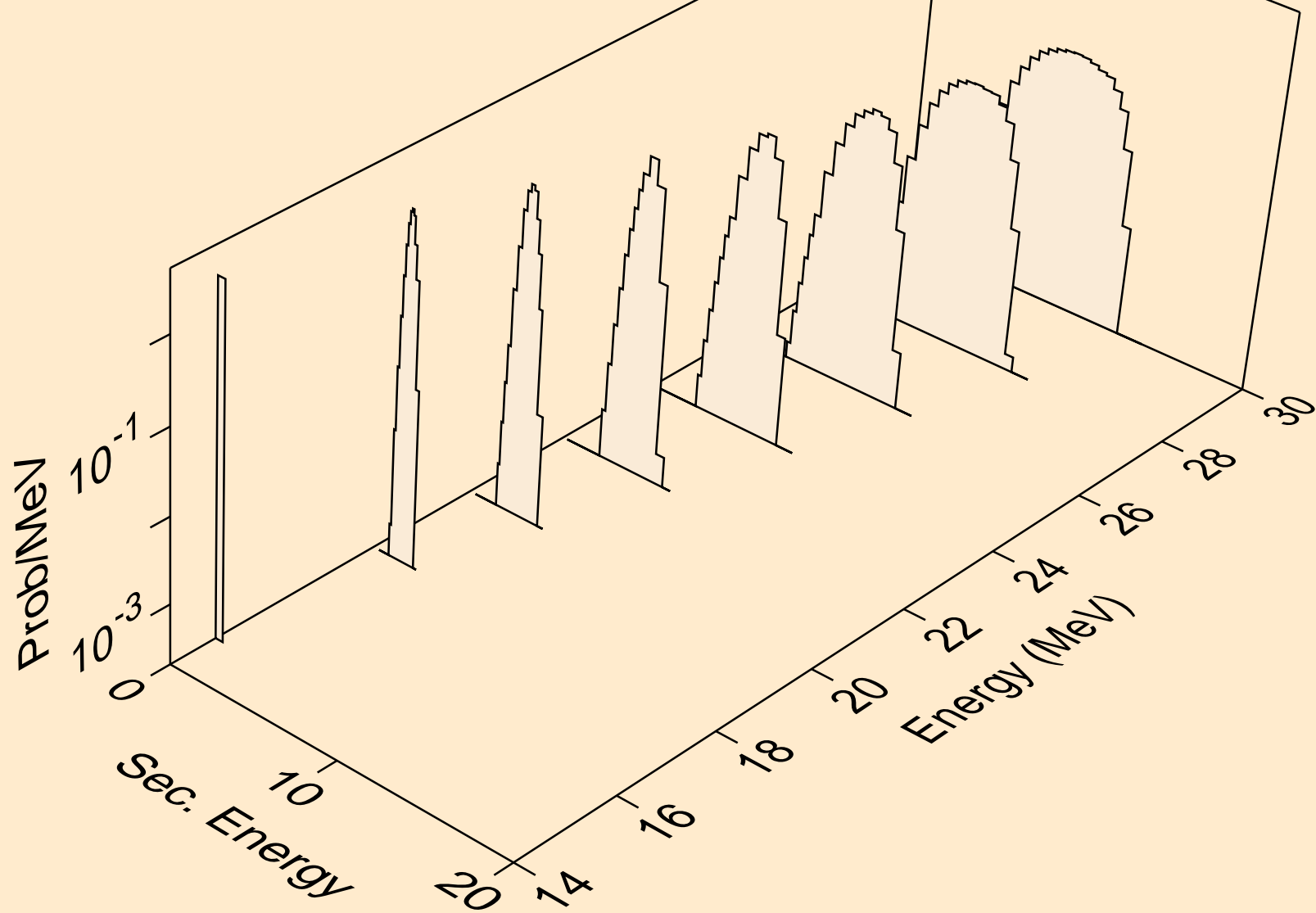

RB079 NEUTRON ACER TENDL-2024 LIBRARY; T=0.K  
he3s from (n,x)

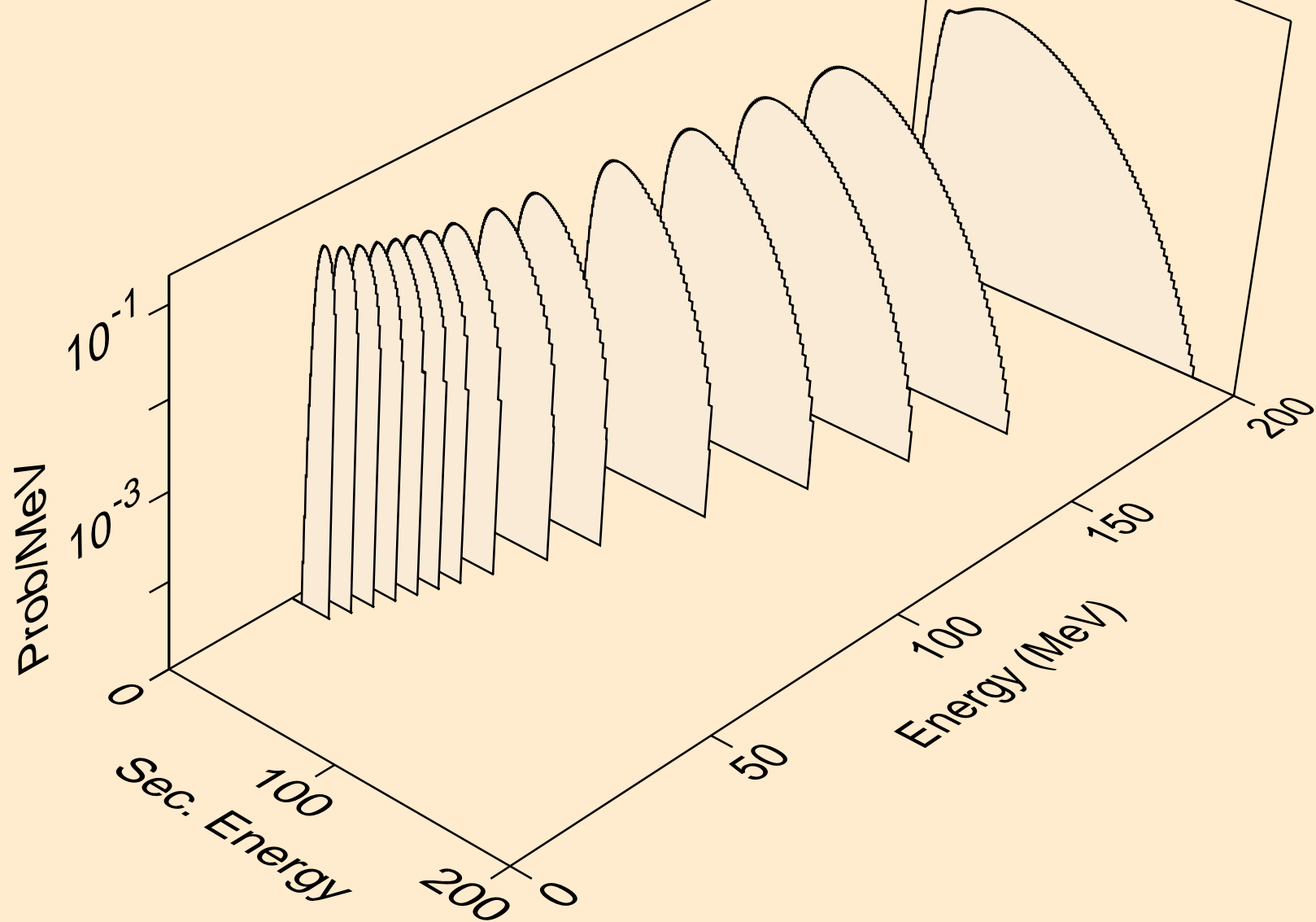

RB079 NEUTRON ACER TENDL-2024 LIBRARY; T=0.K  
he3s from (n,n\*)he3

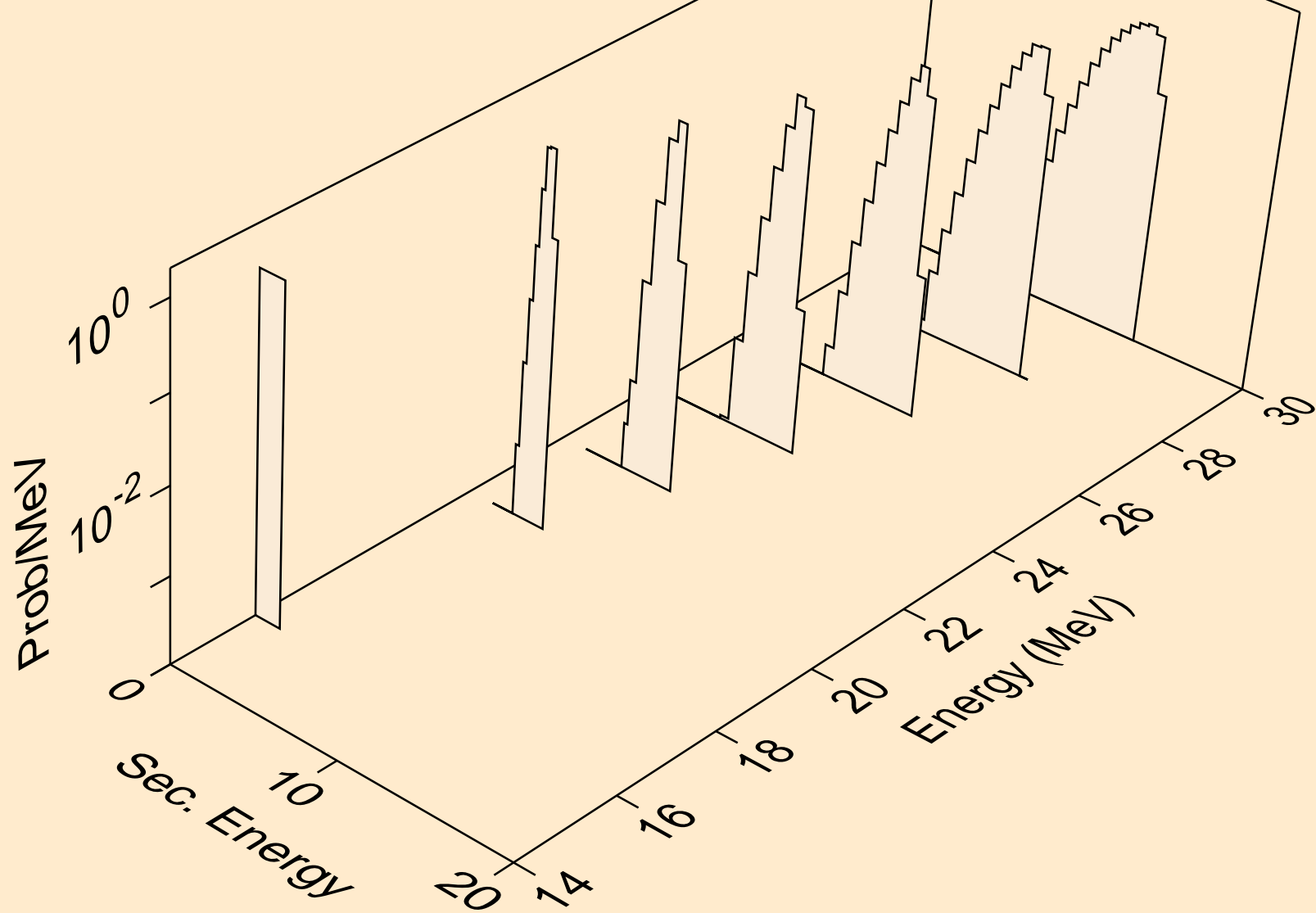

RB079 NEUTRON ACER TENDL-2024 LIBRARY; T=0.K  
he3s from (n,he3)

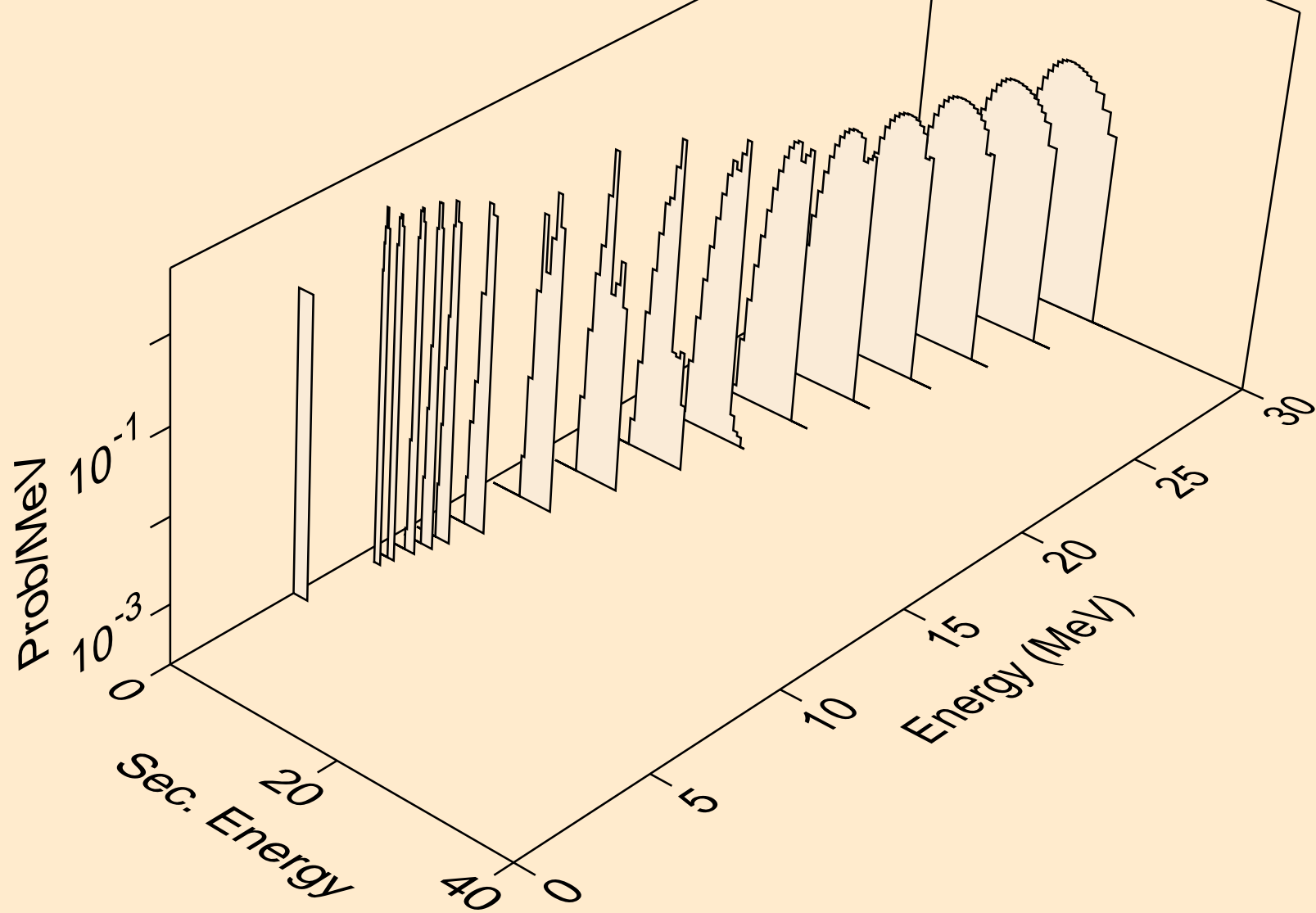

RB079 NEUTRON ACER TENDL-2024 LIBRARY; T=0.K  
alphas from (n,x)

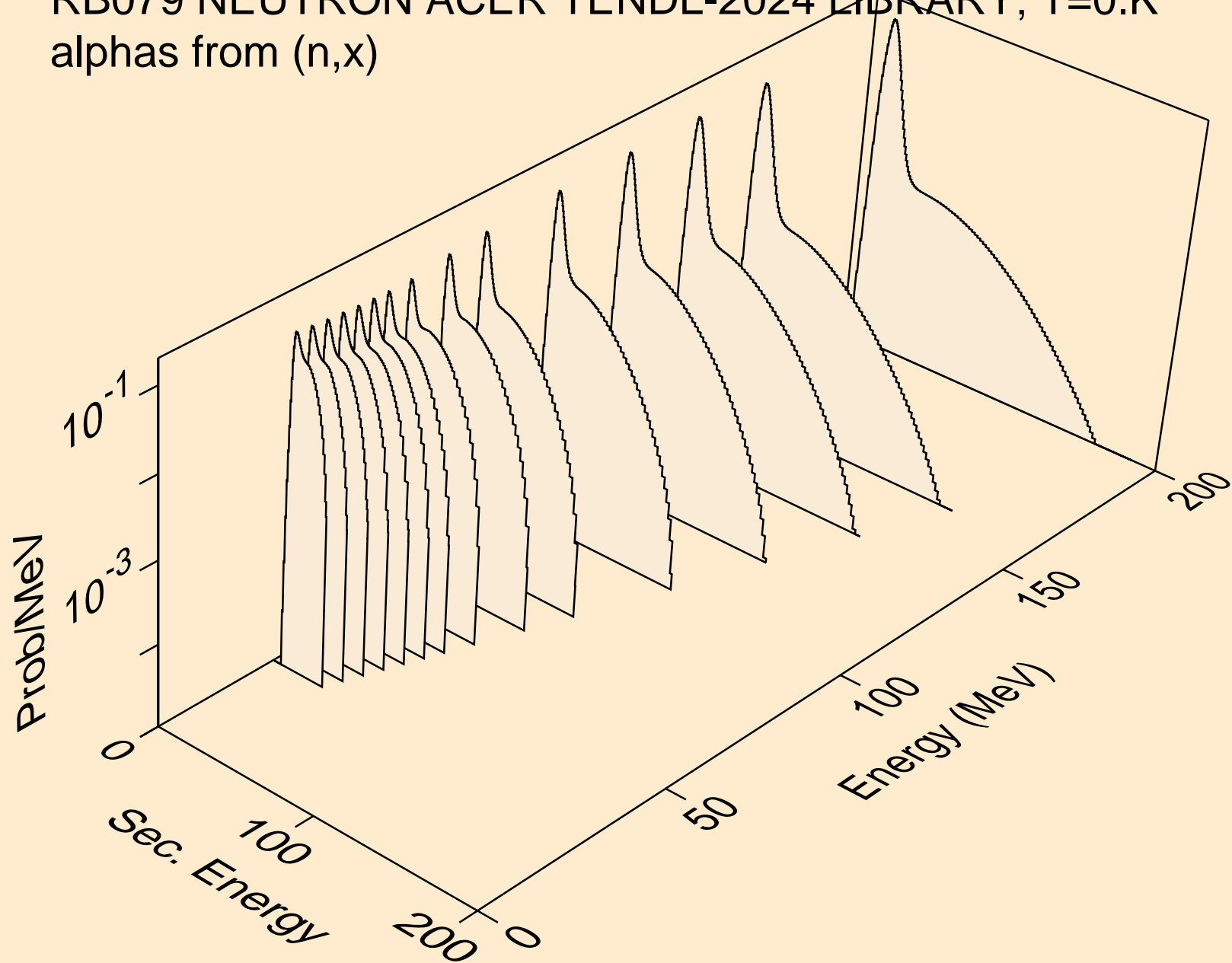

RB079 NEUTRON ACER TENDL-2024 LIBRARY; T=0.K  
alphas from (n,n\*)a

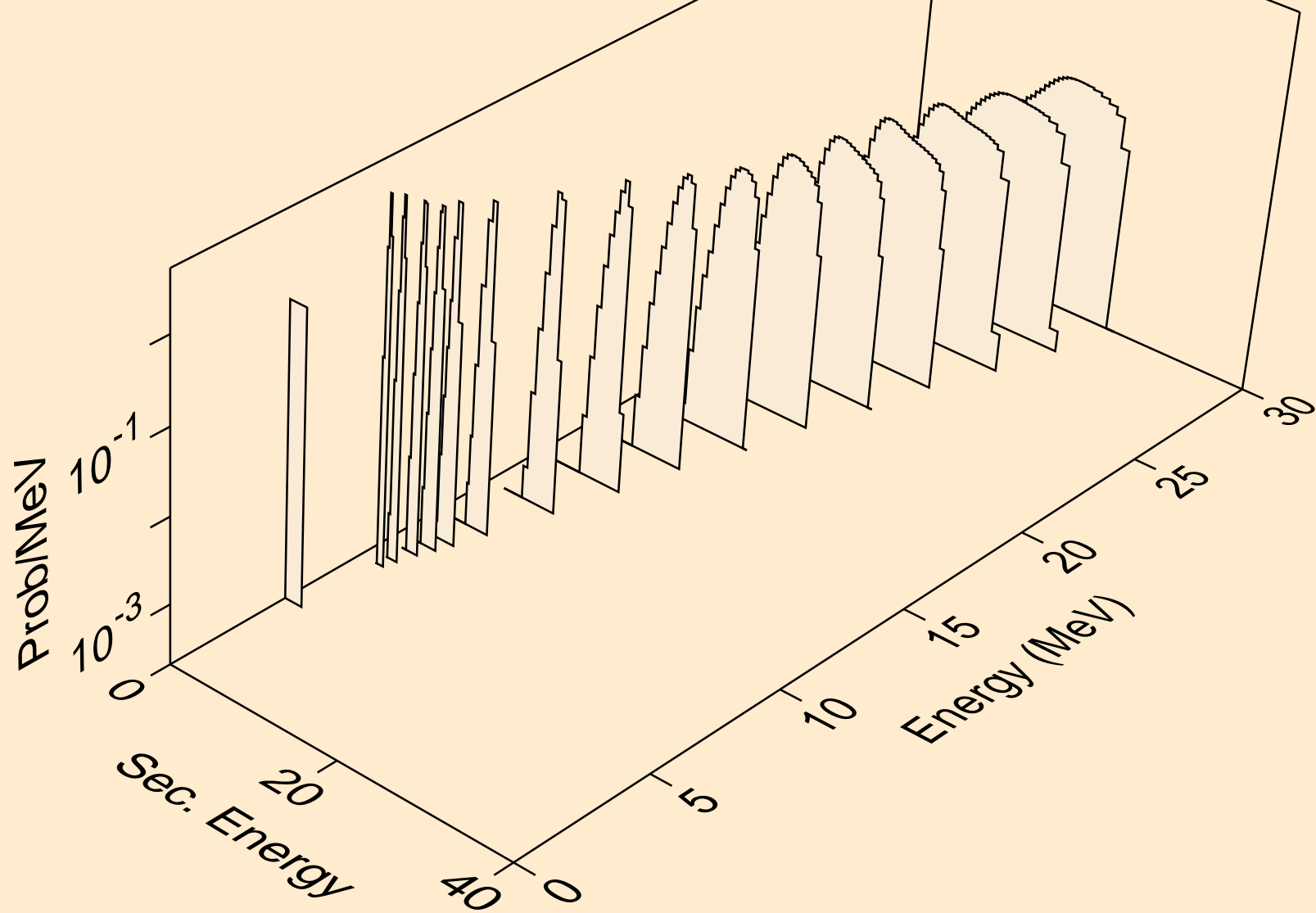

RB079 NEUTRON ACER TENDL-2024 LIBRARY; T=0.K  
alphas from (n,2n)a

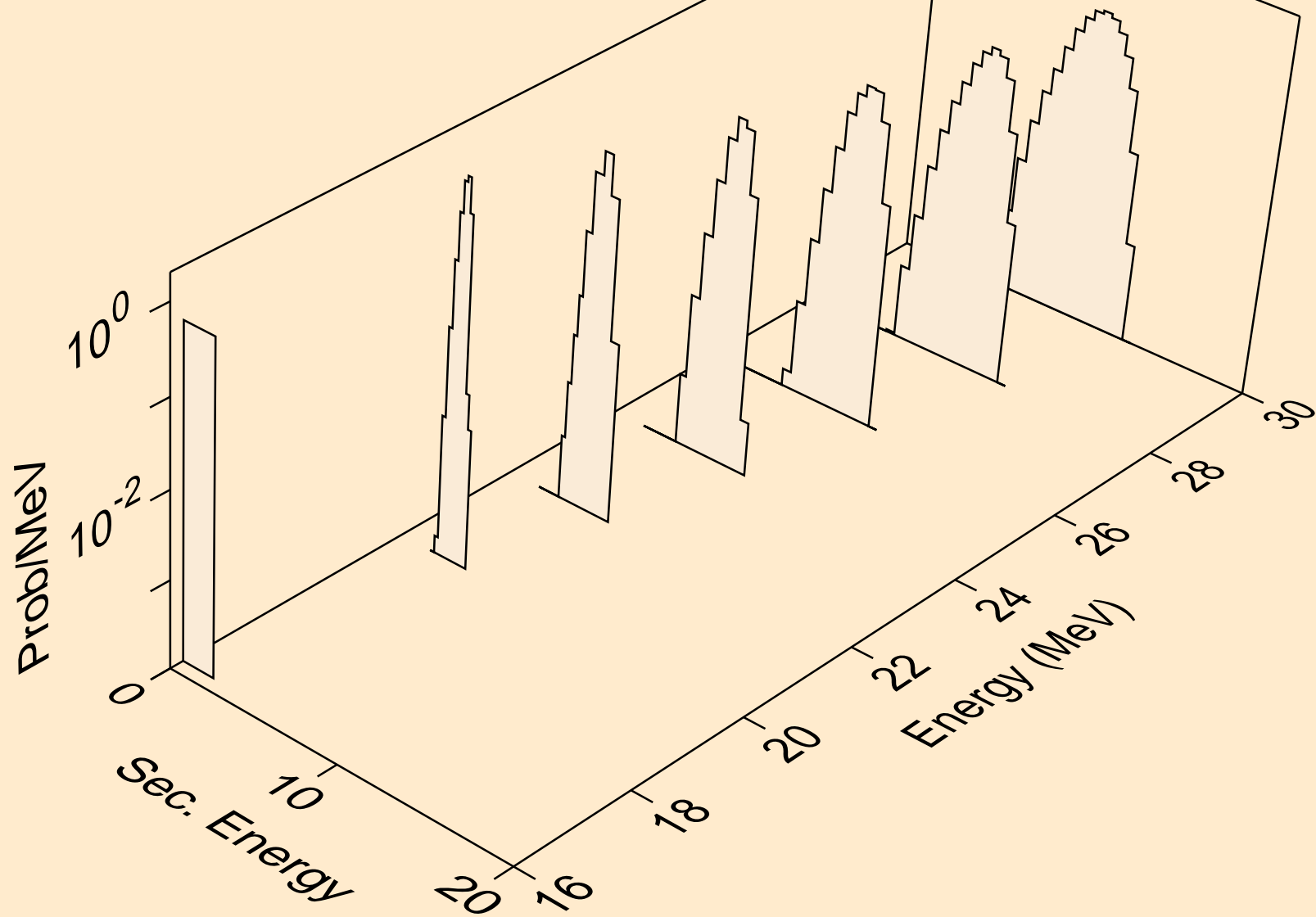



RB079 NEUTRON ACER TENDL-2024 LIBRARY; T=0.K  
alphas from (n,n\*)2a

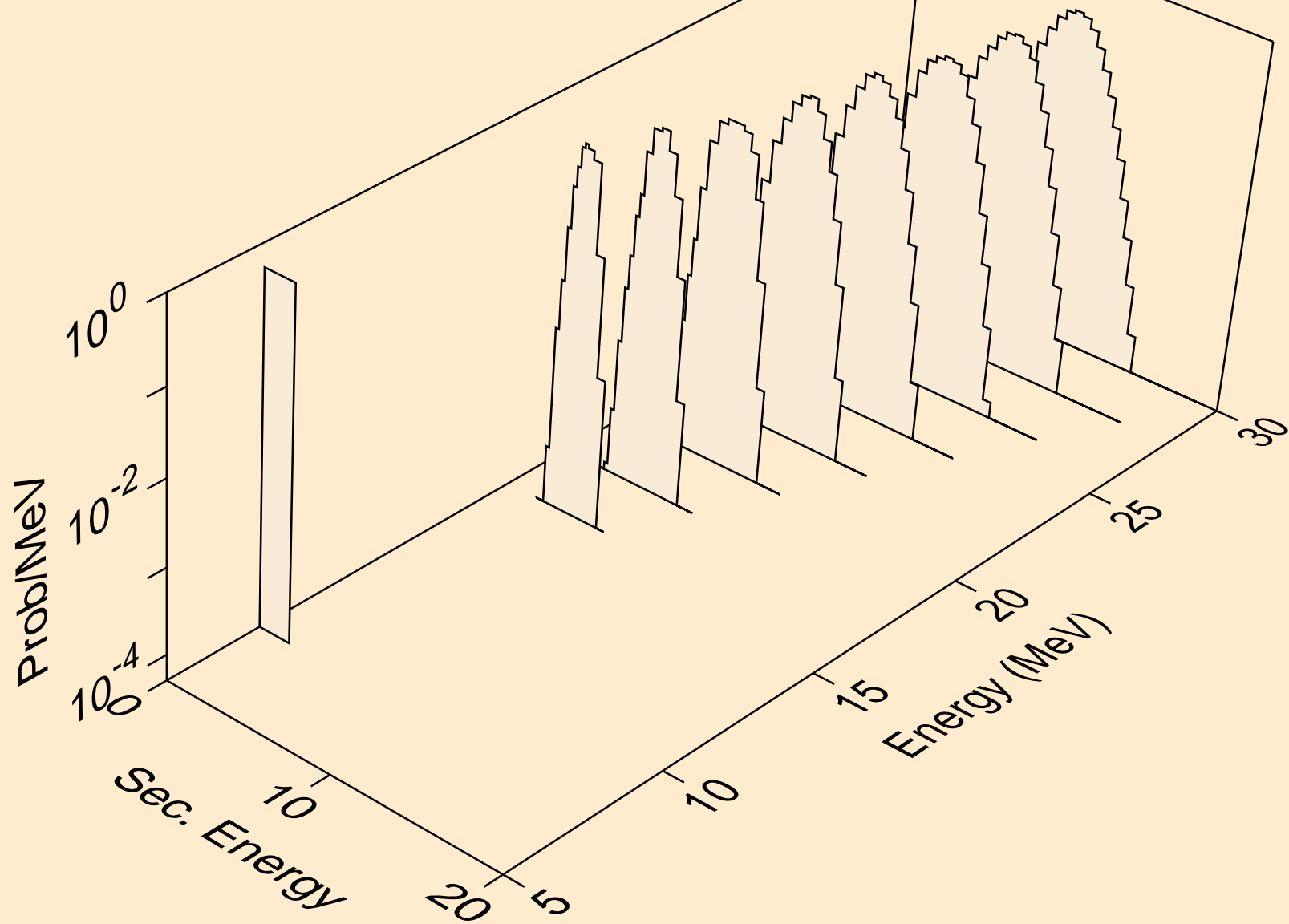

RB079 NEUTRON ACER TENDL-2024 LIBRARY; T=0.K  
alphas from (n,npa)

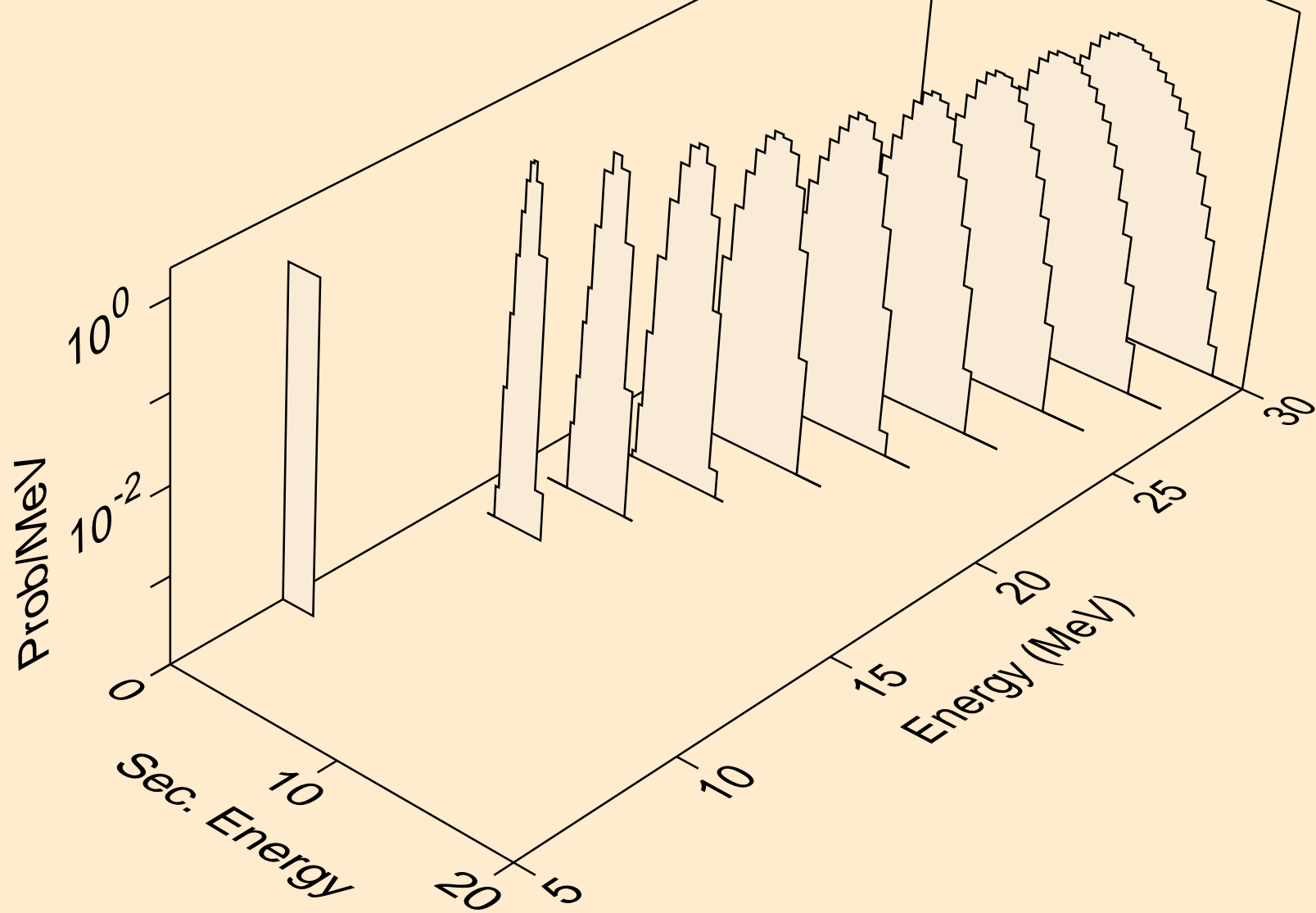

RB079 NEUTRON ACER TENDL-2024 LIBRARY; T=0.K  
alphas from (n,a)

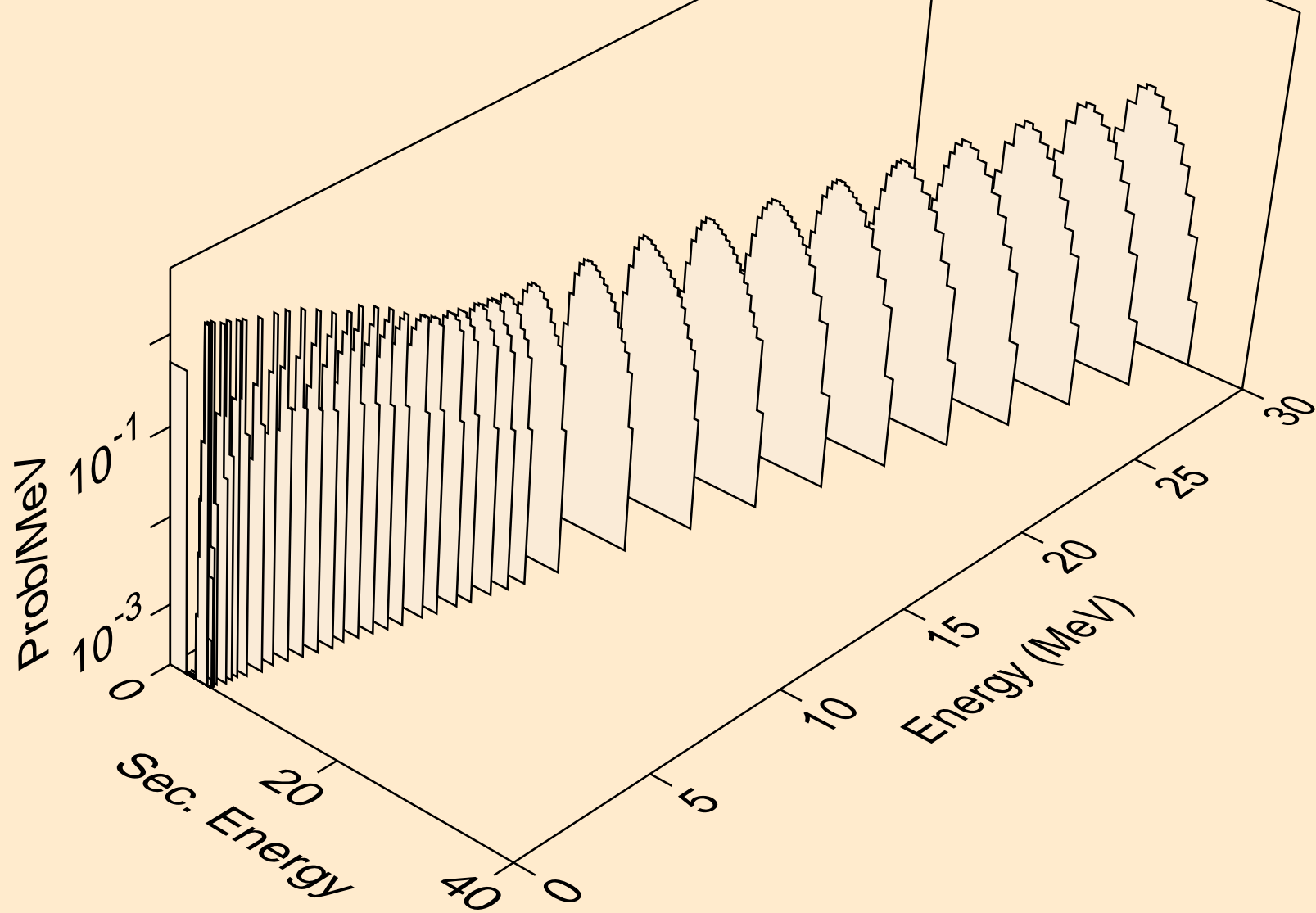

RB079 NEUTRON ACER TENDL-2024 LIBRARY; T=0.K  
alphas from (n,2a)

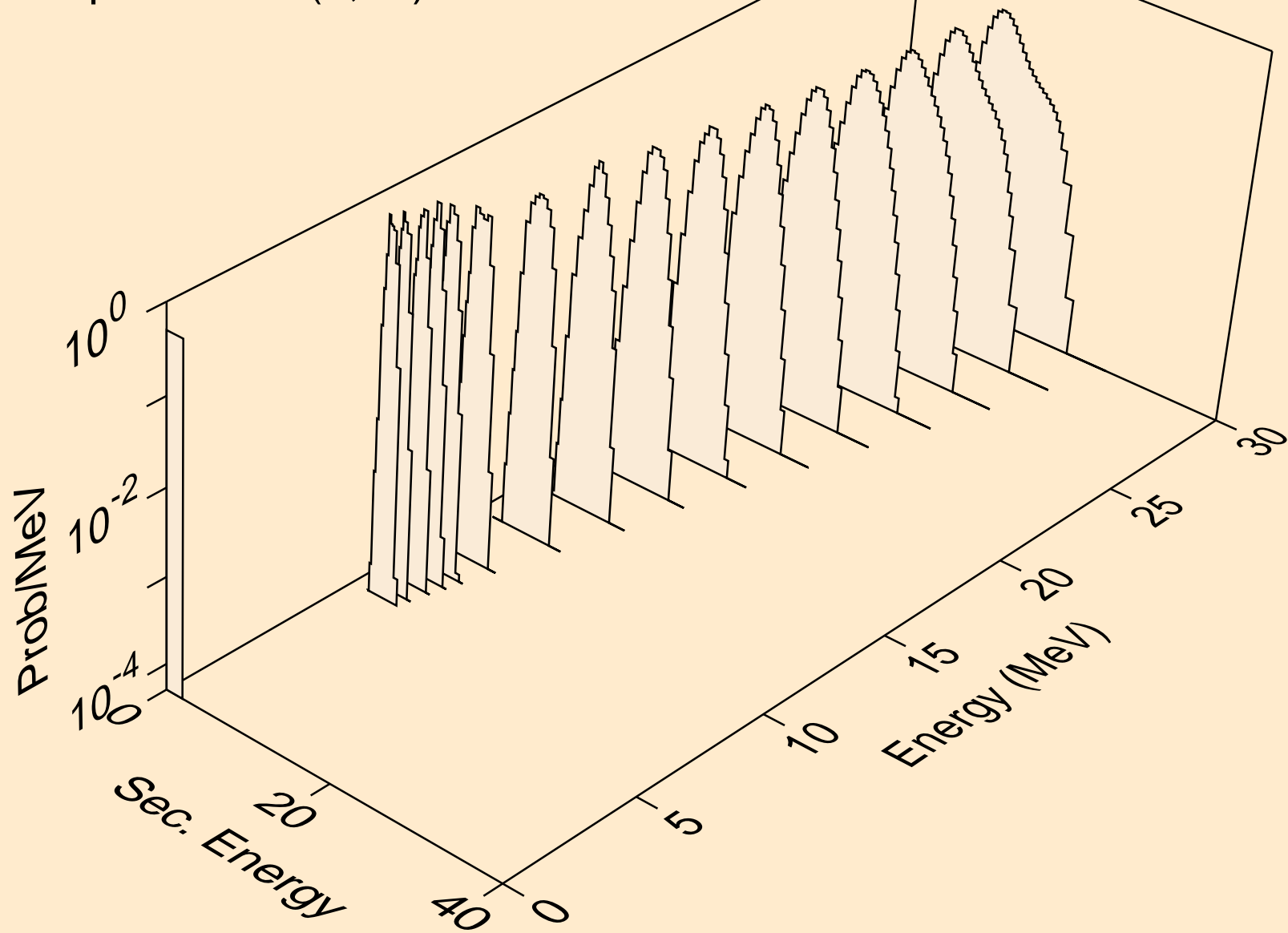

RB079 NEUTRON ACER TENDL-2024 LIBRARY; T=0.K  
alphas from (n,3a)

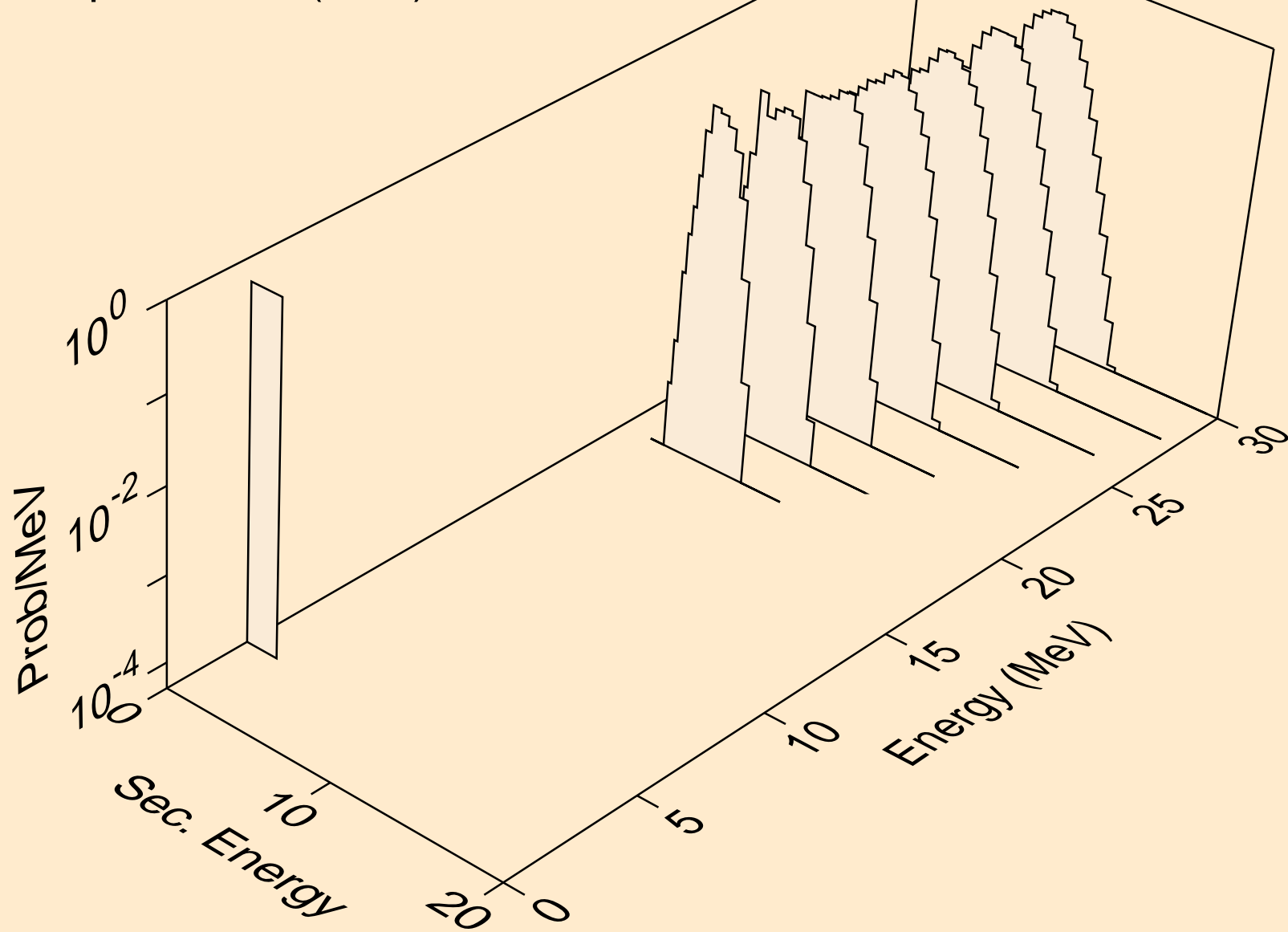

RB079 NEUTRON ACER TENDL-2024 LIBRARY; T=0.K  
alphas from (n,pa)

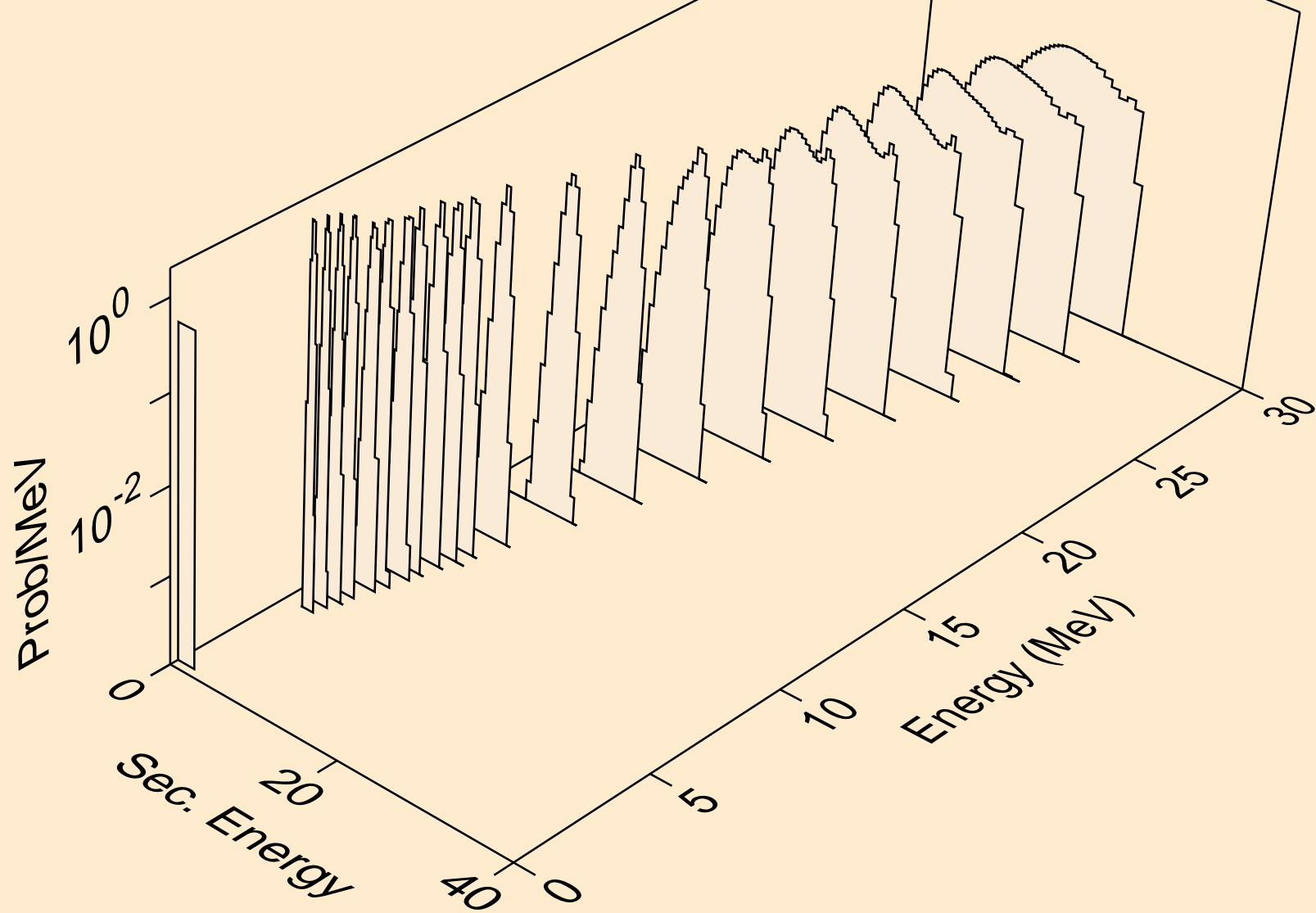

RB079 NEUTRON ACER TENDL-2024 LIBRARY; T=0.K  
alphas from (n,d2a)

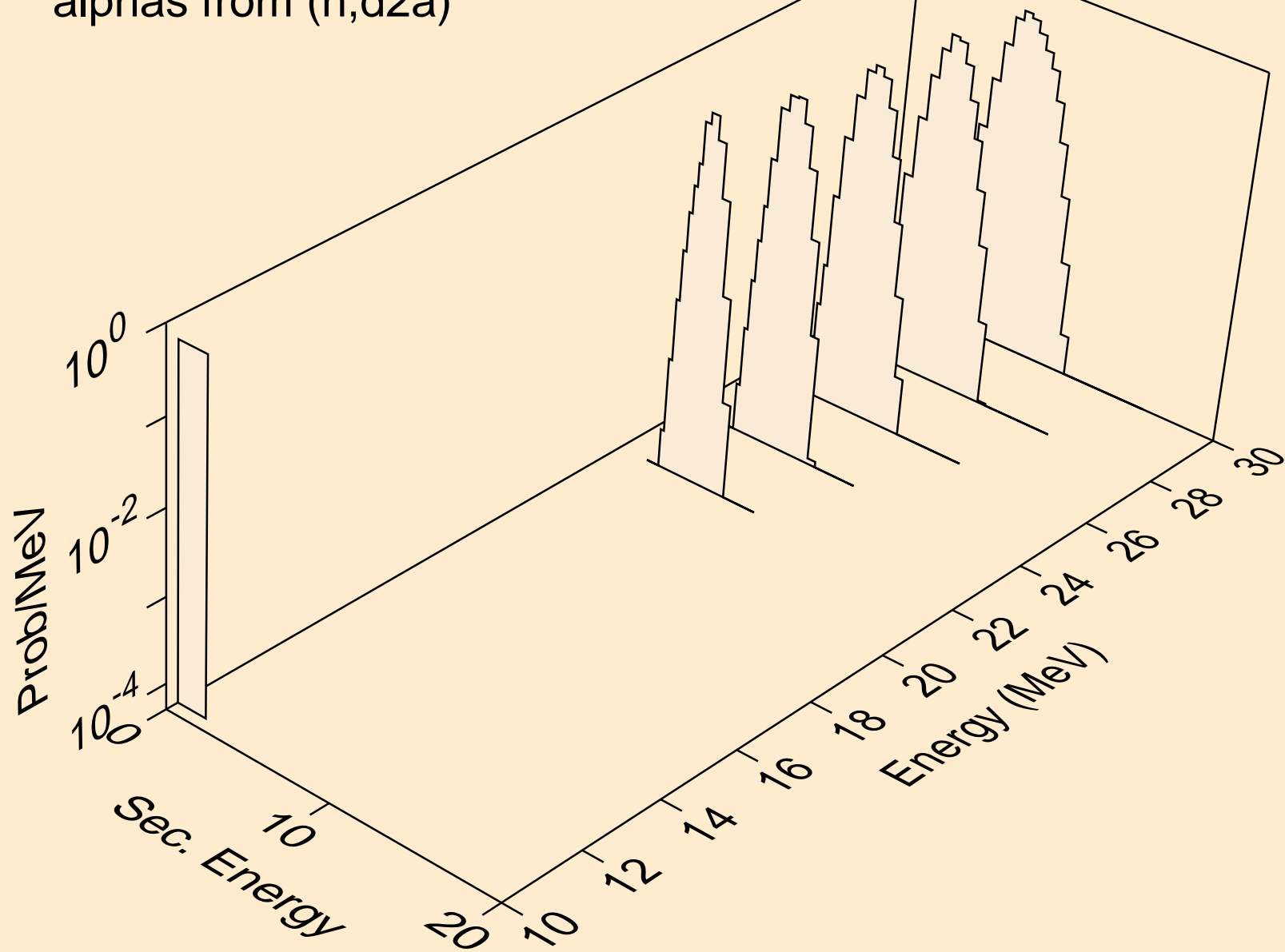

RB079 NEUTRON ACER TENDL-2024 LIBRARY; T=0.K  
alphas from (n,da)

