

# RB083 NEUTRON ACER TENDL-2024 LIBRARY; T=0.K

## Principal cross sections

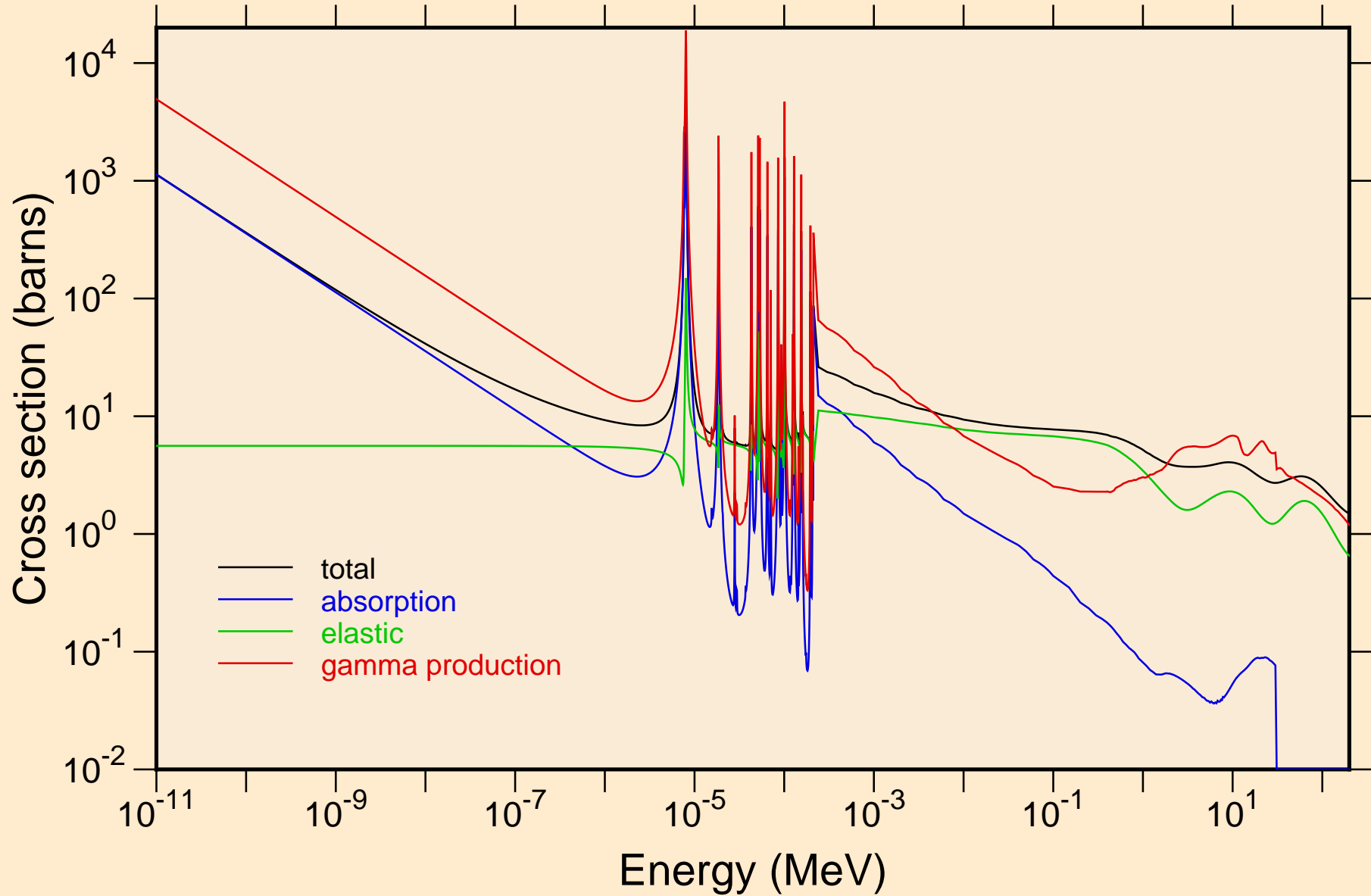

RB083 NEUTRON ACER TENDL-2024 LIBRARY; T=0.K  
resonance total cross section

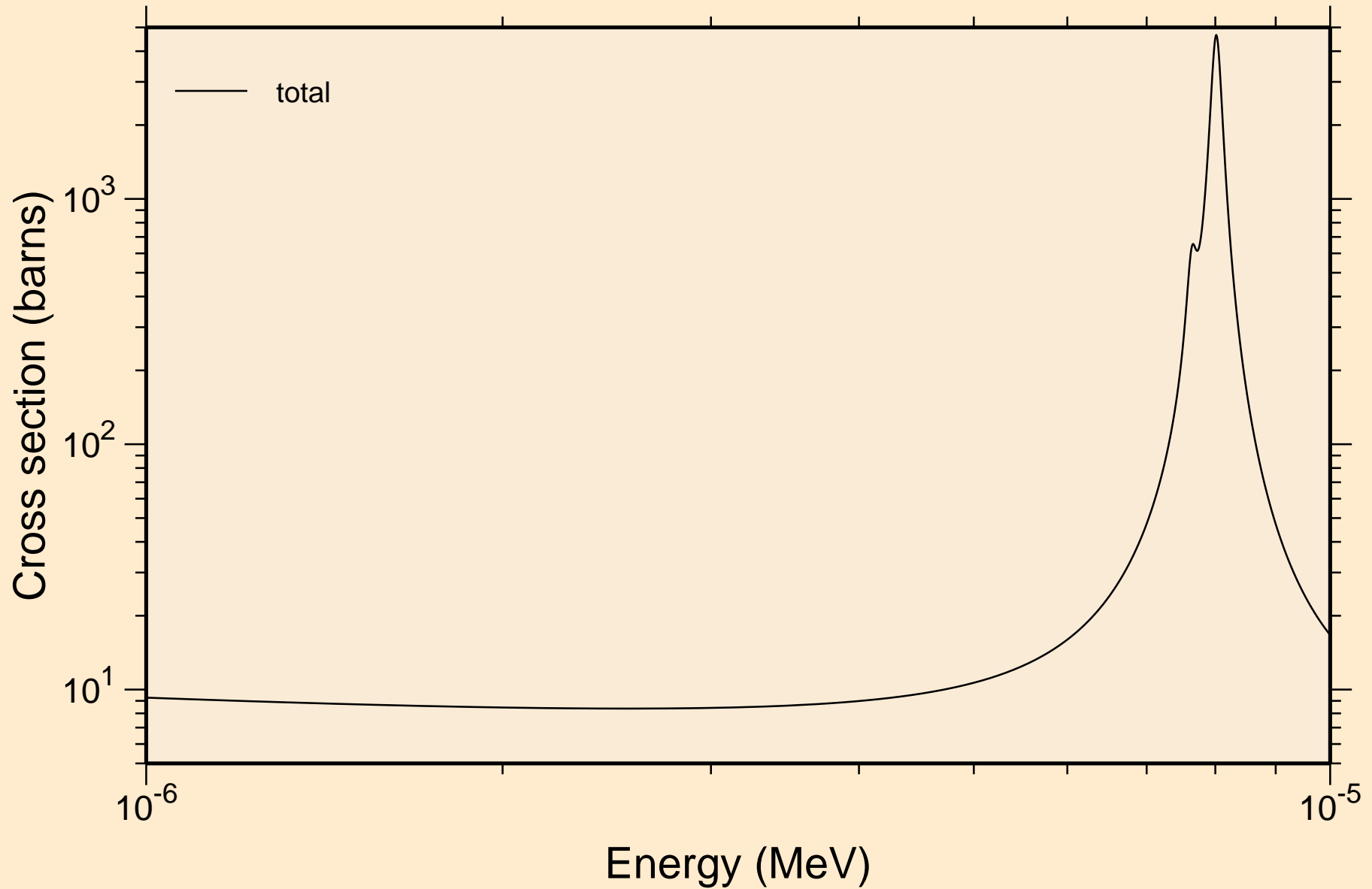

RB083 NEUTRON ACER TENDL-2024 LIBRARY; T=0.K  
resonance total cross section

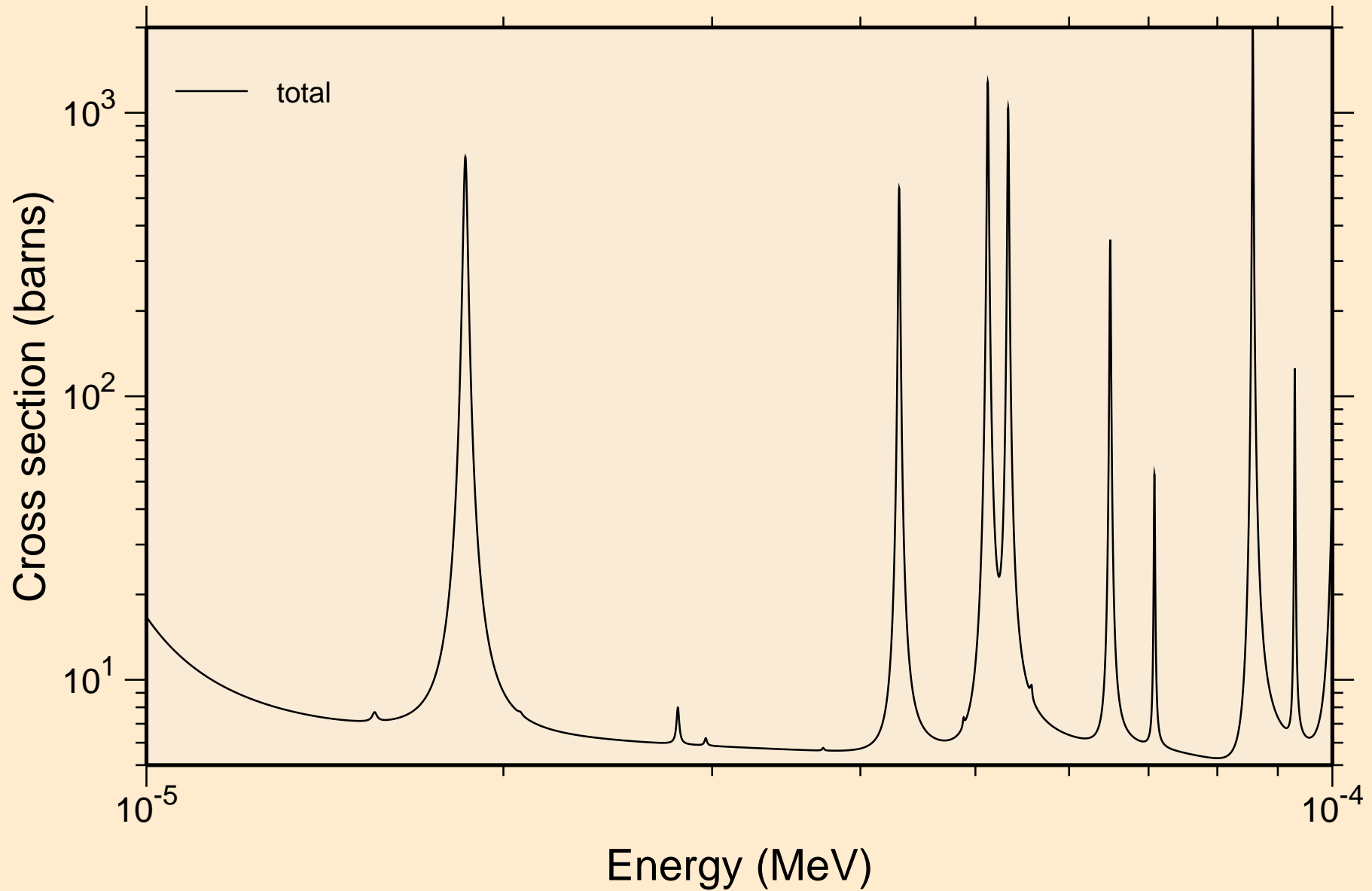

RB083 NEUTRON ACER TENDL-2024 LIBRARY; T=0.K  
resonance total cross section

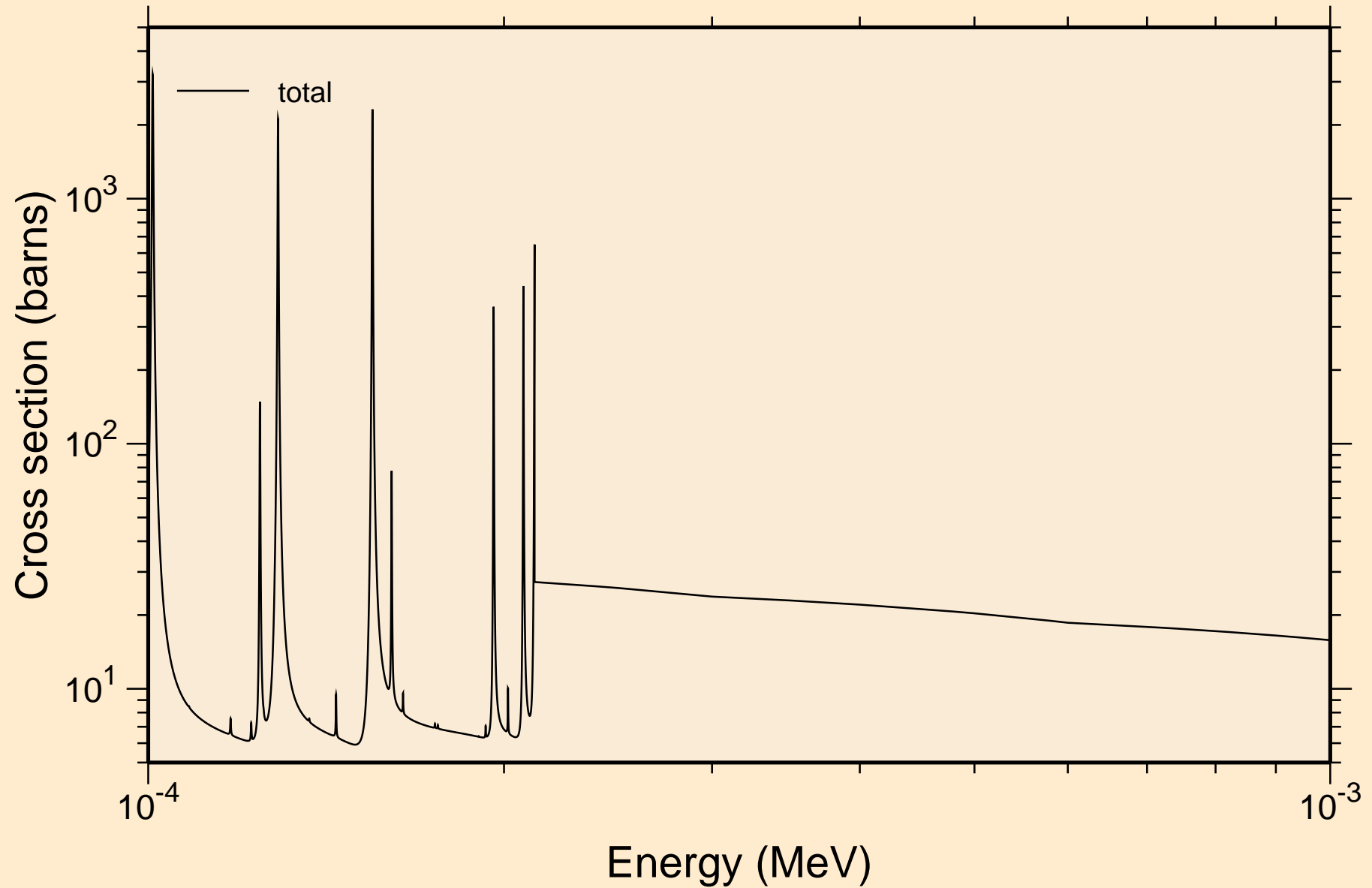

R̄B083 NEUTRON ACER TENDL-2024 LIBRARY; T=0.K  
resonance total cross section

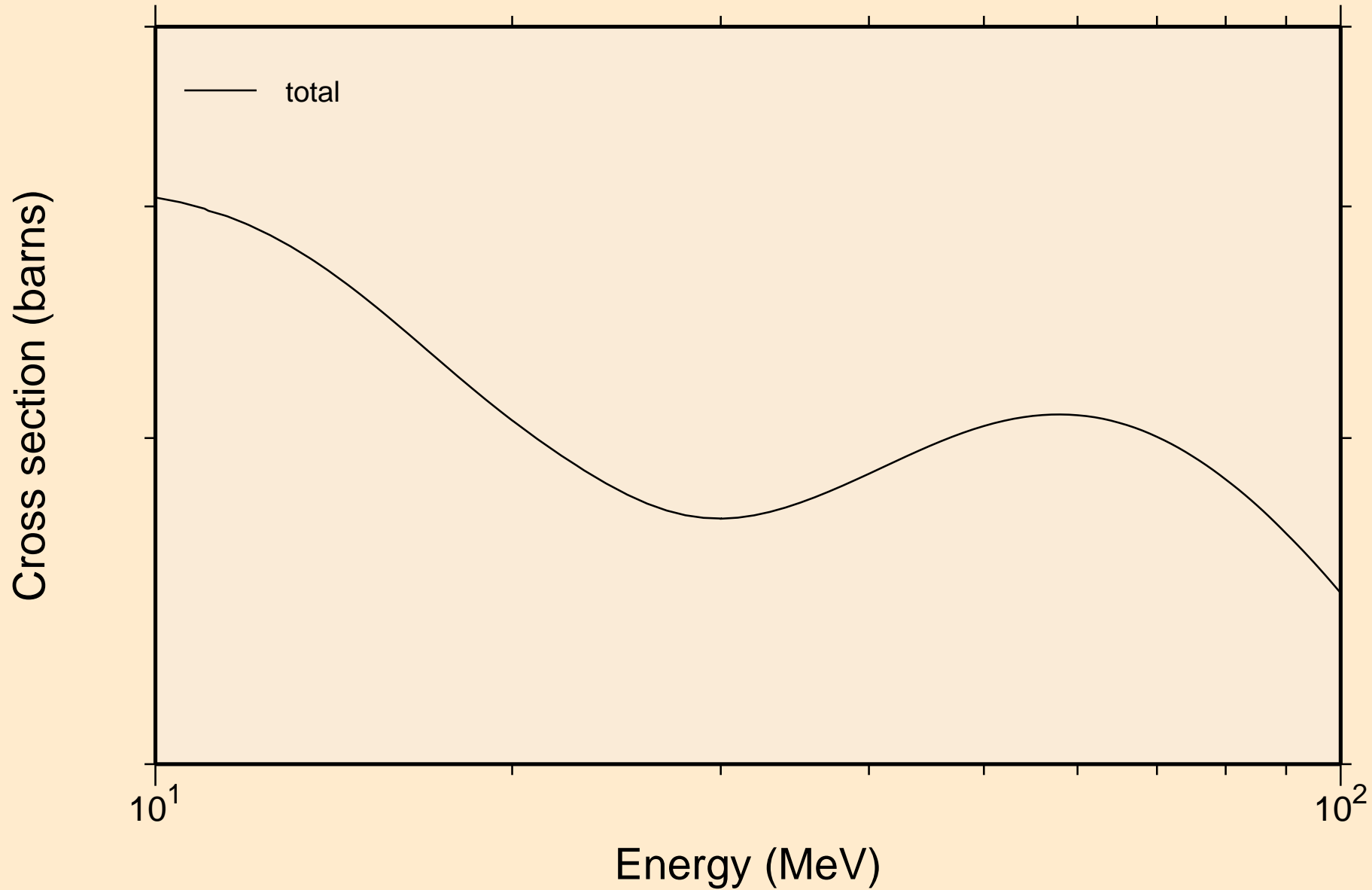

RB083 NEUTRON ACER TENDL-2024 LIBRARY; T=0.K  
resonance absorption cross sections

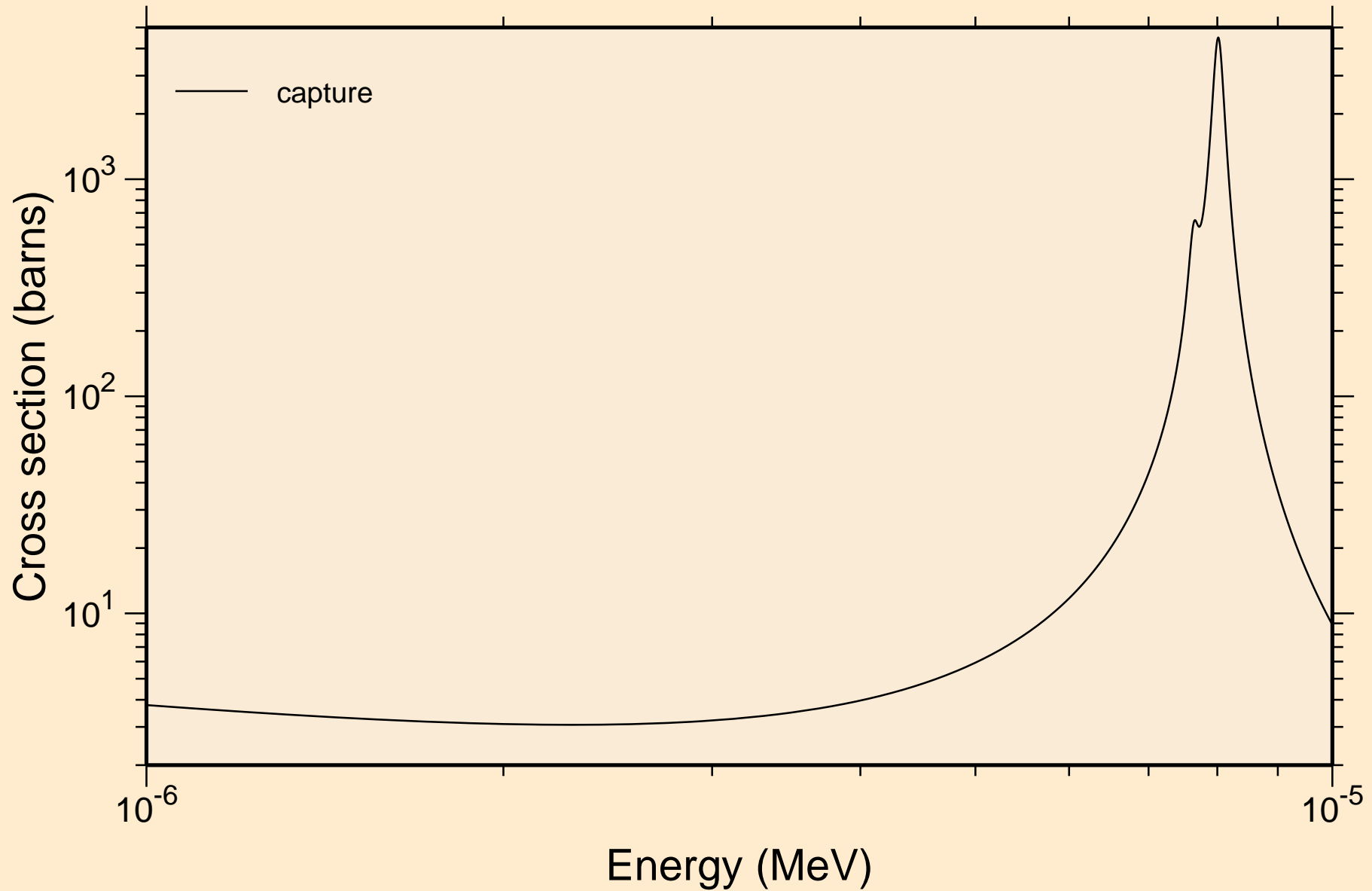

RB083 NEUTRON ACER TENDL-2024 LIBRARY; T=0.K  
resonance absorption cross sections

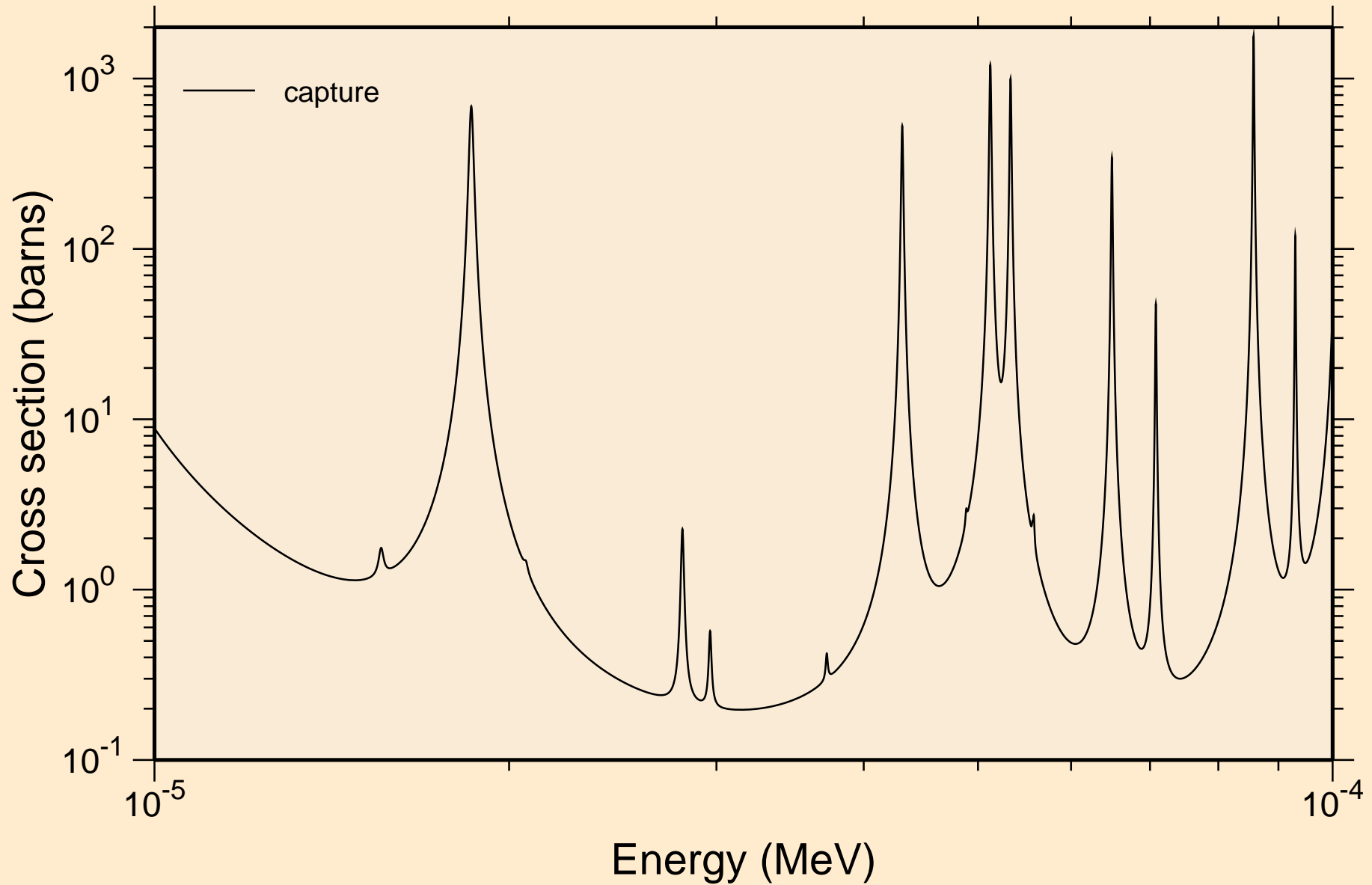

RB083 NEUTRON ACER TENDL-2024 LIBRARY; T=0.K  
resonance absorption cross sections

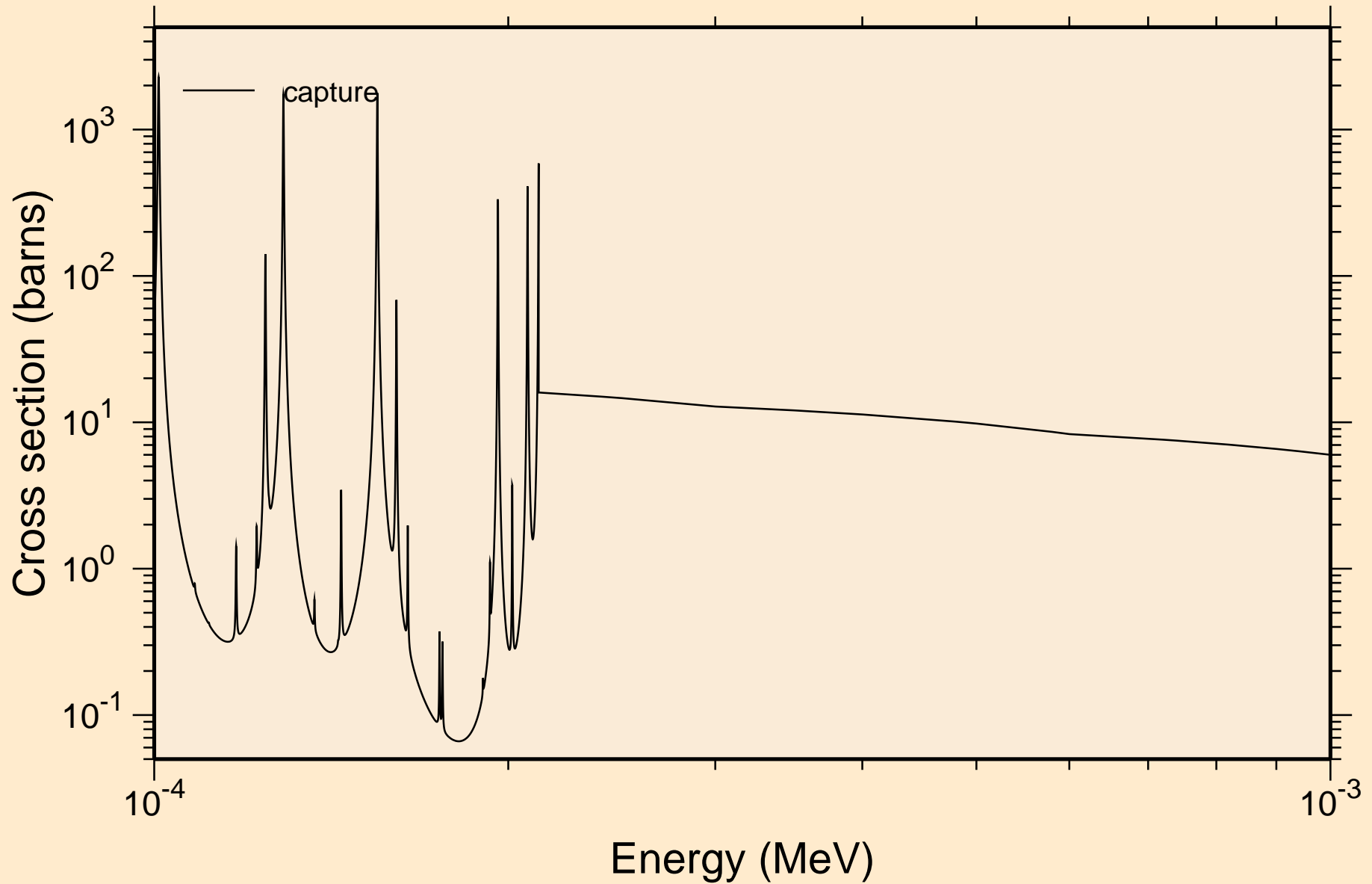



RB083 NEUTRON ACER TENDL-2024 LIBRARY; T=0.K  
resonance absorption cross sections

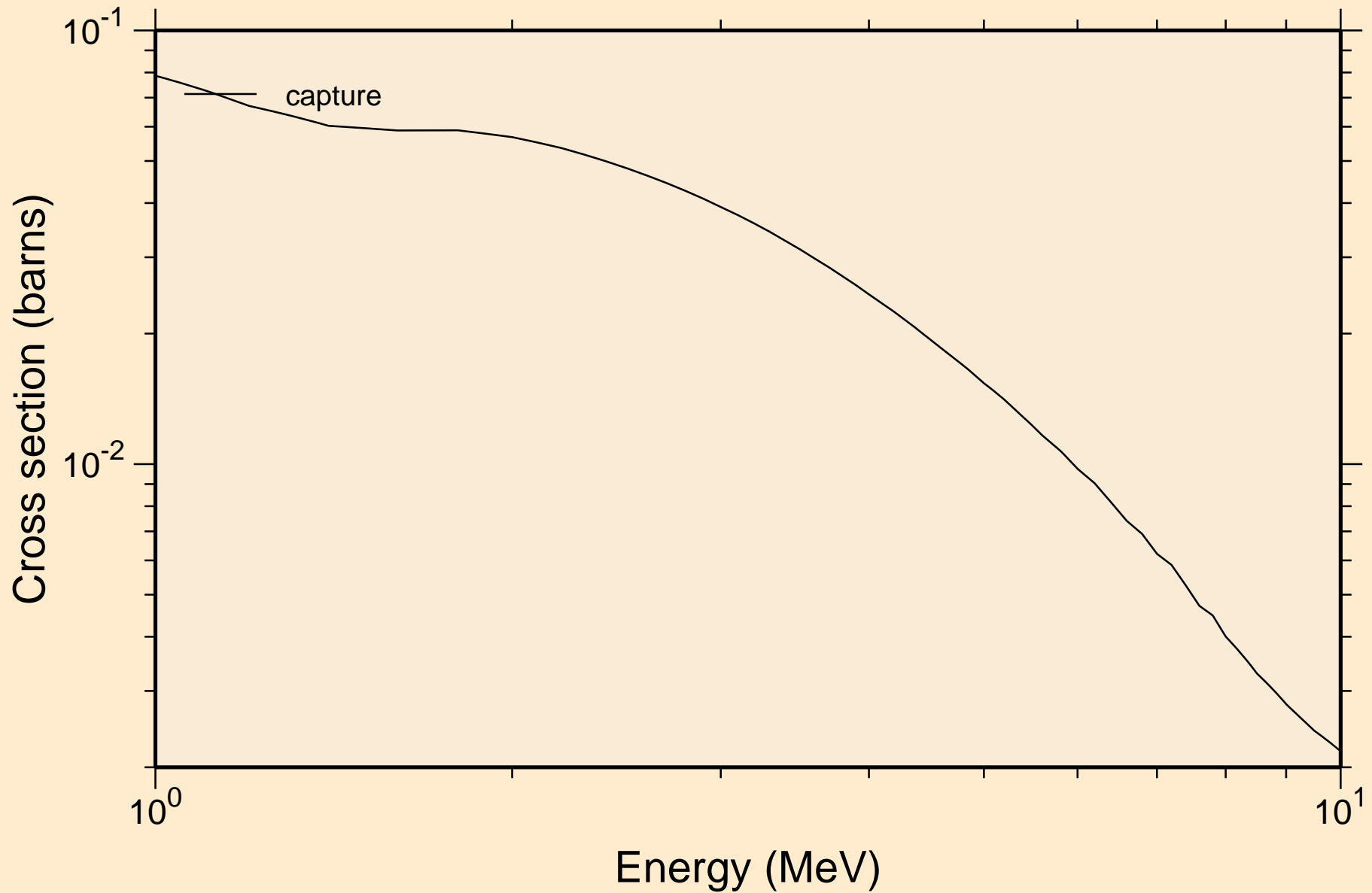

RB083 NEUTRON ACER TENDL-2024 LIBRARY; T=0.K  
Heating

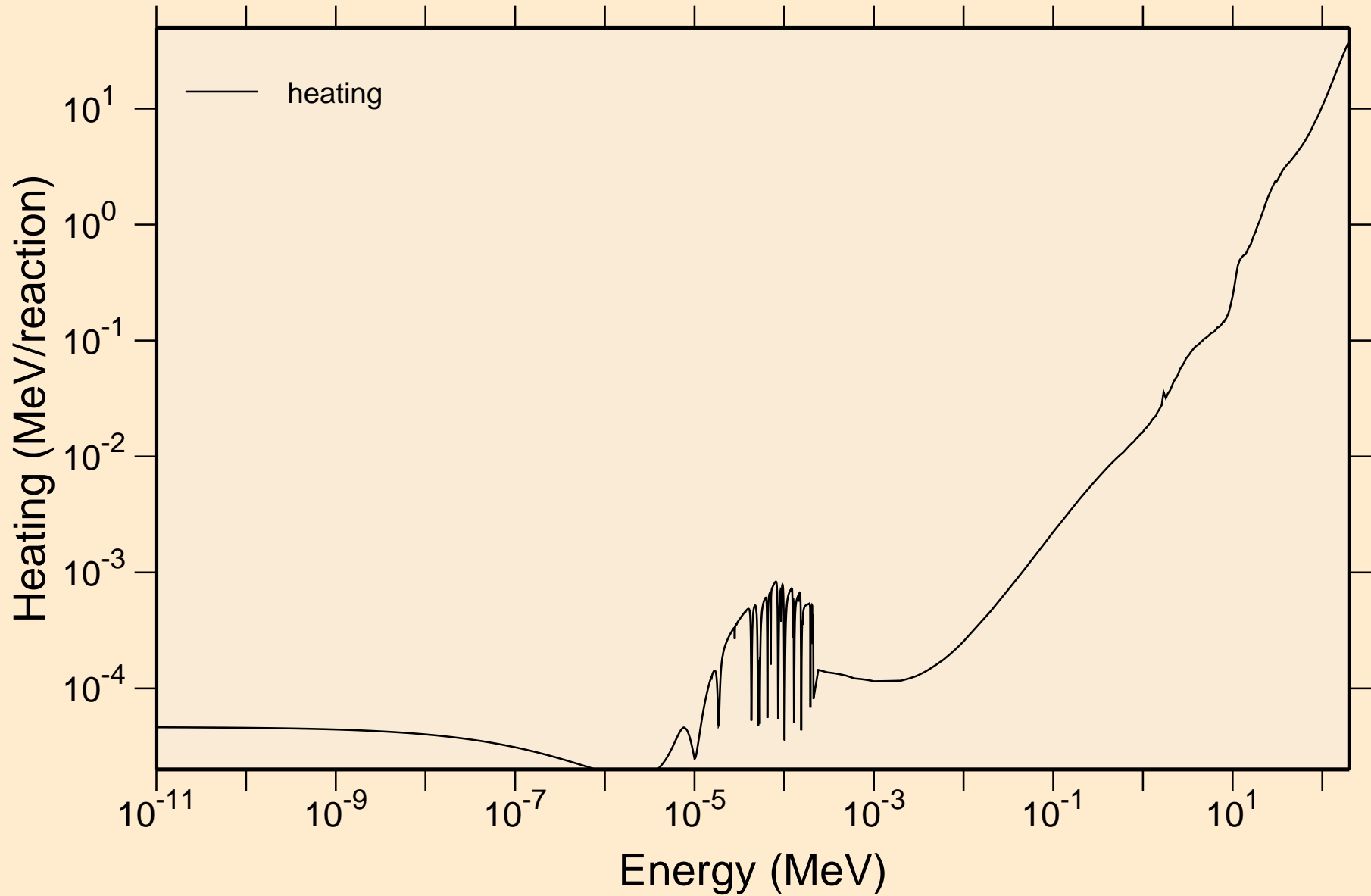

RB083 NEUTRON ACER TENDL-2024 LIBRARY; T=0.K  
Damage

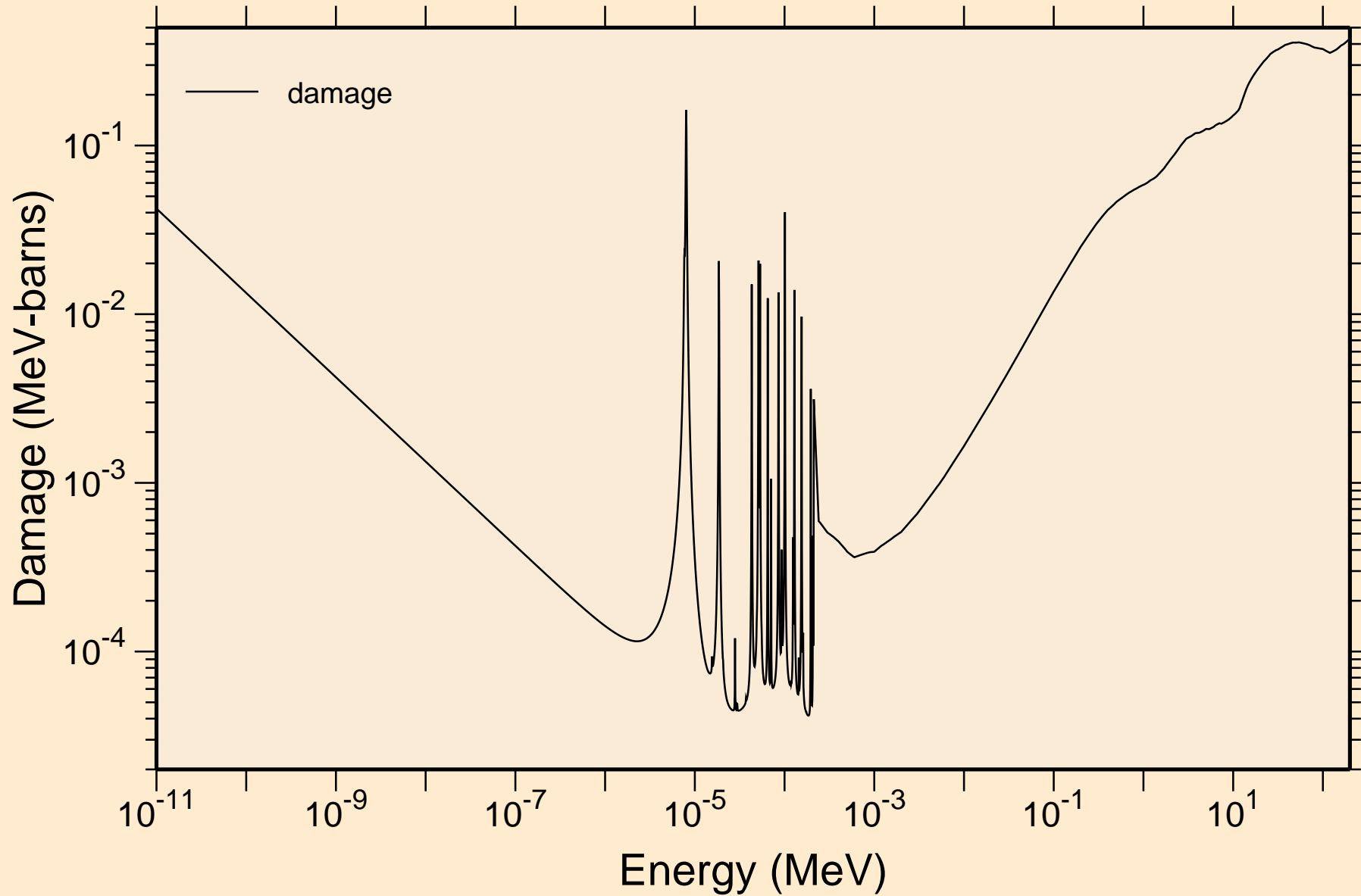

RB083 NEUTRON ACER TENDL-2024 LIBRARY; T=0.K  
Non-threshold reactions

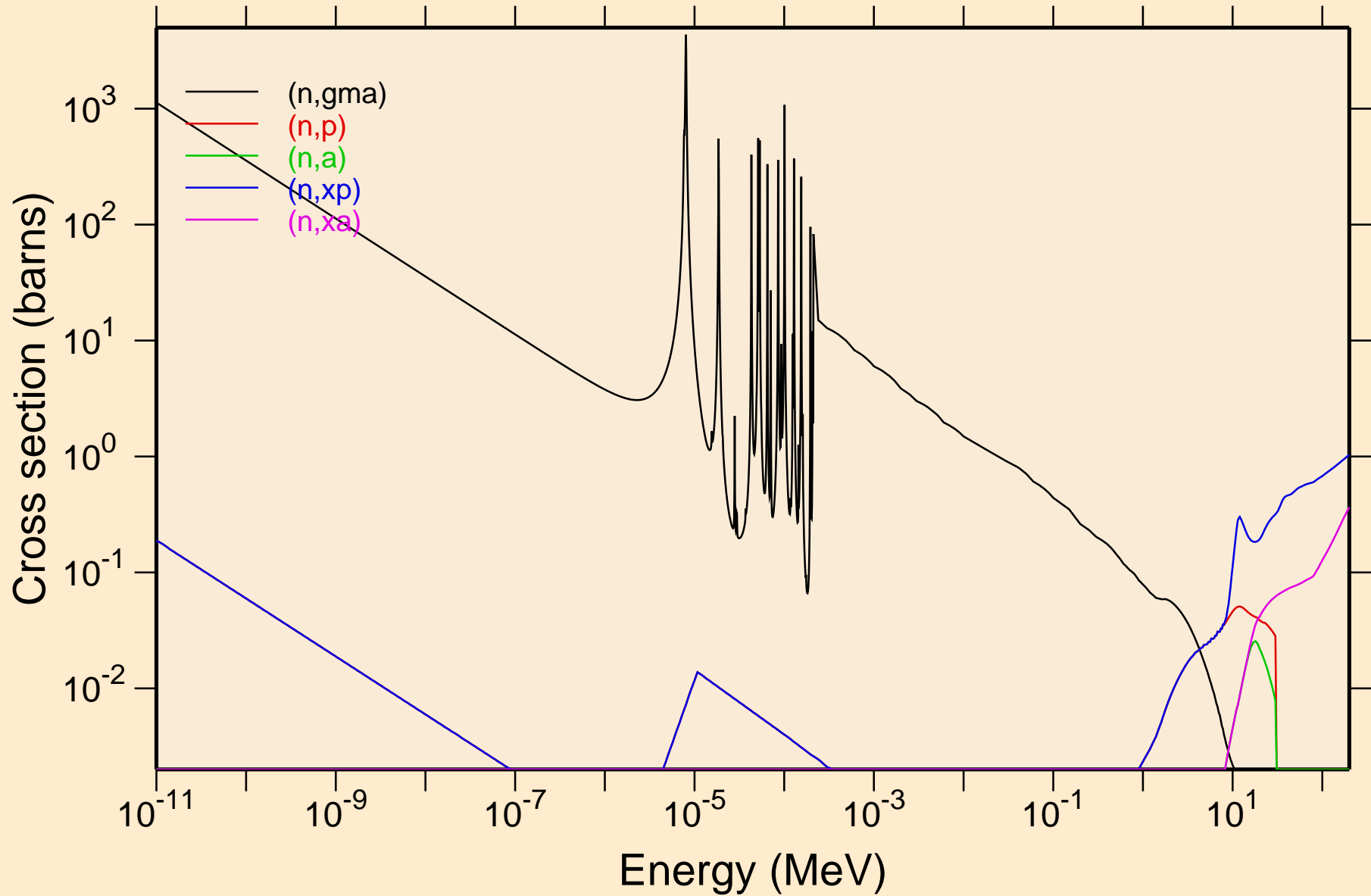

# RB083 NEUTRON ACER TENDL-2024 LIBRARY; T=0.K

## Principal cross sections

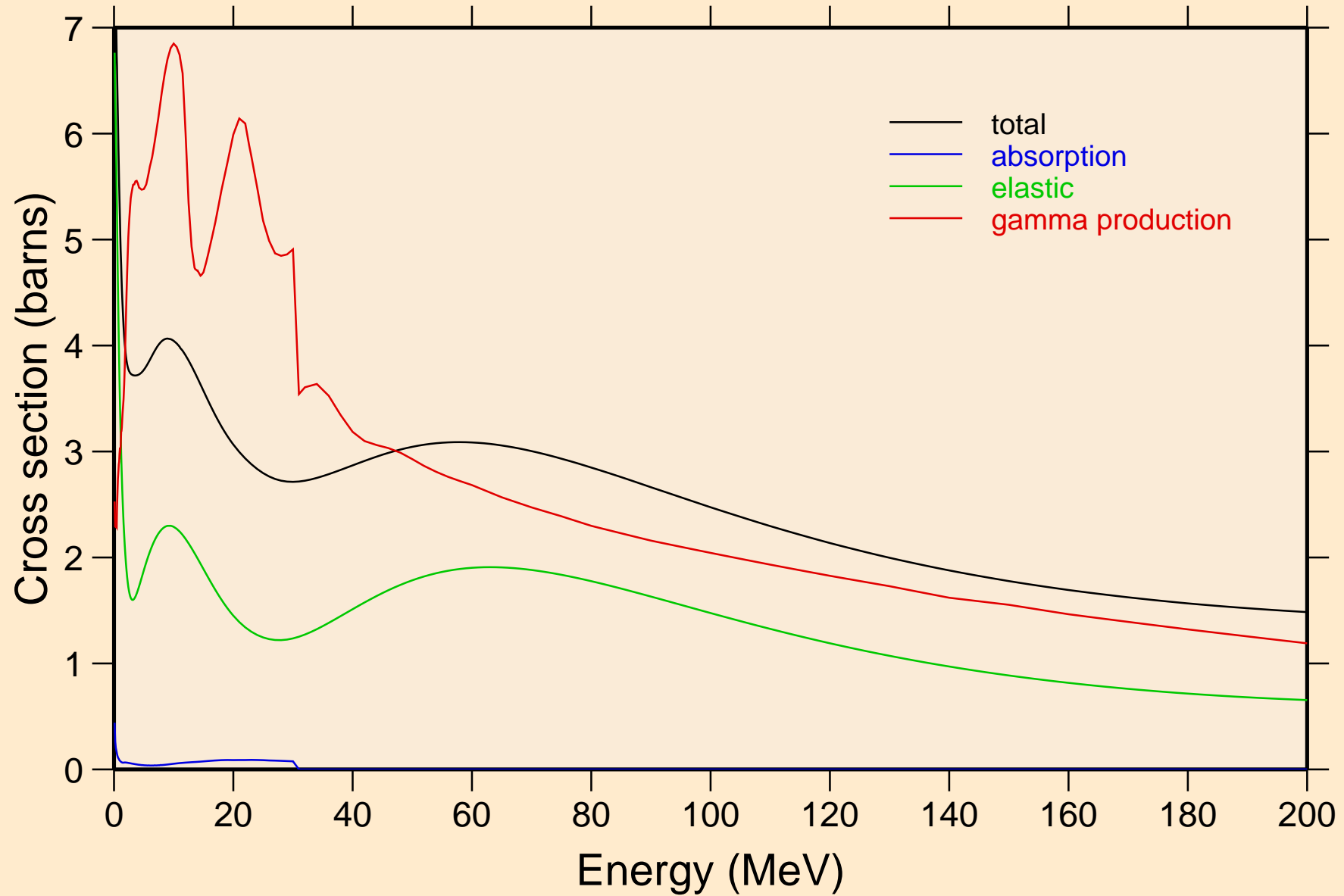

# RB083 NEUTRON ACER TENDL-2024 LIBRARY; T=0.K

## Heating

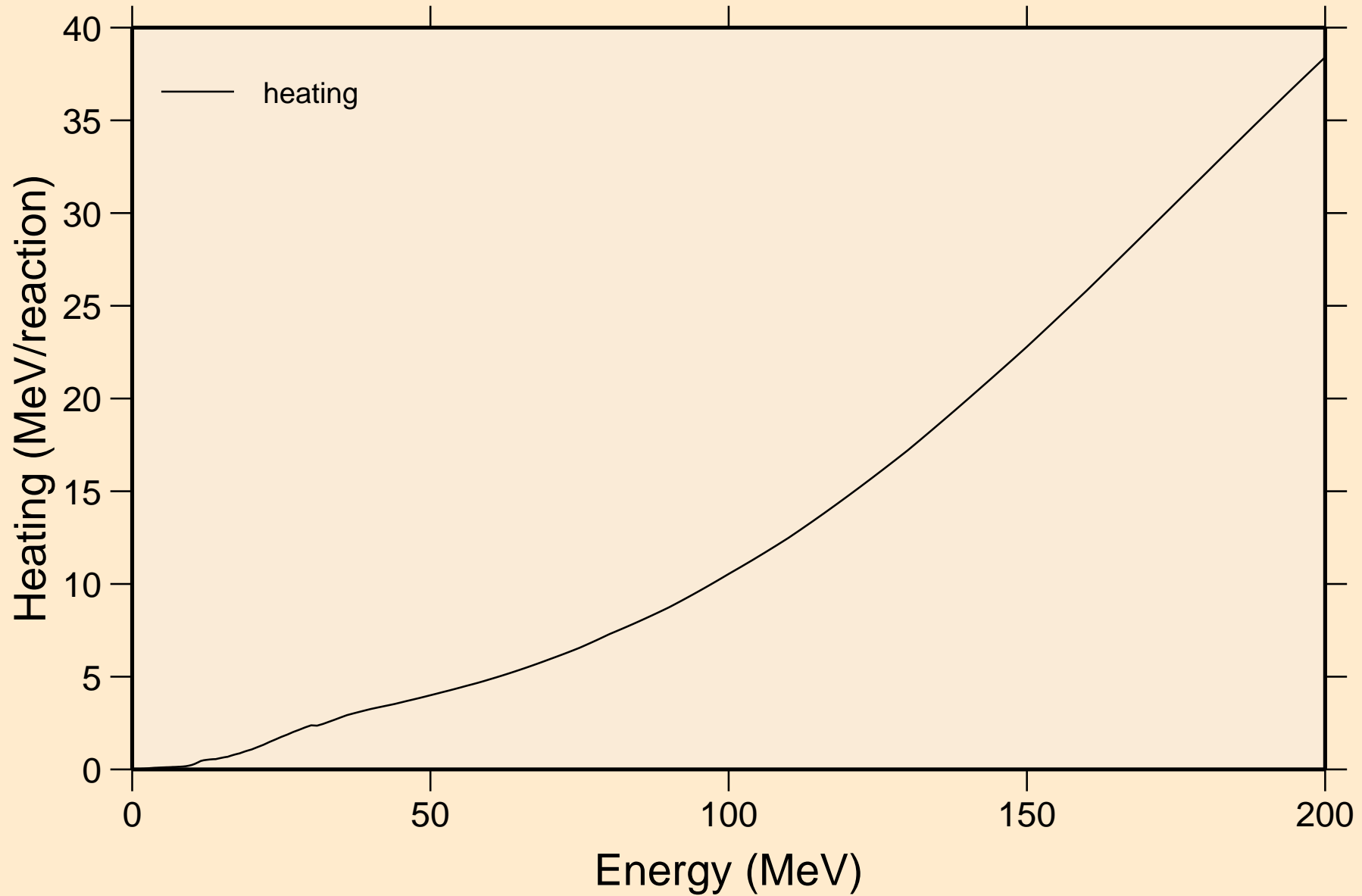

RB083 NEUTRON ACER TENDL-2024 LIBRARY; T=0.K  
Damage

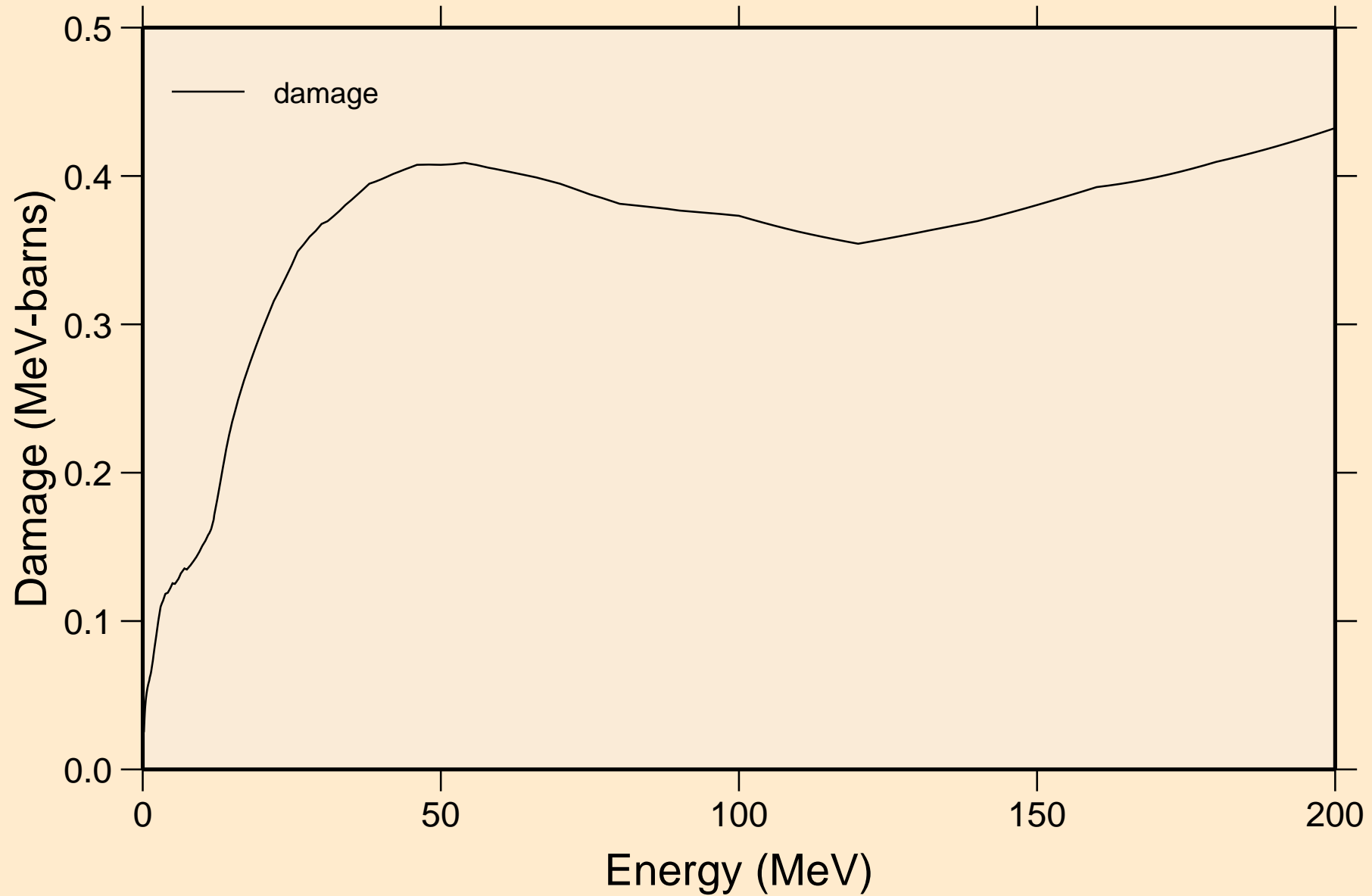

RB083 NEUTRON ACER TENDL-2024 LIBRARY; T=0.K  
Non-threshold reactions

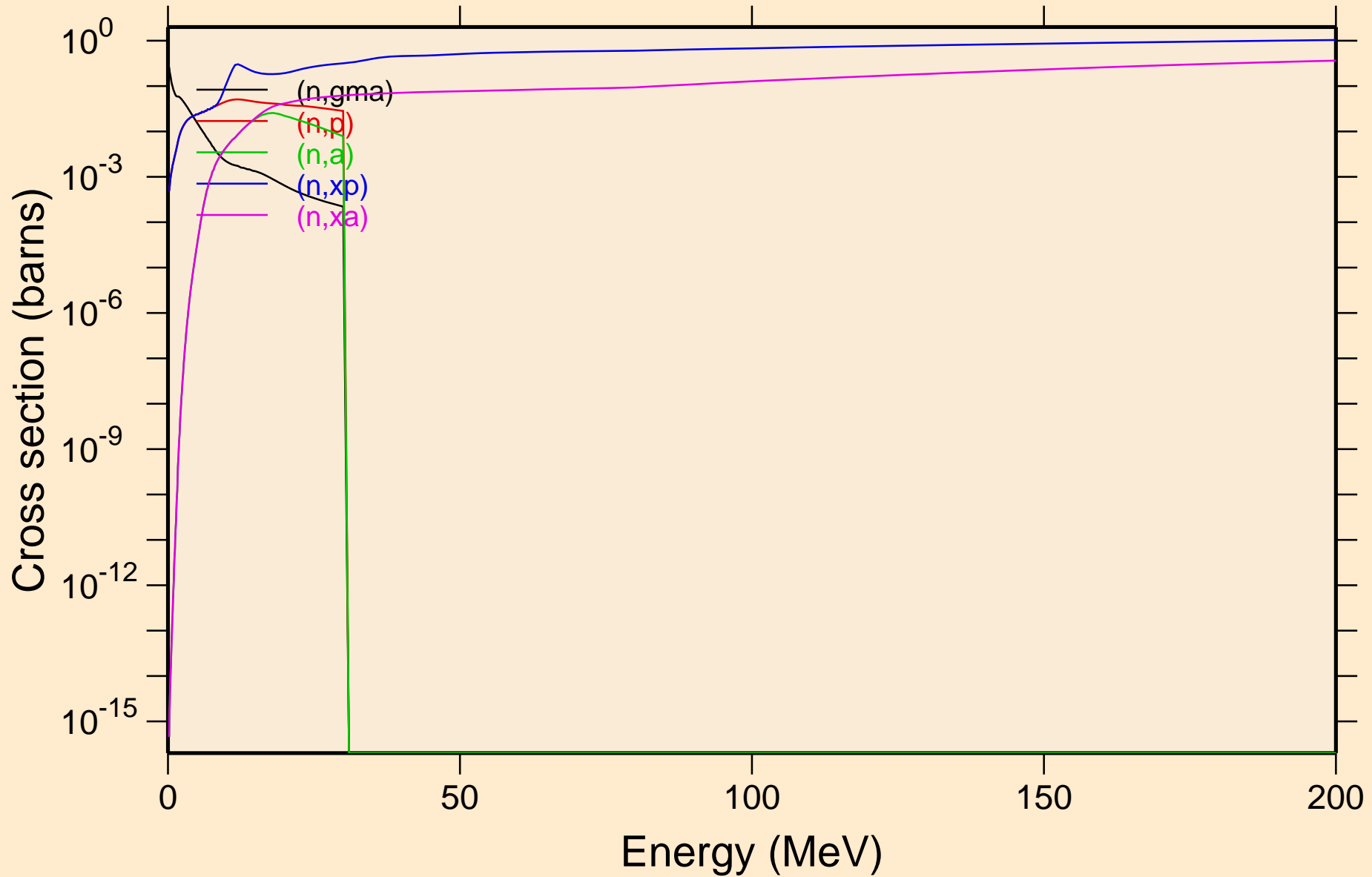



RB083 NEUTRON ACER TENDL-2024 LIBRARY; T=0.K  
Inelastic levels

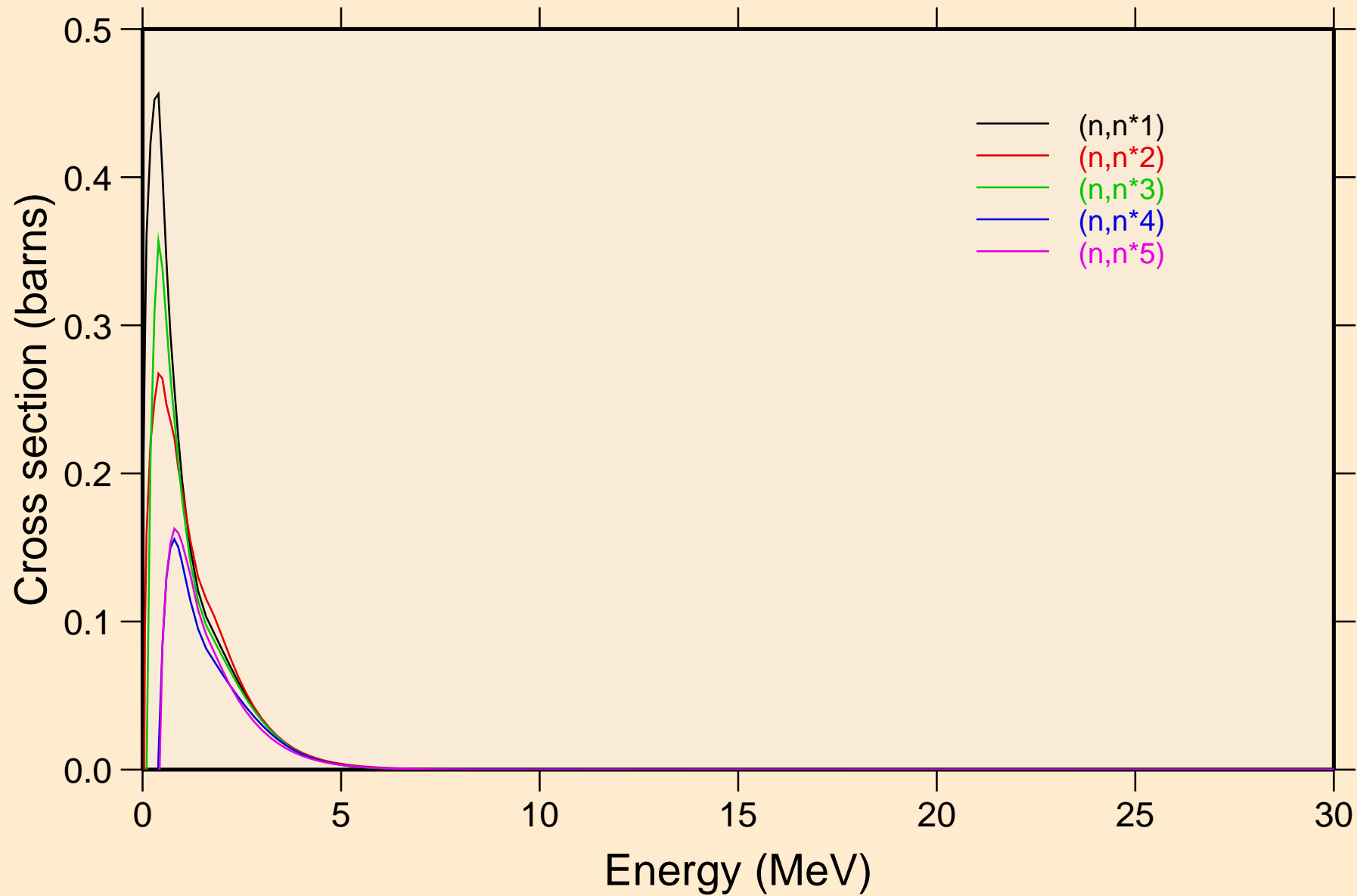

RB083 NEUTRON ACER TENDL-2024 LIBRARY; T=0.K  
Inelastic levels

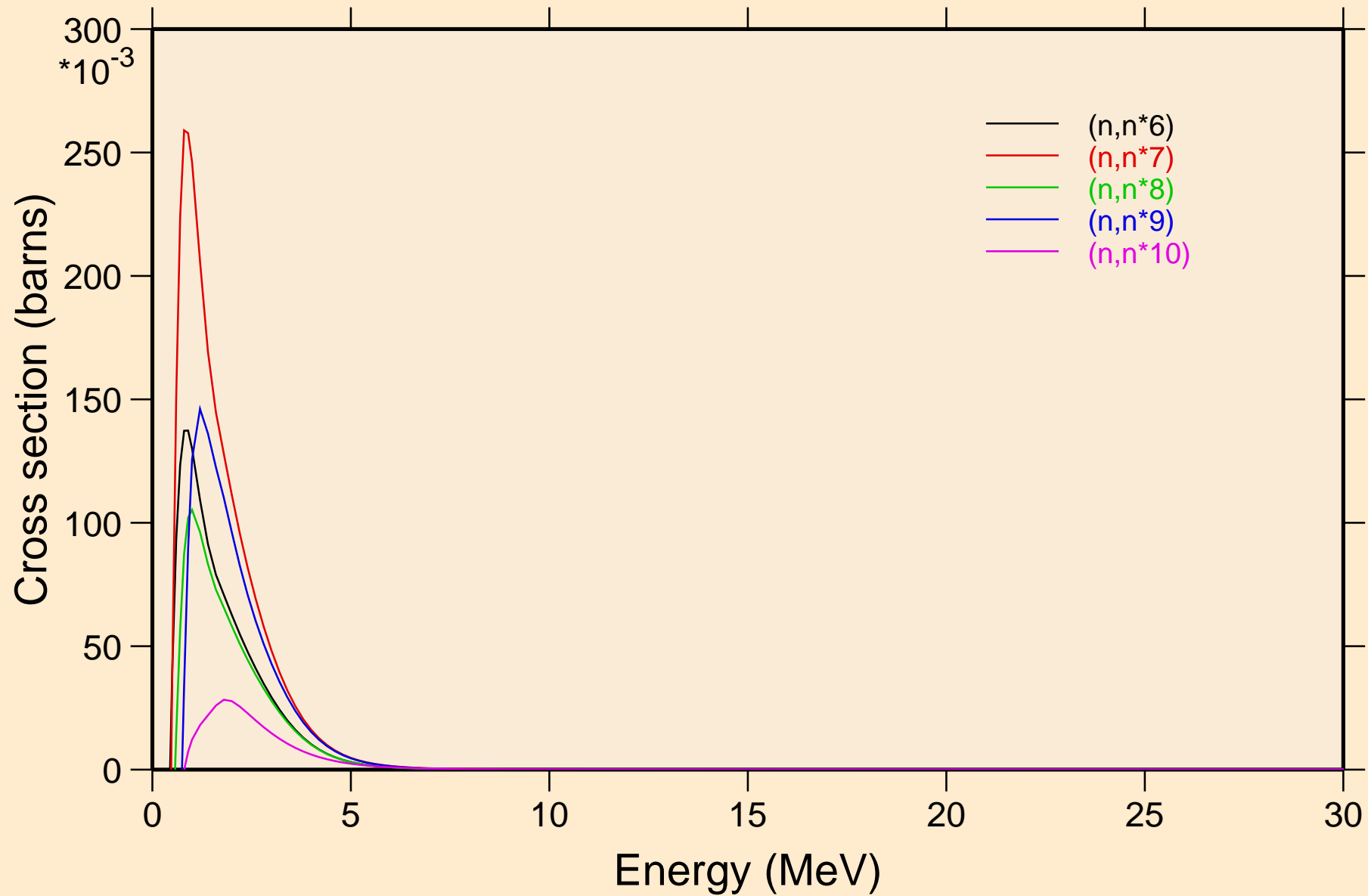

RB083 NEUTRON ACER TENDL-2024 LIBRARY; T=0.K  
Inelastic levels

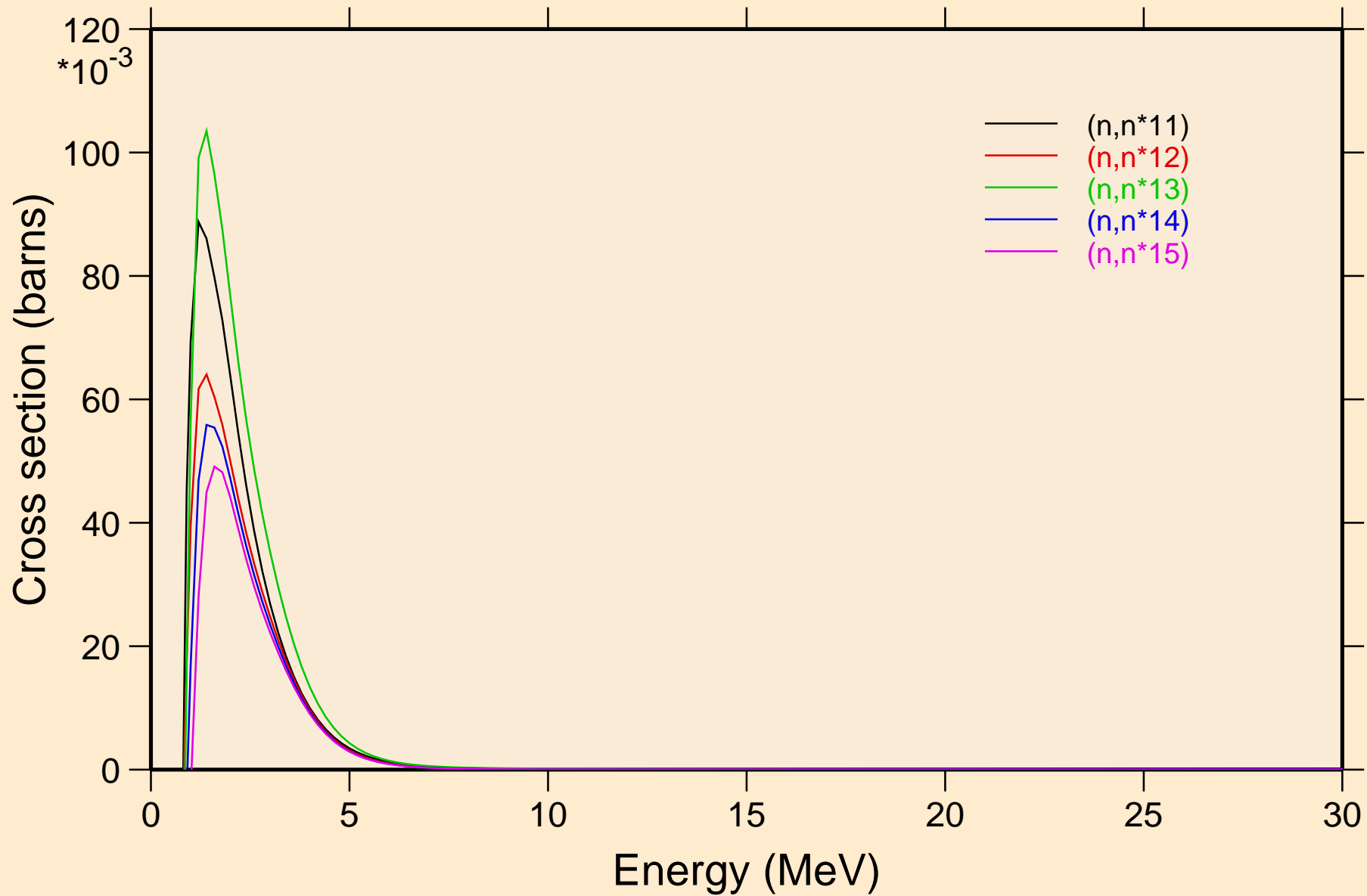

RB083 NEUTRON ACER TENDL-2024 LIBRARY; T=0.K  
Inelastic levels

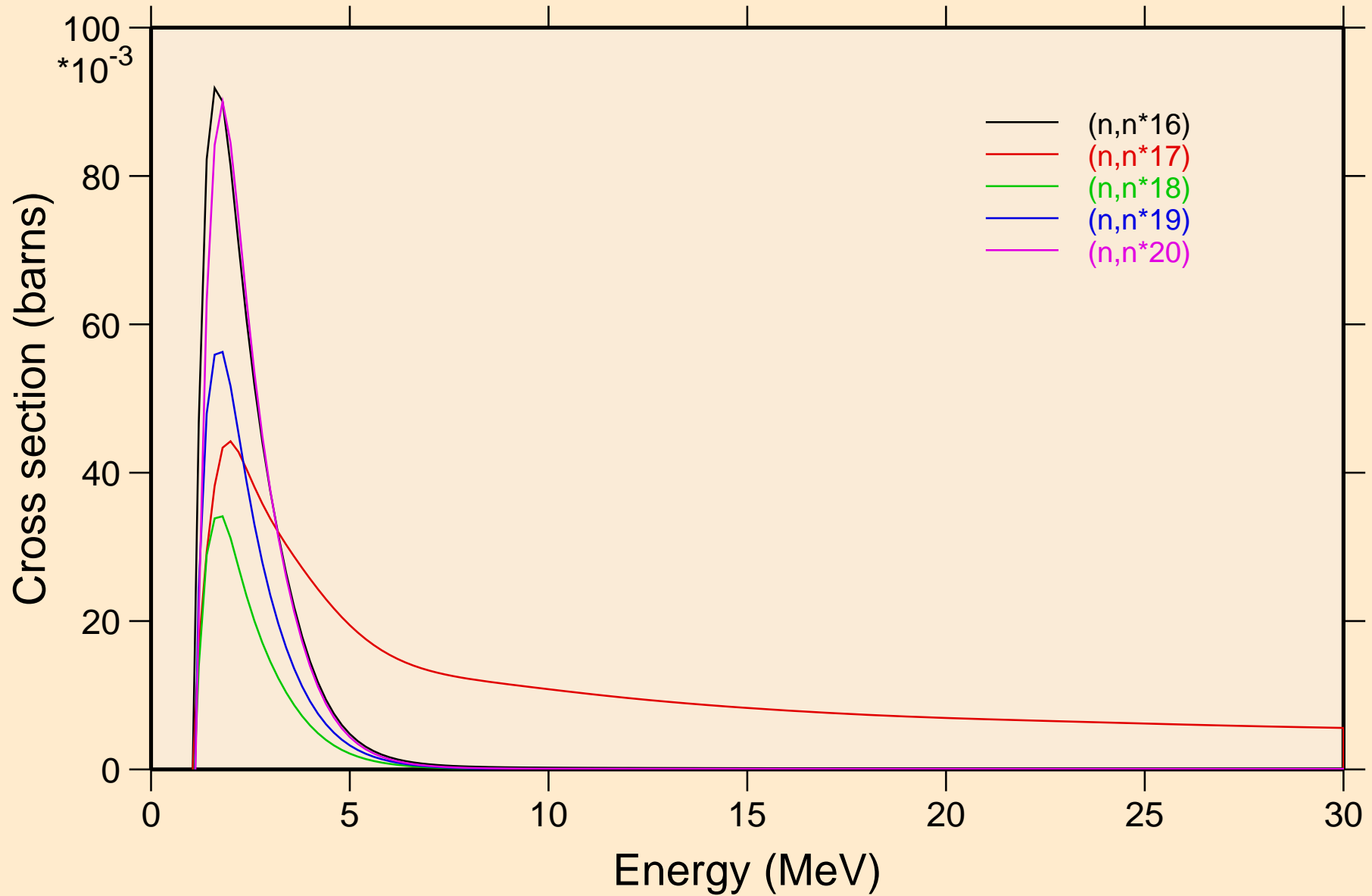

RB083 NEUTRON ACER TENDL-2024 LIBRARY; T=0.K  
Inelastic levels

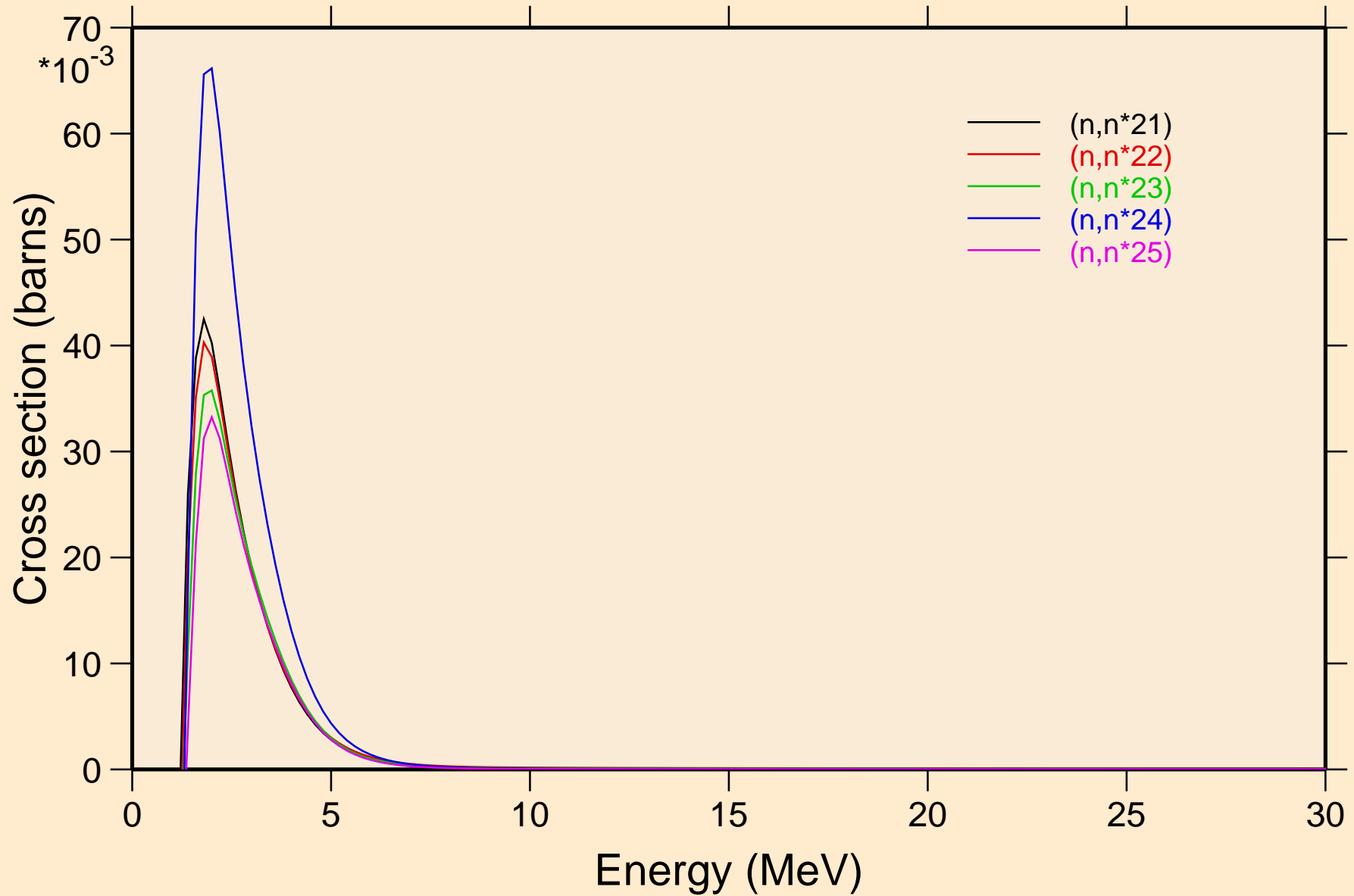

RB083 NEUTRON ACER TENDL-2024 LIBRARY; T=0.K  
Inelastic levels

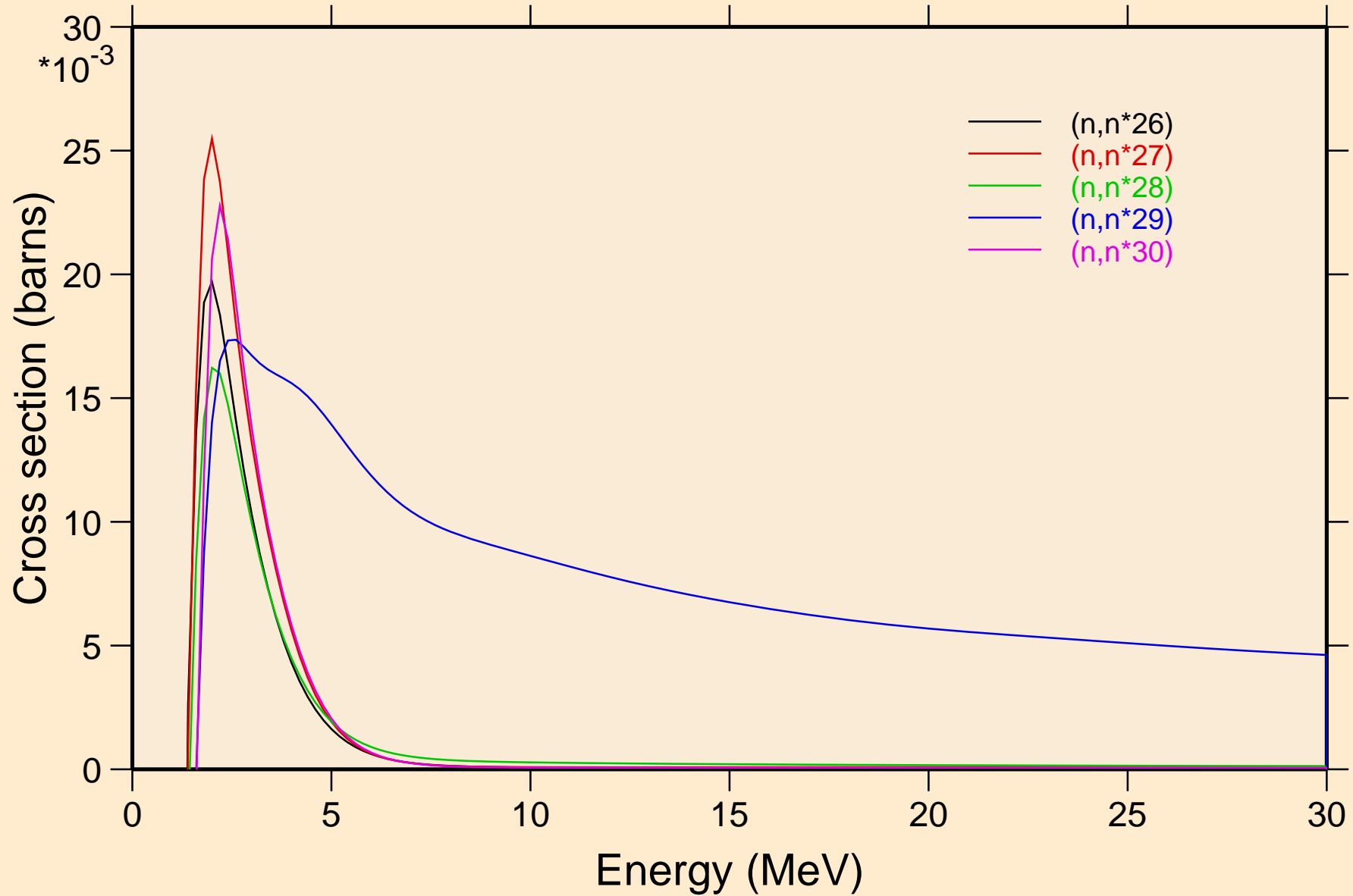

RB083 NEUTRON ACER TENDL-2024 LIBRARY; T=0.K  
Threshold reactions

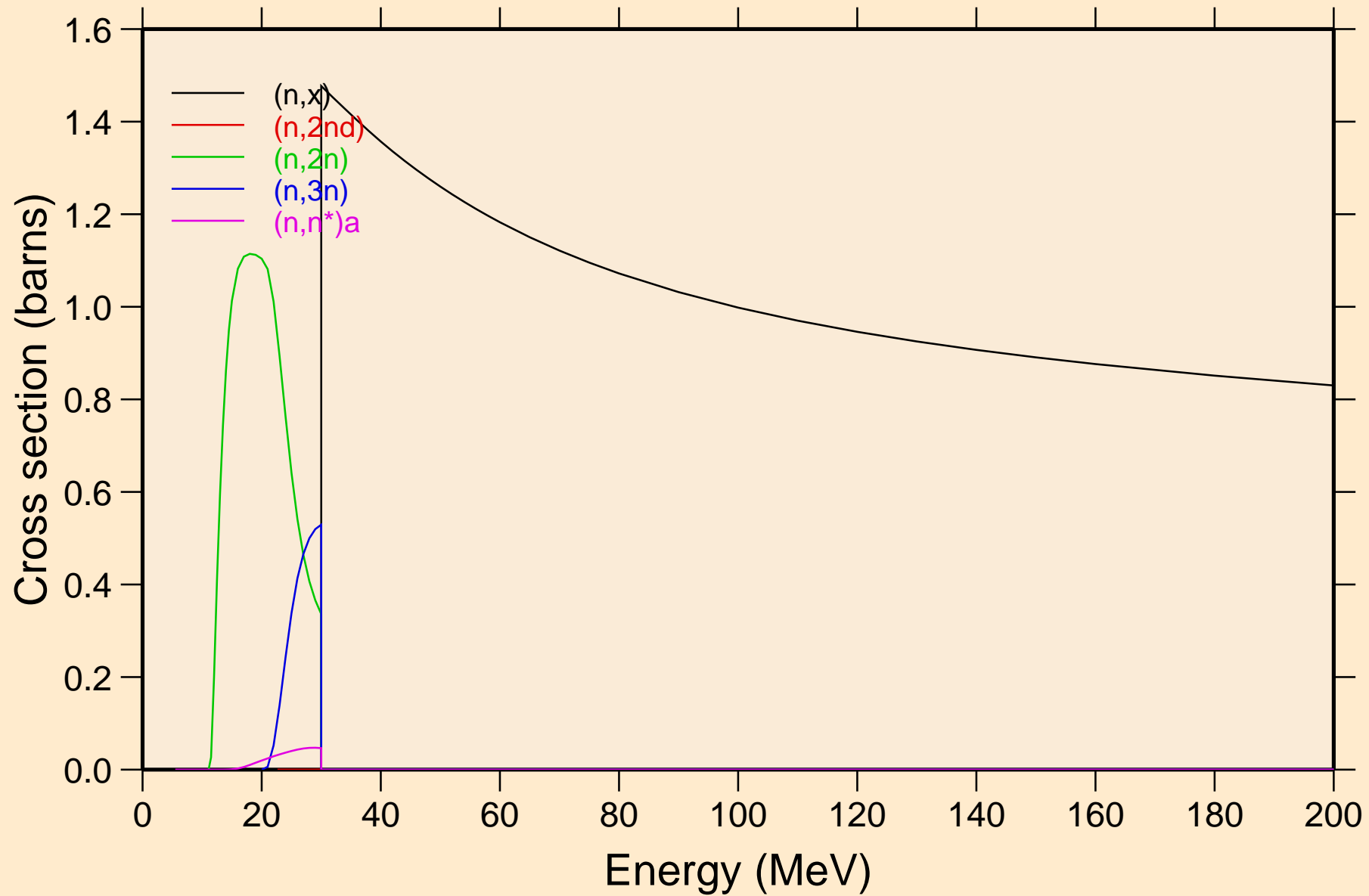

# RB083 NEUTRON ACER TENDL-2024 LIBRARY; T=0.K

## Threshold reactions

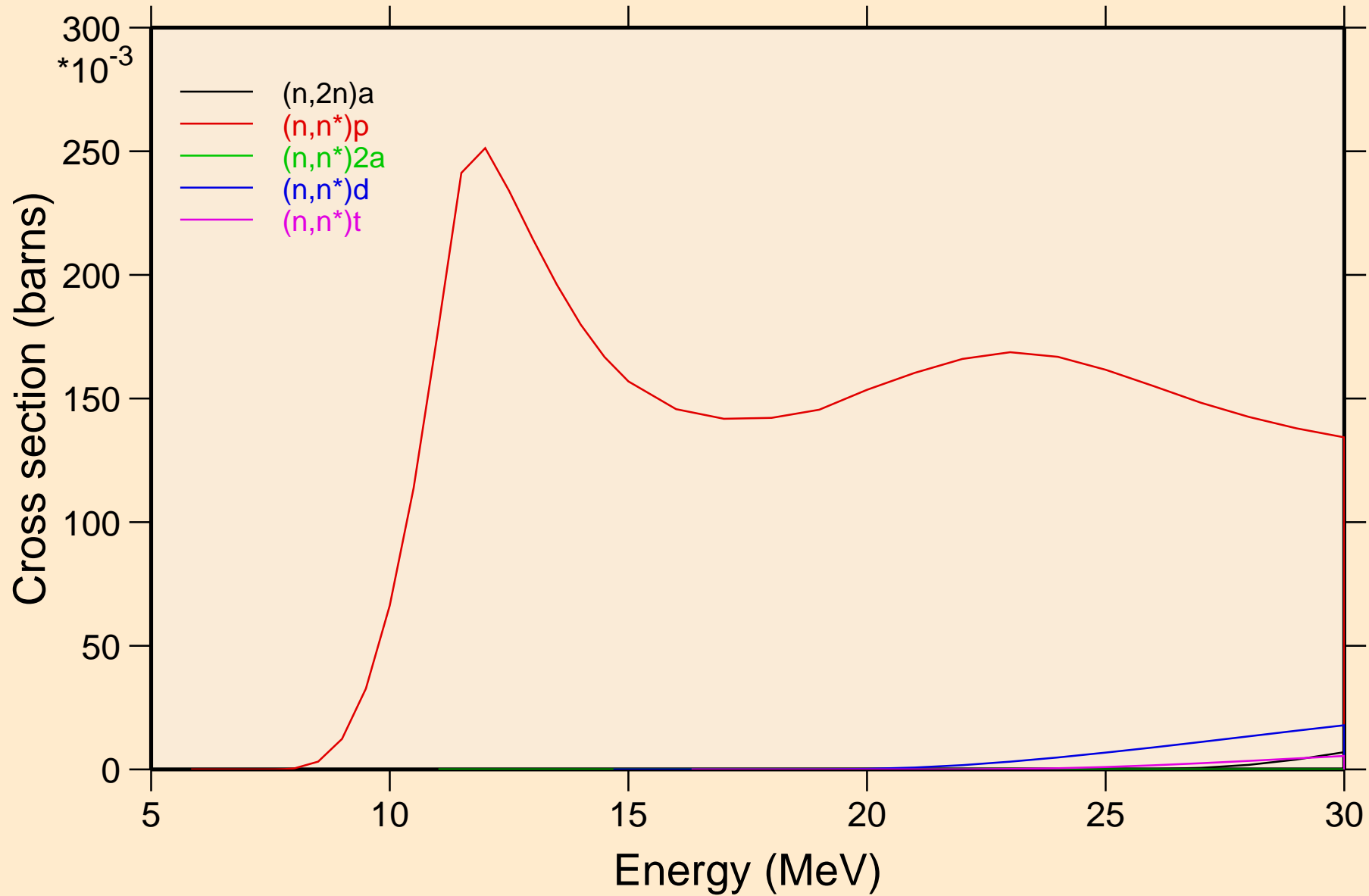



RB083 NEUTRON ACER TENDL-2024 LIBRARY; T=0.K  
Threshold reactions

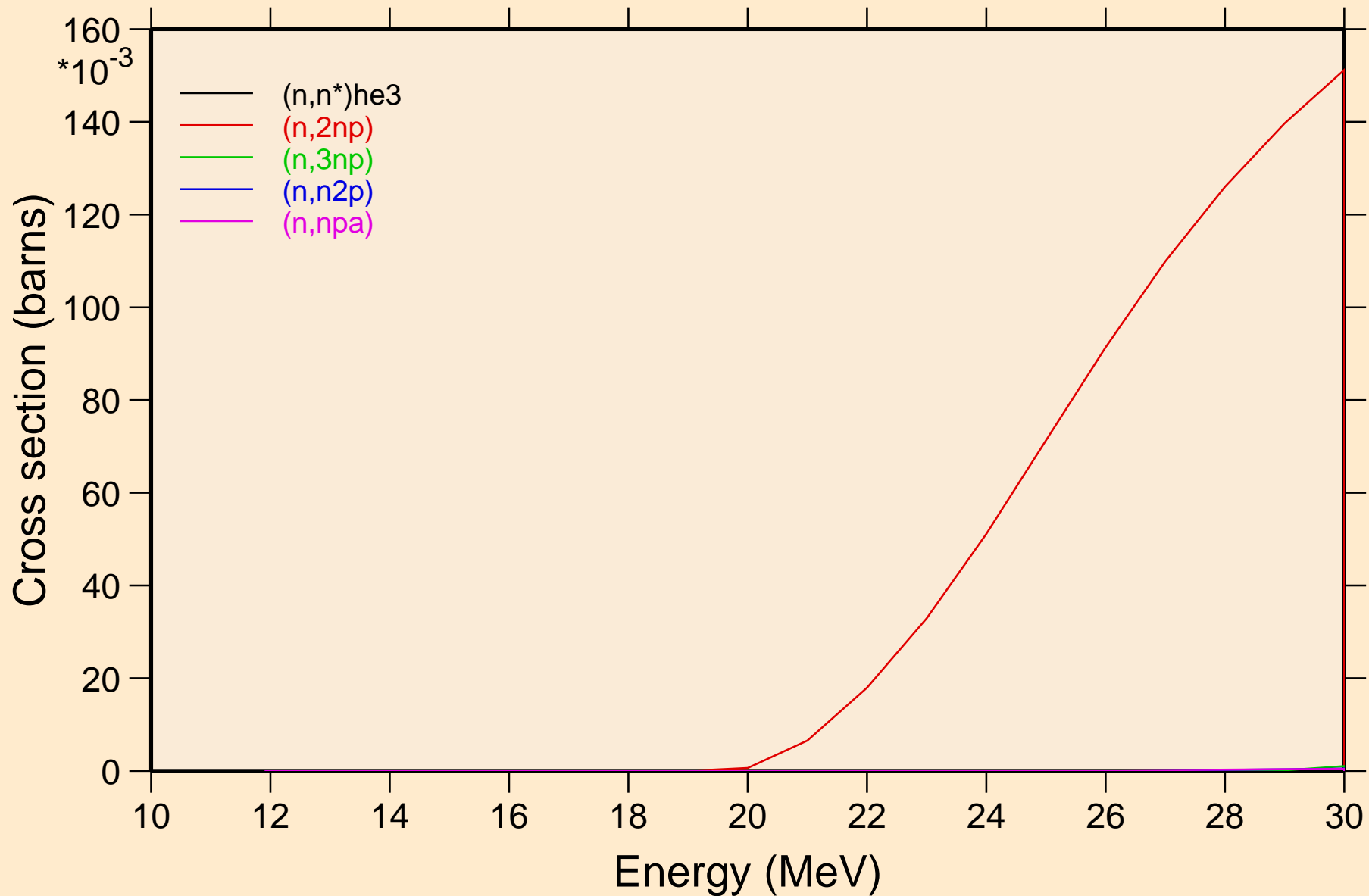

RB083 NEUTRON ACER TENDL-2024 LIBRARY; T=0.K  
Threshold reactions

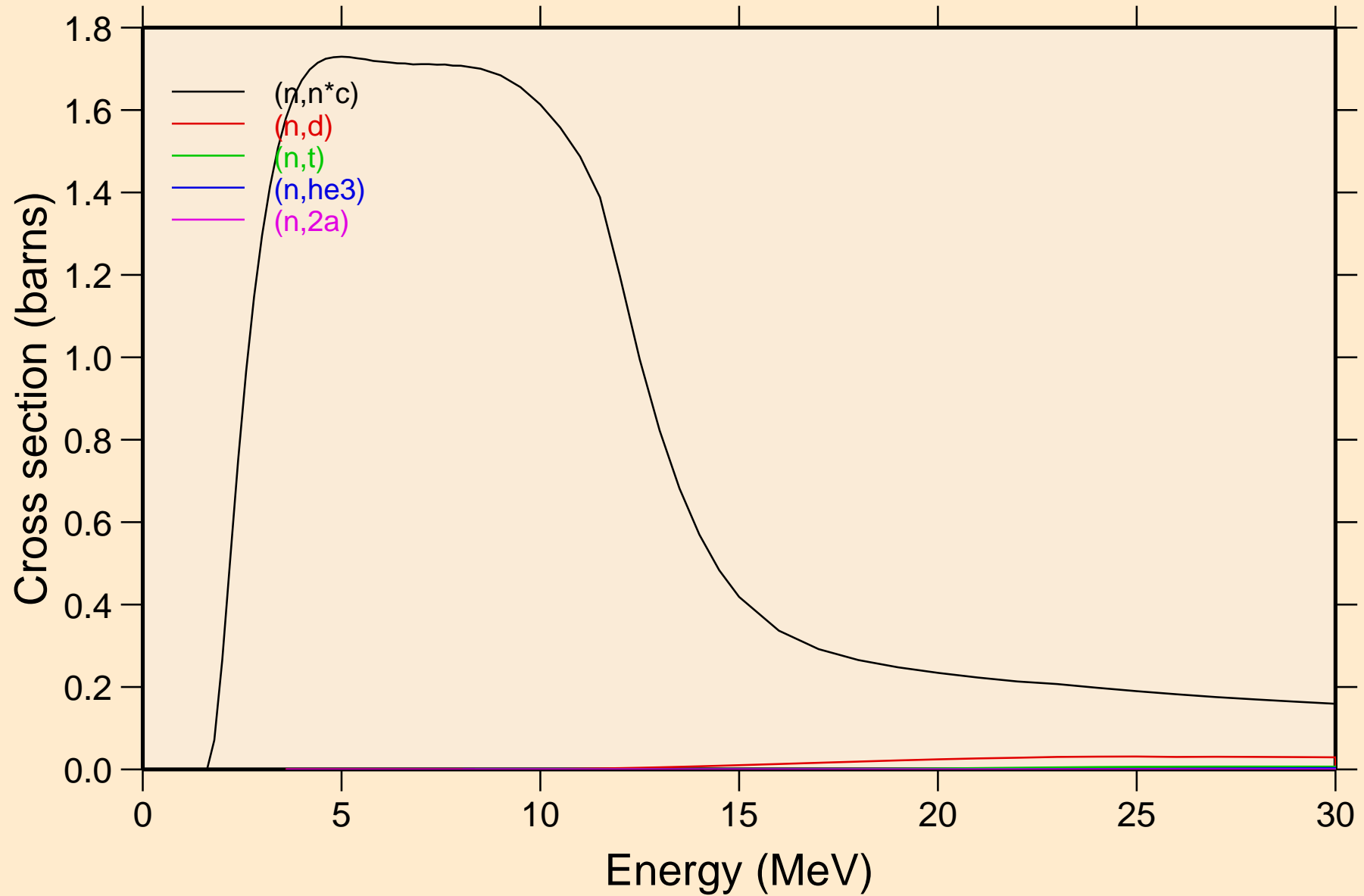

# RB083 NEUTRON ACER TENDL-2024 LIBRARY; T=0.K

## Threshold reactions

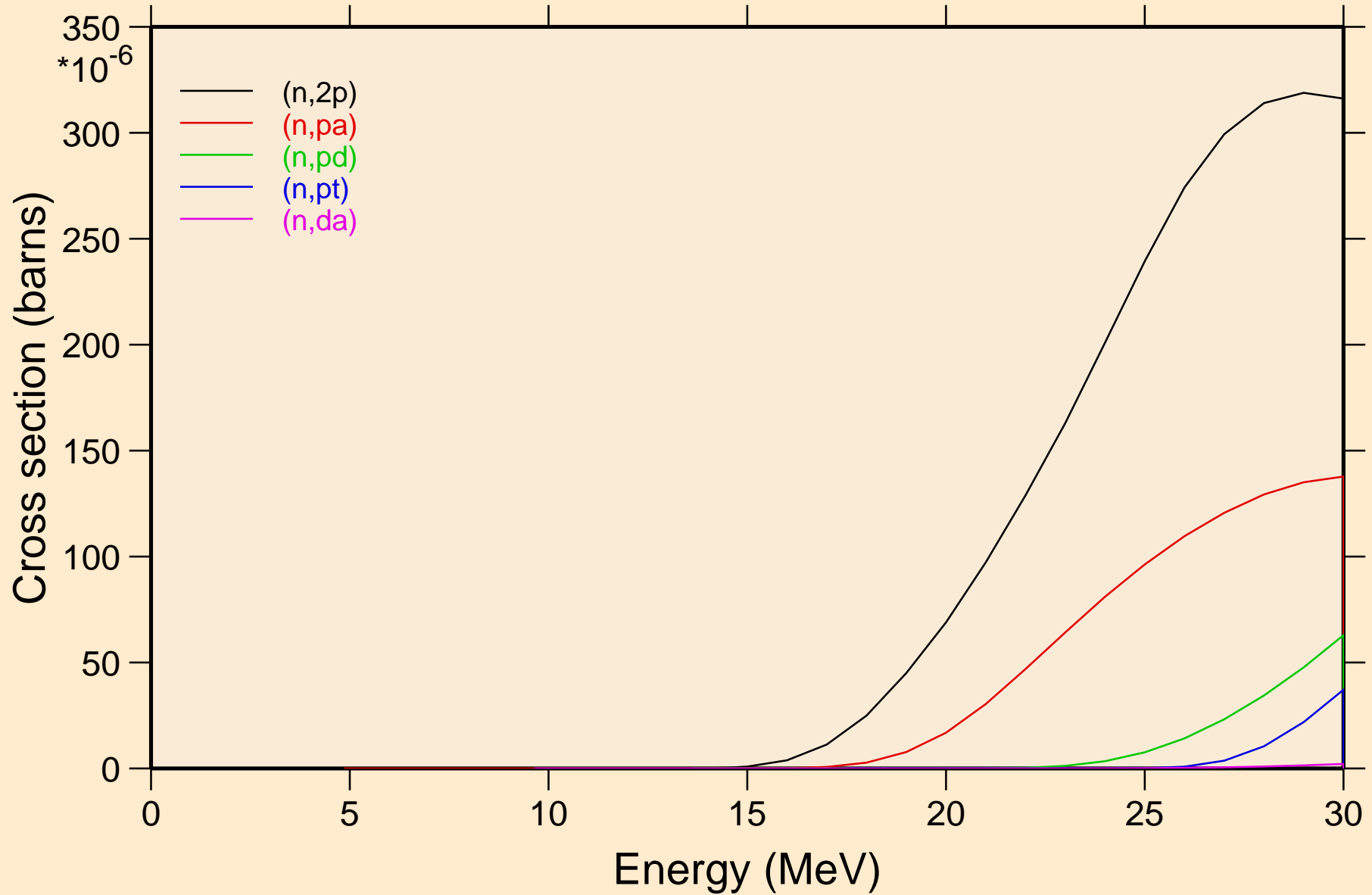

RB083 NEUTRON ACER TENDL-2024 LIBRARY; T=0.K  
Threshold reactions

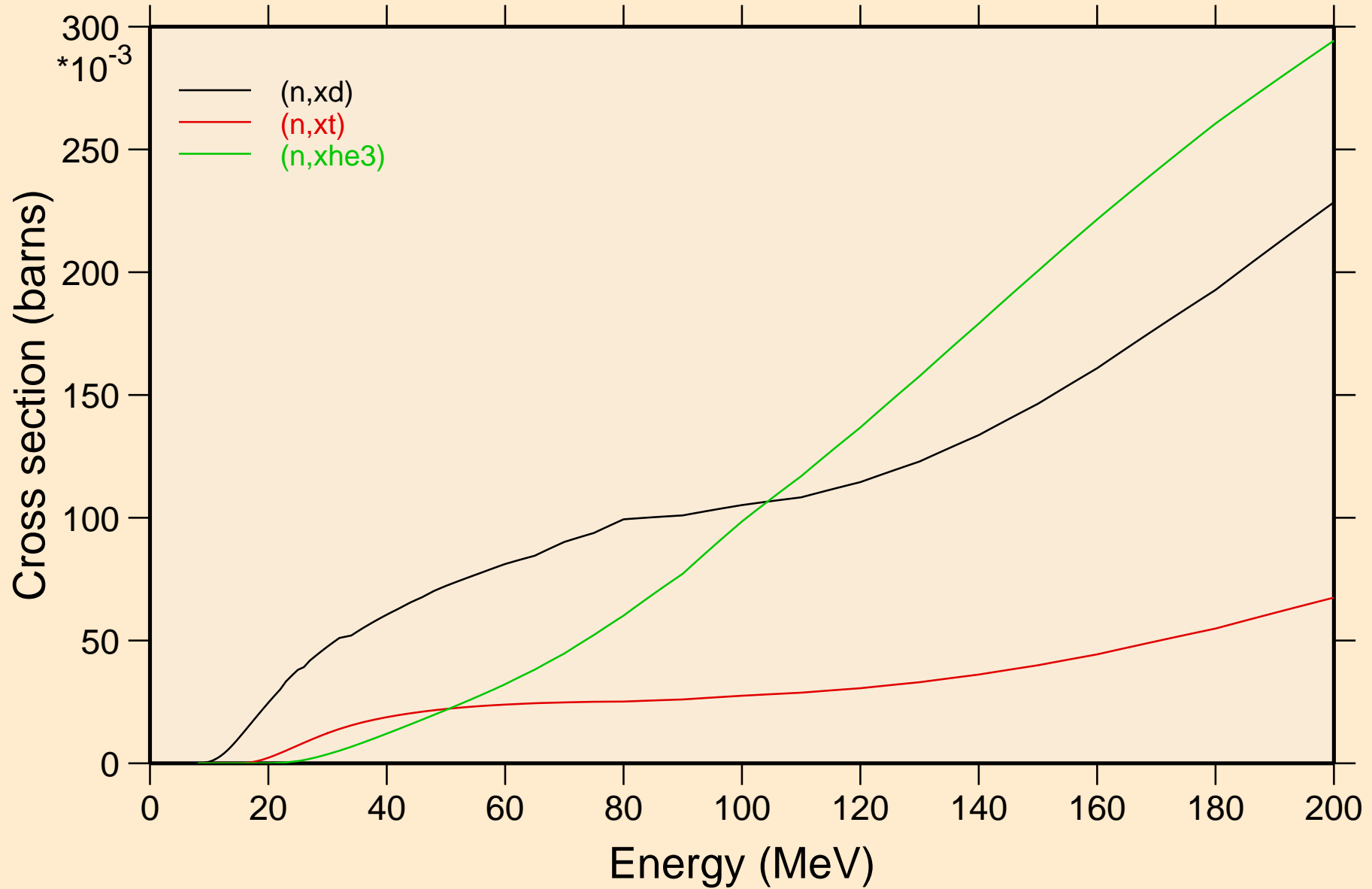

RB083 NEUTRON ACER TENDL-2024 LIBRARY; T=0.K  
angular distribution for elastic

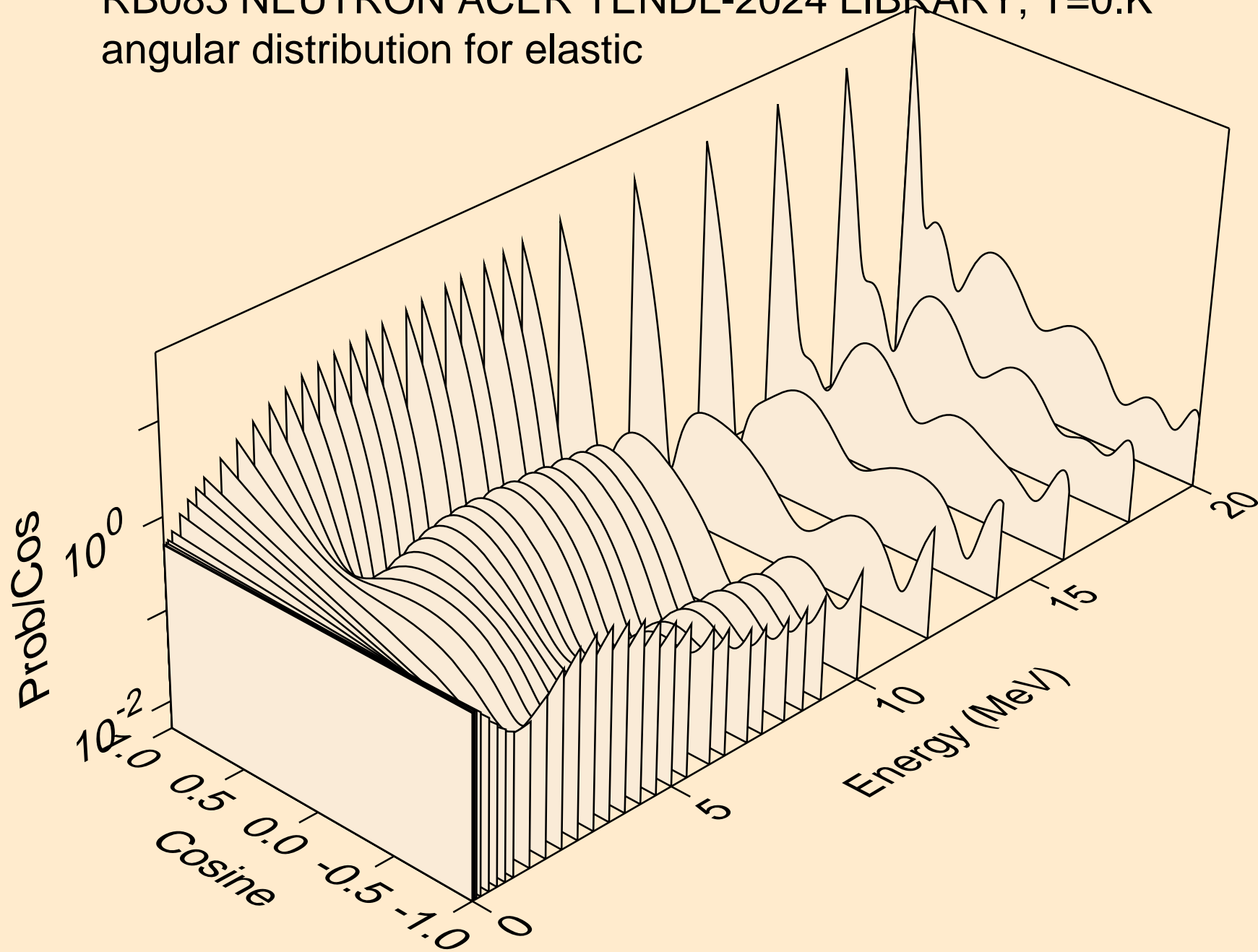

RB083 NEUTRON ACER TENDL-2024 LIBRARY; T=0.K  
angular distribution for elastic

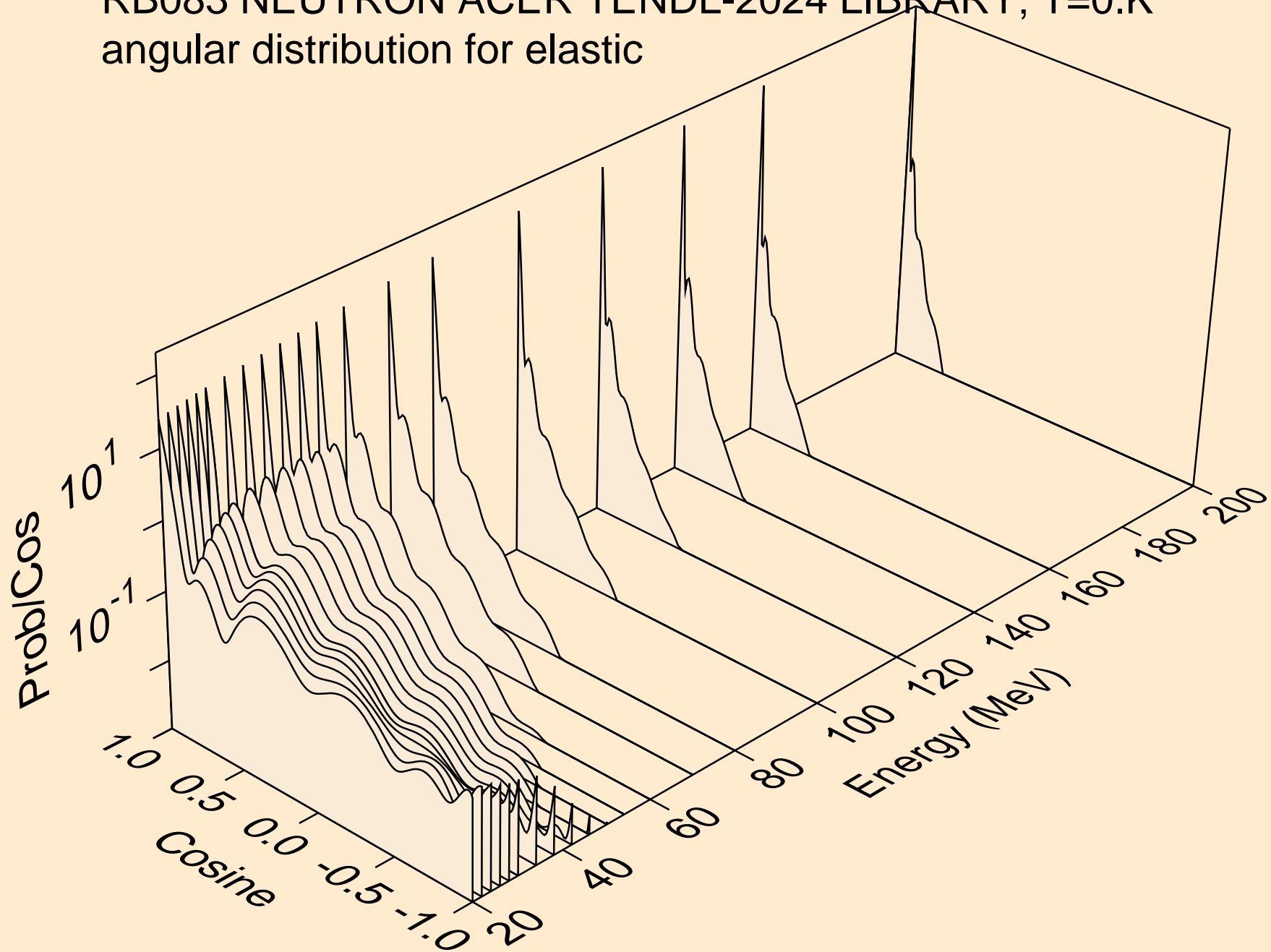

RB083 NEUTRON ACER TENDL-2024 LIBRARY; T=0.K  
angular distribution for (n,n\*1)

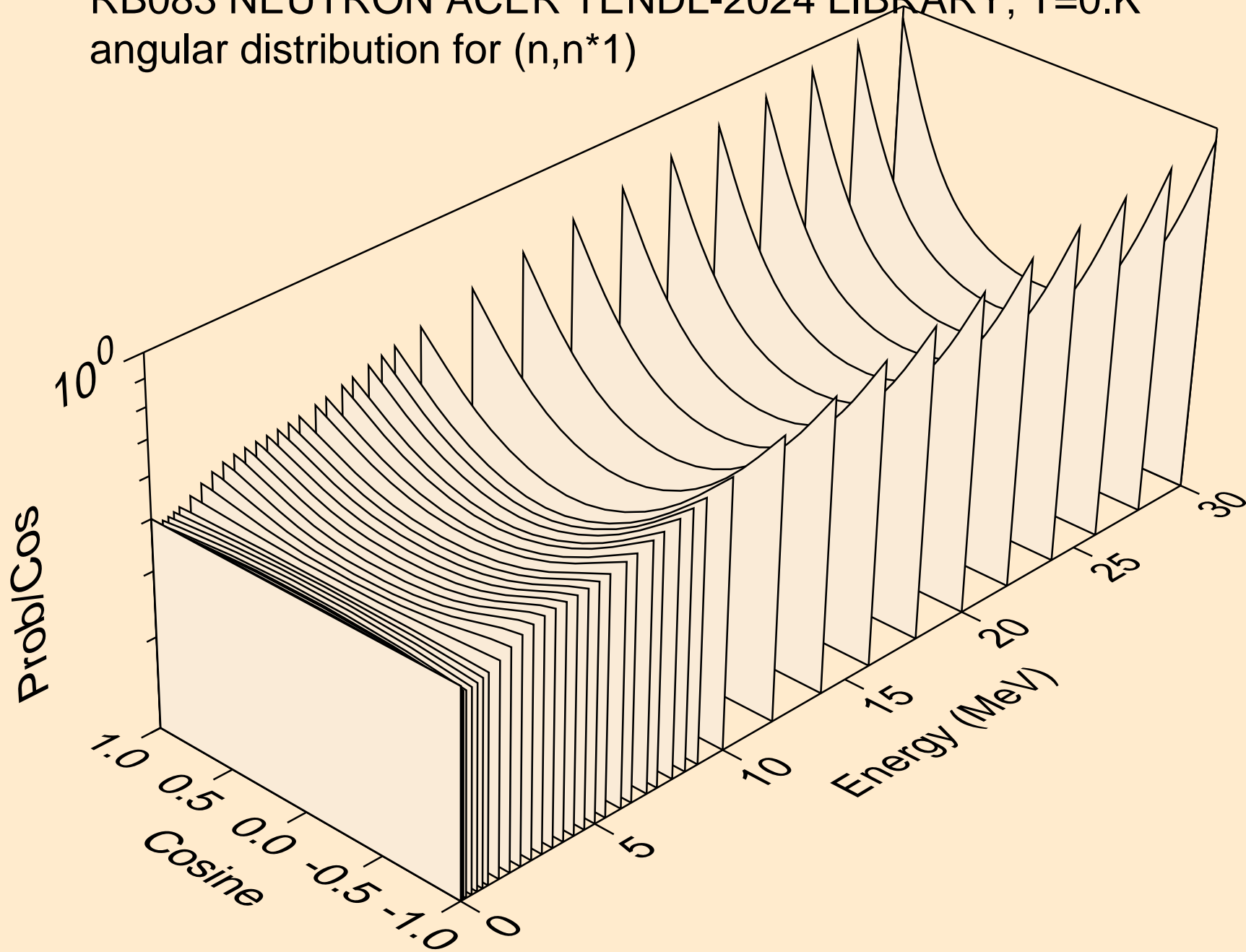

RB083 NEUTRON ACER TENDL-2024 LIBRARY; T=0.K  
angular distribution for (n,n\*2)

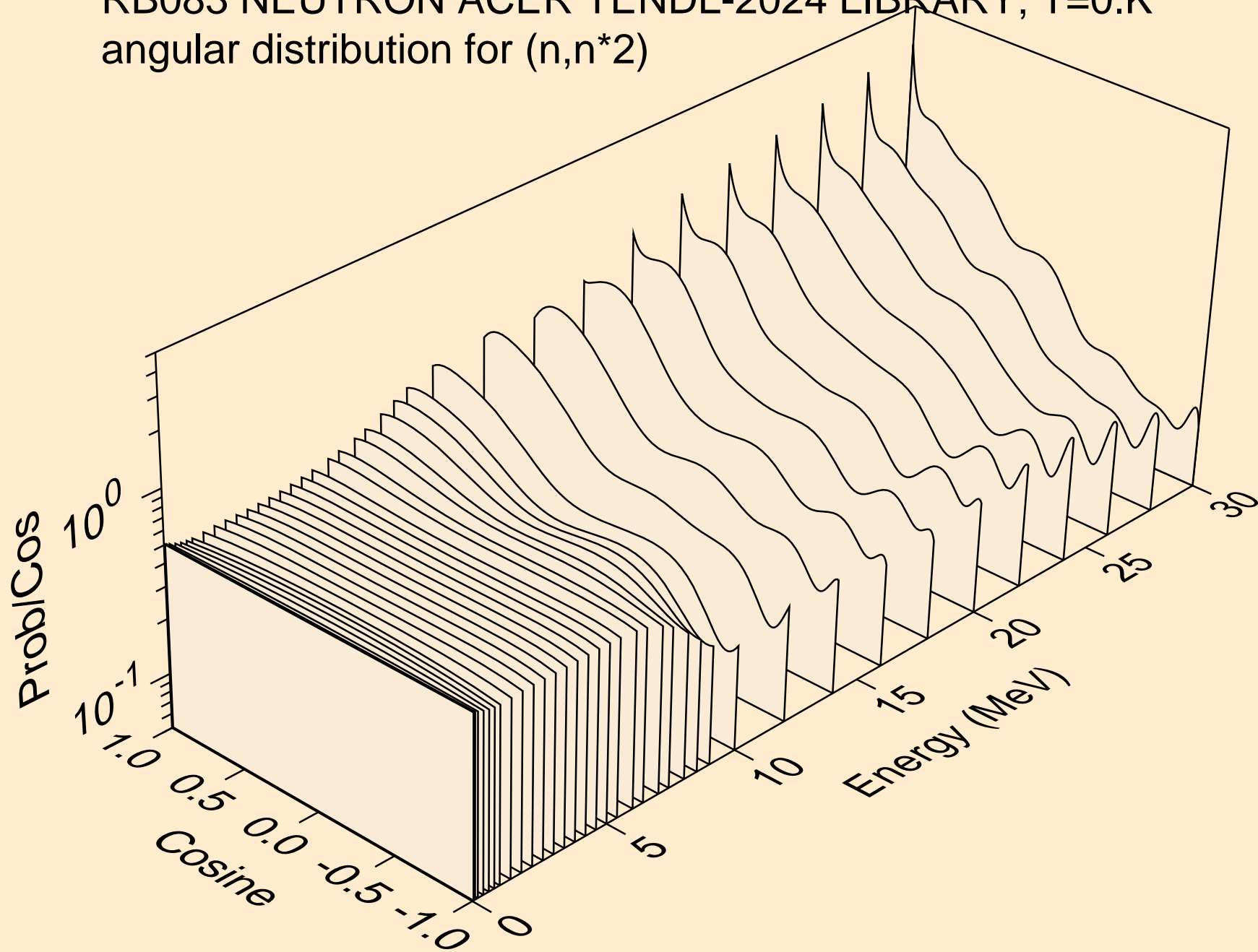



RB083 NEUTRON ACER TENDL-2024 LIBRARY; T=0.K  
angular distribution for (n,n\*3)

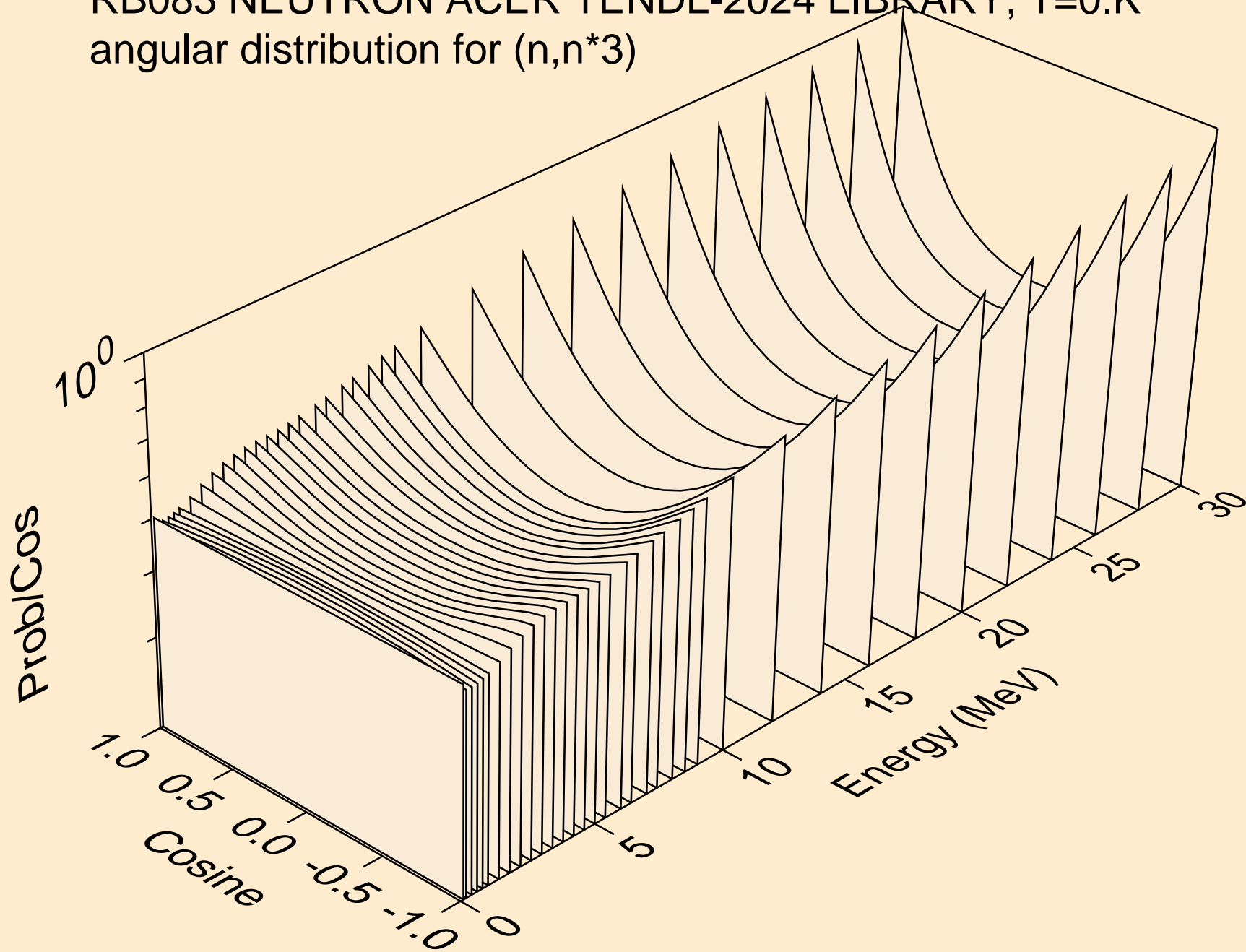

RB083 NEUTRON ACER TENDL-2024 LIBRARY; T=0.K  
angular distribution for (n,n\*4)

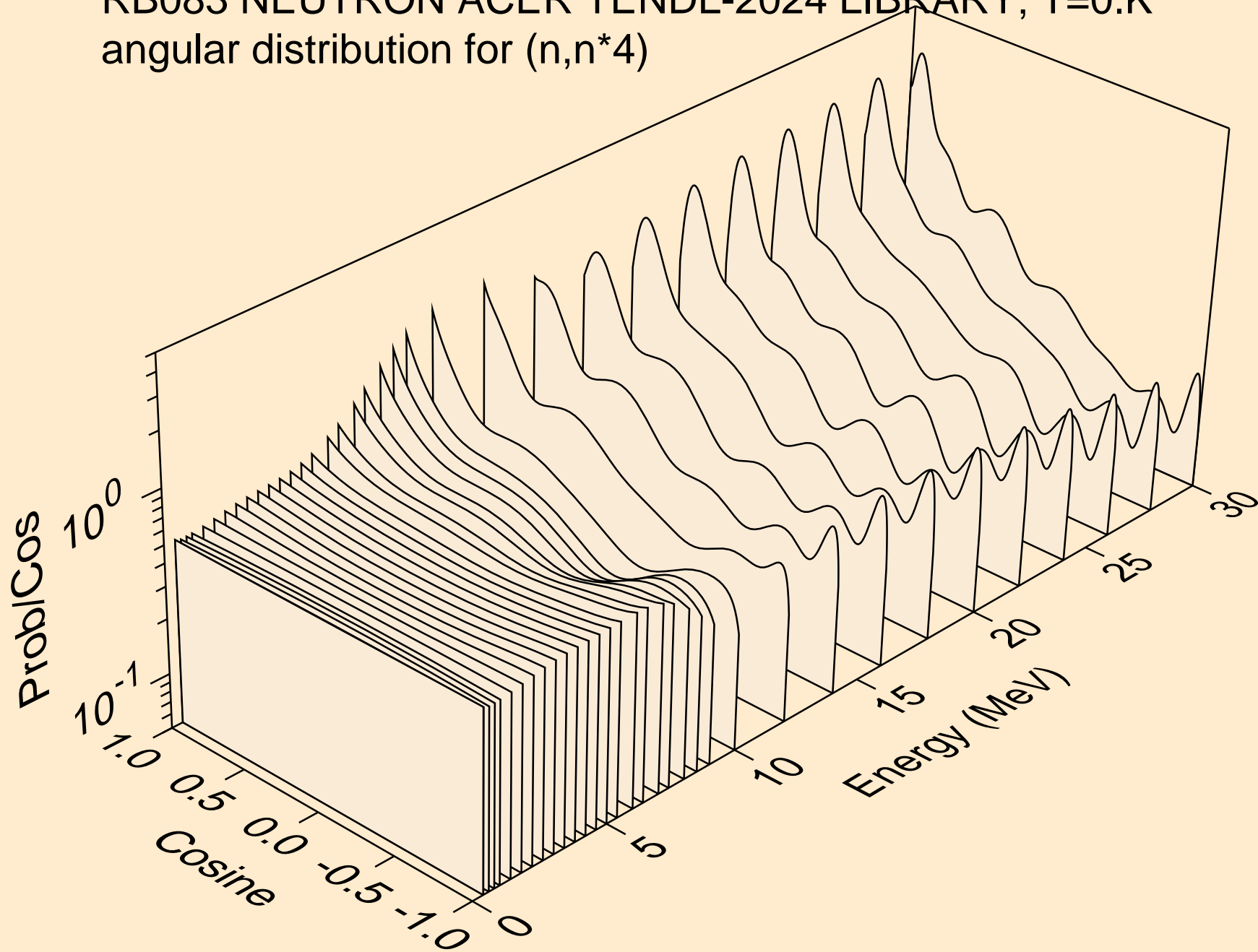

RB083 NEUTRON ACER TENDL-2024 LIBRARY; T=0.K  
angular distribution for (n,n\*5)

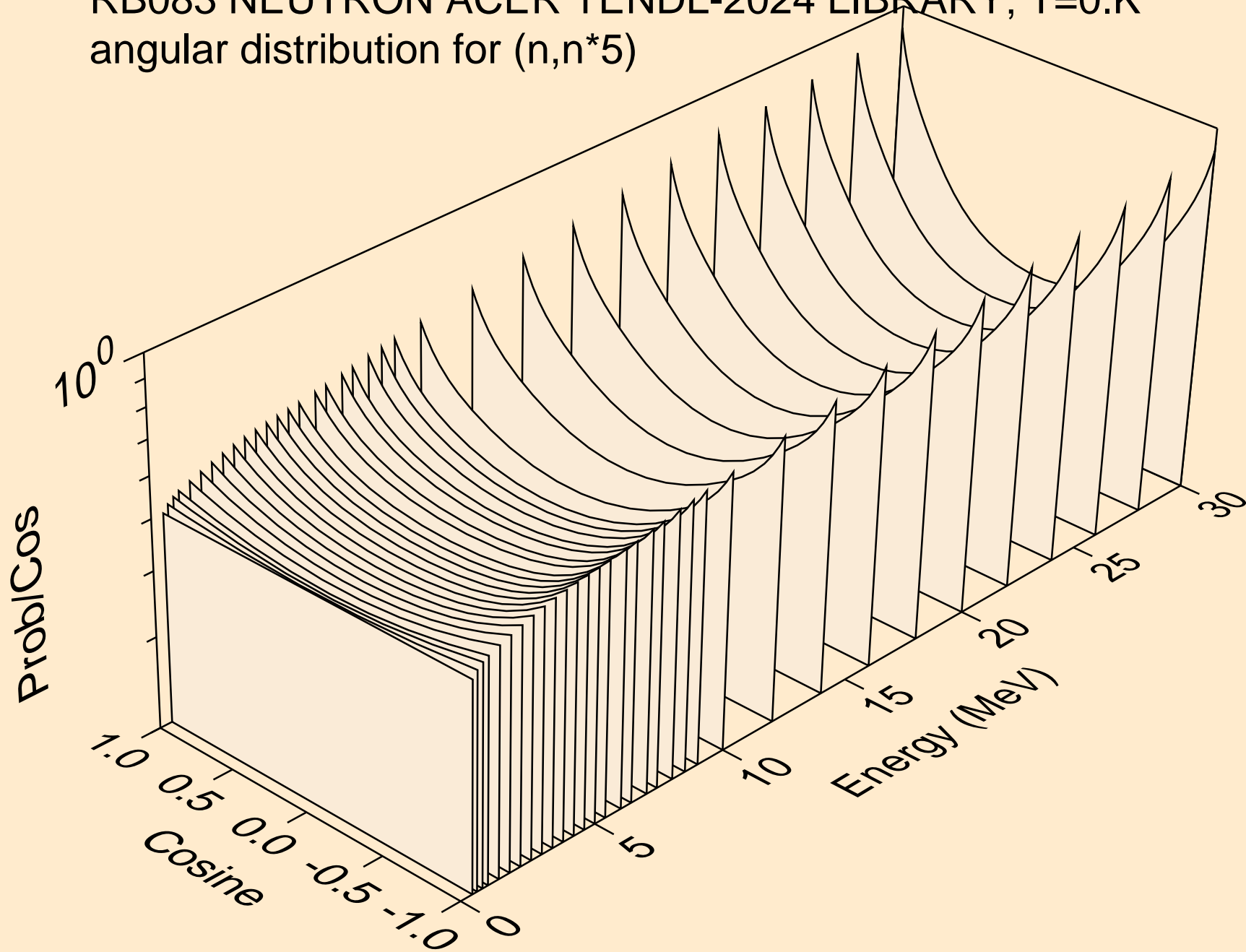

RB083 NEUTRON ACER TENDL-2024 LIBRARY; T=0.K  
angular distribution for (n,n\*6)

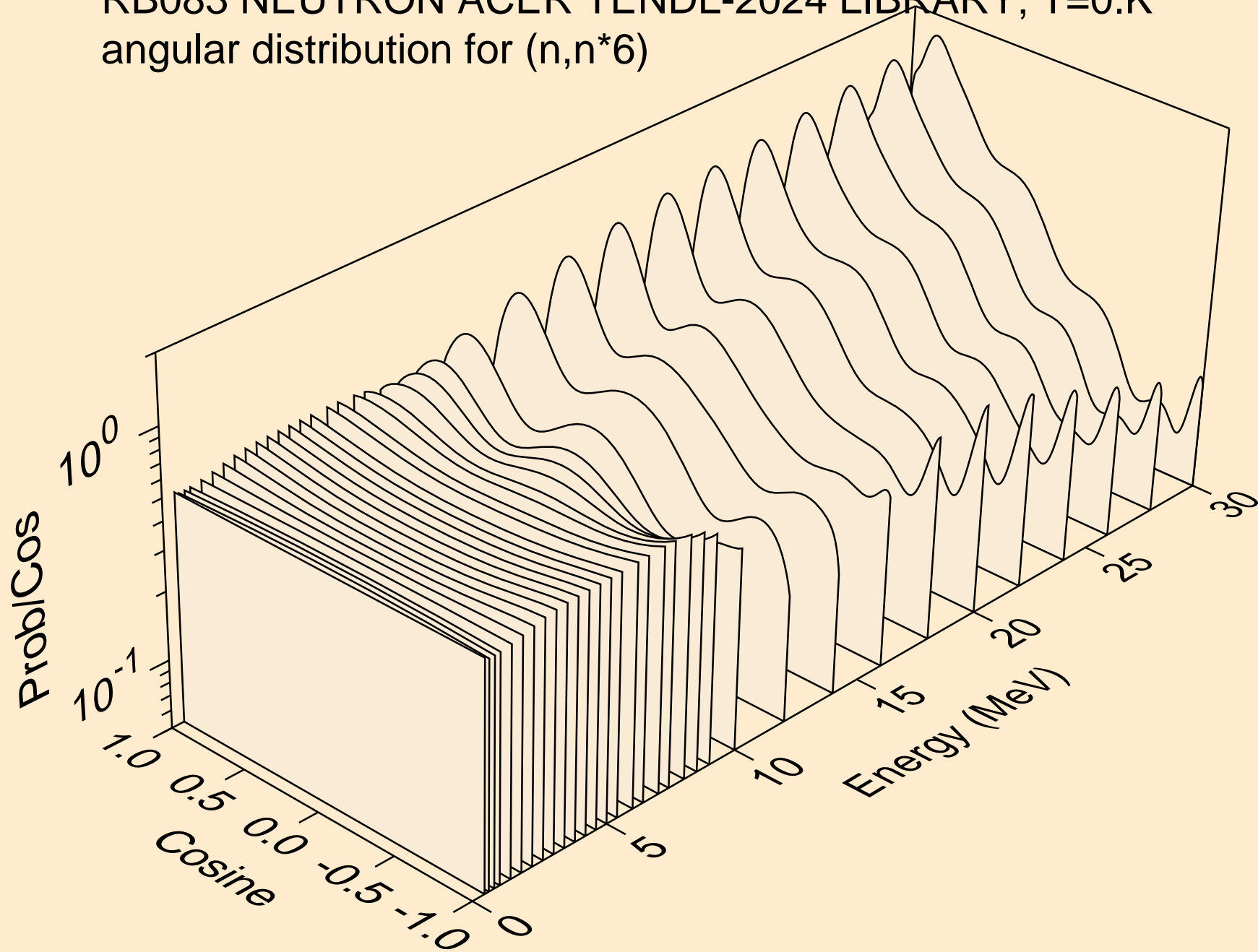

RB083 NEUTRON ACER TENDL-2024 LIBRARY; T=0.K  
angular distribution for (n,n\*7)

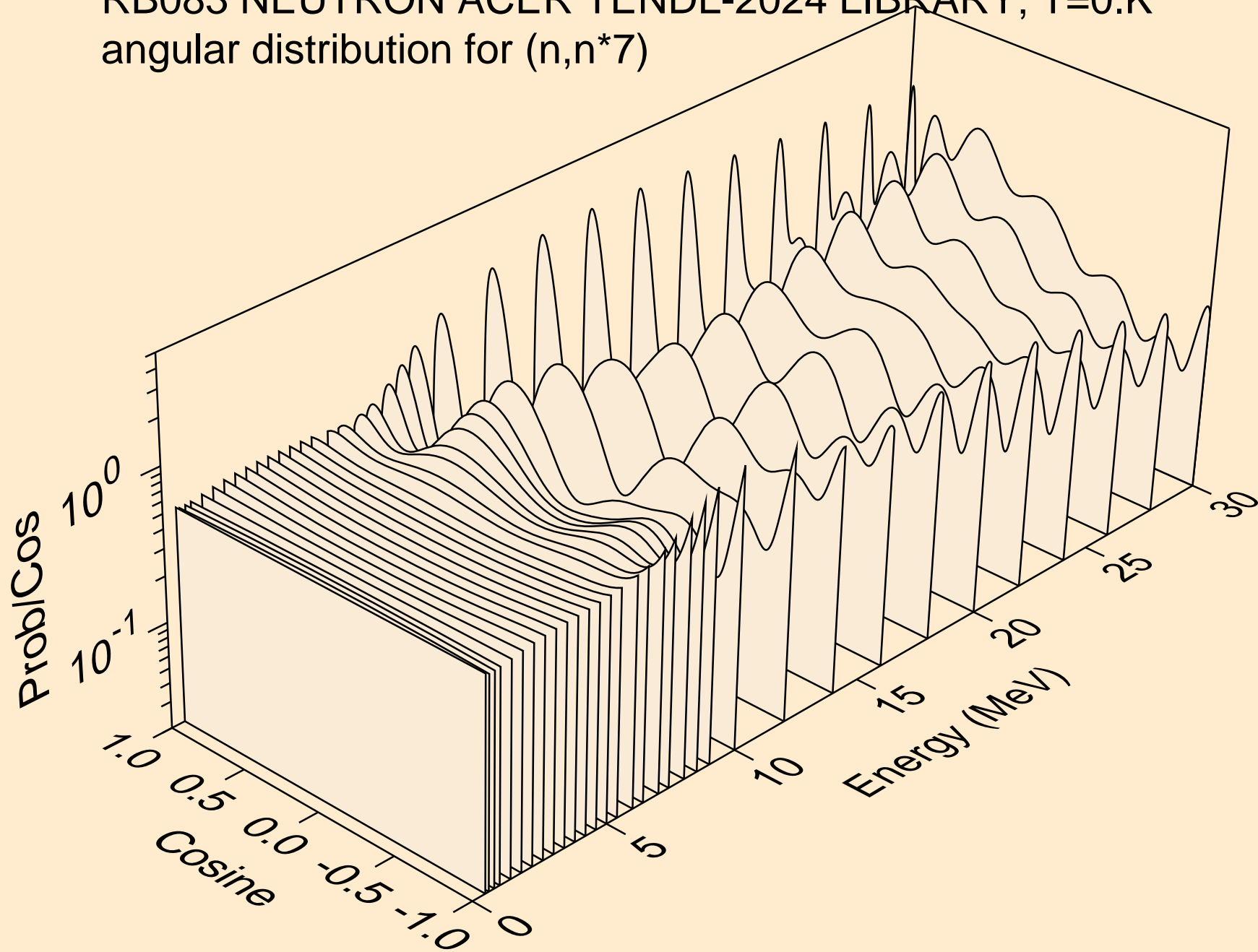

RB083 NEUTRON ACER TENDL-2024 LIBRARY; T=0.K  
angular distribution for (n,n\*8)

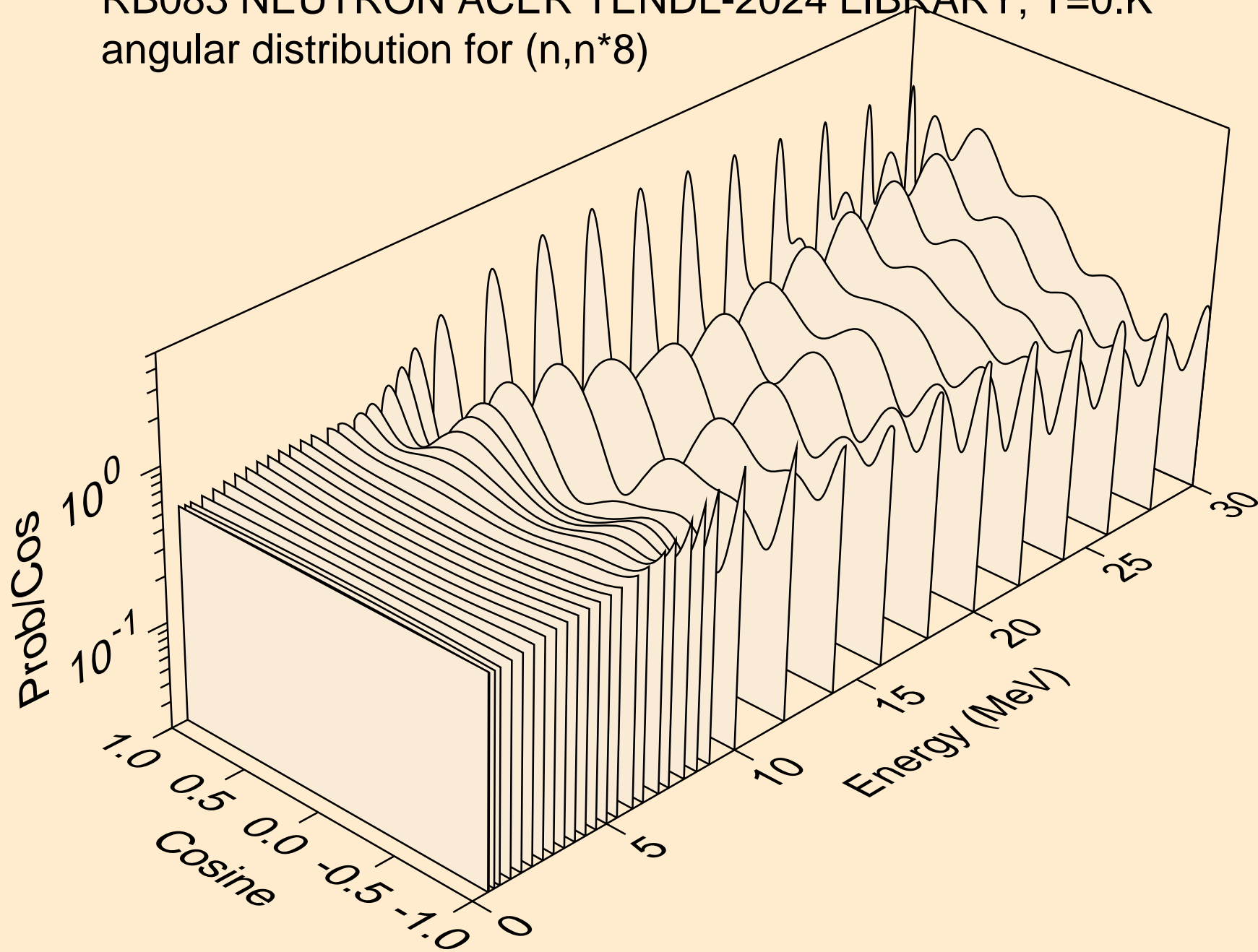

RB083 NEUTRON ACER TENDL-2024 LIBRARY; T=0.K  
angular distribution for (n,n\*9)

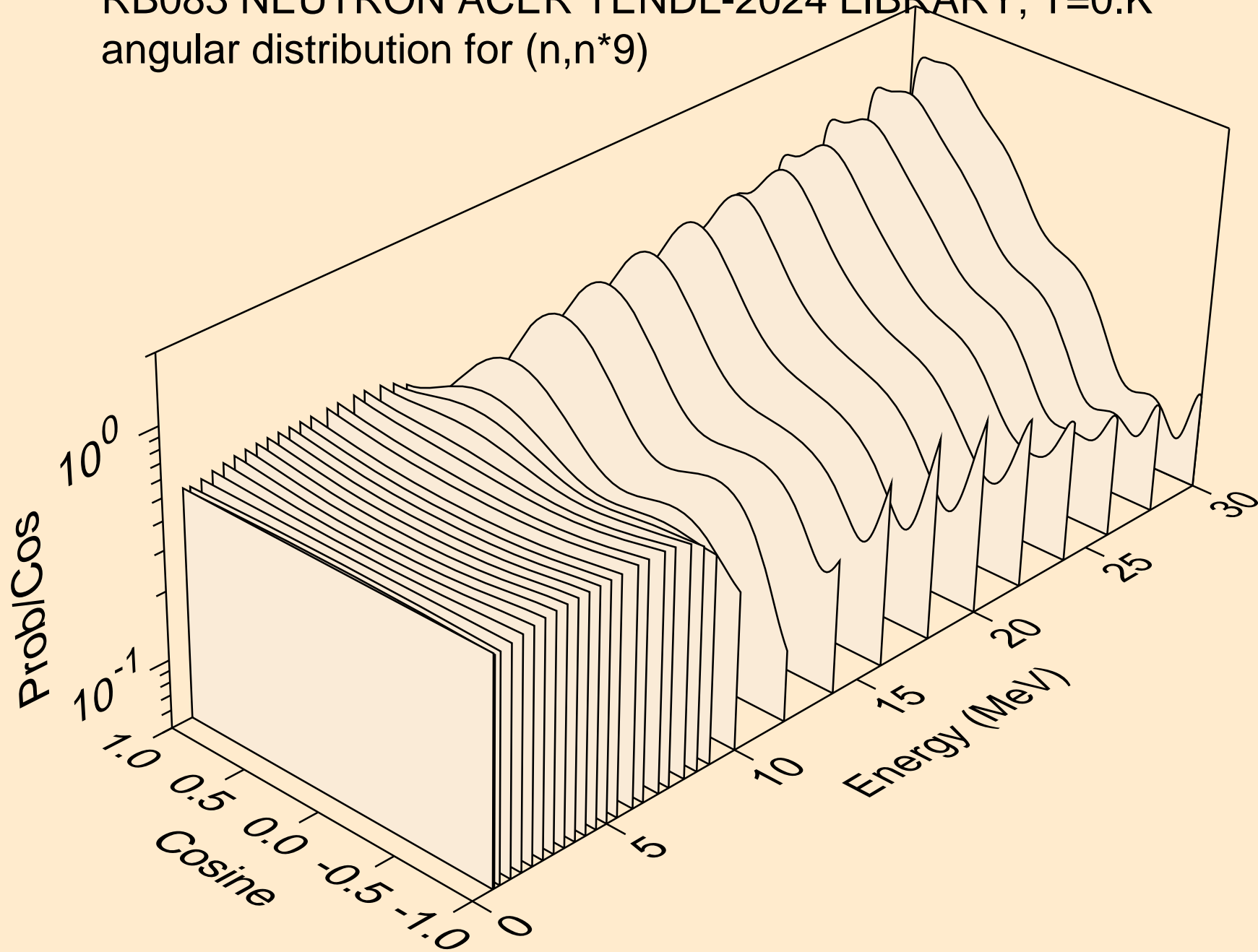

RB083 NEUTRON ACER TENDL-2024 LIBRARY; T=0.K  
angular distribution for (n,n\*10)

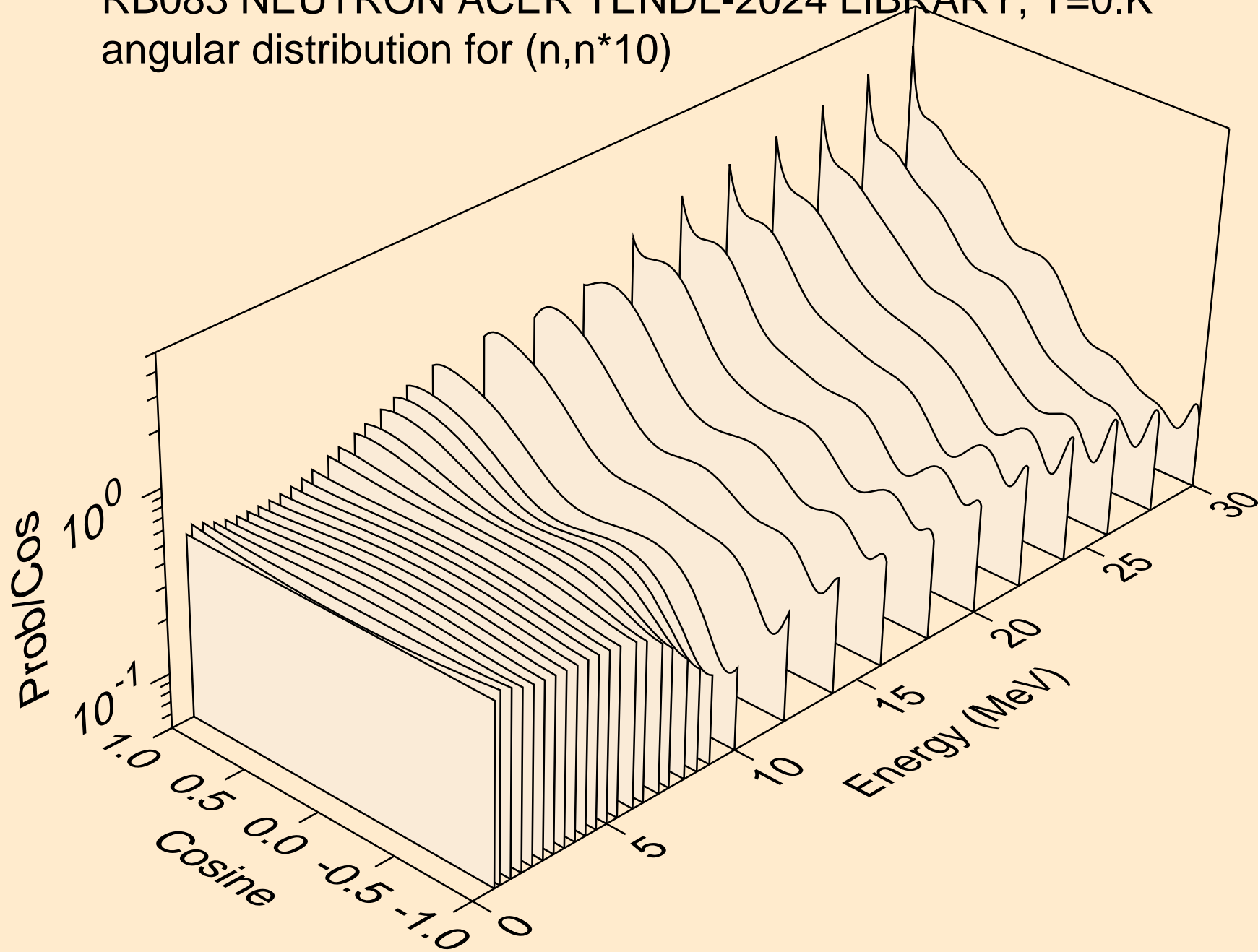



RB083 NEUTRON ACER TENDL-2024 LIBRARY; T=0.K  
angular distribution for (n,n\*11)

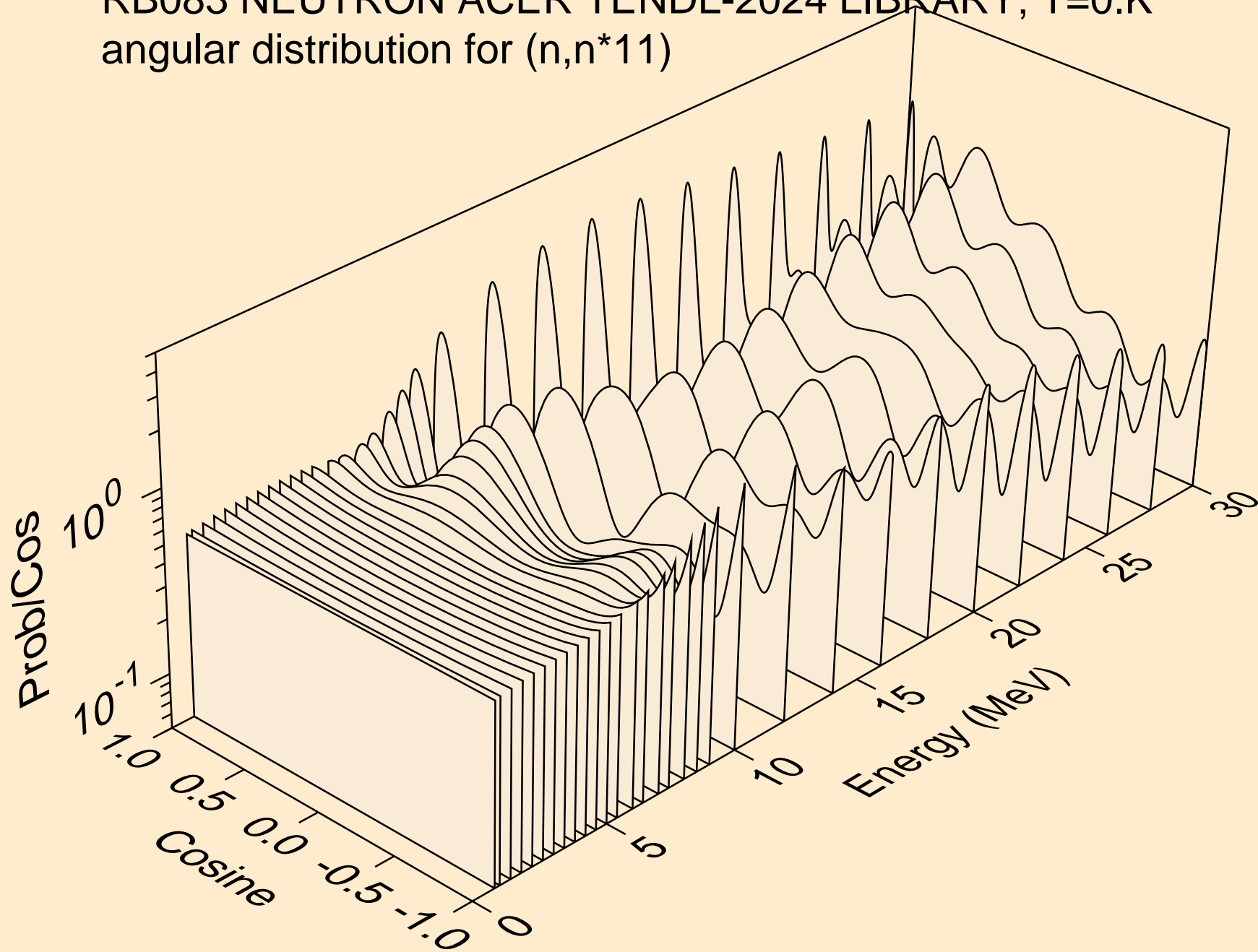

RB083 NEUTRON ACER TENDL-2024 LIBRARY; T=0.K  
angular distribution for (n,n\*12)

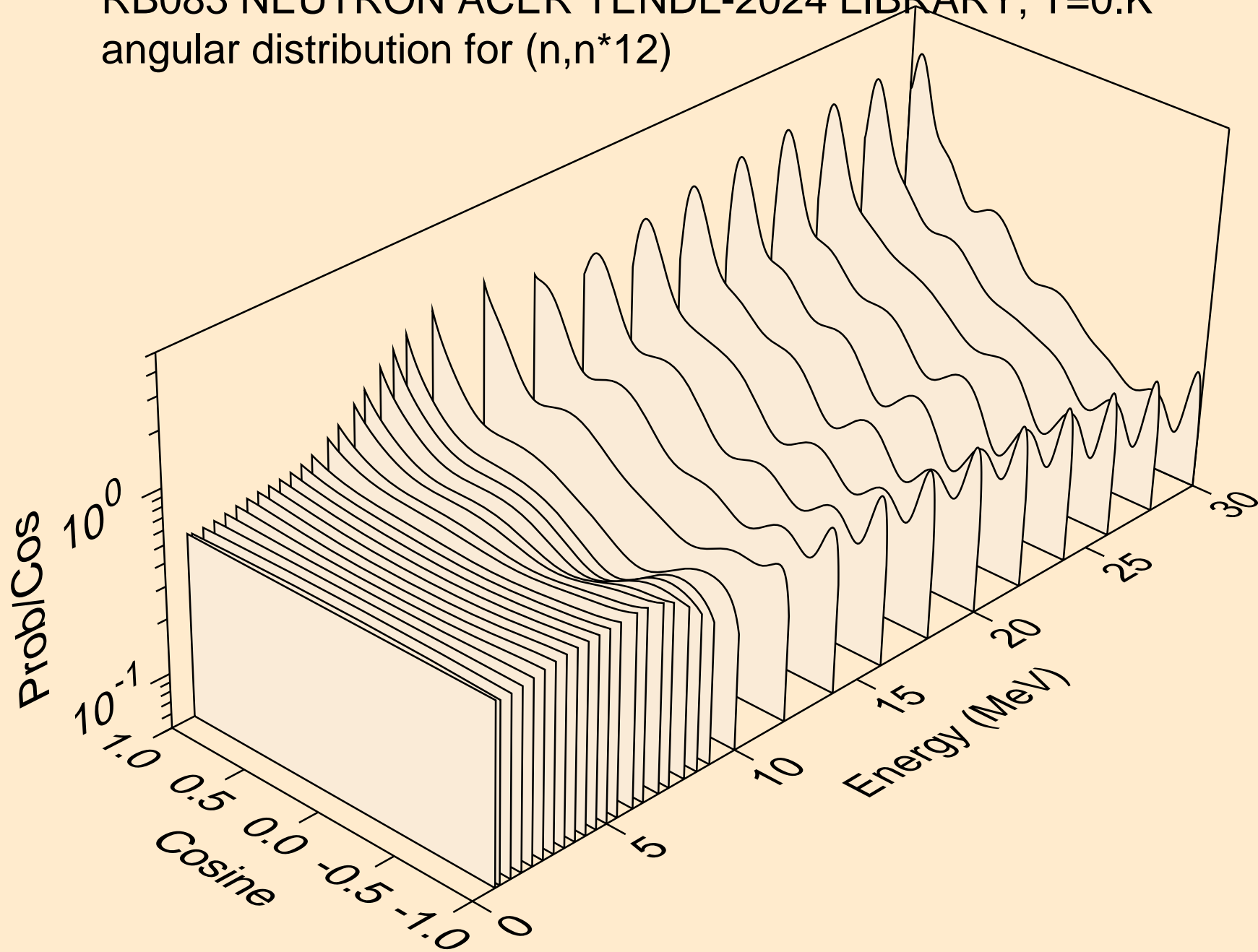

RB083 NEUTRON ACER TENDL-2024 LIBRARY; T=0.K  
angular distribution for (n,n\*13)

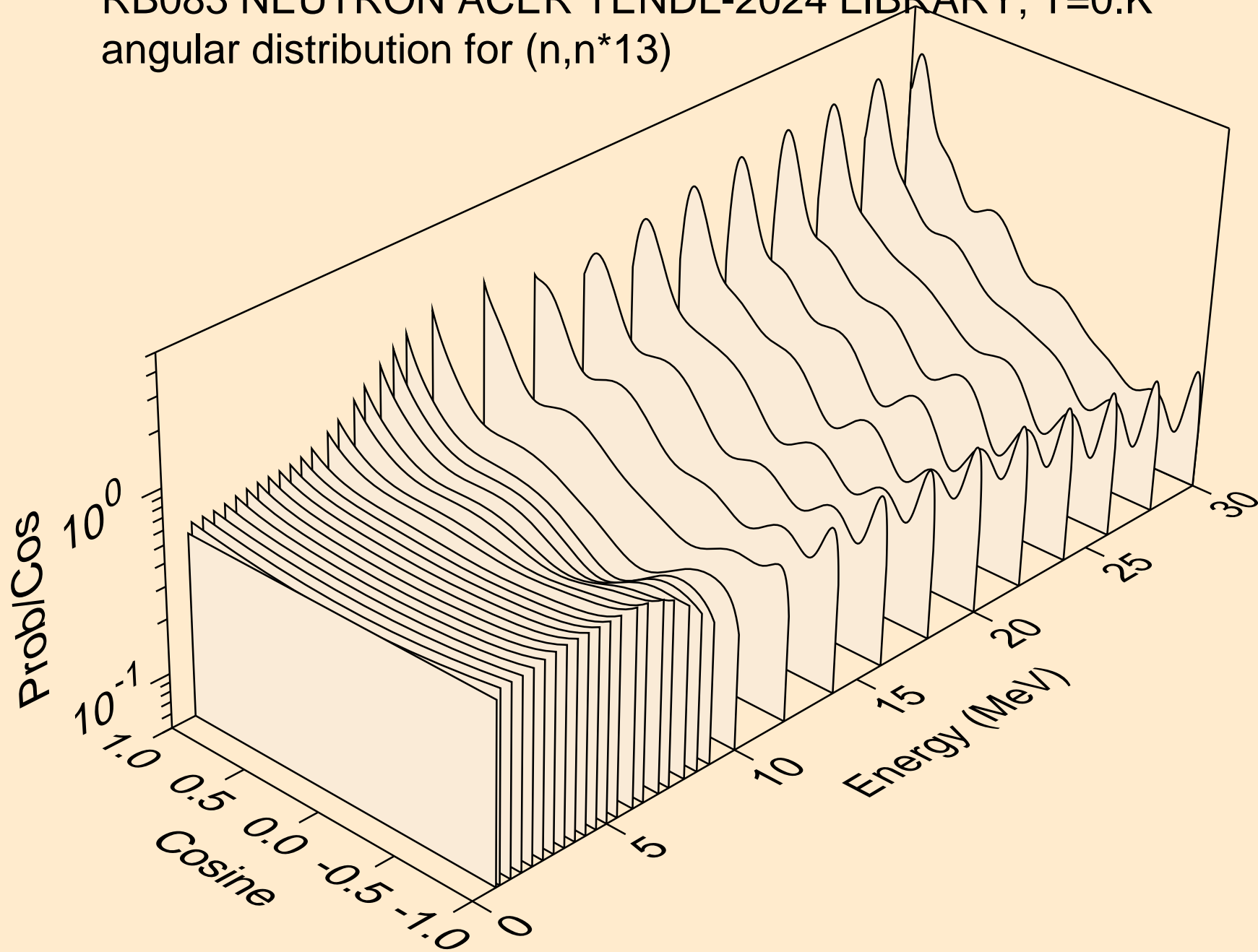

RB083 NEUTRON ACER TENDL-2024 LIBRARY; T=0.K  
angular distribution for (n,n\*14)

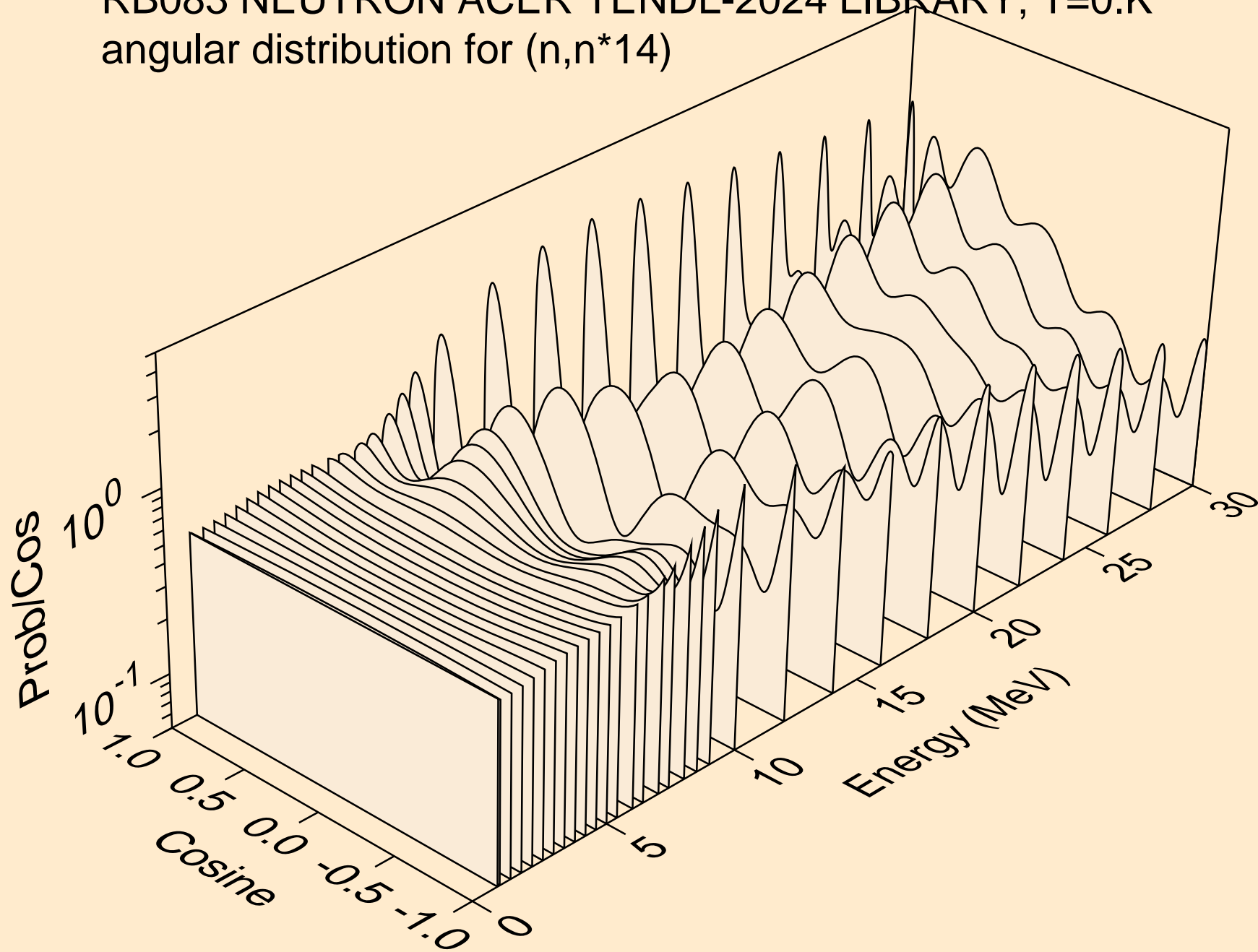

RB083 NEUTRON ACER TENDL-2024 LIBRARY; T=0.K  
angular distribution for (n,n\*15)

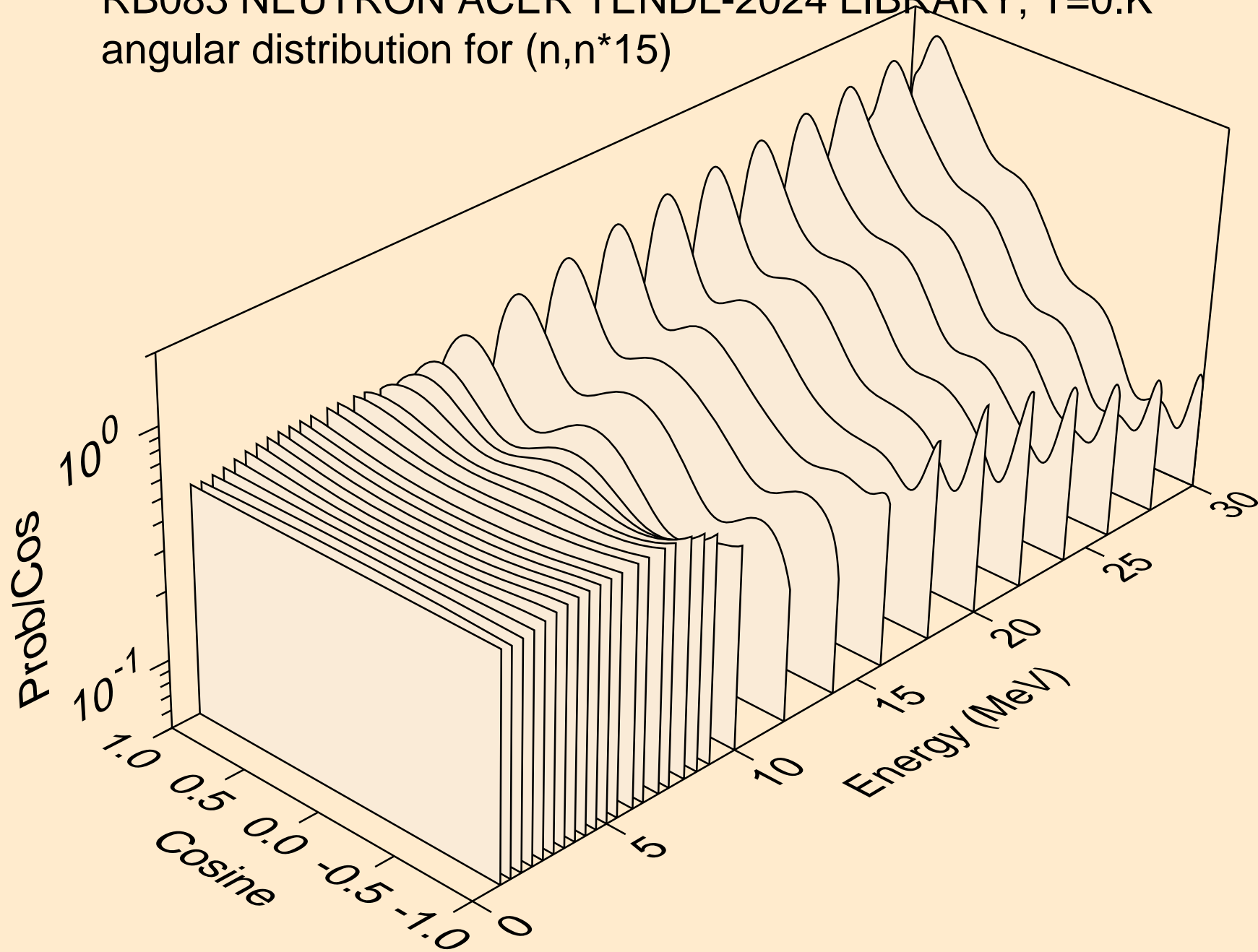

RB083 NEUTRON ACER TENDL-2024 LIBRARY; T=0.K  
angular distribution for (n,n\*16)

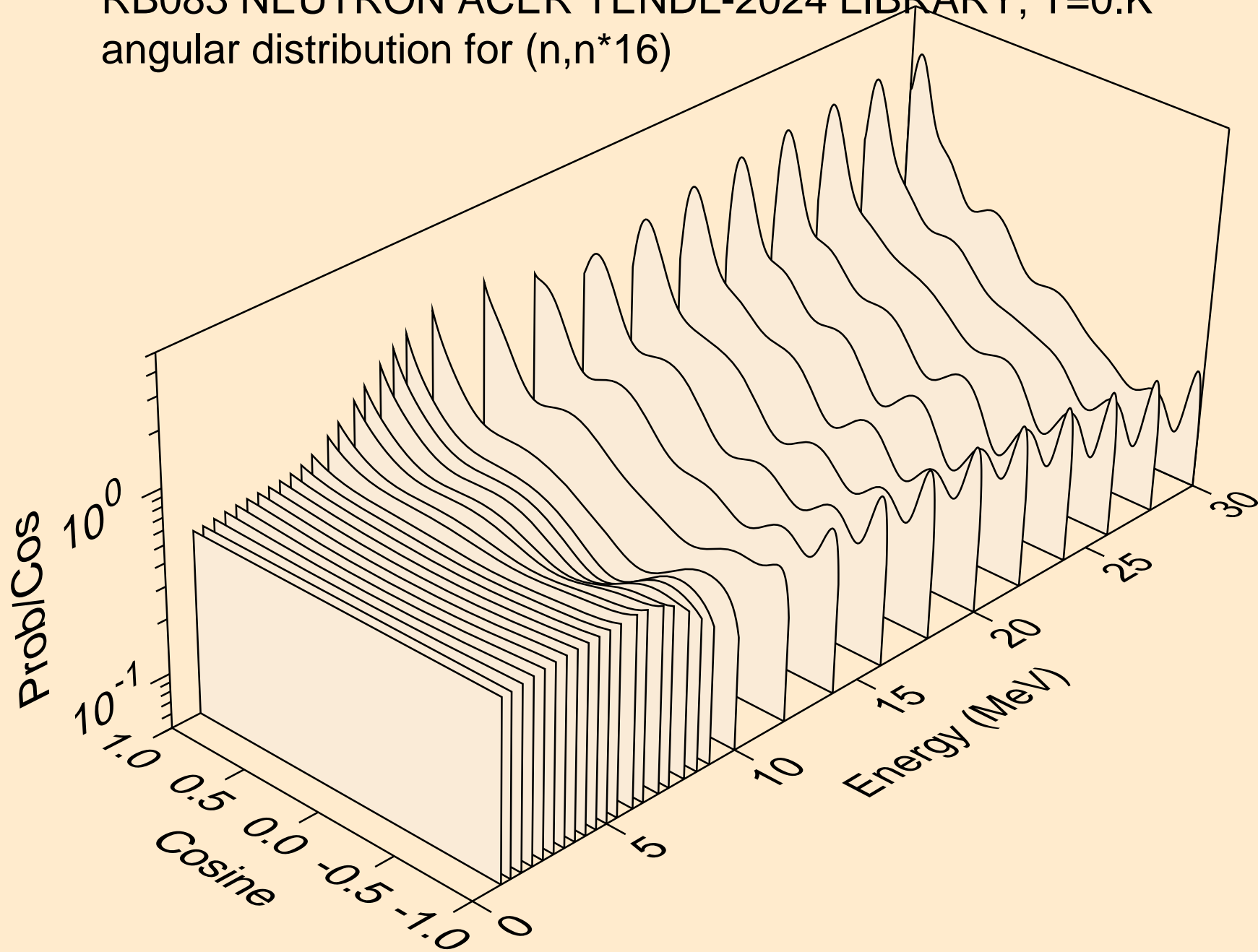

RB083 NEUTRON ACER TENDL-2024 LIBRARY; T=0.K  
angular distribution for (n,n\*17)

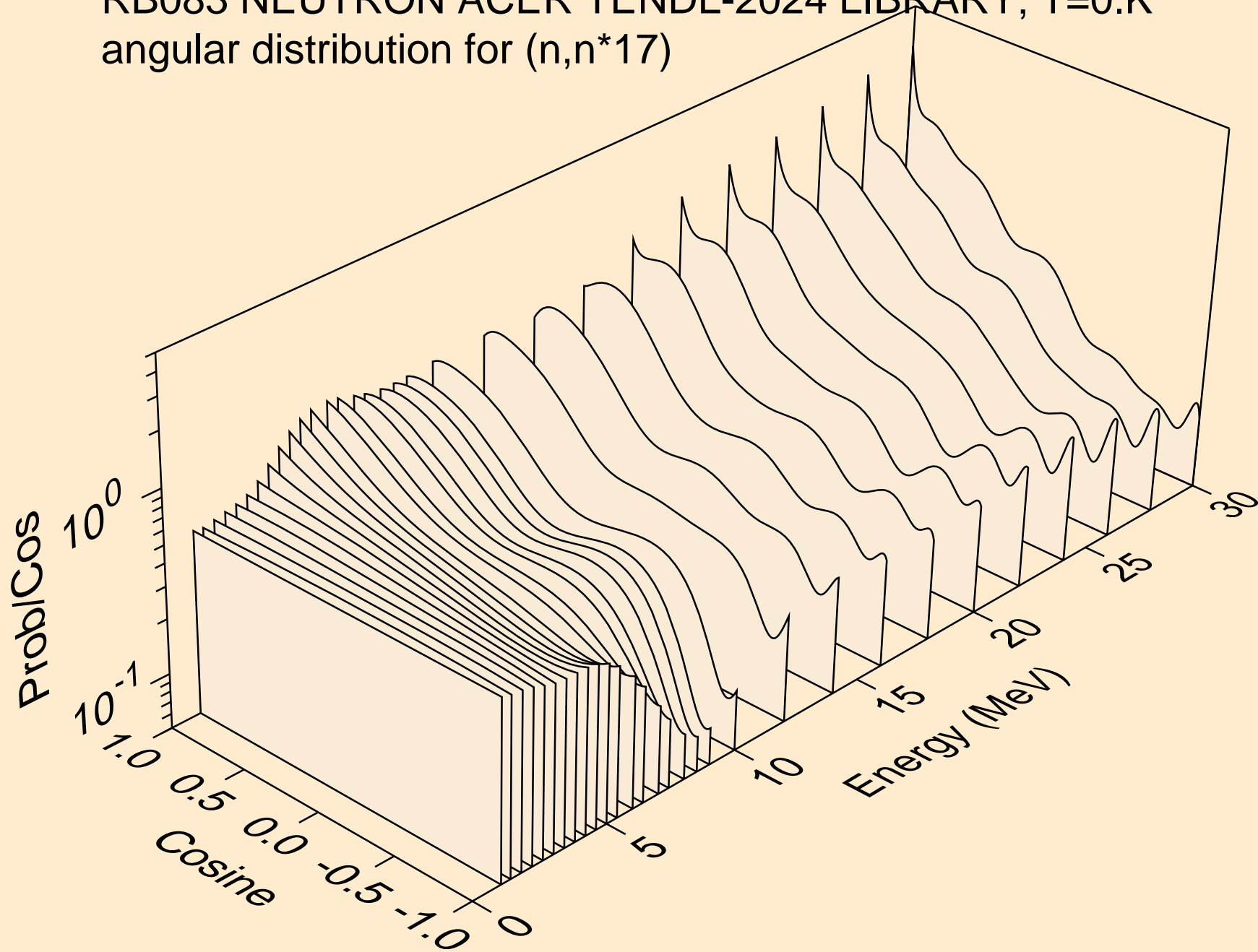

RB083 NEUTRON ACER TENDL-2024 LIBRARY; T=0.K  
angular distribution for (n,n\*18)

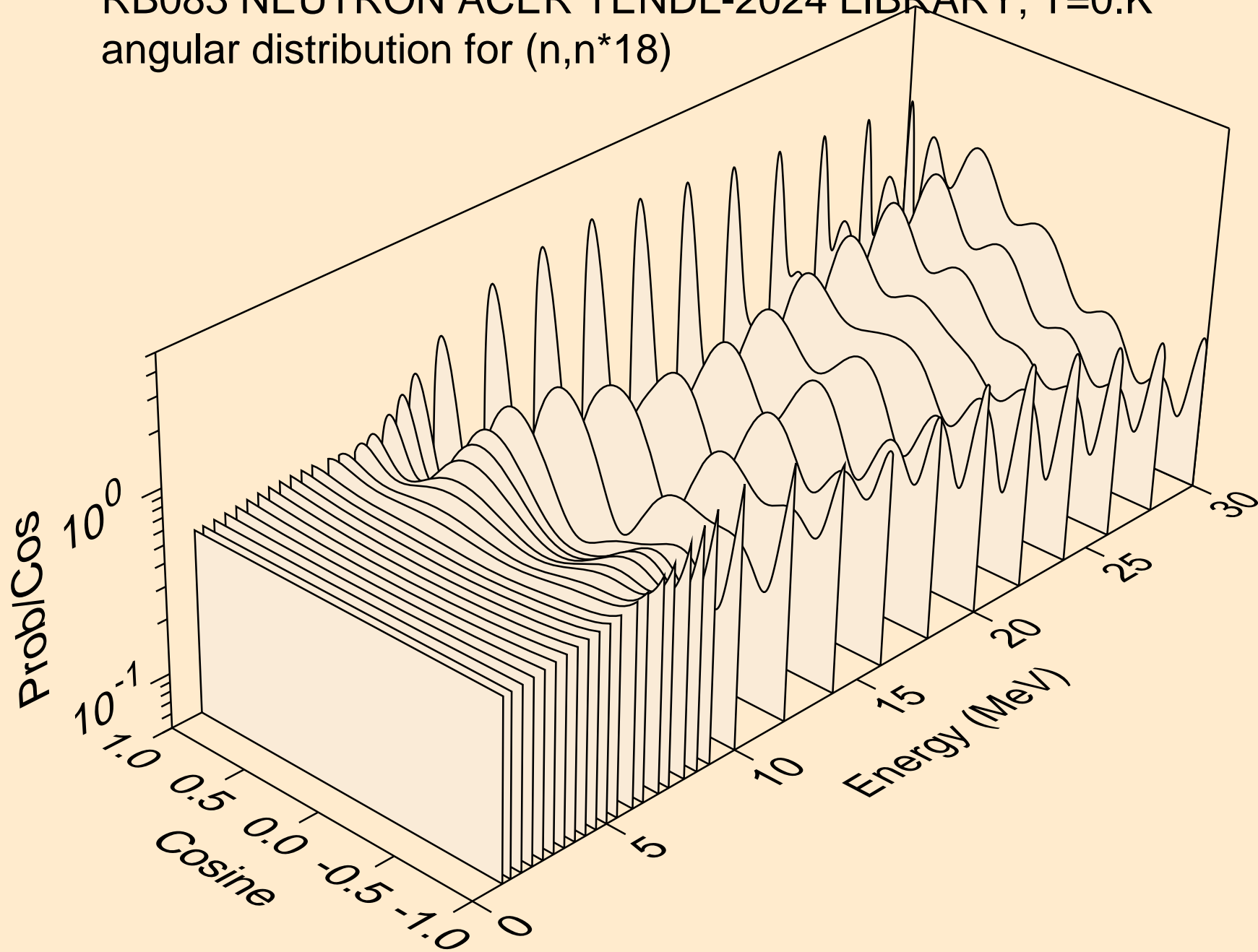



RB083 NEUTRON ACER TENDL-2024 LIBRARY; T=0.K  
angular distribution for (n,n\*19)

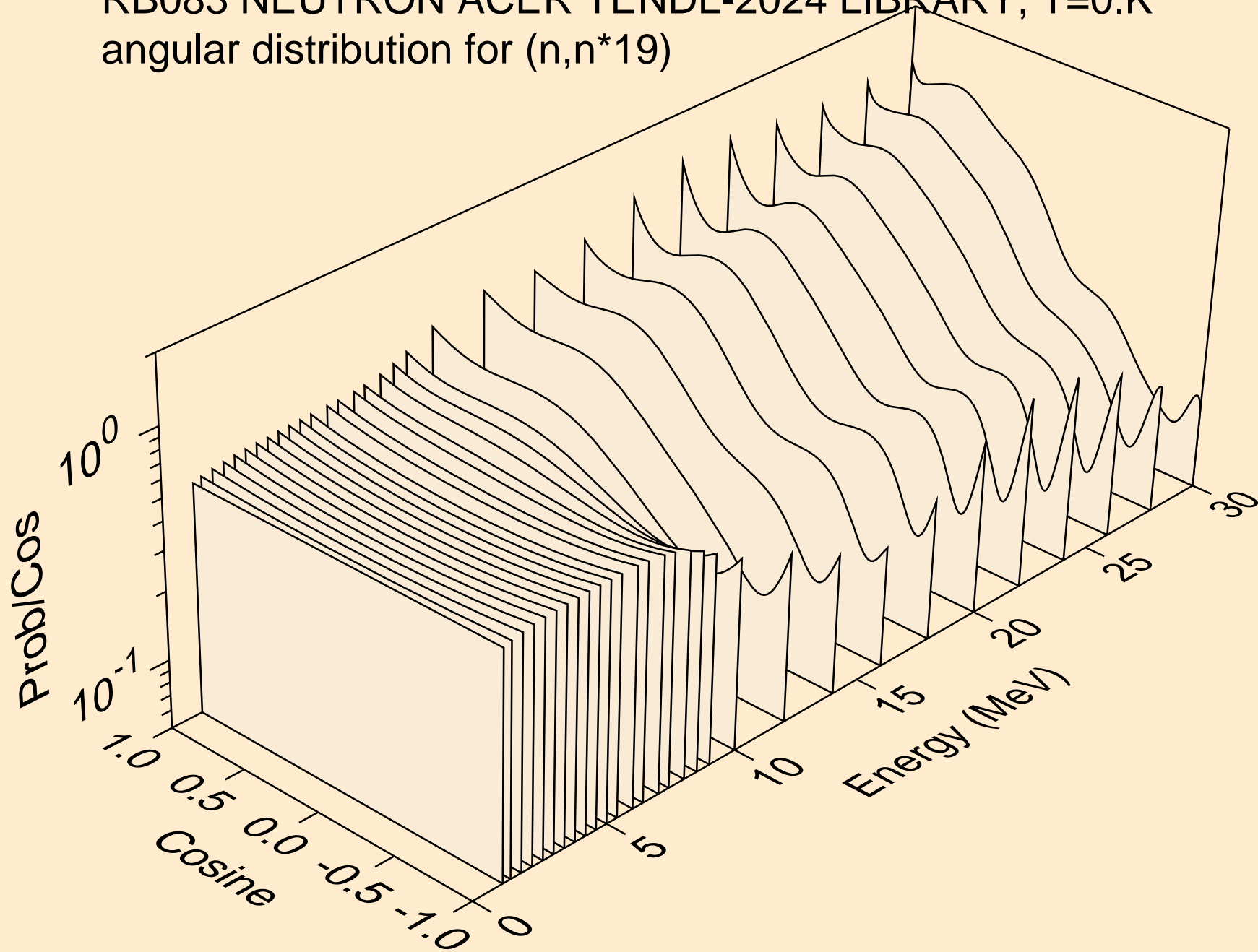

RB083 NEUTRON ACER TENDL-2024 LIBRARY; T=0.K  
angular distribution for (n,n\*20)

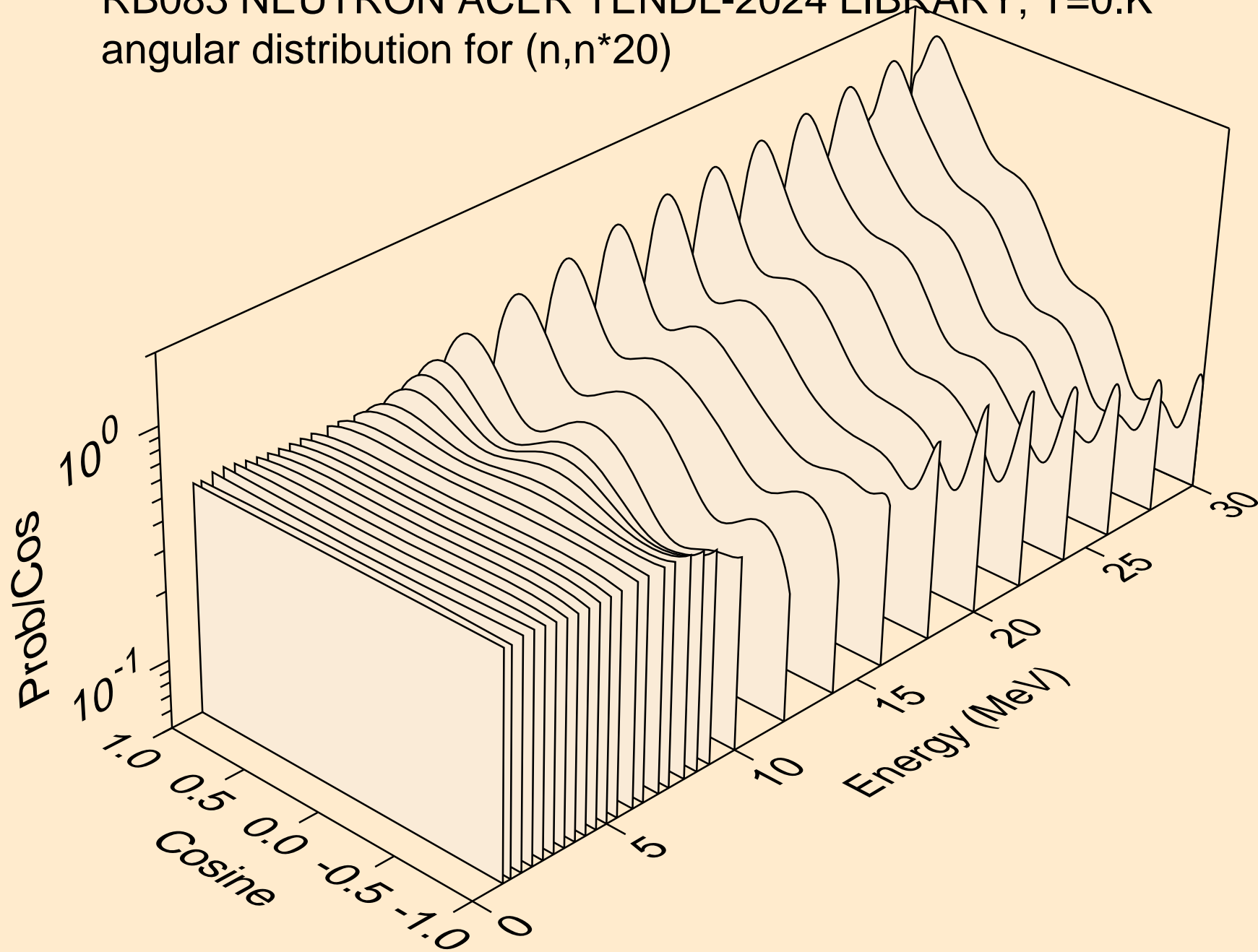

RB083 NEUTRON ACER TENDL-2024 LIBRARY; T=0.K  
angular distribution for (n,n\*21)

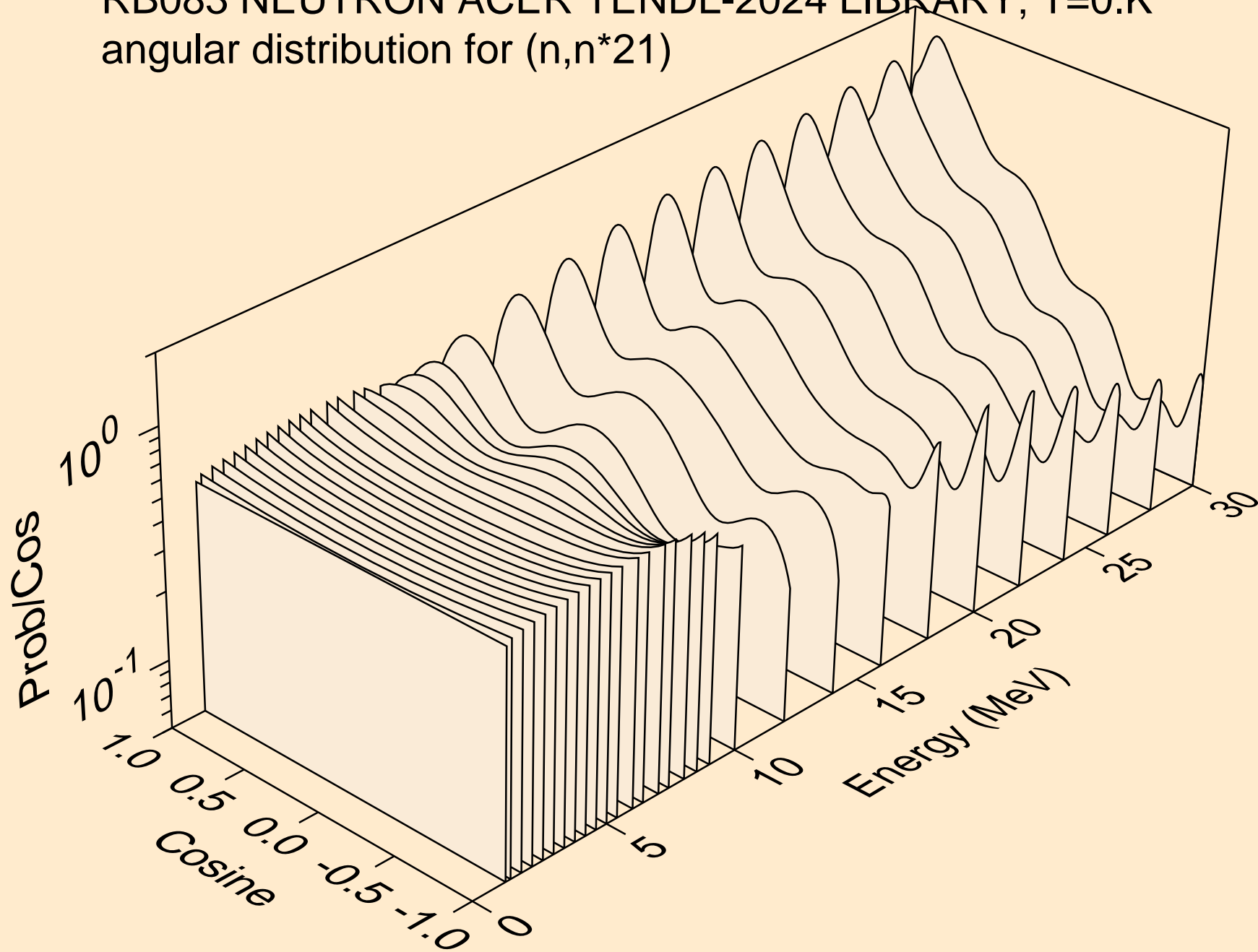

RB083 NEUTRON ACER TENDL-2024 LIBRARY; T=0.K  
angular distribution for (n,n\*22)

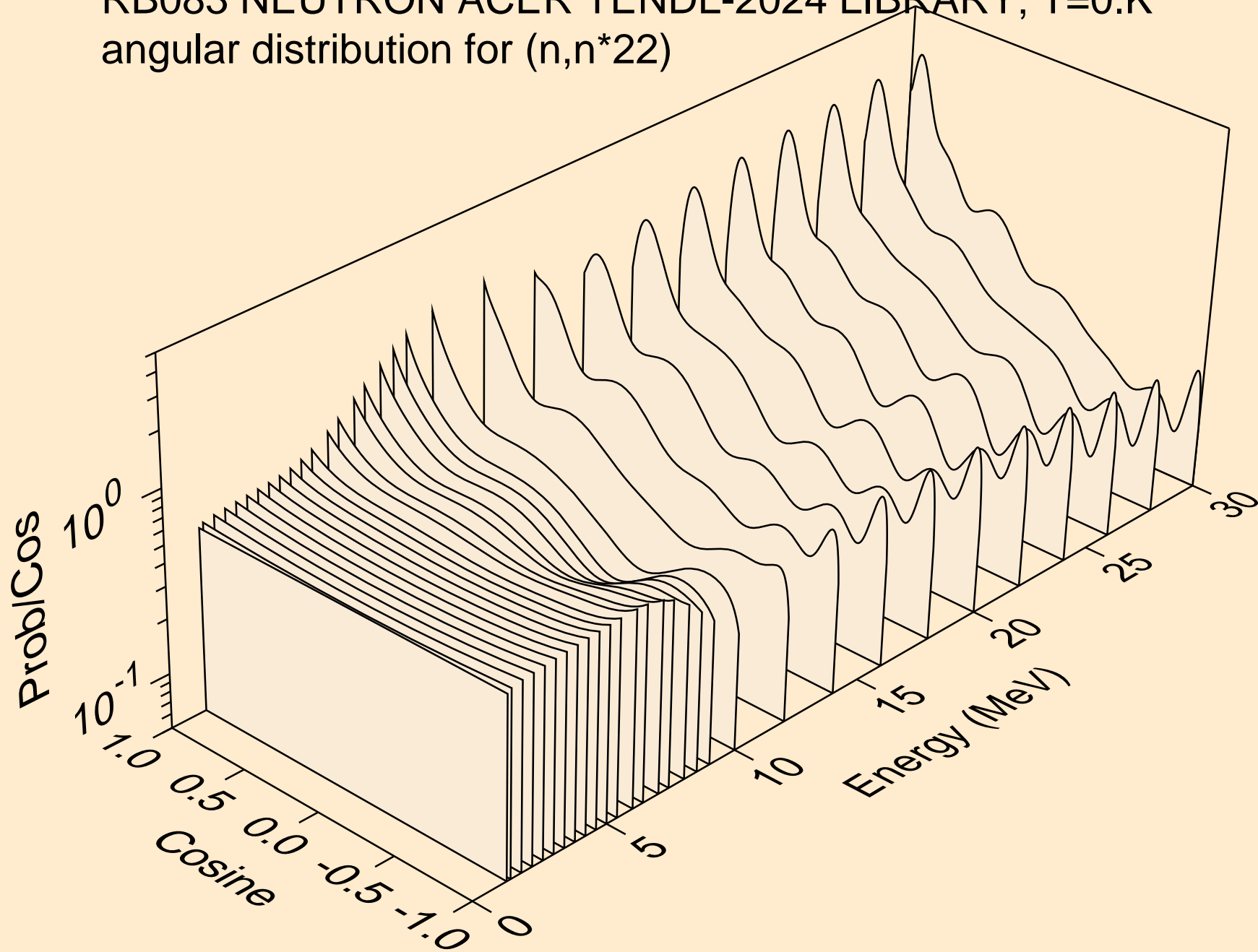

RB083 NEUTRON ACER TENDL-2024 LIBRARY; T=0.K  
angular distribution for (n,n\*23)

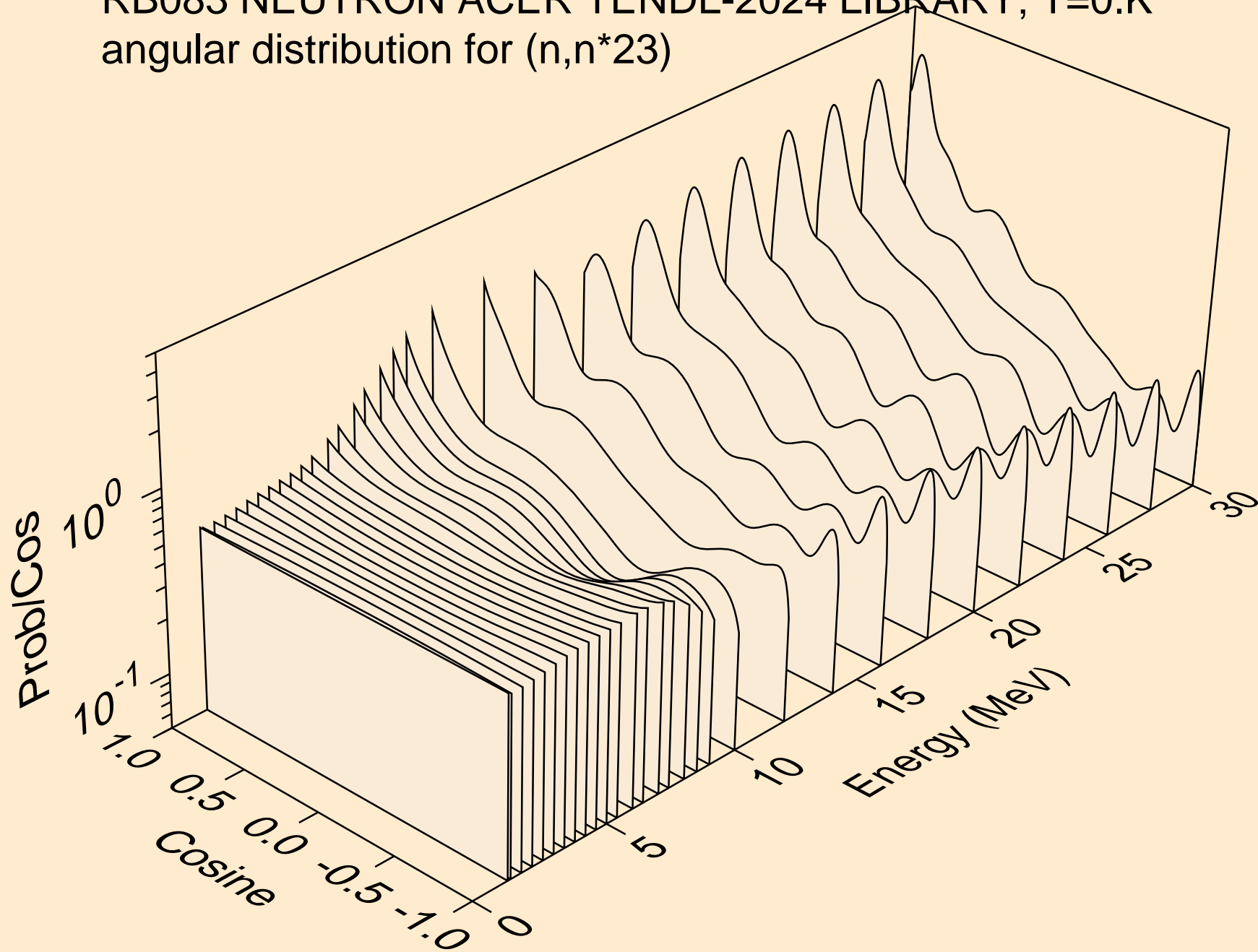

RB083 NEUTRON ACER TENDL-2024 LIBRARY; T=0.K  
angular distribution for (n,n\*24)

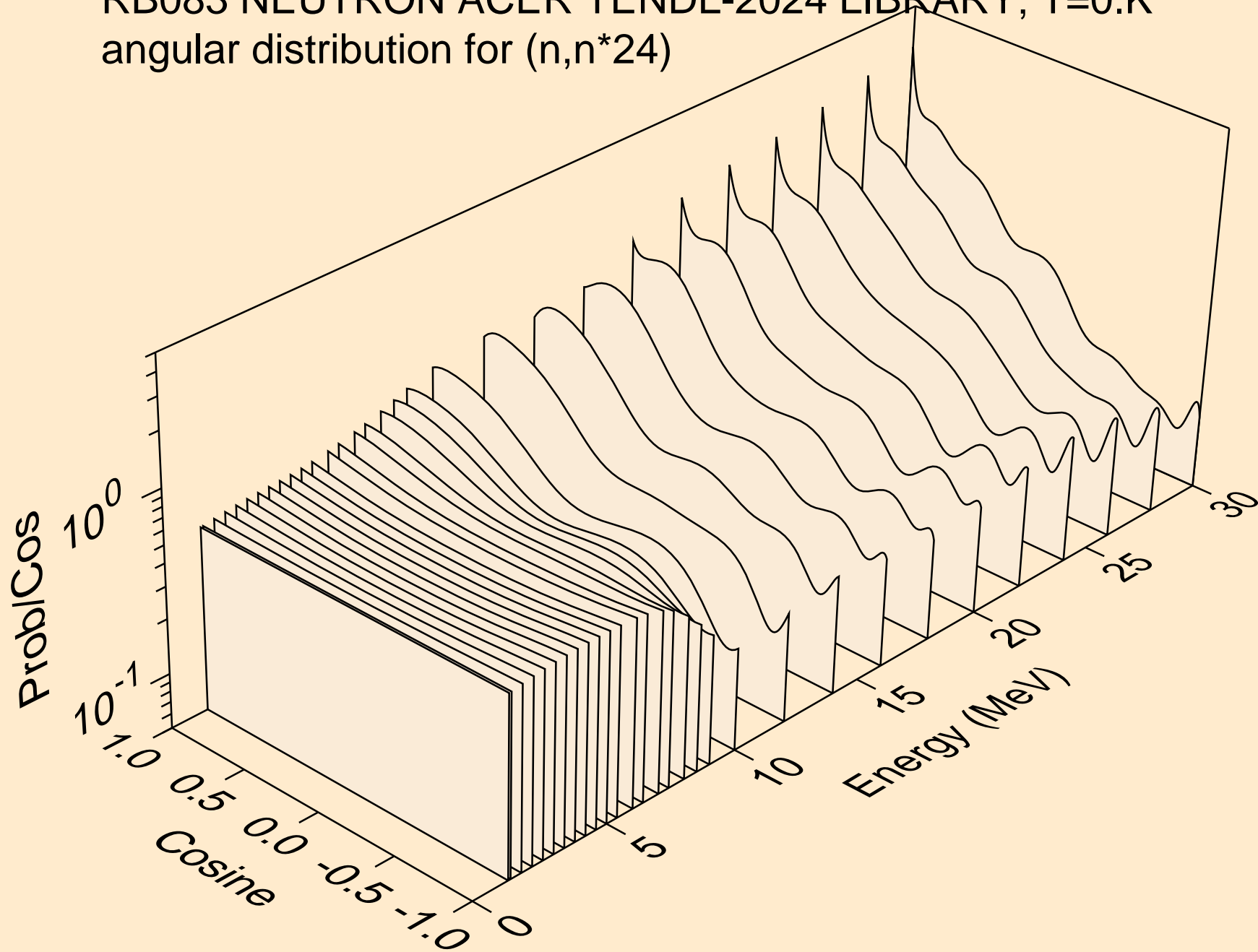

RB083 NEUTRON ACER TENDL-2024 LIBRARY; T=0.K  
angular distribution for (n,n\*25)

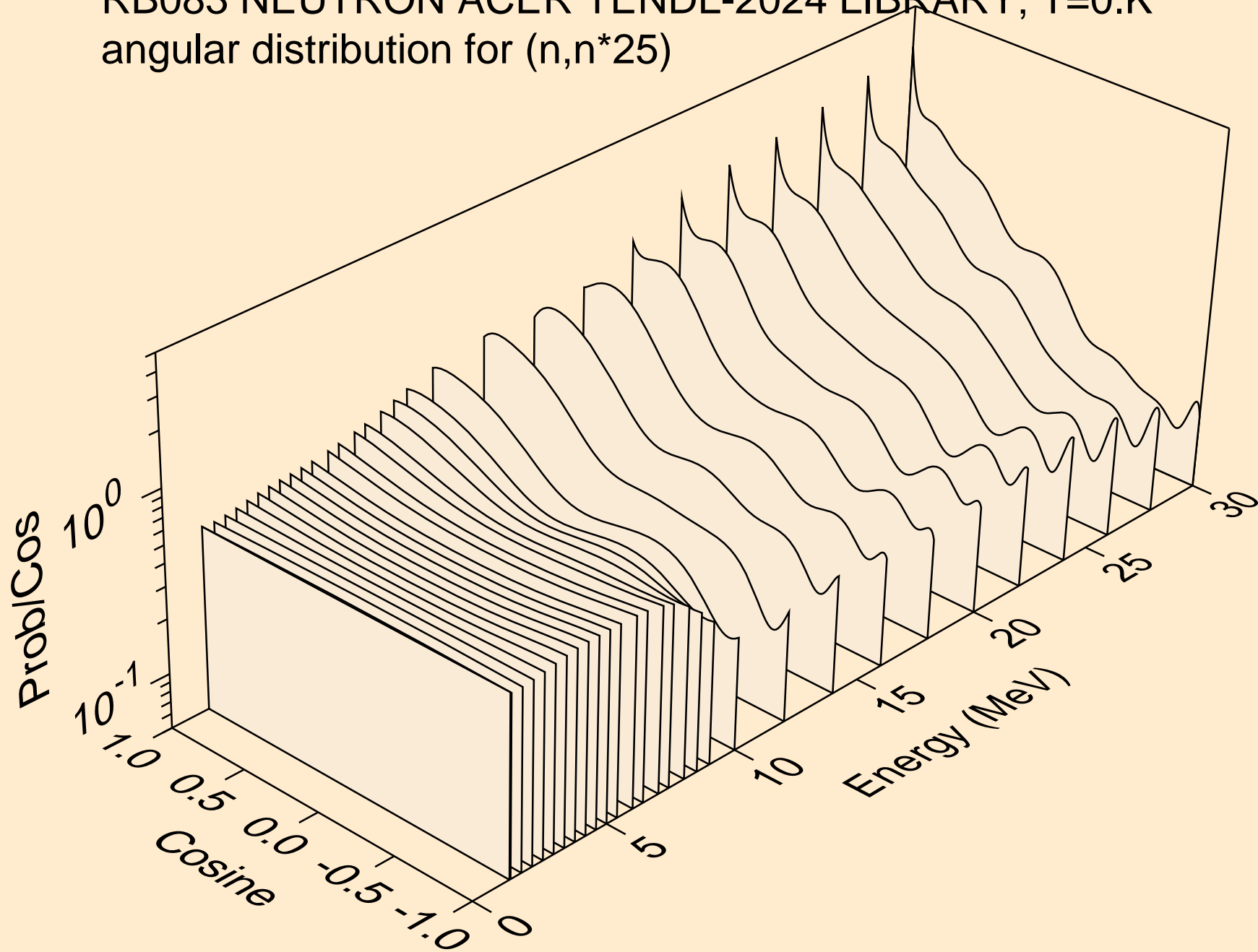

RB083 NEUTRON ACER TENDL-2024 LIBRARY; T=0.K  
angular distribution for (n,n\*26)

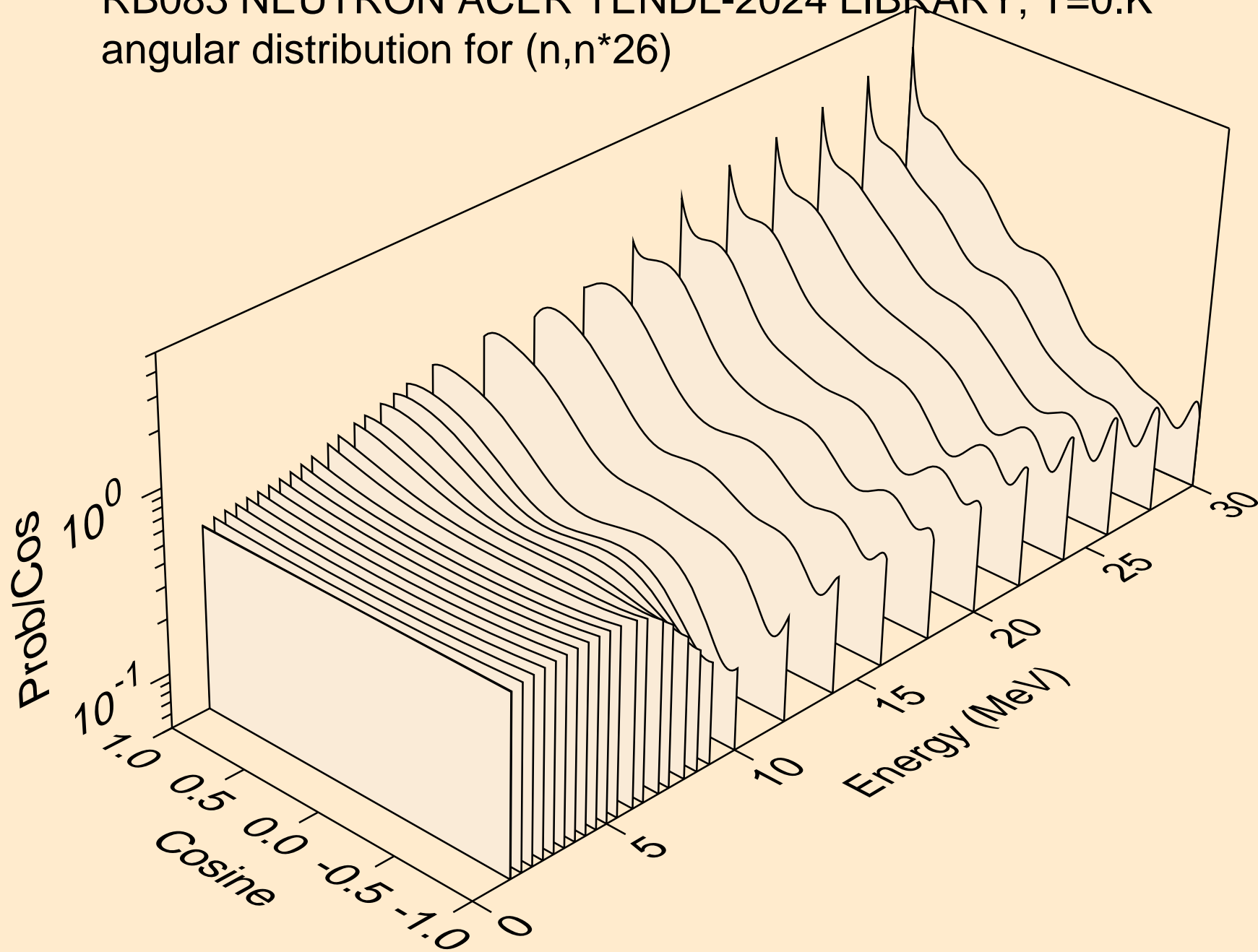



RB083 NEUTRON ACER TENDL-2024 LIBRARY; T=0.K  
angular distribution for (n,n\*27)

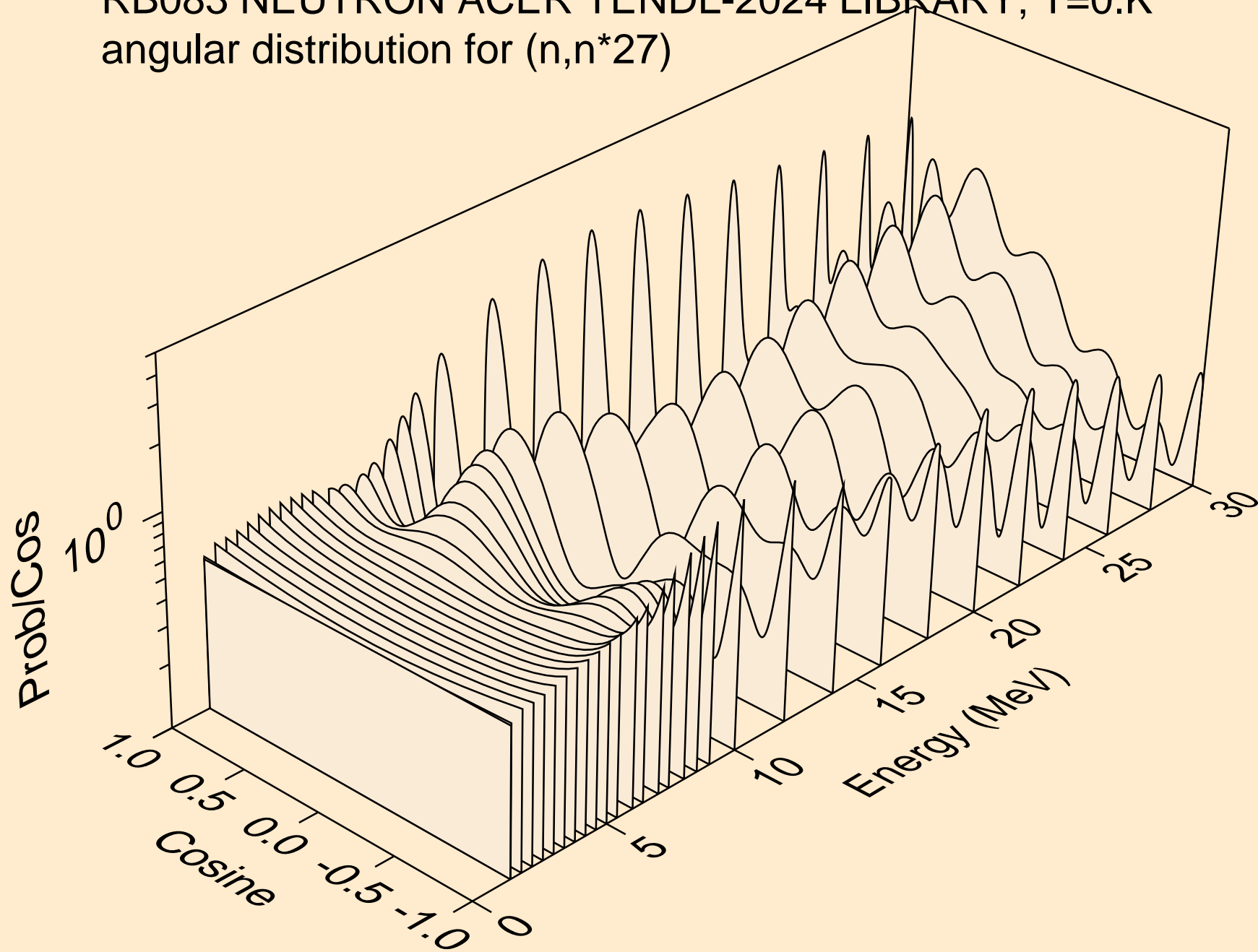

RB083 NEUTRON ACER TENDL-2024 LIBRARY; T=0.K  
angular distribution for (n,n\*28)

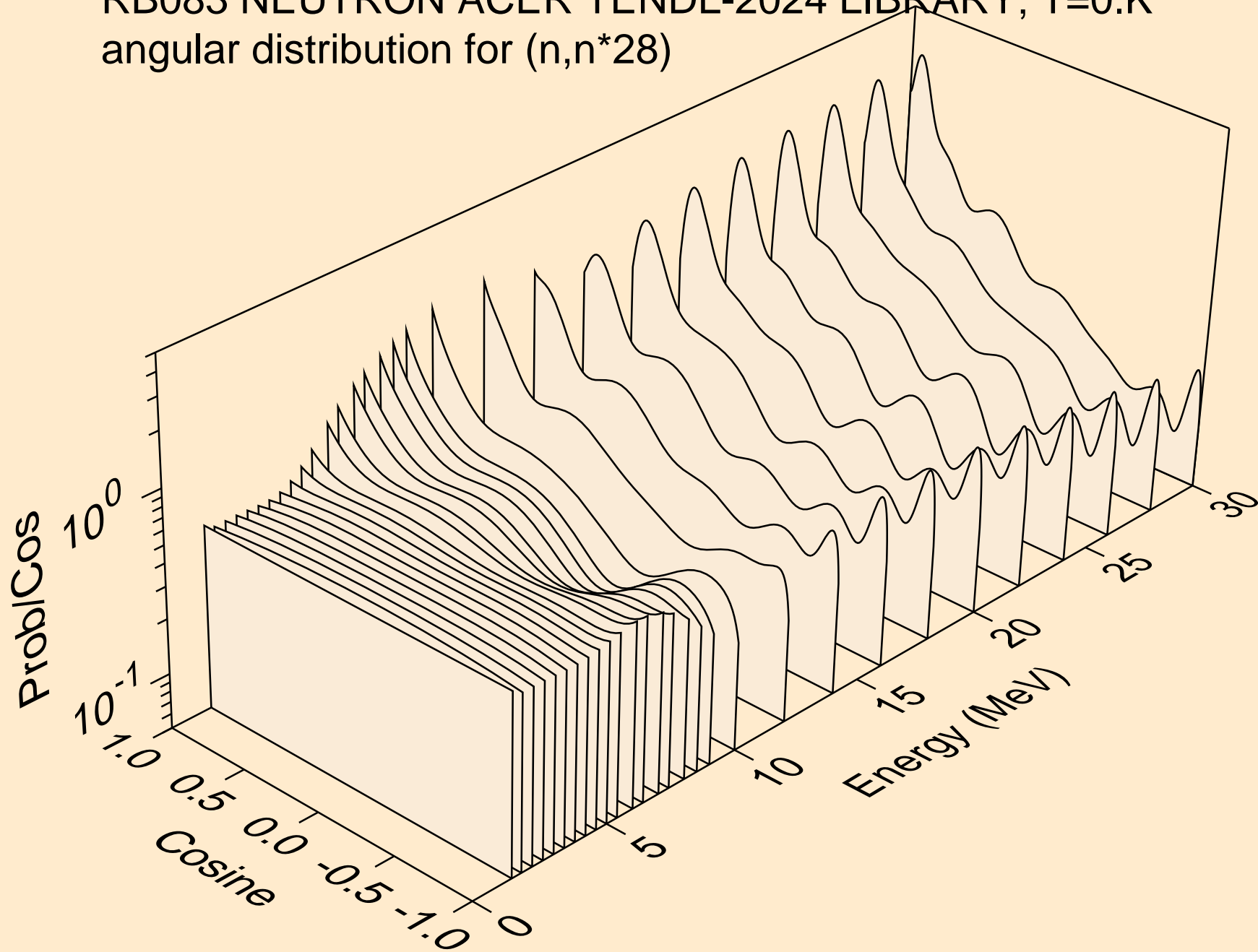

RB083 NEUTRON ACER TENDL-2024 LIBRARY; T=0.K  
angular distribution for (n,n\*29)

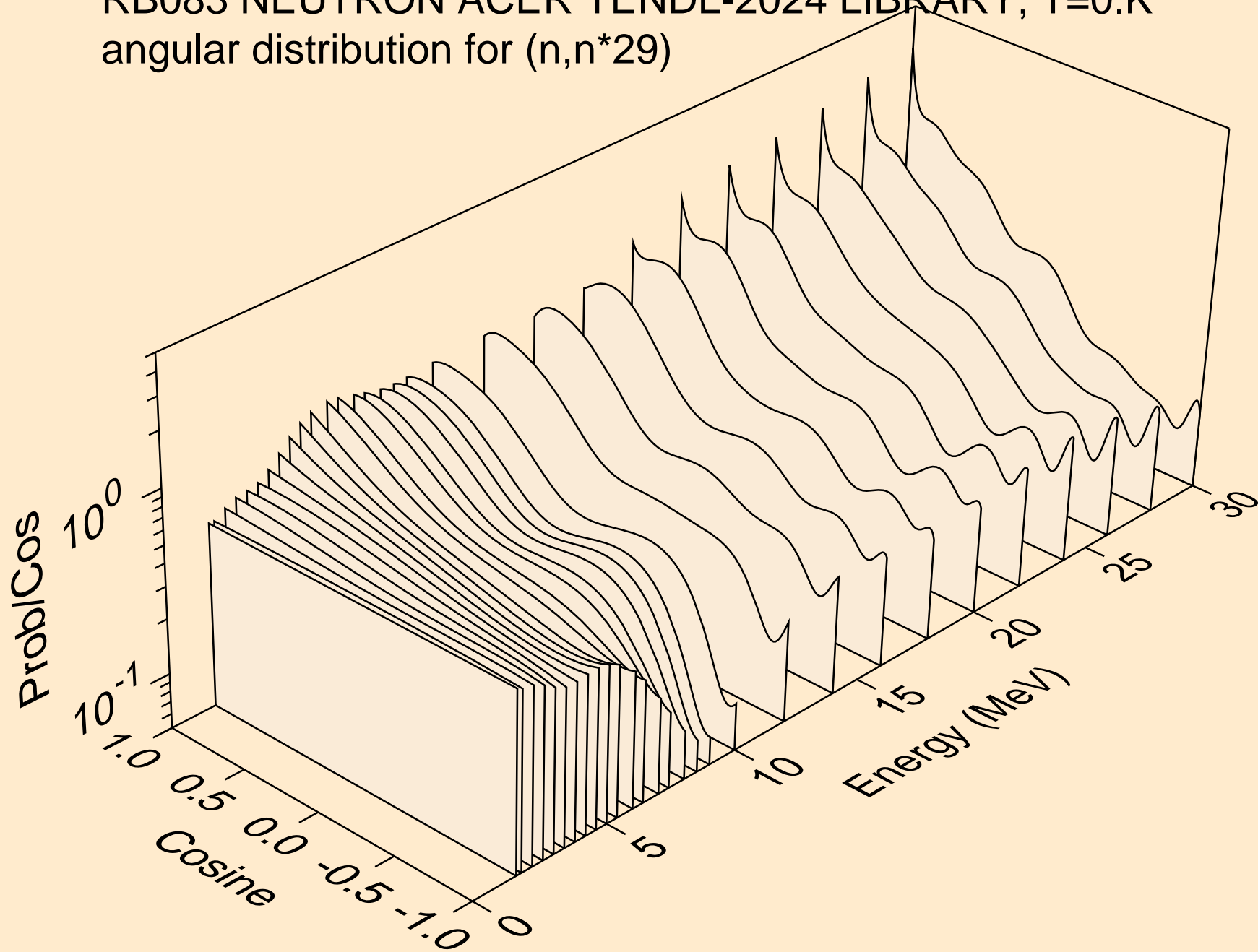

RB083 NEUTRON ACER TENDL-2024 LIBRARY; T=0.K  
angular distribution for (n,n\*30)

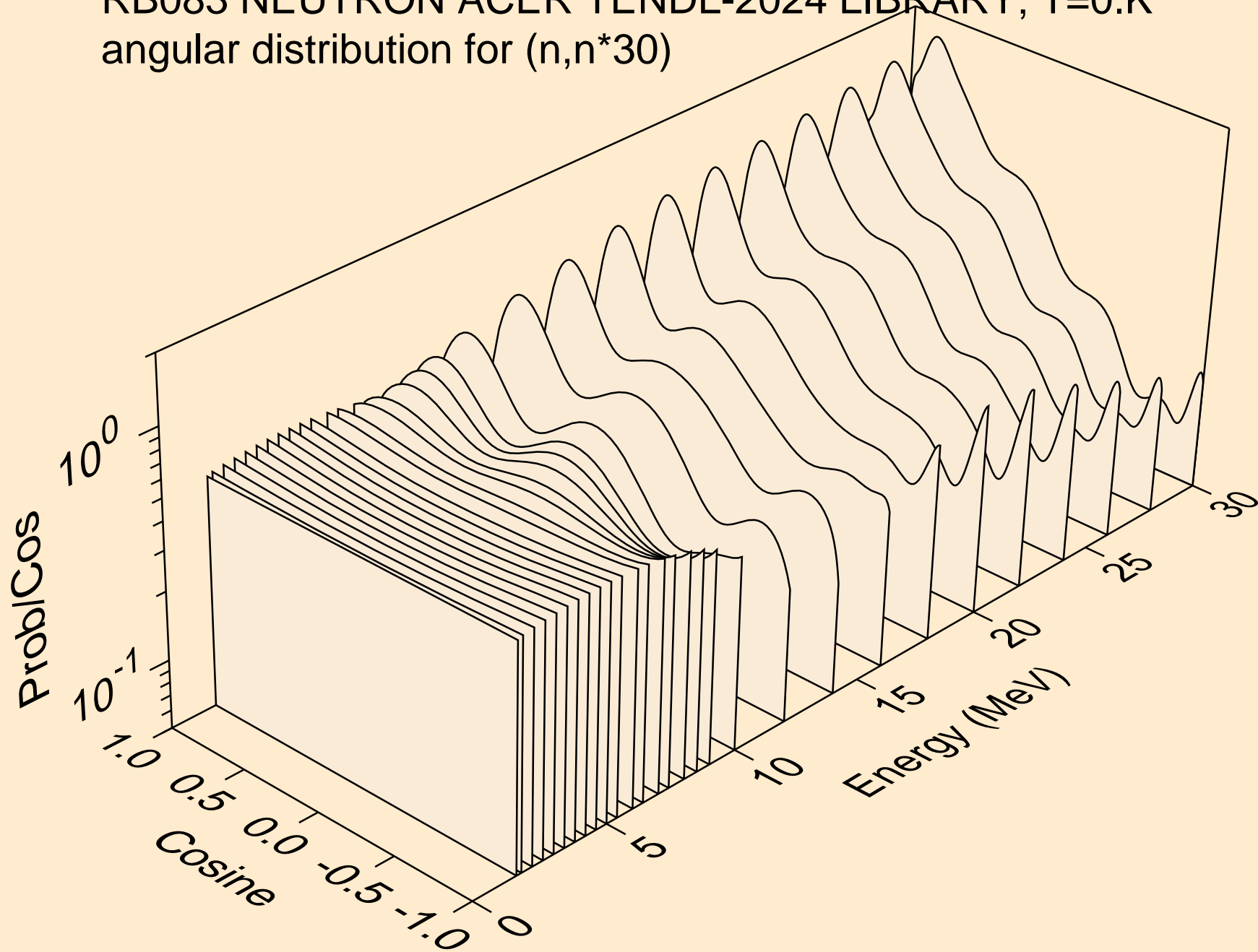

RB083 NEUTRON ACER TENDL-2024 LIBRARY; T=0.K  
Neutron emission for (n,x)

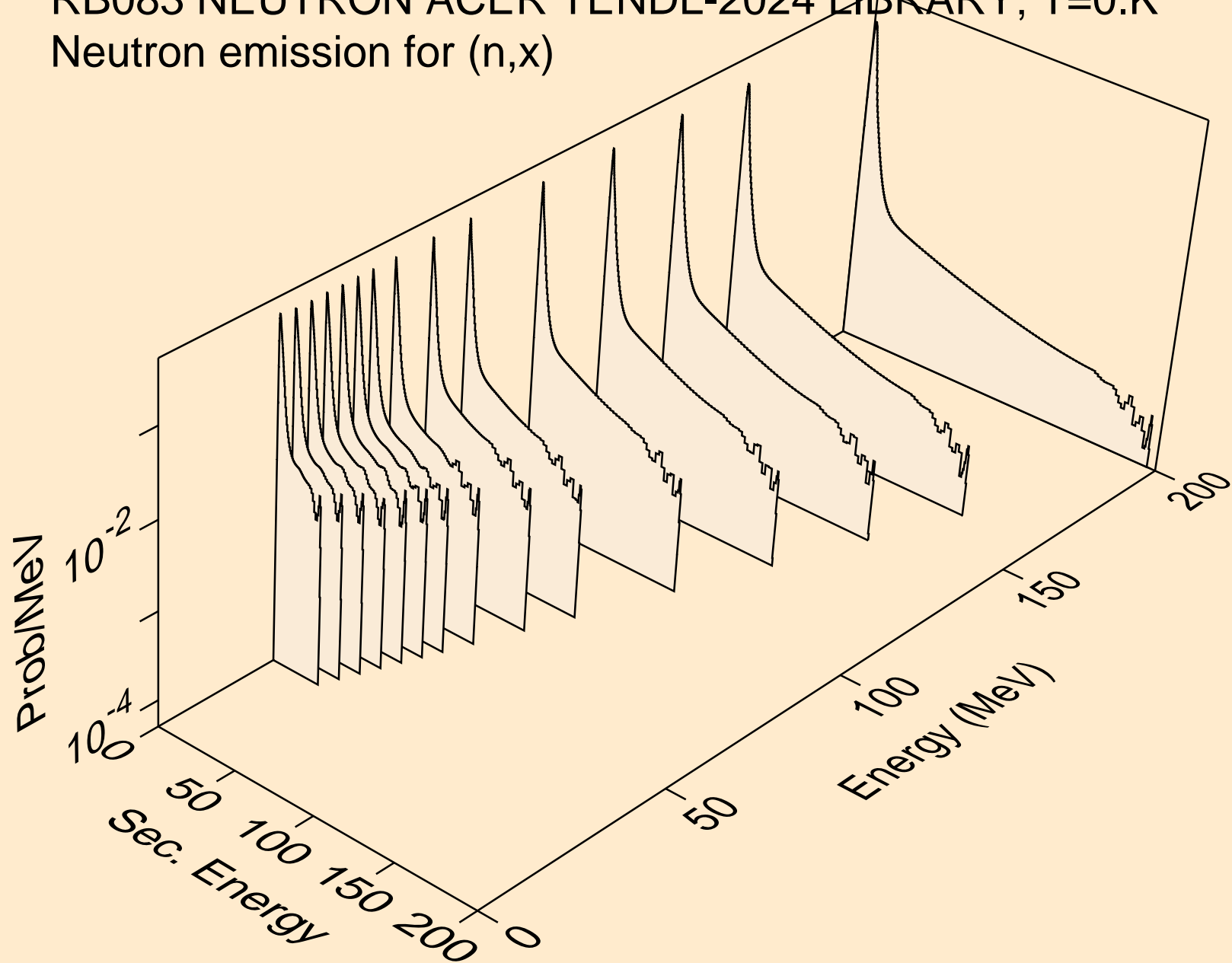

RB083 NEUTRON ACER TENDL-2024 LIBRARY; T=0.K  
Neutron emission for (n,2nd)

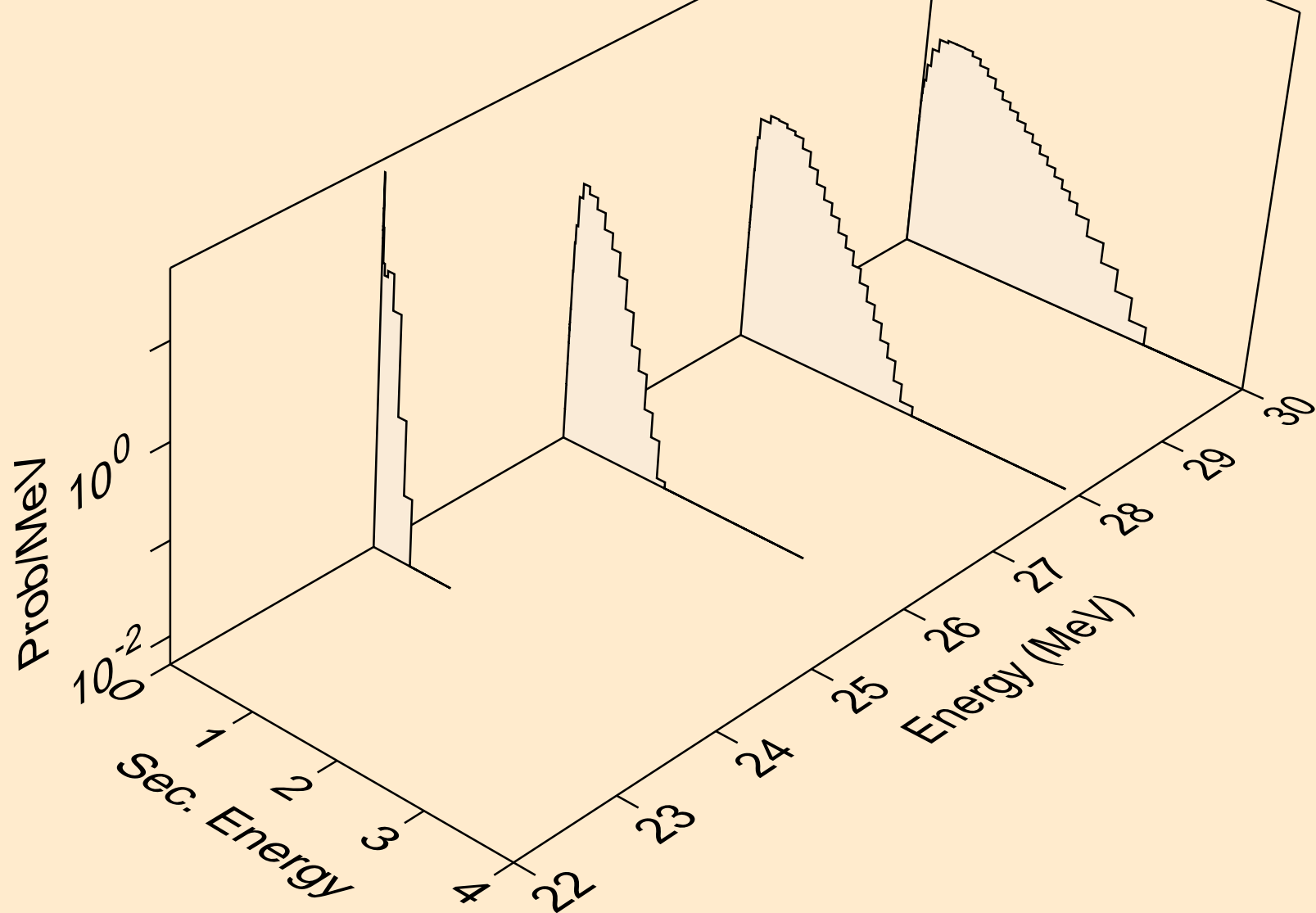

RB083 NEUTRON ACER TENDL-2024 LIBRARY; T=0.K  
Neutron emission for (n,2n)

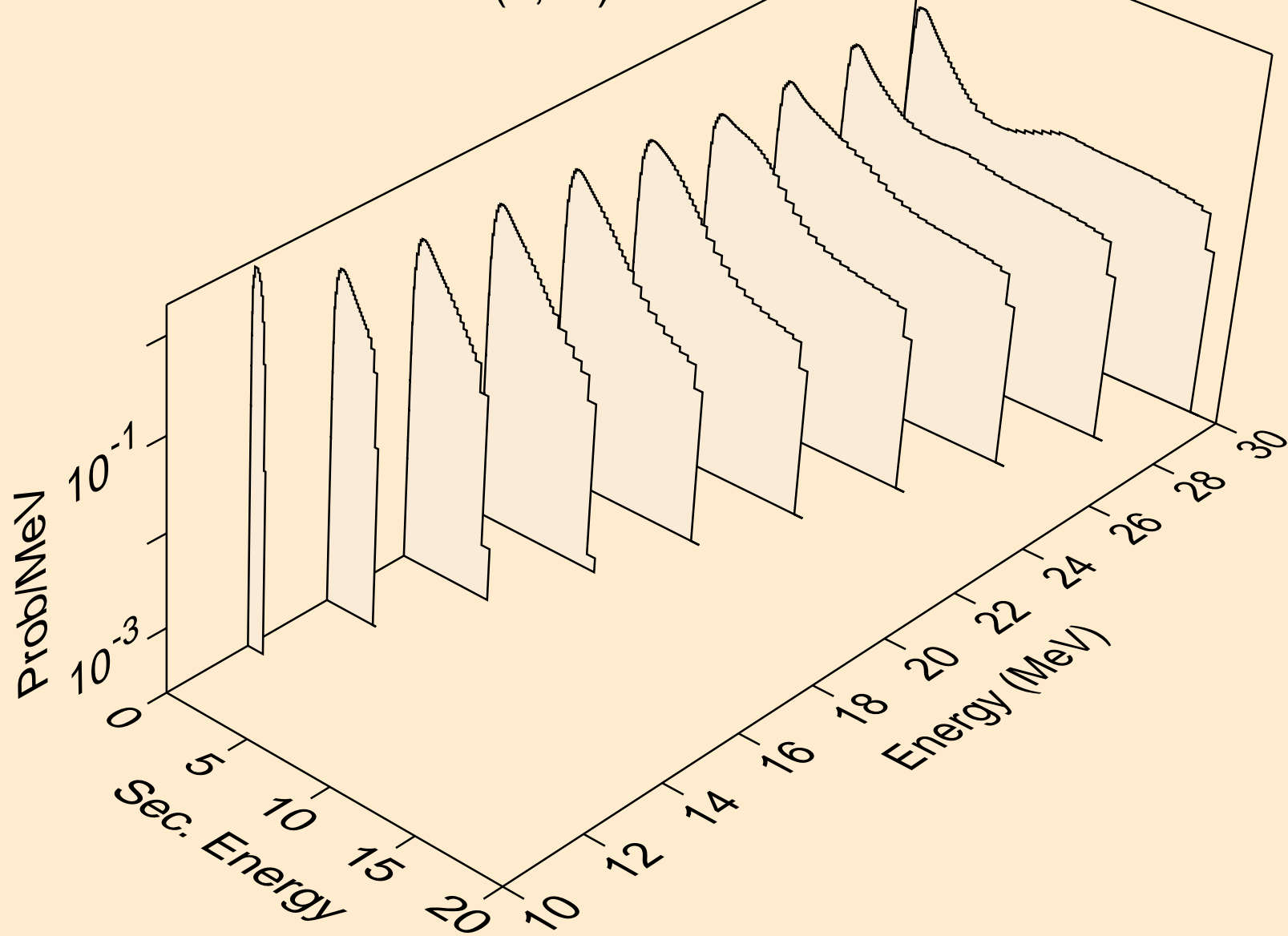

RB083 NEUTRON ACER TENDL-2024 LIBRARY; T=0.K  
Neutron emission for (n,3n)

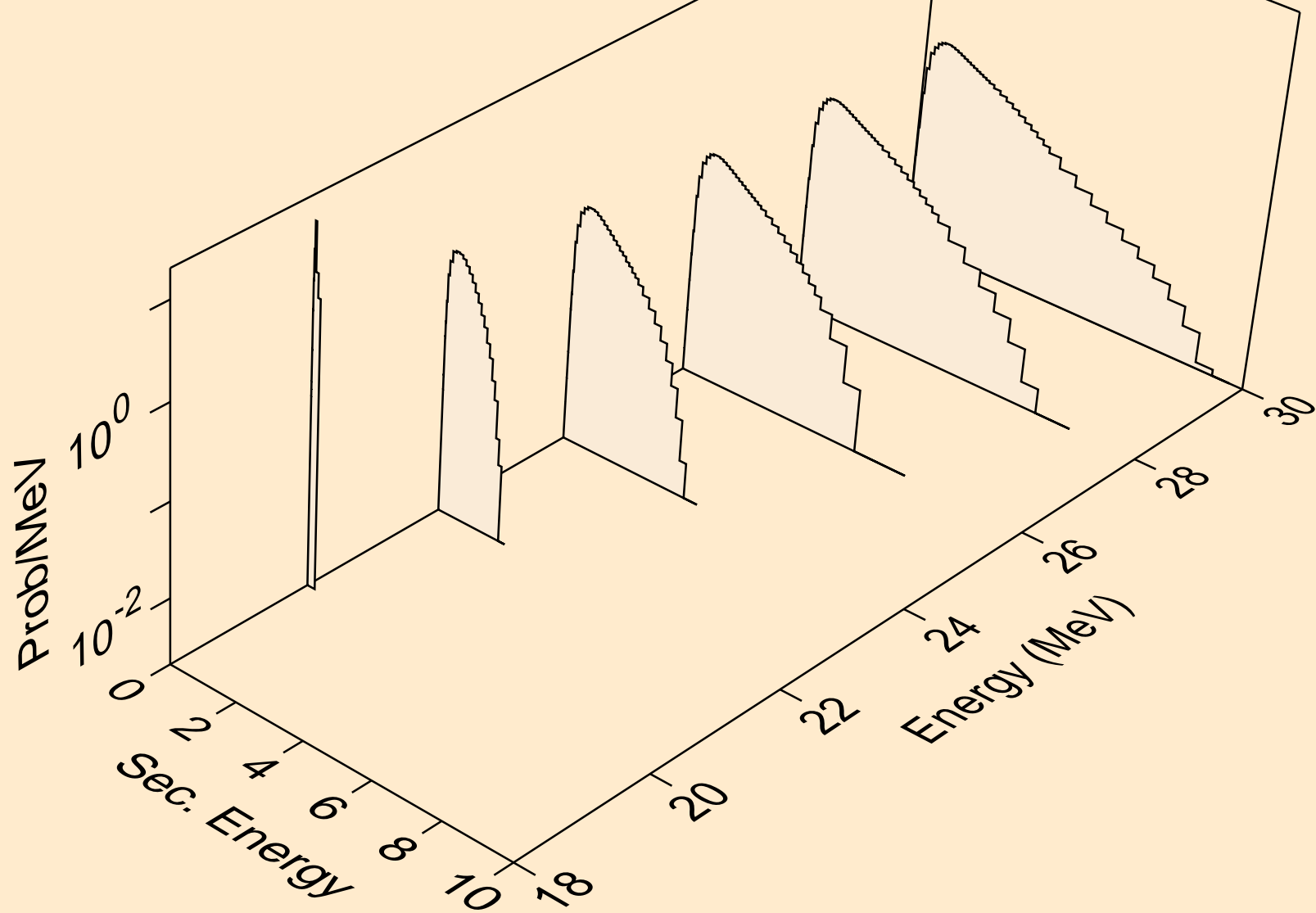



RB083 NEUTRON ACER TENDL-2024 LIBRARY; T=0.K  
Neutron emission for (n,n\*)a

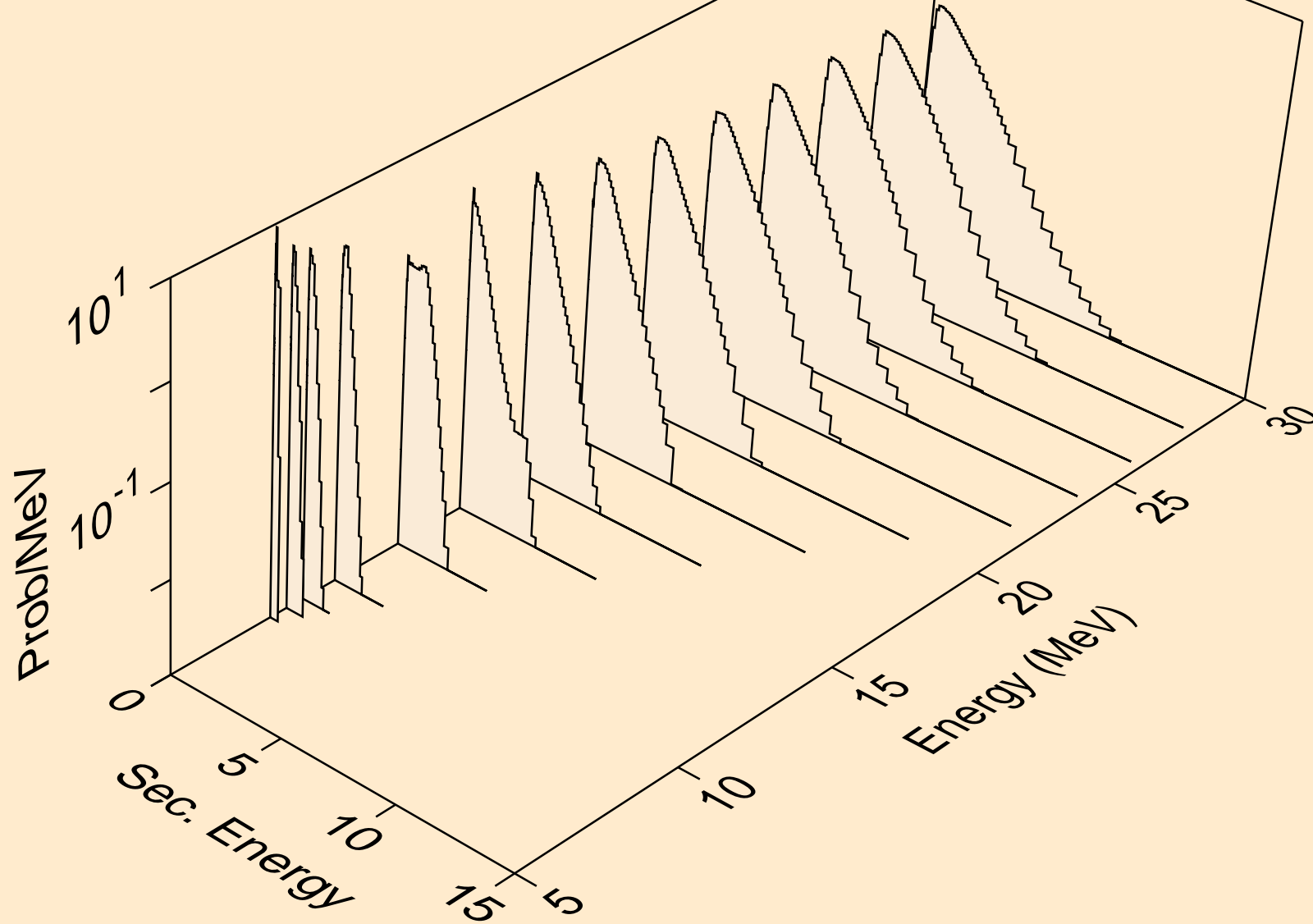

RB083 NEUTRON ACER TENDL-2024 LIBRARY; T=0.K  
Neutron emission for (n,2n)a

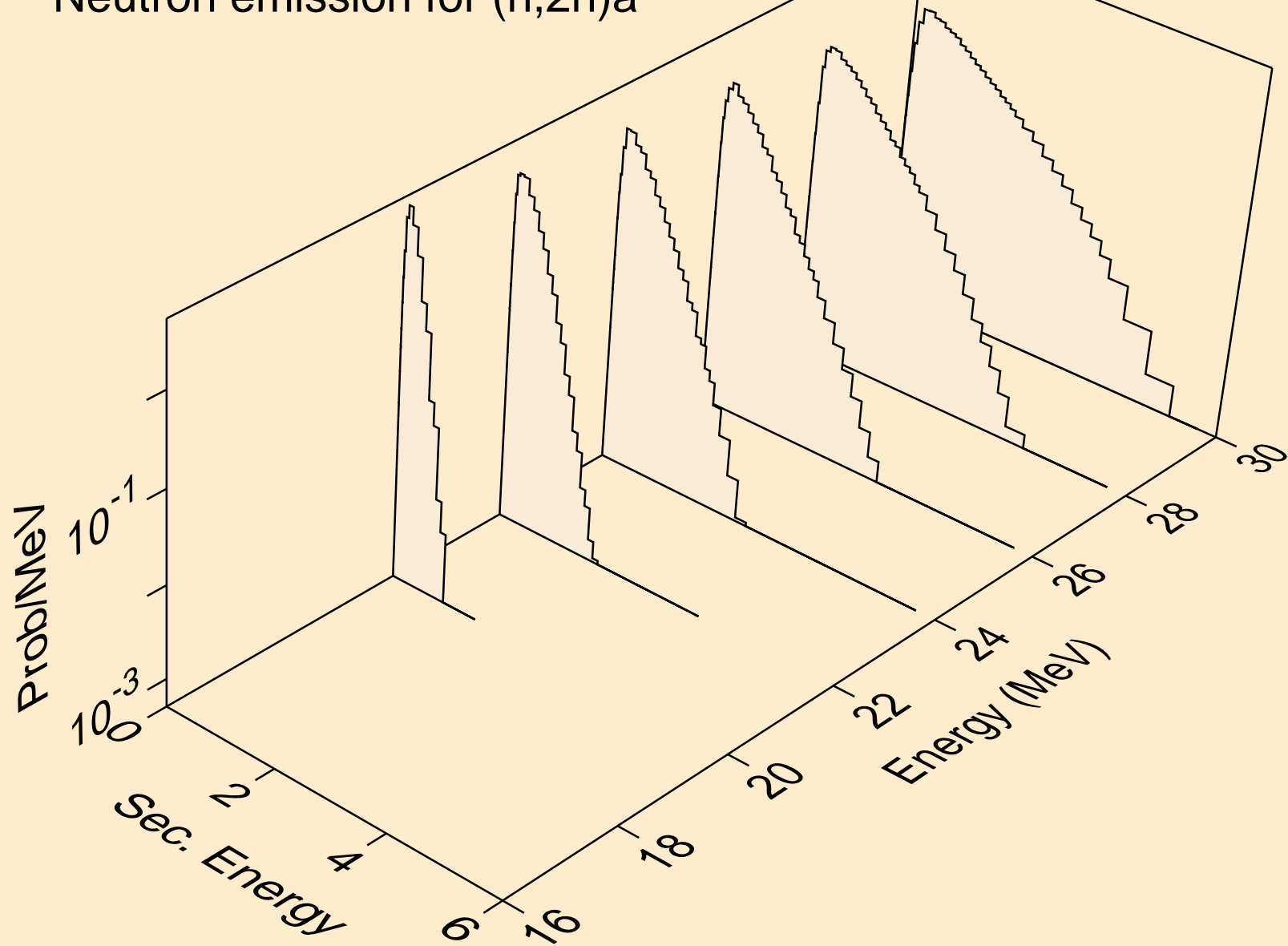

RB083 NEUTRON ACER TENDL-2024 LIBRARY; T=0.K  
Neutron emission for (n,n\*)p

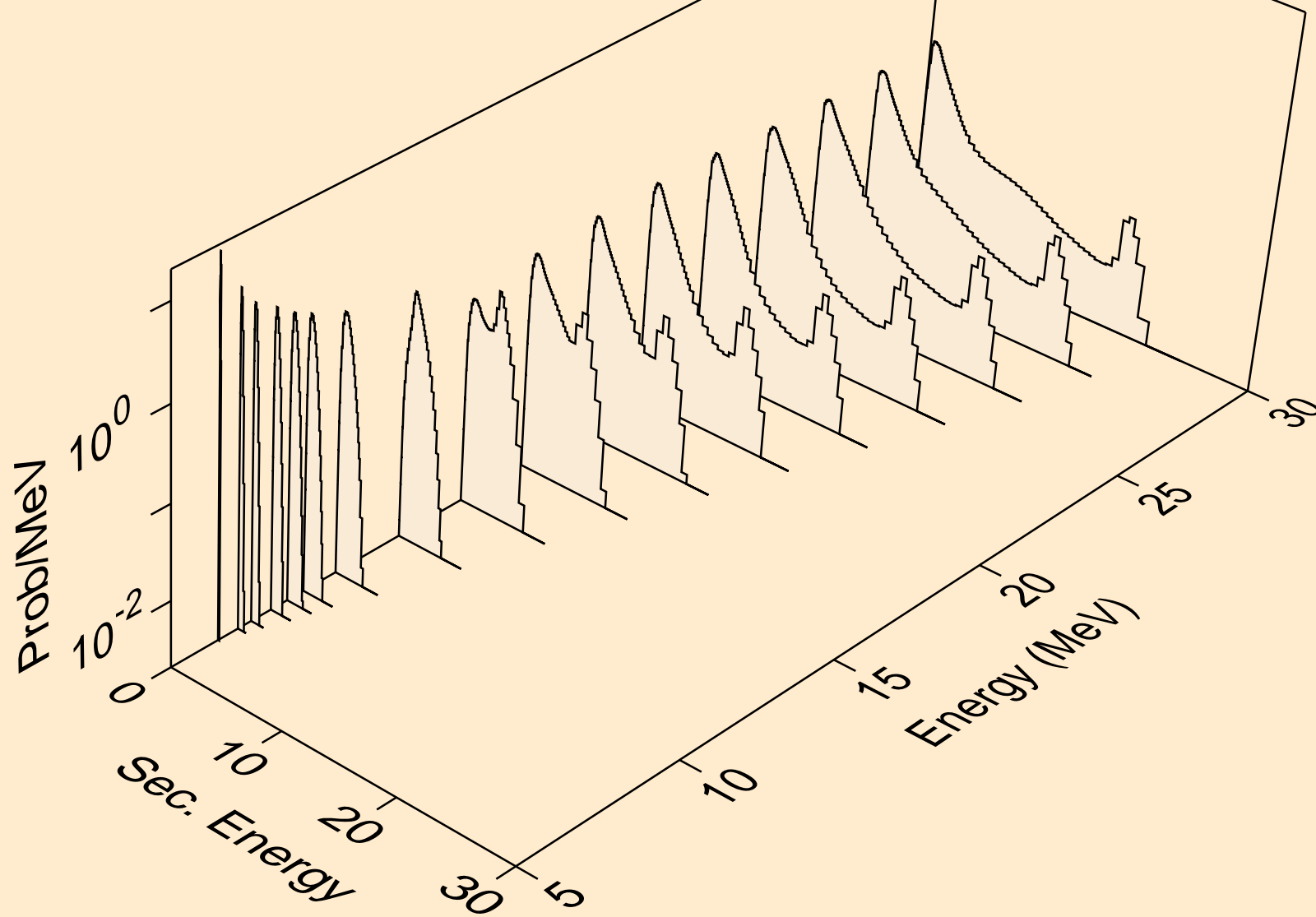

RB083 NEUTRON ACER TENDL-2024 LIBRARY; T=0.K  
Neutron emission for (n,n\*)2a

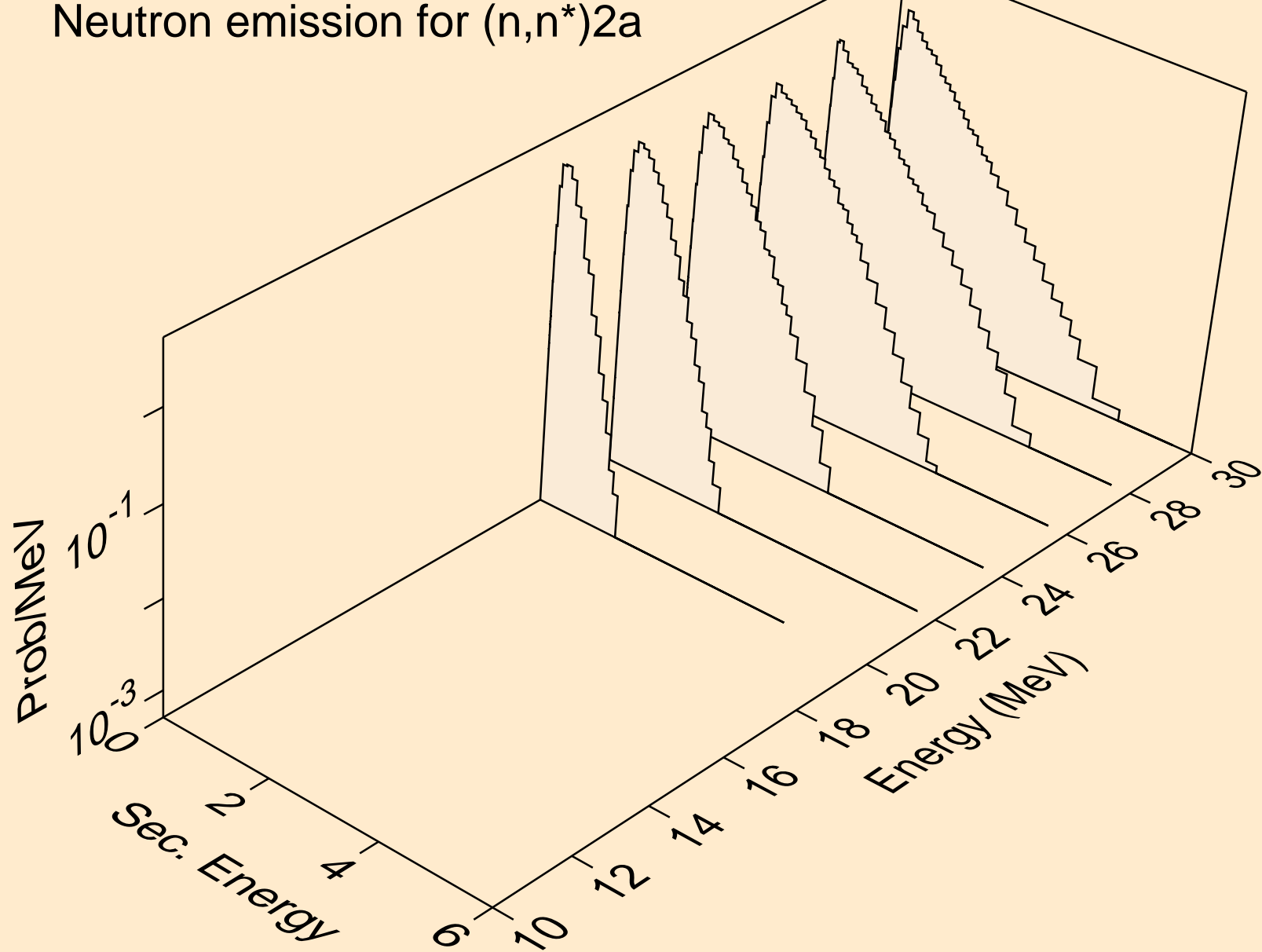

RB083 NEUTRON ACER TENDL-2024 LIBRARY; T=0.K  
Neutron emission for (n,n\*)d

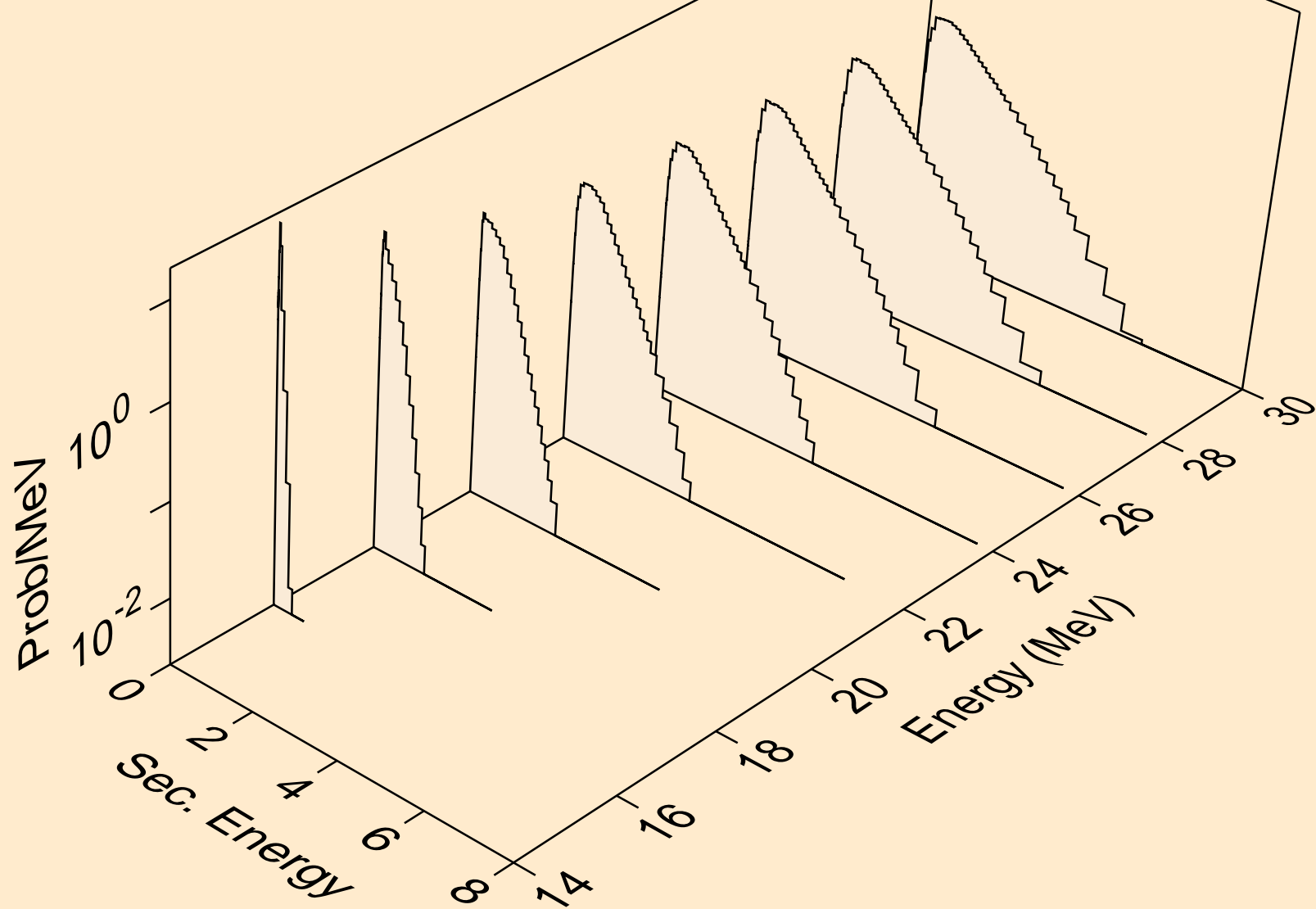

RB083 NEUTRON ACER TENDL-2024 LIBRARY; T=0.K  
Neutron emission for (n,n\*)t

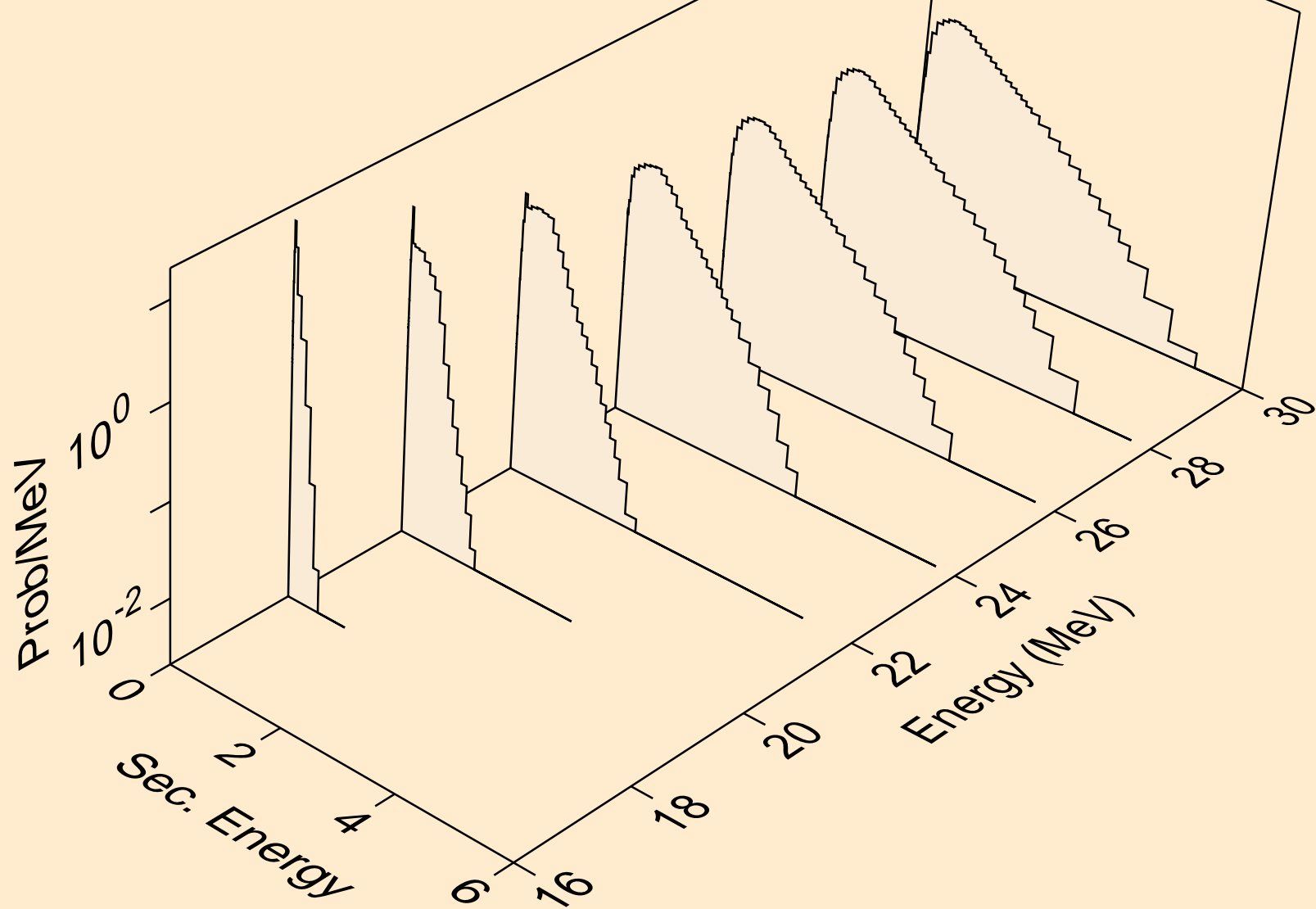

RB083 NEUTRON ACER TENDL-2024 LIBRARY; T=0.K  
Neutron emission for (n,n\*)he3

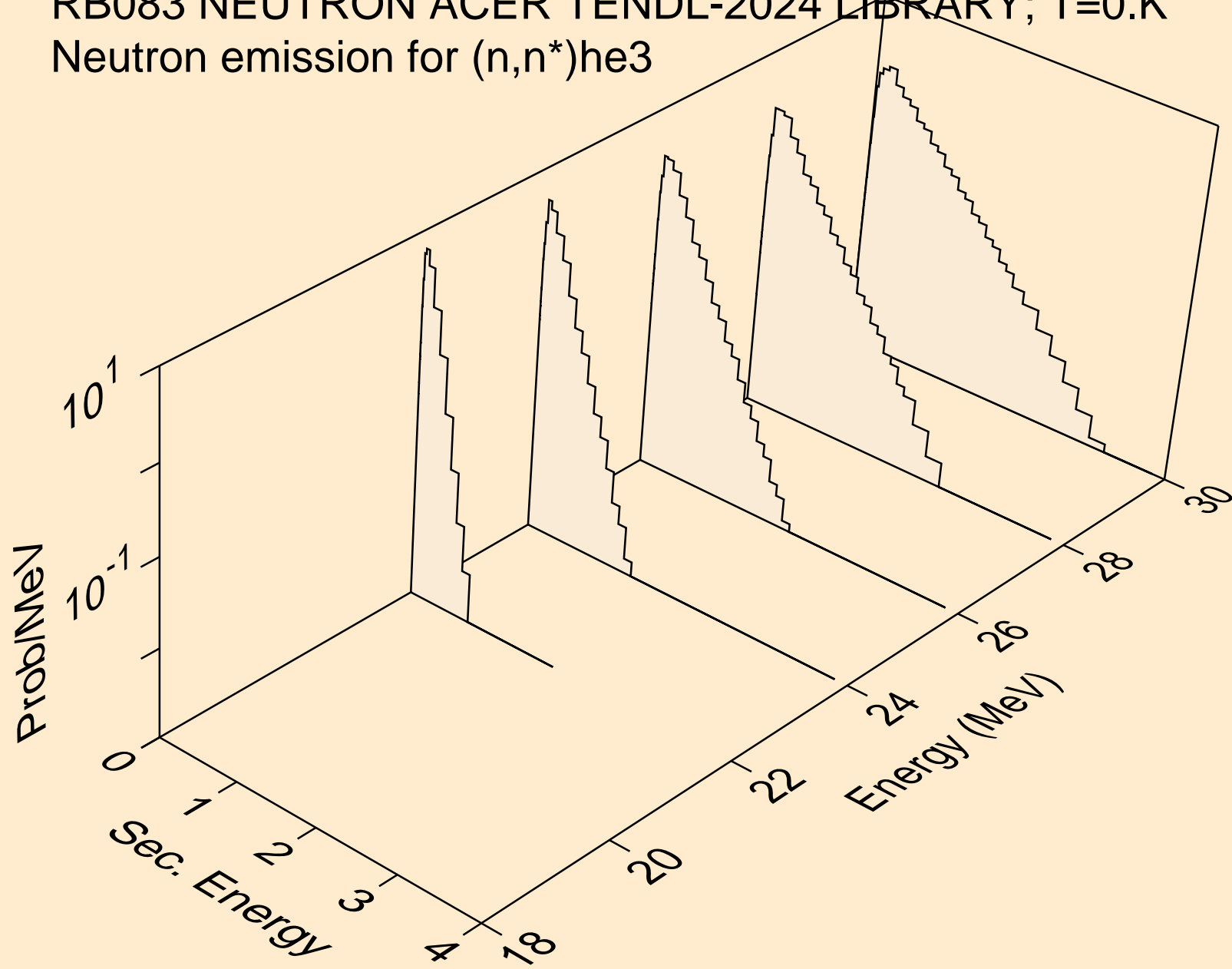

RB083 NEUTRON ACER TENDL-2024 LIBRARY; T=0.K  
Neutron emission for (n,2np)

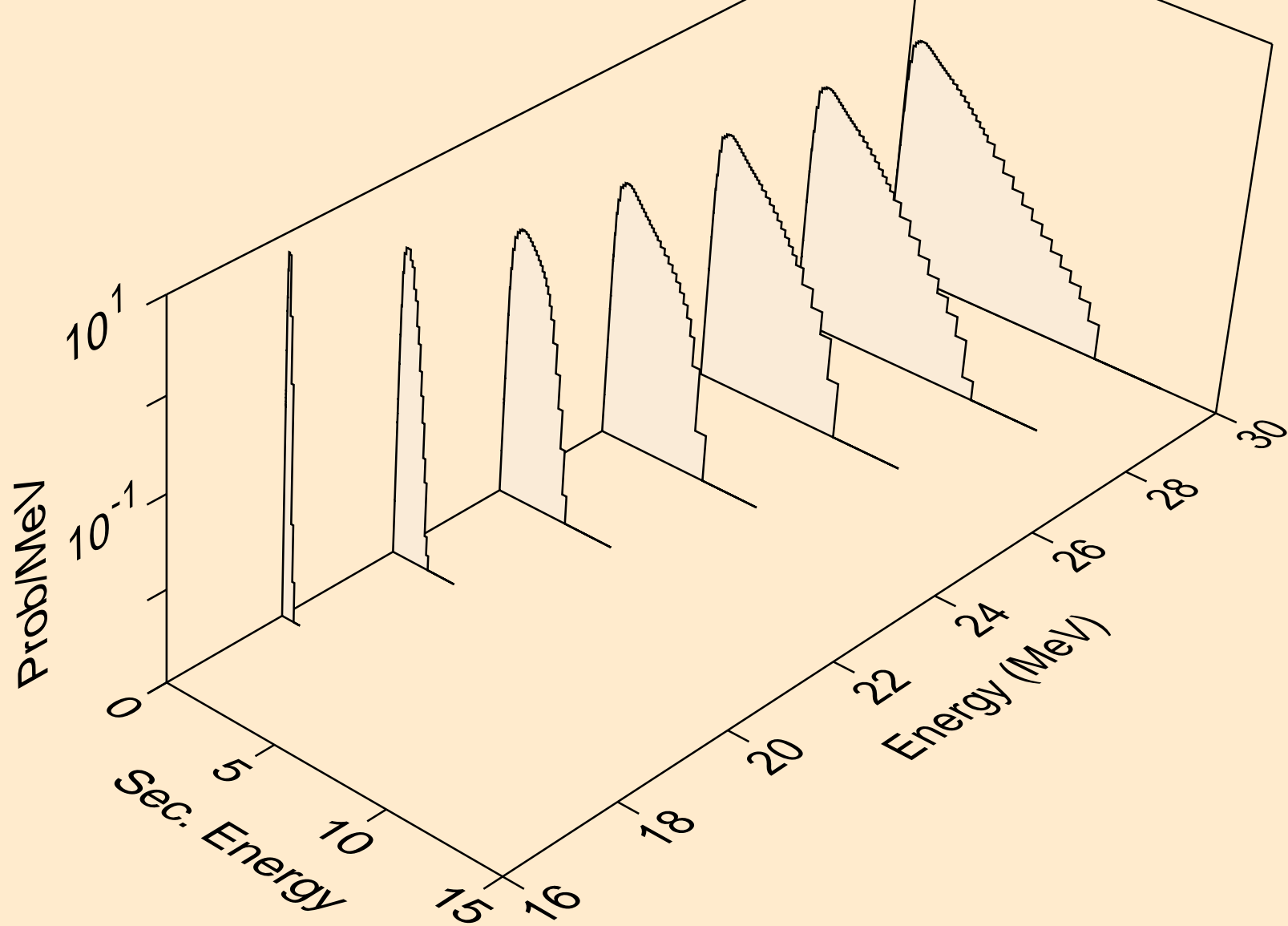



RB083 NEUTRON ACER TENDL-2024 LIBRARY; T=0.K  
Neutron emission for (n,3np)

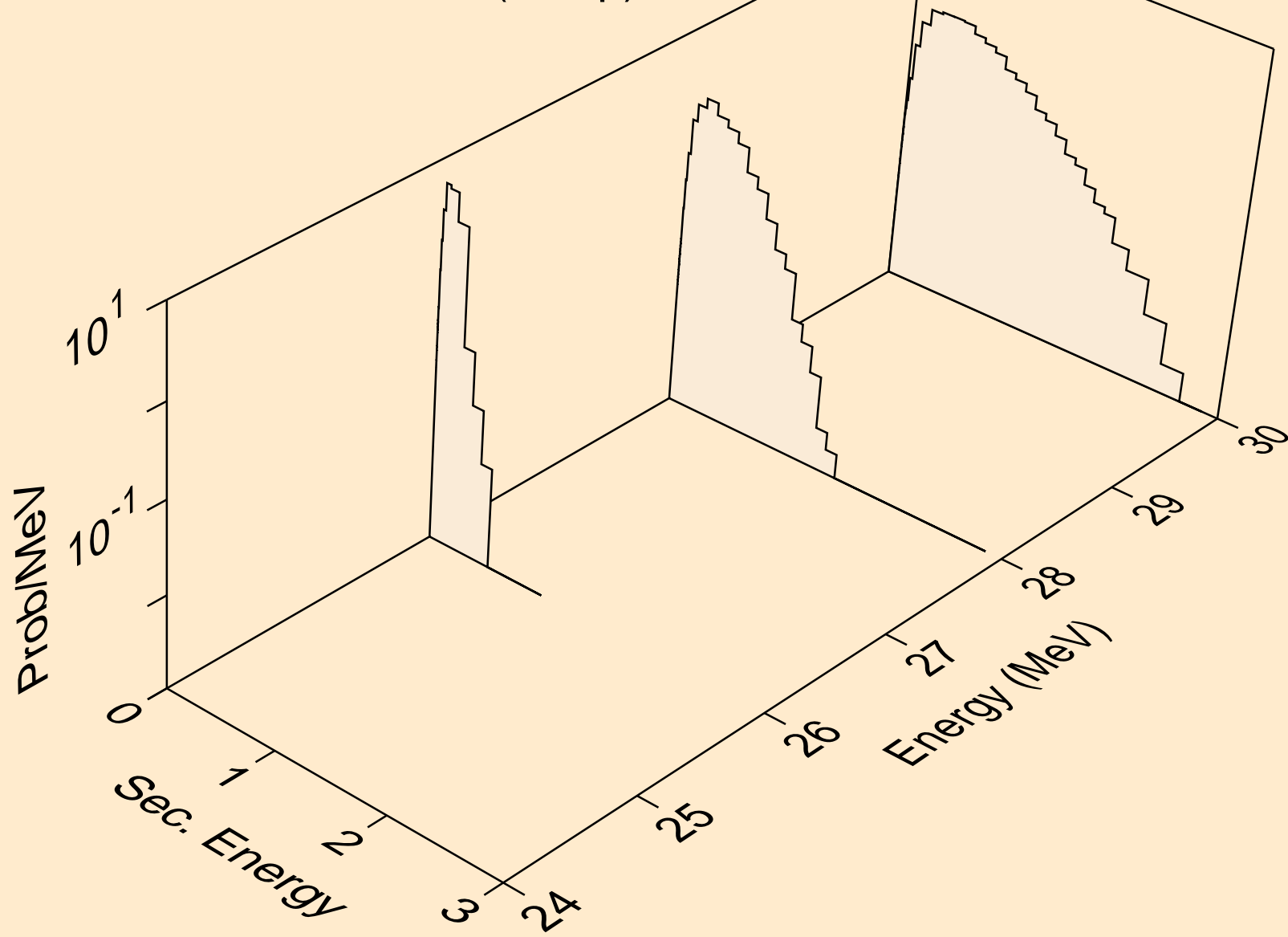

RB083 NEUTRON ACER TENDL-2024 LIBRARY; T=0.K  
Neutron emission for (n,n2p)

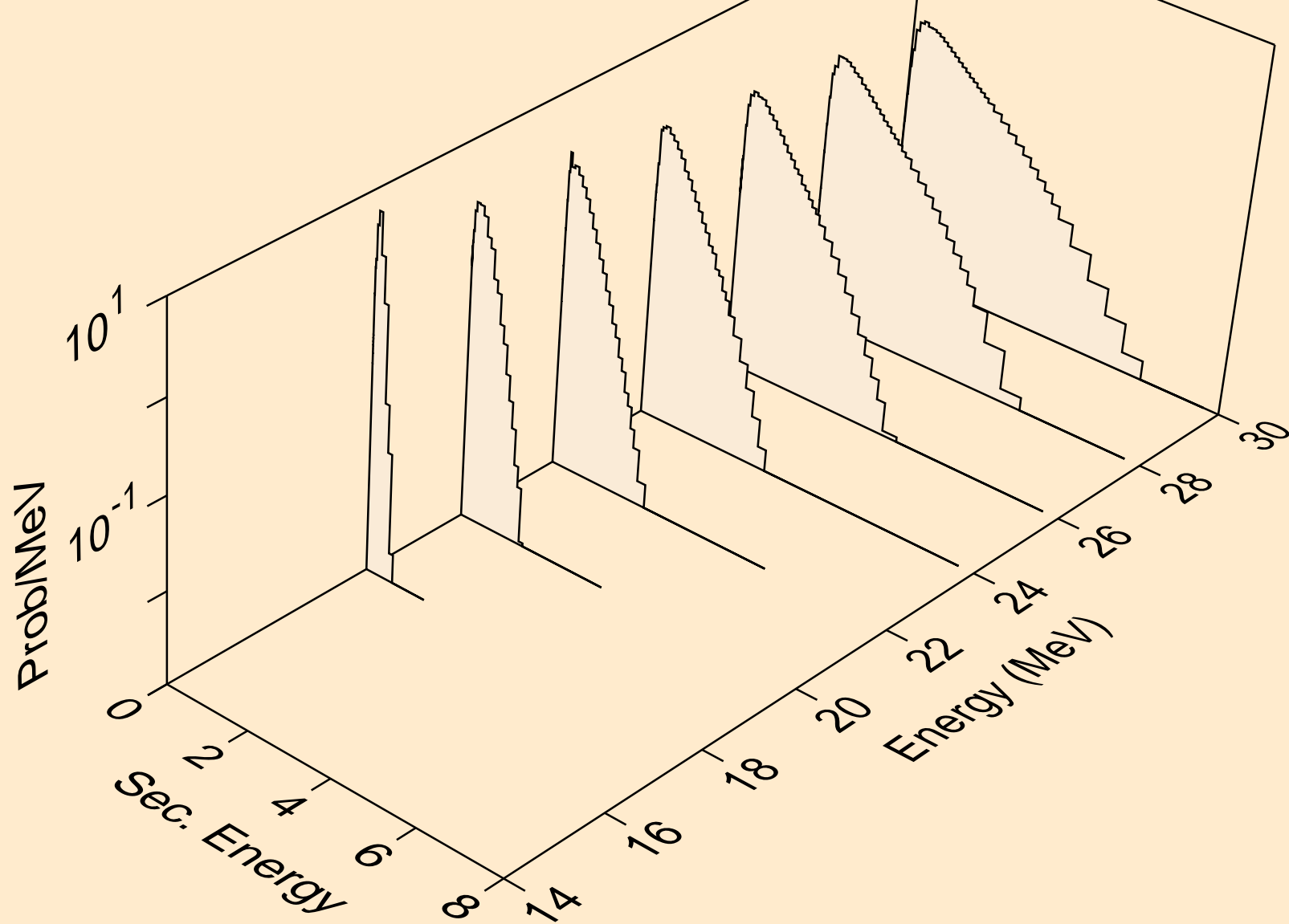

RB083 NEUTRON ACER TENDL-2024 LIBRARY; T=0.K  
Neutron emission for (n,npa)

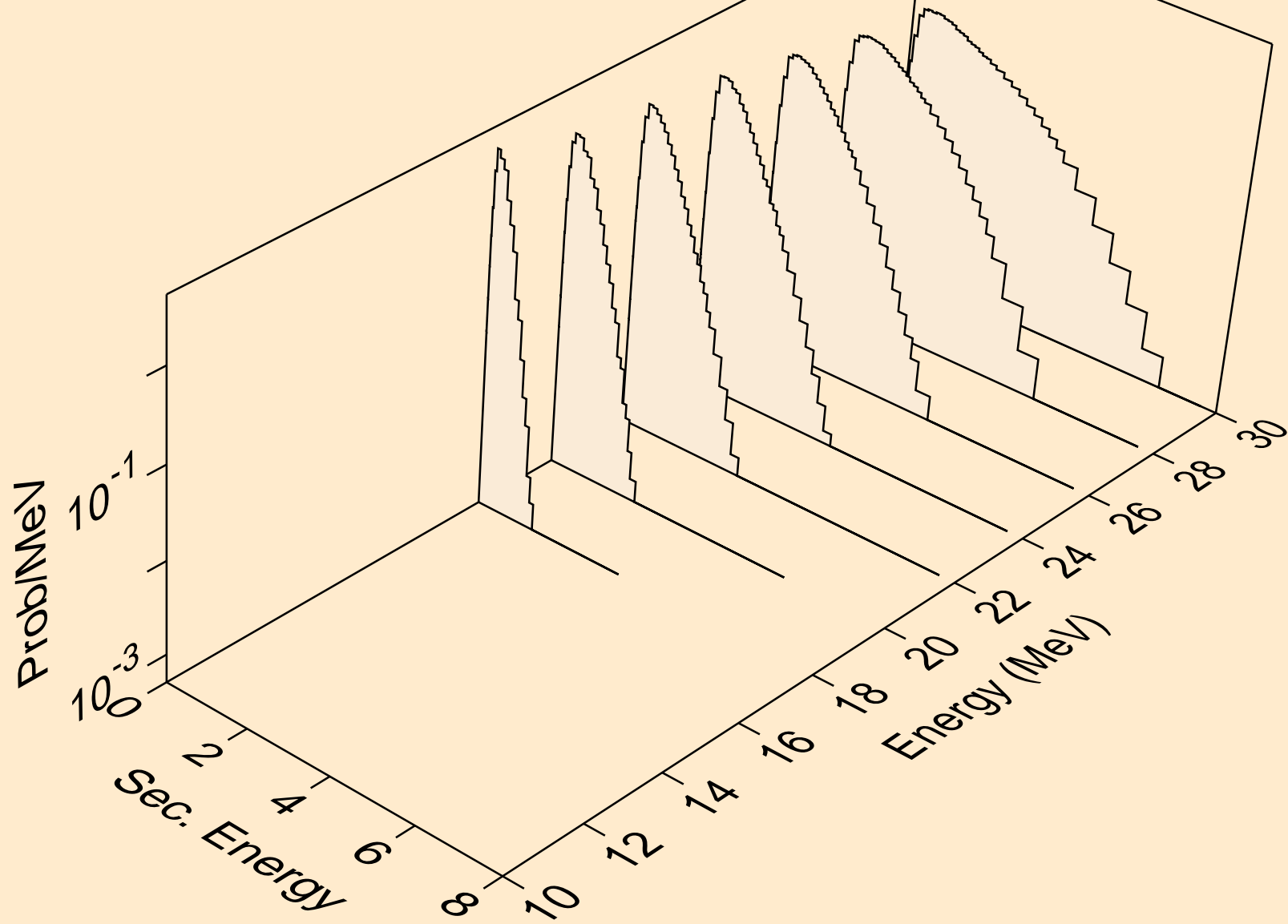

RB083 NEUTRON ACER TENDL-2024 LIBRARY; T=0.K  
Neutron emission for (n,n\*c)

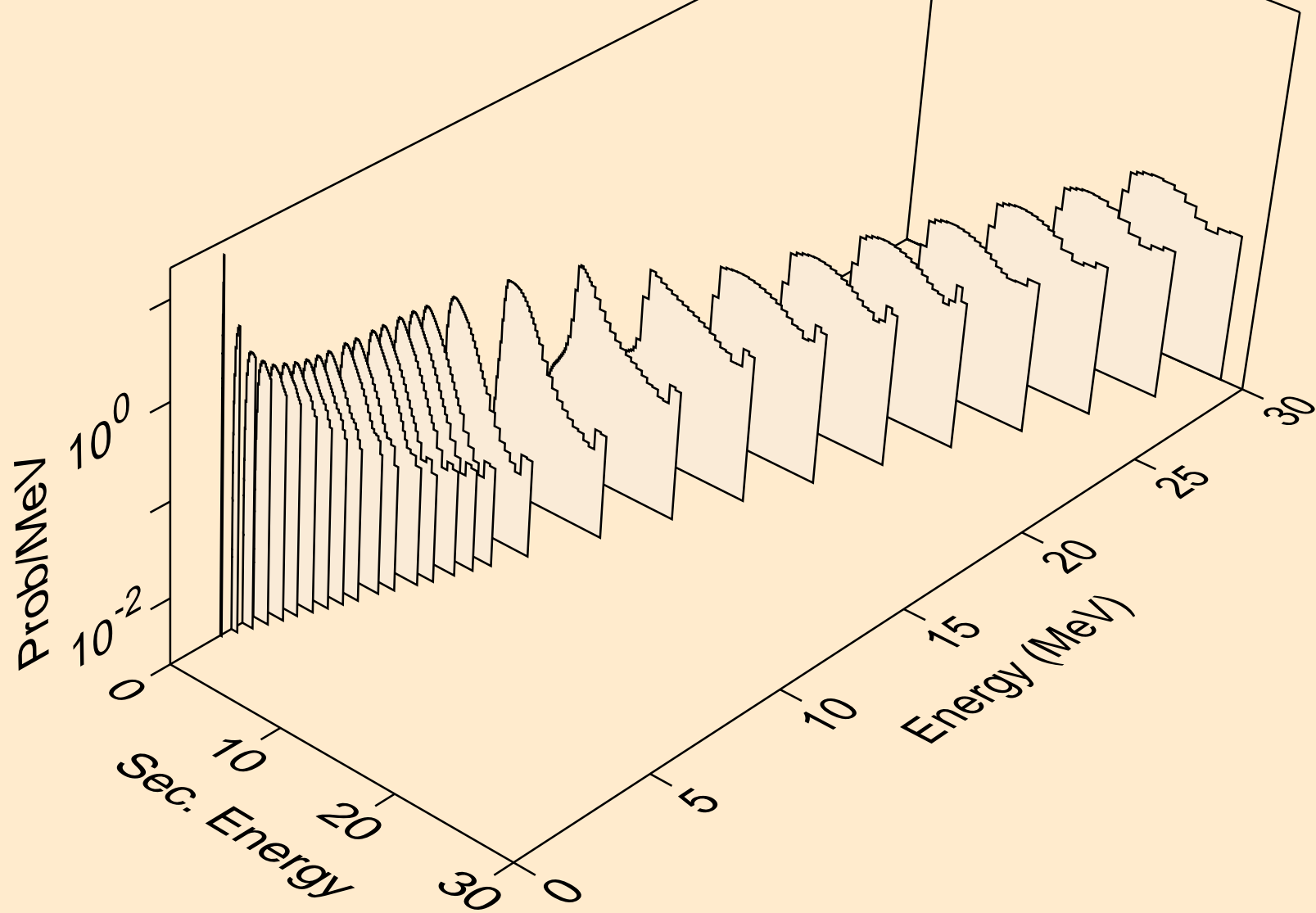

RB083 NEUTRON ACER TENDL-2024 LIBRARY; T=0.K  
Photon emission for (n,x)

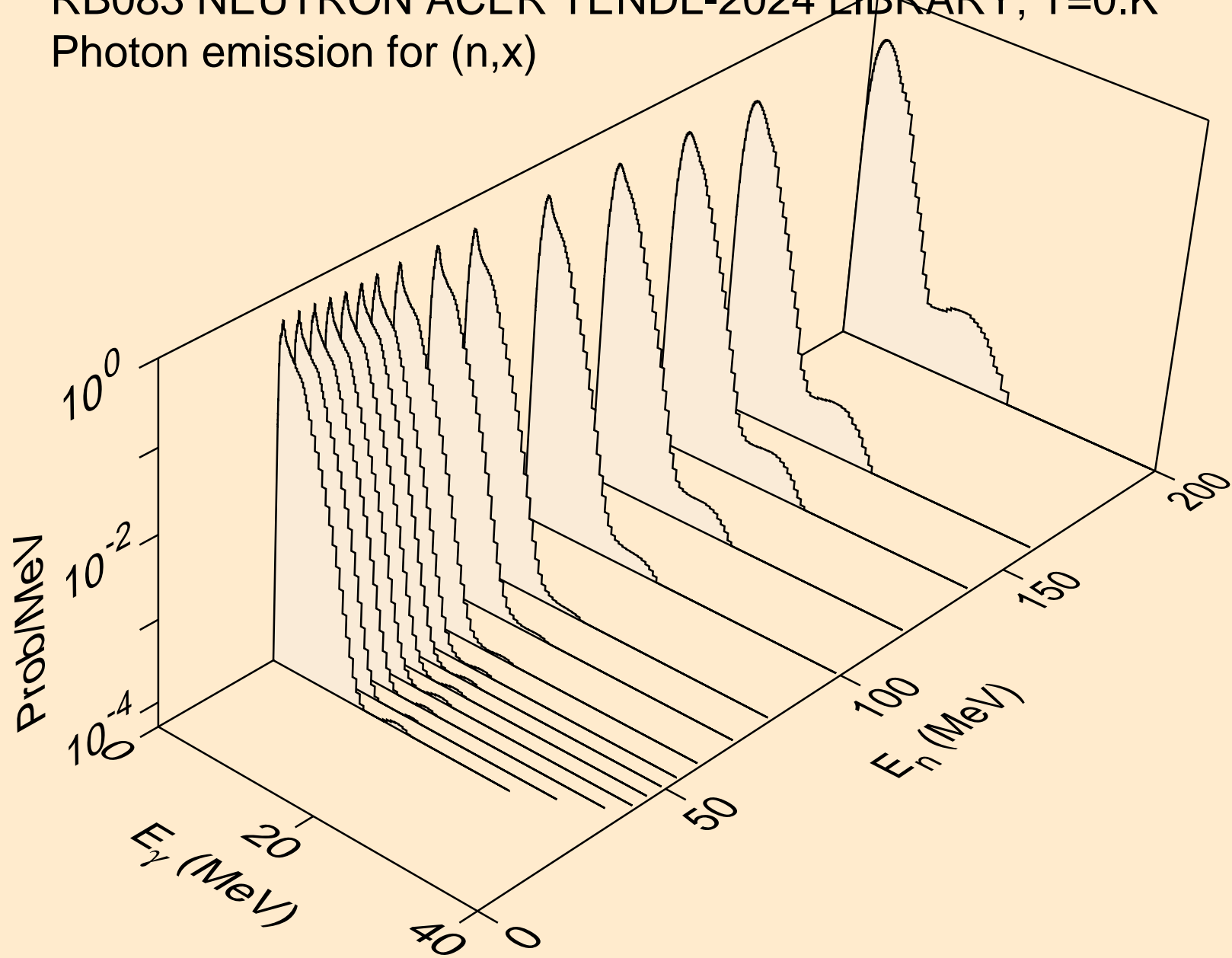

RB083 NEUTRON ACER TENDL-2024 LIBRARY; T=0.K  
Photon emission for (n,2nd)

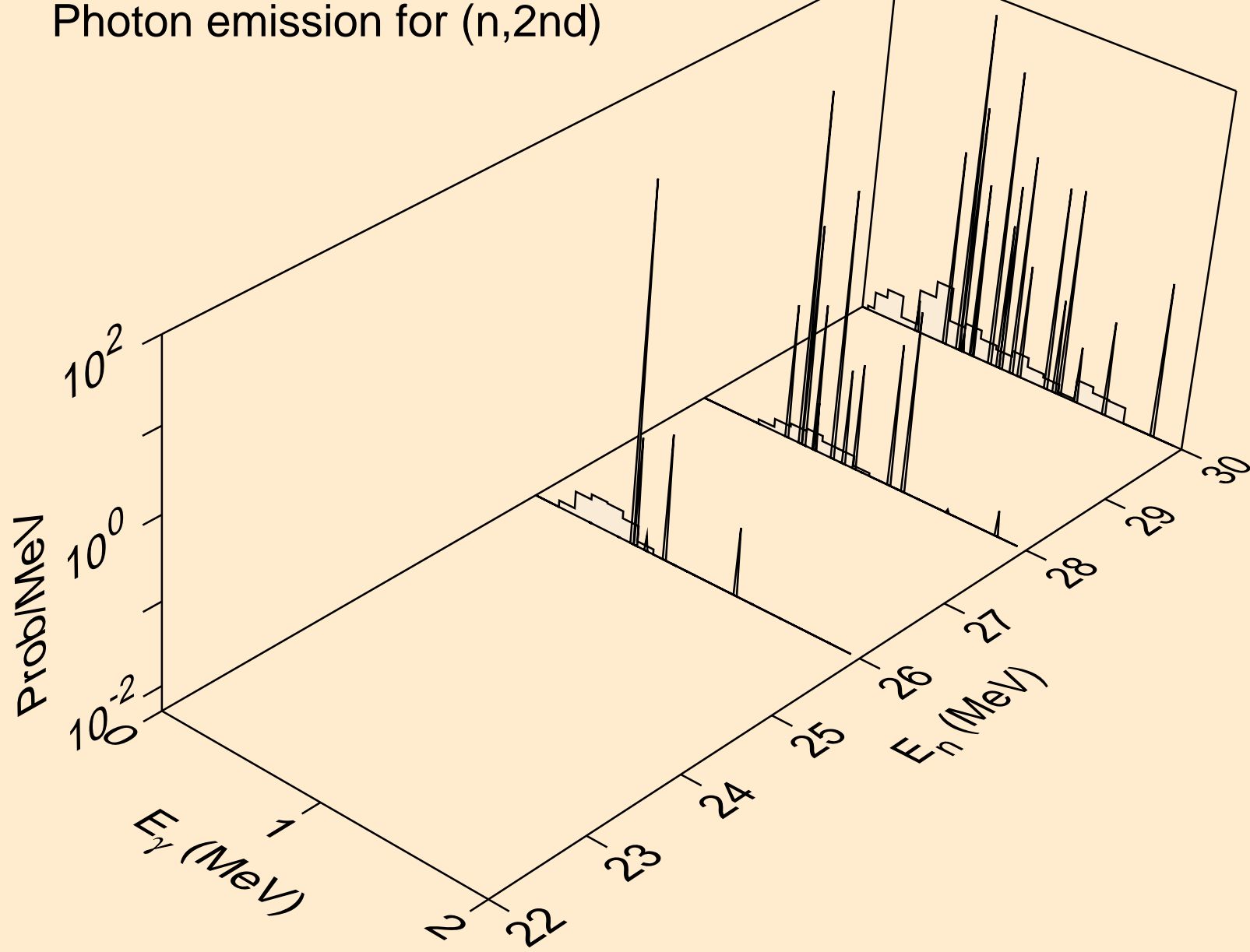

RB083 NEUTRON ACER TENDL-2024 LIBRARY; T=0.K  
Photon emission for (n,2n)

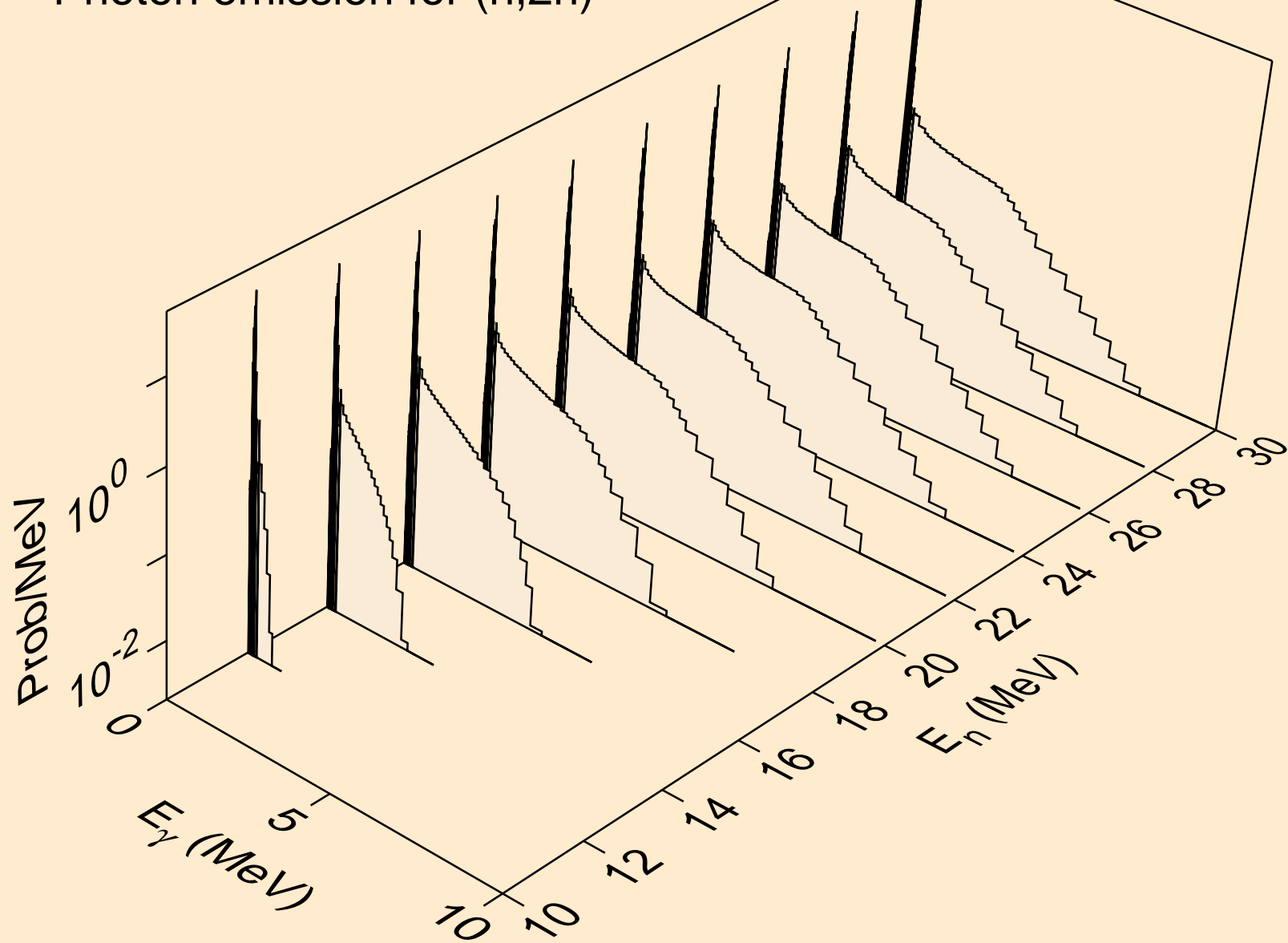

RB083 NEUTRON ACER TENDL-2024 LIBRARY; T=0.K  
Photon emission for (n,3n)

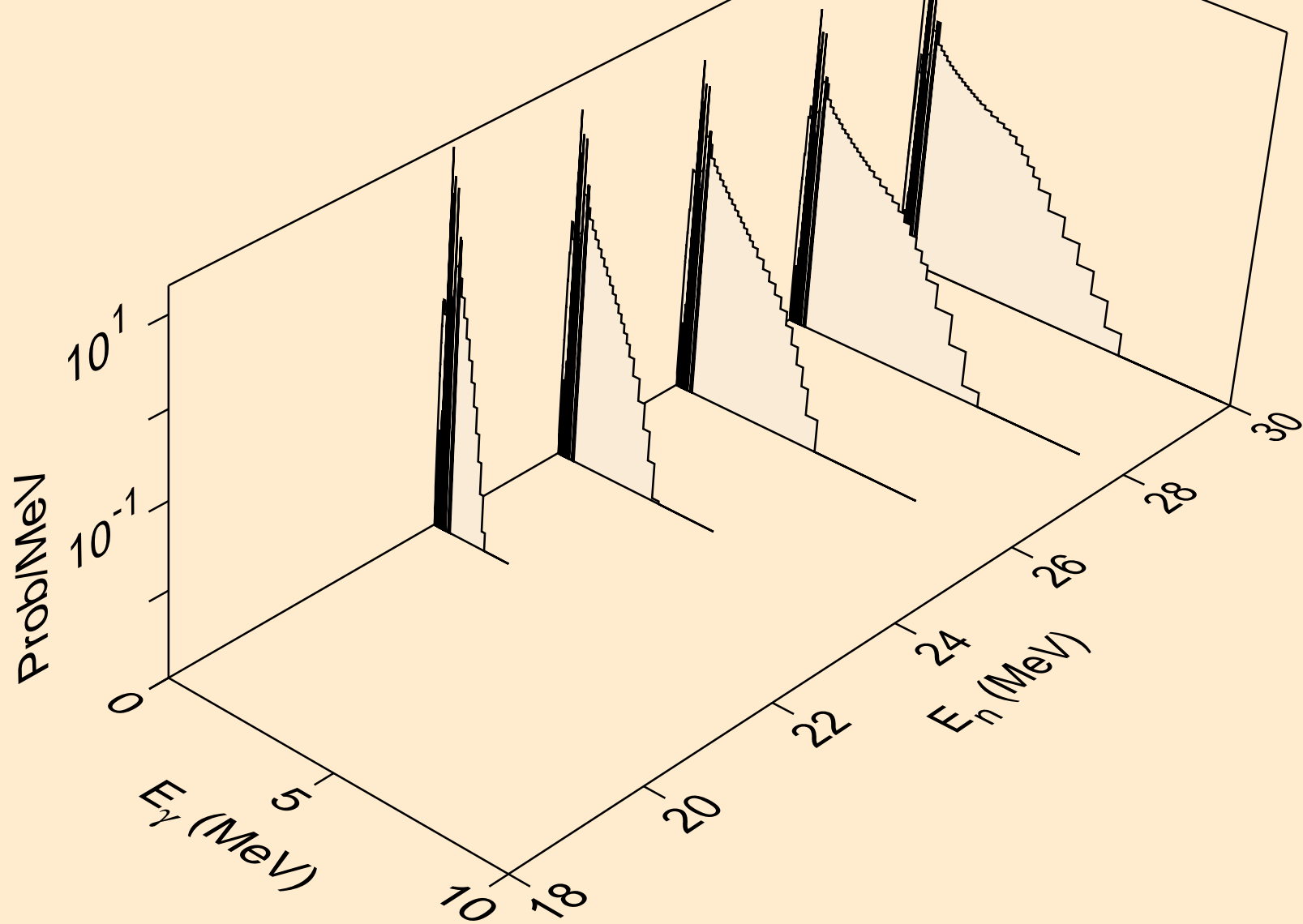



RB083 NEUTRON ACER TENDL-2024 LIBRARY; T=0.K  
Photon emission for (n,n\*)a

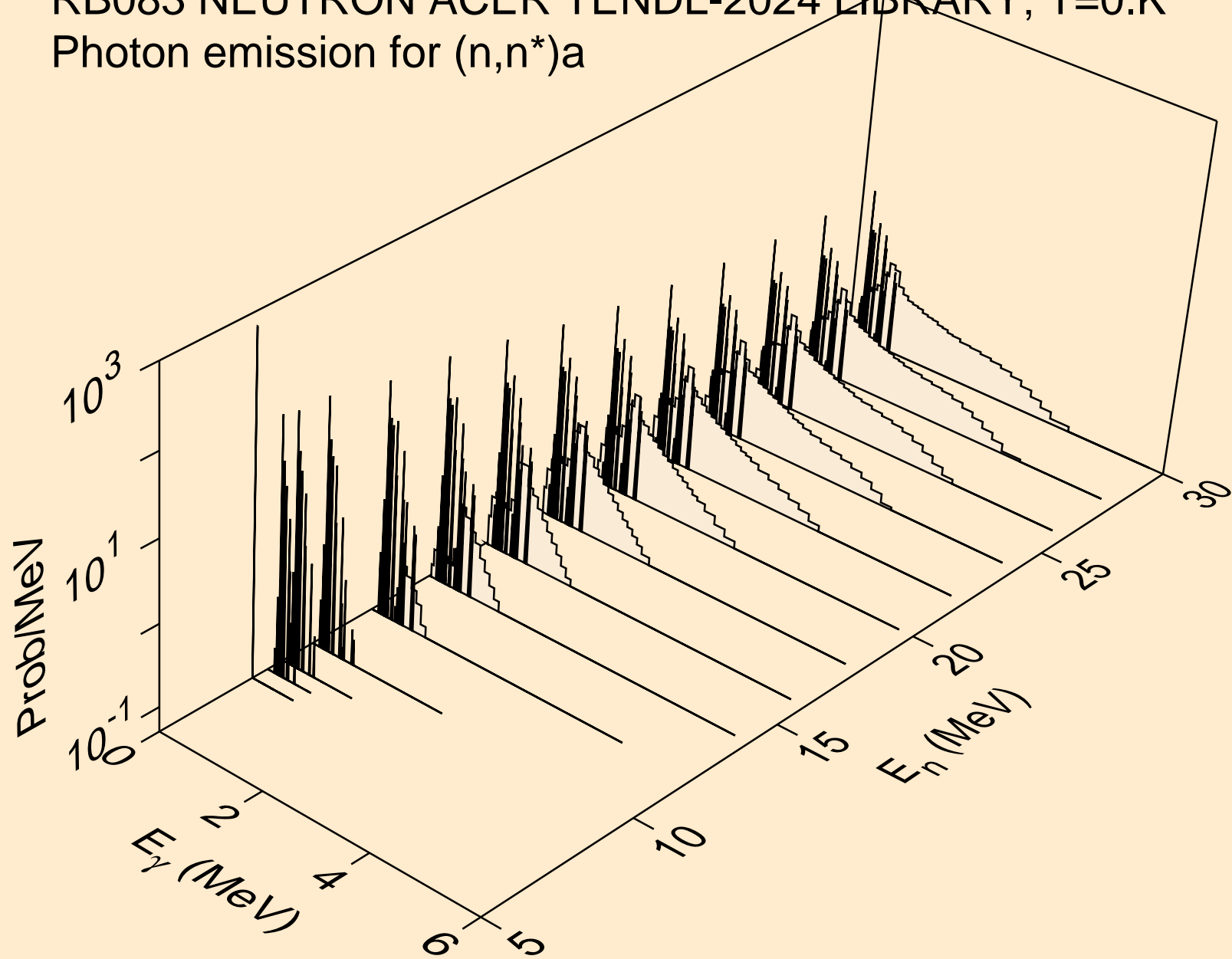

RB083 NEUTRON ACER TENDL-2024 LIBRARY; T=0.K  
Photon emission for (n,2n)a

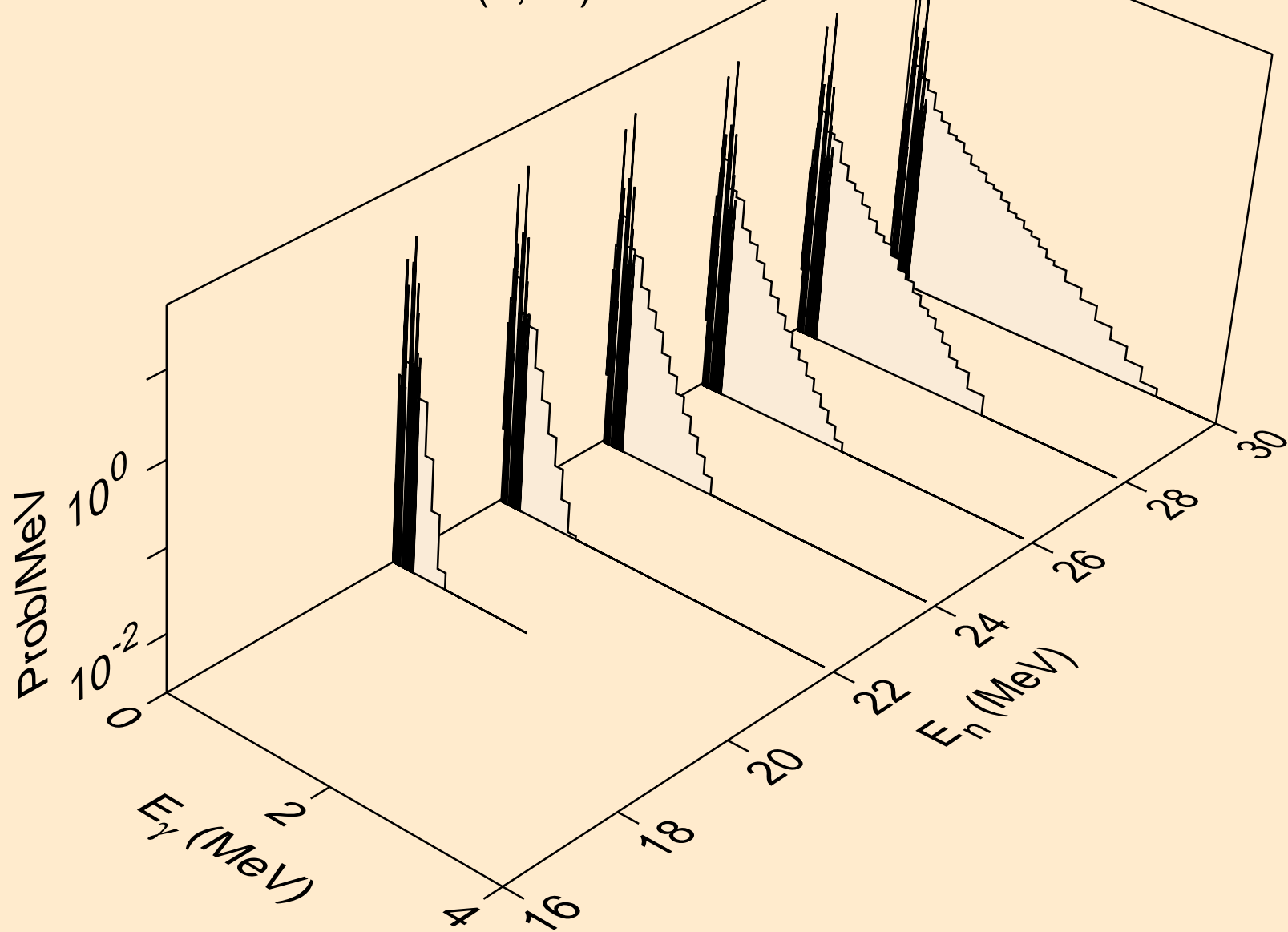

RB083 NEUTRON ACER TENDL-2024 LIBRARY; T=0.K  
Photon emission for (n,n\*)p

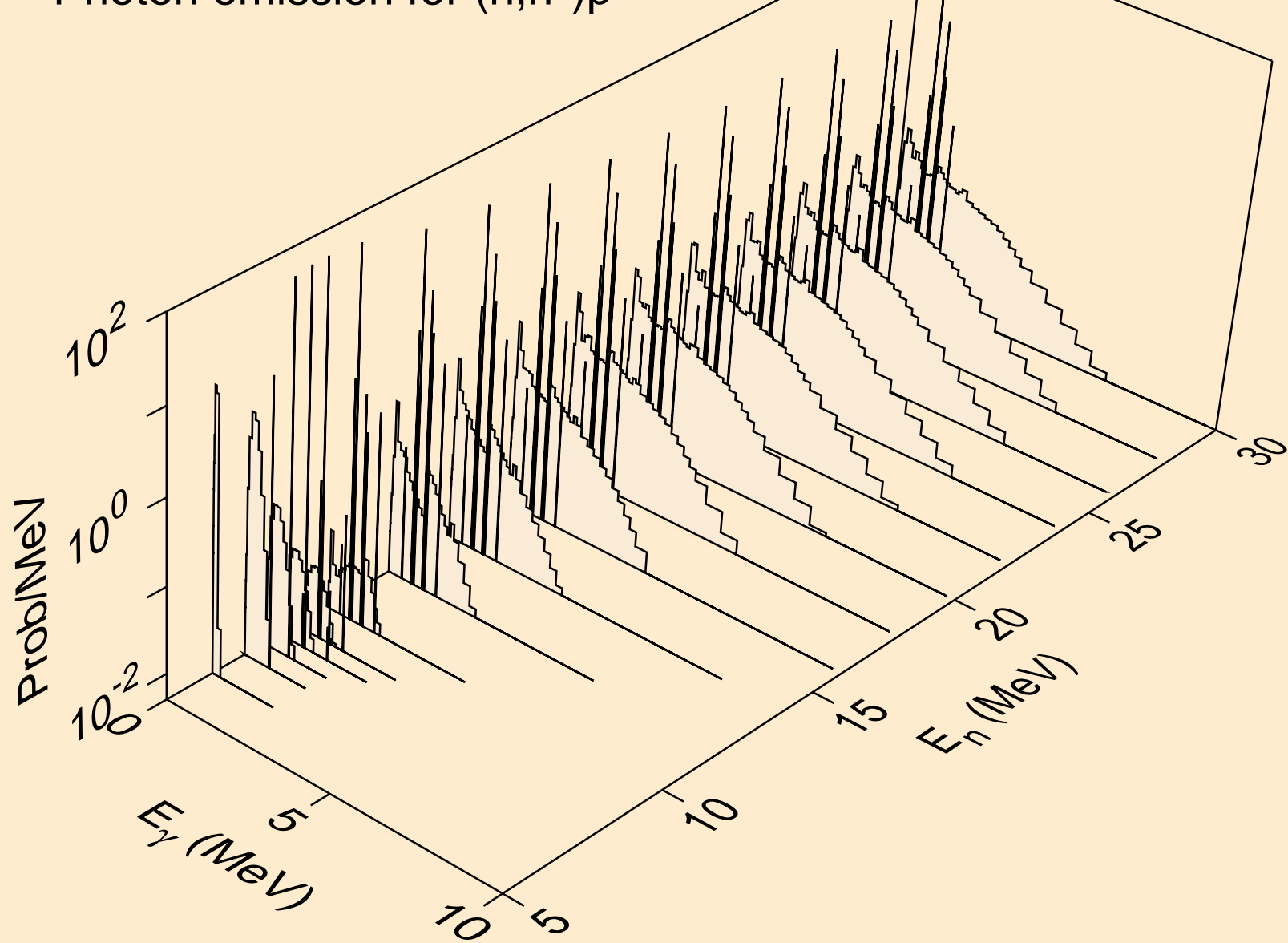

RB083 NEUTRON ACER TENDL-2024 LIBRARY; T=0.K  
Photon emission for (n,n\*)2a

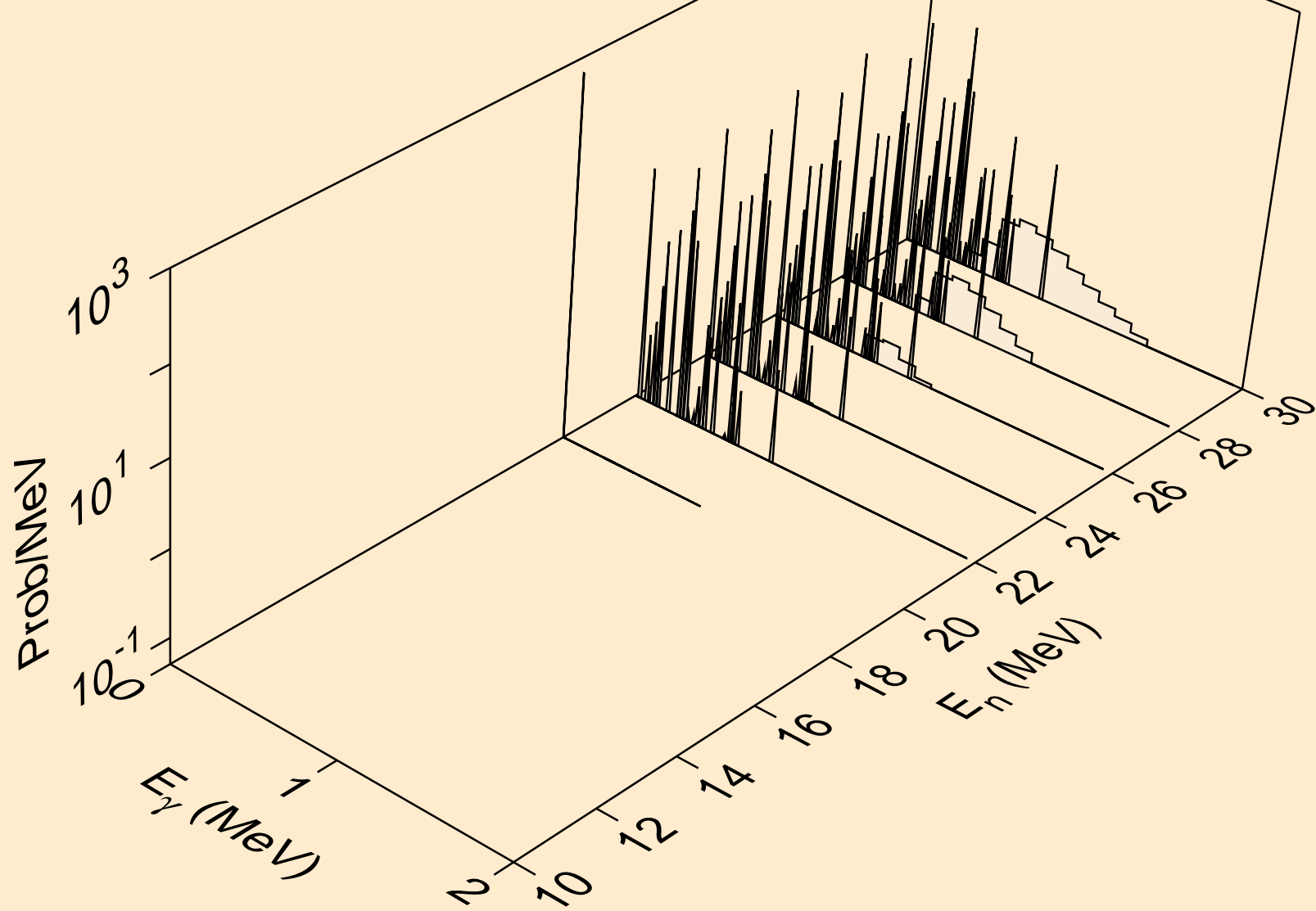

RB083 NEUTRON ACER TENDL-2024 LIBRARY; T=0.K  
Photon emission for (n,n\*)d

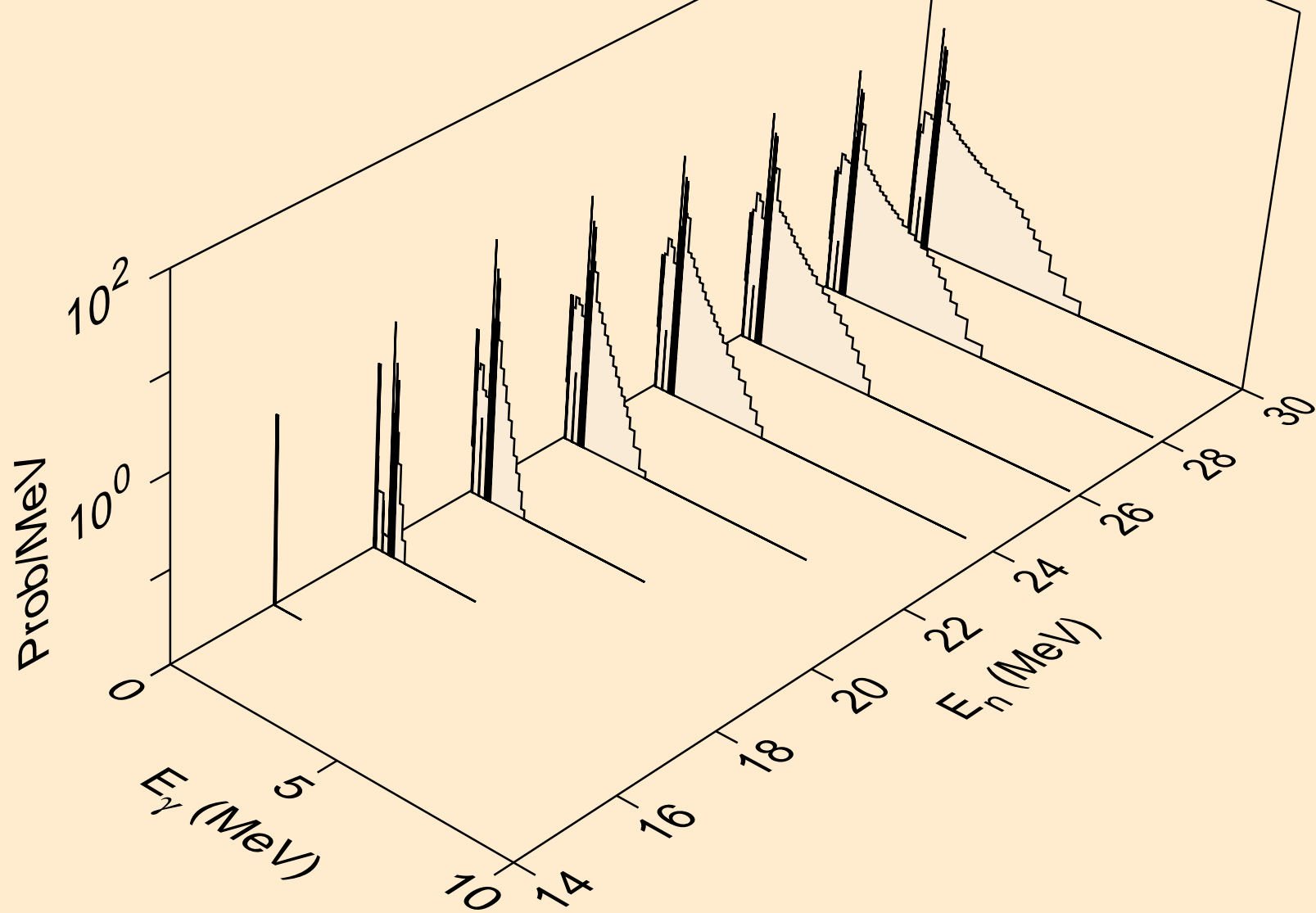

RB083 NEUTRON ACER TENDL-2024 LIBRARY; T=0.K  
Photon emission for (n,n\*)t

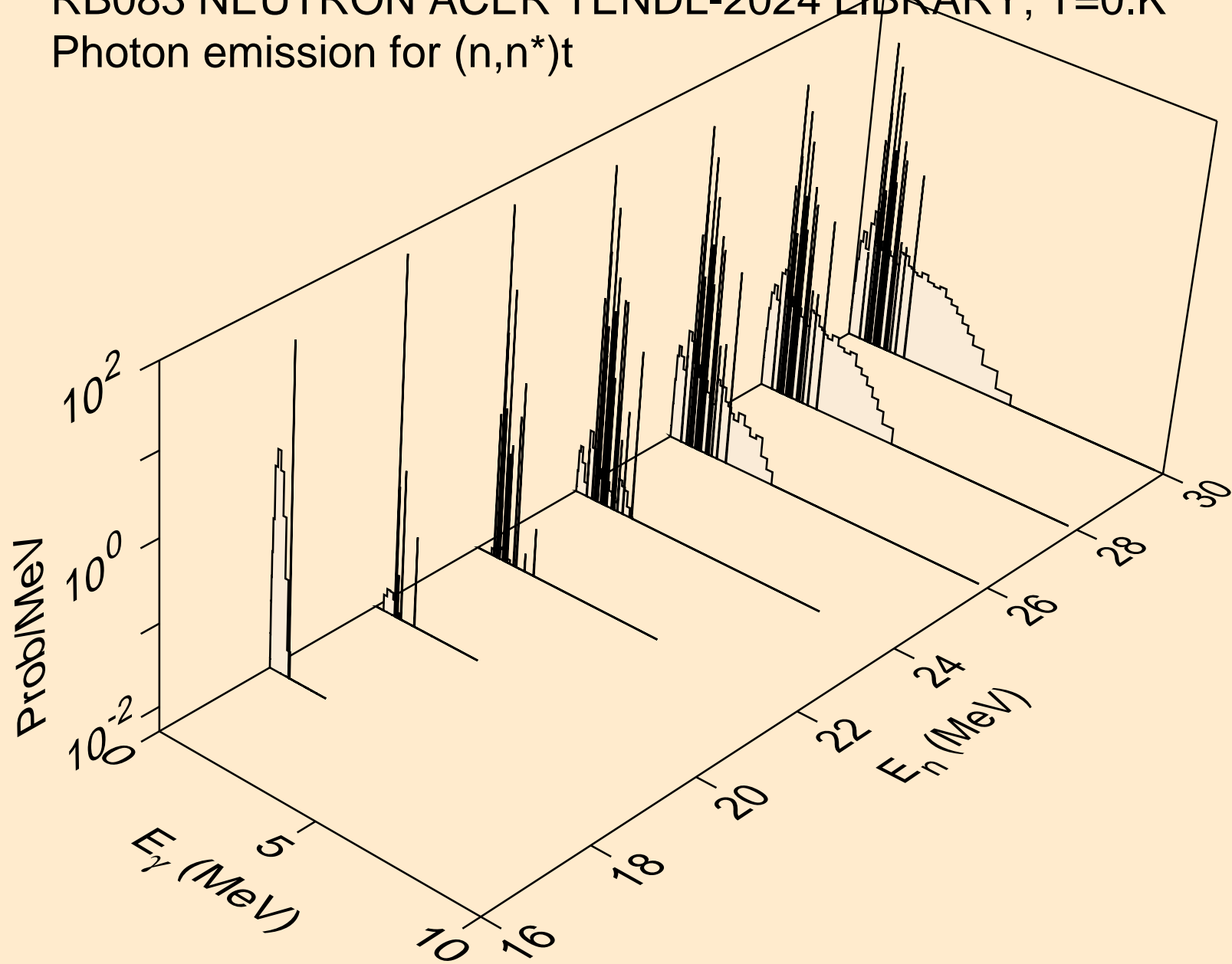

RB083 NEUTRON ACER TENDL-2024 LIBRARY; T=0.K  
Photon emission for (n,n\*)he3

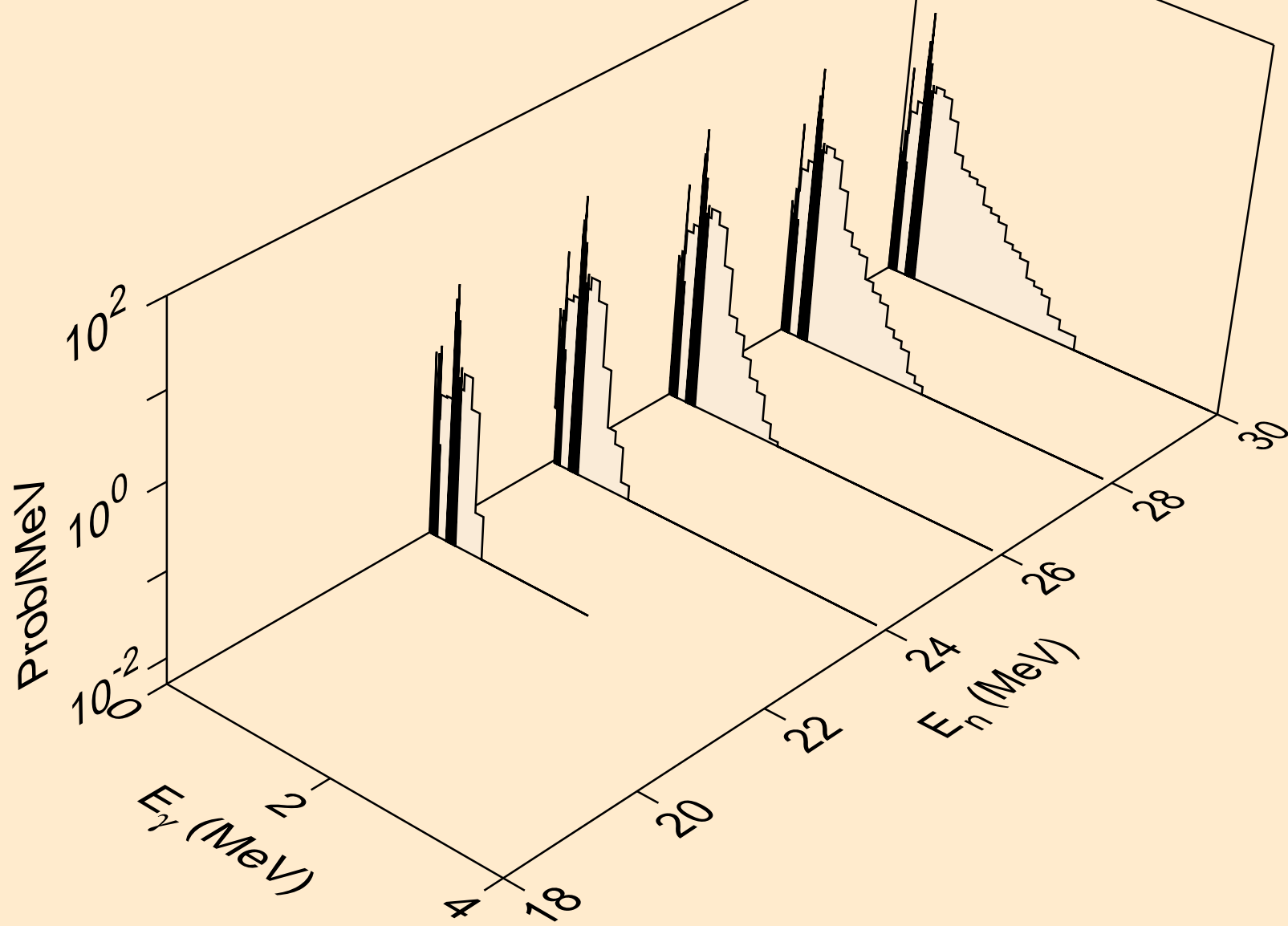

RB083 NEUTRON ACER TENDL-2024 LIBRARY; T=0.K  
Photon emission for (n,2np)

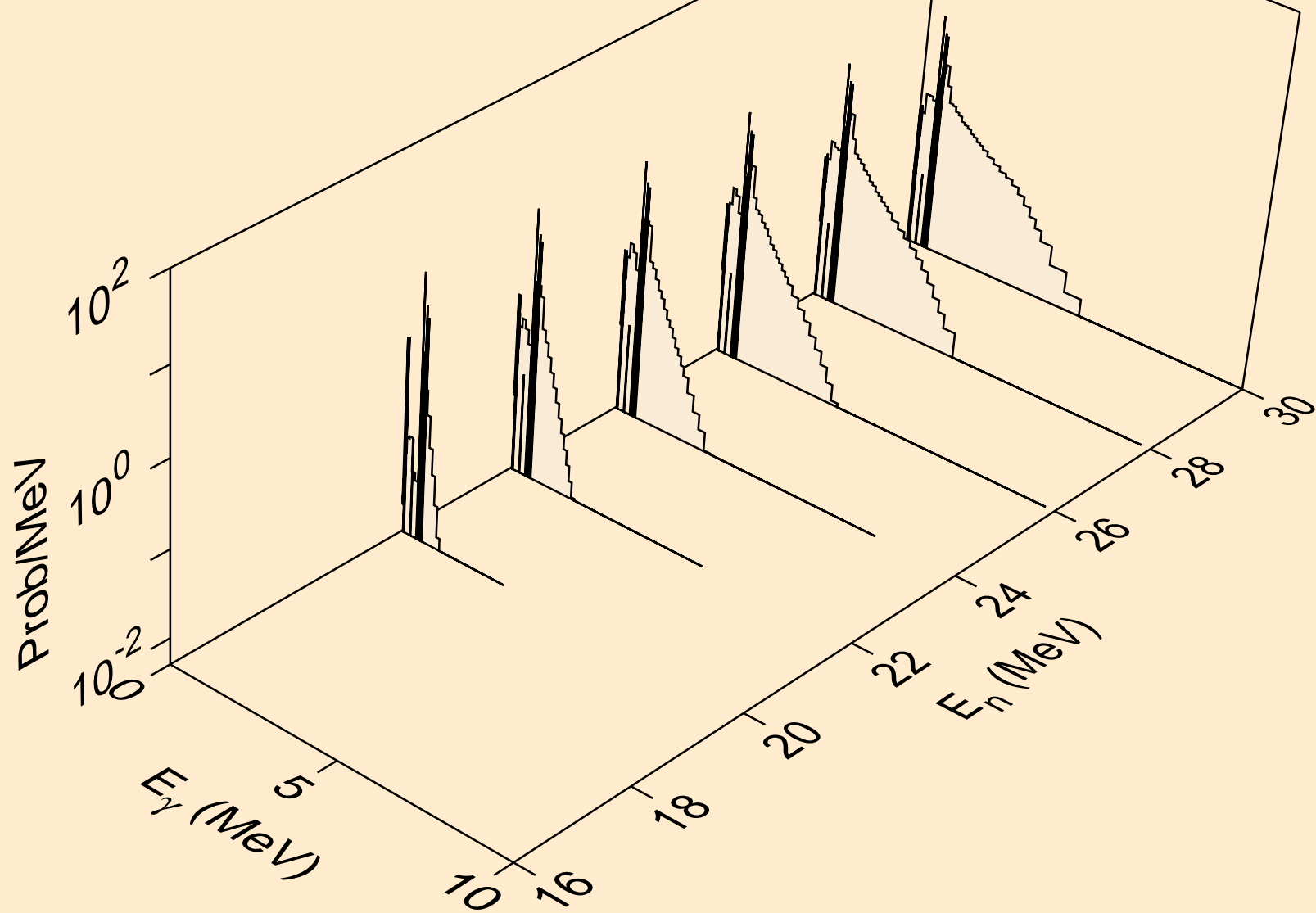



RB083 NEUTRON ACER TENDL-2024 LIBRARY; T=0.K  
Photon emission for (n,3np)

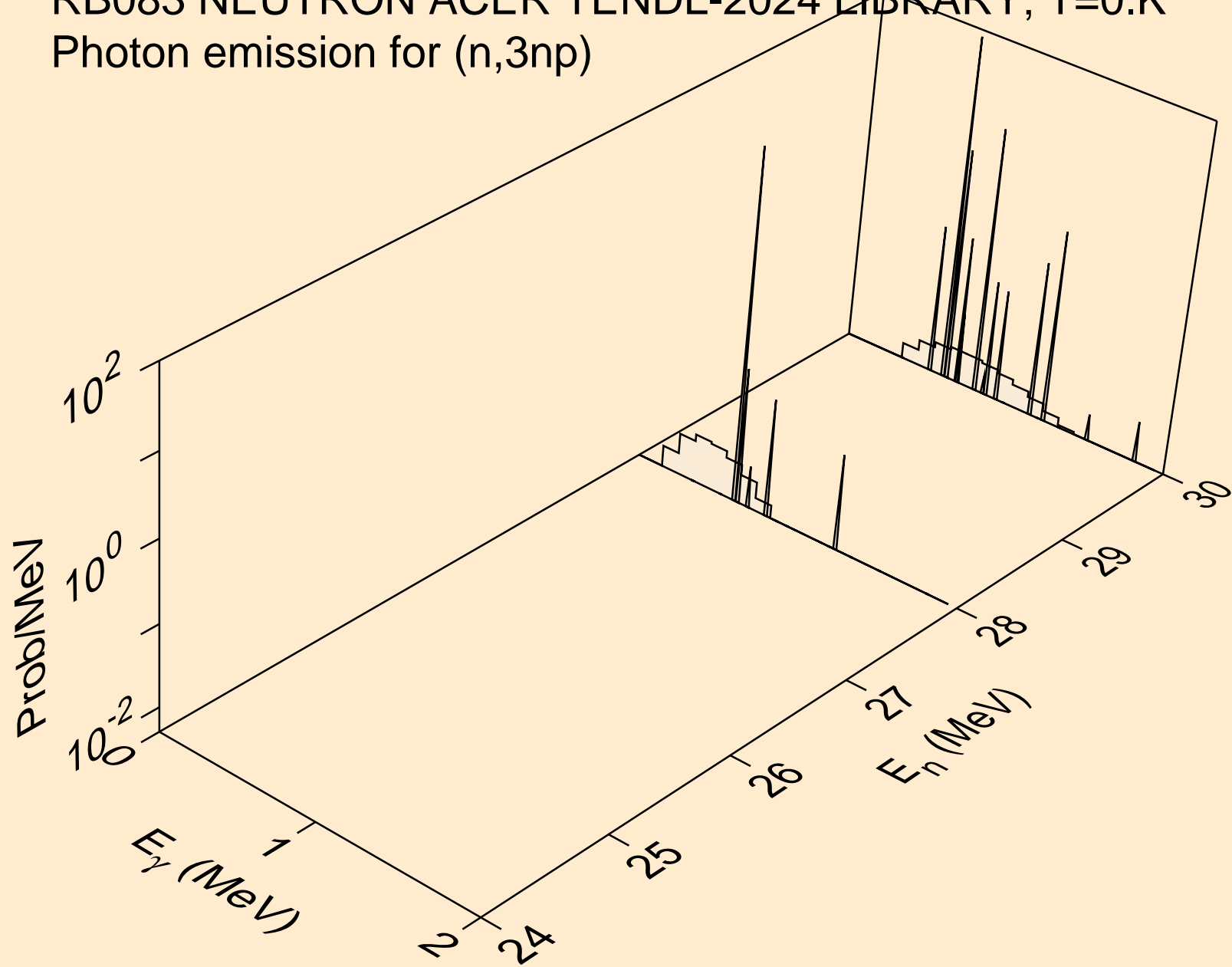

RB083 NEUTRON ACER TENDL-2024 LIBRARY; T=0.K  
Photon emission for (n,n2p)

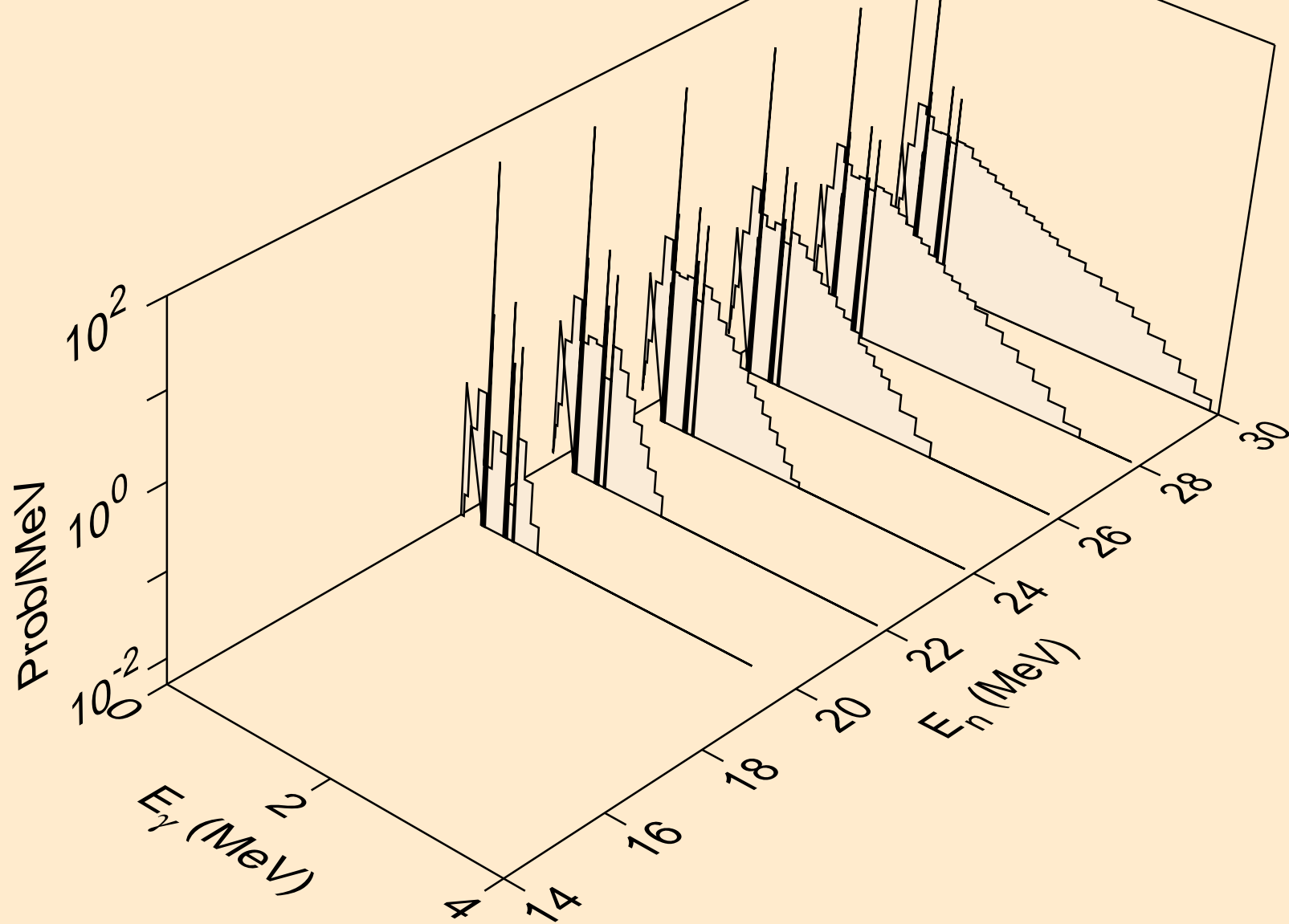

RB083 NEUTRON ACER TENDL-2024 LIBRARY; T=0.K  
Photon emission for (n,npa)

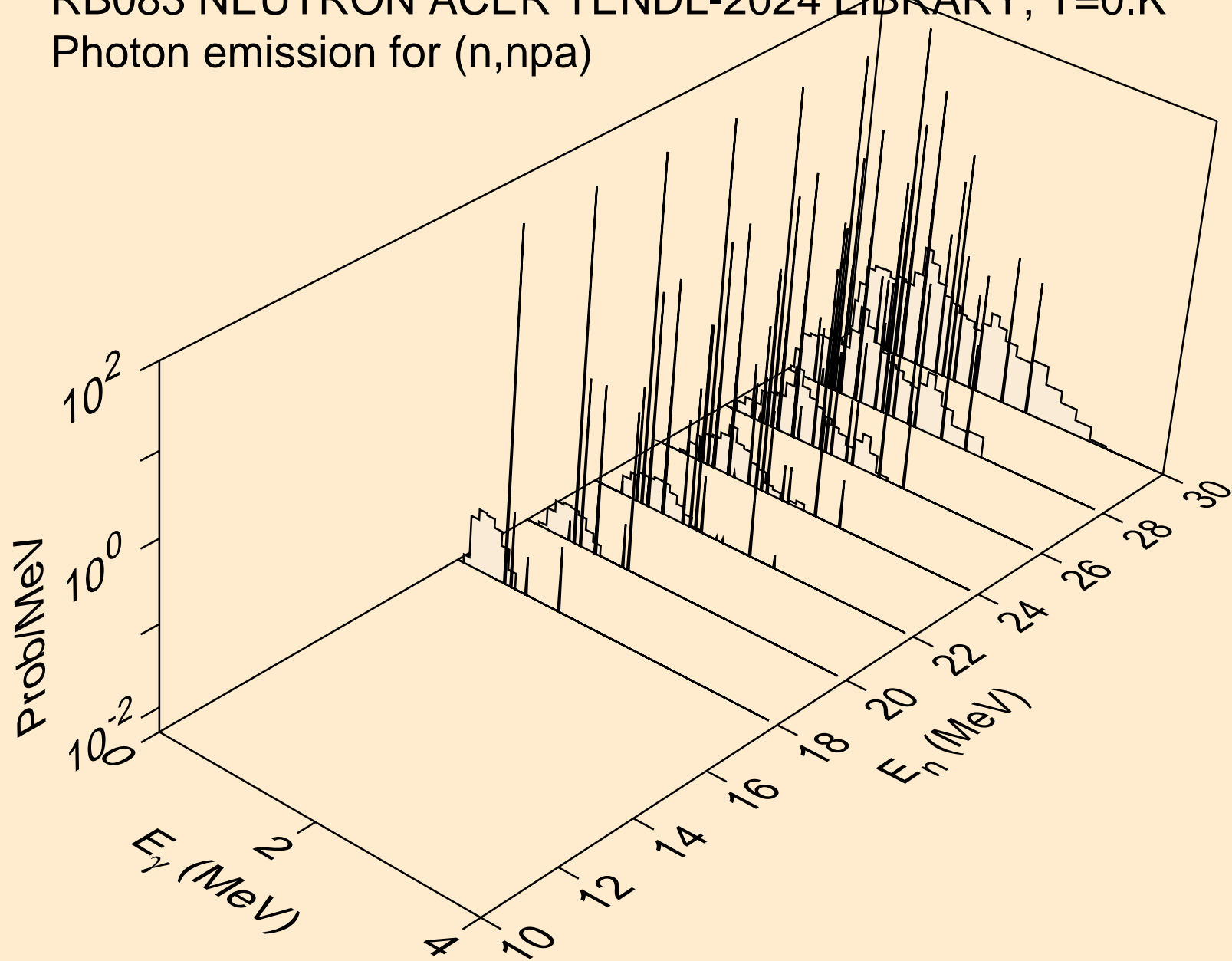

RB083 NEUTRON ACER TENDL-2024 LIBRARY; T=0.K  
Photon emission for (n,n\*c)

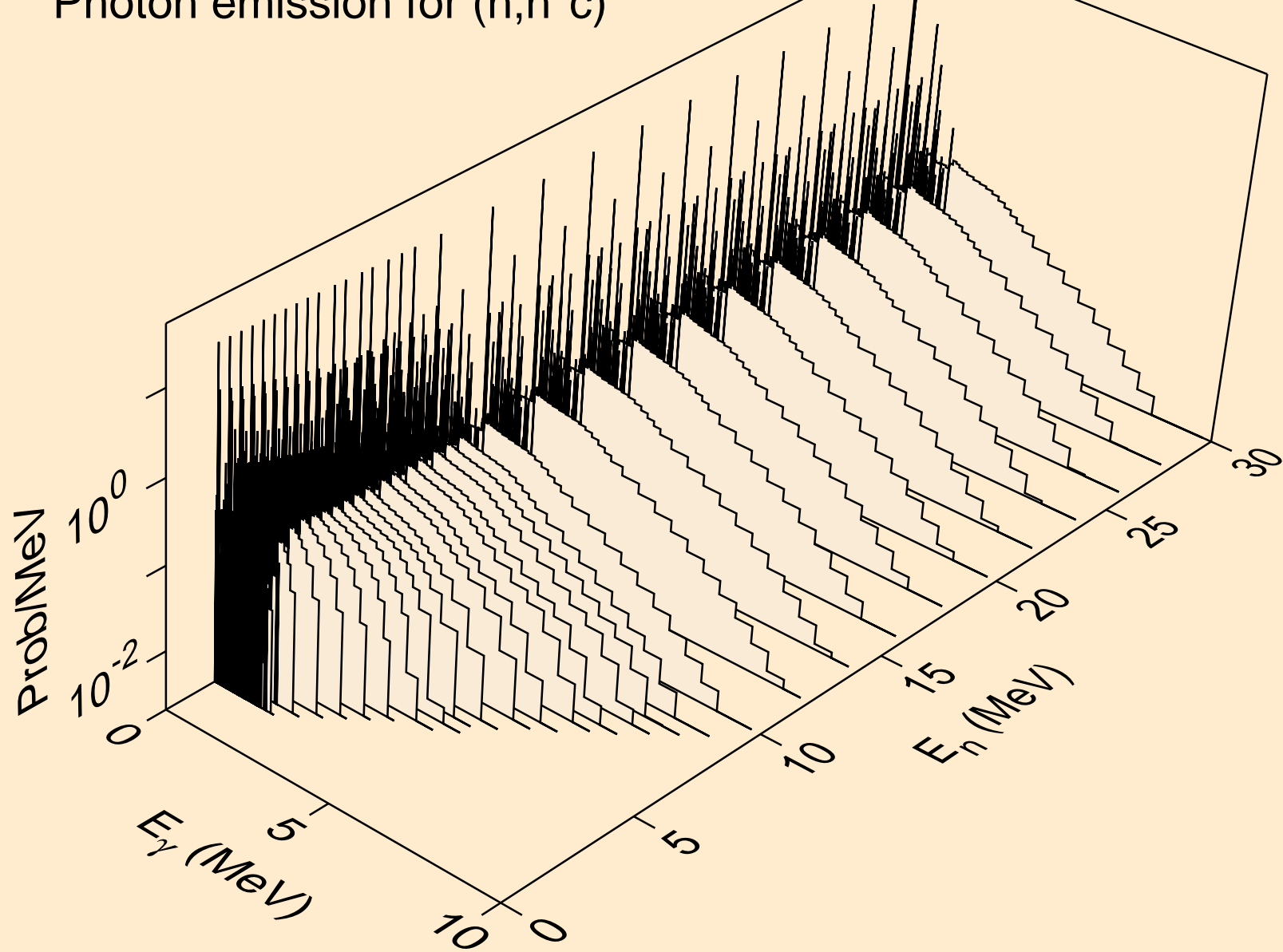

RB083 NEUTRON ACER TENDL-2024 LIBRARY; T=0.K  
Photon emission for (n,gma)

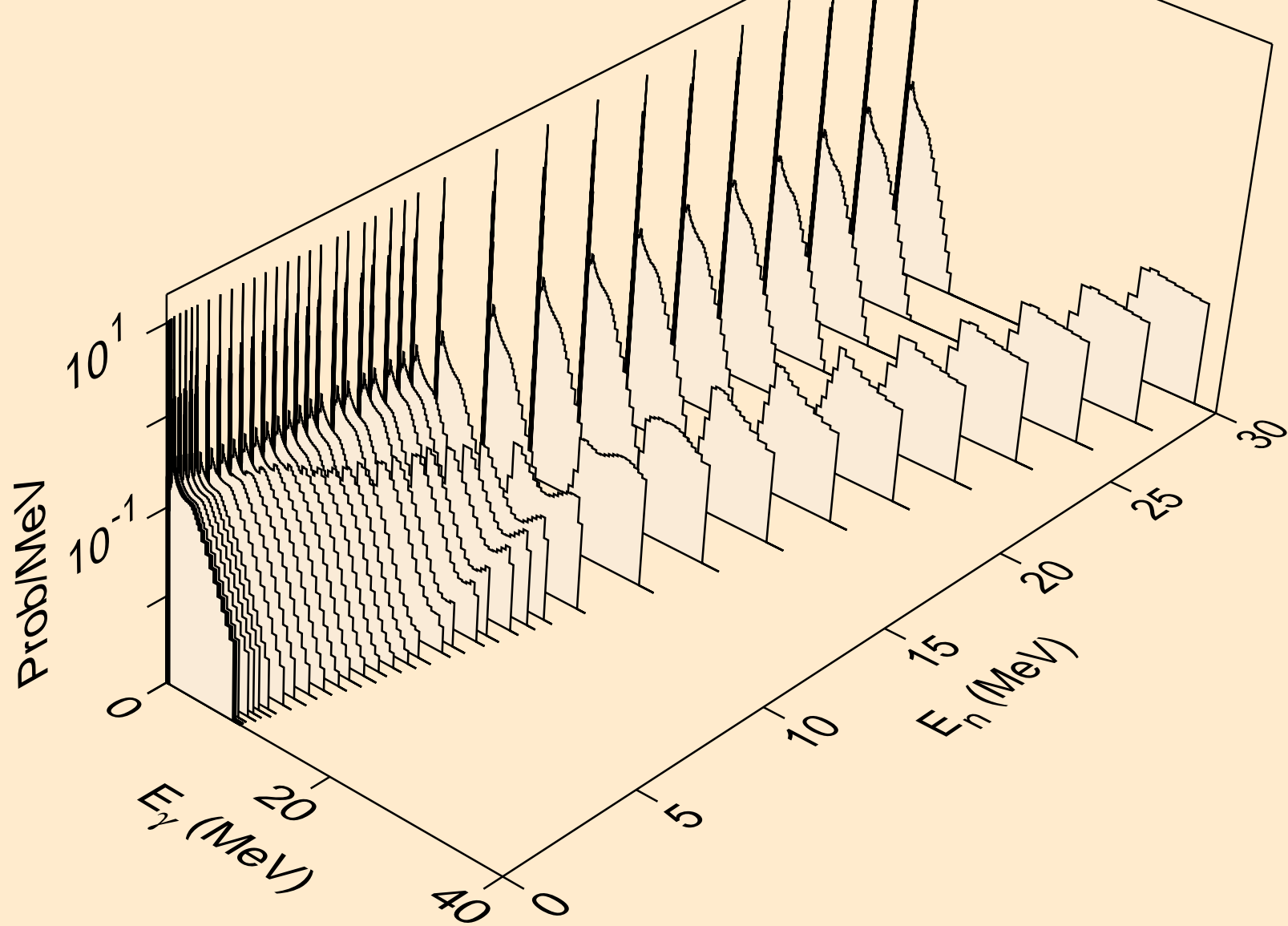

RB083 NEUTRON ACER TENDL-2024 LIBRARY; T=0.K  
Photon emission for (n,p)

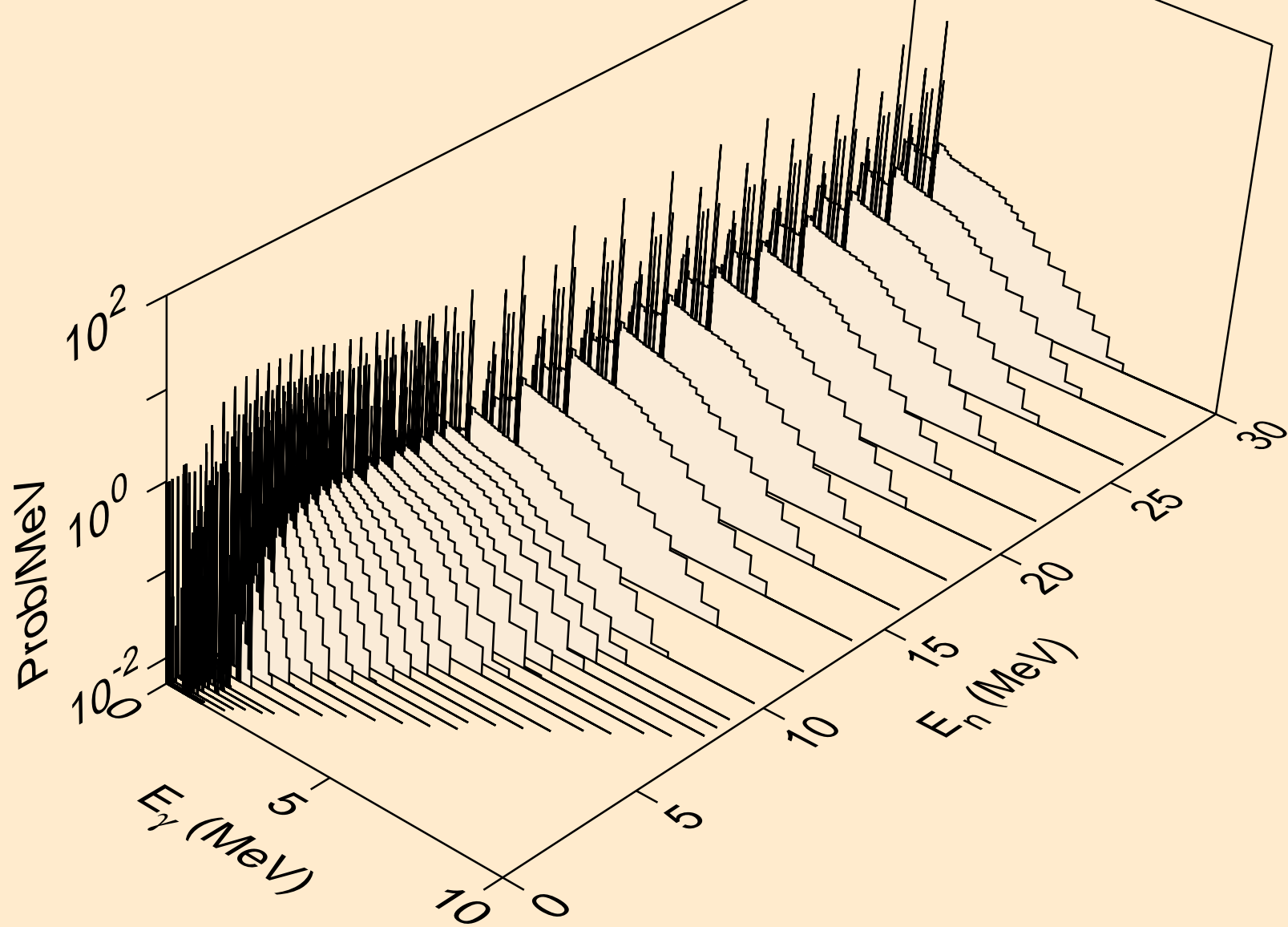

RB083 NEUTRON ACER TENDL-2024 LIBRARY; T=0.K  
Photon emission for (n,d)

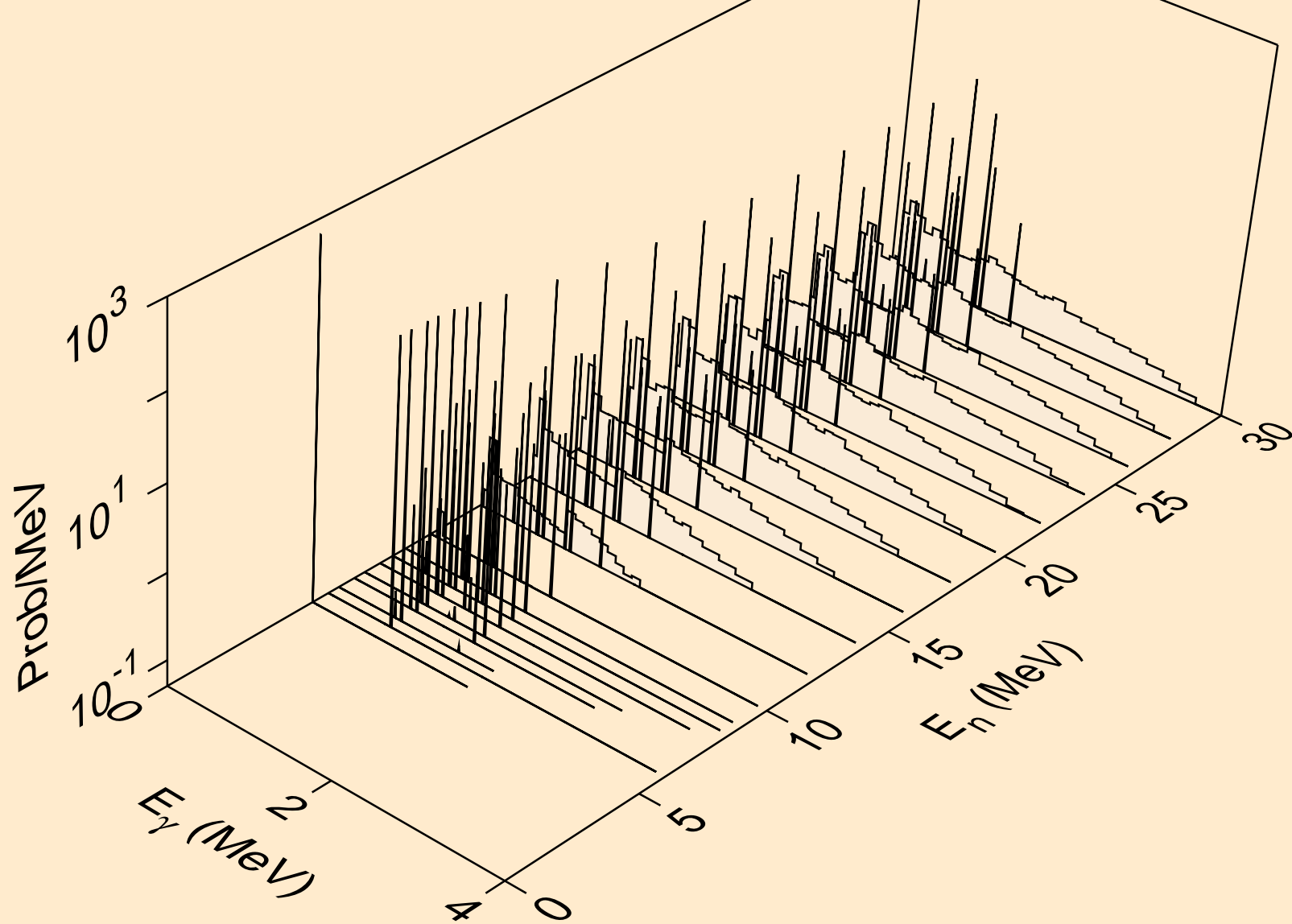

RB083 NEUTRON ACER TENDL-2024 LIBRARY; T=0.K  
Photon emission for (n,t)

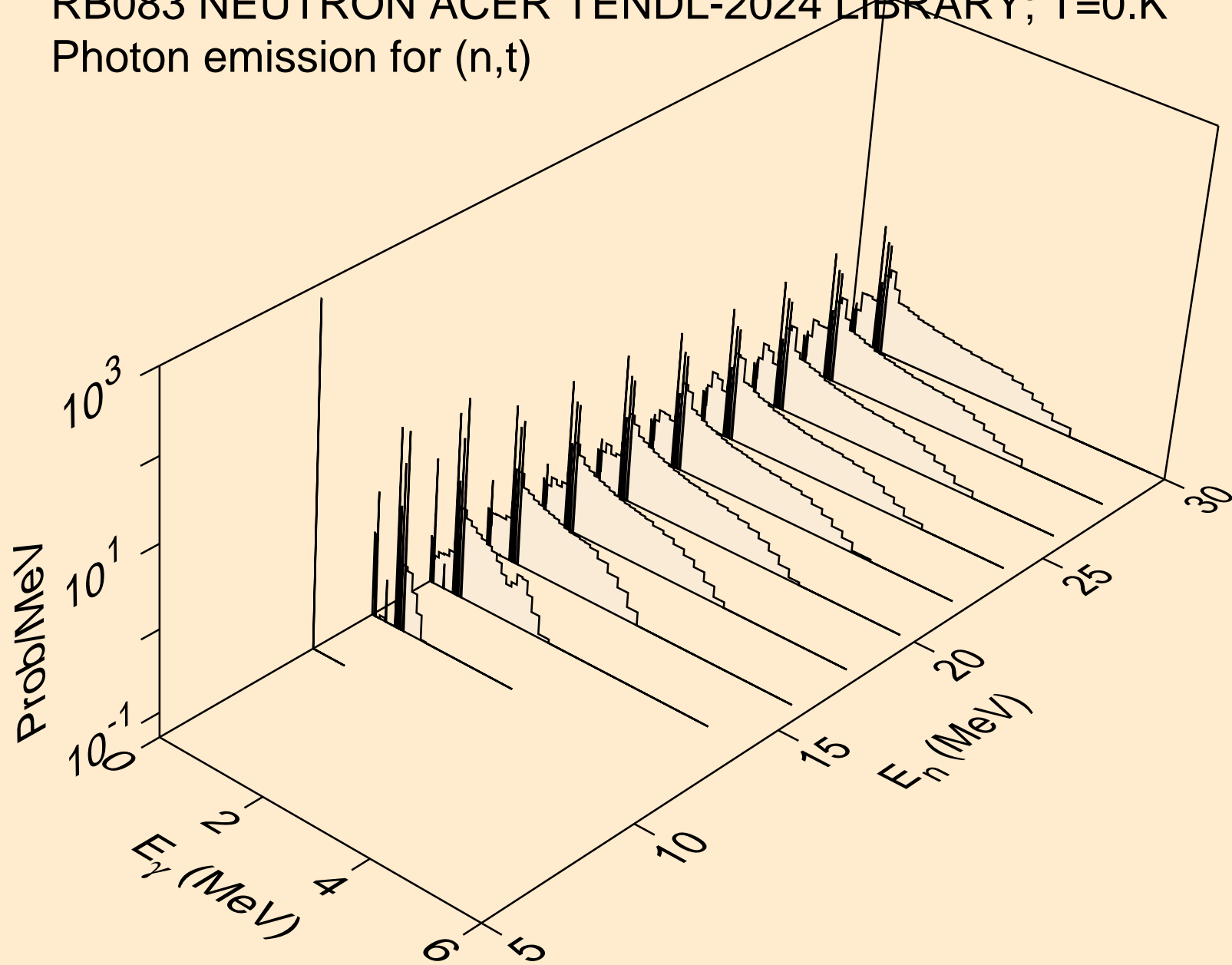



RB083 NEUTRON ACER TENDL-2024 LIBRARY; T=0.K  
Photon emission for (n,he3)

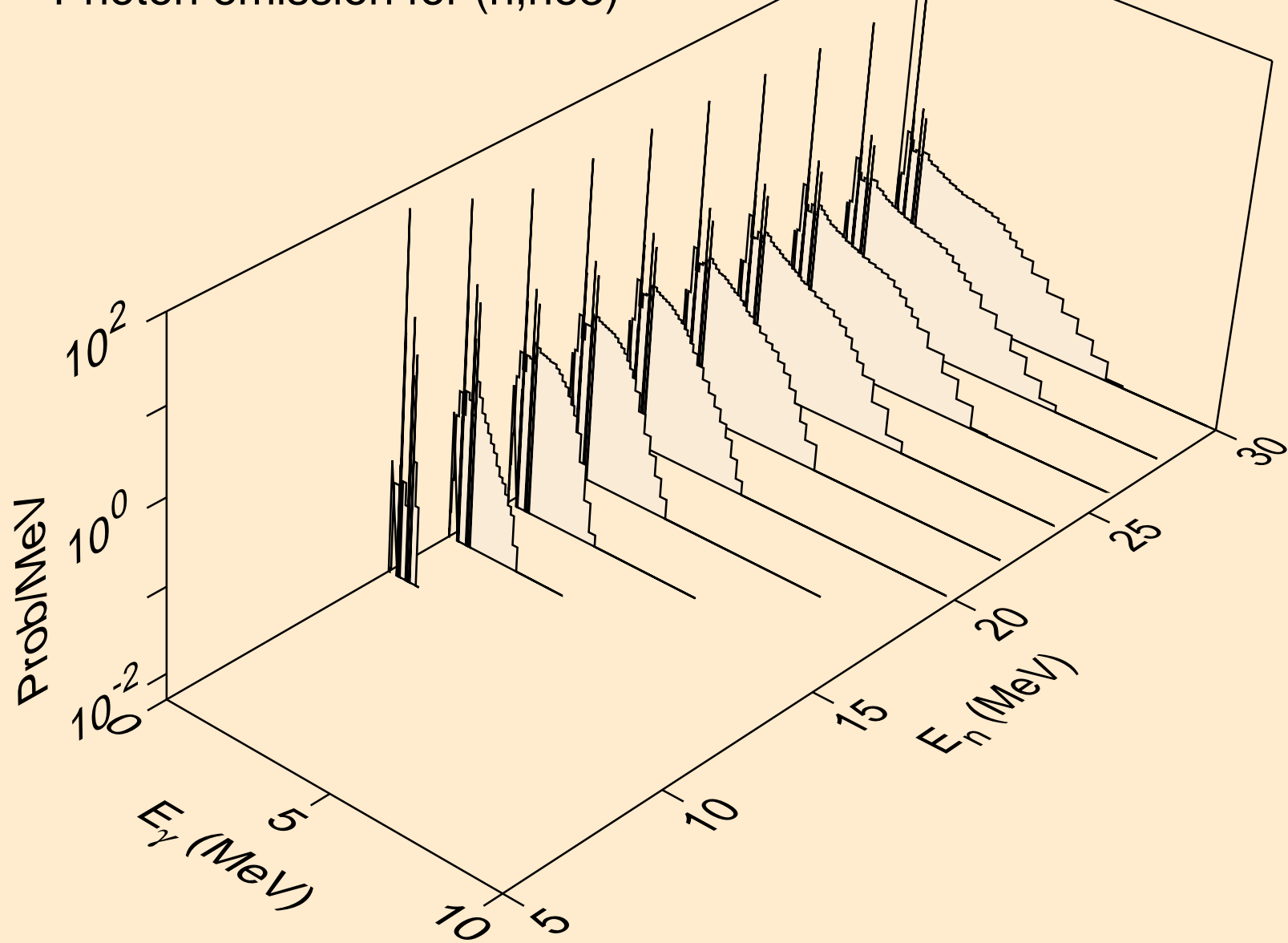

RB083 NEUTRON ACER TENDL-2024 LIBRARY; T=0.K  
Photon emission for (n,a)

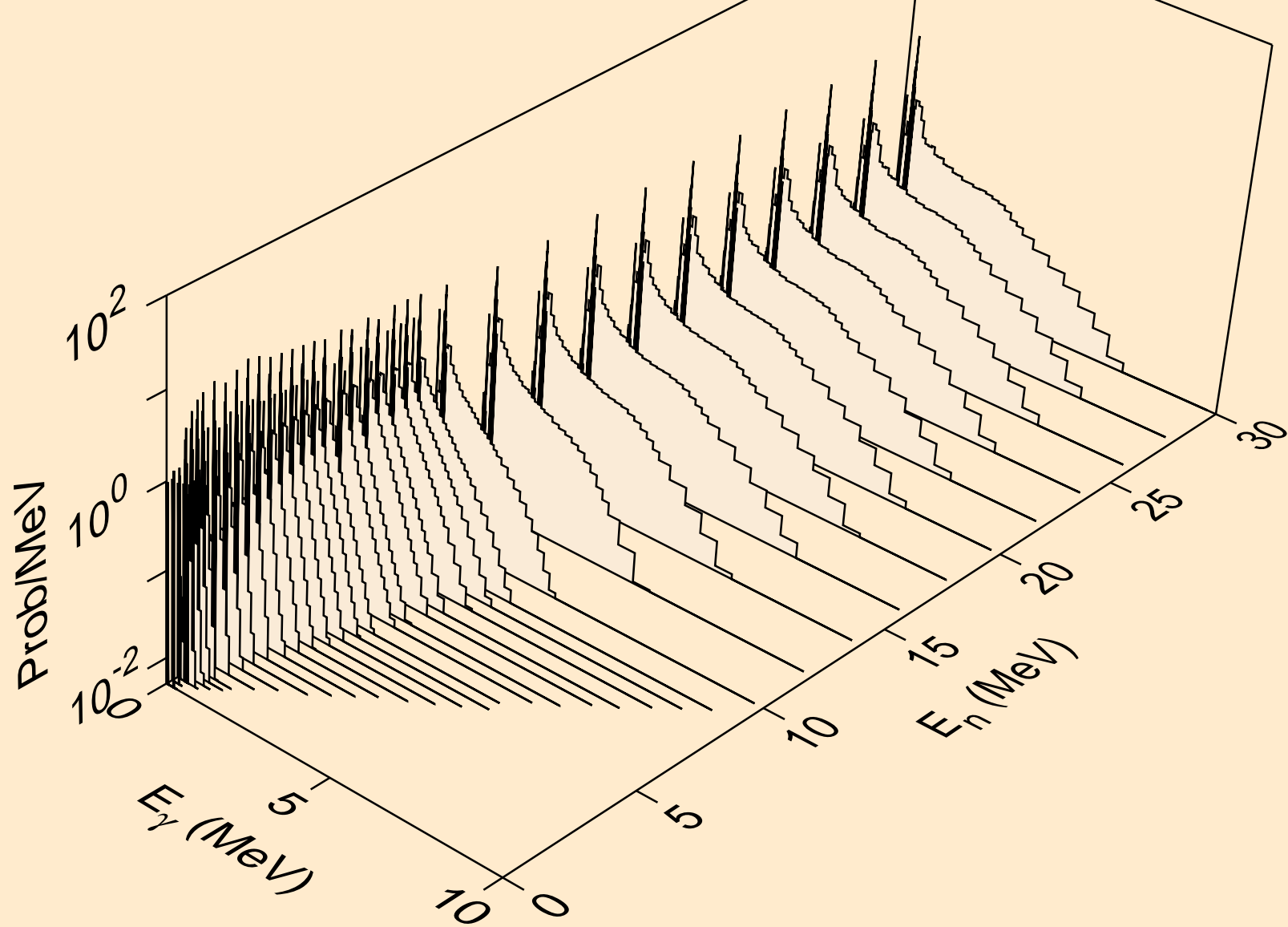

RB083 NEUTRON ACER TENDL-2024 LIBRARY; T=0.K  
Photon emission for (n,2a)

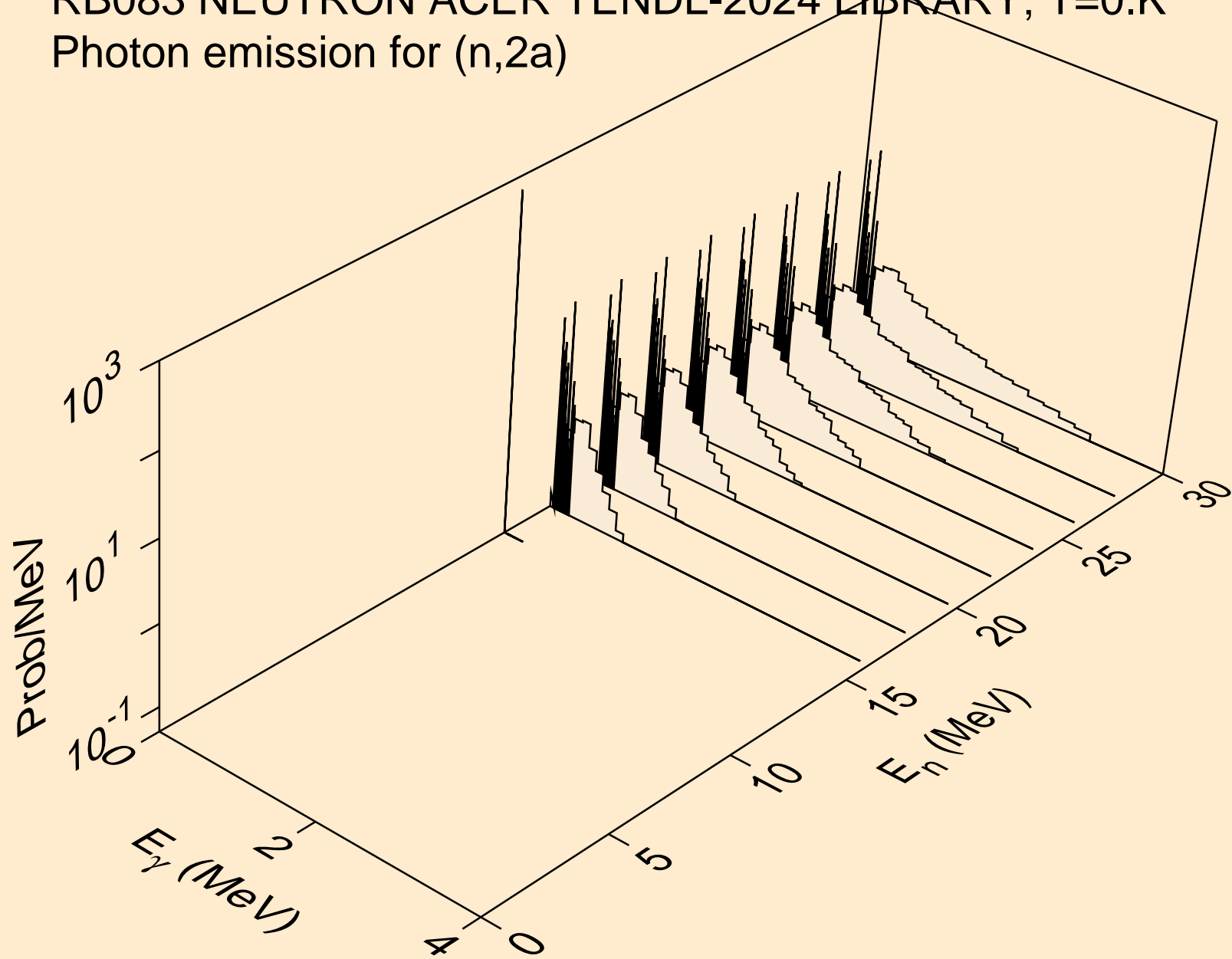

RB083 NEUTRON ACER TENDL-2024 LIBRARY; T=0.K  
Photon emission for (n,2p)

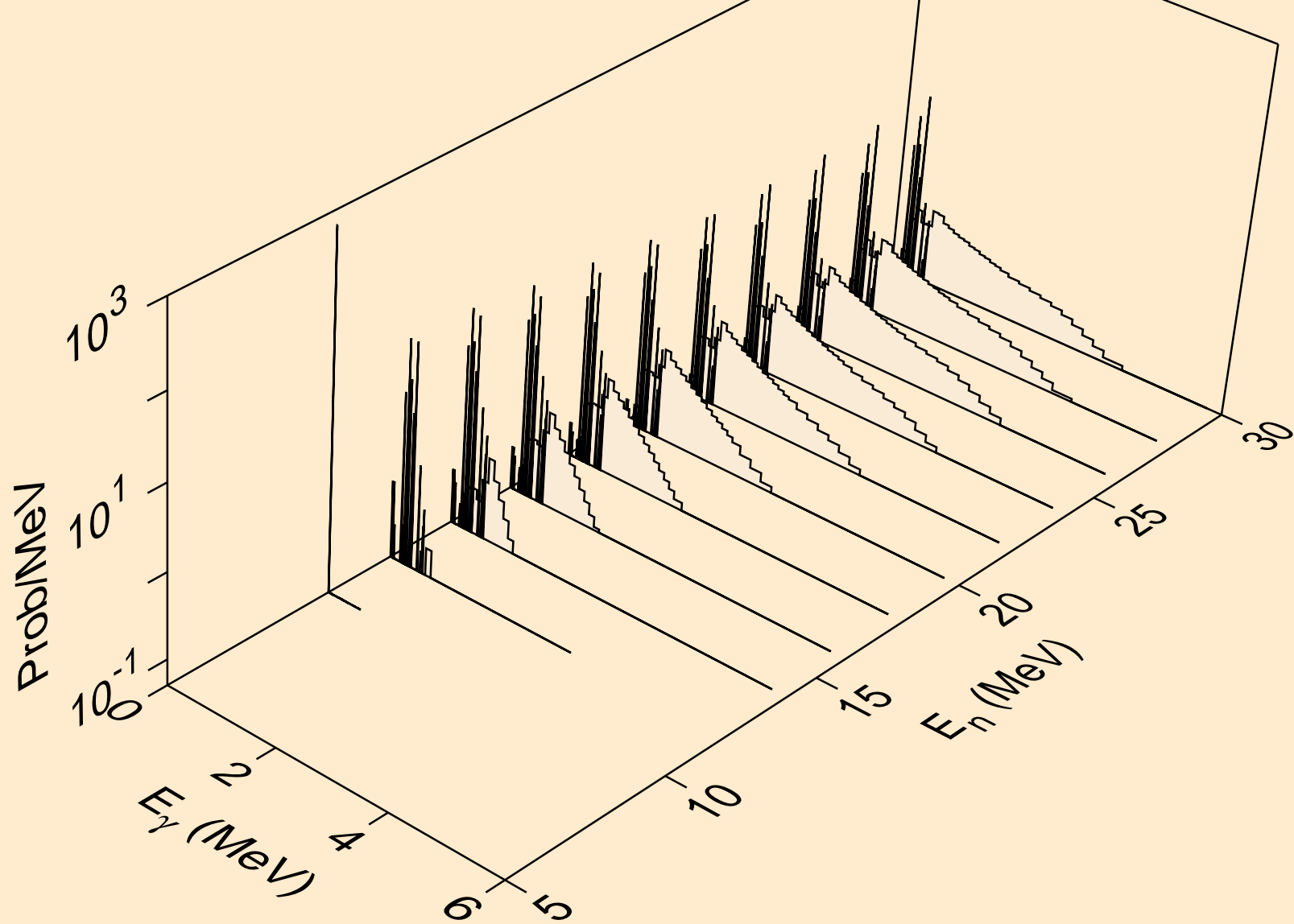

RB083 NEUTRON ACER TENDL-2024 LIBRARY; T=0.K  
Photon emission for (n,p)

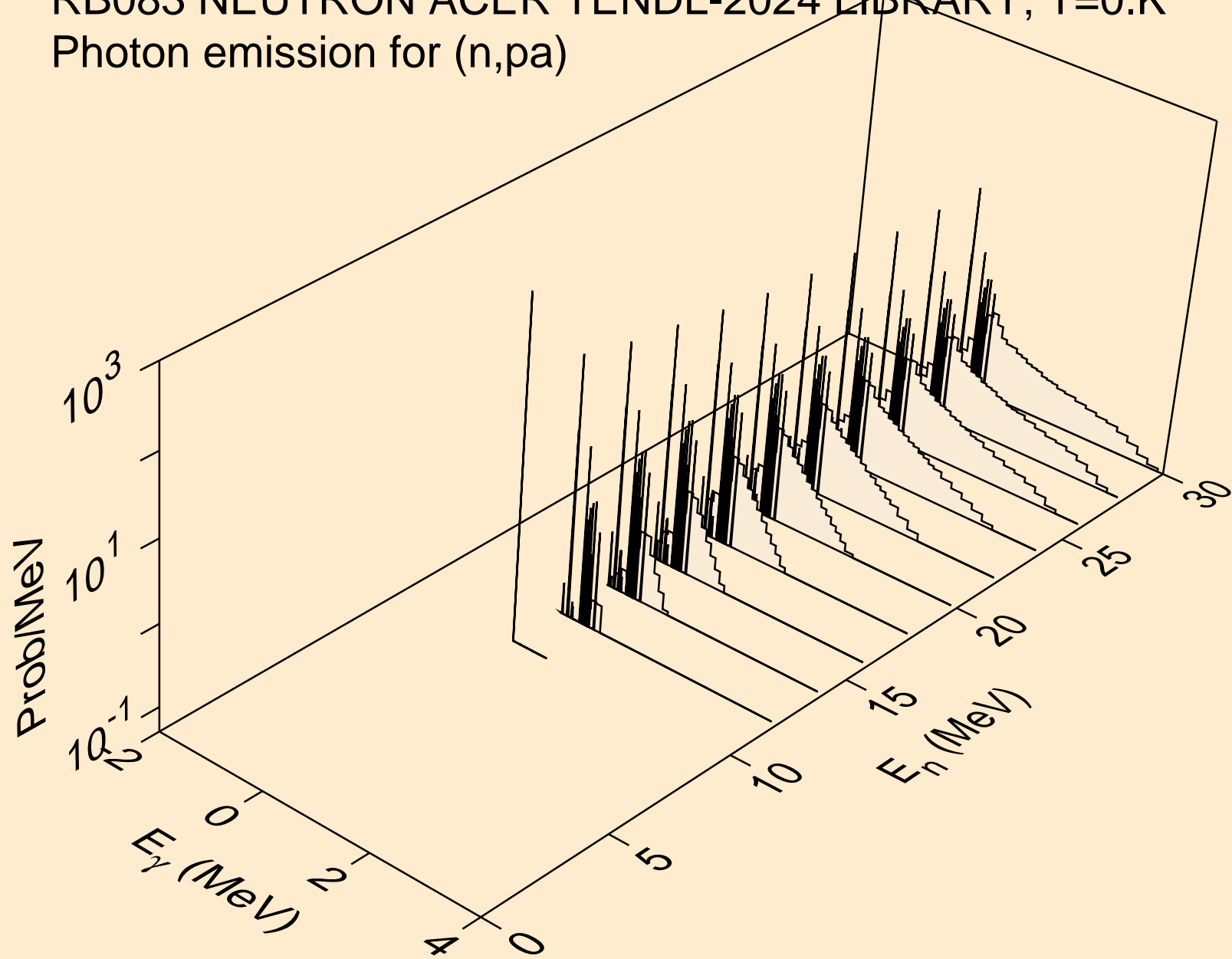

RB083 NEUTRON ACER TENDL-2024 LIBRARY; T=0.K  
Photon emission for (n,pd)

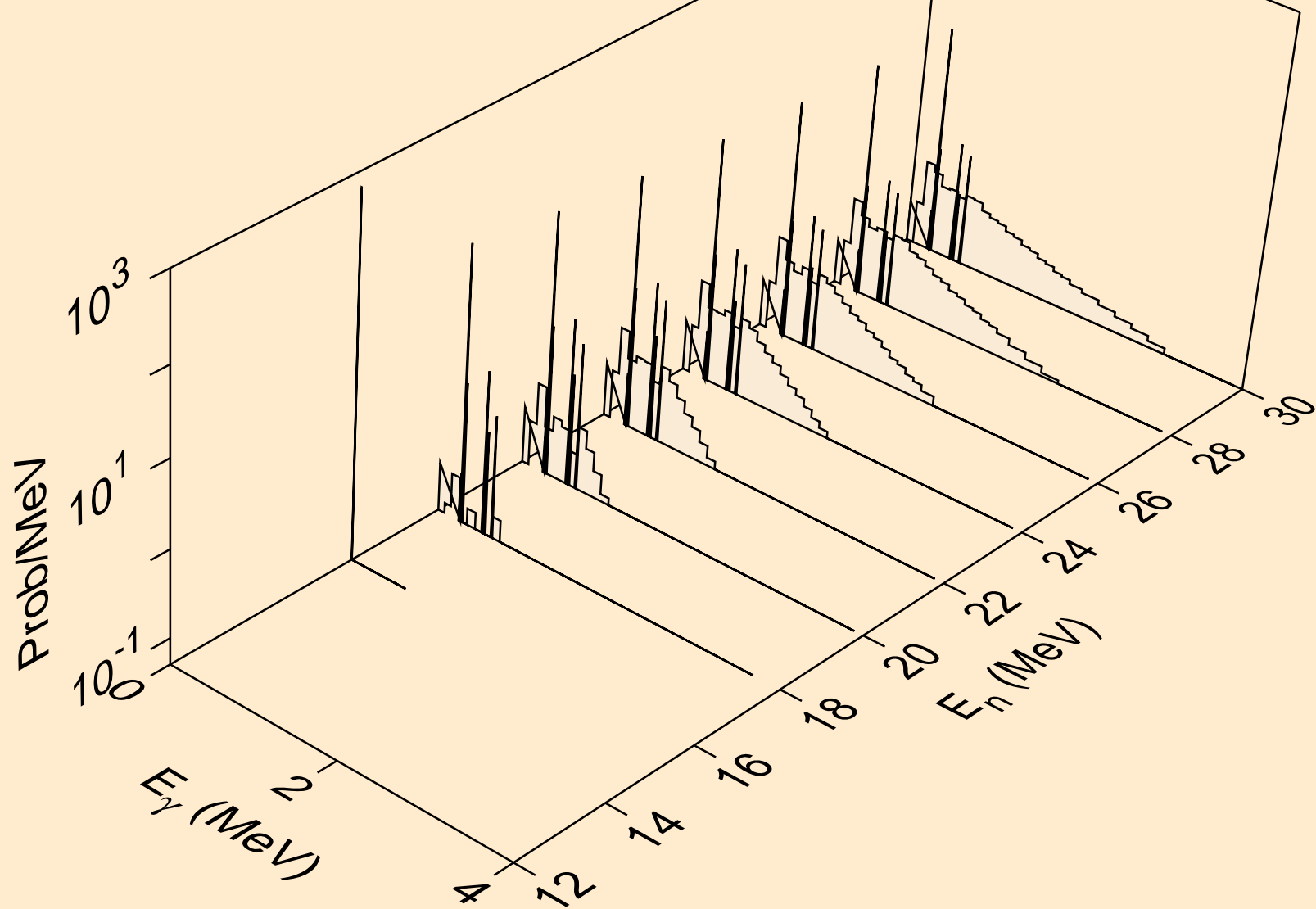

RB083 NEUTRON ACER TENDL-2024 LIBRARY; T=0.K  
Photon emission for (n,pt)

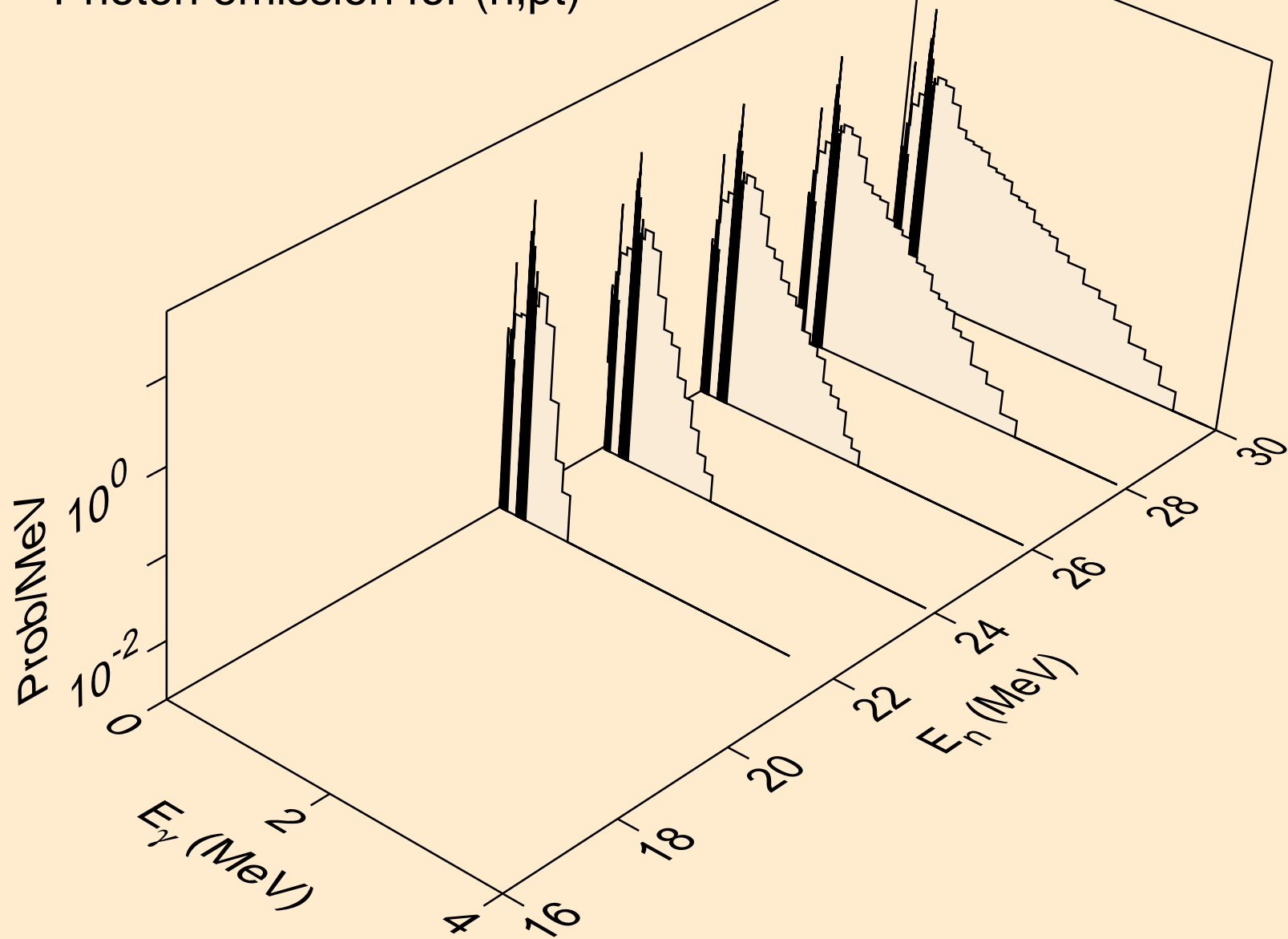

RB083 NEUTRON ACER TENDL-2024 LIBRARY; T=0.K  
Photon emission for (n,da)

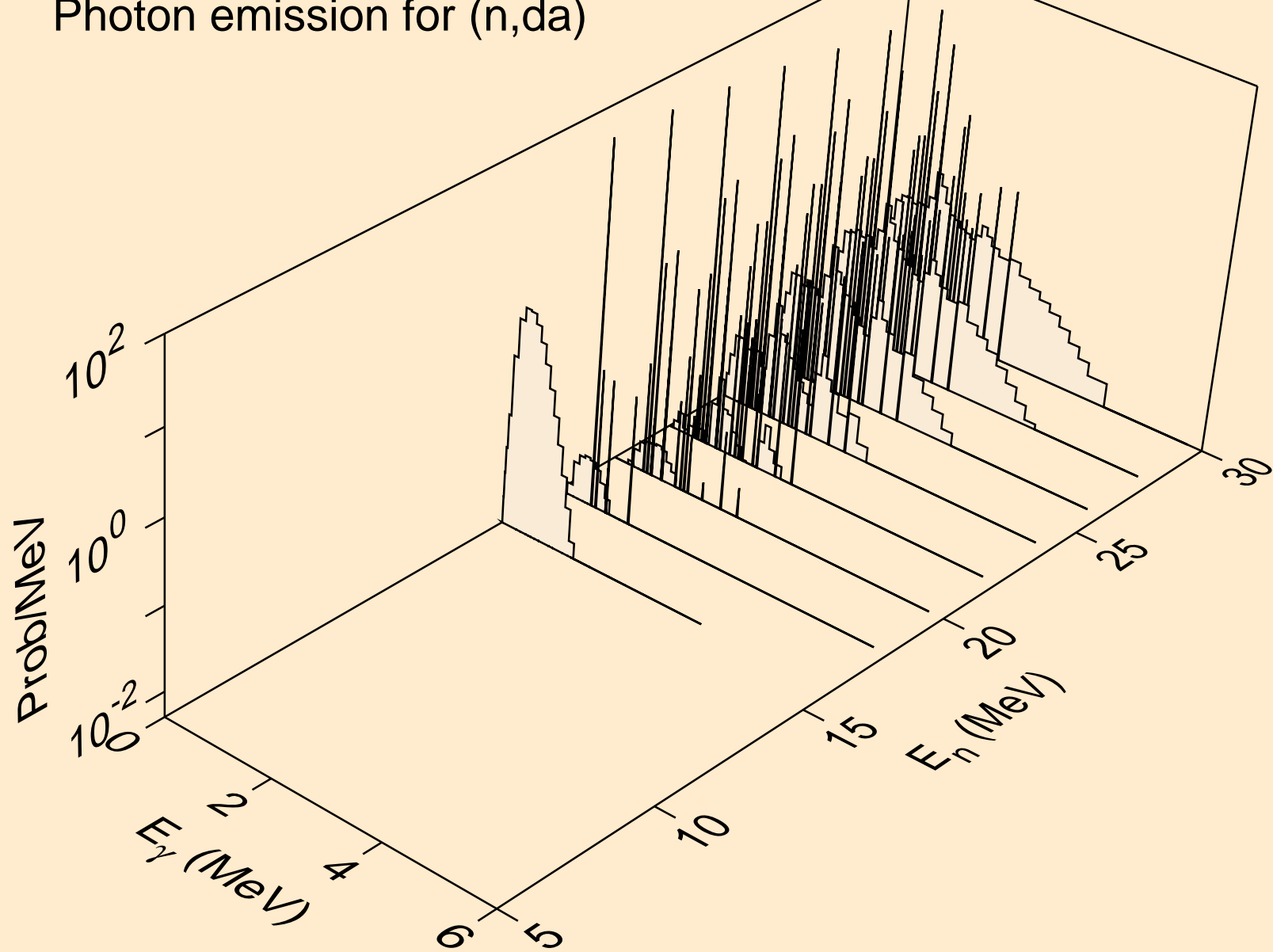



RB083 NEUTRON ACER TENDL-2024 LIBRARY; T=0.K  
thermal capture photon spectrum

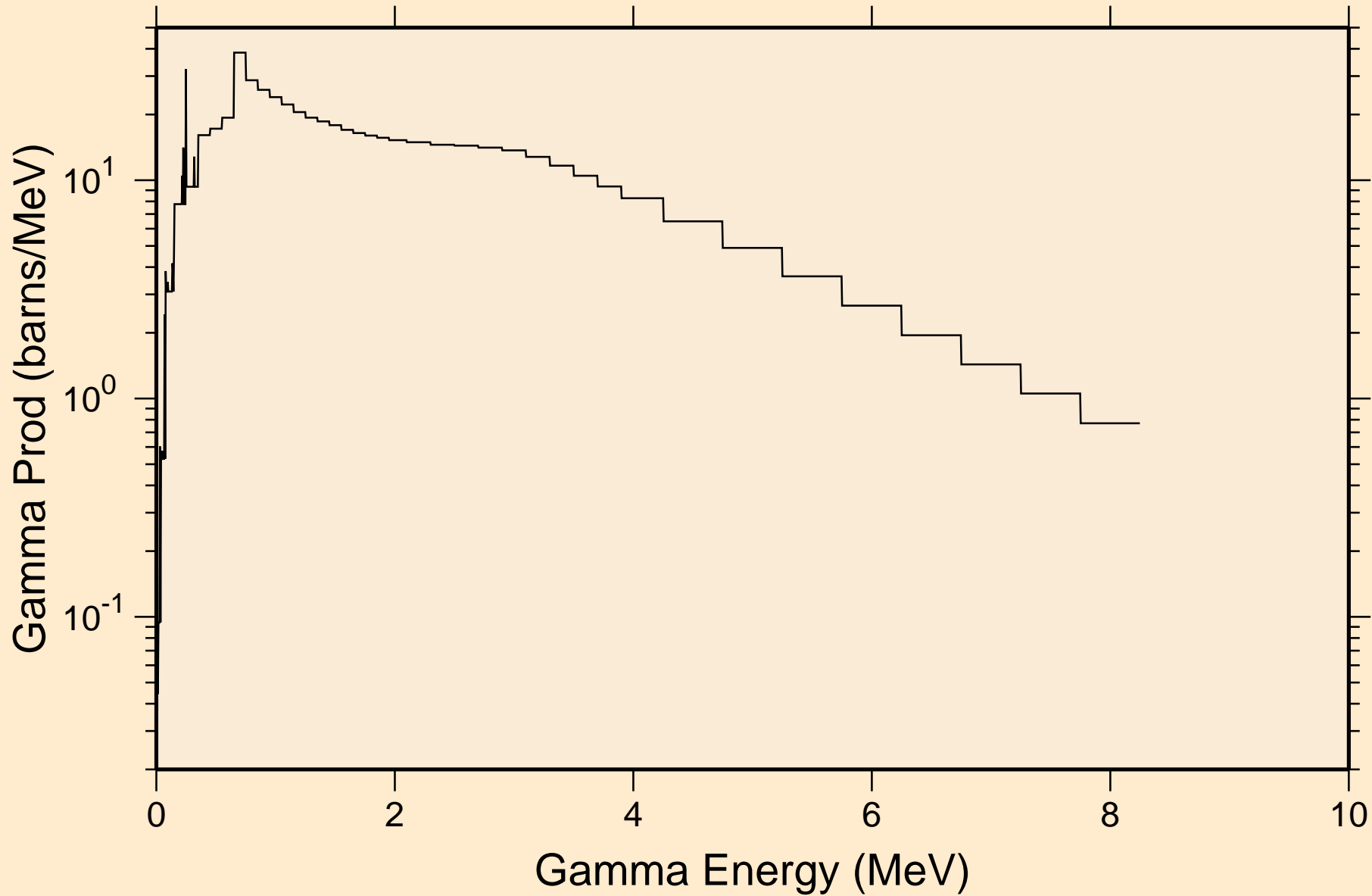

RB083 NEUTRON ACER TENDL-2024 LIBRARY; T=0.K  
14 MeV photon spectrum

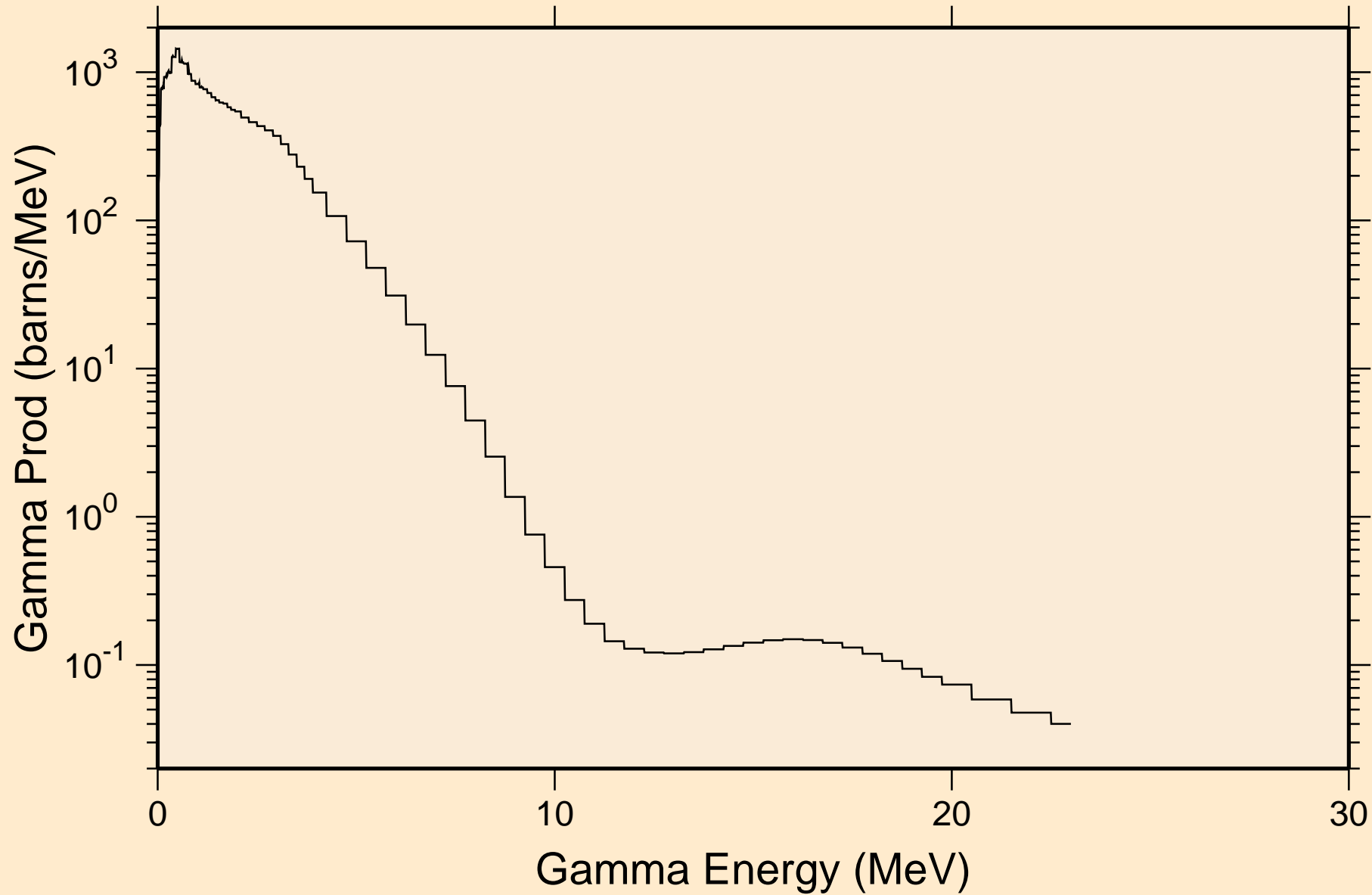

# RB083 NEUTRON ACER TENDL-2024 LIBRARY; T=0.K

## Particle heating contributions

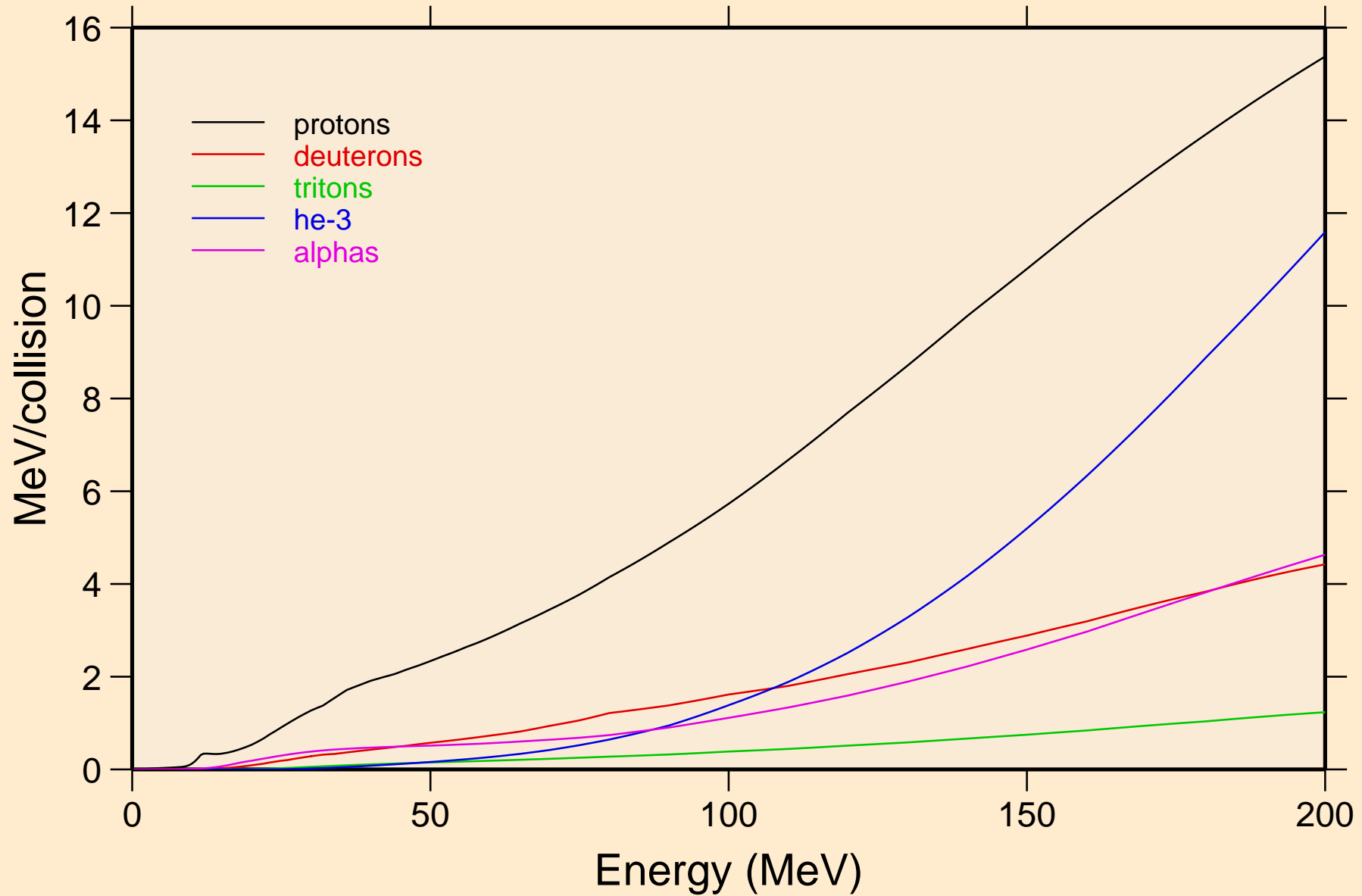

RB083 NEUTRON ACER TENDL-2024 LIBRARY; T=0.K  
Recoil Heating

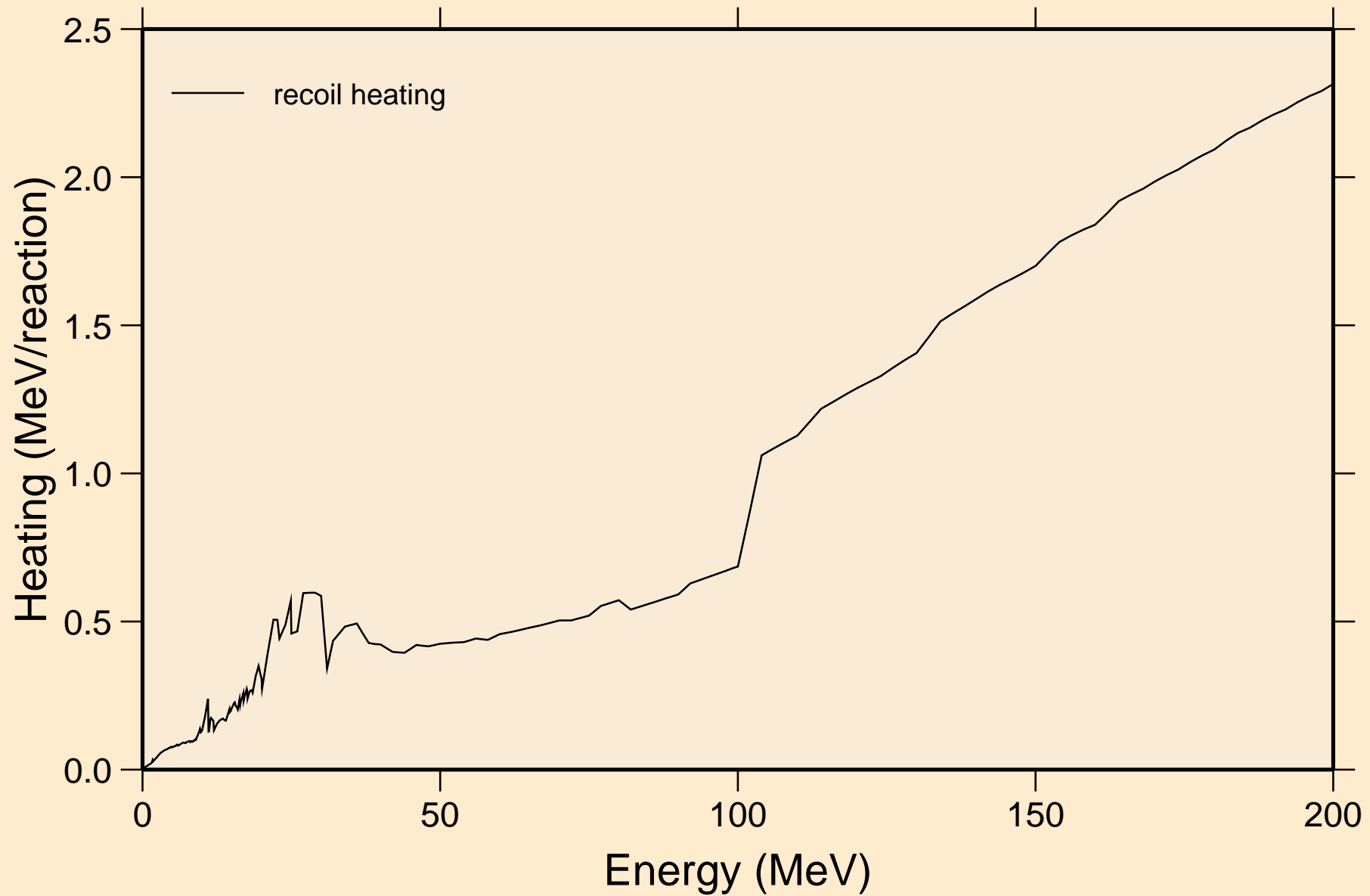

RB083 NEUTRON ACER TENDL-2024 LIBRARY; T=0.K  
Particle production cross sections

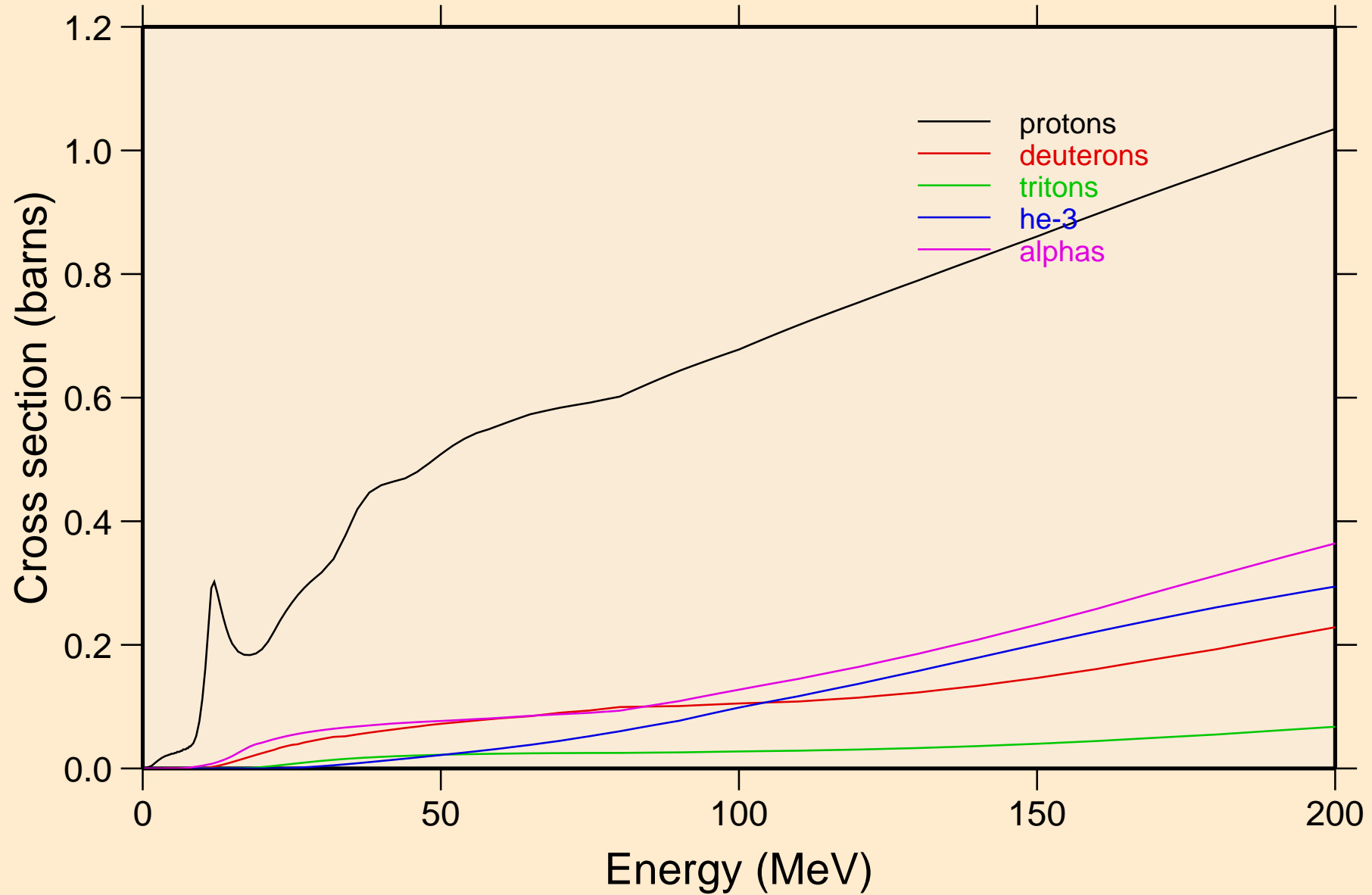

RB083 NEUTRON ACER TENDL-2024 LIBRARY; T=0.K  
protons from (n,x)

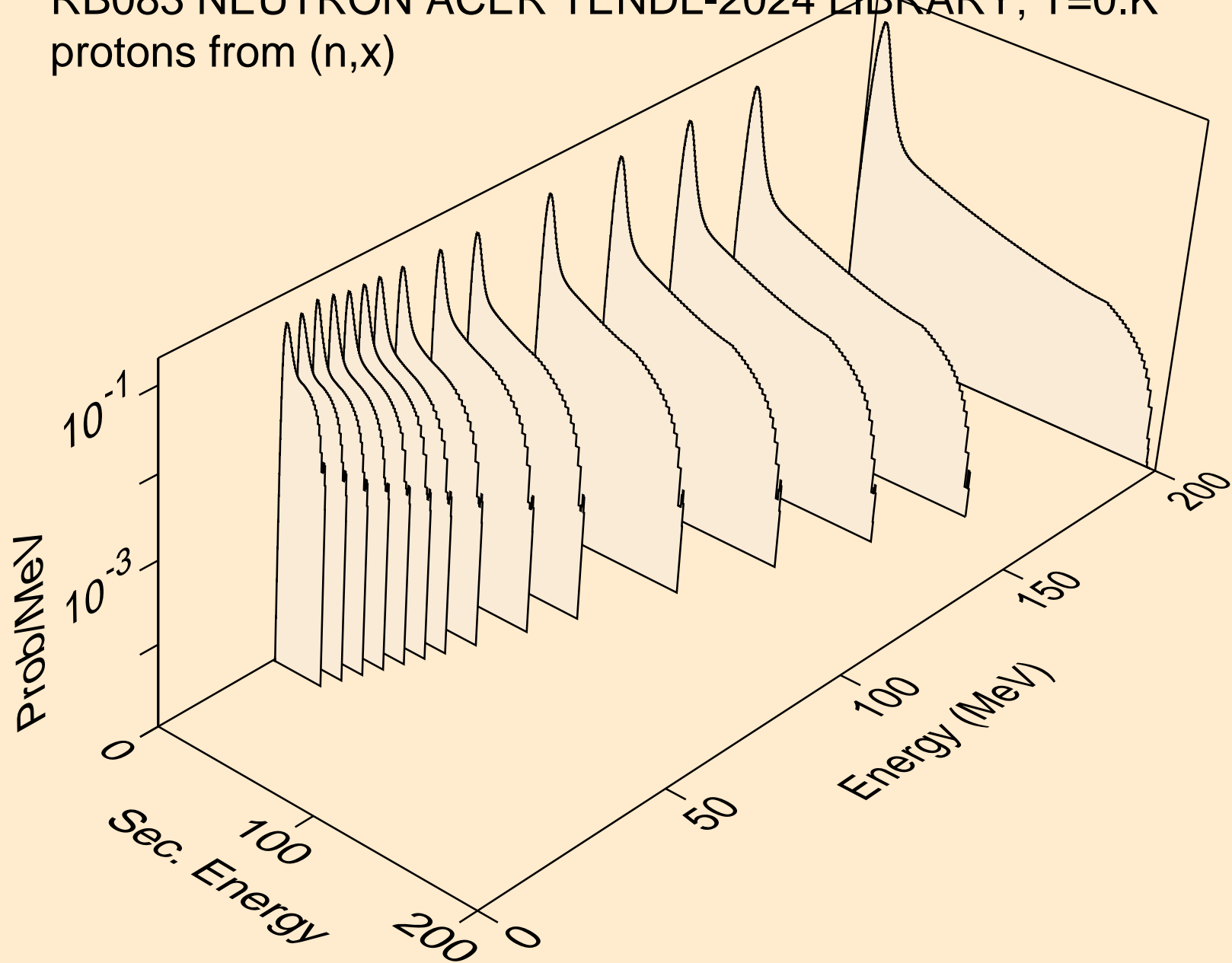

RB083 NEUTRON ACER TENDL-2024 LIBRARY; T=0.K  
protons from (n,n\*)p

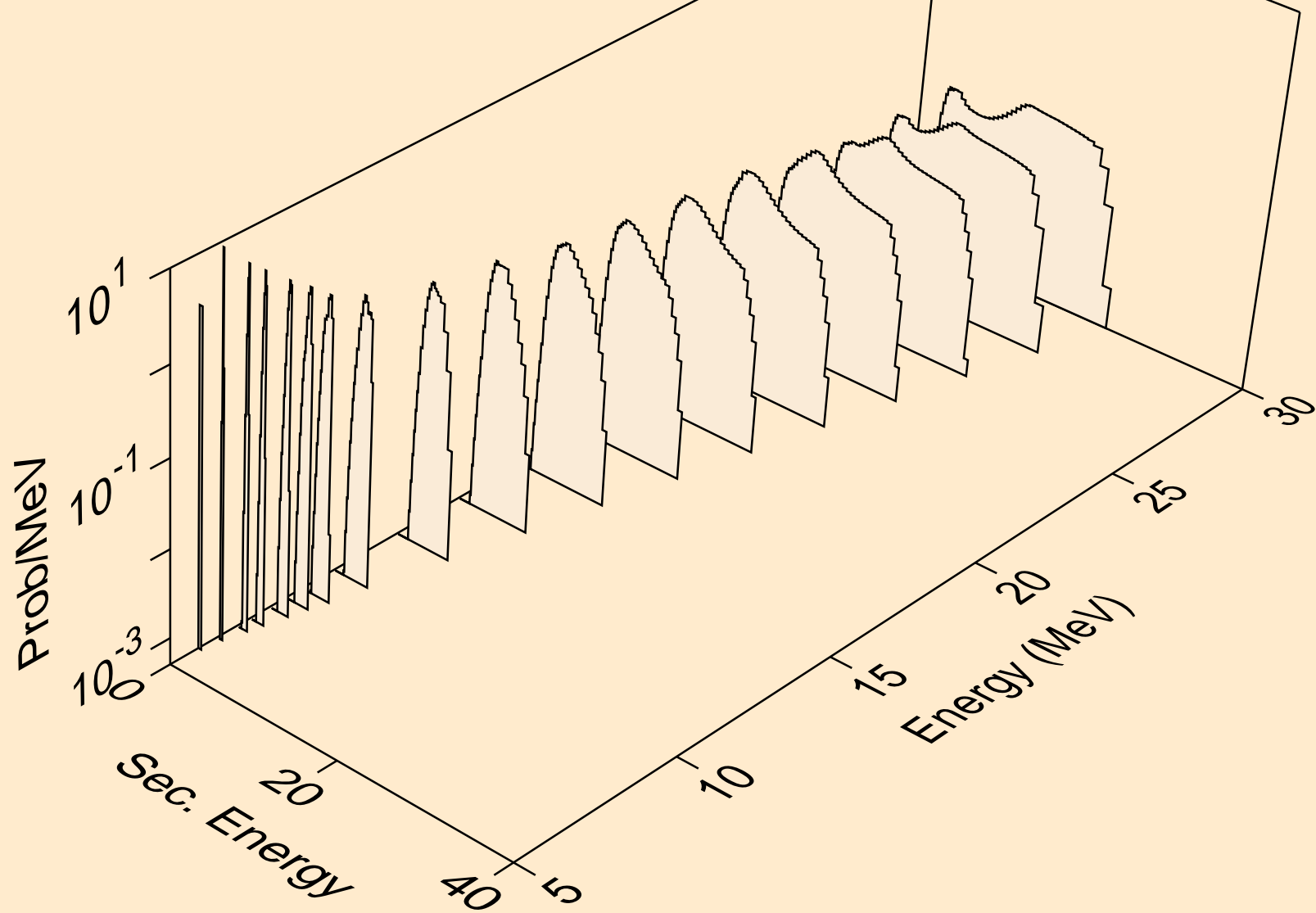

RB083 NEUTRON ACER TENDL-2024 LIBRARY; T=0.K  
protons from (n,2np)

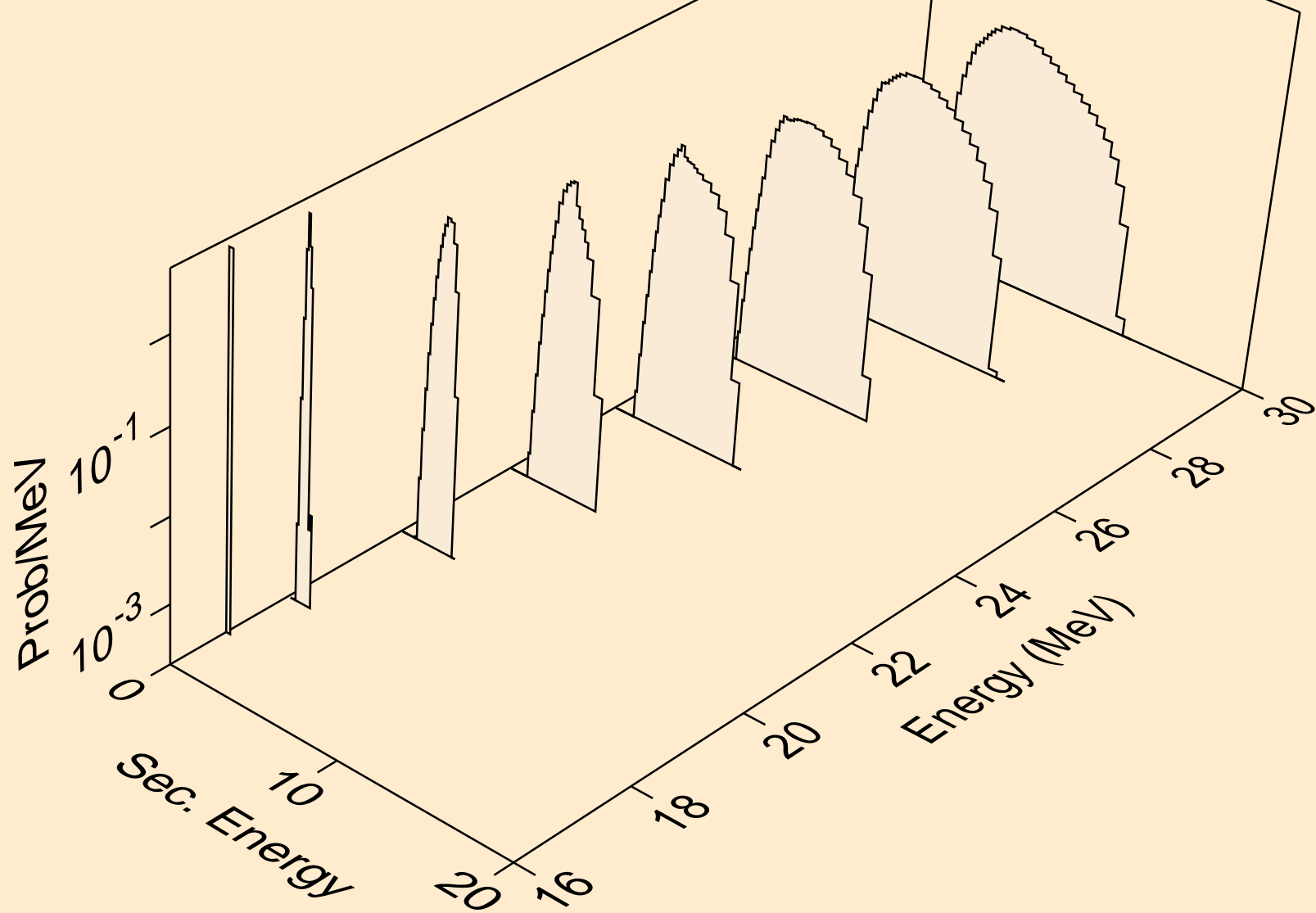



RB083 NEUTRON ACER TENDL-2024 LIBRARY; T=0.K  
protons from (n,3np)

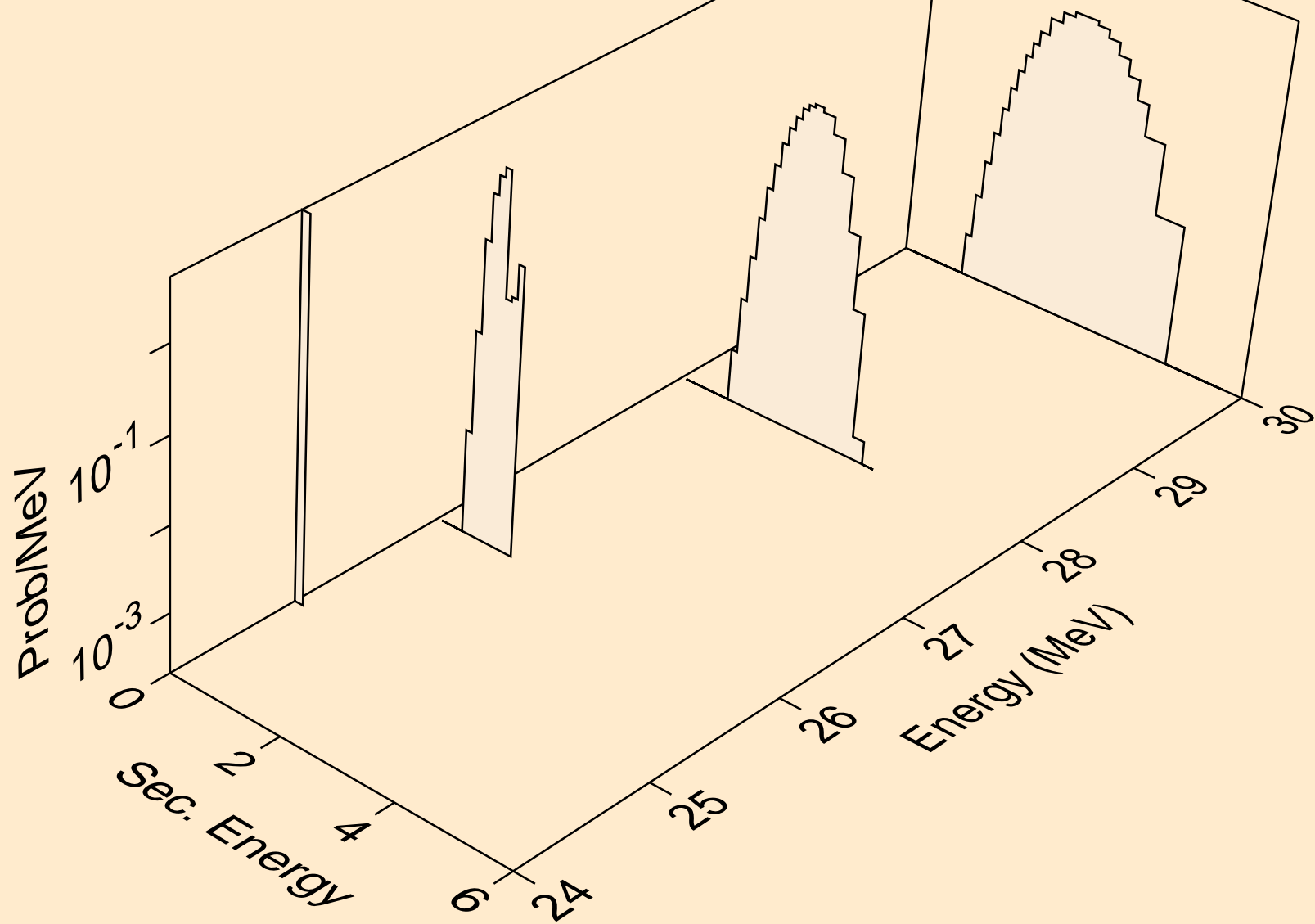

RB083 NEUTRON ACER TENDL-2024 LIBRARY; T=0.K  
protons from (n,n2p)

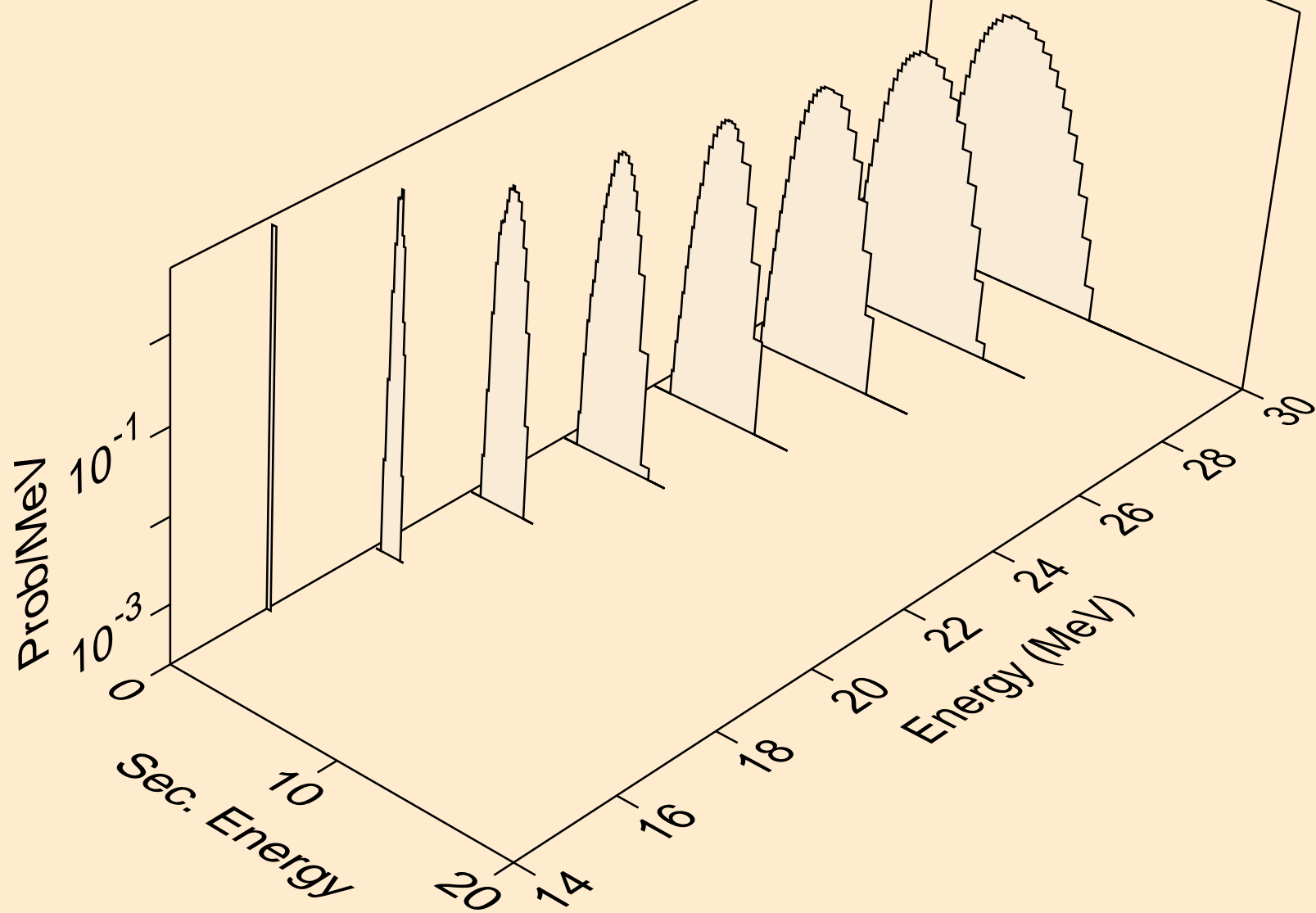

RB083 NEUTRON ACER TENDL-2024 LIBRARY; T=0.K  
protons from (n,npa)

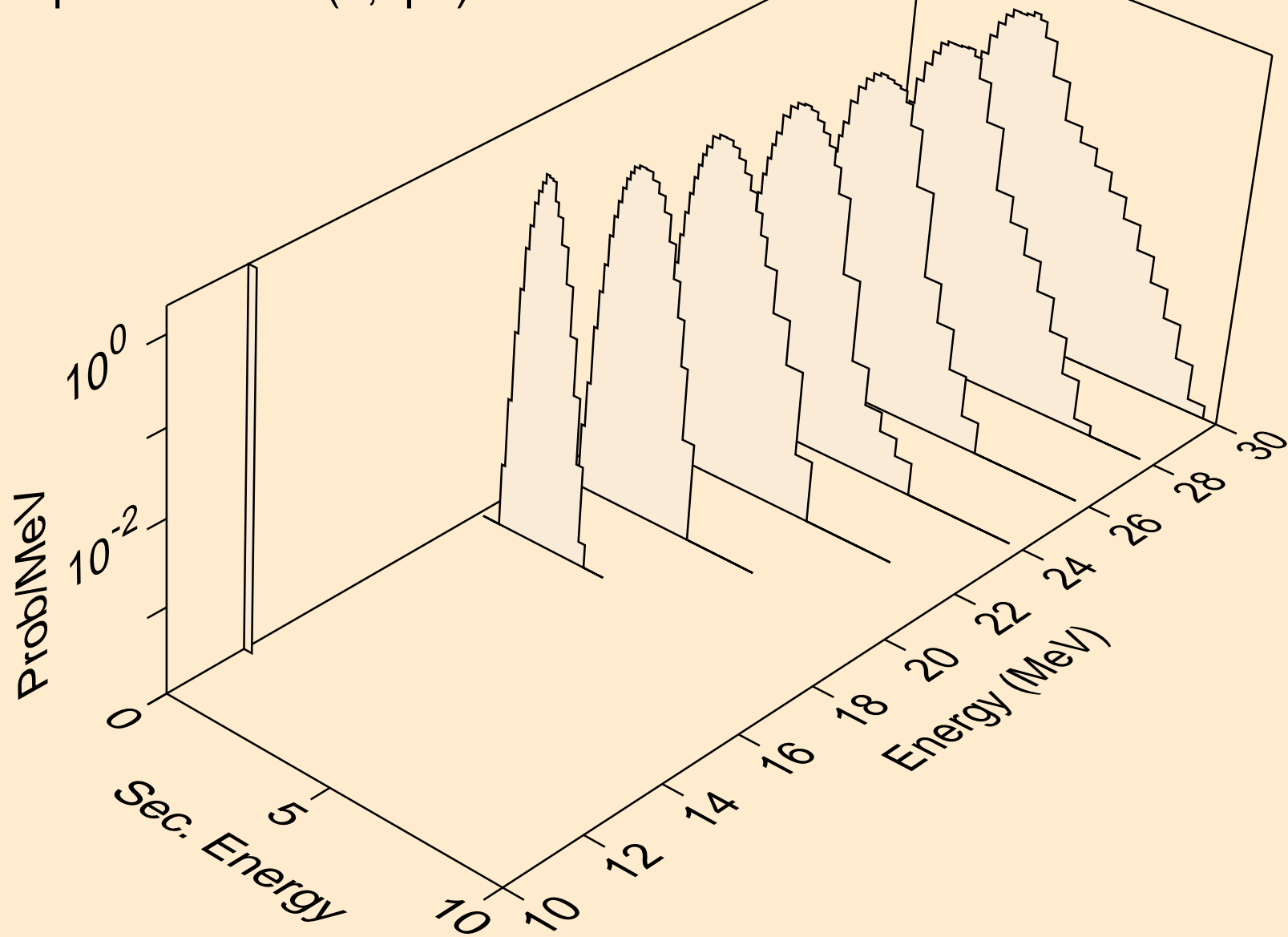

RB083 NEUTRON ACER TENDL-2024 LIBRARY; T=0.K  
protons from (n,p)

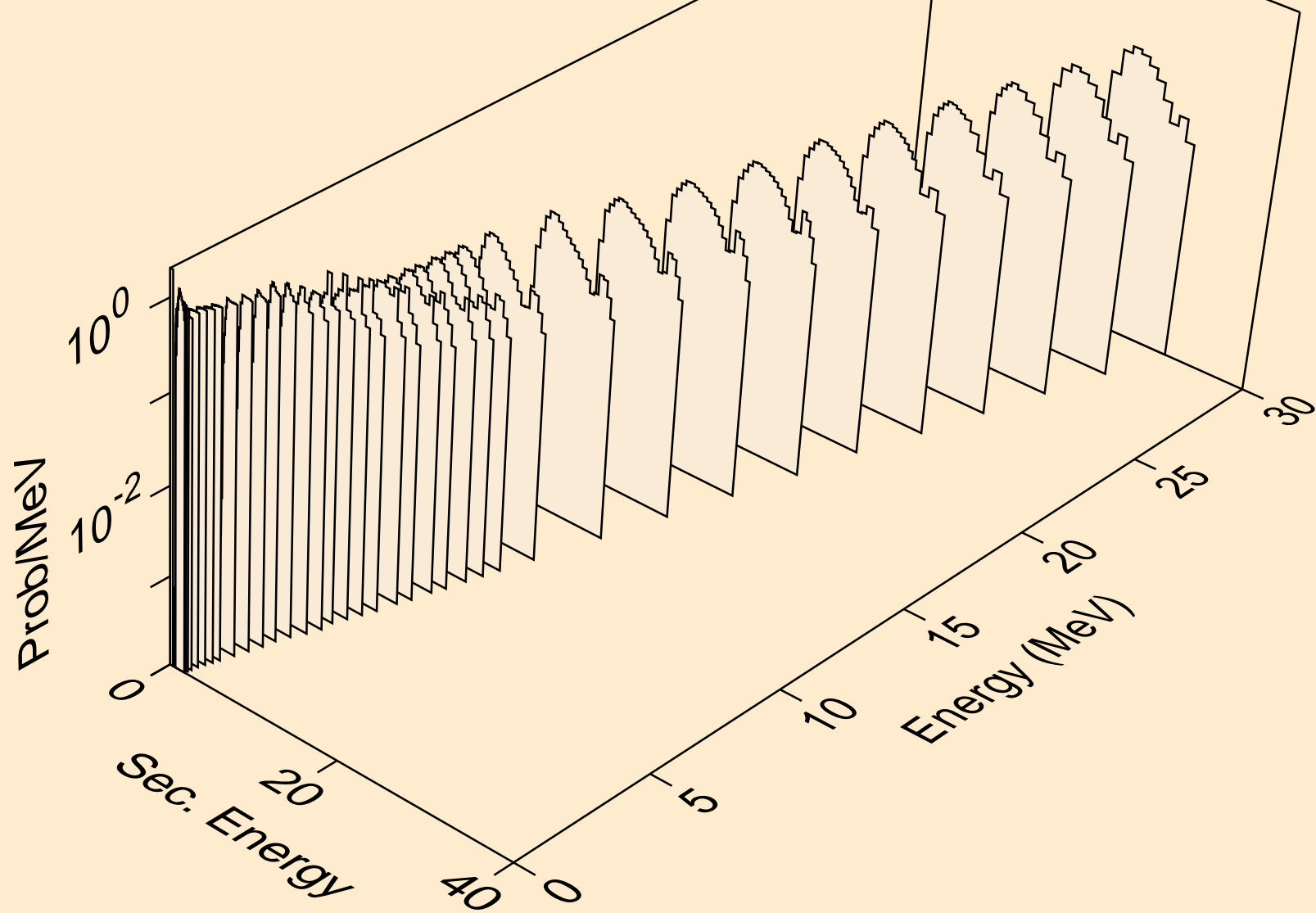

RB083 NEUTRON ACER TENDL-2024 LIBRARY; T=0.K  
protons from (n,2p)

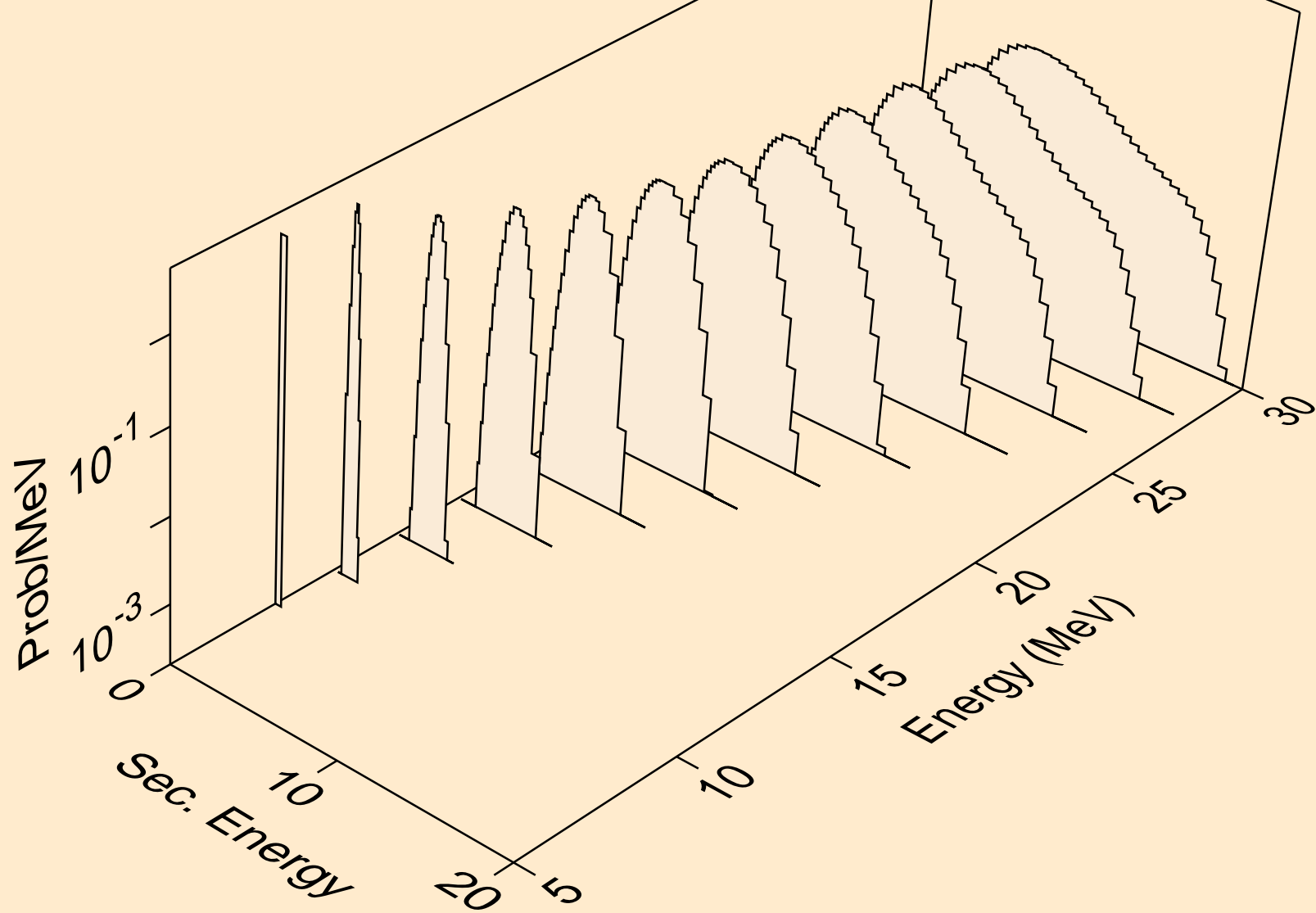

RB083 NEUTRON ACER TENDL-2024 LIBRARY; T=0.K  
protons from (n,pa)

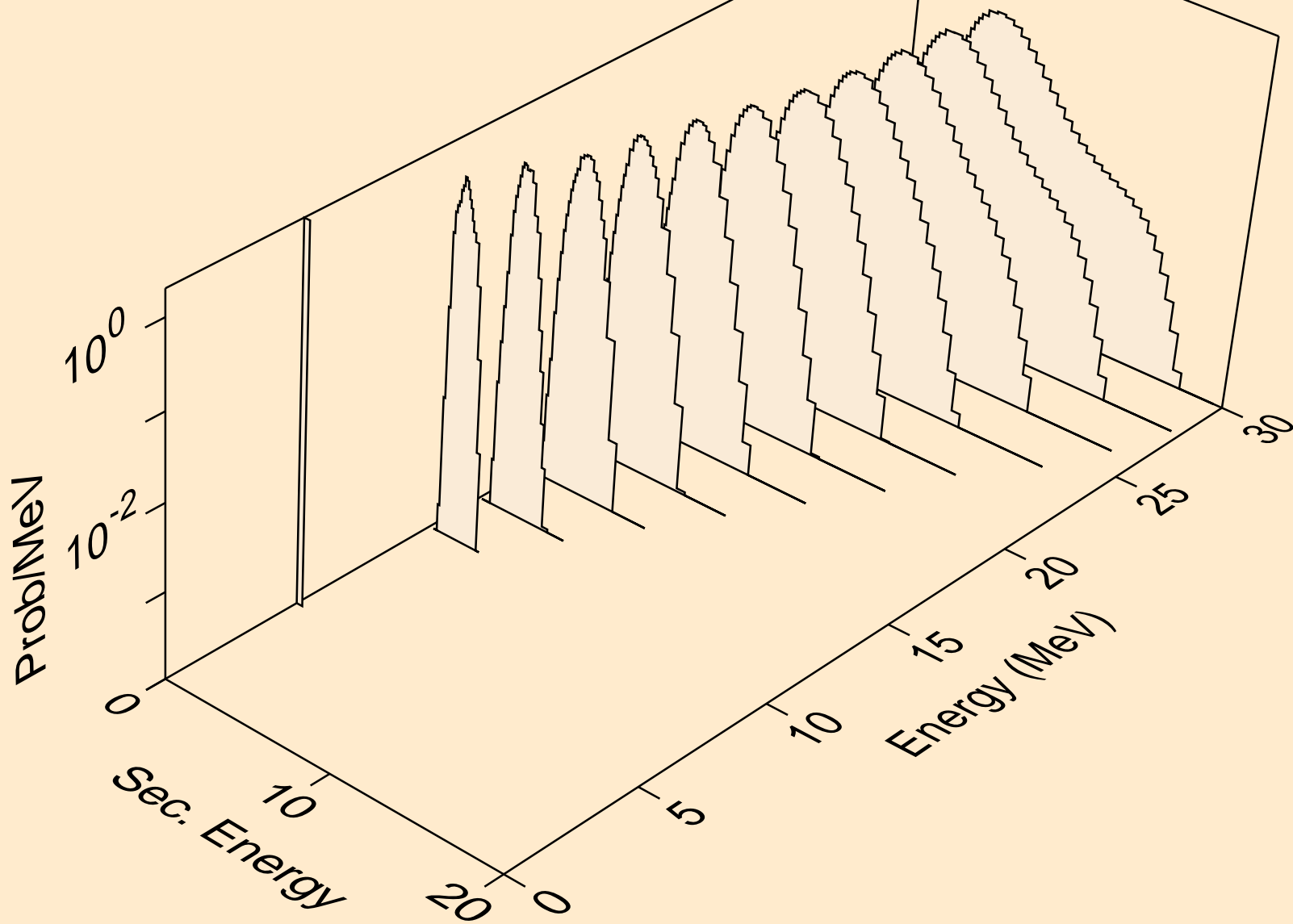

RB083 NEUTRON ACER TENDL-2024 LIBRARY; T=0.K  
protons from (n,pd)

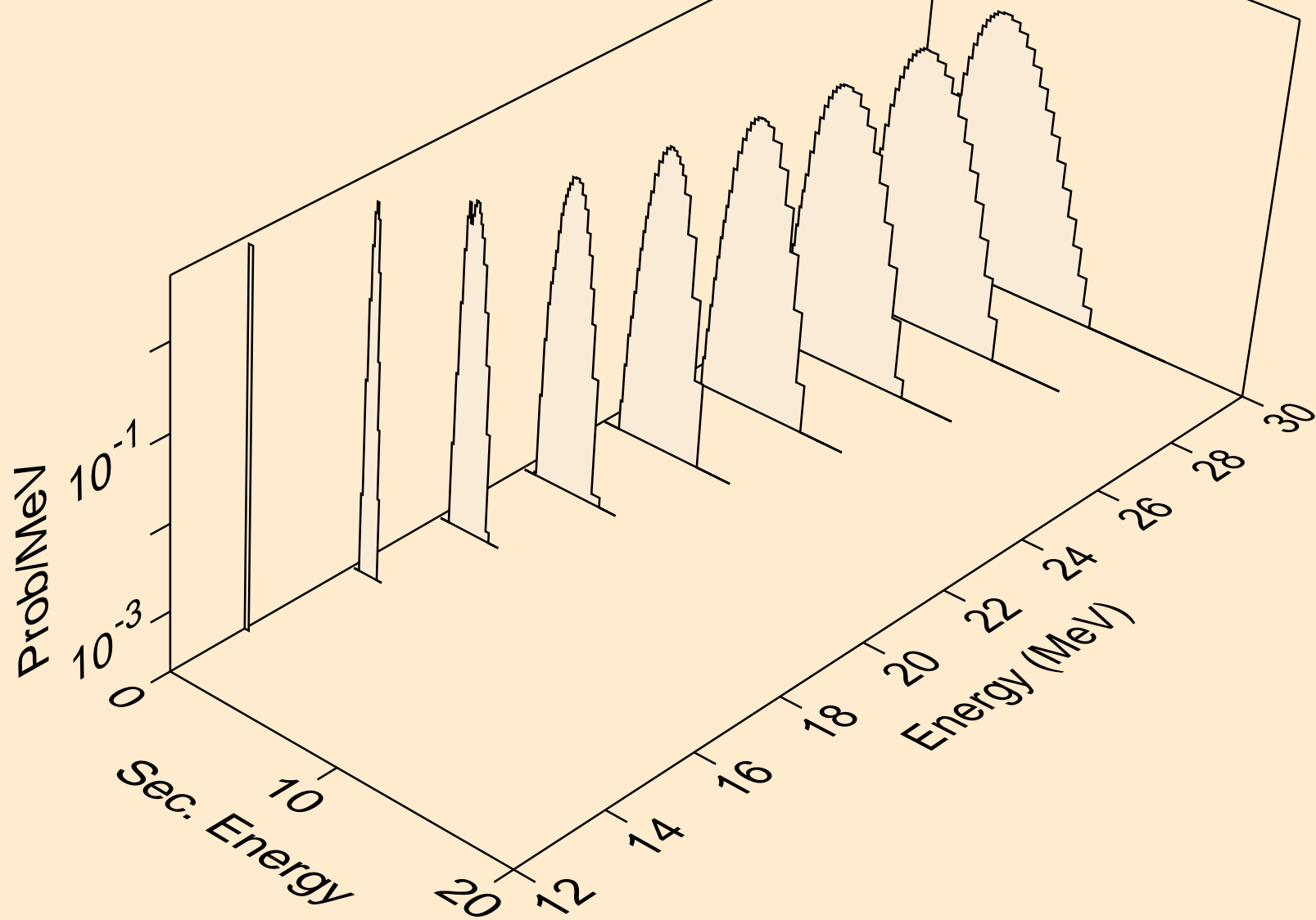

RB083 NEUTRON ACER TENDL-2024 LIBRARY; T=0.K  
protons from (n,pt)

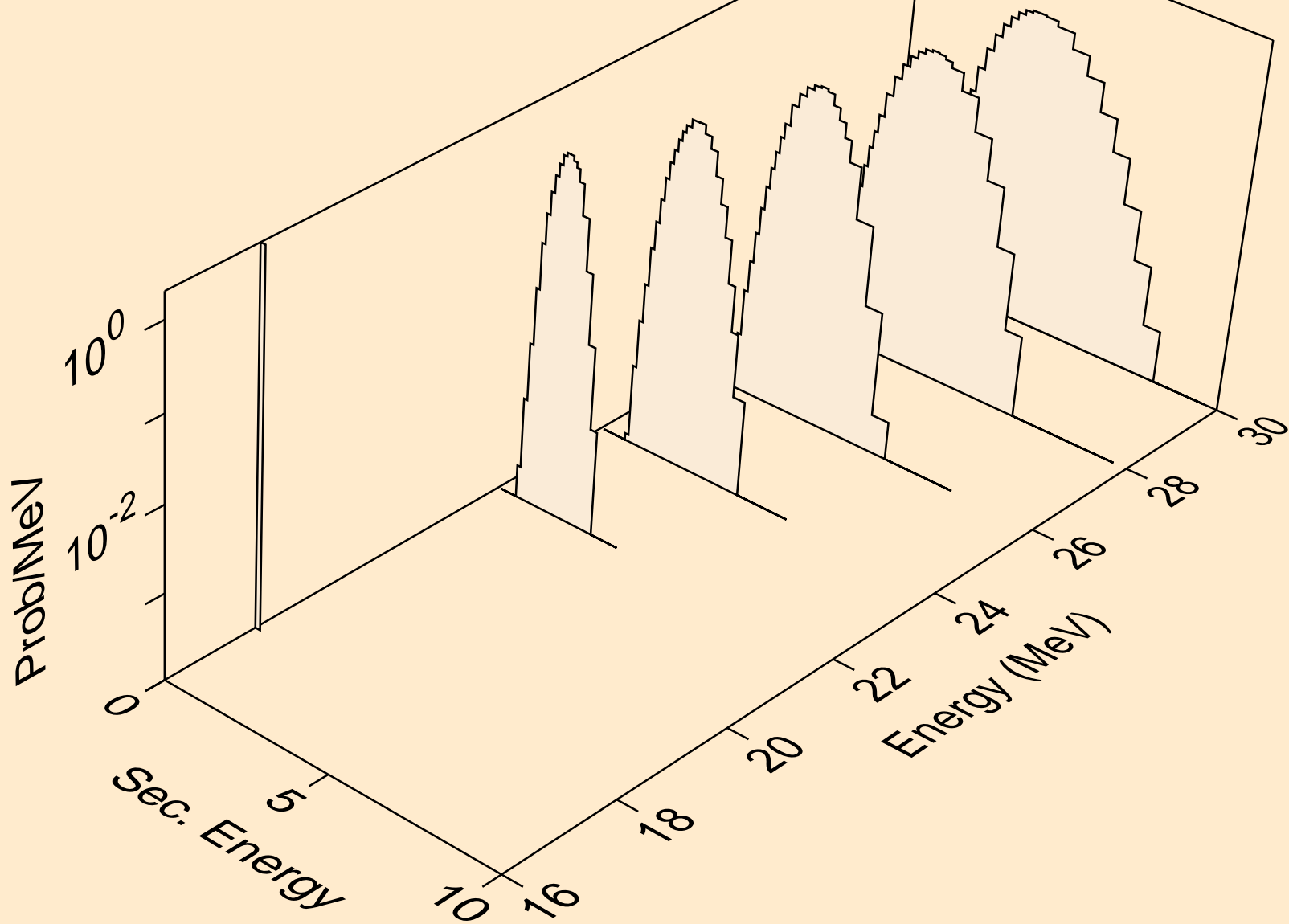



RB083 NEUTRON ACER TENDL-2024 LIBRARY; T=0.K  
deuterons from (n,x)

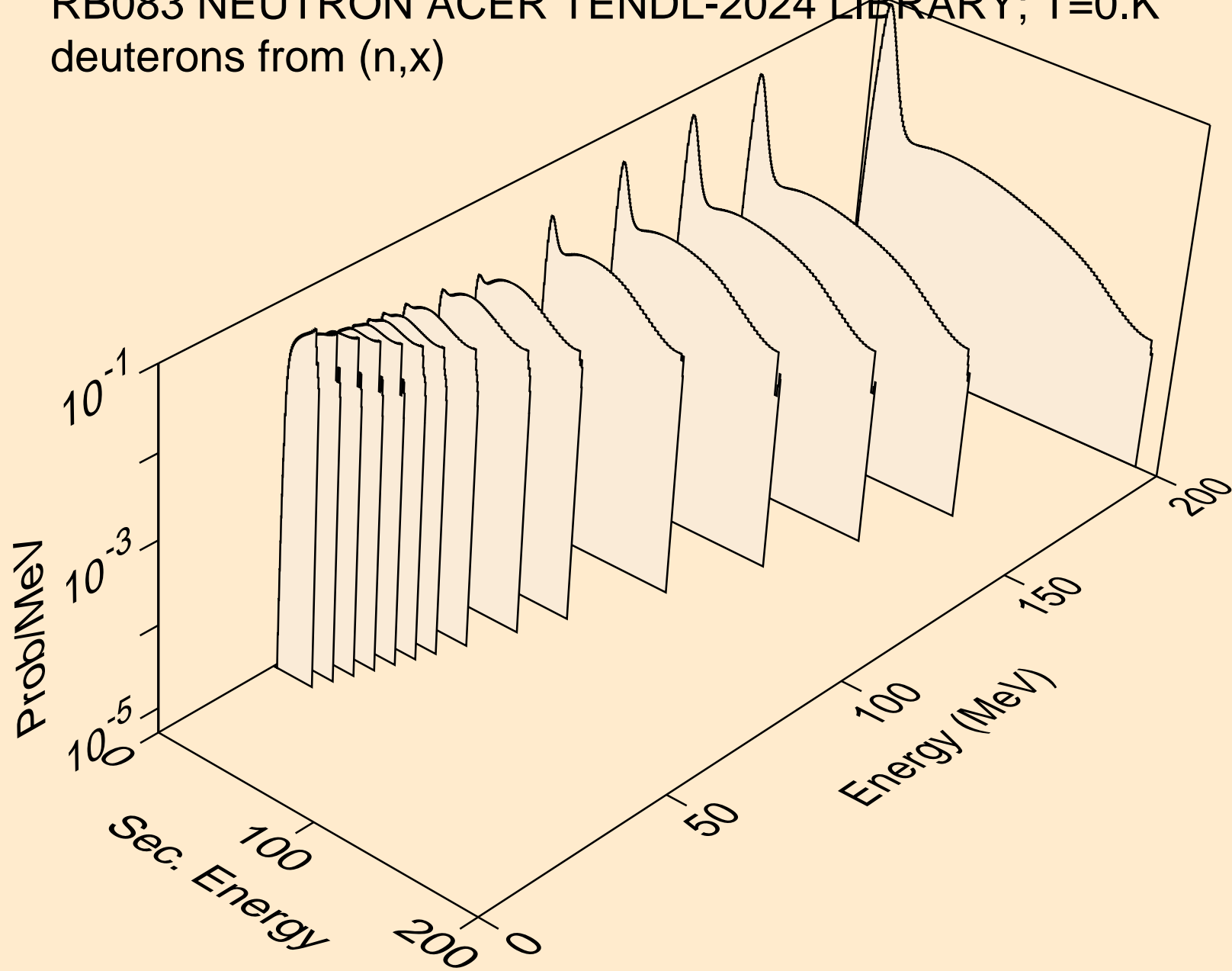

RB083 NEUTRON ACER TENDL-2024 LIBRARY; T=0.K  
deuterons from (n,2nd)

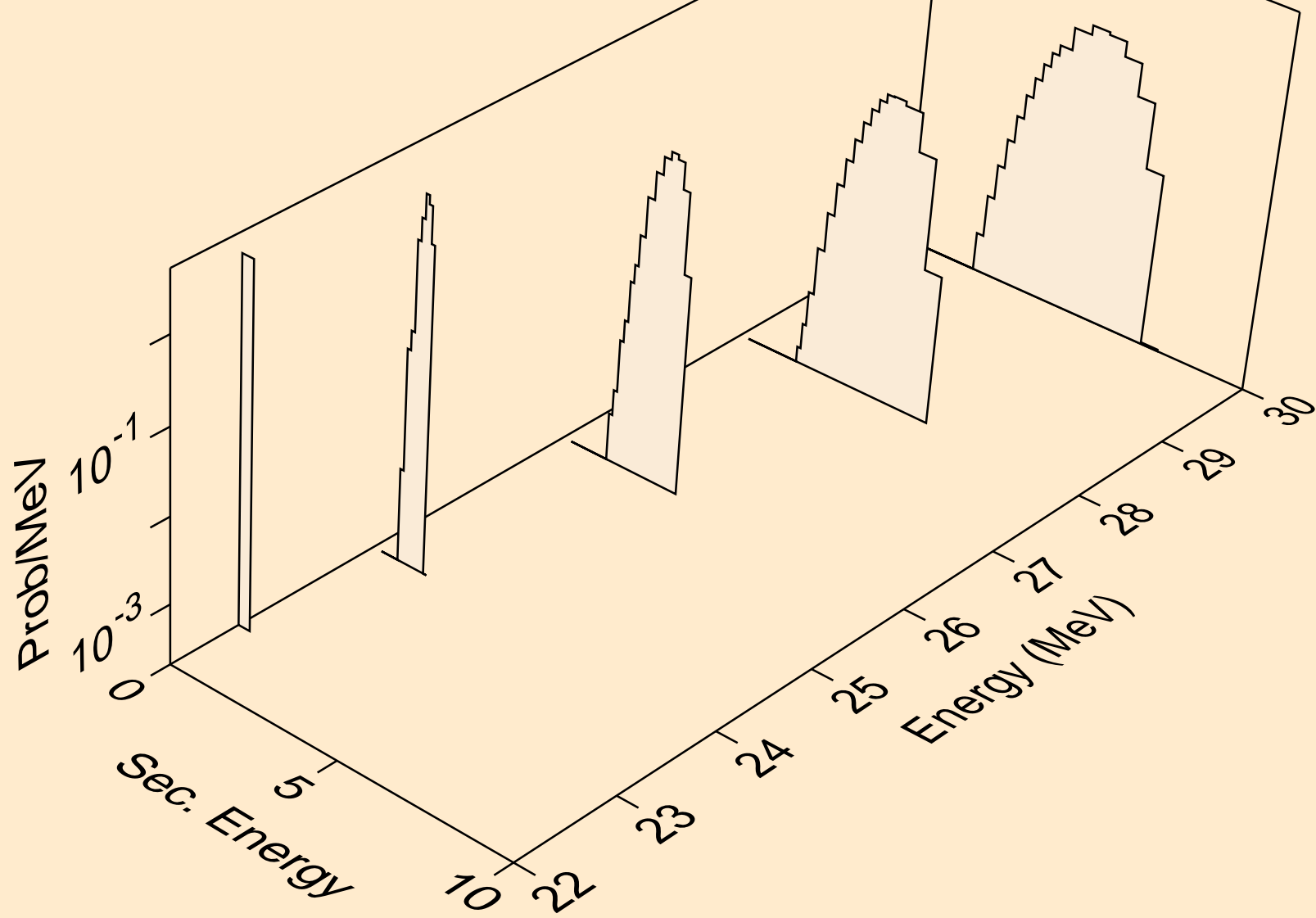

RB083 NEUTRON ACER TENDL-2024 LIBRARY; T=0.K  
deuterons from (n,n\*)d

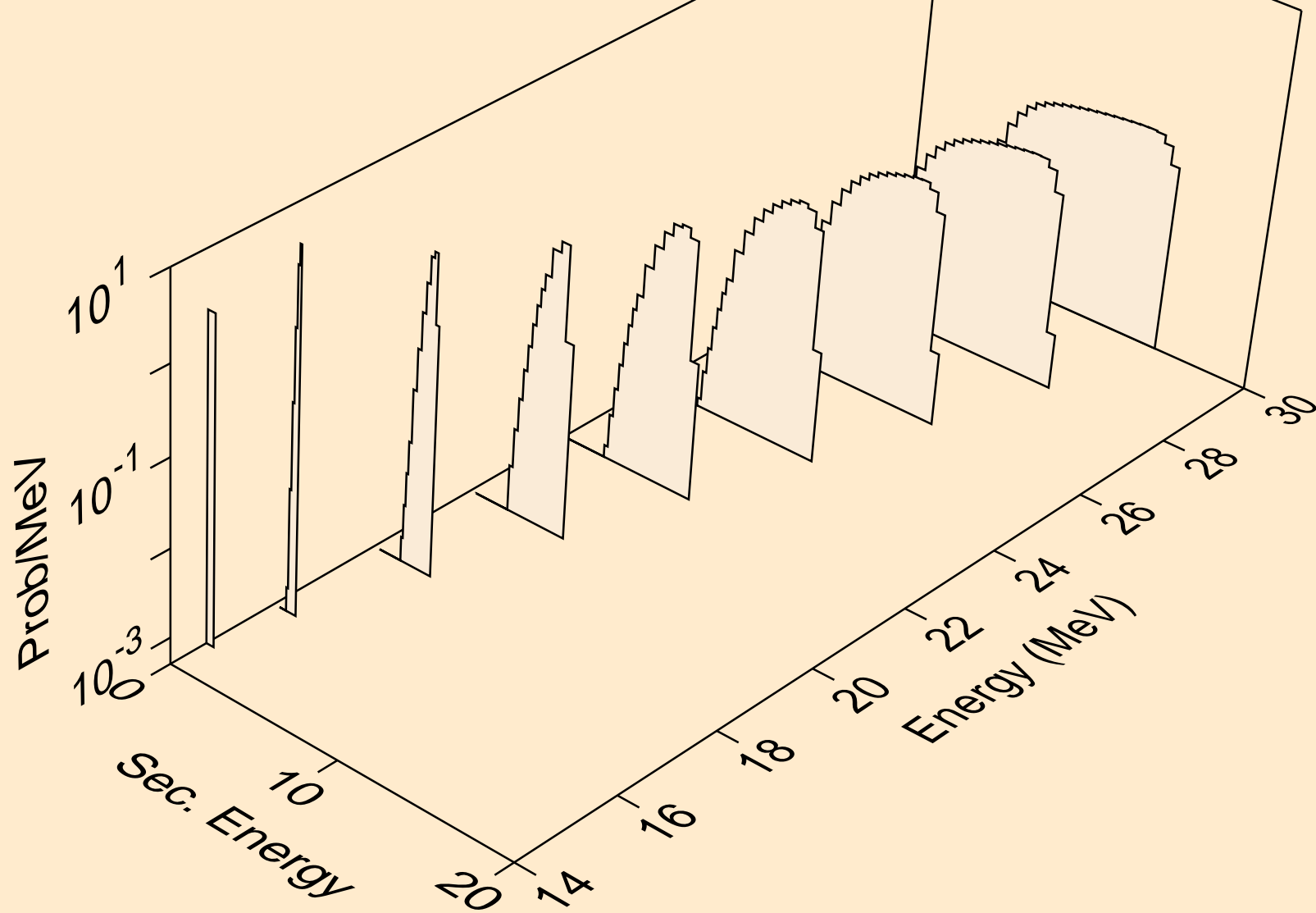

RB083 NEUTRON ACER TENDL-2024 LIBRARY; T=0.K  
deuterons from (n,d)

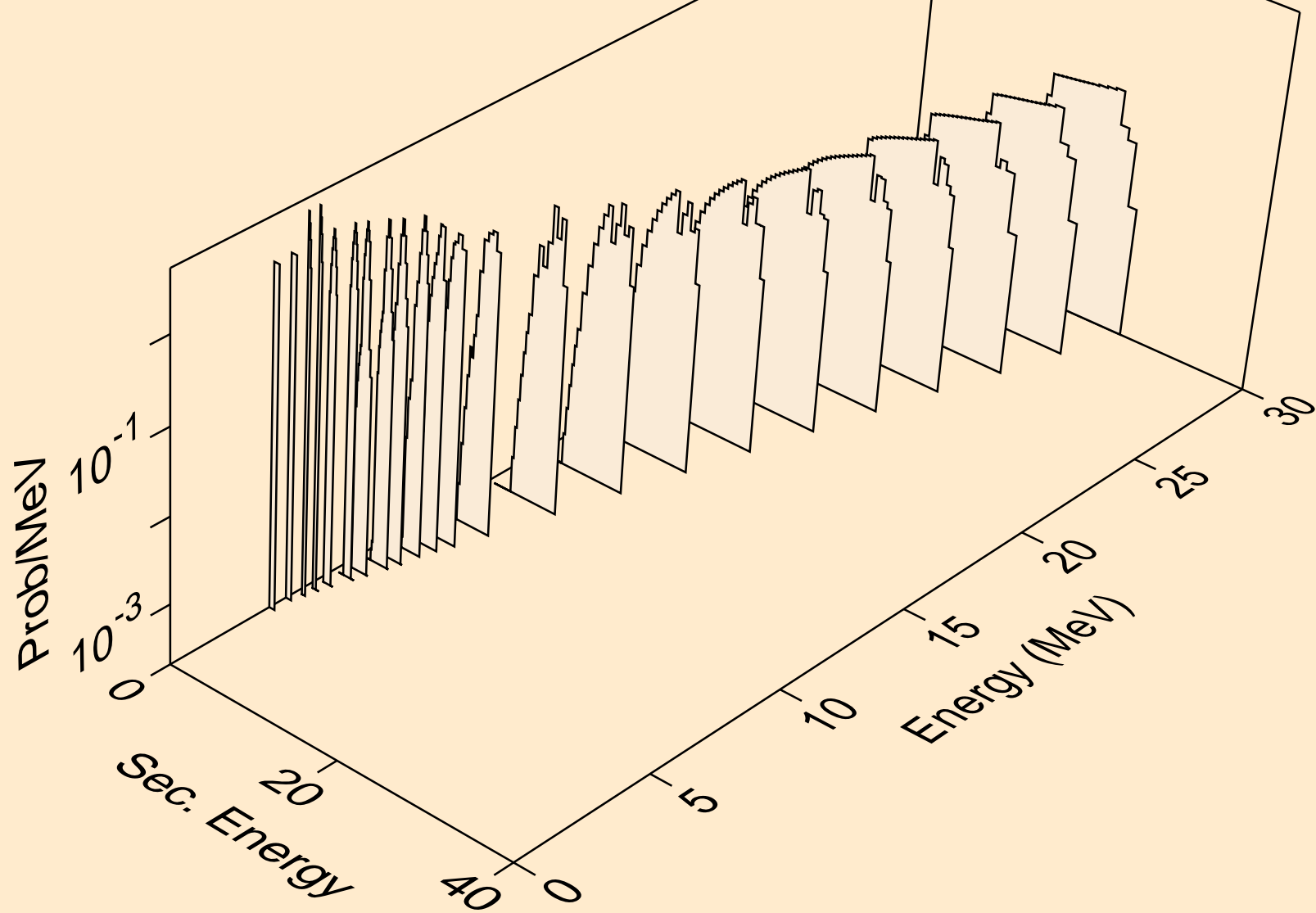

RB083 NEUTRON ACER TENDL-2024 LIBRARY; T=0.K  
deuterons from (n,pd)

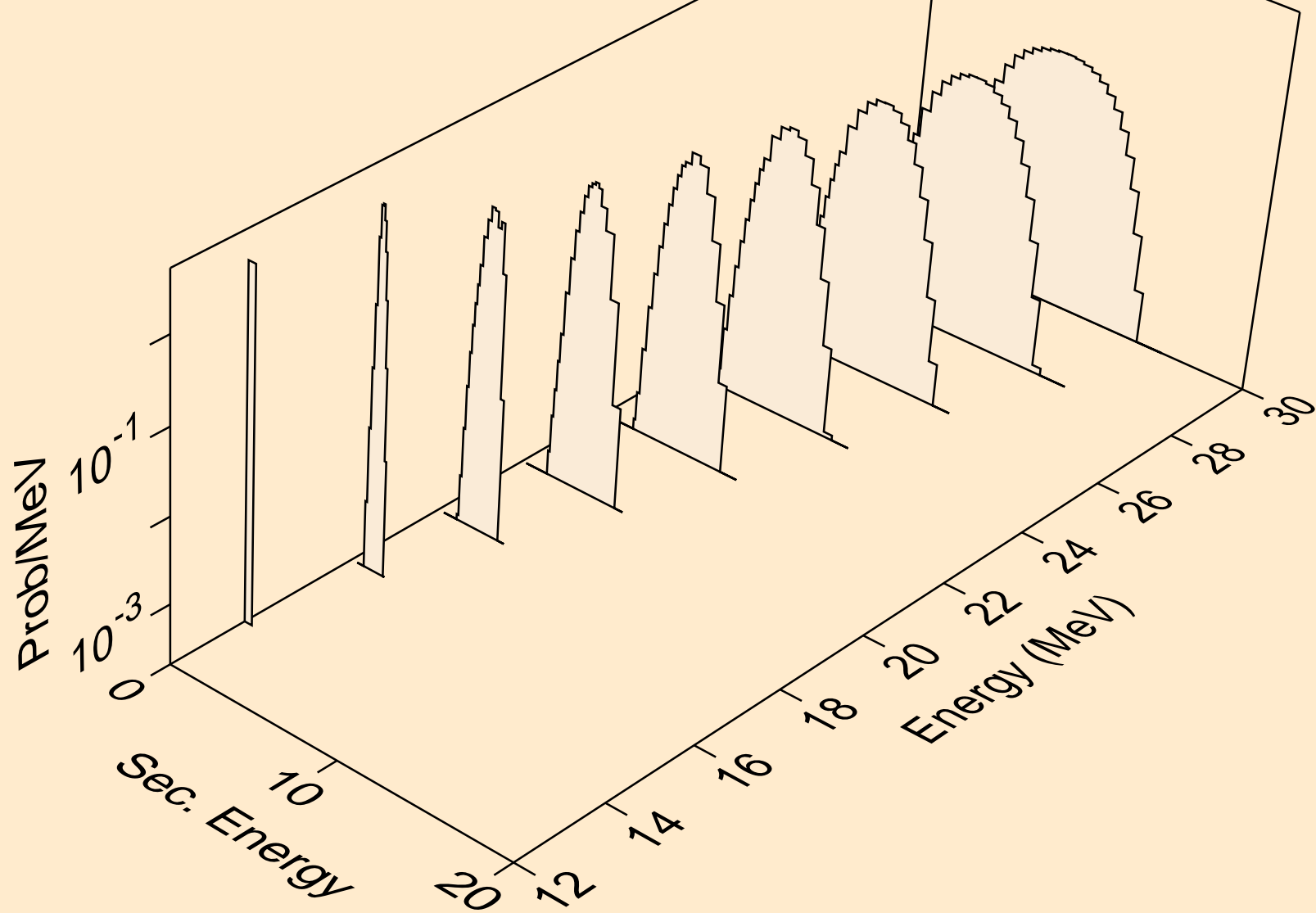

RB083 NEUTRON ACER TENDL-2024 LIBRARY; T=0.K  
deuterons from (n,da)

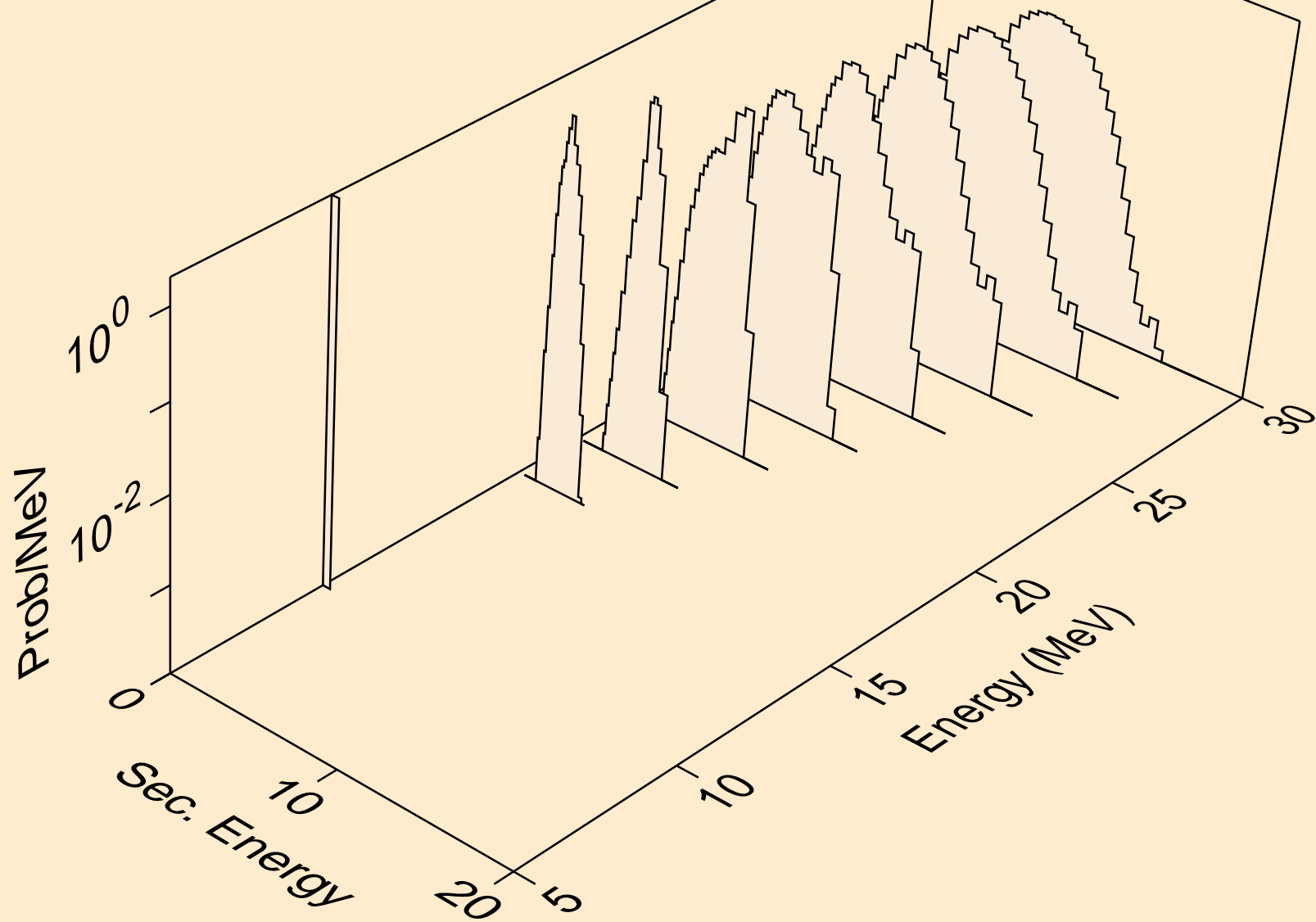

RB083 NEUTRON ACER TENDL-2024 LIBRARY; T=0.K  
tritons from (n,x)

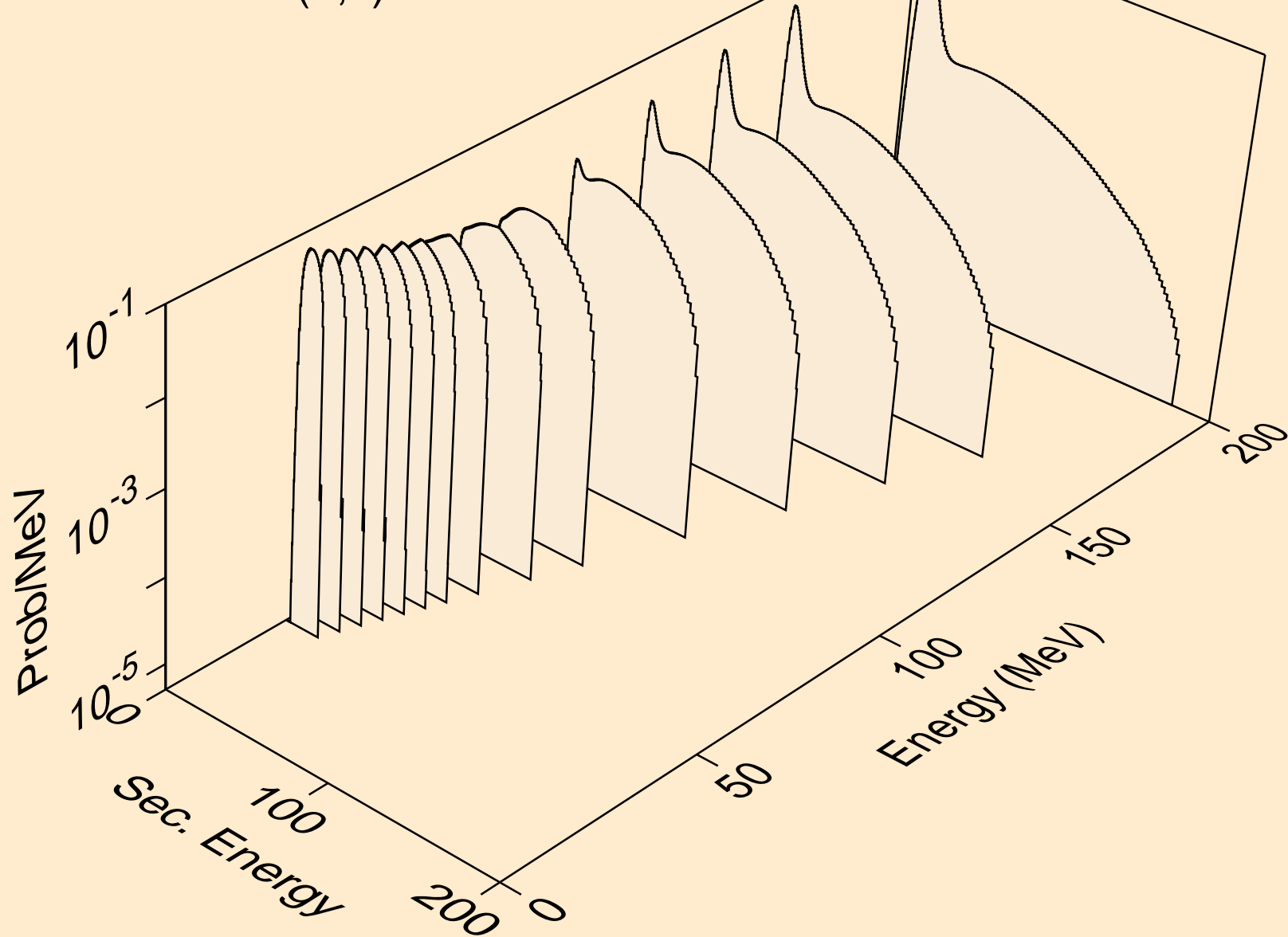

RB083 NEUTRON ACER TENDL-2024 LIBRARY; T=0.K  
tritons from (n,n\*)t

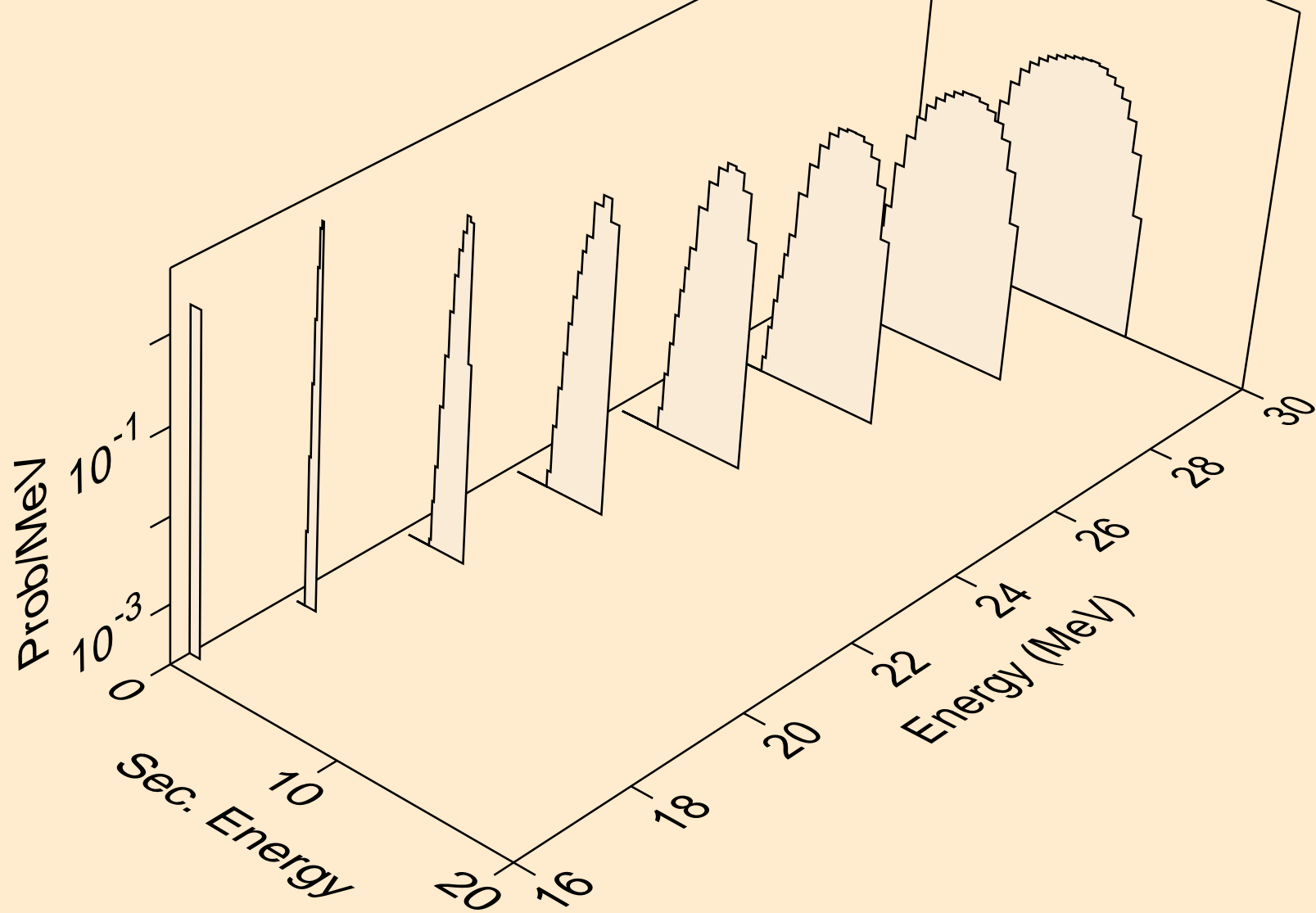



RB083 NEUTRON ACER TENDL-2024 LIBRARY; T=0.K  
tritons from (n,t)

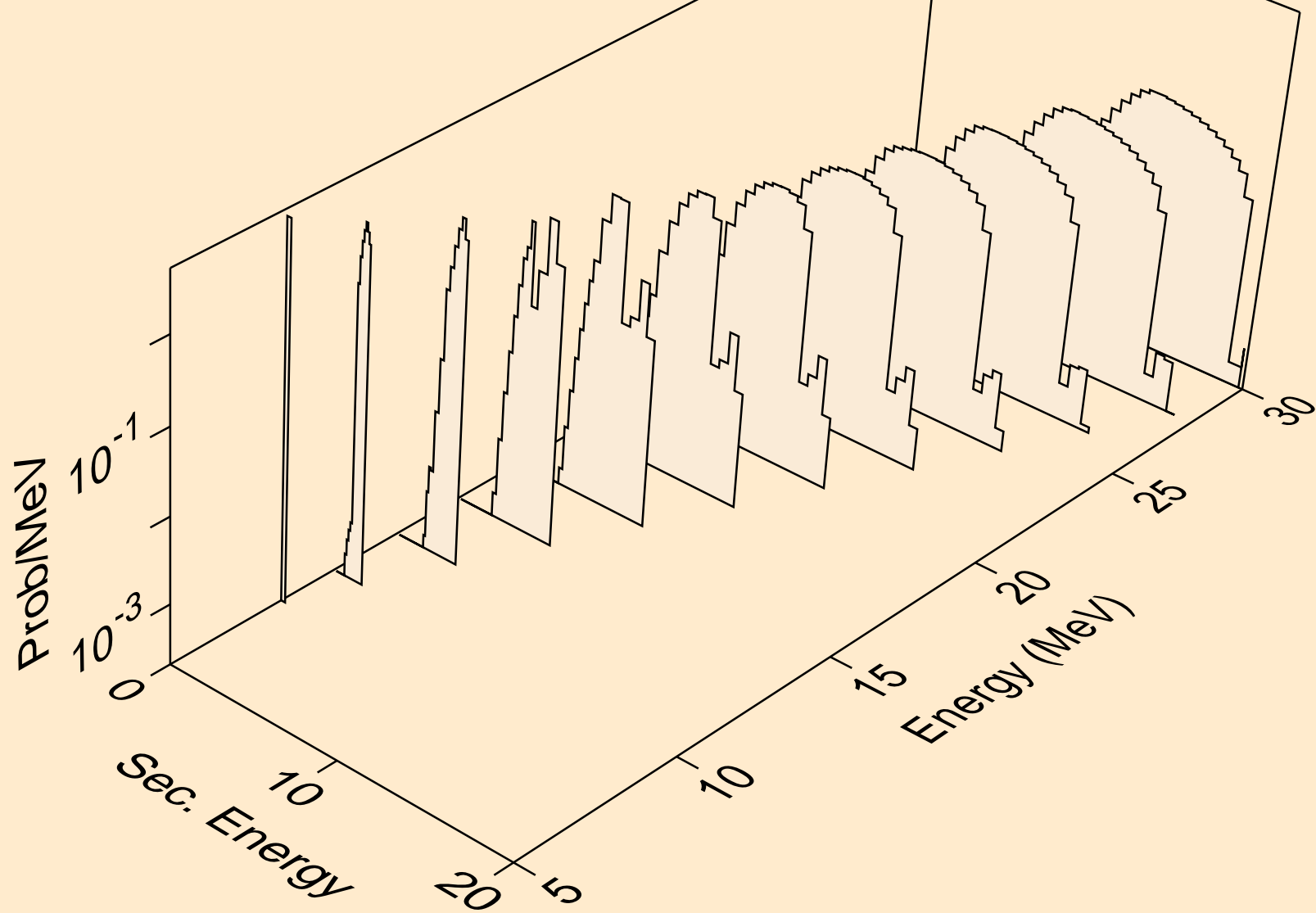

RB083 NEUTRON ACER TENDL-2024 LIBRARY; T=0.K  
tritons from (n,pt)

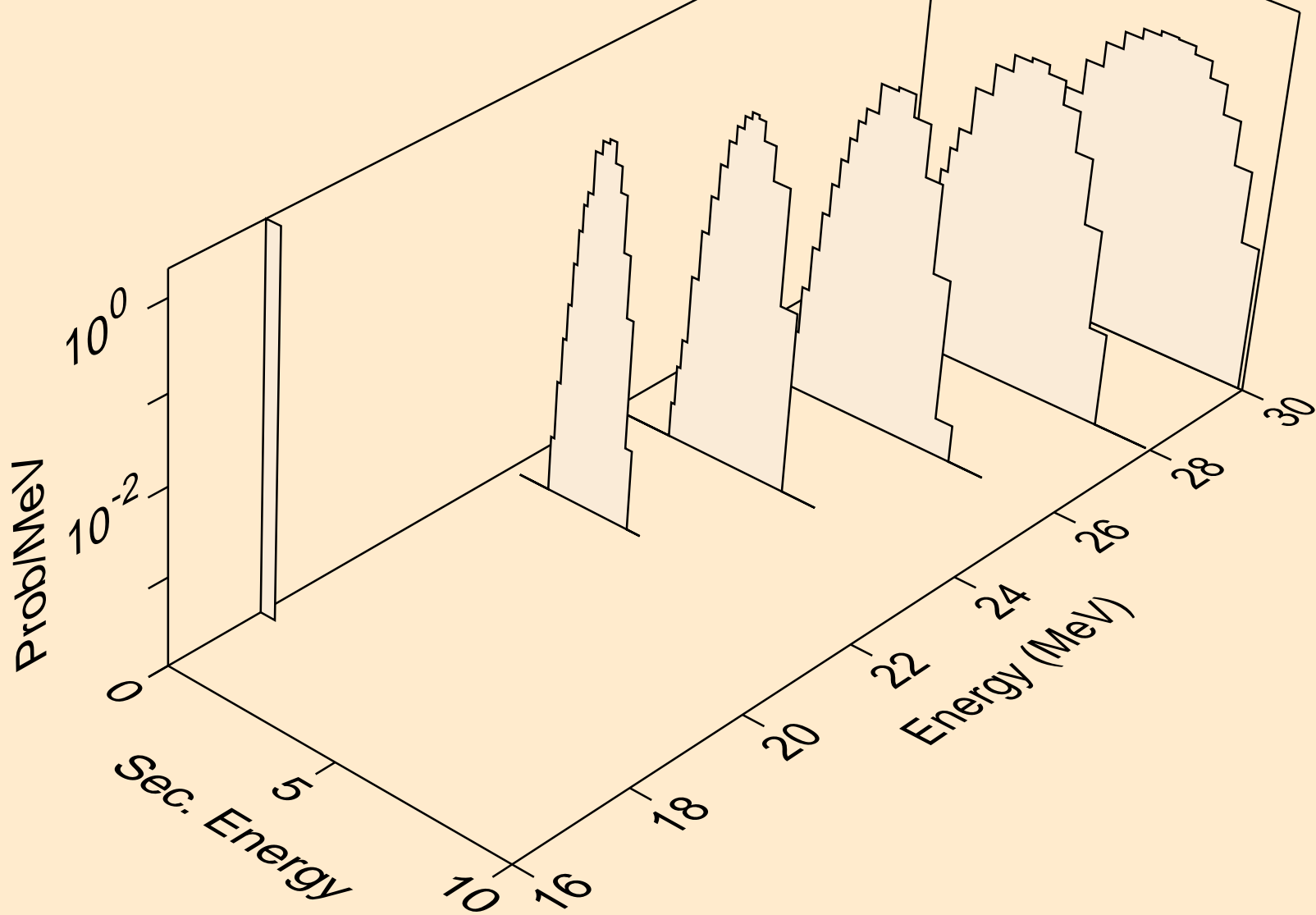

RB083 NEUTRON ACER TENDL-2024 LIBRARY; T=0.K  
he3s from (n,x)

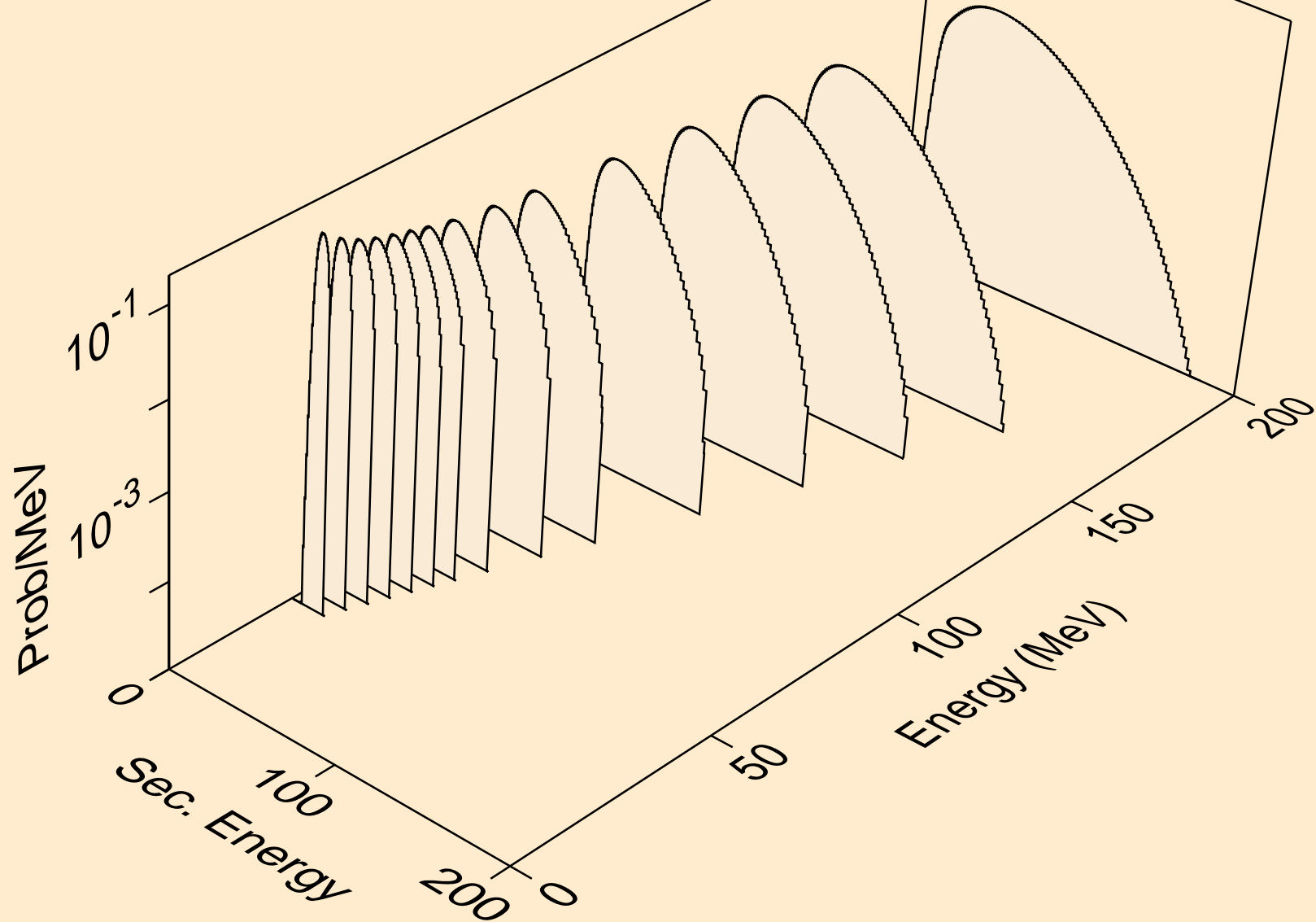

RB083 NEUTRON ACER TENDL-2024 LIBRARY; T=0.K  
he3s from (n,n\*)he3

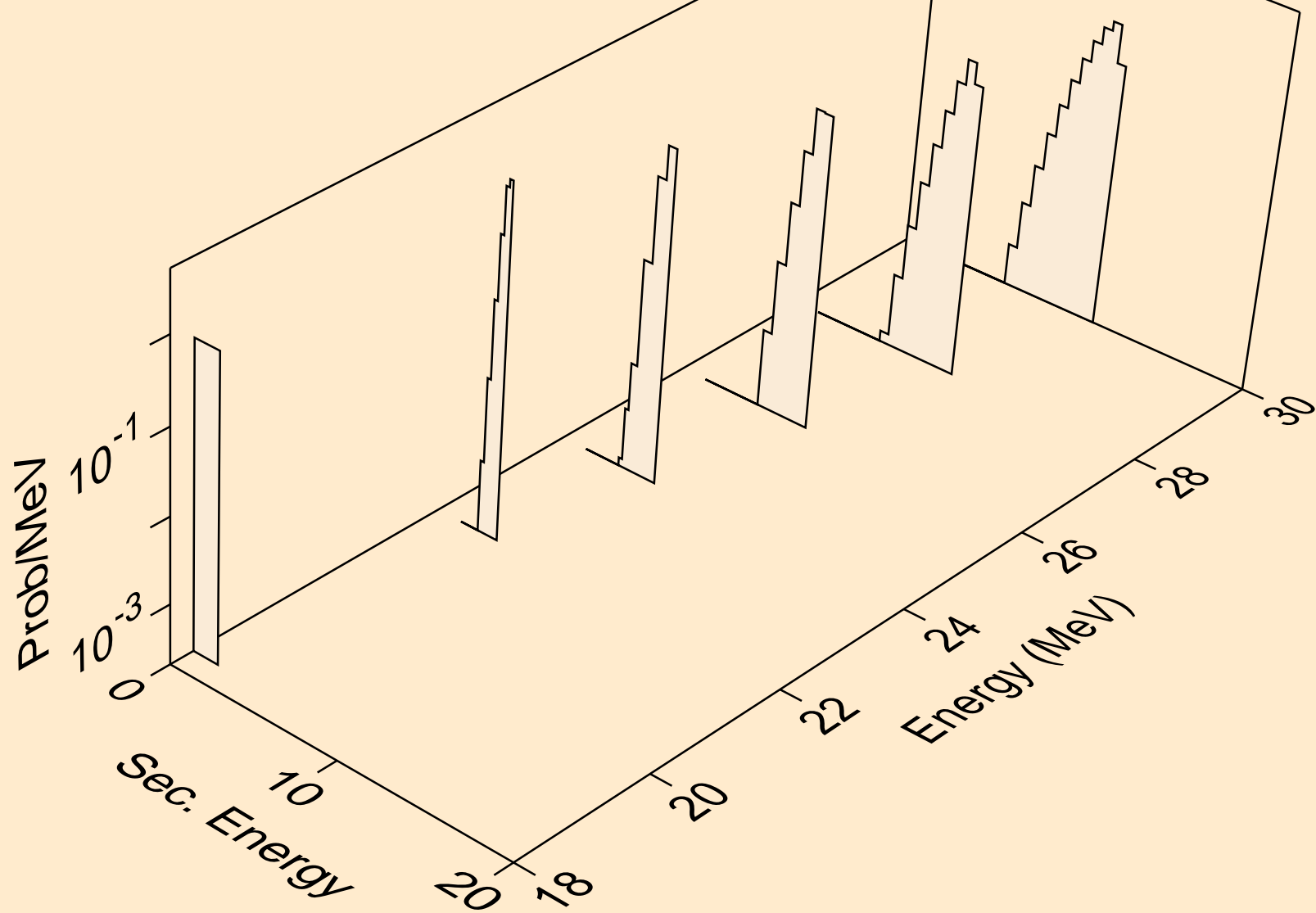

RB083 NEUTRON ACER TENDL-2024 LIBRARY; T=0.K  
he3s from (n,he3)

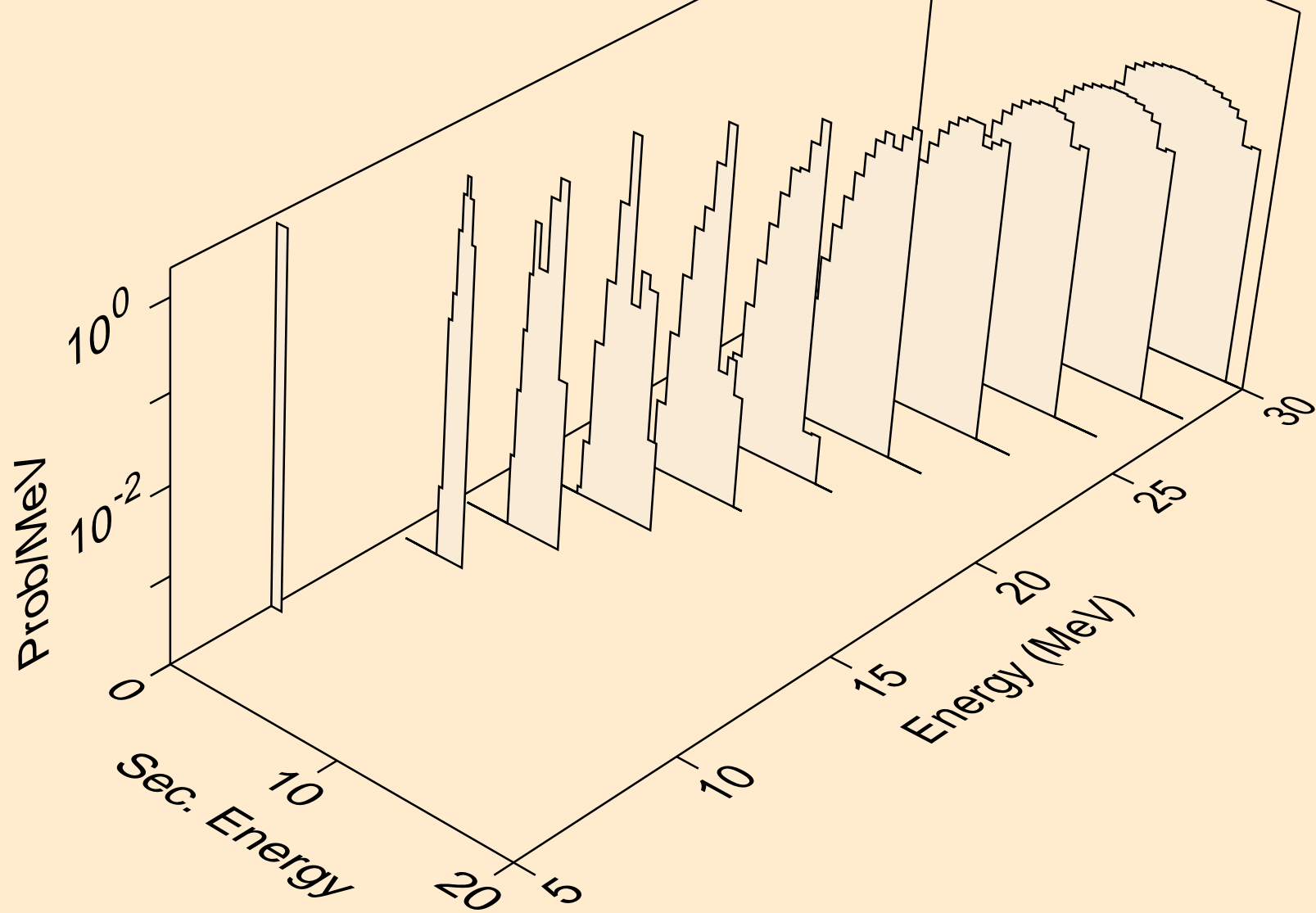

RB083 NEUTRON ACER TENDL-2024 LIBRARY; T=0.K  
alphas from (n,x)

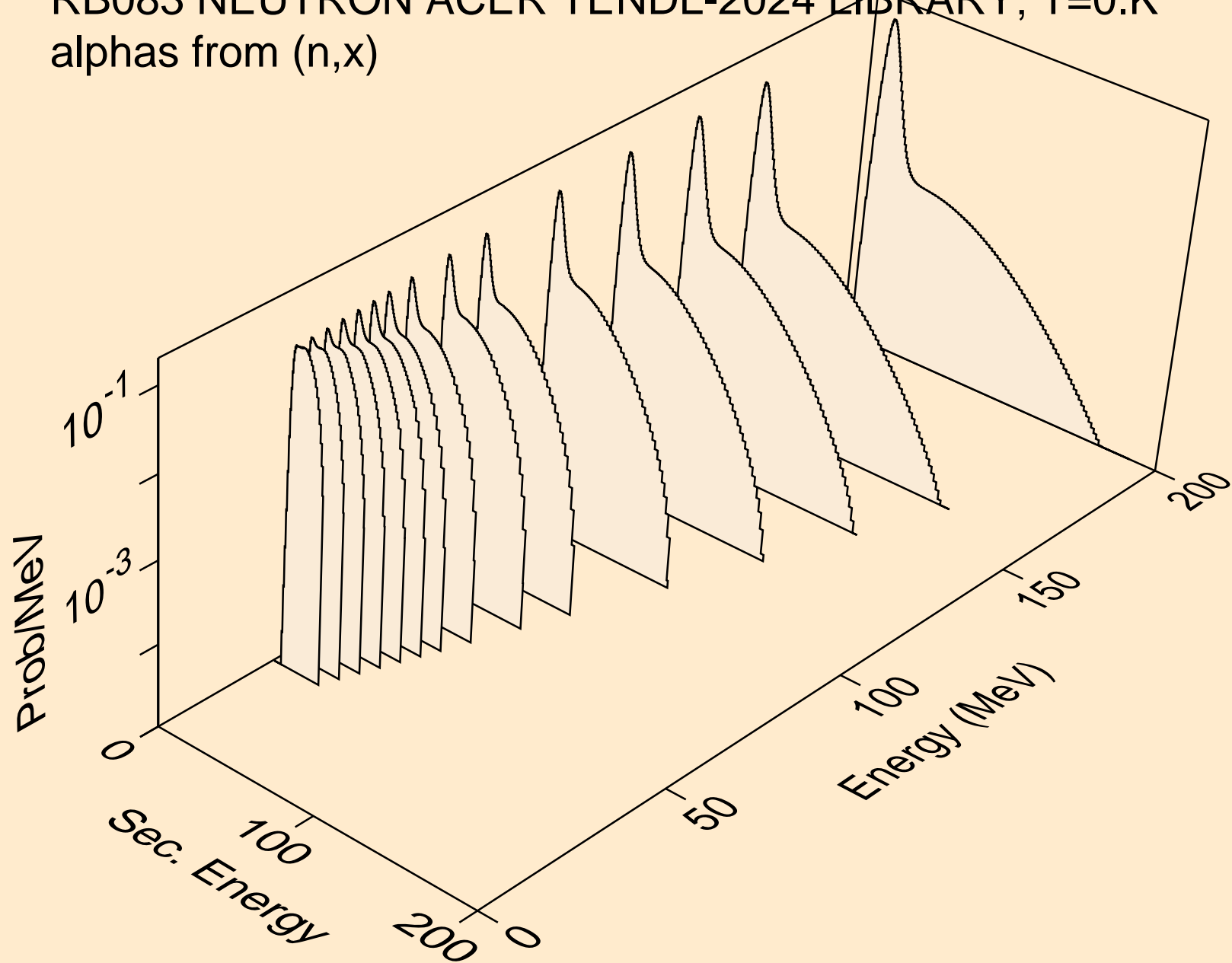

RB083 NEUTRON ACER TENDL-2024 LIBRARY; T=0.K  
alphas from (n,n\*)a

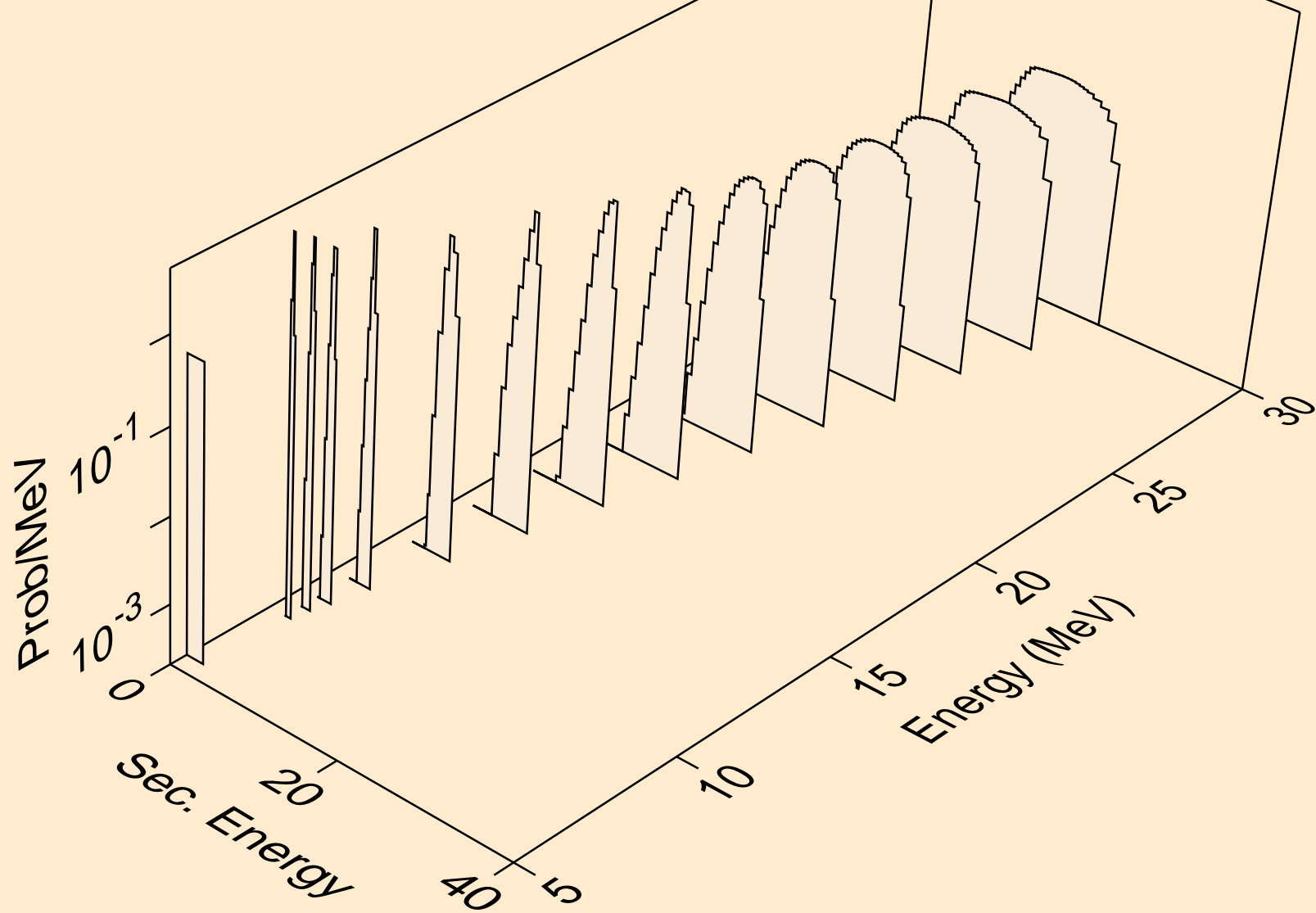

RB083 NEUTRON ACER TENDL-2024 LIBRARY; T=0.K  
alphas from (n,2n)a

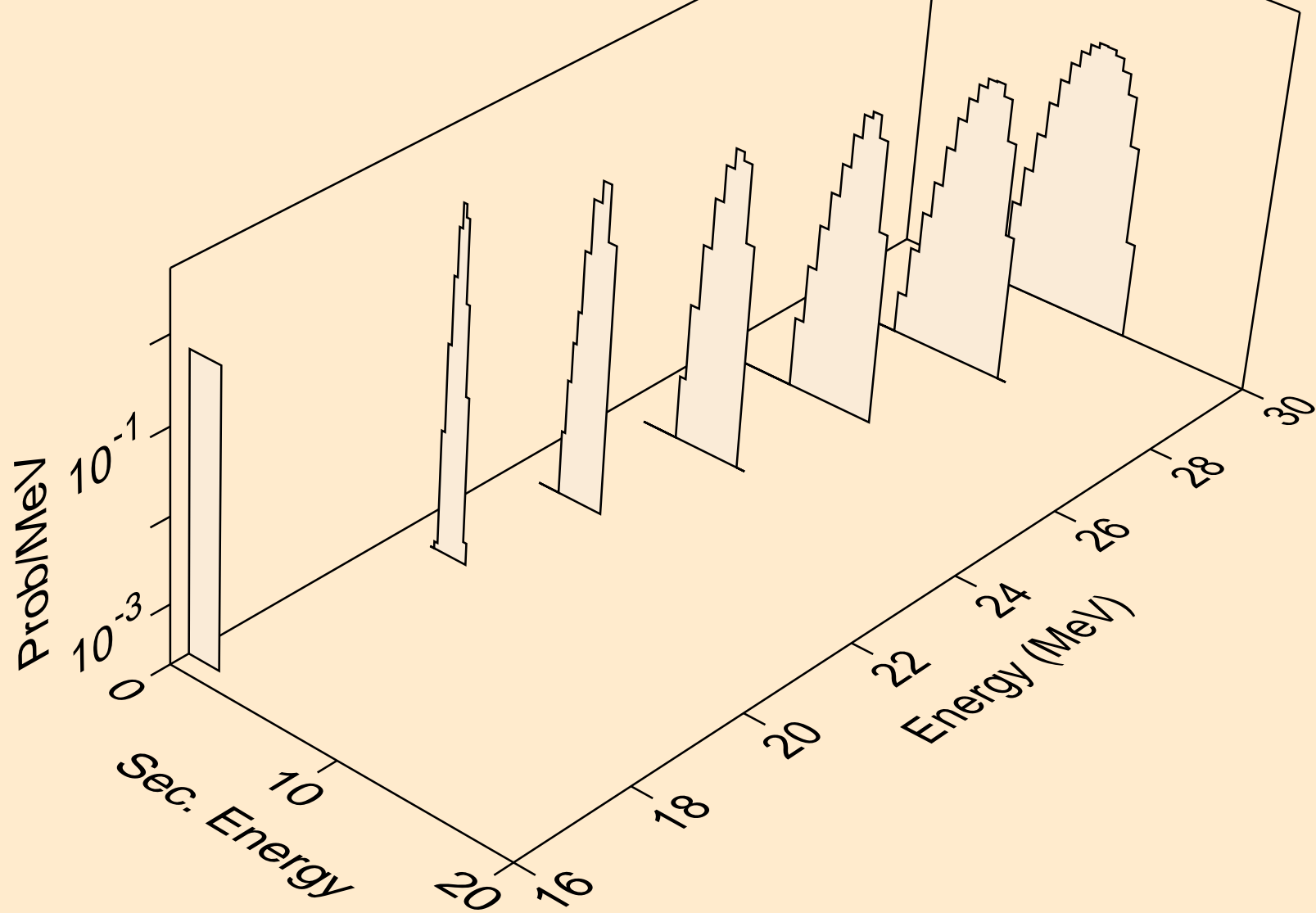



RB083 NEUTRON ACER TENDL-2024 LIBRARY; T=0.K  
alphas from (n,n\*)2a

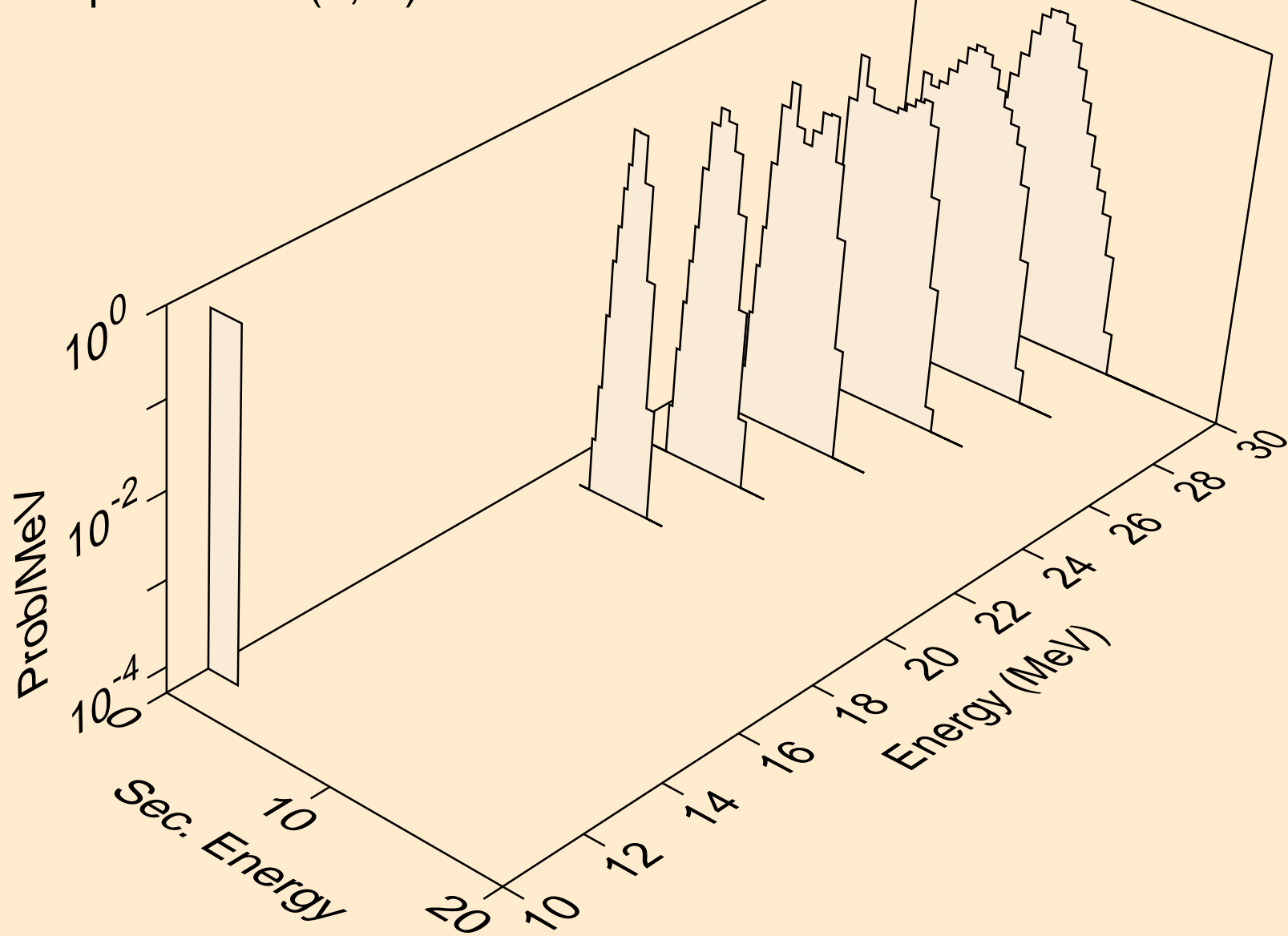

RB083 NEUTRON ACER TENDL-2024 LIBRARY; T=0.K  
alphas from (n,npa)

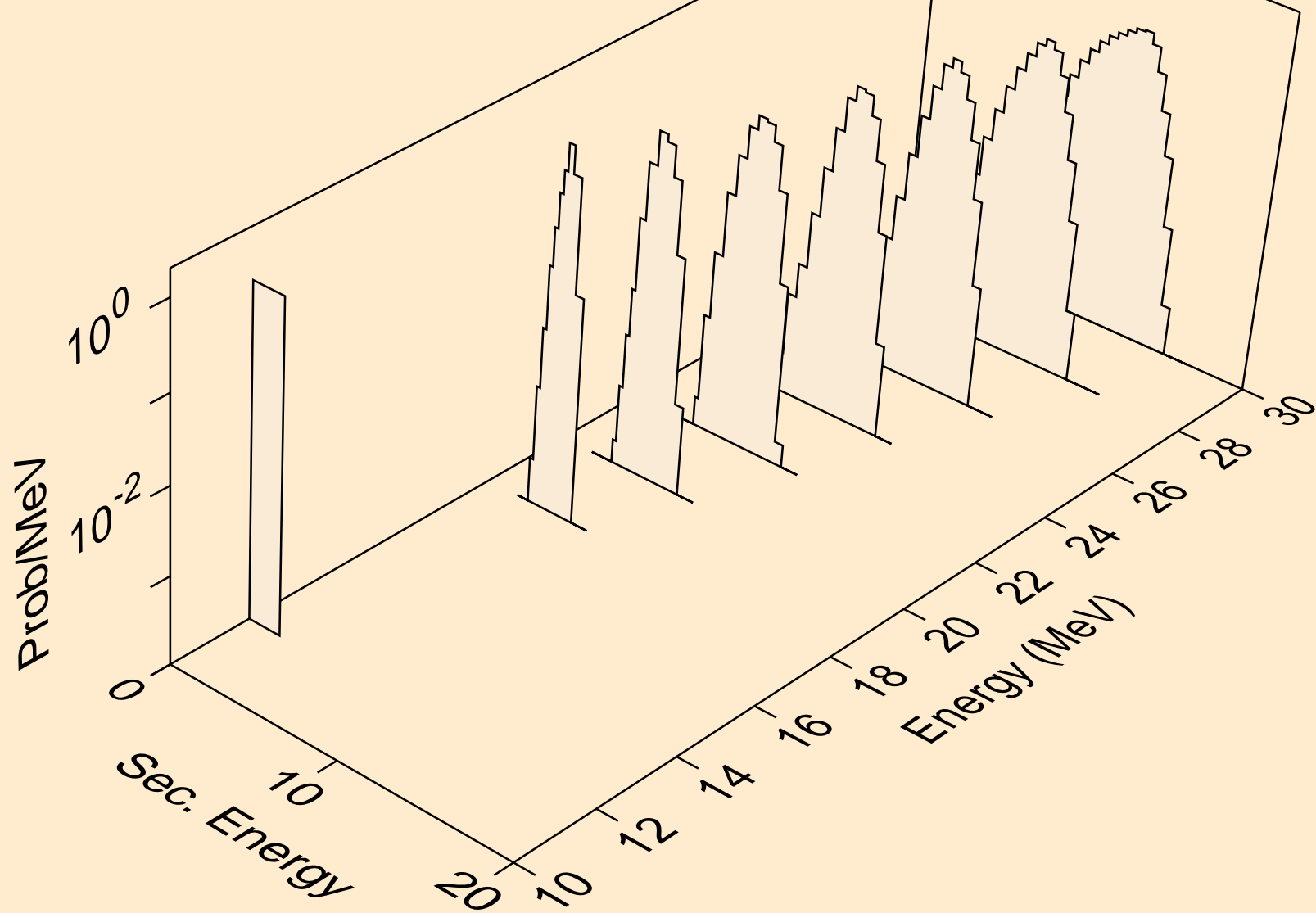

RB083 NEUTRON ACER TENDL-2024 LIBRARY; T=0.K  
alphas from (n,a)

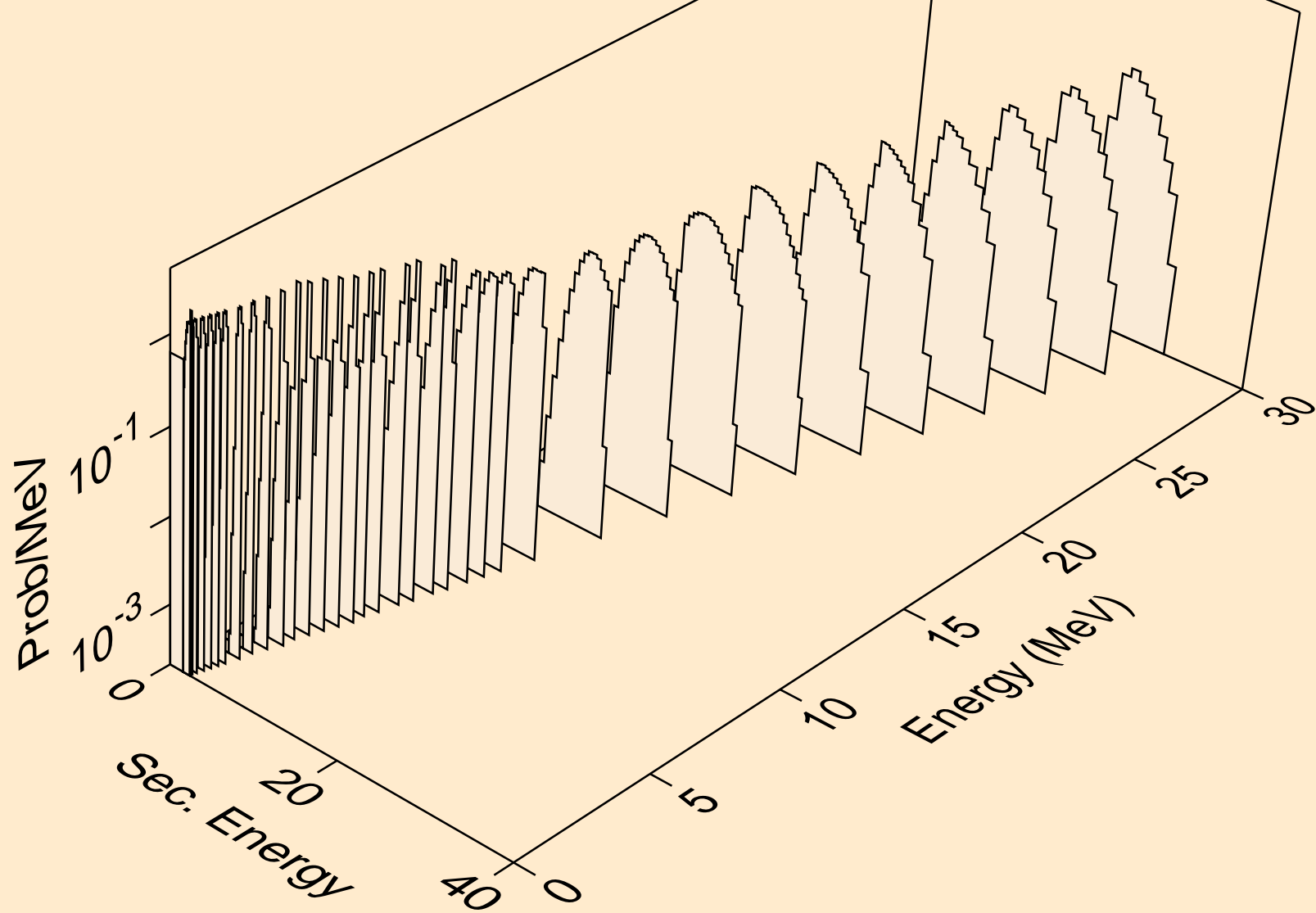

RB083 NEUTRON ACER TENDL-2024 LIBRARY; T=0.K  
alphas from (n,2a)

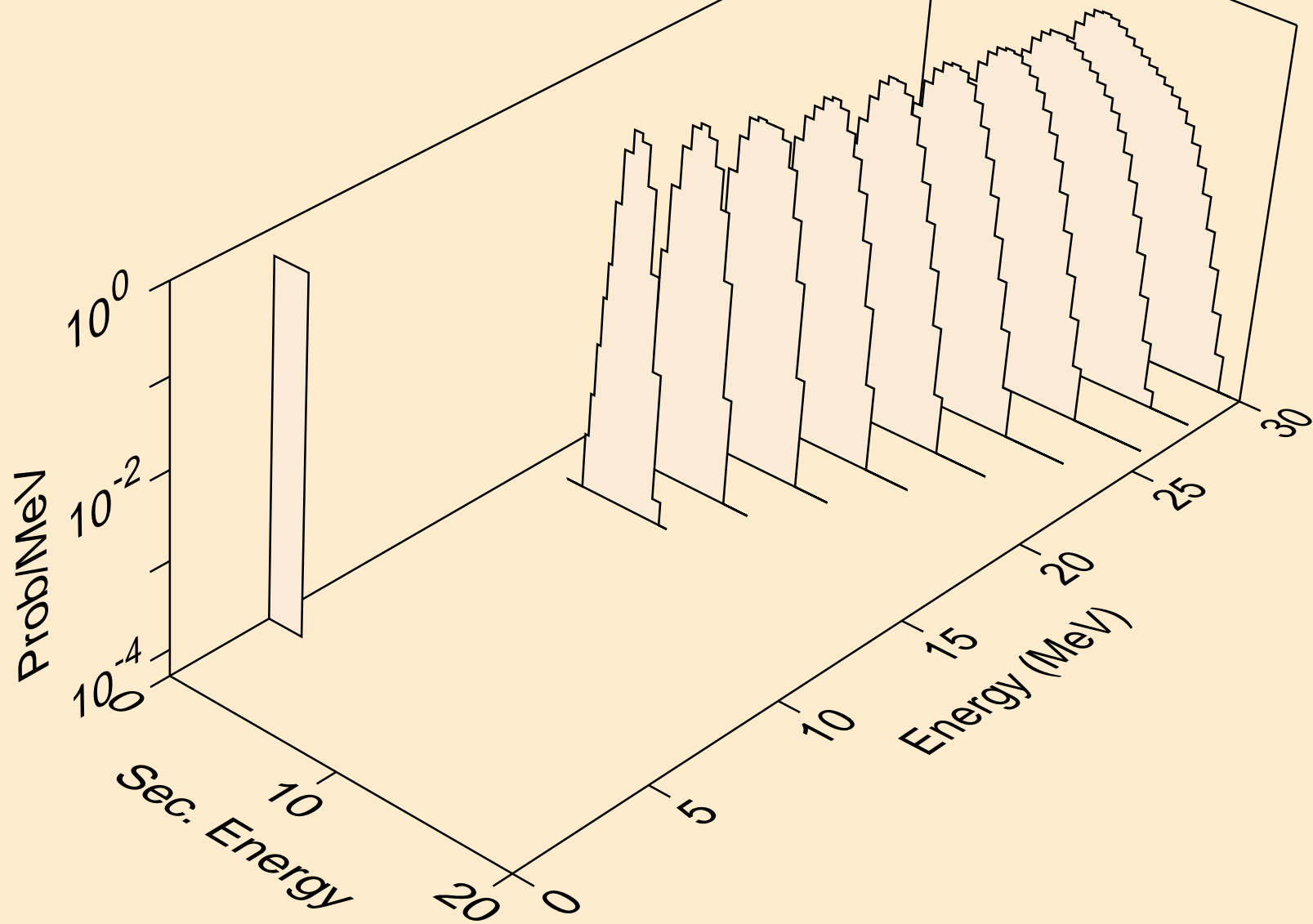

RB083 NEUTRON ACER TENDL-2024 LIBRARY; T=0.K  
alphas from (n,pa)

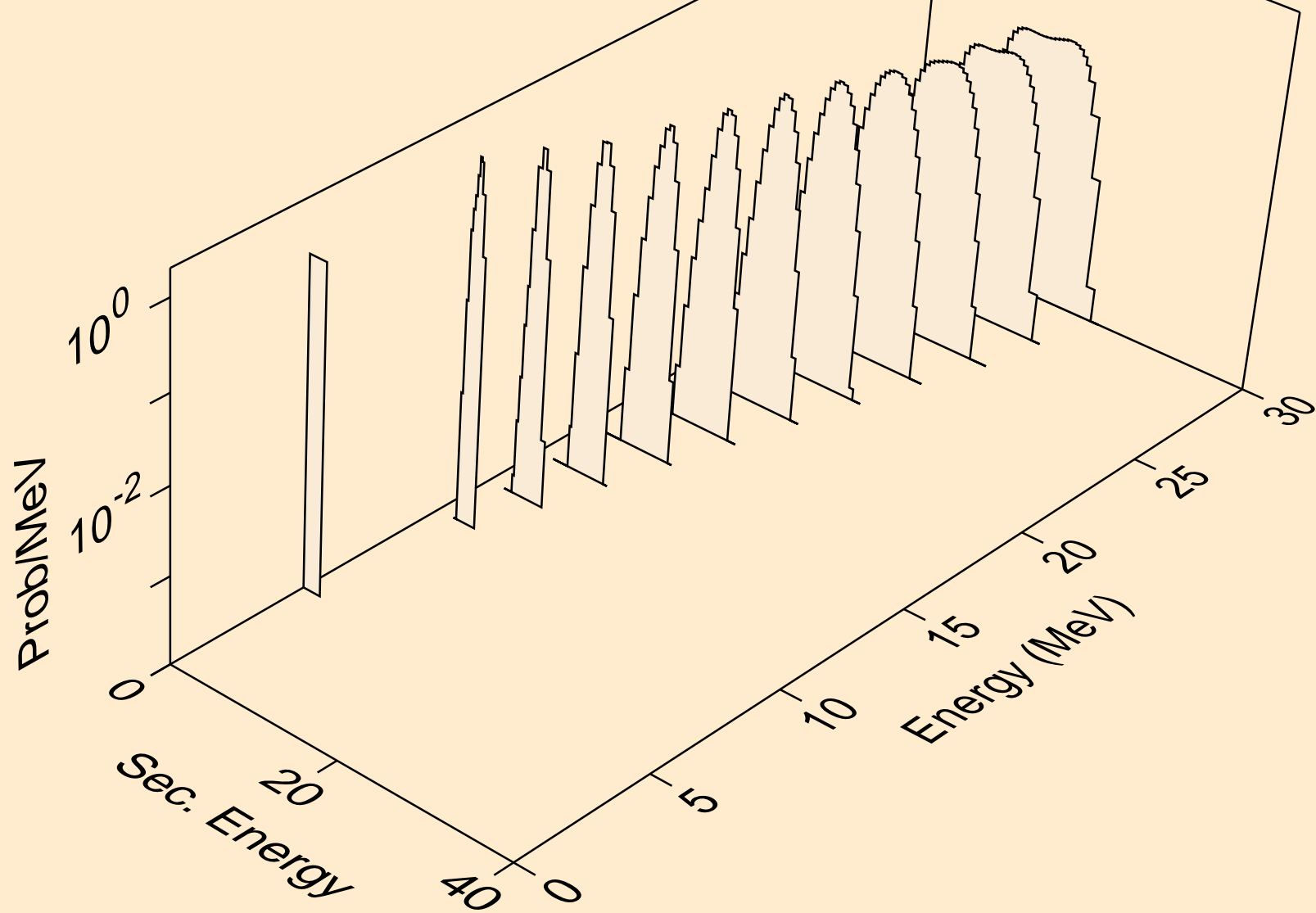

RB083 NEUTRON ACER TENDL-2024 LIBRARY; T=0.K  
alphas from (n,da)

