

RE168 NEUTRON ACER TENDL-2024 LIBRARY; T=0.K

Principal cross sections

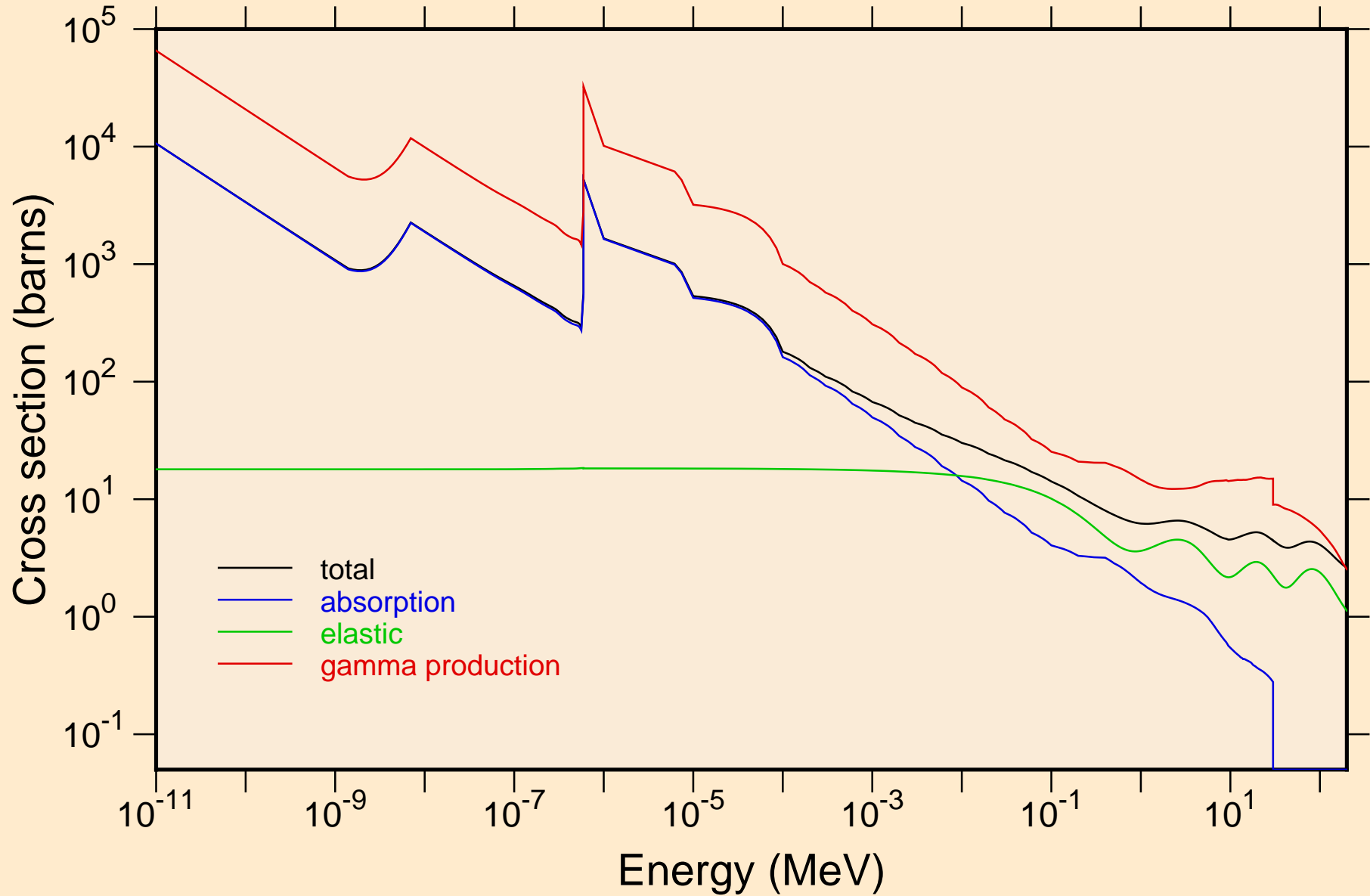

RE168 NEUTRON ACER TENDL-2024 LIBRARY; T=0.K

Heating

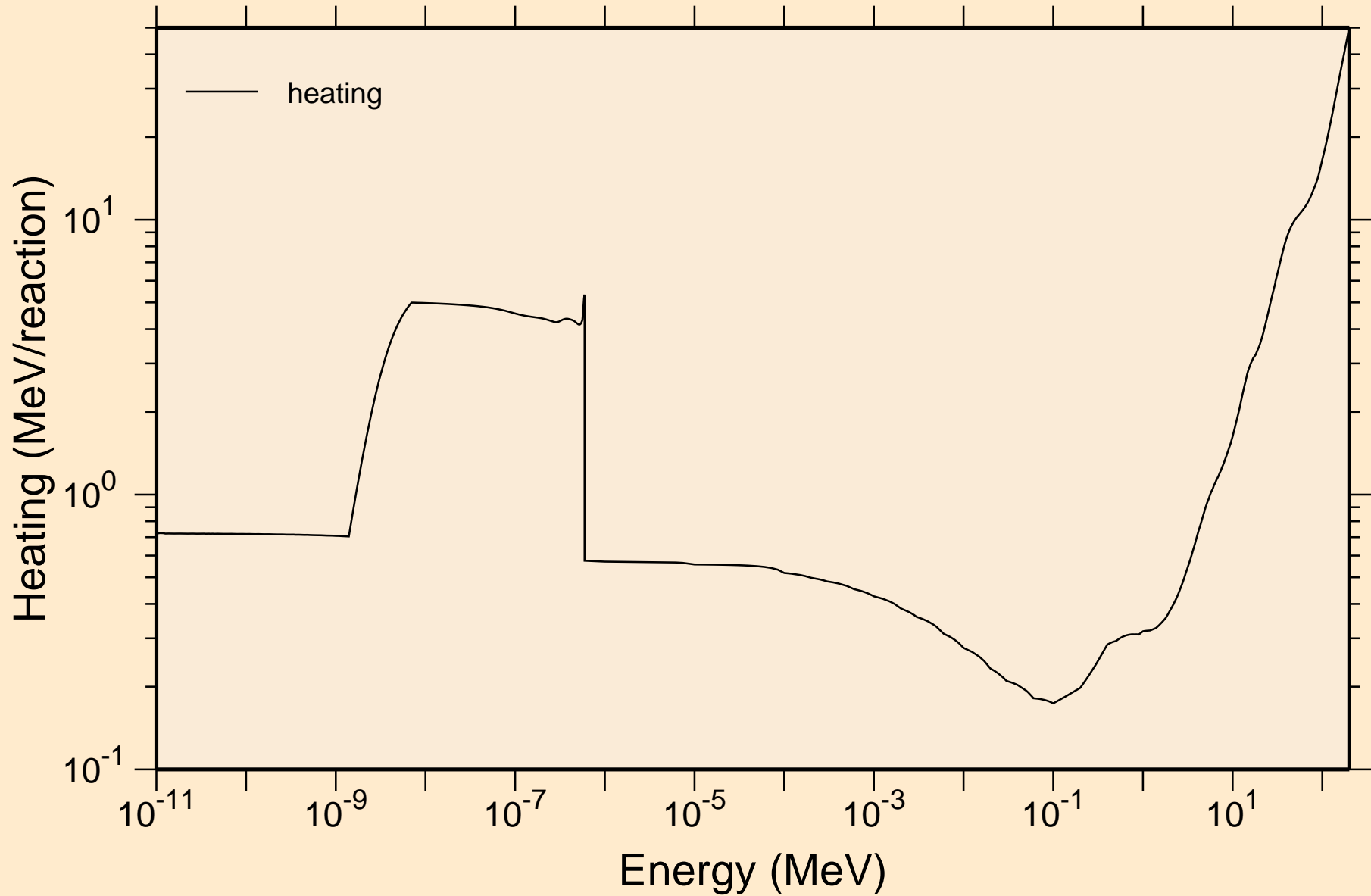

RE168 NEUTRON ACER TENDL-2024 LIBRARY; T=0.K
Damage

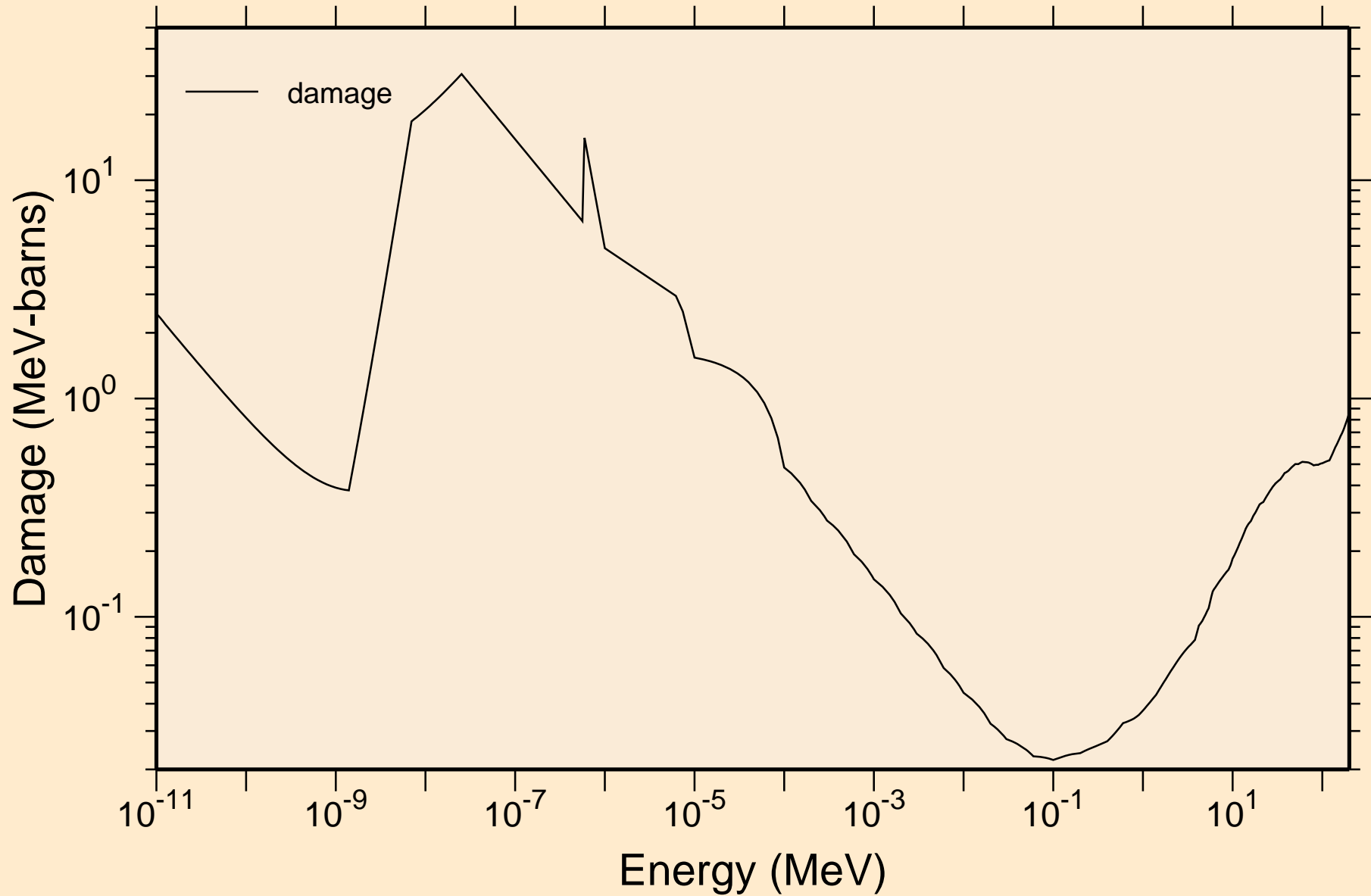

RE168 NEUTRON ACER TENDL-2024 LIBRARY; T=0.K
Non-threshold reactions

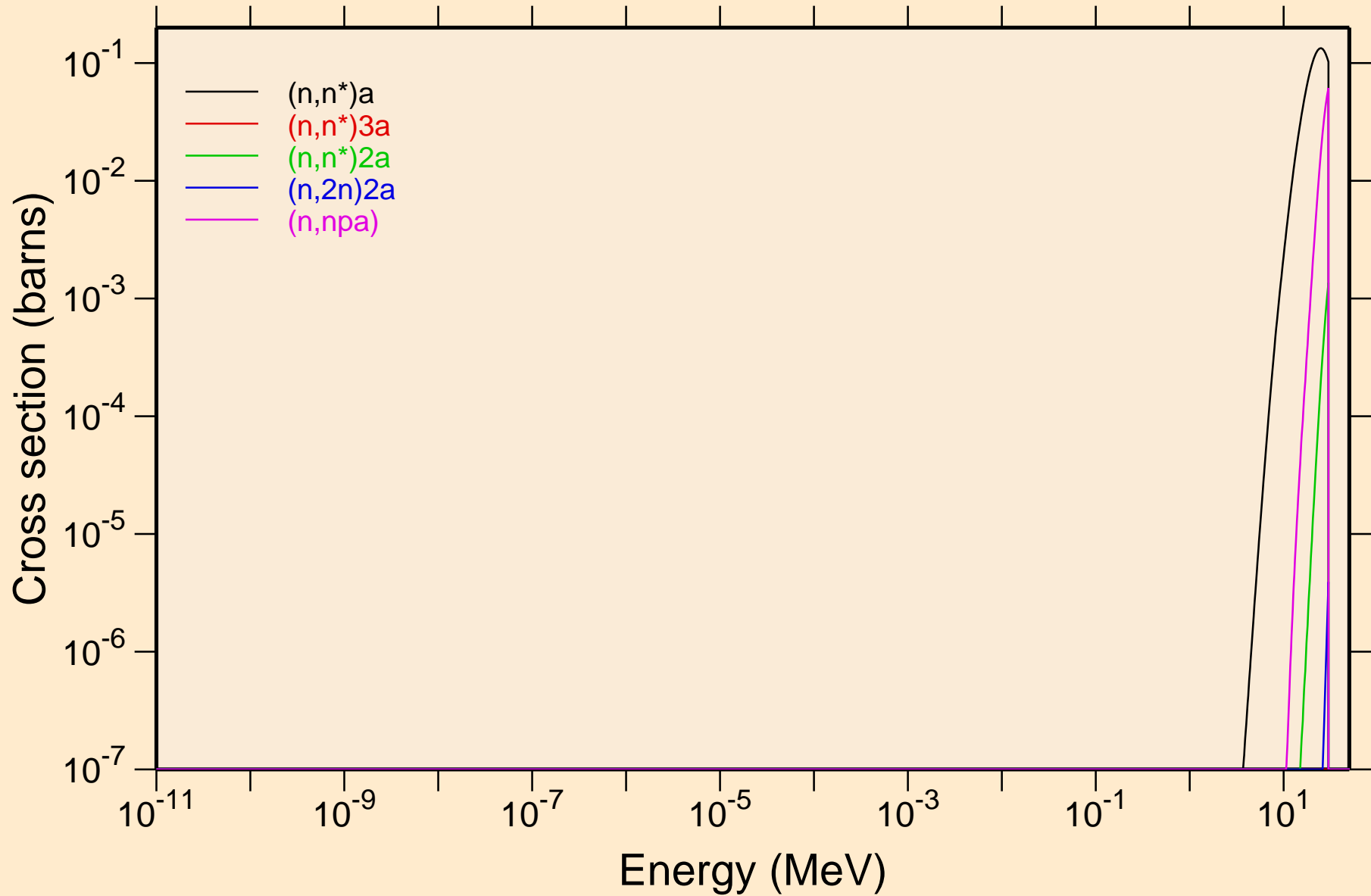

RE168 NEUTRON ACER TENDL-2024 LIBRARY; T=0.K
Non-threshold reactions

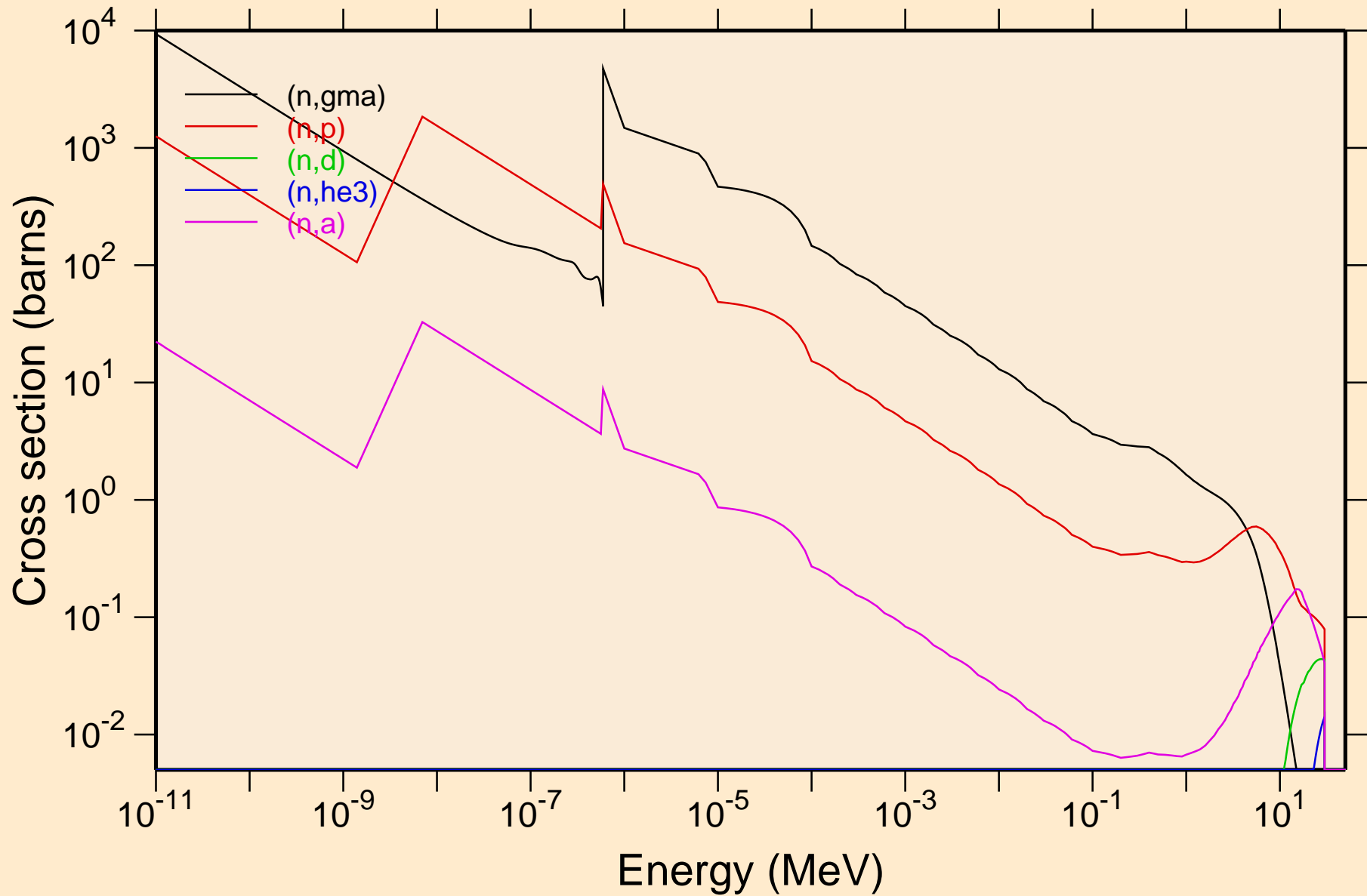

RE168 NEUTRON ACER TENDL-2024 LIBRARY; T=0.K
Non-threshold reactions

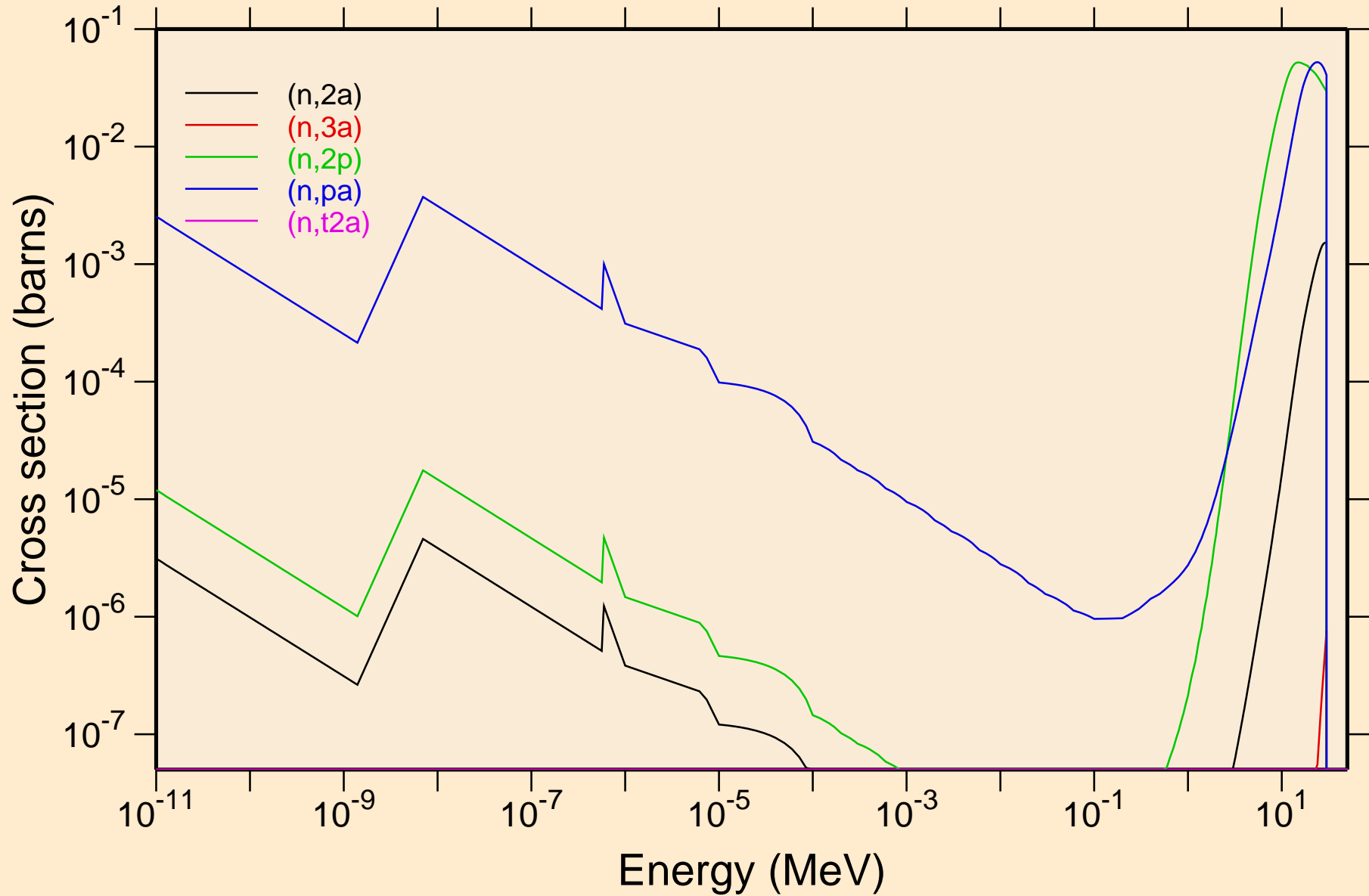

RE168 NEUTRON ACER TENDL-2024 LIBRARY; T=0.K
Non-threshold reactions

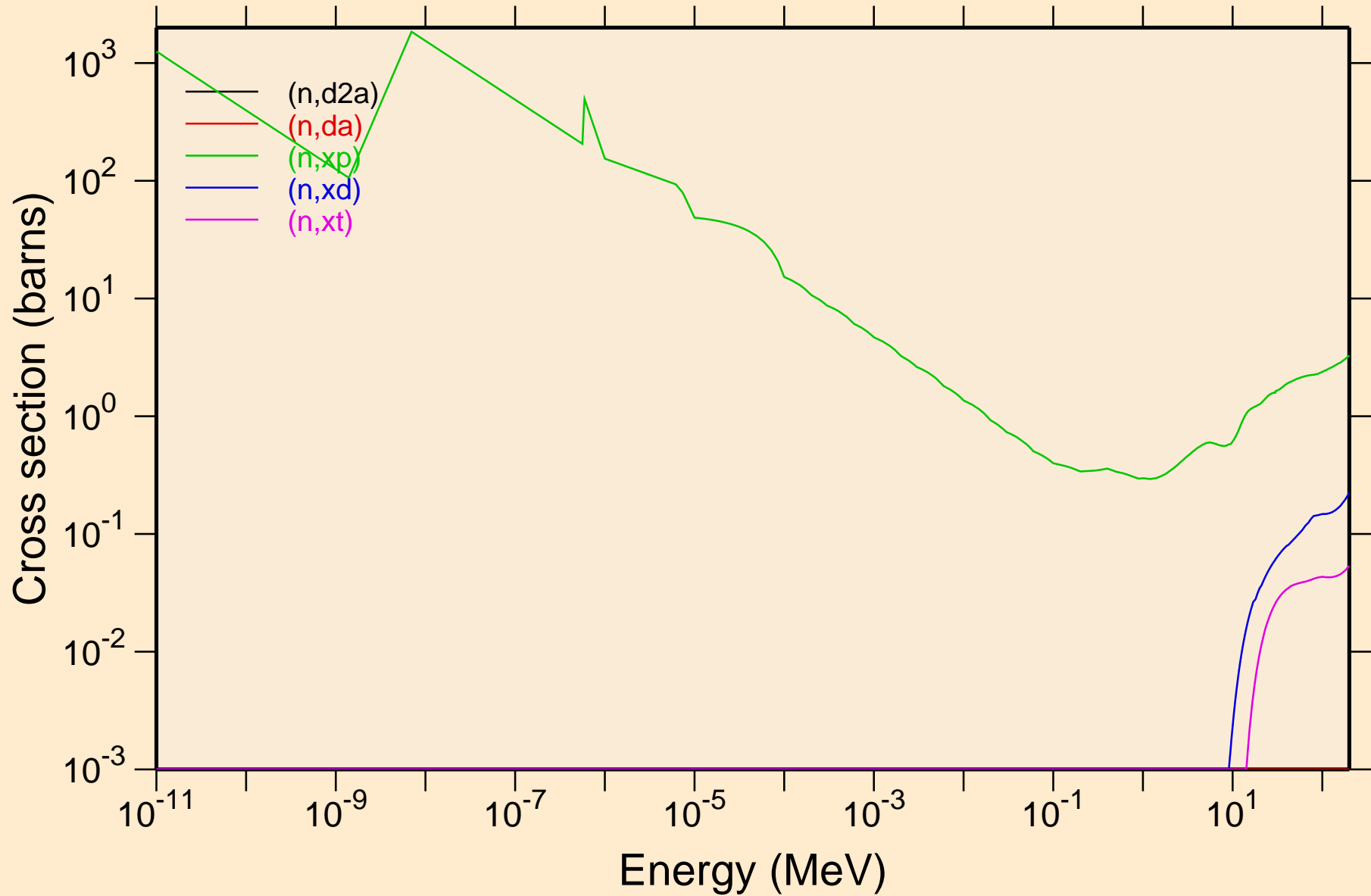

RE168 NEUTRON ACER TENDL-2024 LIBRARY; T=0.K
Non-threshold reactions

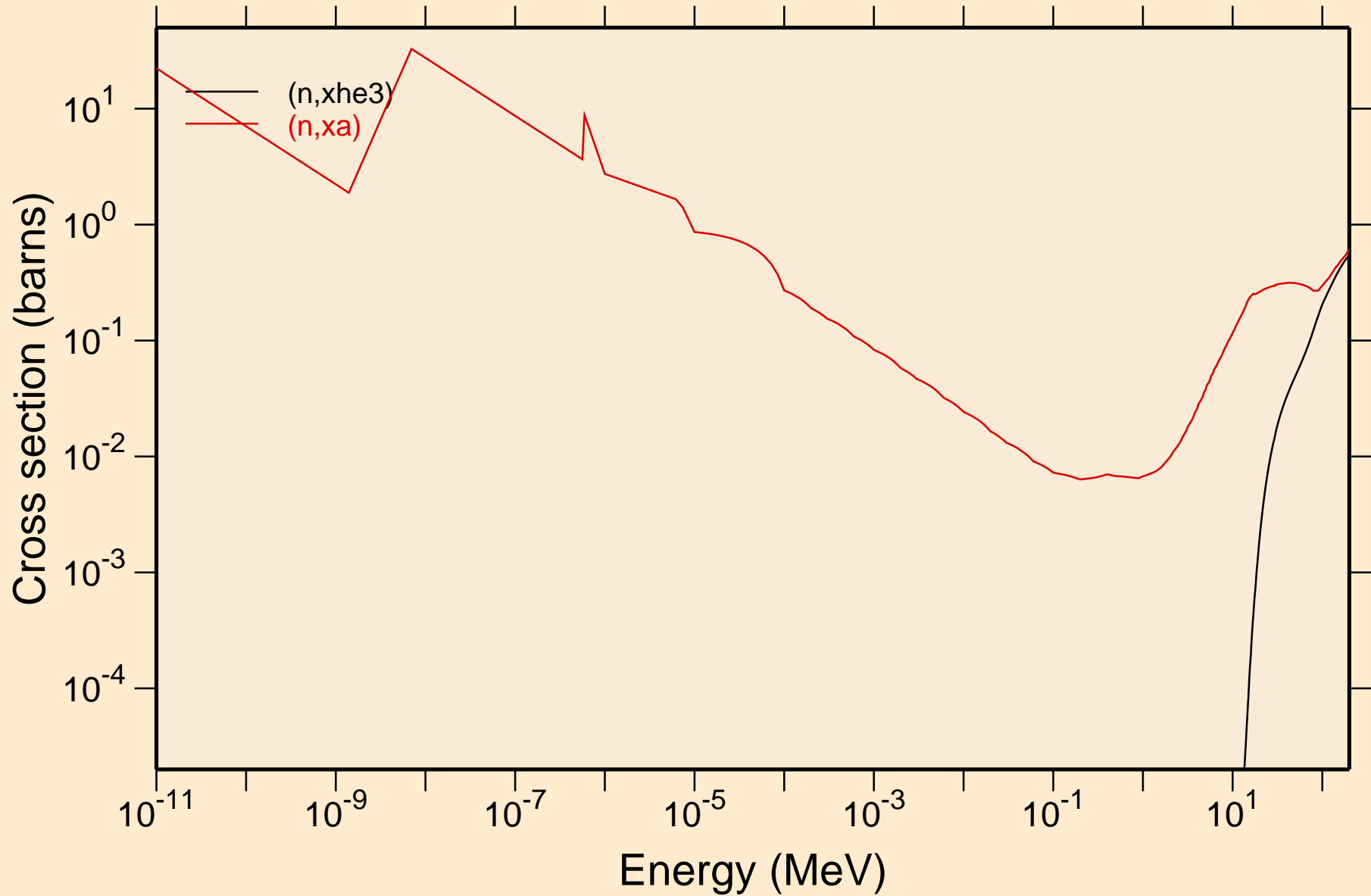

RE168 NEUTRON ACER TENDL-2024 LIBRARY; T=0.K

Principal cross sections

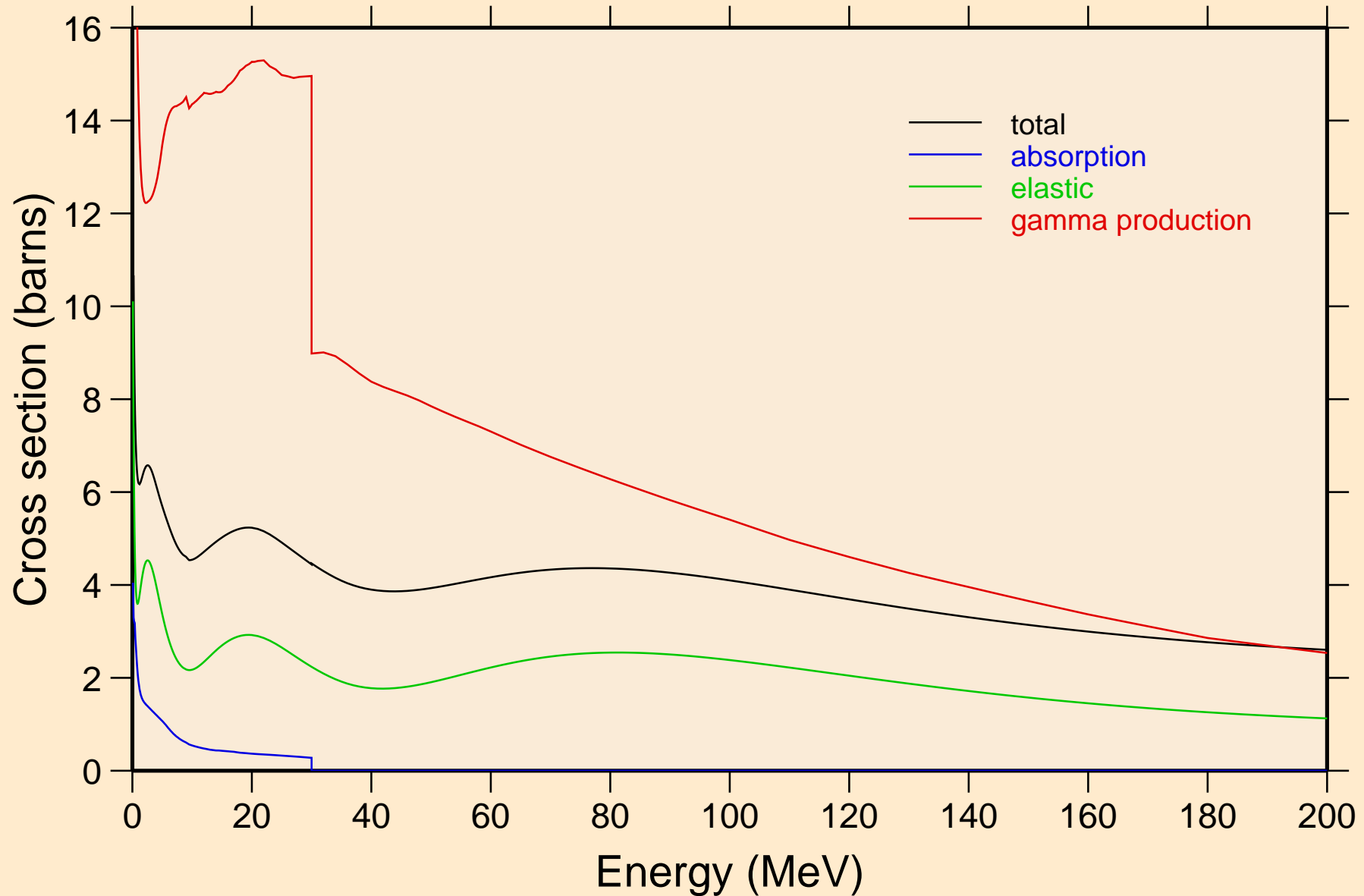

RE168 NEUTRON ACER TENDL-2024 LIBRARY; T=0.K

Heating

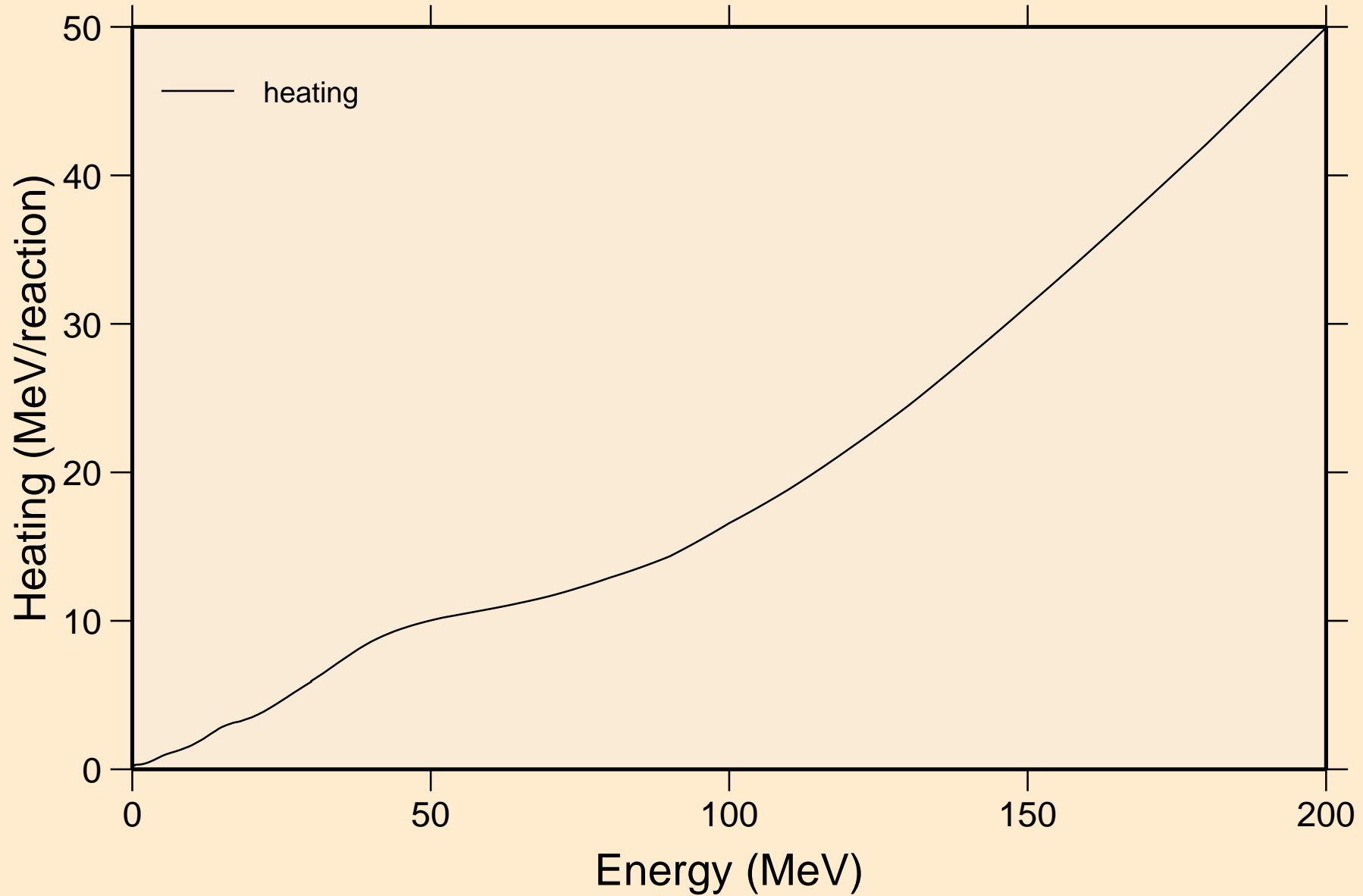

RE168 NEUTRON ACER TENDL-2024 LIBRARY; T=0.K
Damage

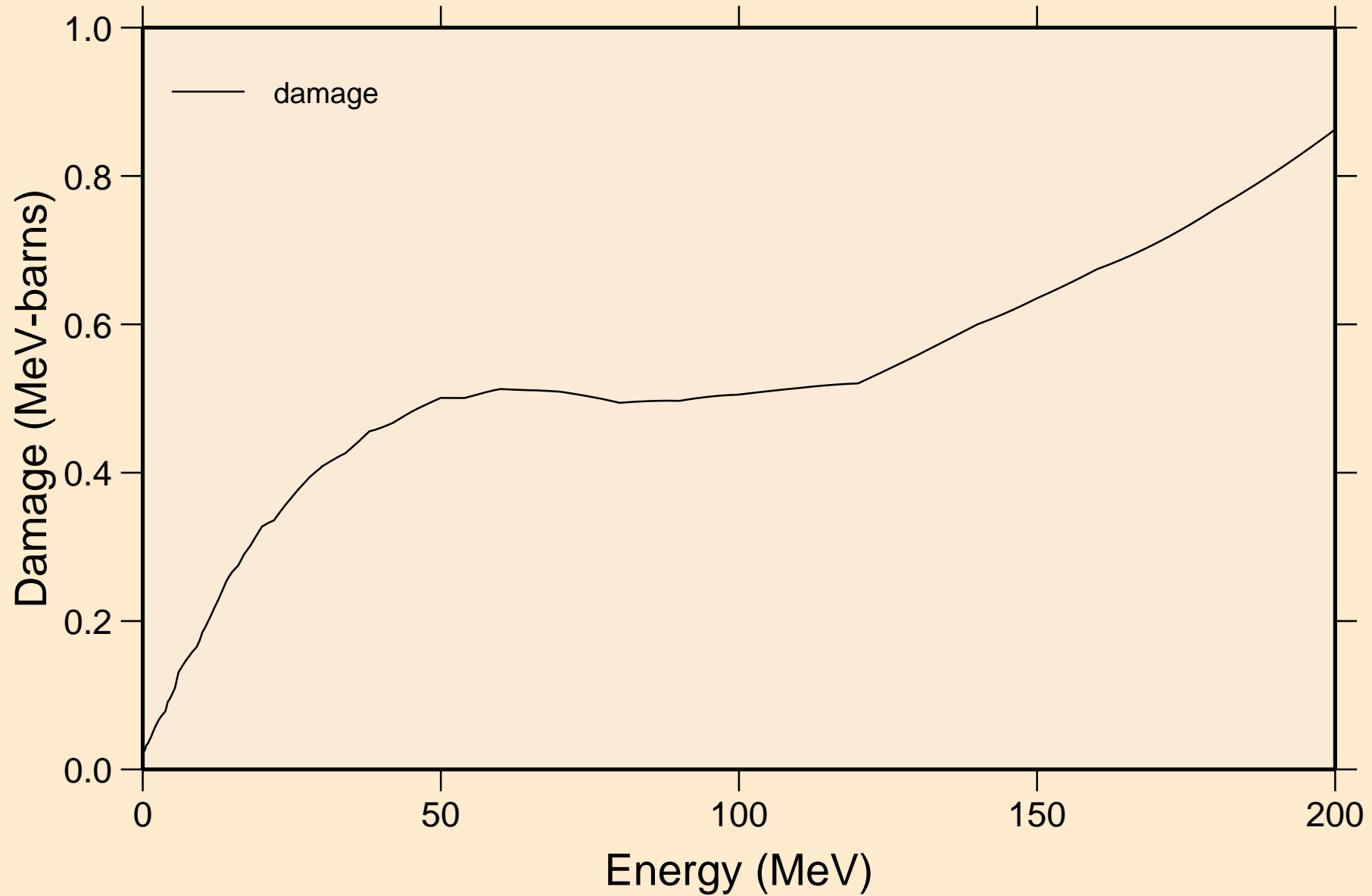

RE168 NEUTRON ACER TENDL-2024 LIBRARY; T=0.K
Non-threshold reactions

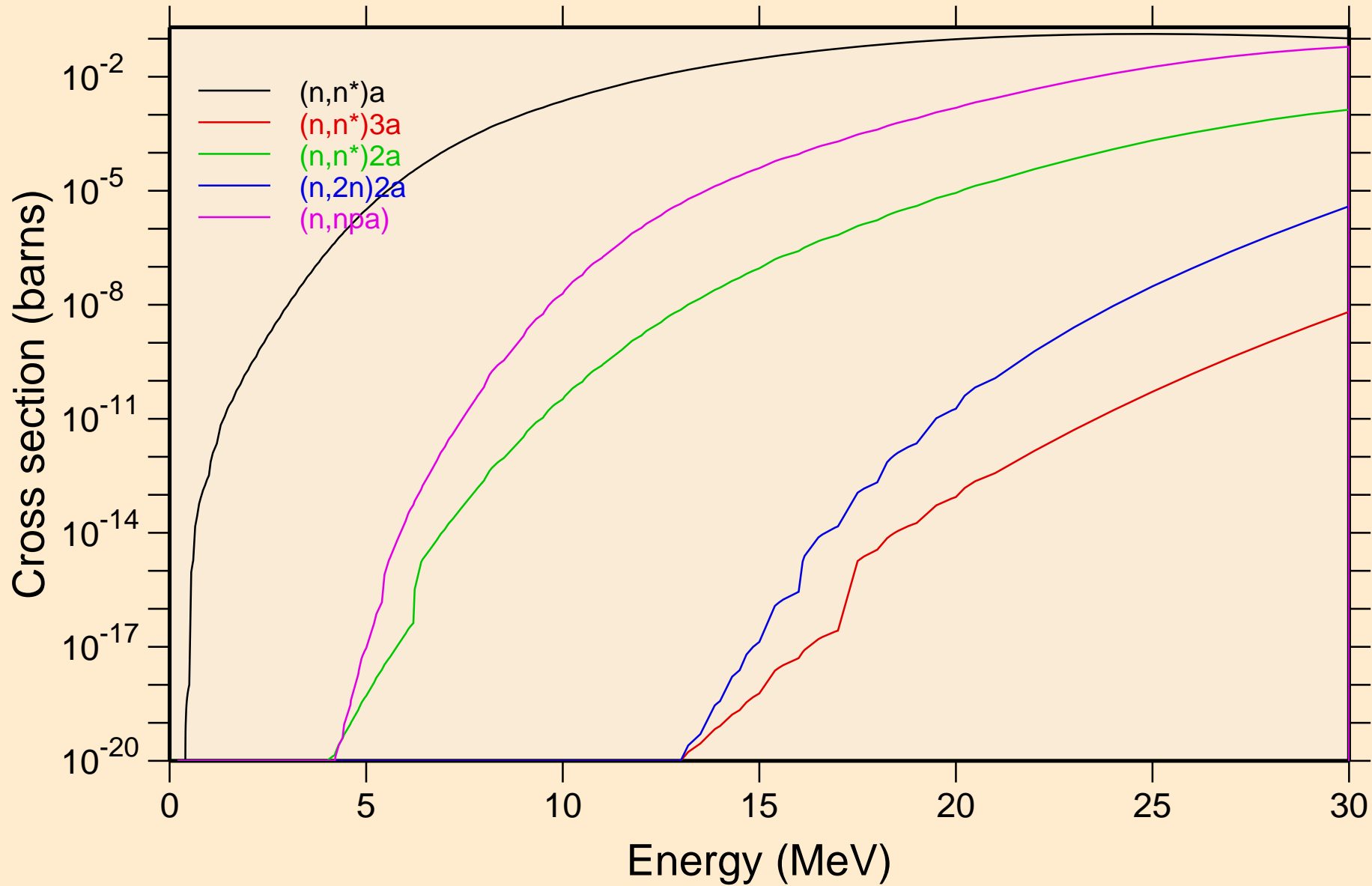

RE168 NEUTRON ACER TENDL-2024 LIBRARY; T=0.K

Non-threshold reactions

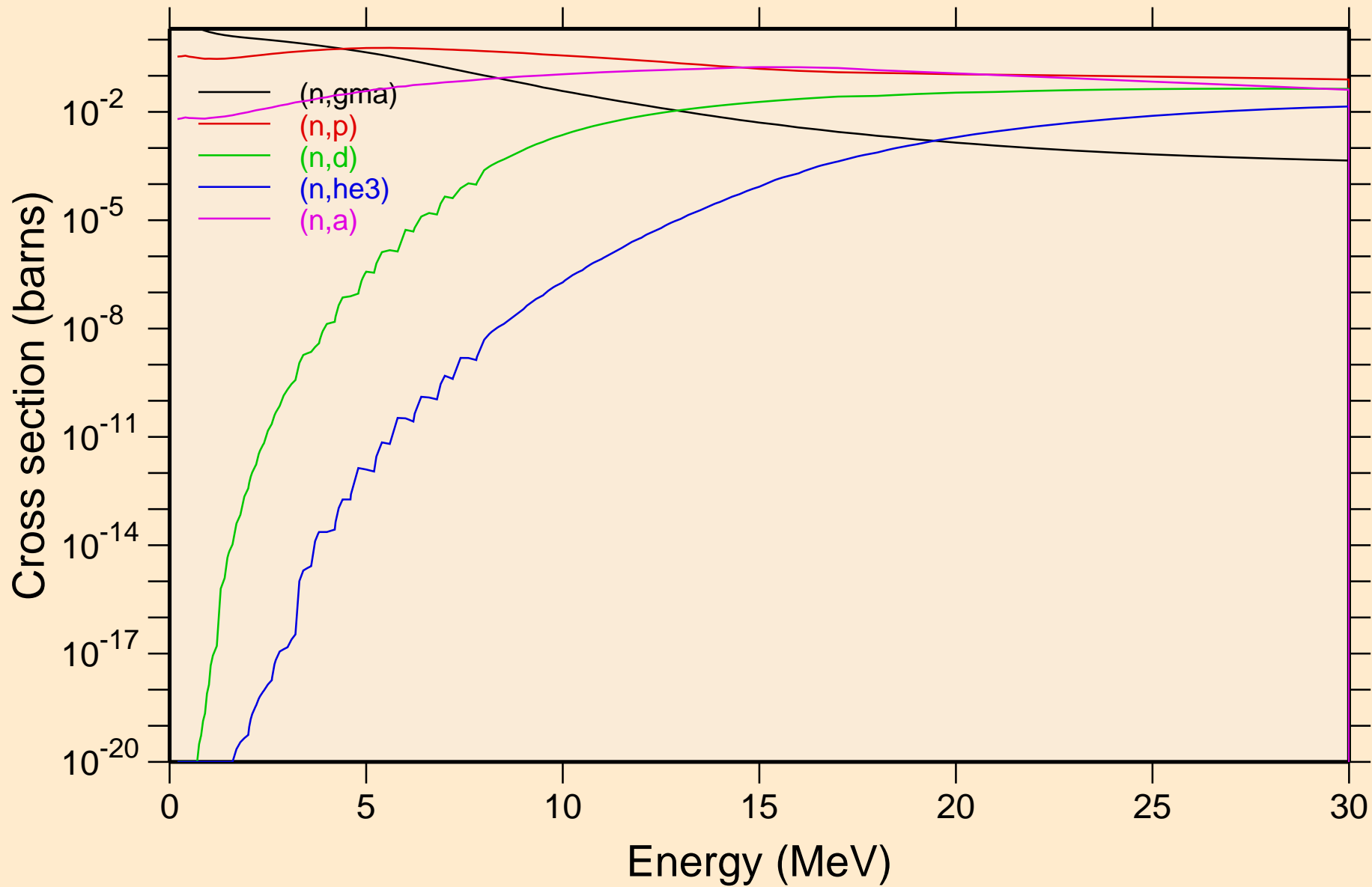

RE168 NEUTRON ACER TENDL-2024 LIBRARY; T=0.K
Non-threshold reactions

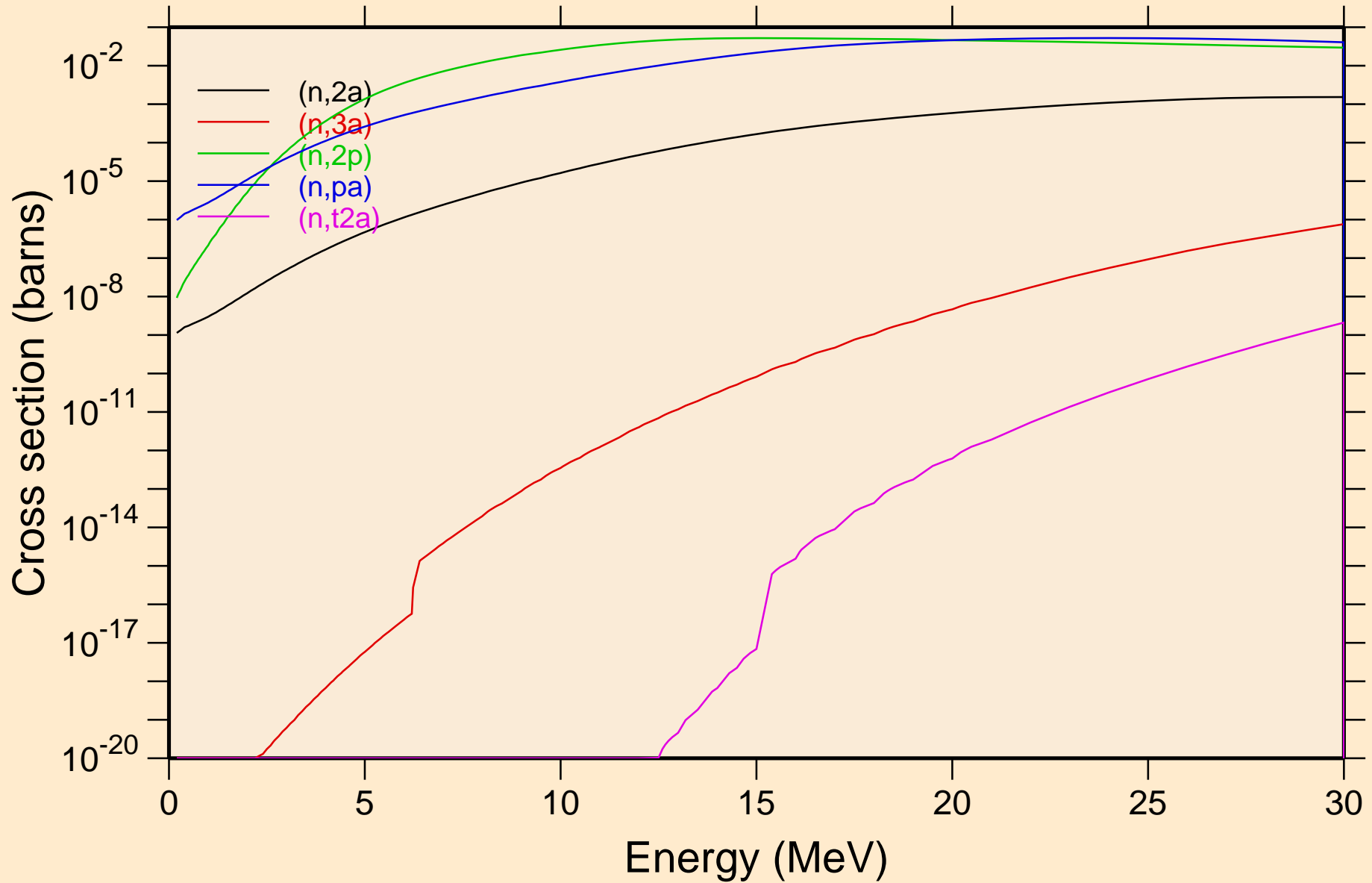

RE168 NEUTRON ACER TENDL-2024 LIBRARY; T=0.K
Non-threshold reactions

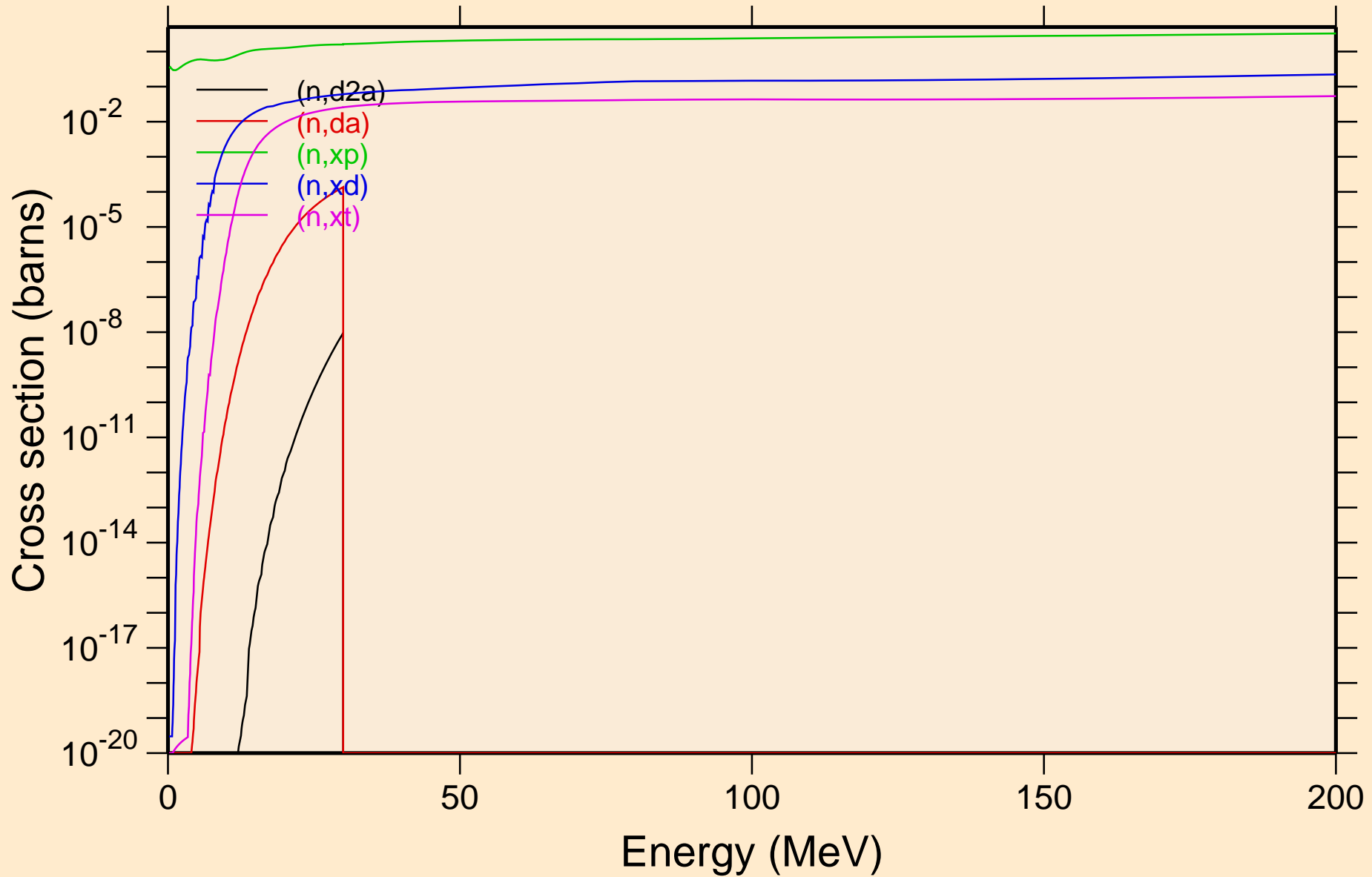

RE168 NEUTRON ACER TENDL-2024 LIBRARY; T=0.K
Non-threshold reactions

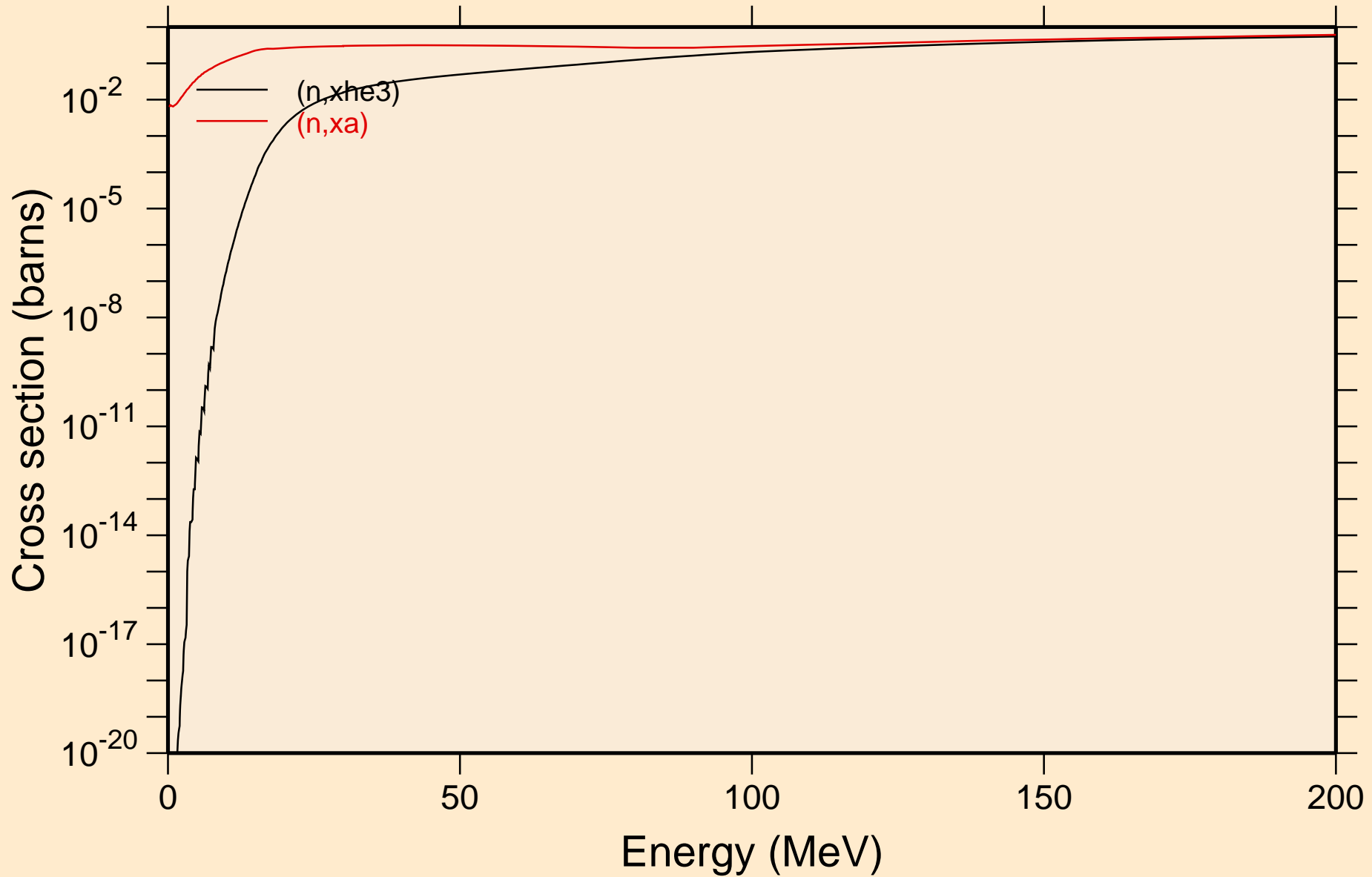

RE168 NEUTRON ACER TENDL-2024 LIBRARY; T=0.K
Inelastic levels

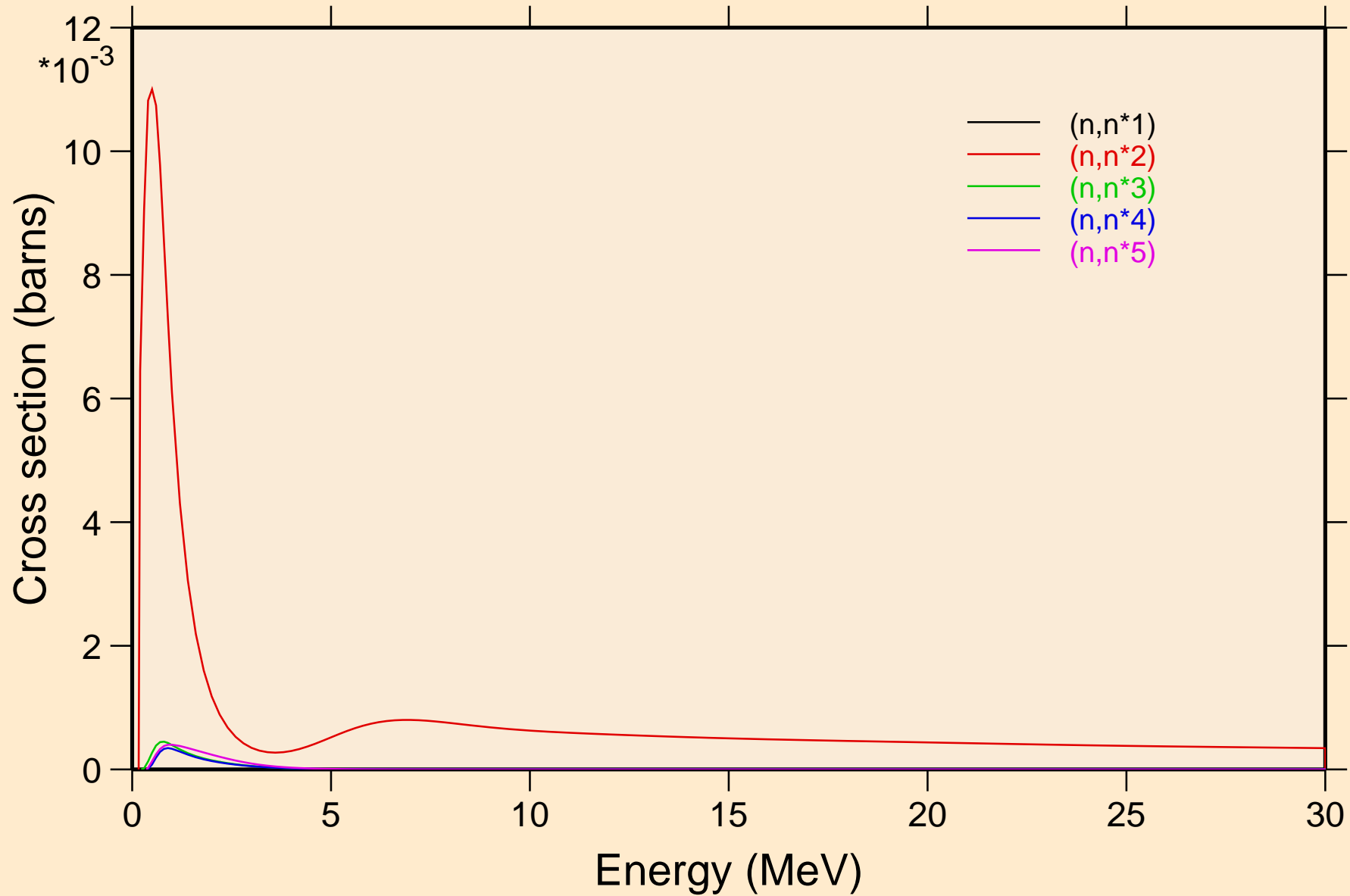

RE168 NEUTRON ACER TENDL-2024 LIBRARY; T=0.K
Inelastic levels

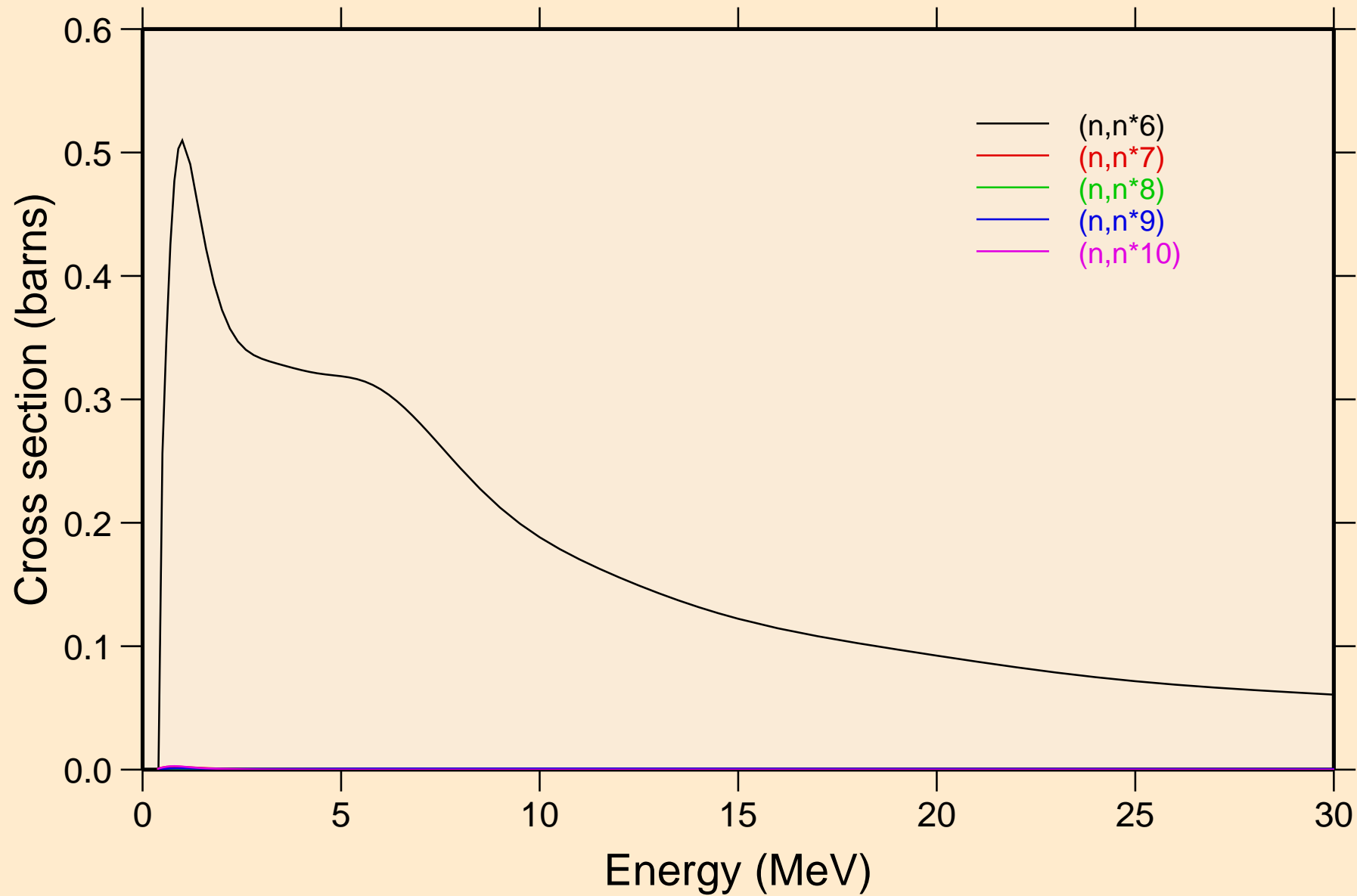

RE168 NEUTRON ACER TENDL-2024 LIBRARY; T=0.K
Inelastic levels

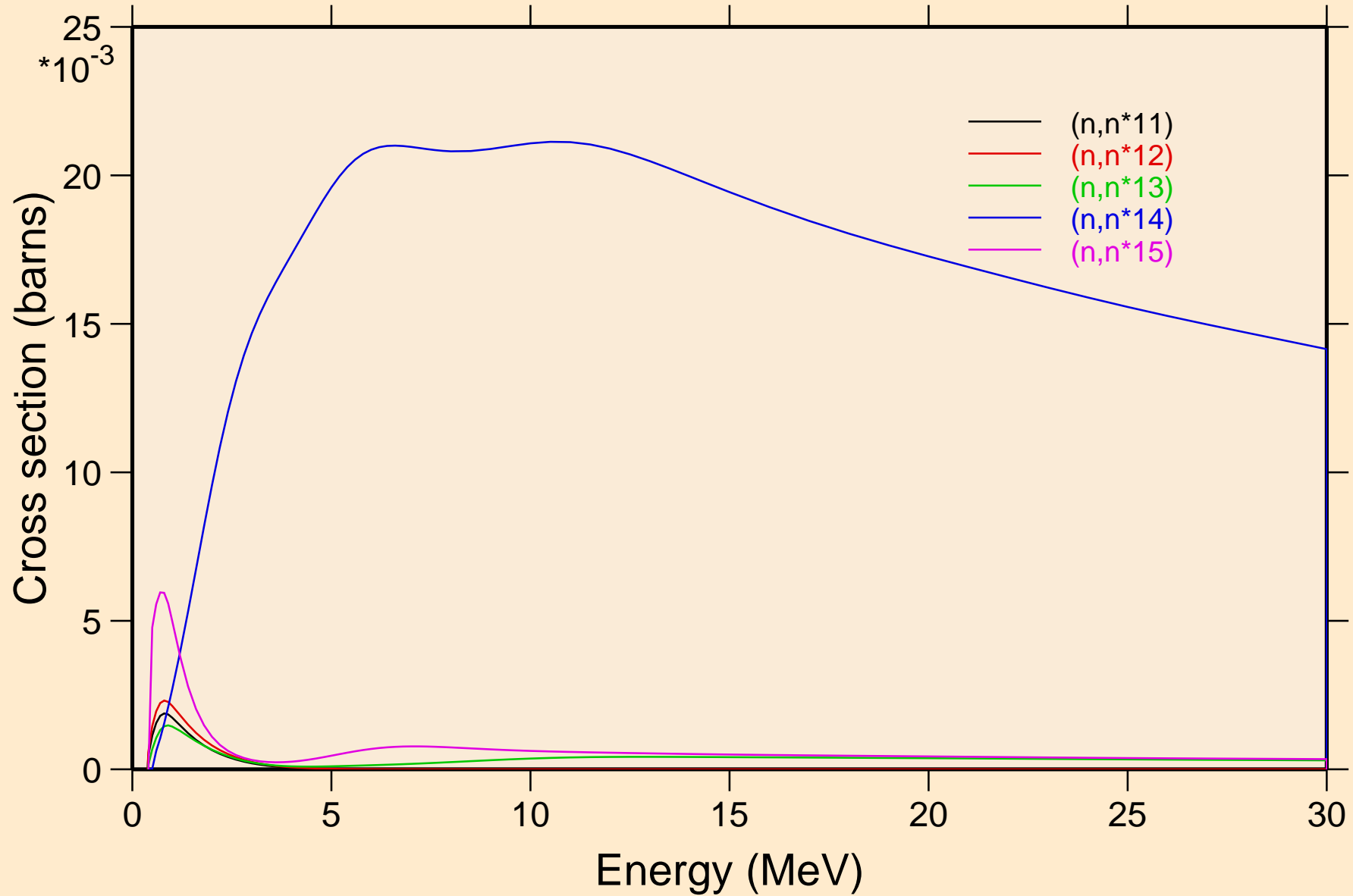

RE168 NEUTRON ACER TENDL-2024 LIBRARY; T=0.K
Inelastic levels

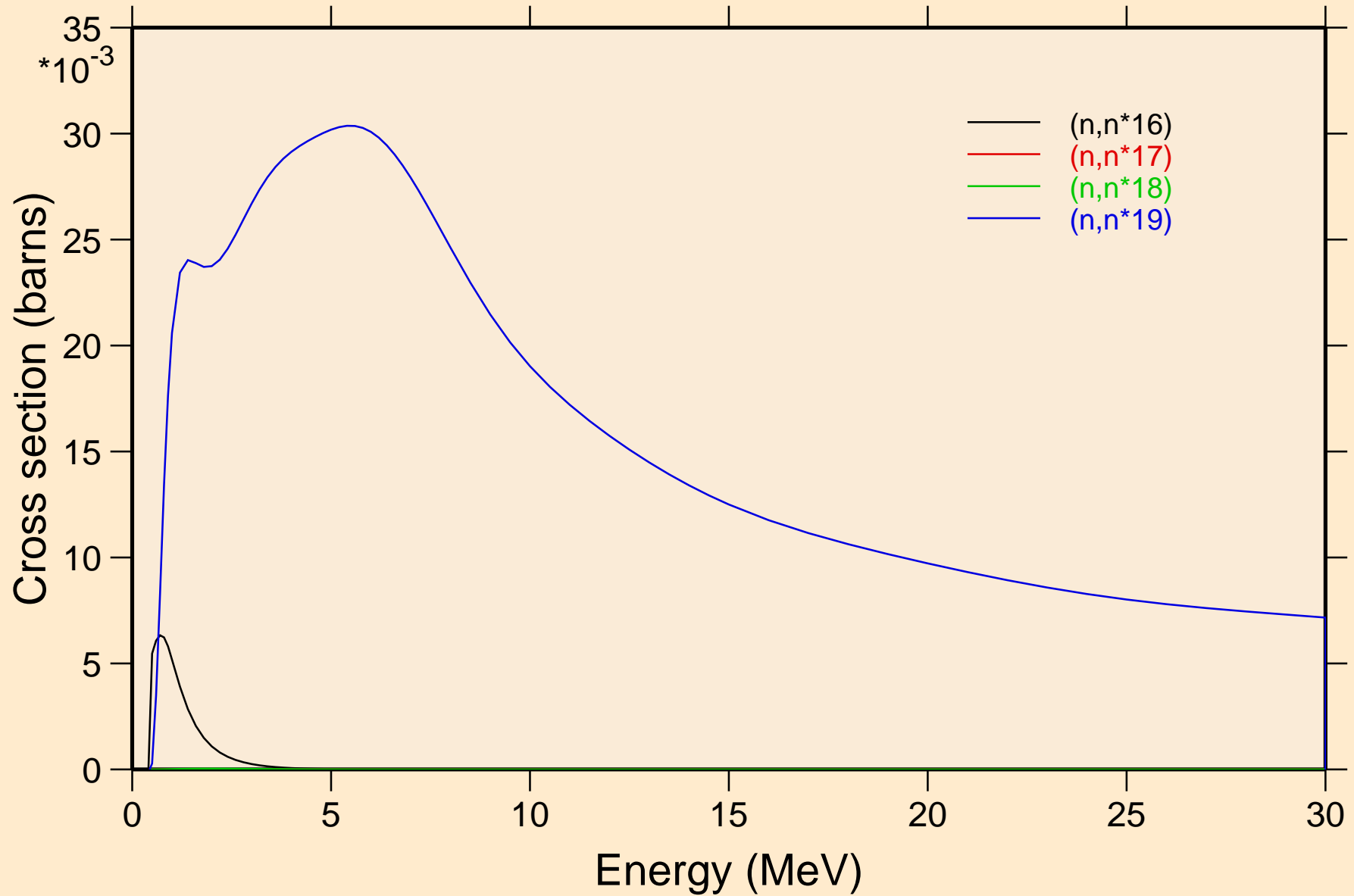

RE168 NEUTRON ACER TENDL-2024 LIBRARY; T=0.K
Threshold reactions

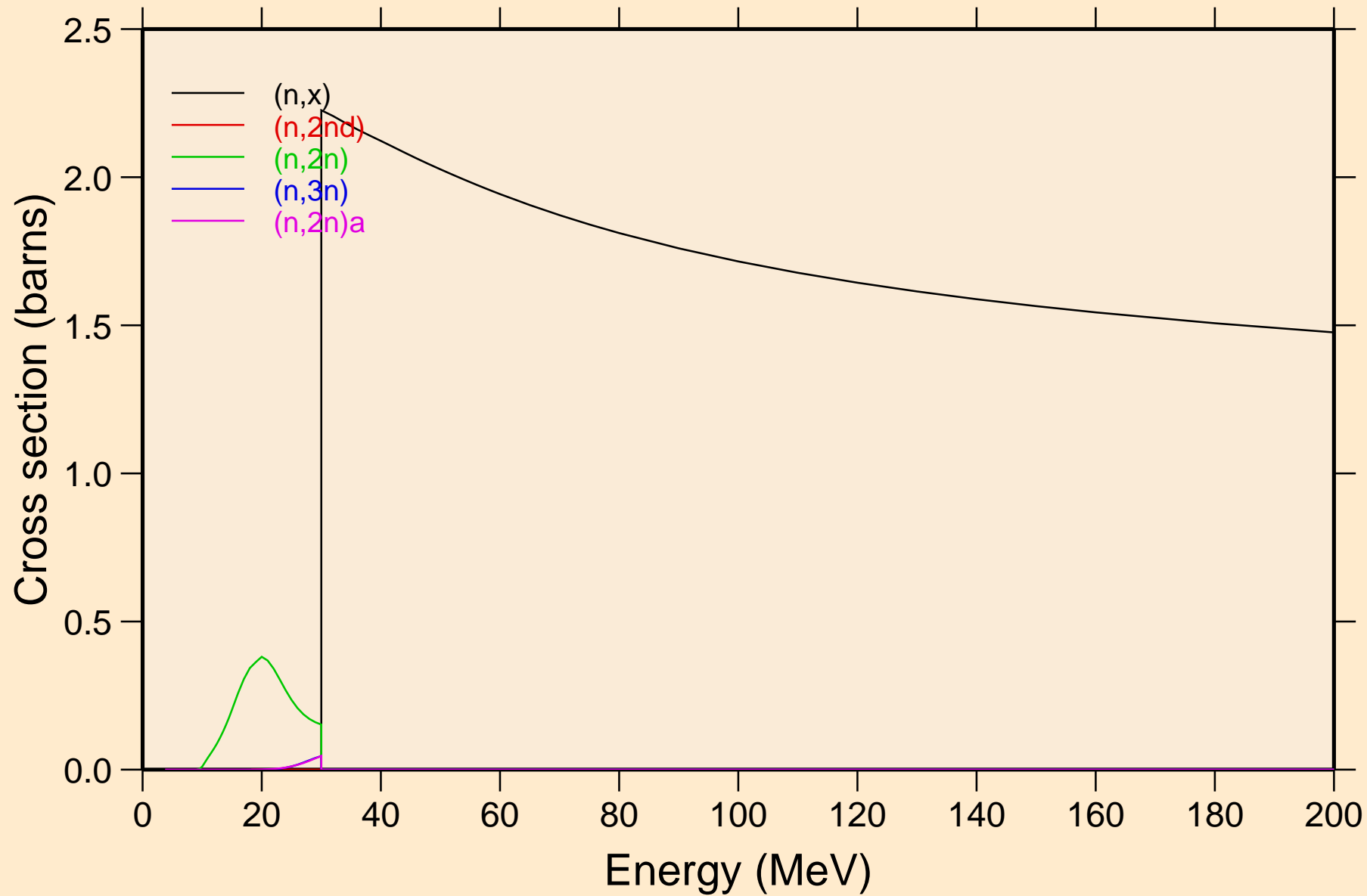

RE168 NEUTRON ACER TENDL-2024 LIBRARY; T=0.K
Threshold reactions

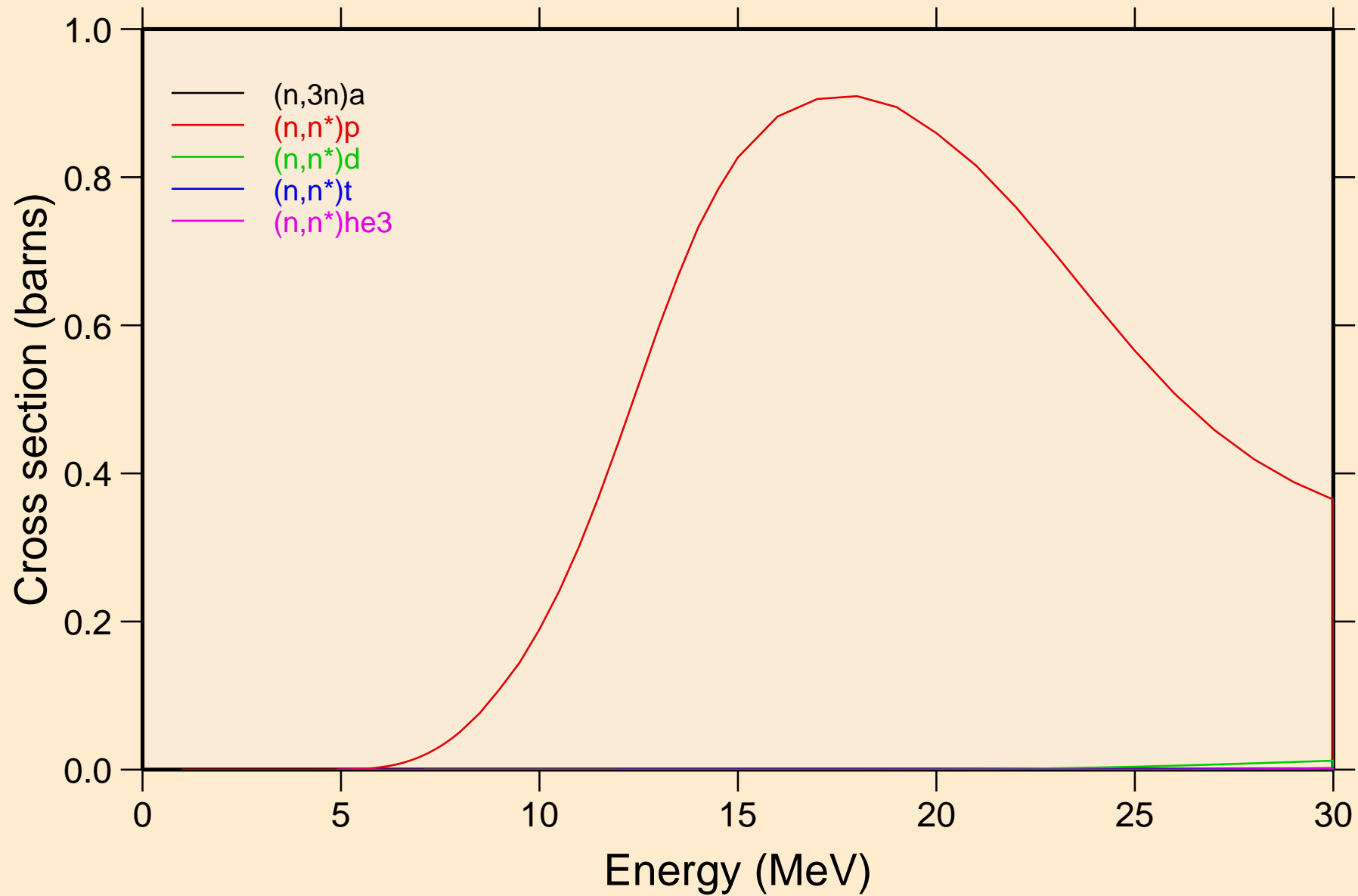

RE168 NEUTRON ACER TENDL-2024 LIBRARY; T=0.K

Threshold reactions

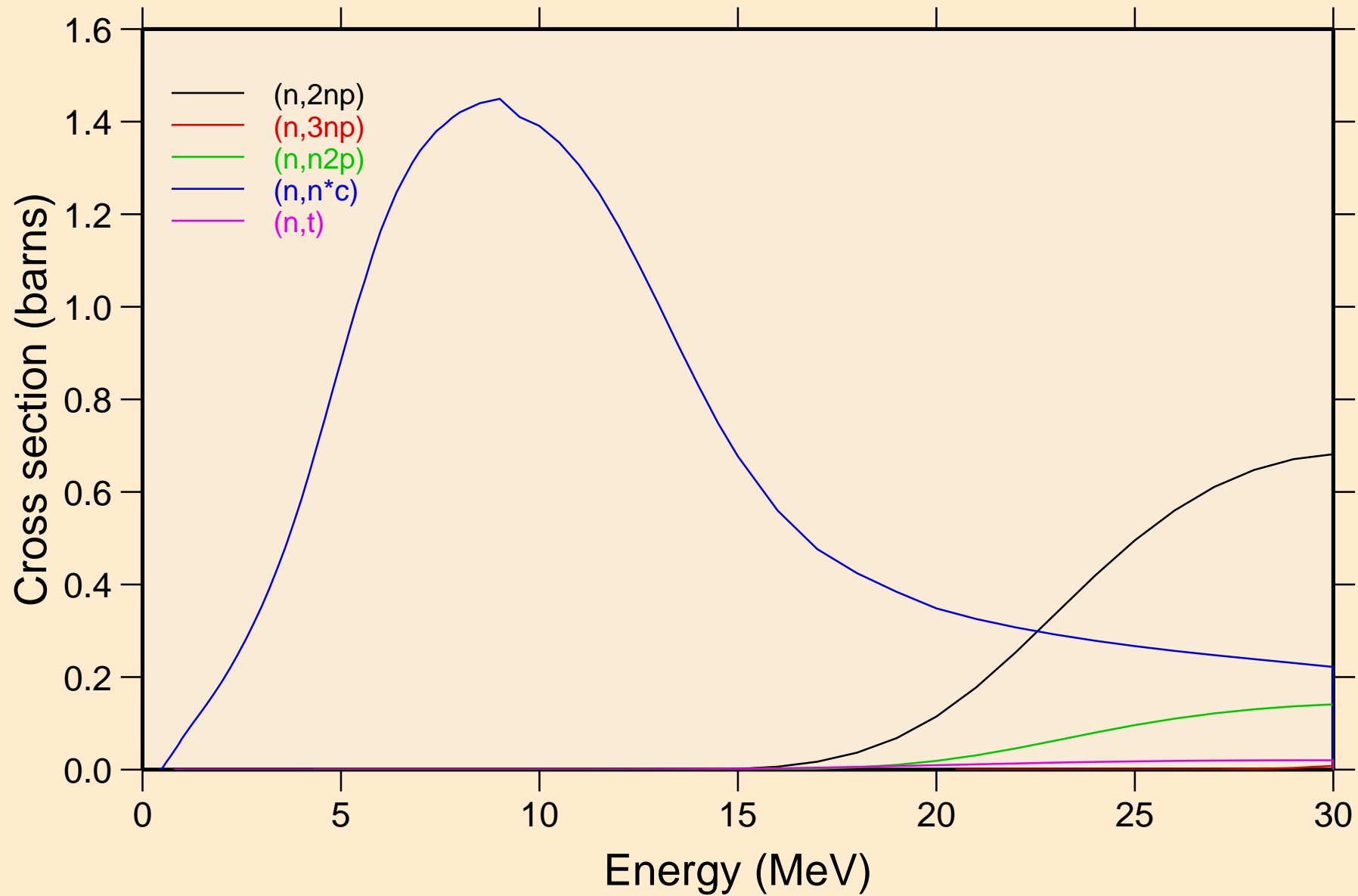

RE168 NEUTRON ACER TENDL-2024 LIBRARY; T=0.K
Threshold reactions

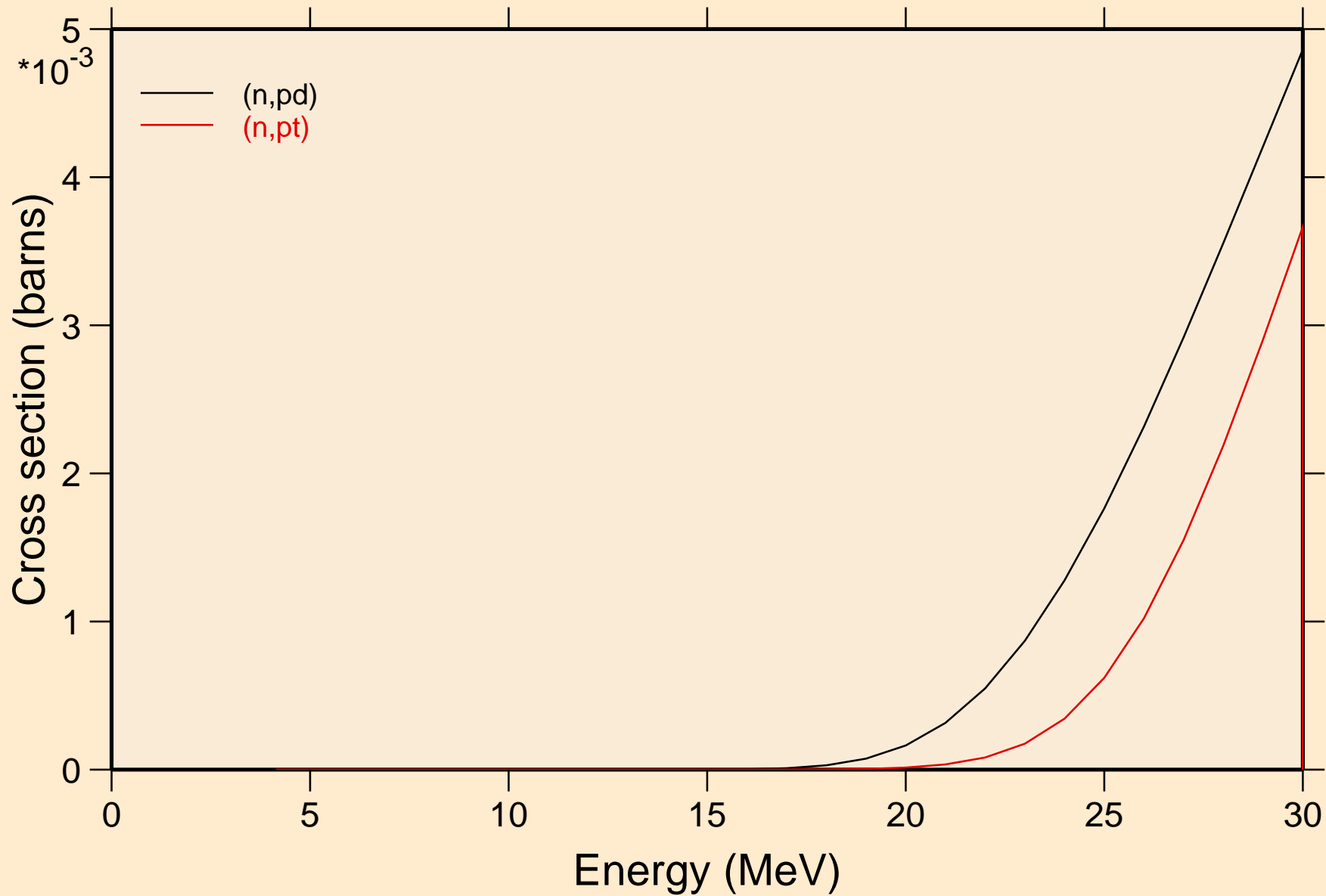

RE168 NEUTRON ACER TENDL-2024 LIBRARY; T=0.K
angular distribution for elastic

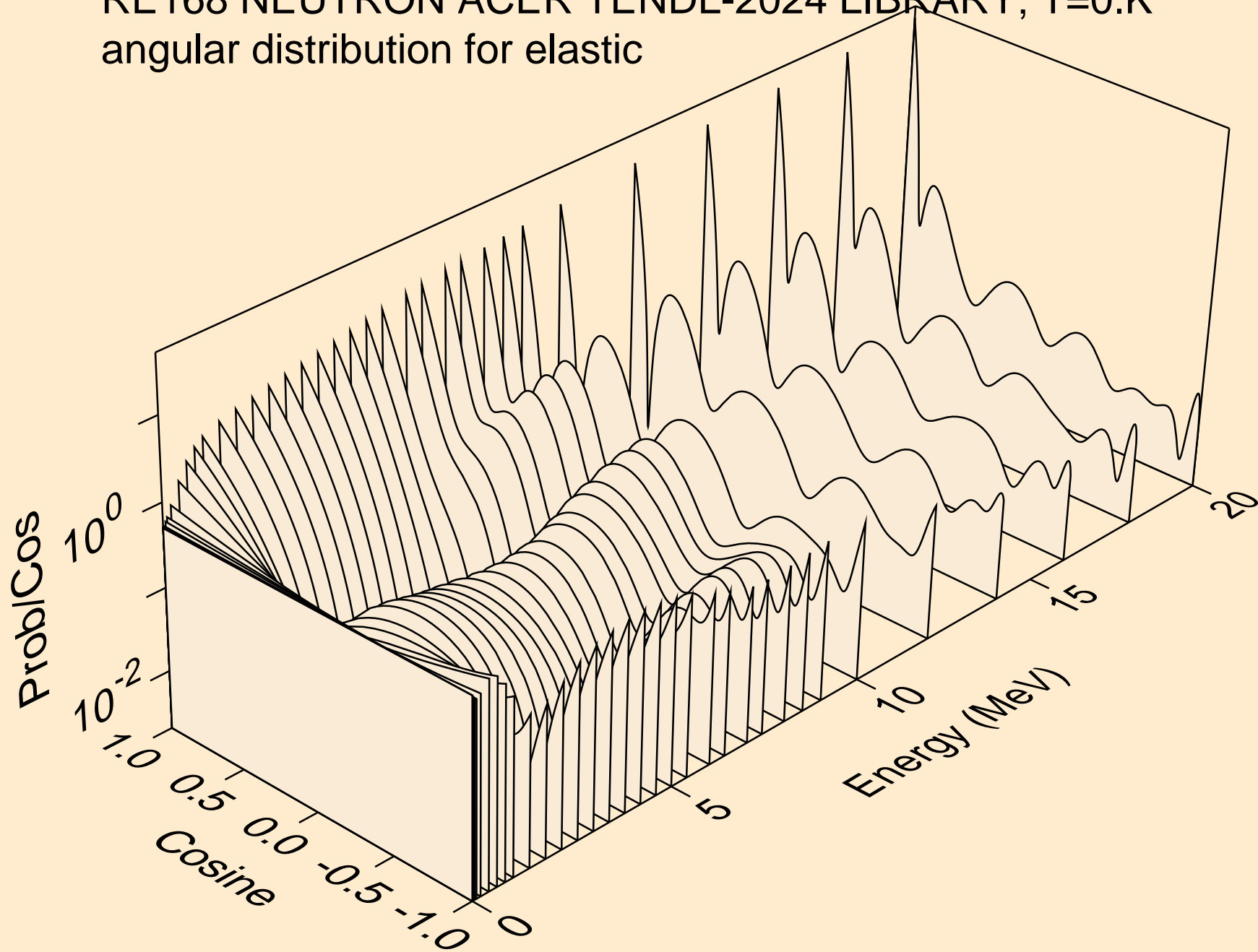

RE168 NEUTRON ACER TENDL-2024 LIBRARY; T=0.K
angular distribution for elastic

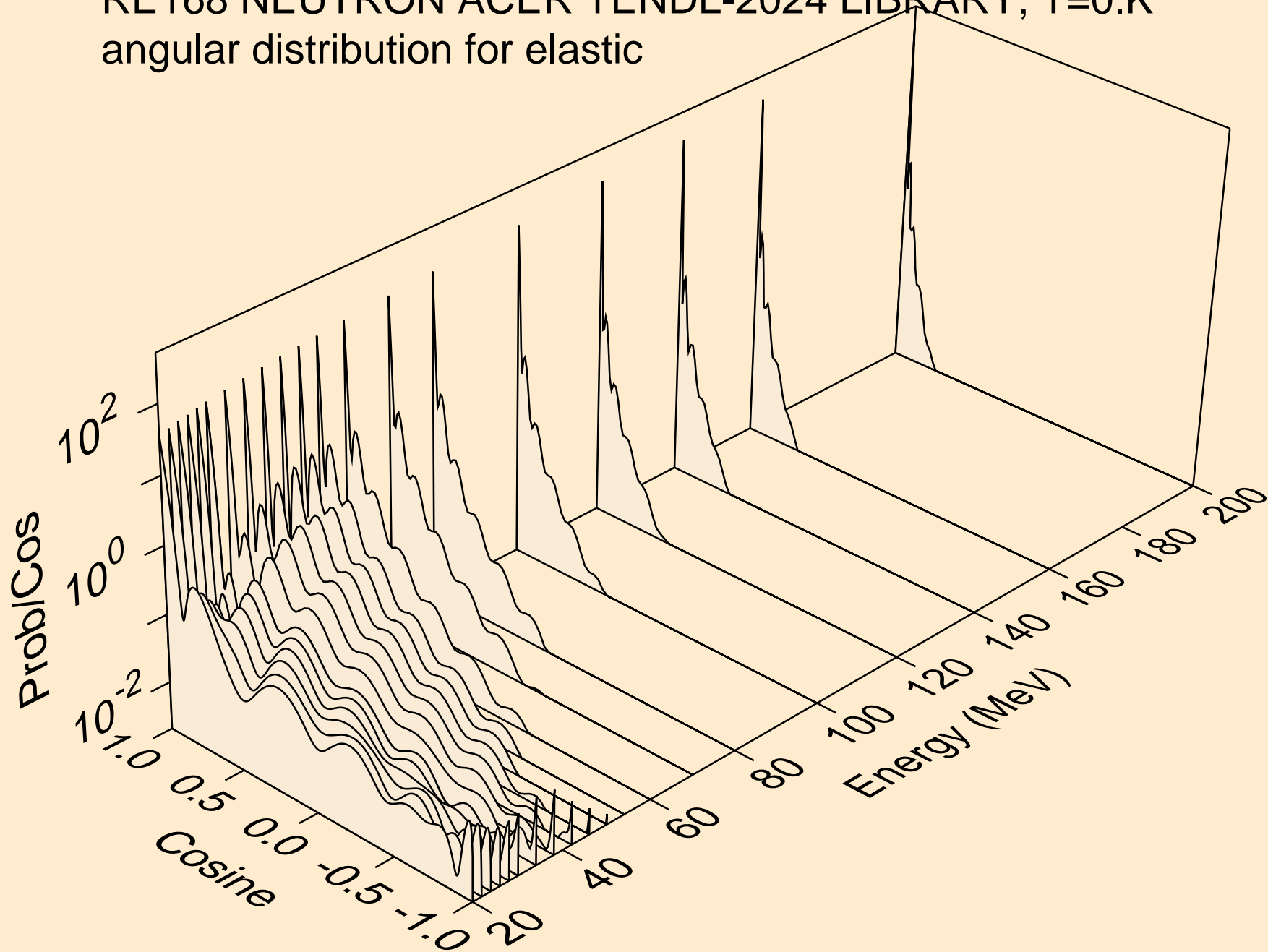

RE168 NEUTRON ACER TENDL-2024 LIBRARY; T=0.K
angular distribution for (n,n*1)

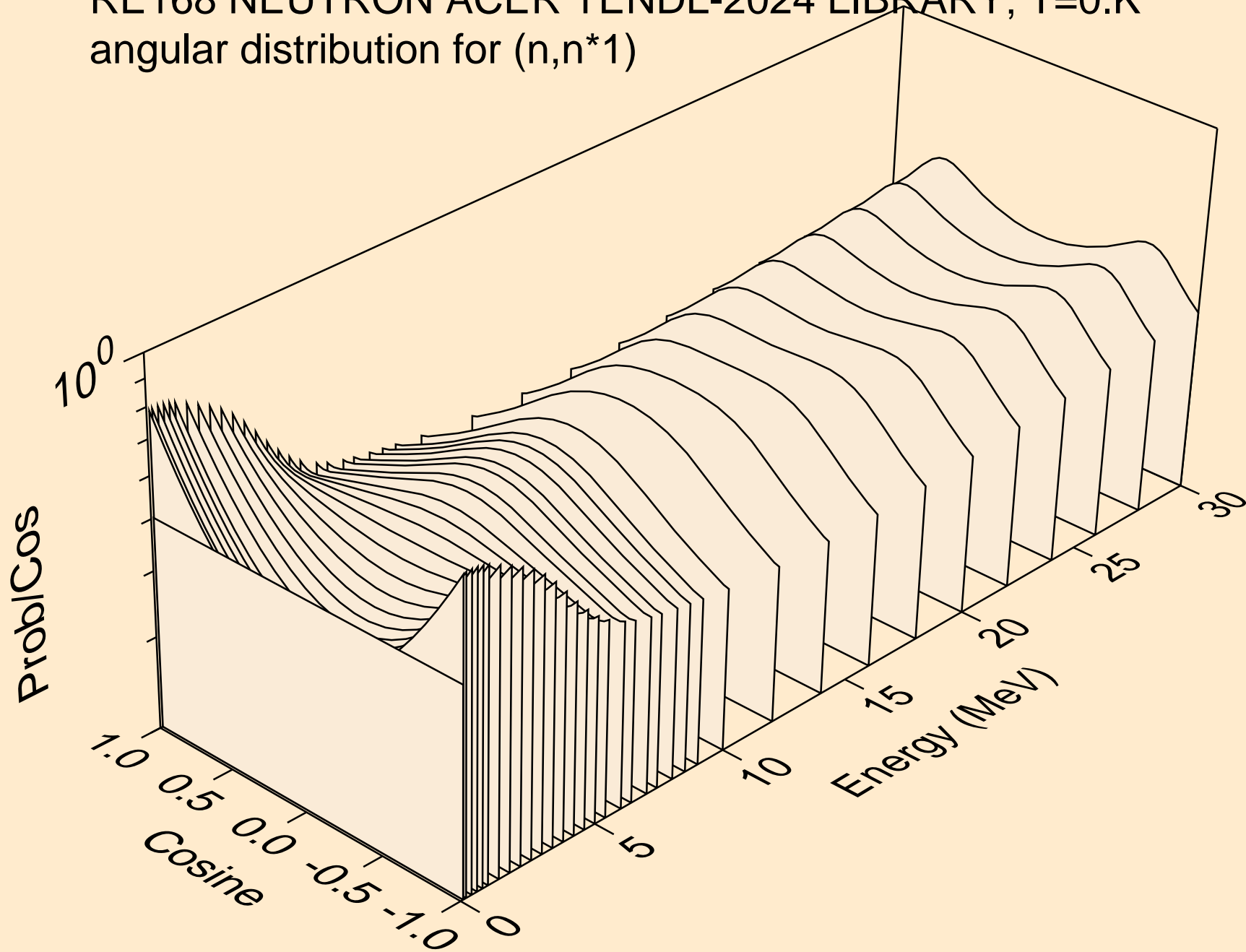

RE168 NEUTRON ACER TENDL-2024 LIBRARY; T=0.K
angular distribution for (n,n*2)

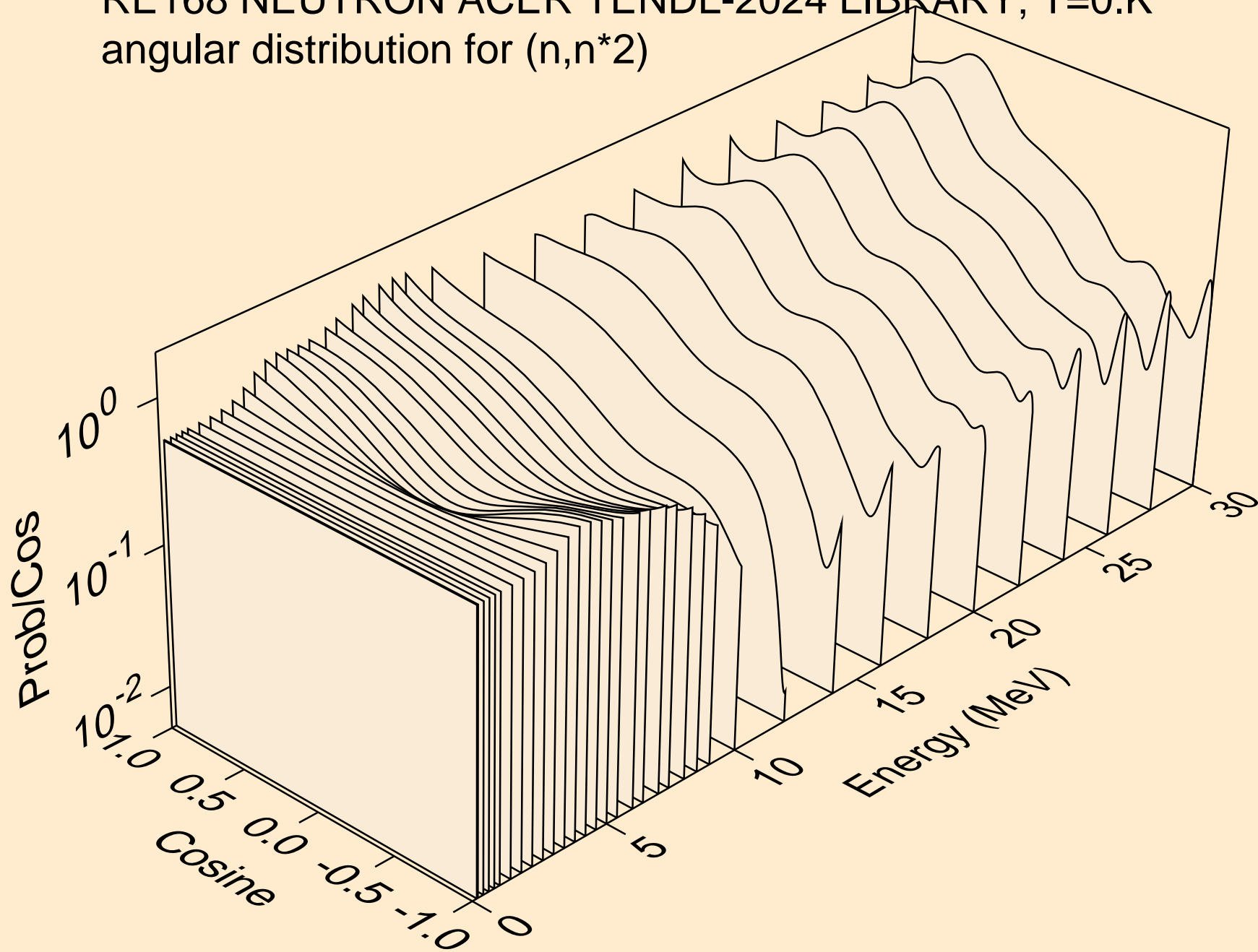

RE168 NEUTRON ACER TENDL-2024 LIBRARY; T=0.K
angular distribution for (n,n*3)

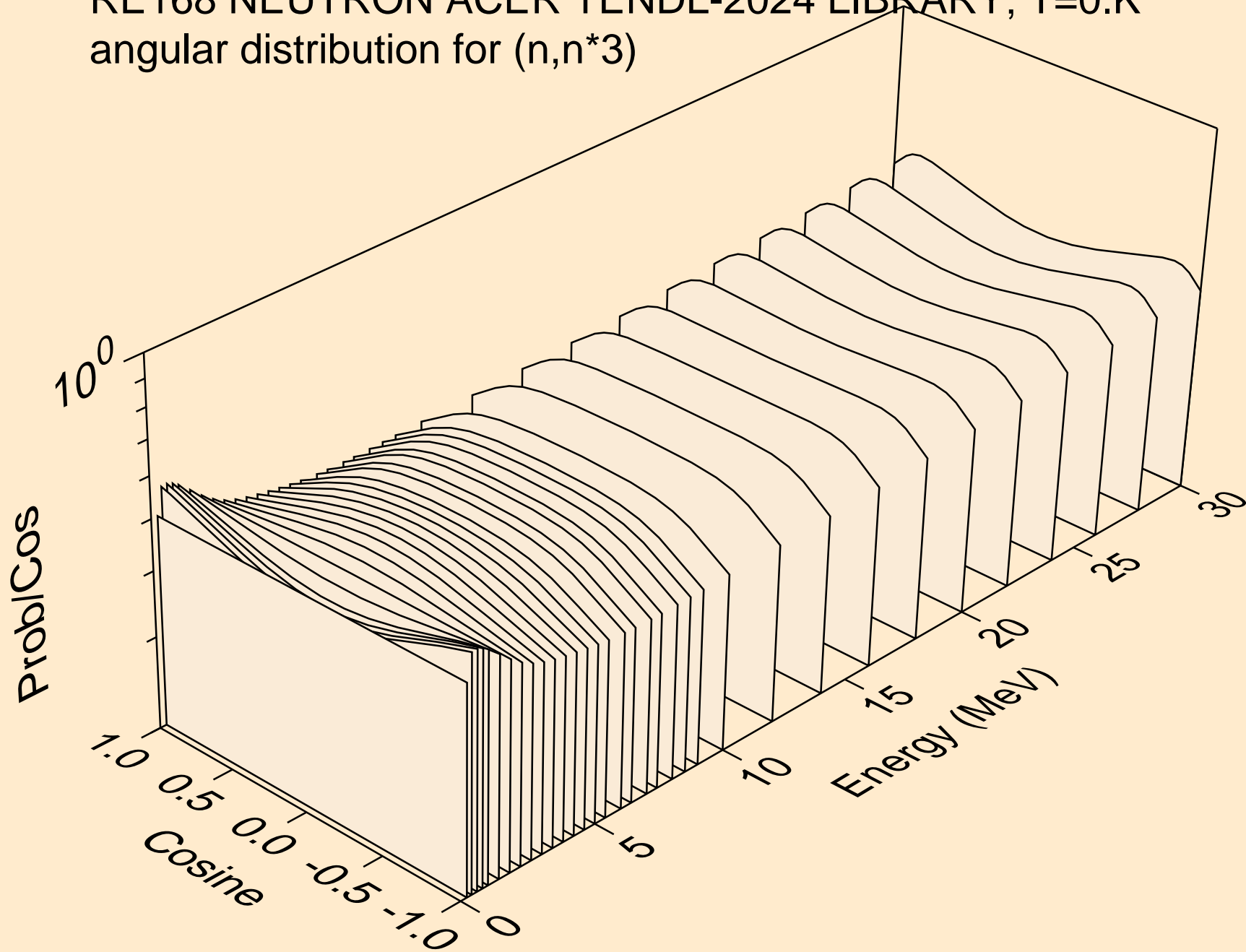

RE168 NEUTRON ACER TENDL-2024 LIBRARY; T=0.K
angular distribution for (n,n*4)

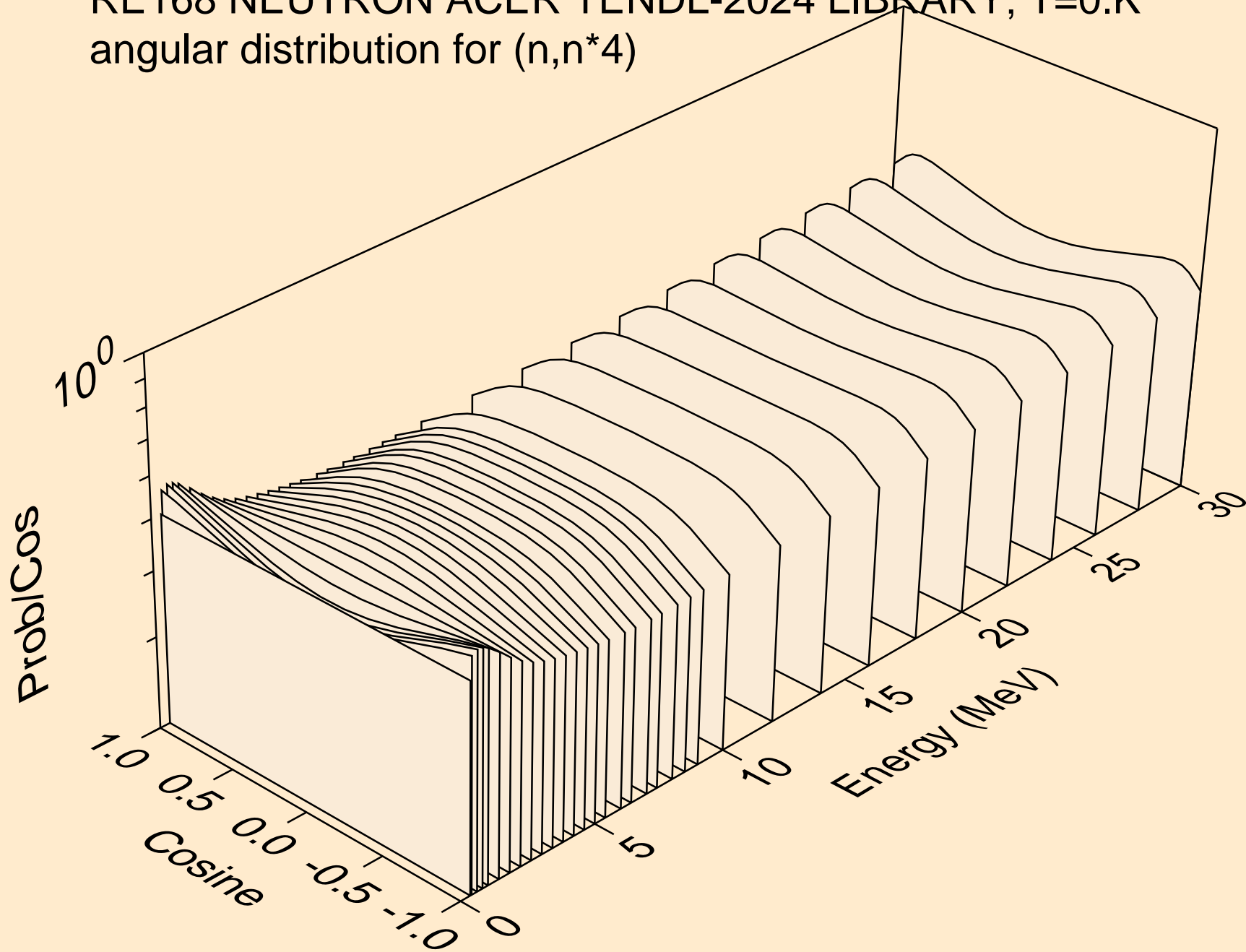

RE168 NEUTRON ACER TENDL-2024 LIBRARY; T=0.K
angular distribution for (n,n*5)

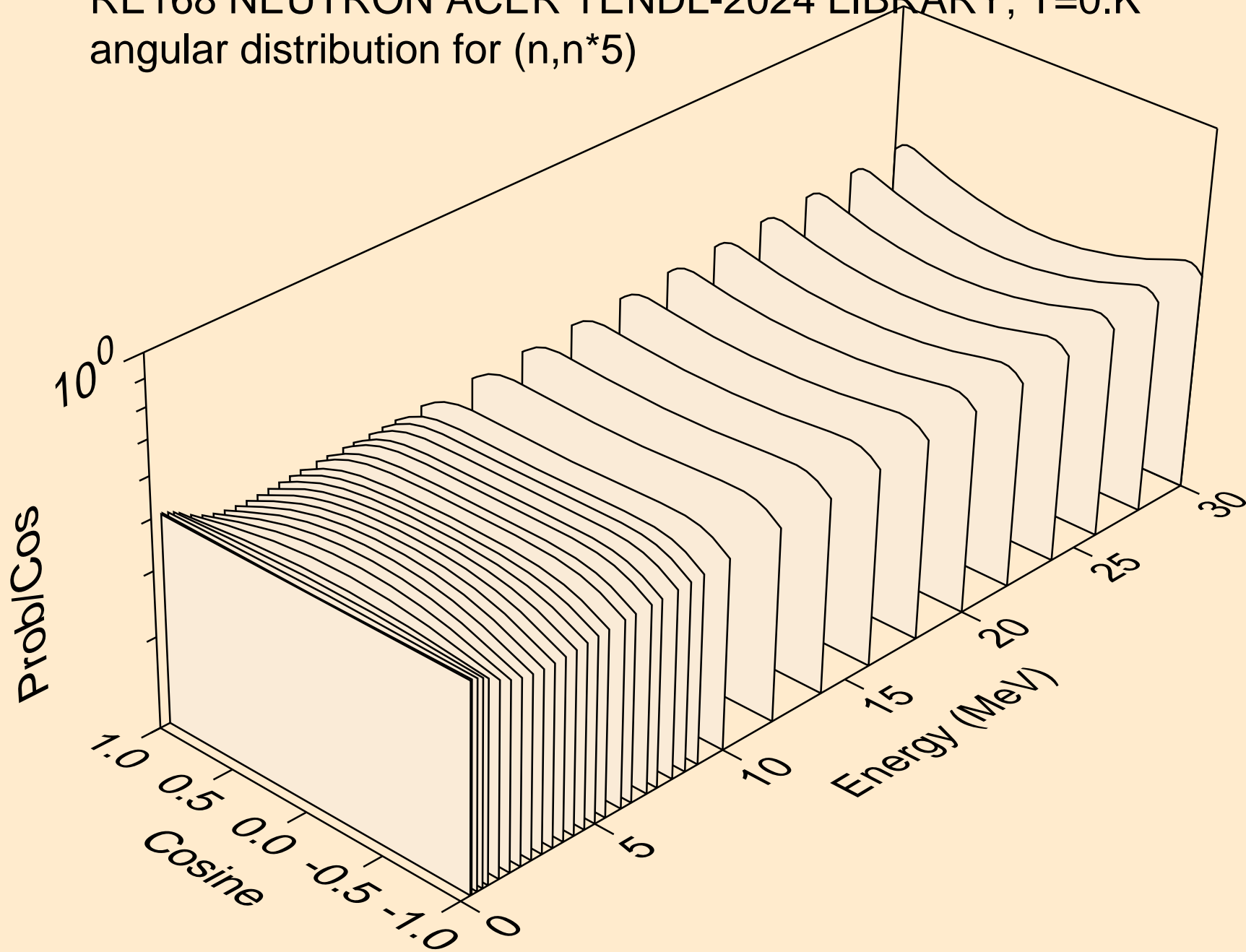

RE168 NEUTRON ACER TENDL-2024 LIBRARY; T=0.K
angular distribution for (n,n*6)

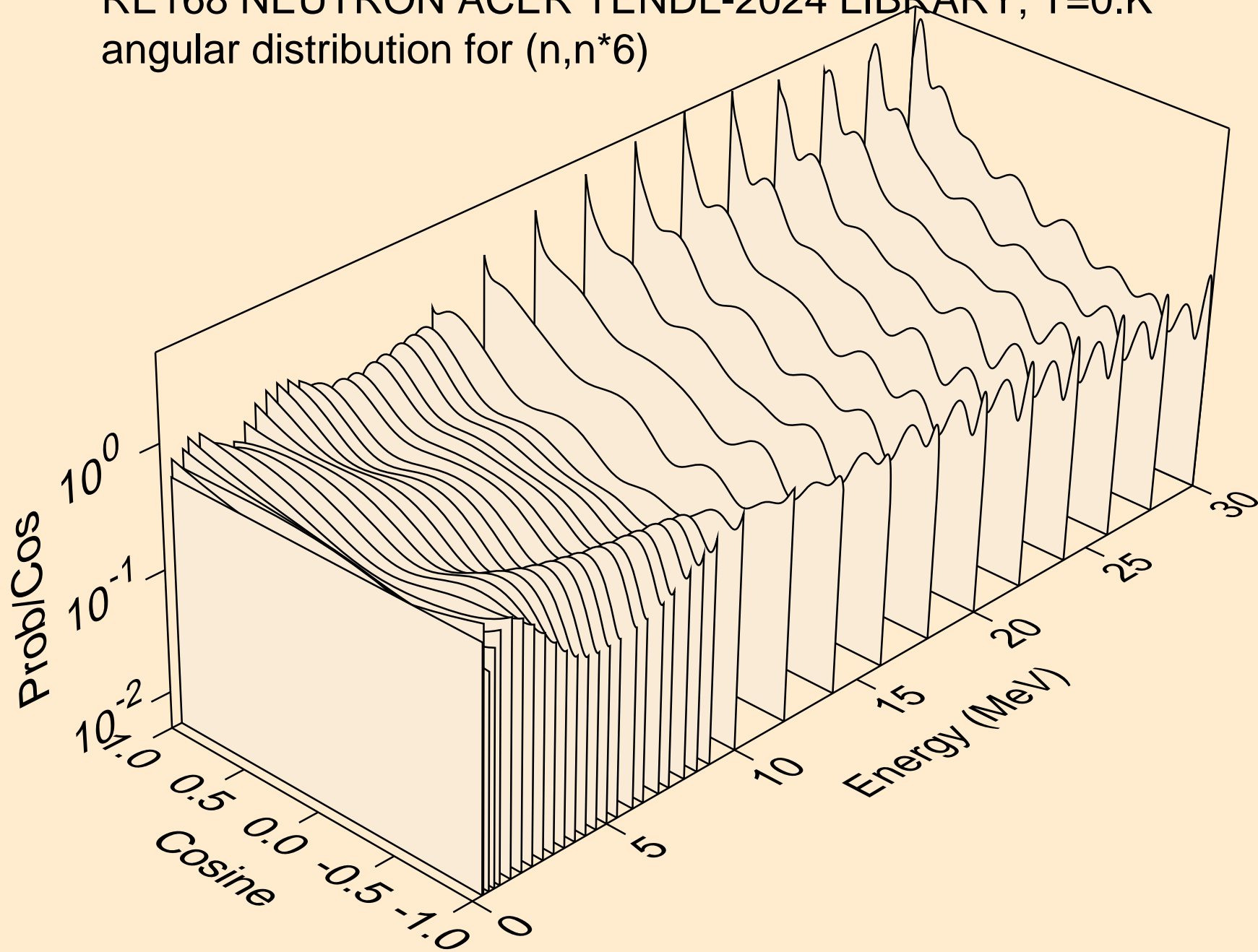

RE168 NEUTRON ACER TENDL-2024 LIBRARY; T=0.K
angular distribution for (n,n*7)

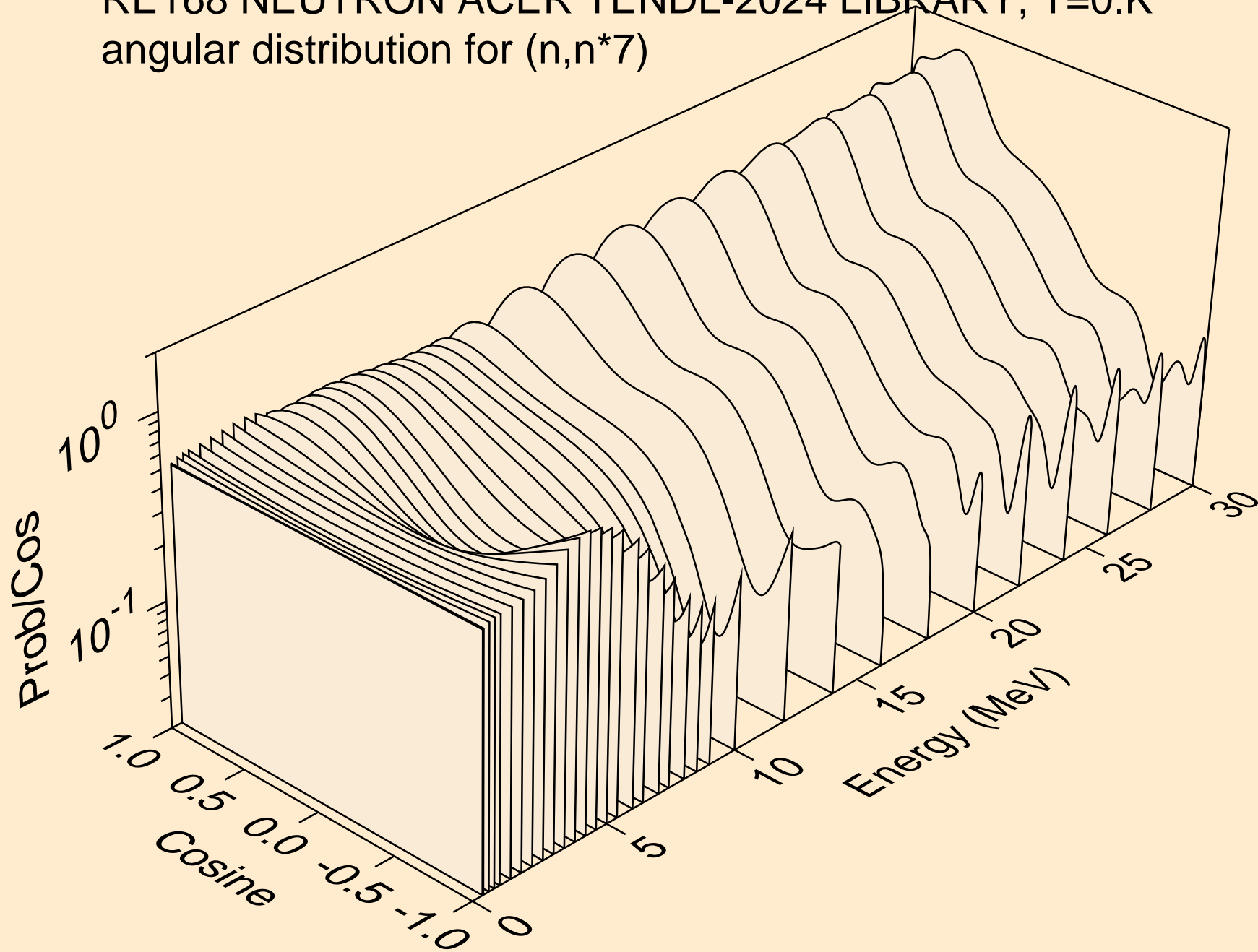

RE168 NEUTRON ACER TENDL-2024 LIBRARY; T=0.K
angular distribution for (n,n*8)

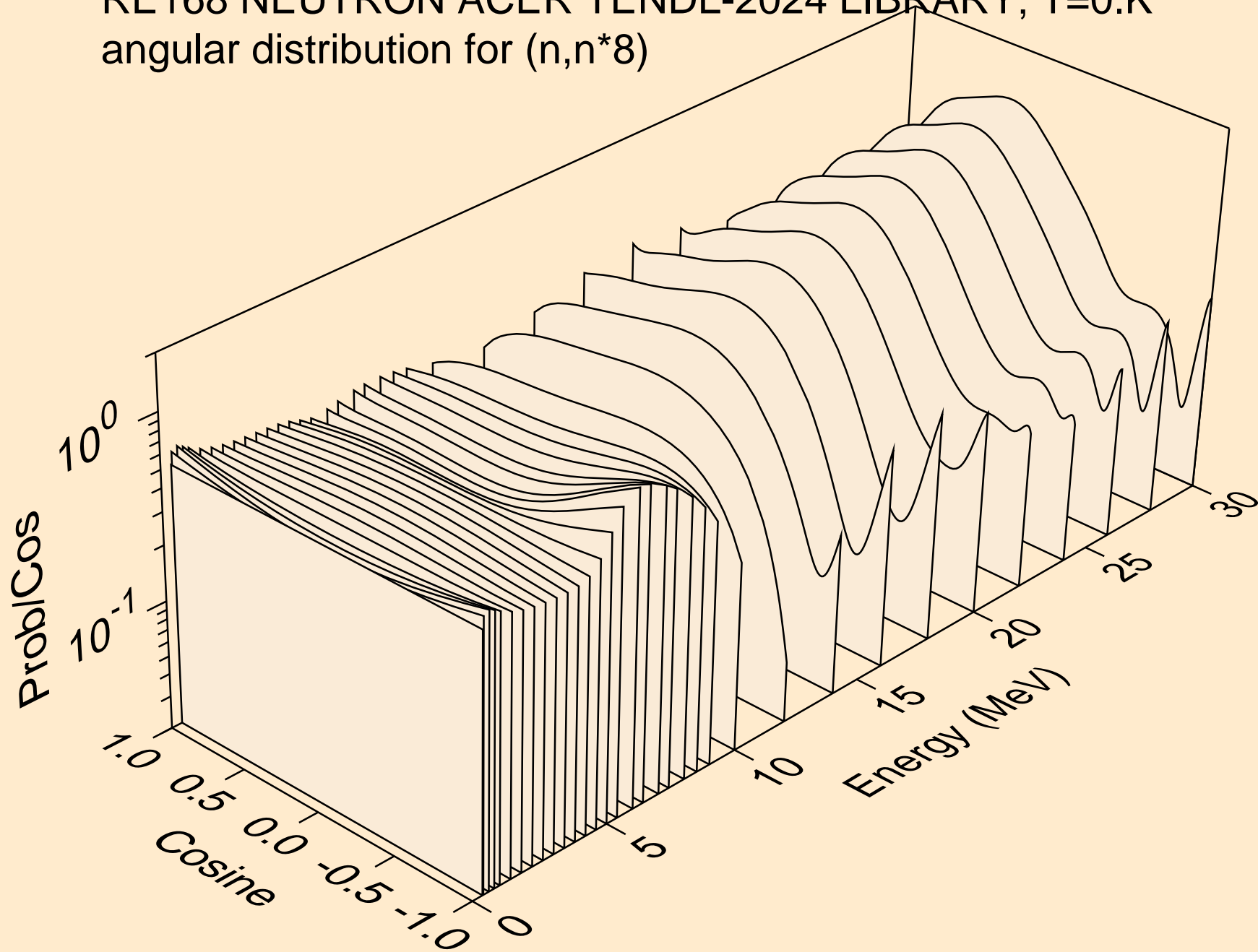

RE168 NEUTRON ACER TENDL-2024 LIBRARY; T=0.K
angular distribution for (n,n*9)

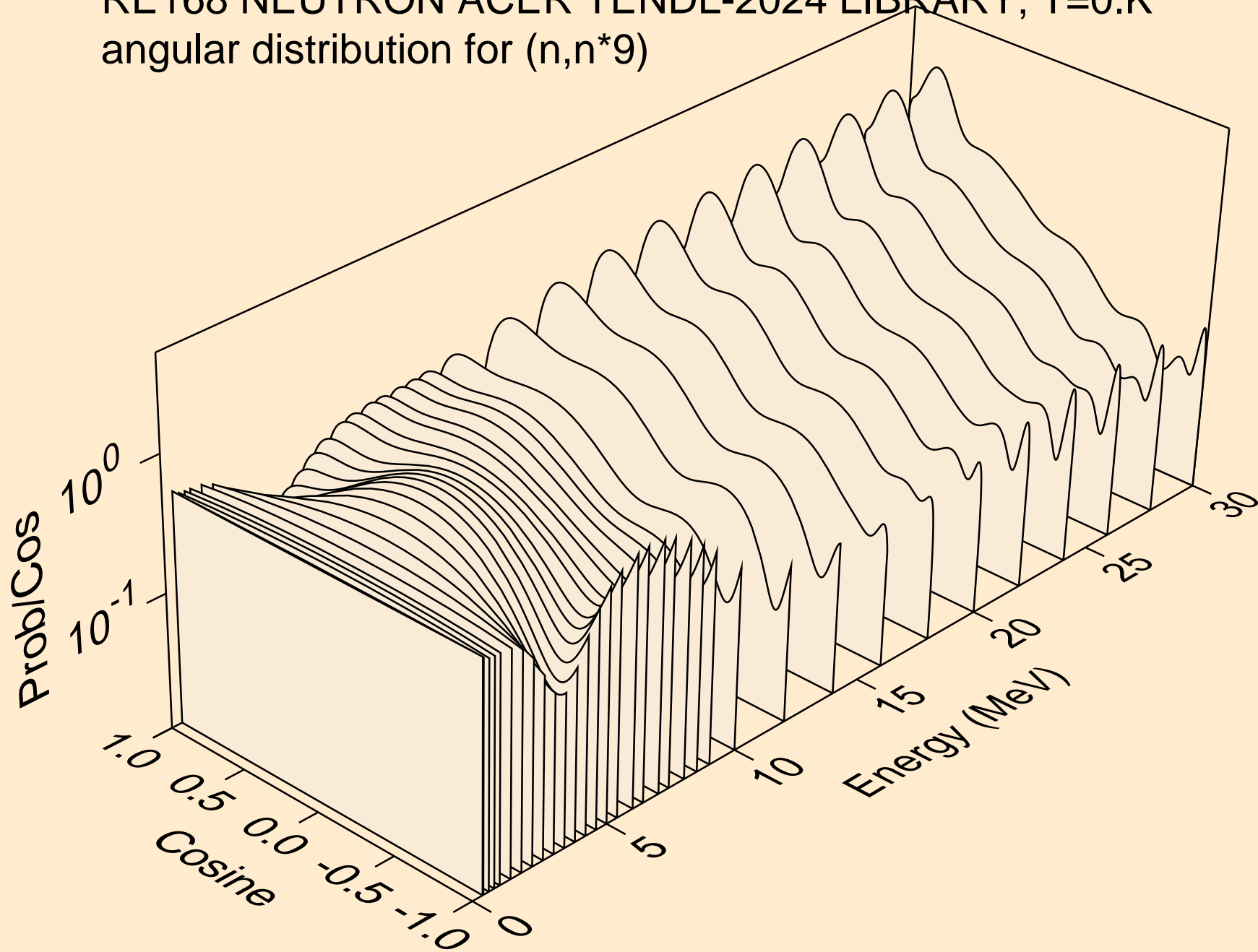

RE168 NEUTRON ACER TENDL-2024 LIBRARY; T=0.K
angular distribution for (n,n*10)

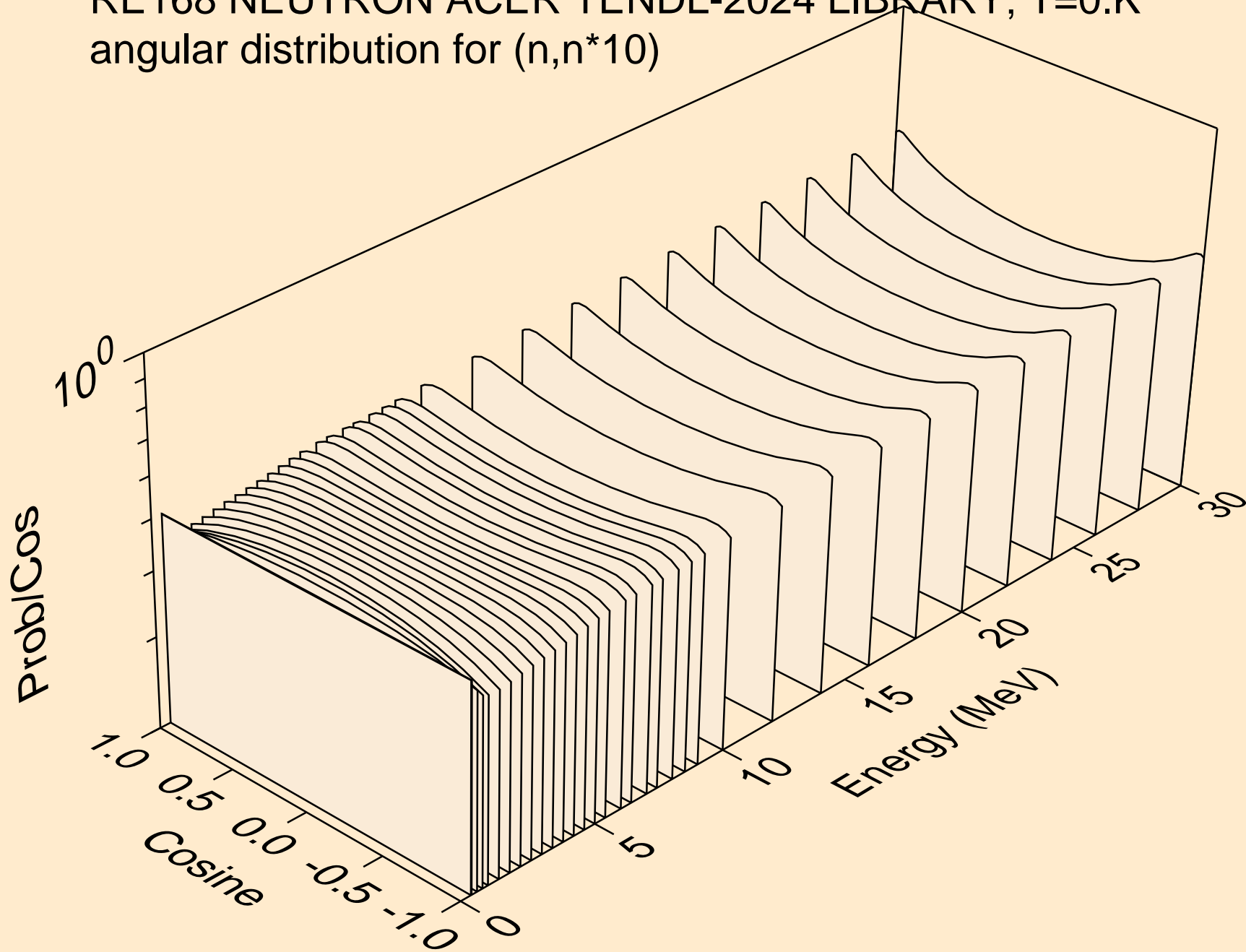

RE168 NEUTRON ACER TENDL-2024 LIBRARY; T=0.K
angular distribution for (n,n*11)

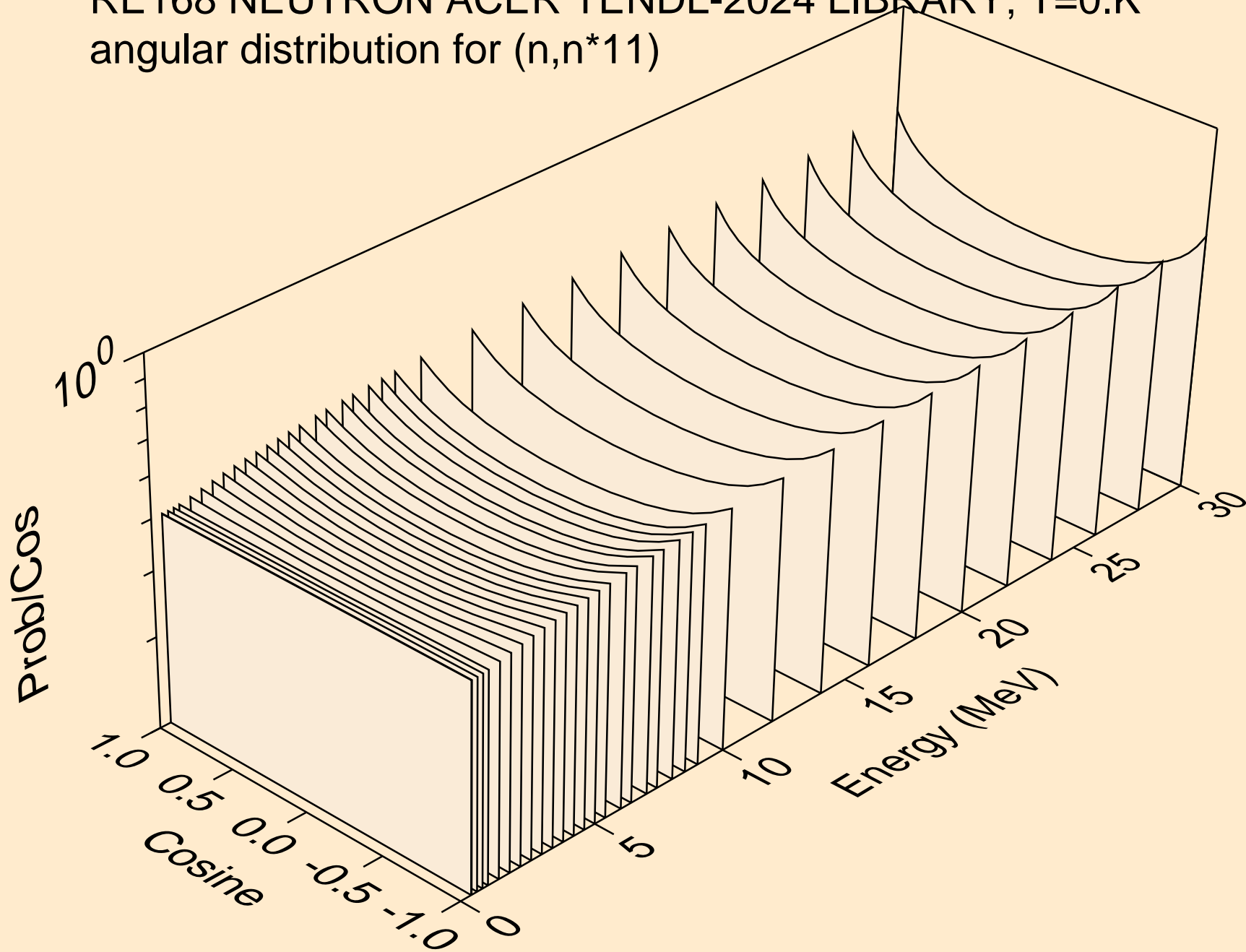

RE168 NEUTRON ACER TENDL-2024 LIBRARY; T=0.K
angular distribution for (n,n*12)

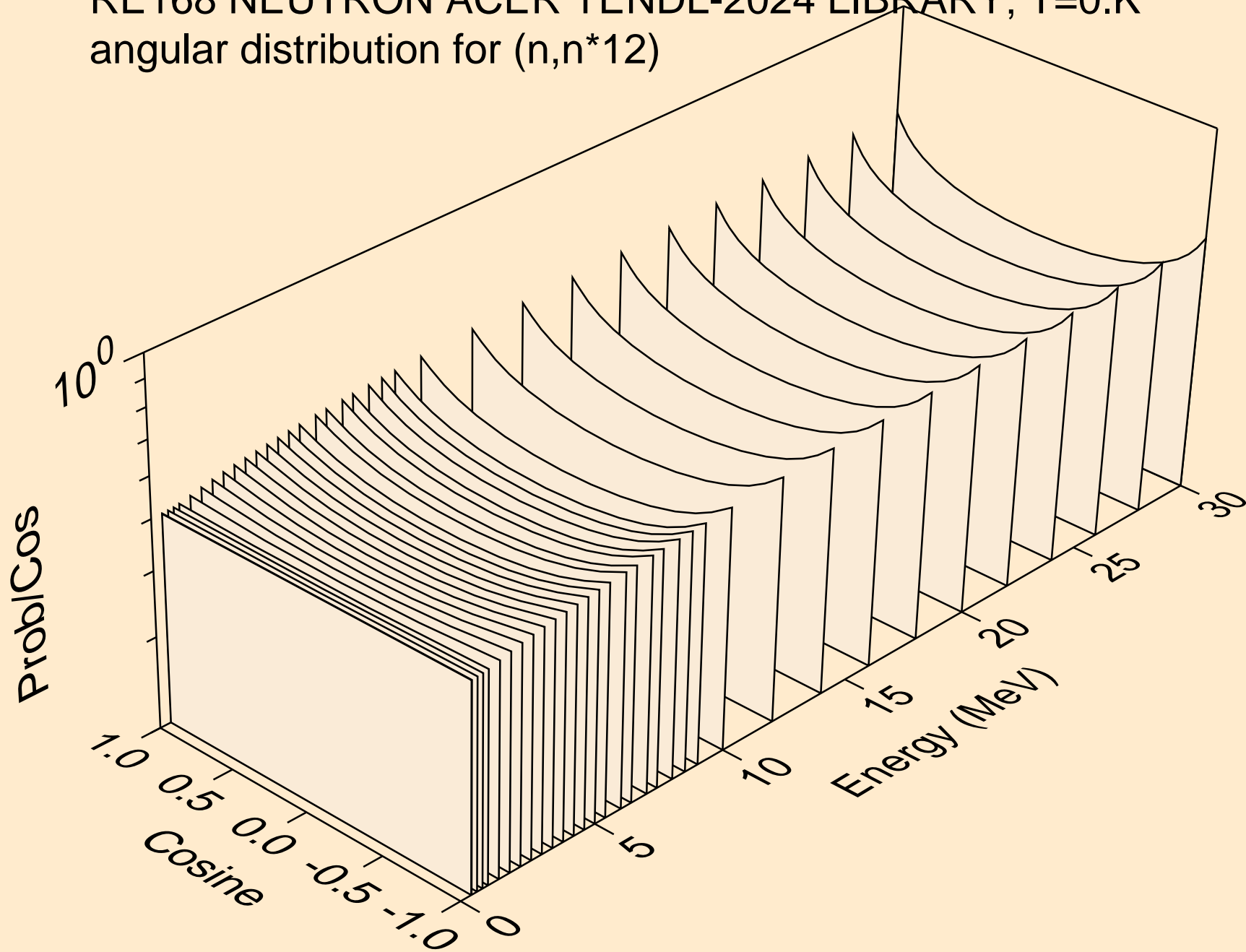

RE168 NEUTRON ACER TENDL-2024 LIBRARY; T=0.K
angular distribution for (n,n*13)

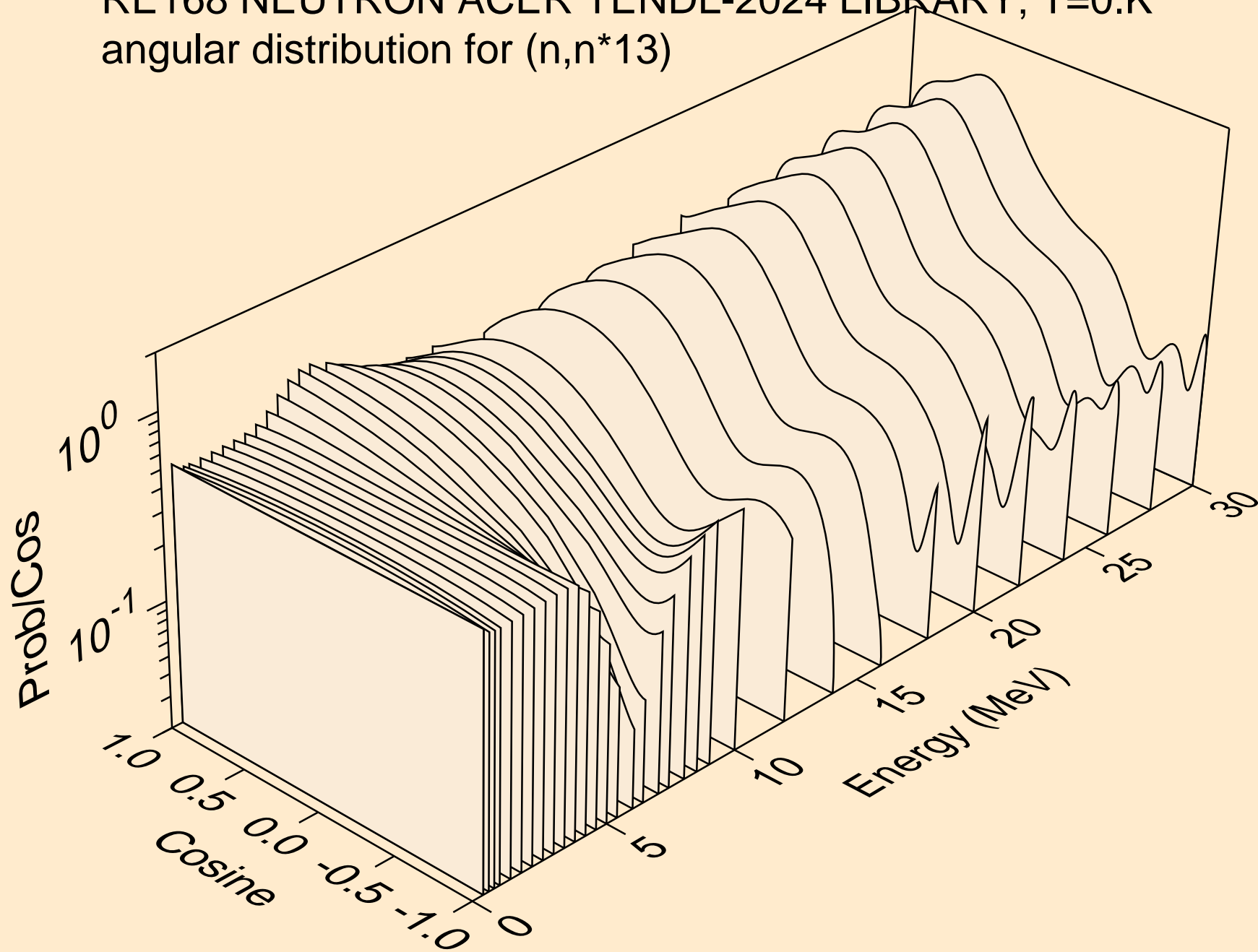

RE168 NEUTRON ACER TENDL-2024 LIBRARY; T=0.K
angular distribution for (n,n*14)

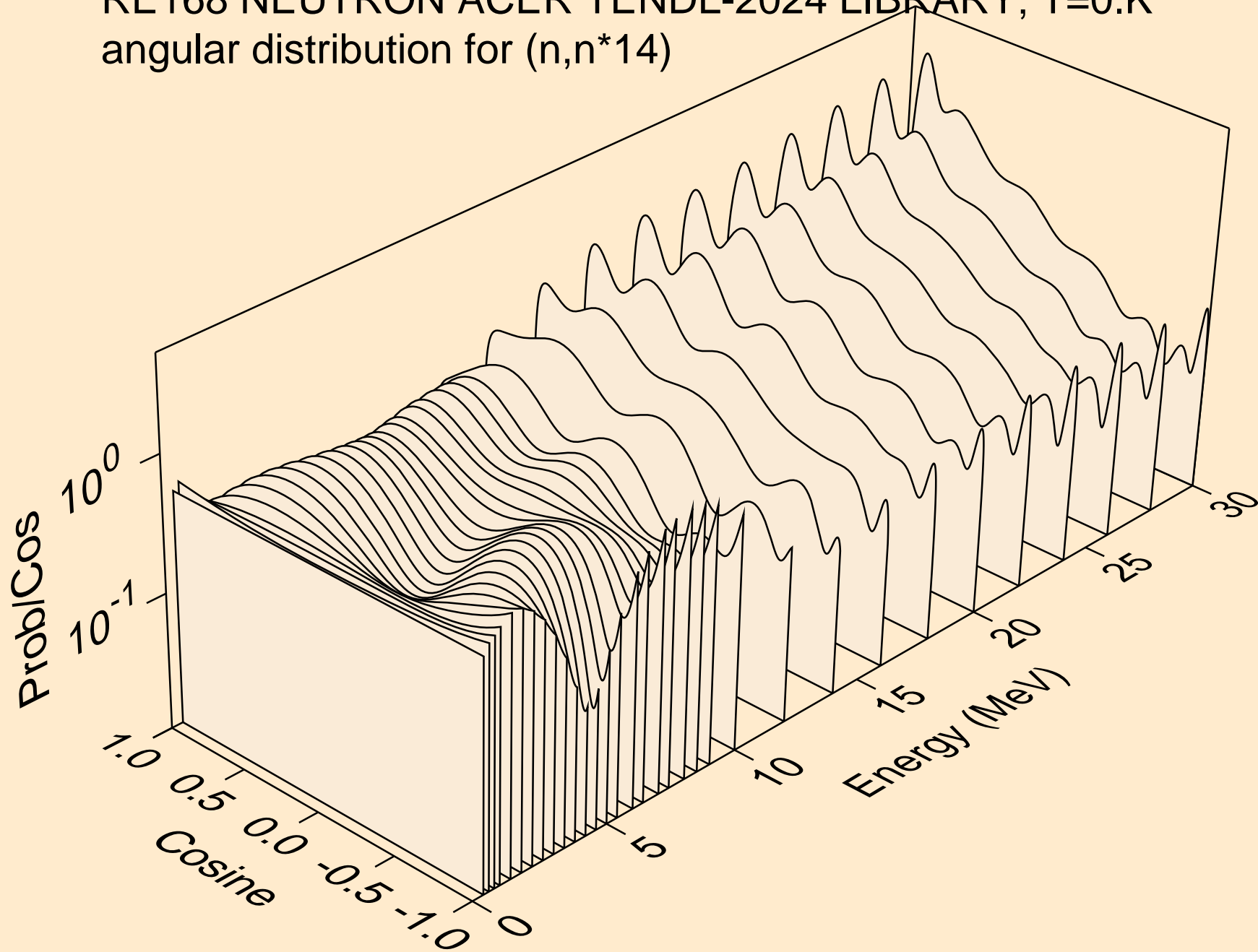

RE168 NEUTRON ACER TENDL-2024 LIBRARY; T=0.K
angular distribution for (n,n*15)

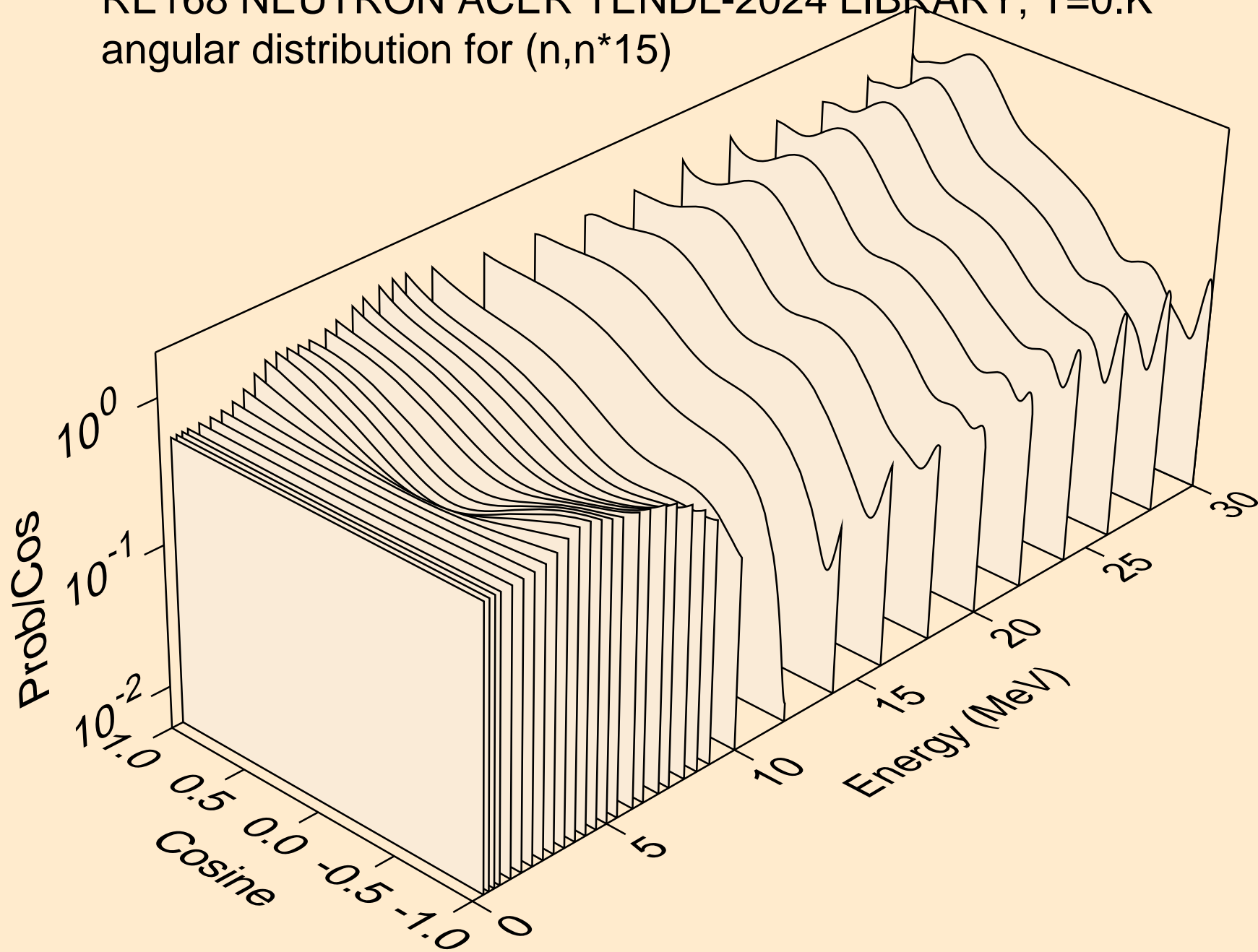

RE168 NEUTRON ACER TENDL-2024 LIBRARY; T=0.K
angular distribution for (n,n*16)

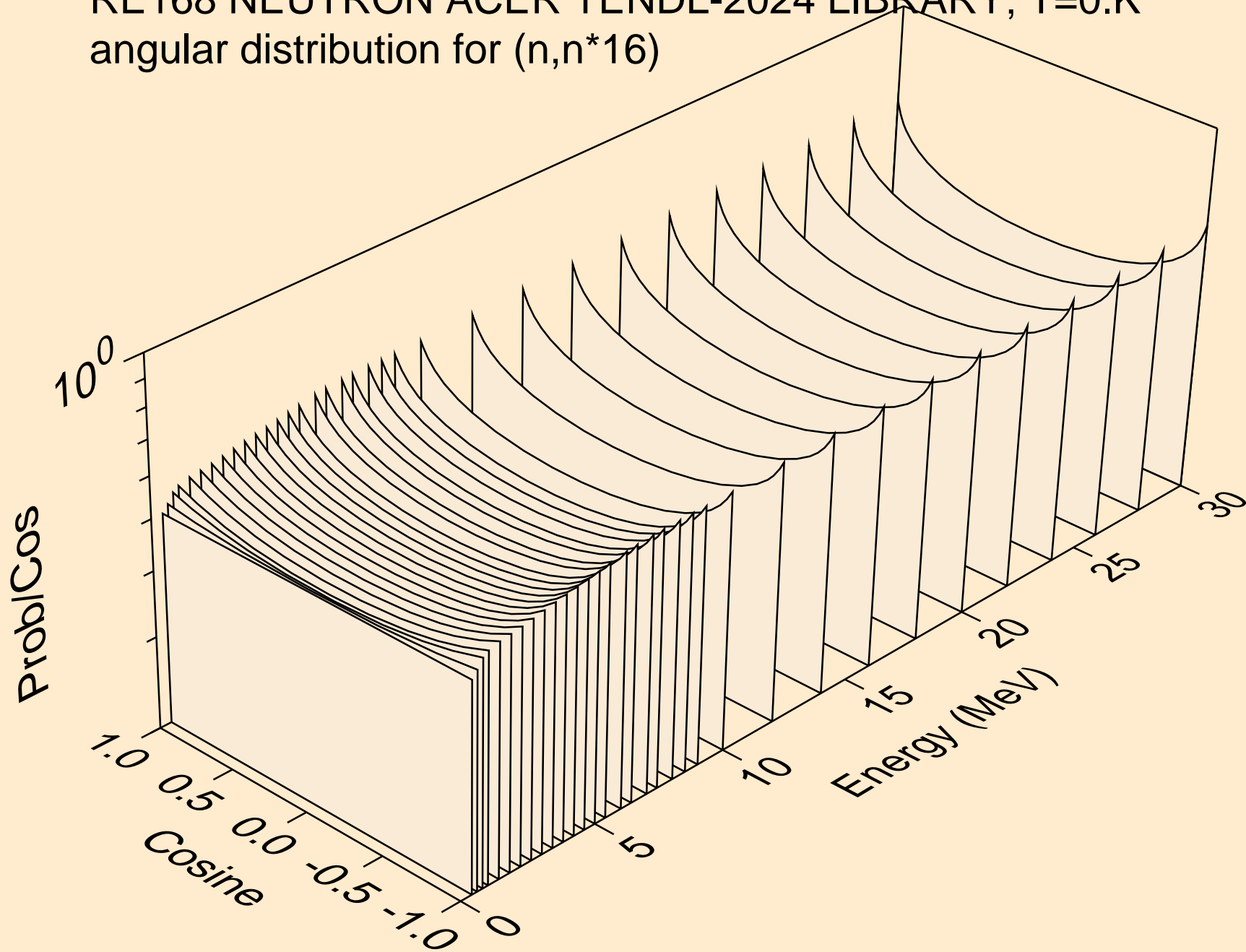

RE168 NEUTRON ACER TENDL-2024 LIBRARY; T=0.K
angular distribution for (n,n*17)

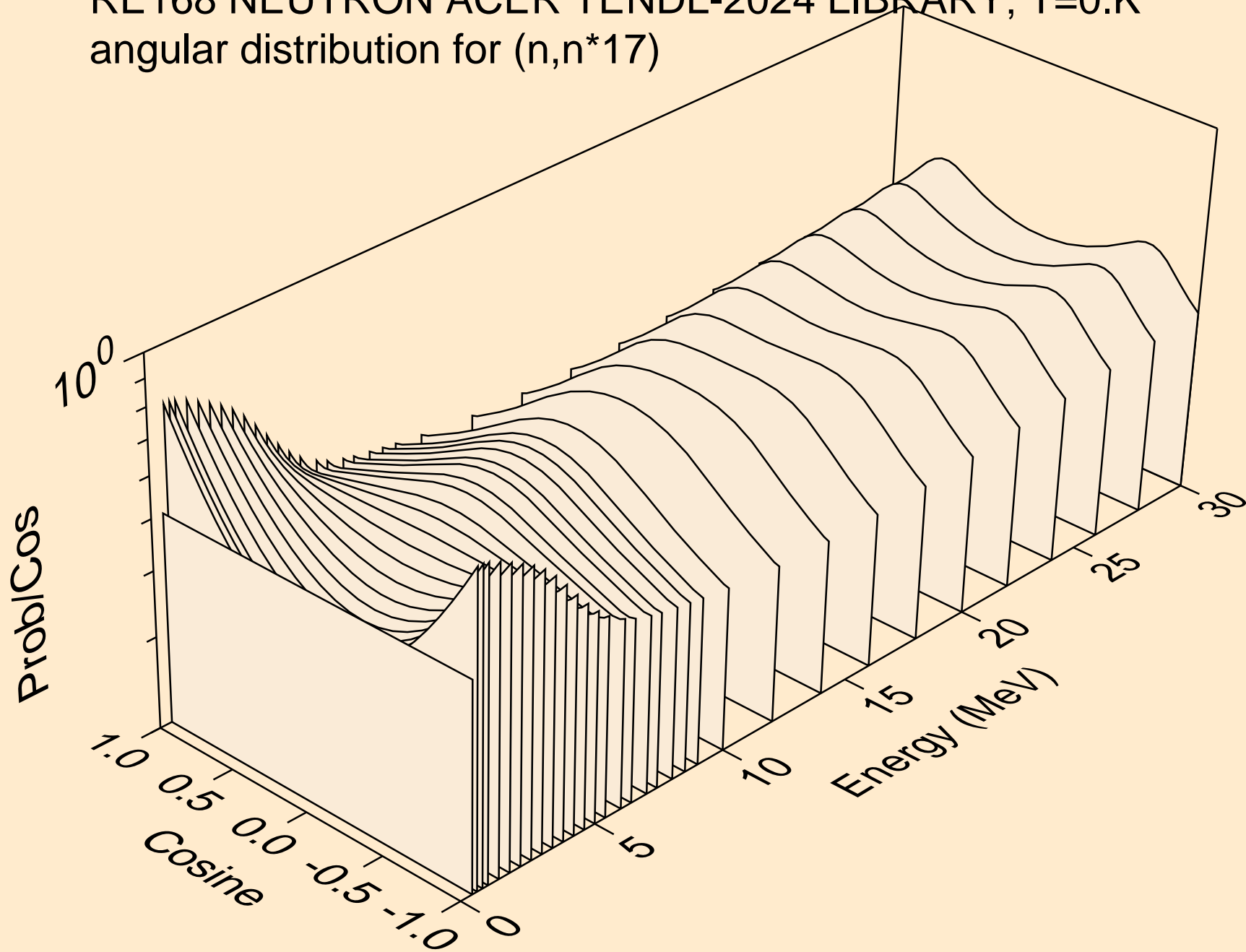

RE168 NEUTRON ACER TENDL-2024 LIBRARY; T=0.K
angular distribution for (n,n*18)

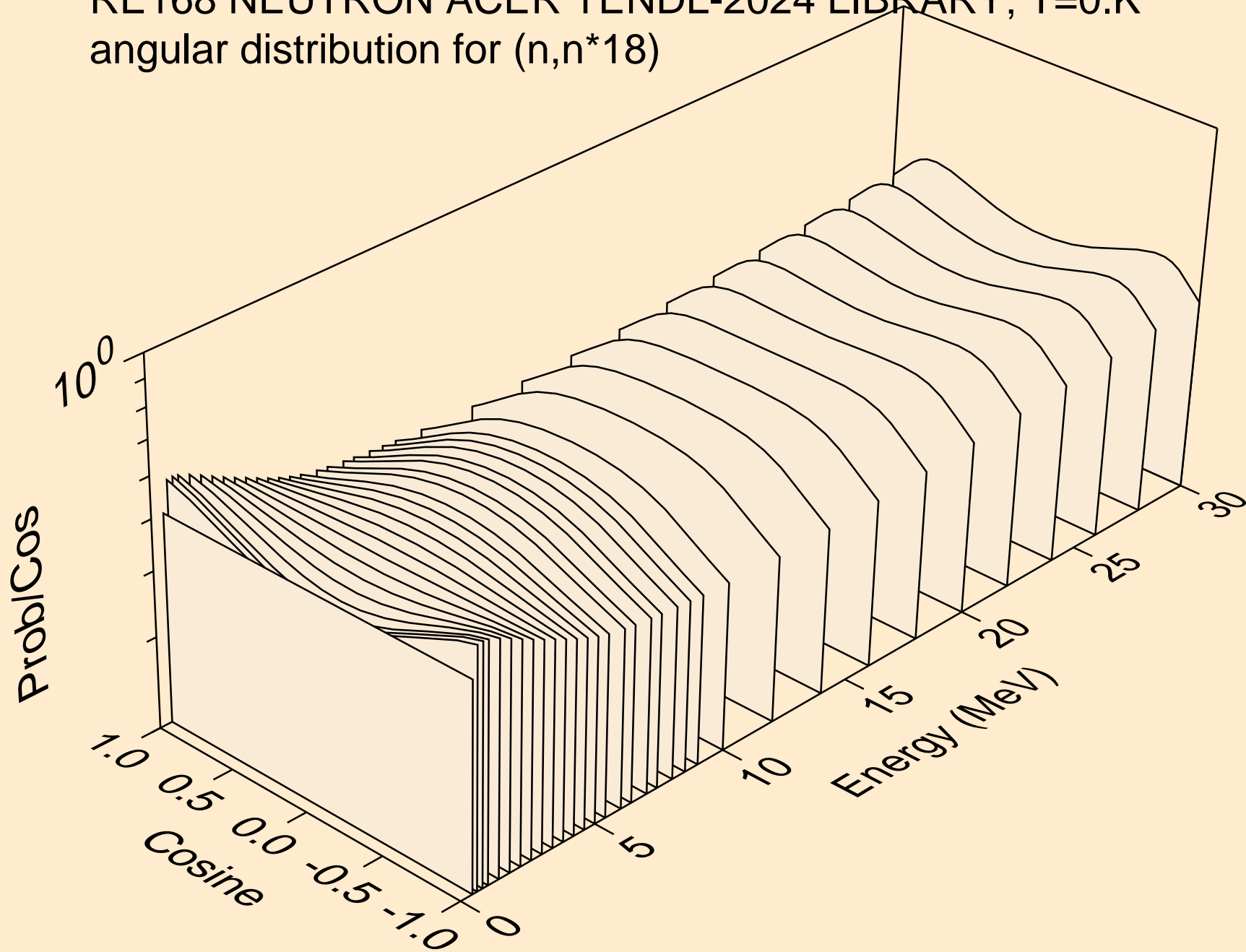

RE168 NEUTRON ACER TENDL-2024 LIBRARY; T=0.K
angular distribution for (n,n*19)

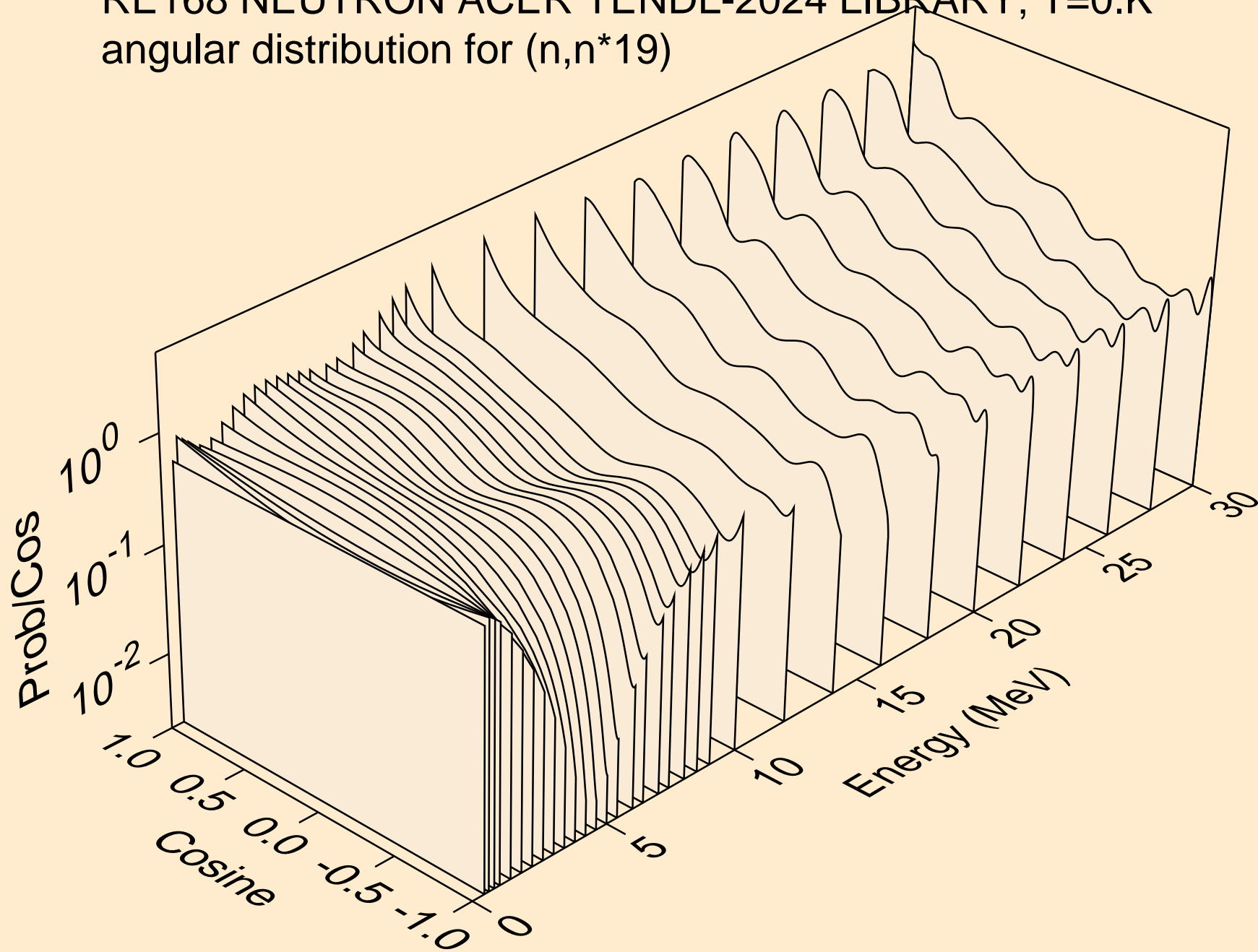

RE168 NEUTRON ACER TENDL-2024 LIBRARY; T=0.K
Neutron emission for (n,x)

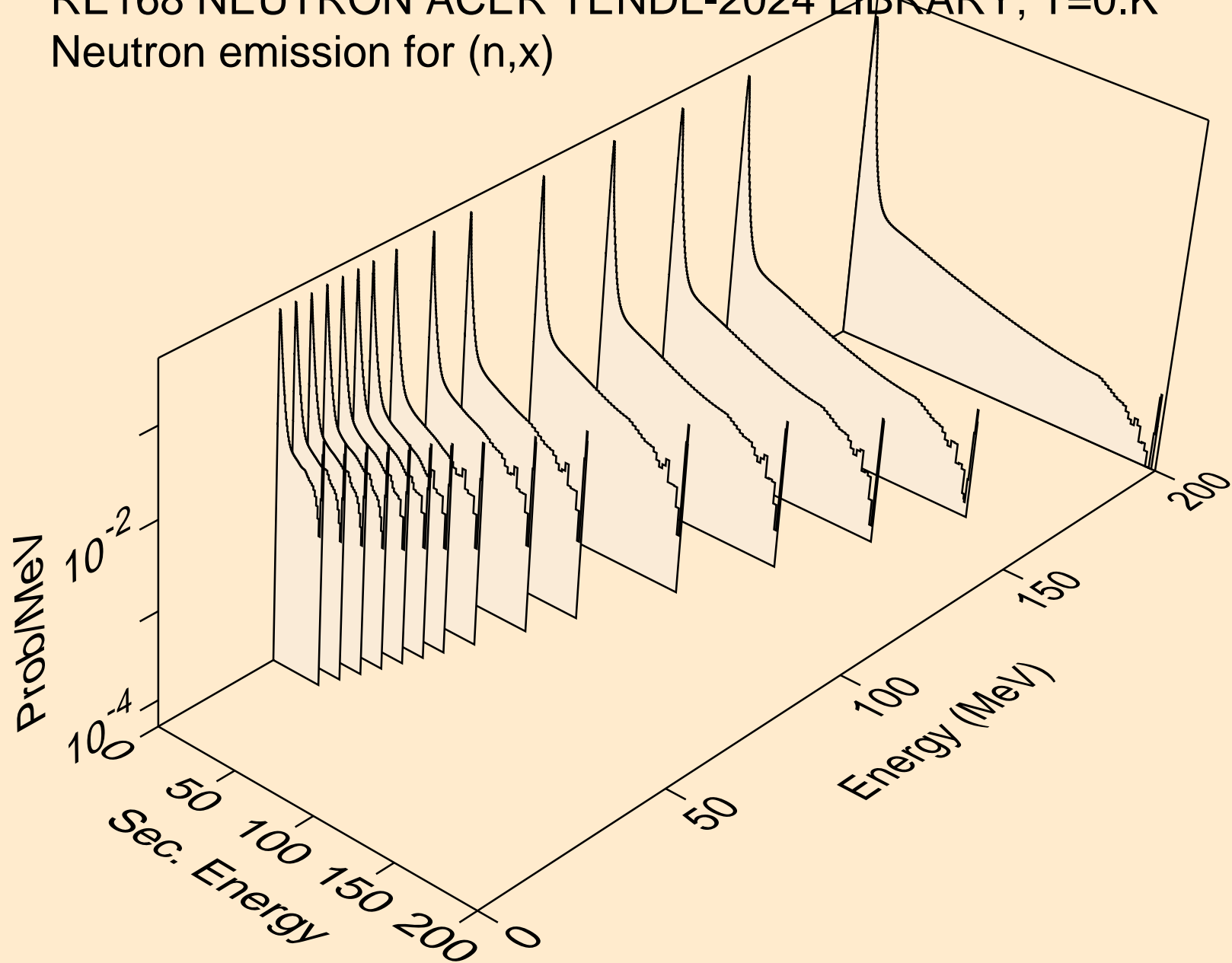

RE168 NEUTRON ACER TENDL-2024 LIBRARY; T=0.K
Neutron emission for (n,2nd)

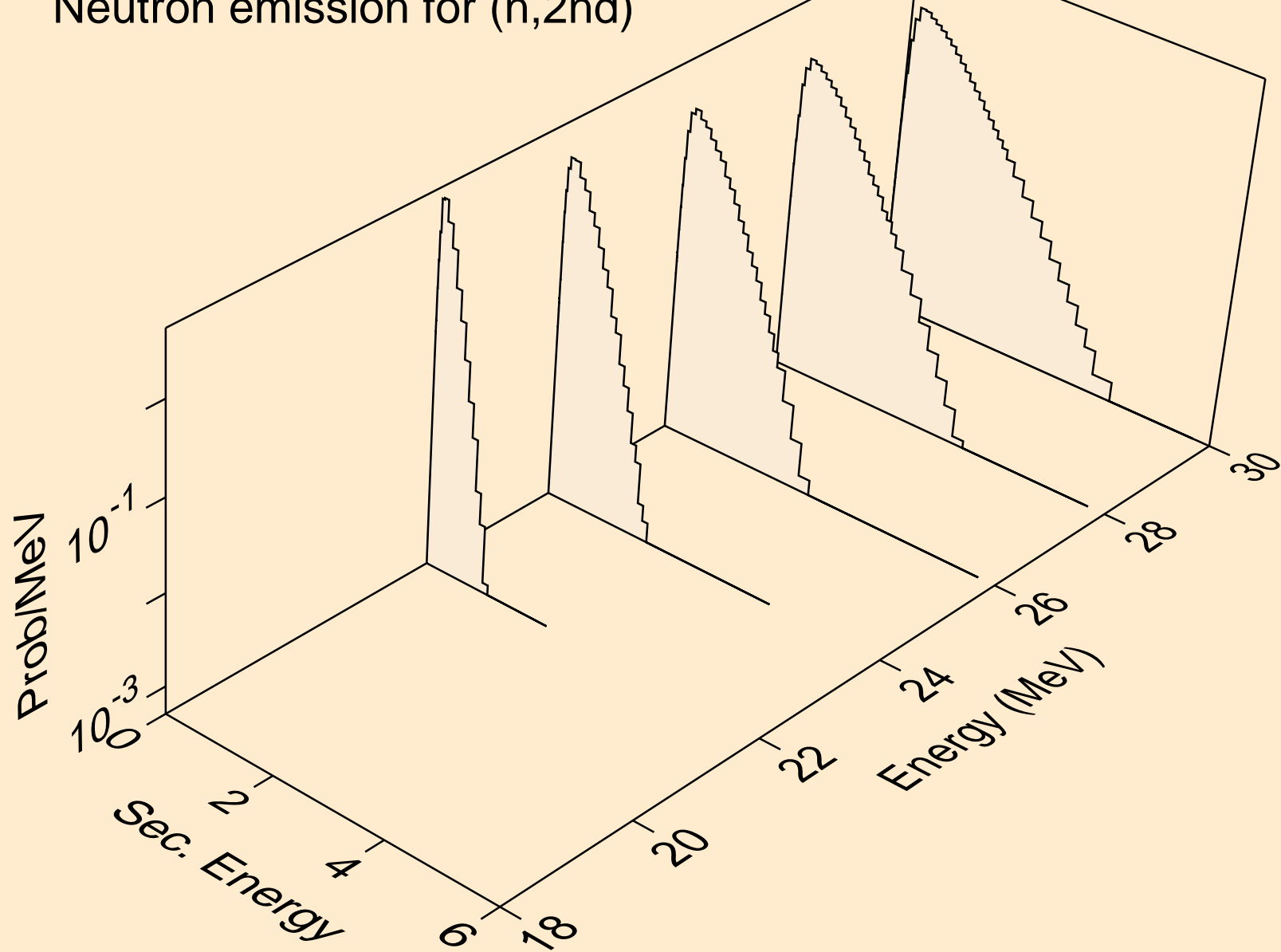

RE168 NEUTRON ACER TENDL-2024 LIBRARY; T=0.K
Neutron emission for (n,2n)

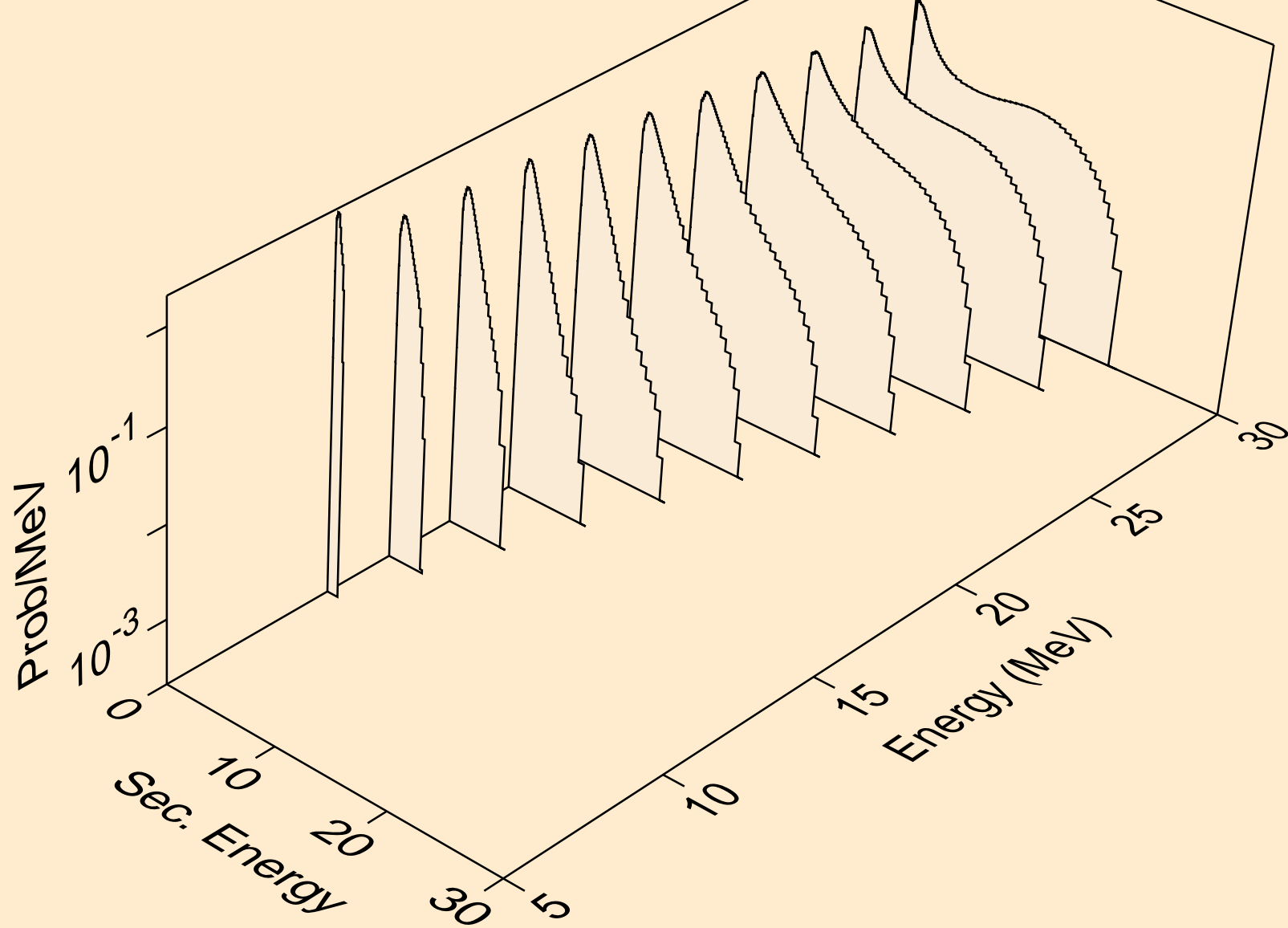

RE168 NEUTRON ACER TENDL-2024 LIBRARY; T=0.K
Neutron emission for (n,3n)

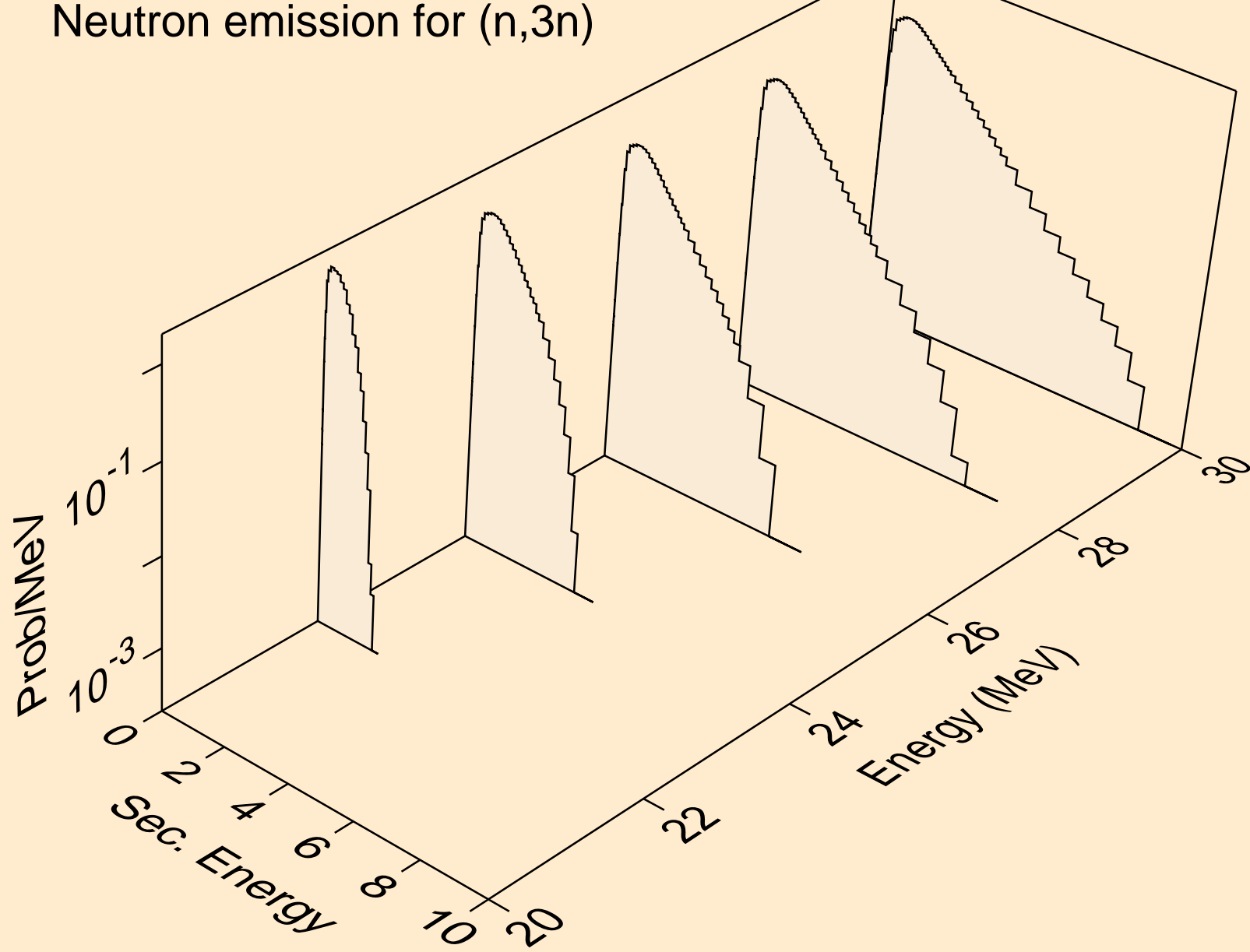

RE168 NEUTRON ACER TENDL-2024 LIBRARY; T=0.K
Neutron emission for (n,n*)a

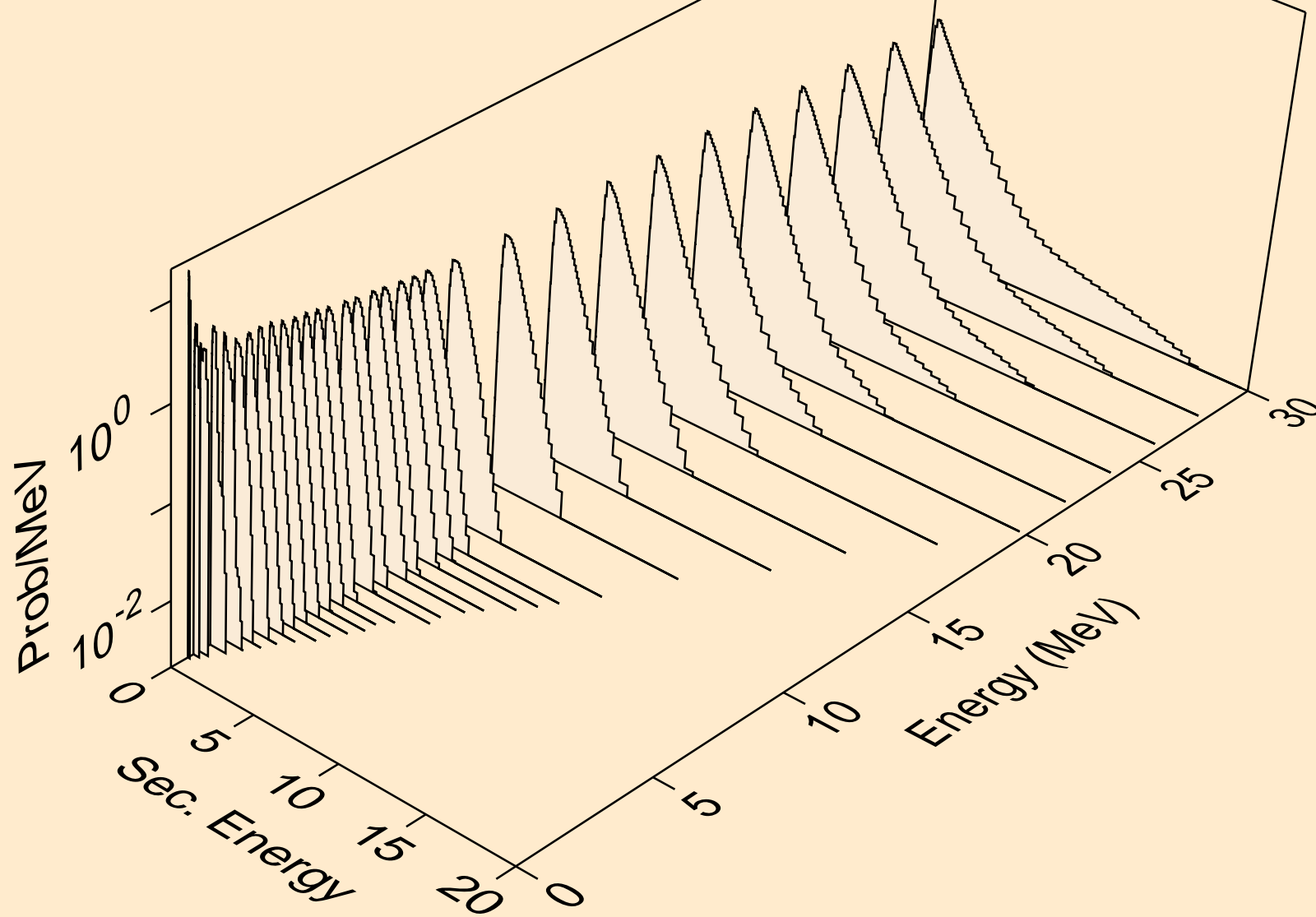

RE168 NEUTRON ACER TENDL-2024 LIBRARY; T=0.K
Neutron emission for (n,n*)3a

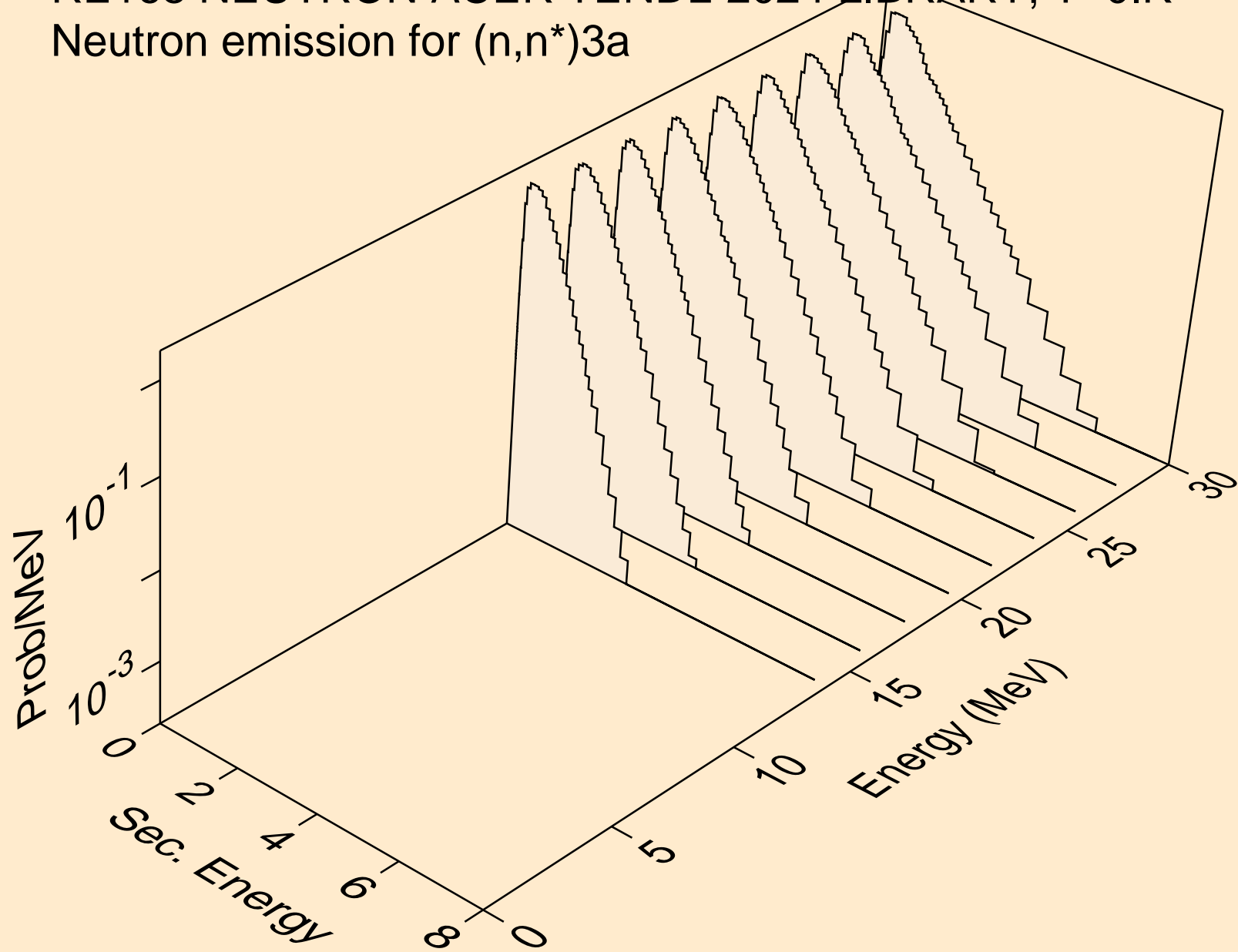

RE168 NEUTRON ACER TENDL-2024 LIBRARY; T=0.K
Neutron emission for (n,2n)a

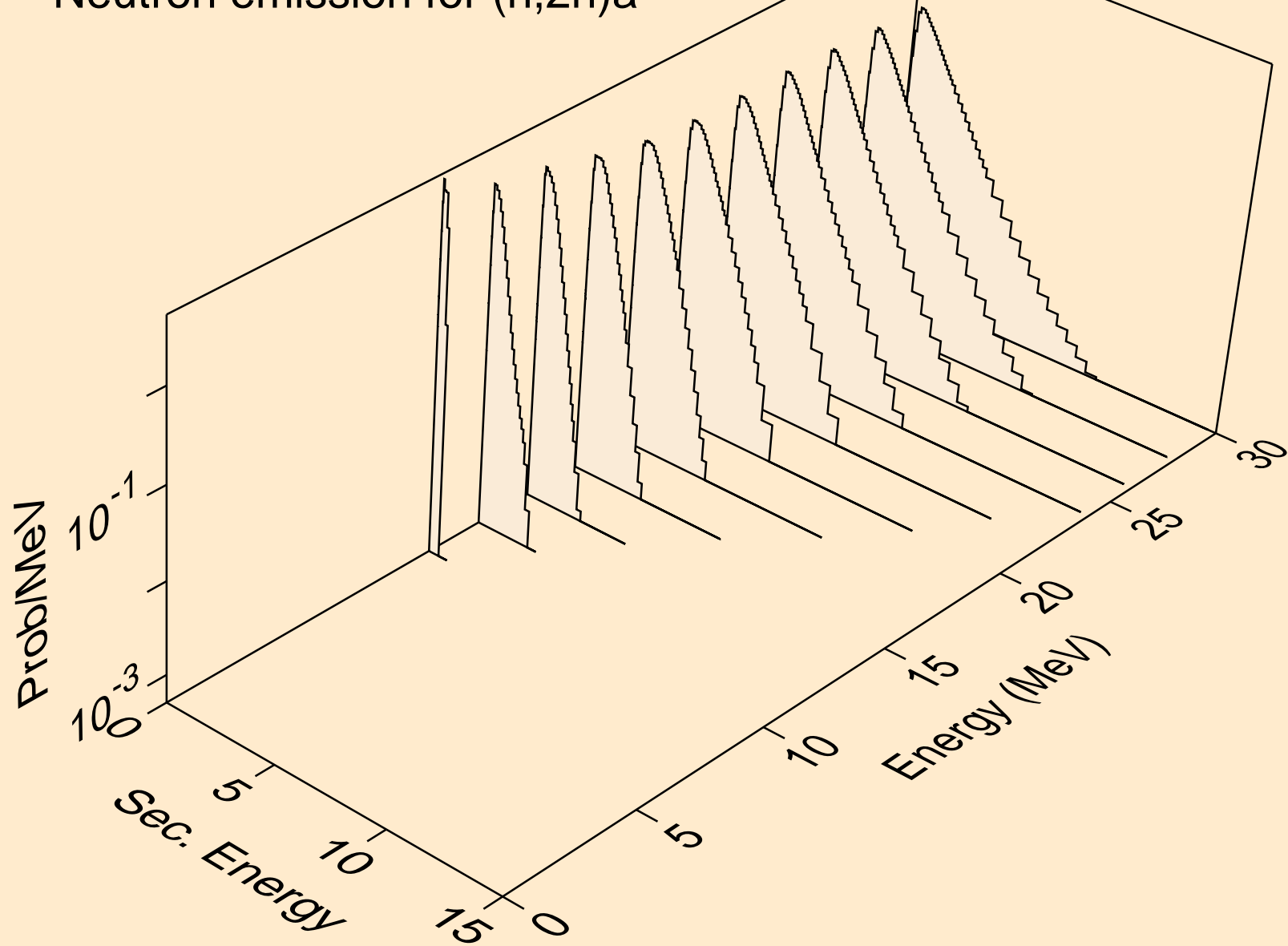

RE168 NEUTRON ACER TENDL-2024 LIBRARY; T=0.K
Neutron emission for (n,3n)a

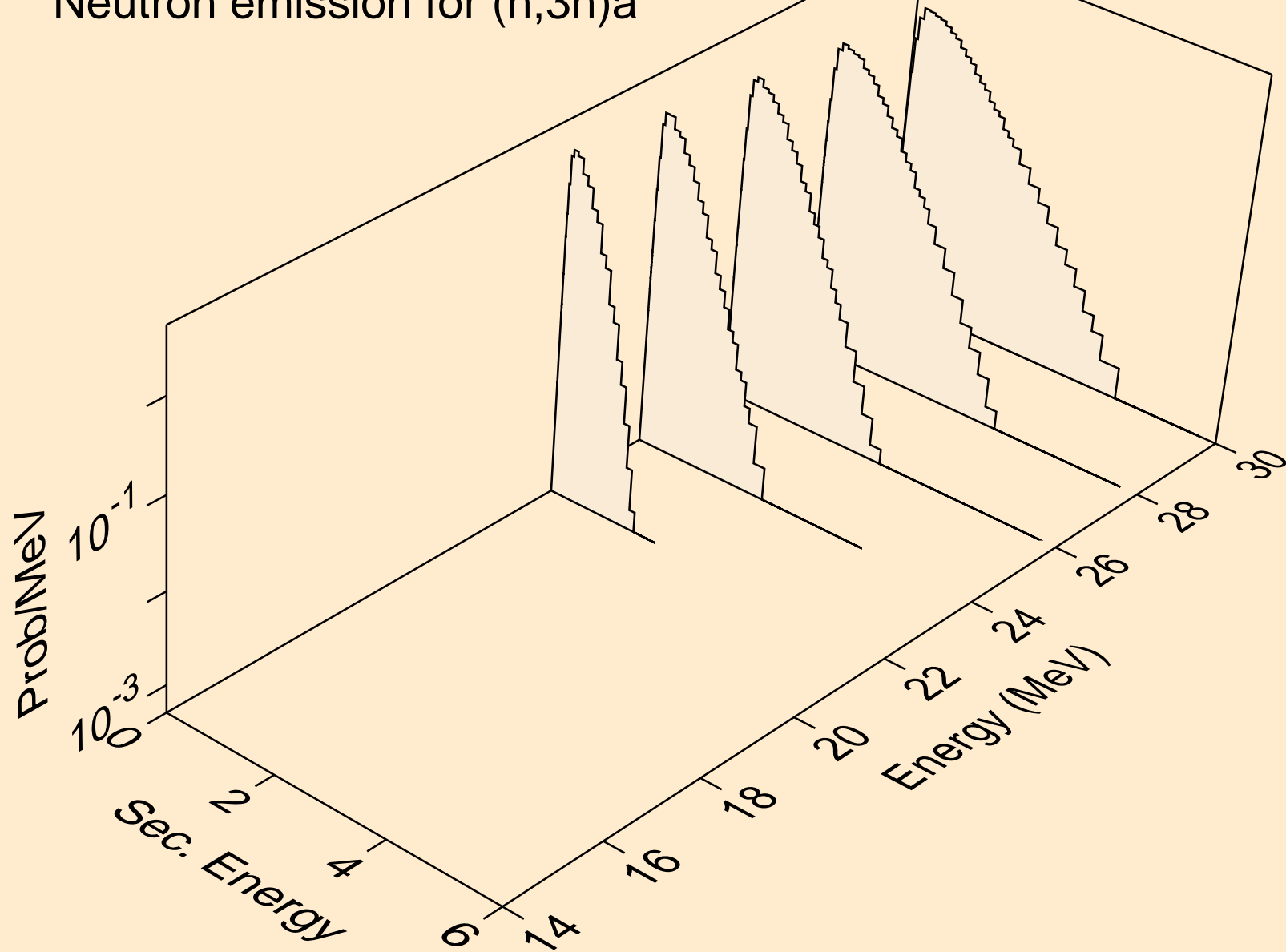

RE168 NEUTRON ACER TENDL-2024 LIBRARY; T=0.K
Neutron emission for (n,n*)p

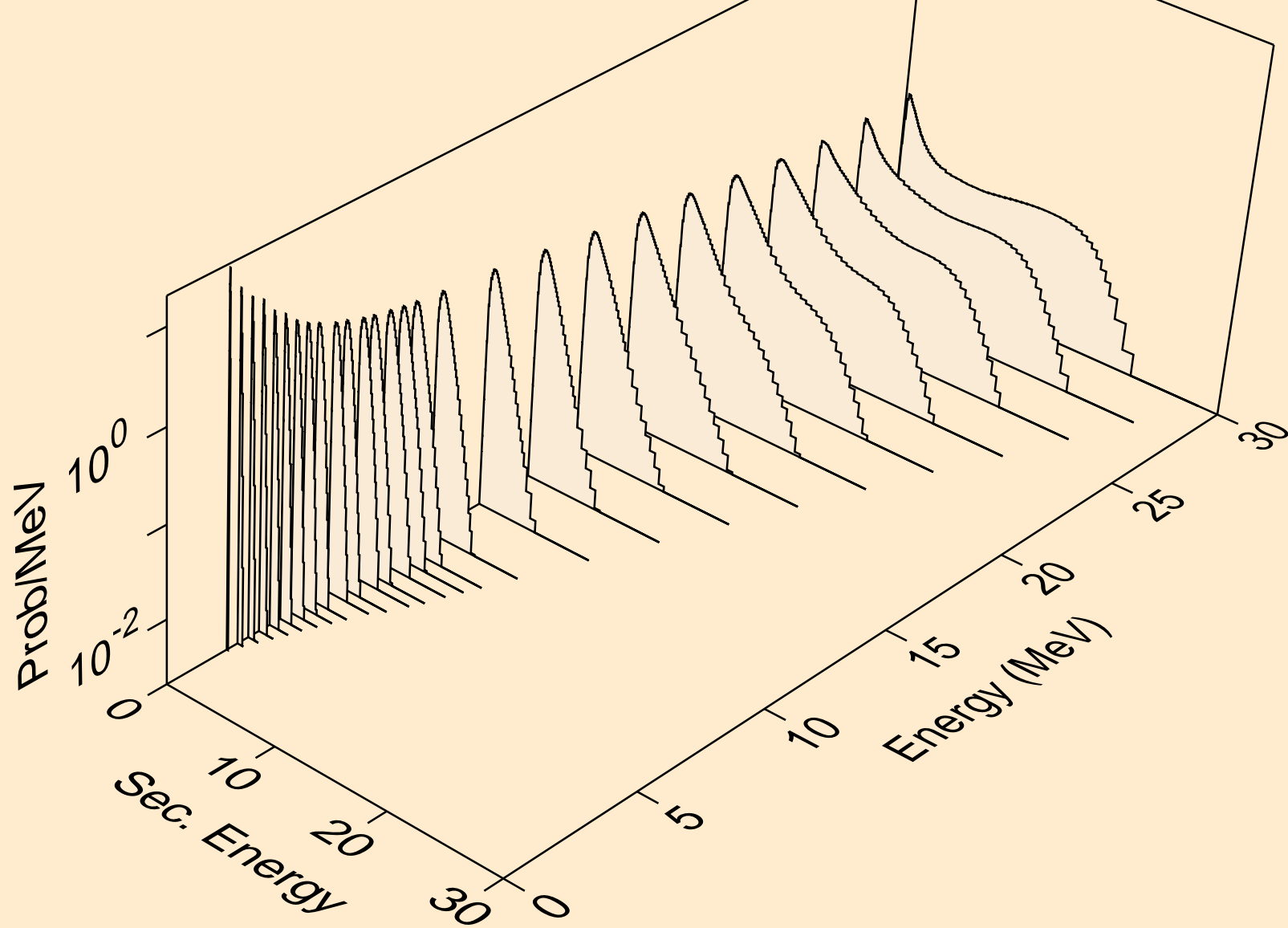

RE168 NEUTRON ACER TENDL-2024 LIBRARY; T=0.K
Neutron emission for (n,n*)2a

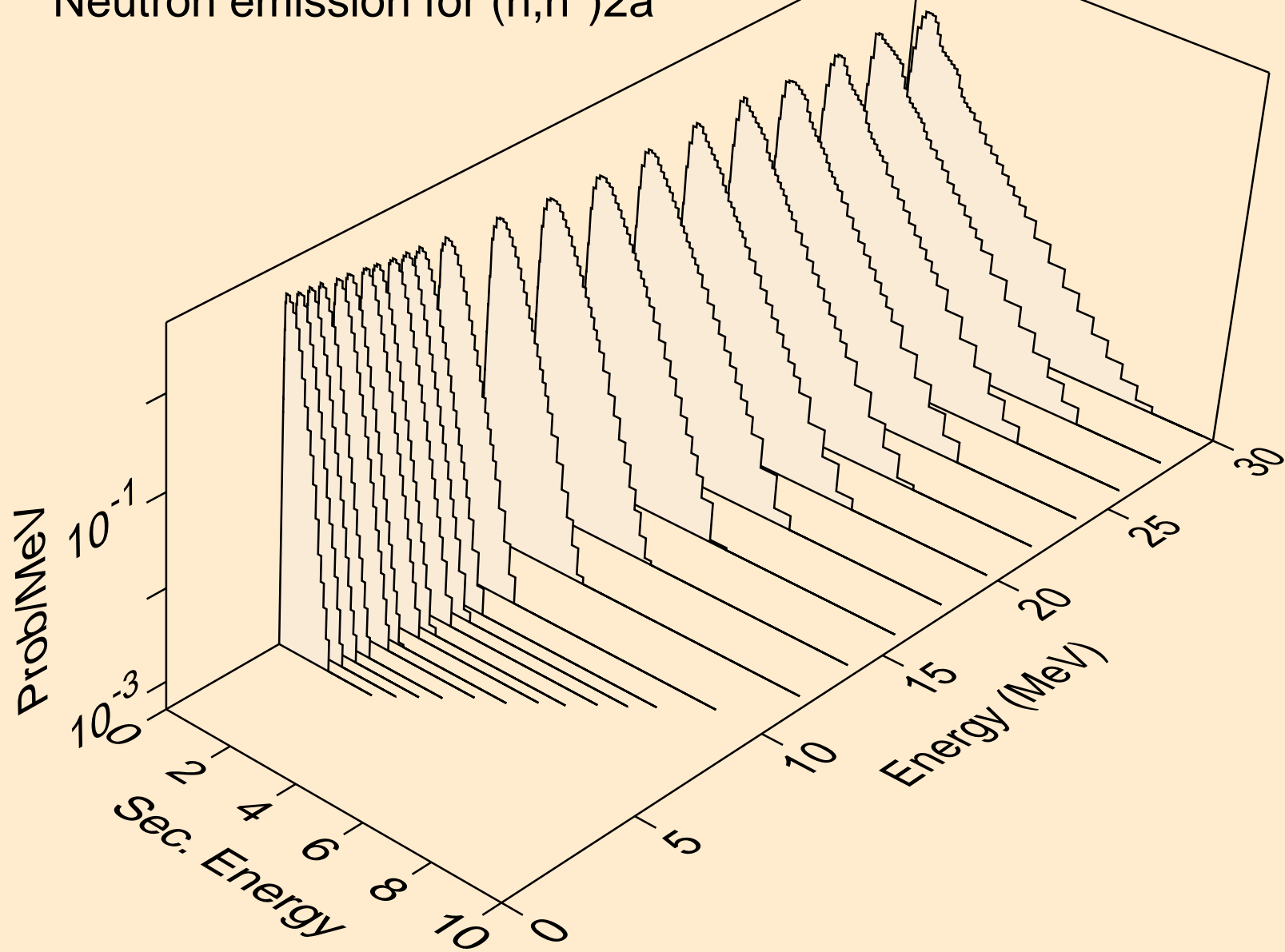

RE168 NEUTRON ACER TENDL-2024 LIBRARY; T=0.K
Neutron emission for (n,2n)2a

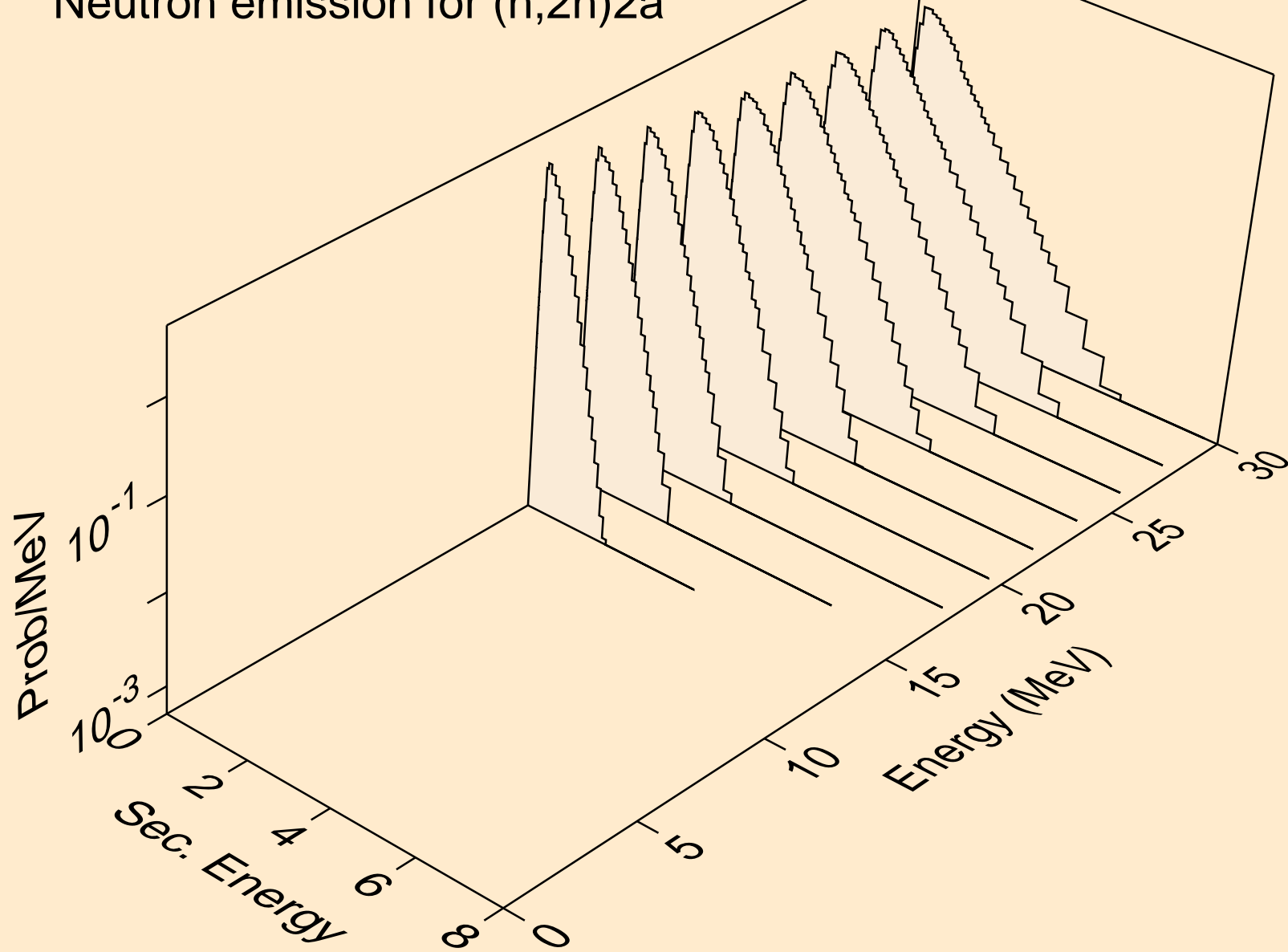

RE168 NEUTRON ACER TENDL-2024 LIBRARY; T=0.K
Neutron emission for (n,n*)d

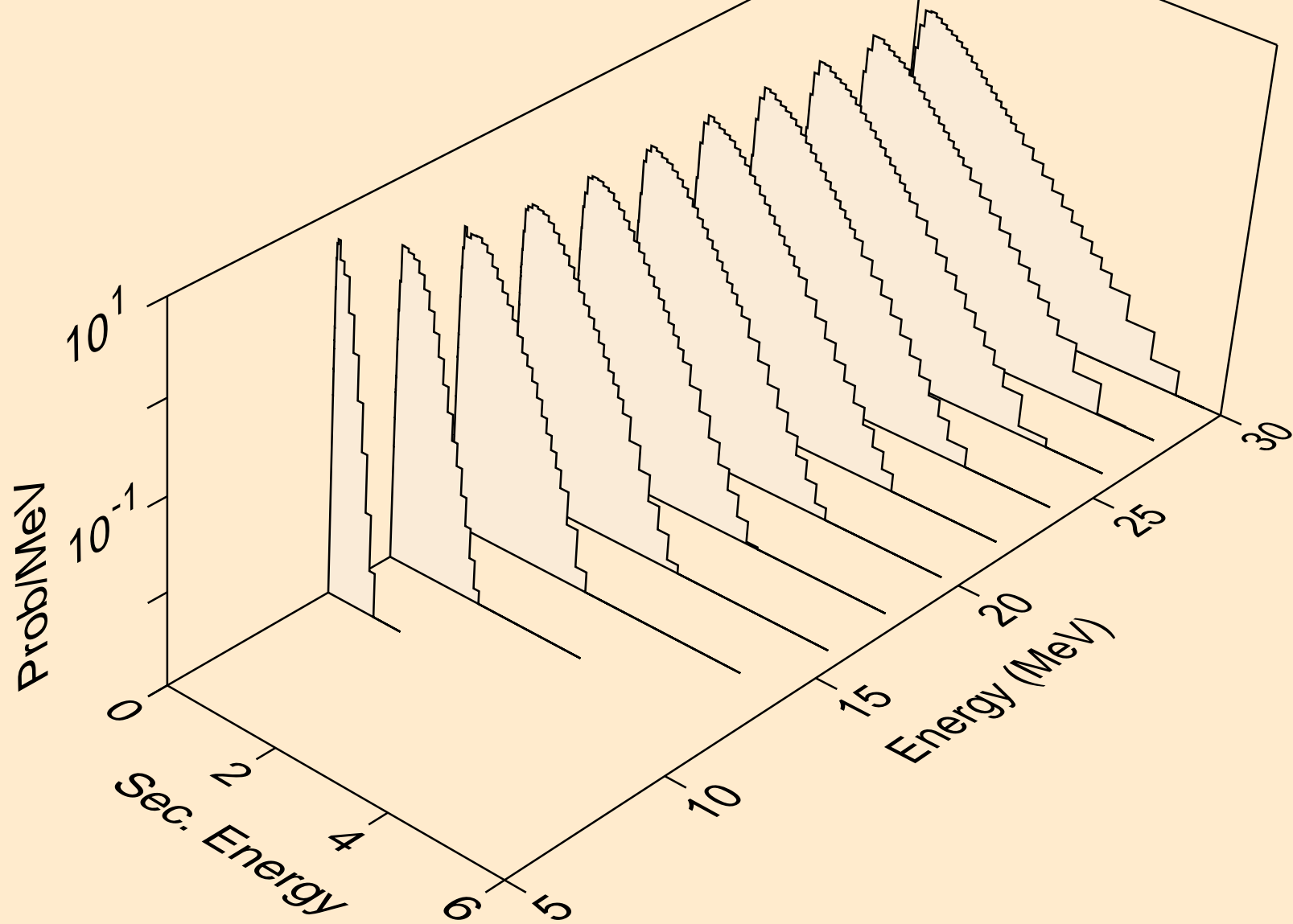

RE168 NEUTRON ACER TENDL-2024 LIBRARY; T=0.K
Neutron emission for (n,n*)t

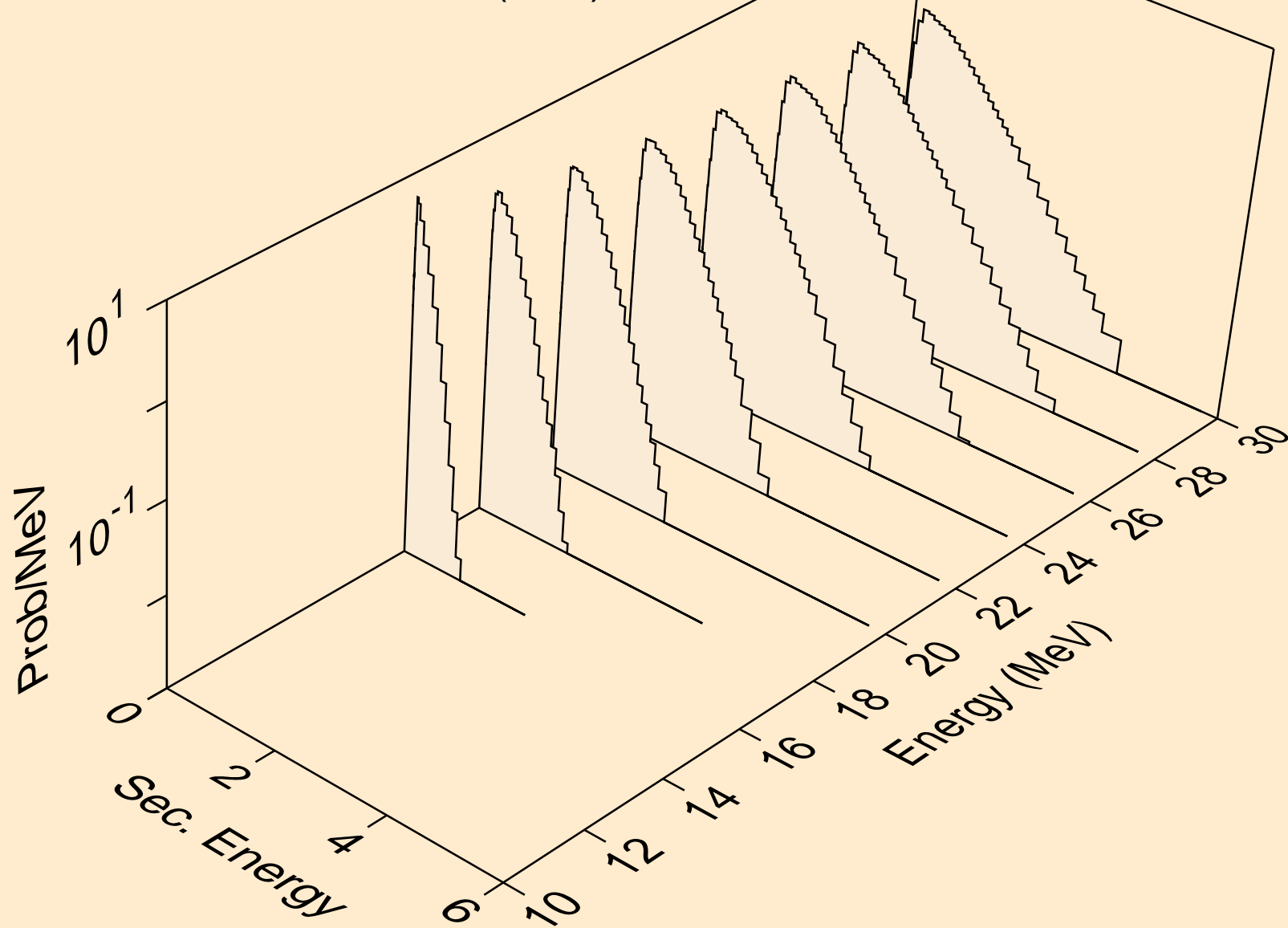

RE168 NEUTRON ACER TENDL-2024 LIBRARY; T=0.K
Neutron emission for (n,n*)he3

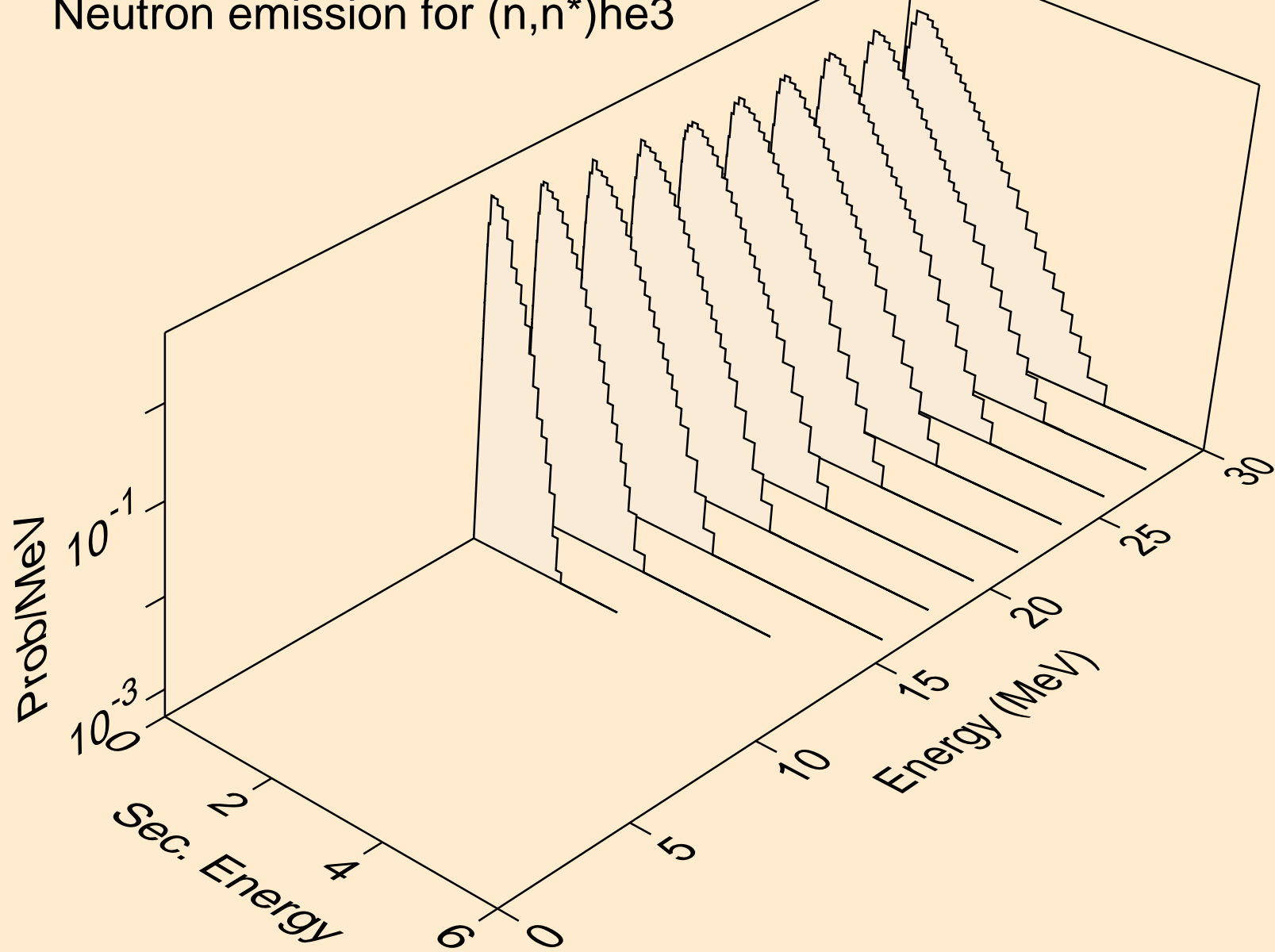

RE168 NEUTRON ACER TENDL-2024 LIBRARY; T=0.K
Neutron emission for (n,2np)

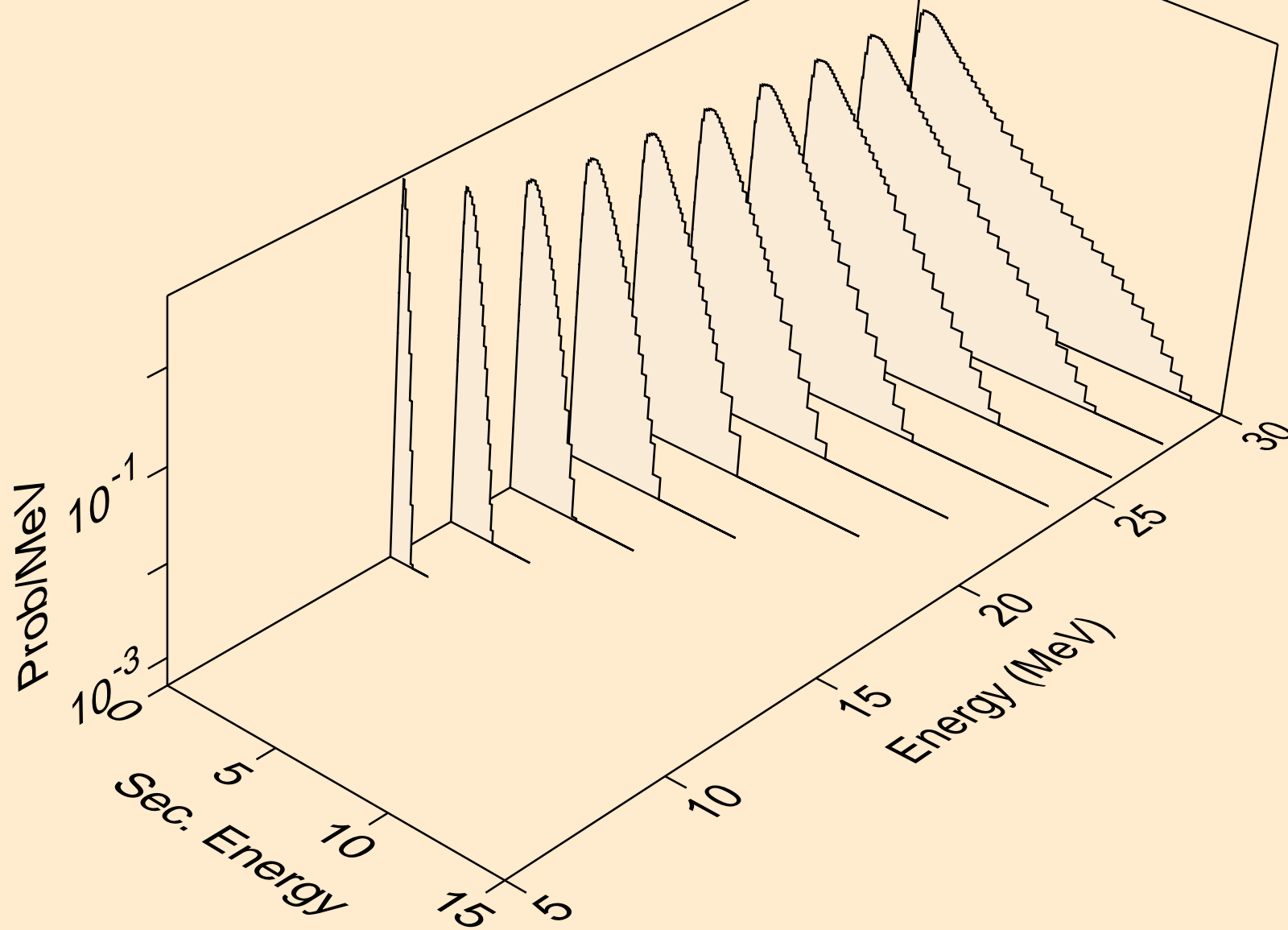

RE168 NEUTRON ACER TENDL-2024 LIBRARY; T=0.K
Neutron emission for (n,3np)

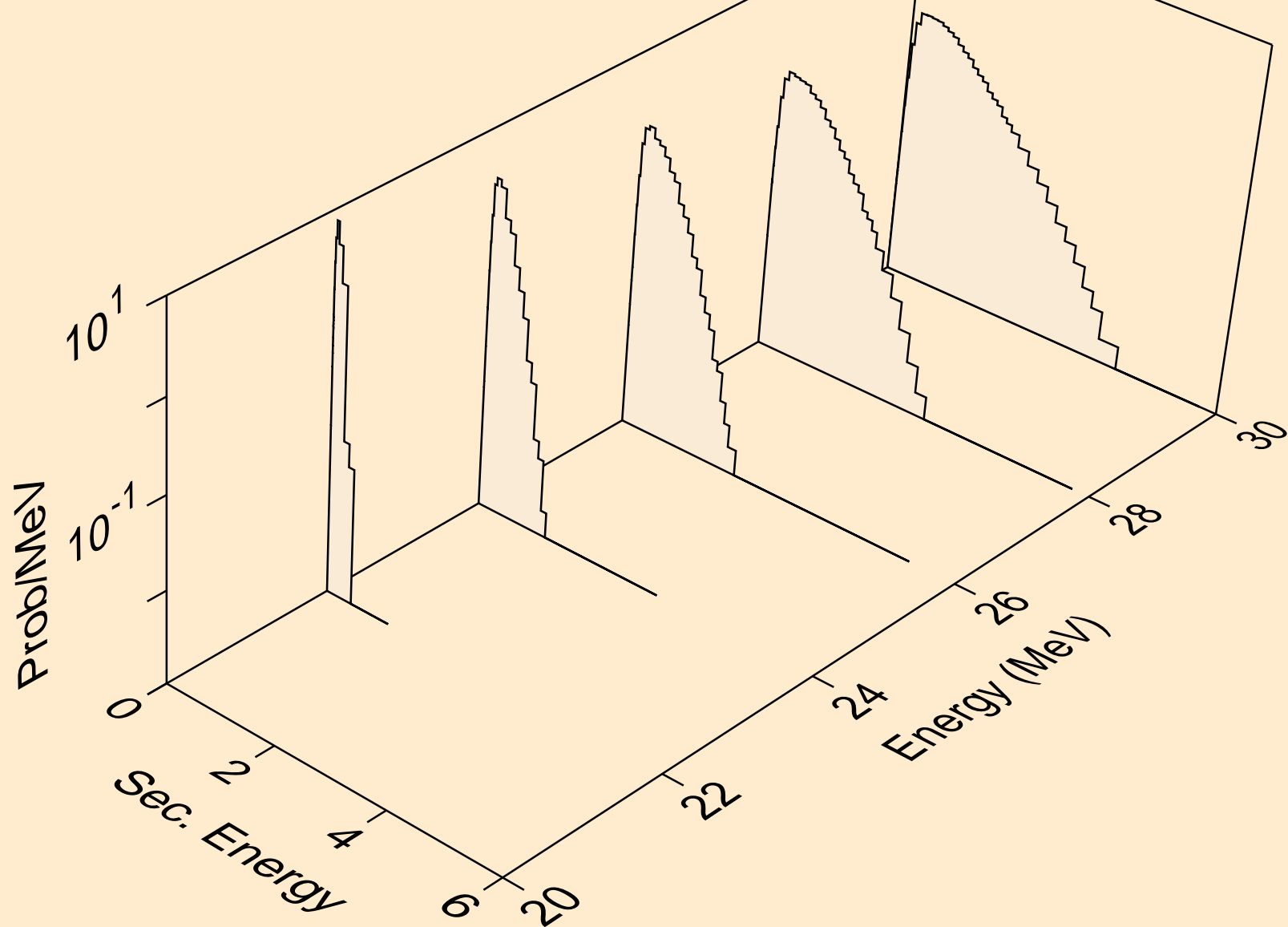

RE168 NEUTRON ACER TENDL-2024 LIBRARY; T=0.K
Neutron emission for (n,n2p)

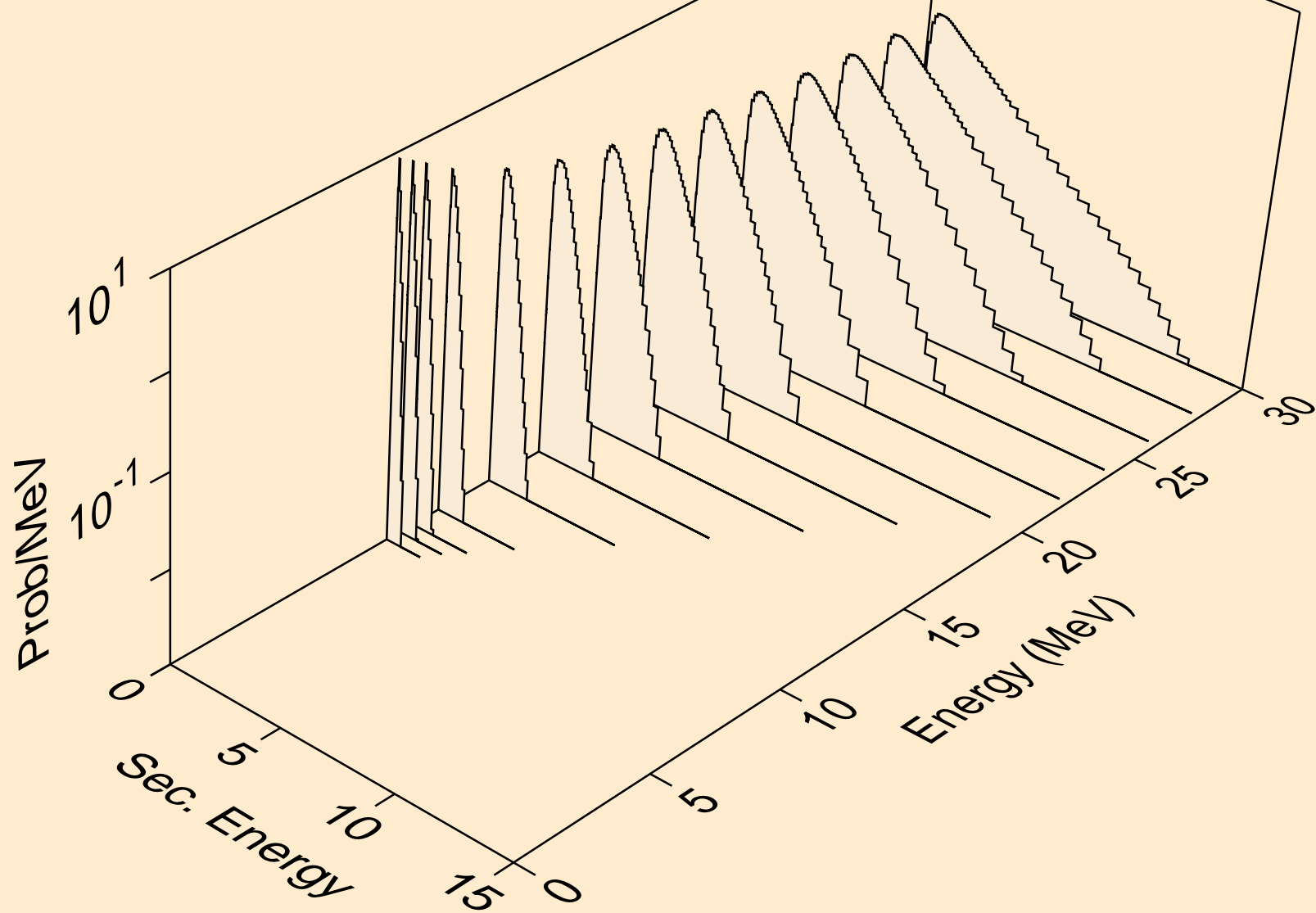

RE168 NEUTRON ACER TENDL-2024 LIBRARY; T=0.K
Neutron emission for (n,npa)

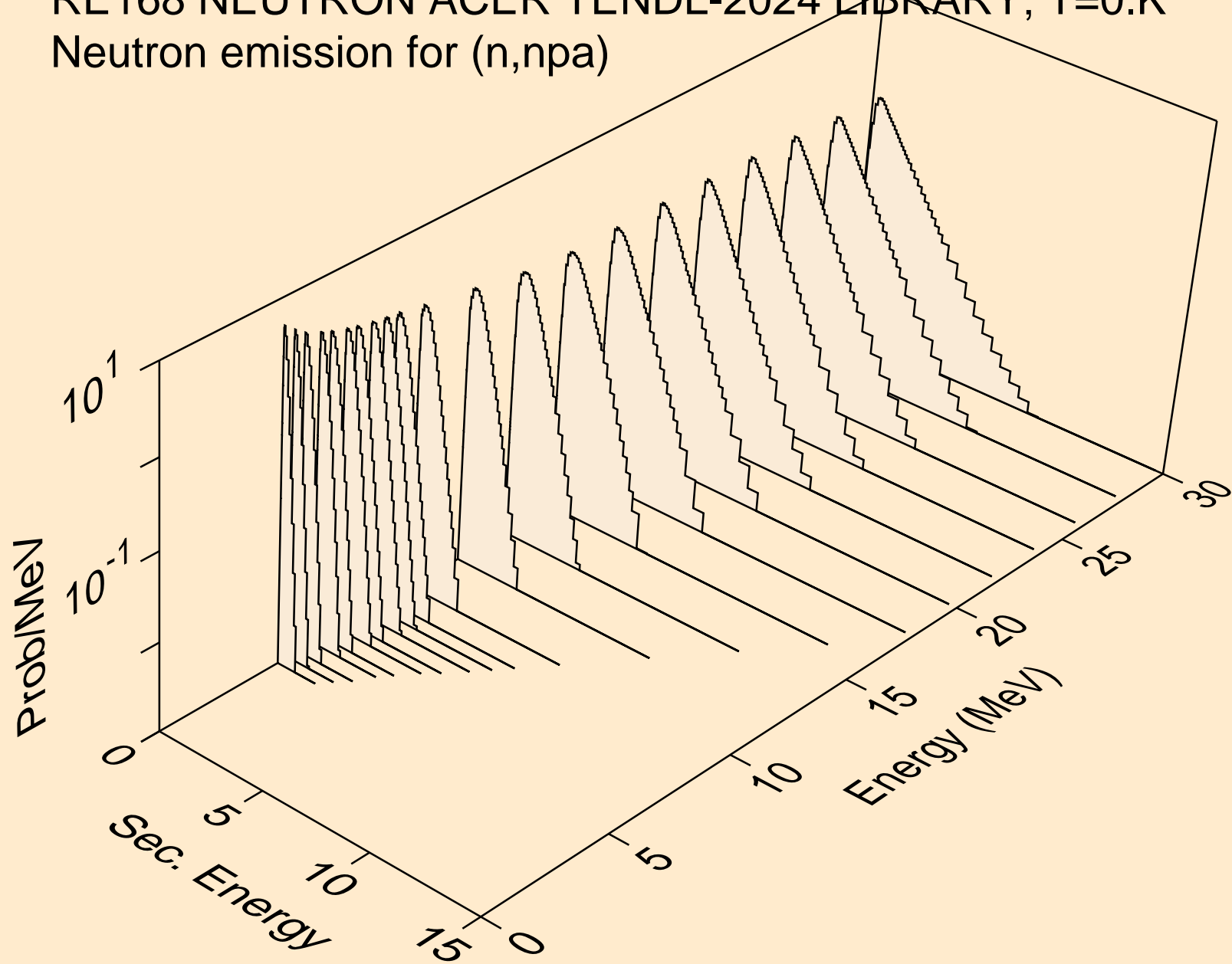

RE168 NEUTRON ACER TENDL-2024 LIBRARY; T=0.K
Neutron emission for (n,n*c)

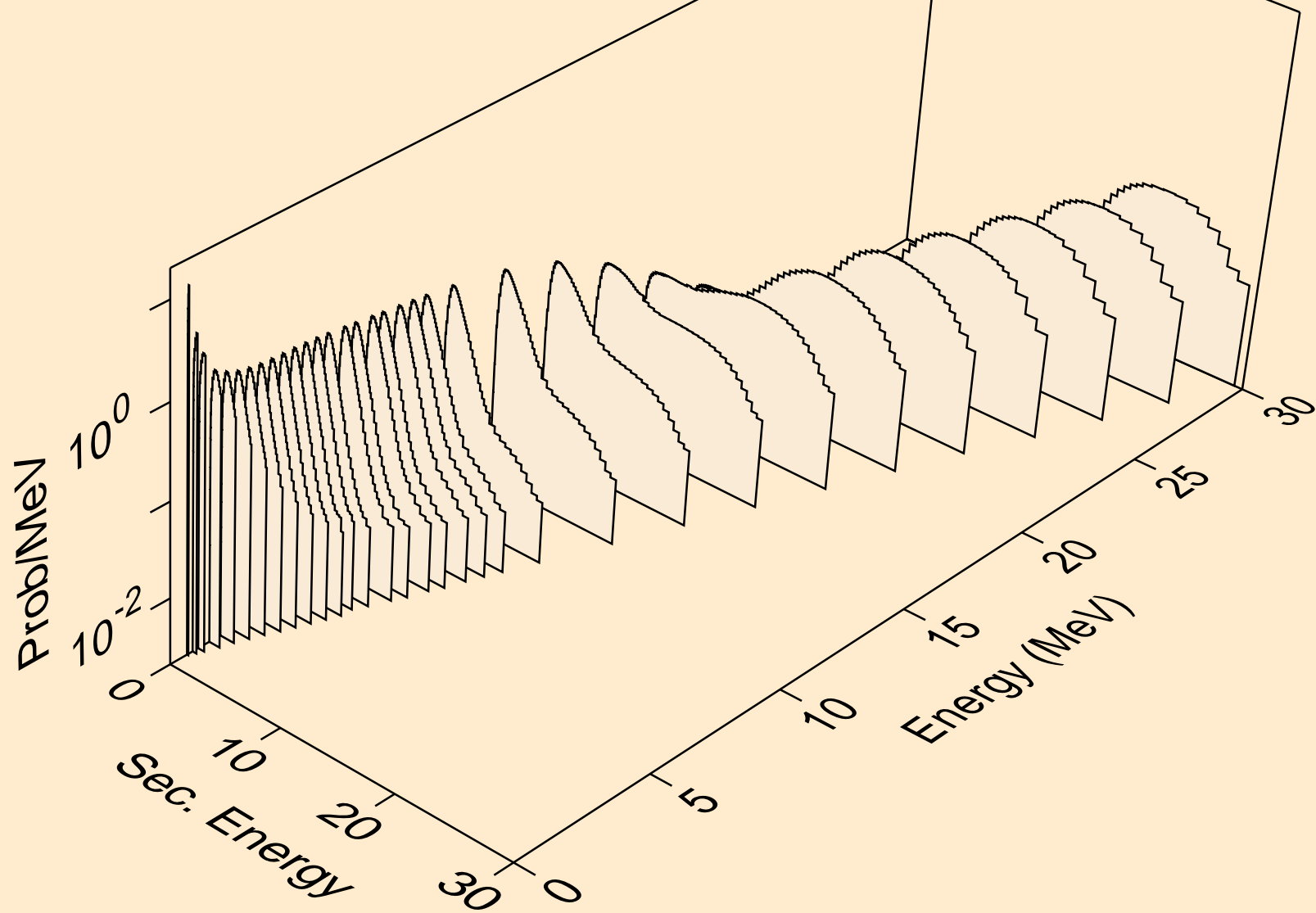

RE168 NEUTRON ACER TENDL-2024 LIBRARY; T=0.K
Photon emission for (n,x)

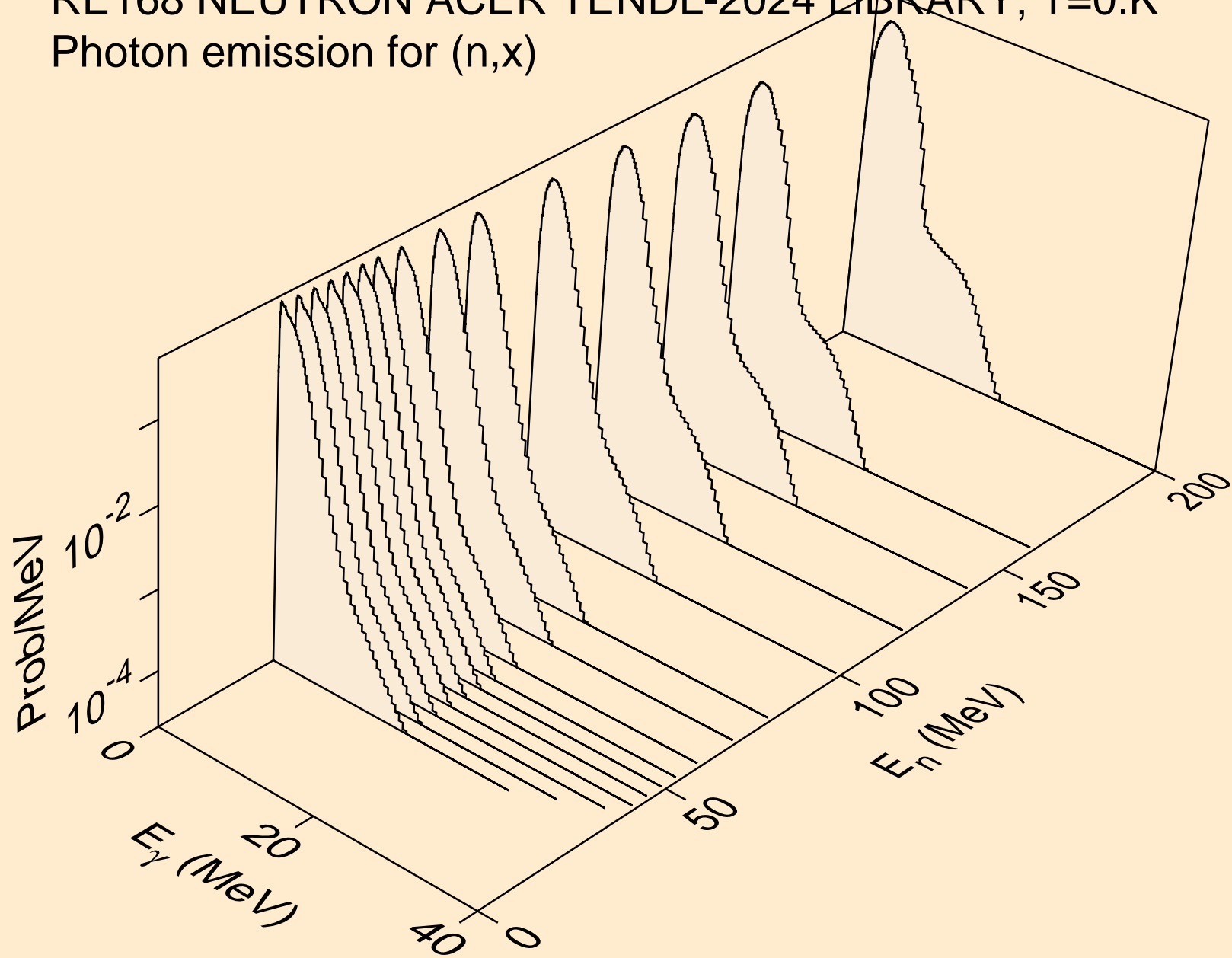

RE168 NEUTRON ACER TENDL-2024 LIBRARY; T=0.K
Photon emission for (n,2nd)

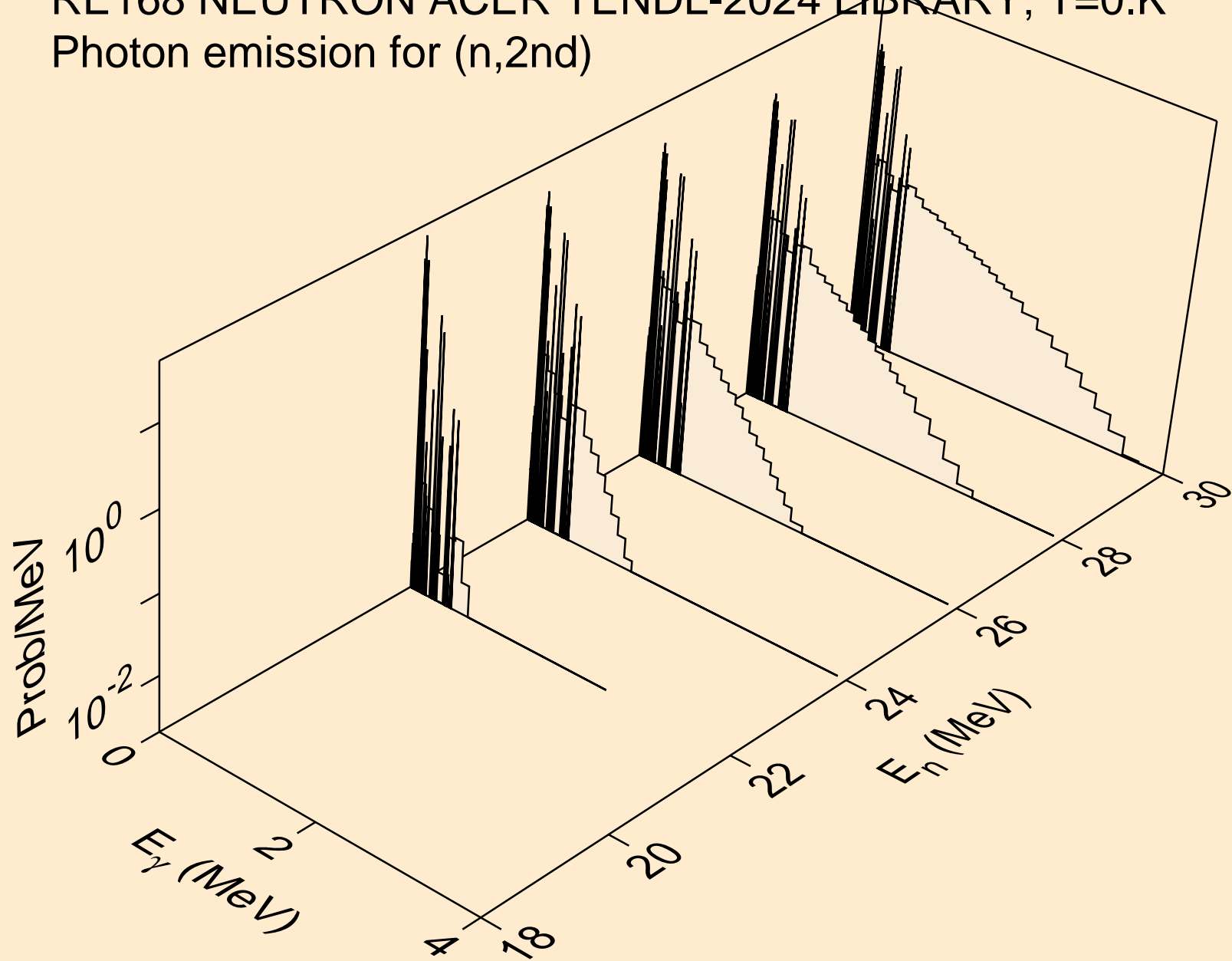

RE168 NEUTRON ACER TENDL-2024 LIBRARY; T=0.K
Photon emission for (n,2n)

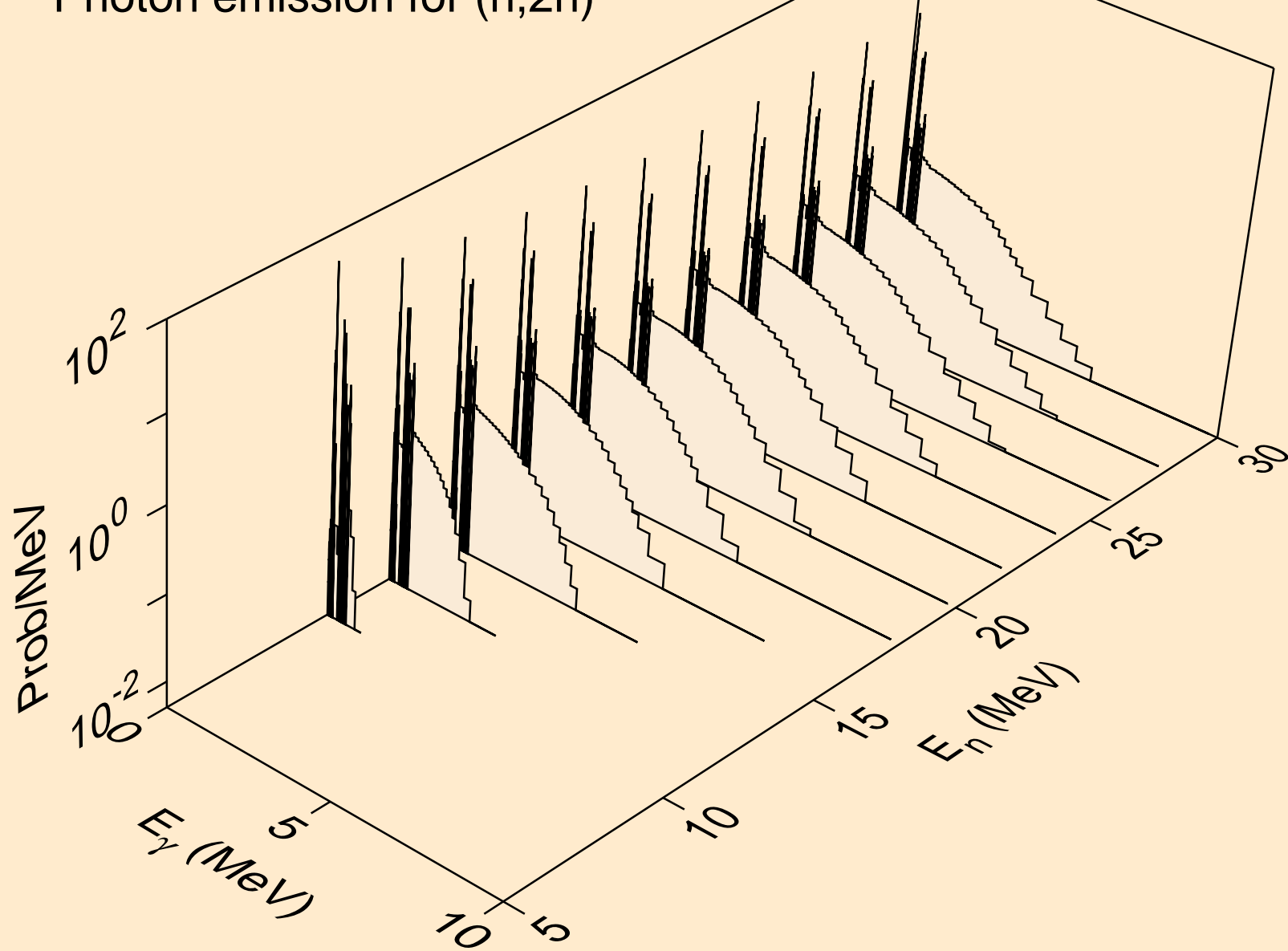

RE168 NEUTRON ACER TENDL-2024 LIBRARY; T=0.K
Photon emission for (n,3n)

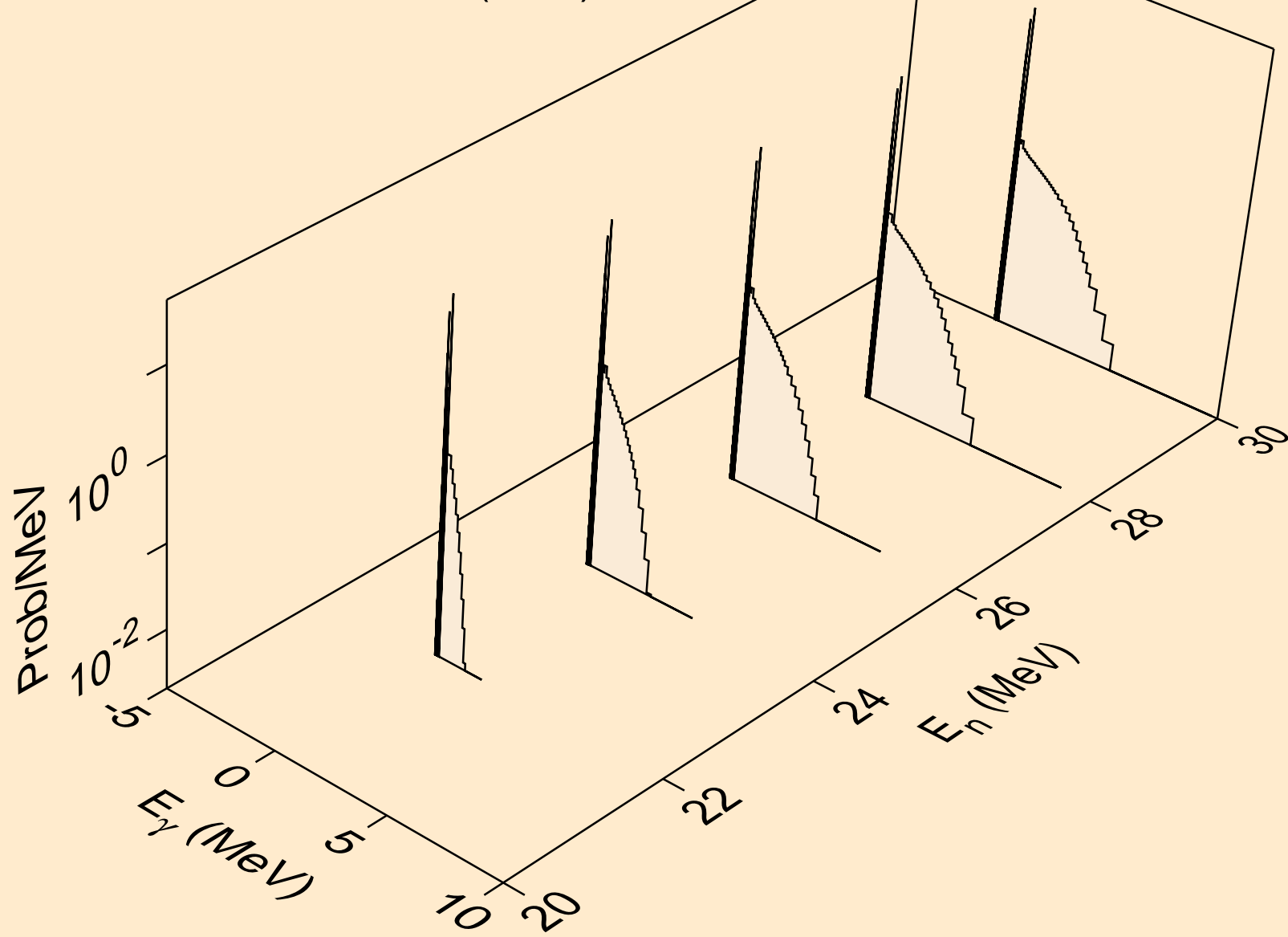

RE168 NEUTRON ACER TENDL-2024 LIBRARY; T=0.K
Photon emission for (n,n*)a

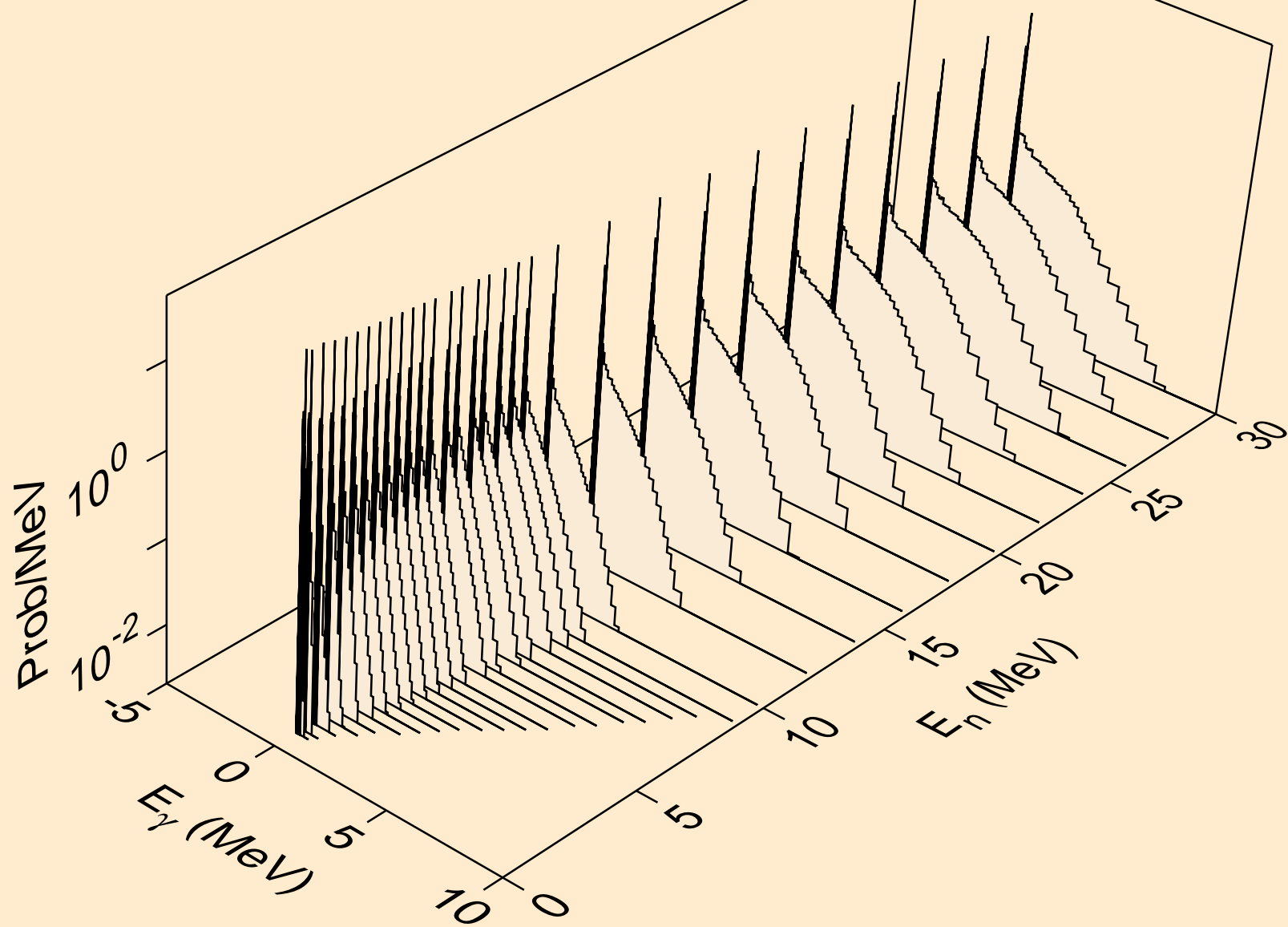

RE168 NEUTRON ACER TENDL-2024 LIBRARY; T=0.K
Photon emission for (n,n*)3a

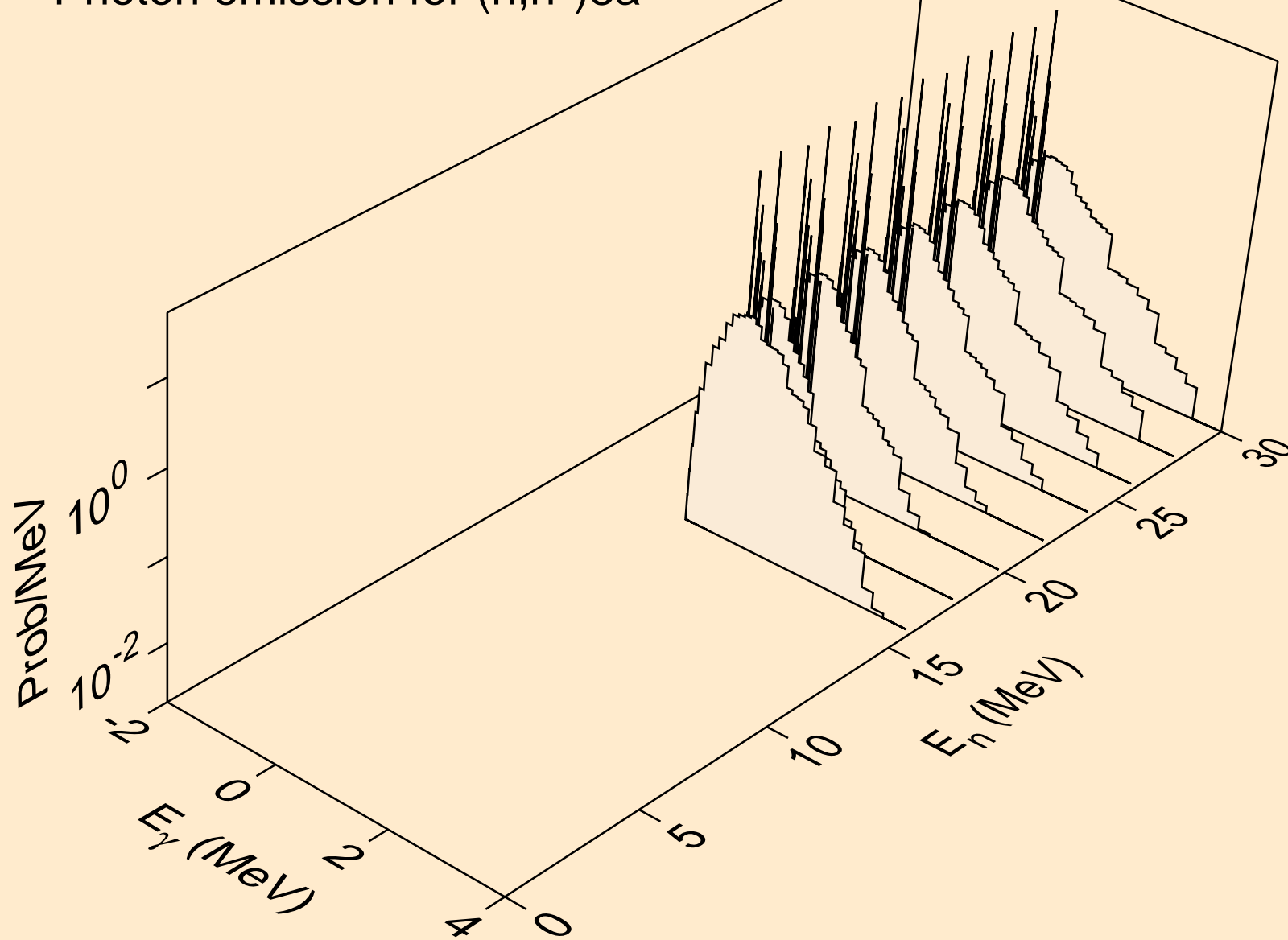

RE168 NEUTRON ACER TENDL-2024 LIBRARY; T=0.K
Photon emission for (n,2n)a

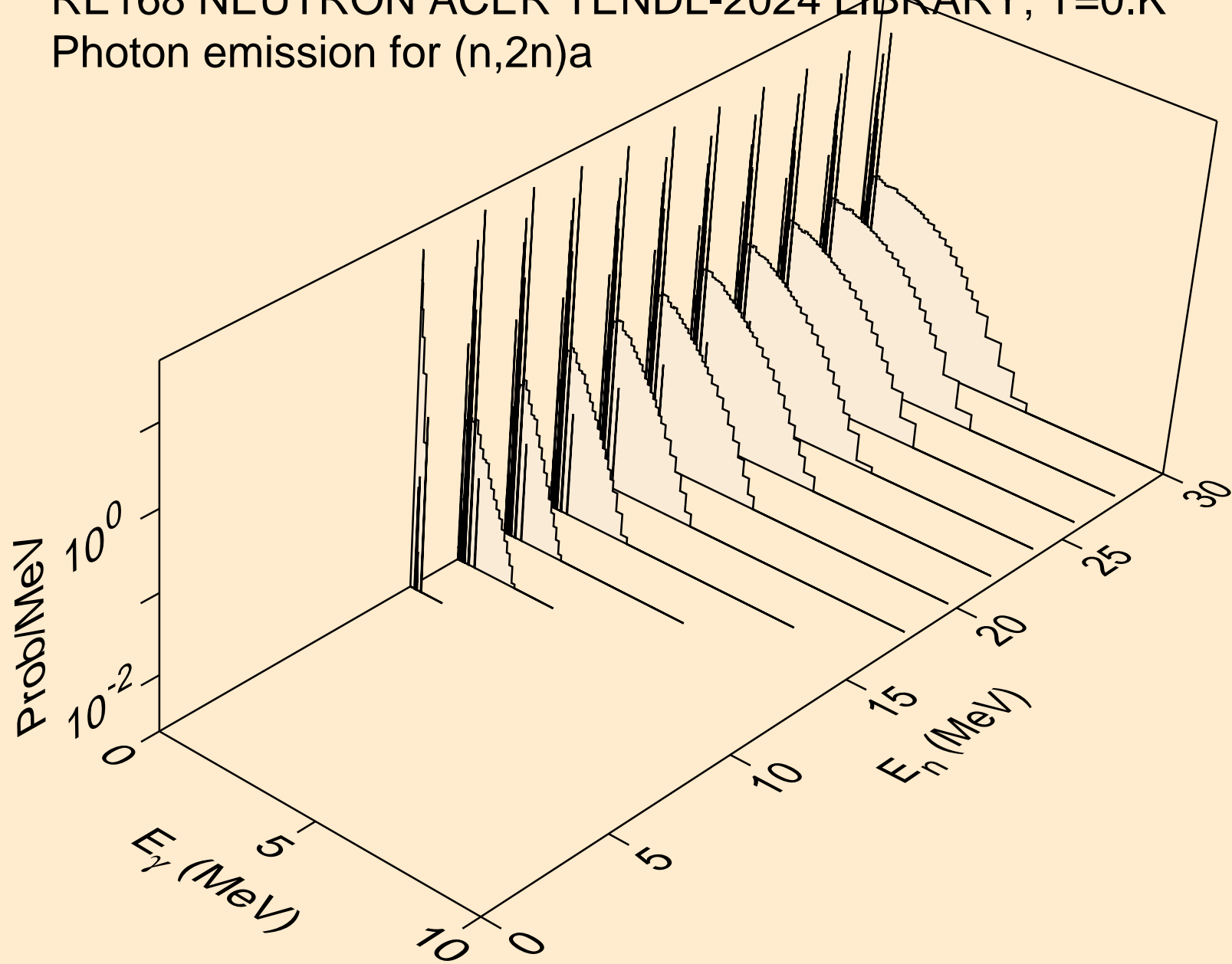

RE168 NEUTRON ACER TENDL-2024 LIBRARY; T=0.K
Photon emission for (n,3n)a

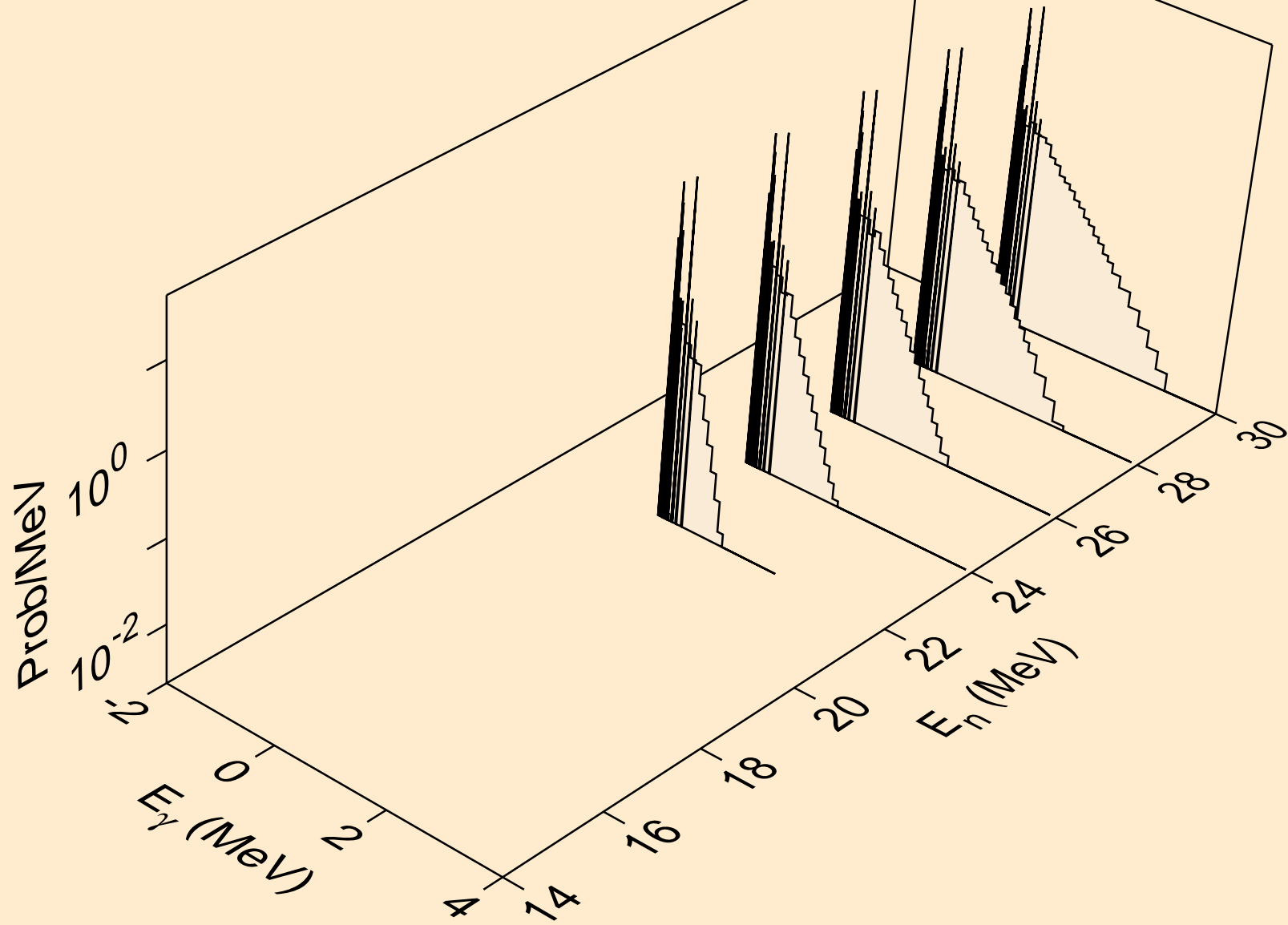

RE168 NEUTRON ACER TENDL-2024 LIBRARY; T=0.K
Photon emission for (n,n*)p

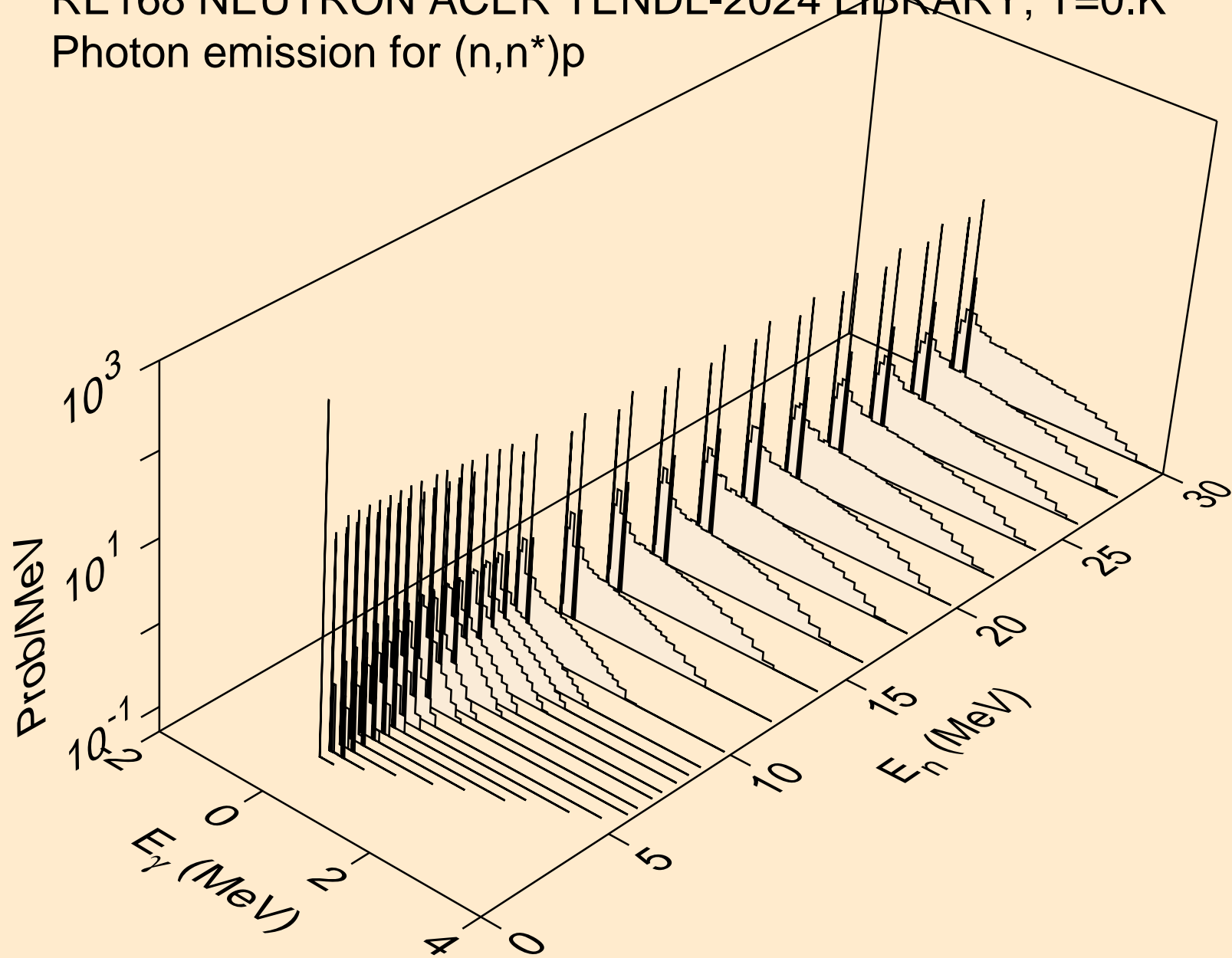

RE168 NEUTRON ACER TENDL-2024 LIBRARY; T=0.K
Photon emission for (n,n*)2a

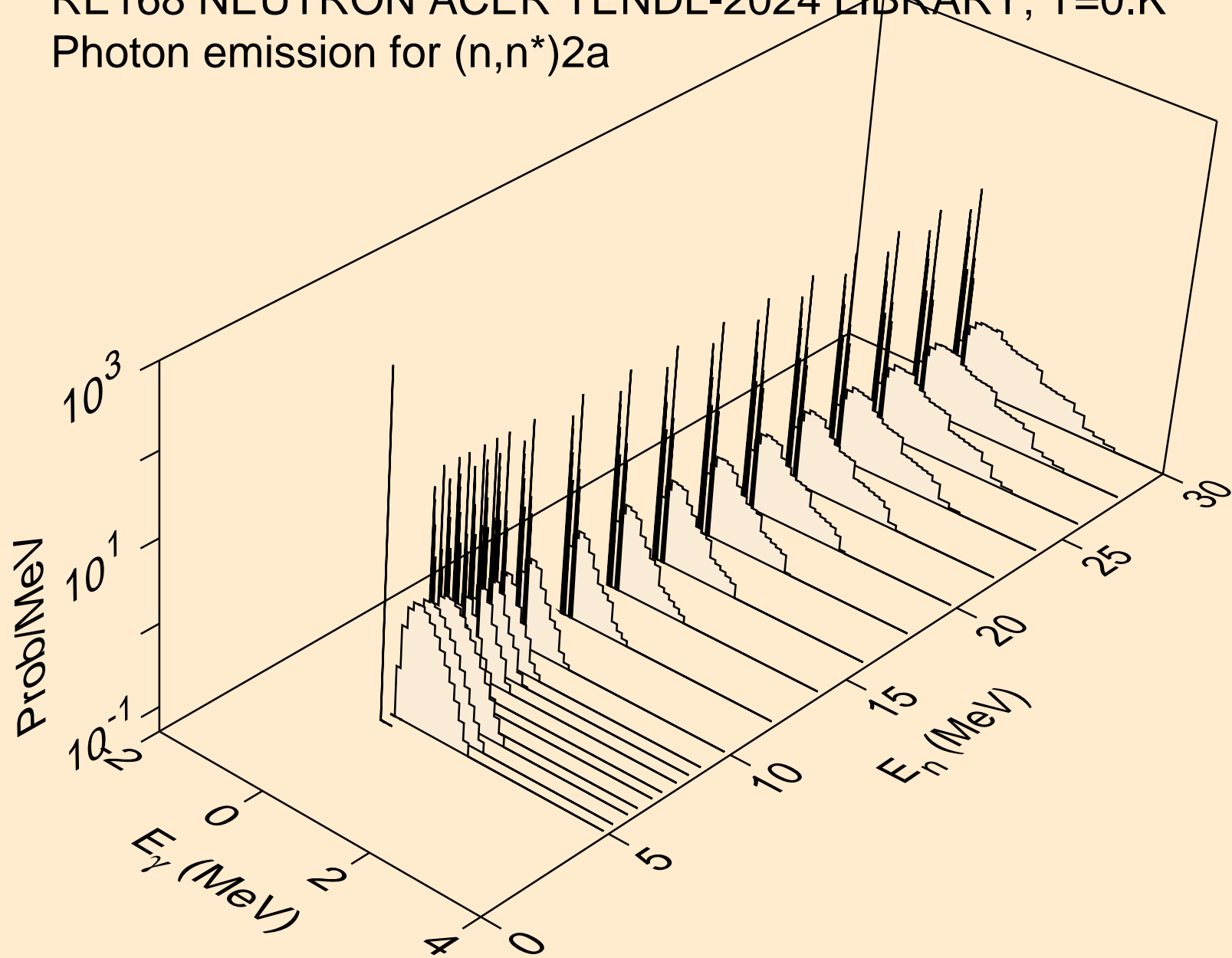

RE168 NEUTRON ACER TENDL-2024 LIBRARY; T=0.K
Photon emission for (n,2n)2a

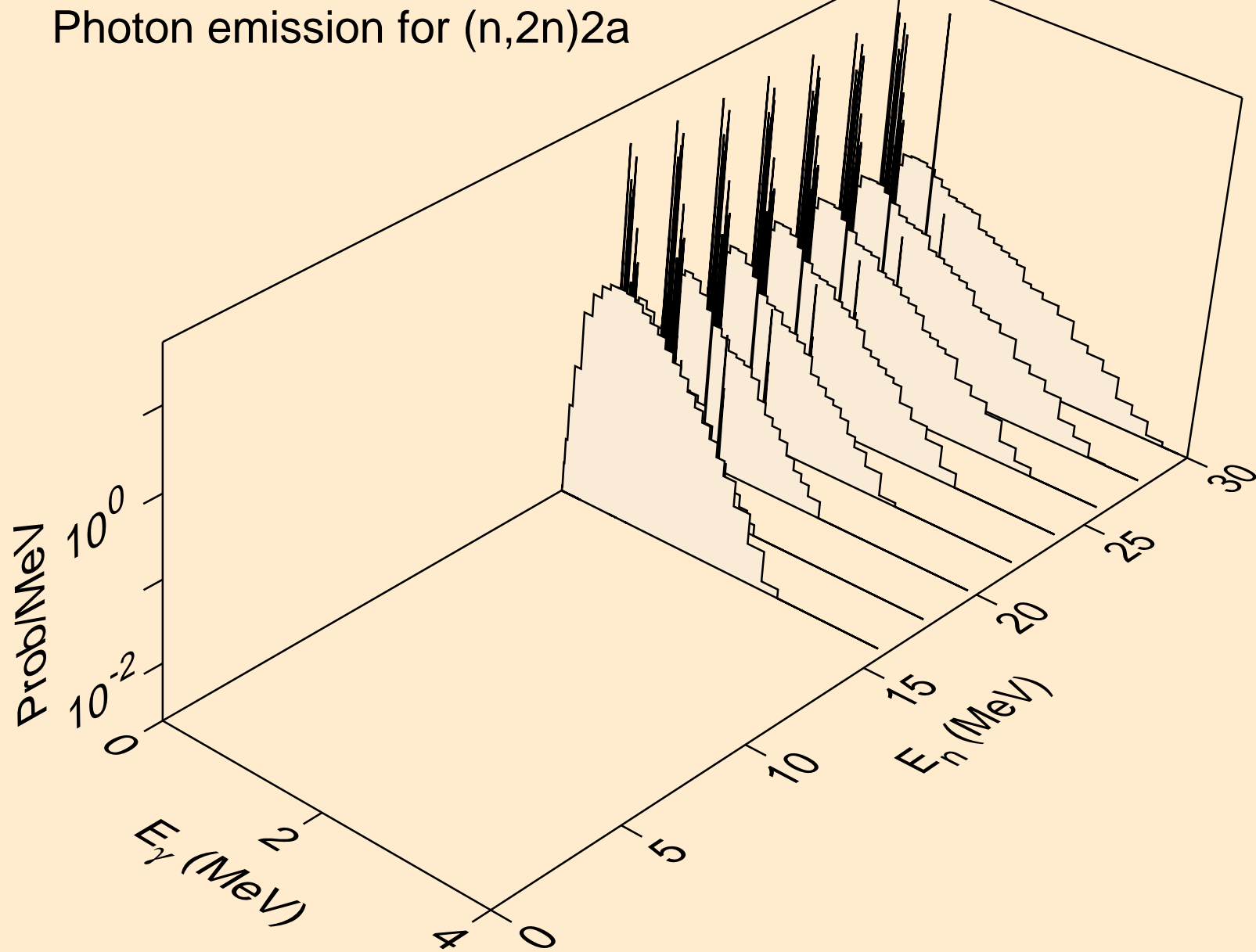

RE168 NEUTRON ACER TENDL-2024 LIBRARY; T=0.K
Photon emission for (n,n*)d

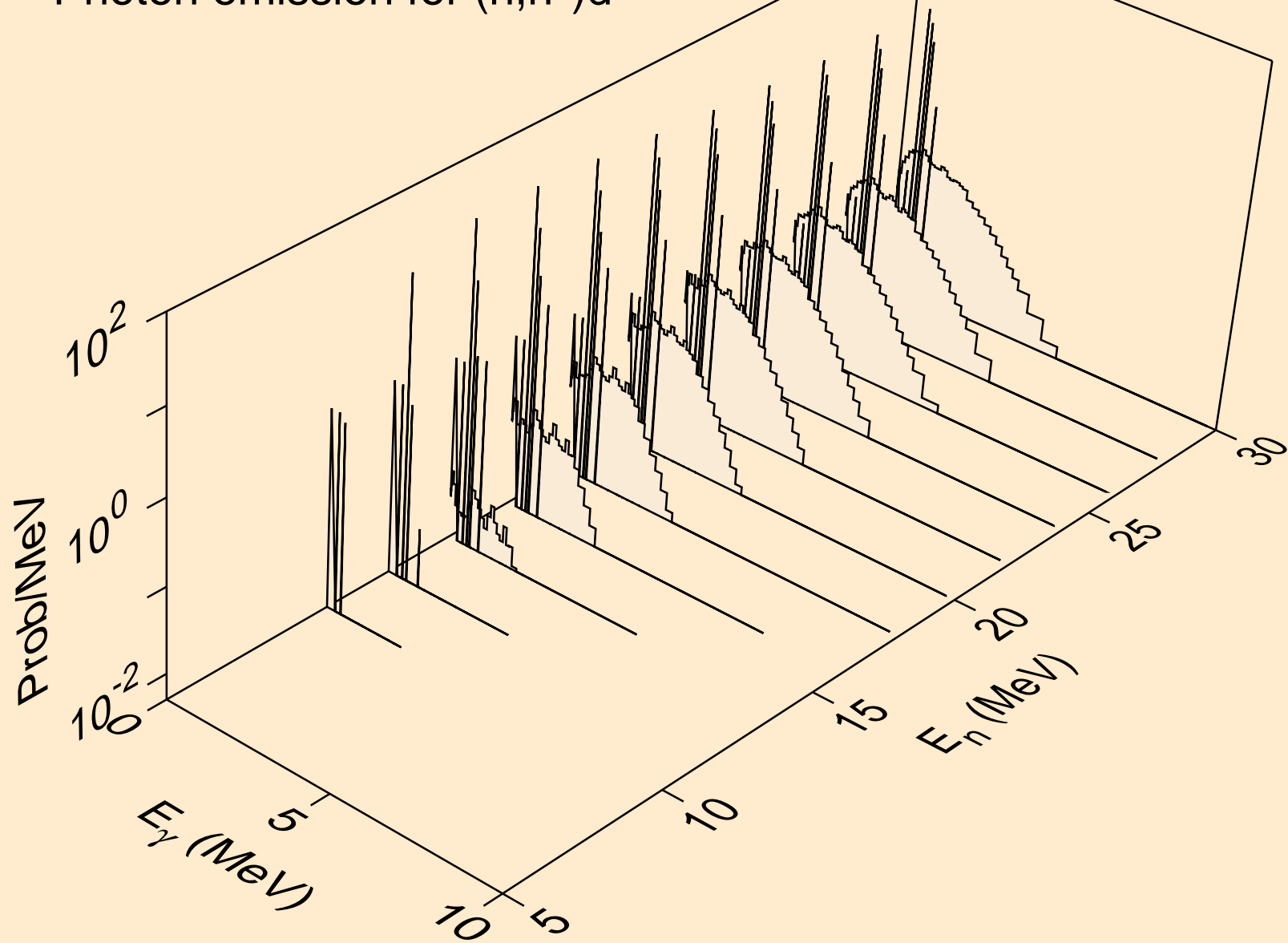

RE168 NEUTRON ACER TENDL-2024 LIBRARY; T=0.K
Photon emission for (n,n*)t

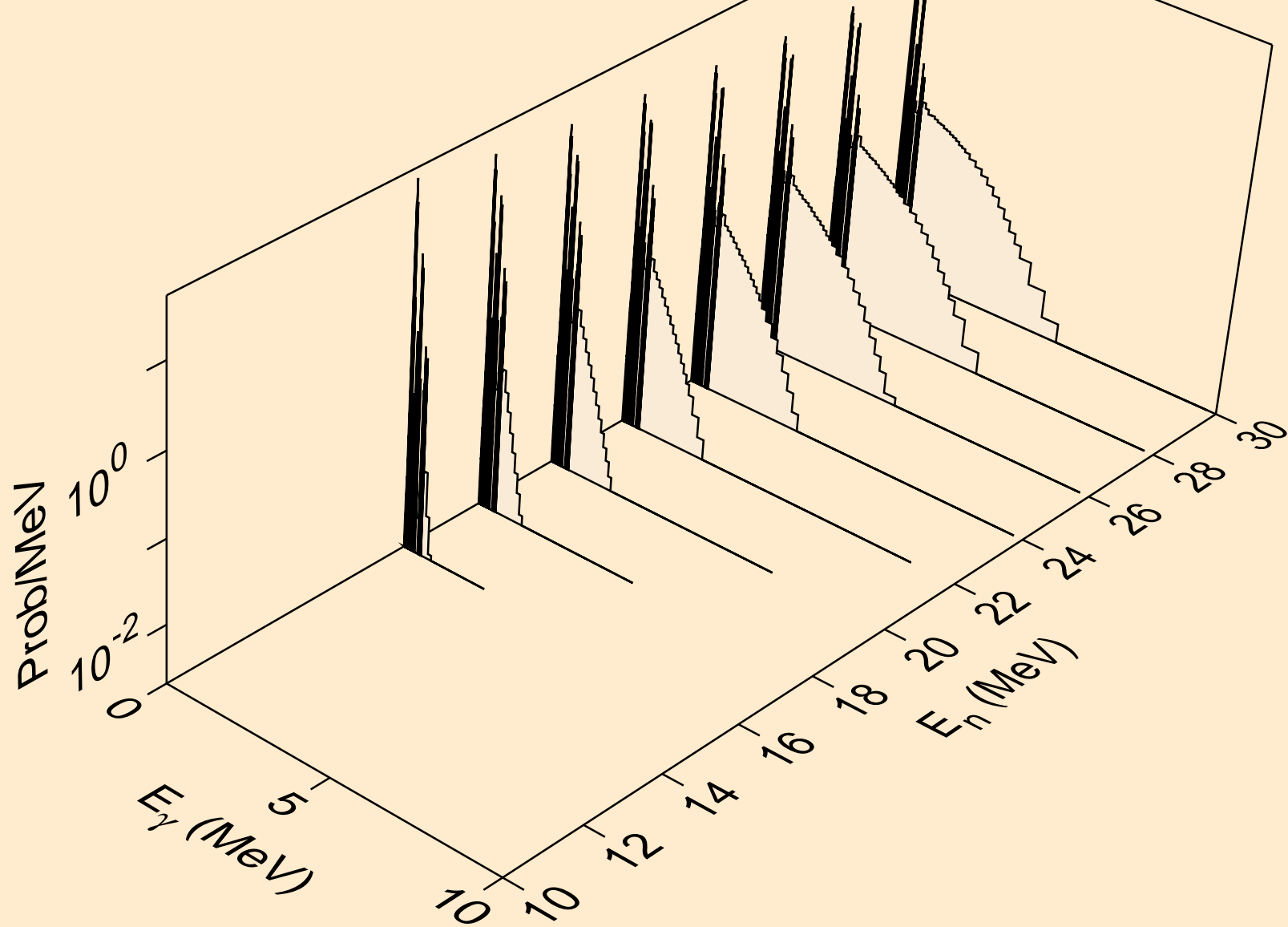

RE168 NEUTRON ACER TENDL-2024 LIBRARY; T=0.K
Photon emission for (n,n*)he3

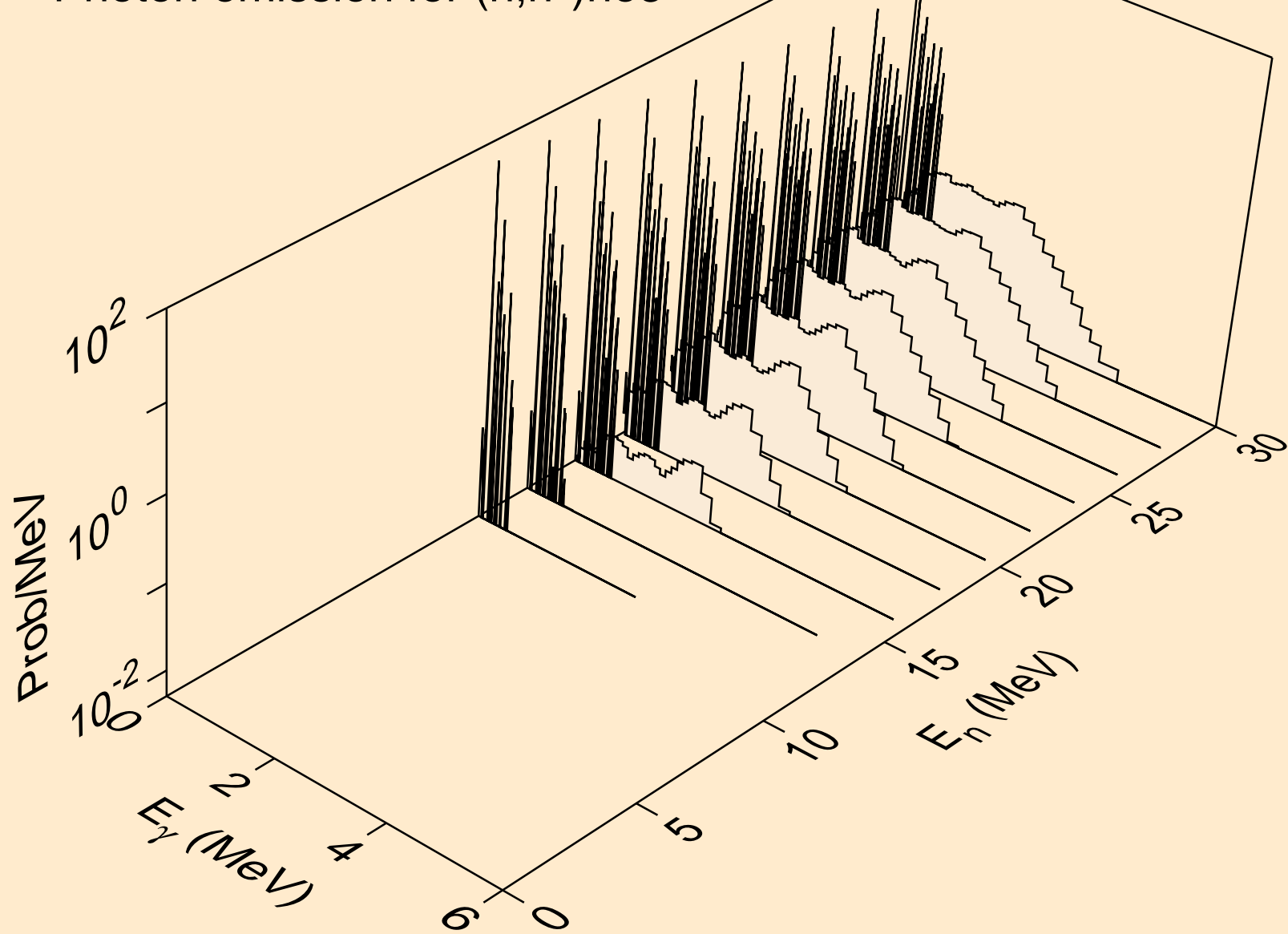

RE168 NEUTRON ACER TENDL-2024 LIBRARY; T=0.K
Photon emission for (n,2np)

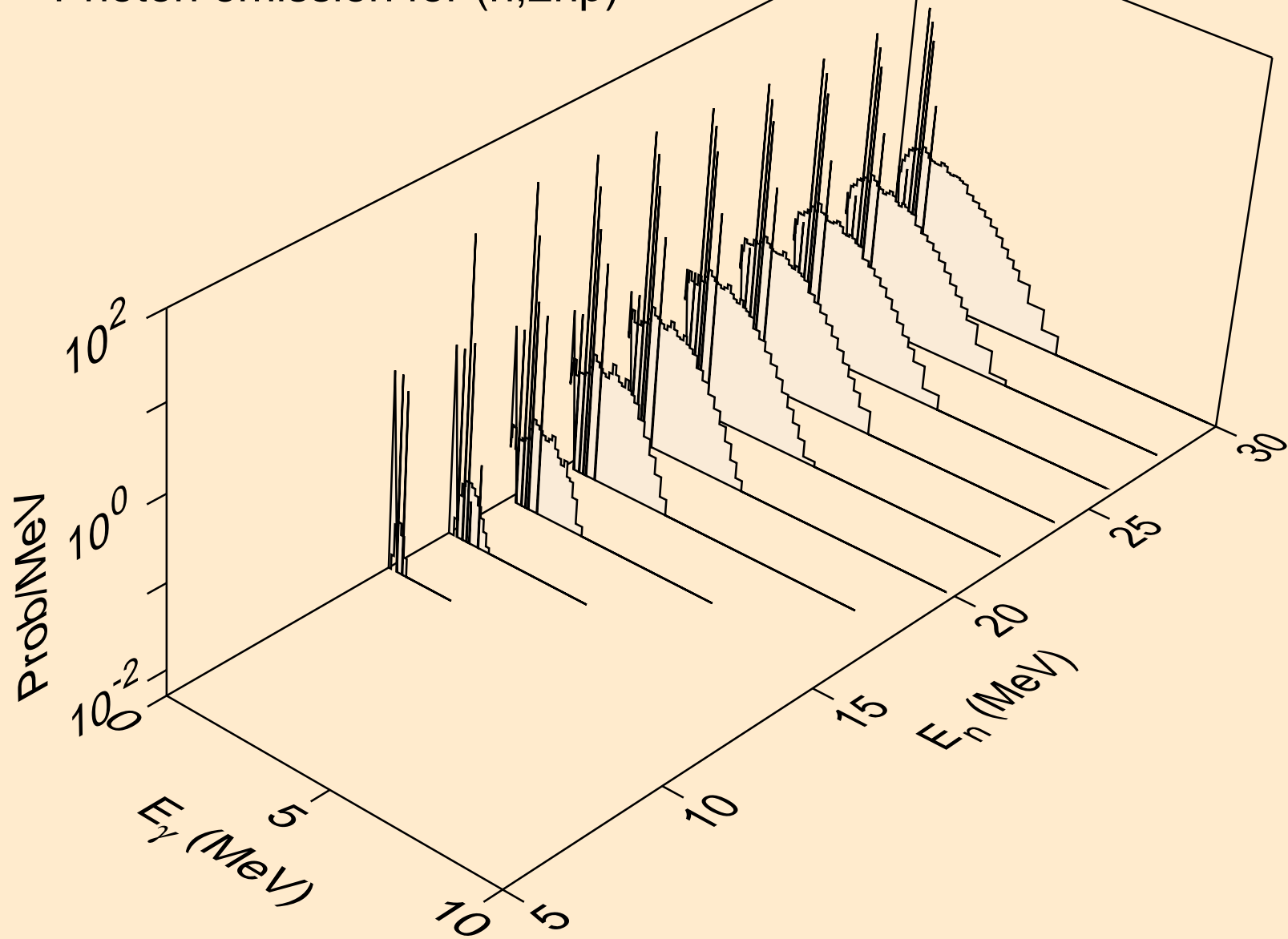

RE168 NEUTRON ACER TENDL-2024 LIBRARY; T=0.K
Photon emission for (n,3np)

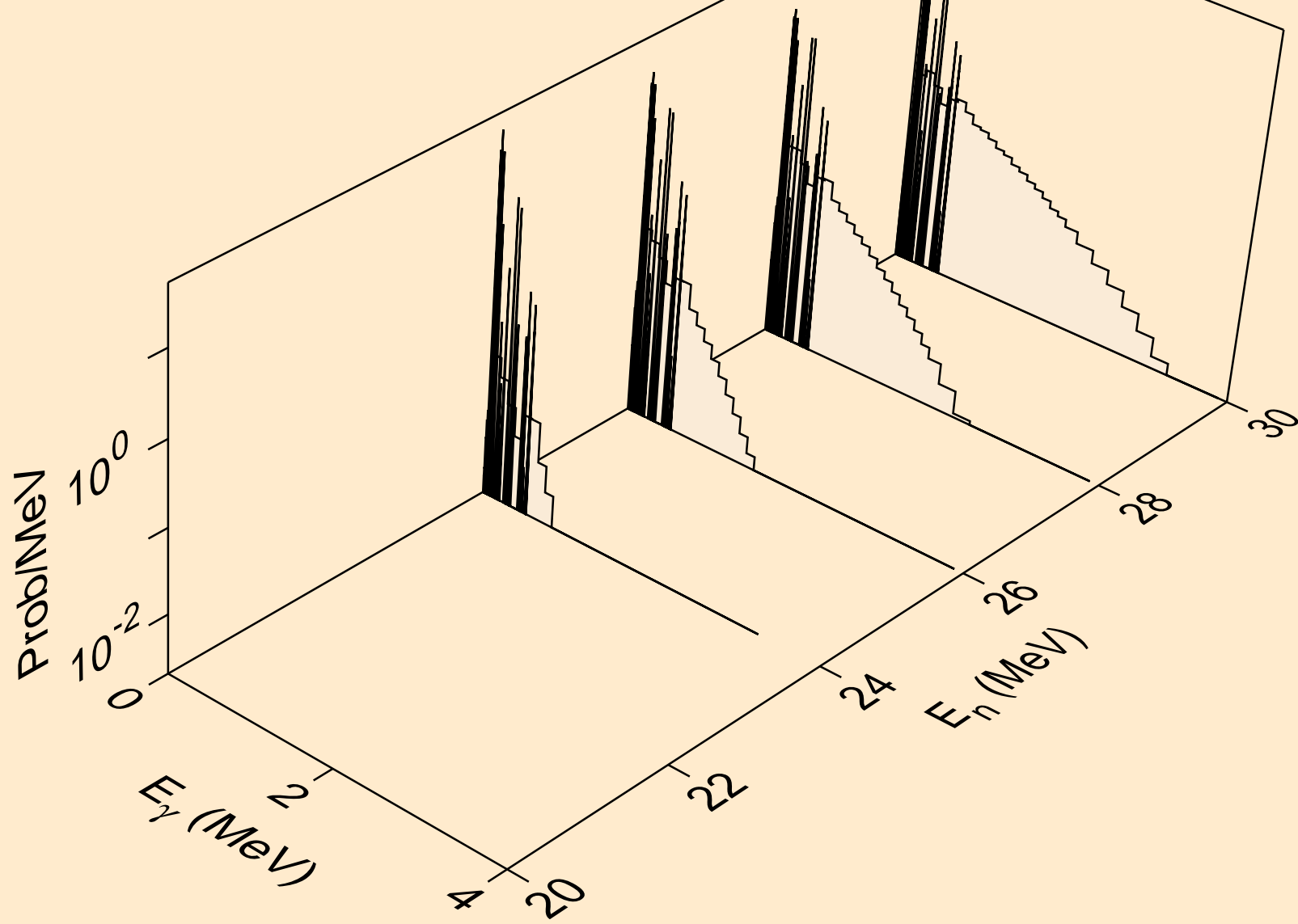

RE168 NEUTRON ACER TENDL-2024 LIBRARY; T=0.K
Photon emission for (n,n2p)

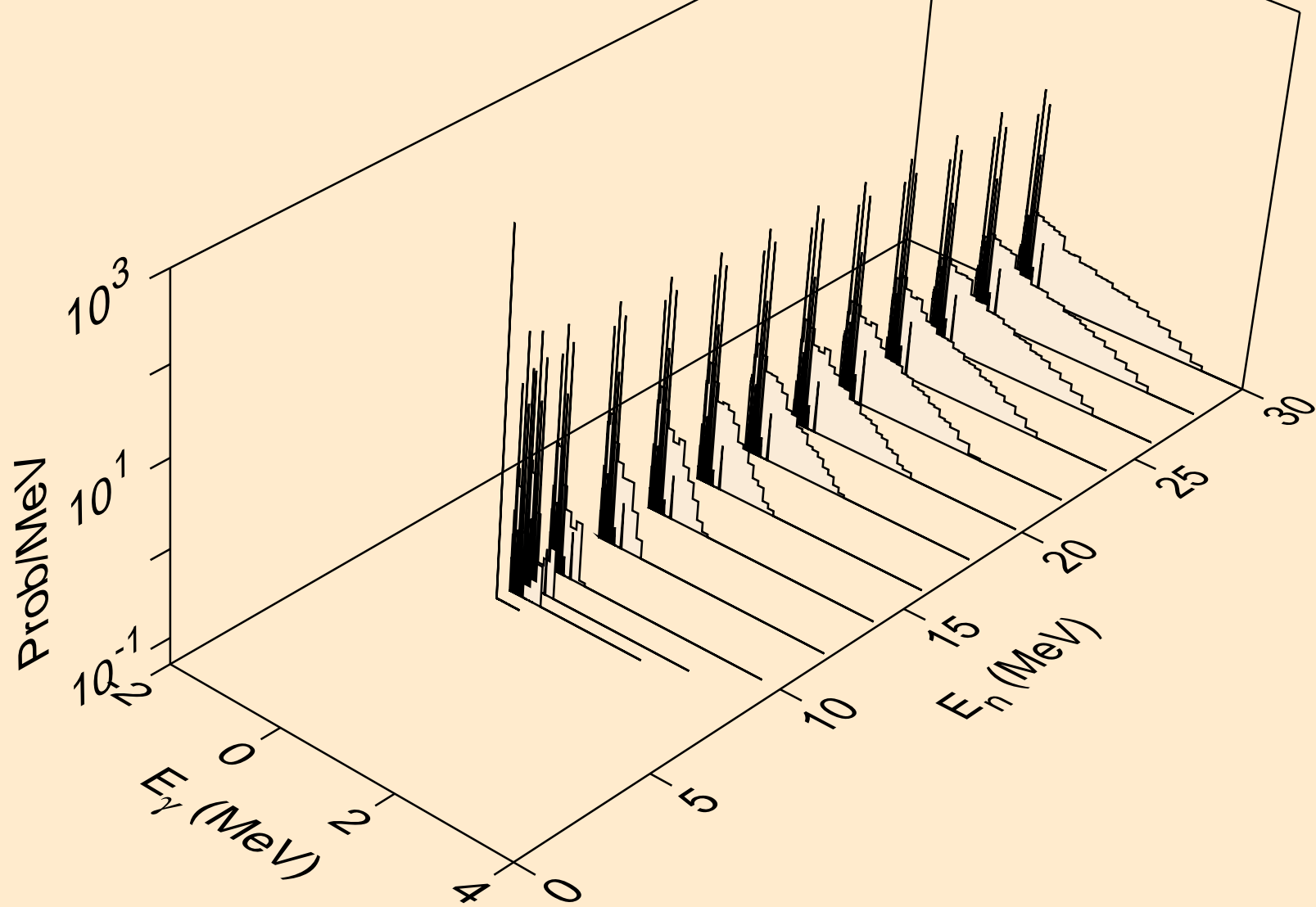

RE168 NEUTRON ACER TENDL-2024 LIBRARY; T=0.K
Photon emission for (n,npa)

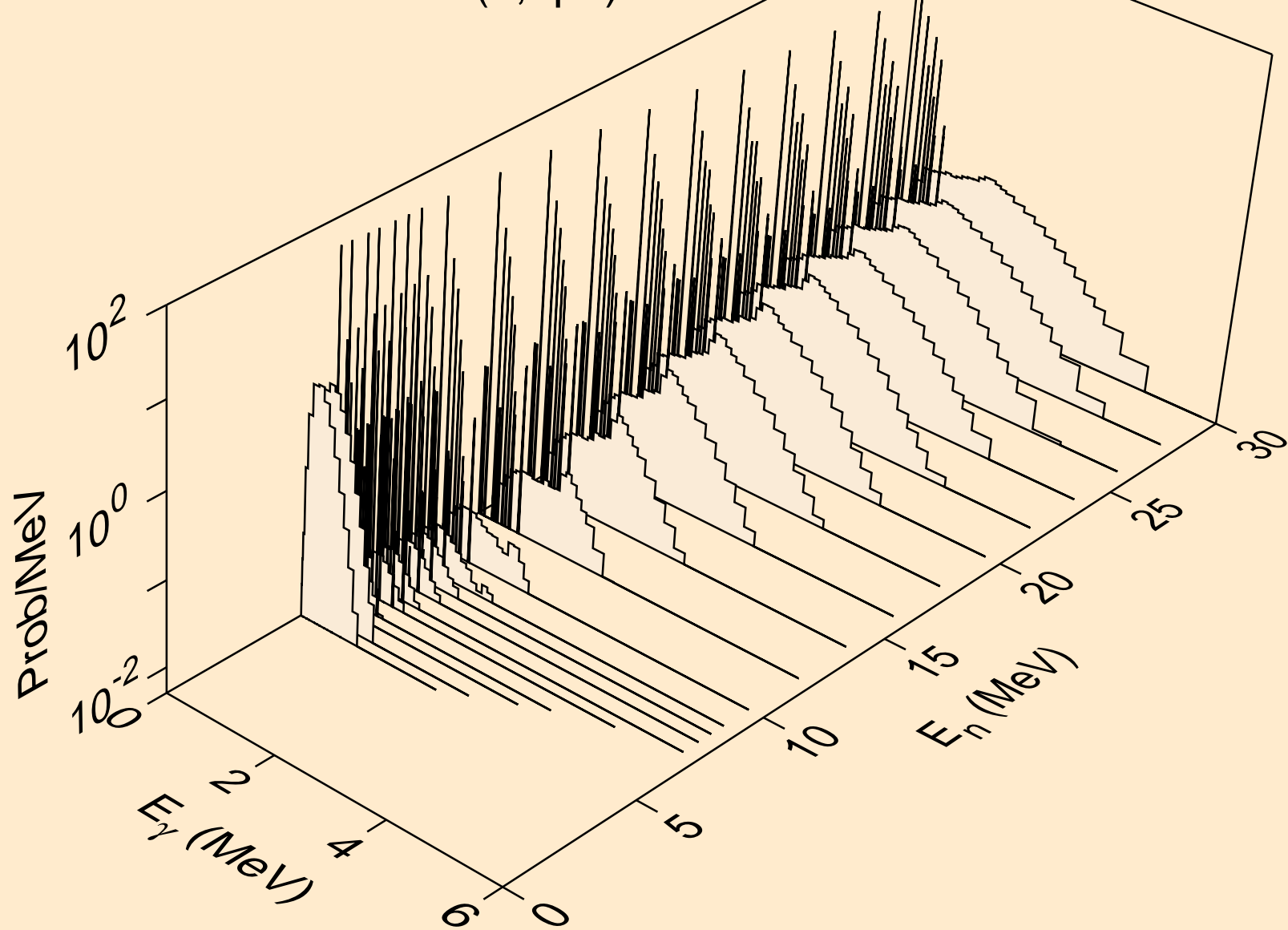

RE168 NEUTRON ACER TENDL-2024 LIBRARY; T=0.K
Photon emission for (n,n*c)

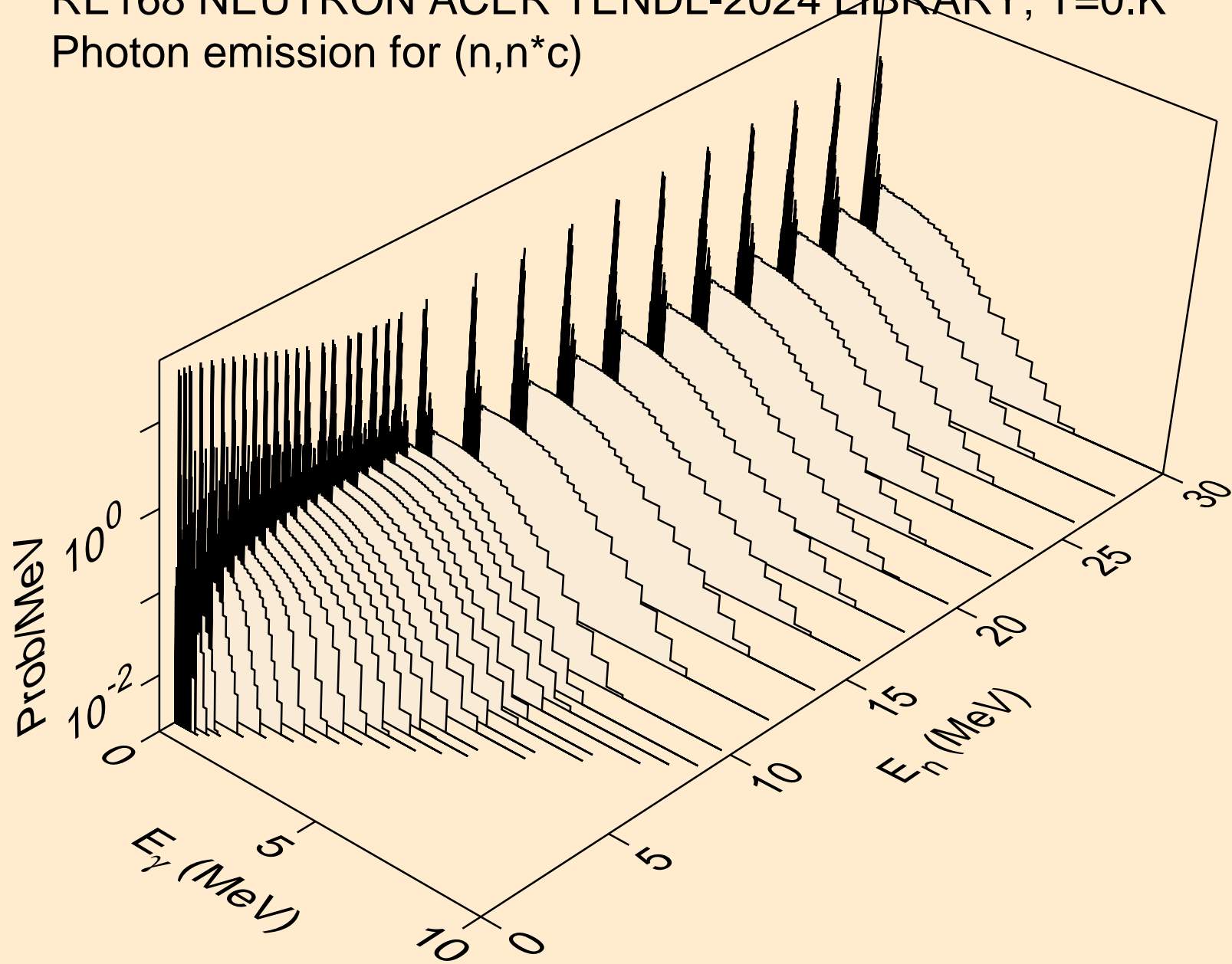

RE168 NEUTRON ACER TENDL-2024 LIBRARY; T=0.K
Photon emission for (n,gma)

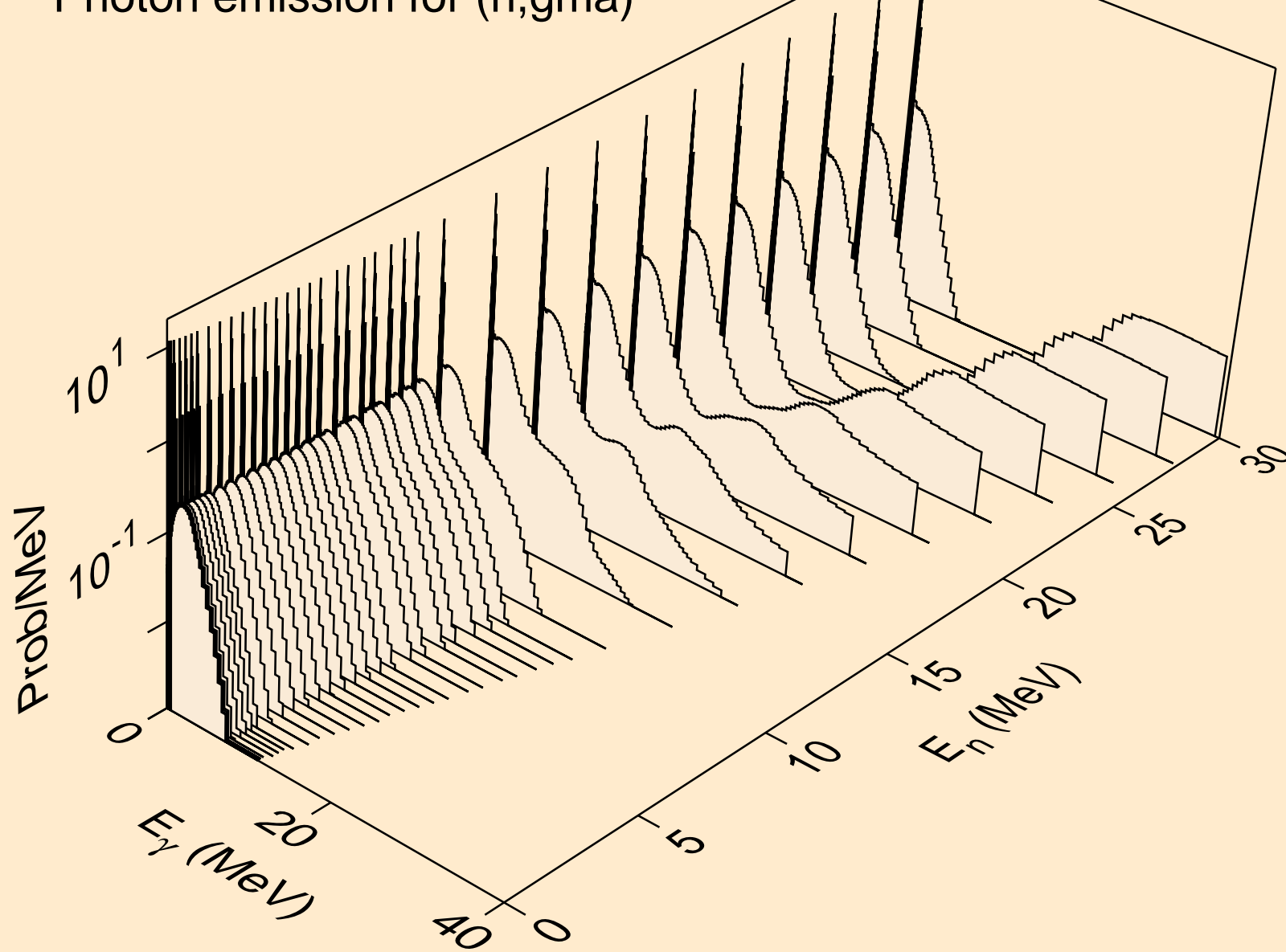

RE168 NEUTRON ACER TENDL-2024 LIBRARY; T=0.K
Photon emission for (n,p)

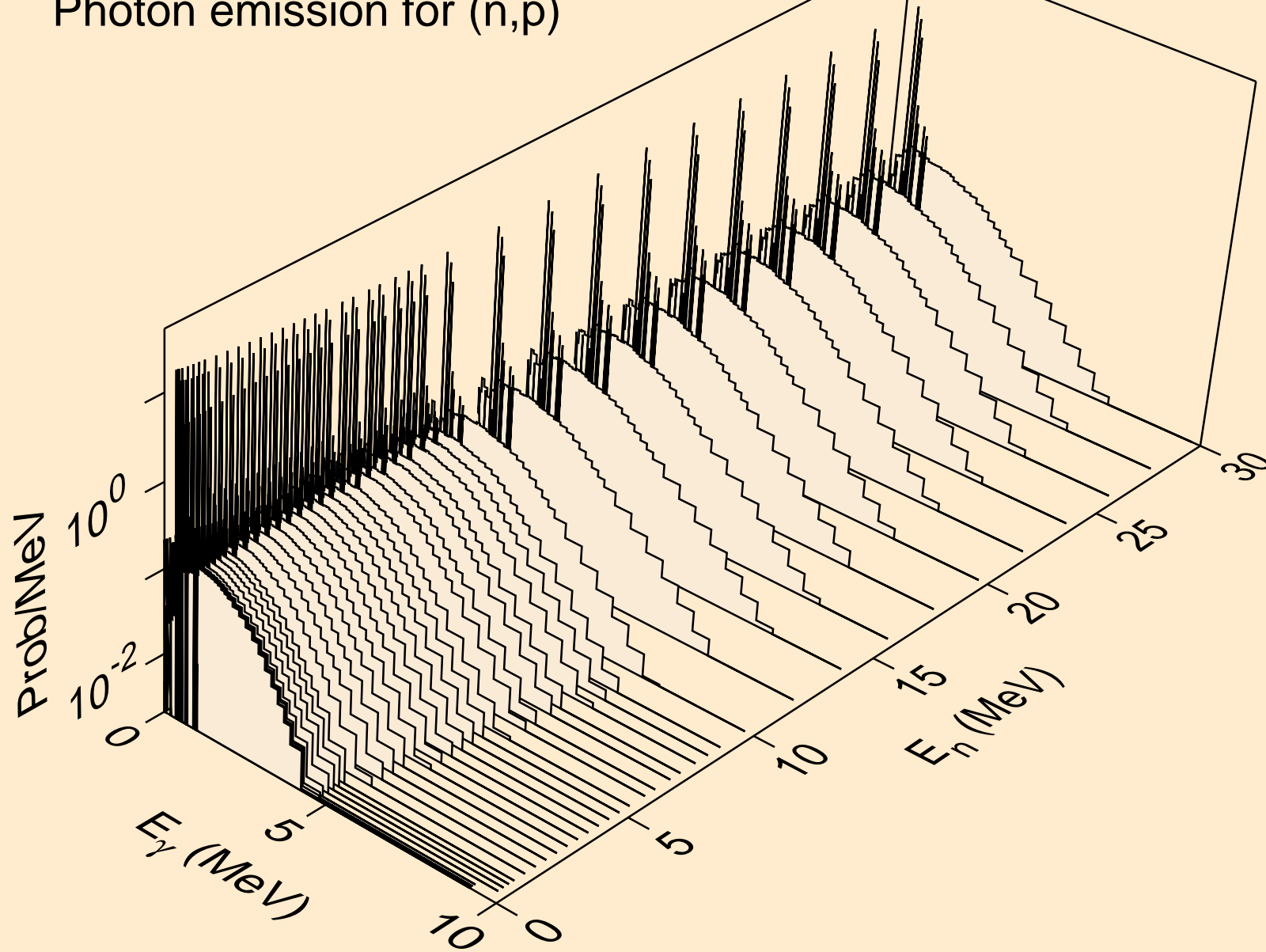

RE168 NEUTRON ACER TENDL-2024 LIBRARY; T=0.K
Photon emission for (n,d)

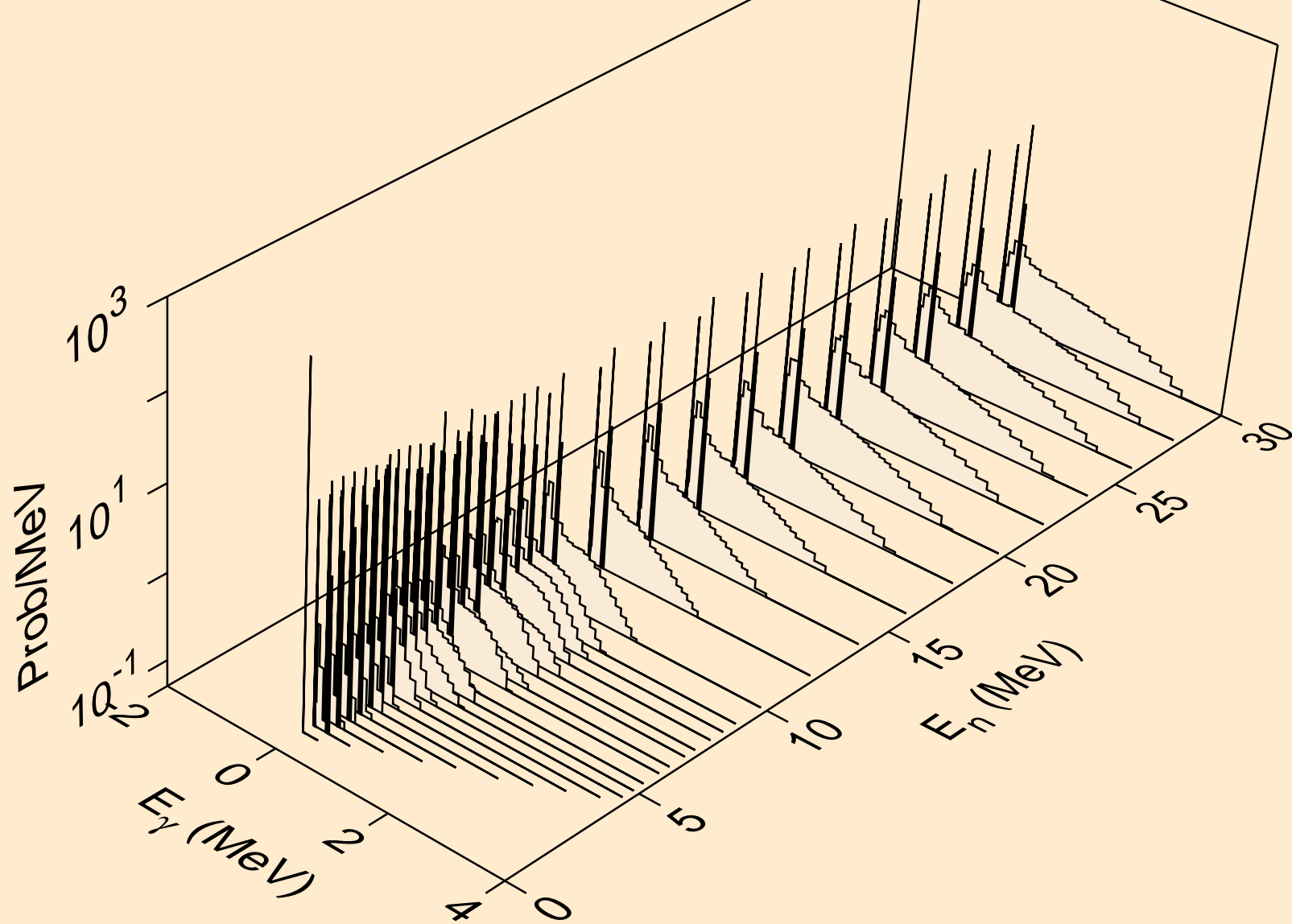

RE168 NEUTRON ACER TENDL-2024 LIBRARY; T=0.K
Photon emission for (n,t)

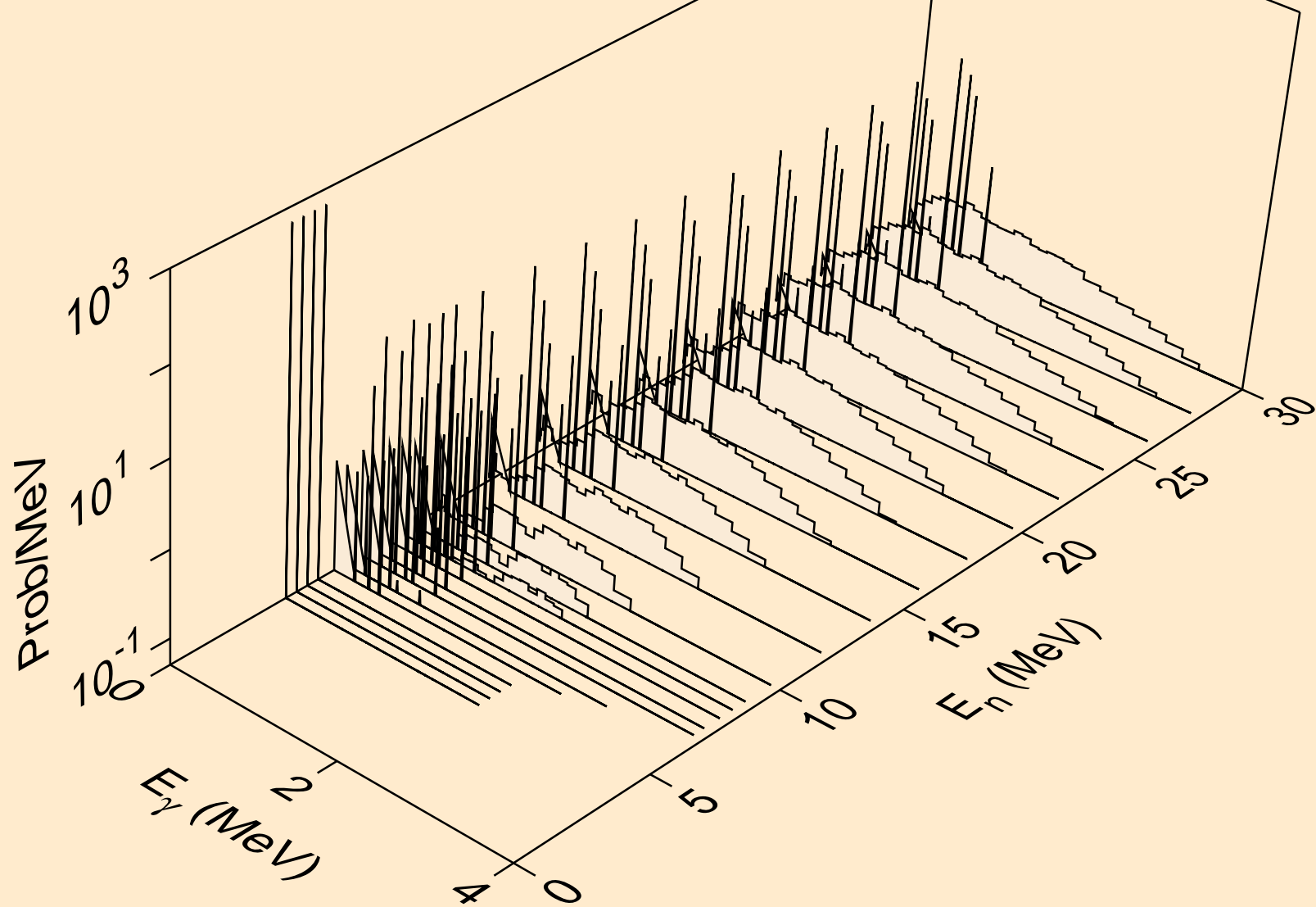

RE168 NEUTRON ACER TENDL-2024 LIBRARY; T=0.K
Photon emission for (n,he3)

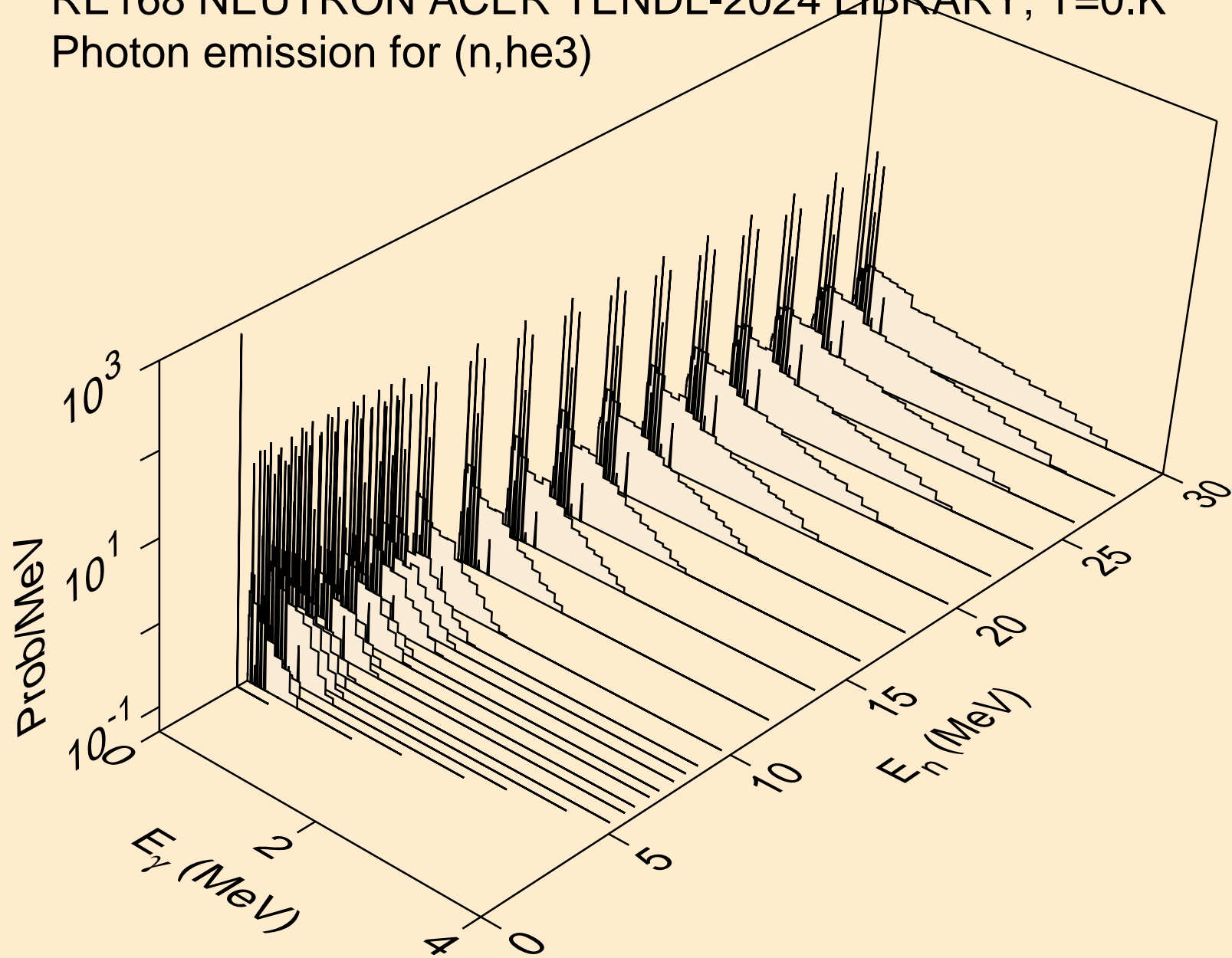

RE168 NEUTRON ACER TENDL-2024 LIBRARY; T=0.K
Photon emission for (n,a)

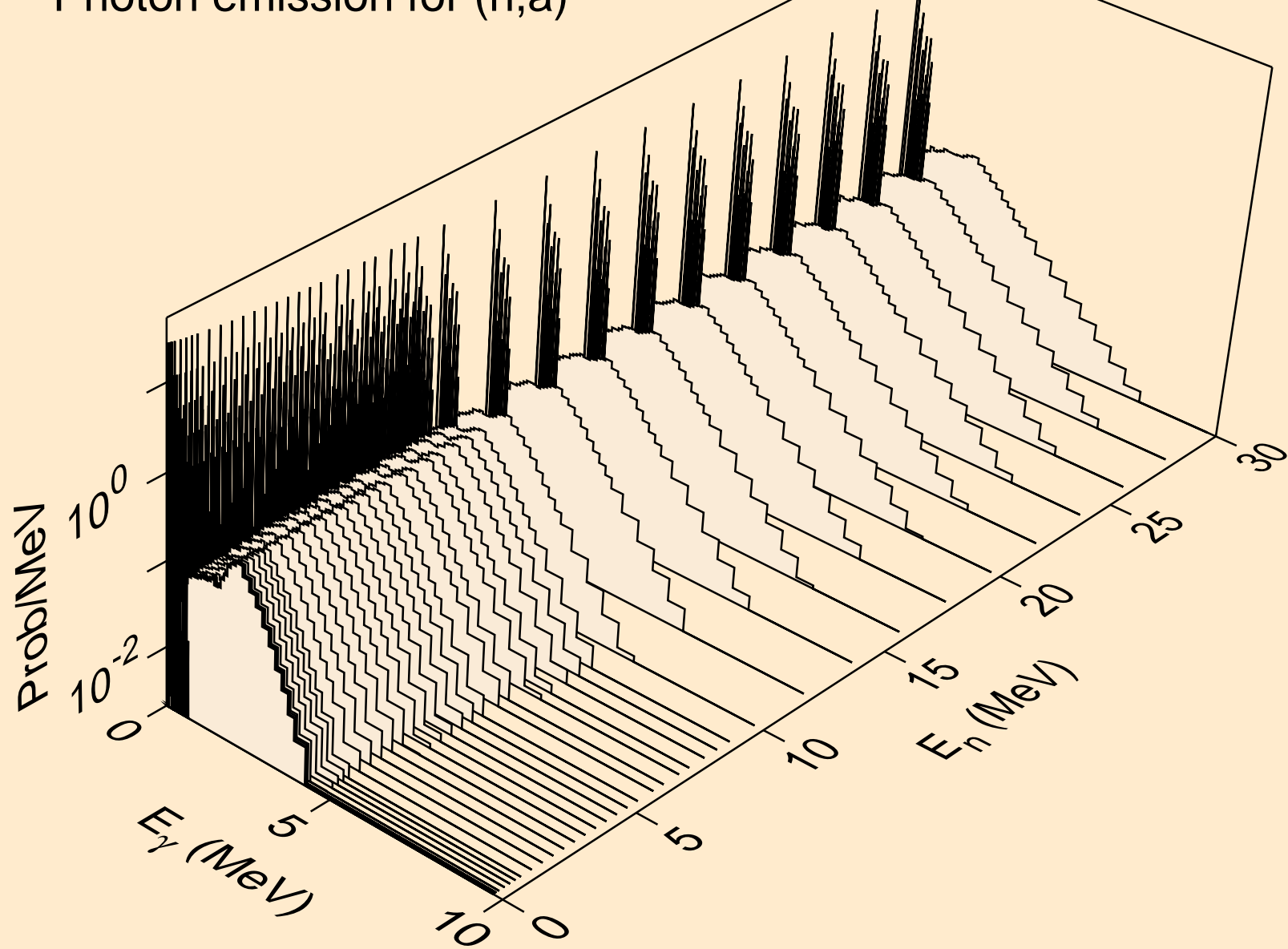

RE168 NEUTRON ACER TENDL-2024 LIBRARY; T=0.K
Photon emission for (n,2a)

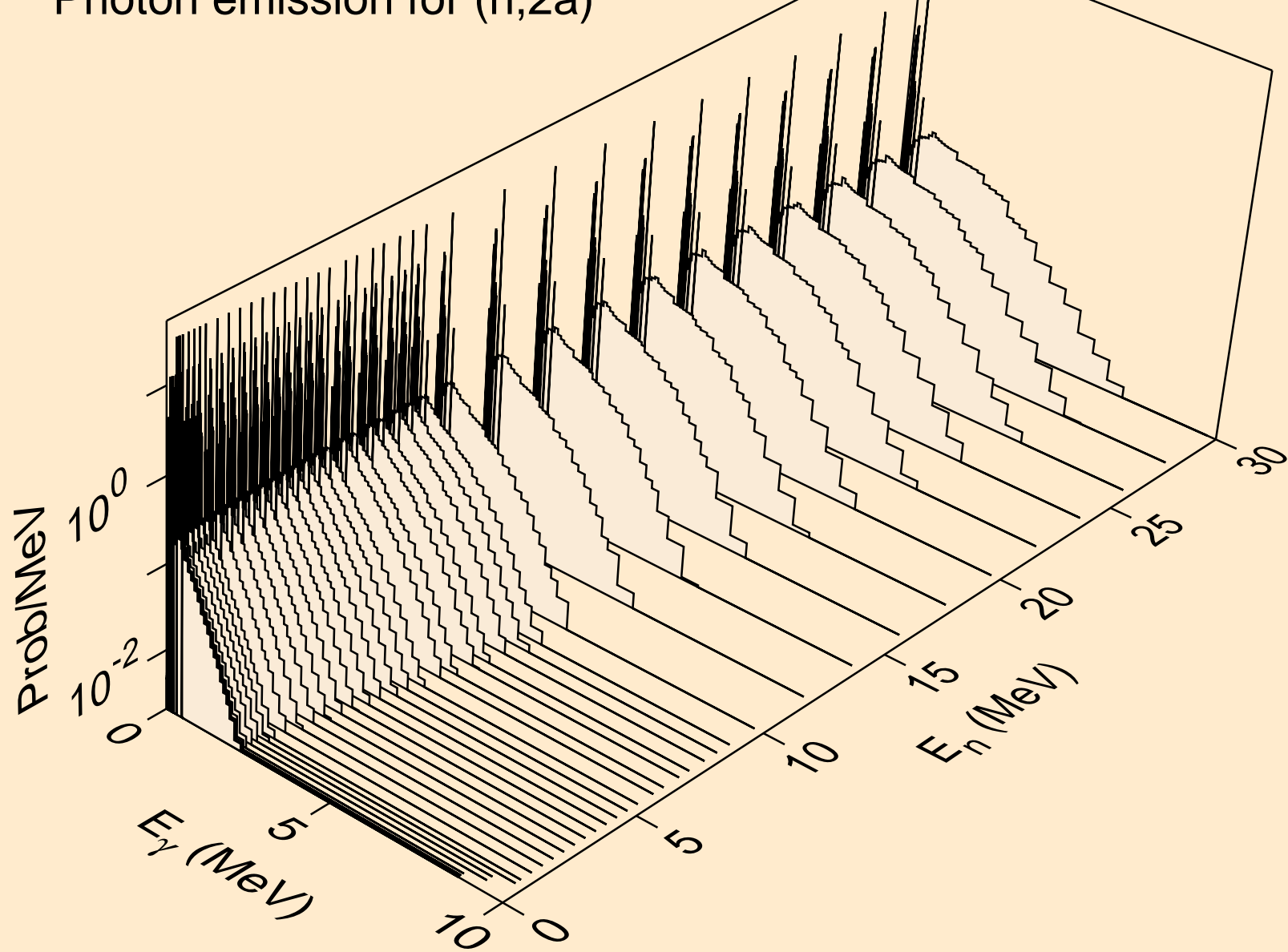

RE168 NEUTRON ACER TENDL-2024 LIBRARY; T=0.K
Photon emission for (n,3a)

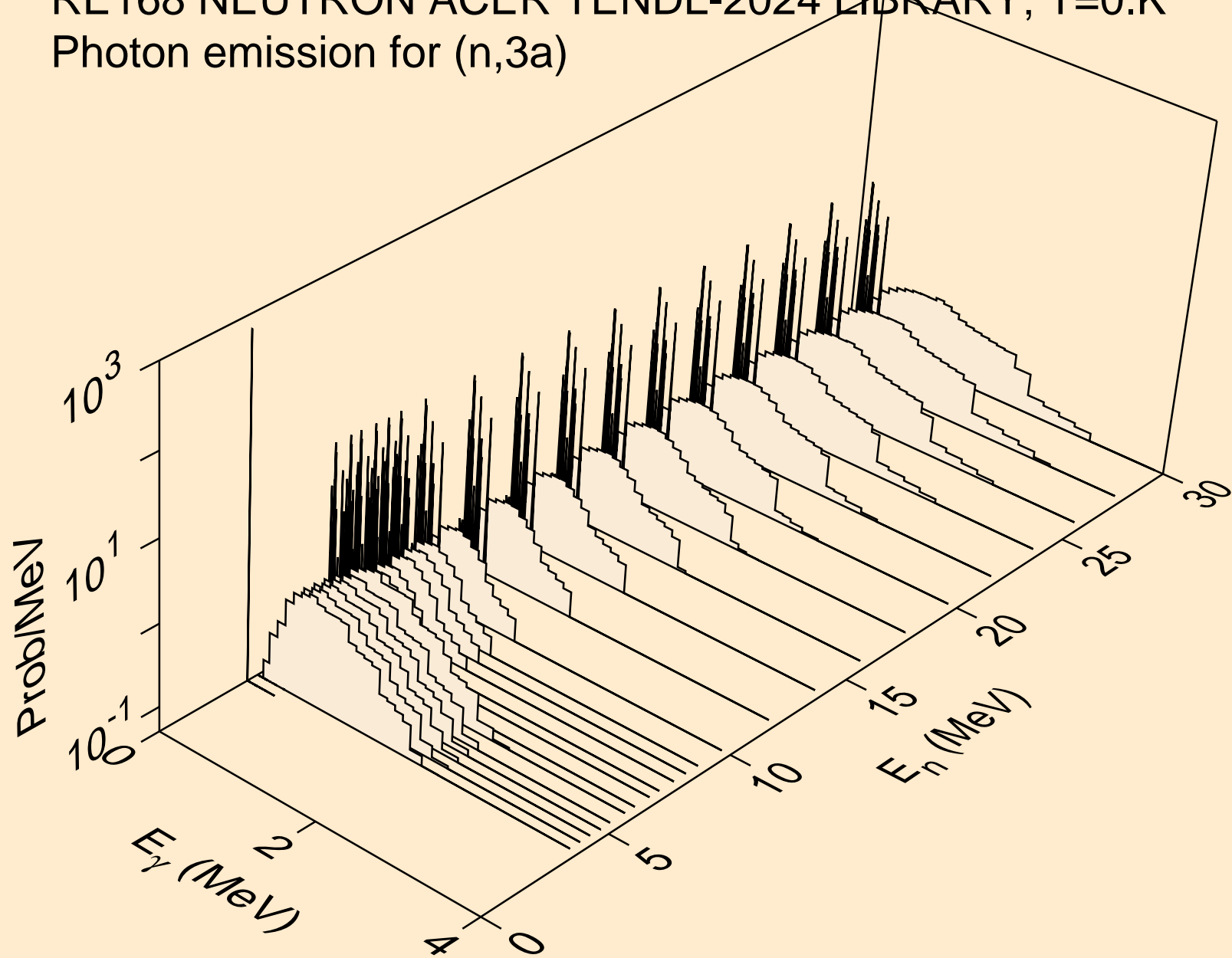

RE168 NEUTRON ACER TENDL-2024 LIBRARY; T=0.K
Photon emission for (n,2p)

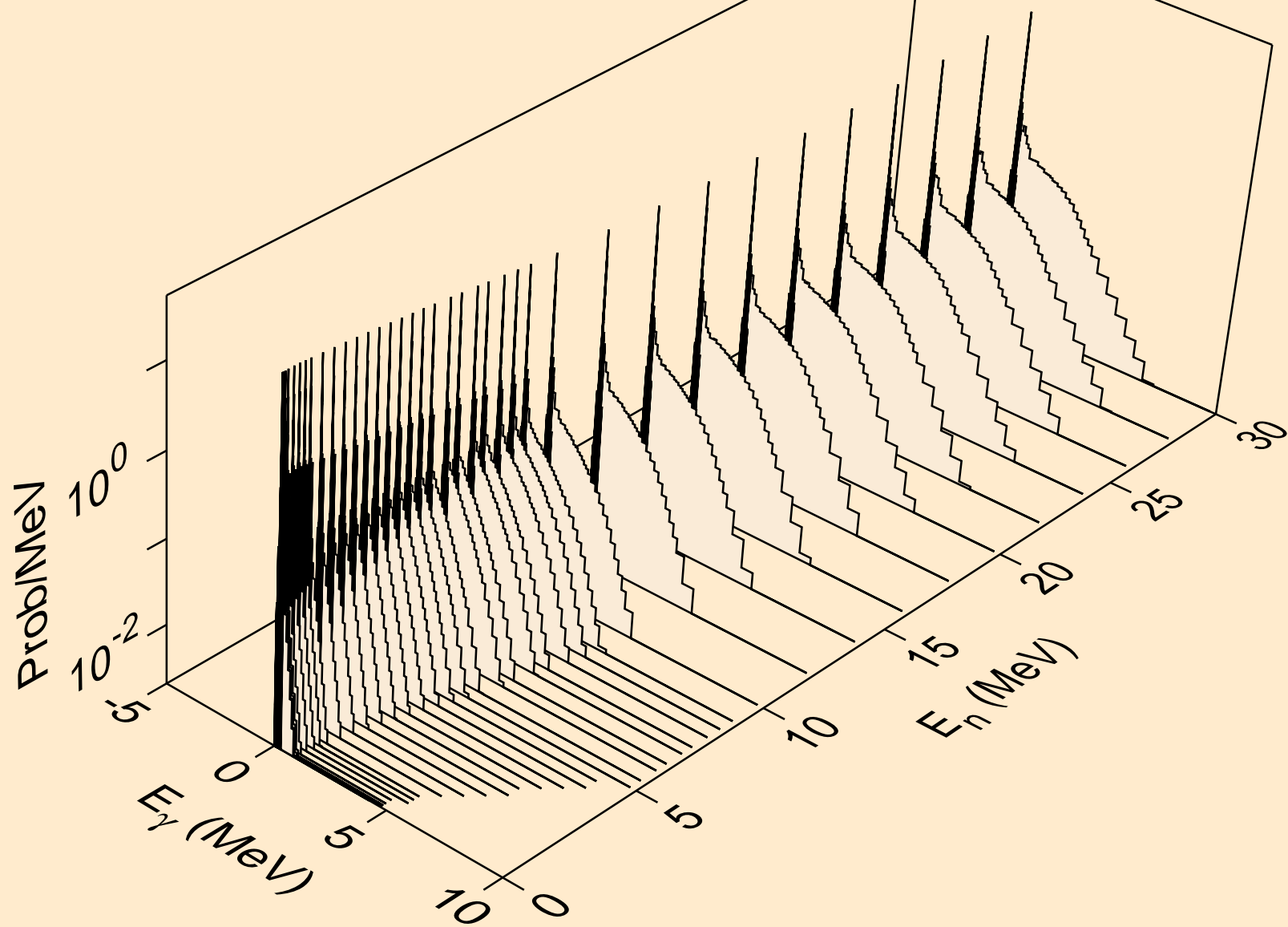

RE168 NEUTRON ACER TENDL-2024 LIBRARY; T=0.K
Photon emission for (n,p α)

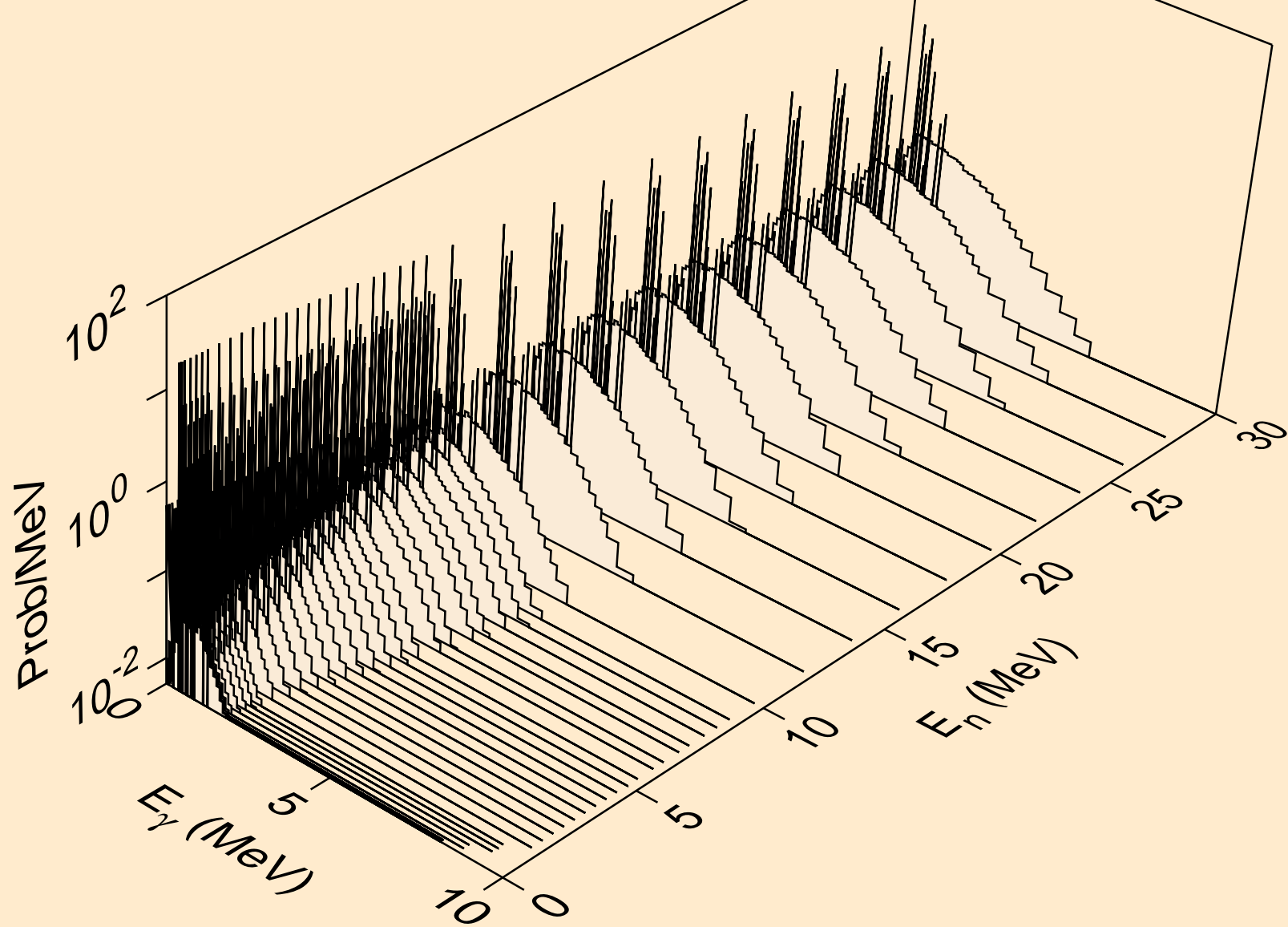

RE168 NEUTRON ACER TENDL-2024 LIBRARY; T=0.K
Photon emission for (n,t2a)

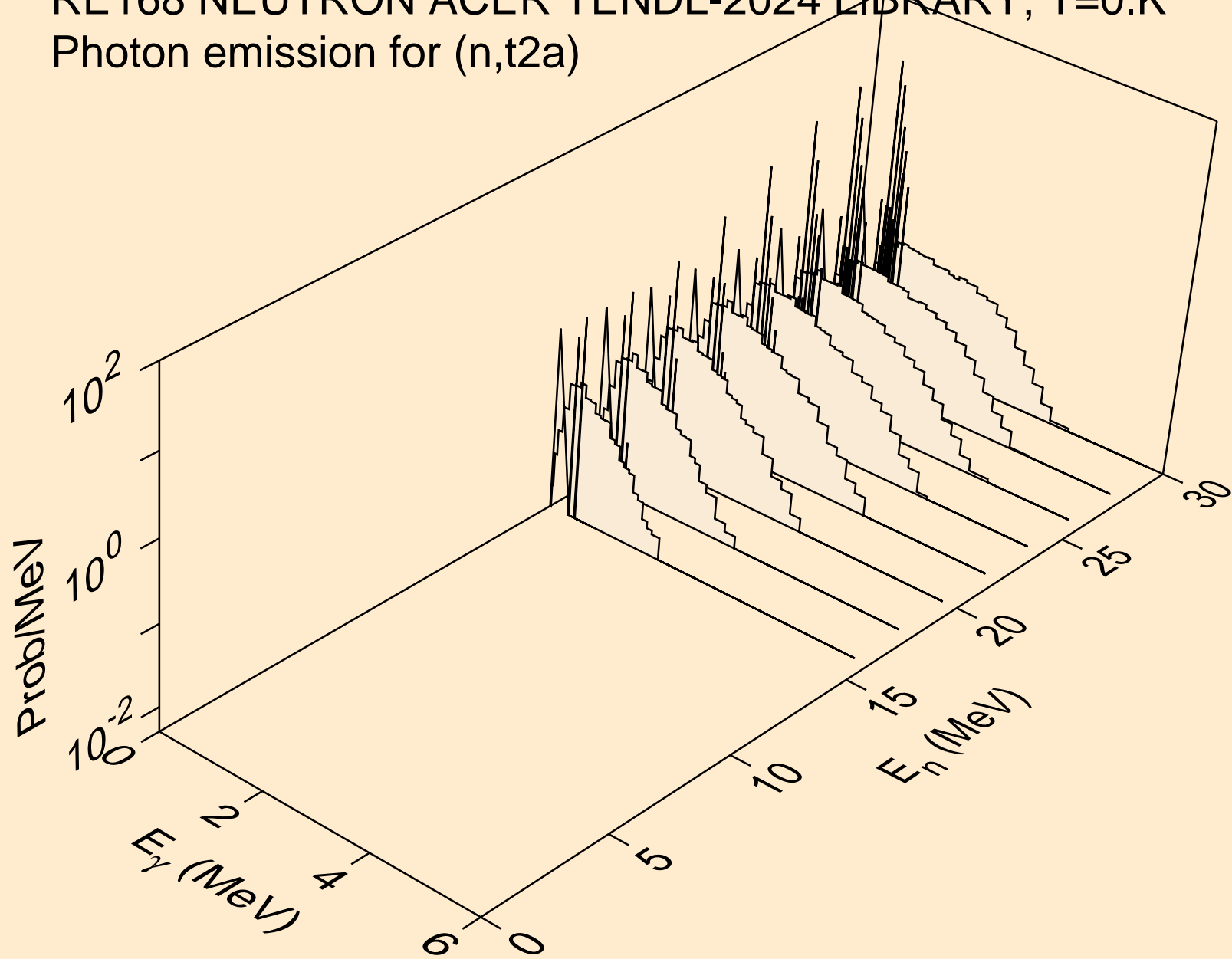

RE168 NEUTRON ACER TENDL-2024 LIBRARY; T=0.K
Photon emission for (n,d2a)

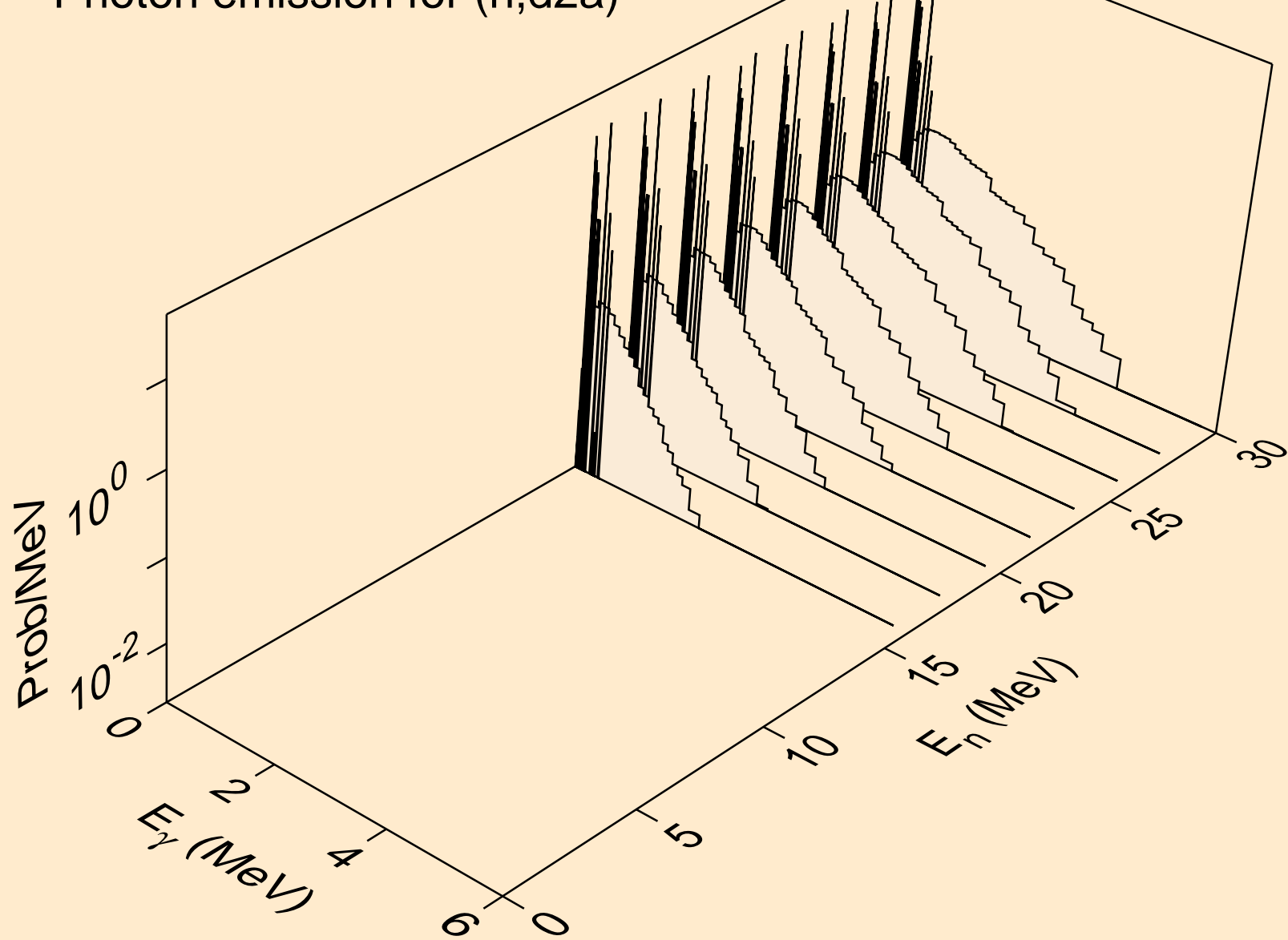

RE168 NEUTRON ACER TENDL-2024 LIBRARY; T=0.K
Photon emission for (n,pd)

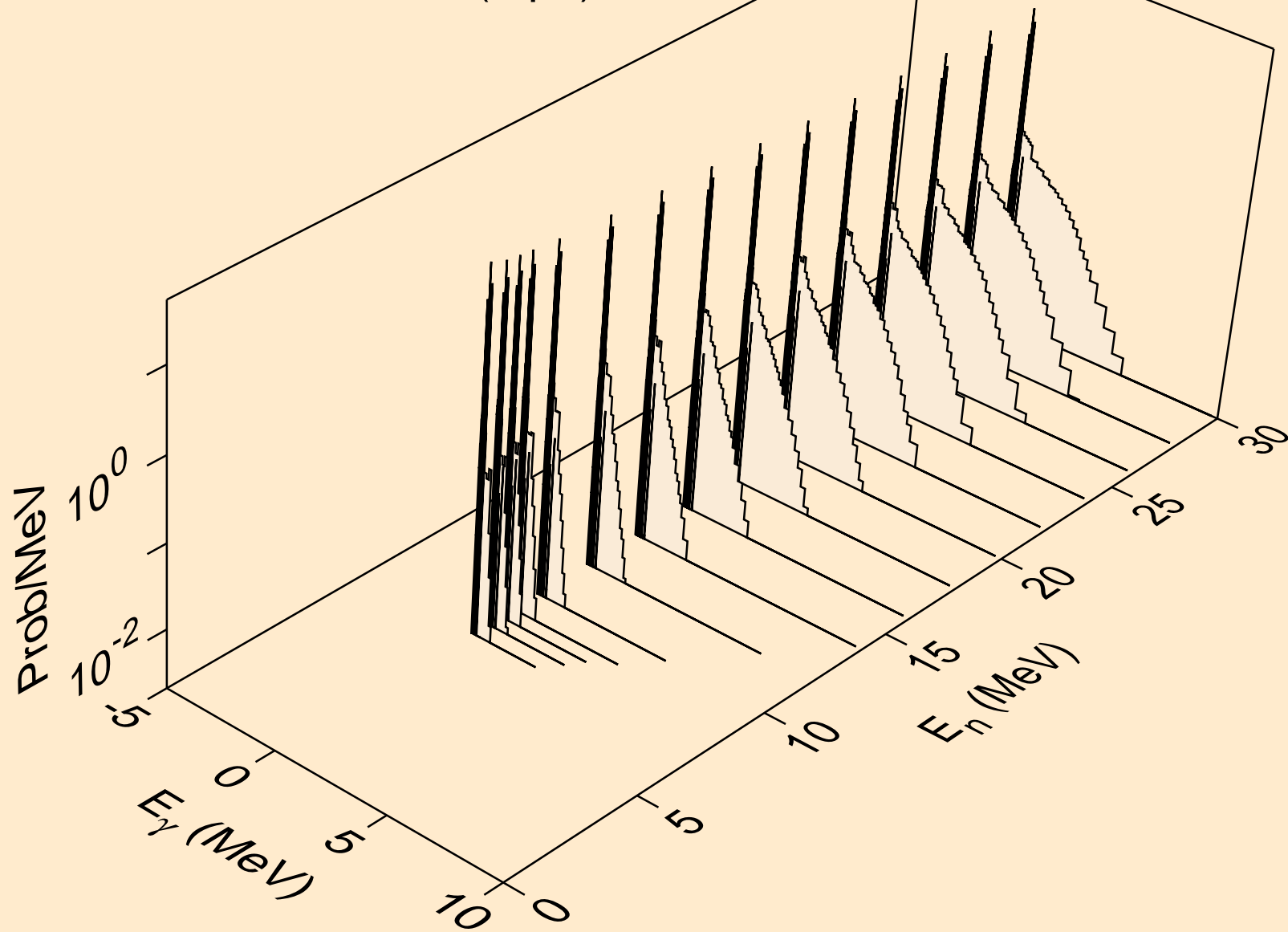

RE168 NEUTRON ACER TENDL-2024 LIBRARY; T=0.K
Photon emission for (n,pt)

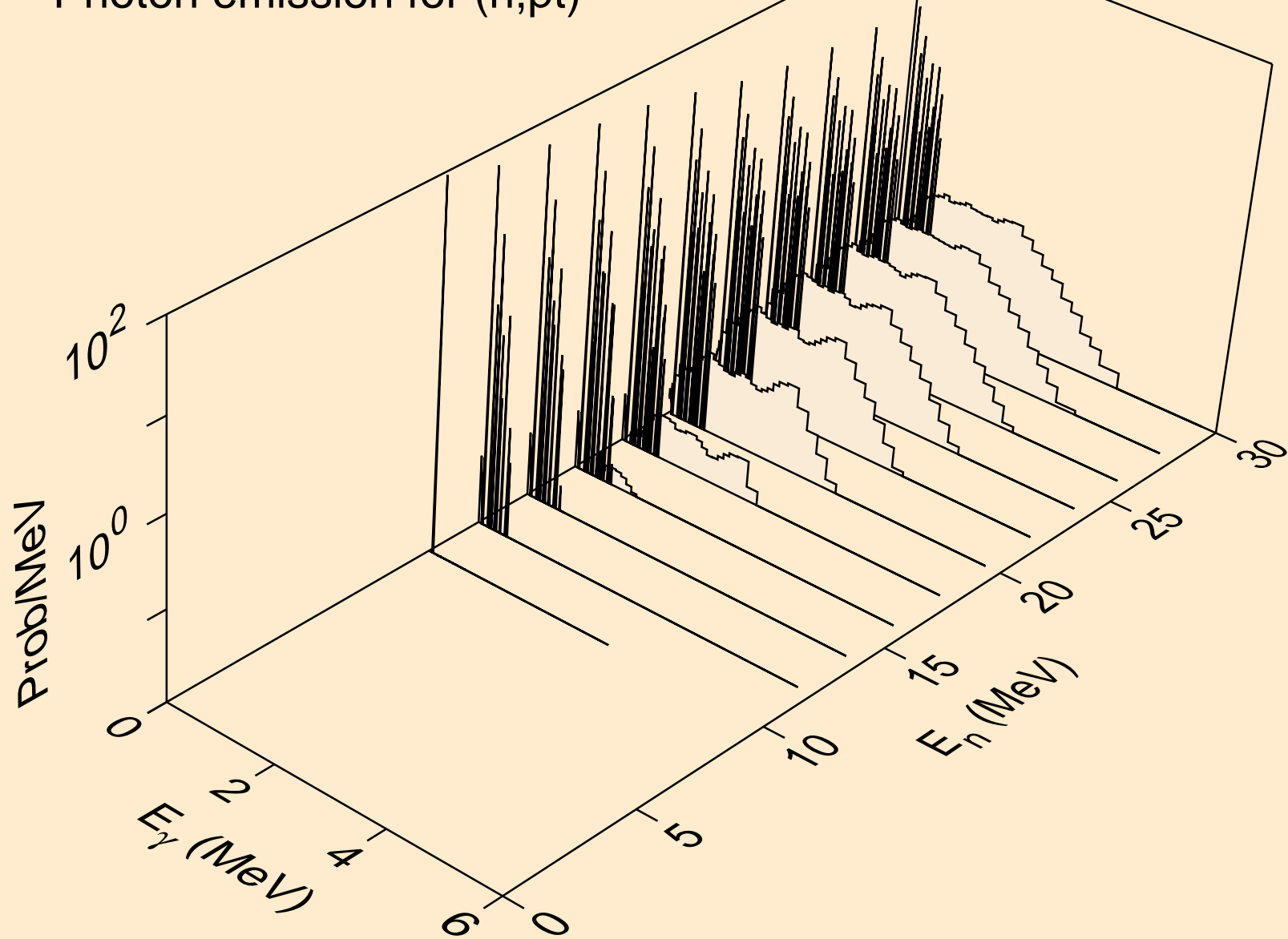

RE168 NEUTRON ACER TENDL-2024 LIBRARY; T=0.K
Photon emission for (n,da)

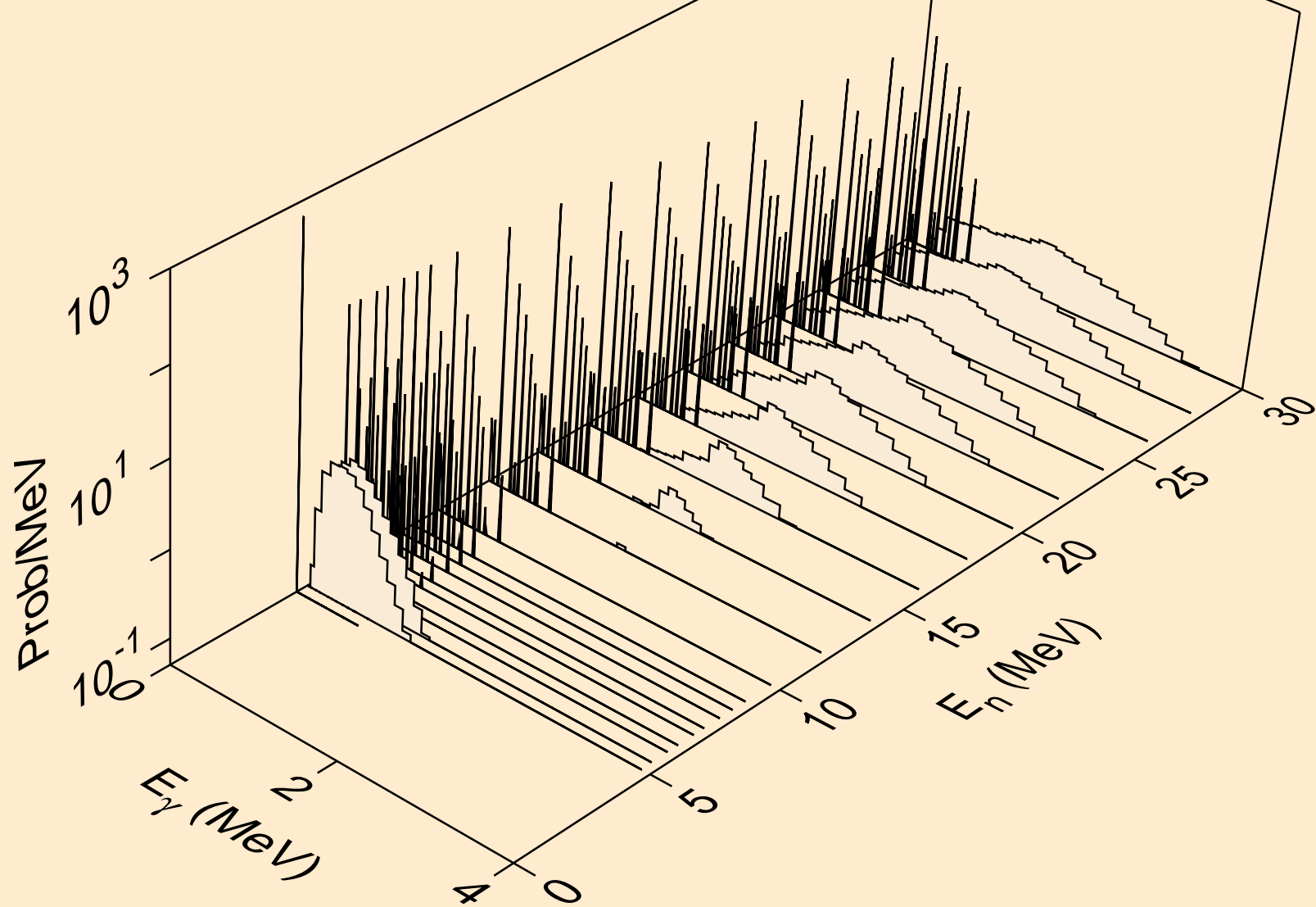

RE168 NEUTRON ACER TENDL-2024 LIBRARY; T=0.K
thermal capture photon spectrum

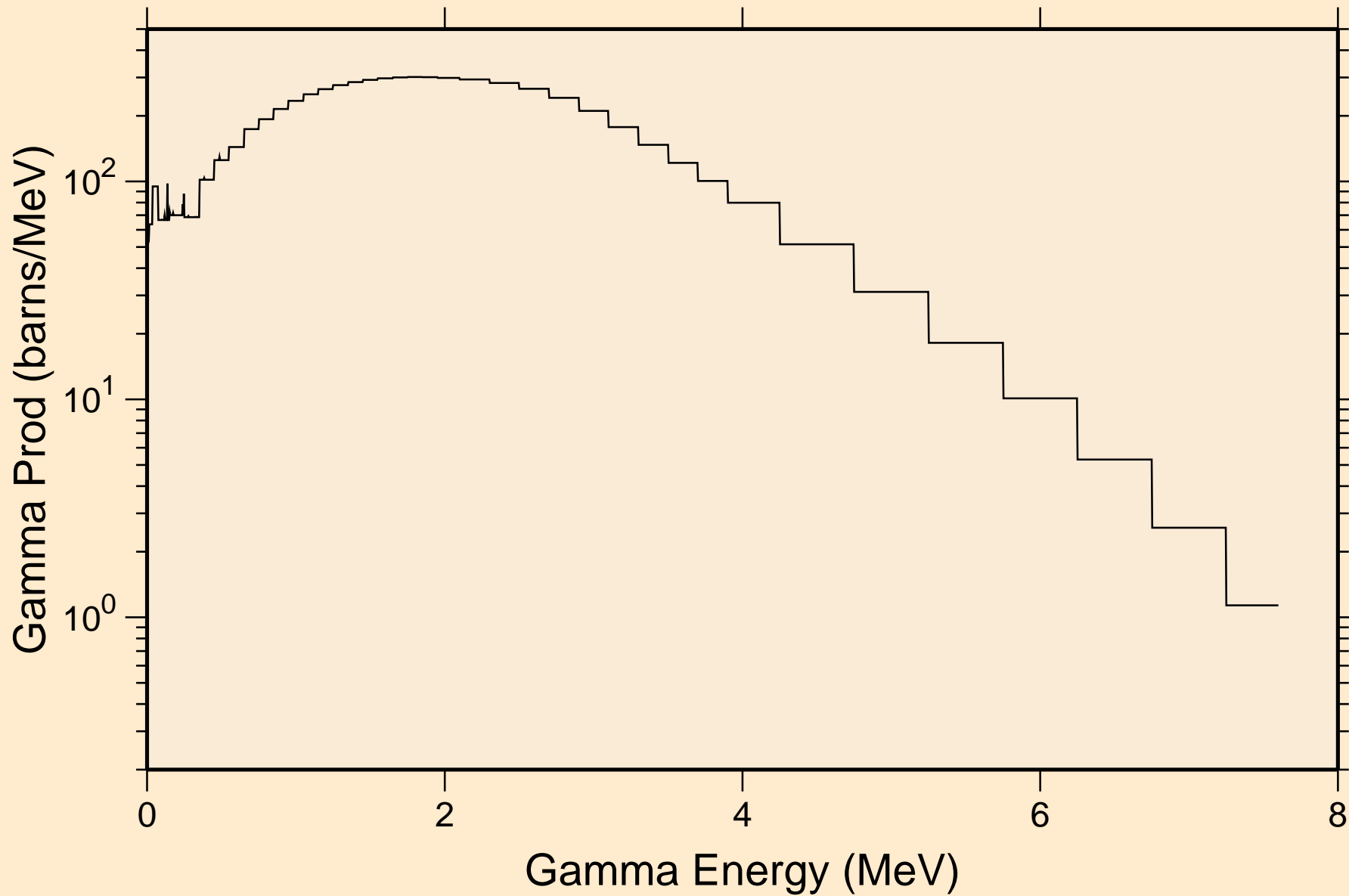

RE168 NEUTRON ACER TENDL-2024 LIBRARY; T=0.K
14 MeV photon spectrum

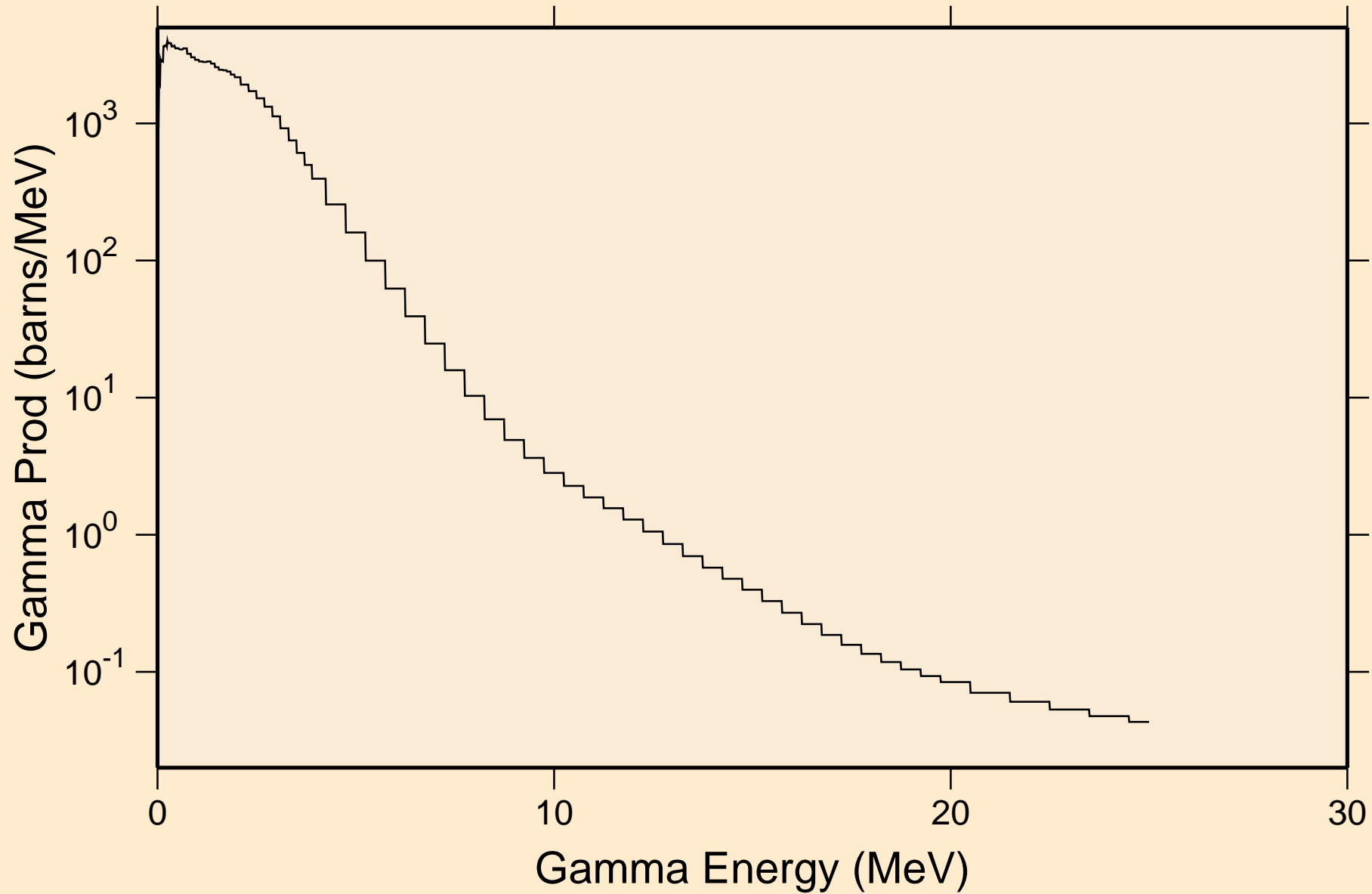

RE168 NEUTRON ACER TENDL-2024 LIBRARY; T=0.K
Particle heating contributions

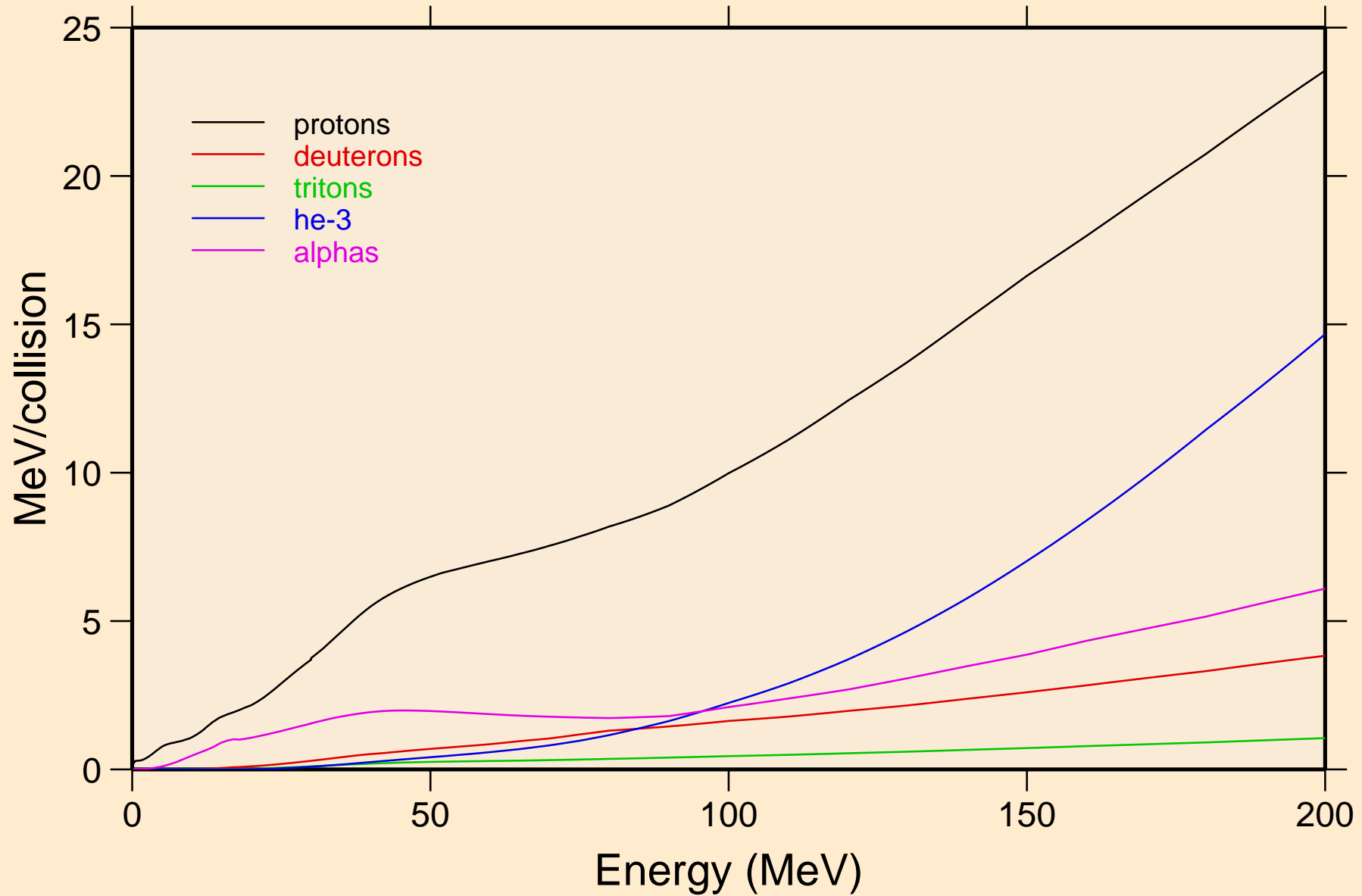

RE168 NEUTRON ACER TENDL-2024 LIBRARY; T=0.K

Recoil Heating

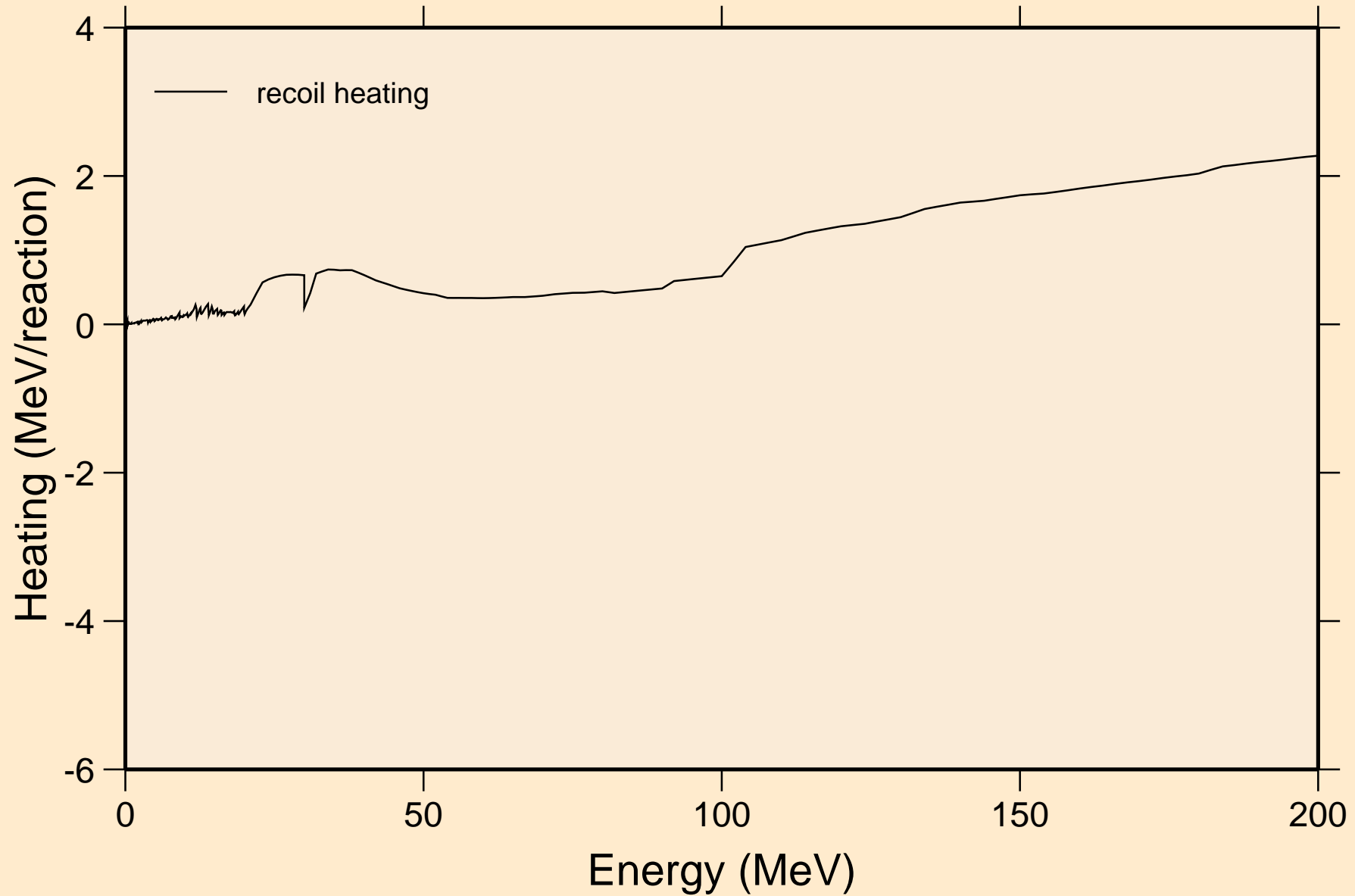

RE168 NEUTRON ACER TENDL-2024 LIBRARY; T=0.K
Particle production cross sections

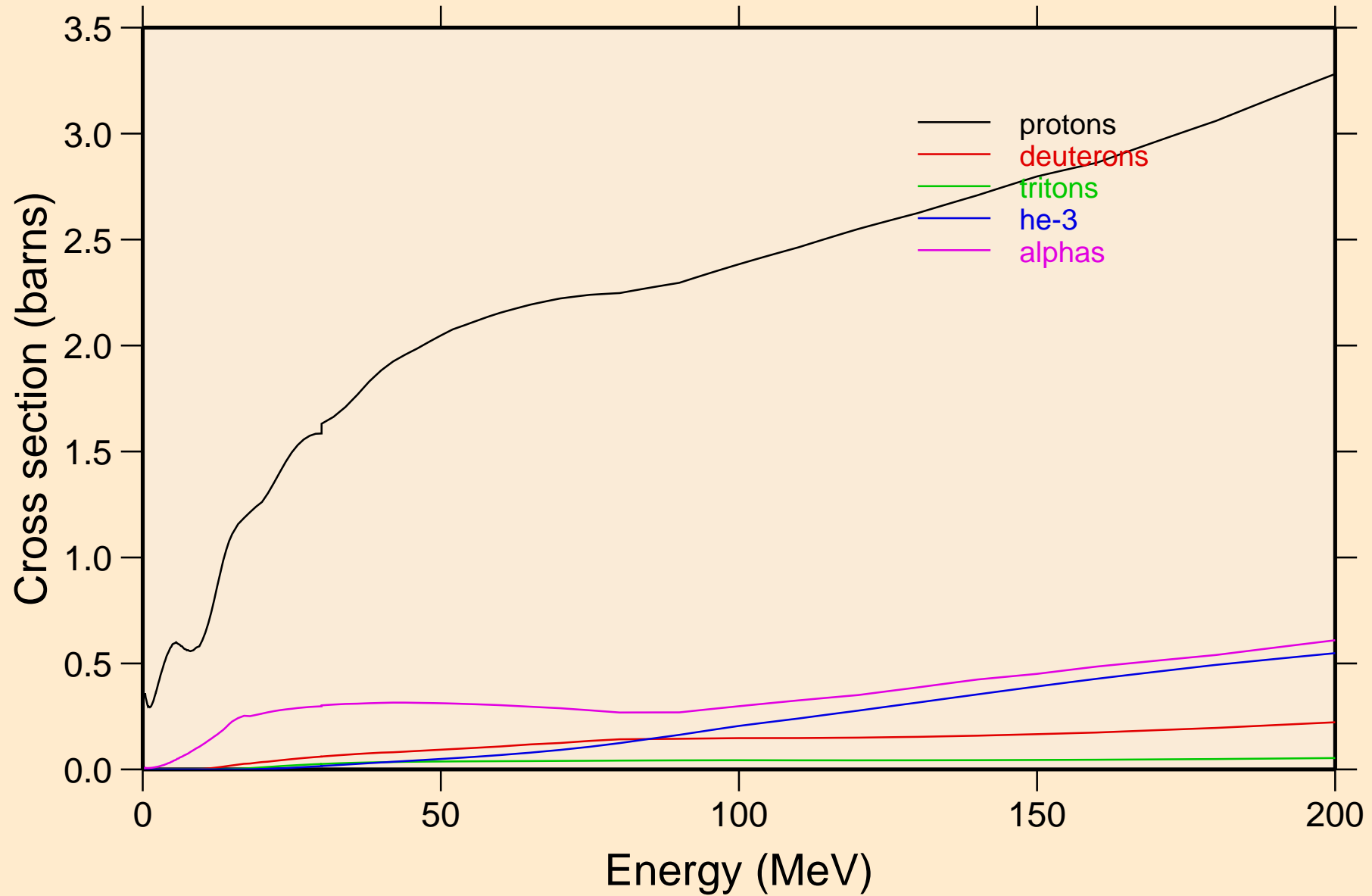

RE168 NEUTRON ACER TENDL-2024 LIBRARY; T=0.K
protons from (n,x)

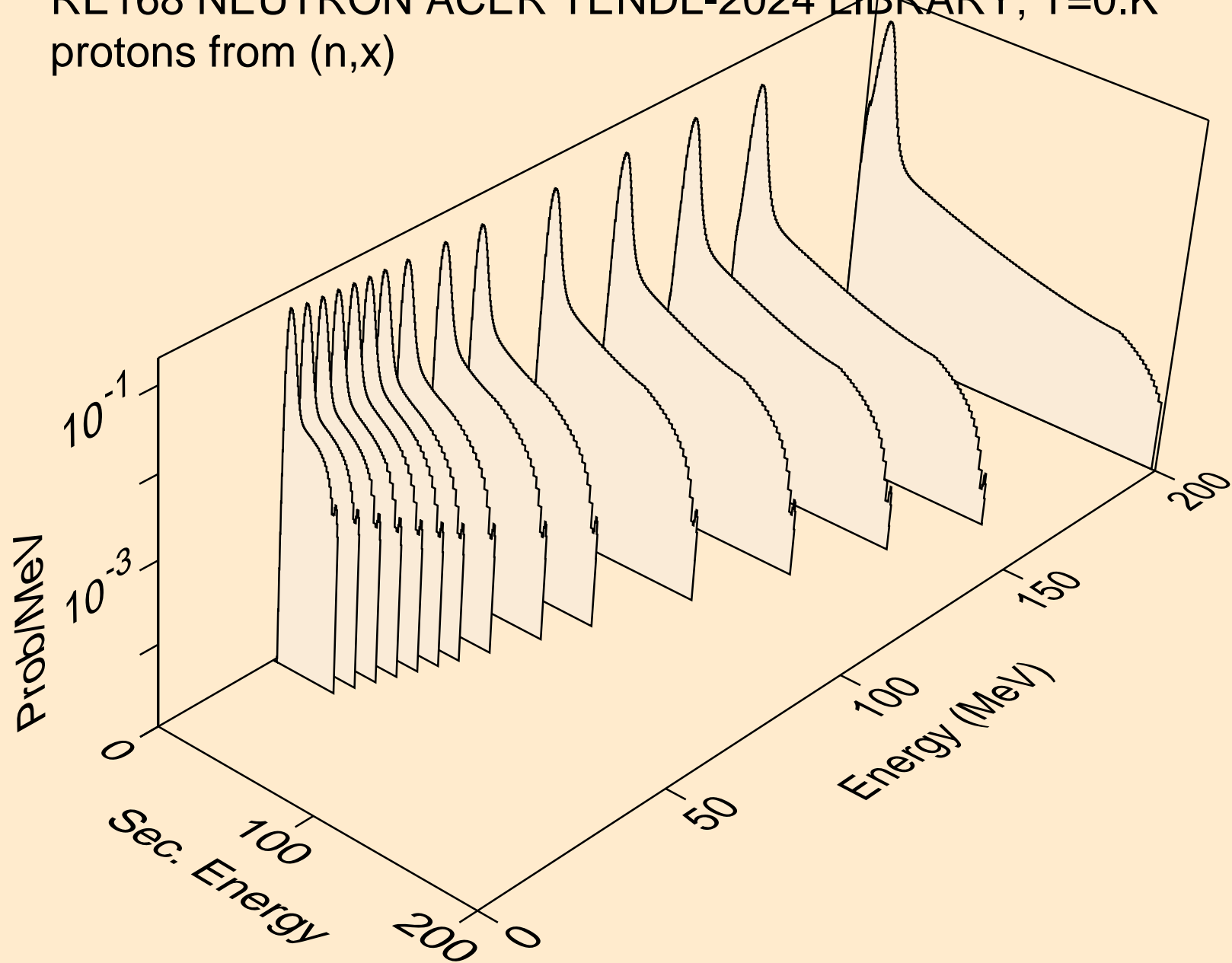

RE168 NEUTRON ACER TENDL-2024 LIBRARY; T=0.K
protons from (n,n*)p

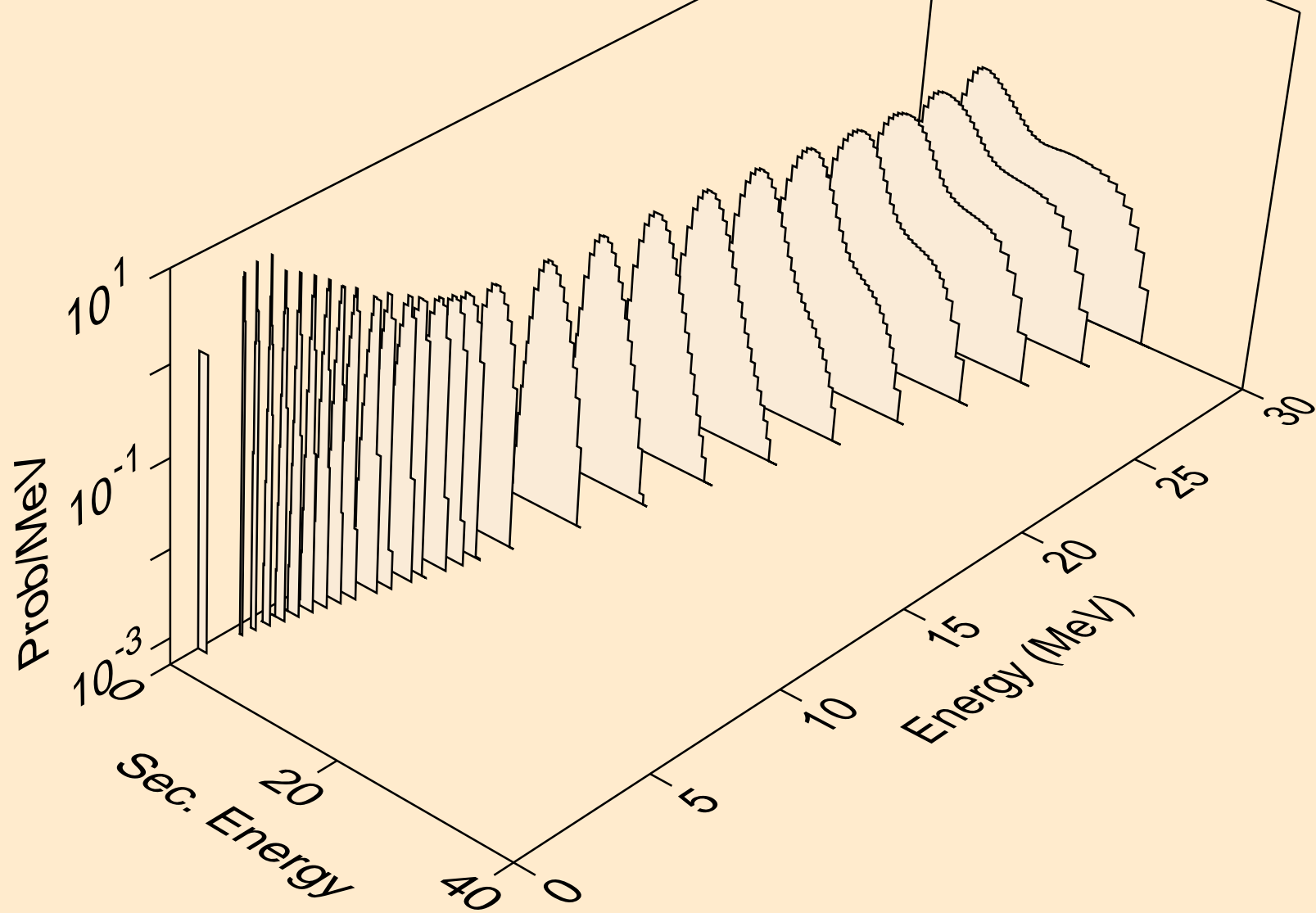

RE168 NEUTRON ACER TENDL-2024 LIBRARY; T=0.K
protons from (n,2np)

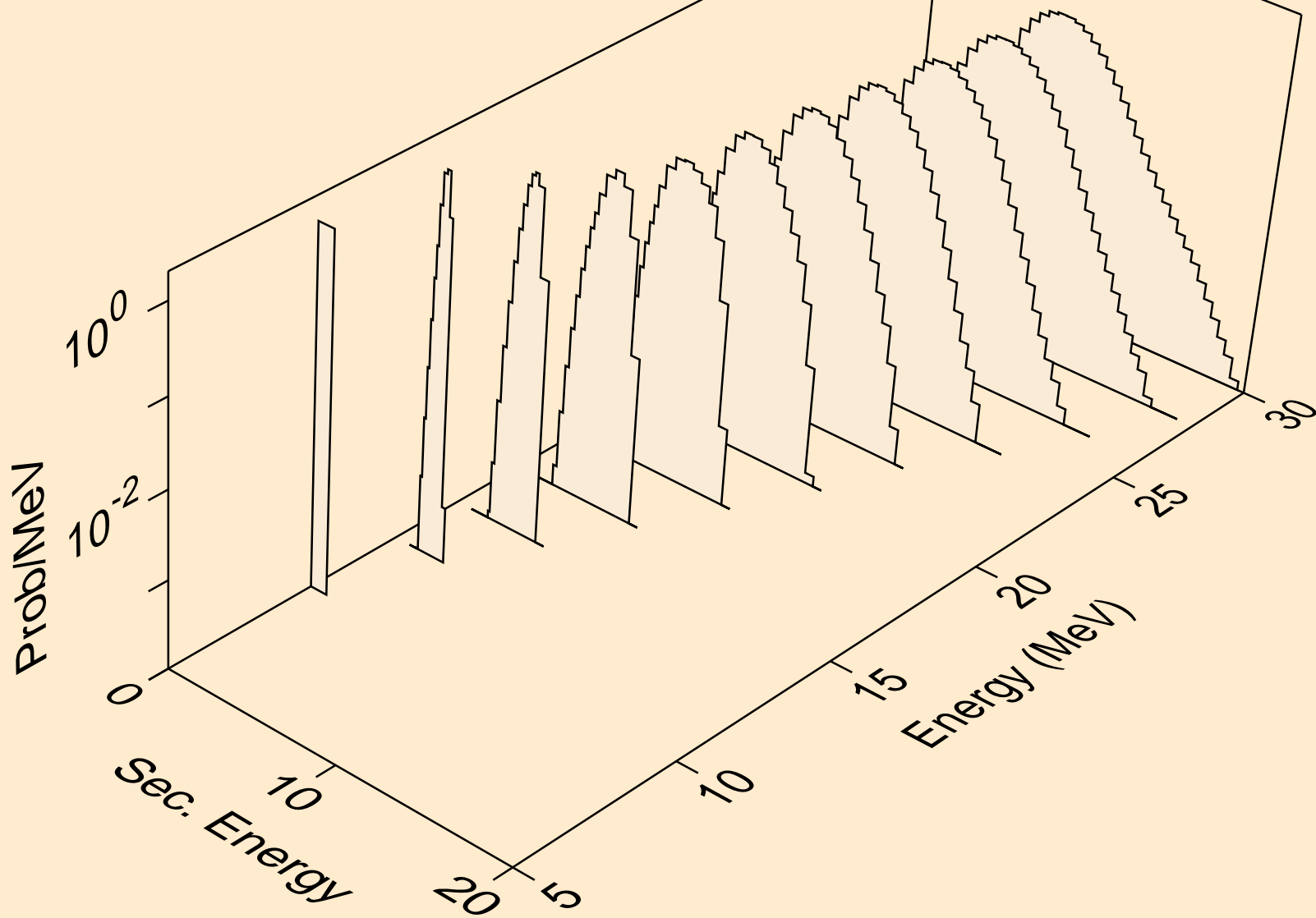

RE168 NEUTRON ACER TENDL-2024 LIBRARY; T=0.K
protons from (n,3np)

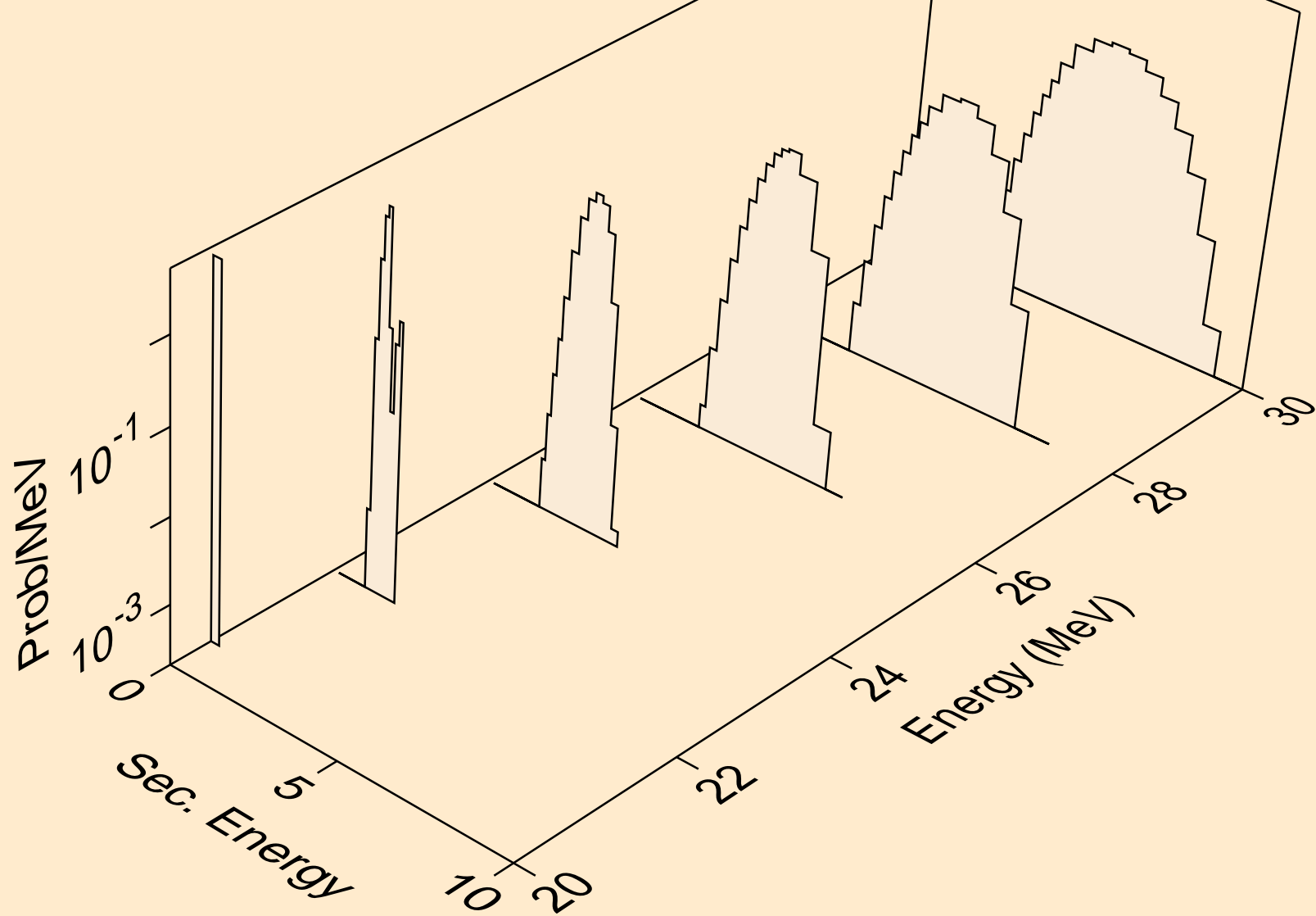

RE168 NEUTRON ACER TENDL-2024 LIBRARY; T=0.K
protons from (n,n2p)

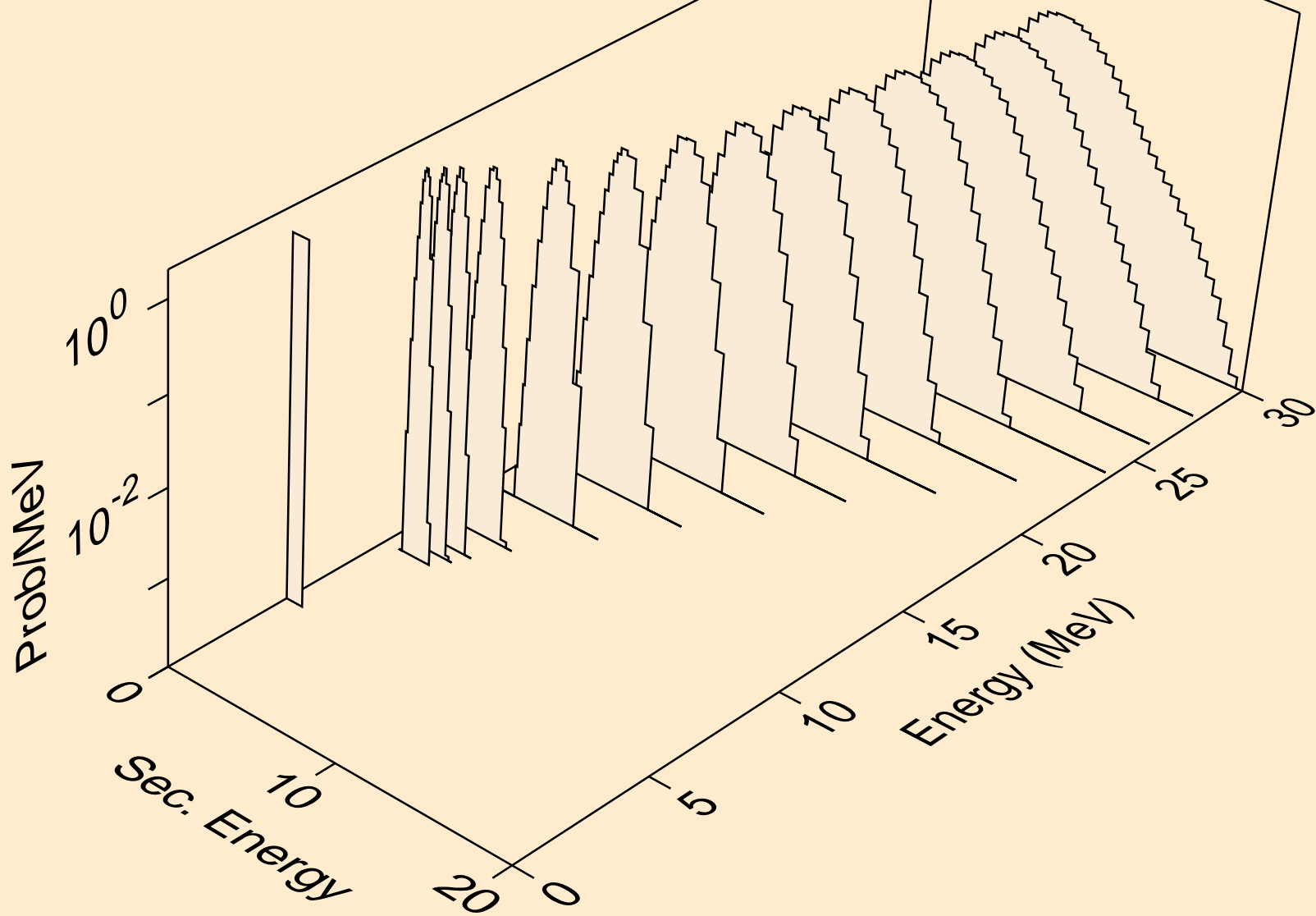

RE168 NEUTRON ACER TENDL-2024 LIBRARY; T=0.K
protons from (n,npa)

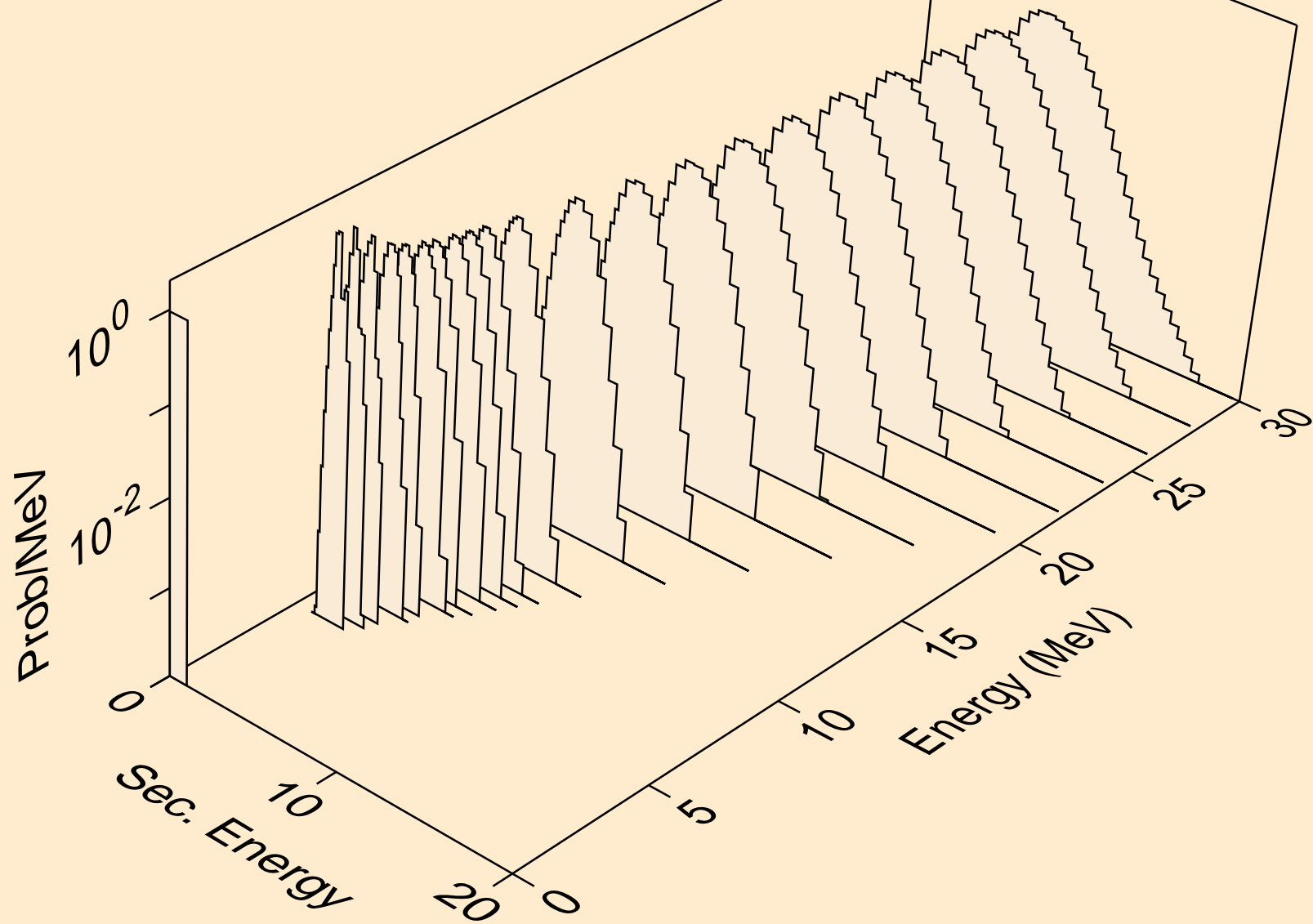

RE168 NEUTRON ACER TENDL-2024 LIBRARY; T=0.K
protons from (n,p)

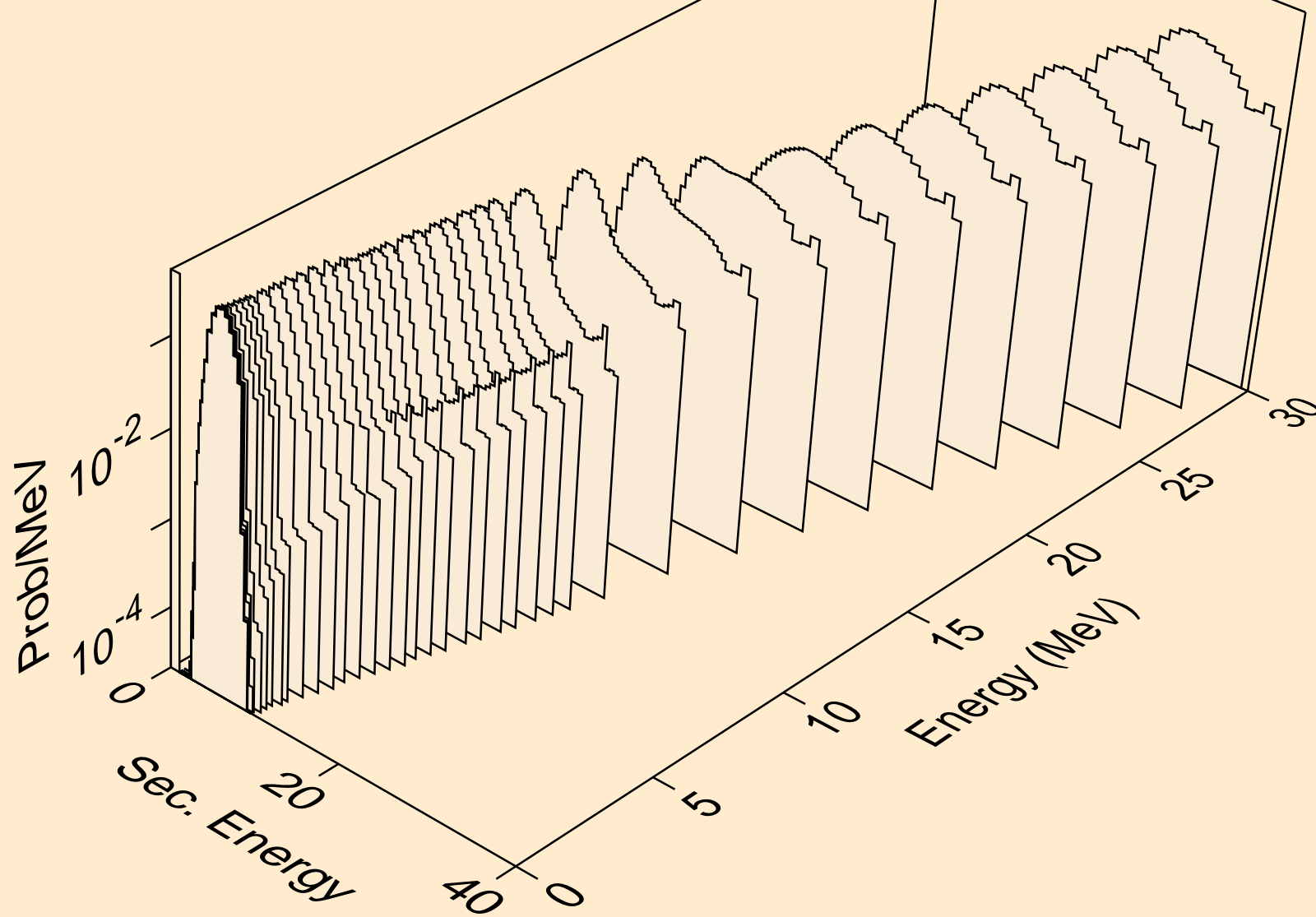

RE168 NEUTRON ACER TENDL-2024 LIBRARY; T=0.K
protons from (n,2p)

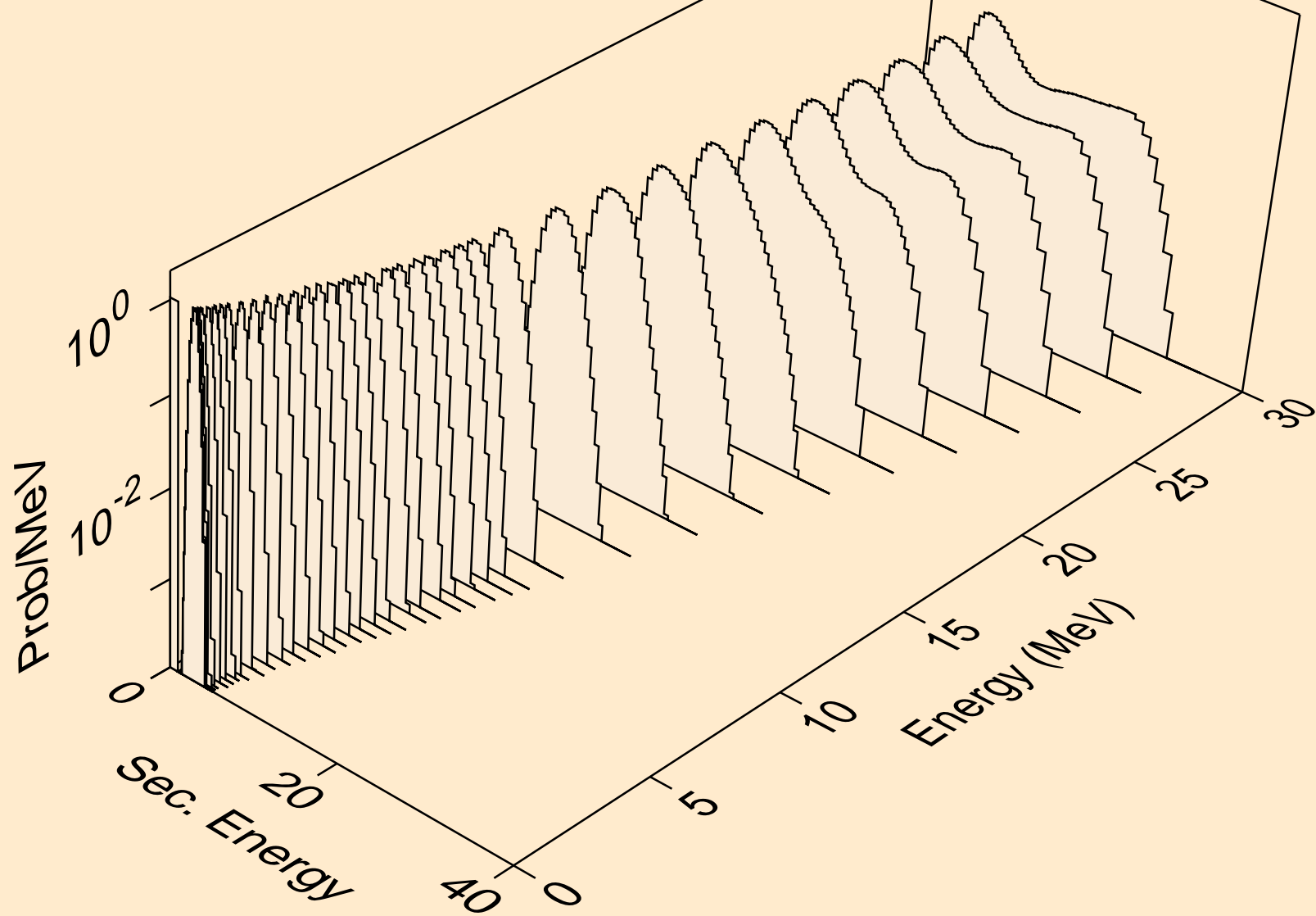

RE168 NEUTRON ACER TENDL-2024 LIBRARY; T=0.K
protons from (n,p)

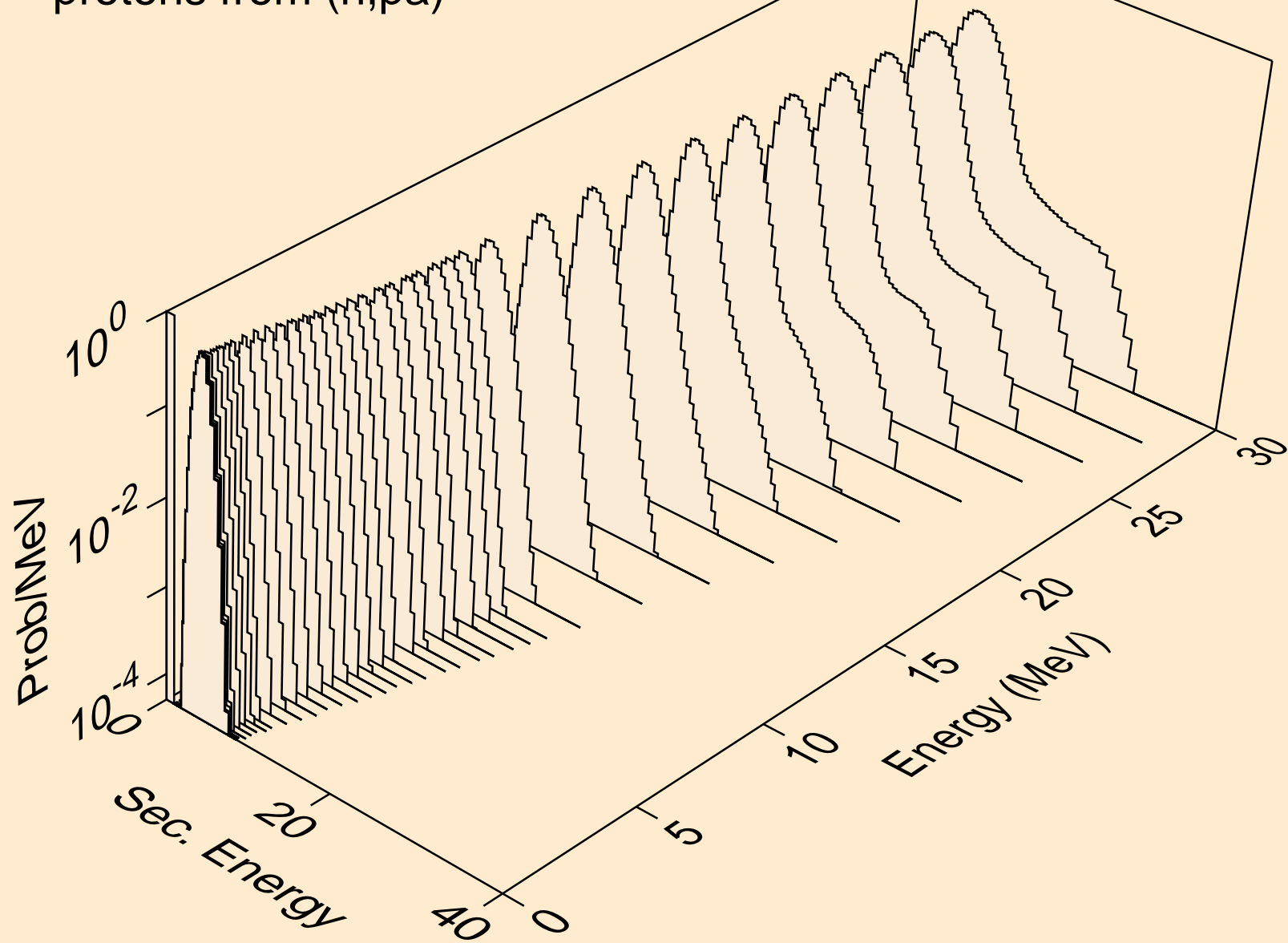

RE168 NEUTRON ACER TENDL-2024 LIBRARY; T=0.K
protons from (n,pd)

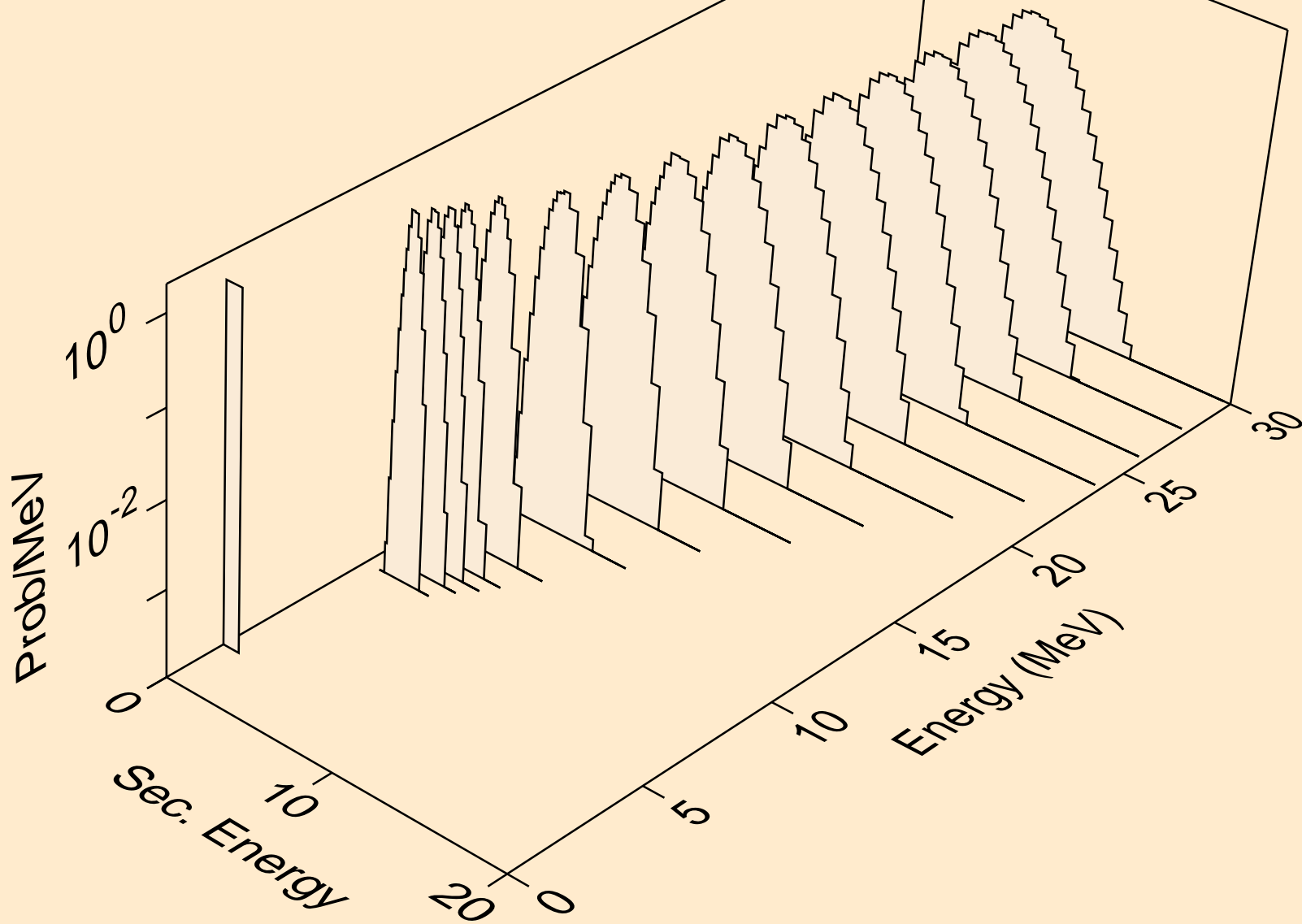

RE168 NEUTRON ACER TENDL-2024 LIBRARY; T=0.K
protons from (n,pt)

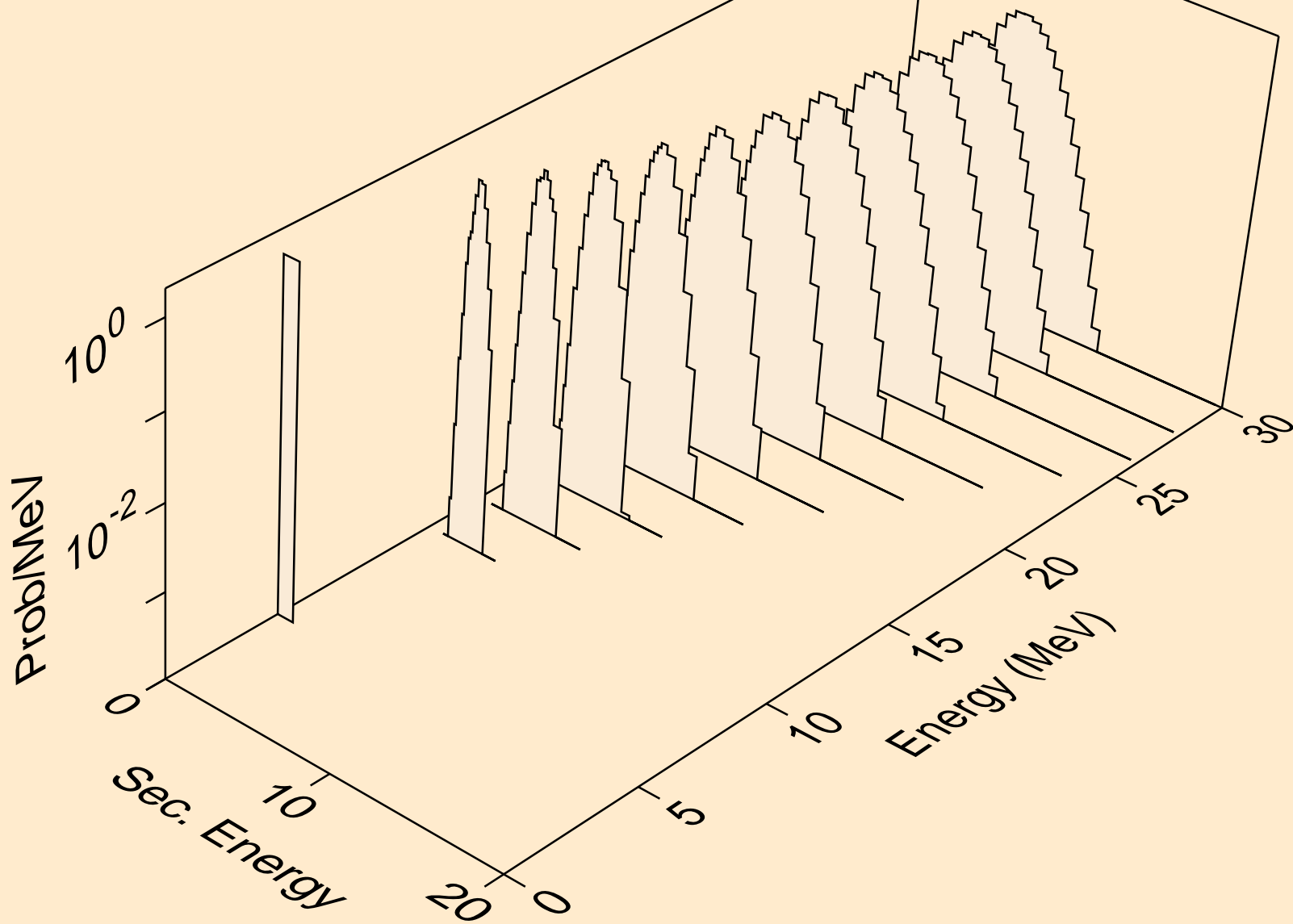

RE168 NEUTRON ACER TENDL-2024 LIBRARY; T=0.K
deuterons from (n,x)

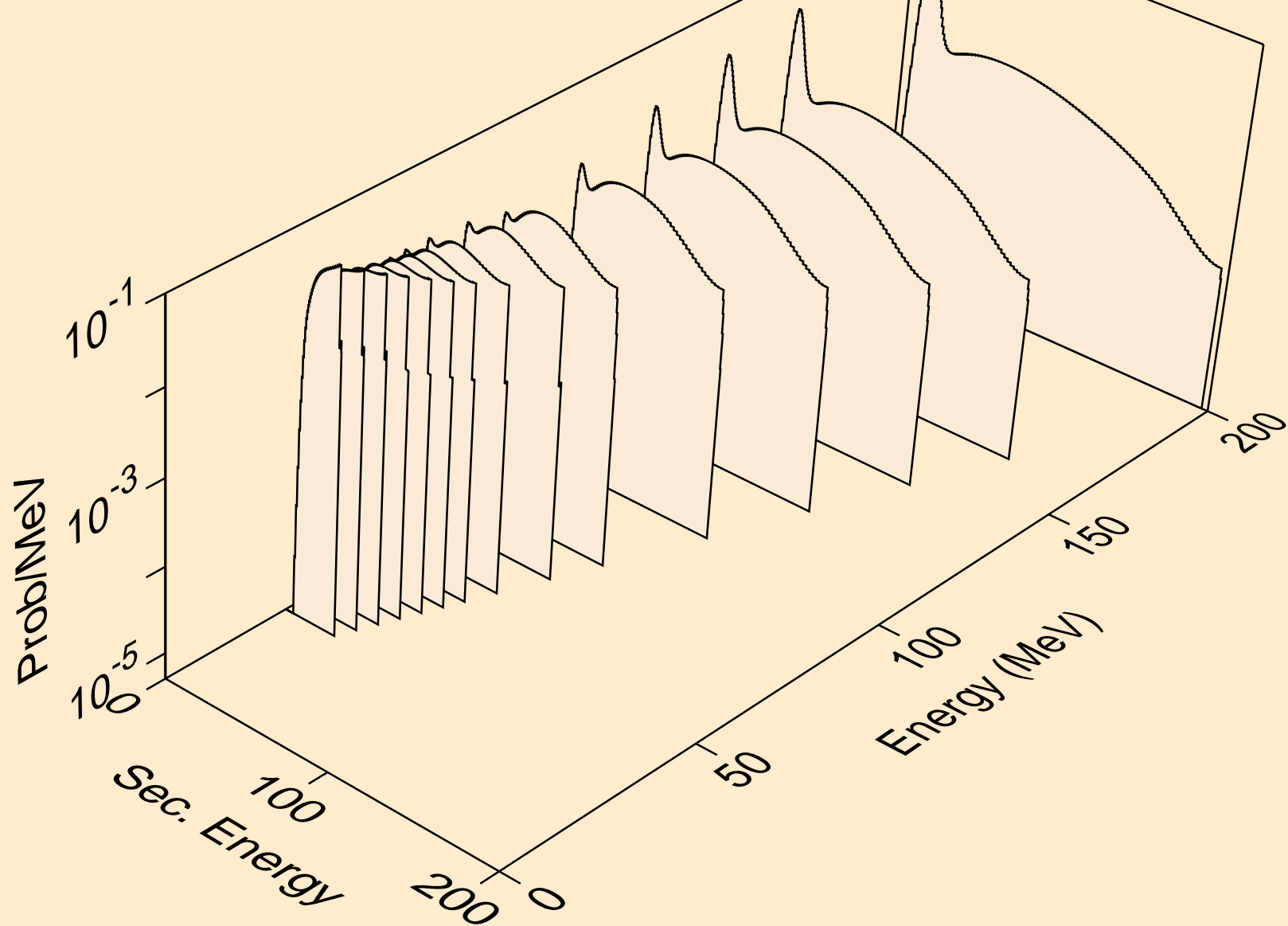

RE168 NEUTRON ACER TENDL-2024 LIBRARY; T=0.K
deuterons from (n,2nd)

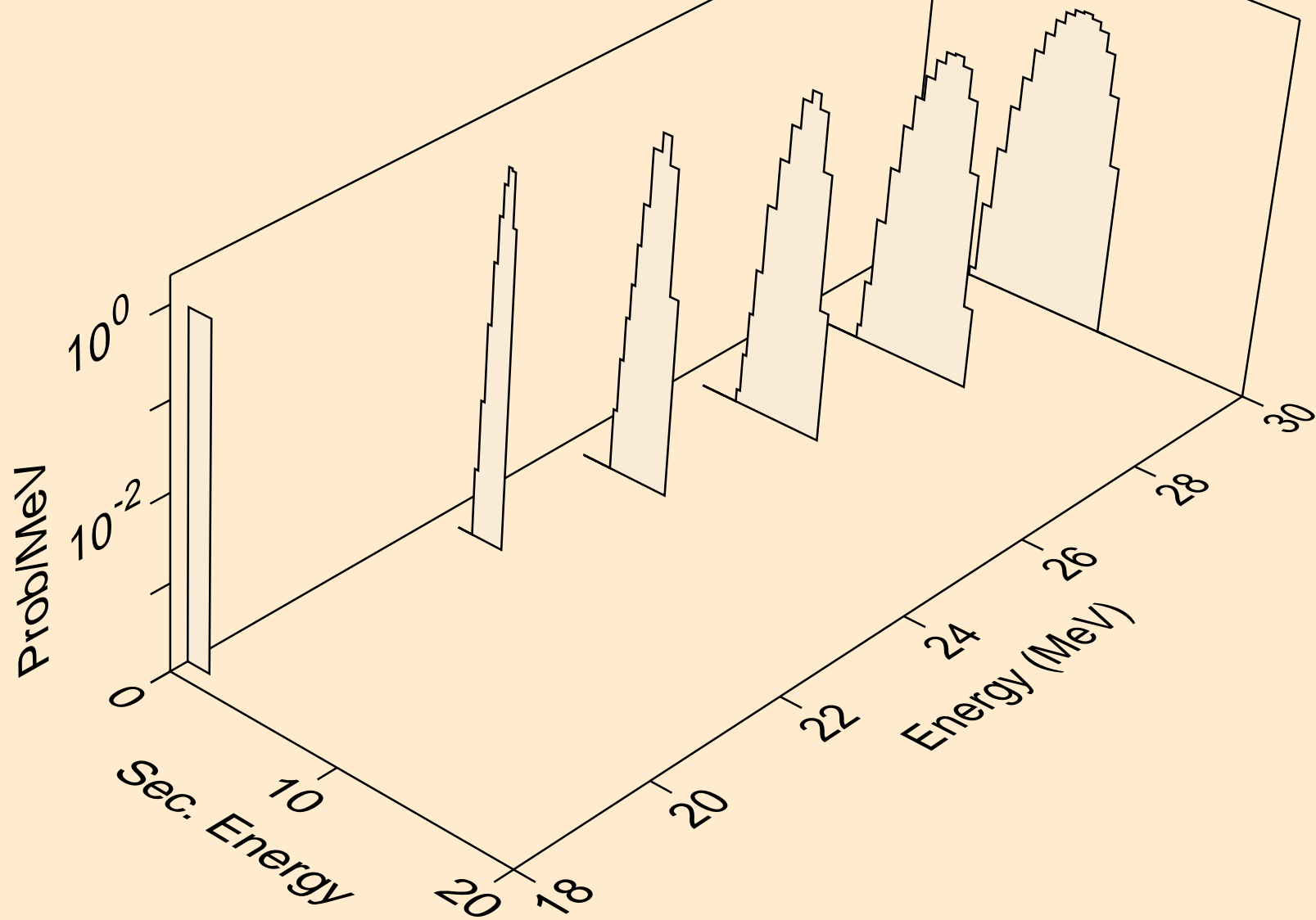

RE168 NEUTRON ACER TENDL-2024 LIBRARY; T=0.K
deuterons from (n,n*)d

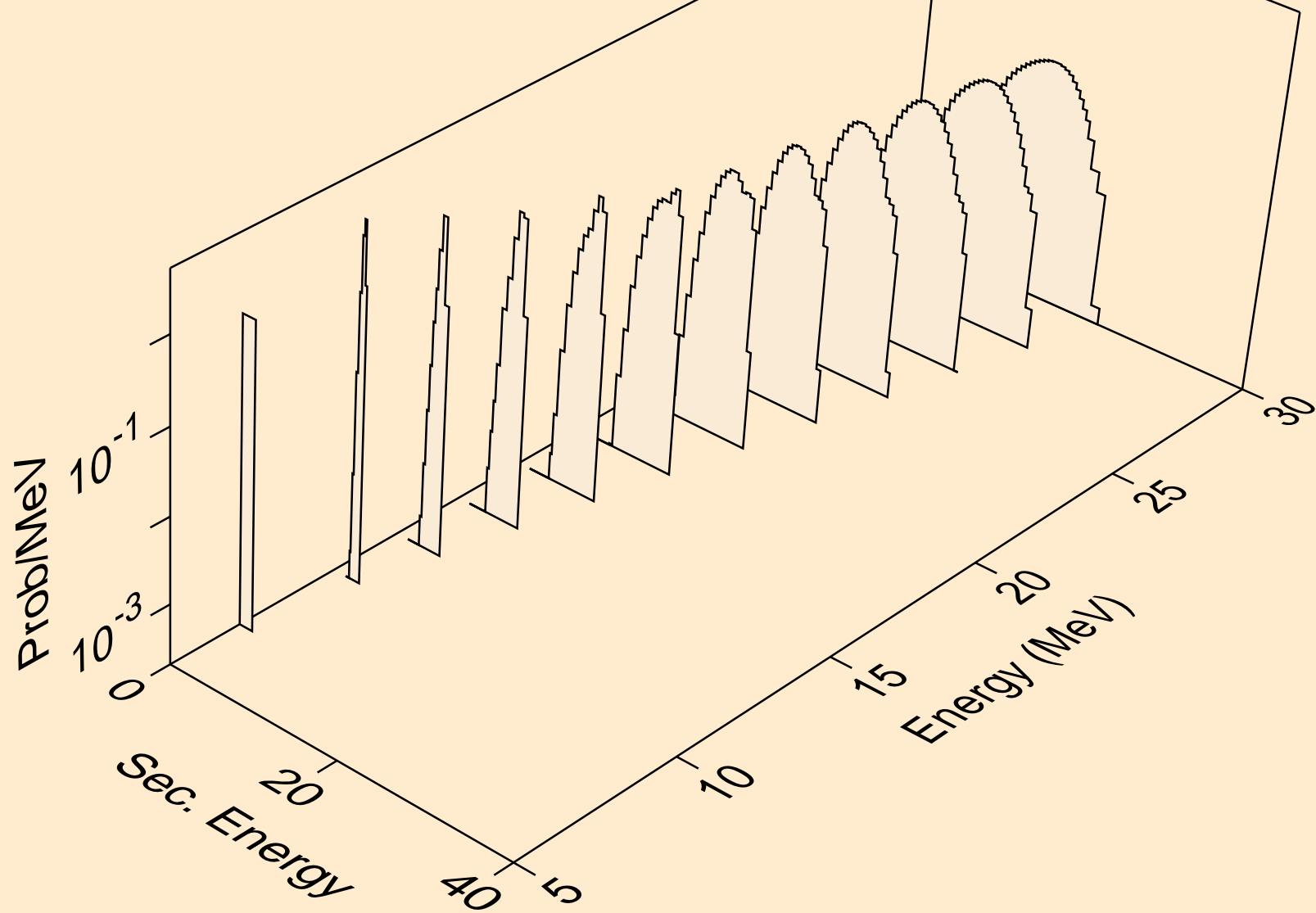

RE168 NEUTRON ACER TENDL-2024 LIBRARY; T=0.K
deuterons from (n,d)

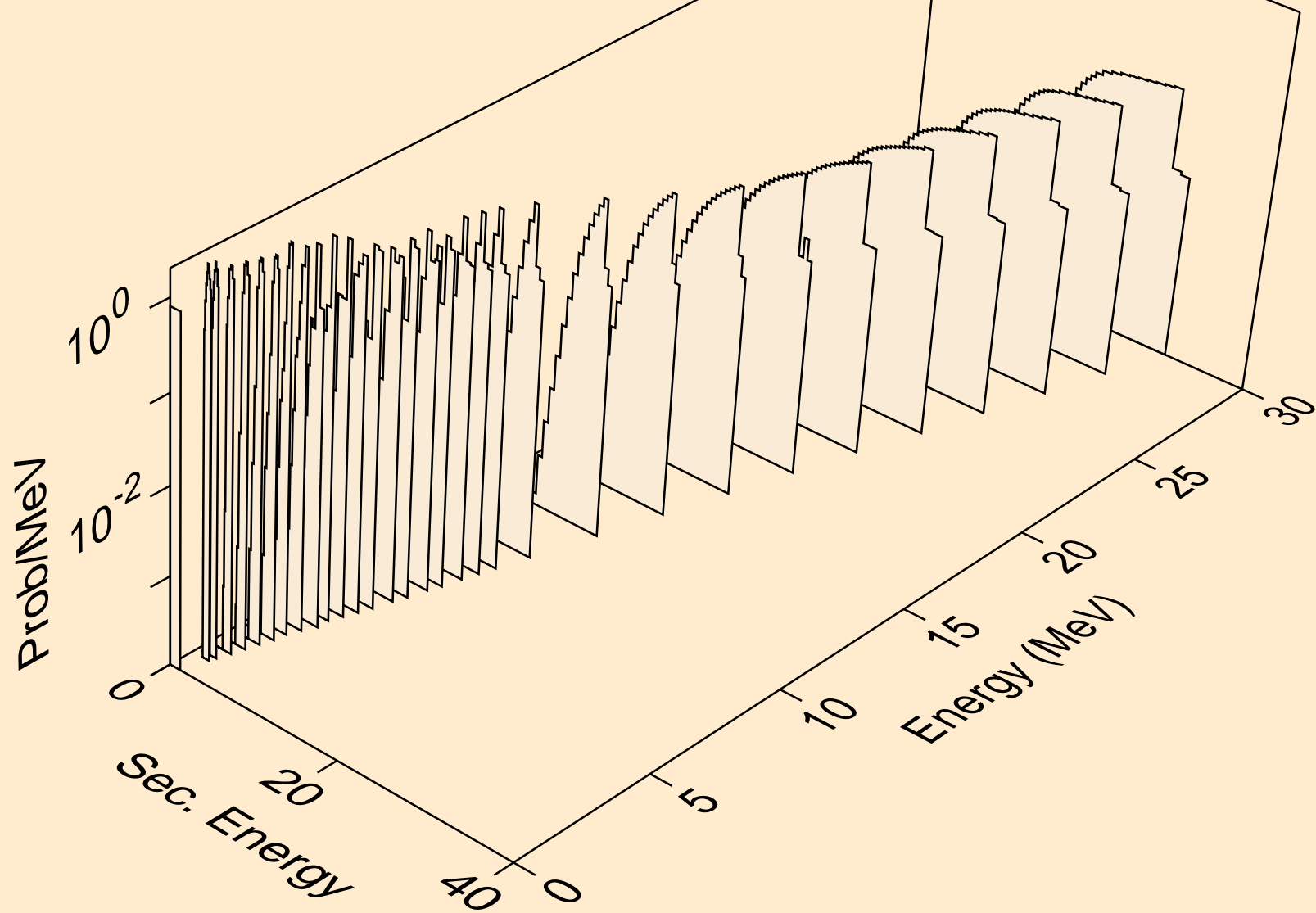

RE168 NEUTRON ACER TENDL-2024 LIBRARY; T=0.K
deuterons from (n,d2a)

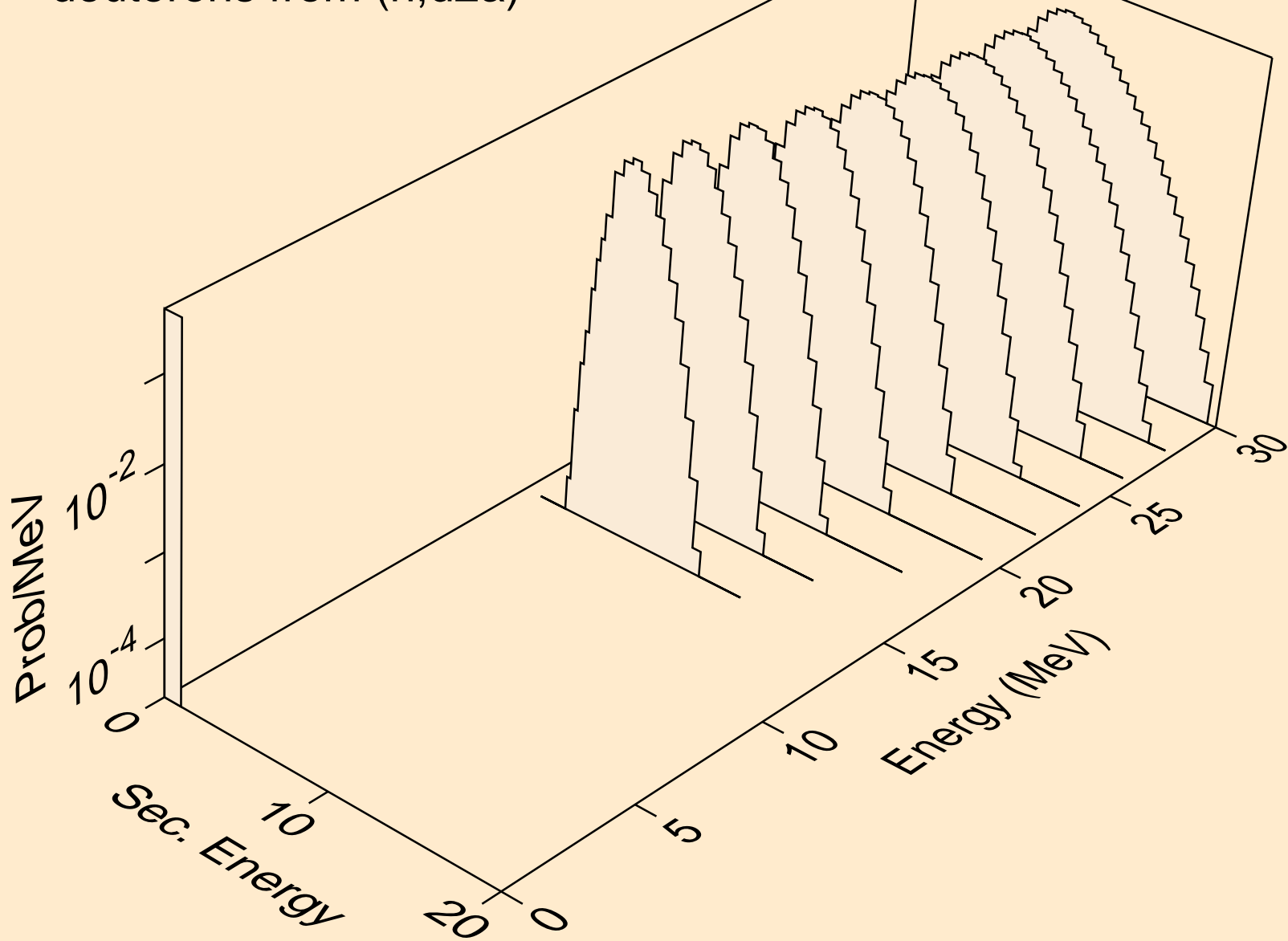

RE168 NEUTRON ACER TENDL-2024 LIBRARY; T=0.K
deuterons from (n,pd)

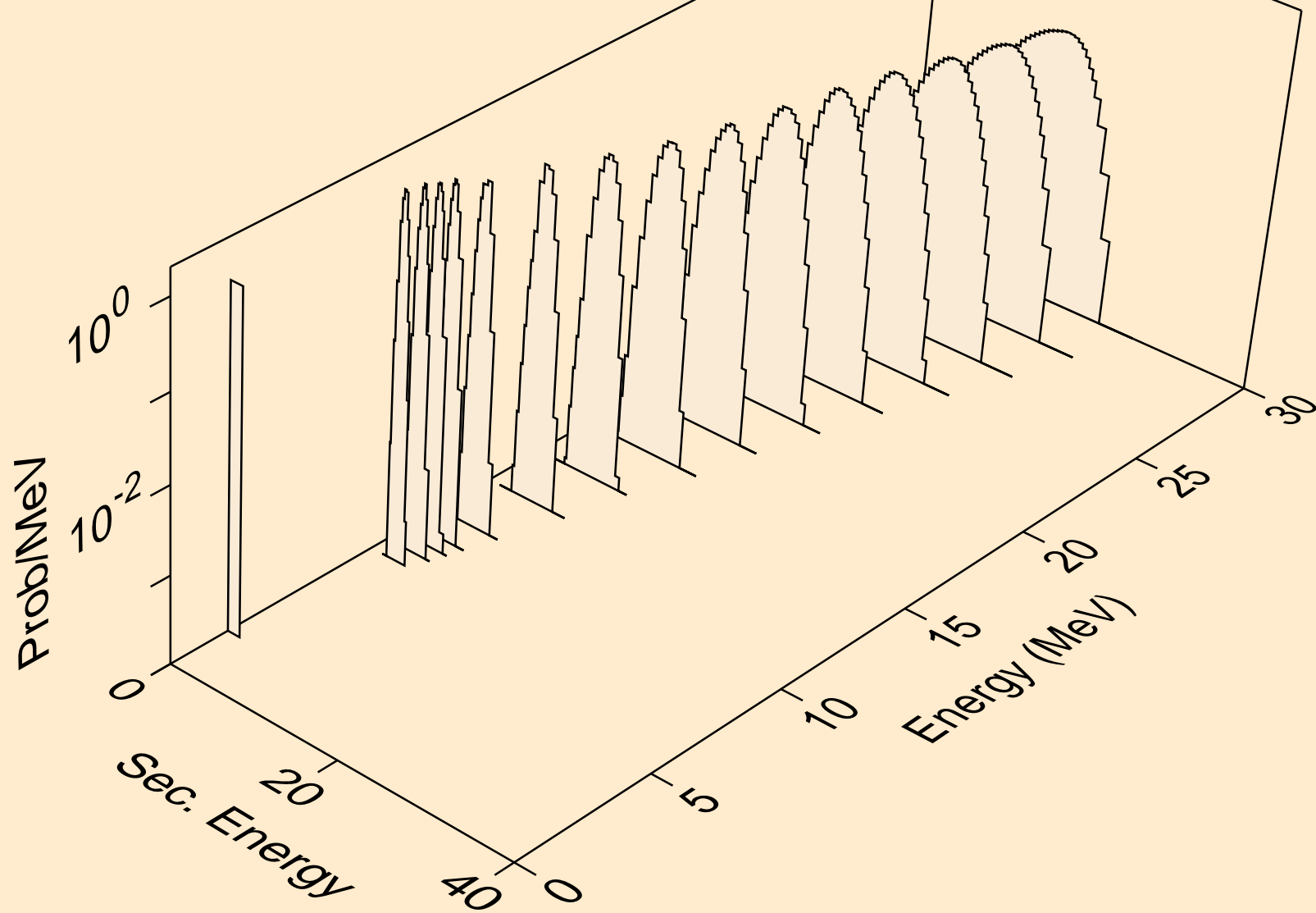

RE168 NEUTRON ACER TENDL-2024 LIBRARY; T=0.K
deuterons from (n,da)

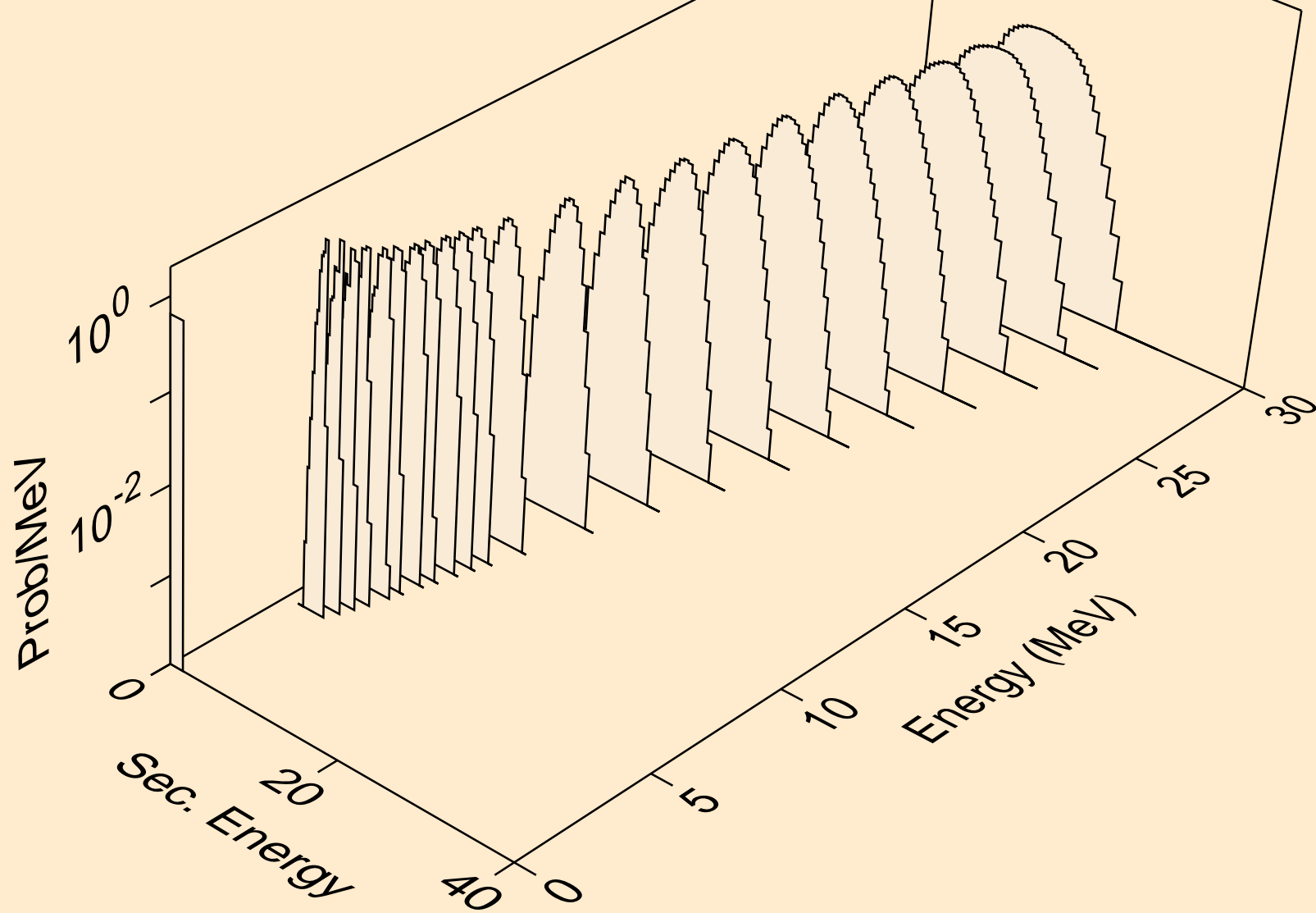

RE168 NEUTRON ACER TENDL-2024 LIBRARY; T=0.K
tritons from (n,x)

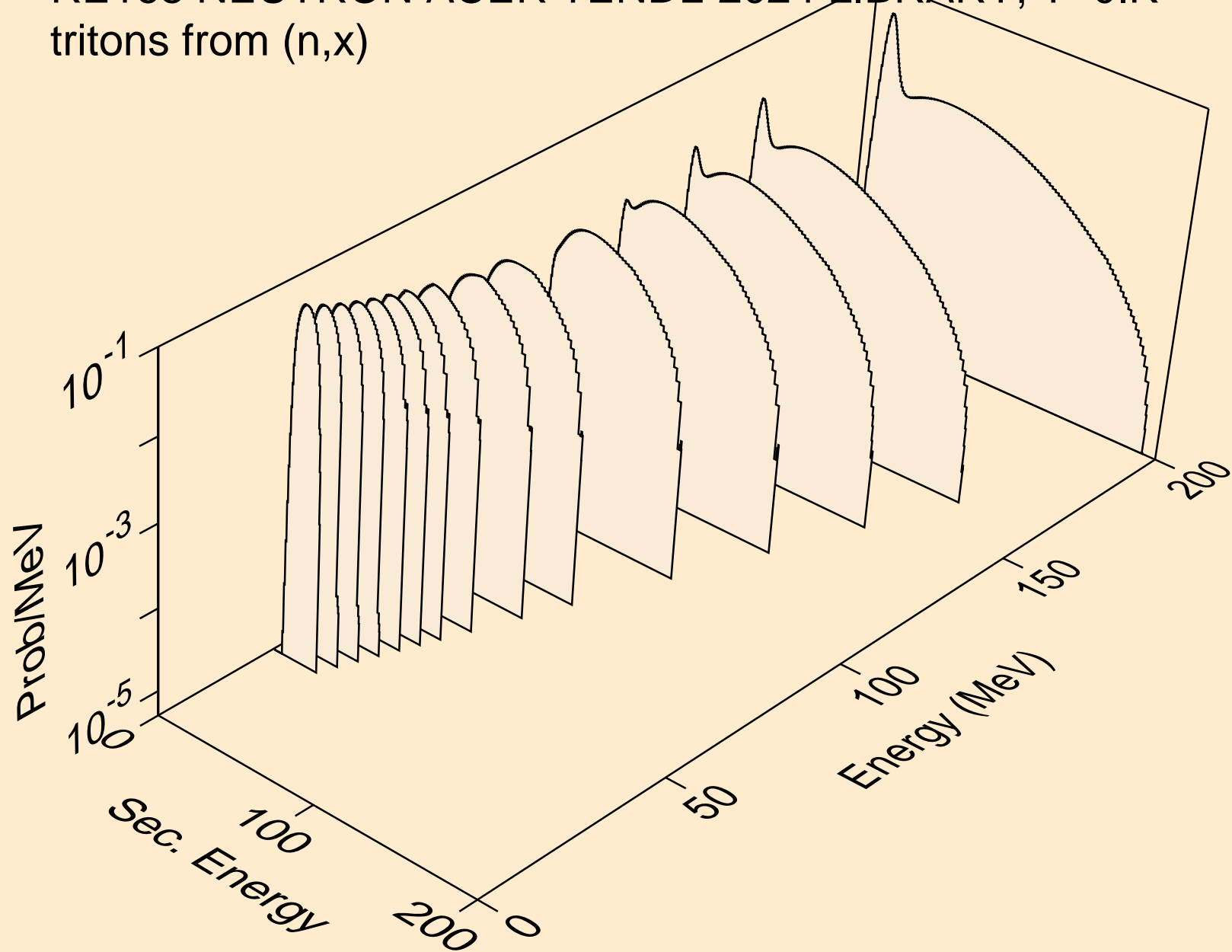

RE168 NEUTRON ACER TENDL-2024 LIBRARY; T=0.K
tritons from (n,n*)t

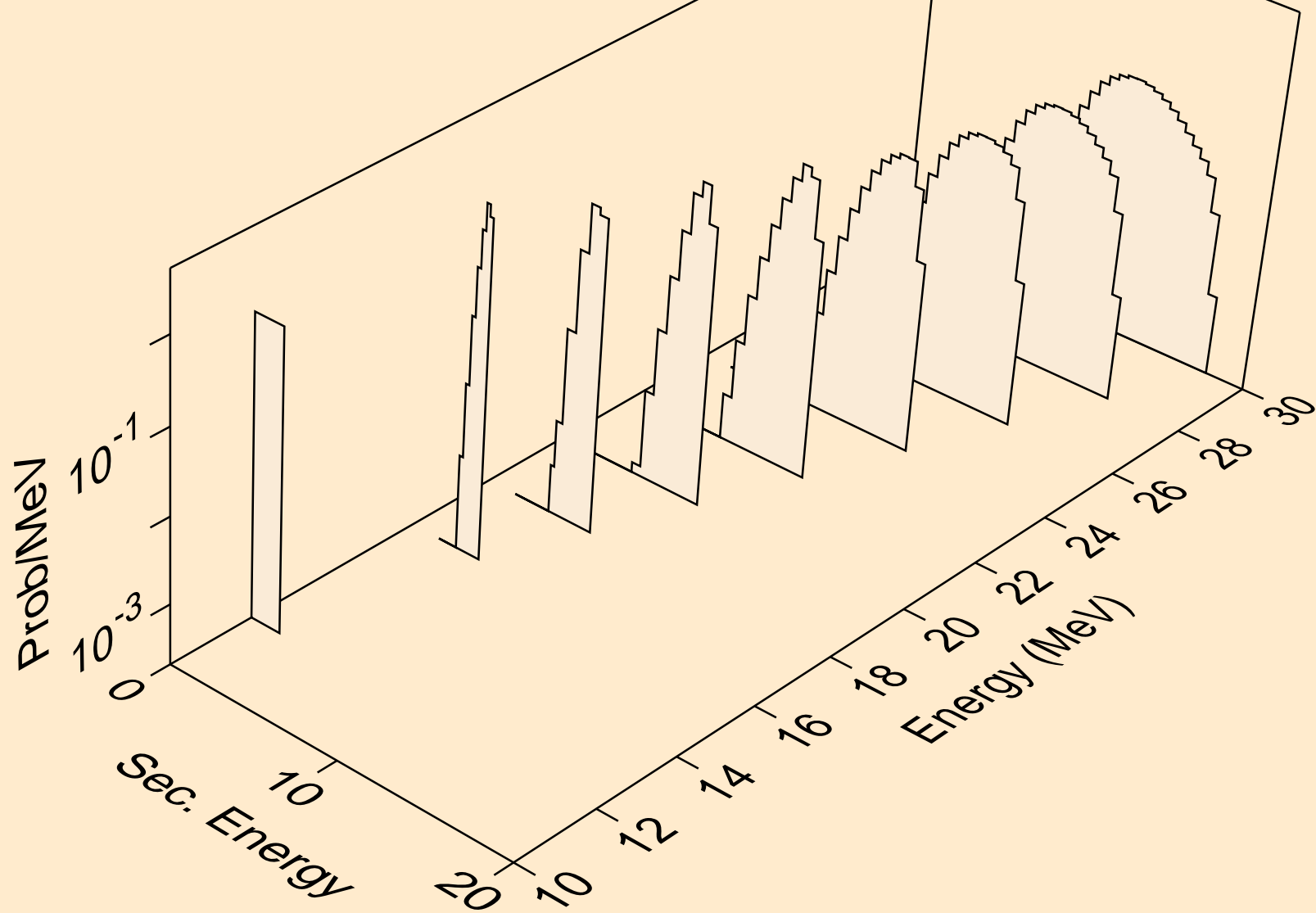

RE168 NEUTRON ACER TENDL-2024 LIBRARY; T=0.K
tritons from (n,t)

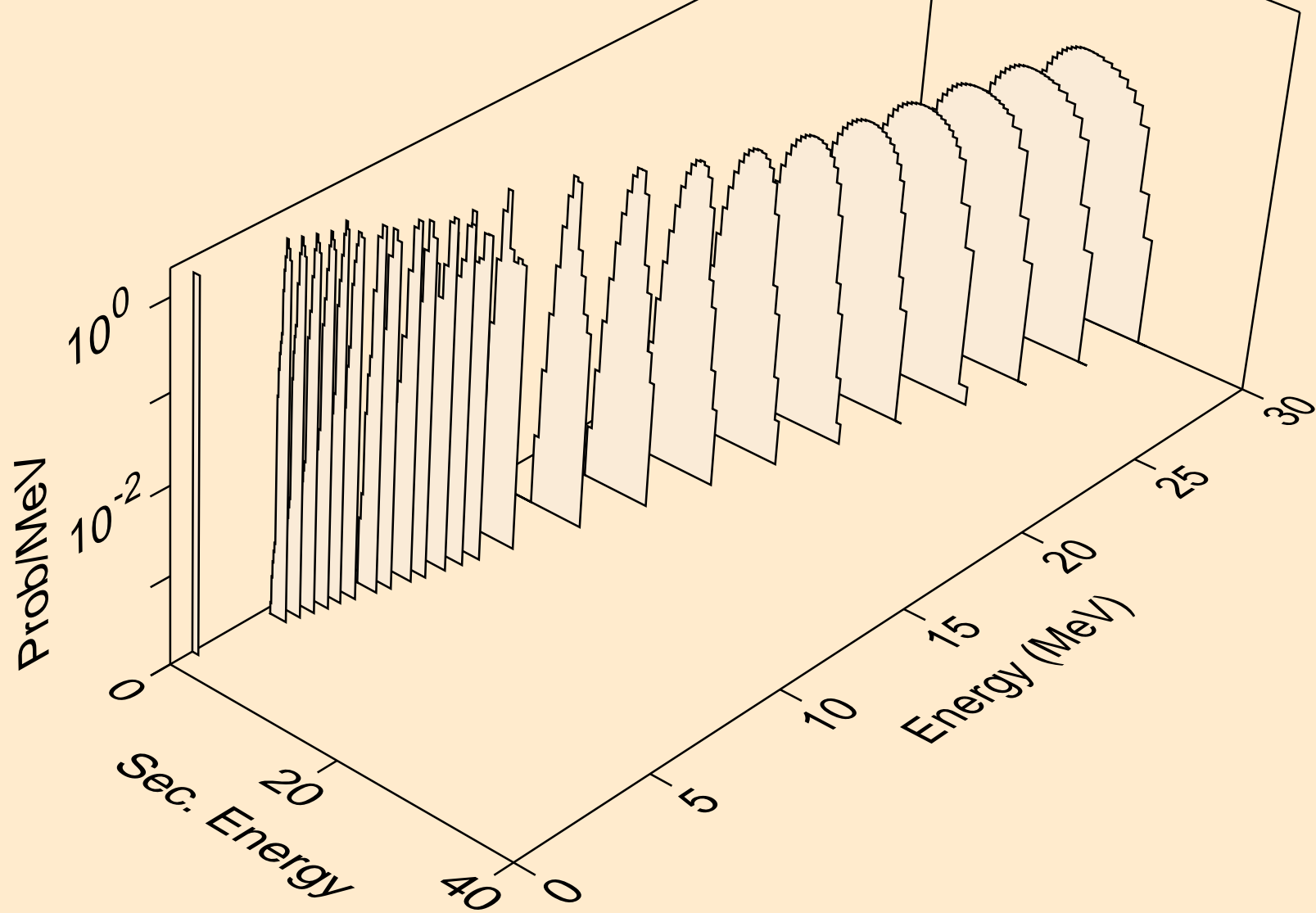

RE168 NEUTRON ACER TENDL-2024 LIBRARY; T=0.K
tritons from (n,t2a)

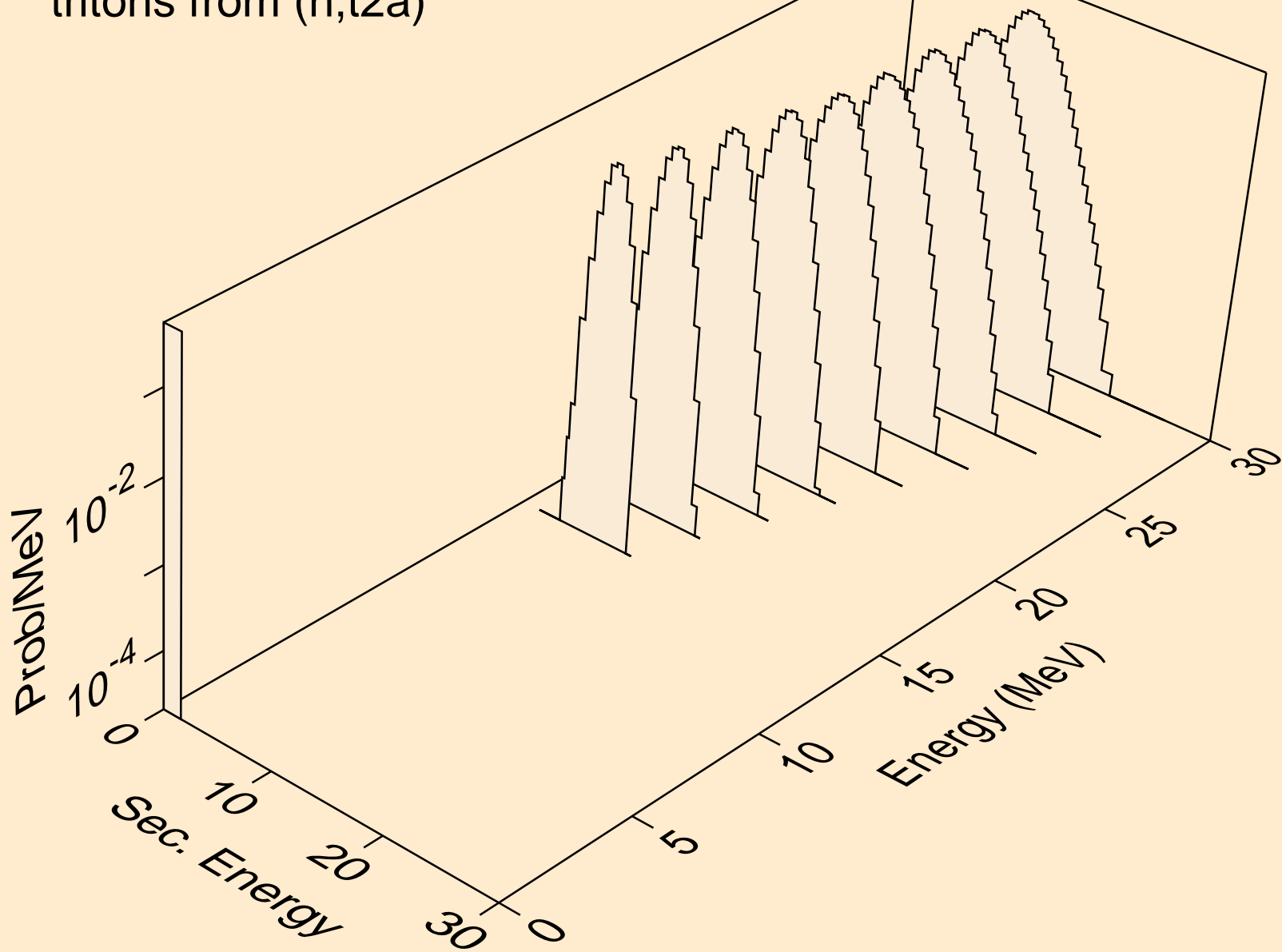

RE168 NEUTRON ACER TENDL-2024 LIBRARY; T=0.K
tritons from (n,pt)

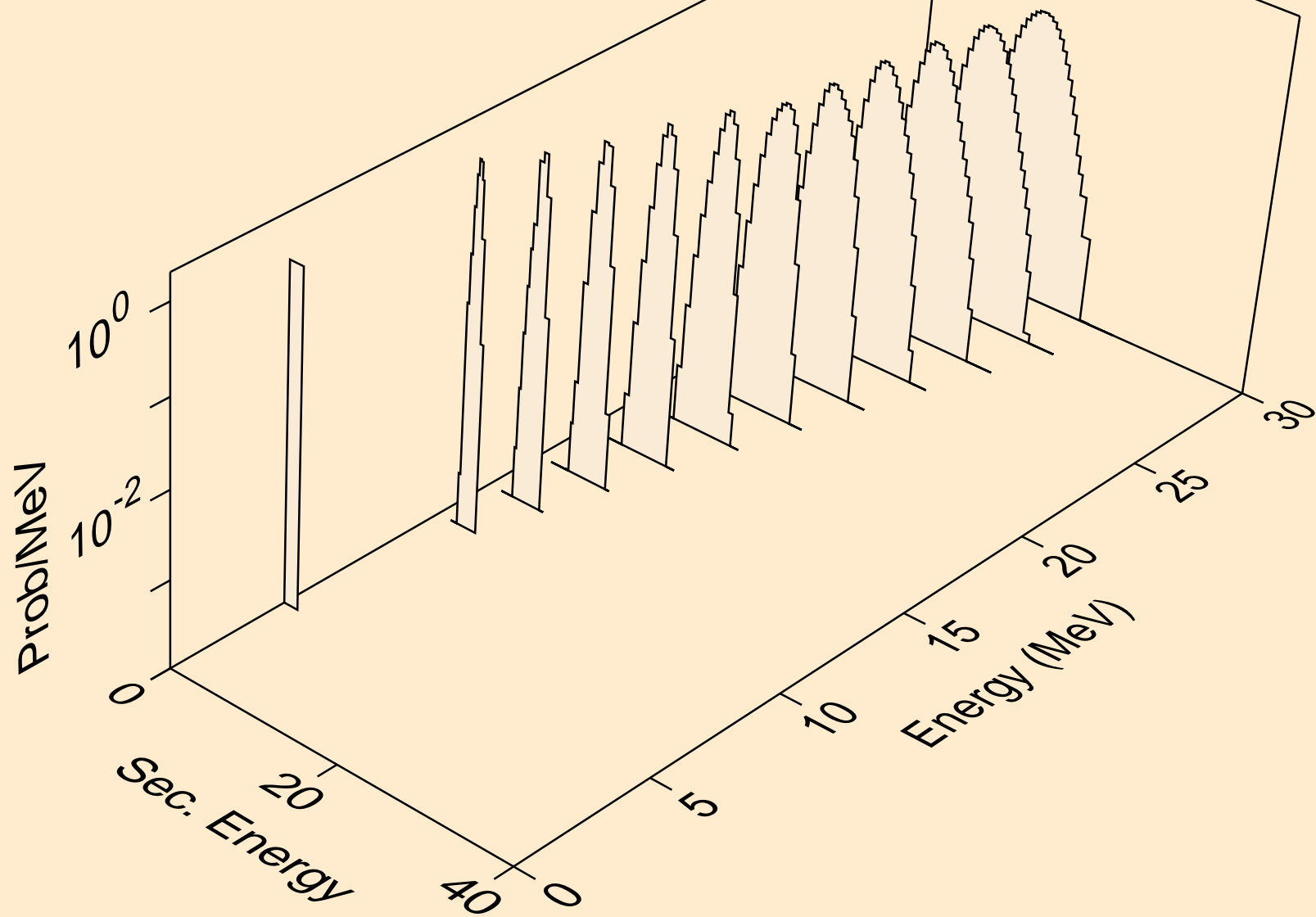

RE168 NEUTRON ACER TENDL-2024 LIBRARY; T=0.K
he3s from (n,x)

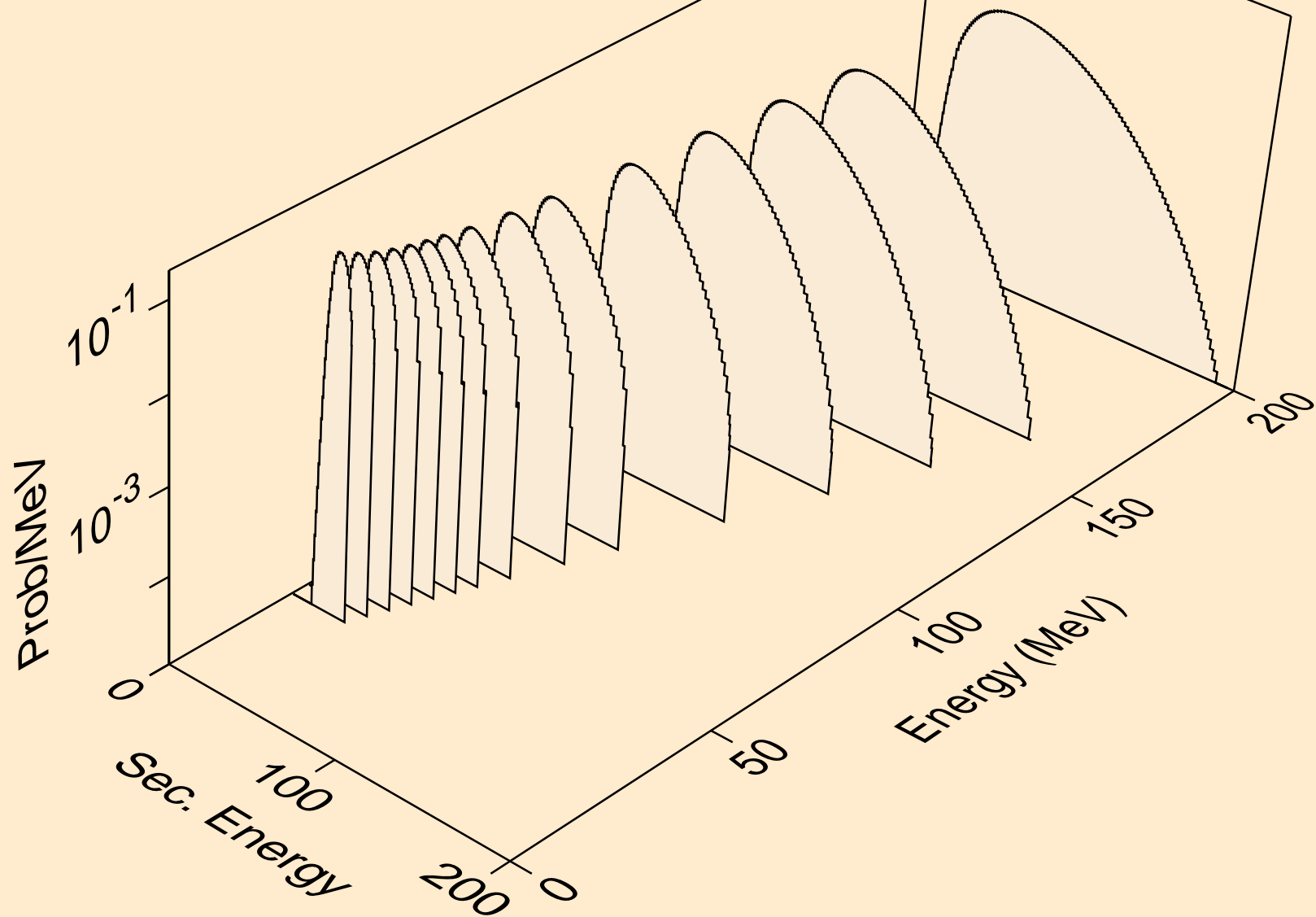

RE168 NEUTRON ACER TENDL-2024 LIBRARY; T=0.K
he3s from (n,n*)he3

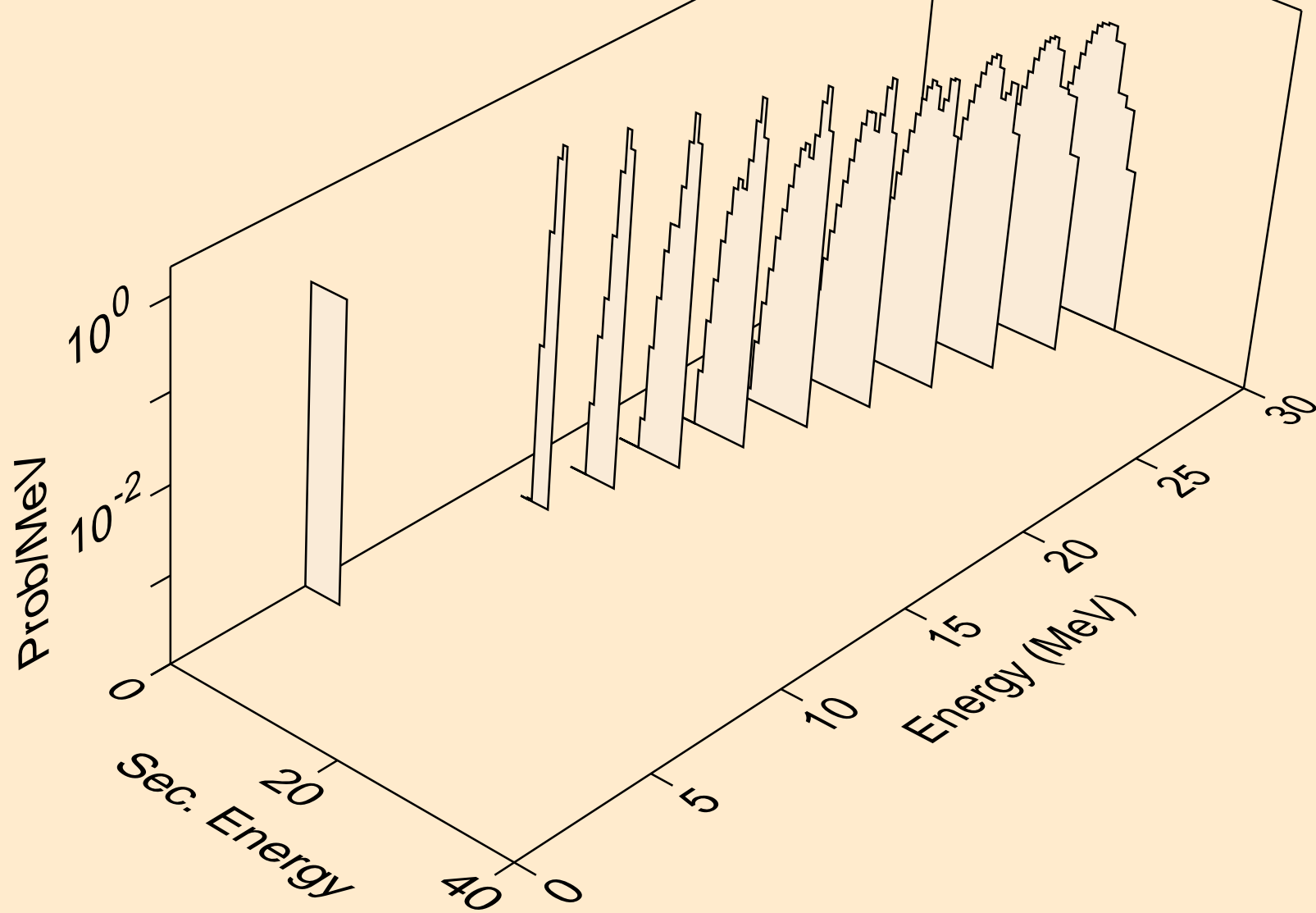

RE168 NEUTRON ACER TENDL-2024 LIBRARY; T=0.K
he3s from (n,he3)

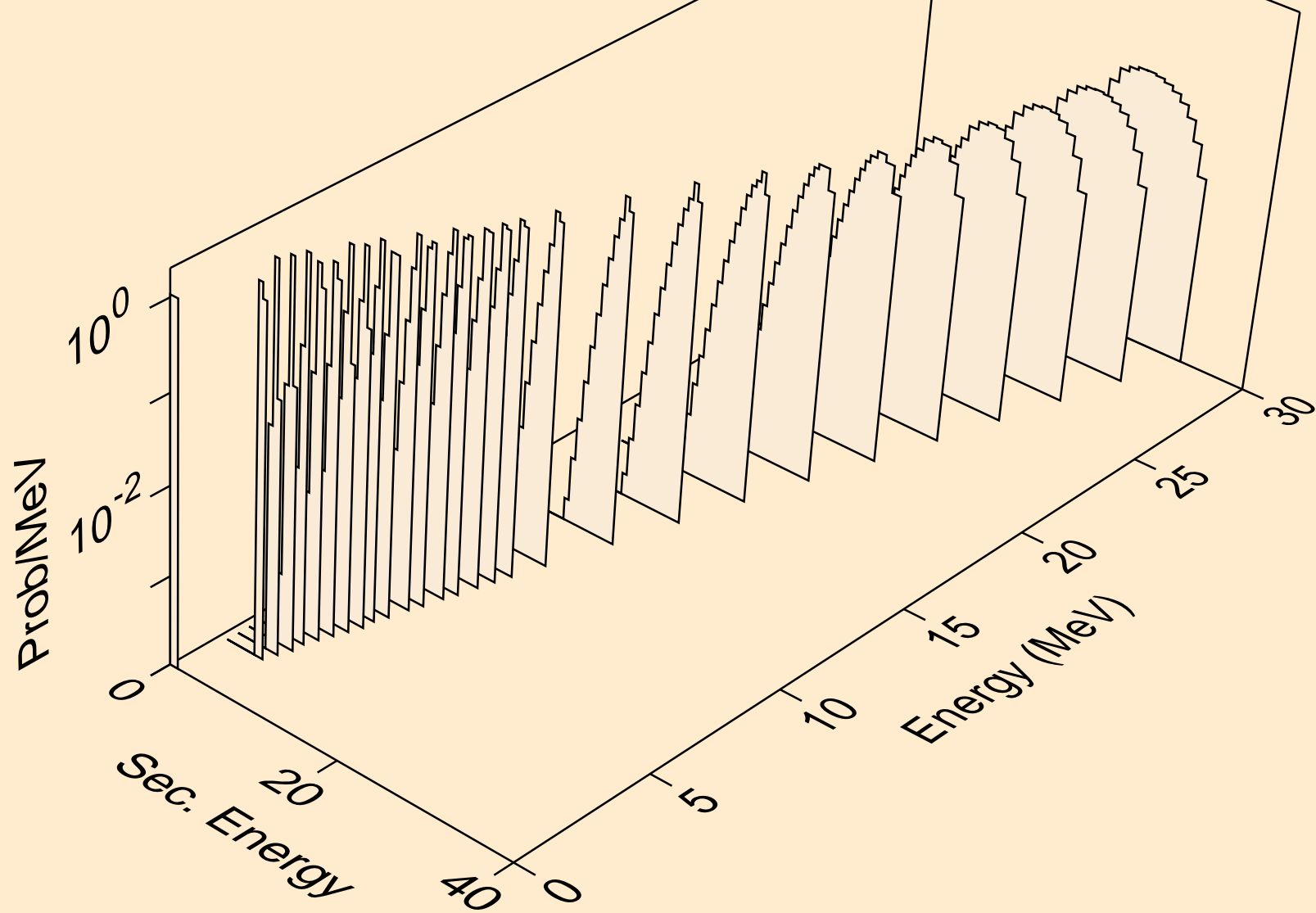

RE168 NEUTRON ACER TENDL-2024 LIBRARY; T=0.K
alphas from (n,x)

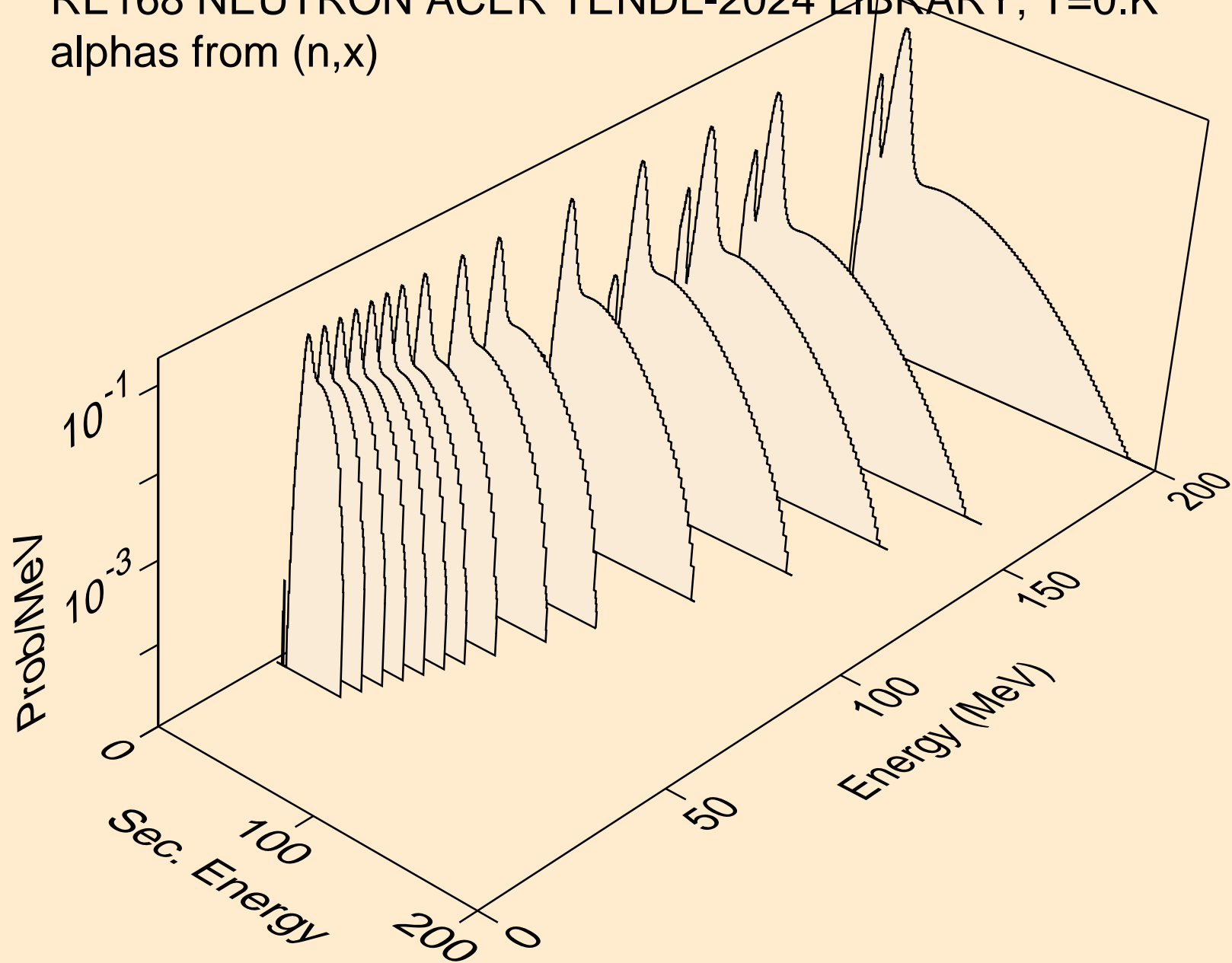

RE168 NEUTRON ACER TENDL-2024 LIBRARY; T=0.K
alphas from (n,n*)a

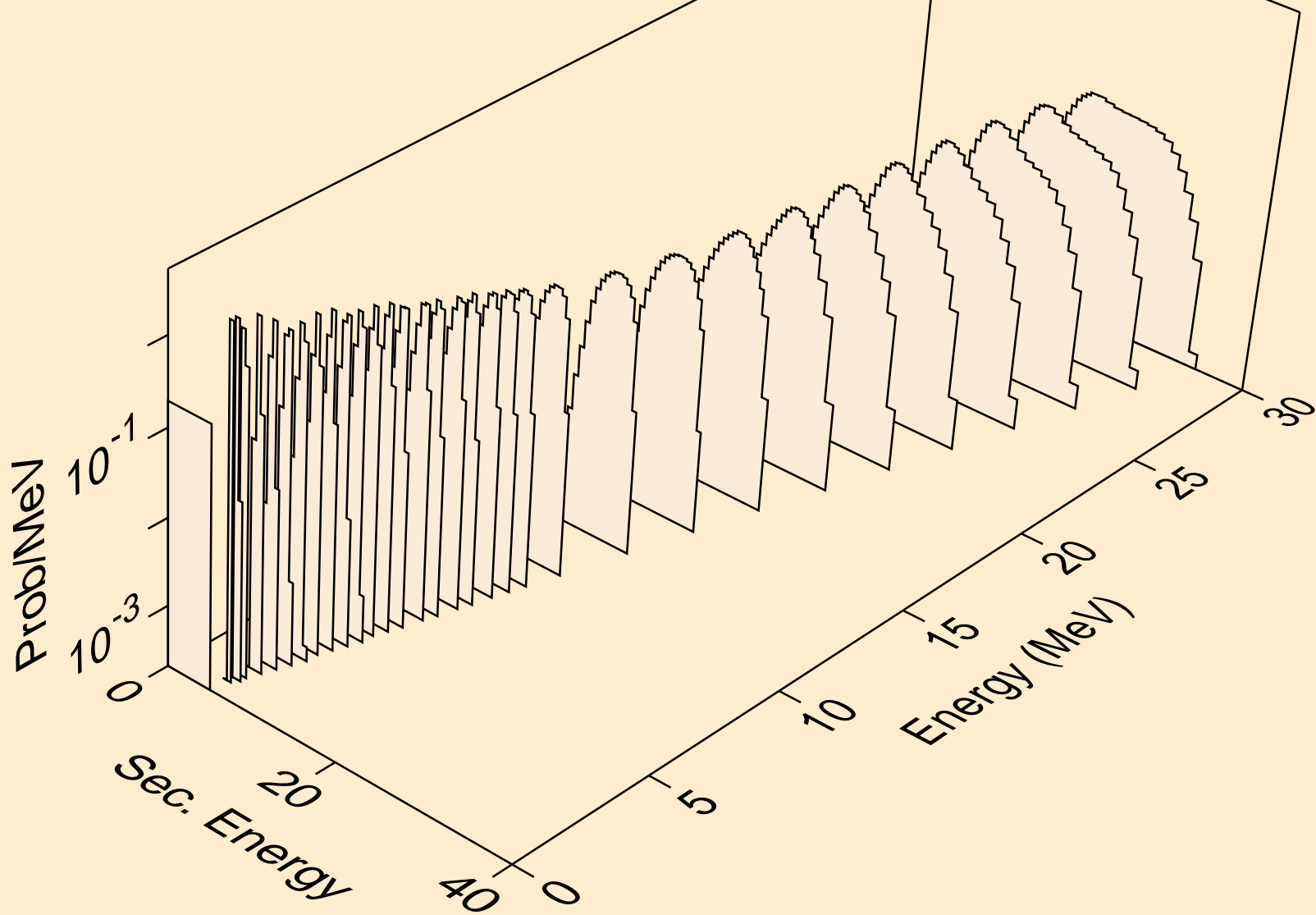

RE168 NEUTRON ACER TENDL-2024 LIBRARY; T=0.K
alphas from (n,n*)3a

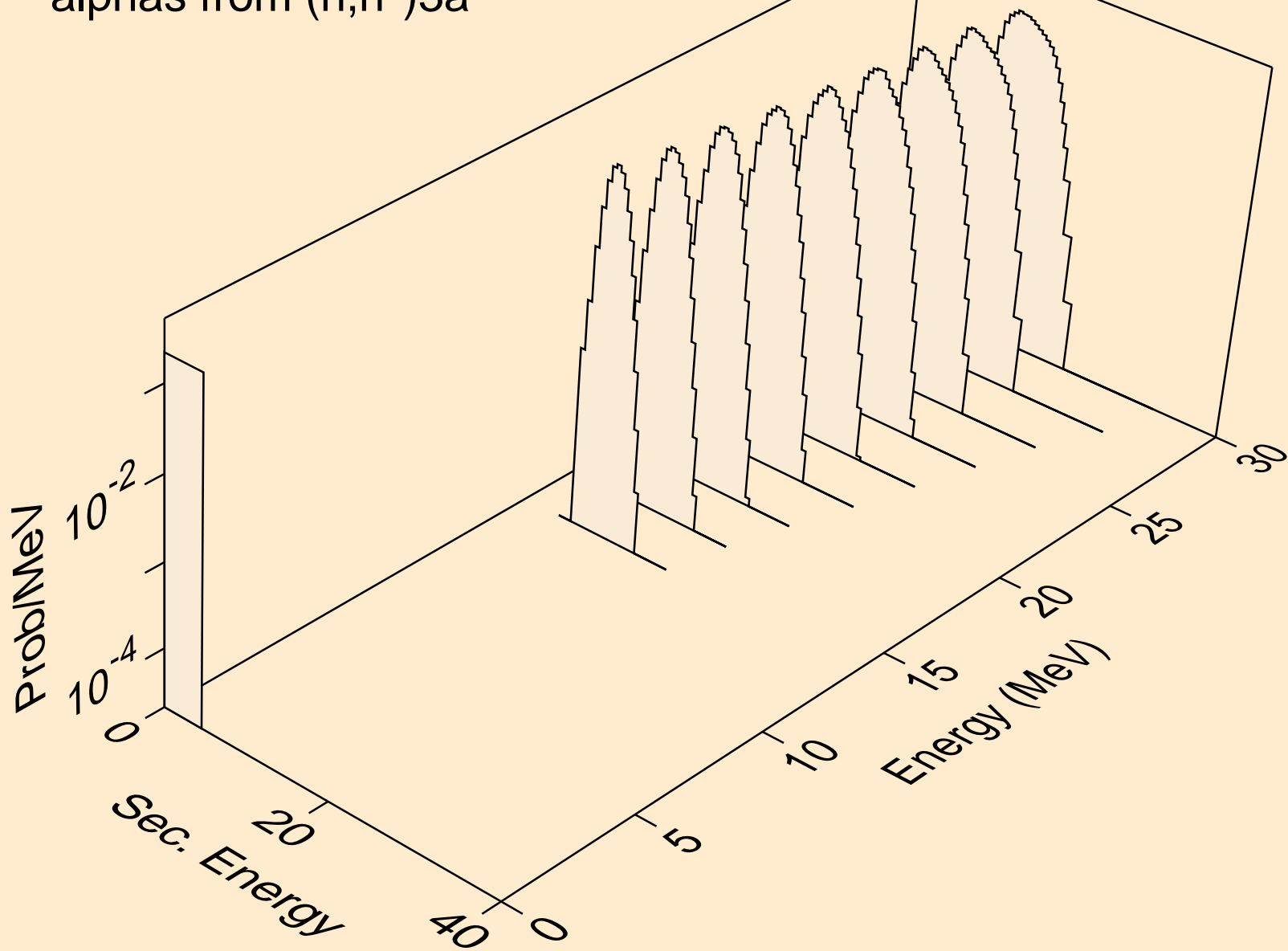

RE168 NEUTRON ACER TENDL-2024 LIBRARY; T=0.K
alphas from (n,2n)a

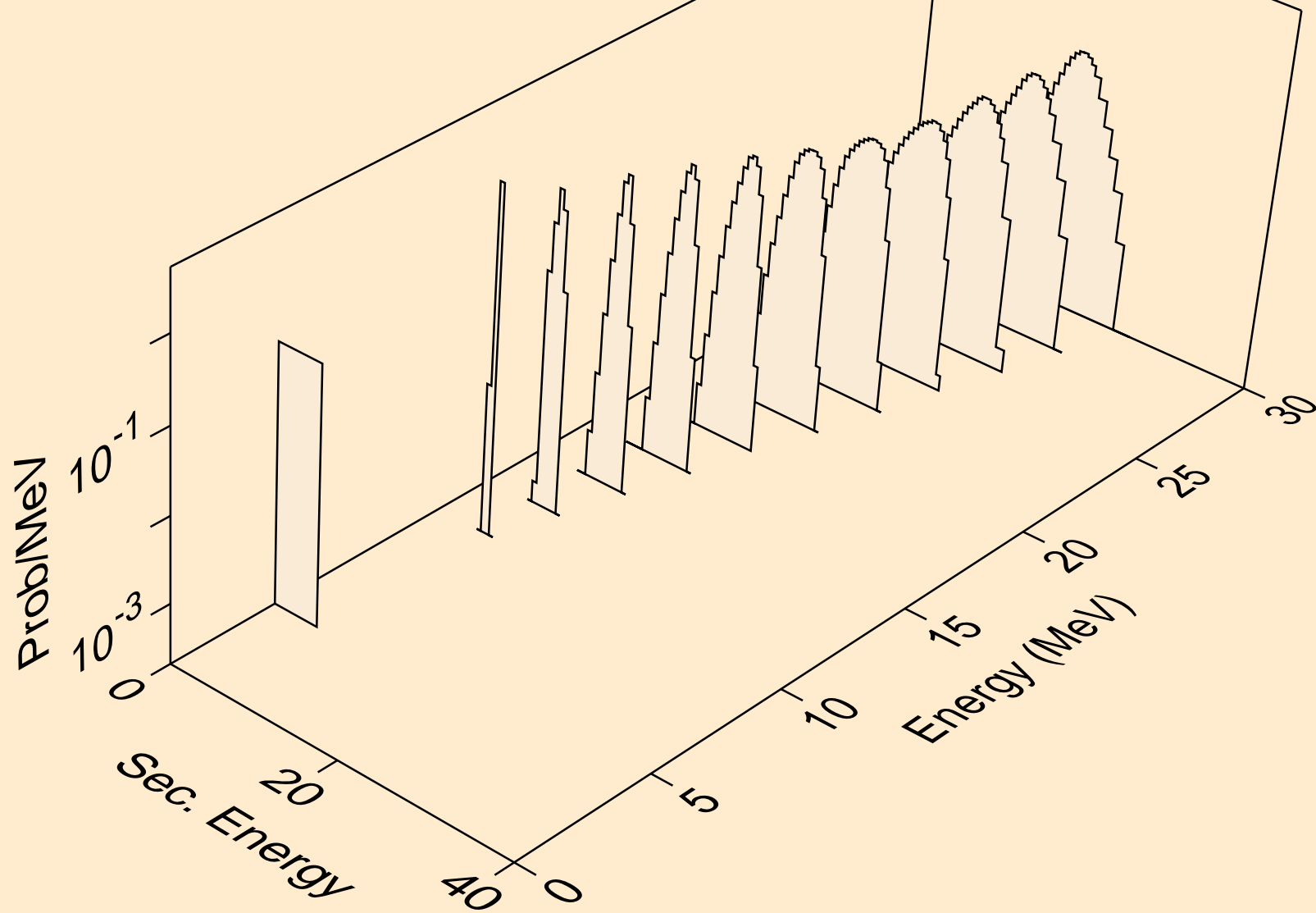

RE168 NEUTRON ACER TENDL-2024 LIBRARY; T=0.K
alphas from (n,3n)a

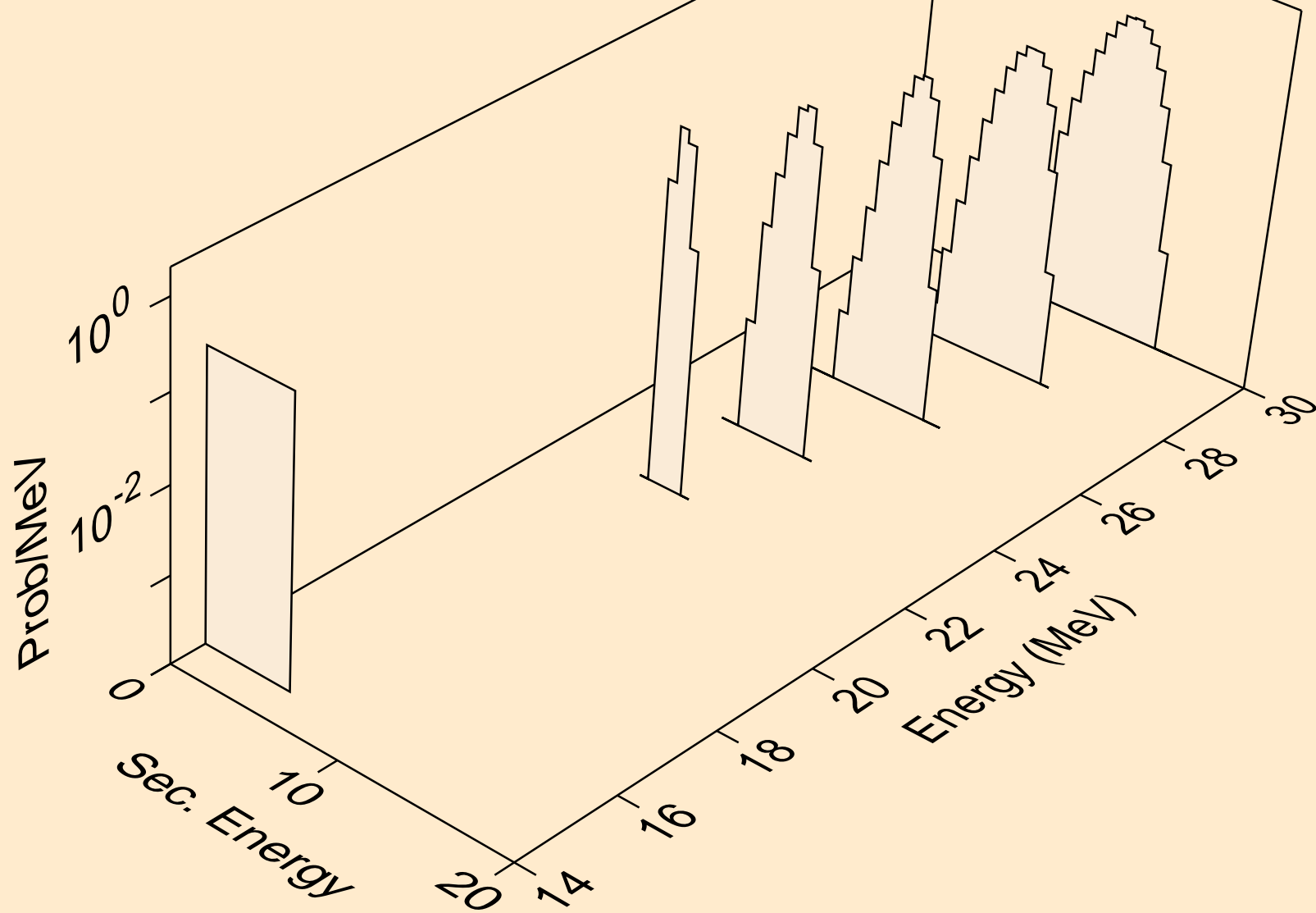

RE168 NEUTRON ACER TENDL-2024 LIBRARY; T=0.K
alphas from (n,n*)2a

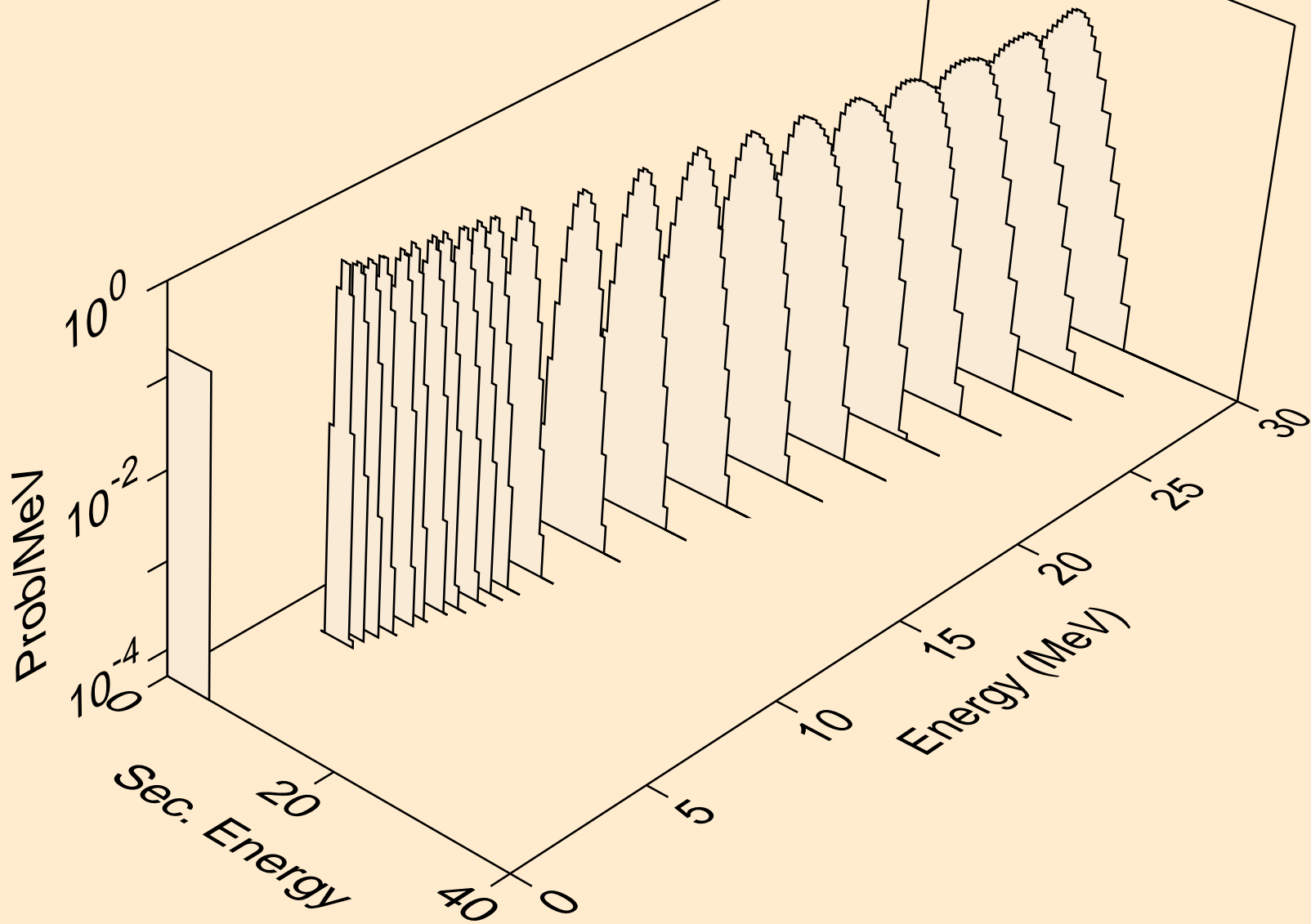

RE168 NEUTRON ACER TENDL-2024 LIBRARY; T=0.K
alphas from (n,2n)2a

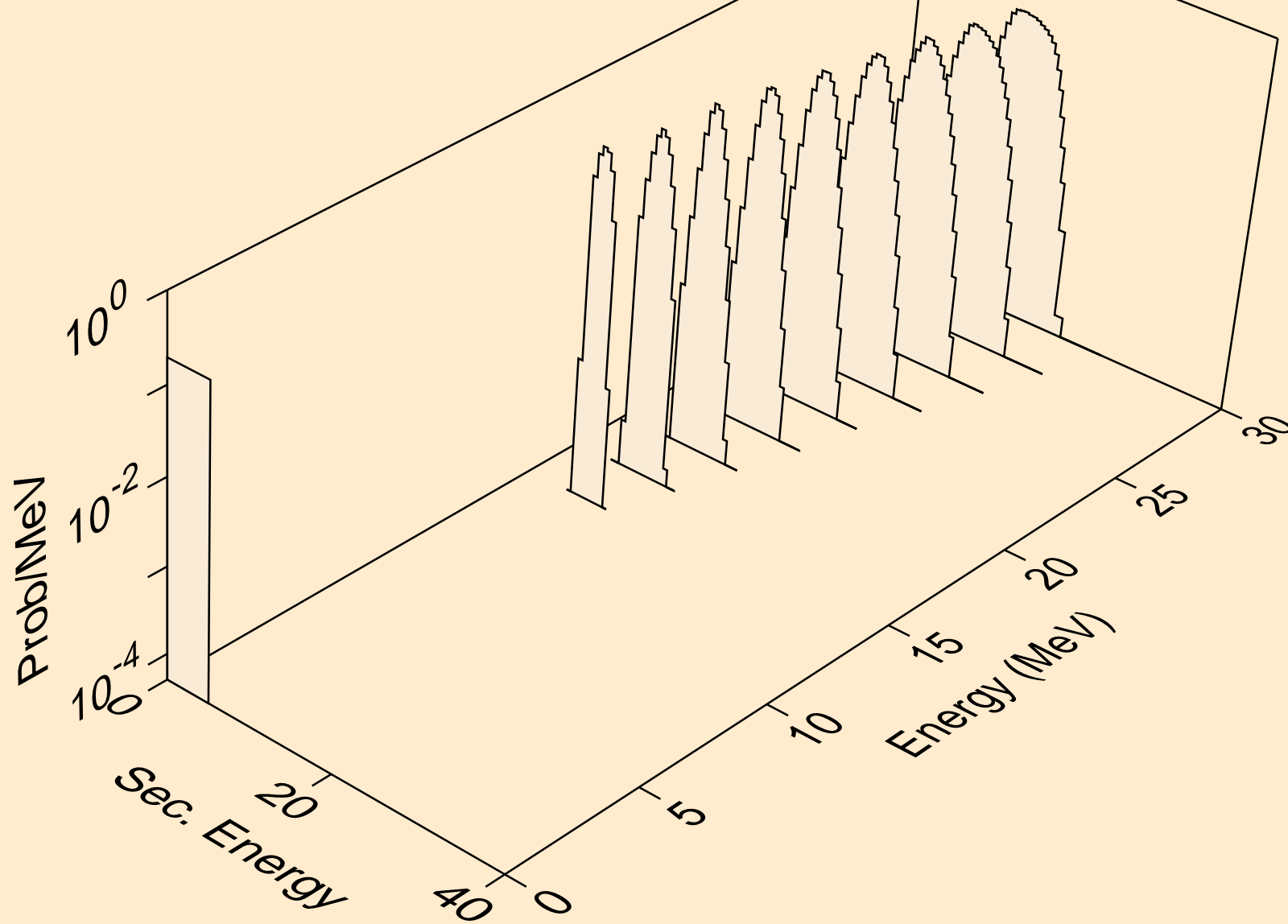

RE168 NEUTRON ACER TENDL-2024 LIBRARY; T=0.K
alphas from (n,npa)

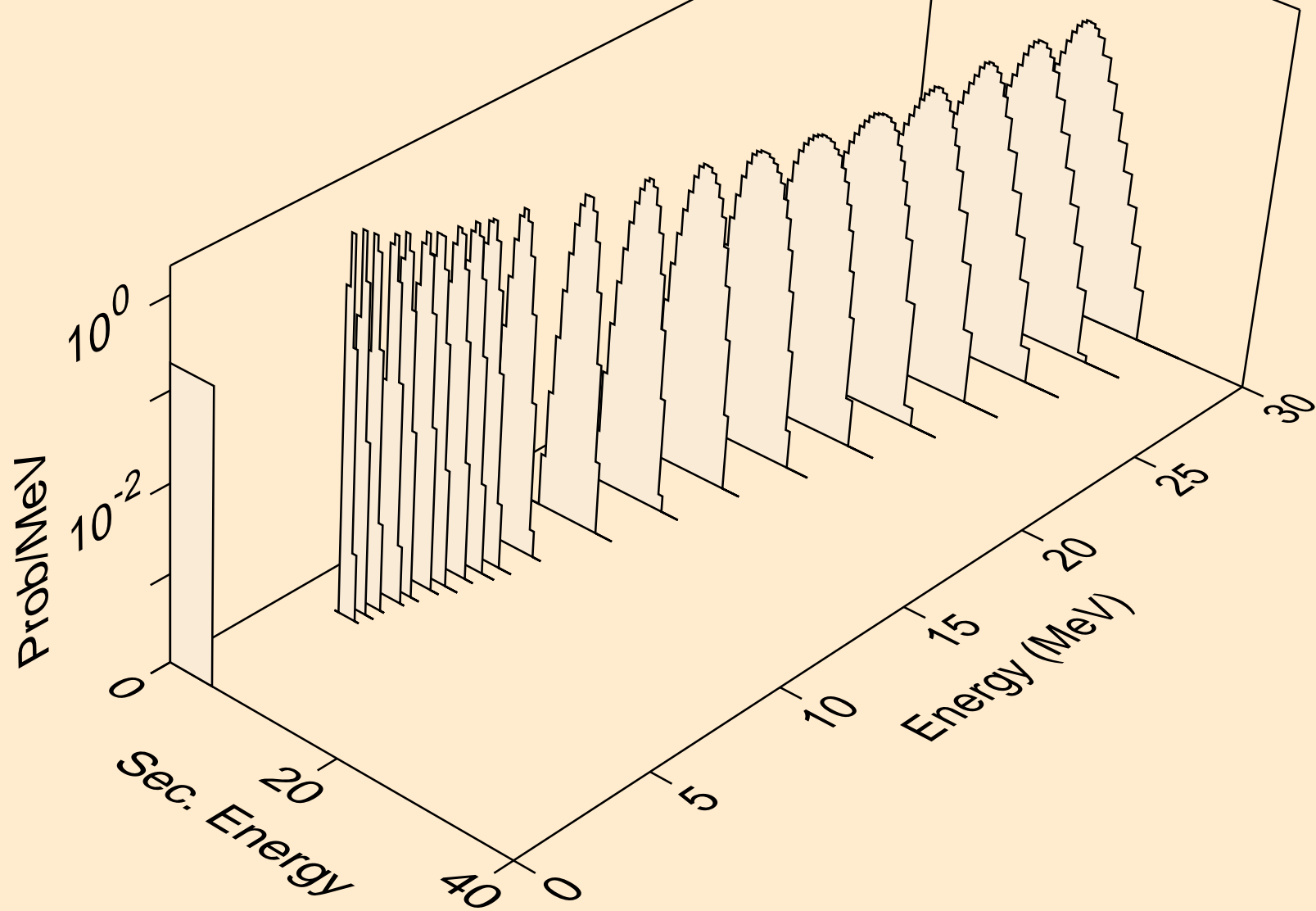

RE168 NEUTRON ACER TENDL-2024 LIBRARY; T=0.K
alphas from (n,a)

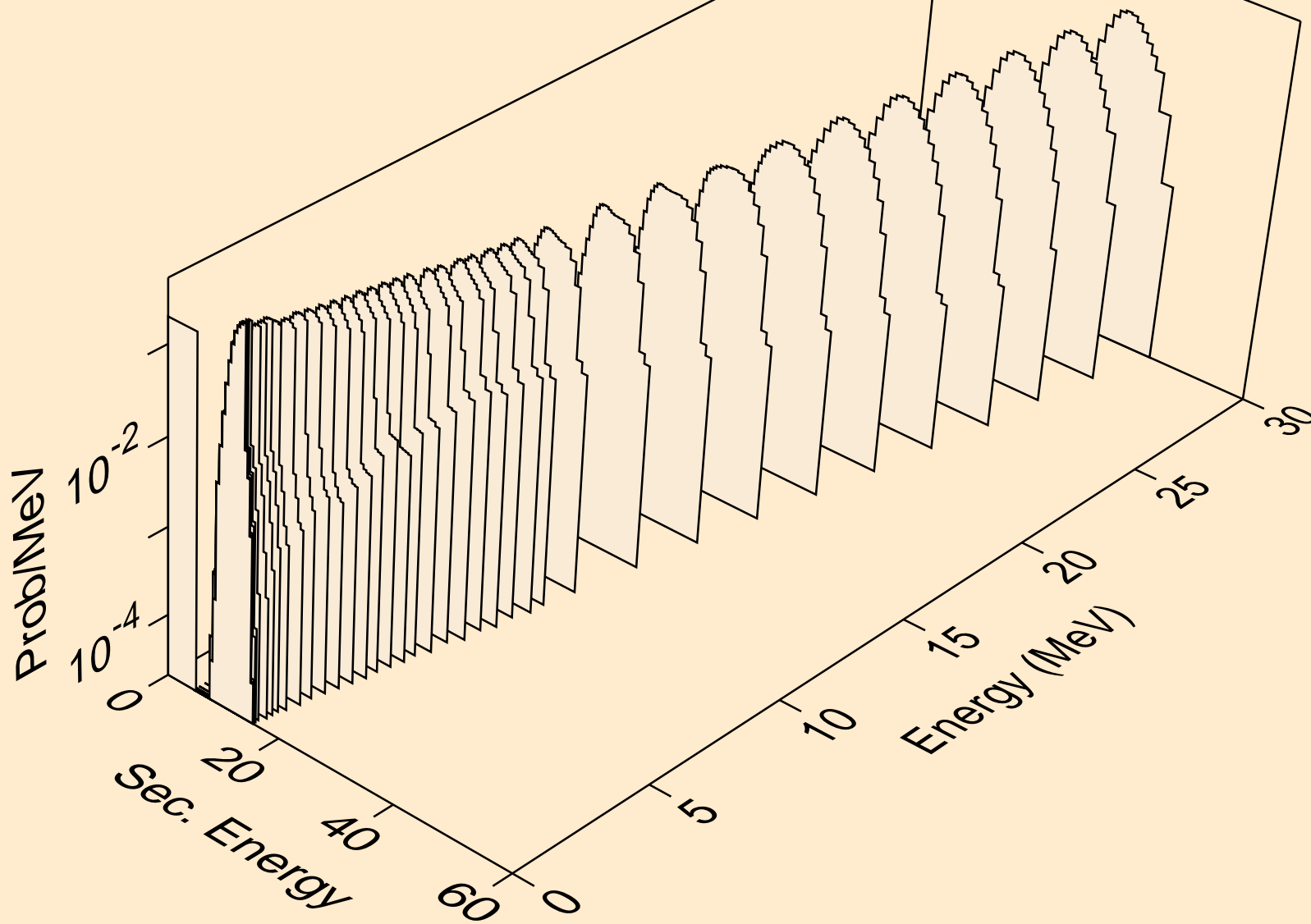

RE168 NEUTRON ACER TENDL-2024 LIBRARY; T=0.K
alphas from (n,2a)

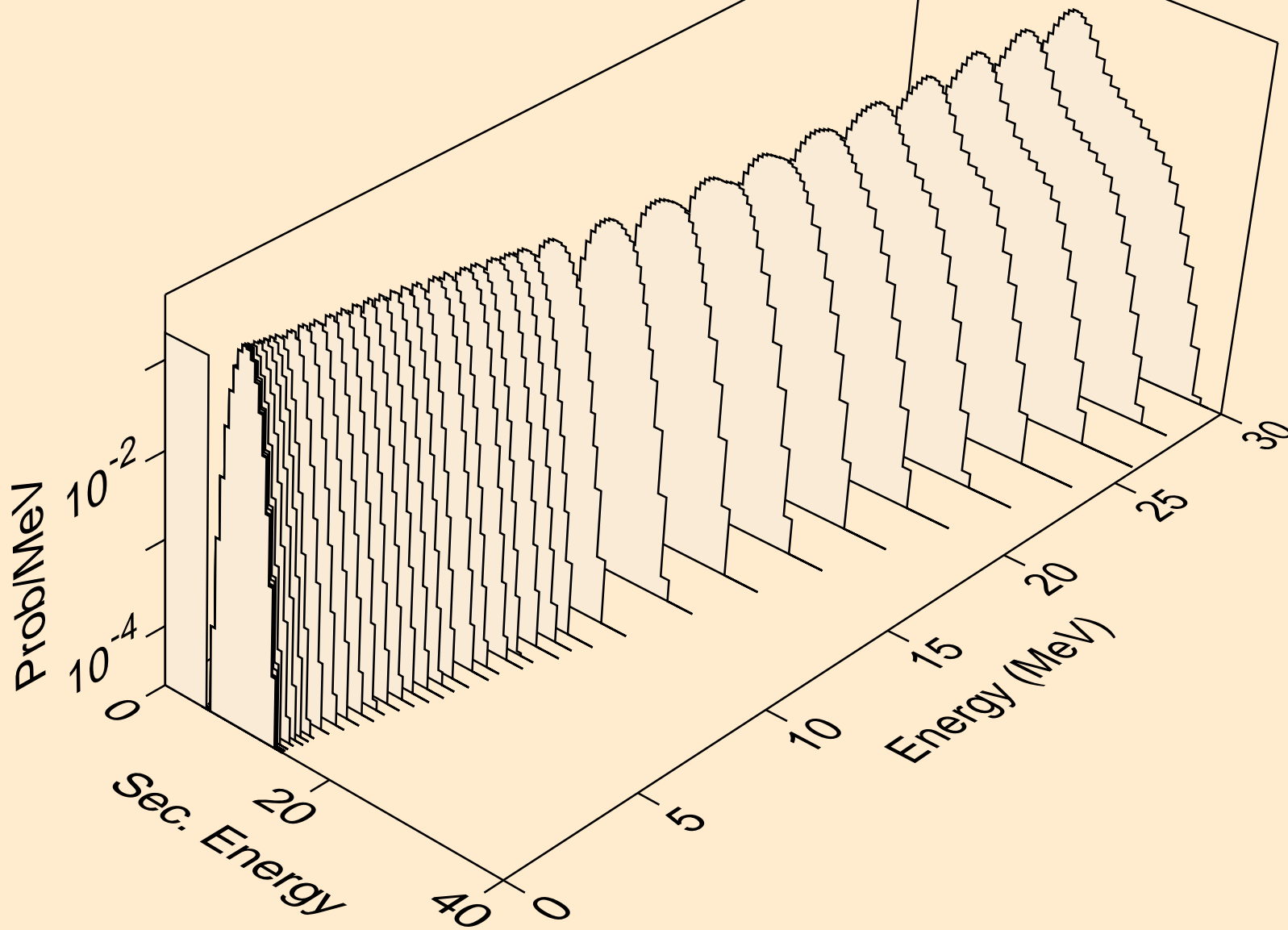

RE168 NEUTRON ACER TENDL-2024 LIBRARY; T=0.K
alphas from (n,3a)

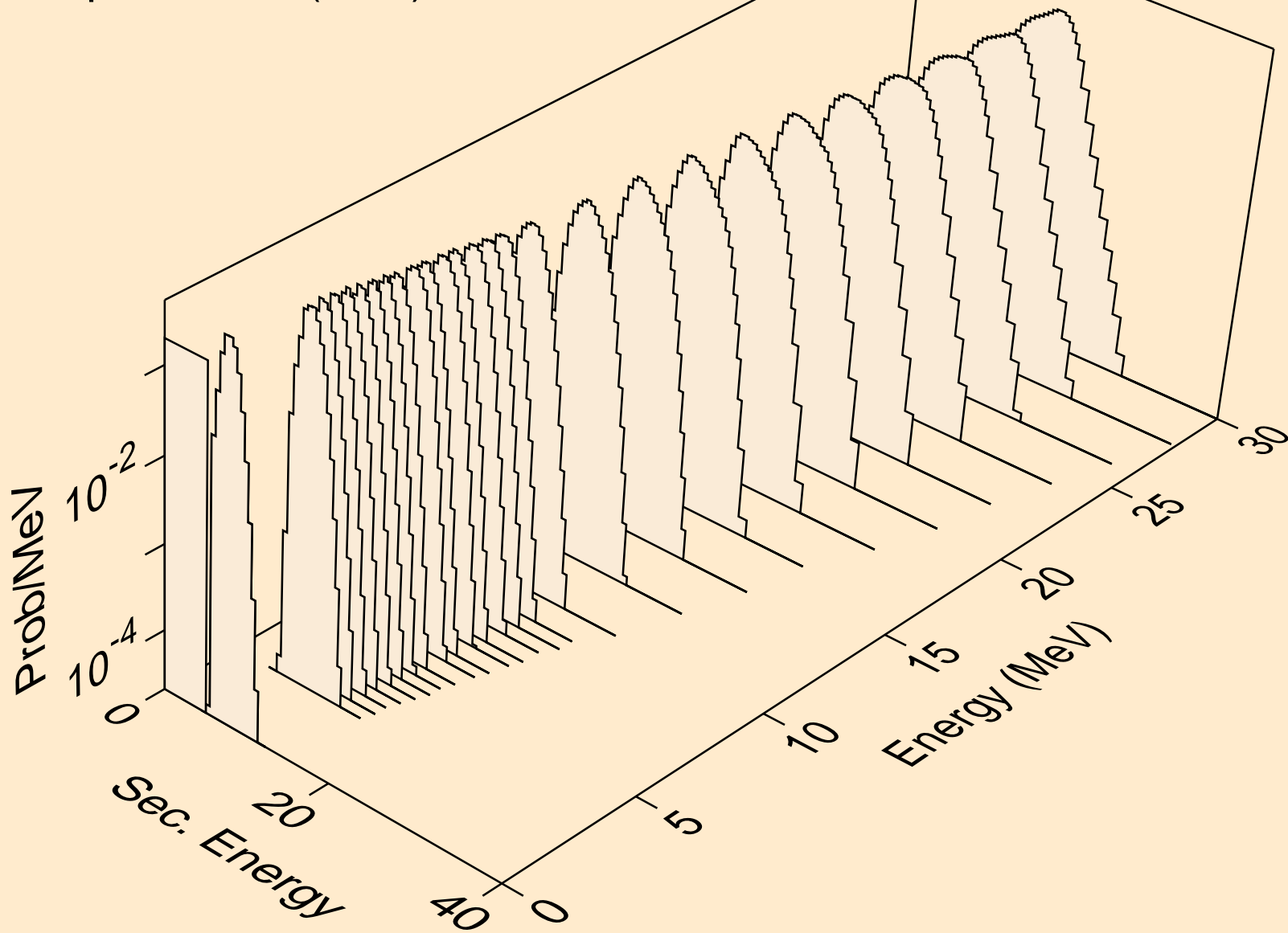

RE168 NEUTRON ACER TENDL-2024 LIBRARY; T=0.K
alphas from (n,pa)

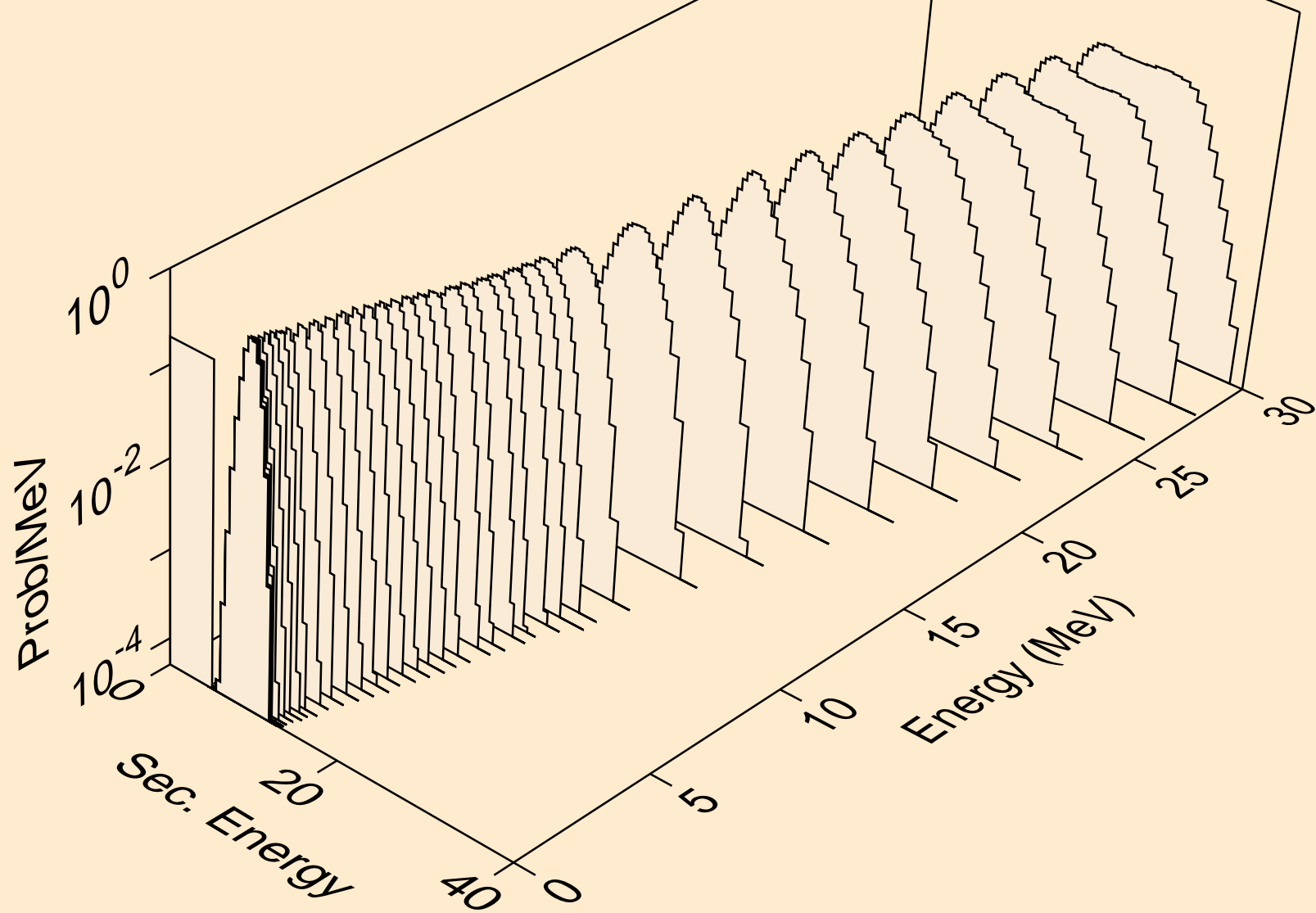

RE168 NEUTRON ACER TENDL-2024 LIBRARY; T=0.K
alphas from (n,t2a)

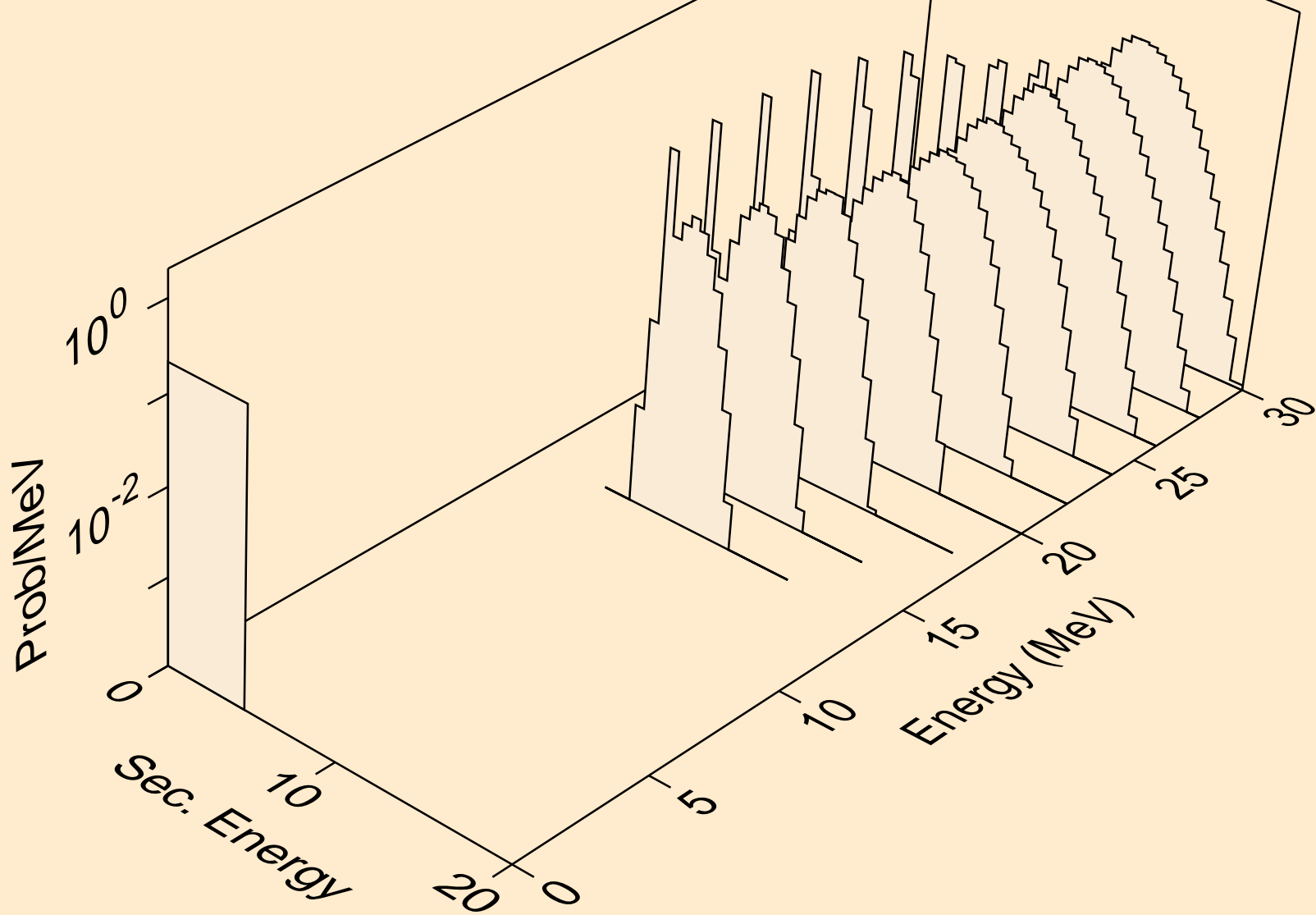

RE168 NEUTRON ACER TENDL-2024 LIBRARY; T=0.K
alphas from (n,d2a)

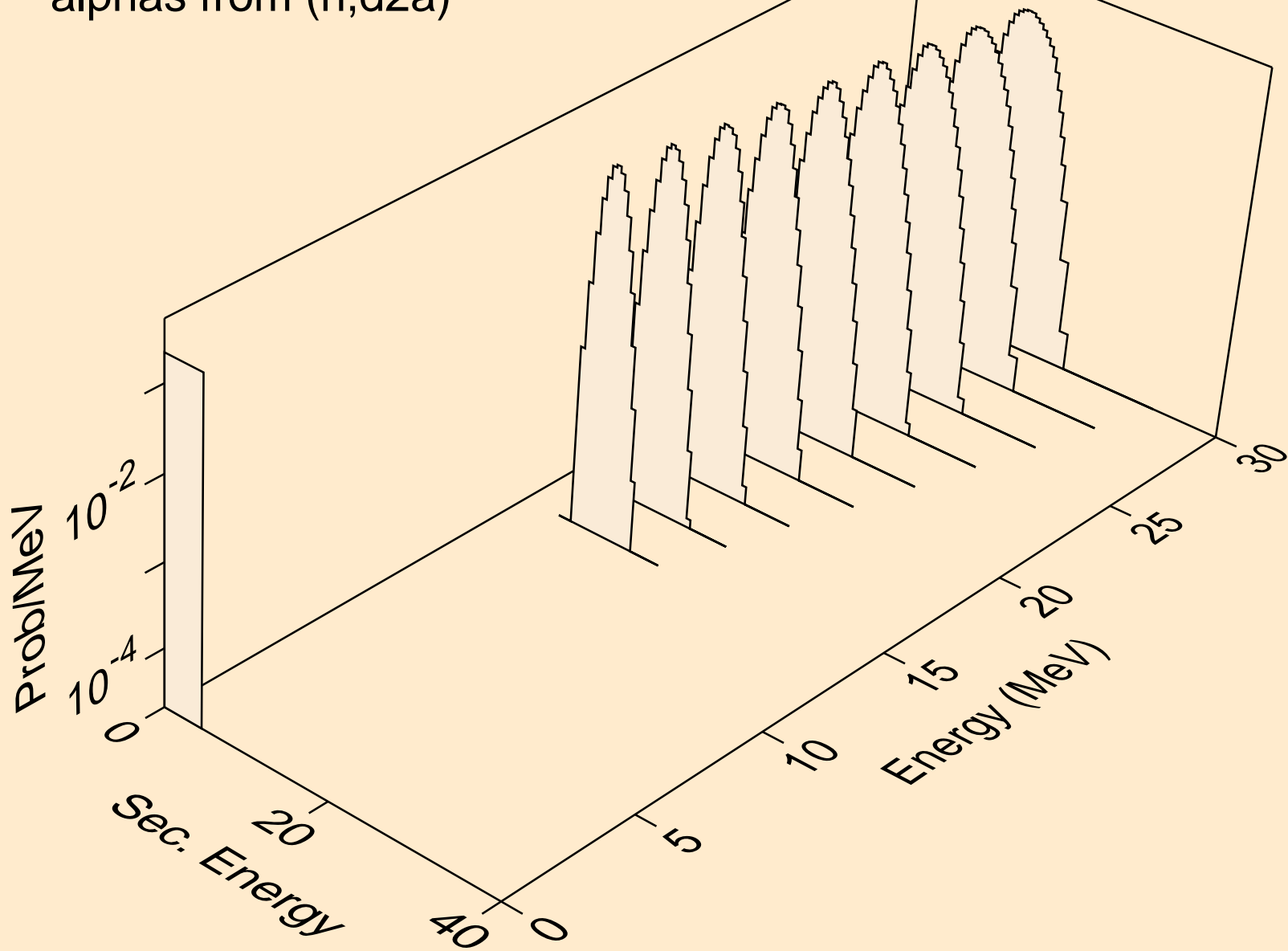

RE168 NEUTRON ACER TENDL-2024 LIBRARY; T=0.K
alphas from (n,da)

