

RF265 NEUTRON ACER TENDL-2024 LIBRARY; T=0.K

Principal cross sections

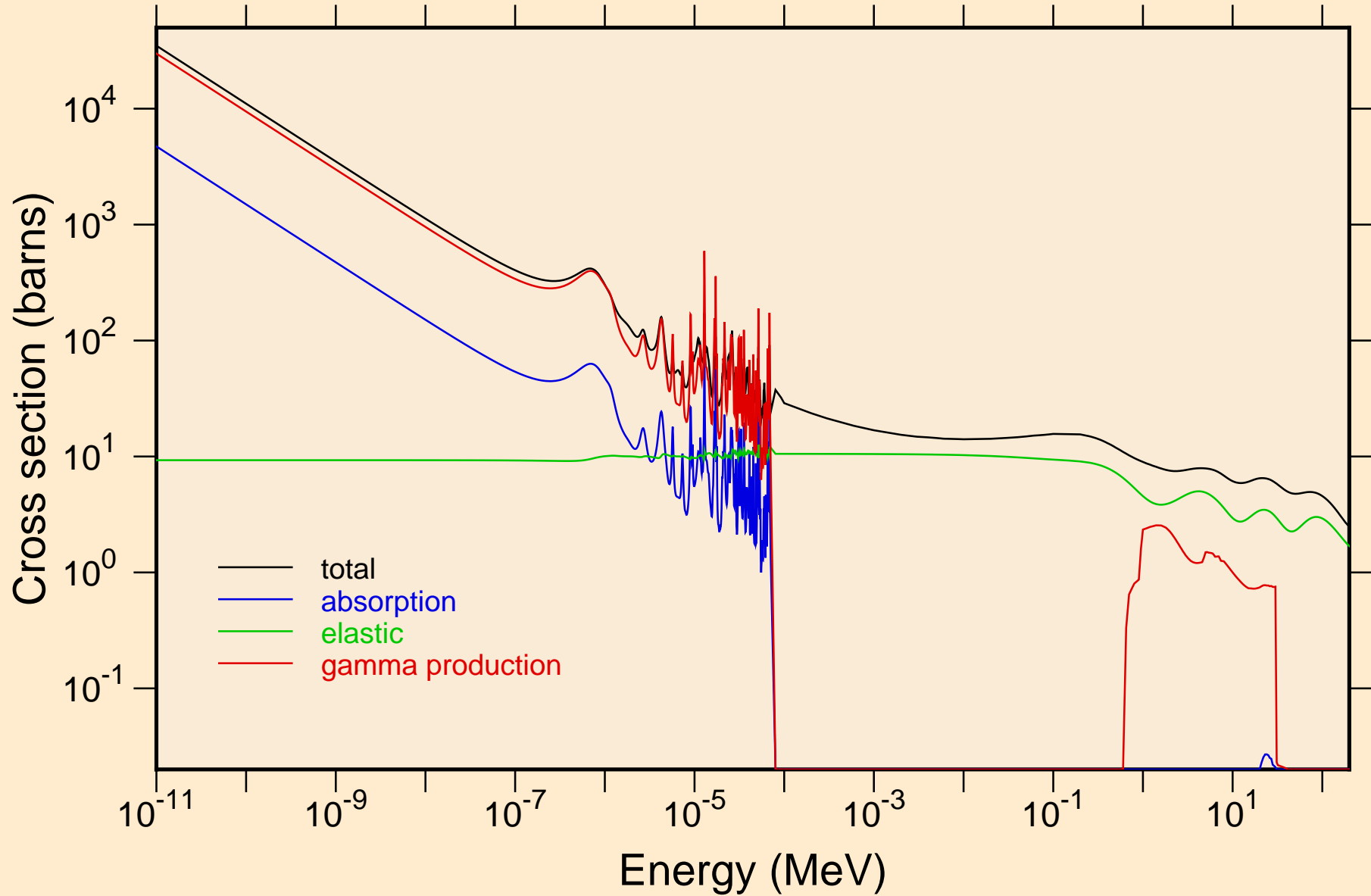

RF265 NEUTRON ACER TENDL-2024 LIBRARY; T=0.K
resonance total cross section

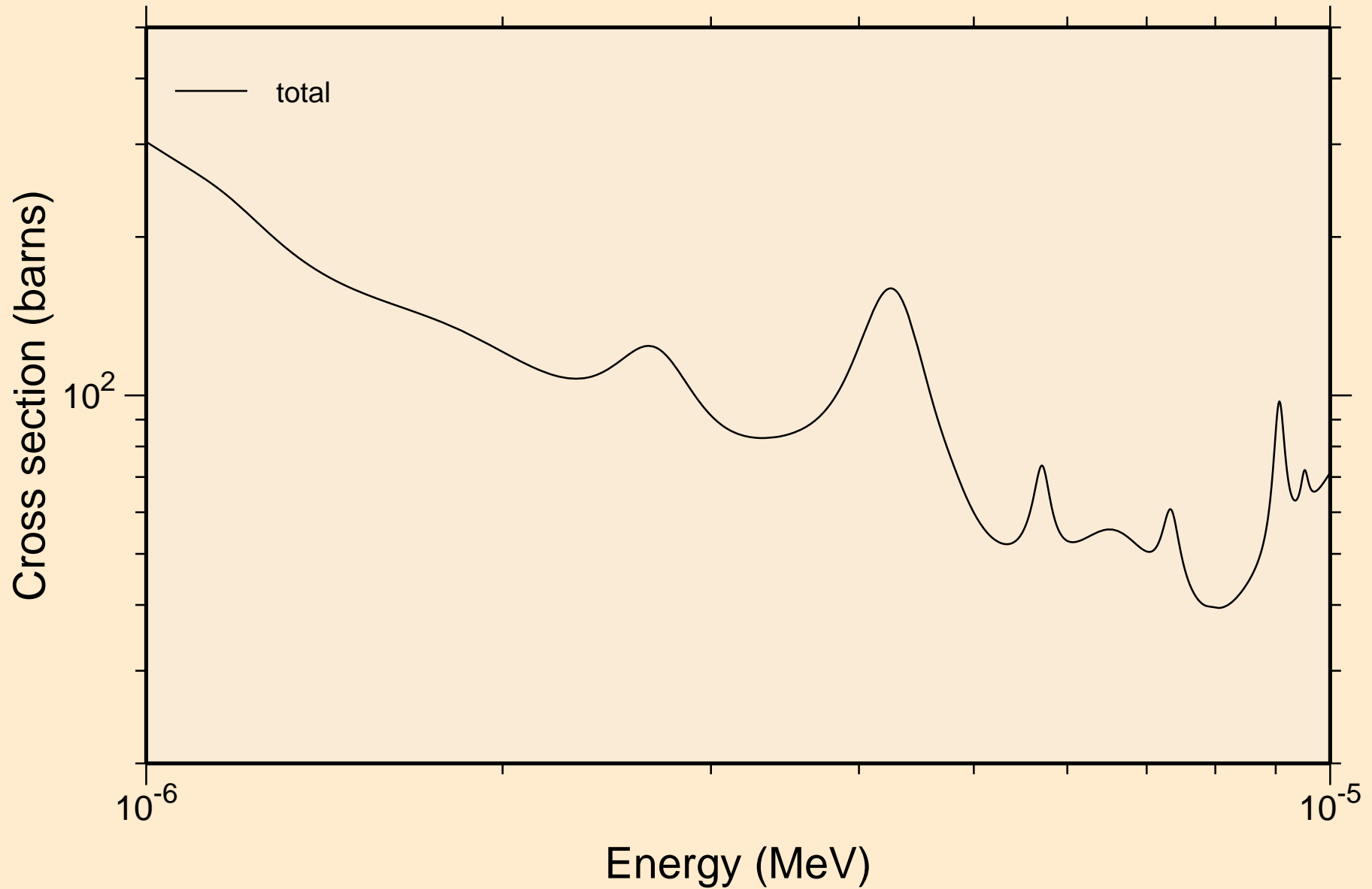

RF265 NEUTRON ACER TENDL-2024 LIBRARY; T=0.K
resonance total cross section

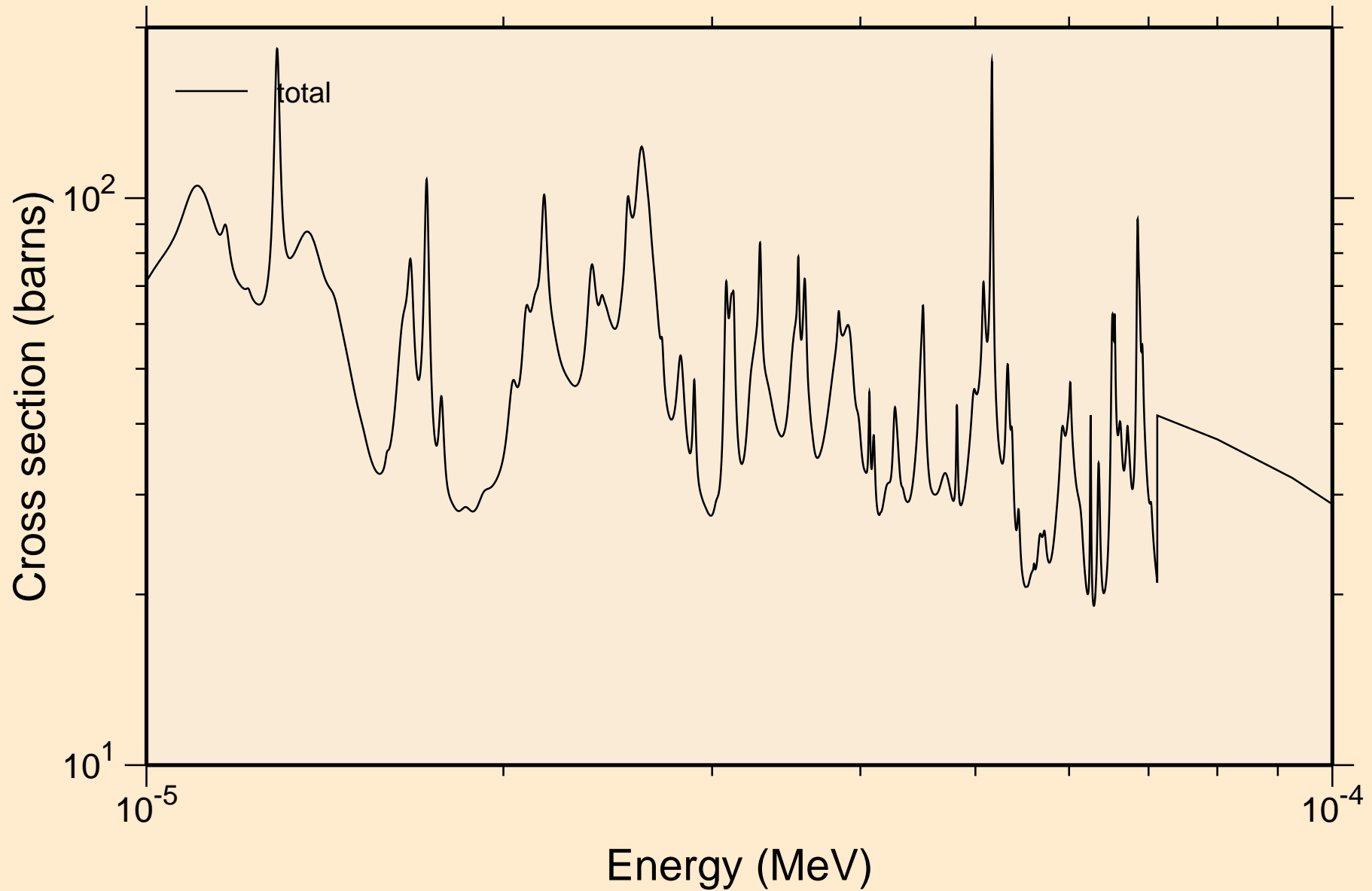

RF265 NEUTRON ACER TENDL-2024 LIBRARY; T=0.K
resonance total cross section

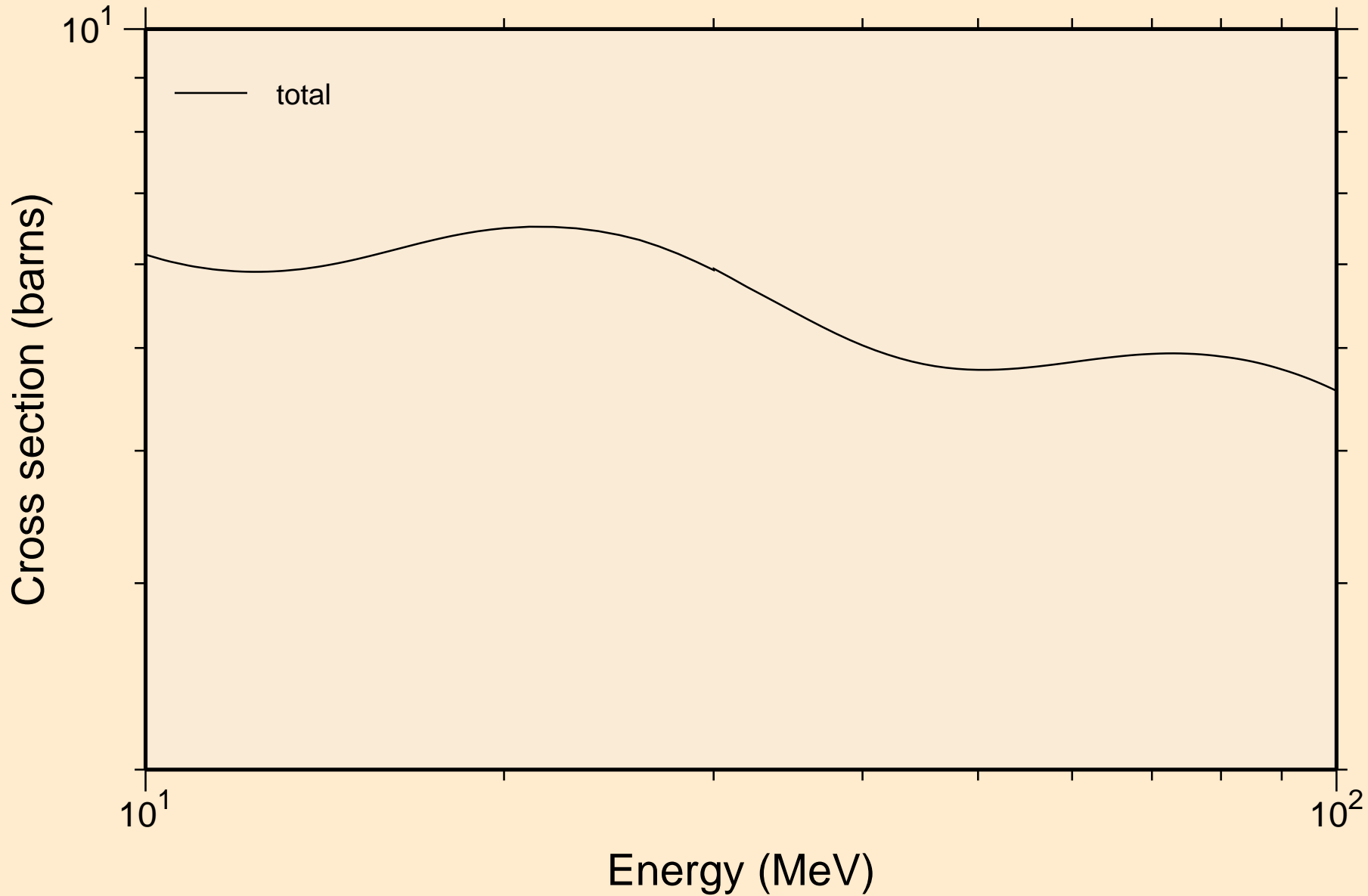

RF265 NEUTRON ACER TENDL-2024 LIBRARY; T=0.K
resonance absorption cross sections

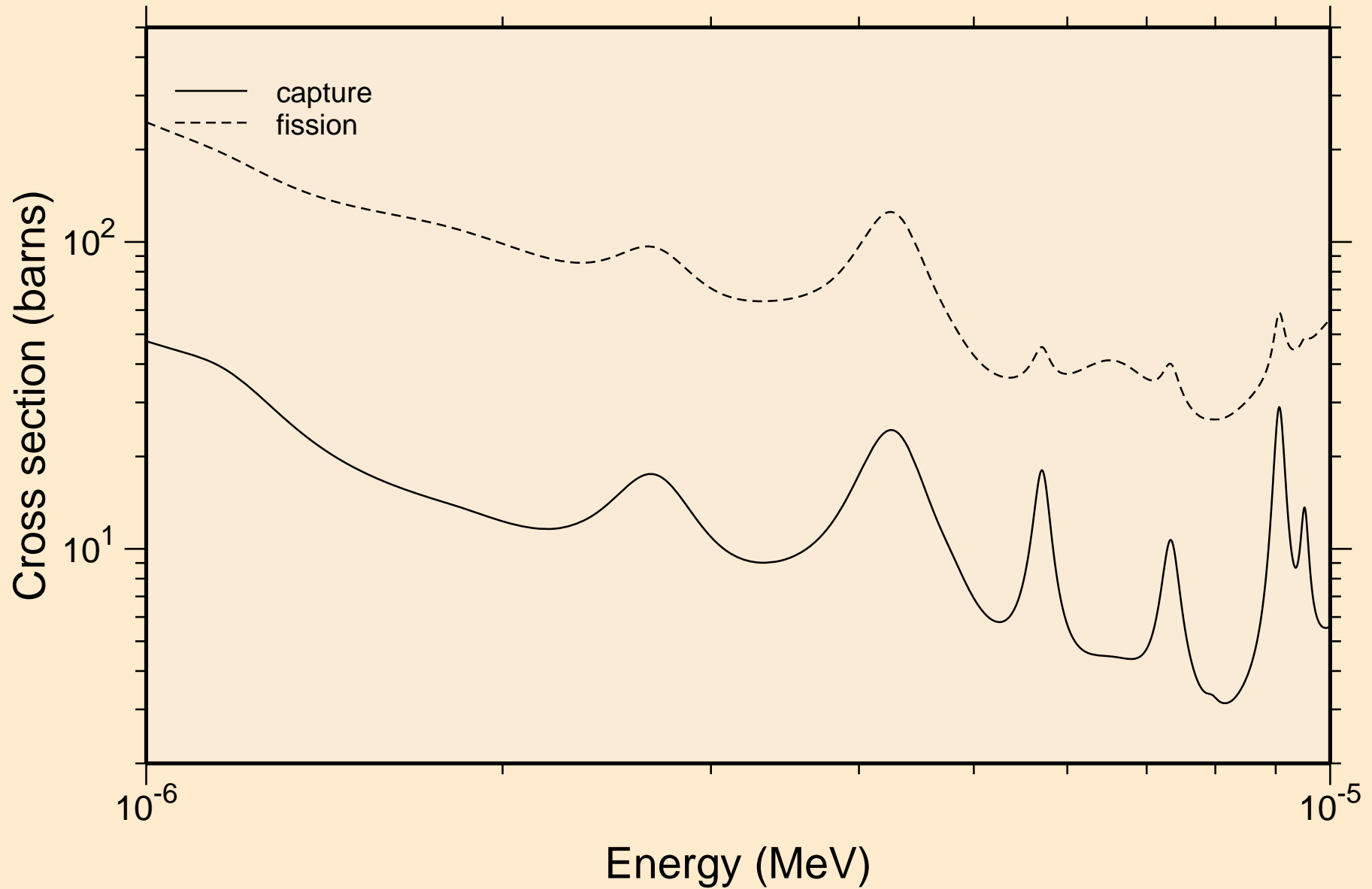

RF265 NEUTRON ACER TENDL-2024 LIBRARY; T=0.K
resonance absorption cross sections

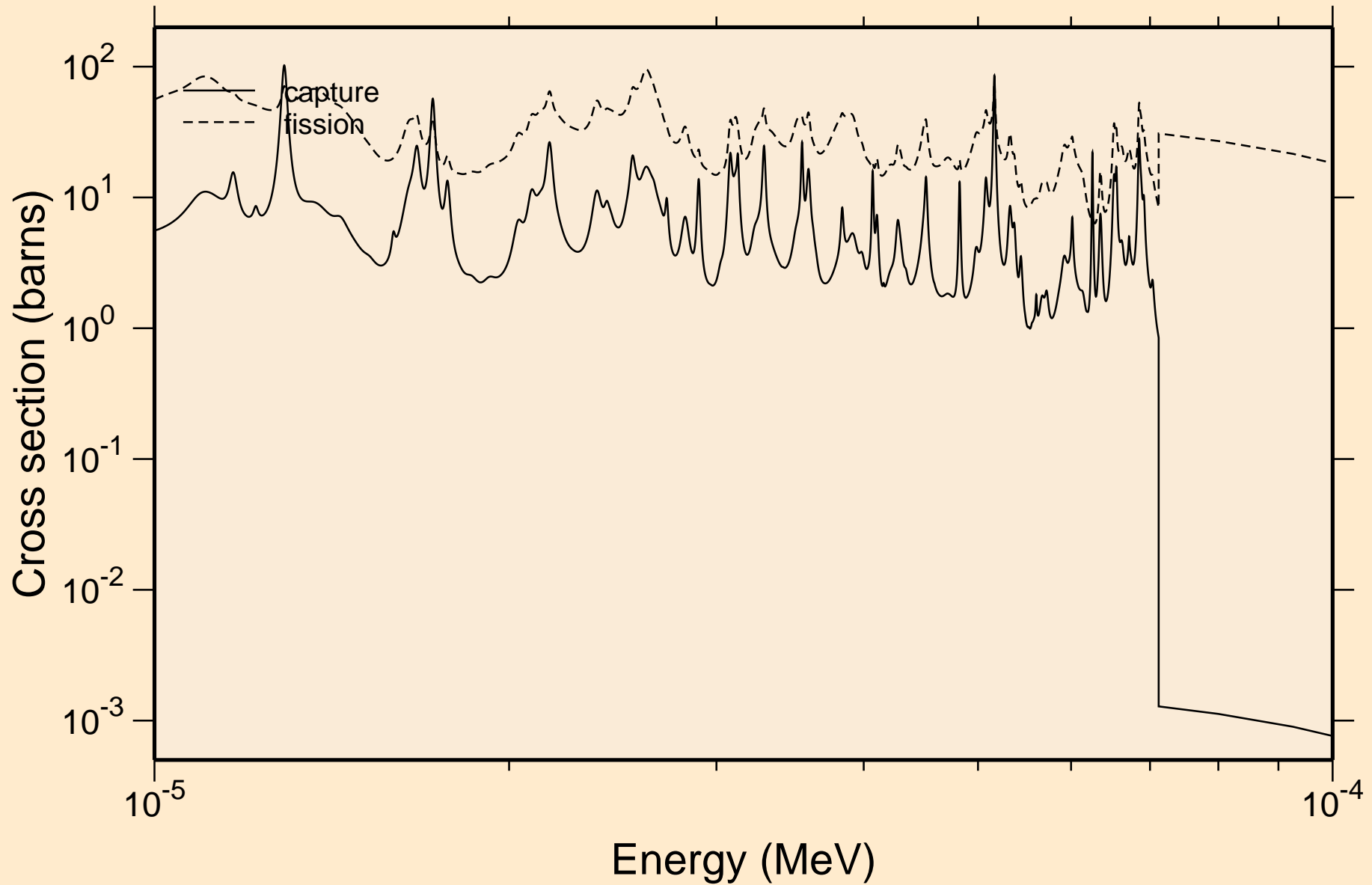

RF265 NEUTRON ACER TENDL-2024 LIBRARY; T=0.K
resonance absorption cross sections

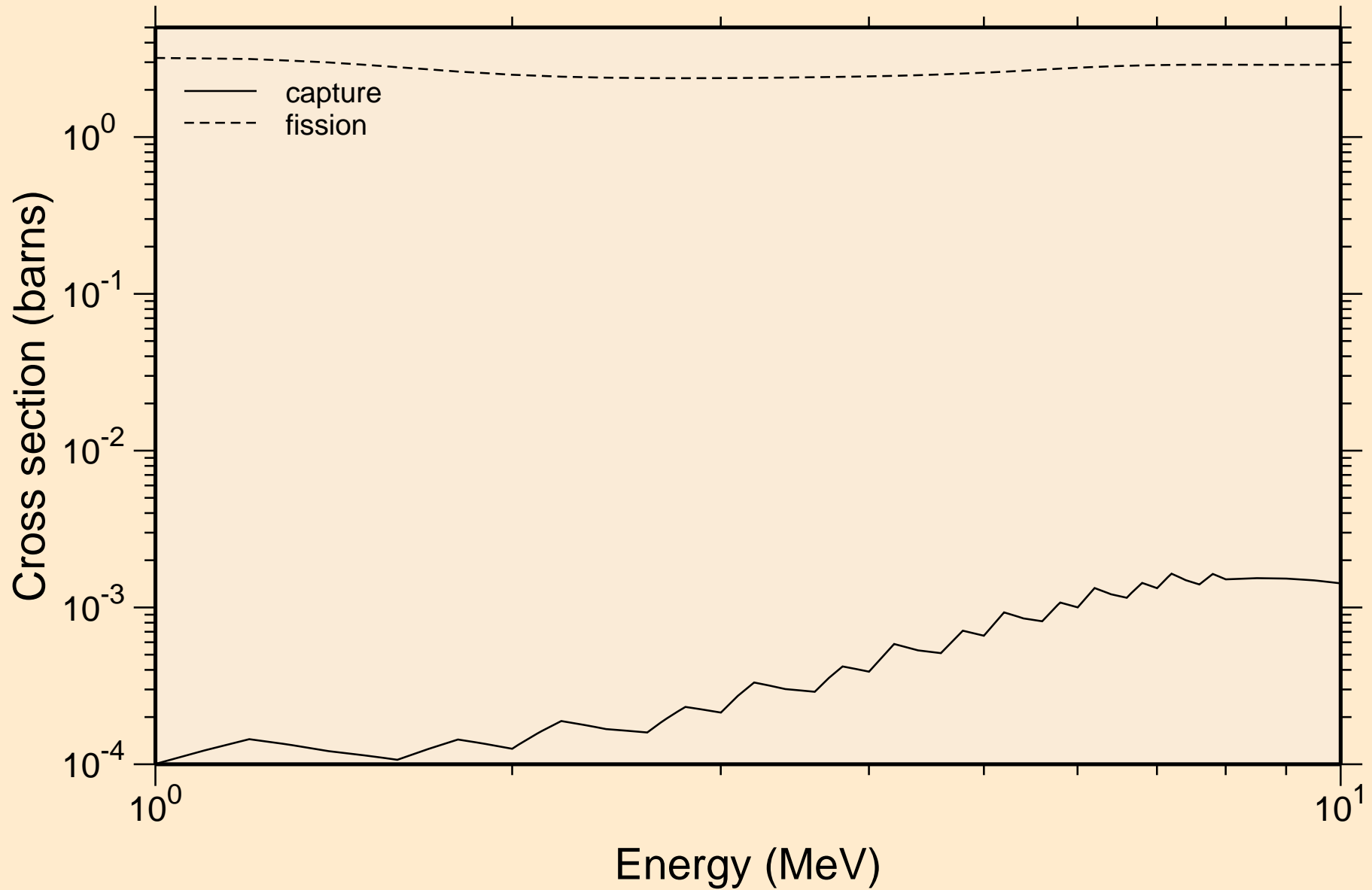

RF265 NEUTRON ACER TENDL-2024 LIBRARY; T=0.K

Heating

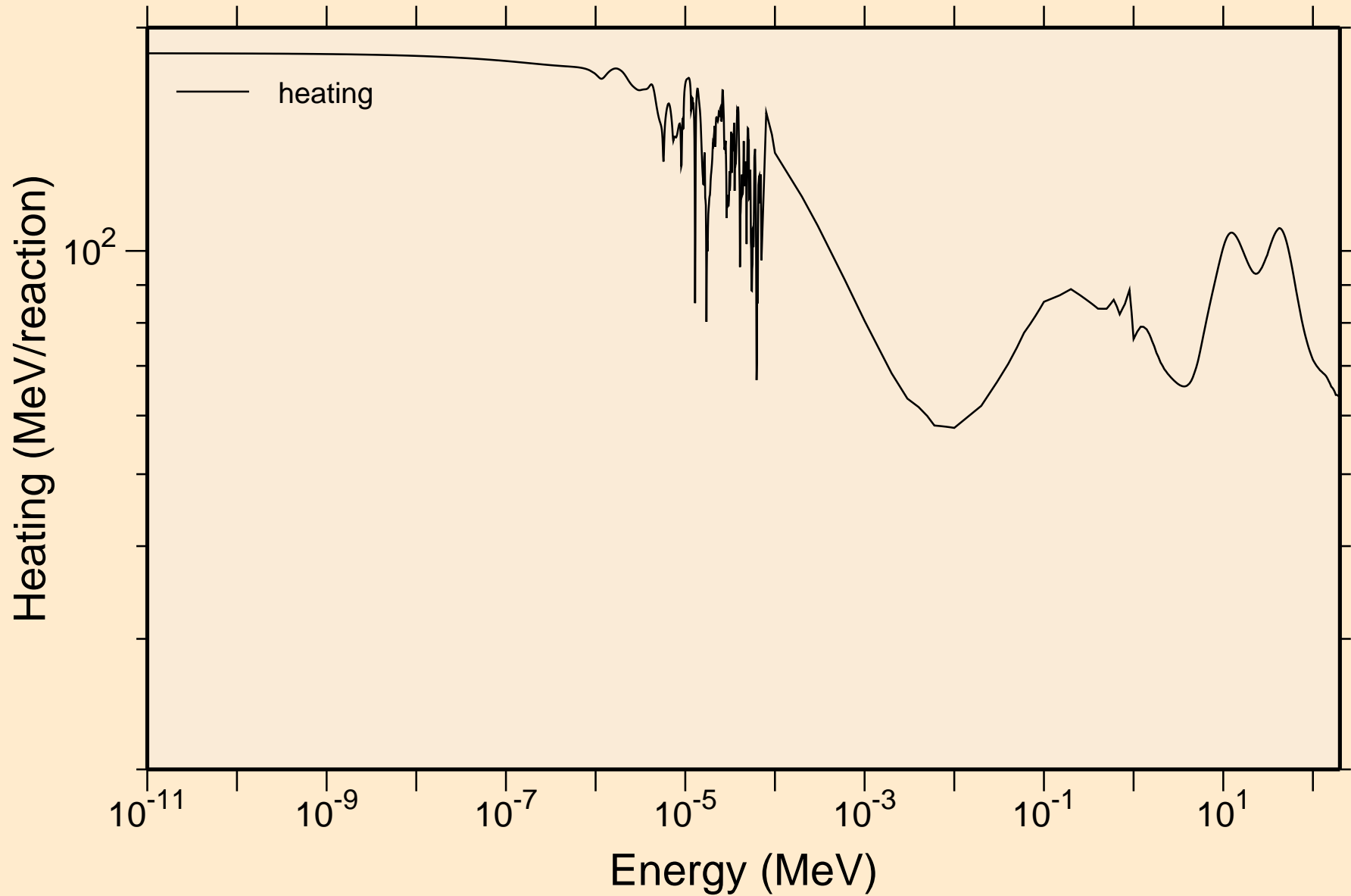

RF265 NEUTRON ACER TENDL-2024 LIBRARY; T=0.K
Damage

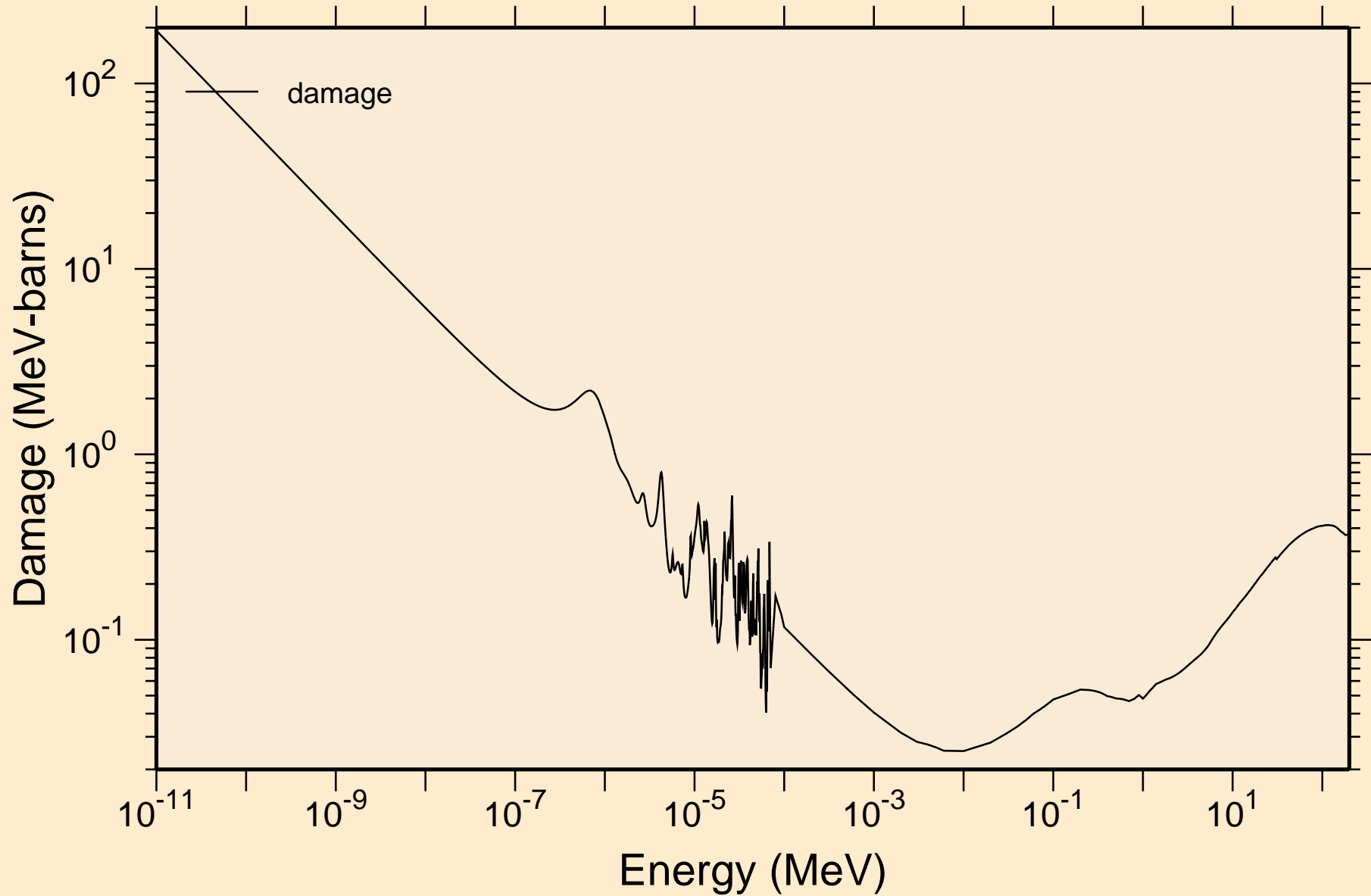

RF265 NEUTRON ACER TENDL-2024 LIBRARY; T=0.K
Non-threshold reactions

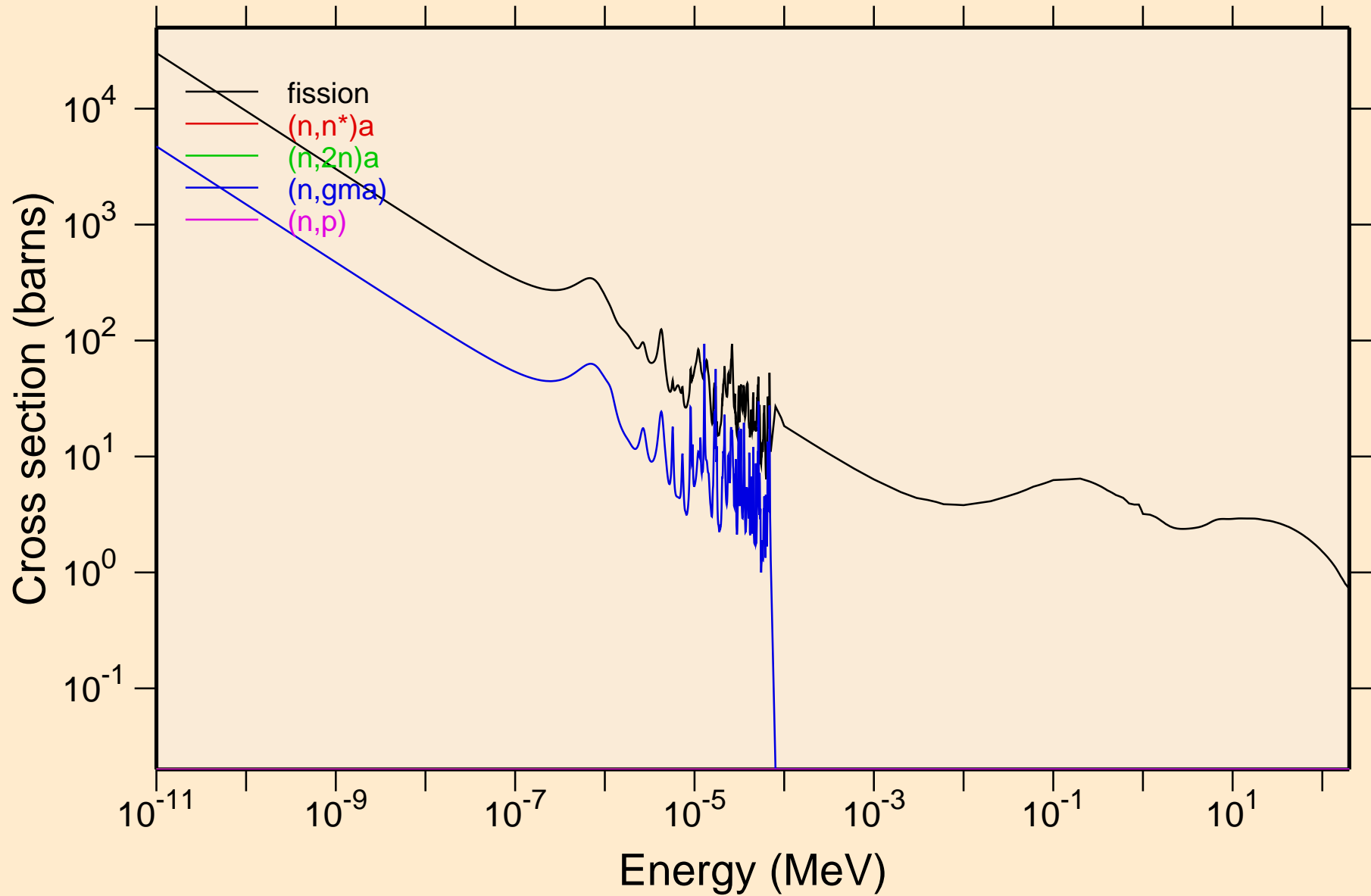

RF265 NEUTRON ACER TENDL-2024 LIBRARY; T=0.K
Non-threshold reactions

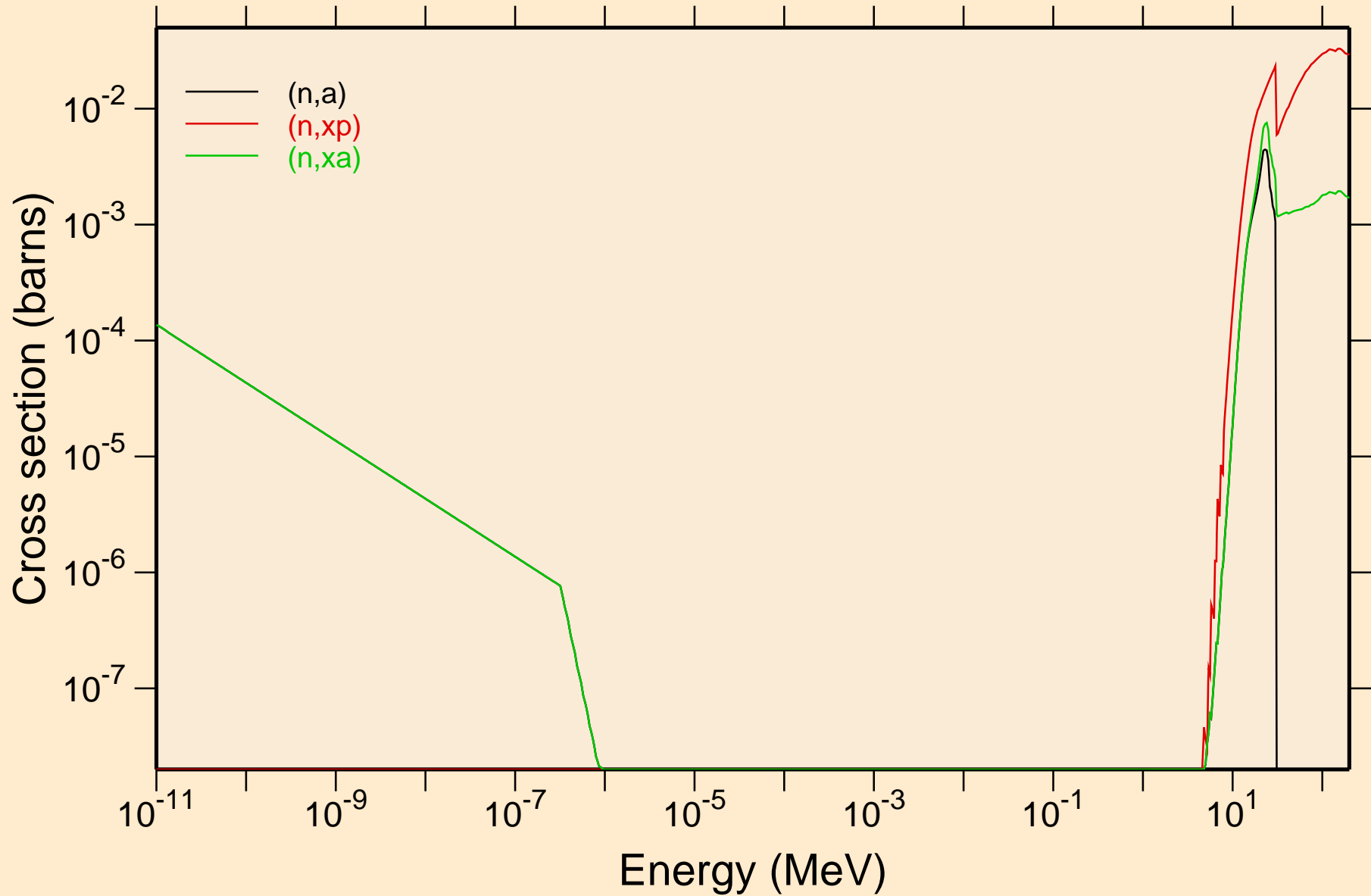

RF265 NEUTRON ACER TENDL-2024 LIBRARY; T=0.K

Principal cross sections

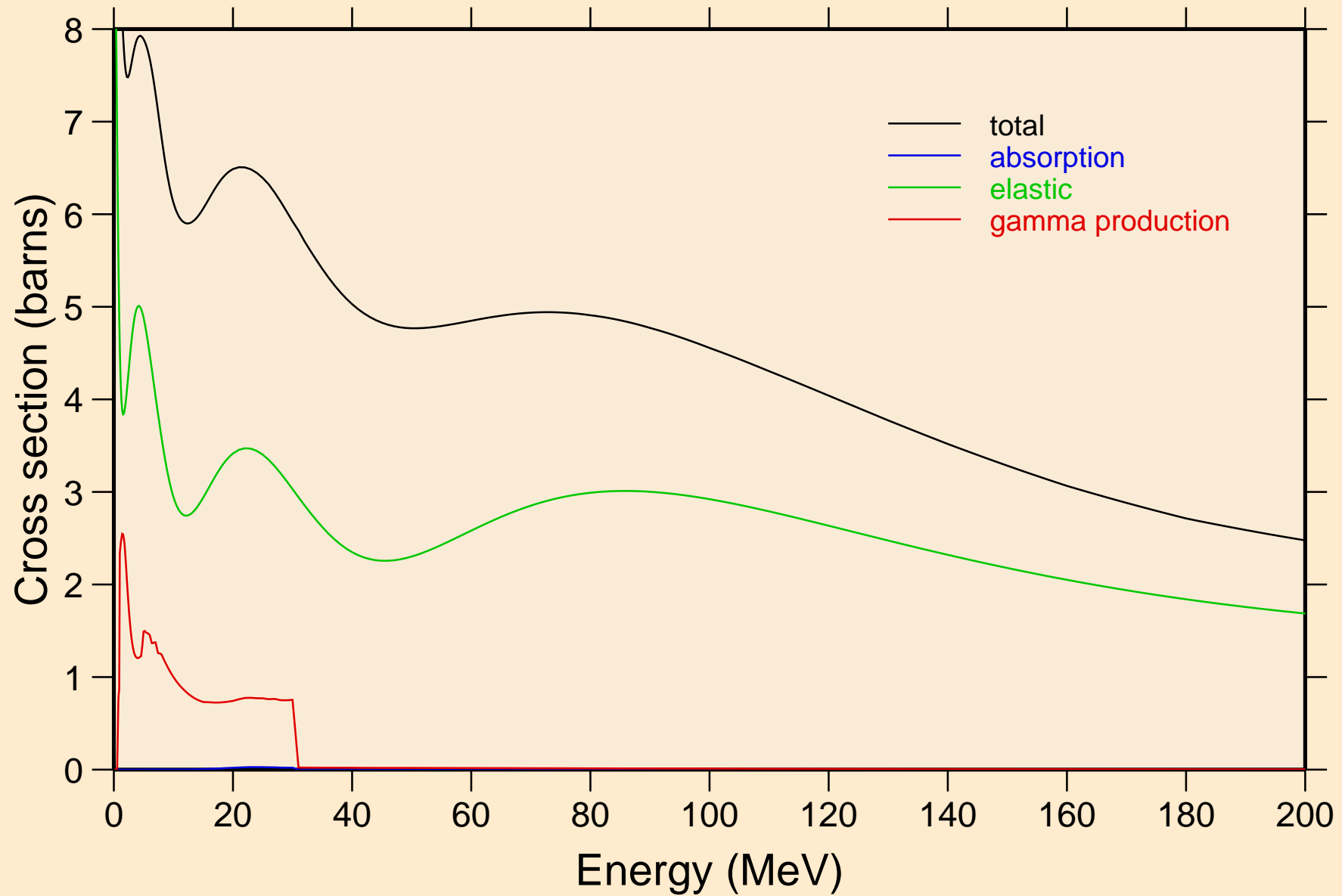

RF265 NEUTRON ACER TENDL-2024 LIBRARY; T=0.K

Heating

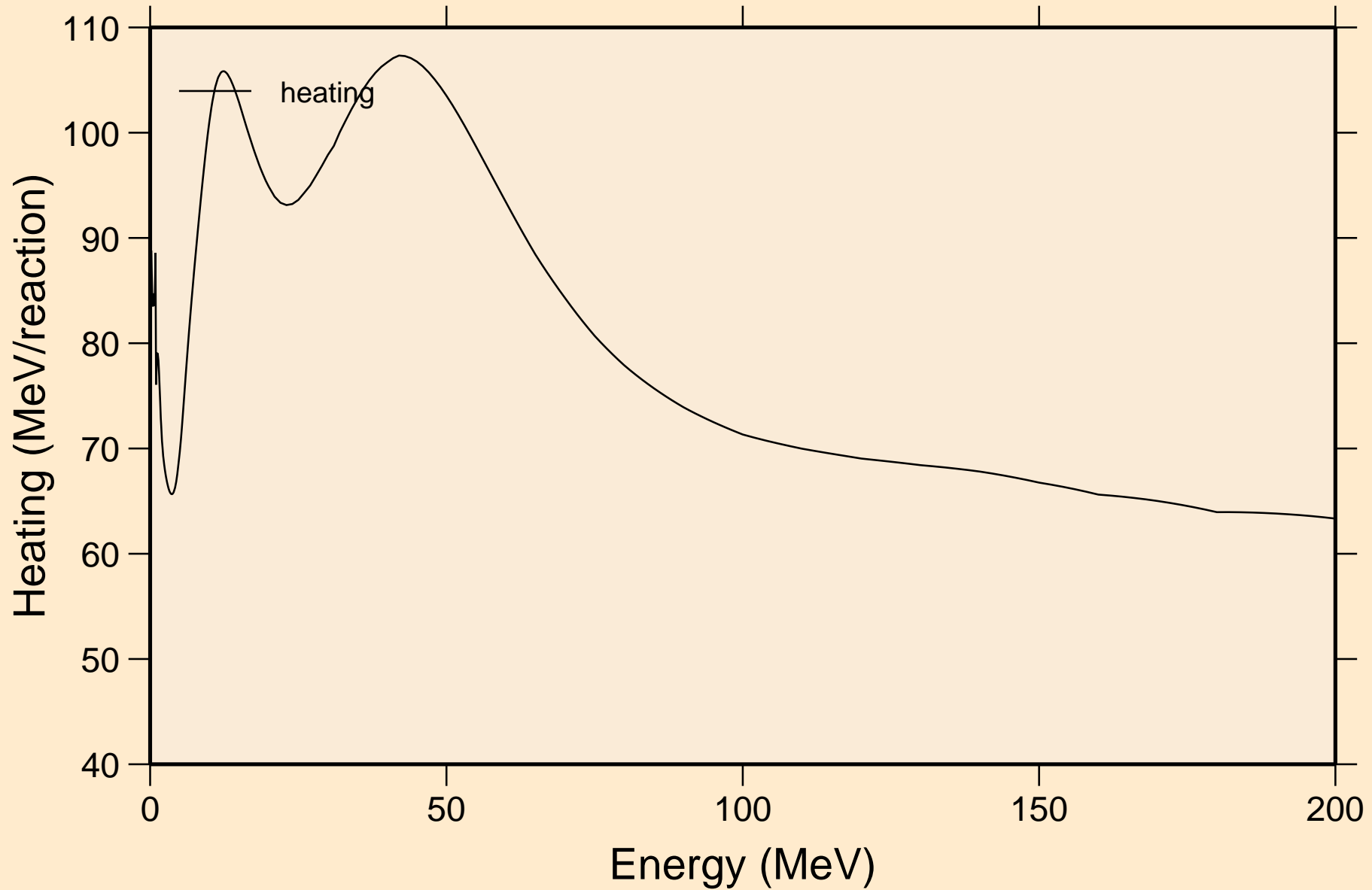

RF265 NEUTRON ACER TENDL-2024 LIBRARY; T=0.K
Damage

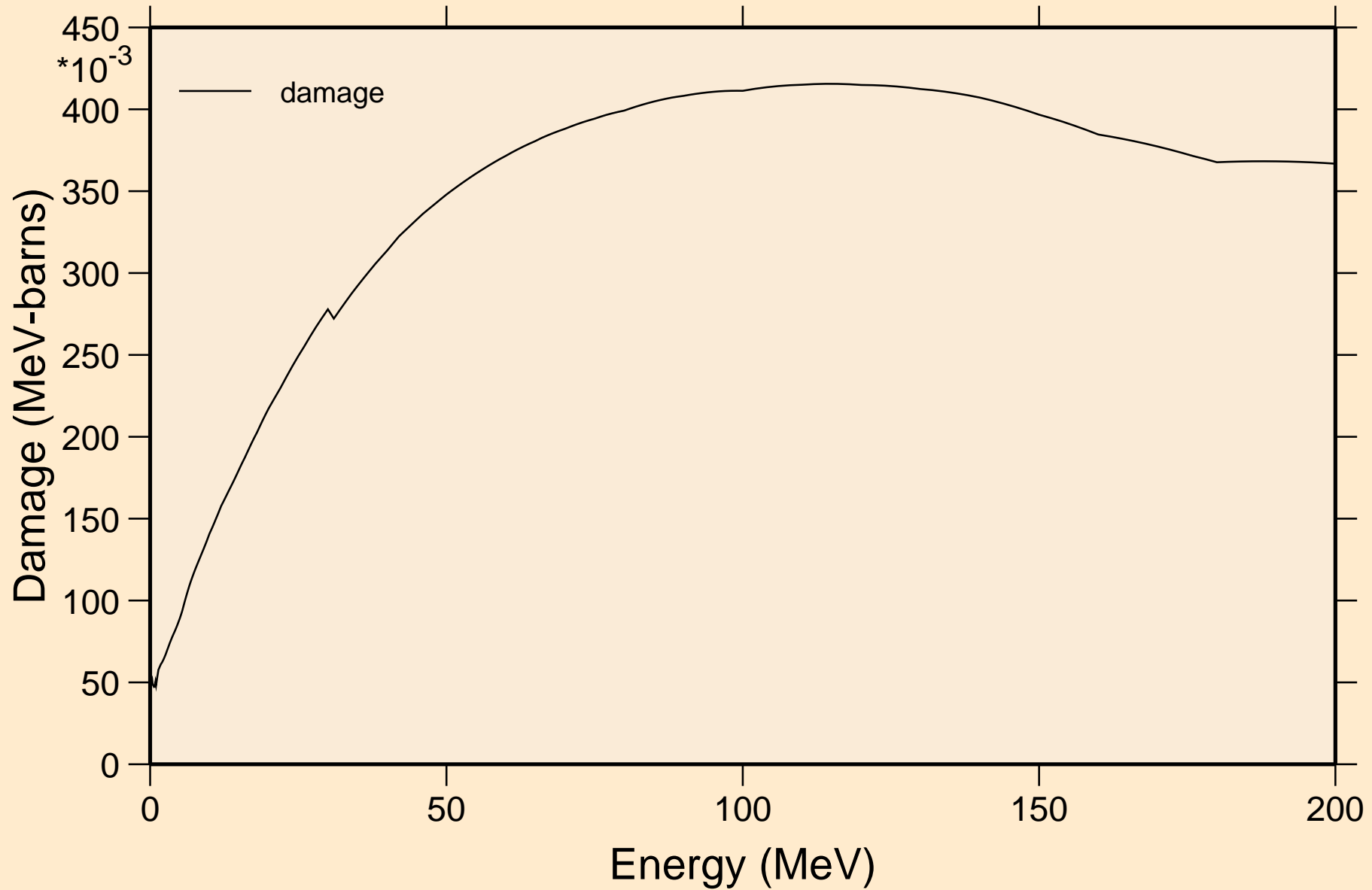

RF265 NEUTRON ACER TENDL-2024 LIBRARY; T=0.K

Non-threshold reactions

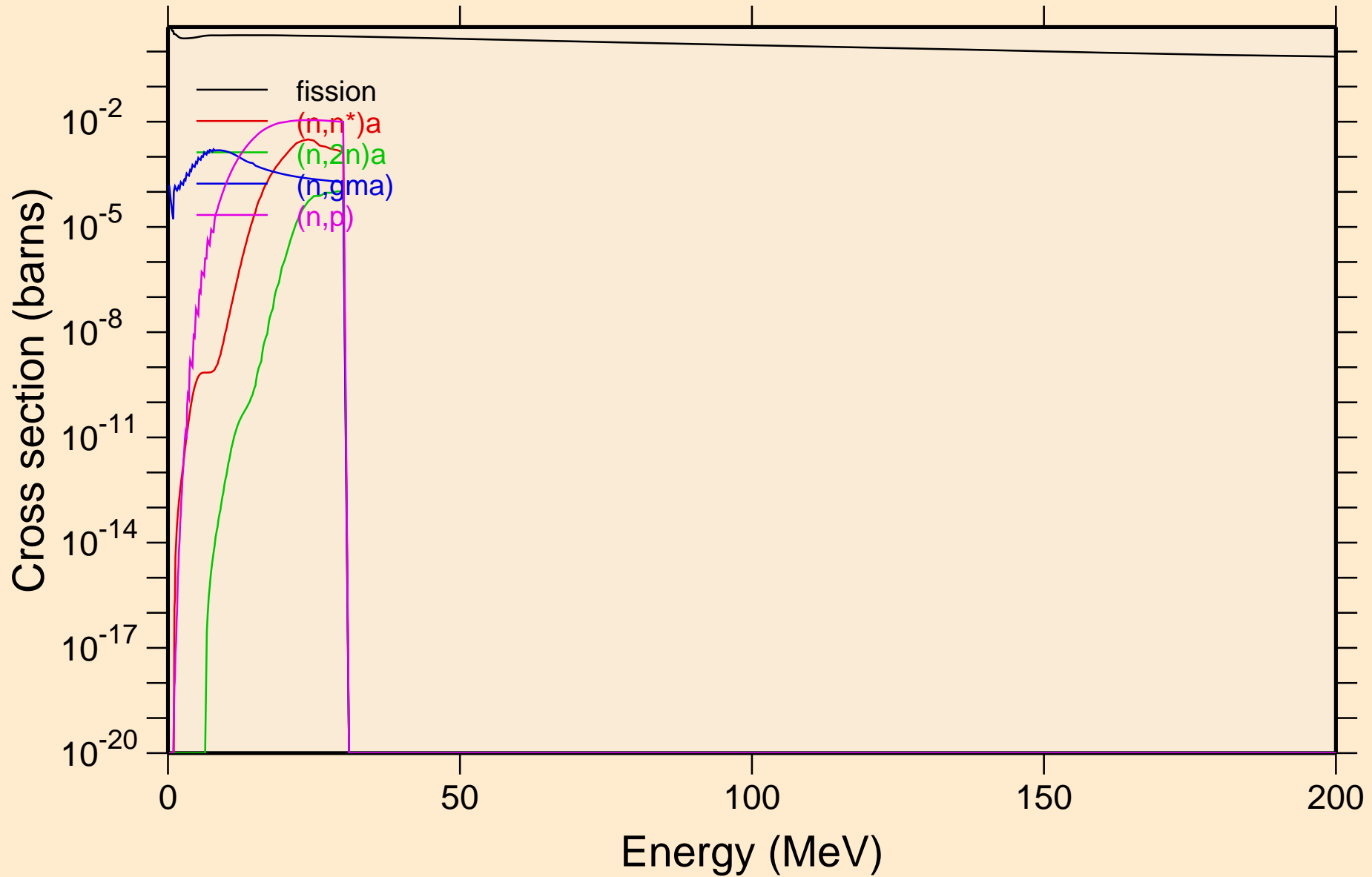

RF265 NEUTRON ACER TENDL-2024 LIBRARY; T=0.K
Non-threshold reactions

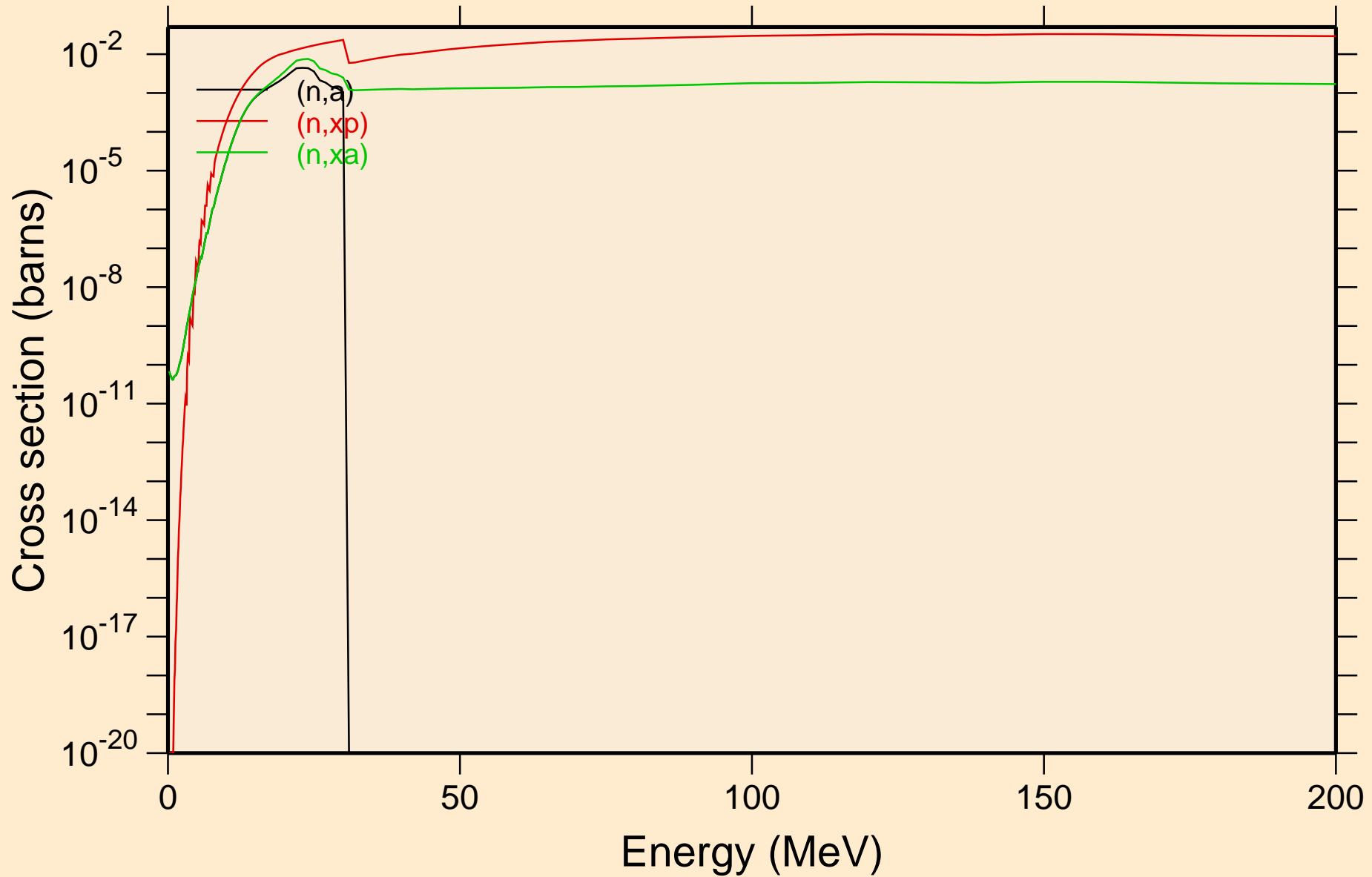

RF265 NEUTRON ACER TENDL-2024 LIBRARY; T=0.K
Inelastic levels

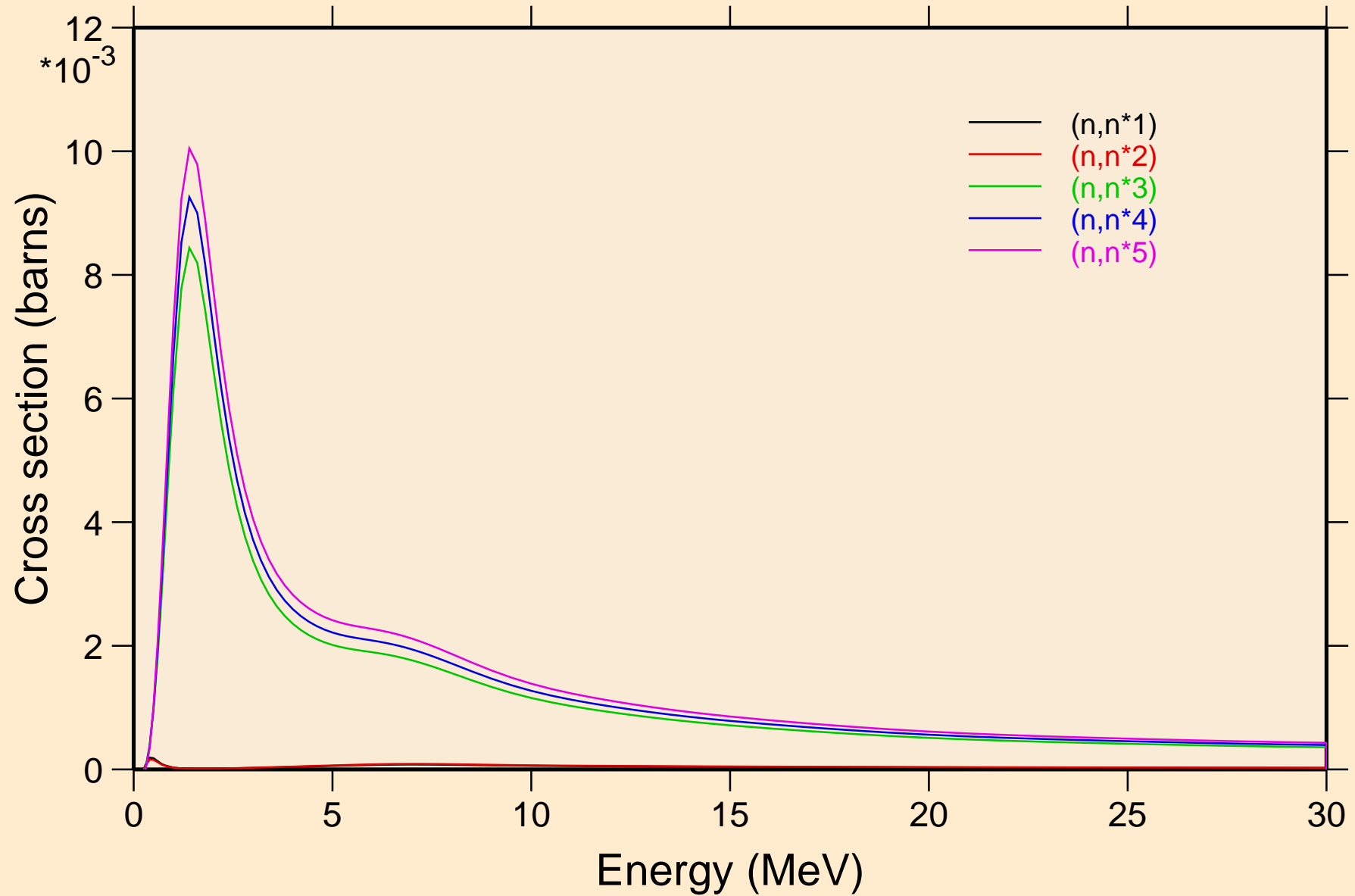

RF265 NEUTRON ACER TENDL-2024 LIBRARY; T=0.K
Inelastic levels

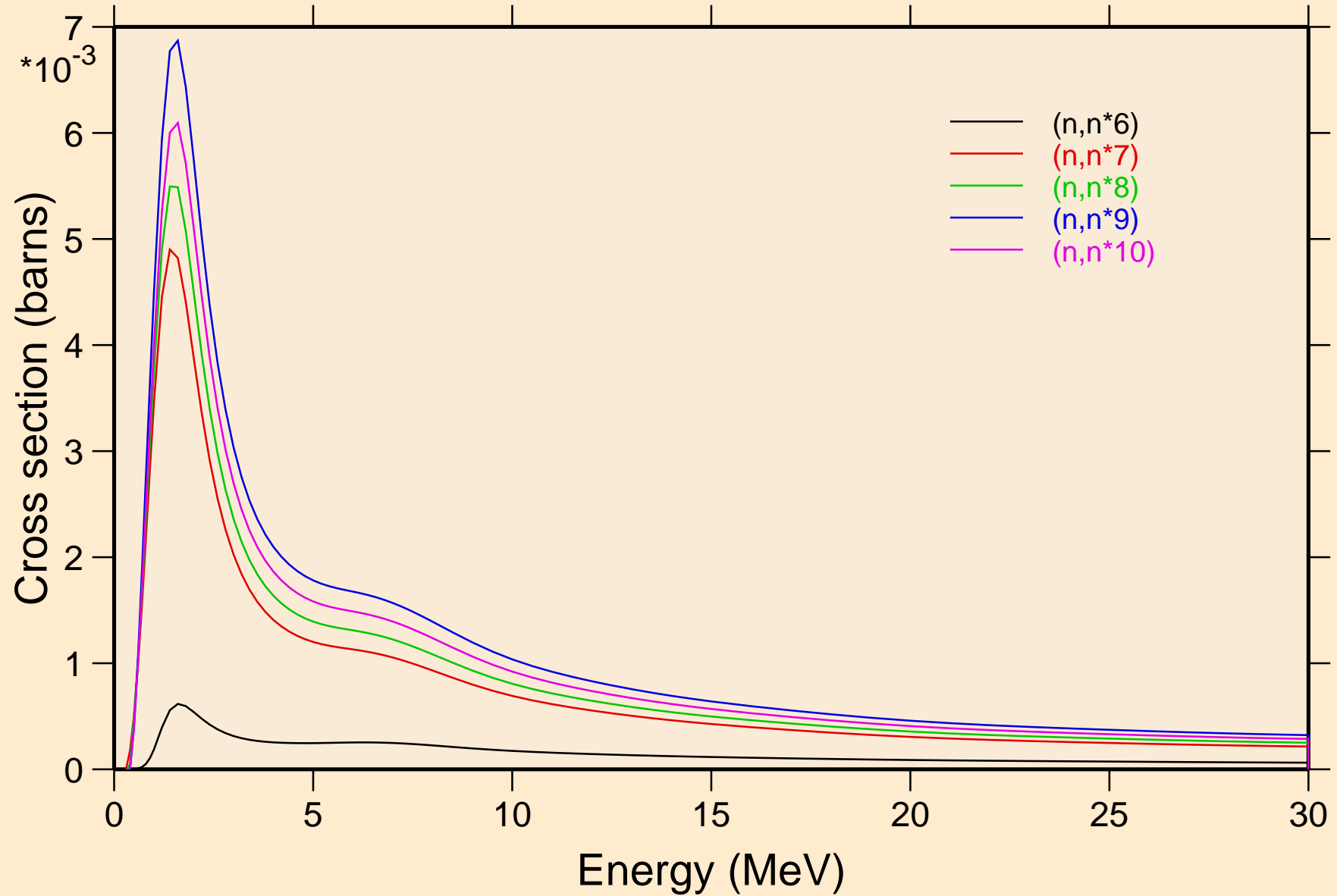

RF265 NEUTRON ACER TENDL-2024 LIBRARY; T=0.K
Inelastic levels

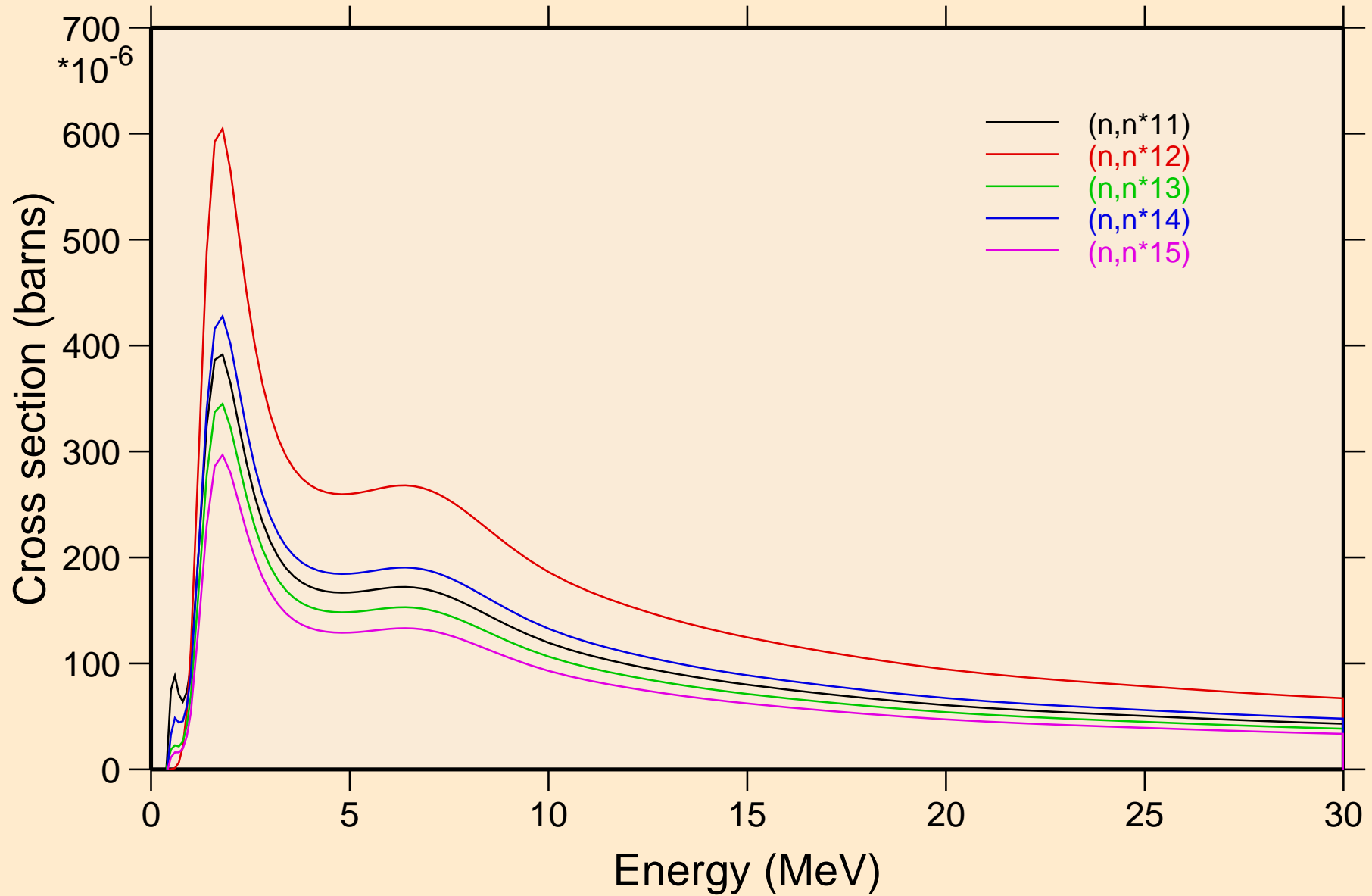

RF265 NEUTRON ACER TENDL-2024 LIBRARY; T=0.K
Inelastic levels

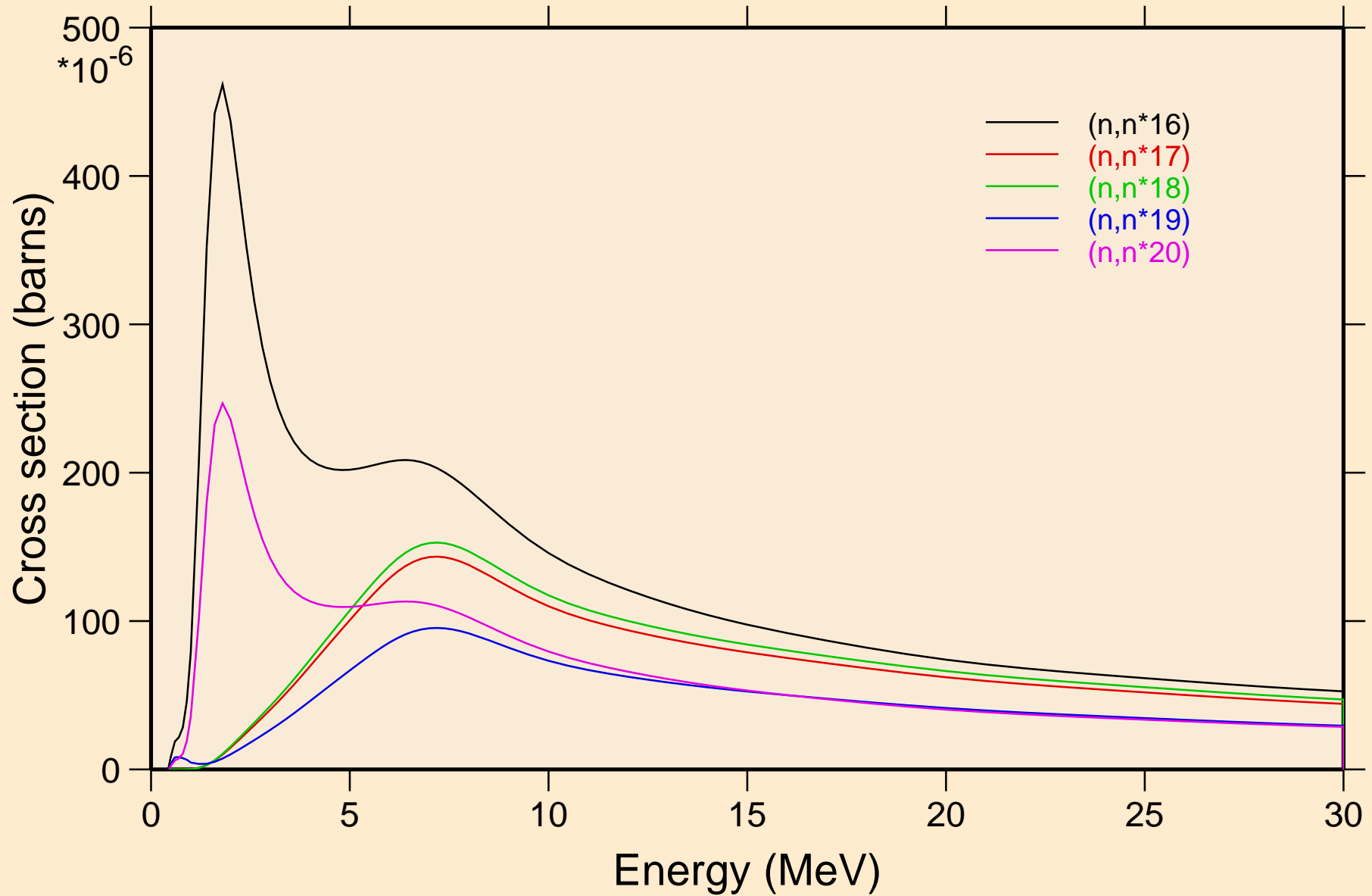

RF265 NEUTRON ACER TENDL-2024 LIBRARY; T=0.K
Inelastic levels

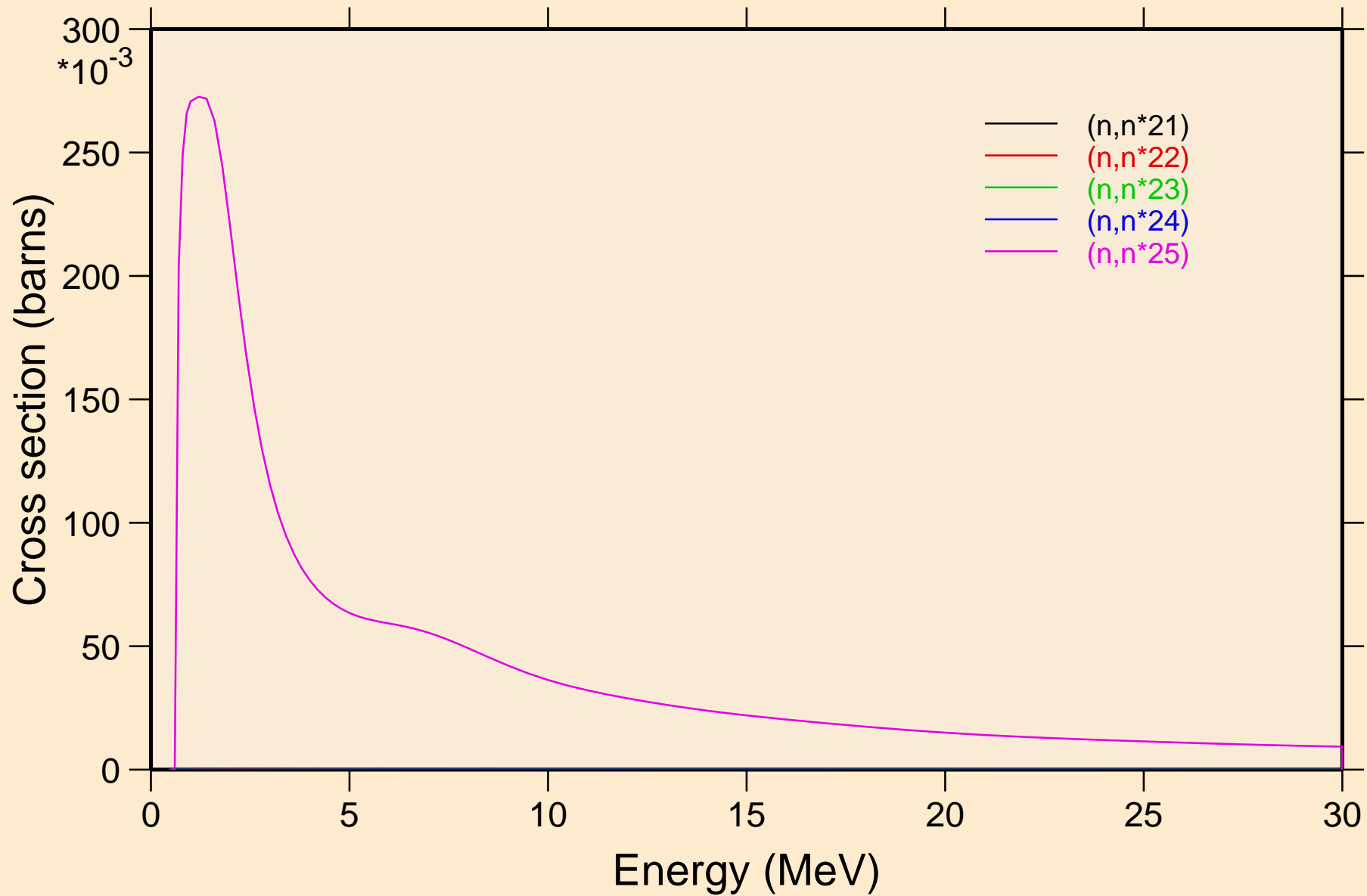

RF265 NEUTRON ACER TENDL-2024 LIBRARY; T=0.K
Inelastic levels

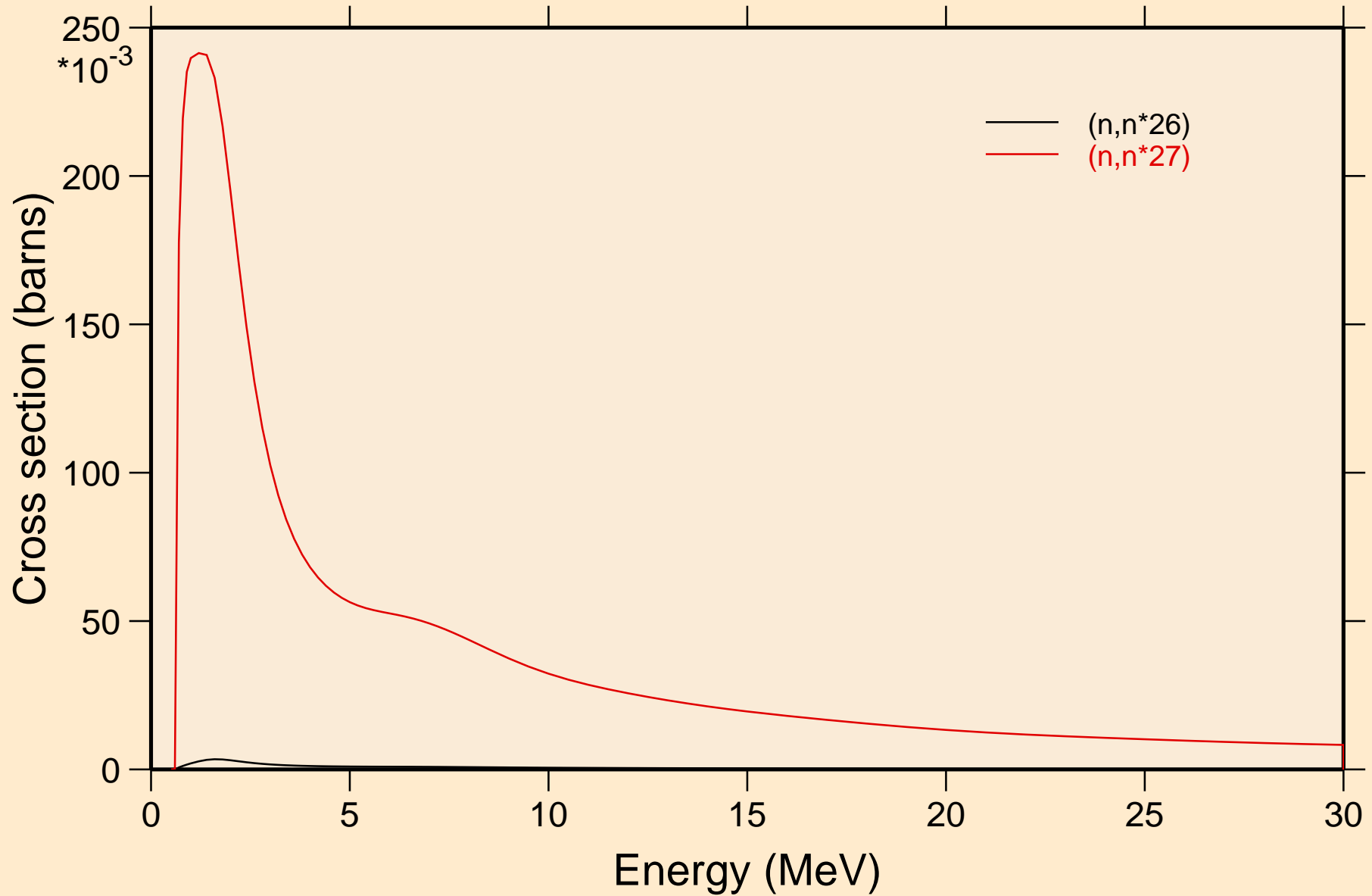

RF265 NEUTRON ACER TENDL-2024 LIBRARY; T=0.K

Threshold reactions

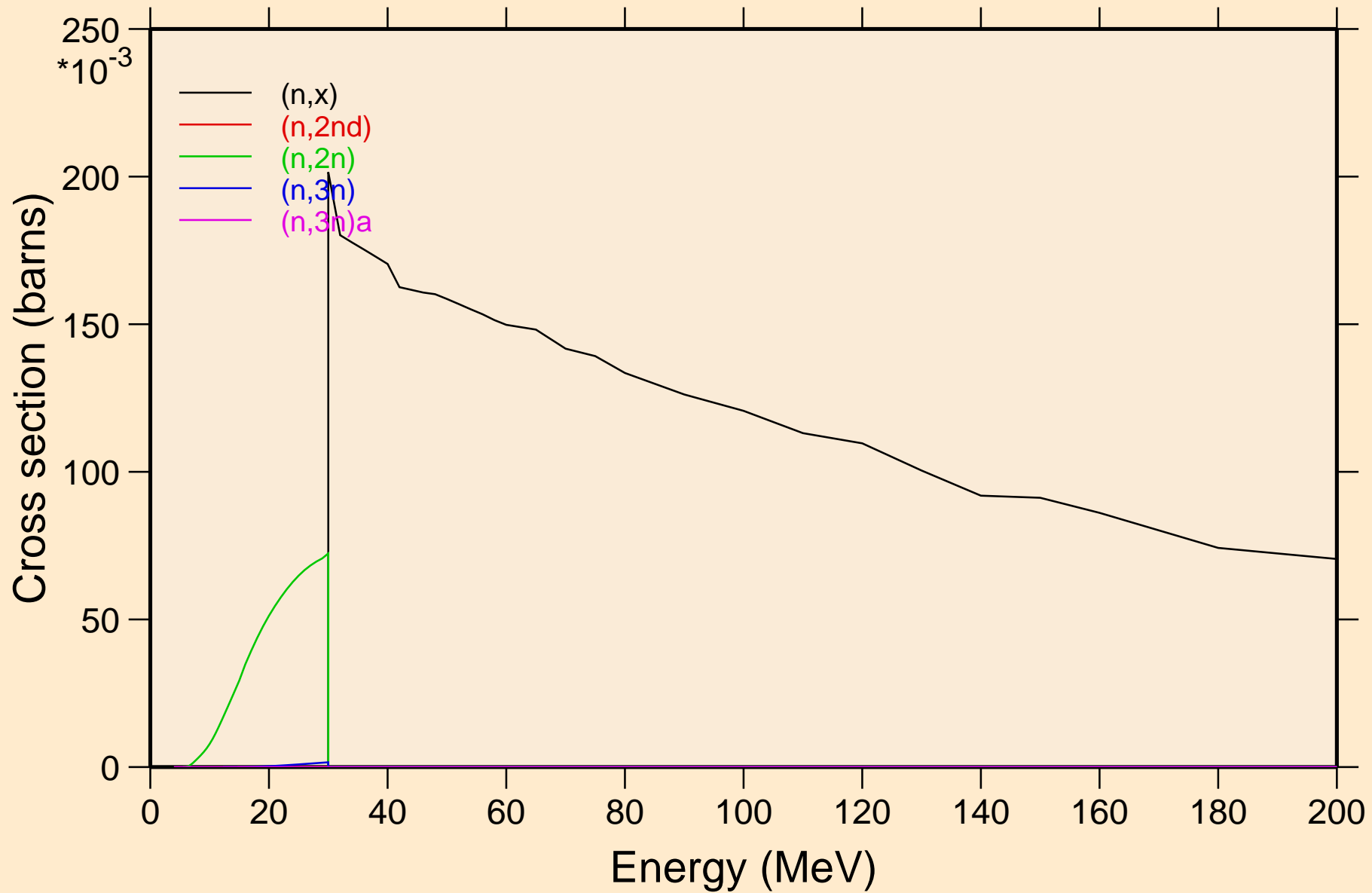

RF265 NEUTRON ACER TENDL-2024 LIBRARY; T=0.K
Threshold reactions

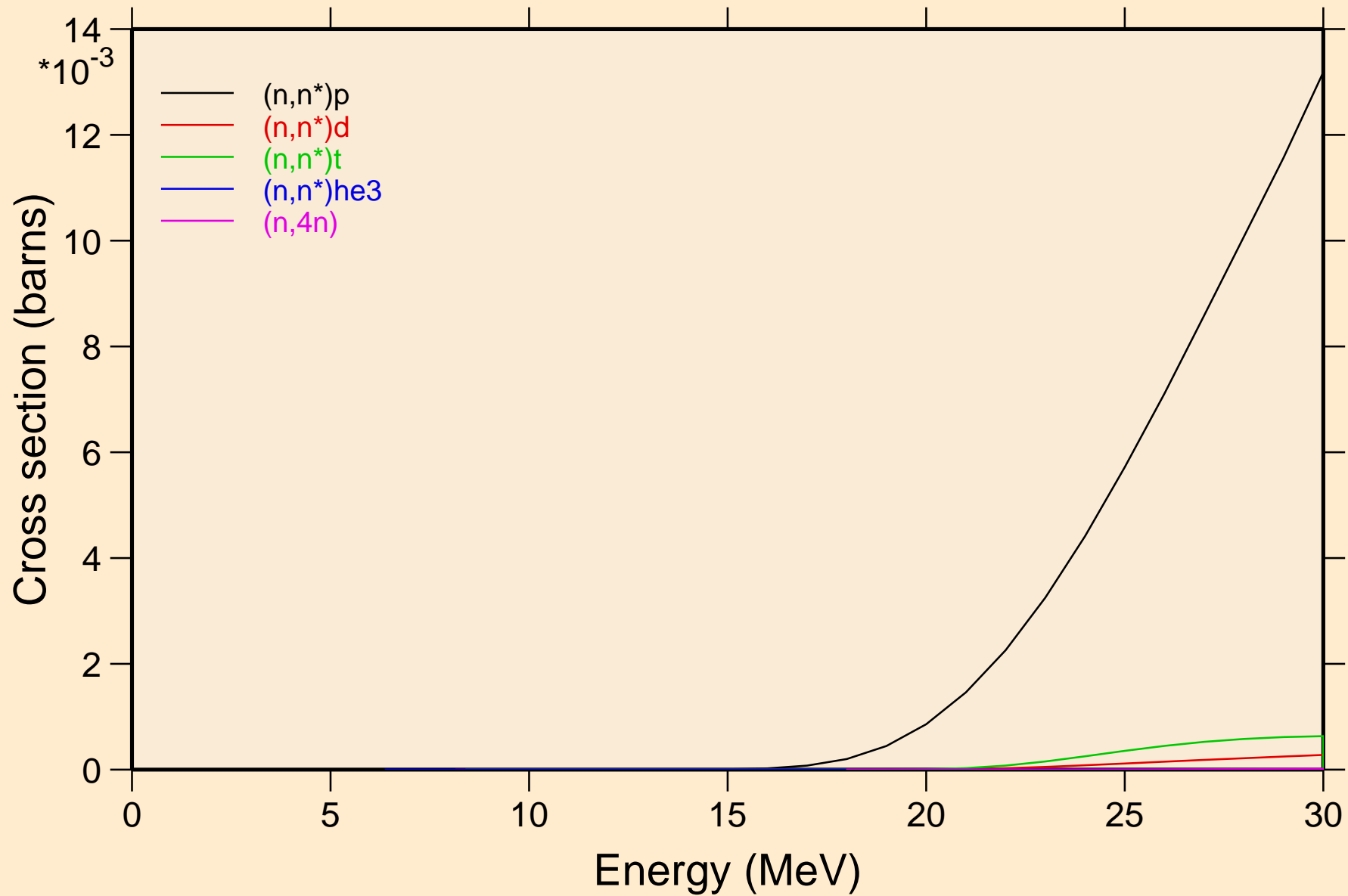

RF265 NEUTRON ACER TENDL-2024 LIBRARY; T=0.K

Threshold reactions

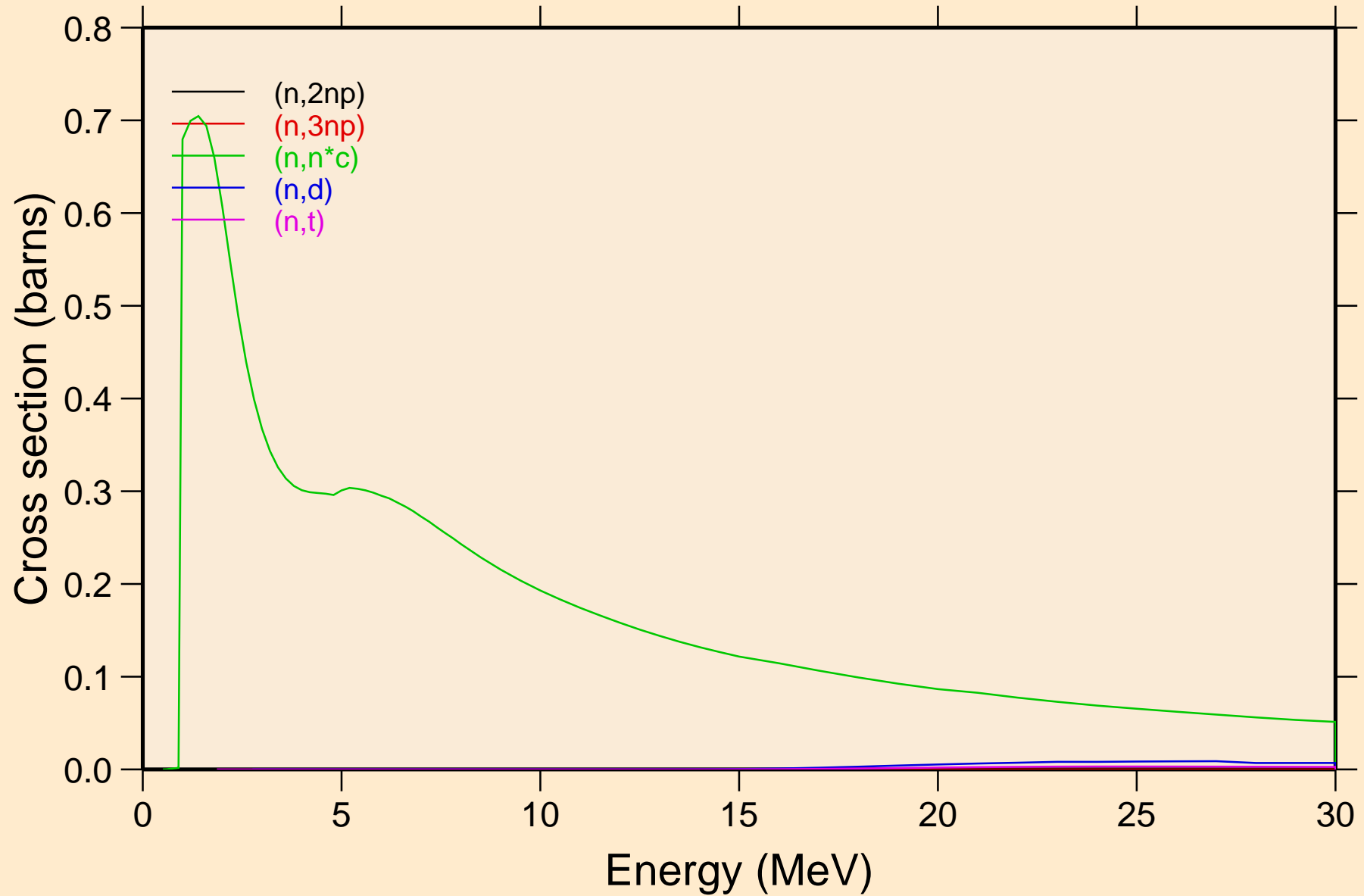

RF265 NEUTRON ACER TENDL-2024 LIBRARY; T=0.K
Threshold reactions

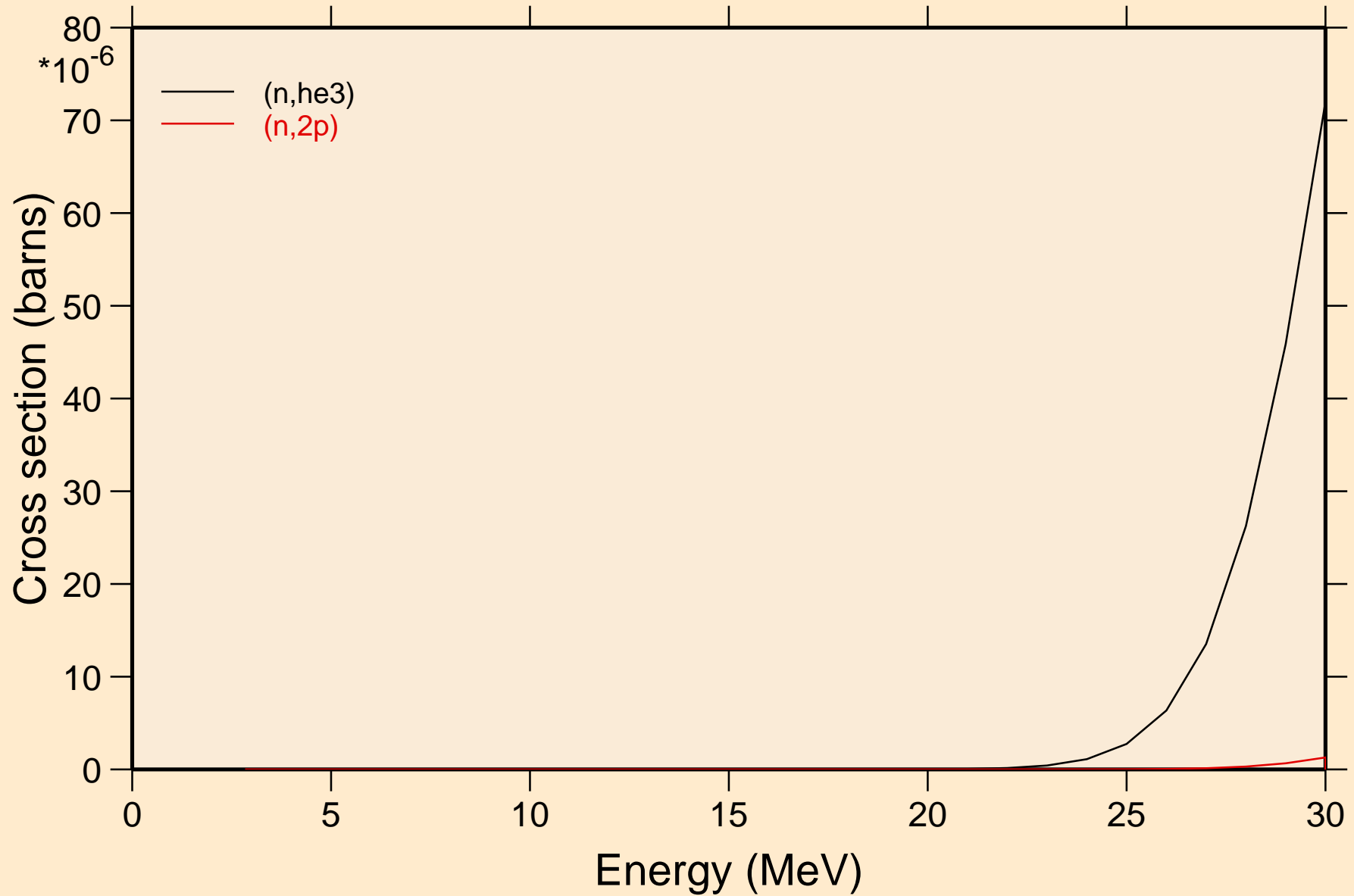

RF265 NEUTRON ACER TENDL-2024 LIBRARY; T=0.K

Threshold reactions

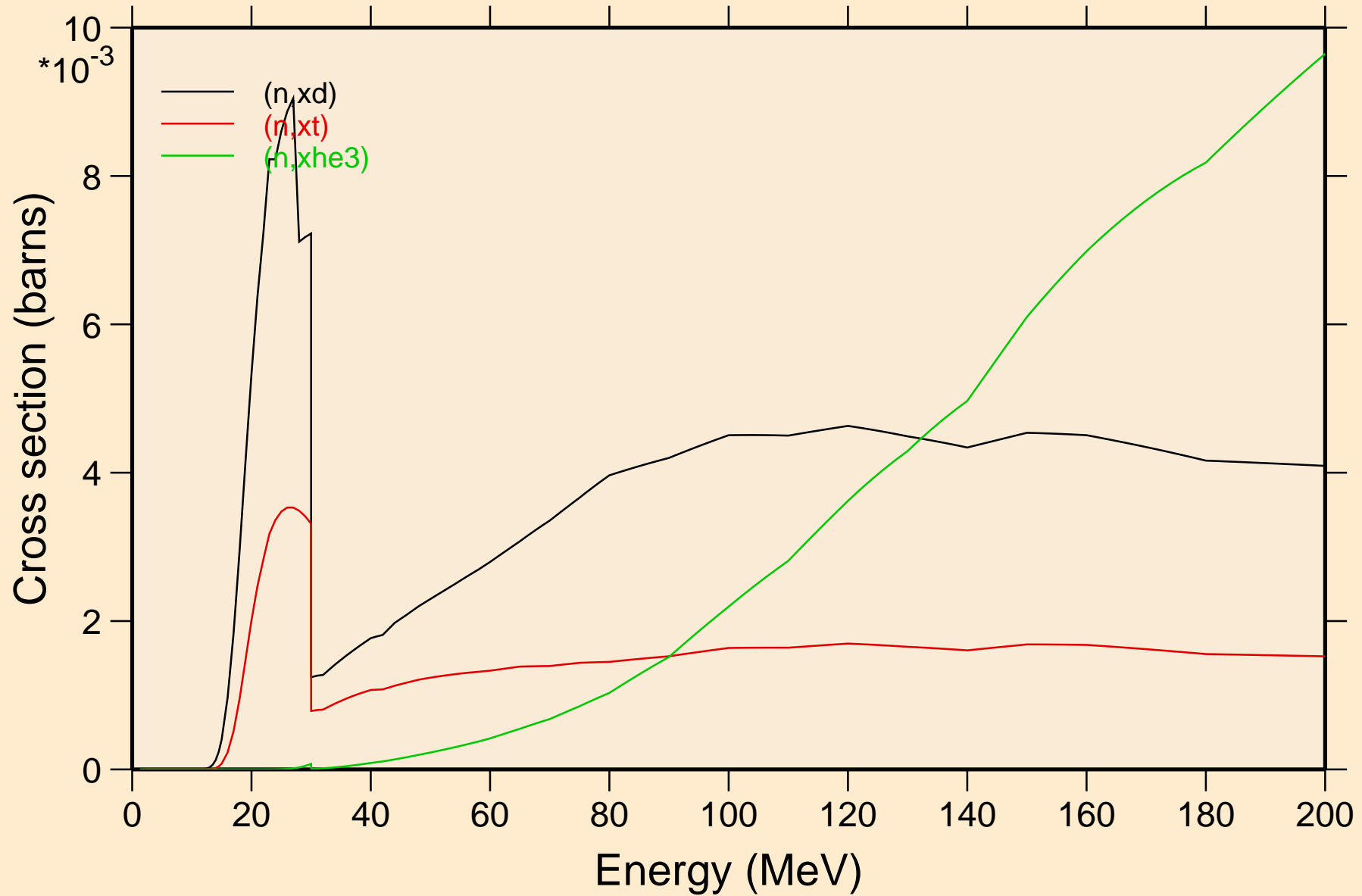

RF265 NEUTRON ACER TENDL-2024 LIBRARY; T=0.K
angular distribution for elastic

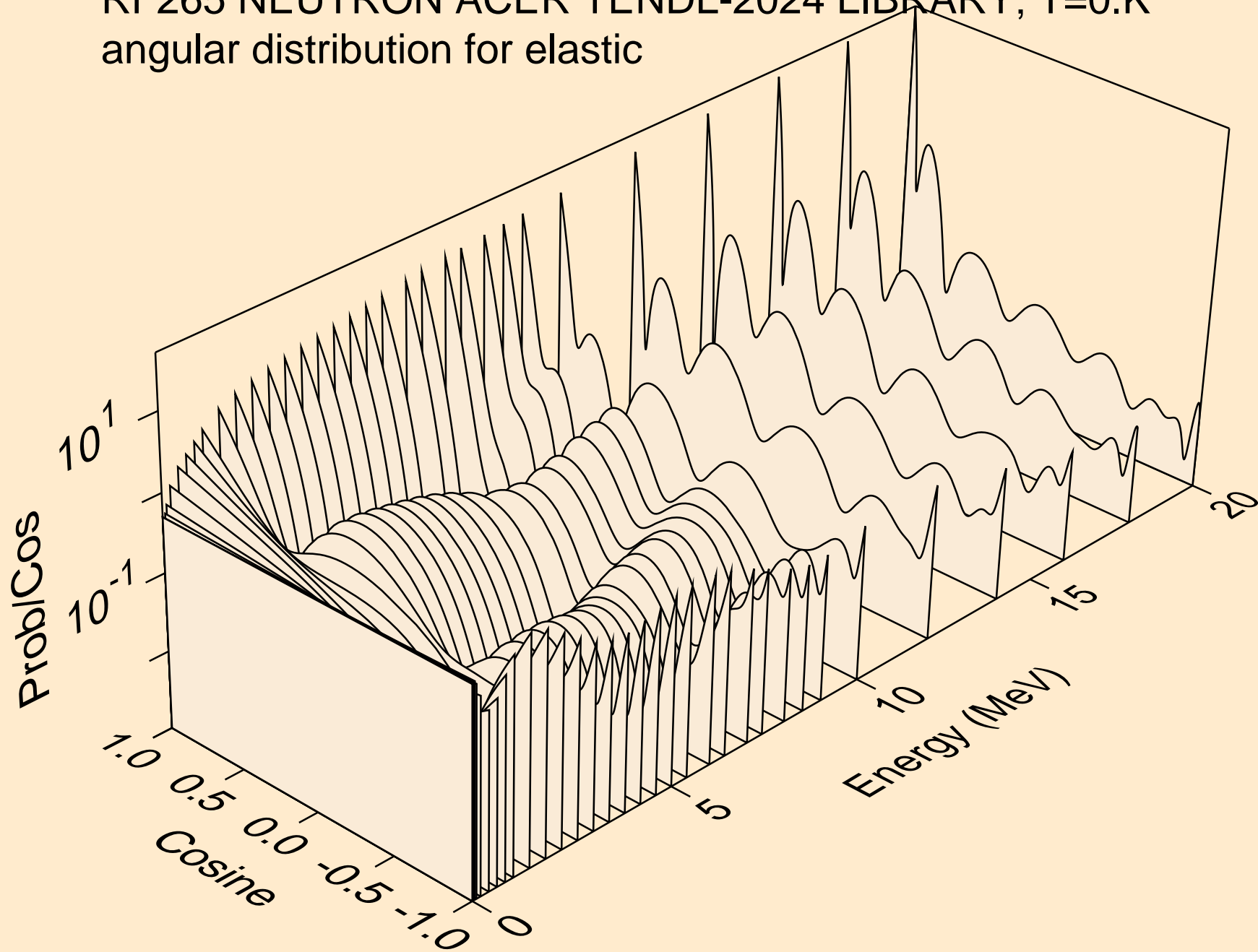

RF265 NEUTRON ACER TENDL-2024 LIBRARY; T=0.K
angular distribution for elastic

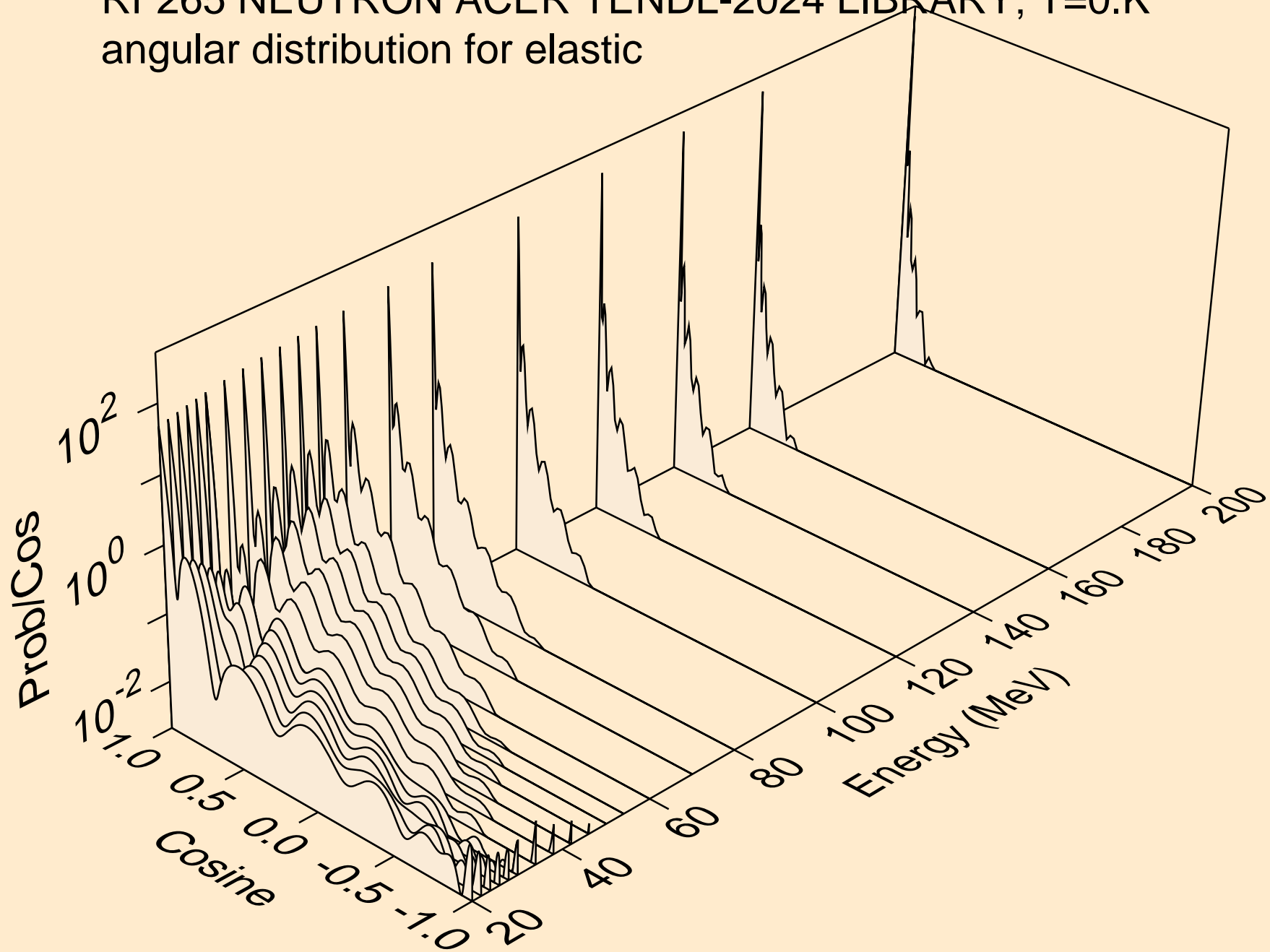

RF265 NEUTRON ACER TENDL-2024 LIBRARY; T=0.K
angular distribution for (n,n*1)

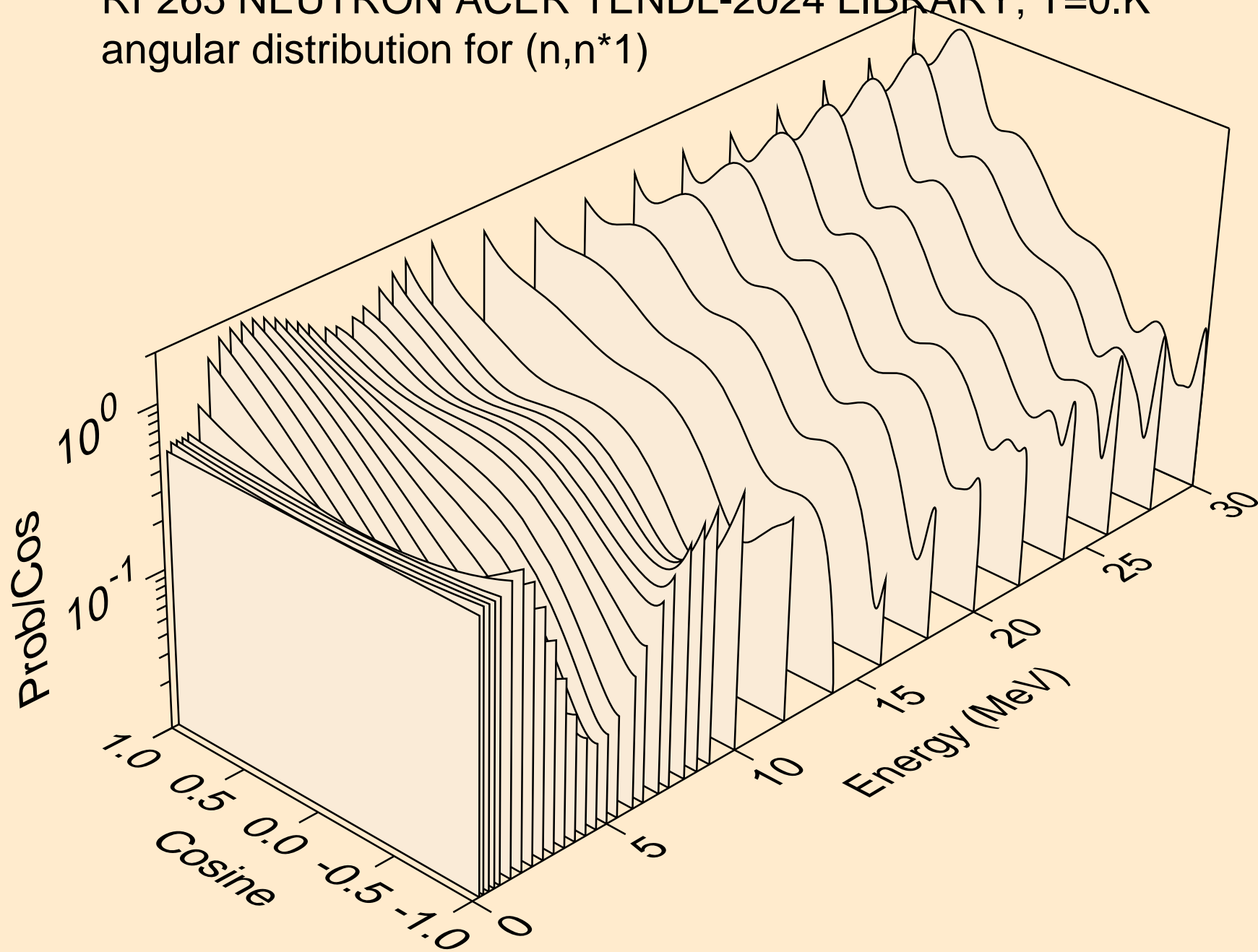

RF265 NEUTRON ACER TENDL-2024 LIBRARY; T=0.K
angular distribution for (n,n*2)

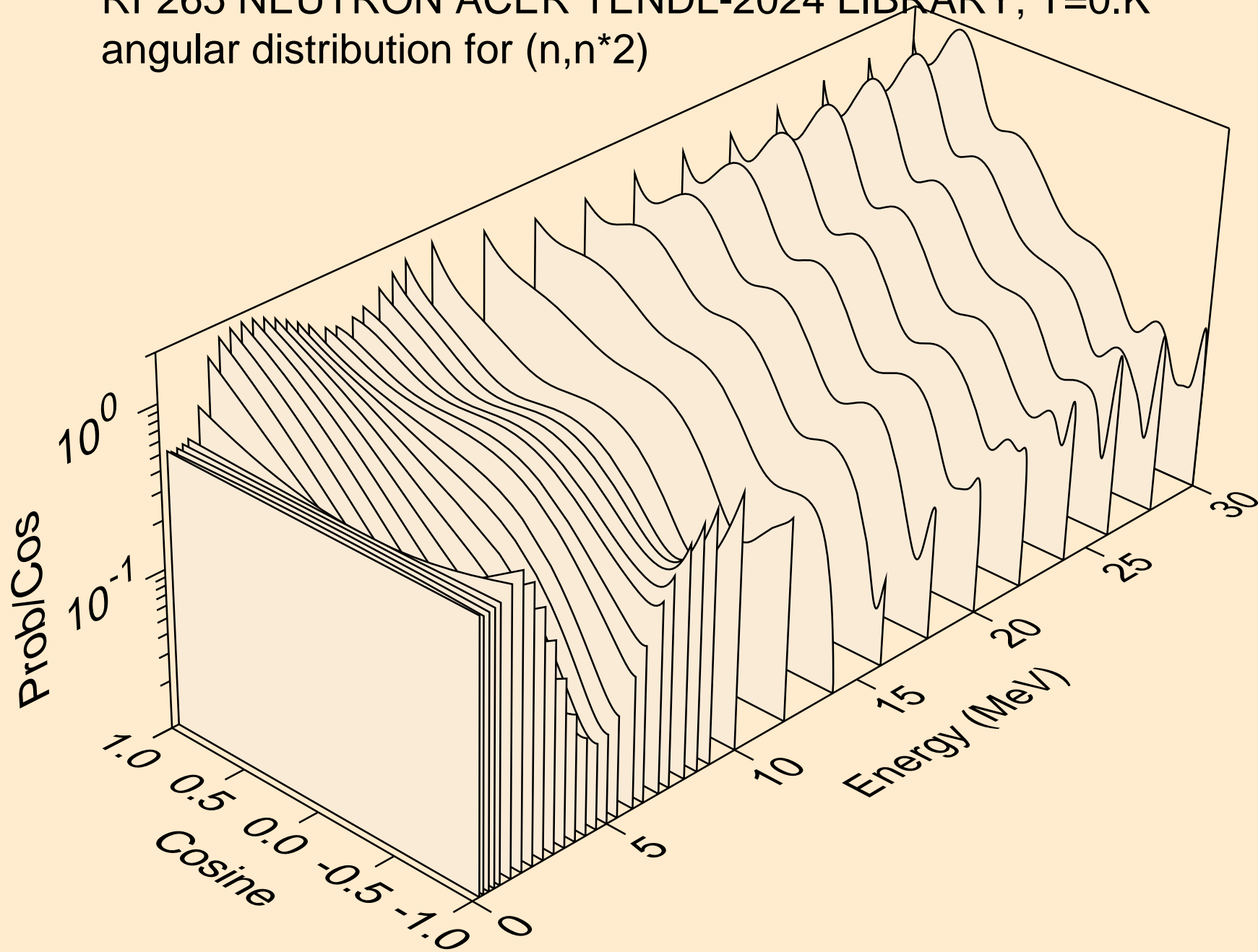

RF265 NEUTRON ACER TENDL-2024 LIBRARY; T=0.K
angular distribution for (n,n*3)

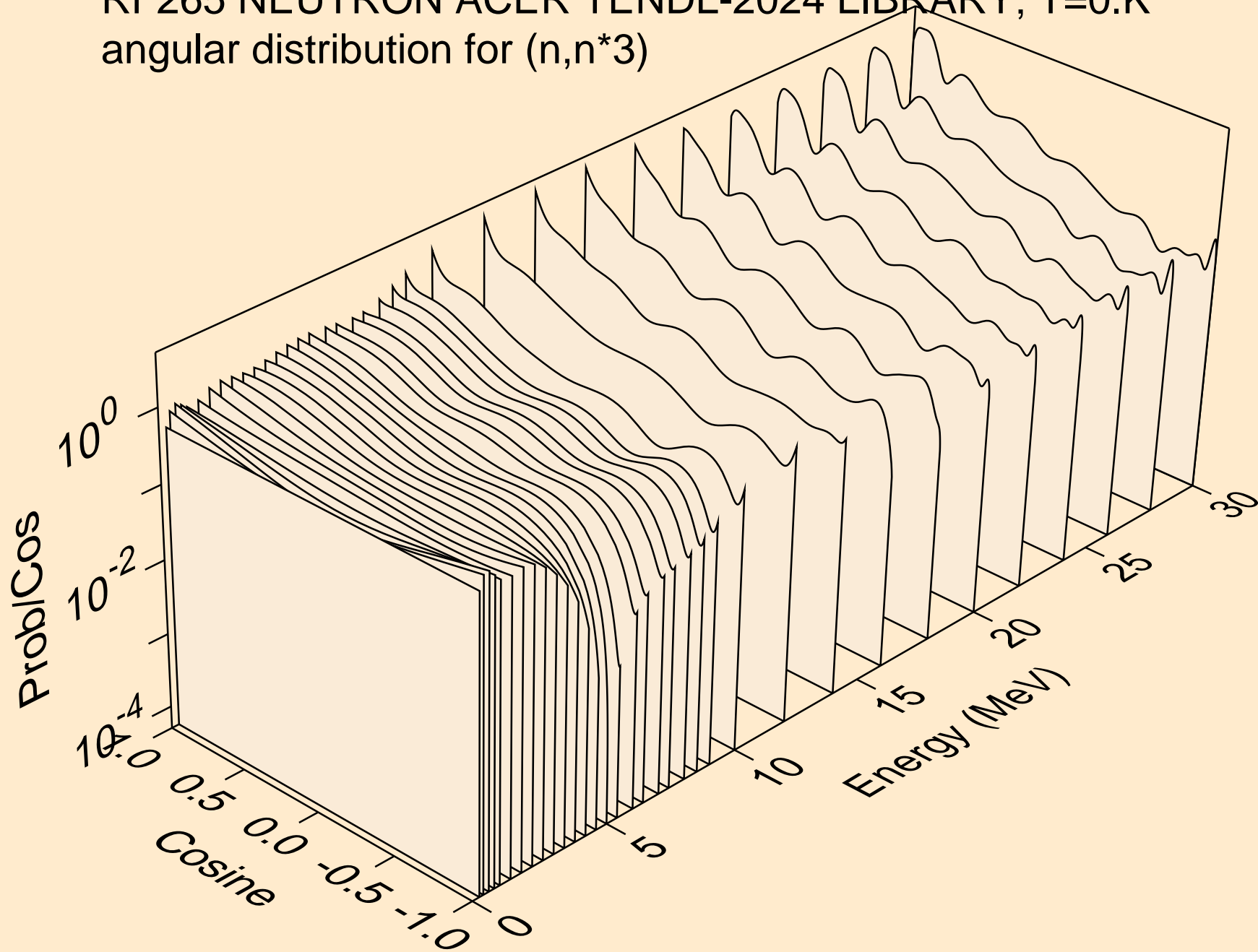

RF265 NEUTRON ACER TENDL-2024 LIBRARY; T=0.K
angular distribution for (n,n*4)

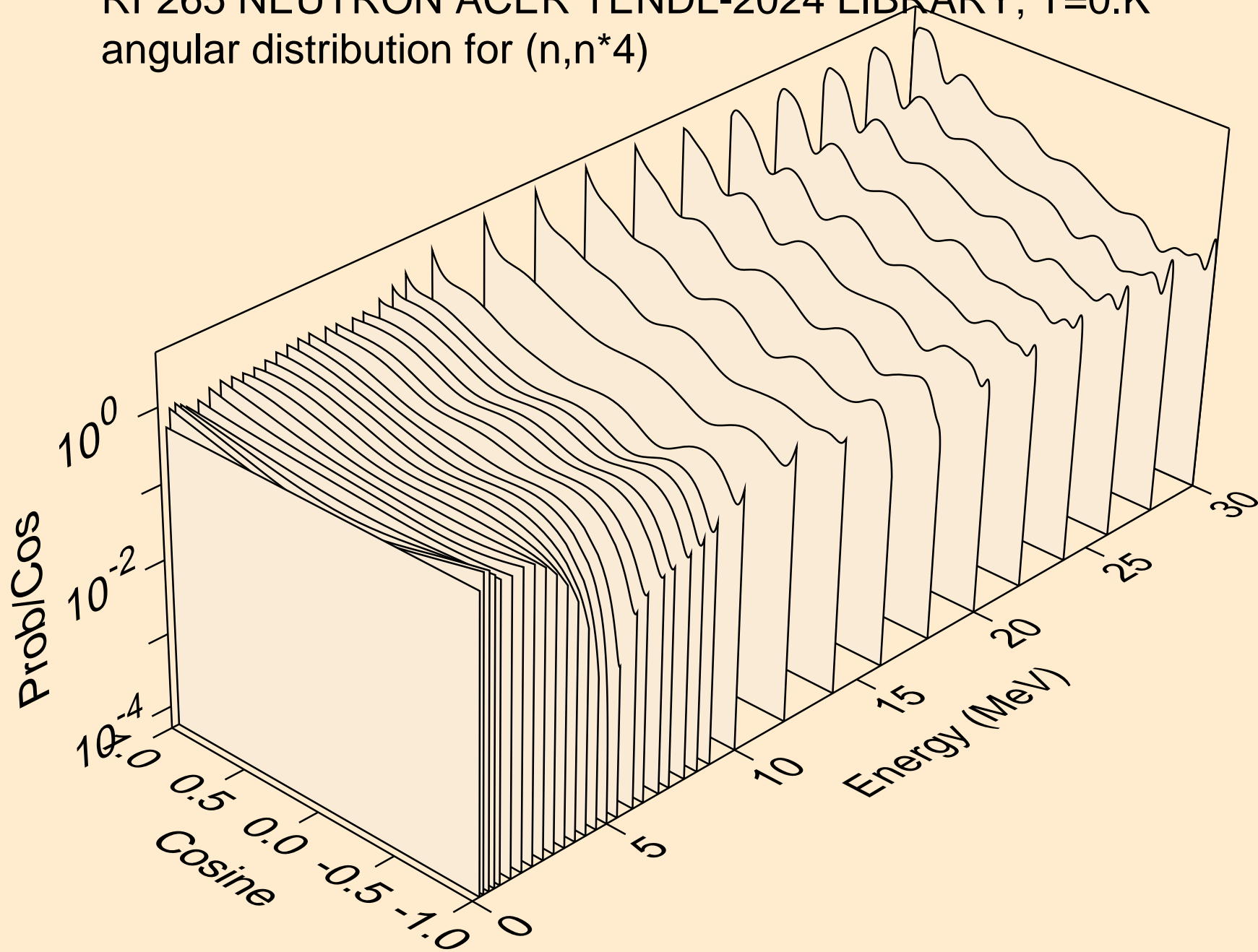

RF265 NEUTRON ACER TENDL-2024 LIBRARY; T=0.K
angular distribution for (n,n*5)

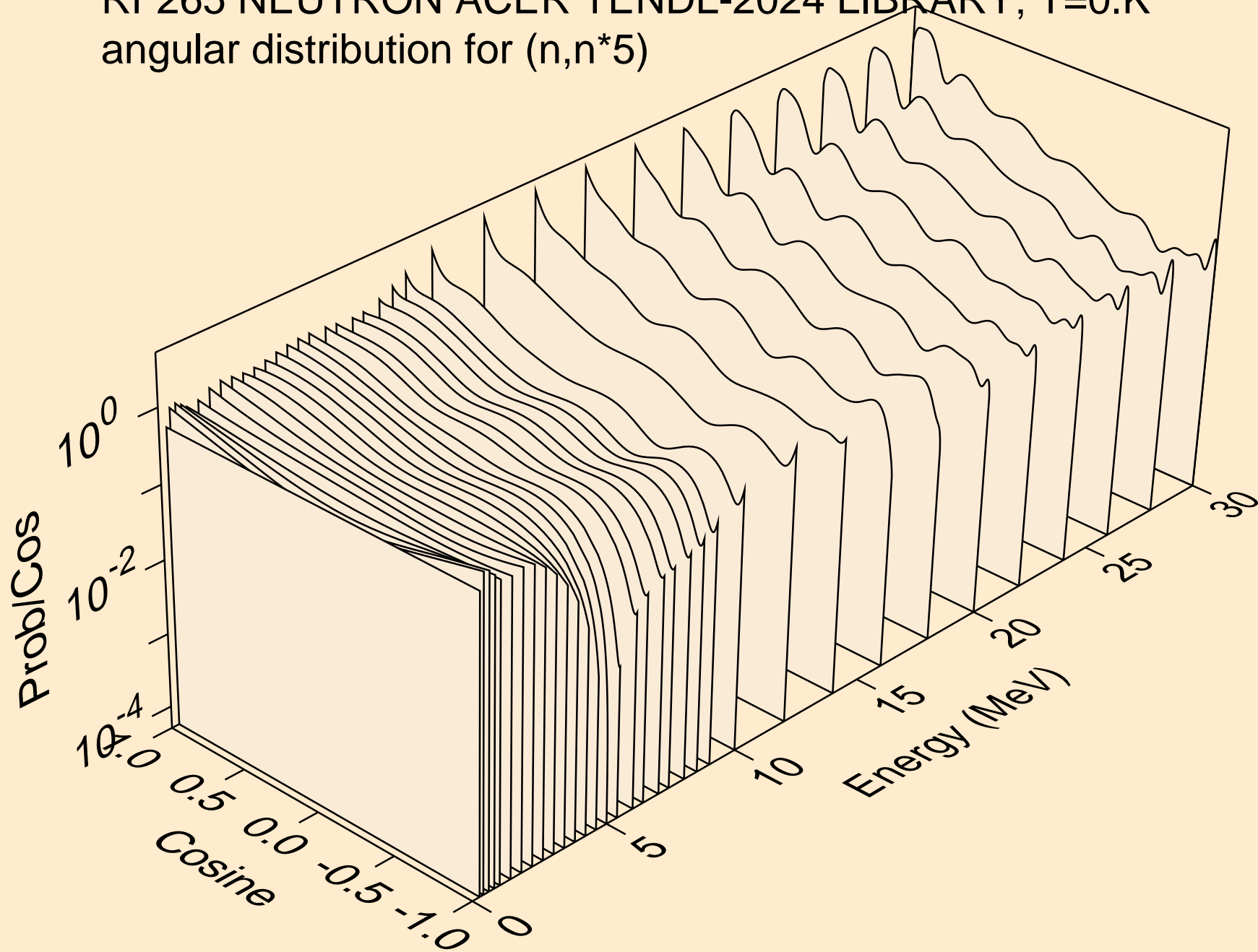

RF265 NEUTRON ACER TENDL-2024 LIBRARY; T=0.K
angular distribution for (n,n*6)

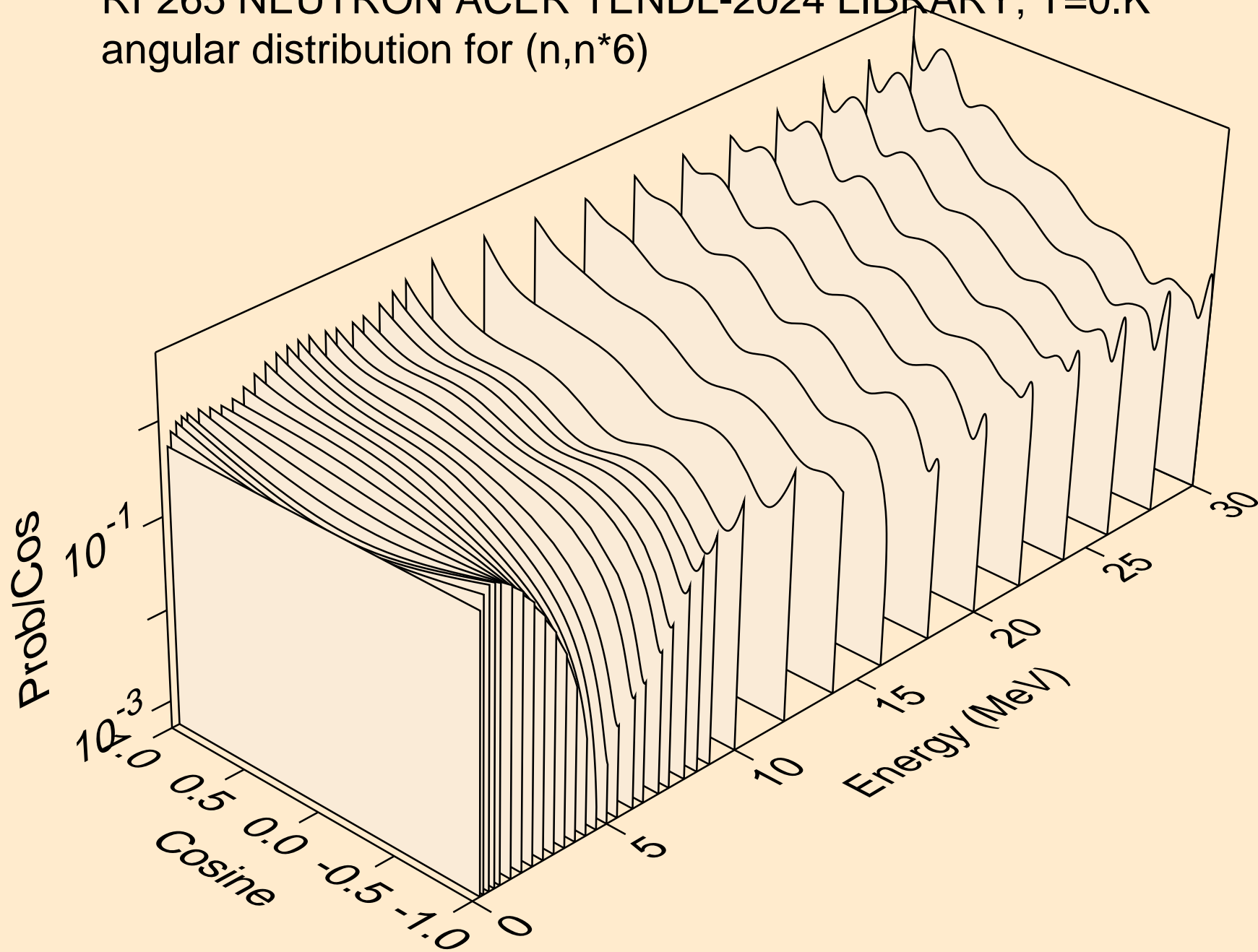

RF265 NEUTRON ACER TENDL-2024 LIBRARY; T=0.K
angular distribution for (n,n*7)

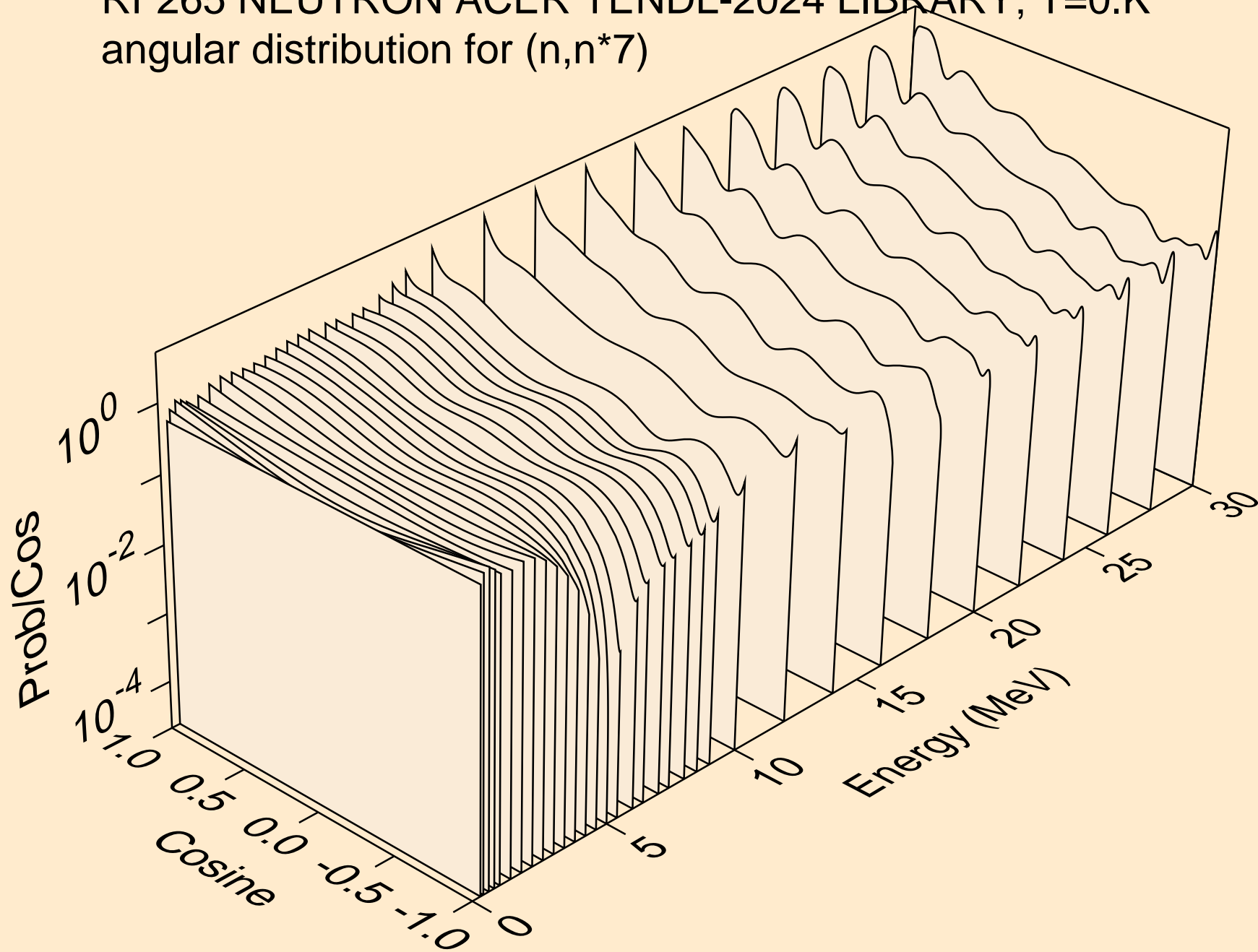

RF265 NEUTRON ACER TENDL-2024 LIBRARY; T=0.K
angular distribution for (n,n*8)

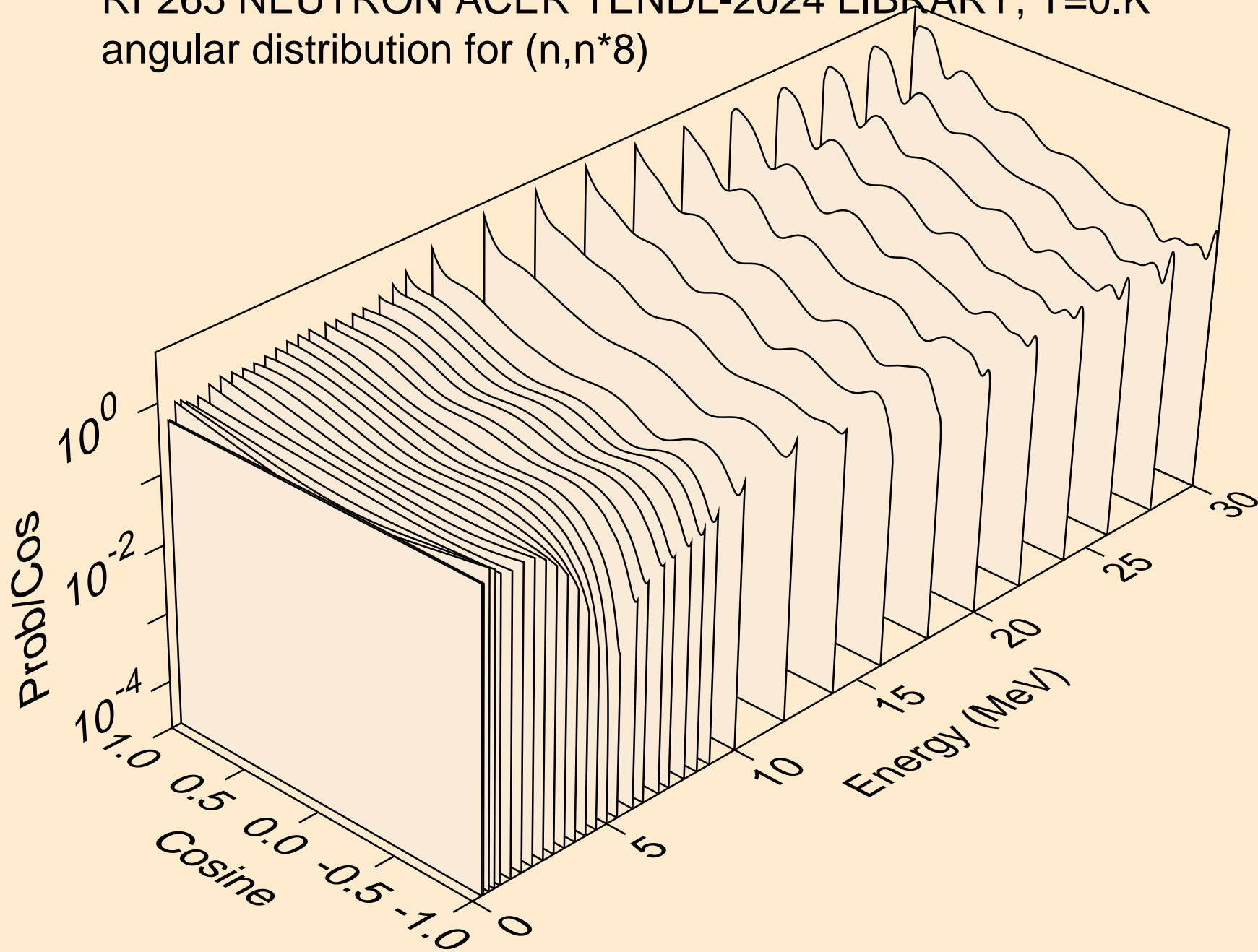

RF265 NEUTRON ACER TENDL-2024 LIBRARY; T=0.K
angular distribution for (n,n*9)

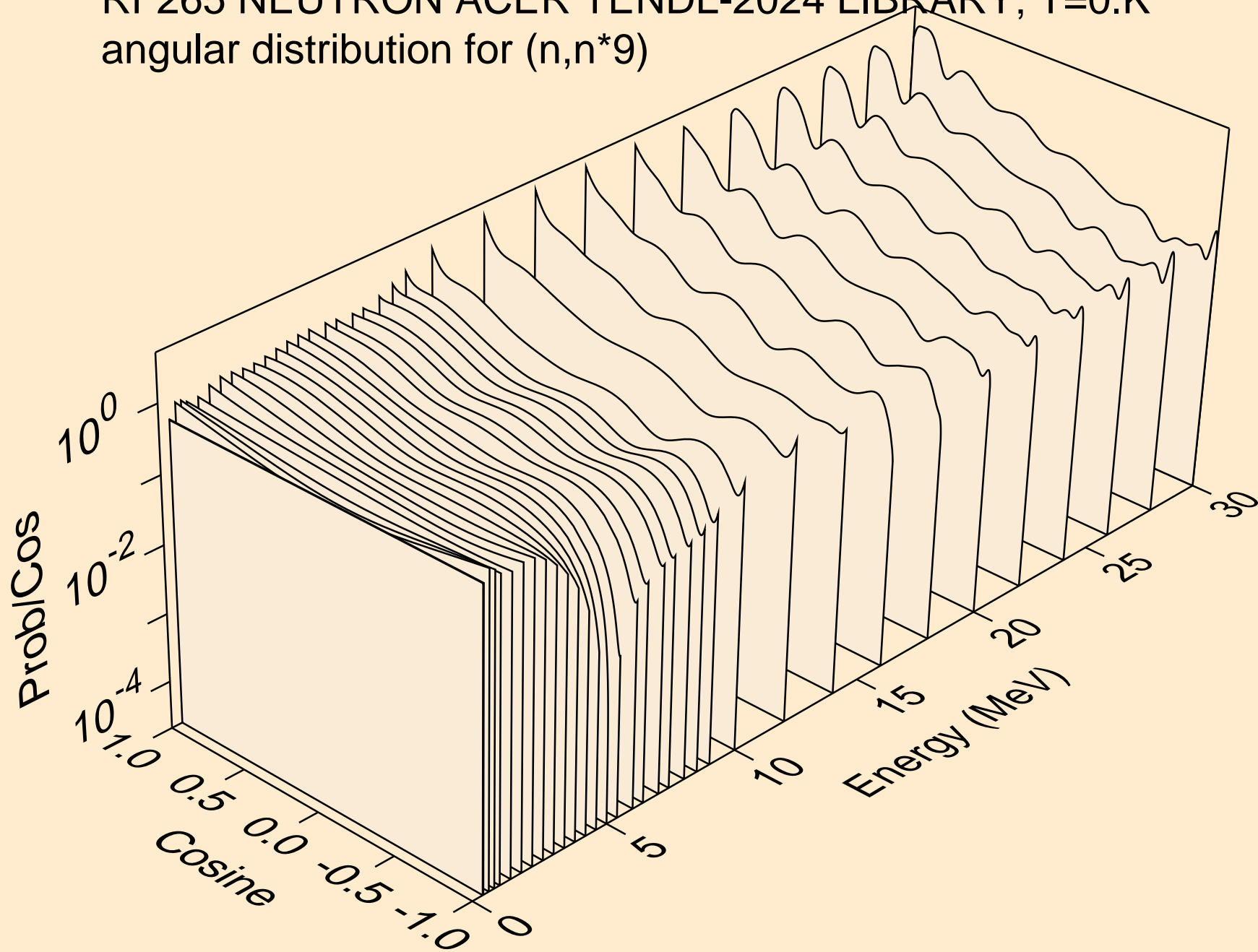

RF265 NEUTRON ACER TENDL-2024 LIBRARY; T=0.K
angular distribution for (n,n*10)

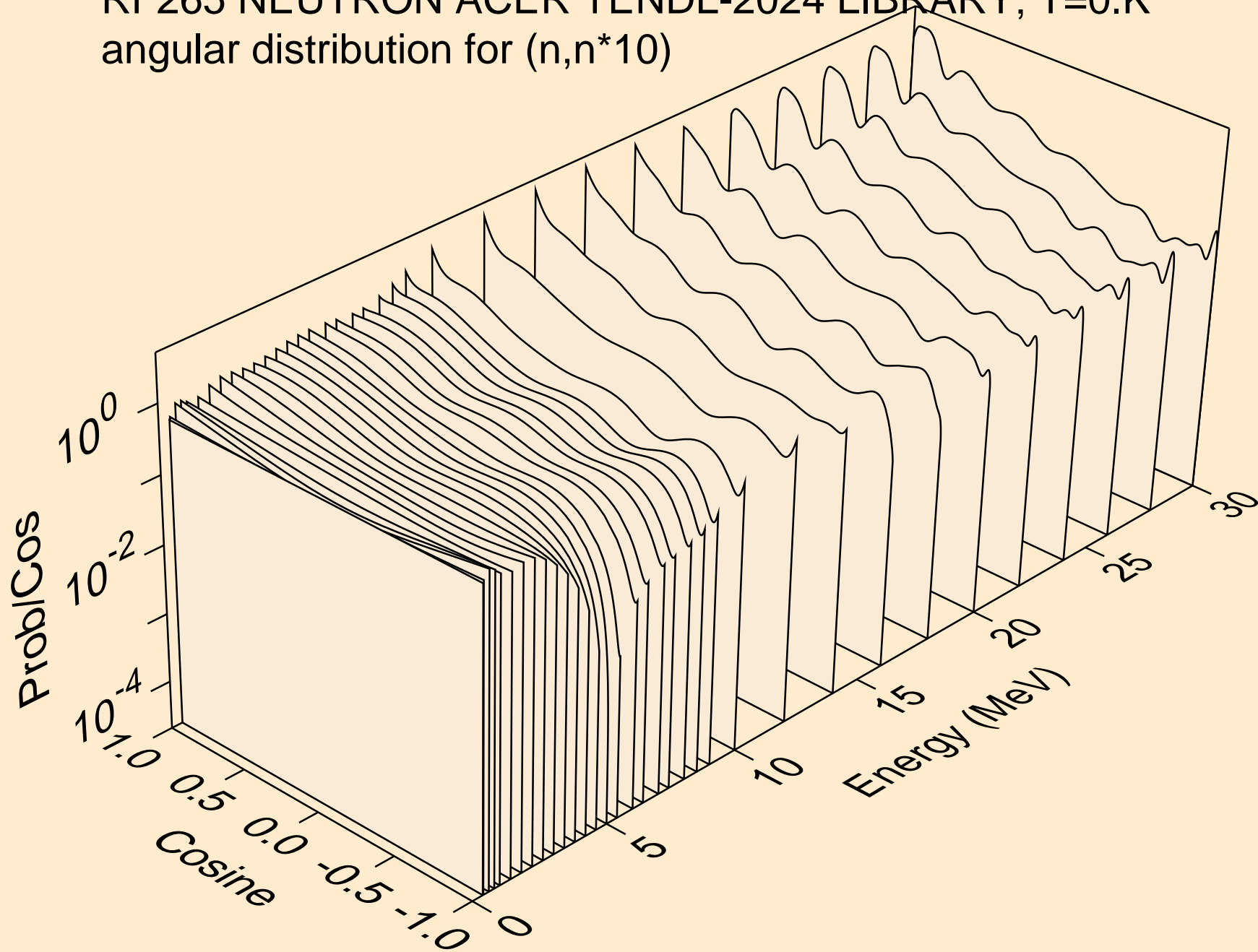

RF265 NEUTRON ACER TENDL-2024 LIBRARY; T=0.K
angular distribution for (n,n*11)

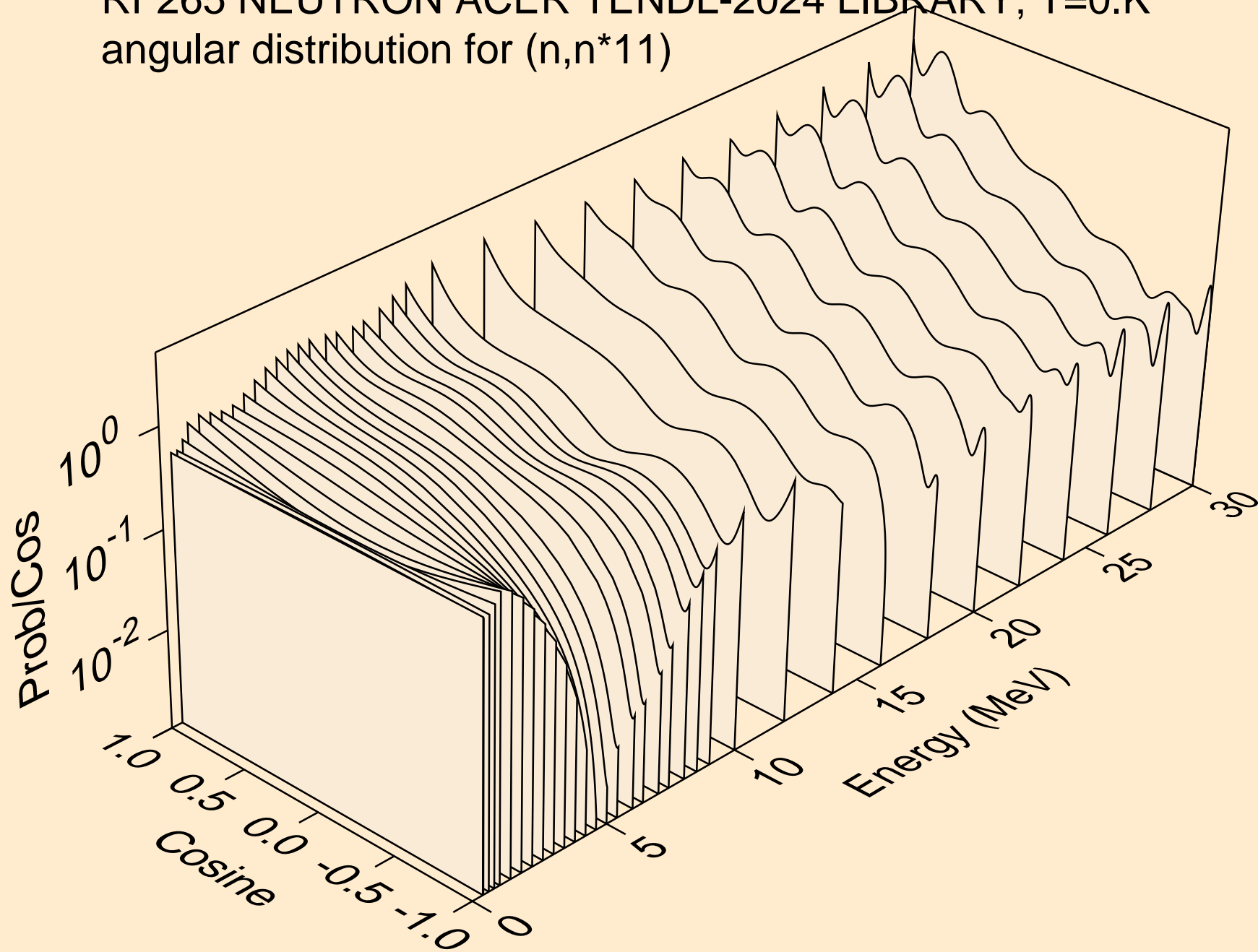

RF265 NEUTRON ACER TENDL-2024 LIBRARY; T=0.K
angular distribution for (n,n*12)

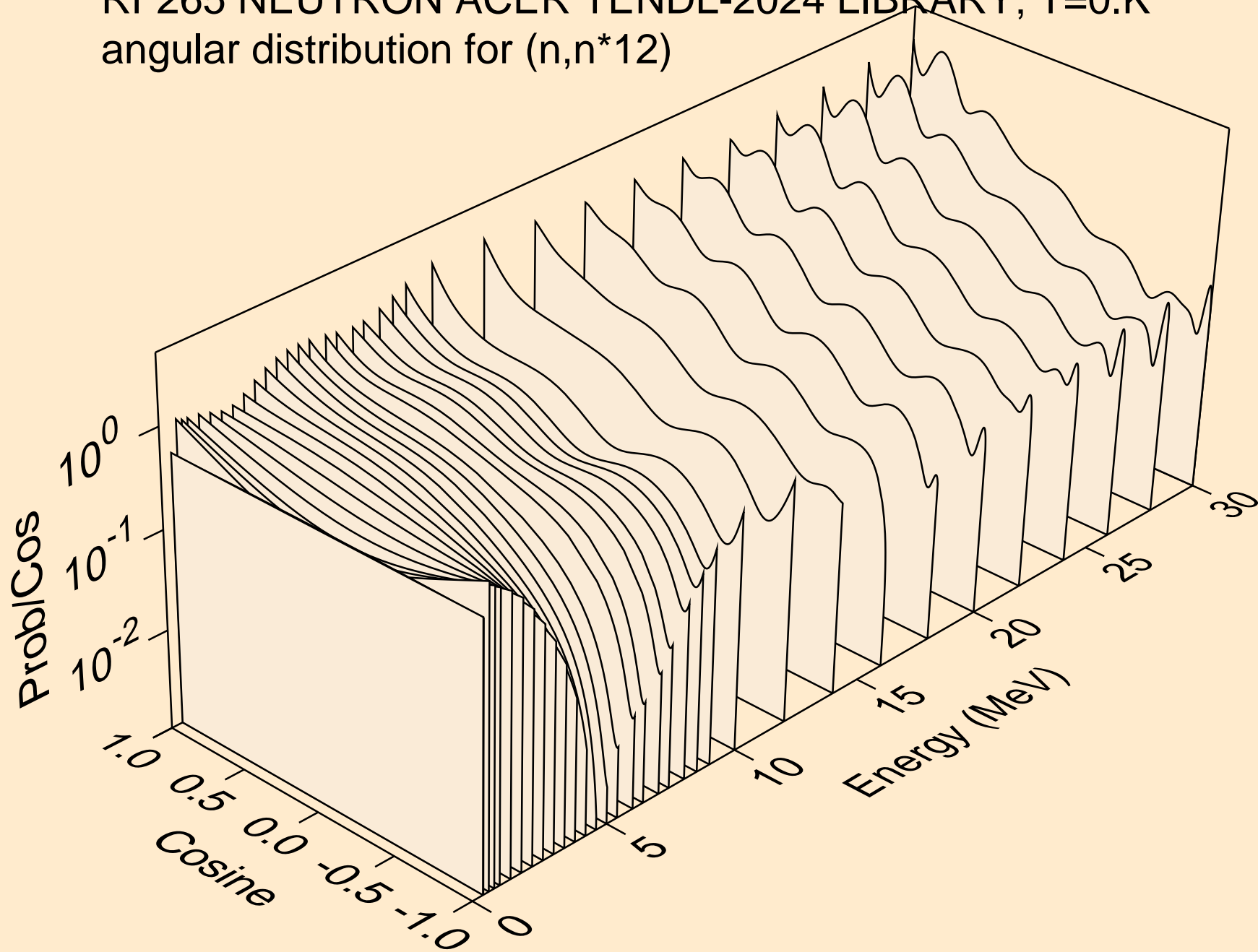

RF265 NEUTRON ACER TENDL-2024 LIBRARY; T=0.K
angular distribution for (n,n*13)

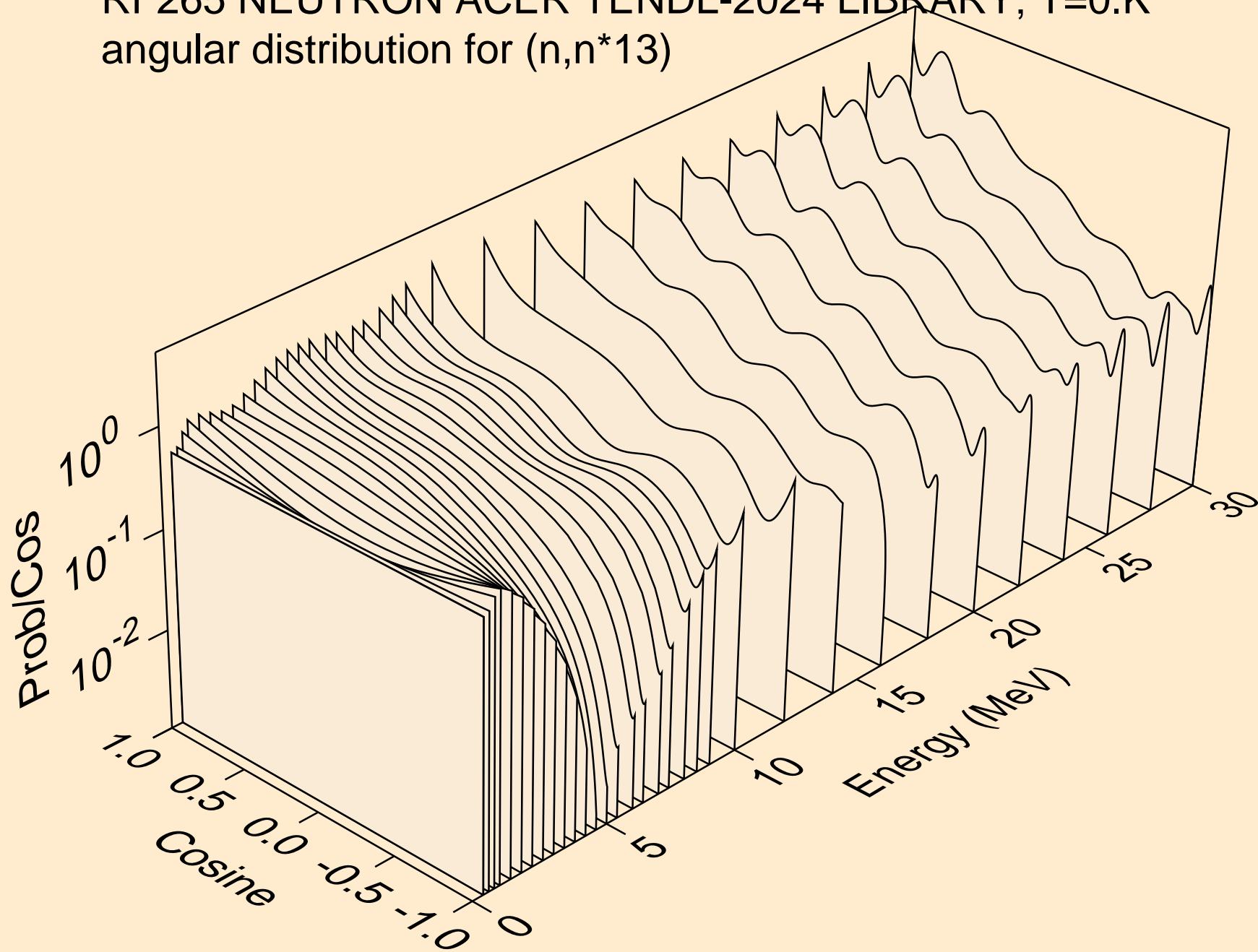

RF265 NEUTRON ACER TENDL-2024 LIBRARY; T=0.K
angular distribution for (n,n*14)

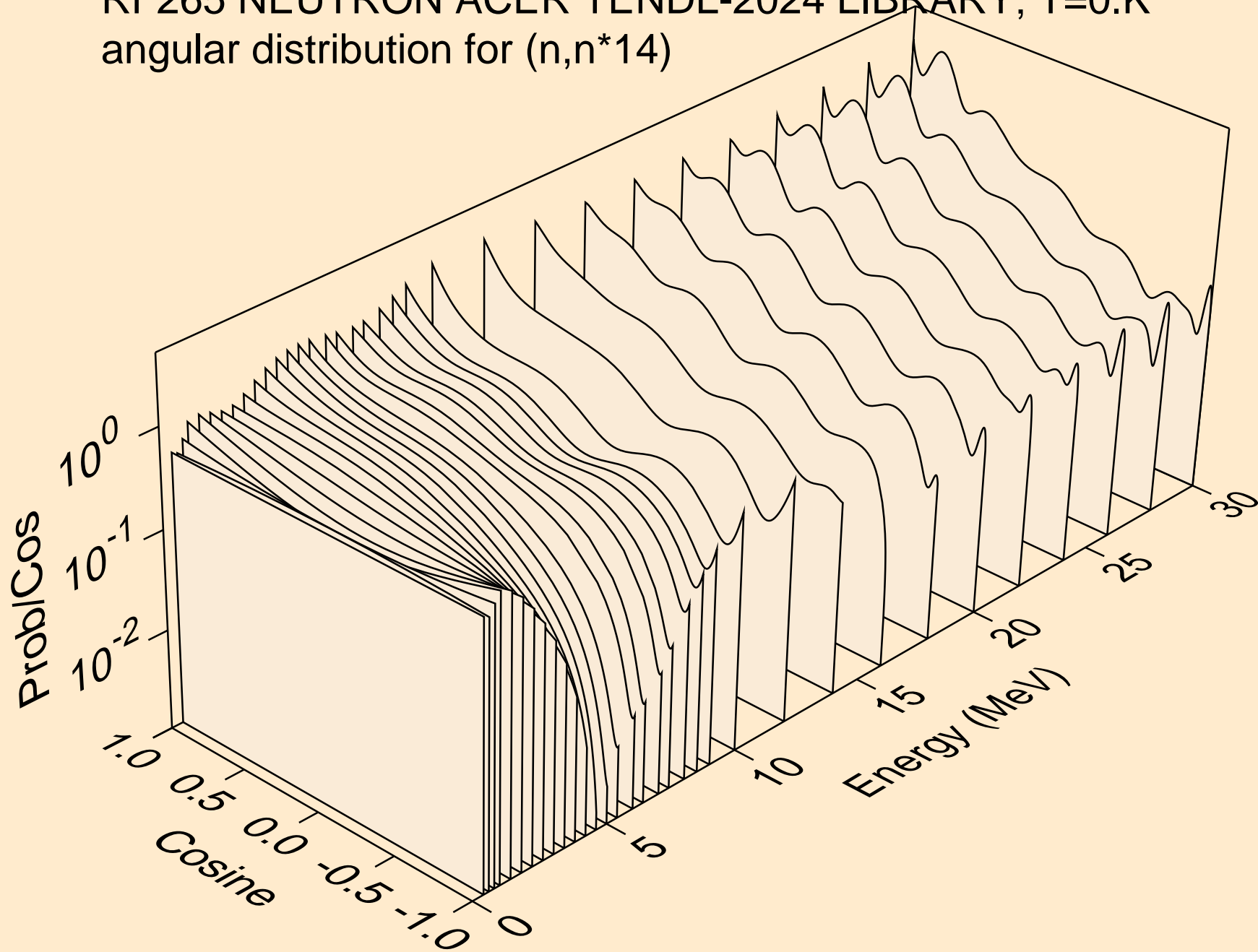

RF265 NEUTRON ACER TENDL-2024 LIBRARY; T=0.K
angular distribution for (n,n*15)

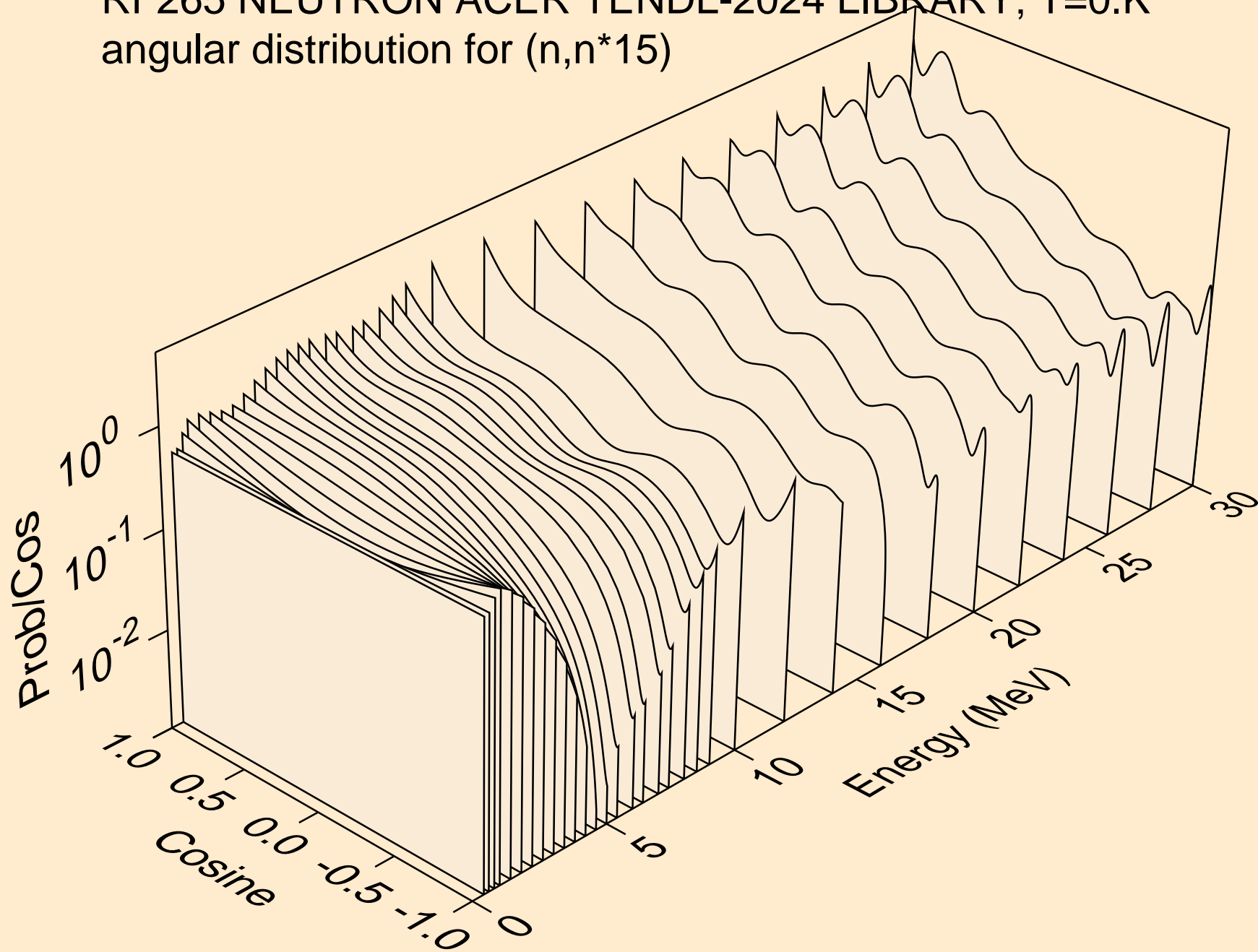

RF265 NEUTRON ACER TENDL-2024 LIBRARY; T=0.K
angular distribution for (n,n*16)

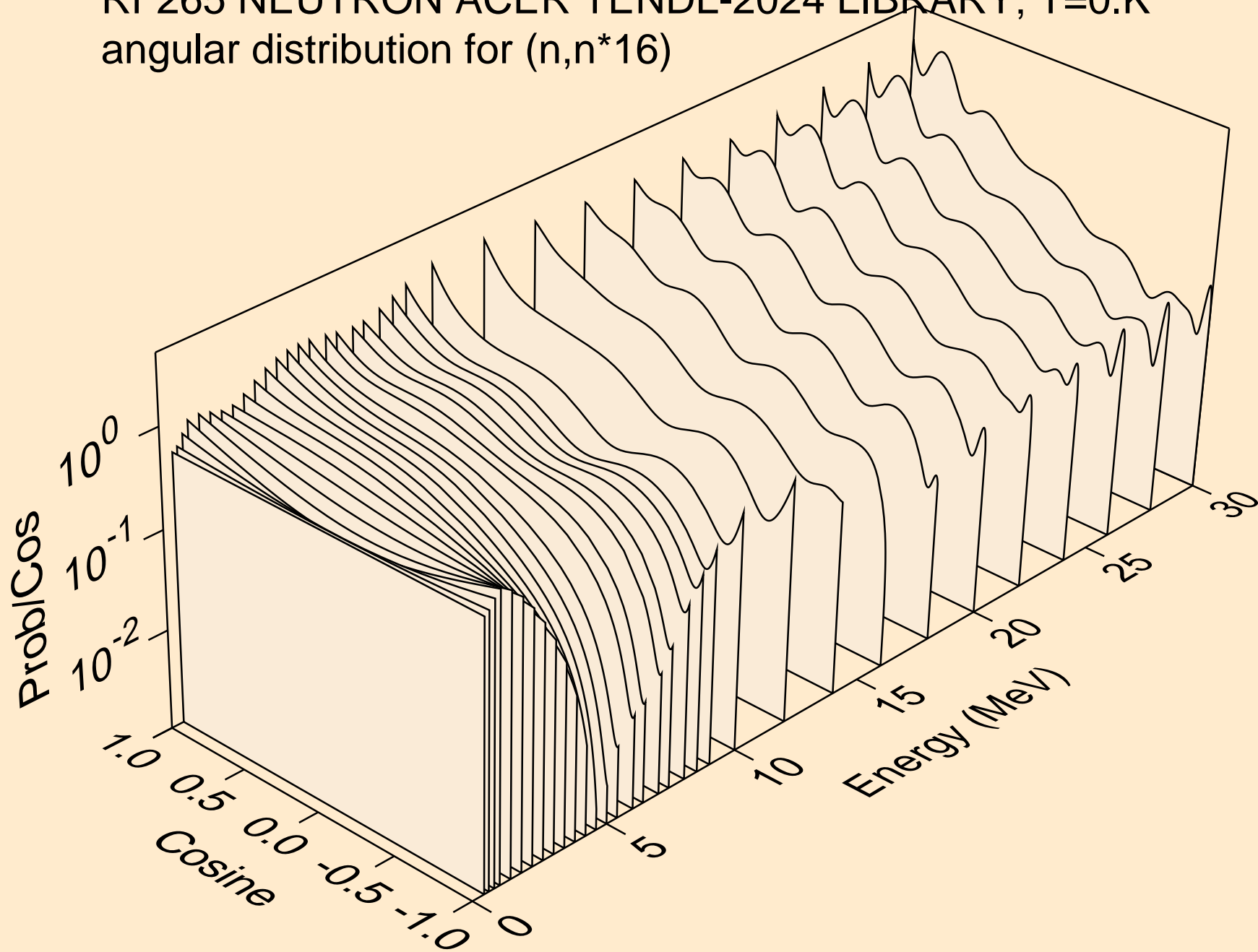

RF265 NEUTRON ACER TENDL-2024 LIBRARY; T=0.K
angular distribution for (n,n*17)

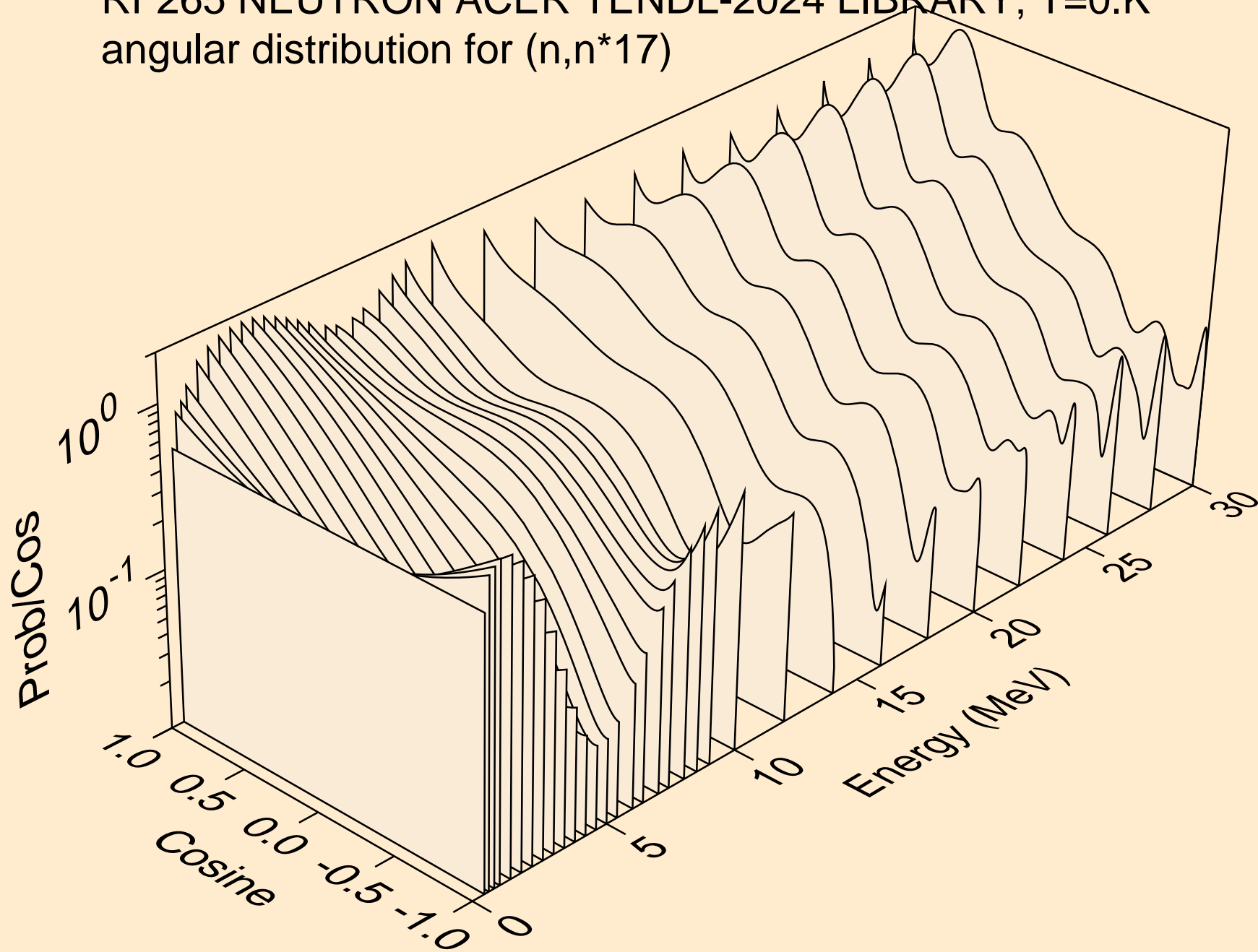

RF265 NEUTRON ACER TENDL-2024 LIBRARY; T=0.K
angular distribution for (n,n*18)

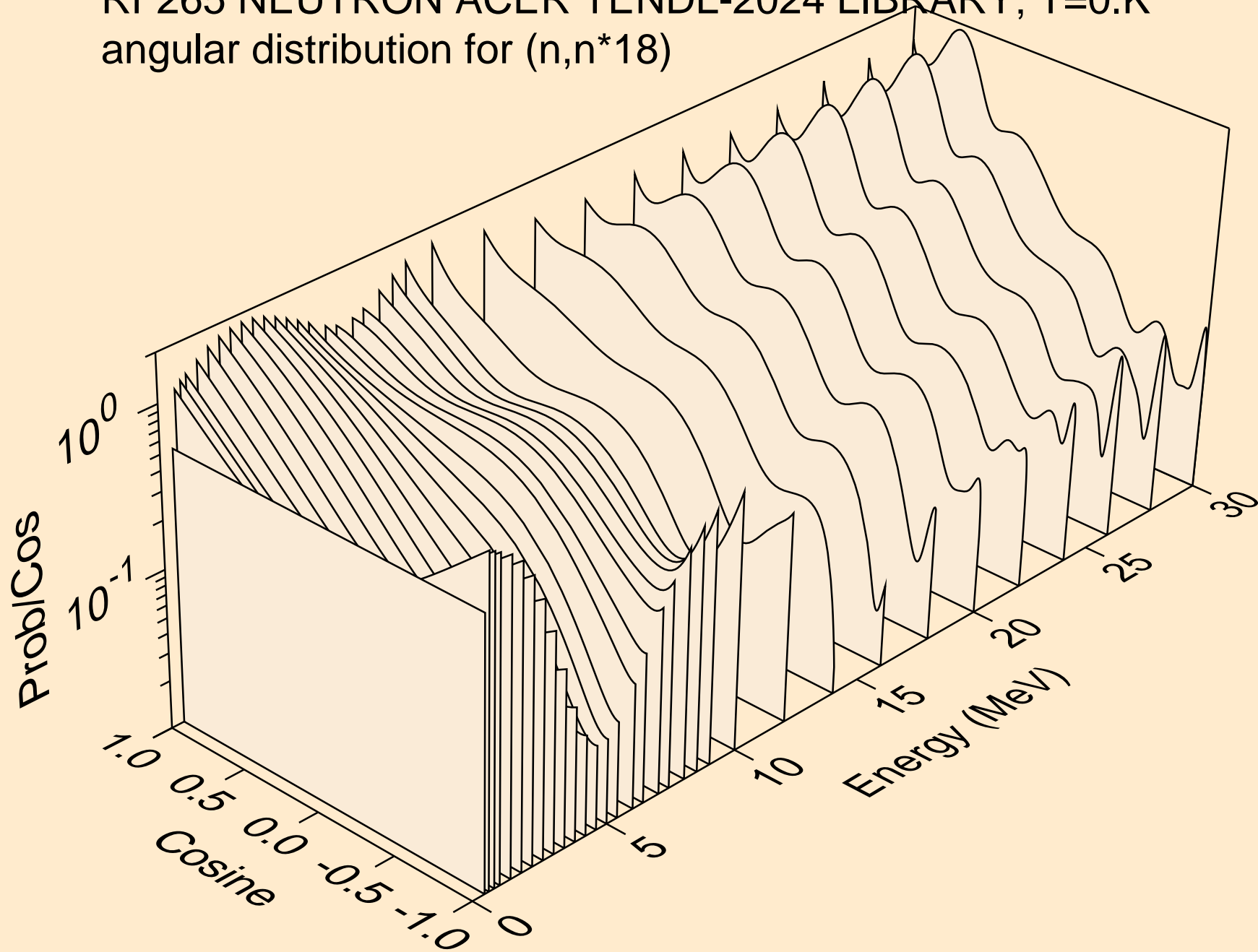

RF265 NEUTRON ACER TENDL-2024 LIBRARY; T=0.K
angular distribution for (n,n*19)

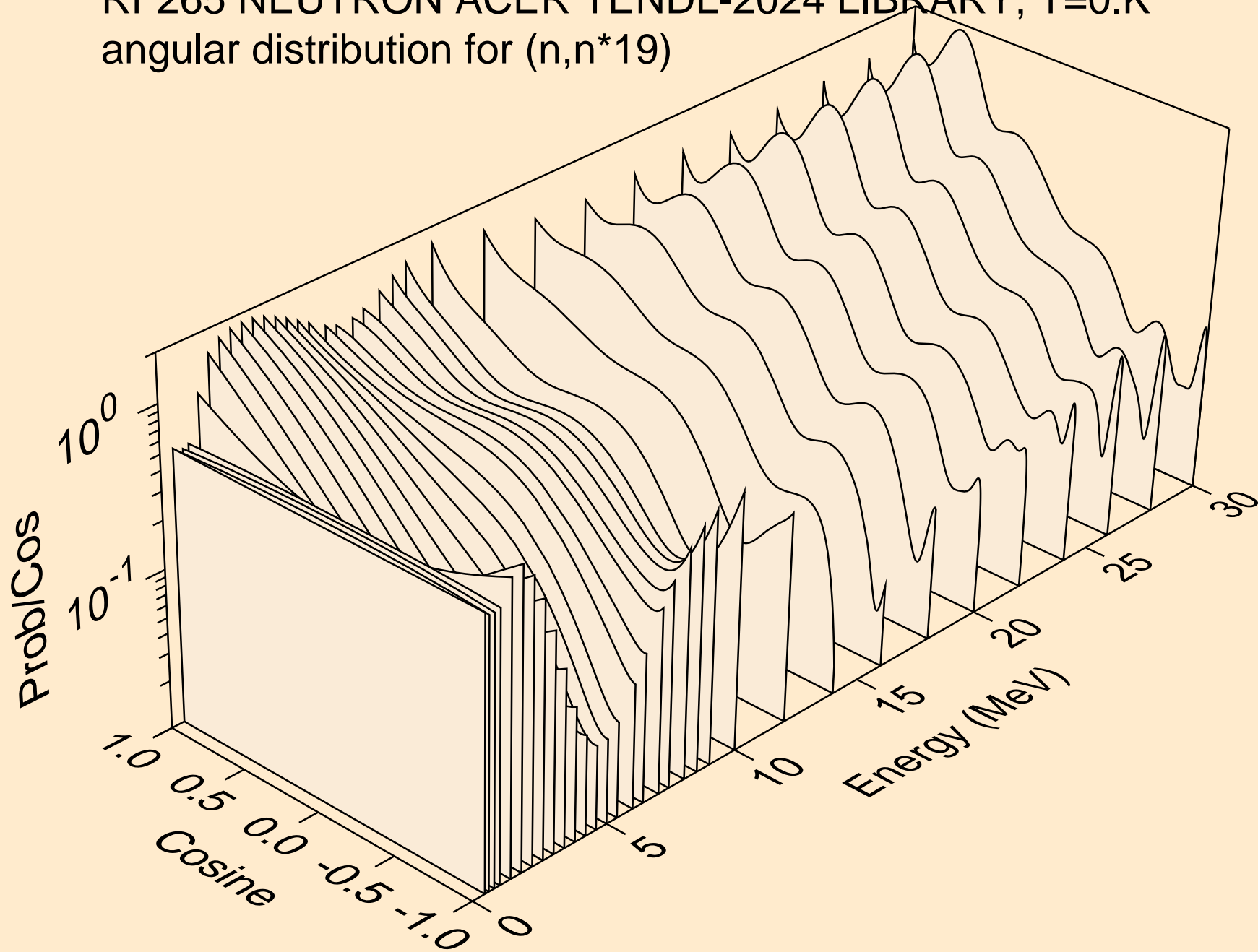

RF265 NEUTRON ACER TENDL-2024 LIBRARY; T=0.K
angular distribution for (n,n*20)

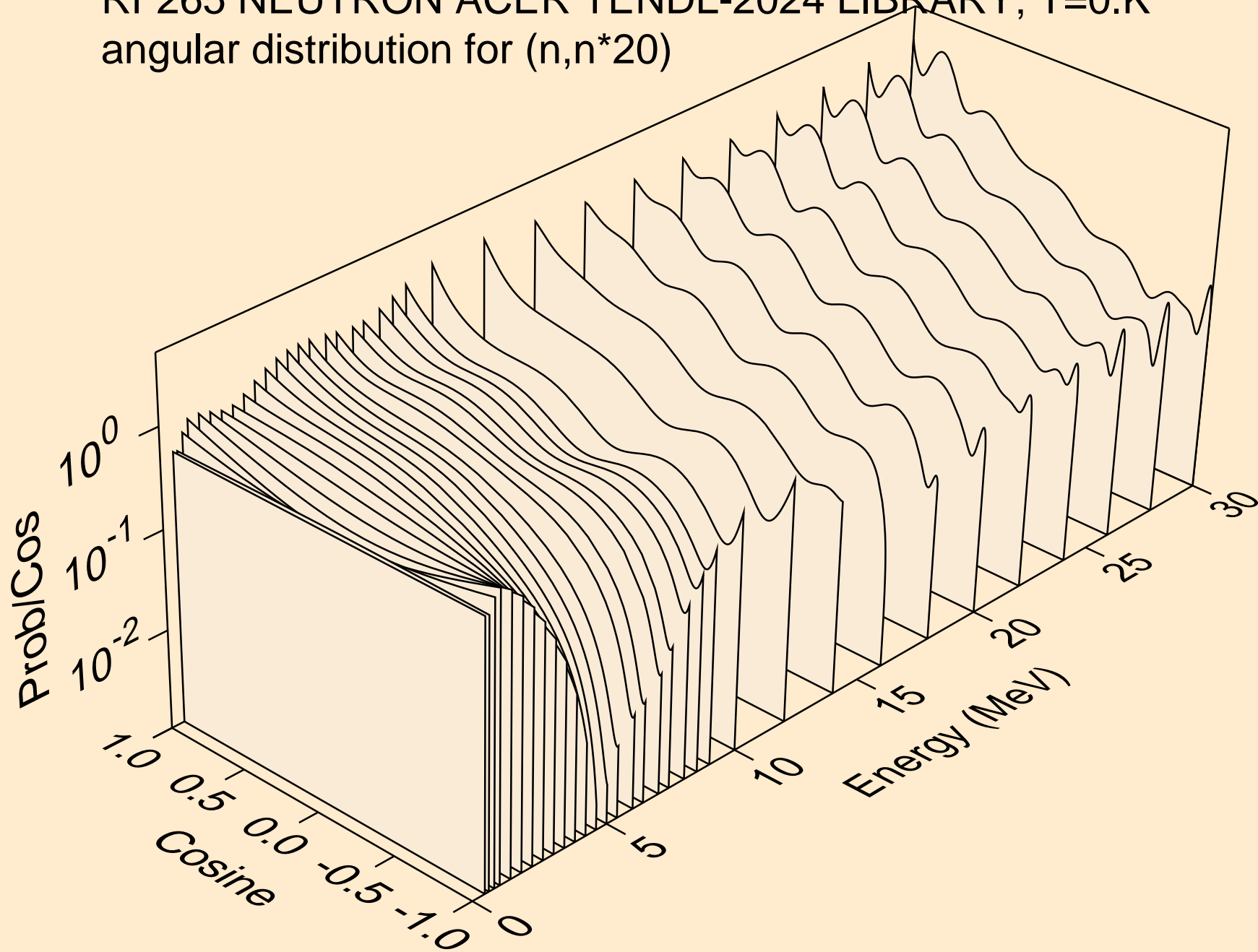

RF265 NEUTRON ACER TENDL-2024 LIBRARY; T=0.K
angular distribution for (n,n*21)

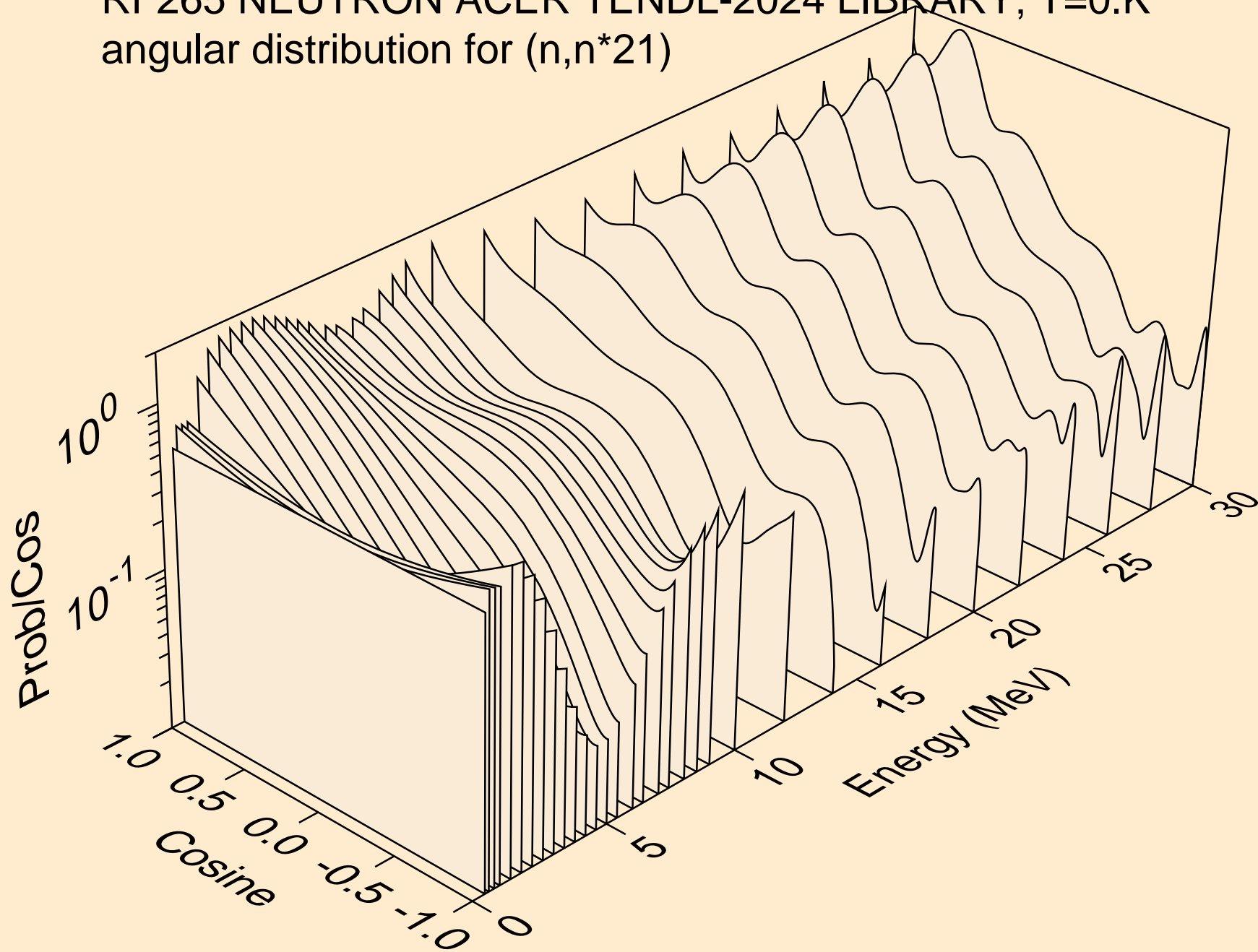

RF265 NEUTRON ACER TENDL-2024 LIBRARY; T=0.K
angular distribution for (n,n*22)

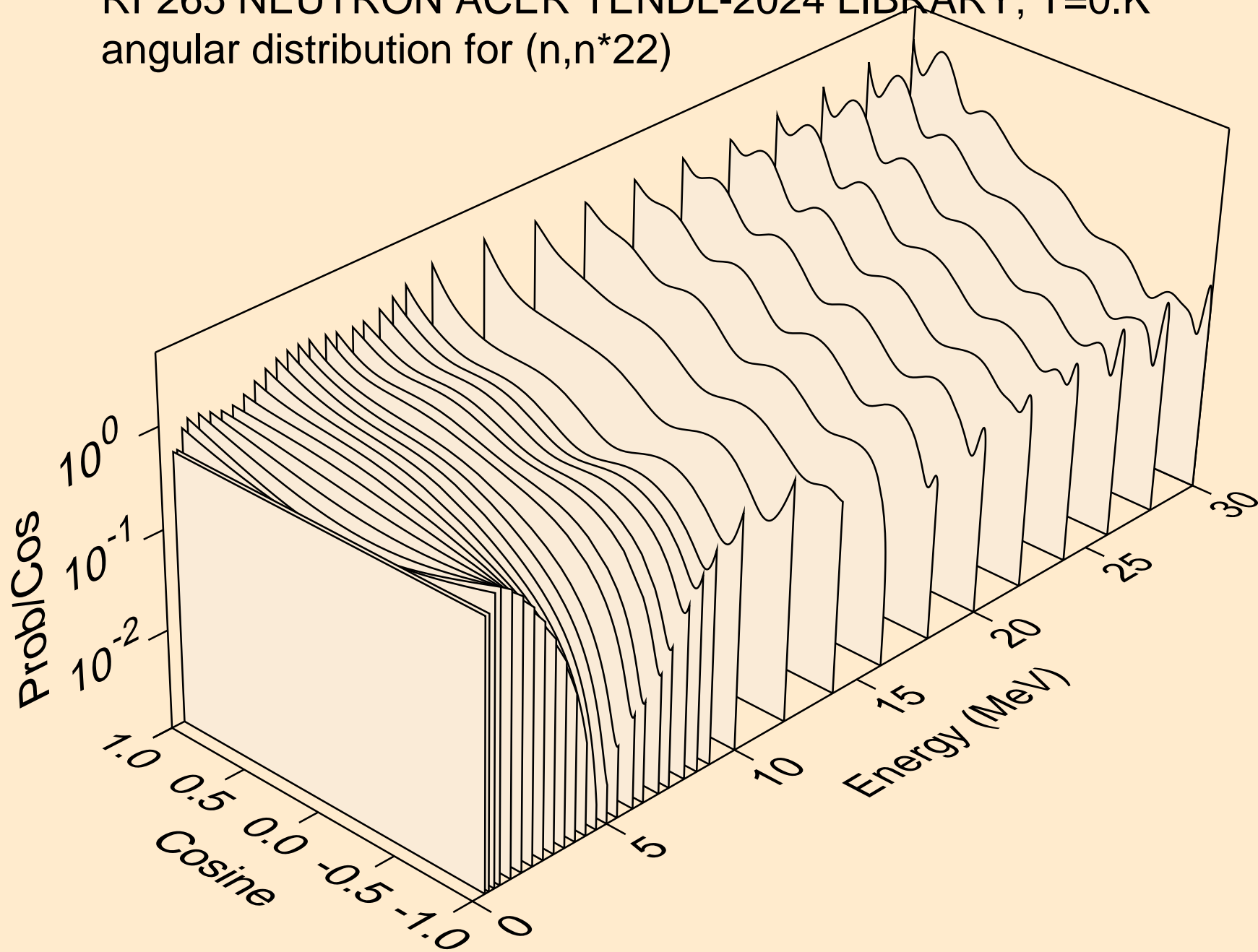

RF265 NEUTRON ACER TENDL-2024 LIBRARY; T=0.K
angular distribution for (n,n*23)

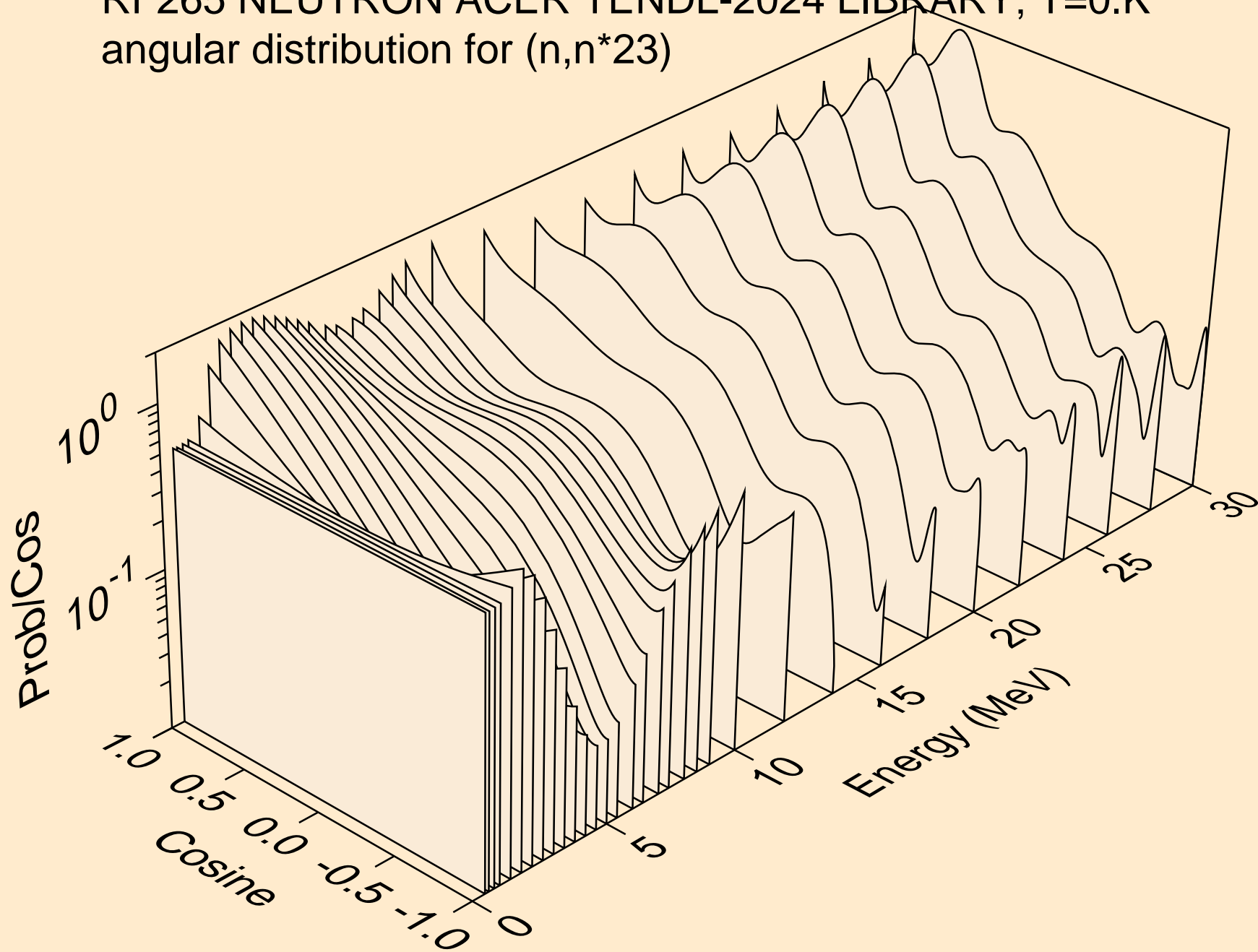

RF265 NEUTRON ACER TENDL-2024 LIBRARY; T=0.K
angular distribution for (n,n*24)

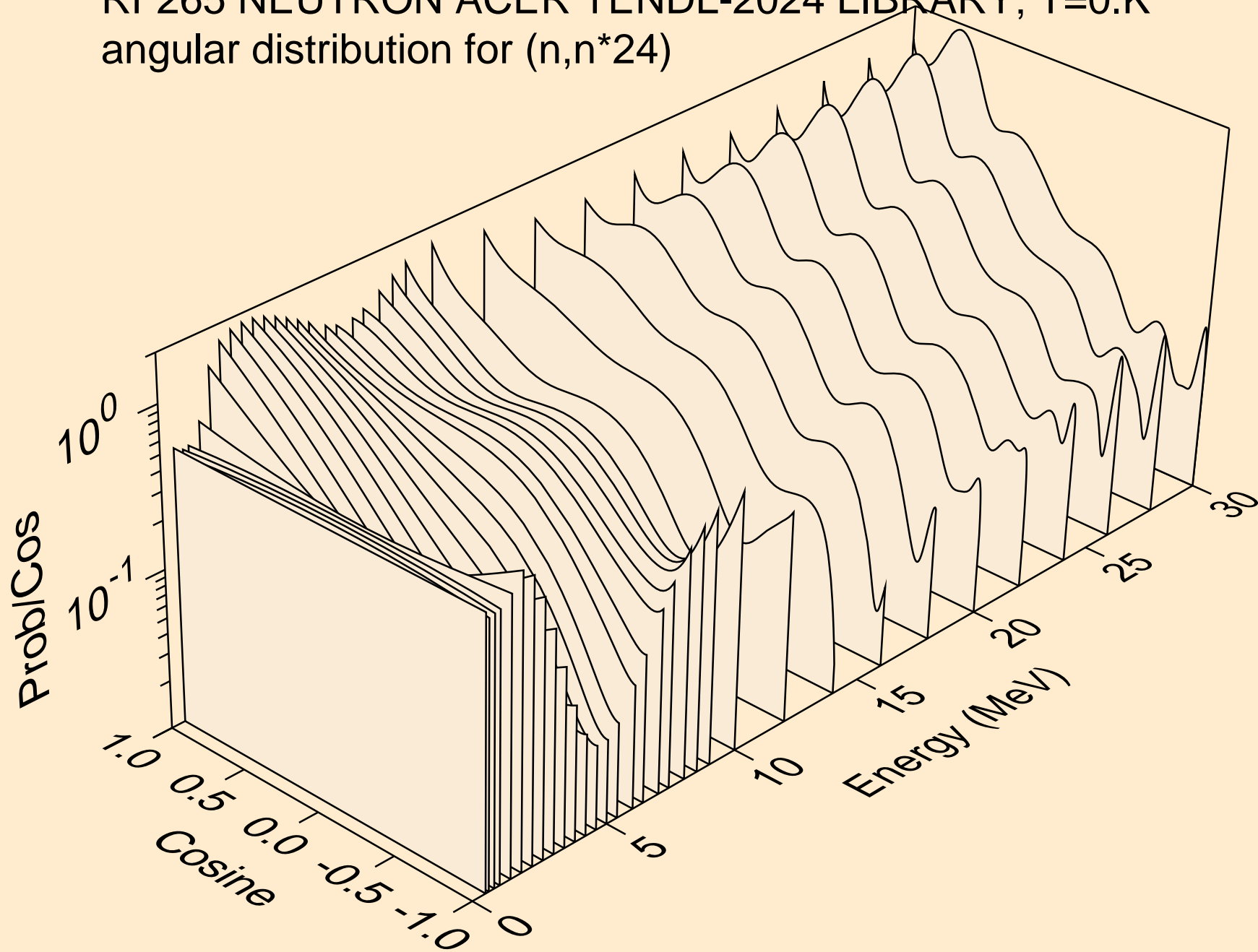

RF265 NEUTRON ACER TENDL-2024 LIBRARY; T=0.K
angular distribution for (n,n*25)

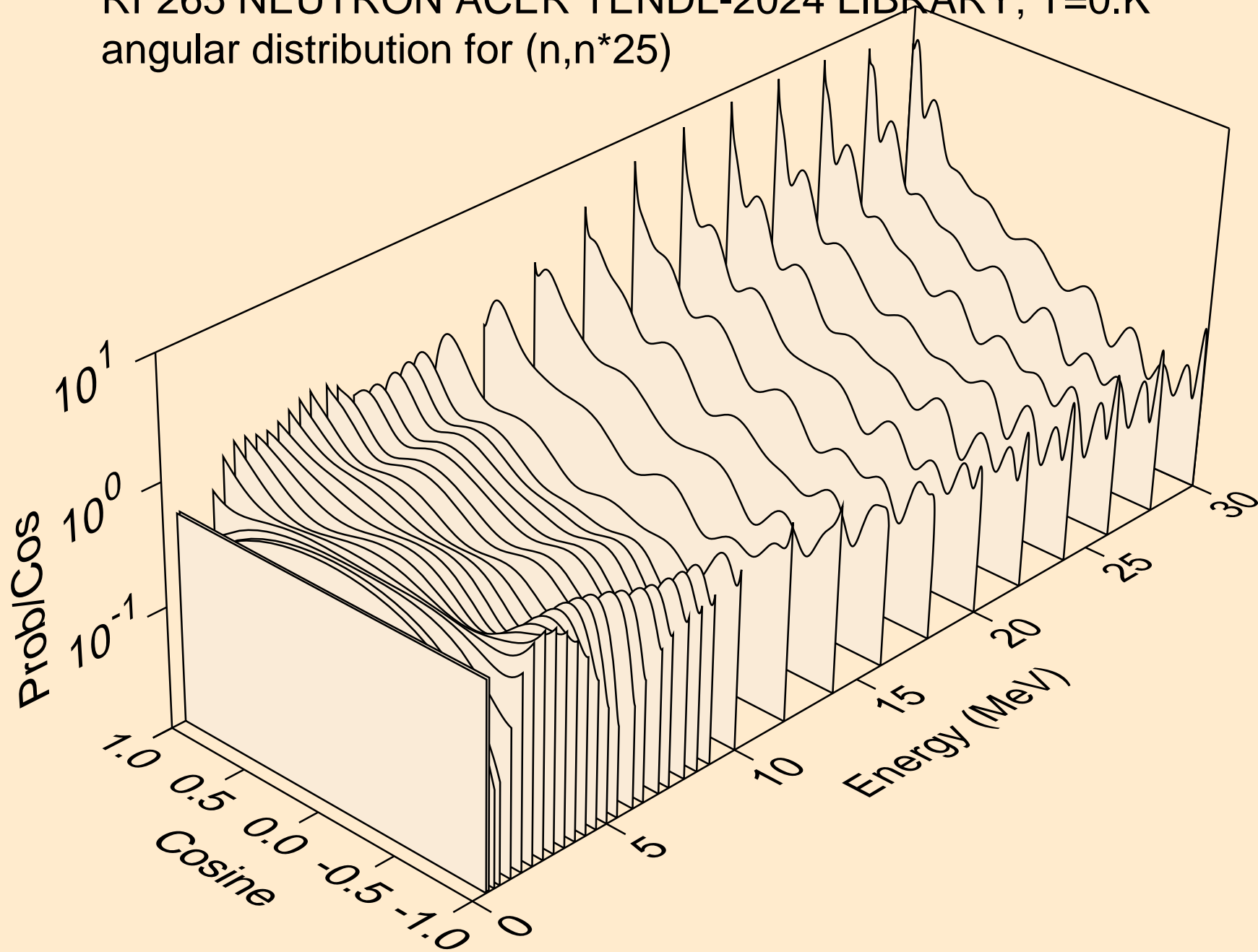

RF265 NEUTRON ACER TENDL-2024 LIBRARY; T=0.K
angular distribution for (n,n*26)

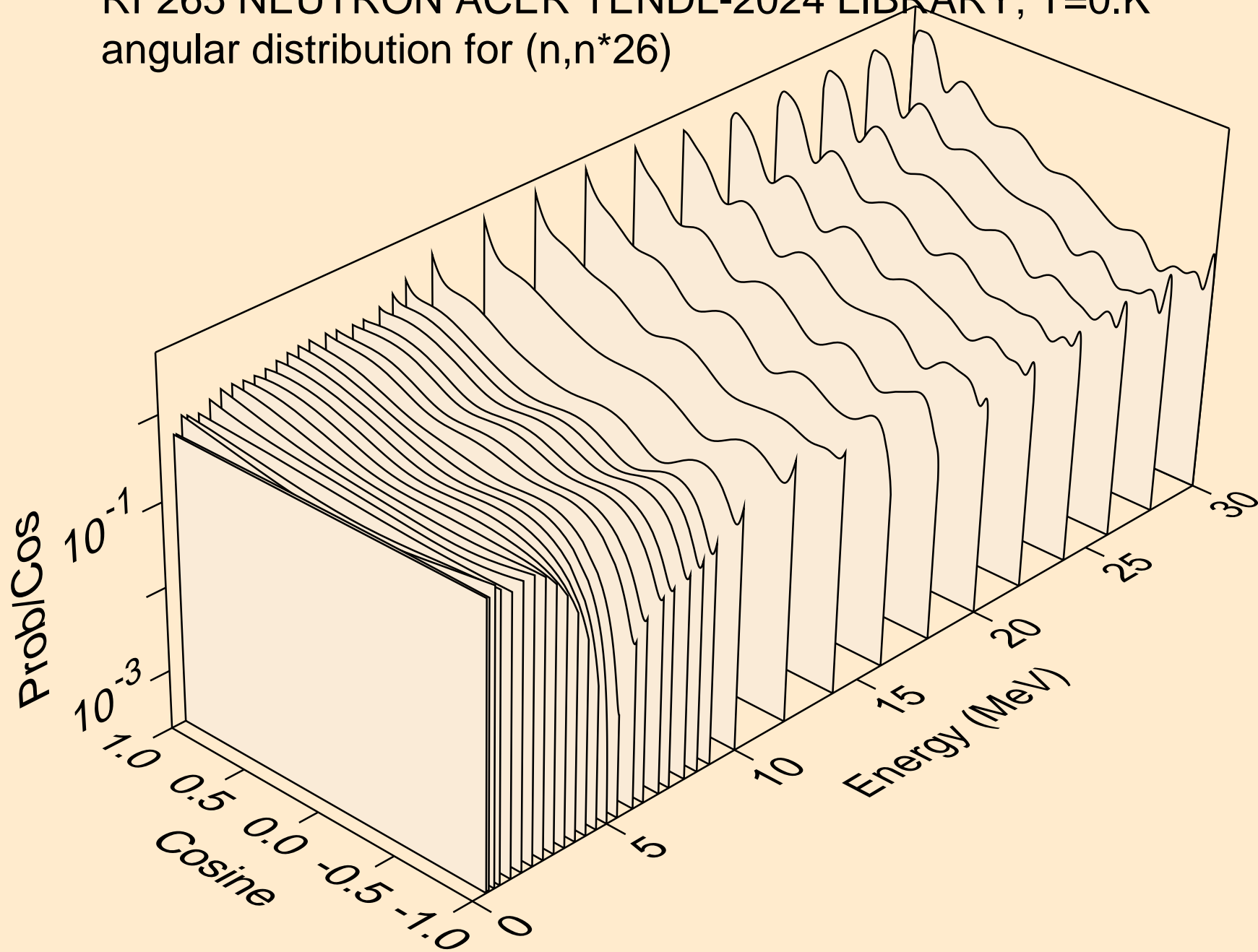

RF265 NEUTRON ACER TENDL-2024 LIBRARY; T=0.K
angular distribution for (n,n*27)

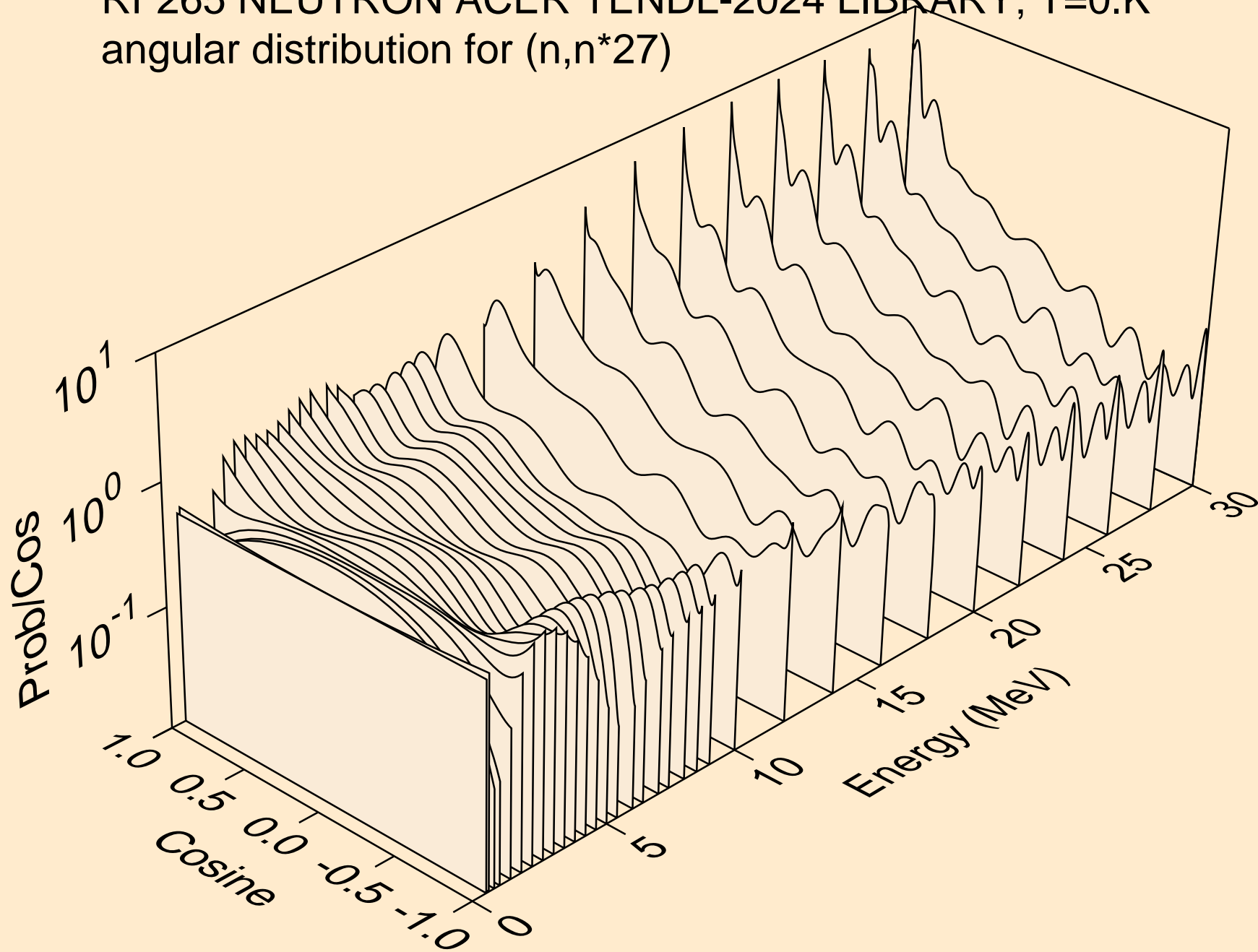

RF265 NEUTRON ACER TENDL-2024 LIBRARY; T=0.K

Total fission nubar

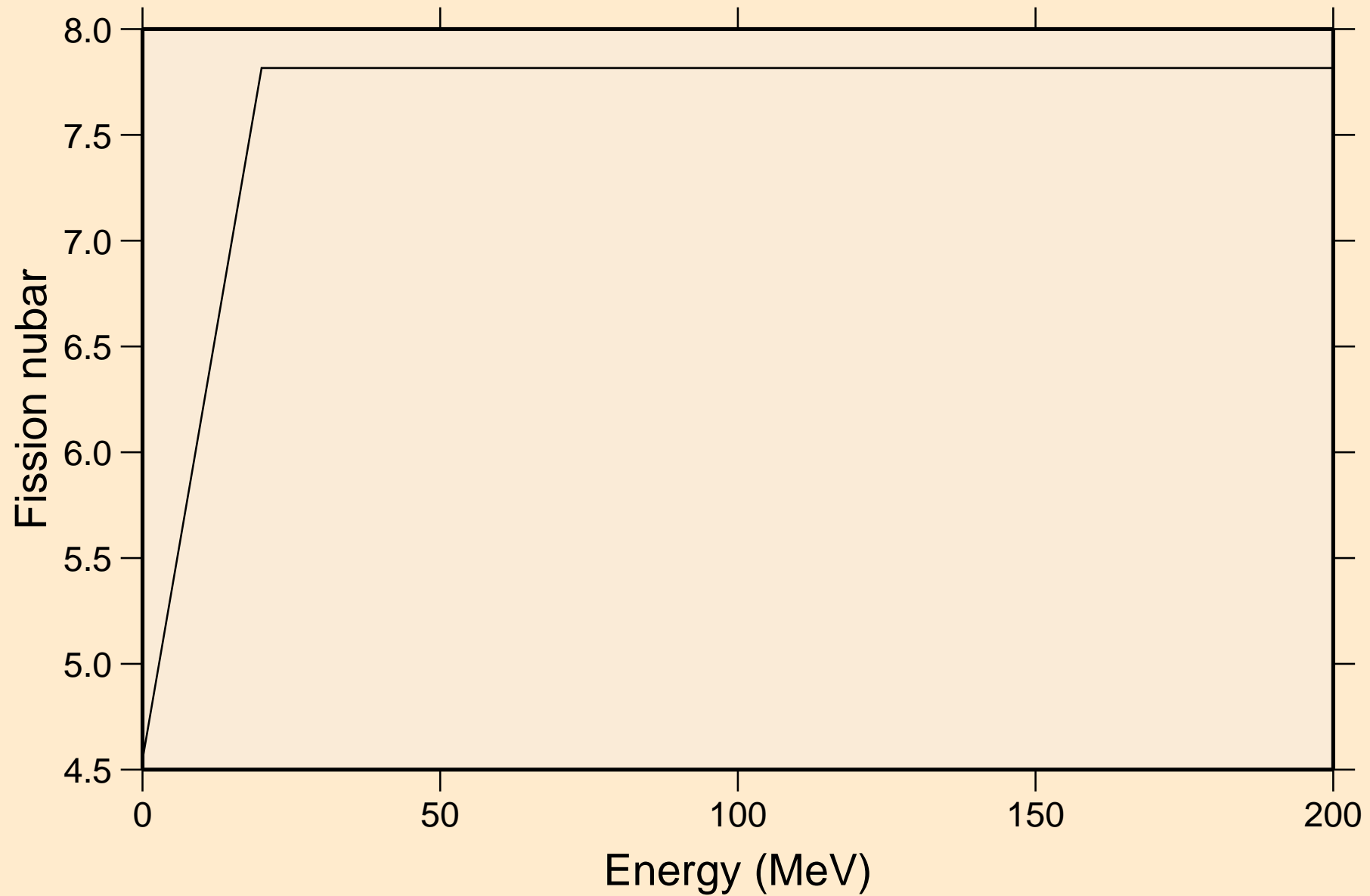

RF265 NEUTRON ACER TENDL-2024 LIBRARY; T=0.K
Neutron emission for (n,x)

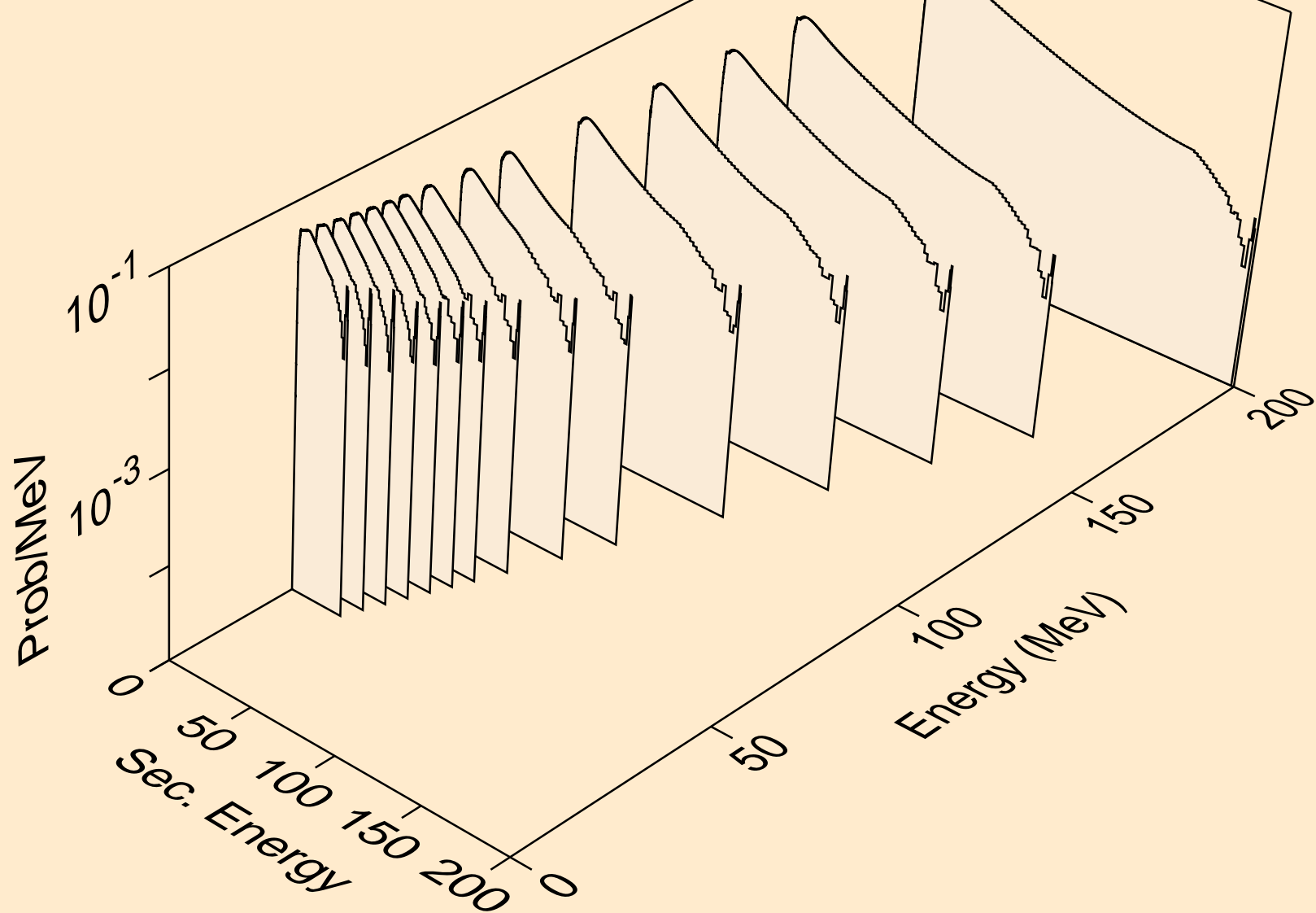

RF265 NEUTRON ACER TENDL-2024 LIBRARY; T=0.K
Neutron emission for (n,2nd)

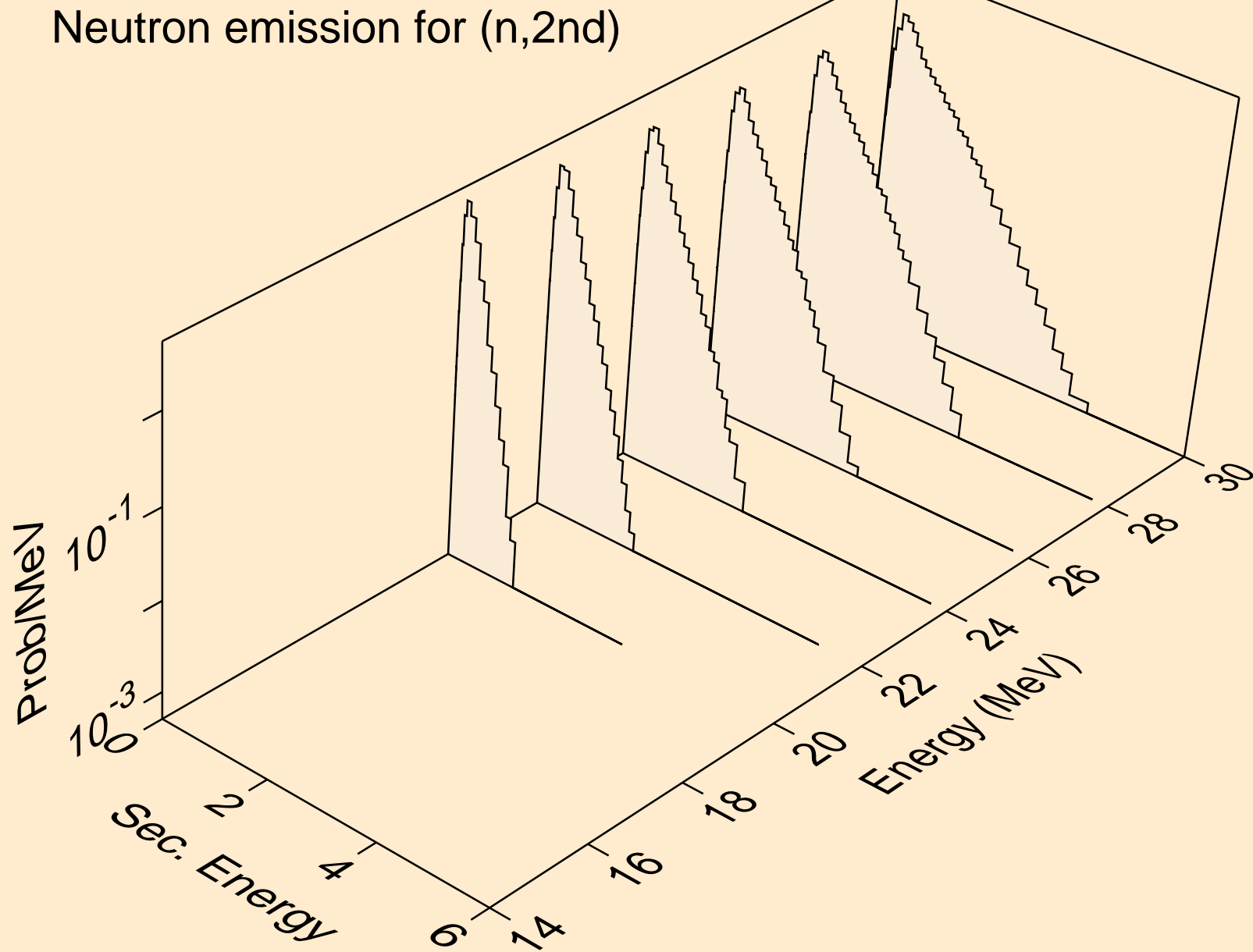

RF265 NEUTRON ACER TENDL-2024 LIBRARY; T=0.K
Neutron emission for (n,2n)

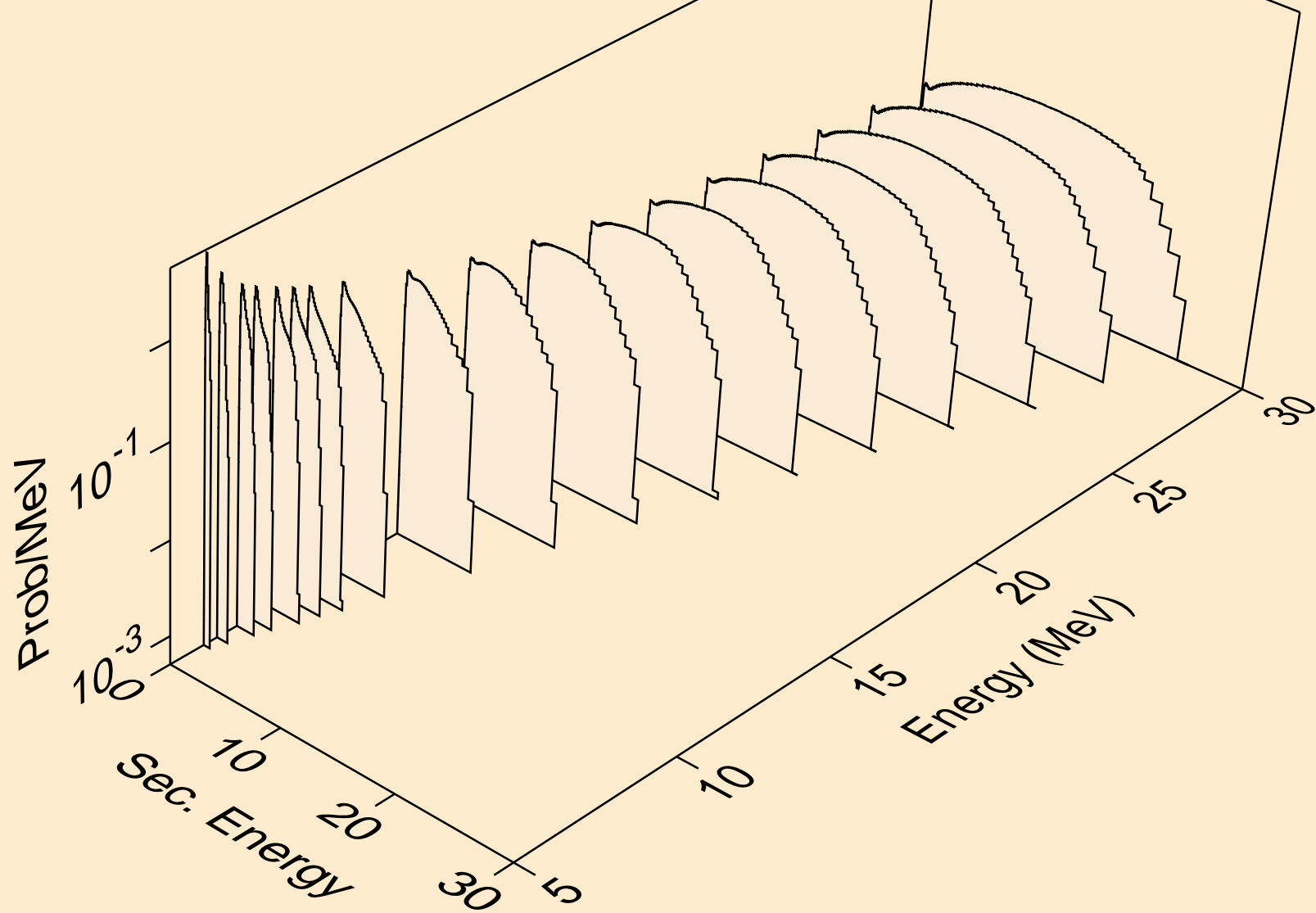

RF265 NEUTRON ACER TENDL-2024 LIBRARY; T=0.K
Neutron emission for (n,3n)

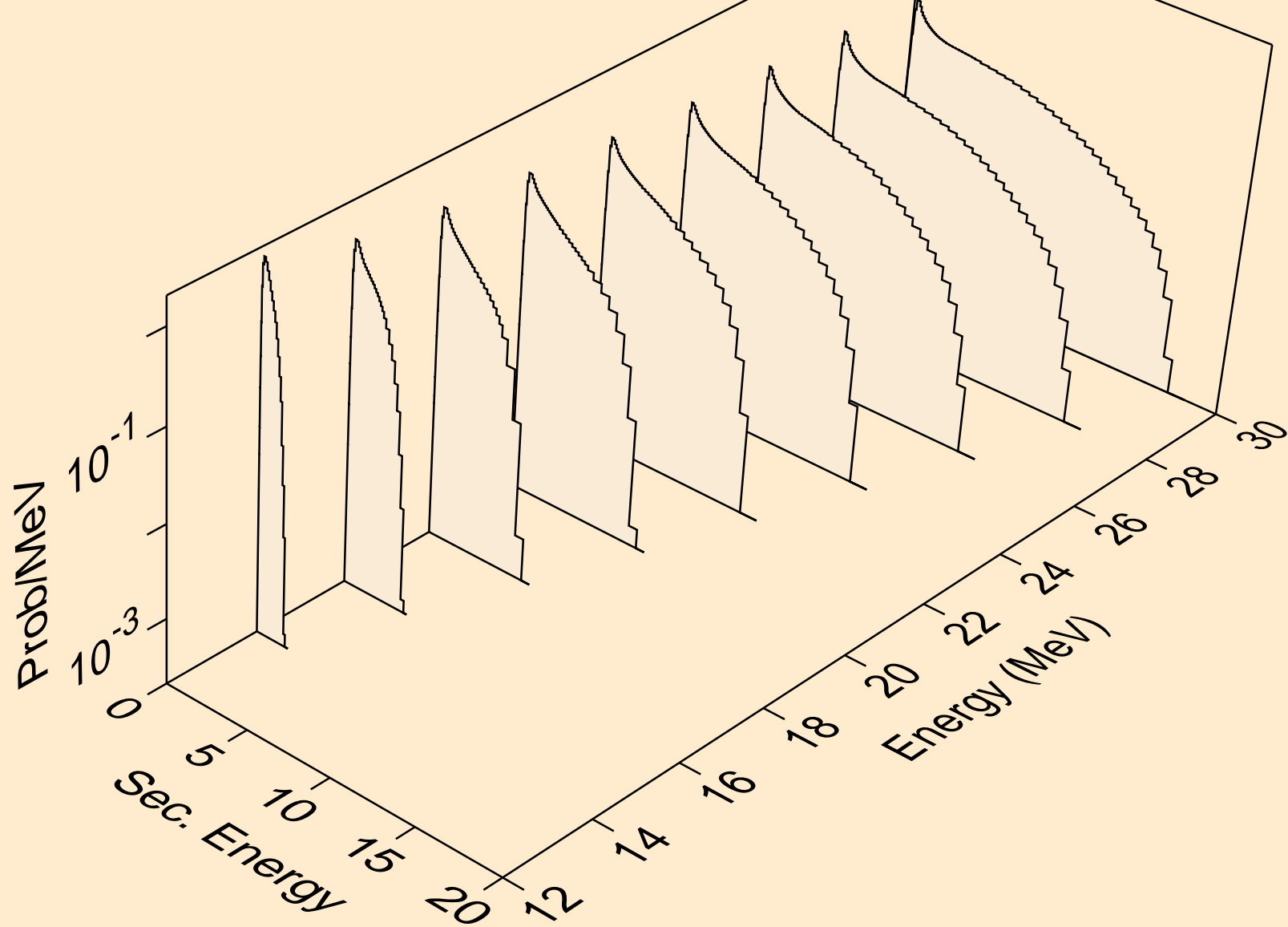

RF265 NEUTRON ACER TENDL-2024 LIBRARY; T=0.K
Neutron emission for fission

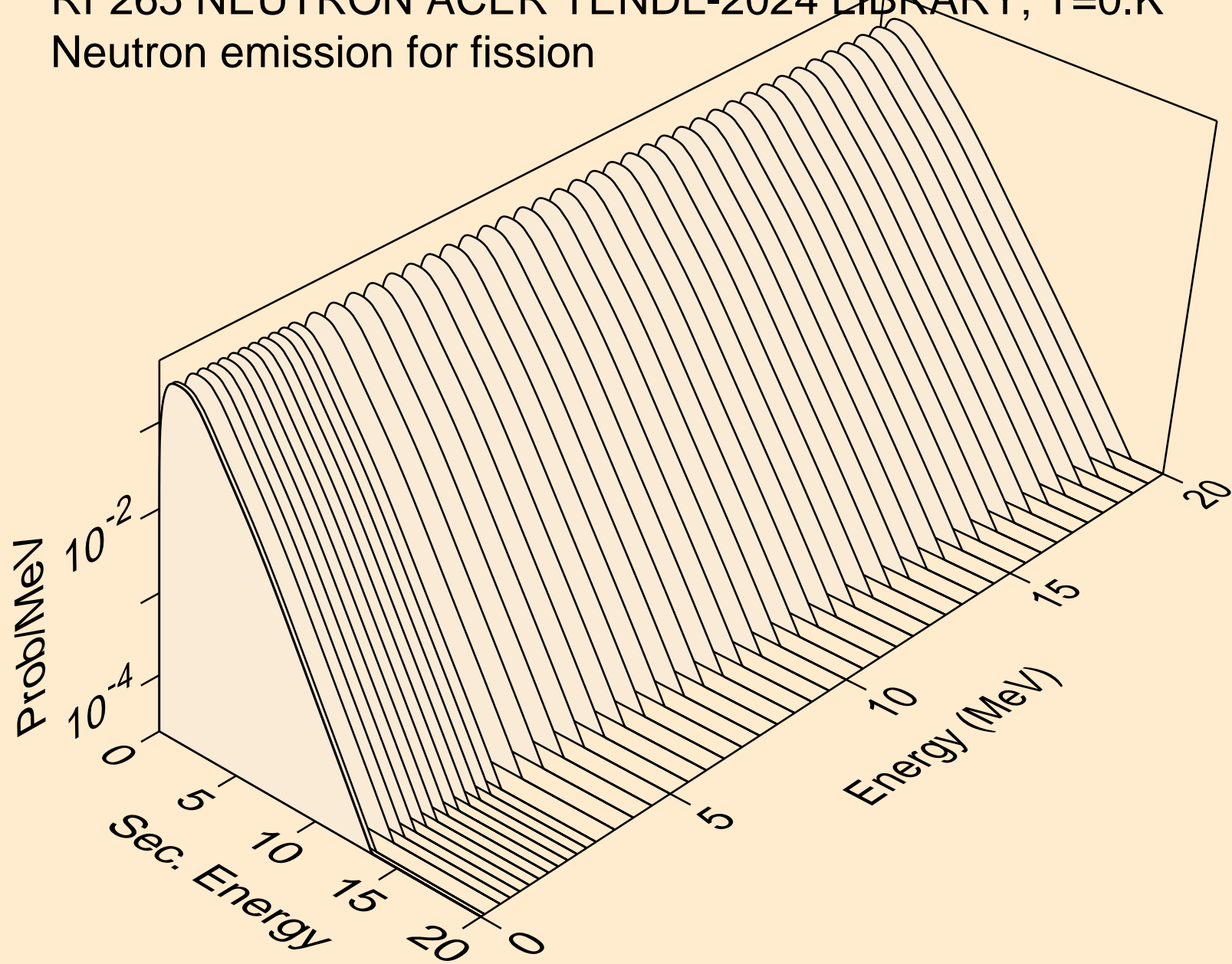

RF265 NEUTRON ACER TENDL-2024 LIBRARY; T=0.K
Neutron emission for (n,n*)a

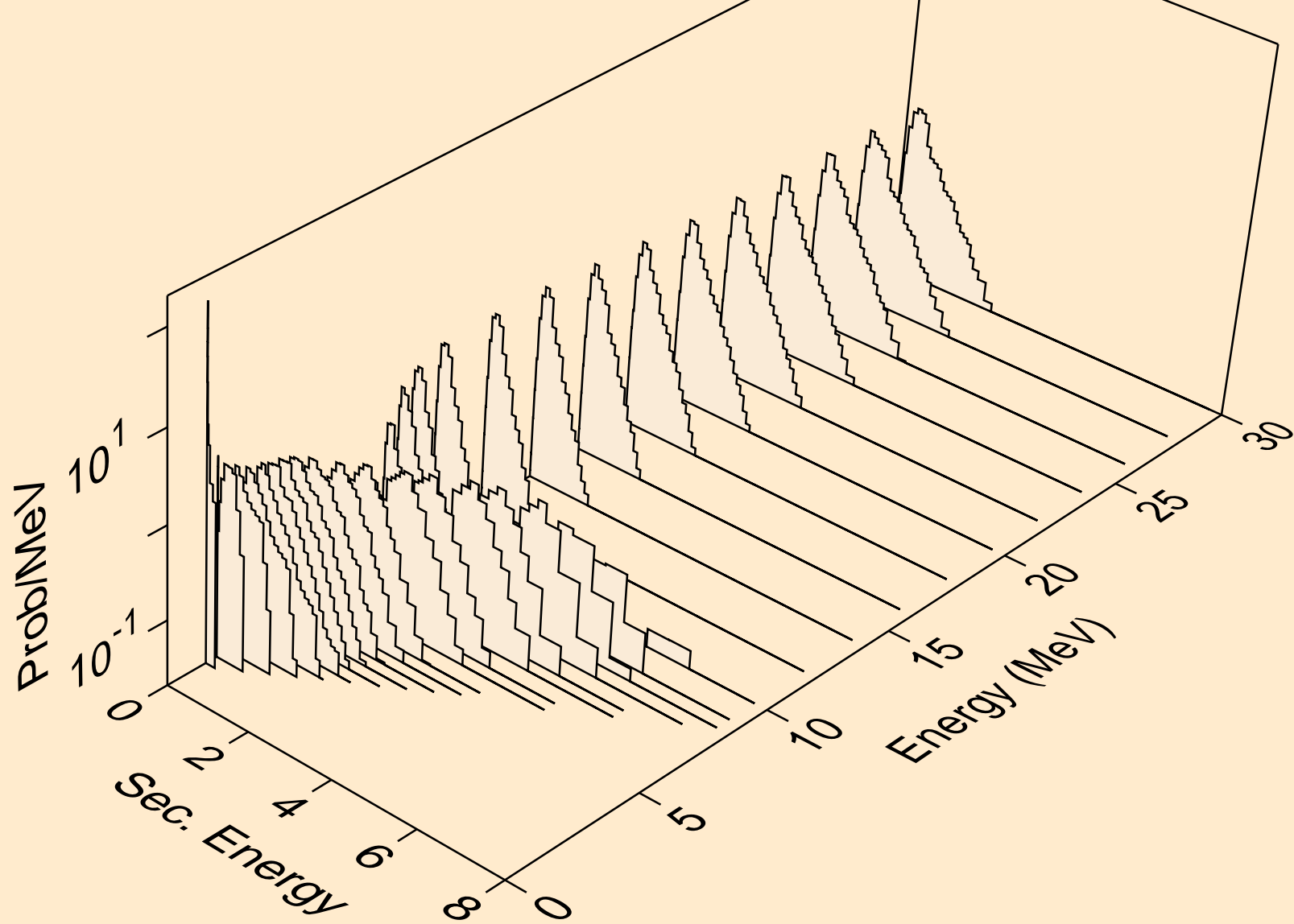

RF265 NEUTRON ACER TENDL-2024 LIBRARY; T=0.K
Neutron emission for (n,2n)a

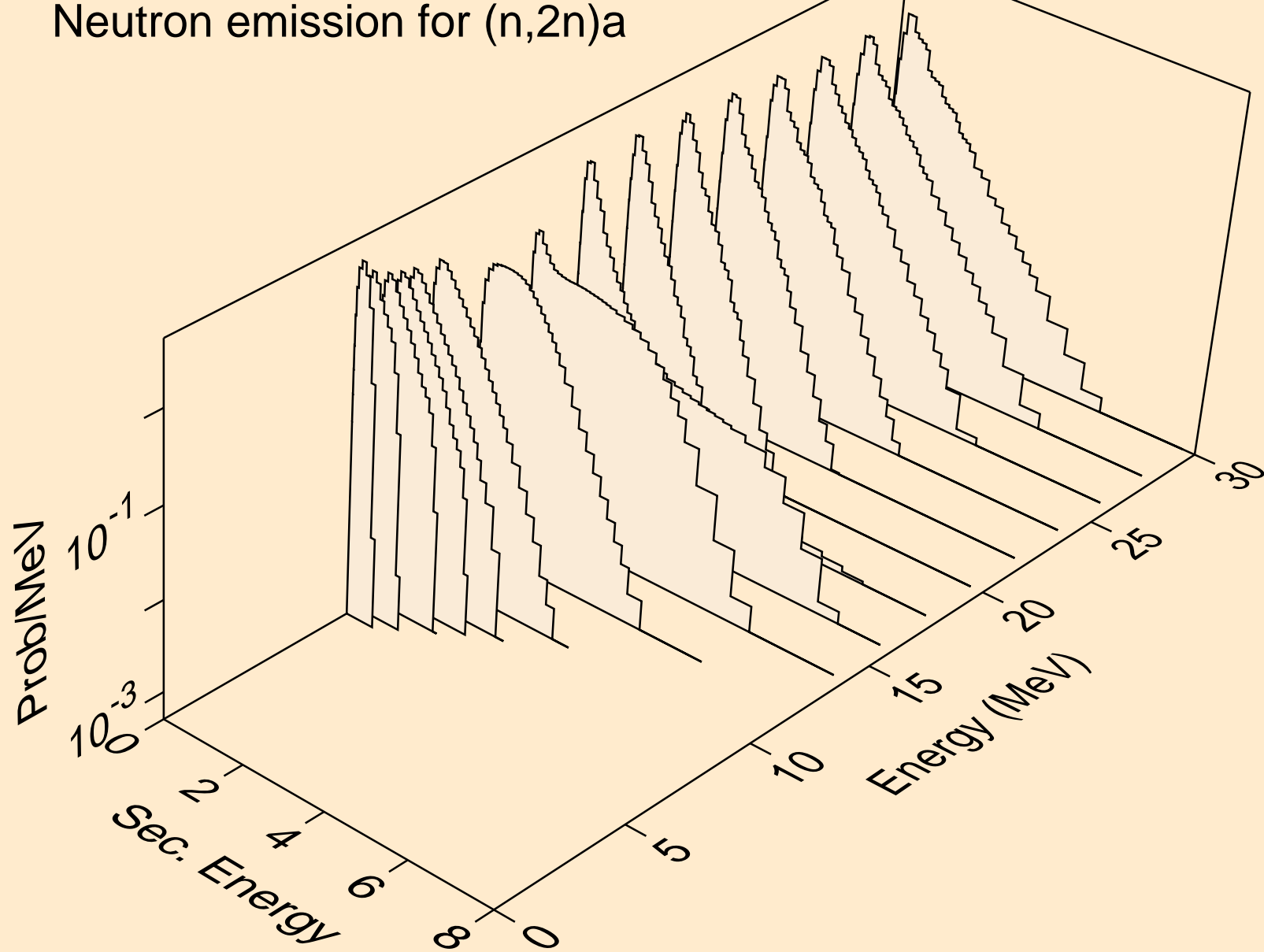

RF265 NEUTRON ACER TENDL-2024 LIBRARY; T=0.K
Neutron emission for (n,3n)a

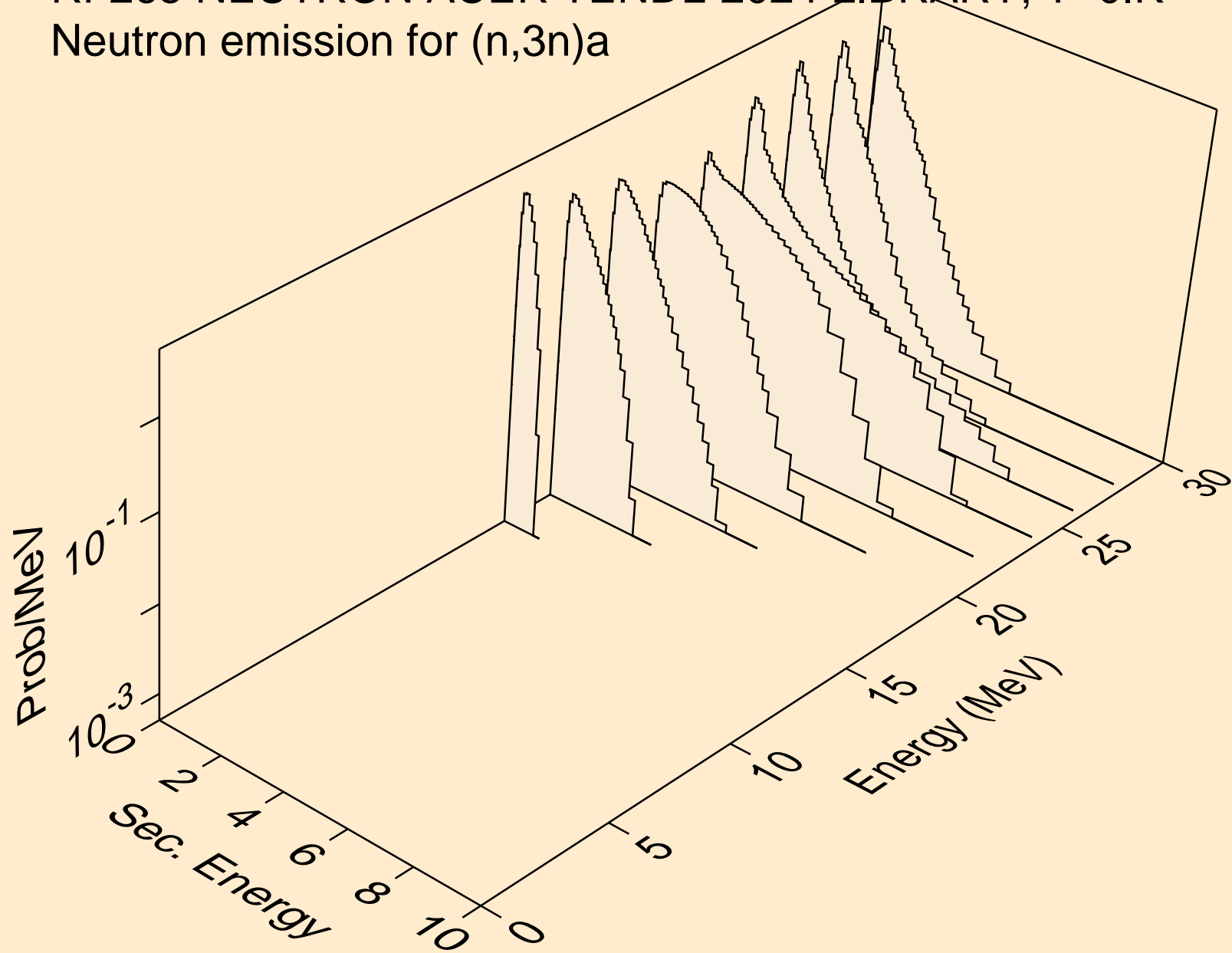

RF265 NEUTRON ACER TENDL-2024 LIBRARY; T=0.K
Neutron emission for (n,n*)p

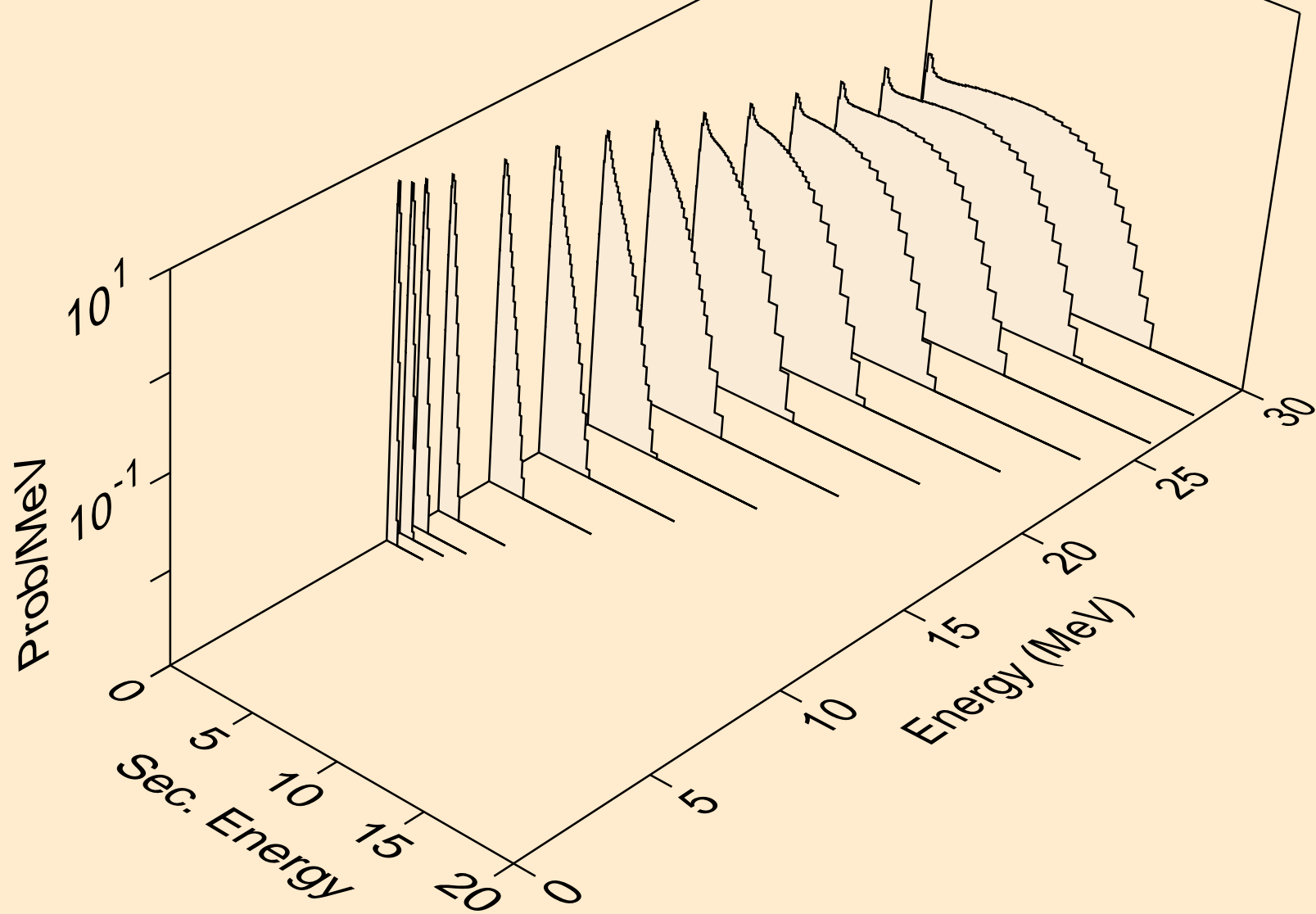

RF265 NEUTRON ACER TENDL-2024 LIBRARY; T=0.K
Neutron emission for (n,n*)d

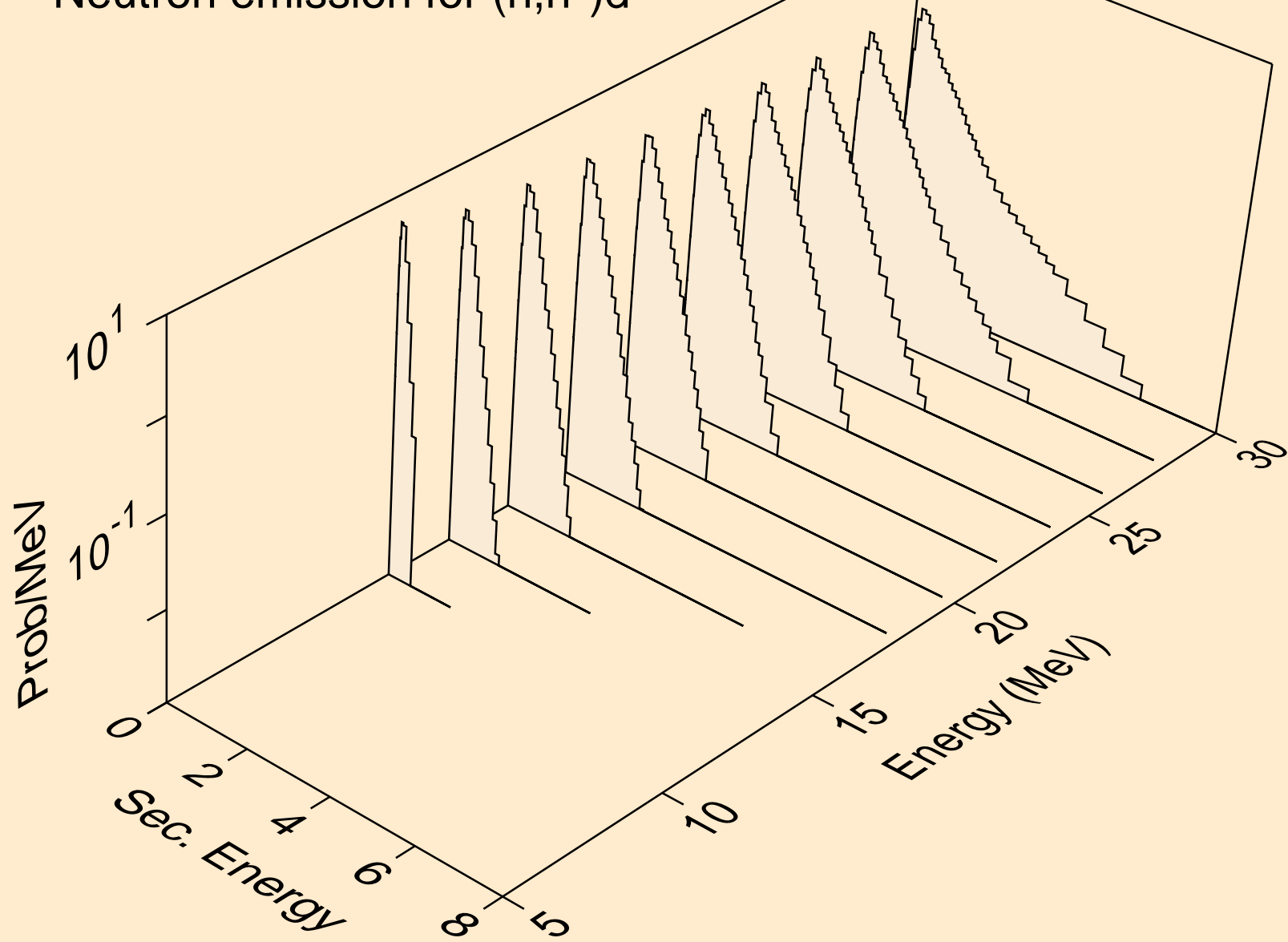

RF265 NEUTRON ACER TENDL-2024 LIBRARY; T=0.K
Neutron emission for (n,n*)t

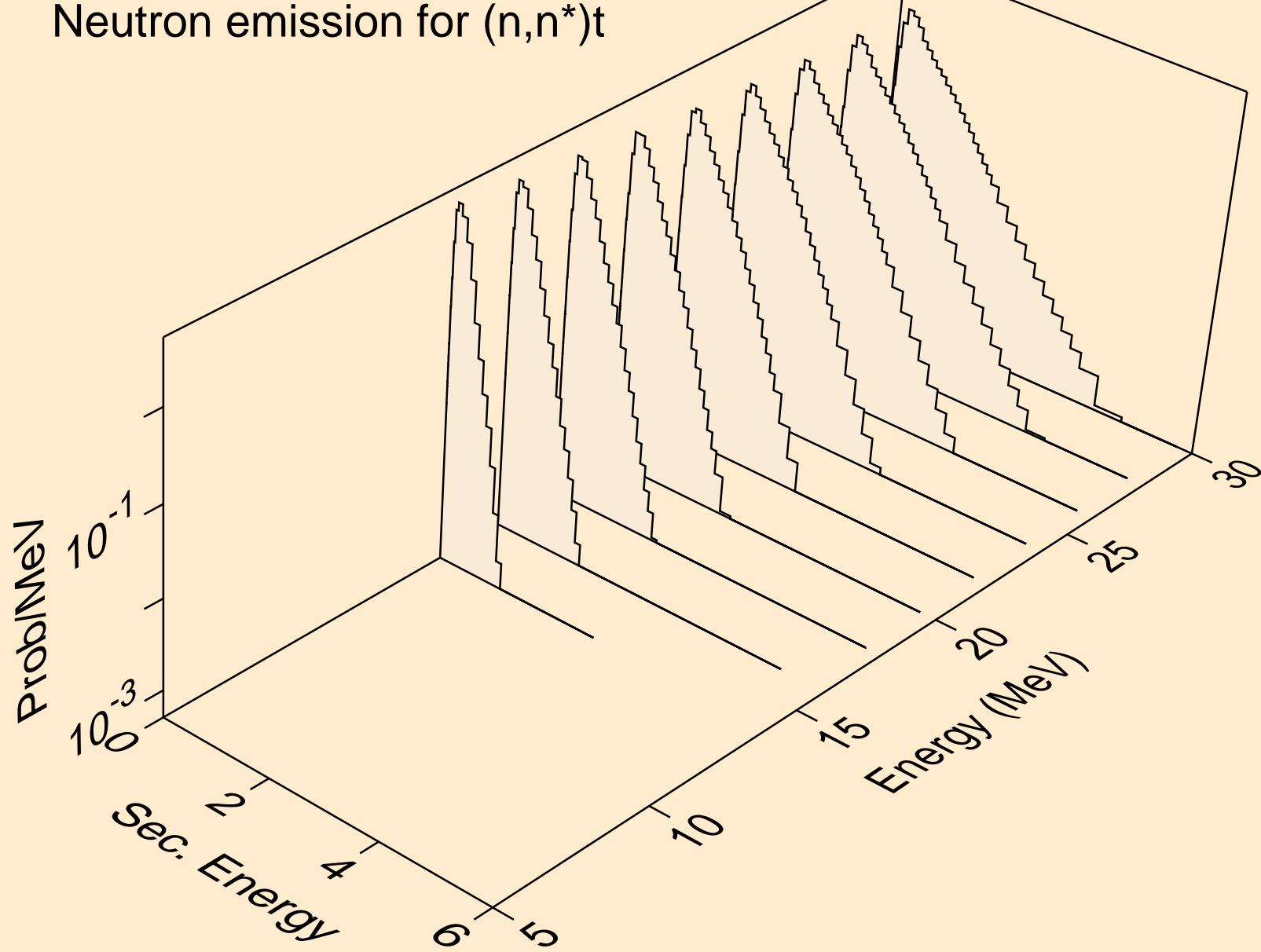

RF265 NEUTRON ACER TENDL-2024 LIBRARY; T=0.K
Neutron emission for (n,n*)he3

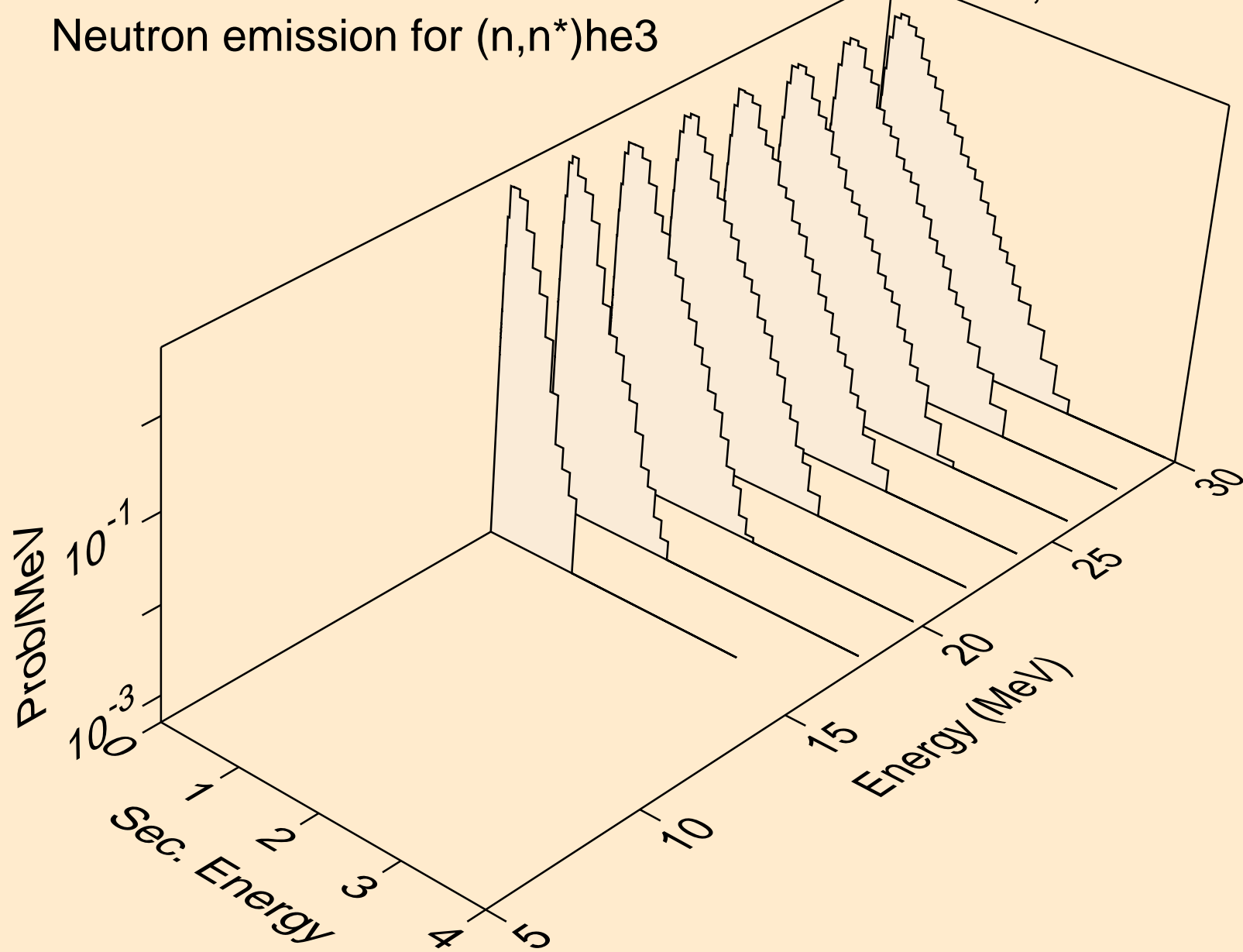

RF265 NEUTRON ACER TENDL-2024 LIBRARY; T=0.K
Neutron emission for (n,4n)

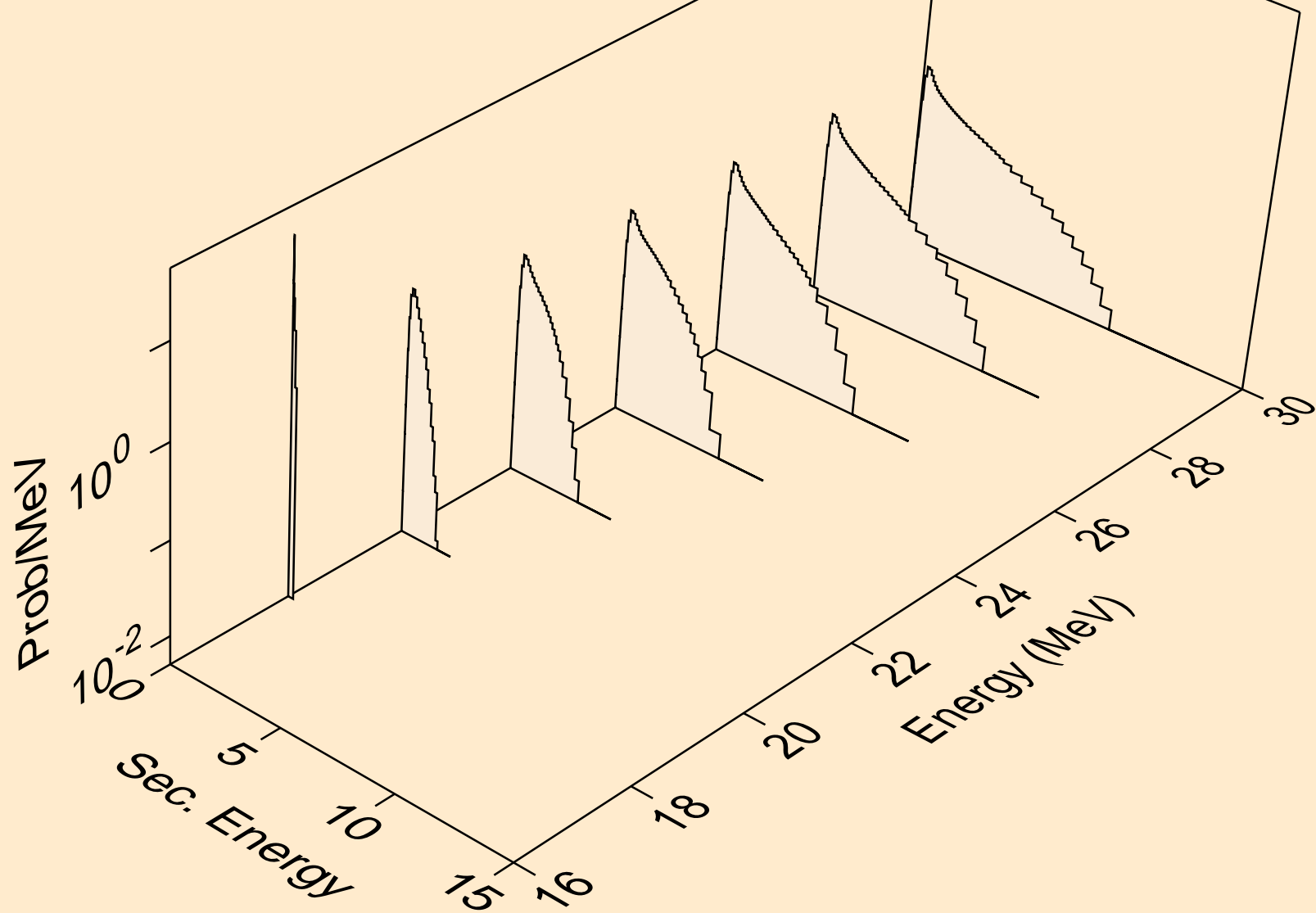

RF265 NEUTRON ACER TENDL-2024 LIBRARY; T=0.K
Neutron emission for (n,2np)

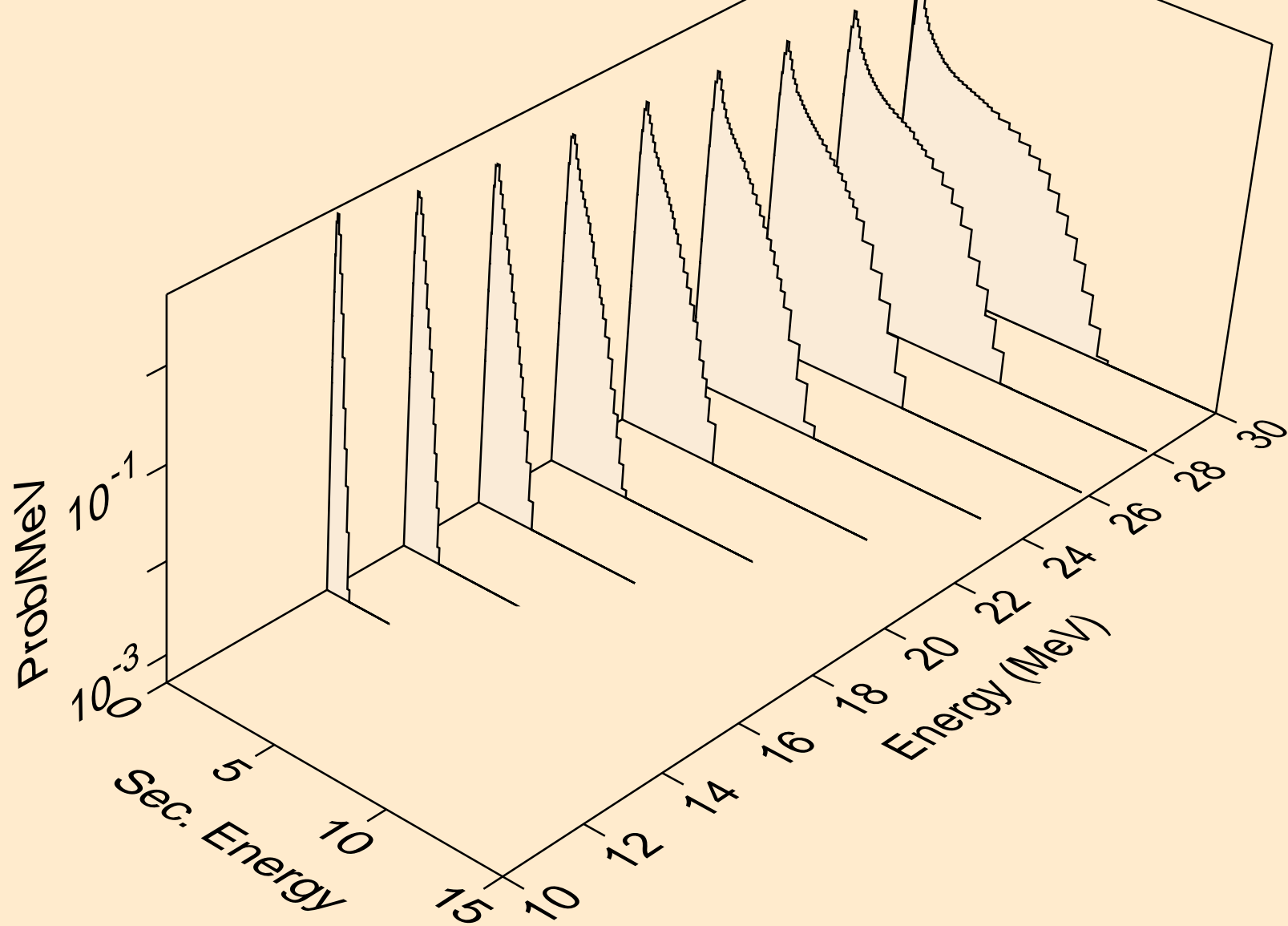

RF265 NEUTRON ACER TENDL-2024 LIBRARY; T=0.K
Neutron emission for (n,3np)

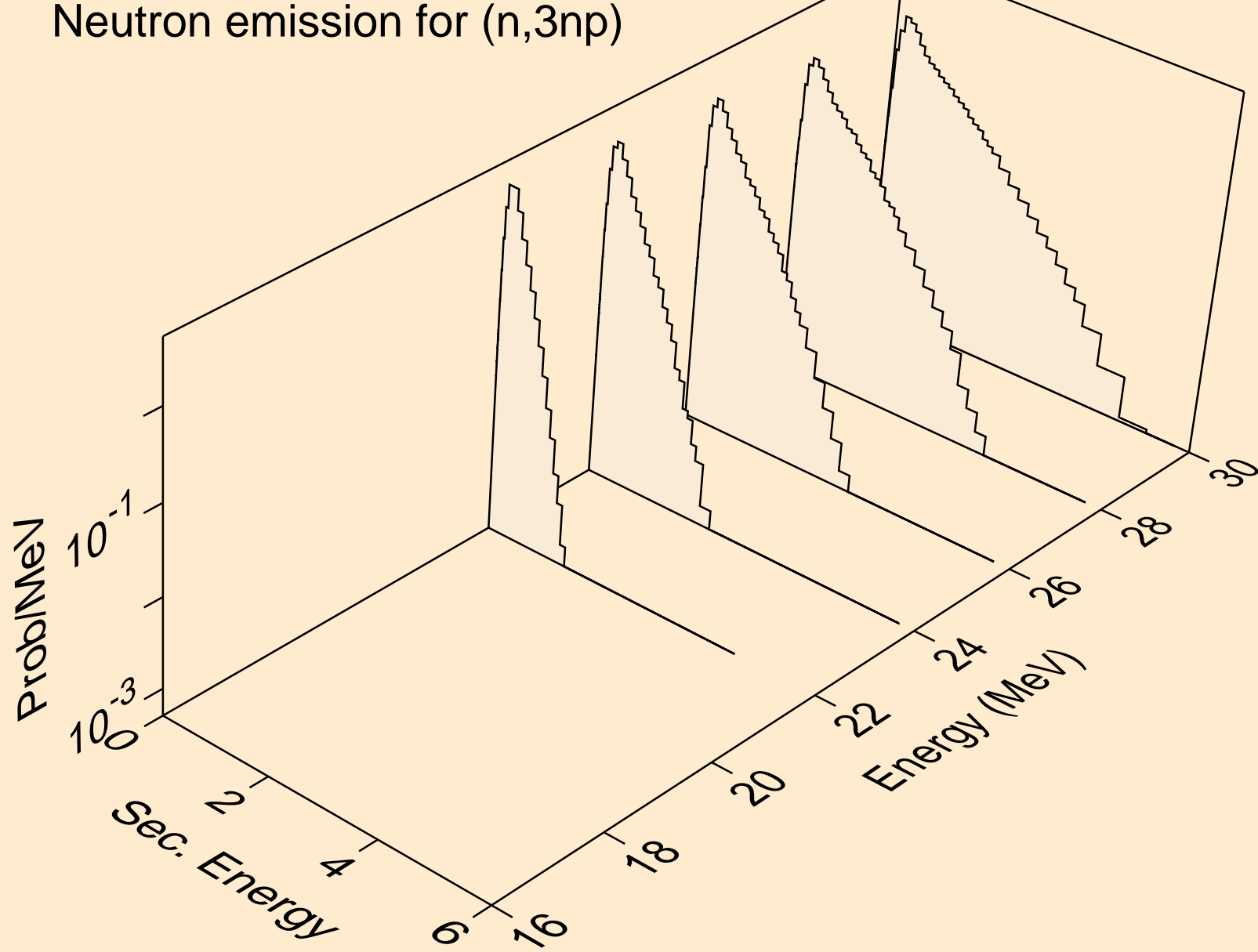

RF265 NEUTRON ACER TENDL-2024 LIBRARY; T=0.K
Neutron emission for (n,n*c)

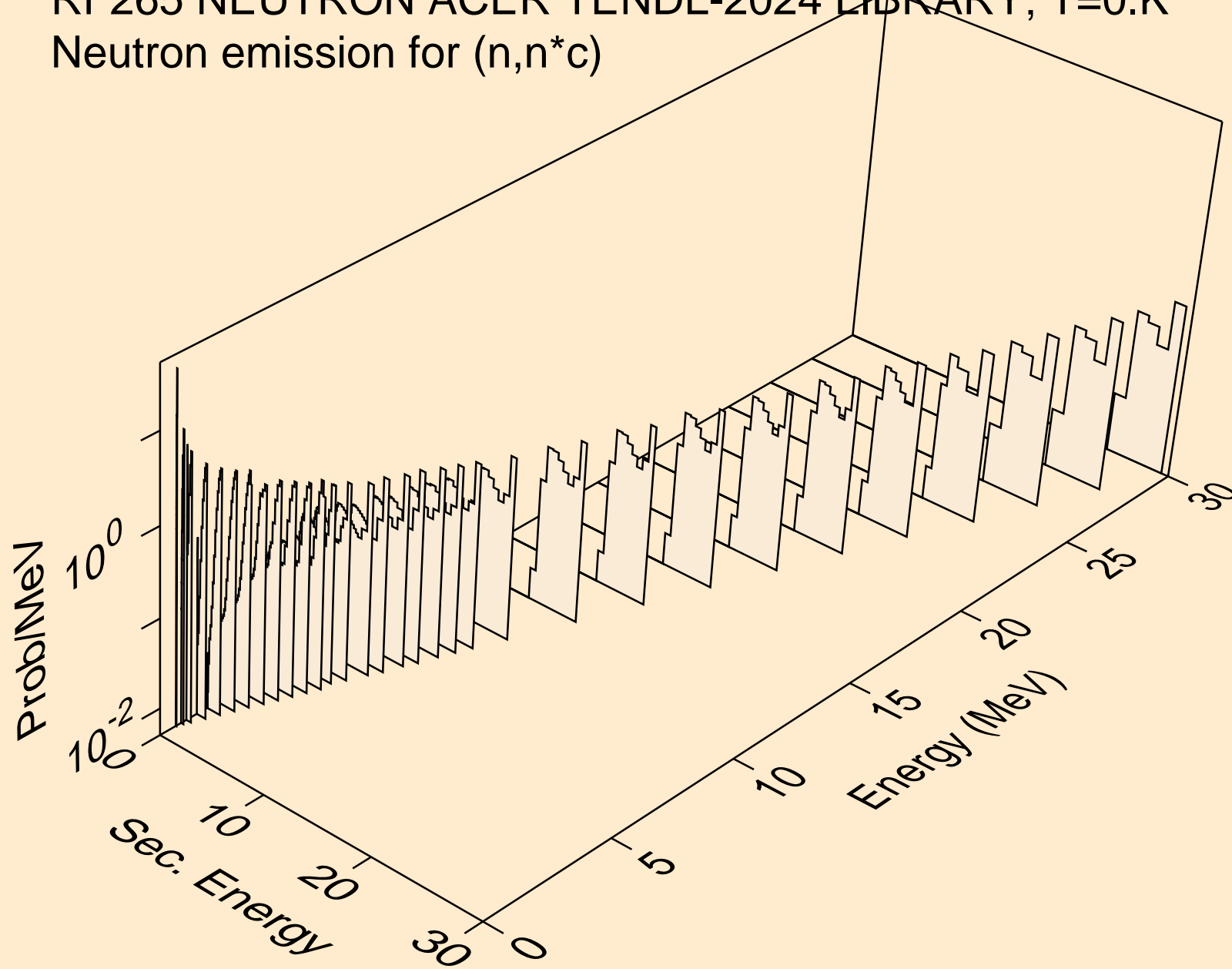

RF265 NEUTRON ACER TENDL-2024 LIBRARY; T=0.K

Delayed nubar

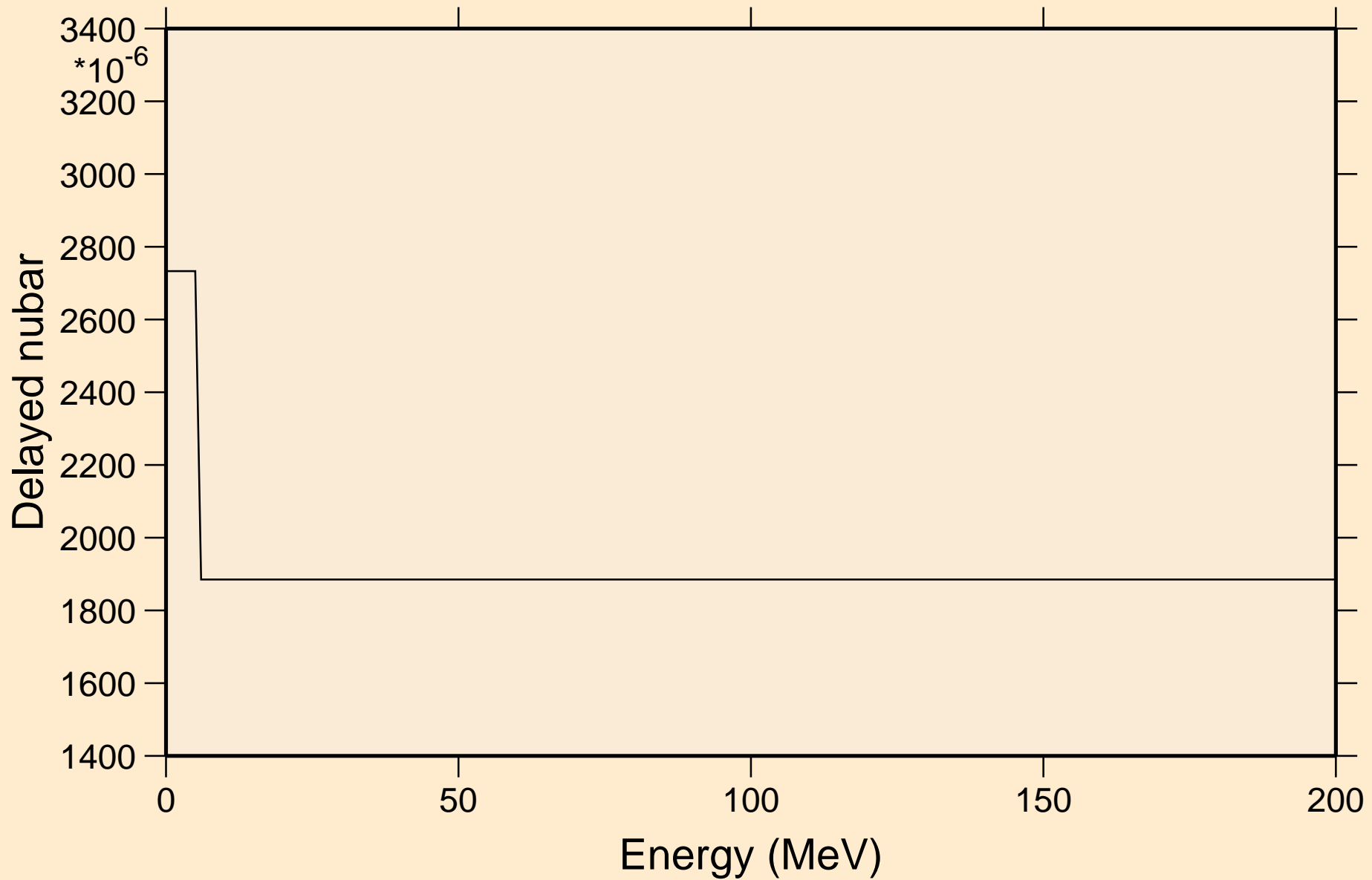

RF265 NEUTRON ACER TENDL-2024 LIBRARY; T=0.K

Delayed neutron spectra

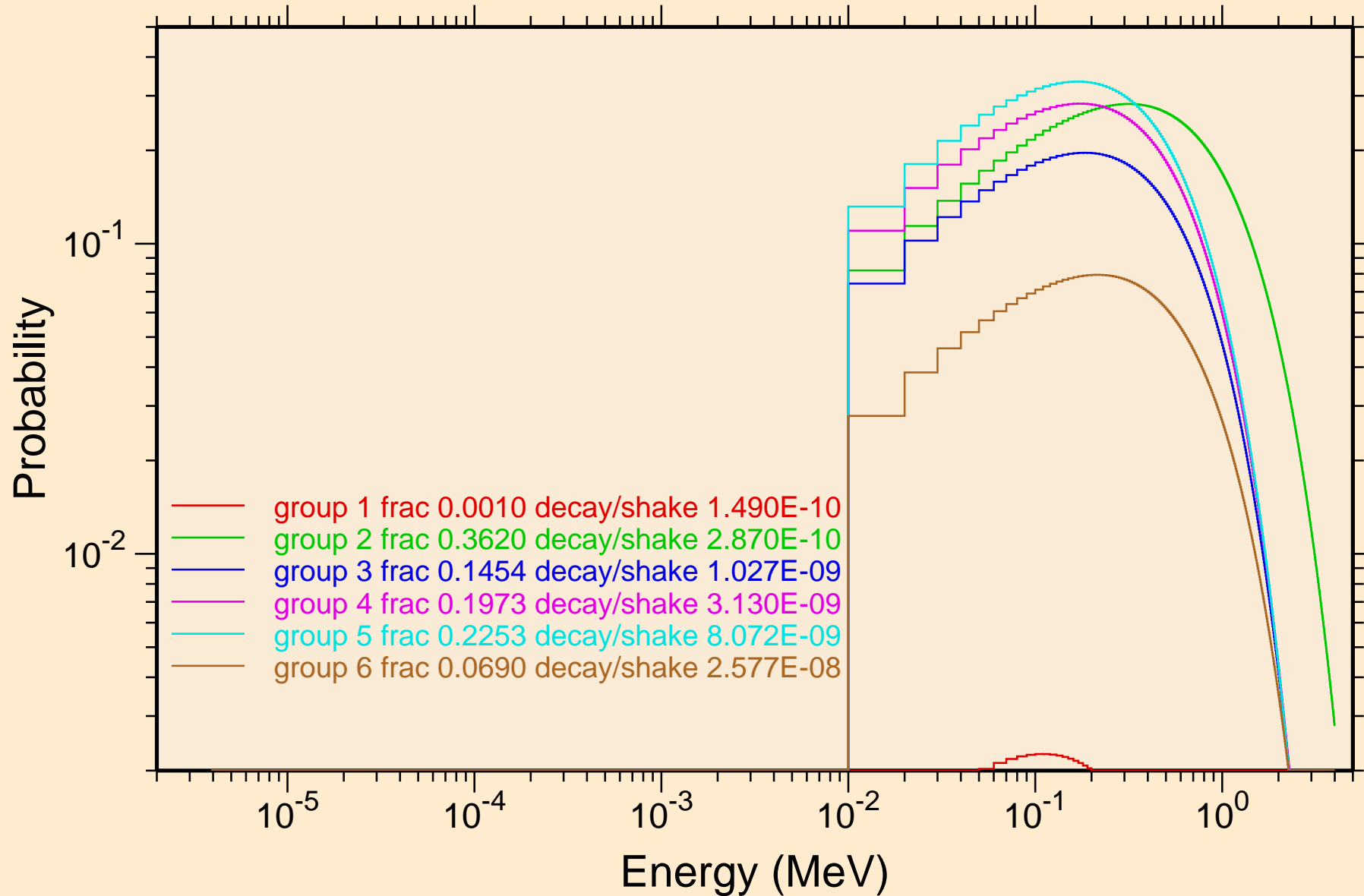

RF265 NEUTRON ACER TENDL-2024 LIBRARY; T=0.K
Photon emission for (n,x)

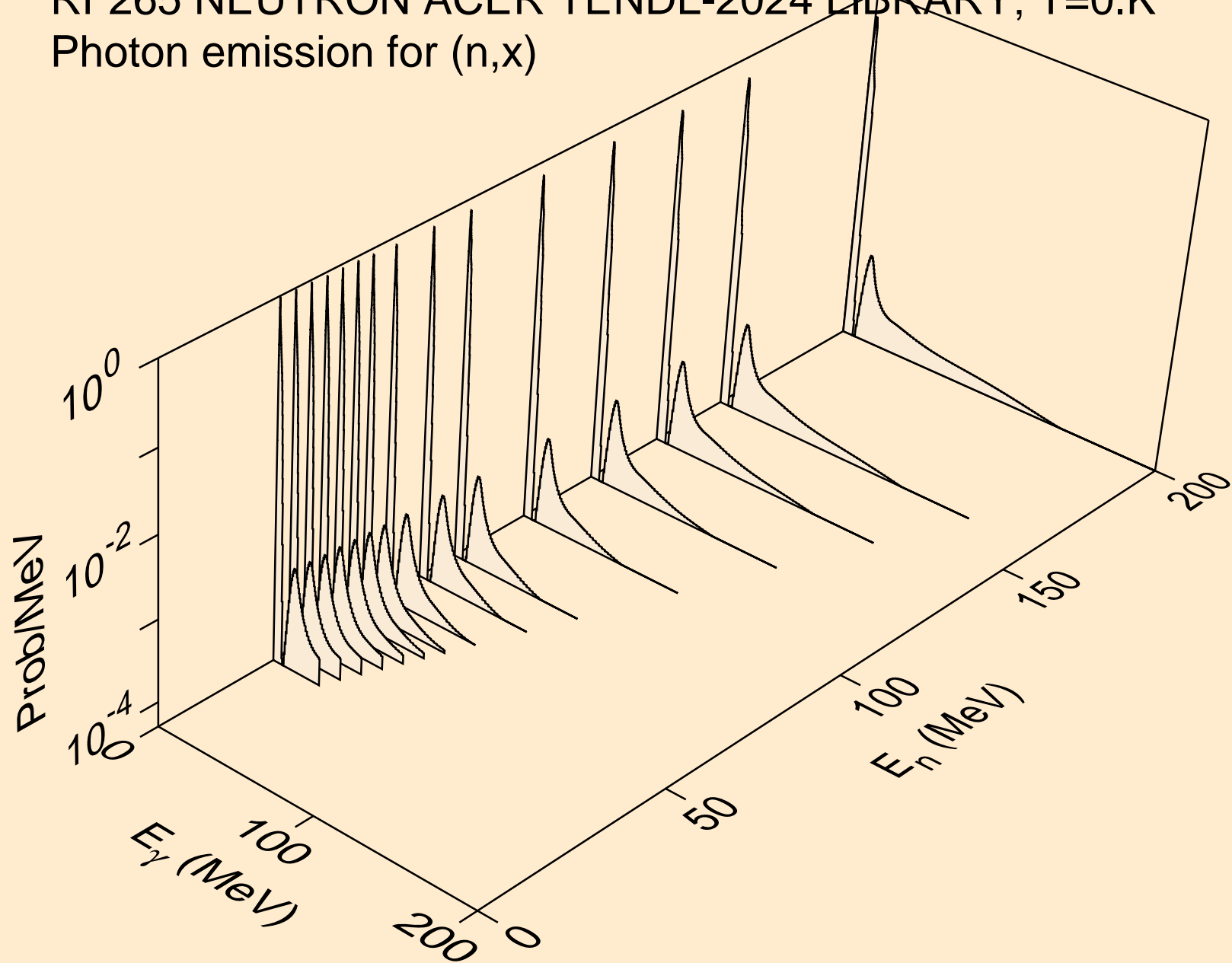

RF265 NEUTRON ACER TENDL-2024 LIBRARY; T=0.K
Photon emission for (n,2nd)

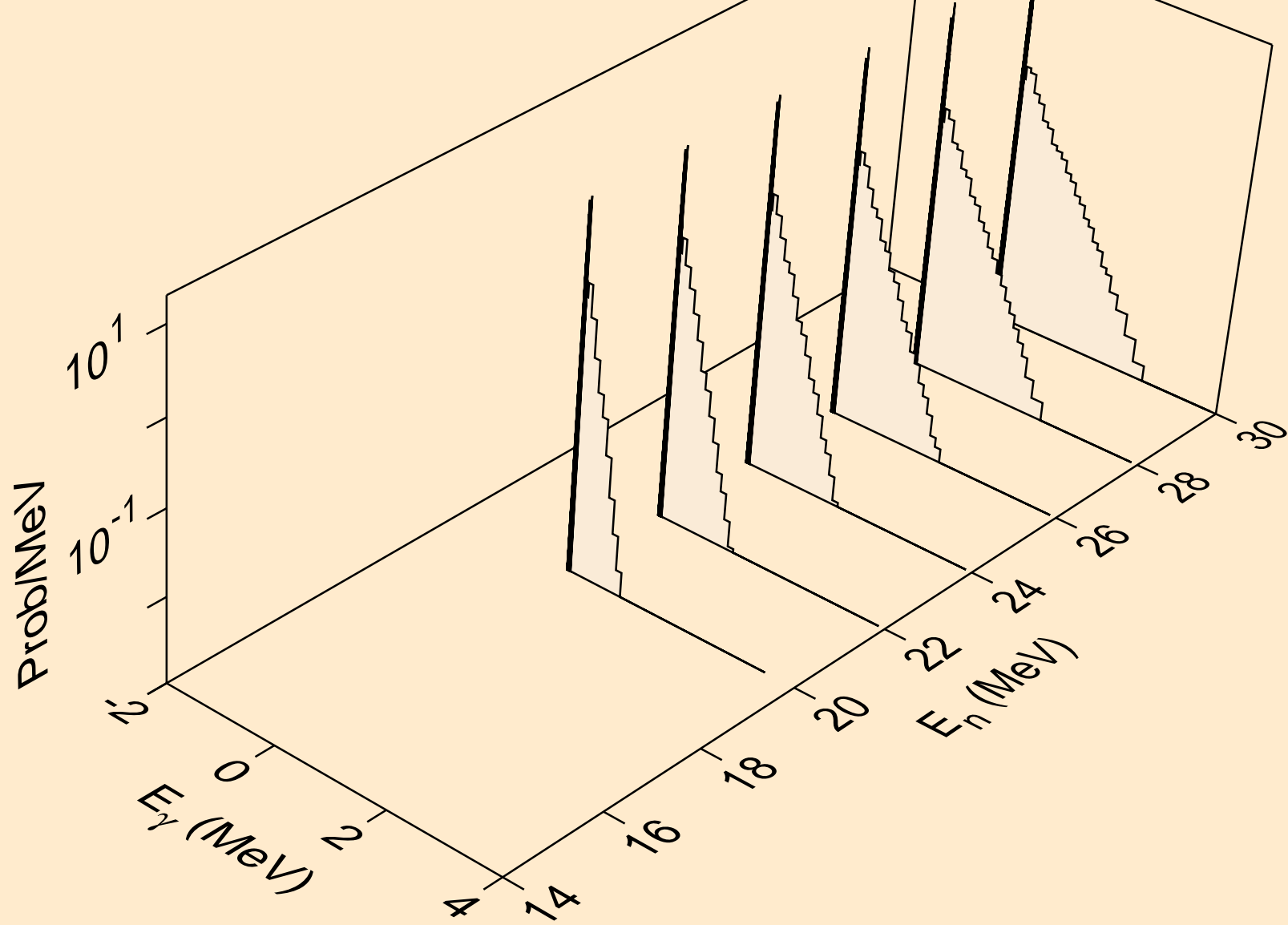

RF265 NEUTRON ACER TENDL-2024 LIBRARY; T=0.K
Photon emission for (n,2n)

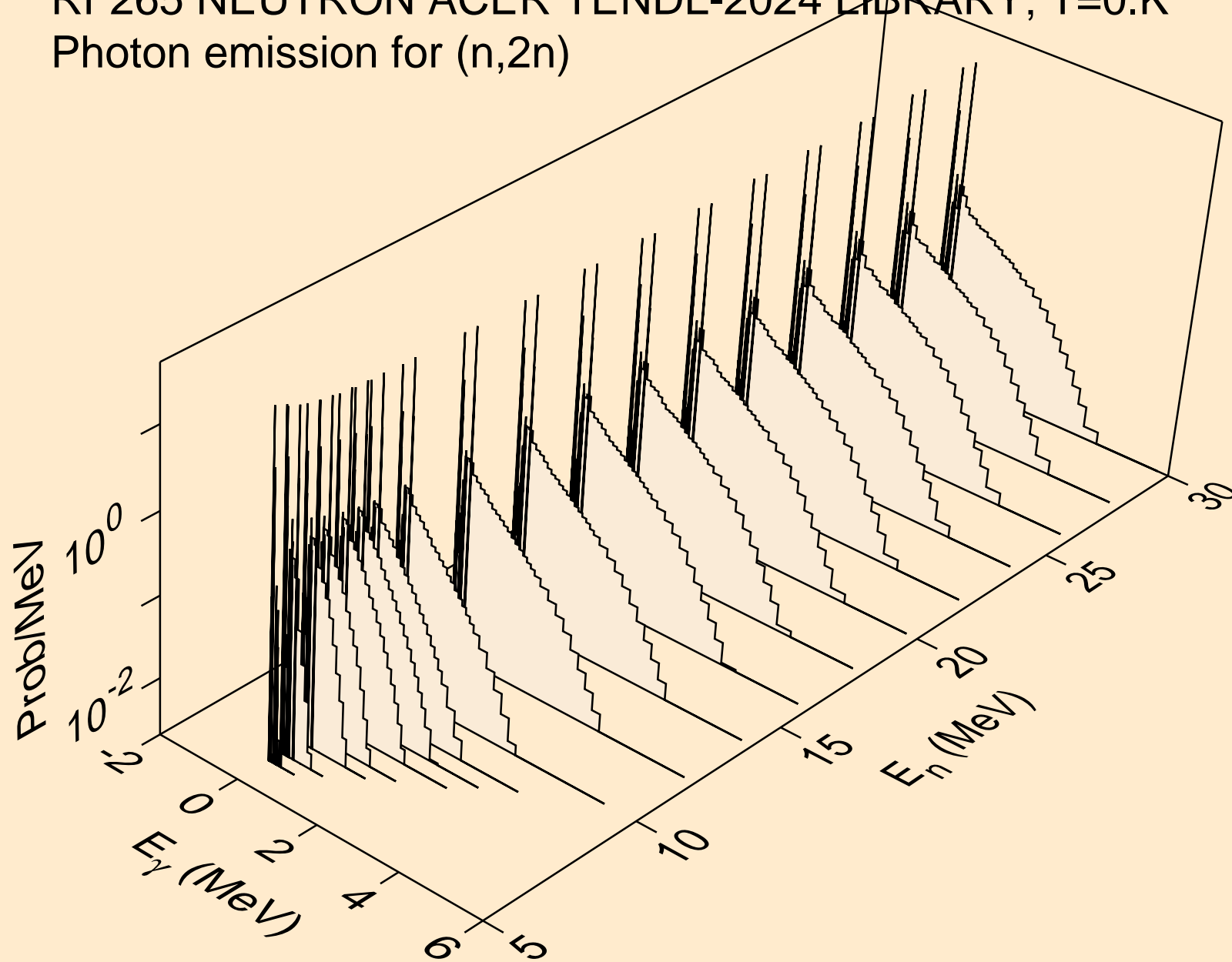

RF265 NEUTRON ACER TENDL-2024 LIBRARY; T=0.K
Photon emission for (n,3n)

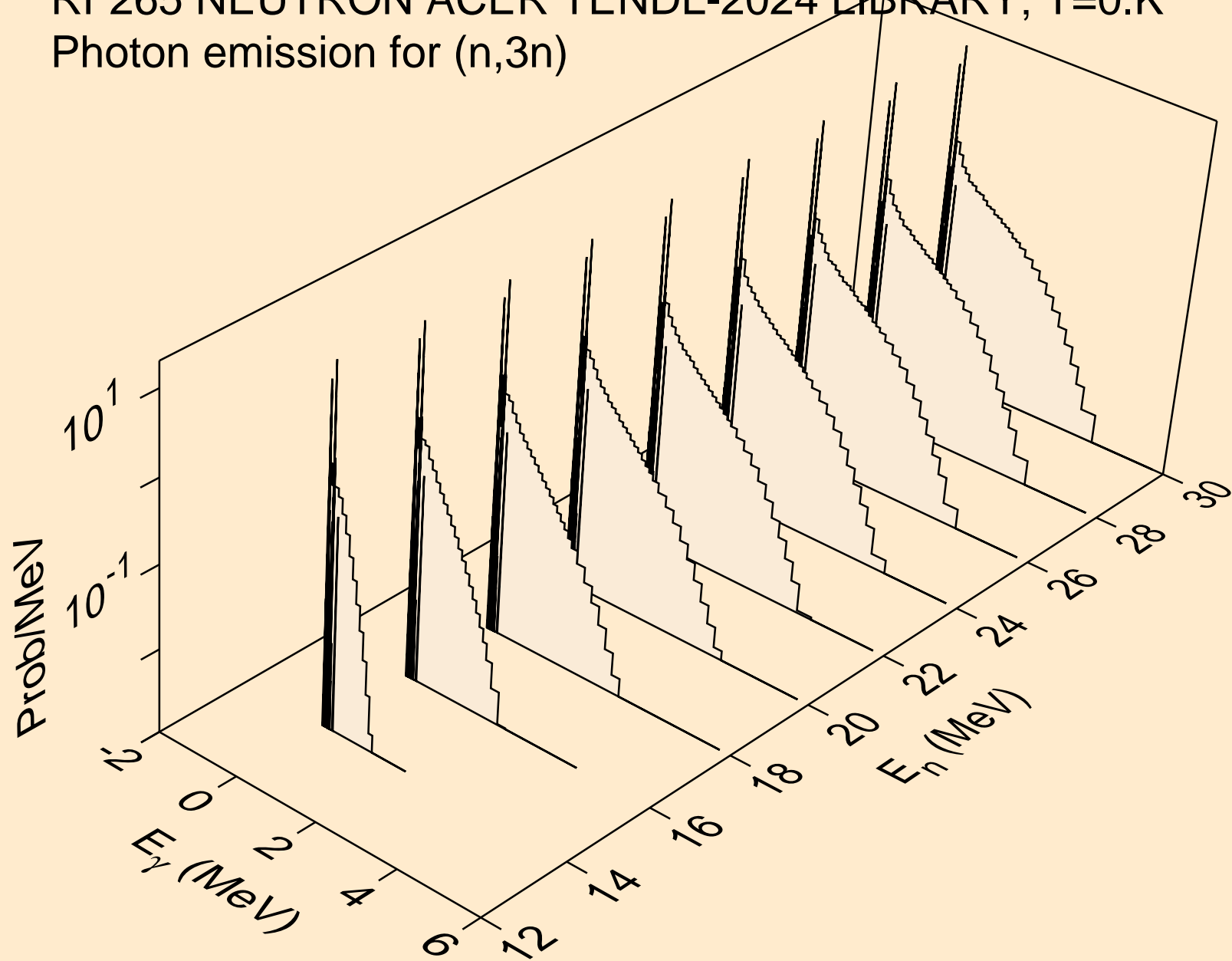

RF265 NEUTRON ACER TENDL-2024 LIBRARY; T=0.K
Photon emission for (n,n*)a

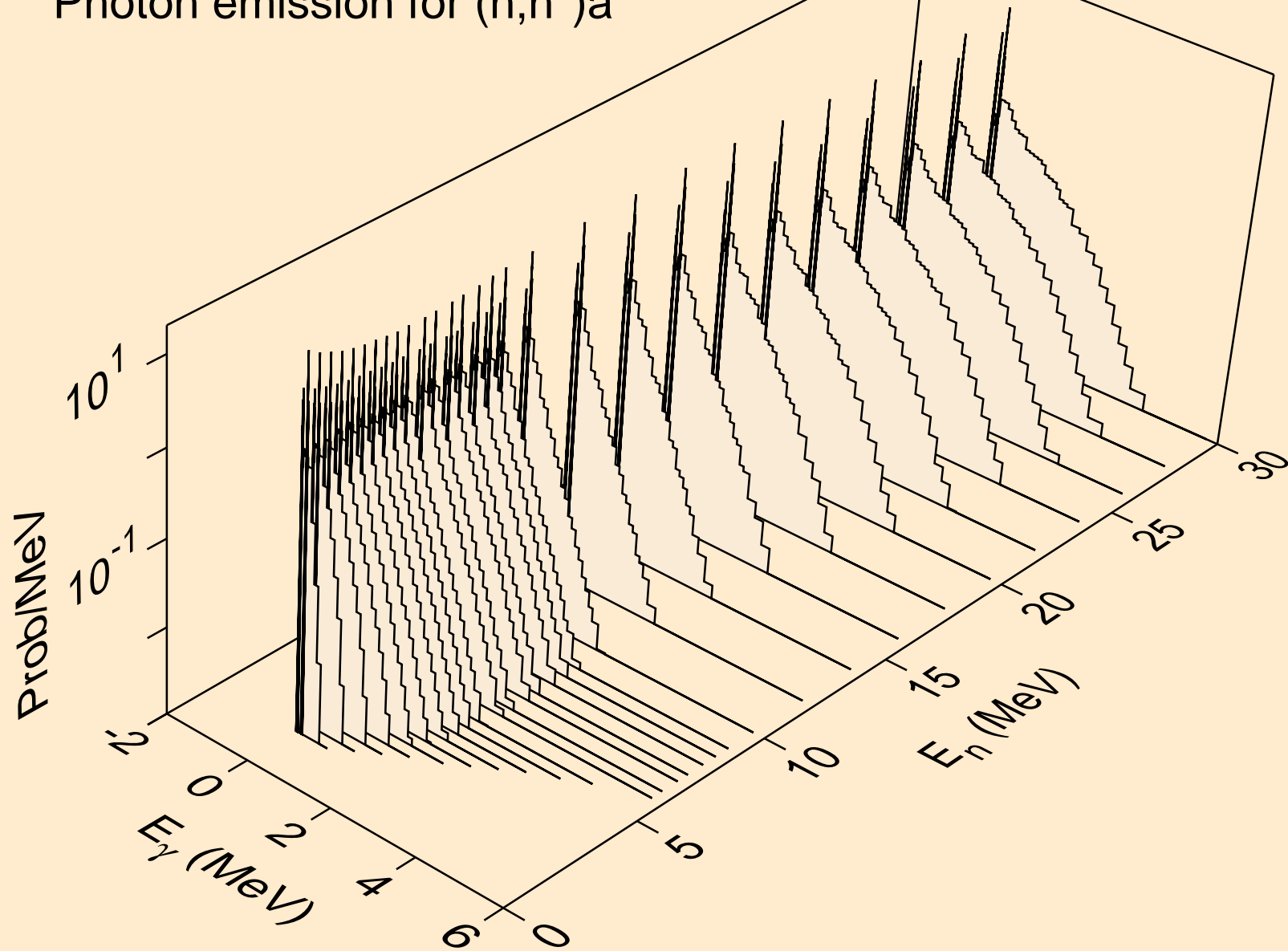

RF265 NEUTRON ACER TENDL-2024 LIBRARY; T=0.K
Photon emission for (n,2n)a

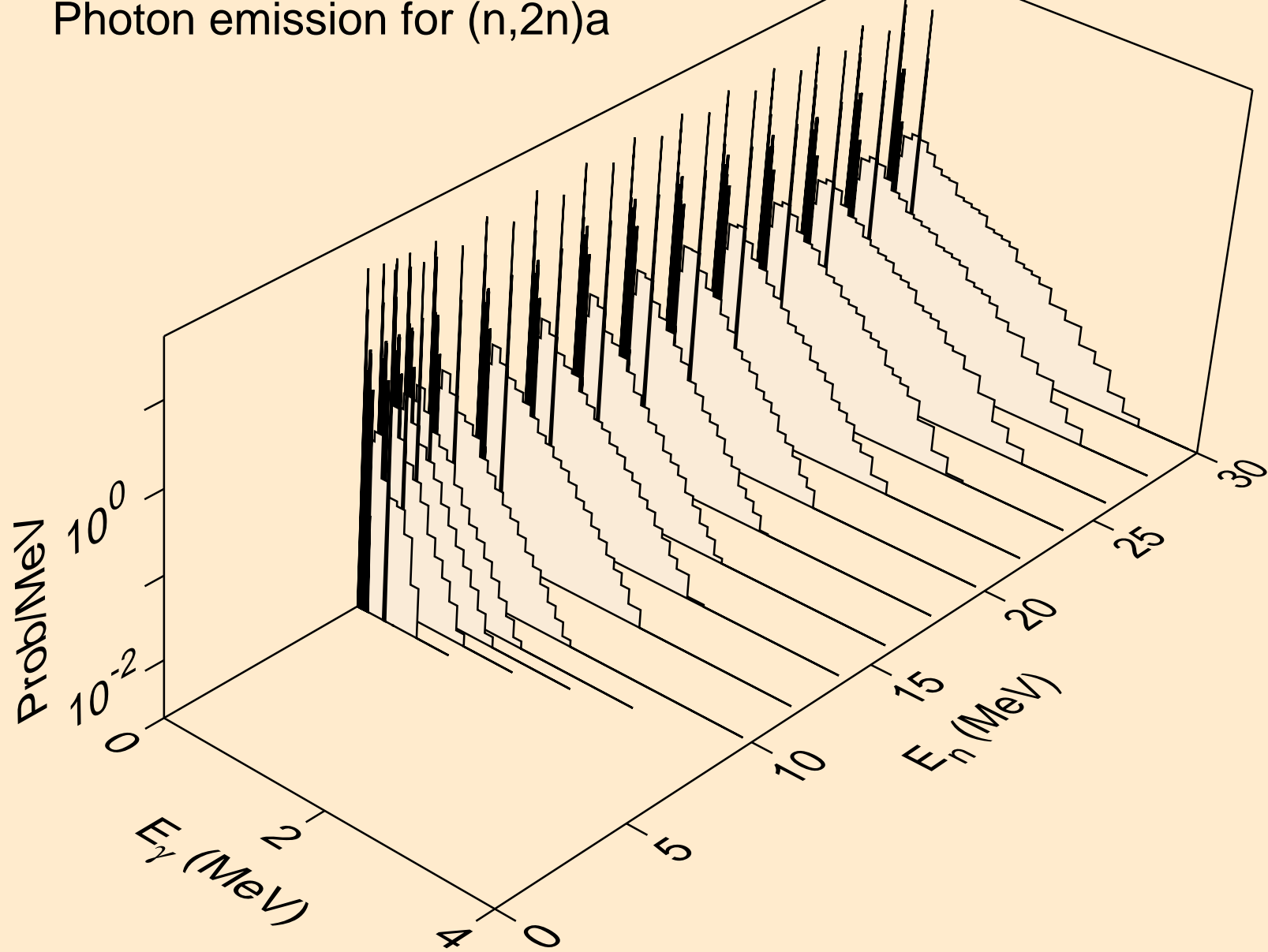

RF265 NEUTRON ACER TENDL-2024 LIBRARY; T=0.K
Photon emission for (n,3n)a

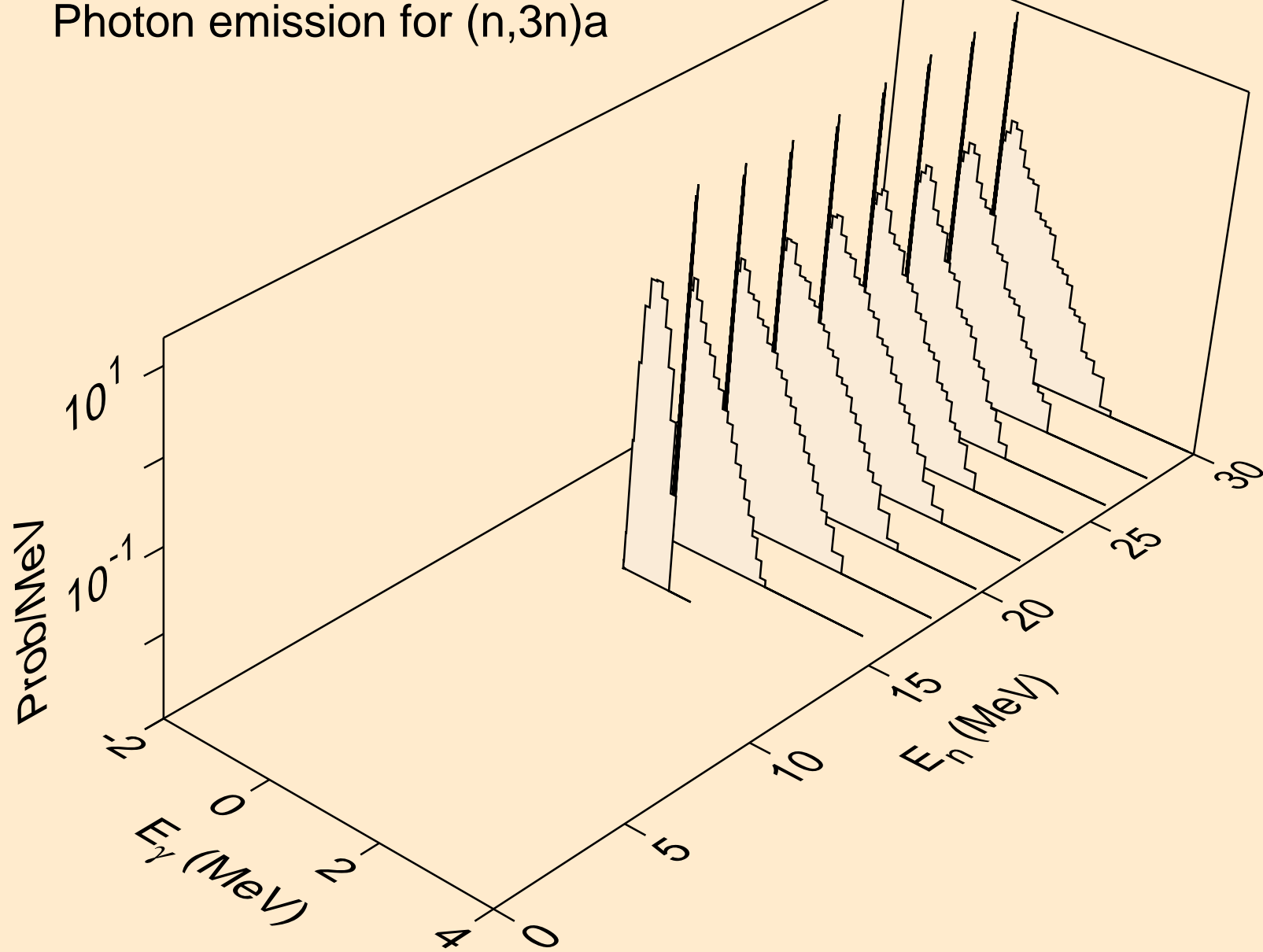

RF265 NEUTRON ACER TENDL-2024 LIBRARY; T=0.K
Photon emission for (n,n*)p

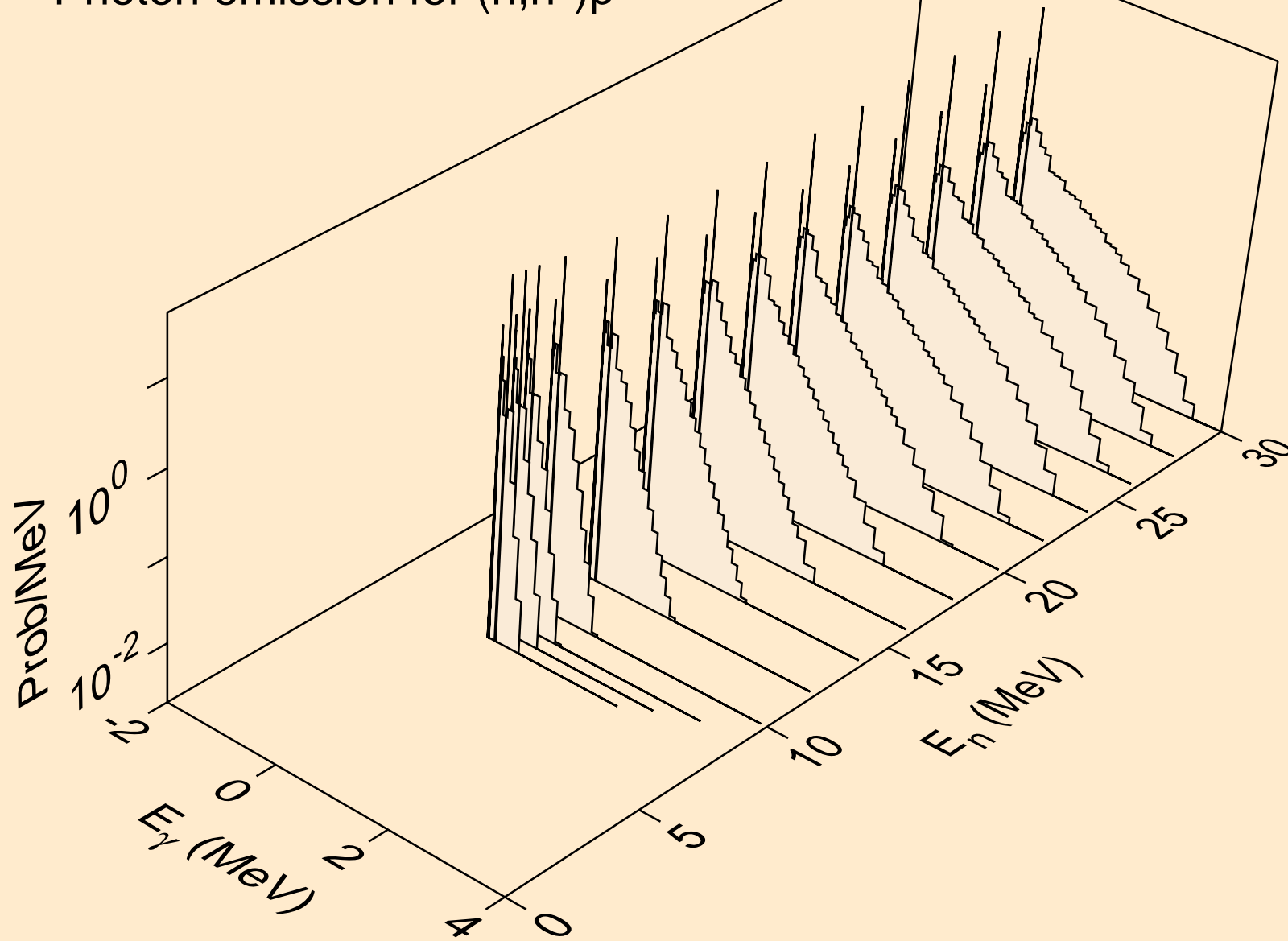

RF265 NEUTRON ACER TENDL-2024 LIBRARY; T=0.K
Photon emission for (n,n*)d

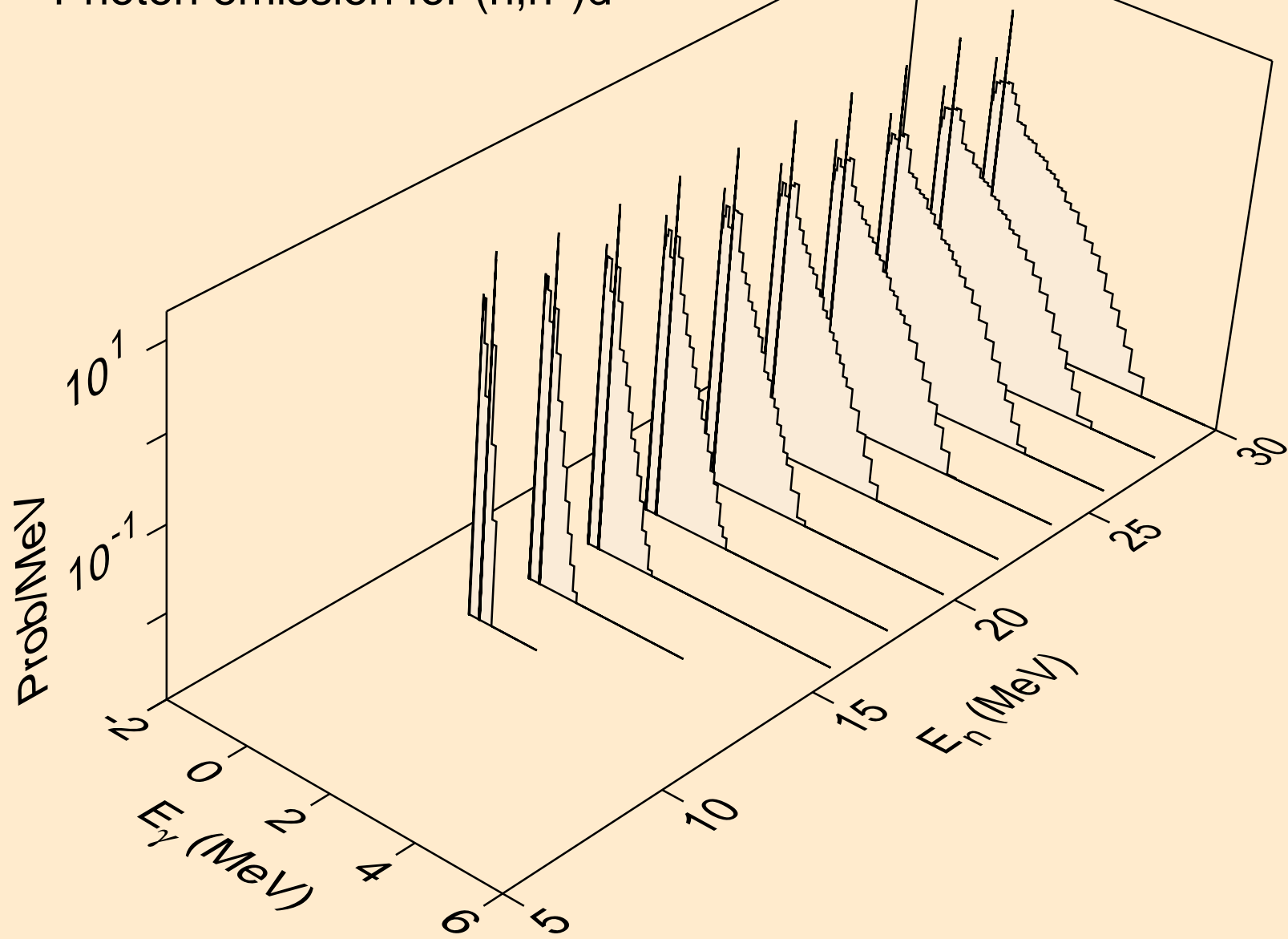

RF265 NEUTRON ACER TENDL-2024 LIBRARY; T=0.K
Photon emission for (n,n*)t

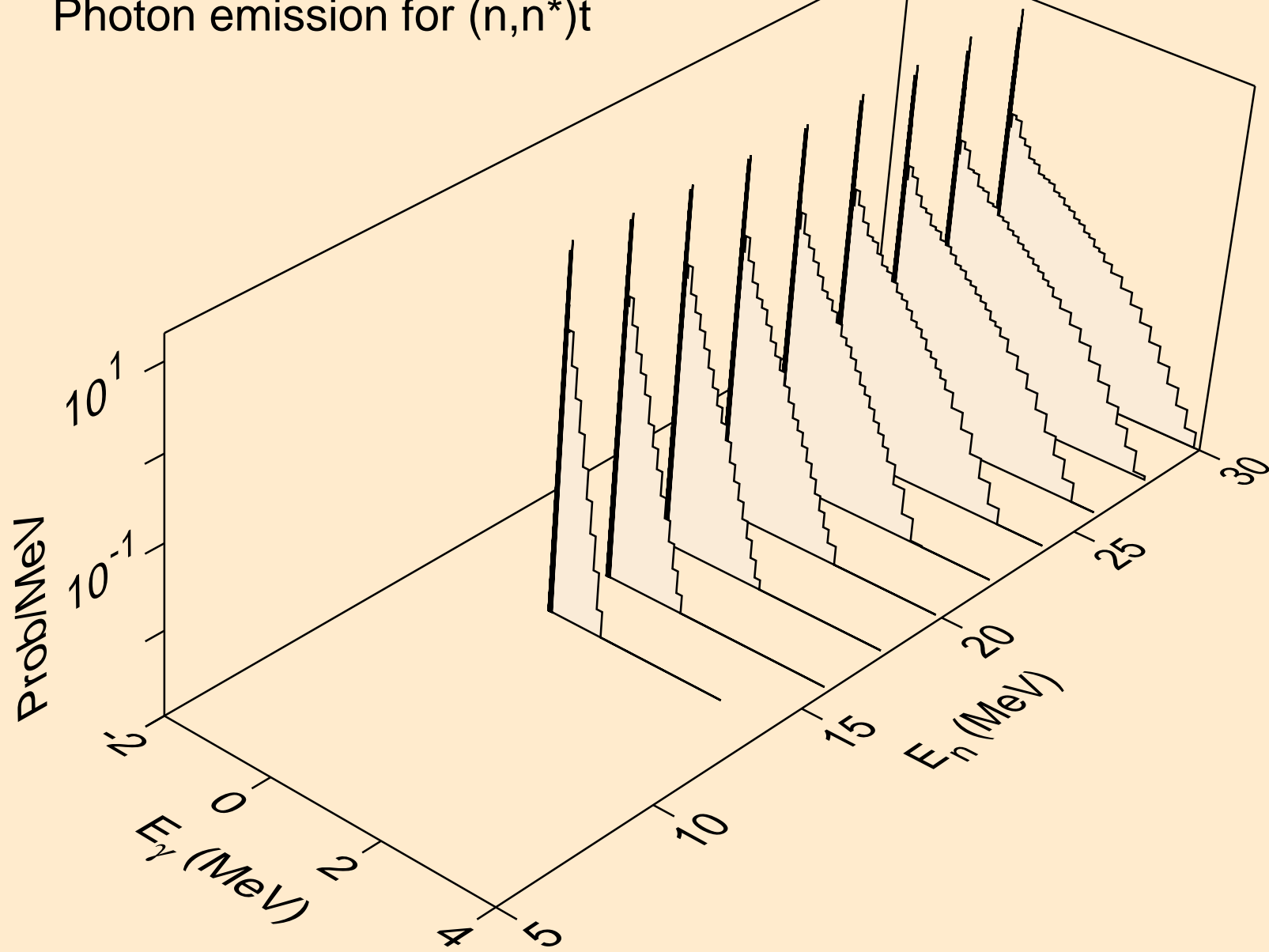

RF265 NEUTRON ACER TENDL-2024 LIBRARY; T=0.K
Photon emission for (n,n*)he3

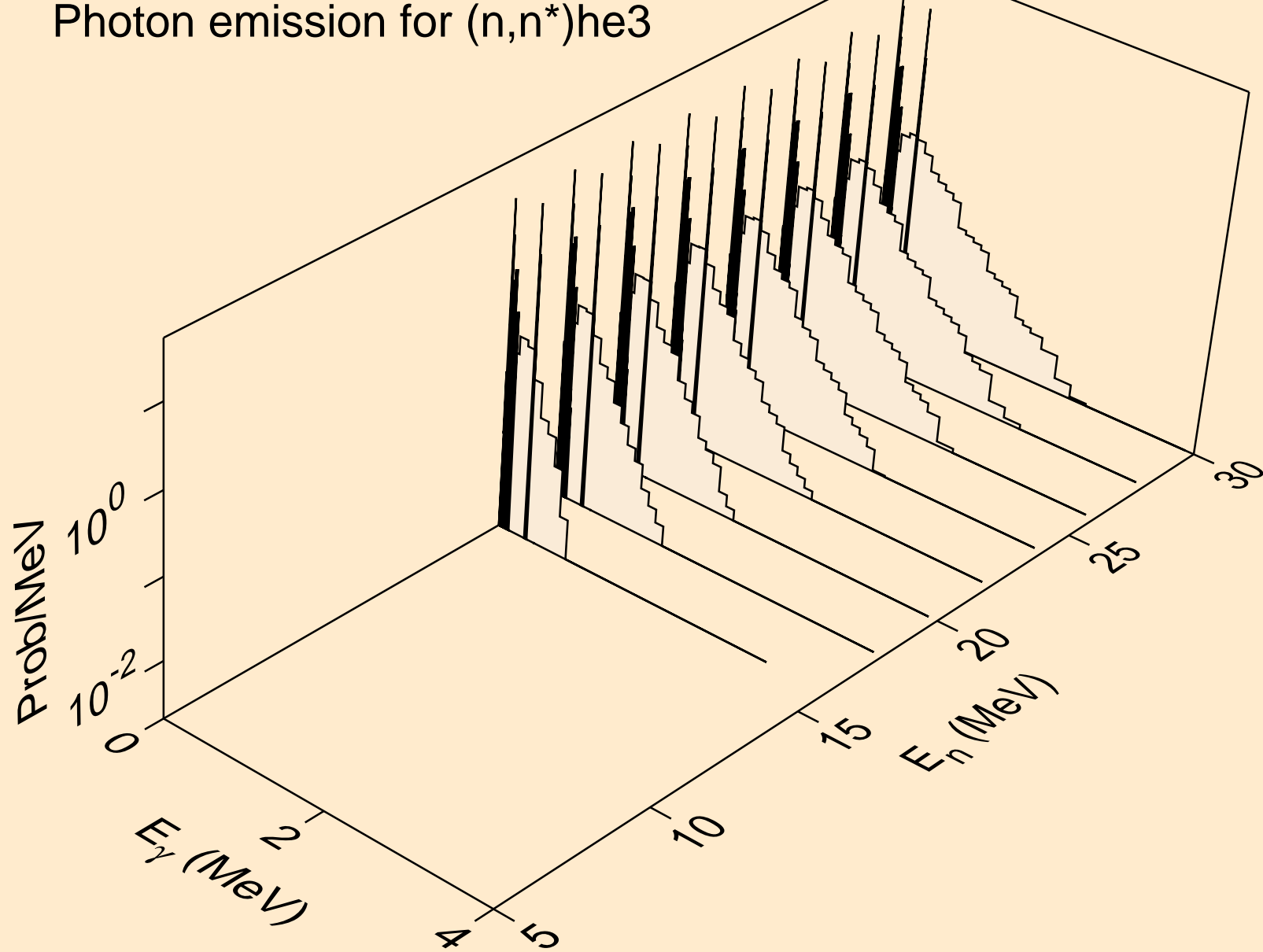

RF265 NEUTRON ACER TENDL-2024 LIBRARY; T=0.K
Photon emission for (n,4n)

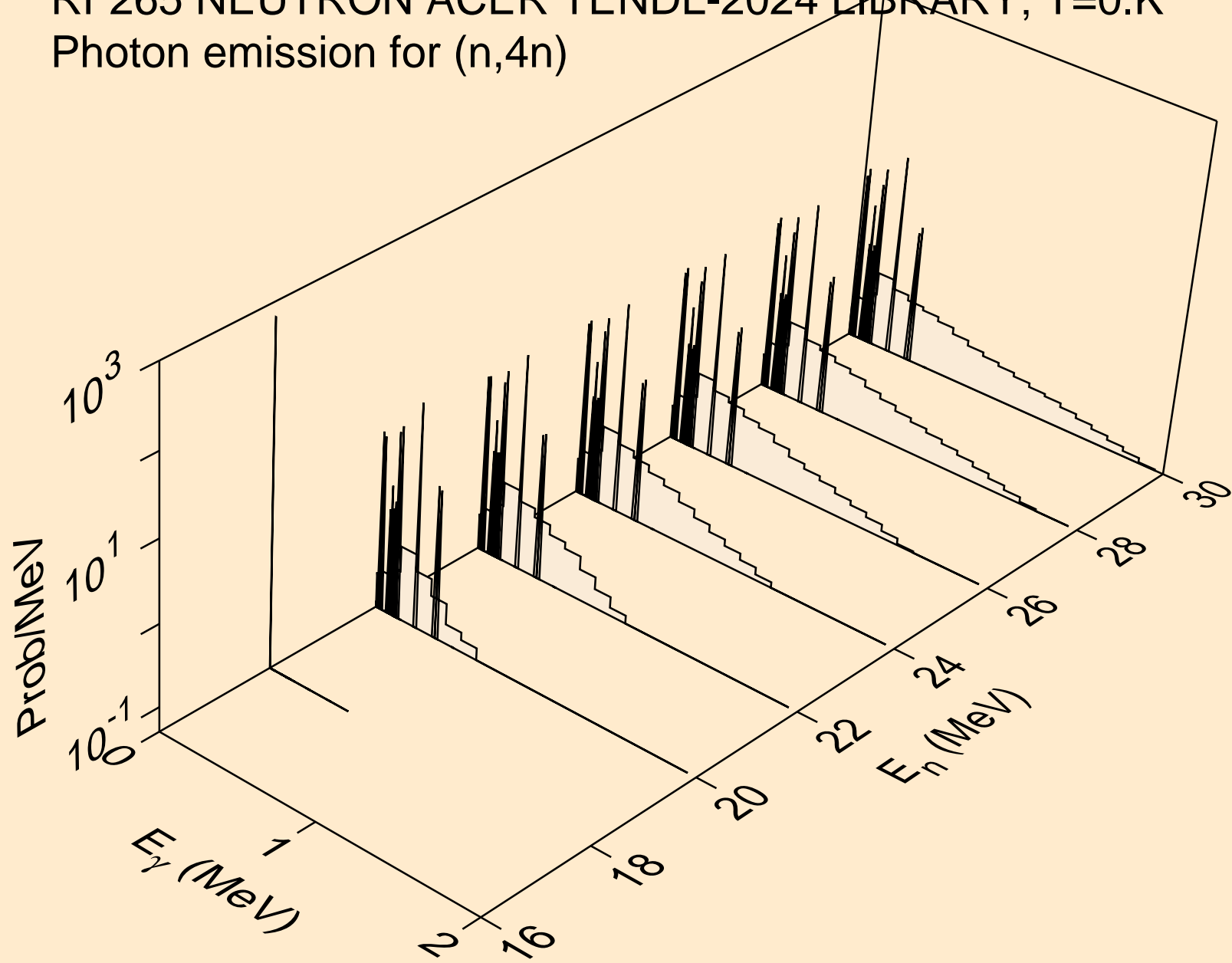

RF265 NEUTRON ACER TENDL-2024 LIBRARY; T=0.K
Photon emission for (n,2np)

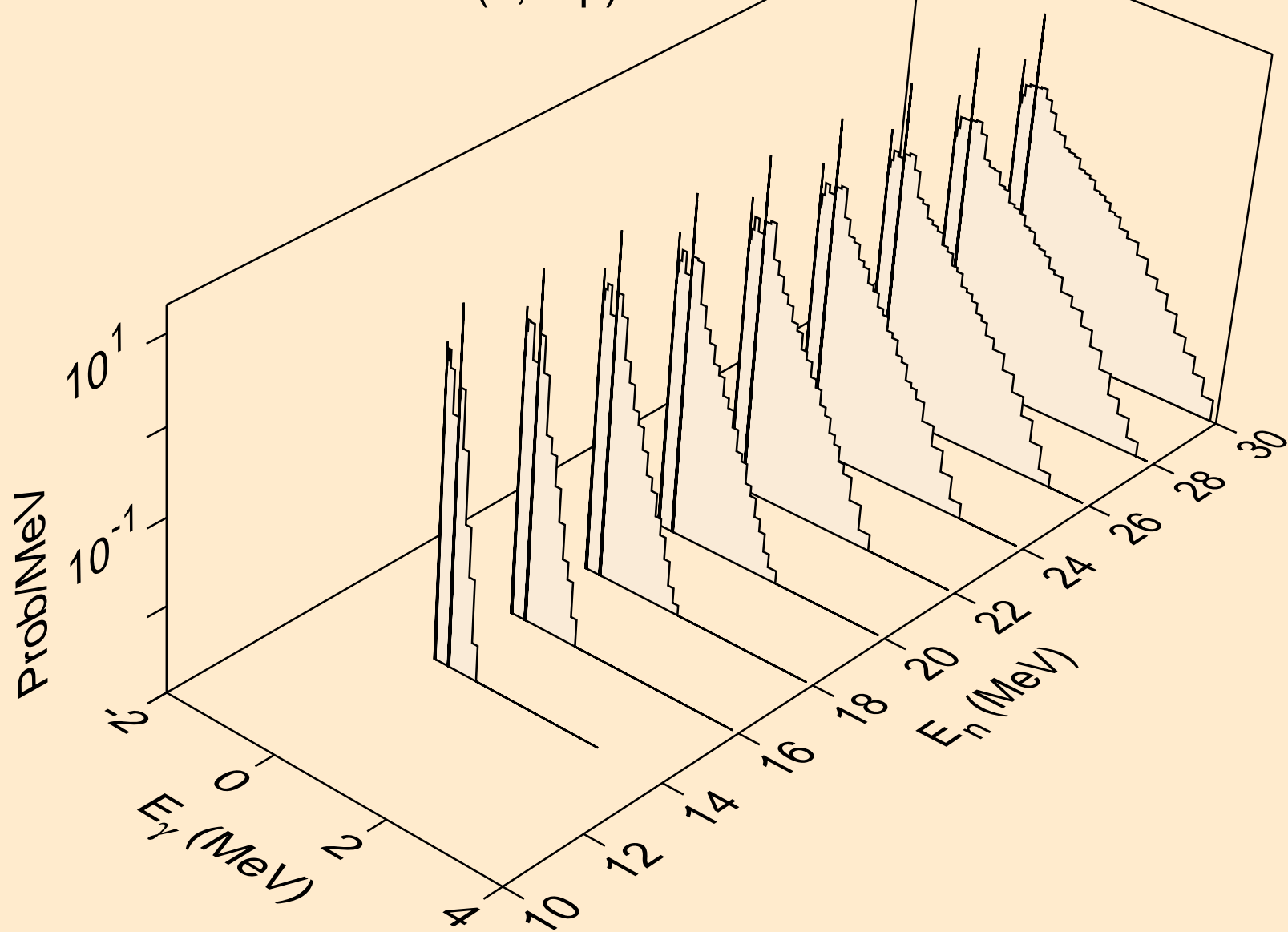

RF265 NEUTRON ACER TENDL-2024 LIBRARY; T=0.K
Photon emission for (n,3np)

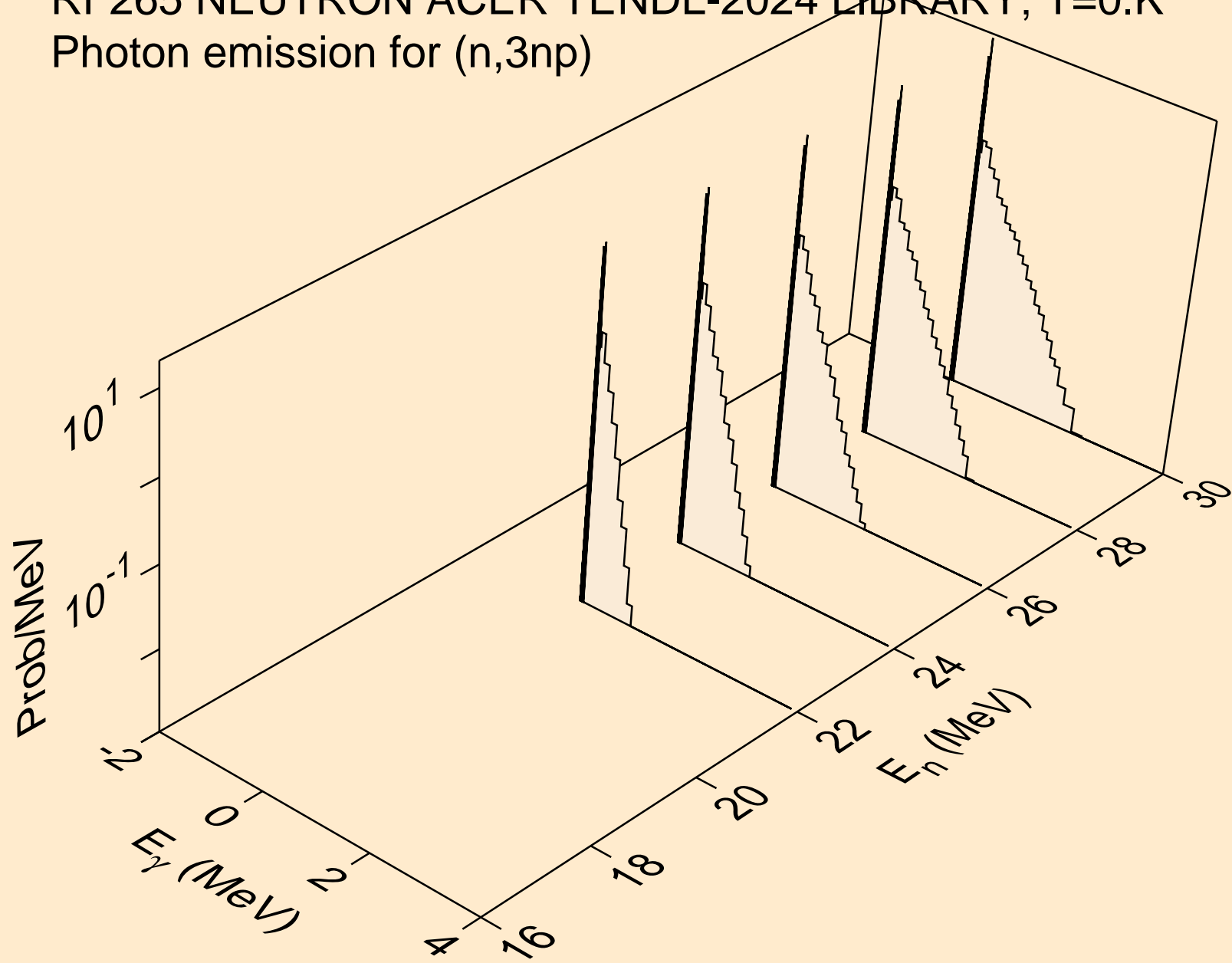

RF265 NEUTRON ACER TENDL-2024 LIBRARY; T=0.K
Photon emission for (n,n*c)

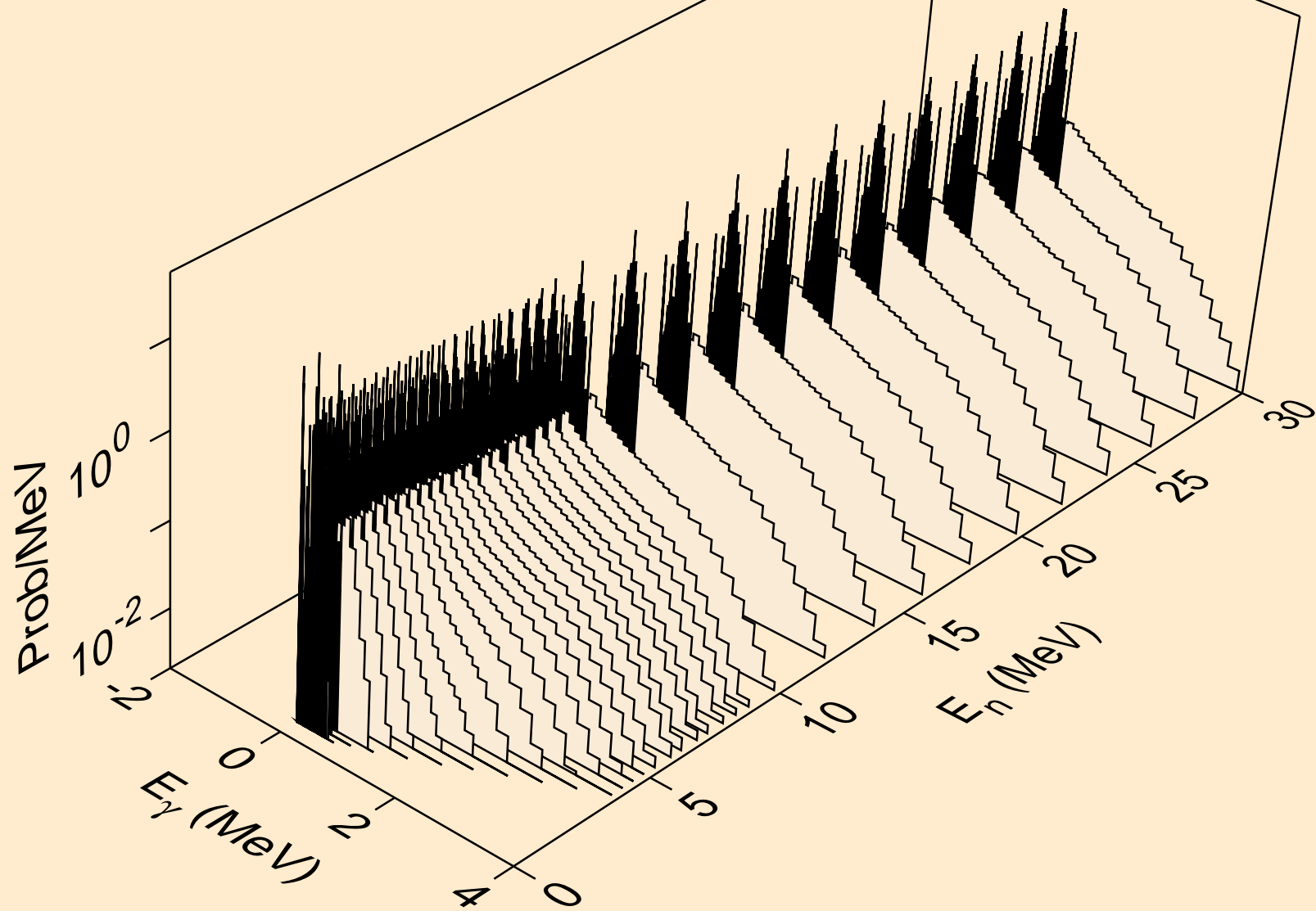

RF265 NEUTRON ACER TENDL-2024 LIBRARY; T=0.K
Photon emission for (n,gma)

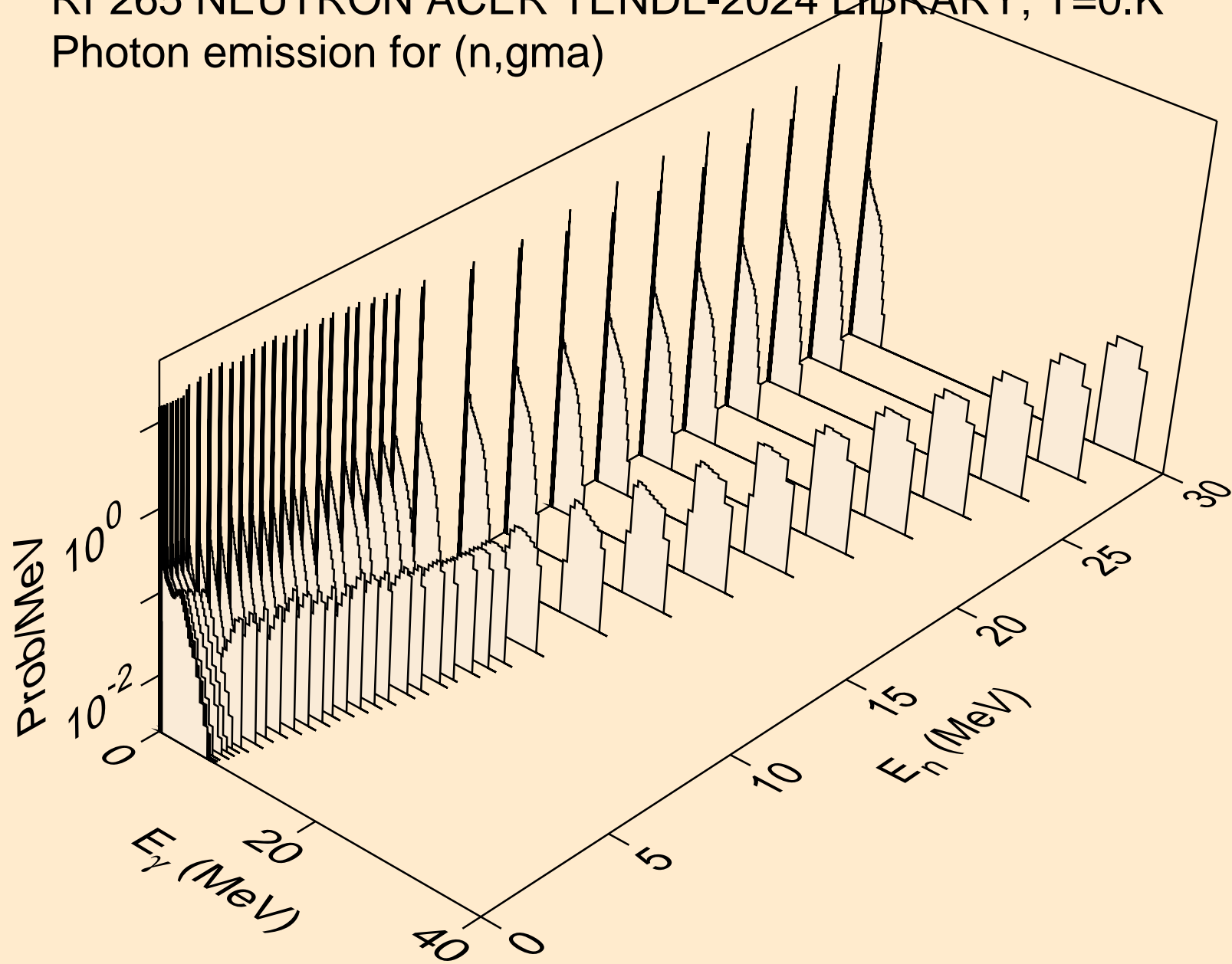

RF265 NEUTRON ACER TENDL-2024 LIBRARY; T=0.K
Photon emission for (n,p)

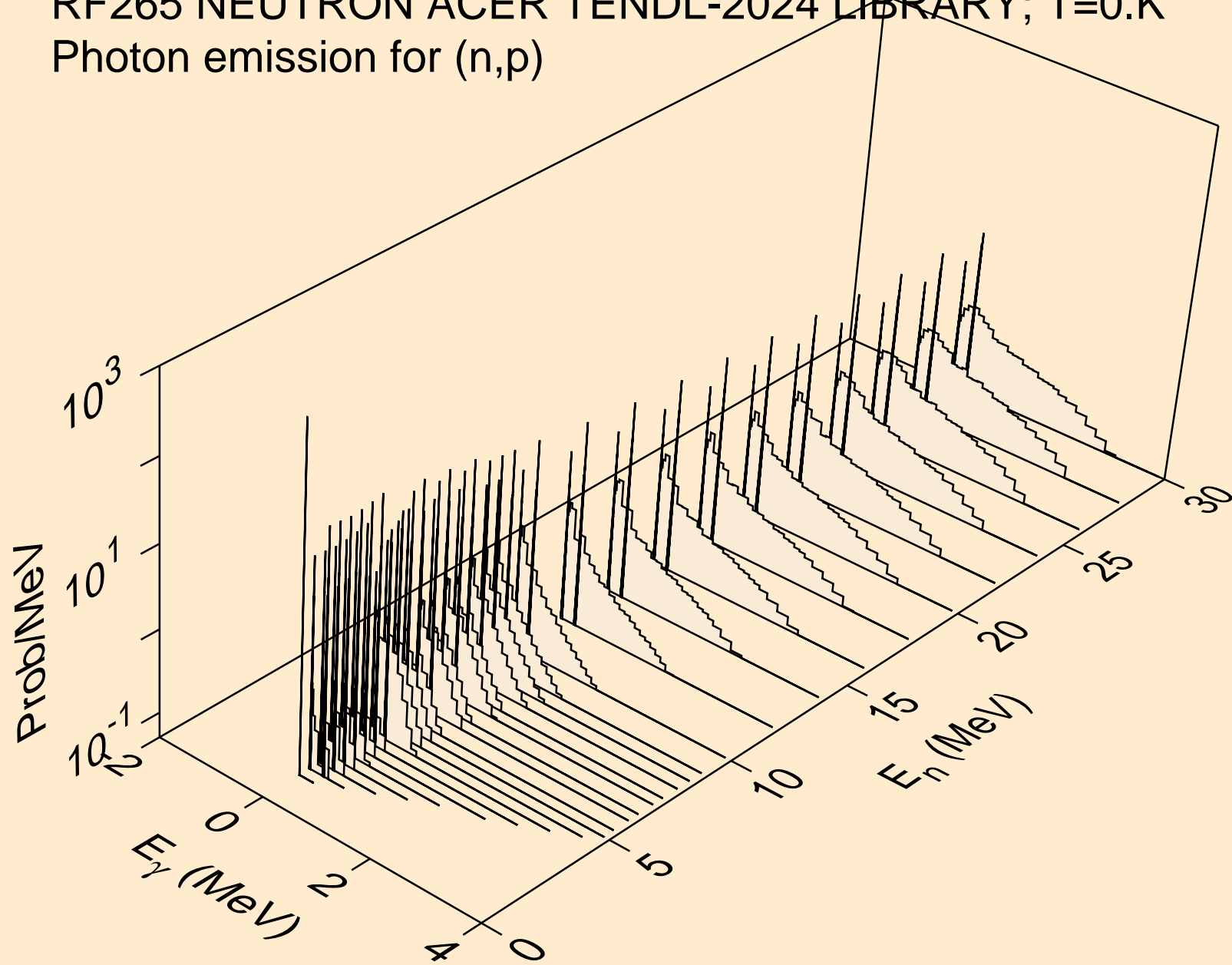

RF265 NEUTRON ACER TENDL-2024 LIBRARY; T=0.K
Photon emission for (n,d)

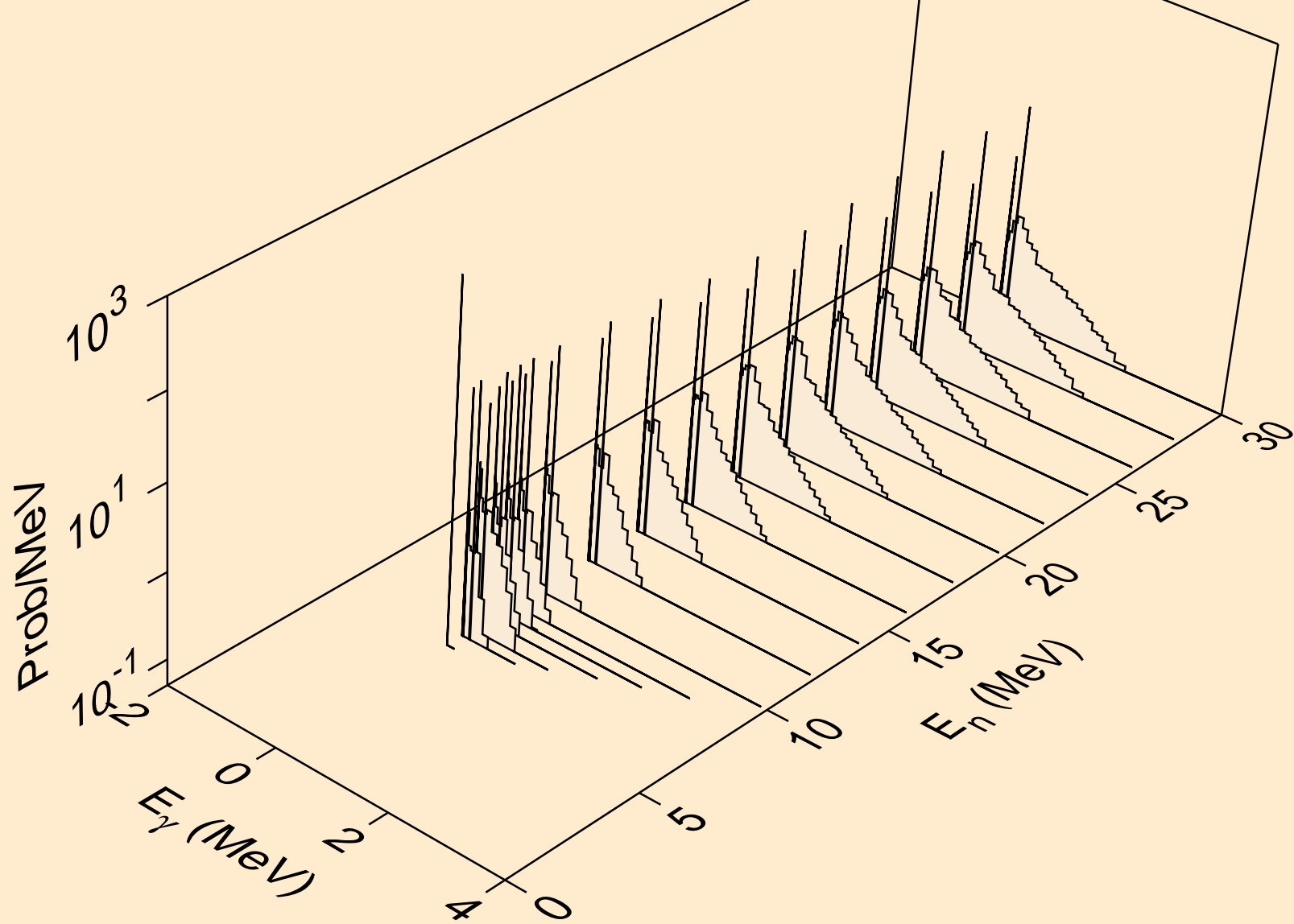

RF265 NEUTRON ACER TENDL-2024 LIBRARY; T=0.K
Photon emission for (n,t)

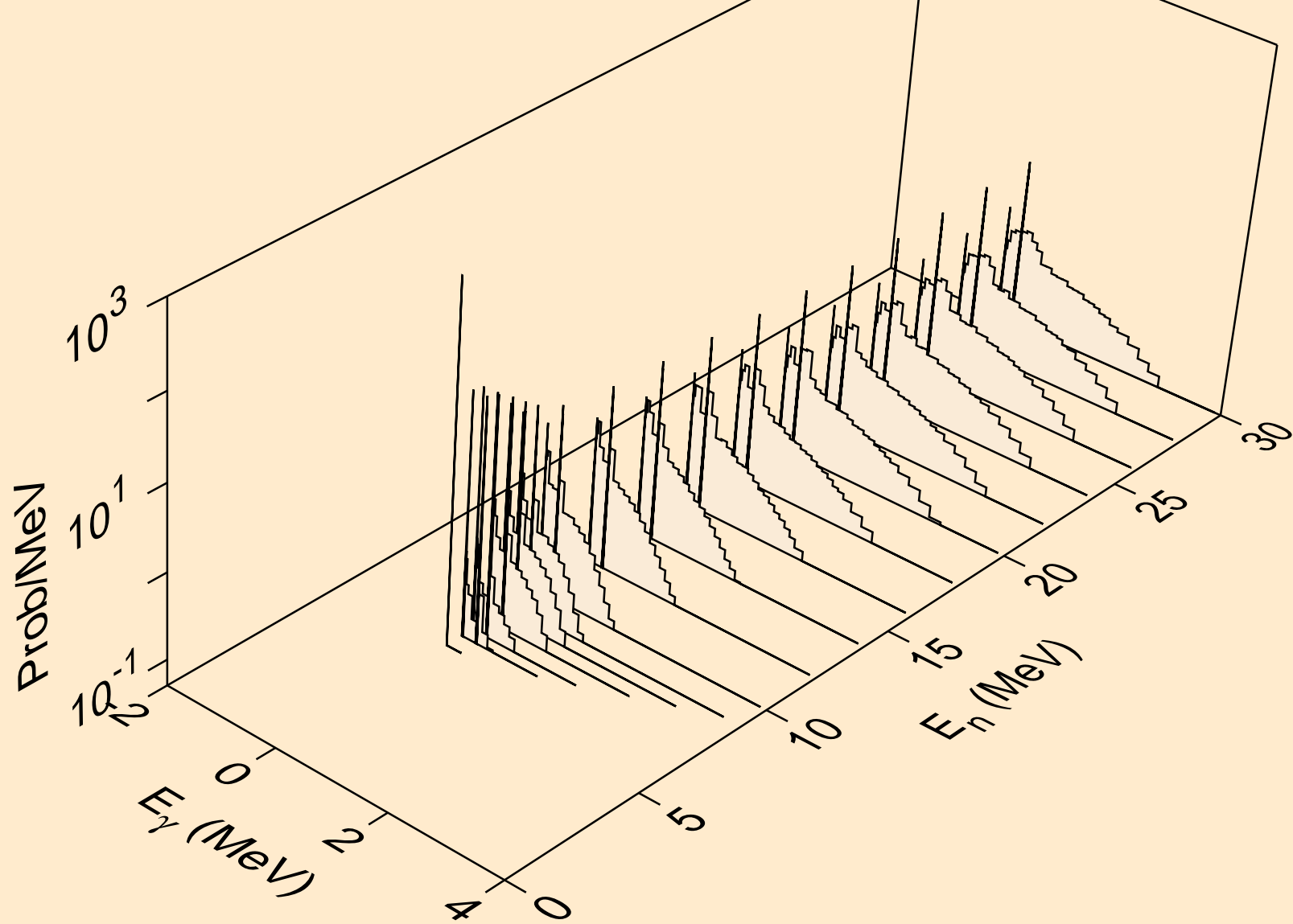

RF265 NEUTRON ACER TENDL-2024 LIBRARY; T=0.K
Photon emission for (n,he3)

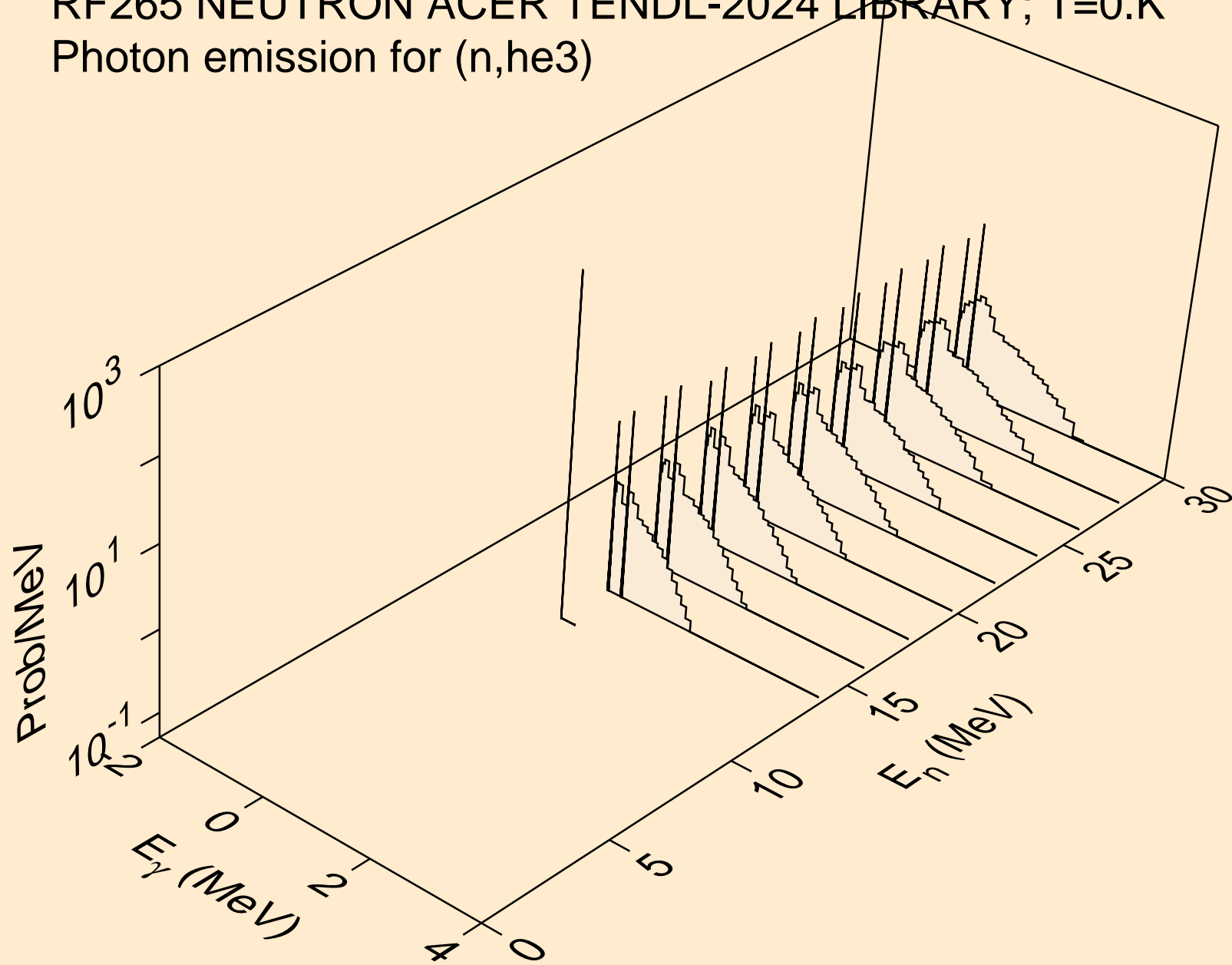

RF265 NEUTRON ACER TENDL-2024 LIBRARY; T=0.K
Photon emission for (n,a)

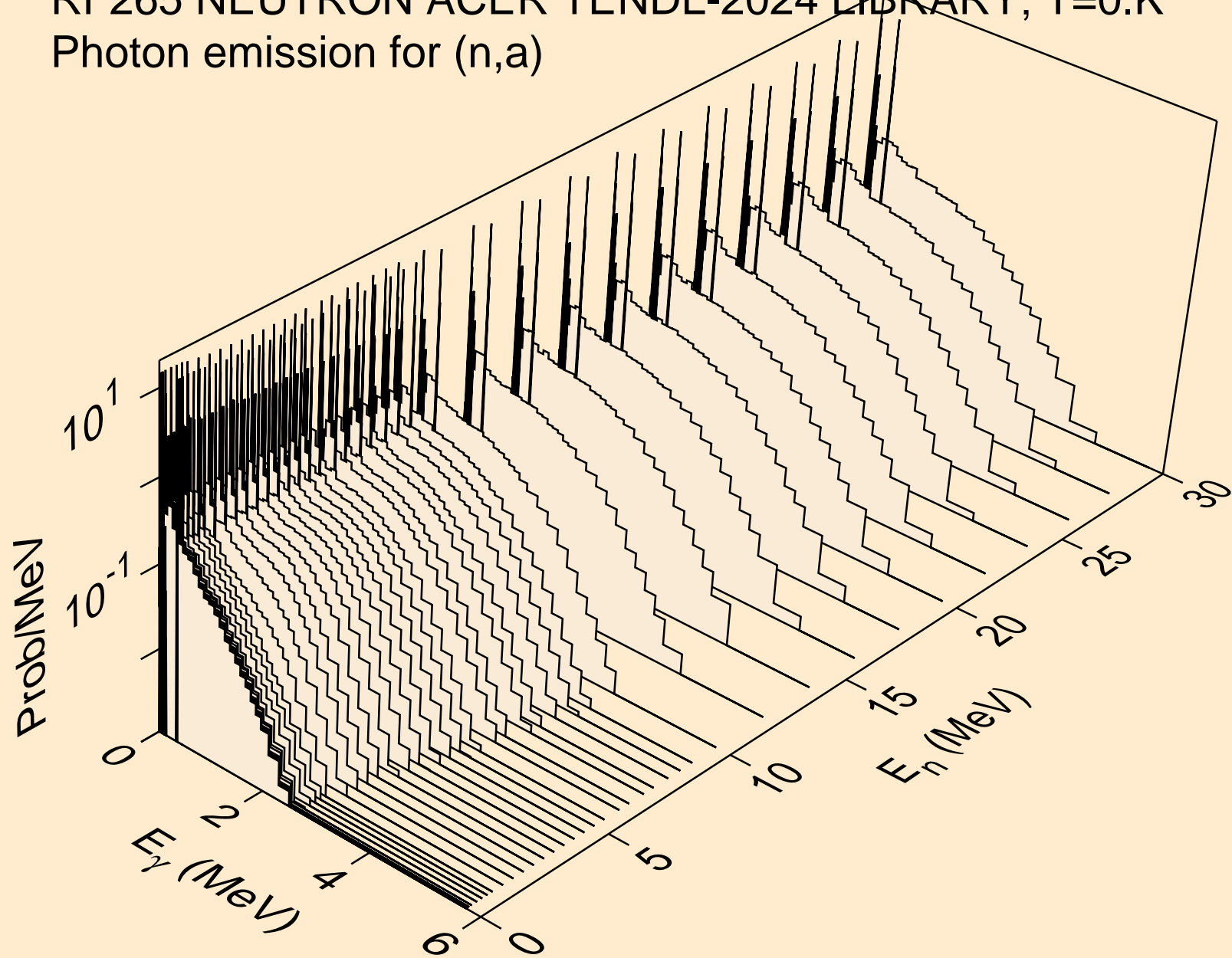

RF265 NEUTRON ACER TENDL-2024 LIBRARY; T=0.K
Photon emission for (n,2p)

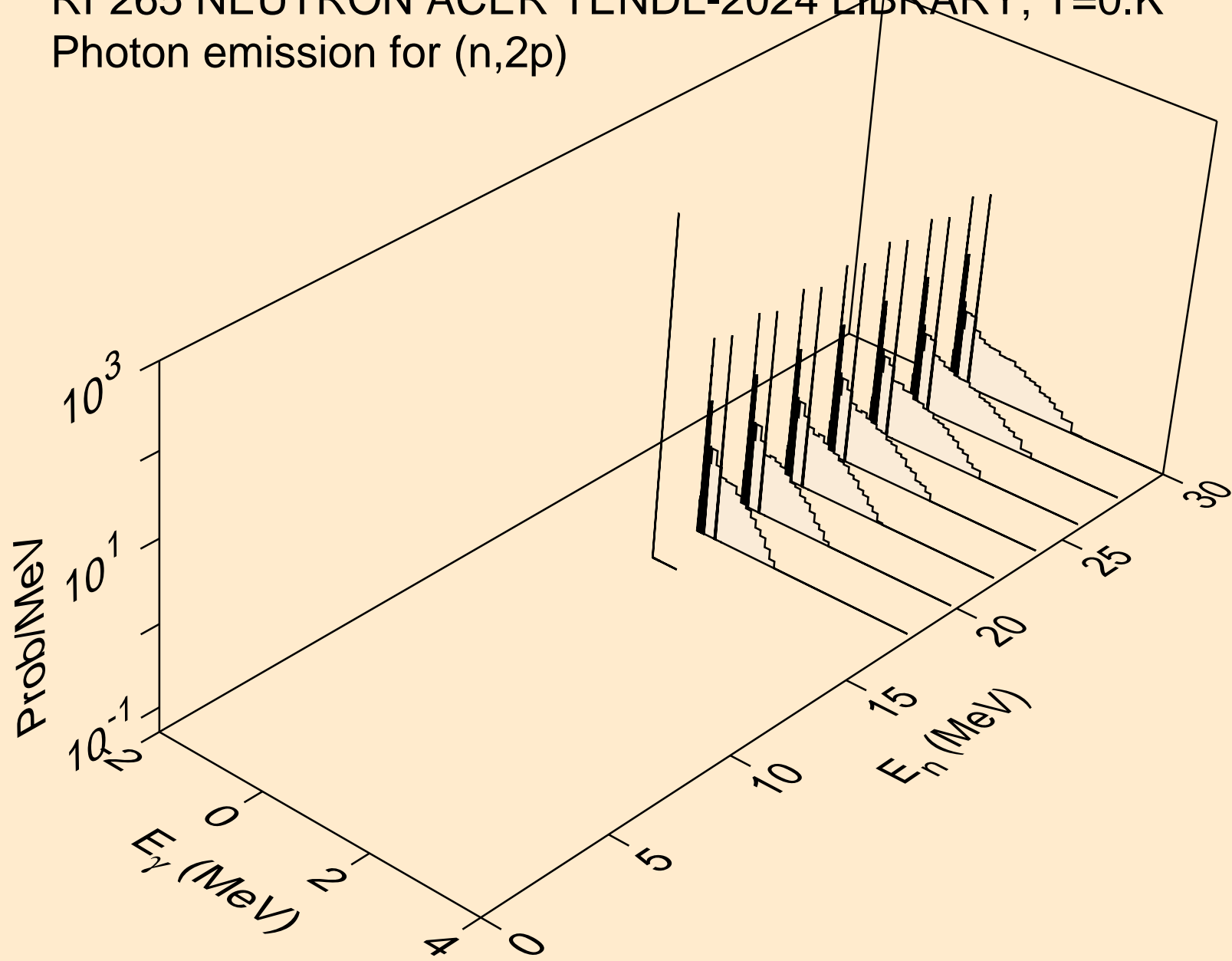

RF265 NEUTRON ACER TENDL-2024 LIBRARY; T=0.K
thermal capture photon spectrum

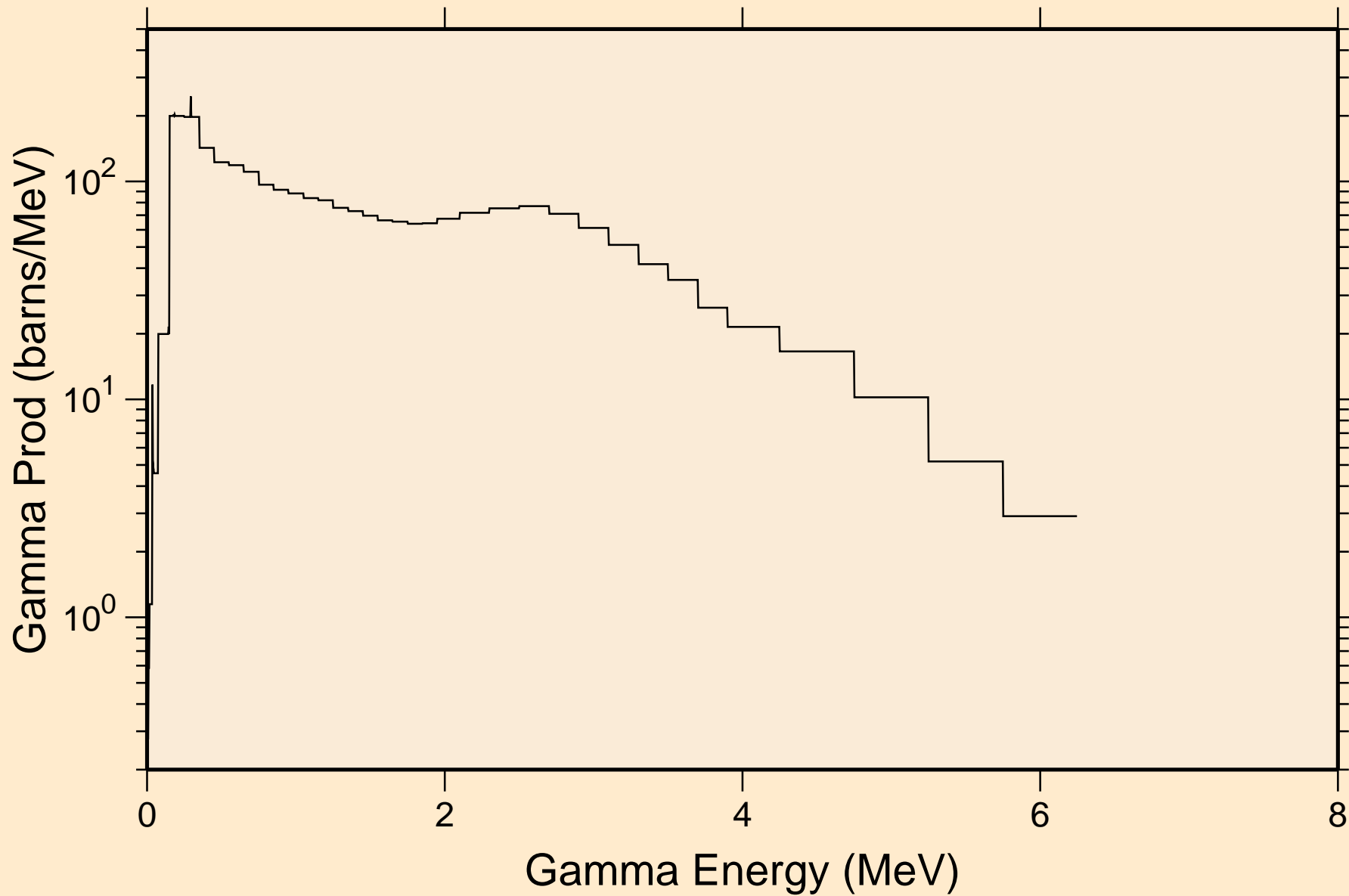

RF265 NEUTRON ACER TENDL-2024 LIBRARY; T=0.K
14 MeV photon spectrum

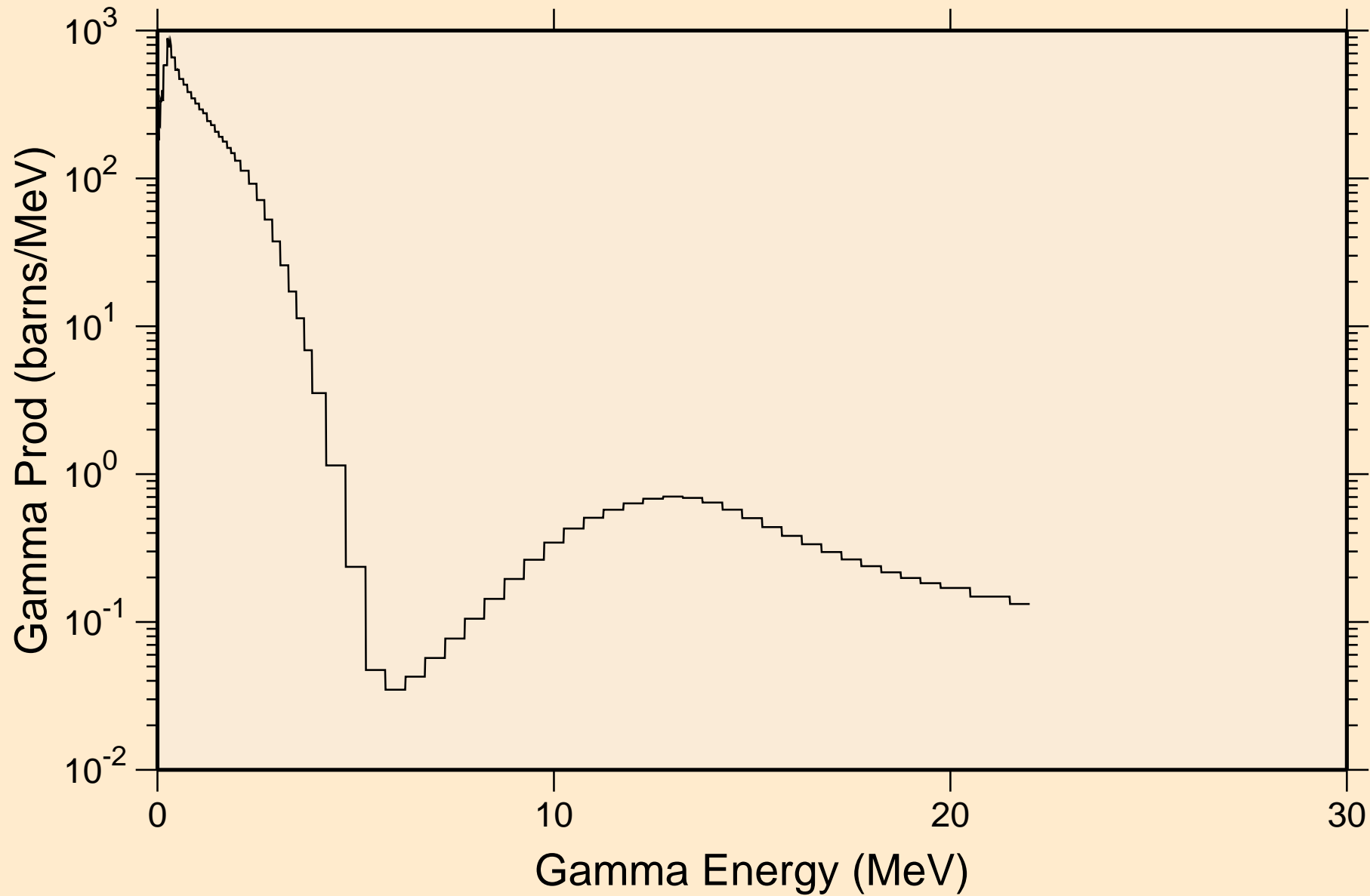

RF265 NEUTRON ACER TENDL-2024 LIBRARY; T=0.K

Particle heating contributions

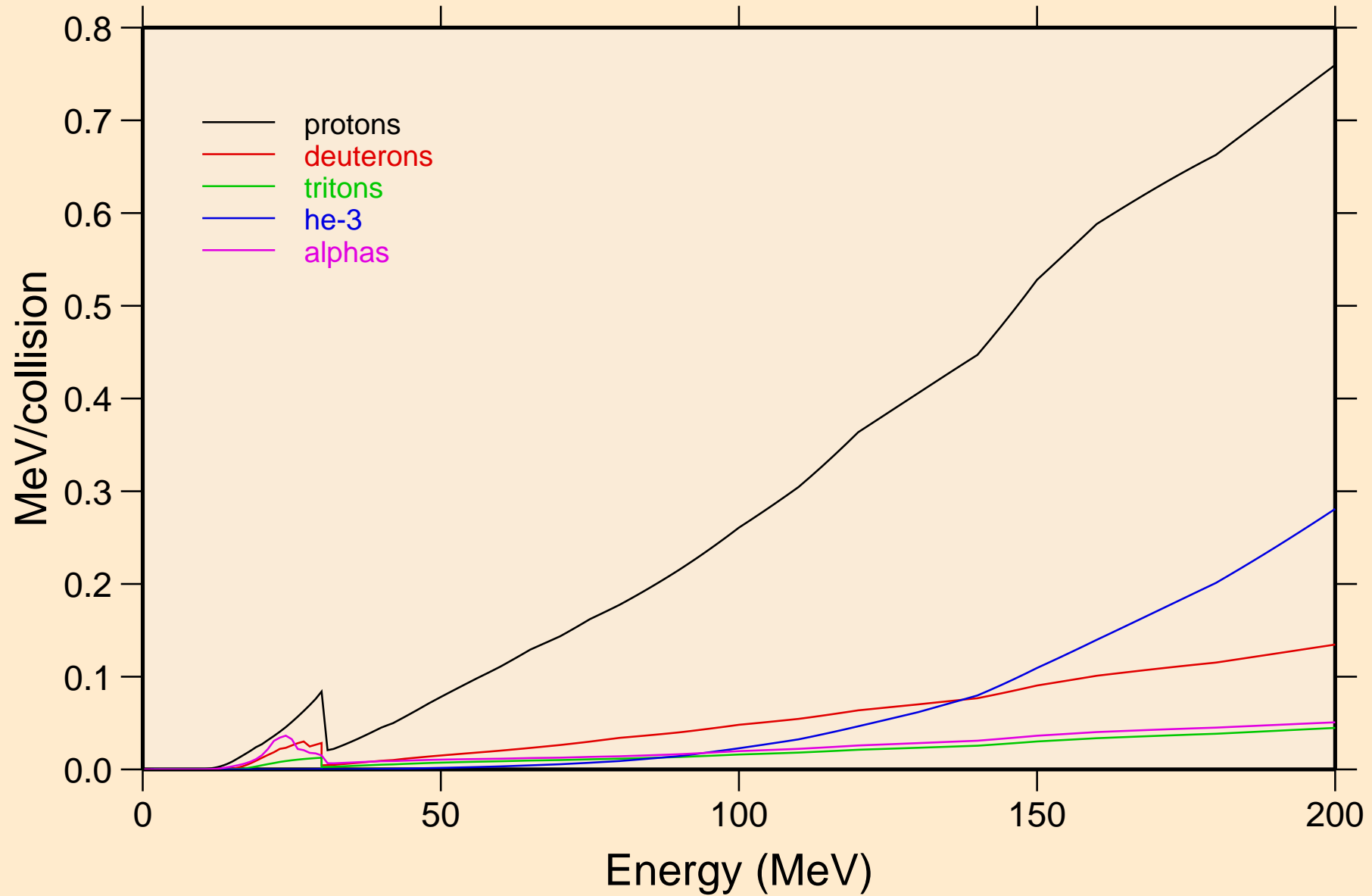

RF265 NEUTRON ACER TENDL-2024 LIBRARY; T=0.K
Recoil Heating

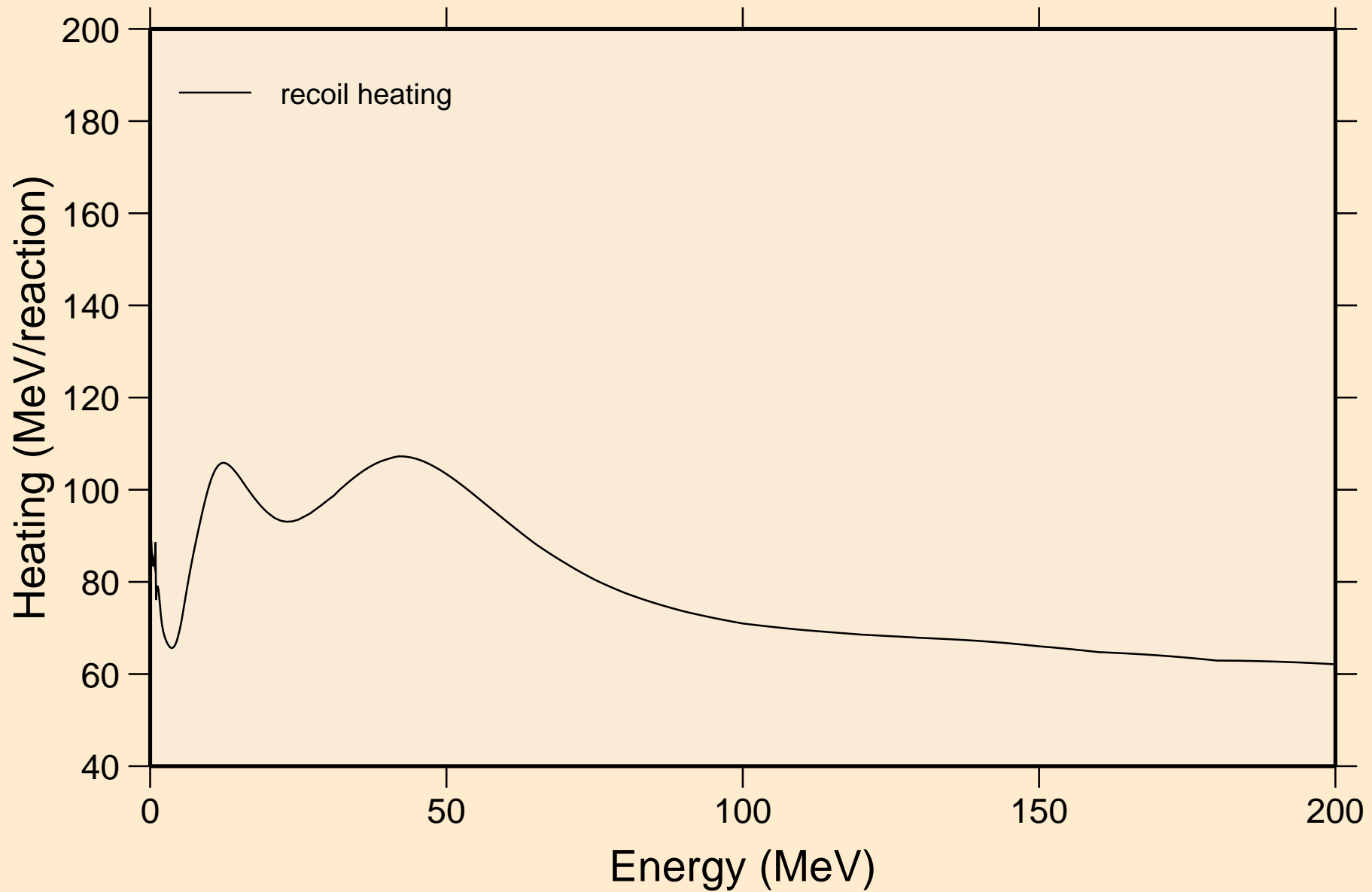

RF265 NEUTRON ACER TENDL-2024 LIBRARY; T=0.K

Particle production cross sections

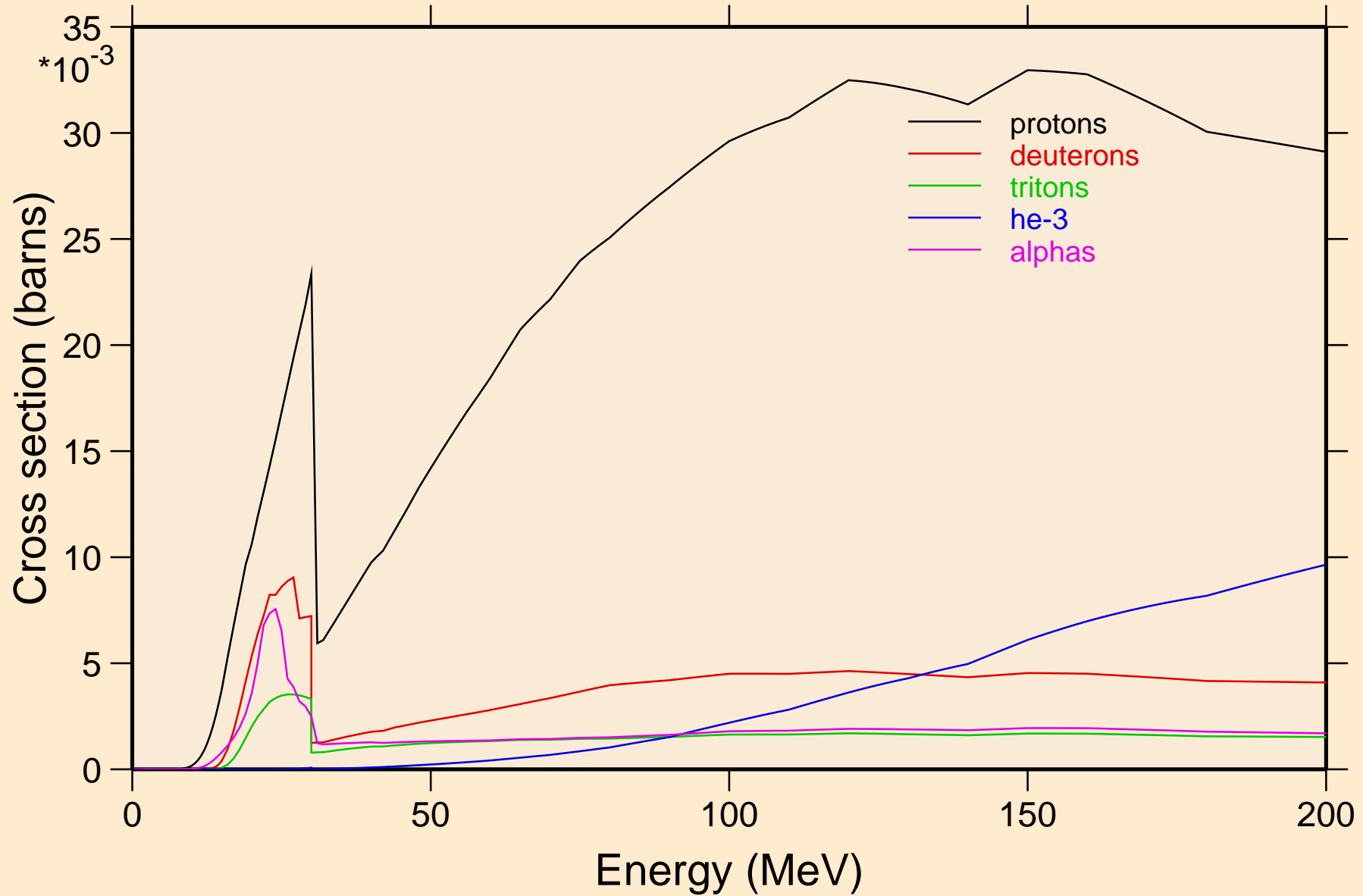

RF265 NEUTRON ACER TENDL-2024 LIBRARY; T=0.K
protons from (n,x)

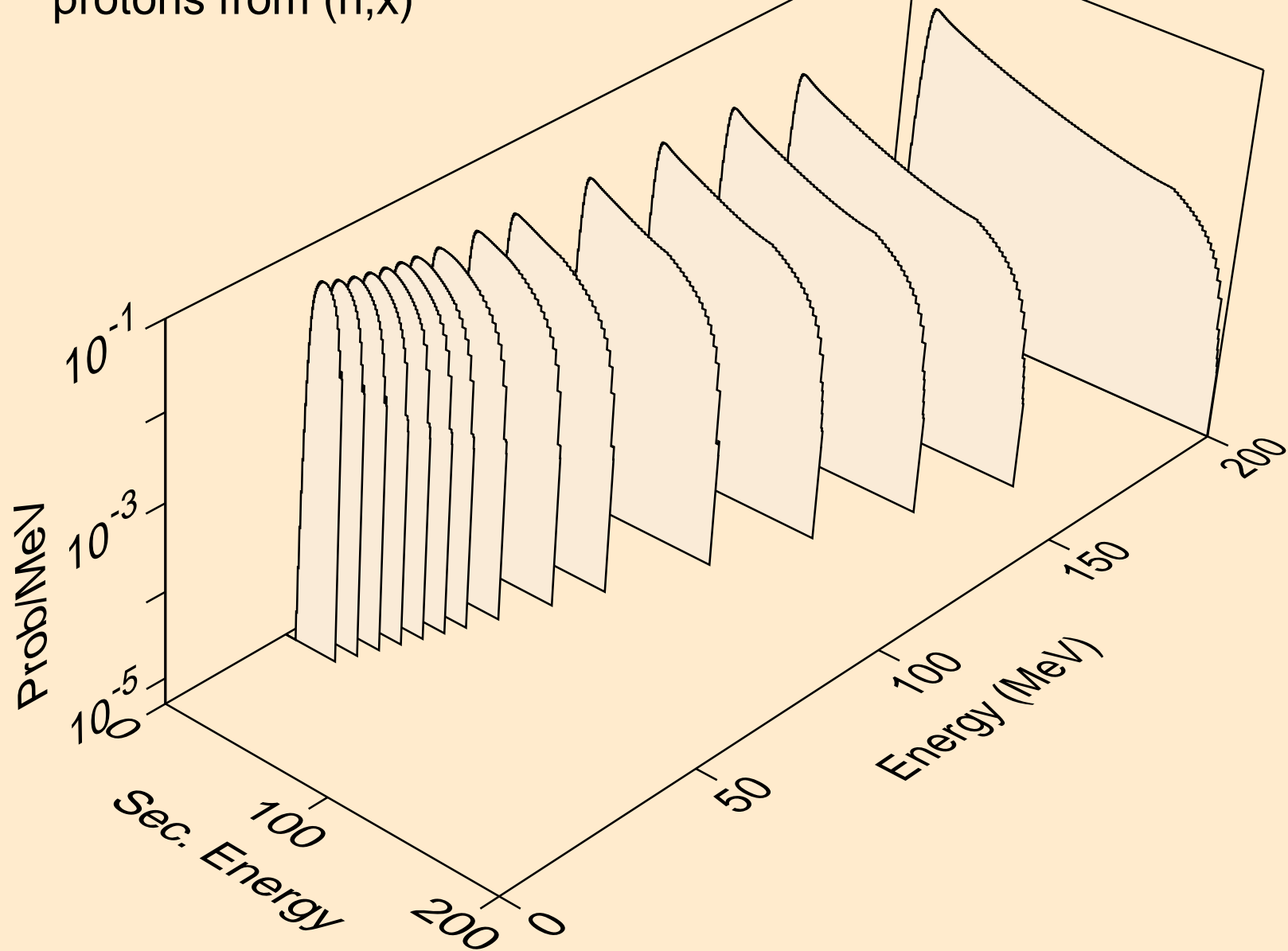

RF265 NEUTRON ACER TENDL-2024 LIBRARY; T=0.K
protons from (n,n*)p

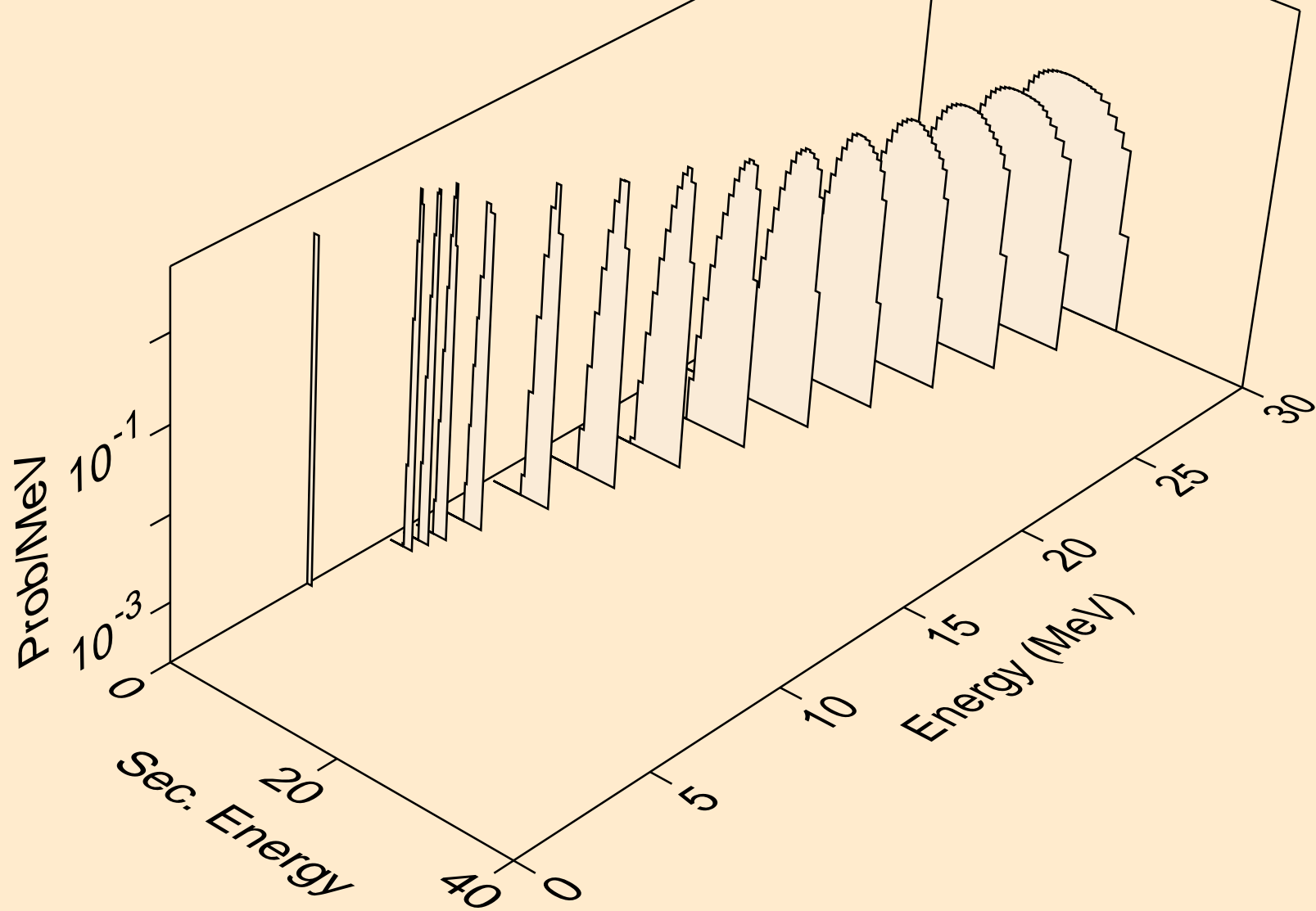

RF265 NEUTRON ACER TENDL-2024 LIBRARY; T=0.K
protons from (n,2np)

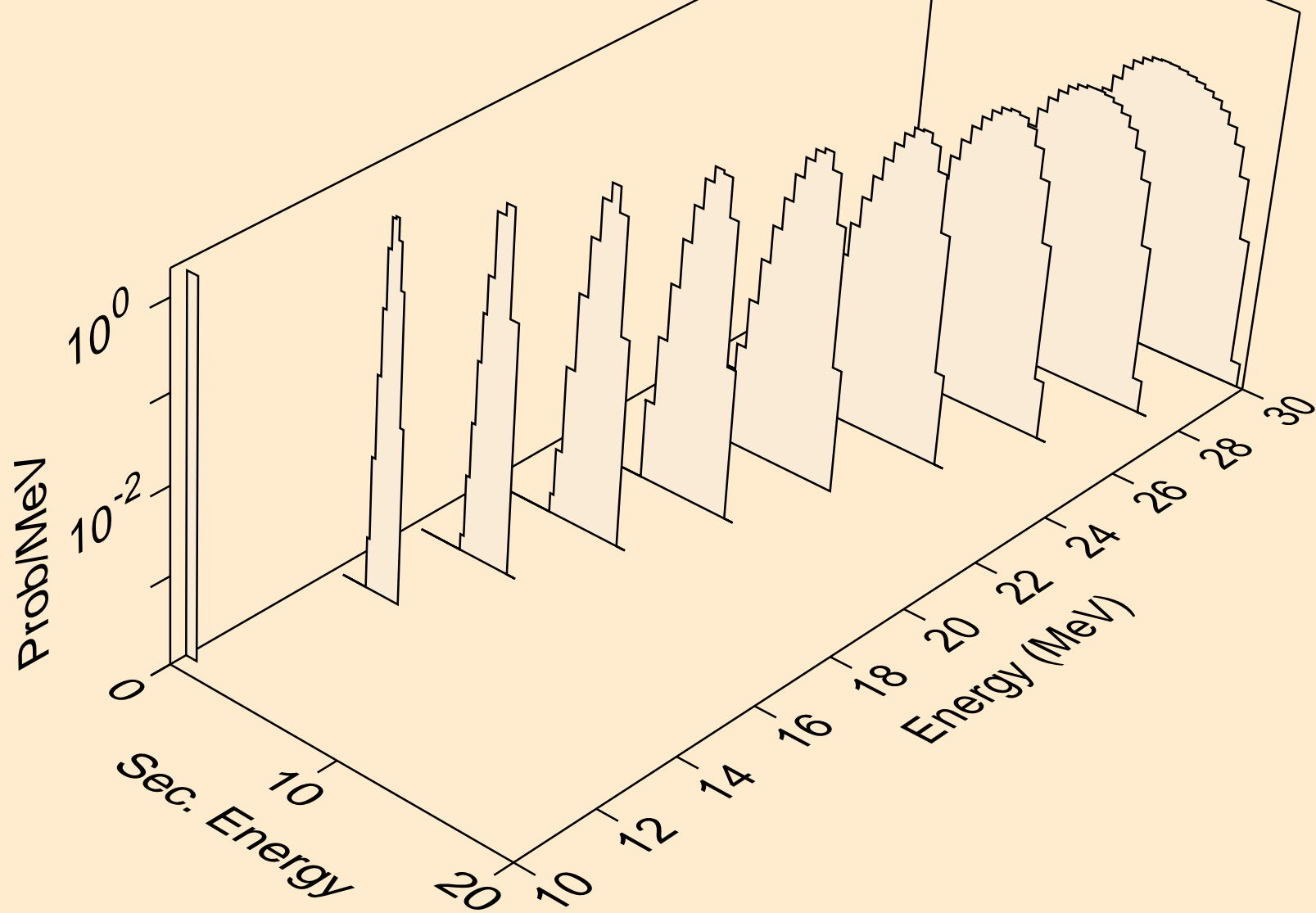

RF265 NEUTRON ACER TENDL-2024 LIBRARY; T=0.K
protons from (n,3np)

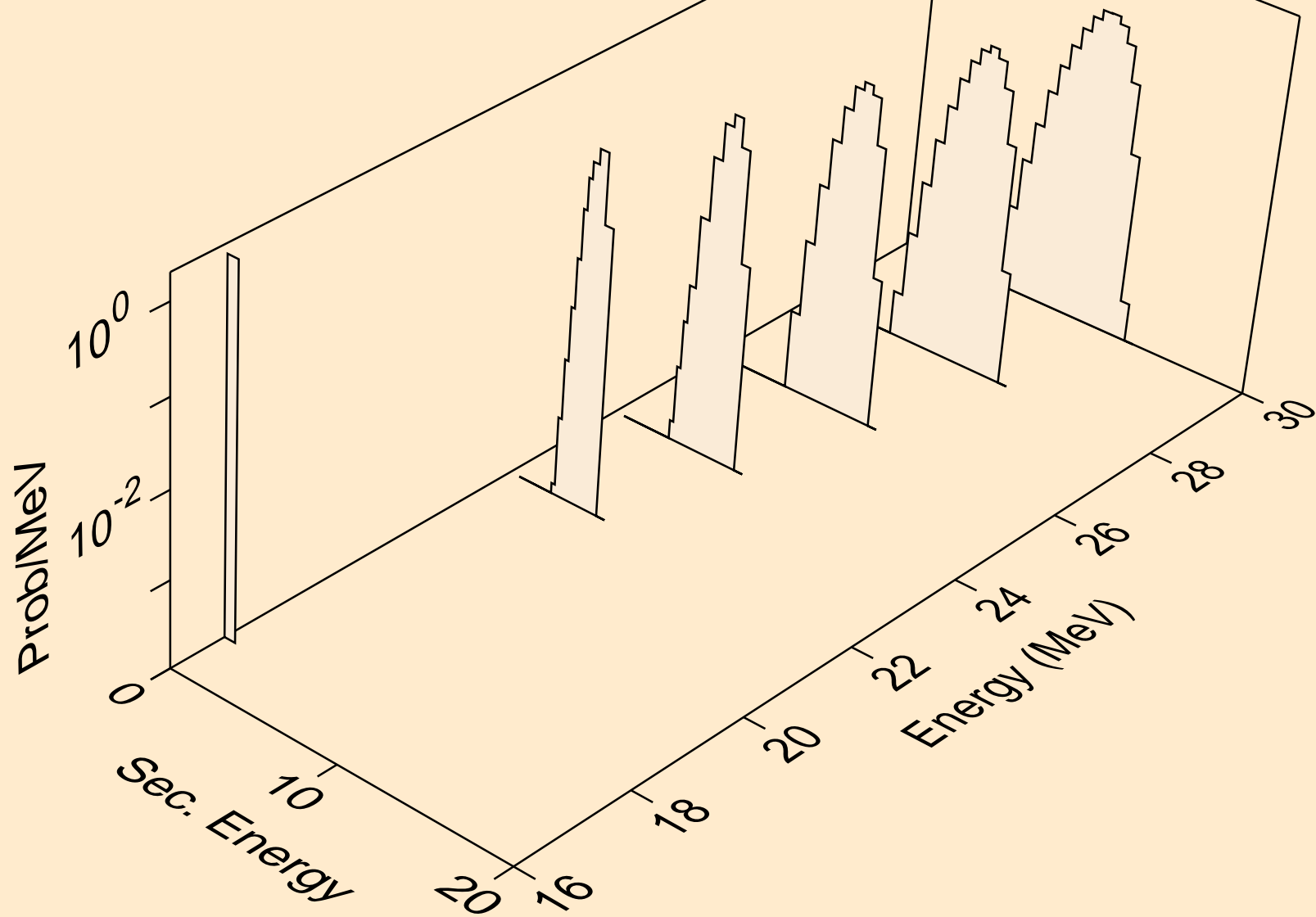

RF265 NEUTRON ACER TENDL-2024 LIBRARY; T=0.K
protons from (n,p)

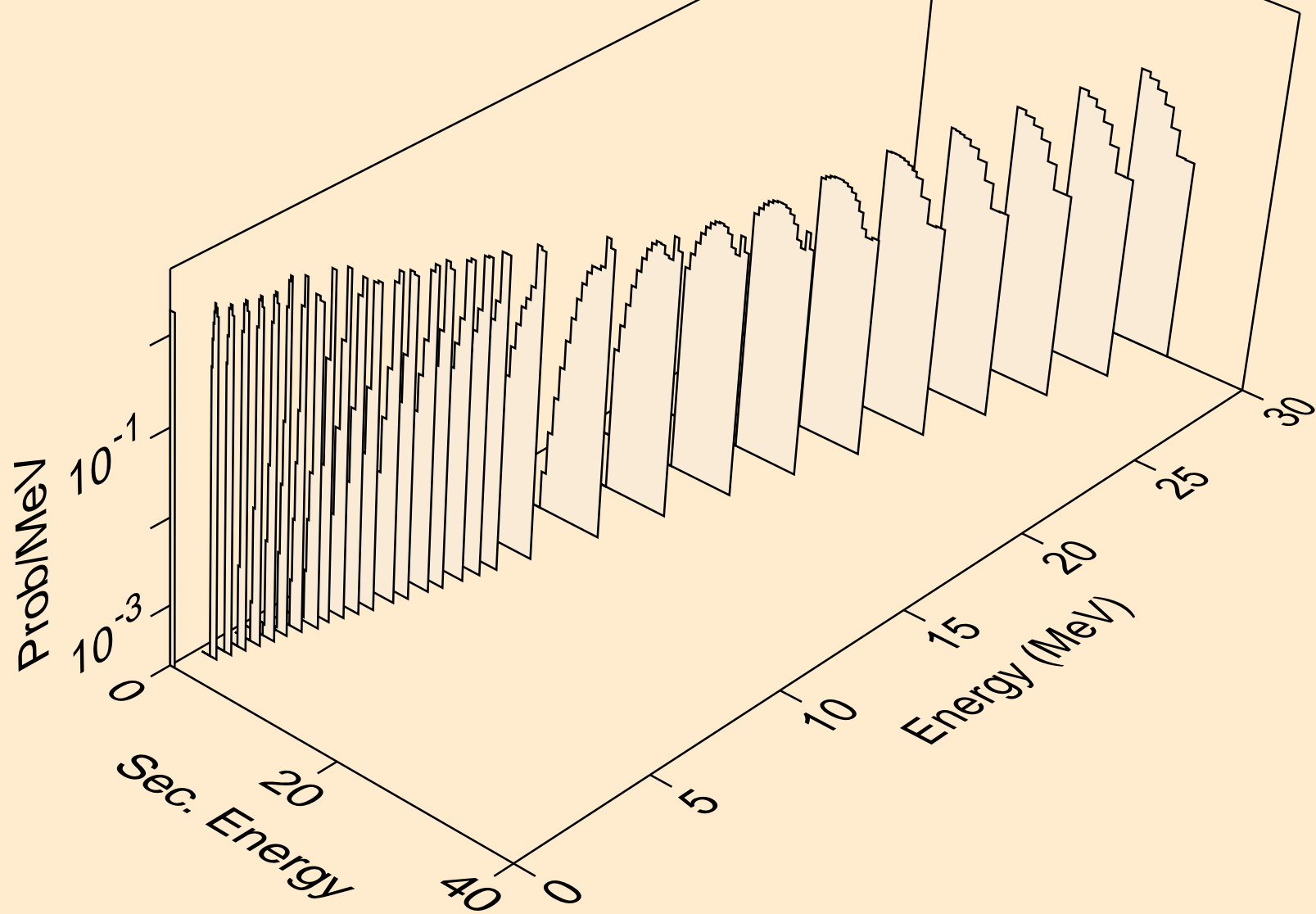

RF265 NEUTRON ACER TENDL-2024 LIBRARY; T=0.K
protons from (n,2p)

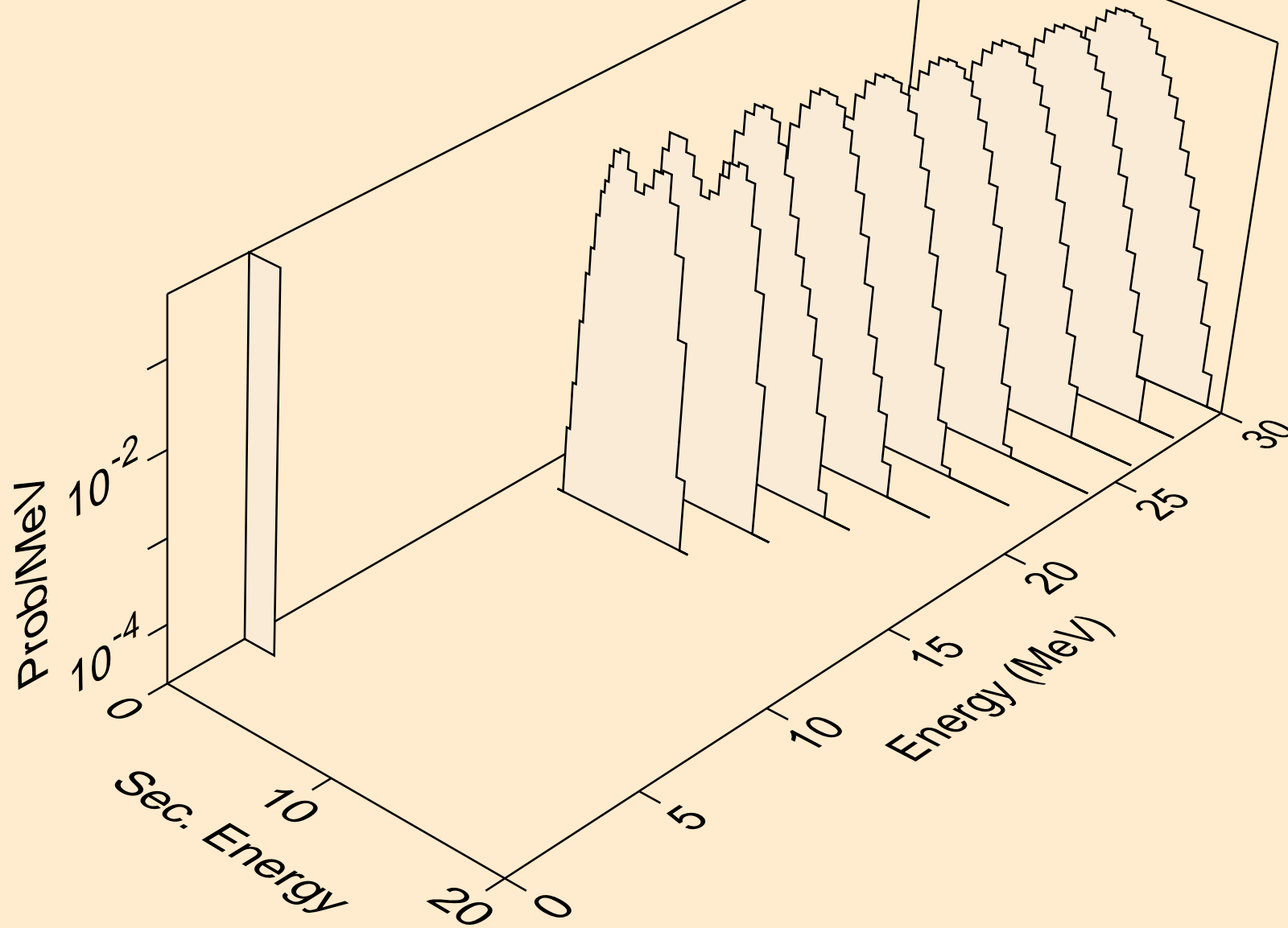

RF265 NEUTRON ACER TENDL-2024 LIBRARY; T=0.K
deuterons from (n,x)

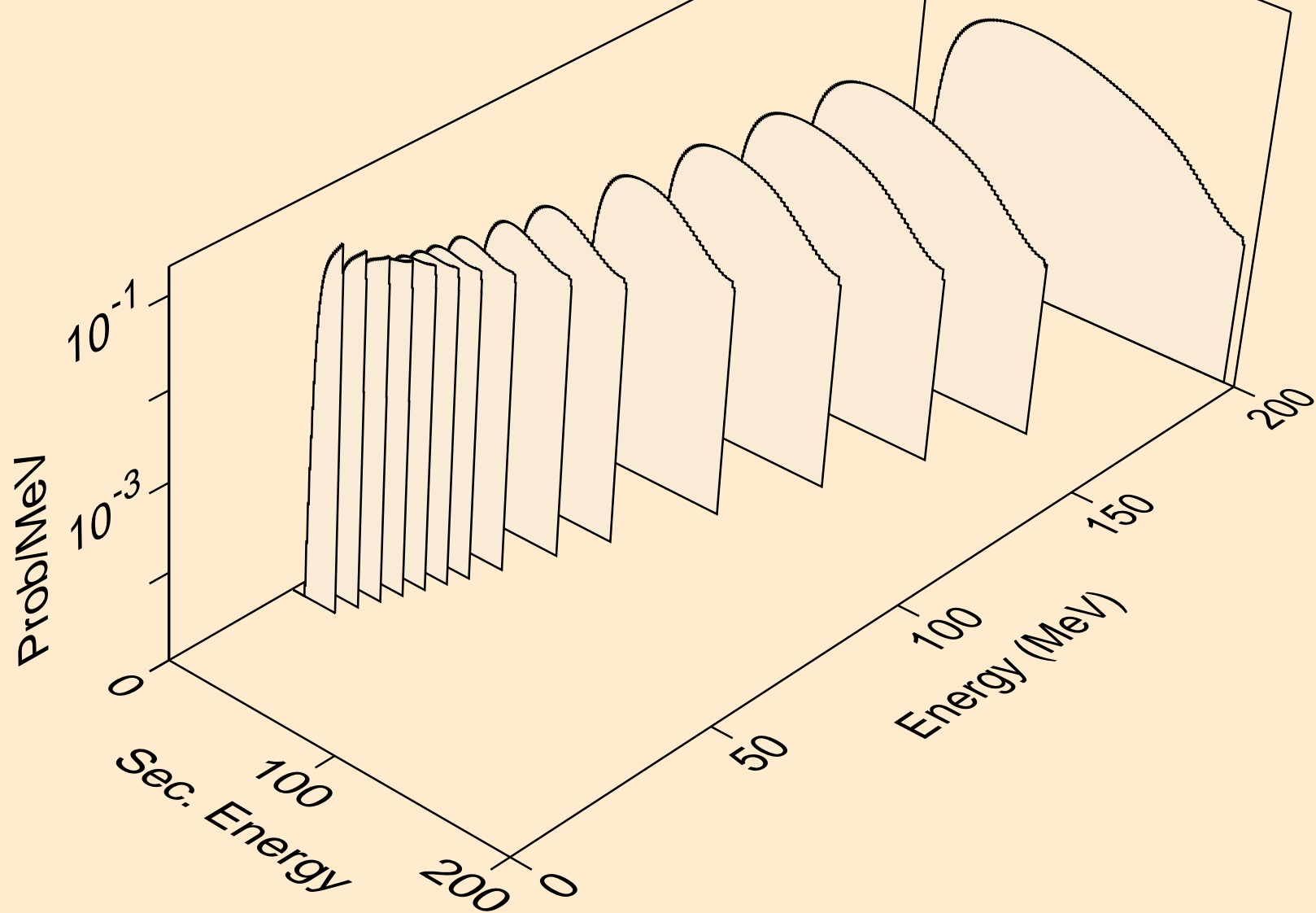

RF265 NEUTRON ACER TENDL-2024 LIBRARY; T=0.K
deuterons from (n,2nd)

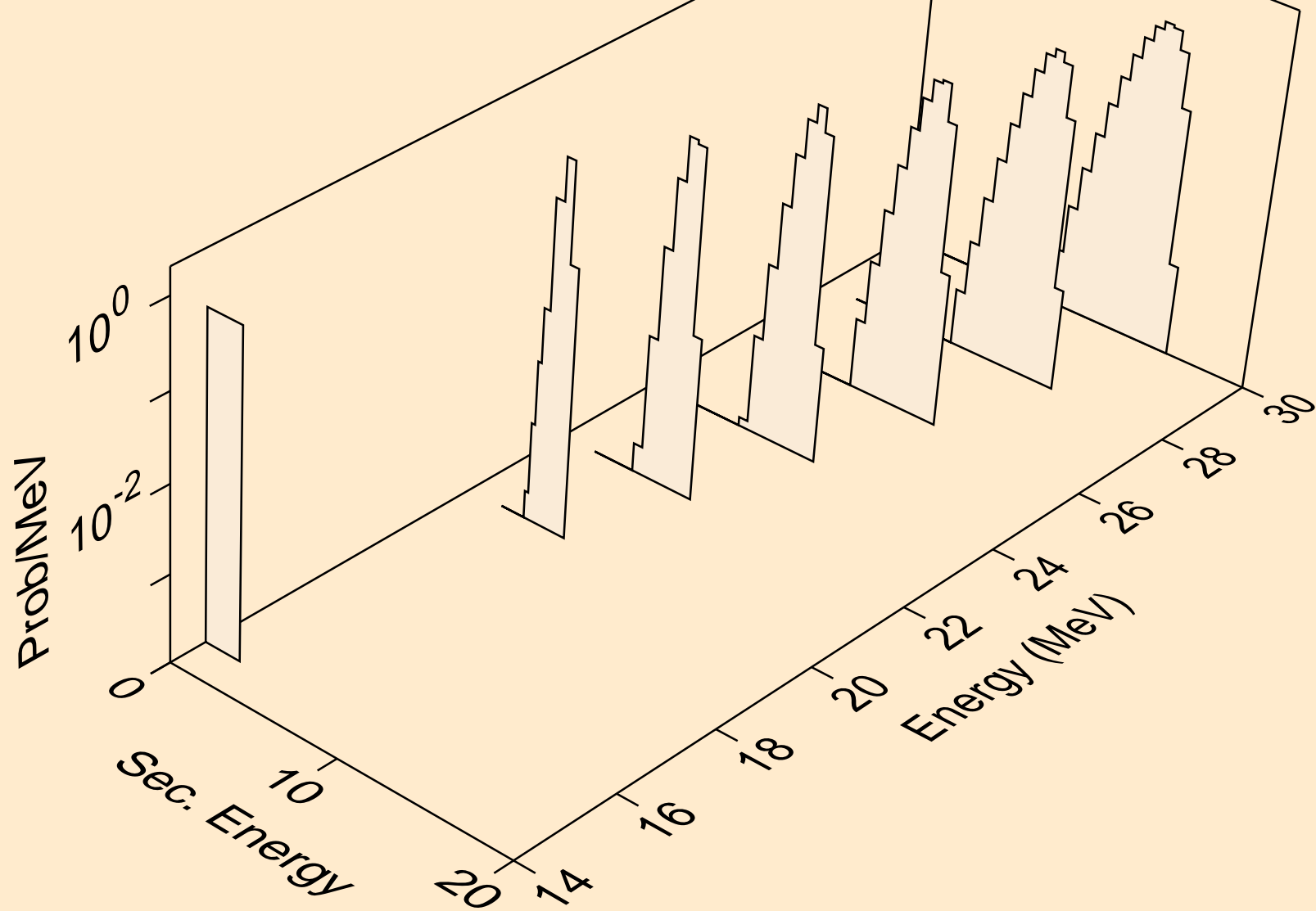

RF265 NEUTRON ACER TENDL-2024 LIBRARY; T=0.K
deuterons from (n,n*)d

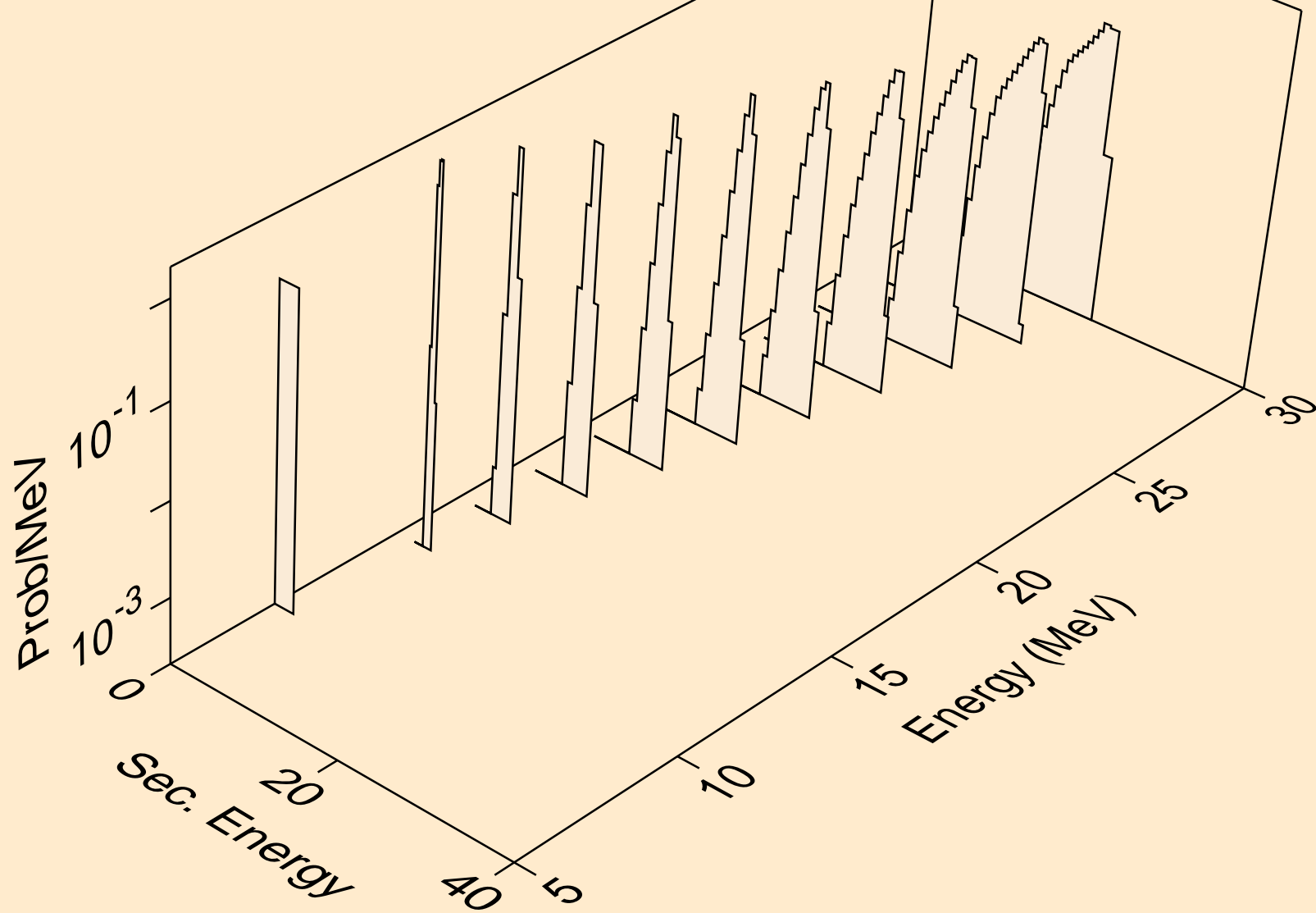

RF265 NEUTRON ACER TENDL-2024 LIBRARY; T=0.K
deuterons from (n,d)

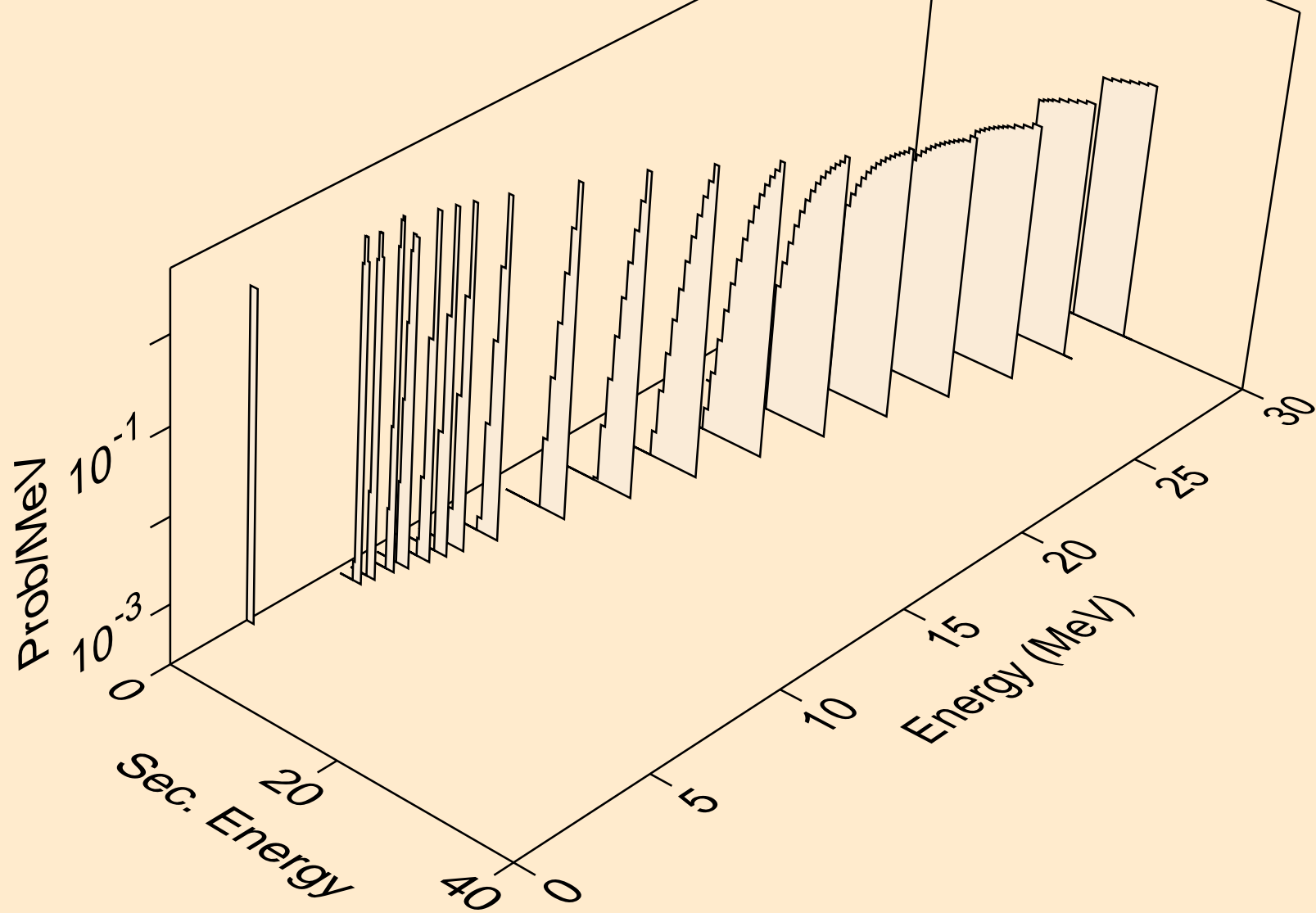

RF265 NEUTRON ACER TENDL-2024 LIBRARY; T=0.K
tritons from (n,x)

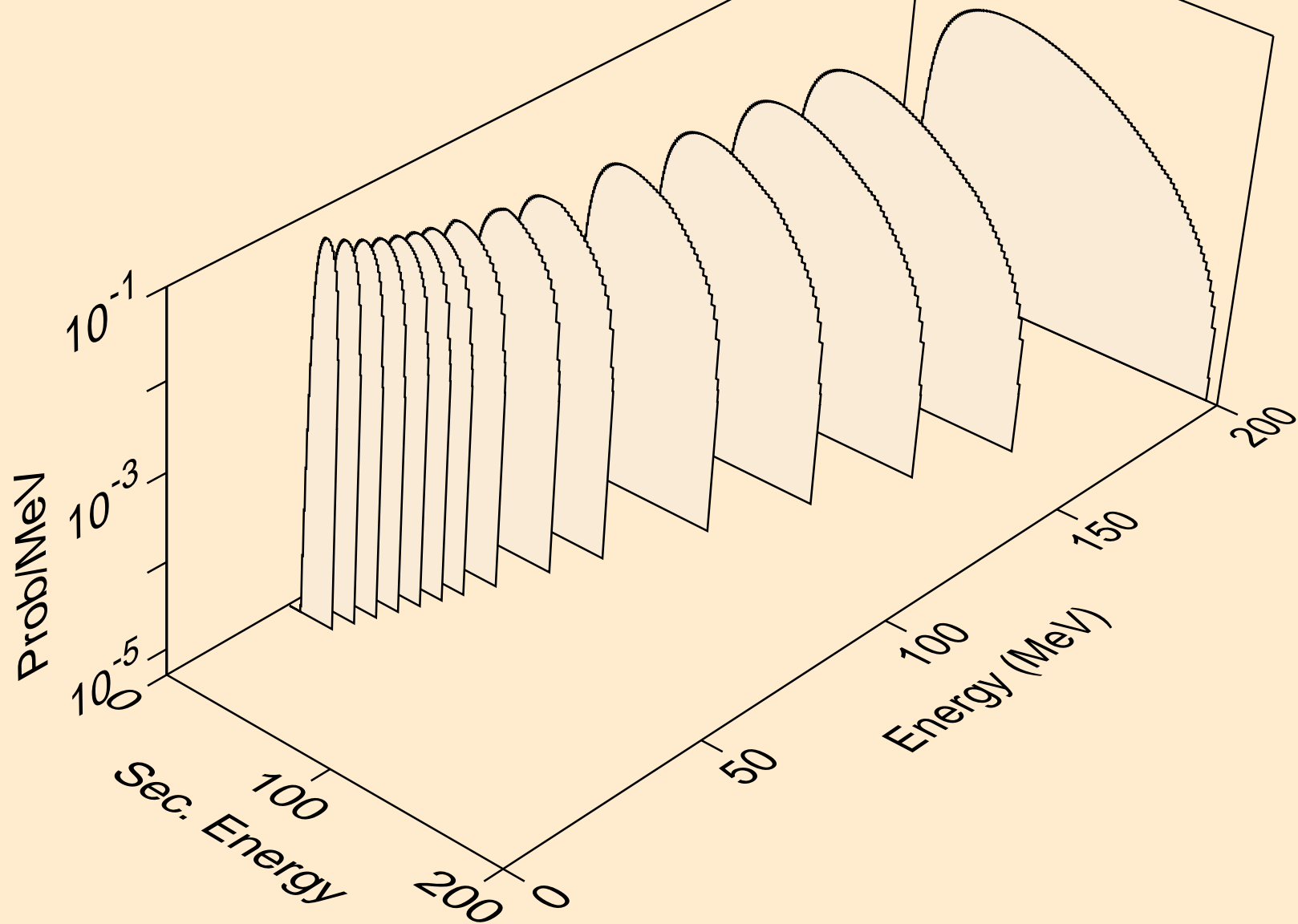

RF265 NEUTRON ACER TENDL-2024 LIBRARY; T=0.K
tritons from (n,n*)t

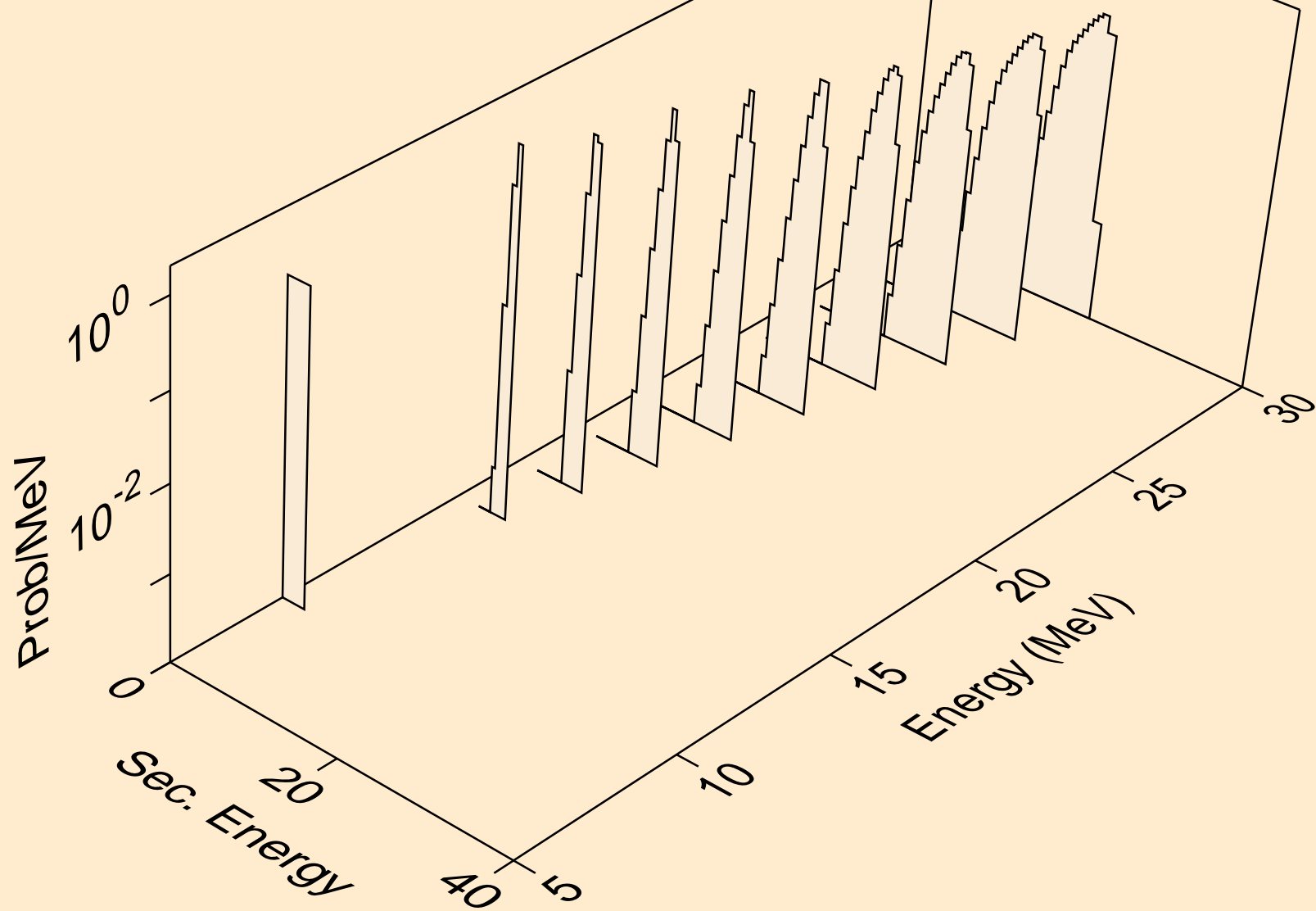

RF265 NEUTRON ACER TENDL-2024 LIBRARY; T=0.K
tritons from (n,t)

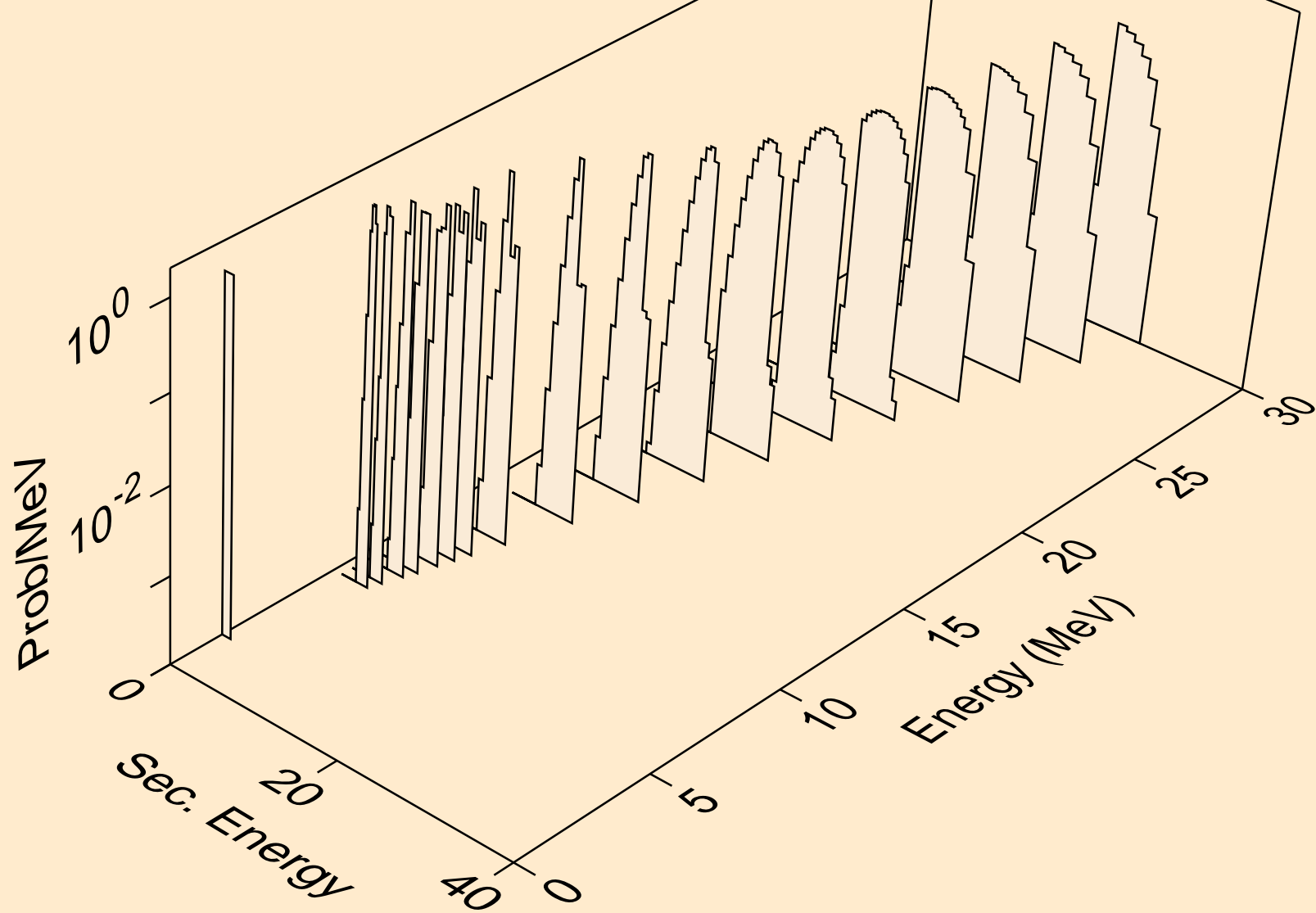

RF265 NEUTRON ACER TENDL-2024 LIBRARY; T=0.K
he3s from (n,x)

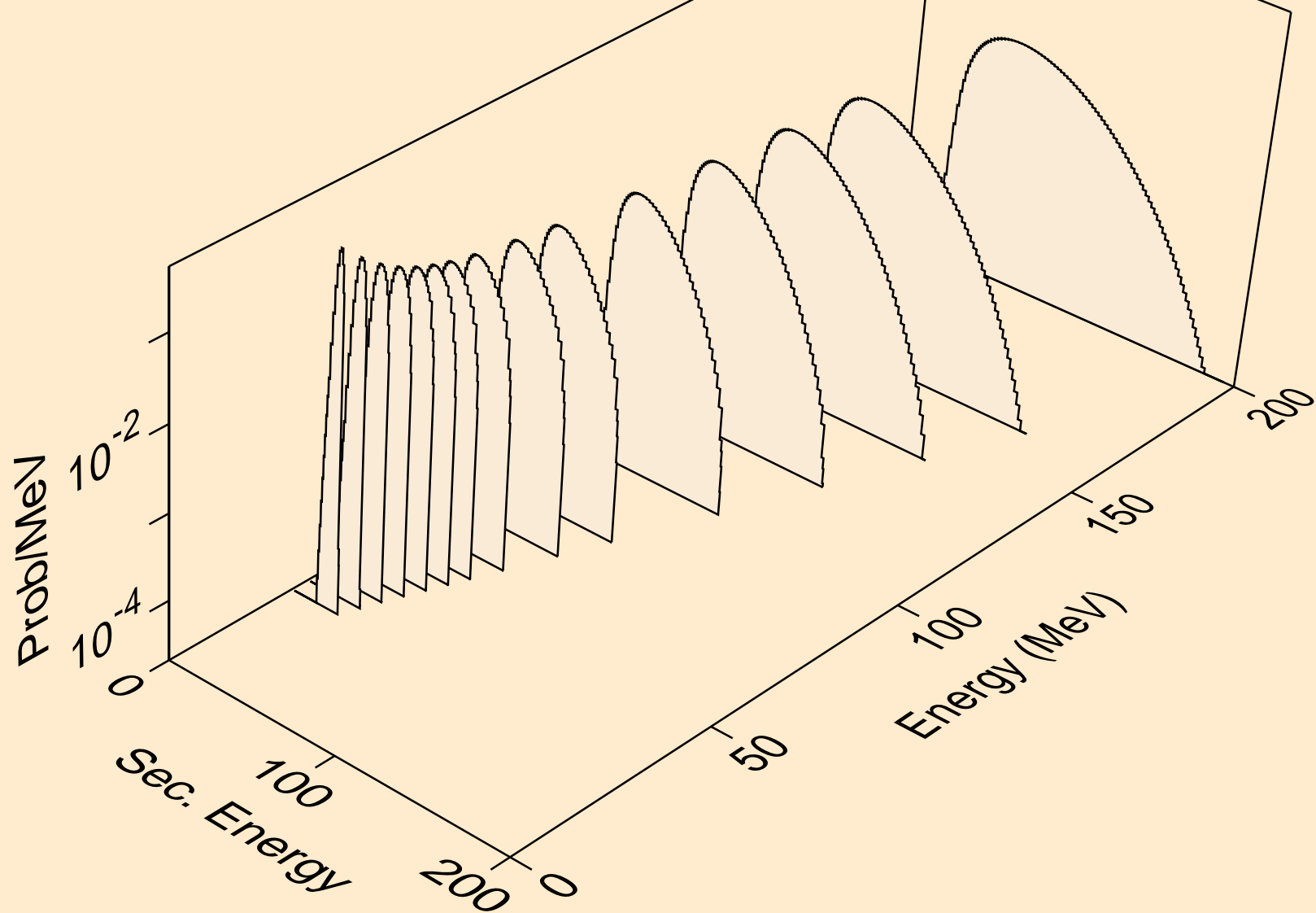

RF265 NEUTRON ACER TENDL-2024 LIBRARY; T=0.K
he3s from (n,n*)he3

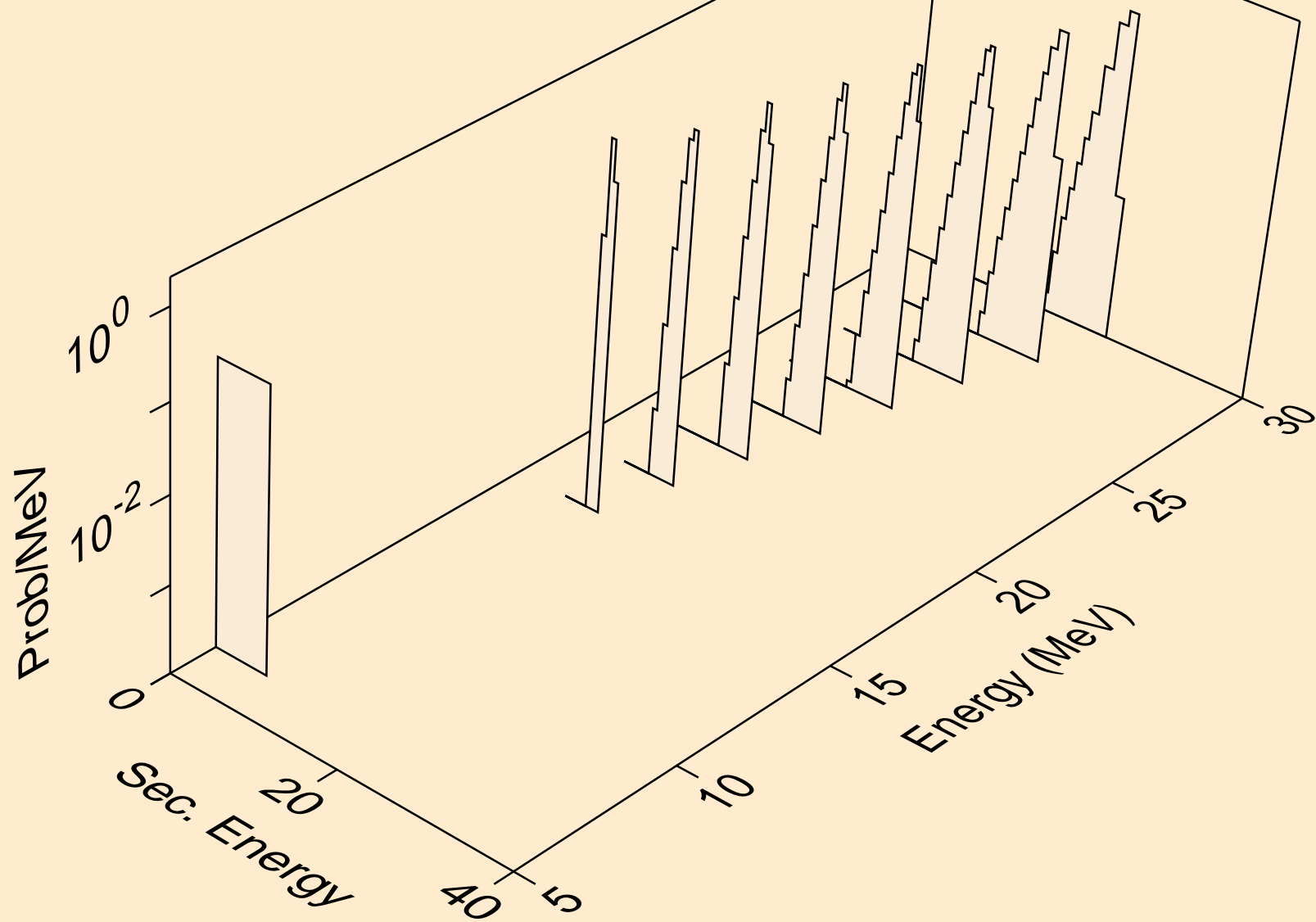

RF265 NEUTRON ACER TENDL-2024 LIBRARY; T=0.K
he3s from (n,he3)

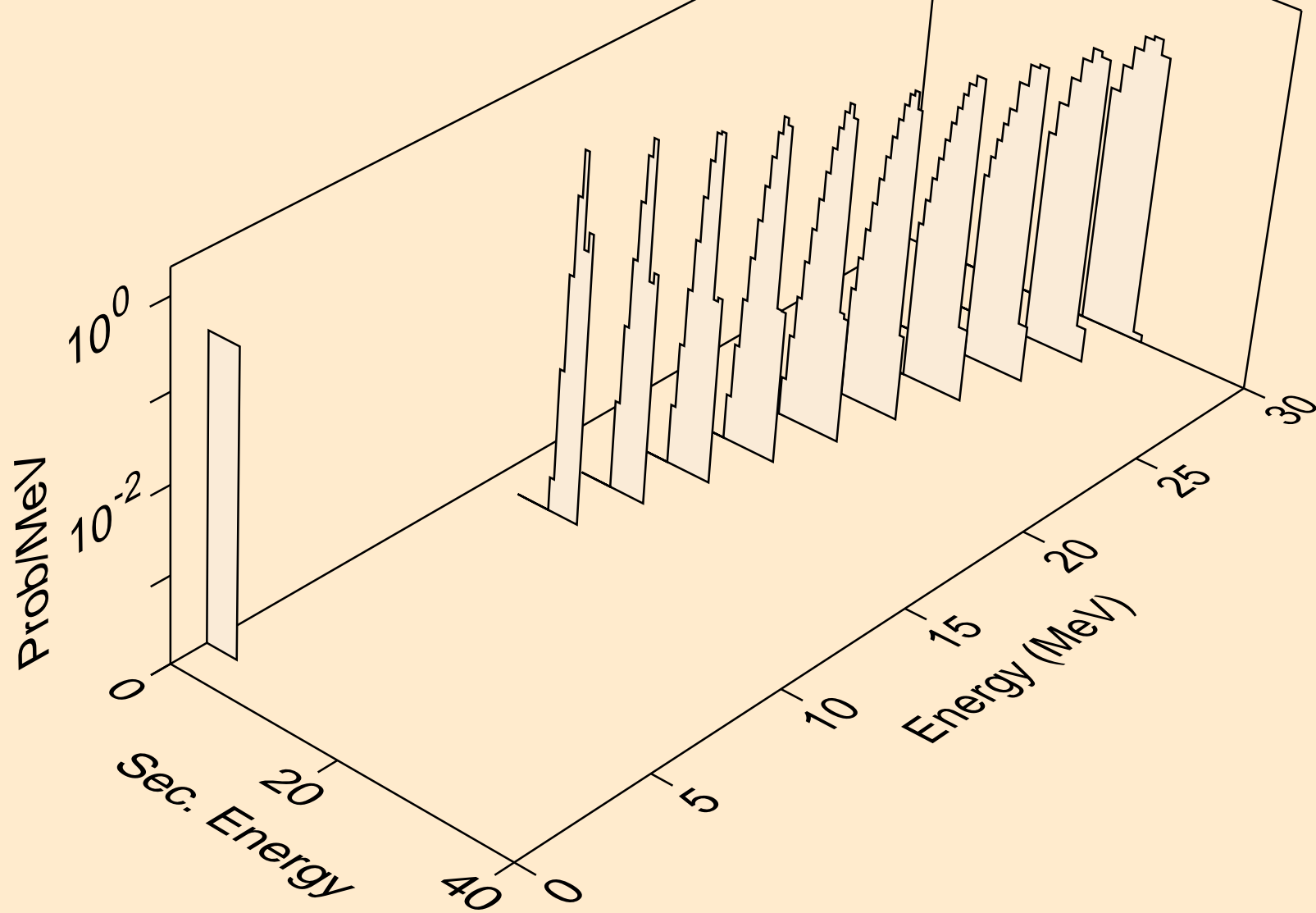

RF265 NEUTRON ACER TENDL-2024 LIBRARY; T=0.K
alphas from (n,x)

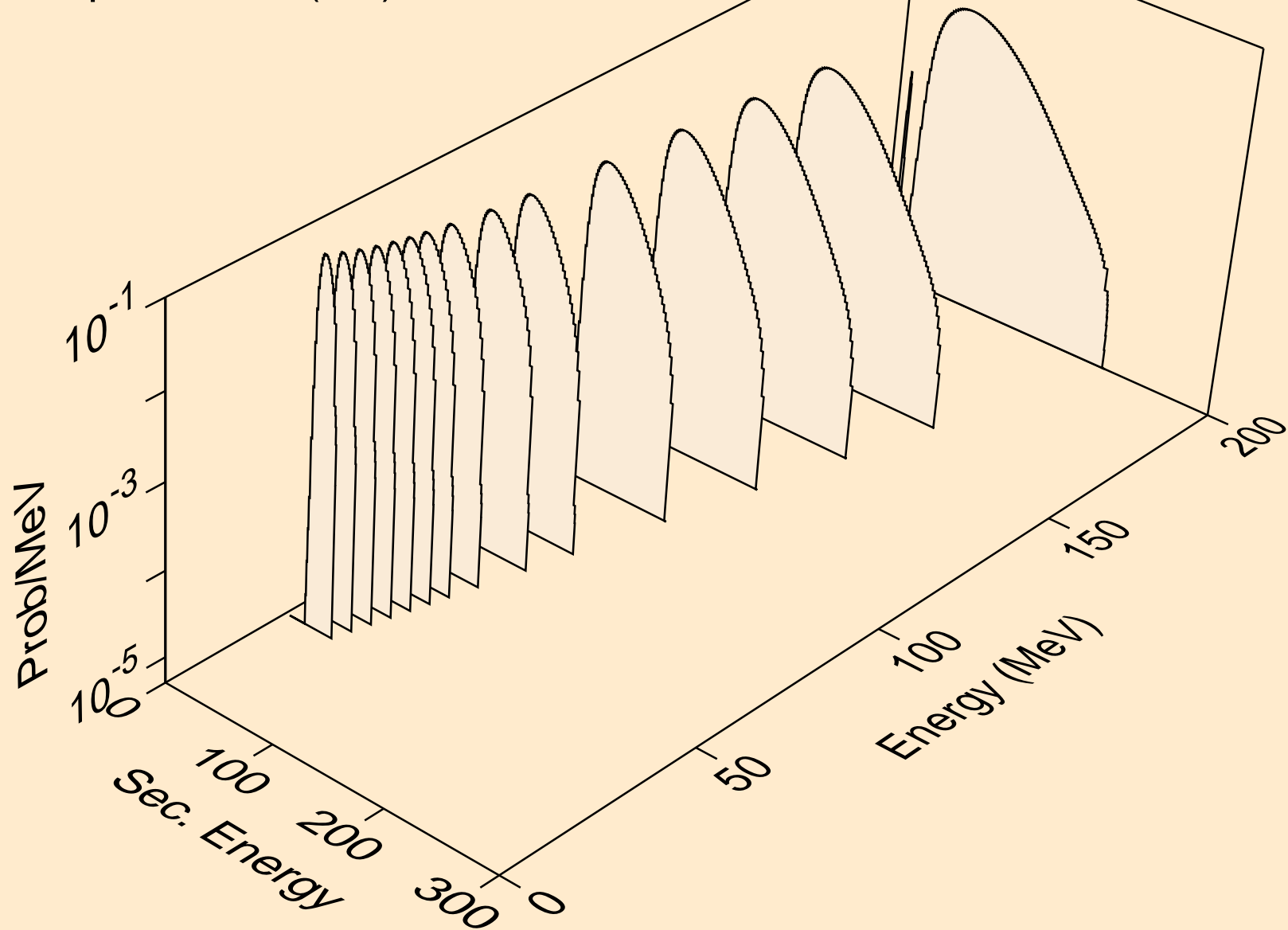

RF265 NEUTRON ACER TENDL-2024 LIBRARY; T=0.K
alphas from (n,n*)a

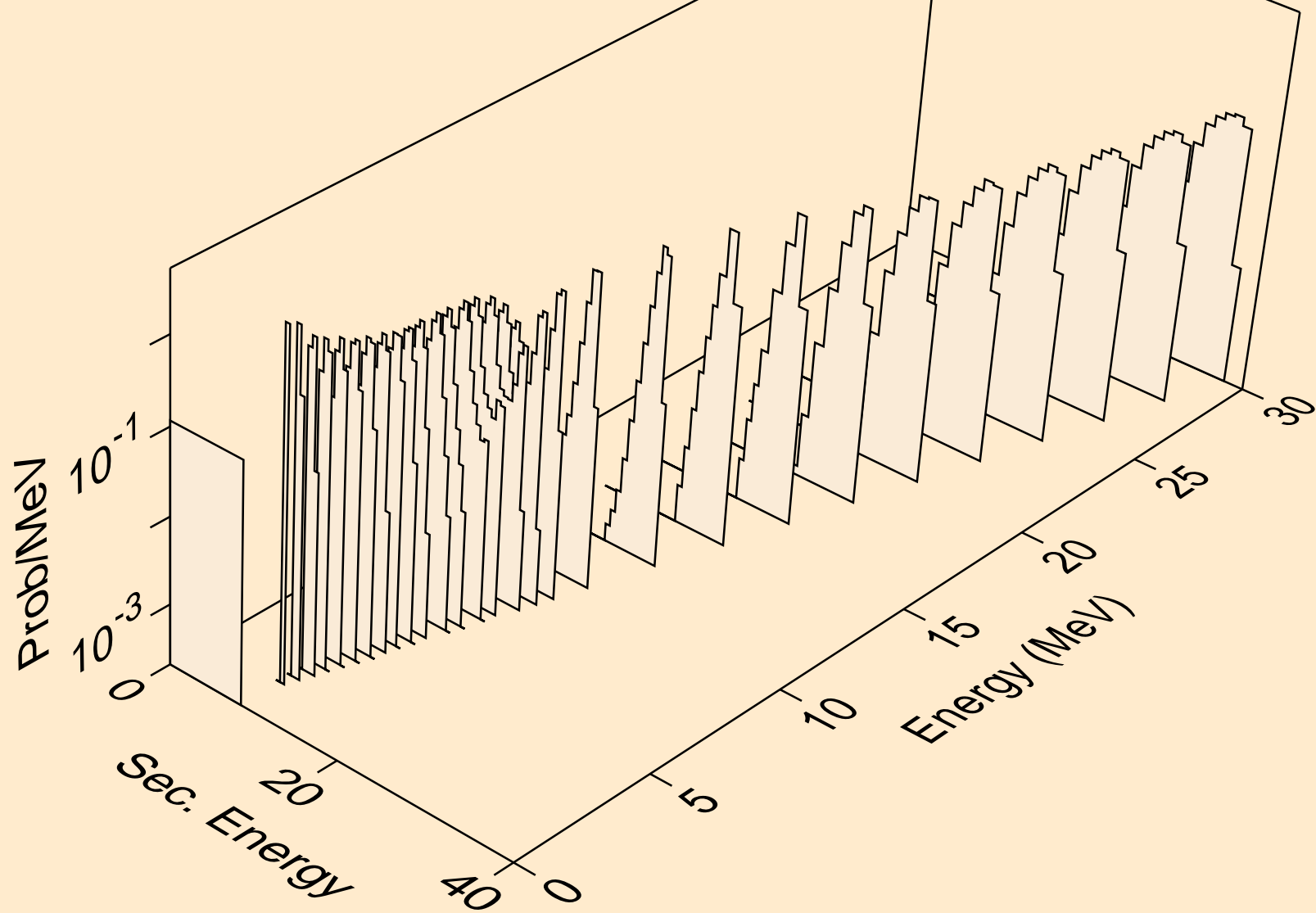

RF265 NEUTRON ACER TENDL-2024 LIBRARY; T=0.K
alphas from (n,2n)a

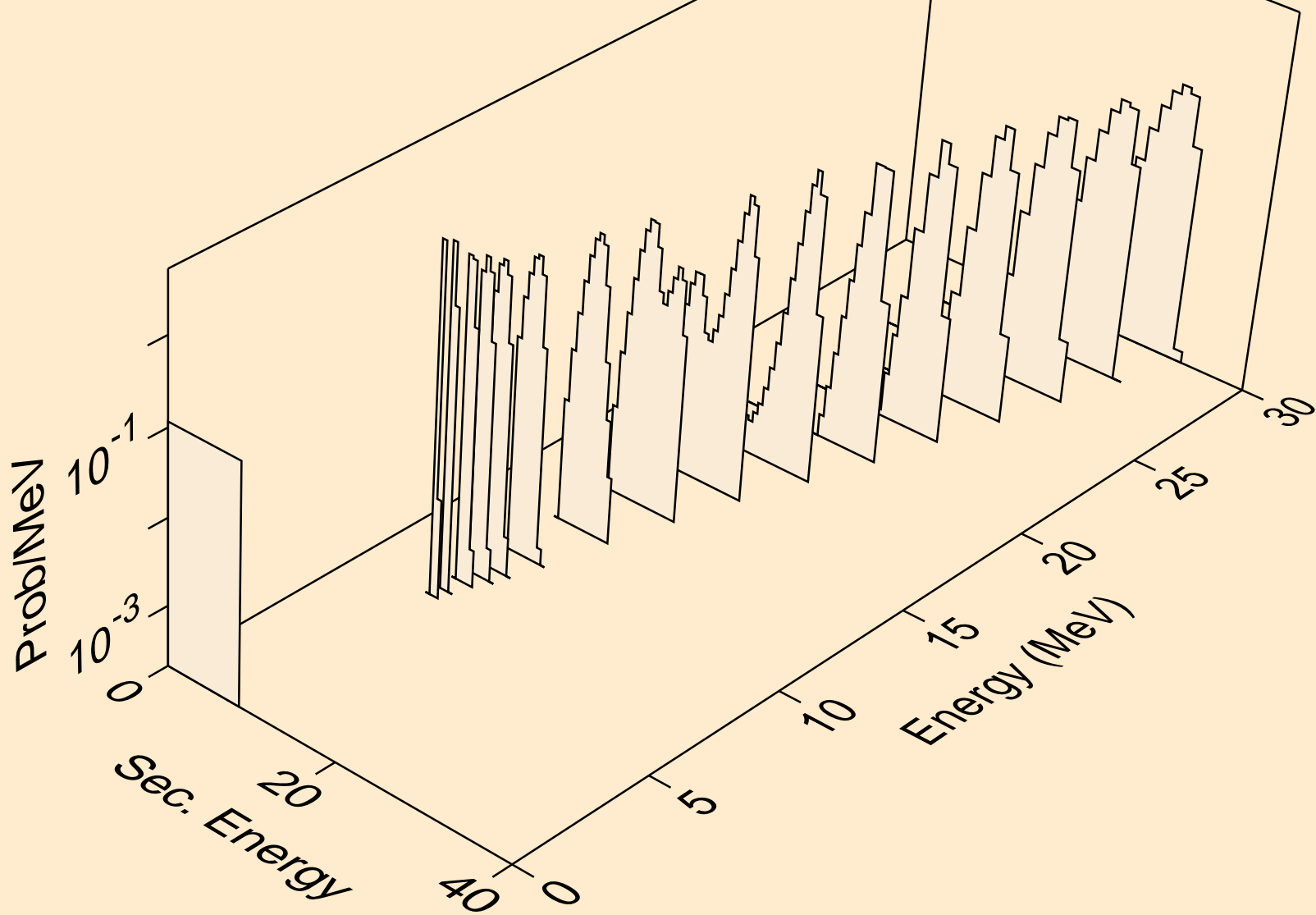

RF265 NEUTRON ACER TENDL-2024 LIBRARY; T=0.K
alphas from (n,3n)a

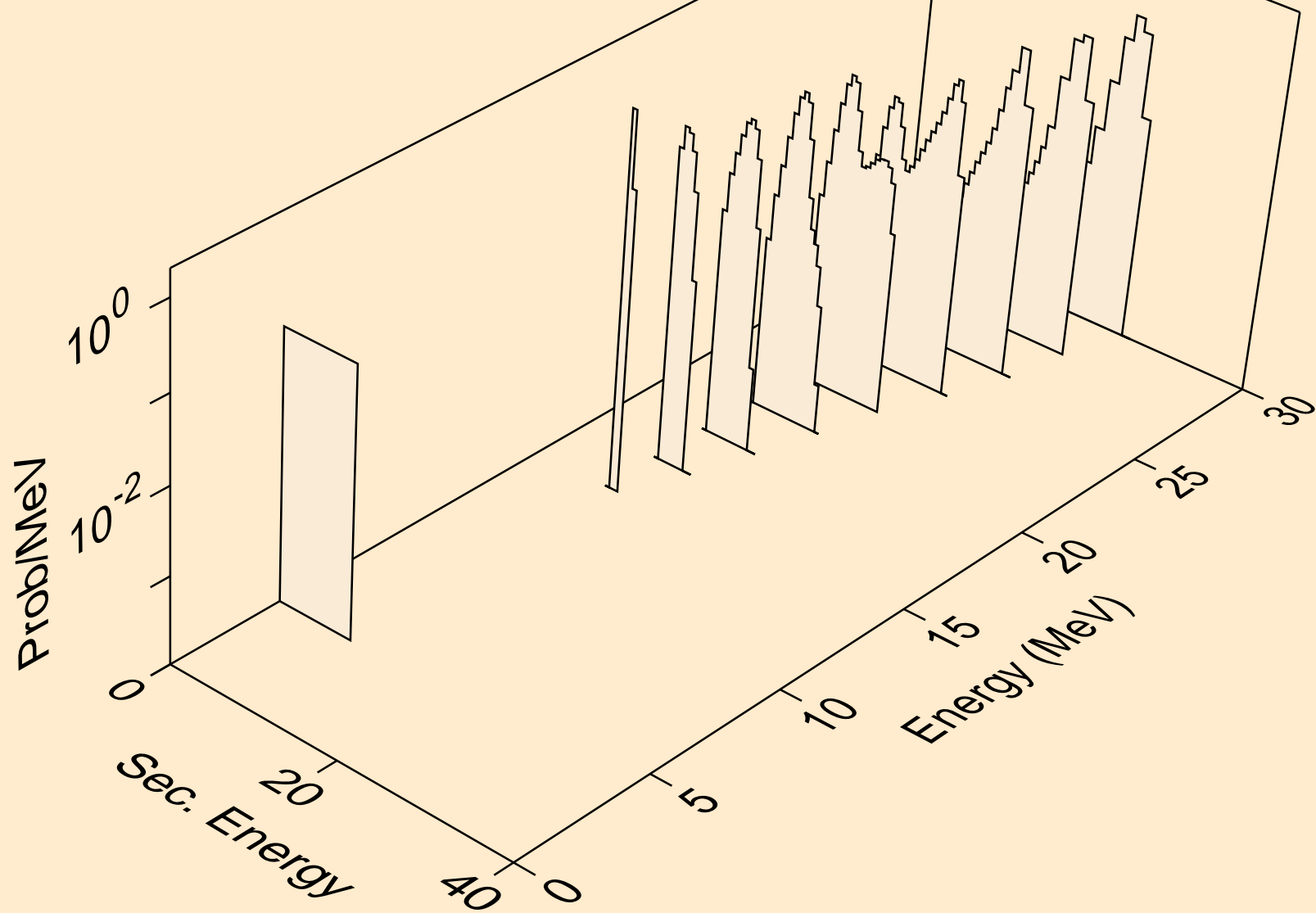

RF265 NEUTRON ACER TENDL-2024 LIBRARY; T=0.K
alphas from (n,a)

