

RH092 NEUTRON ACER TENDL-2024 LIBRARY; T=0.K

Principal cross sections

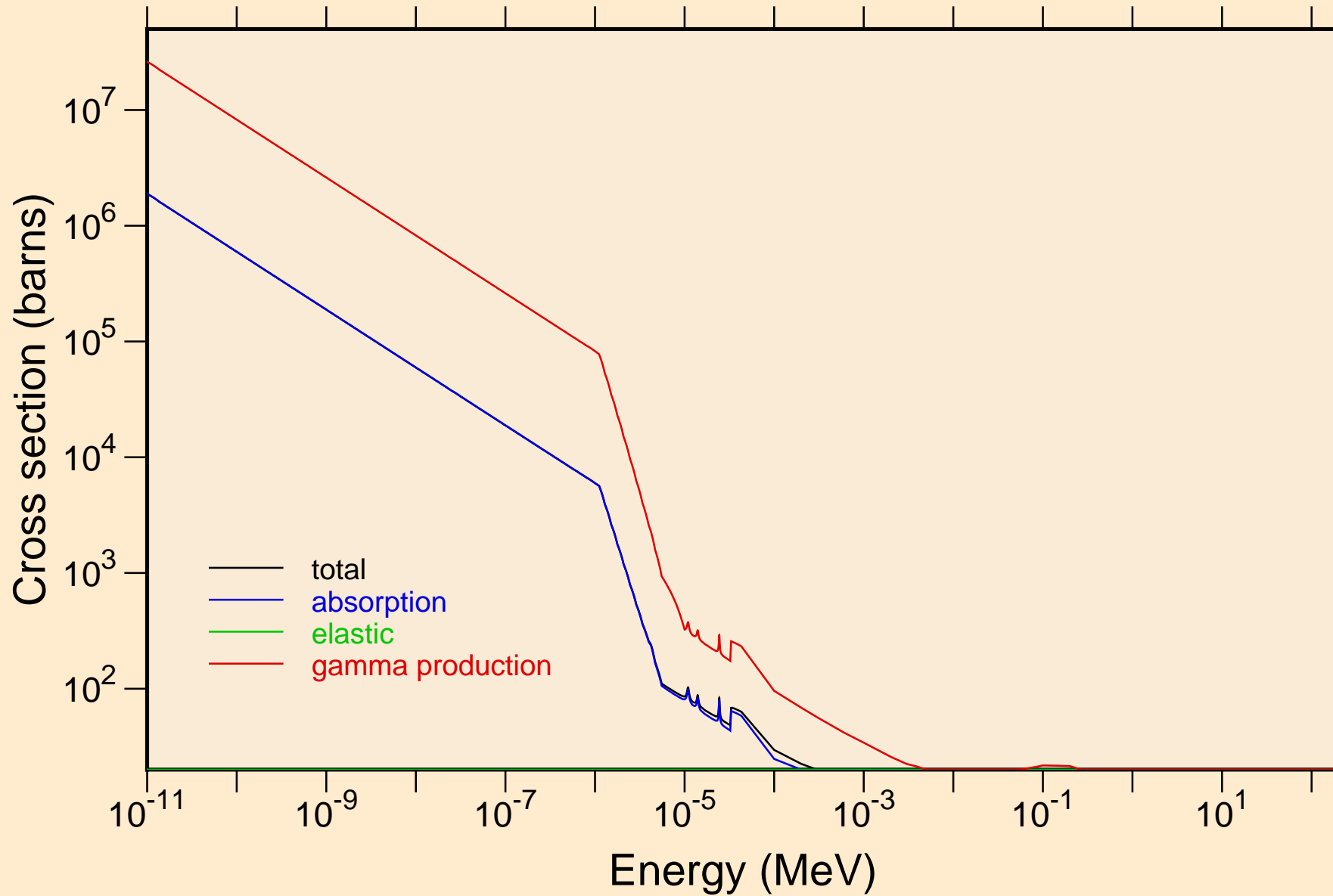

RH092 NEUTRON ACER TENDL-2024 LIBRARY; T=0.K

Heating

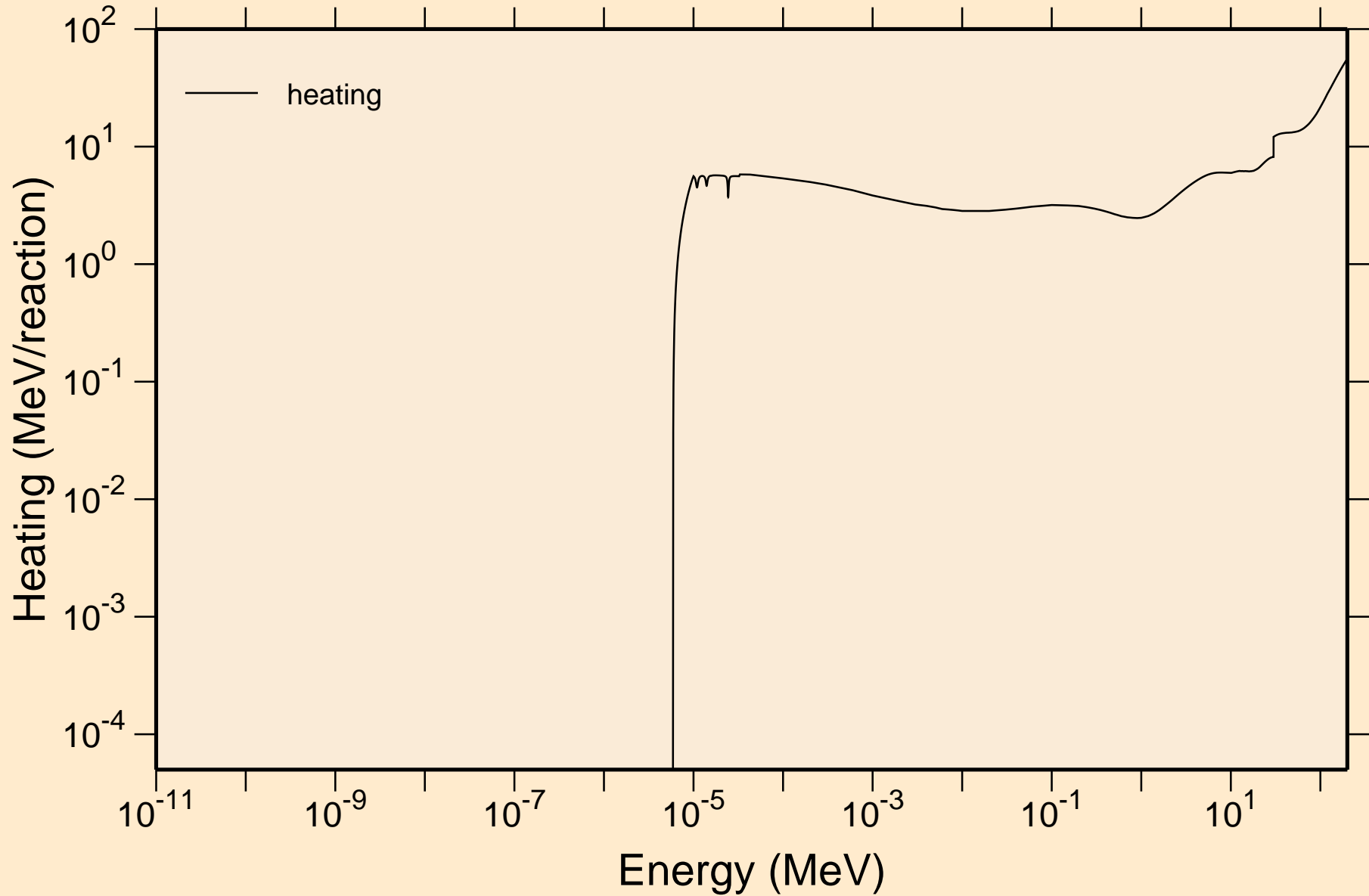

RH092 NEUTRON ACER TENDL-2024 LIBRARY; T=0.K
Damage

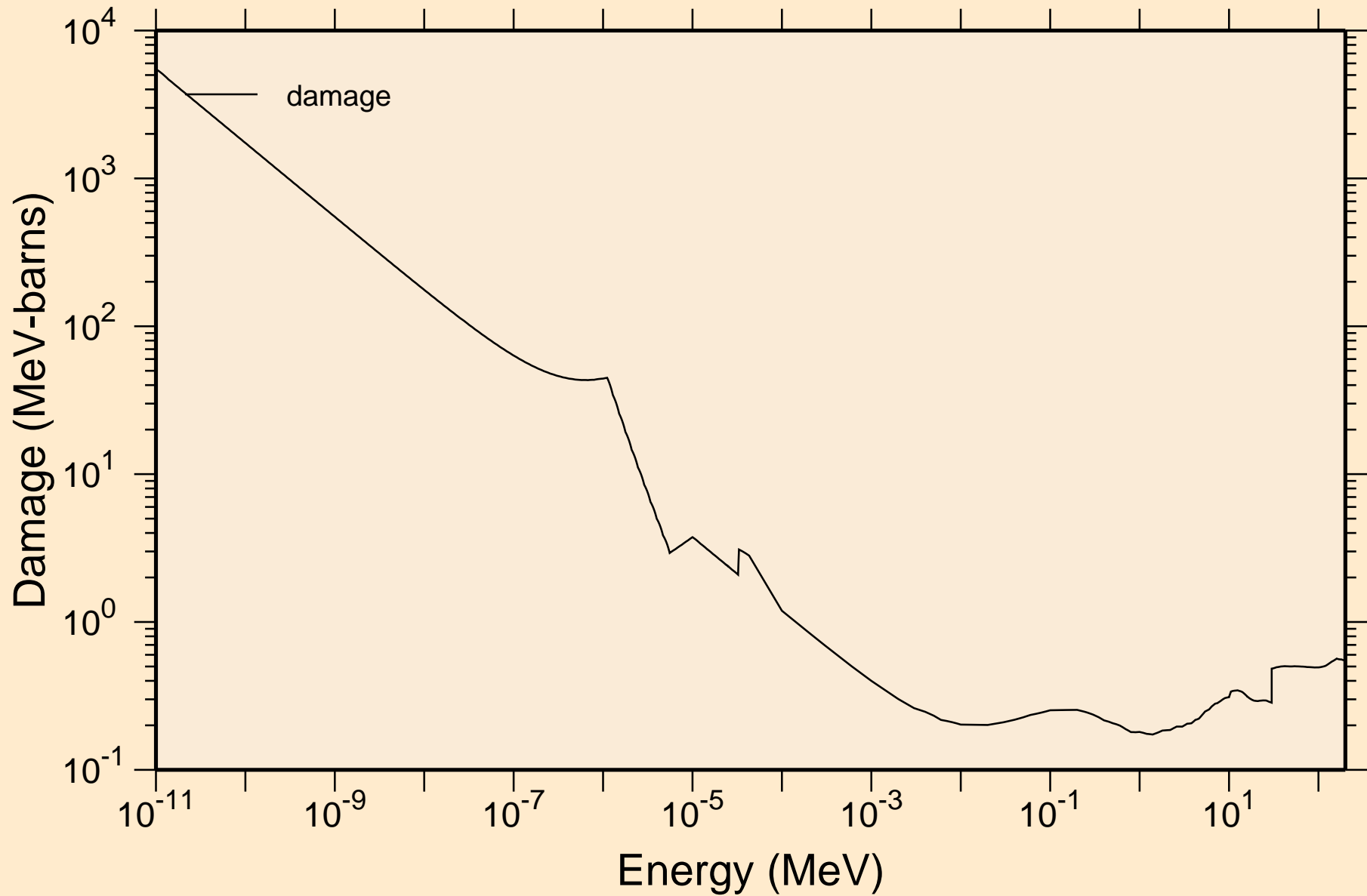

RH092 NEUTRON ACER TENDL-2024 LIBRARY; T=0.K

Non-threshold reactions

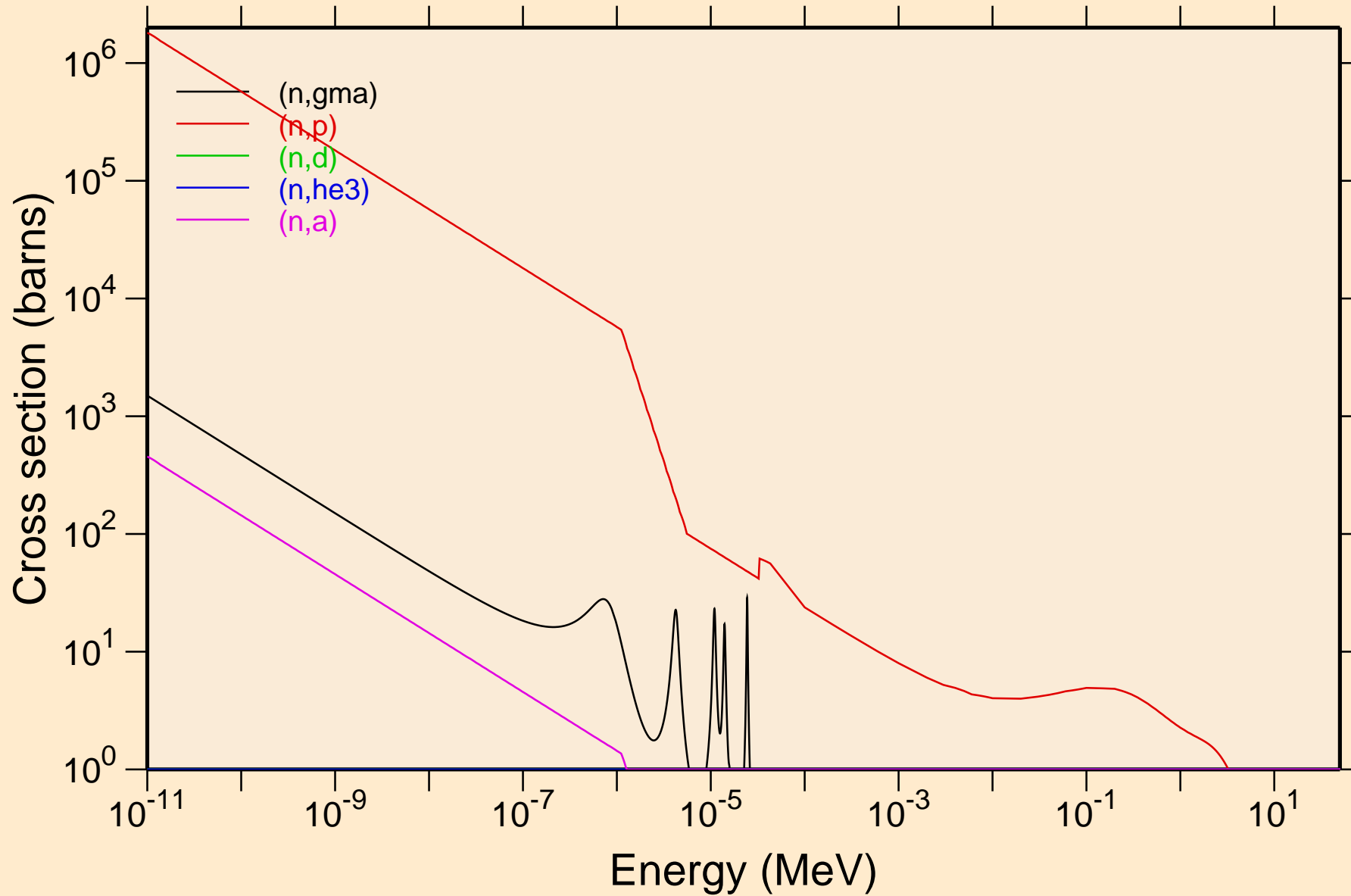

RH092 NEUTRON ACER TENDL-2024 LIBRARY; T=0.K

Non-threshold reactions

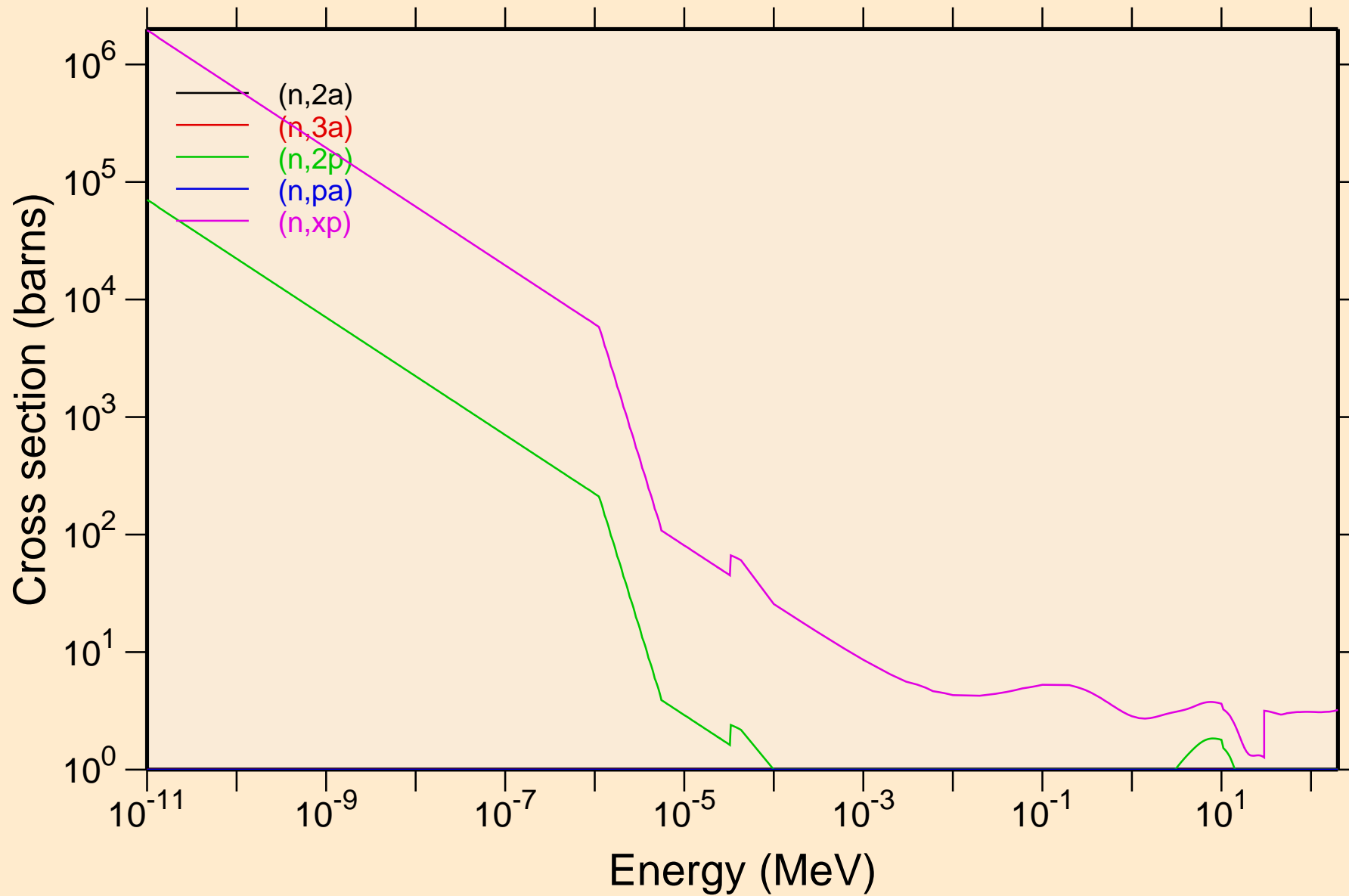

RH092 NEUTRON ACER TENDL-2024 LIBRARY; T=0.K
Non-threshold reactions

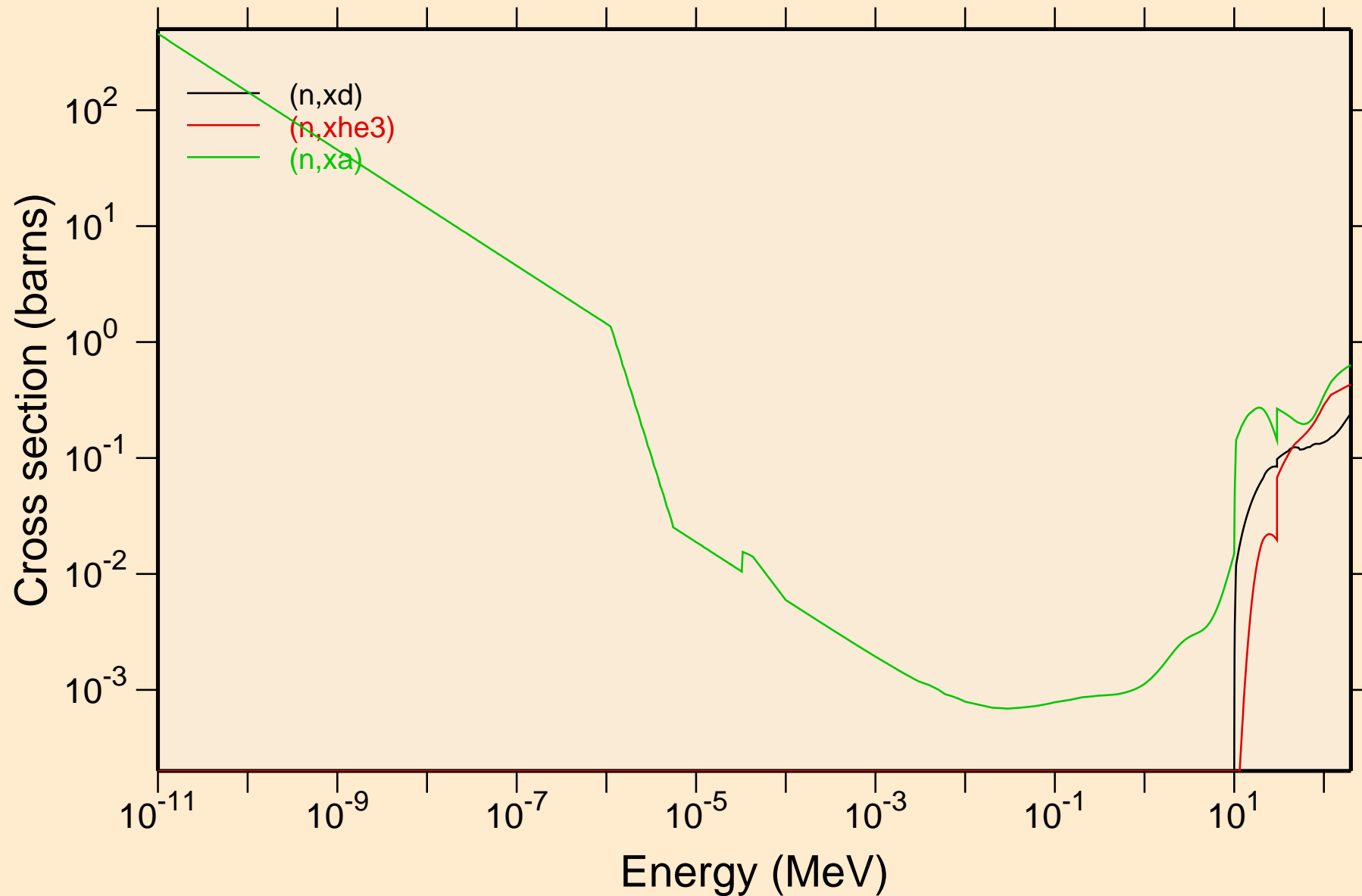

RH092 NEUTRON ACER TENDL-2024 LIBRARY; T=0.K

Principal cross sections

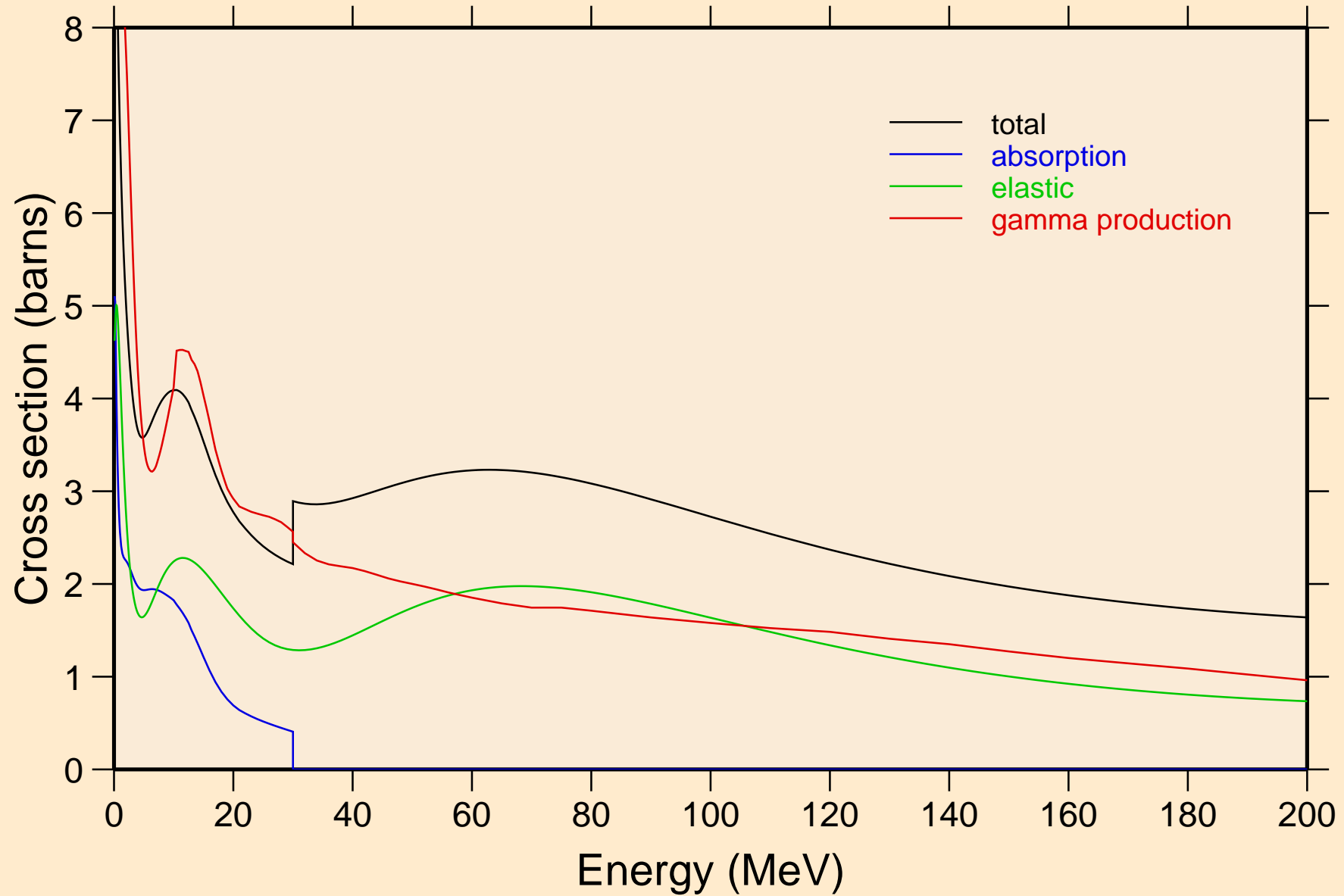

RH092 NEUTRON ACER TENDL-2024 LIBRARY; T=0.K

Heating

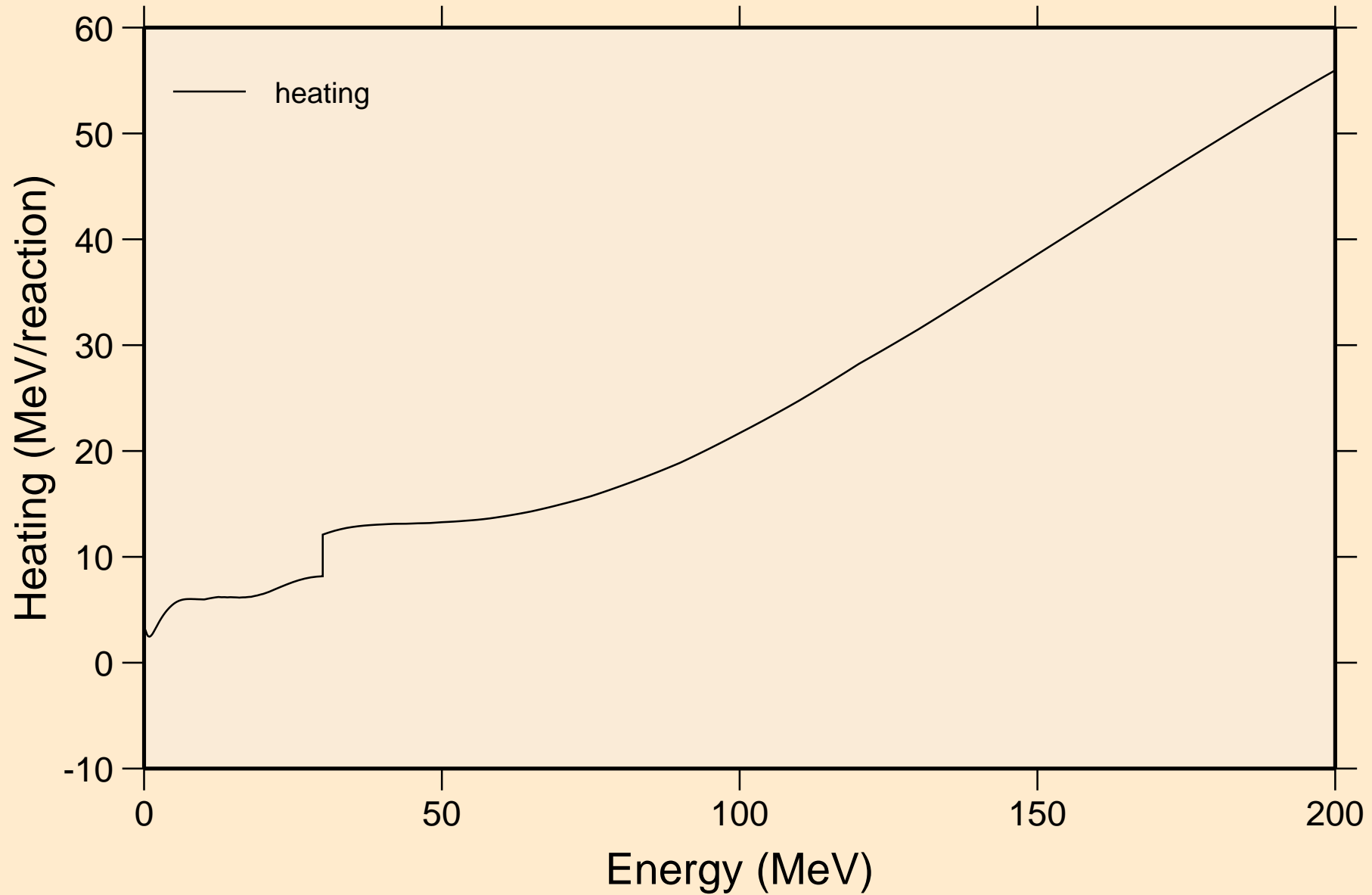

RH092 NEUTRON ACER TENDL-2024 LIBRARY; T=0.K

Damage

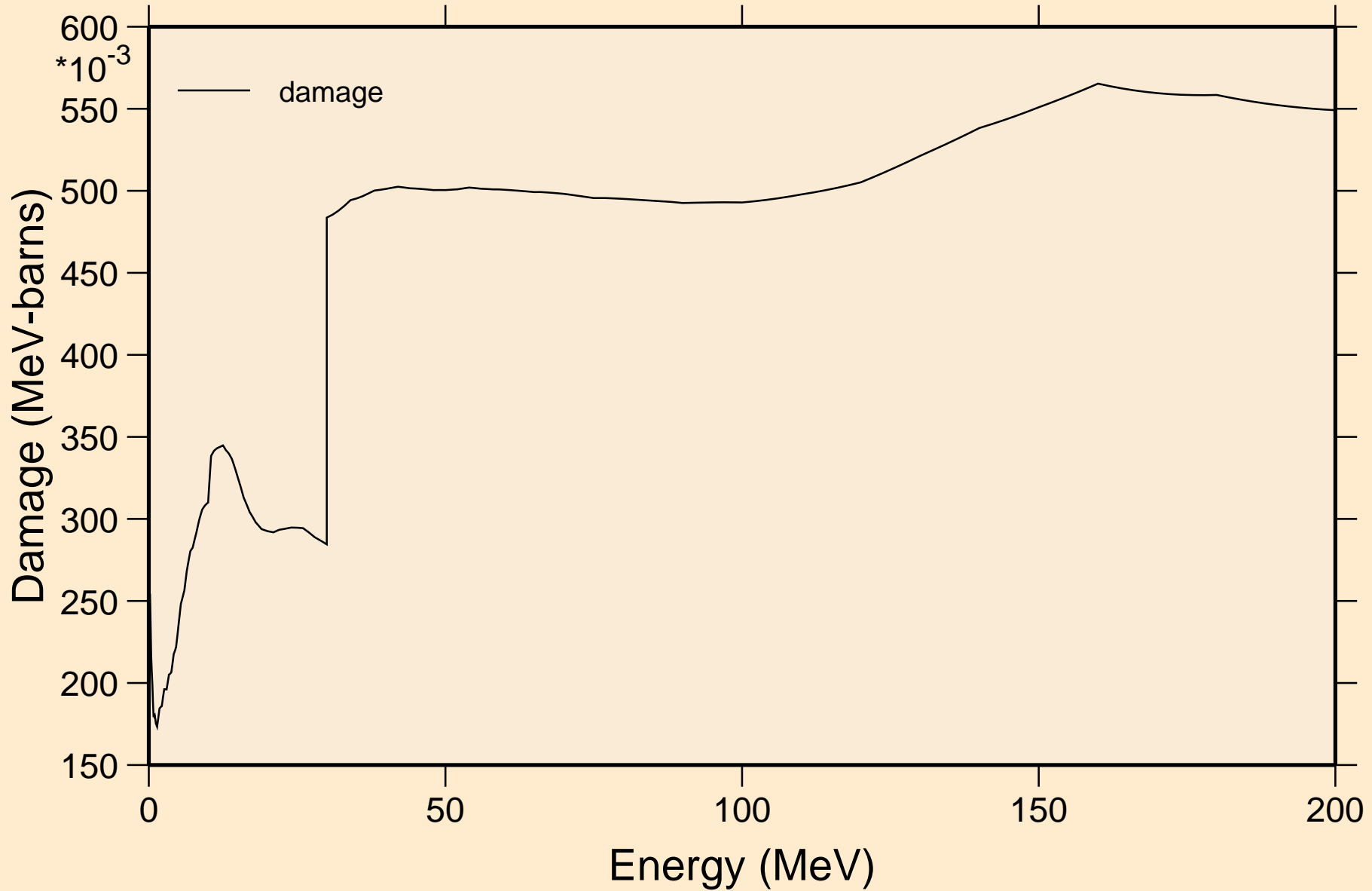

RH092 NEUTRON ACER TENDL-2024 LIBRARY; T=0.K
Non-threshold reactions

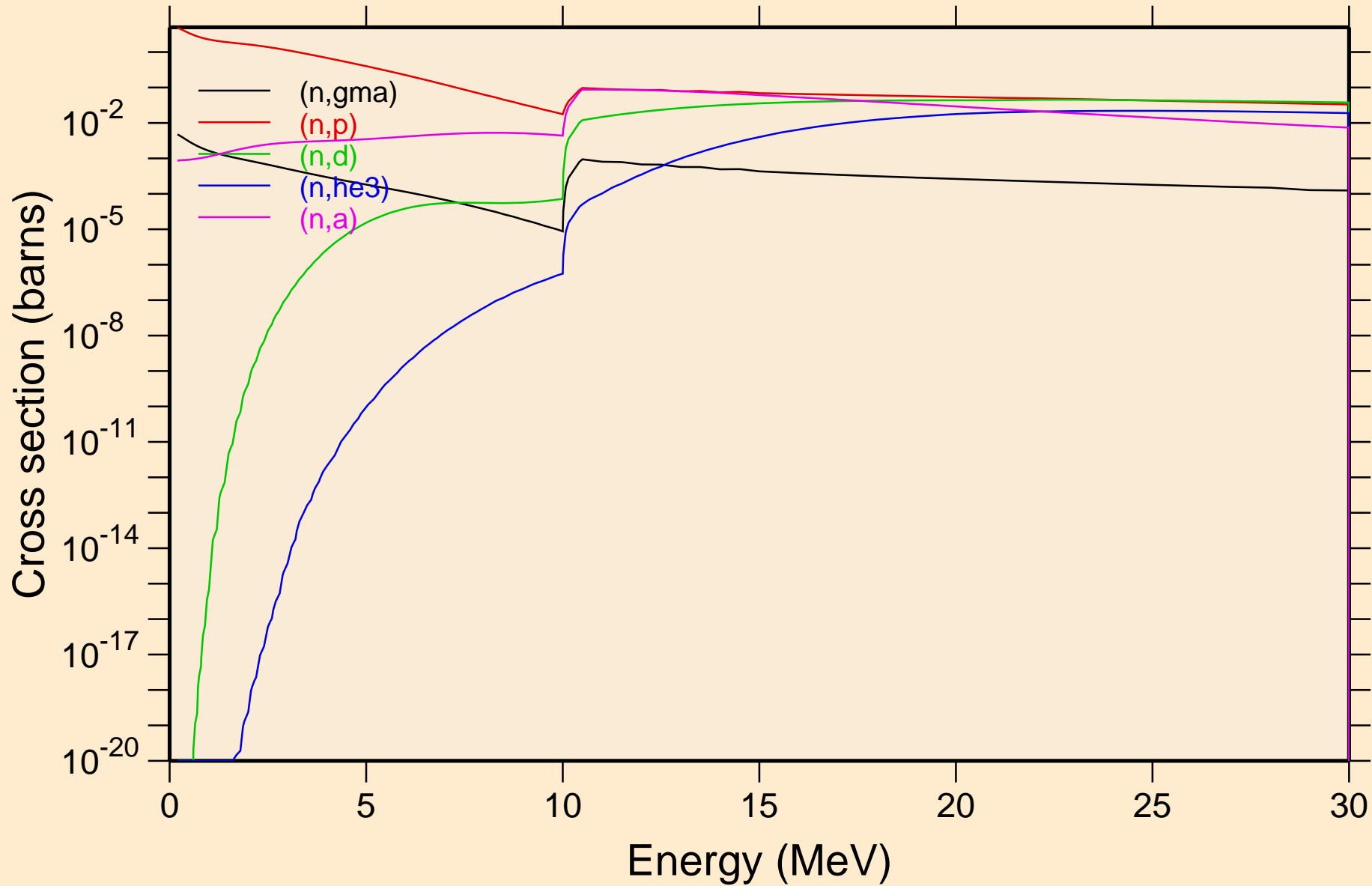

RH092 NEUTRON ACER TENDL-2024 LIBRARY; T=0.K
Non-threshold reactions

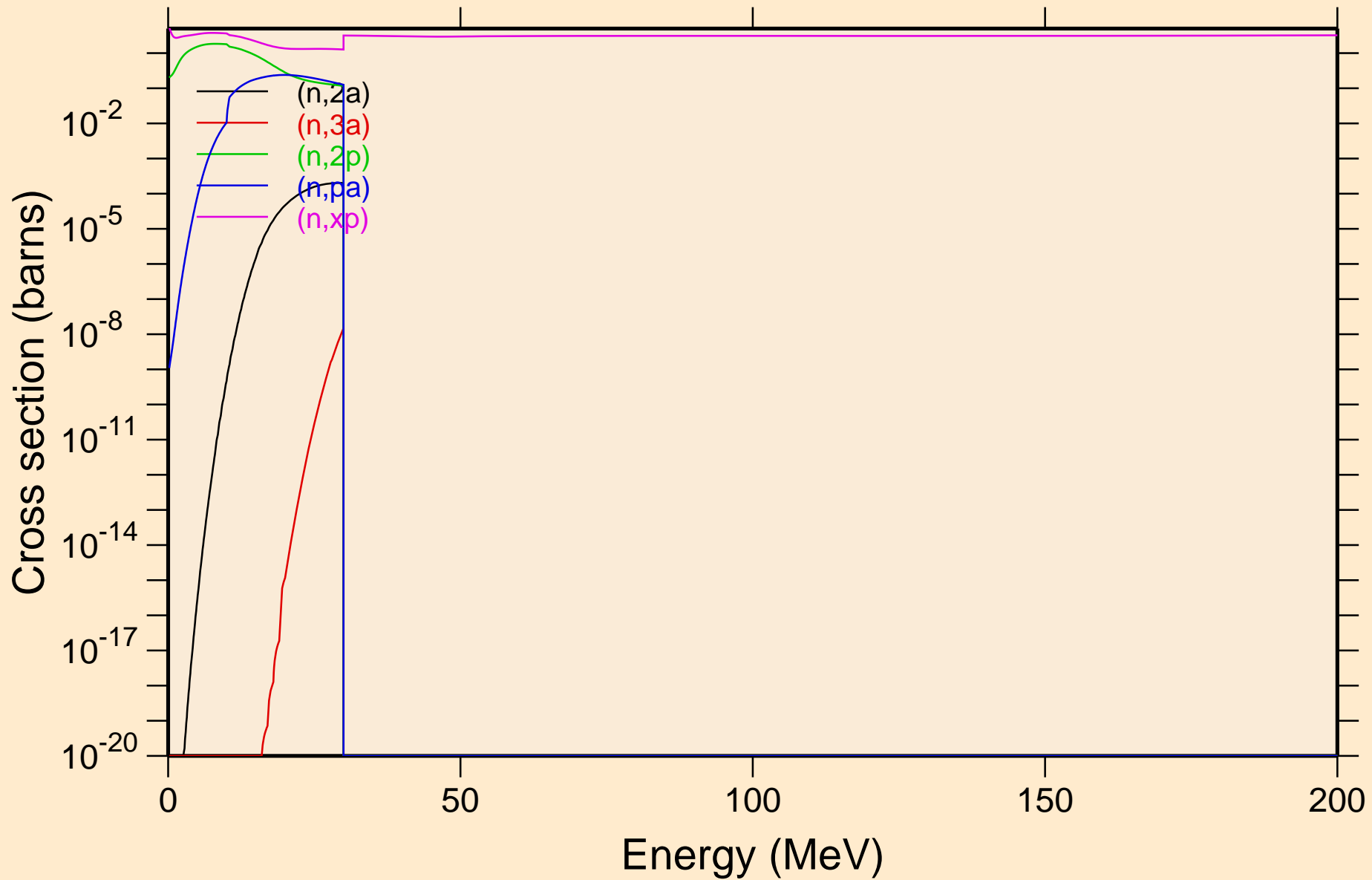

RH092 NEUTRON ACER TENDL-2024 LIBRARY; T=0.K
Non-threshold reactions

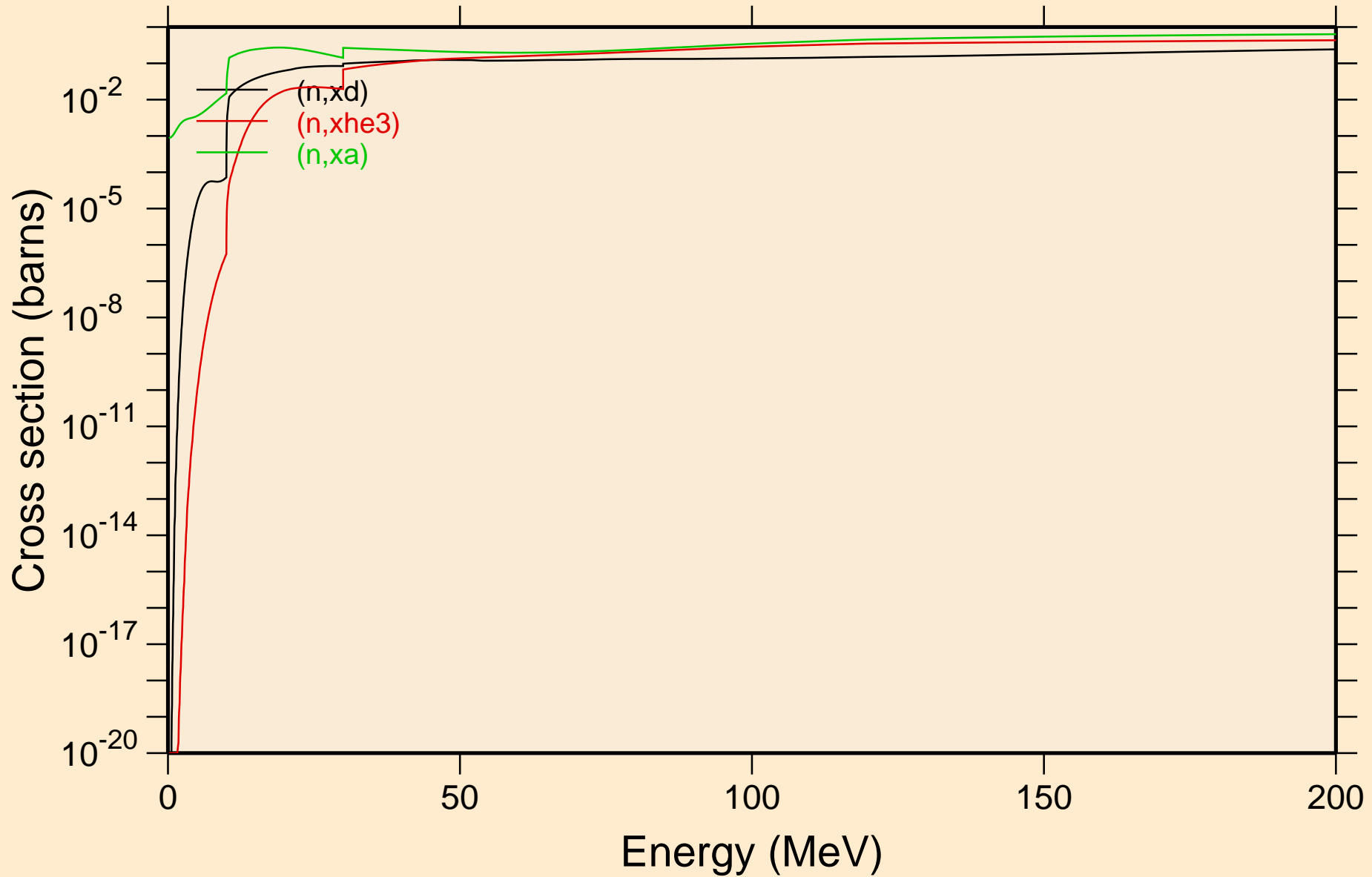

RH092 NEUTRON ACER TENDL-2024 LIBRARY; T=0.K
Inelastic levels

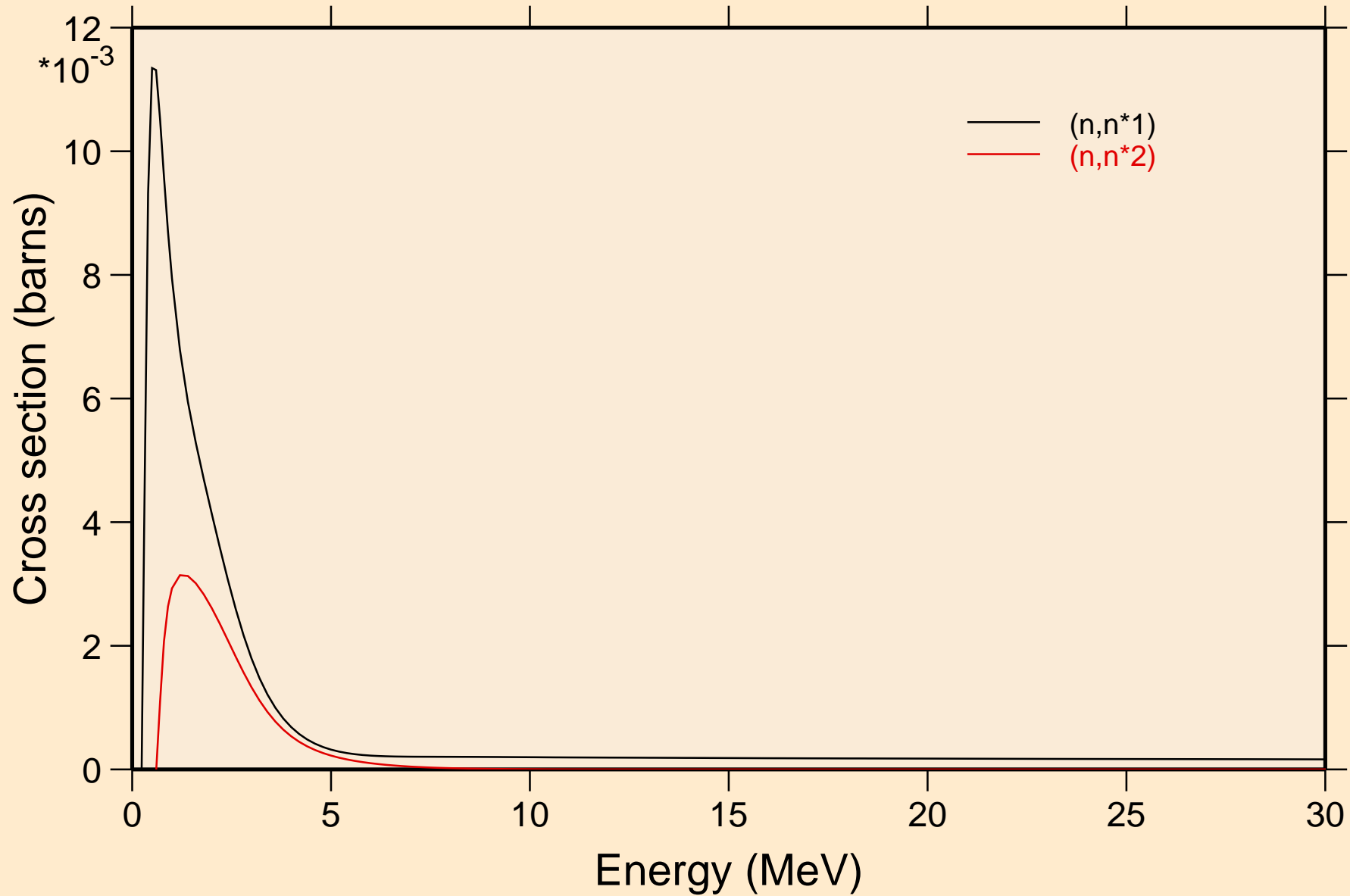

RH092 NEUTRON ACER TENDL-2024 LIBRARY; T=0.K
Threshold reactions

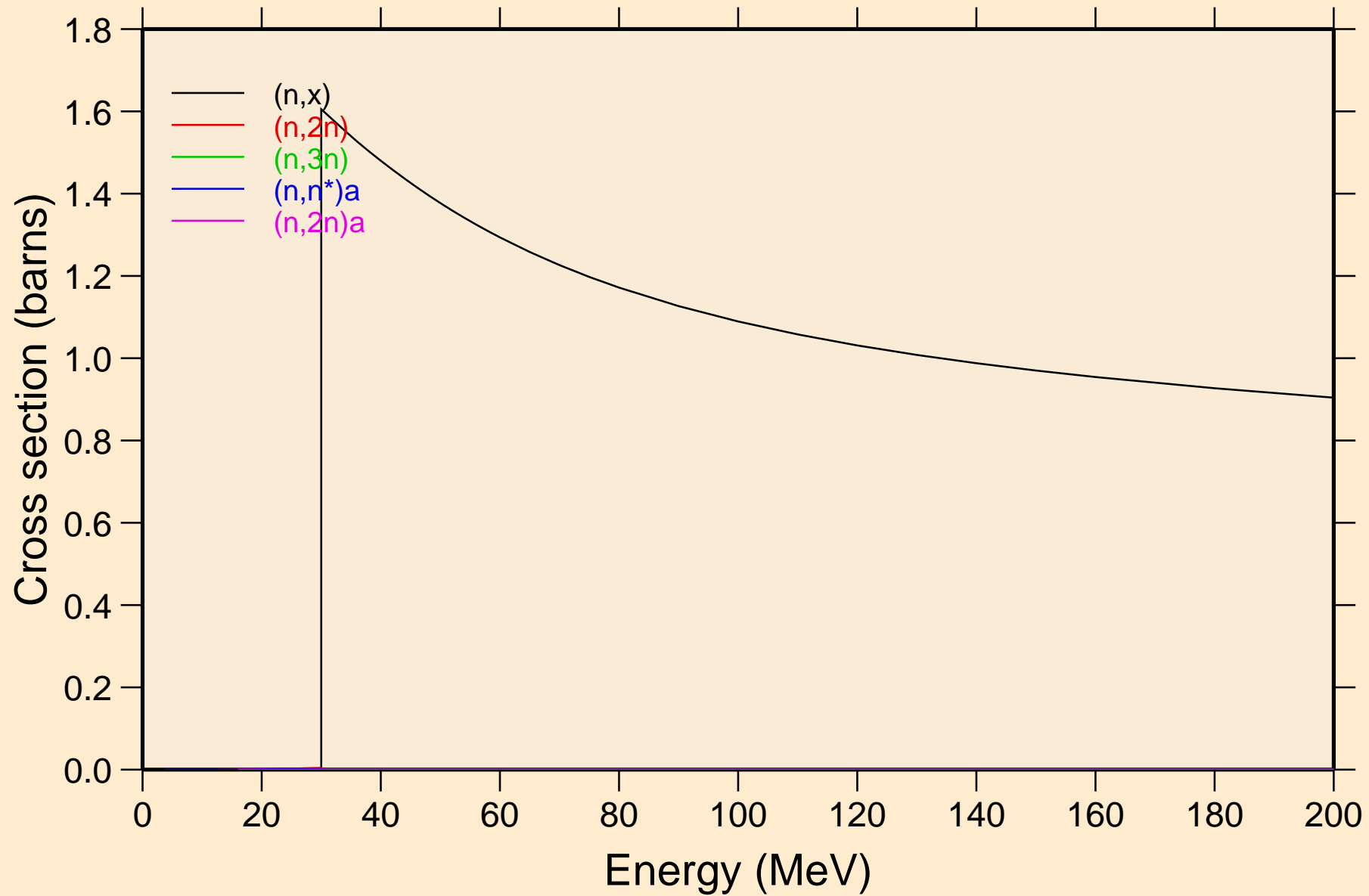

RH092 NEUTRON ACER TENDL-2024 LIBRARY; T=0.K
Threshold reactions

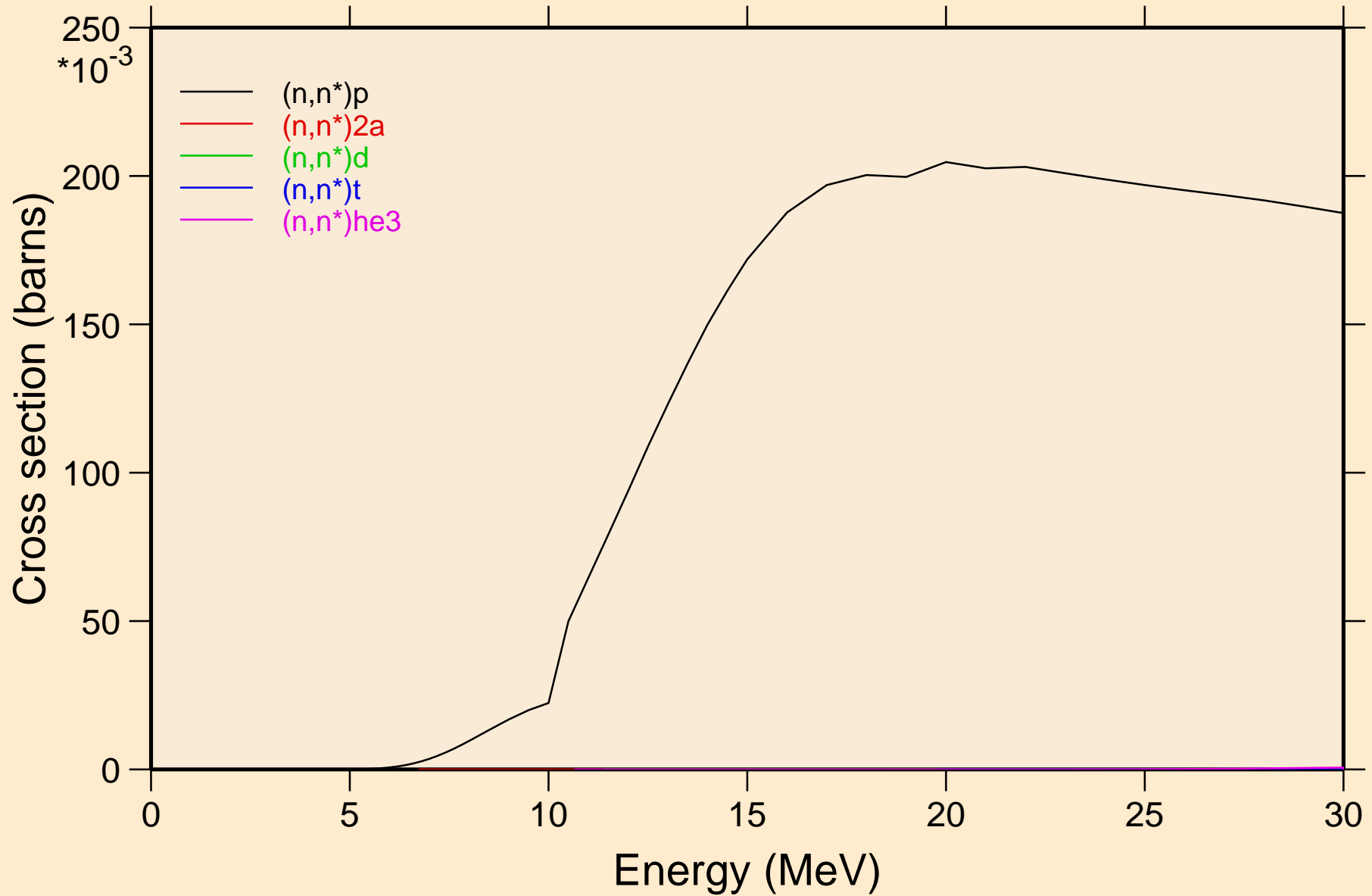

RH092 NEUTRON ACER TENDL-2024 LIBRARY; T=0.K
Threshold reactions

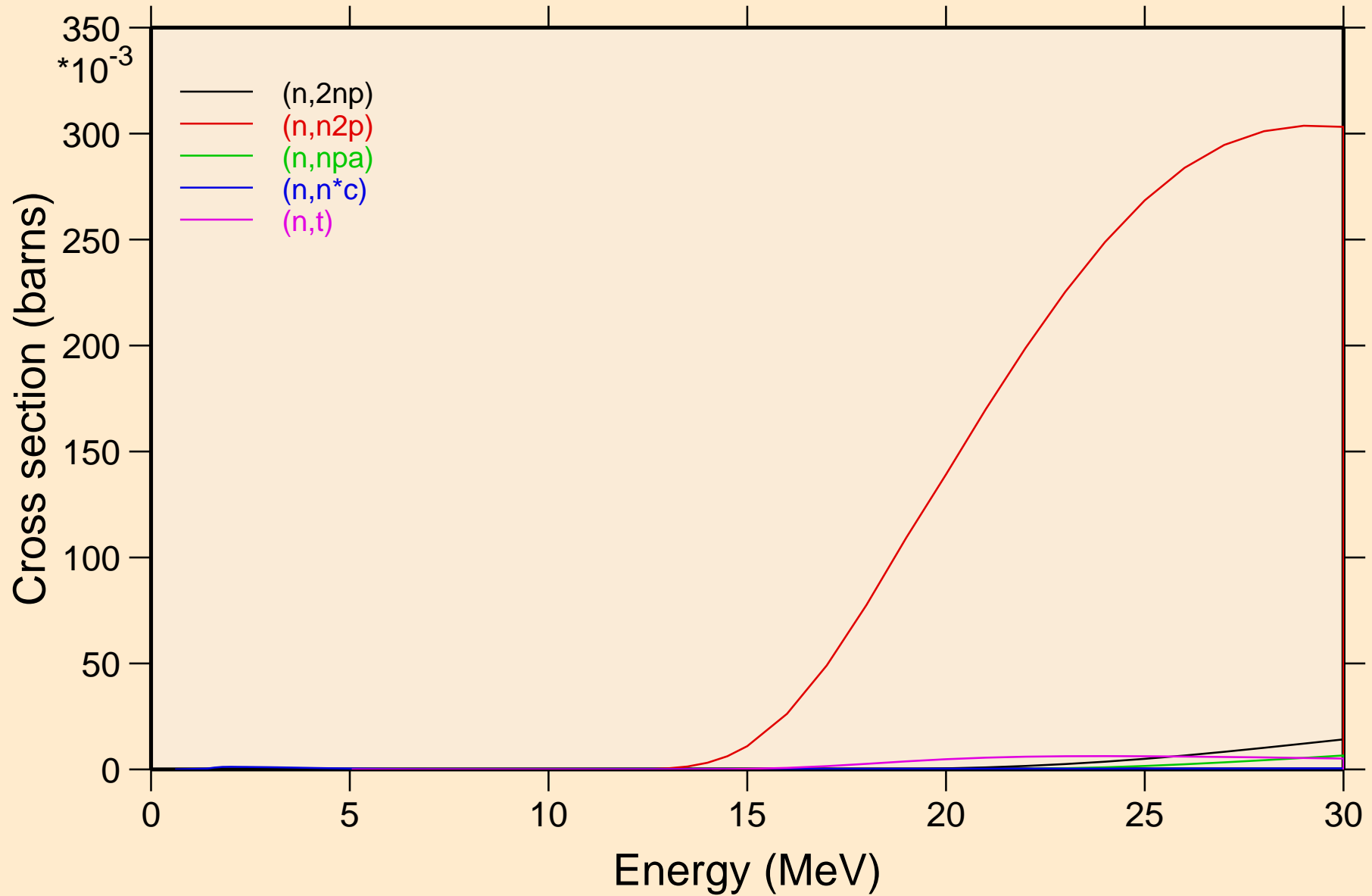

RH092 NEUTRON ACER TENDL-2024 LIBRARY; T=0.K
Threshold reactions

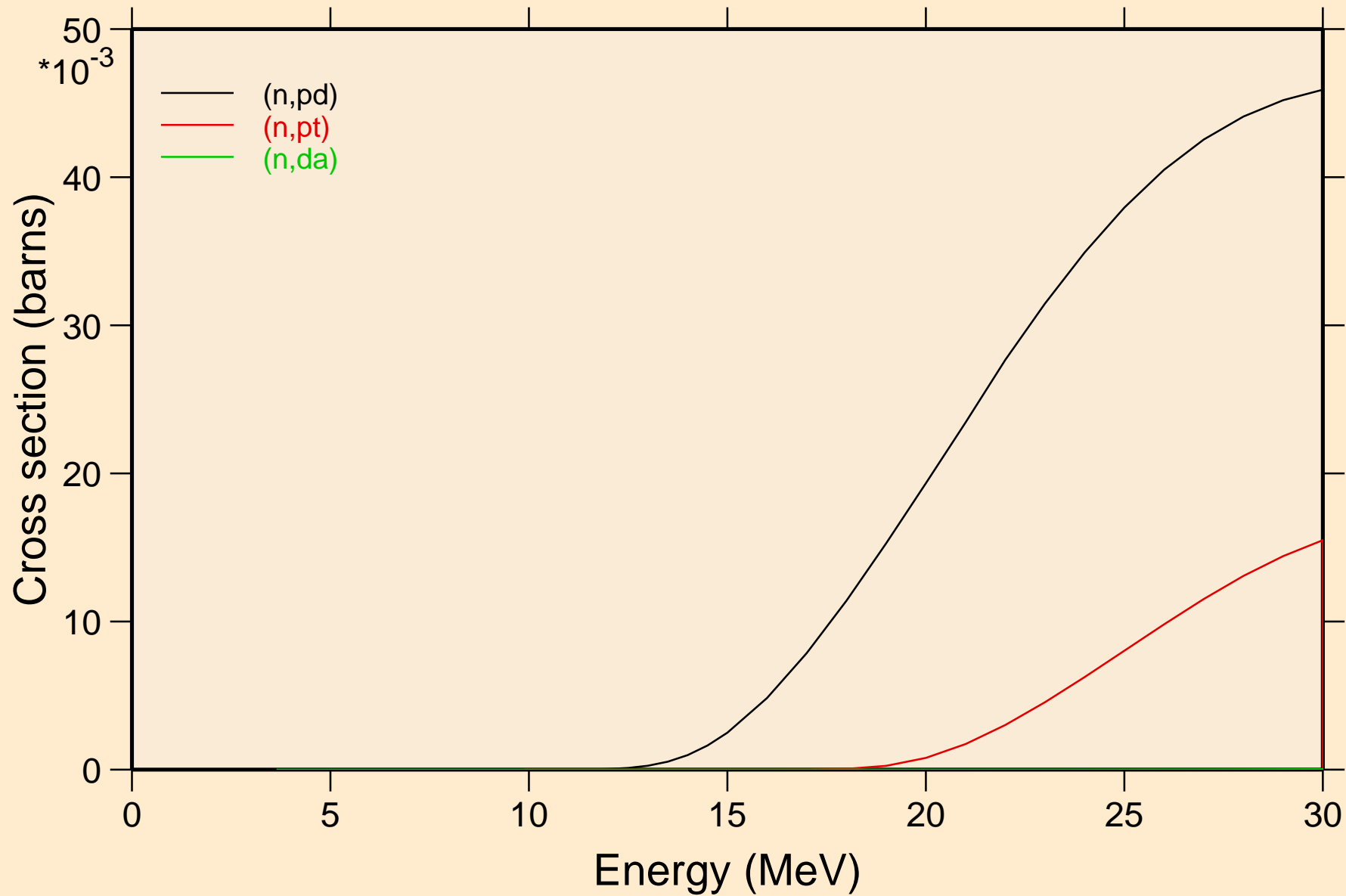

RH092 NEUTRON ACER TENDL-2024 LIBRARY; T=0.K
Threshold reactions

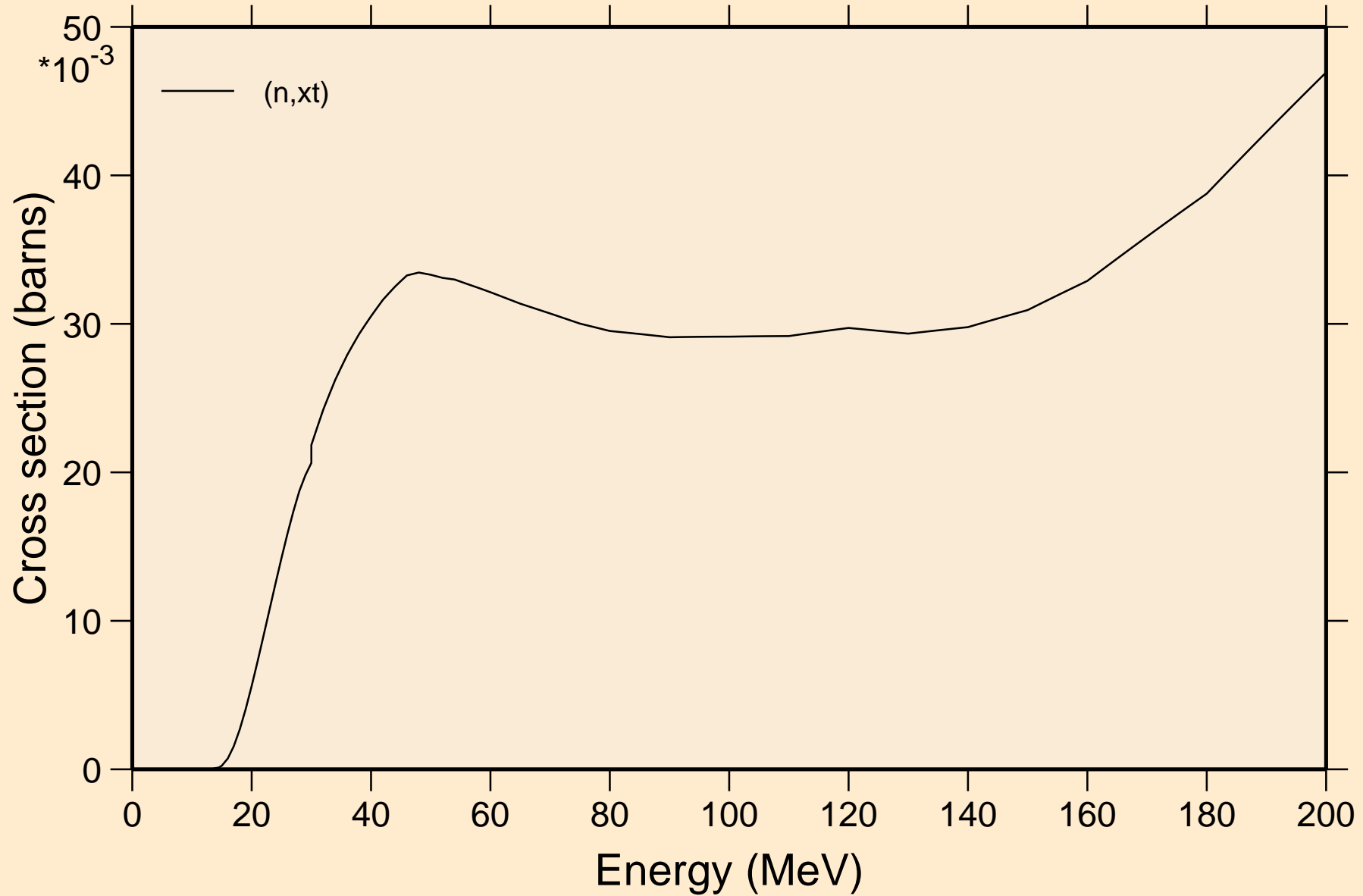

RH092 NEUTRON ACER TENDL-2024 LIBRARY; T=0.K
angular distribution for elastic

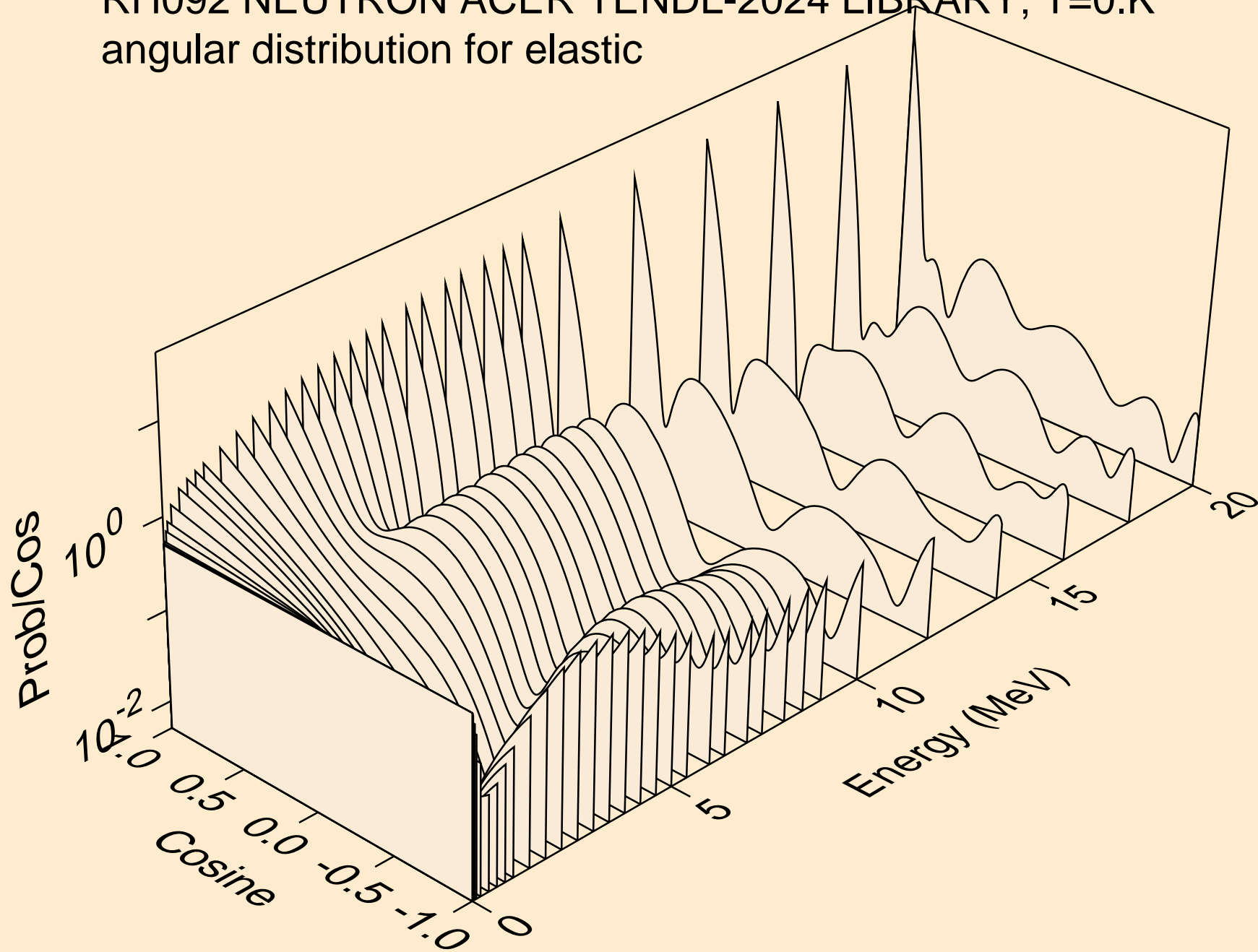

RH092 NEUTRON ACER TENDL-2024 LIBRARY; T=0.K
angular distribution for elastic

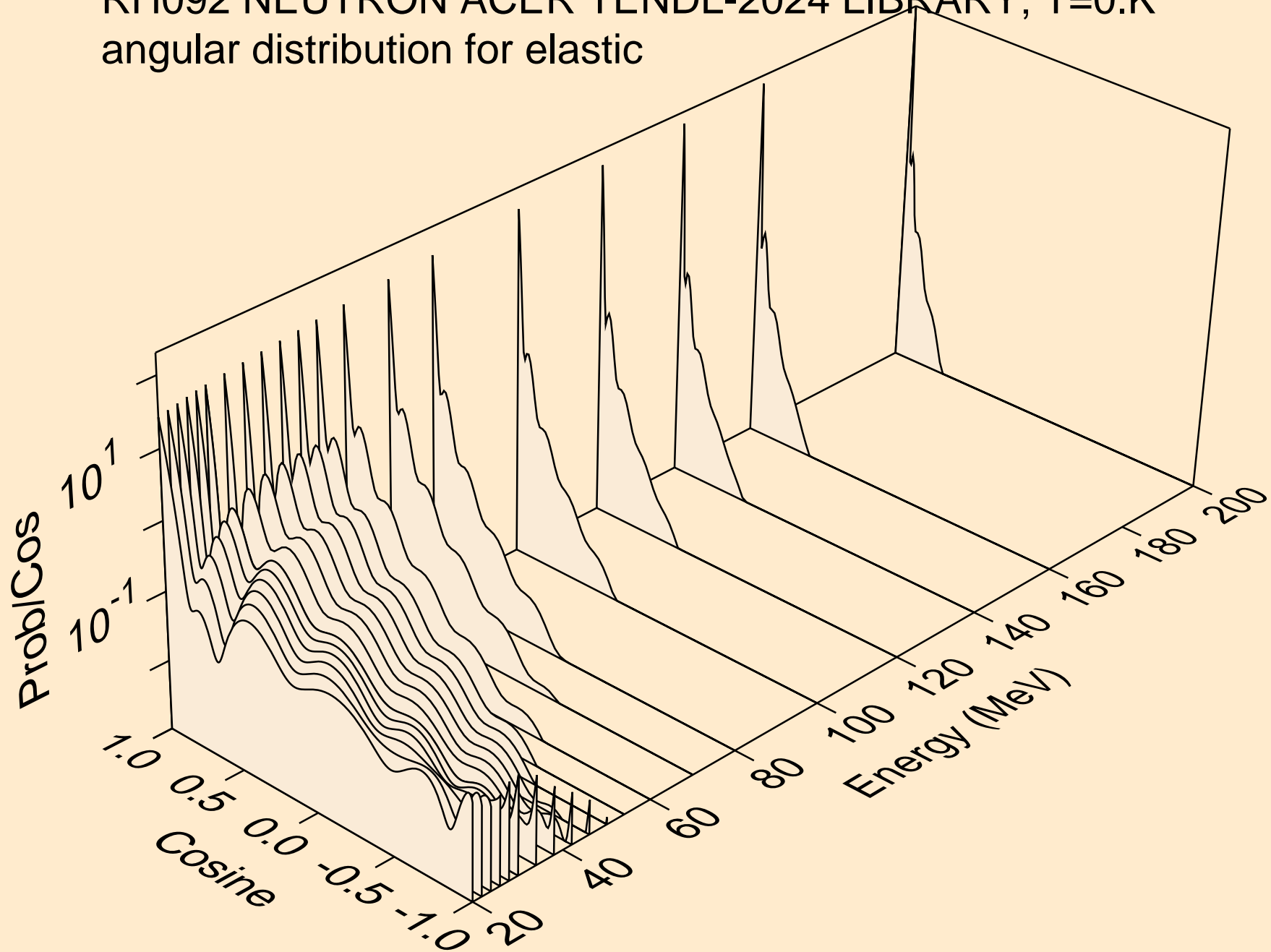

RH092 NEUTRON ACER TENDL-2024 LIBRARY; T=0.K
angular distribution for (n,n*1)

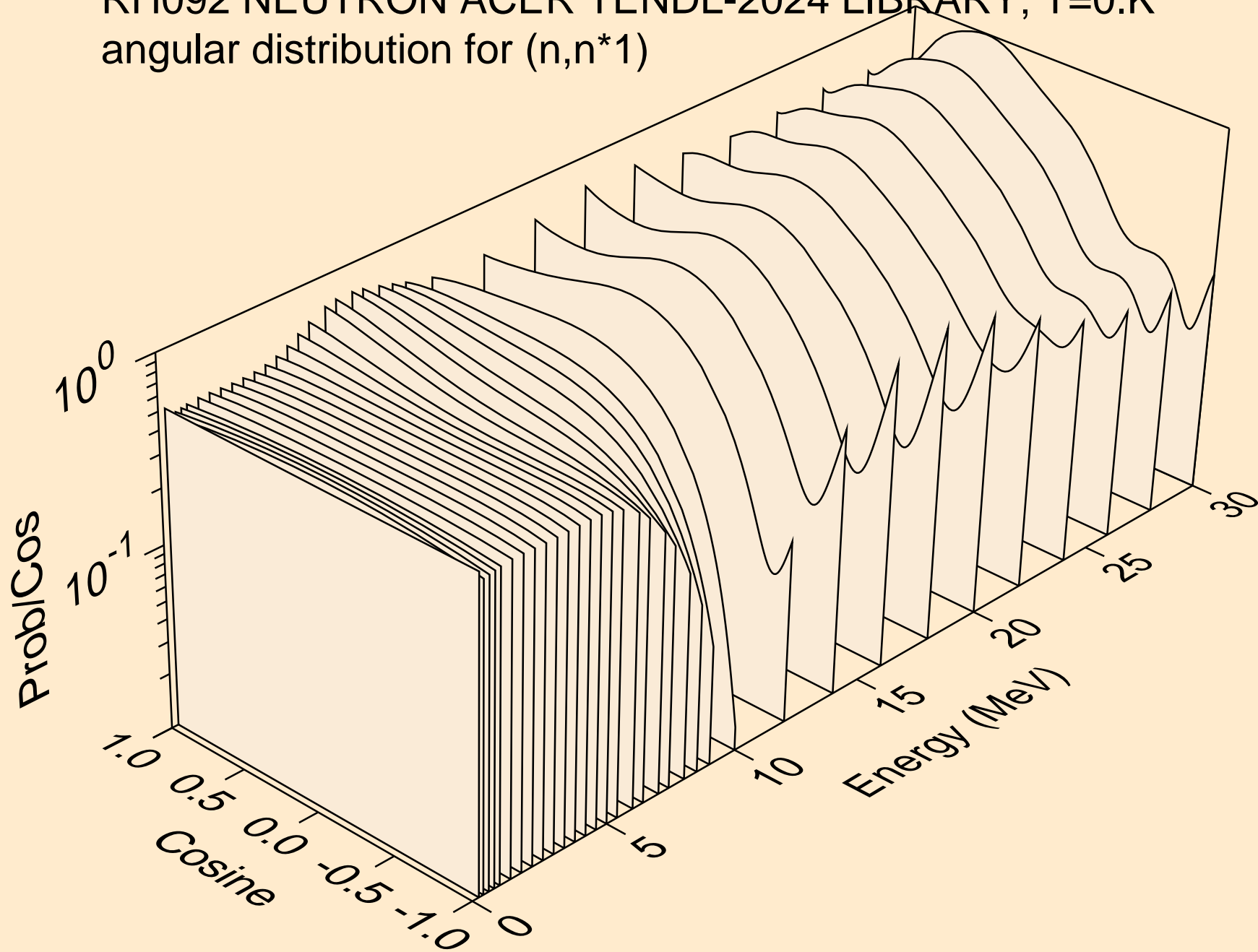

RH092 NEUTRON ACER TENDL-2024 LIBRARY; T=0.K
angular distribution for (n,n*2)

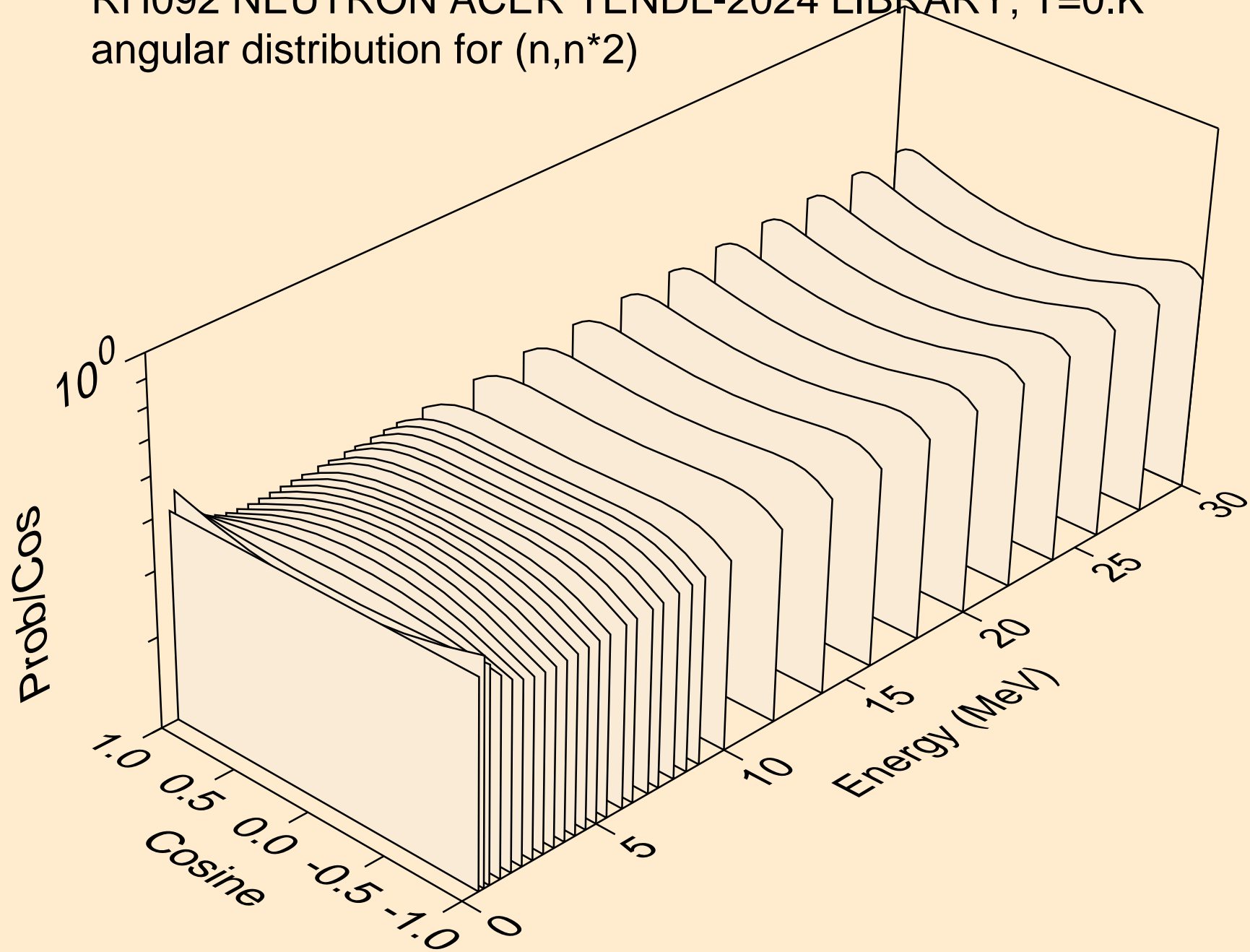

RH092 NEUTRON ACER TENDL-2024 LIBRARY; T=0.K
Neutron emission for (n,x)

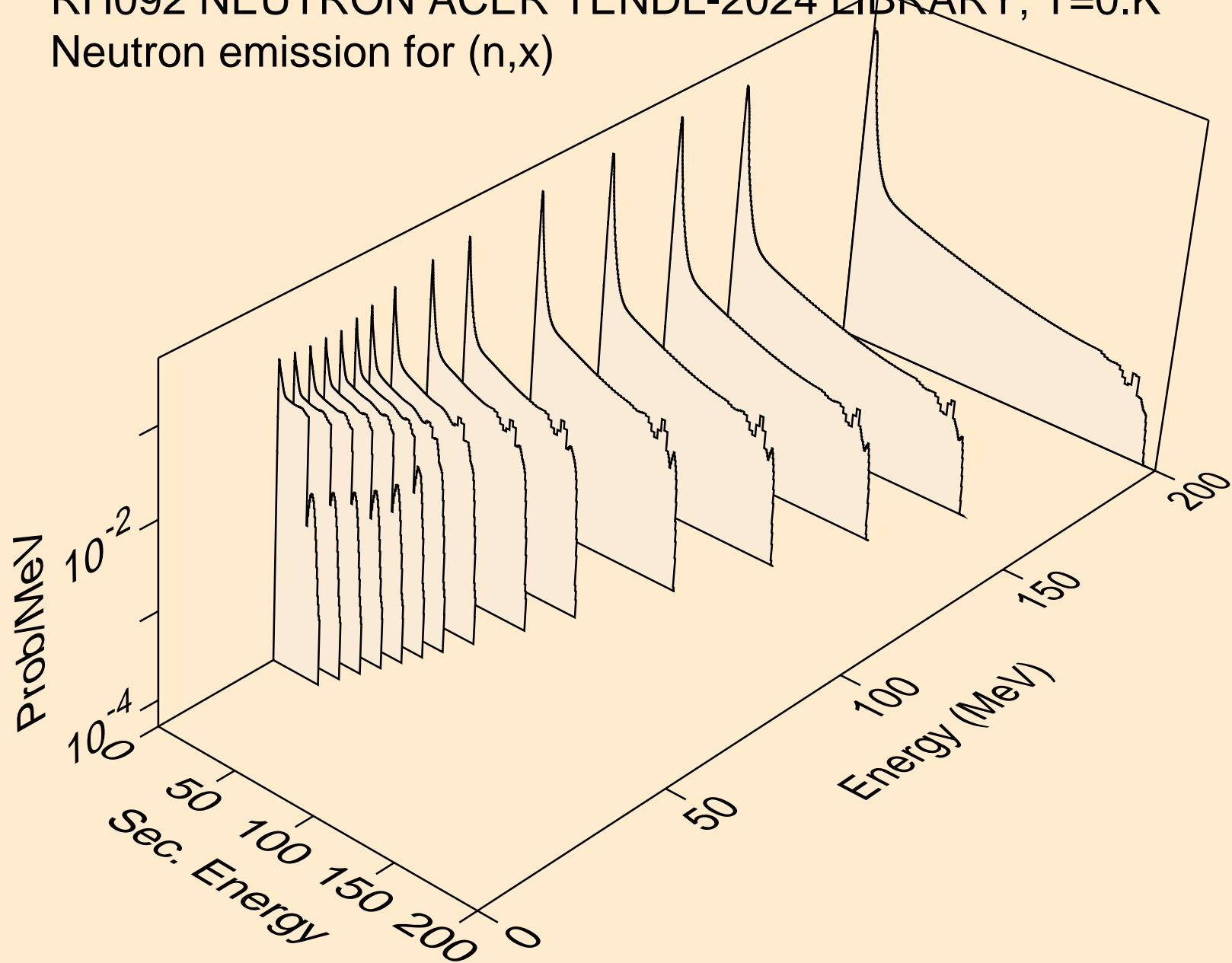

RH092 NEUTRON ACER TENDL-2024 LIBRARY; T=0.K
Neutron emission for (n,2n)

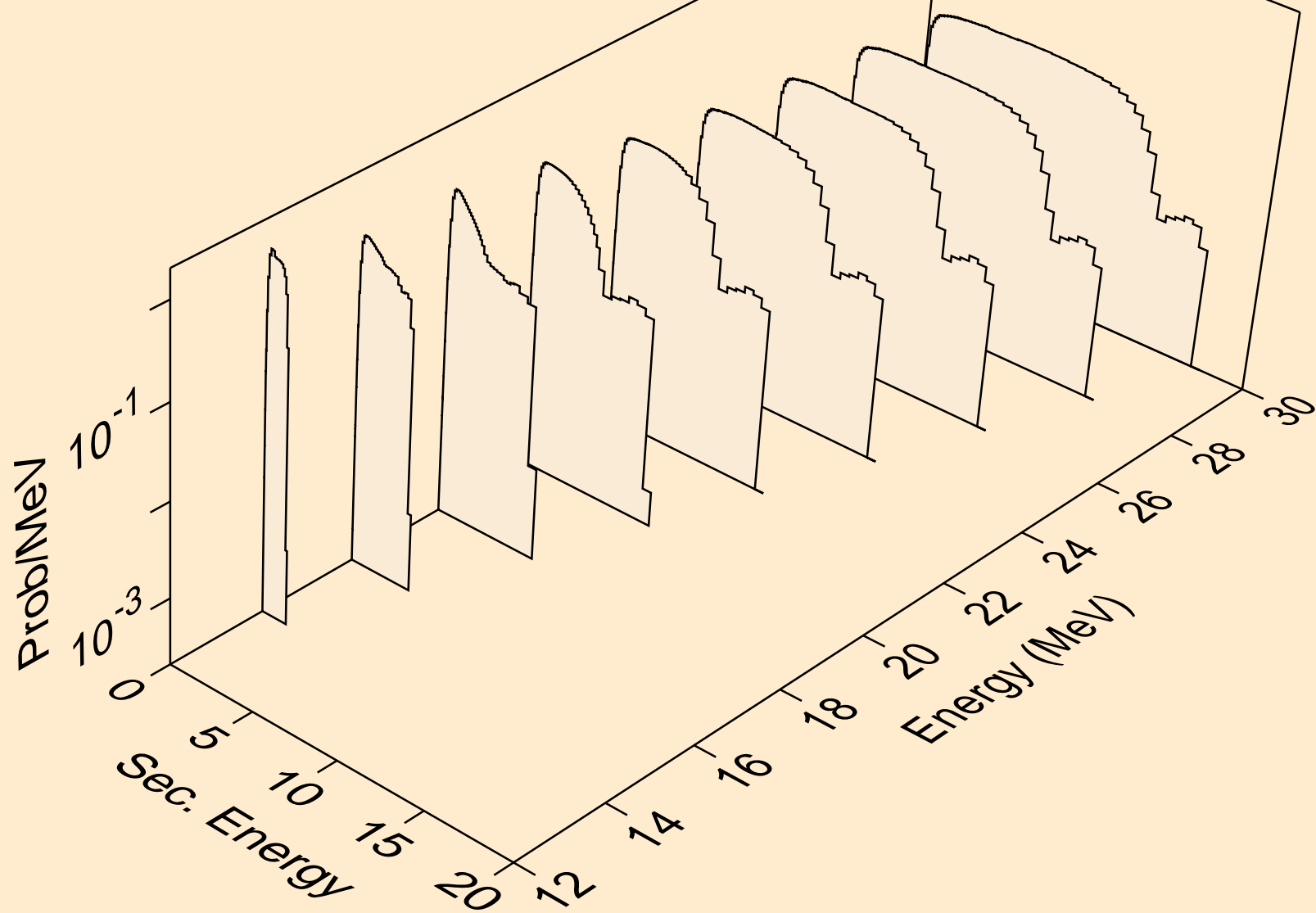

RH092 NEUTRON ACER TENDL-2024 LIBRARY; T=0.K
Neutron emission for (n,3n)

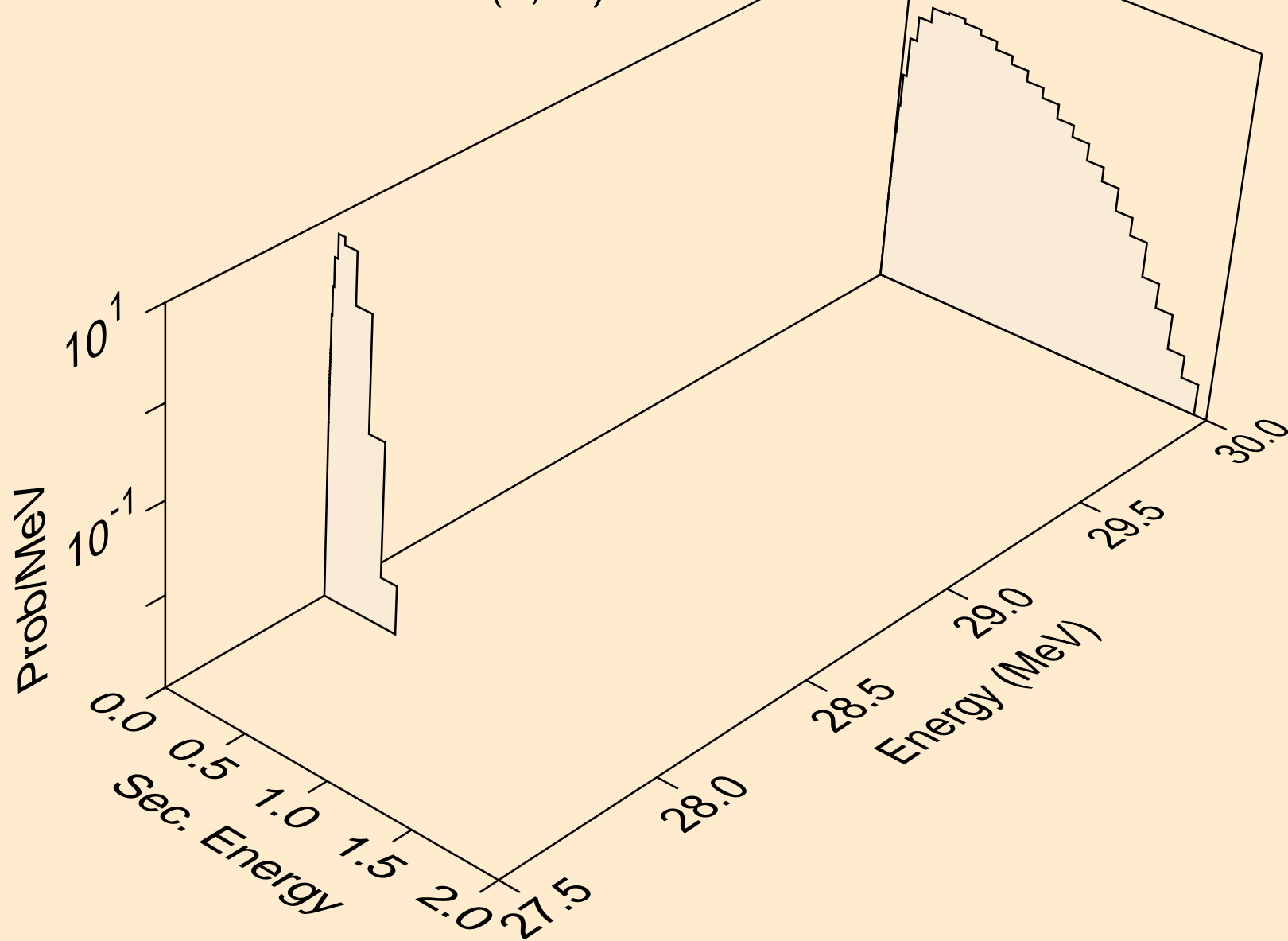

RH092 NEUTRON ACER TENDL-2024 LIBRARY; T=0.K
Neutron emission for (n,n*)a

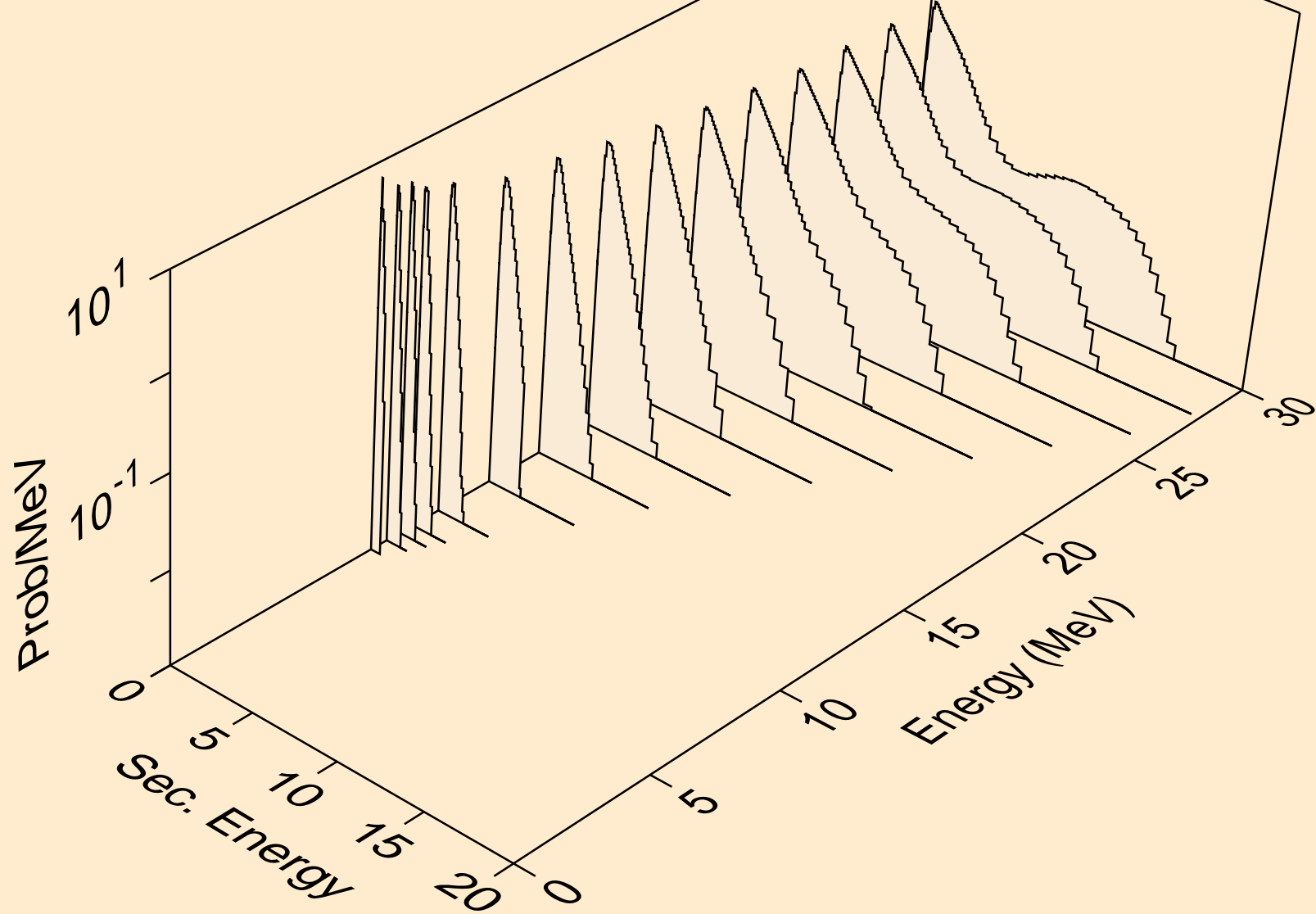

RH092 NEUTRON ACER TENDL-2024 LIBRARY; T=0.K
Neutron emission for (n,2n)a

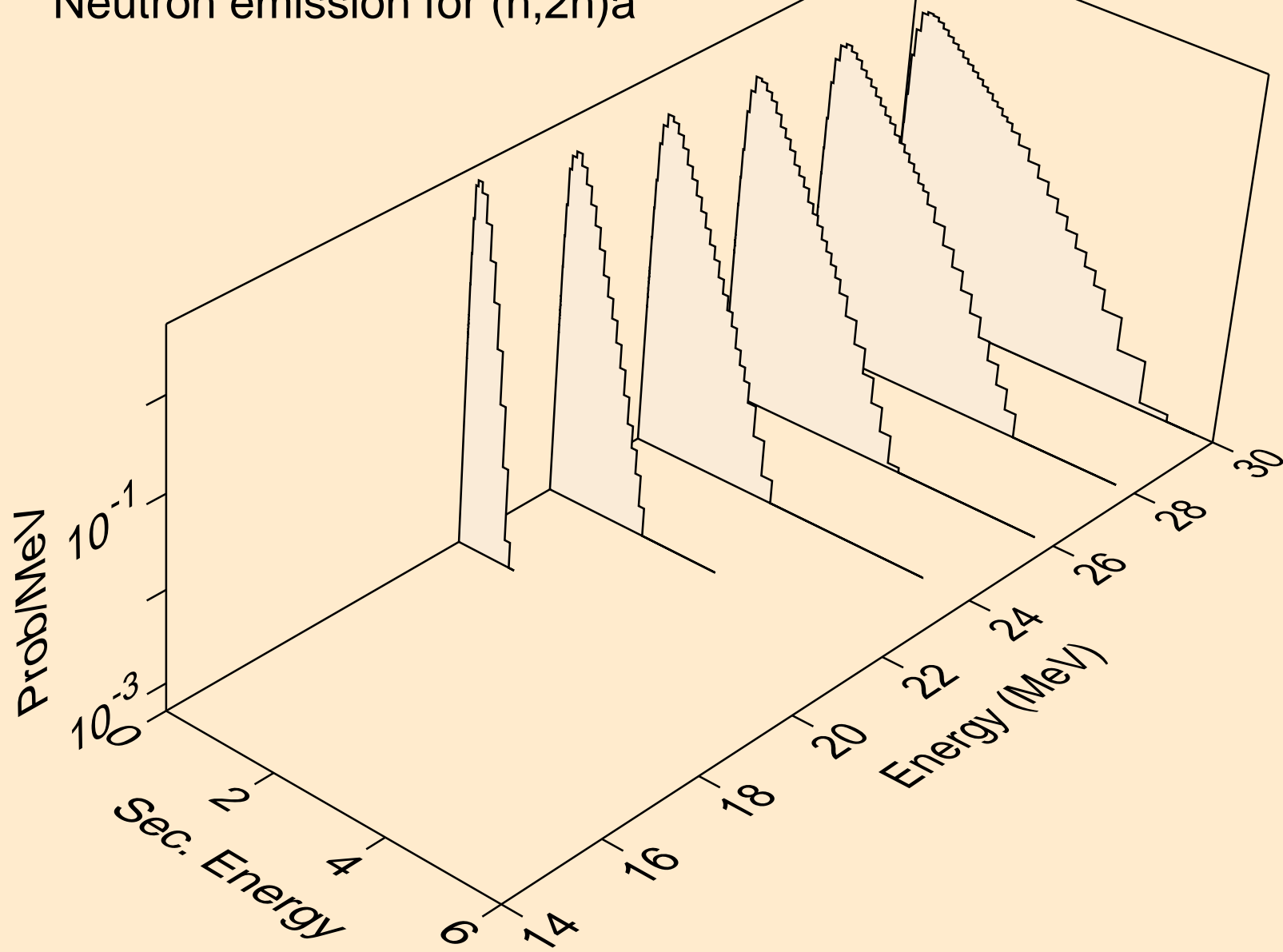

RH092 NEUTRON ACER TENDL-2024 LIBRARY; T=0.K
Neutron emission for (n,n*)p

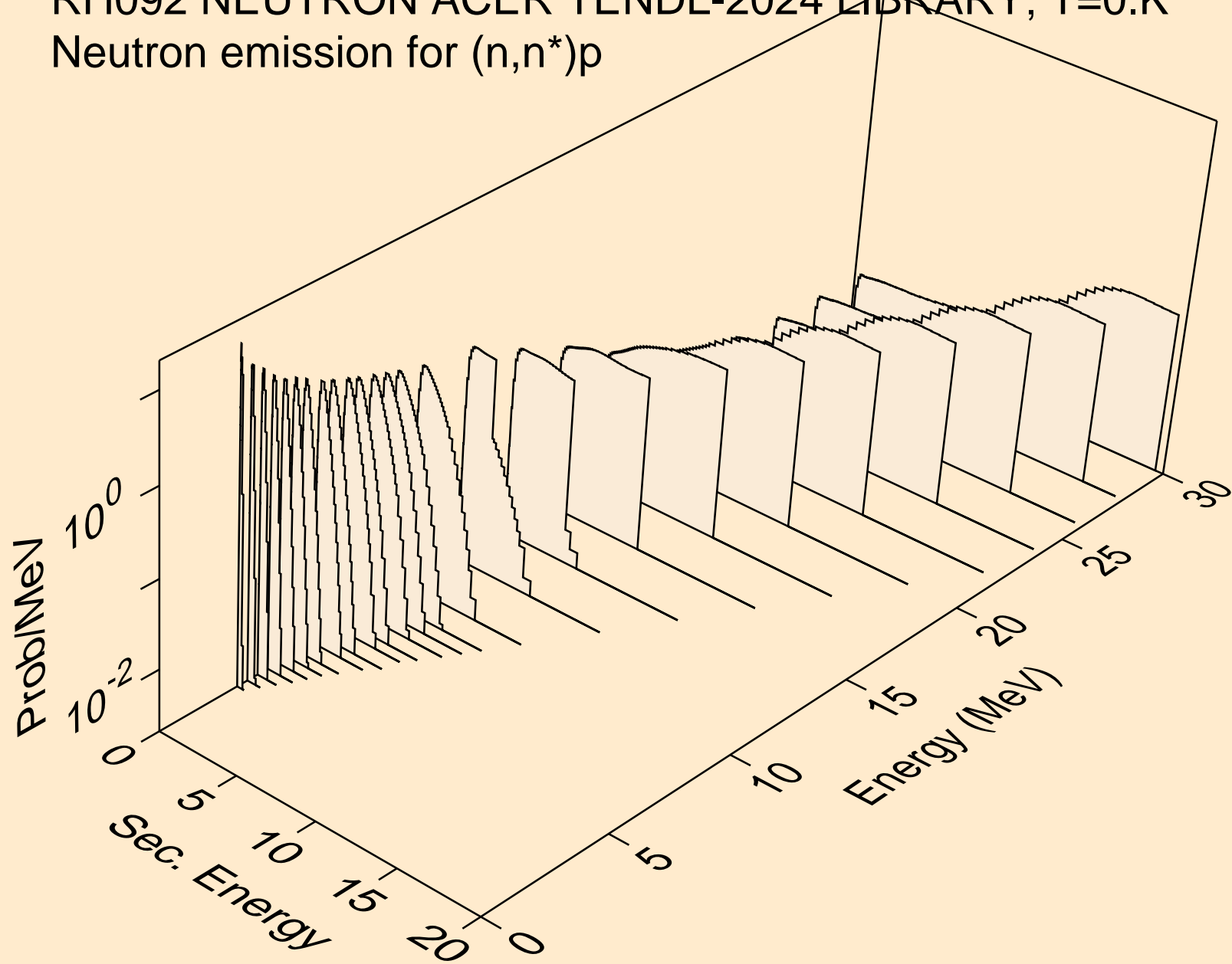

RH092 NEUTRON ACER TENDL-2024 LIBRARY; T=0.K
Neutron emission for (n,n*)2a

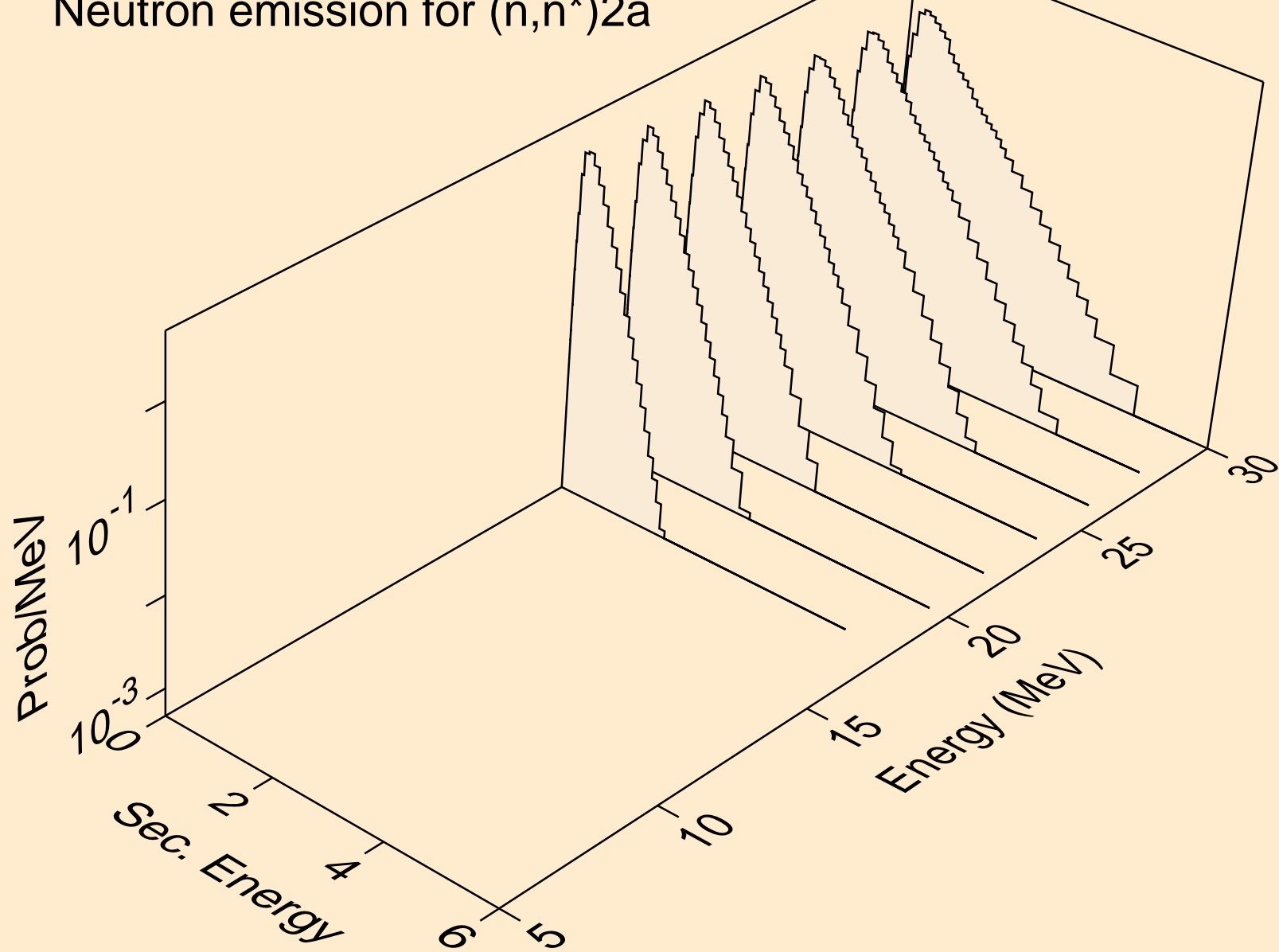

RH092 NEUTRON ACER TENDL-2024 LIBRARY; T=0.K
Neutron emission for (n,n*)d

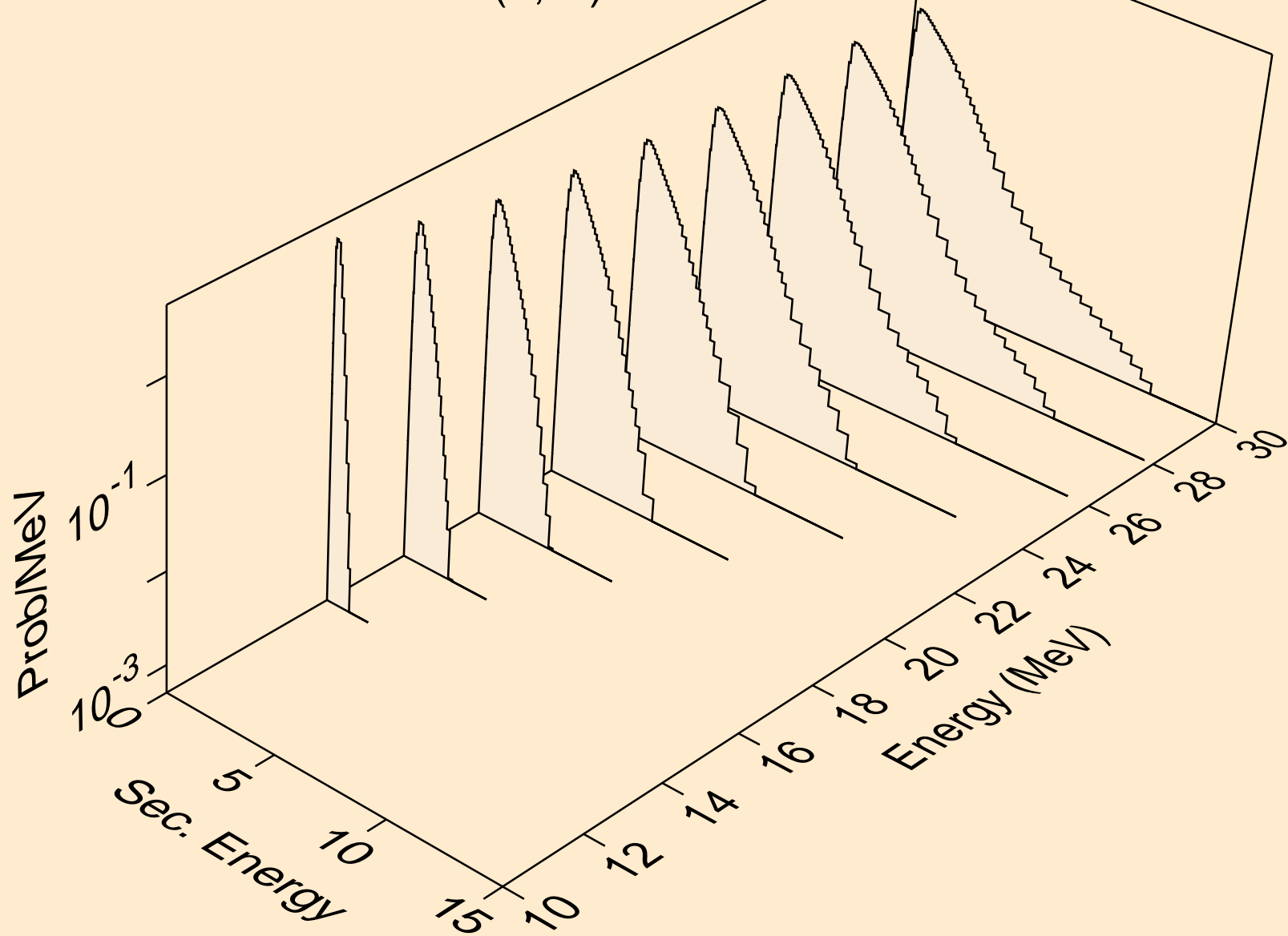

RH092 NEUTRON ACER TENDL-2024 LIBRARY; T=0.K
Neutron emission for (n,n*)t

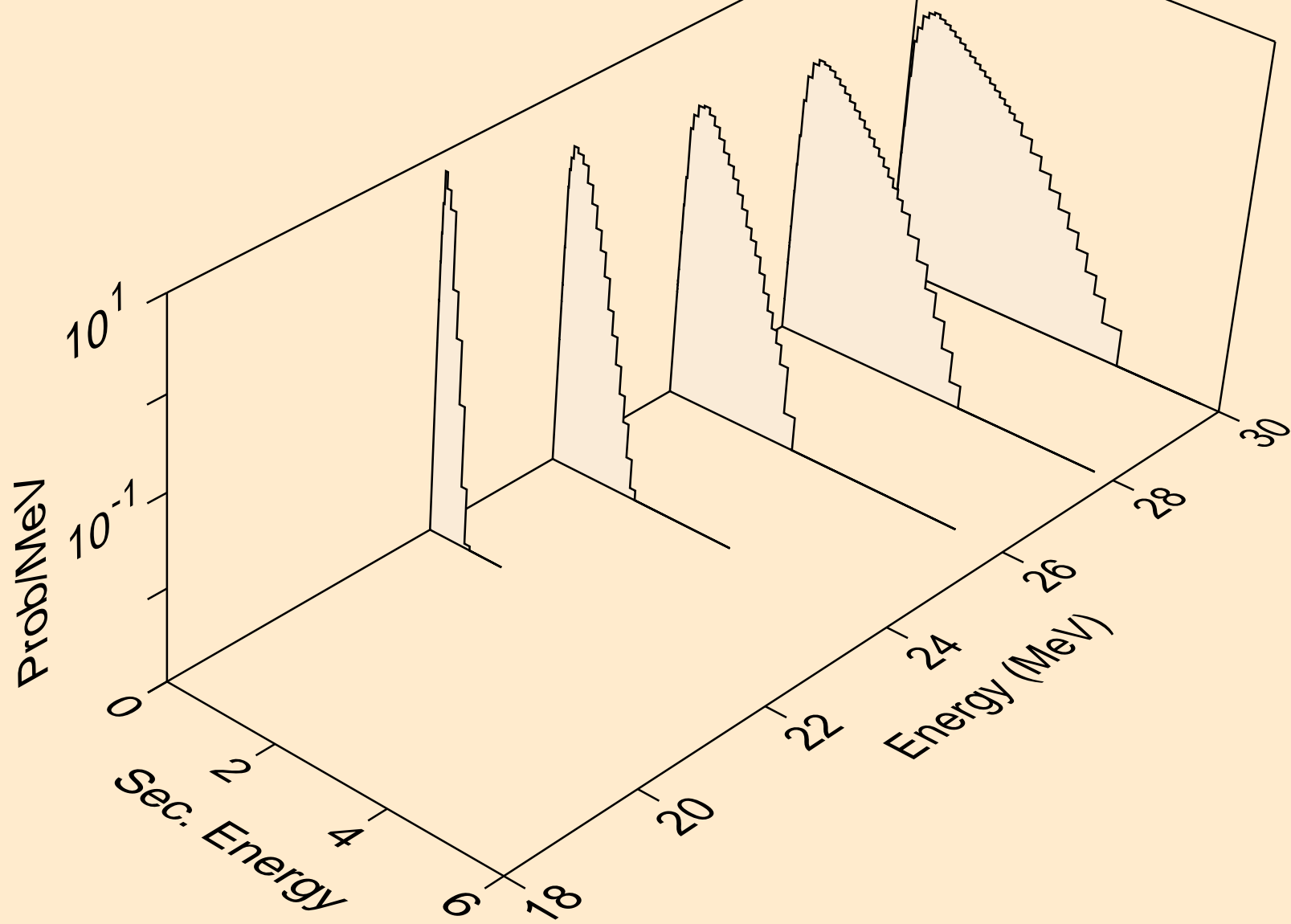

RH092 NEUTRON ACER TENDL-2024 LIBRARY; T=0.K
Neutron emission for (n,n*)he3

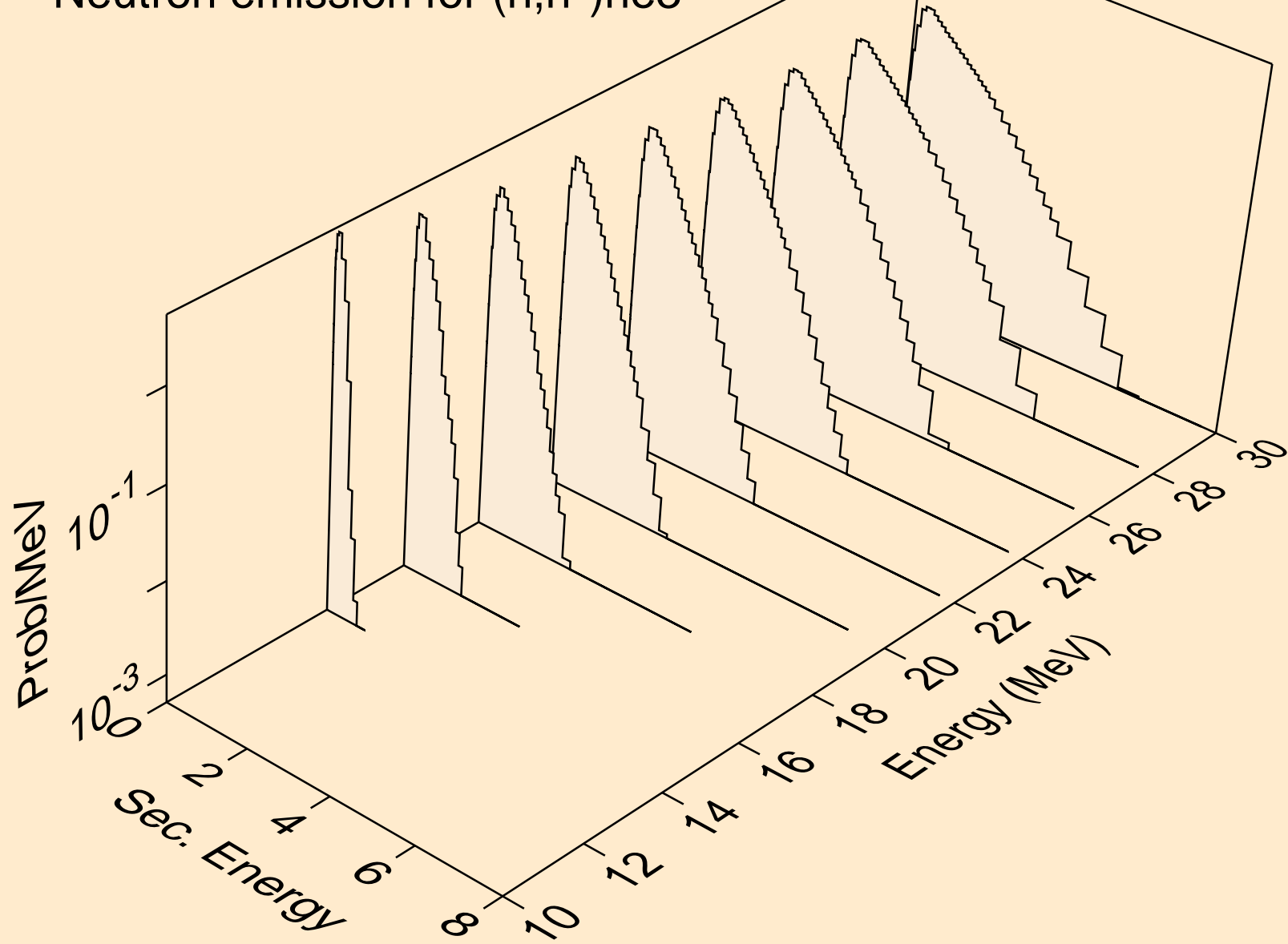

RH092 NEUTRON ACER TENDL-2024 LIBRARY; T=0.K
Neutron emission for (n,2np)

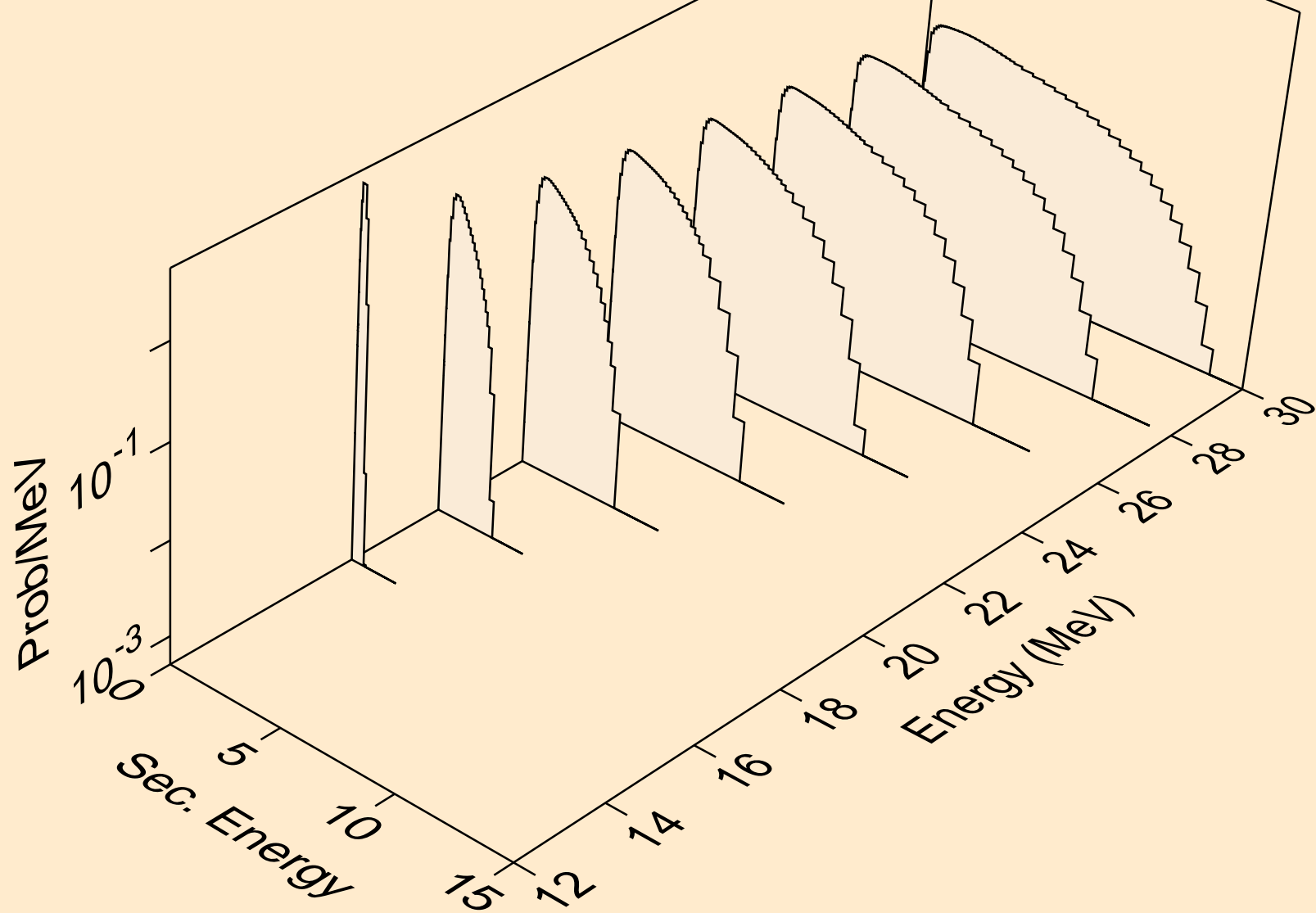

RH092 NEUTRON ACER TENDL-2024 LIBRARY; T=0.K
Neutron emission for (n,n2p)

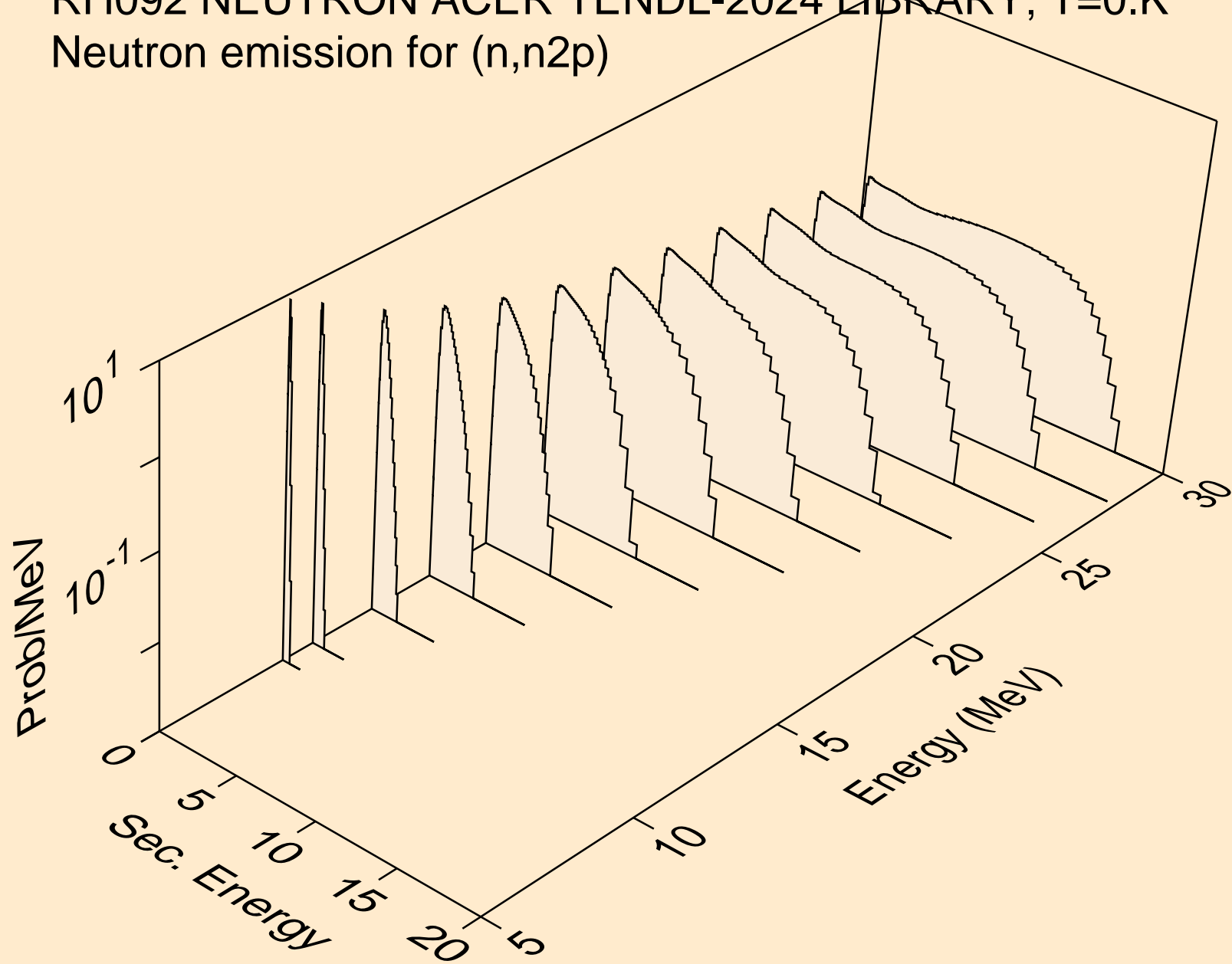

RH092 NEUTRON ACER TENDL-2024 LIBRARY; T=0.K
Neutron emission for (n,npa)

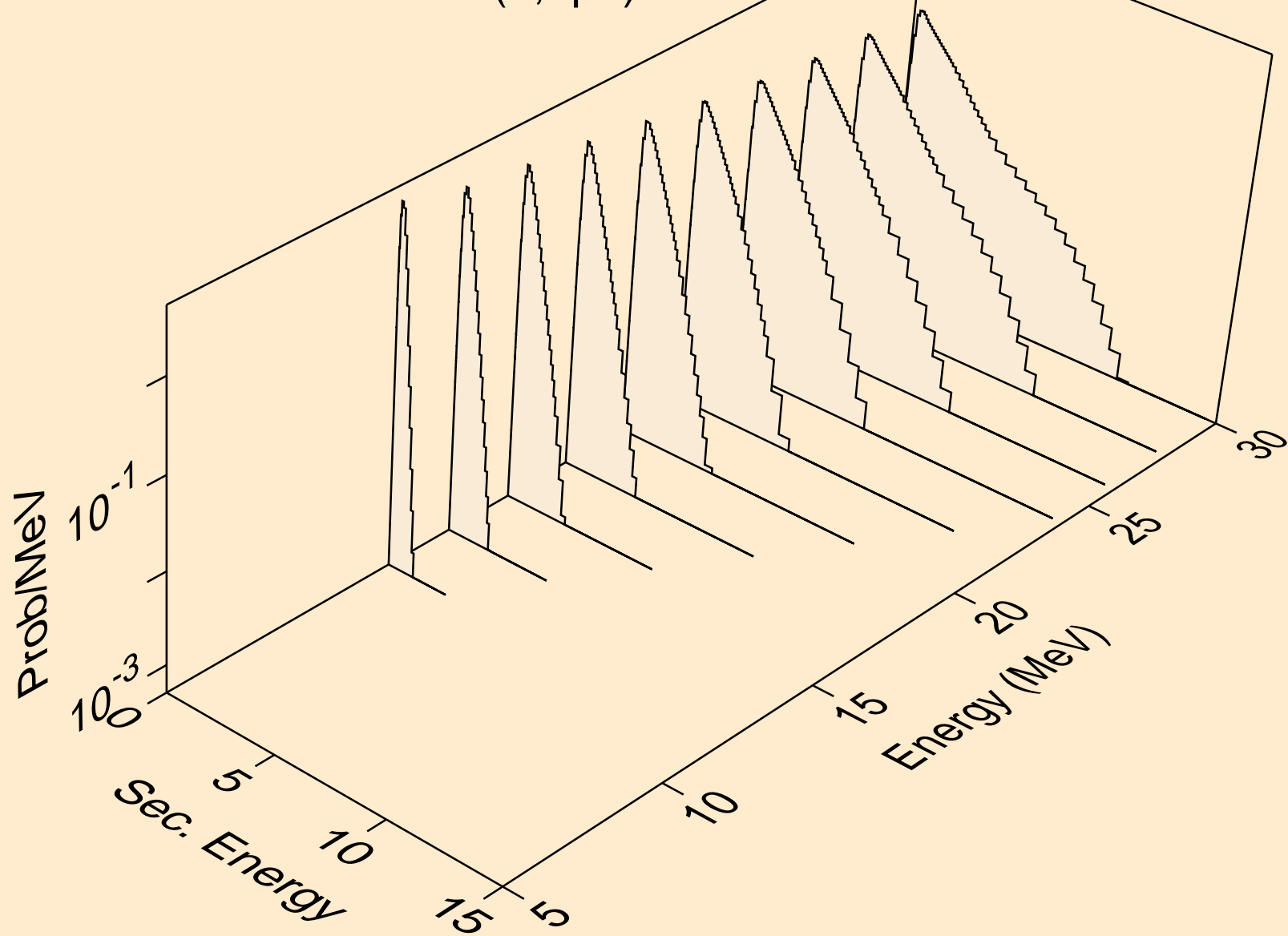

RH092 NEUTRON ACER TENDL-2024 LIBRARY; T=0.K
Neutron emission for (n,n*c)

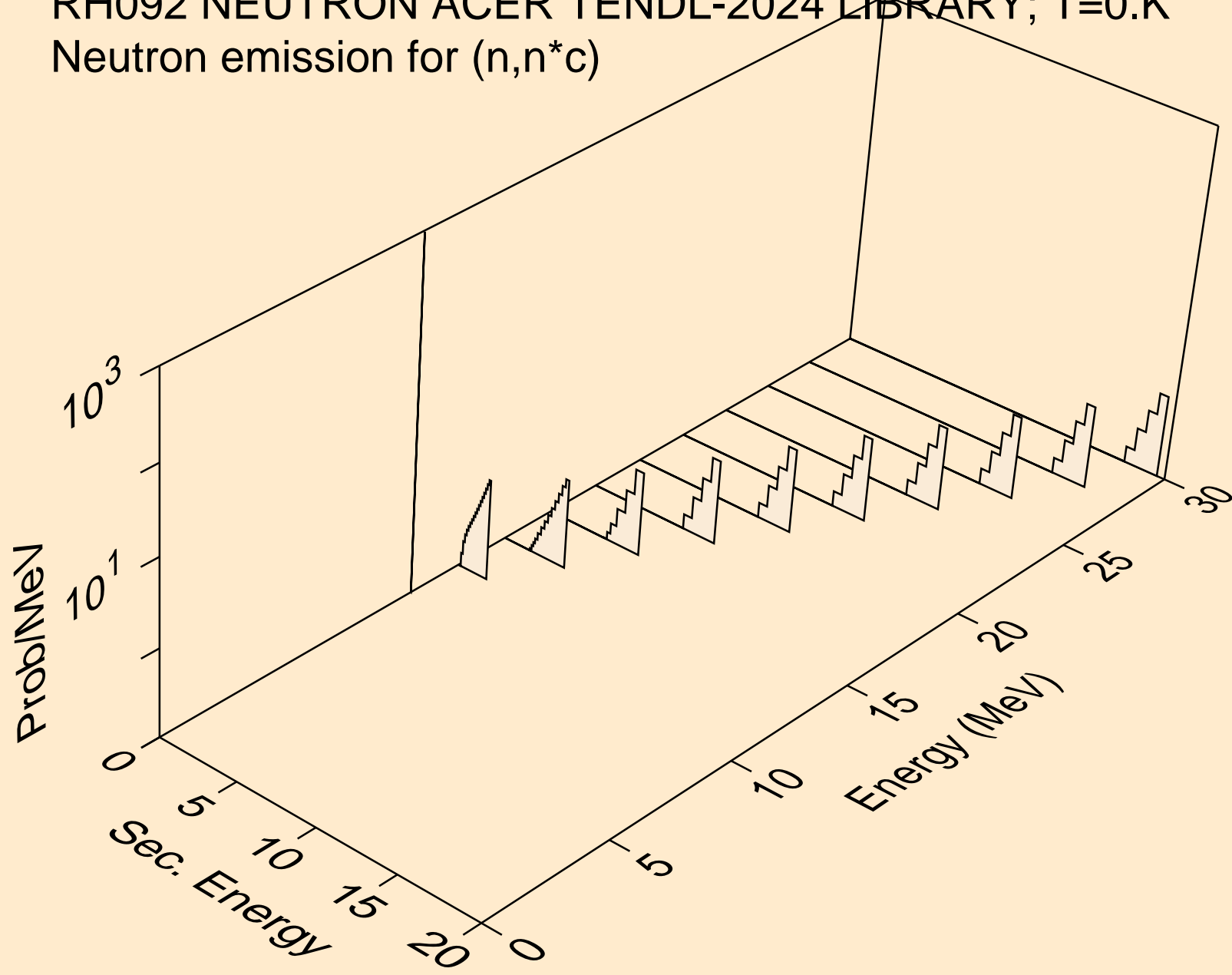

RH092 NEUTRON ACER TENDL-2024 LIBRARY; T=0.K
Photon emission for (n,x)

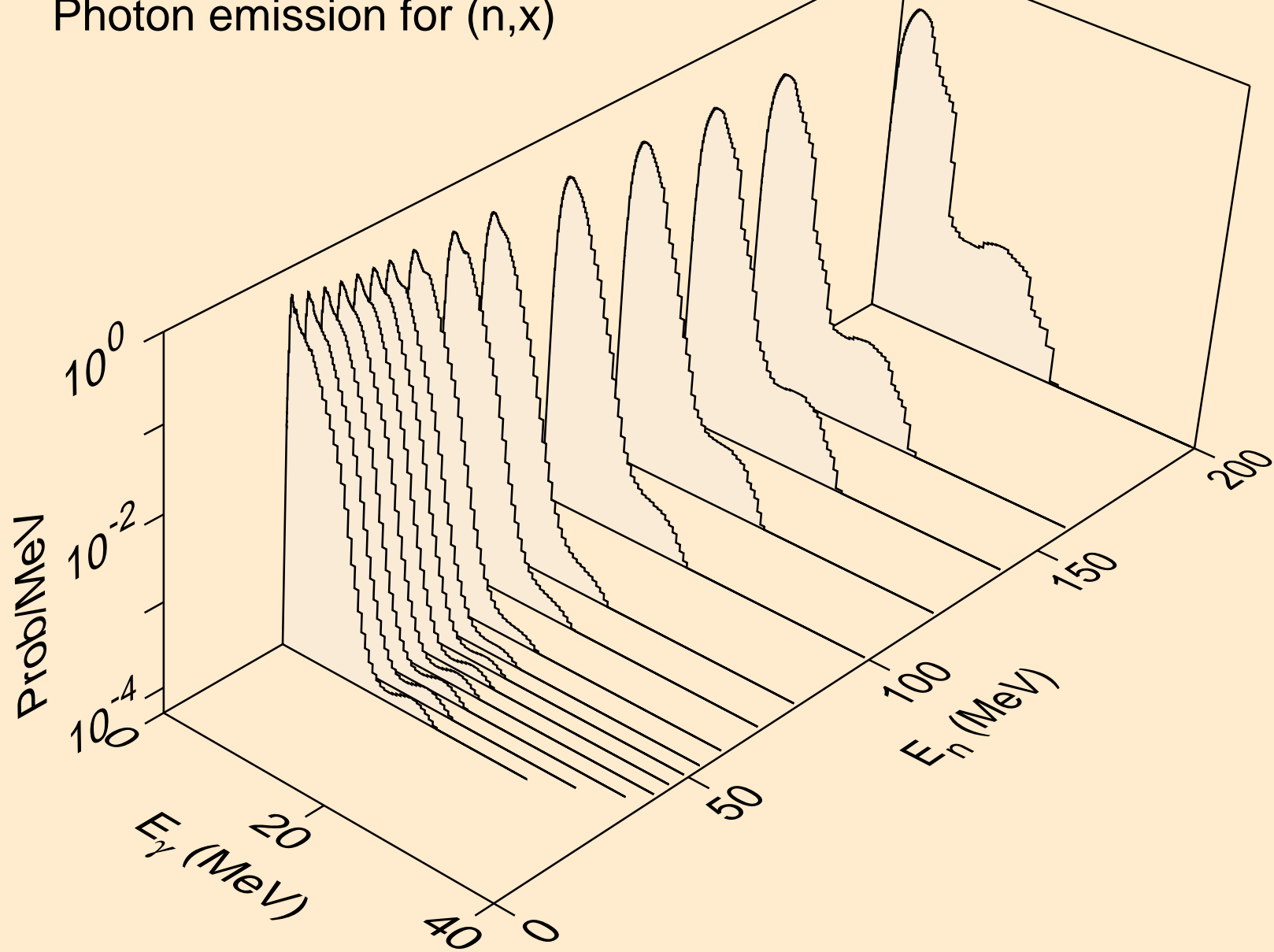

RH092 NEUTRON ACER TENDL-2024 LIBRARY; T=0.K
Photon emission for (n,2n)

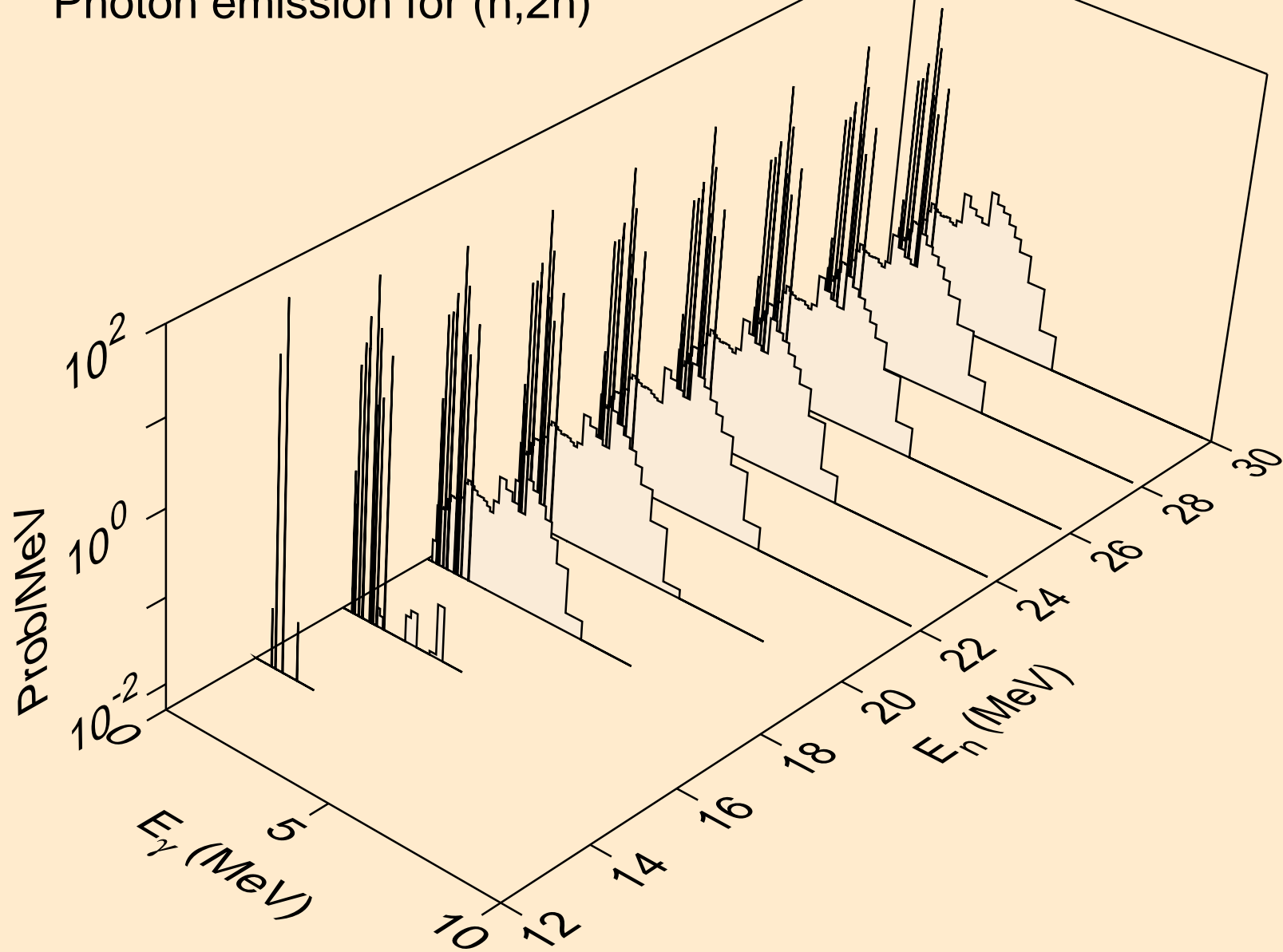

RH092 NEUTRON ACER TENDL-2024 LIBRARY; T=0.K
Photon emission for (n,3n)

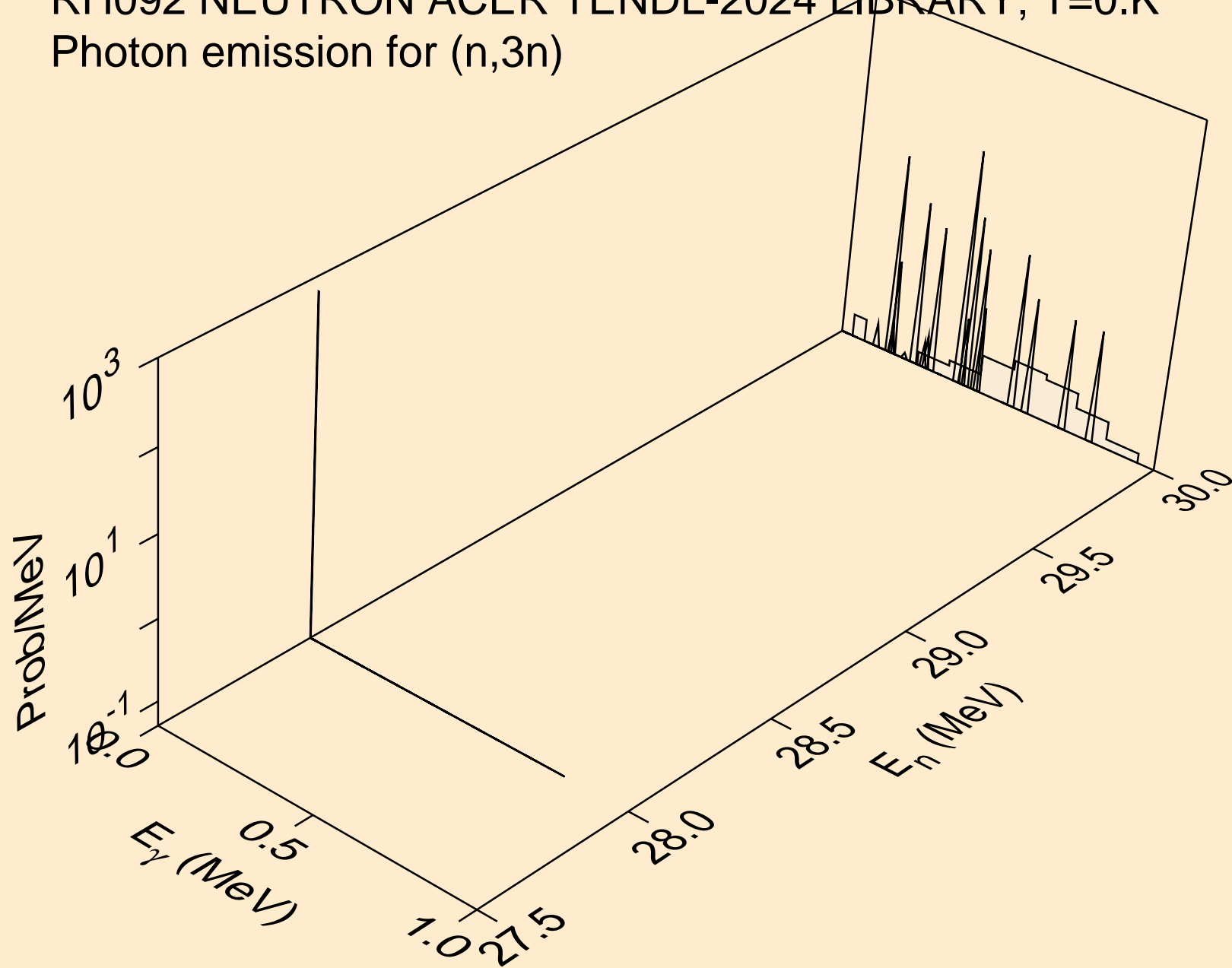

RH092 NEUTRON ACER TENDL-2024 LIBRARY; T=0.K
Photon emission for (n,n*)a

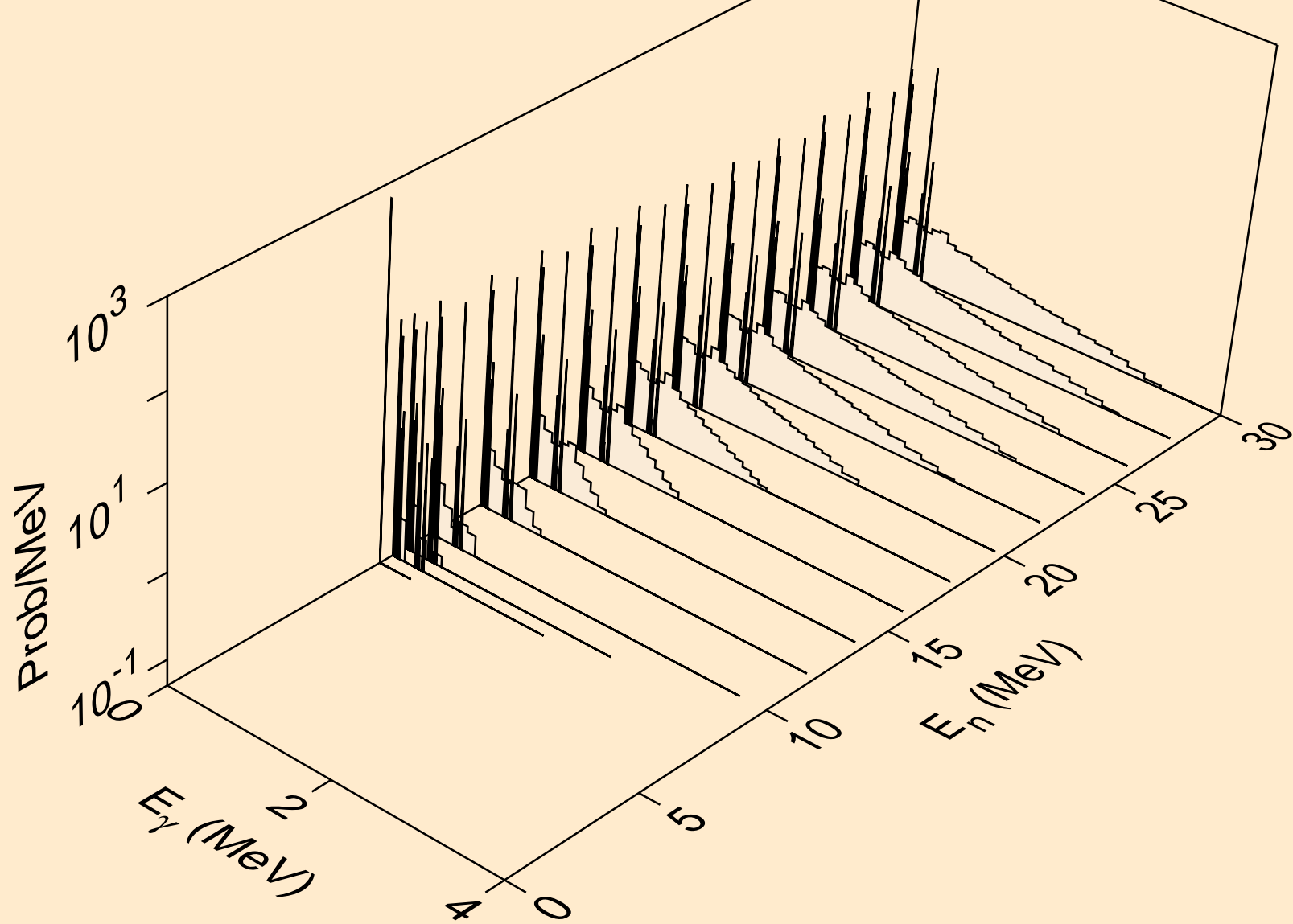

RH092 NEUTRON ACER TENDL-2024 LIBRARY; T=0.K
Photon emission for (n,2n)a

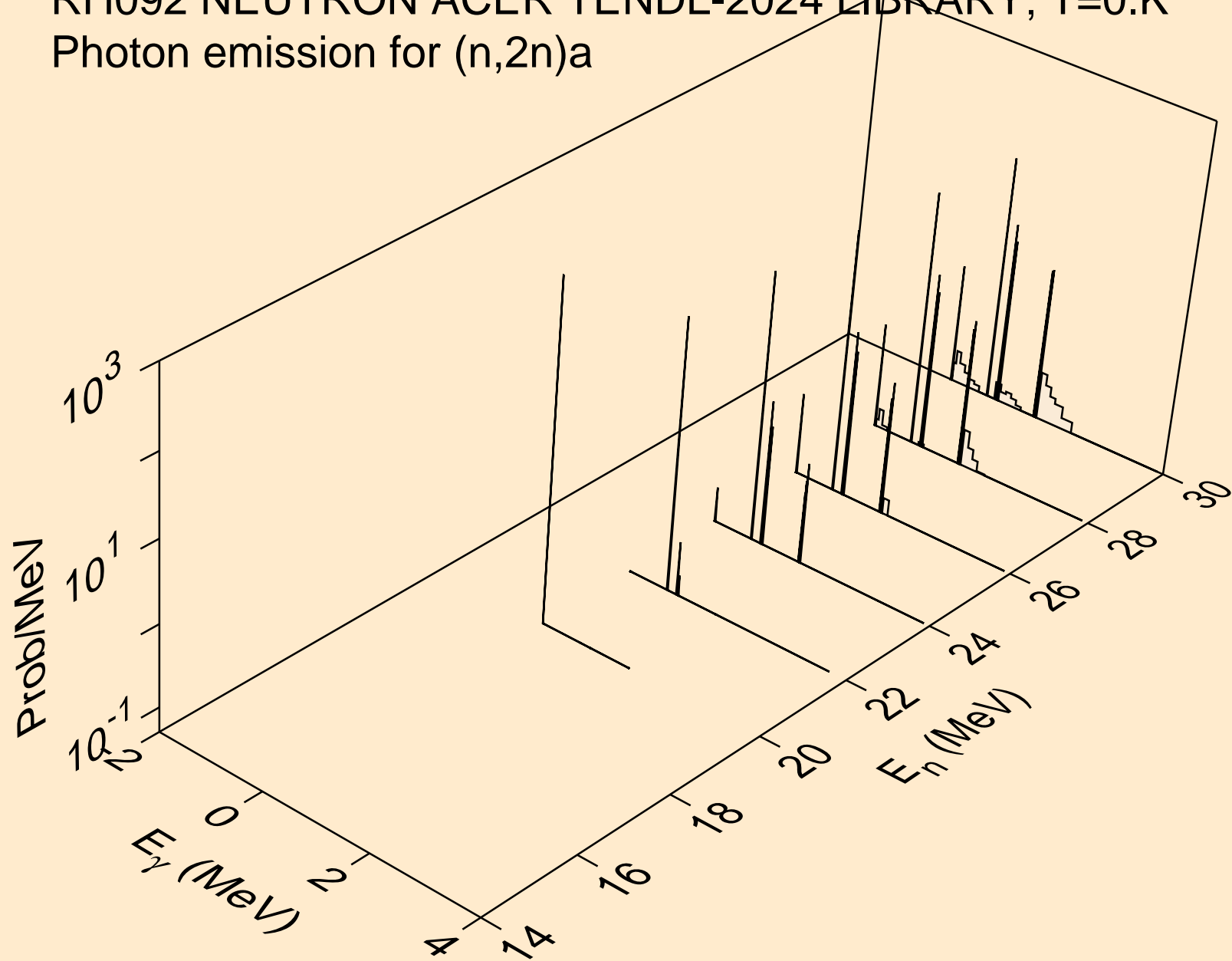

RH092 NEUTRON ACER TENDL-2024 LIBRARY; T=0.K
Photon emission for (n,n*)p

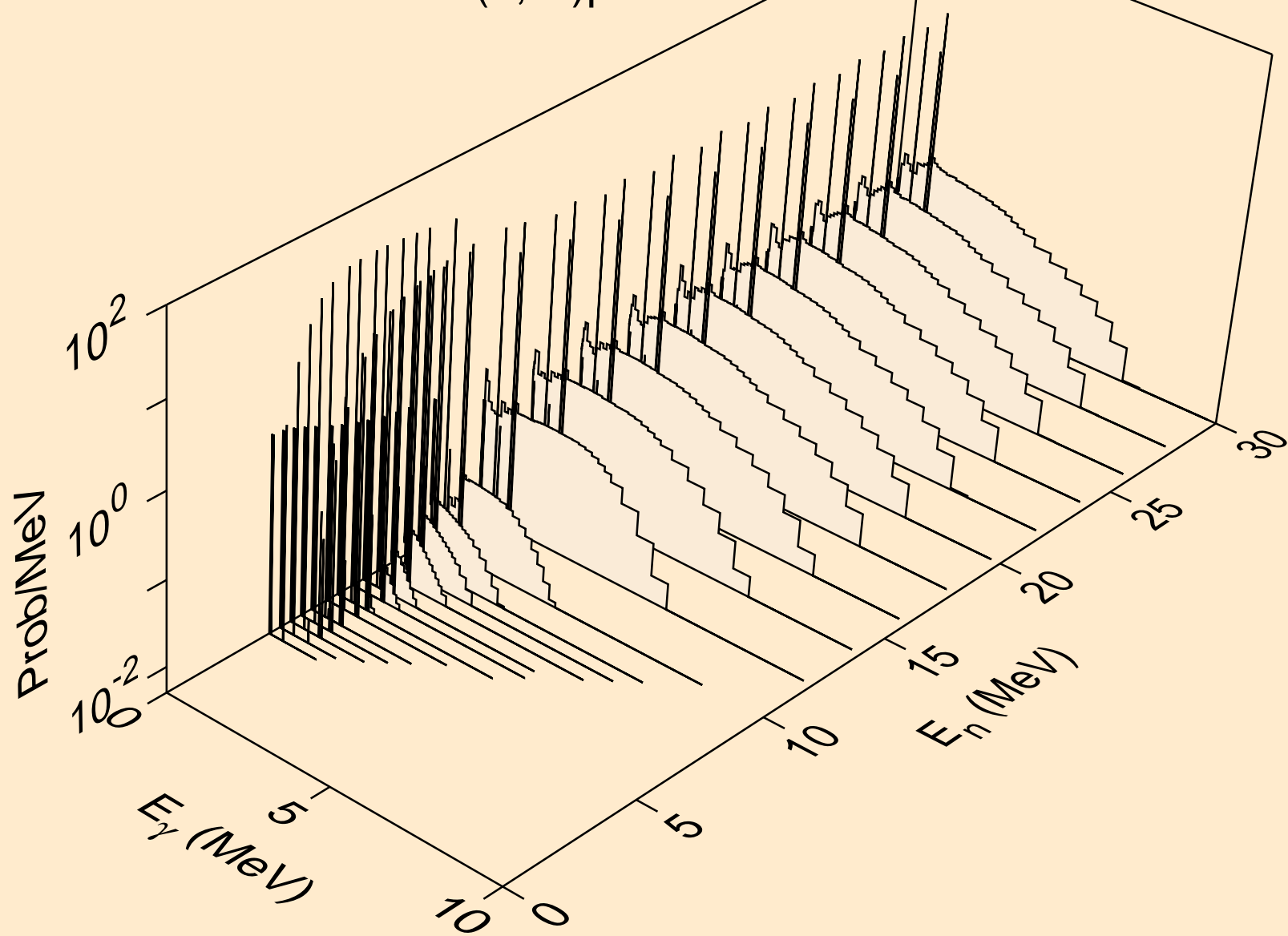

RH092 NEUTRON ACER TENDL-2024 LIBRARY; T=0.K
Photon emission for (n,n*)2a

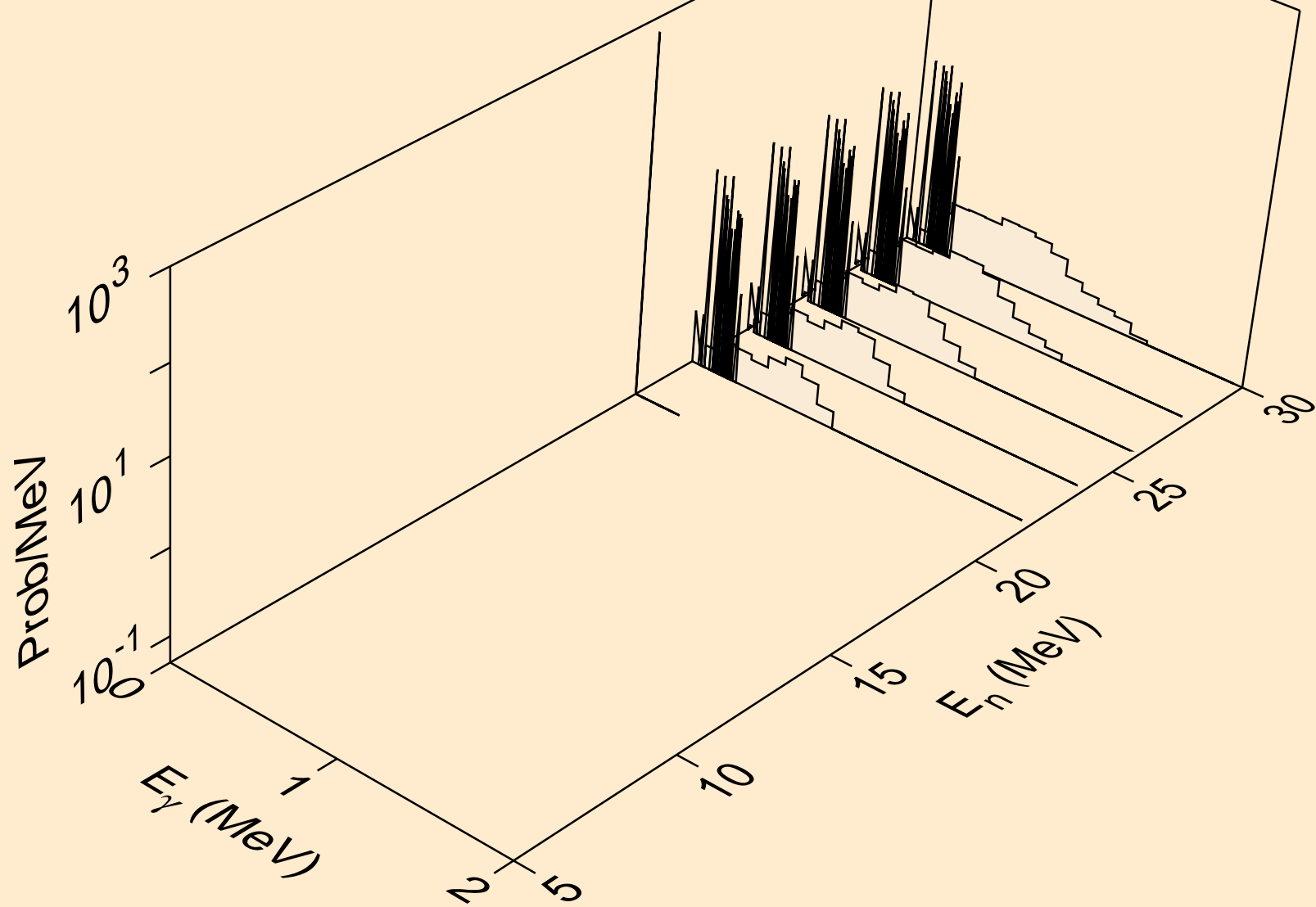

RH092 NEUTRON ACER TENDL-2024 LIBRARY; T=0.K
Photon emission for (n,n*)d

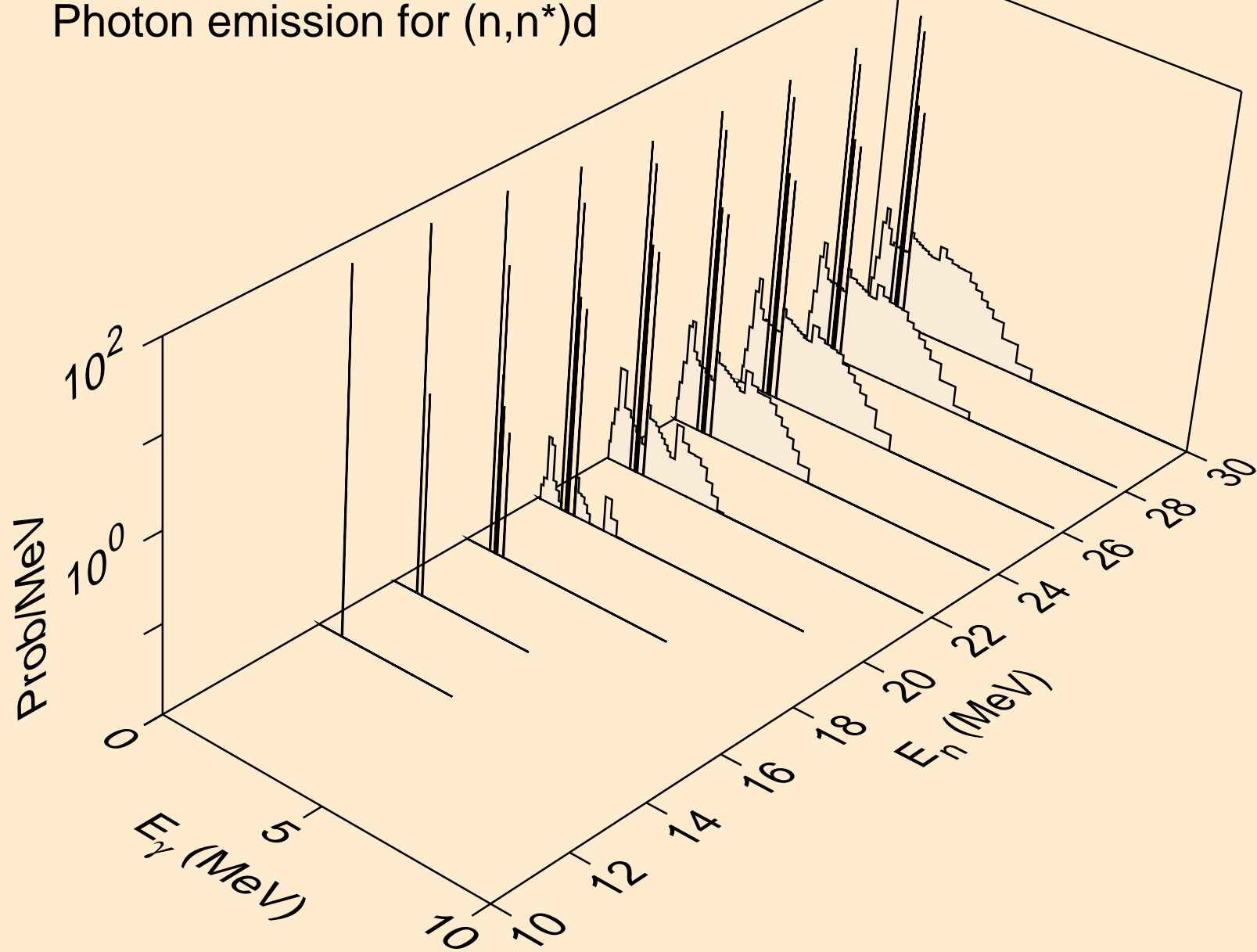

RH092 NEUTRON ACER TENDL-2024 LIBRARY; T=0.K
Photon emission for (n,n*)t

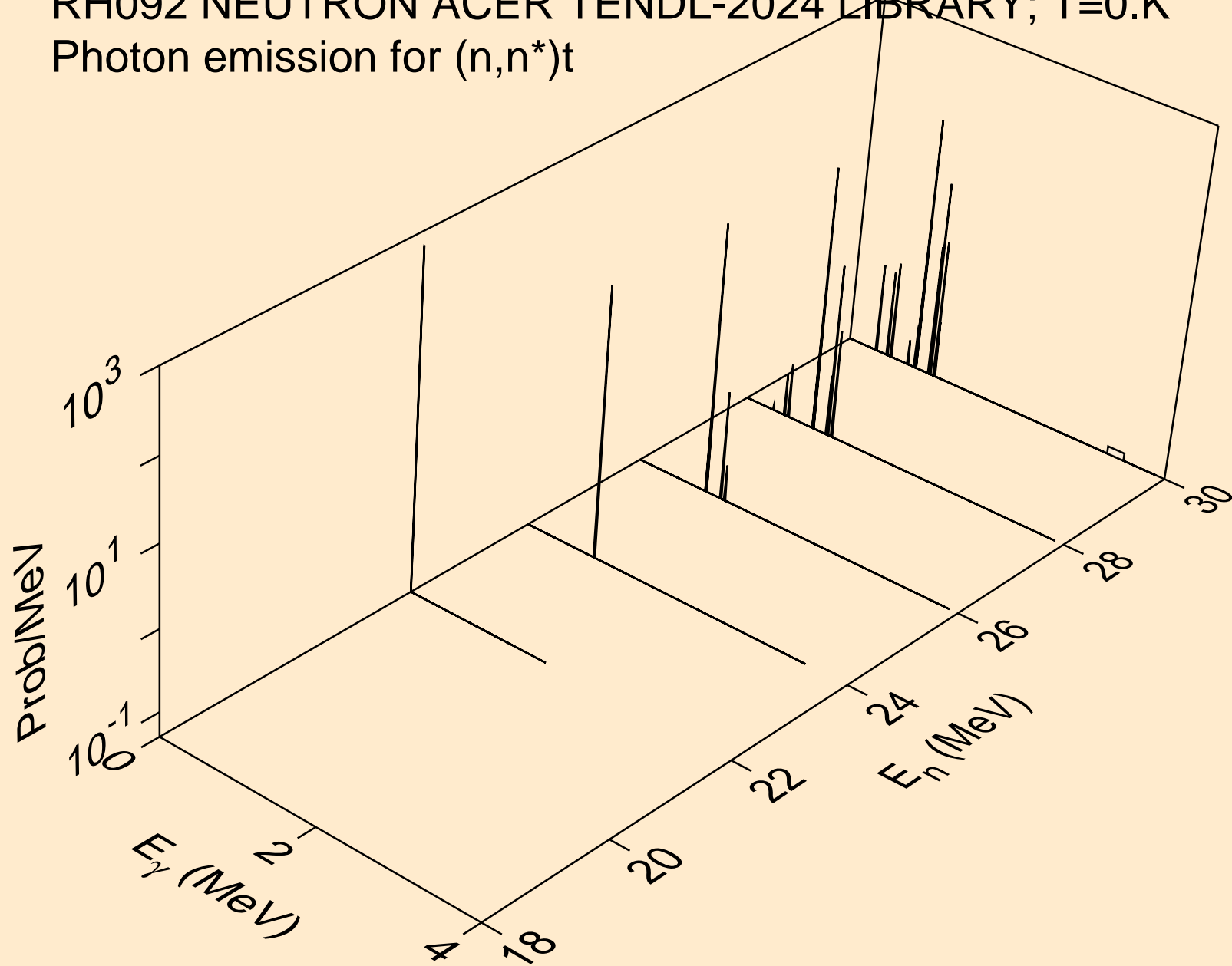

RH092 NEUTRON ACER TENDL-2024 LIBRARY; T=0.K
Photon emission for (n,n*)he3

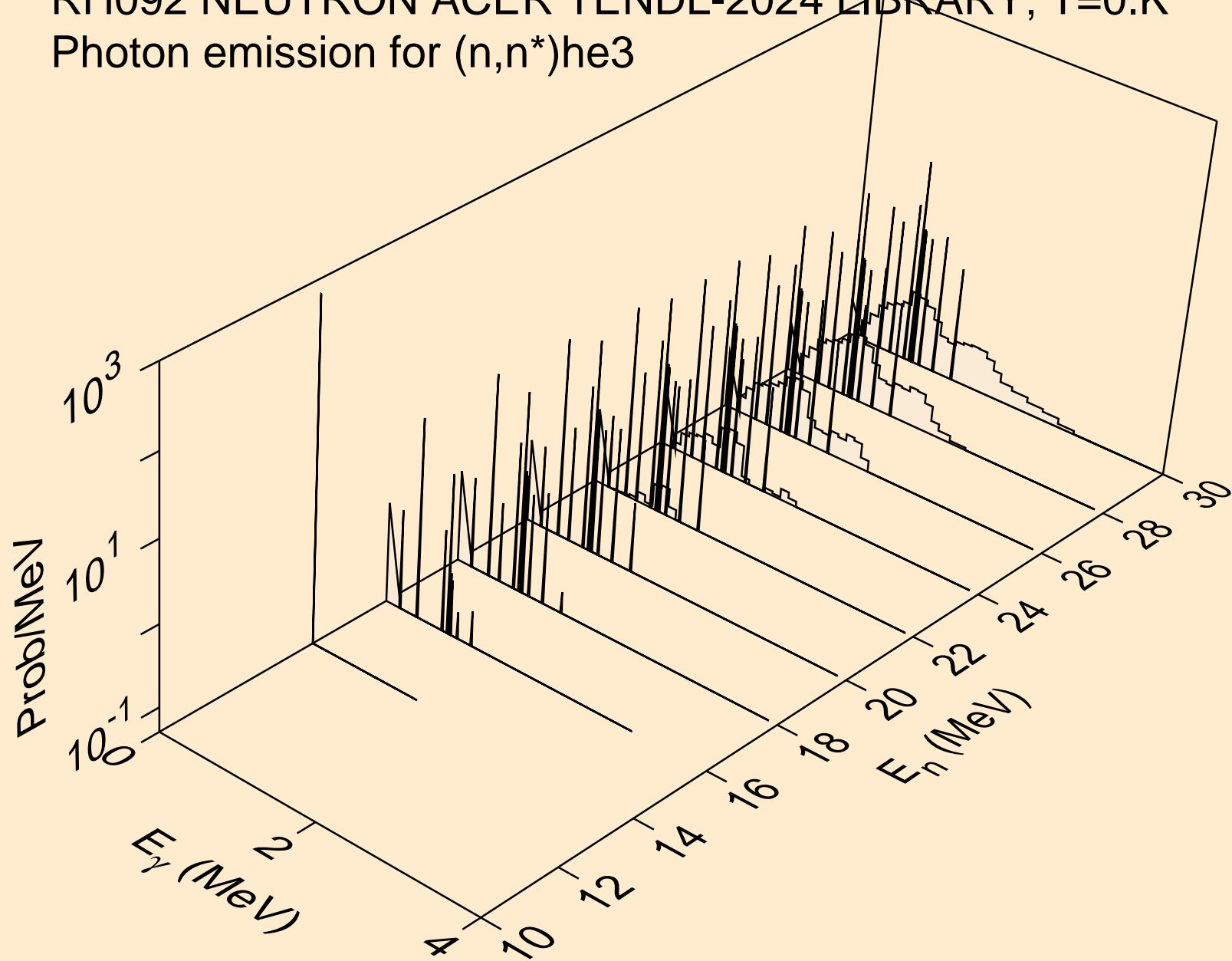

RH092 NEUTRON ACER TENDL-2024 LIBRARY; T=0.K
Photon emission for (n,2np)

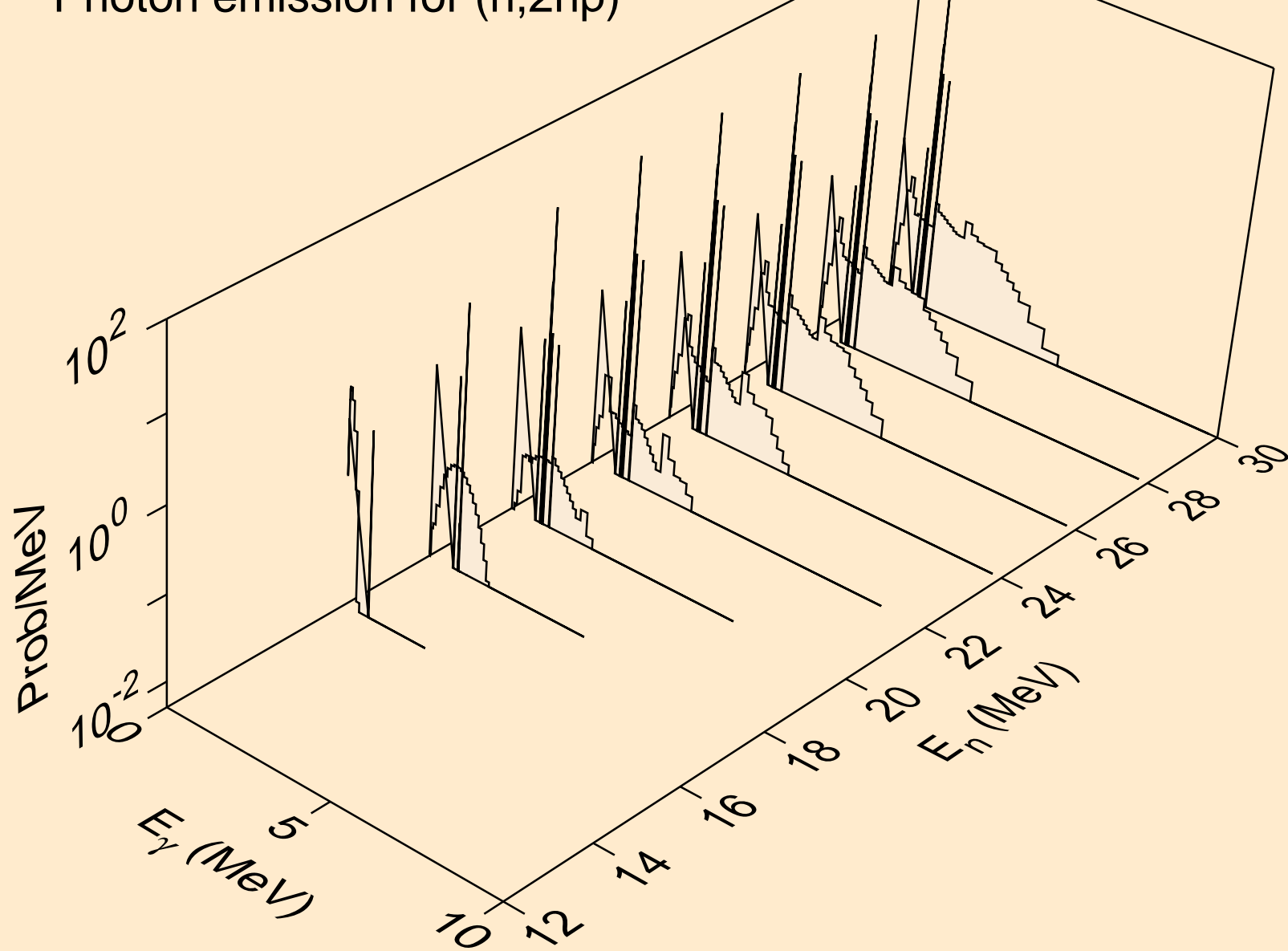

RH092 NEUTRON ACER TENDL-2024 LIBRARY; T=0.K
Photon emission for (n,n2p)

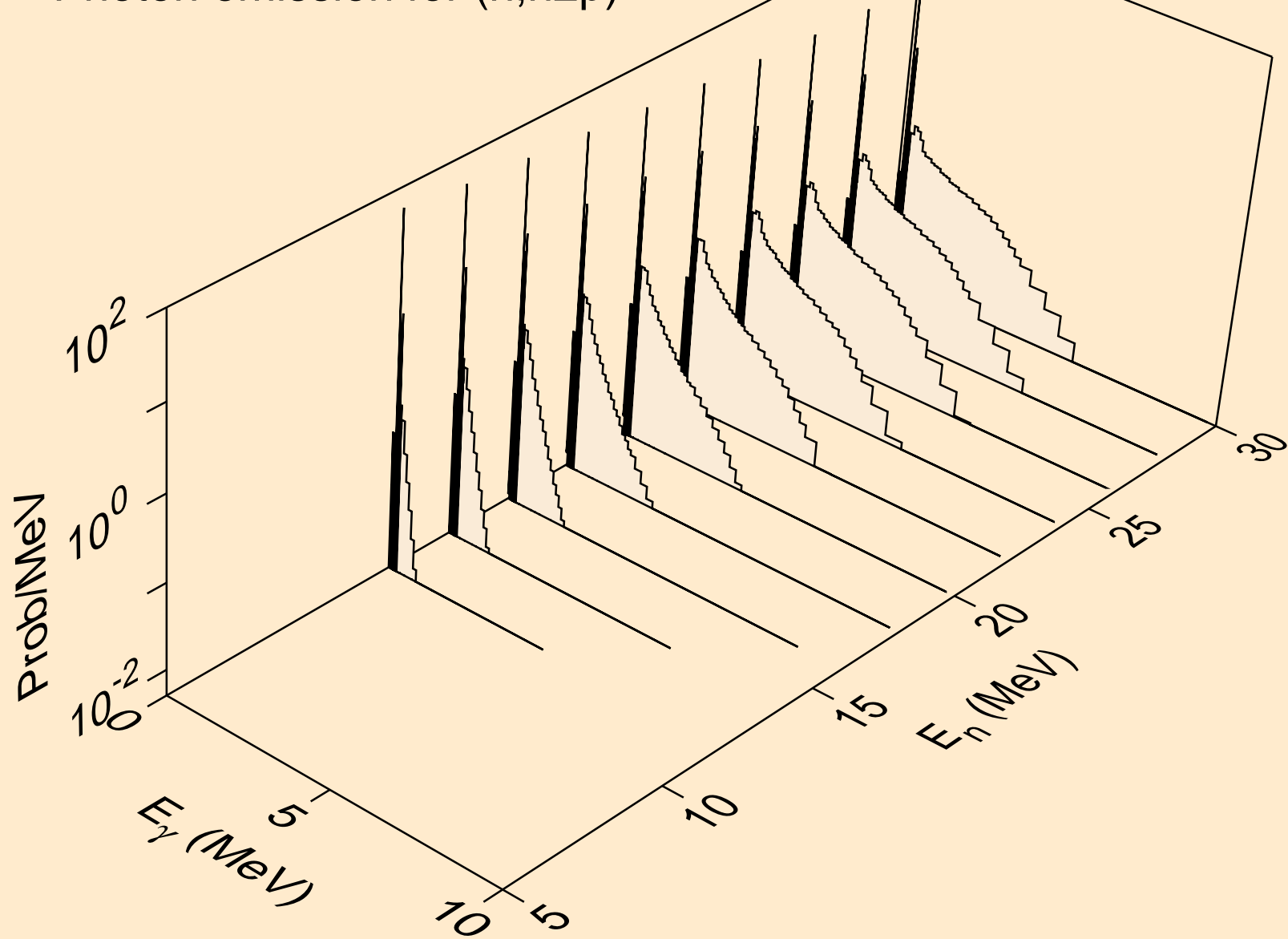

RH092 NEUTRON ACER TENDL-2024 LIBRARY; T=0.K
Photon emission for (n,npa)

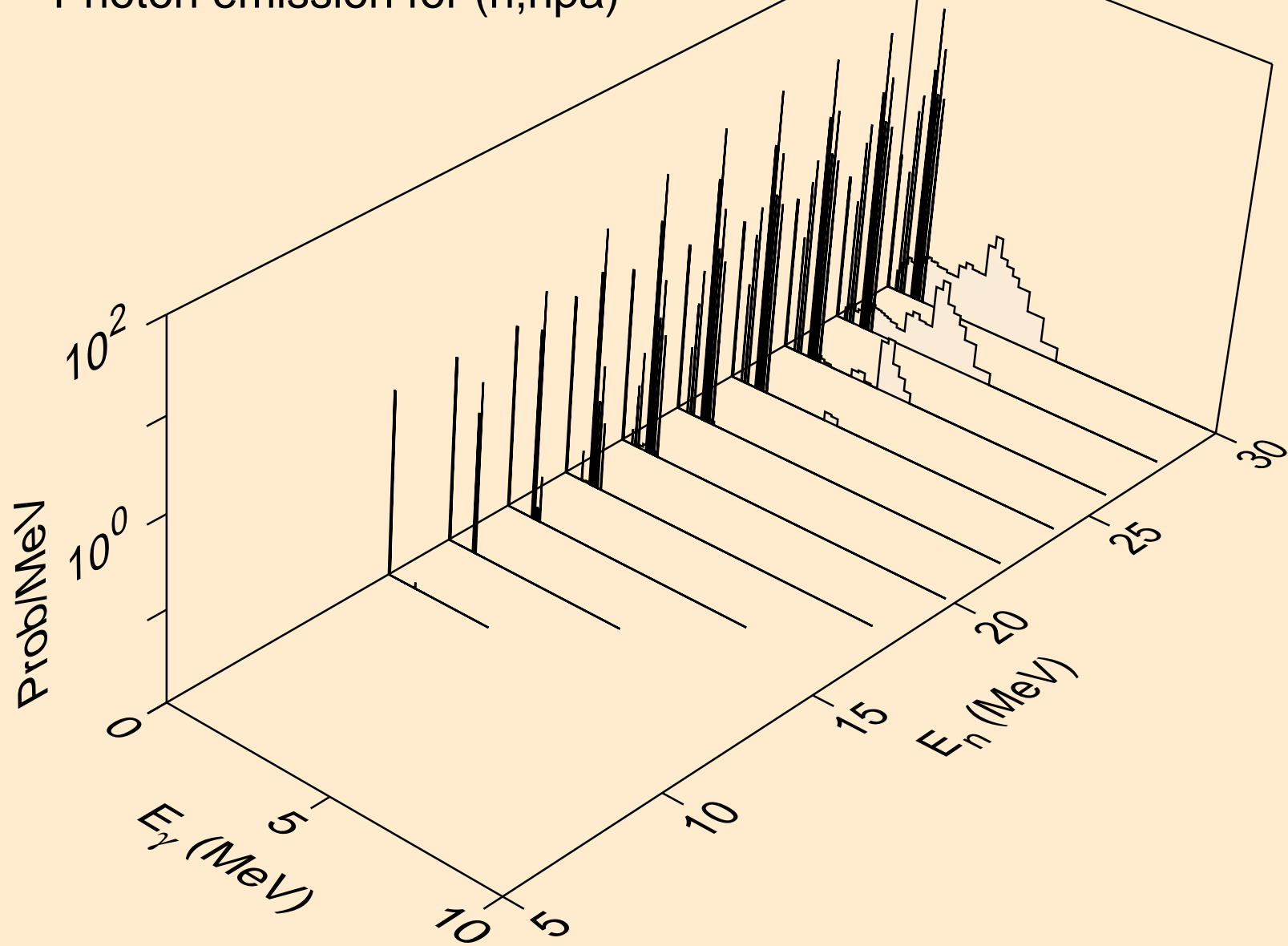

RH092 NEUTRON ACER TENDL-2024 LIBRARY; T=0.K
Photon emission for (n,n*c)

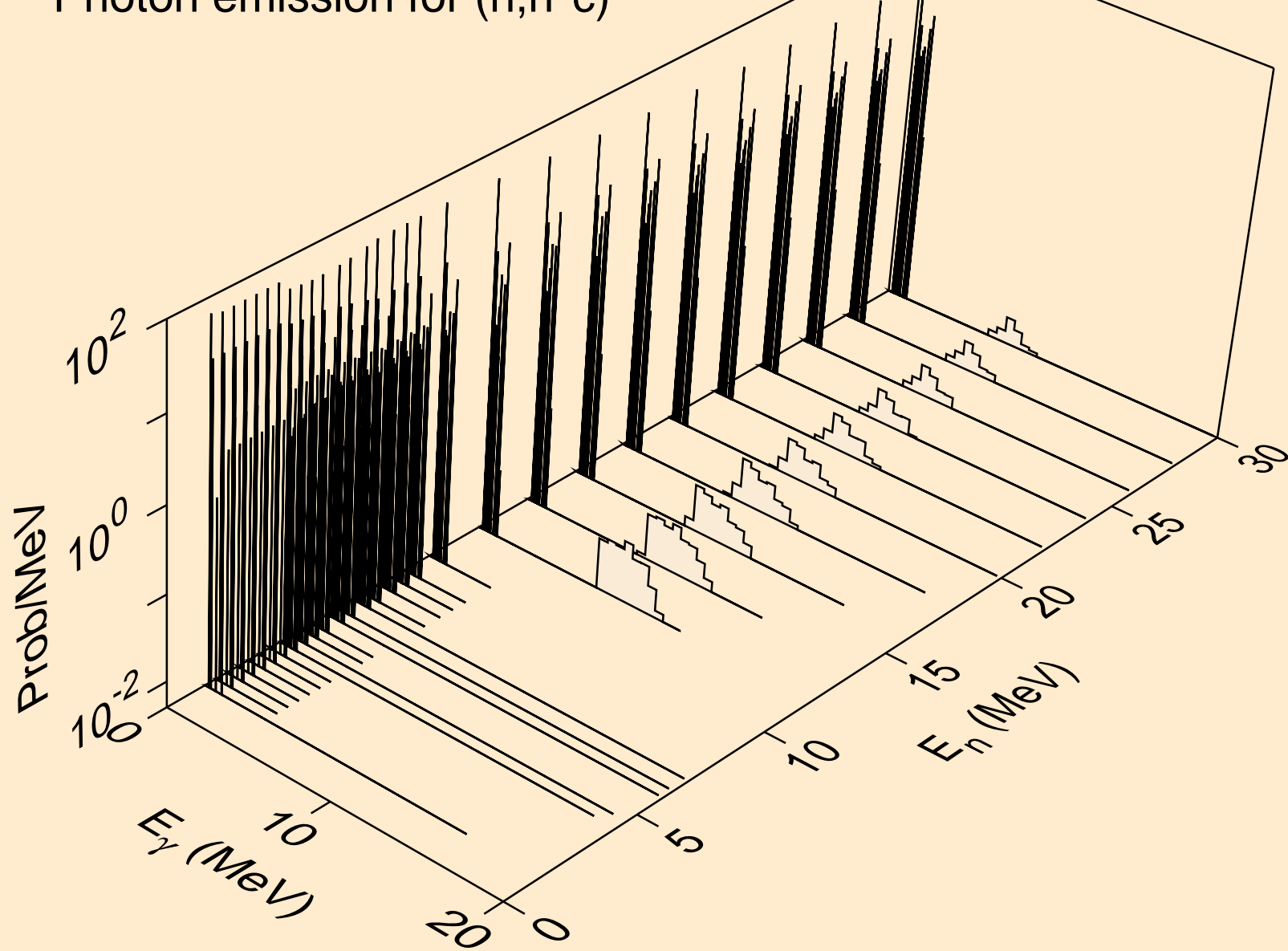

RH092 NEUTRON ACER TENDL-2024 LIBRARY; T=0.K
Photon emission for (n,gma)

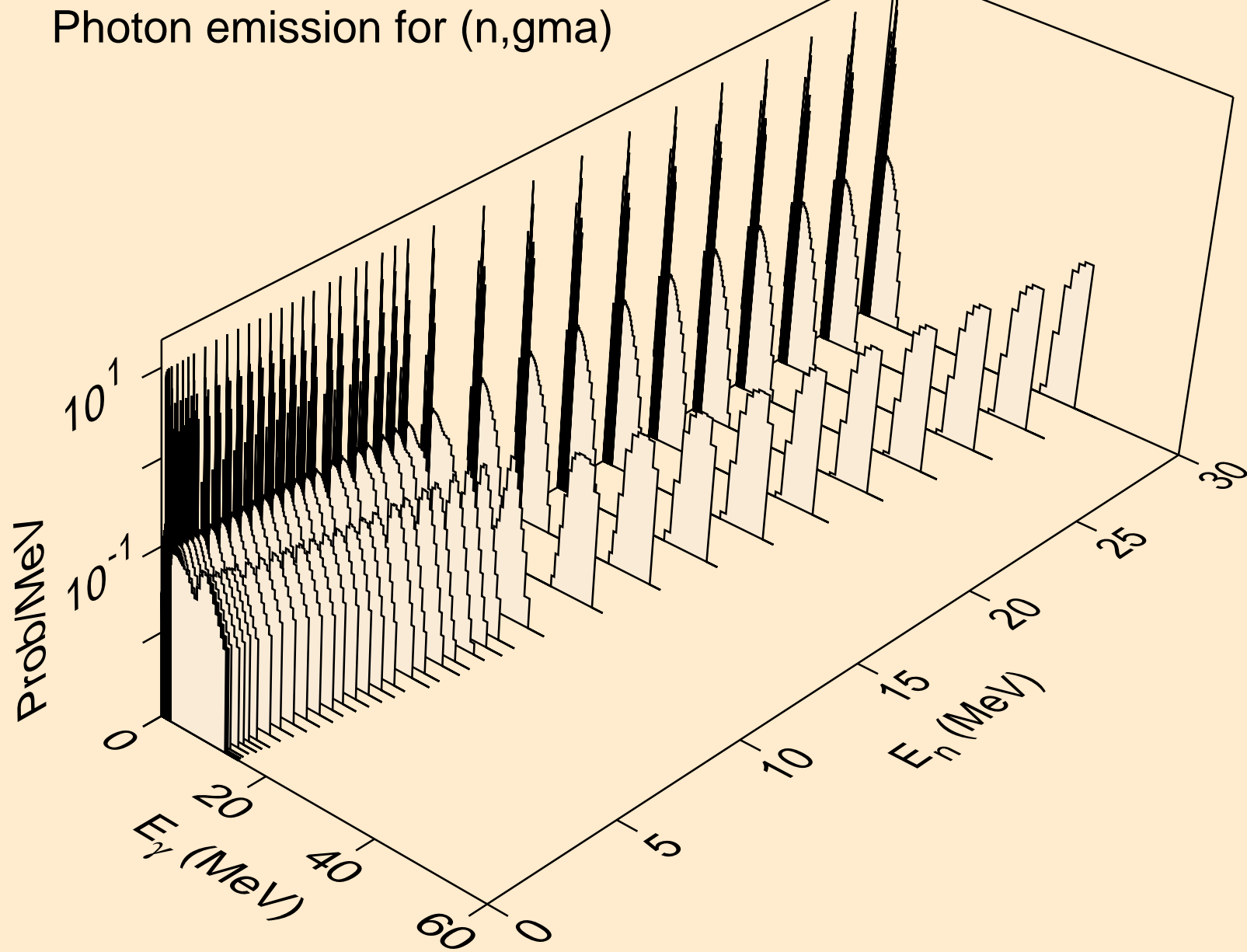

RH092 NEUTRON ACER TENDL-2024 LIBRARY; T=0.K
Photon emission for (n,p)

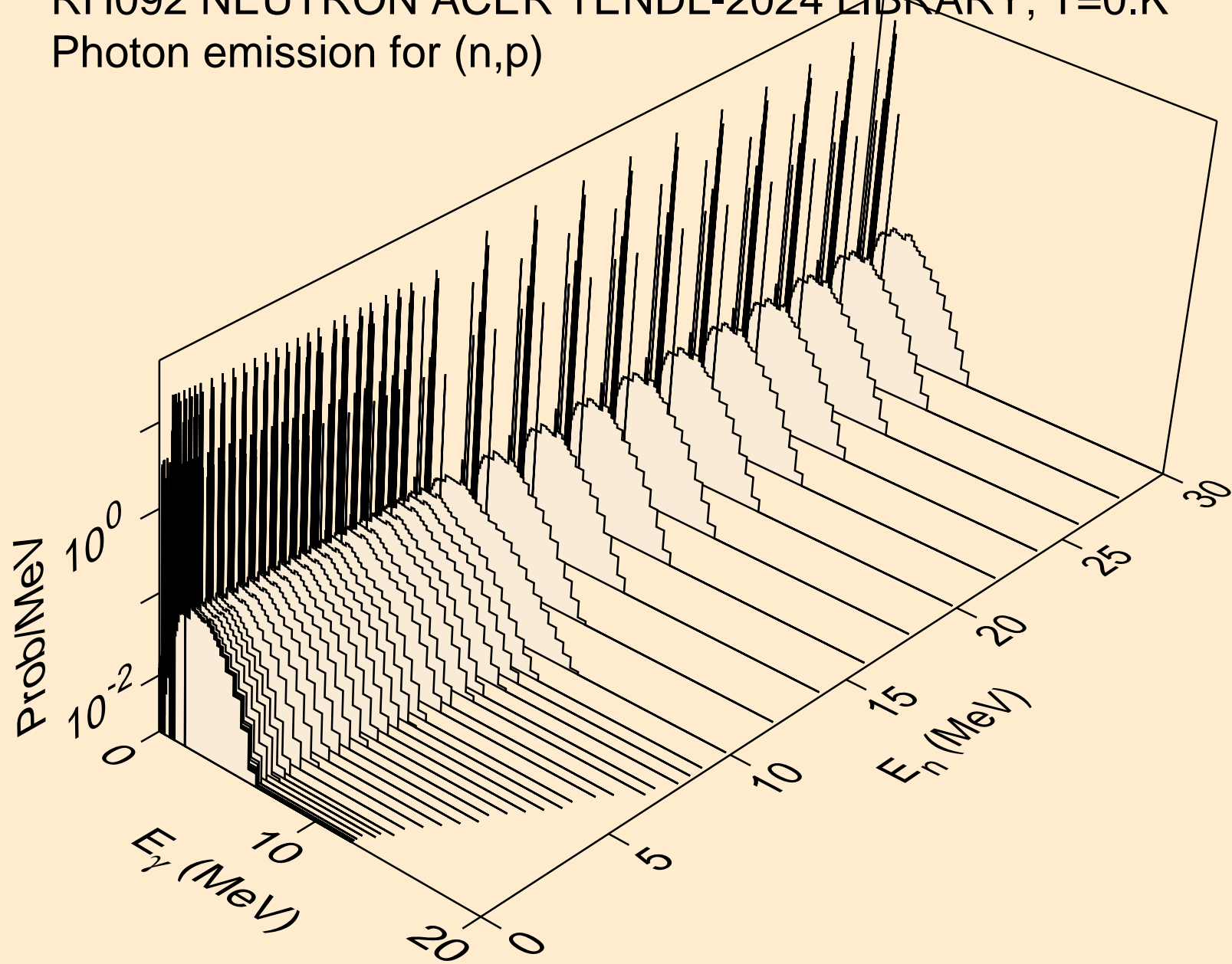

RH092 NEUTRON ACER TENDL-2024 LIBRARY; T=0.K
Photon emission for (n,d)

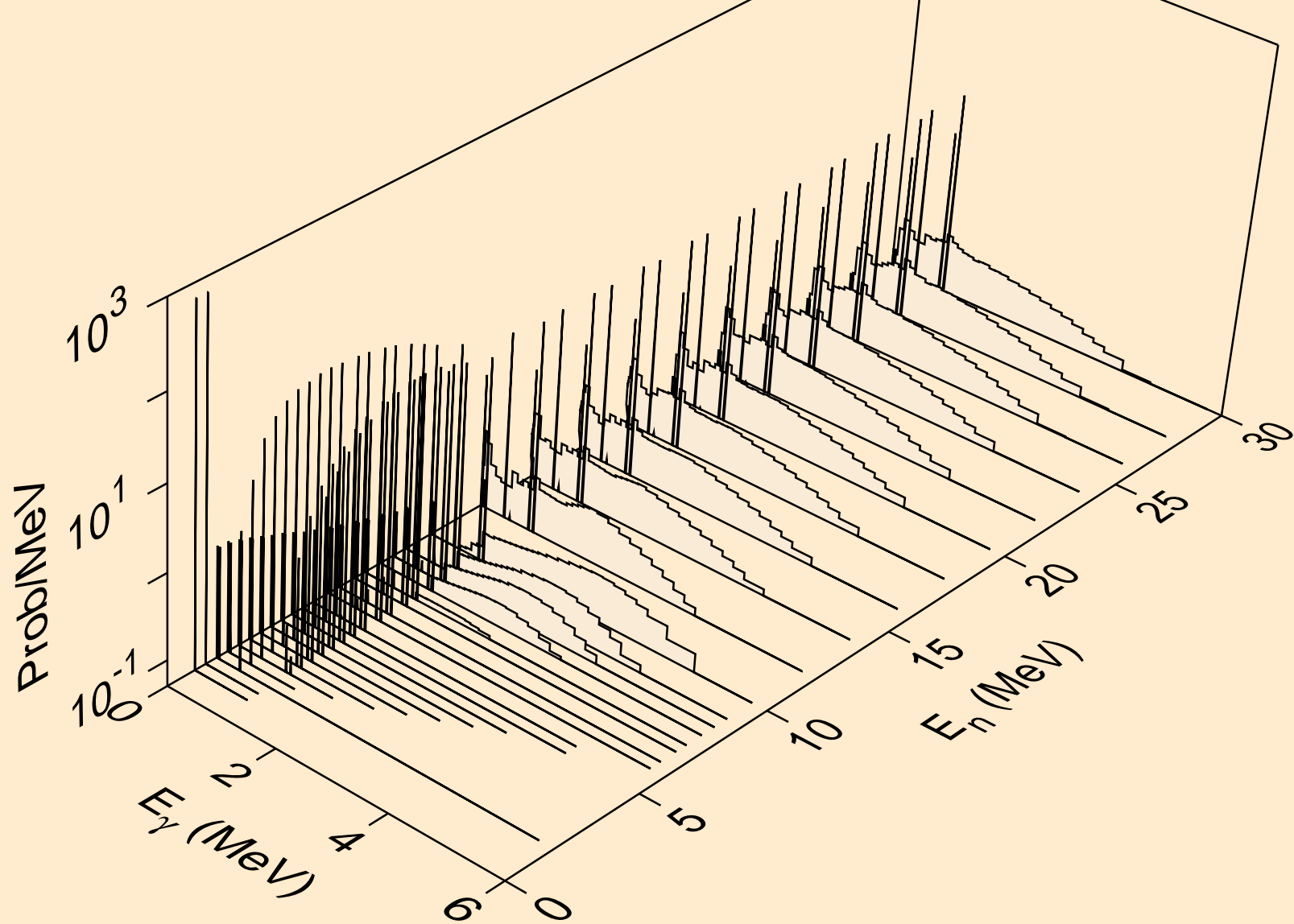

RH092 NEUTRON ACER TENDL-2024 LIBRARY; T=0.K
Photon emission for (n,t)

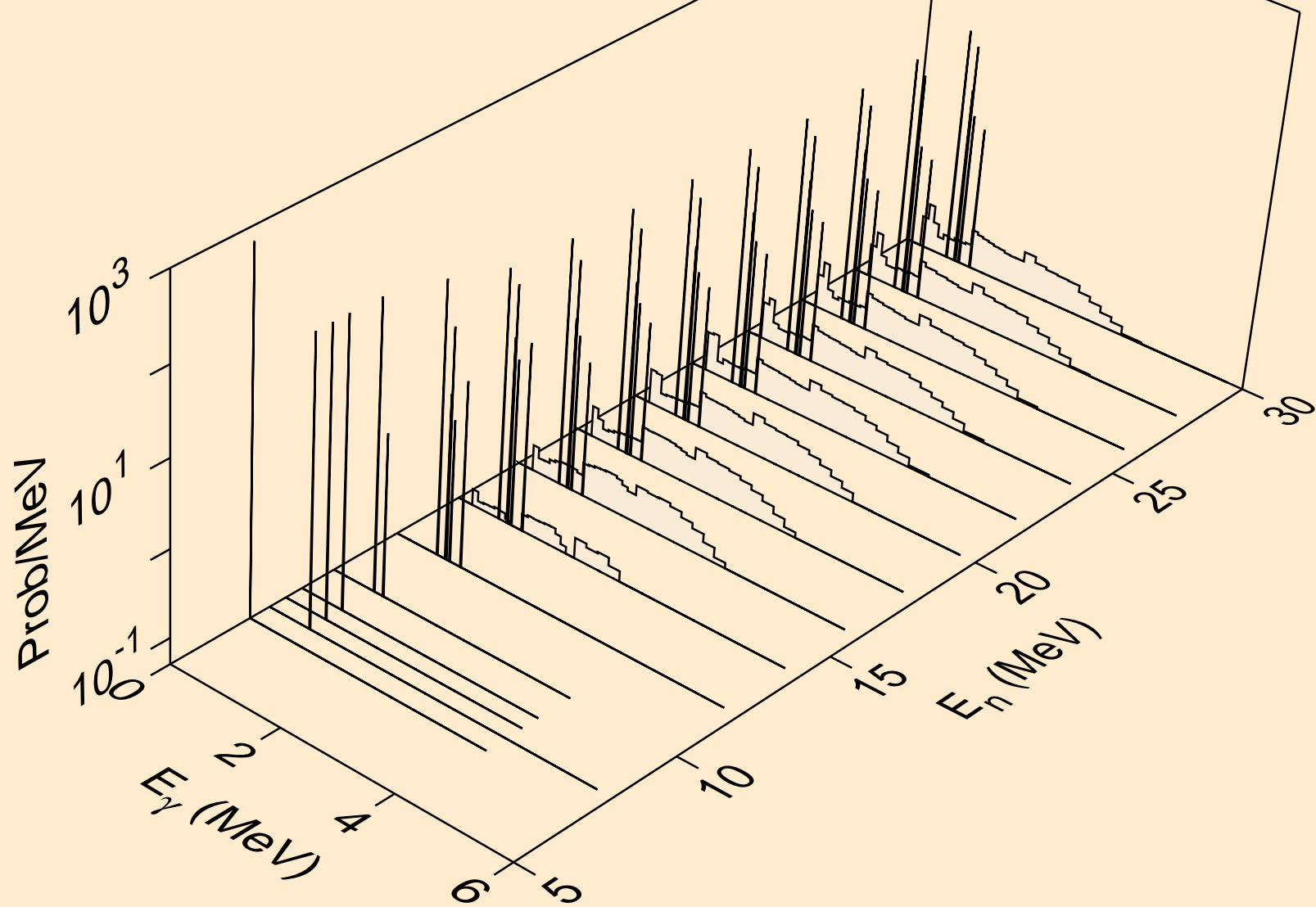

RH092 NEUTRON ACER TENDL-2024 LIBRARY; T=0.K
Photon emission for (n,he3)

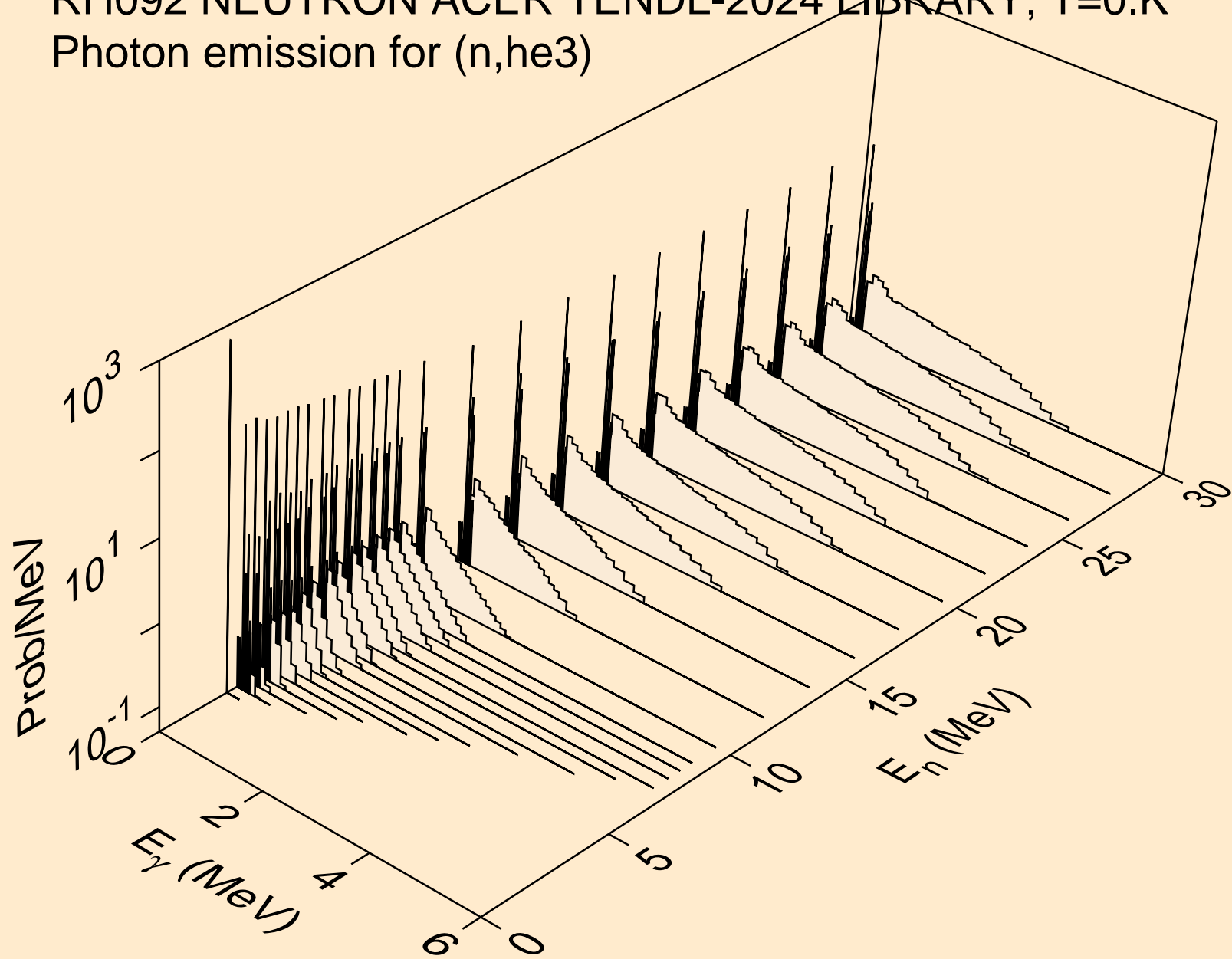

RH092 NEUTRON ACER TENDL-2024 LIBRARY; T=0.K
Photon emission for (n,a)

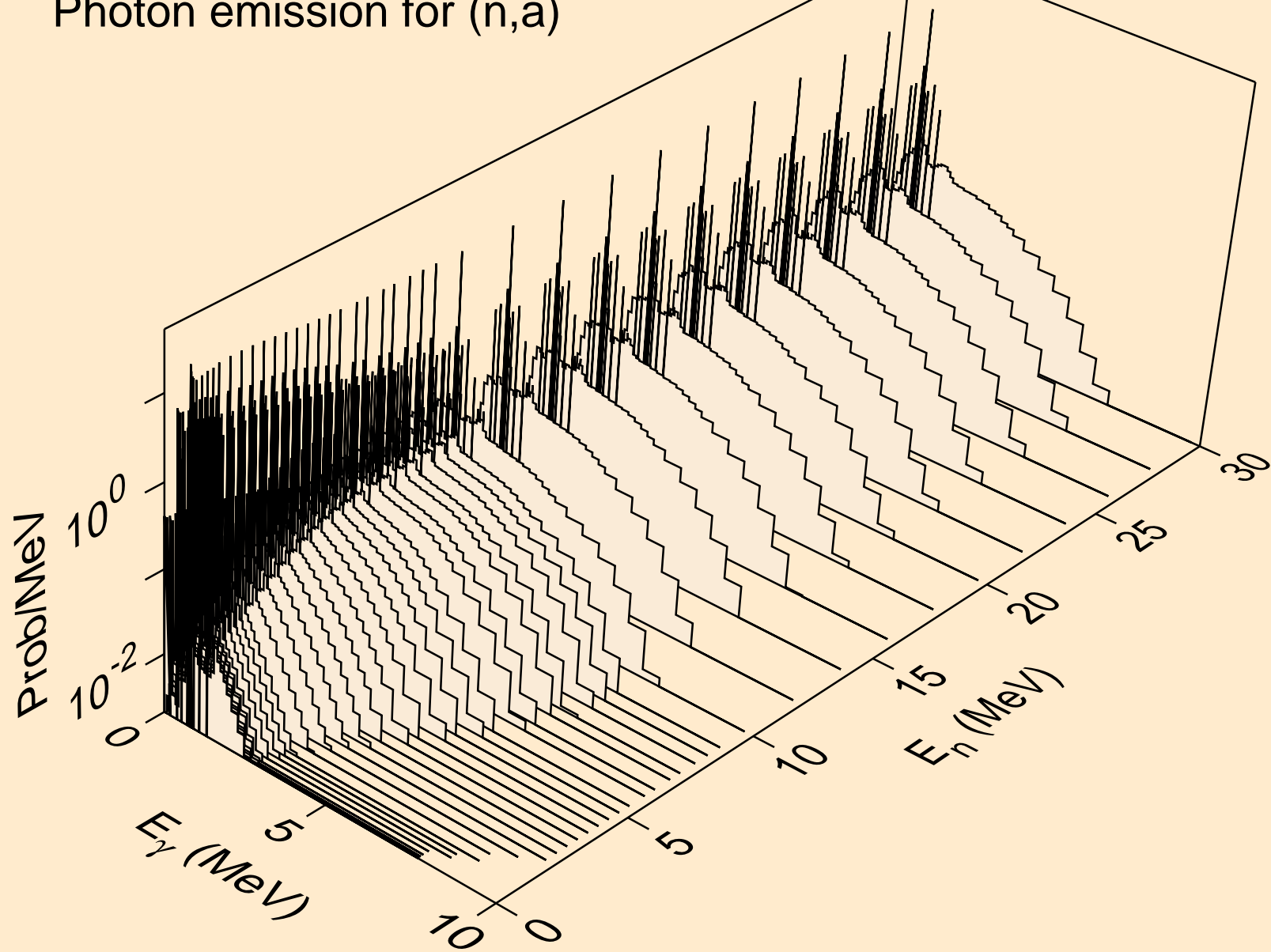

RH092 NEUTRON ACER TENDL-2024 LIBRARY; T=0.K
Photon emission for (n,2a)

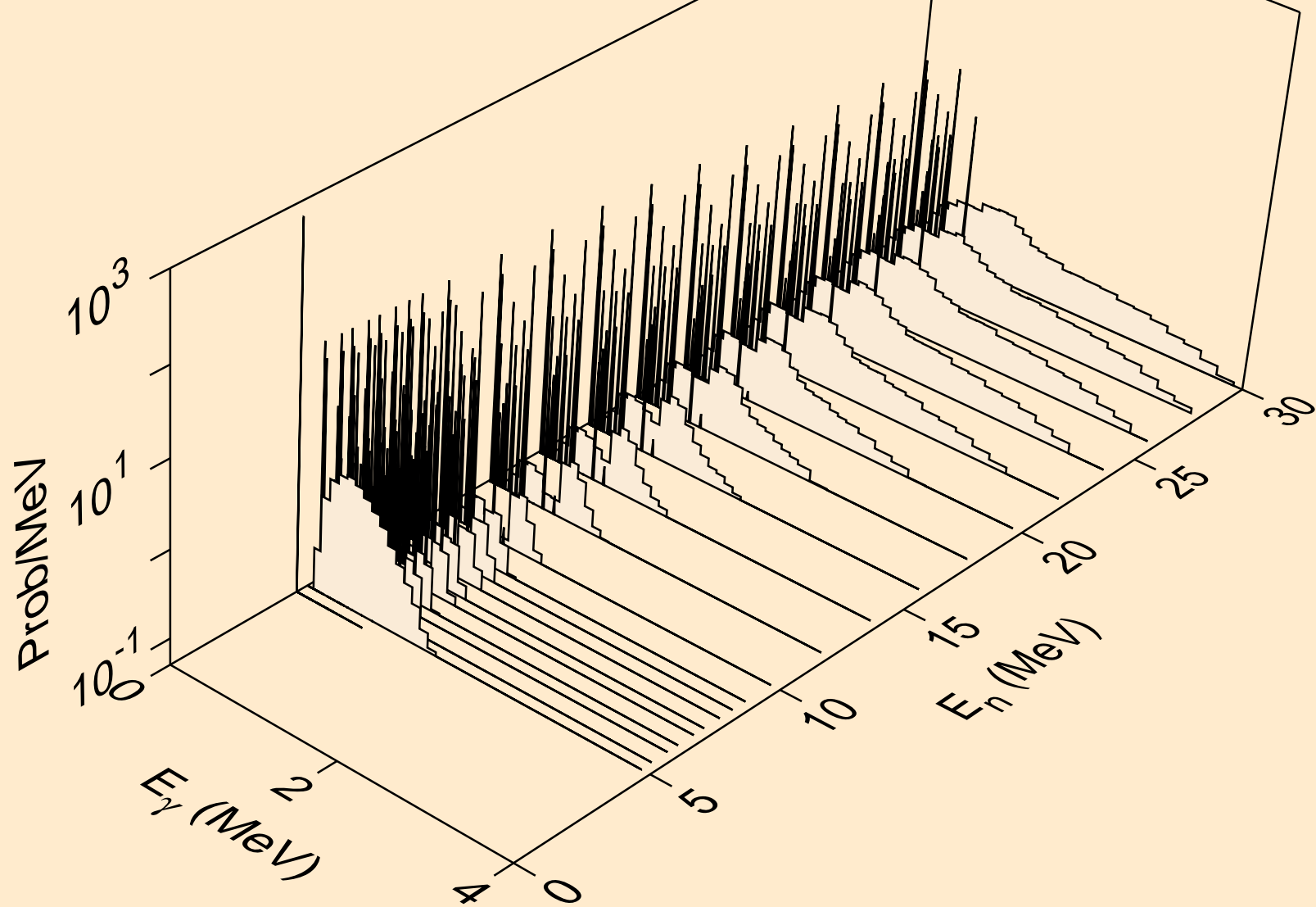

RH092 NEUTRON ACER TENDL-2024 LIBRARY; T=0.K
Photon emission for (n,3a)

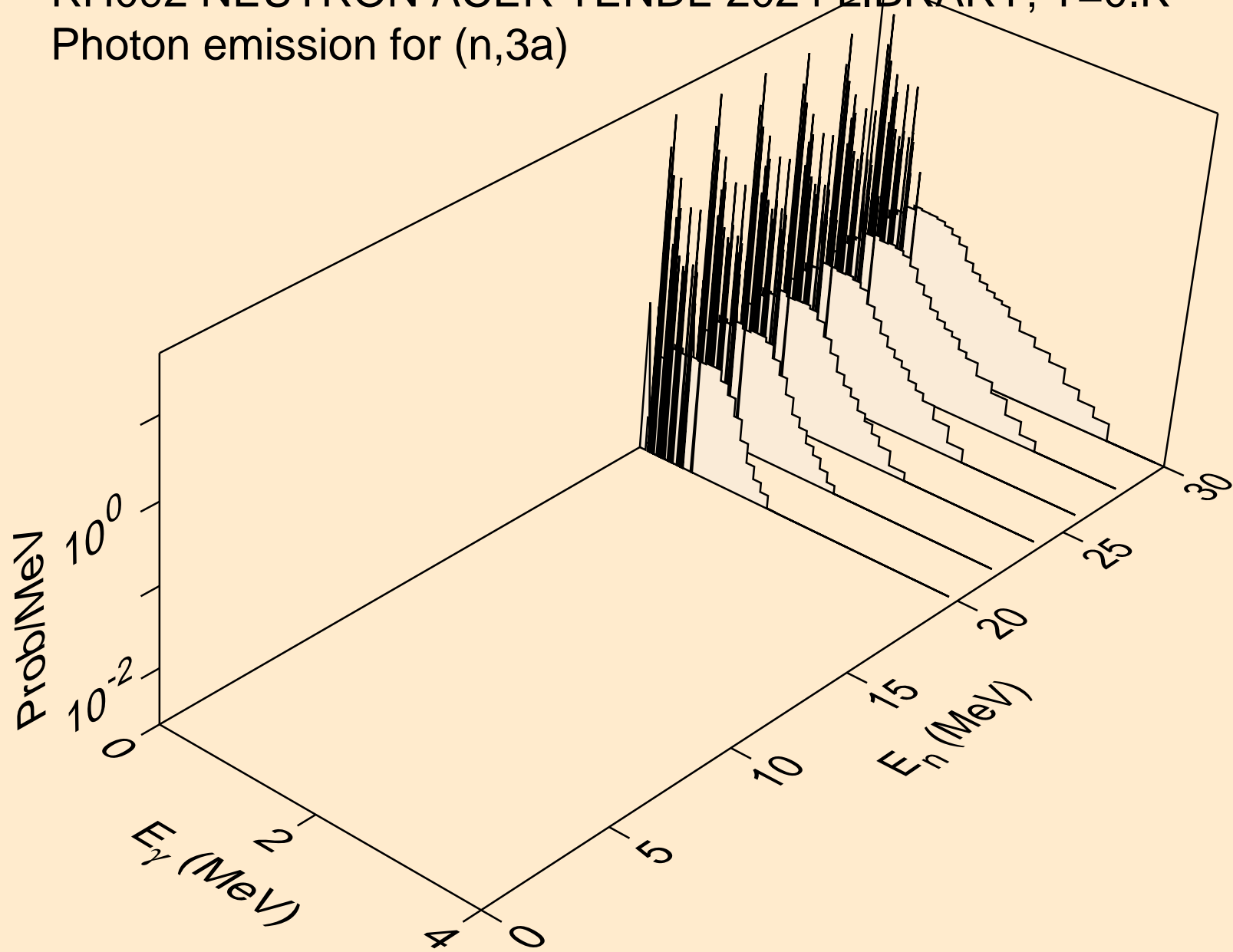

RH092 NEUTRON ACER TENDL-2024 LIBRARY; T=0.K
Photon emission for (n,2p)

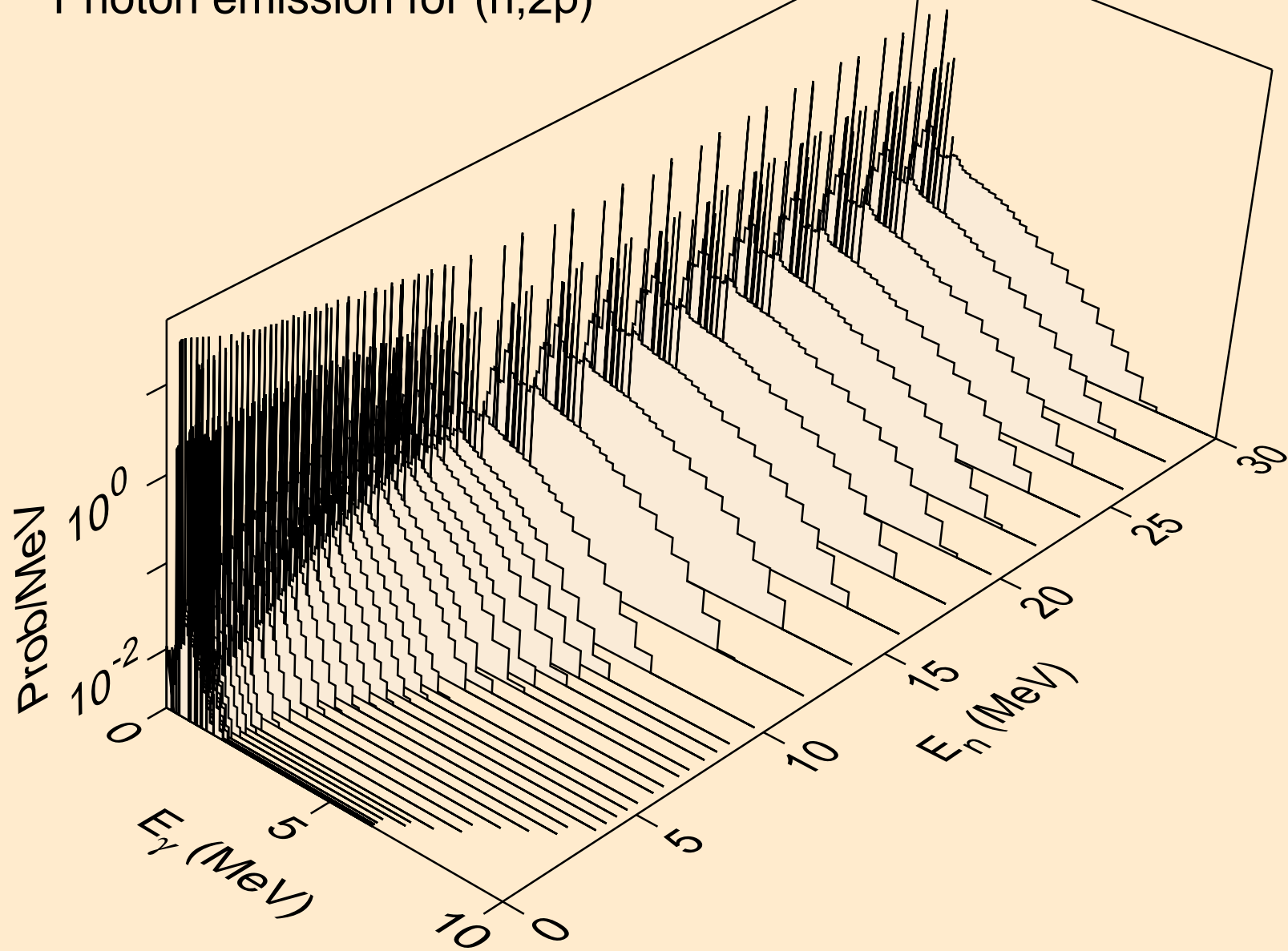

RH092 NEUTRON ACER TENDL-2024 LIBRARY; T=0.K
Photon emission for (n,p α)

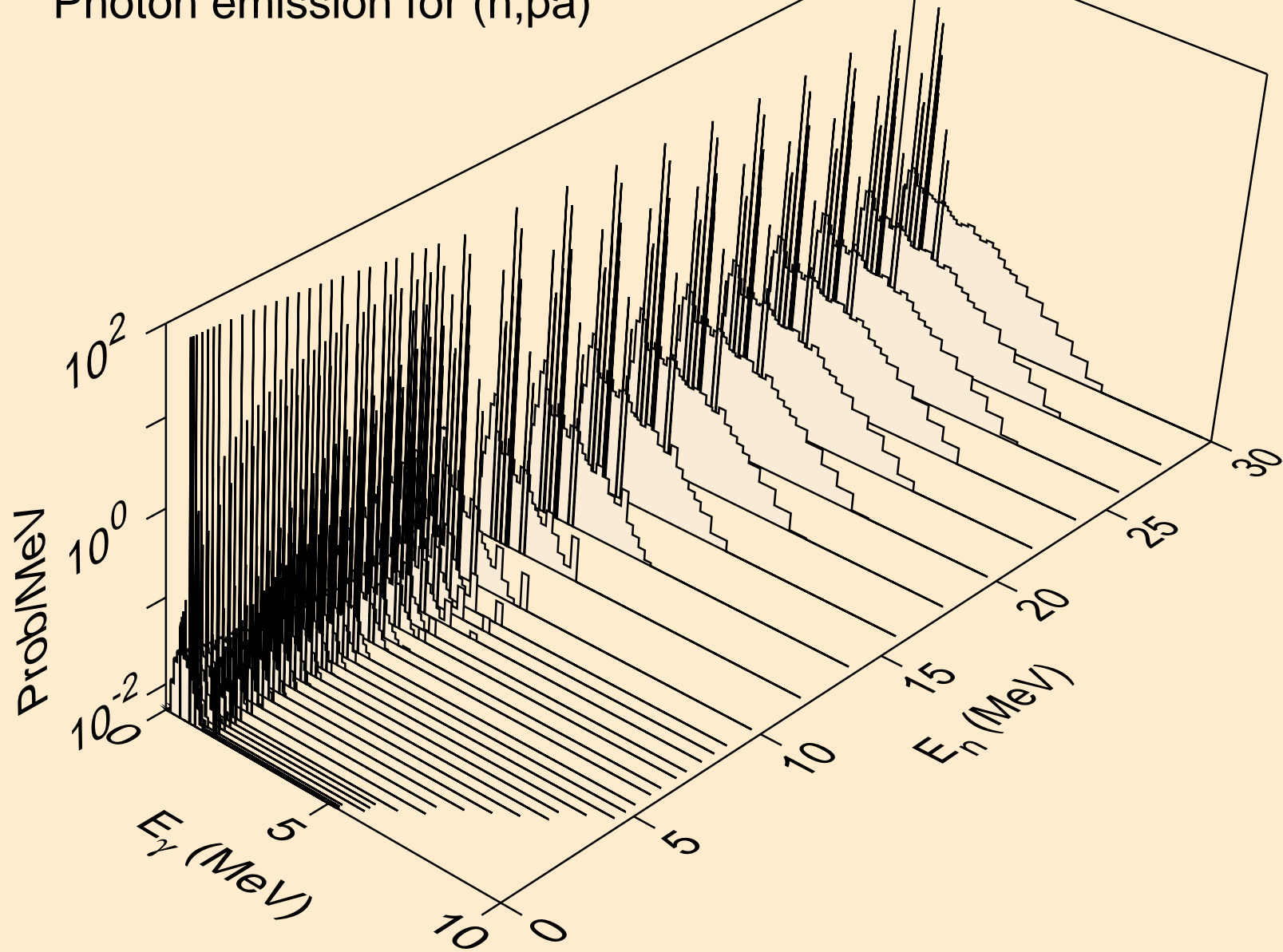

RH092 NEUTRON ACER TENDL-2024 LIBRARY; T=0.K
Photon emission for (n,pd)

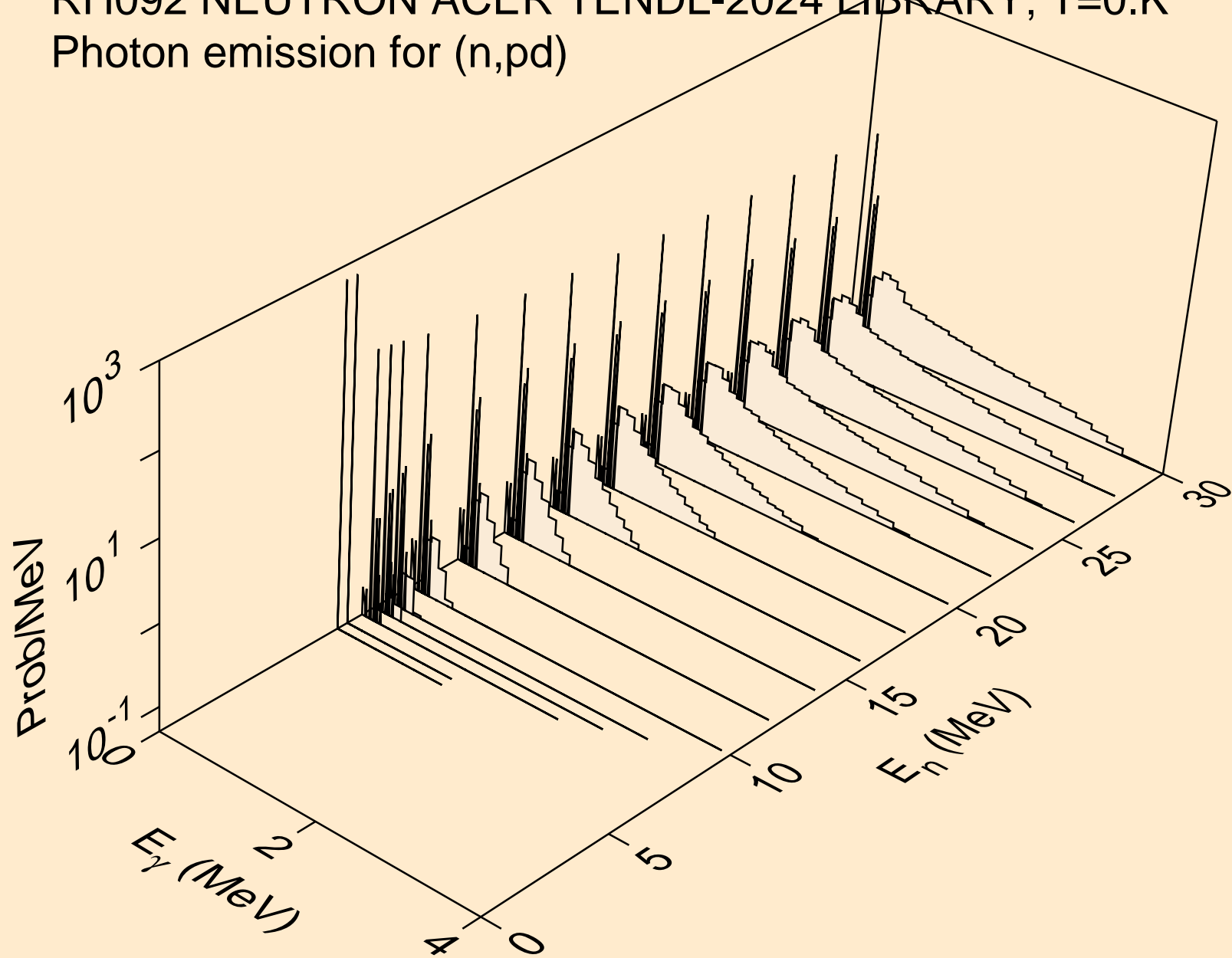

RH092 NEUTRON ACER TENDL-2024 LIBRARY; T=0.K
Photon emission for (n,pt)

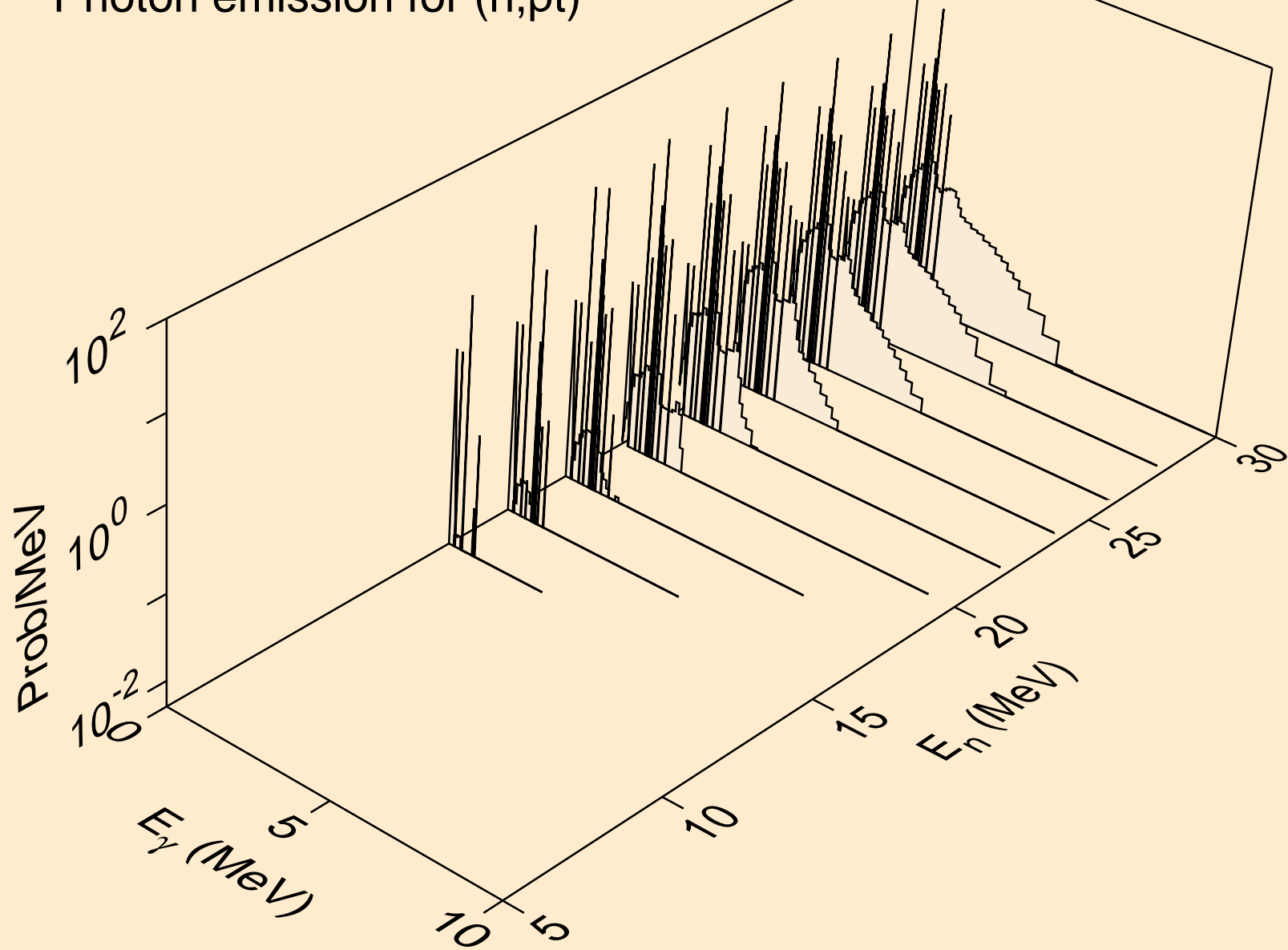

RH092 NEUTRON ACER TENDL-2024 LIBRARY; T=0.K
Photon emission for (n,da)

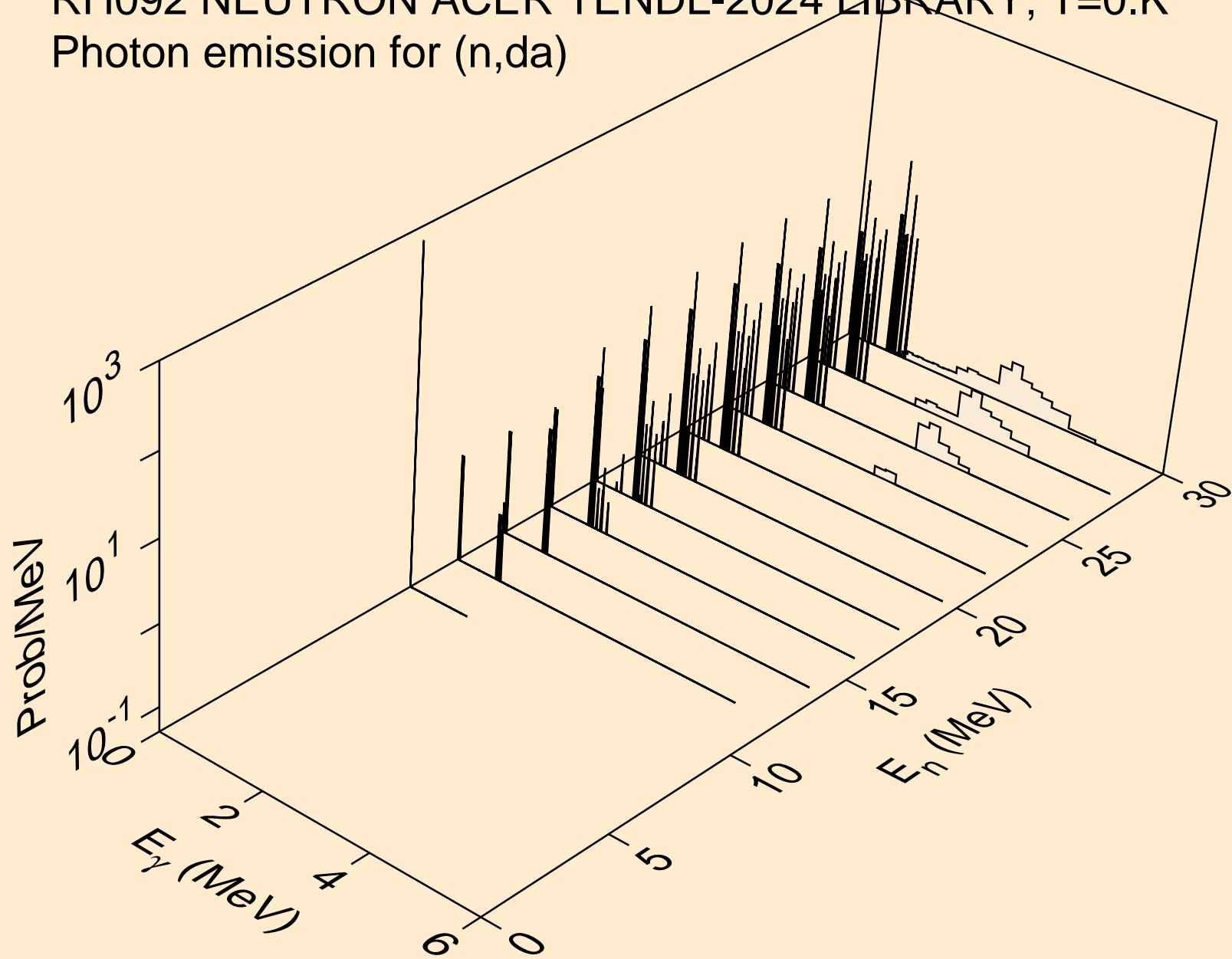

RH092 NEUTRON ACER TENDL-2024 LIBRARY; T=0.K
thermal capture photon spectrum

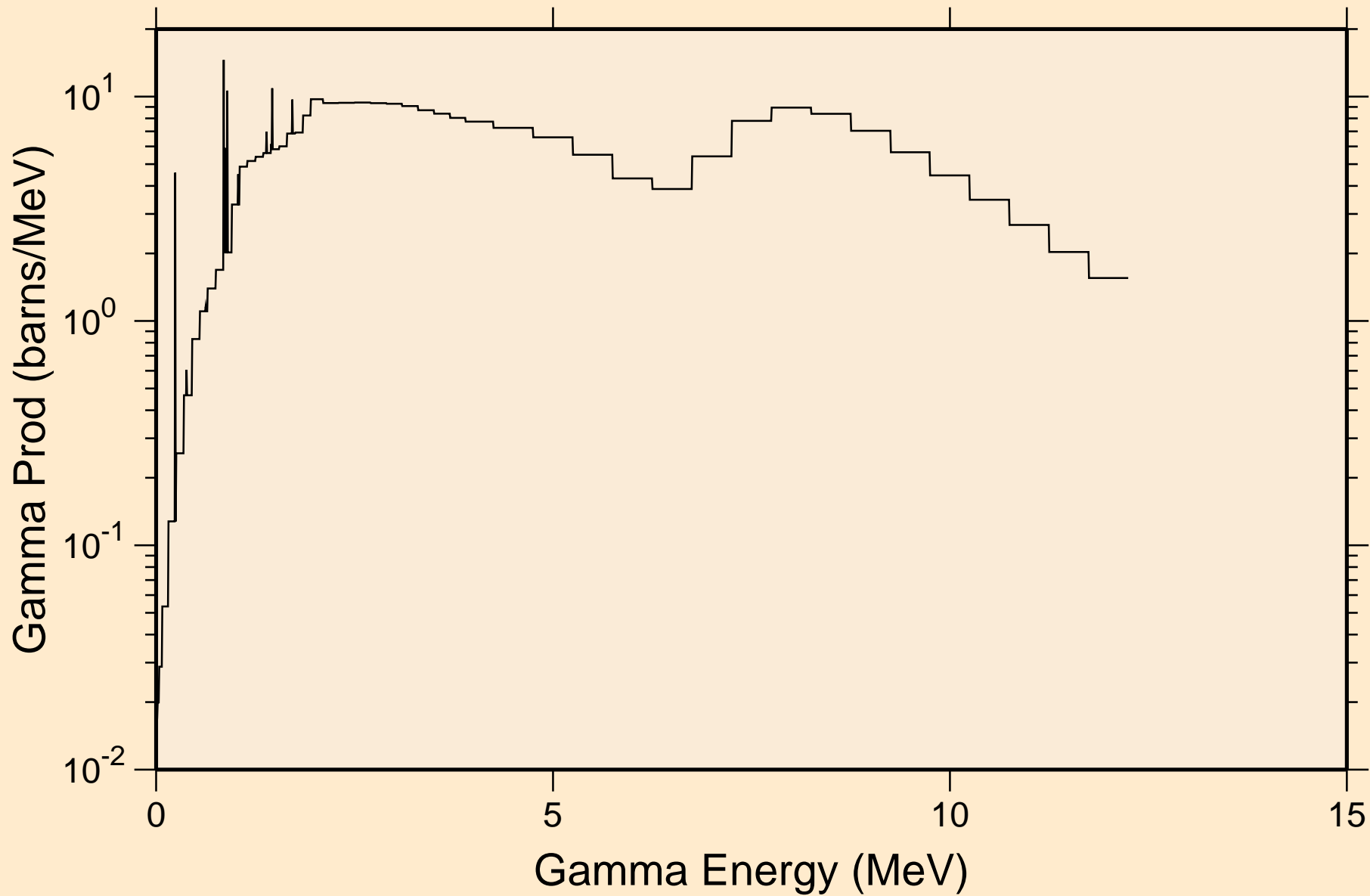

RH092 NEUTRON ACER TENDL-2024 LIBRARY; T=0.K
14 MeV photon spectrum

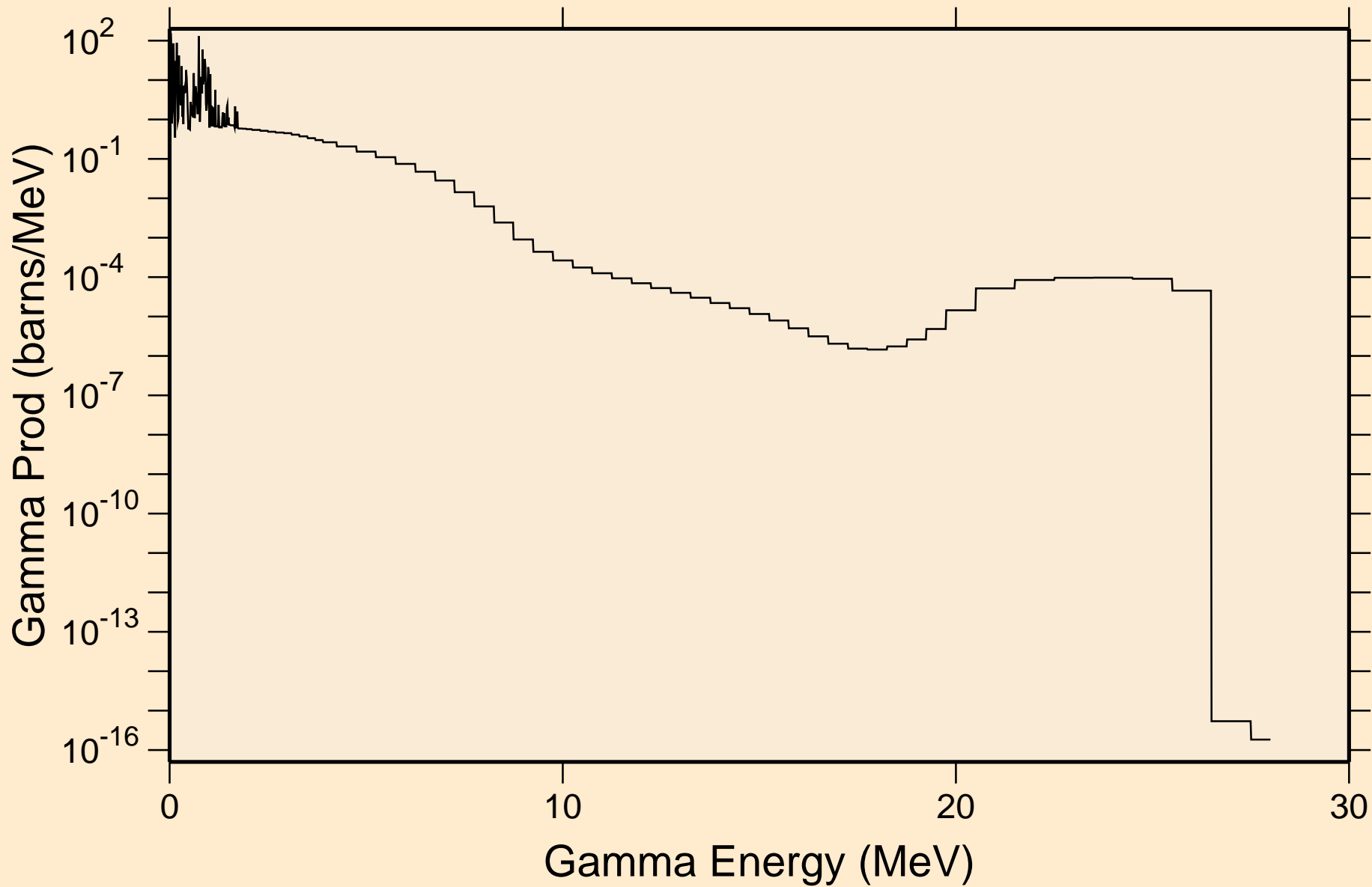

RH092 NEUTRON ACER TENDL-2024 LIBRARY; T=0.K

Particle heating contributions

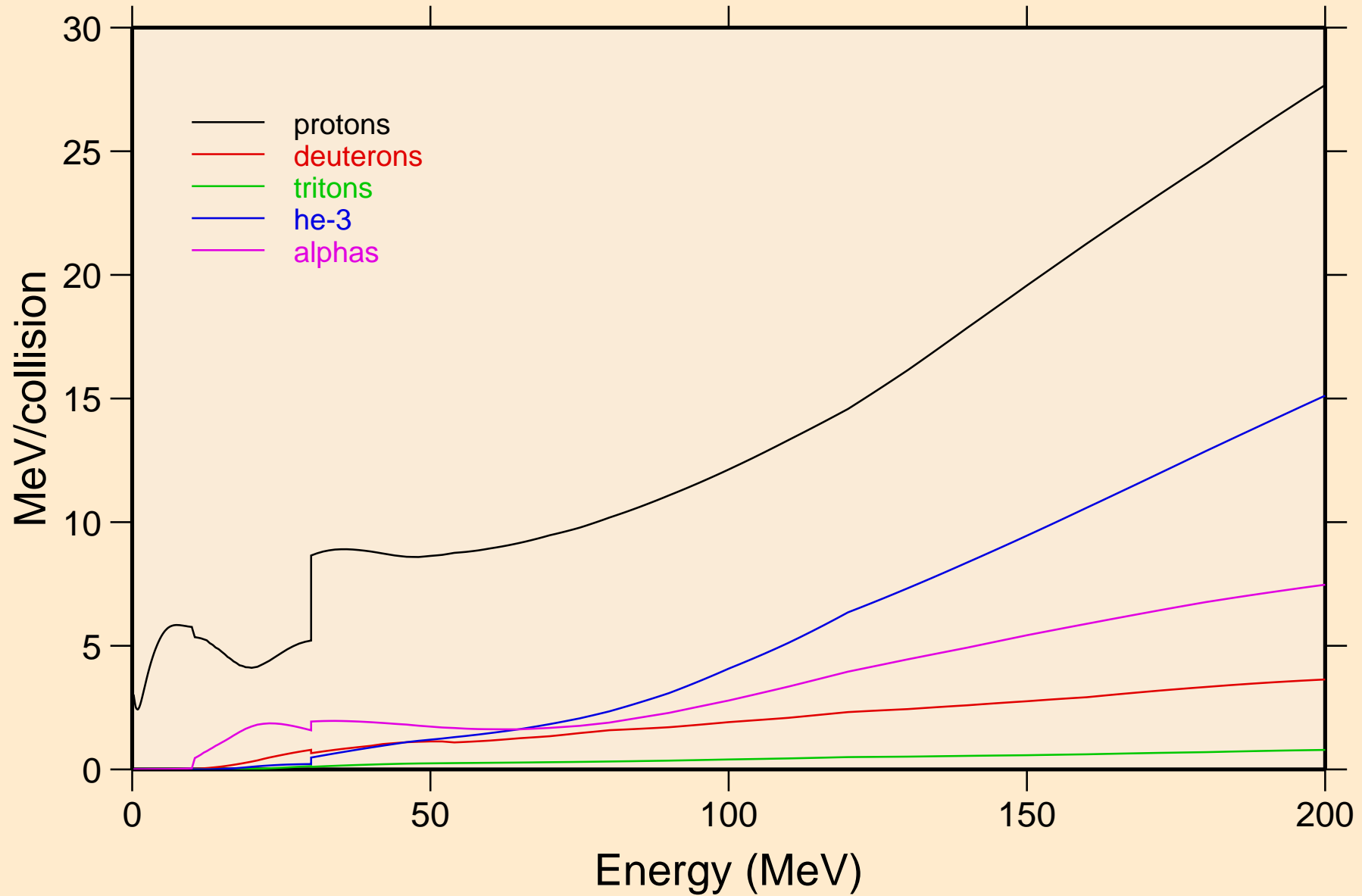

RH092 NEUTRON ACER TENDL-2024 LIBRARY; T=0.K
Recoil Heating

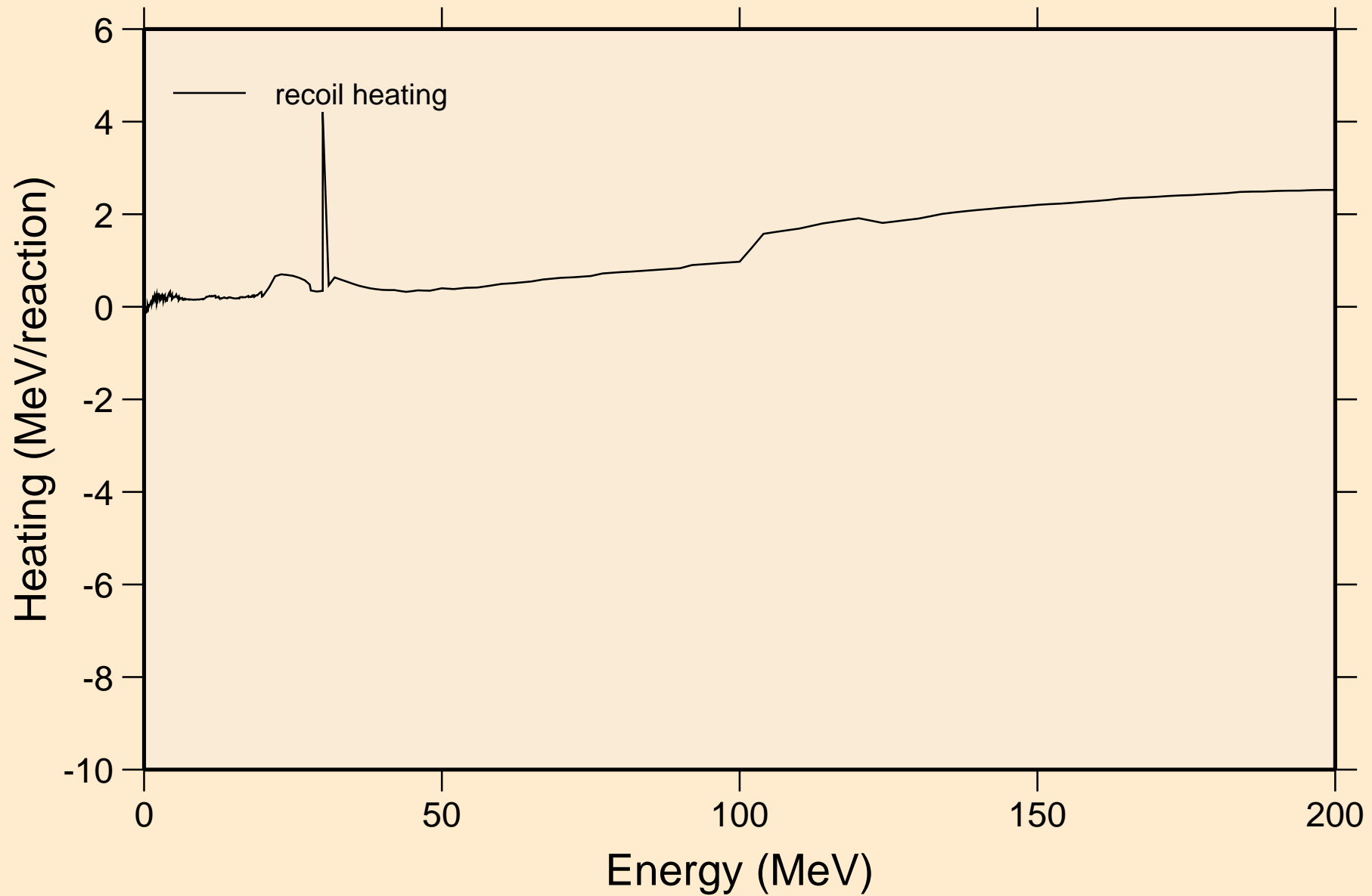

RH092 NEUTRON ACER TENDL-2024 LIBRARY; T=0.K

Particle production cross sections

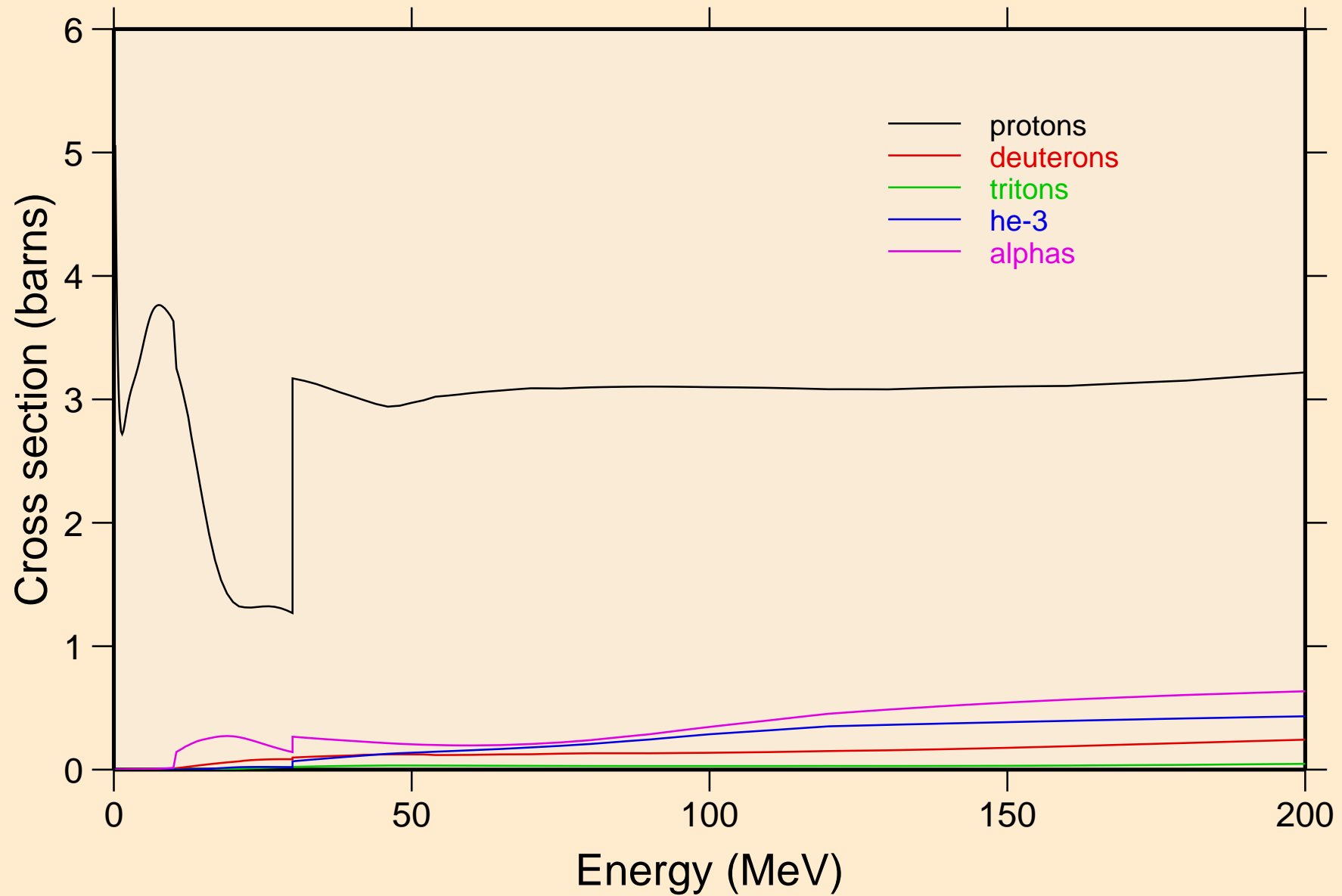

RH092 NEUTRON ACER TENDL-2024 LIBRARY; T=0.K
protons from (n,x)

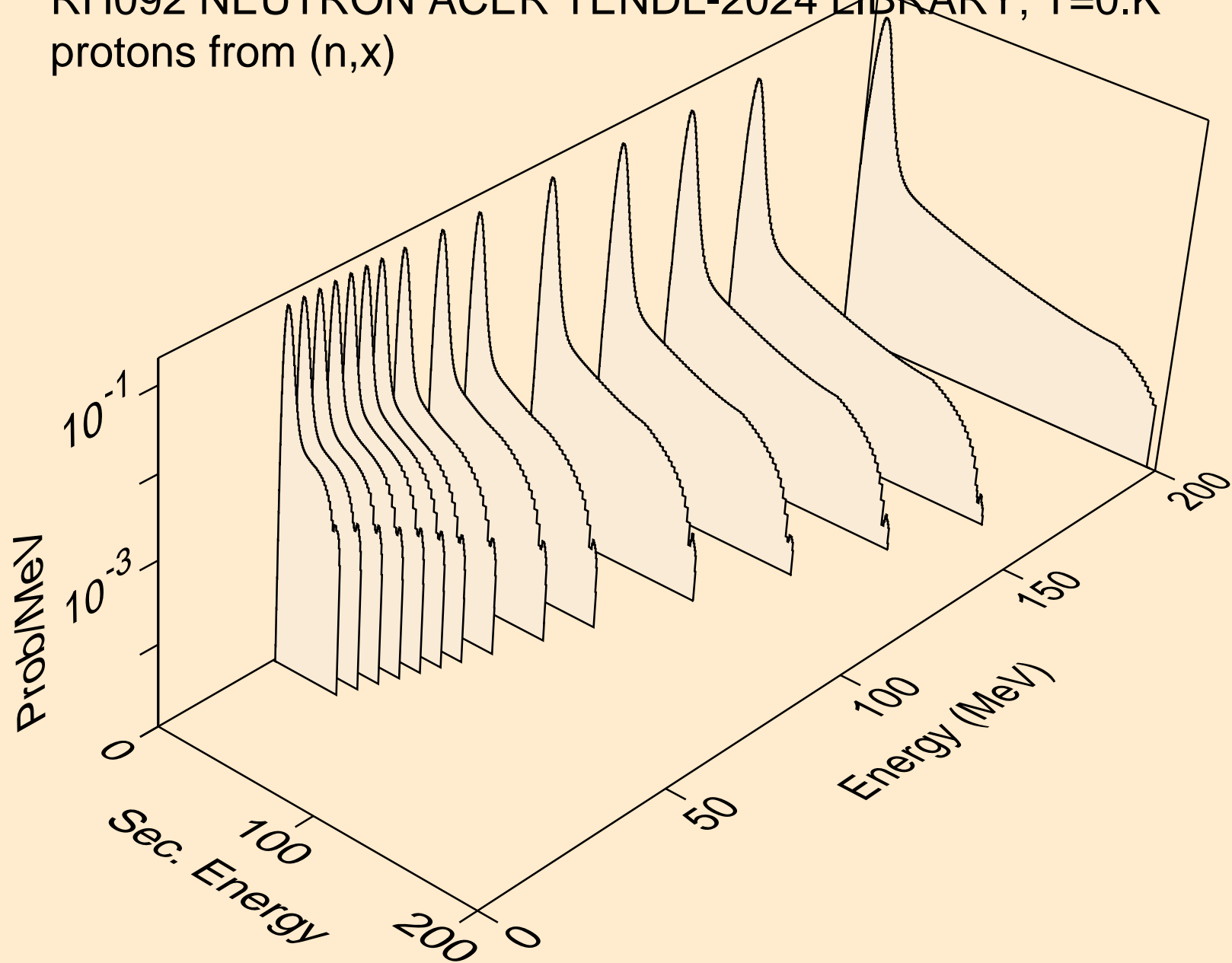

RH092 NEUTRON ACER TENDL-2024 LIBRARY; T=0.K
protons from (n,n*)p

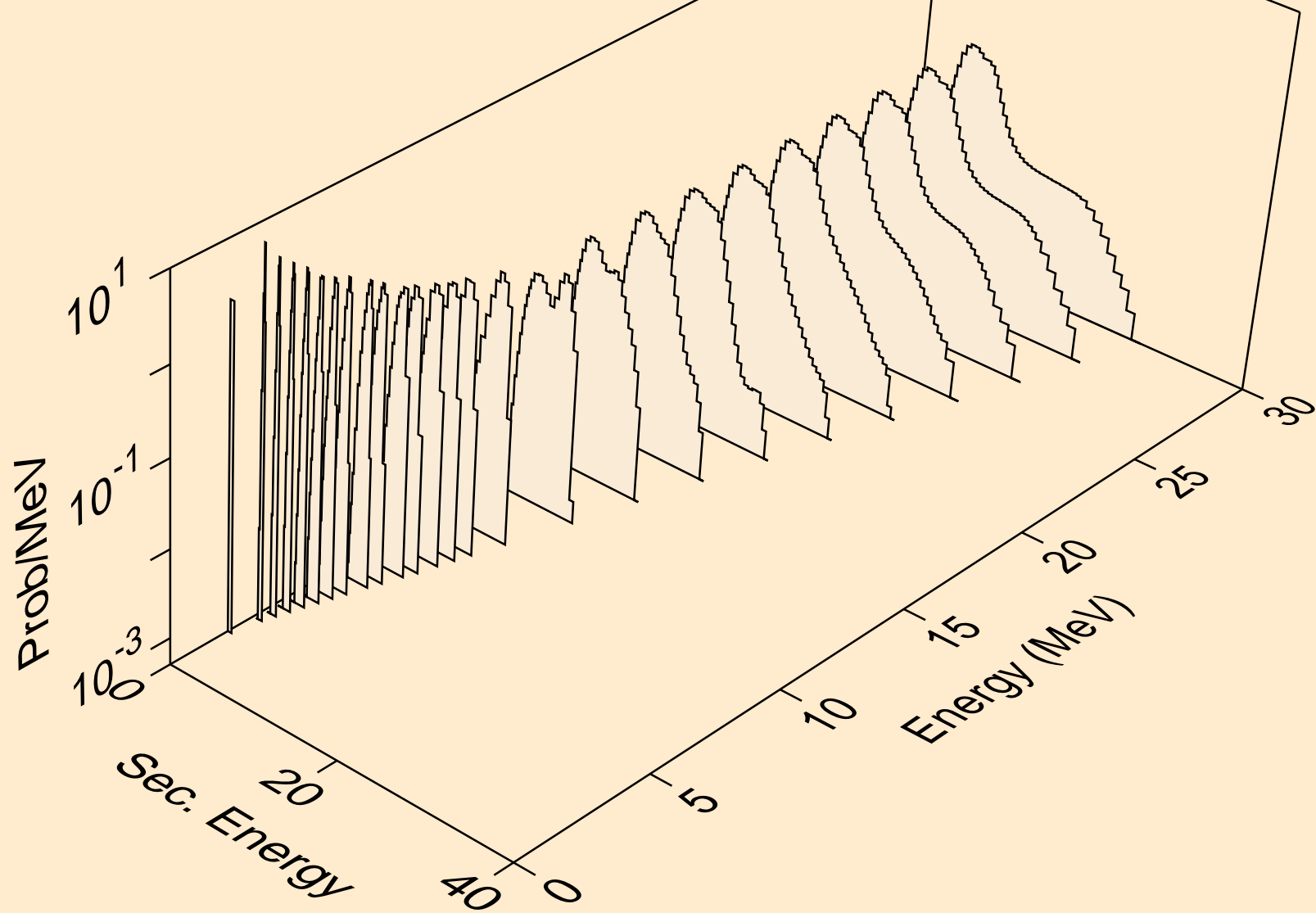

RH092 NEUTRON ACER TENDL-2024 LIBRARY; T=0.K
protons from (n,2np)

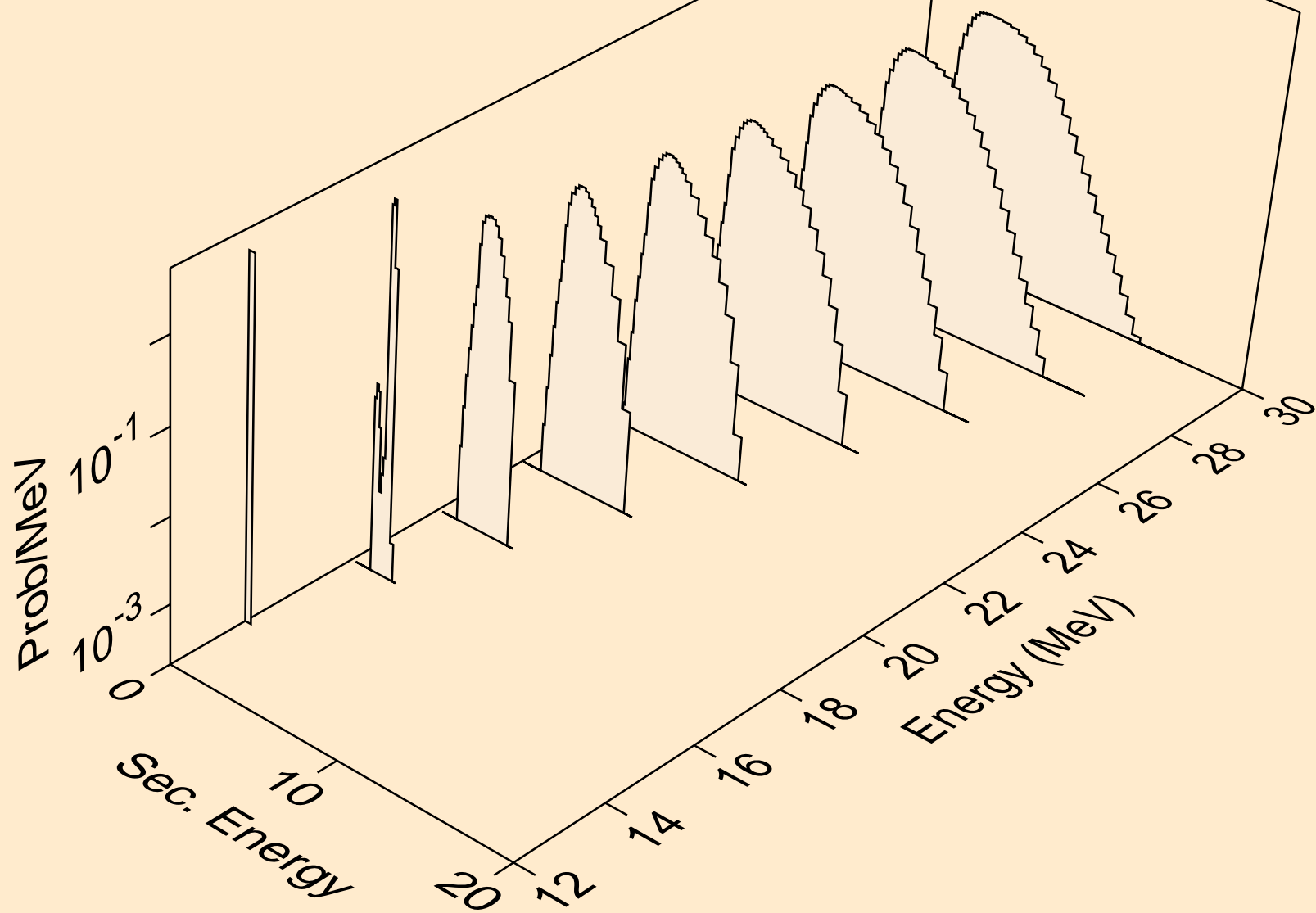

RH092 NEUTRON ACER TENDL-2024 LIBRARY; T=0.K
protons from (n,n2p)

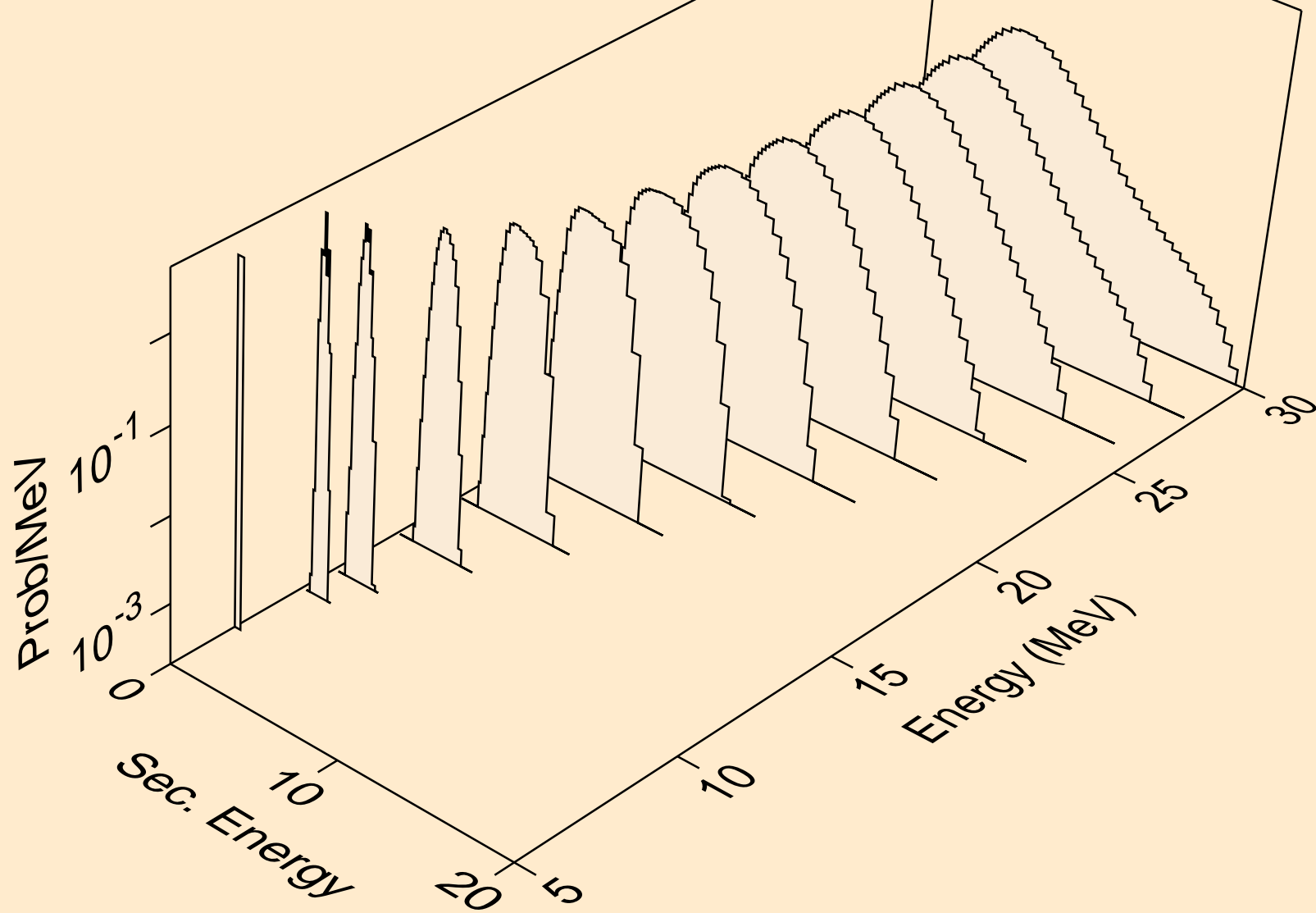

RH092 NEUTRON ACER TENDL-2024 LIBRARY; T=0.K
protons from (n,npa)

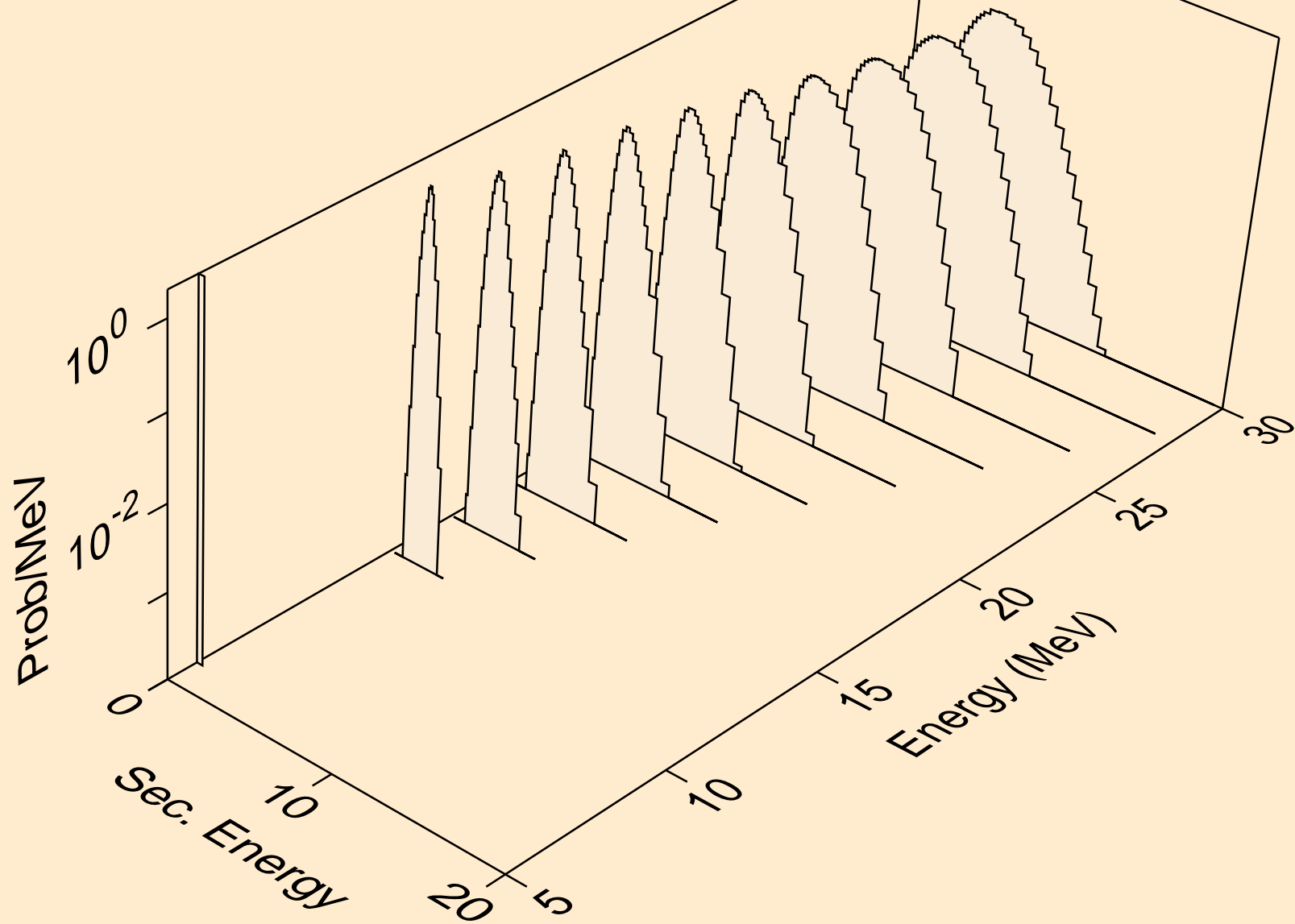

RH092 NEUTRON ACER TENDL-2024 LIBRARY; T=0.K
protons from (n,p)

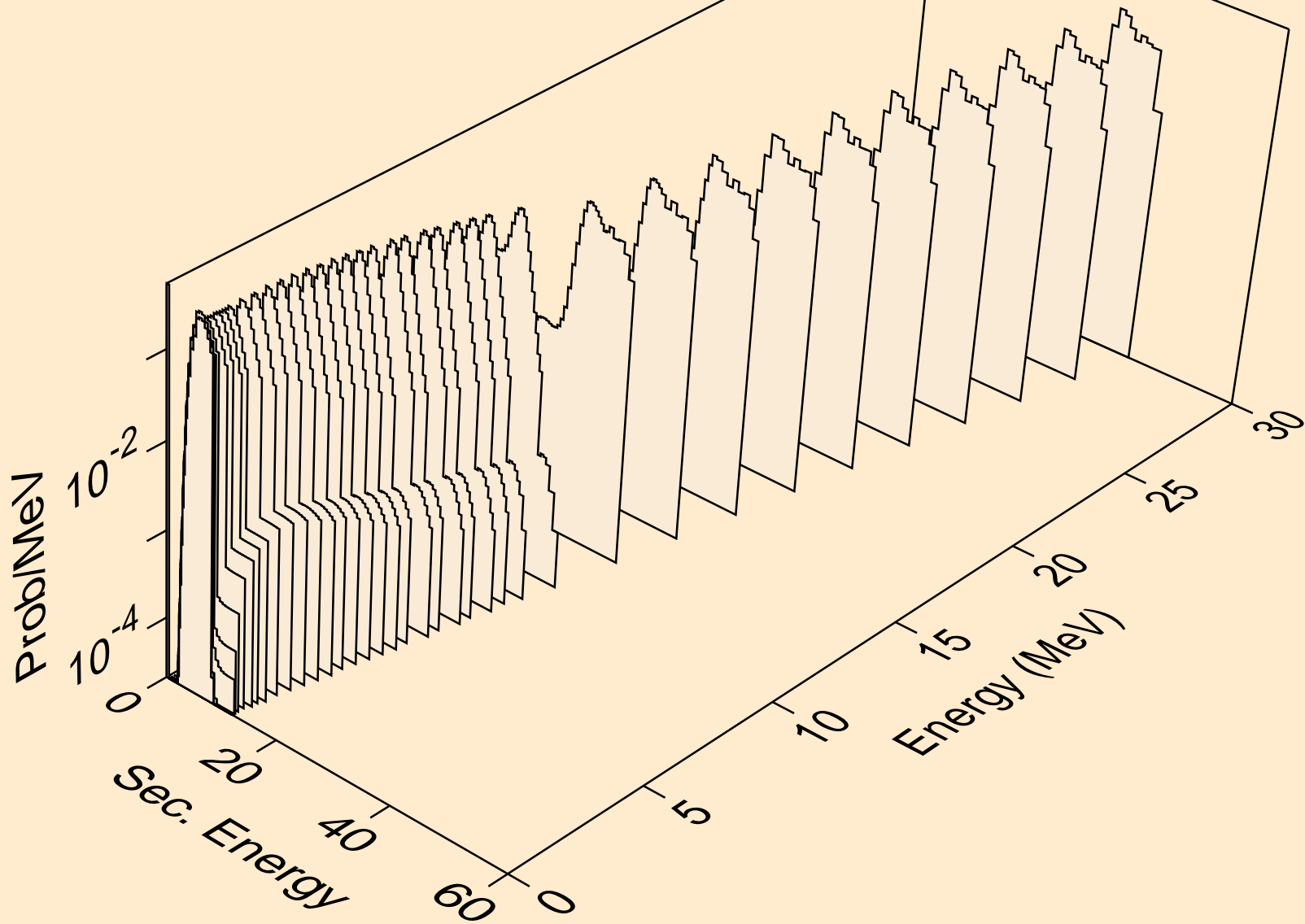

RH092 NEUTRON ACER TENDL-2024 LIBRARY; T=0.K
protons from (n,2p)

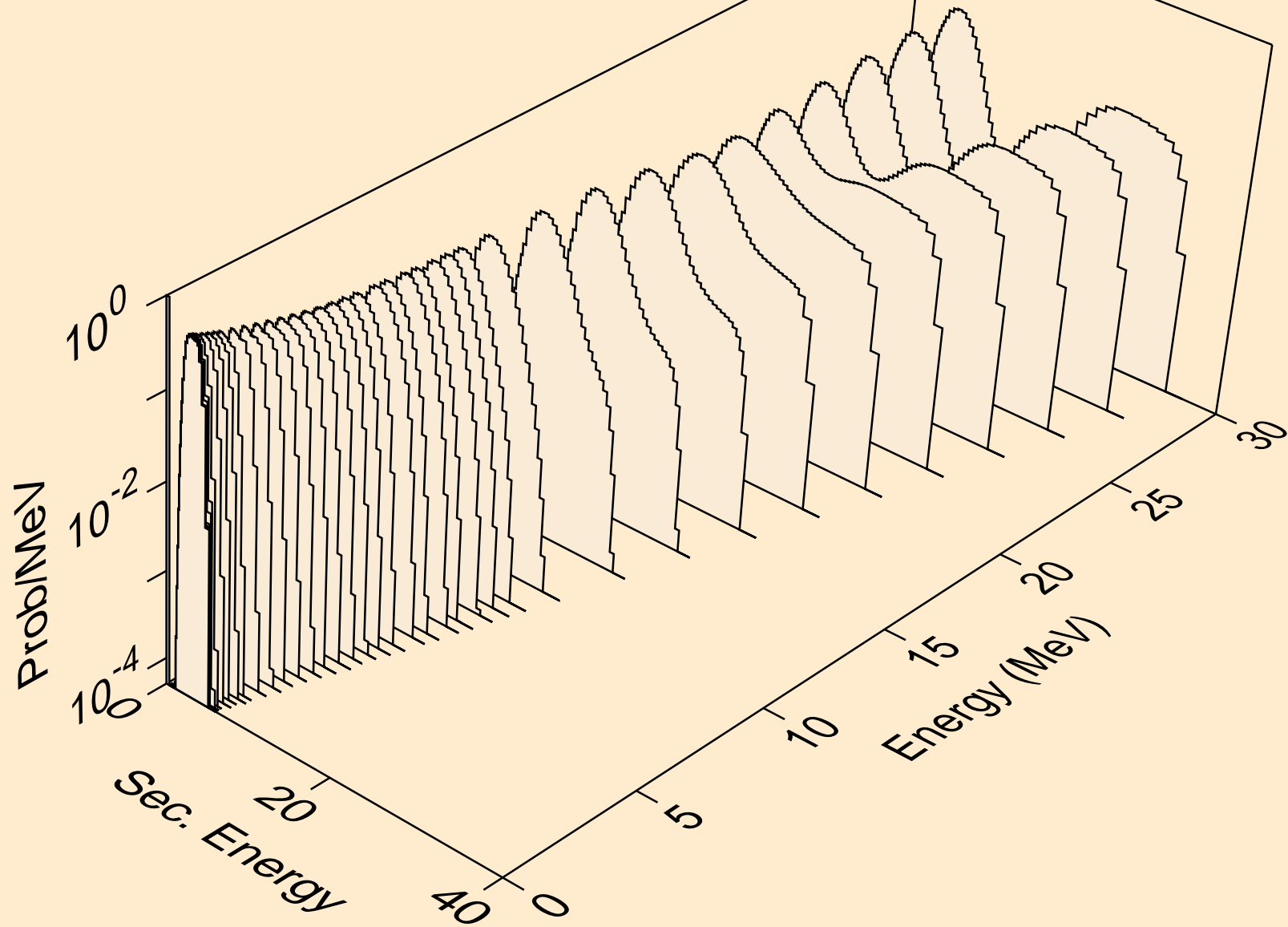

RH092 NEUTRON ACER TENDL-2024 LIBRARY; T=0.K
protons from (n,p)

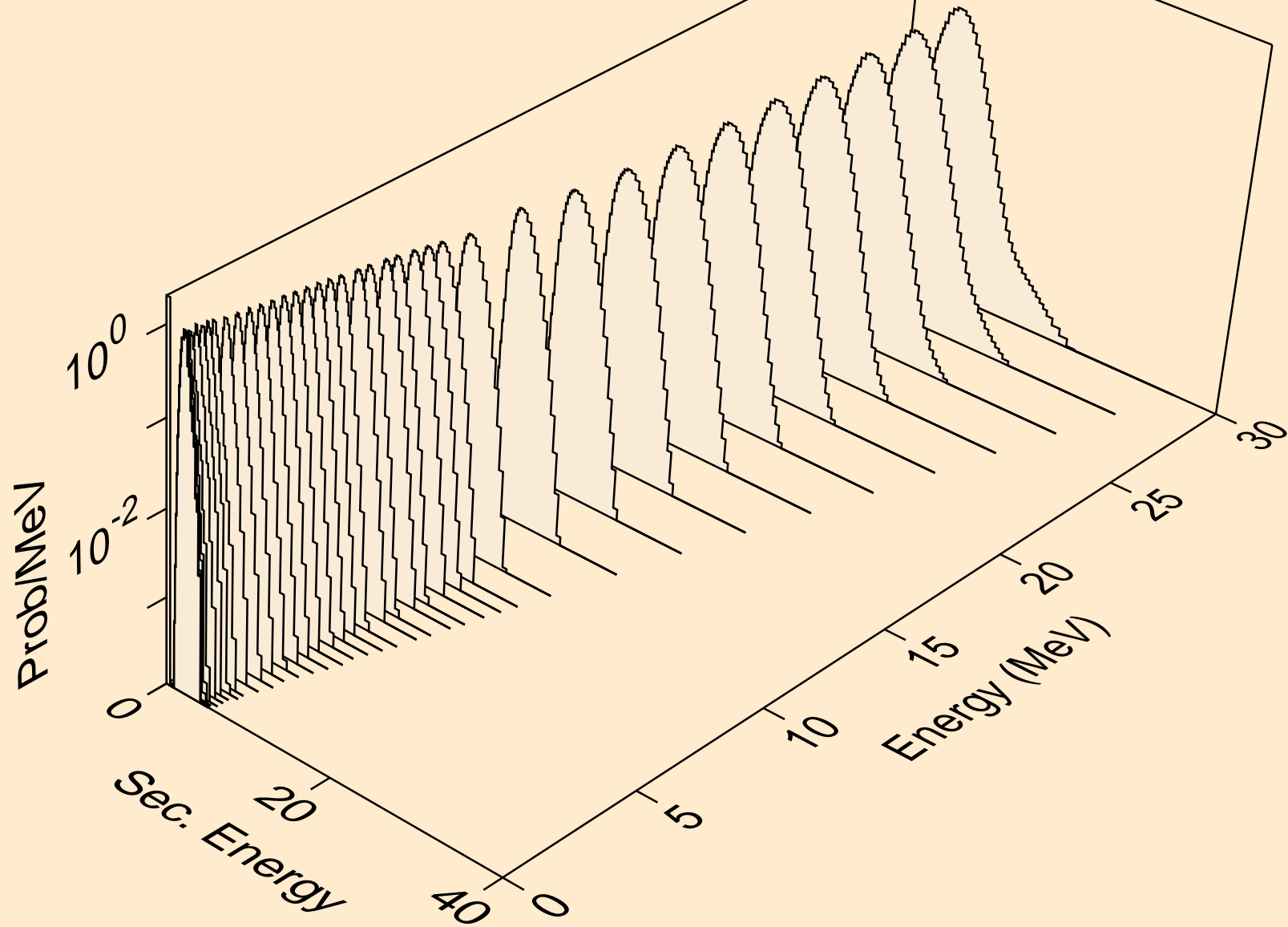

RH092 NEUTRON ACER TENDL-2024 LIBRARY; T=0.K
protons from (n,pd)

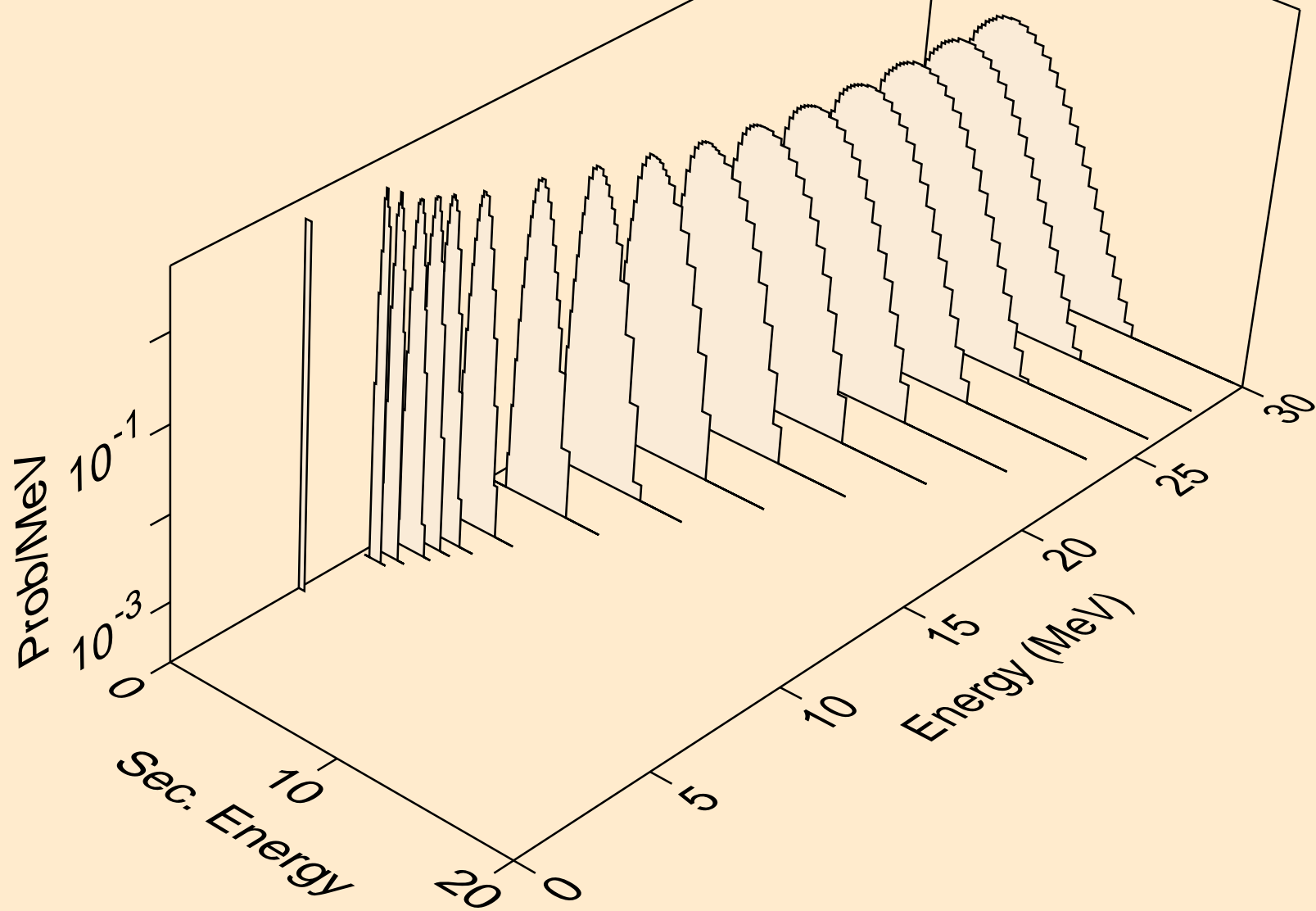

RH092 NEUTRON ACER TENDL-2024 LIBRARY; T=0.K
protons from (n,pt)

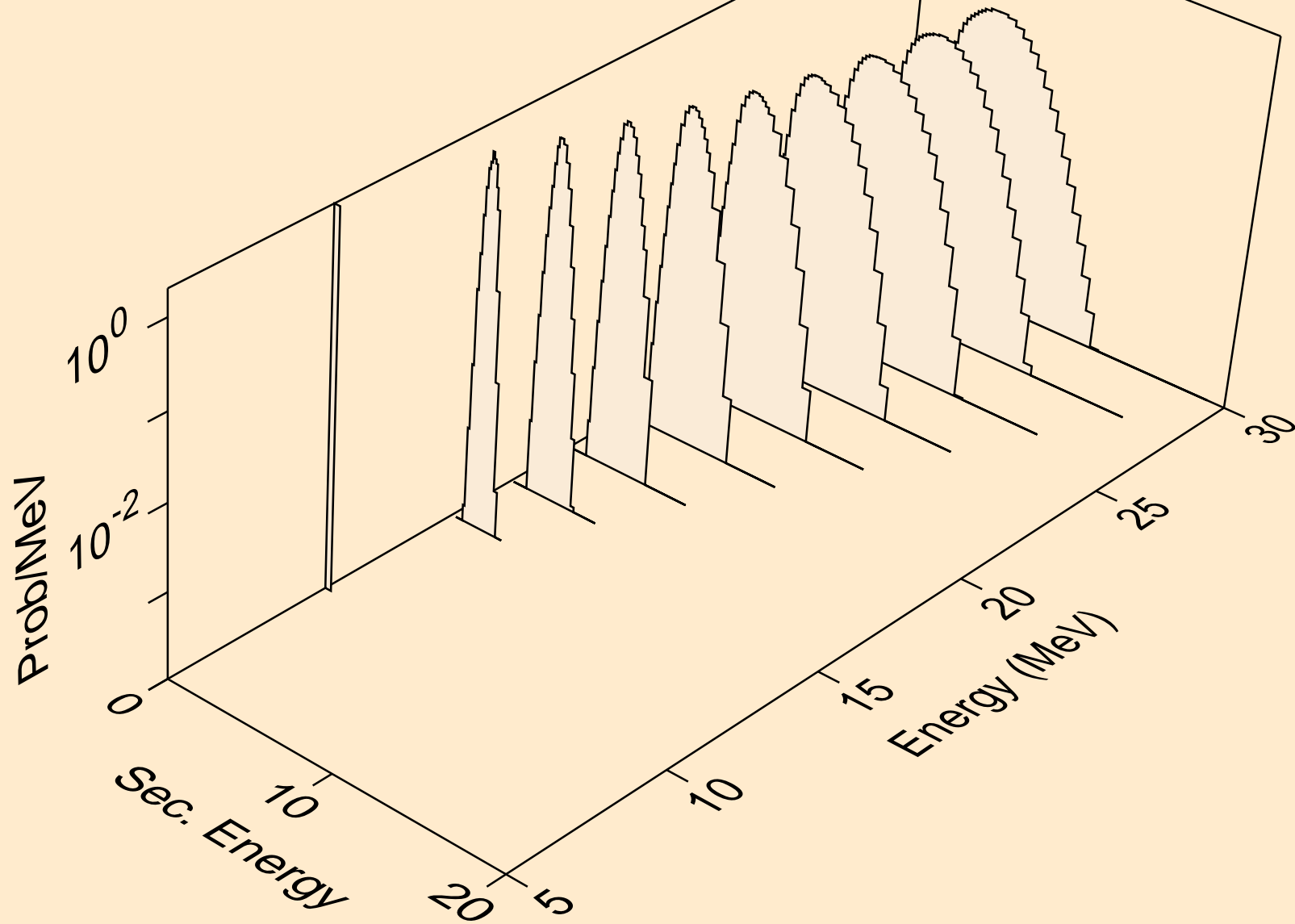

RH092 NEUTRON ACER TENDL-2024 LIBRARY; T=0.K
deuterons from (n,x)

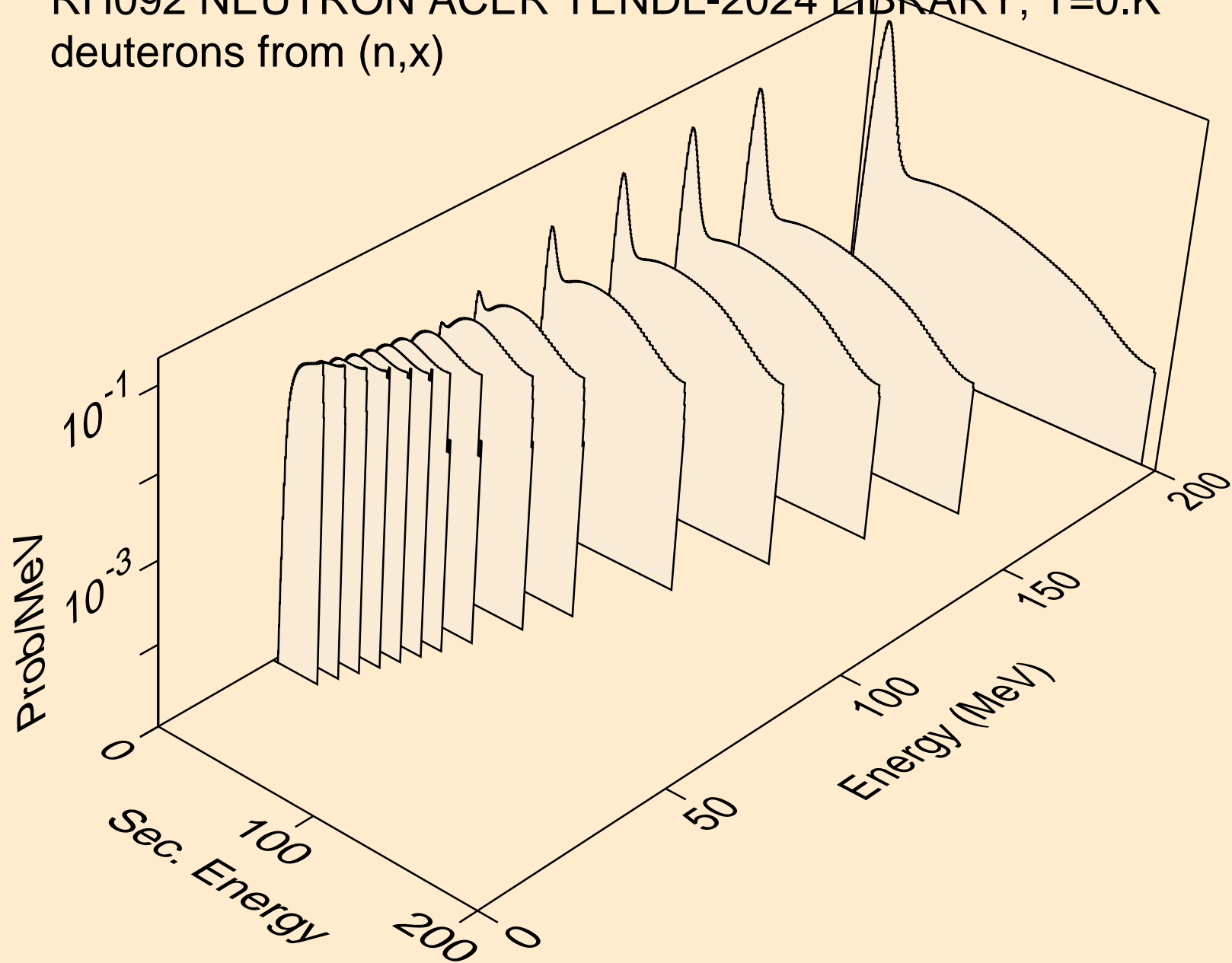

RH092 NEUTRON ACER TENDL-2024 LIBRARY; T=0.K
deuterons from (n,n*)d

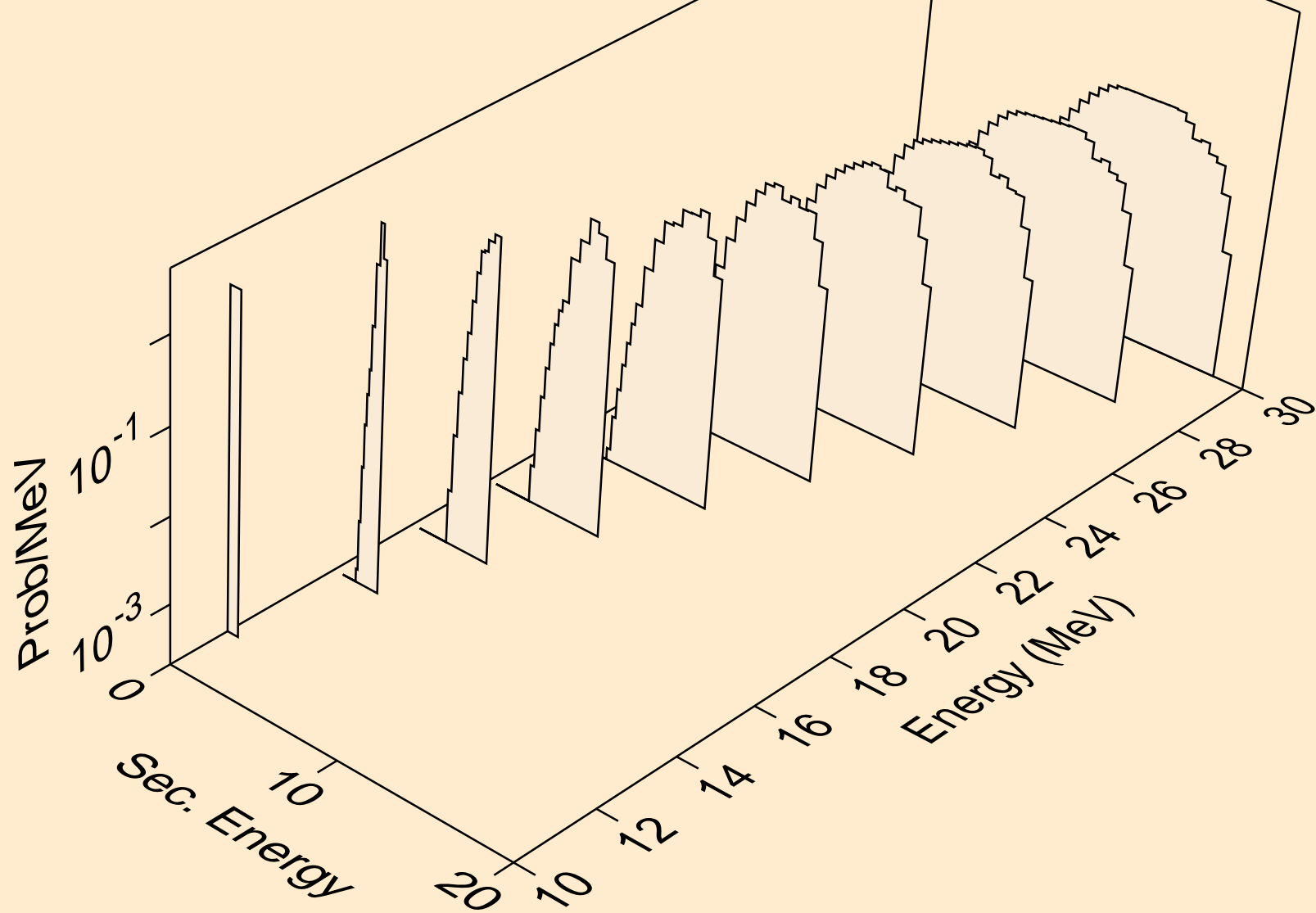

RH092 NEUTRON ACER TENDL-2024 LIBRARY; T=0.K
deuterons from (n,d)

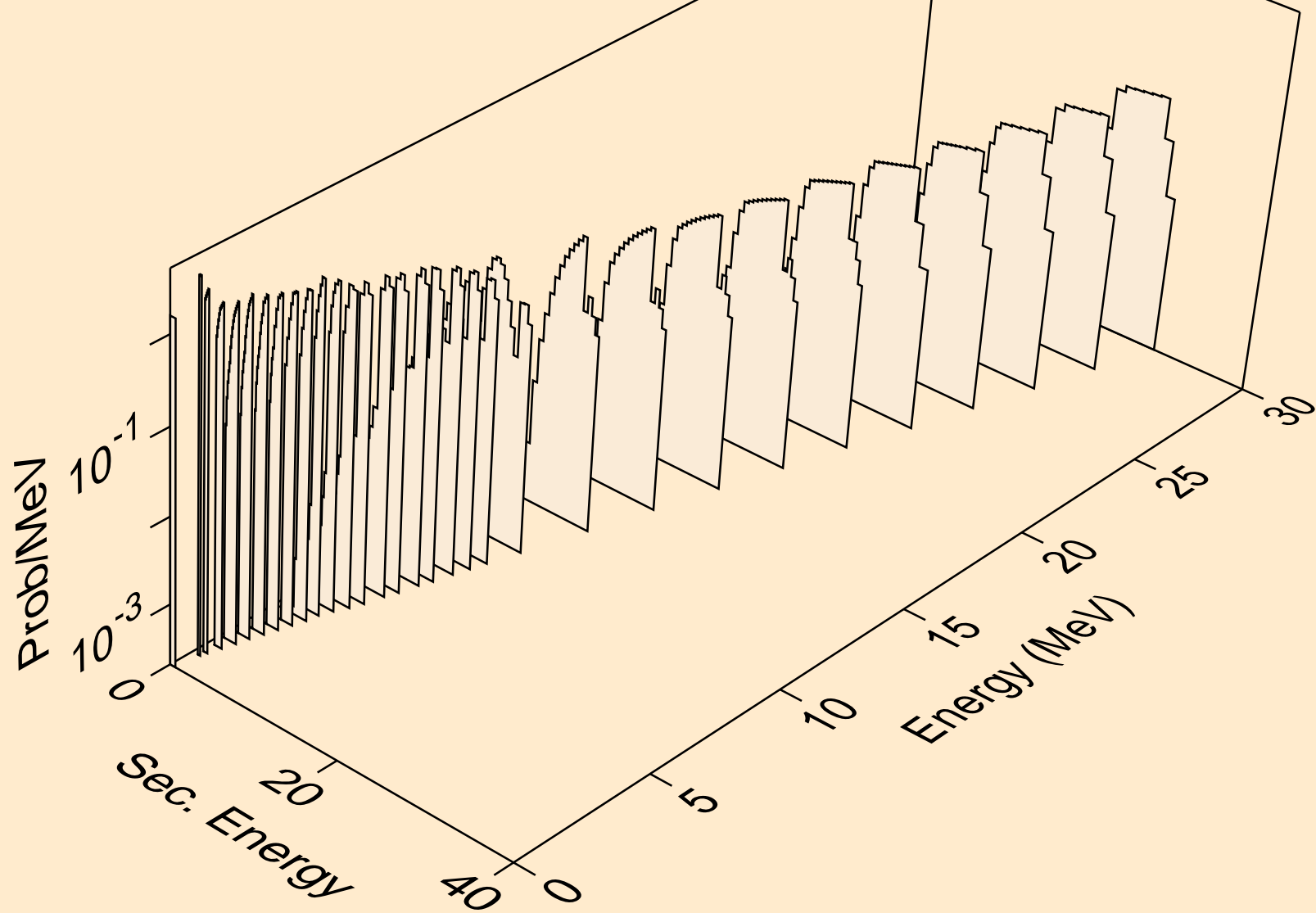

RH092 NEUTRON ACER TENDL-2024 LIBRARY; T=0.K
deuterons from (n,pd)

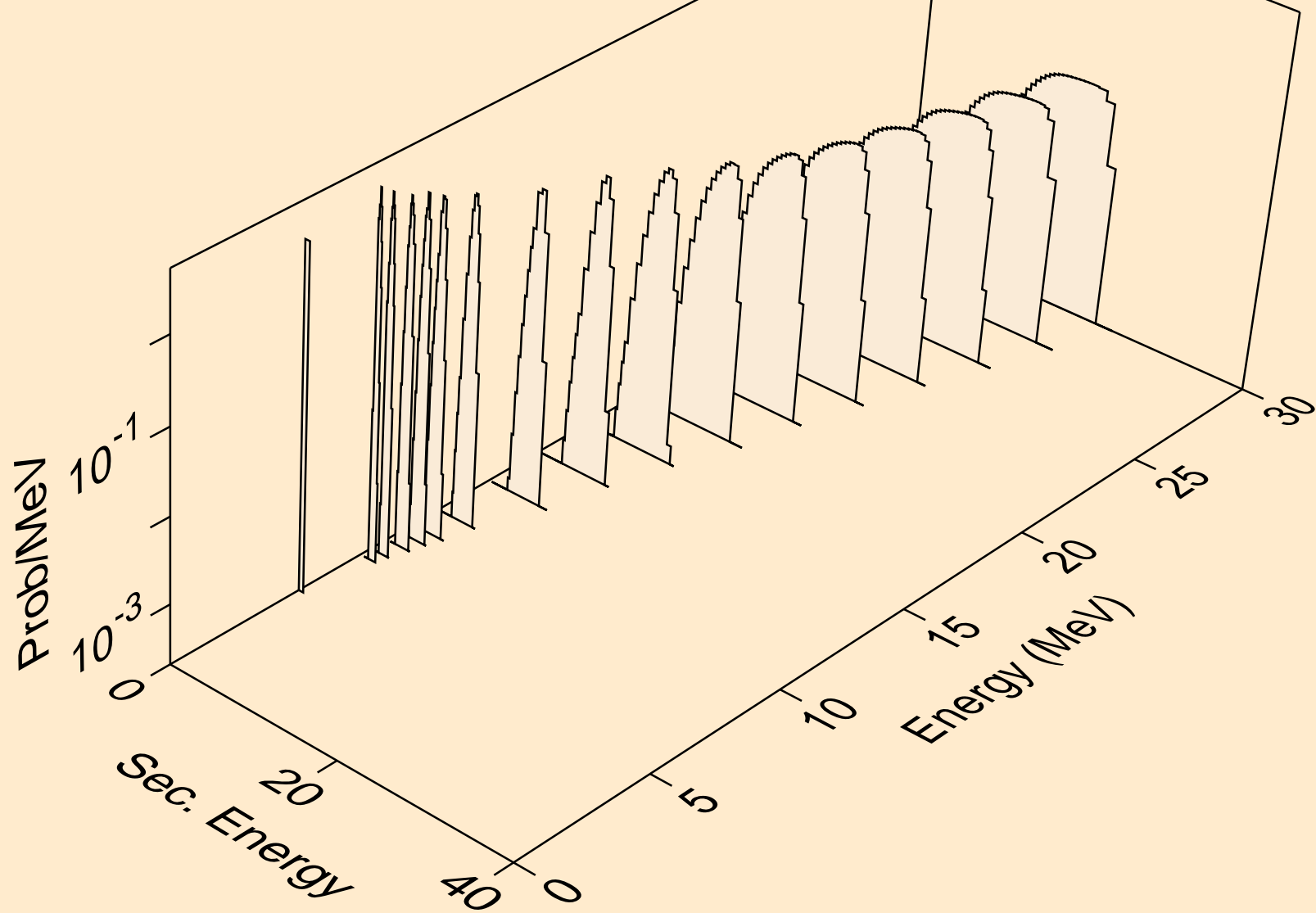

RH092 NEUTRON ACER TENDL-2024 LIBRARY; T=0.K
deuterons from (n,da)

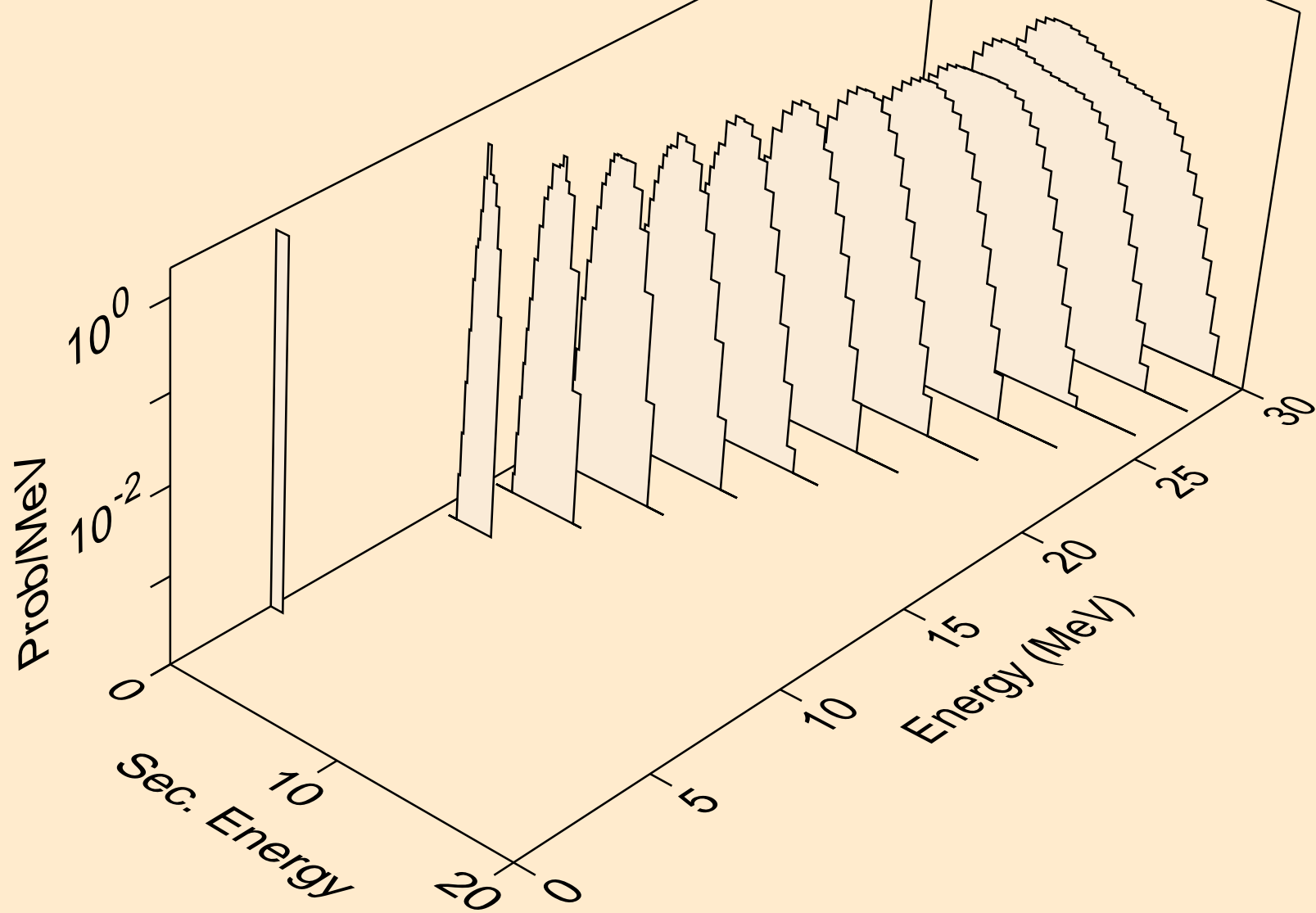

RH092 NEUTRON ACER TENDL-2024 LIBRARY; T=0.K
tritons from (n,x)

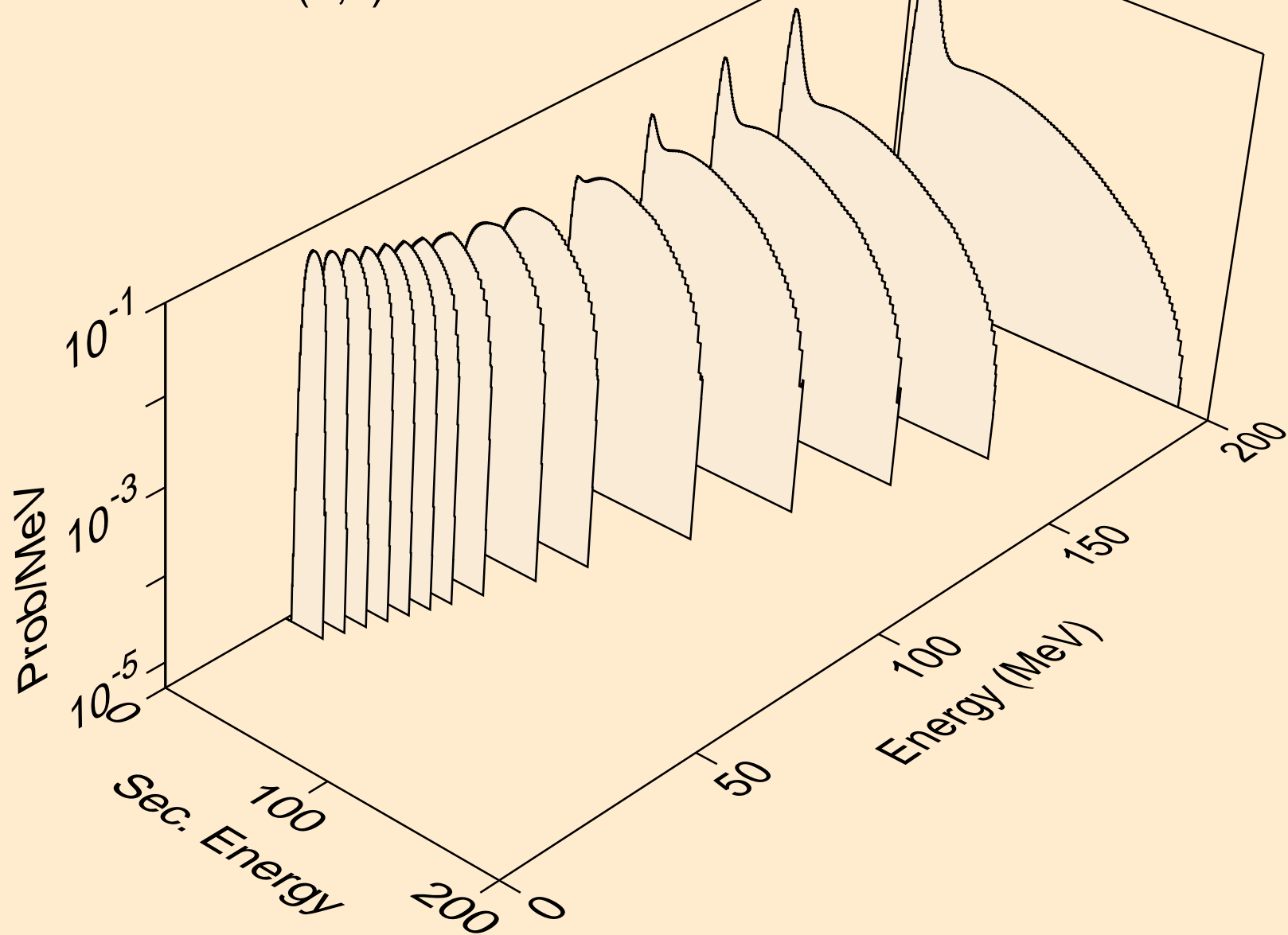

RH092 NEUTRON ACER TENDL-2024 LIBRARY; T=0.K
tritons from (n,n*)t

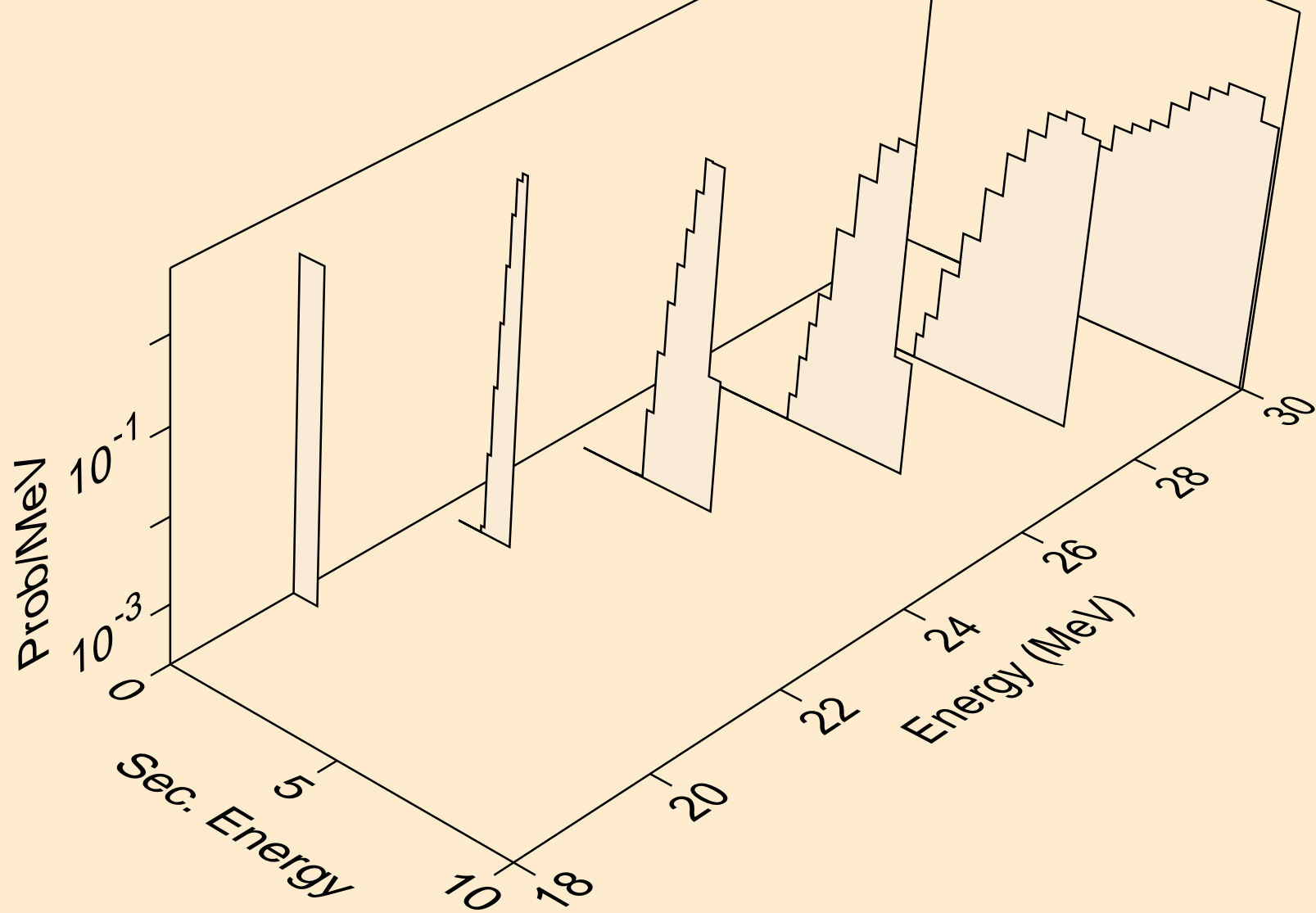

RH092 NEUTRON ACER TENDL-2024 LIBRARY; T=0.K
tritons from (n,t)

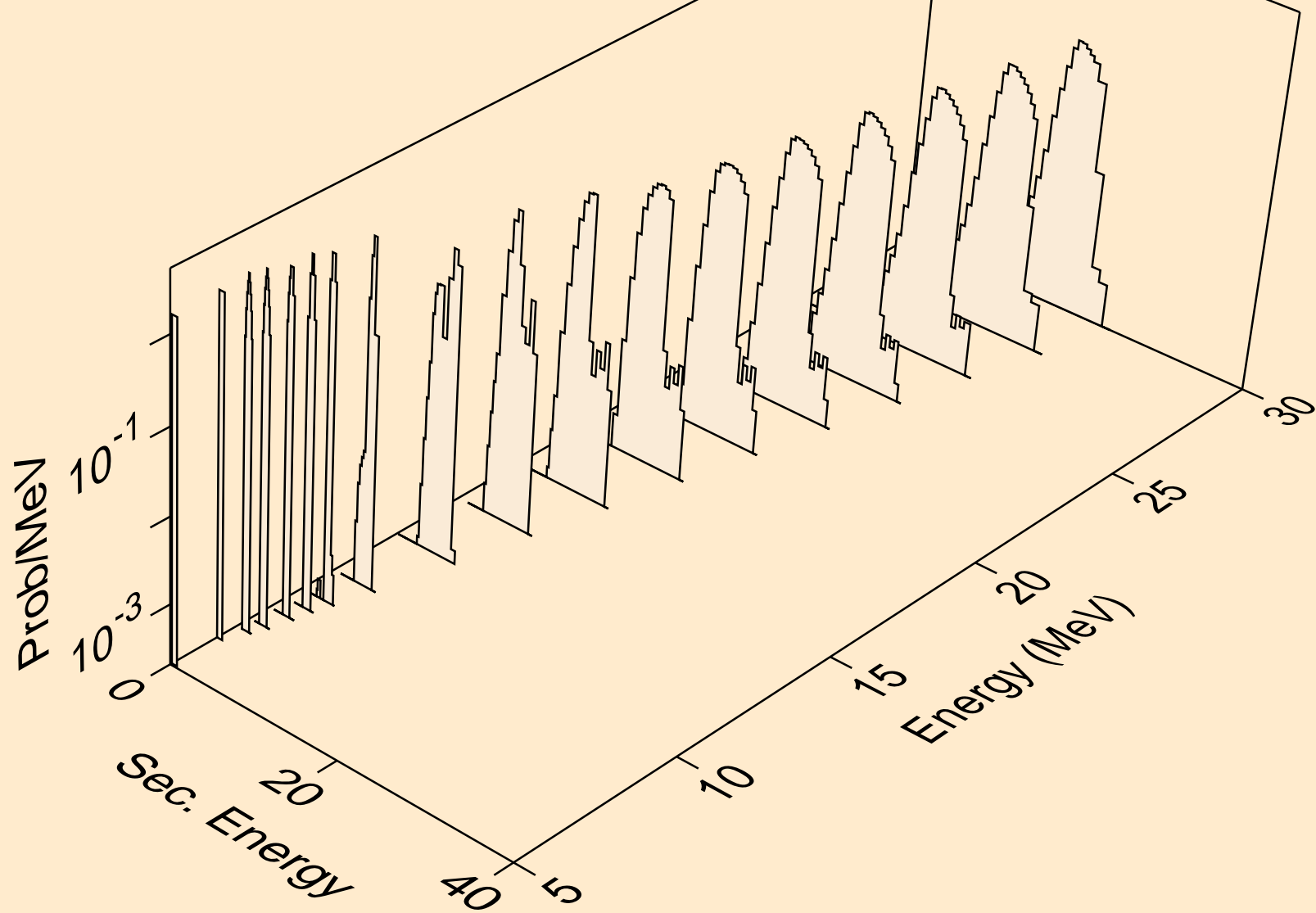

RH092 NEUTRON ACER TENDL-2024 LIBRARY; T=0.K
tritons from (n,pt)

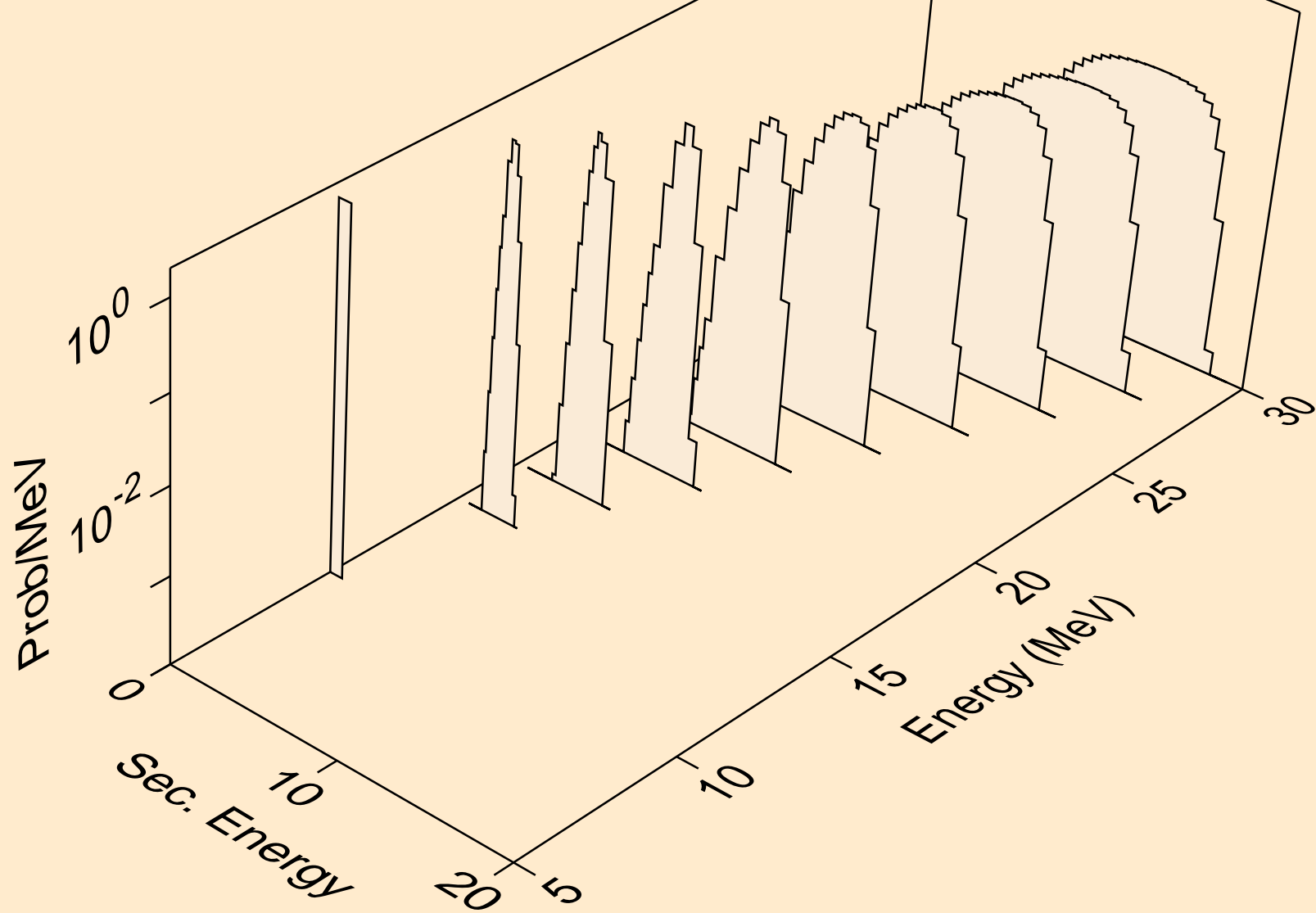

RH092 NEUTRON ACER TENDL-2024 LIBRARY; T=0.K
he3s from (n,x)

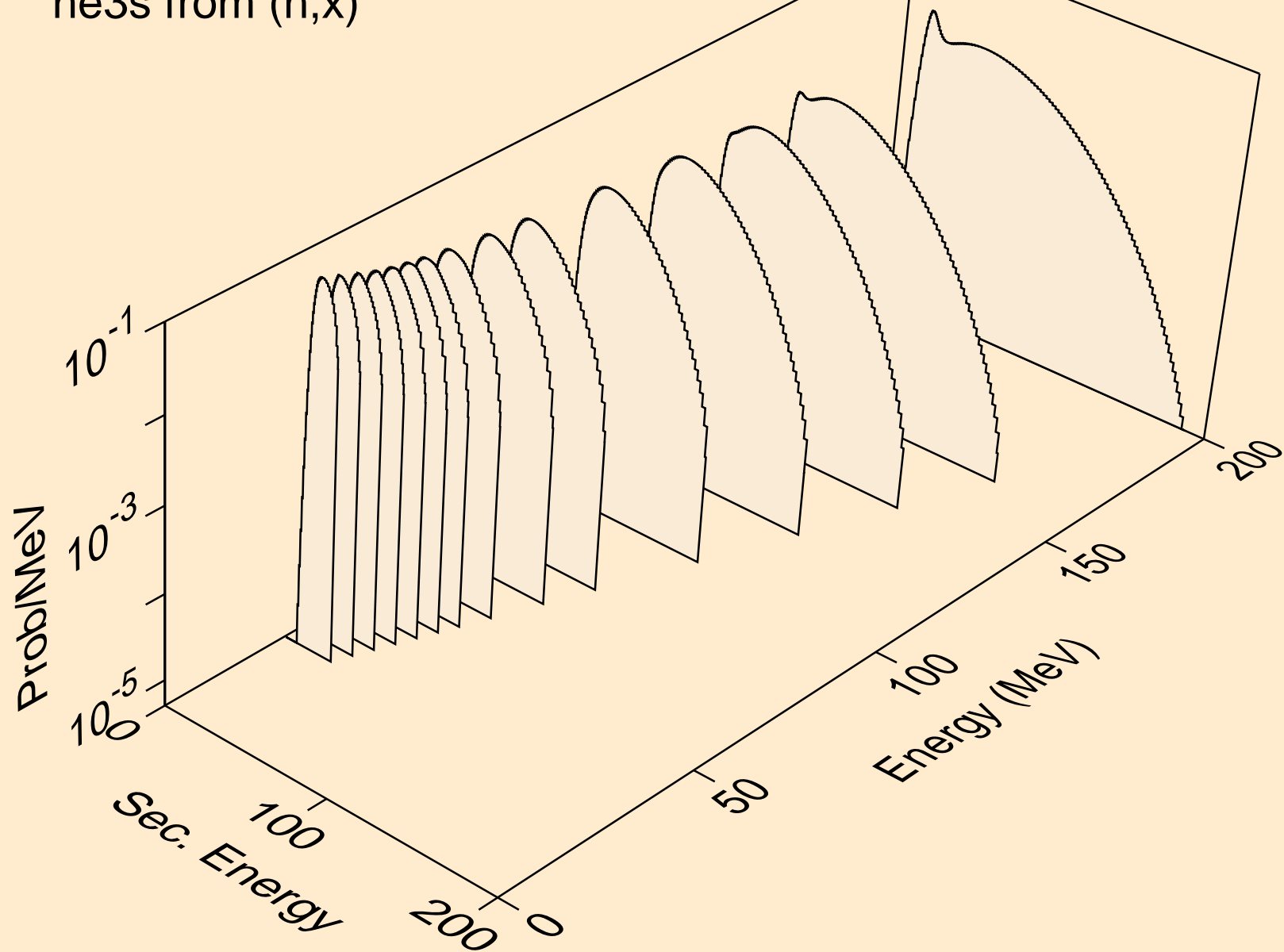

RH092 NEUTRON ACER TENDL-2024 LIBRARY; T=0.K
he3s from (n,n*)he3

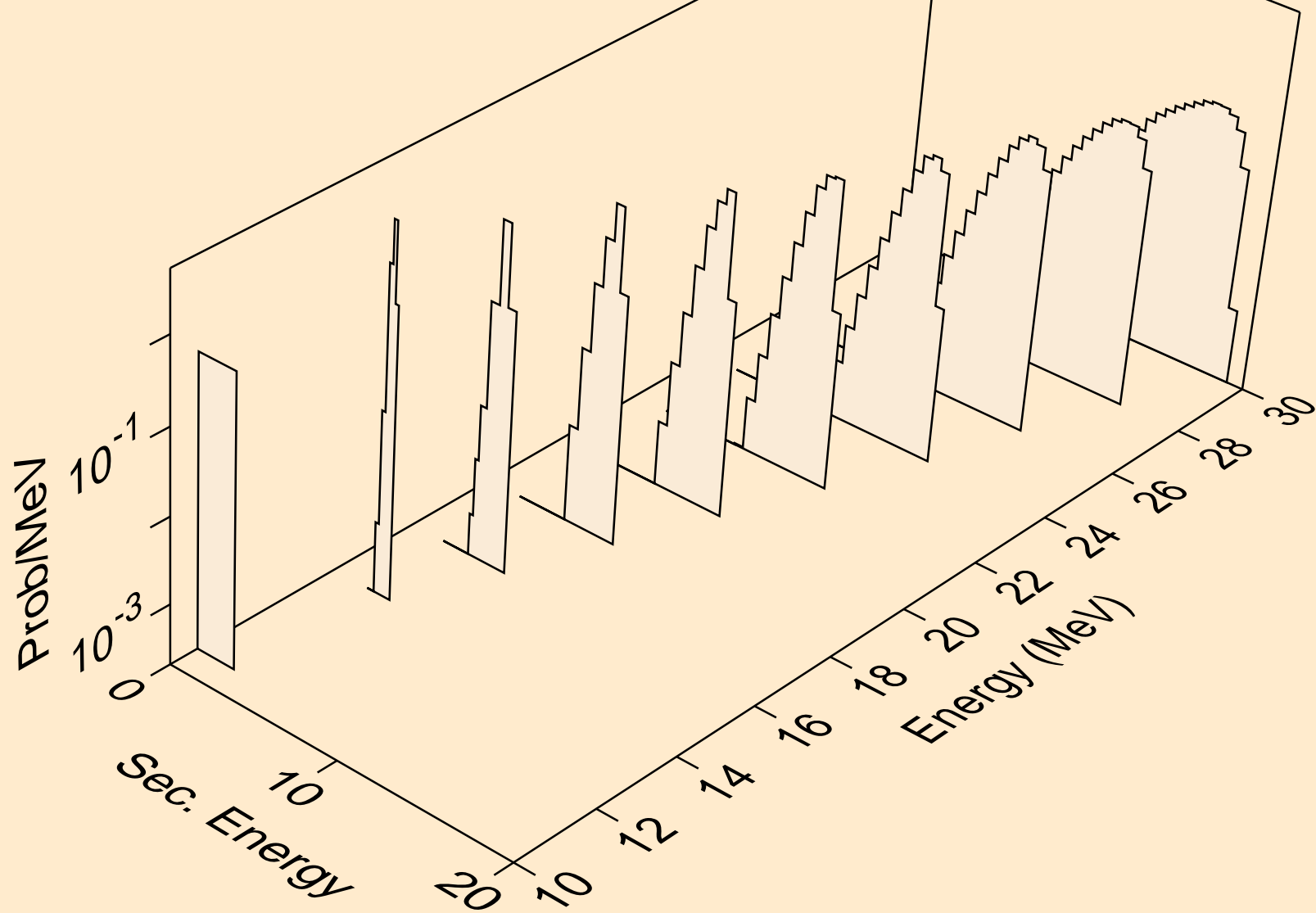

RH092 NEUTRON ACER TENDL-2024 LIBRARY; T=0.K
he3s from (n,he3)

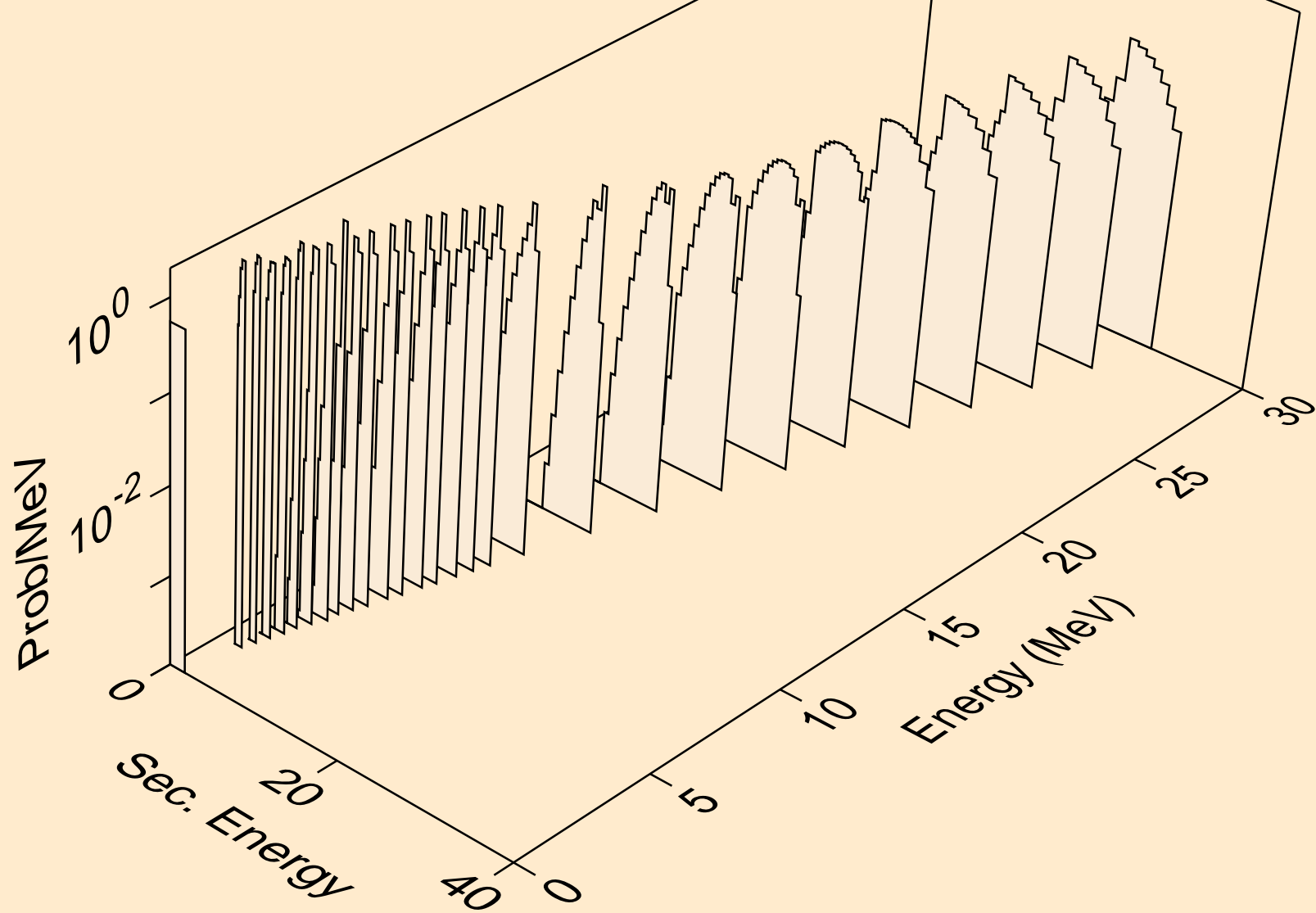

RH092 NEUTRON ACER TENDL-2024 LIBRARY; T=0.K
alphas from (n,x)

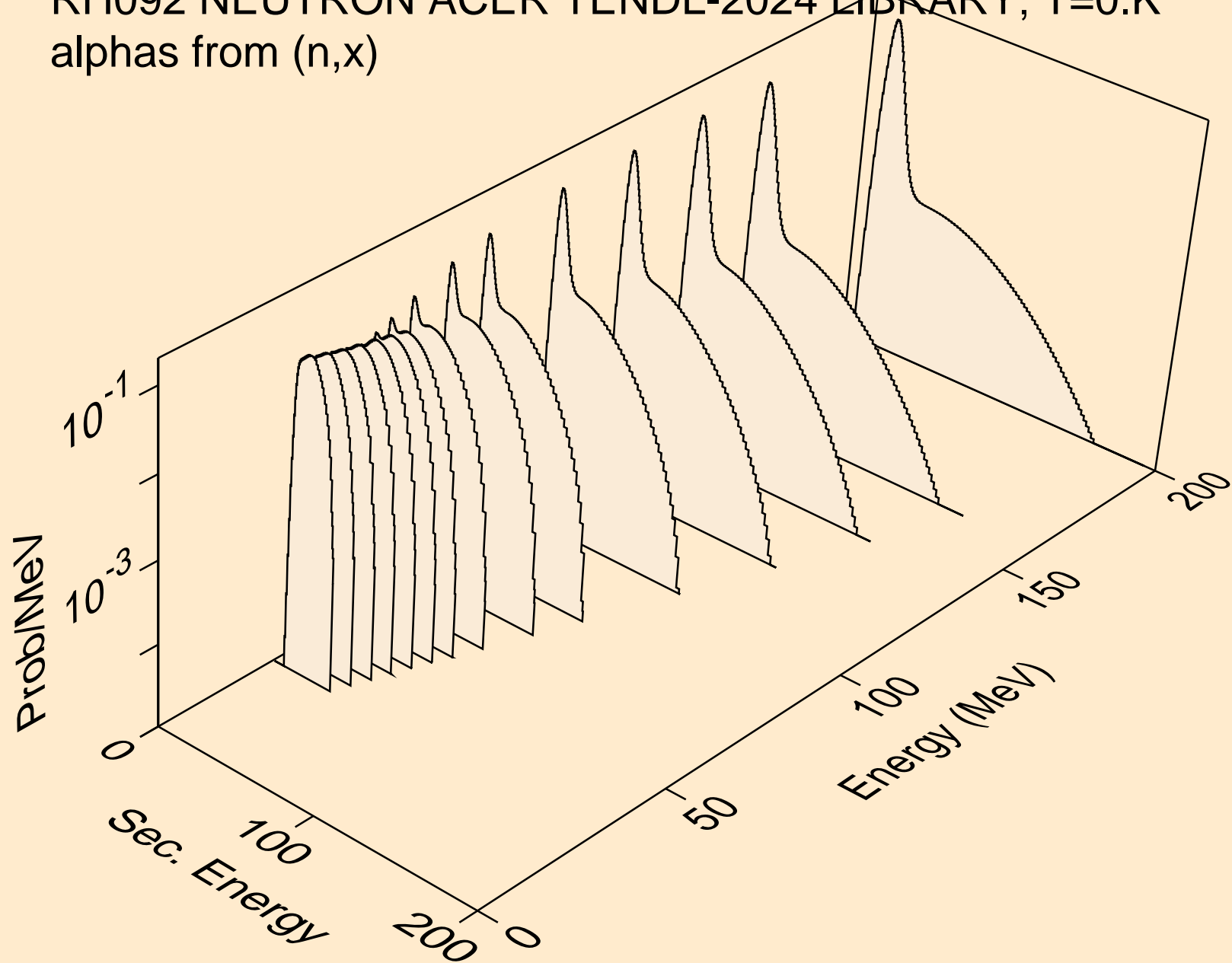

RH092 NEUTRON ACER TENDL-2024 LIBRARY; T=0.K
alphas from (n,n*)a

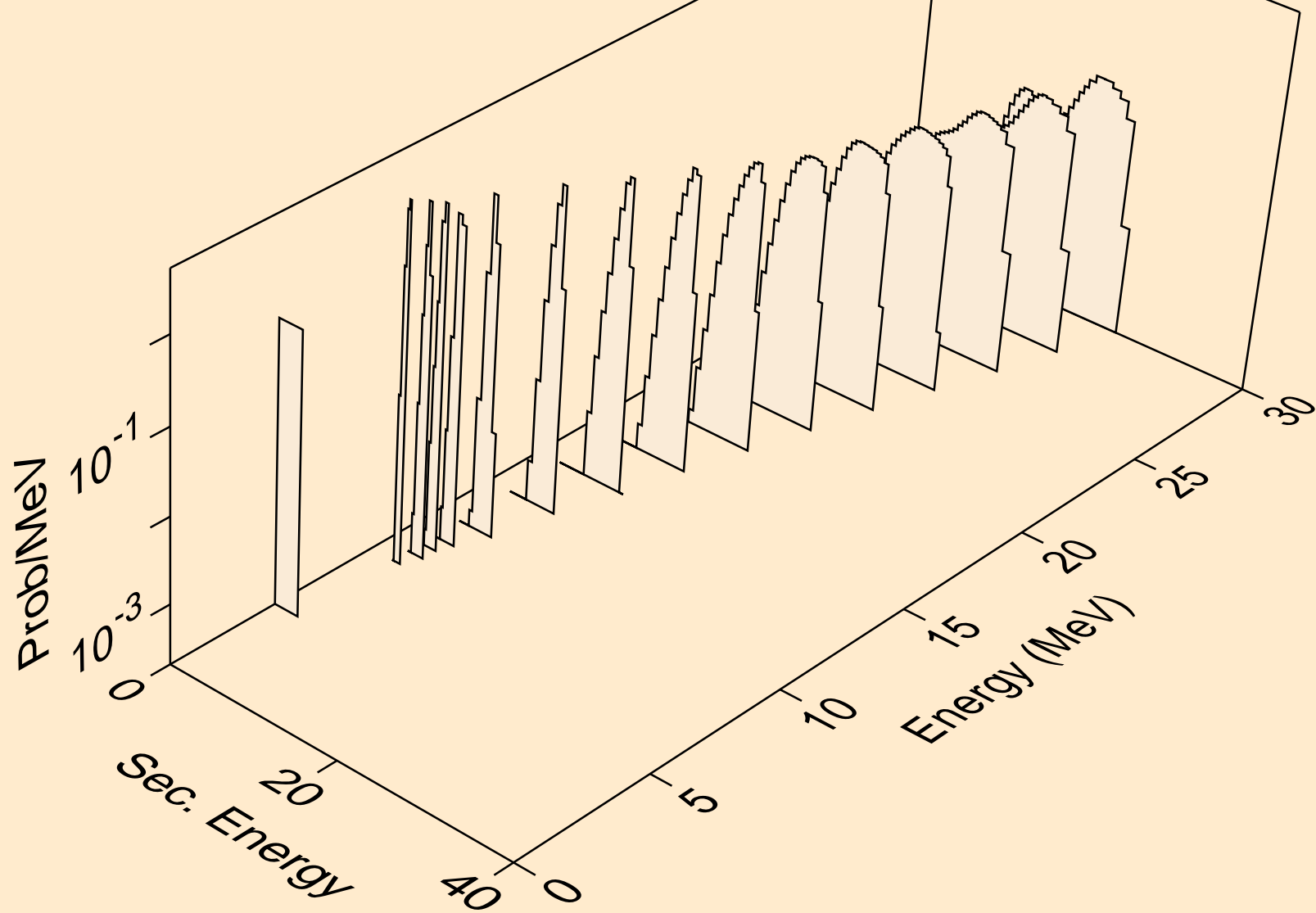

RH092 NEUTRON ACER TENDL-2024 LIBRARY; T=0.K
alphas from (n,2n)a

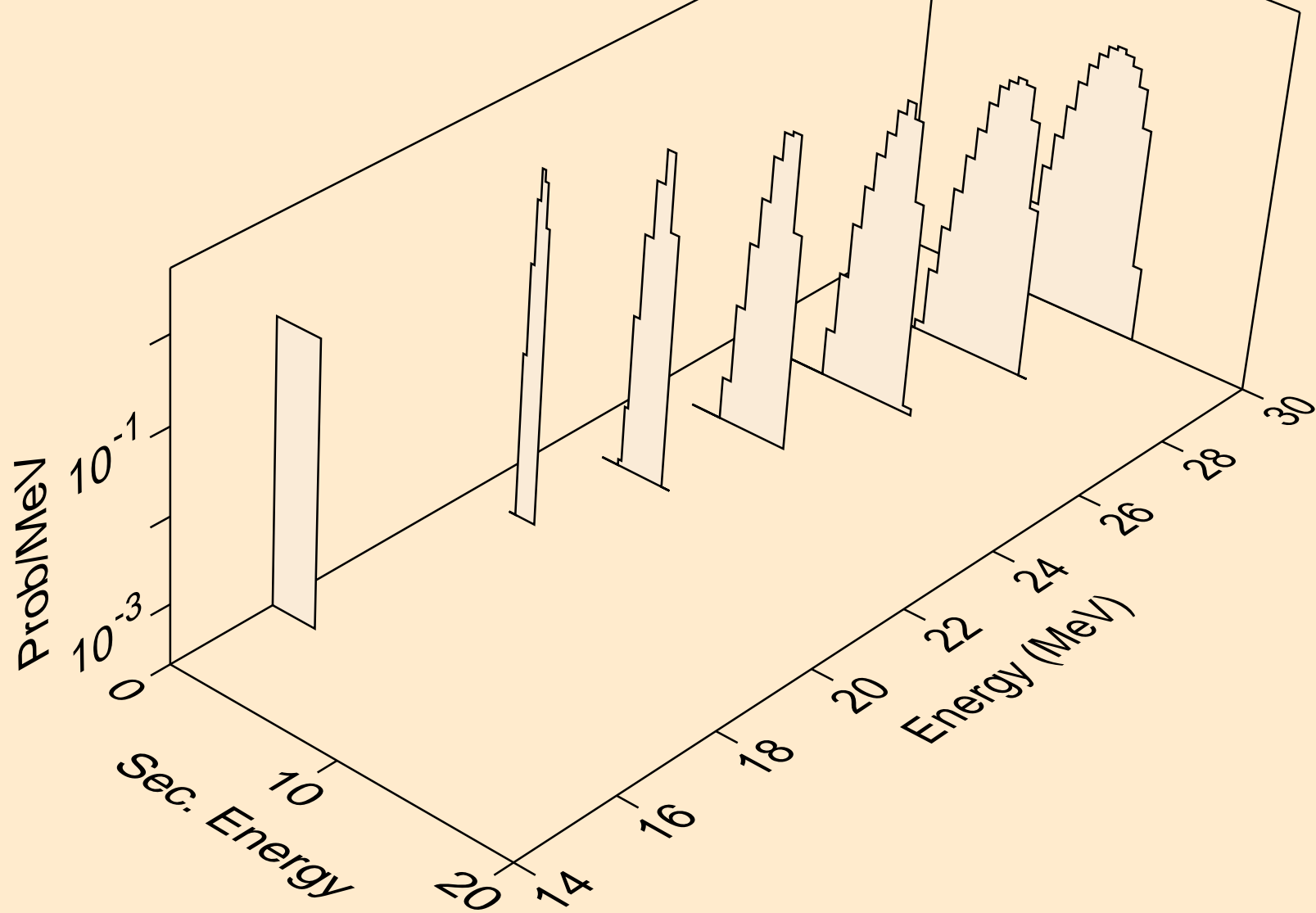

RH092 NEUTRON ACER TENDL-2024 LIBRARY; T=0.K
alphas from (n,n*)2a

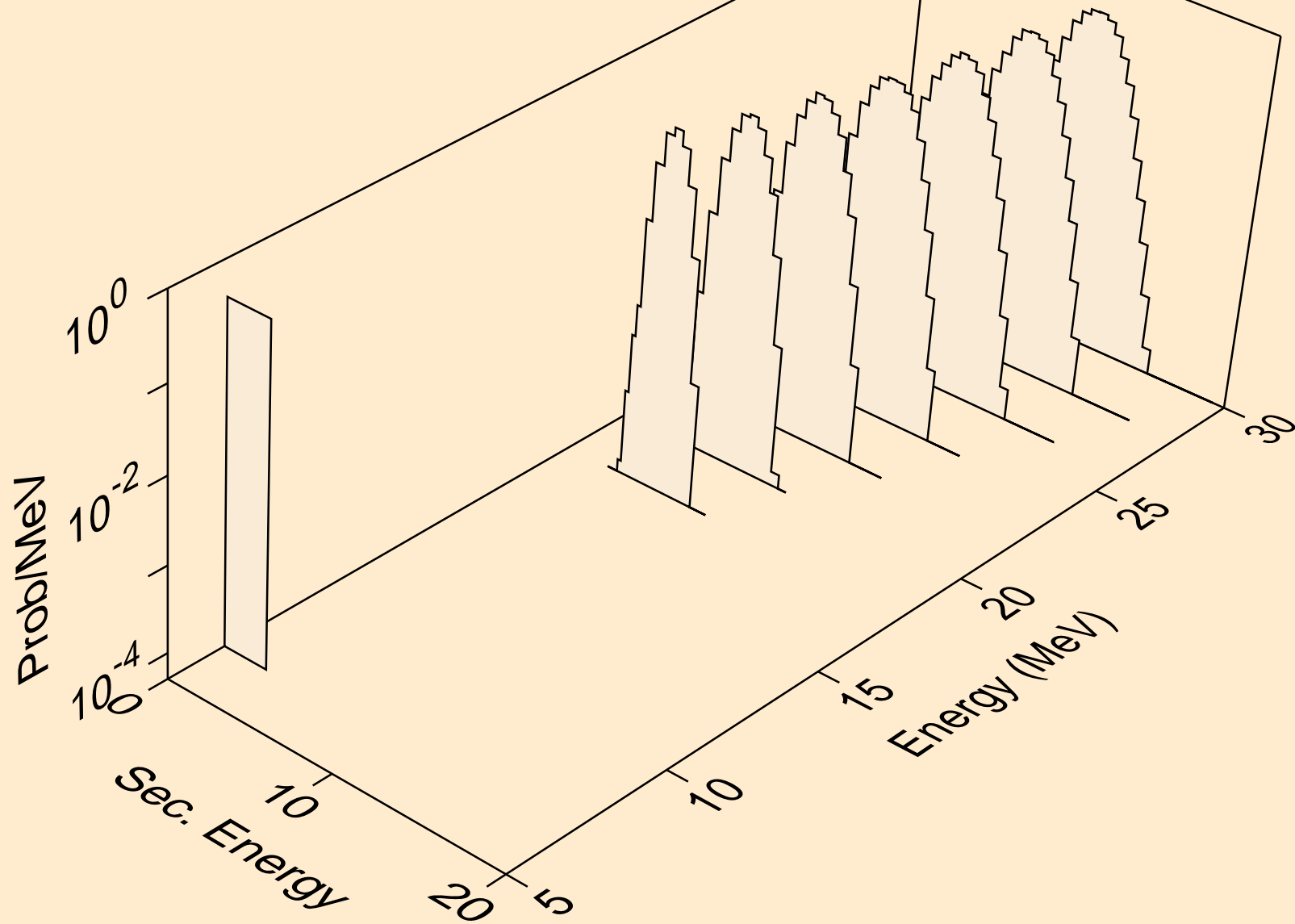

RH092 NEUTRON ACER TENDL-2024 LIBRARY; T=0.K
alphas from (n,npa)

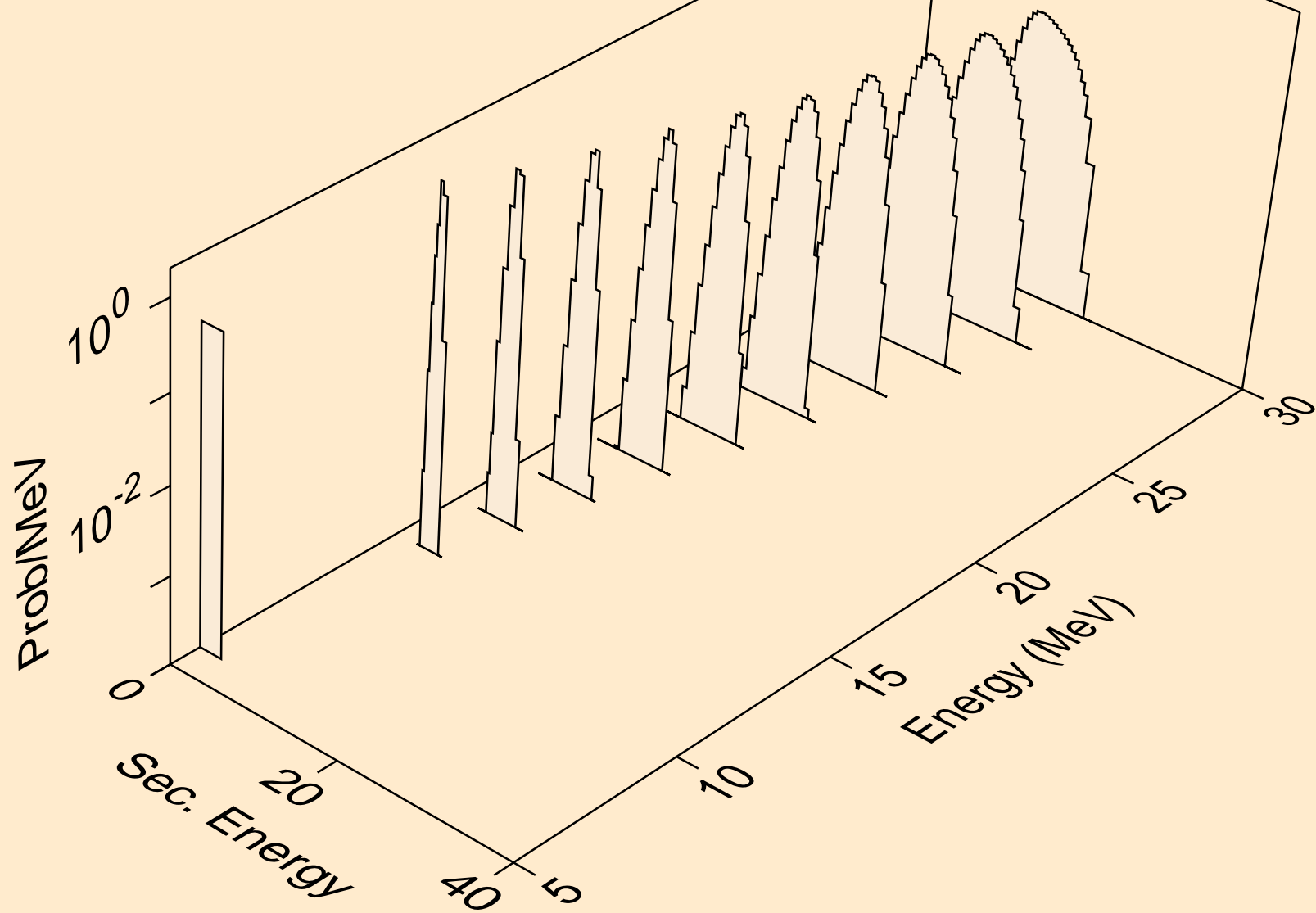

RH092 NEUTRON ACER TENDL-2024 LIBRARY; T=0.K
alphas from (n,a)

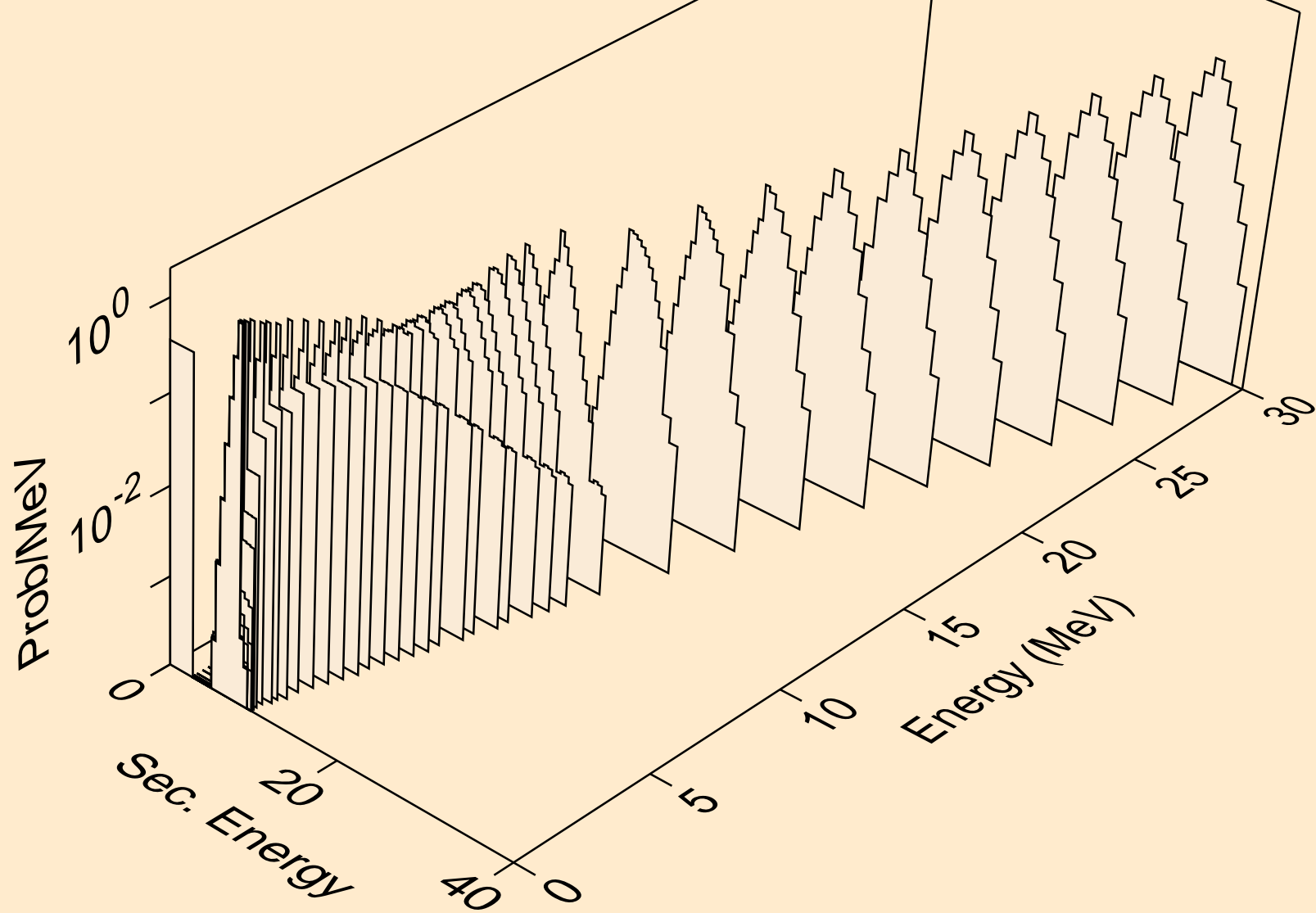

RH092 NEUTRON ACER TENDL-2024 LIBRARY; T=0.K
alphas from (n,2a)

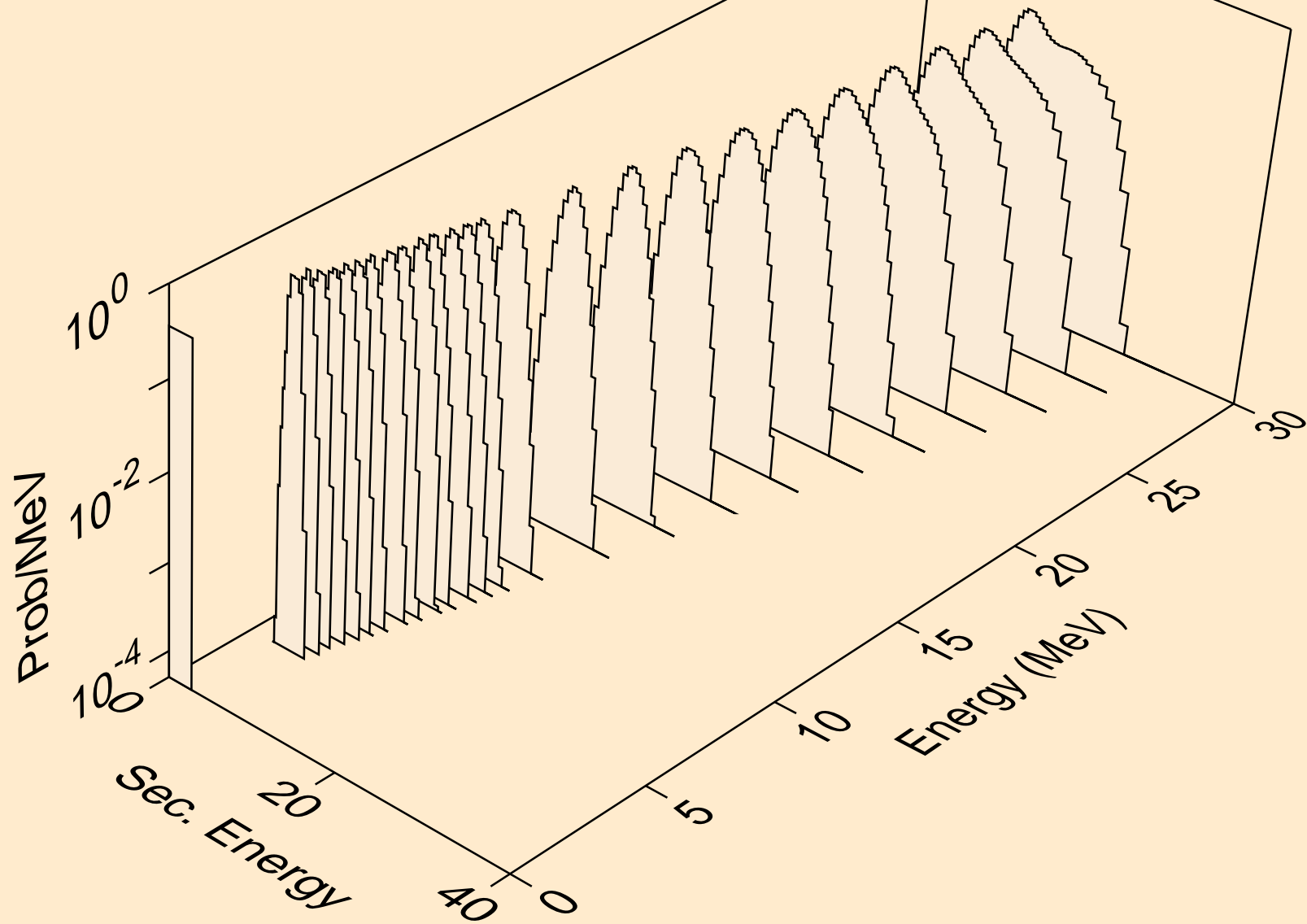

RH092 NEUTRON ACER TENDL-2024 LIBRARY; T=0.K
alphas from (n,3a)

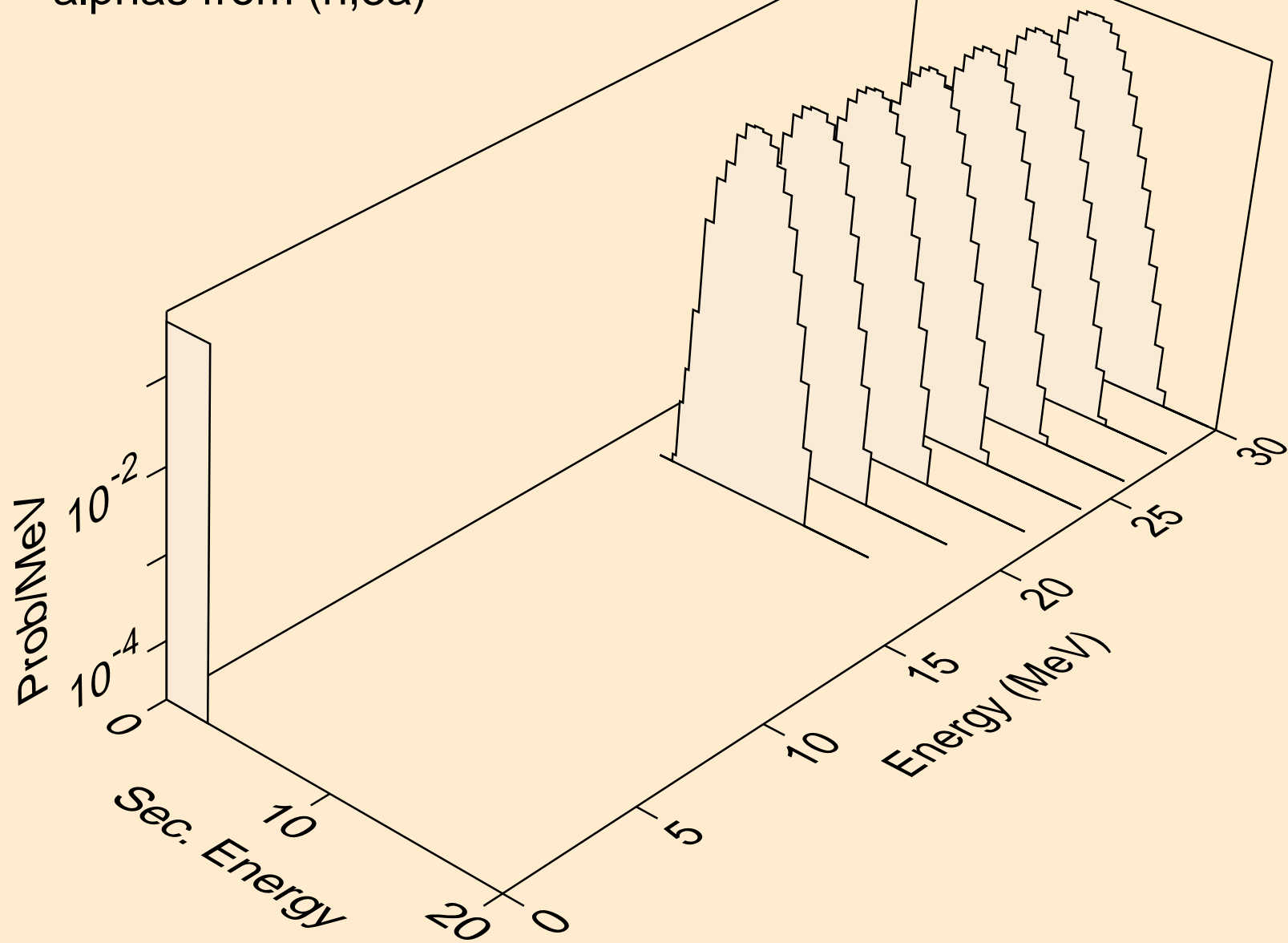

RH092 NEUTRON ACER TENDL-2024 LIBRARY; T=0.K
alphas from (n,pa)

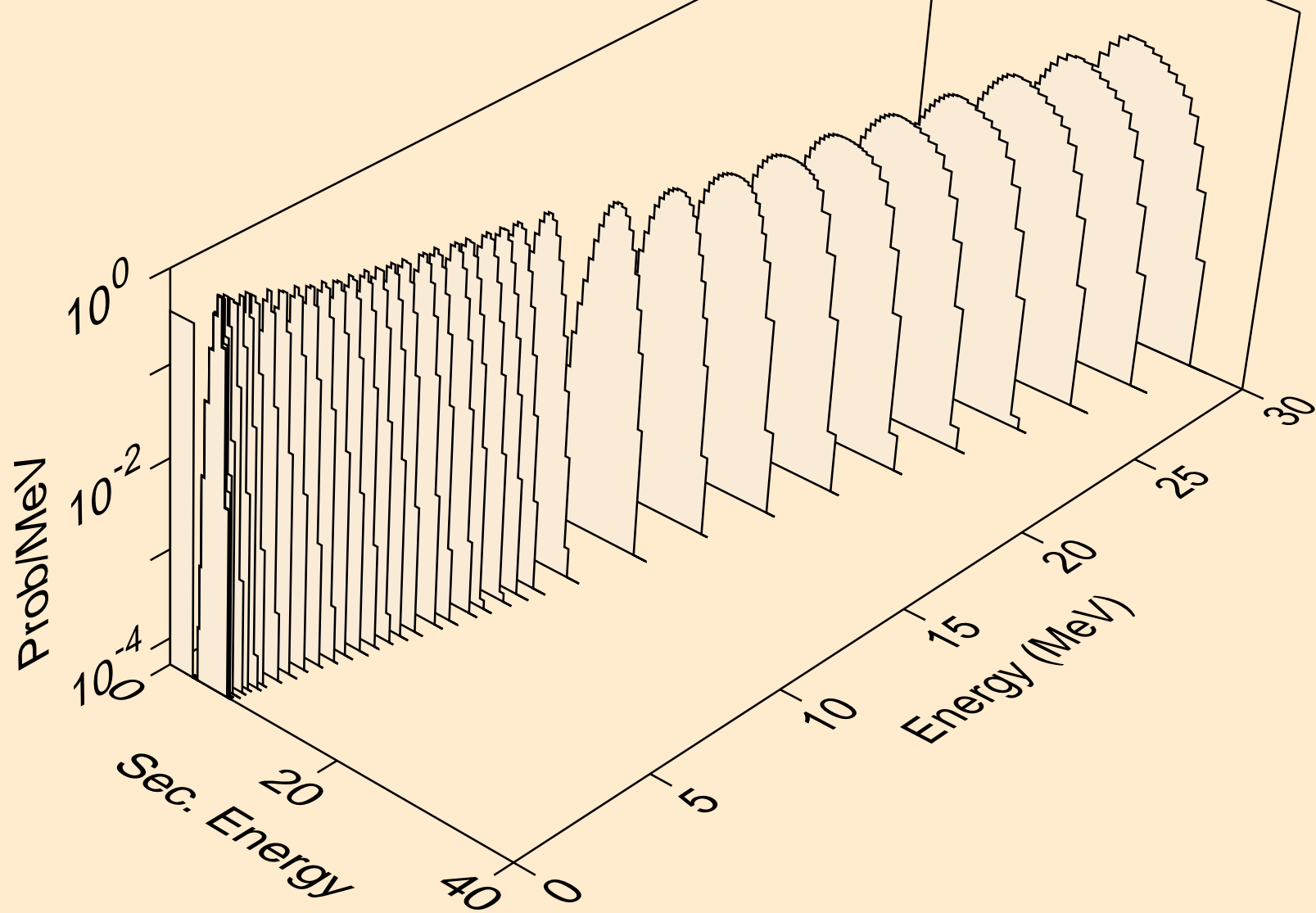

RH092 NEUTRON ACER TENDL-2024 LIBRARY; T=0.K
alphas from (n,da)

