

RH093 NEUTRON ACER TENDL-2024 LIBRARY; T=0.K
Principal cross sections

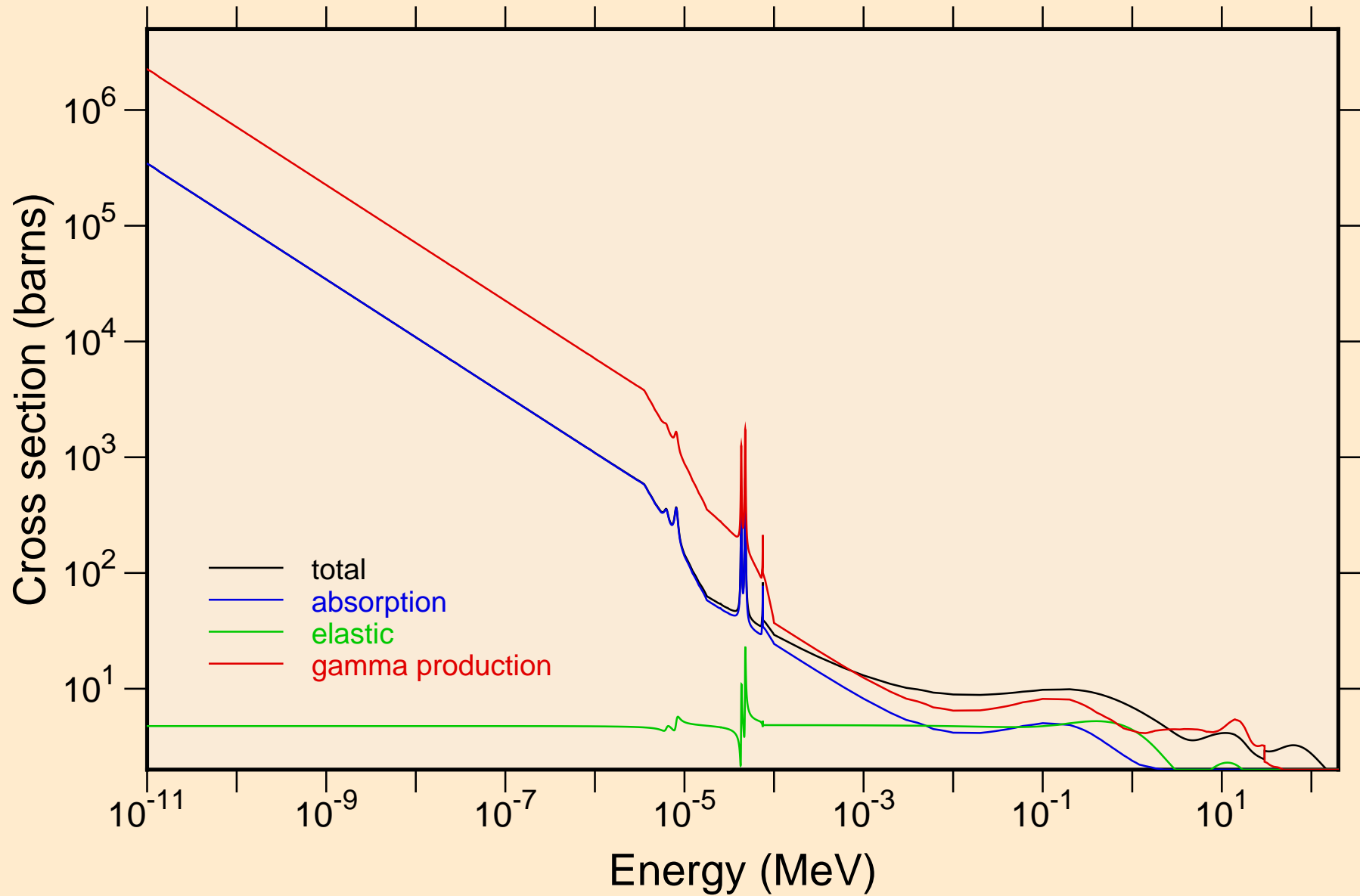

RH093 NEUTRON ACER TENDL-2024 LIBRARY; T=0.K
Heating

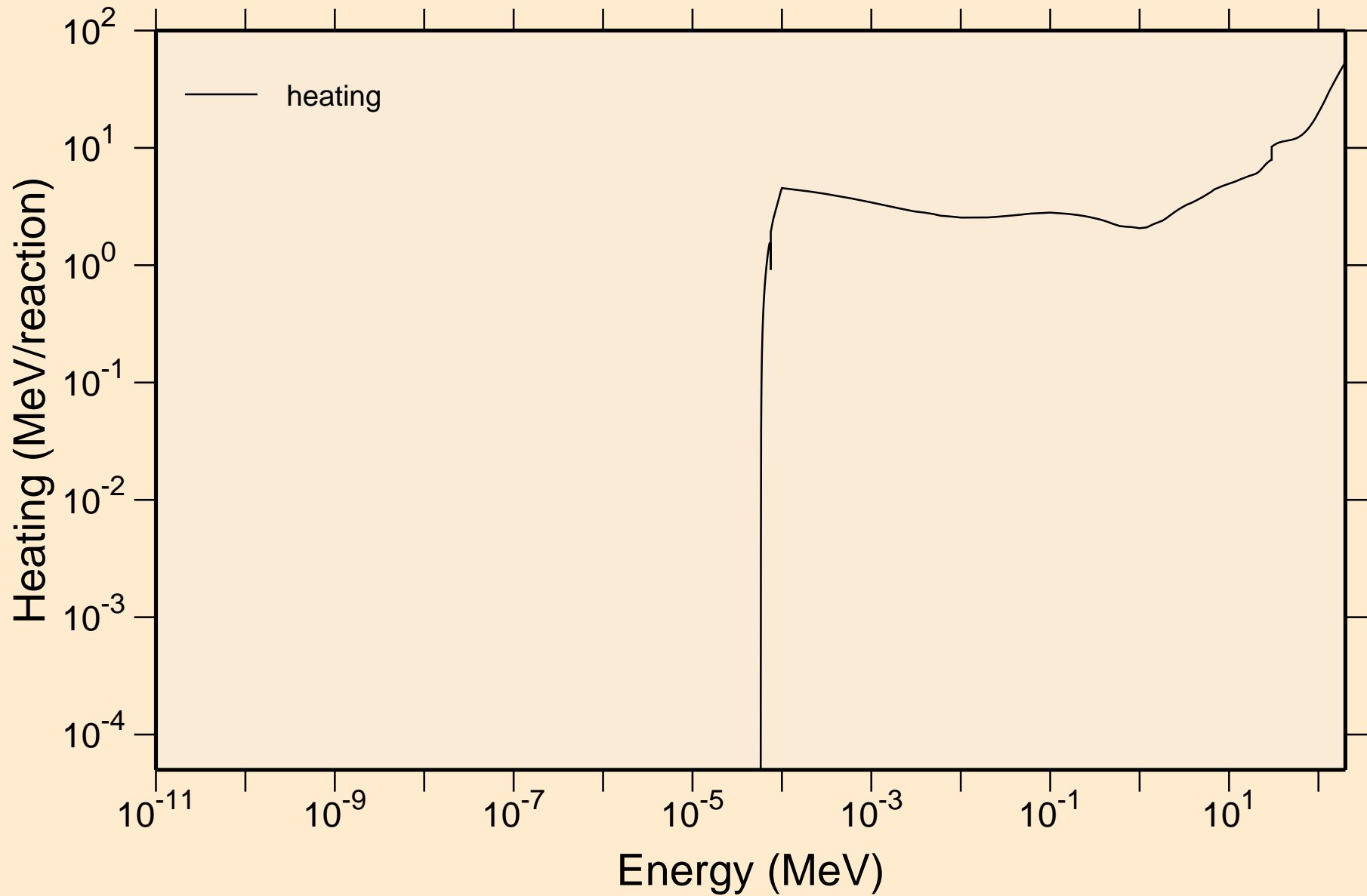

RH093 NEUTRON ACER TENDL-2024 LIBRARY; T=0.K
Damage

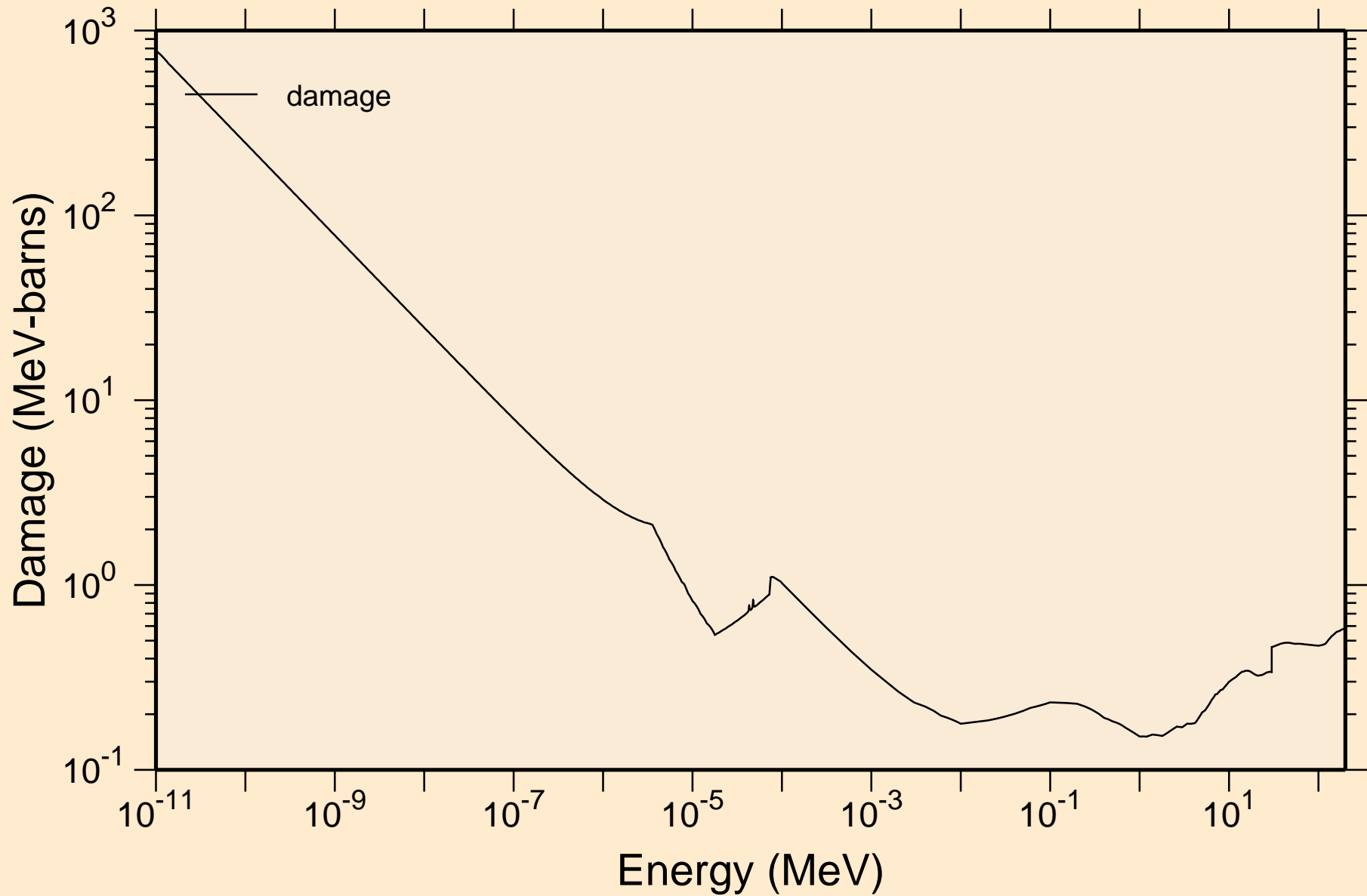

RH093 NEUTRON ACER TENDL-2024 LIBRARY; T=0.K
Non-threshold reactions

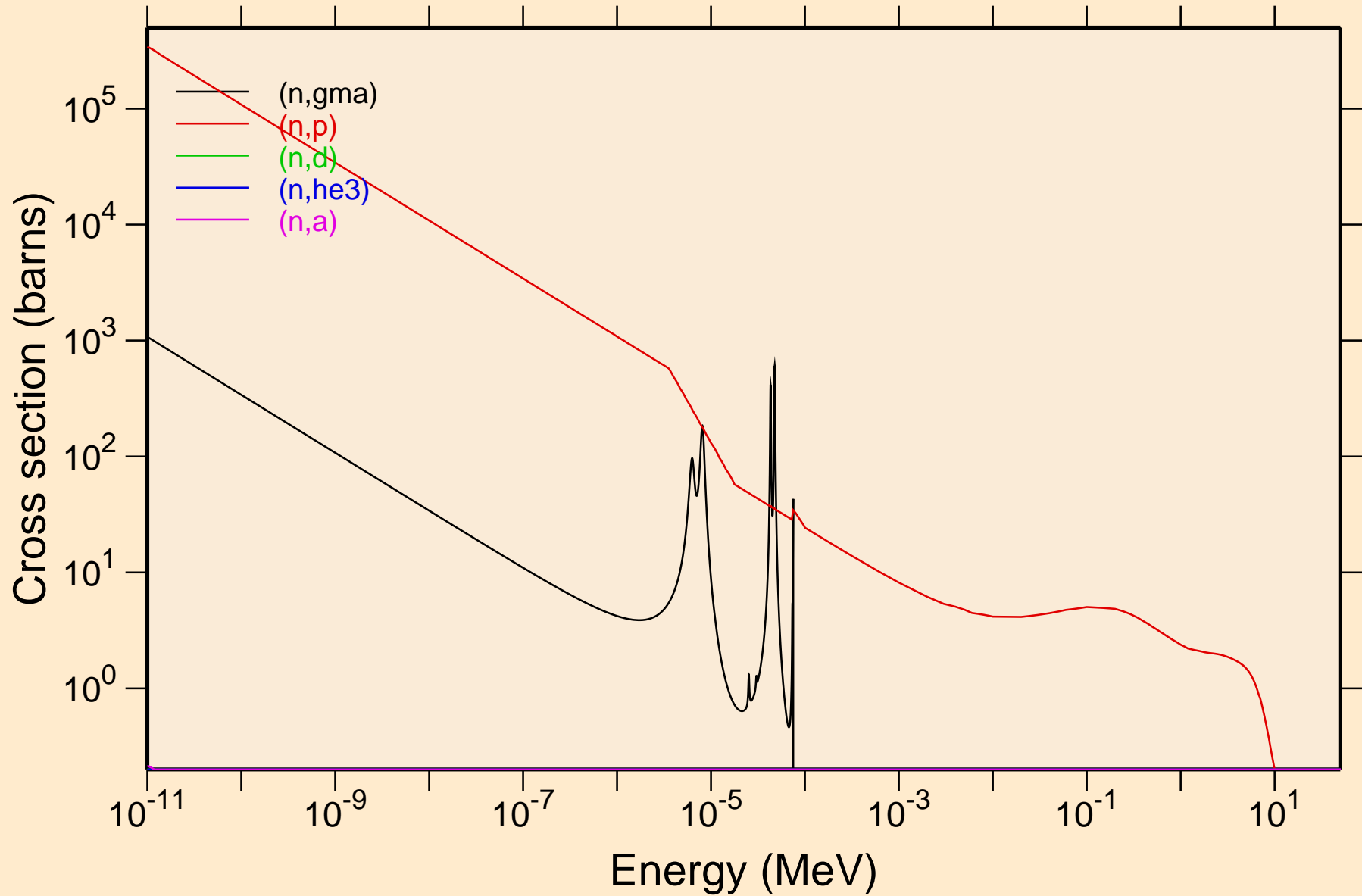

RH093 NEUTRON ACER TENDL-2024 LIBRARY; T=0.K
Non-threshold reactions

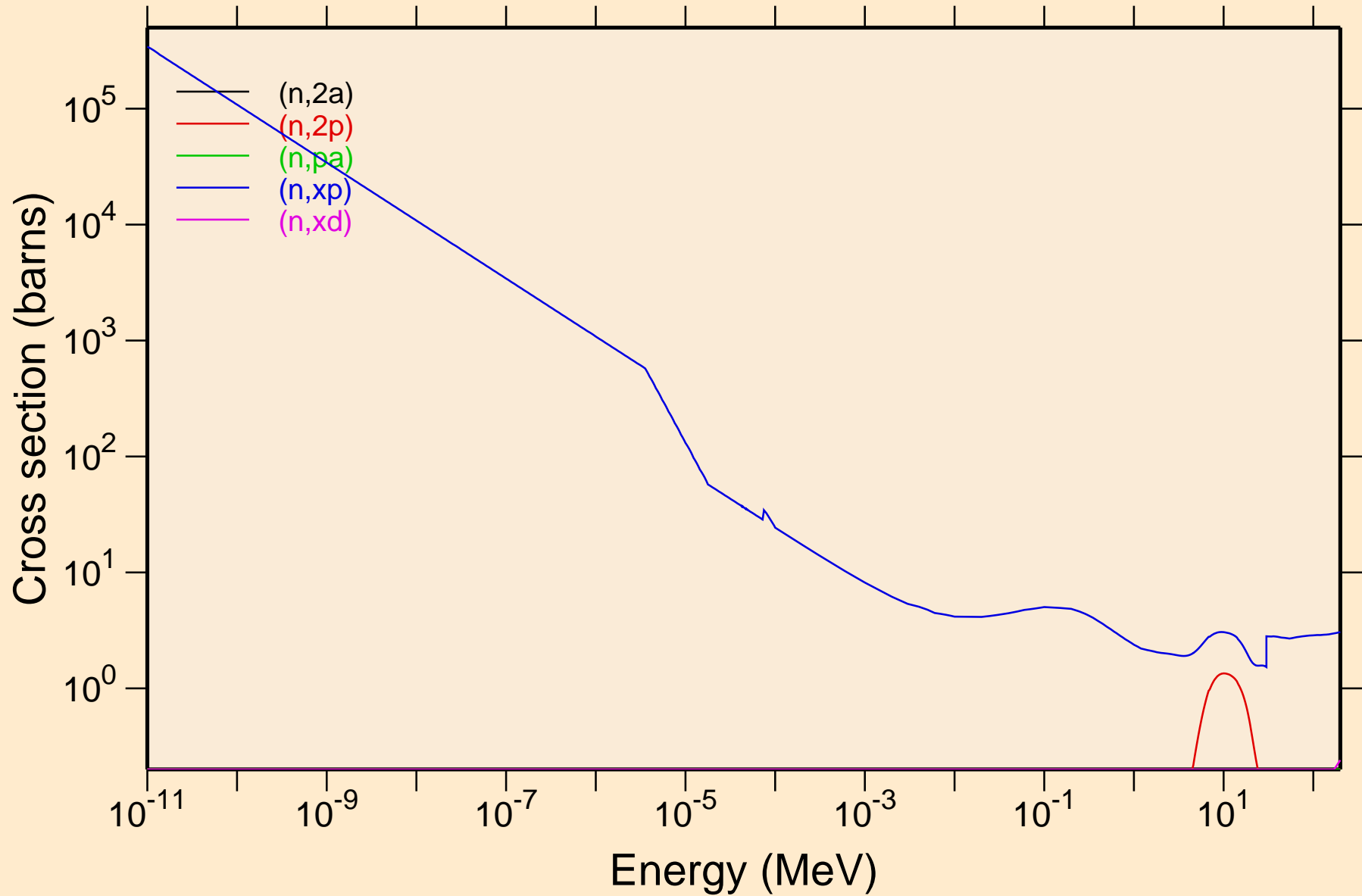

RH093 NEUTRON ACER TENDL-2024 LIBRARY; T=0.K
Non-threshold reactions

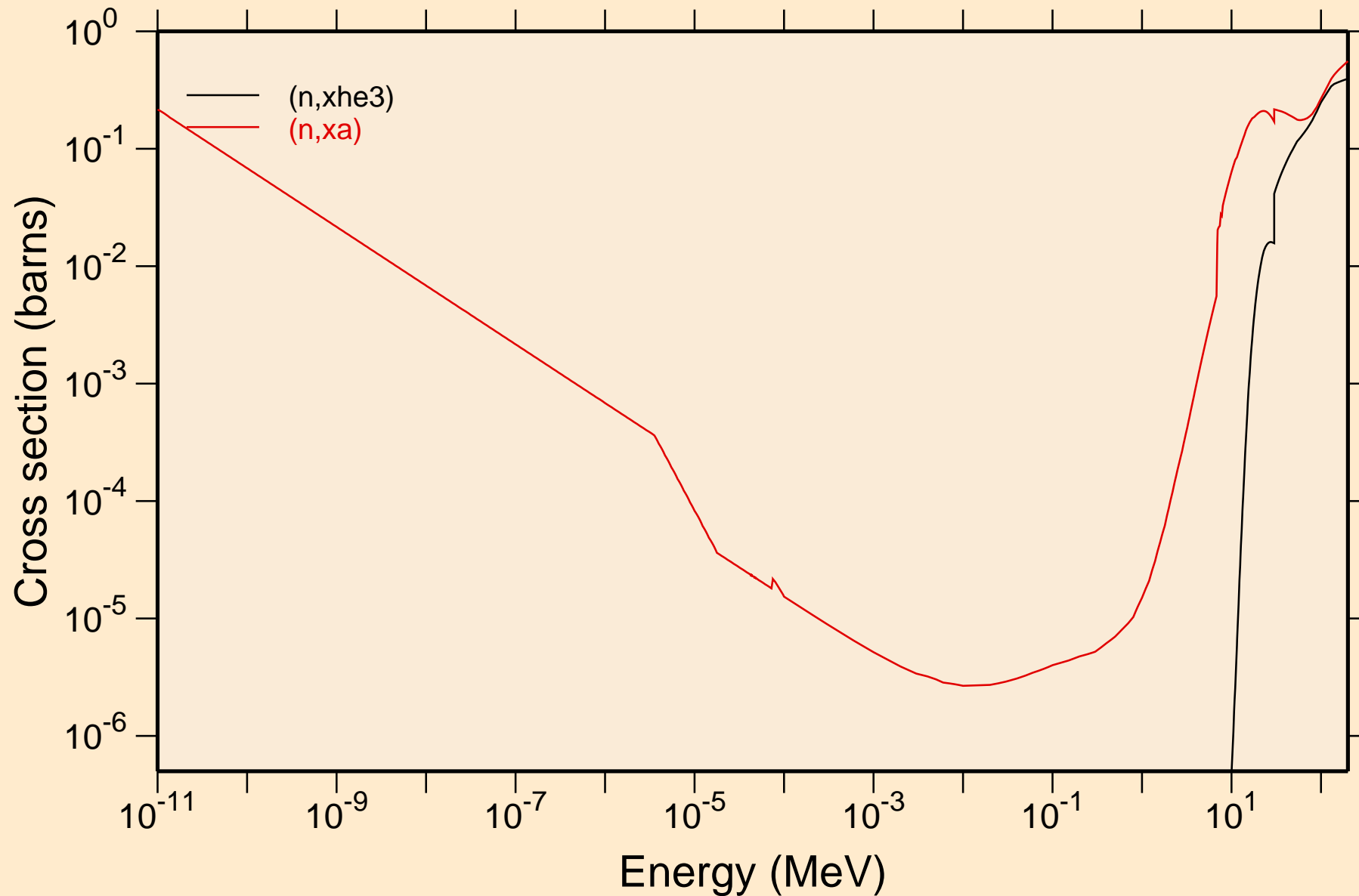

RH093 NEUTRON ACER TENDL-2024 LIBRARY; T=0.K

Principal cross sections

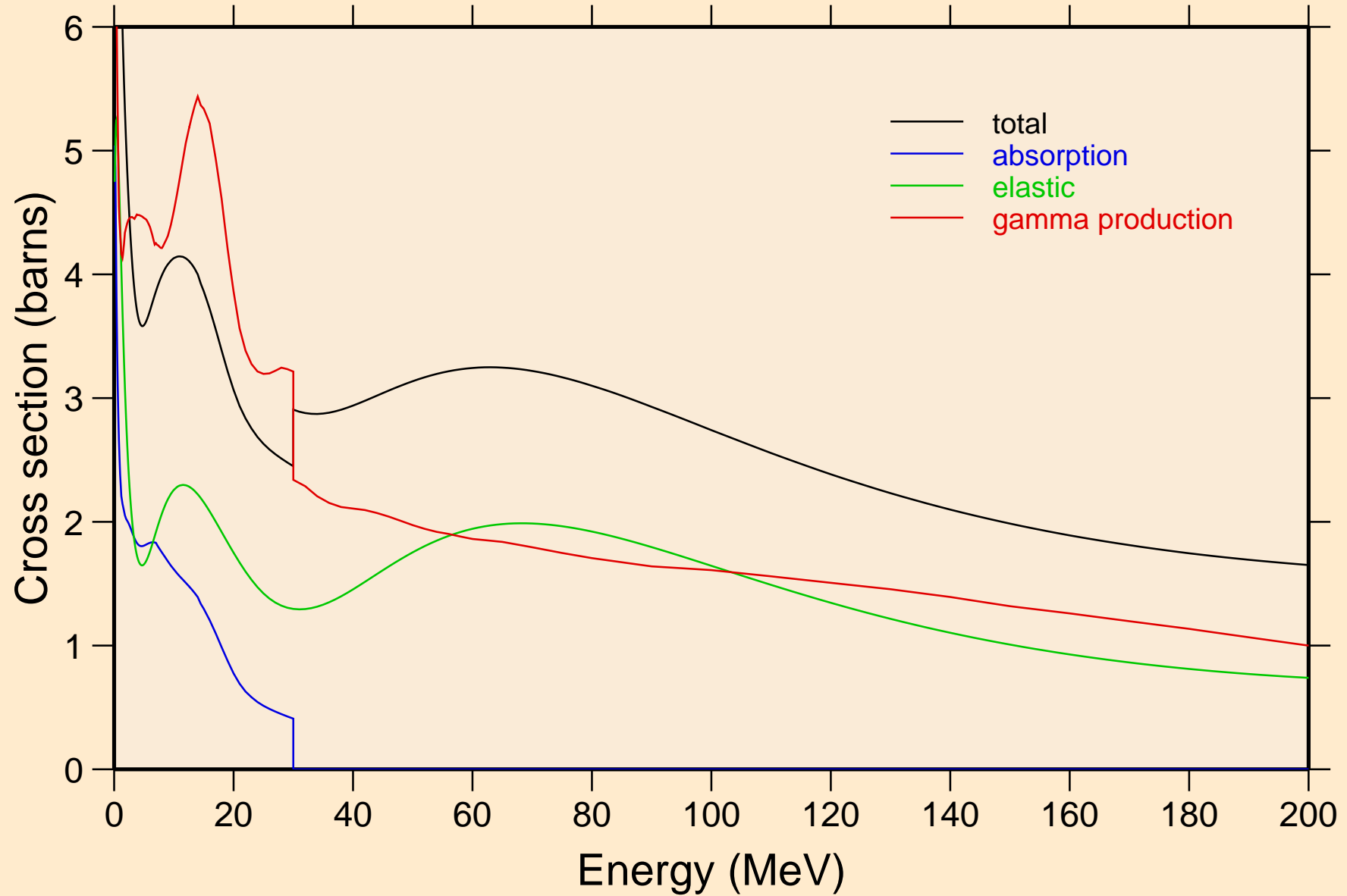

RH093 NEUTRON ACER TENDL-2024 LIBRARY; T=0.K

Heating

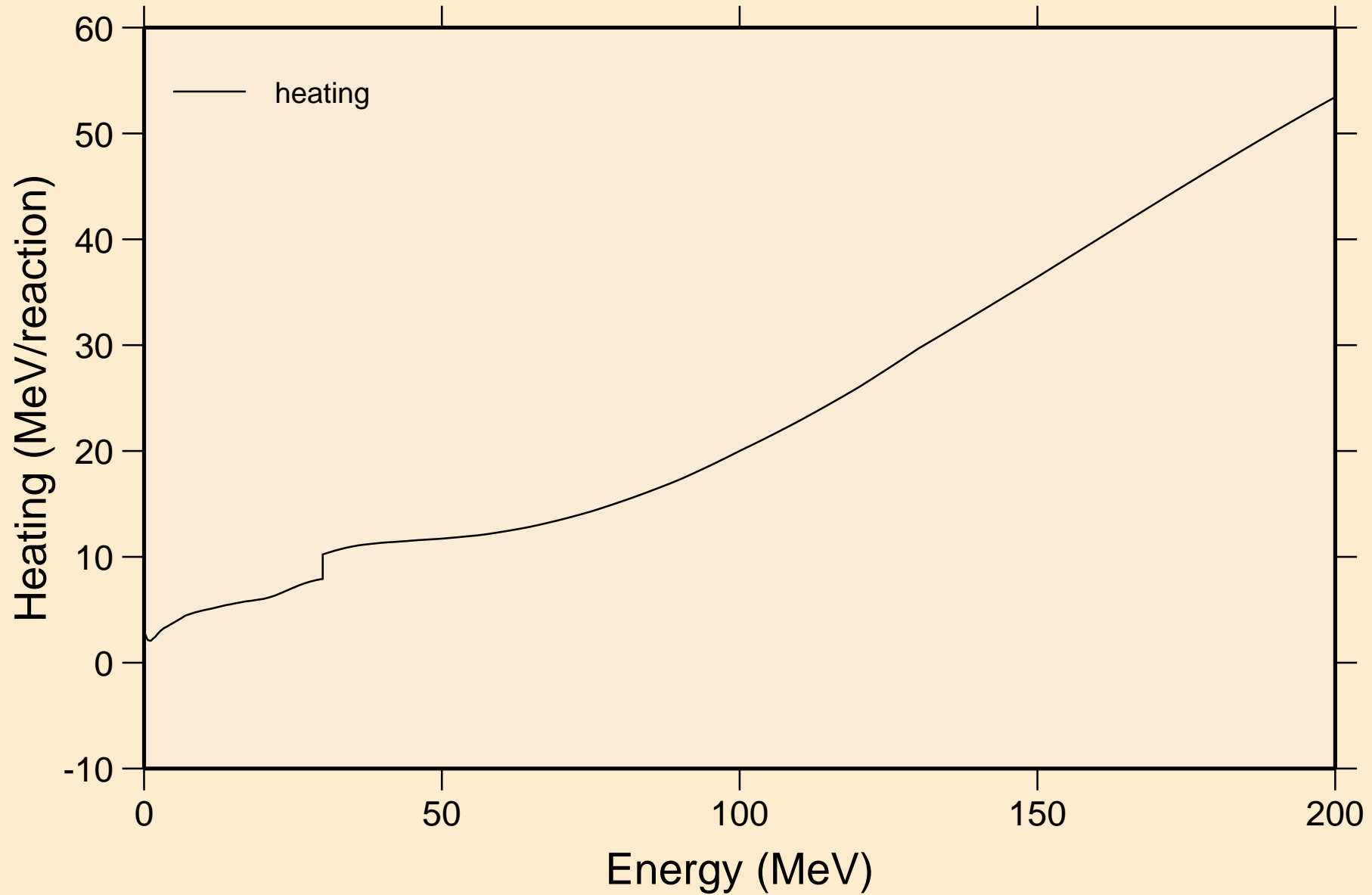

RH093 NEUTRON ACER TENDL-2024 LIBRARY; T=0.K
Damage

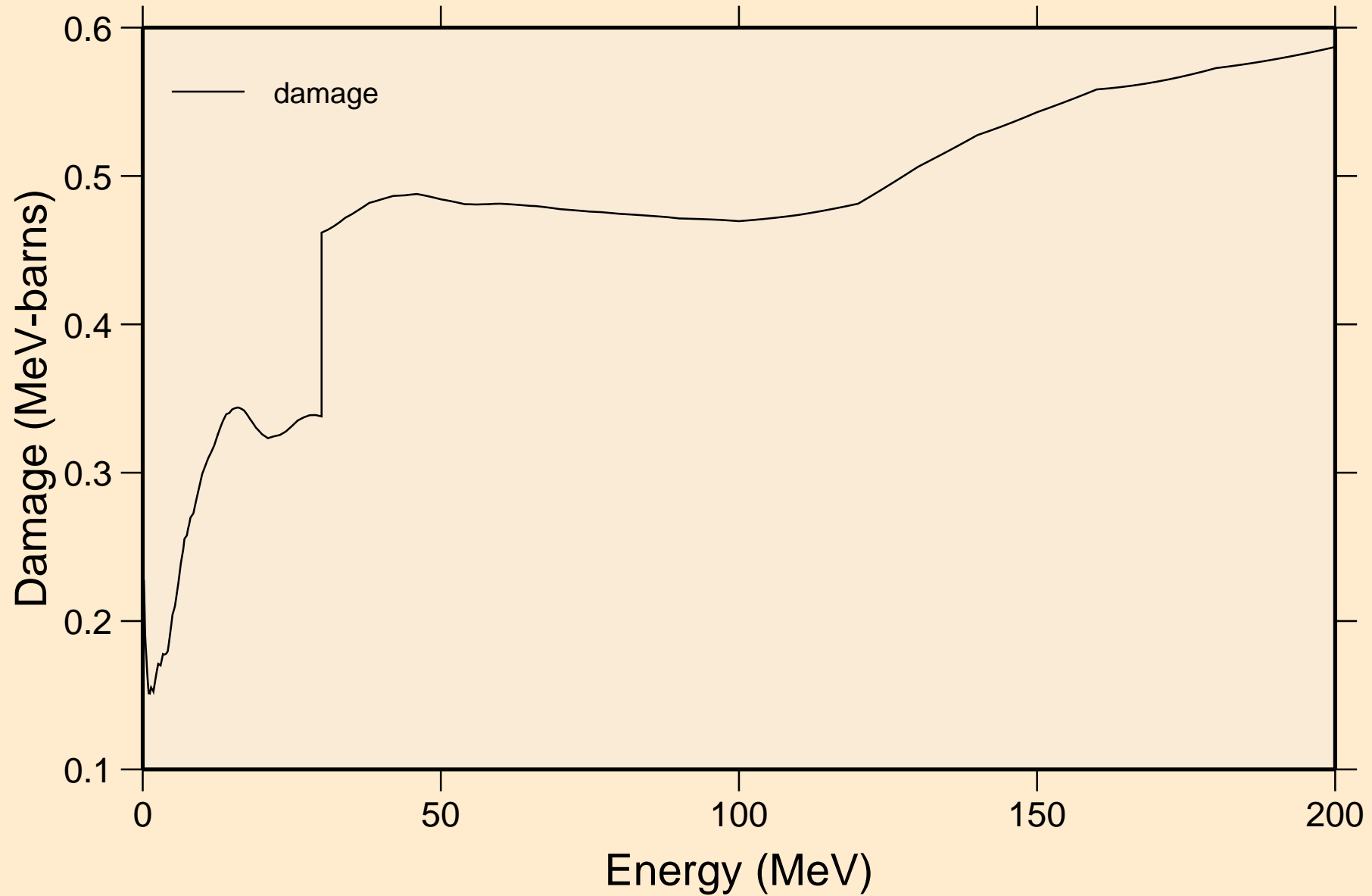

RH093 NEUTRON ACER TENDL-2024 LIBRARY; T=0.K
Non-threshold reactions

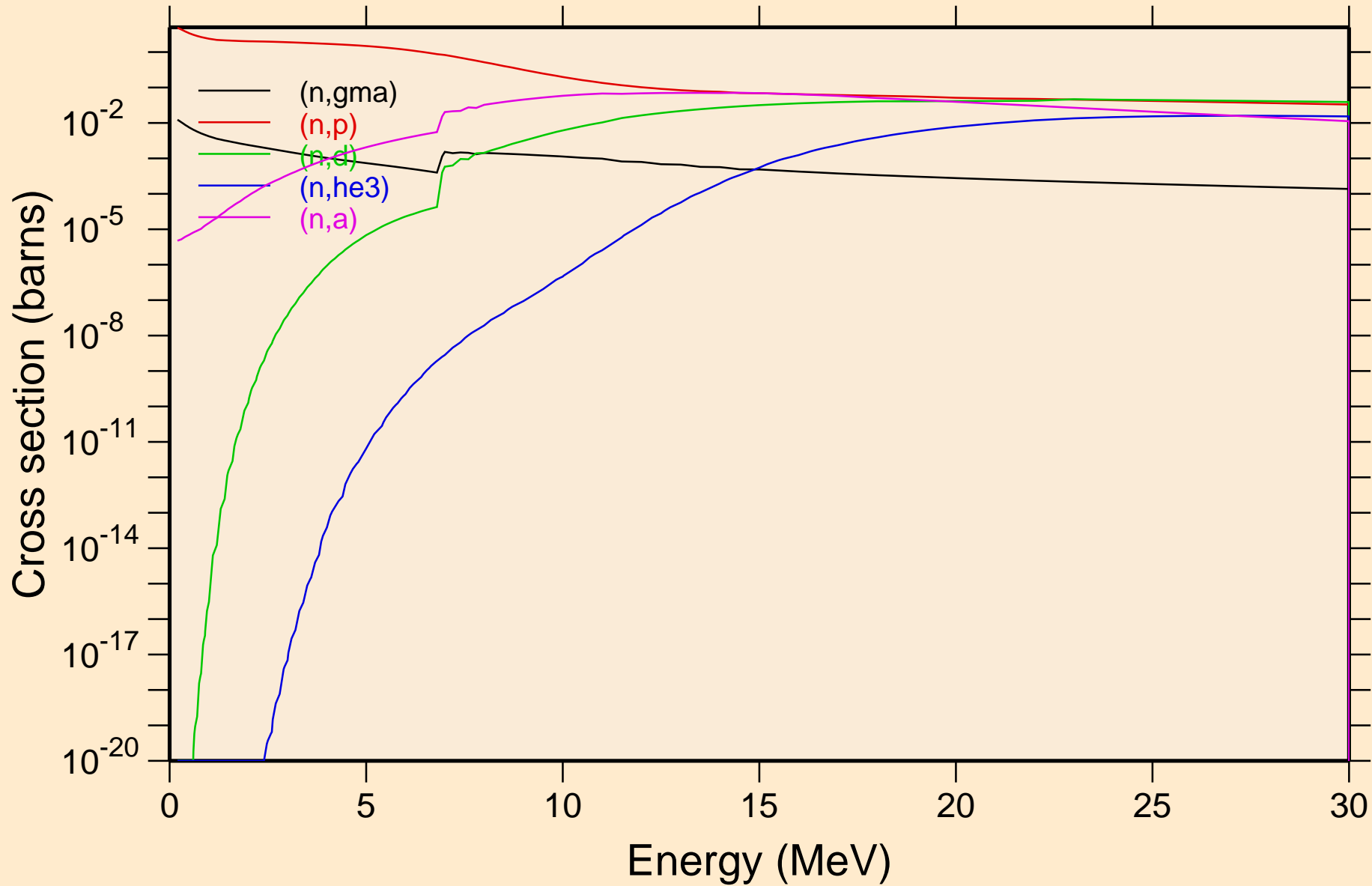

RH093 NEUTRON ACER TENDL-2024 LIBRARY; T=0.K
Non-threshold reactions

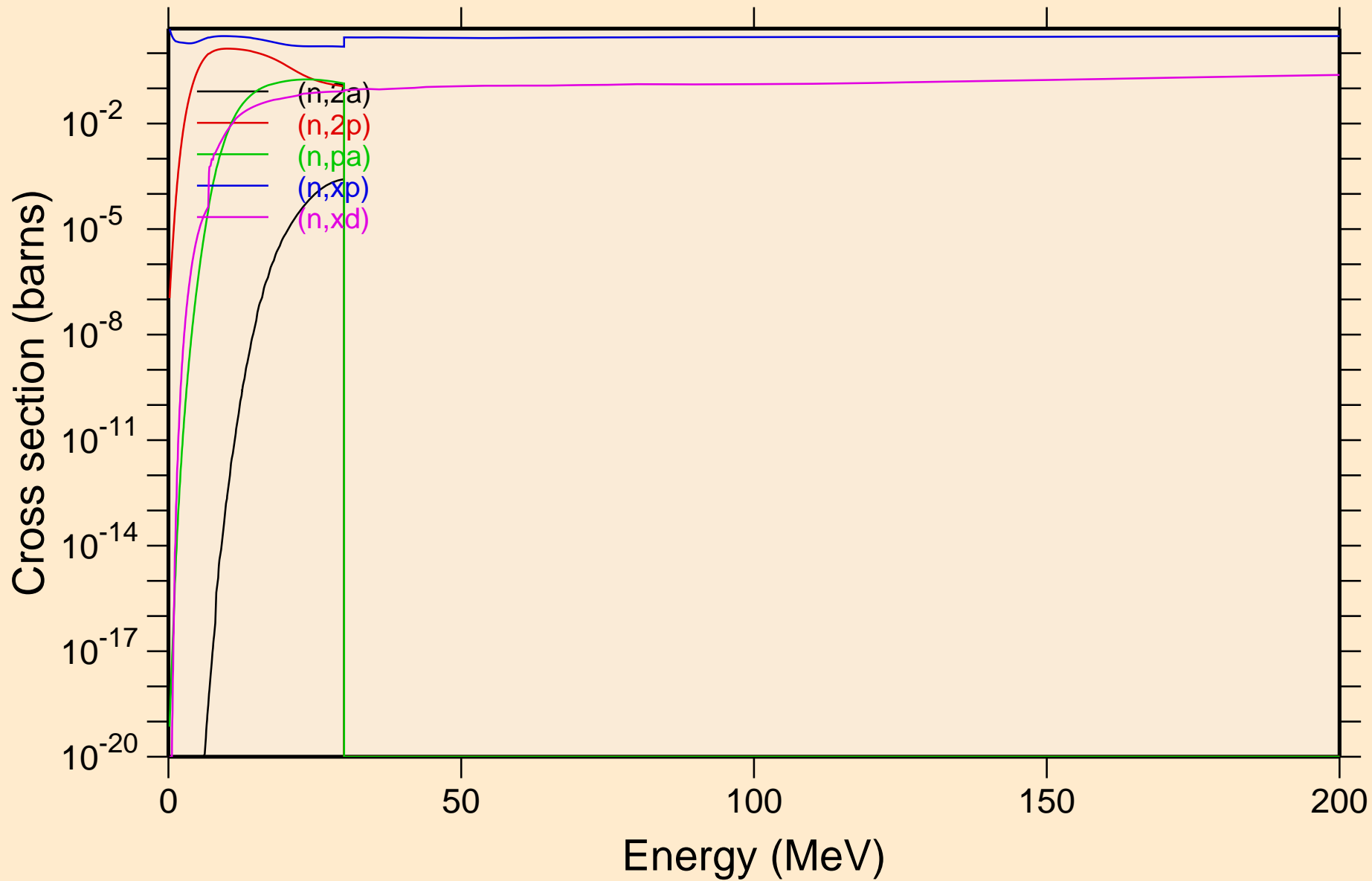

RH093 NEUTRON ACER TENDL-2024 LIBRARY; T=0.K
Non-threshold reactions

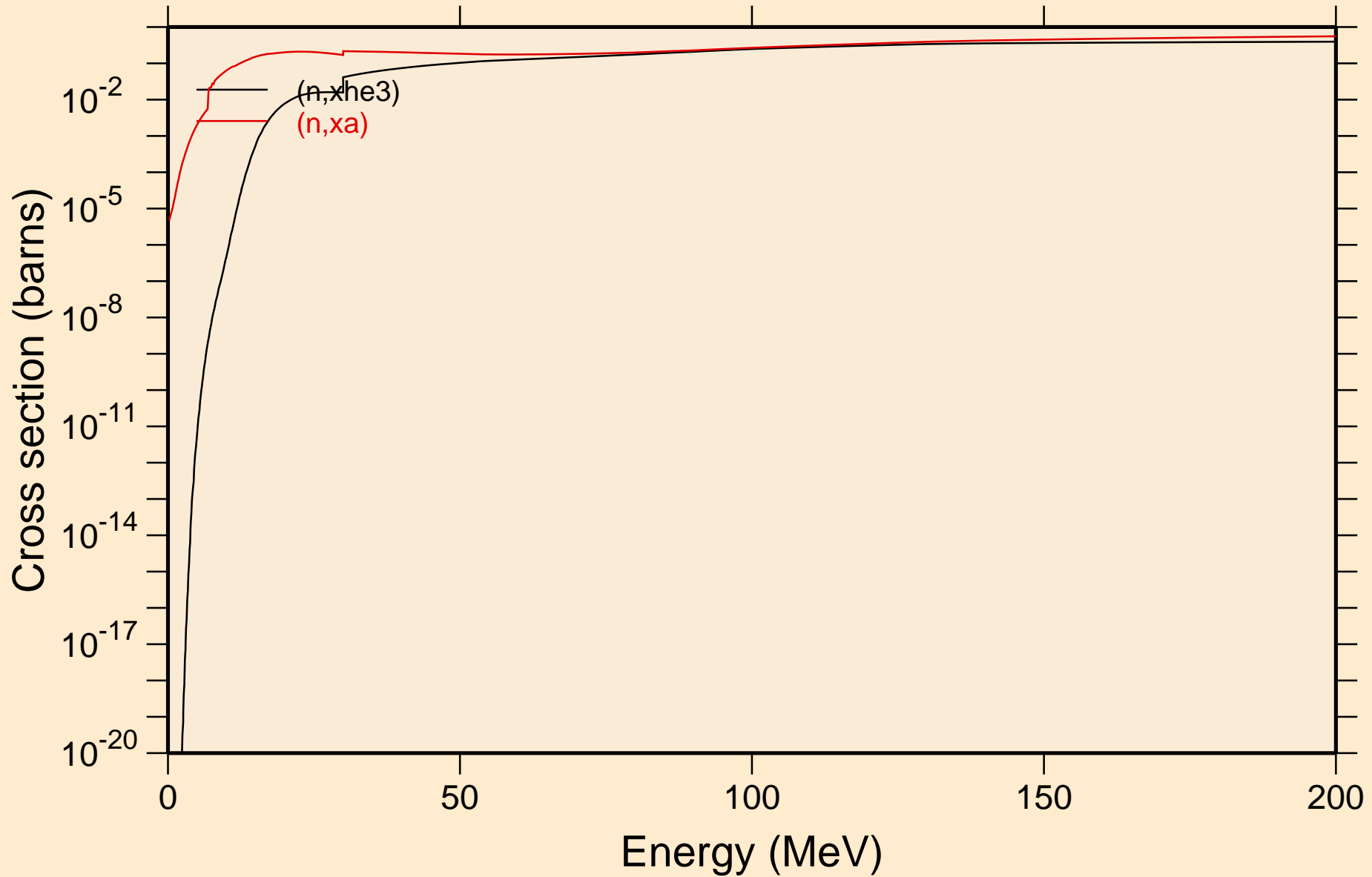

RH093 NEUTRON ACER TENDL-2024 LIBRARY; T=0.K
Inelastic levels

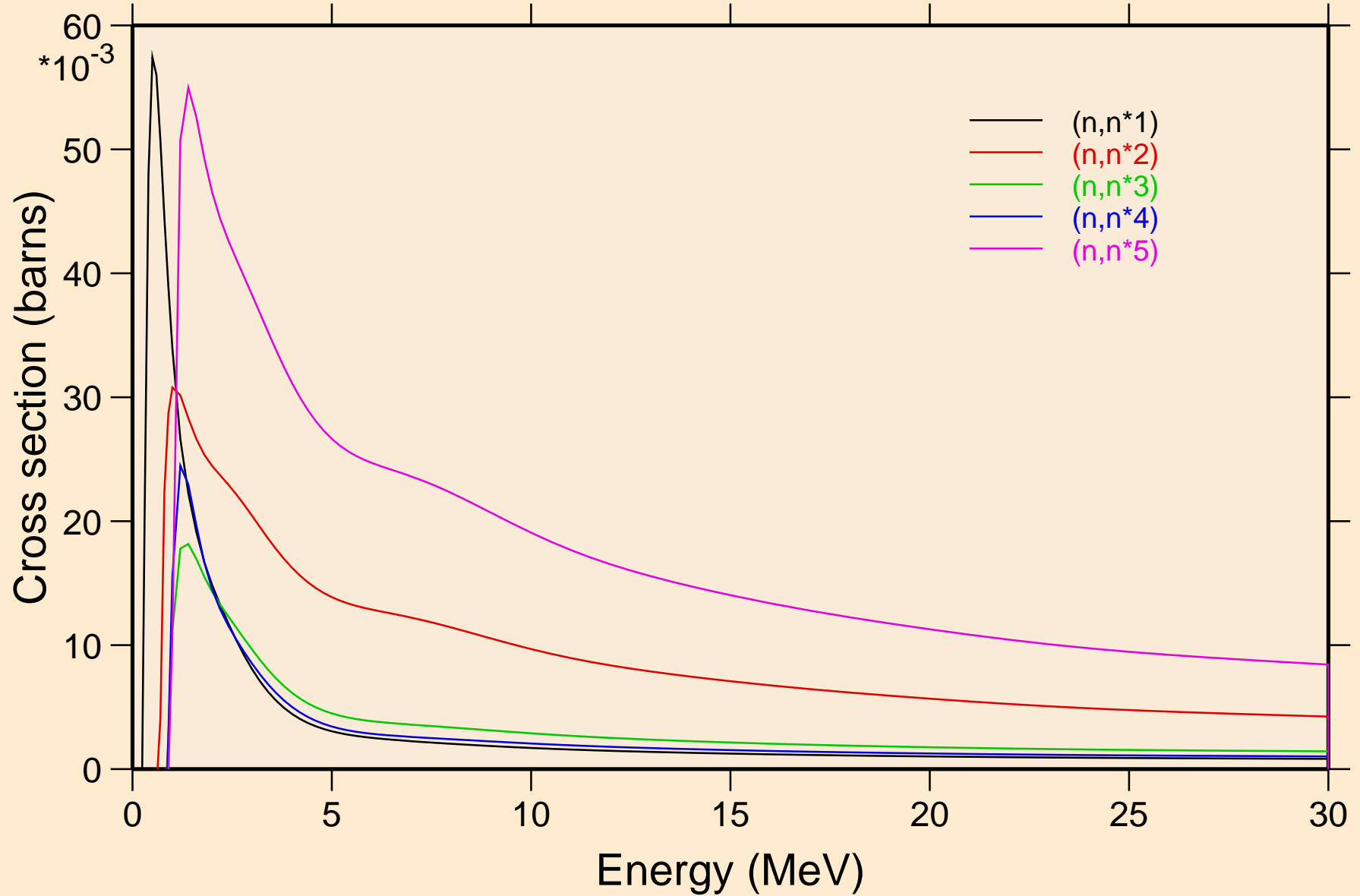

RH093 NEUTRON ACER TENDL-2024 LIBRARY; T=0.K
Inelastic levels

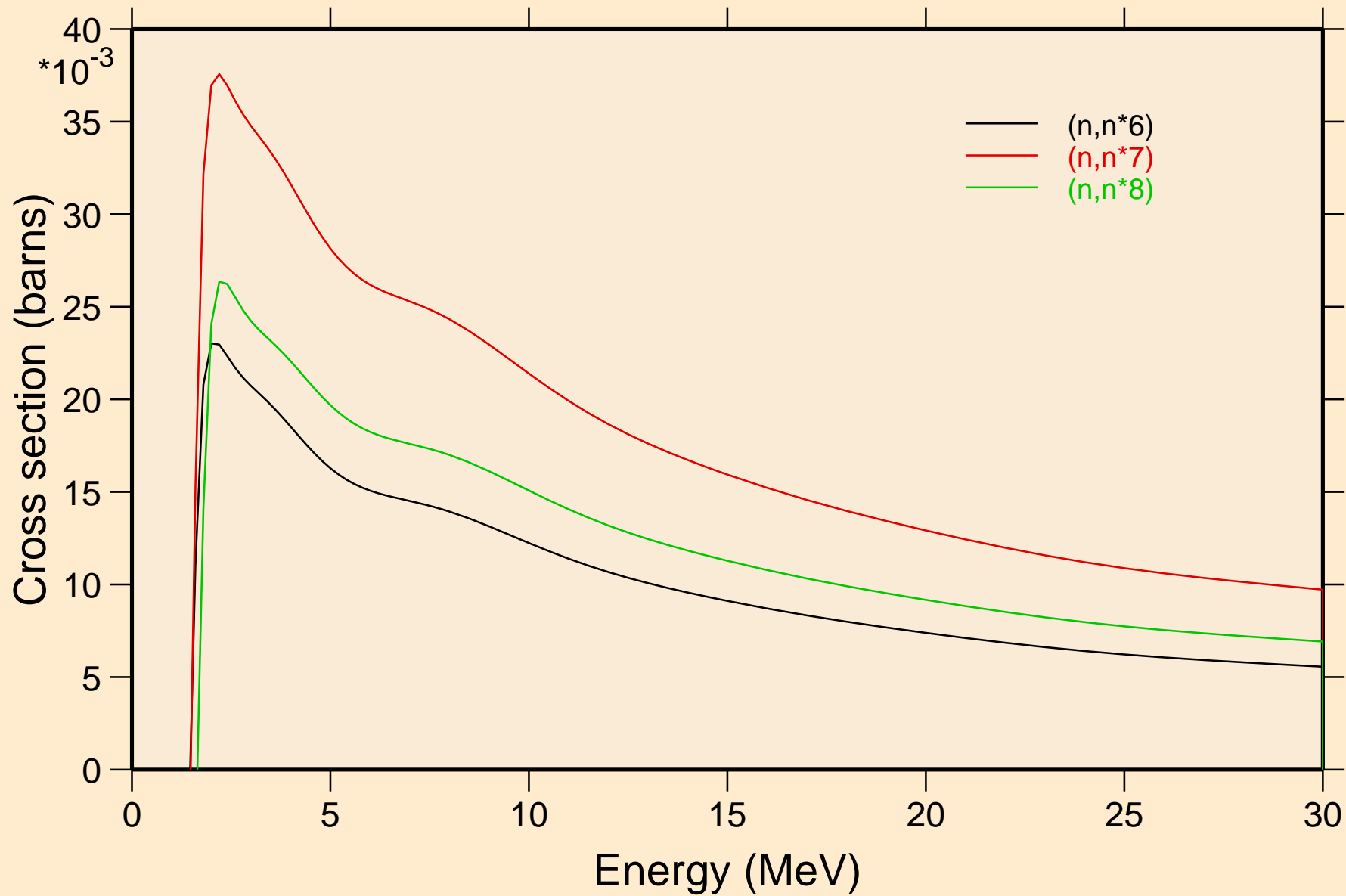

RH093 NEUTRON ACER TENDL-2024 LIBRARY; T=0.K
Threshold reactions

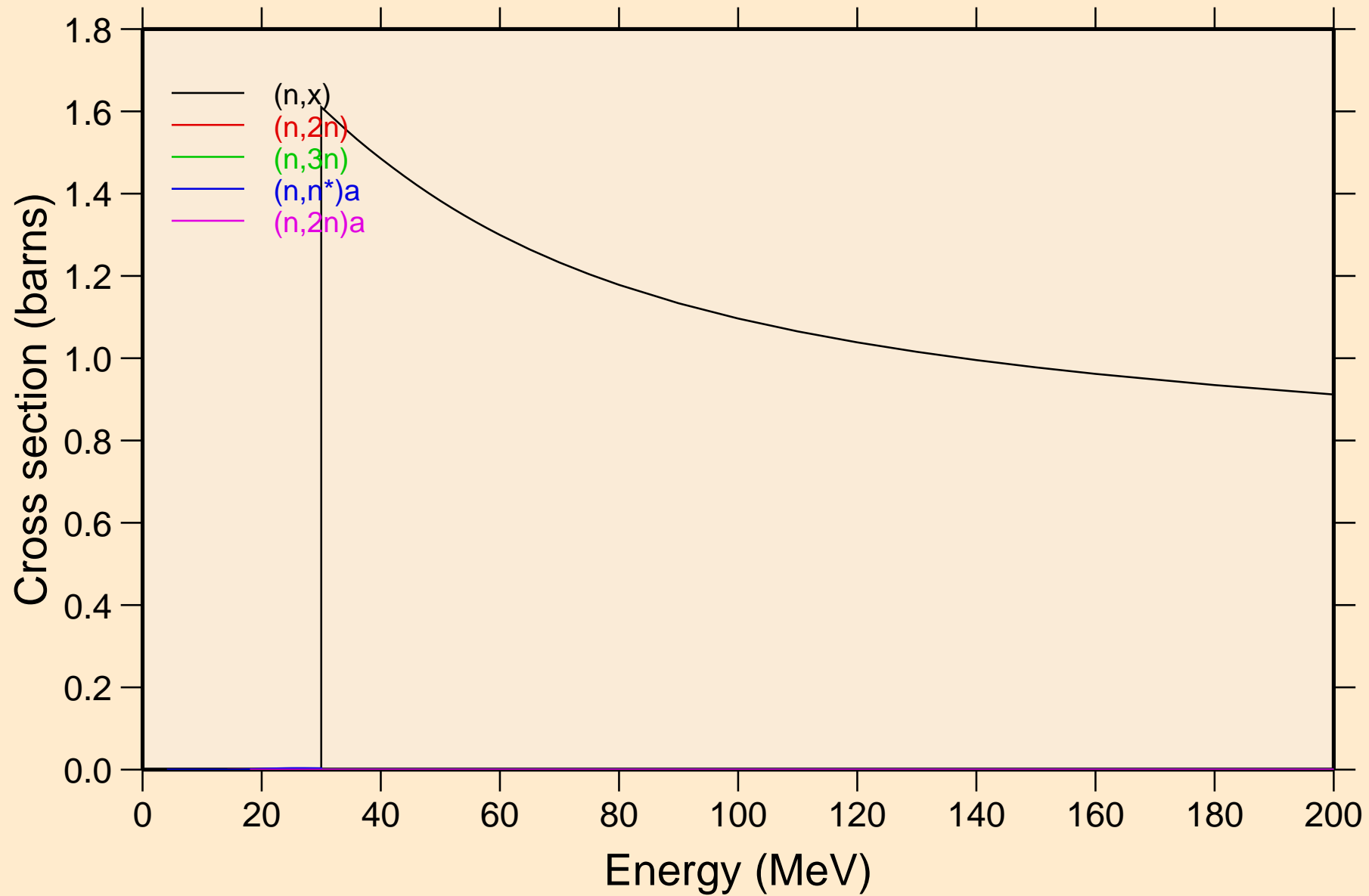

RH093 NEUTRON ACER TENDL-2024 LIBRARY; T=0.K
Threshold reactions

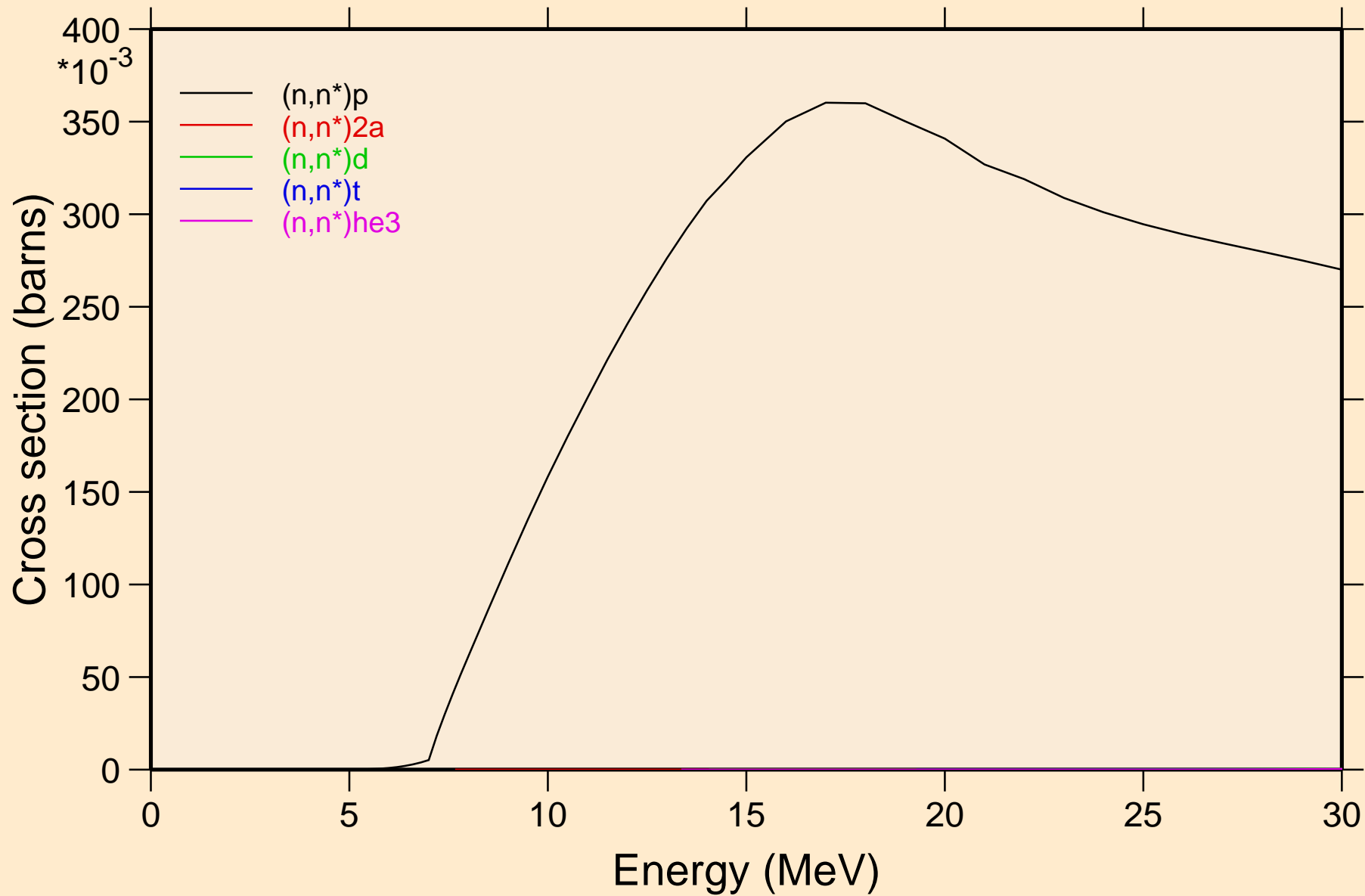

RH093 NEUTRON ACER TENDL-2024 LIBRARY; T=0.K

Threshold reactions

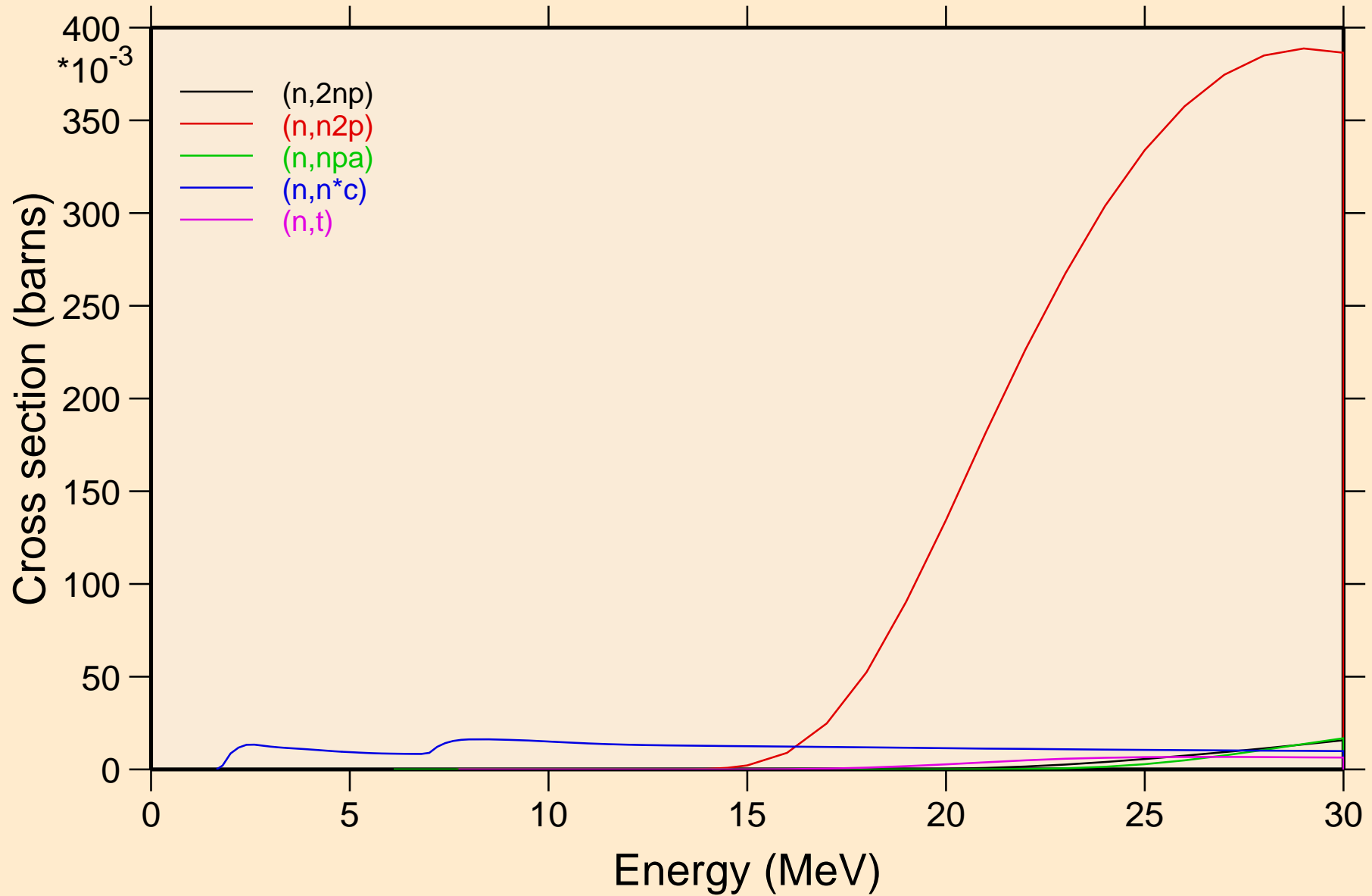

RH093 NEUTRON ACER TENDL-2024 LIBRARY; T=0.K
Threshold reactions

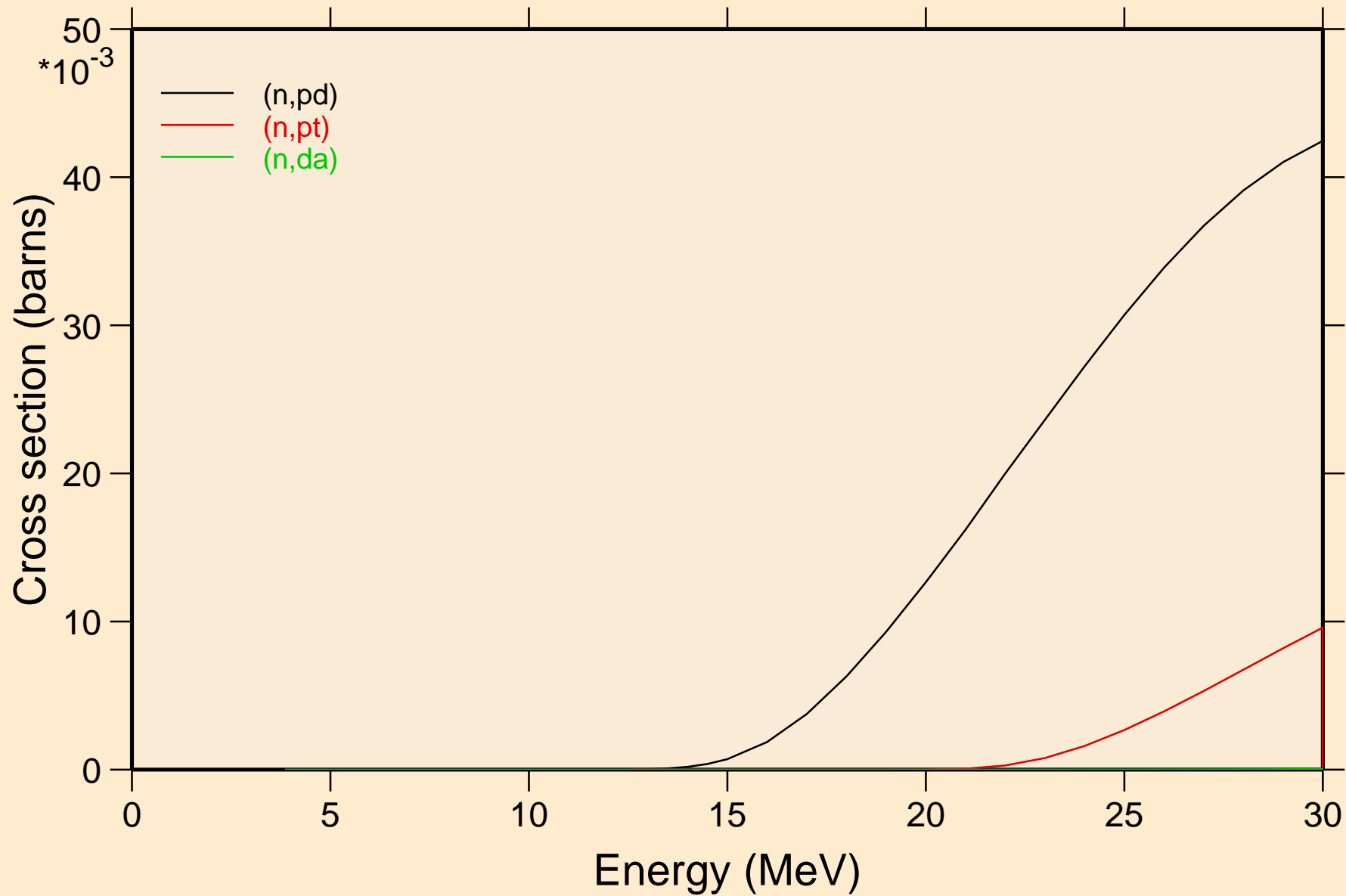

RH093 NEUTRON ACER TENDL-2024 LIBRARY; T=0.K
Threshold reactions

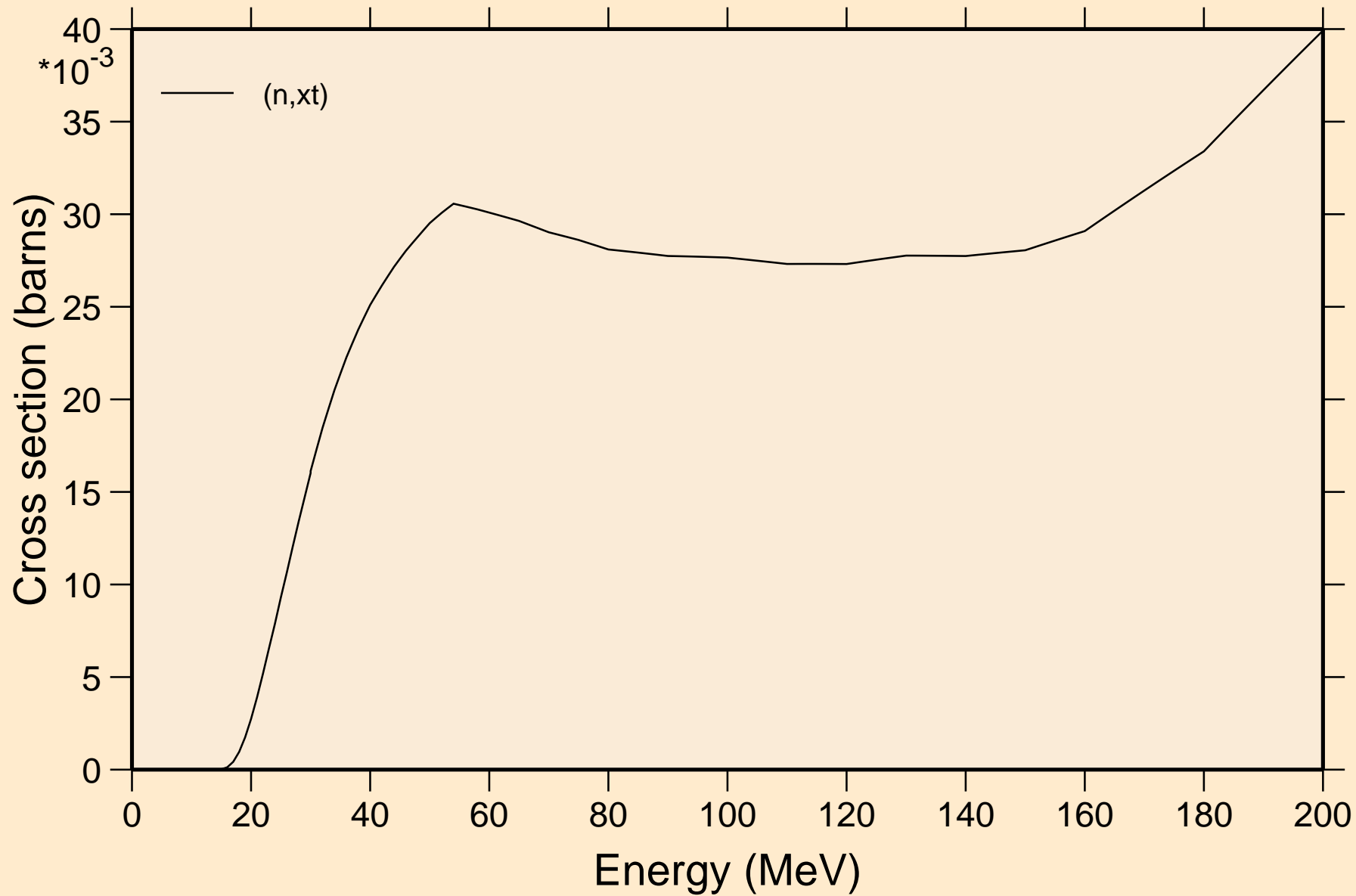

RH093 NEUTRON ACER TENDL-2024 LIBRARY; T=0.K
angular distribution for elastic

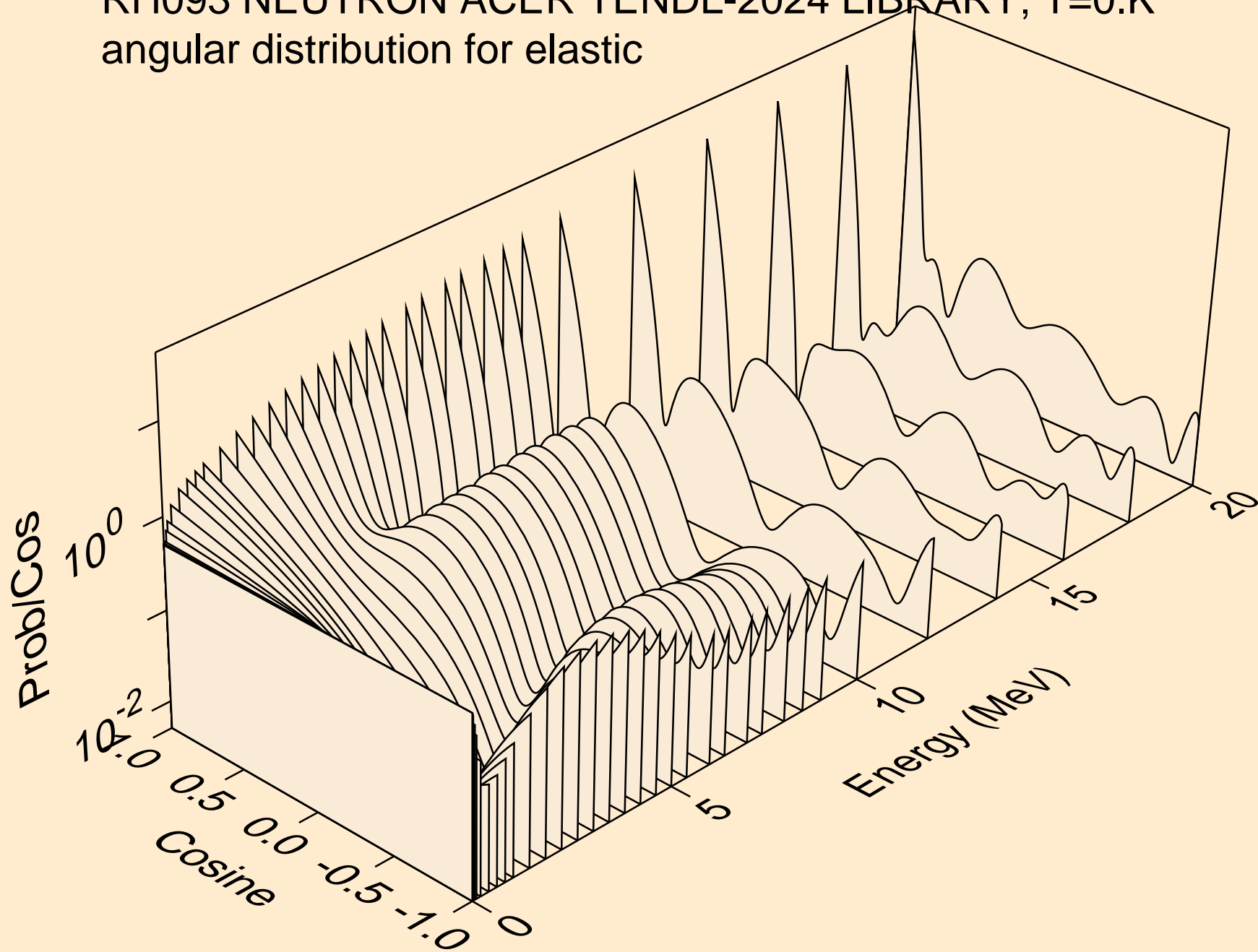

RH093 NEUTRON ACER TENDL-2024 LIBRARY; T=0.K
angular distribution for elastic

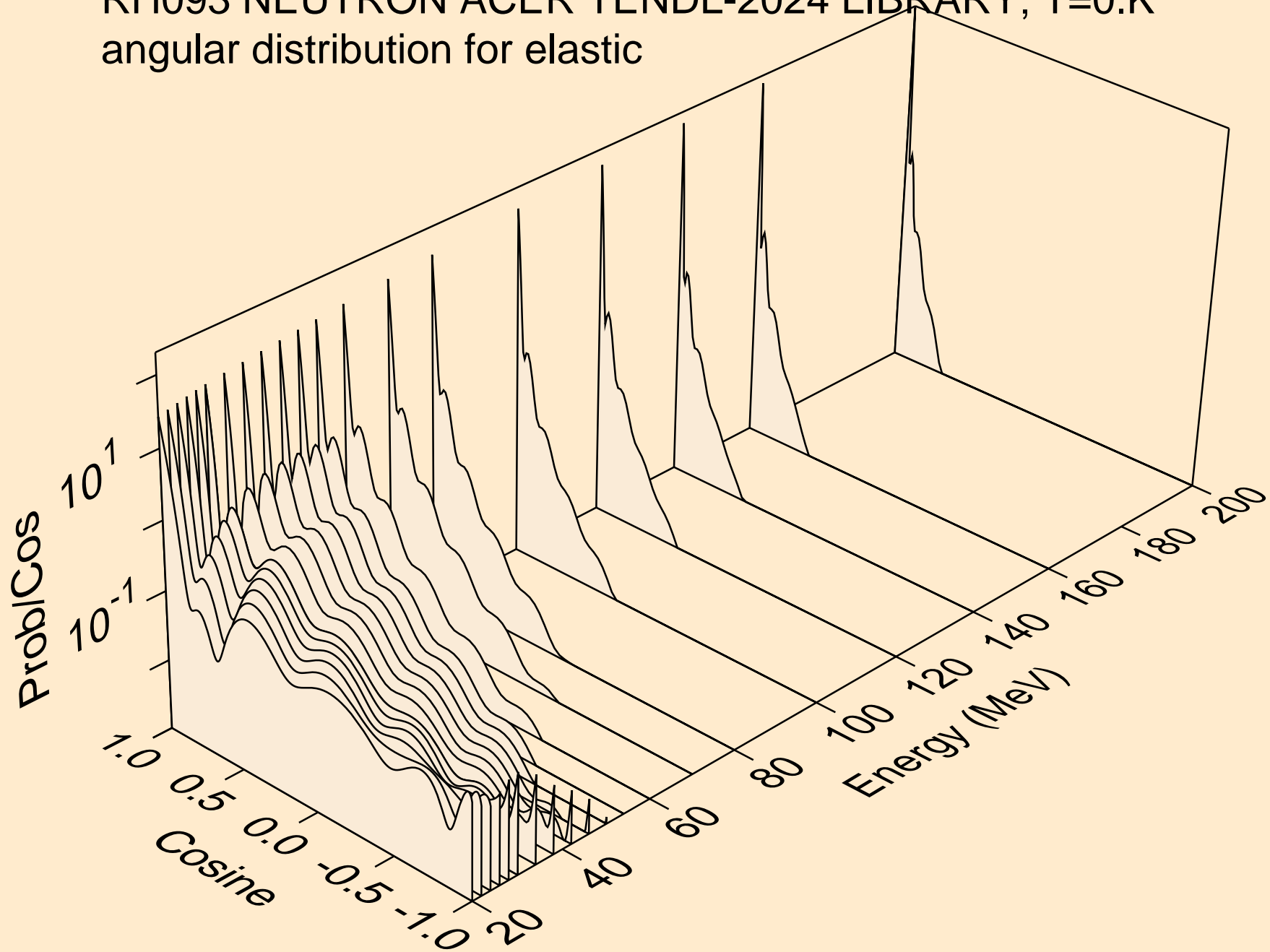

RH093 NEUTRON ACER TENDL-2024 LIBRARY; T=0.K
angular distribution for (n,n*1)

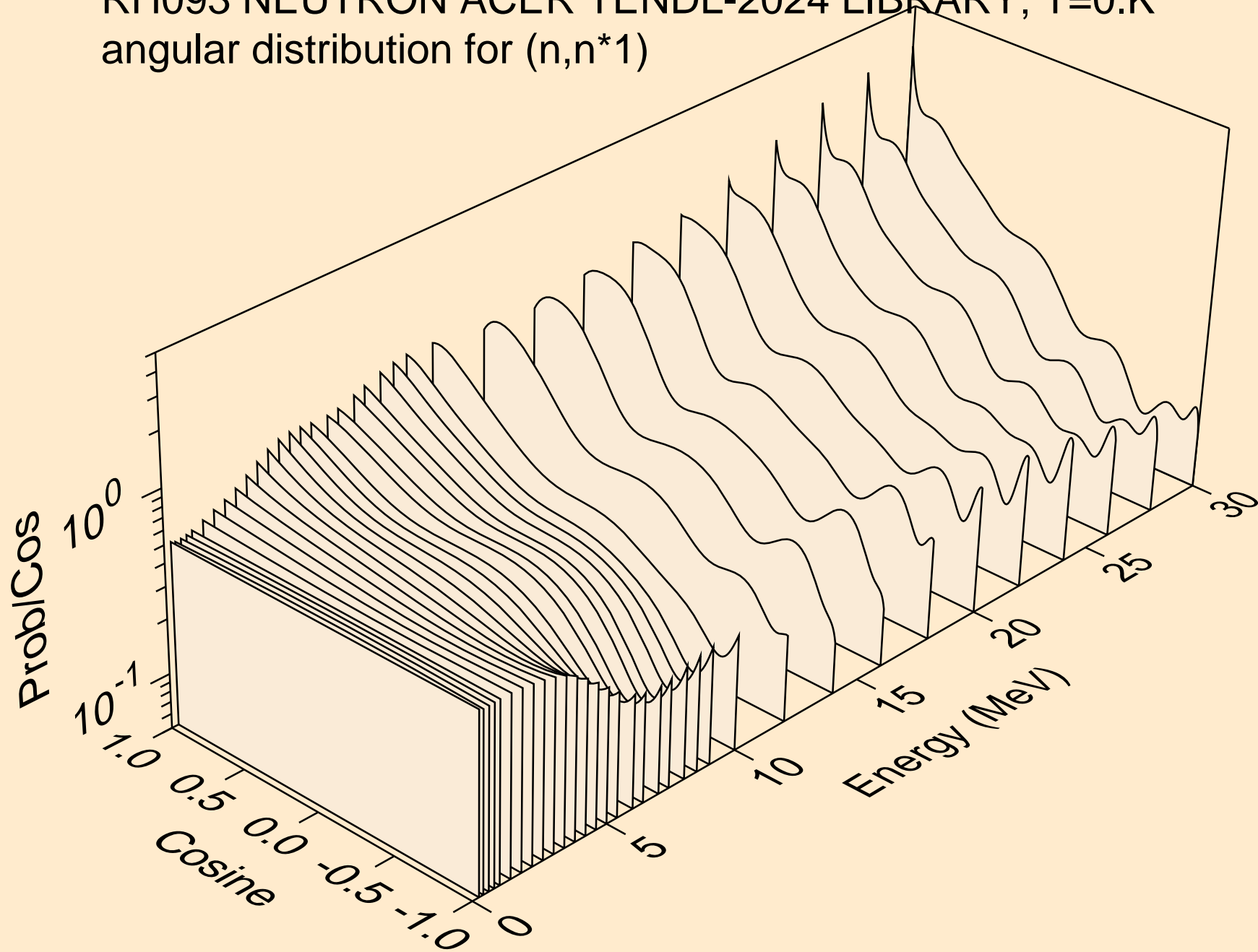

RH093 NEUTRON ACER TENDL-2024 LIBRARY; T=0.K
angular distribution for (n,n*2)

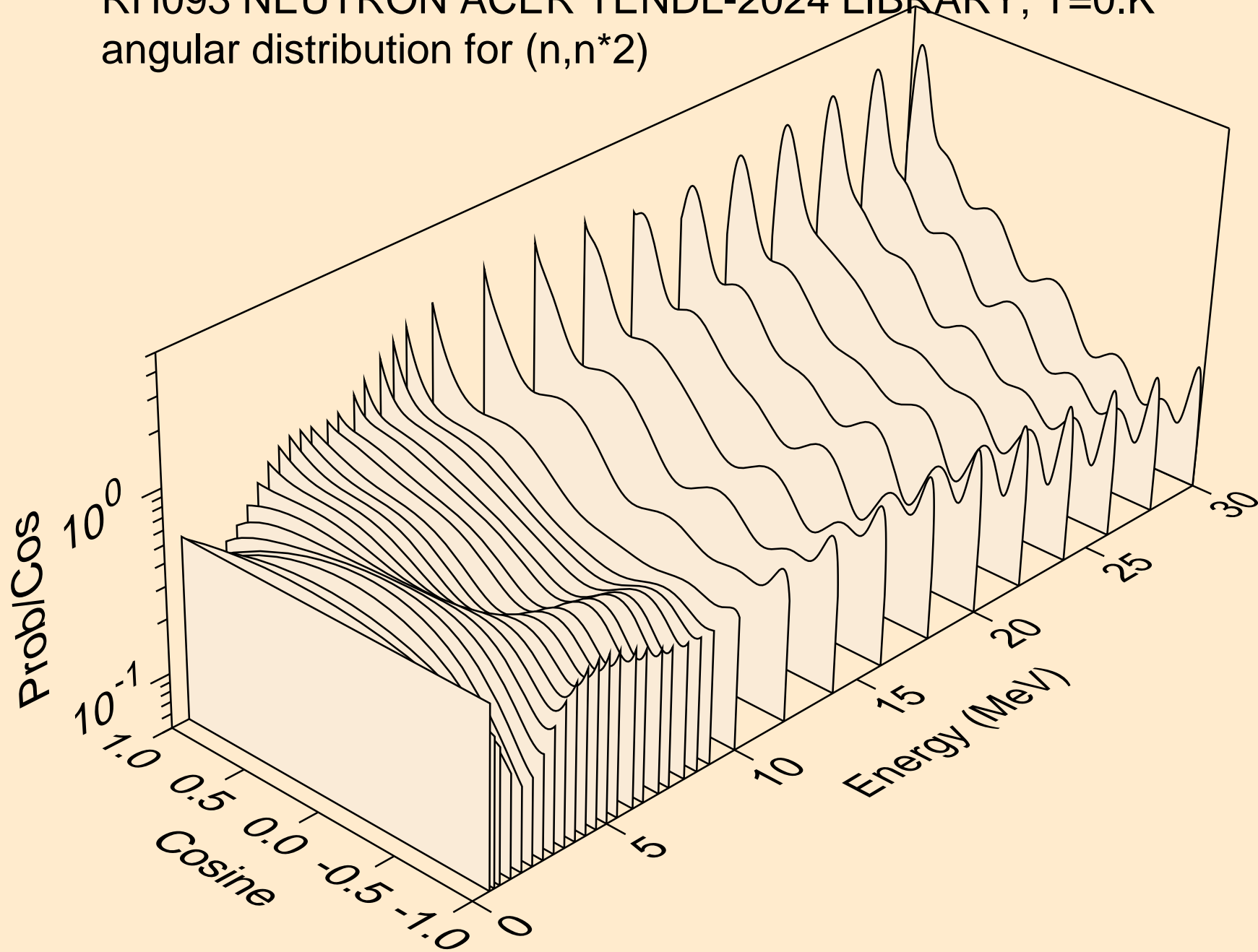

RH093 NEUTRON ACER TENDL-2024 LIBRARY; T=0.K
angular distribution for (n,n*3)

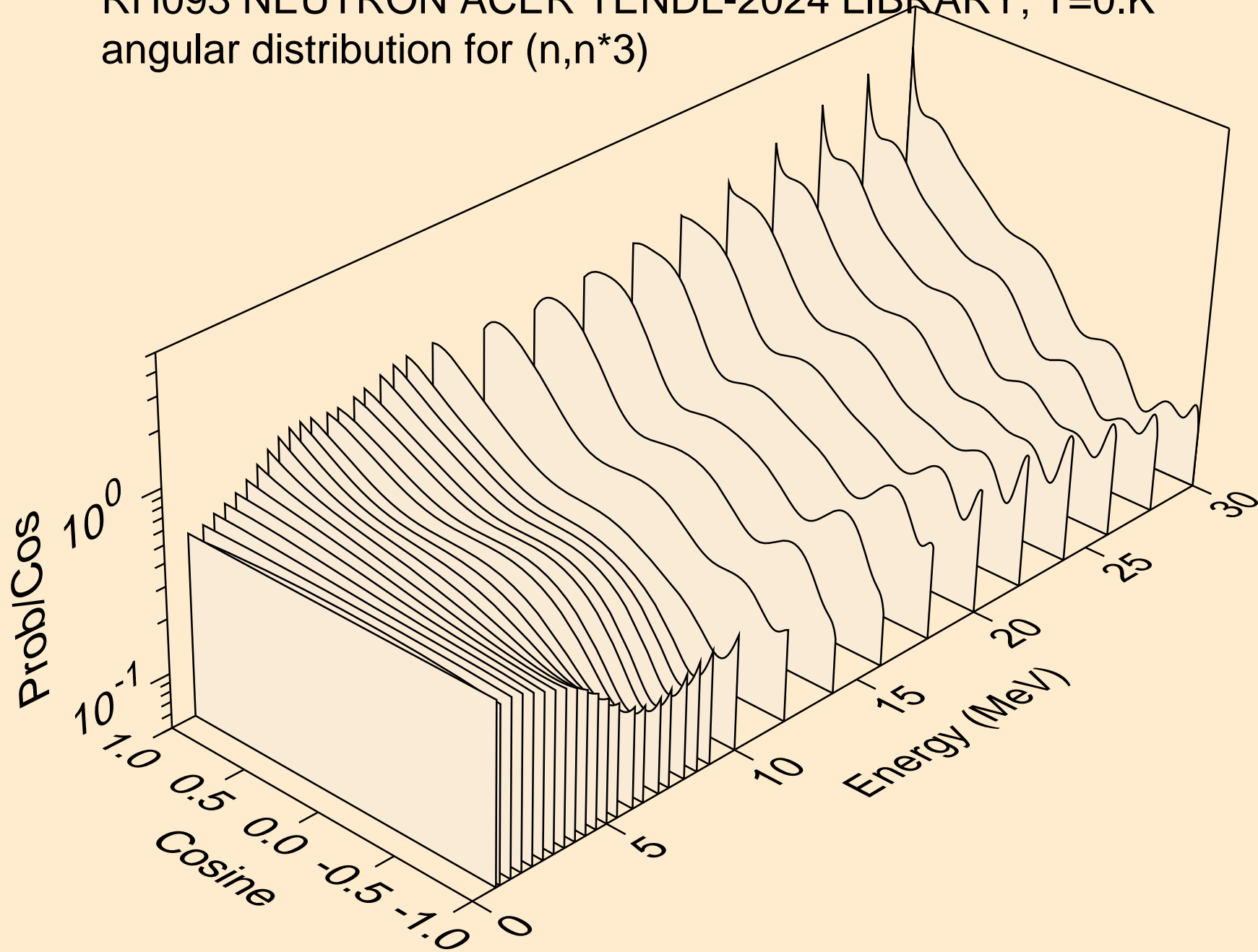

RH093 NEUTRON ACER TENDL-2024 LIBRARY; T=0.K
angular distribution for (n,n*4)

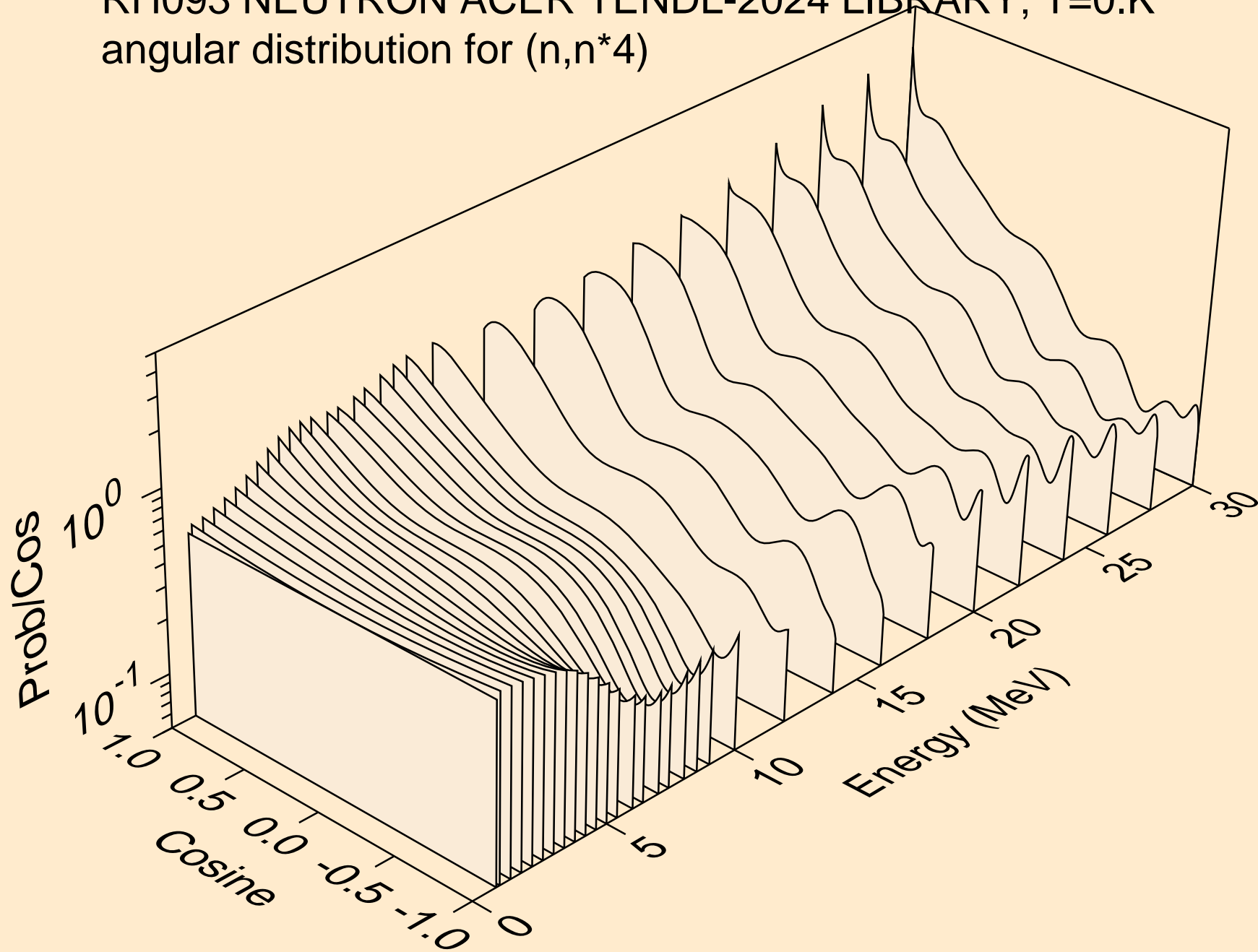

RH093 NEUTRON ACER TENDL-2024 LIBRARY; T=0.K
angular distribution for (n,n*5)

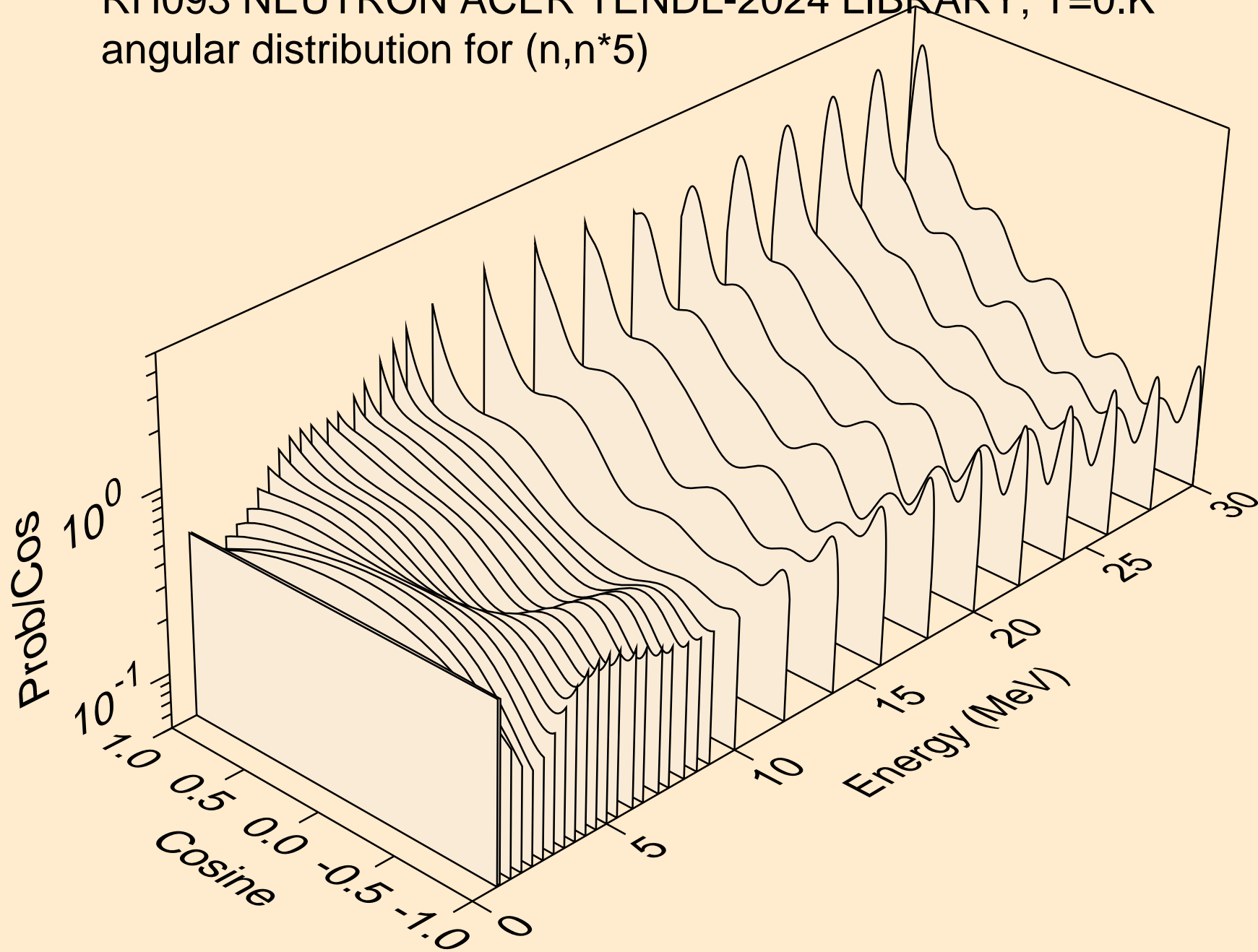

RH093 NEUTRON ACER TENDL-2024 LIBRARY; T=0.K
angular distribution for (n,n*6)

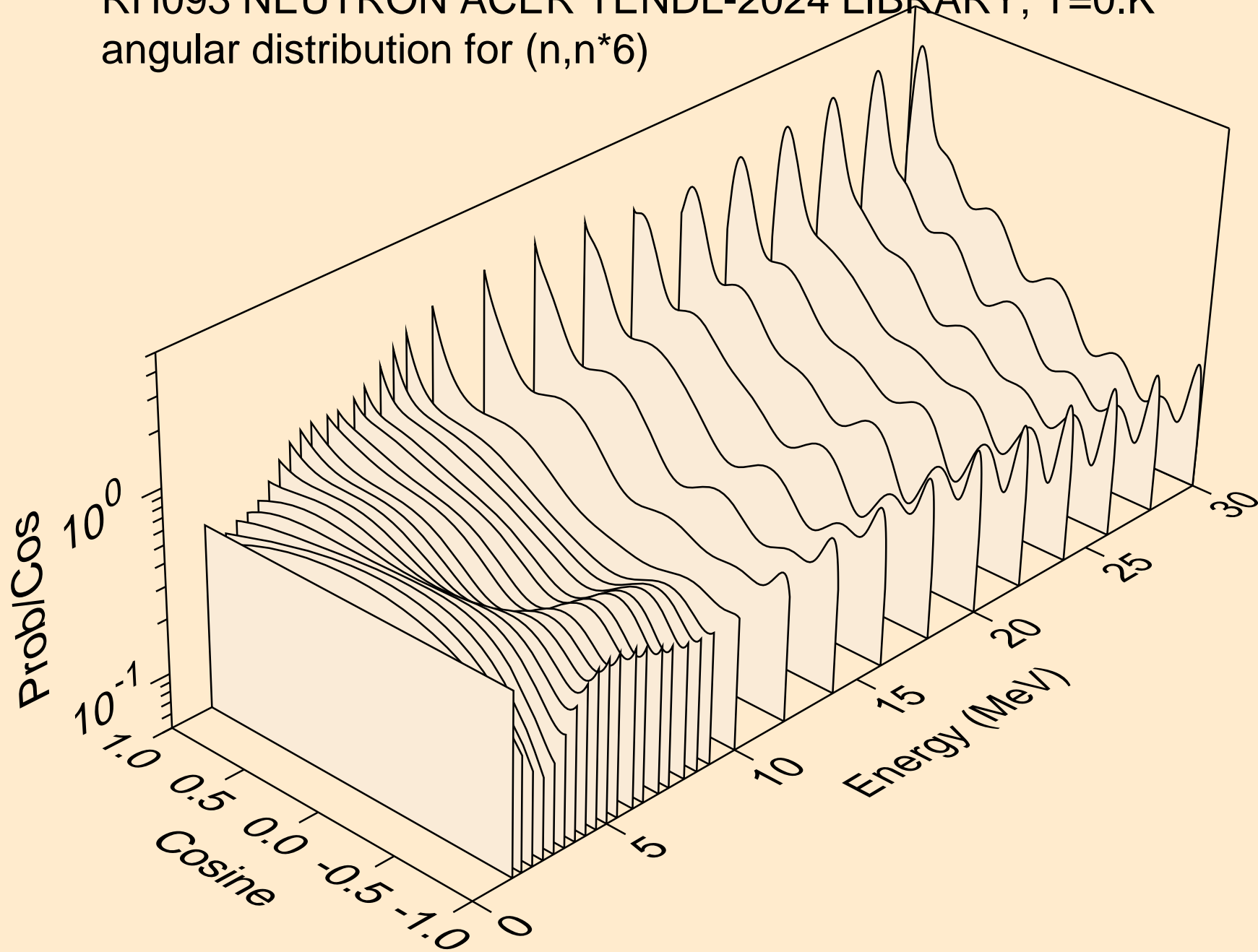

RH093 NEUTRON ACER TENDL-2024 LIBRARY; T=0.K
angular distribution for (n,n*7)

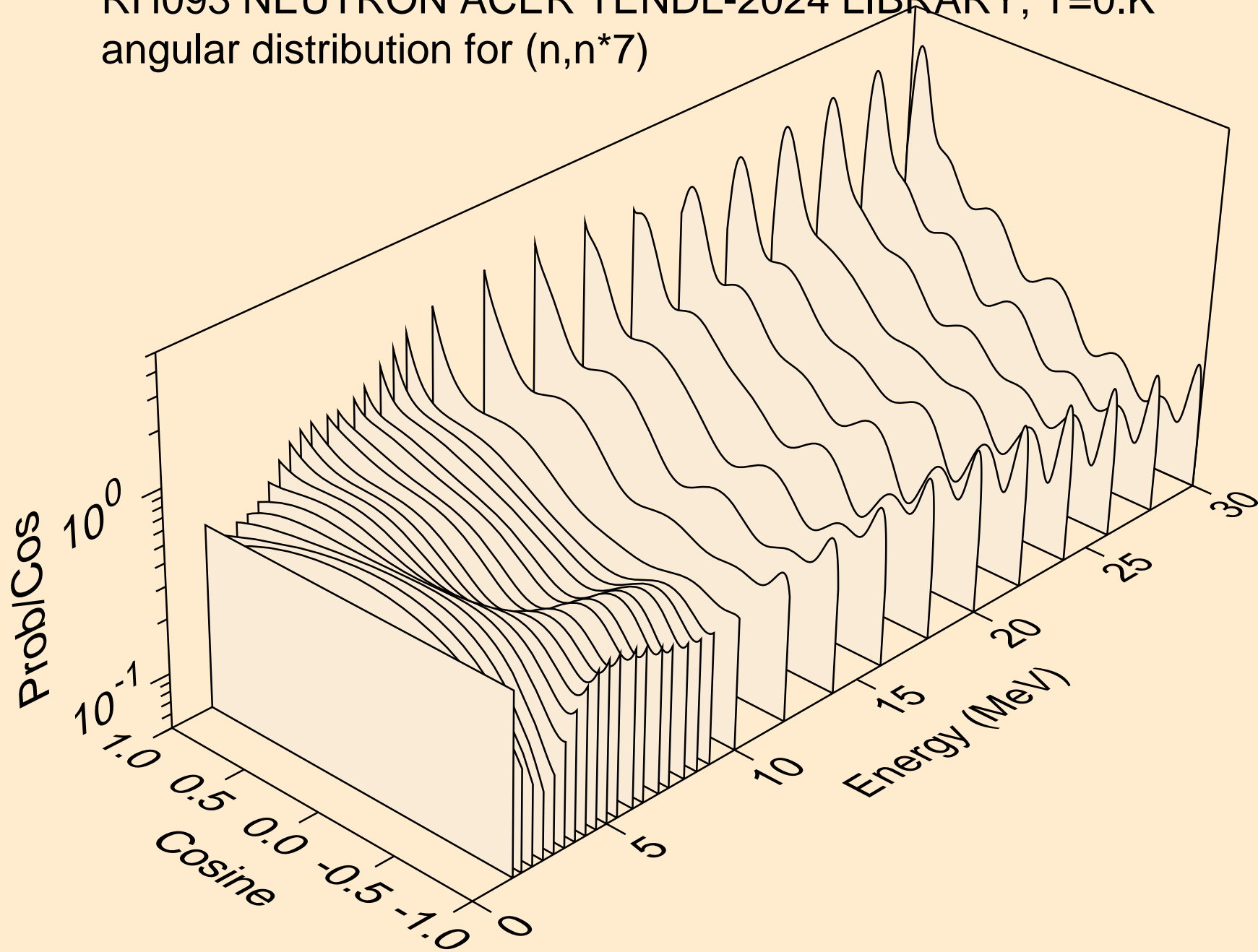

RH093 NEUTRON ACER TENDL-2024 LIBRARY; T=0.K
angular distribution for (n,n*8)

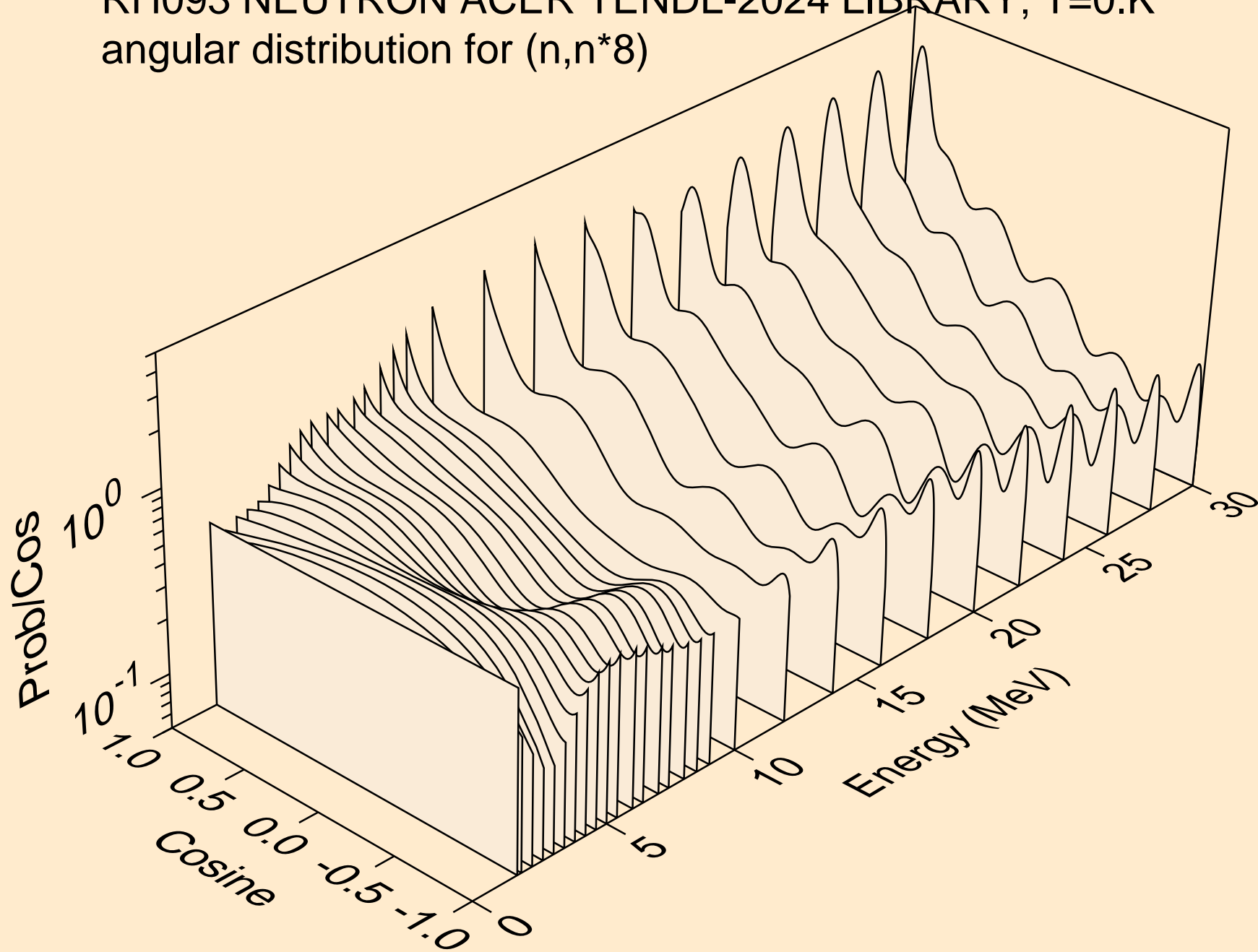

RH093 NEUTRON ACER TENDL-2024 LIBRARY; T=0.K
Neutron emission for (n,x)

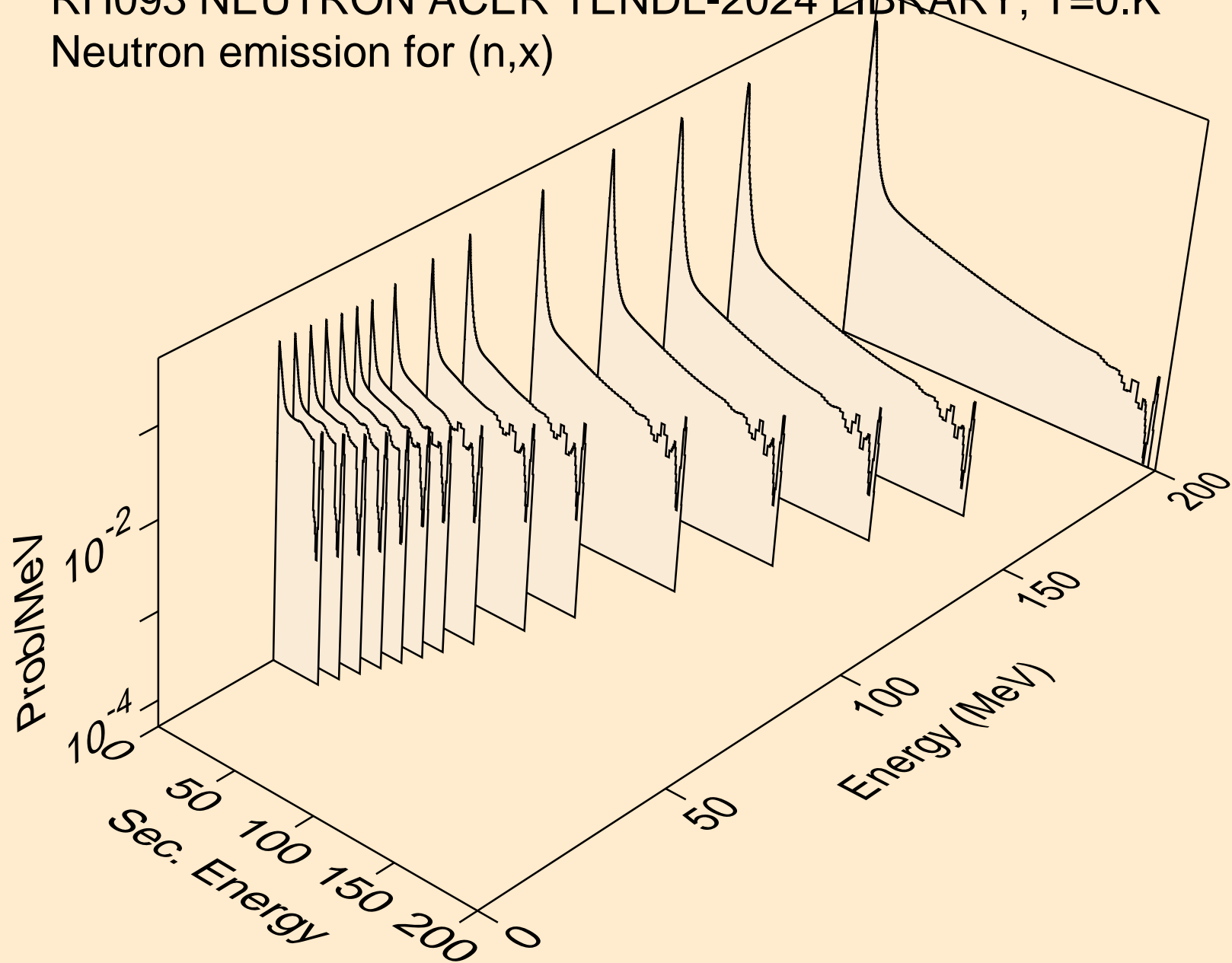

RH093 NEUTRON ACER TENDL-2024 LIBRARY; T=0.K
Neutron emission for (n,2n)

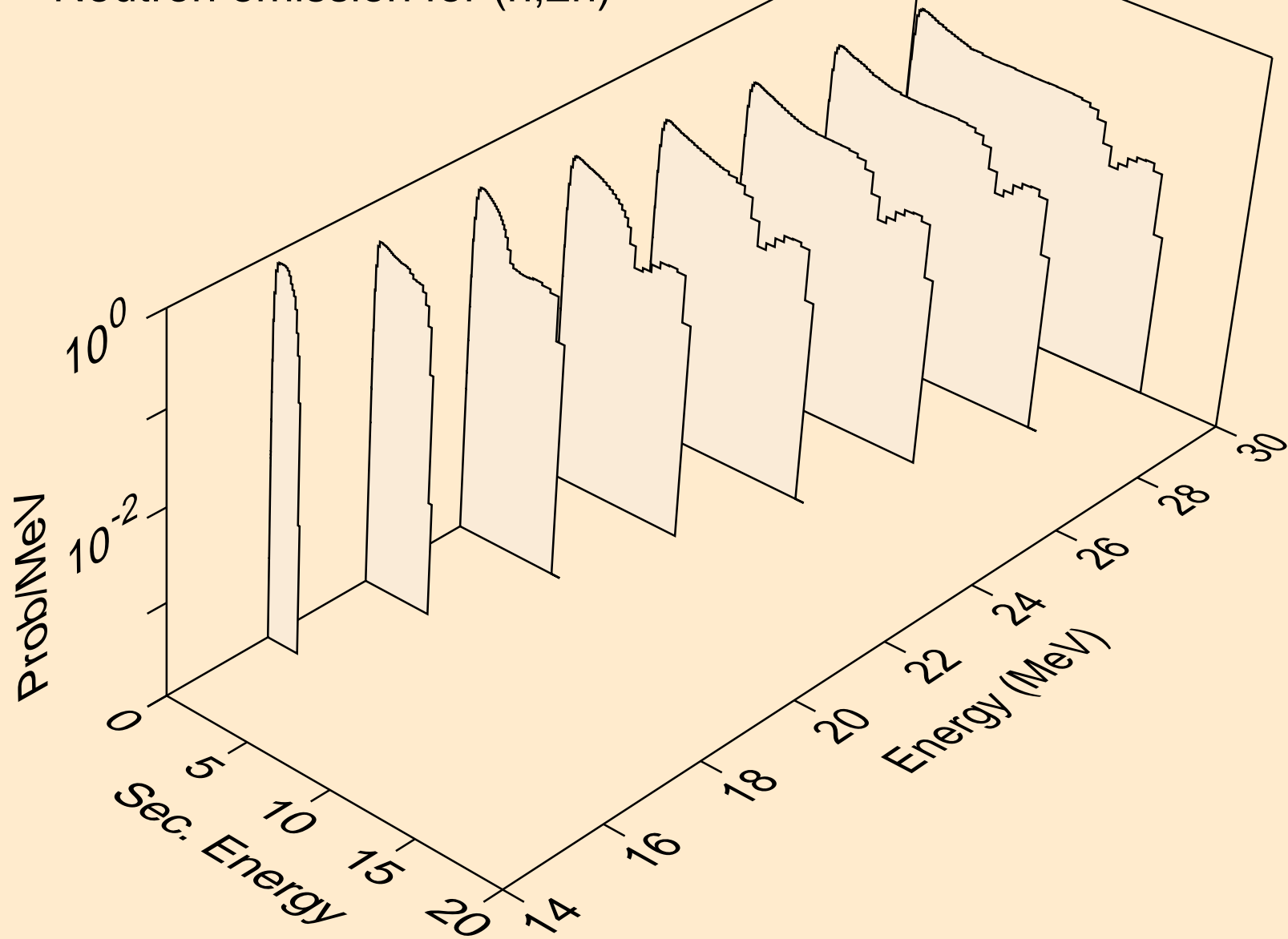

RH093 NEUTRON ACER TENDL-2024 LIBRARY; T=0.K
Neutron emission for (n,3n)

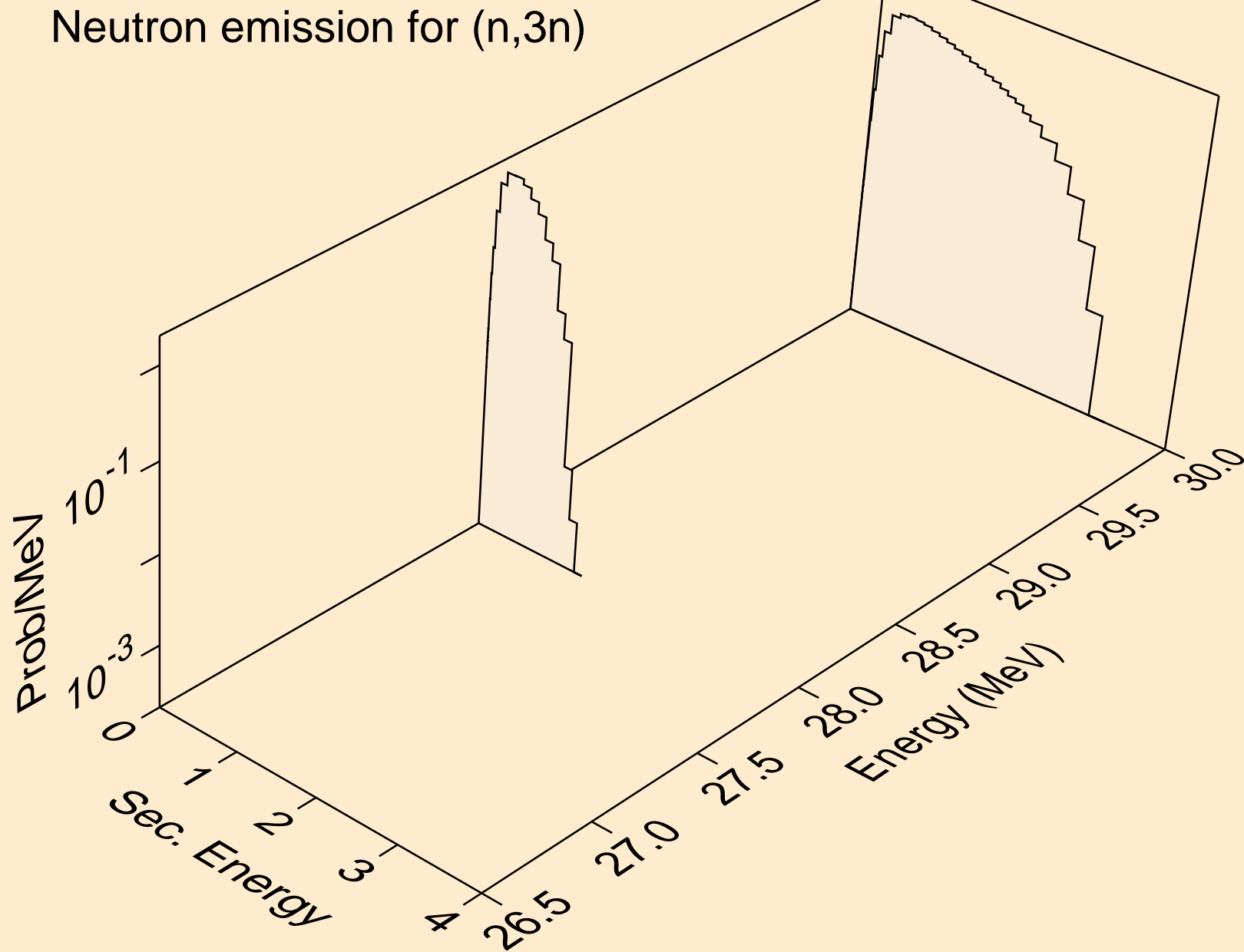

RH093 NEUTRON ACER TENDL-2024 LIBRARY; T=0.K
Neutron emission for (n,n*)a

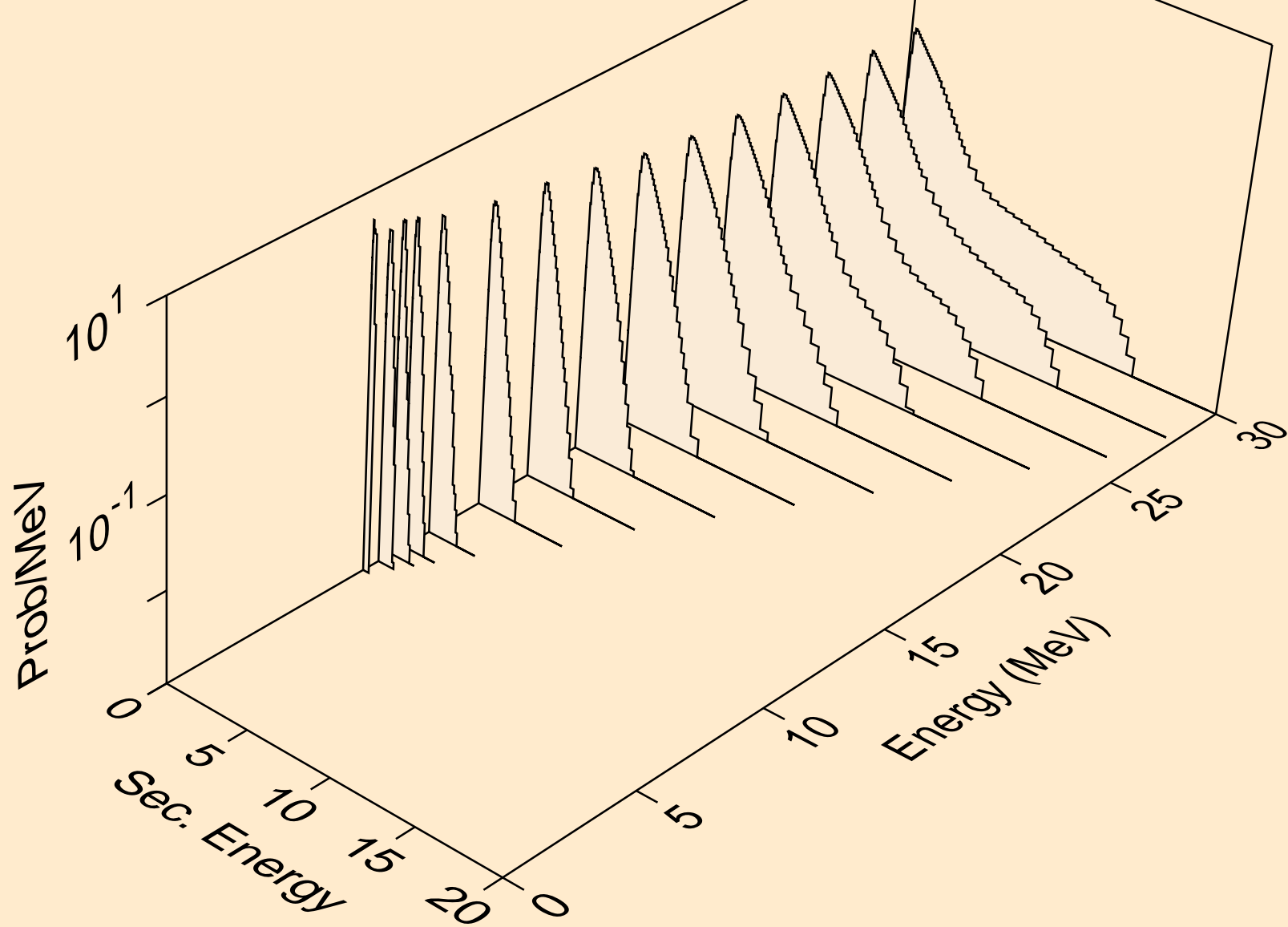

RH093 NEUTRON ACER TENDL-2024 LIBRARY; T=0.K
Neutron emission for (n,2n)a

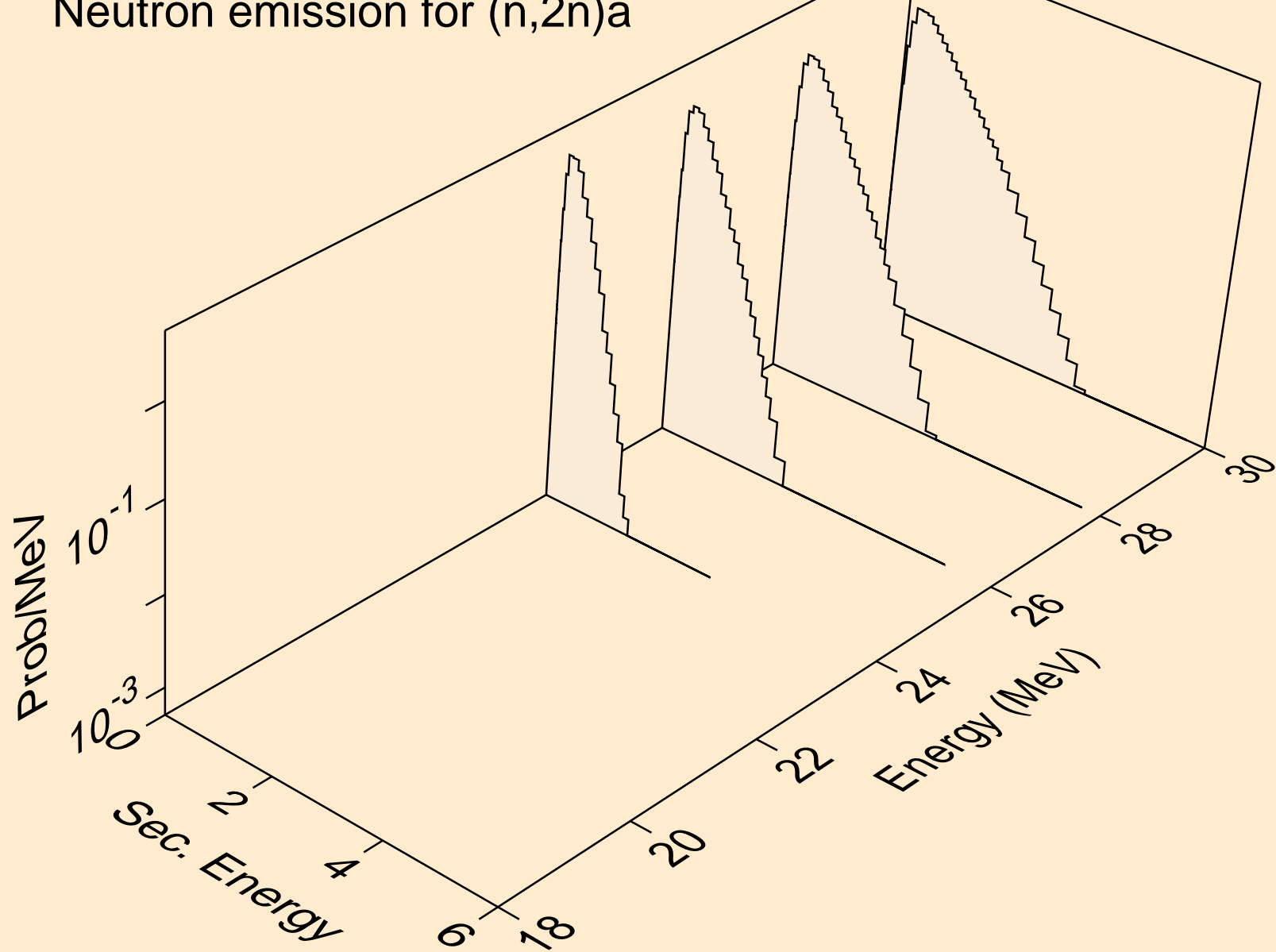

RH093 NEUTRON ACER TENDL-2024 LIBRARY; T=0.K
Neutron emission for (n,n*)p

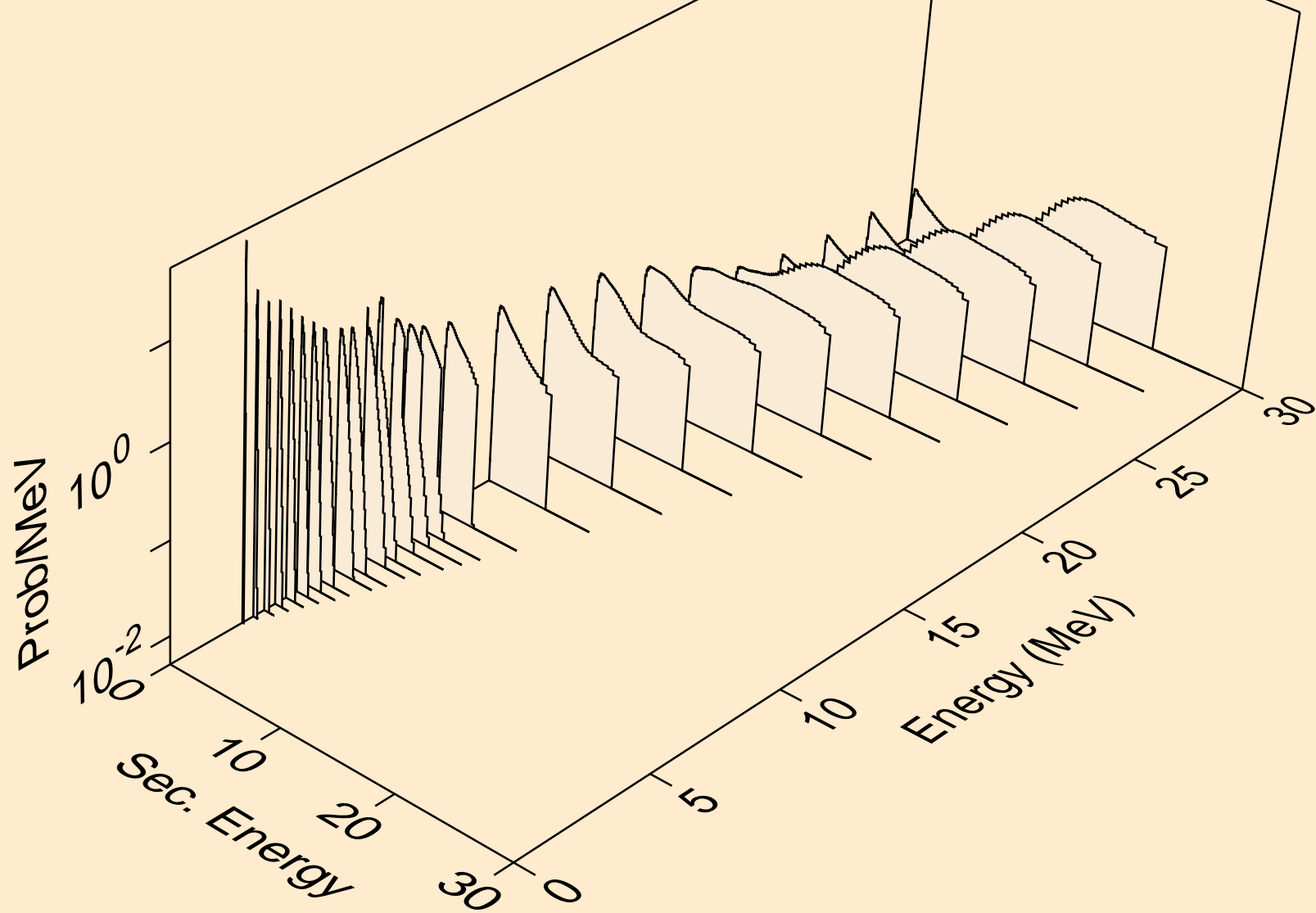

RH093 NEUTRON ACER TENDL-2024 LIBRARY; T=0.K
Neutron emission for (n,n*)2a

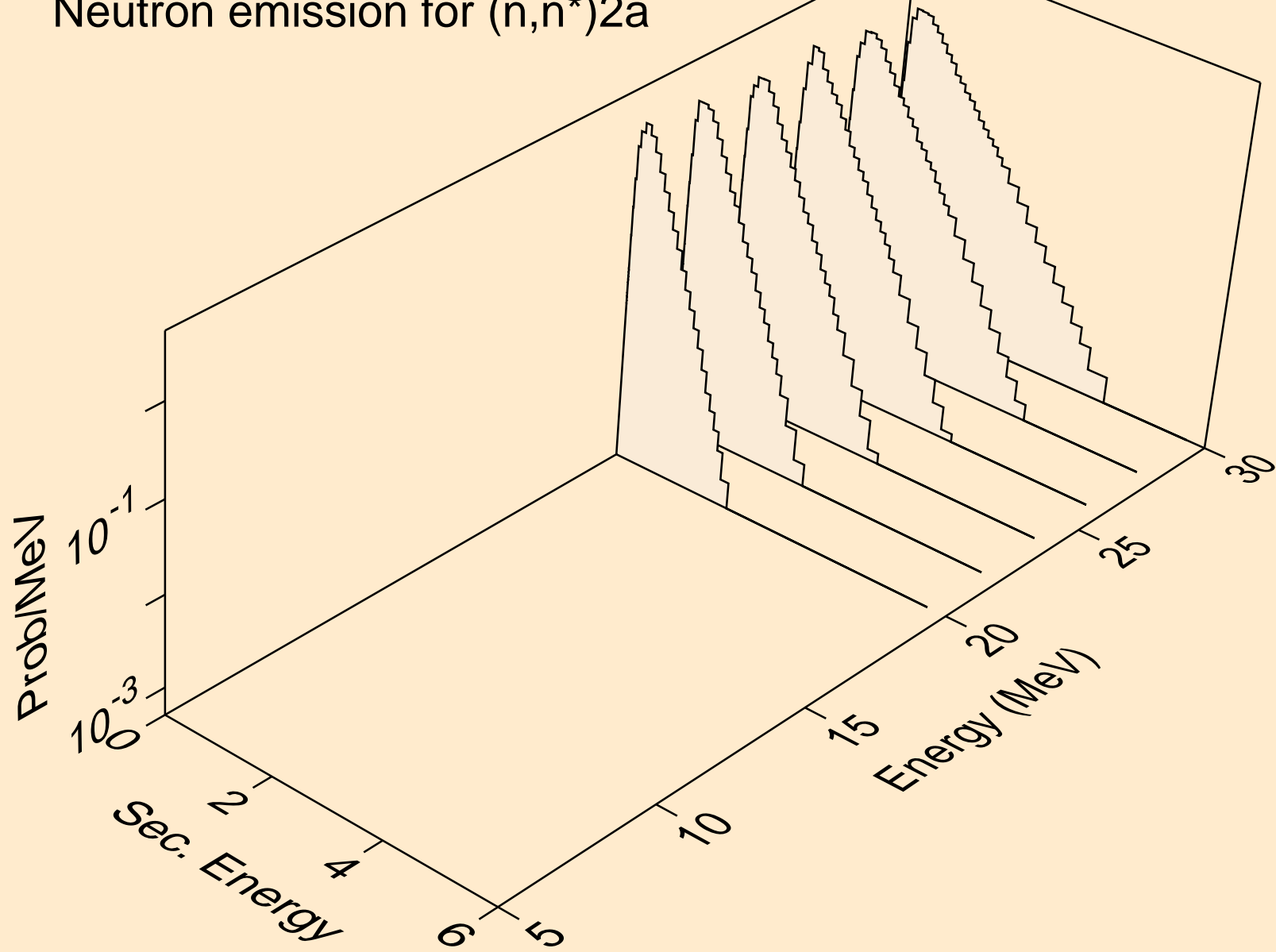

RH093 NEUTRON ACER TENDL-2024 LIBRARY; T=0.K
Neutron emission for (n,n*)d

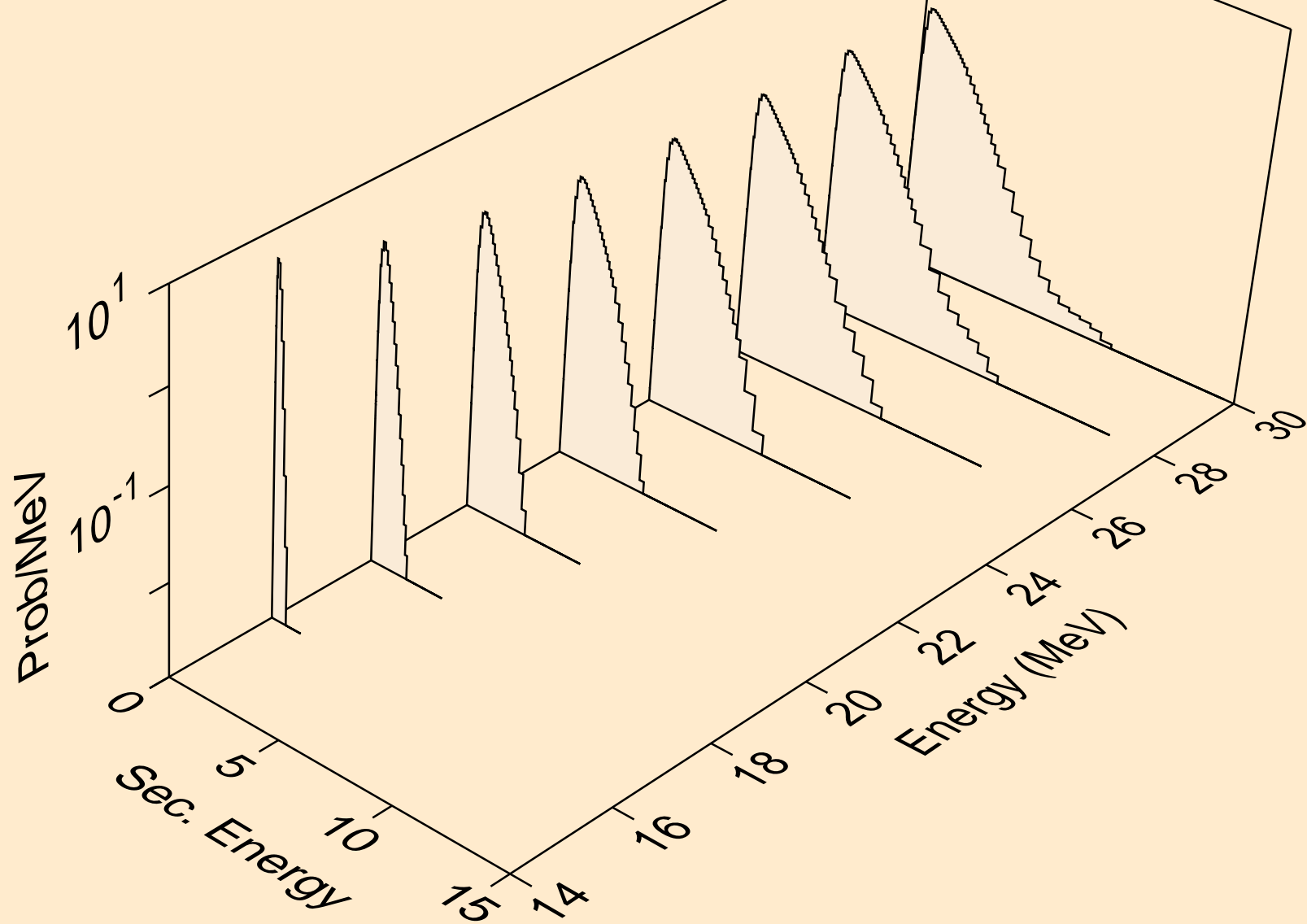

RH093 NEUTRON ACER TENDL-2024 LIBRARY; T=0.K
Neutron emission for (n,n*)t

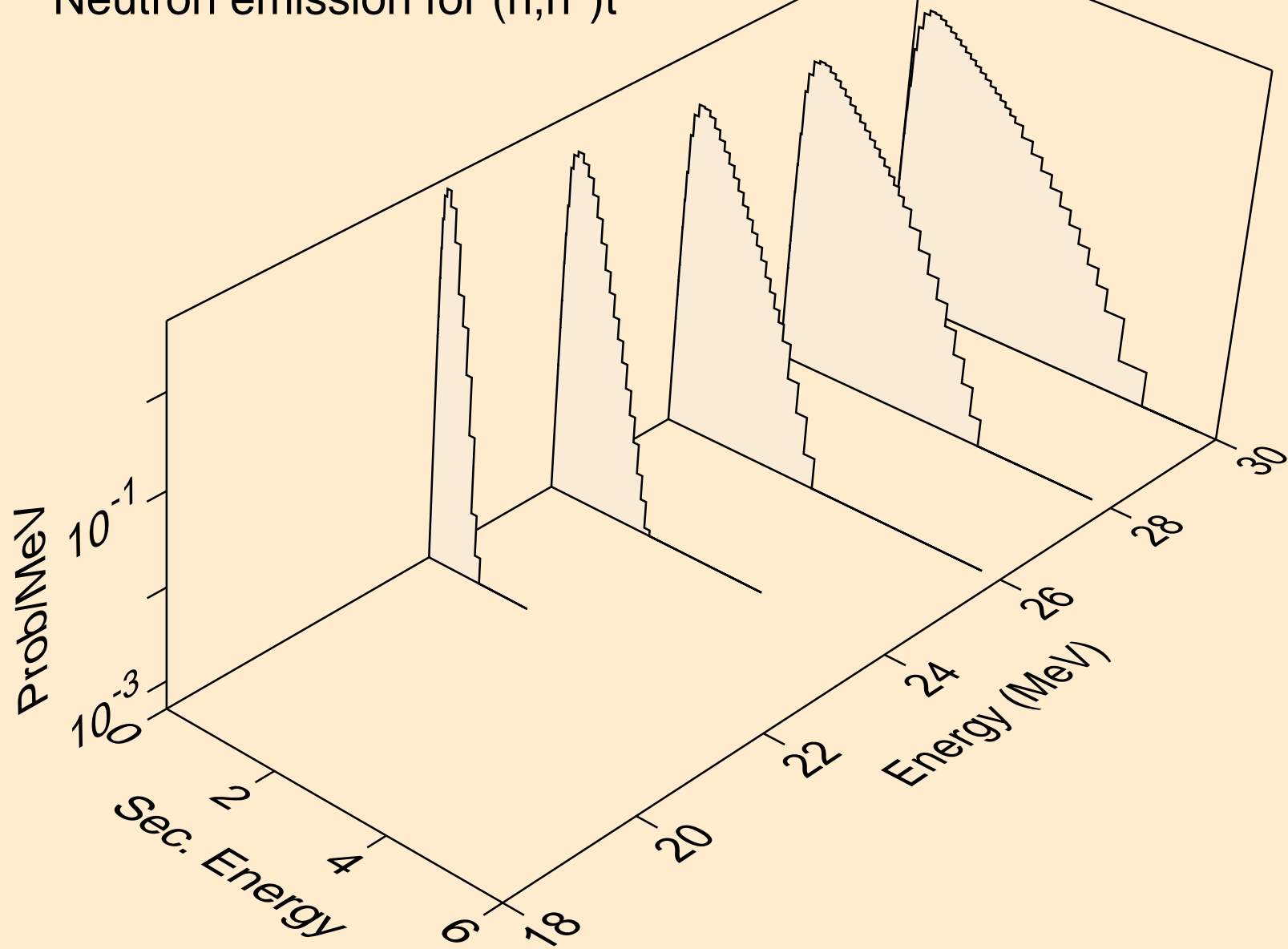

RH093 NEUTRON ACER TENDL-2024 LIBRARY; T=0.K
Neutron emission for (n,n*)he3

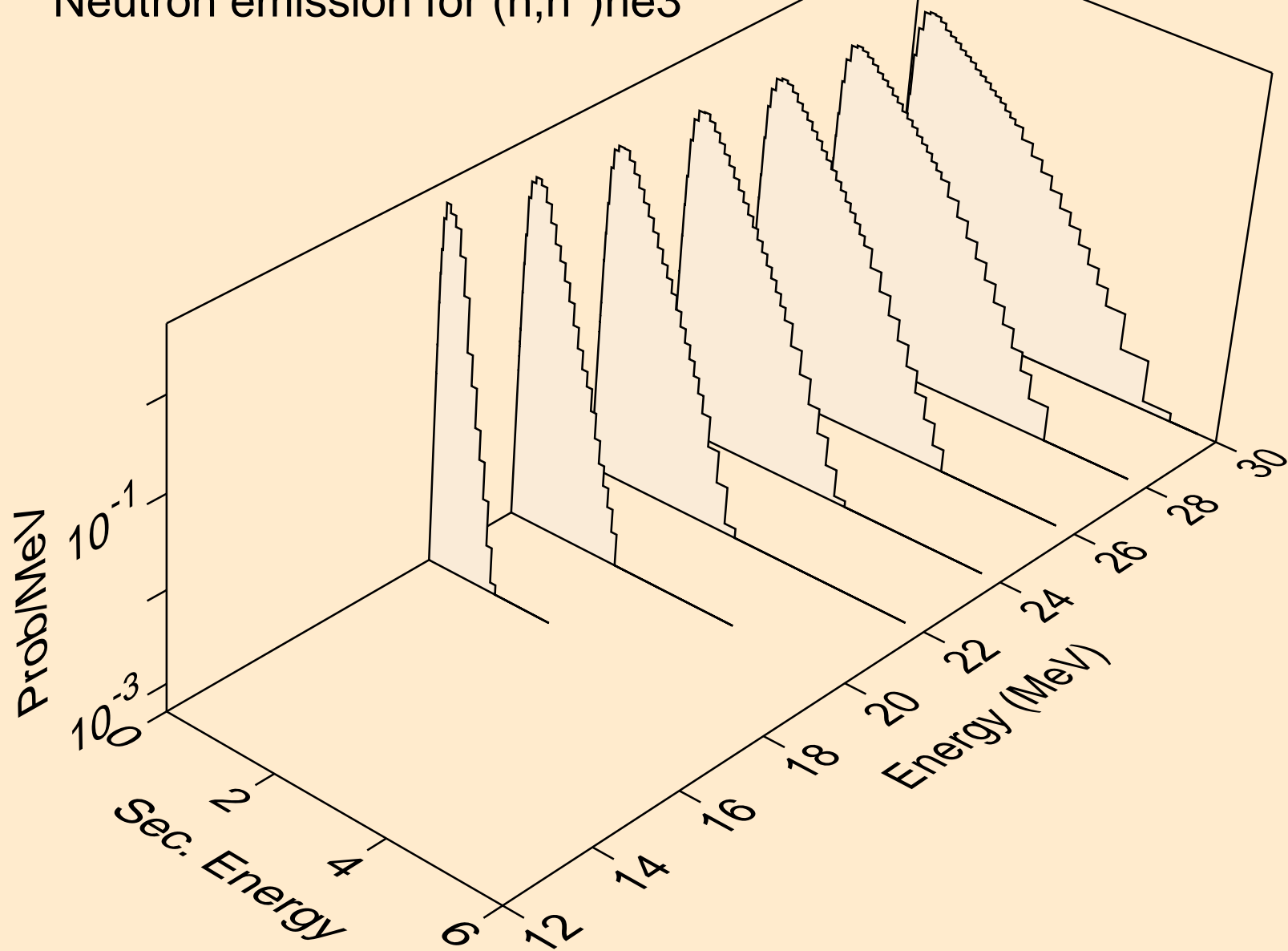

RH093 NEUTRON ACER TENDL-2024 LIBRARY; T=0.K
Neutron emission for (n,2np)

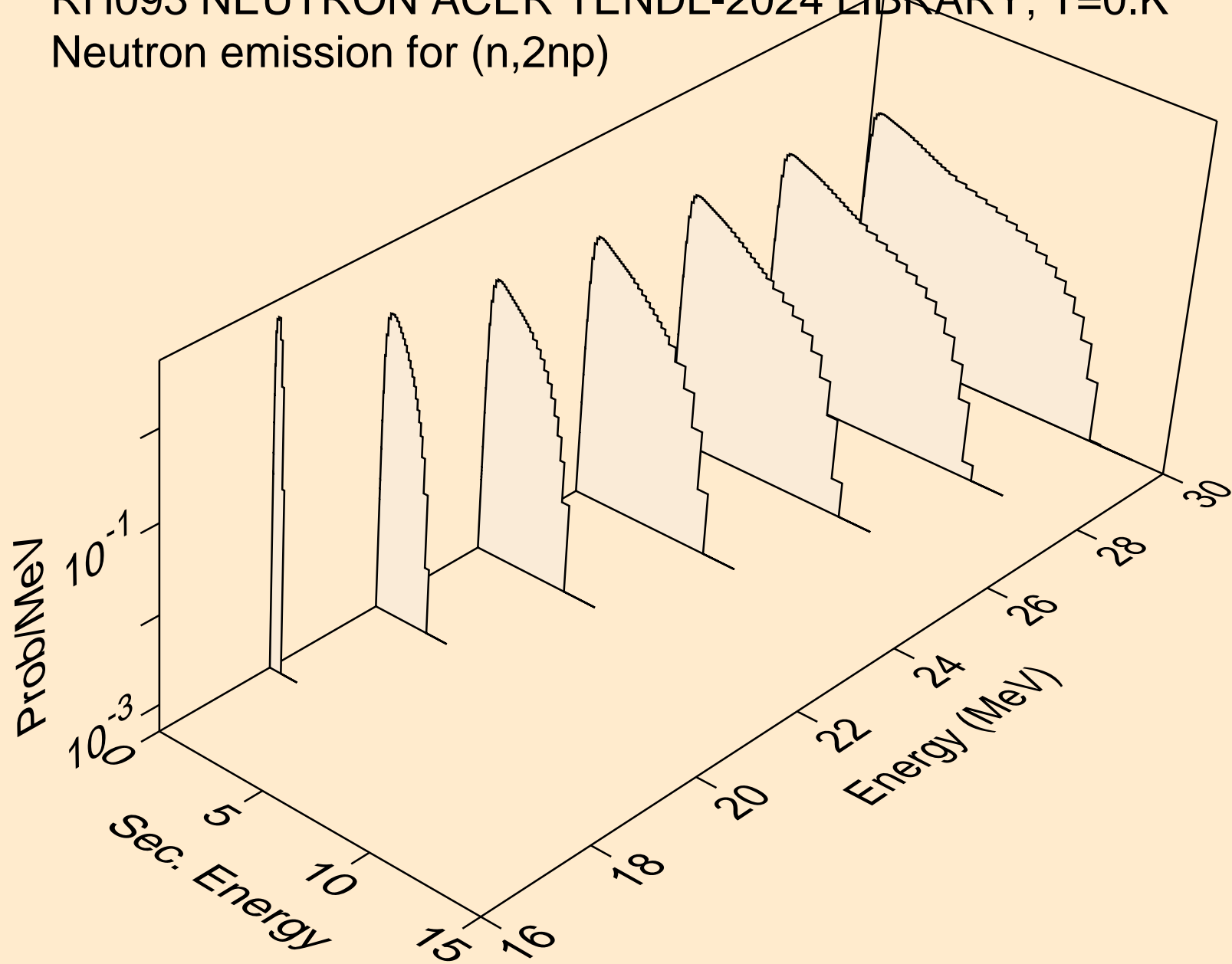

RH093 NEUTRON ACER TENDL-2024 LIBRARY; T=0.K
Neutron emission for (n,n2p)

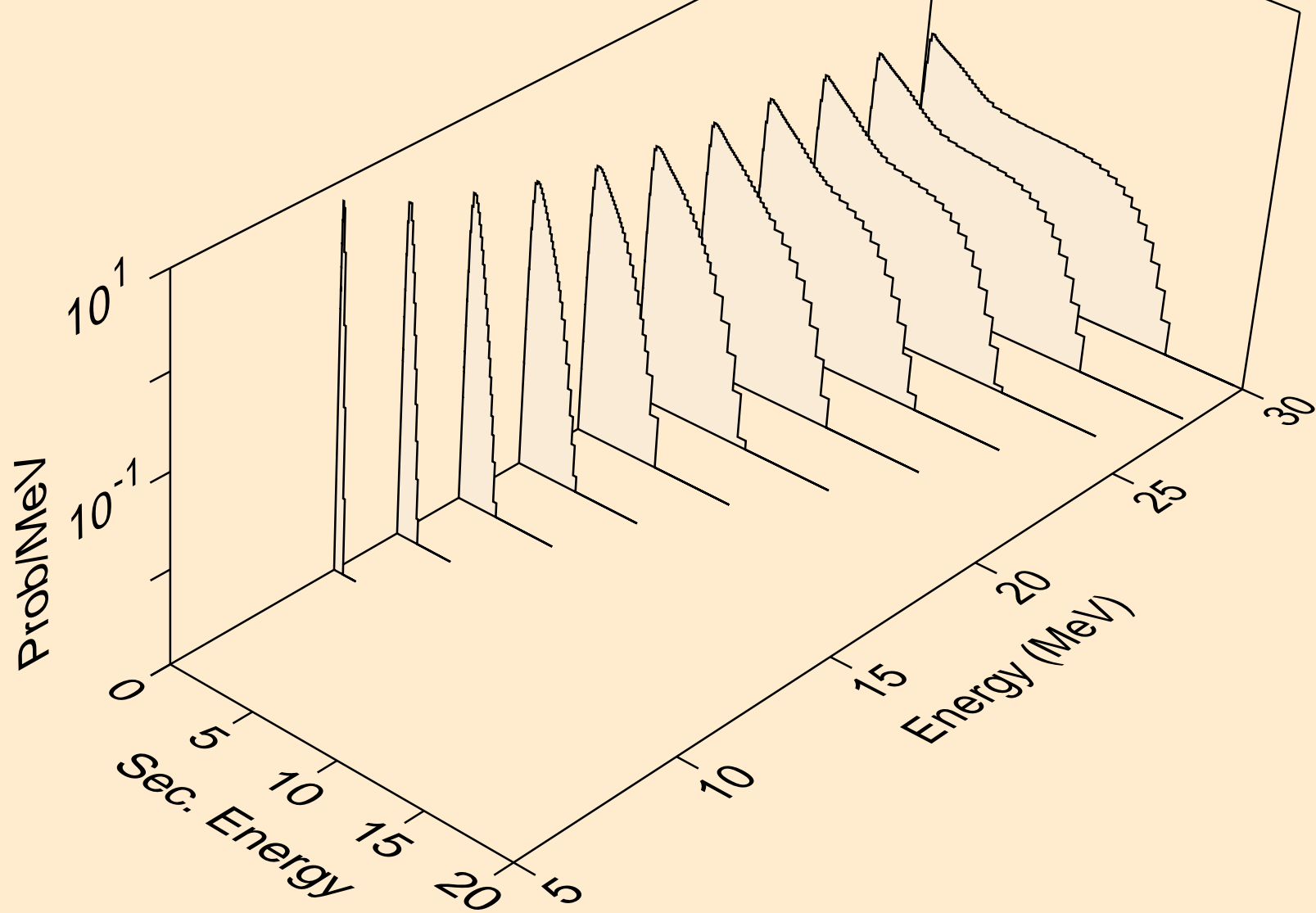

RH093 NEUTRON ACER TENDL-2024 LIBRARY; T=0.K
Neutron emission for (n,npa)

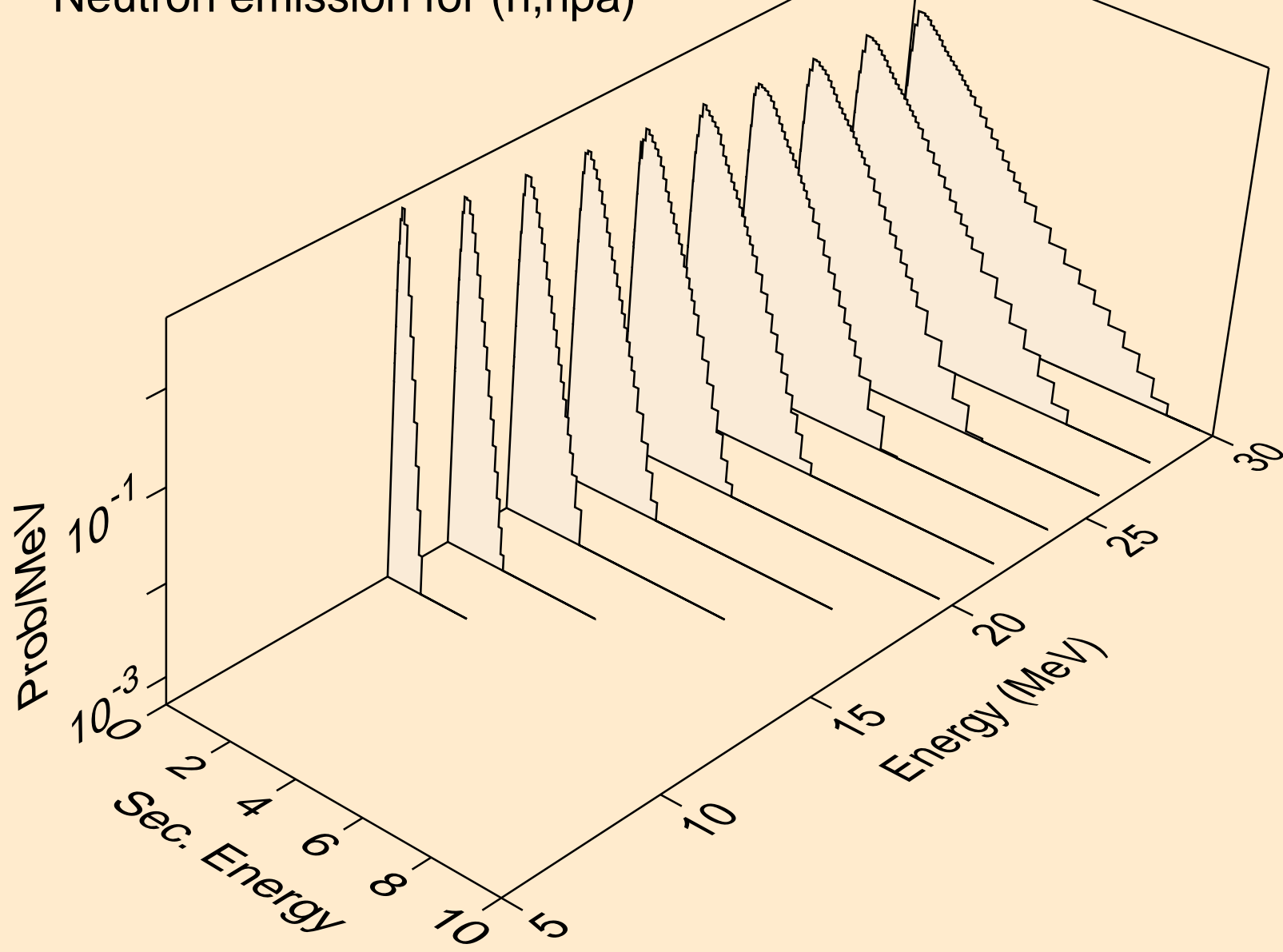

RH093 NEUTRON ACER TENDL-2024 LIBRARY; T=0.K
Neutron emission for (n,n*c)

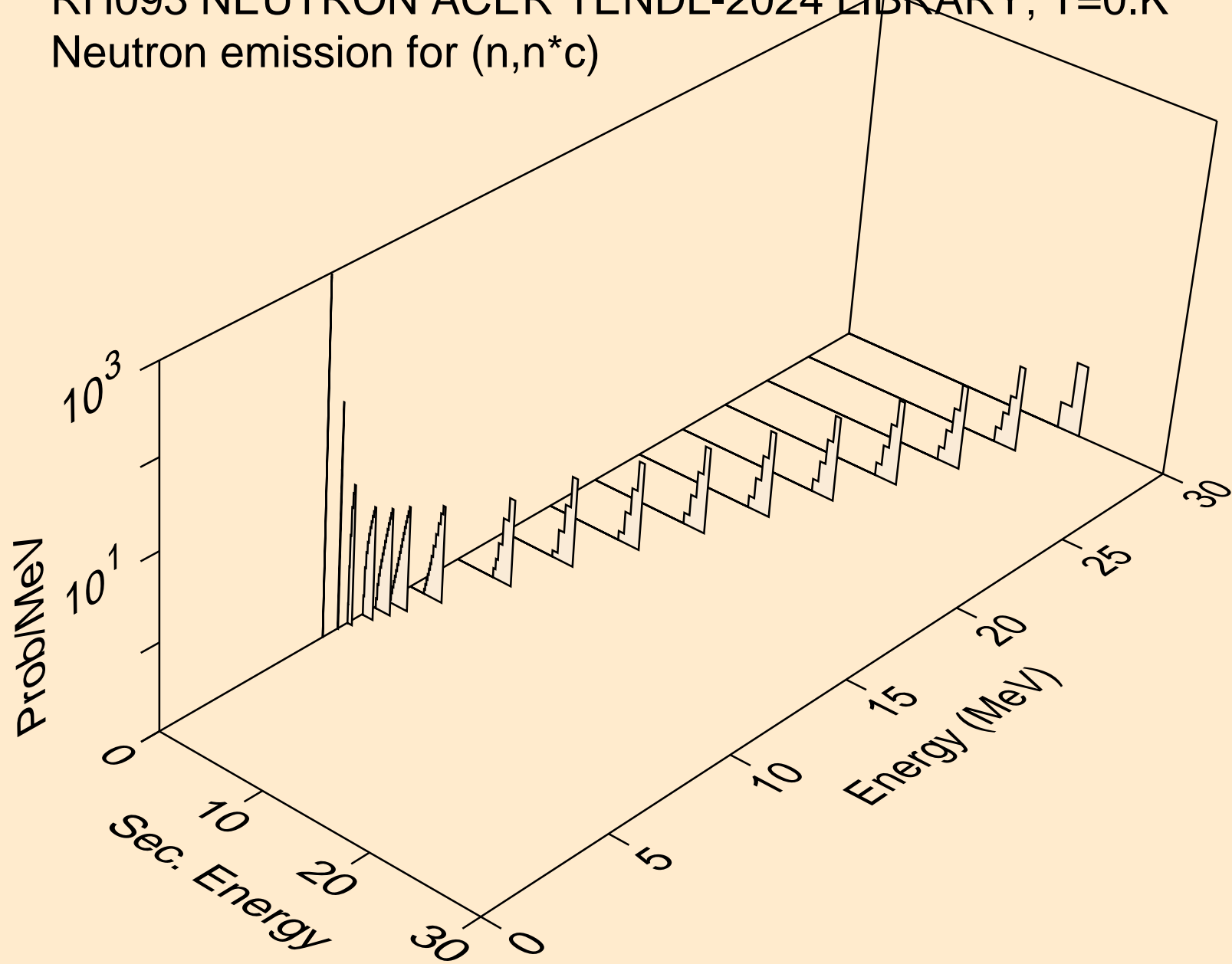

RH093 NEUTRON ACER TENDL-2024 LIBRARY; T=0.K
Photon emission for (n,x)

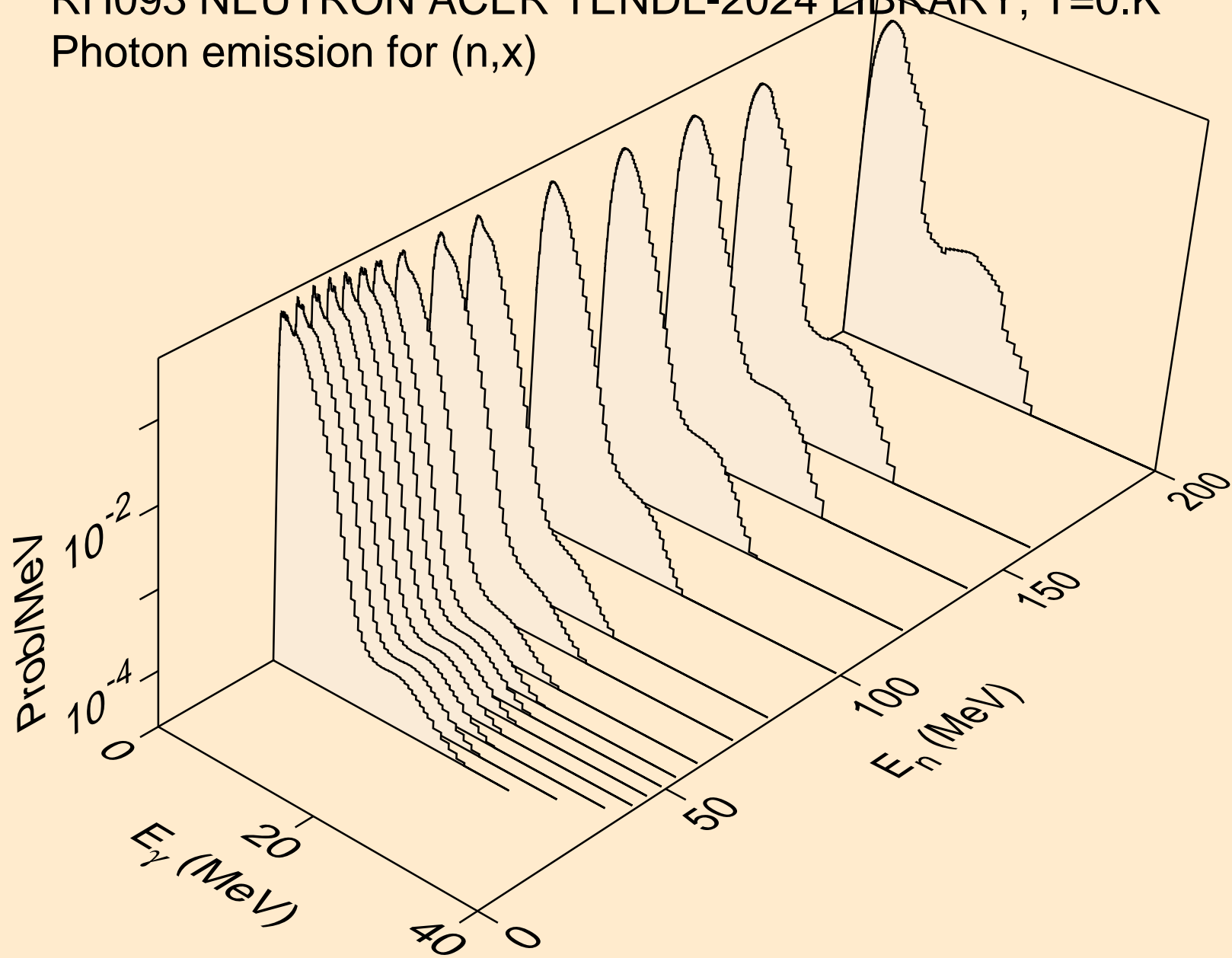

RH093 NEUTRON ACER TENDL-2024 LIBRARY; T=0.K
Photon emission for (n,2n)

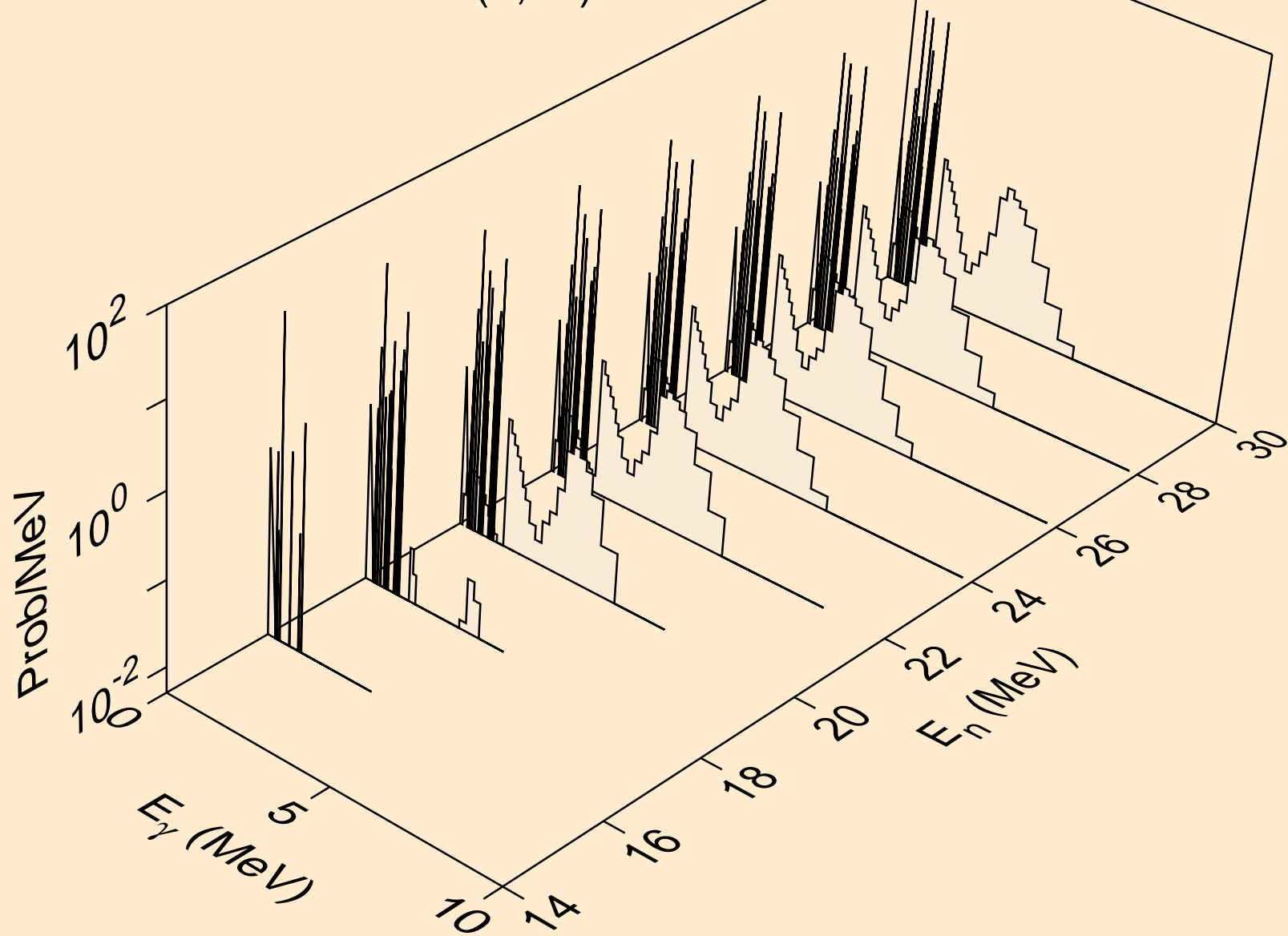

RH093 NEUTRON ACER TENDL-2024 LIBRARY; T=0.K
Photon emission for (n,3n)

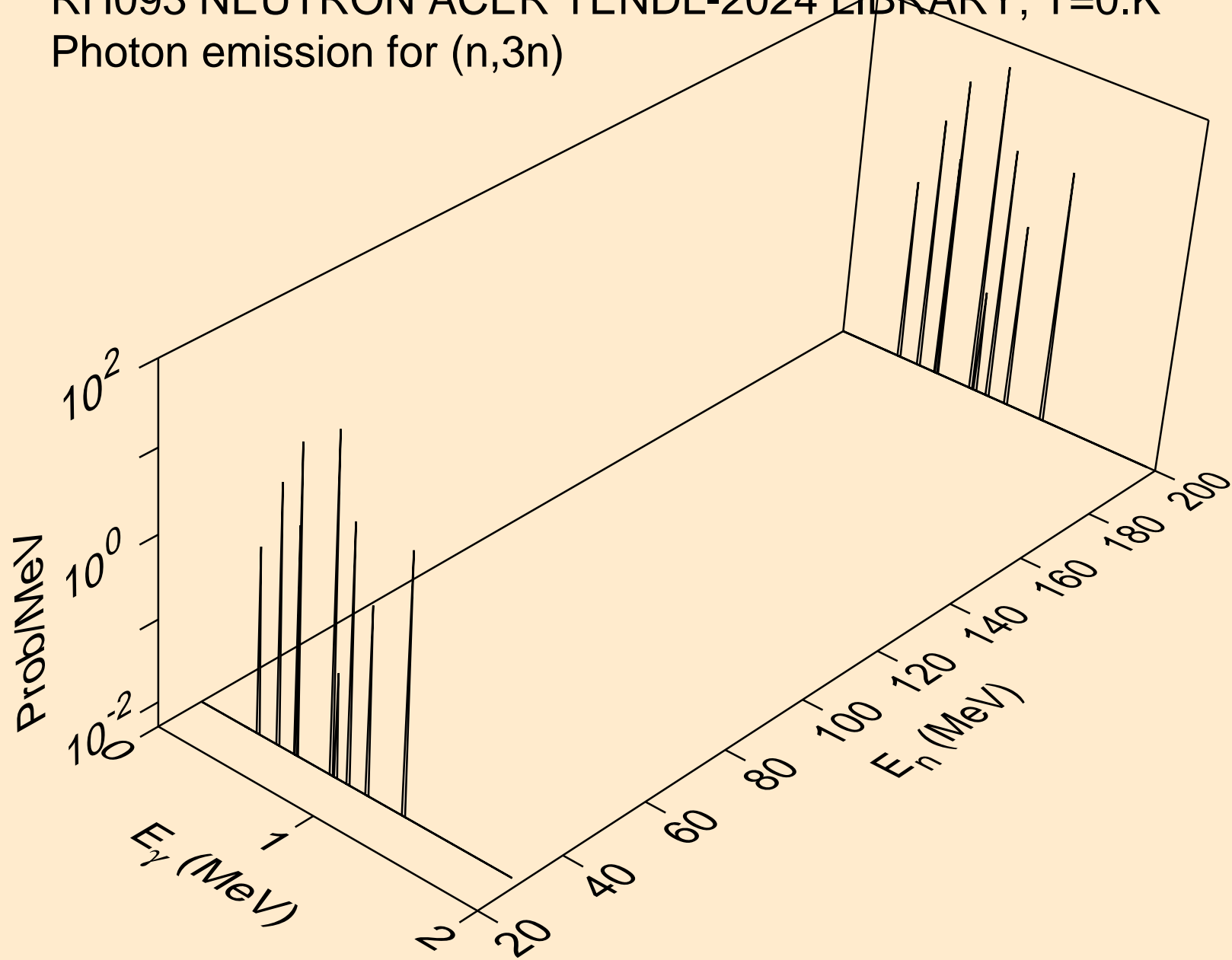

RH093 NEUTRON ACER TENDL-2024 LIBRARY; T=0.K
Photon emission for (n,n*)a

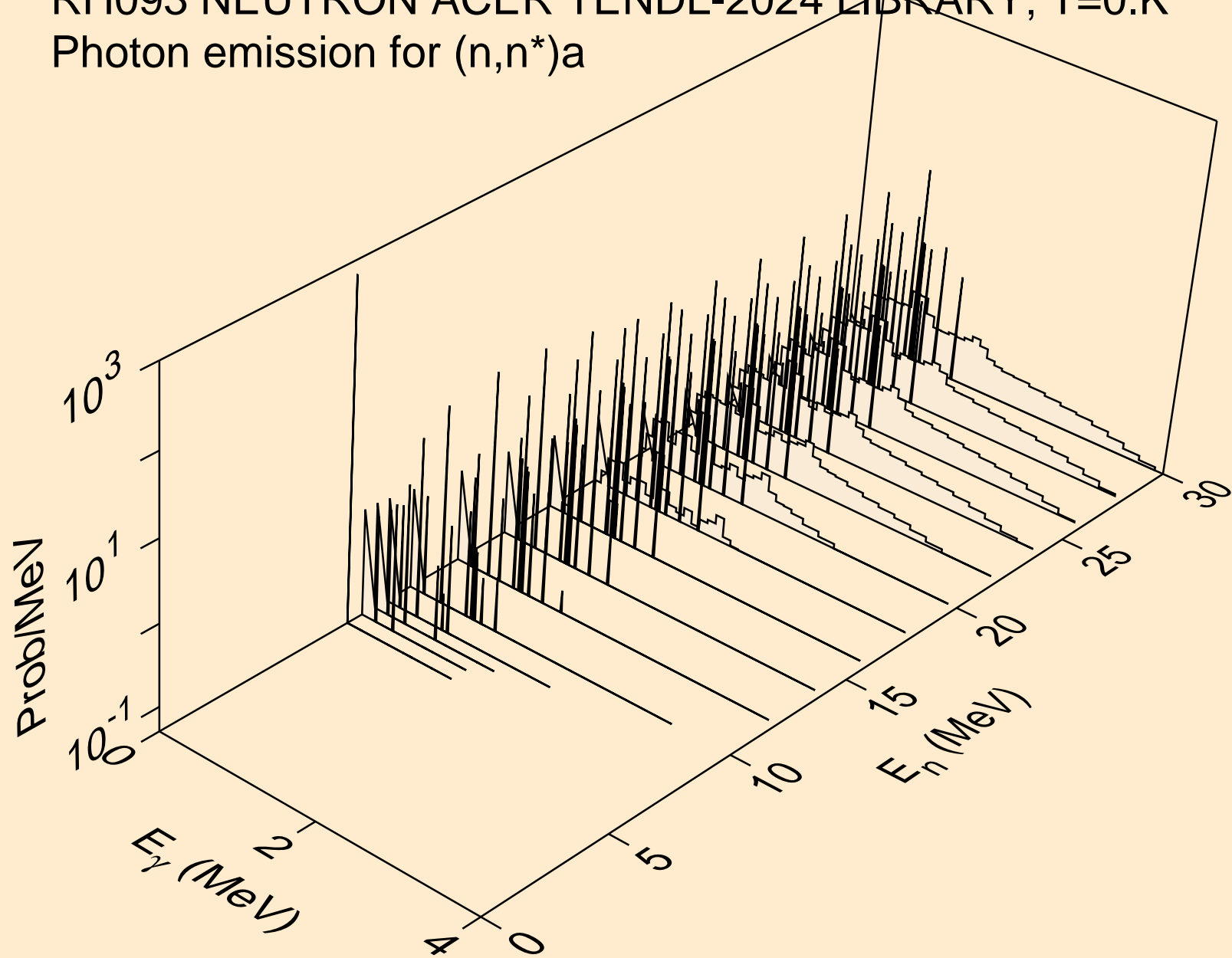

RH093 NEUTRON ACER TENDL-2024 LIBRARY; T=0.K
Photon emission for (n,2n)a

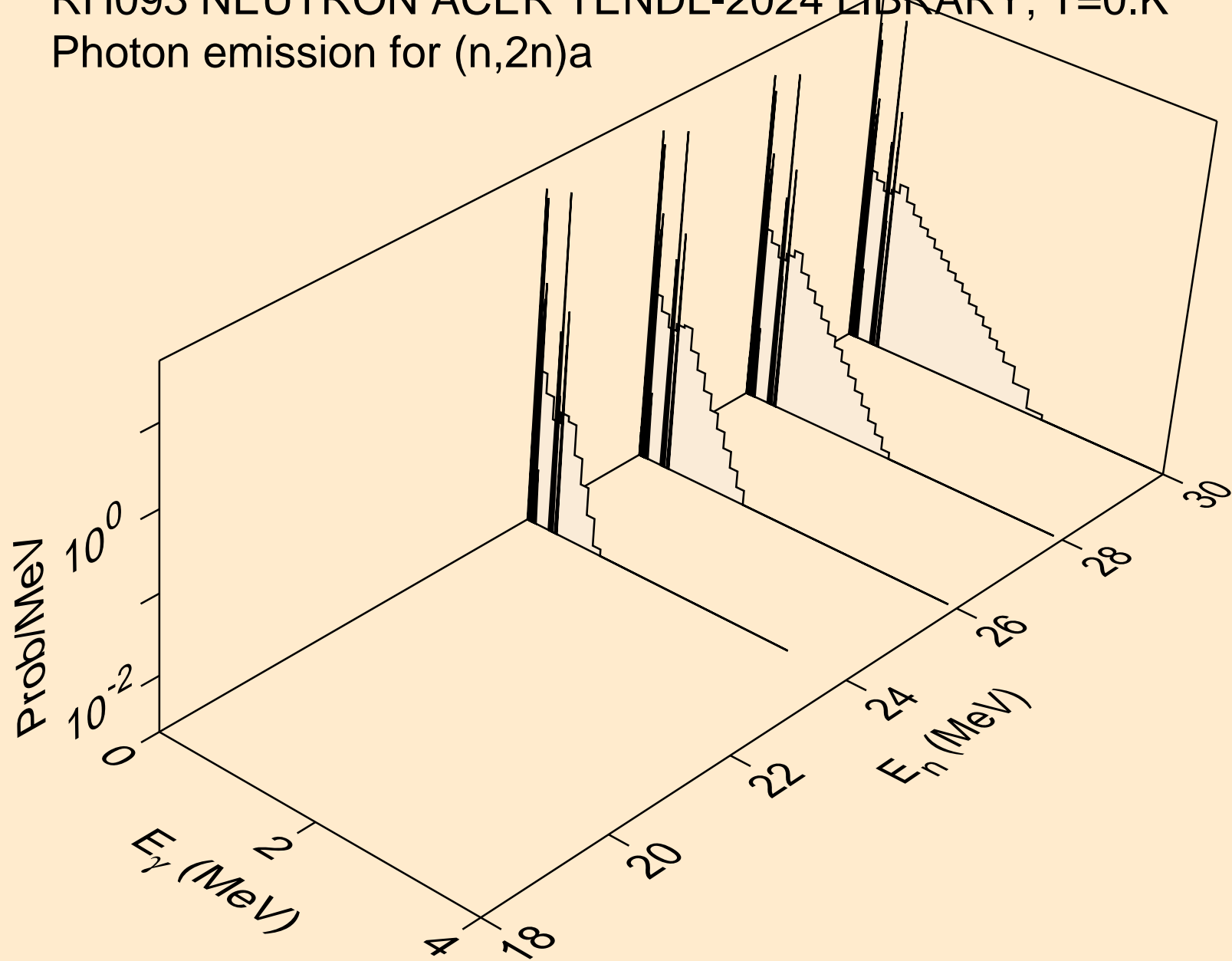

RH093 NEUTRON ACER TENDL-2024 LIBRARY; T=0.K
Photon emission for (n,n*)p

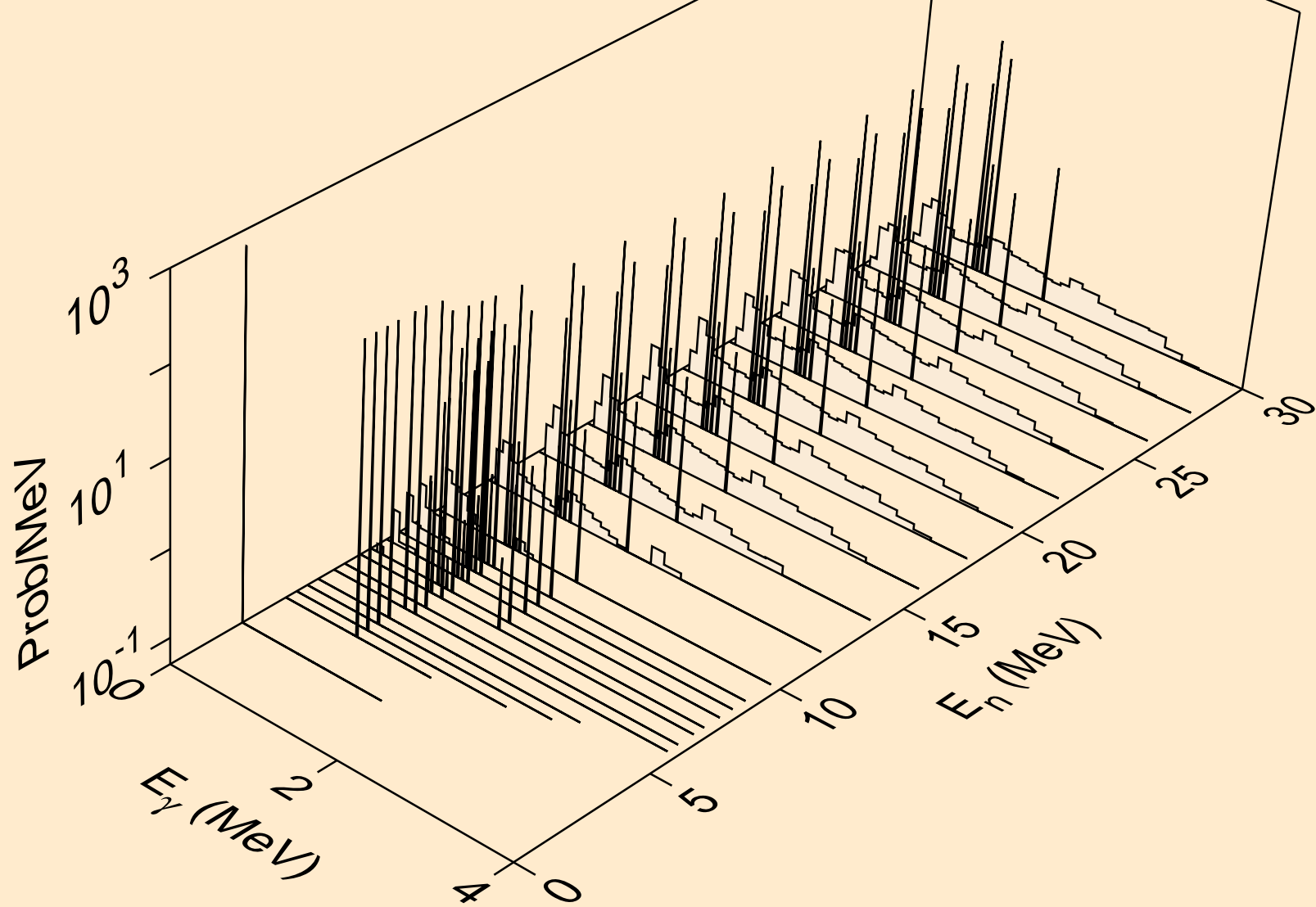

RH093 NEUTRON ACER TENDL-2024 LIBRARY; T=0.K
Photon emission for (n,n*)2a

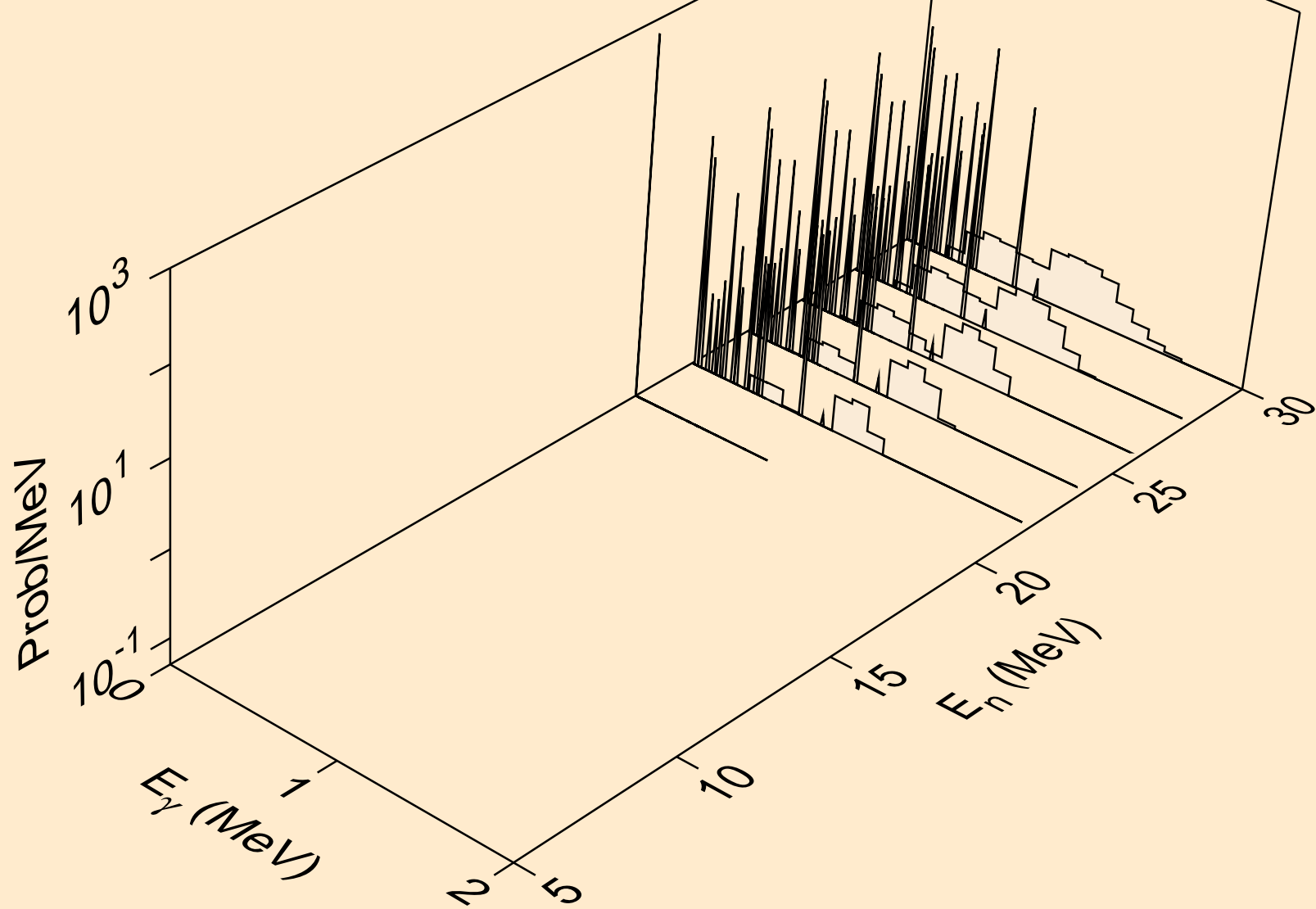

RH093 NEUTRON ACER TENDL-2024 LIBRARY; T=0.K
Photon emission for (n,n*)d

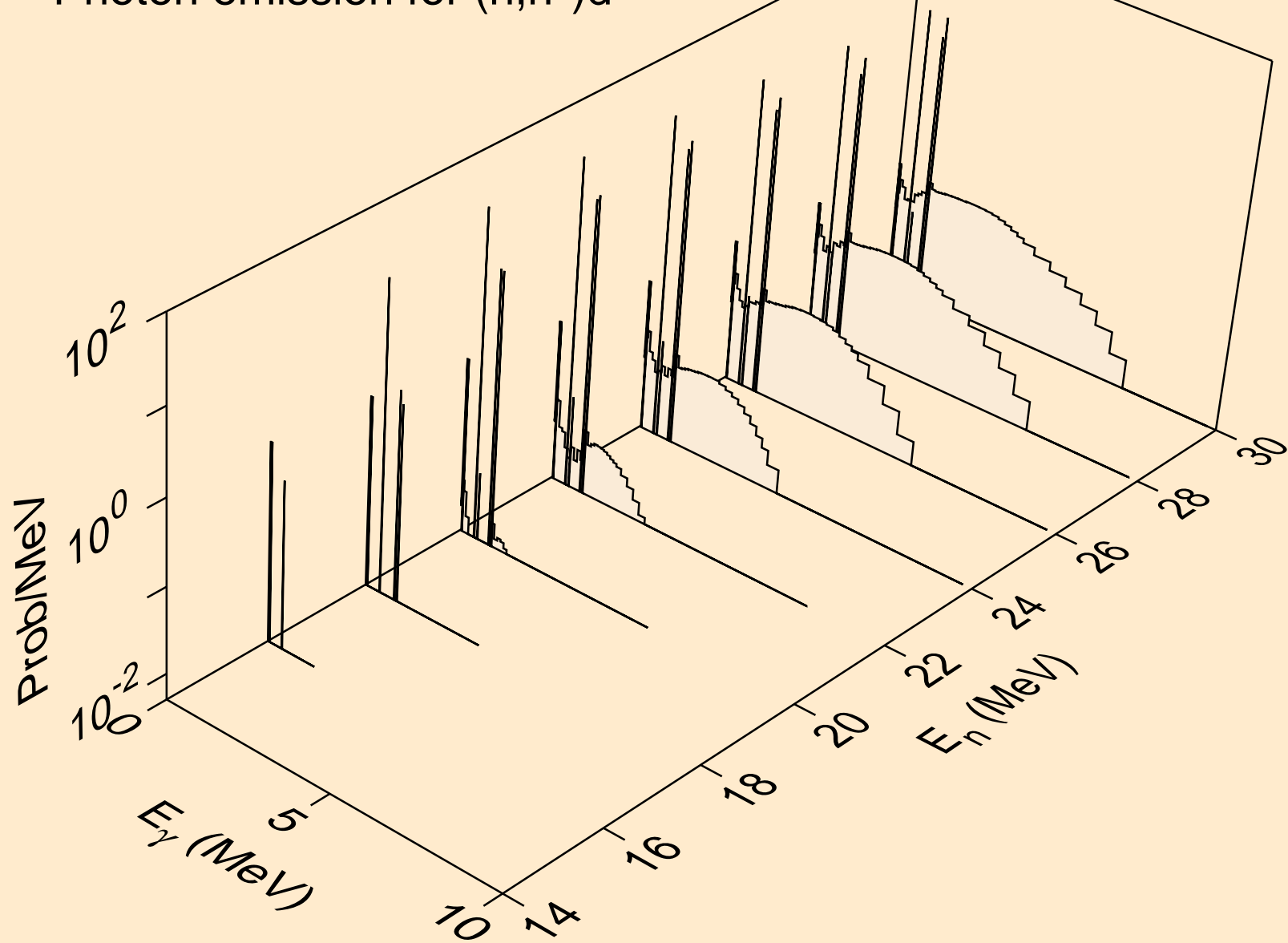

RH093 NEUTRON ACER TENDL-2024 LIBRARY; T=0.K
Photon emission for (n,n*)t

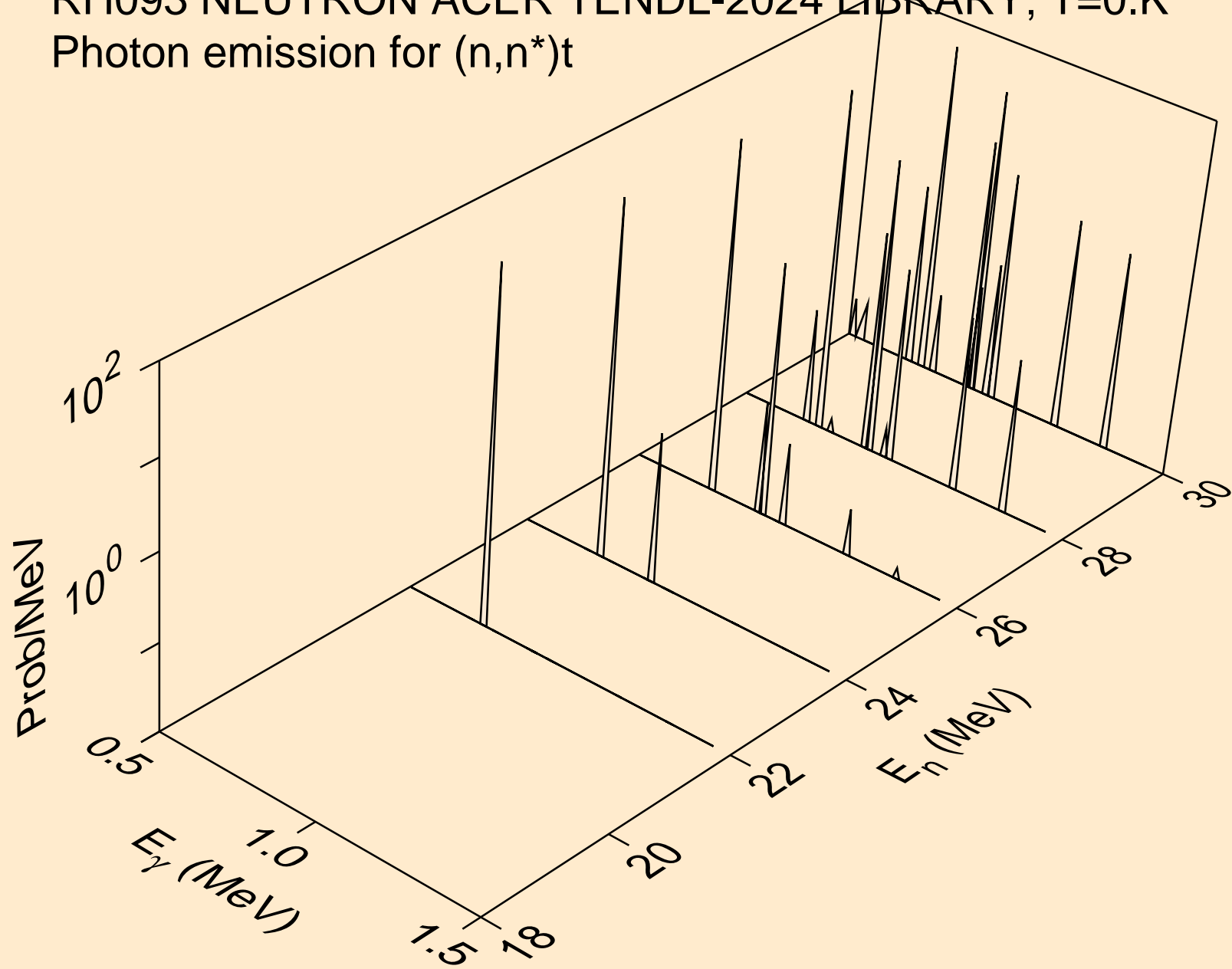

RH093 NEUTRON ACER TENDL-2024 LIBRARY; T=0.K
Photon emission for (n,n*)he3

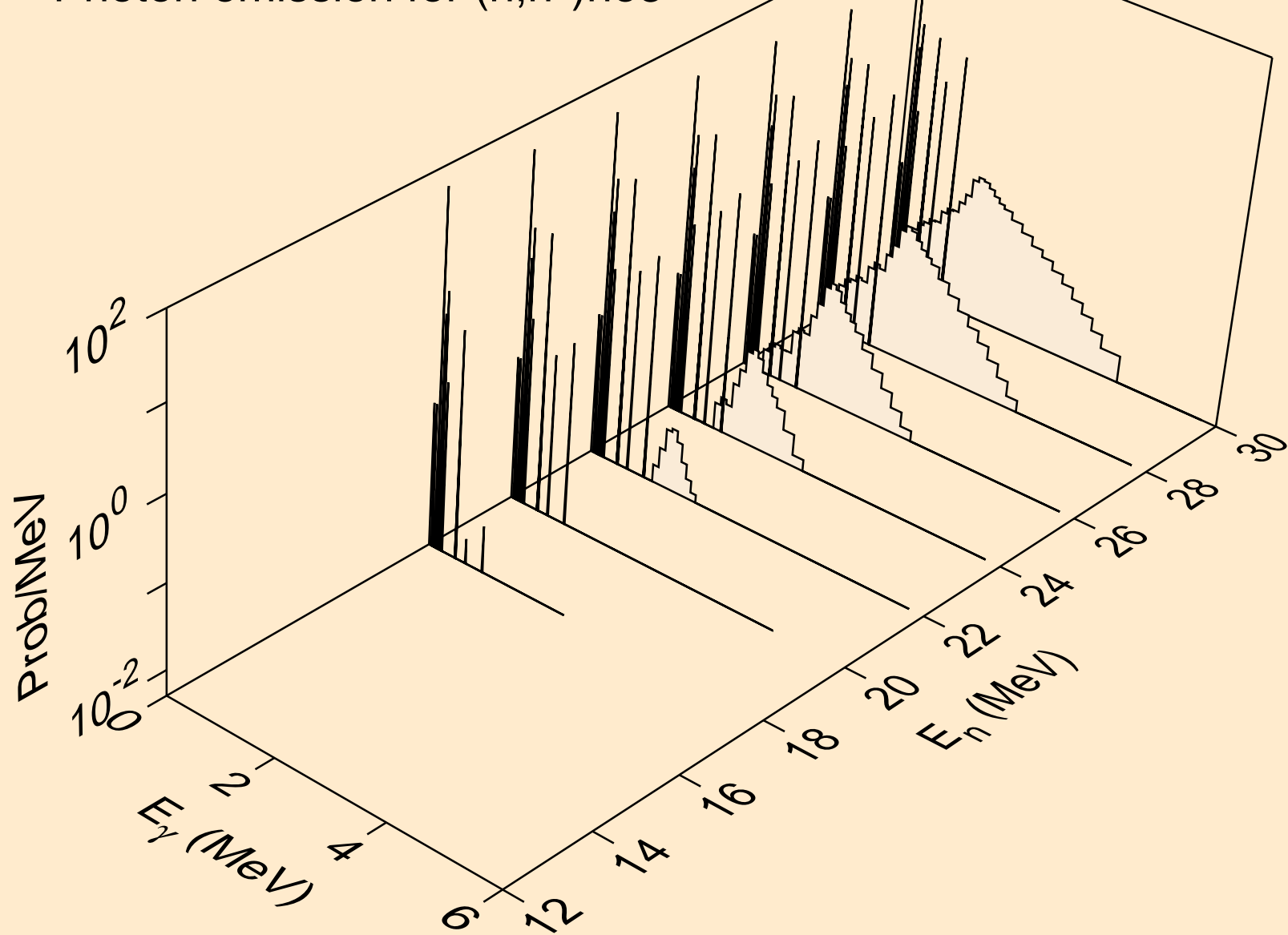

RH093 NEUTRON ACER TENDL-2024 LIBRARY; T=0.K
Photon emission for (n,2np)

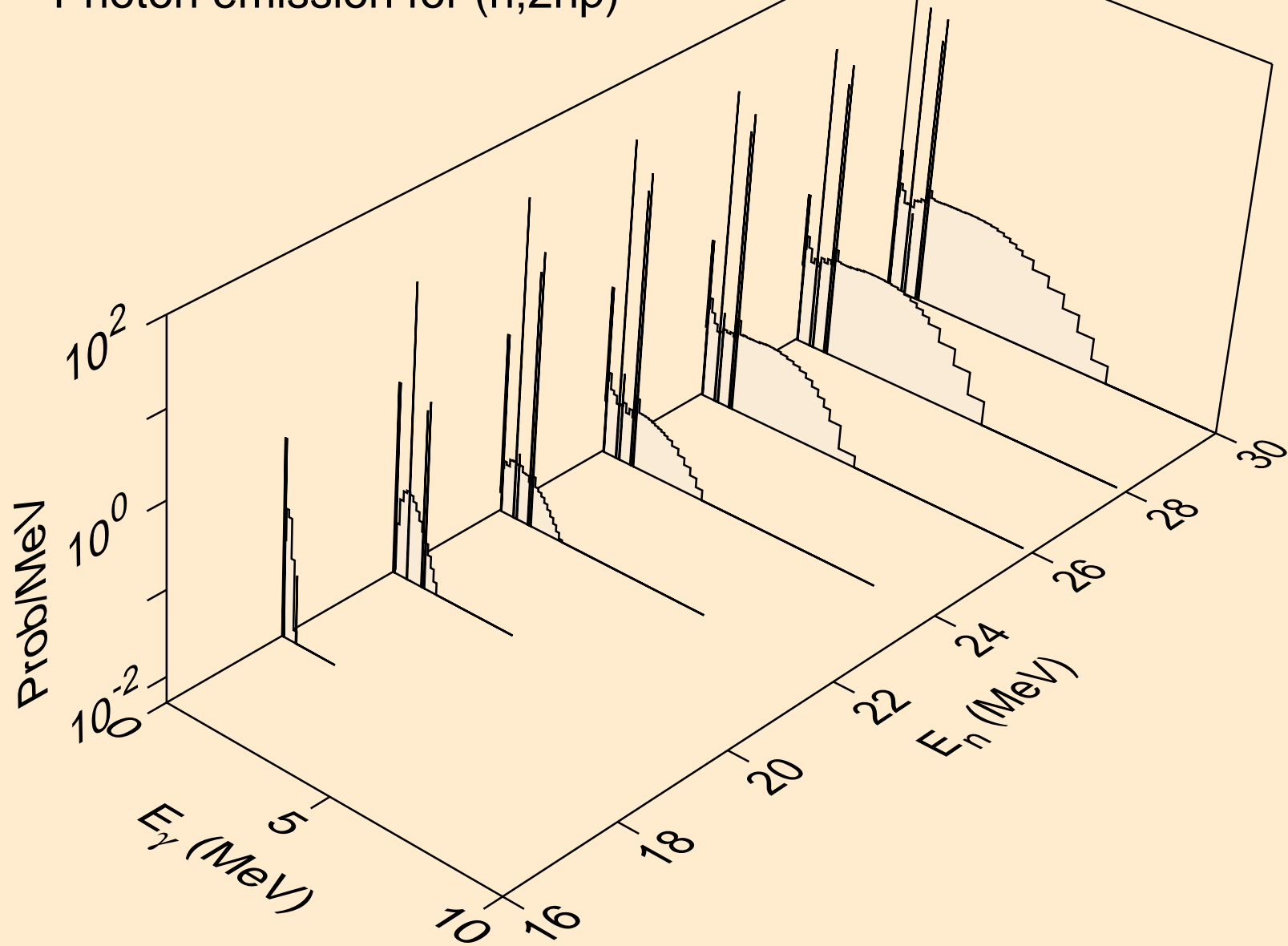

RH093 NEUTRON ACER TENDL-2024 LIBRARY; T=0.K
Photon emission for (n,n2p)

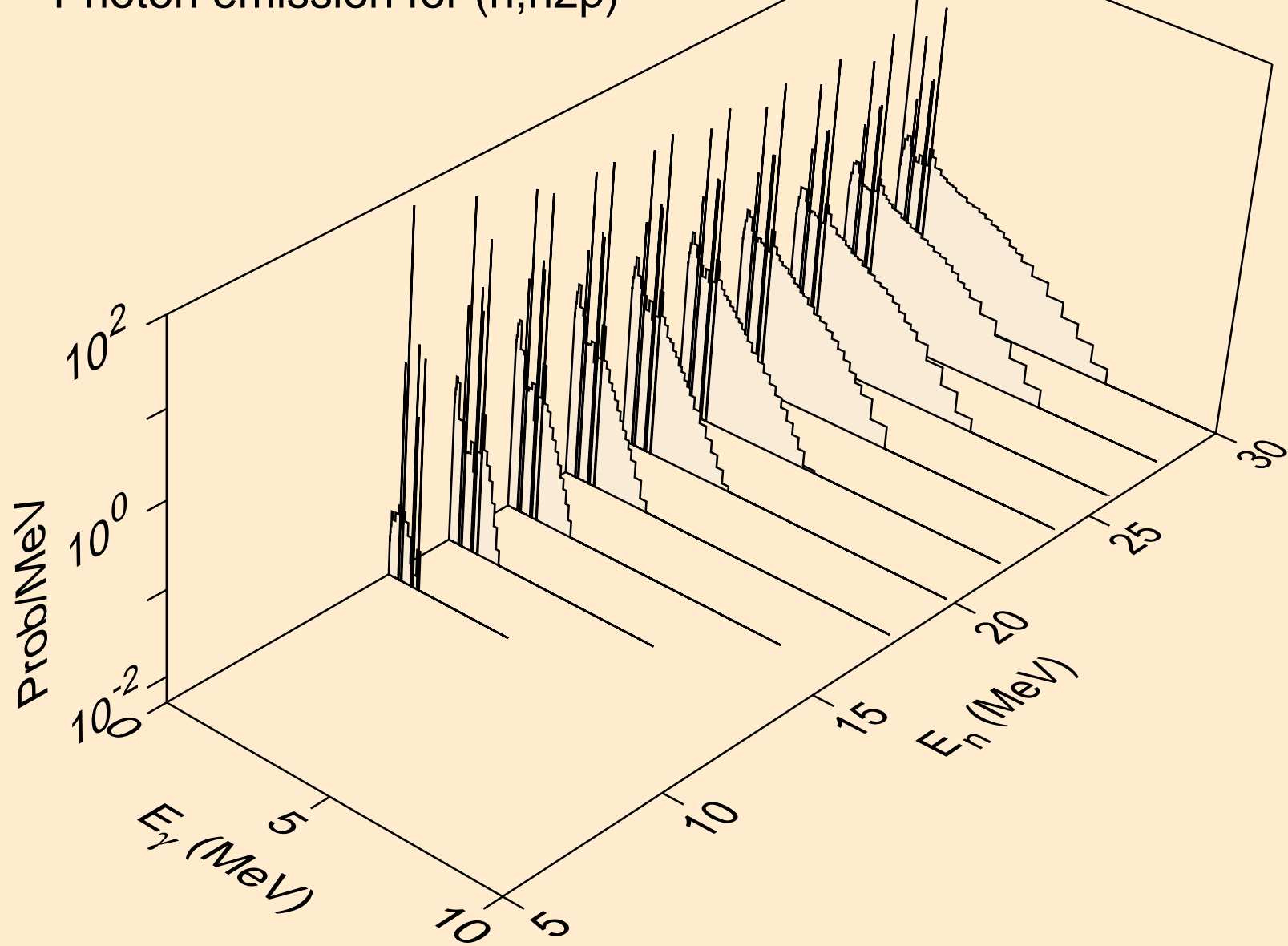

RH093 NEUTRON ACER TENDL-2024 LIBRARY; T=0.K
Photon emission for (n,npa)

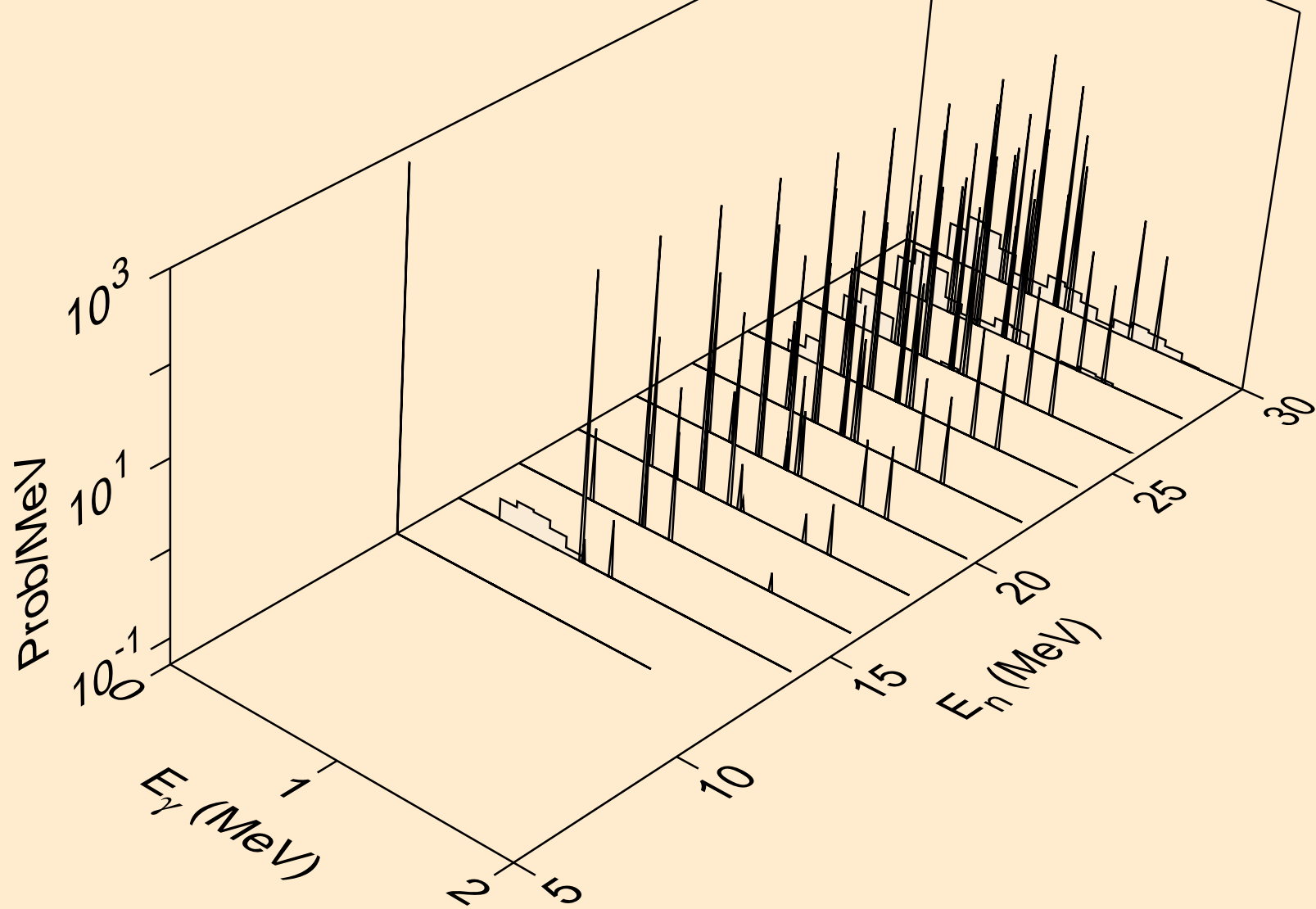

RH093 NEUTRON ACER TENDL-2024 LIBRARY; T=0.K
Photon emission for (n,n*c)

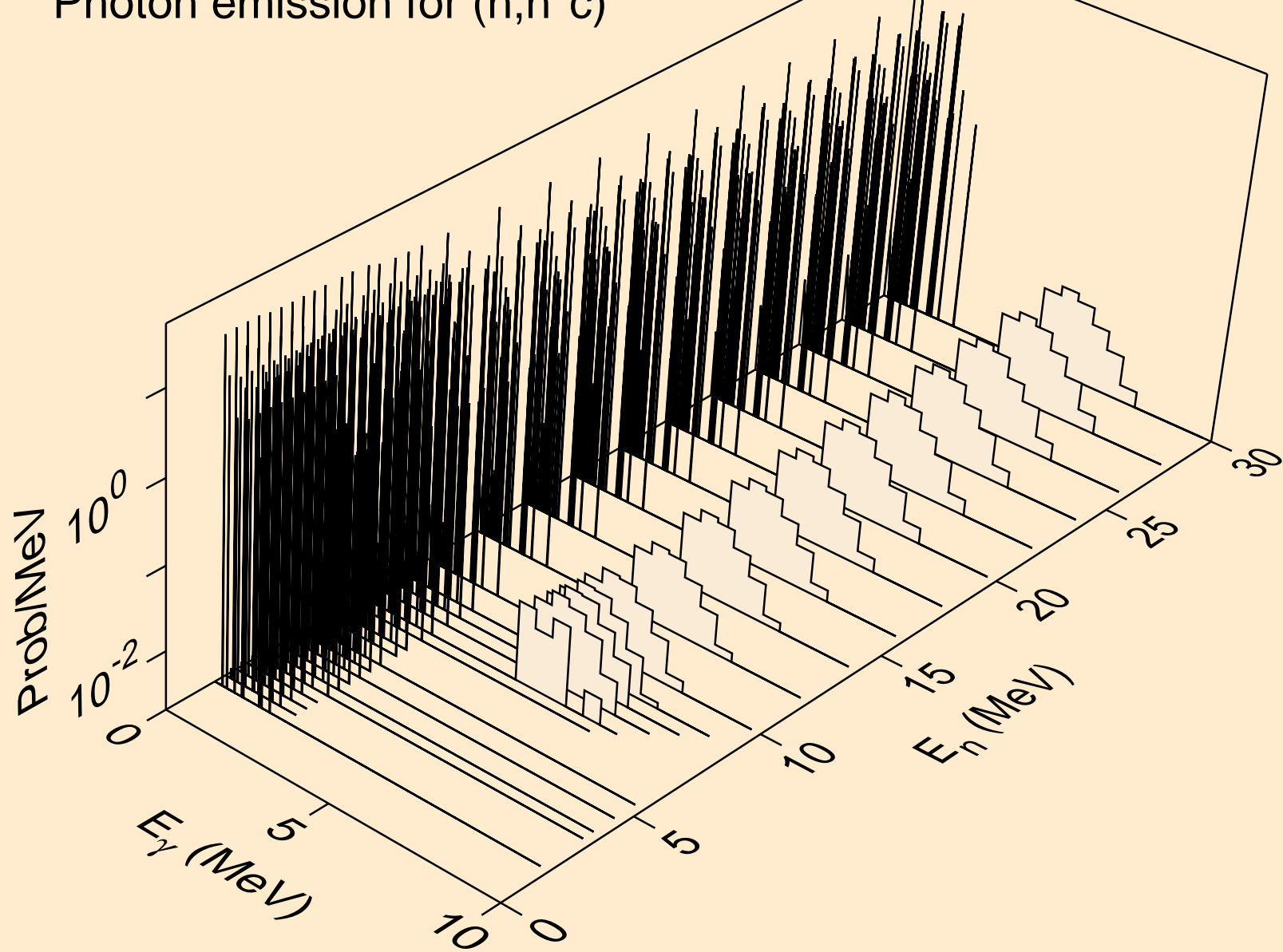

RH093 NEUTRON ACER TENDL-2024 LIBRARY; T=0.K
Photon emission for (n,gma)

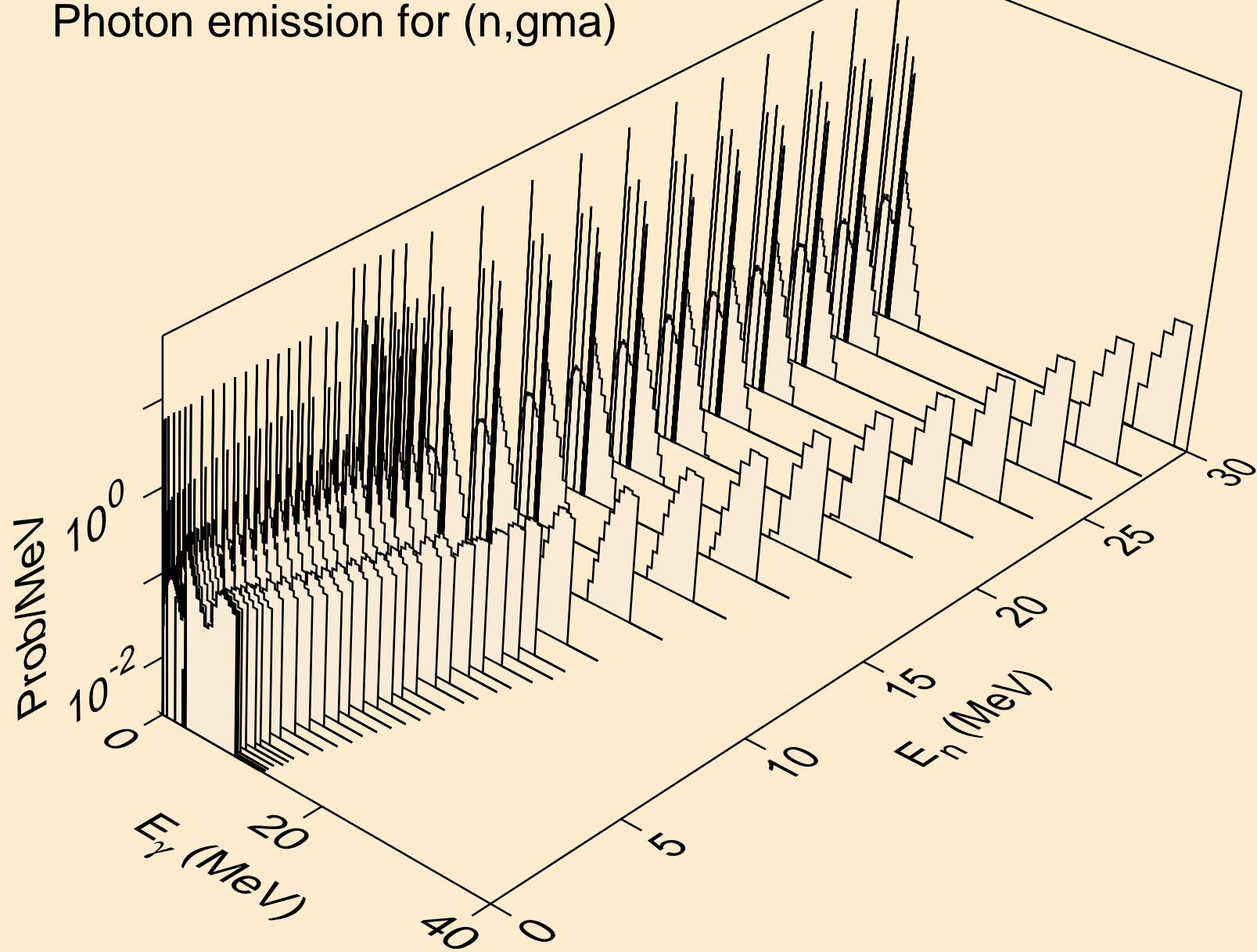

RH093 NEUTRON ACER TENDL-2024 LIBRARY; T=0.K
Photon emission for (n,p)

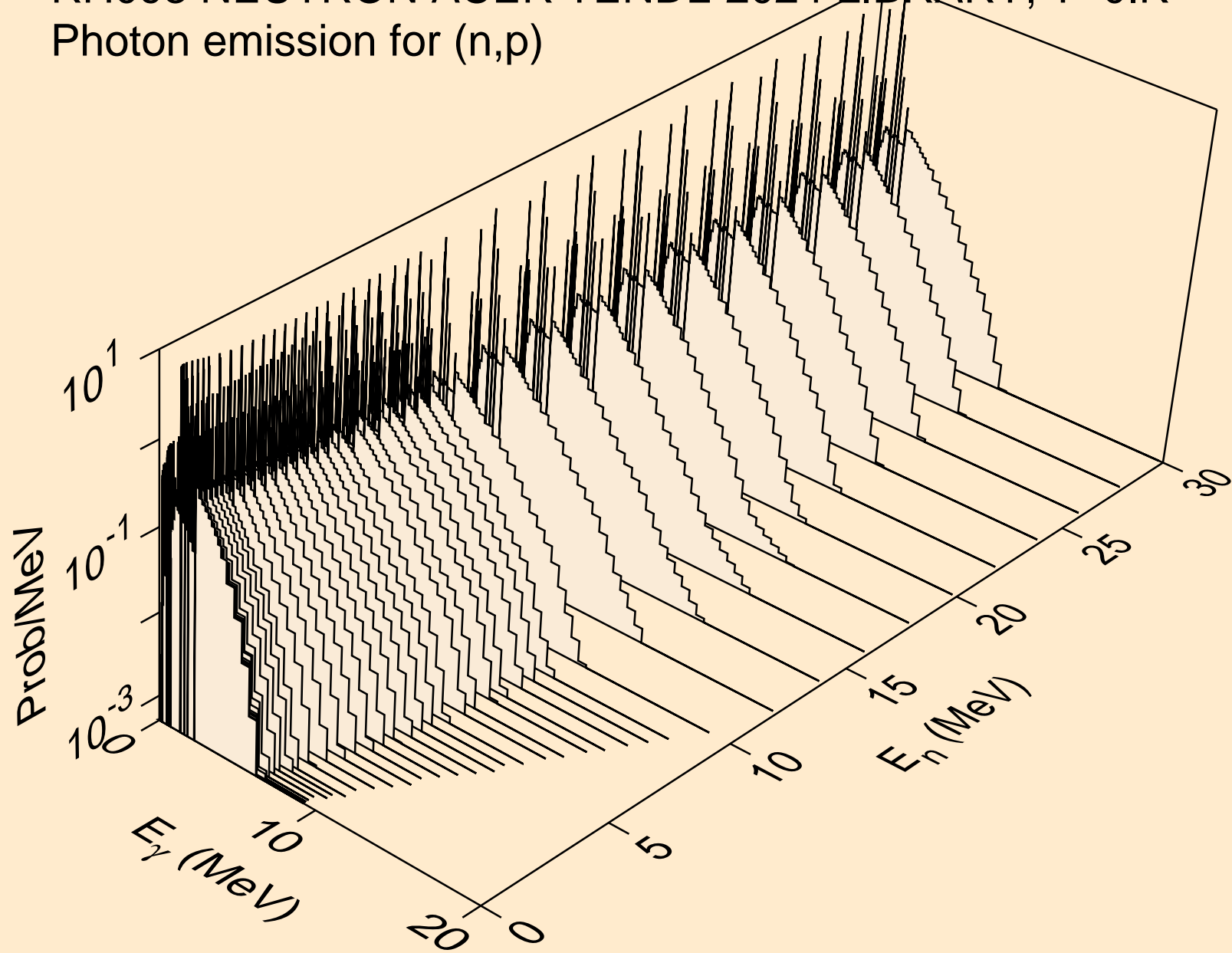

RH093 NEUTRON ACER TENDL-2024 LIBRARY; T=0.K
Photon emission for (n,d)

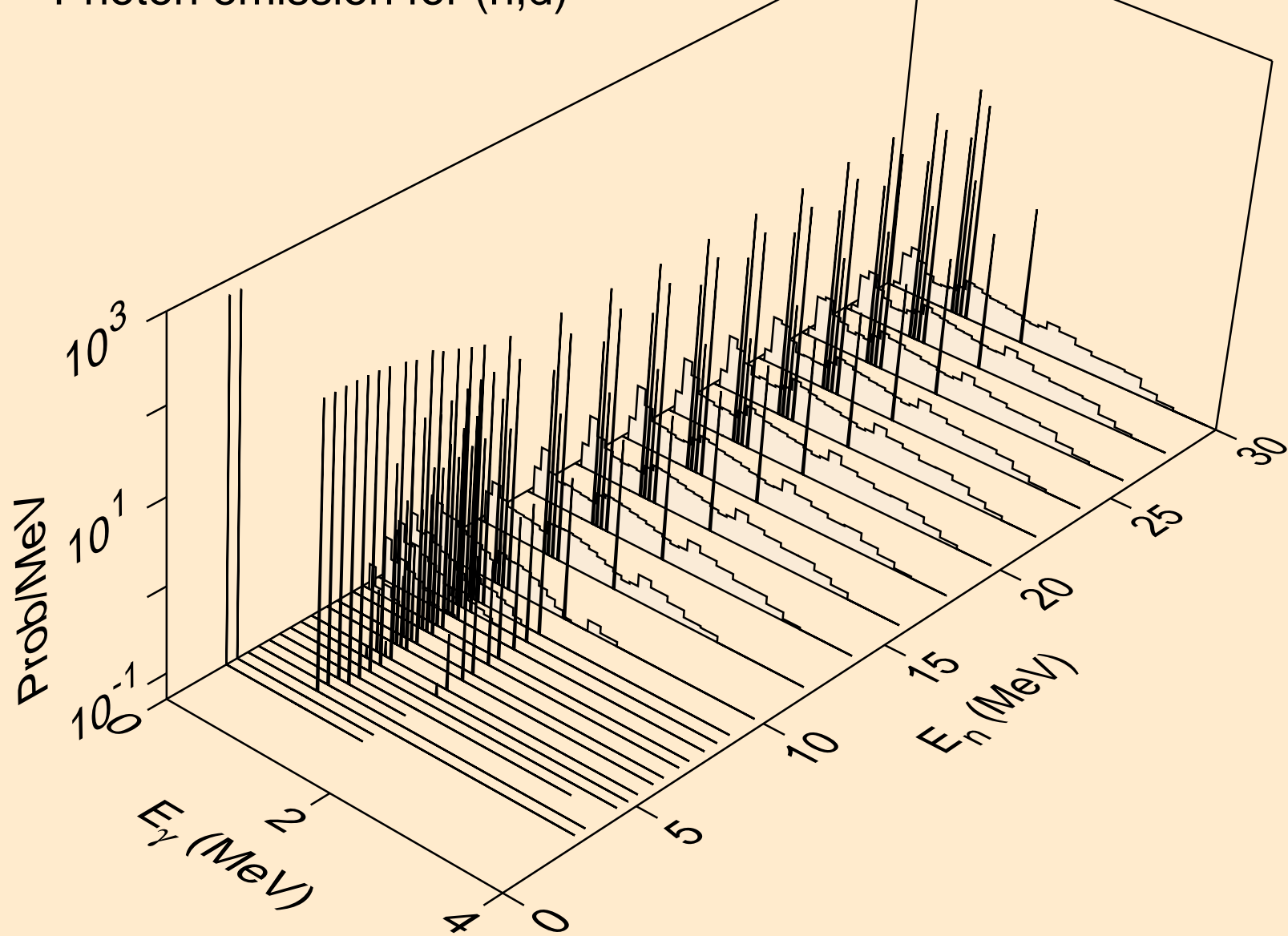

RH093 NEUTRON ACER TENDL-2024 LIBRARY; T=0.K
Photon emission for (n,t)

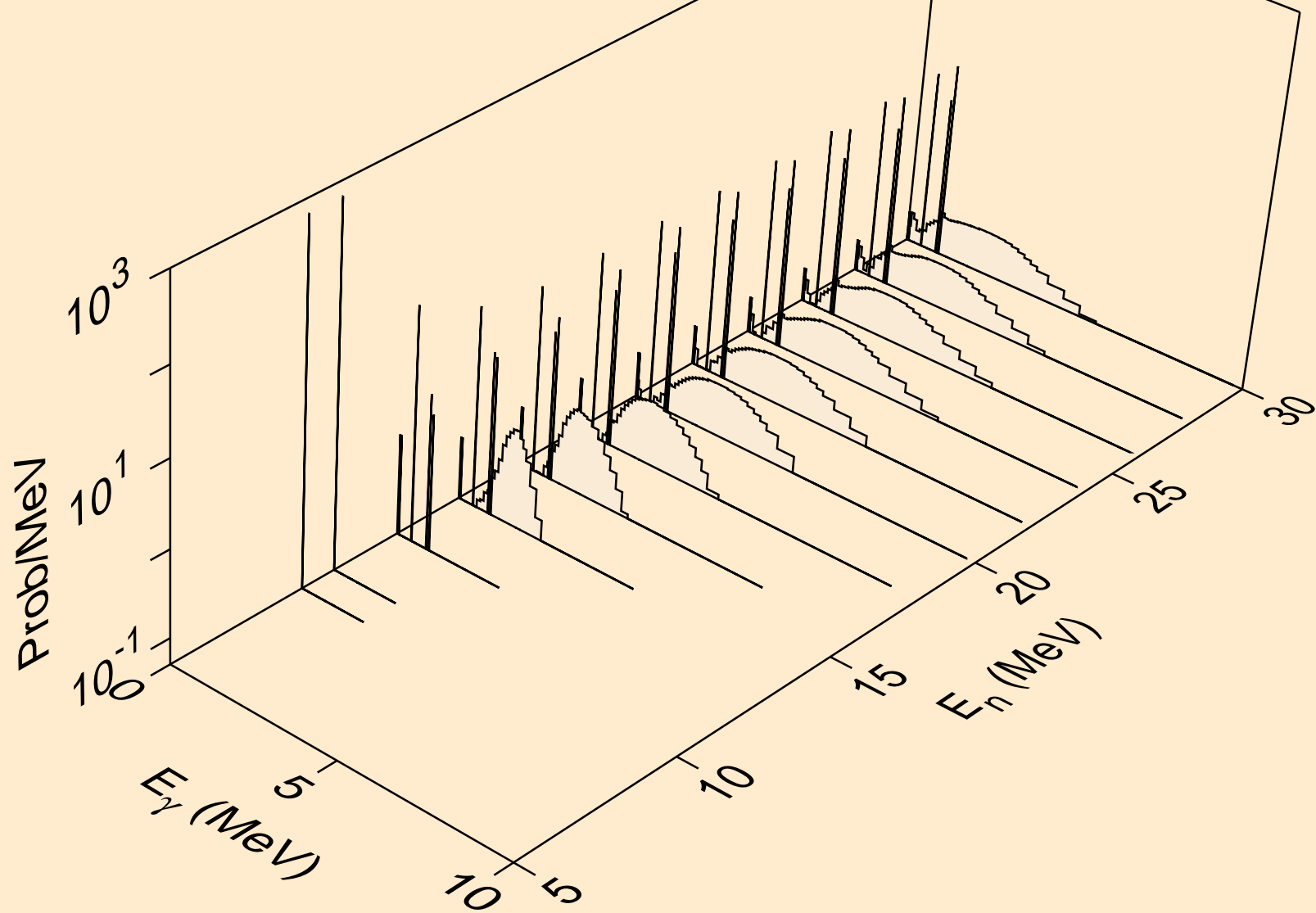

RH093 NEUTRON ACER TENDL-2024 LIBRARY; T=0.K
Photon emission for (n,he3)

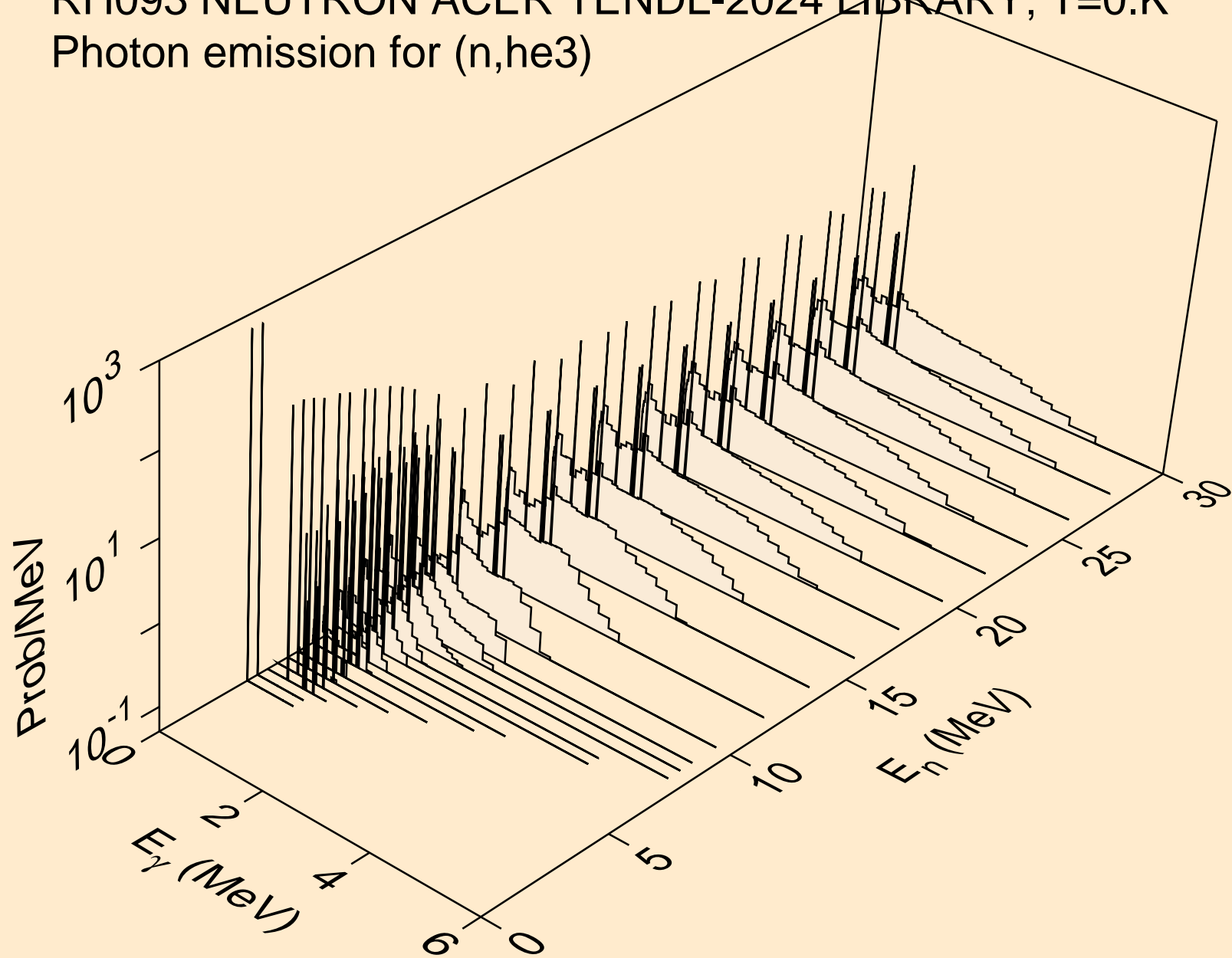

RH093 NEUTRON ACER TENDL-2024 LIBRARY; T=0.K
Photon emission for (n,a)

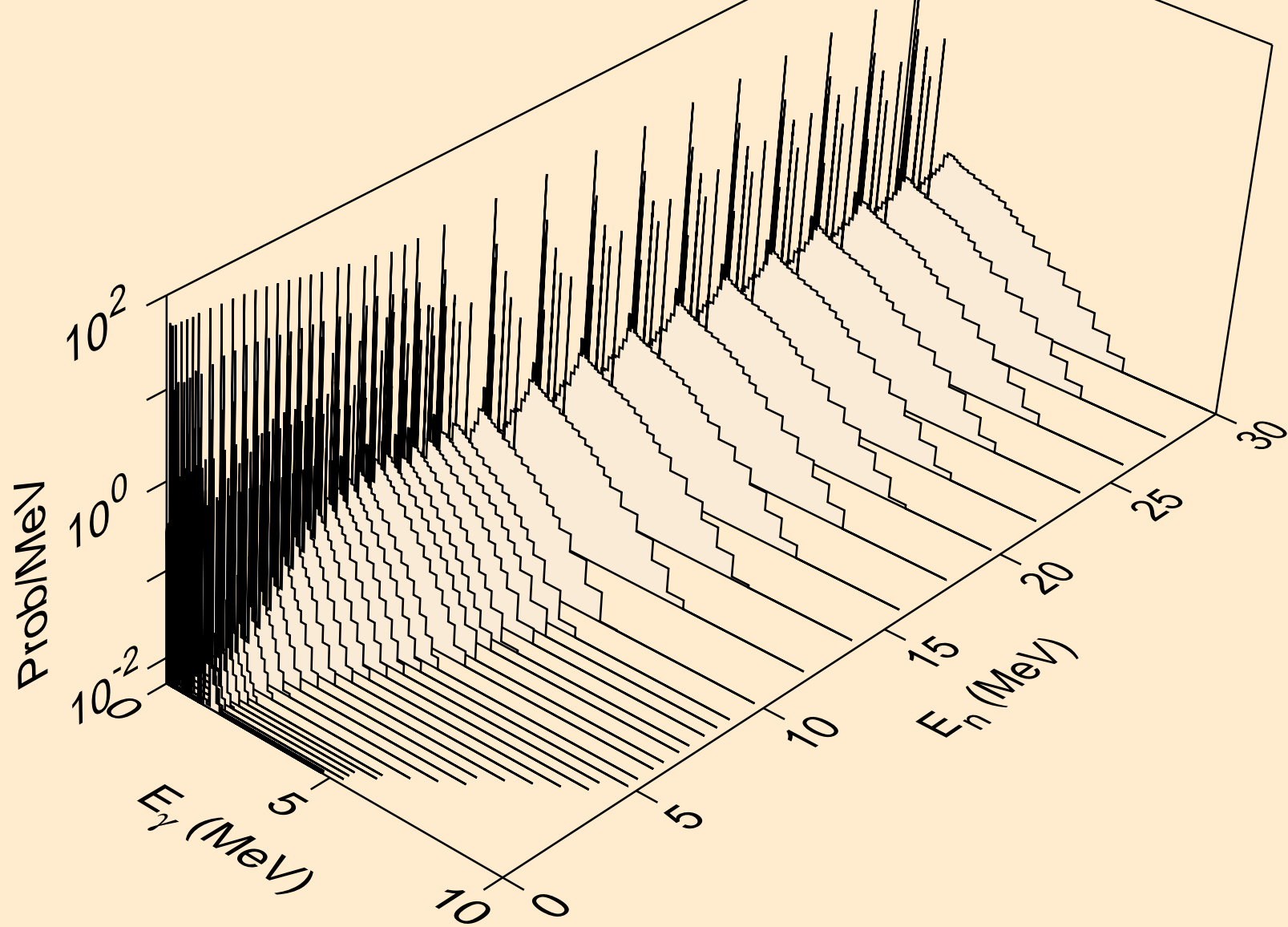

RH093 NEUTRON ACER TENDL-2024 LIBRARY; T=0.K
Photon emission for (n,2a)

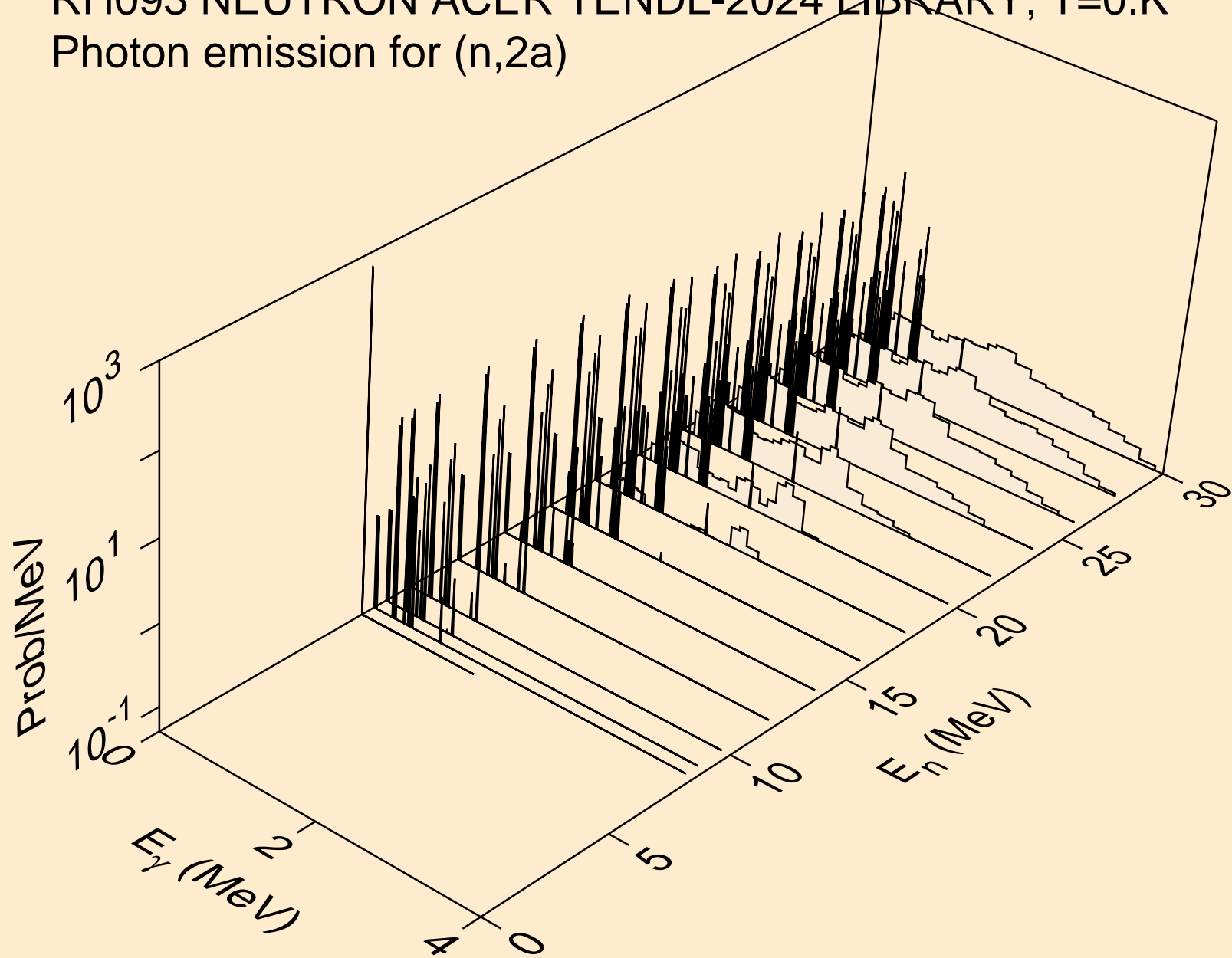

RH093 NEUTRON ACER TENDL-2024 LIBRARY; T=0.K
Photon emission for (n,2p)

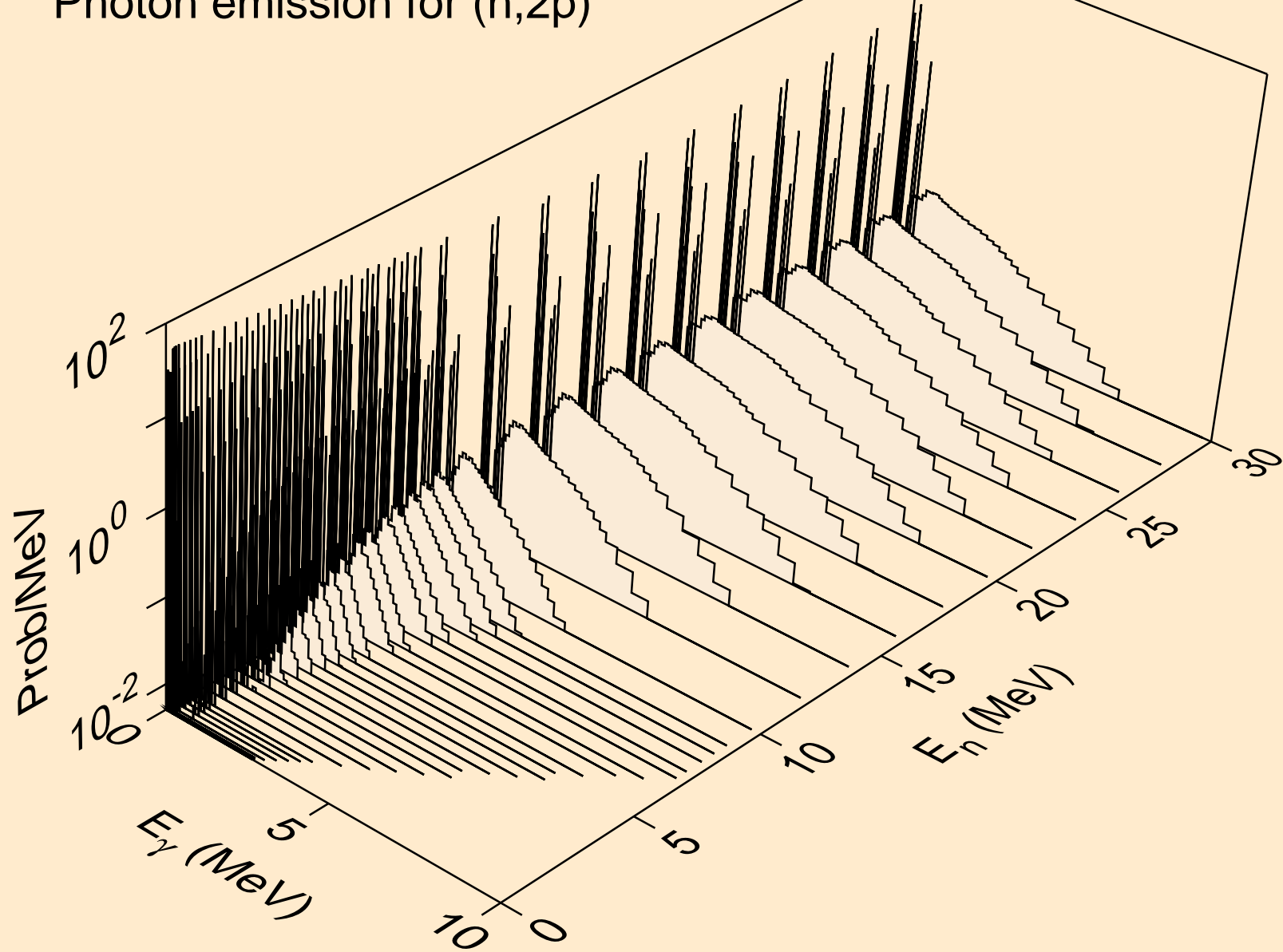

RH093 NEUTRON ACER TENDL-2024 LIBRARY; T=0.K
Photon emission for (n,p)

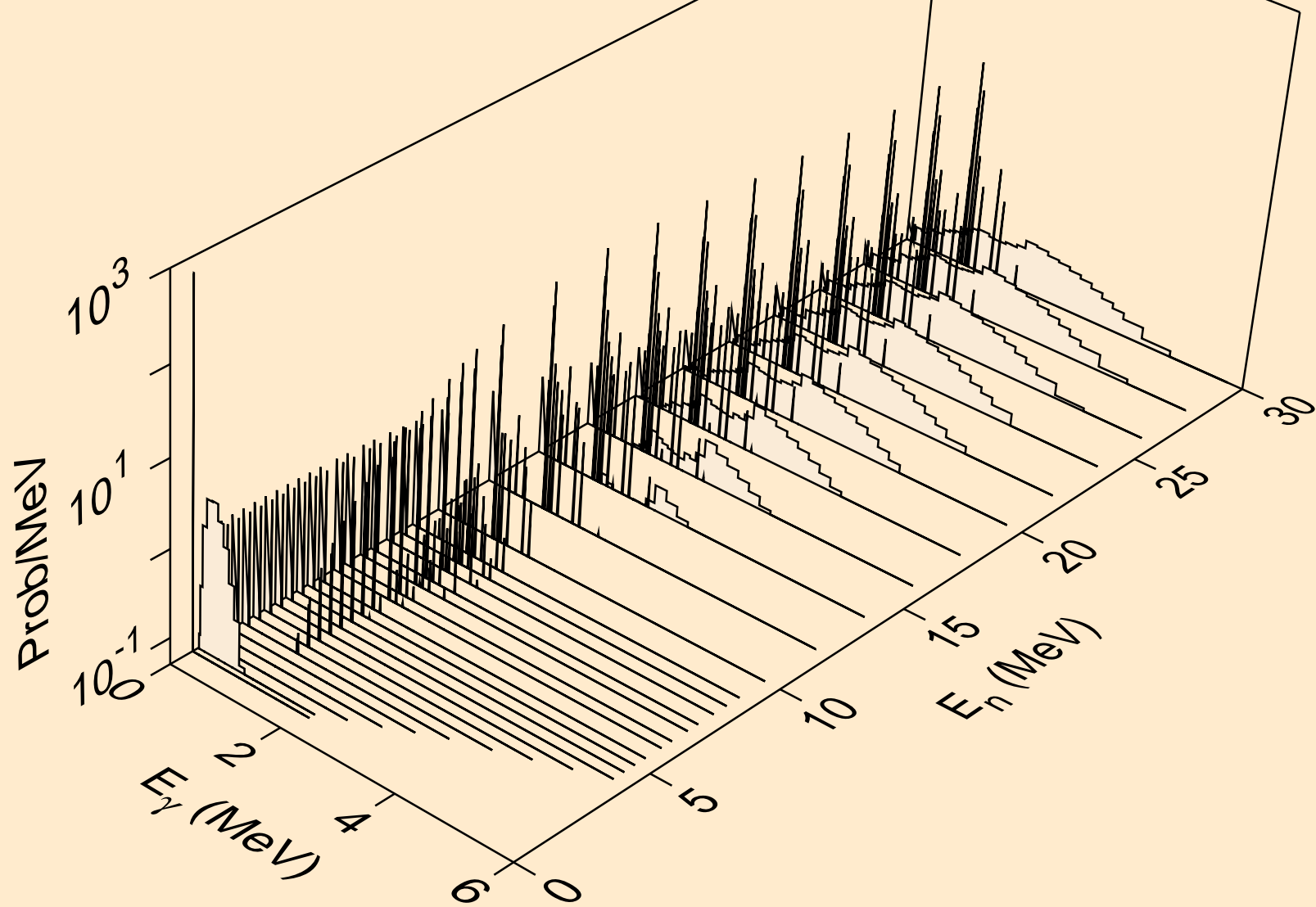

RH093 NEUTRON ACER TENDL-2024 LIBRARY; T=0.K
Photon emission for (n,pd)

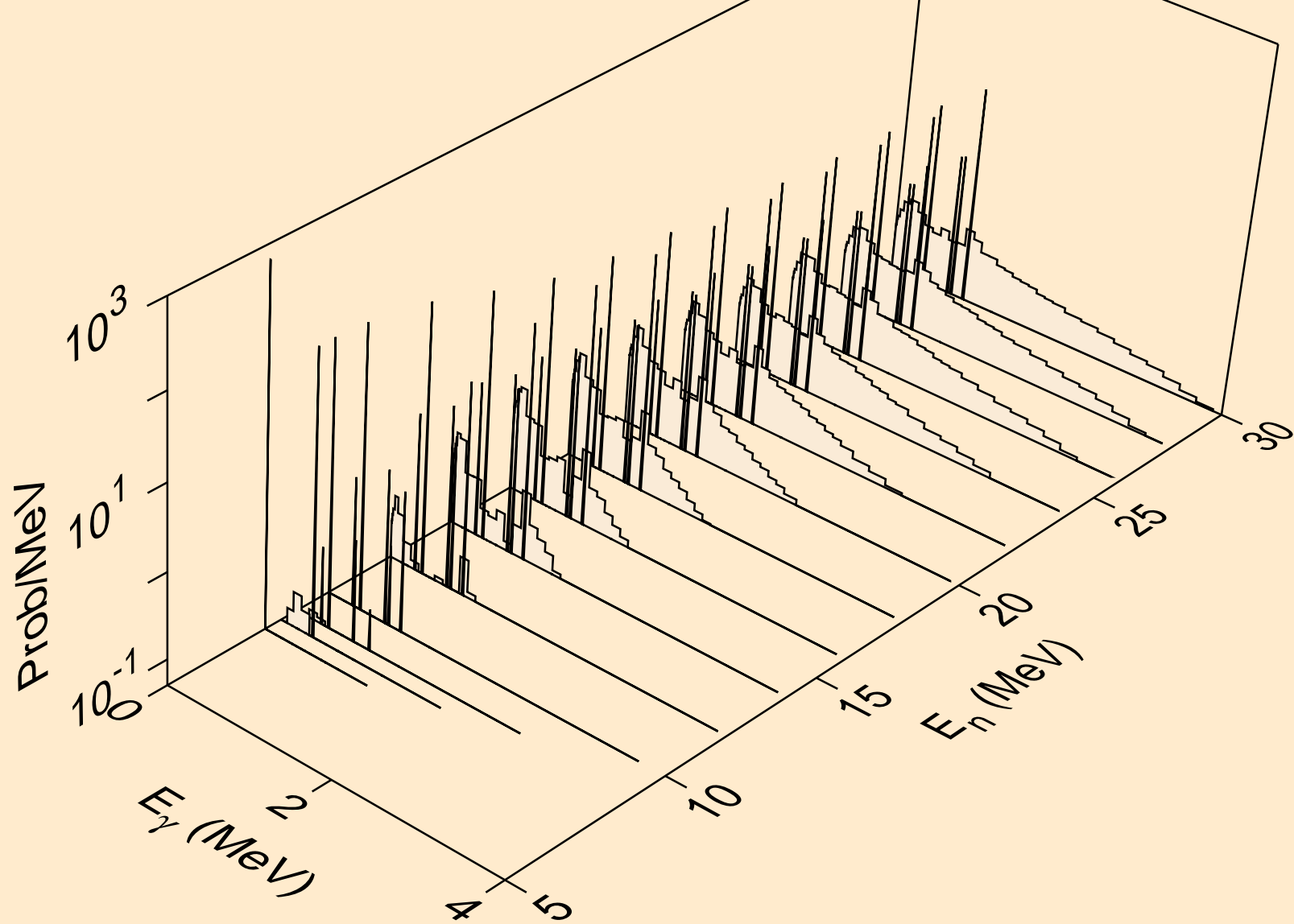

RH093 NEUTRON ACER TENDL-2024 LIBRARY; T=0.K
Photon emission for (n,pt)

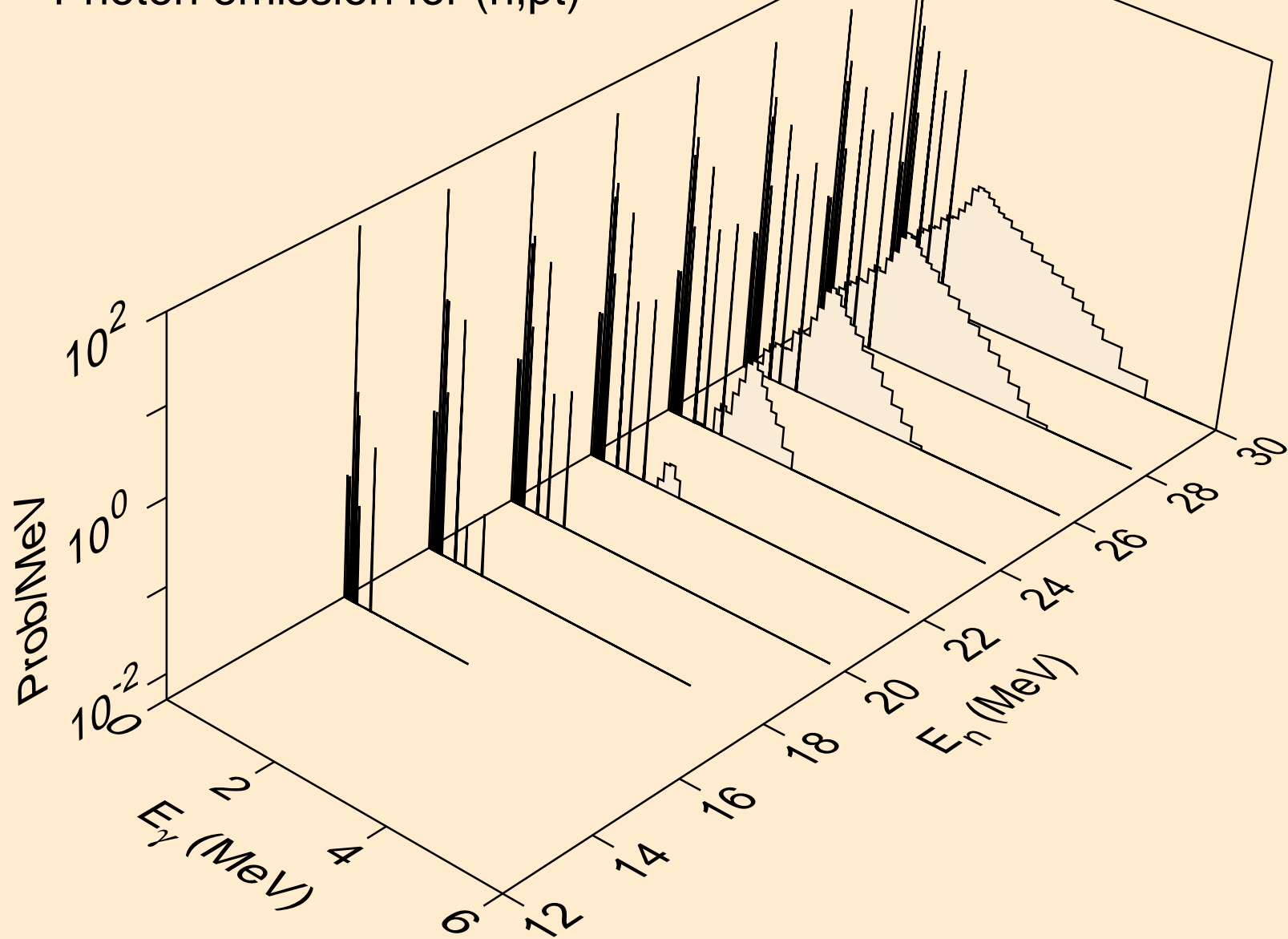

RH093 NEUTRON ACER TENDL-2024 LIBRARY; T=0.K
Photon emission for (n,da)

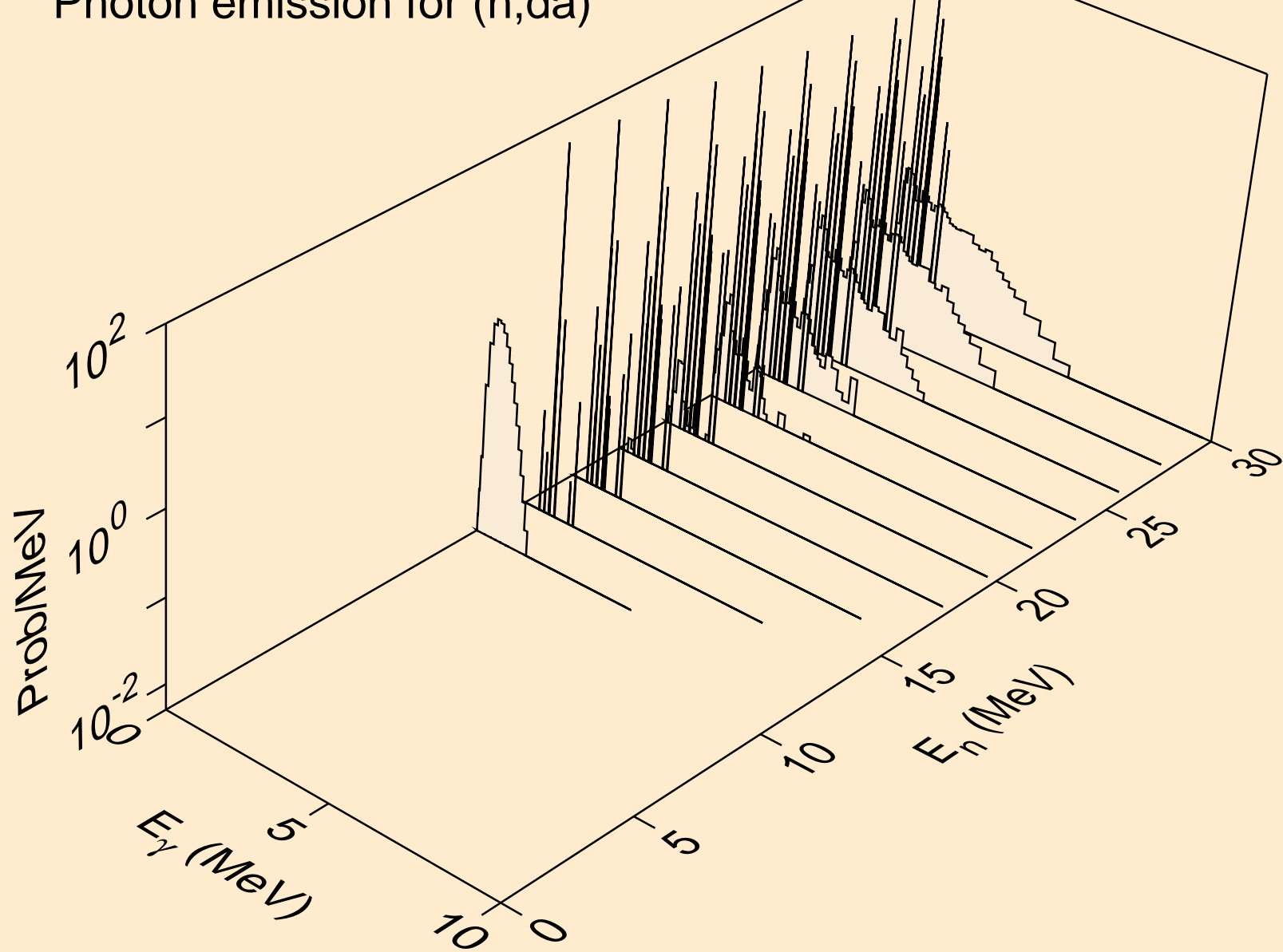

RH093 NEUTRON ACER TENDL-2024 LIBRARY; T=0.K
thermal capture photon spectrum

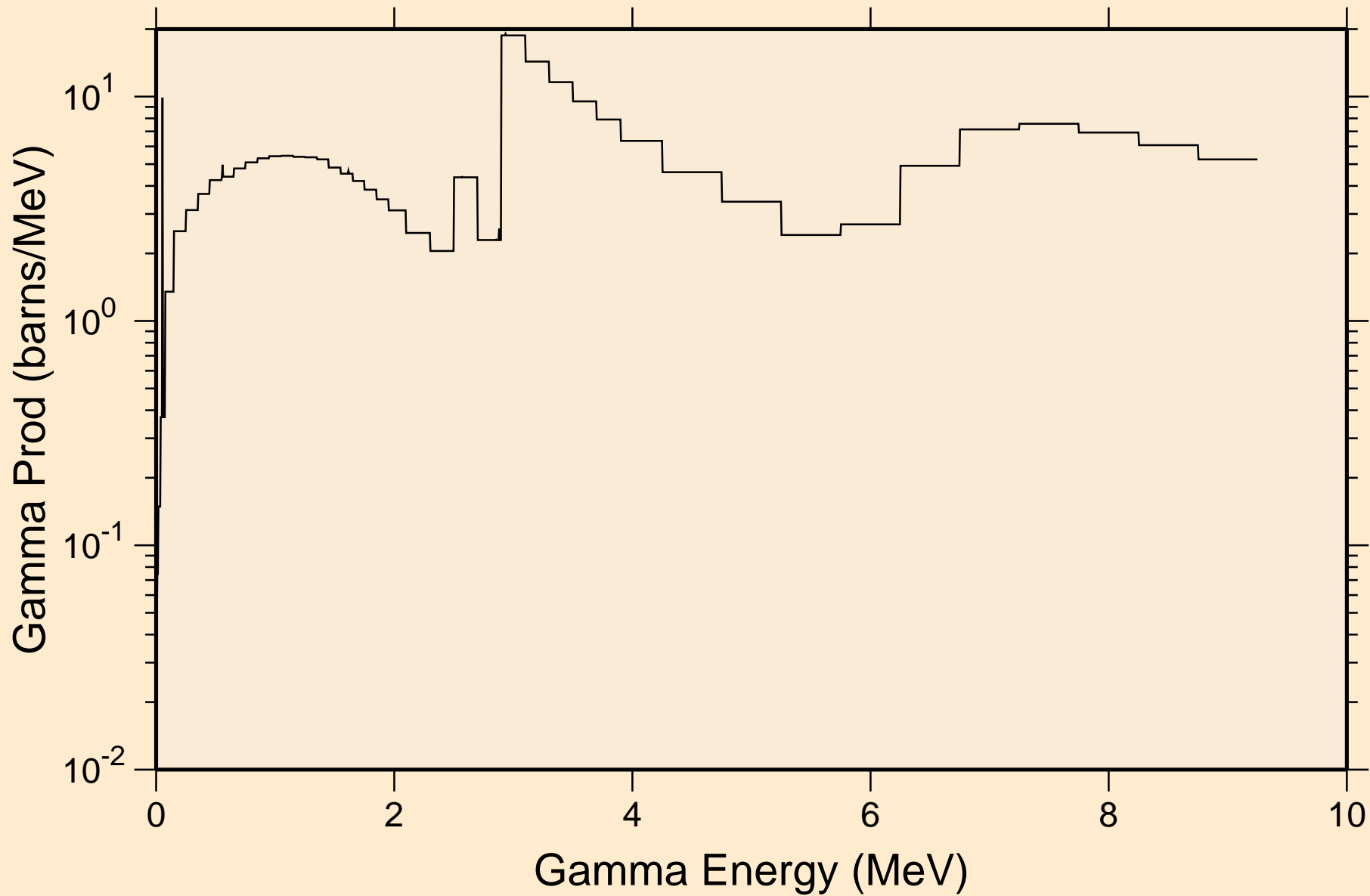

RH093 NEUTRON ACER TENDL-2024 LIBRARY; T=0.K
14 MeV photon spectrum

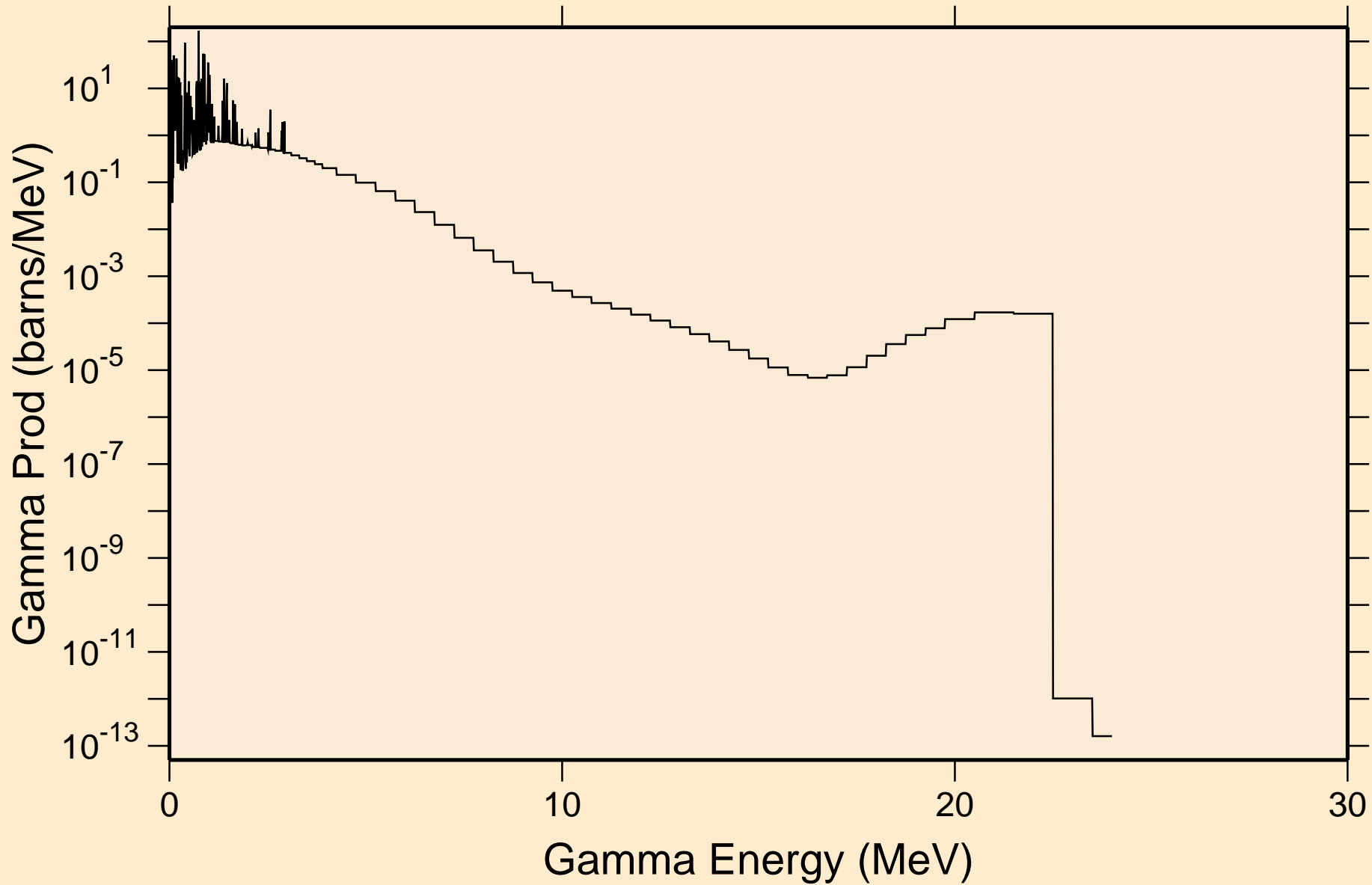

RH093 NEUTRON ACER TENDL-2024 LIBRARY; T=0.K

Particle heating contributions

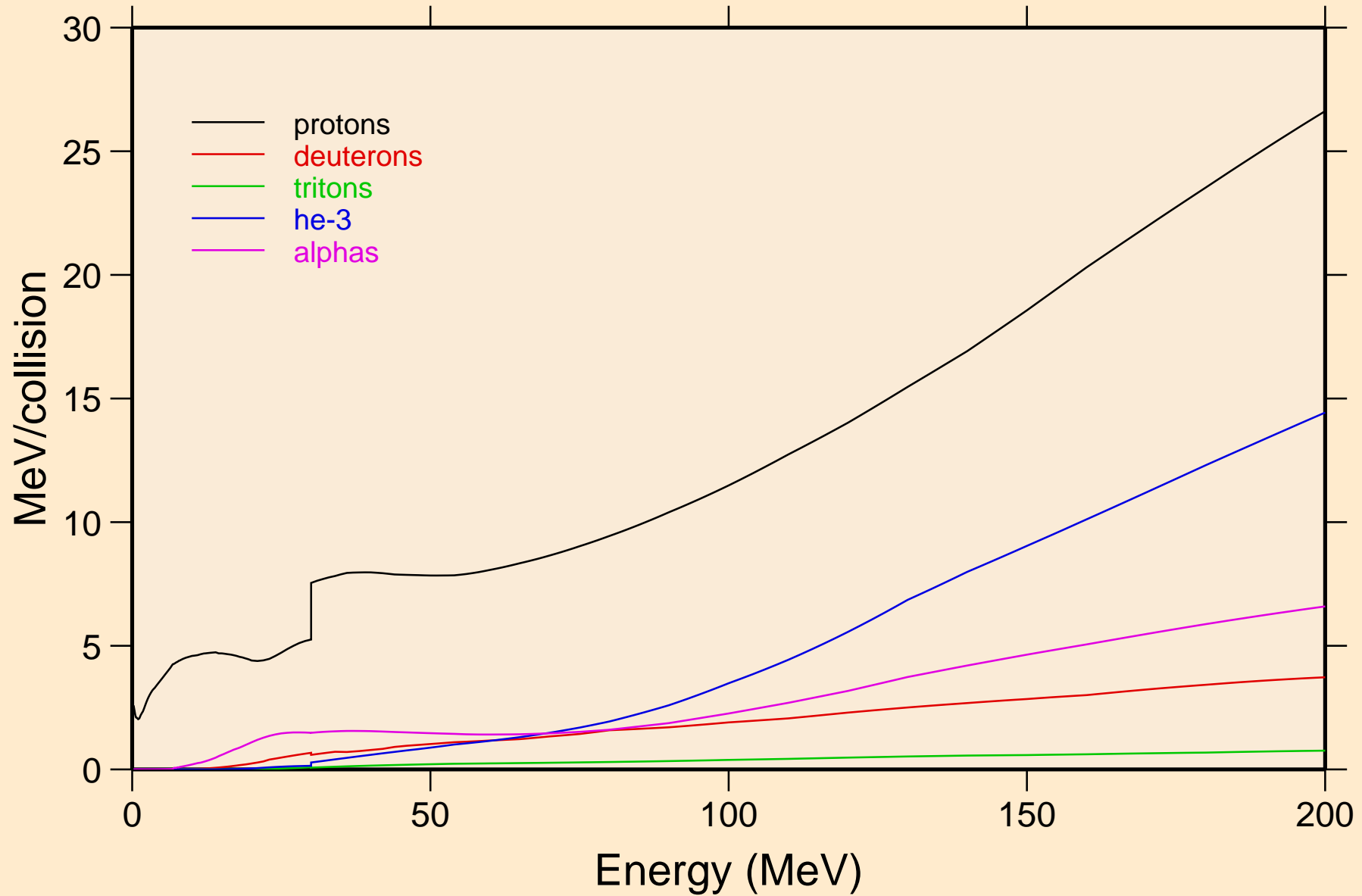

RH093 NEUTRON ACER TENDL-2024 LIBRARY; T=0.K
Recoil Heating

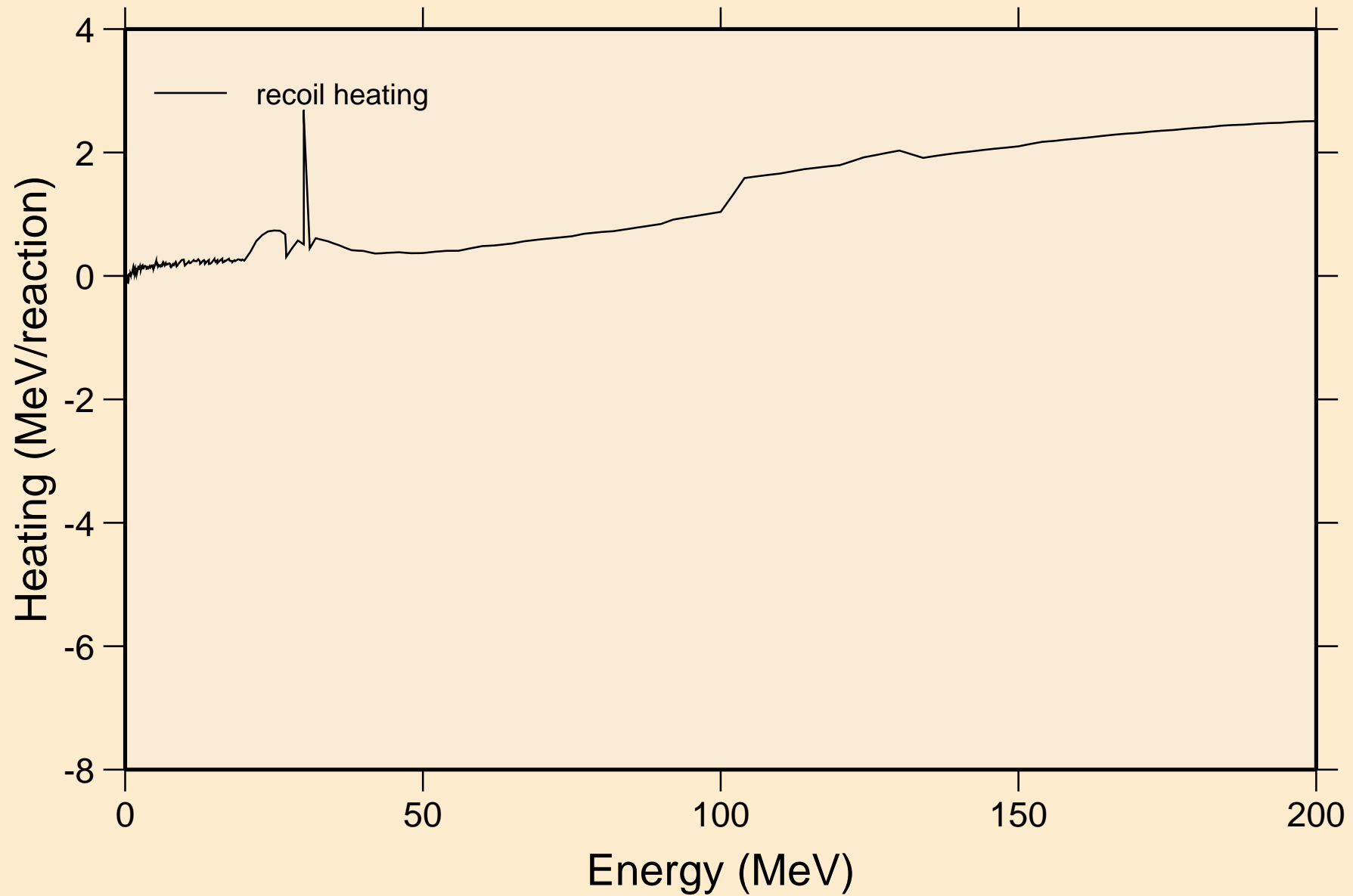

RH093 NEUTRON ACER TENDL-2024 LIBRARY; T=0.K
Particle production cross sections

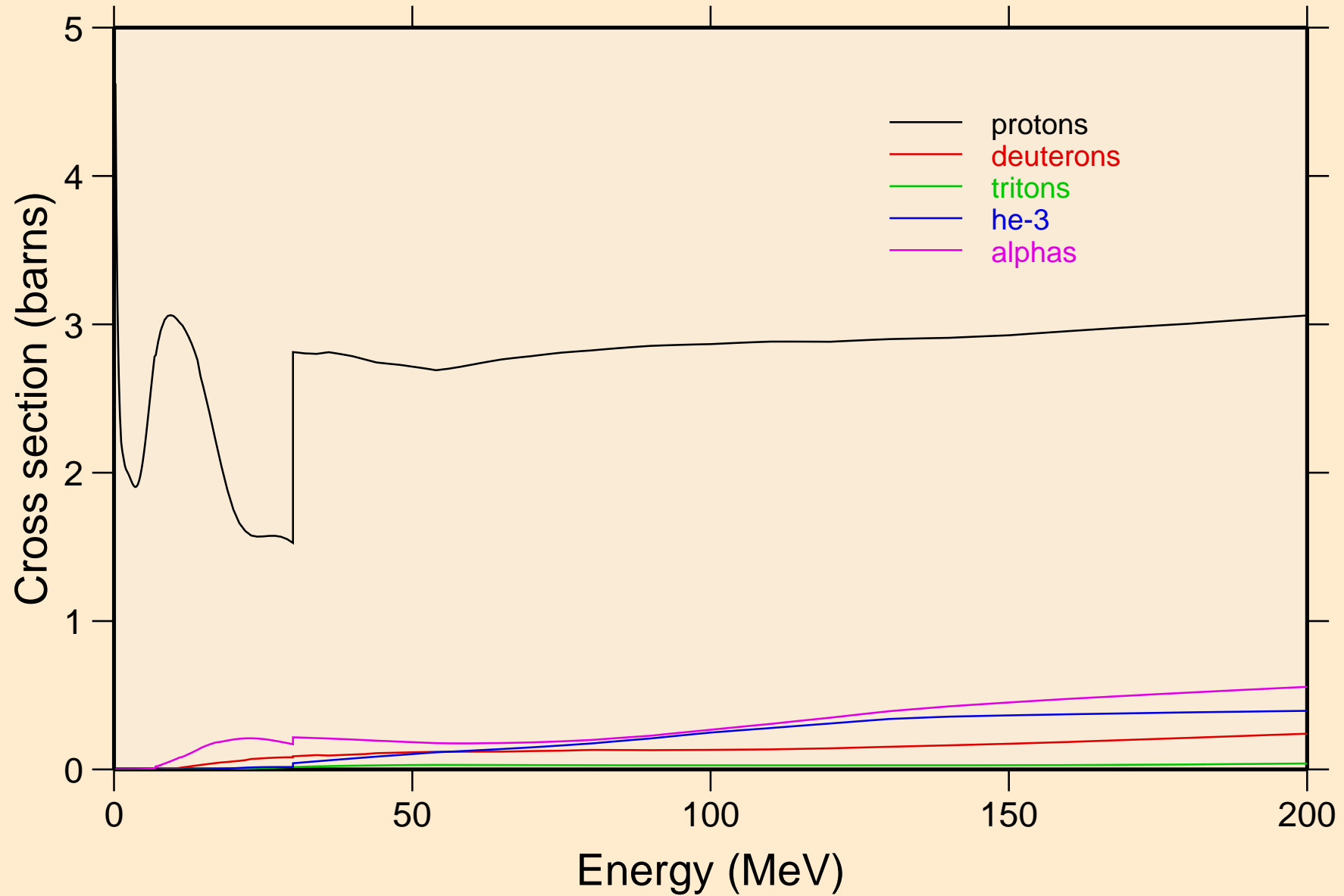

RH093 NEUTRON ACER TENDL-2024 LIBRARY; T=0.K
protons from (n,x)

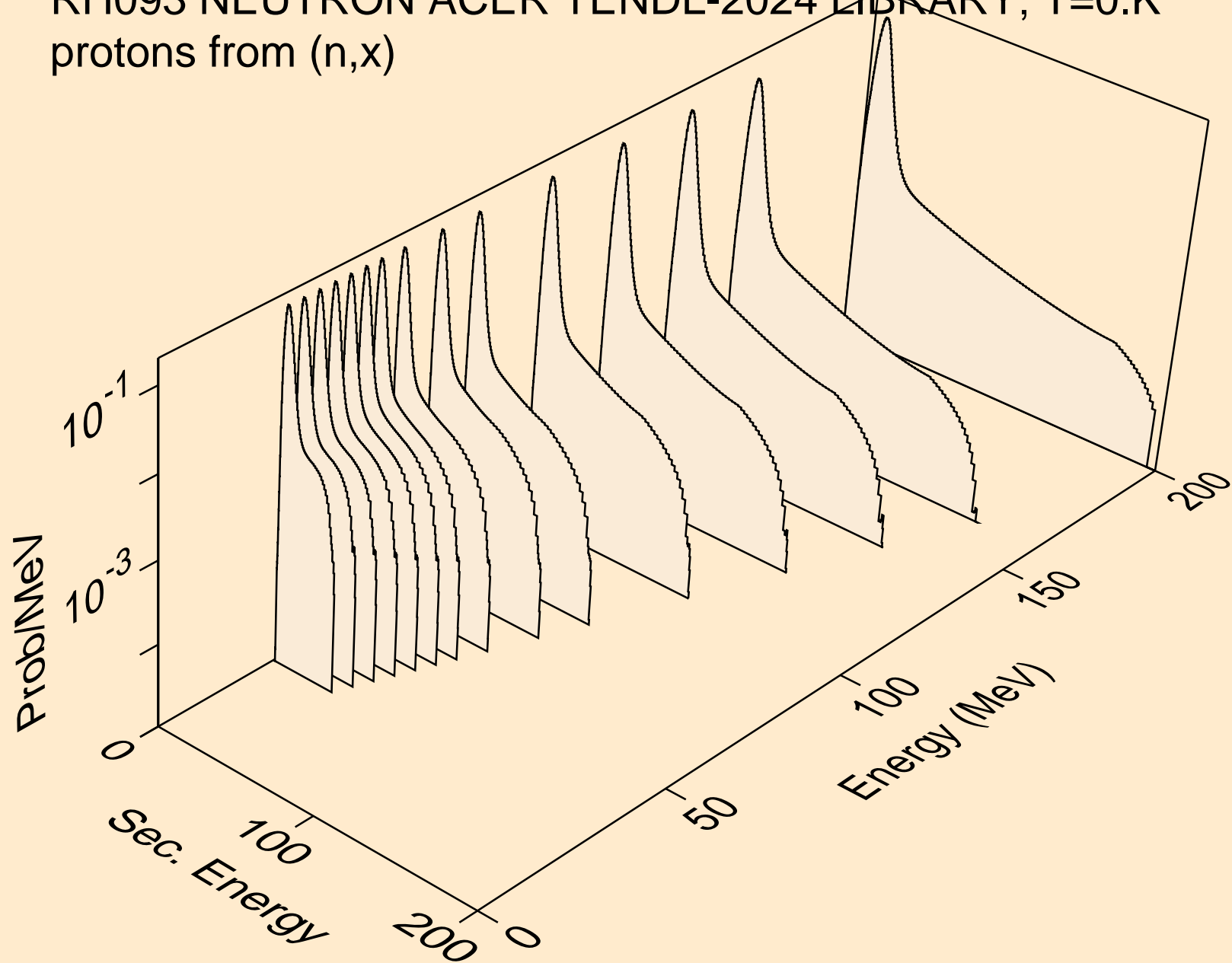

RH093 NEUTRON ACER TENDL-2024 LIBRARY; T=0.K
protons from (n,n*)p

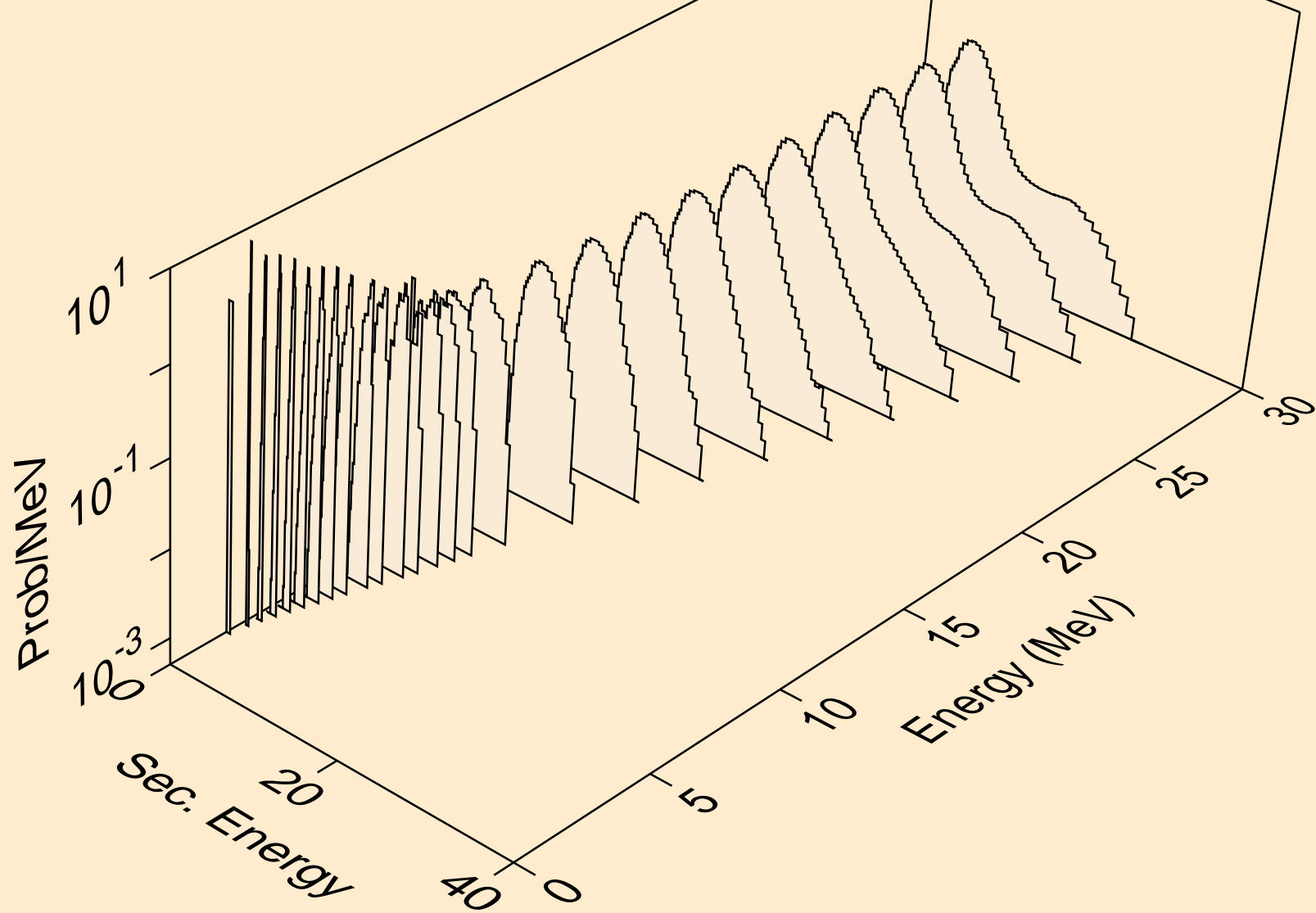

RH093 NEUTRON ACER TENDL-2024 LIBRARY; T=0.K
protons from (n,2np)

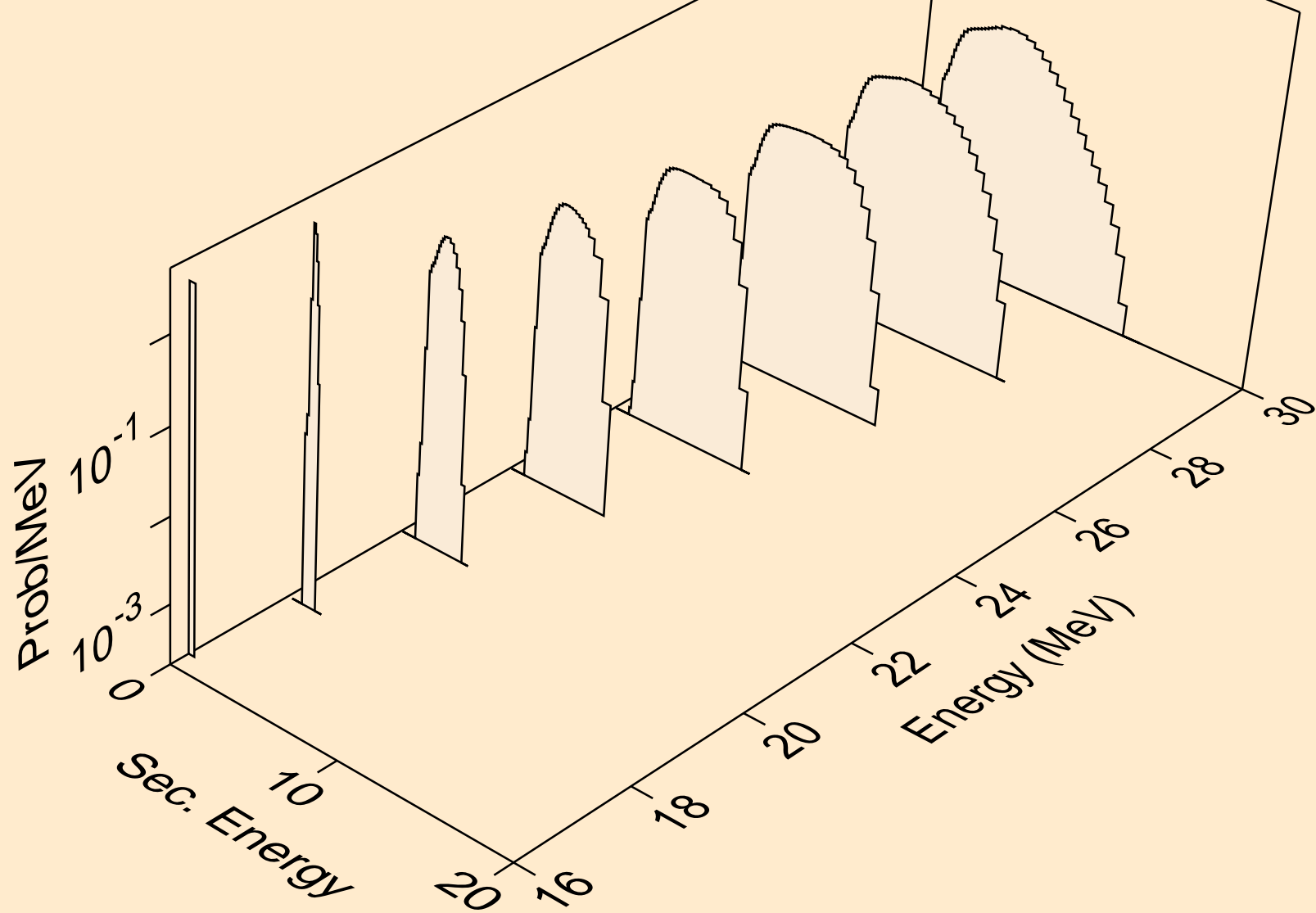

RH093 NEUTRON ACER TENDL-2024 LIBRARY; T=0.K
protons from (n,n2p)

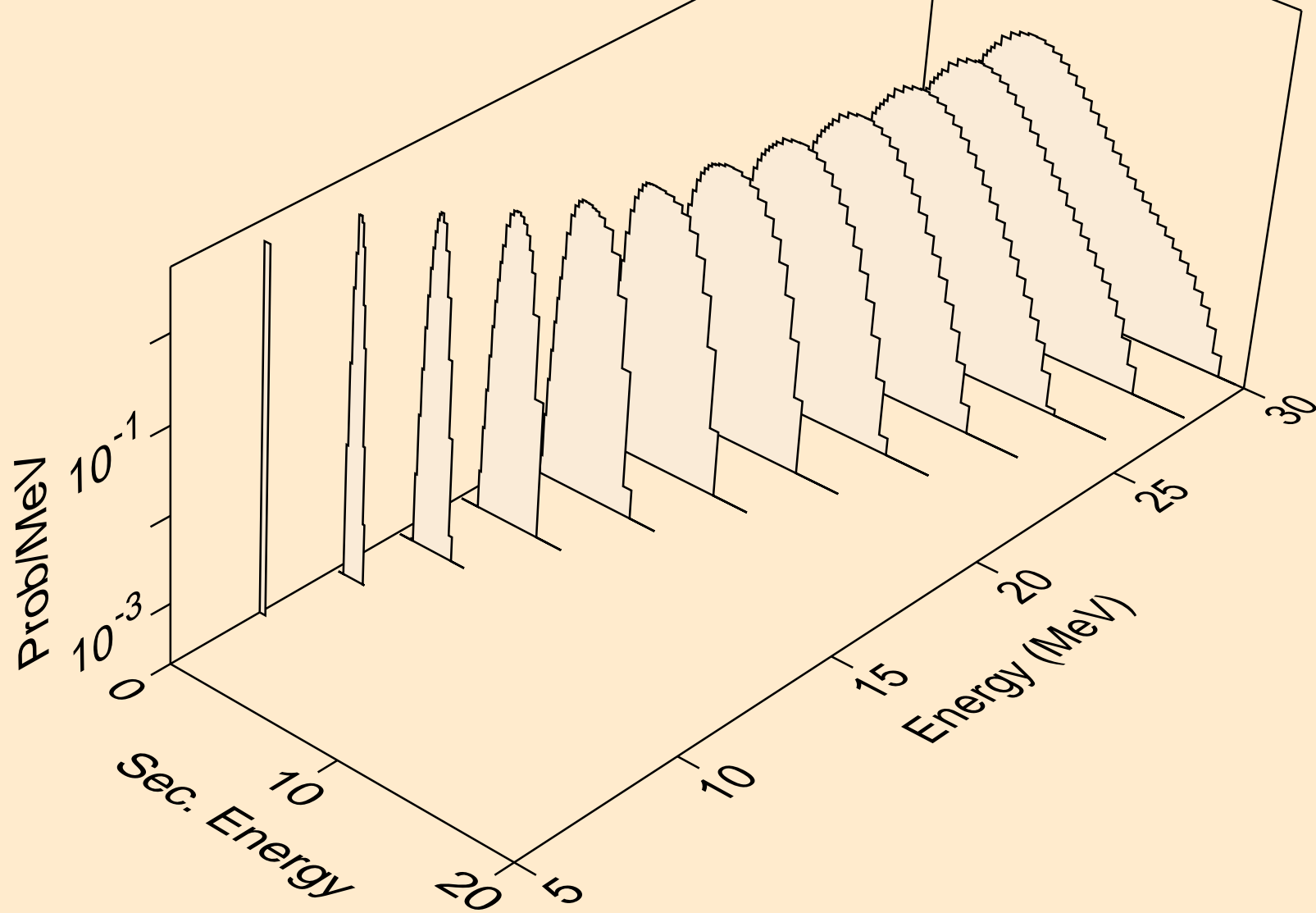

RH093 NEUTRON ACER TENDL-2024 LIBRARY; T=0.K
protons from (n,npa)

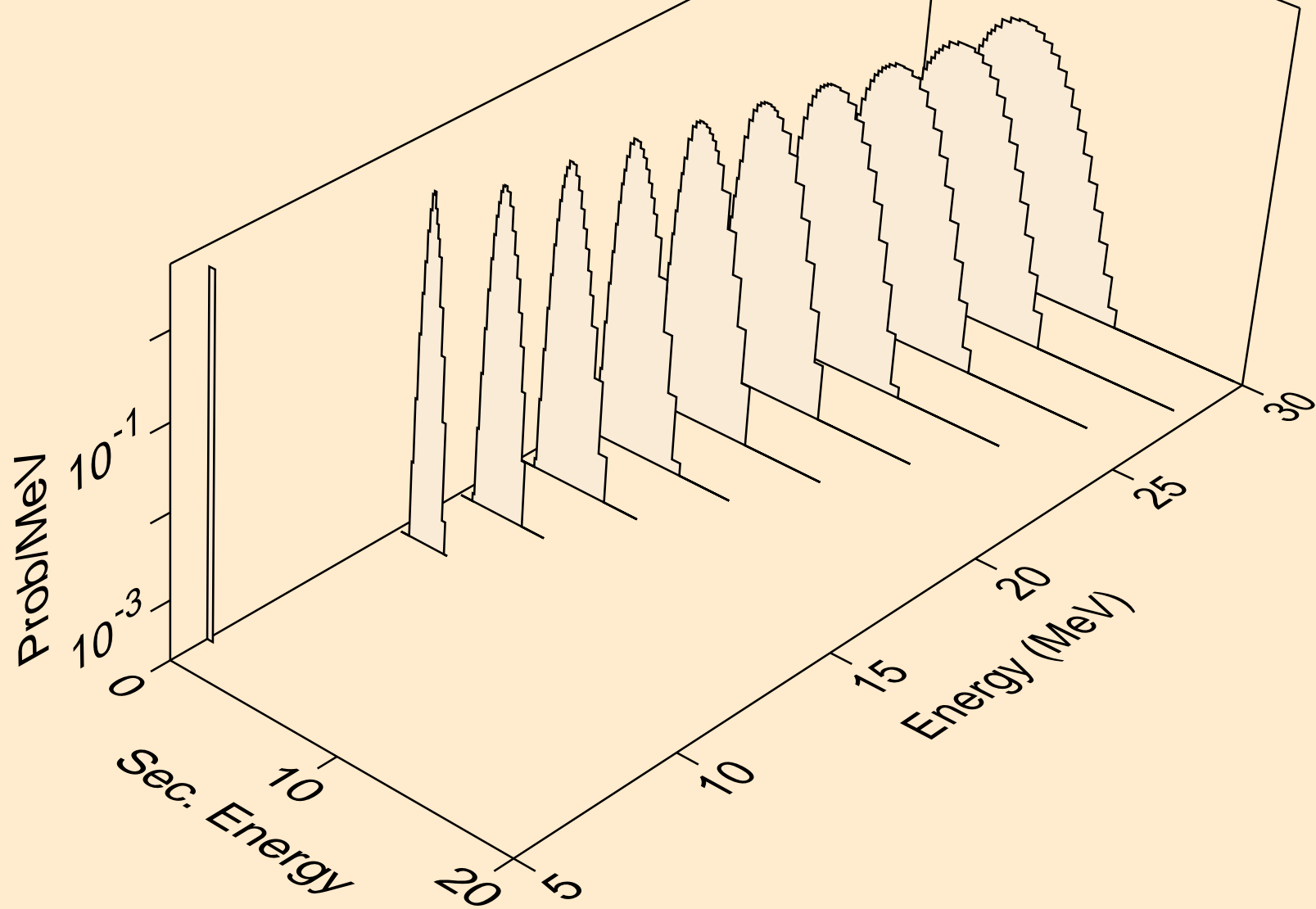

RH093 NEUTRON ACER TENDL-2024 LIBRARY; T=0.K
protons from (n,p)

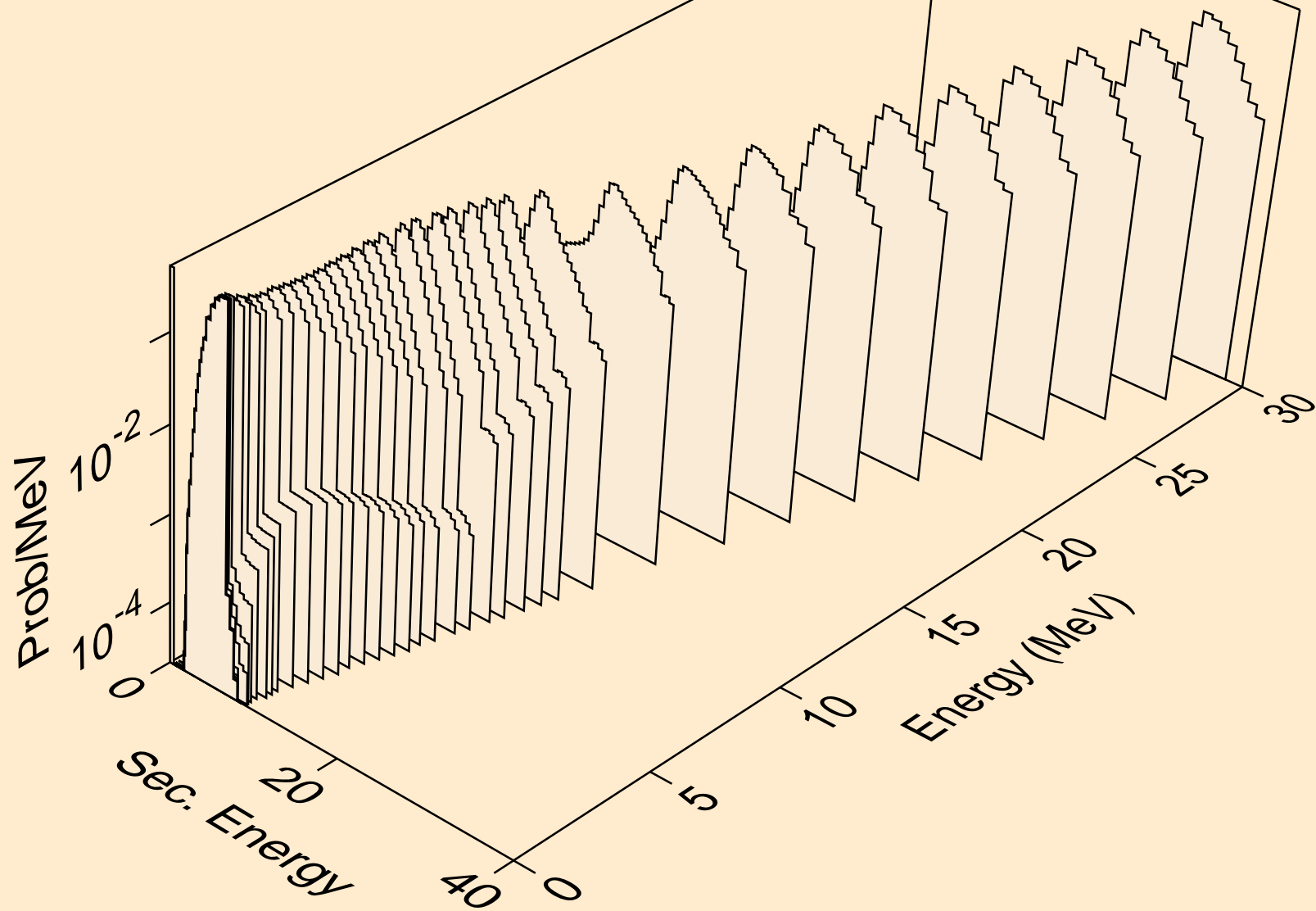

RH093 NEUTRON ACER TENDL-2024 LIBRARY; T=0.K
protons from (n,2p)

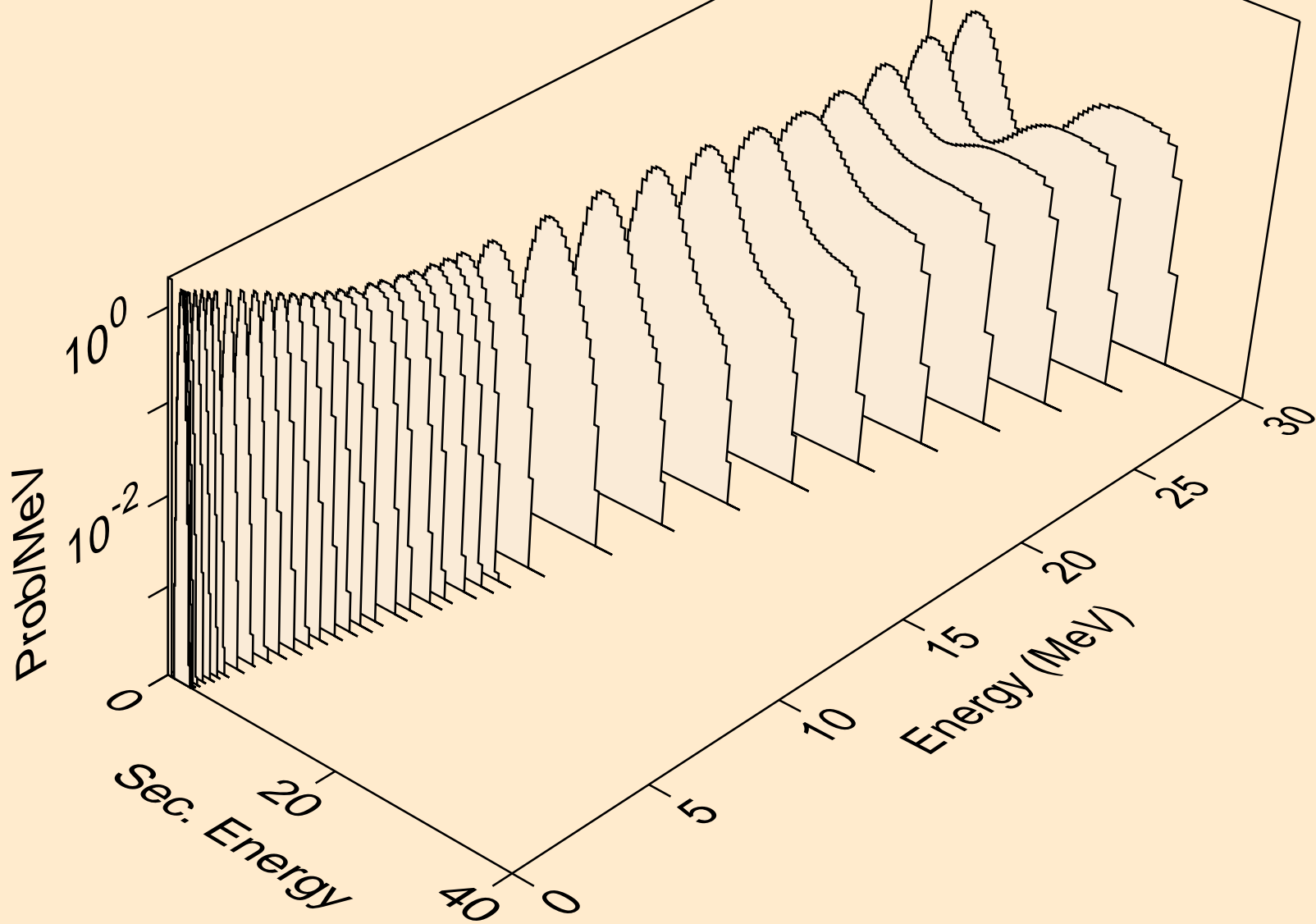

RH093 NEUTRON ACER TENDL-2024 LIBRARY; T=0.K
protons from (n,p)

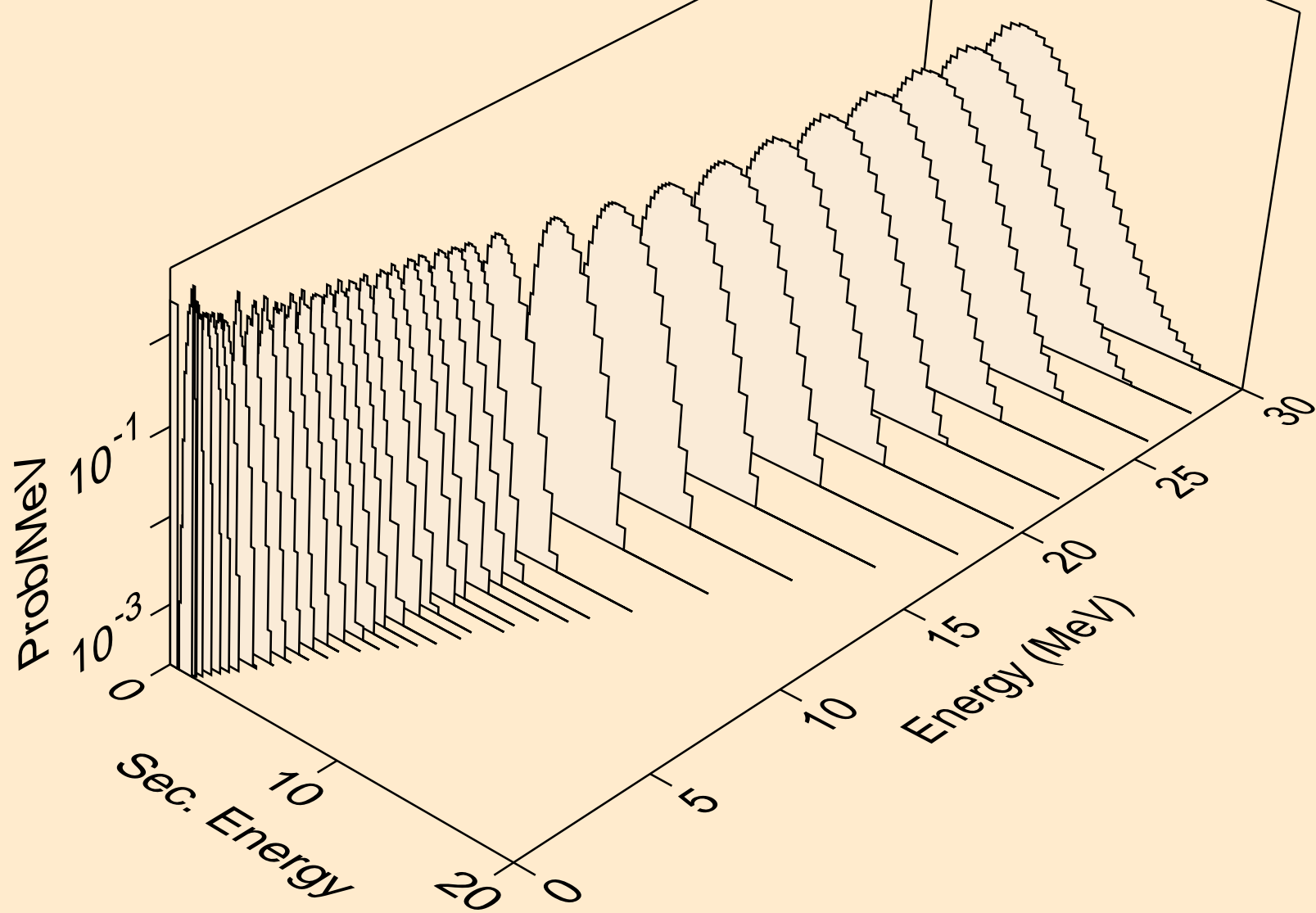

RH093 NEUTRON ACER TENDL-2024 LIBRARY; T=0.K
protons from (n,pd)

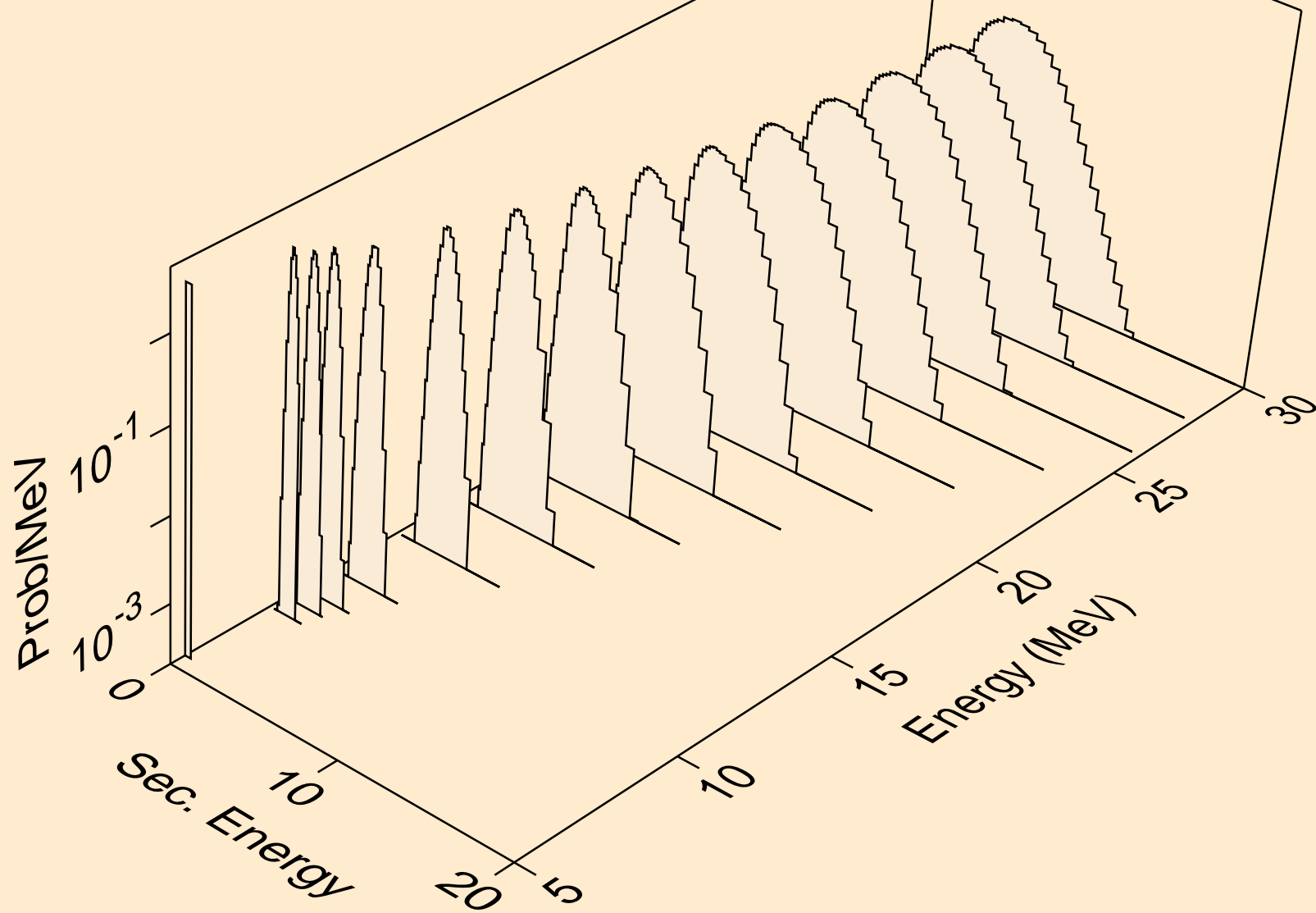

RH093 NEUTRON ACER TENDL-2024 LIBRARY; T=0.K
protons from (n,pt)

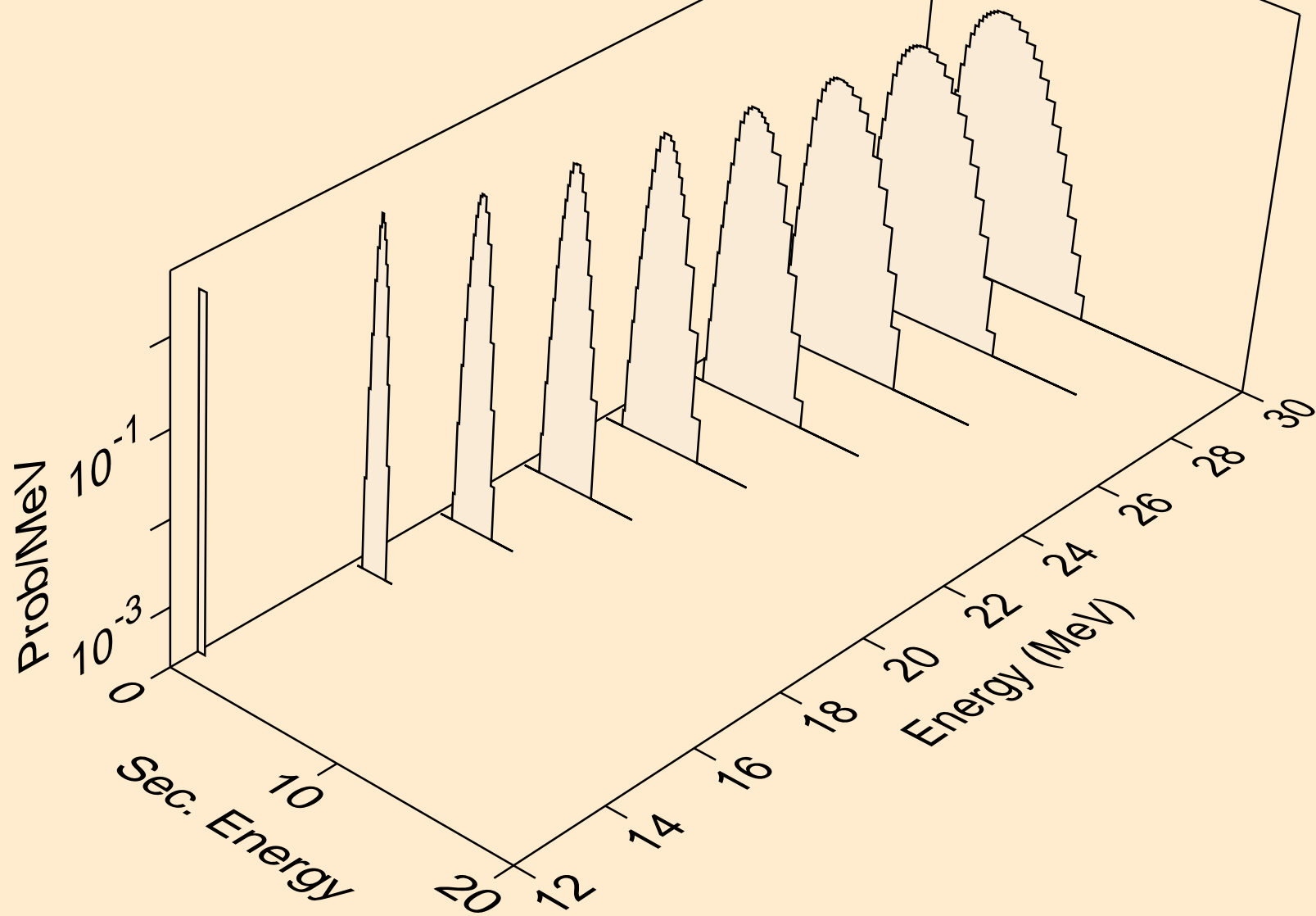

RH093 NEUTRON ACER TENDL-2024 LIBRARY; T=0.K
deuterons from (n,x)

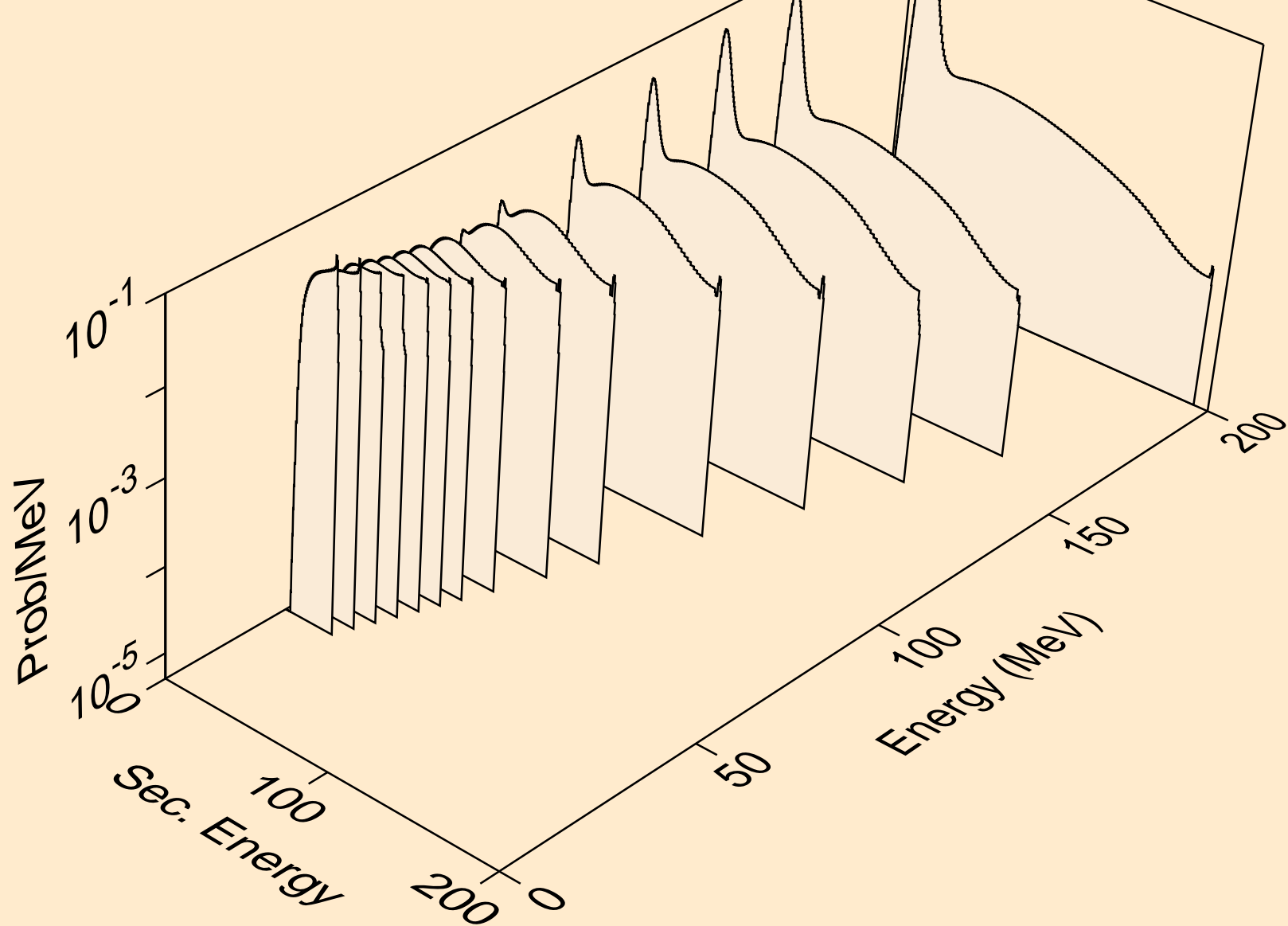

RH093 NEUTRON ACER TENDL-2024 LIBRARY; T=0.K
deuterons from (n,n*)d

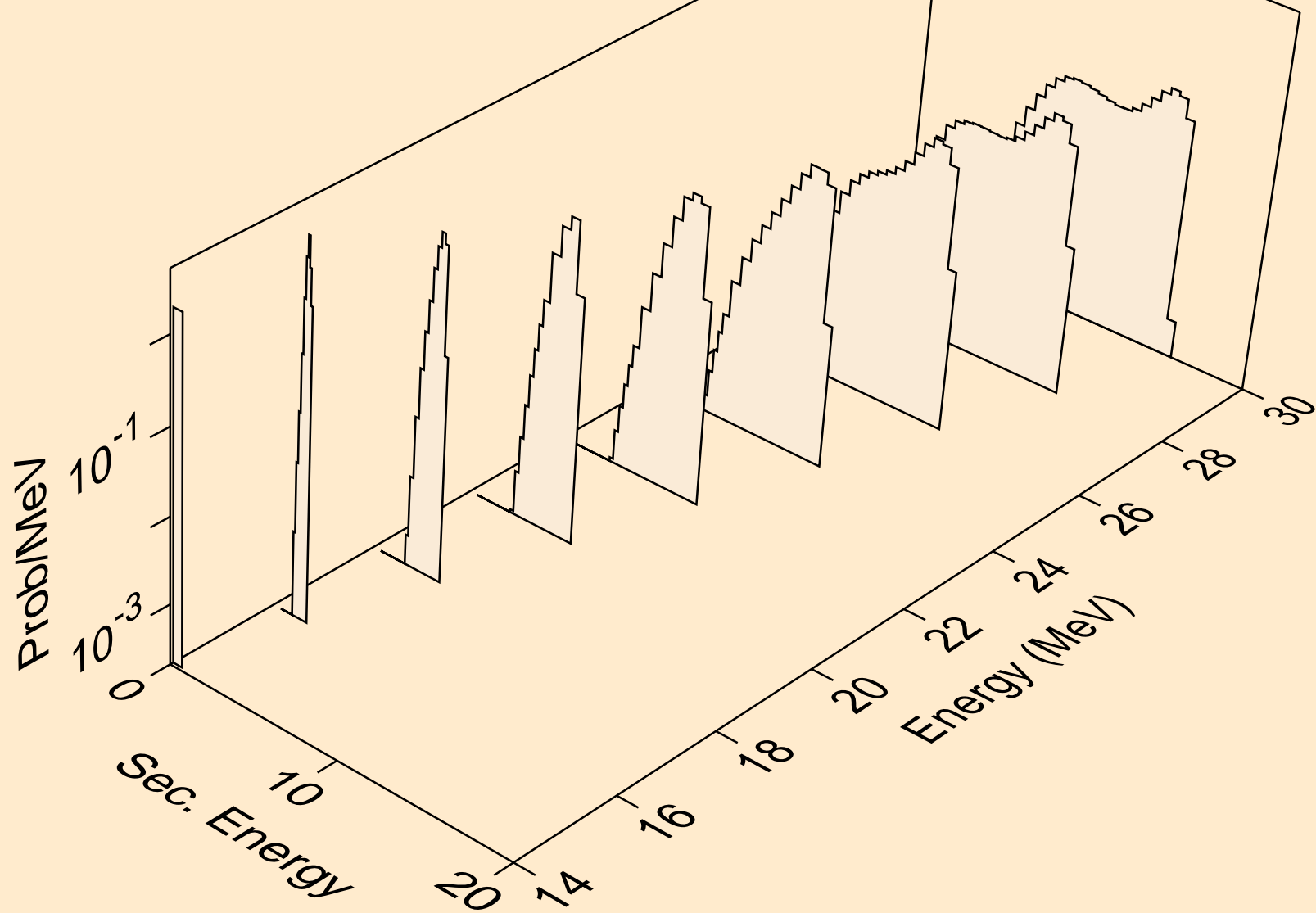

RH093 NEUTRON ACER TENDL-2024 LIBRARY; T=0.K
deuterons from (n,d)

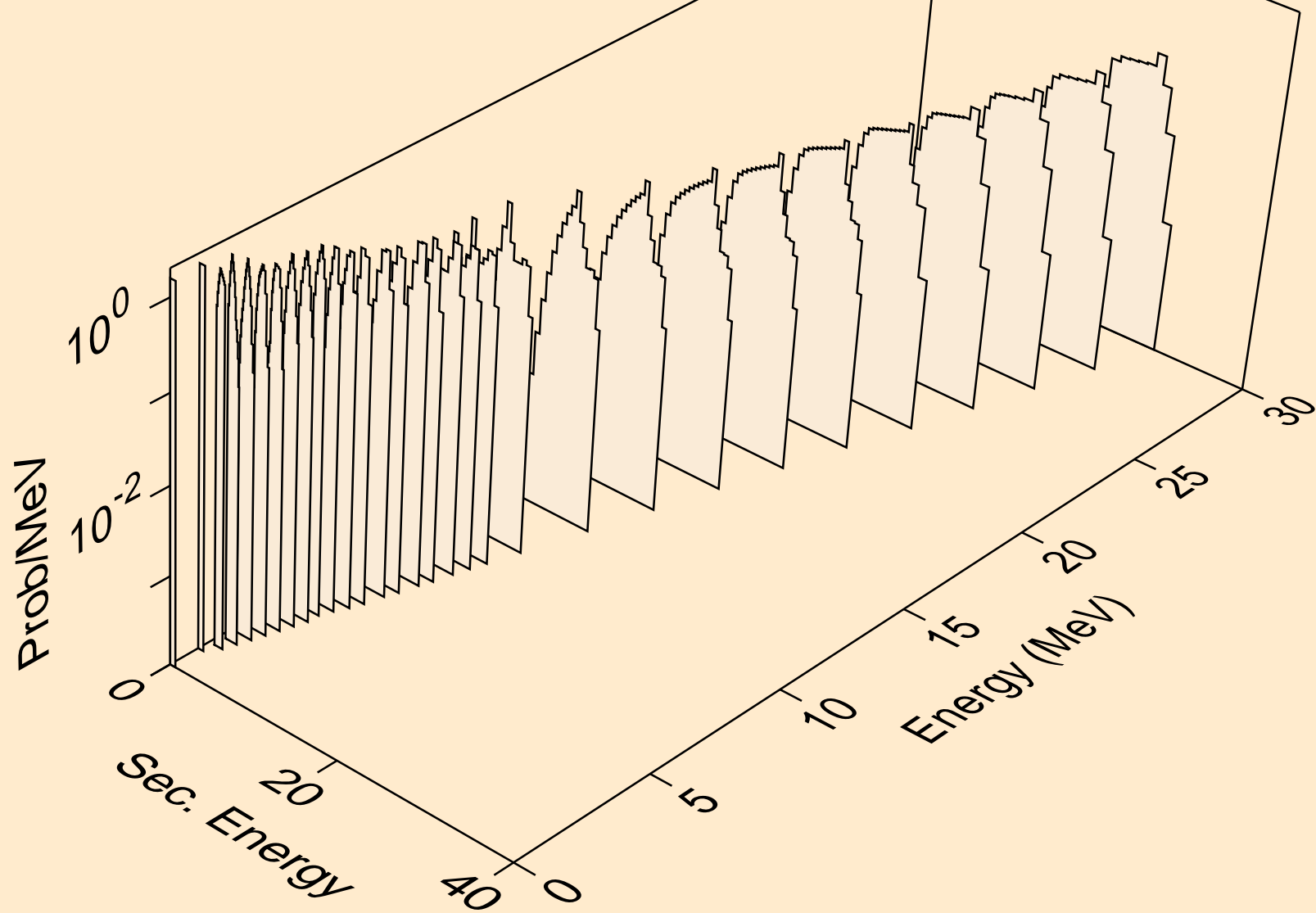

RH093 NEUTRON ACER TENDL-2024 LIBRARY; T=0.K
deuterons from (n,pd)

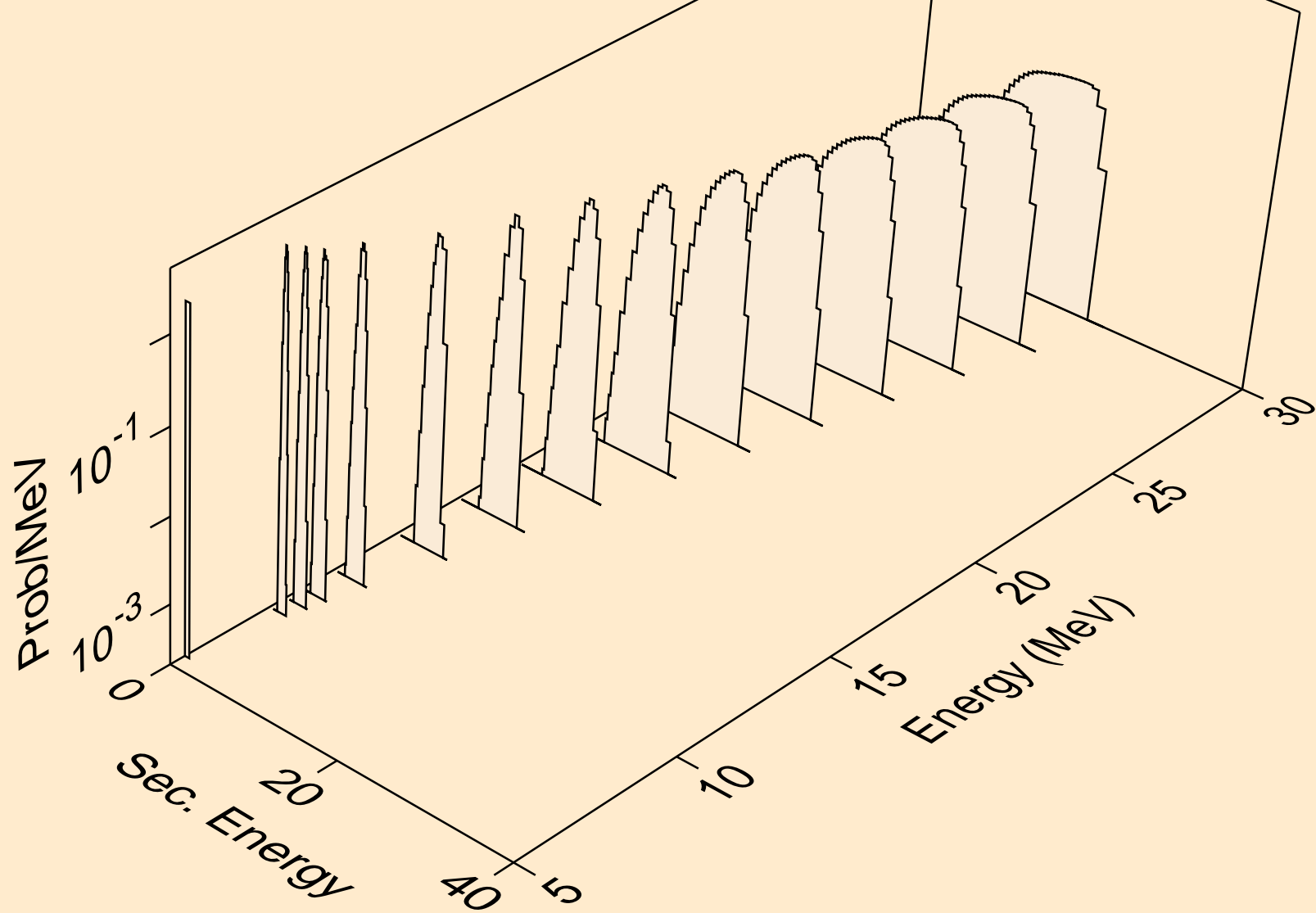

RH093 NEUTRON ACER TENDL-2024 LIBRARY; T=0.K
deuterons from (n,da)

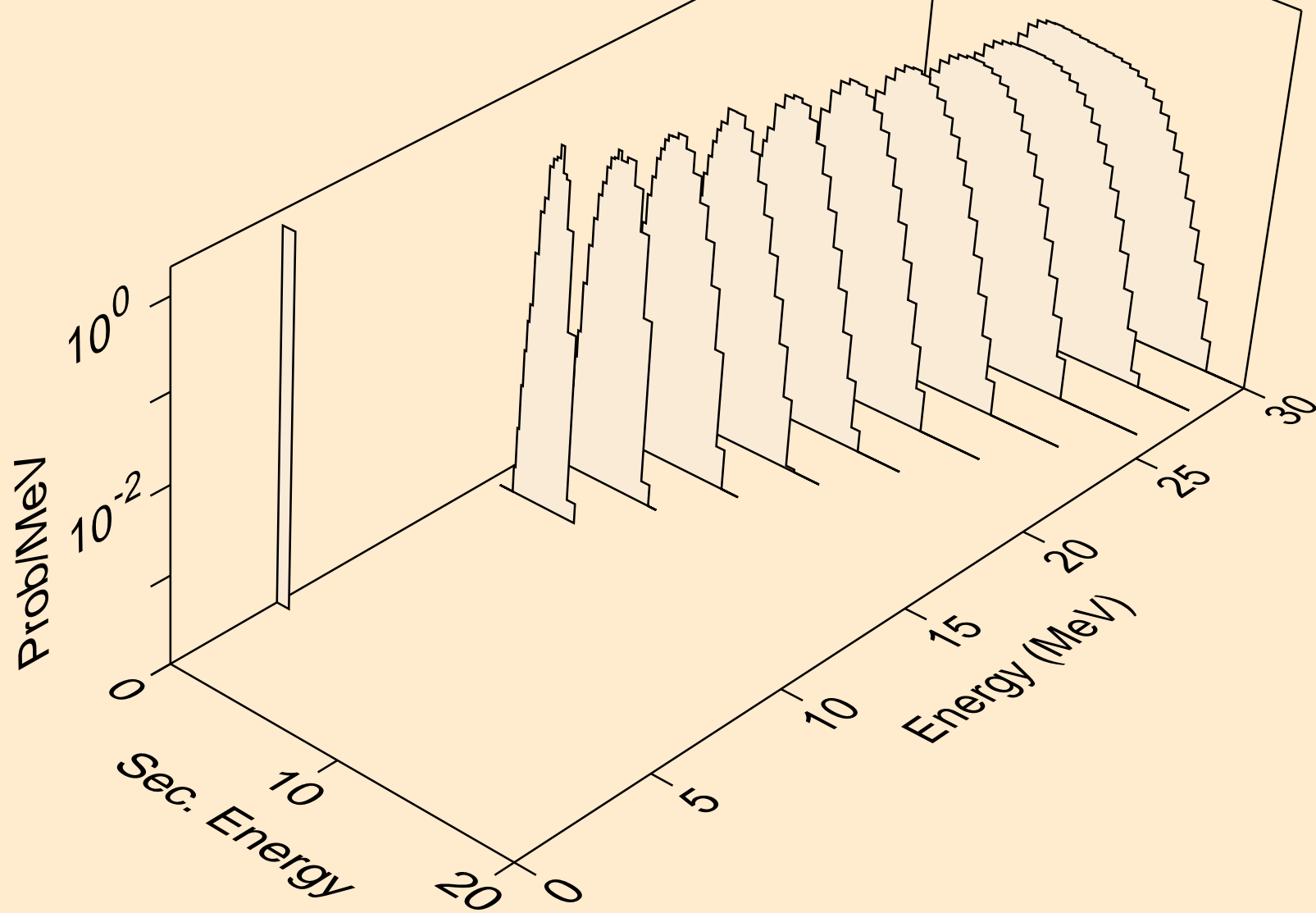

RH093 NEUTRON ACER TENDL-2024 LIBRARY; T=0.K
tritons from (n,x)

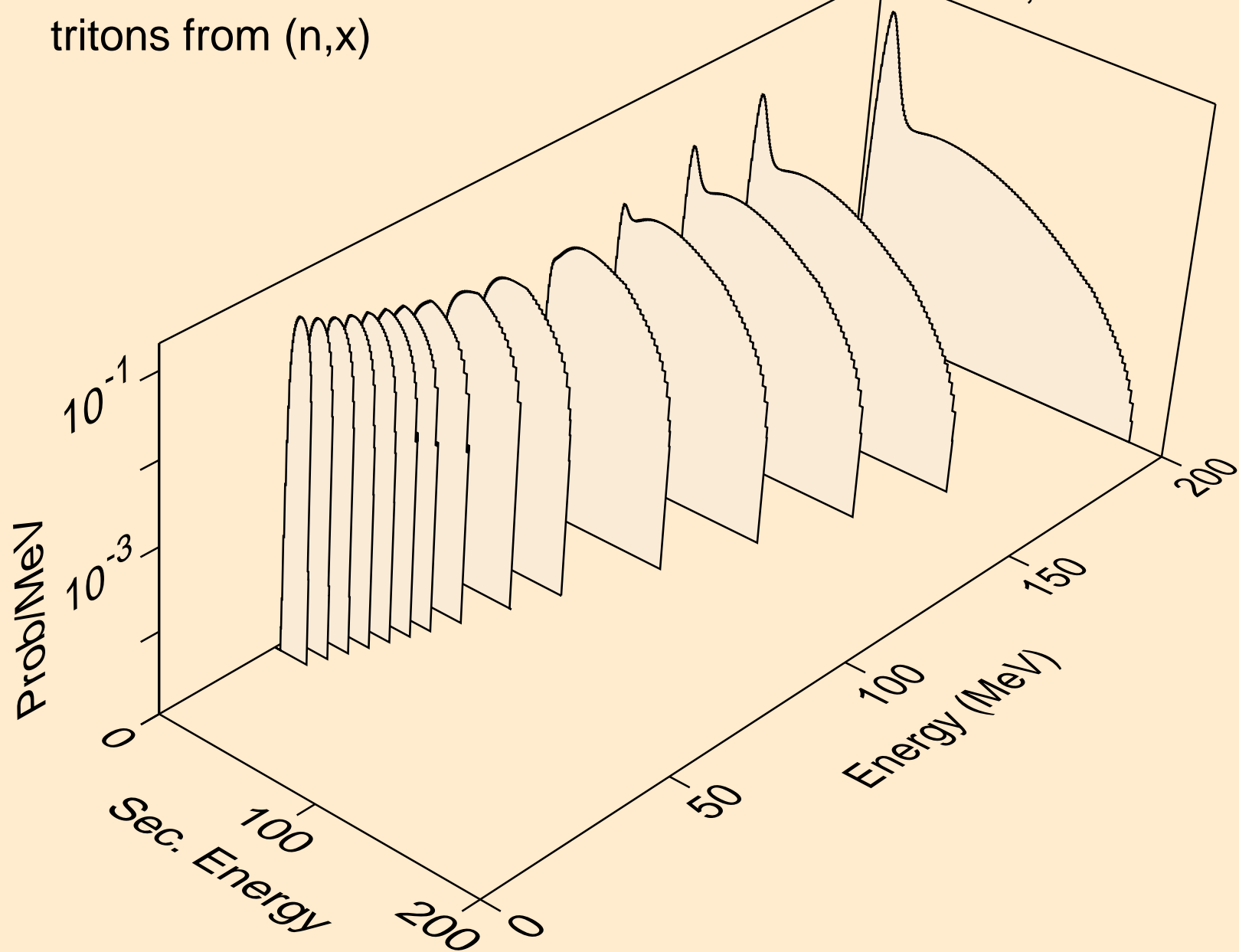

RH093 NEUTRON ACER TENDL-2024 LIBRARY; T=0.K
tritons from (n,n*)t

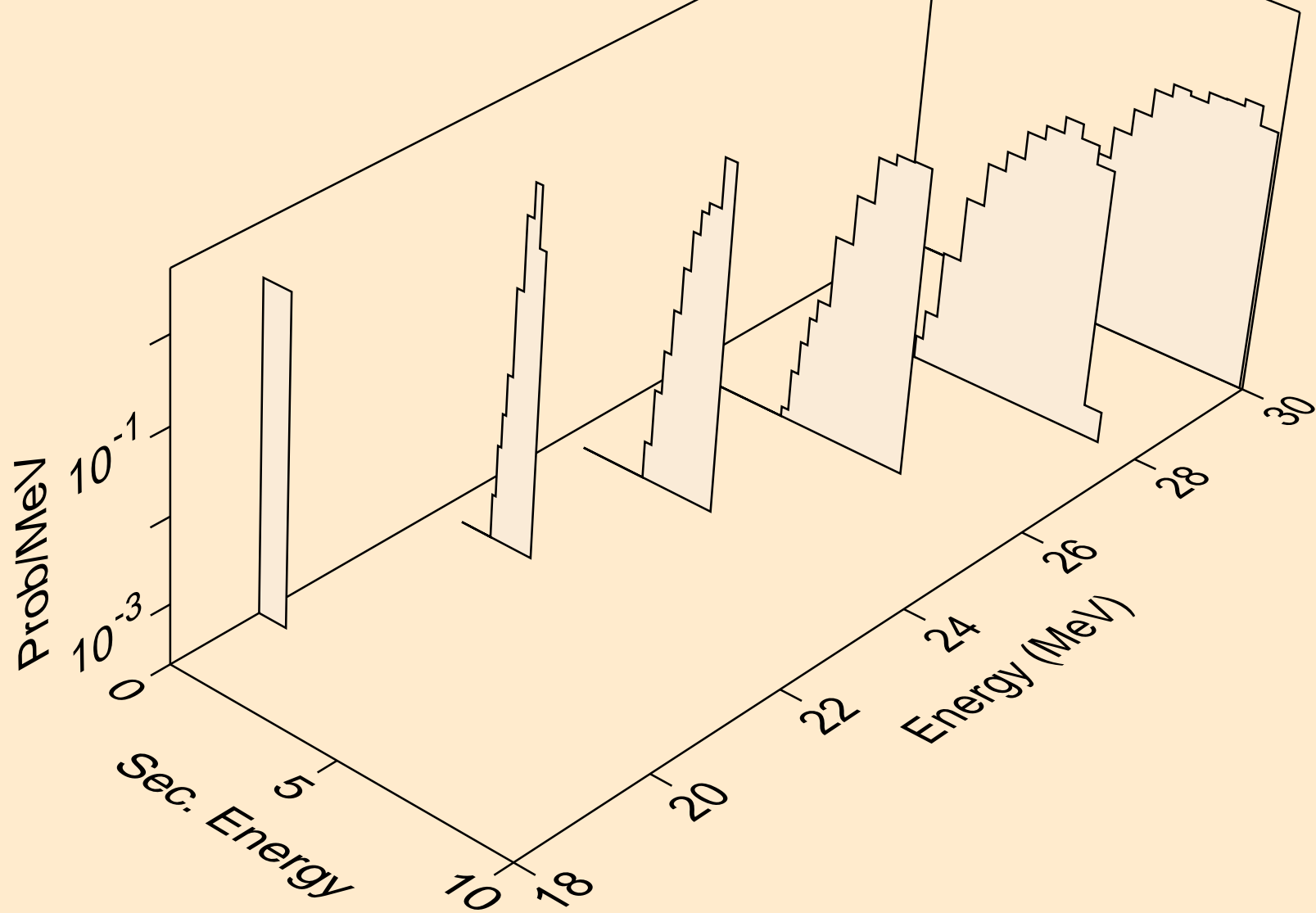

RH093 NEUTRON ACER TENDL-2024 LIBRARY; T=0.K
tritons from (n,t)

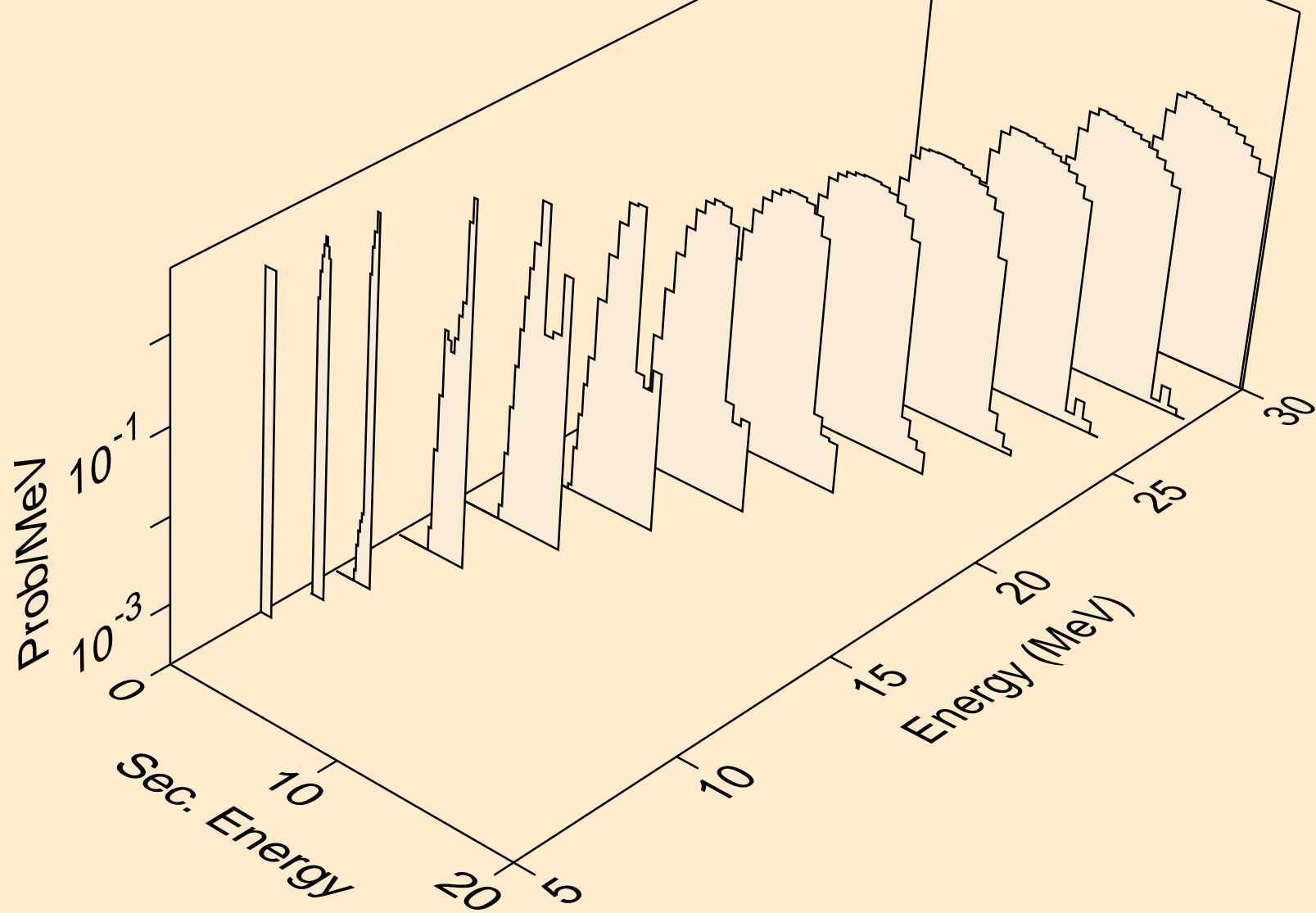

RH093 NEUTRON ACER TENDL-2024 LIBRARY; T=0.K
tritons from (n,pt)

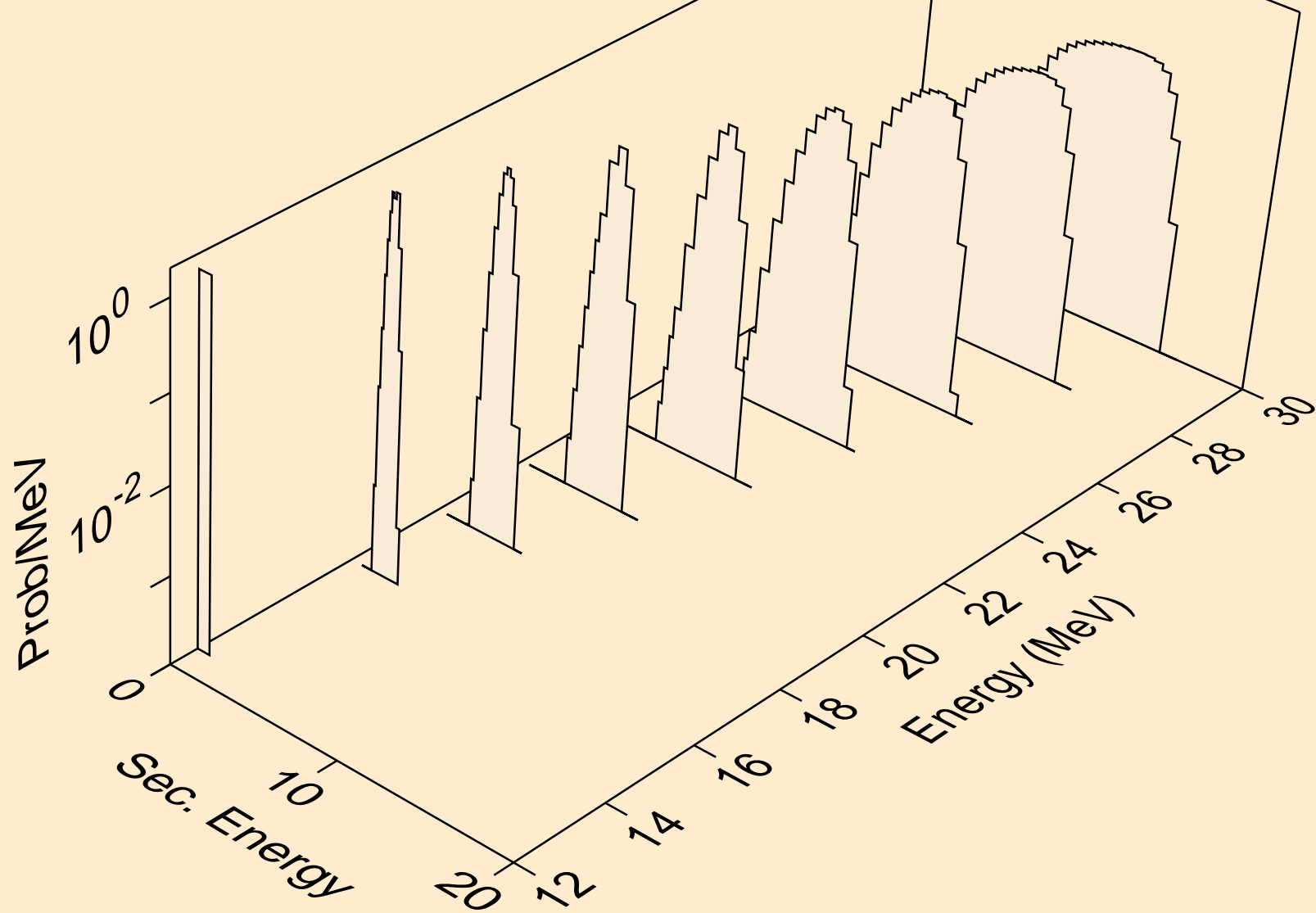

RH093 NEUTRON ACER TENDL-2024 LIBRARY; T=0.K
he3s from (n,x)

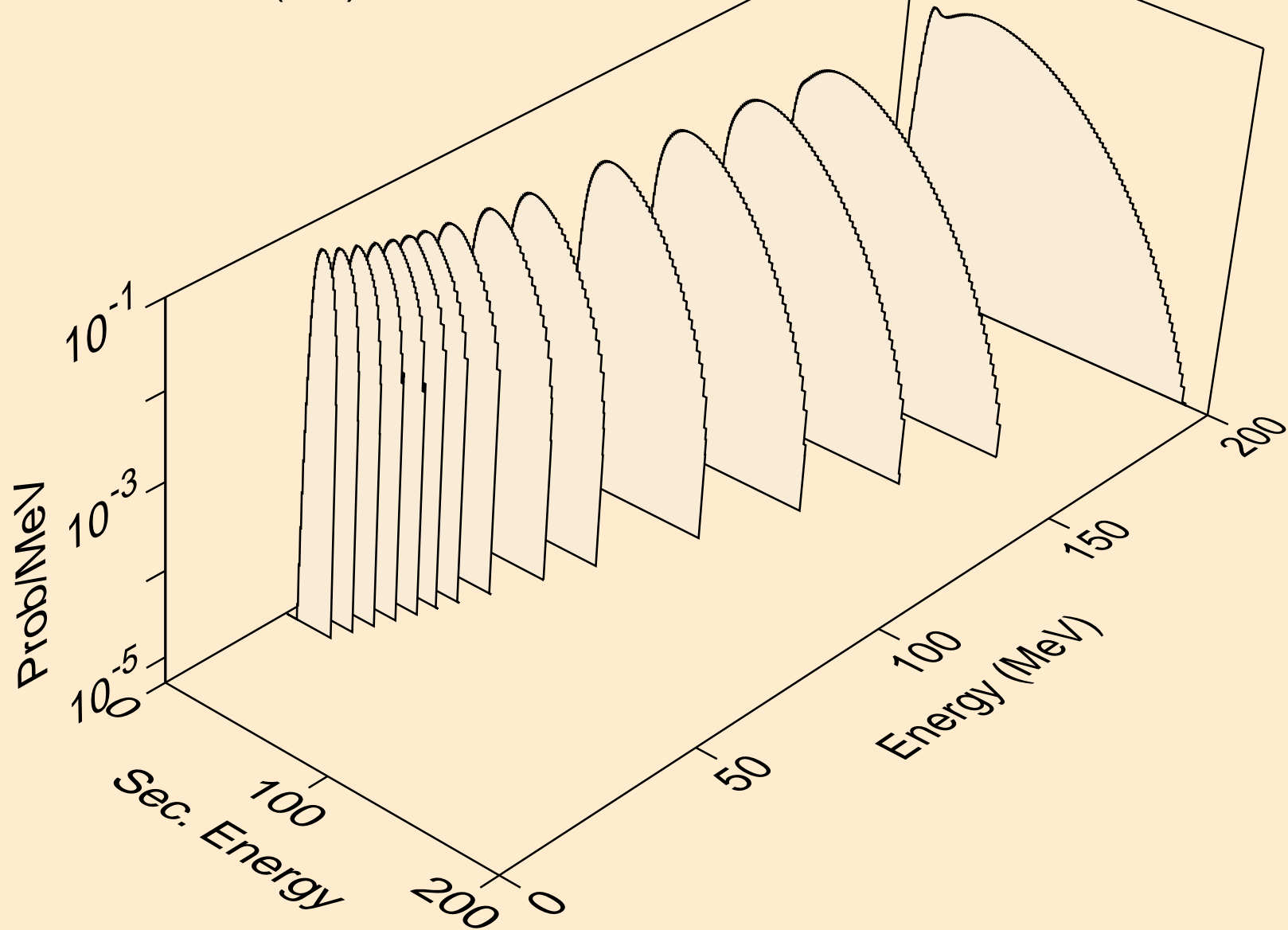

RH093 NEUTRON ACER TENDL-2024 LIBRARY; T=0.K
he3s from (n,n*)he3

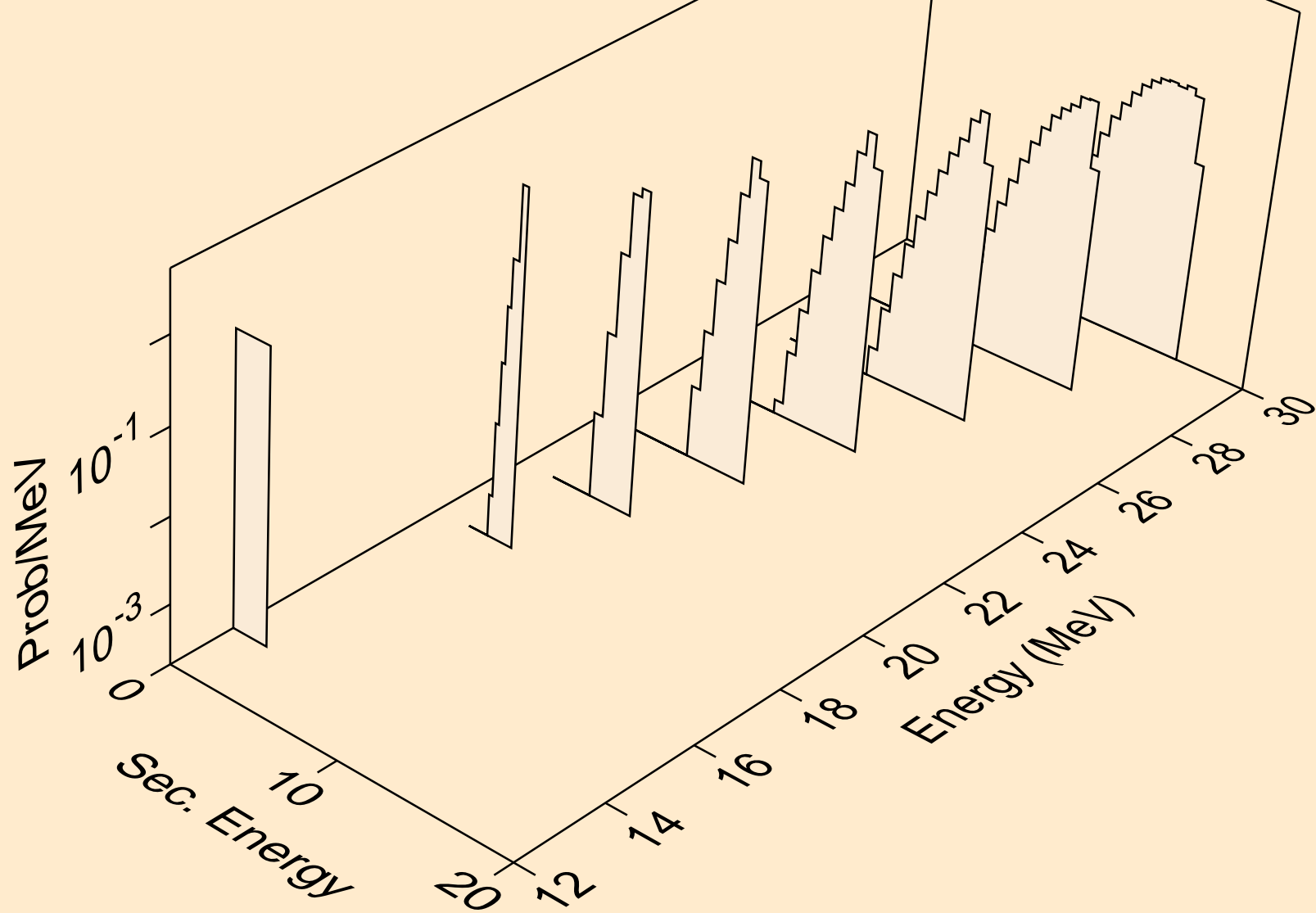

RH093 NEUTRON ACER TENDL-2024 LIBRARY; T=0.K
he3s from (n,he3)

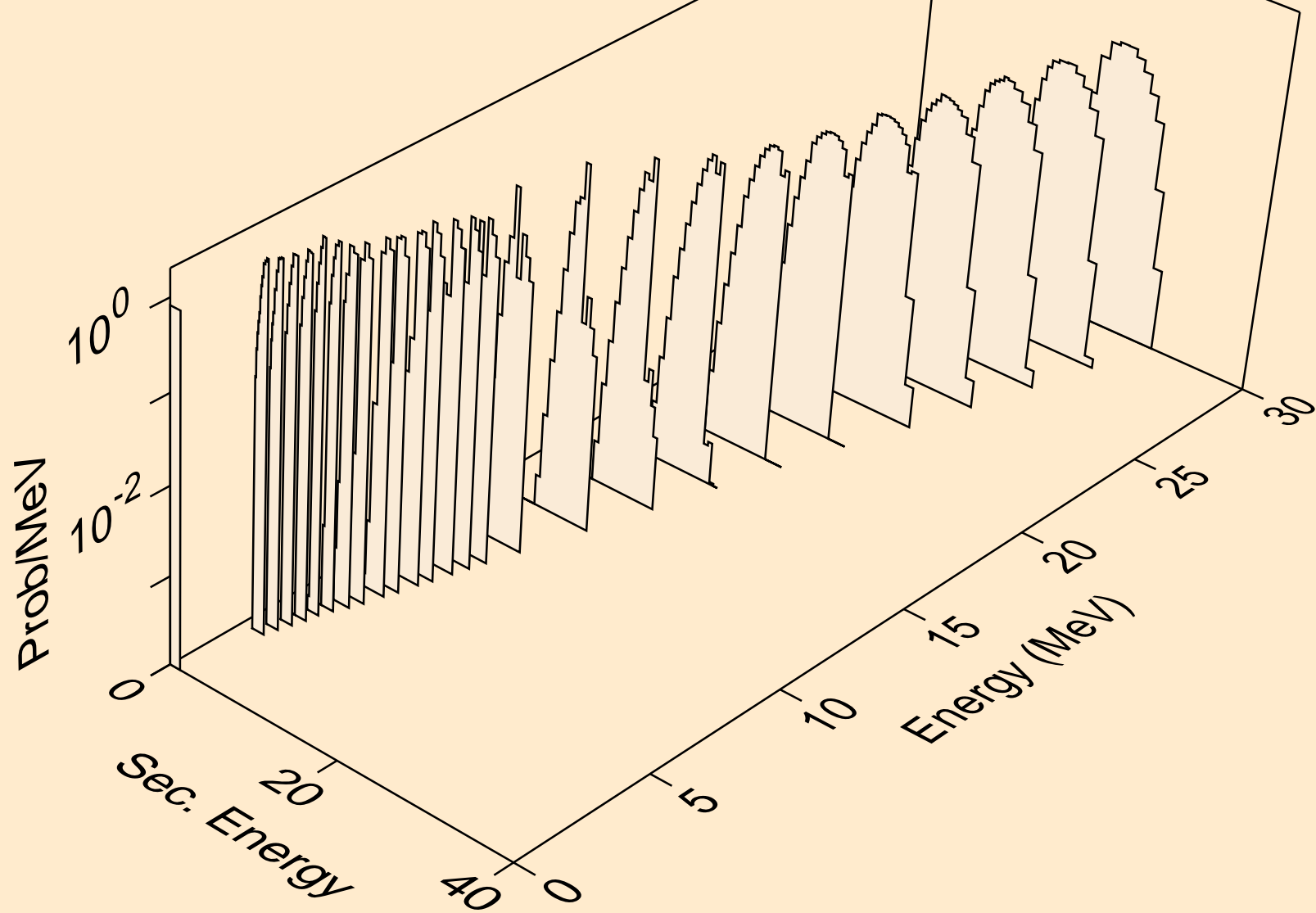

RH093 NEUTRON ACER TENDL-2024 LIBRARY; T=0.K
alphas from (n,x)

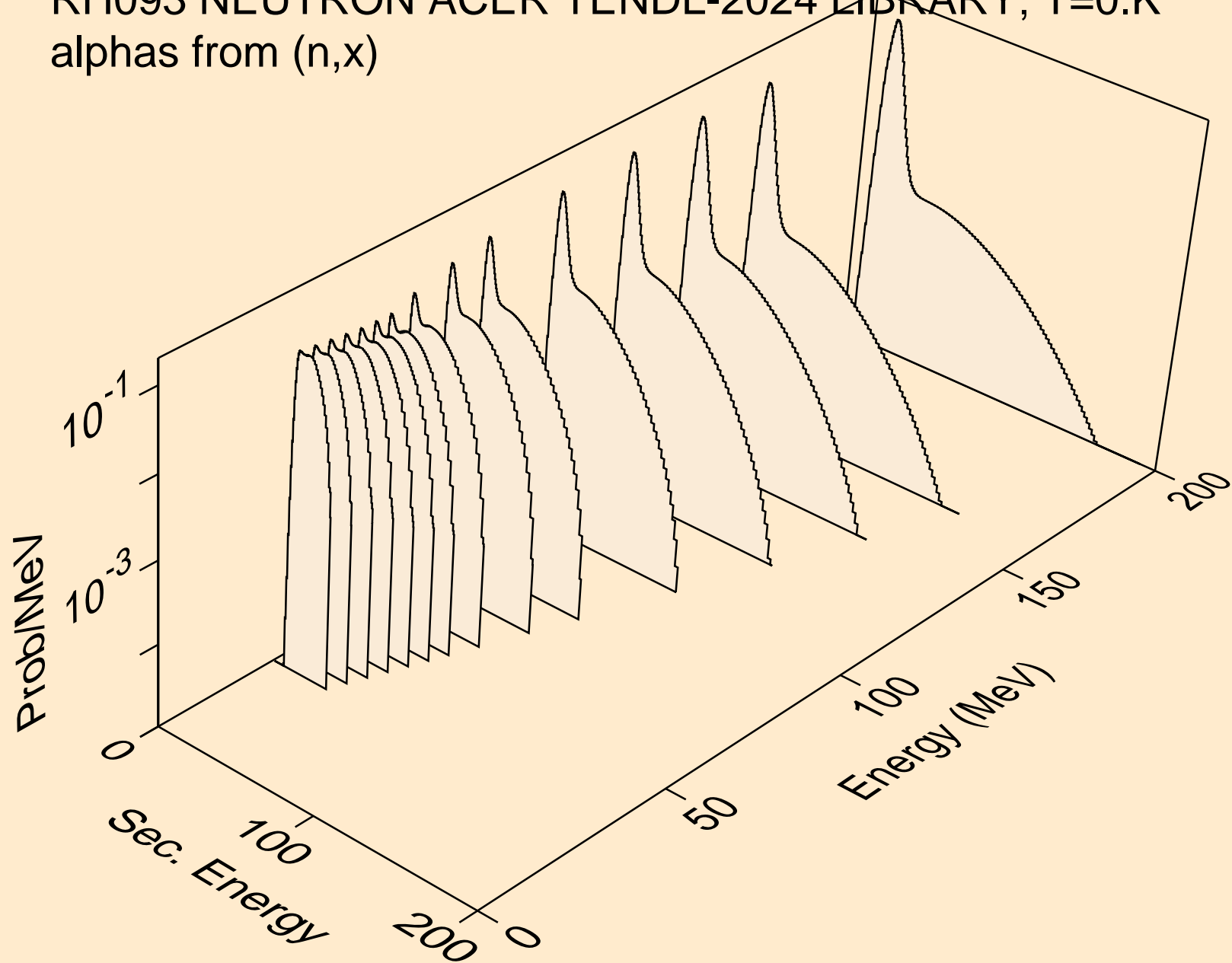

RH093 NEUTRON ACER TENDL-2024 LIBRARY; T=0.K
alphas from (n,n*)a

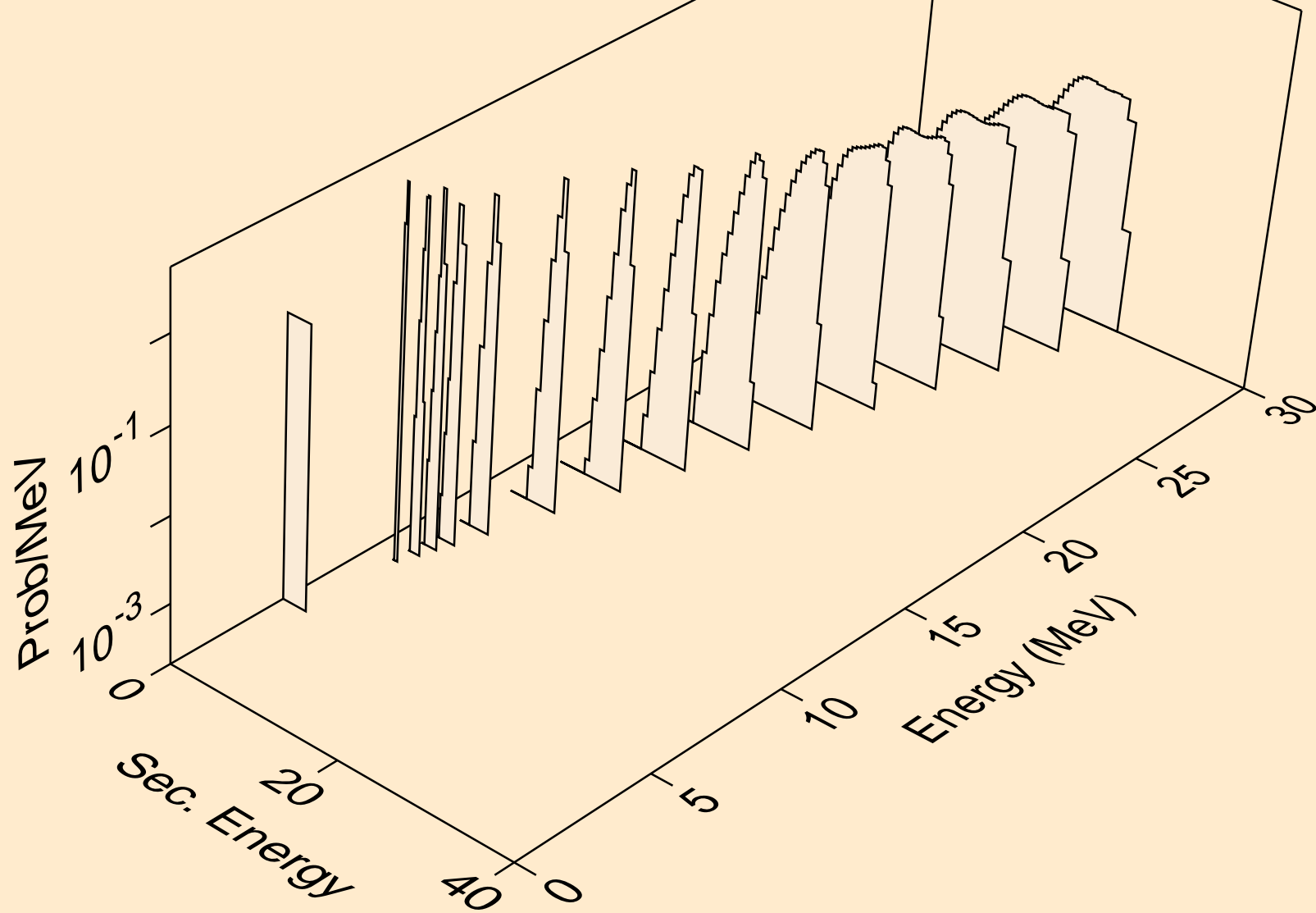

RH093 NEUTRON ACER TENDL-2024 LIBRARY; T=0.K
alphas from (n,2n)a

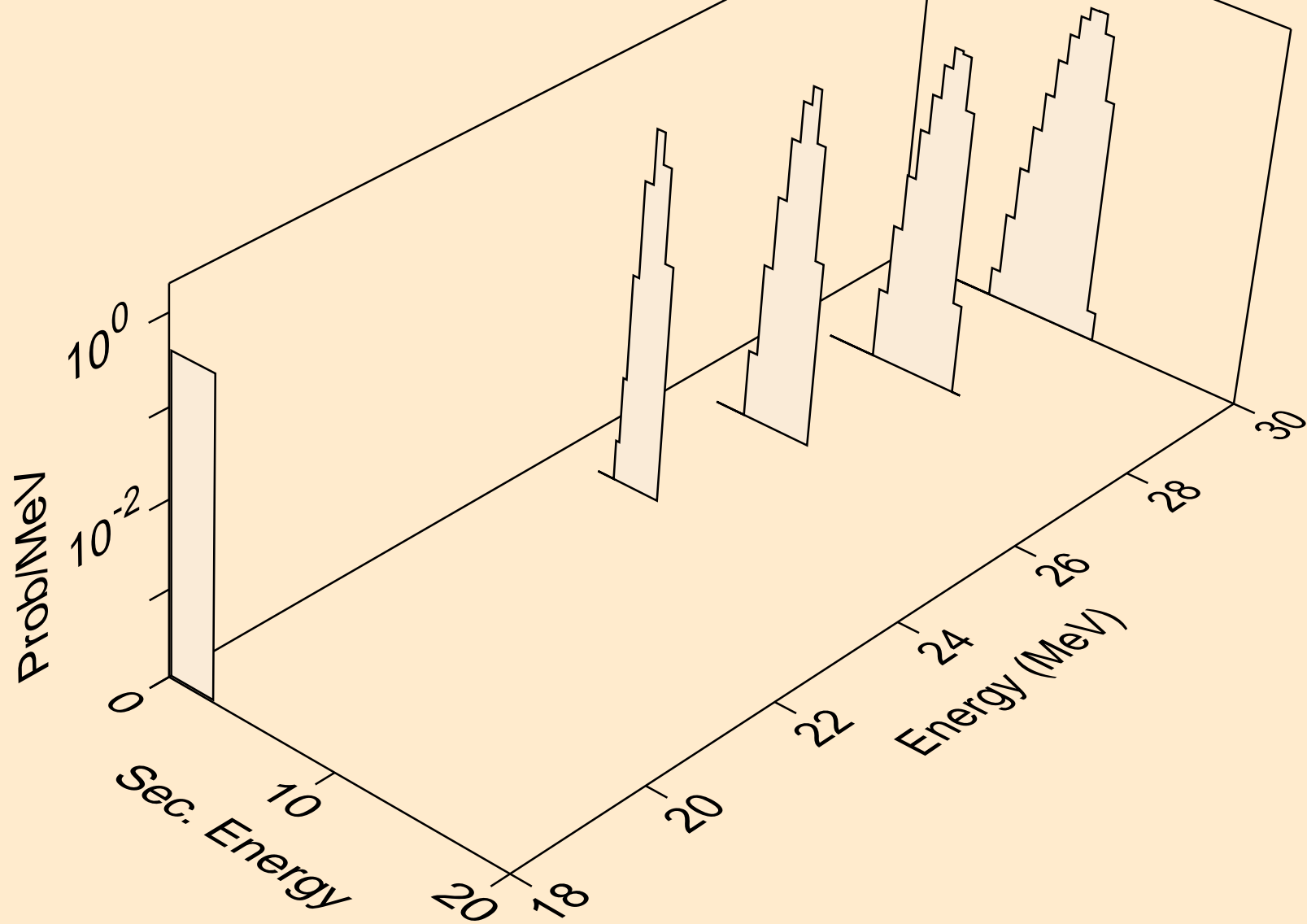

RH093 NEUTRON ACER TENDL-2024 LIBRARY; T=0.K
alphas from (n,n*)2a

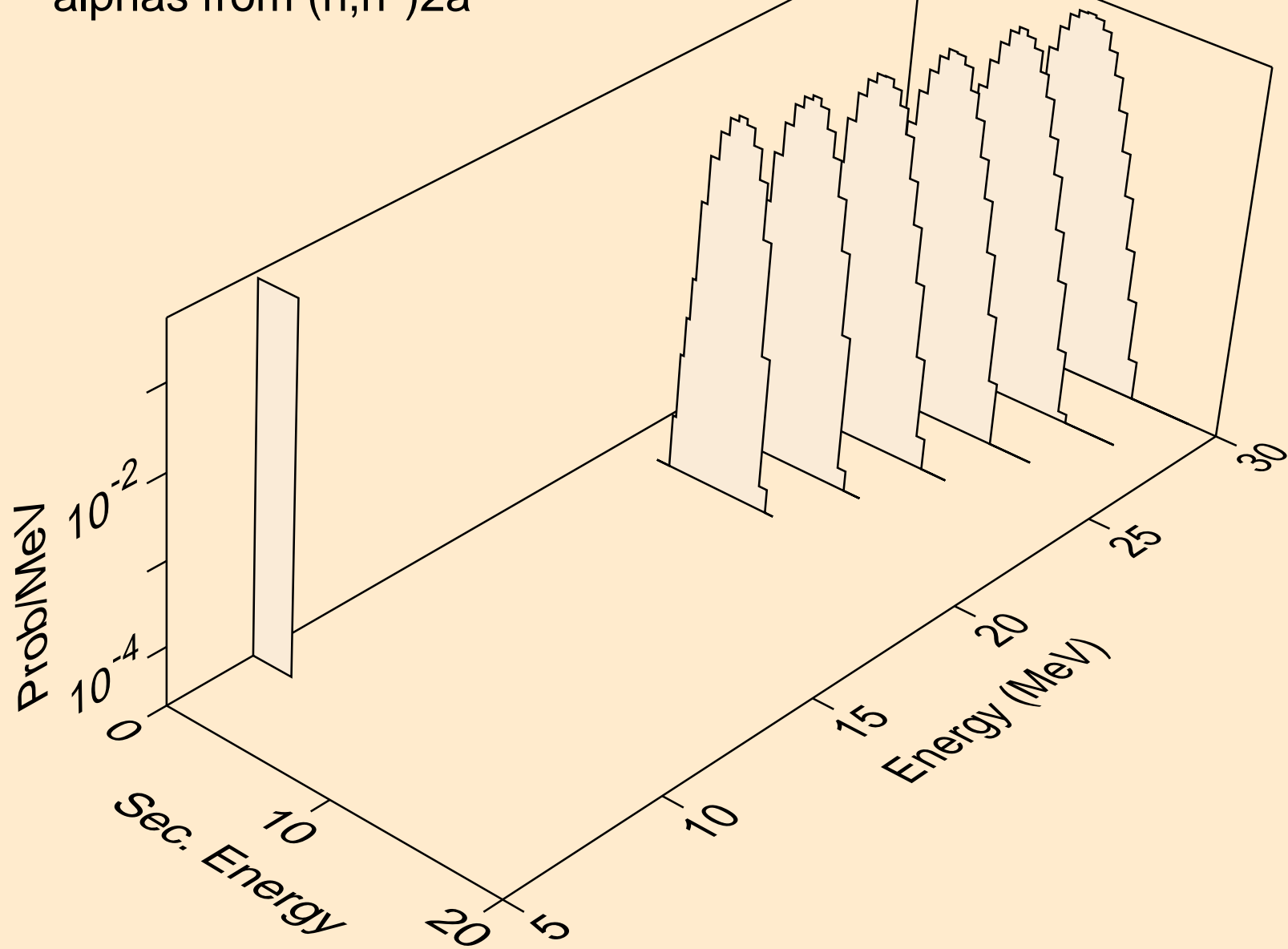

RH093 NEUTRON ACER TENDL-2024 LIBRARY; T=0.K
alphas from (n,npa)

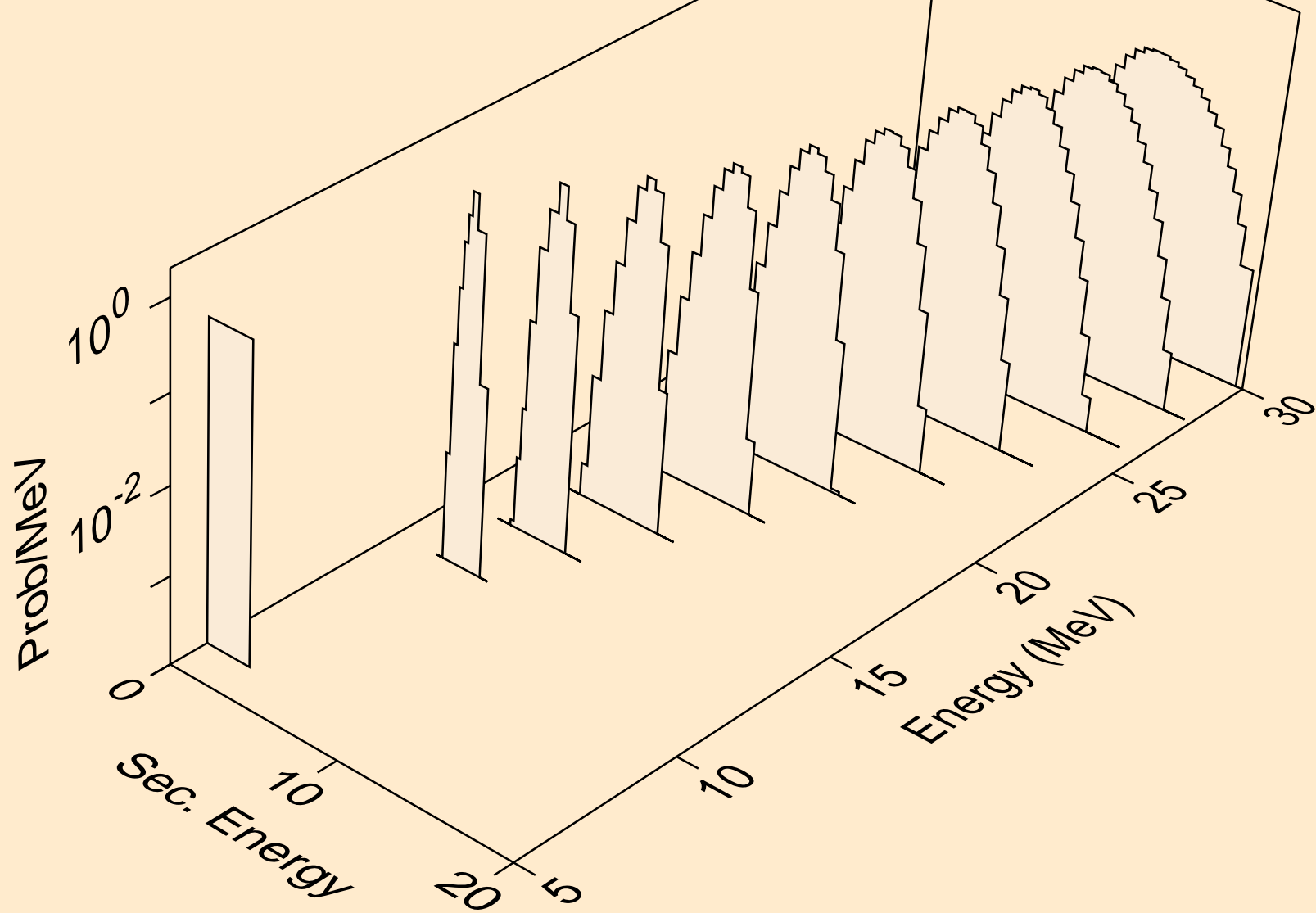

RH093 NEUTRON ACER TENDL-2024 LIBRARY; T=0.K
alphas from (n,a)

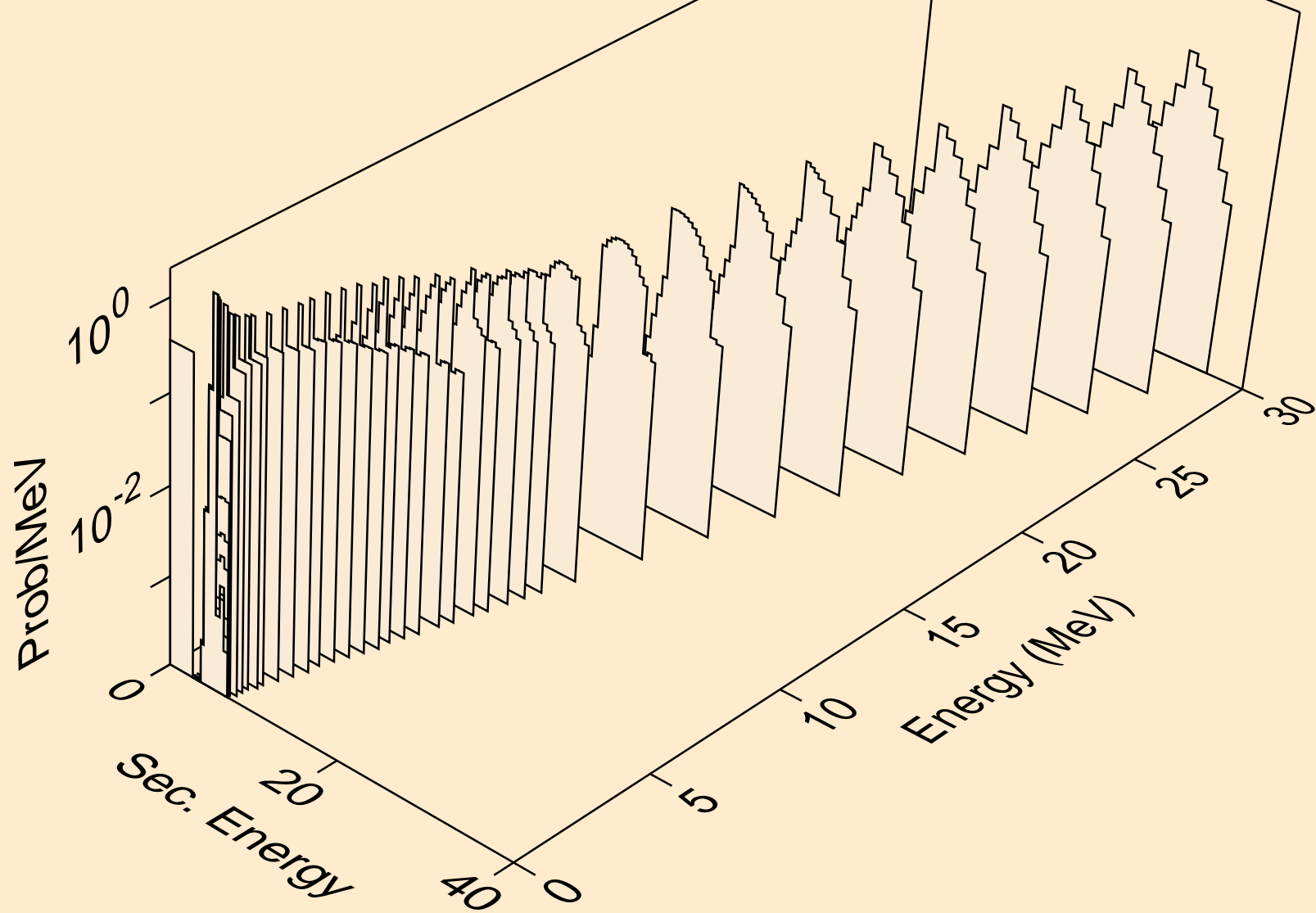

RH093 NEUTRON ACER TENDL-2024 LIBRARY; T=0.K
alphas from (n,2a)

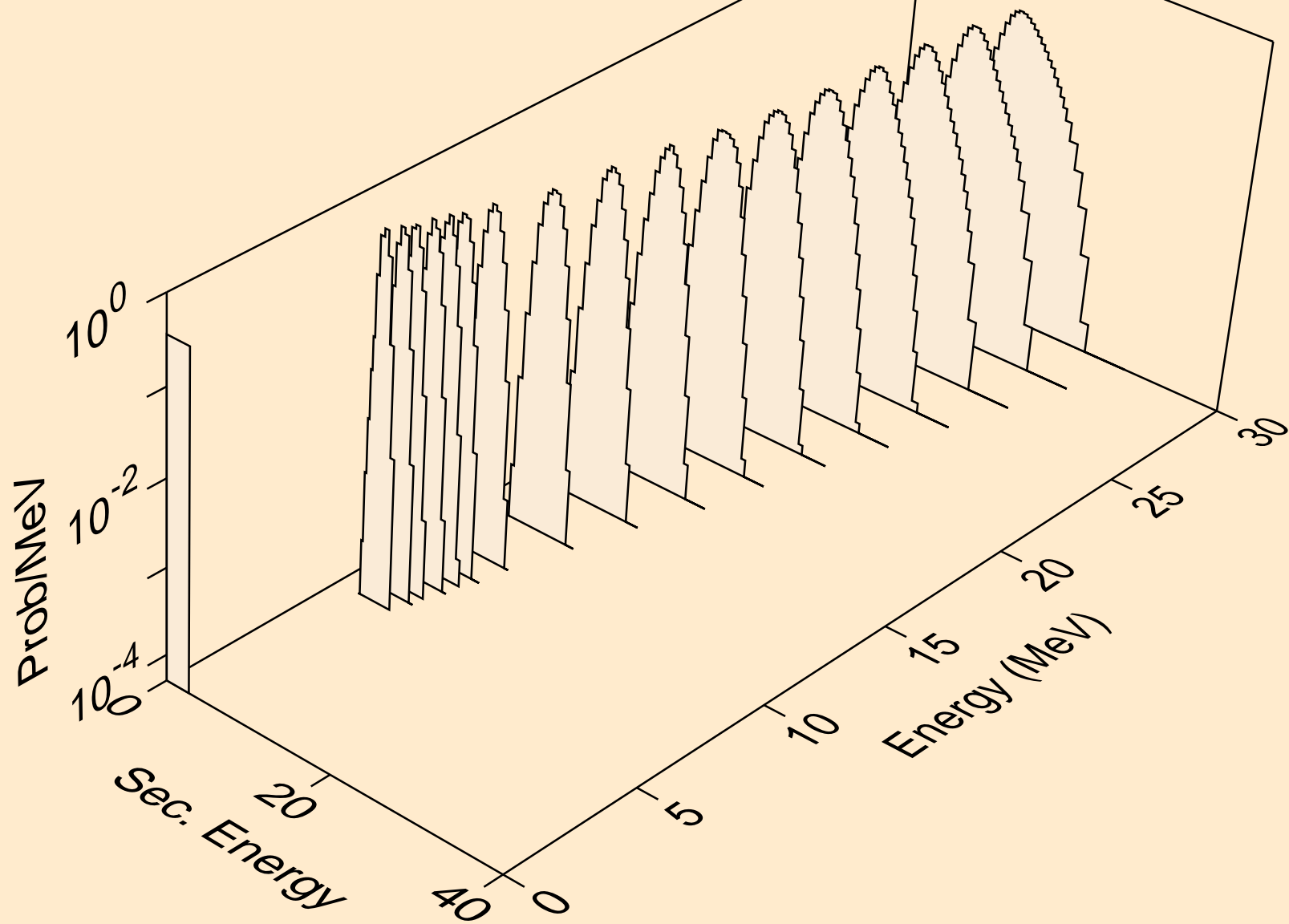

RH093 NEUTRON ACER TENDL-2024 LIBRARY; T=0.K
alphas from (n,pa)

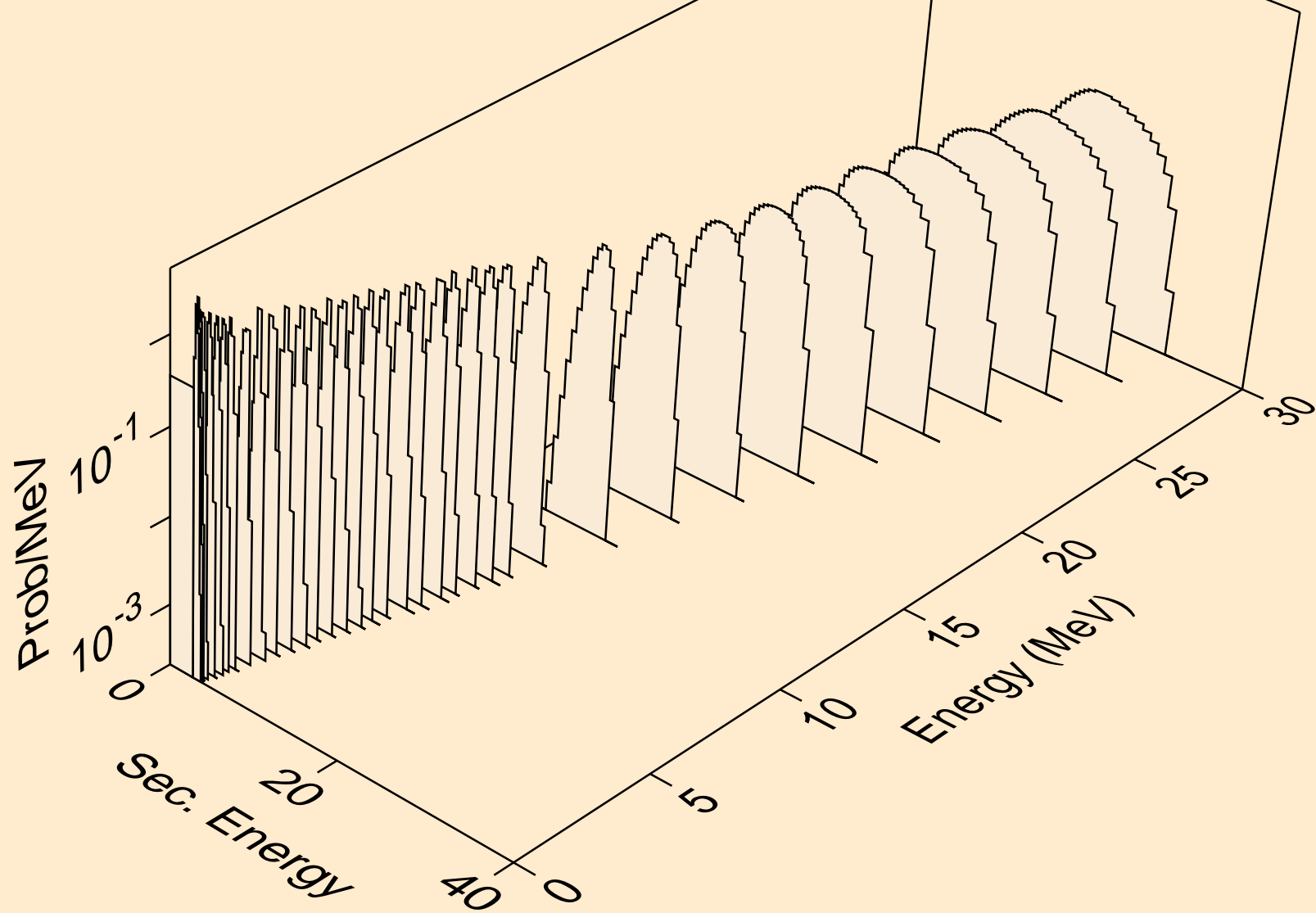

RH093 NEUTRON ACER TENDL-2024 LIBRARY; T=0.K
alphas from (n,da)

