

RU093M NEUTRON ACER TENDL-2024 LIBRARY; T=0.K

Principal cross sections

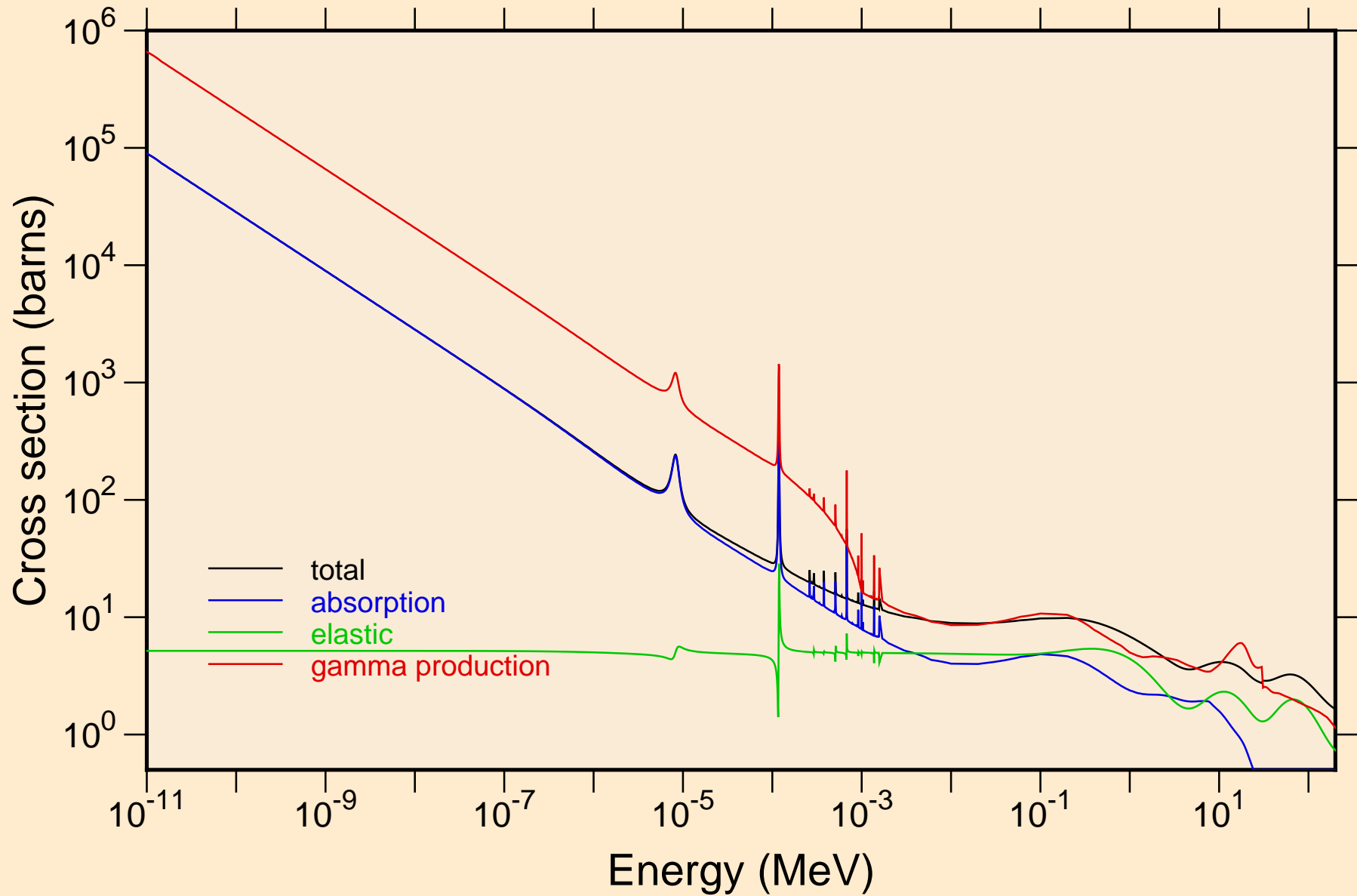

RU093M NEUTRON ACER TENDL-2024 LIBRARY; T=0.K
resonance total cross section

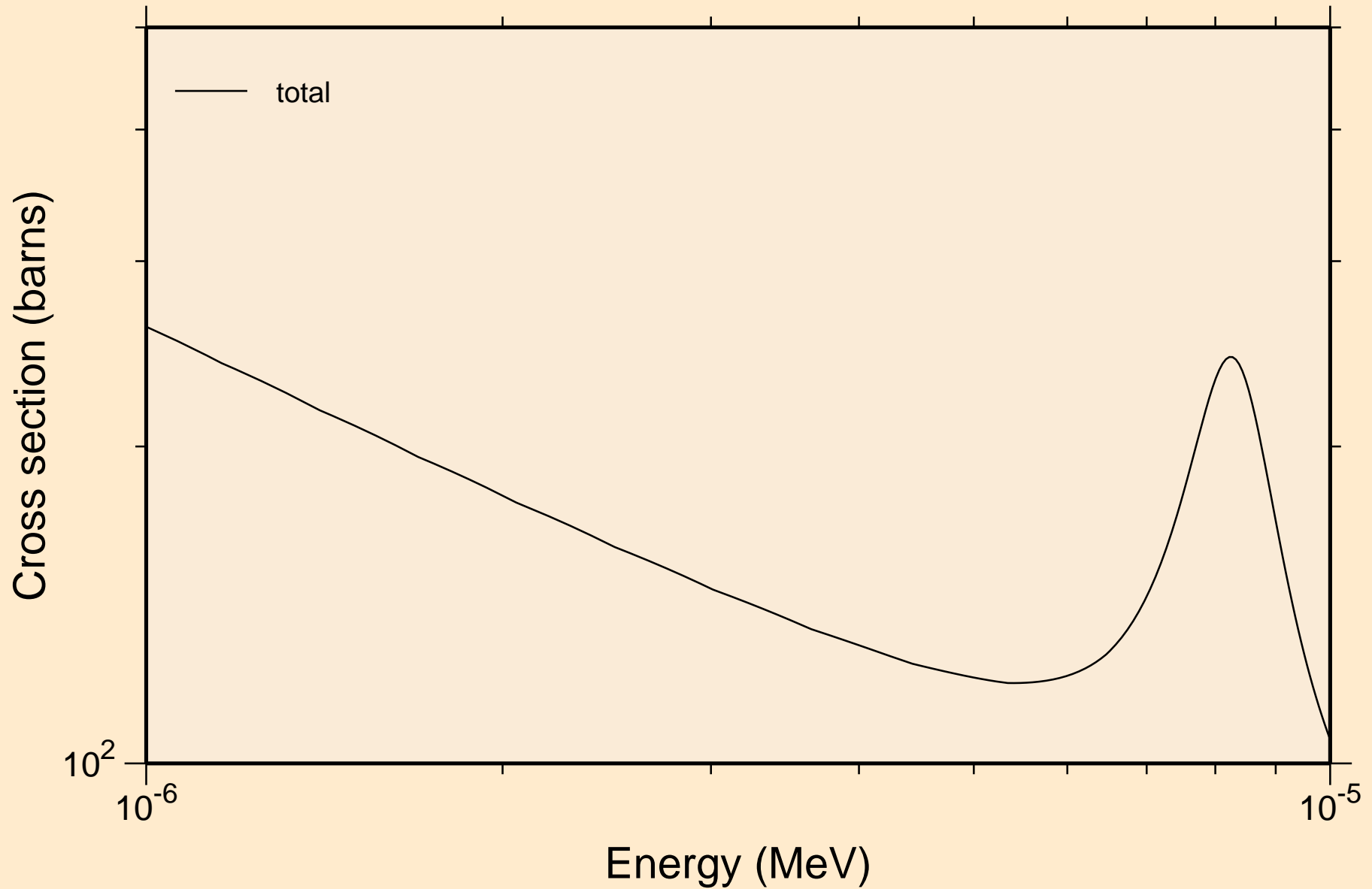

RU093M NEUTRON ACER TENDL-2024 LIBRARY; T=0.K
resonance total cross section

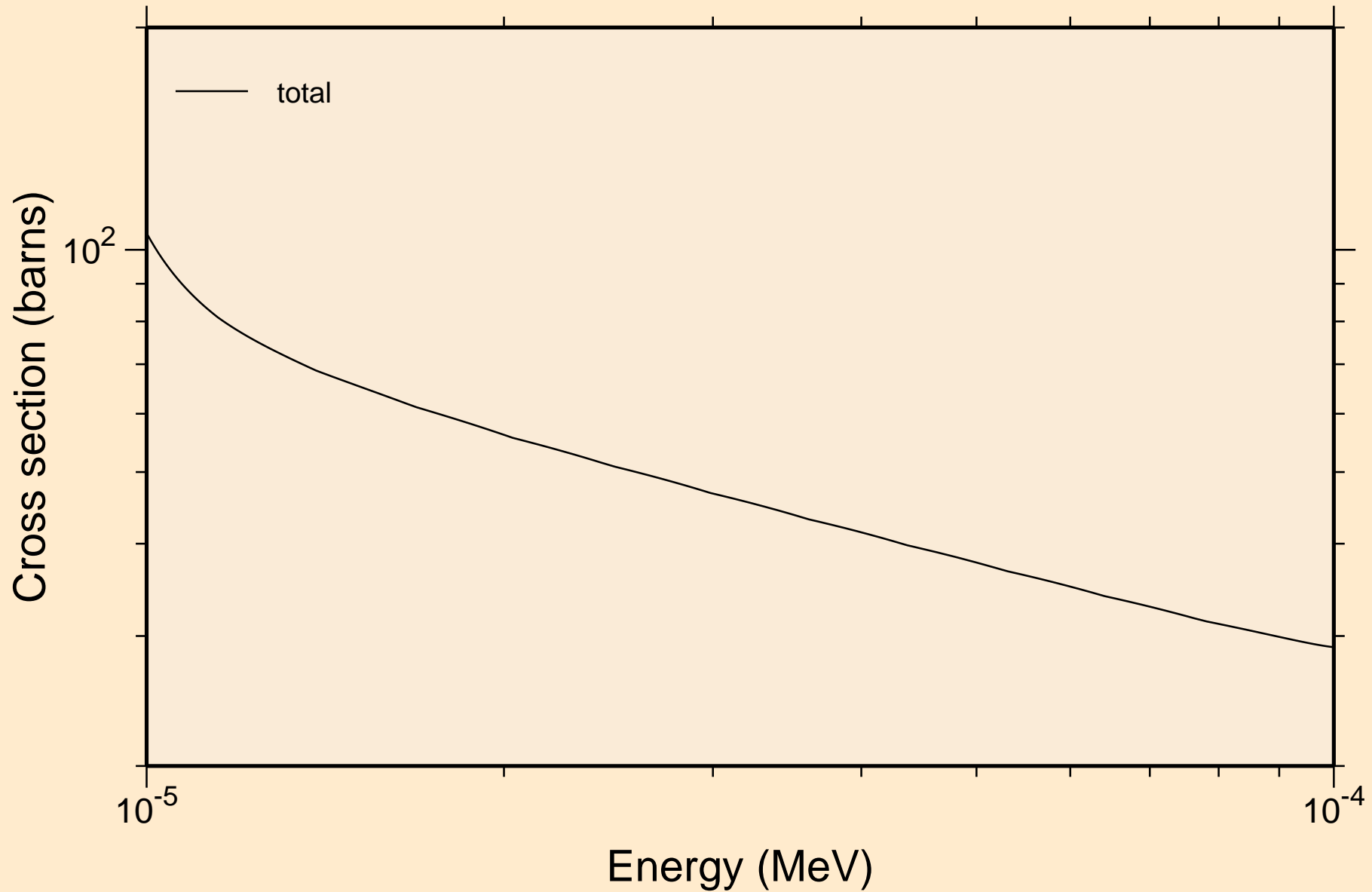

RU093M NEUTRON ACER TENDL-2024 LIBRARY; T=0.K
resonance total cross section

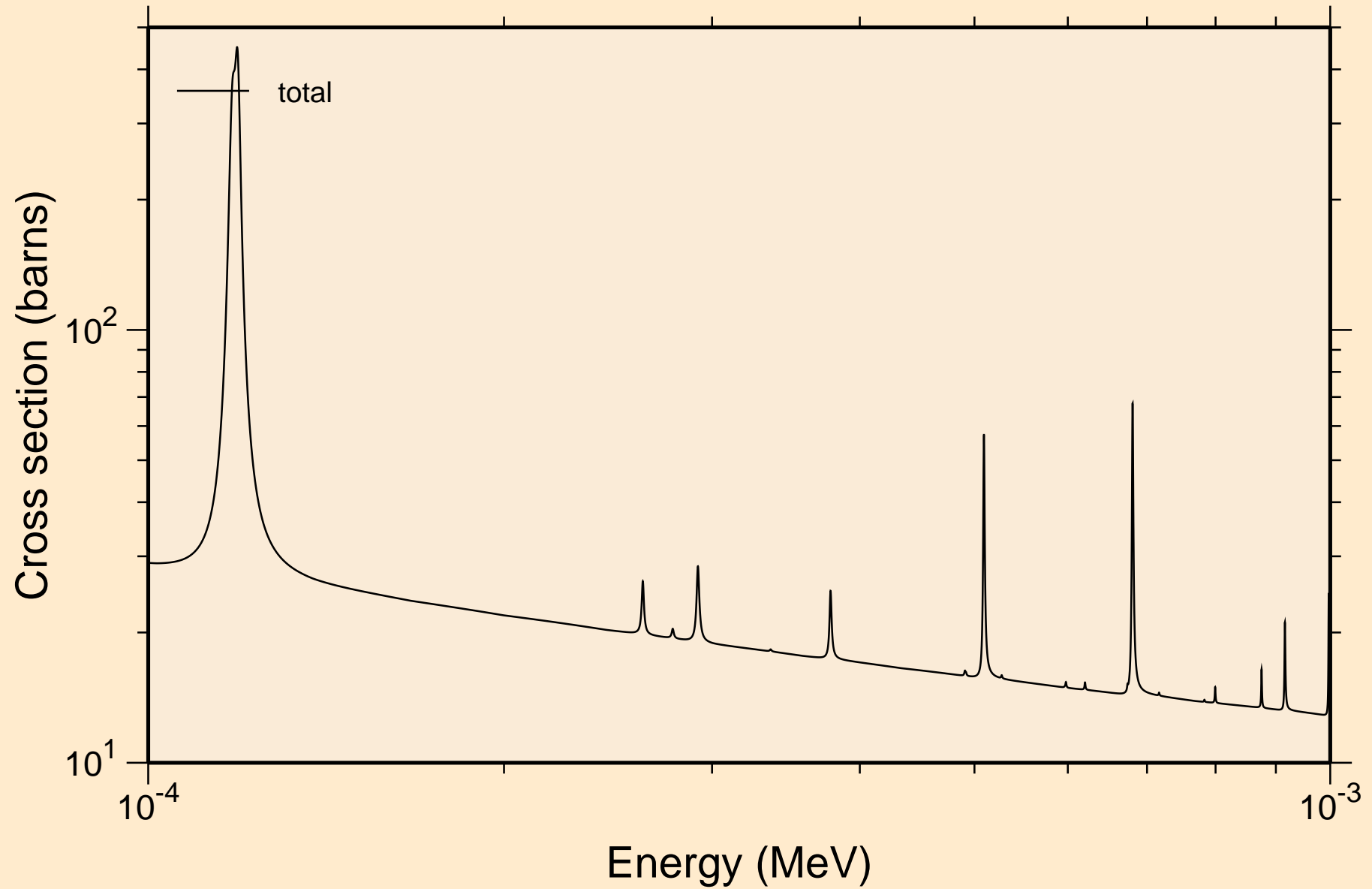

RU093M NEUTRON ACER TENDL-2024 LIBRARY; T=0.K
resonance total cross section

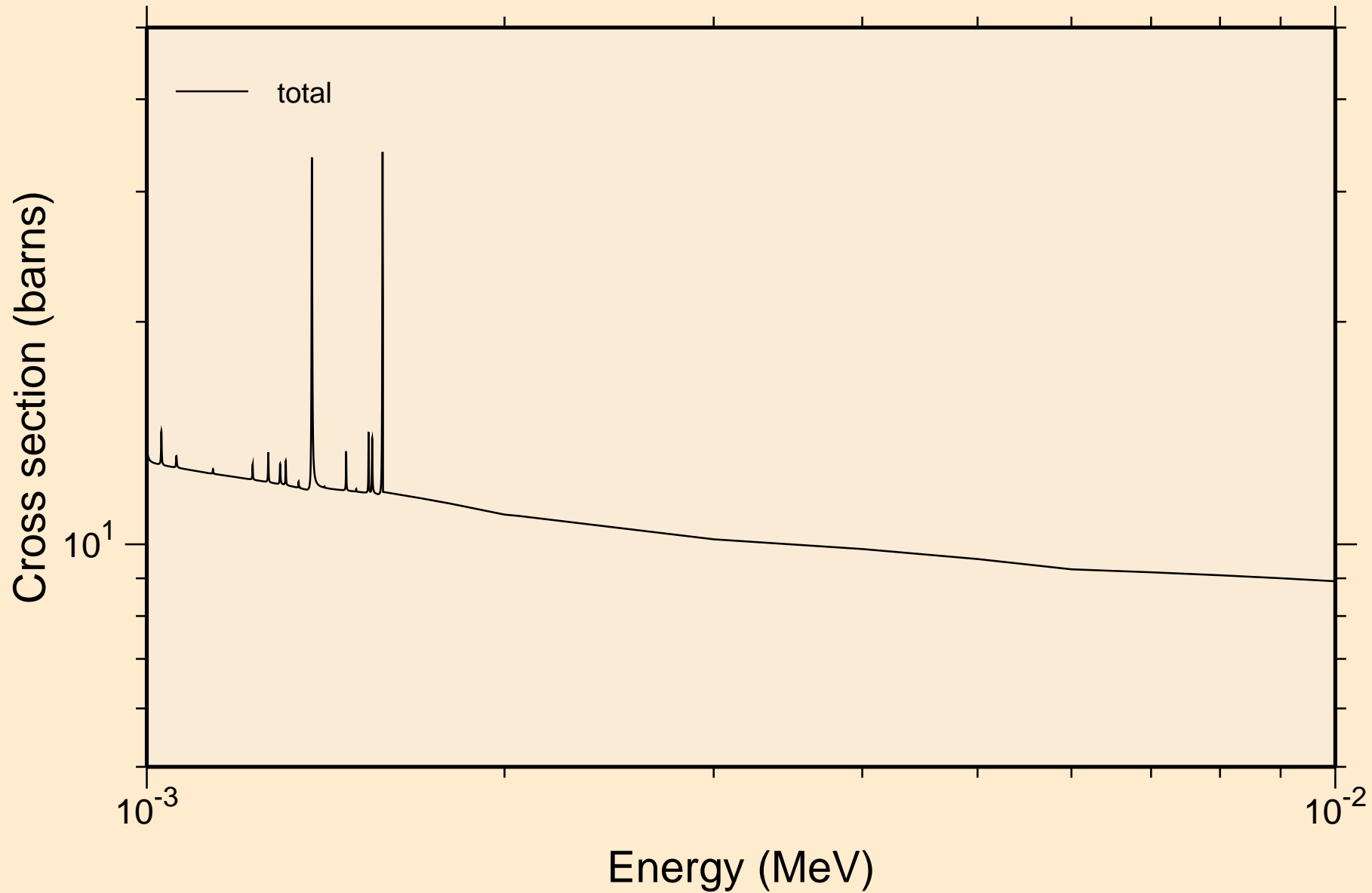

RŪ093M NEUTRON ACER TENDL-2024 LIBRARY; T=0.K
resonance total cross section

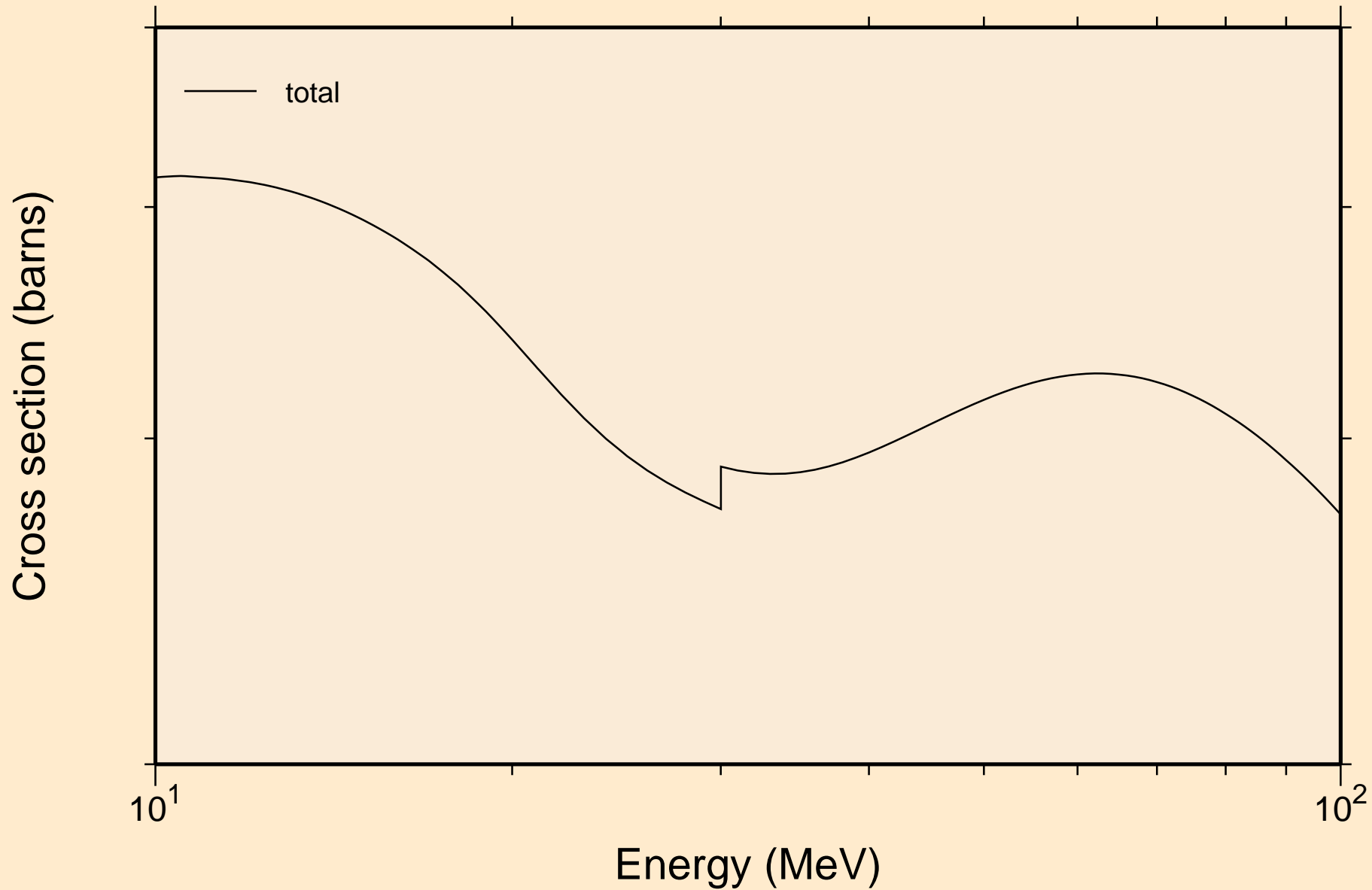

RU093M NEUTRON ACER TENDL-2024 LIBRARY; T=0.K
resonance absorption cross sections

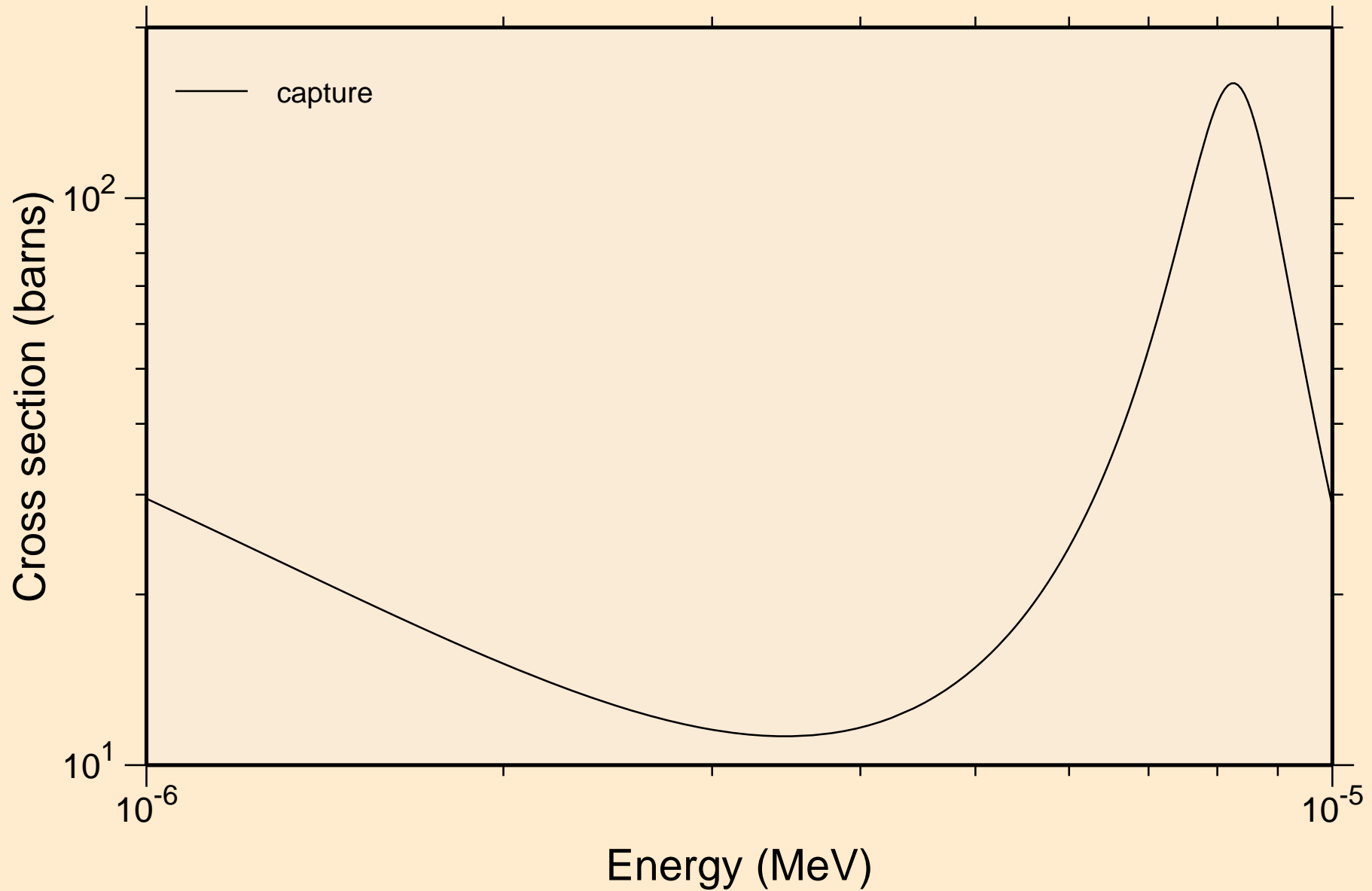

RU093M NEUTRON ACER TENDL-2024 LIBRARY; T=0.K
resonance absorption cross sections

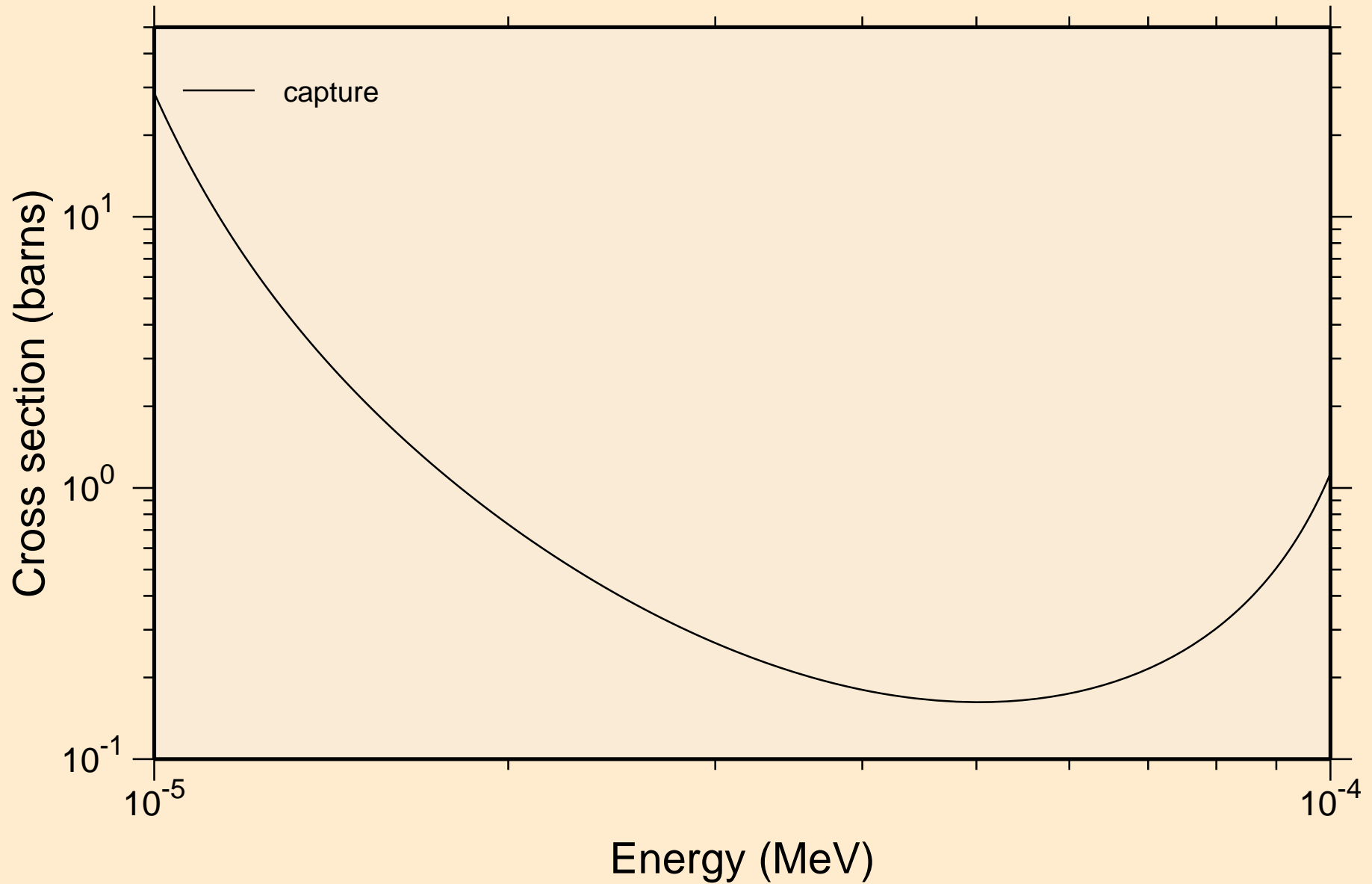

RU093M NEUTRON ACER TENDL-2024 LIBRARY; T=0.K
resonance absorption cross sections

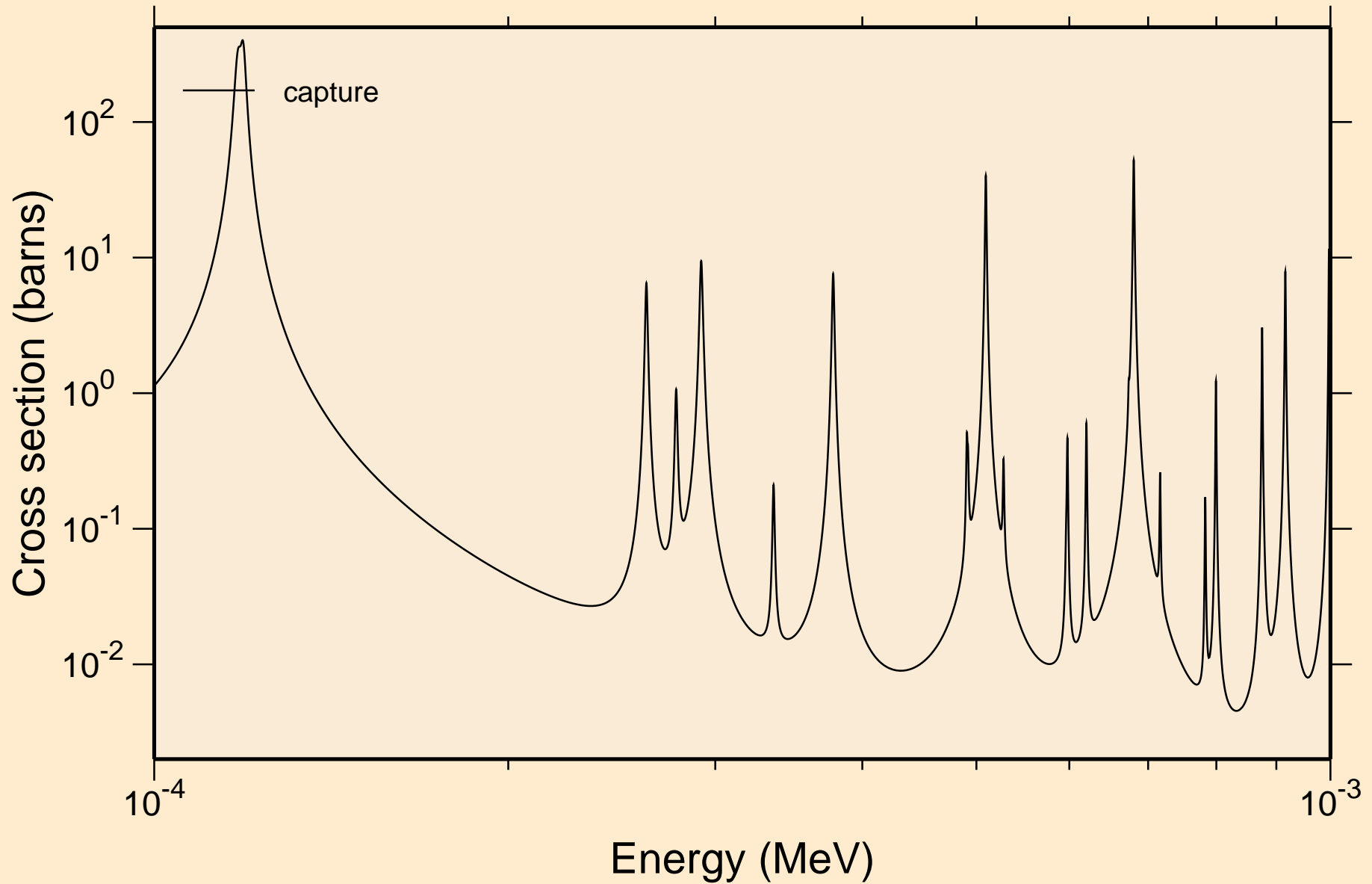

RU093M NEUTRON ACER TENDL-2024 LIBRARY; T=0.K
resonance absorption cross sections

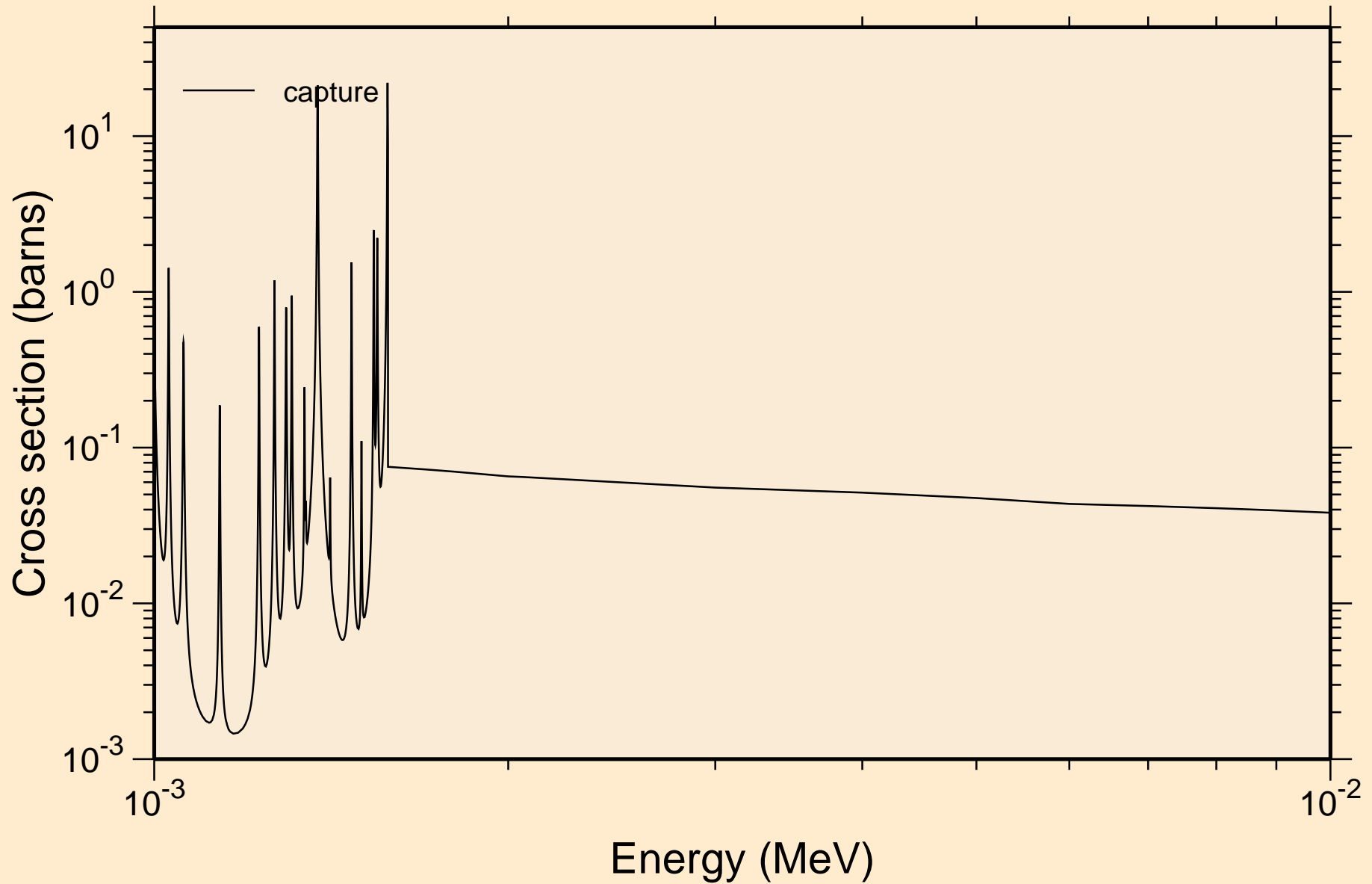

RU093M NEUTRON ACER TENDL-2024 LIBRARY; T=0.K
resonance absorption cross sections

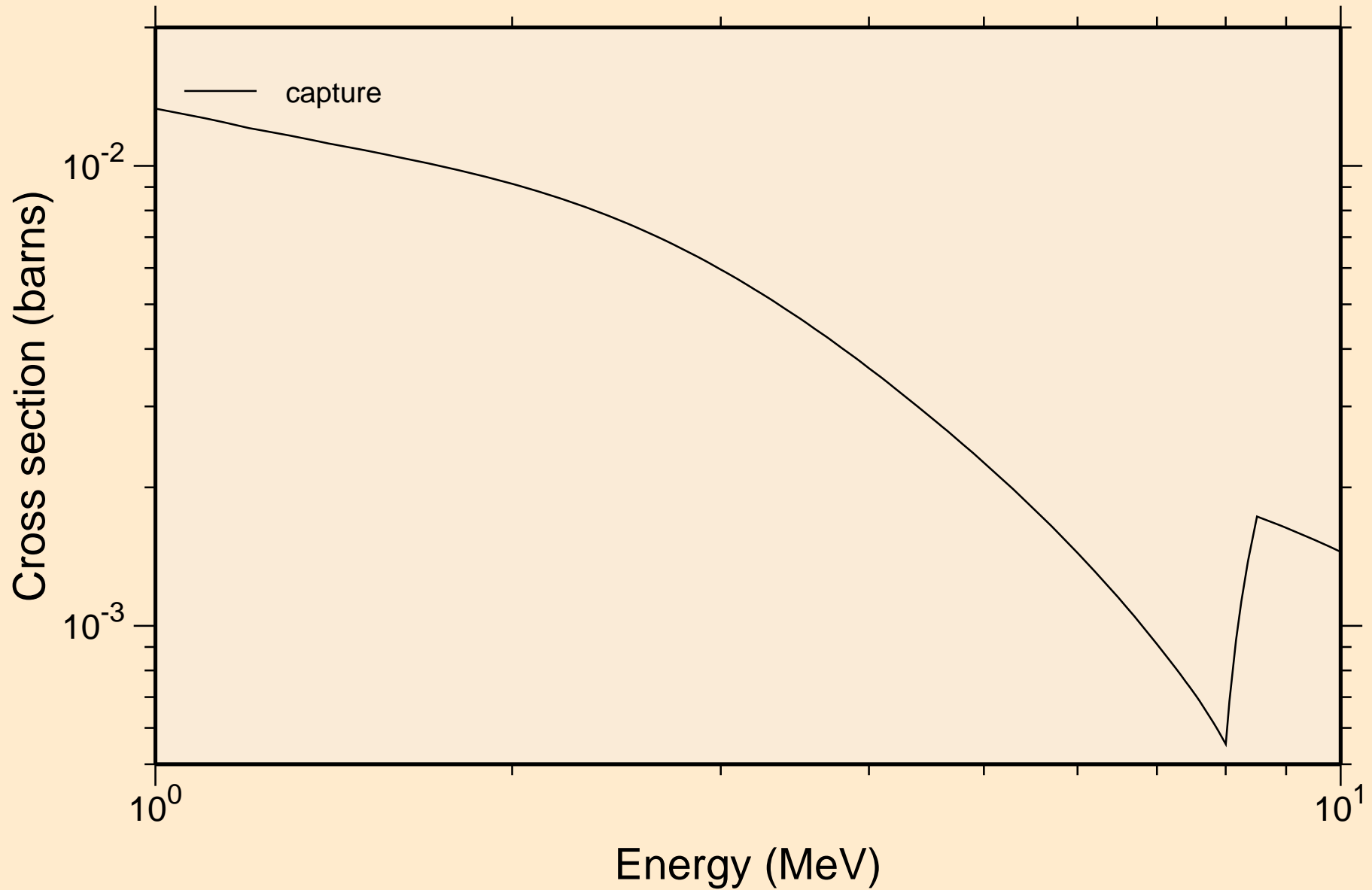

RU093M NEUTRON ACER TENDL-2024 LIBRARY; T=0.K
Heating

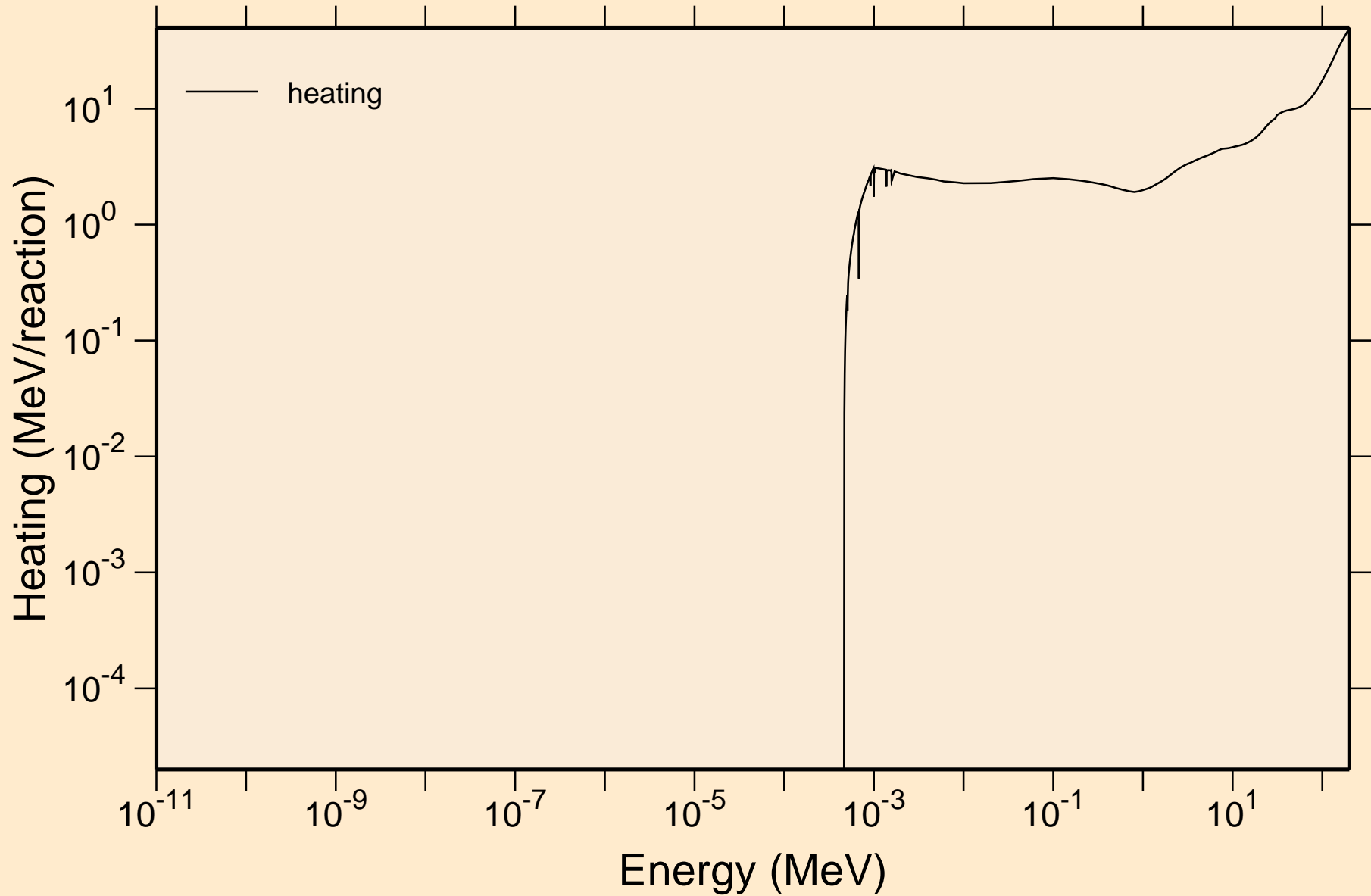

RU093M NEUTRON ACER TENDL-2024 LIBRARY; T=0.K
Damage

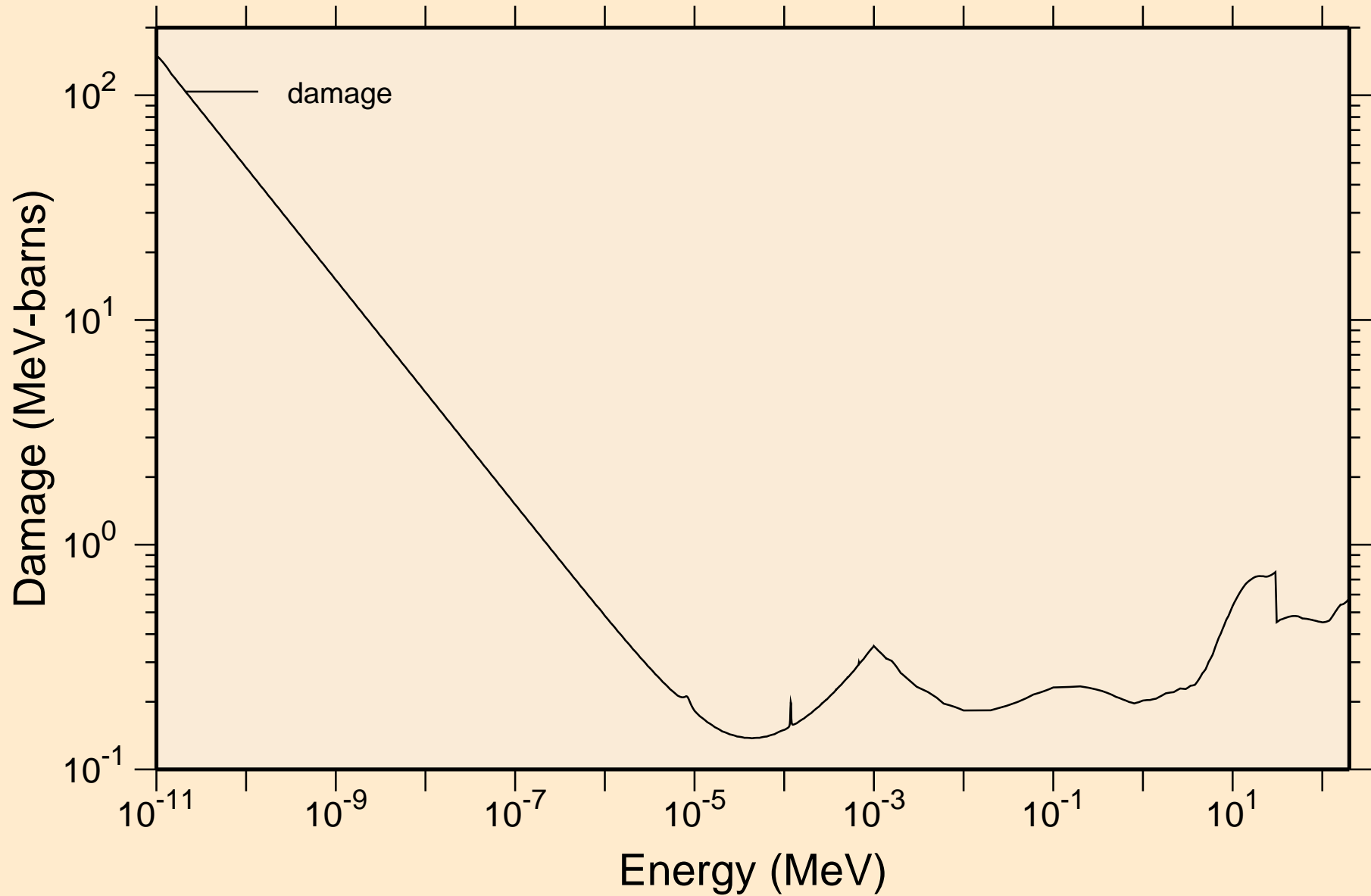

RU093M NEUTRON ACER TENDL-2024 LIBRARY; T=0.K
Non-threshold reactions

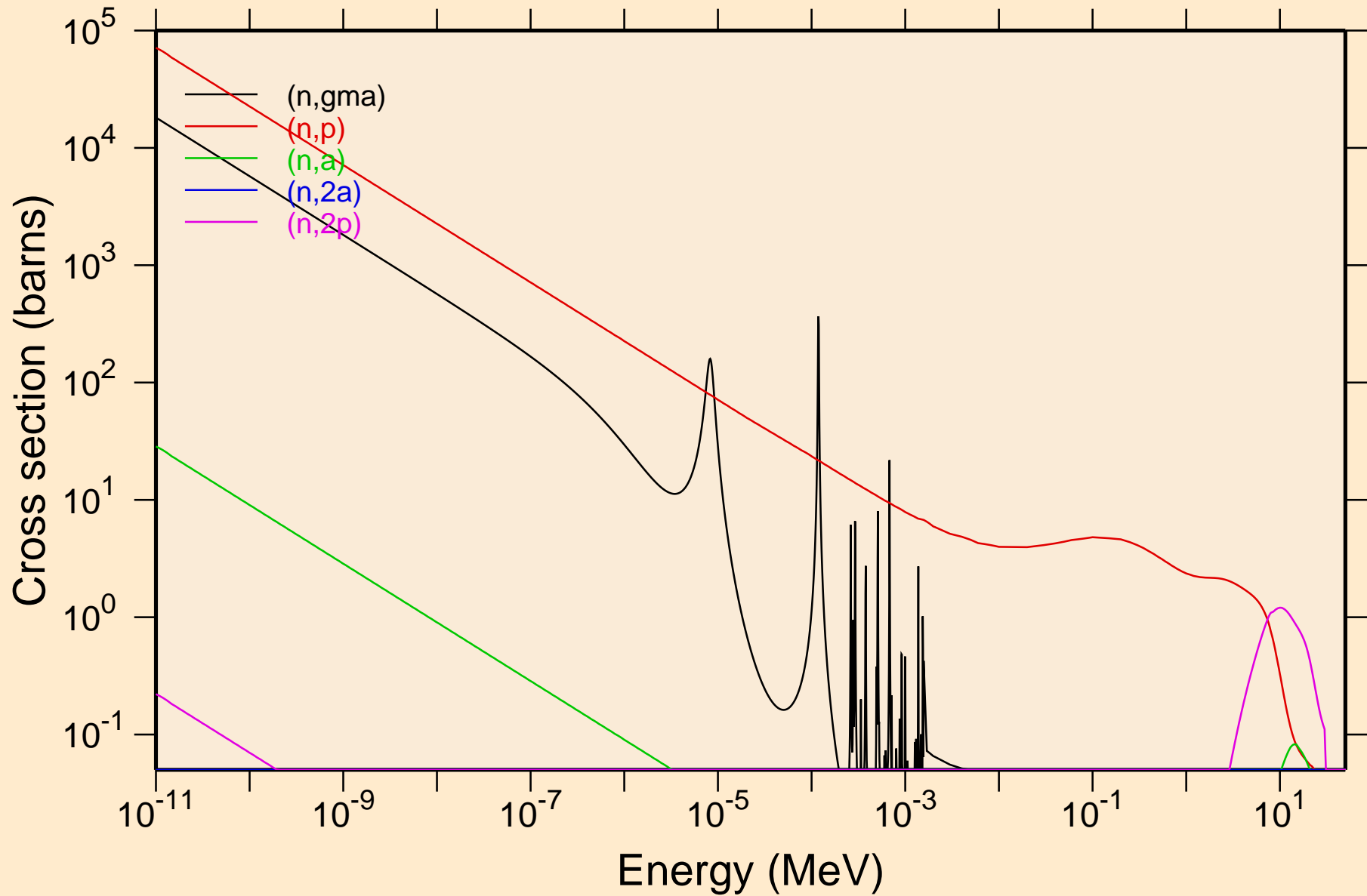

RU093M NEUTRON ACER TENDL-2024 LIBRARY; T=0.K
Non-threshold reactions

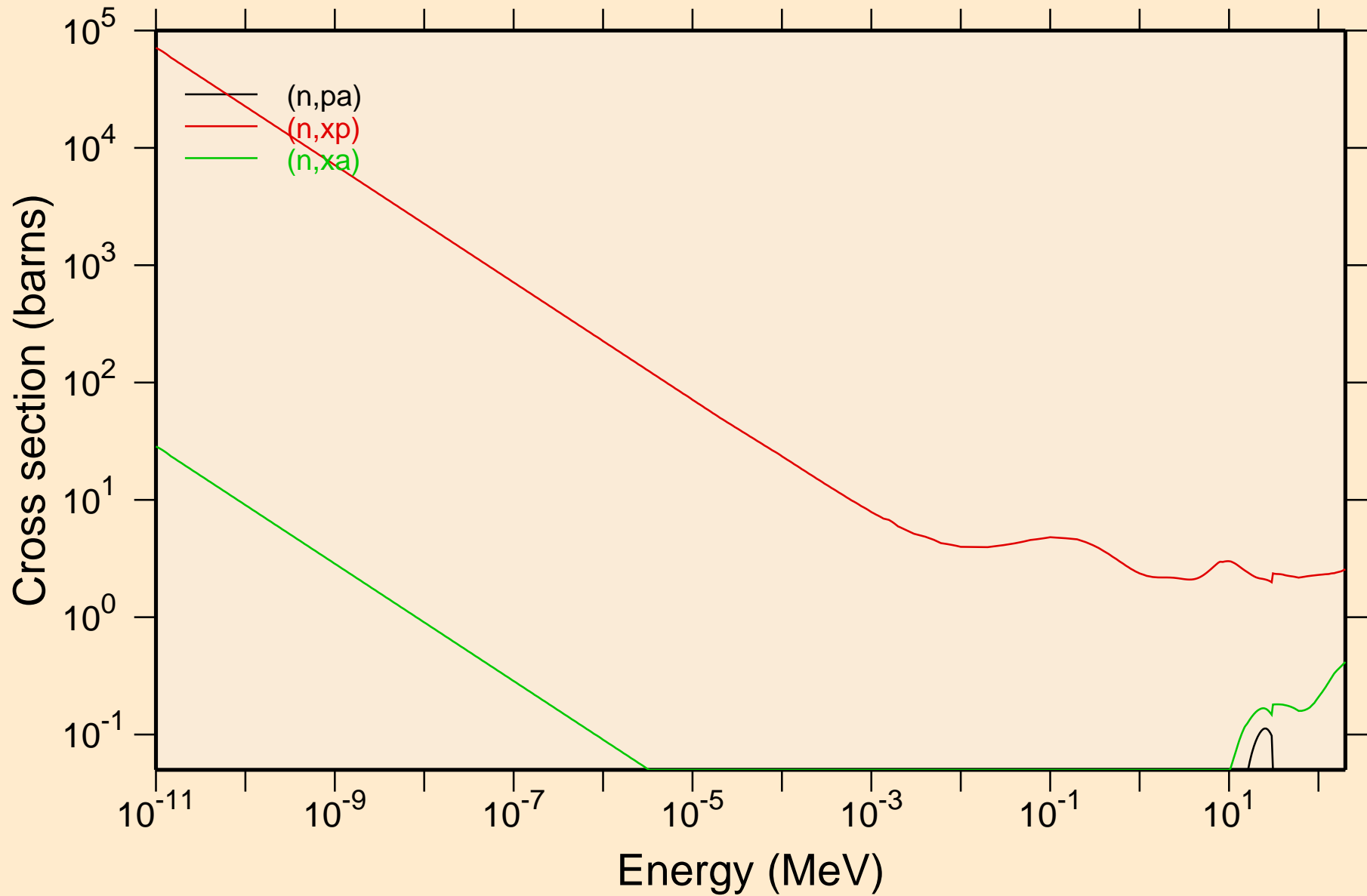

RU093M NEUTRON ACER TENDL-2024 LIBRARY; T=0.K
Principal cross sections

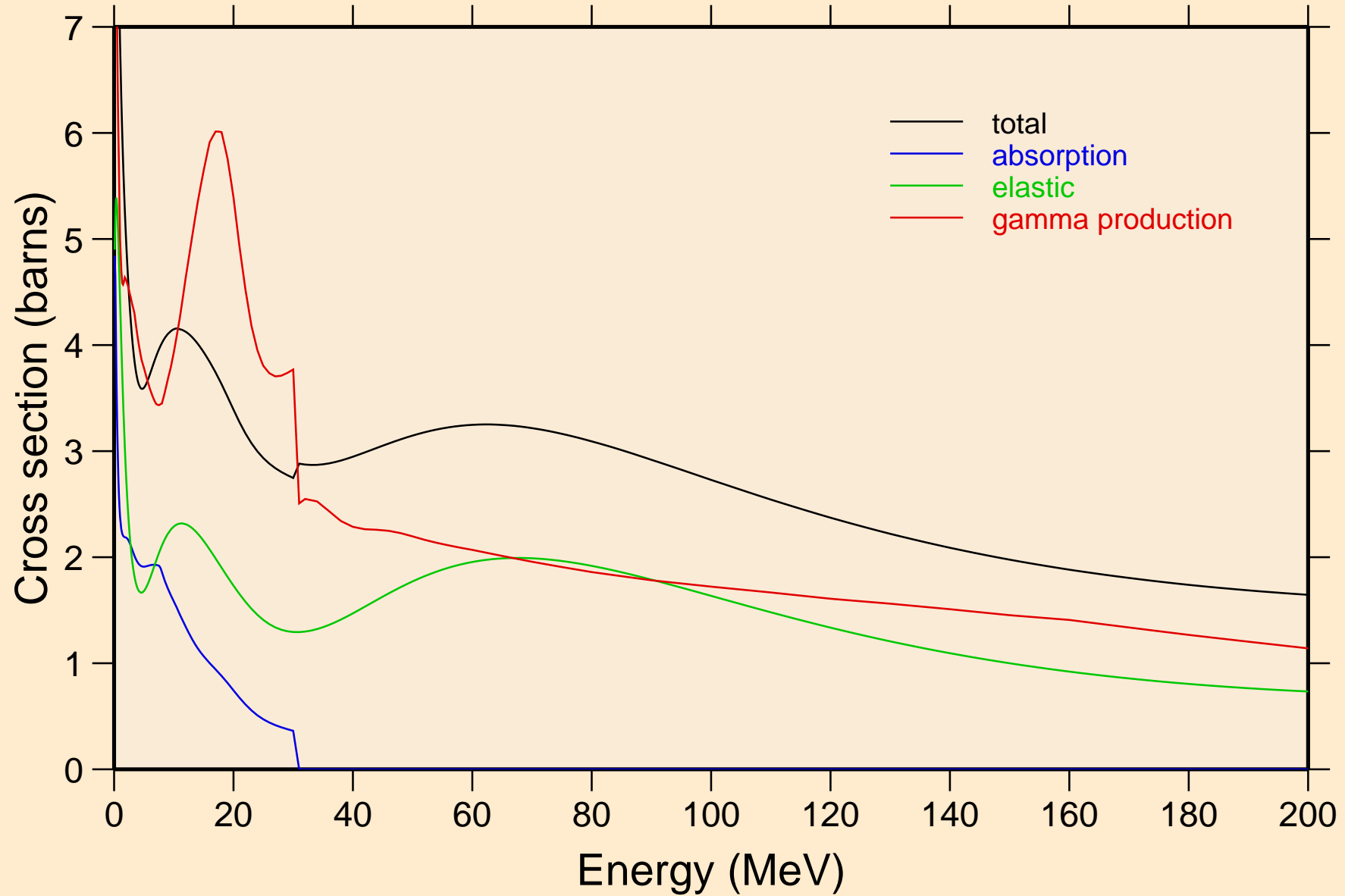

RU093M NEUTRON ACER TENDL-2024 LIBRARY; T=0.K

Heating

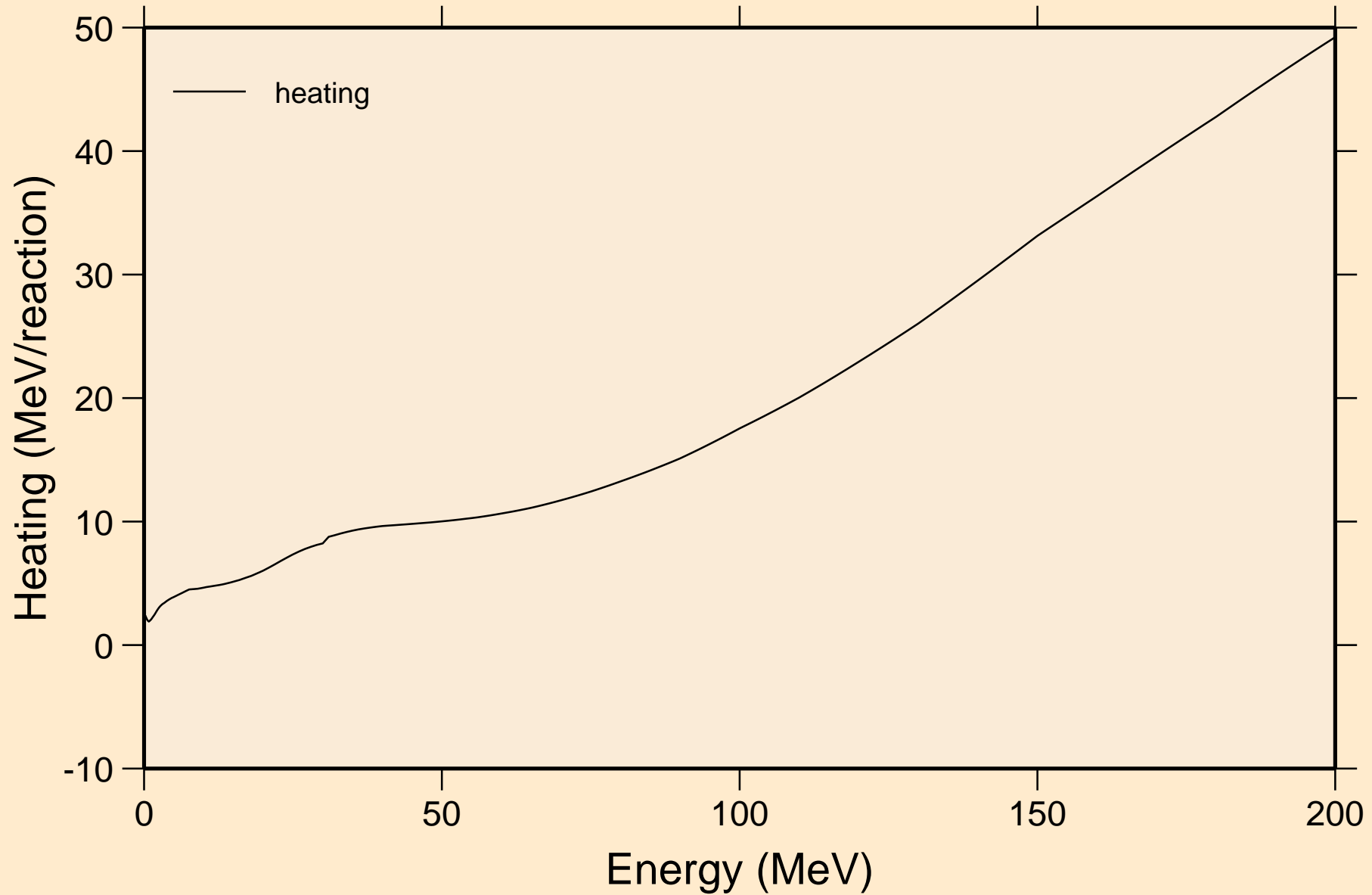

RU093M NEUTRON ACER TENDL-2024 LIBRARY; T=0.K
Damage

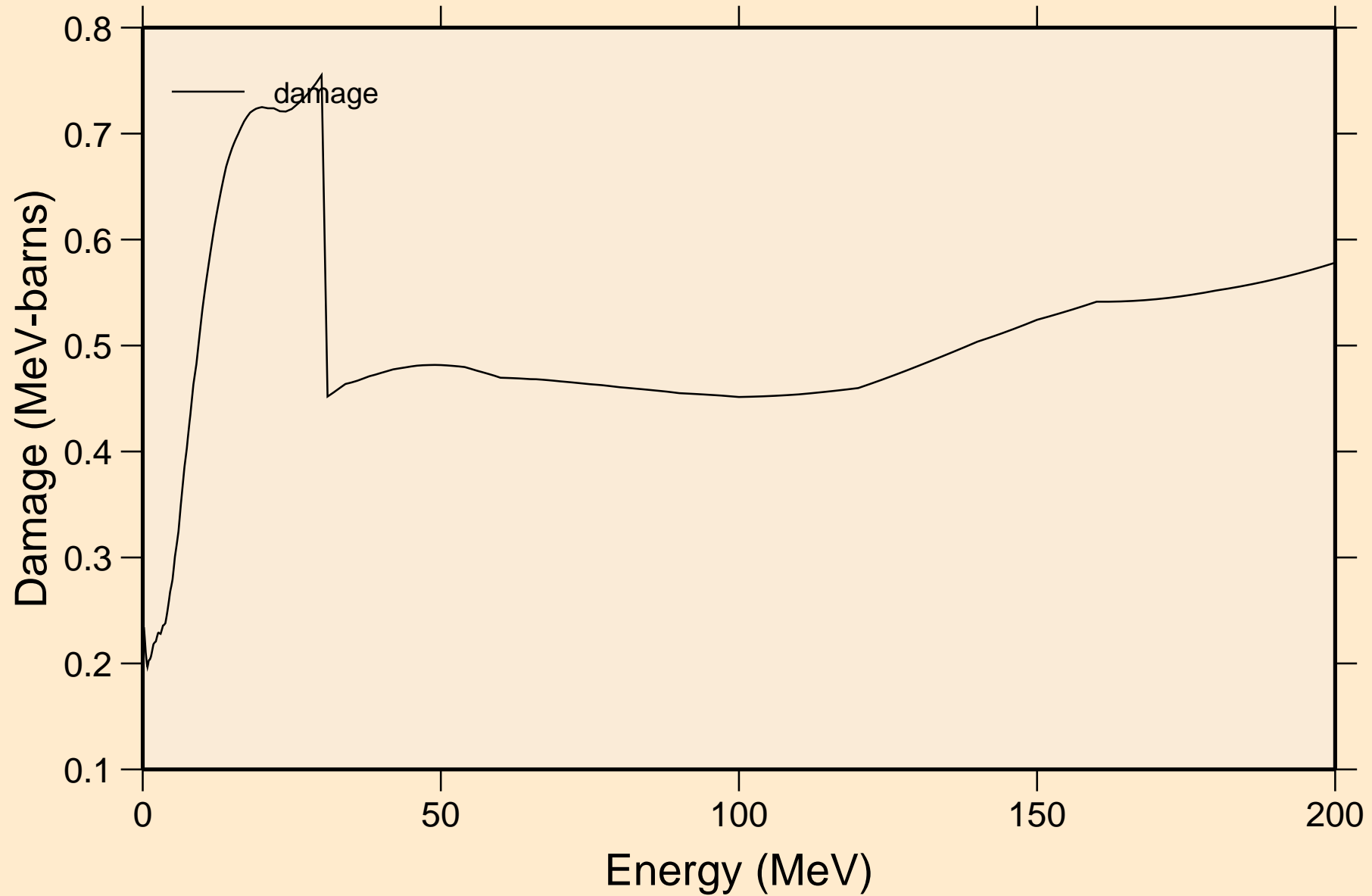

RU093M NEUTRON ACER TENDL-2024 LIBRARY; T=0.K
Non-threshold reactions

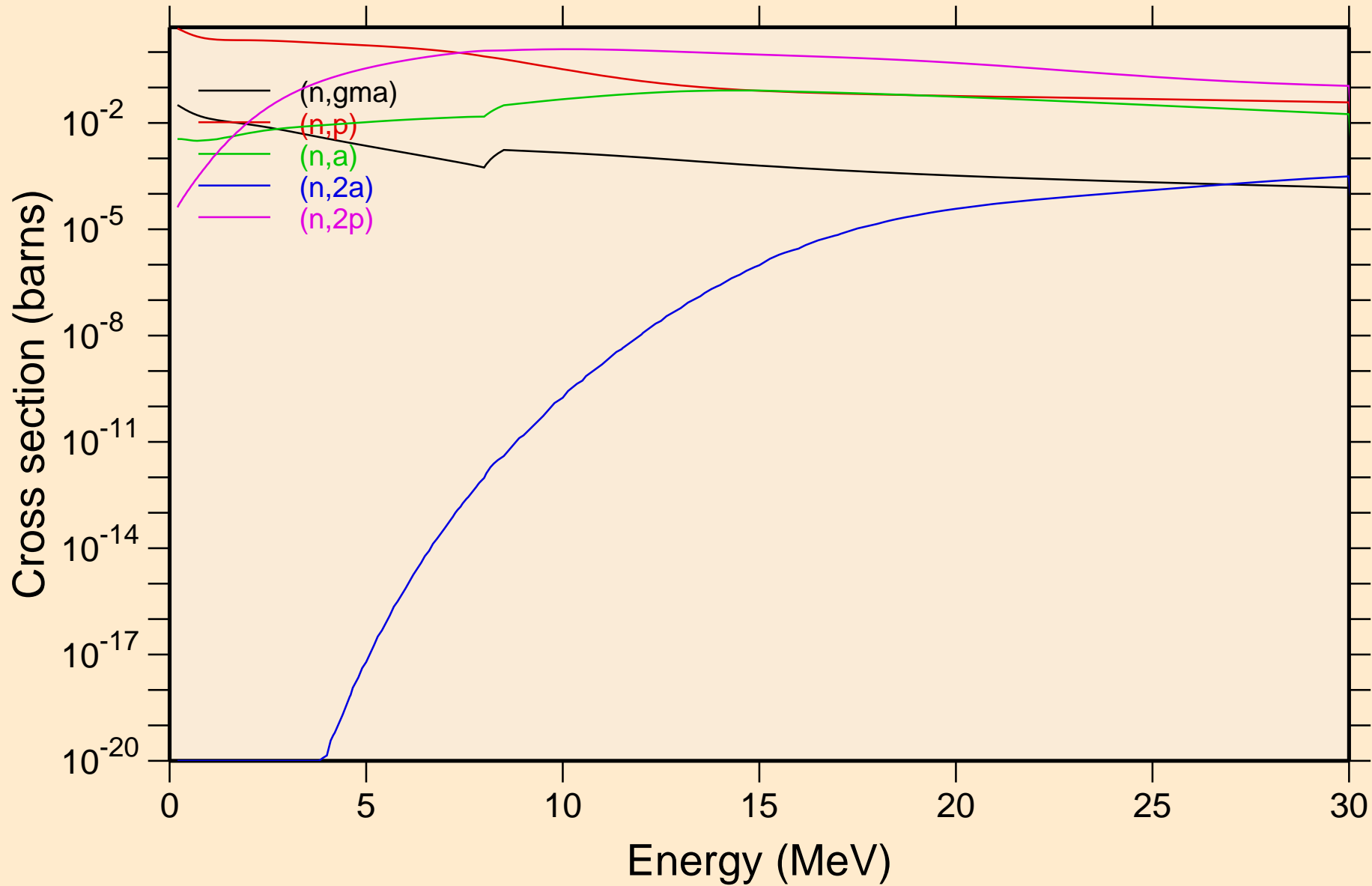

RU093M NEUTRON ACER TENDL-2024 LIBRARY; T=0.K
Non-threshold reactions

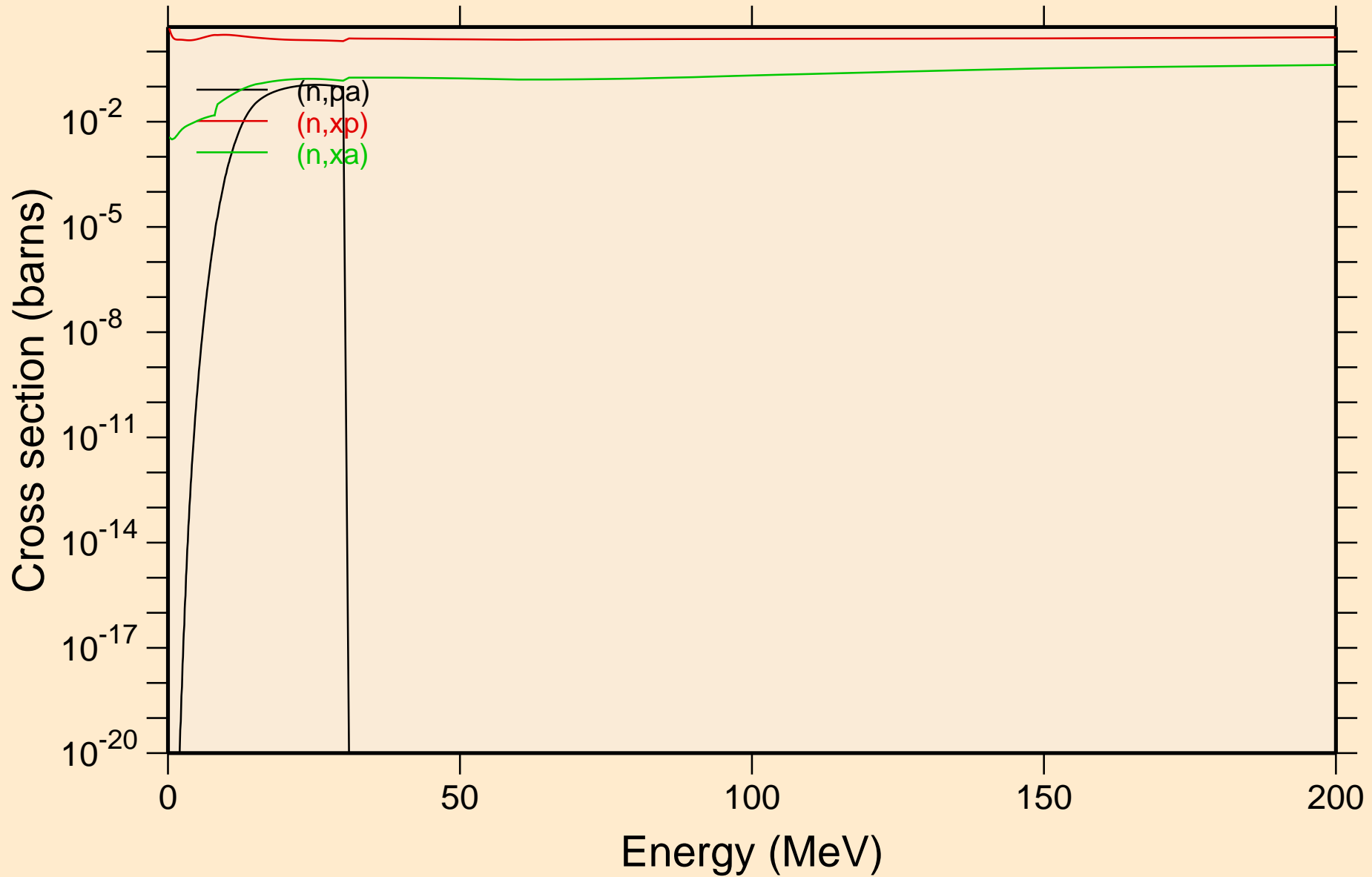

RU093M NEUTRON ACER TENDL-2024 LIBRARY; T=0.K
Inelastic levels

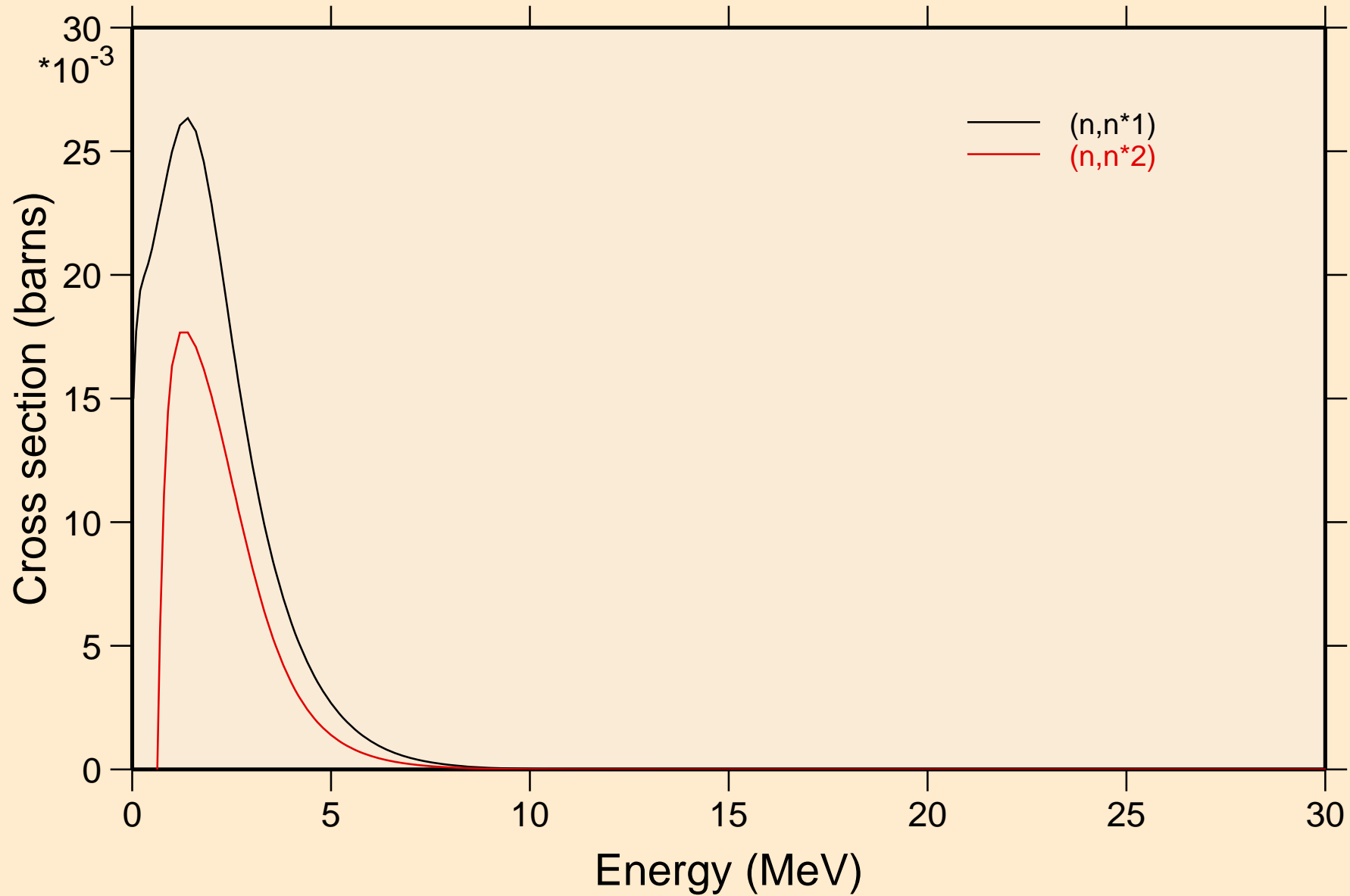

RU093M NEUTRON ACER TENDL-2024 LIBRARY; T=0.K
Threshold reactions

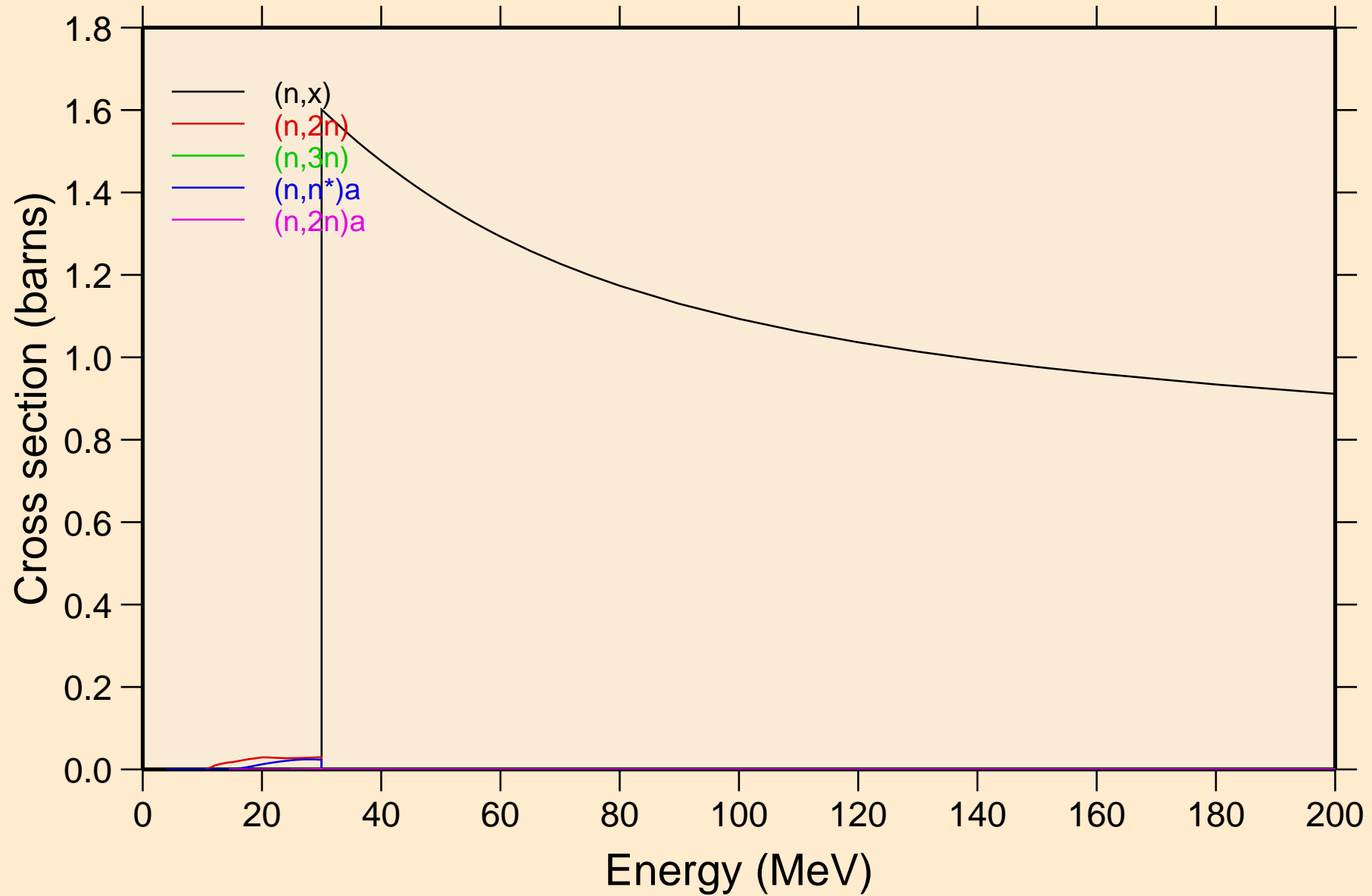

RU093M NEUTRON ACER TENDL-2024 LIBRARY; T=0.K
Threshold reactions

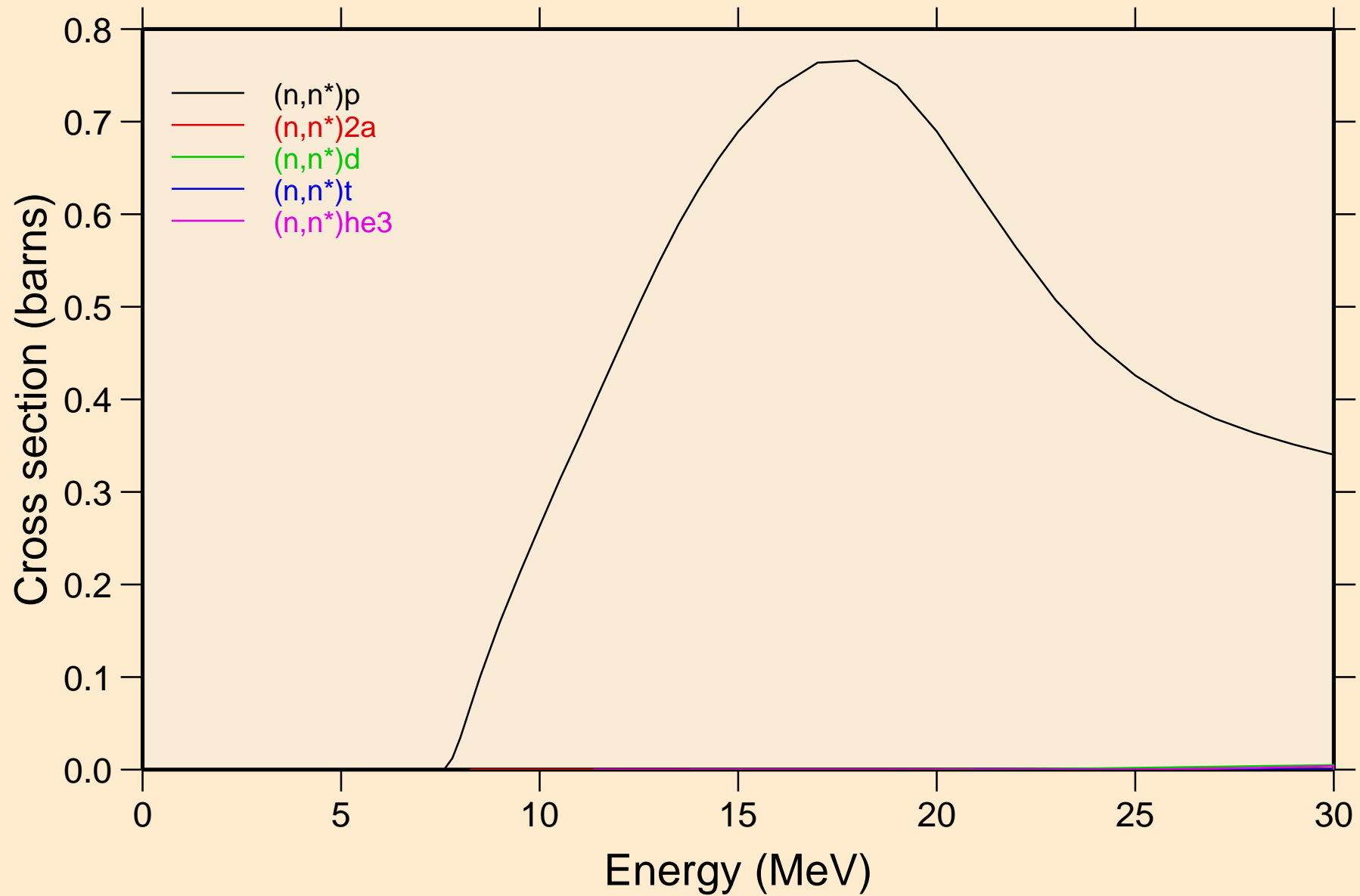

RU093M NEUTRON ACER TENDL-2024 LIBRARY; T=0.K
Threshold reactions

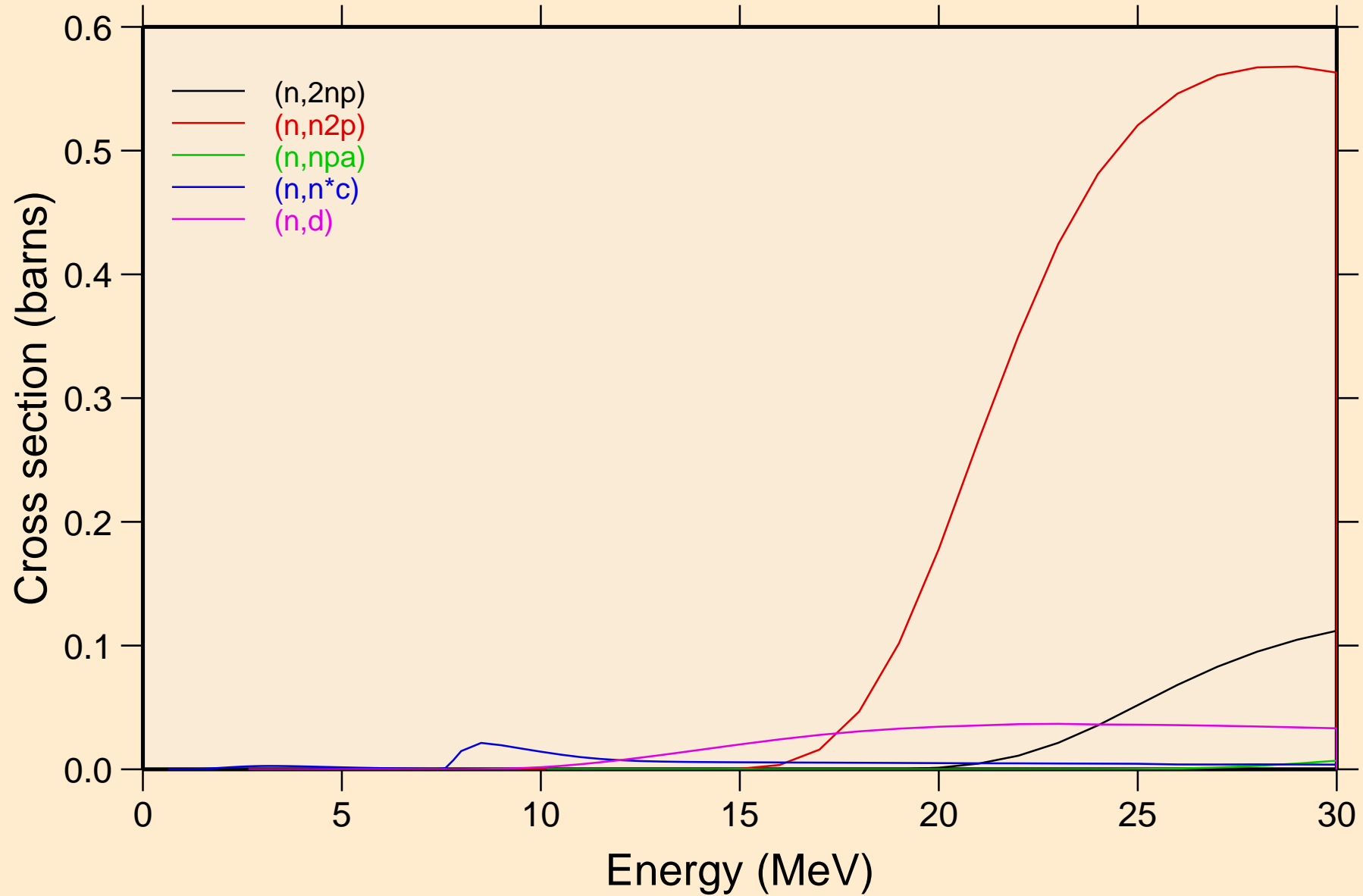

RU093M NEUTRON ACER TENDL-2024 LIBRARY; T=0.K
Threshold reactions

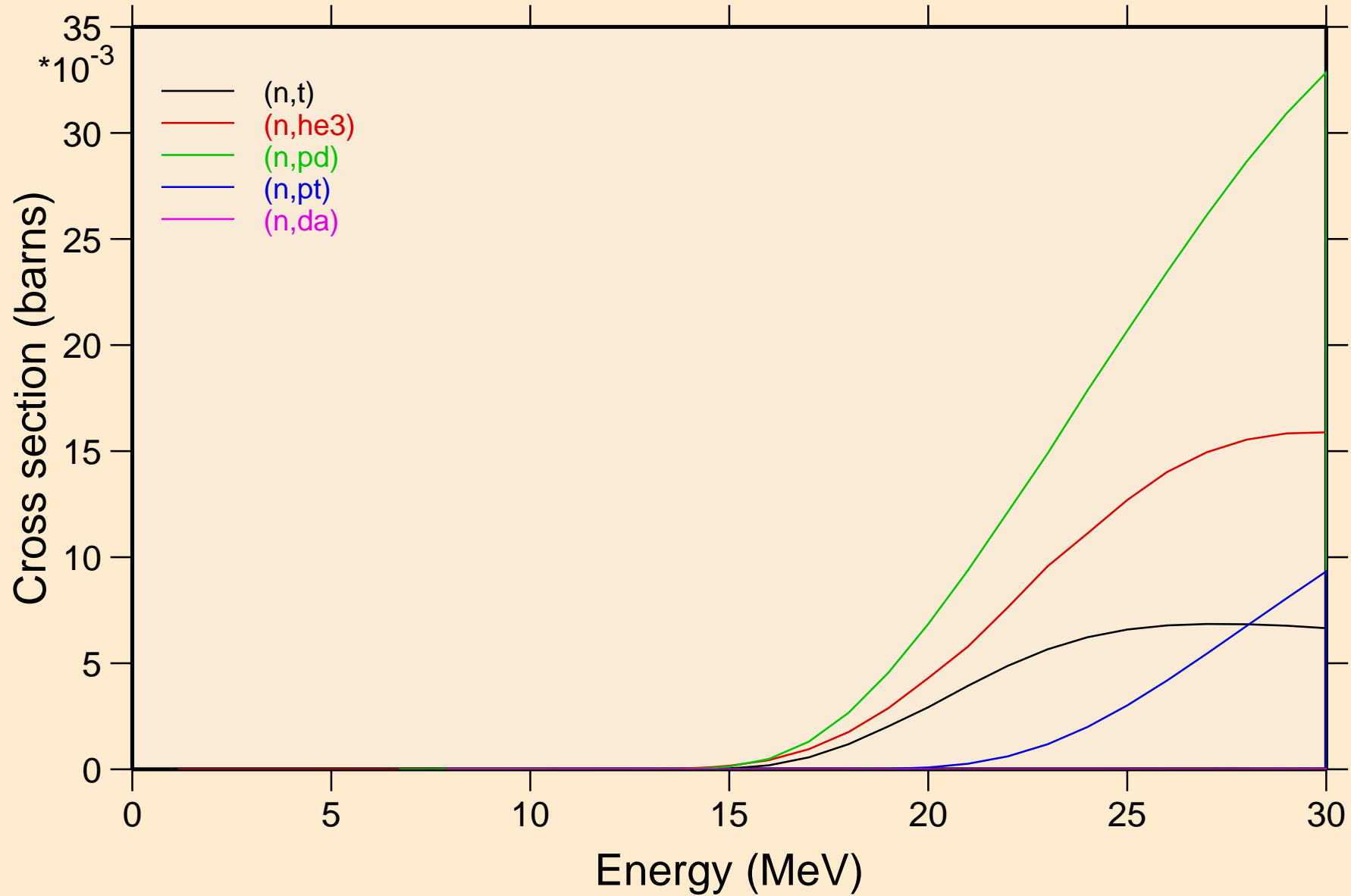

RU093M NEUTRON ACER TENDL-2024 LIBRARY; T=0.K

Threshold reactions

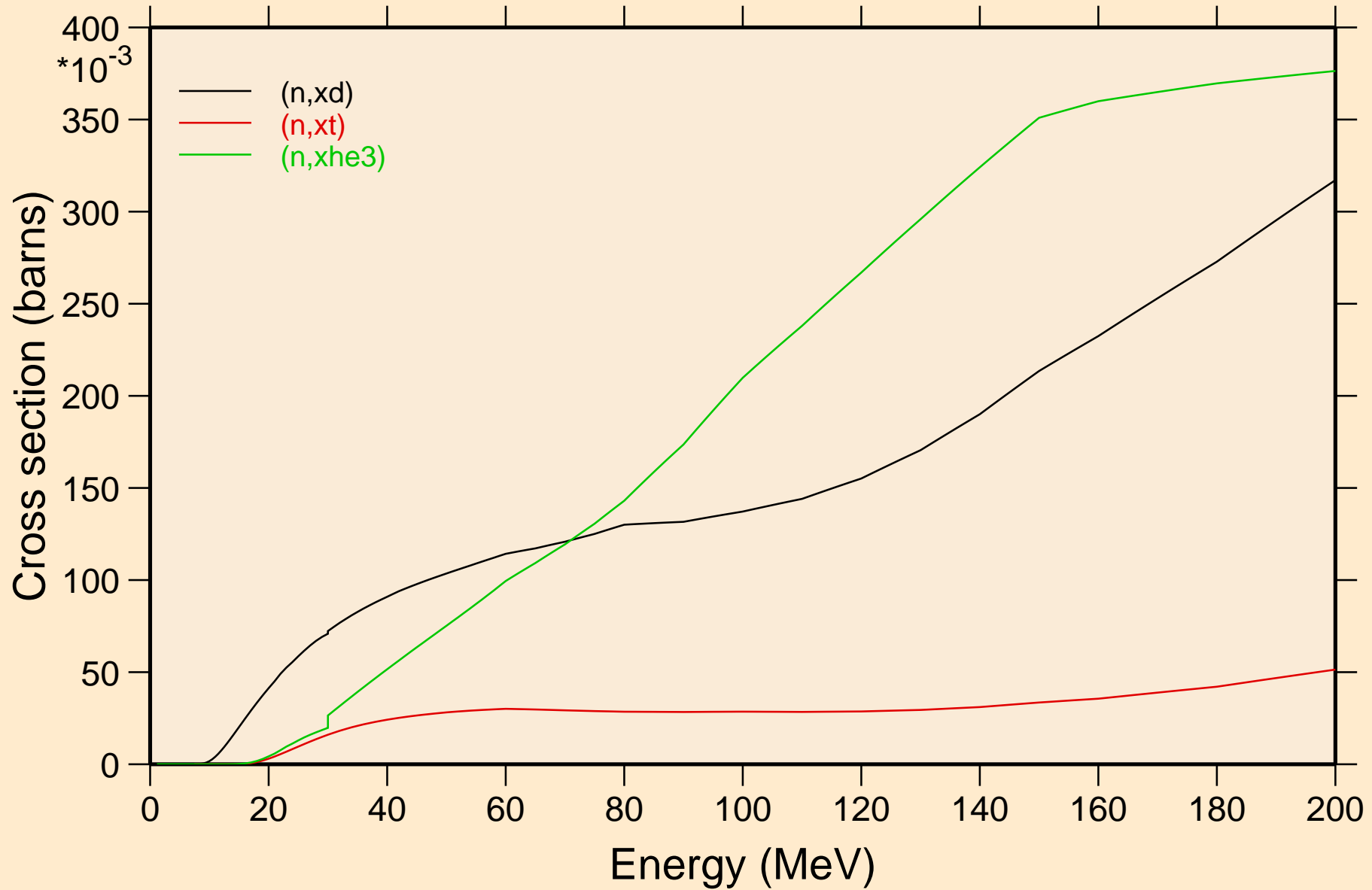

RU093M NEUTRON ACER TENDL-2024 LIBRARY; T=0.K
angular distribution for elastic

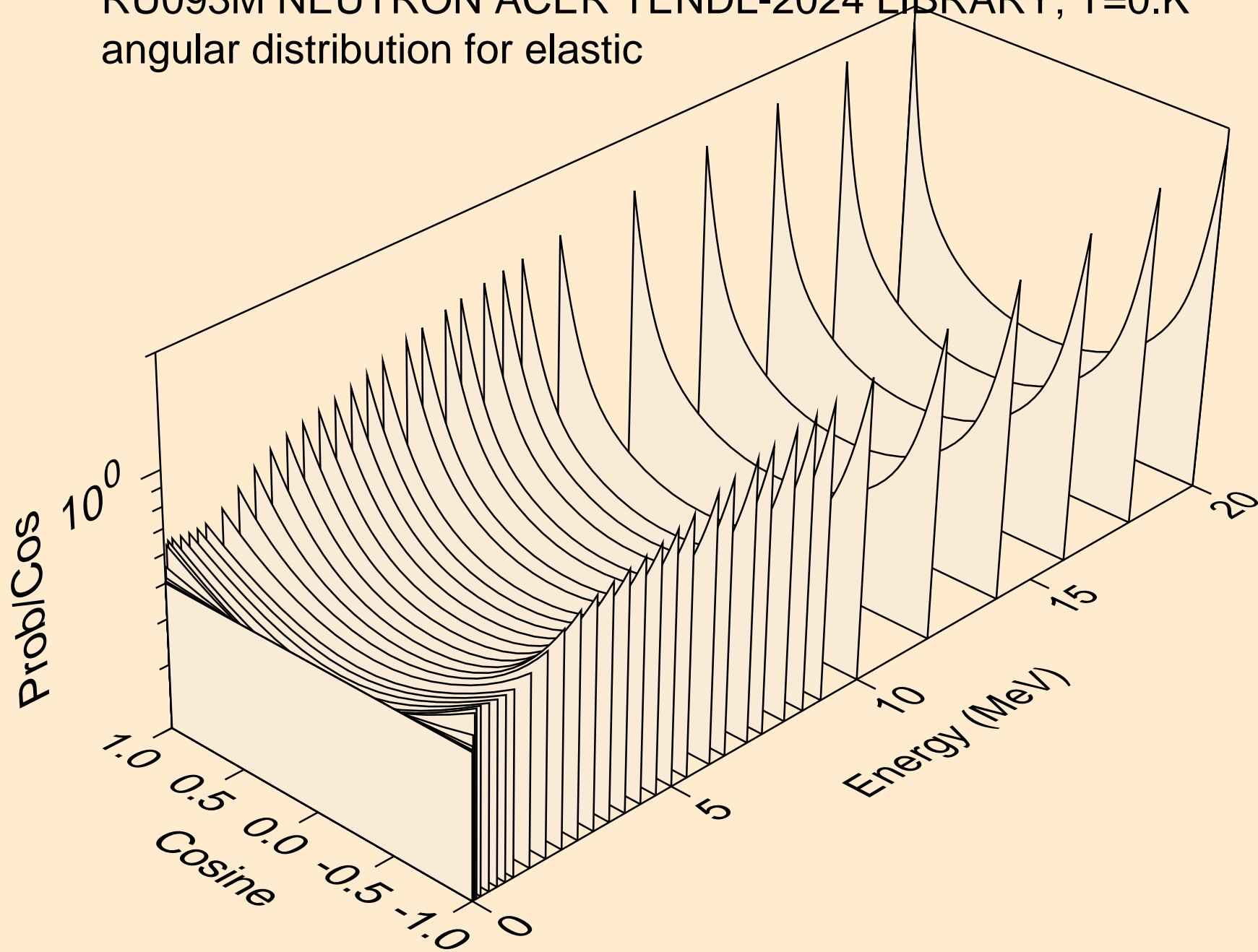

RU093M NEUTRON ACER TENDL-2024 LIBRARY; T=0.K
angular distribution for elastic

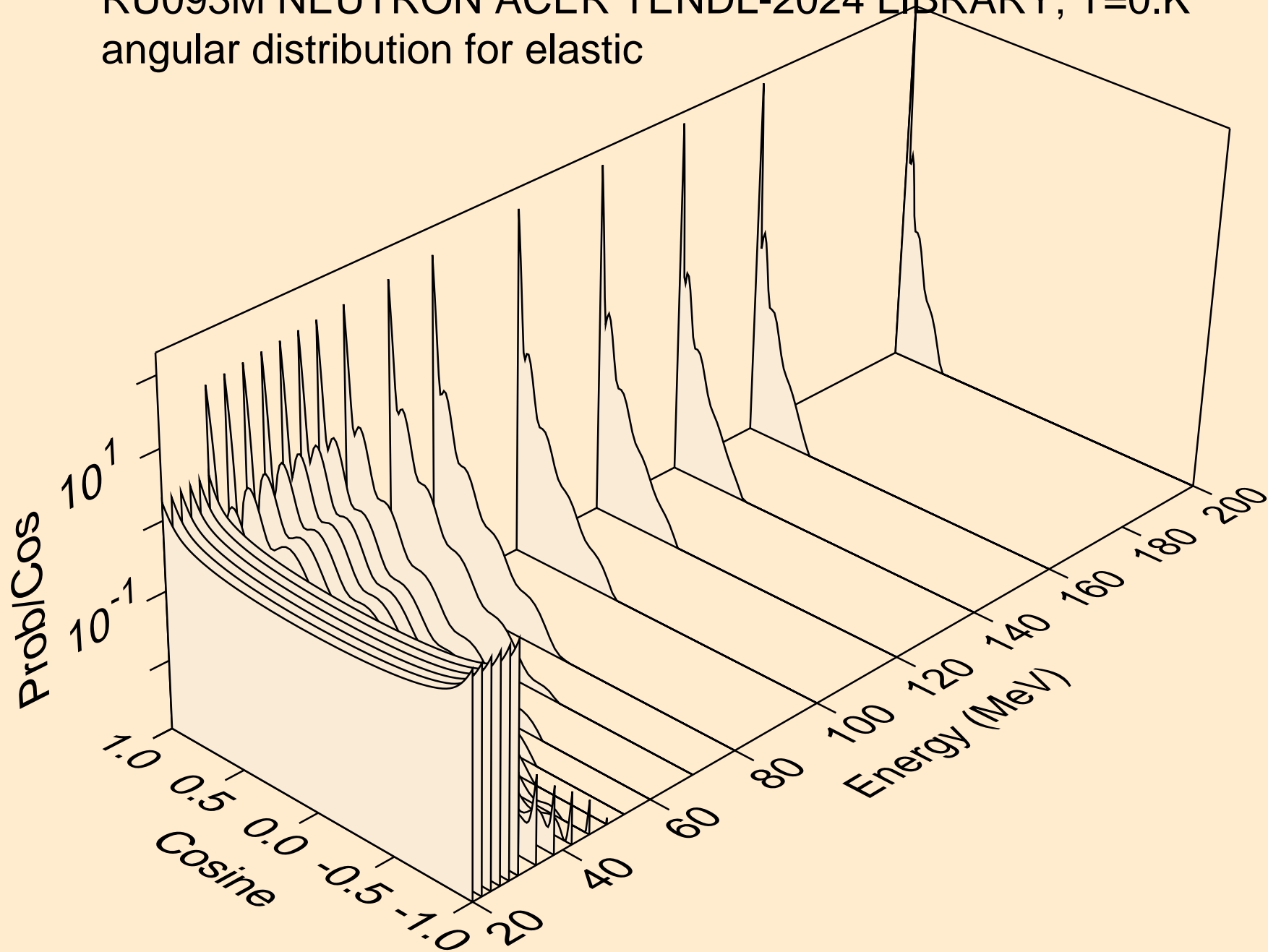

RU093M NEUTRON ACER TENDL-2024 LIBRARY; T=0.K
angular distribution for (n,n*1)

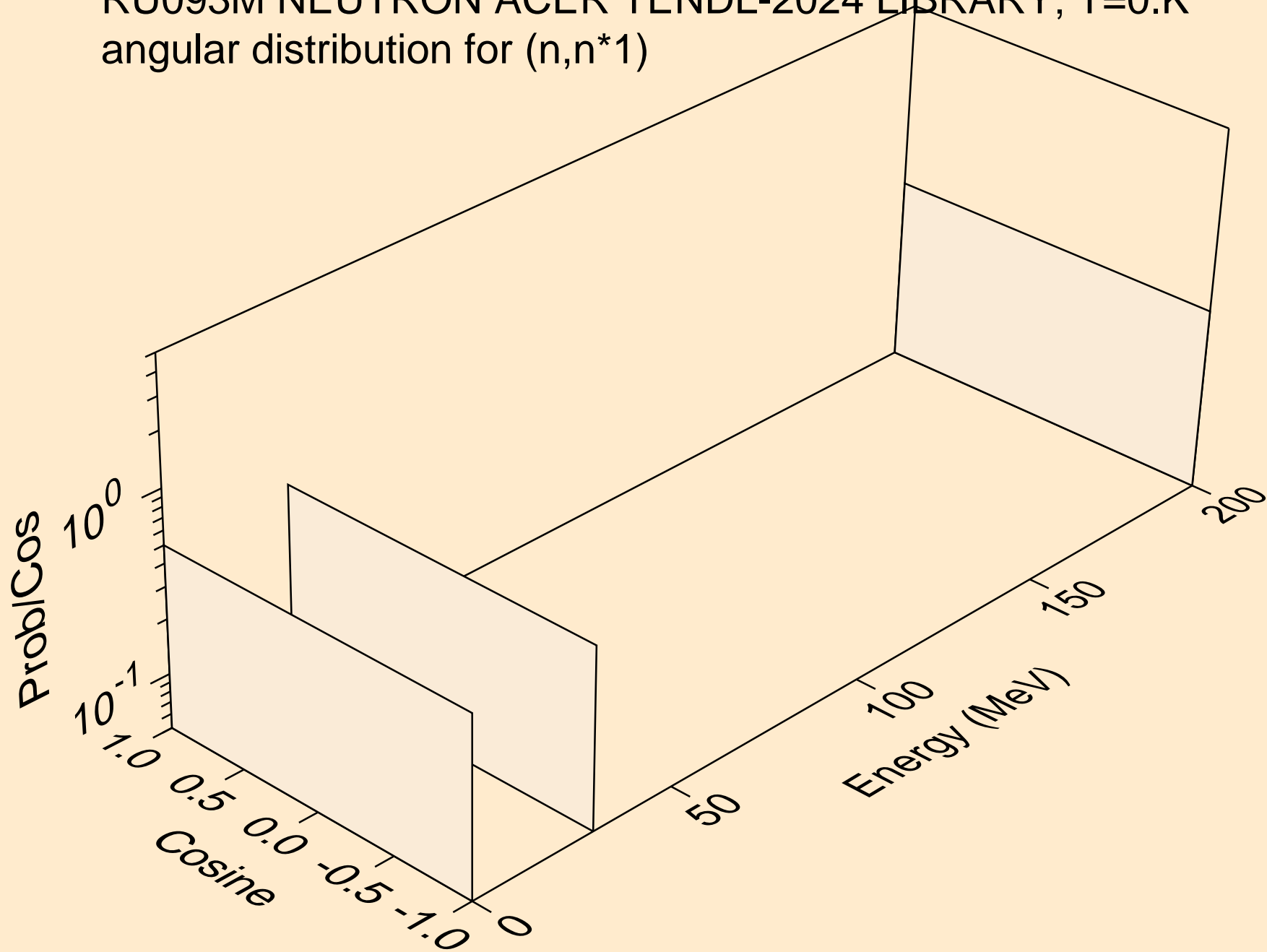

RU093M NEUTRON ACER TENDL-2024 LIBRARY; T=0.K
angular distribution for (n,n*2)

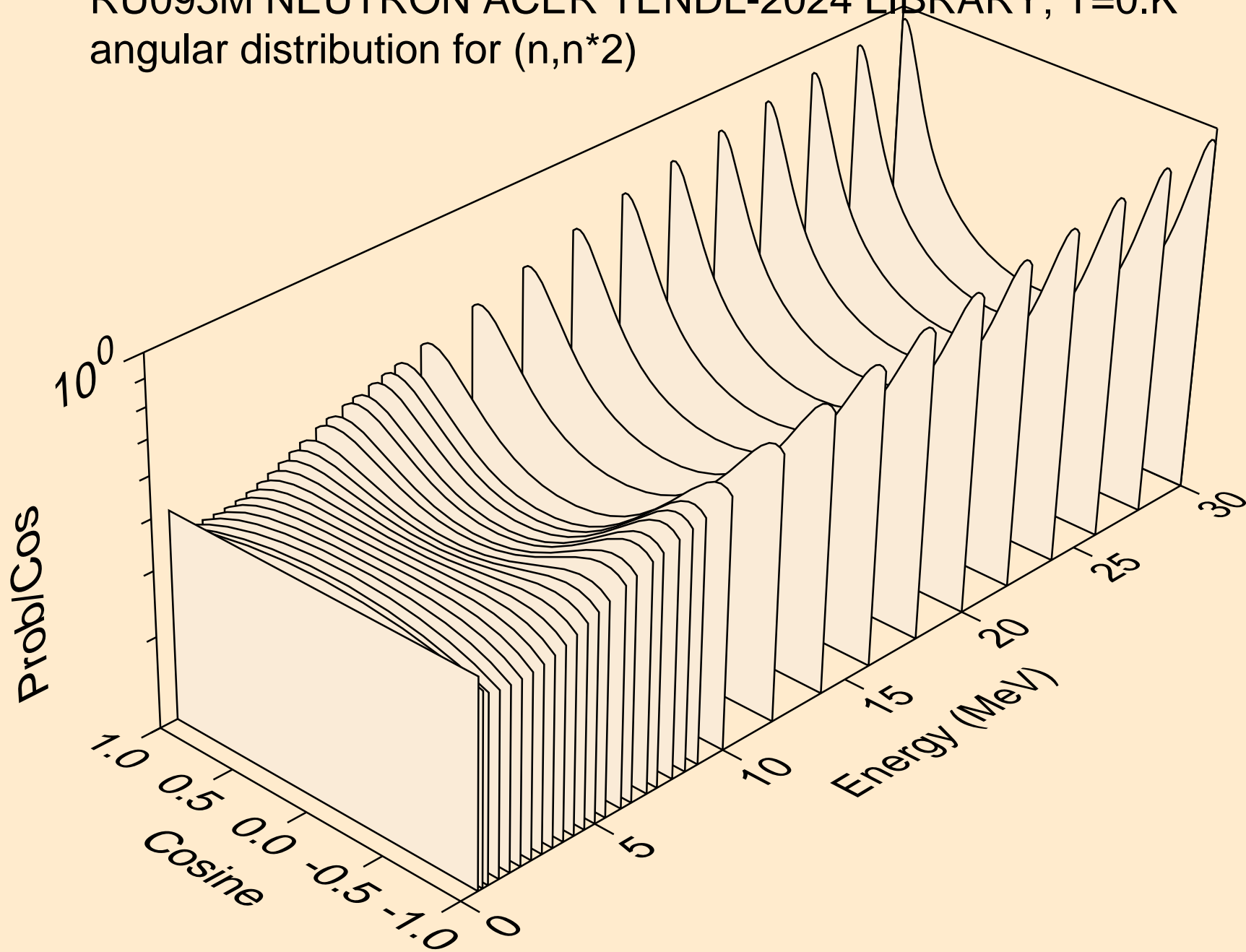

RU093M NEUTRON ACER TENDL-2024 LIBRARY; T=0.K
Neutron emission for (n,x)

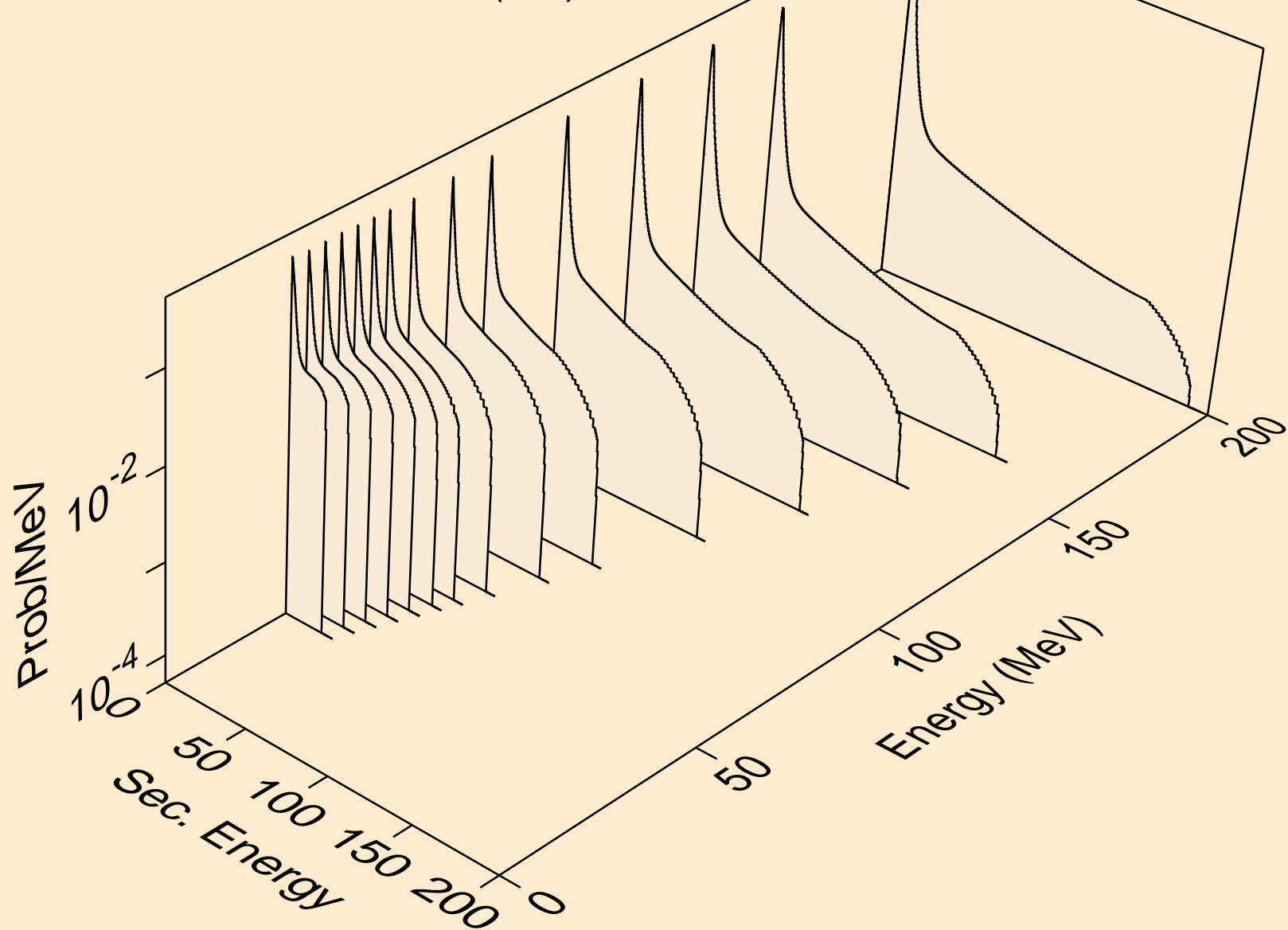

RU093M NEUTRON ACER TENDL-2024 LIBRARY; T=0.K
Neutron emission for (n,2n)

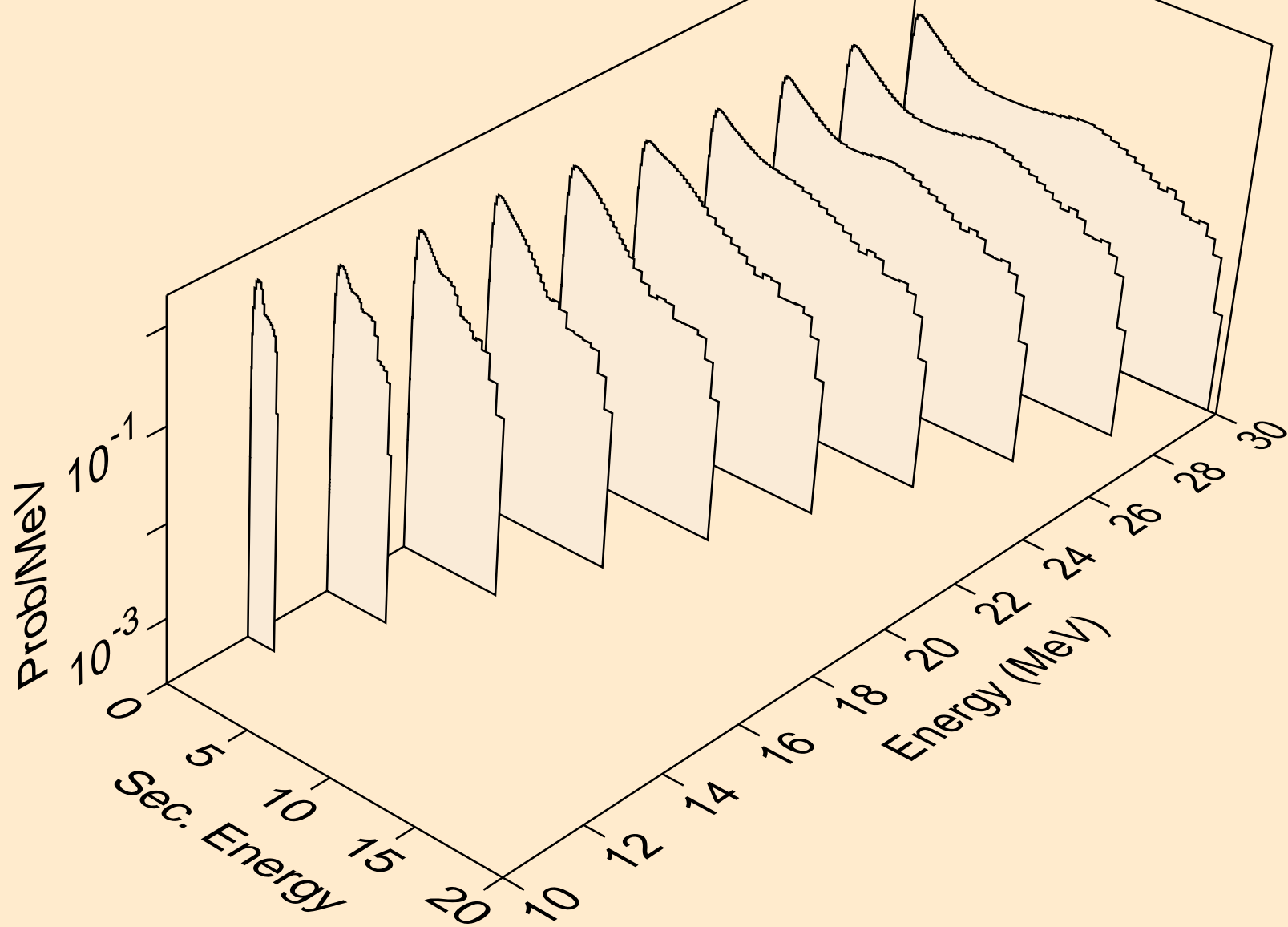

RU093M NEUTRON ACER TENDL-2024 LIBRARY; T=0.K
Neutron emission for (n,3n)

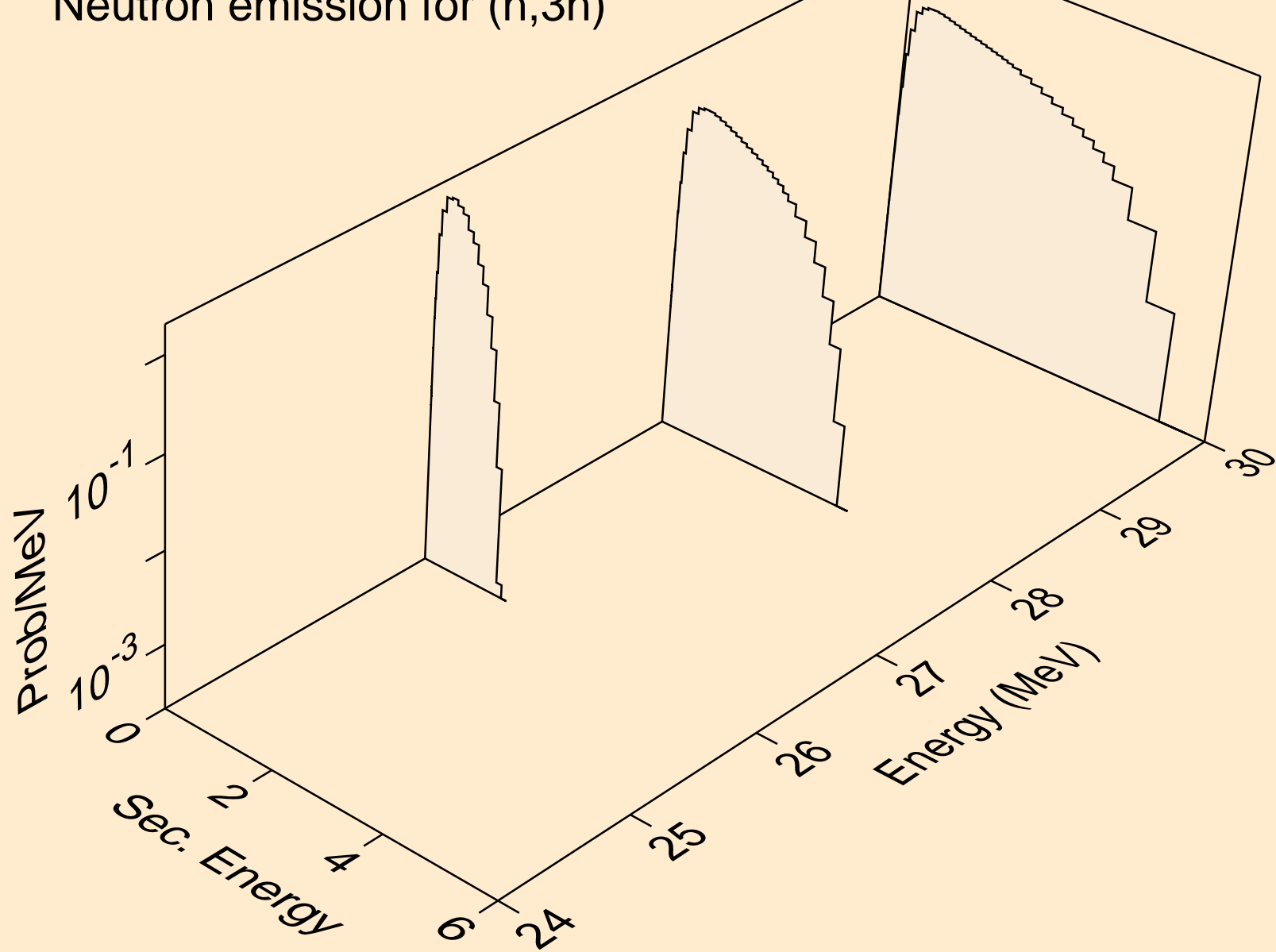

RU093M NEUTRON ACER TENDL-2024 LIBRARY; T=0.K
Neutron emission for (n,n*)a

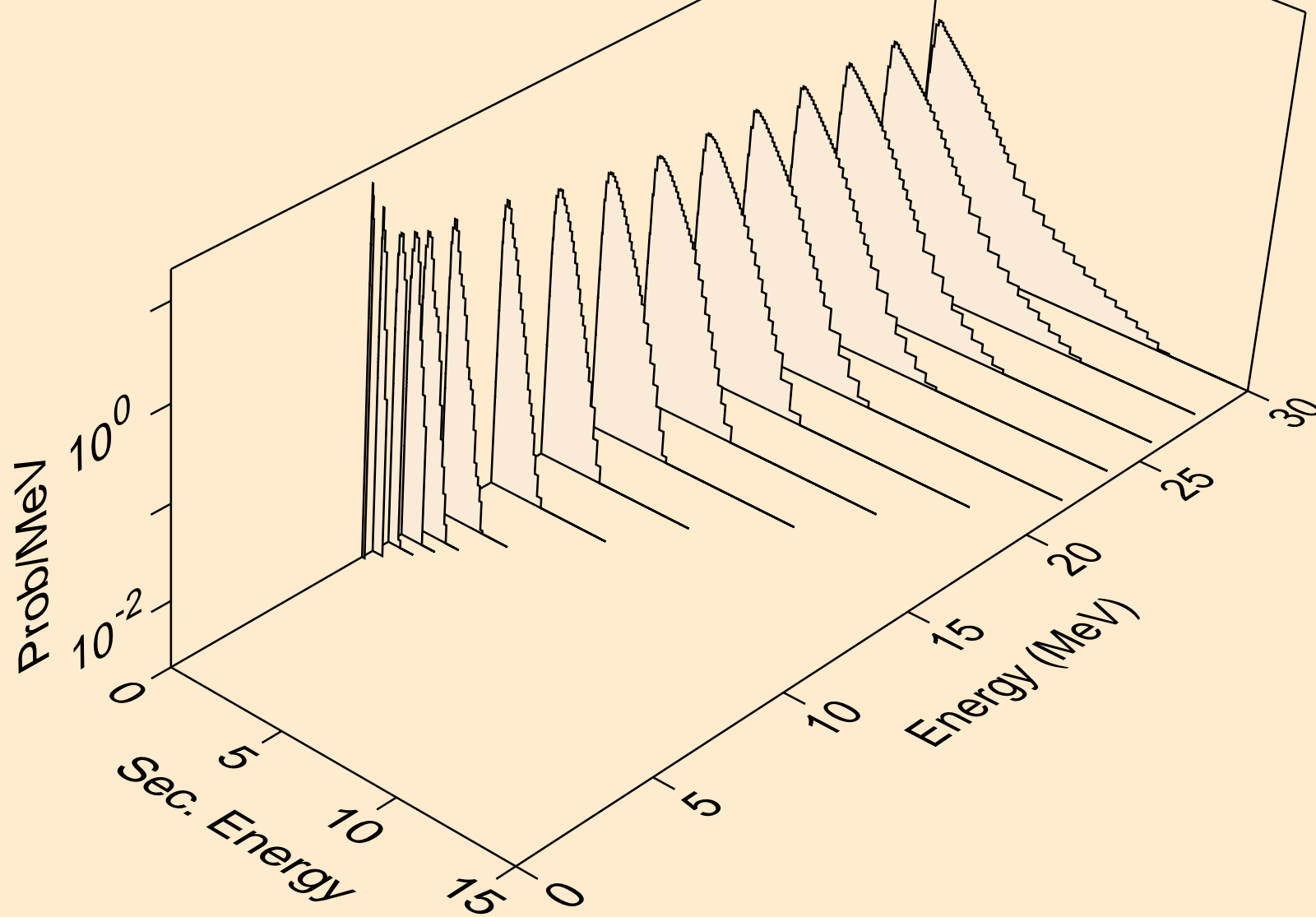

RU093M NEUTRON ACER TENDL-2024 LIBRARY; T=0.K
Neutron emission for (n,2n)a

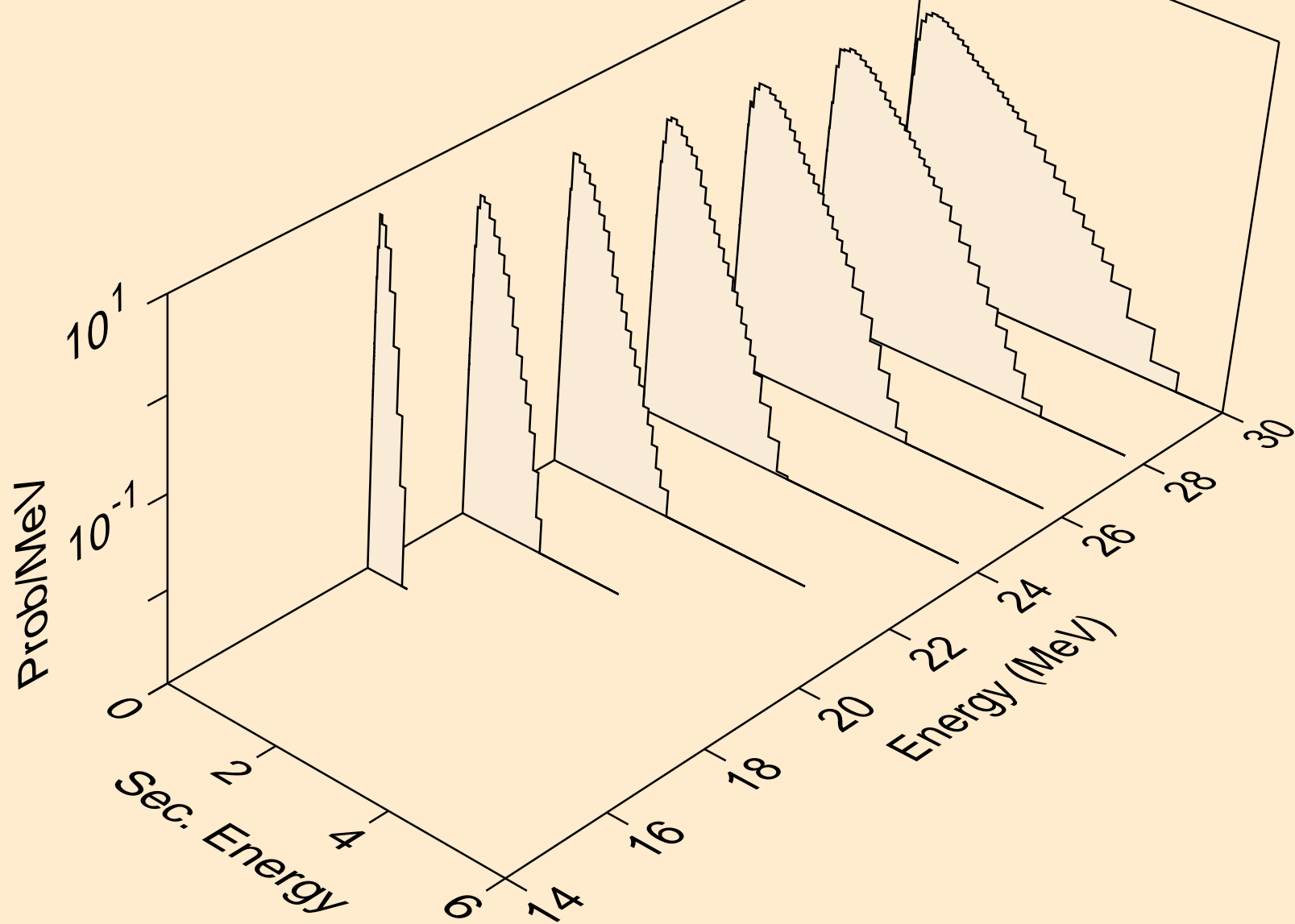

RU093M NEUTRON ACER TENDL-2024 LIBRARY; T=0.K
Neutron emission for (n,n*)p

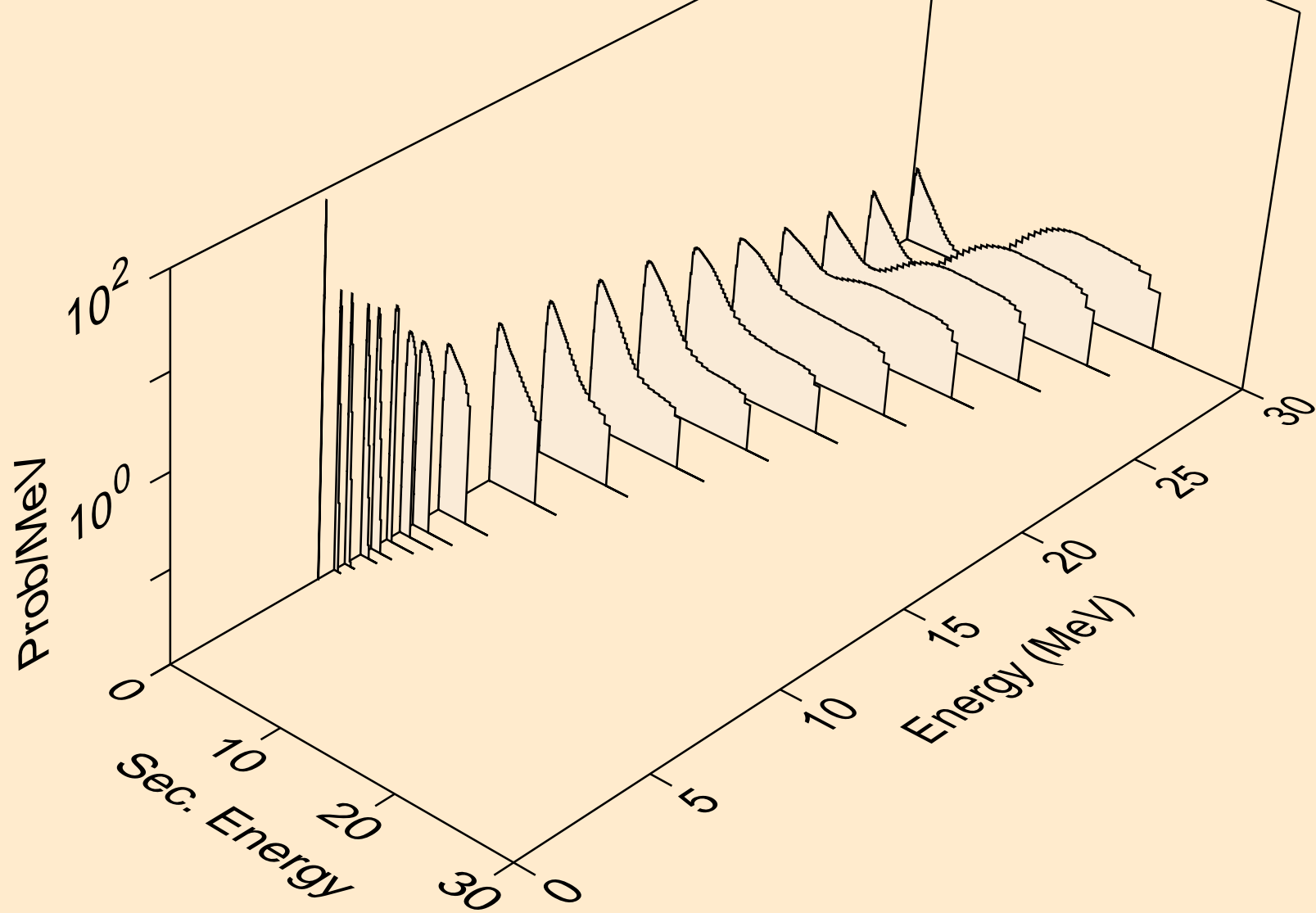

RU093M NEUTRON ACER TENDL-2024 LIBRARY; T=0.K
Neutron emission for (n,n*)2a

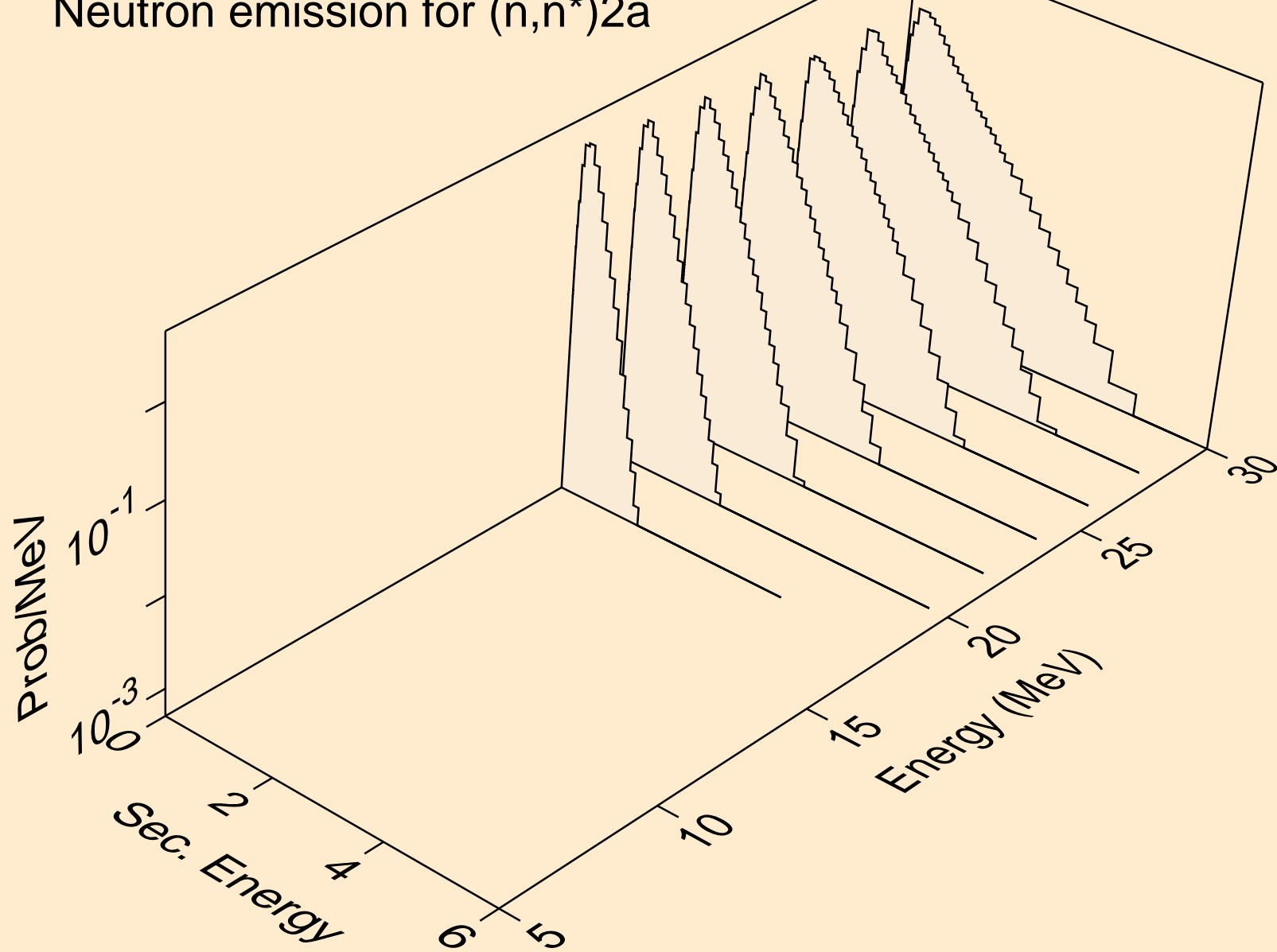

RU093M NEUTRON ACER TENDL-2024 LIBRARY; T=0.K
Neutron emission for (n,n*)d

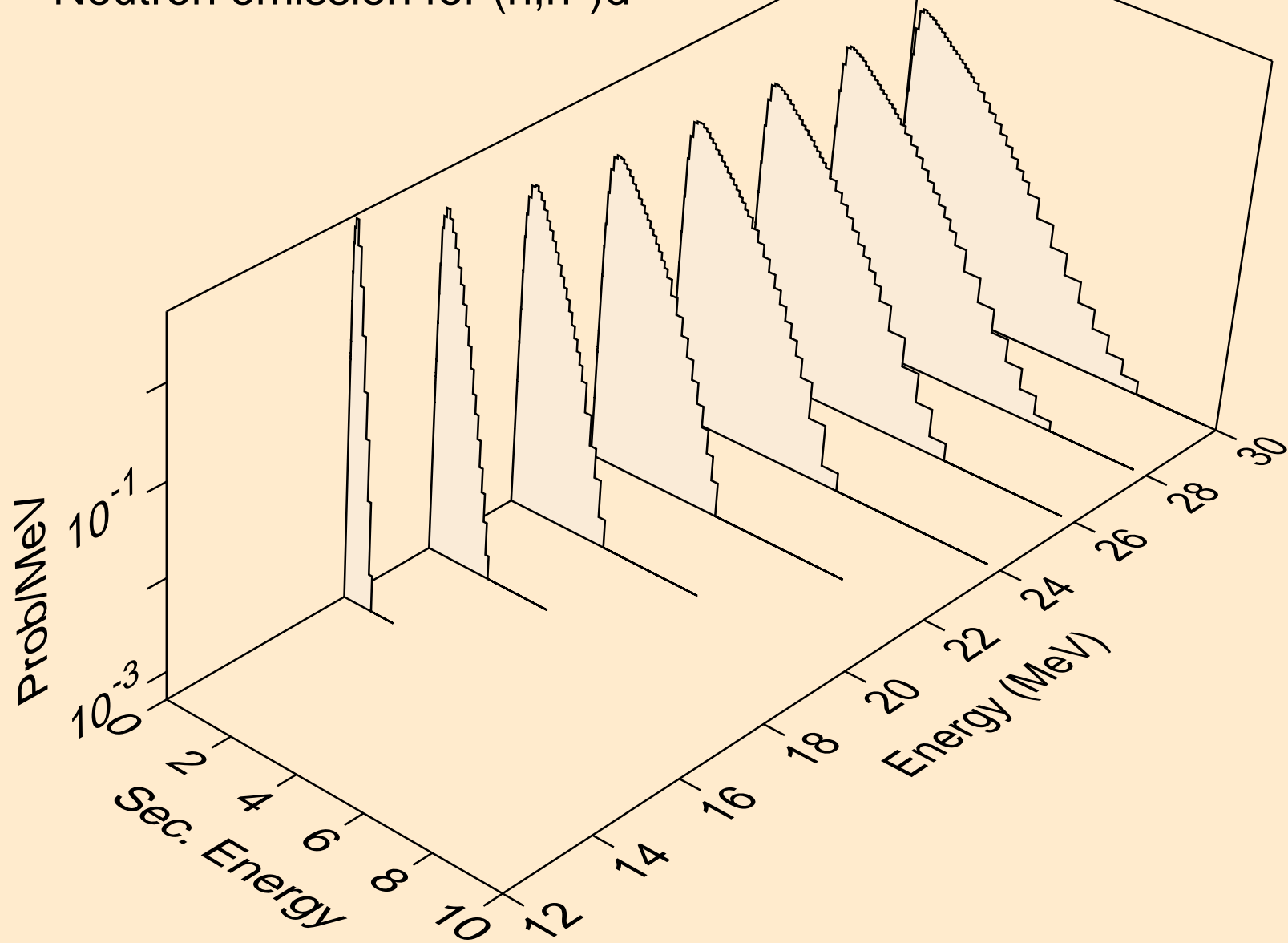

RU093M NEUTRON ACER TENDL-2024 LIBRARY; T=0.K
Neutron emission for (n,n*)t

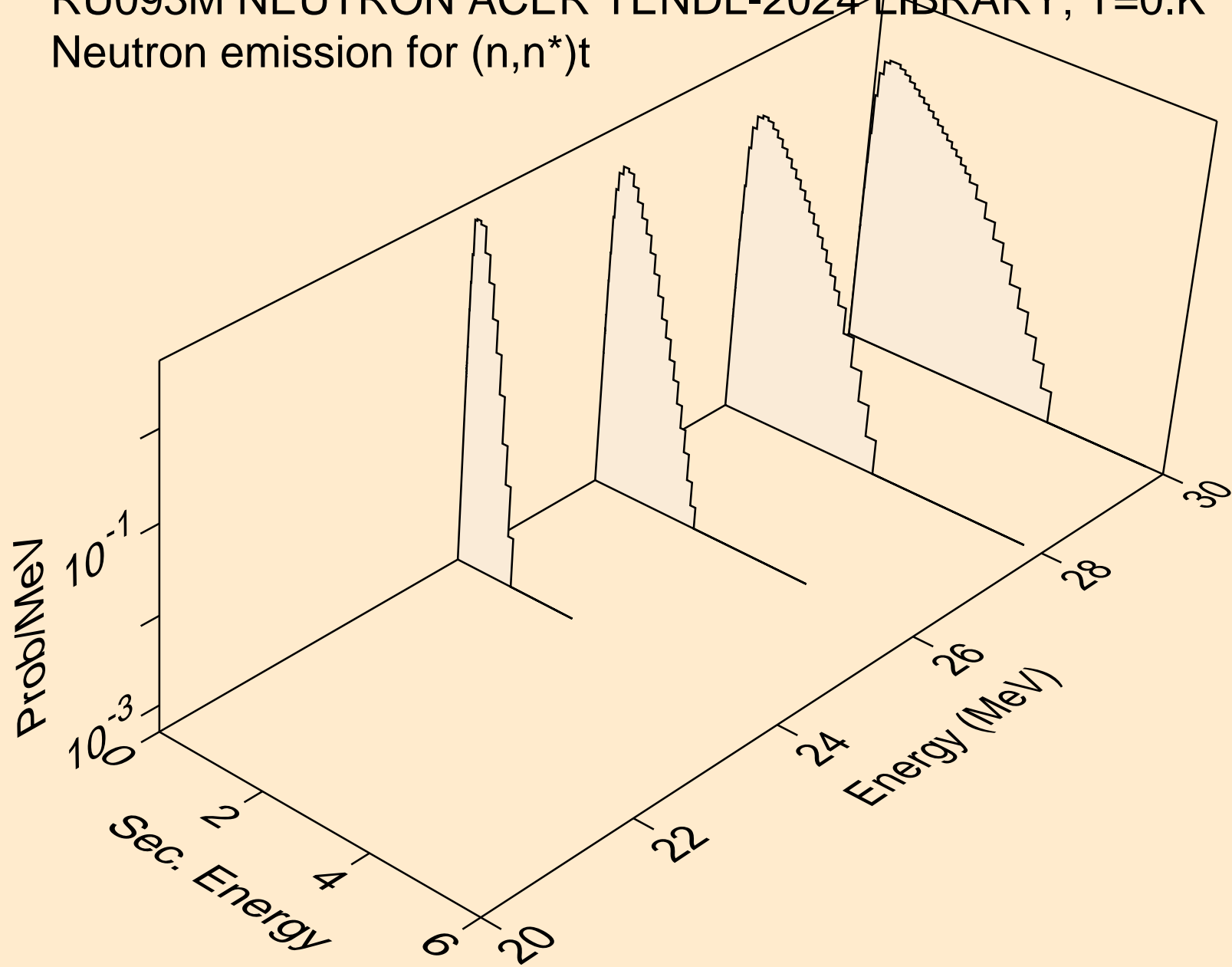

RU093M NEUTRON ACER TENDL-2024 LIBRARY; T=0.K
Neutron emission for (n,n*)he3

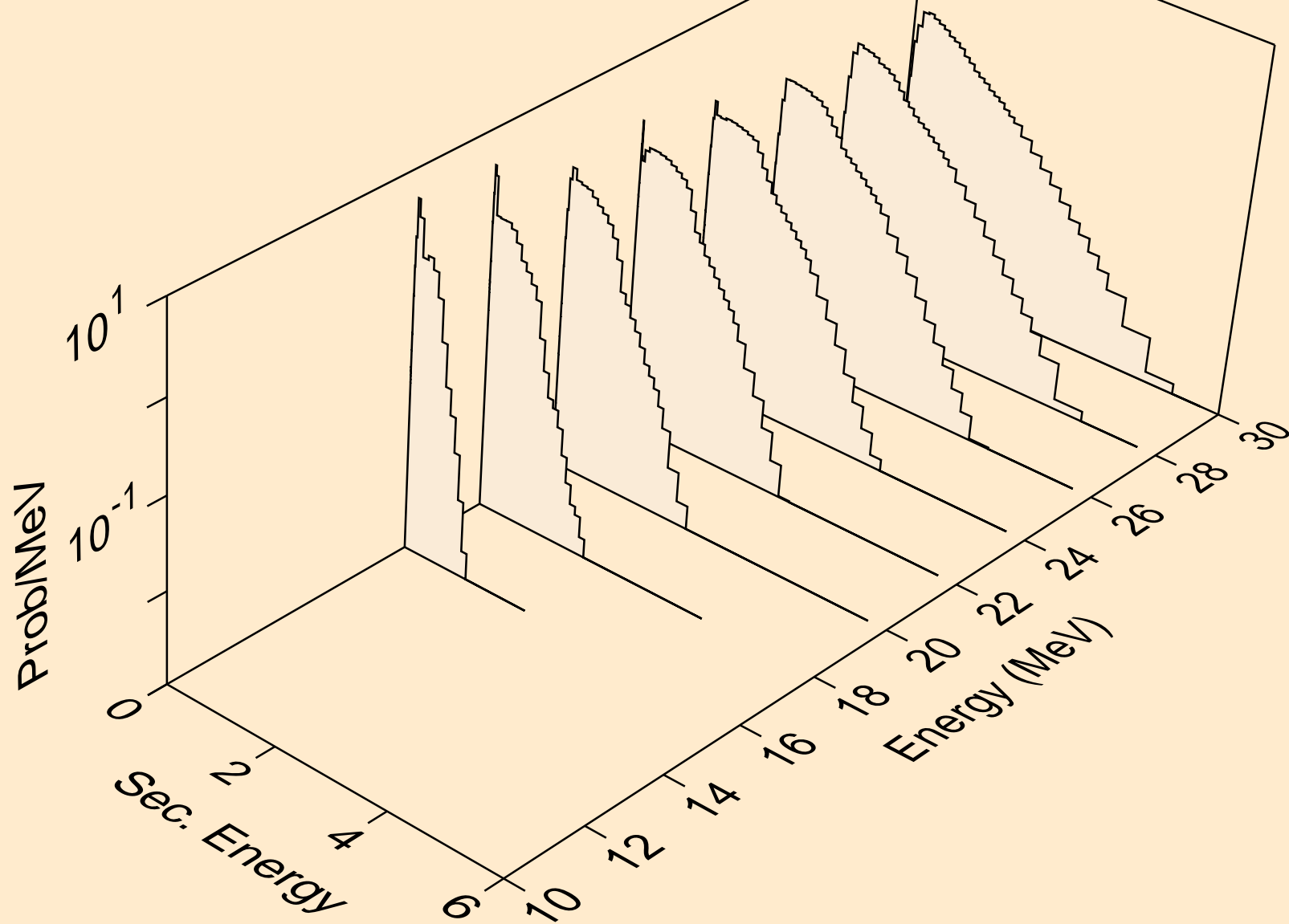

RU093M NEUTRON ACER TENDL-2024 LIBRARY; T=0.K
Neutron emission for (n,2np)

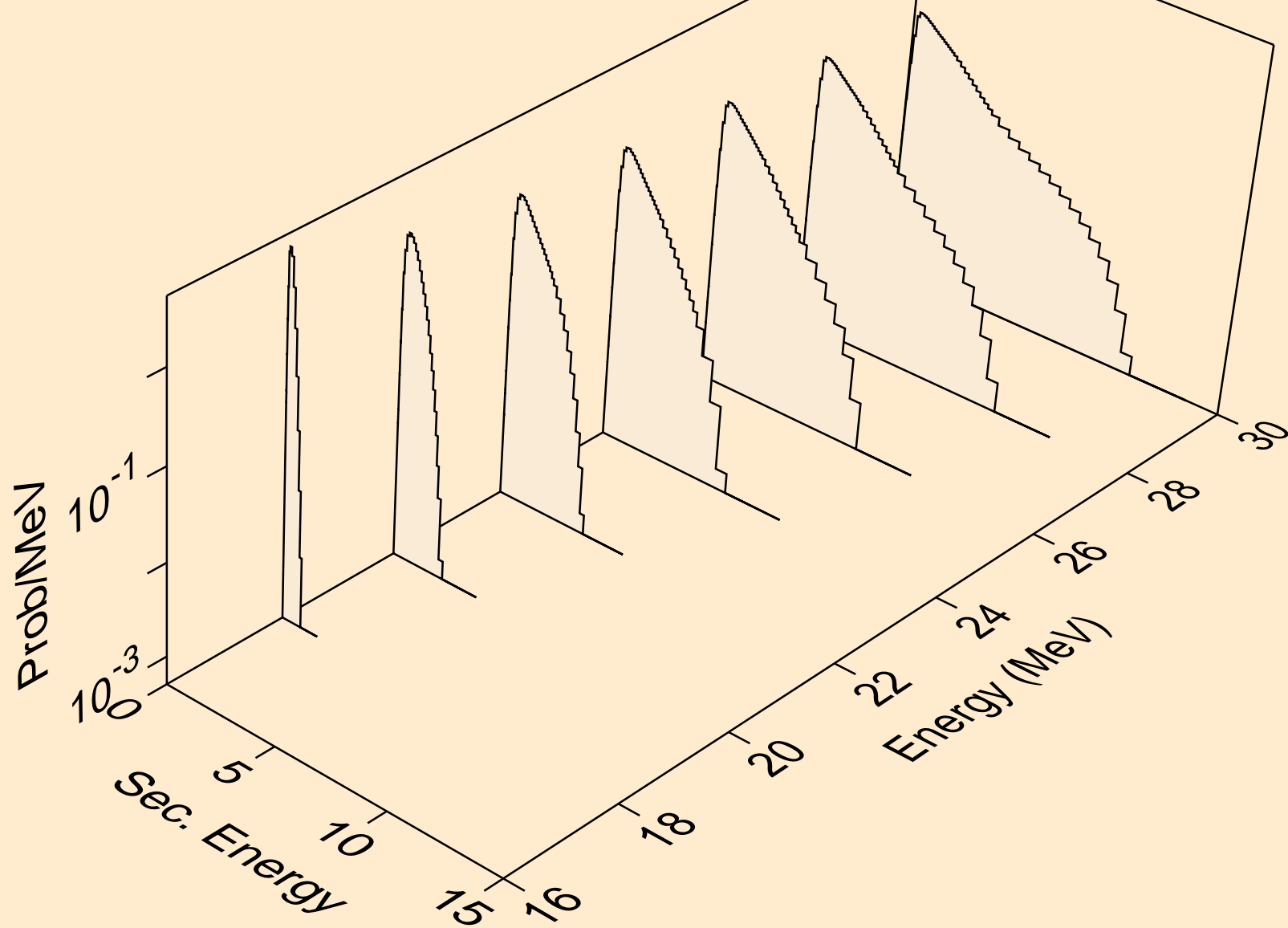

RU093M NEUTRON ACER TENDL-2024 LIBRARY; T=0.K
Neutron emission for (n,n2p)

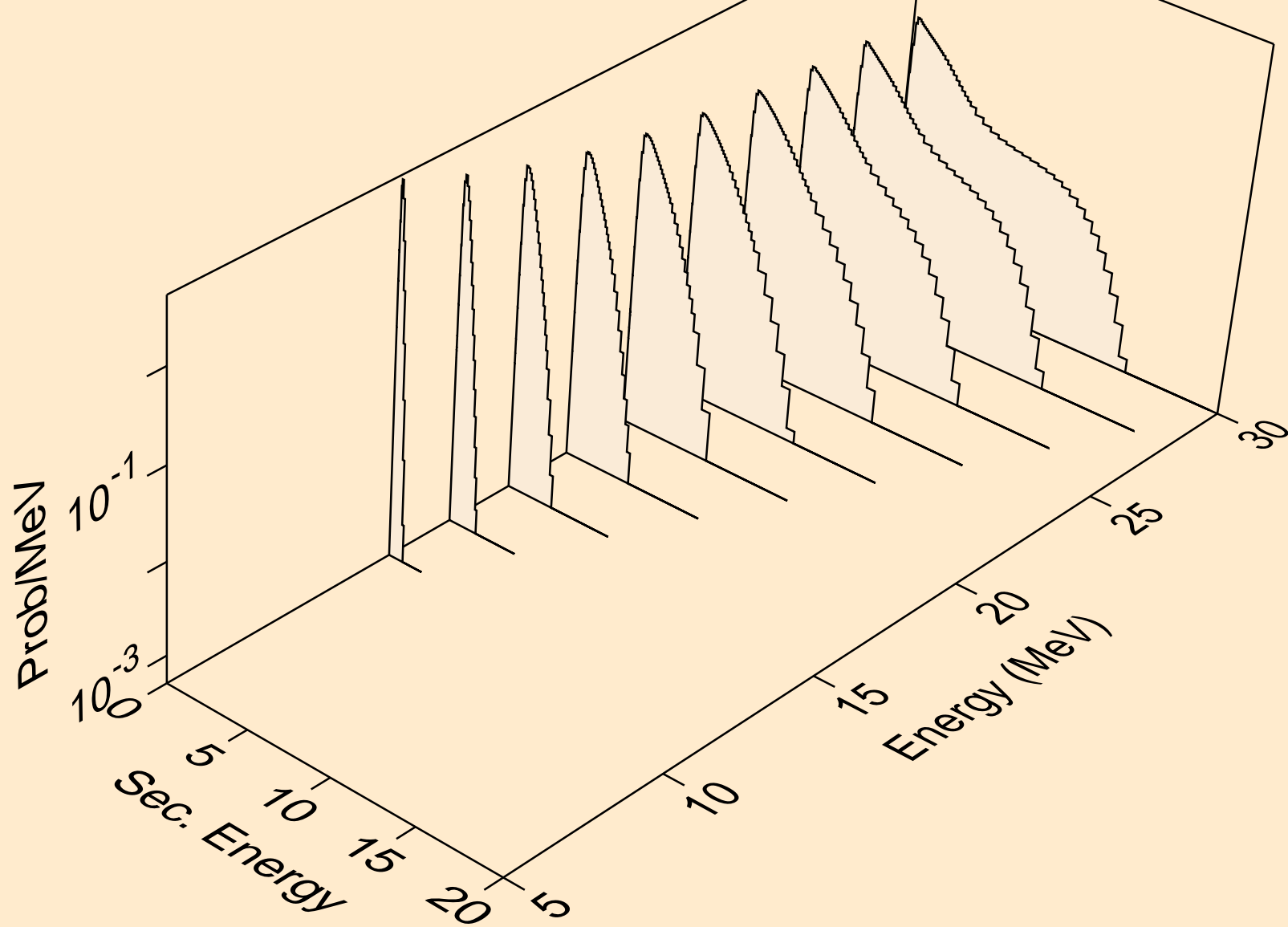

RU093M NEUTRON ACER TENDL-2024 LIBRARY; T=0.K
Neutron emission for (n,npa)

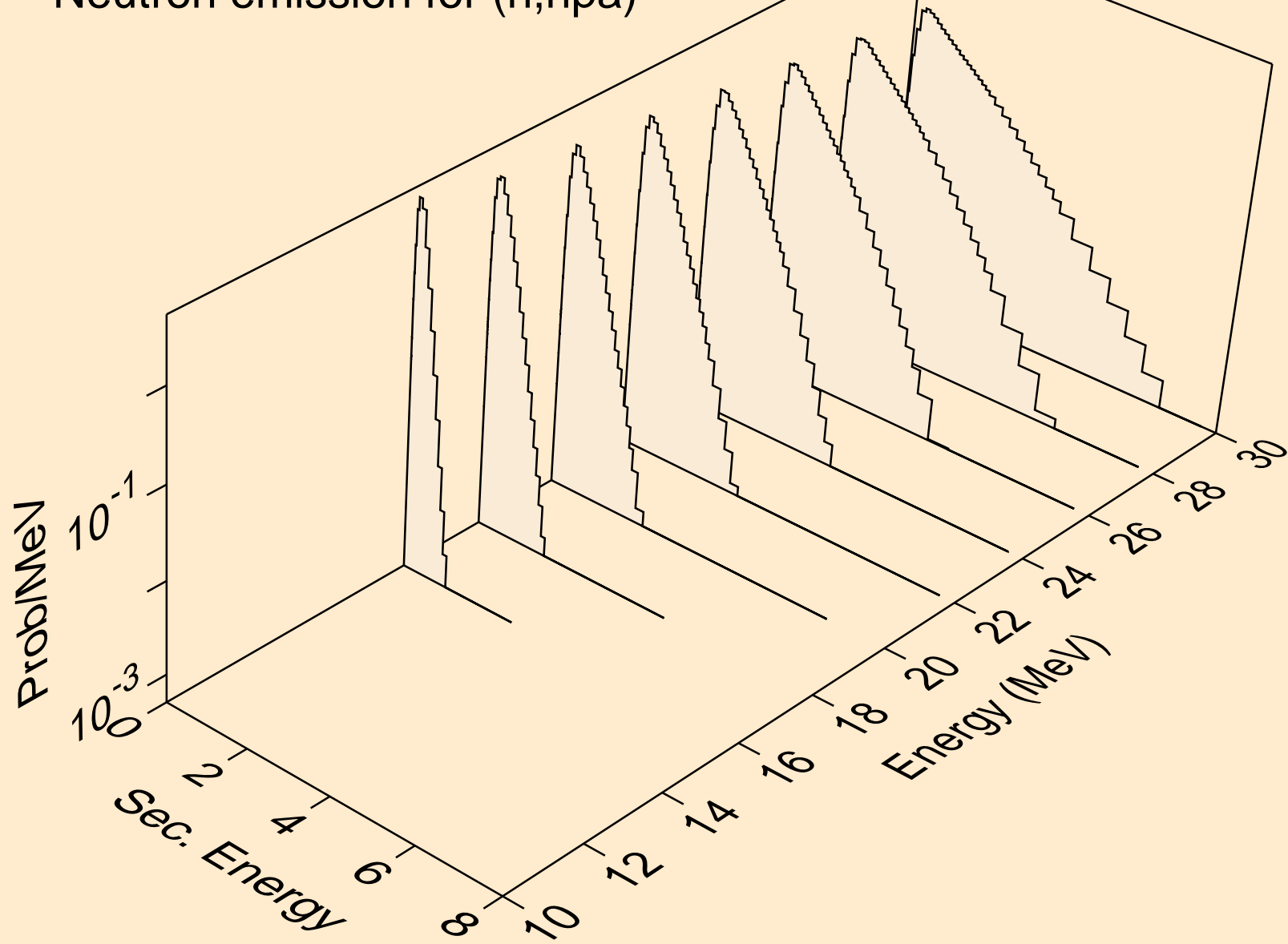

RU093M NEUTRON ACER TENDL-2024 LIBRARY; T=0.K
Neutron emission for (n,n*c)

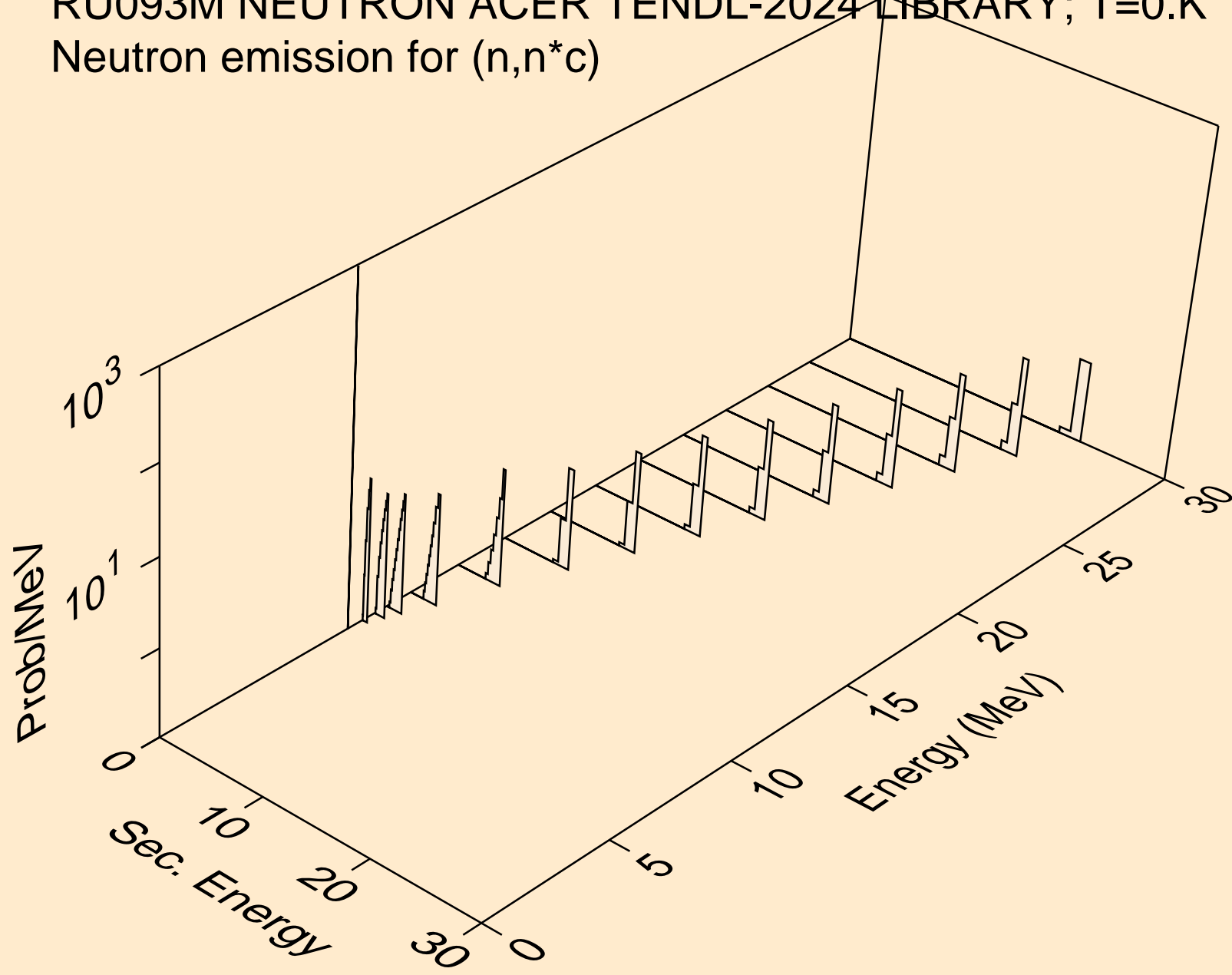

RU093M NEUTRON ACER TENDL-2024 LIBRARY; T=0.K
Photon emission for (n,x)

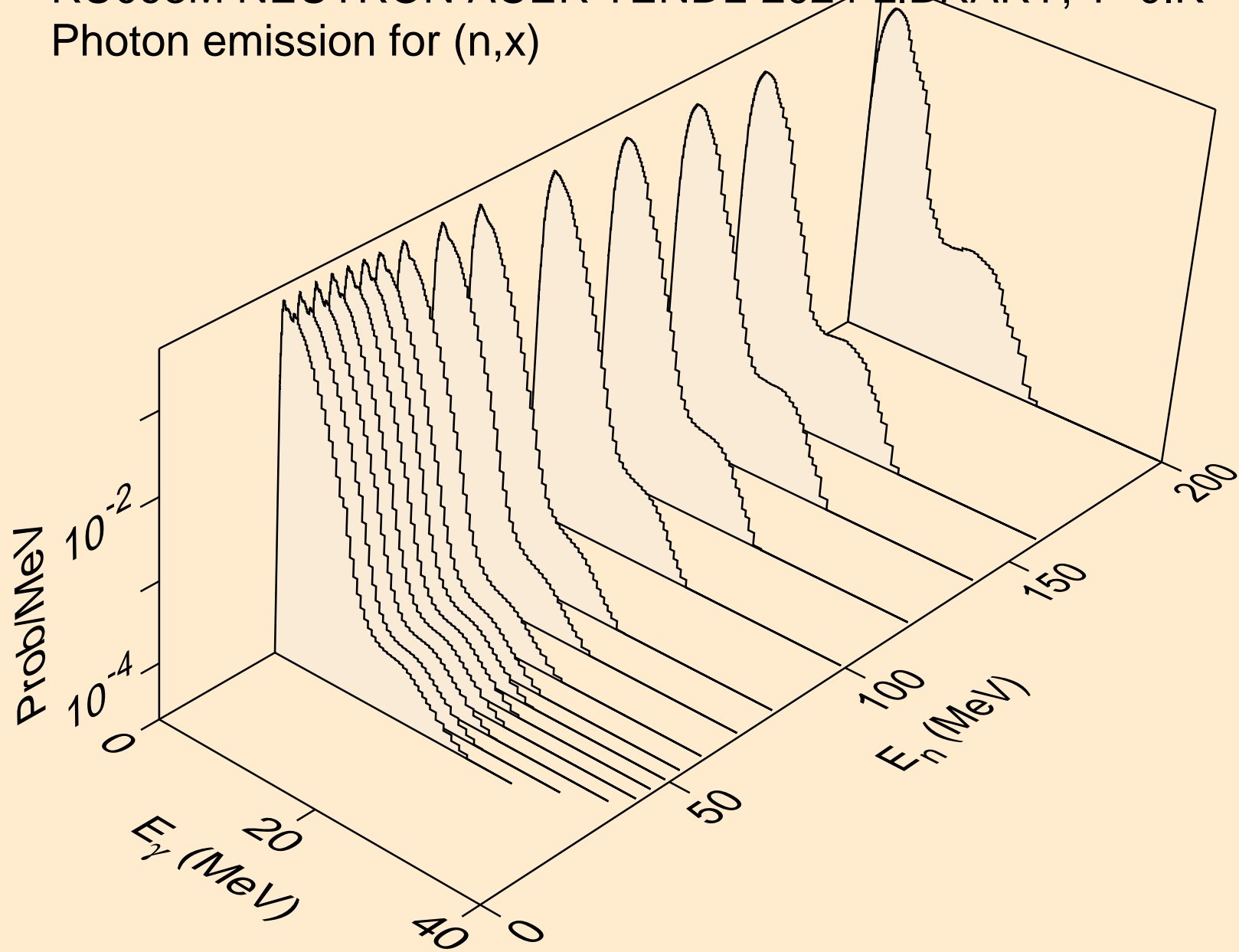

RU093M NEUTRON ACER TENDL-2024 LIBRARY; T=0.K
Photon emission for (n,2n)

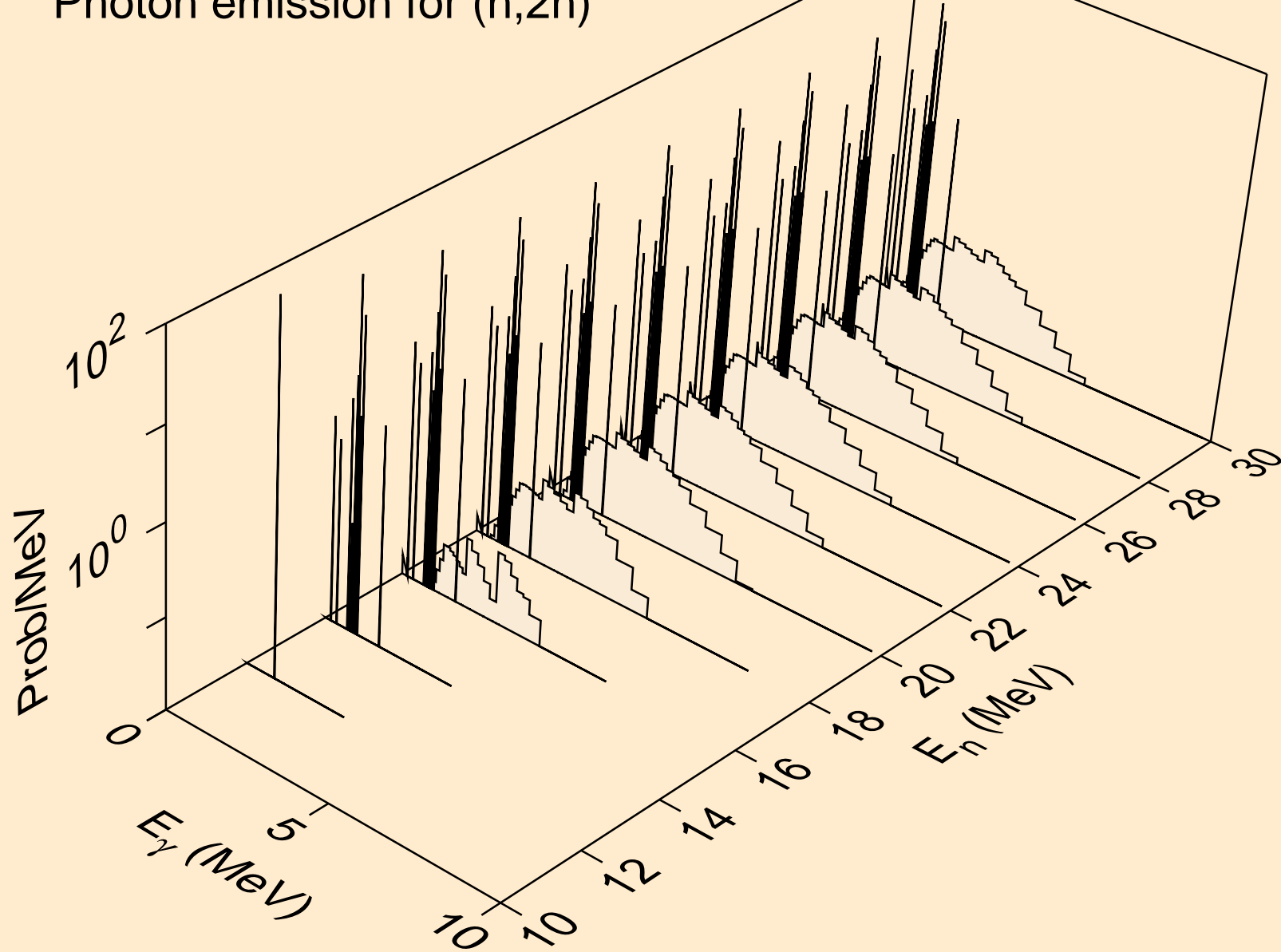

RU093M NEUTRON ACER TENDL-2024 LIBRARY; T=0.K
Photon emission for (n,3n)

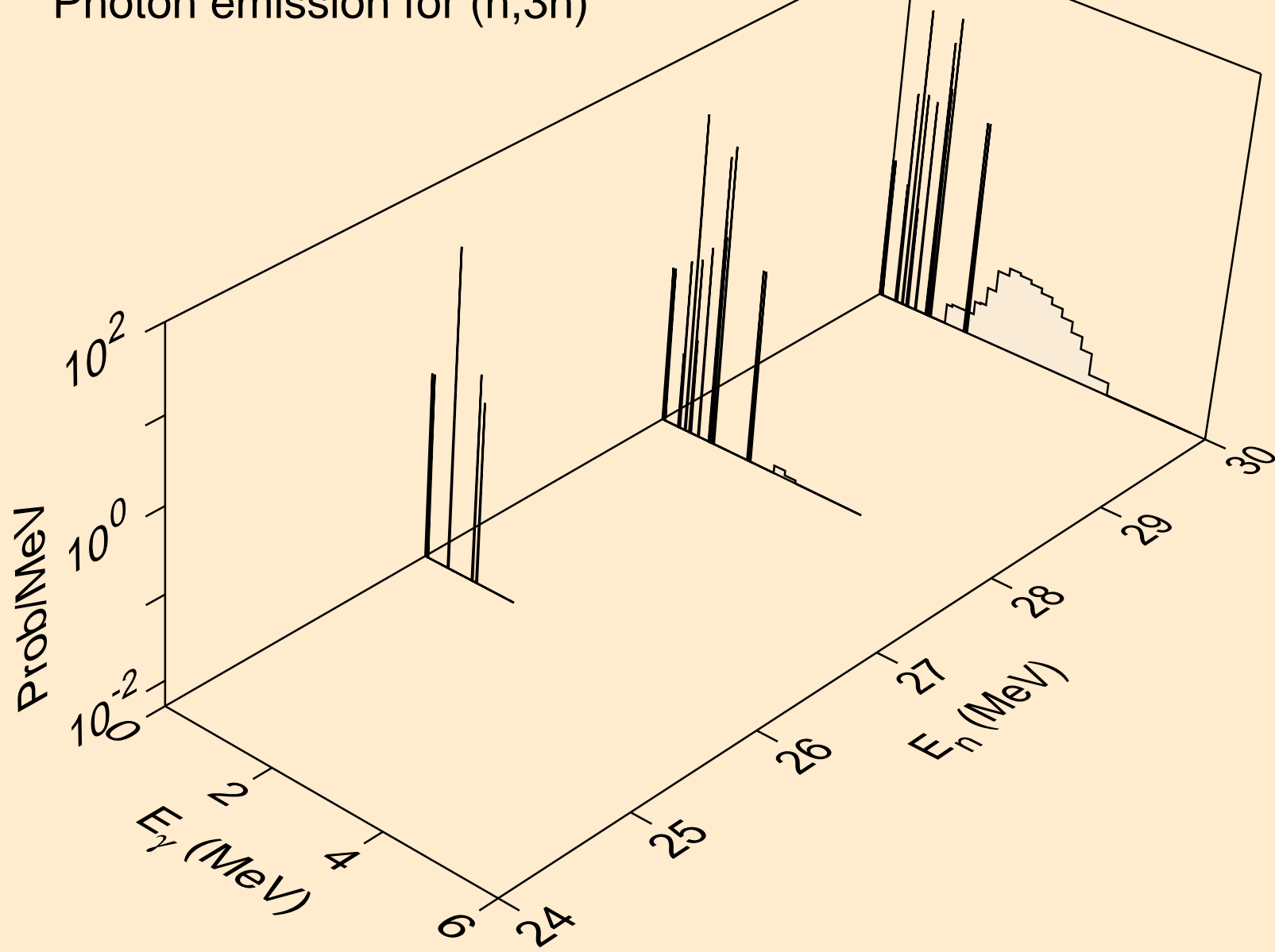

RU093M NEUTRON ACER TENDL-2024 LIBRARY; T=0.K
Photon emission for (n,n*)a

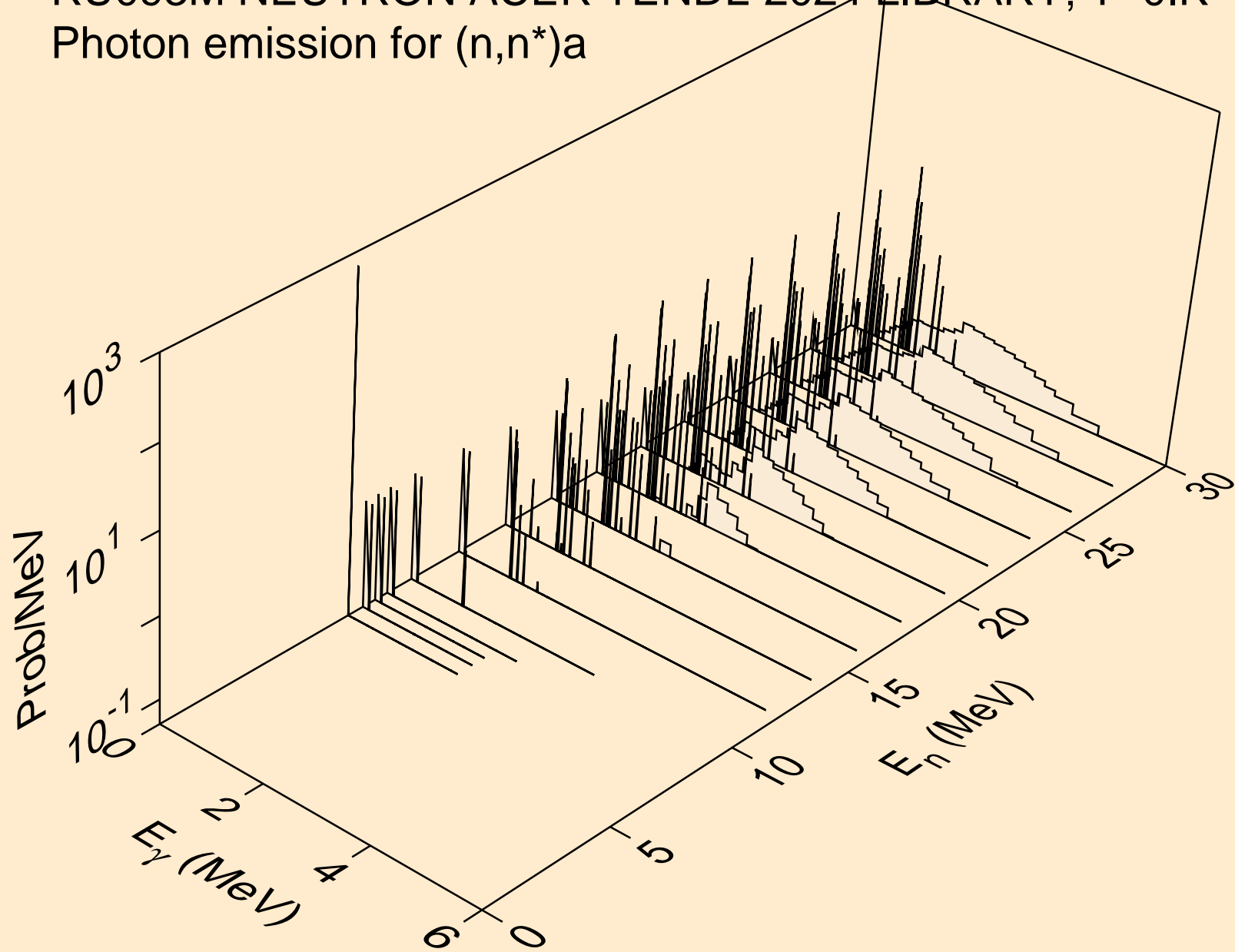

RU093M NEUTRON ACER TENDL-2024 LIBRARY; T=0.K
Photon emission for (n,2n)a

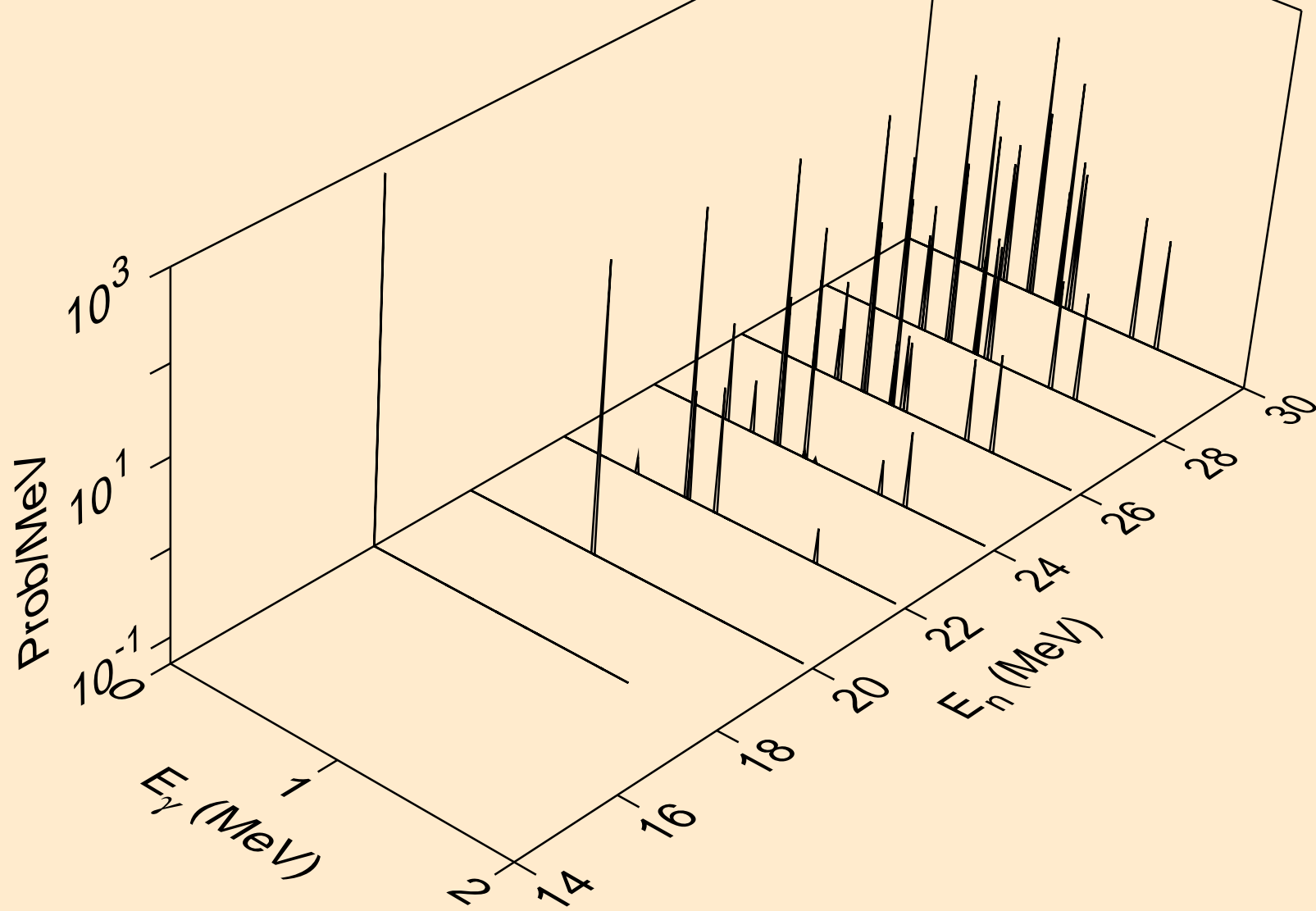

RU093M NEUTRON ACER TENDL-2024 LIBRARY; T=0.K
Photon emission for (n,n*)p

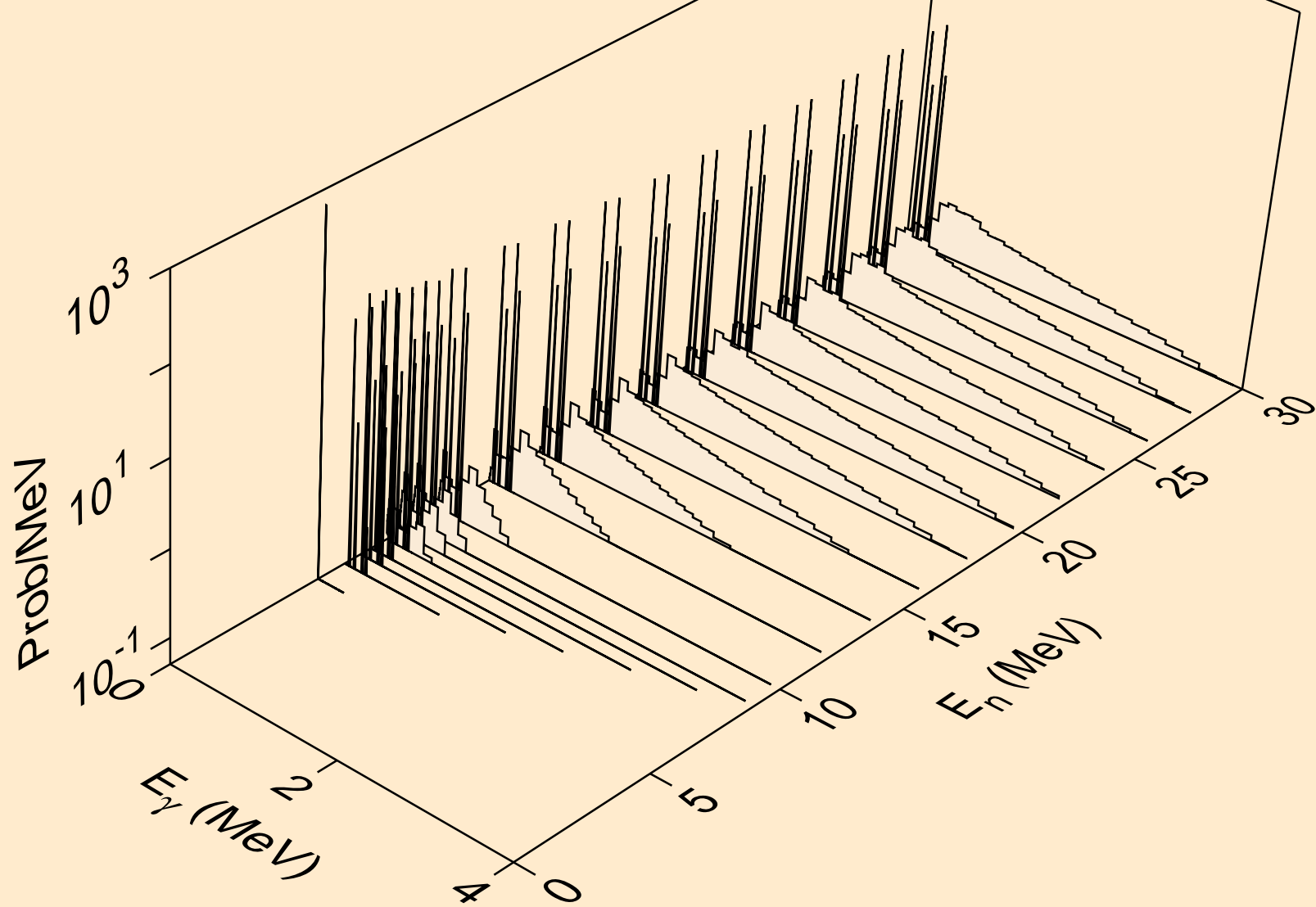

RU093M NEUTRON ACER TENDL-2024 LIBRARY; T=0.K
Photon emission for (n,n*)2a

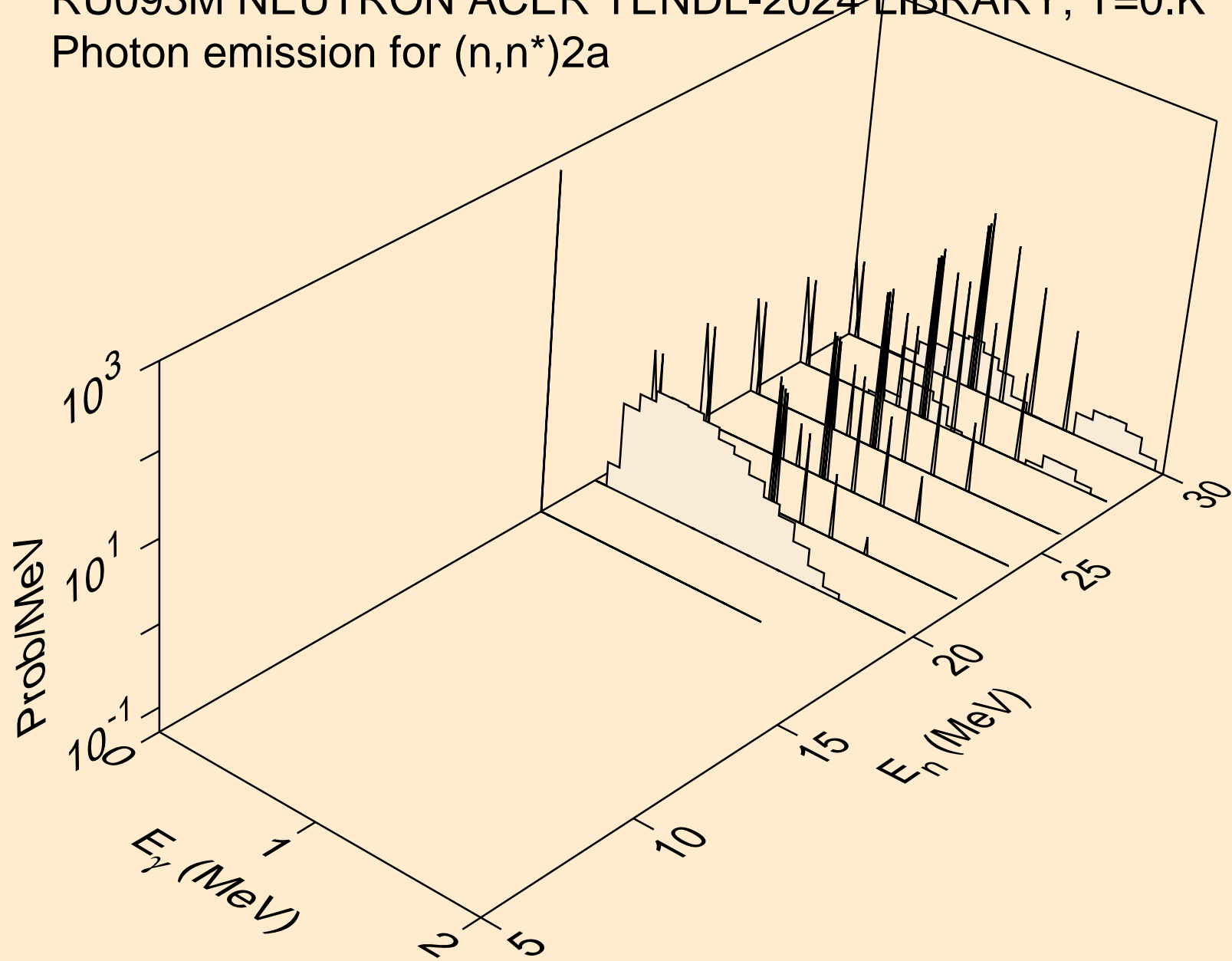

RU093M NEUTRON ACER TENDL-2024 LIBRARY; T=0.K
Photon emission for (n,n*)d

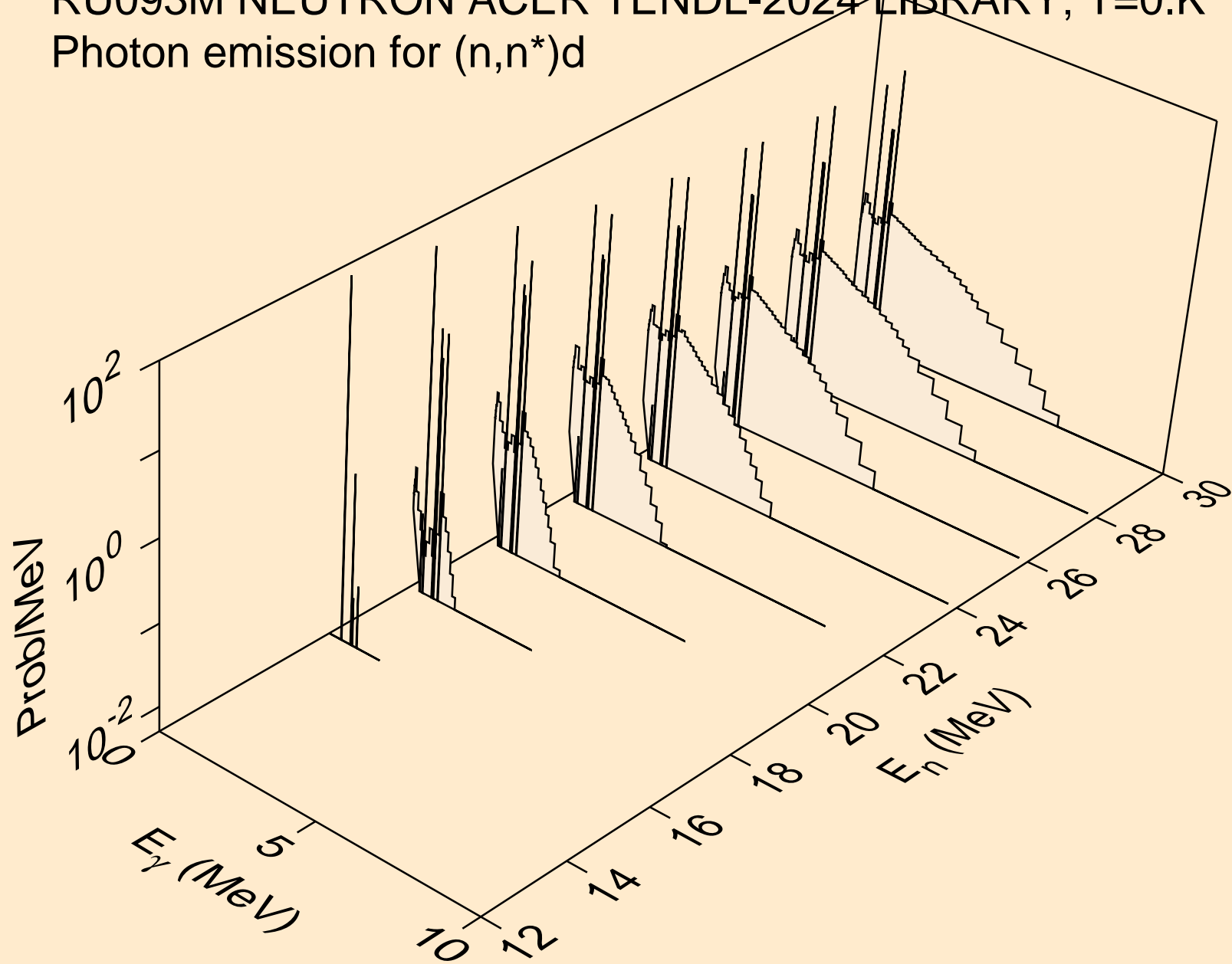

RU093M NEUTRON ACER TENDL-2024 LIBRARY; T=0.K
Photon emission for (n,n*)t

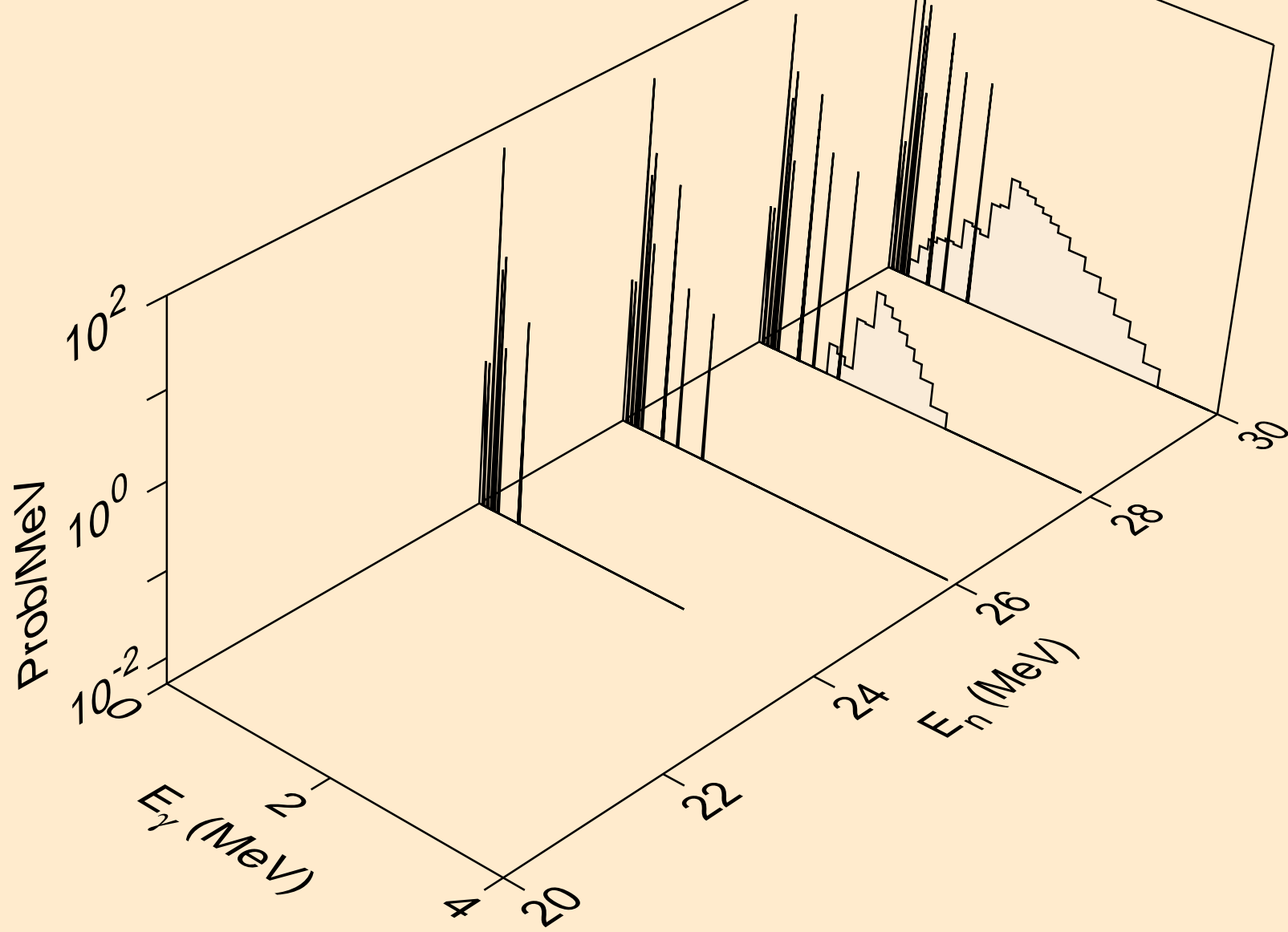

RU093M NEUTRON ACER TENDL-2024 LIBRARY; T=0.K
Photon emission for (n,n*)he3

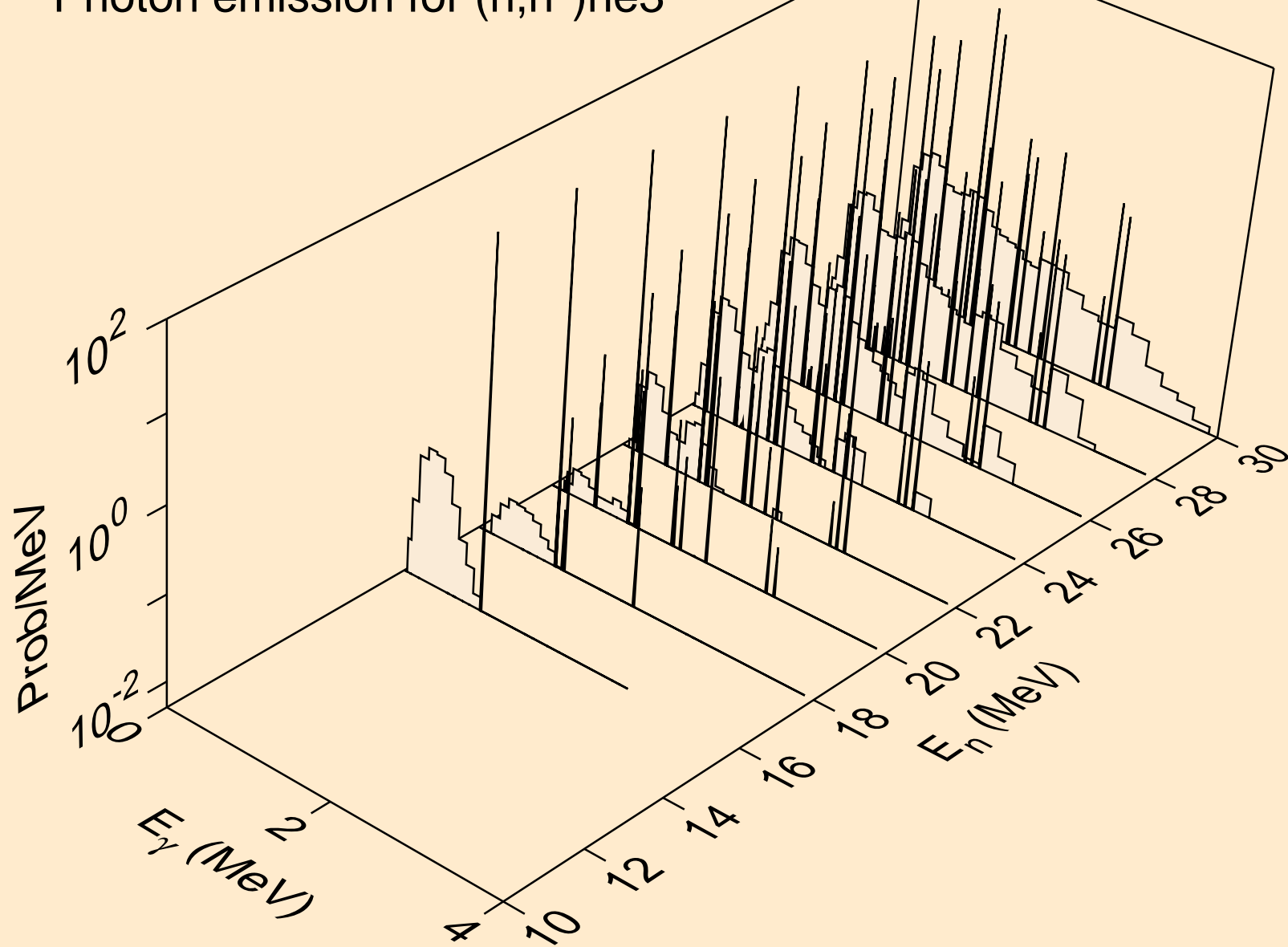

RU093M NEUTRON ACER TENDL-2024 LIBRARY; T=0.K
Photon emission for (n,2np)

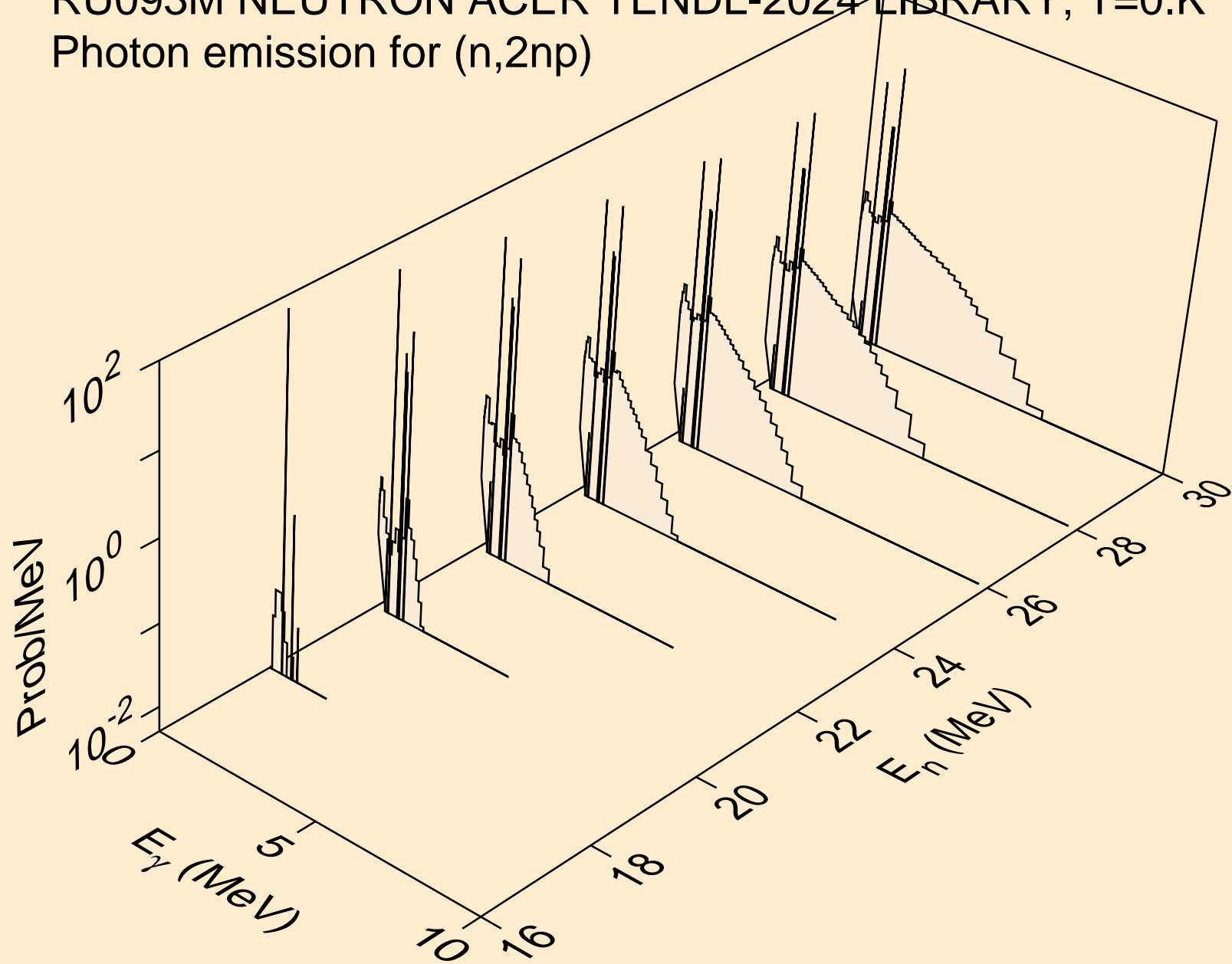

RU093M NEUTRON ACER TENDL-2024 LIBRARY; T=0.K
Photon emission for (n,n2p)

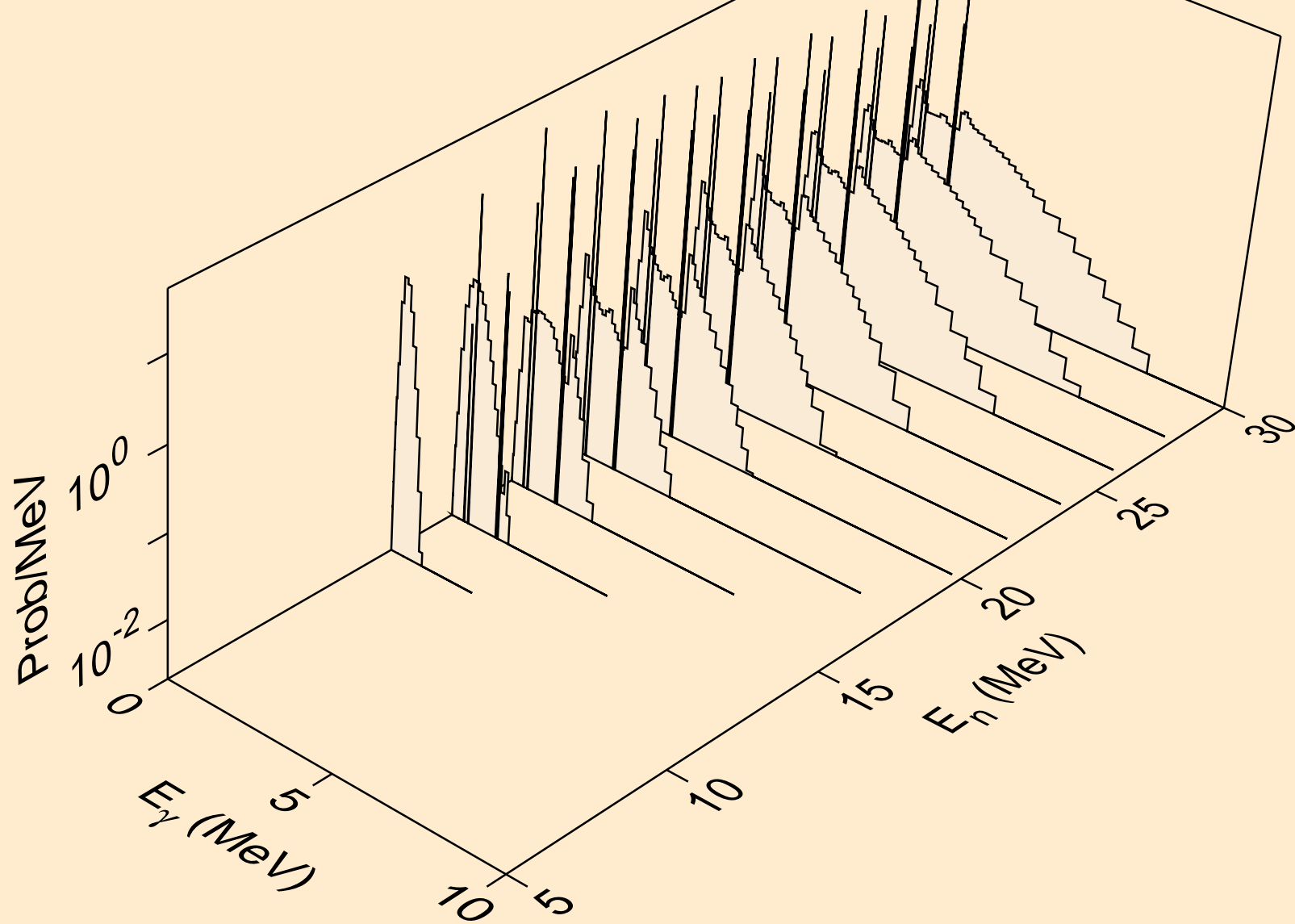

RU093M NEUTRON ACER TENDL-2024 LIBRARY; T=0.K
Photon emission for (n,npa)

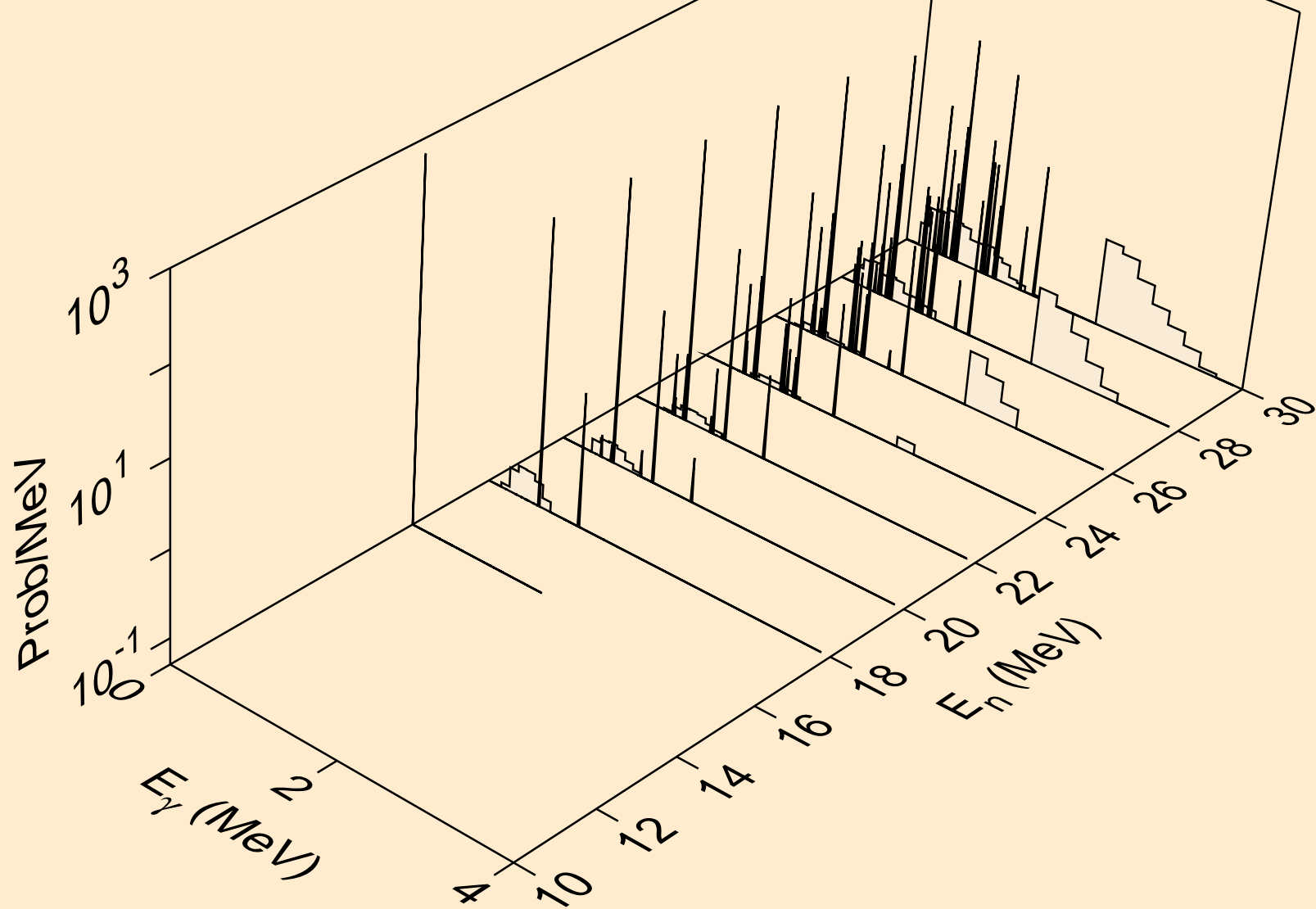

RU093M NEUTRON ACER TENDL-2024 LIBRARY; T=0.K
Photon emission for (n,n*2)

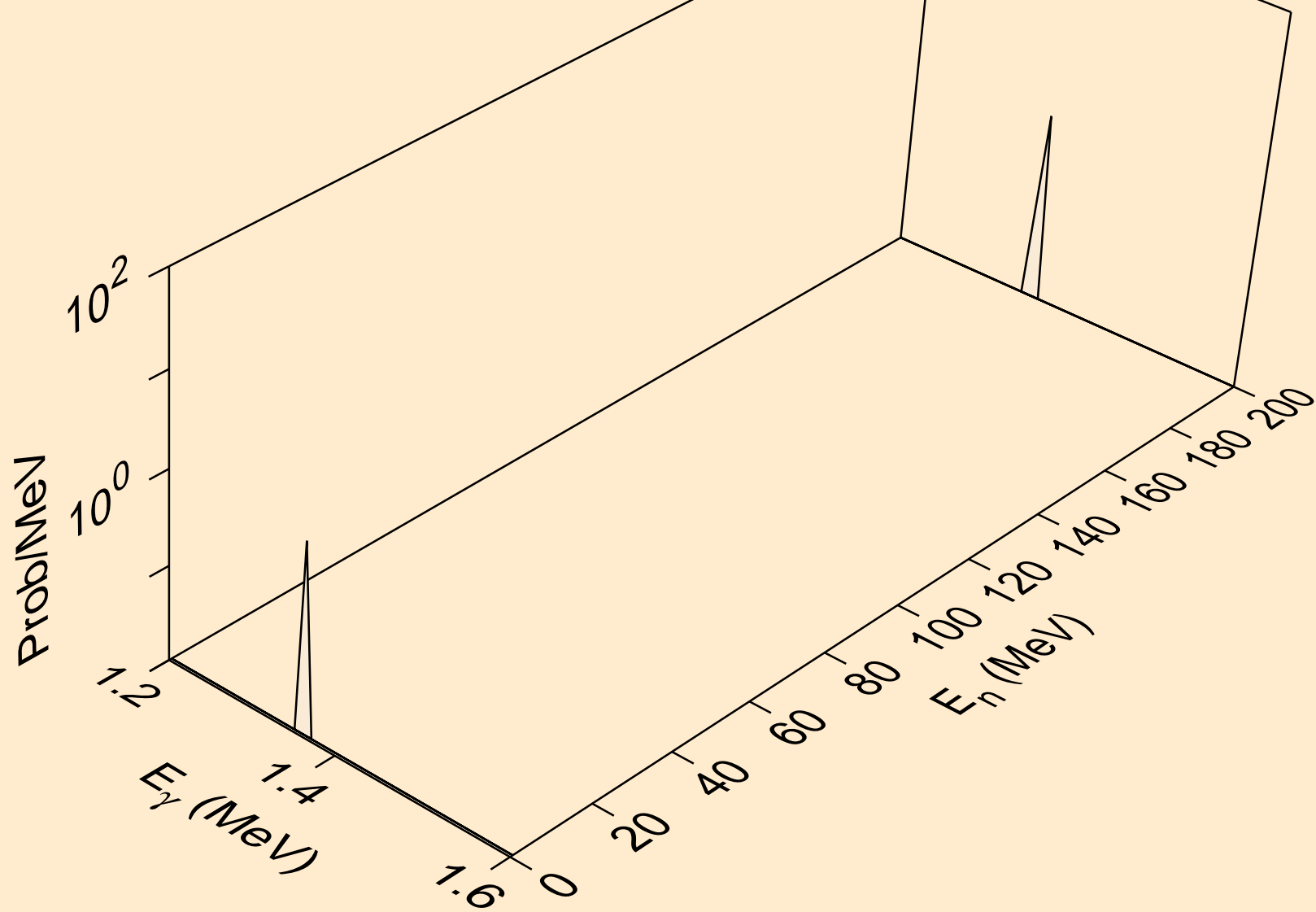

RU093M NEUTRON ACER TENDL-2024 LIBRARY; T=0.K
Photon emission for (n,n*c)

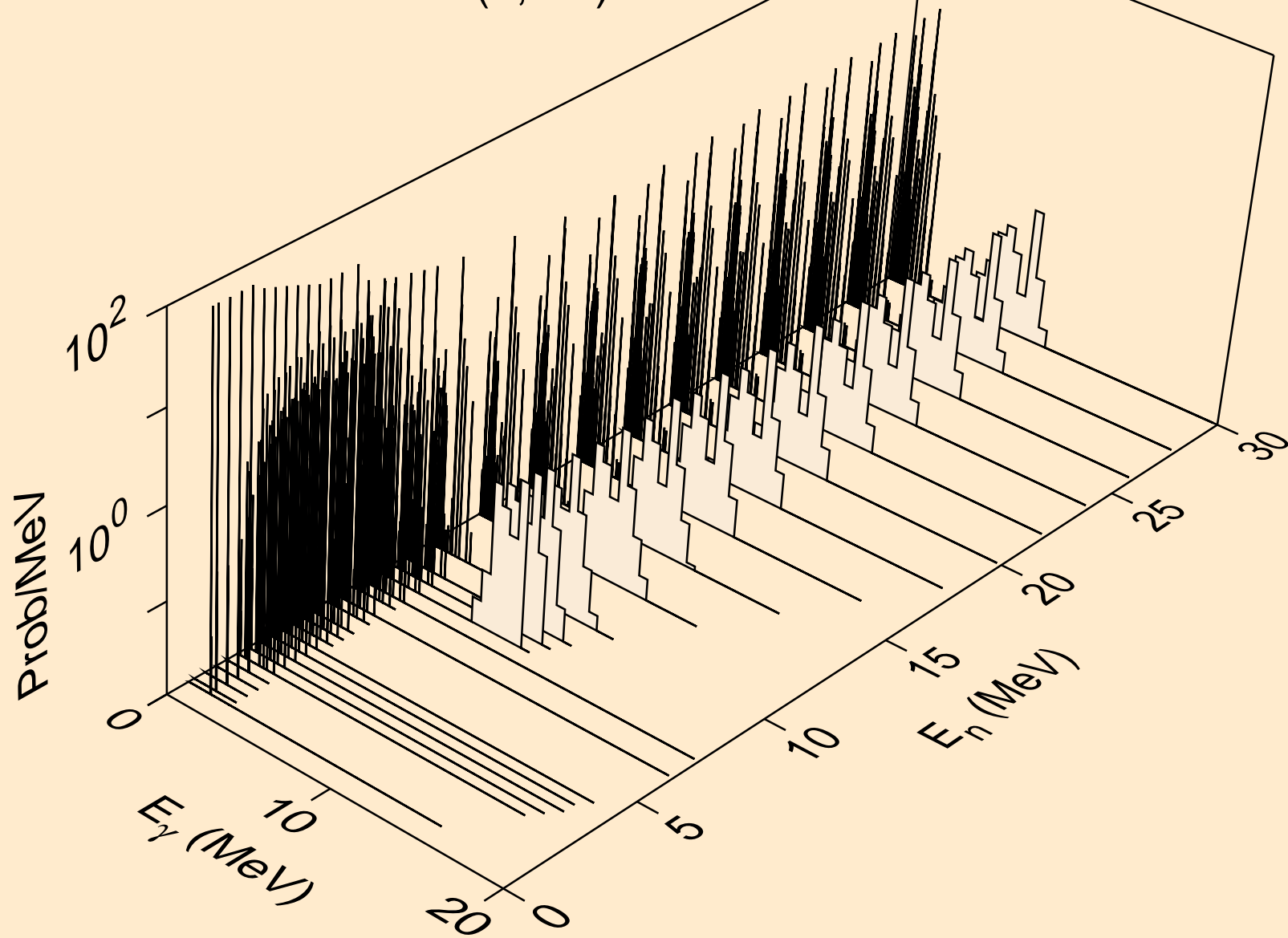

RU093M NEUTRON ACER TENDL-2024 LIBRARY; T=0.K
Photon emission for (n,gma)

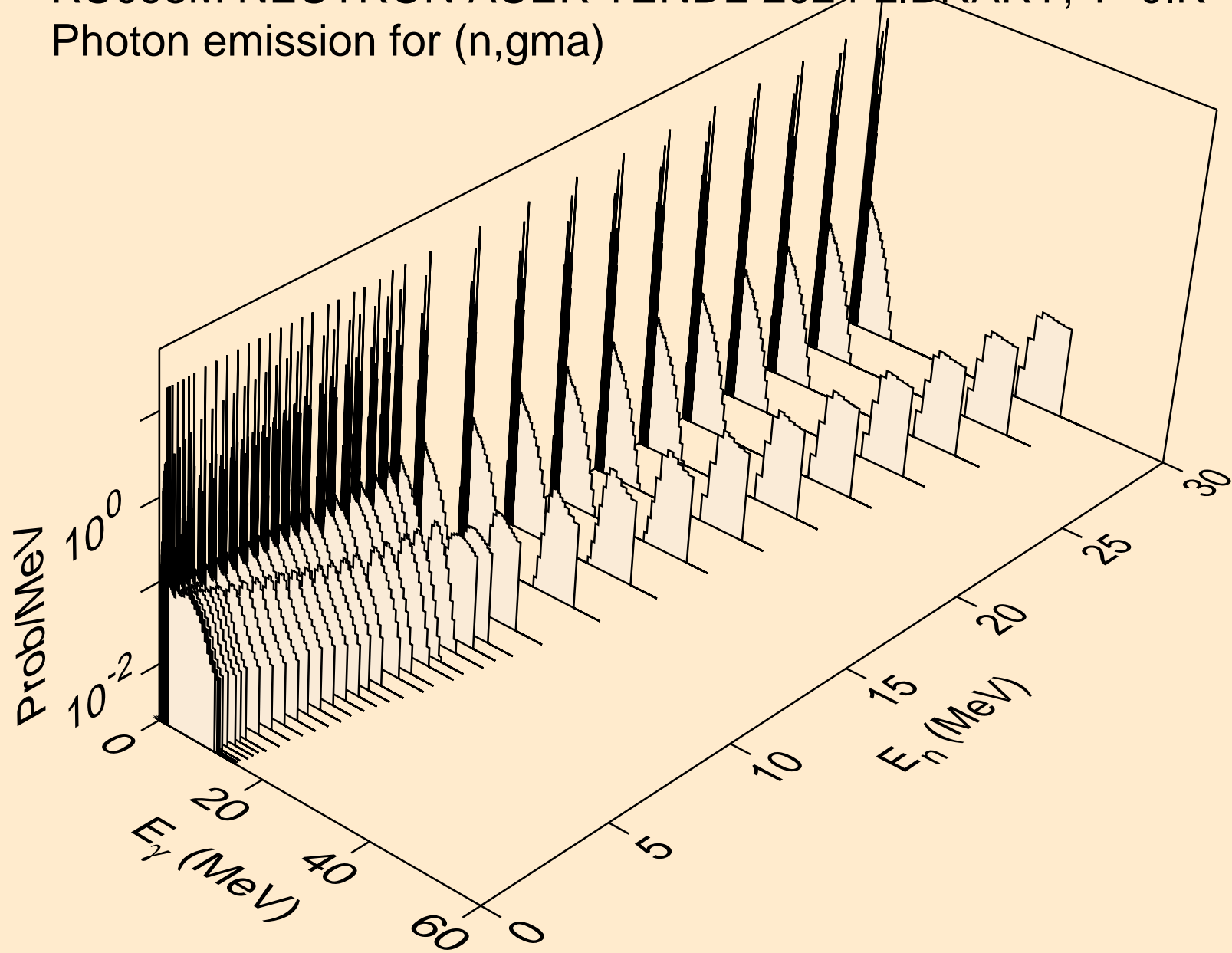

RU093M NEUTRON ACER TENDL-2024 LIBRARY; T=0.K
Photon emission for (n,p)

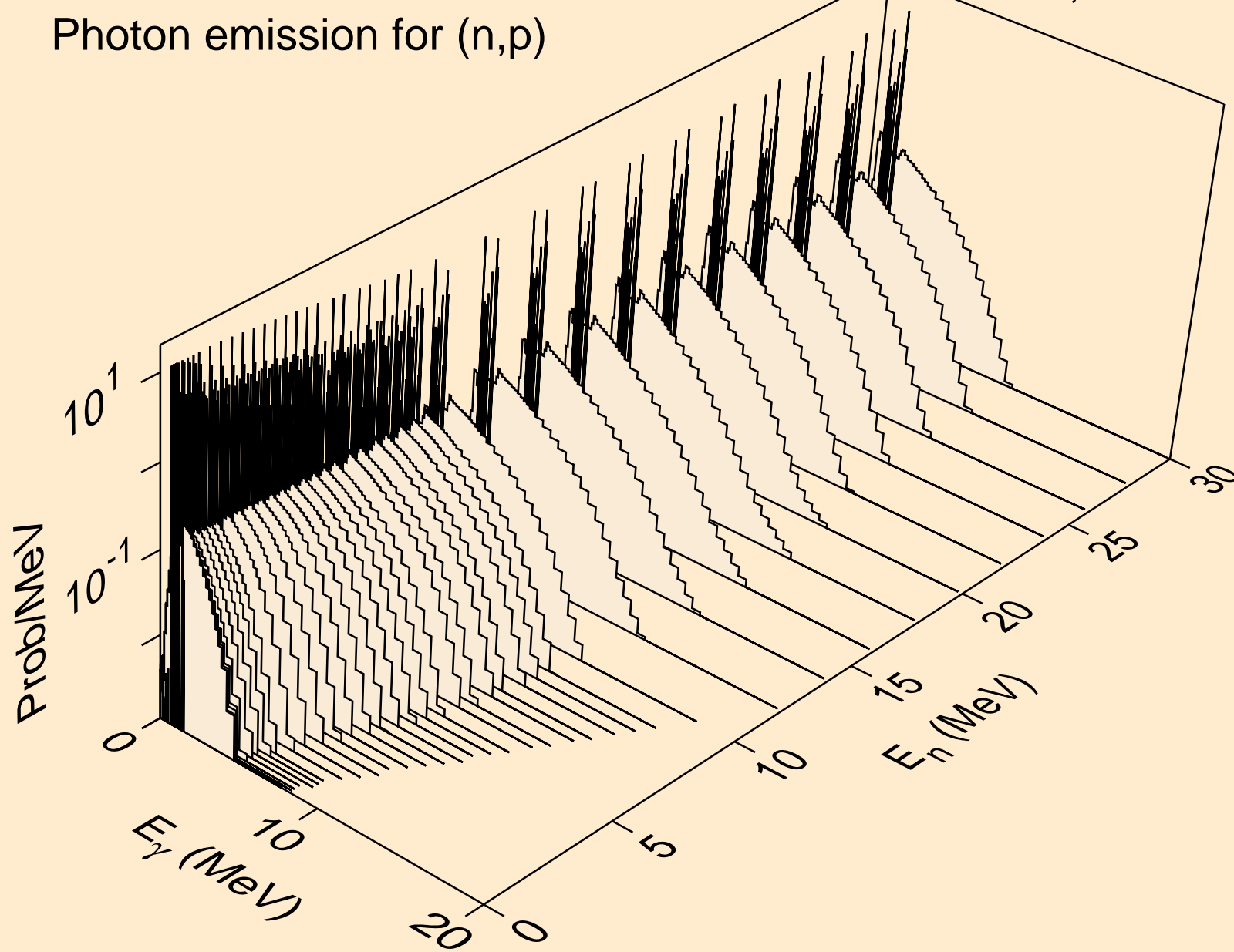

RU093M NEUTRON ACER TENDL-2024 LIBRARY; T=0.K
Photon emission for (n,d)

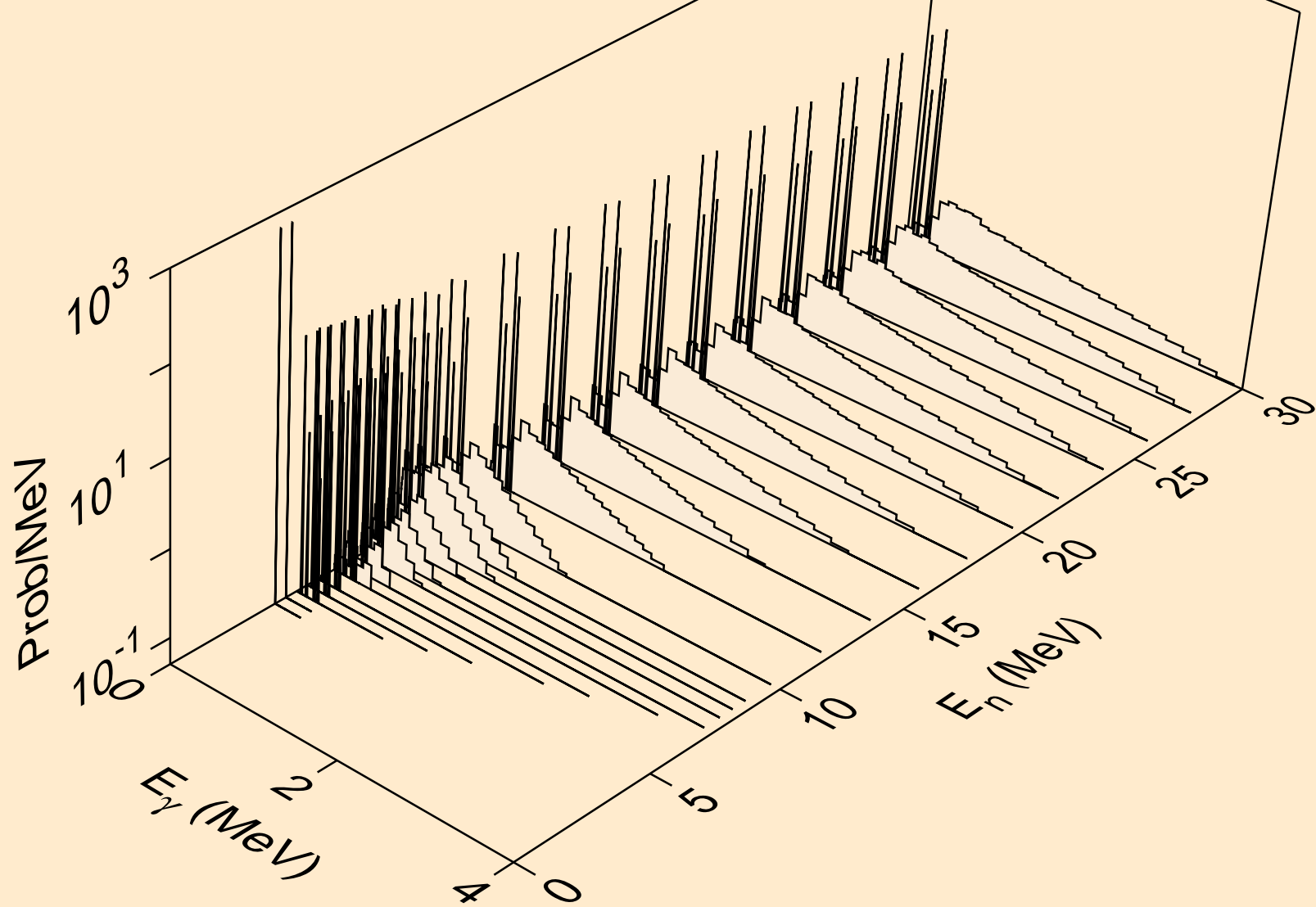

RU093M NEUTRON ACER TENDL-2024 LIBRARY; T=0.K
Photon emission for (n,t)

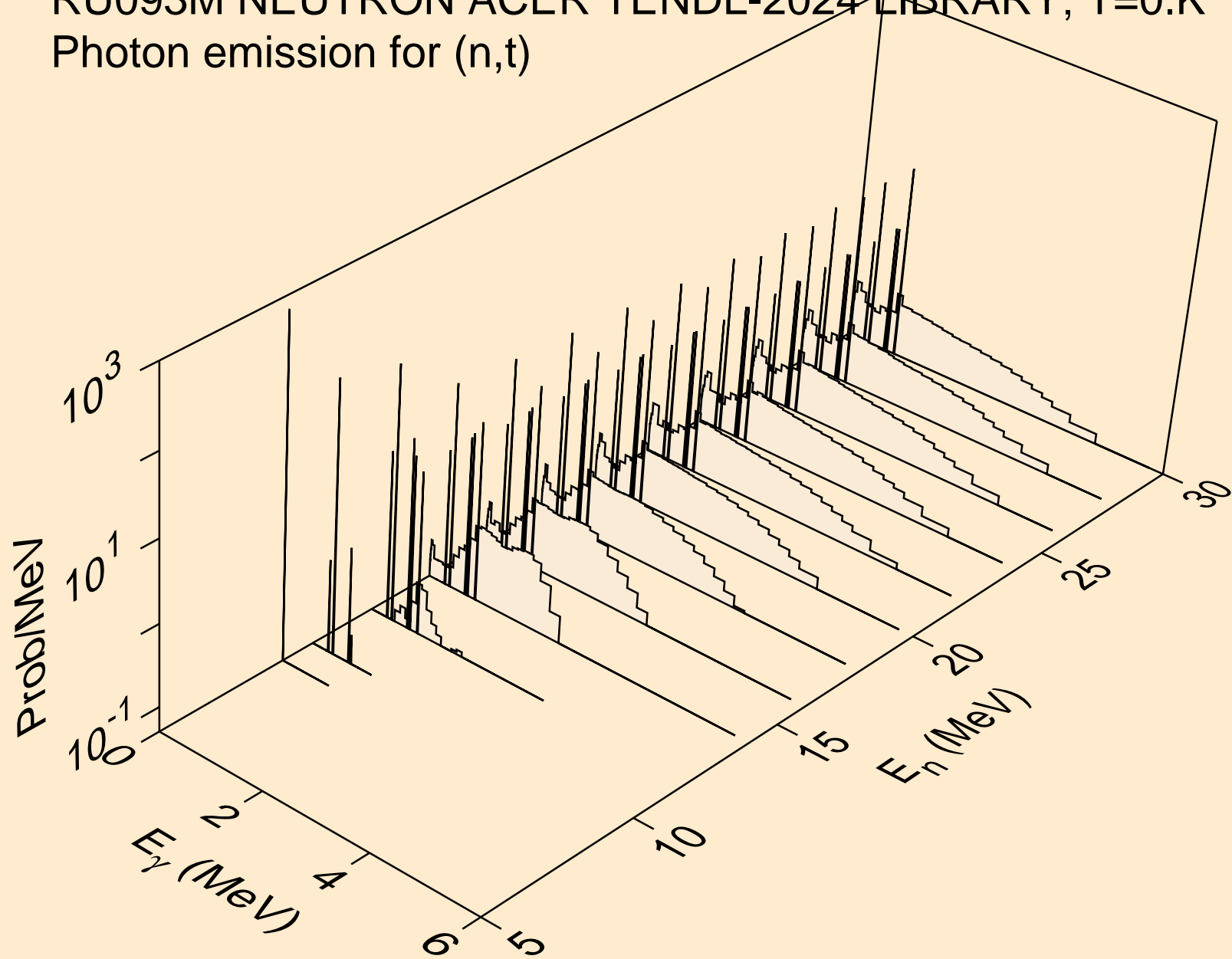

RU093M NEUTRON ACER TENDL-2024 LIBRARY; T=0.K
Photon emission for (n,he3)

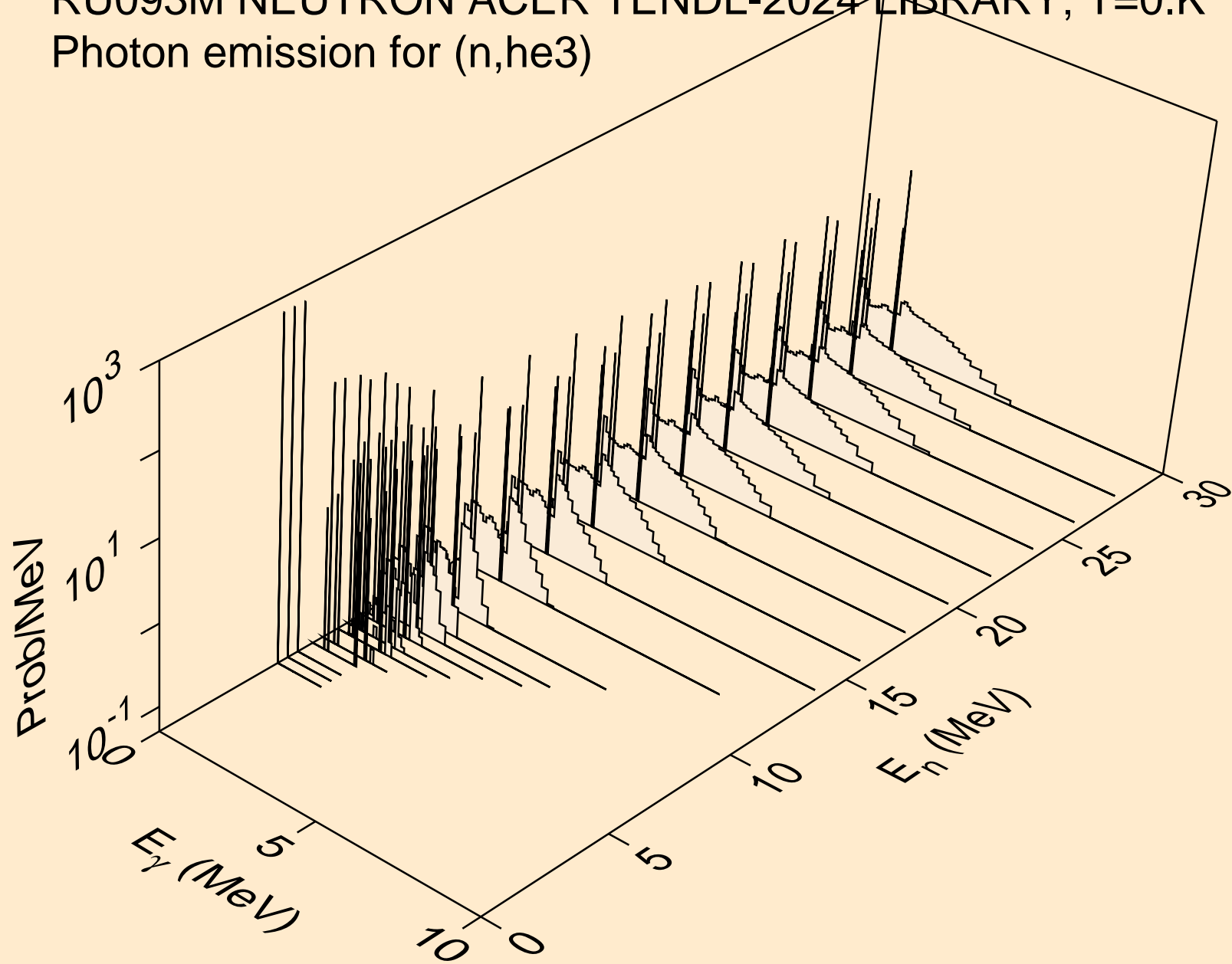

RU093M NEUTRON ACER TENDL-2024 LIBRARY; T=0.K
Photon emission for (n,a)

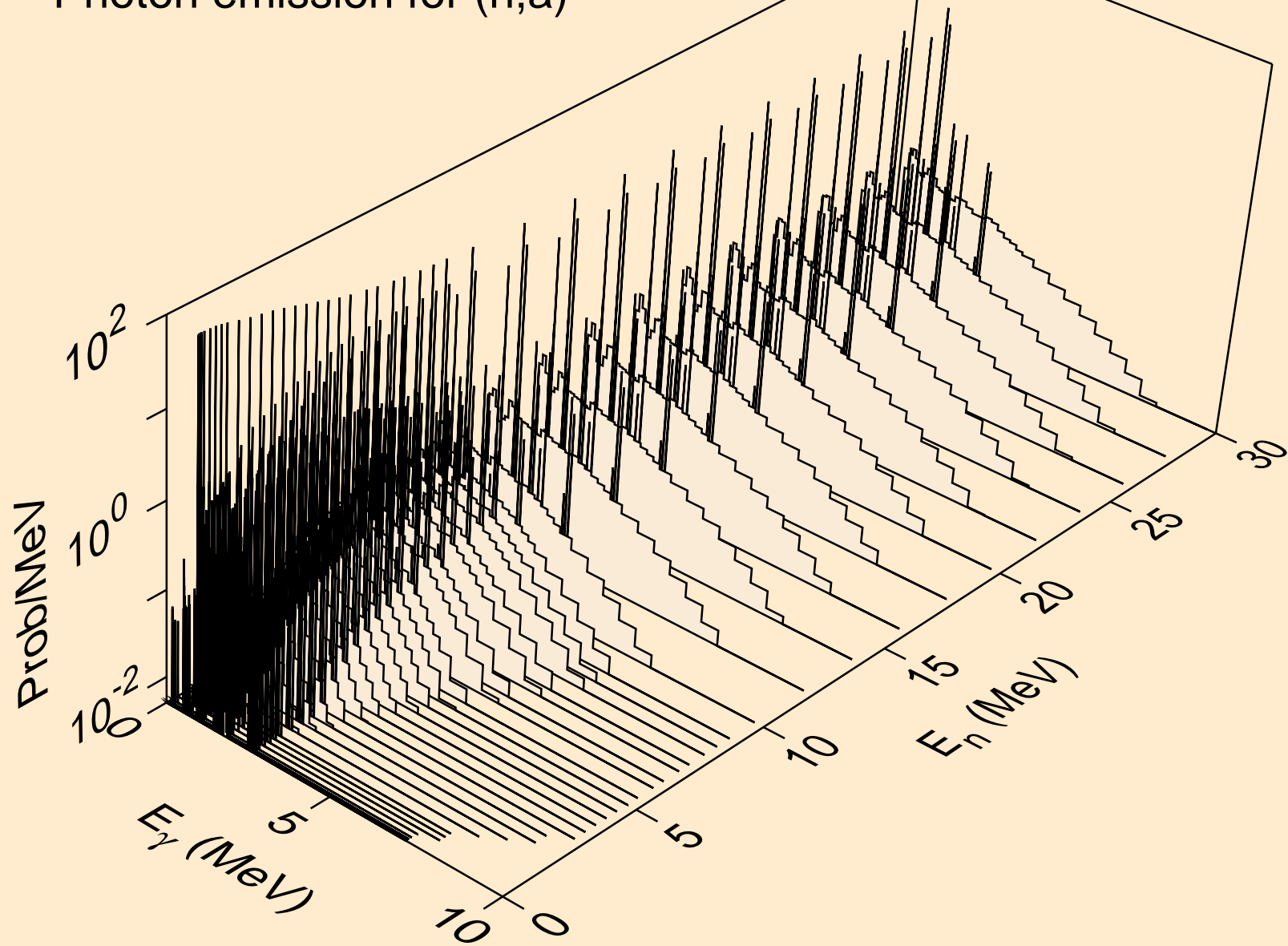

RU093M NEUTRON ACER TENDL-2024 LIBRARY; T=0.K
Photon emission for (n,2a)

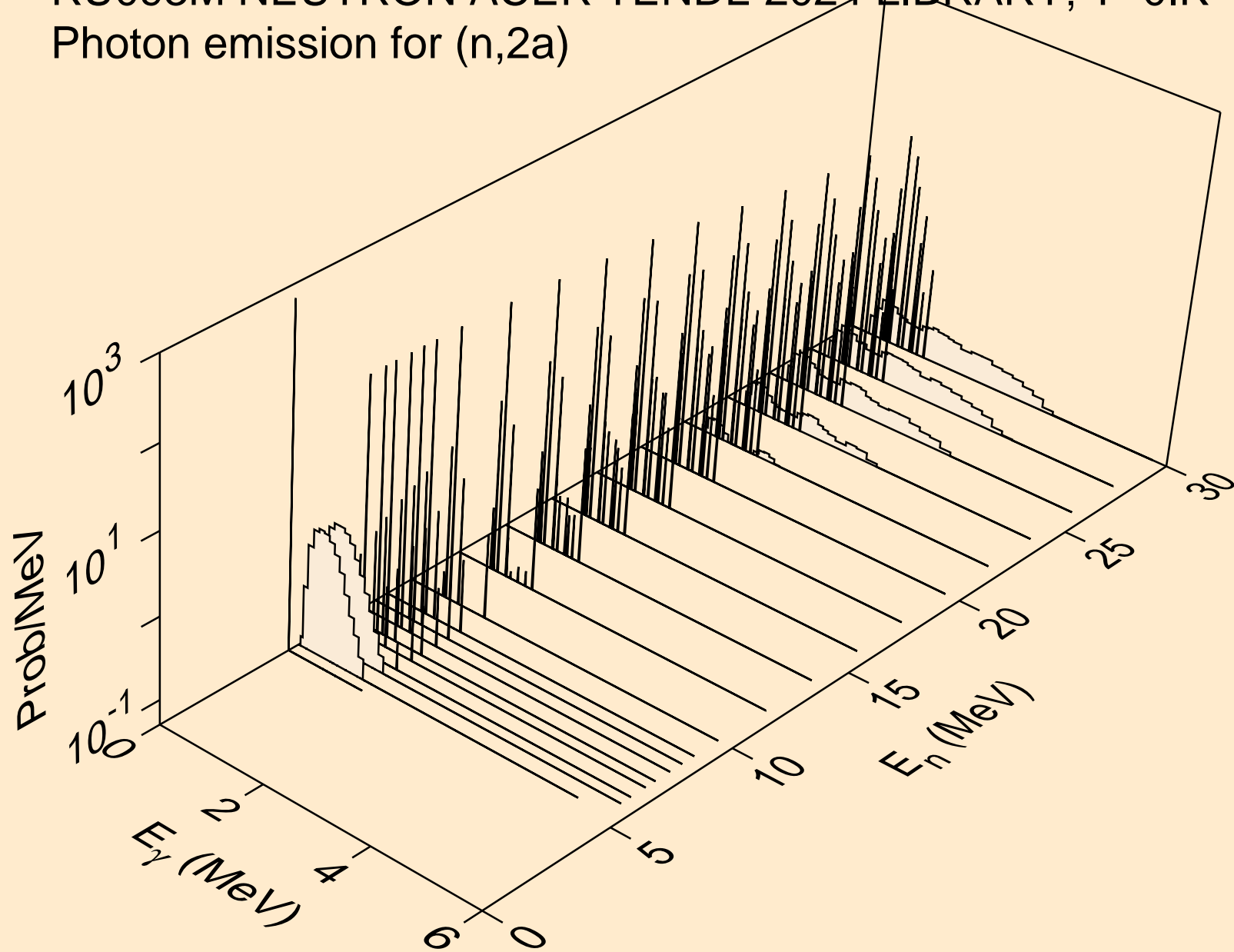

RU093M NEUTRON ACER TENDL-2024 LIBRARY; T=0.K
Photon emission for (n,2p)

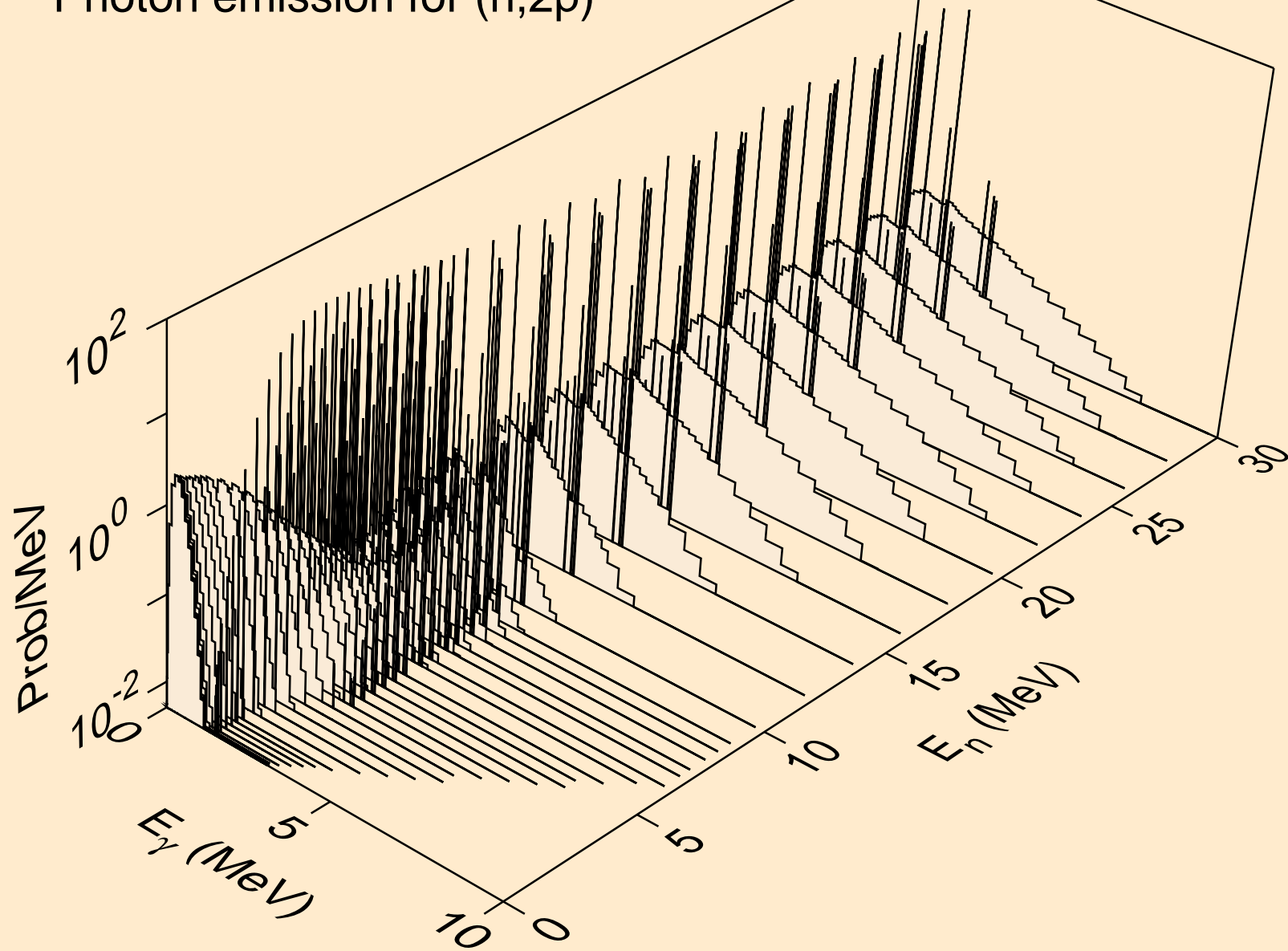

RU093M NEUTRON ACER TENDL-2024 LIBRARY; T=0.K
Photon emission for (n,p)

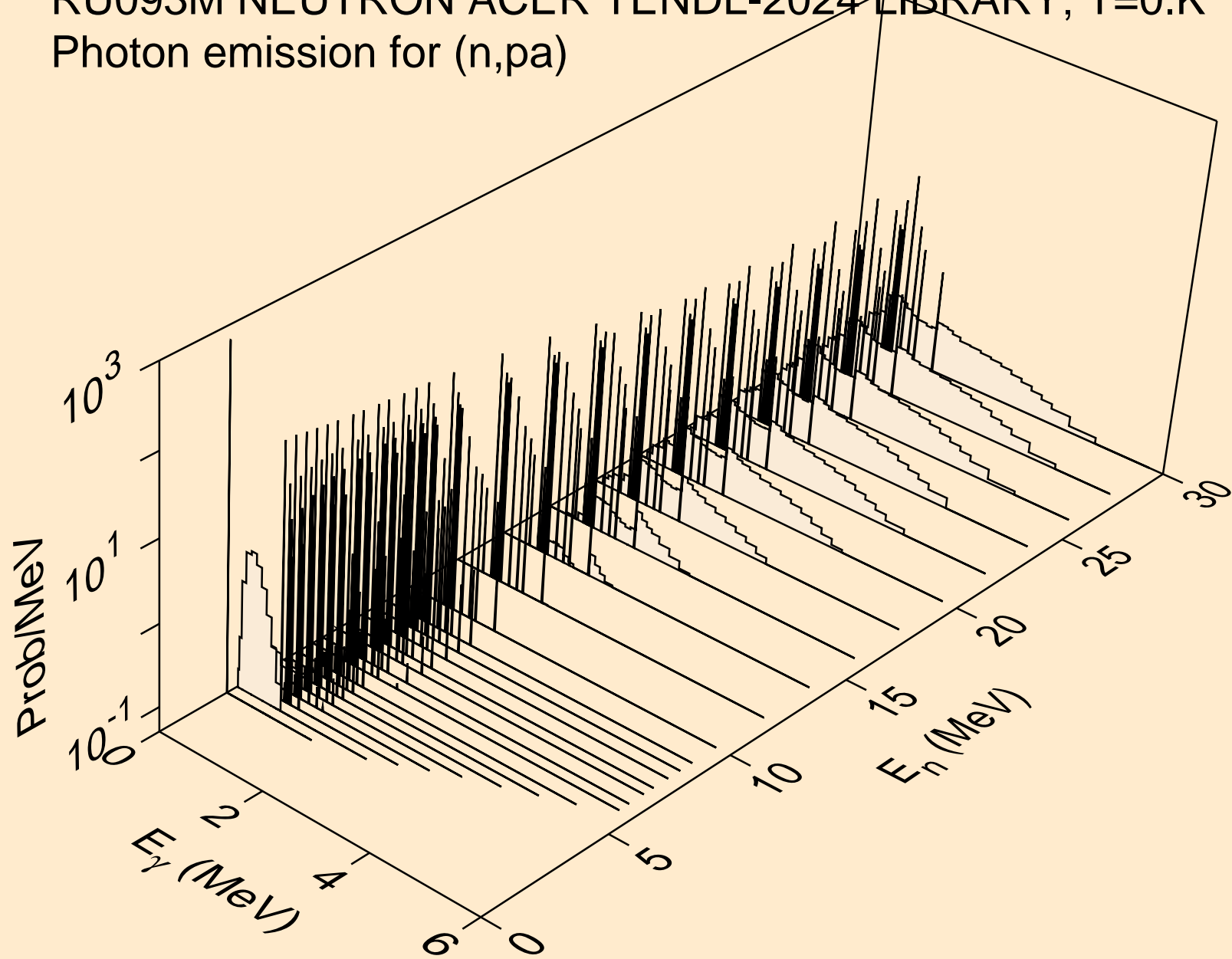

RU093M NEUTRON ACER TENDL-2024 LIBRARY; T=0.K
Photon emission for (n,pd)

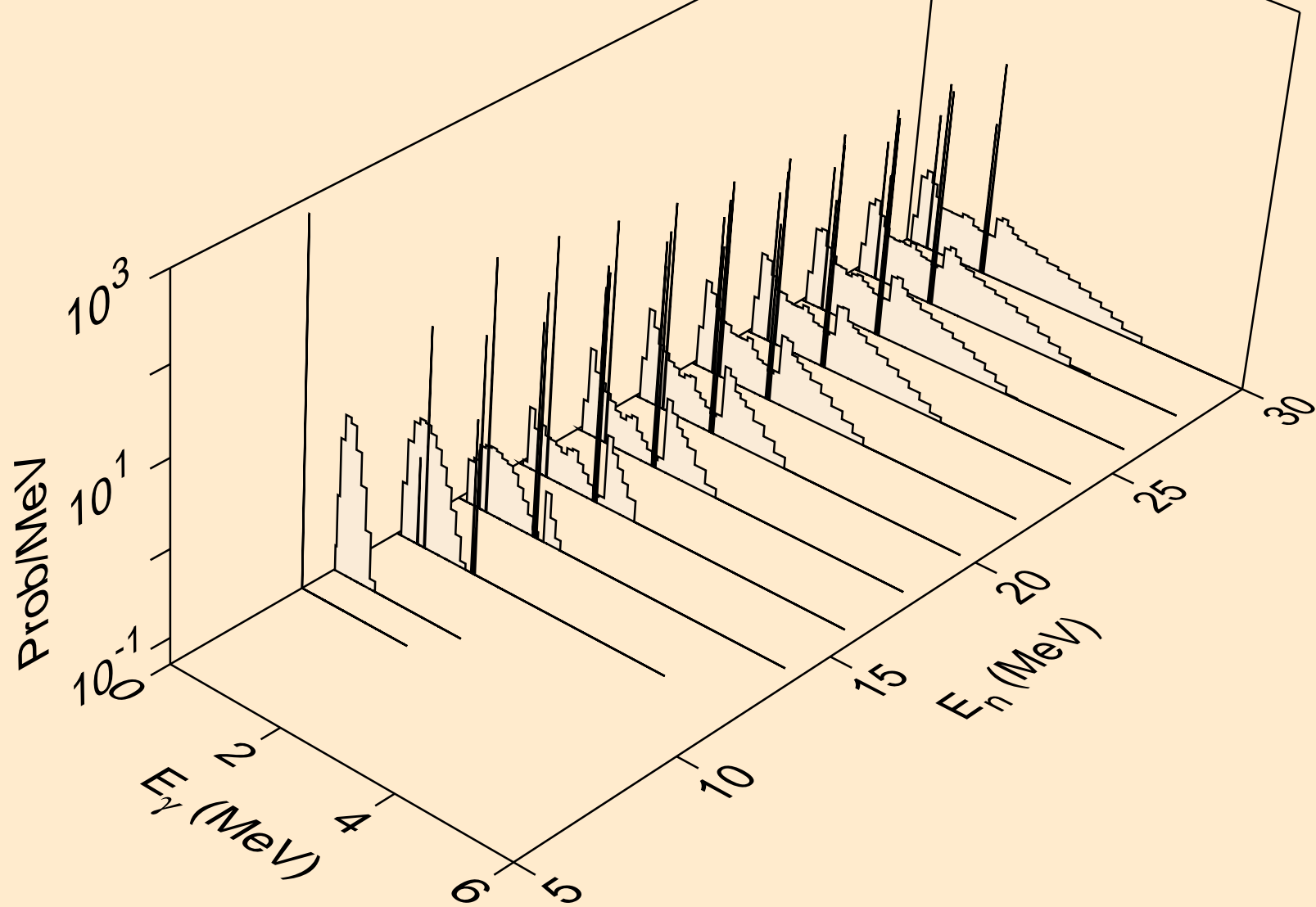

RU093M NEUTRON ACER TENDL-2024 LIBRARY; T=0.K
Photon emission for (n,pt)

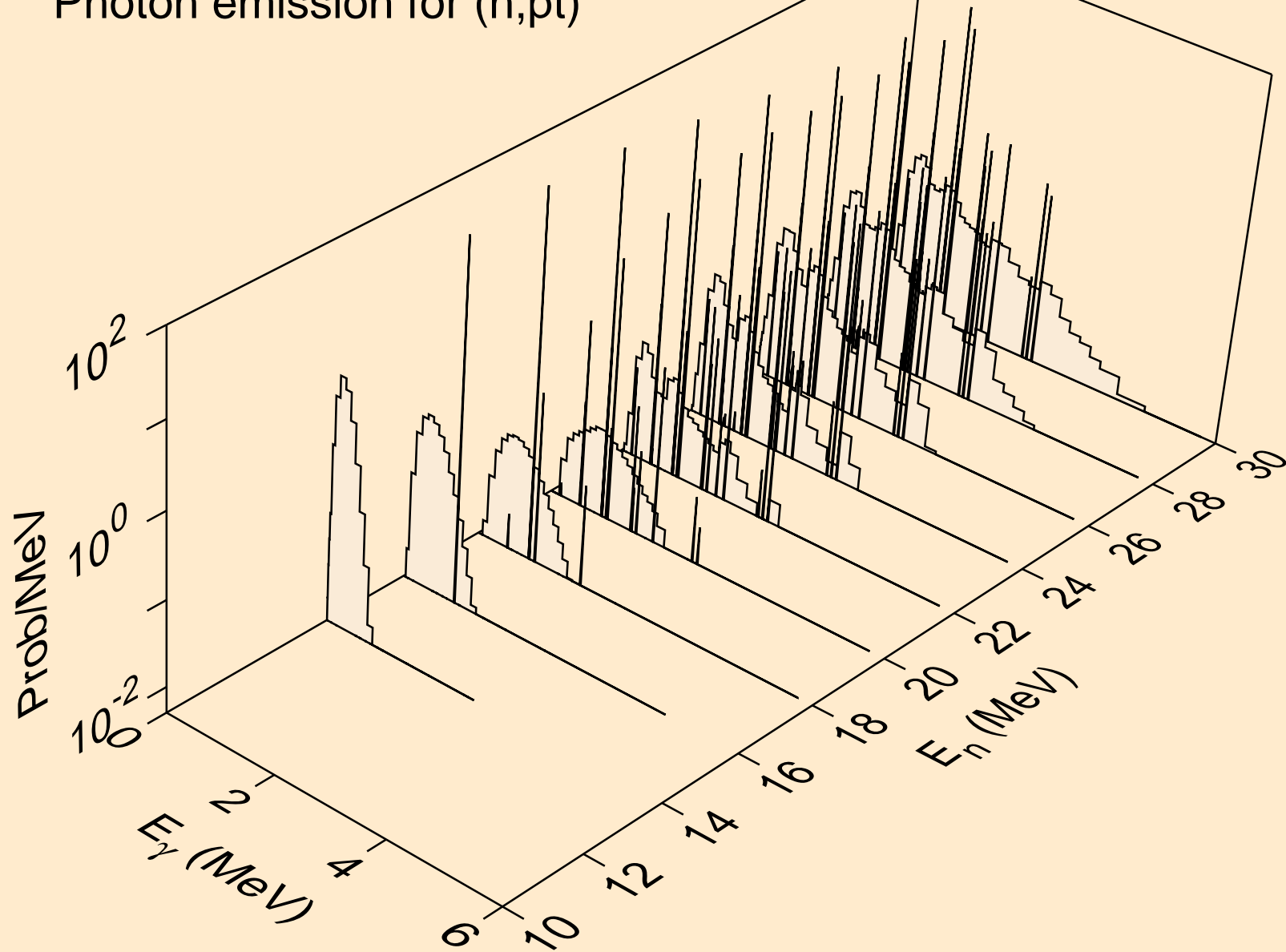

RU093M NEUTRON ACER TENDL-2024 LIBRARY; T=0.K
Photon emission for (n,da)

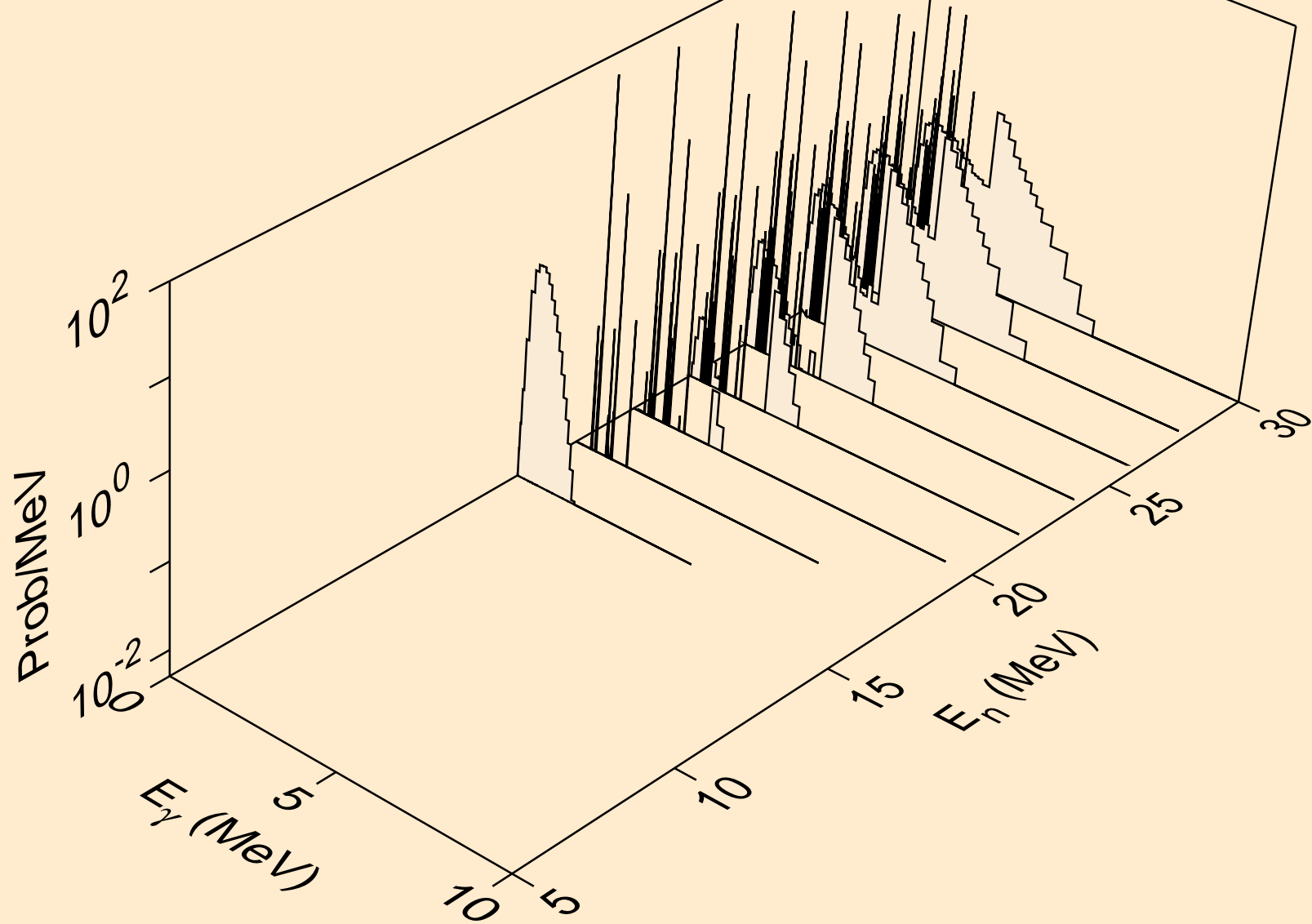

RU093M NEUTRON ACER TENDL-2024 LIBRARY; T=0.K
thermal capture photon spectrum

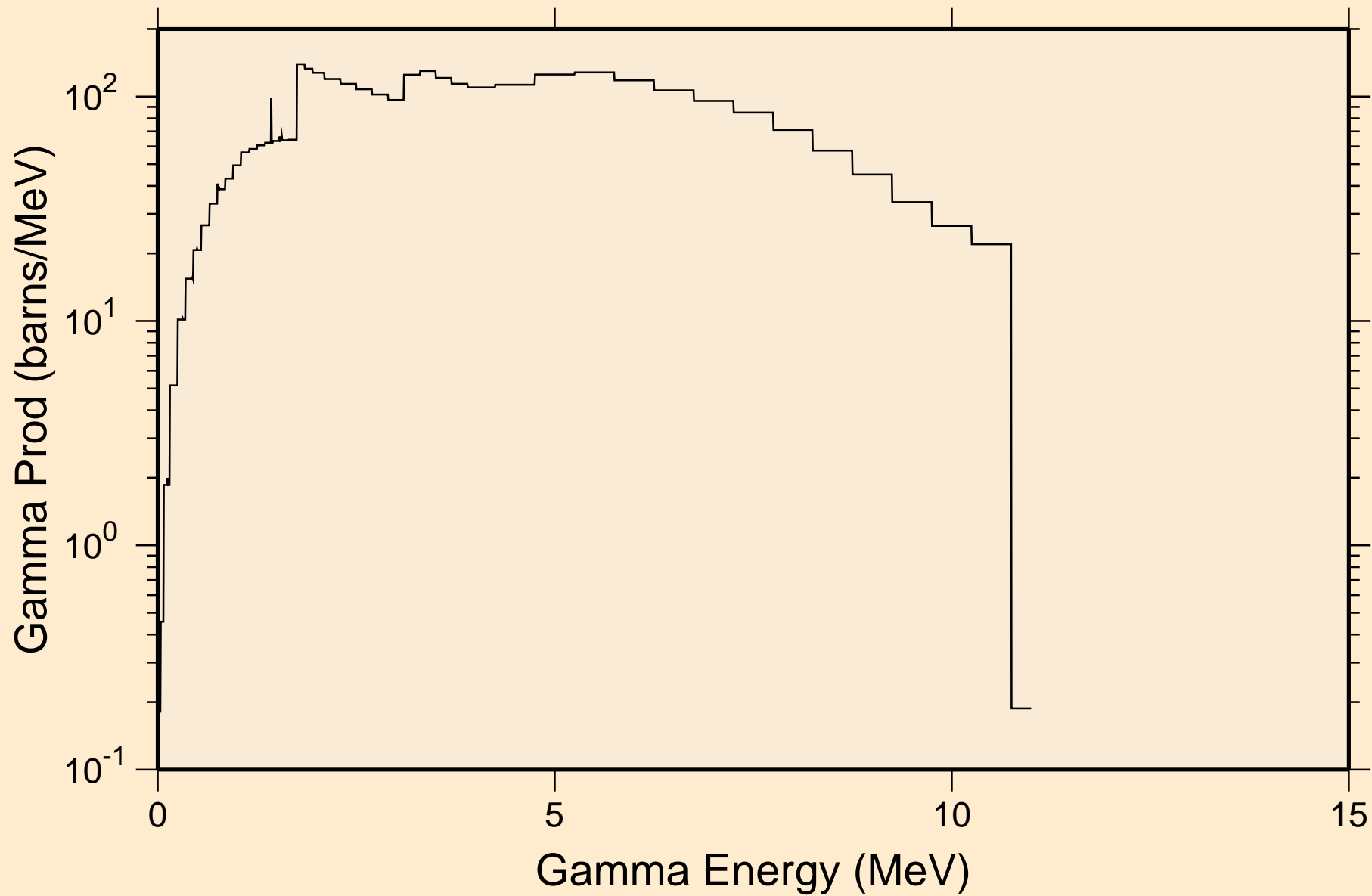

RU093M NEUTRON ACER TENDL-2024 LIBRARY; T=0.K
14 MeV photon spectrum

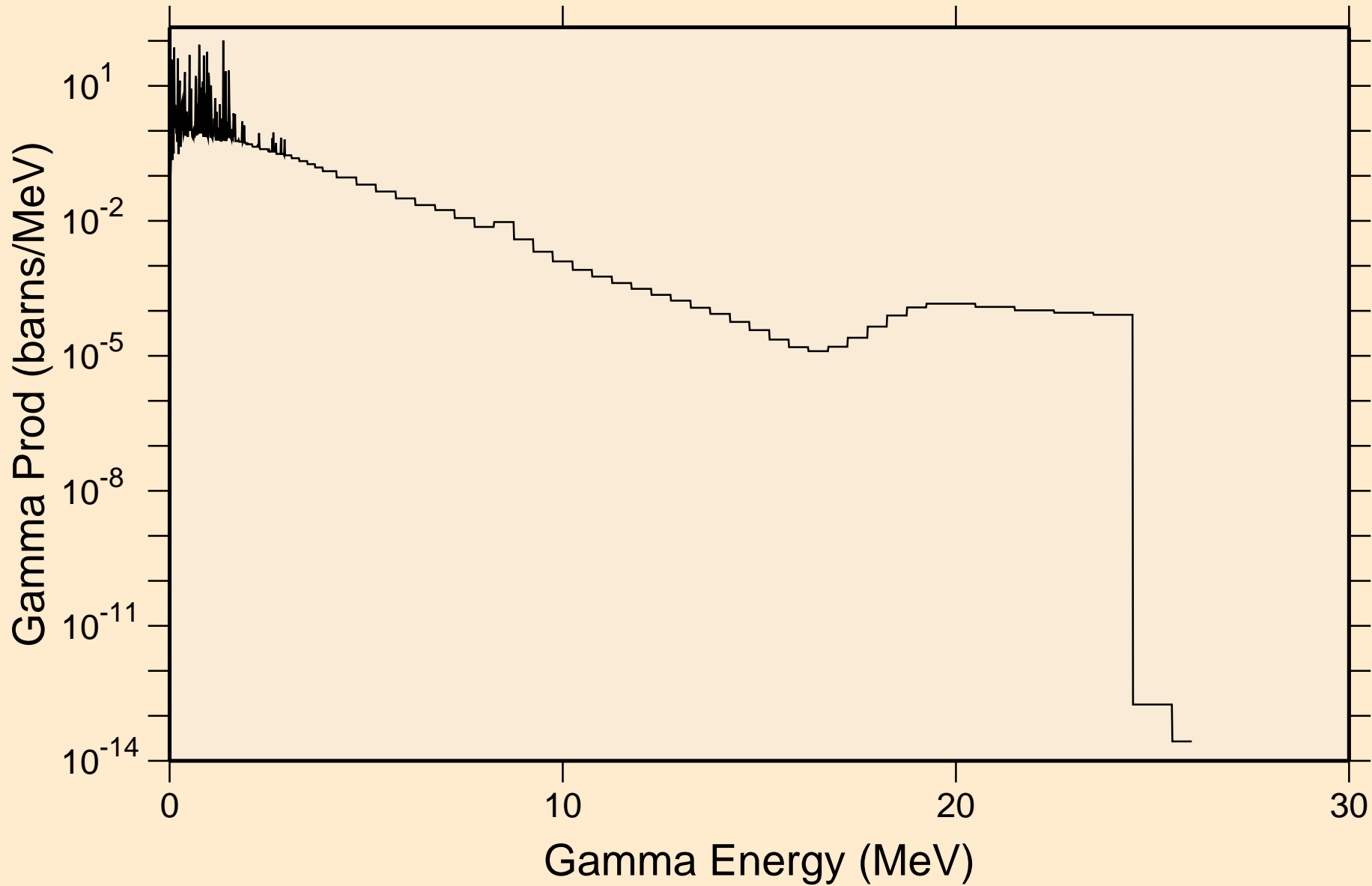

RU093M NEUTRON ACER TENDL-2024 LIBRARY; T=0.K

Particle heating contributions

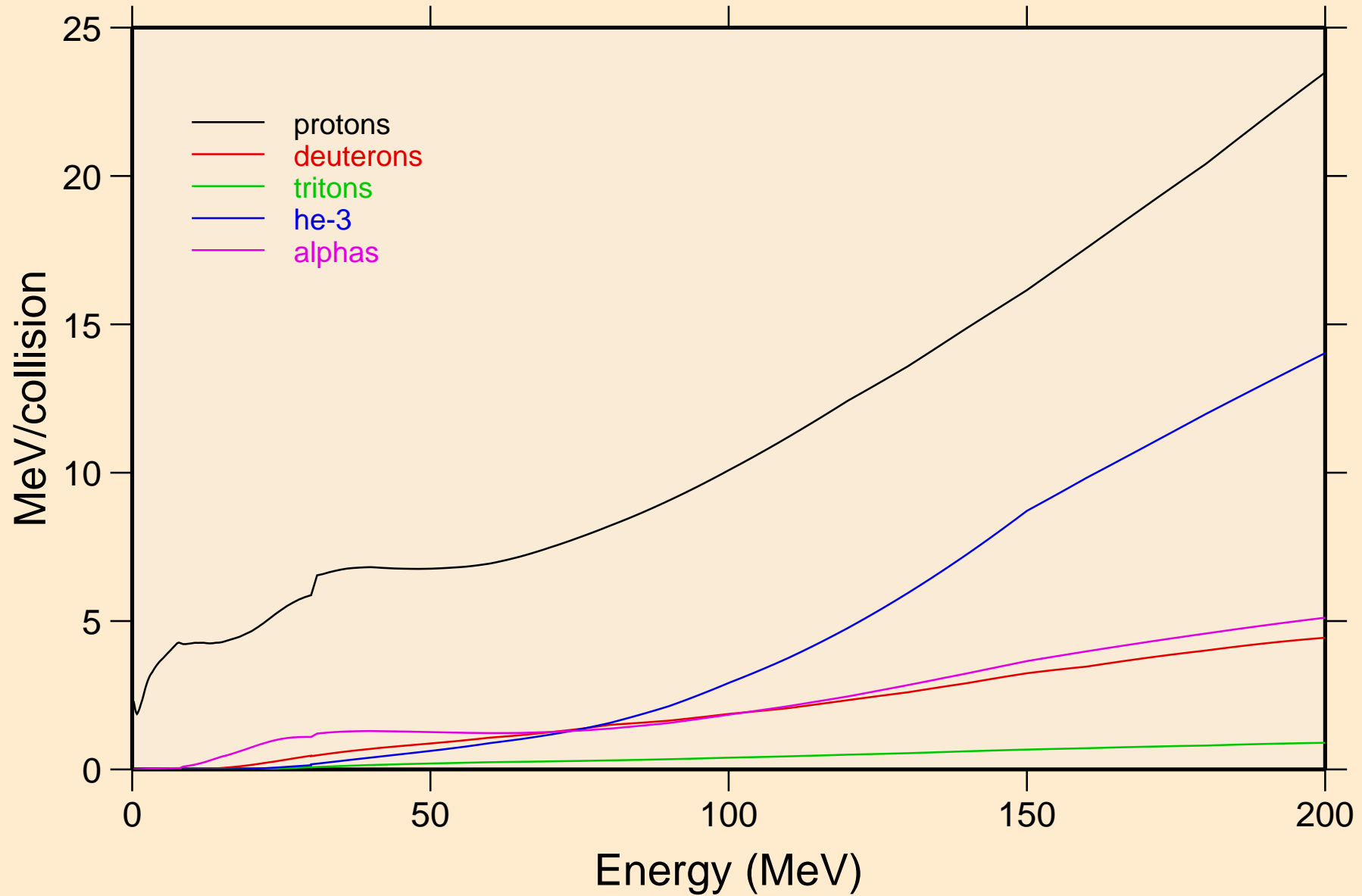

RU093M NEUTRON ACER TENDL-2024 LIBRARY; T=0.K
Recoil Heating

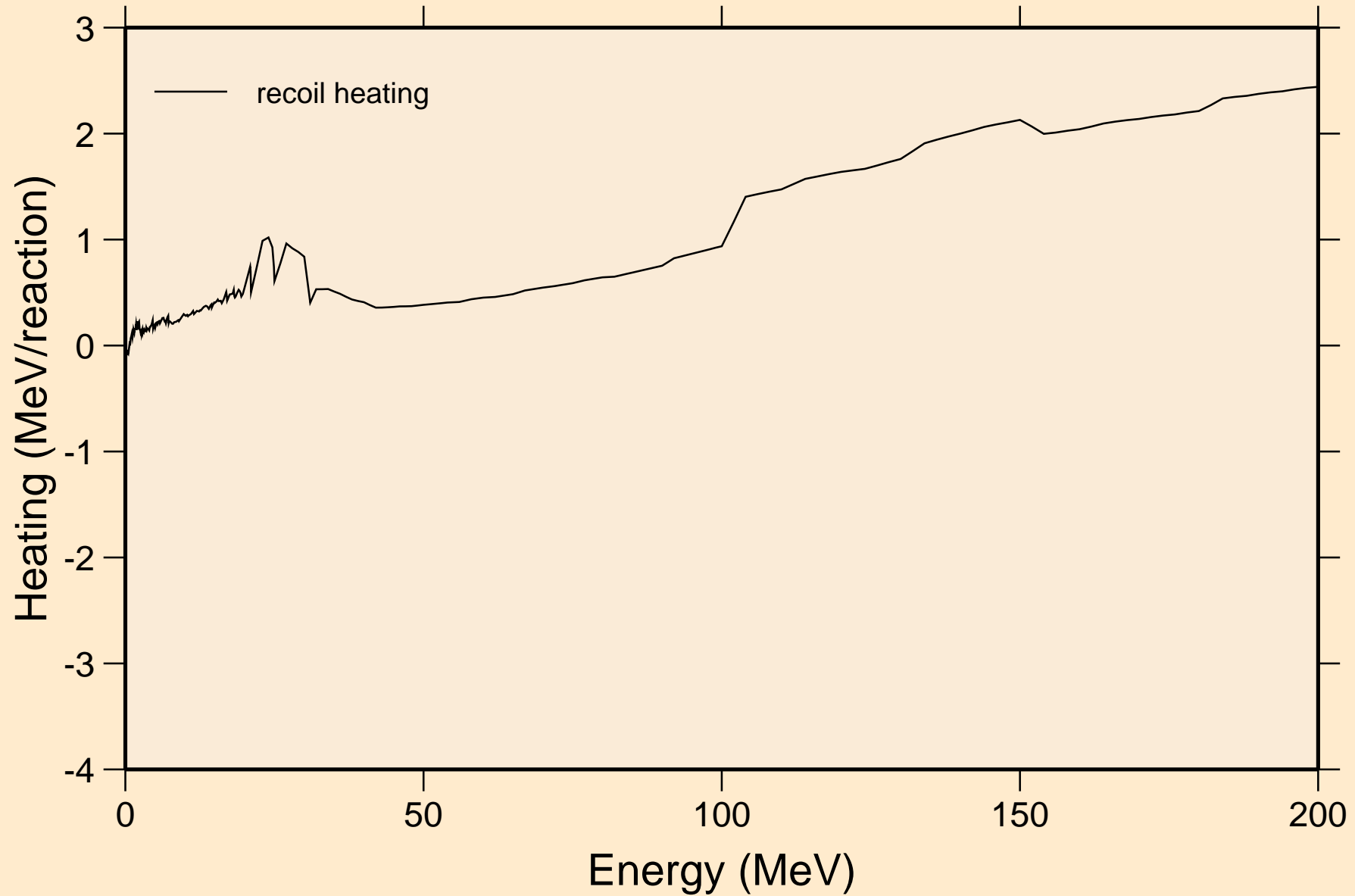

RU093M NEUTRON ACER TENDL-2024 LIBRARY; T=0.K
Particle production cross sections

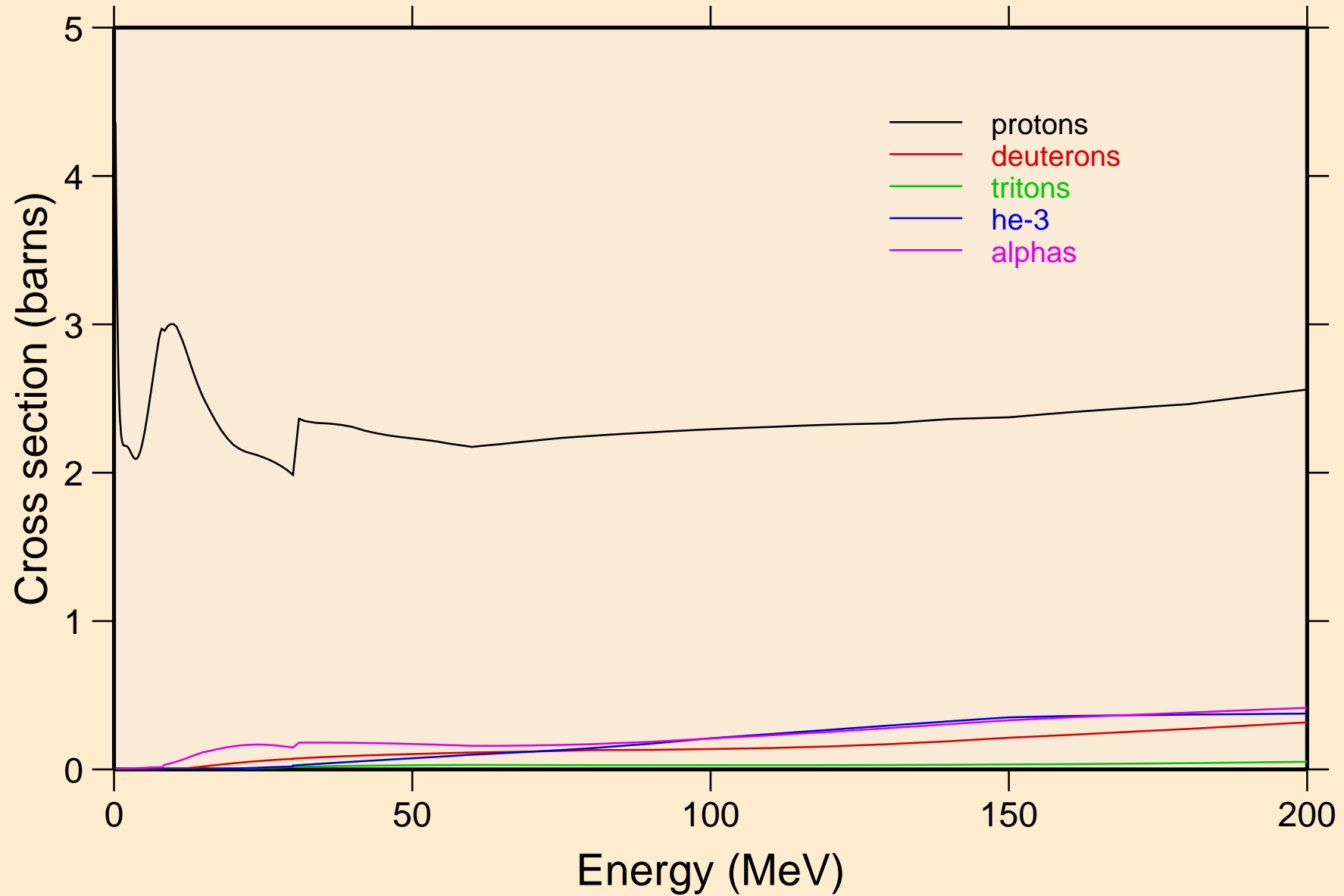

RU093M NEUTRON ACER TENDL-2024 LIBRARY; T=0.K
protons from (n,x)

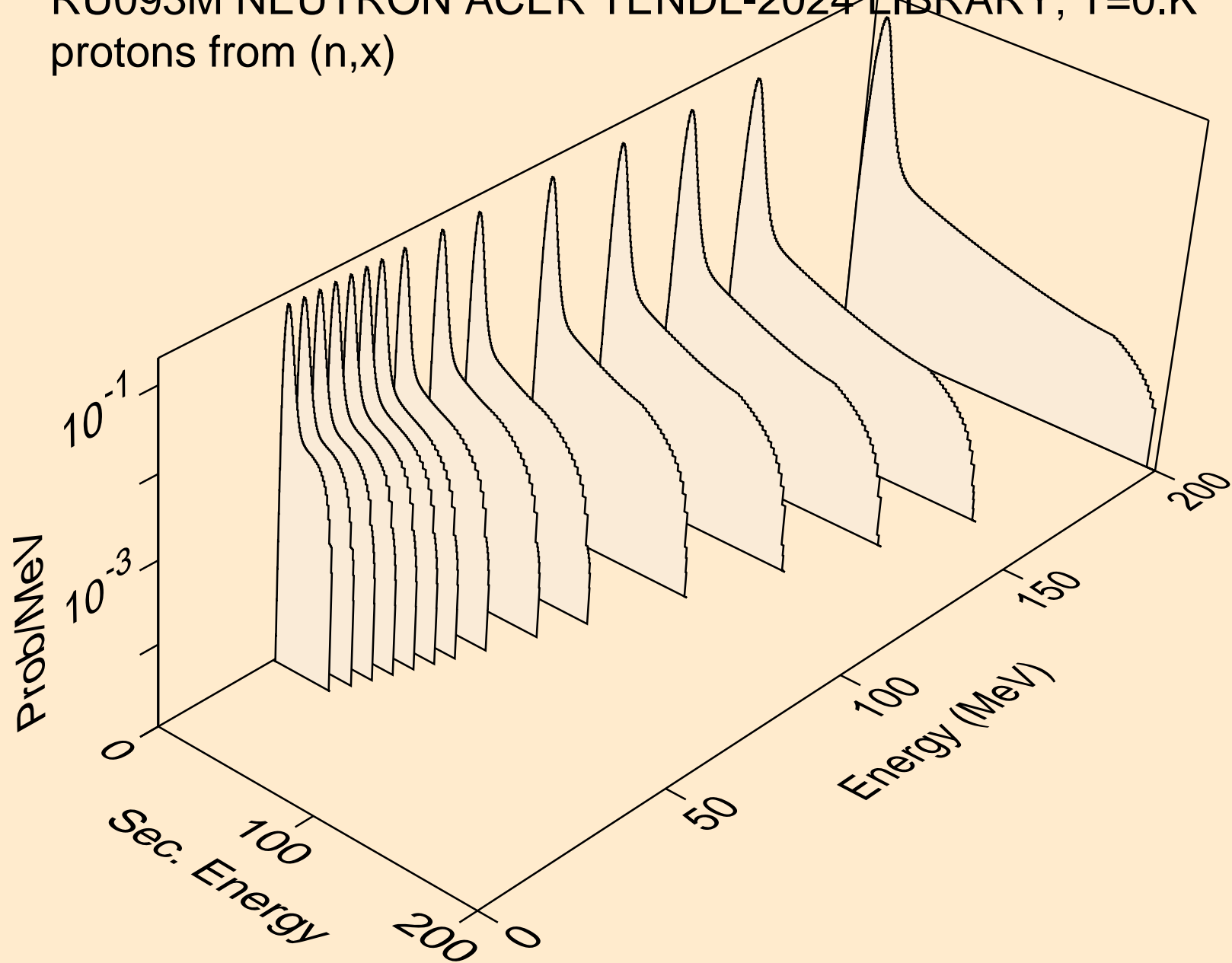

RU093M NEUTRON ACER TENDL-2024 LIBRARY; T=0.K
protons from (n,n*)p

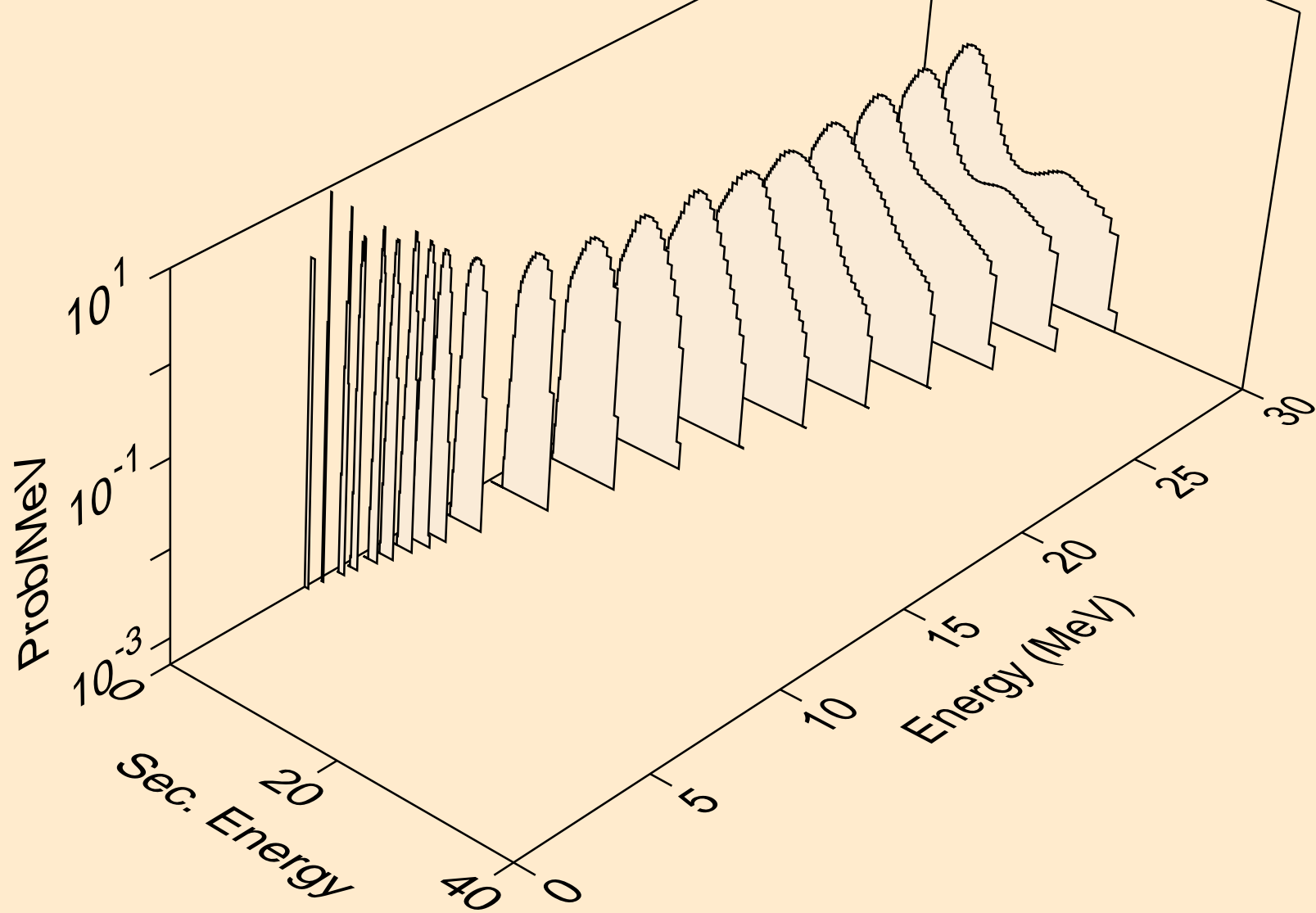

RU093M NEUTRON ACER TENDL-2024 LIBRARY; T=0.K
protons from (n,2np)

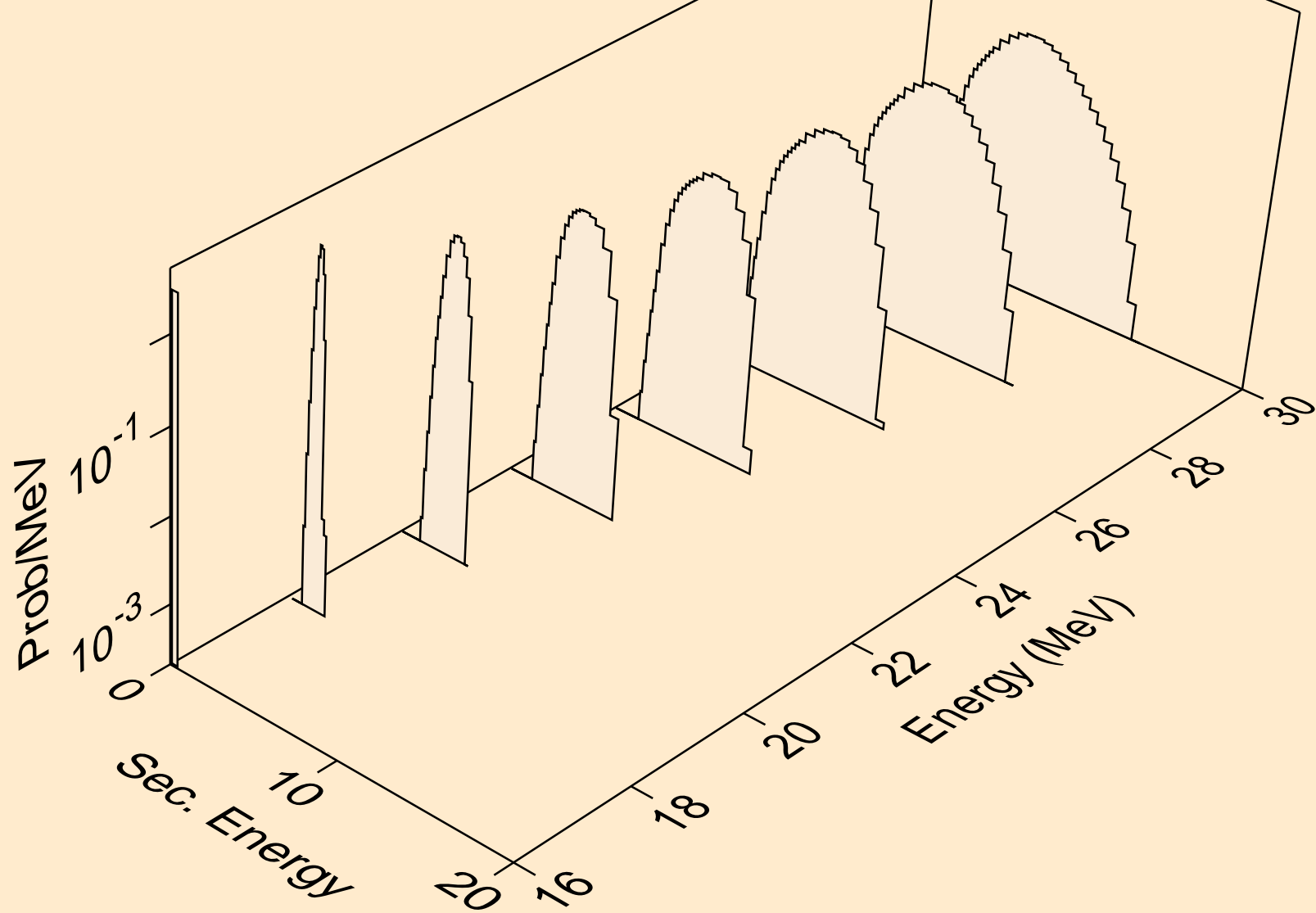

RU093M NEUTRON ACER TENDL-2024 LIBRARY; T=0.K
protons from (n,n2p)

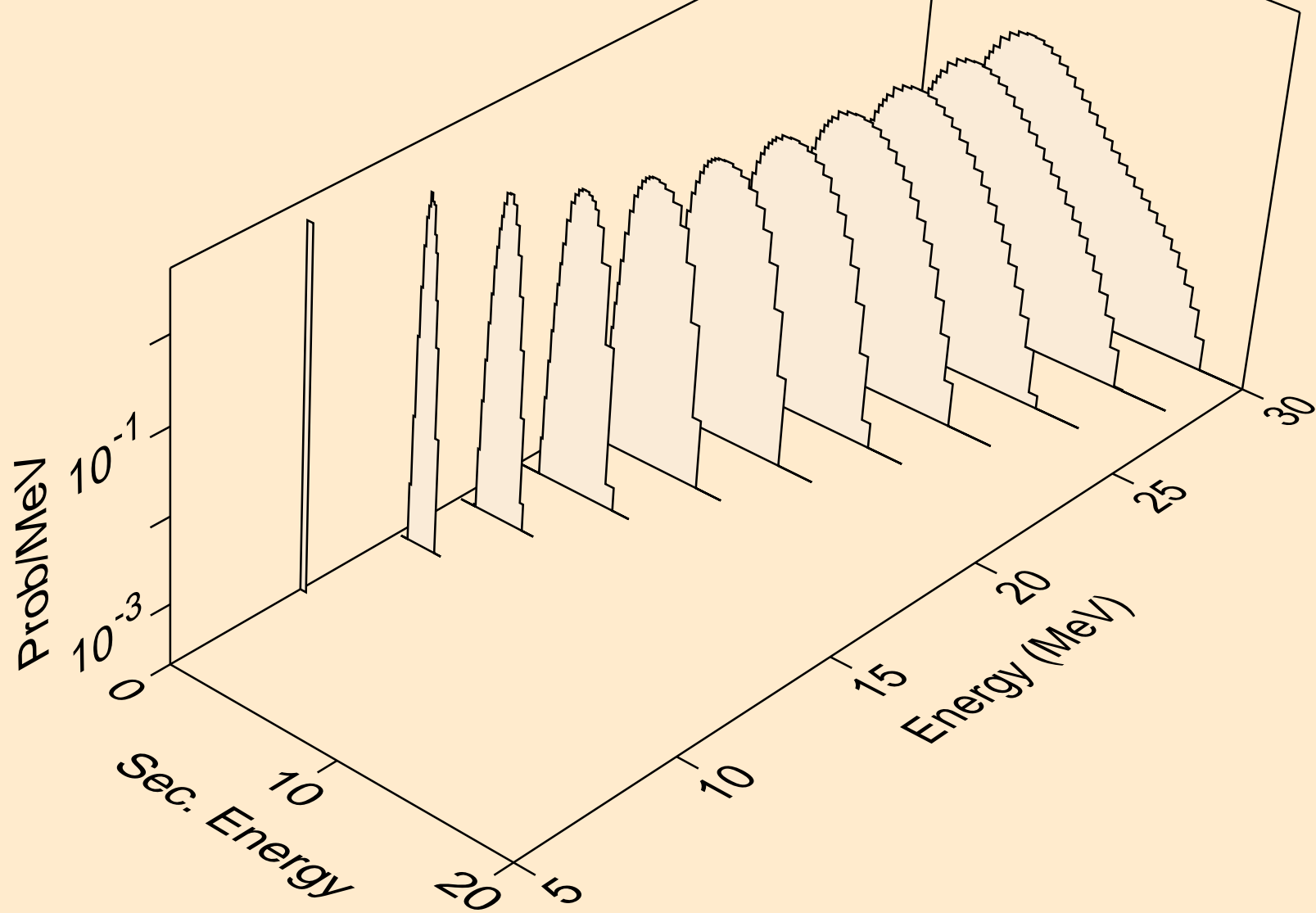

RU093M NEUTRON ACER TENDL-2024 LIBRARY; T=0.K
protons from (n,npa)

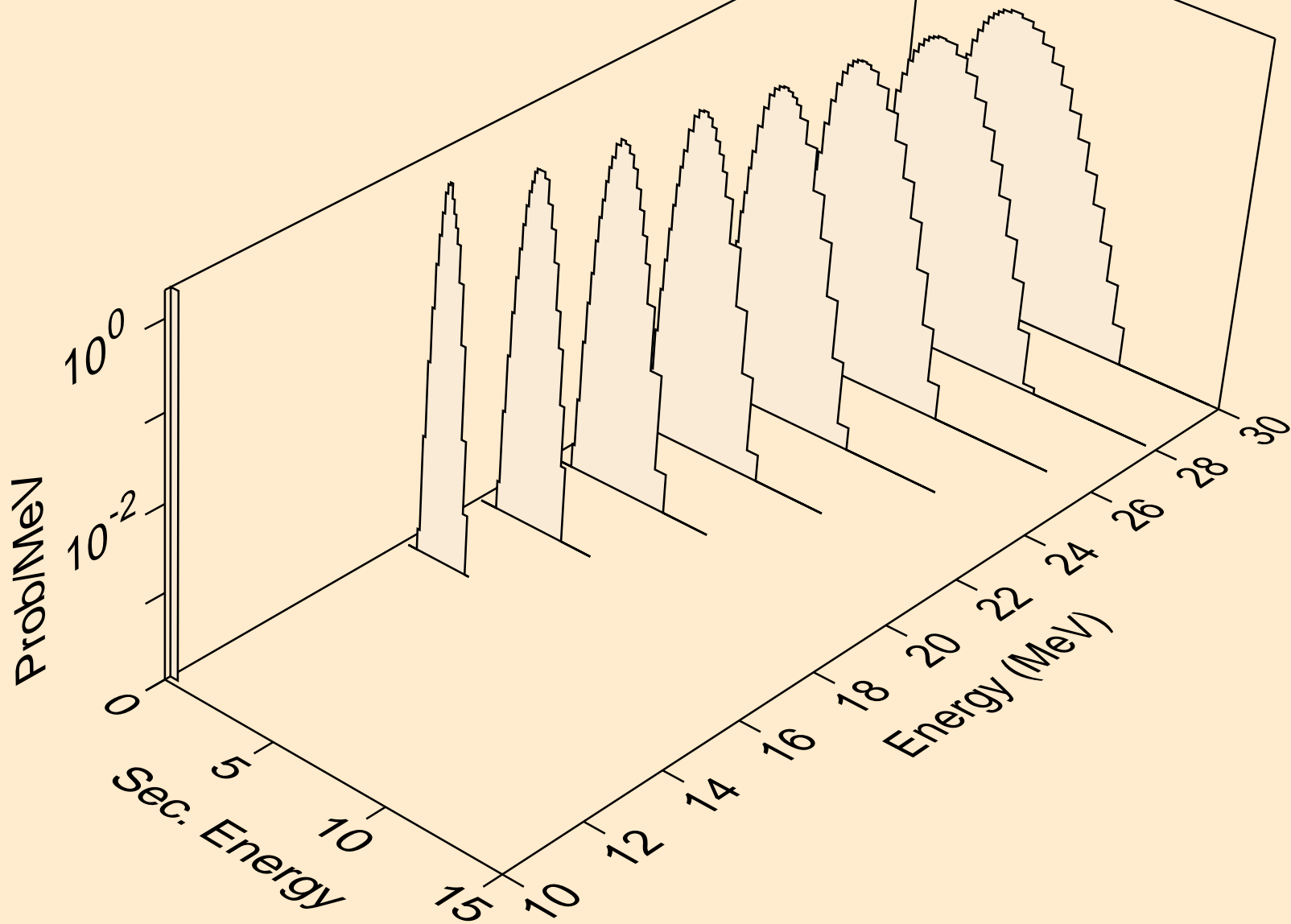

RU093M NEUTRON ACER TENDL-2024 LIBRARY; T=0.K
protons from (n,p)

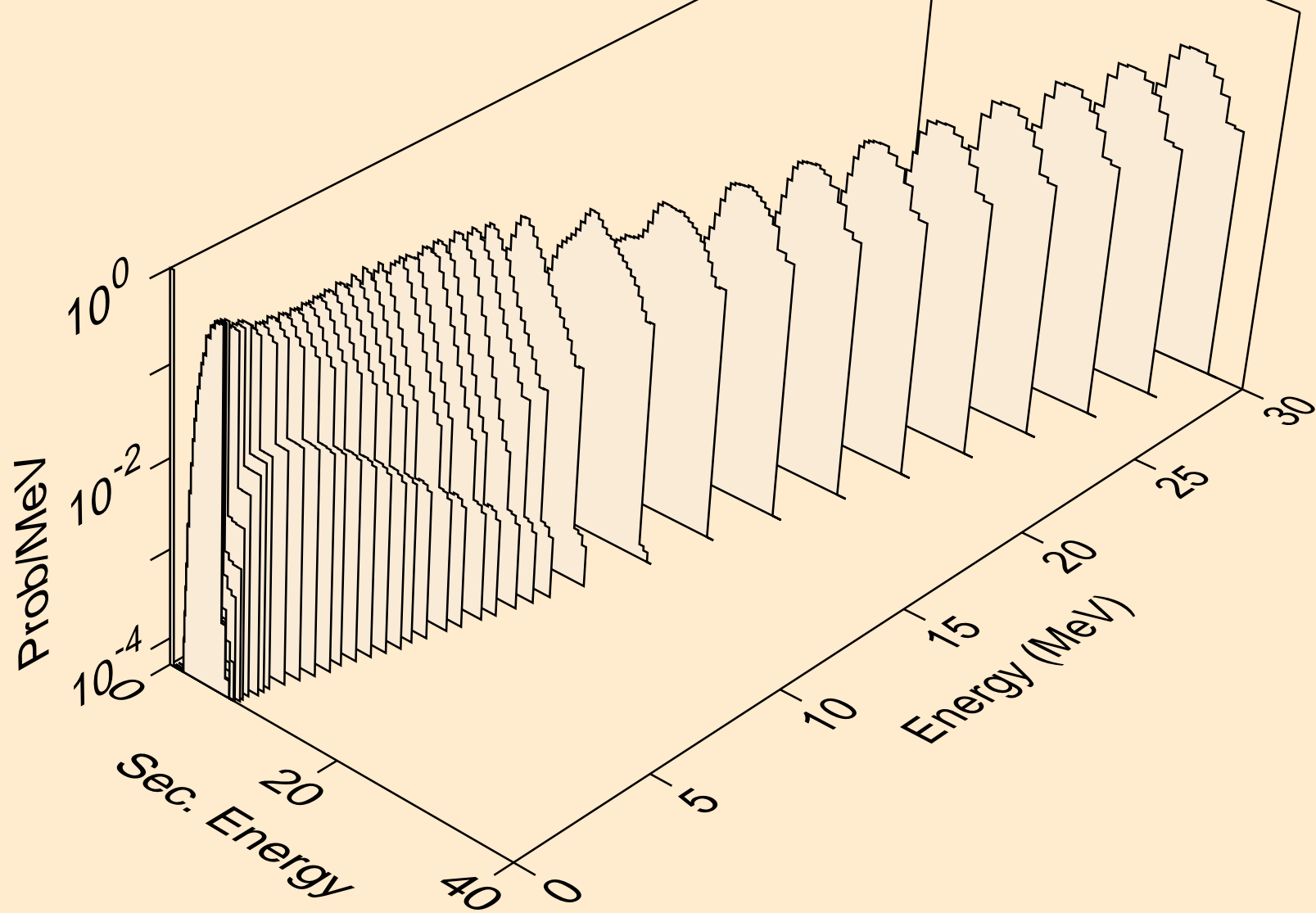

RU093M NEUTRON ACER TENDL-2024 LIBRARY; T=0.K
protons from (n,2p)

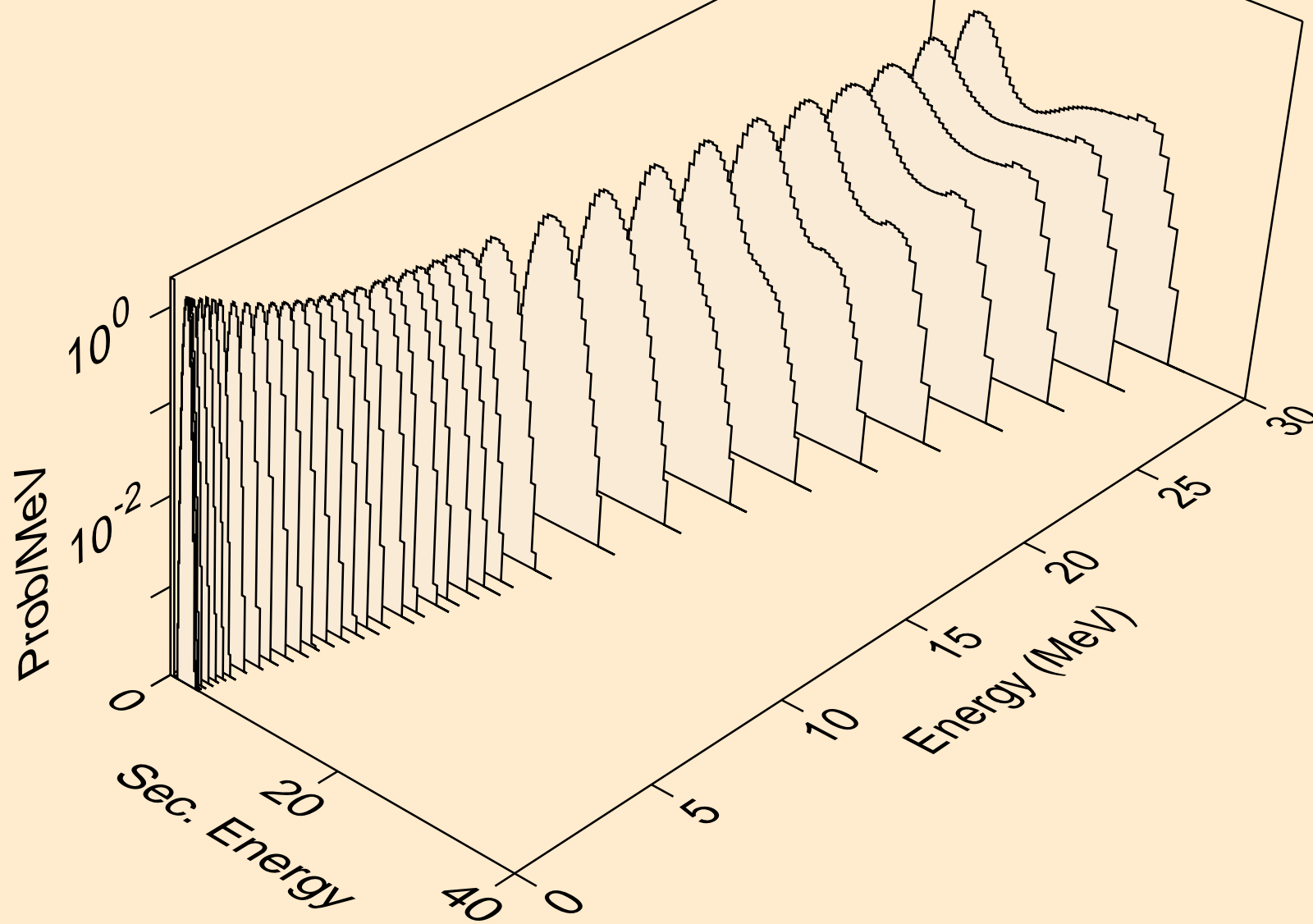

RU093M NEUTRON ACER TENDL-2024 LIBRARY; T=0.K
protons from (n,p)

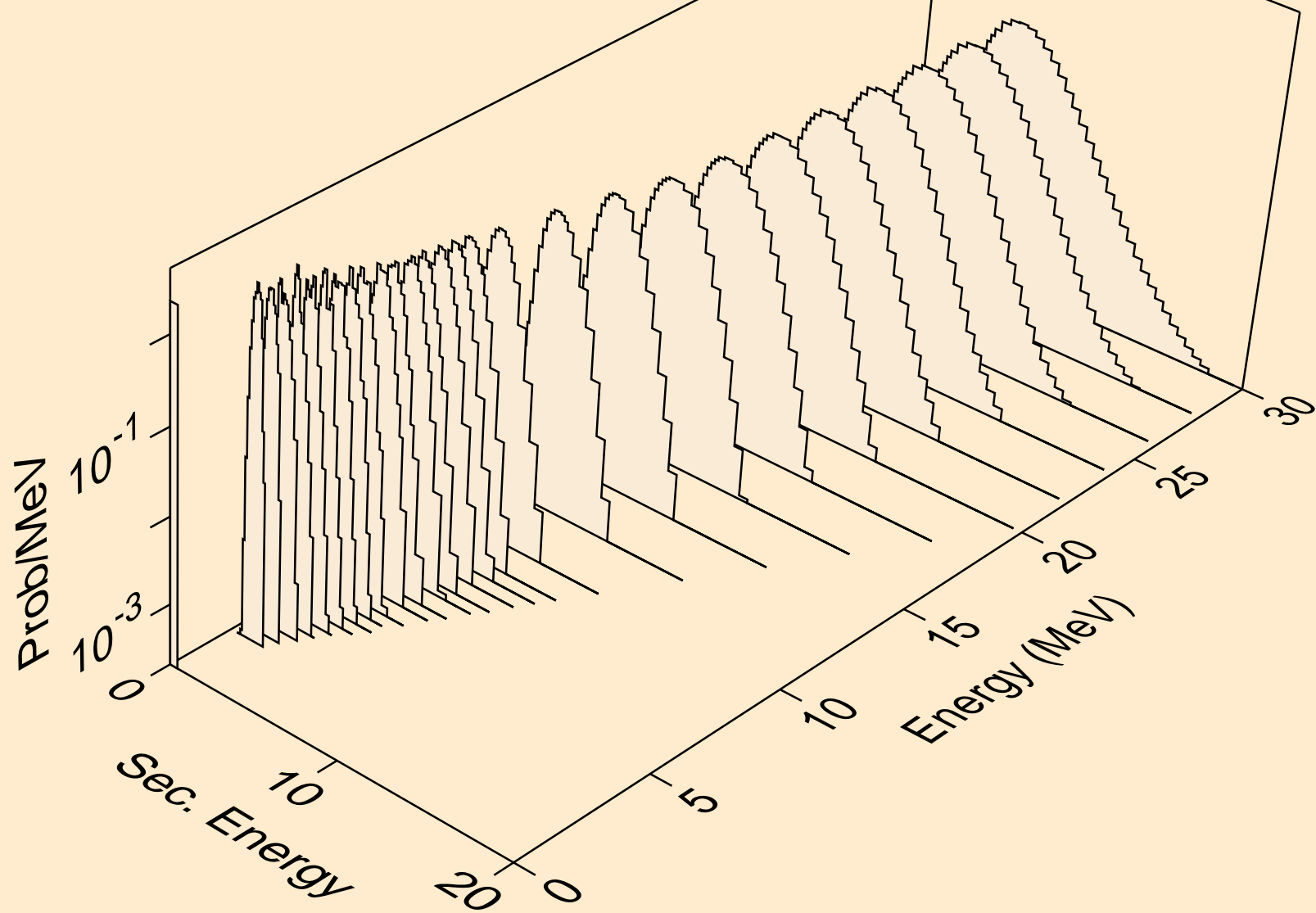

RU093M NEUTRON ACER TENDL-2024 LIBRARY; T=0.K
protons from (n,pd)

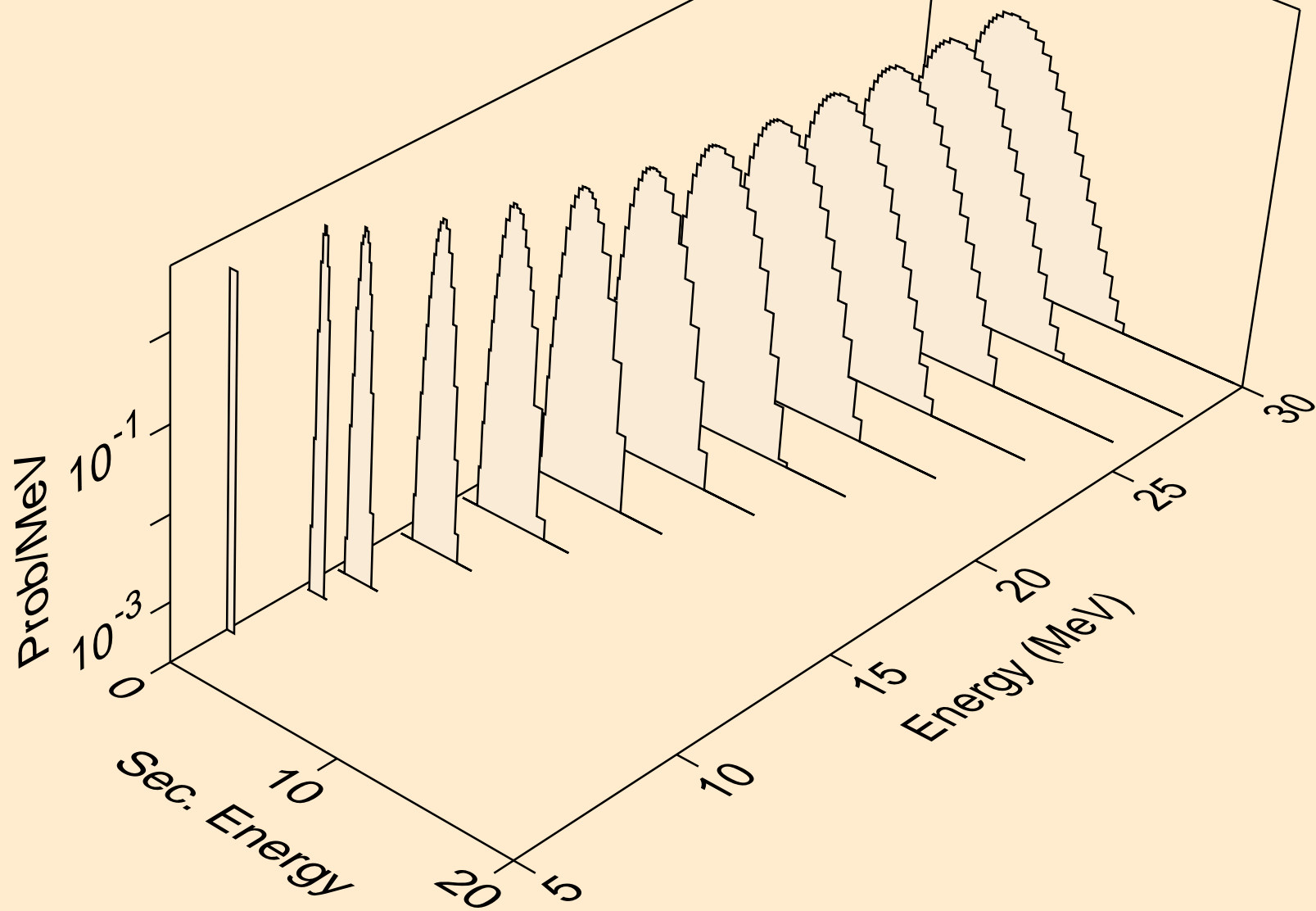

RU093M NEUTRON ACER TENDL-2024 LIBRARY; T=0.K
protons from (n,pt)

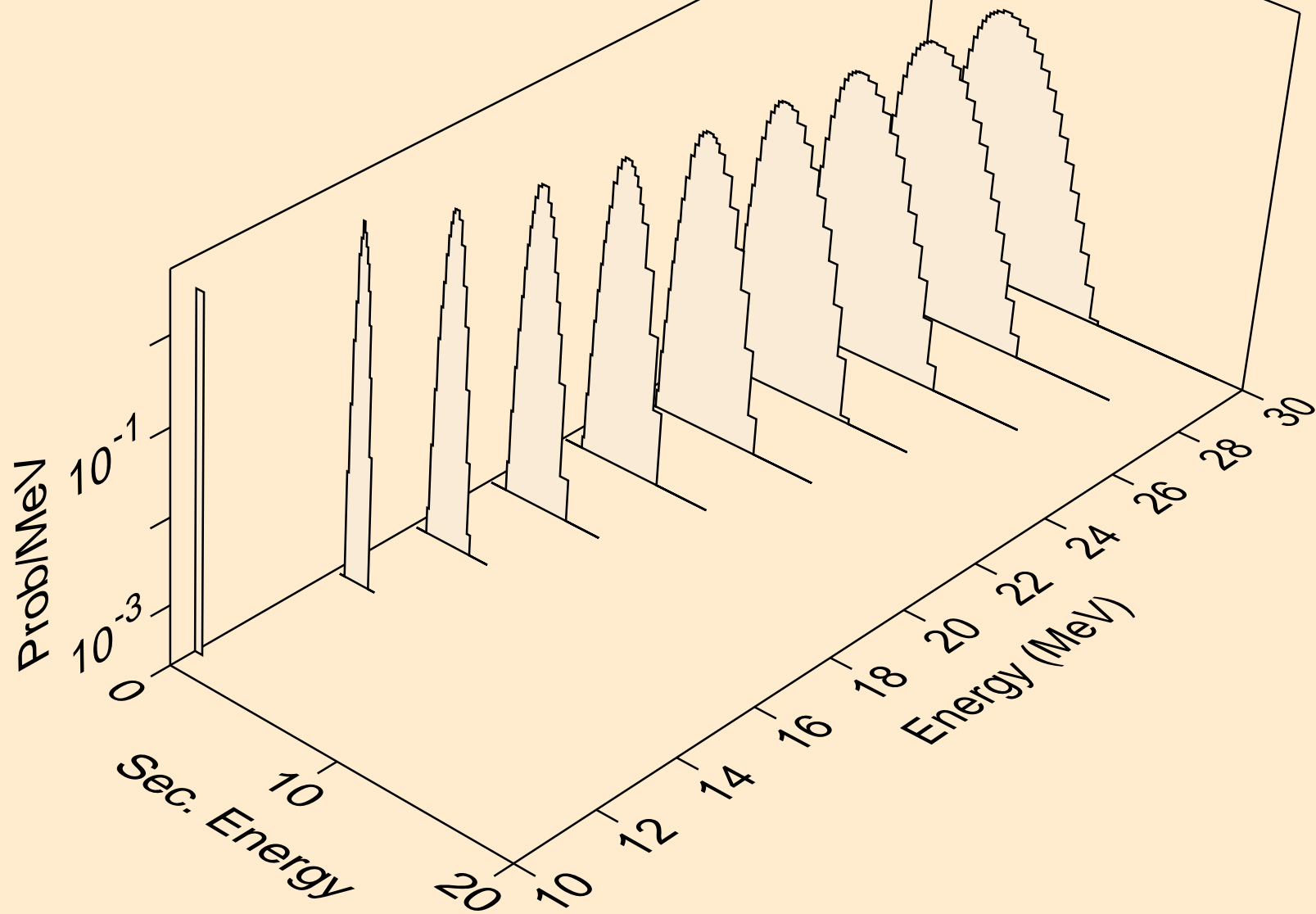

RU093M NEUTRON ACER TENDL-2024 LIBRARY; T=0.K
deuterons from (n,x)

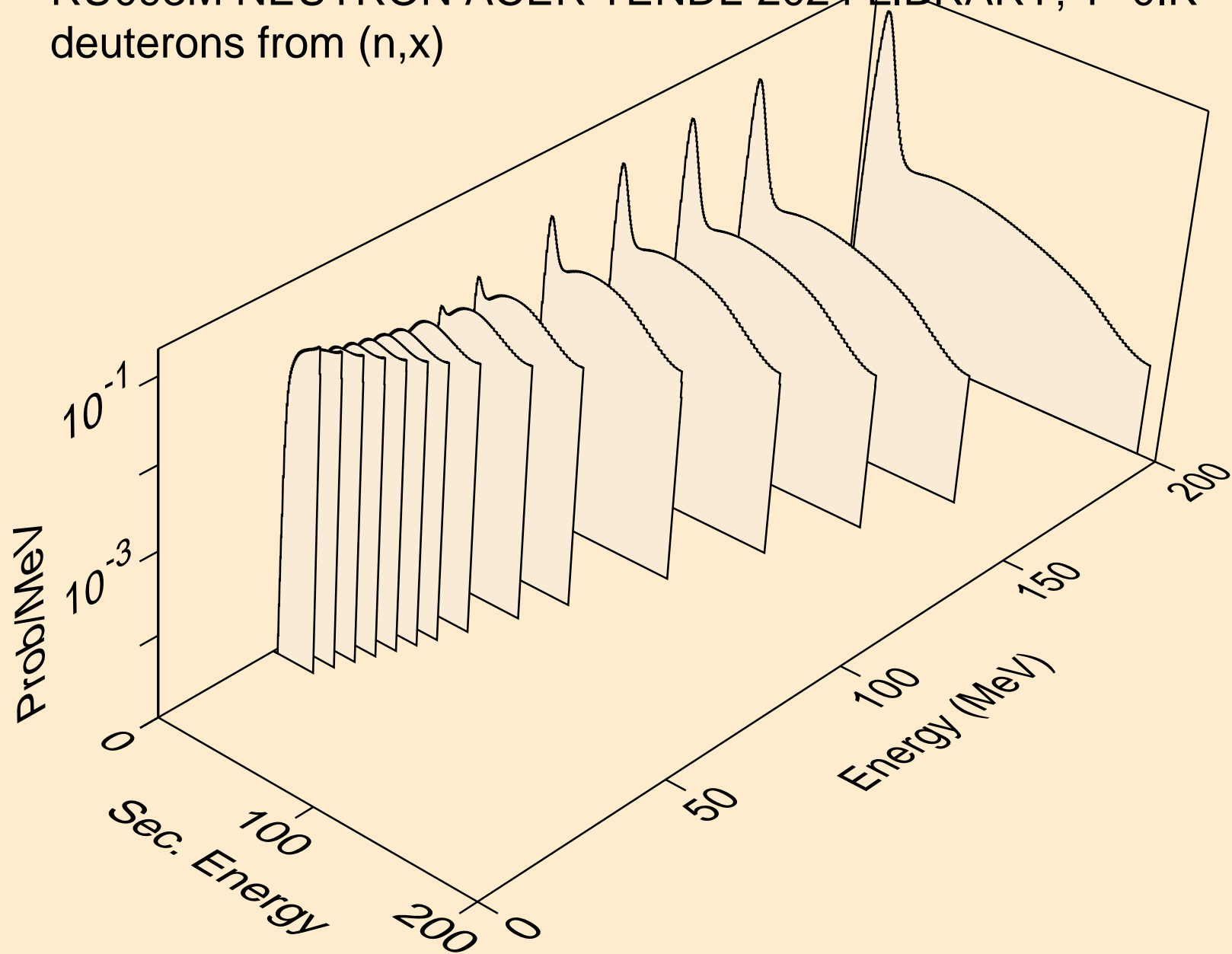

RU093M NEUTRON ACER TENDL-2024 LIBRARY; T=0.K
deuterons from (n,n*)d

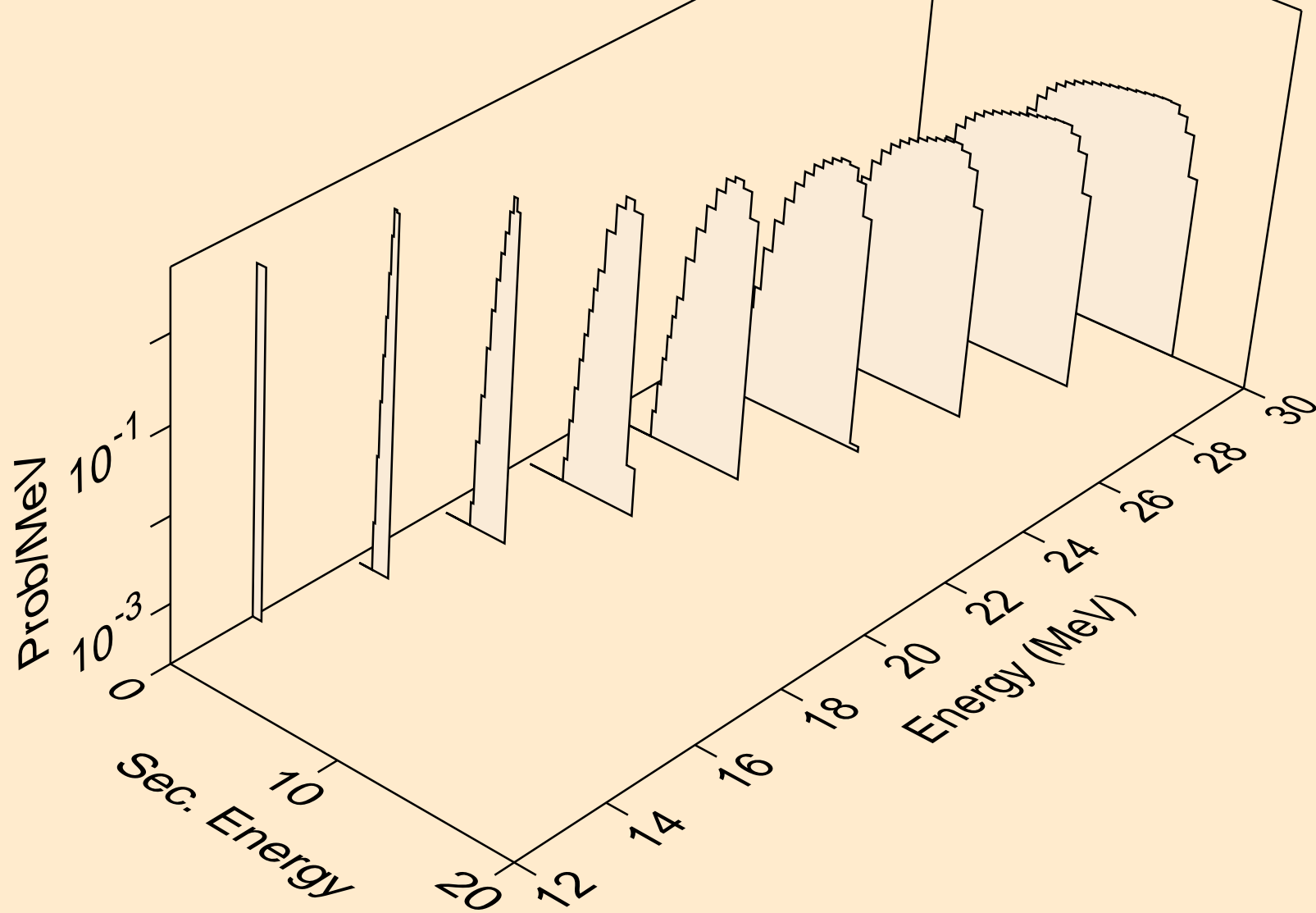

RU093M NEUTRON ACER TENDL-2024 LIBRARY; T=0.K
deuterons from (n,d)

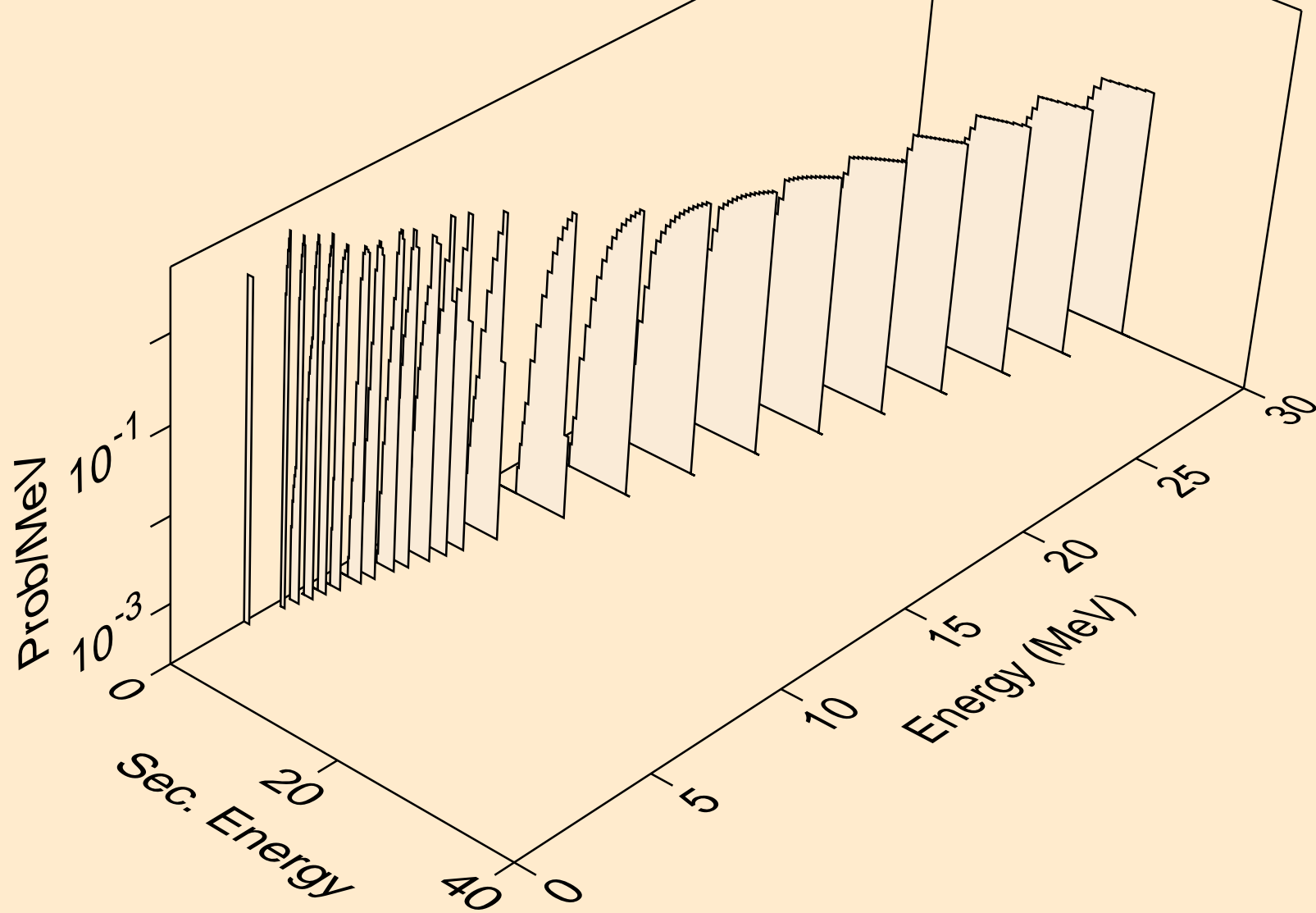

RU093M NEUTRON ACER TENDL-2024 LIBRARY; T=0.K
deuterons from (n,pd)

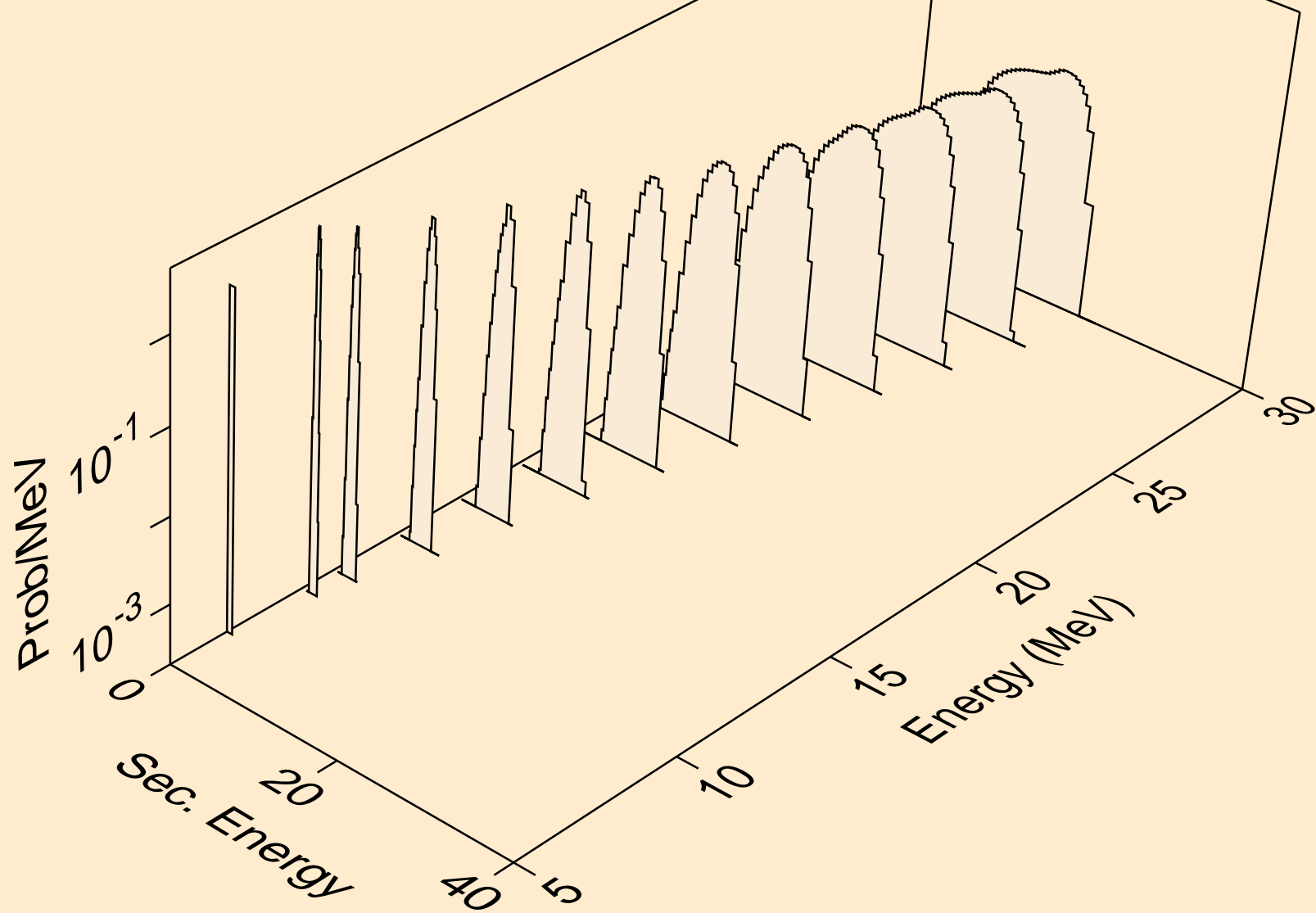

RU093M NEUTRON ACER TENDL-2024 LIBRARY; T=0.K
deuterons from (n,da)

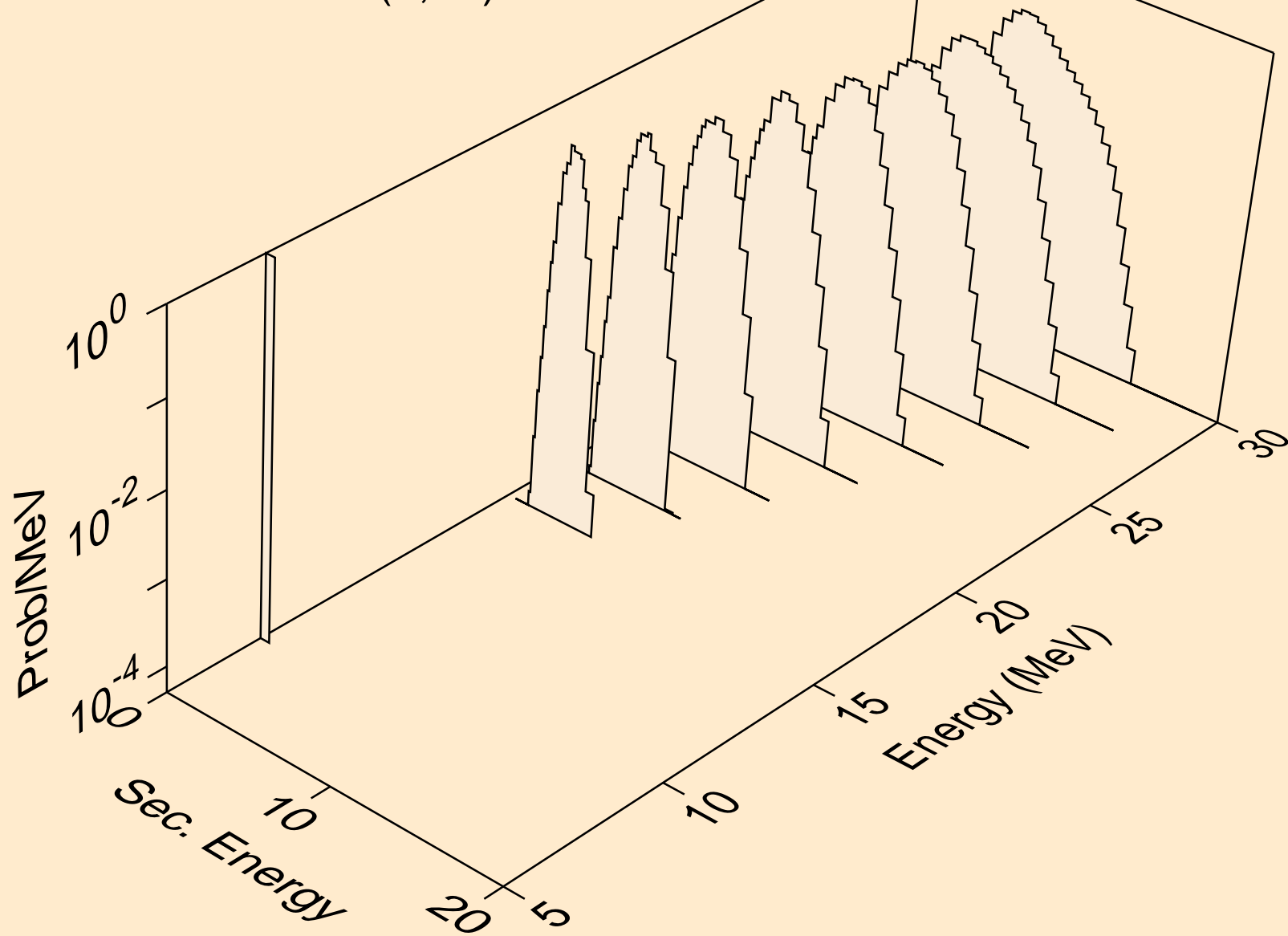

RU093M NEUTRON ACER TENDL-2024 LIBRARY; T=0.K
tritons from (n,x)

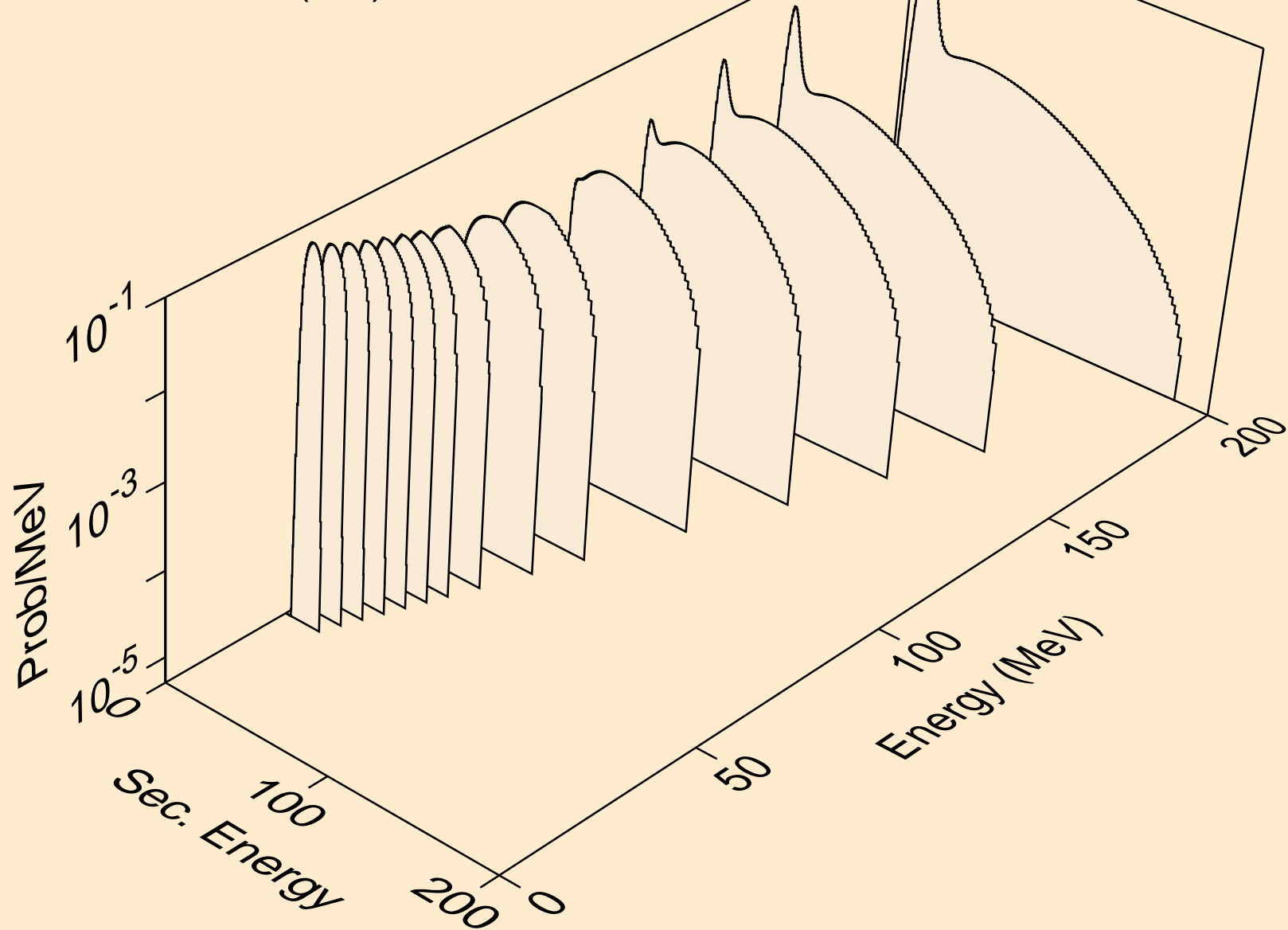

RU093M NEUTRON ACER TENDL-2024 LIBRARY; T=0.K
tritons from (n,n*)t

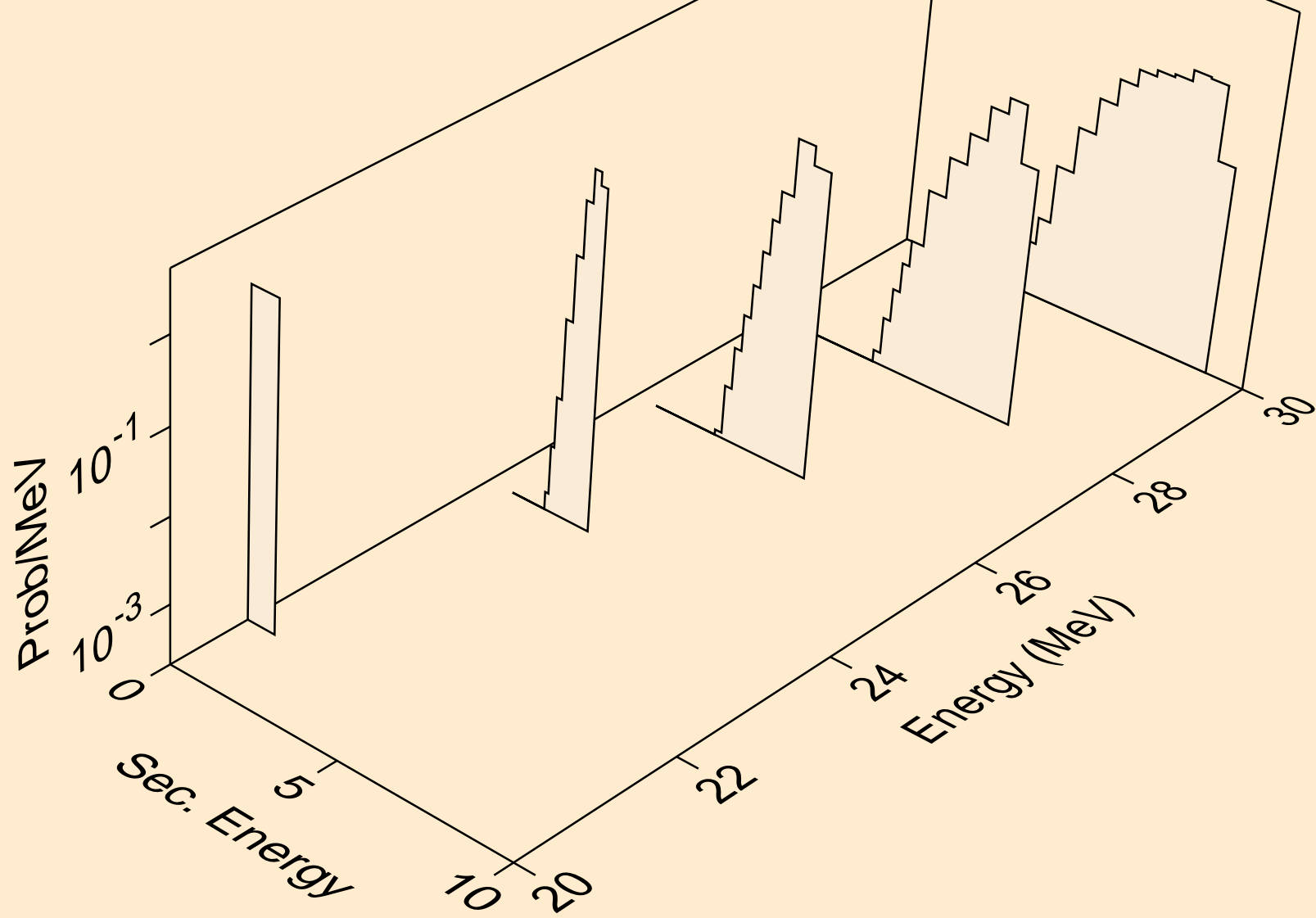

RU093M NEUTRON ACER TENDL-2024 LIBRARY; T=0.K
tritons from (n,t)

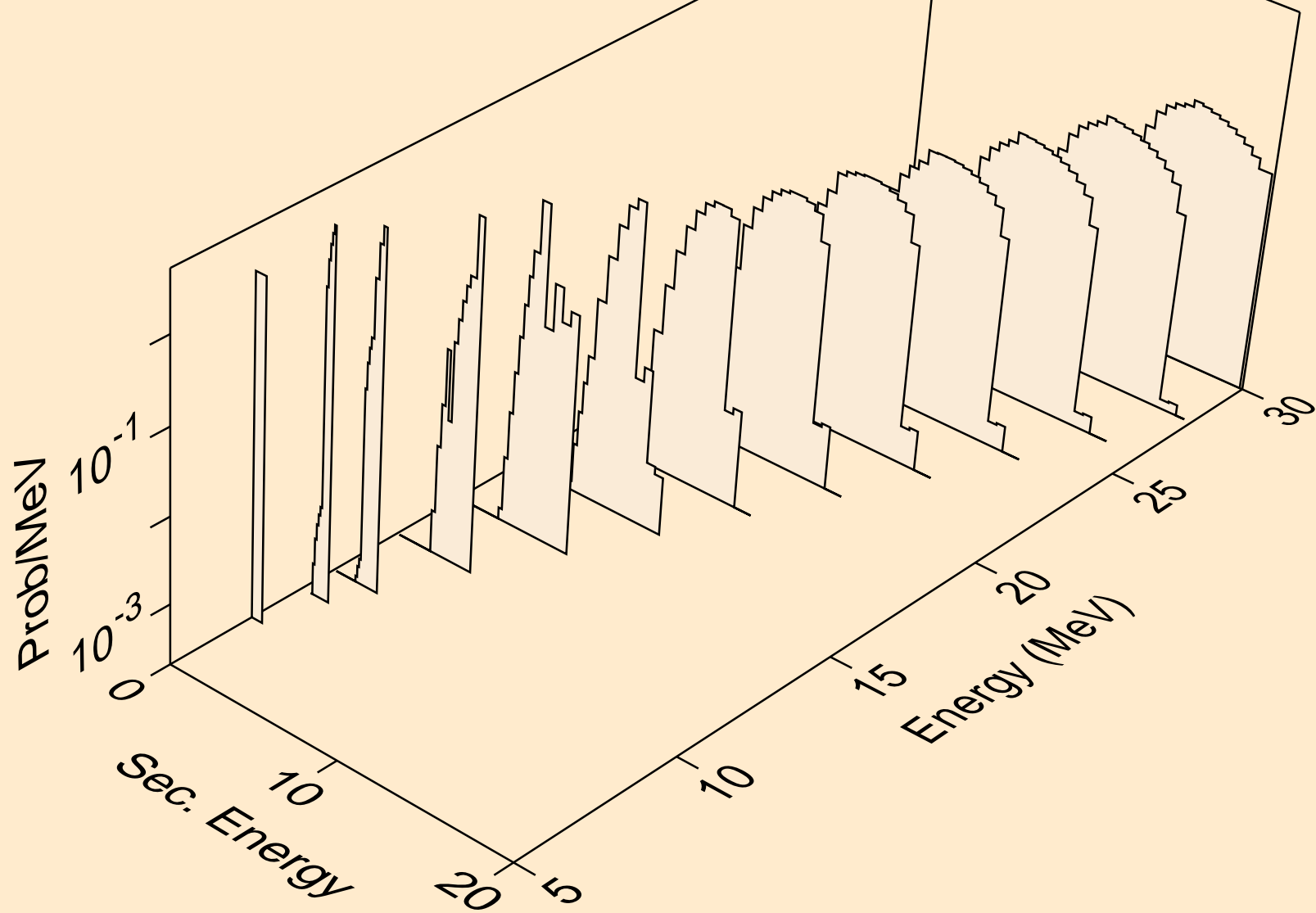

RU093M NEUTRON ACER TENDL-2024 LIBRARY; T=0.K
tritons from (n,pt)

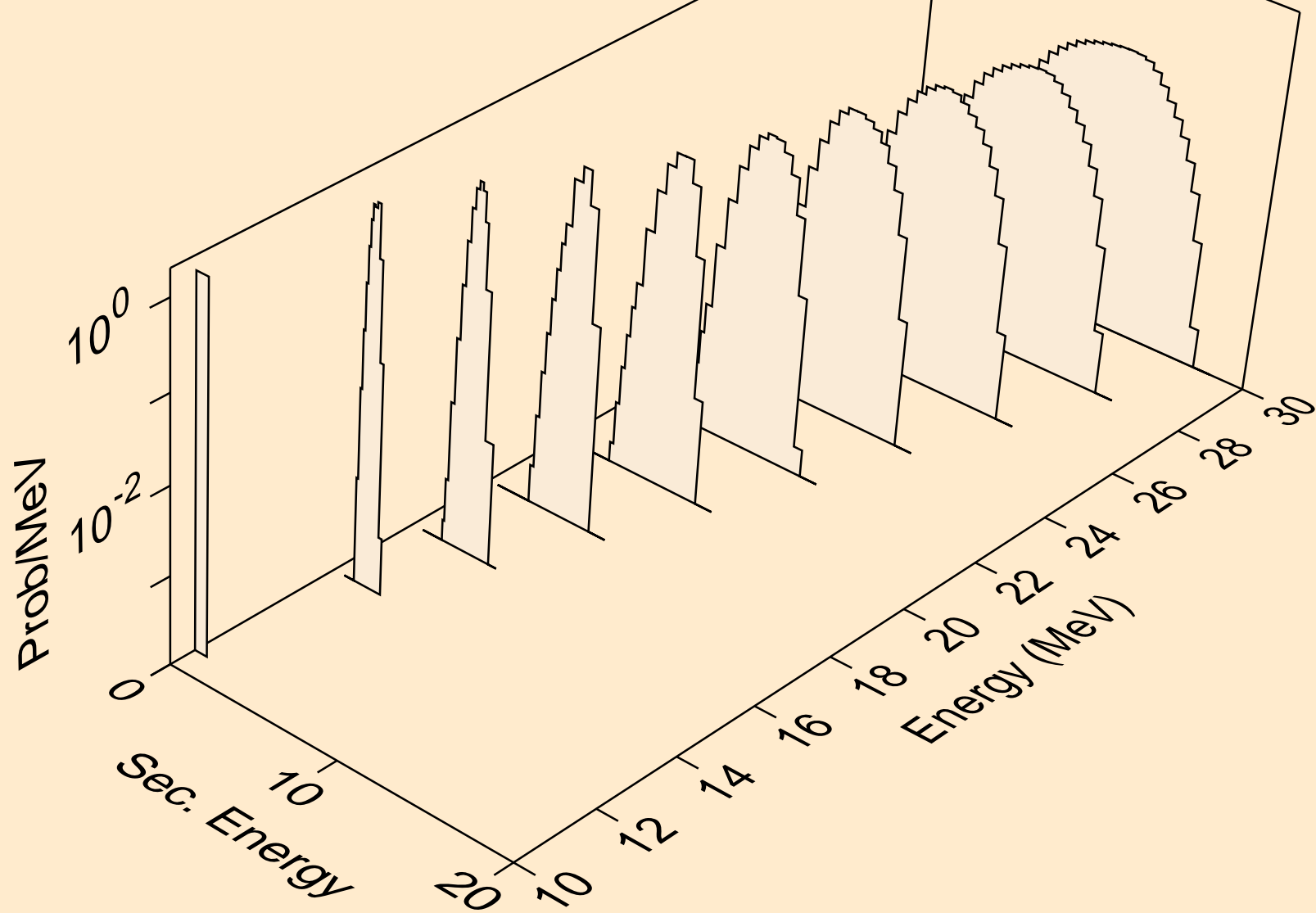

RU093M NEUTRON ACER TENDL-2024 LIBRARY; T=0.K
he3s from (n,x)

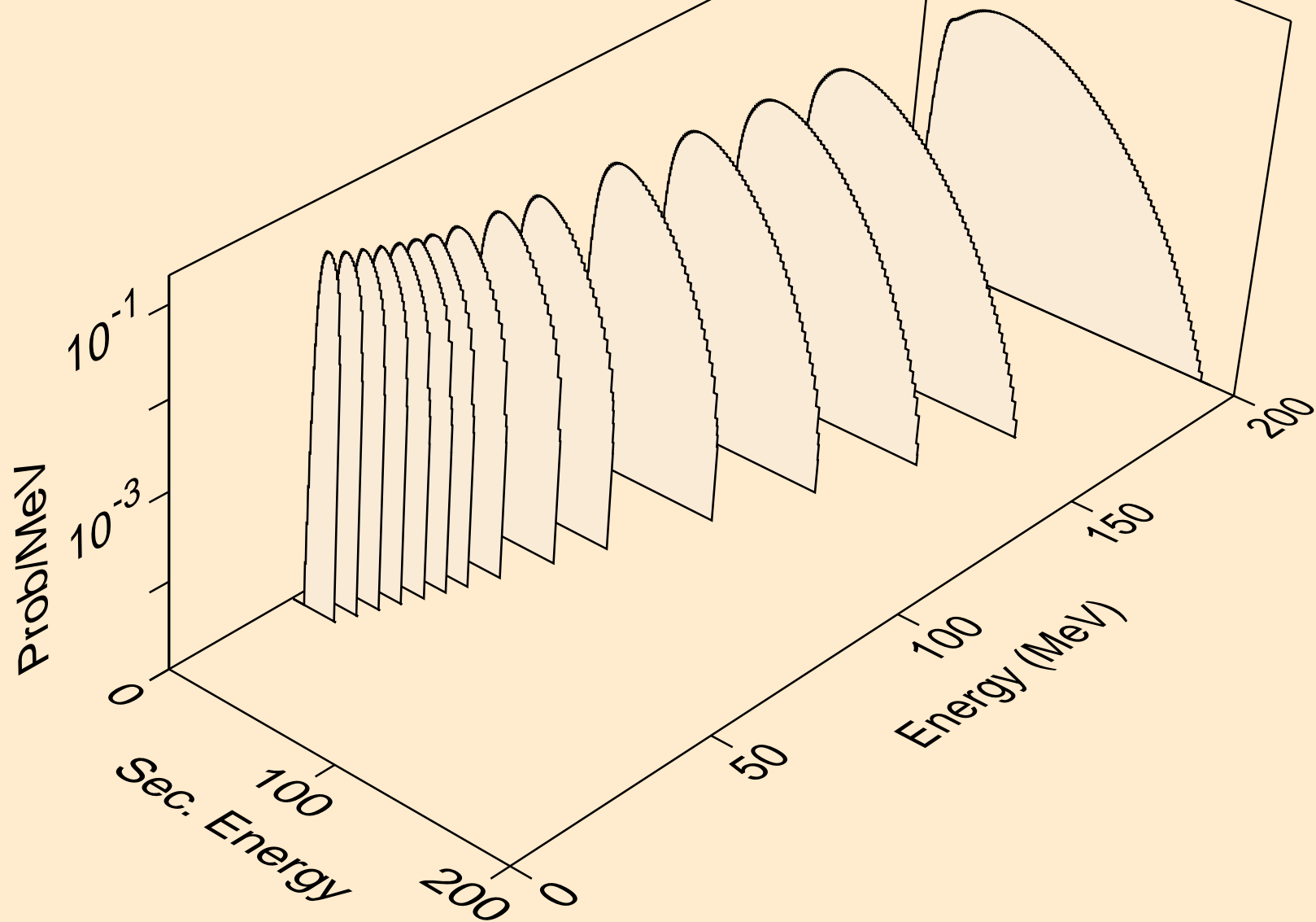

RU093M NEUTRON ACER TENDL-2024 LIBRARY; T=0.K
he3s from (n,n*)he3

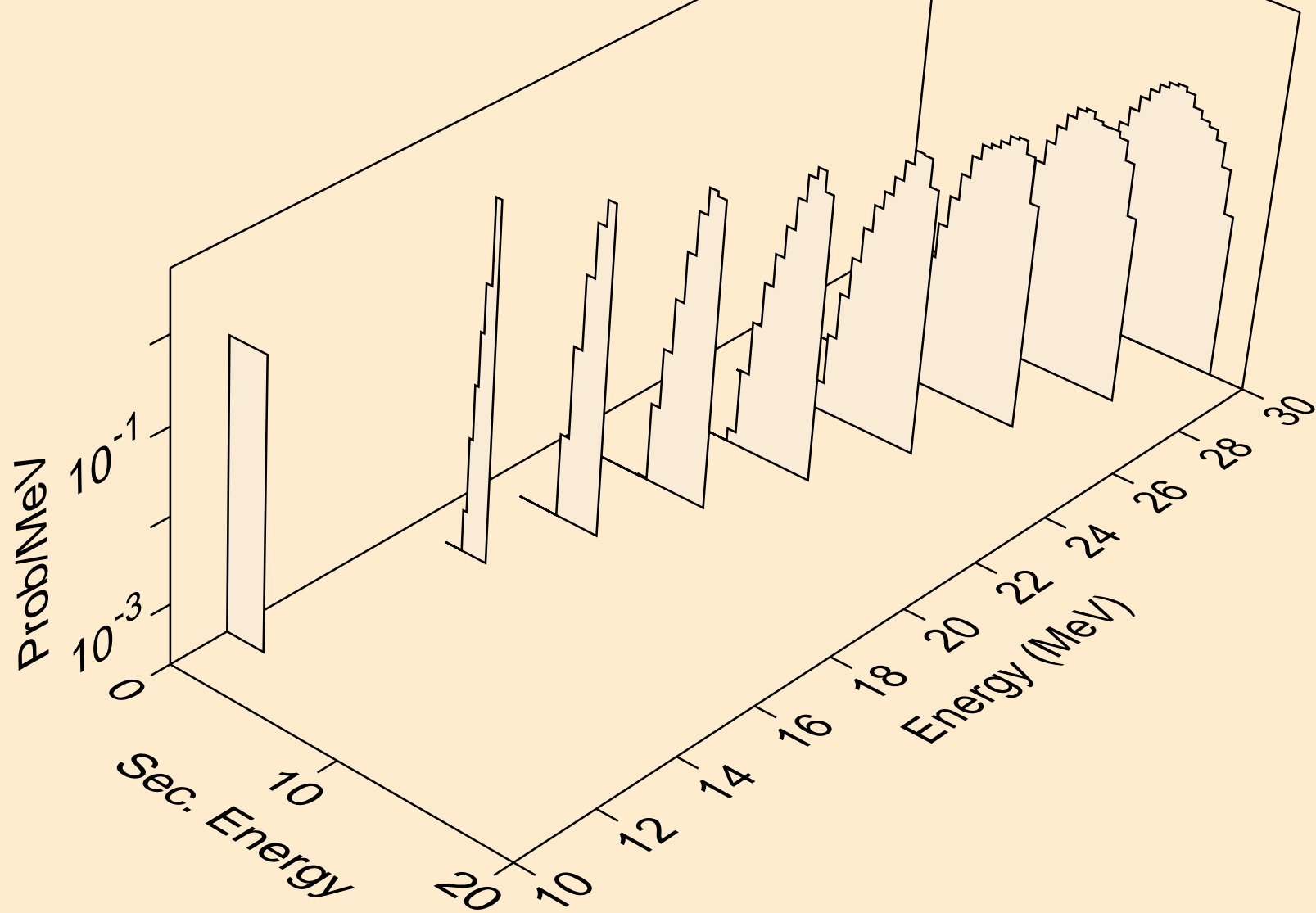

RU093M NEUTRON ACER TENDL-2024 LIBRARY; T=0.K
he3s from (n,he3)

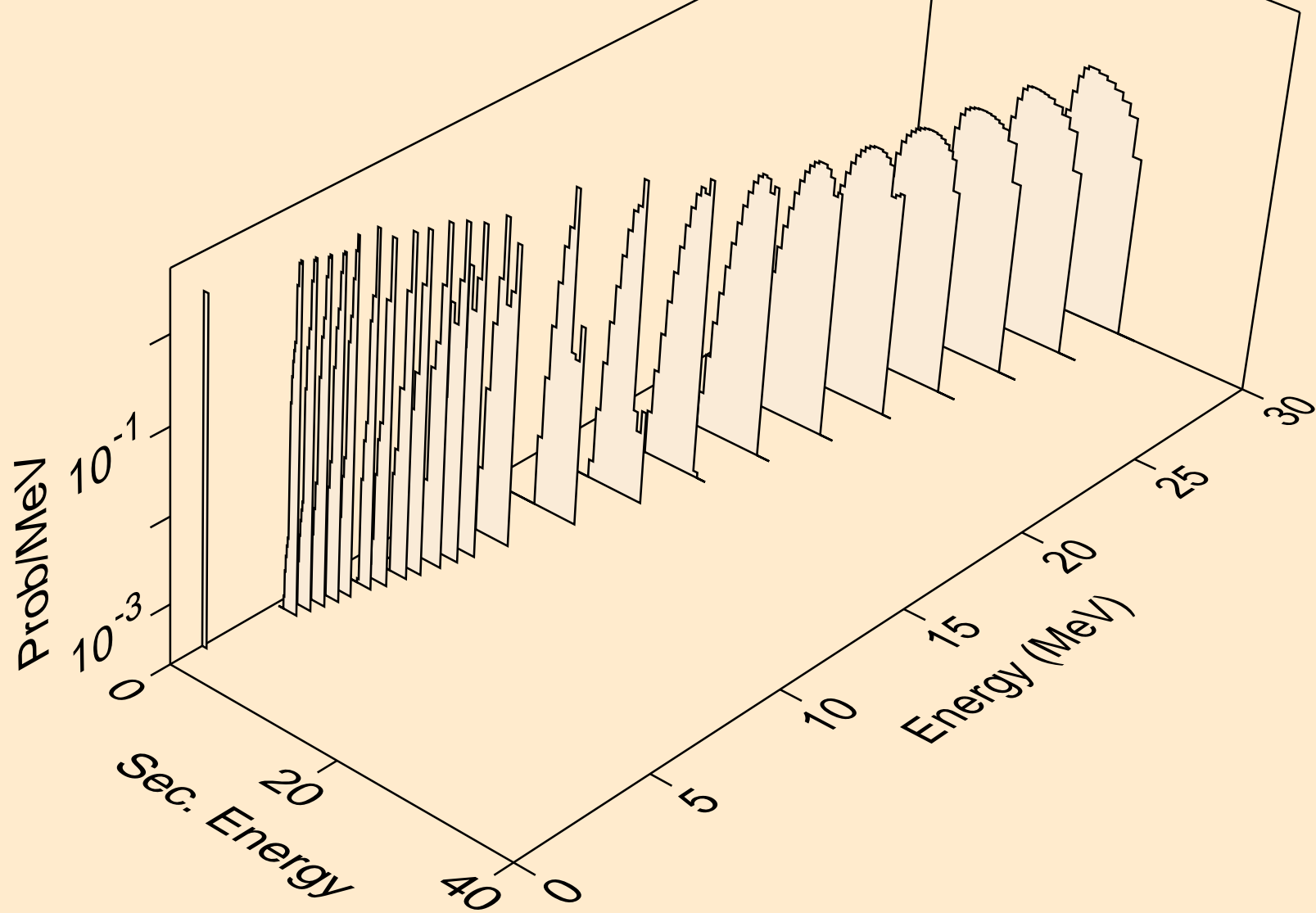

RU093M NEUTRON ACER TENDL-2024 LIBRARY; T=0.K
alphas from (n,x)

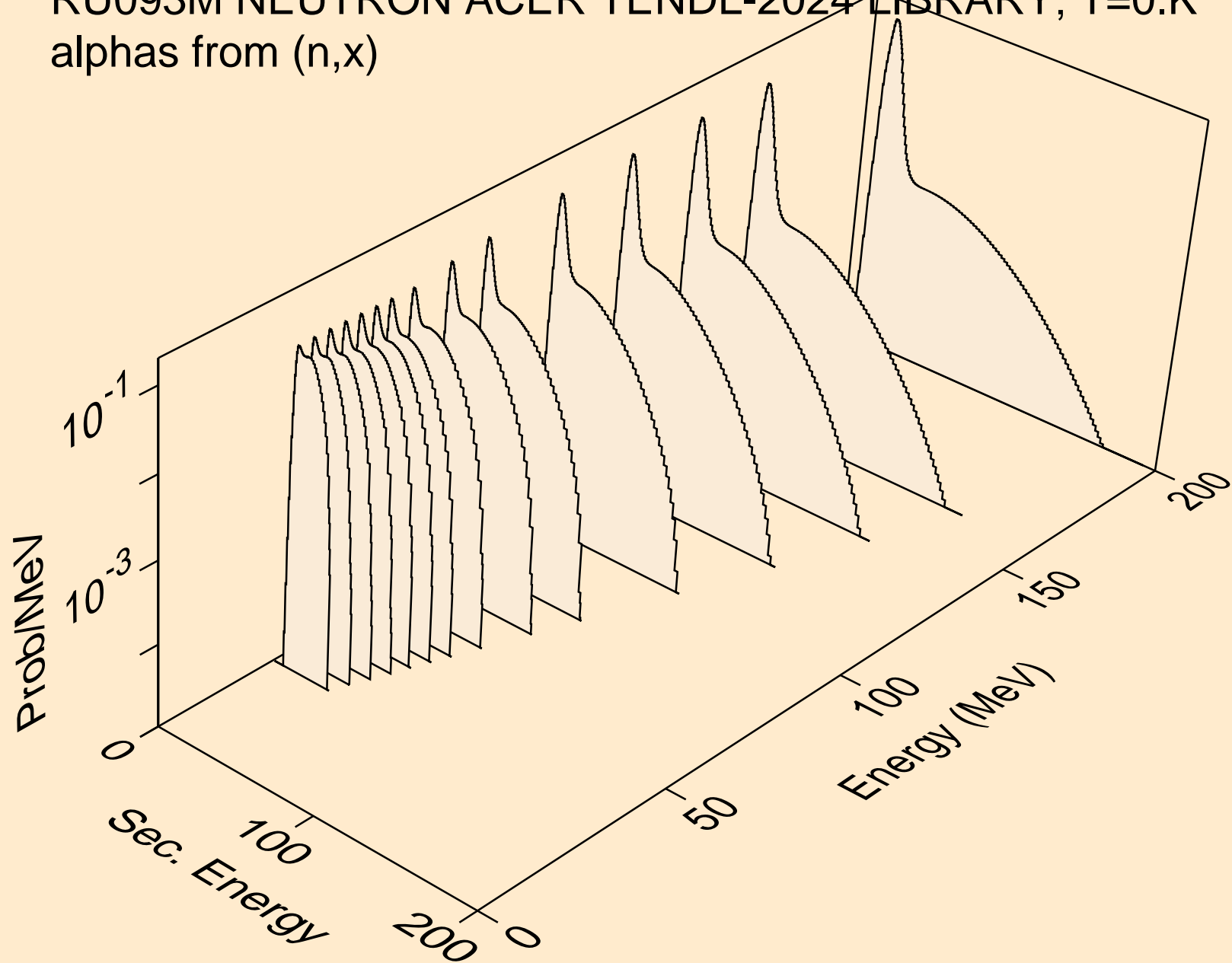

RU093M NEUTRON ACER TENDL-2024 LIBRARY; T=0.K
alphas from (n,n*)a

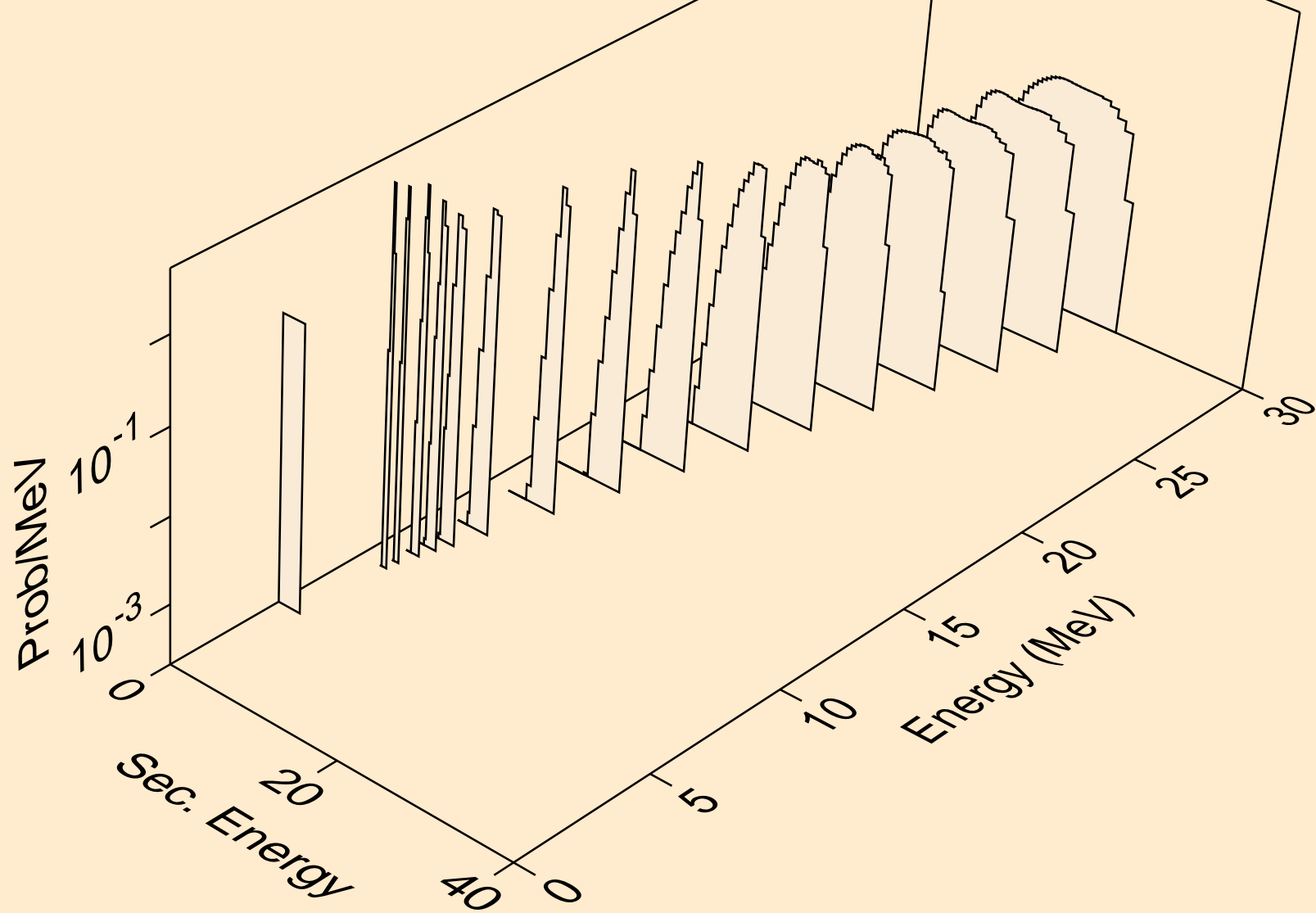

RU093M NEUTRON ACER TENDL-2024 LIBRARY; T=0.K
alphas from (n,2n)a

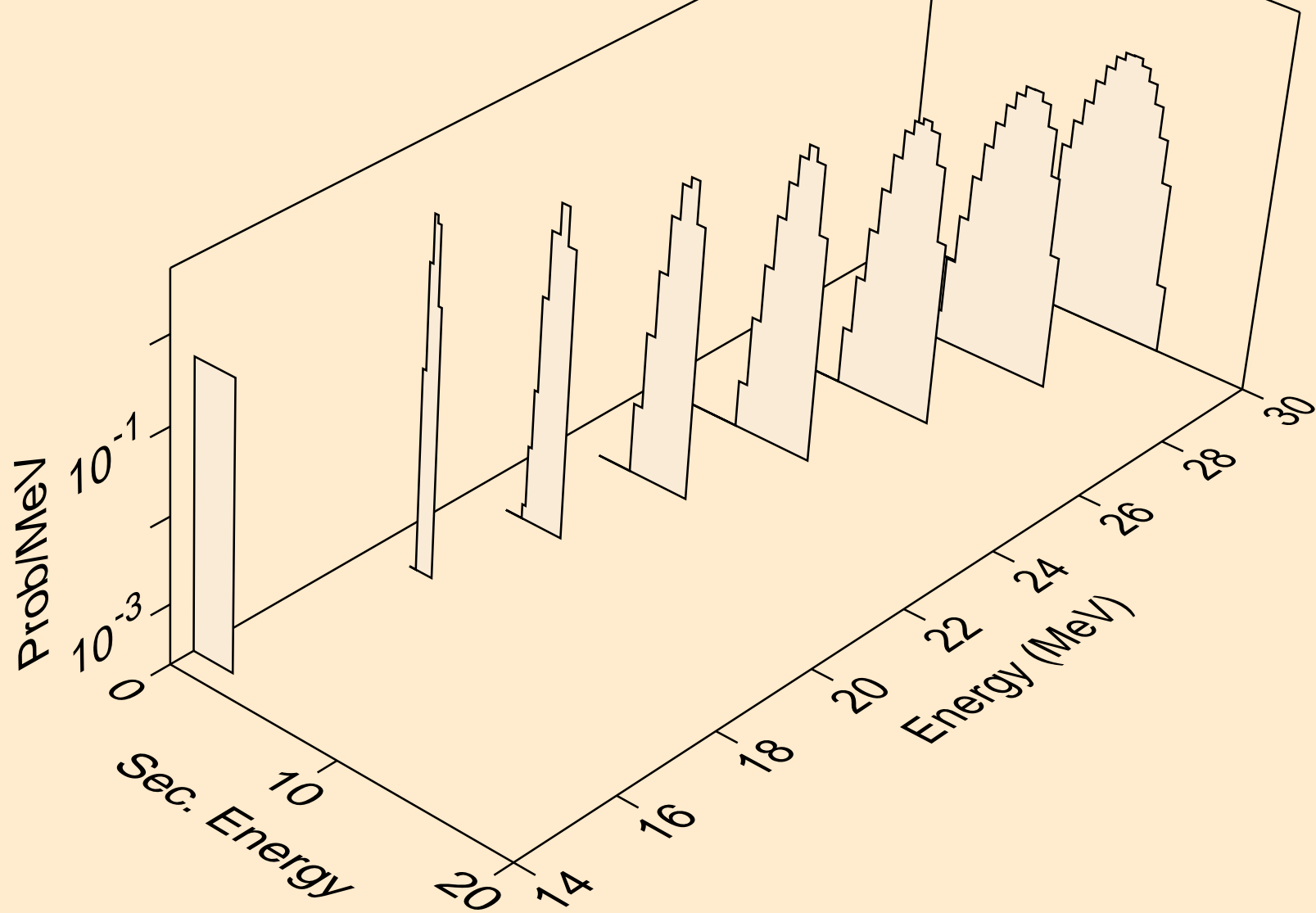

RU093M NEUTRON ACER TENDL-2024 LIBRARY; T=0.K
alphas from (n,n*)2a

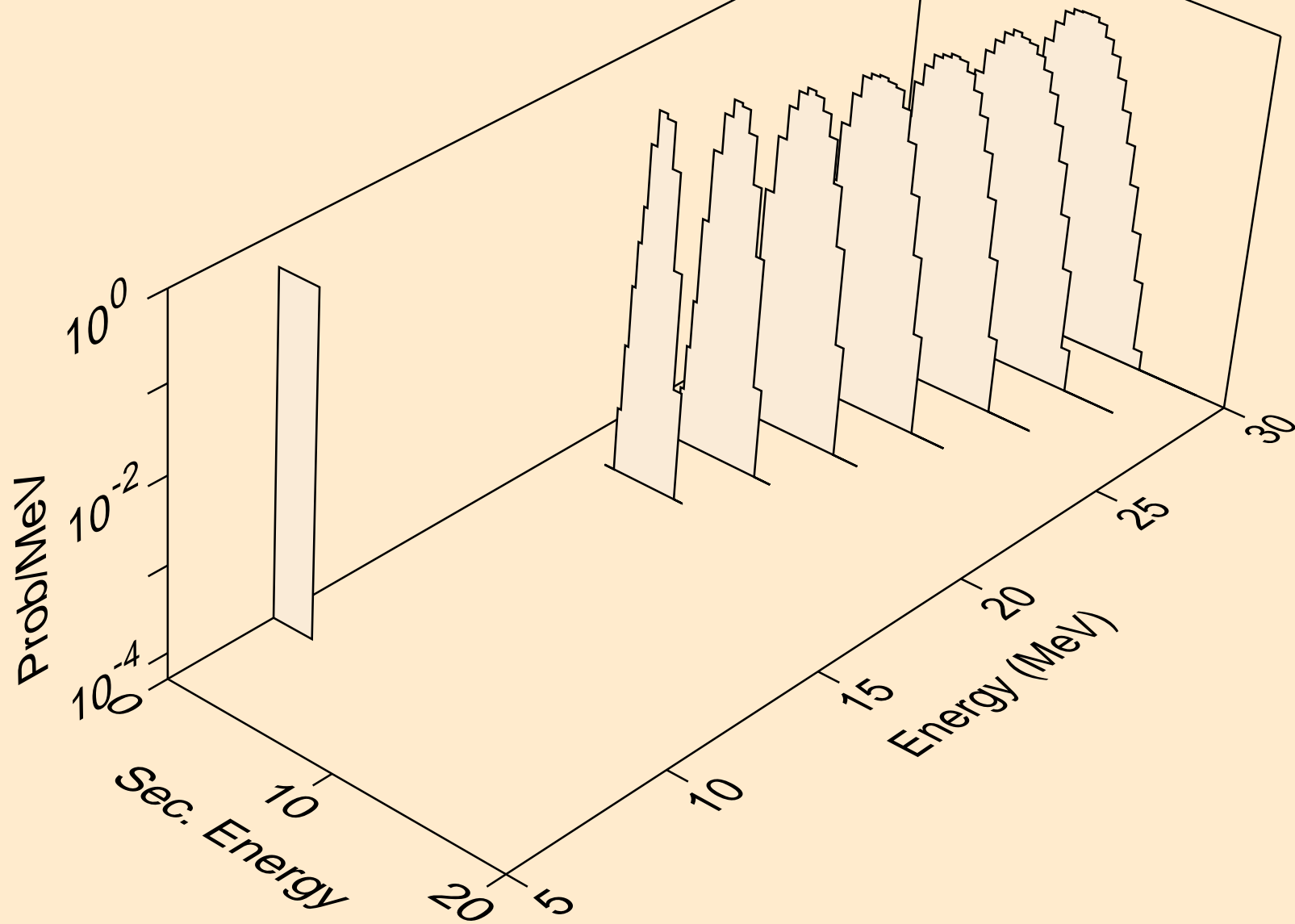

RU093M NEUTRON ACER TENDL-2024 LIBRARY; T=0.K
alphas from (n,npa)

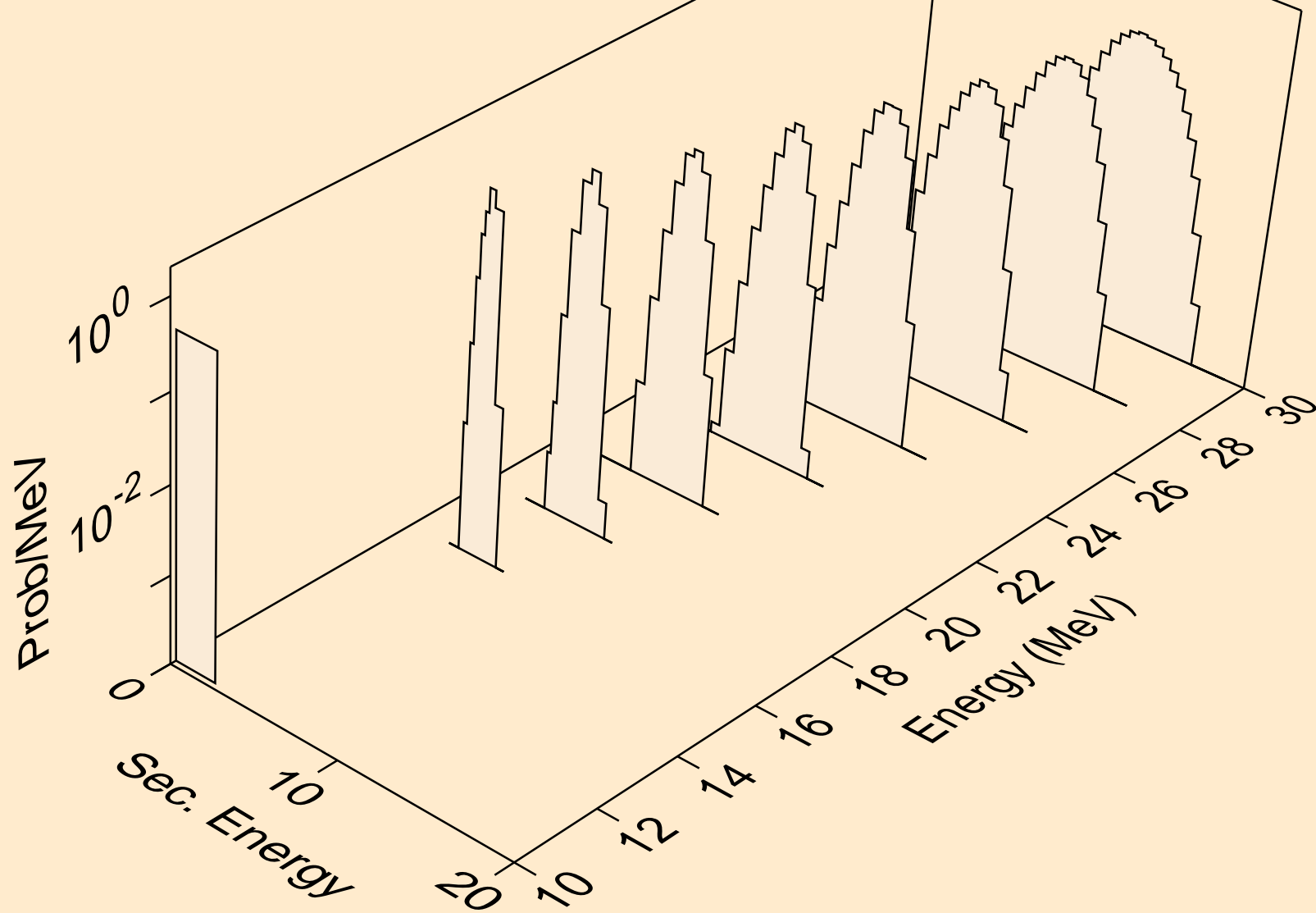

RU093M NEUTRON ACER TENDL-2024 LIBRARY; T=0.K
alphas from (n,a)

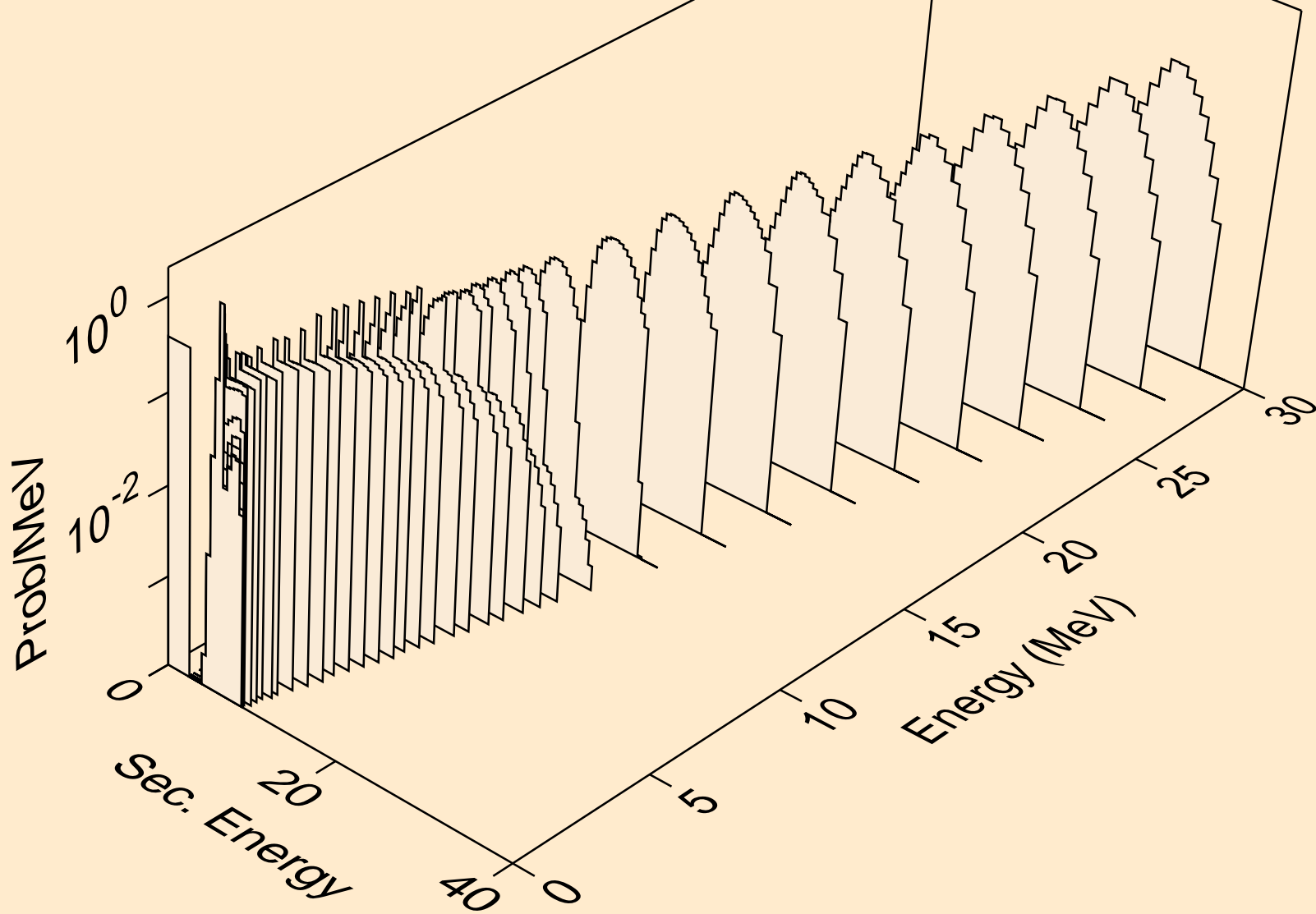

RU093M NEUTRON ACER TENDL-2024 LIBRARY; T=0.K
alphas from (n,2a)

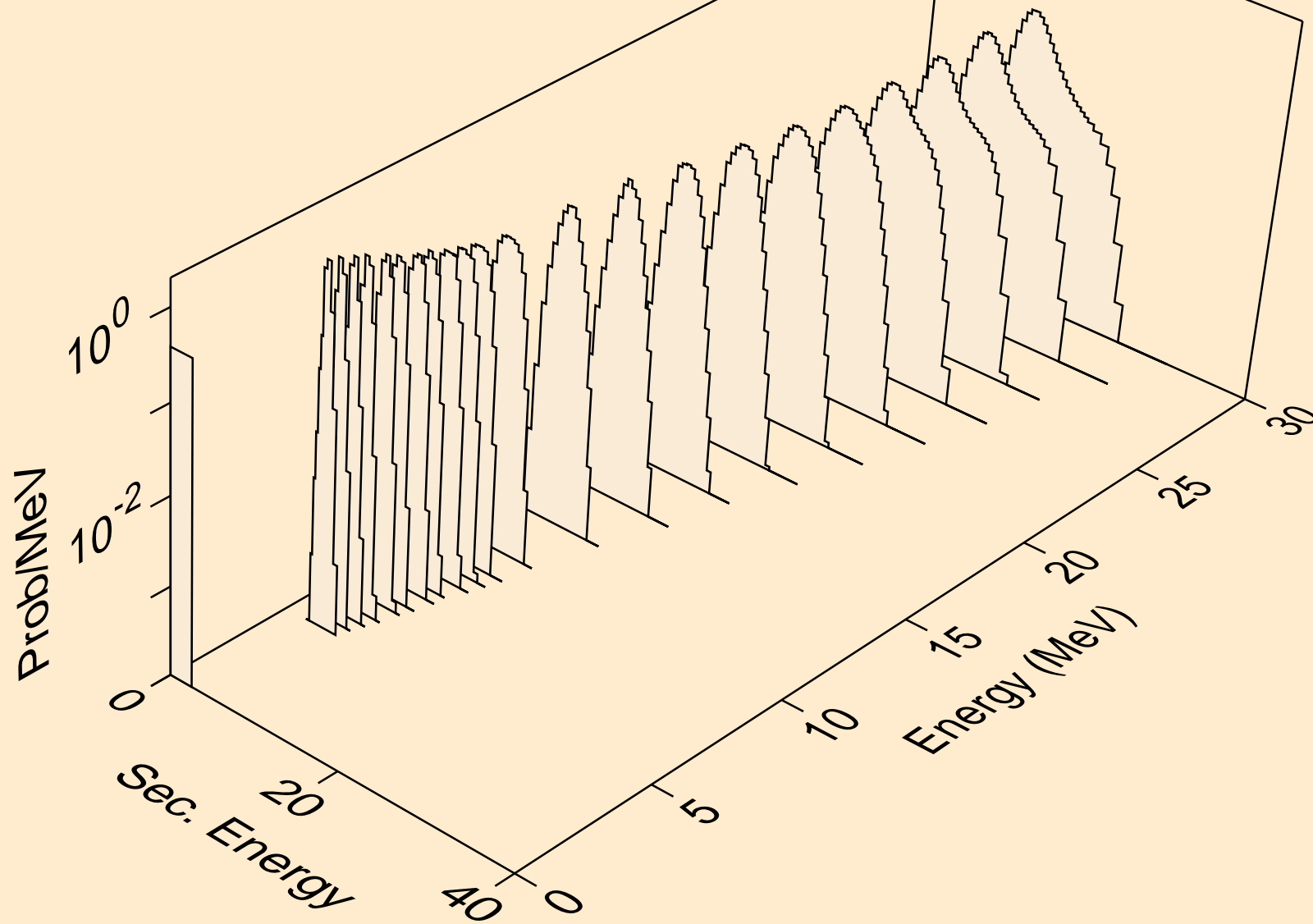

RU093M NEUTRON ACER TENDL-2024 LIBRARY; T=0.K
alphas from (n,pa)

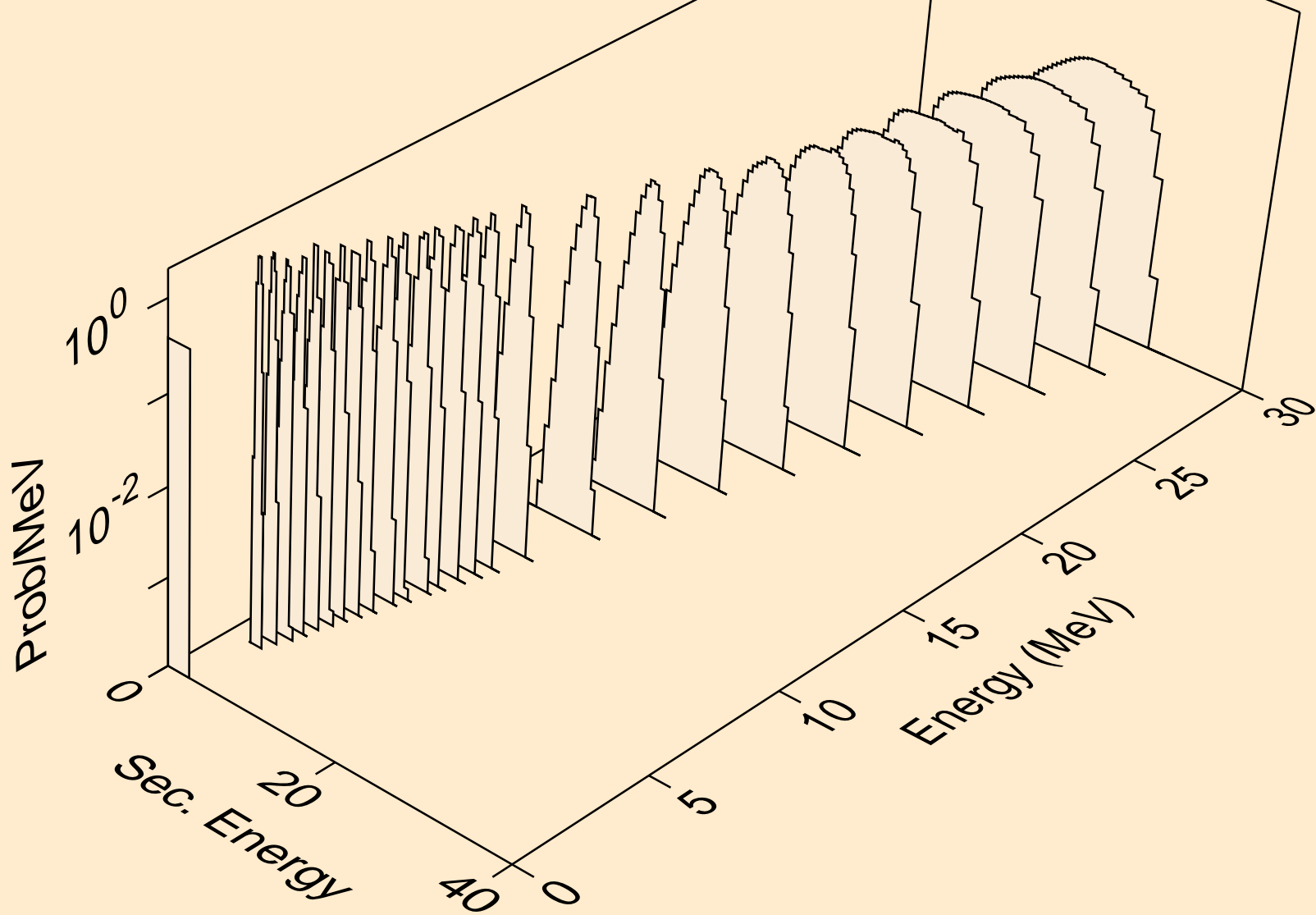

RU093M NEUTRON ACER TENDL-2024 LIBRARY; T=0.K
alphas from (n,da)

