

S031 NEUTRON ACER TENDL-2024 LIBRARY; T=0.K

Principal cross sections

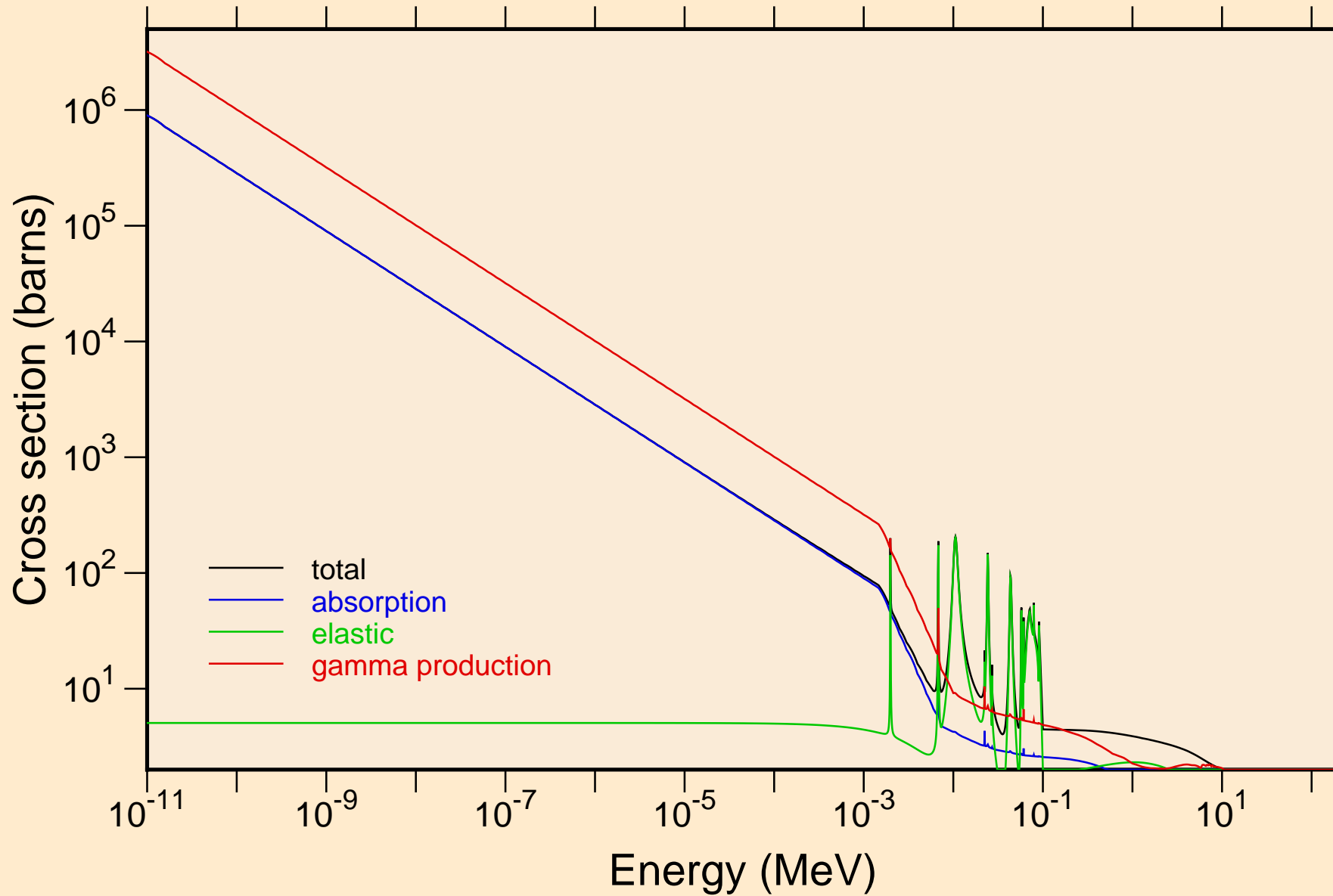

S031 NEUTRON ACER TENDL-2024 LIBRARY; T=0.K
resonance total cross section

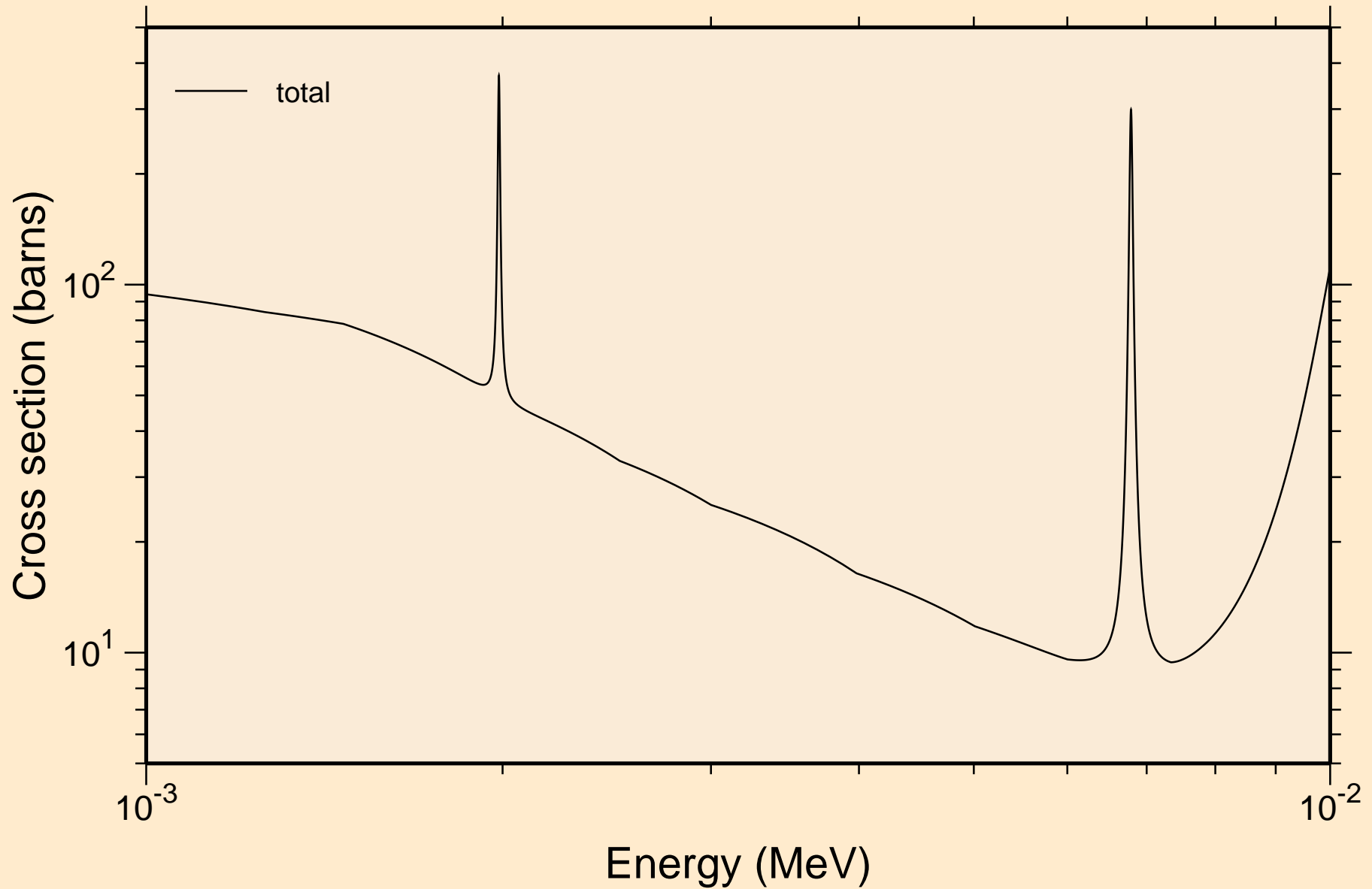

S031 NEUTRON ACER TENDL-2024 LIBRARY; T=0.K
resonance total cross section

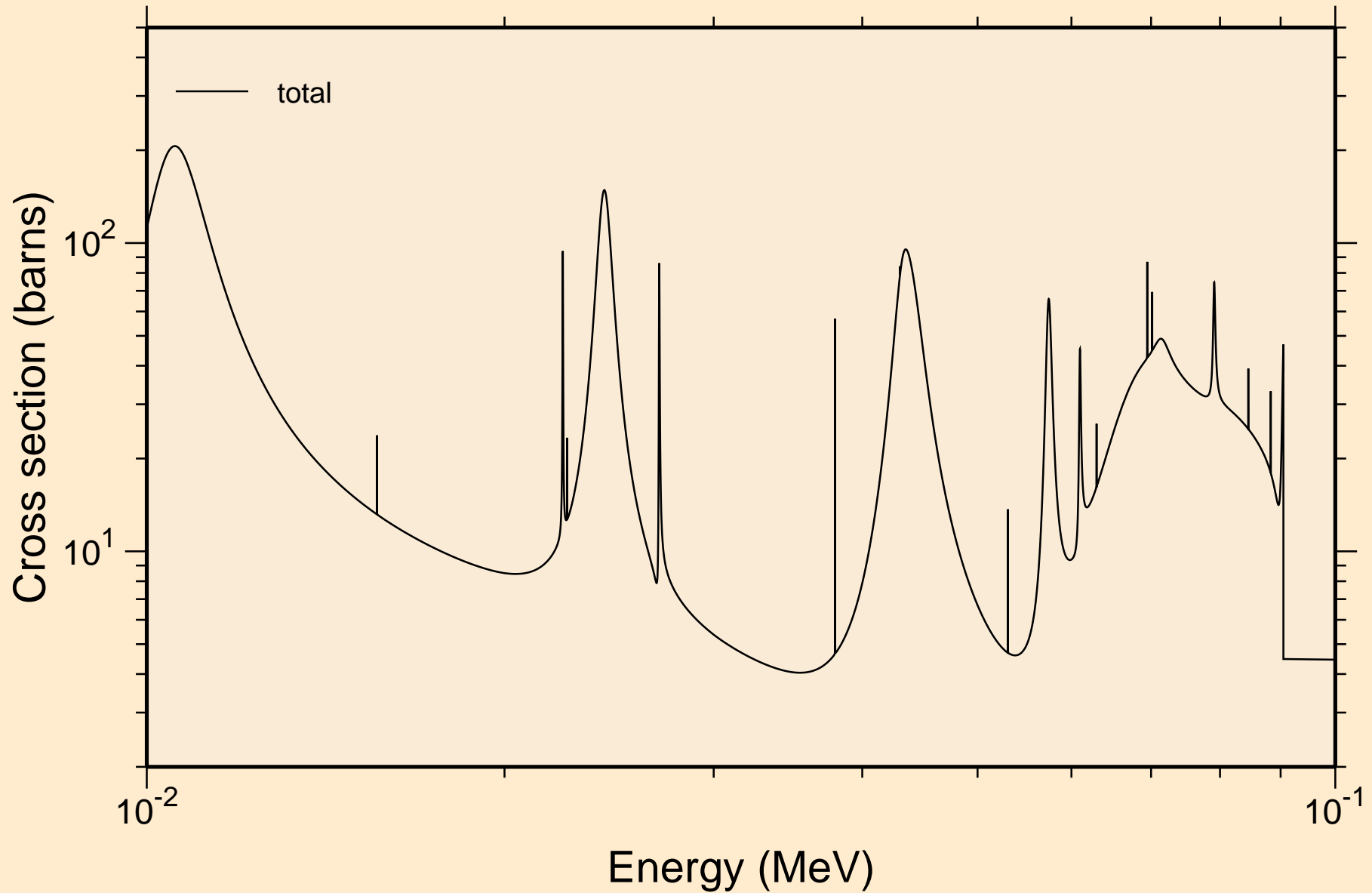

S031 NEUTRON ACER TENDL-2024 LIBRARY; T=0.K
resonance total cross section

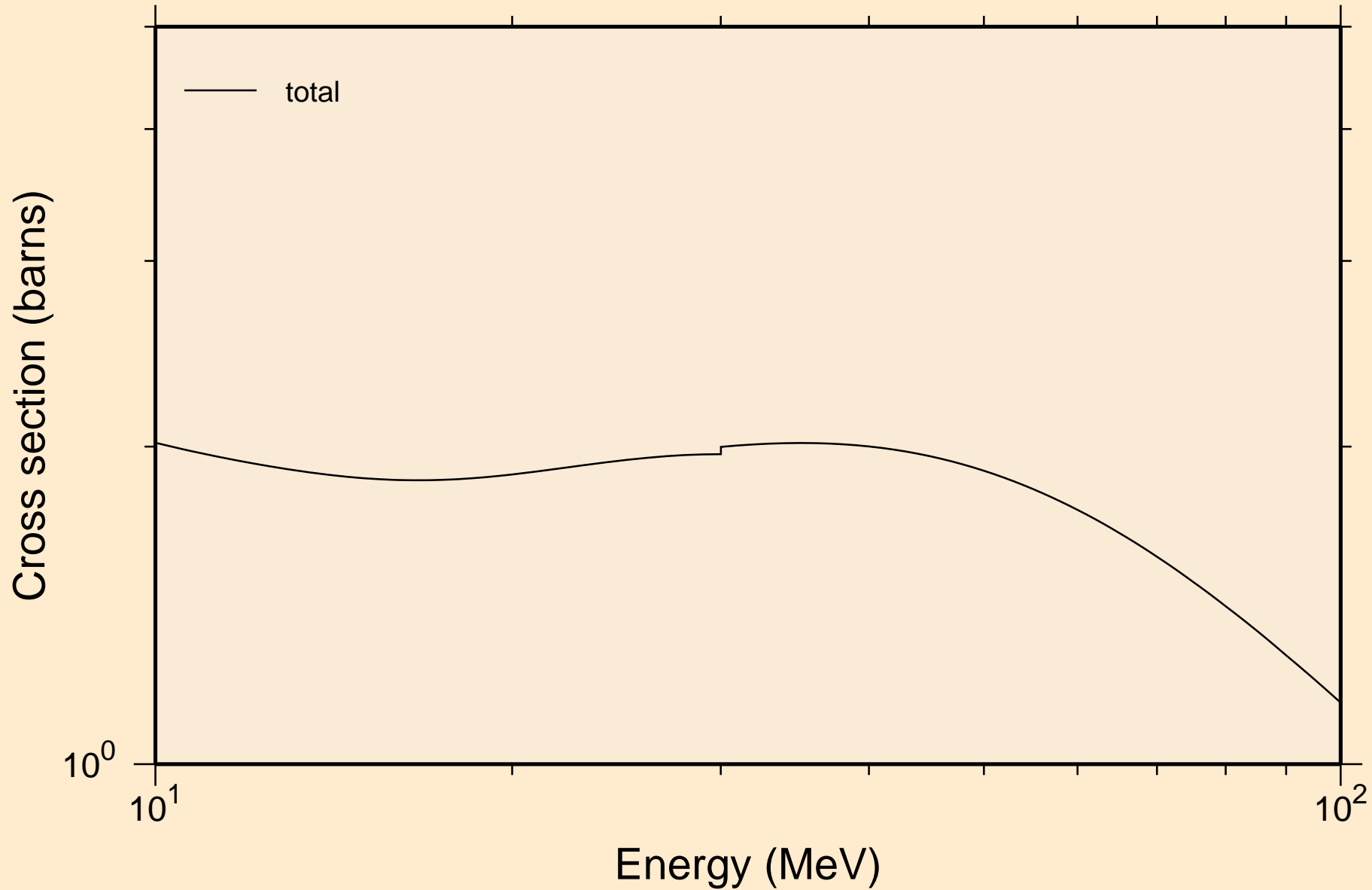

S031 NEUTRON ACER TENDL-2024 LIBRARY; T=0.K
resonance absorption cross sections

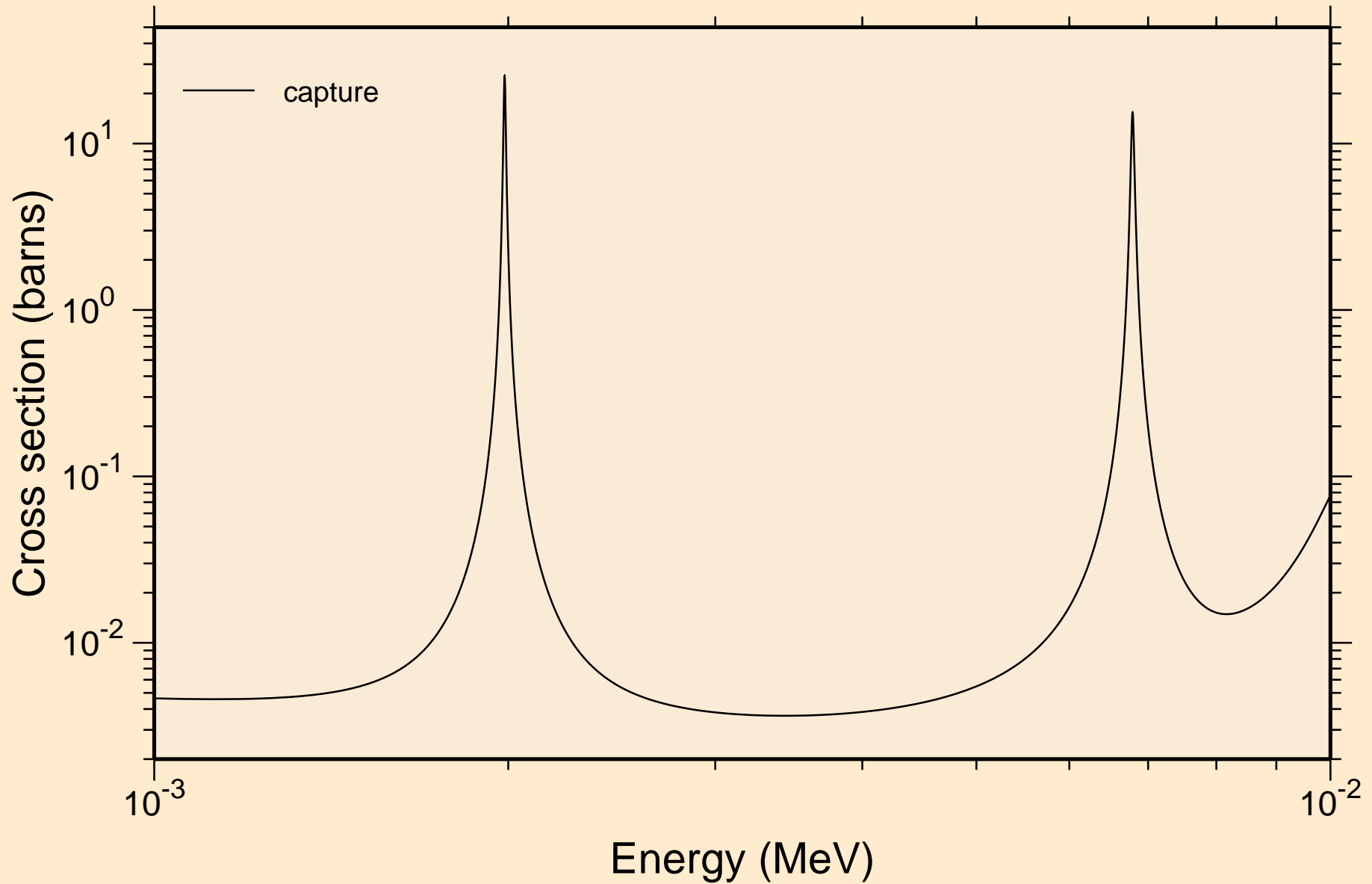

S031 NEUTRON ACER TENDL-2024 LIBRARY; T=0.K
resonance absorption cross sections

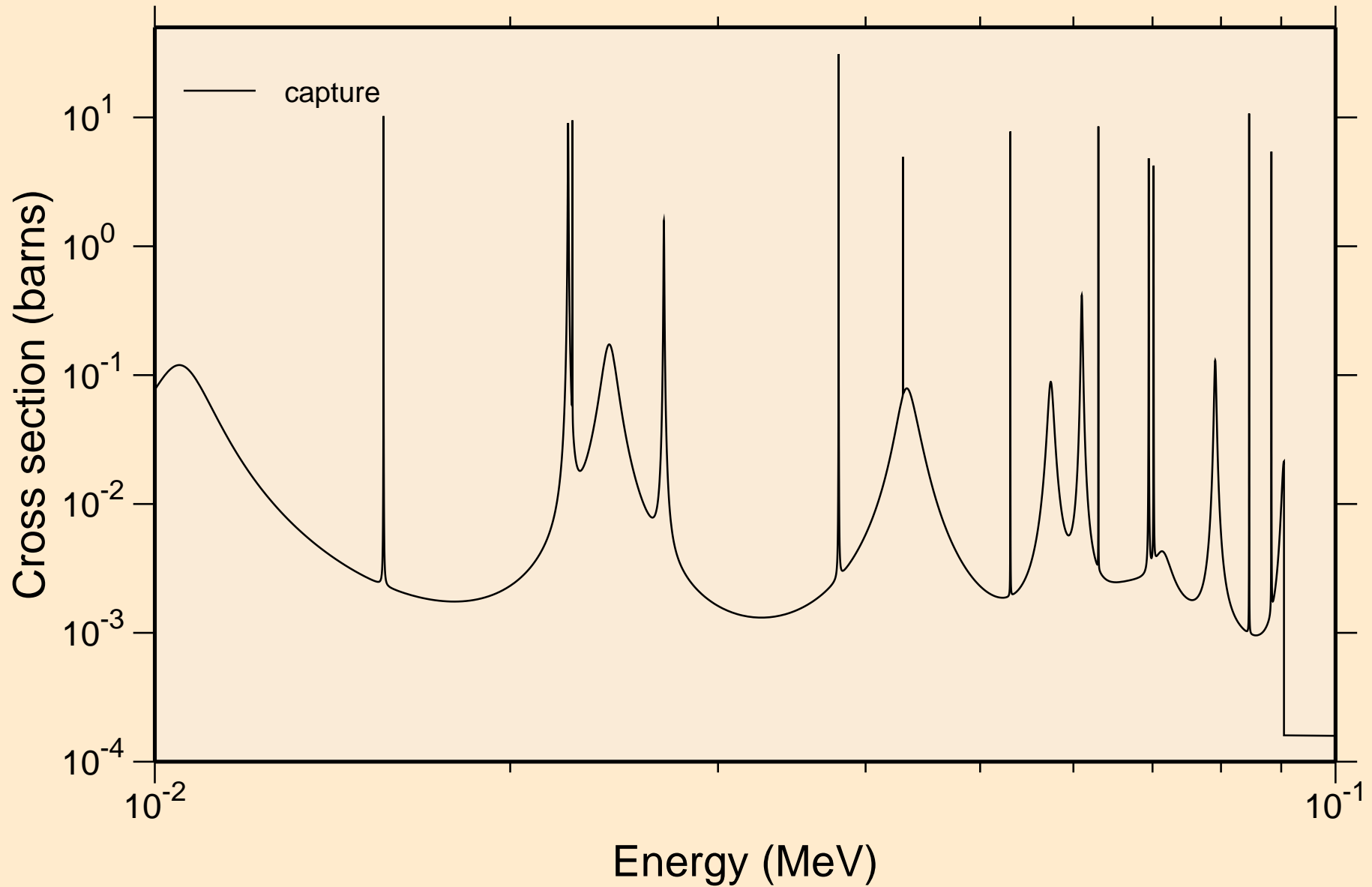

S031 NEUTRON ACER TENDL-2024 LIBRARY; T=0.K
resonance absorption cross sections

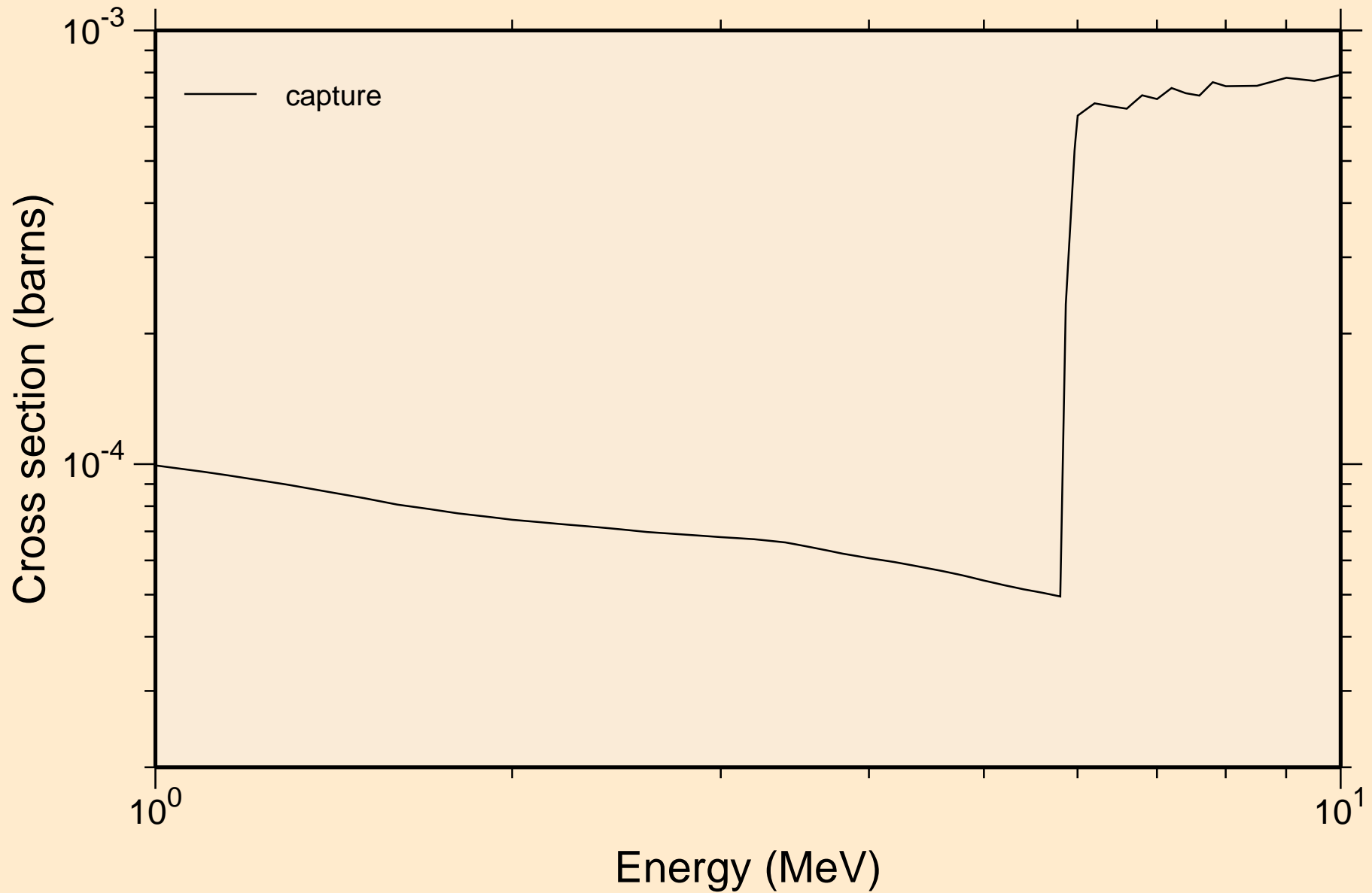

S031 NEUTRON ACER TENDL-2024 LIBRARY; T=0.K

Heating

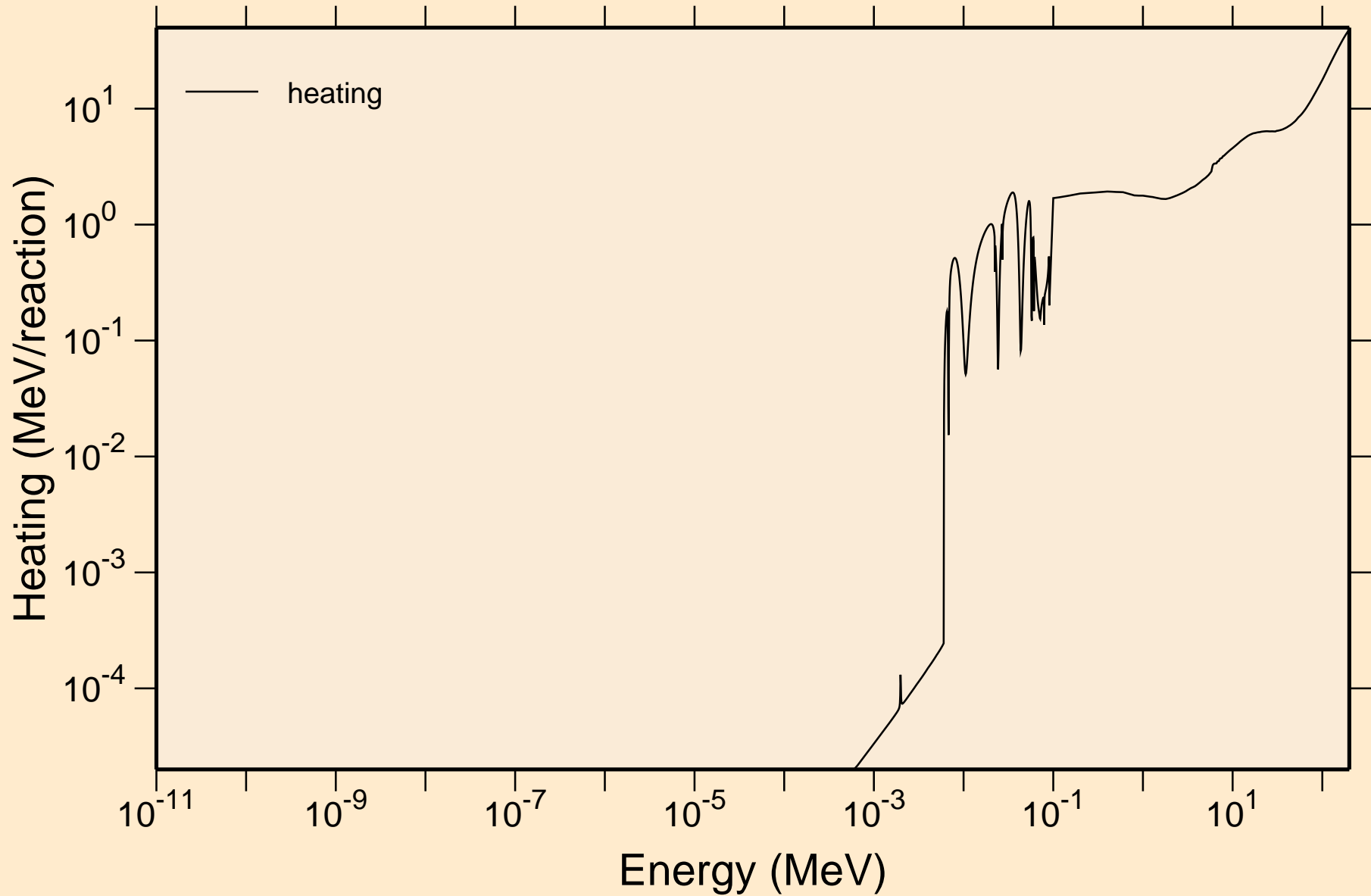

S031 NEUTRON ACER TENDL-2024 LIBRARY; T=0.K

Damage

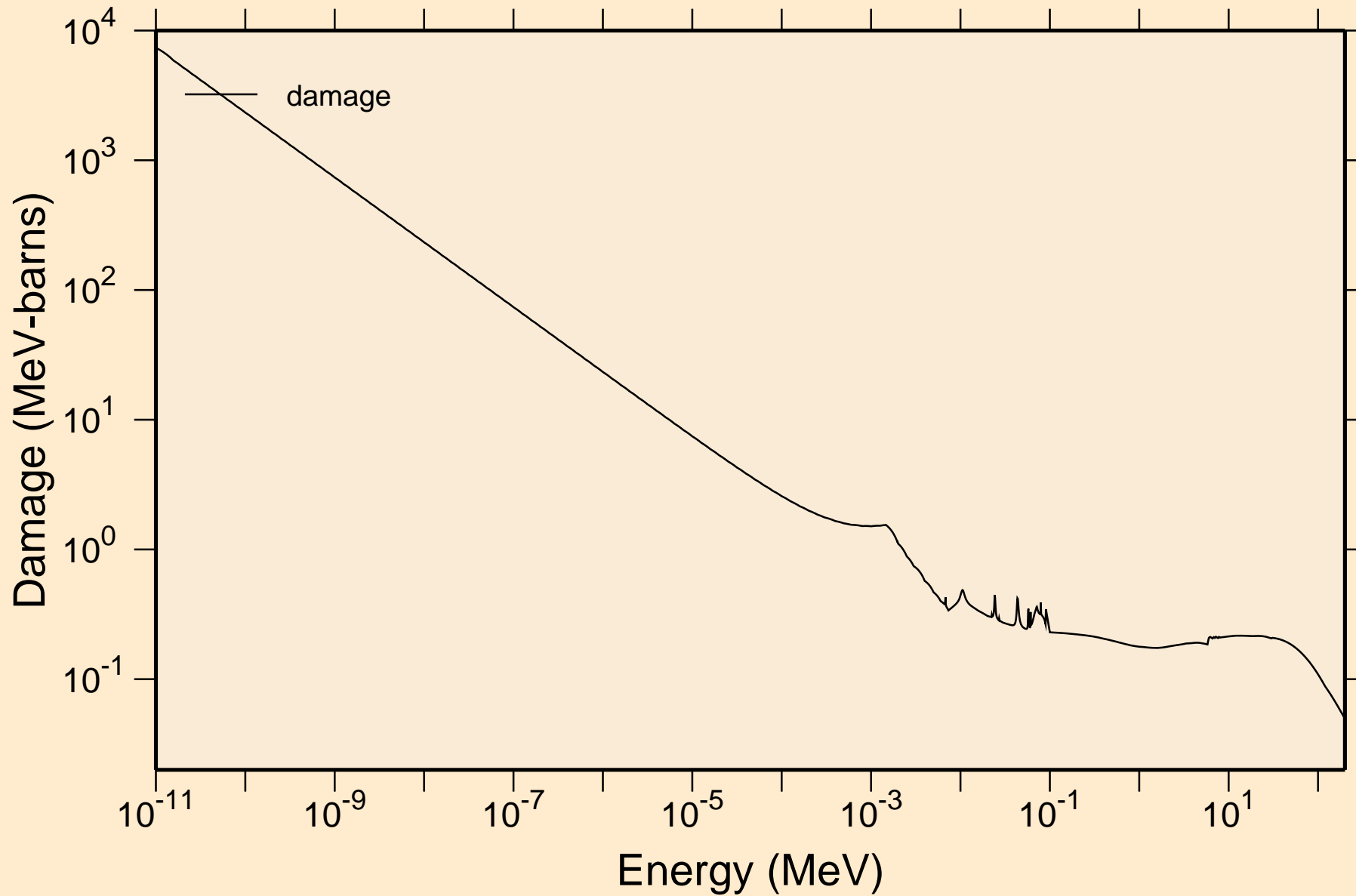

S031 NEUTRON ACER TENDL-2024 LIBRARY; T=0.K

Non-threshold reactions

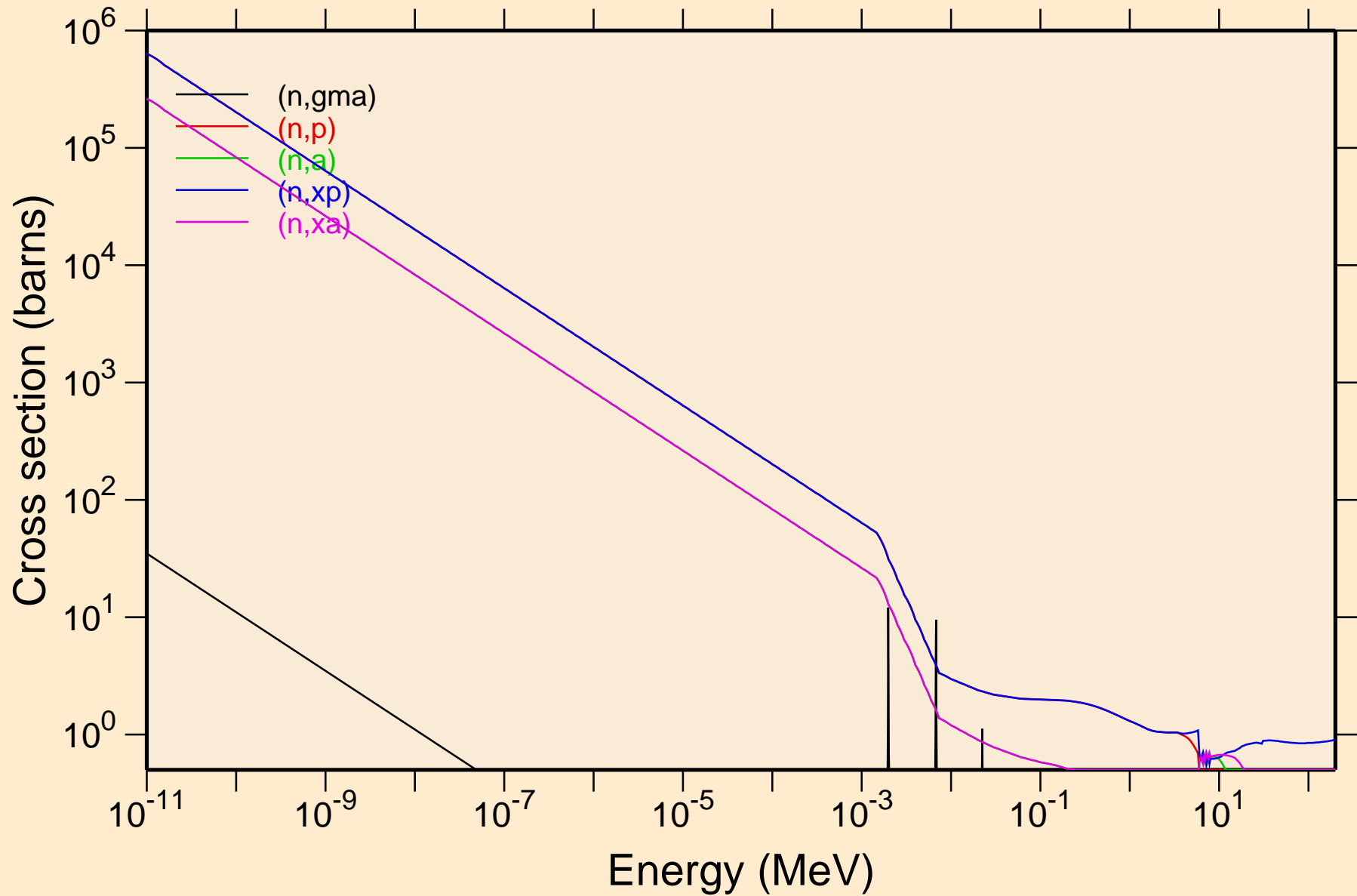

S031 NEUTRON ACER TENDL-2024 LIBRARY; T=0.K

Principal cross sections

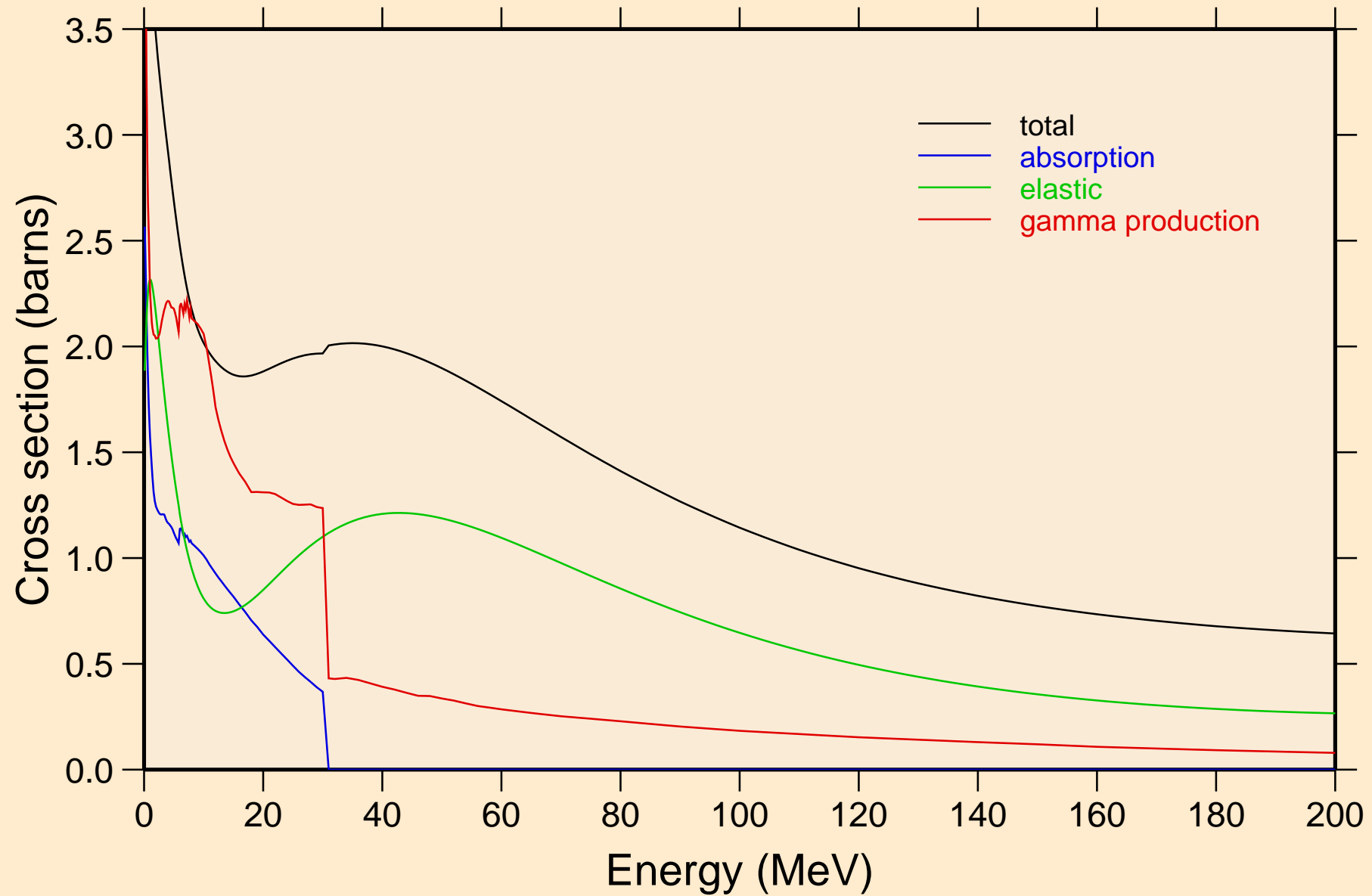

S031 NEUTRON ACER TENDL-2024 LIBRARY; T=0.K

Heating

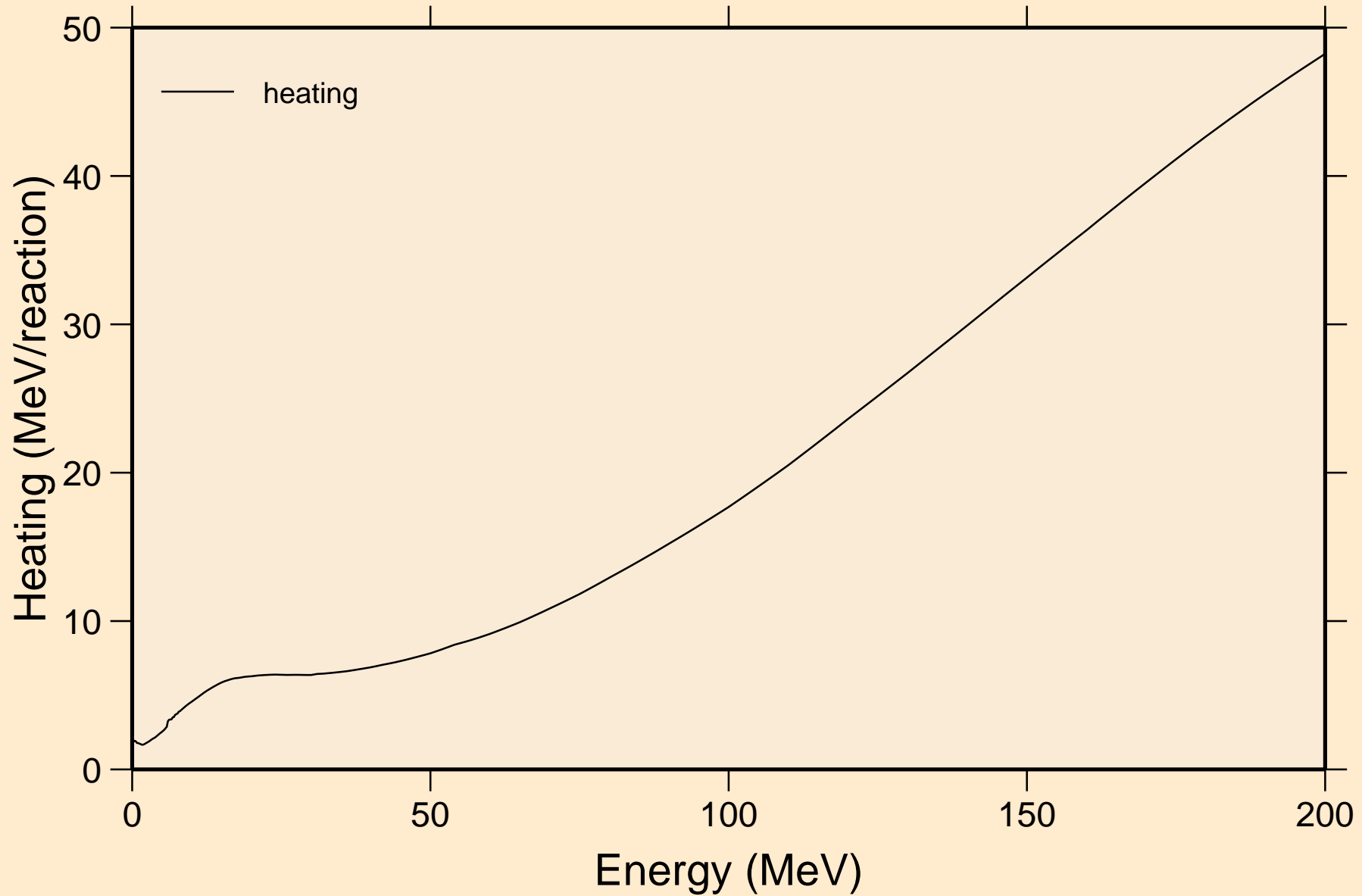

S031 NEUTRON ACER TENDL-2024 LIBRARY; T=0.K

Damage

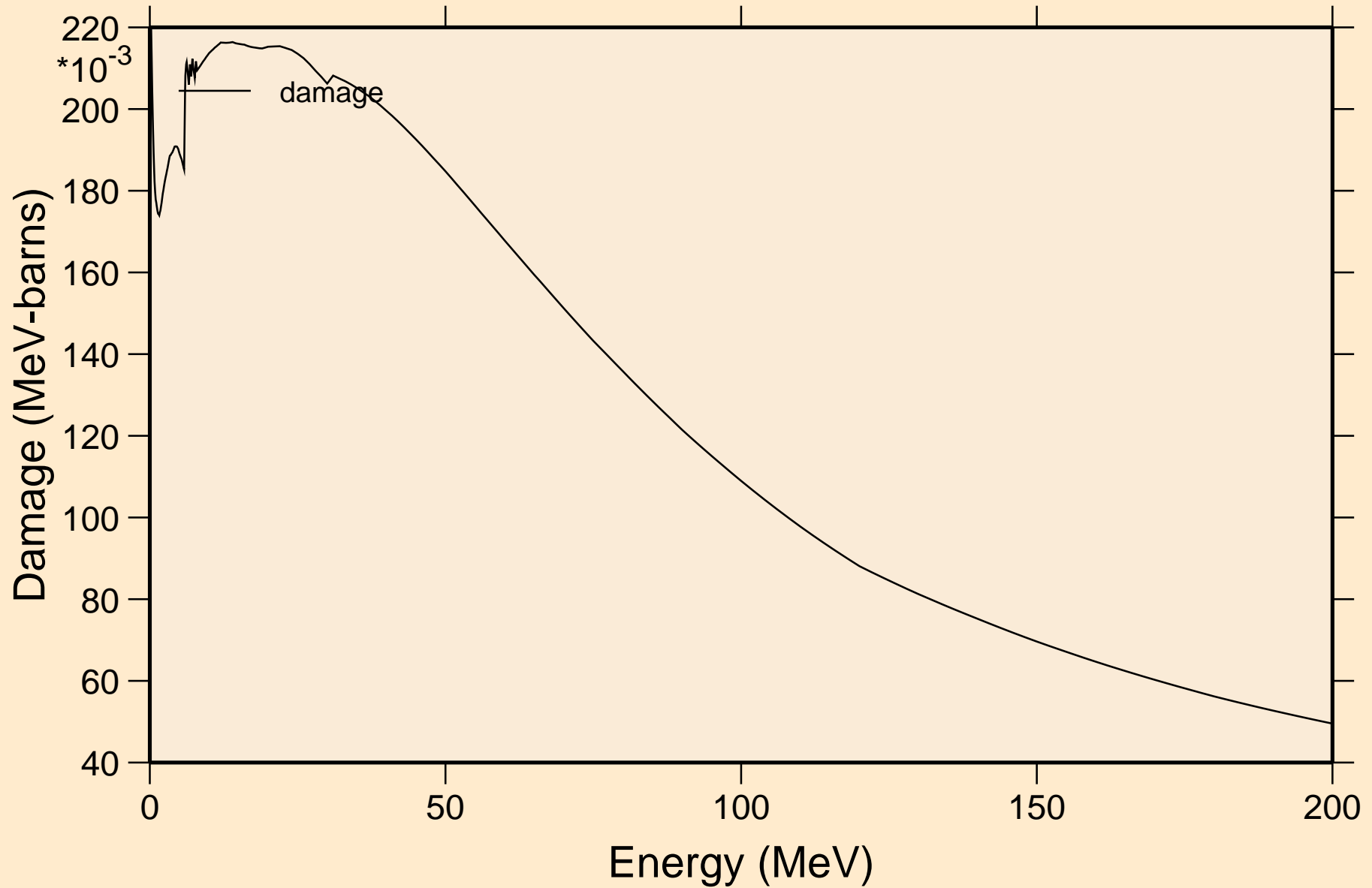

S031 NEUTRON ACER TENDL-2024 LIBRARY; T=0.K

Non-threshold reactions

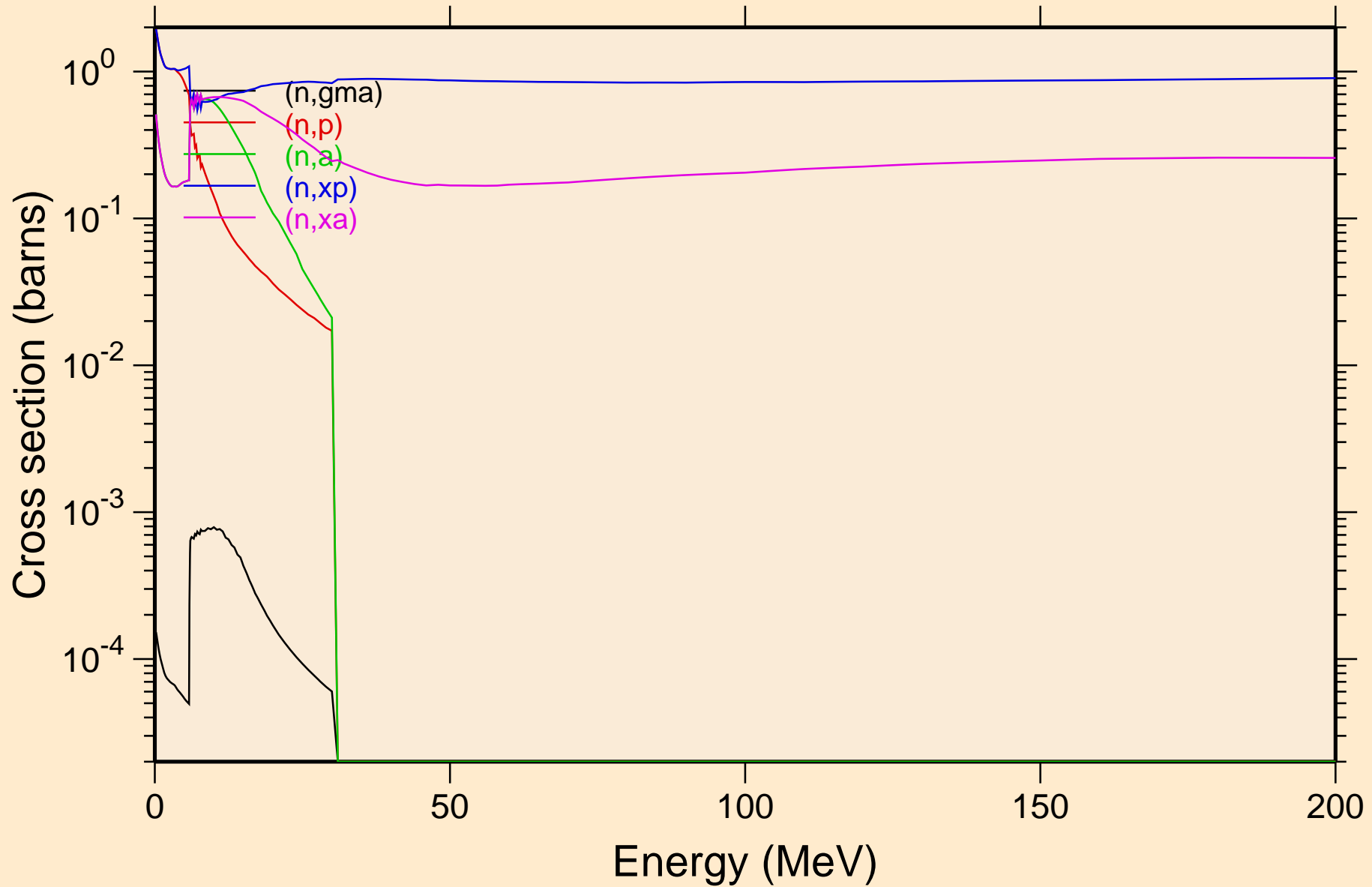

S031 NEUTRON ACER TENDL-2024 LIBRARY; T=0.K
Inelastic levels

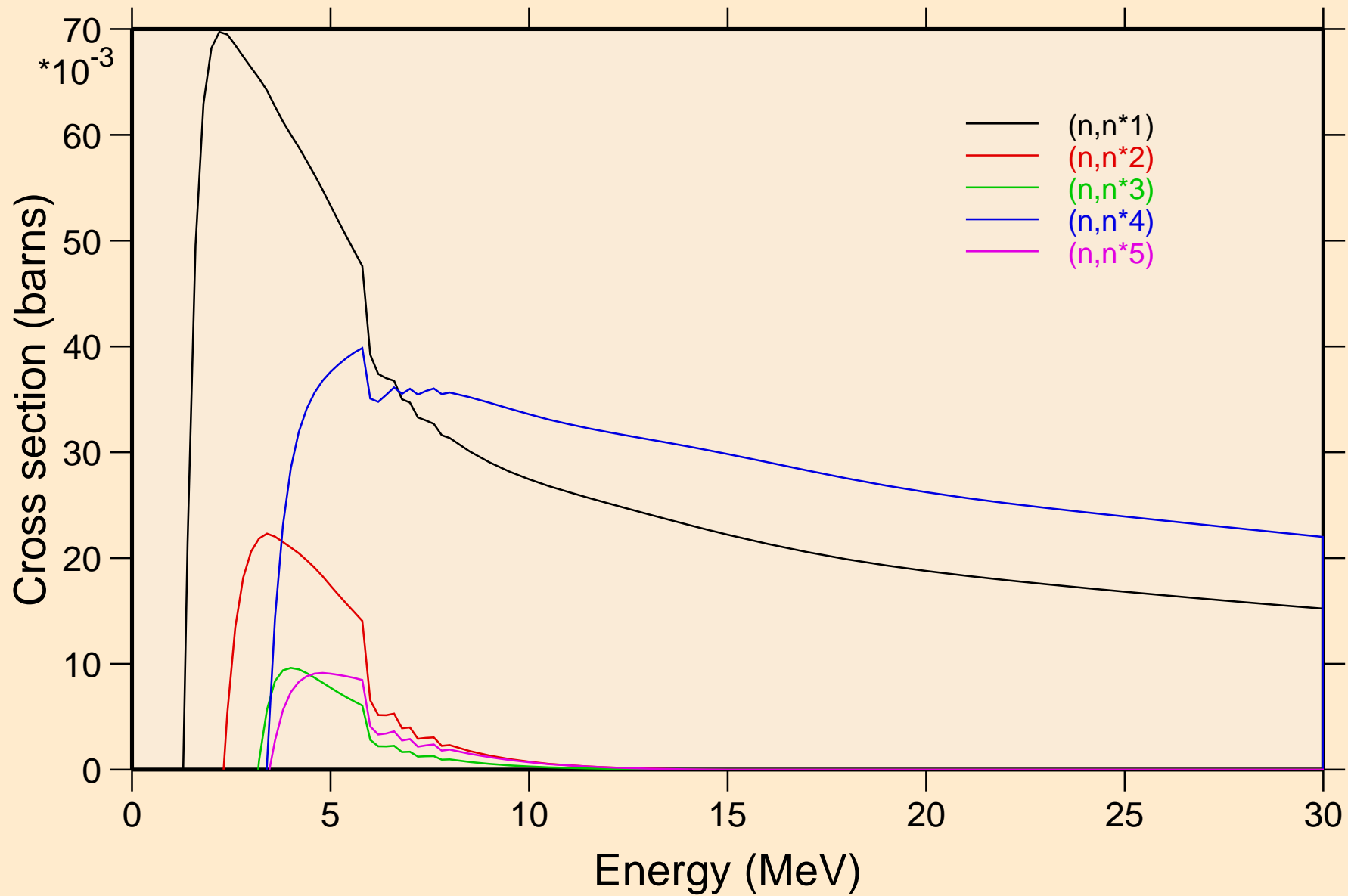

S031 NEUTRON ACER TENDL-2024 LIBRARY; T=0.K
Inelastic levels

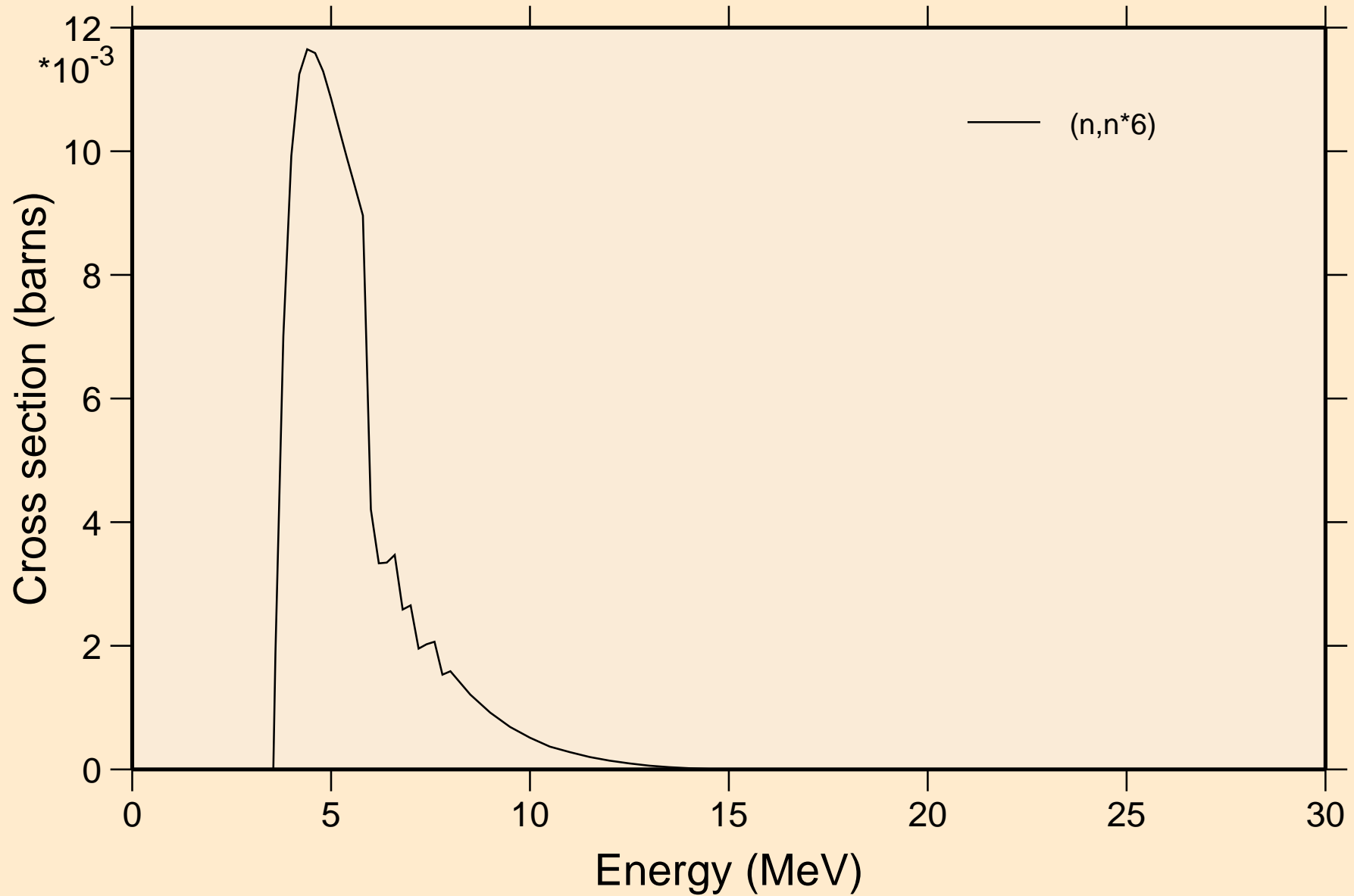

S031 NEUTRON ACER TENDL-2024 LIBRARY; T=0.K

Threshold reactions

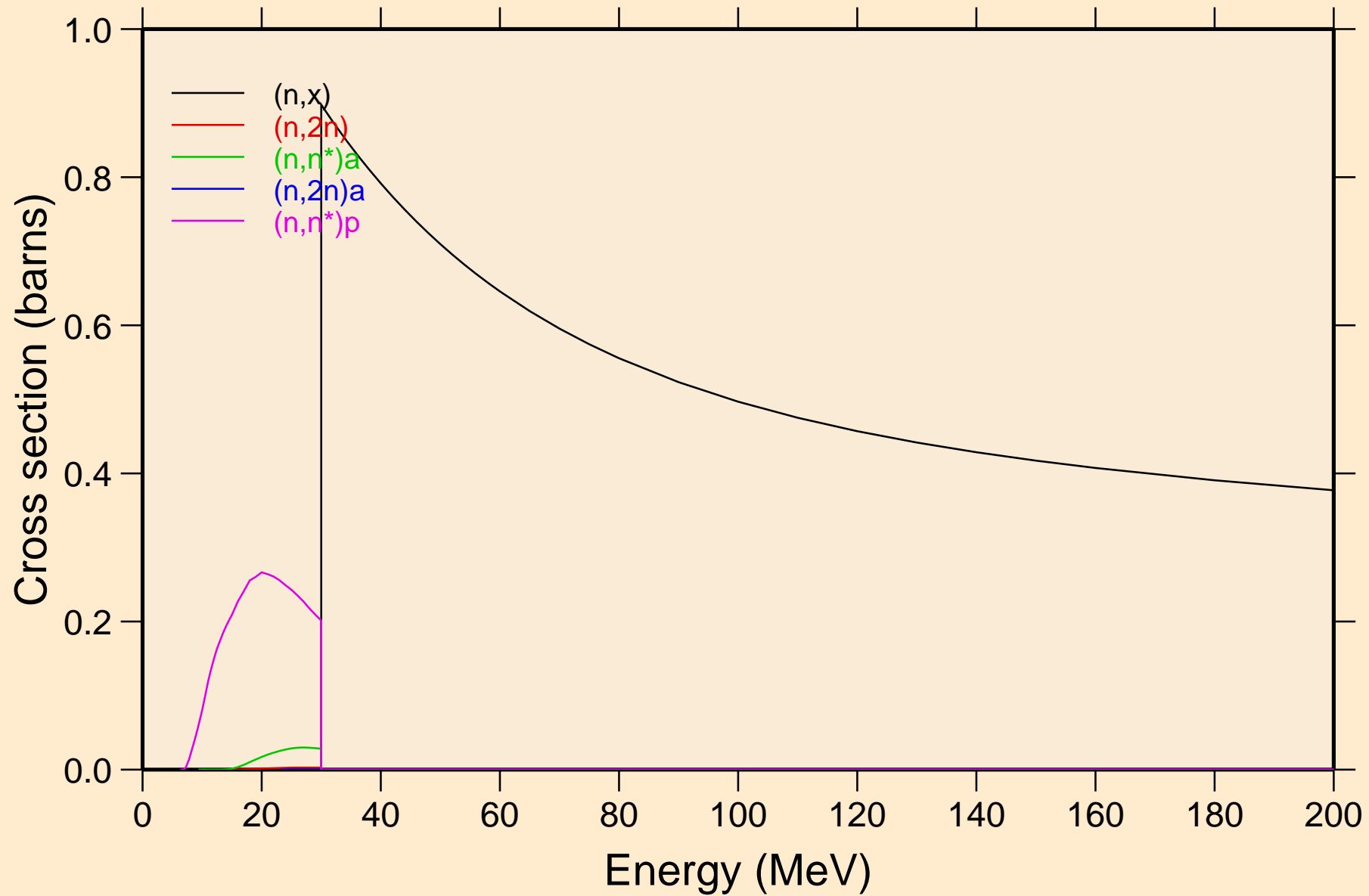

S031 NEUTRON ACER TENDL-2024 LIBRARY; T=0.K

Threshold reactions

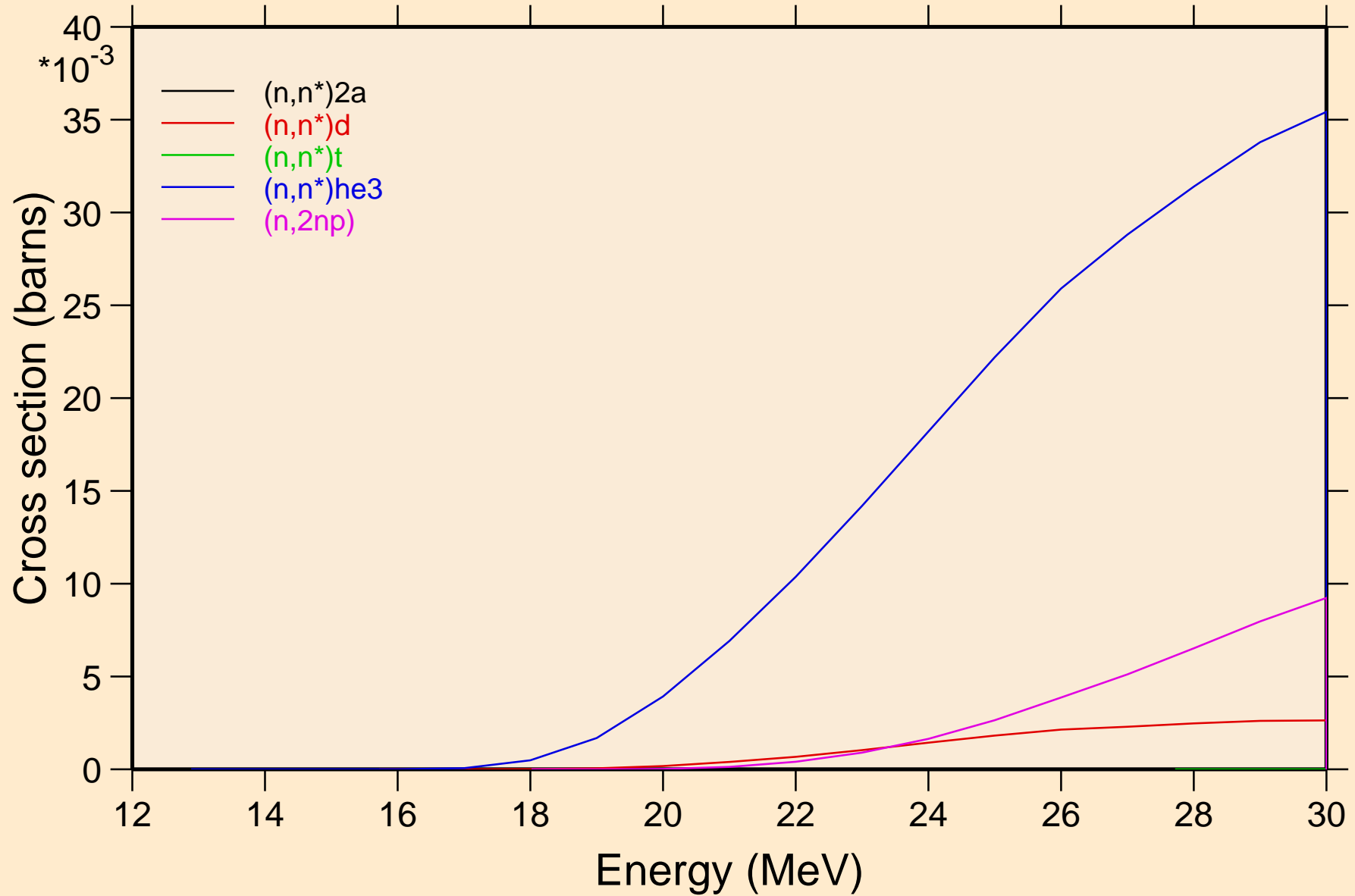

S031 NEUTRON ACER TENDL-2024 LIBRARY; T=0.K

Threshold reactions

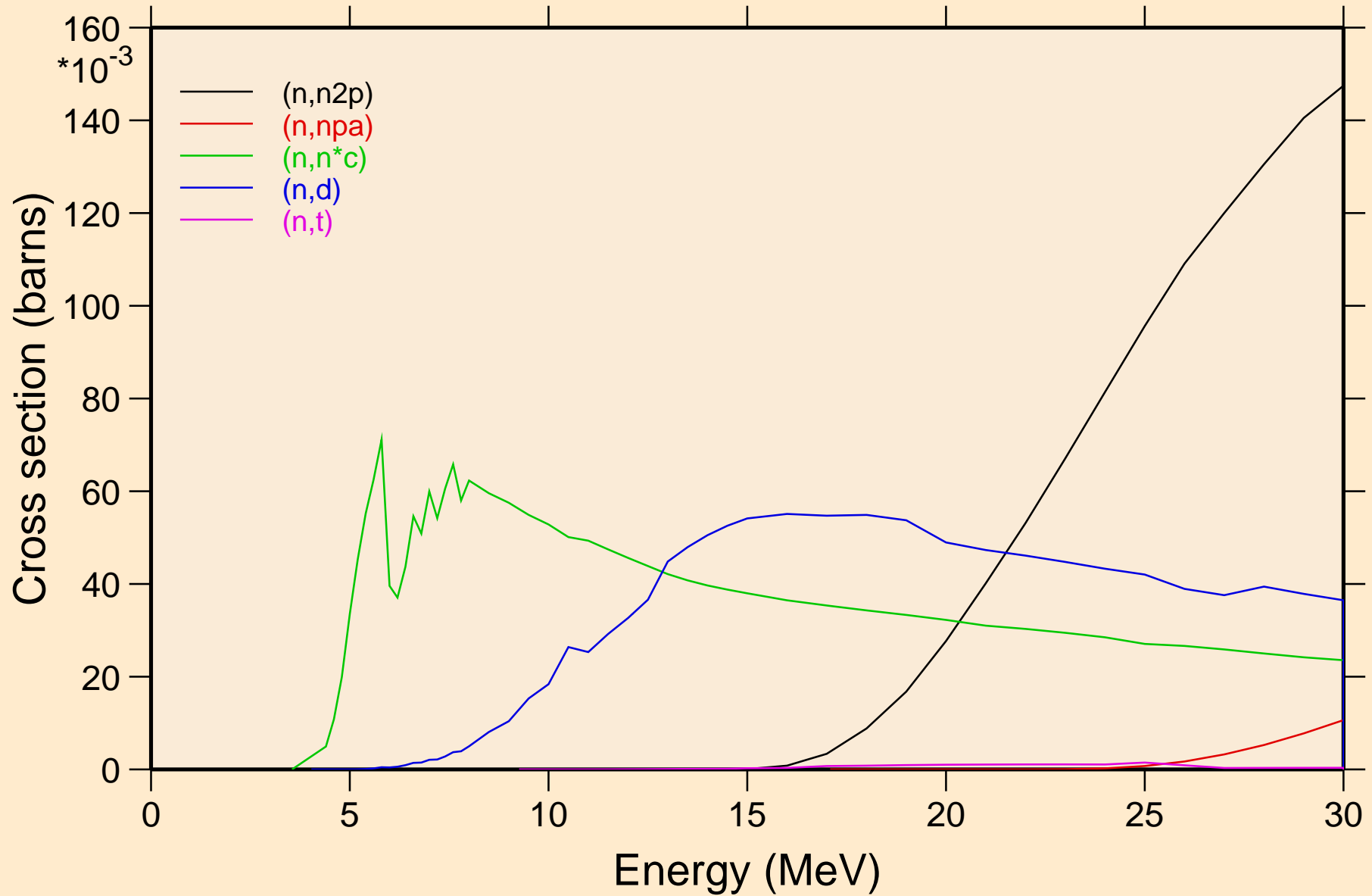

S031 NEUTRON ACER TENDL-2024 LIBRARY; T=0.K

Threshold reactions

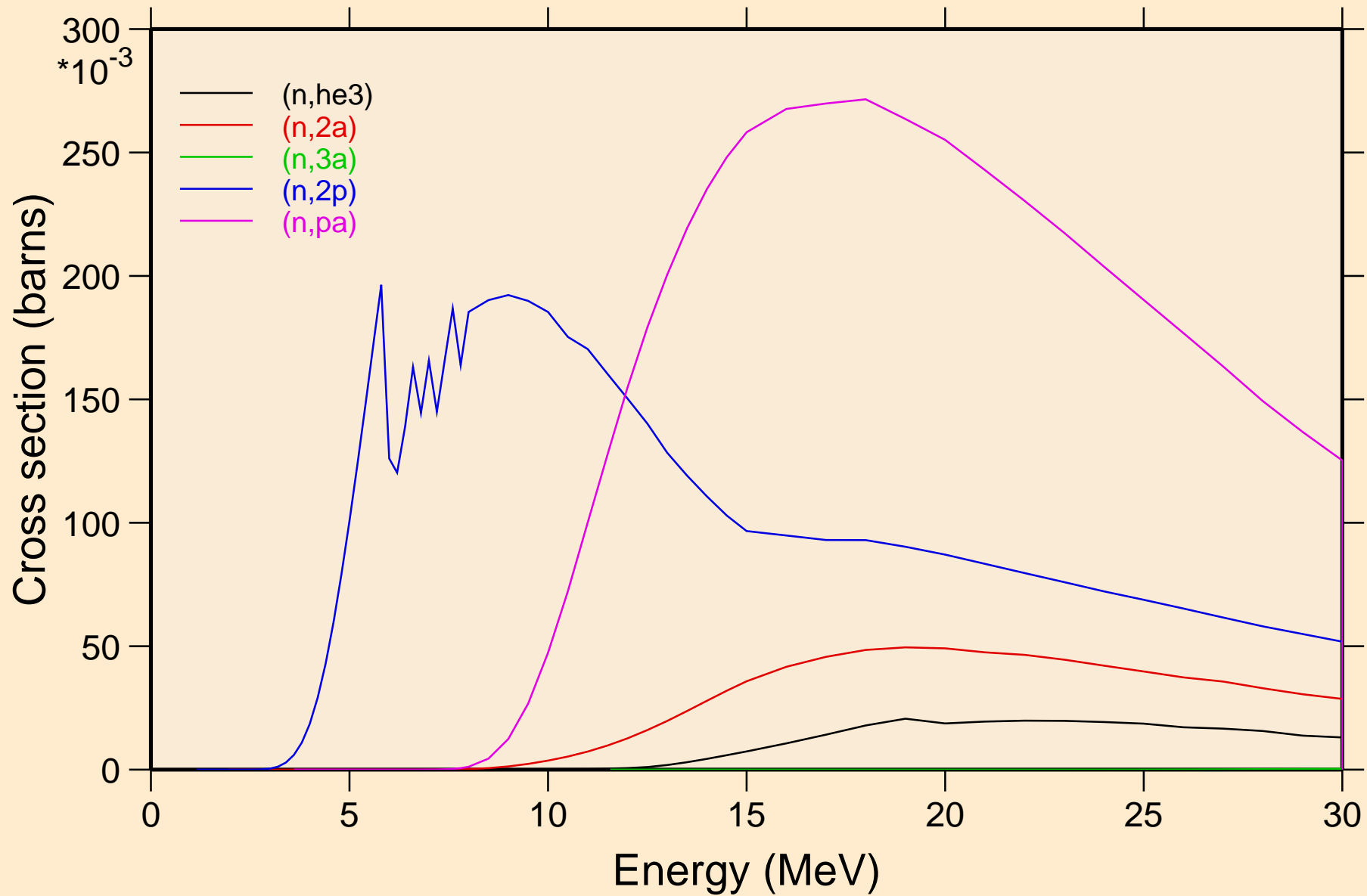

S031 NEUTRON ACER TENDL-2024 LIBRARY; T=0.K
Threshold reactions

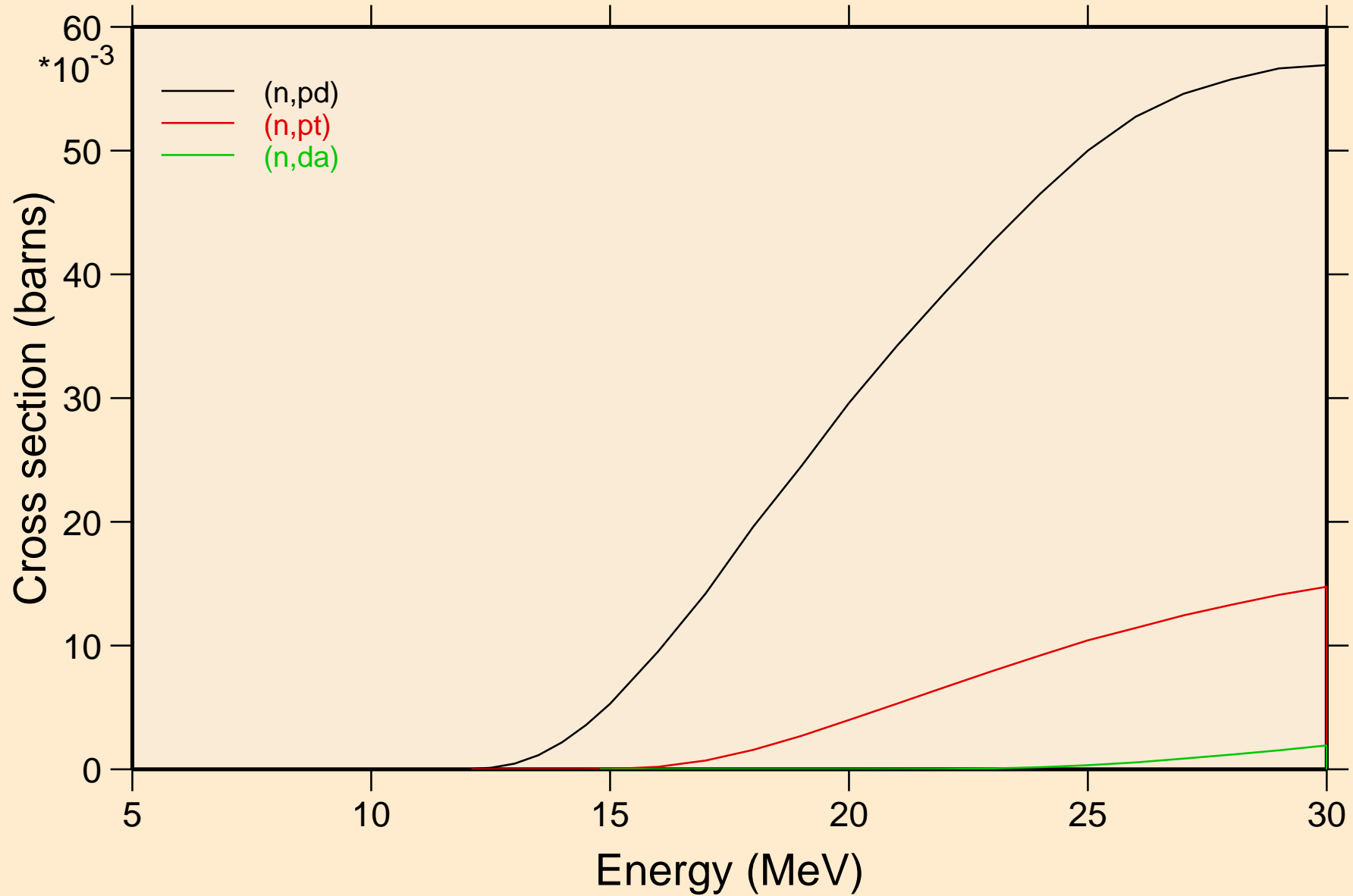

S031 NEUTRON ACER TENDL-2024 LIBRARY; T=0.K

Threshold reactions

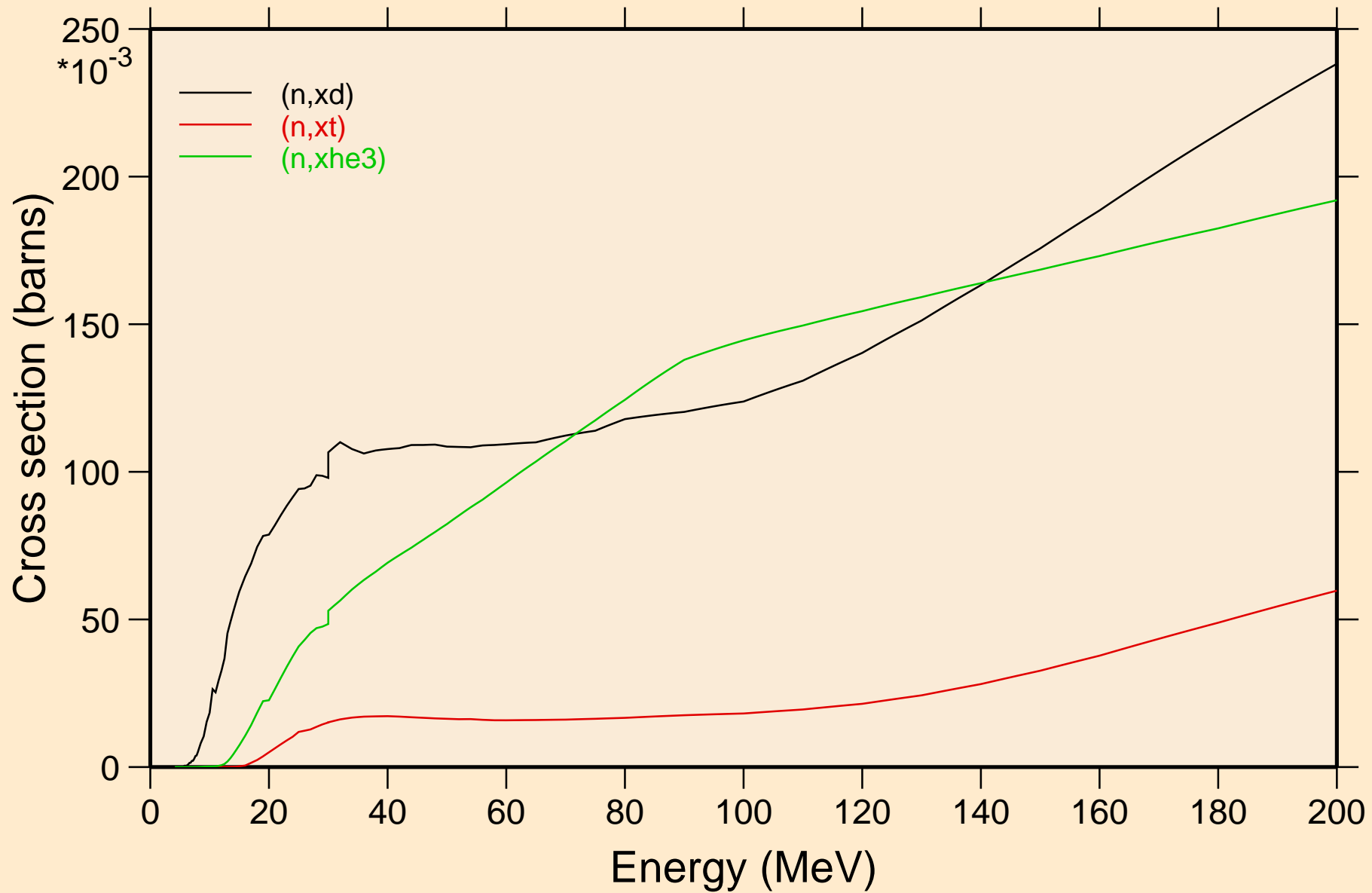

S031 NEUTRON ACER TENDL-2024 LIBRARY; T=0.K
angular distribution for elastic

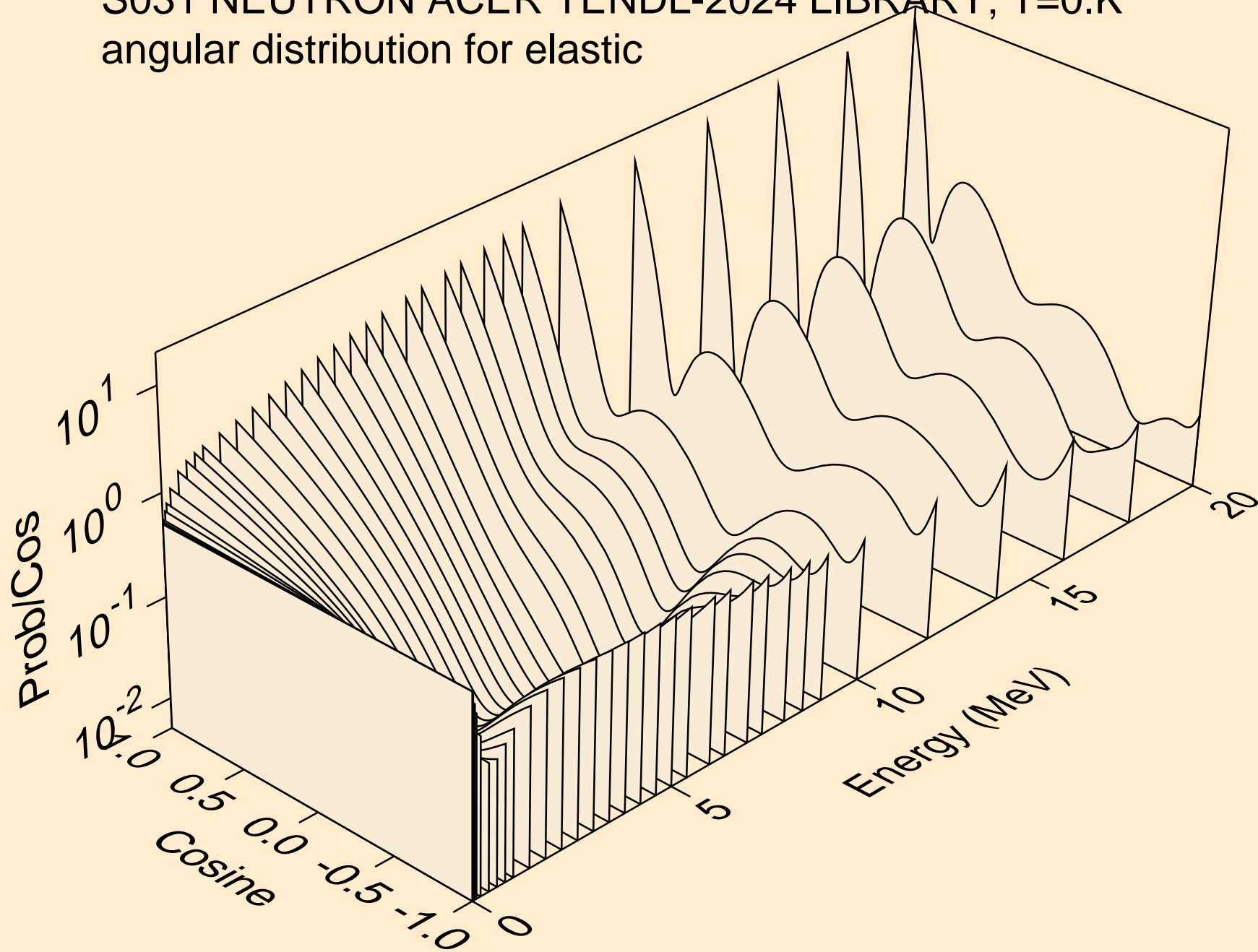

S031 NEUTRON ACER TENDL-2024 LIBRARY; T=0.K
angular distribution for elastic

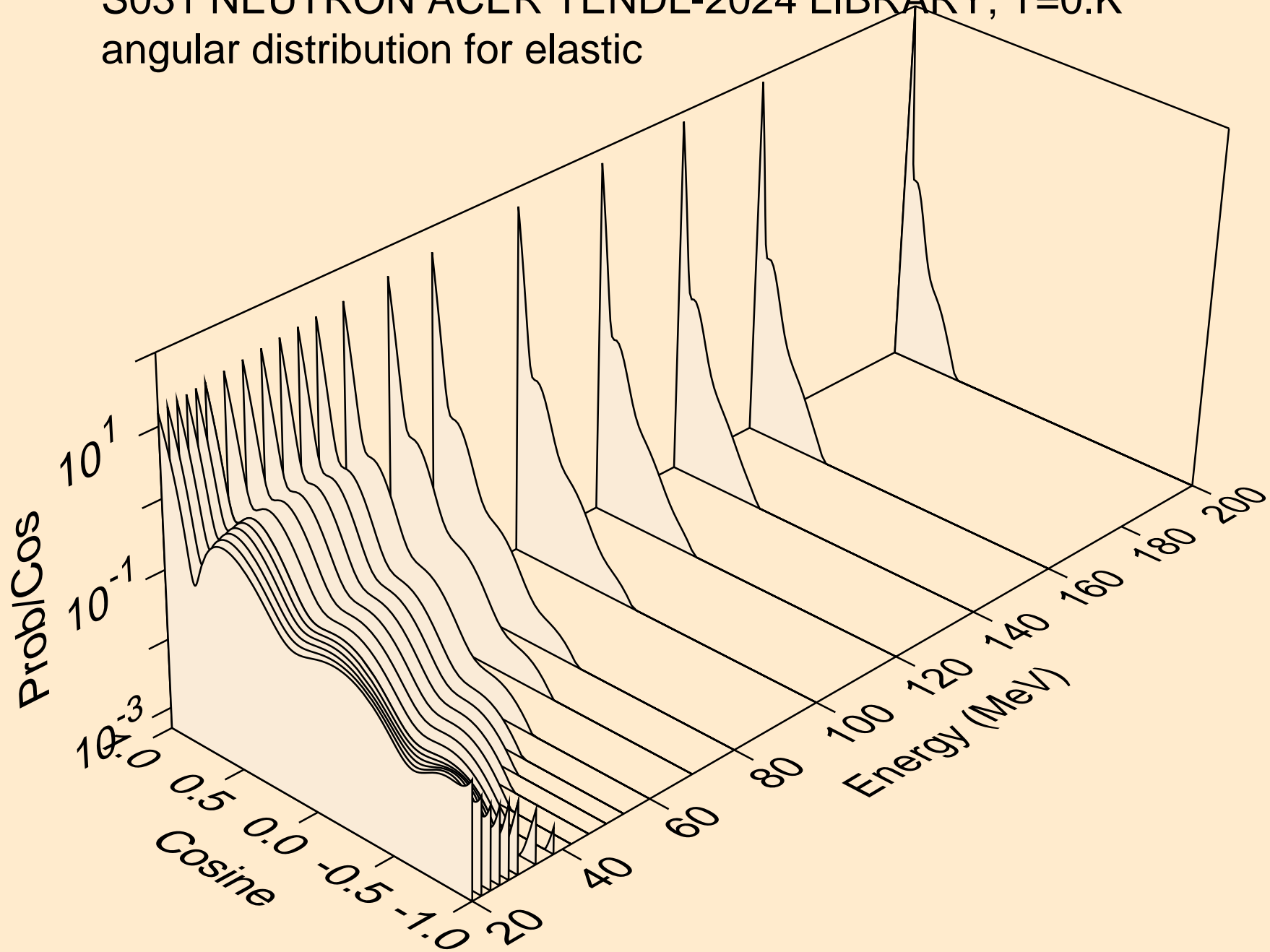

S031 NEUTRON ACER TENDL-2024 LIBRARY; T=0.K
angular distribution for (n,n*1)

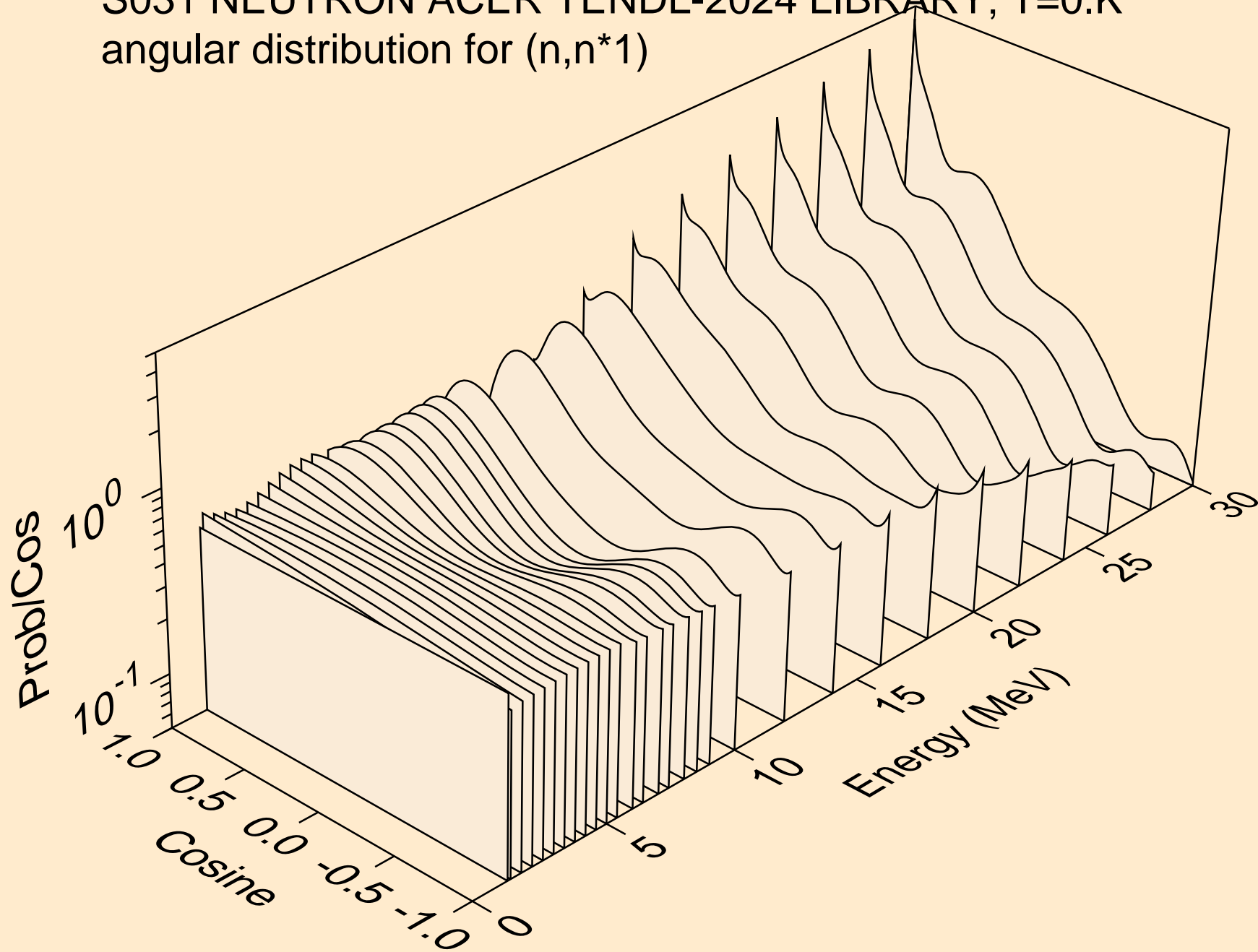

S031 NEUTRON ACER TENDL-2024 LIBRARY; T=0.K
angular distribution for (n,n*2)

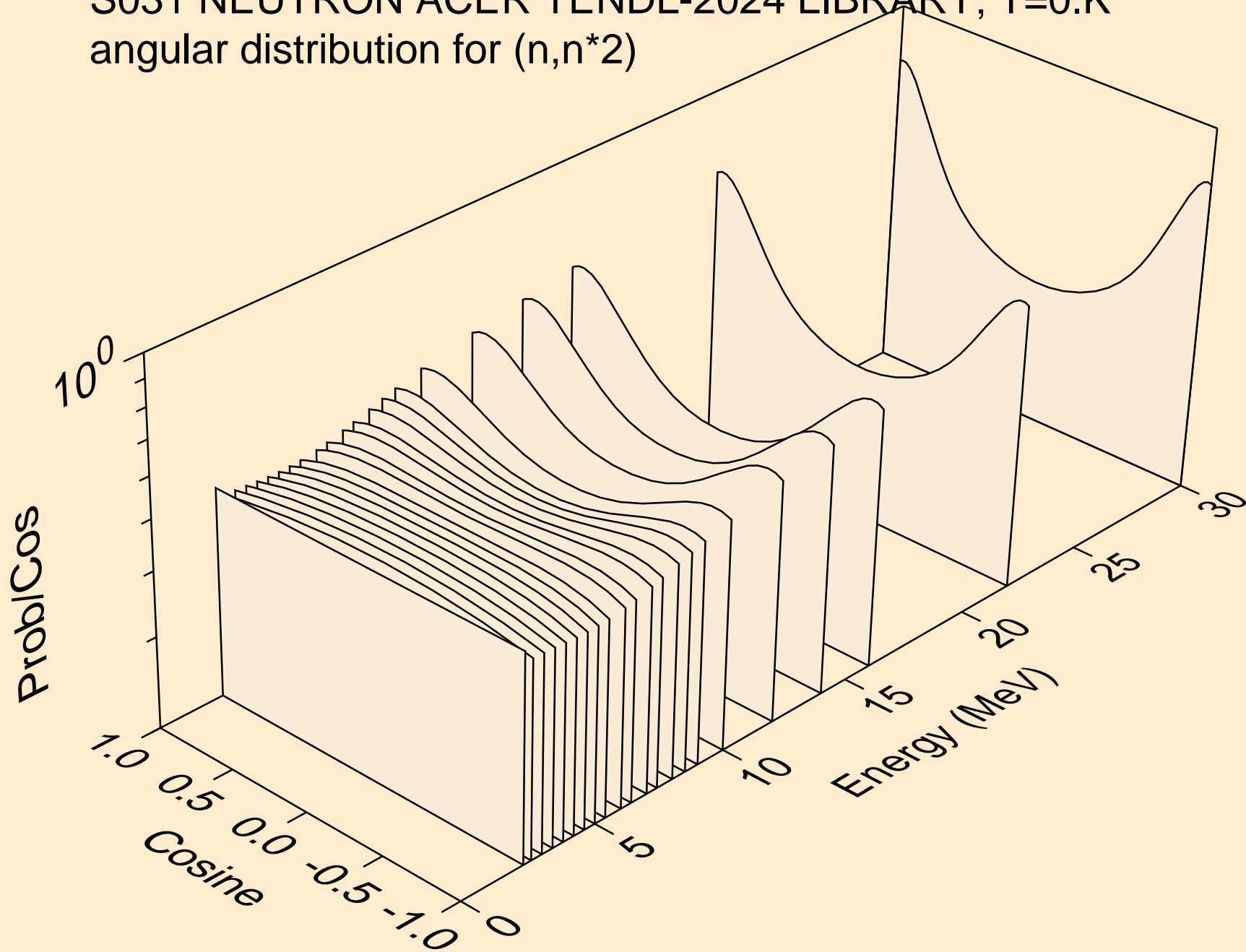

S031 NEUTRON ACER TENDL-2024 LIBRARY; T=0.K
angular distribution for (n,n*3)

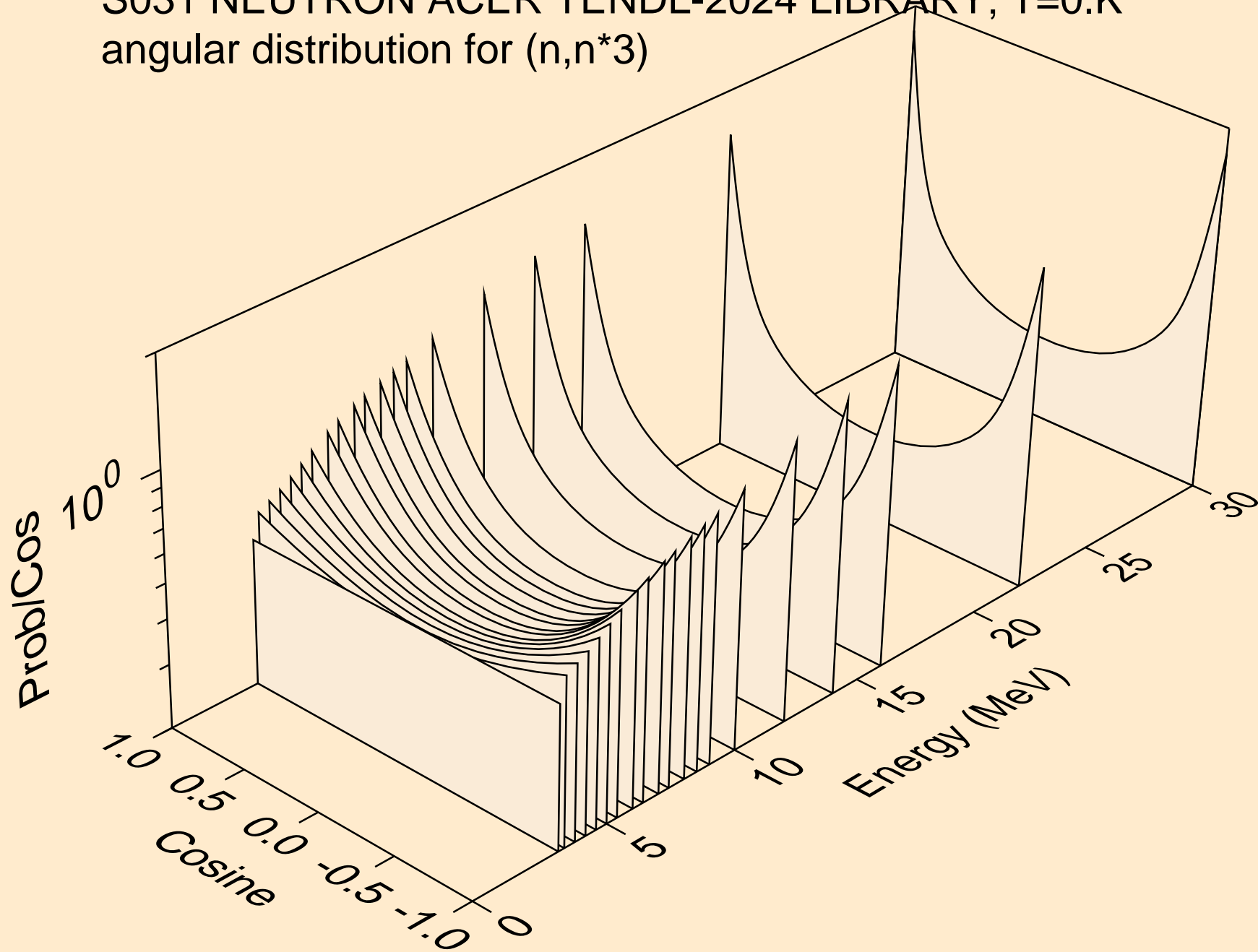

S031 NEUTRON ACER TENDL-2024 LIBRARY; T=0.K
angular distribution for (n,n*4)

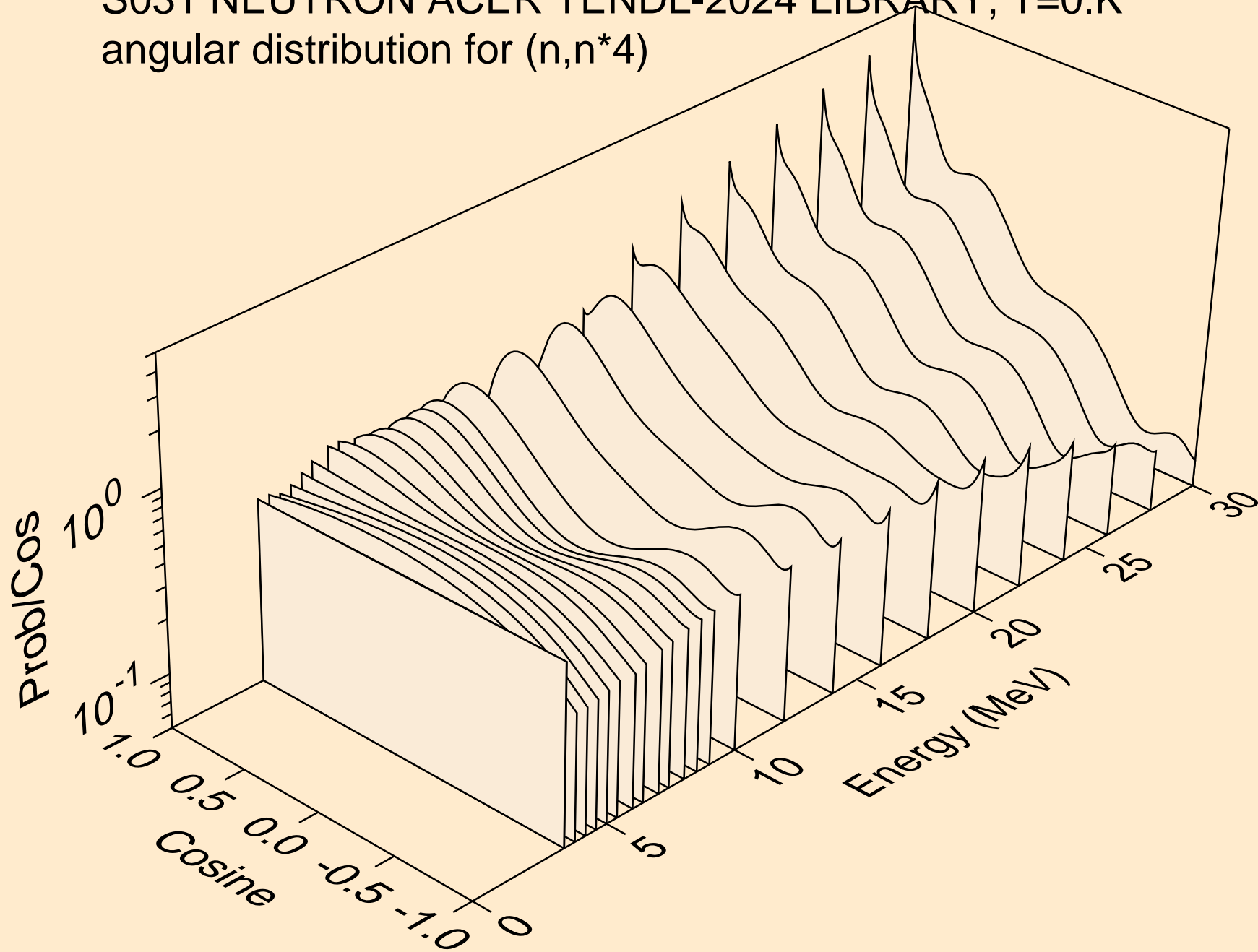

S031 NEUTRON ACER TENDL-2024 LIBRARY; T=0.K
angular distribution for (n,n*5)

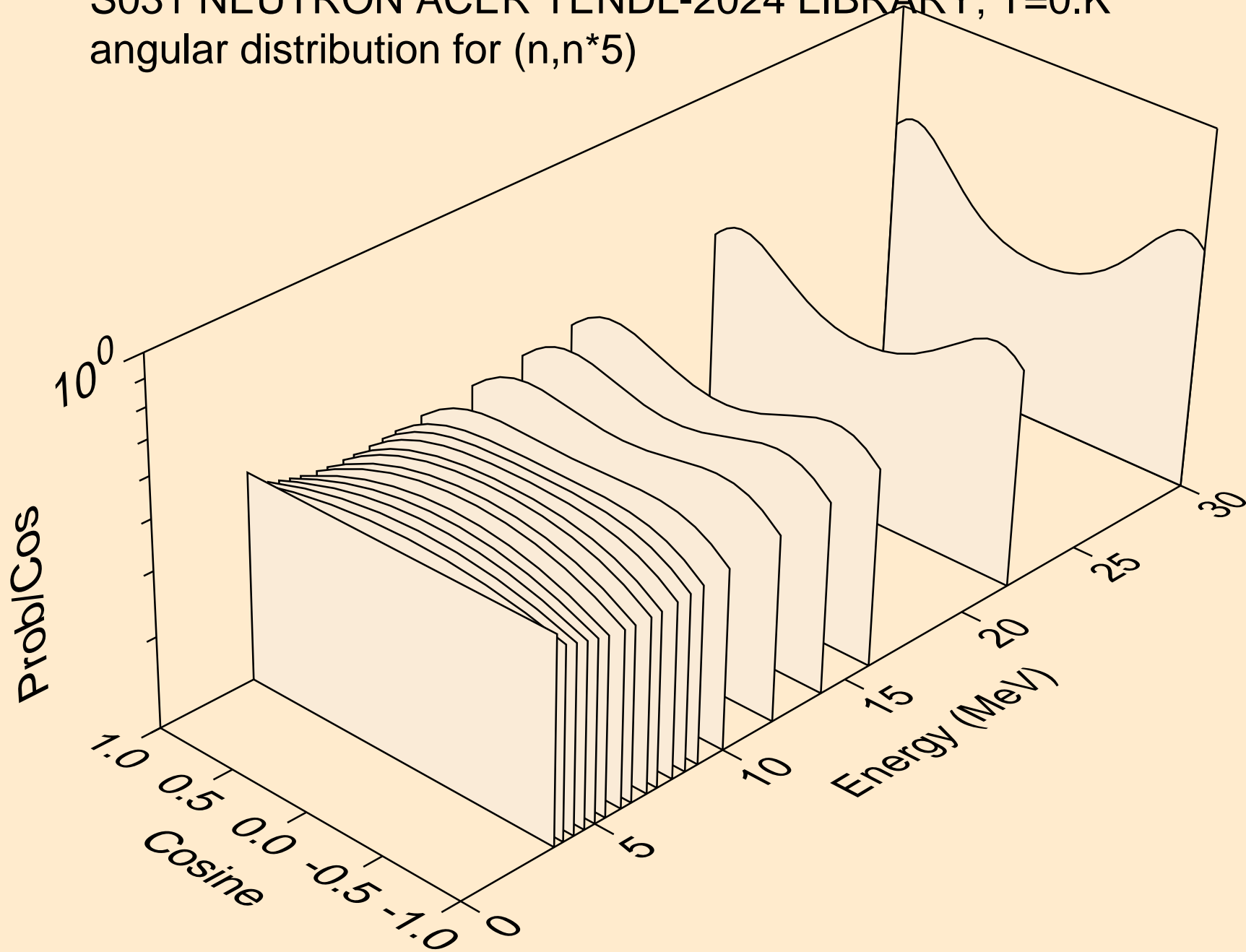

S031 NEUTRON ACER TENDL-2024 LIBRARY; T=0.K
angular distribution for (n,n*6)

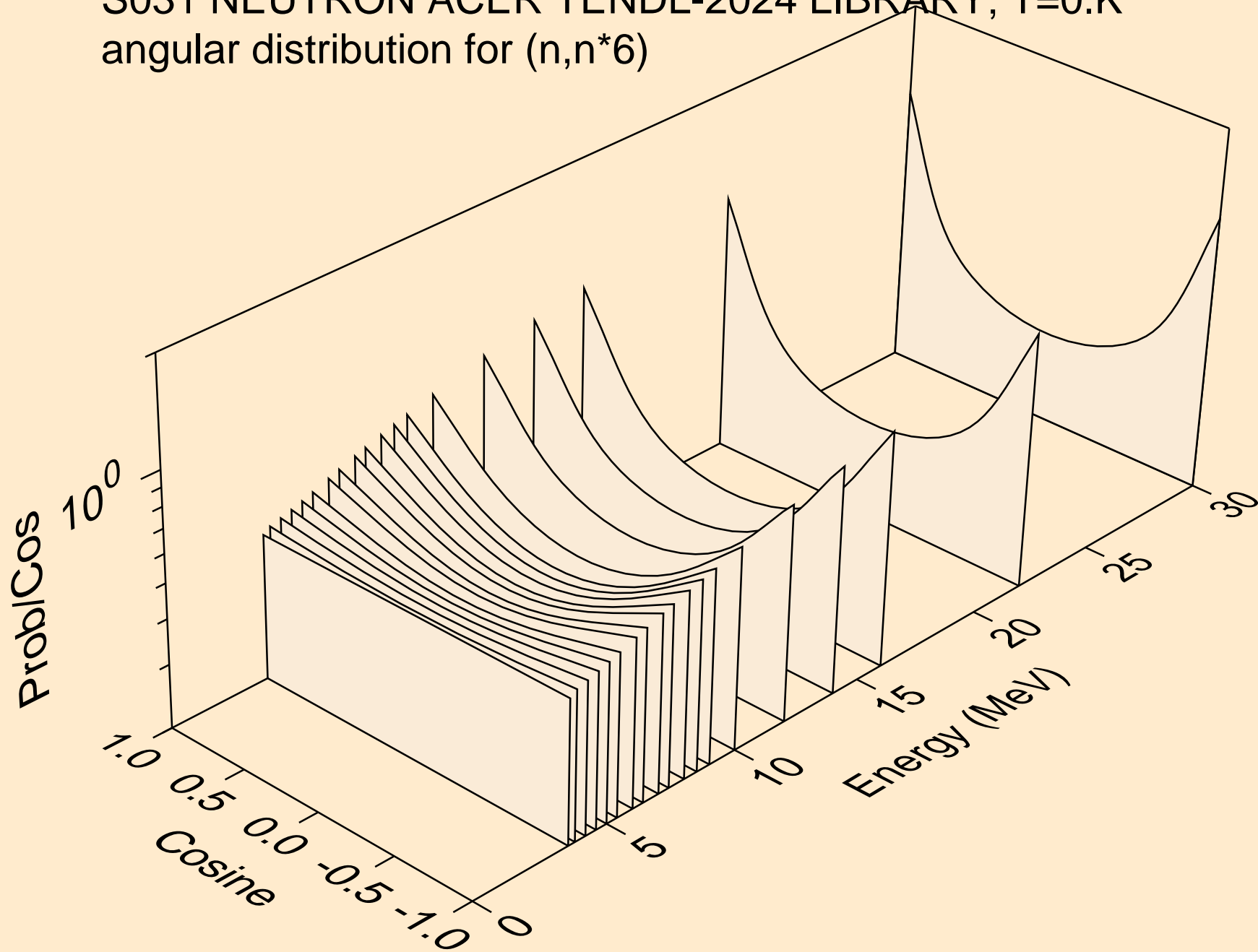

S031 NEUTRON ACER TENDL-2024 LIBRARY; T=0.K
Neutron emission for (n,x)

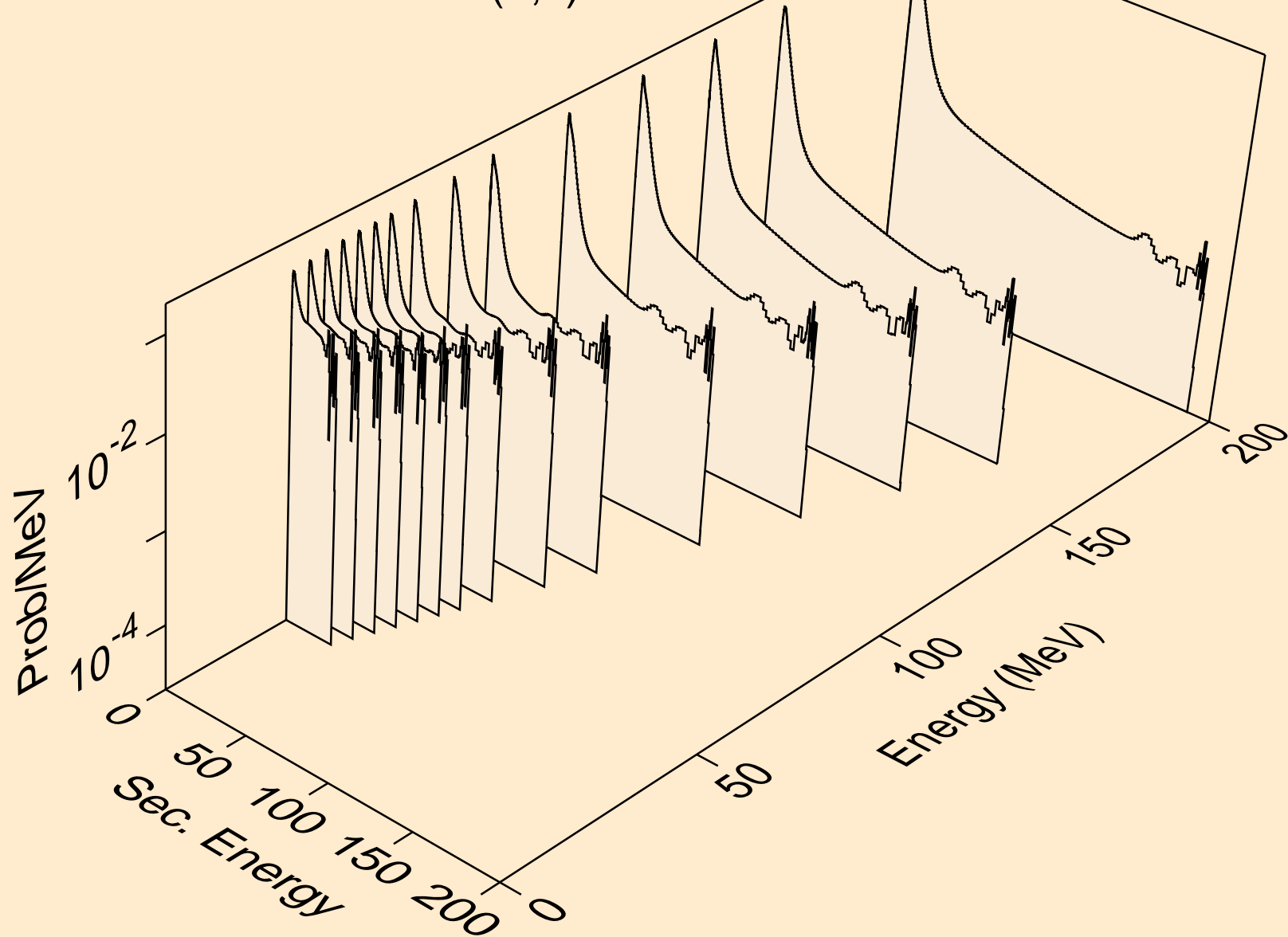

S031 NEUTRON ACER TENDL-2024 LIBRARY; T=0.K
Neutron emission for (n,2n)

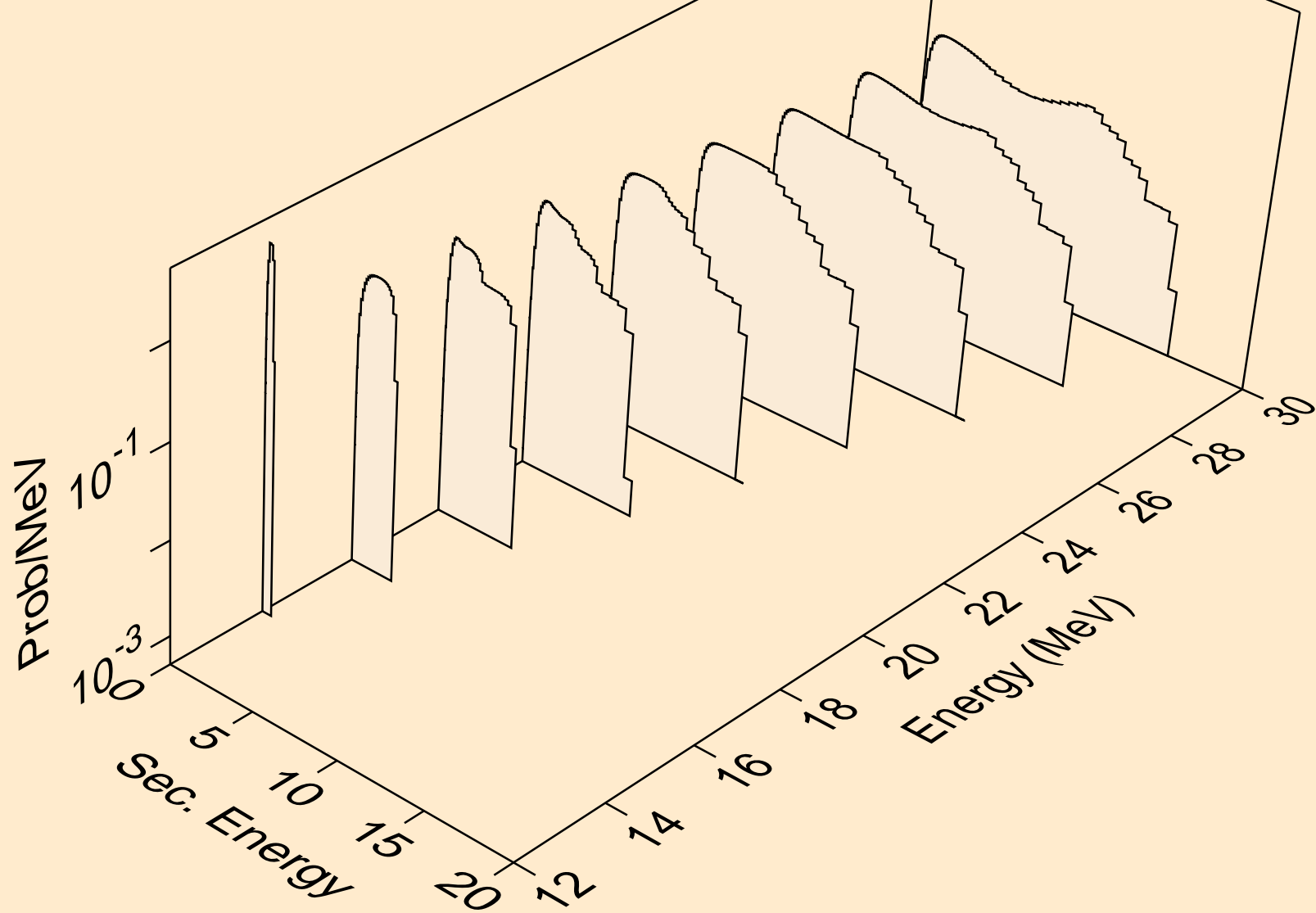

S031 NEUTRON ACER TENDL-2024 LIBRARY; T=0.K
Neutron emission for (n,n*)a

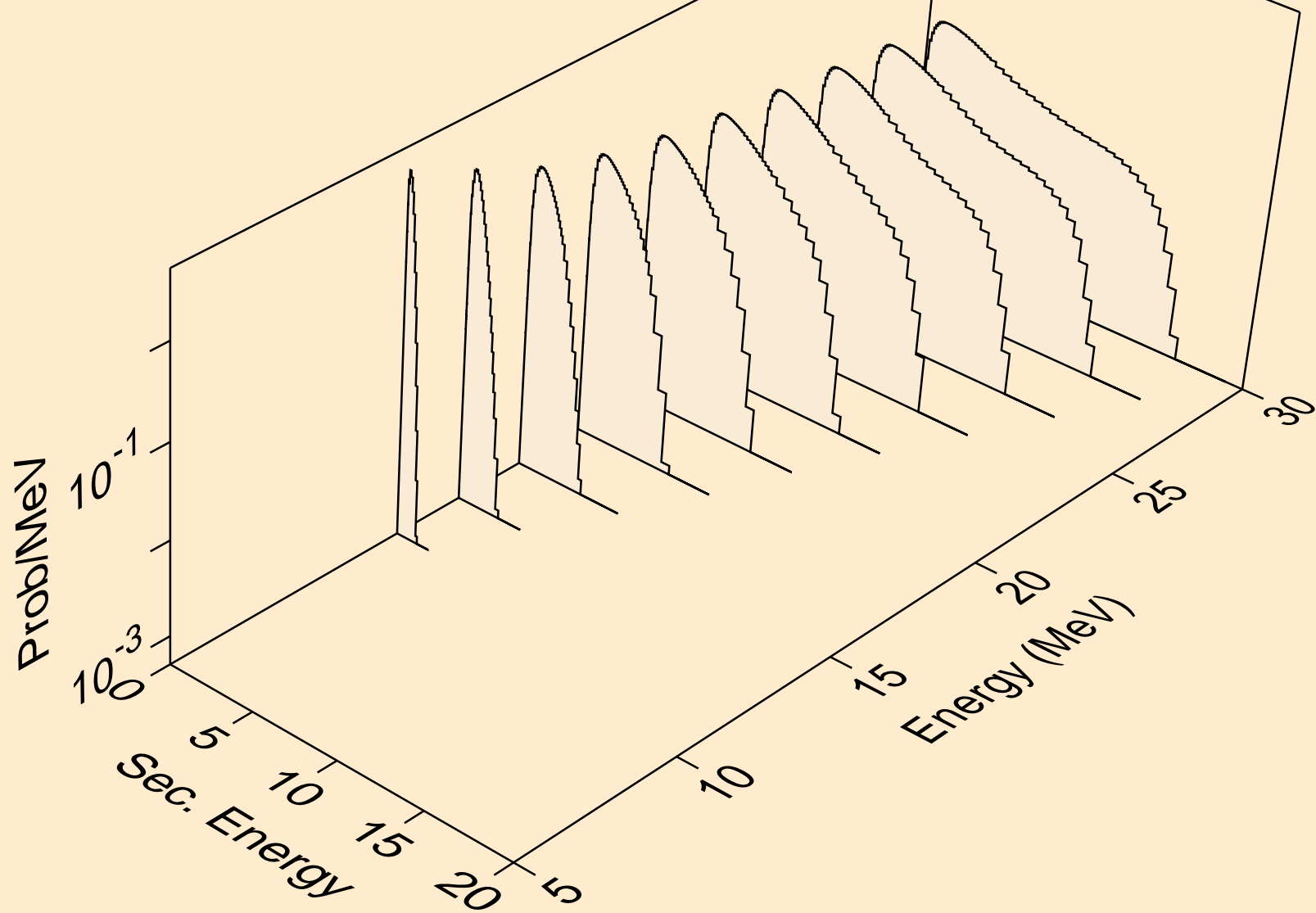

S031 NEUTRON ACER TENDL-2024 LIBRARY; T=0.K
Neutron emission for (n,2n)a

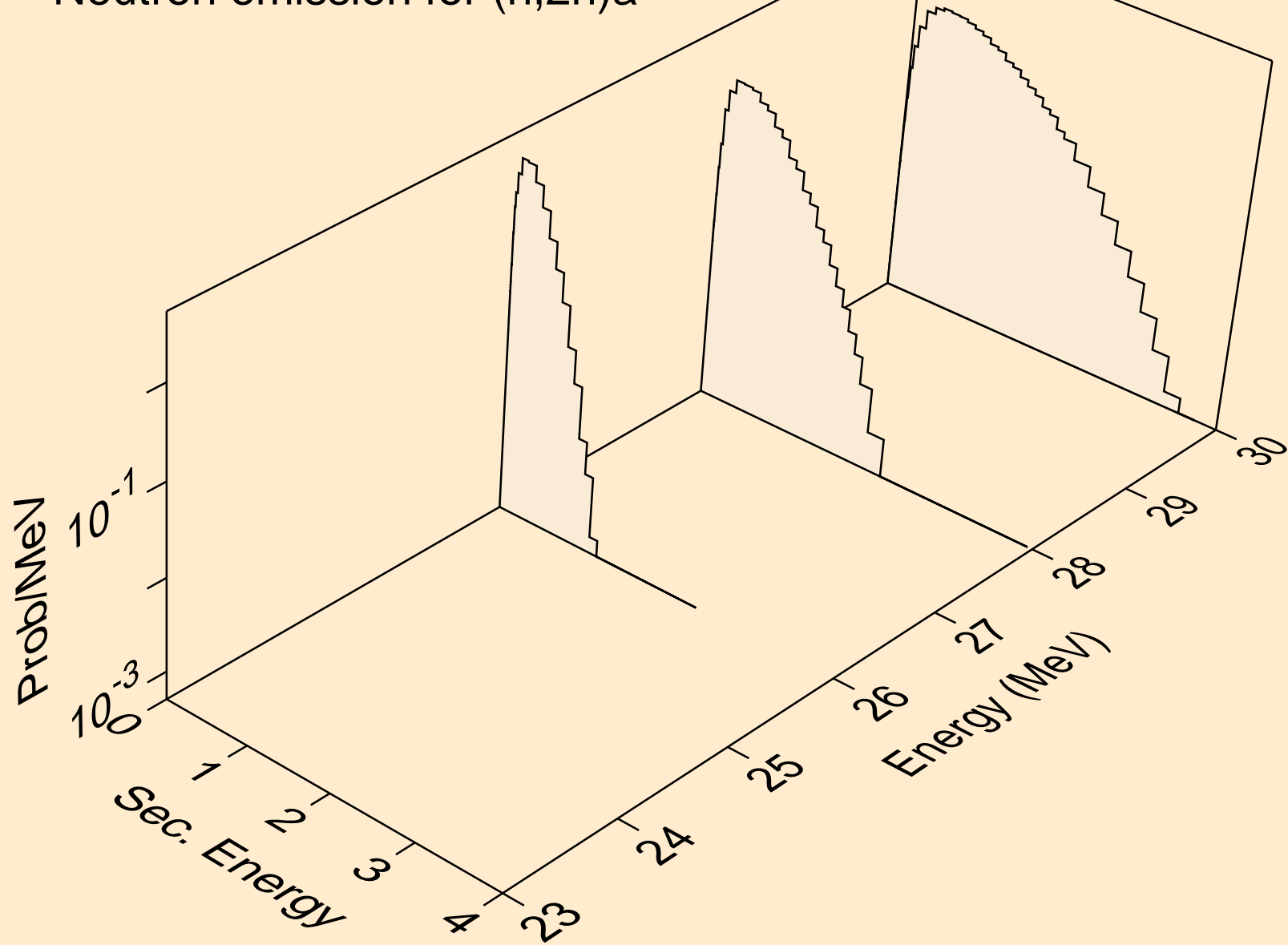

S031 NEUTRON ACER TENDL-2024 LIBRARY; T=0.K
Neutron emission for (n,n*)p

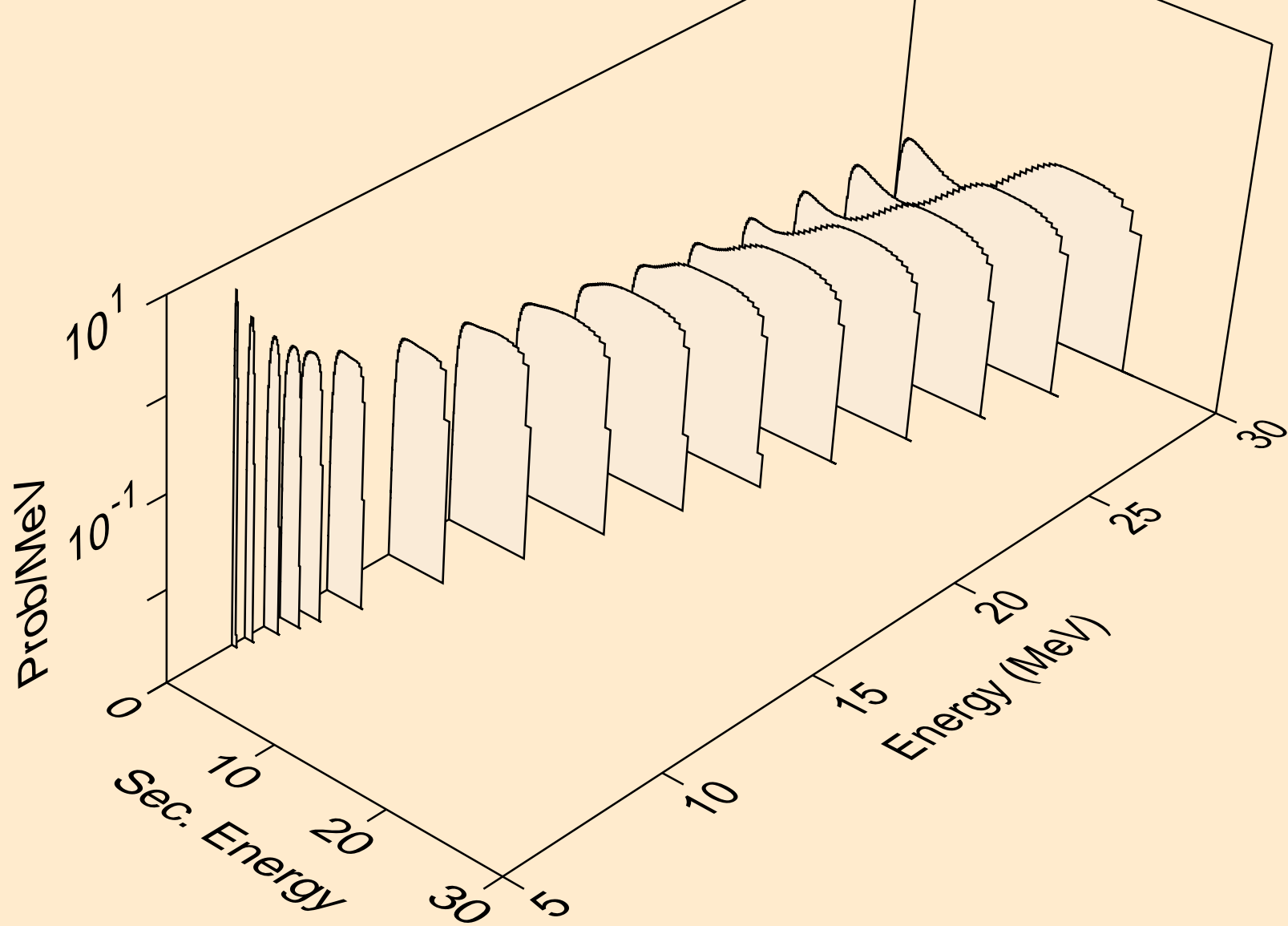

S031 NEUTRON ACER TENDL-2024 LIBRARY; T=0.K
Neutron emission for (n,n*)2a

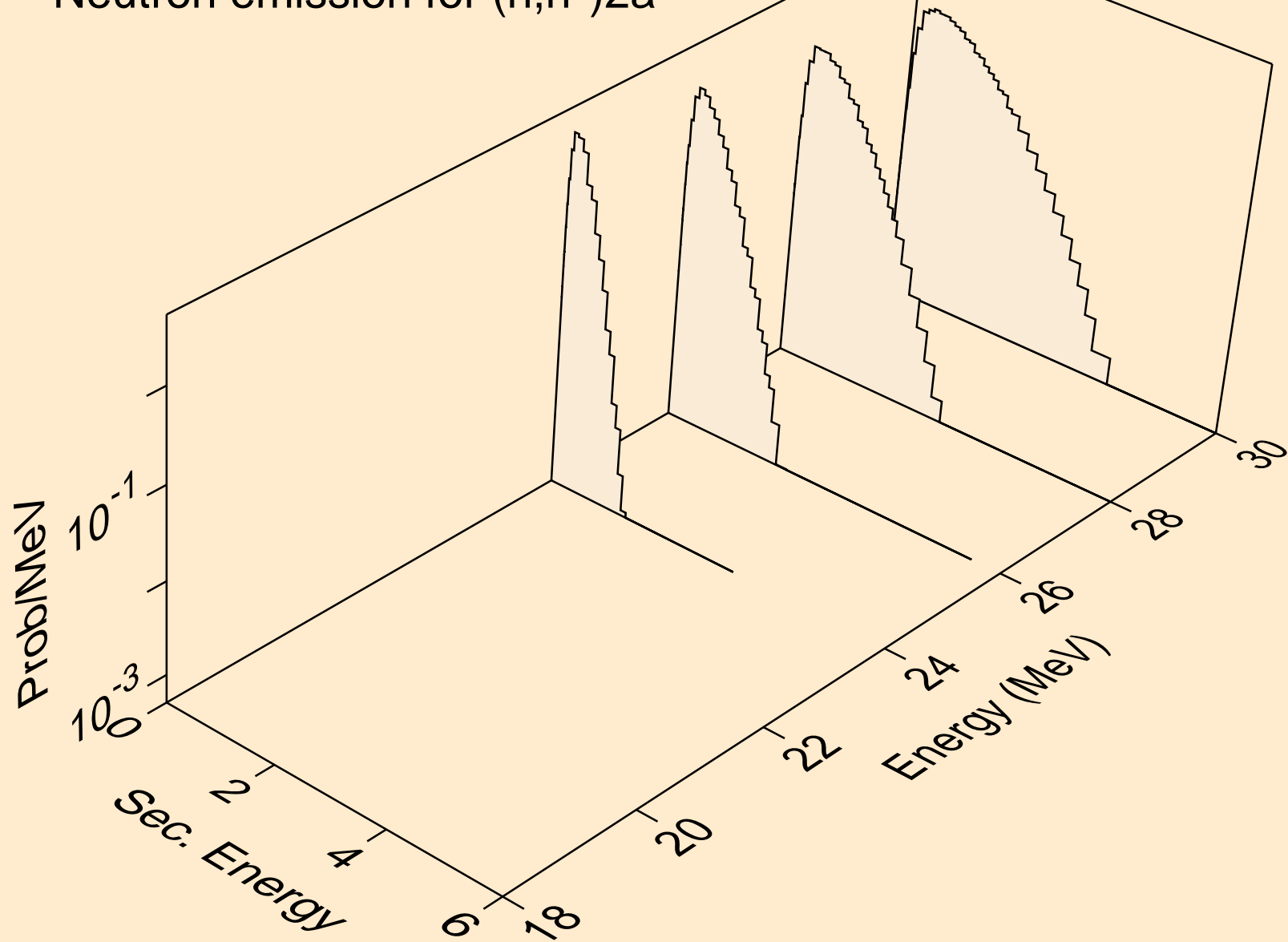

S031 NEUTRON ACER TENDL-2024 LIBRARY; T=0.K
Neutron emission for (n,n*)d

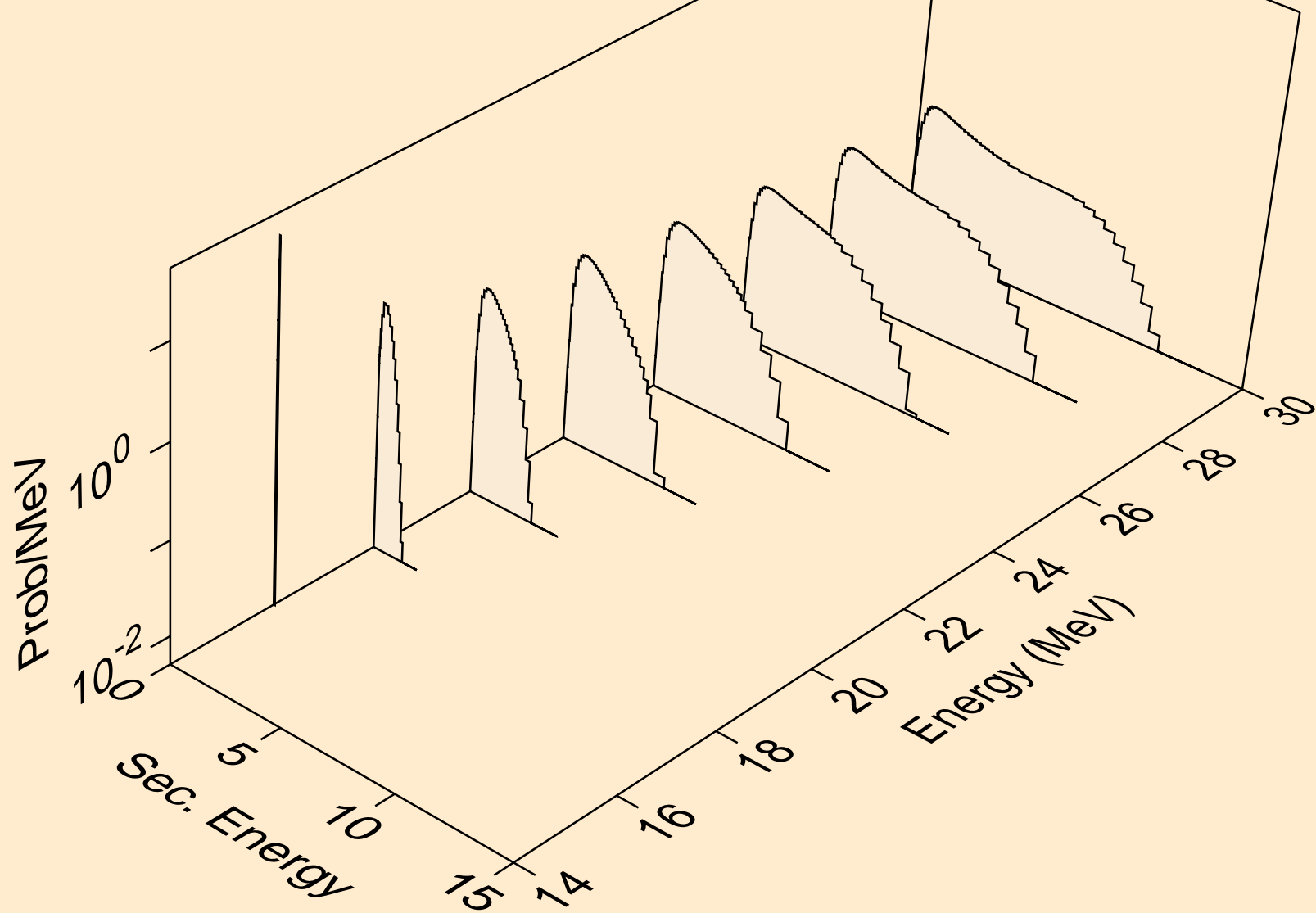

S031 NEUTRON ACER TENDL-2024 LIBRARY; T=0.K
Neutron emission for (n,n*)t

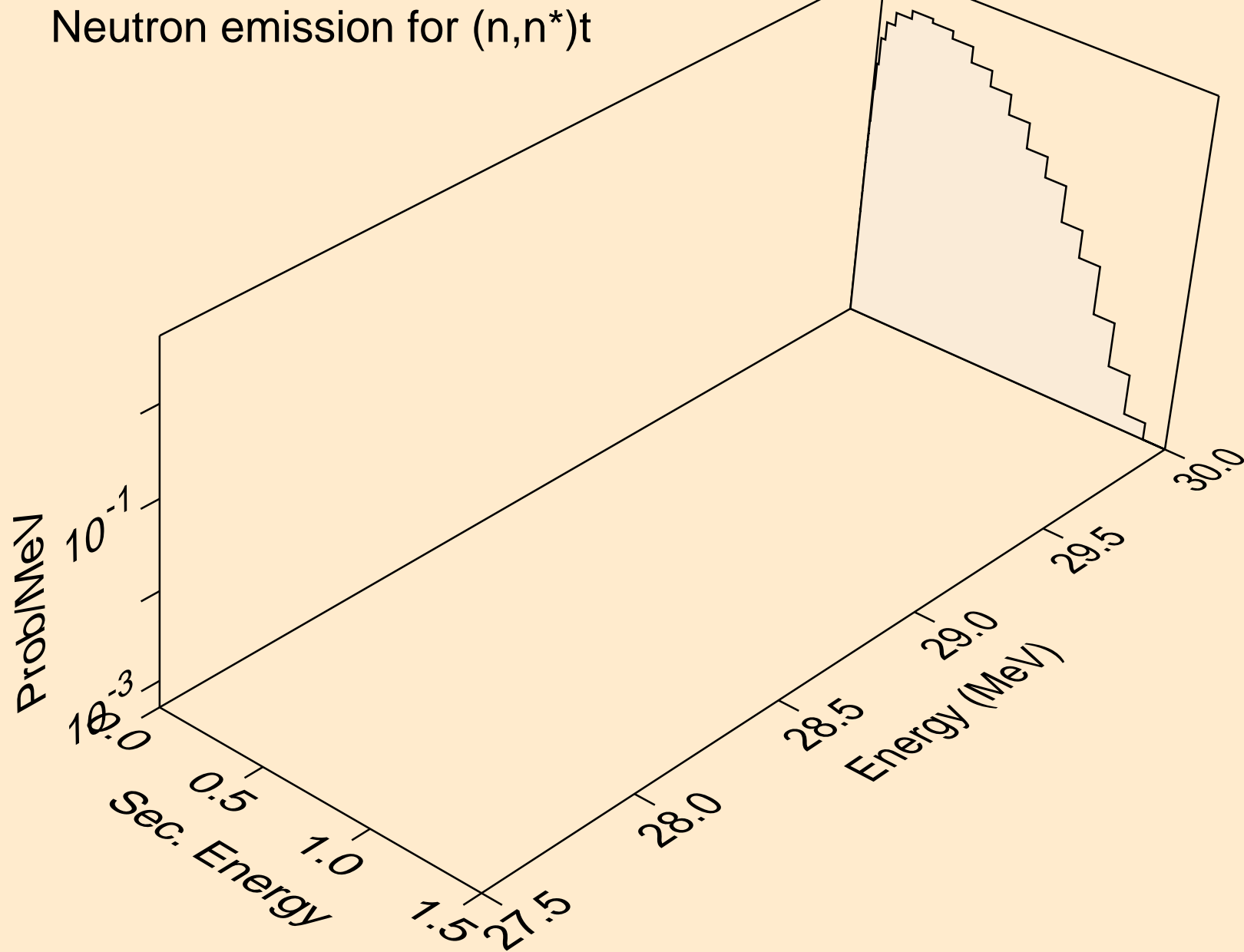

S031 NEUTRON ACER TENDL-2024 LIBRARY; T=0.K
Neutron emission for (n,n*)he3

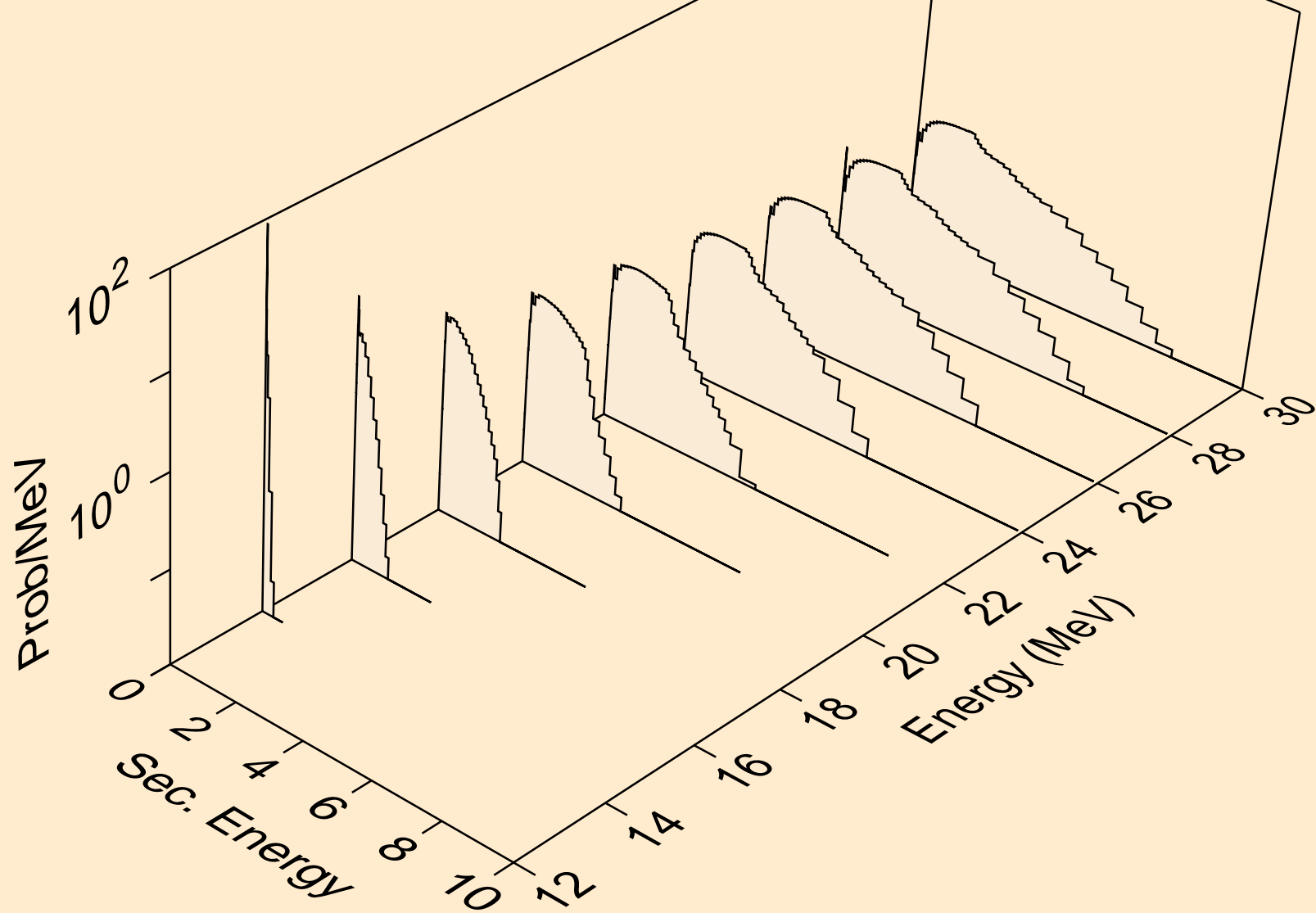

S031 NEUTRON ACER TENDL-2024 LIBRARY; T=0.K
Neutron emission for (n,2np)

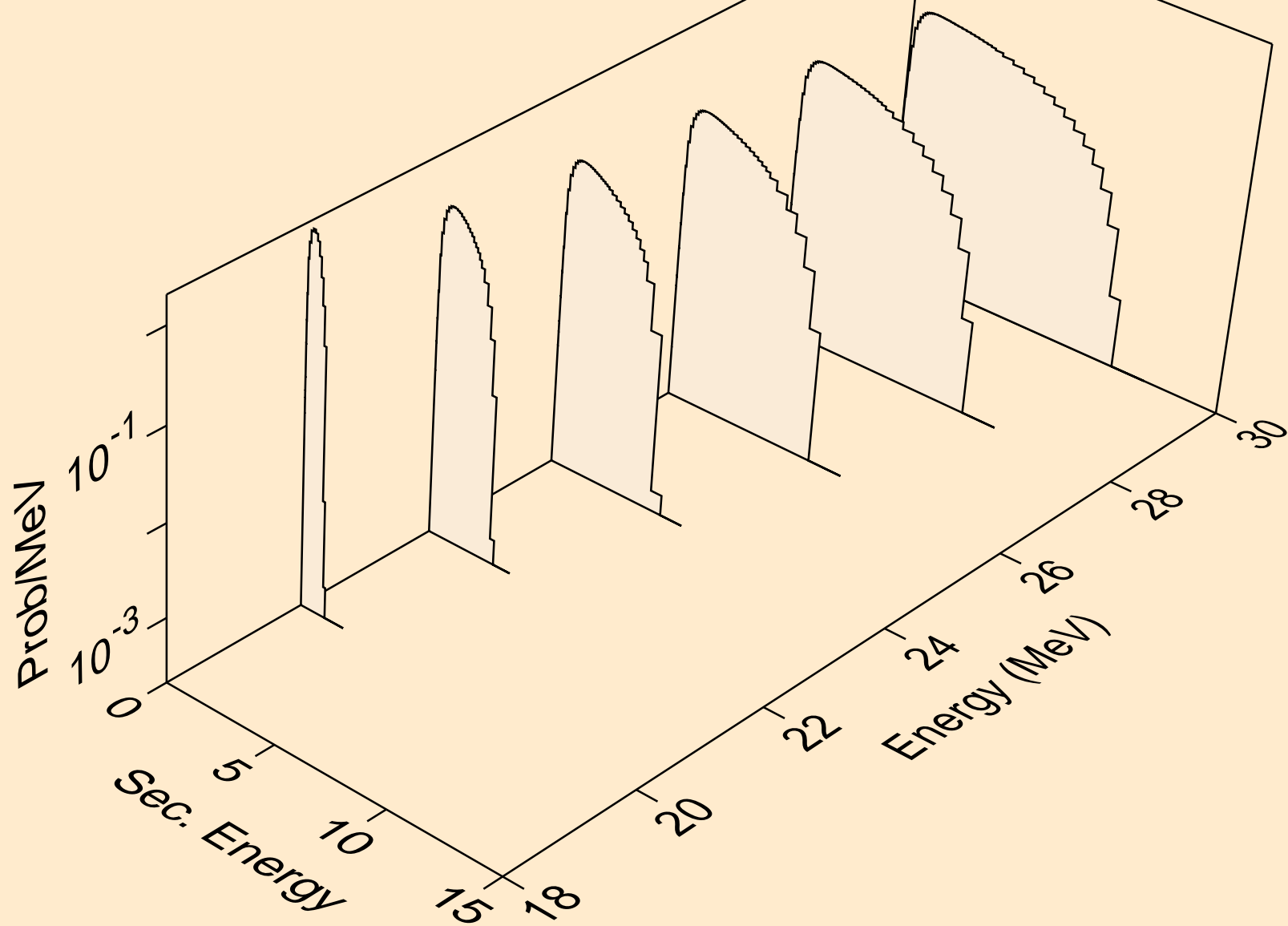

S031 NEUTRON ACER TENDL-2024 LIBRARY; T=0.K
Neutron emission for (n,n2p)

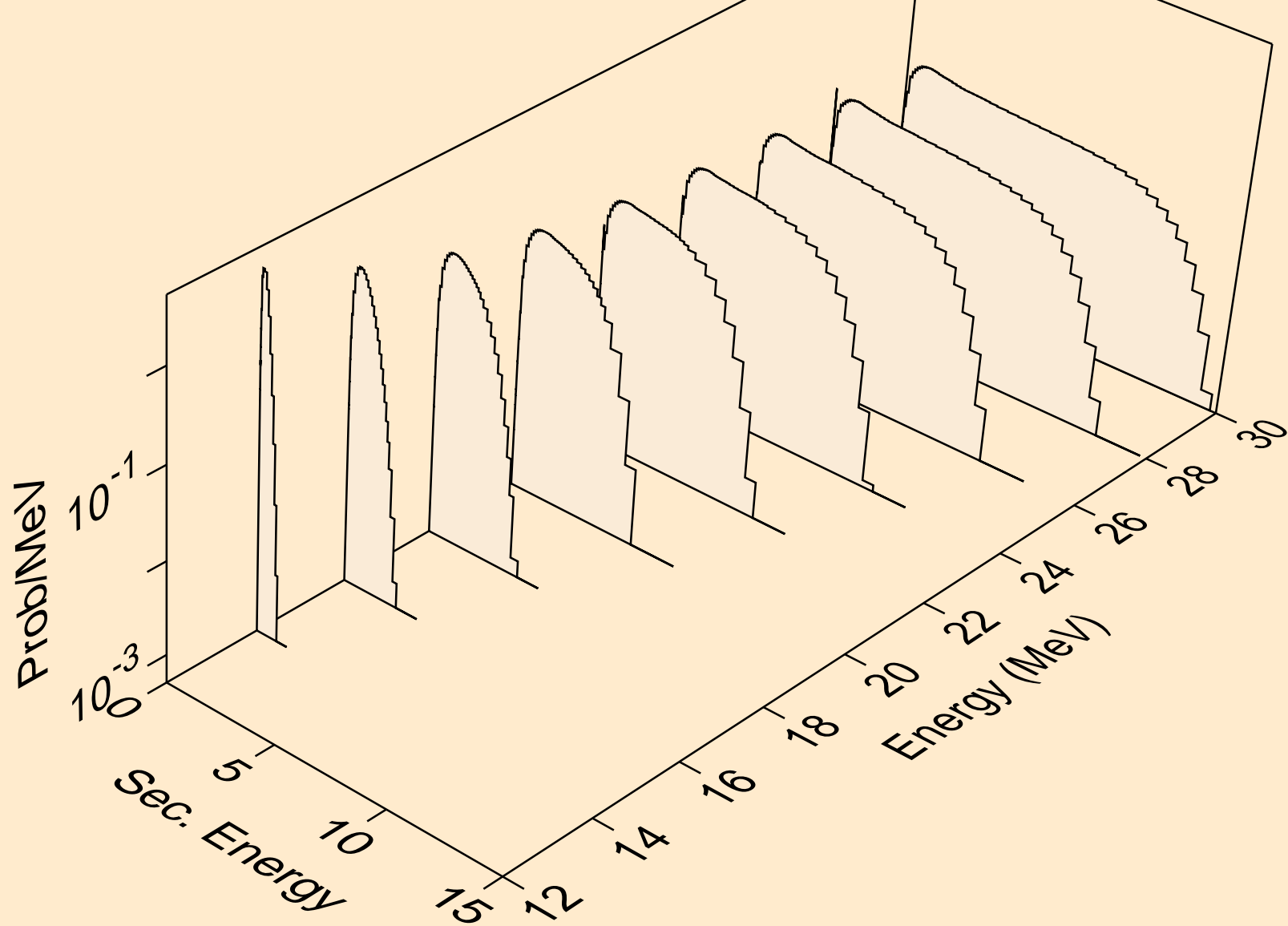

S031 NEUTRON ACER TENDL-2024 LIBRARY; T=0.K
Neutron emission for (n,npa)

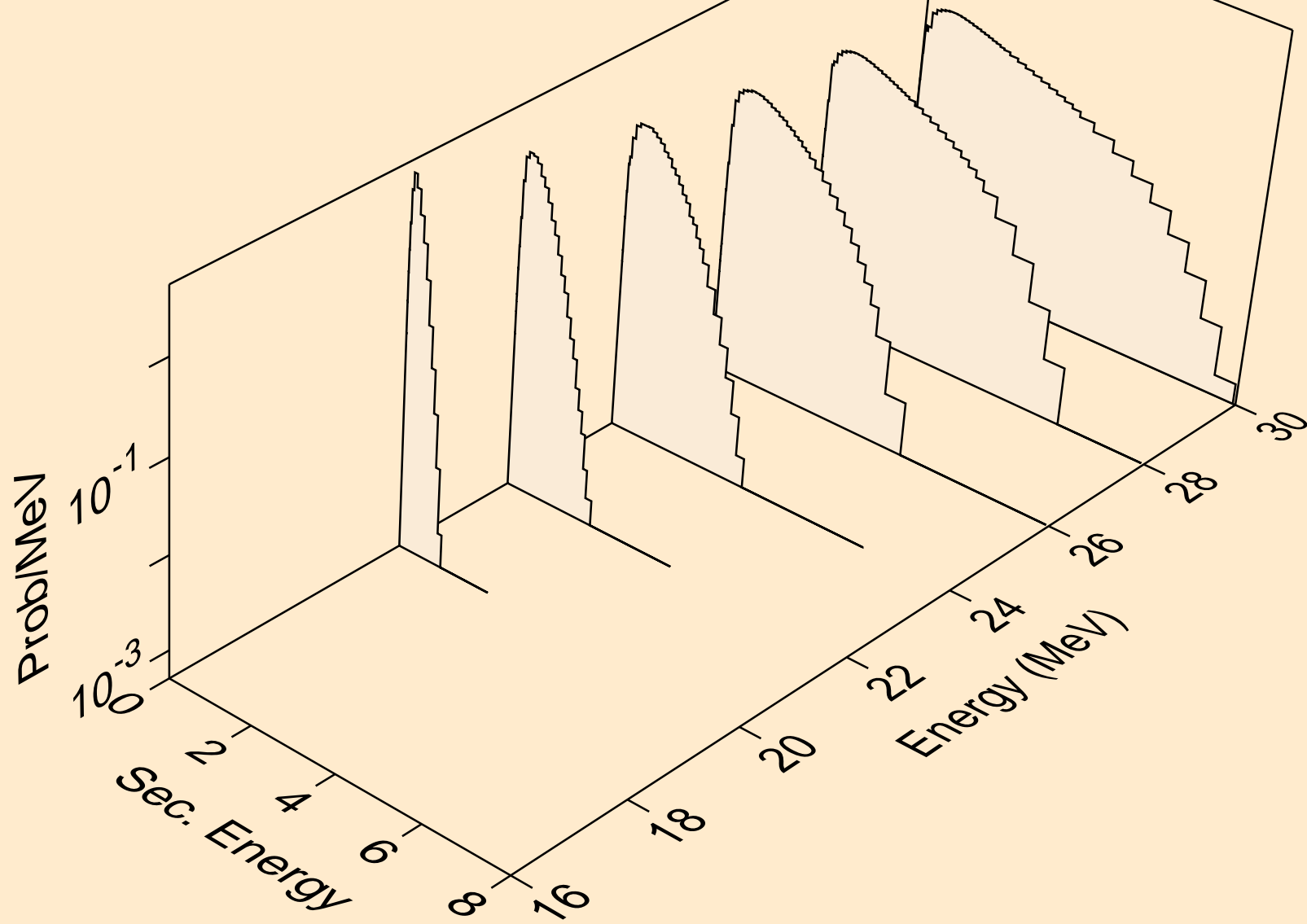

S031 NEUTRON ACER TENDL-2024 LIBRARY; T=0.K
Neutron emission for (n,n*c)

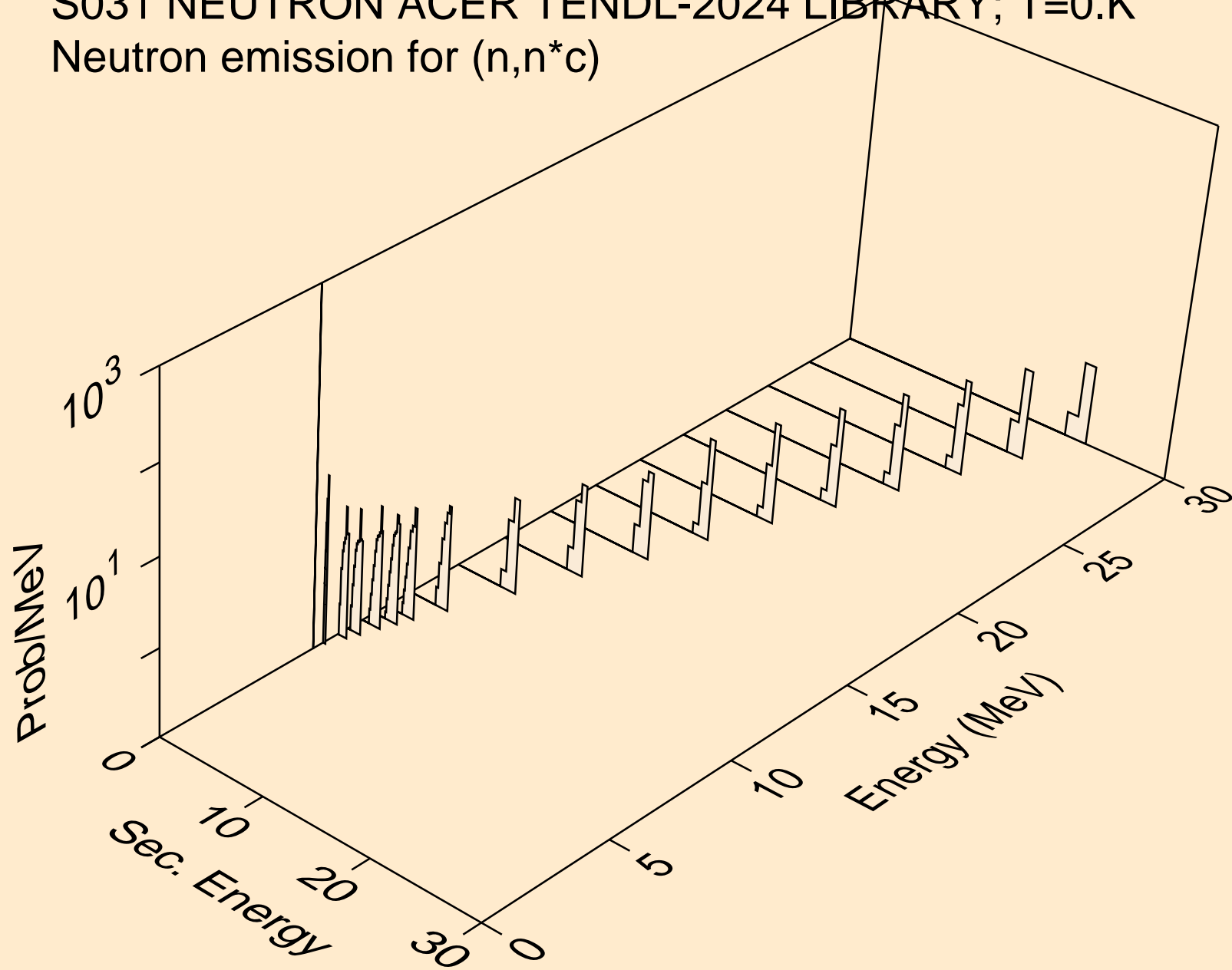

S031 NEUTRON ACER TENDL-2024 LIBRARY; T=0.K
Photon emission for (n,x)

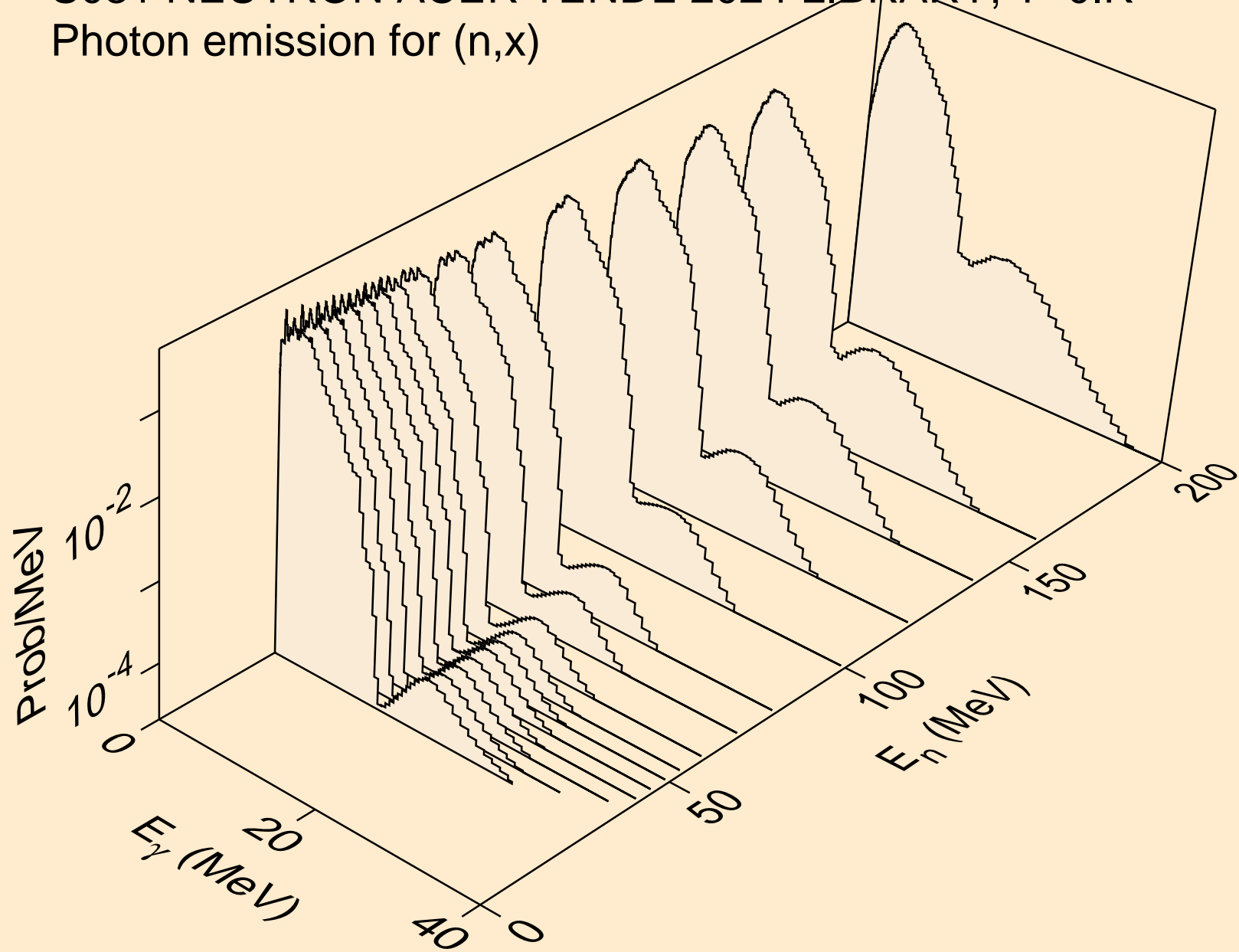

S031 NEUTRON ACER TENDL-2024 LIBRARY; T=0.K
Photon emission for (n,2n)

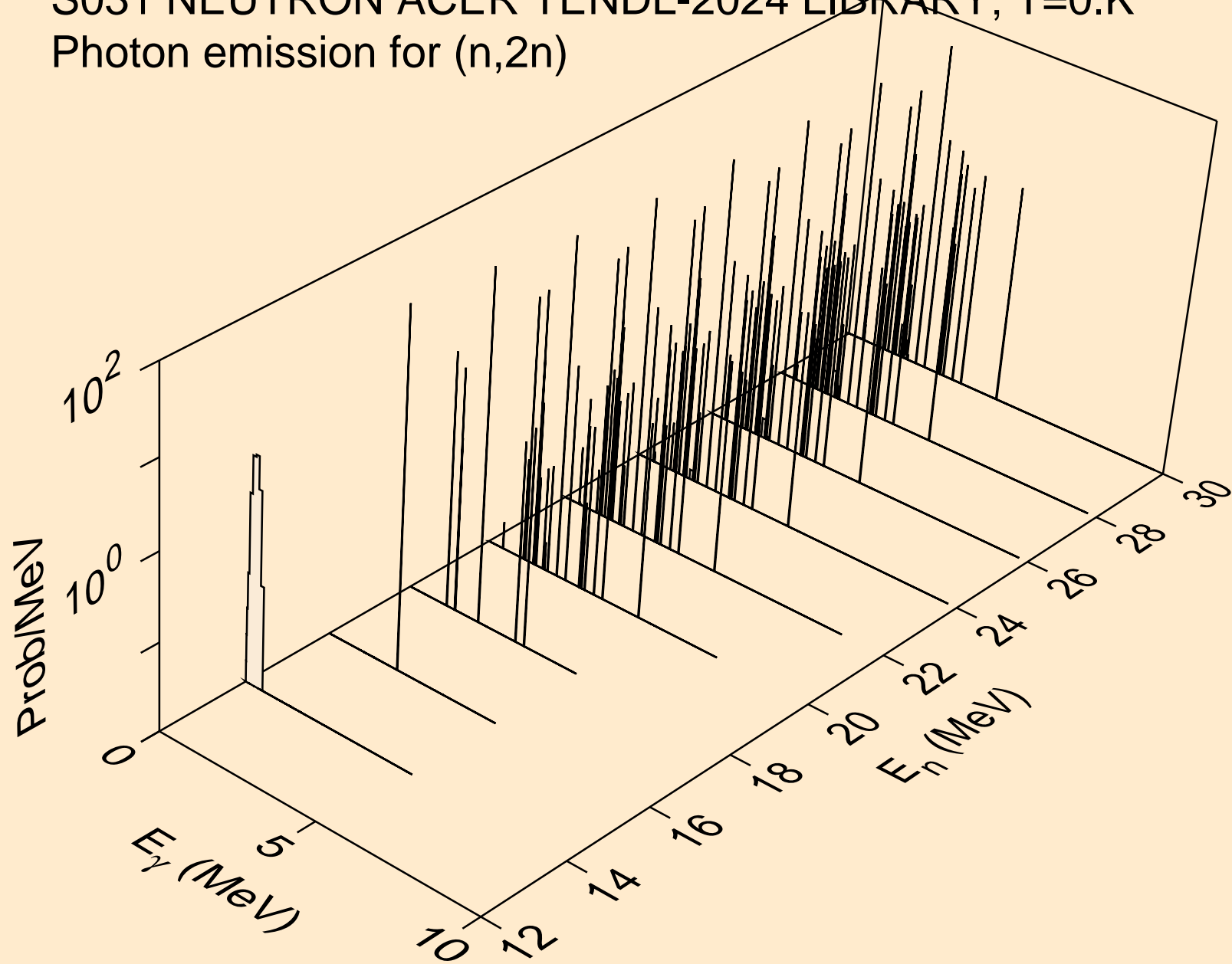

S031 NEUTRON ACER TENDL-2024 LIBRARY; T=0.K
Photon emission for (n,n*)a

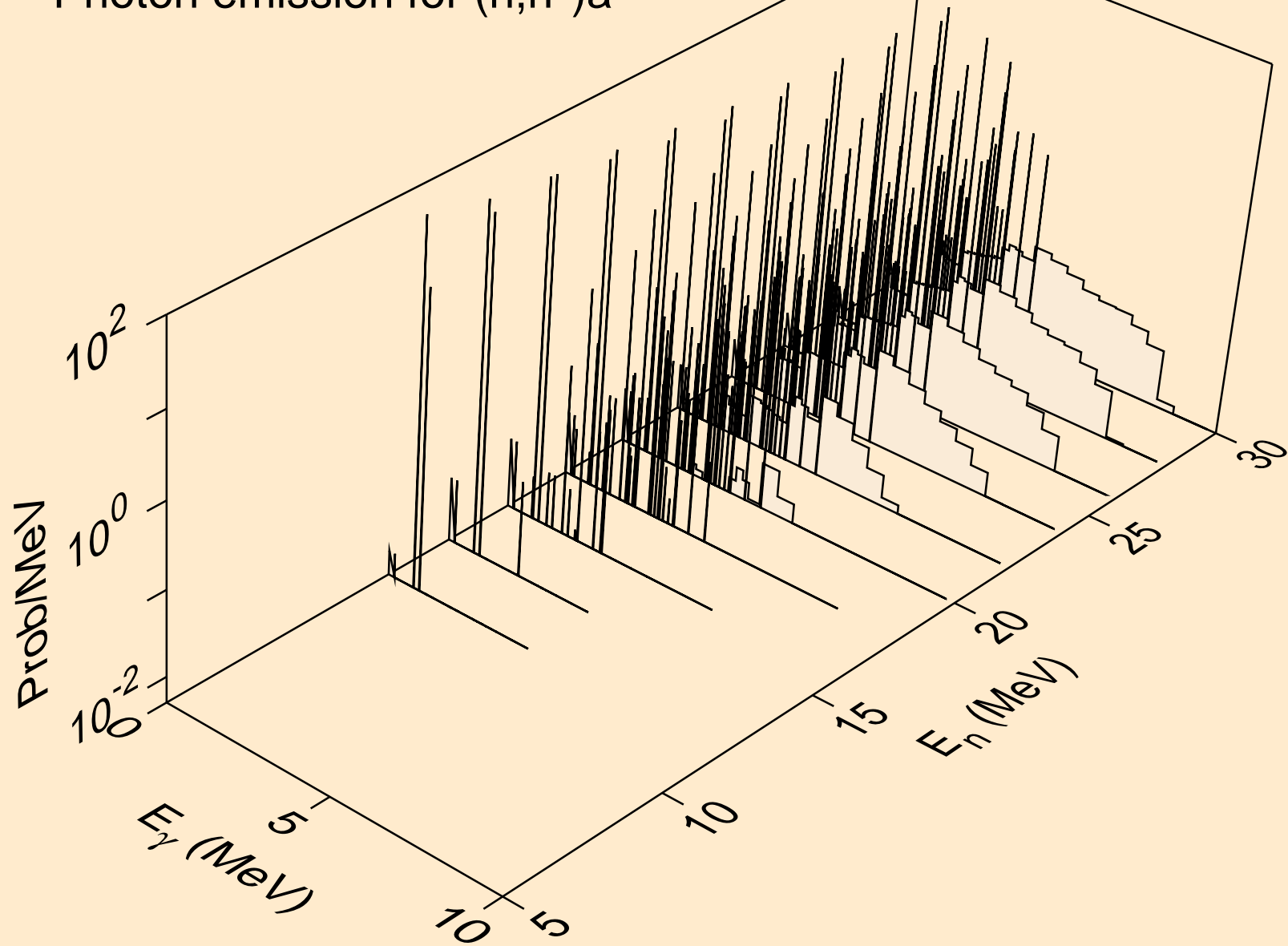

S031 NEUTRON ACER TENDL-2024 LIBRARY; T=0.K
Photon emission for (n,2n)a

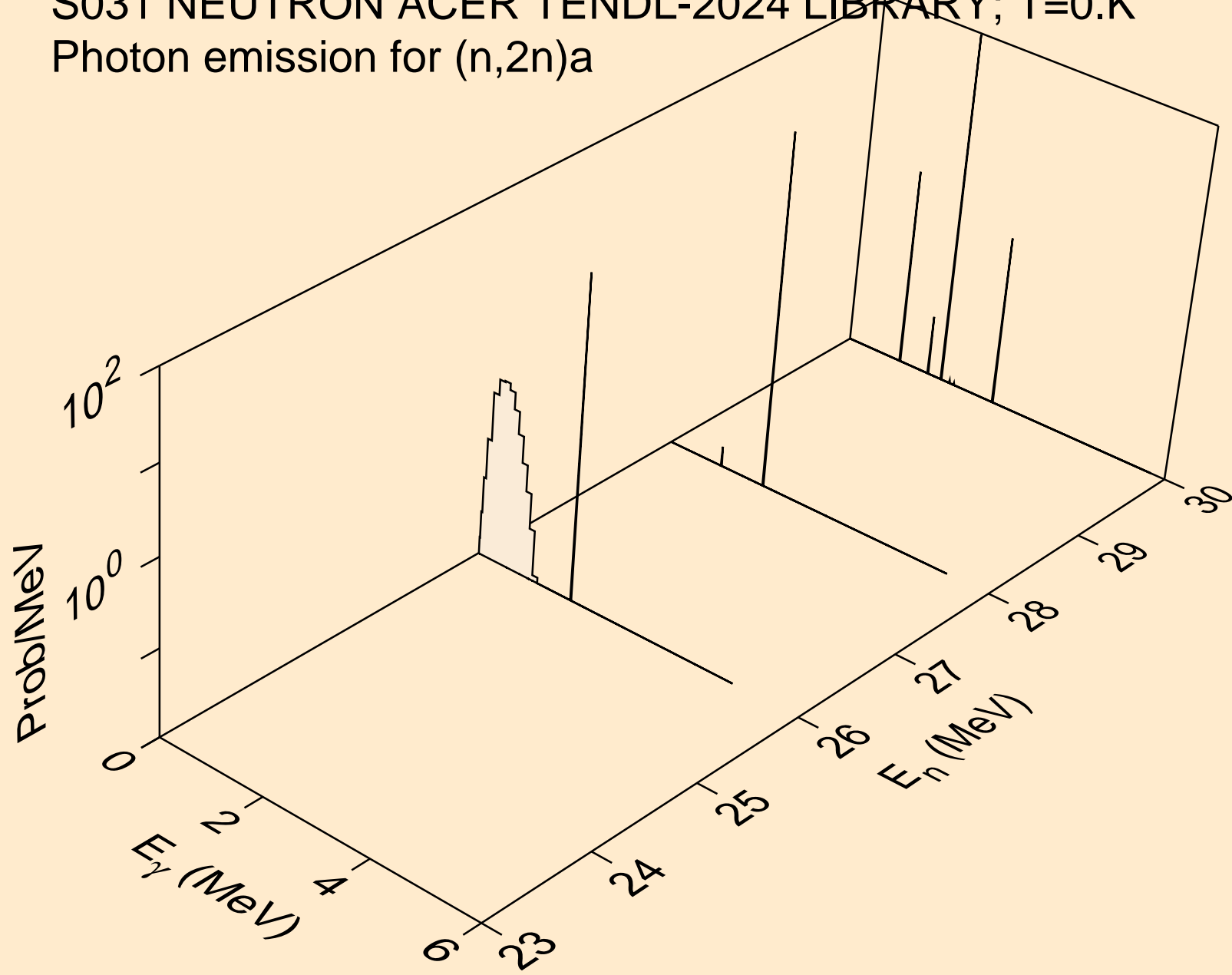

S031 NEUTRON ACER TENDL-2024 LIBRARY; T=0.K
Photon emission for (n,n*)p

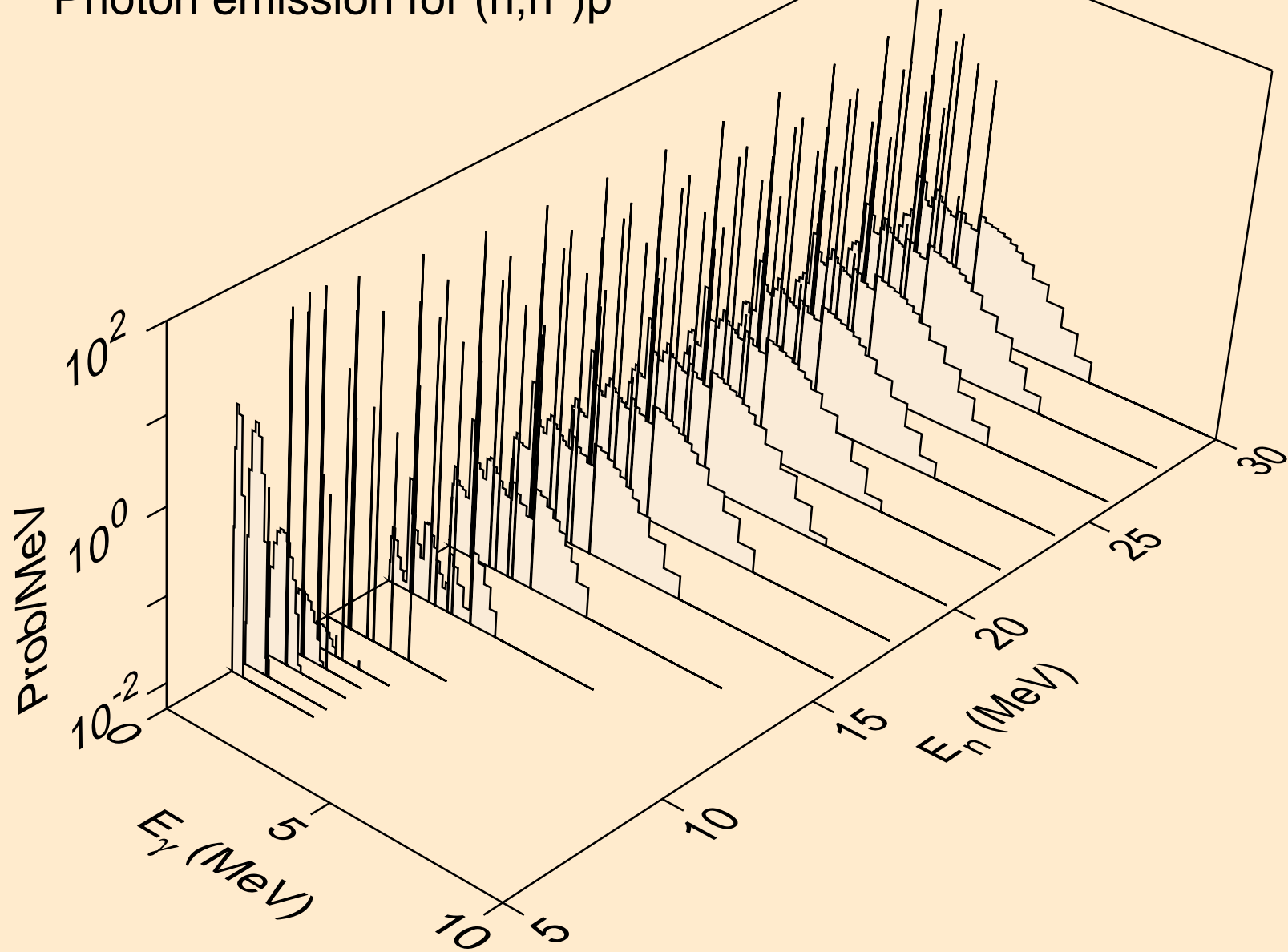

S031 NEUTRON ACER TENDL-2024 LIBRARY; T=0.K
Photon emission for (n,n*)2a

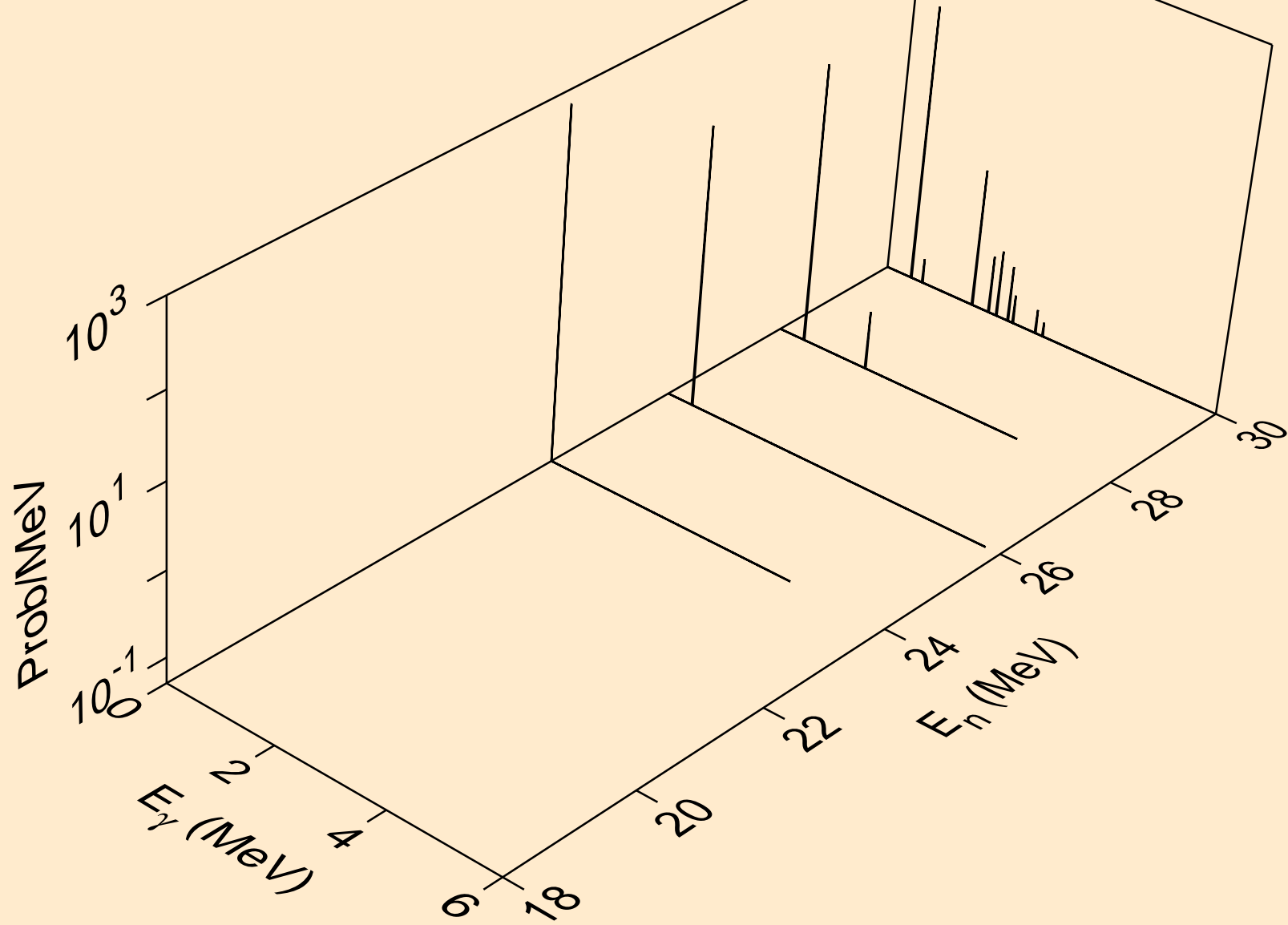

S031 NEUTRON ACER TENDL-2024 LIBRARY; T=0.K
Photon emission for (n,n*)d

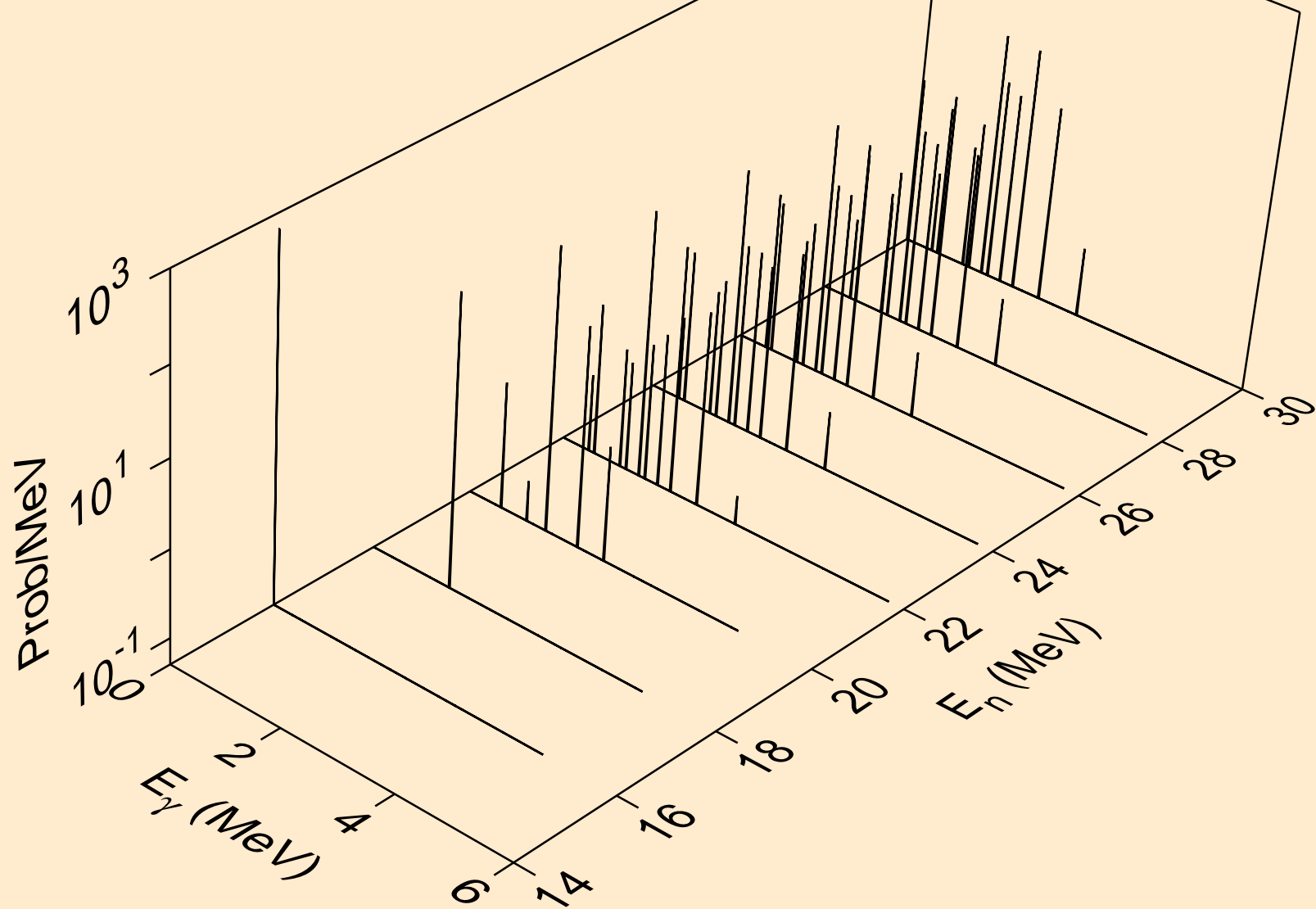

S031 NEUTRON ACER TENDL-2024 LIBRARY; T=0.K
Photon emission for (n,n*)t

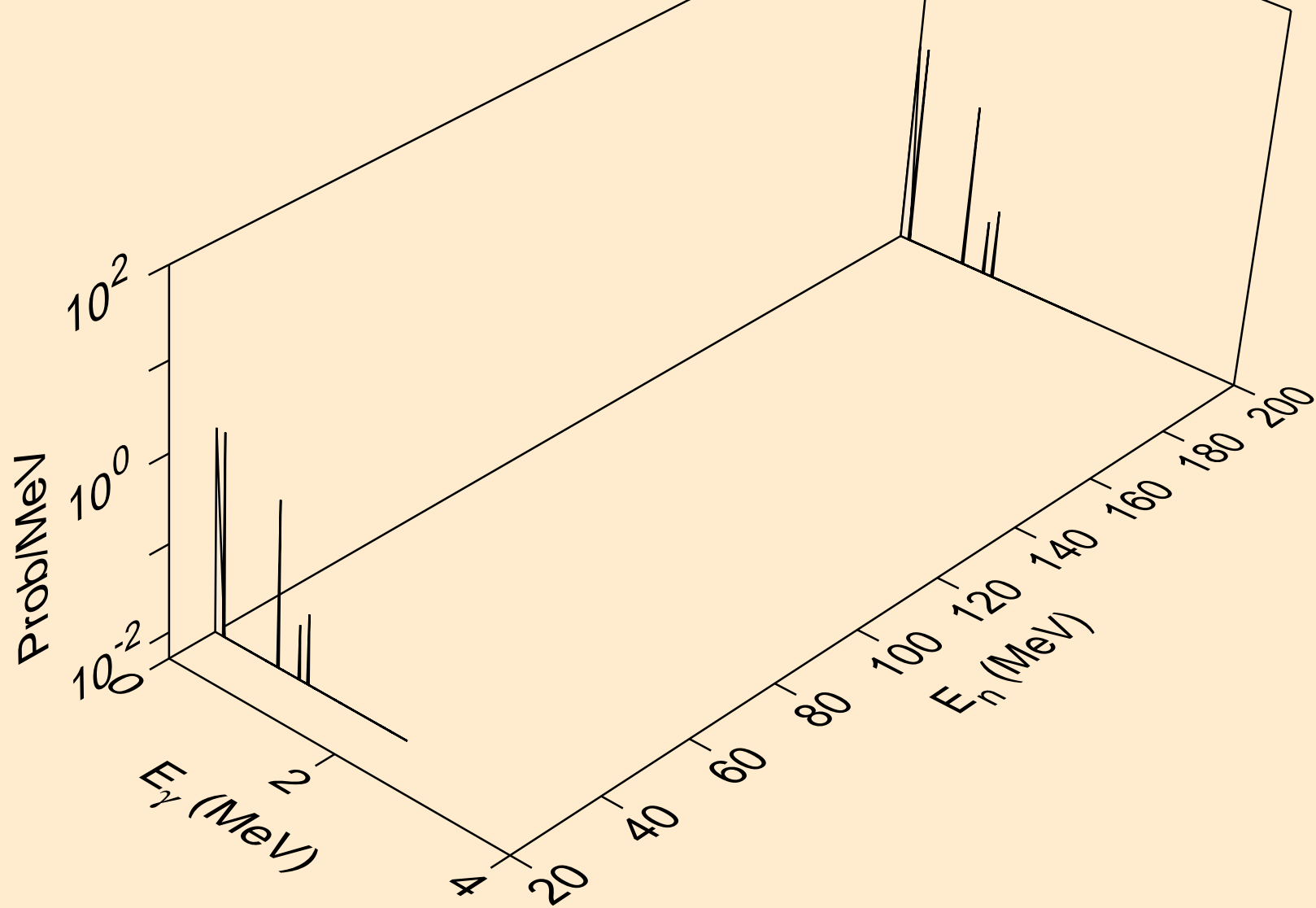

S031 NEUTRON ACER TENDL-2024 LIBRARY; T=0.K
Photon emission for (n,n*)he3

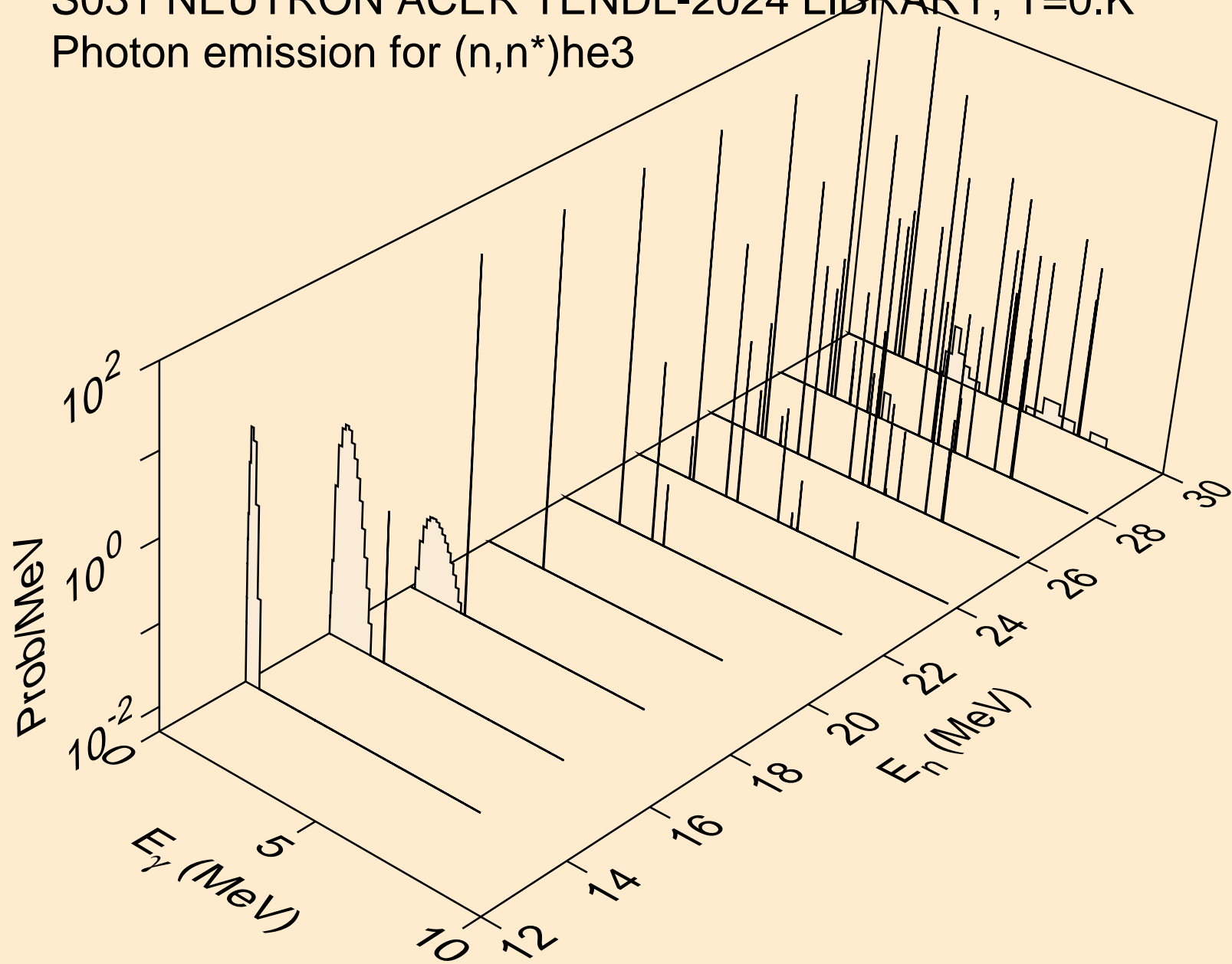

S031 NEUTRON ACER TENDL-2024 LIBRARY; T=0.K
Photon emission for (n,2np)

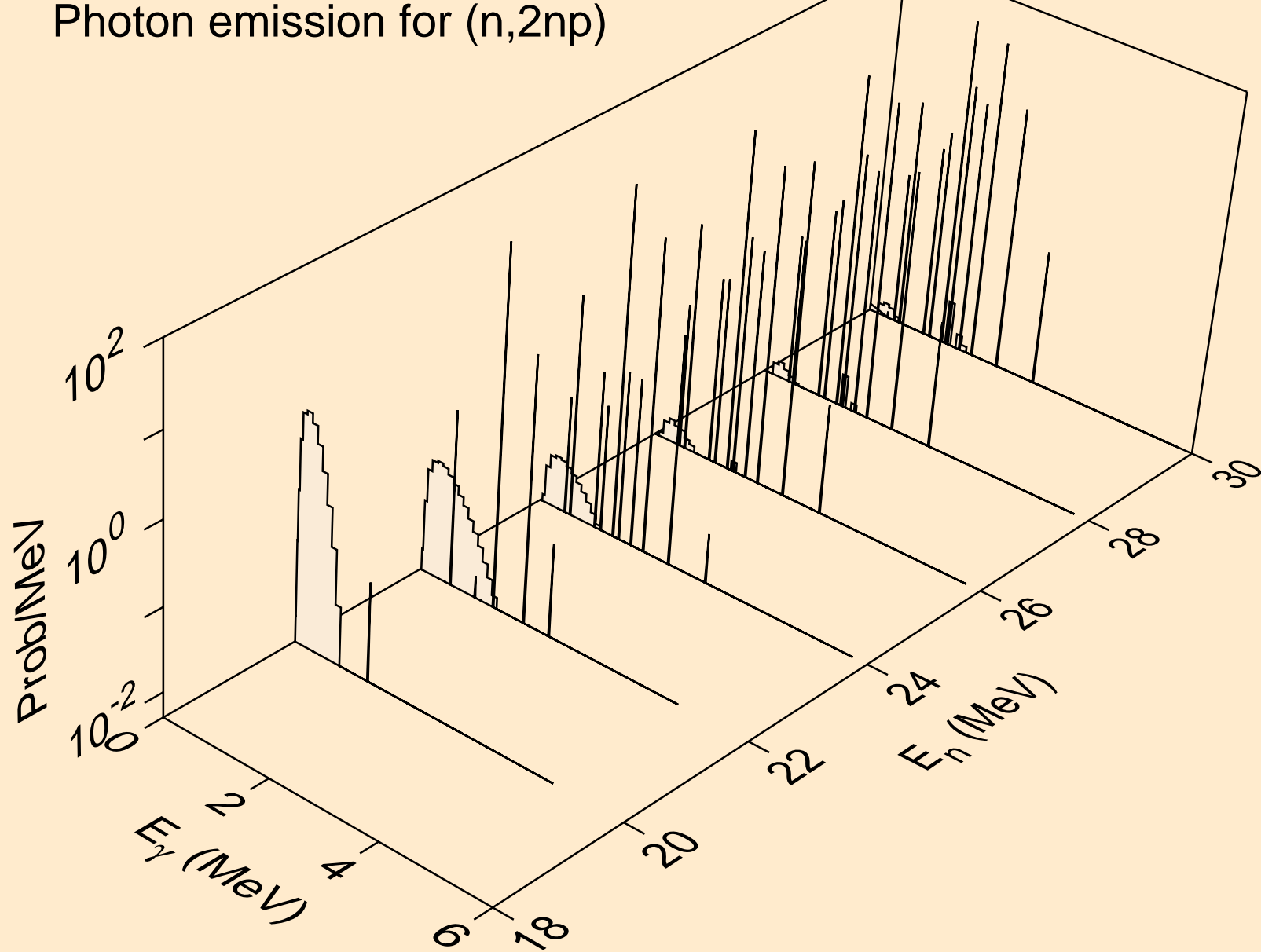

S031 NEUTRON ACER TENDL-2024 LIBRARY; T=0.K
Photon emission for (n,n2p)

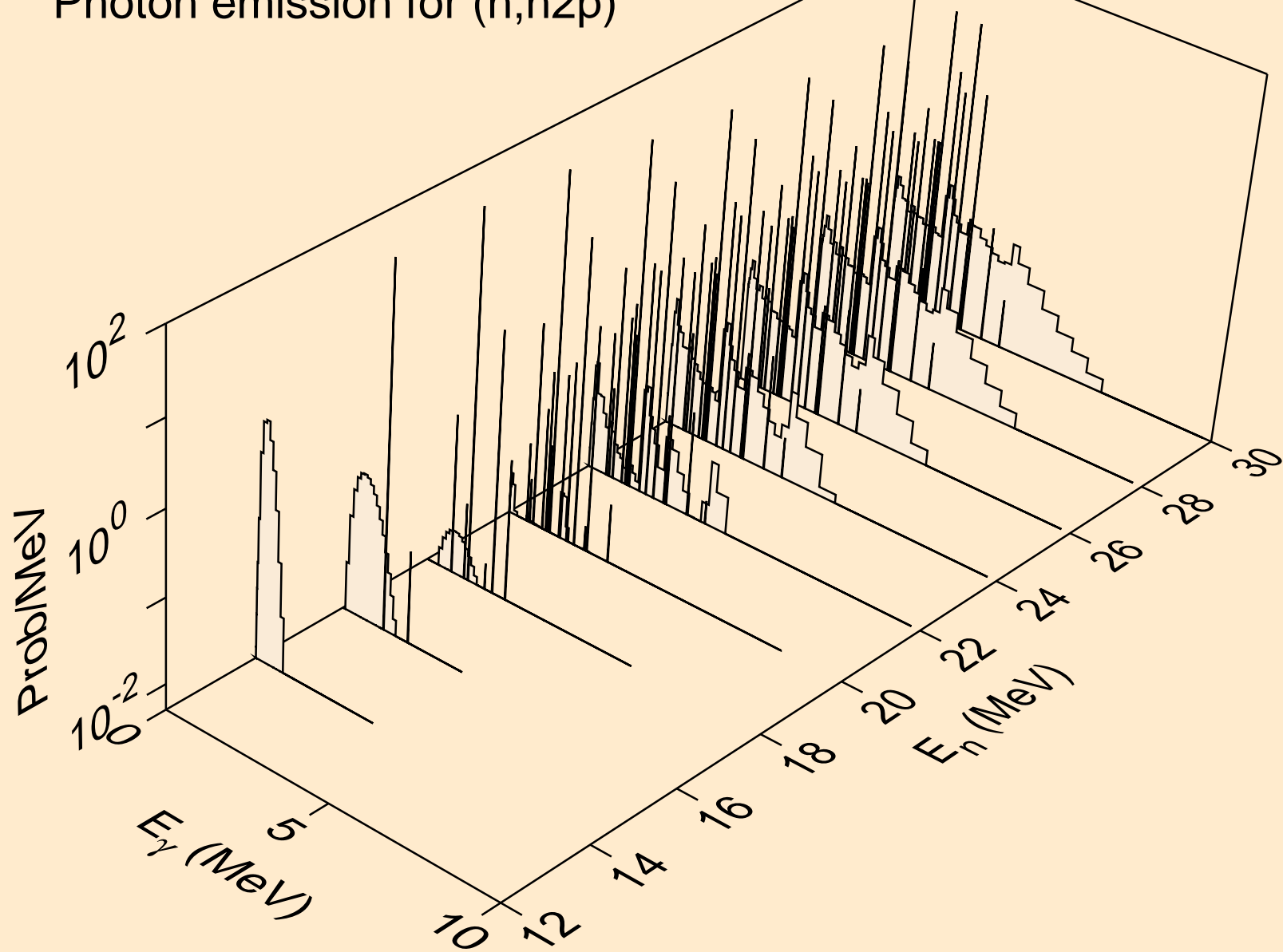

S031 NEUTRON ACER TENDL-2024 LIBRARY; T=0.K
Photon emission for (n,npa)

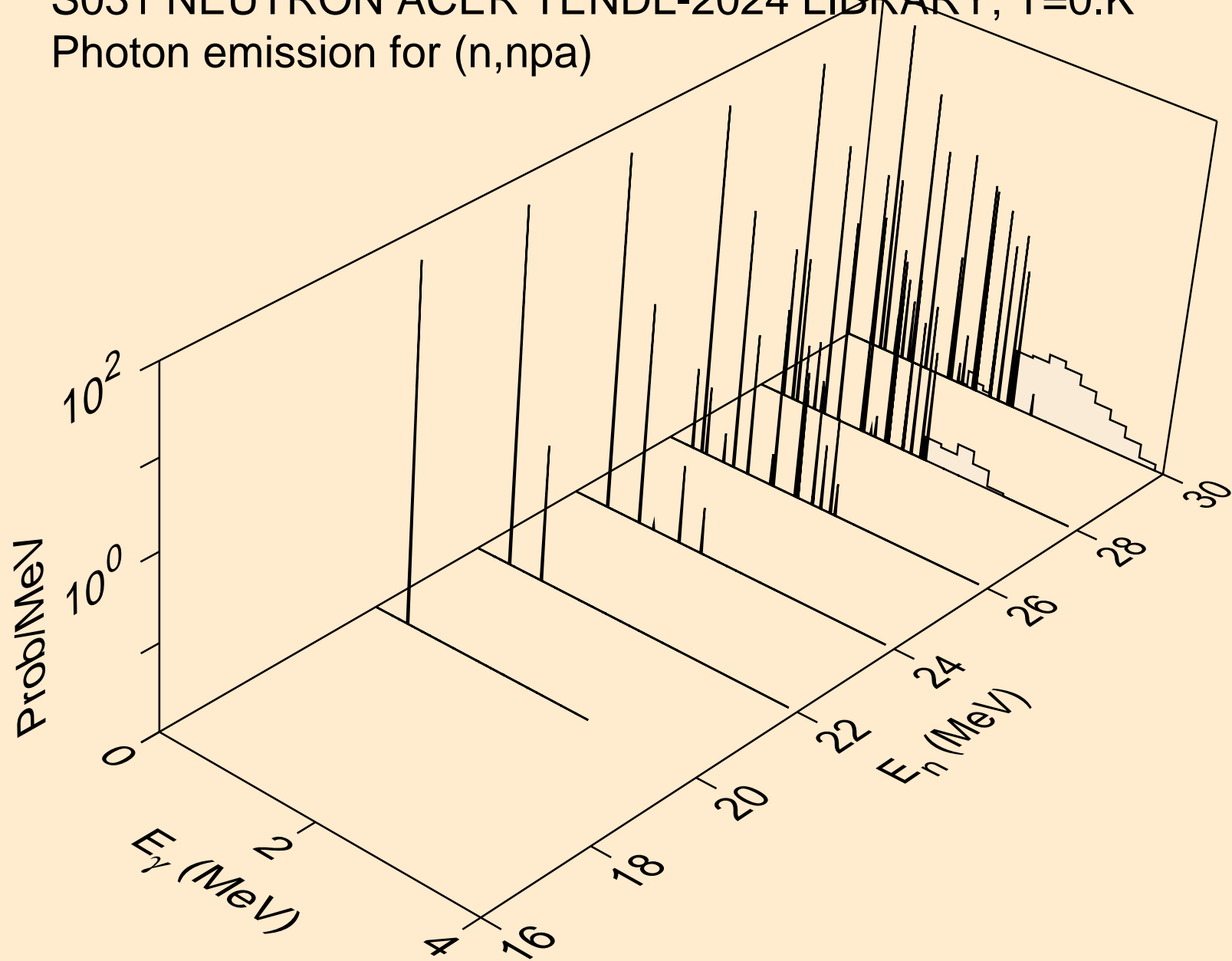

S031 NEUTRON ACER TENDL-2024 LIBRARY; T=0.K
Photon emission for (n,n*c)

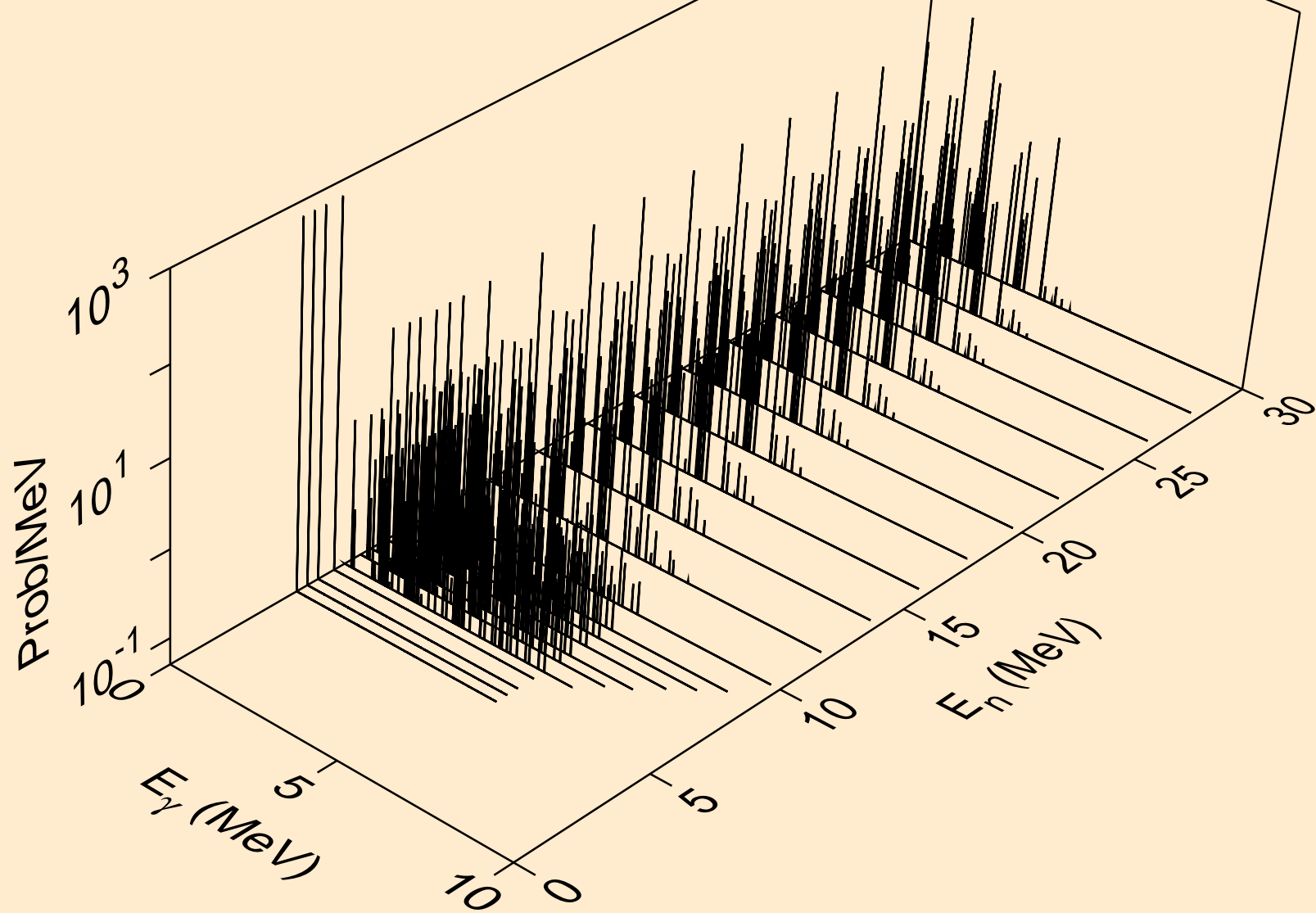

S031 NEUTRON ACER TENDL-2024 LIBRARY; T=0.K
Photon emission for (n,gma)

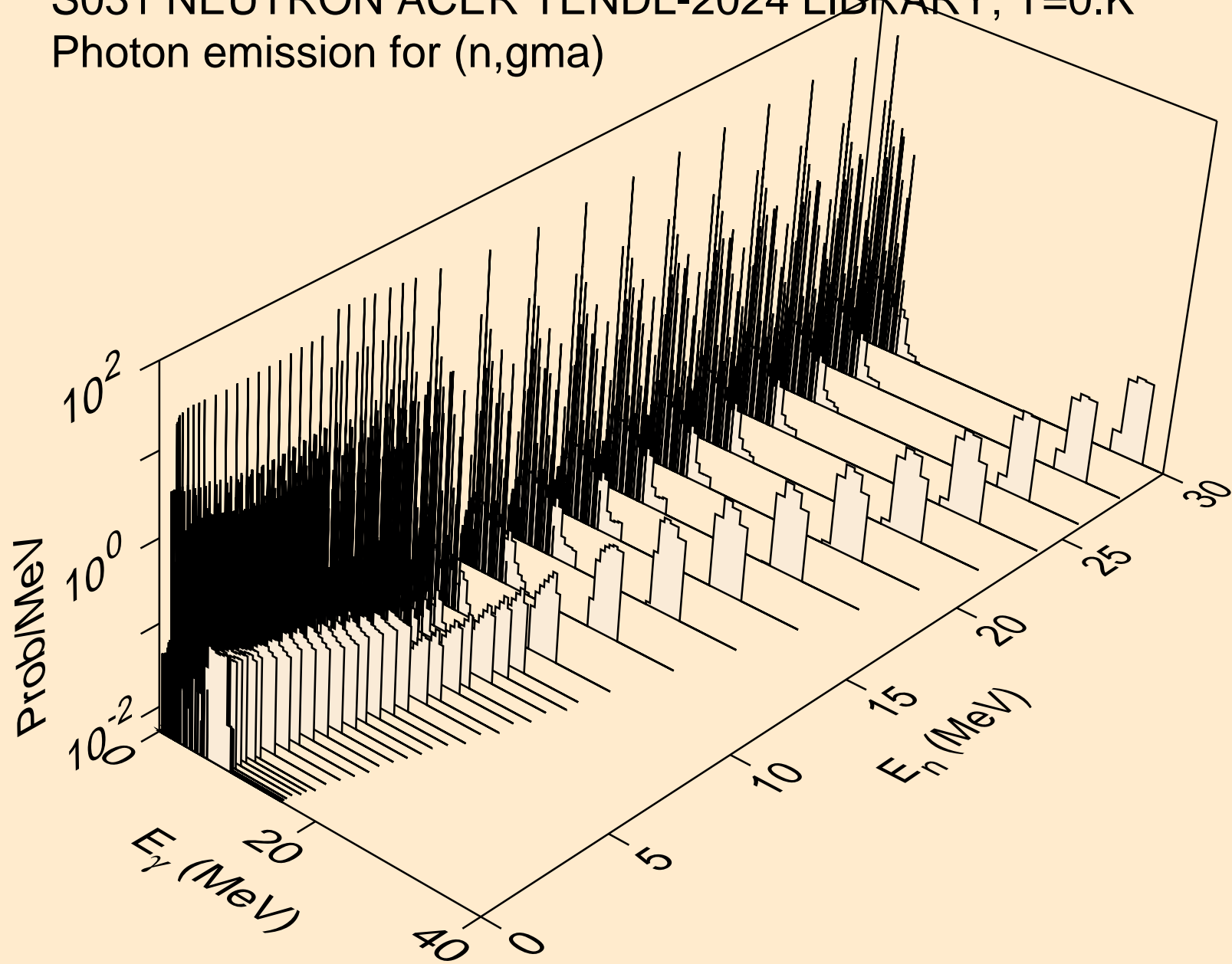

S031 NEUTRON ACER TENDL-2024 LIBRARY; T=0.K
Photon emission for (n,p)

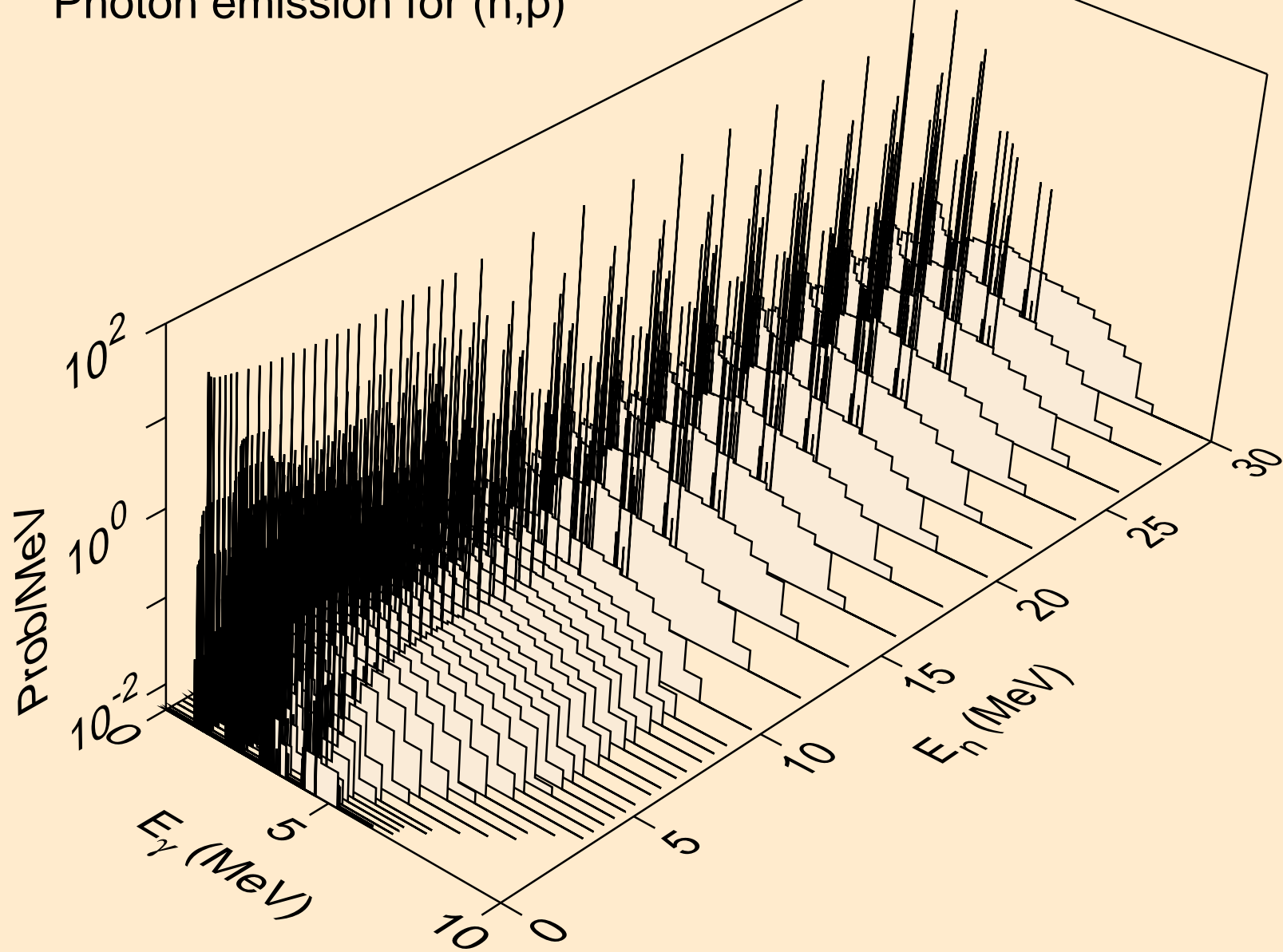

S031 NEUTRON ACER TENDL-2024 LIBRARY; T=0.K
Photon emission for (n,d)

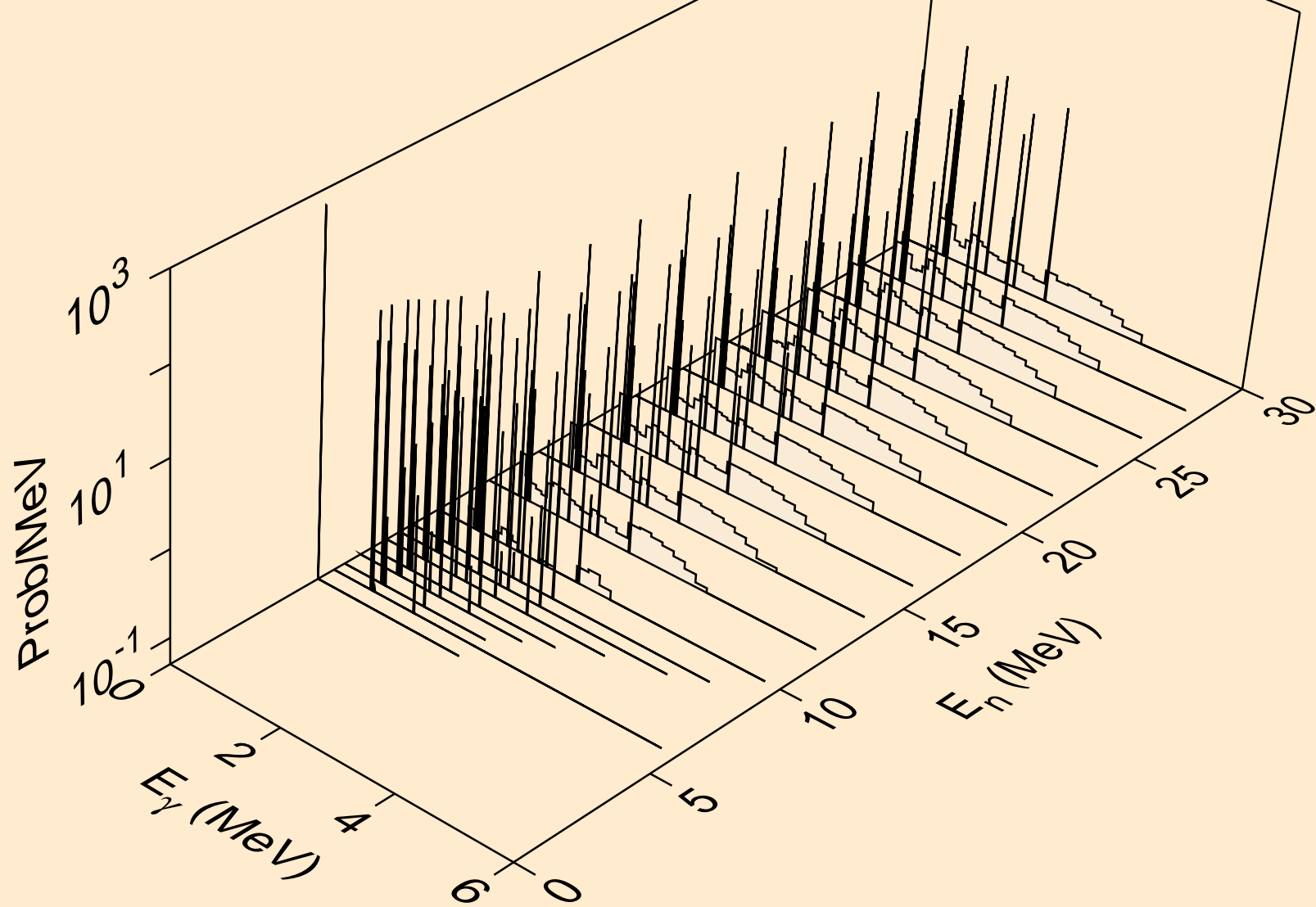

S031 NEUTRON ACER TENDL-2024 LIBRARY; T=0.K
Photon emission for (n,t)

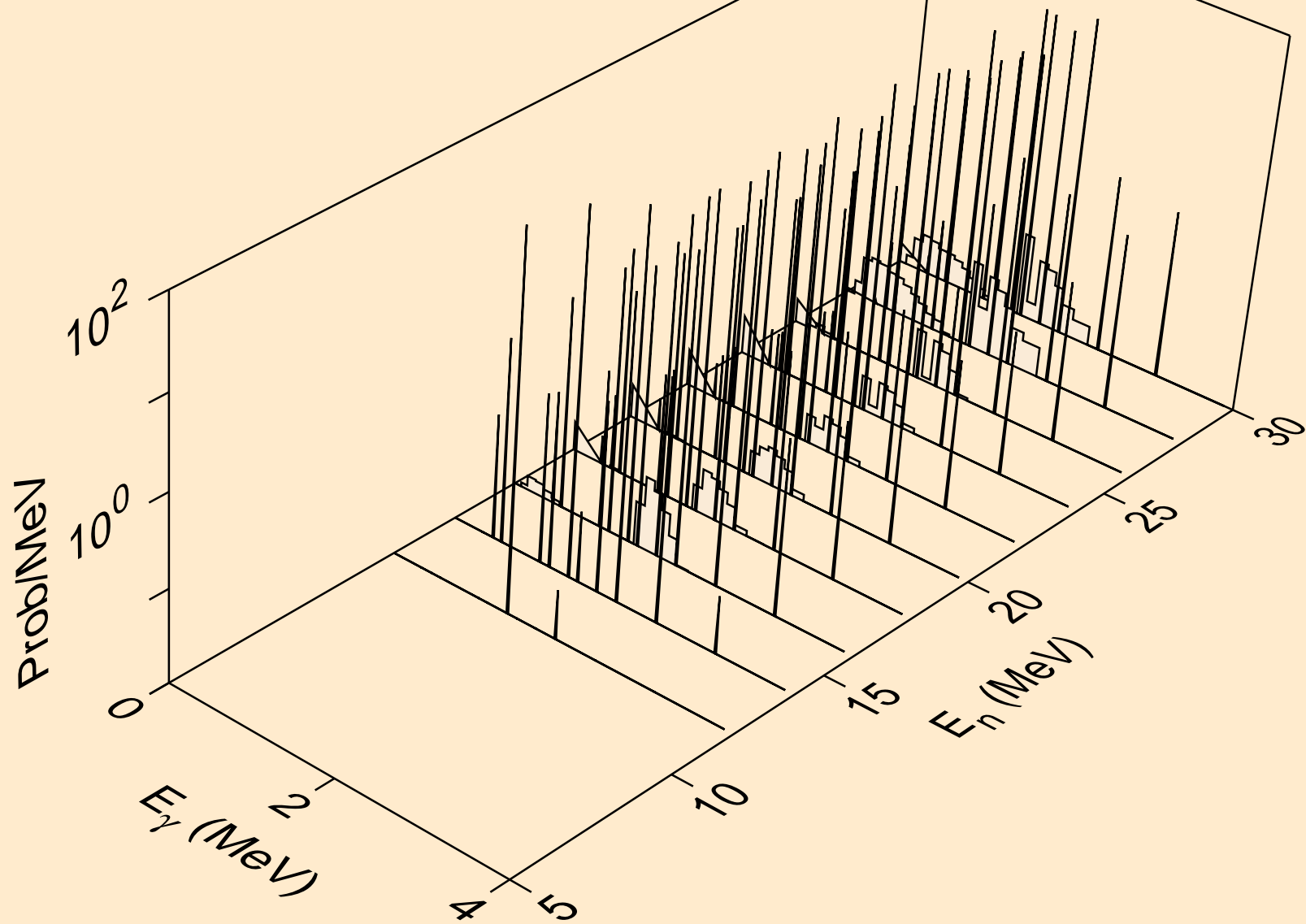

S031 NEUTRON ACER TENDL-2024 LIBRARY; T=0.K
Photon emission for (n,he3)

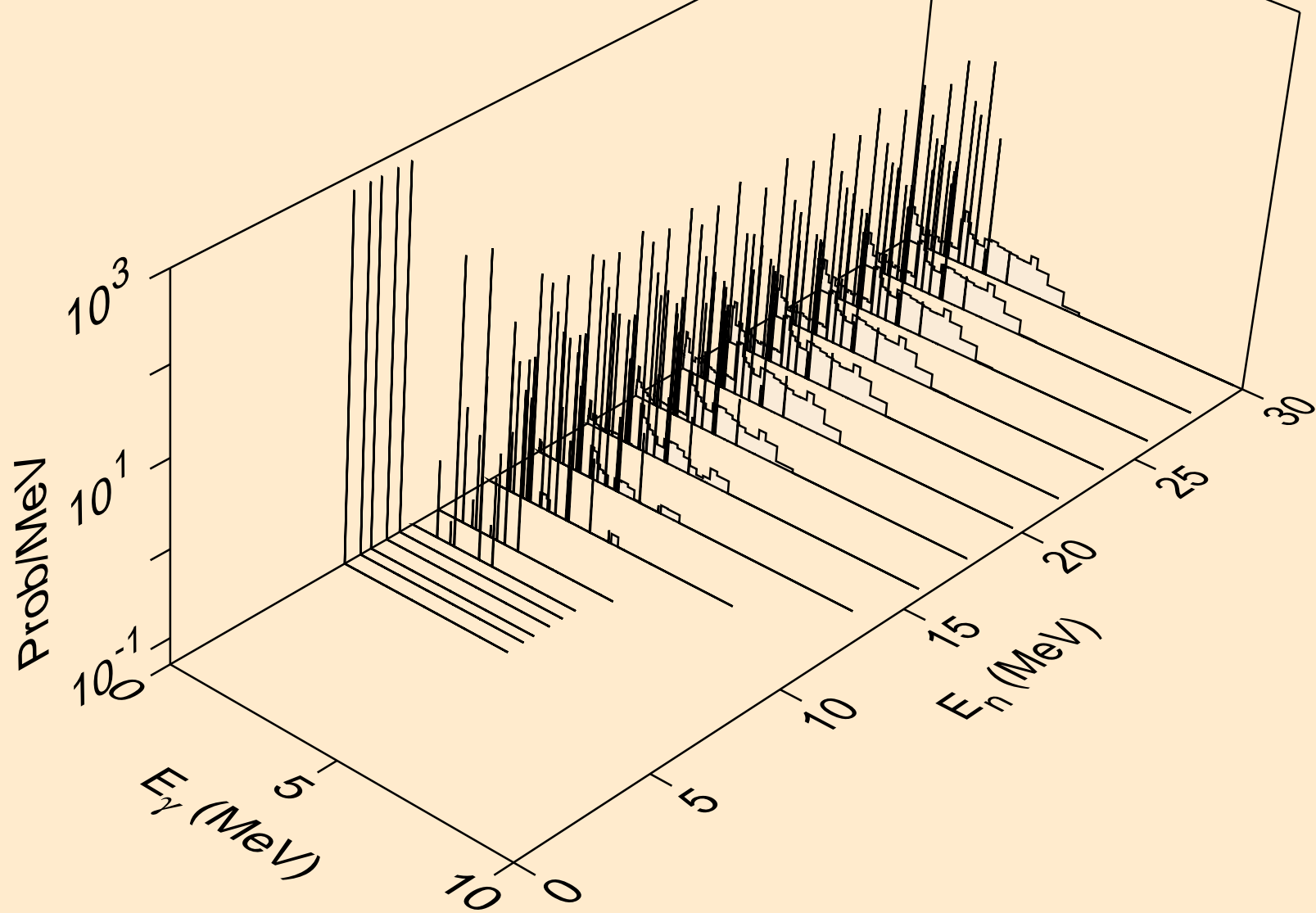

S031 NEUTRON ACER TENDL-2024 LIBRARY; T=0.K
Photon emission for (n,a)

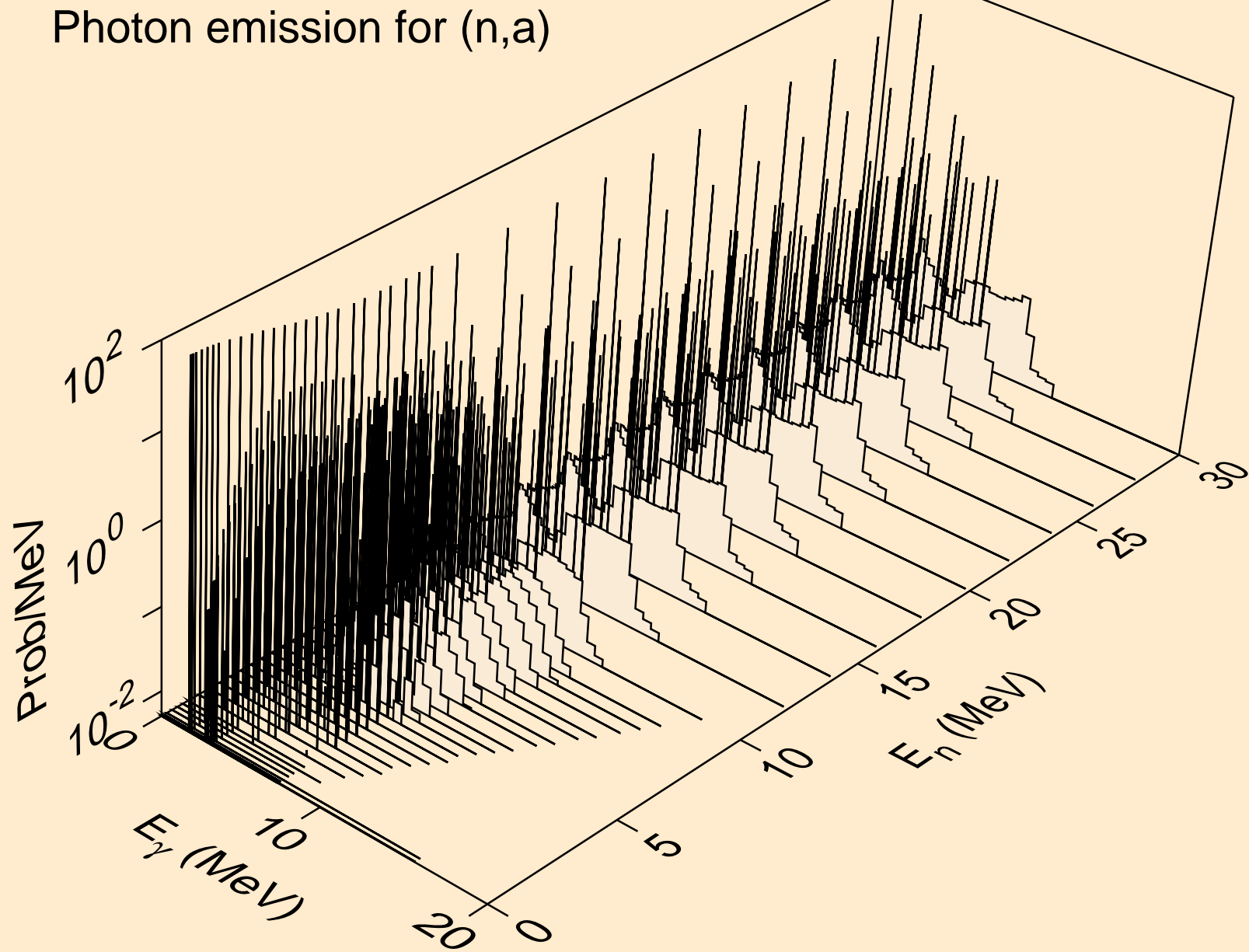

S031 NEUTRON ACER TENDL-2024 LIBRARY; T=0.K
Photon emission for (n,2a)

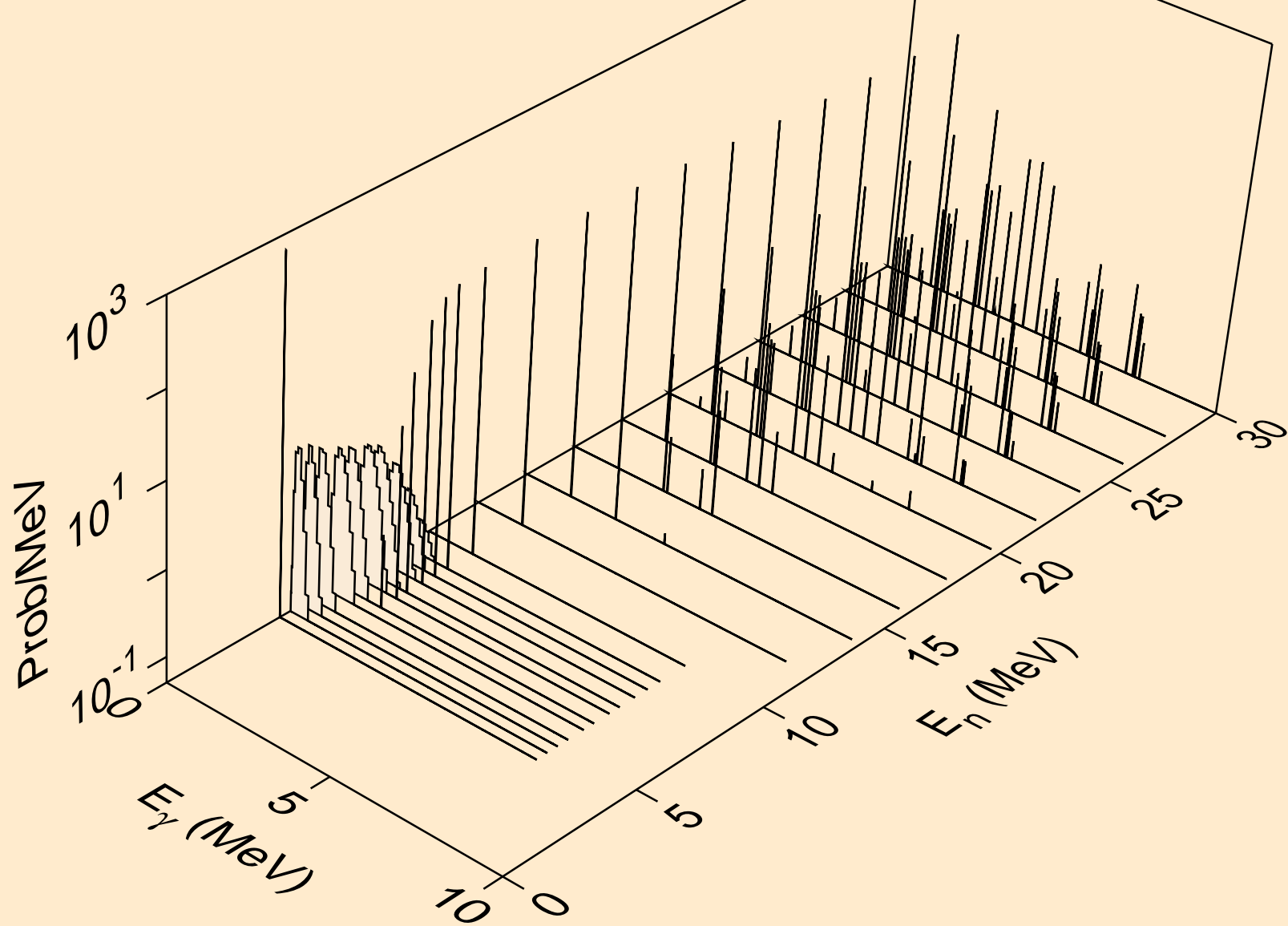

S031 NEUTRON ACER TENDL-2024 LIBRARY; T=0.K
Photon emission for (n,3a)

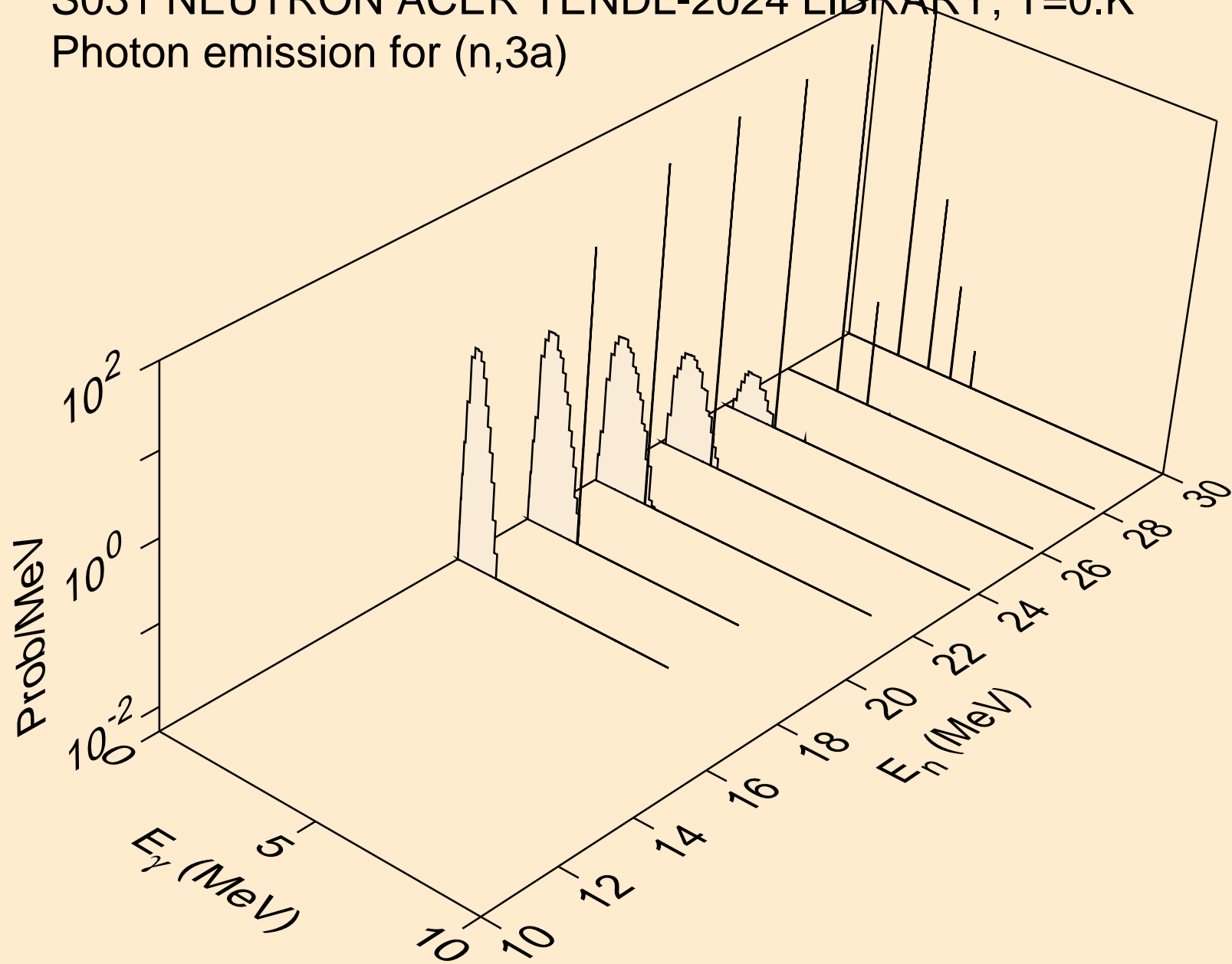

S031 NEUTRON ACER TENDL-2024 LIBRARY; T=0.K
Photon emission for (n,2p)

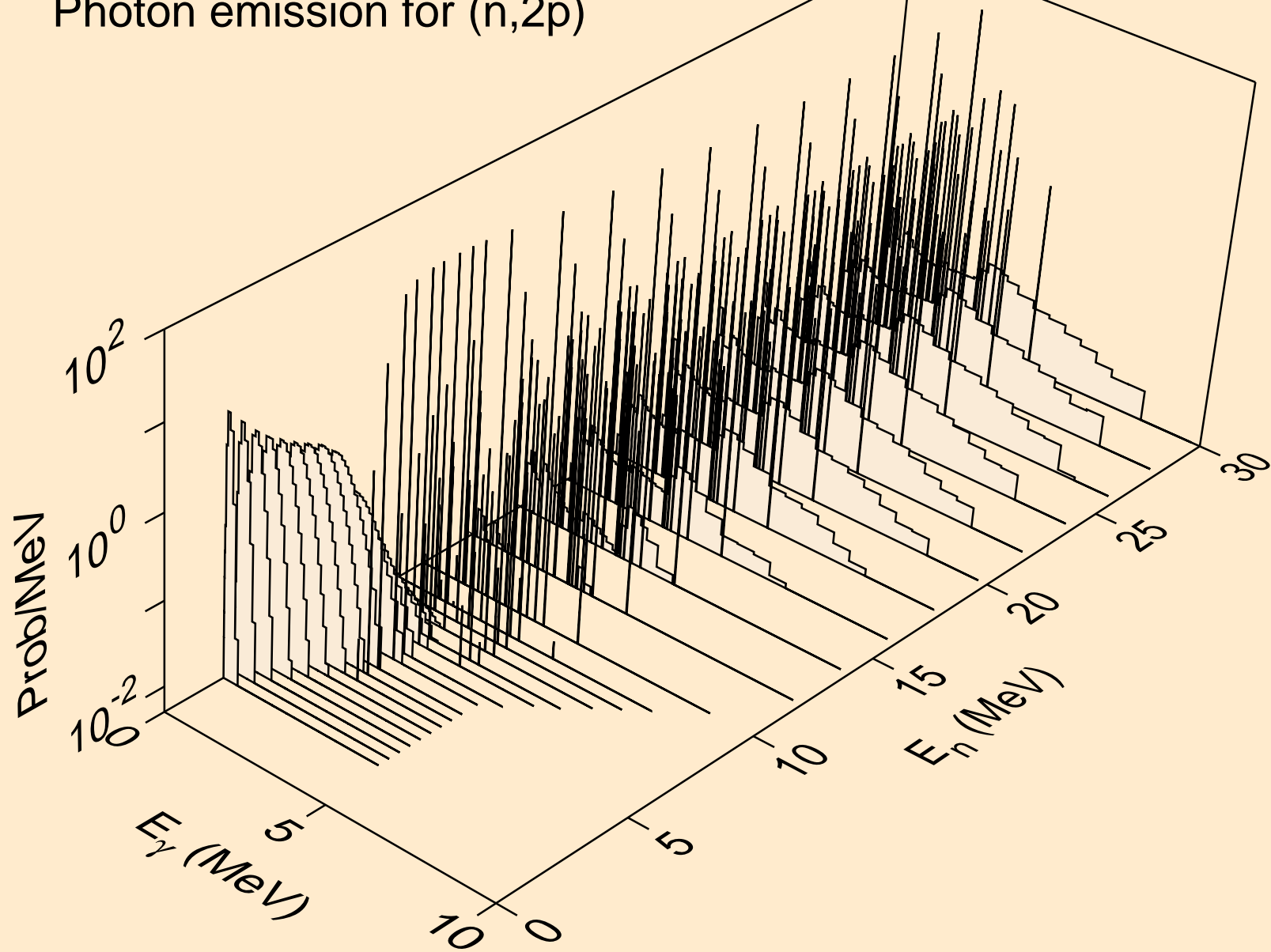

S031 NEUTRON ACER TENDL-2024 LIBRARY; T=0.K
Photon emission for (n,p α)

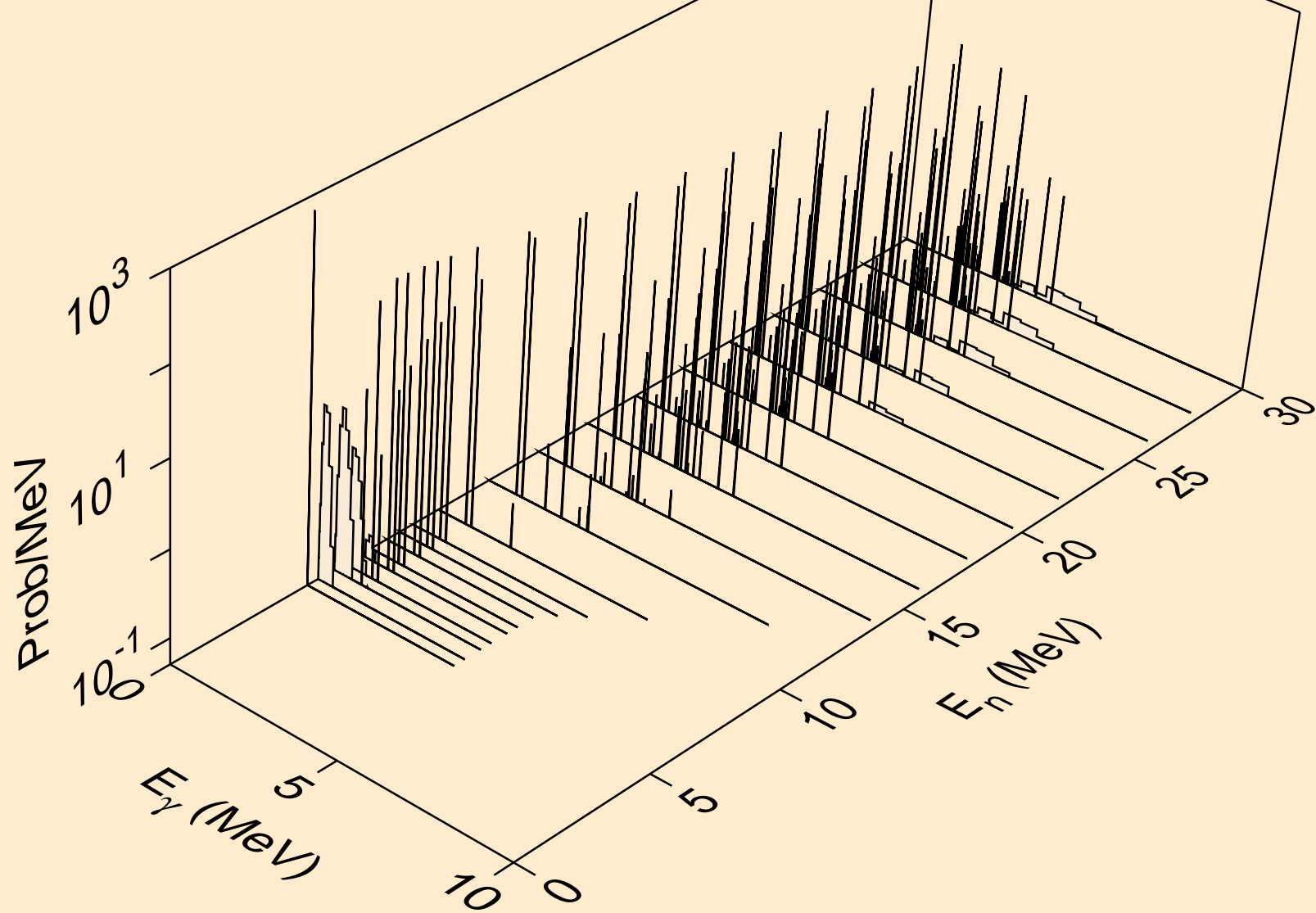

S031 NEUTRON ACER TENDL-2024 LIBRARY; T=0.K
Photon emission for (n,pd)

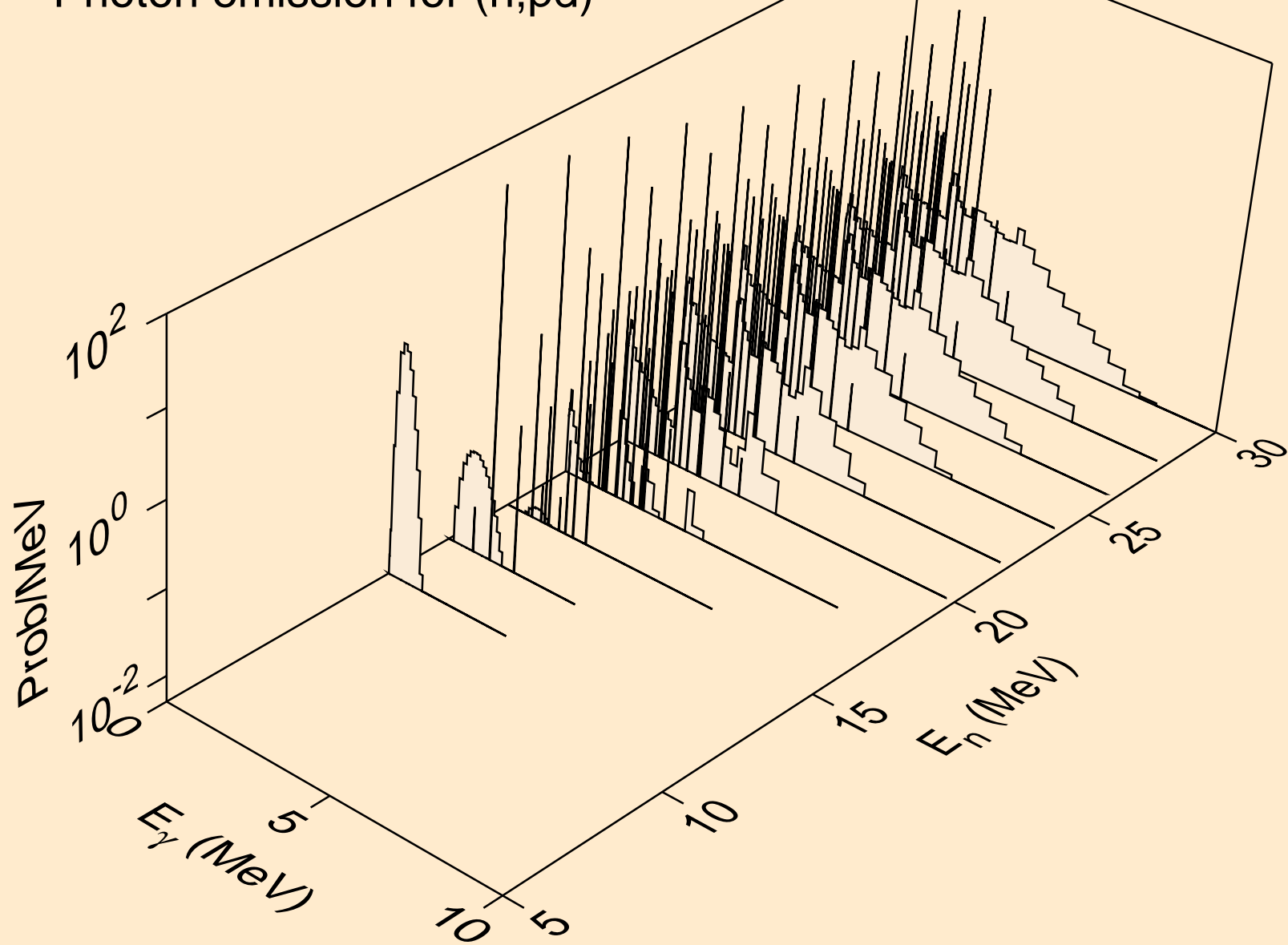

S031 NEUTRON ACER TENDL-2024 LIBRARY; T=0.K
Photon emission for (n,pt)

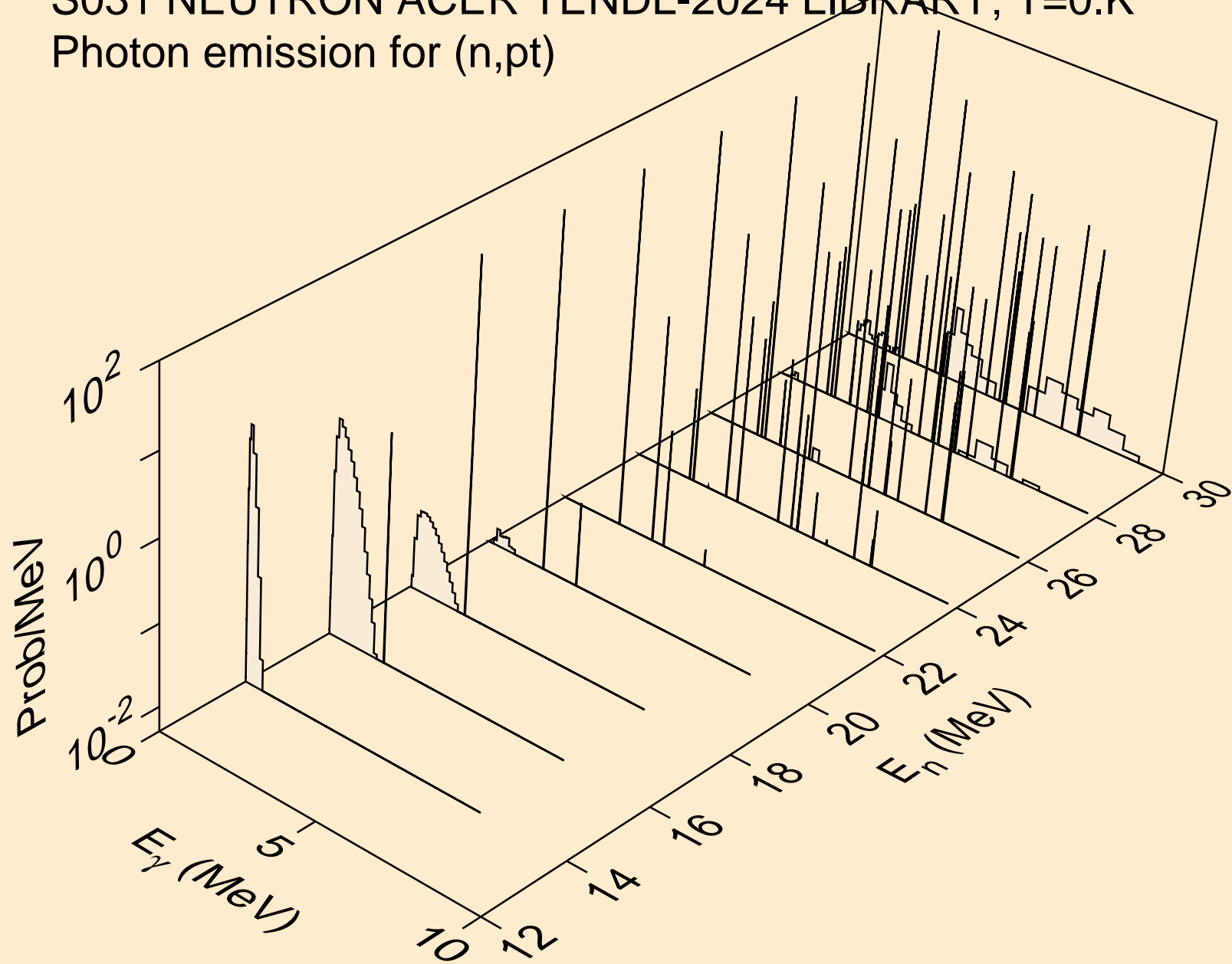

S031 NEUTRON ACER TENDL-2024 LIBRARY; T=0.K
Photon emission for (n,da)

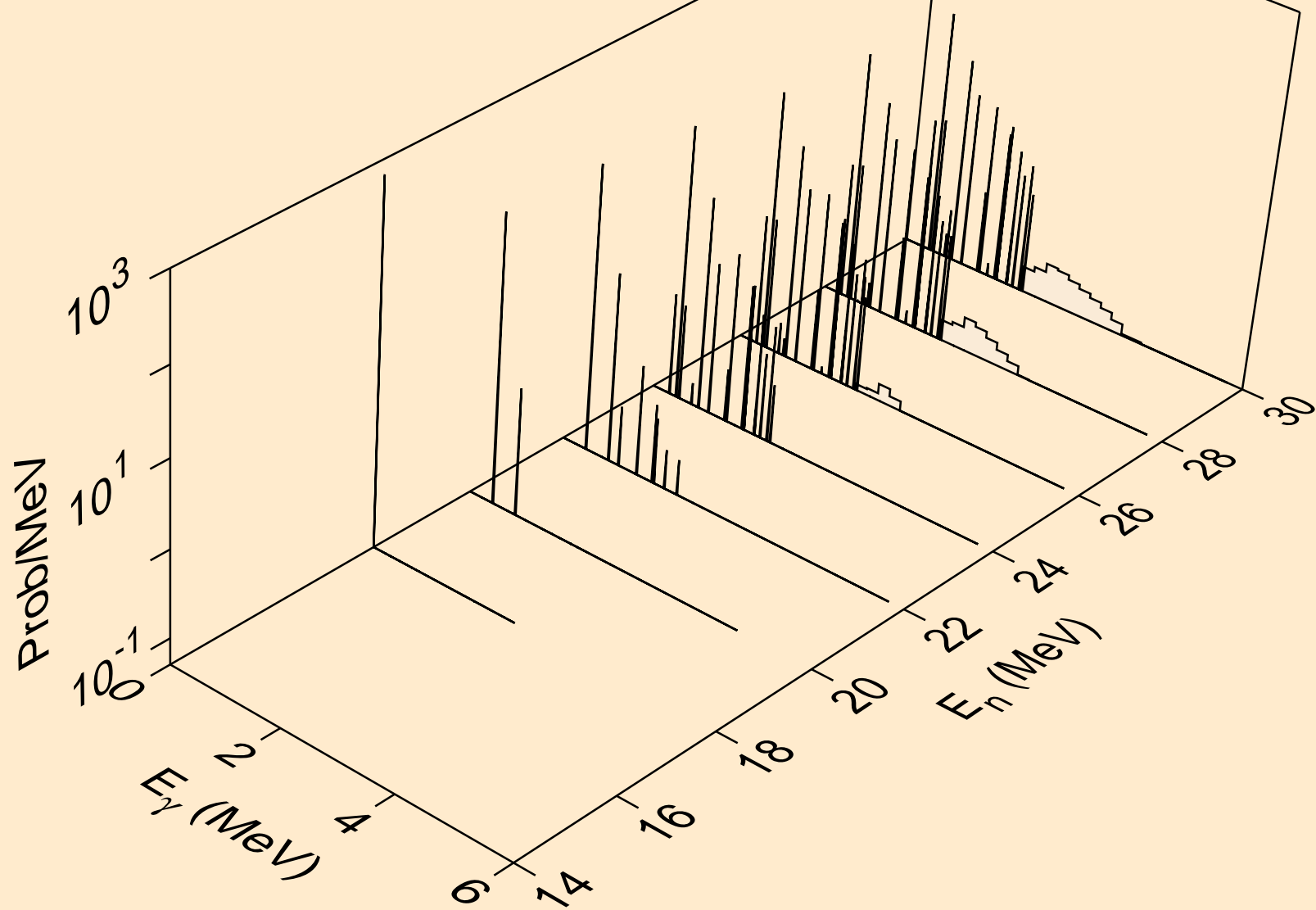

S031 NEUTRON ACER TENDL-2024 LIBRARY; T=0.K
thermal capture photon spectrum

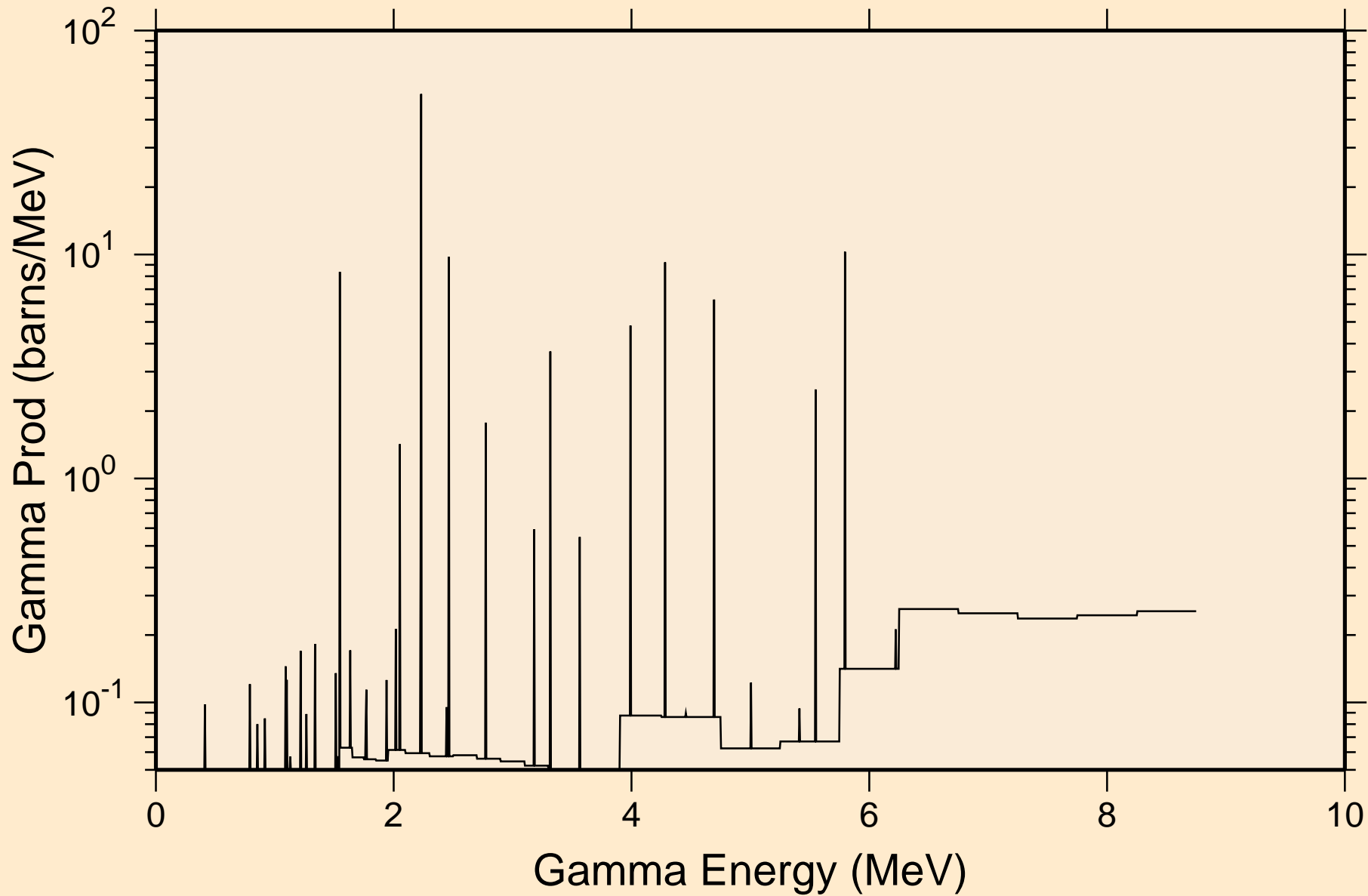

S031 NEUTRON ACER TENDL-2024 LIBRARY; T=0.K
14 MeV photon spectrum

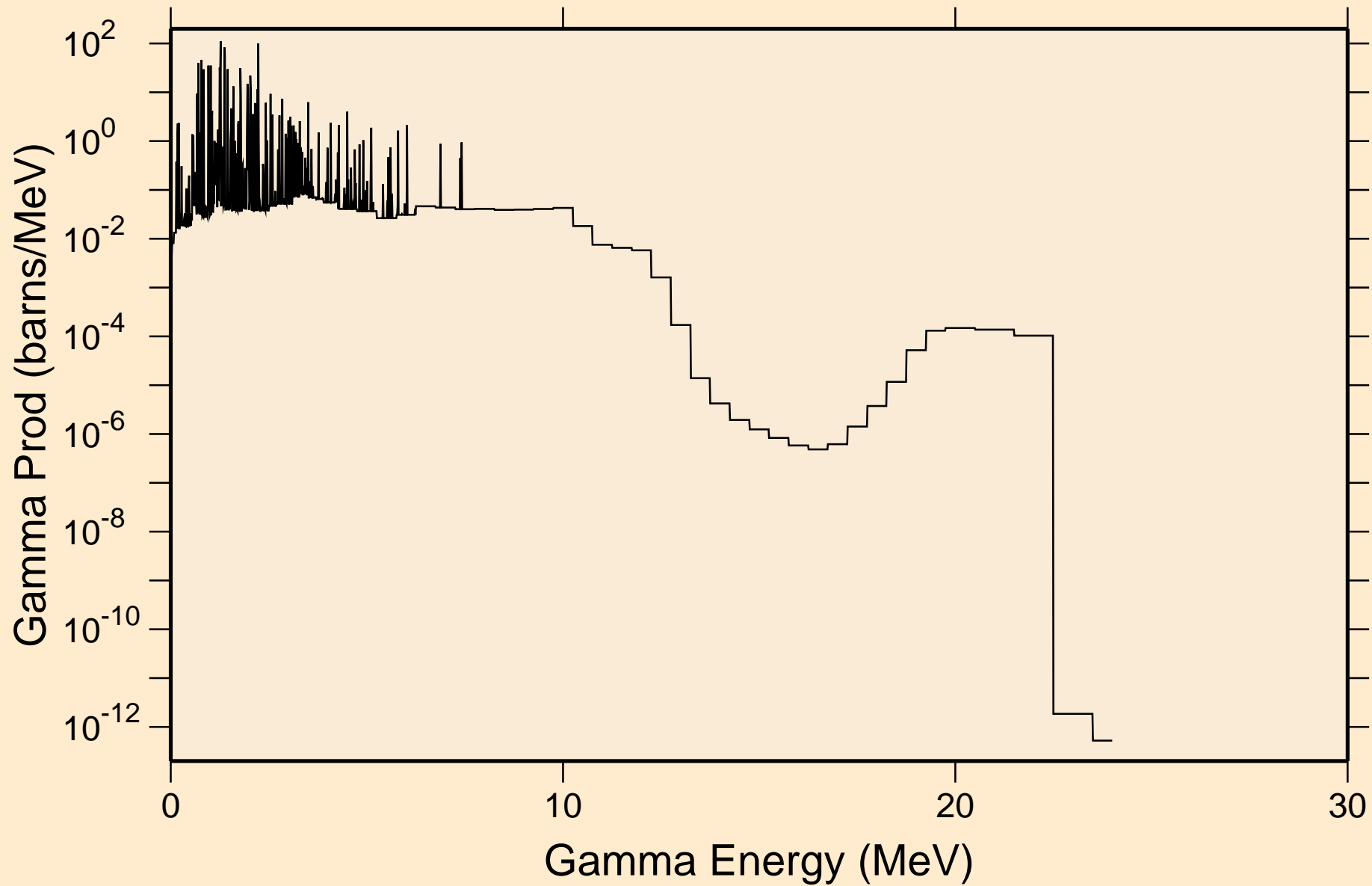

S031 NEUTRON ACER TENDL-2024 LIBRARY; T=0.K

Particle heating contributions

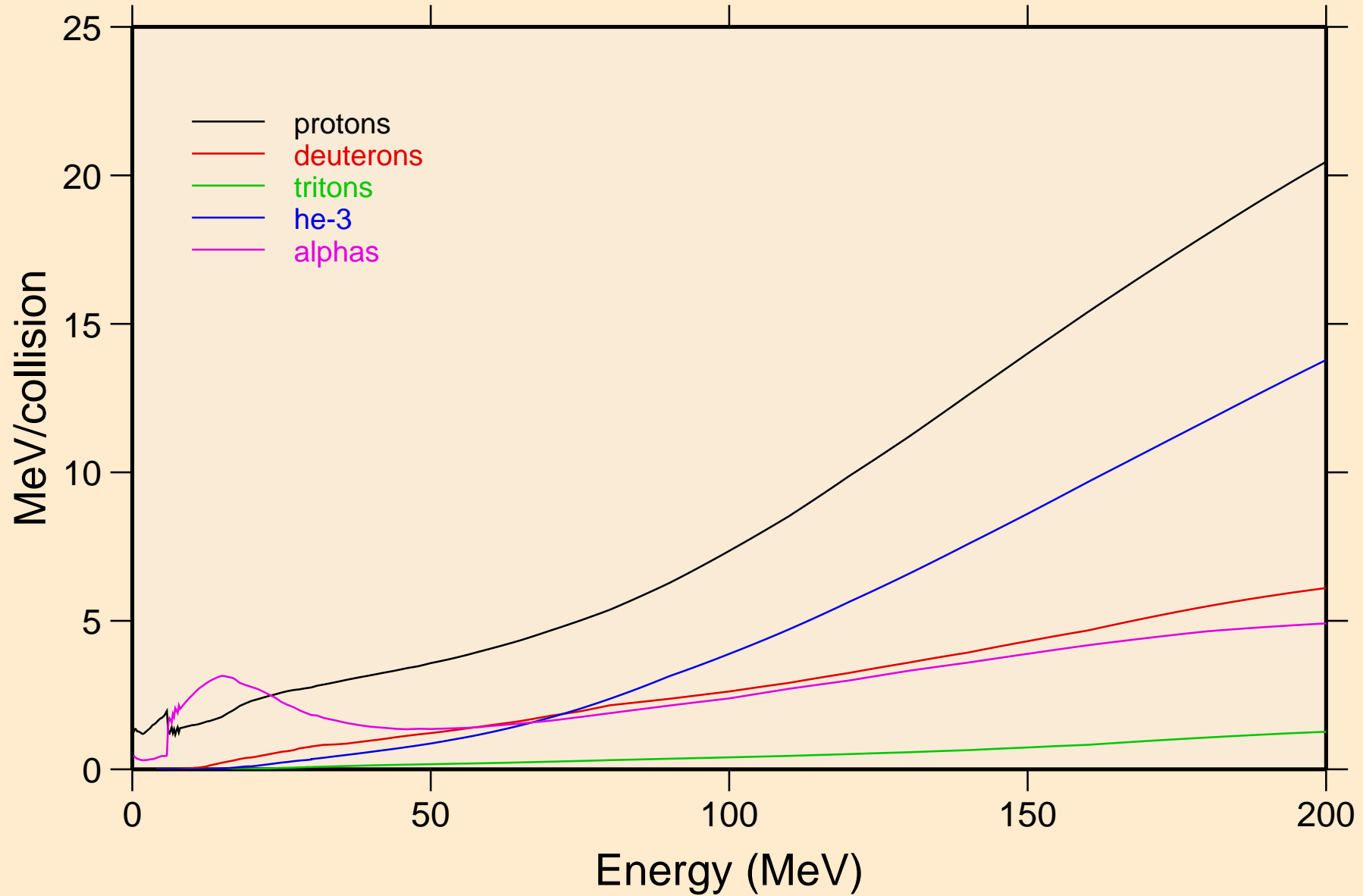

S031 NEUTRON ACER TENDL-2024 LIBRARY; T=0.K
Recoil Heating

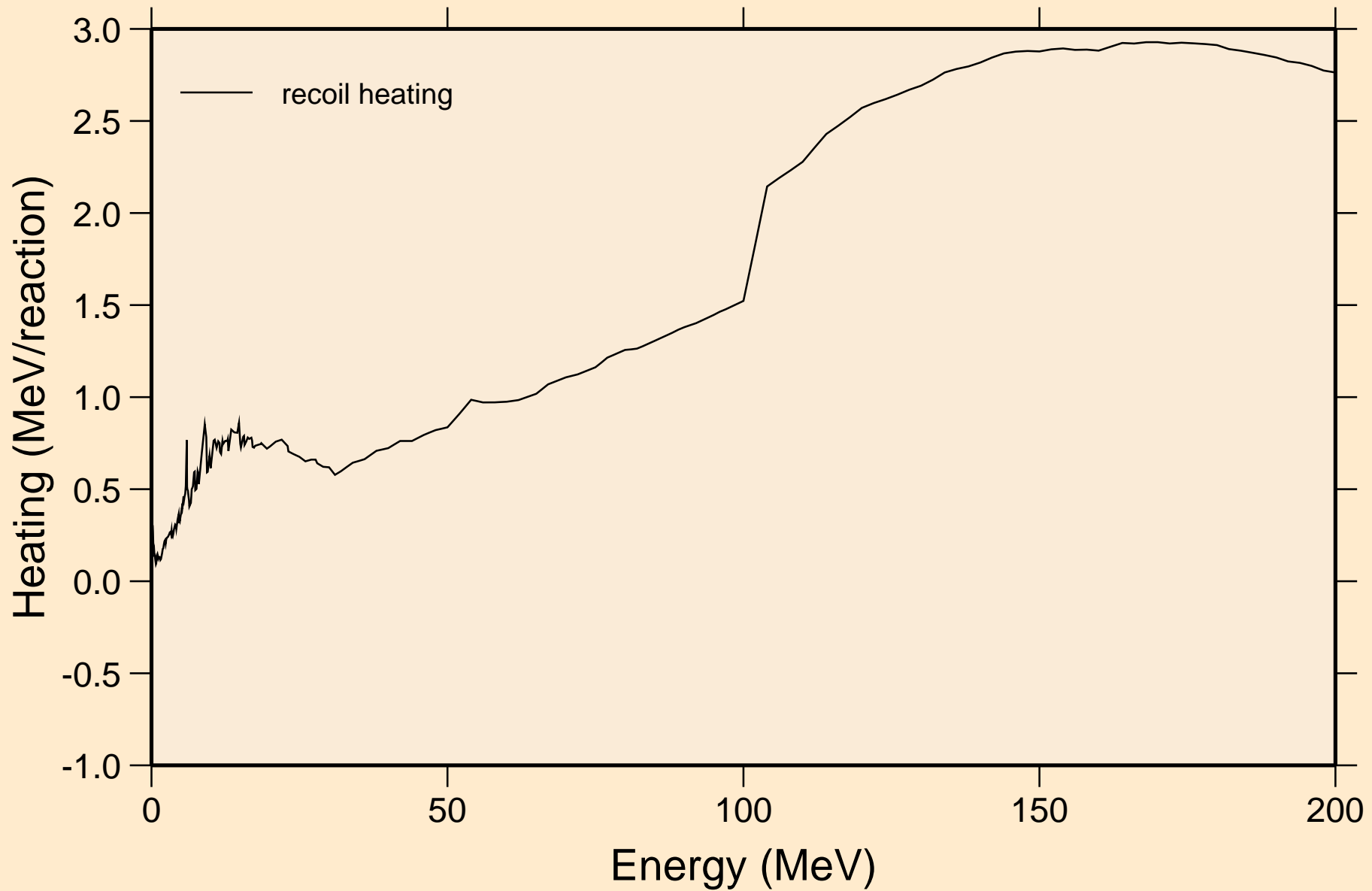

S031 NEUTRON ACER TENDL-2024 LIBRARY; T=0.K

Particle production cross sections

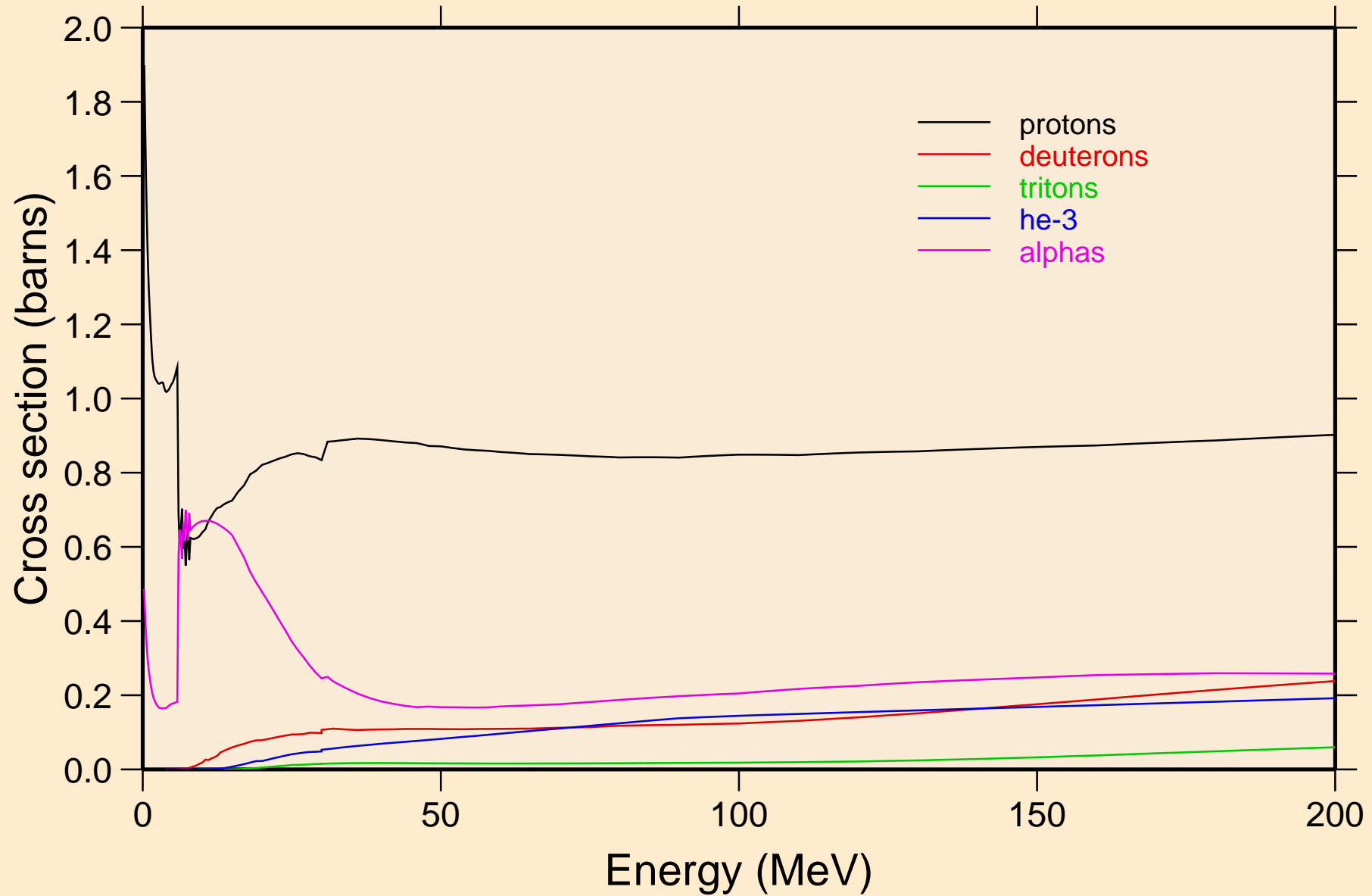

S031 NEUTRON ACER TENDL-2024 LIBRARY; T=0.K
protons from (n,x)

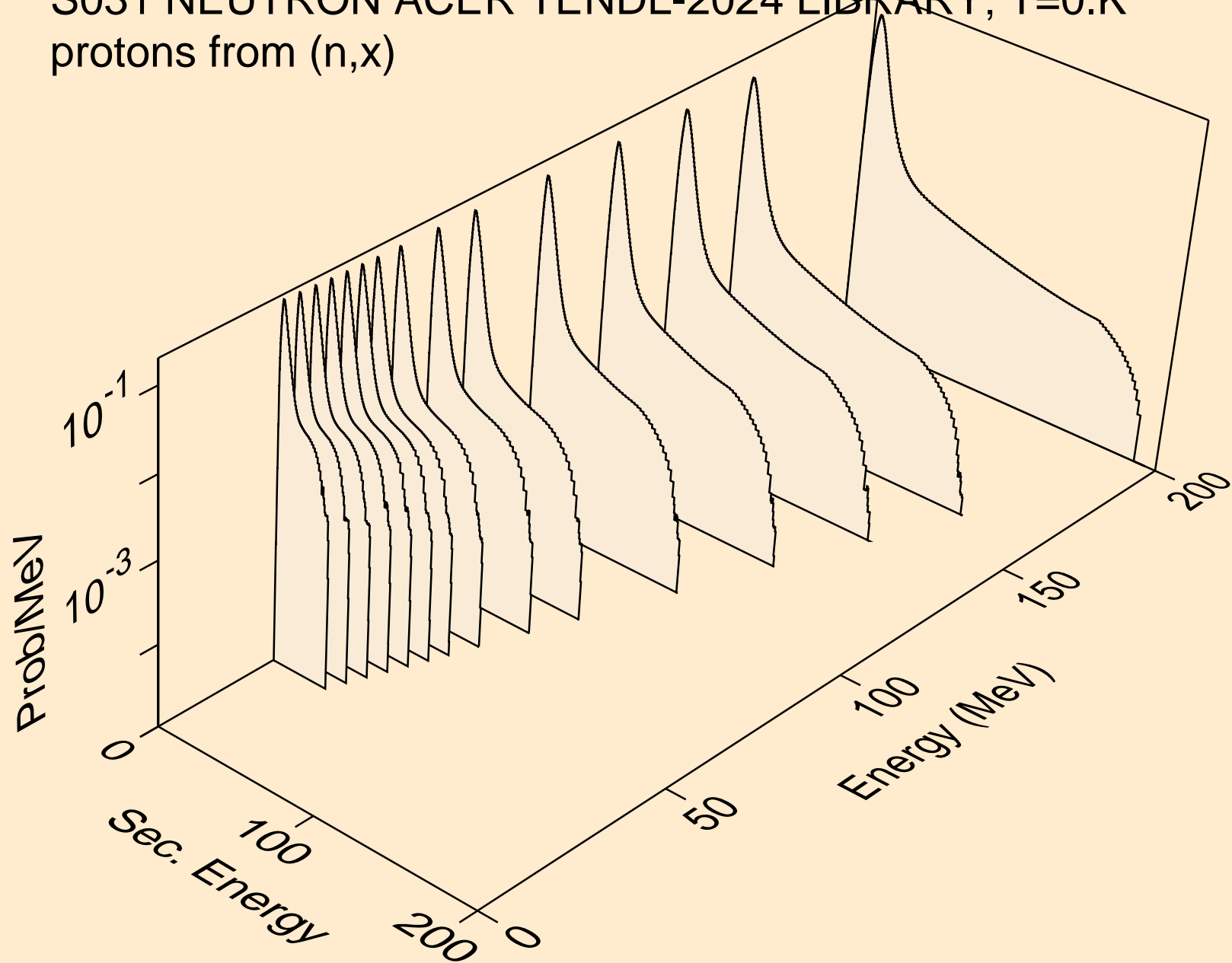

S031 NEUTRON ACER TENDL-2024 LIBRARY; T=0.K
protons from (n,n*)p

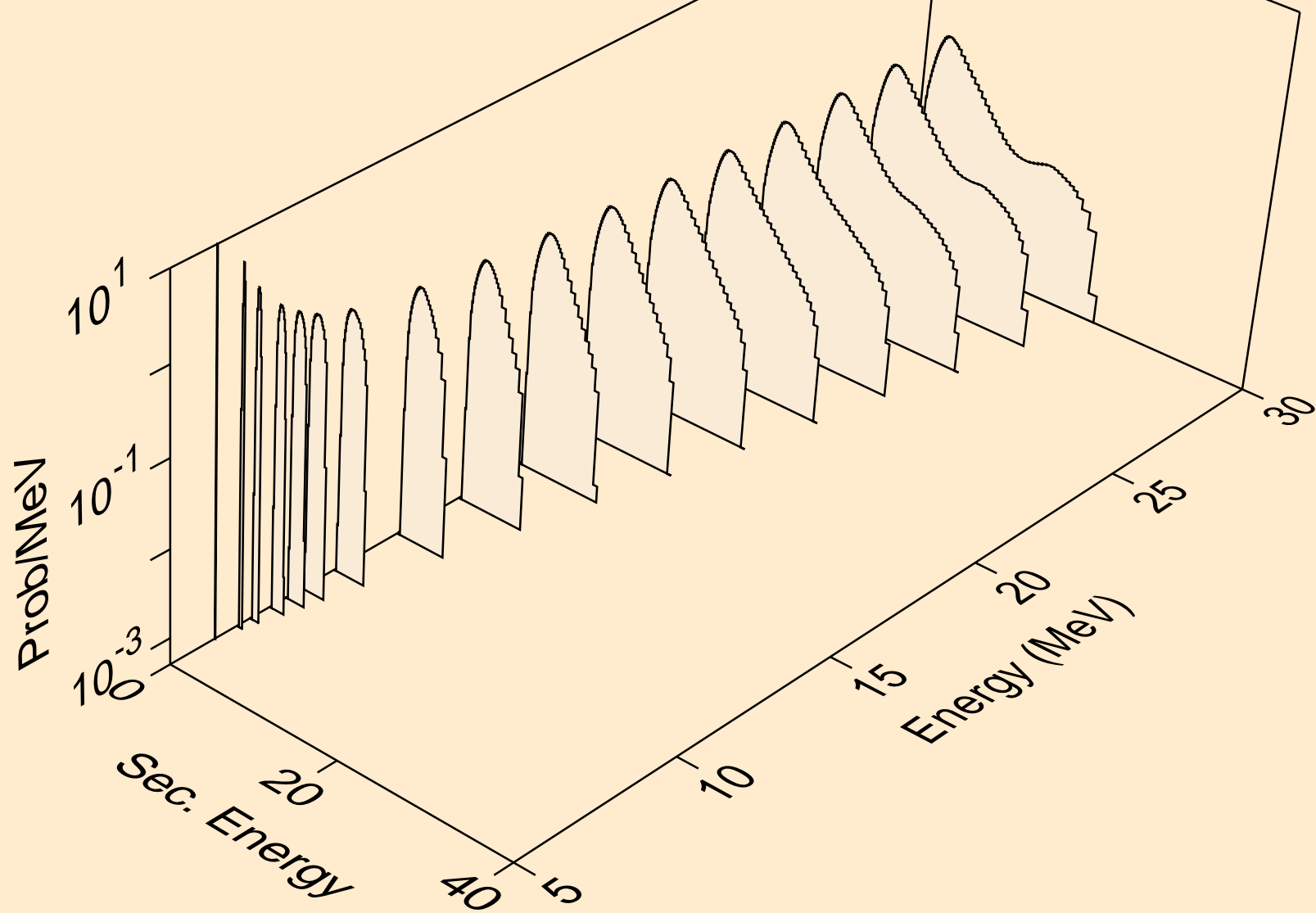

S031 NEUTRON ACER TENDL-2024 LIBRARY; T=0.K
protons from (n,2np)

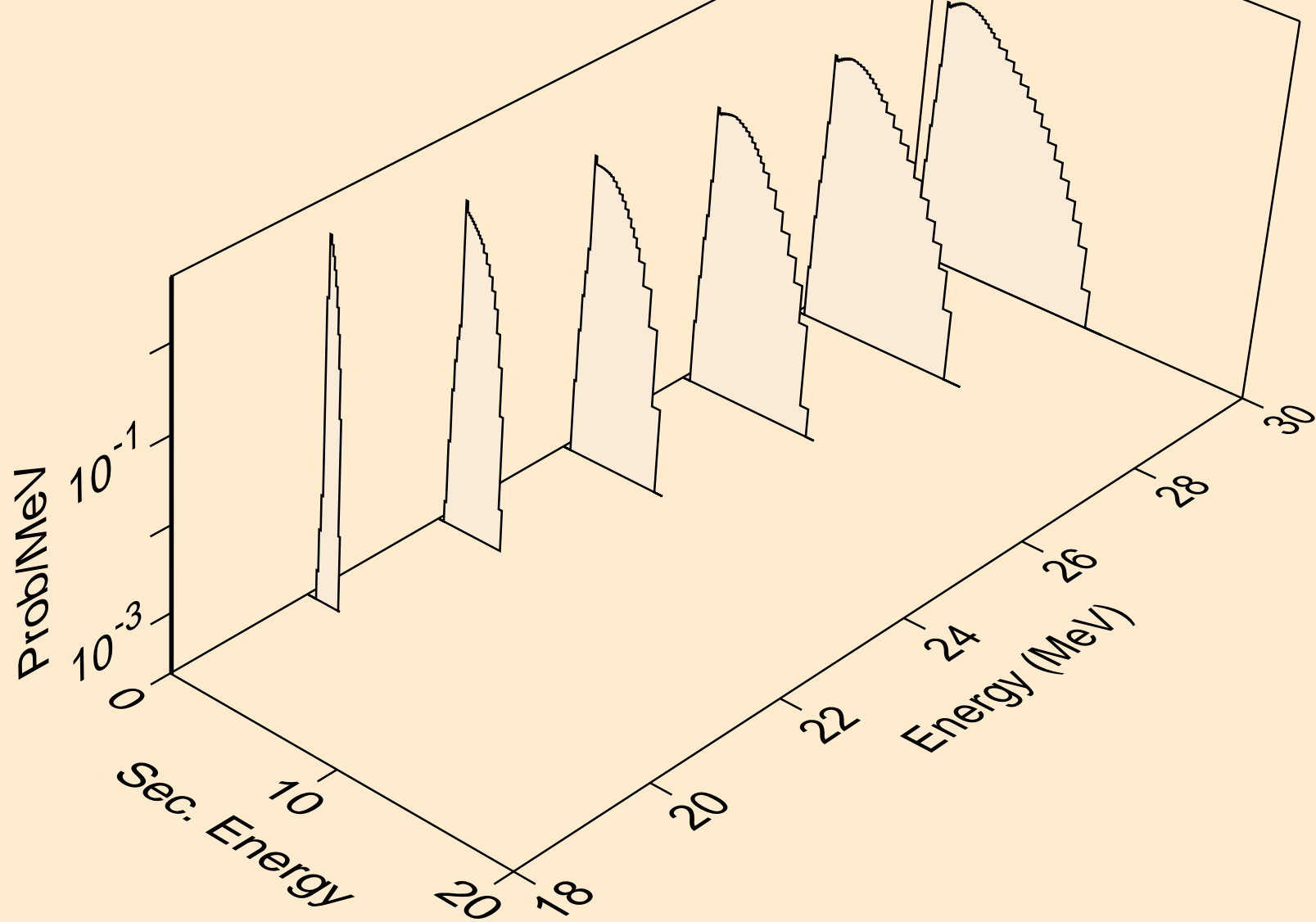

S031 NEUTRON ACER TENDL-2024 LIBRARY; T=0.K
protons from (n,n2p)

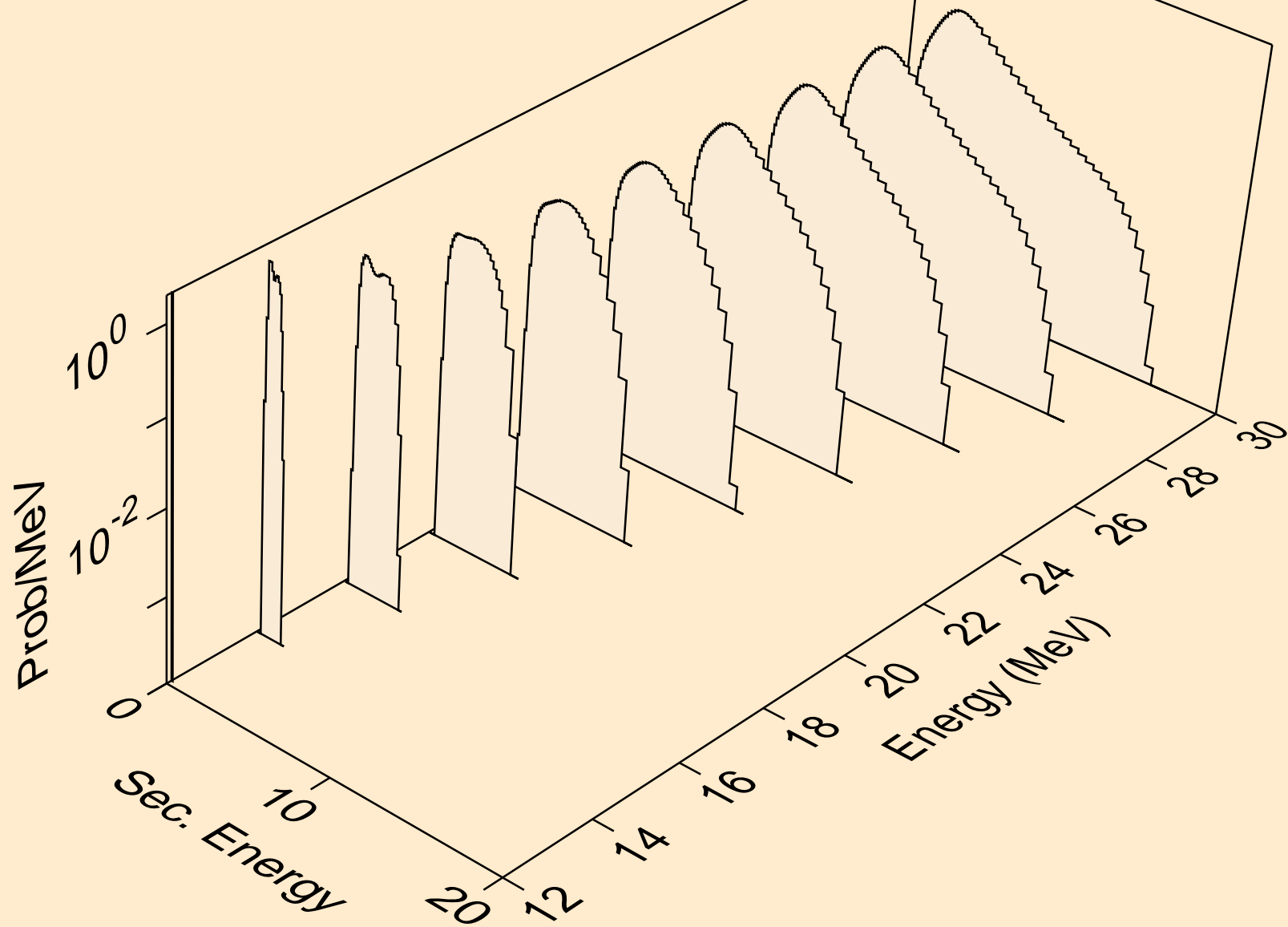

S031 NEUTRON ACER TENDL-2024 LIBRARY; T=0.K
protons from (n,npa)

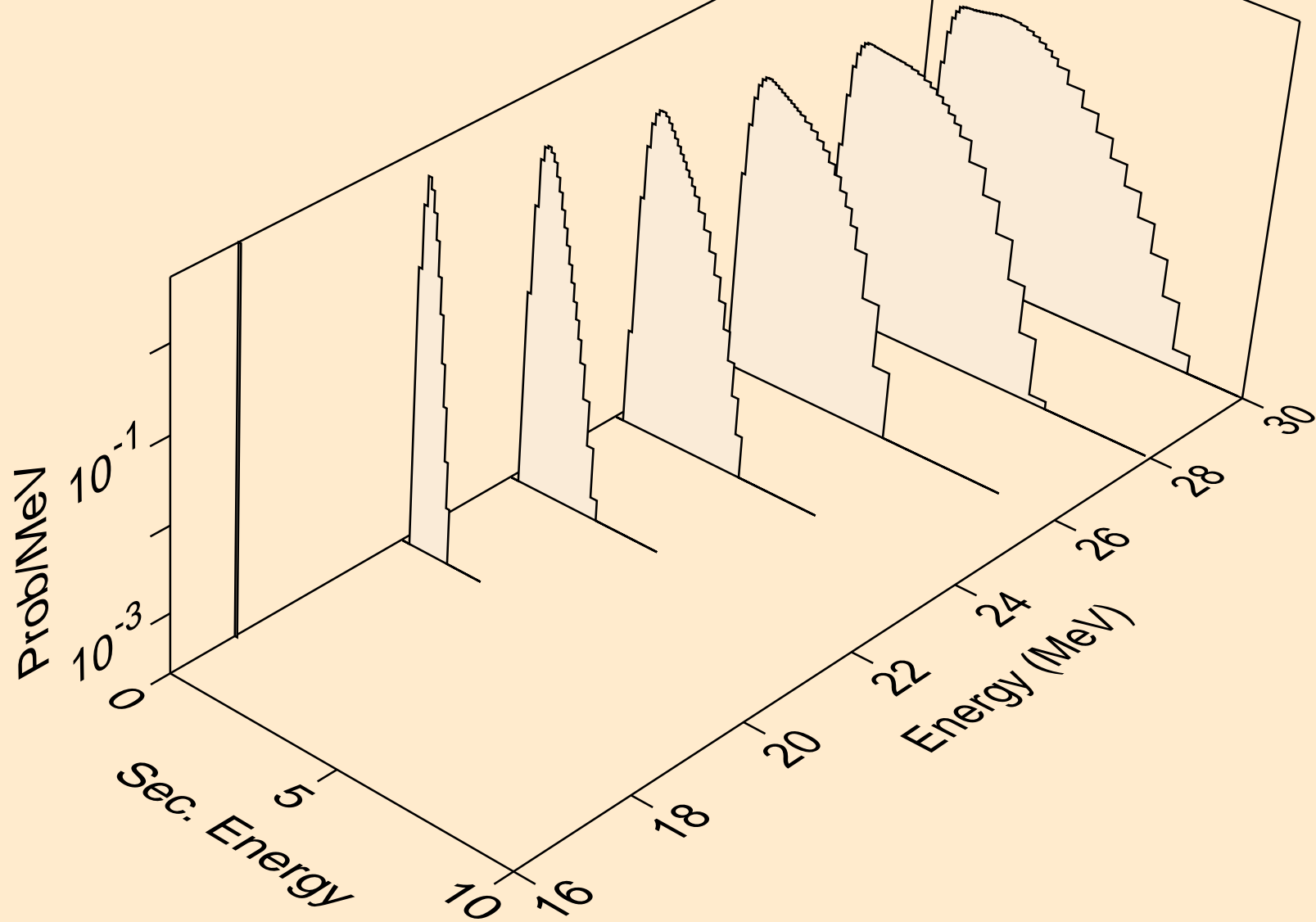

S031 NEUTRON ACER TENDL-2024 LIBRARY; T=0.K
protons from (n,p)

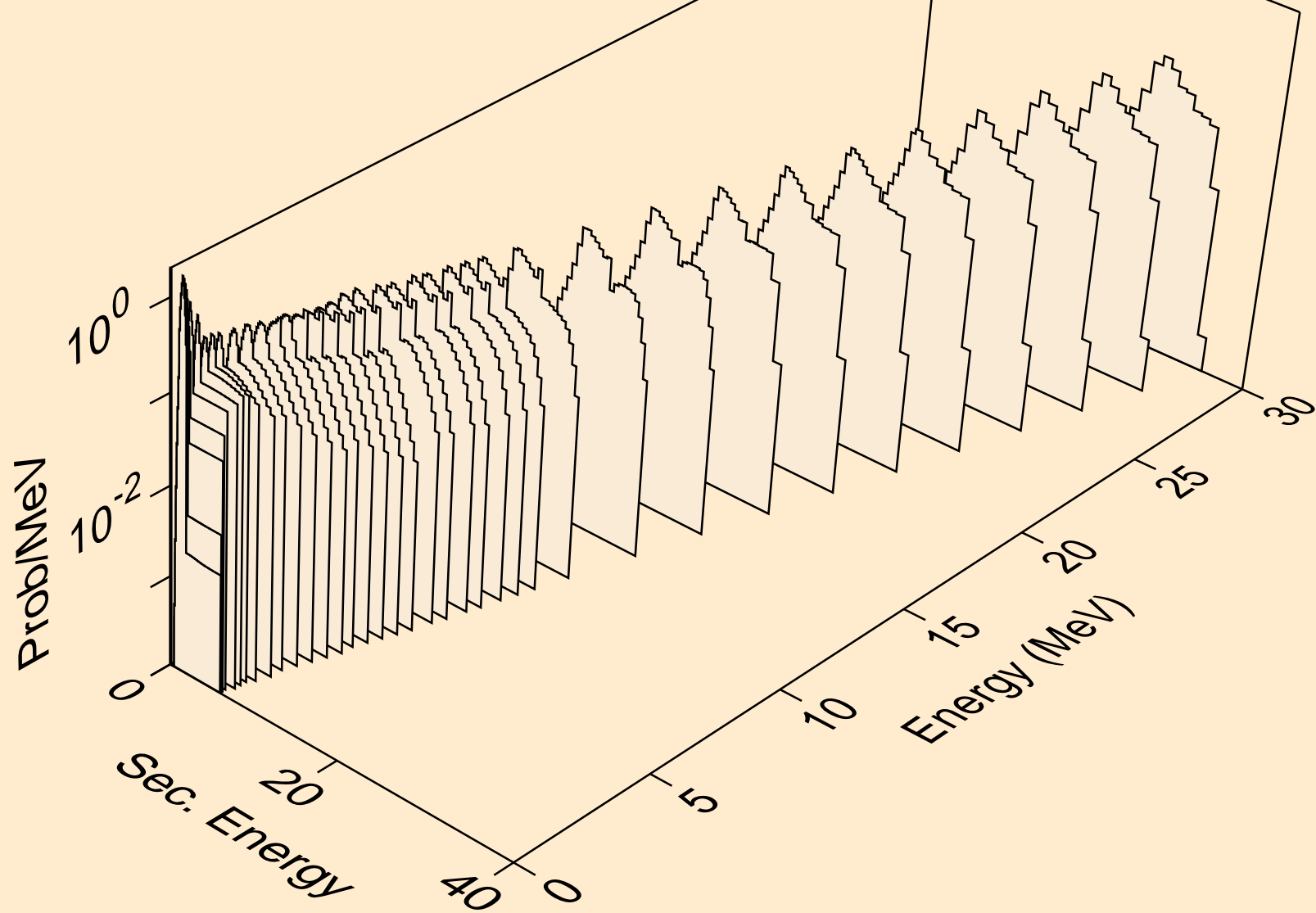

S031 NEUTRON ACER TENDL-2024 LIBRARY; T=0.K
protons from (n,2p)

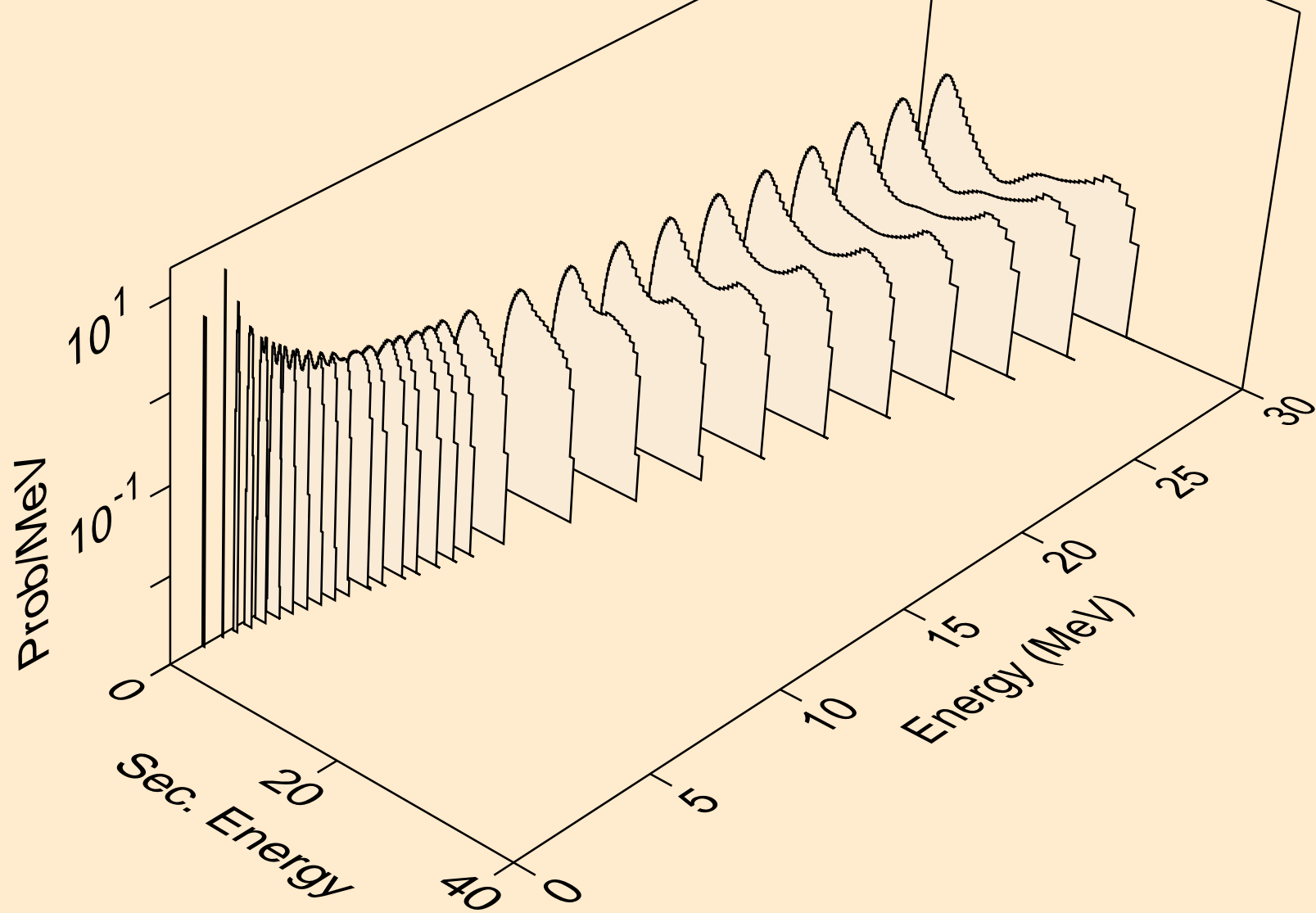

S031 NEUTRON ACER TENDL-2024 LIBRARY; T=0.K
protons from (n,p)

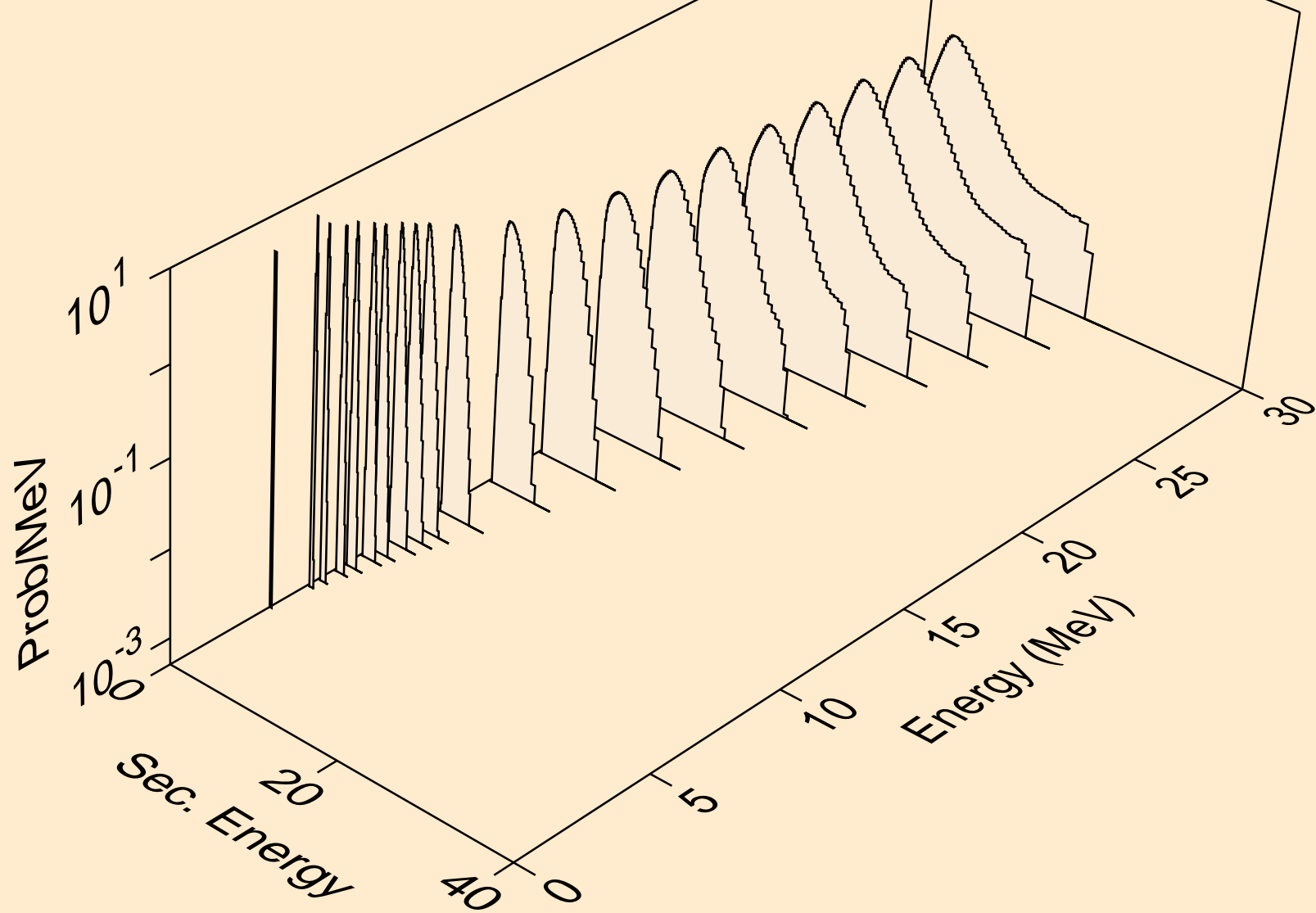

S031 NEUTRON ACER TENDL-2024 LIBRARY; T=0.K
protons from (n,pd)

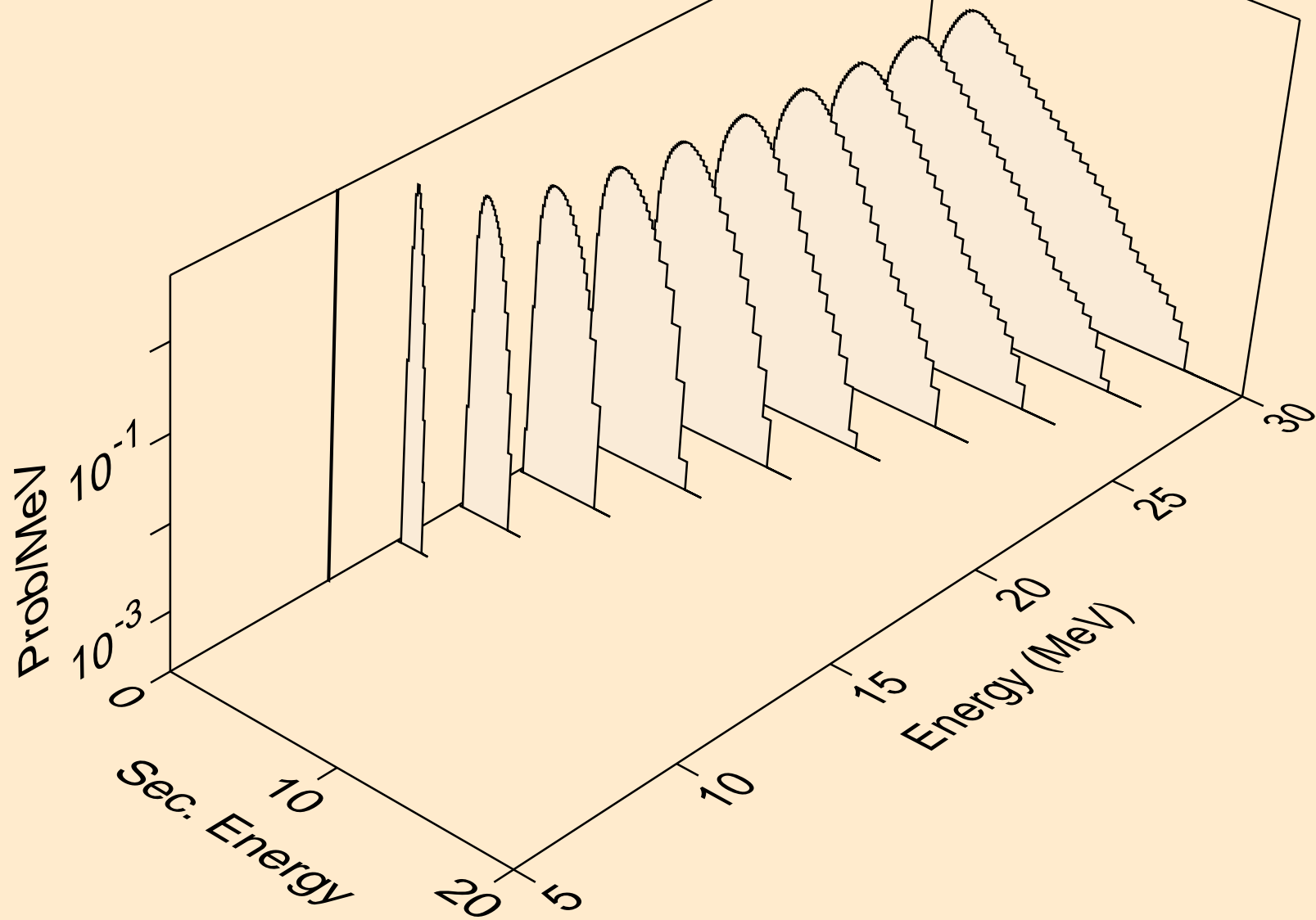

S031 NEUTRON ACER TENDL-2024 LIBRARY; T=0.K
protons from (n,pt)

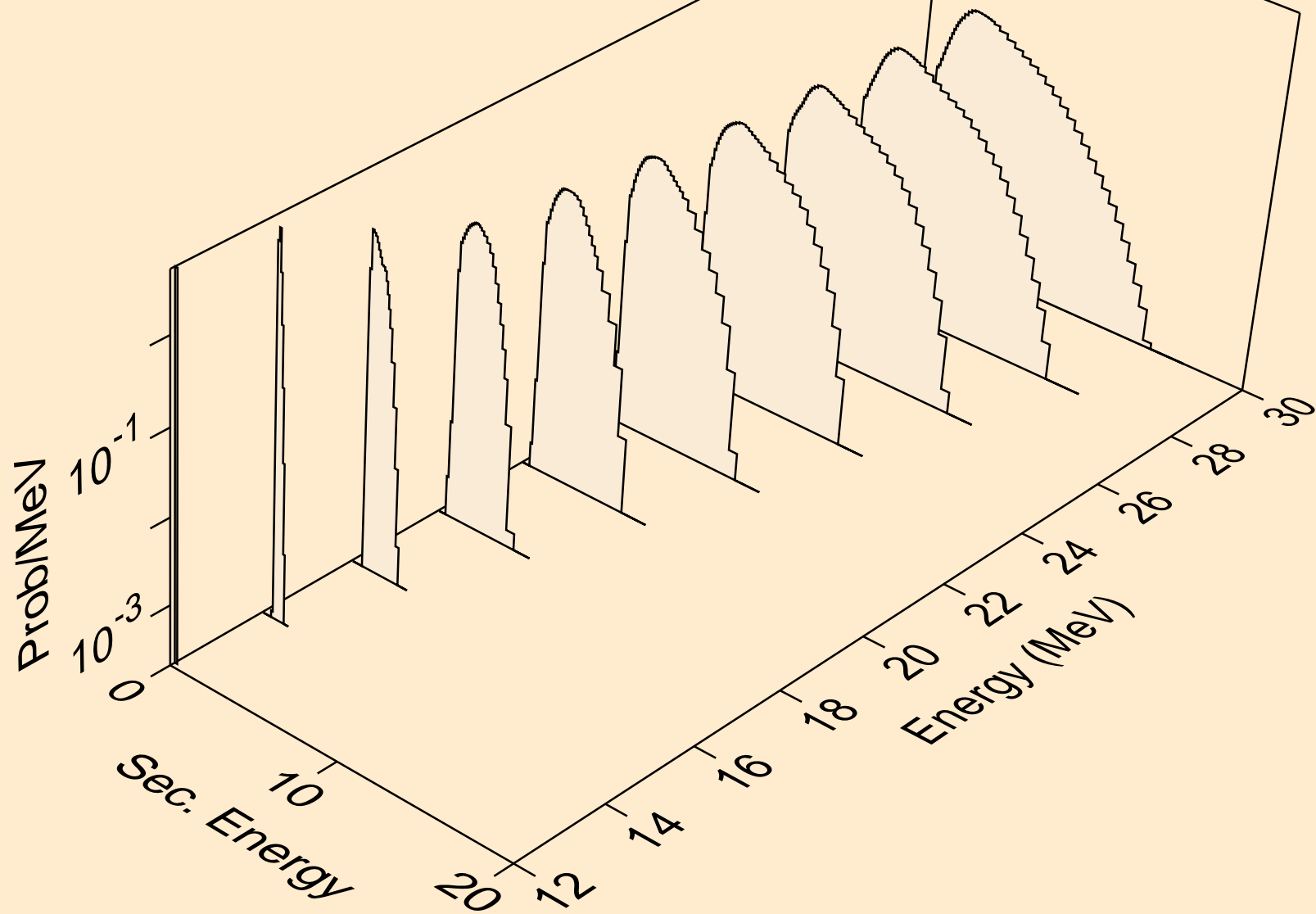

S031 NEUTRON ACER TENDL-2024 LIBRARY; T=0.K
deuterons from (n,x)

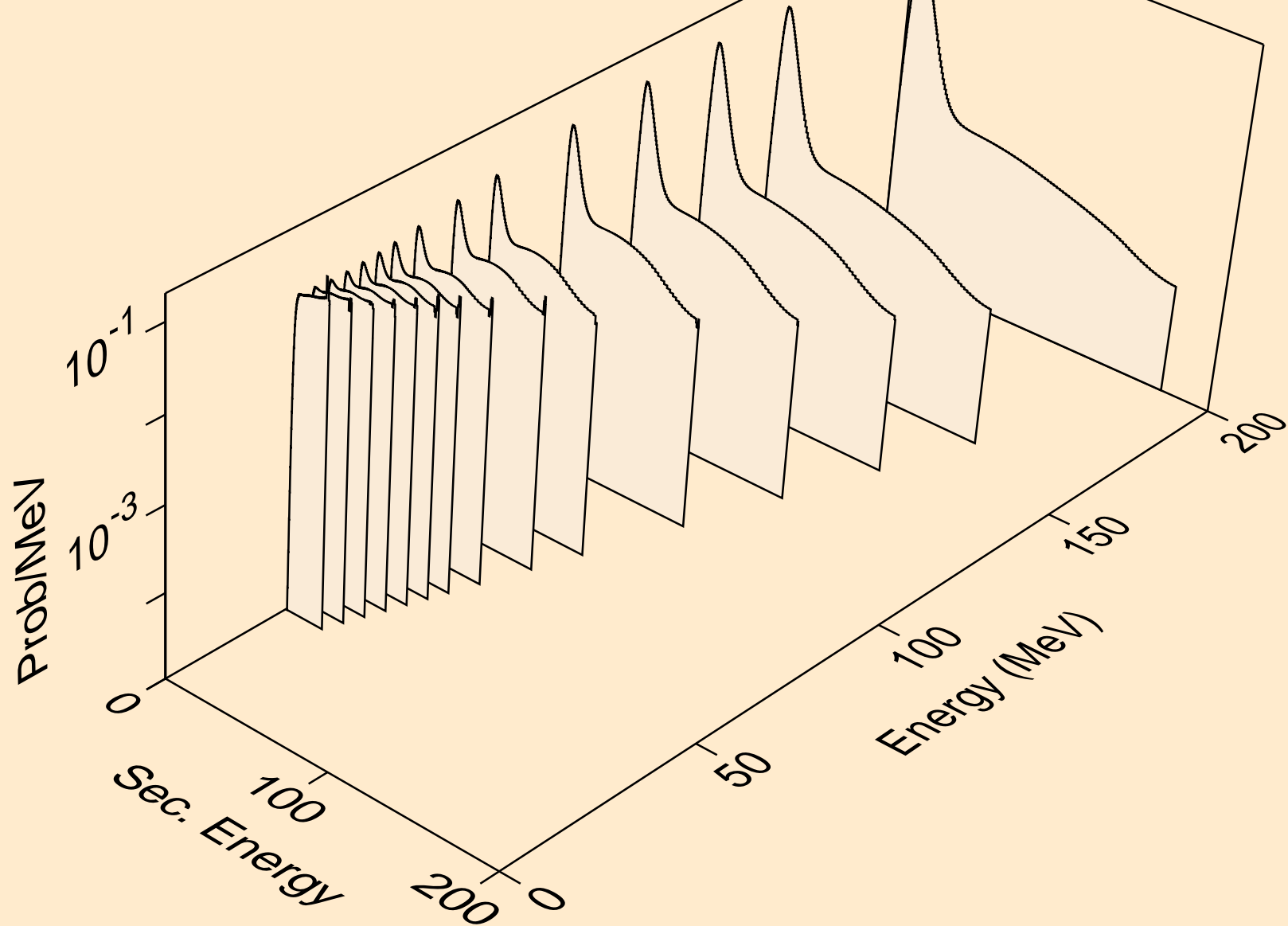

S031 NEUTRON ACER TENDL-2024 LIBRARY; T=0.K
deuterons from (n,n*)d

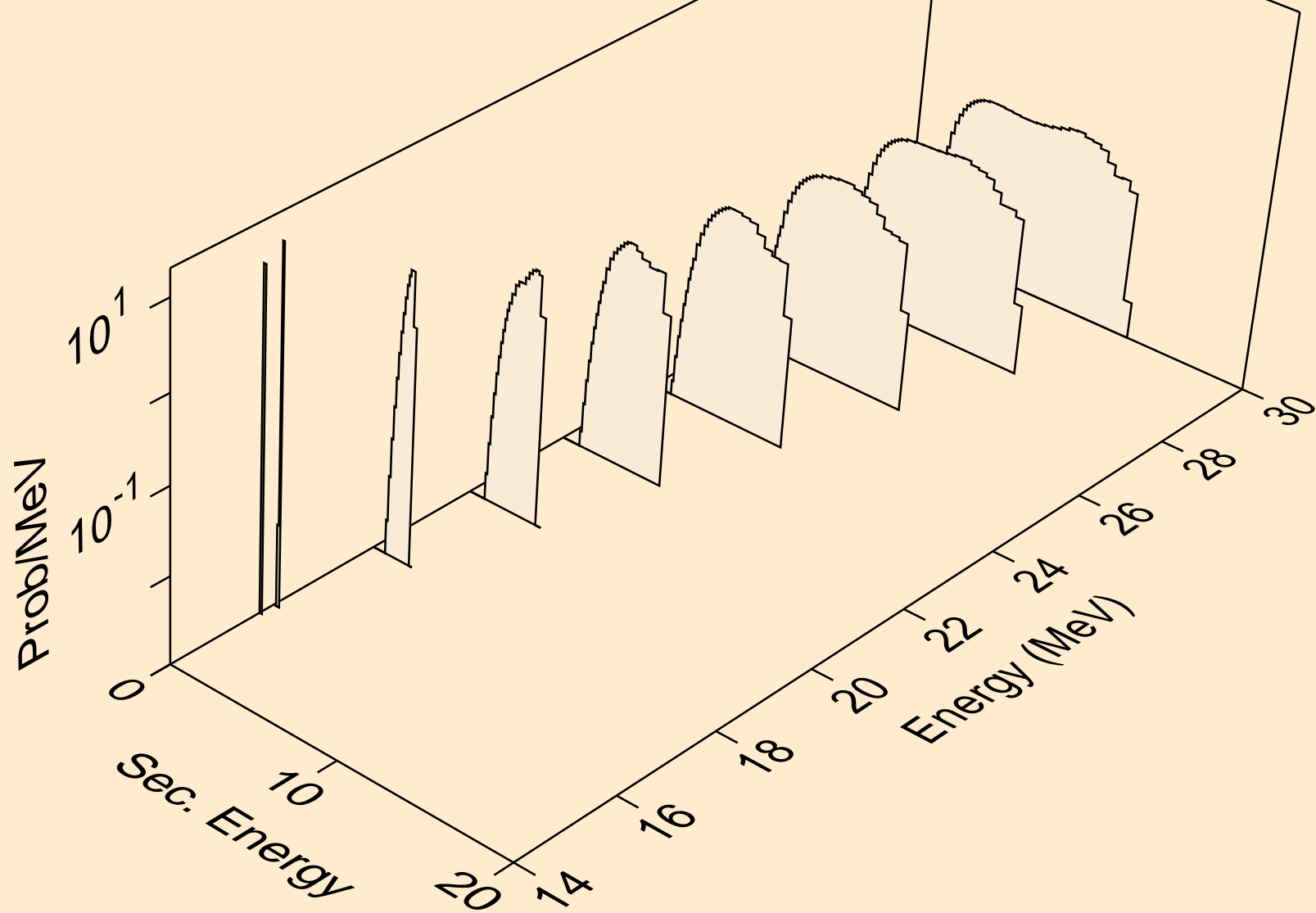

S031 NEUTRON ACER TENDL-2024 LIBRARY; T=0.K
deuterons from (n,d)

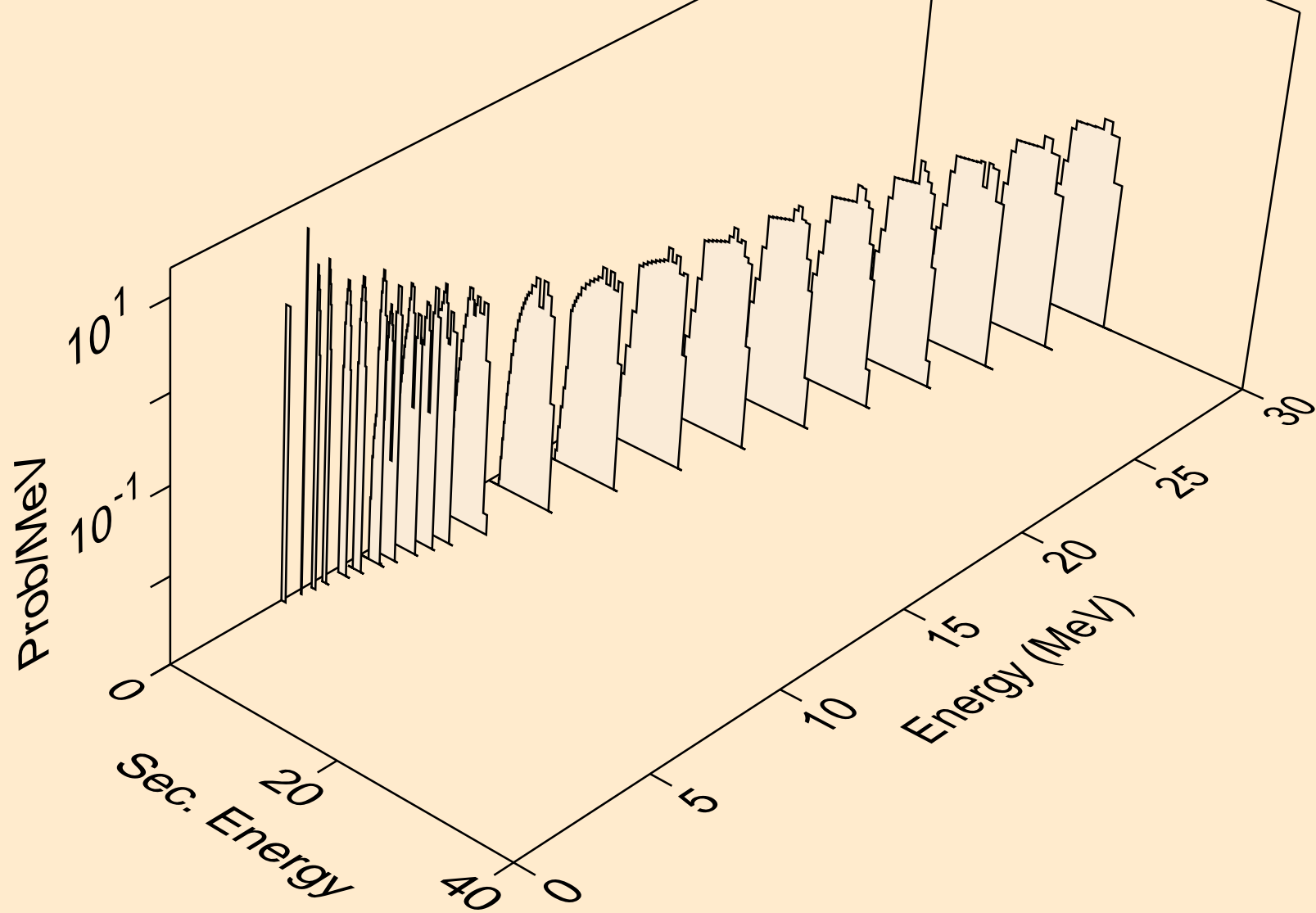

S031 NEUTRON ACER TENDL-2024 LIBRARY; T=0.K
deuterons from (n,pd)

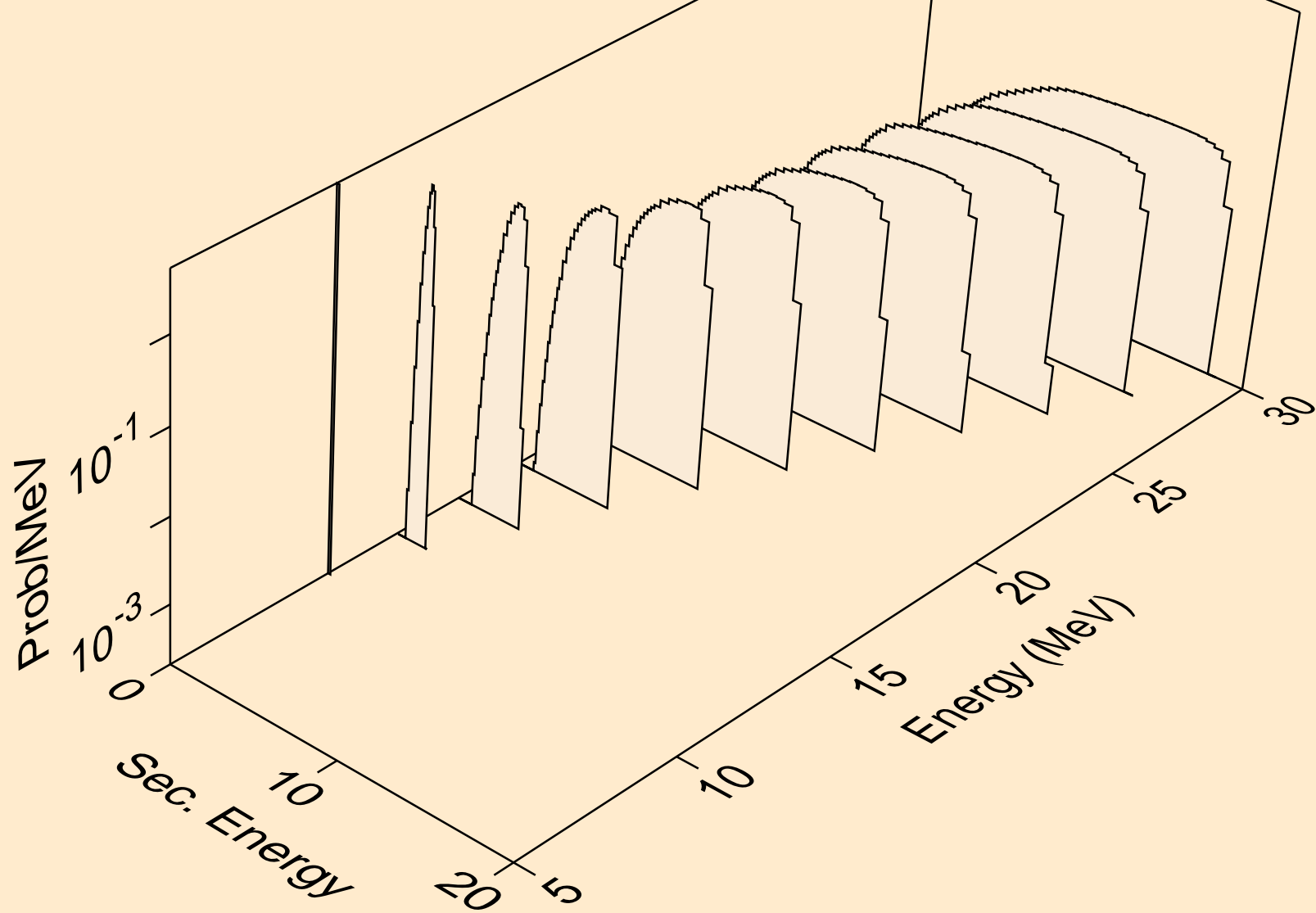

S031 NEUTRON ACER TENDL-2024 LIBRARY; T=0.K
deuterons from (n,da)

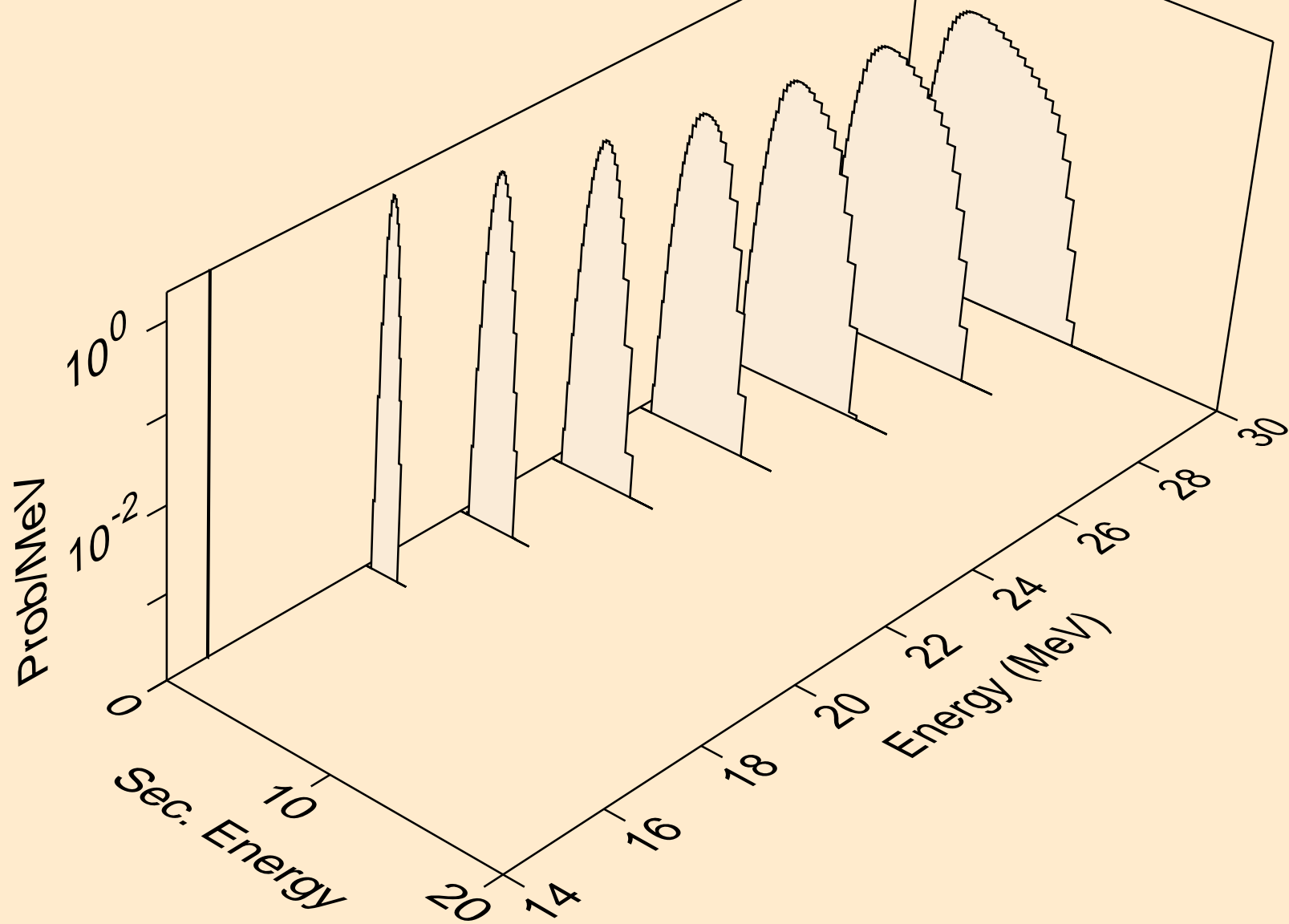

S031 NEUTRON ACER TENDL-2024 LIBRARY; T=0.K
tritons from (n,x)

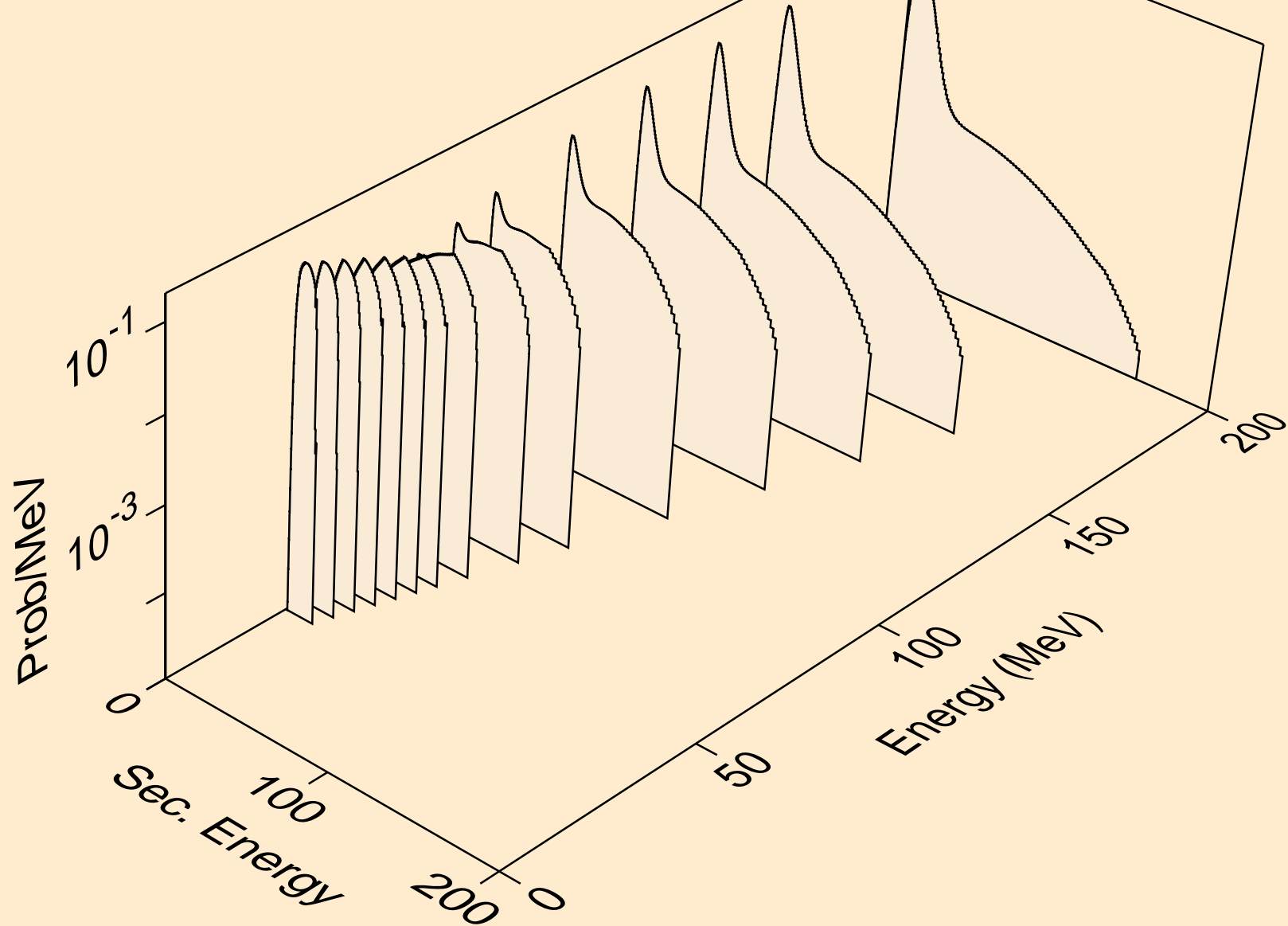

S031 NEUTRON ACER TENDL-2024 LIBRARY; T=0.K
tritons from (n,n*)t

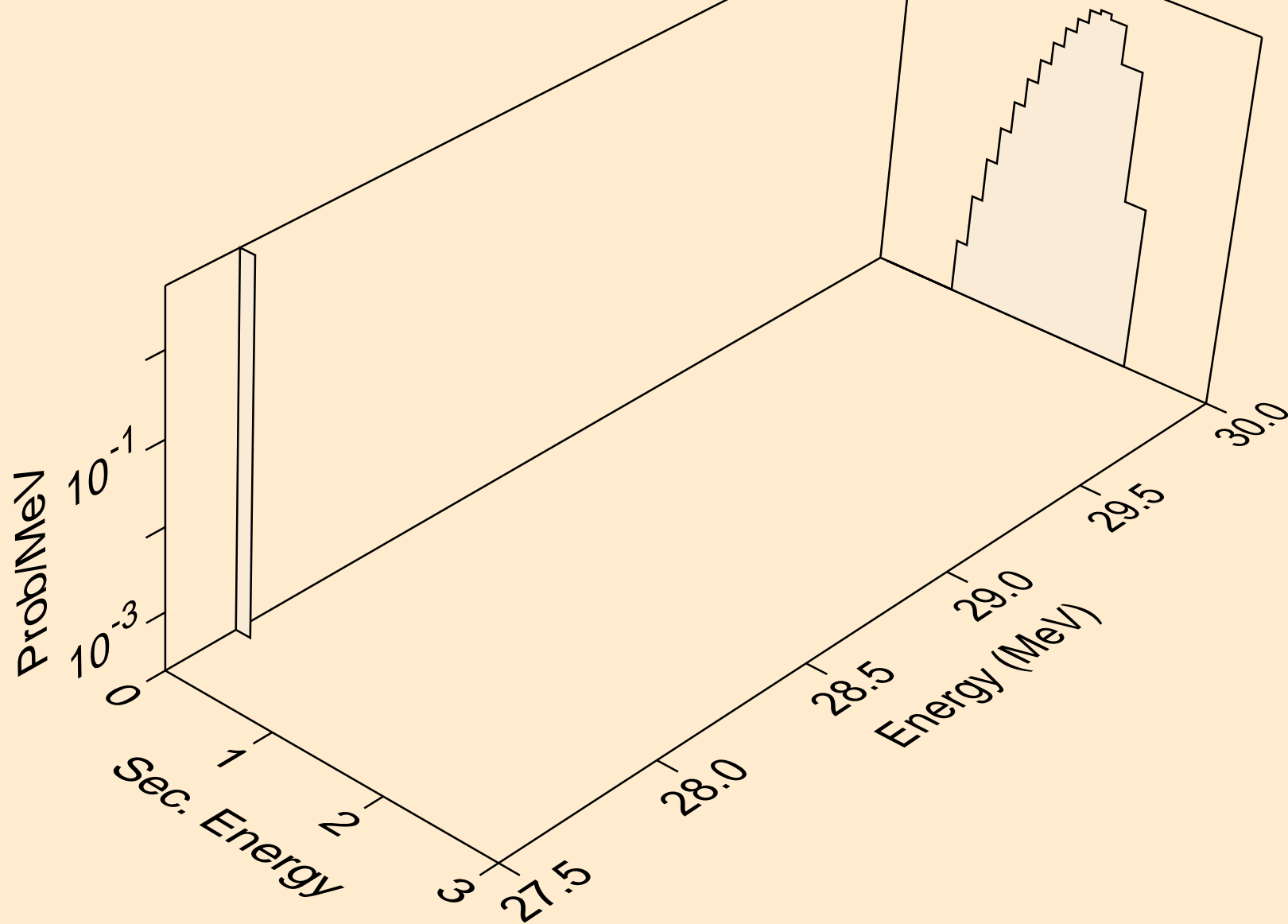

S031 NEUTRON ACER TENDL-2024 LIBRARY; T=0.K
tritons from (n,t)

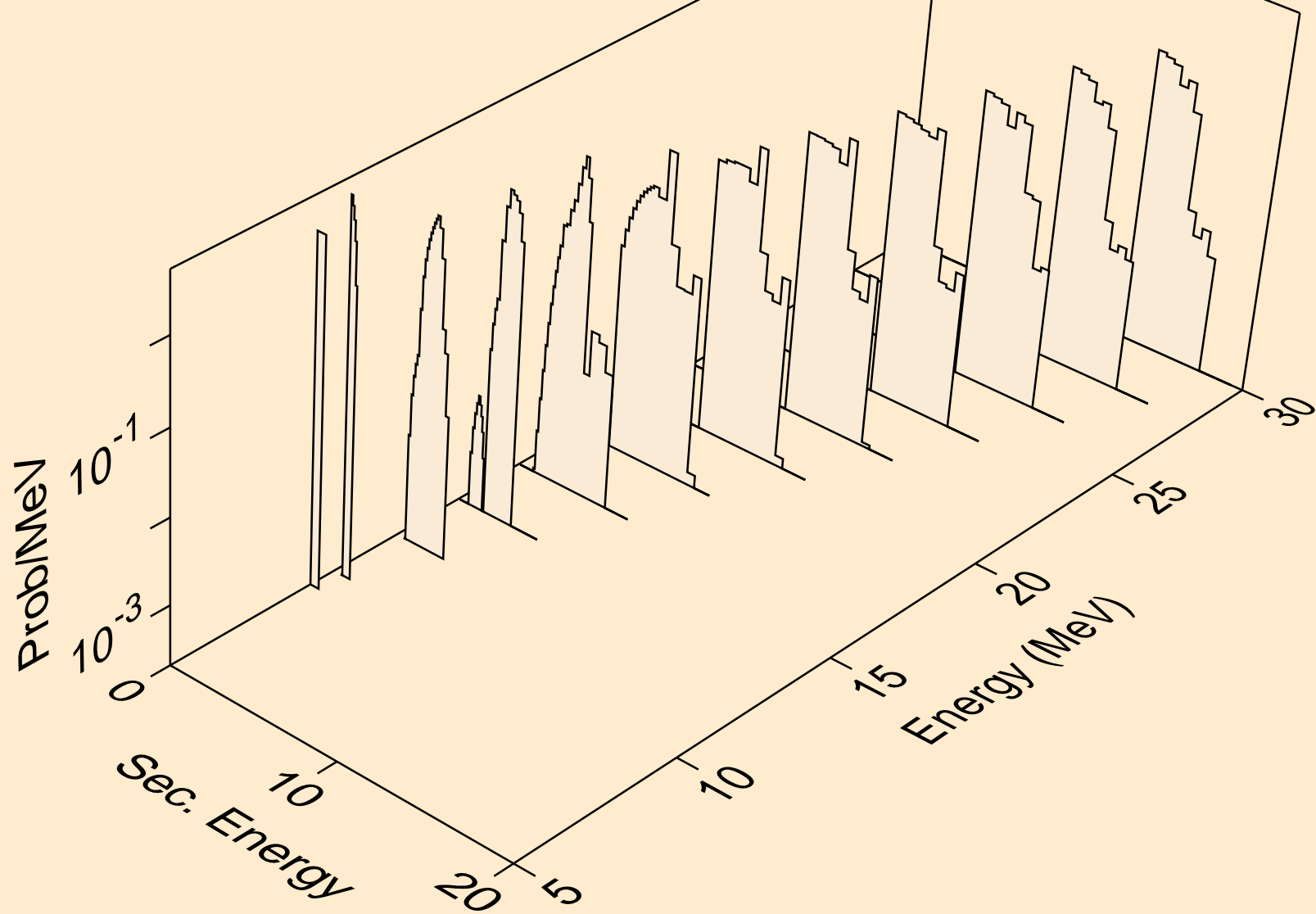

S031 NEUTRON ACER TENDL-2024 LIBRARY; T=0.K
tritons from (n,pt)

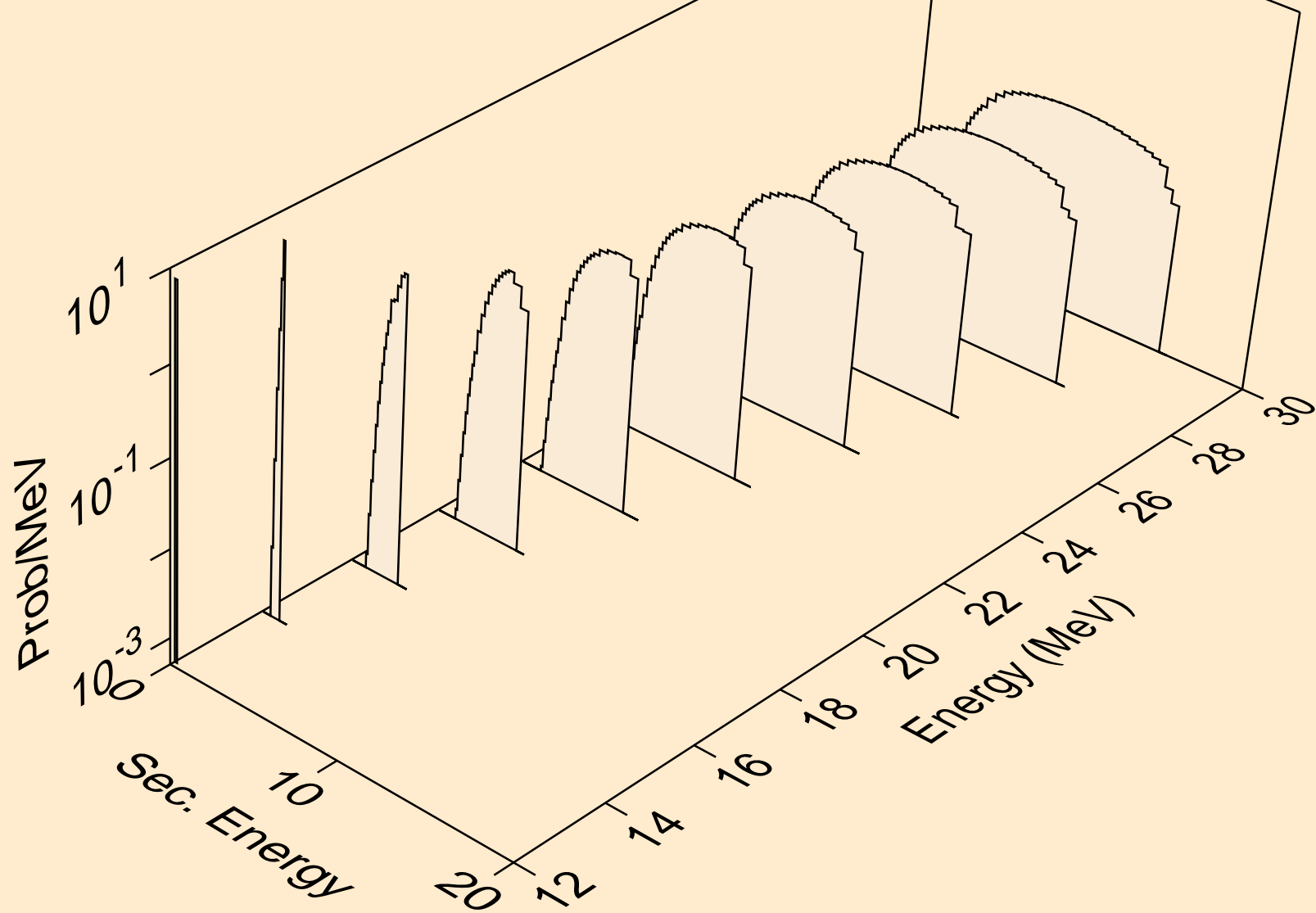

S031 NEUTRON ACER TENDL-2024 LIBRARY; T=0.K
he3s from (n,x)

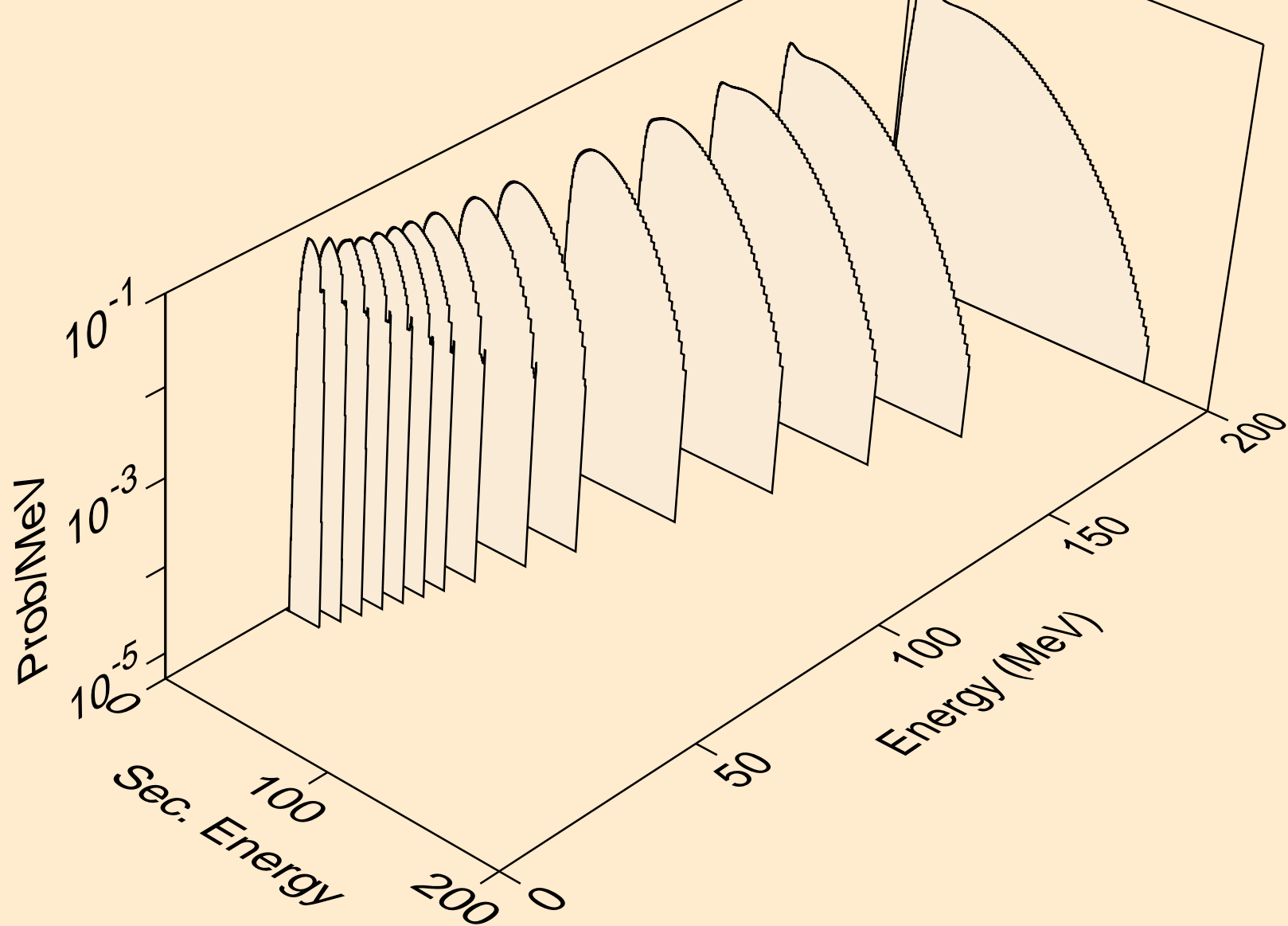

S031 NEUTRON ACER TENDL-2024 LIBRARY; T=0.K
he3s from (n,n*)he3

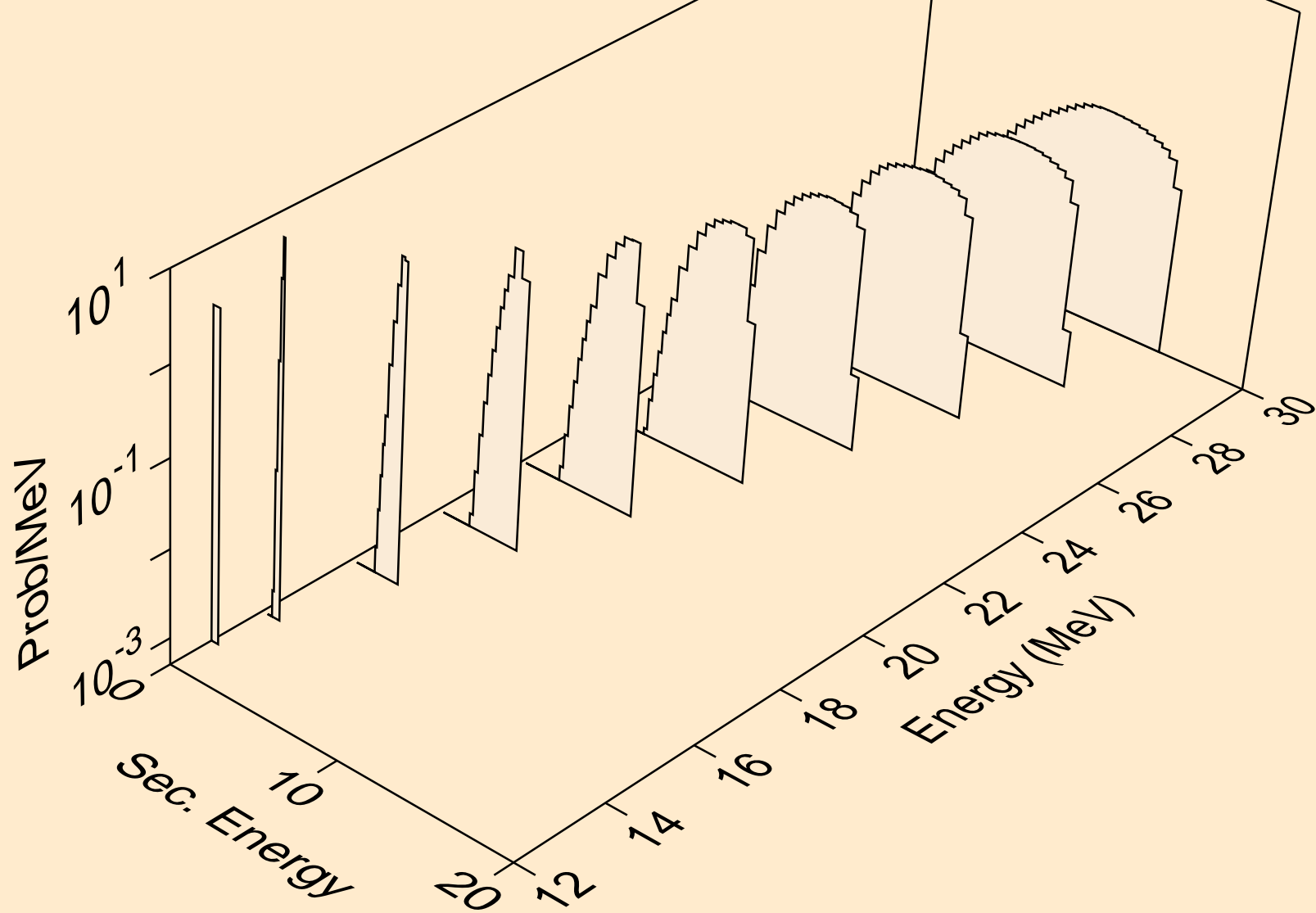

S031 NEUTRON ACER TENDL-2024 LIBRARY; T=0.K
he3s from (n,he3)

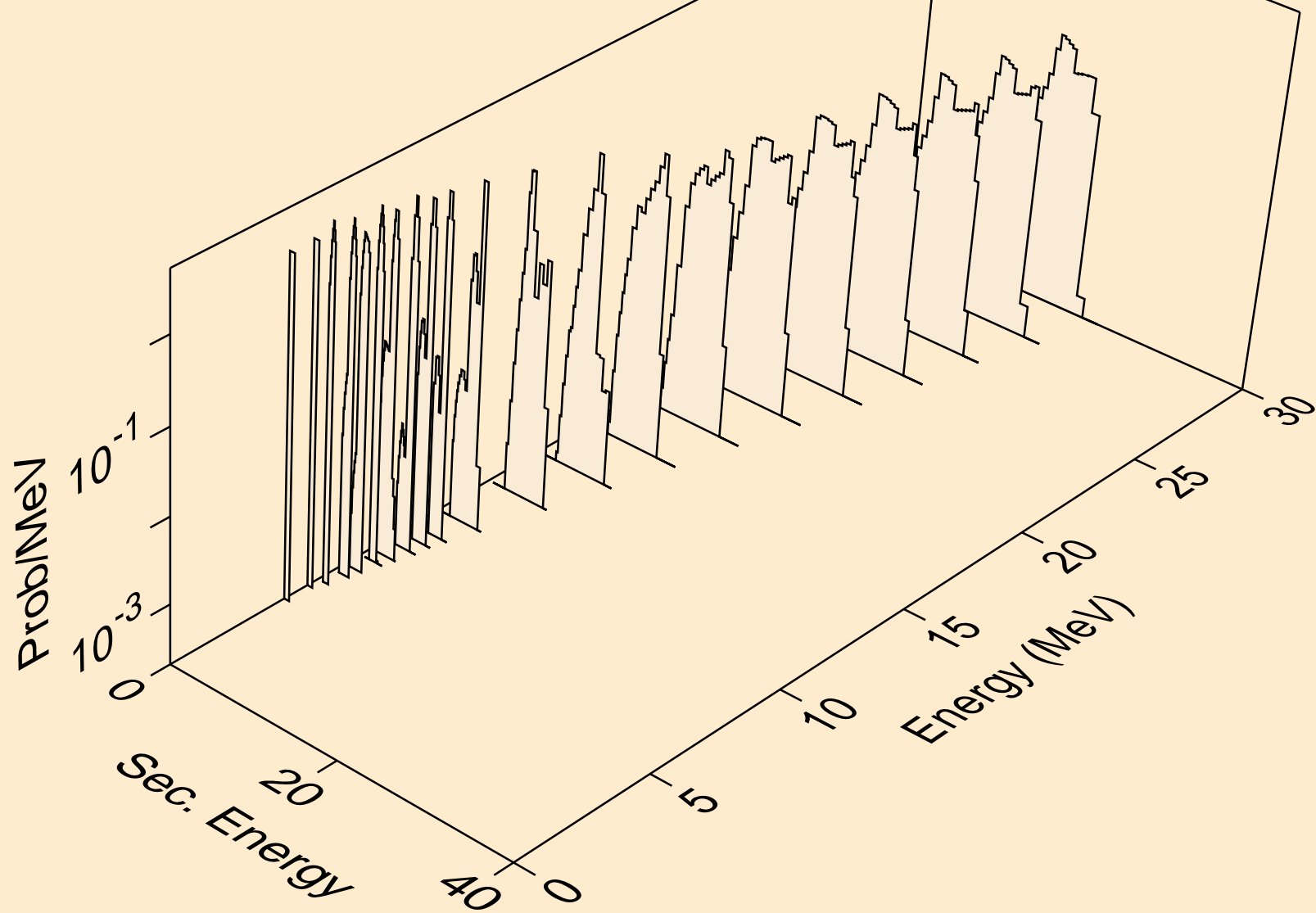

S031 NEUTRON ACER TENDL-2024 LIBRARY; T=0.K
alphas from (n,x)

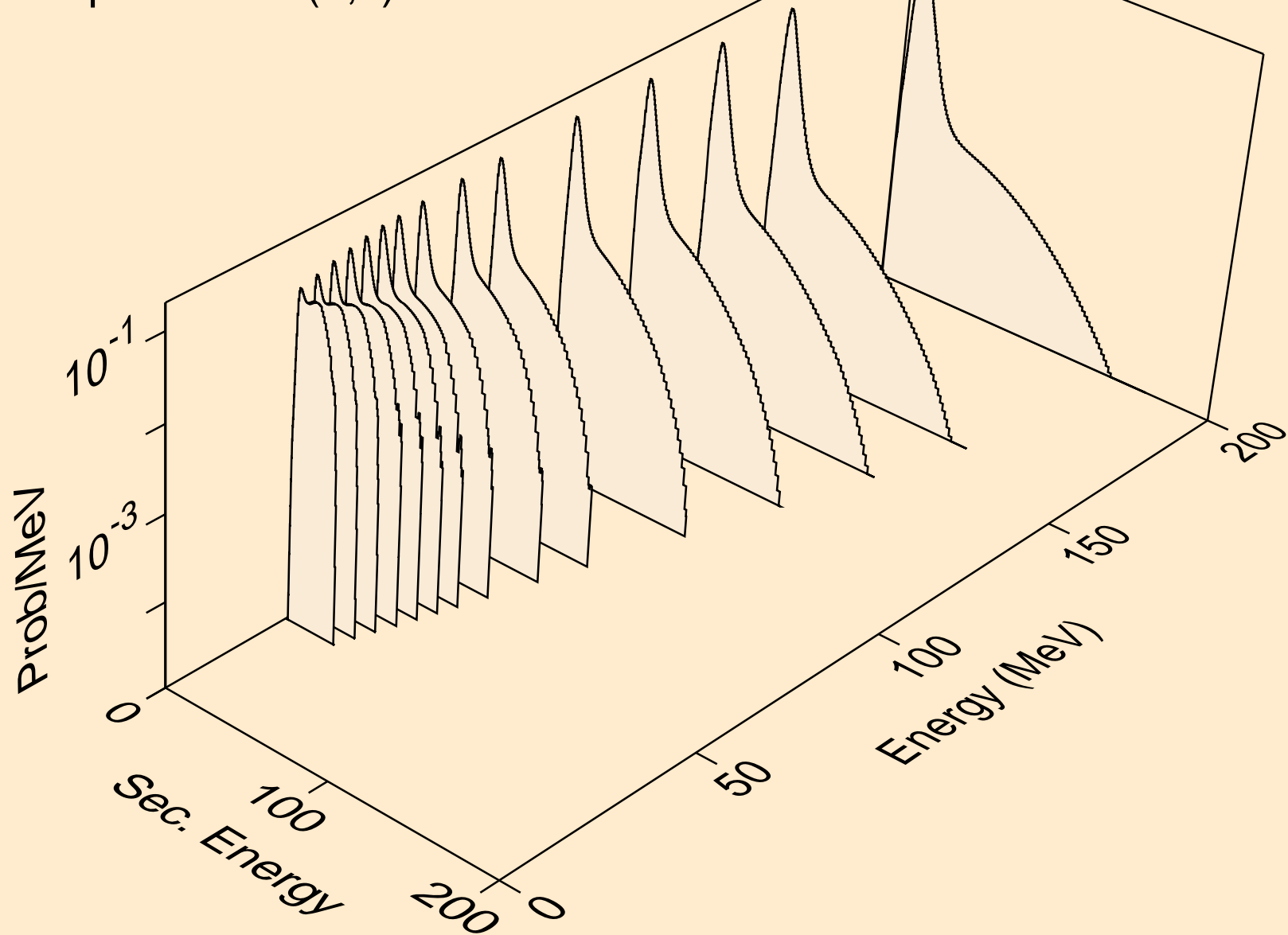

S031 NEUTRON ACER TENDL-2024 LIBRARY; T=0.K
alphas from (n,n*)a

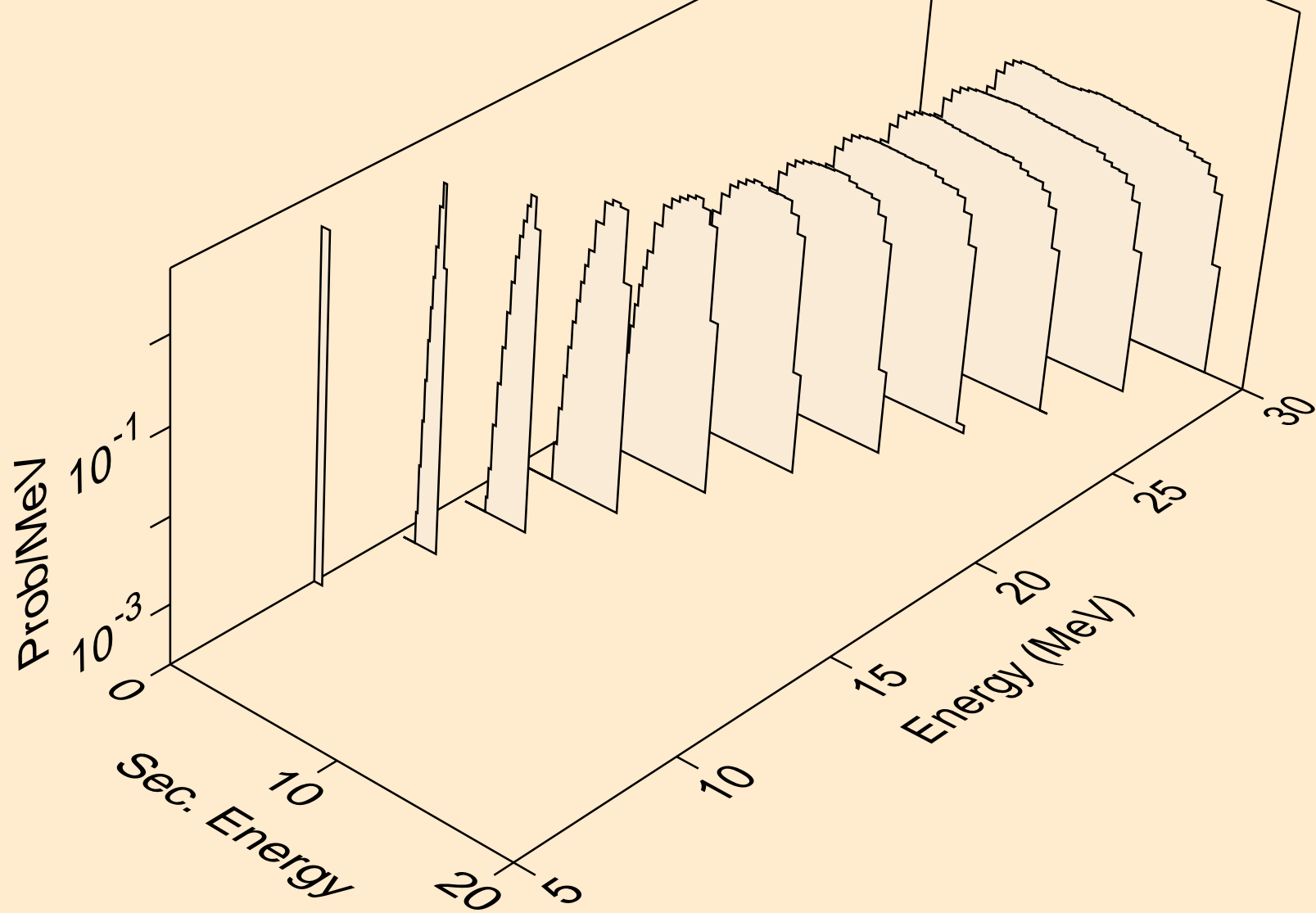

S031 NEUTRON ACER TENDL-2024 LIBRARY; T=0.K
alphas from (n,2n)a

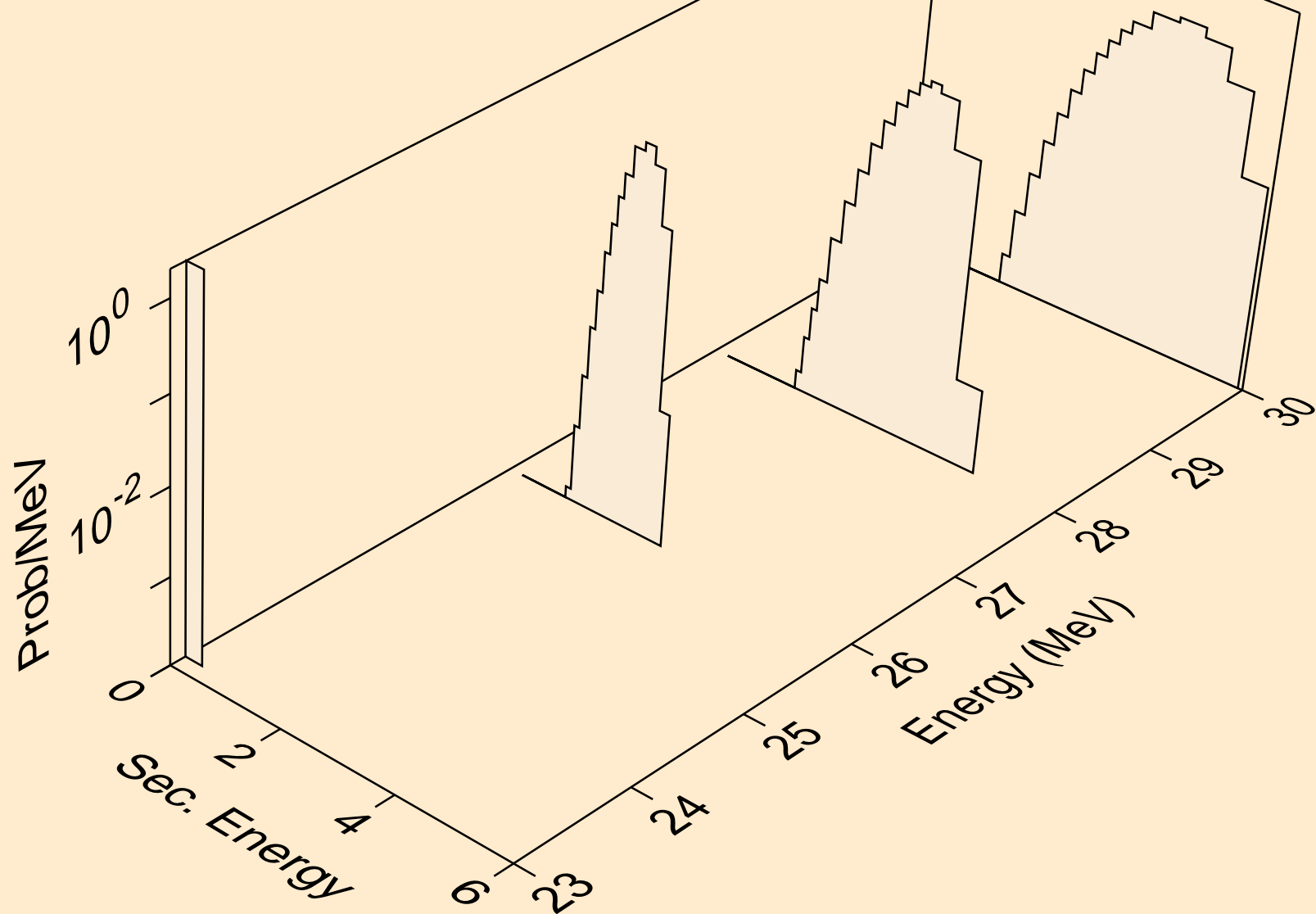

S031 NEUTRON ACER TENDL-2024 LIBRARY; T=0.K
alphas from (n,n*)2a

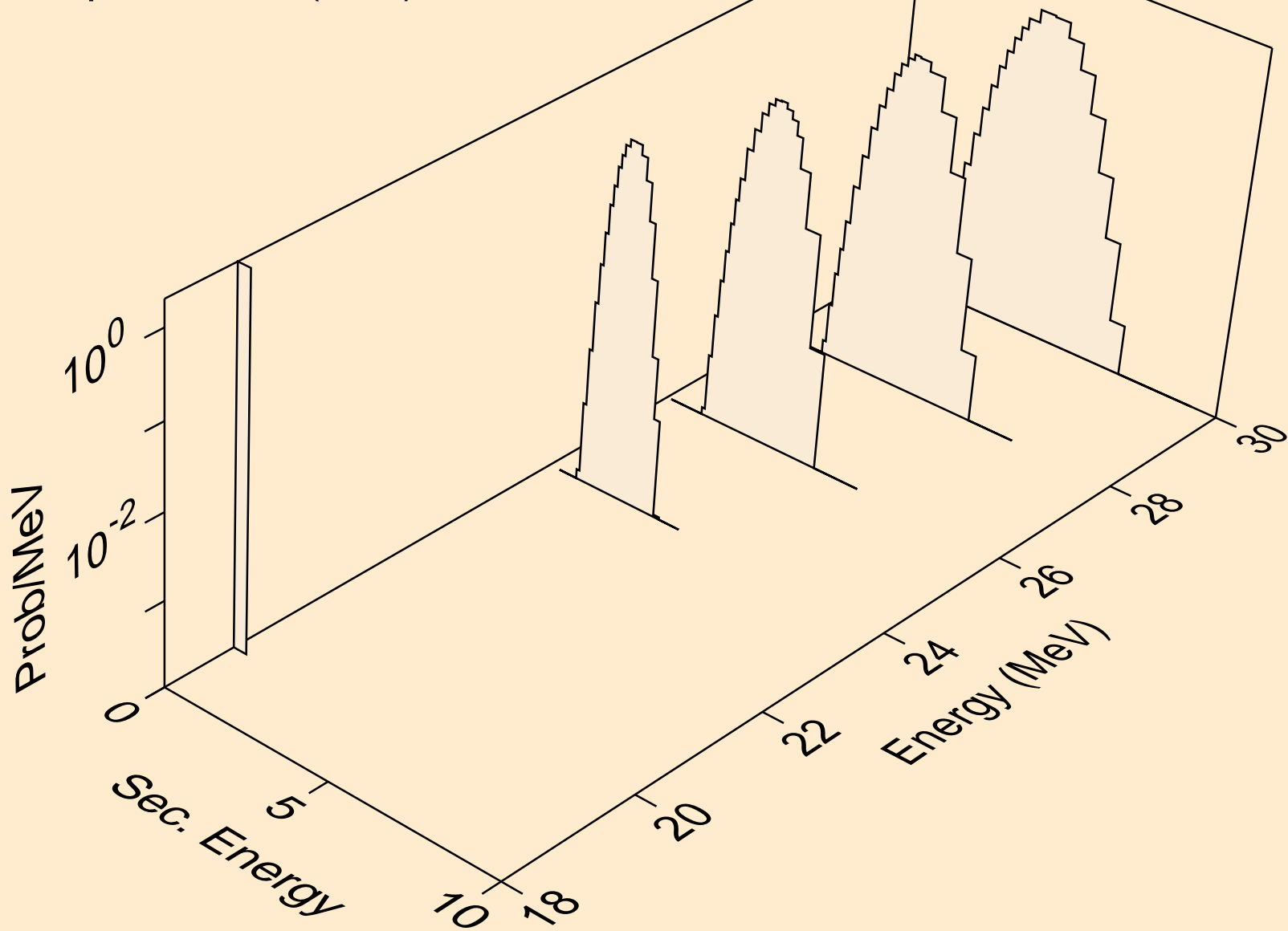

S031 NEUTRON ACER TENDL-2024 LIBRARY; T=0.K
alphas from (n,npa)

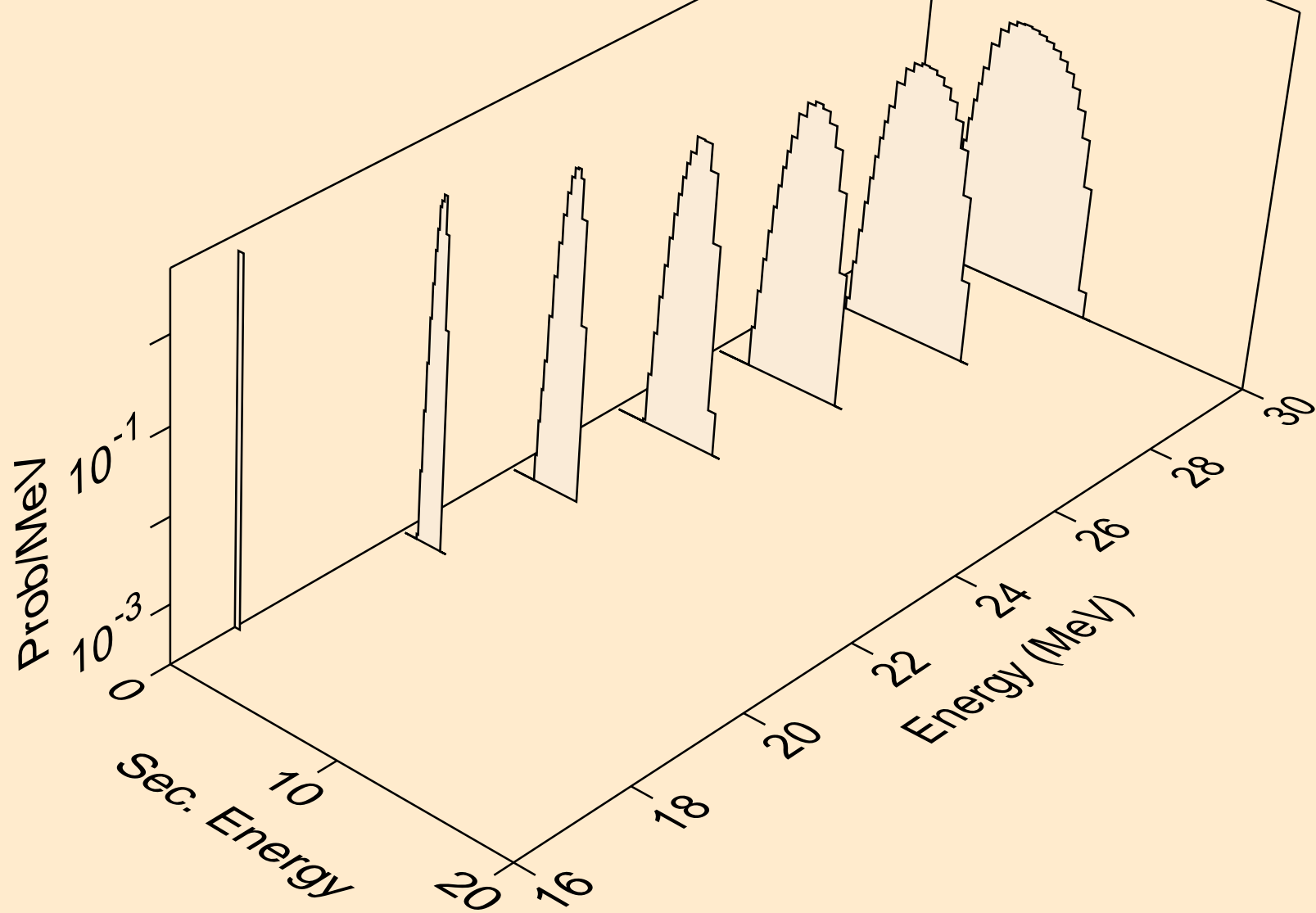

S031 NEUTRON ACER TENDL-2024 LIBRARY; T=0.K
alphas from (n,a)

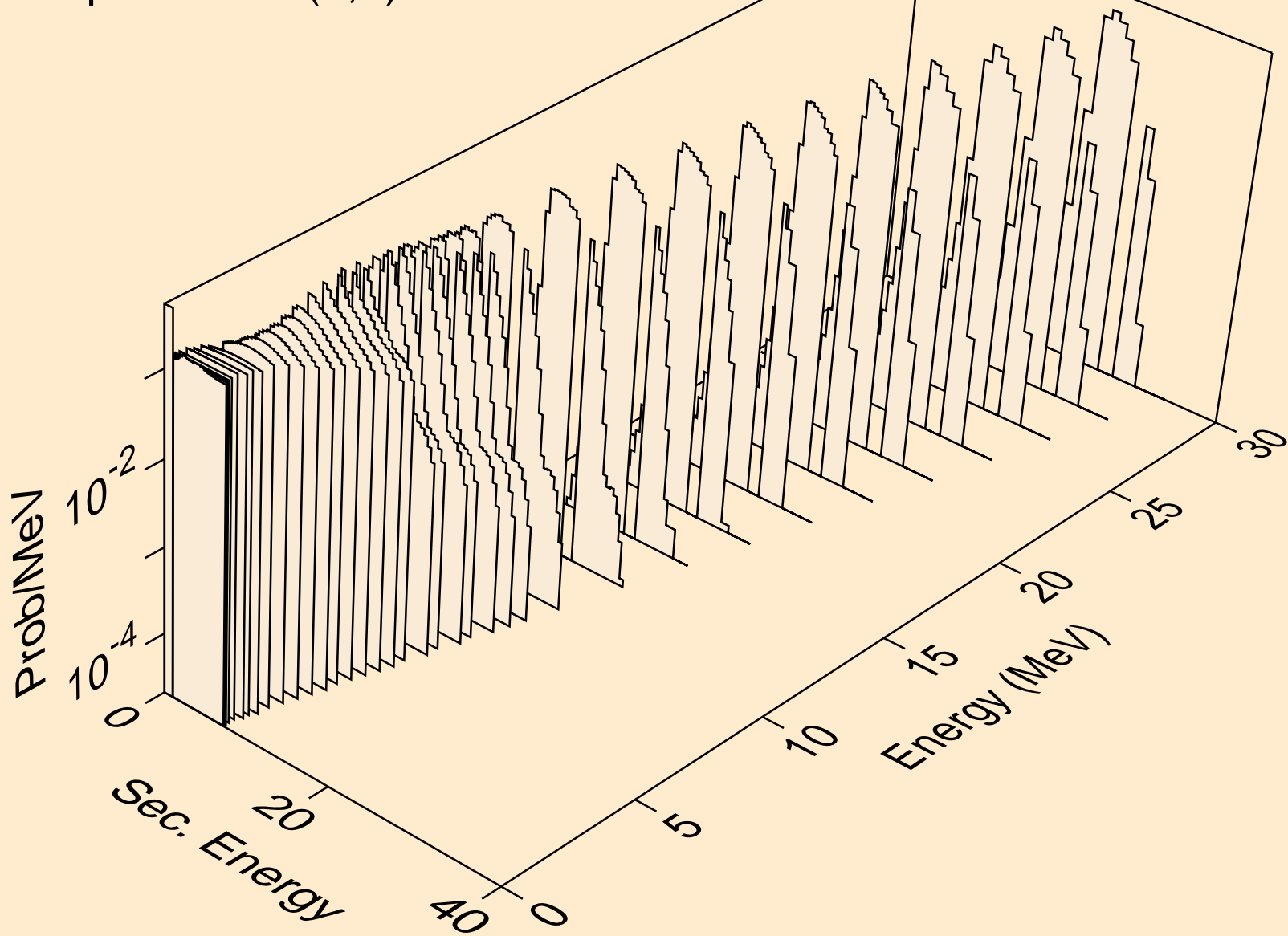

S031 NEUTRON ACER TENDL-2024 LIBRARY; T=0.K
alphas from (n,2a)

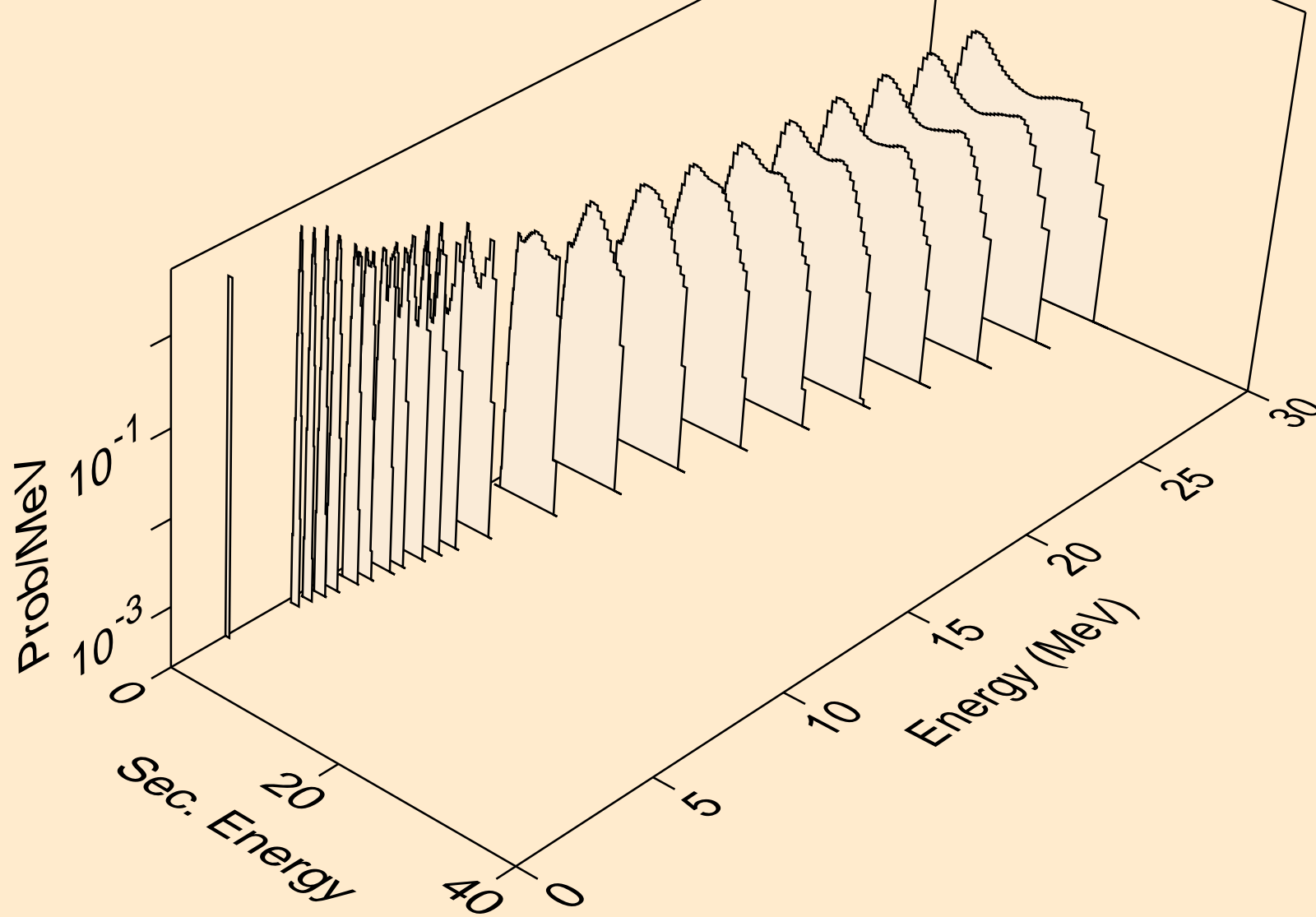

S031 NEUTRON ACER TENDL-2024 LIBRARY; T=0.K
alphas from (n,3a)

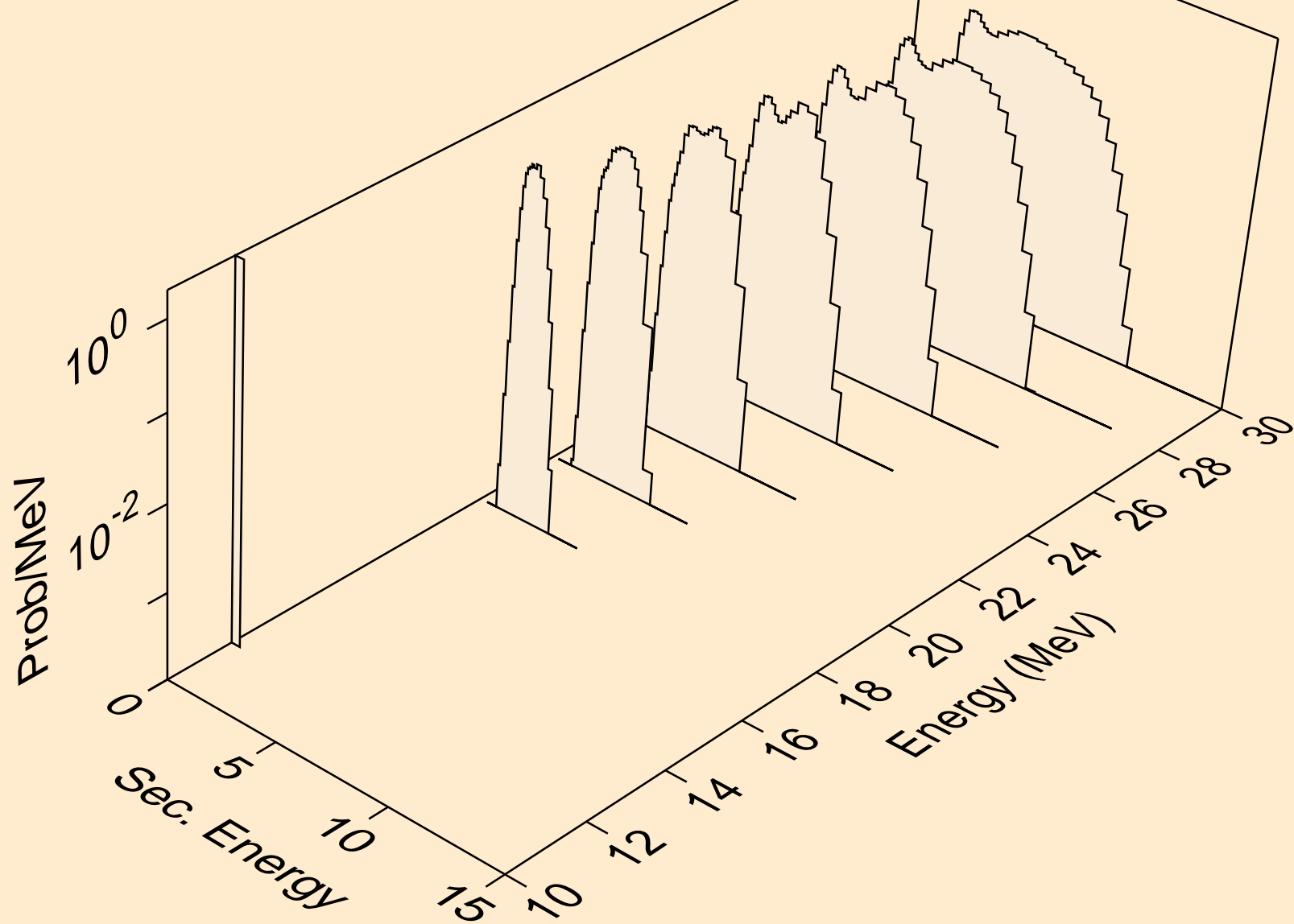

S031 NEUTRON ACER TENDL-2024 LIBRARY; T=0.K
alphas from (n,pa)

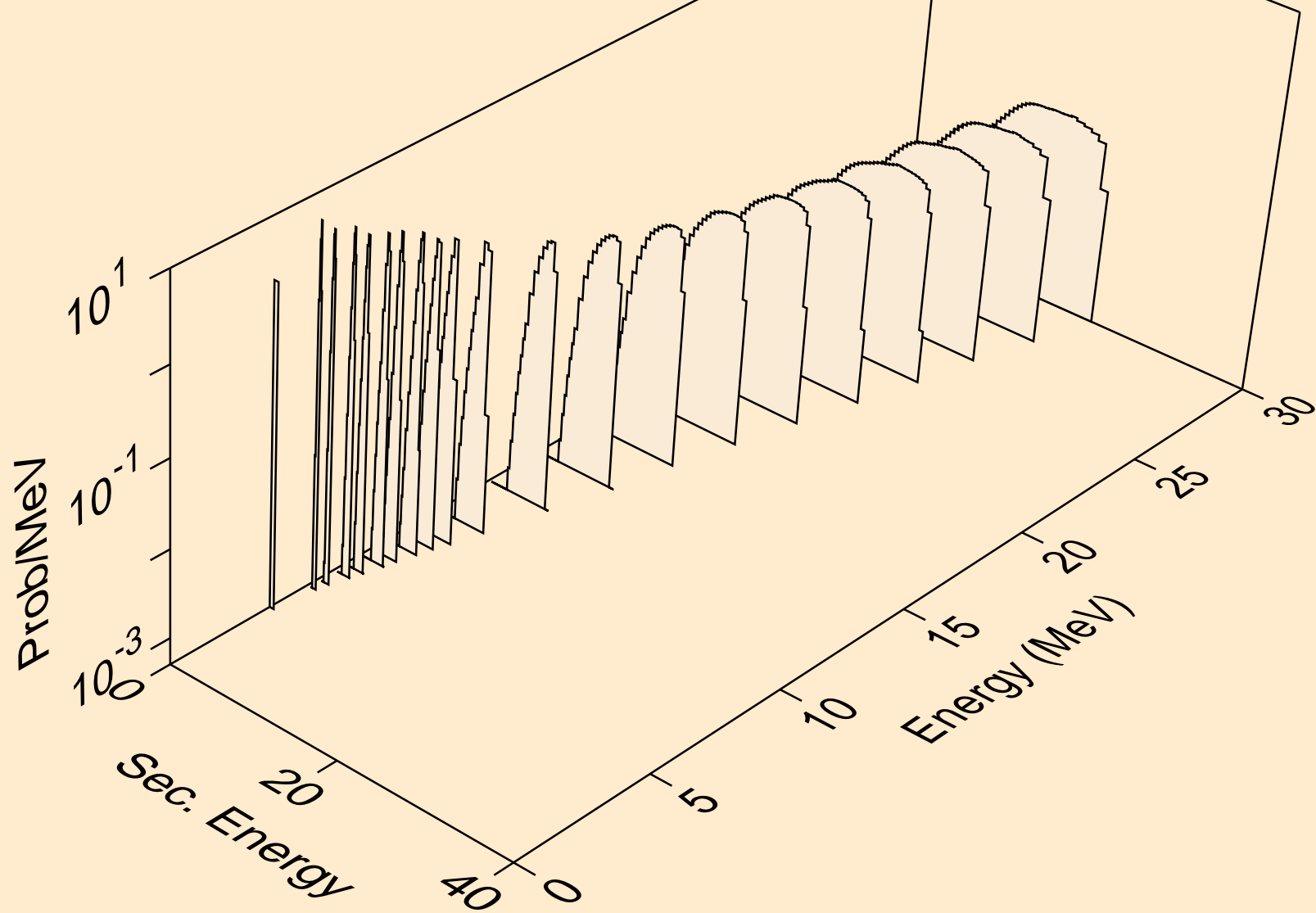

S031 NEUTRON ACER TENDL-2024 LIBRARY; T=0.K
alphas from (n,da)

