

# SB110 NEUTRON ACER TENDL-2024 LIBRARY; T=0.K

## Principal cross sections

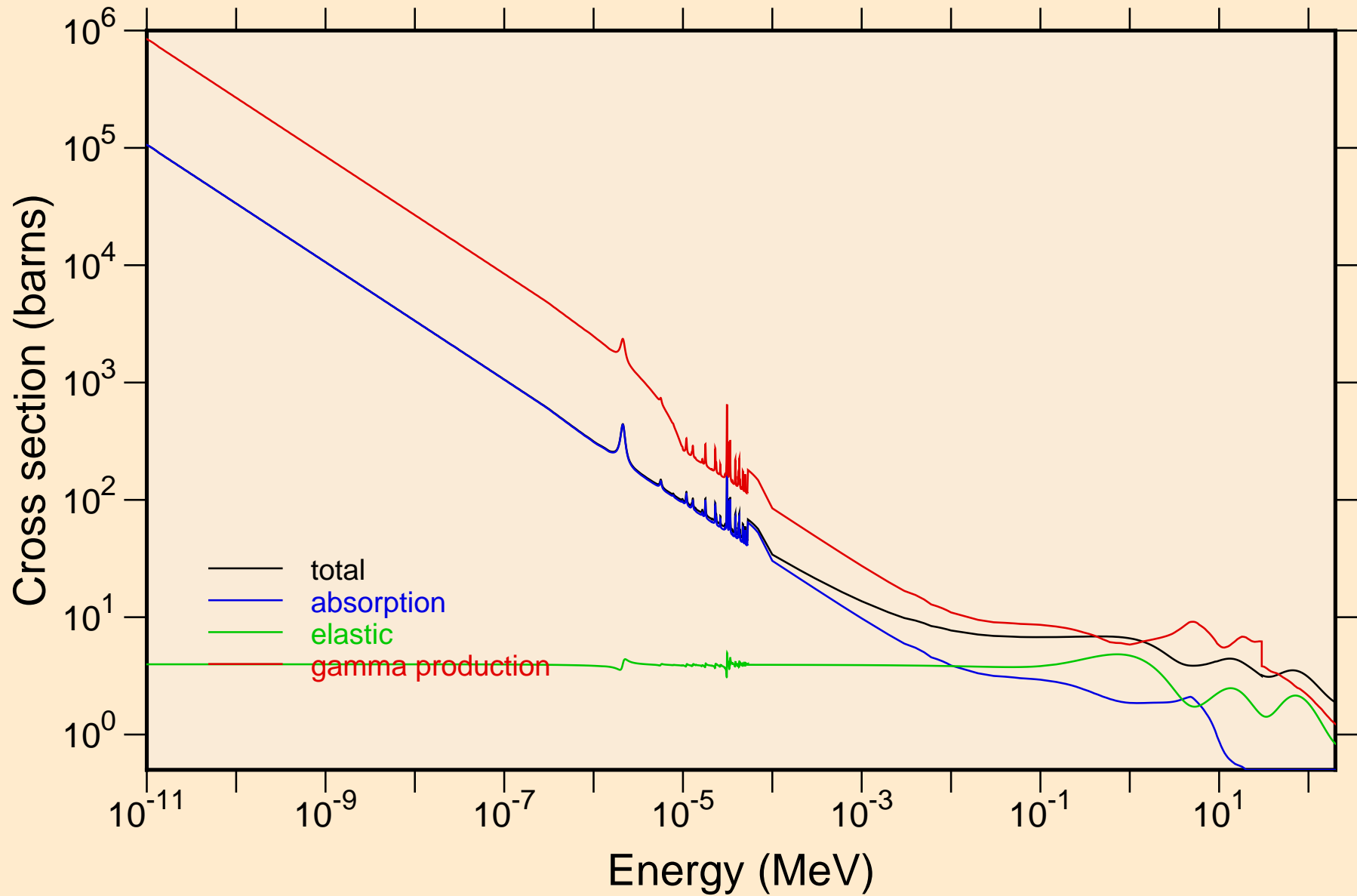

SB110 NEUTRON ACER TENDL-2024 LIBRARY; T=0.K  
resonance total cross section

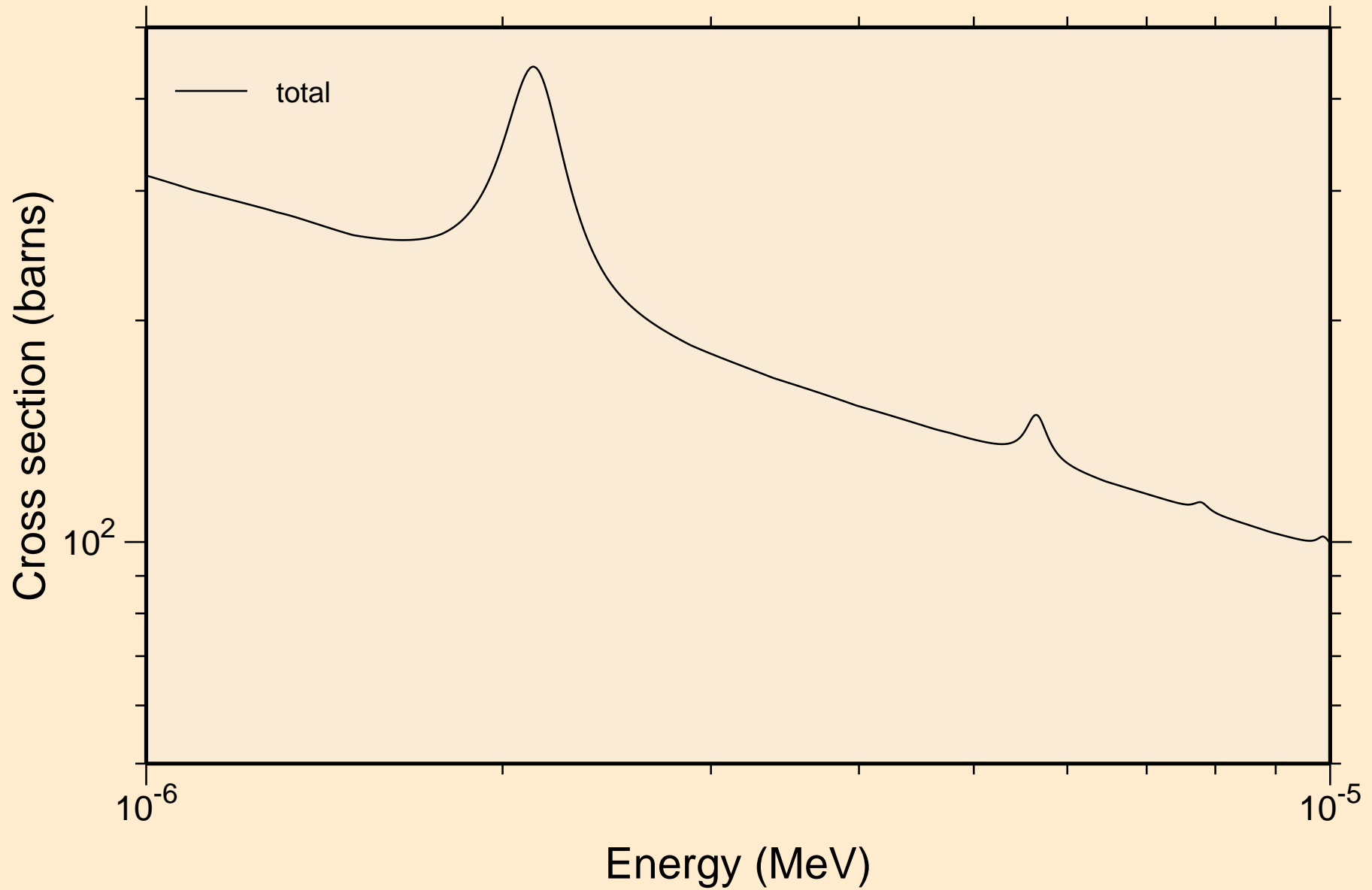

SB110 NEUTRON ACER TENDL-2024 LIBRARY; T=0.K  
resonance total cross section

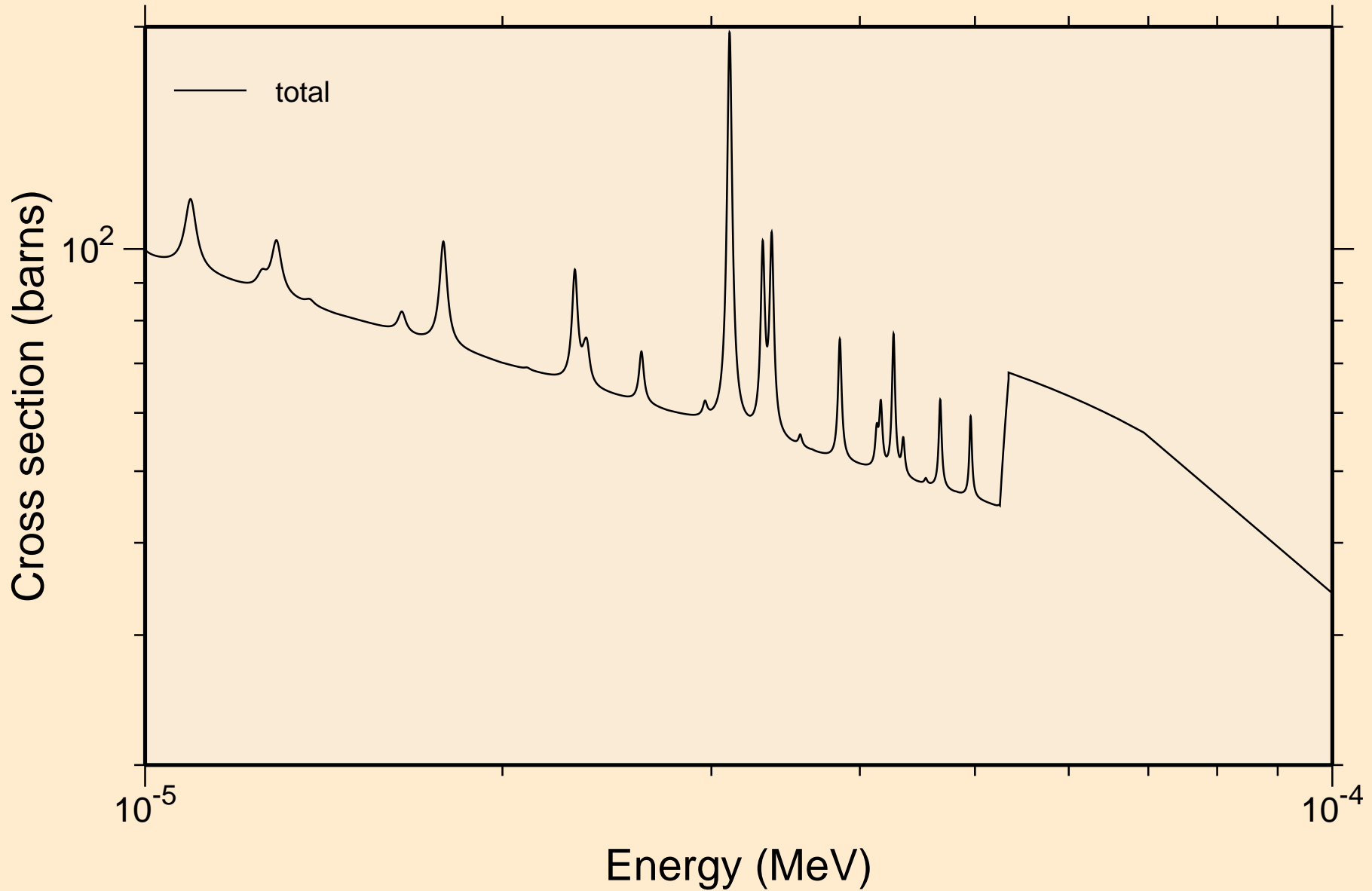

SB110 NEUTRON ACER TENDL-2024 LIBRARY; T=0.K  
resonance total cross section

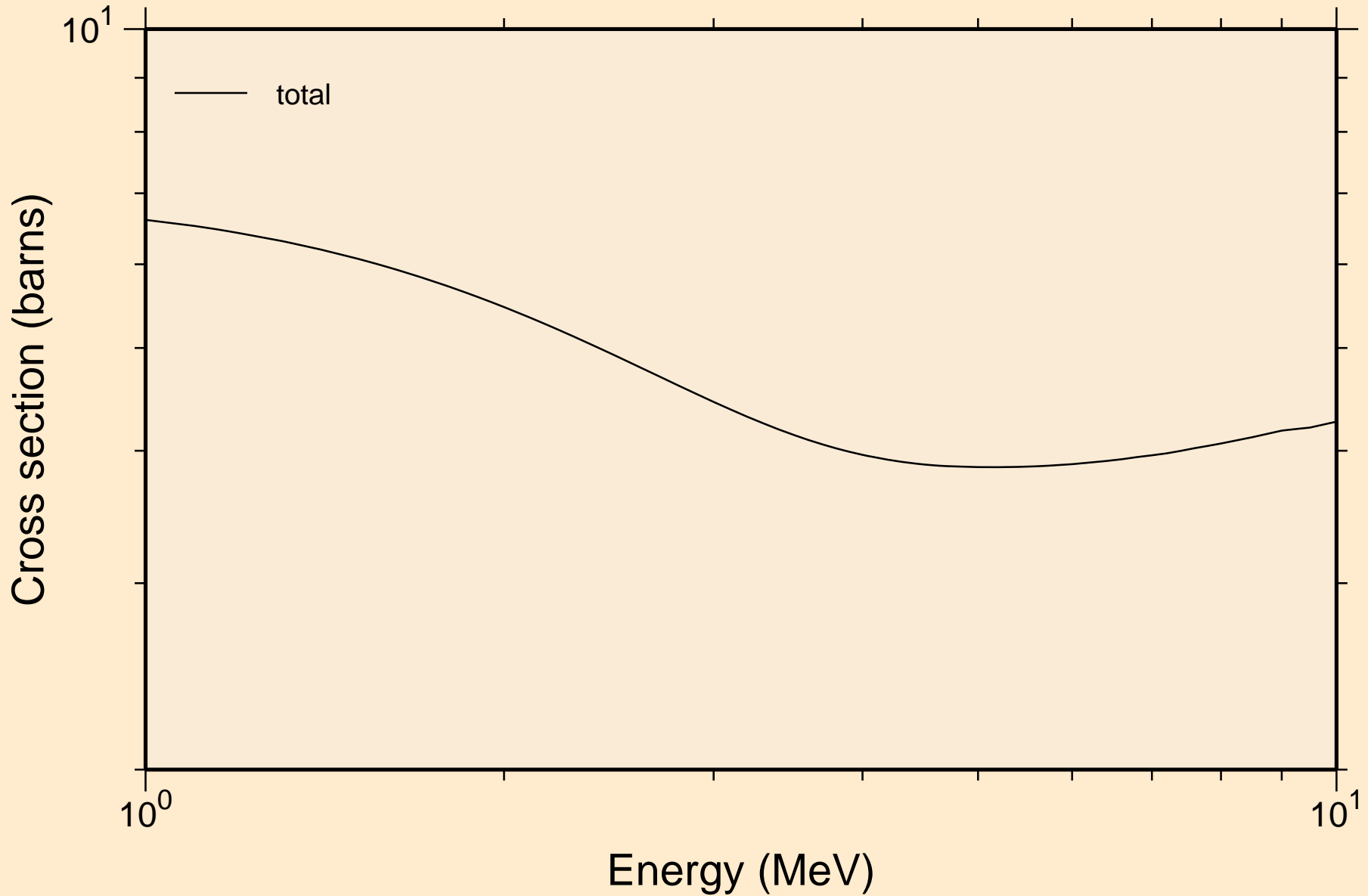

SB110 NEUTRON ACER TENDL-2024 LIBRARY; T=0.K  
resonance absorption cross sections

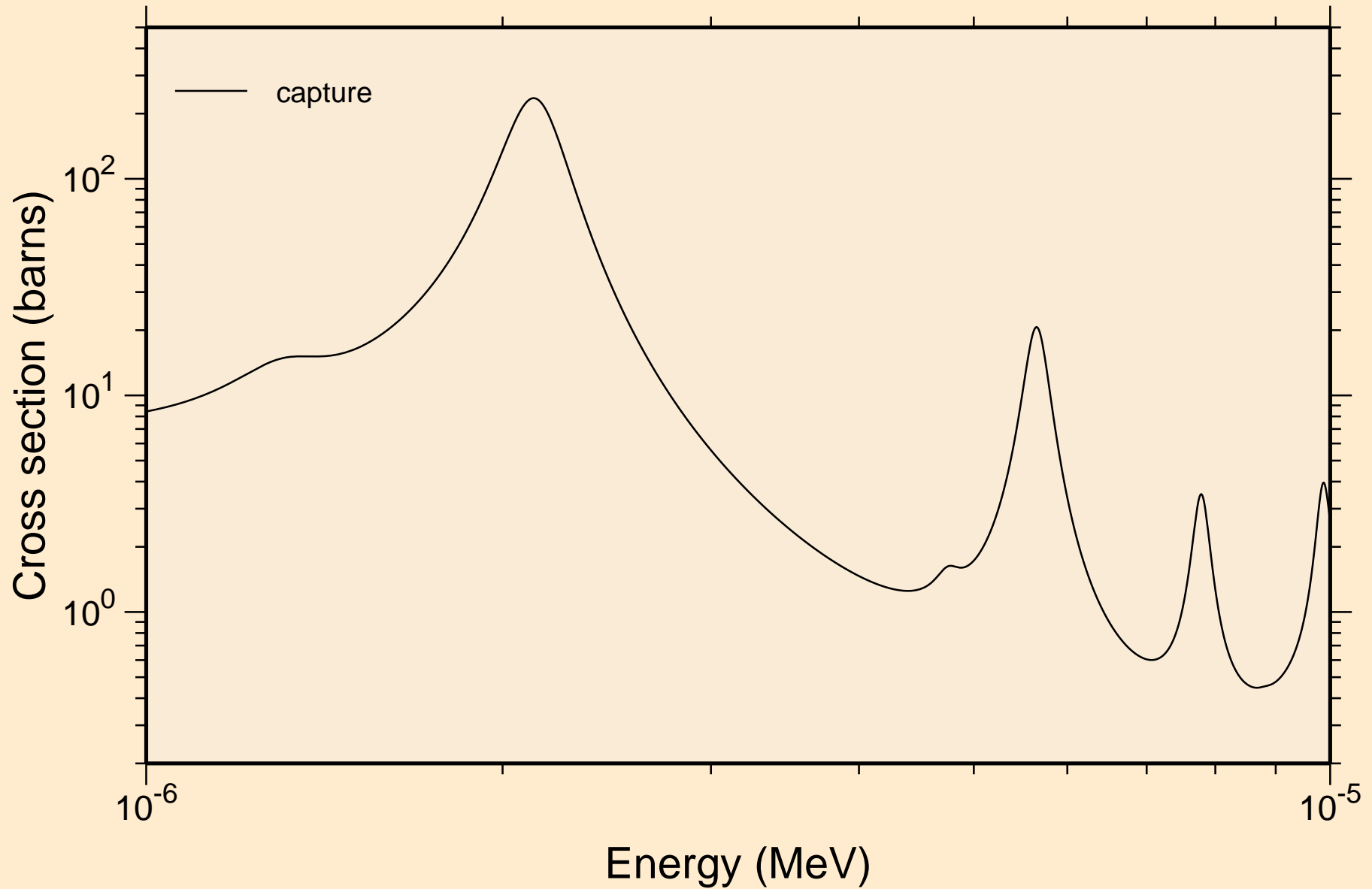

SB110 NEUTRON ACER TENDL-2024 LIBRARY; T=0.K  
resonance absorption cross sections

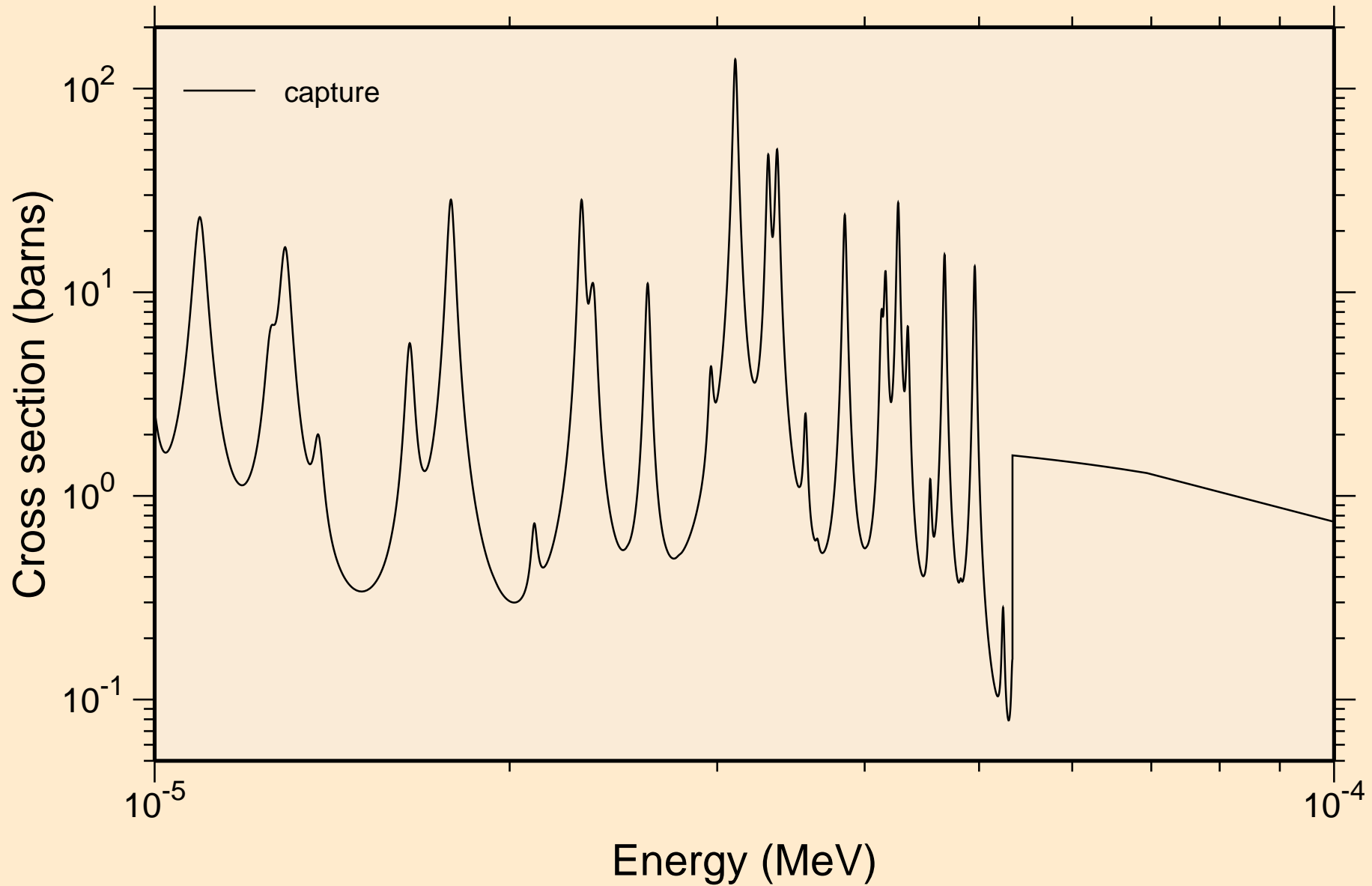

SB110 NEUTRON ACER TENDL-2024 LIBRARY; T=0.K  
resonance absorption cross sections

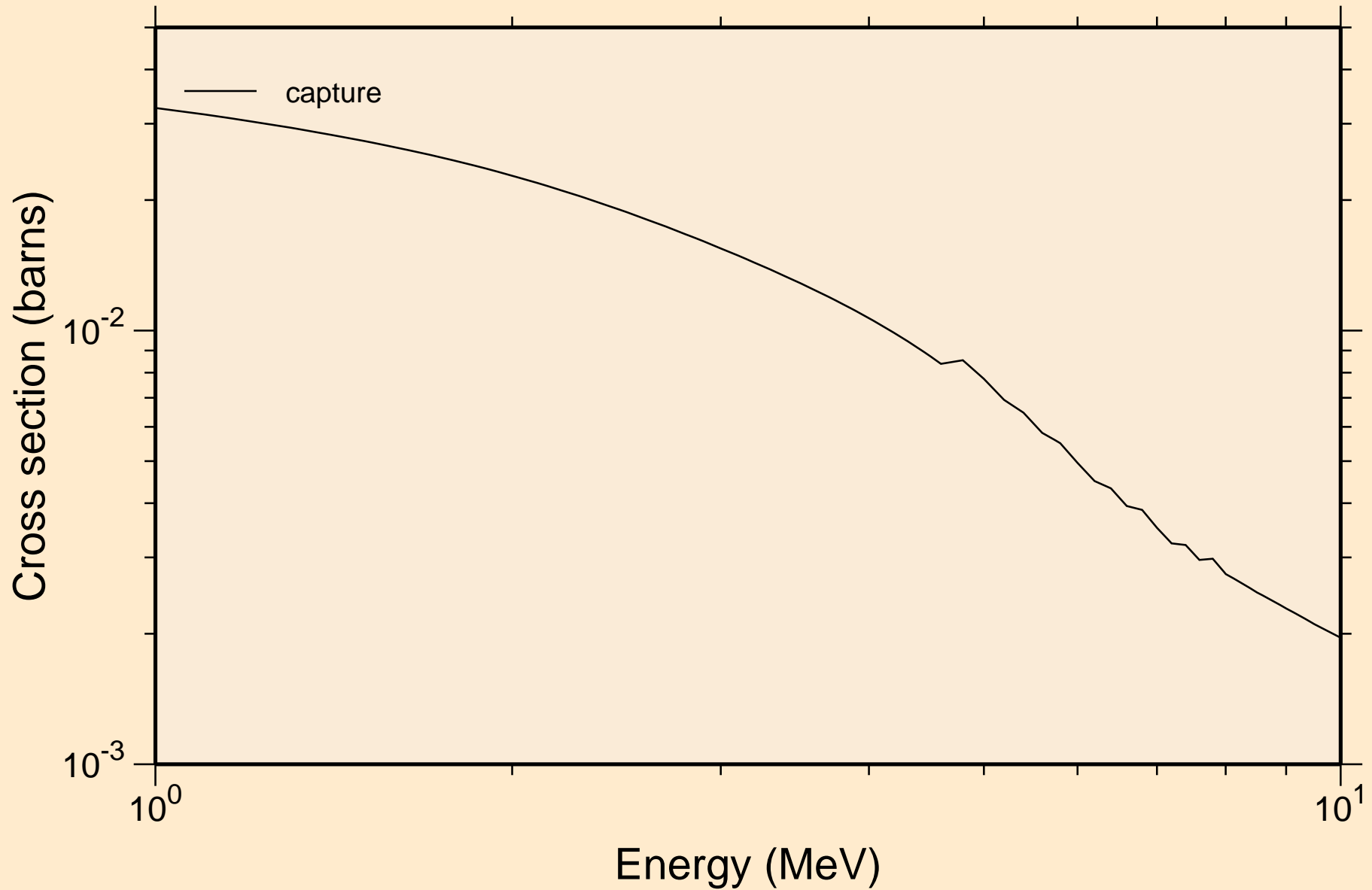

# SB110 NEUTRON ACER TENDL-2024 LIBRARY; T=0.K

## Heating

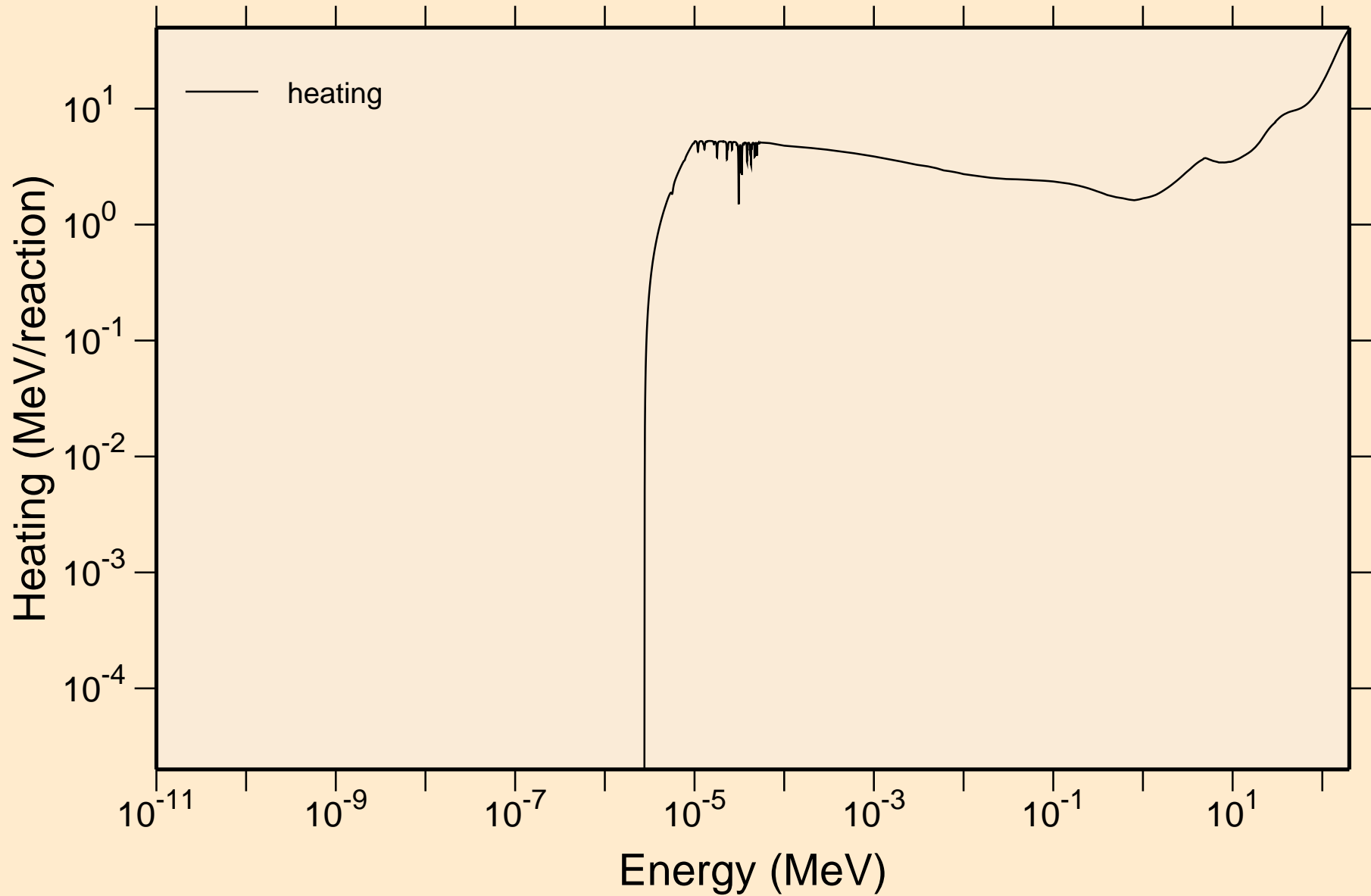



# SB110 NEUTRON ACER TENDL-2024 LIBRARY; T=0.K

## Damage

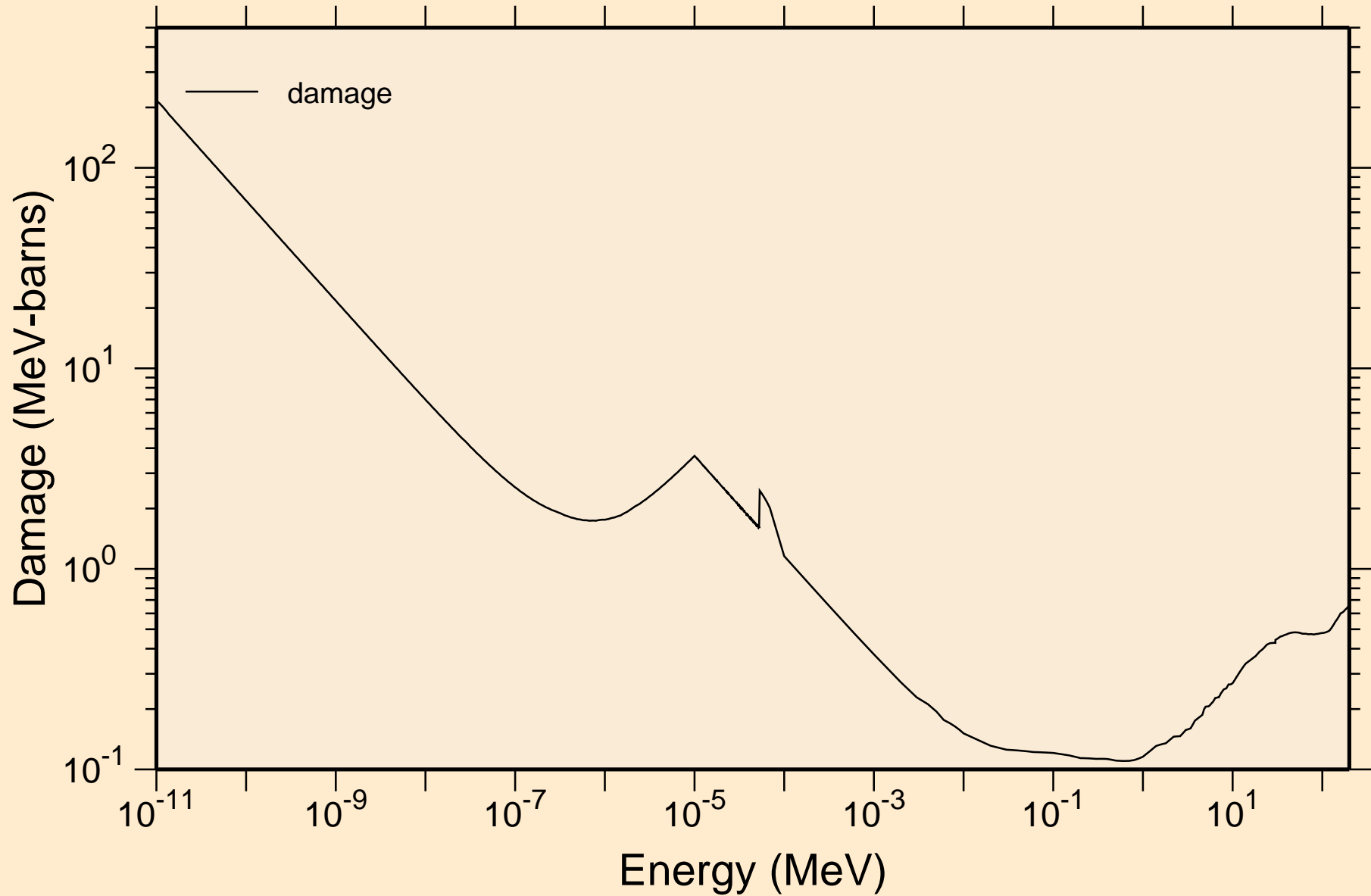

# SB110 NEUTRON ACER TENDL-2024 LIBRARY; T=0.K

## Non-threshold reactions

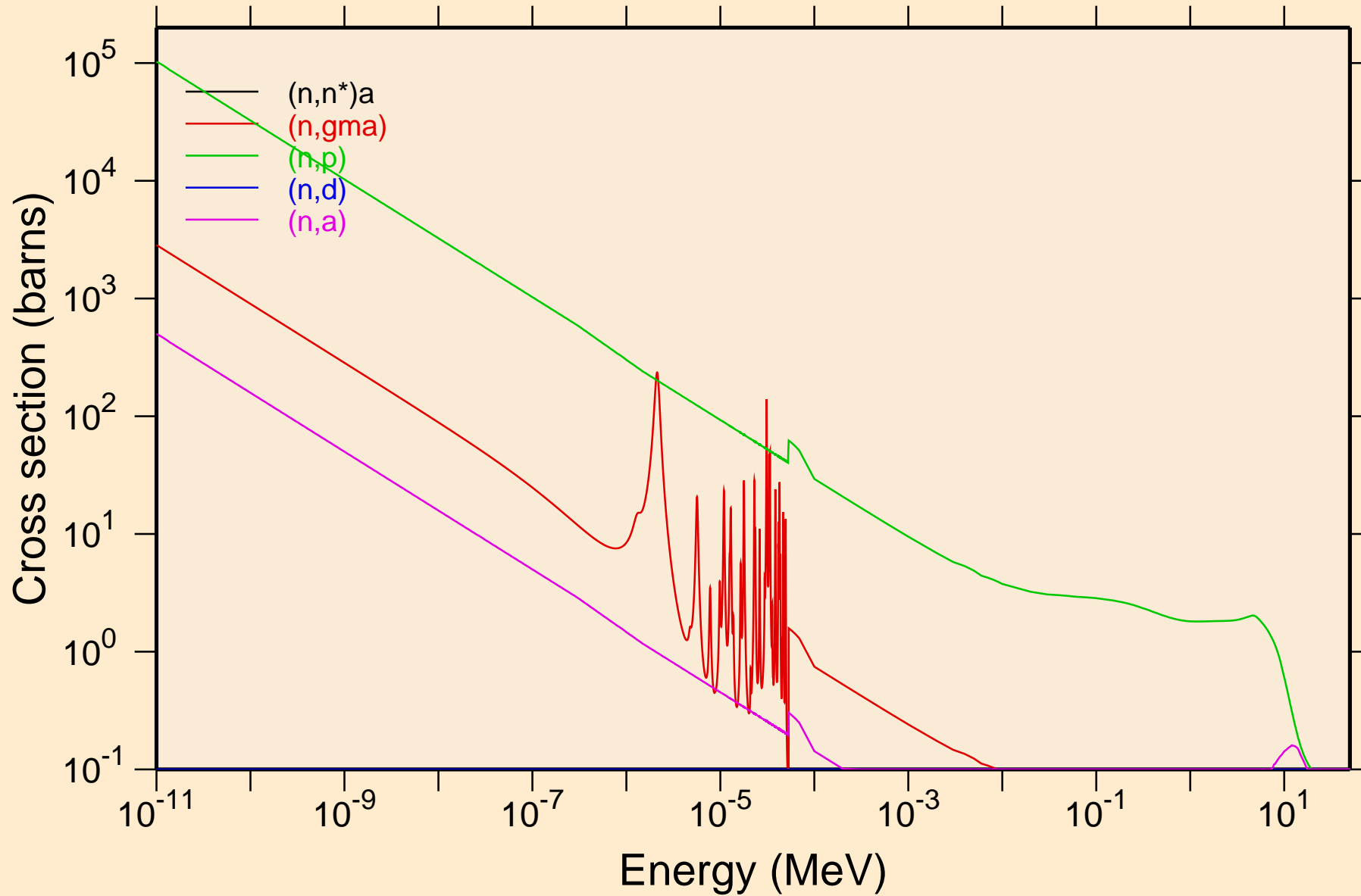

# SB110 NEUTRON ACER TENDL-2024 LIBRARY; T=0.K

## Non-threshold reactions

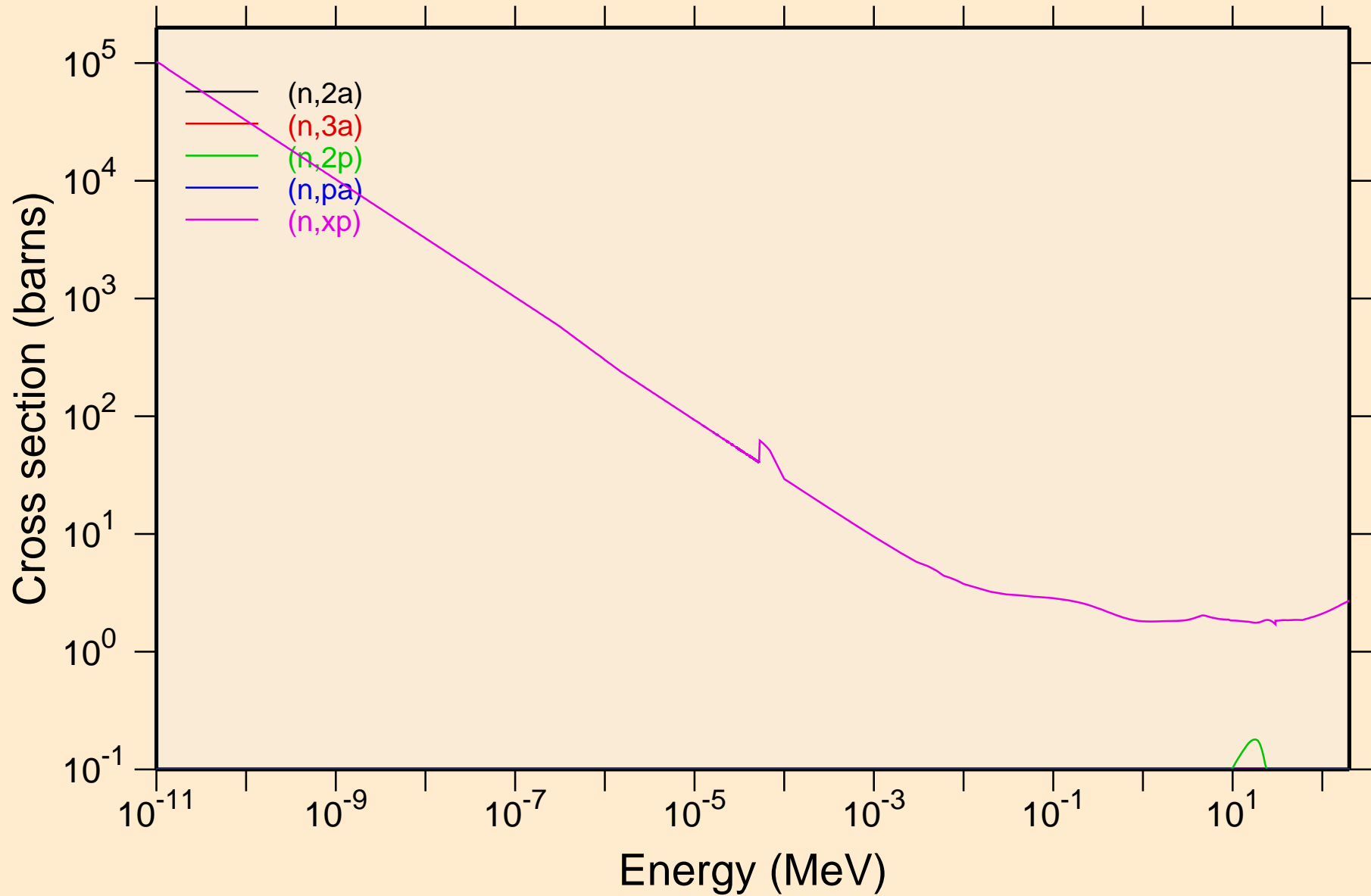

SB110 NEUTRON ACER TENDL-2024 LIBRARY; T=0.K  
Non-threshold reactions

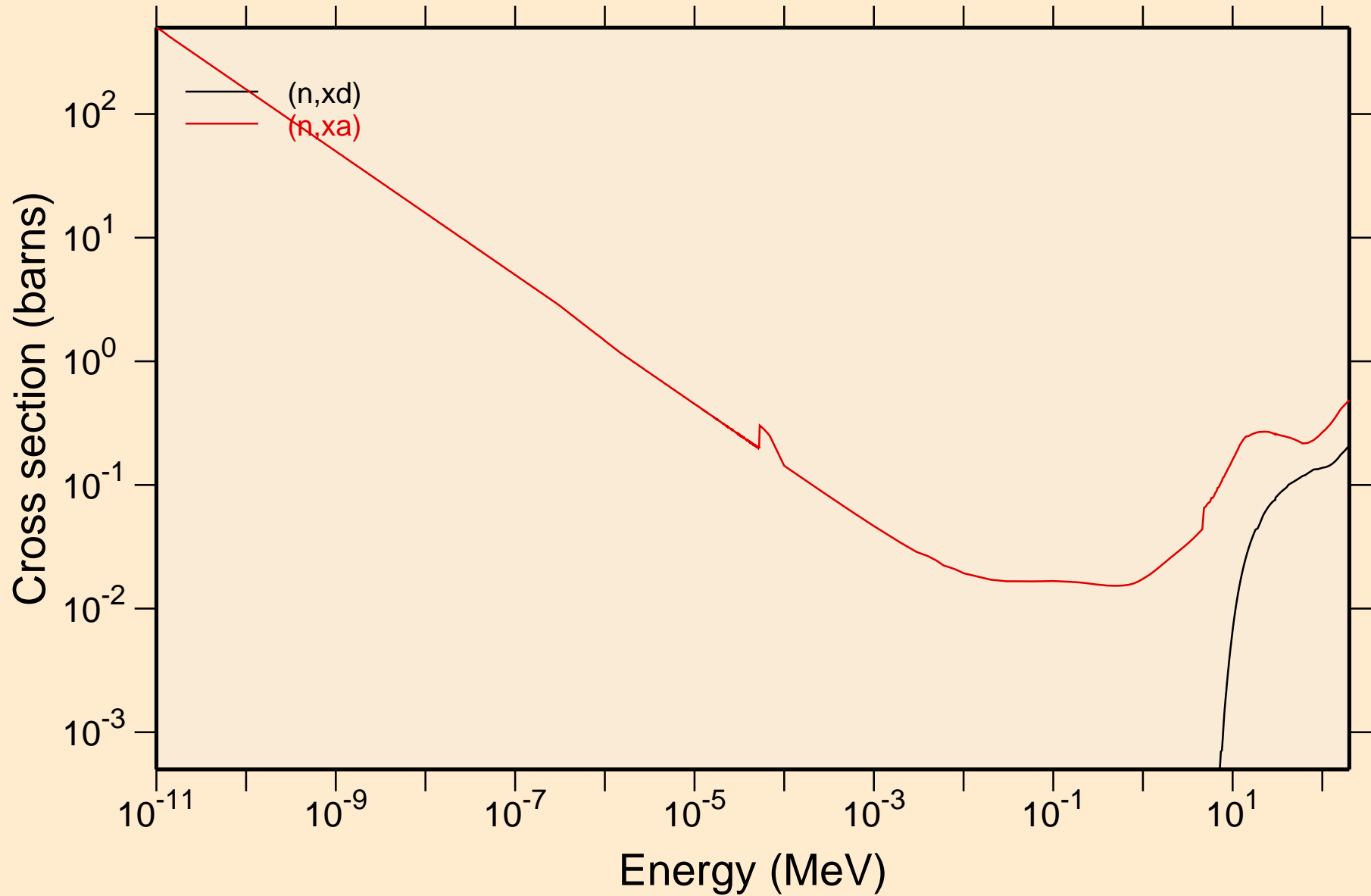

# SB110 NEUTRON ACER TENDL-2024 LIBRARY; T=0.K

## Principal cross sections

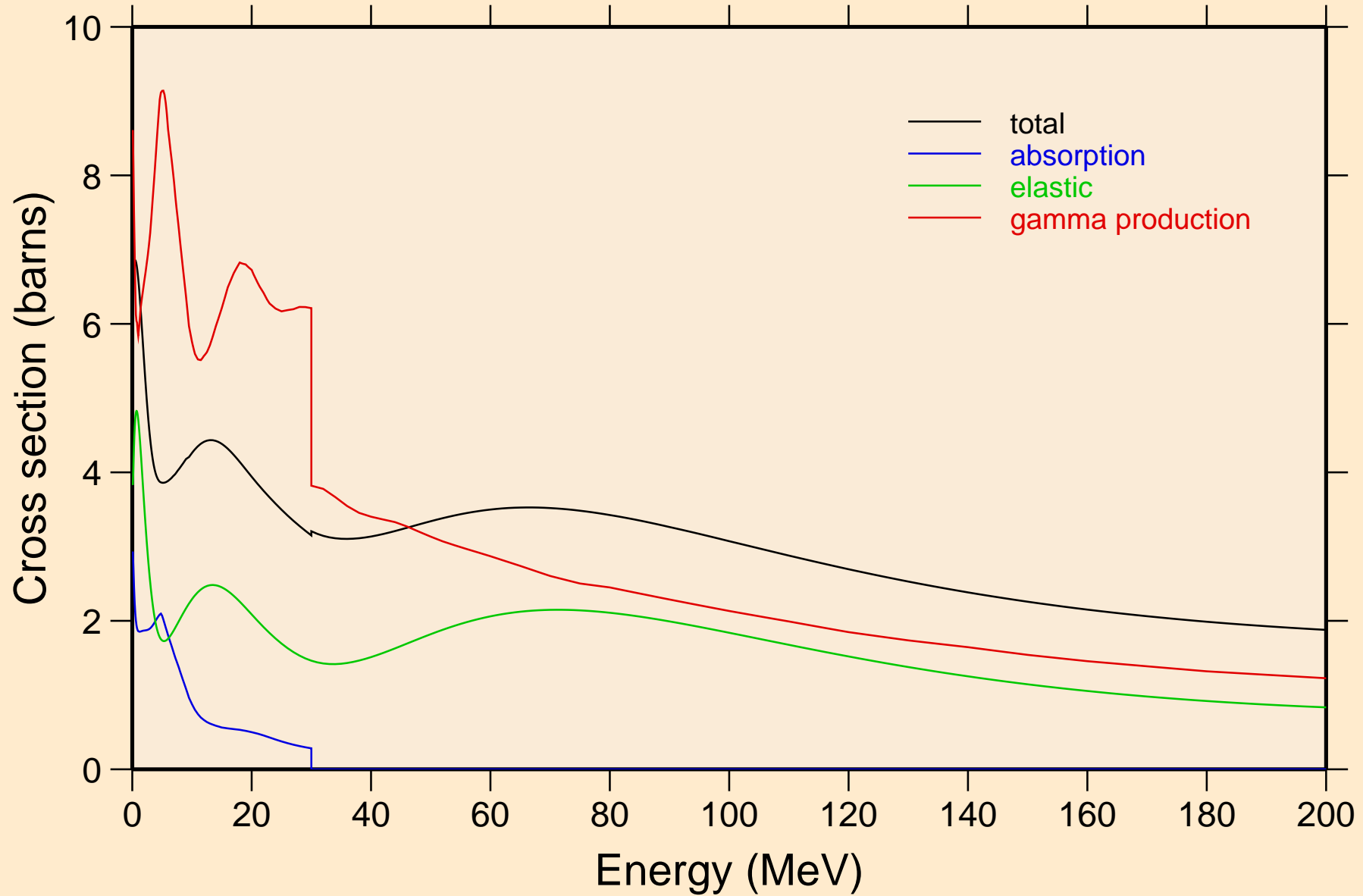

# SB110 NEUTRON ACER TENDL-2024 LIBRARY; T=0.K

## Heating

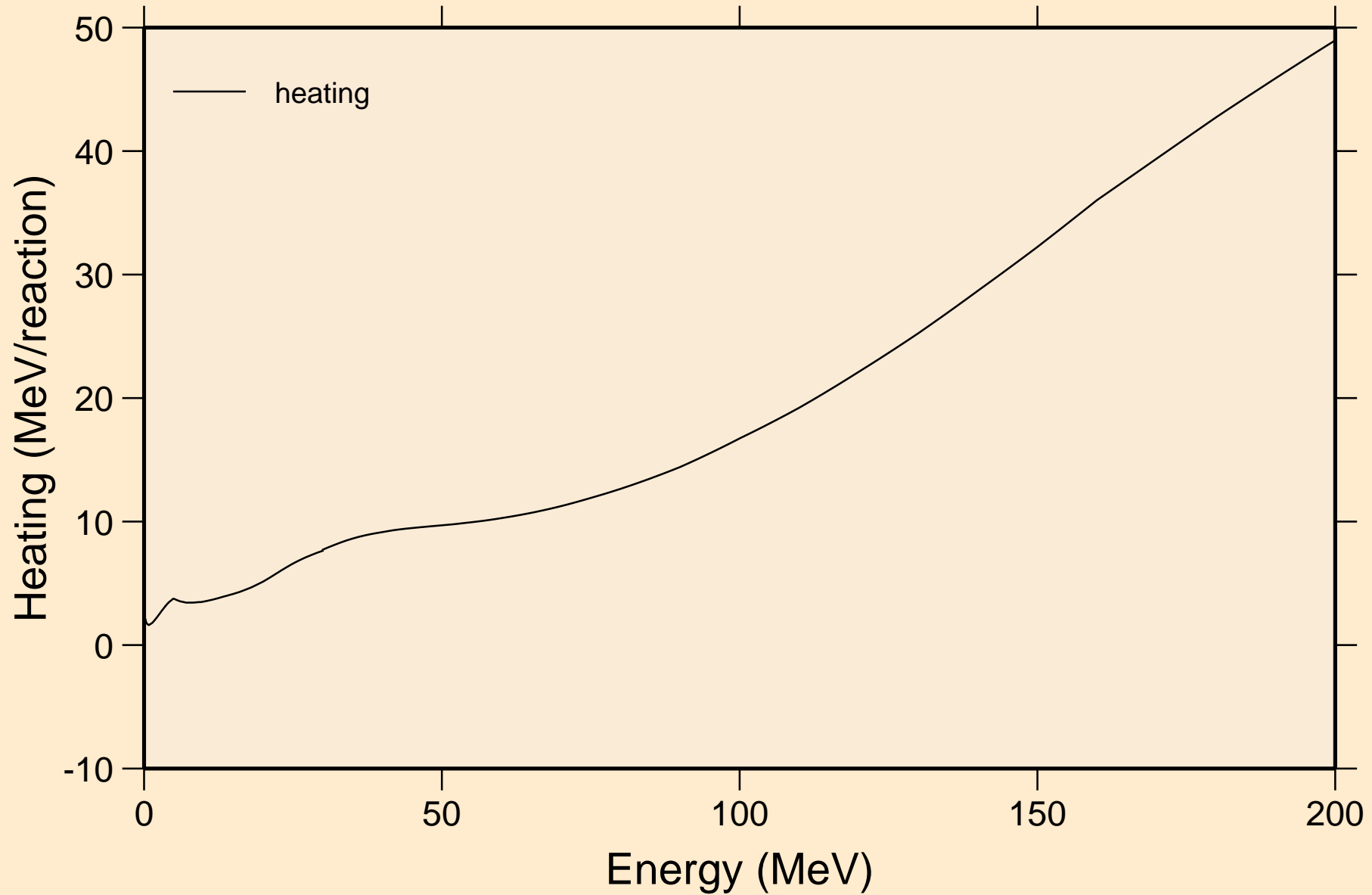

# SB110 NEUTRON ACER TENDL-2024 LIBRARY; T=0.K

## Damage

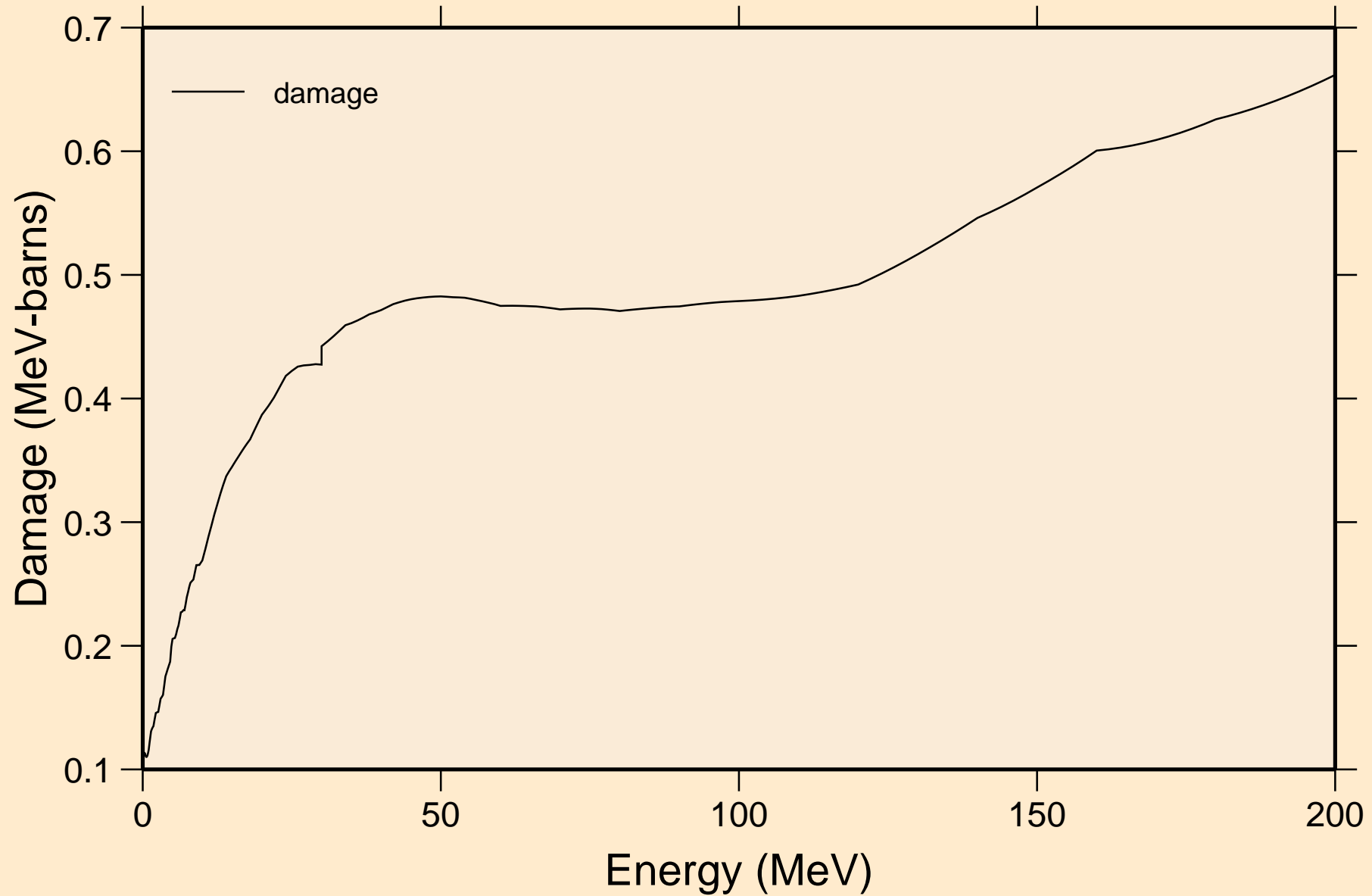

SB110 NEUTRON ACER TENDL-2024 LIBRARY; T=0.K  
Non-threshold reactions

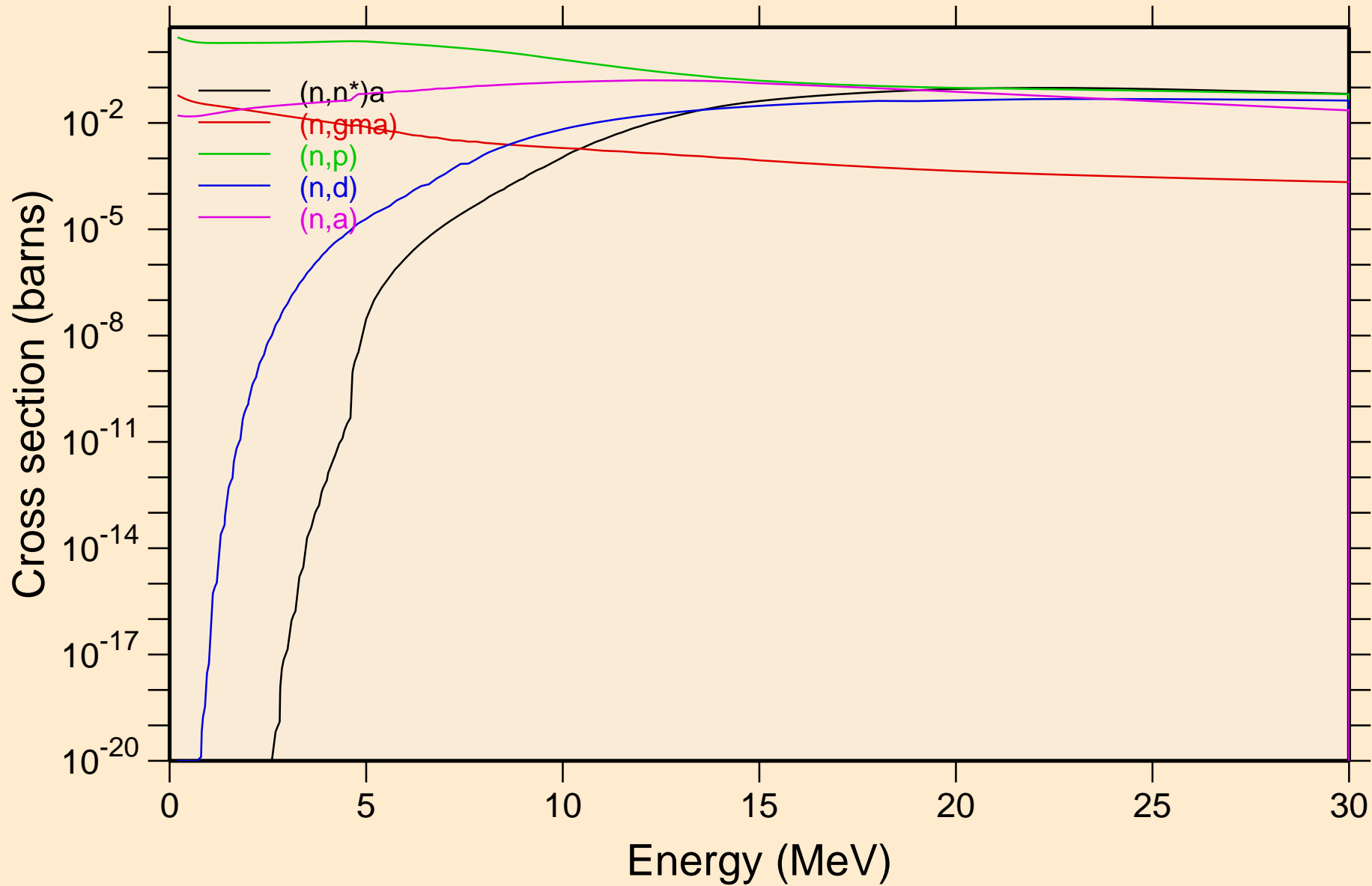



# SB110 NEUTRON ACER TENDL-2024 LIBRARY; T=0.K

## Non-threshold reactions

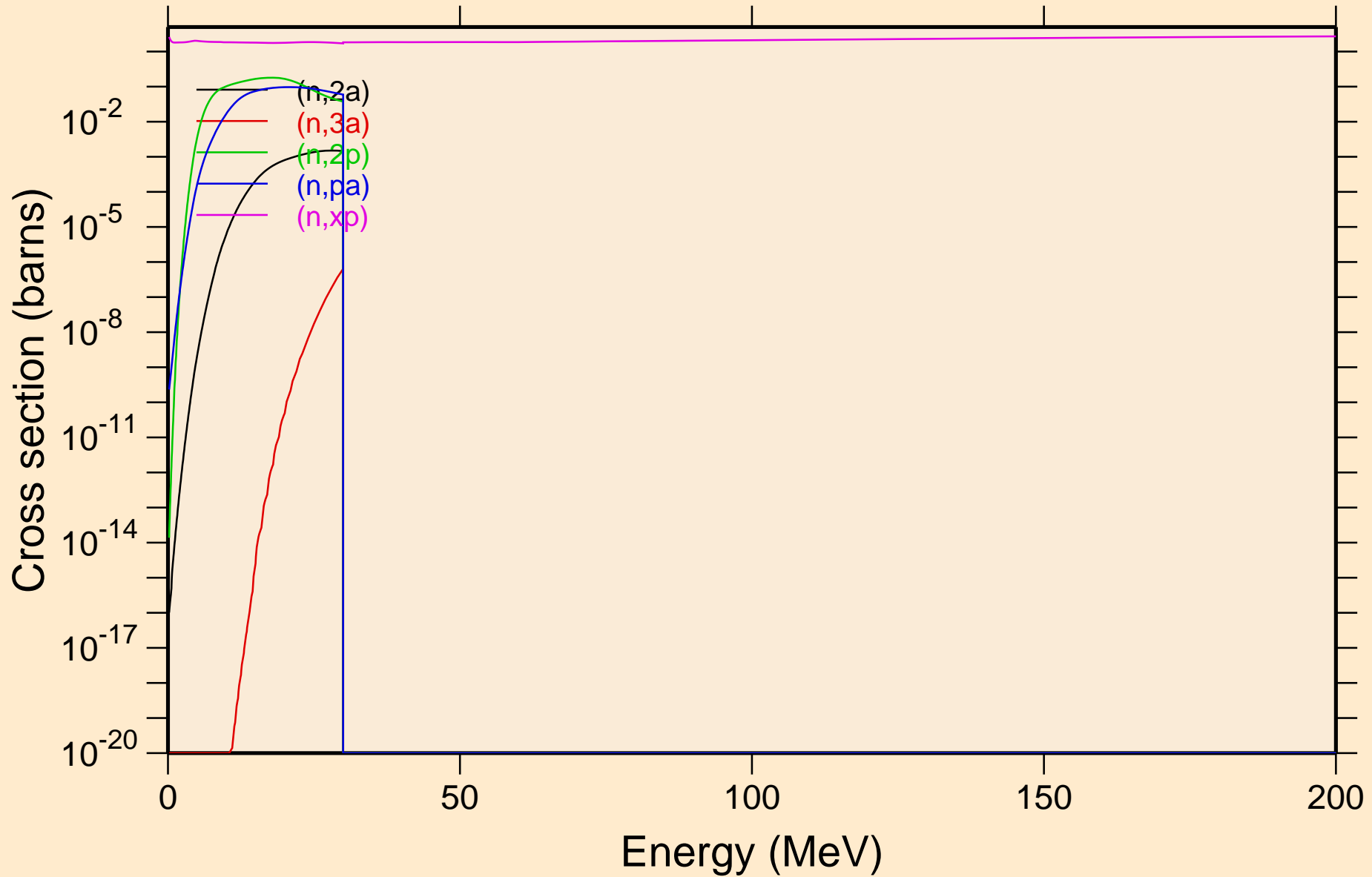

SB110 NEUTRON ACER TENDL-2024 LIBRARY; T=0.K  
Non-threshold reactions

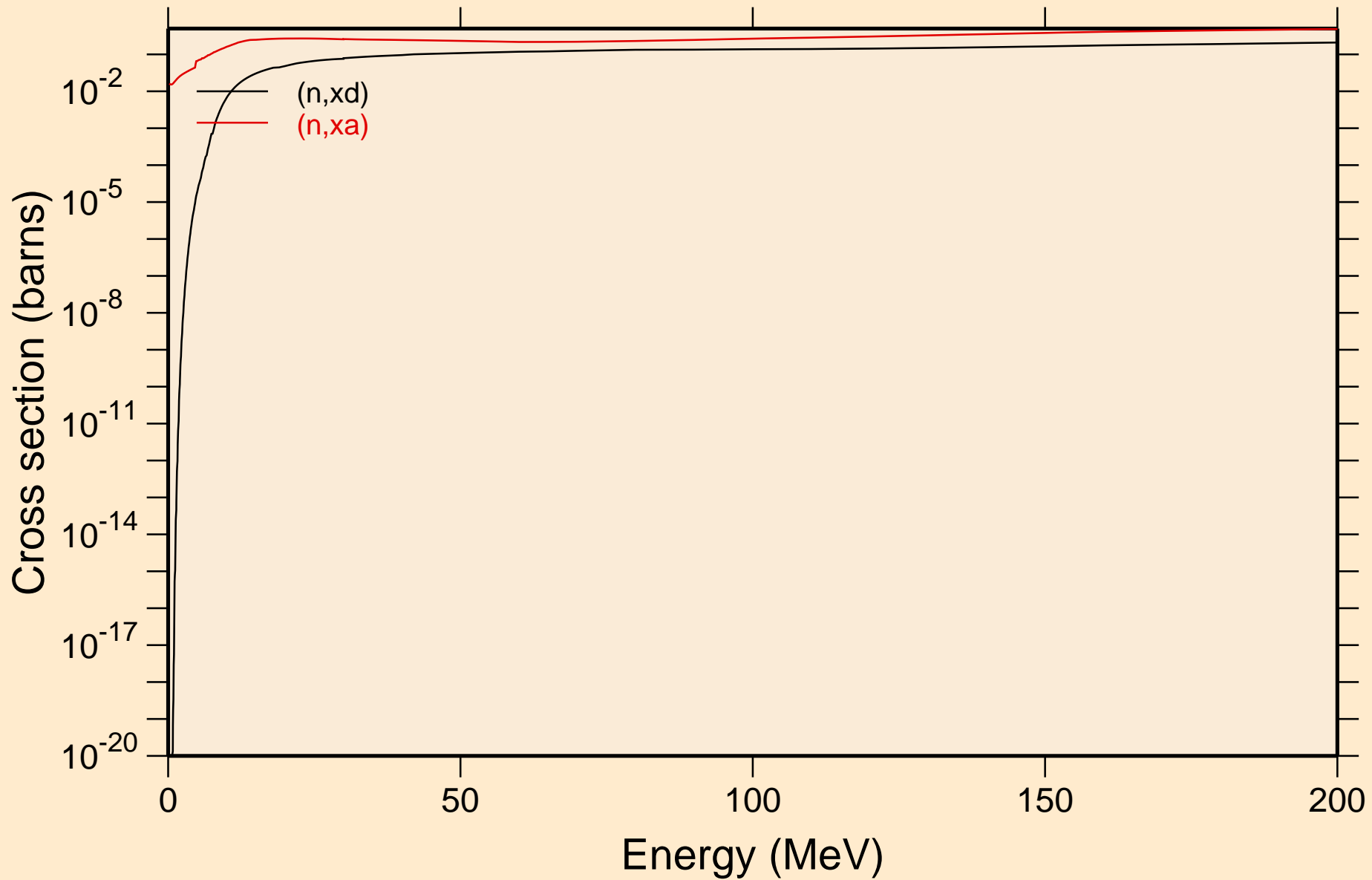

# SB110 NEUTRON ACER TENDL-2024 LIBRARY; T=0.K

## Inelastic levels

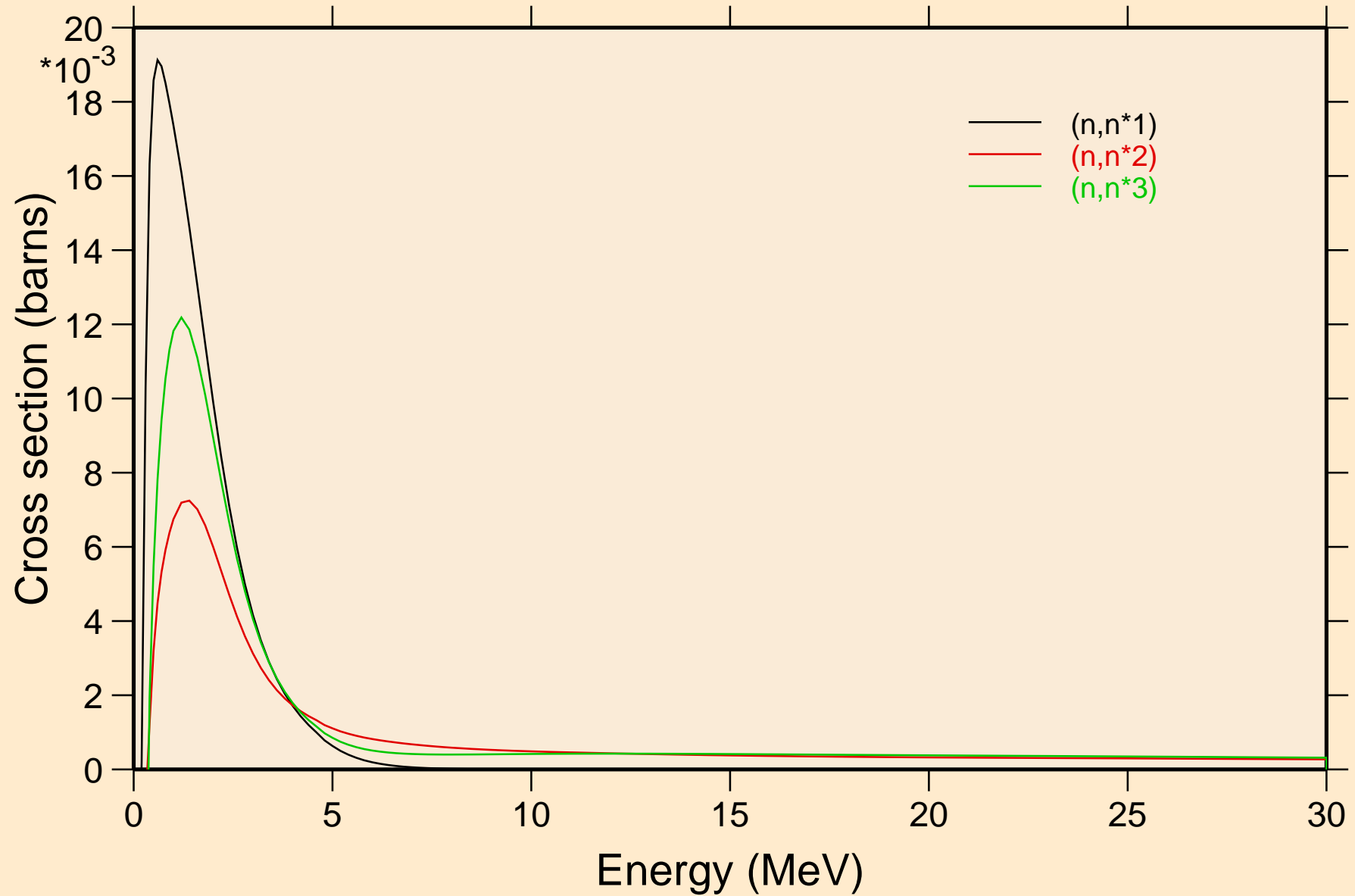

# SB110 NEUTRON ACER TENDL-2024 LIBRARY; T=0.K

## Threshold reactions

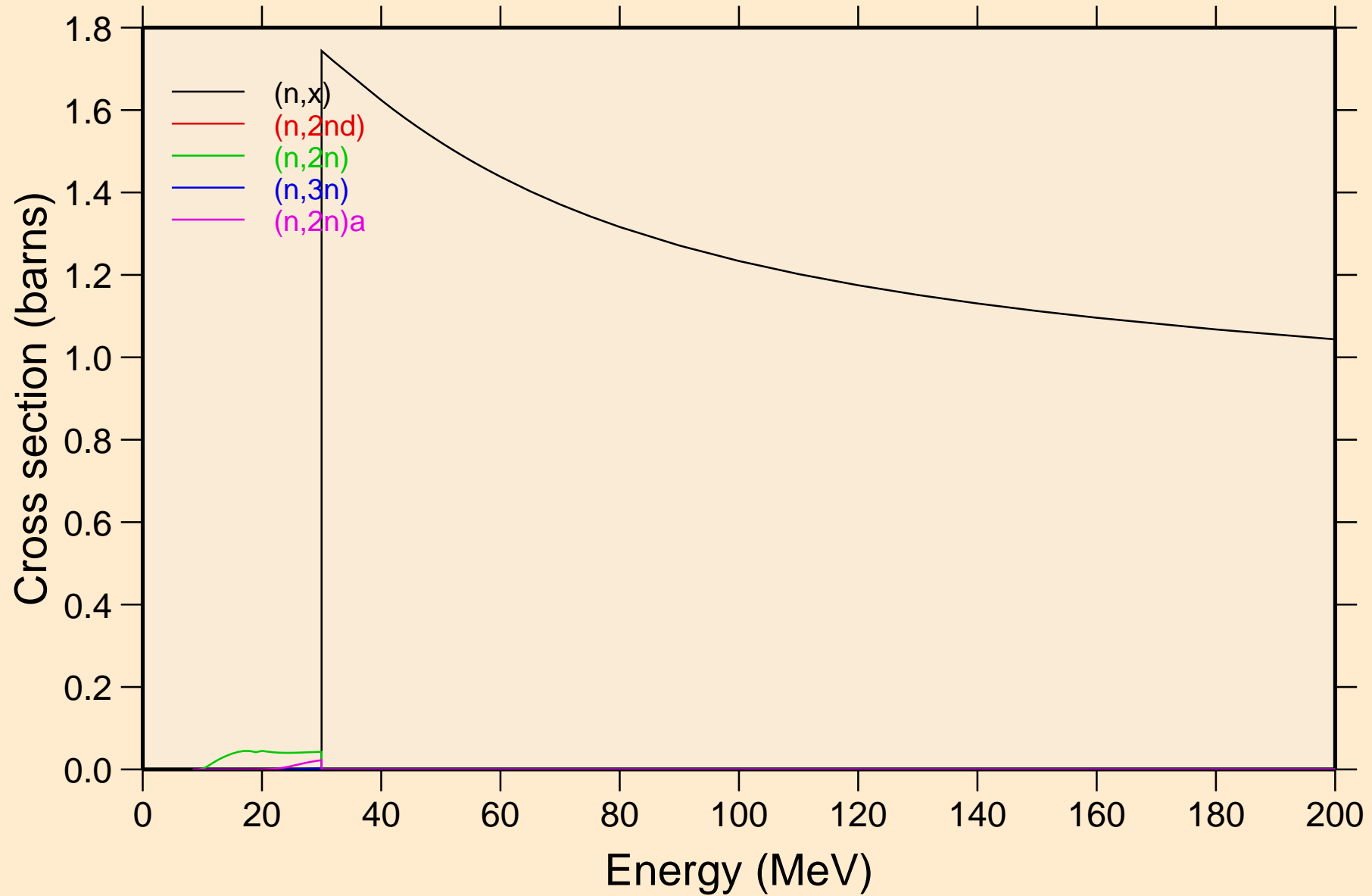

# SB110 NEUTRON ACER TENDL-2024 LIBRARY; T=0.K

## Threshold reactions

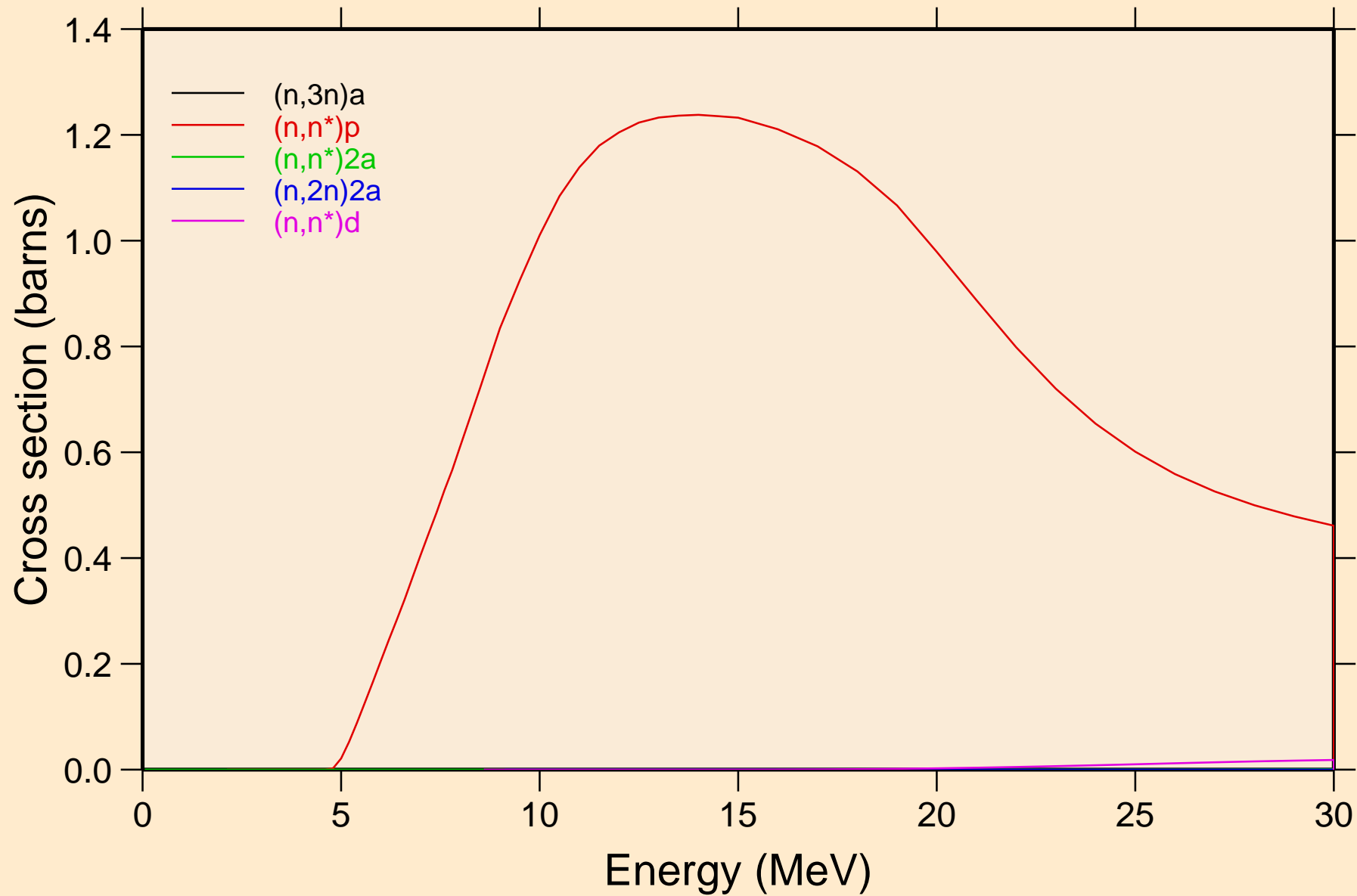

# SB110 NEUTRON ACER TENDL-2024 LIBRARY; T=0.K

## Threshold reactions

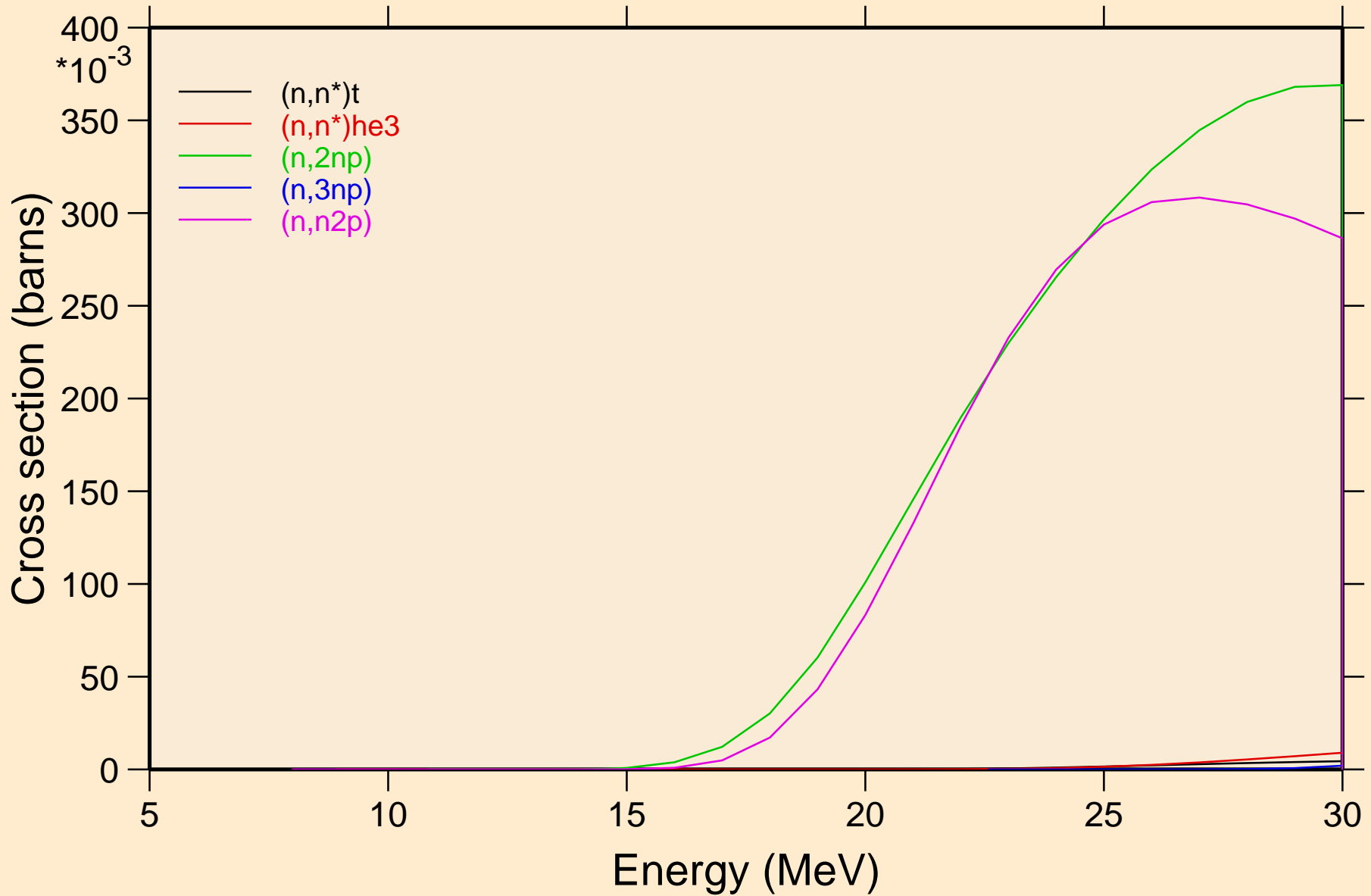

# SB110 NEUTRON ACER TENDL-2024 LIBRARY; T=0.K

## Threshold reactions

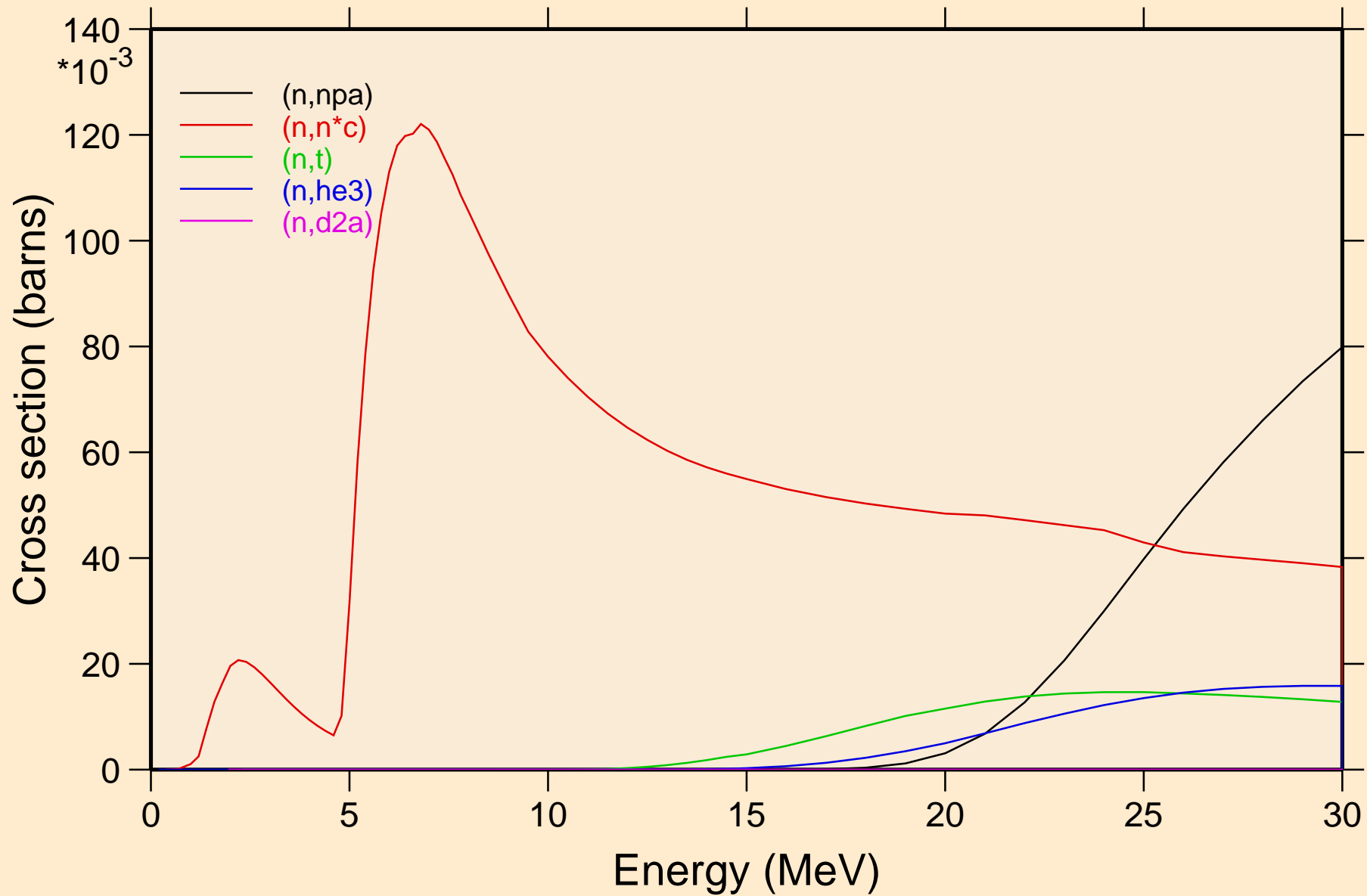

# SB110 NEUTRON ACER TENDL-2024 LIBRARY; T=0.K

## Threshold reactions

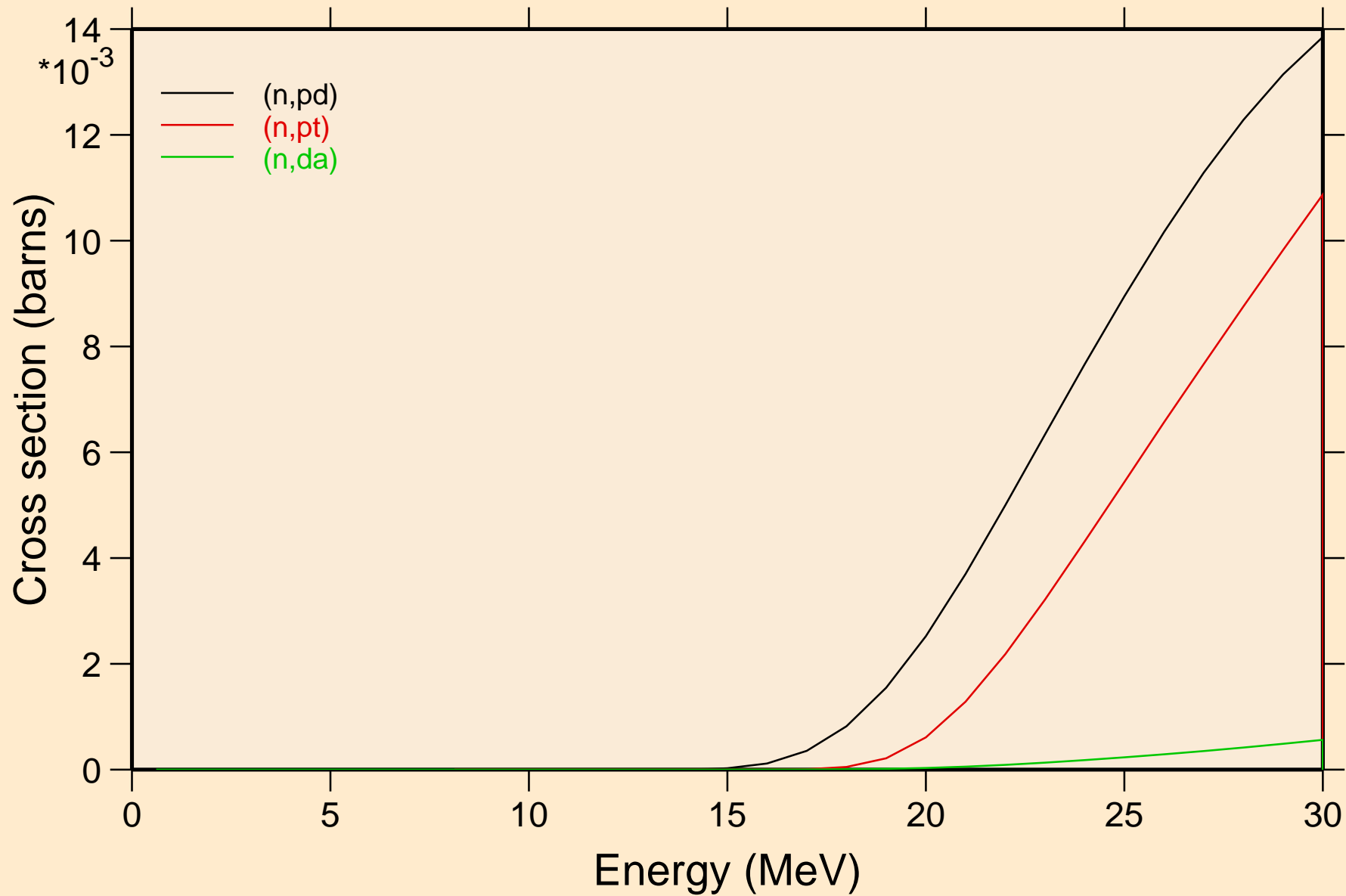



SB110 NEUTRON ACER TENDL-2024 LIBRARY; T=0.K  
Threshold reactions

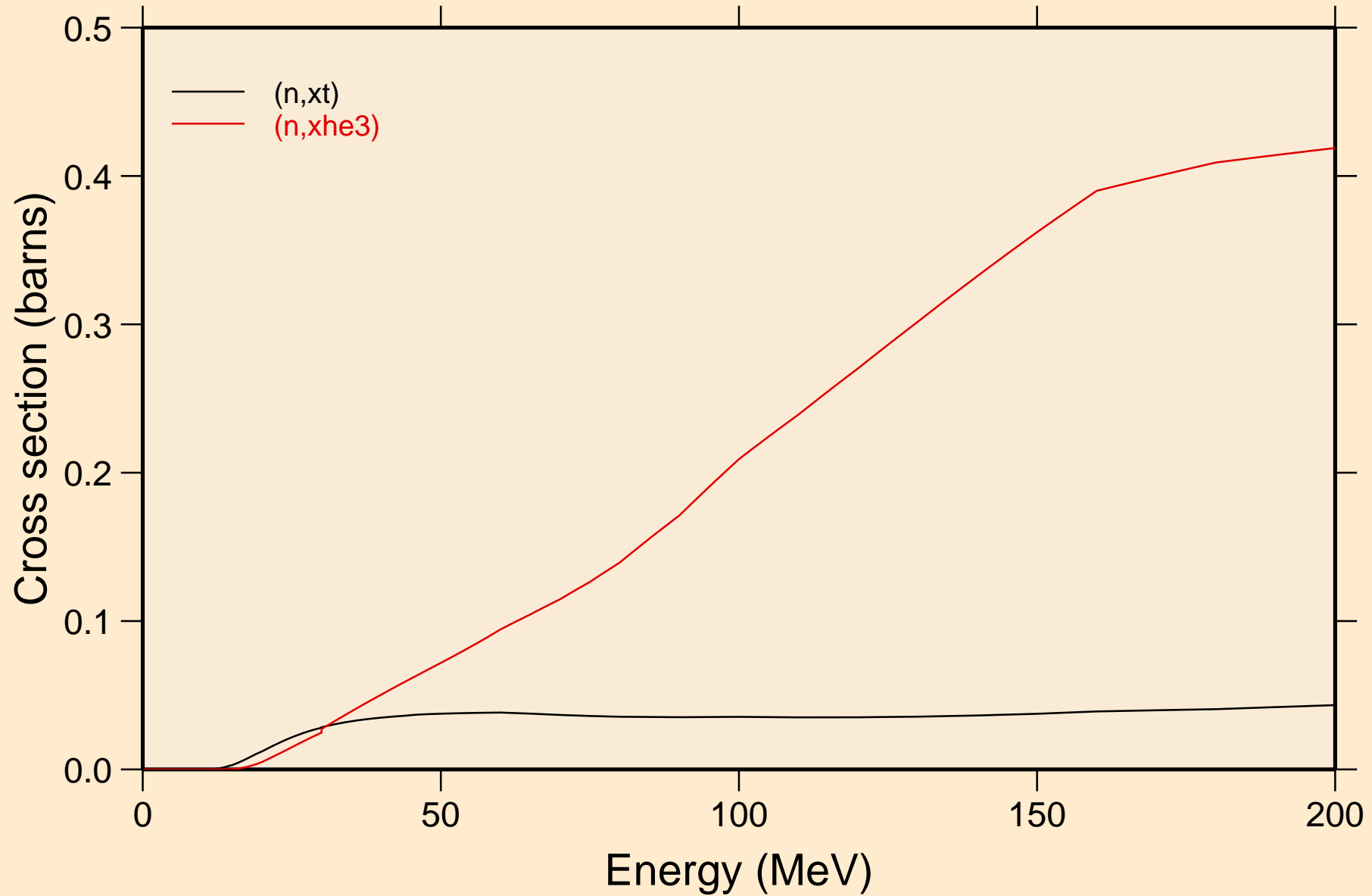

SB110 NEUTRON ACER TENDL-2024 LIBRARY; T=0.K  
angular distribution for elastic

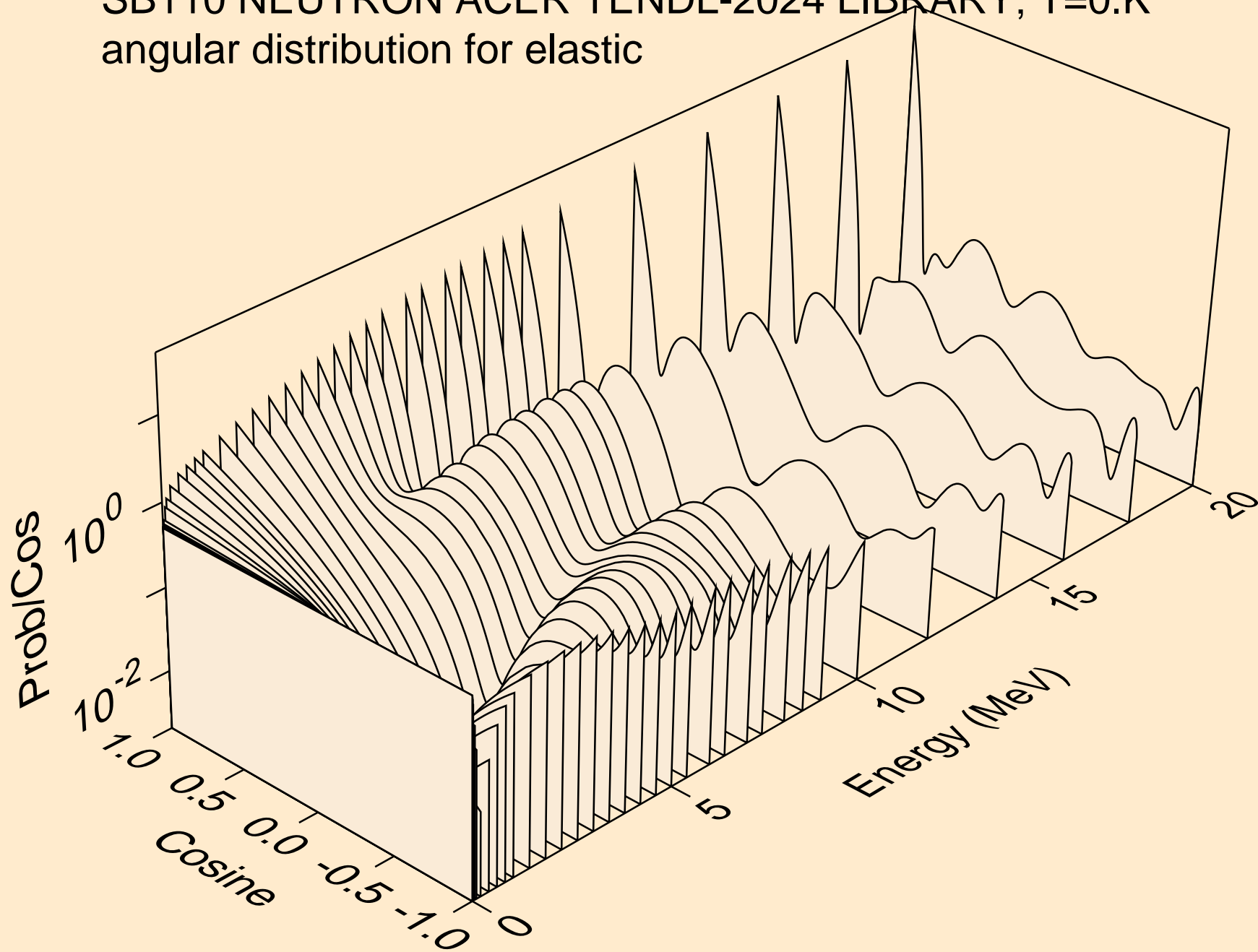

SB110 NEUTRON ACER TENDL-2024 LIBRARY; T=0.K  
angular distribution for elastic

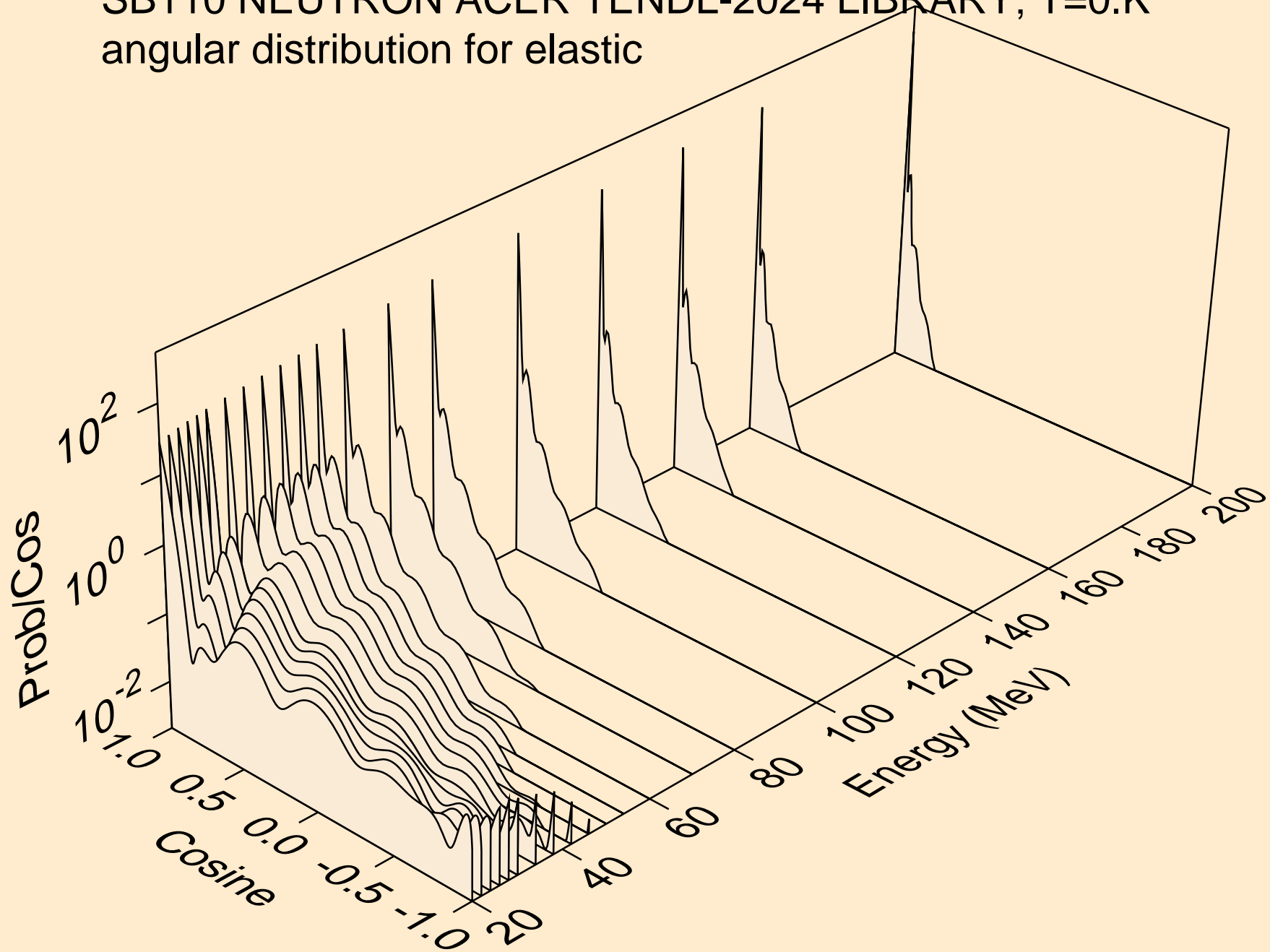

SB110 NEUTRON ACER TENDL-2024 LIBRARY; T=0.K  
angular distribution for (n,n\*1)

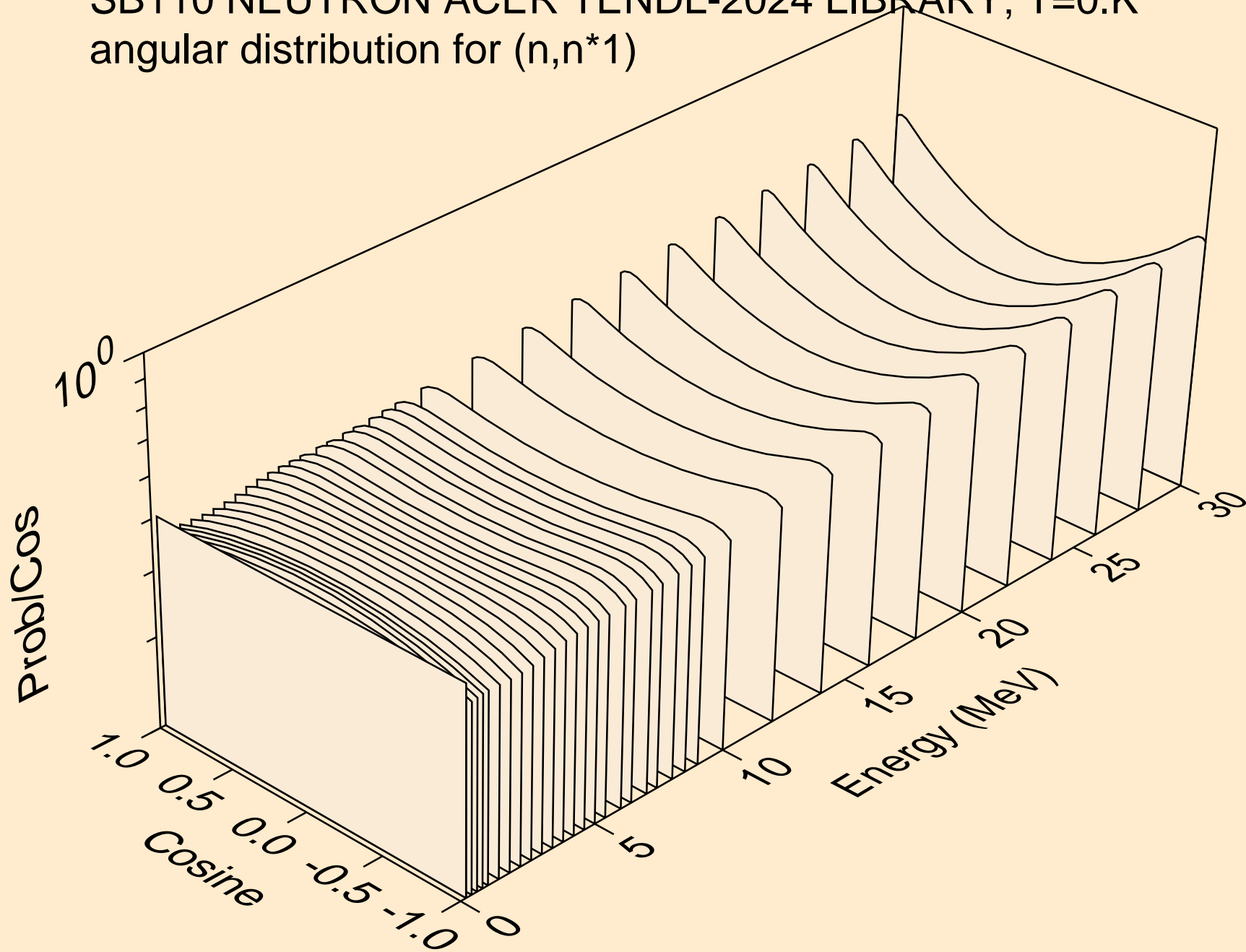

SB110 NEUTRON ACER TENDL-2024 LIBRARY; T=0.K  
angular distribution for (n,n\*2)

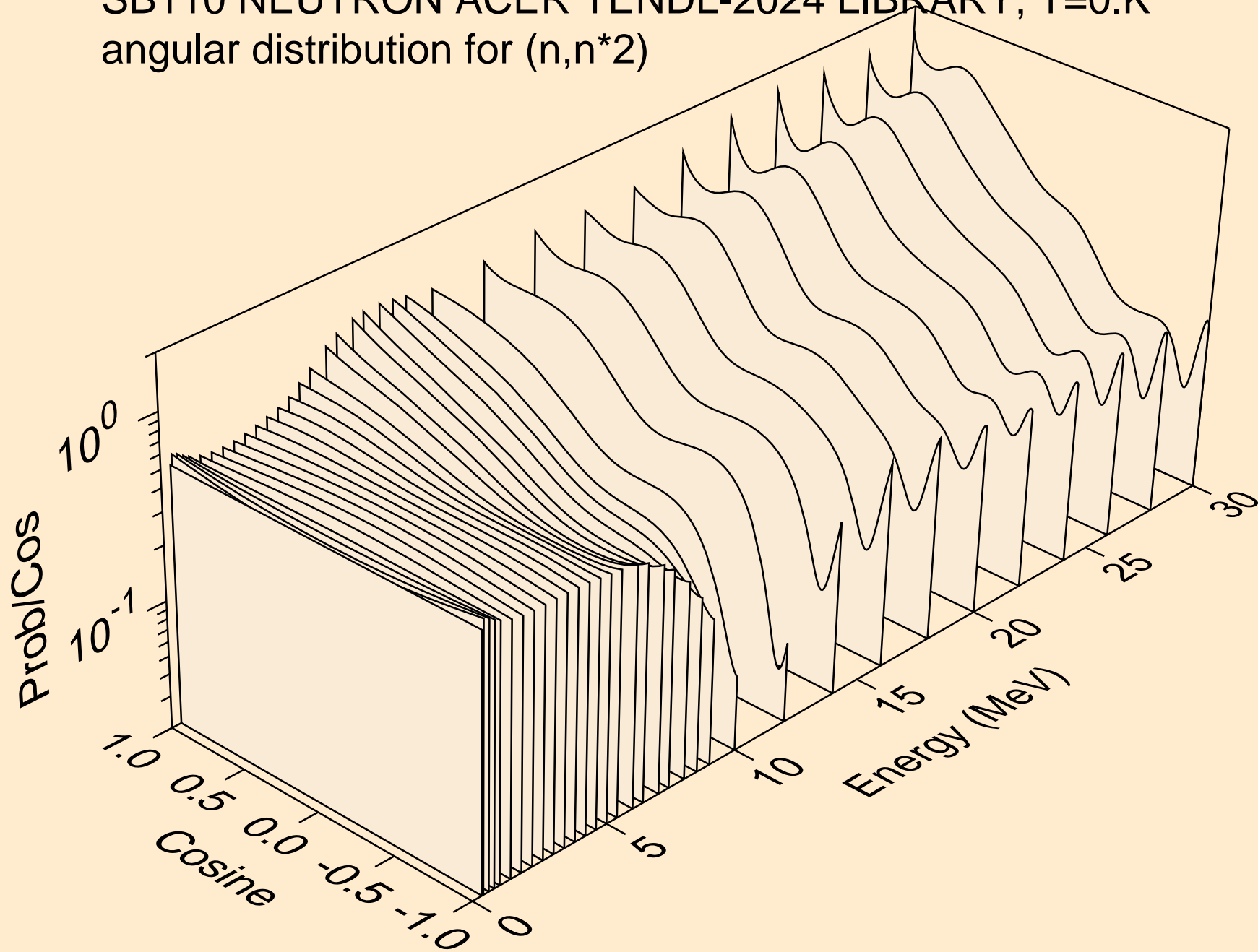

SB110 NEUTRON ACER TENDL-2024 LIBRARY; T=0.K  
angular distribution for (n,n\*3)

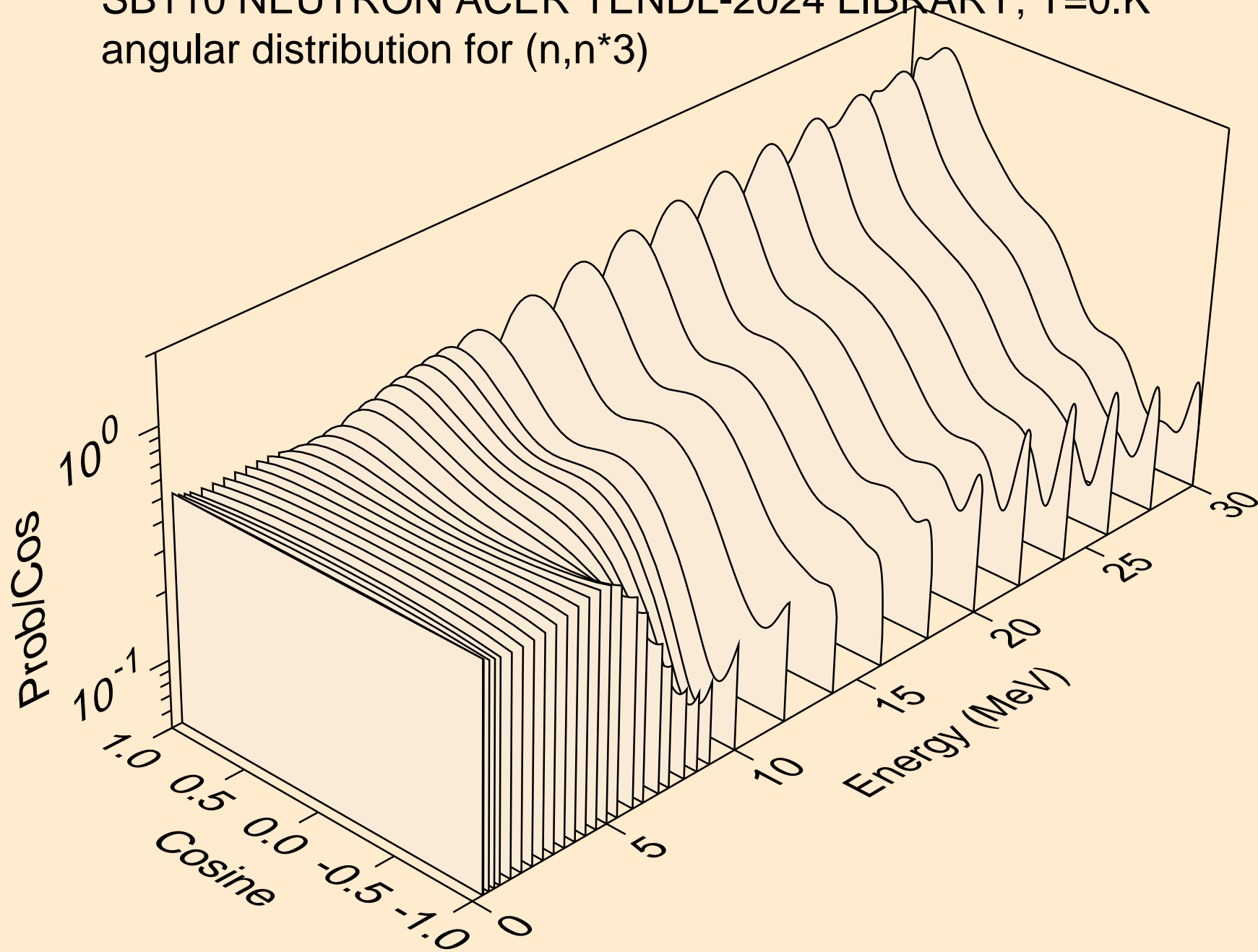

SB110 NEUTRON ACER TENDL-2024 LIBRARY; T=0.K  
Neutron emission for (n,x)

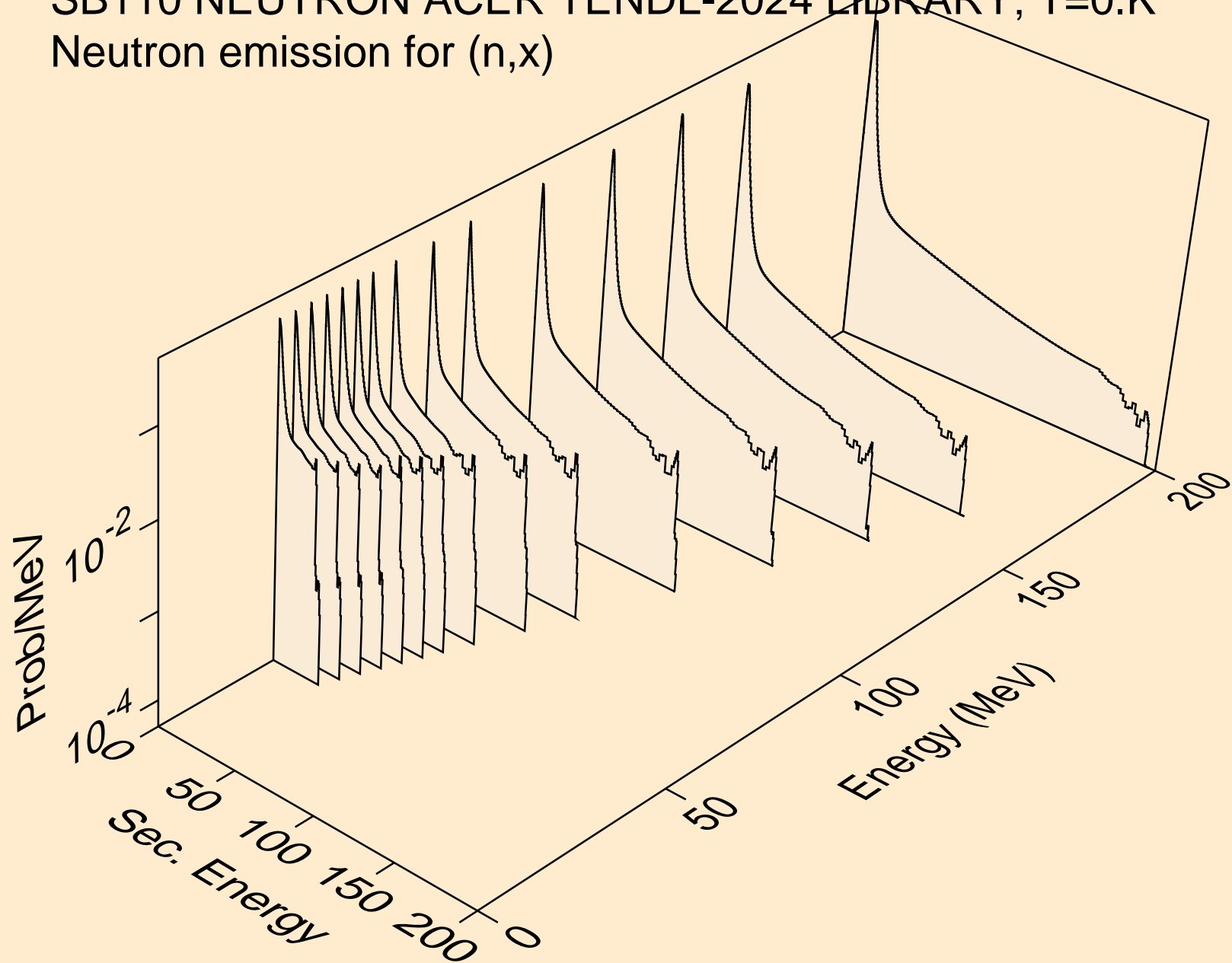

SB110 NEUTRON ACER TENDL-2024 LIBRARY; T=0.K  
Neutron emission for (n,2nd)

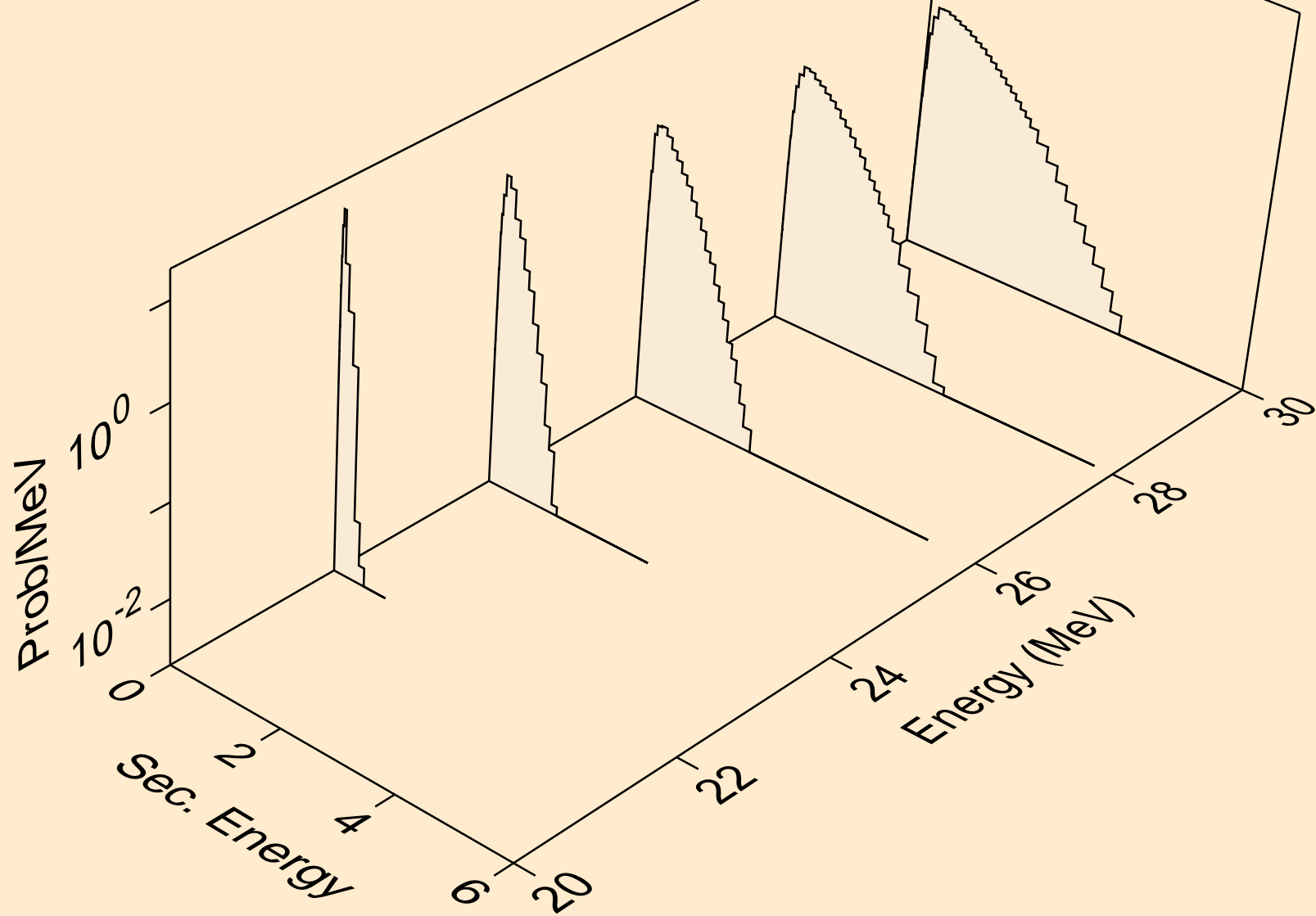



SB110 NEUTRON ACER TENDL-2024 LIBRARY; T=0.K  
Neutron emission for (n,2n)

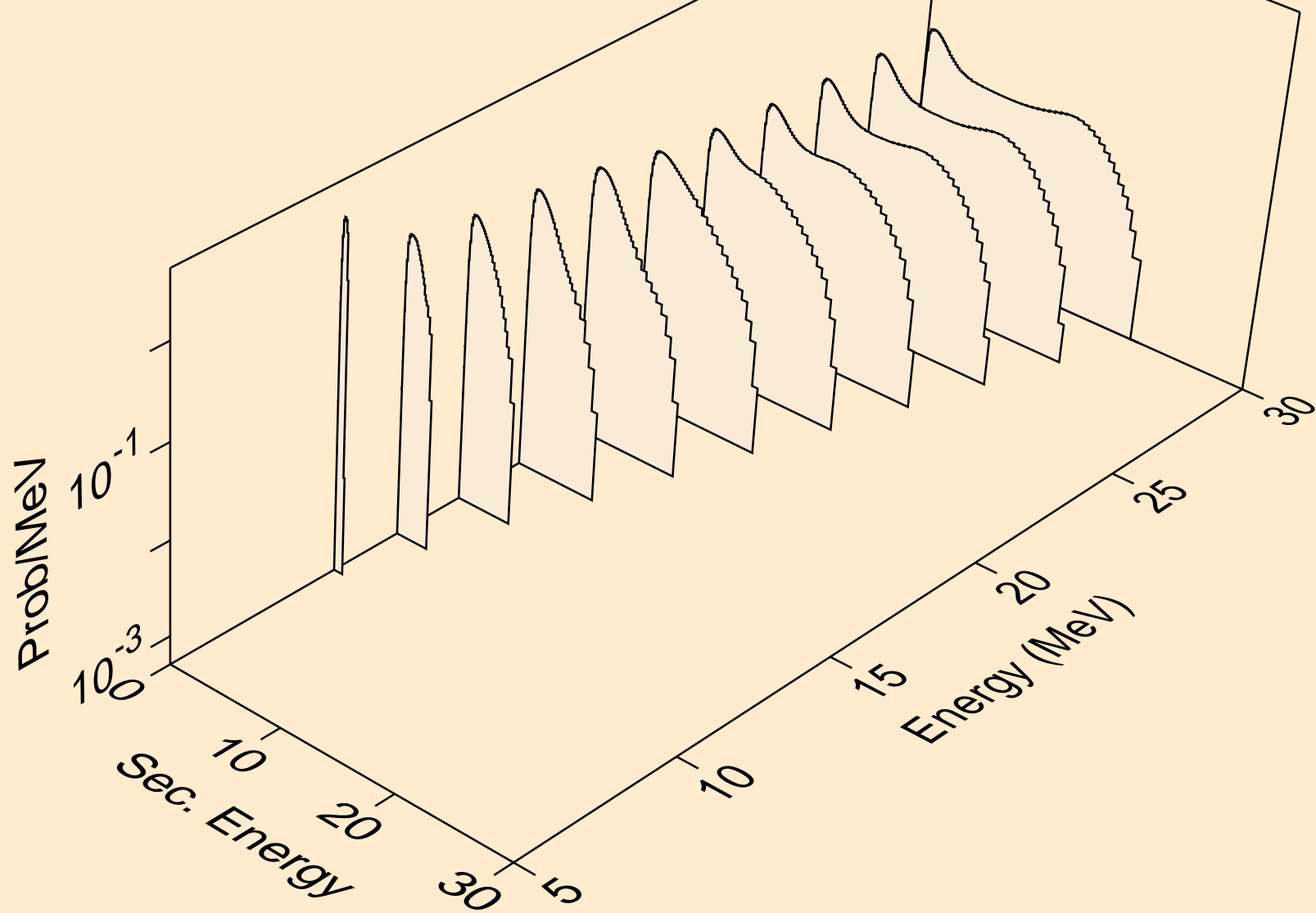

SB110 NEUTRON ACER TENDL-2024 LIBRARY; T=0.K  
Neutron emission for (n,3n)

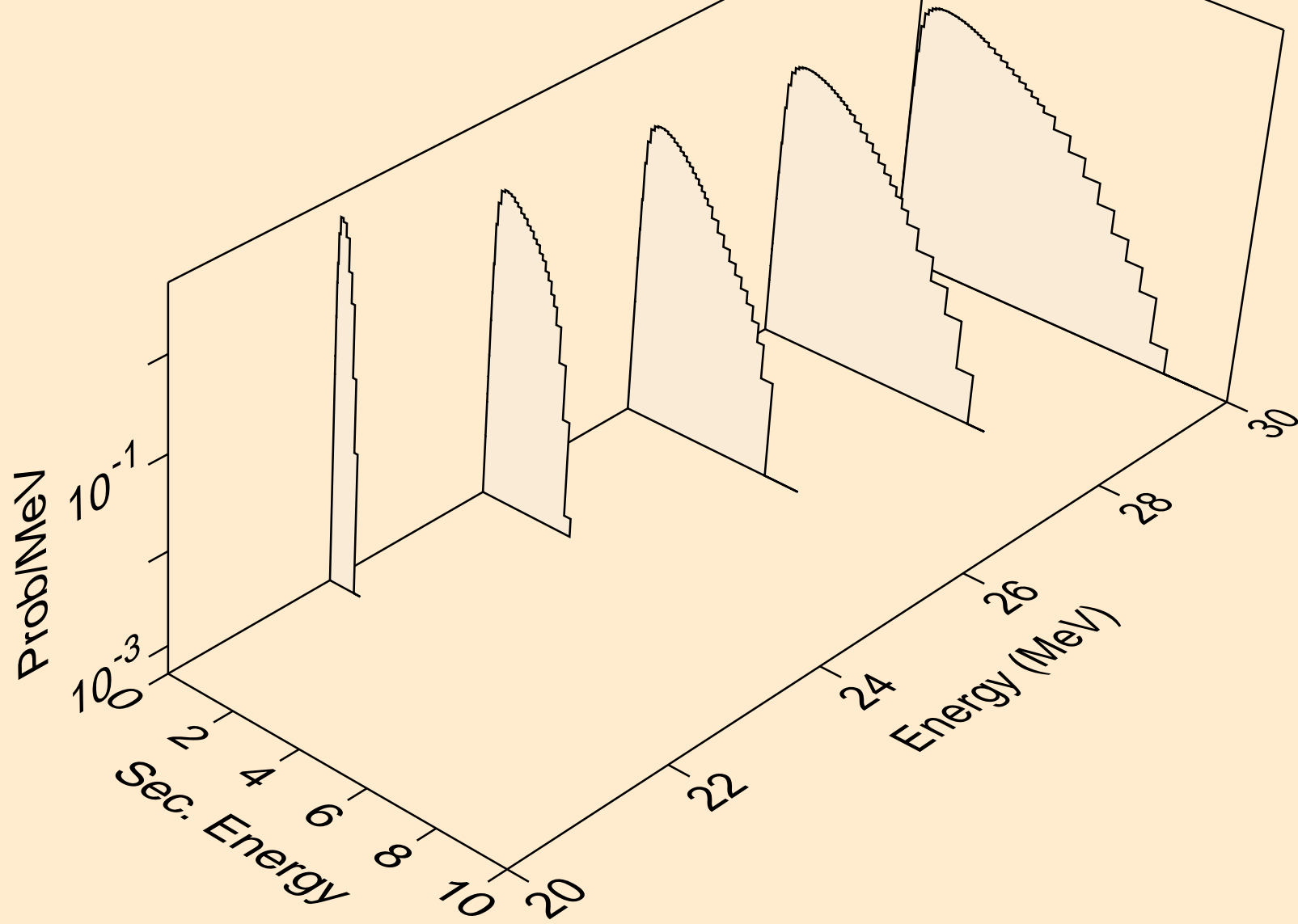

SB110 NEUTRON ACER TENDL-2024 LIBRARY; T=0.K  
Neutron emission for (n,n\*)a

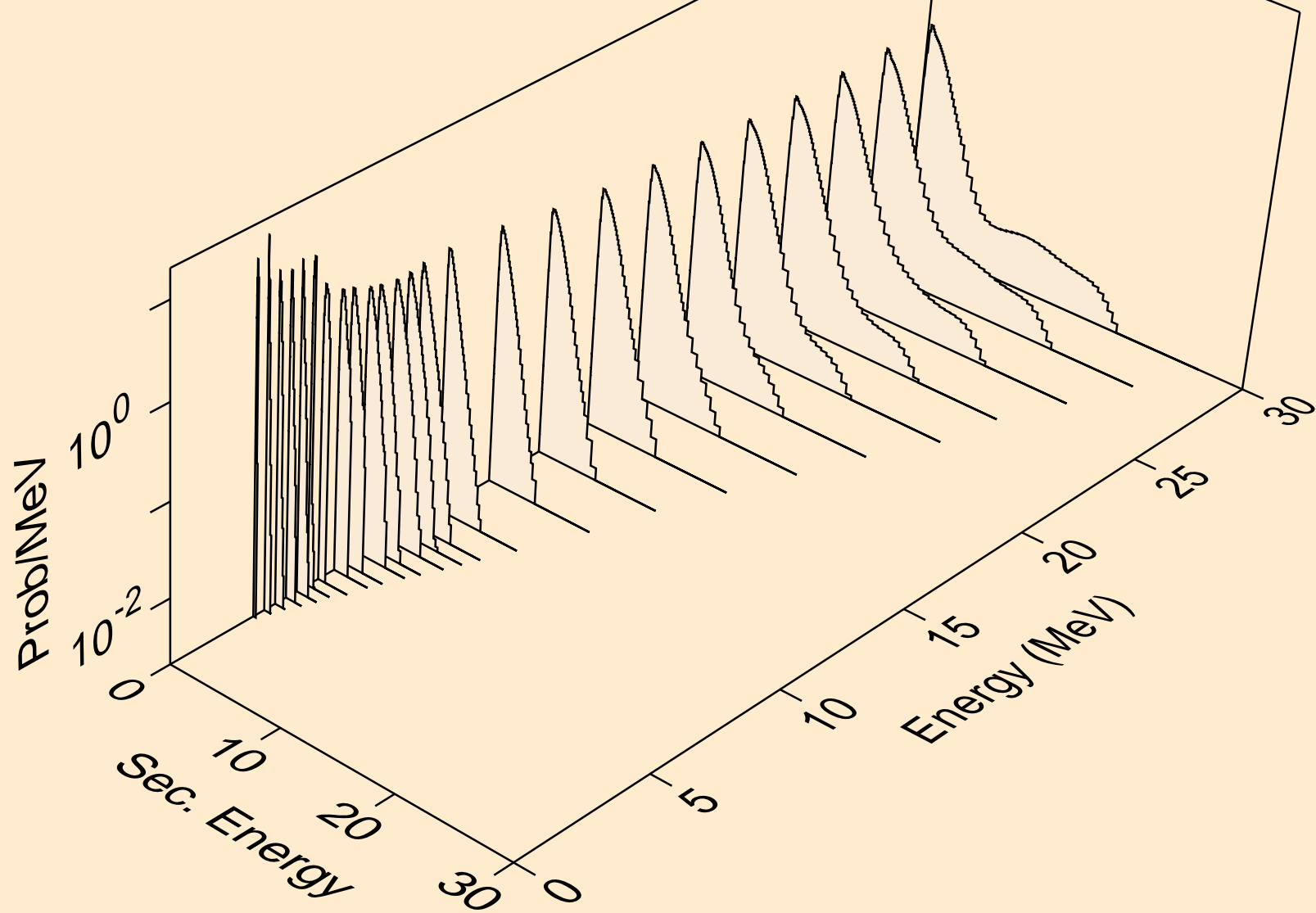

SB110 NEUTRON ACER TENDL-2024 LIBRARY; T=0.K  
Neutron emission for (n,2n)a

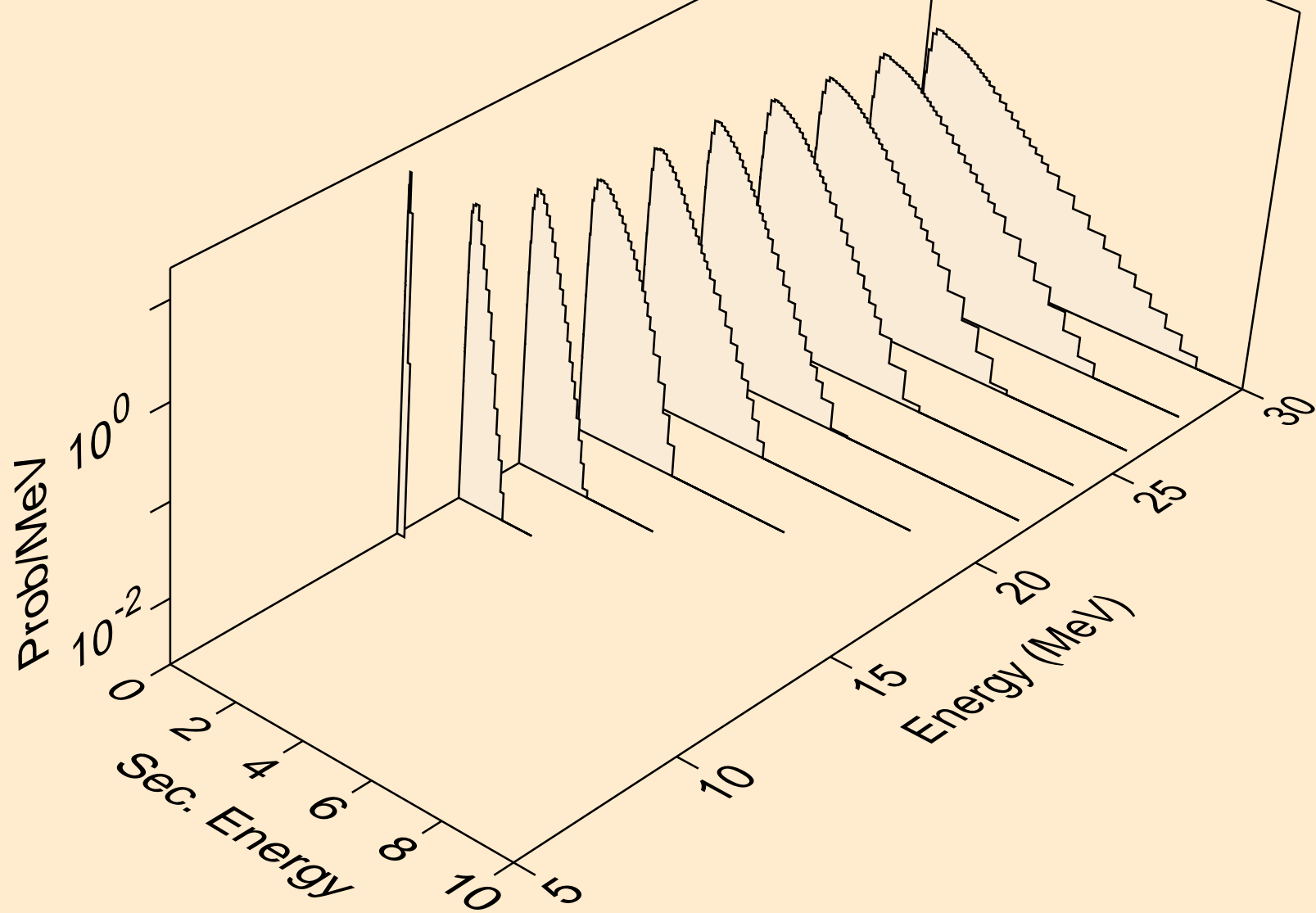

SB110 NEUTRON ACER TENDL-2024 LIBRARY; T=0.K  
Neutron emission for (n,3n)a

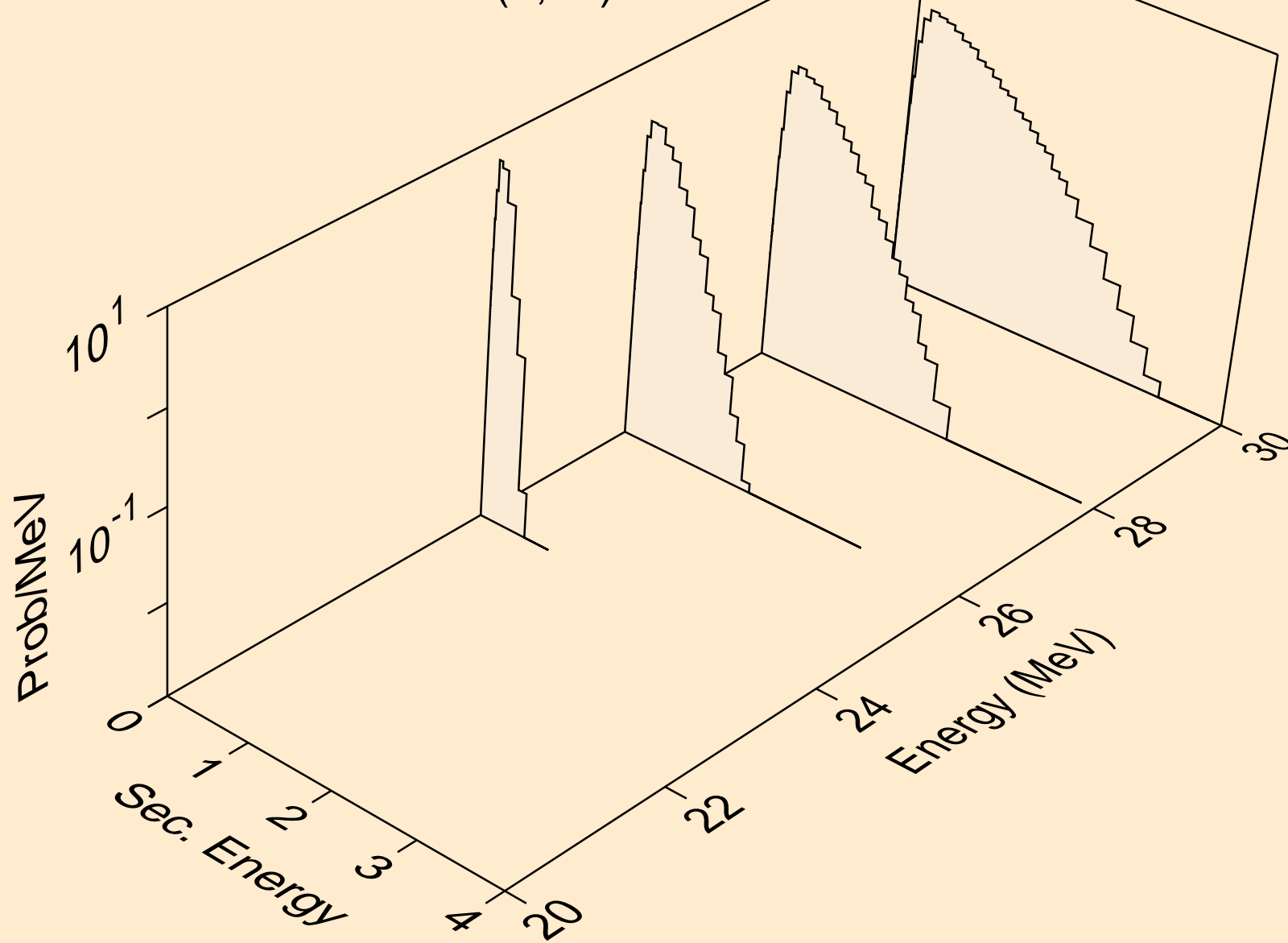

SB110 NEUTRON ACER TENDL-2024 LIBRARY; T=0.K  
Neutron emission for (n,n\*)p

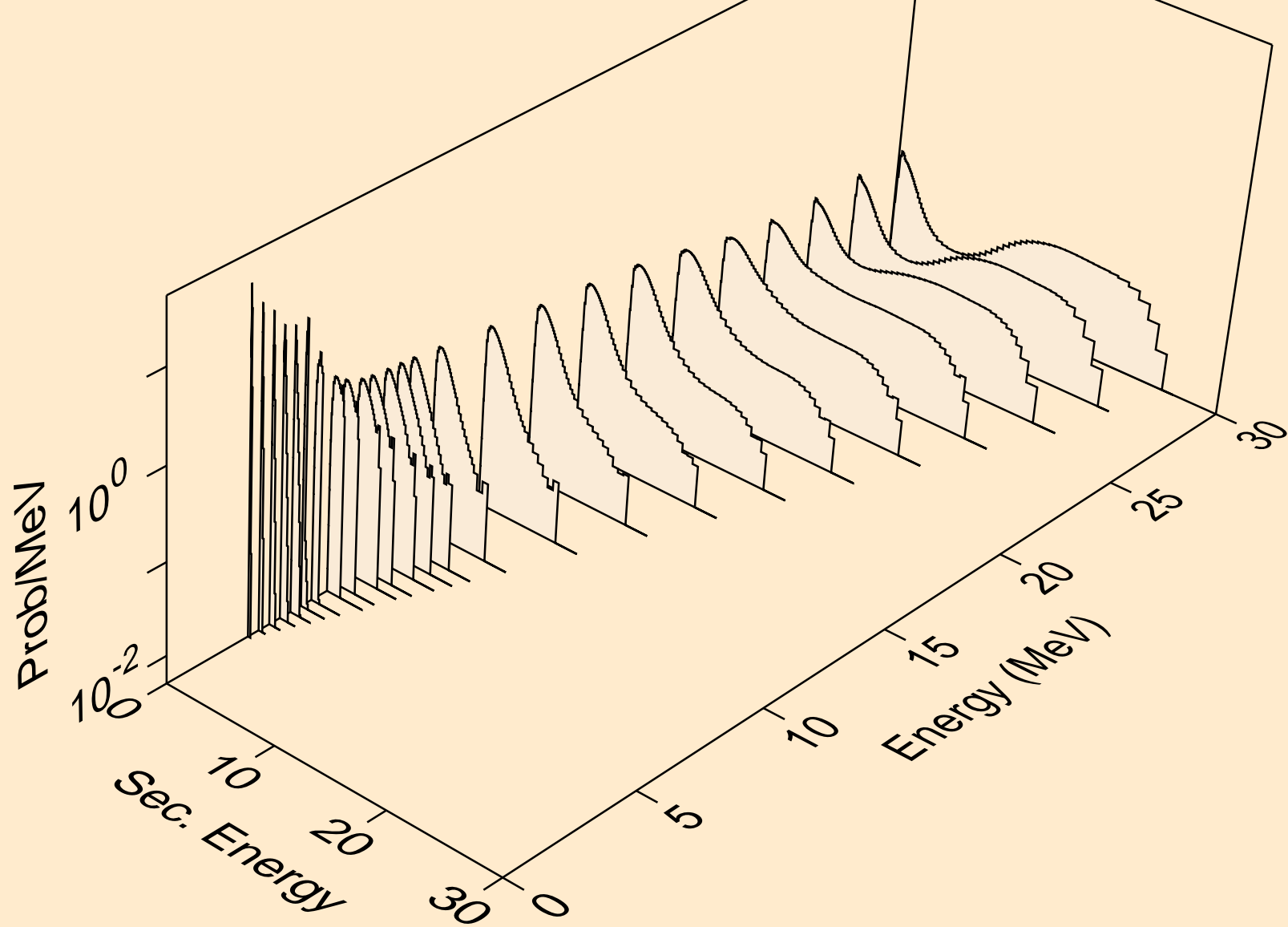

SB110 NEUTRON ACER TENDL-2024 LIBRARY; T=0.K  
Neutron emission for (n,n\*)2a

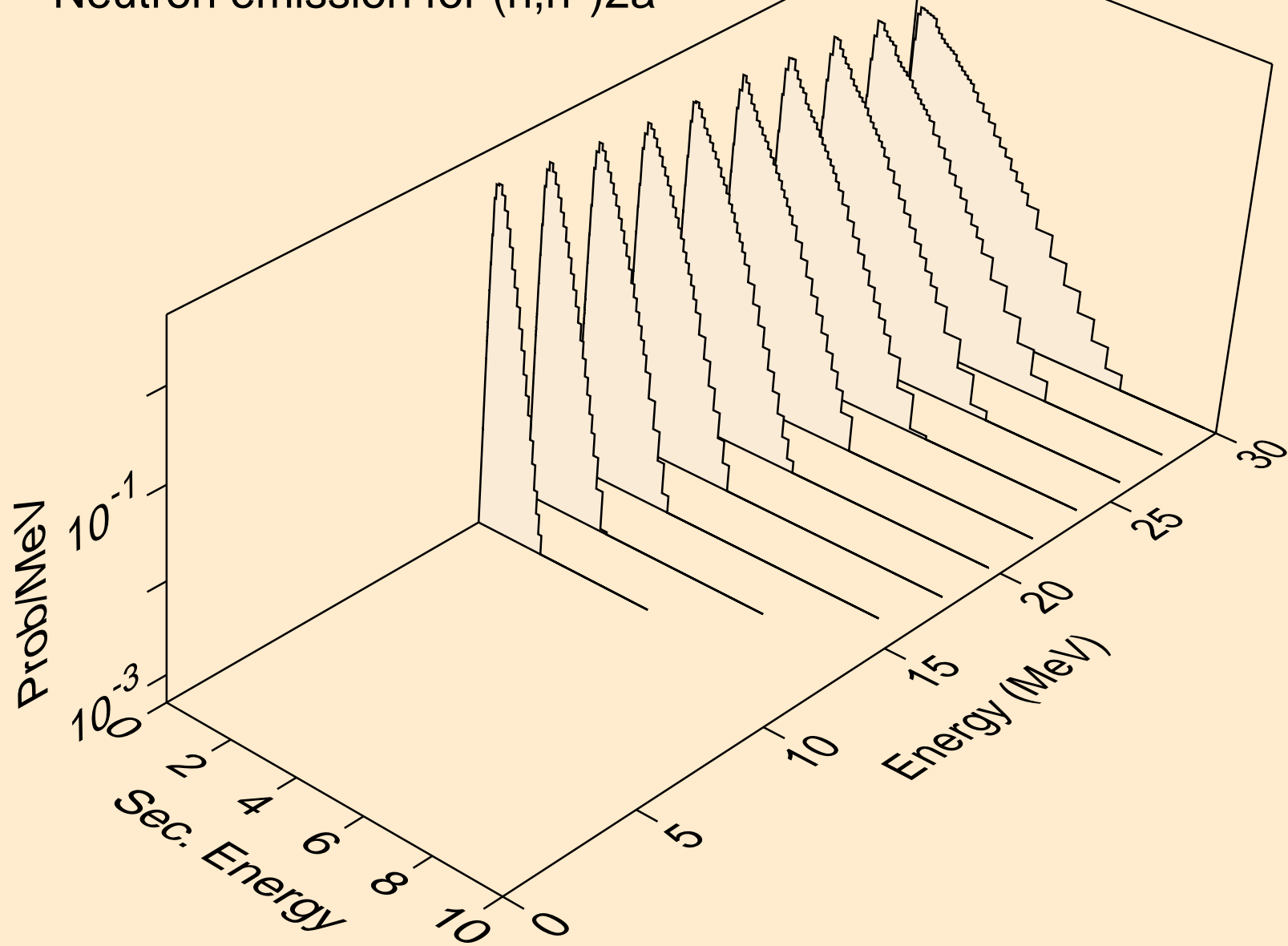

SB110 NEUTRON ACER TENDL-2024 LIBRARY; T=0.K  
Neutron emission for (n,2n)2a

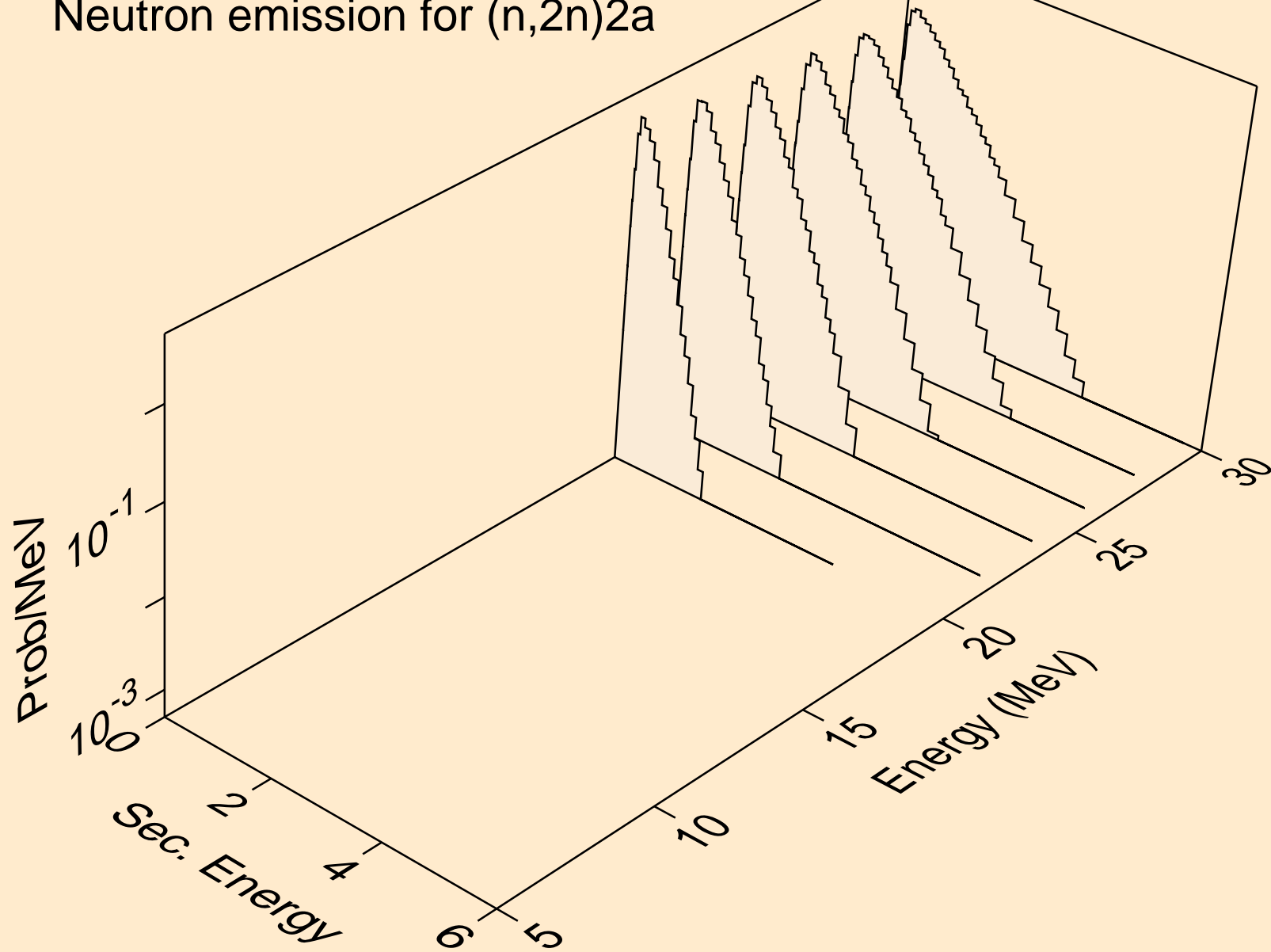



SB110 NEUTRON ACER TENDL-2024 LIBRARY; T=0.K  
Neutron emission for (n,n\*)d

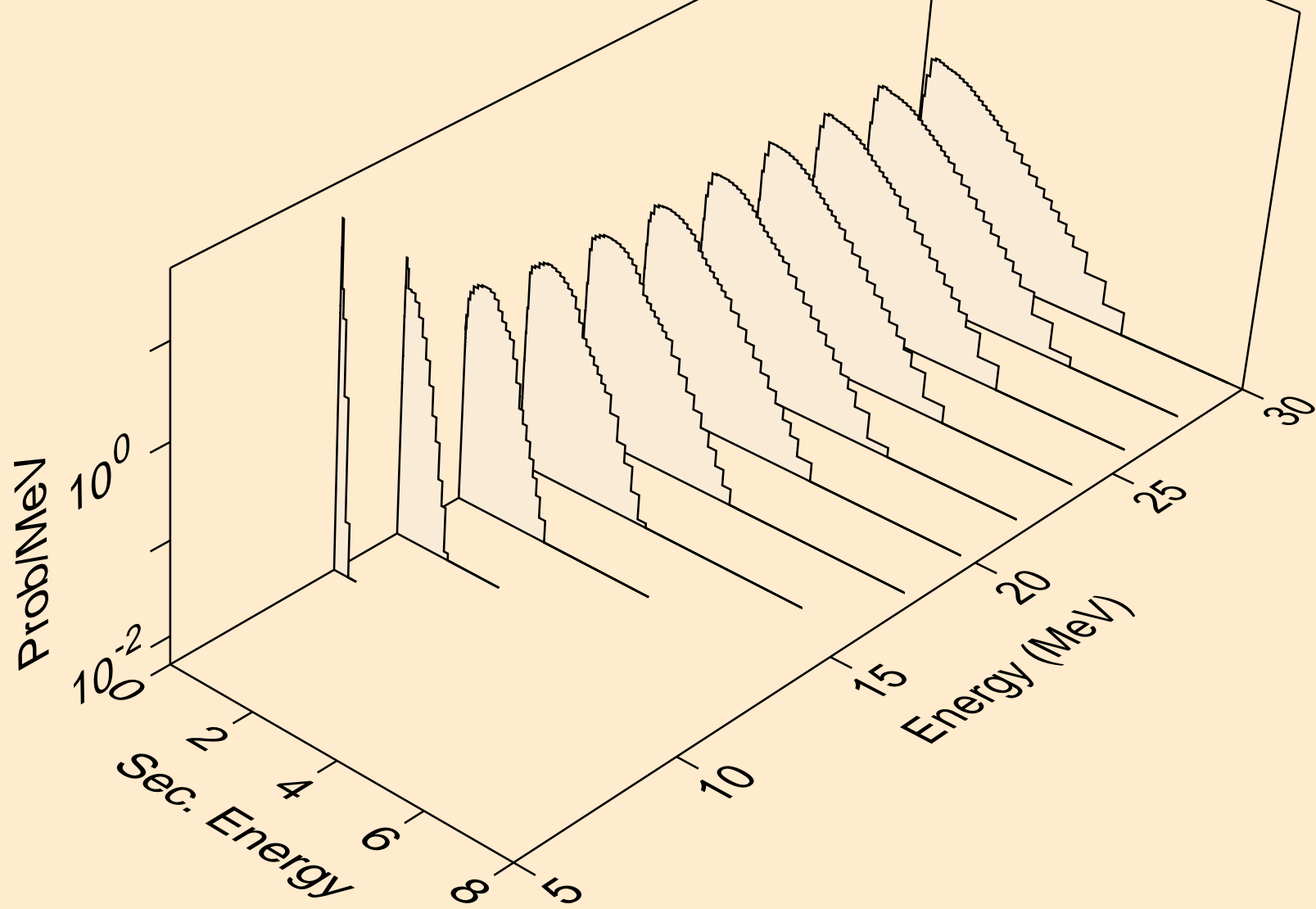

SB110 NEUTRON ACER TENDL-2024 LIBRARY; T=0.K  
Neutron emission for (n,n\*)t

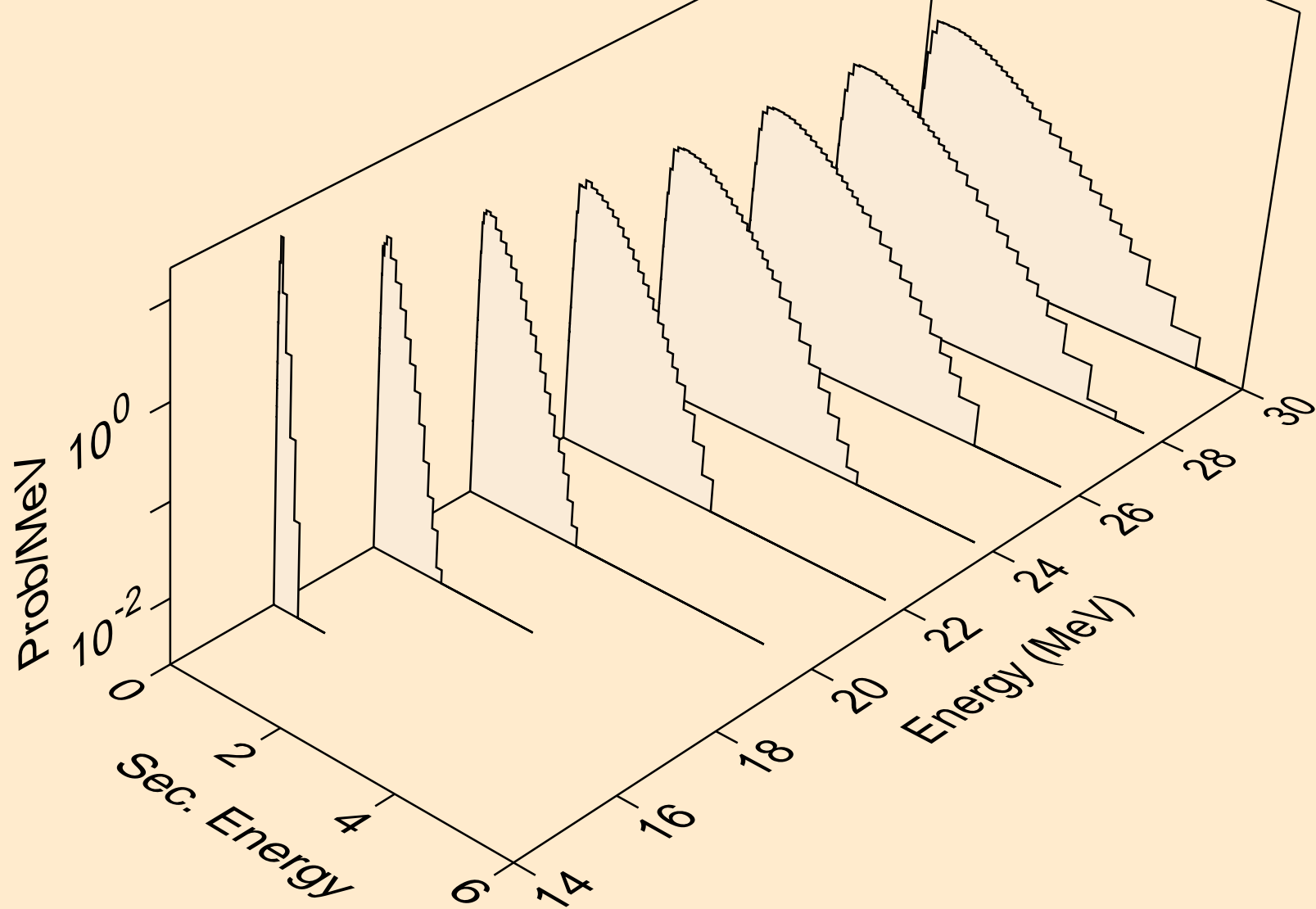

SB110 NEUTRON ACER TENDL-2024 LIBRARY; T=0.K  
Neutron emission for (n,n\*)he3

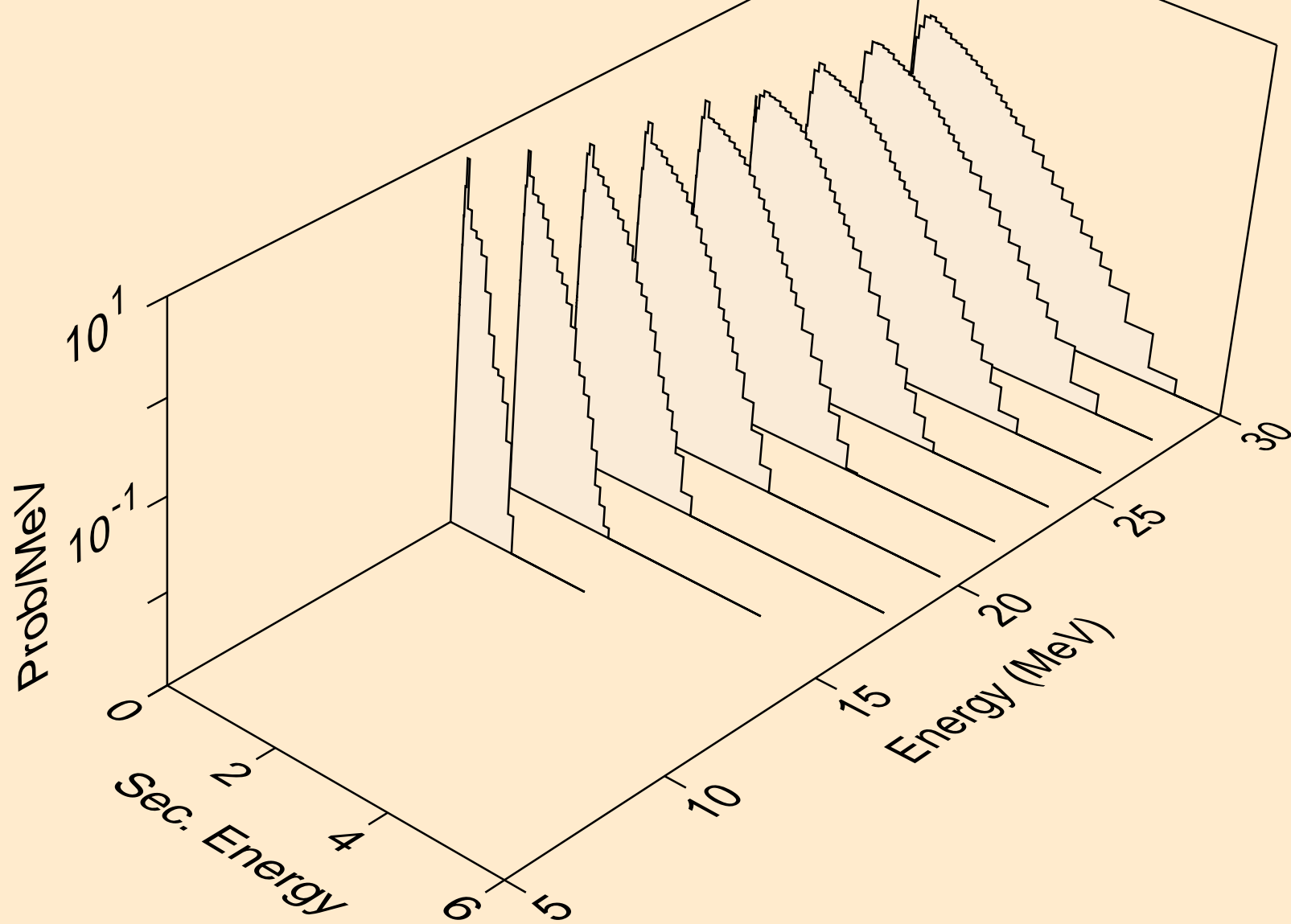

SB110 NEUTRON ACER TENDL-2024 LIBRARY; T=0.K  
Neutron emission for (n,2np)

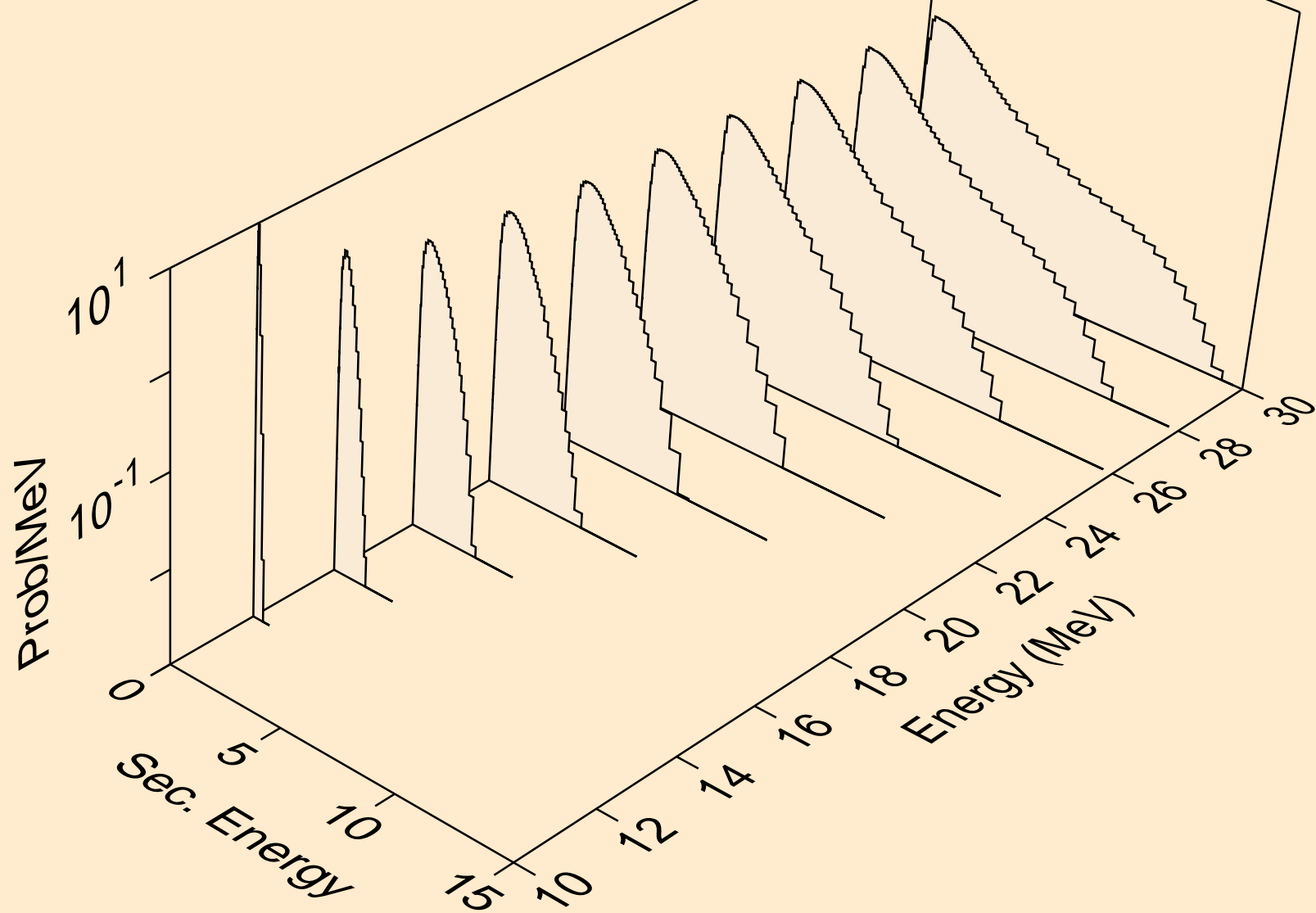

SB110 NEUTRON ACER TENDL-2024 LIBRARY; T=0.K  
Neutron emission for (n,3np)

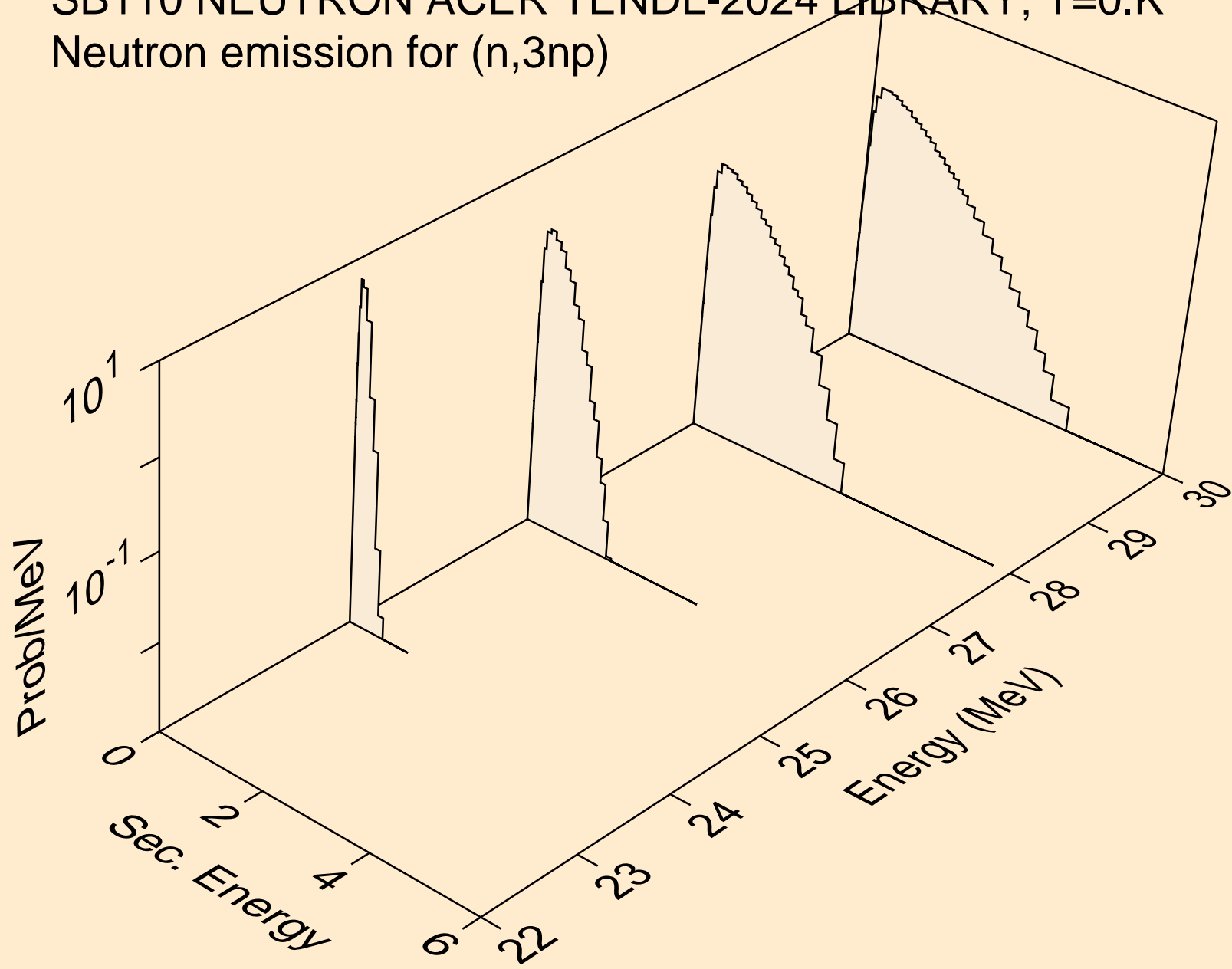

SB110 NEUTRON ACER TENDL-2024 LIBRARY; T=0.K  
Neutron emission for (n,n2p)

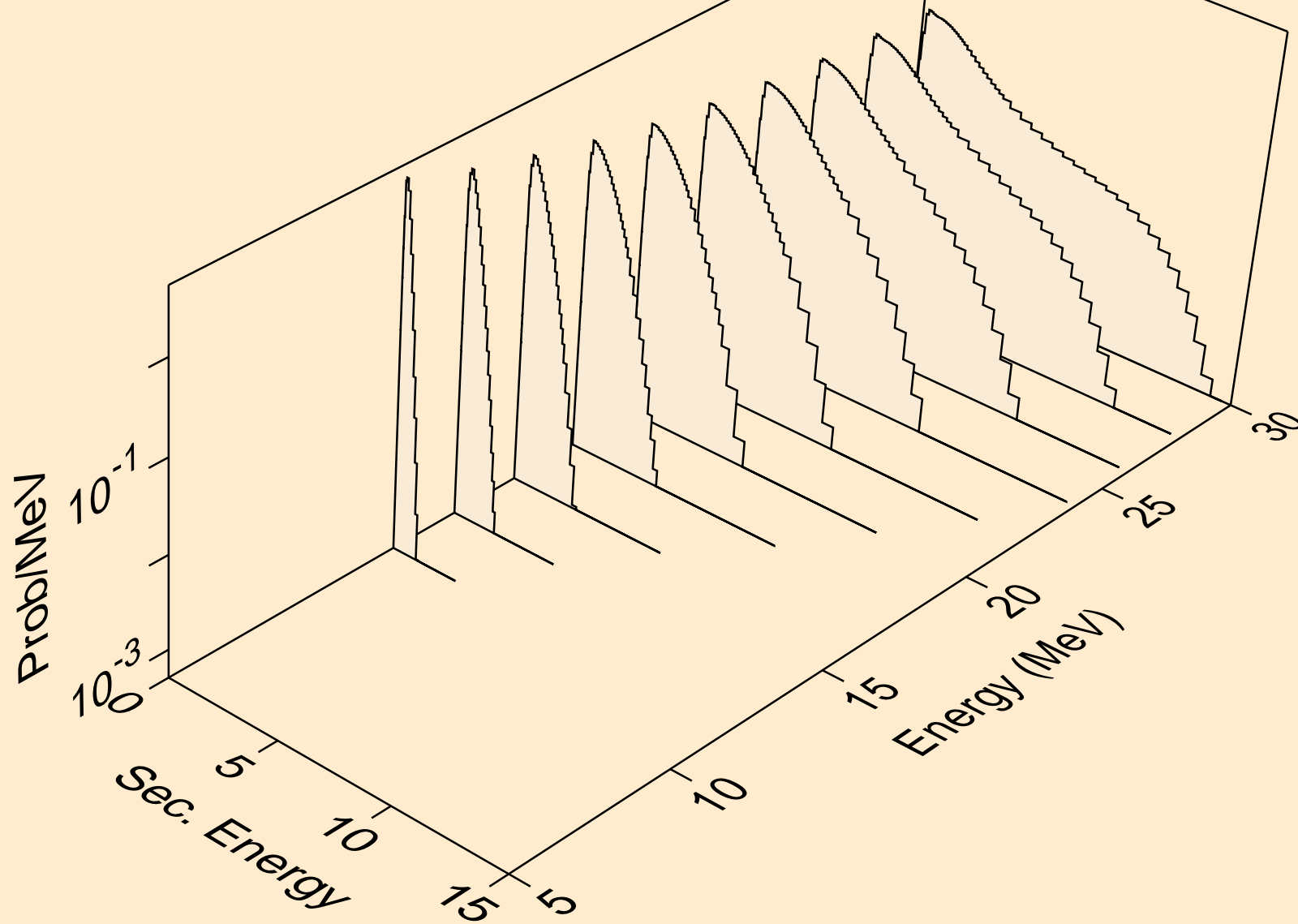

SB110 NEUTRON ACER TENDL-2024 LIBRARY; T=0.K  
Neutron emission for (n,npa)

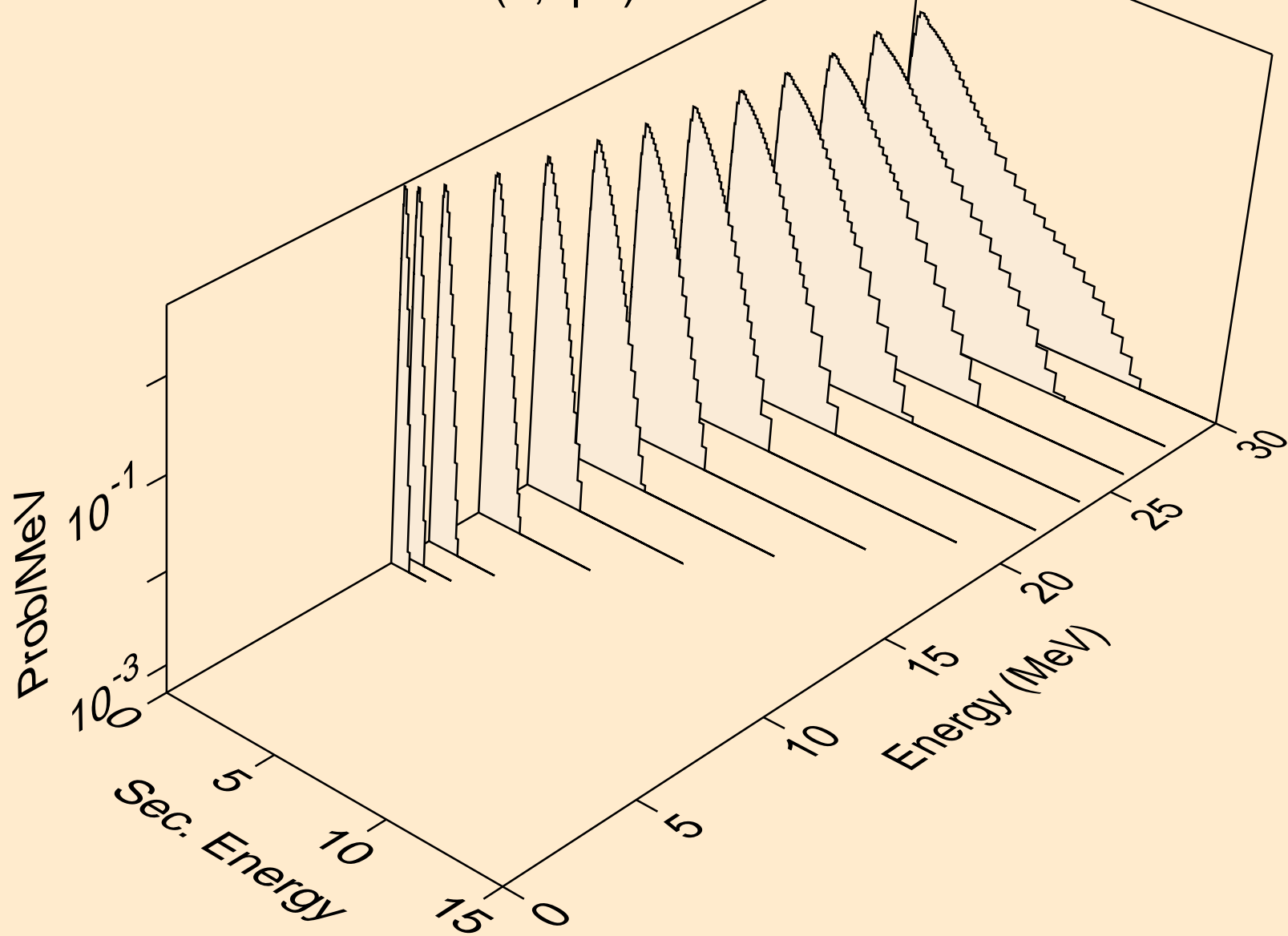

SB110 NEUTRON ACER TENDL-2024 LIBRARY; T=0.K  
Neutron emission for (n,n\*c)

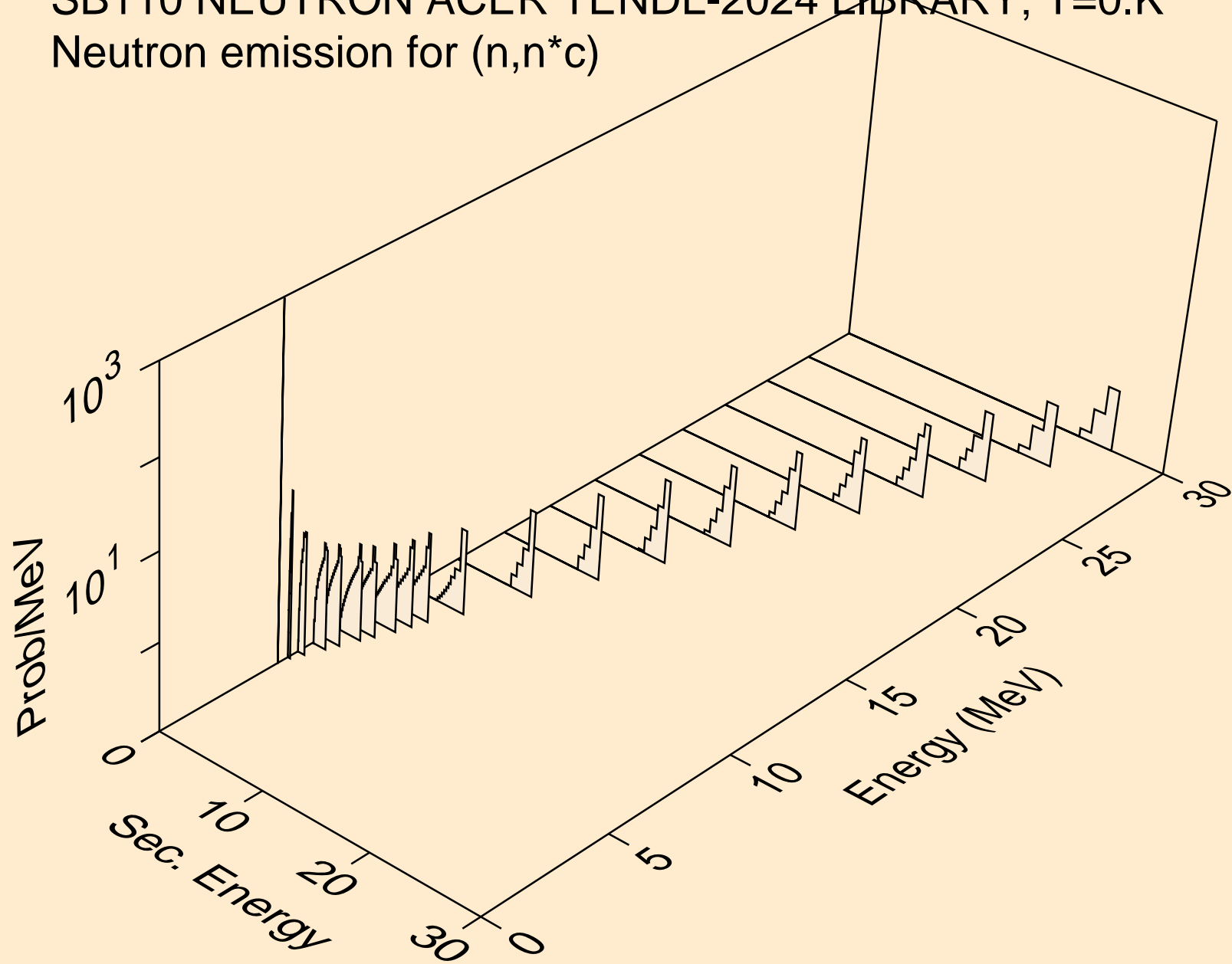



SB110 NEUTRON ACER TENDL-2024 LIBRARY; T=0.K  
Photon emission for (n,x)

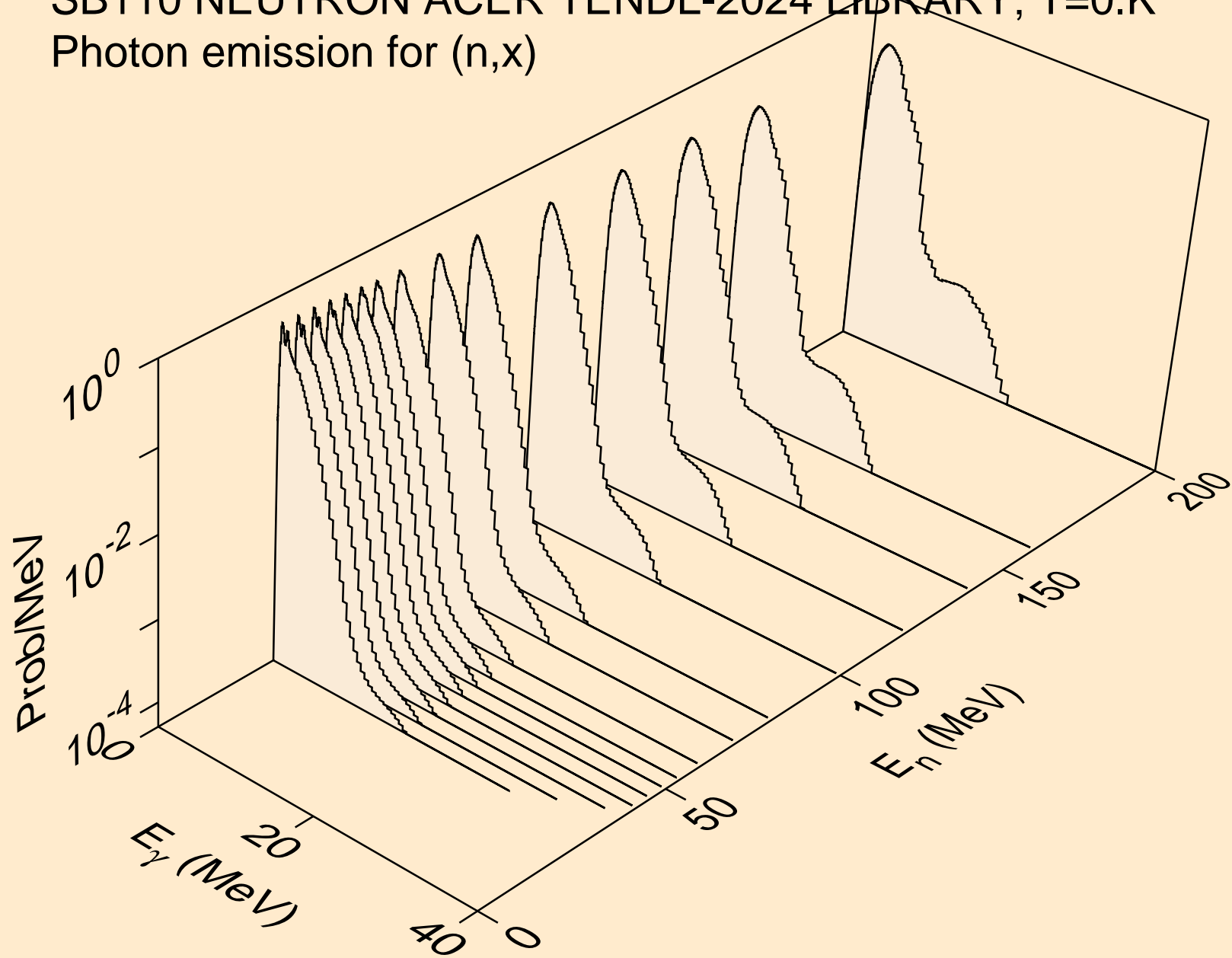

SB110 NEUTRON ACER TENDL-2024 LIBRARY; T=0.K  
Photon emission for (n,2nd)

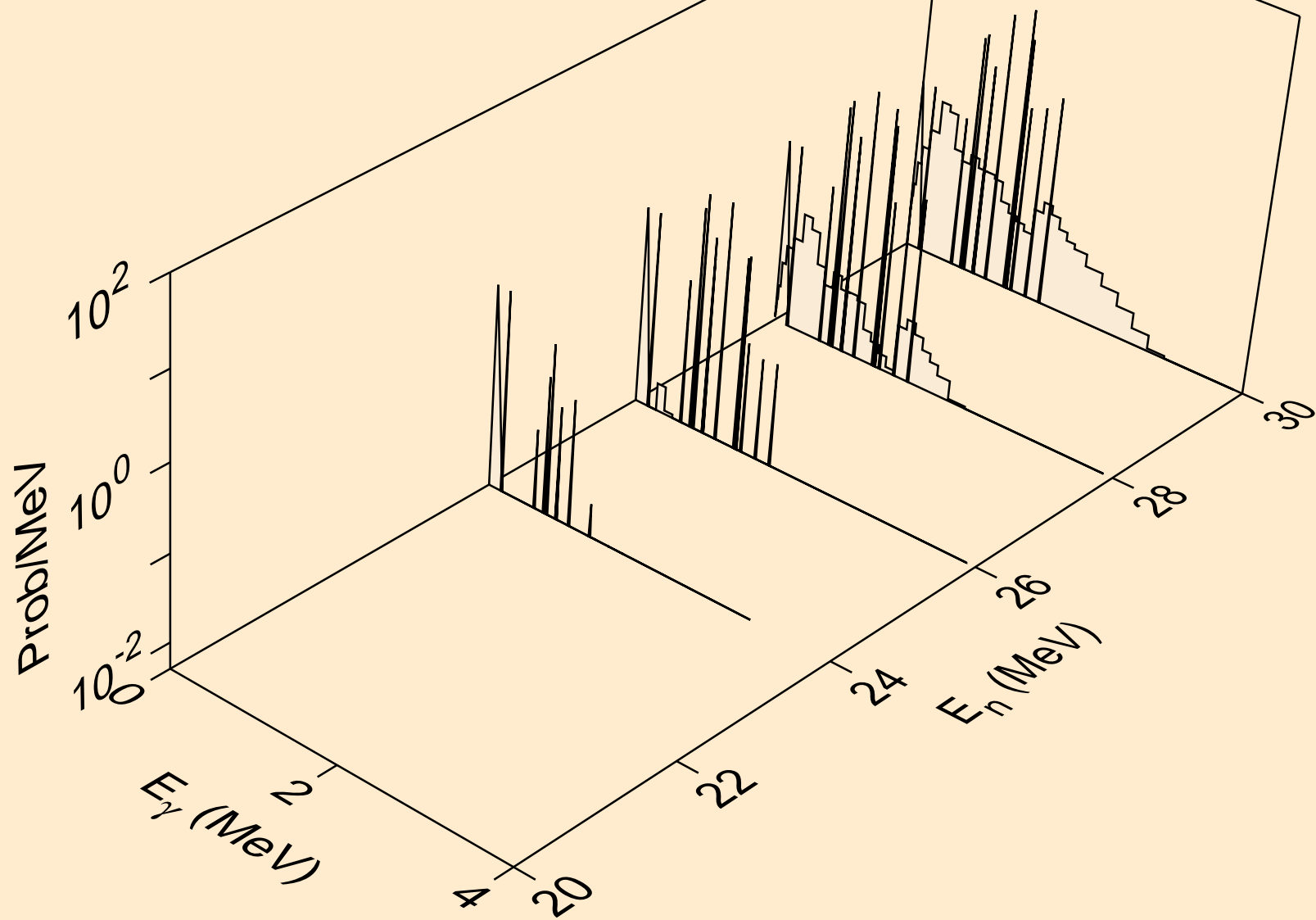

SB110 NEUTRON ACER TENDL-2024 LIBRARY; T=0.K  
Photon emission for (n,2n)

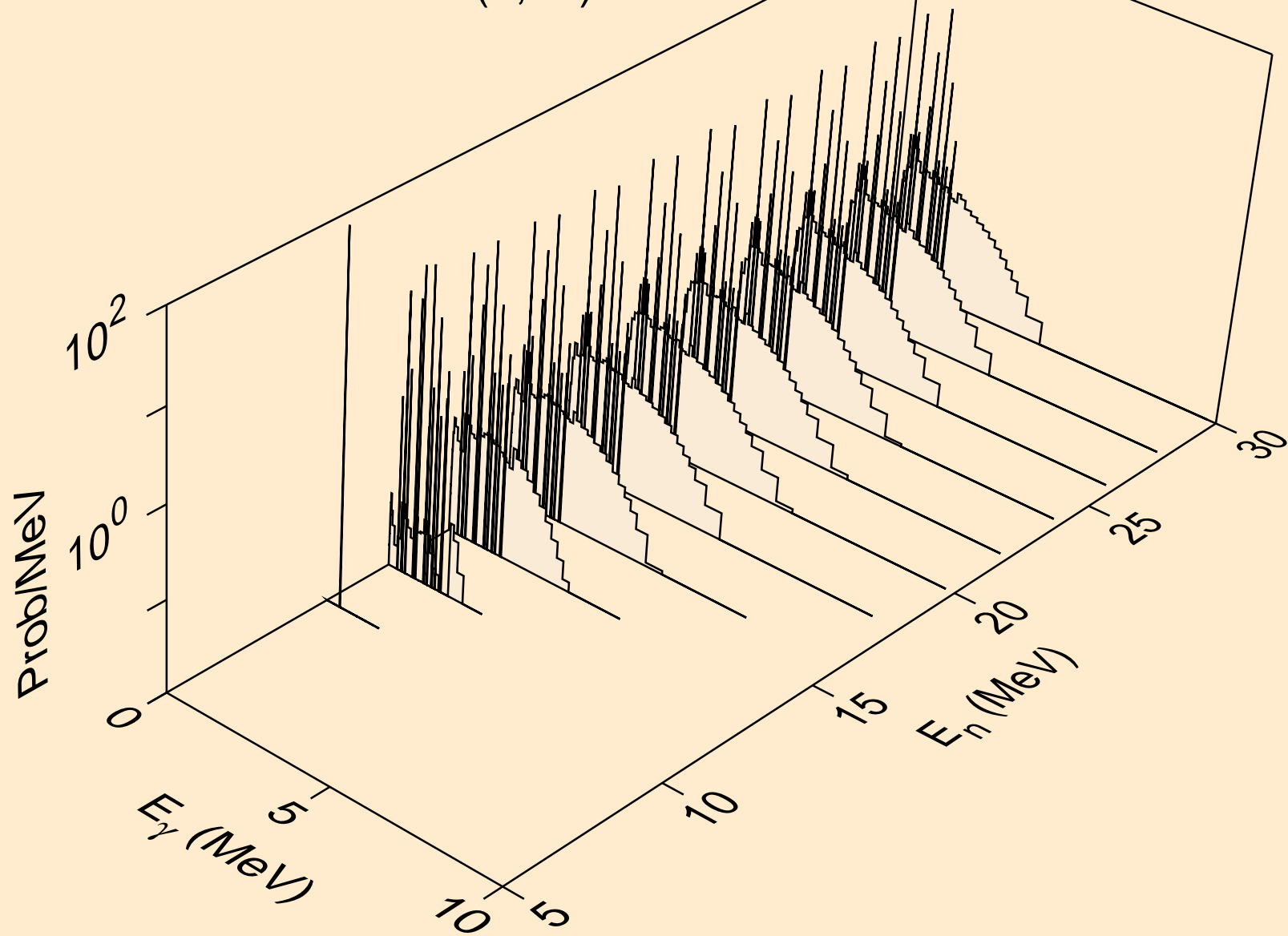

SB110 NEUTRON ACER TENDL-2024 LIBRARY; T=0.K  
Photon emission for (n,3n)

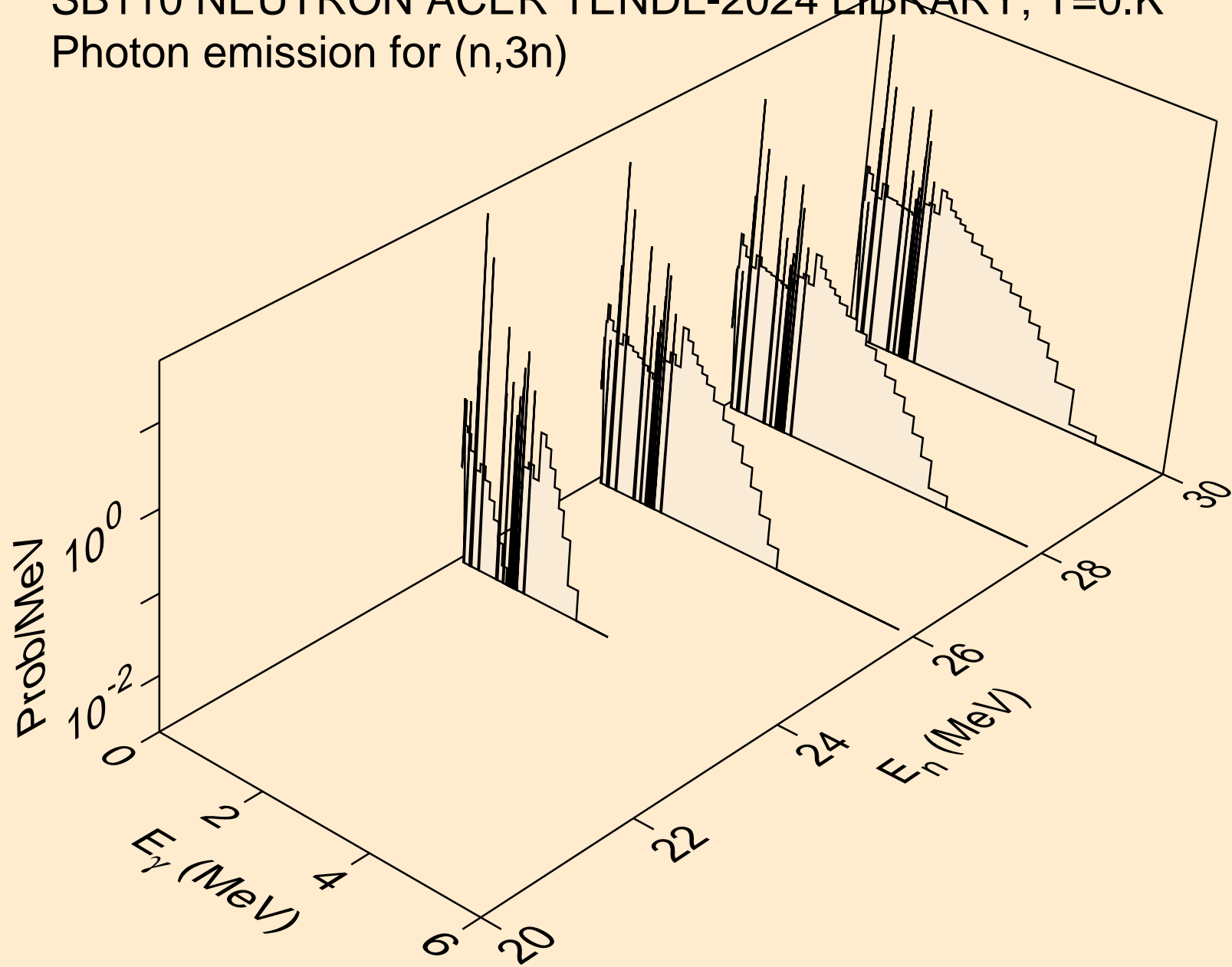

SB110 NEUTRON ACER TENDL-2024 LIBRARY; T=0.K  
Photon emission for (n,n\*)a

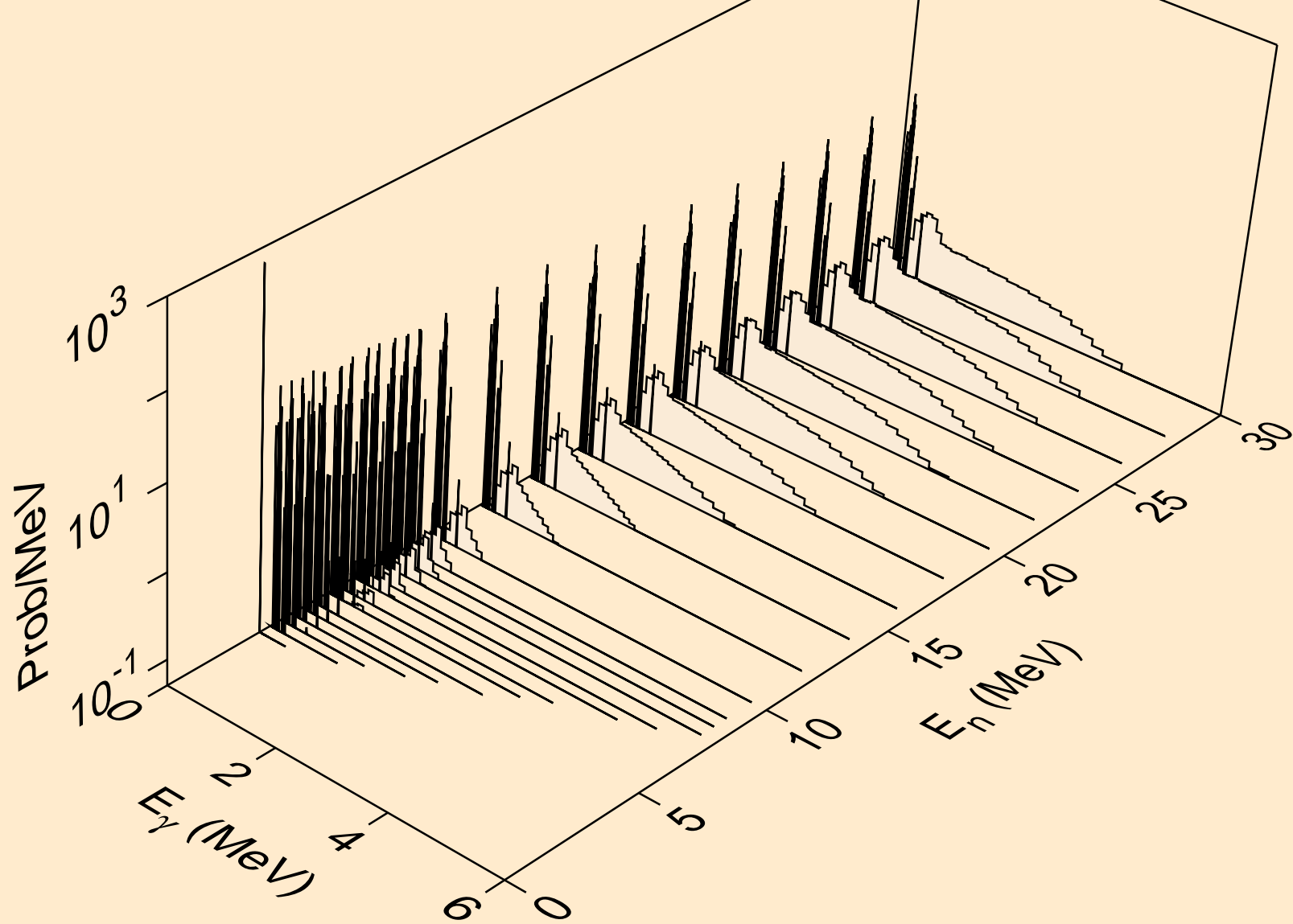

SB110 NEUTRON ACER TENDL-2024 LIBRARY; T=0.K  
Photon emission for (n,2n)a

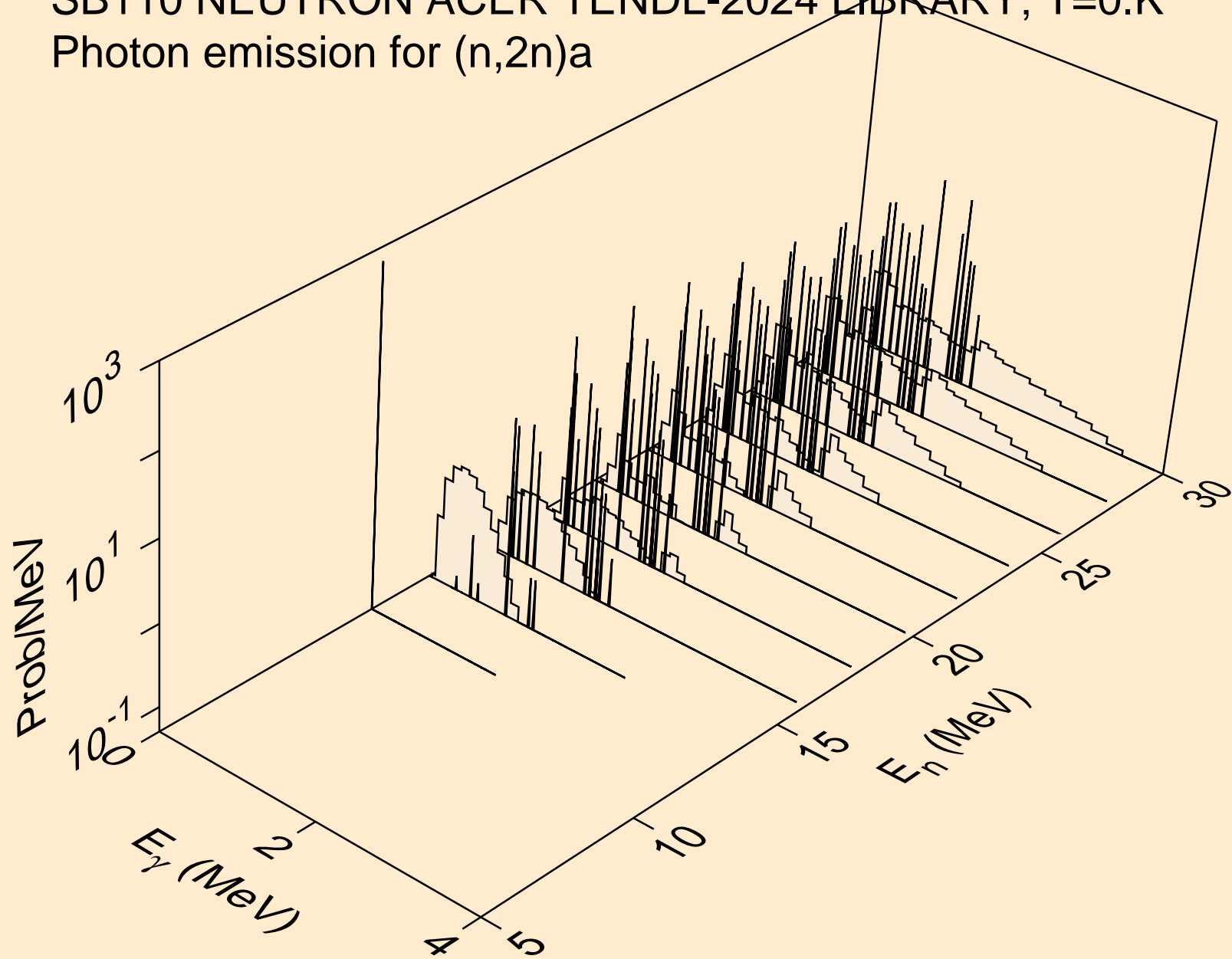

SB110 NEUTRON ACER TENDL-2024 LIBRARY; T=0.K  
Photon emission for (n,3n)a

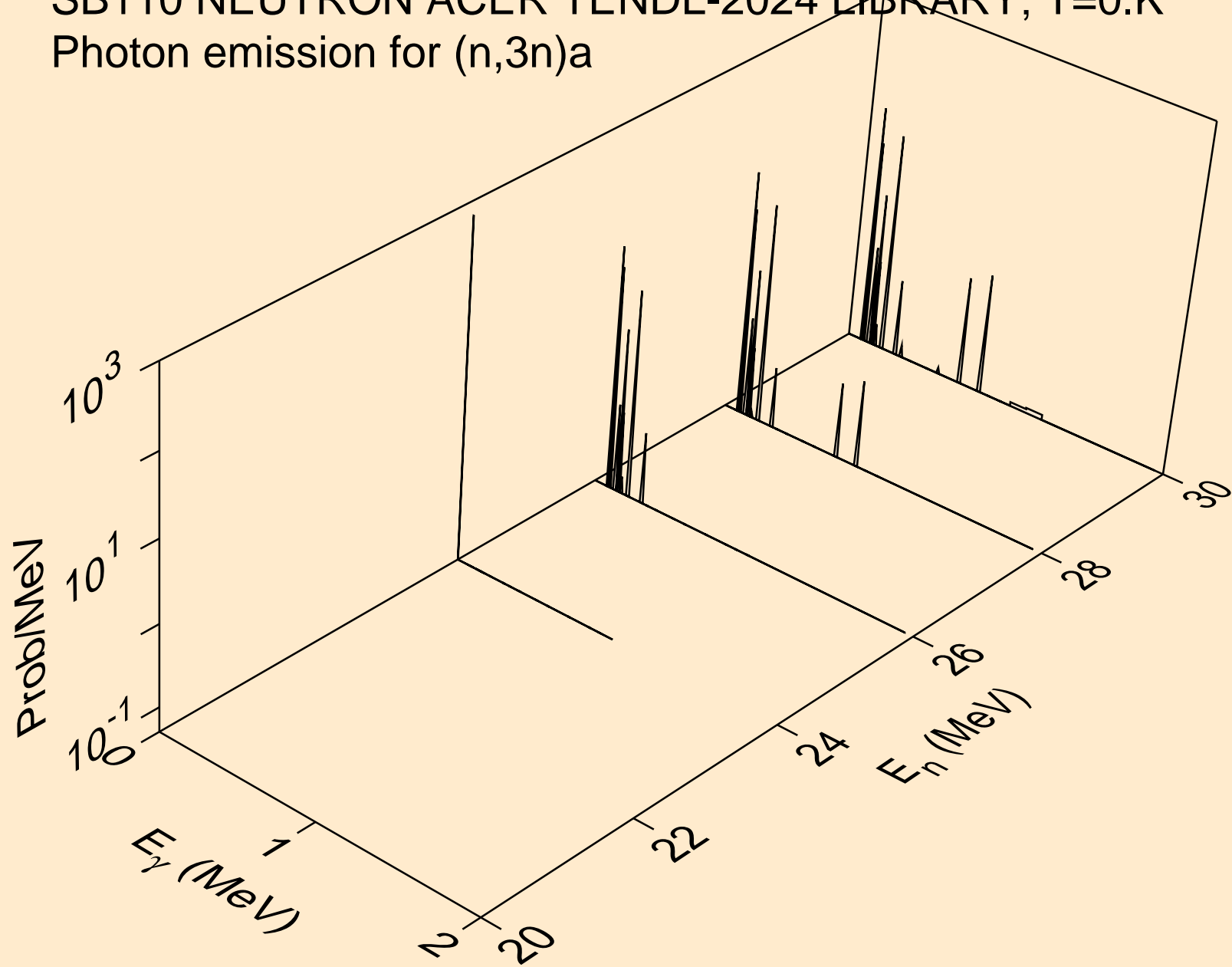

SB110 NEUTRON ACER TENDL-2024 LIBRARY; T=0.K  
Photon emission for (n,n\*)p

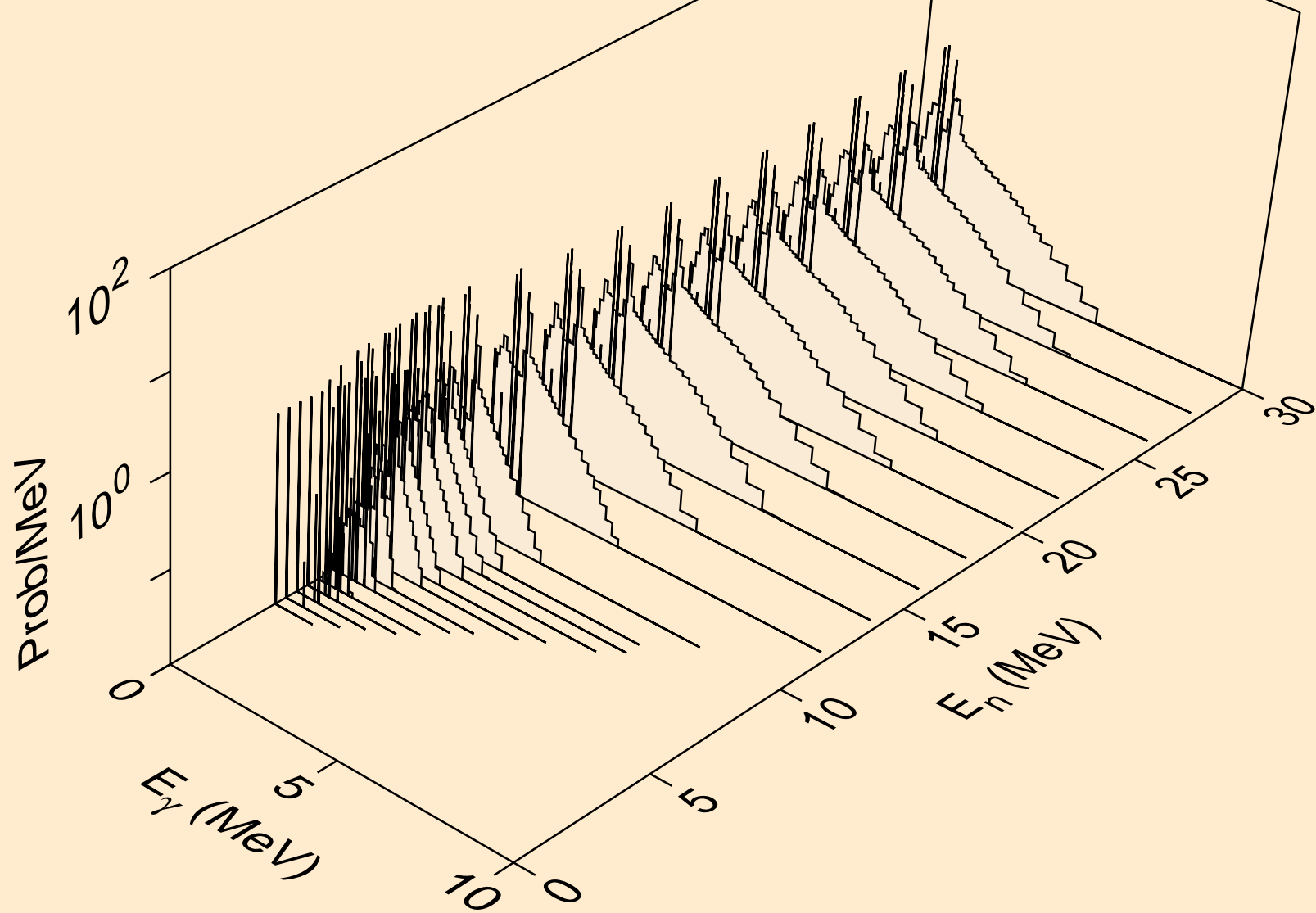



SB110 NEUTRON ACER TENDL-2024 LIBRARY; T=0.K  
Photon emission for (n,n\*)2a

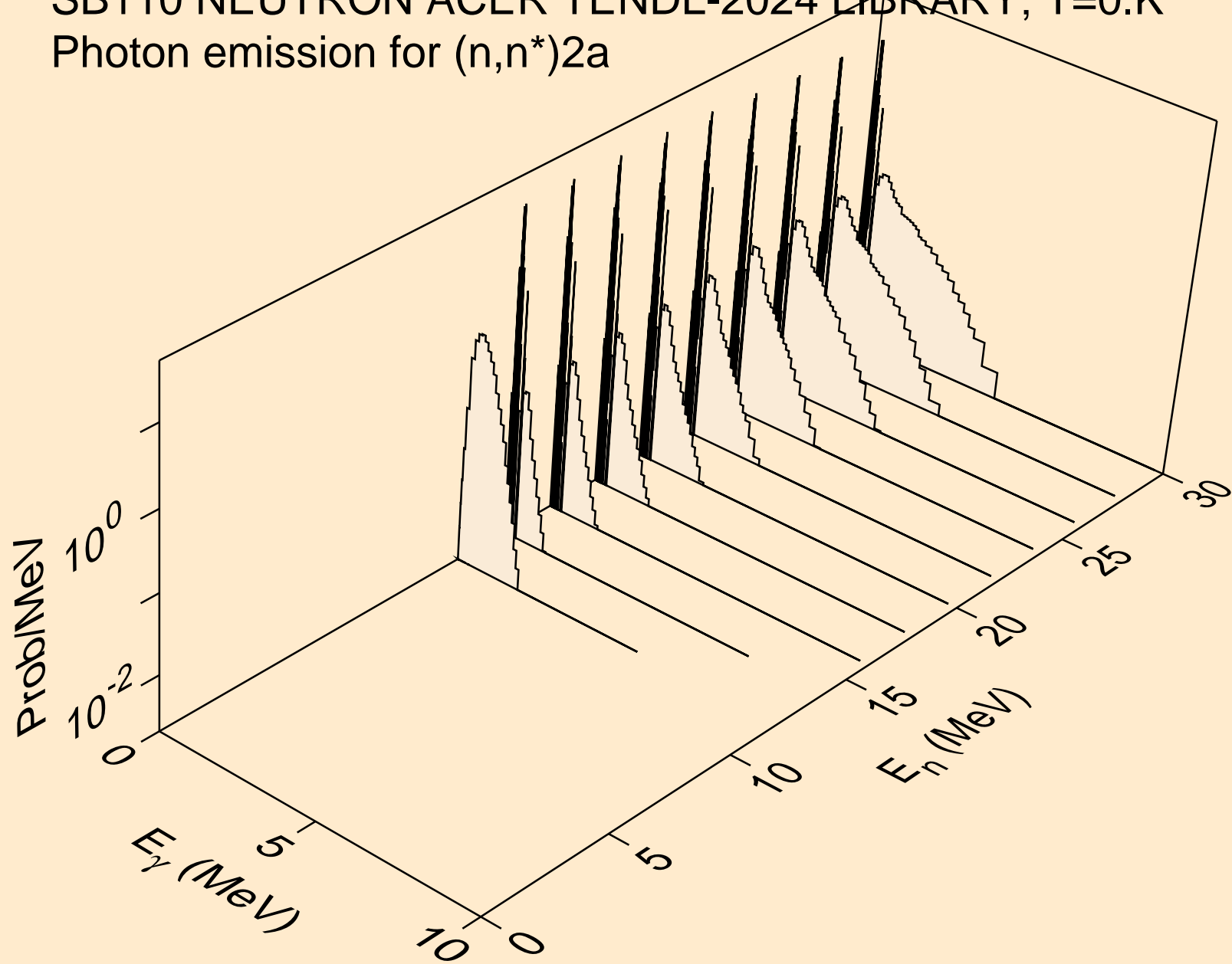

SB110 NEUTRON ACER TENDL-2024 LIBRARY; T=0.K  
Photon emission for (n,2n)2a

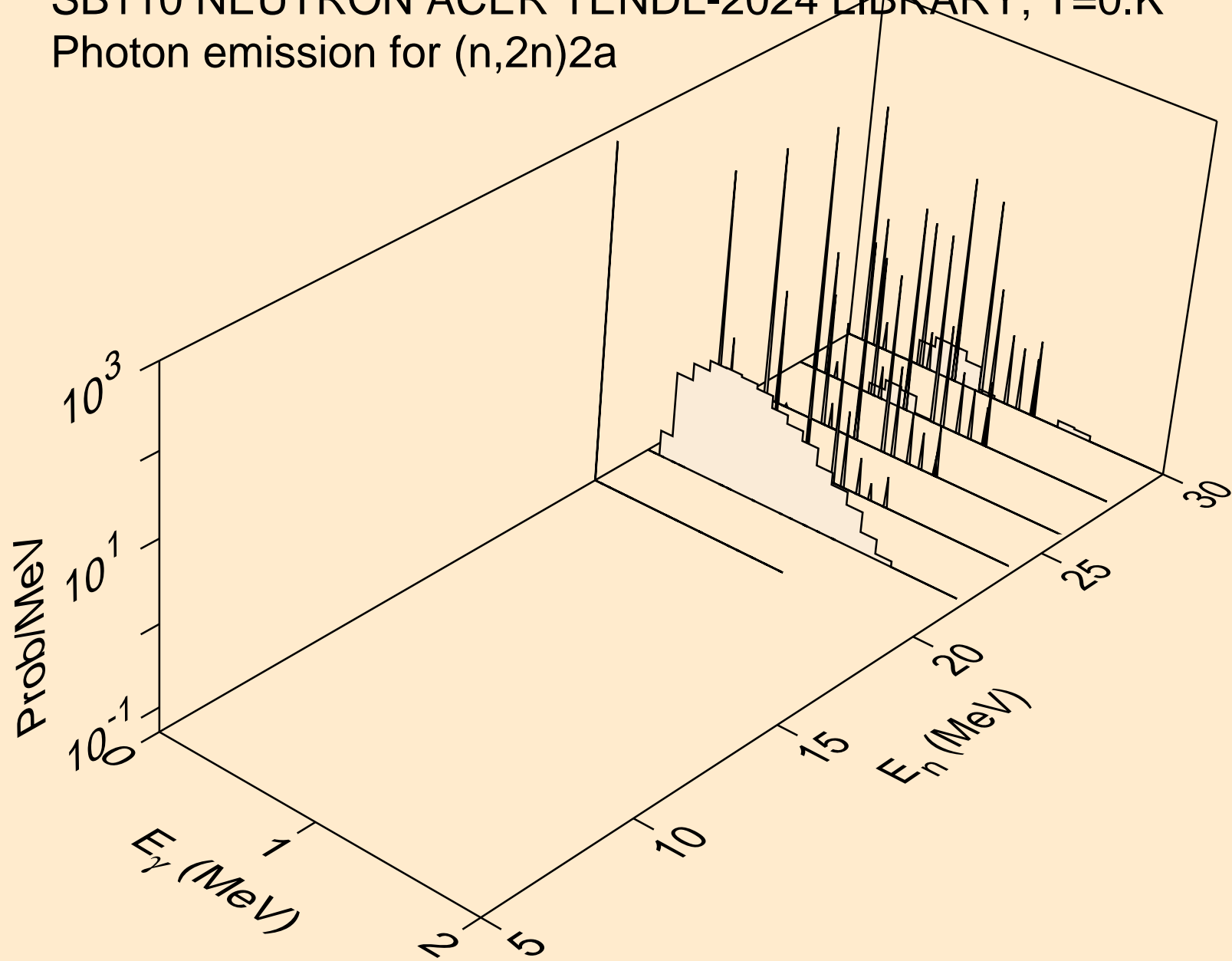

SB110 NEUTRON ACER TENDL-2024 LIBRARY; T=0.K  
Photon emission for (n,n\*)d

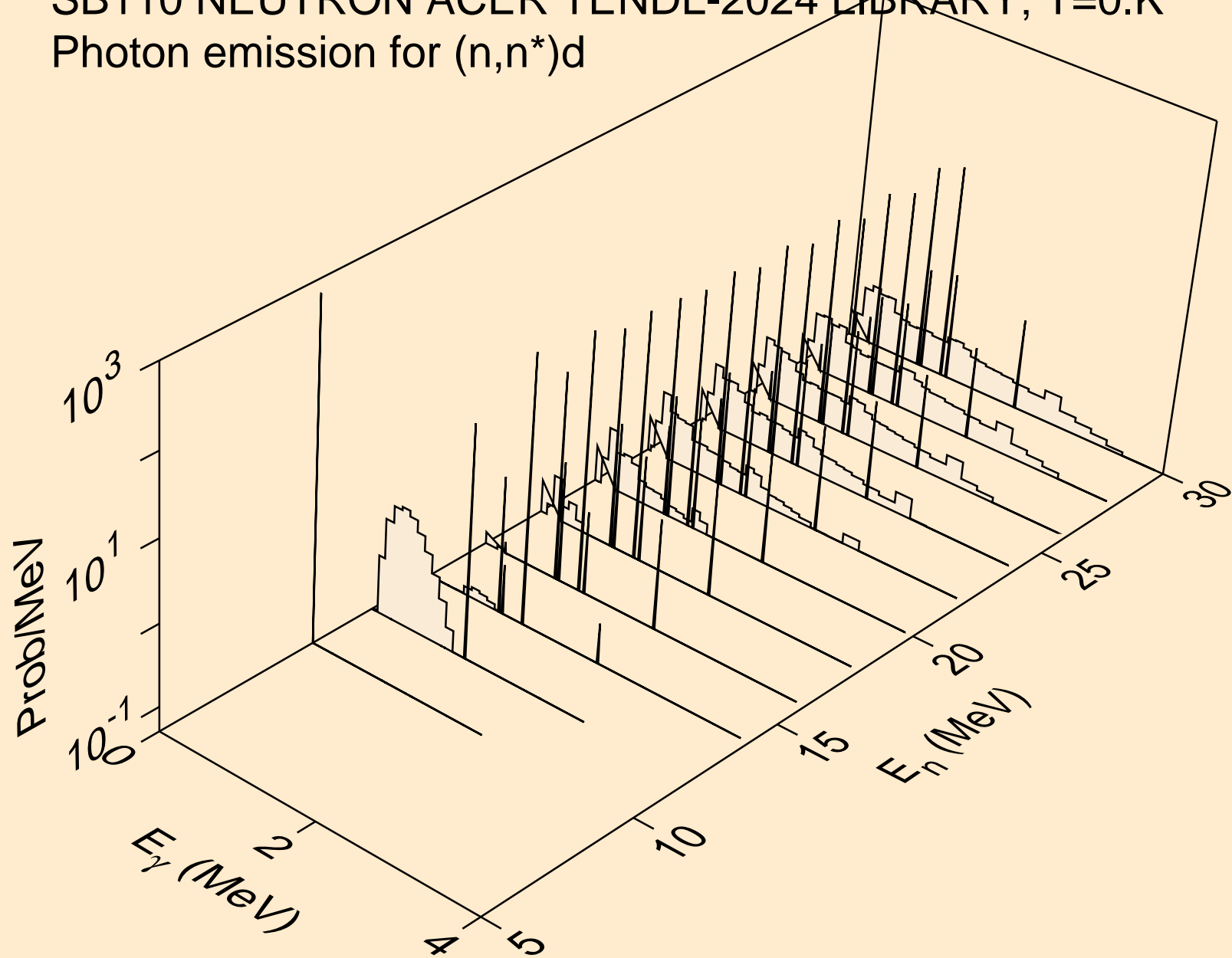

SB110 NEUTRON ACER TENDL-2024 LIBRARY; T=0.K  
Photon emission for (n,n\*)t

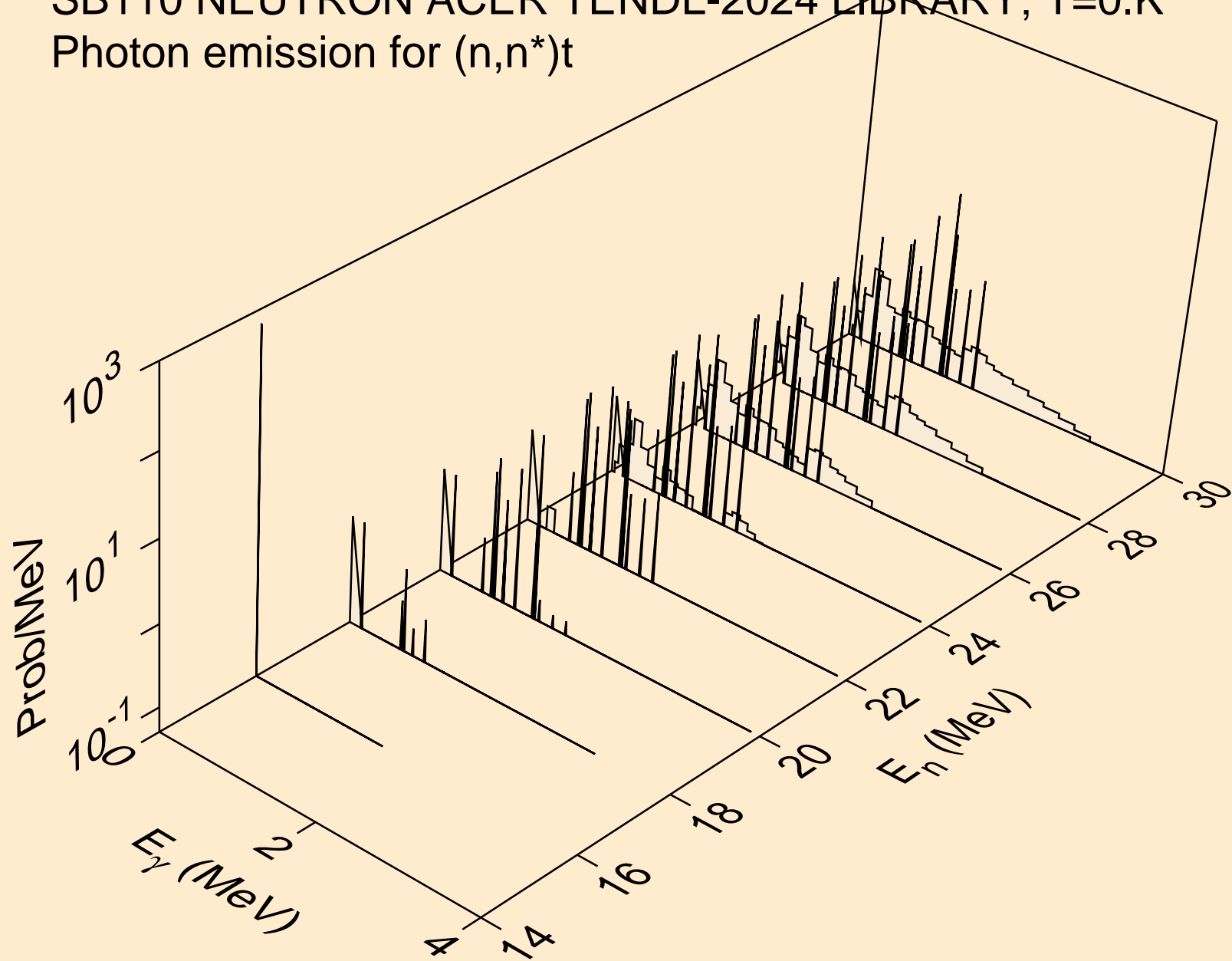

SB110 NEUTRON ACER TENDL-2024 LIBRARY; T=0.K  
Photon emission for (n,n\*)he3

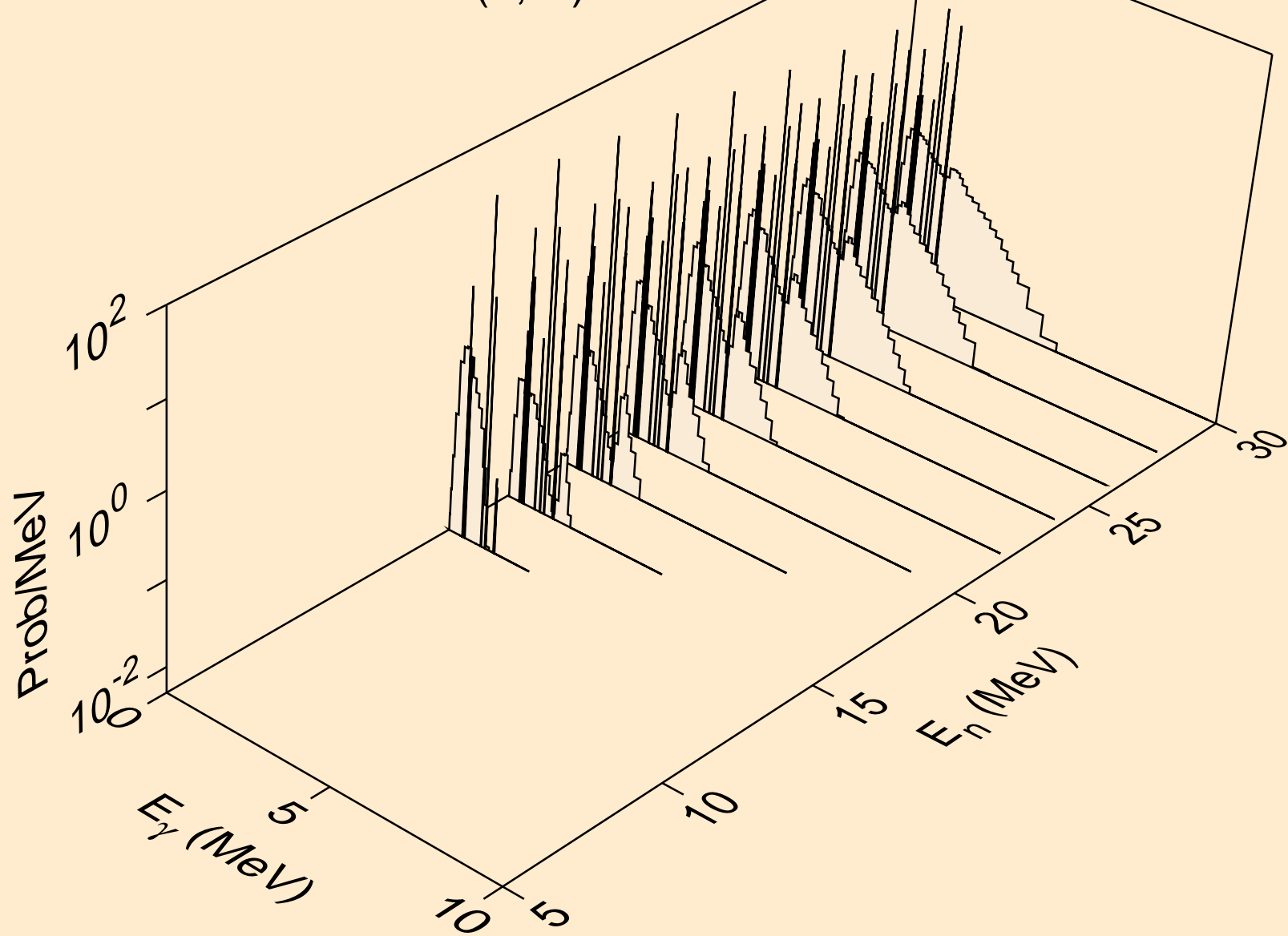

SB110 NEUTRON ACER TENDL-2024 LIBRARY; T=0.K  
Photon emission for (n,2np)

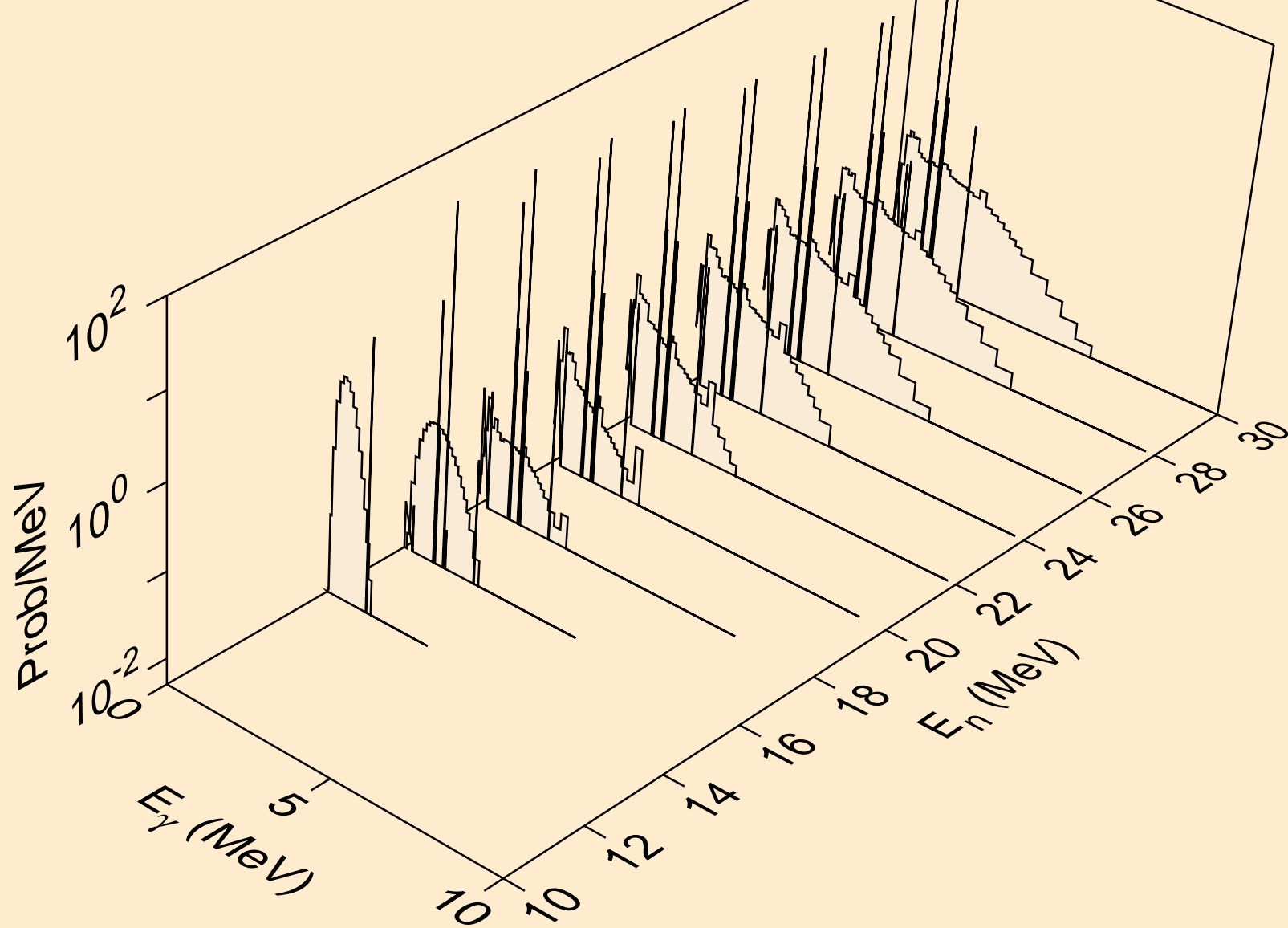

SB110 NEUTRON ACER TENDL-2024 LIBRARY; T=0.K  
Photon emission for (n,3np)

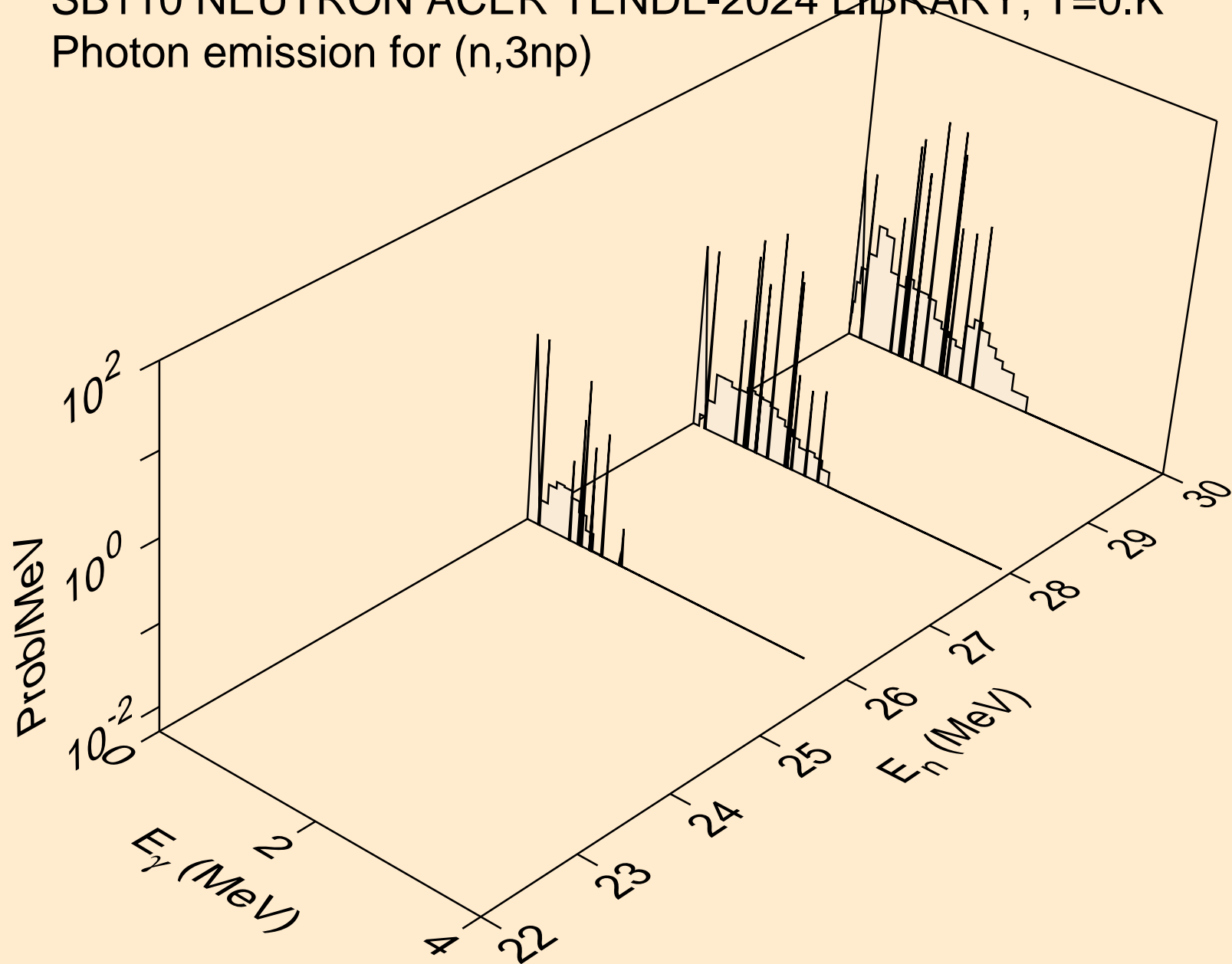

SB110 NEUTRON ACER TENDL-2024 LIBRARY; T=0.K  
Photon emission for (n,n2p)

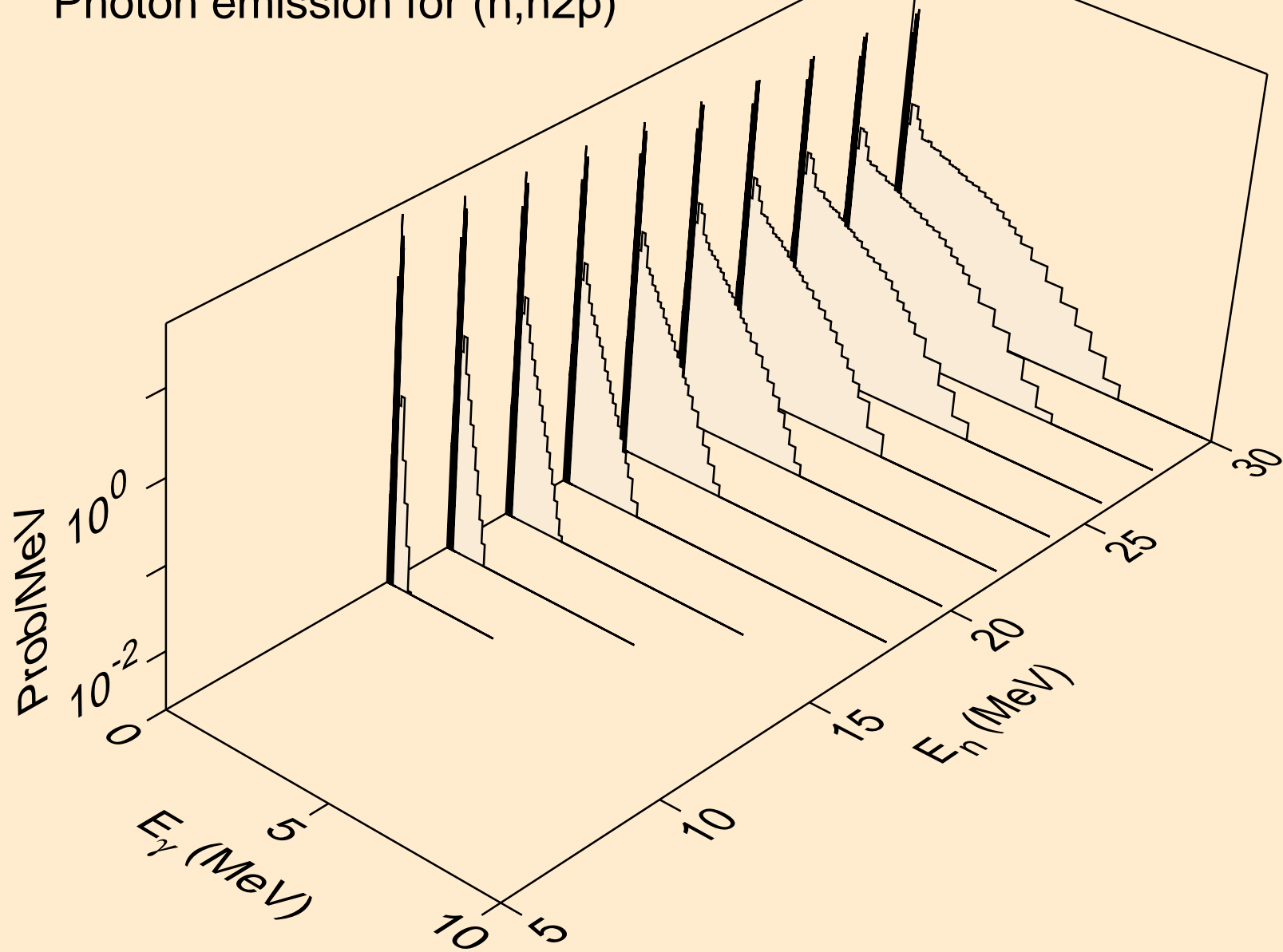



SB110 NEUTRON ACER TENDL-2024 LIBRARY; T=0.K  
Photon emission for (n,npa)

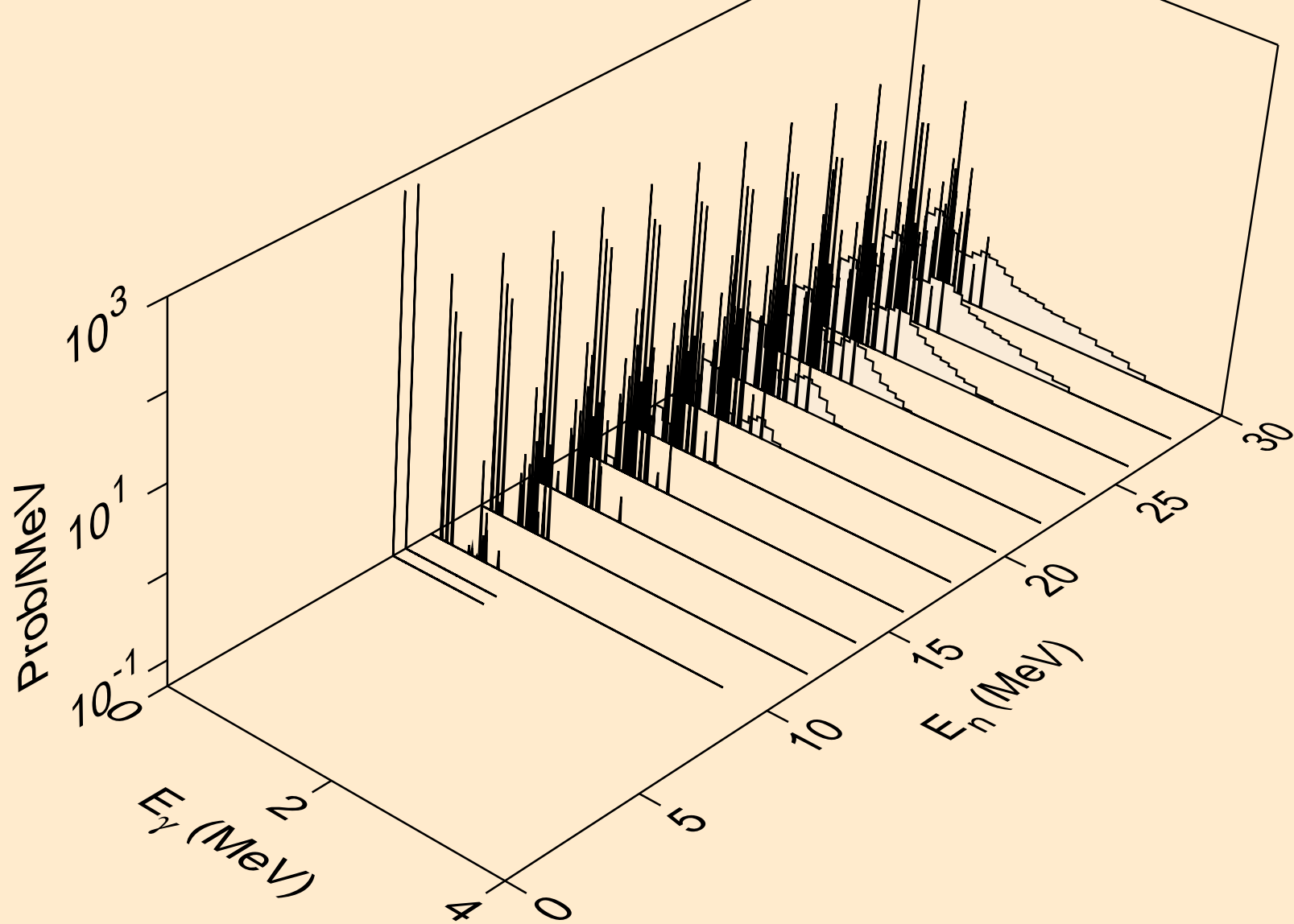

SB110 NEUTRON ACER TENDL-2024 LIBRARY; T=0.K  
Photon emission for (n,n\*c)

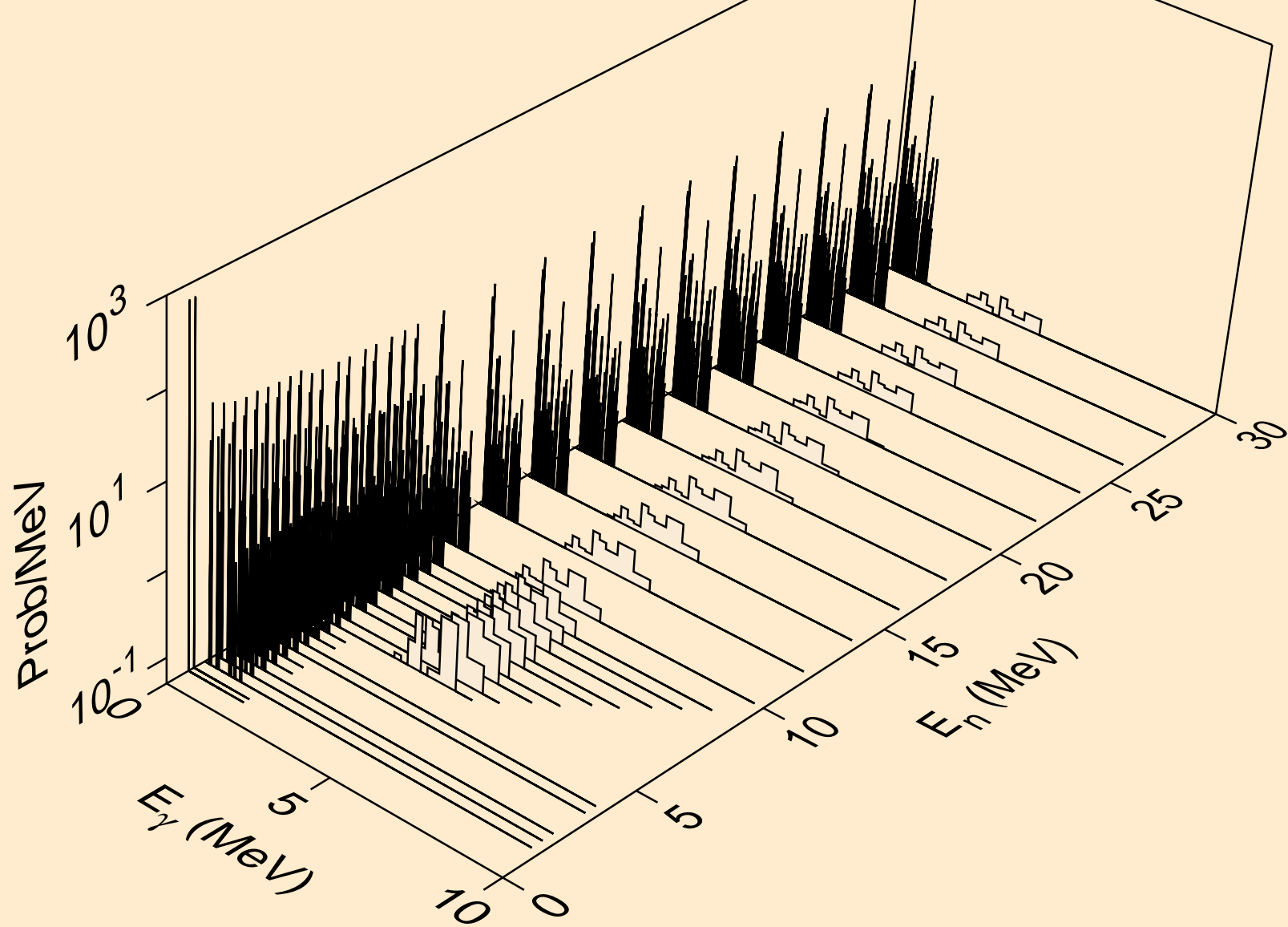

SB110 NEUTRON ACER TENDL-2024 LIBRARY; T=0.K  
Photon emission for (n,gma)

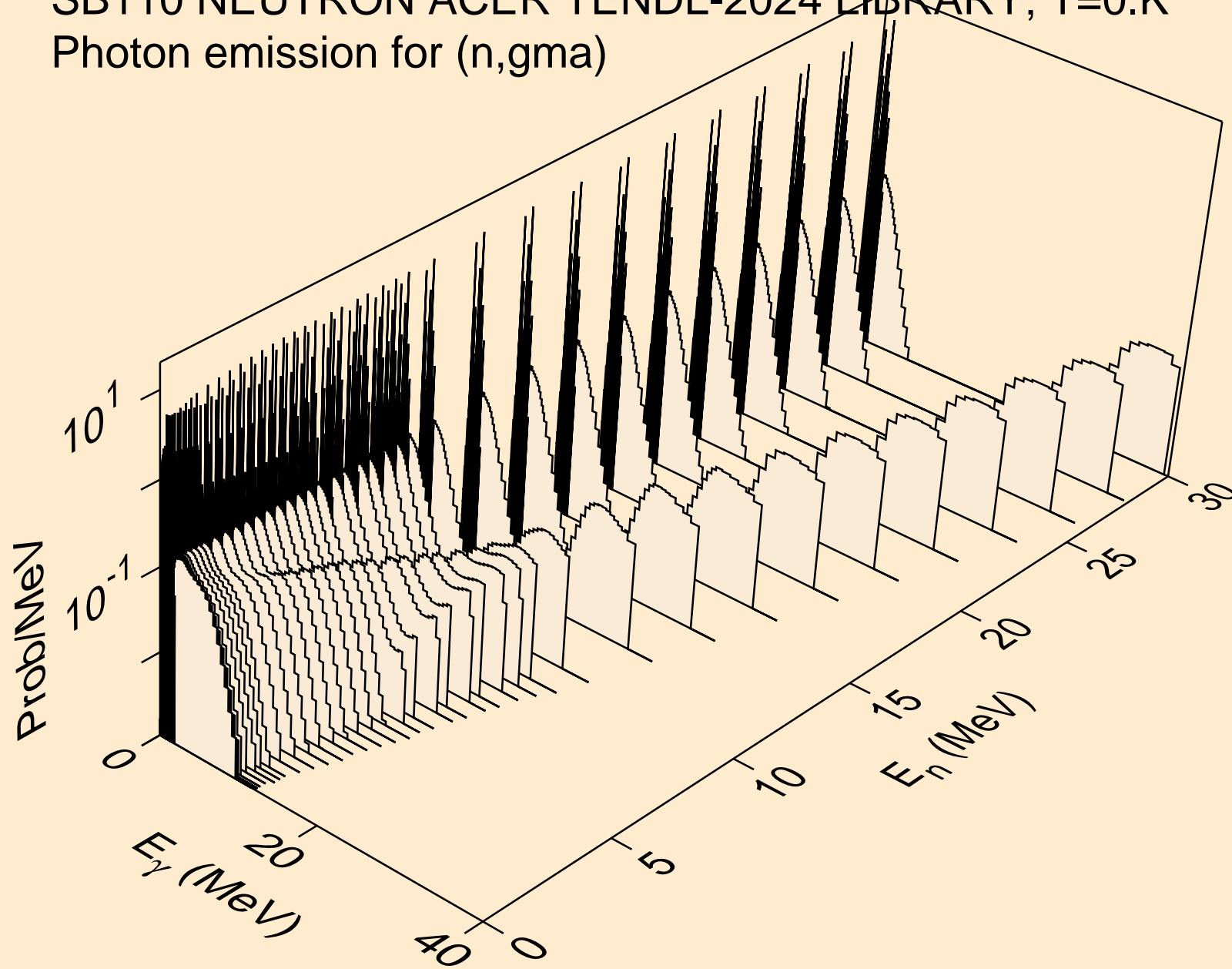

SB110 NEUTRON ACER TENDL-2024 LIBRARY; T=0.K  
Photon emission for (n,p)

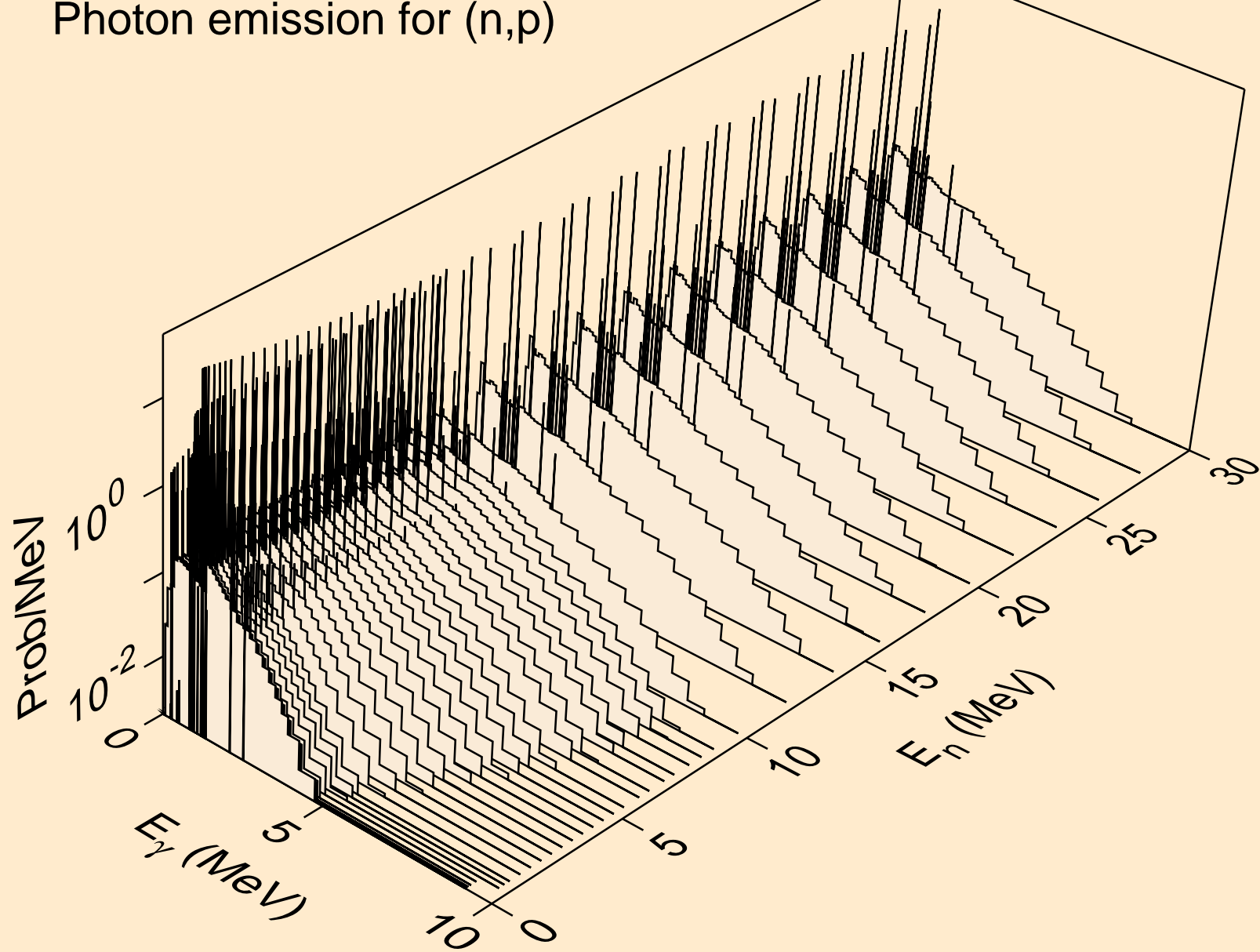

SB110 NEUTRON ACER TENDL-2024 LIBRARY; T=0.K  
Photon emission for (n,d)

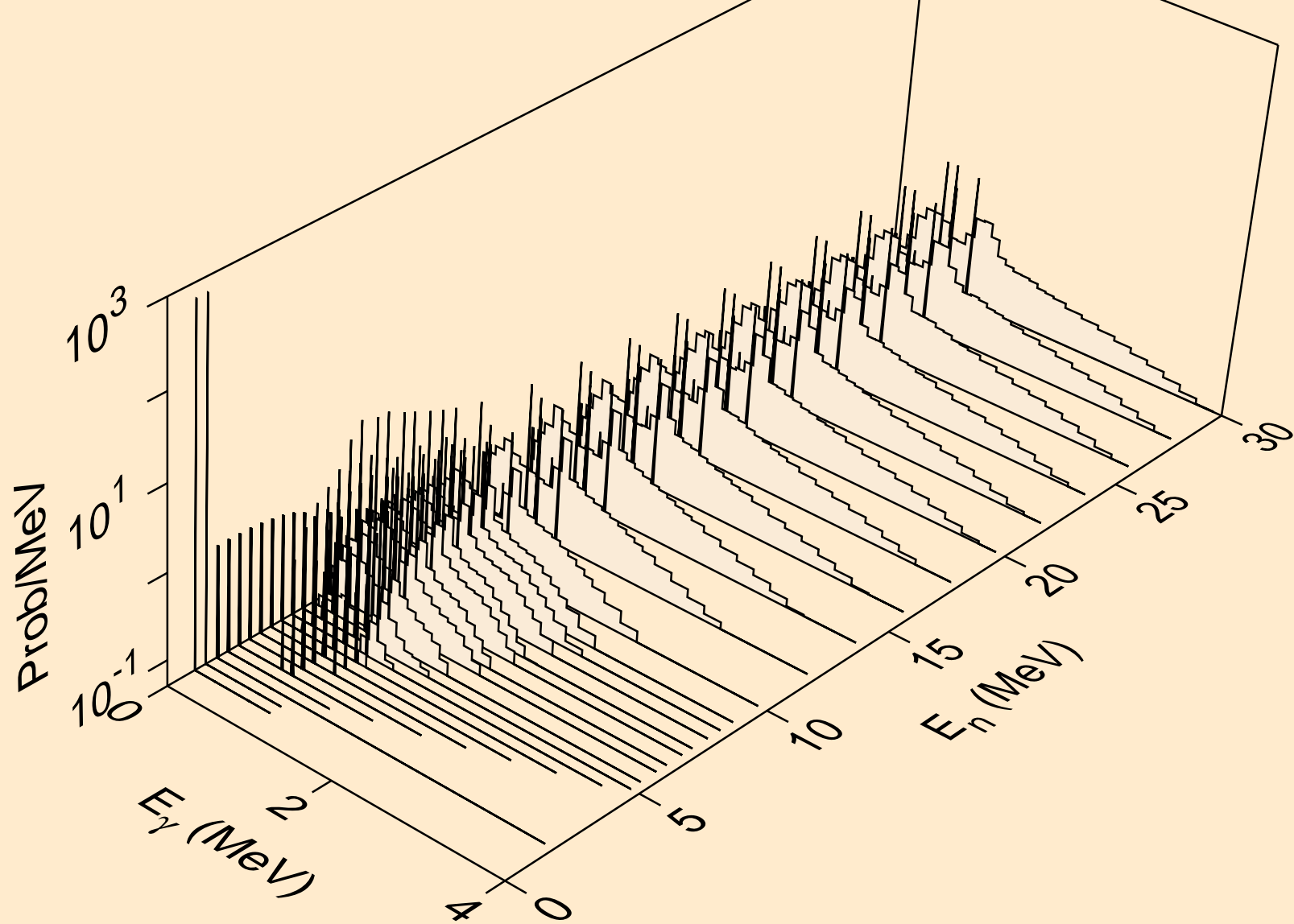

SB110 NEUTRON ACER TENDL-2024 LIBRARY; T=0.K  
Photon emission for (n,t)

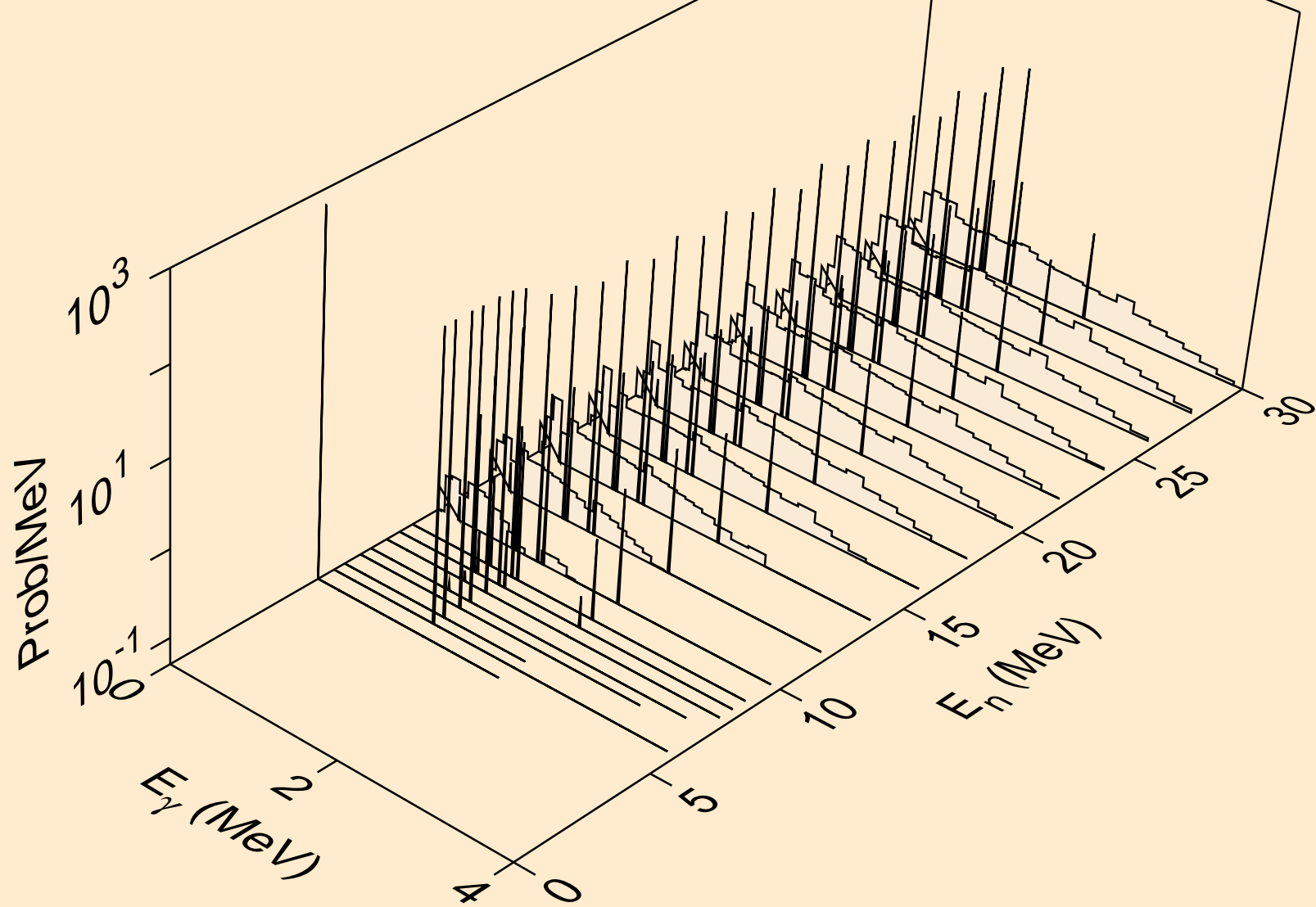

SB110 NEUTRON ACER TENDL-2024 LIBRARY; T=0.K  
Photon emission for (n,he3)

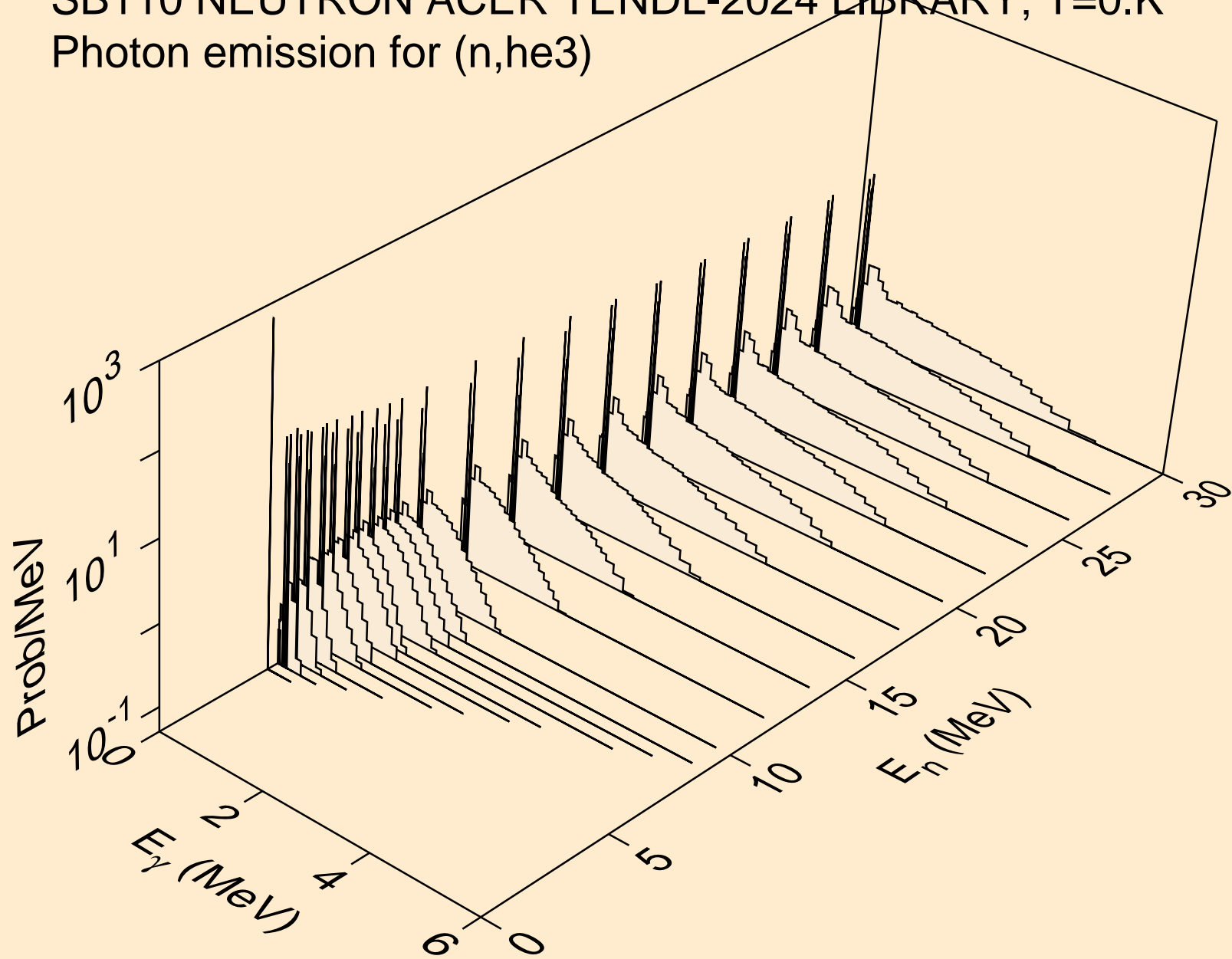

SB110 NEUTRON ACER TENDL-2024 LIBRARY; T=0.K  
Photon emission for (n,a)

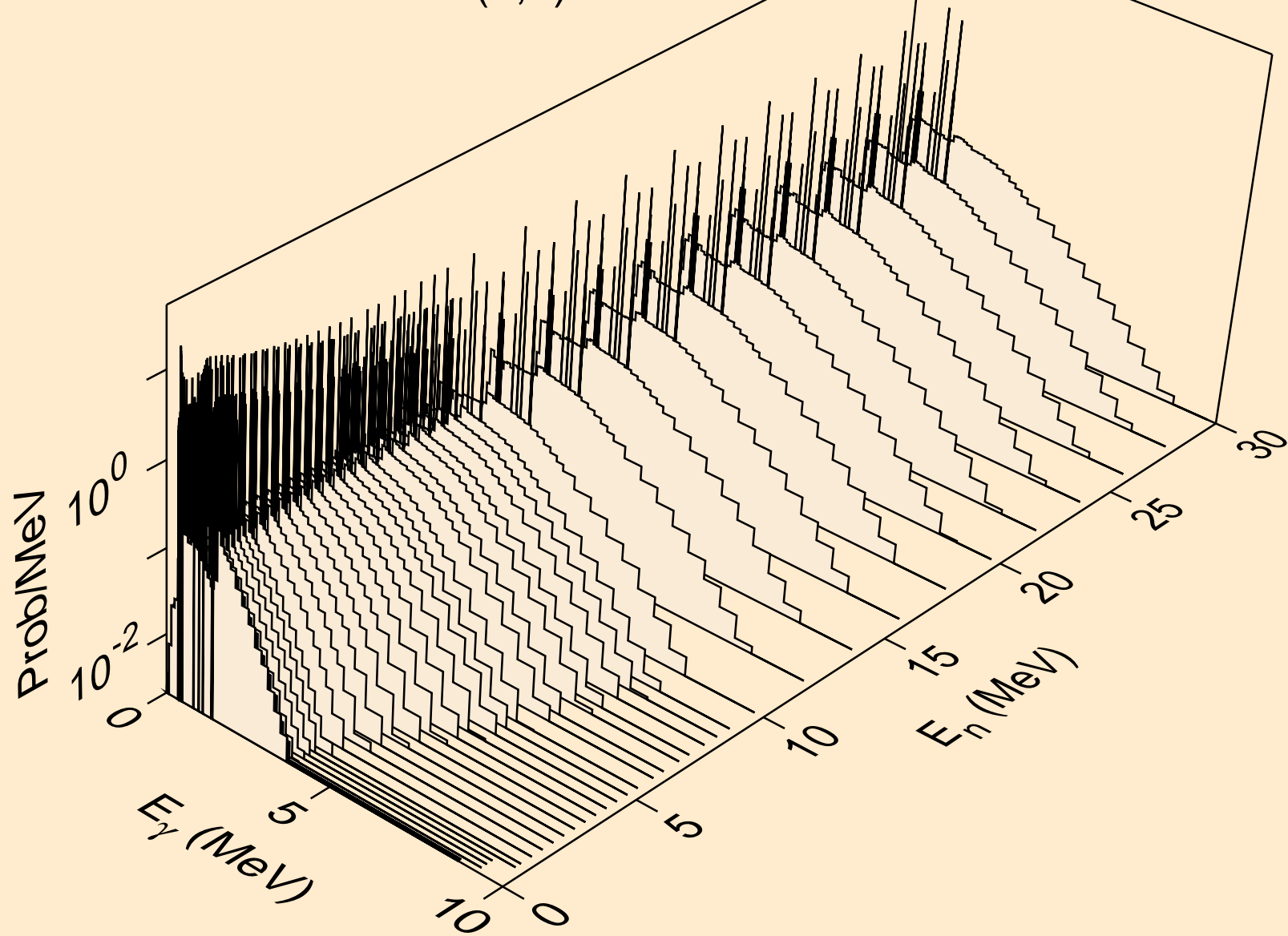



SB110 NEUTRON ACER TENDL-2024 LIBRARY; T=0.K  
Photon emission for (n,2a)

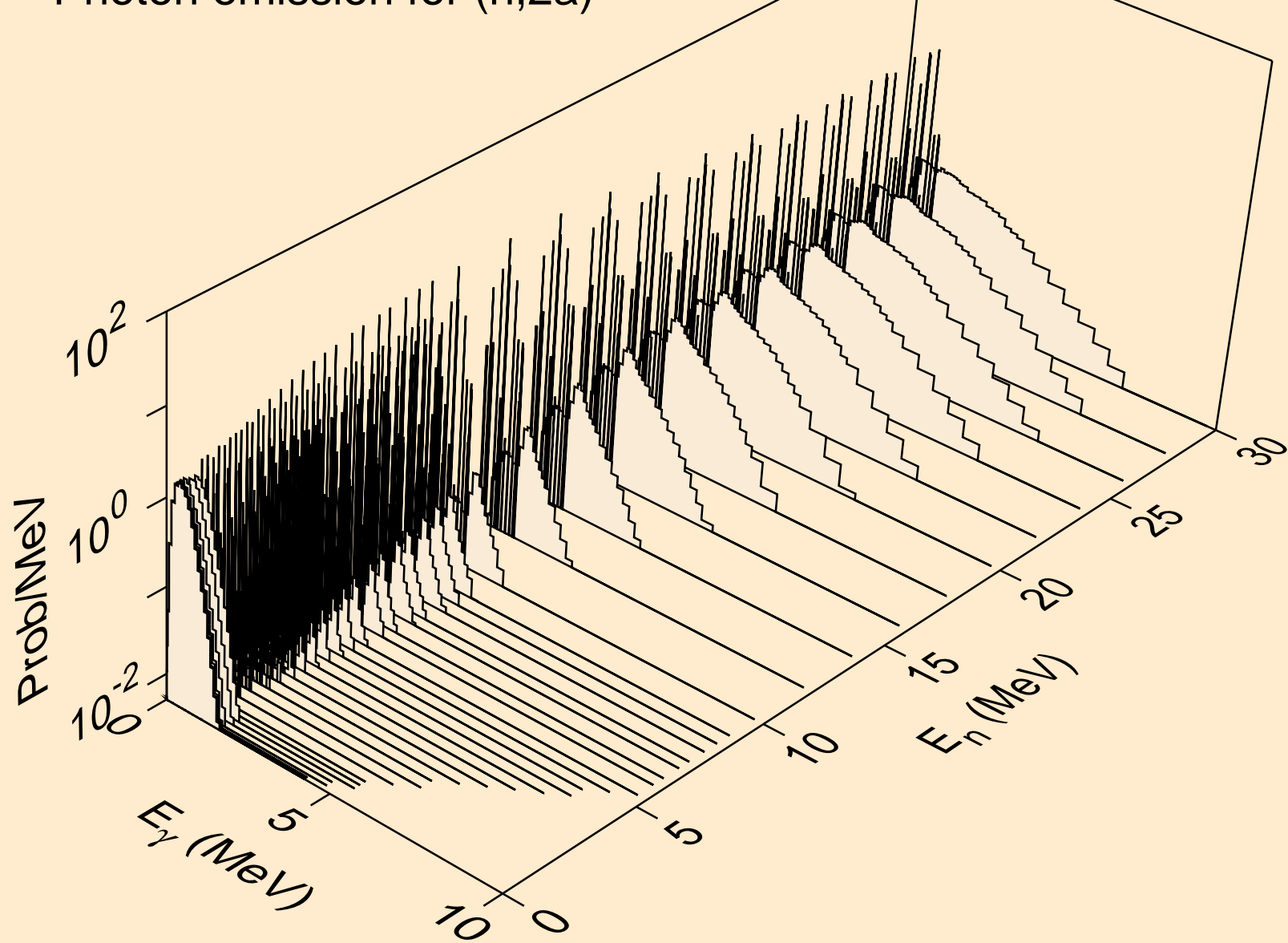

SB110 NEUTRON ACER TENDL-2024 LIBRARY; T=0.K  
Photon emission for (n,3a)

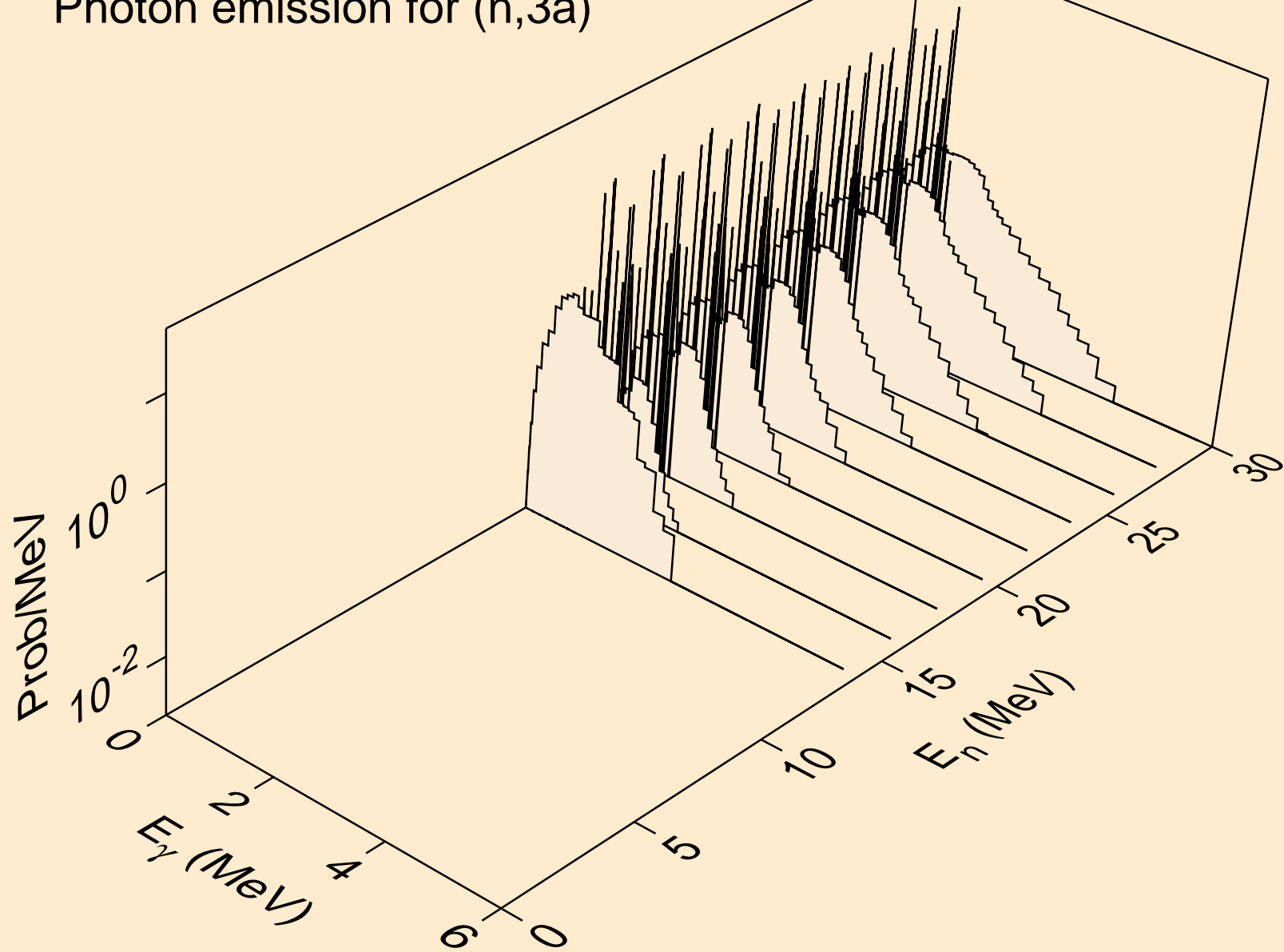

SB110 NEUTRON ACER TENDL-2024 LIBRARY; T=0.K  
Photon emission for (n,2p)

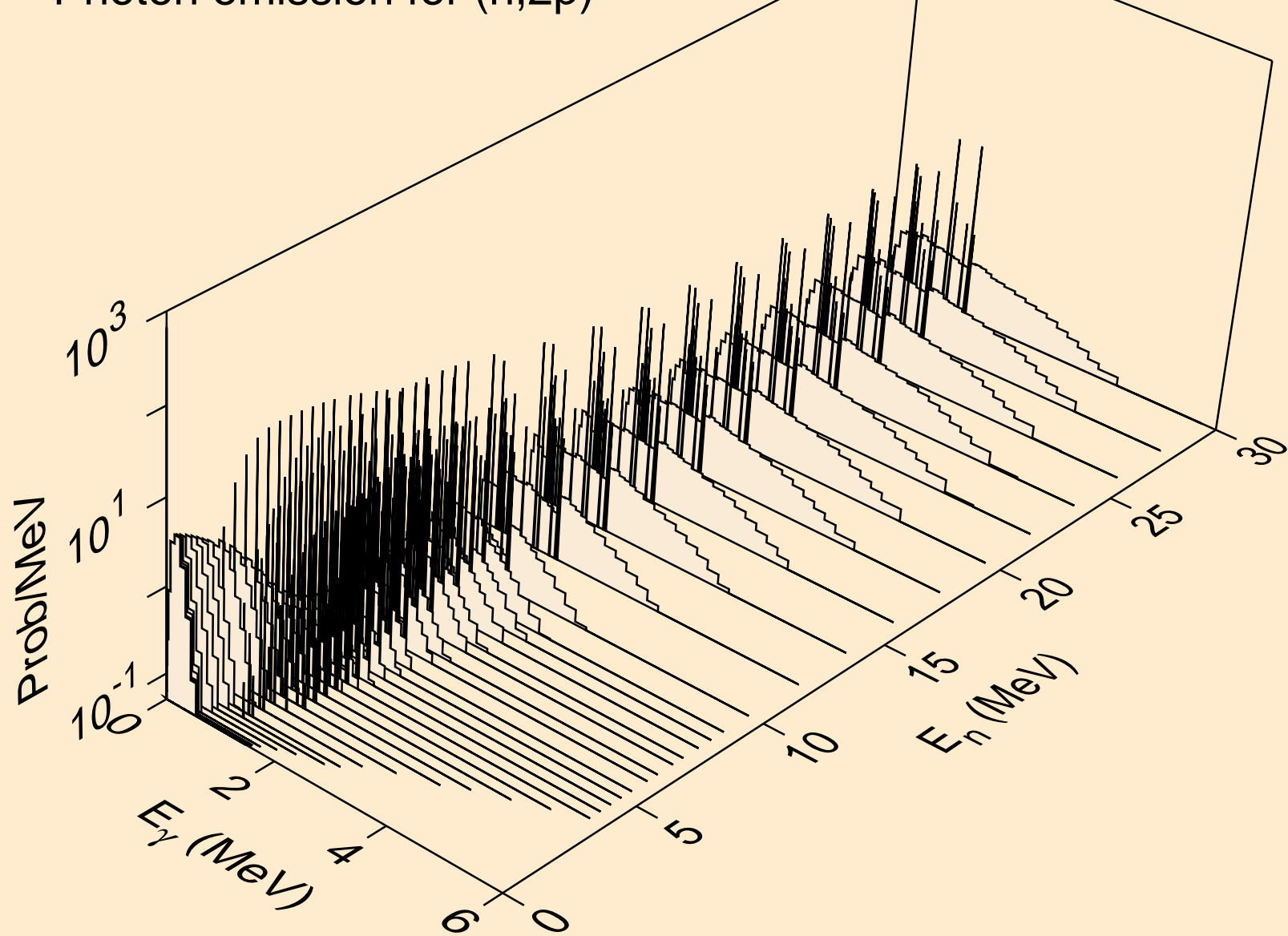

SB110 NEUTRON ACER TENDL-2024 LIBRARY; T=0.K  
Photon emission for (n,p $\alpha$ )

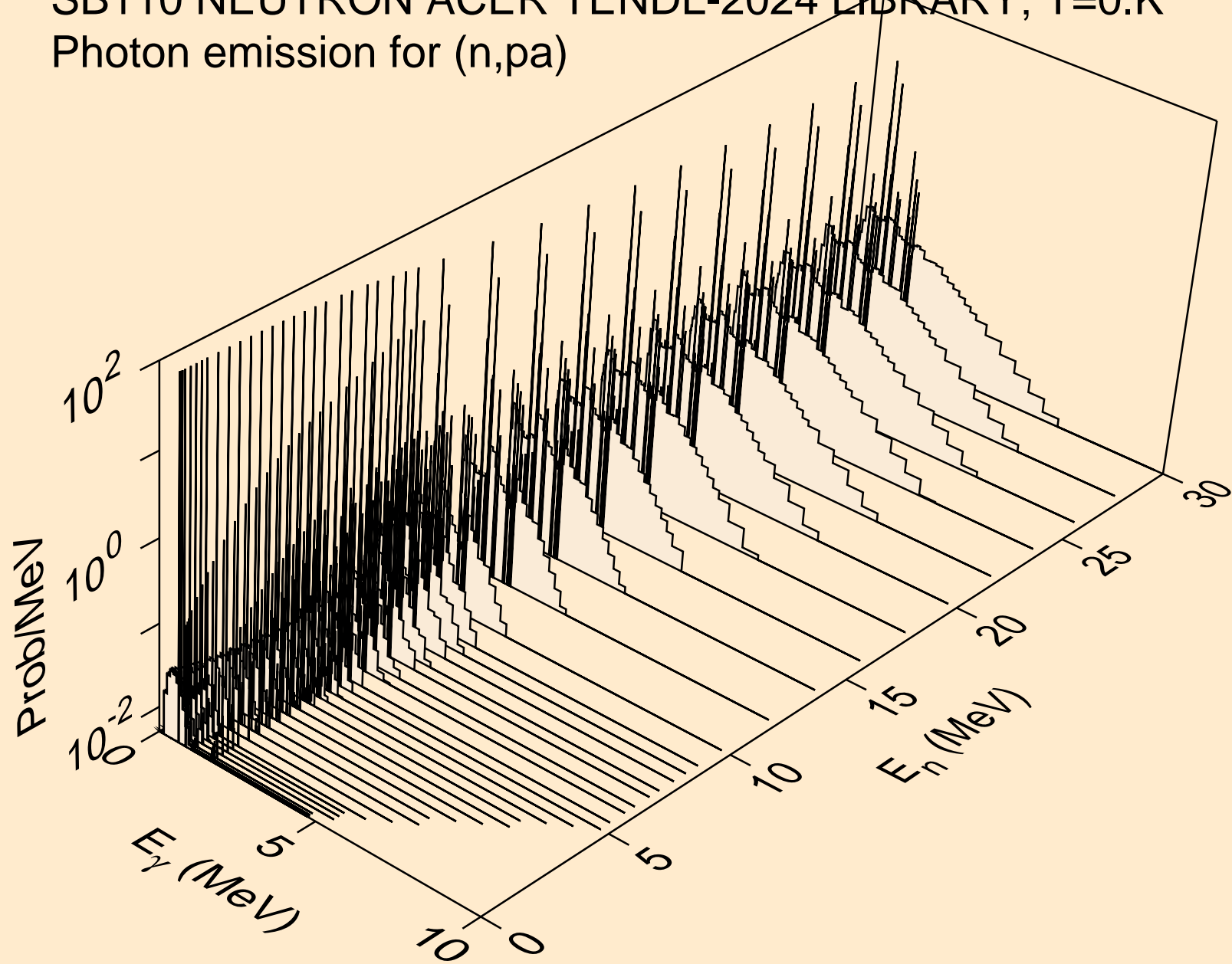

SB110 NEUTRON ACER TENDL-2024 LIBRARY; T=0.K  
Photon emission for (n,d2a)

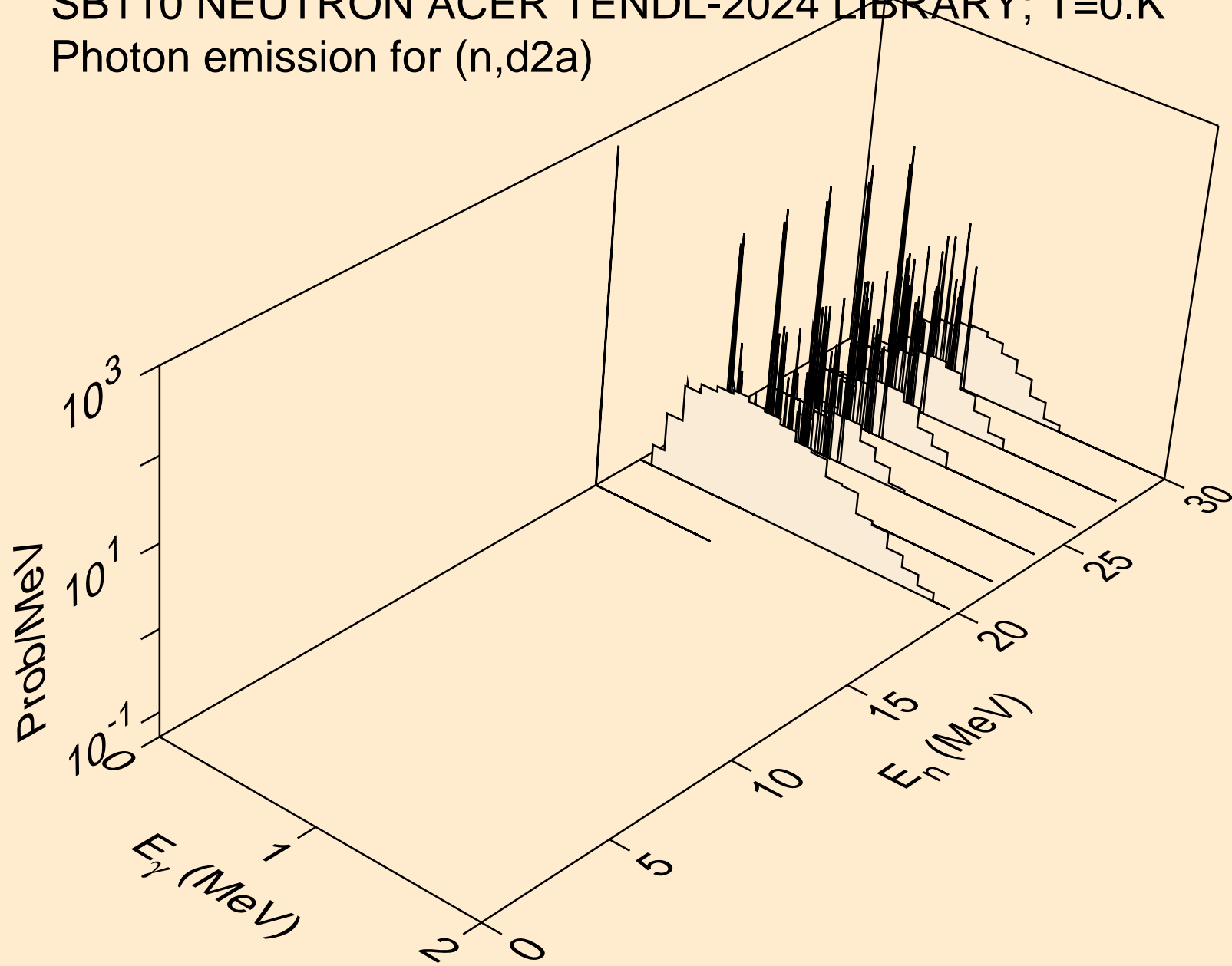

SB110 NEUTRON ACER TENDL-2024 LIBRARY; T=0.K  
Photon emission for (n,pd)

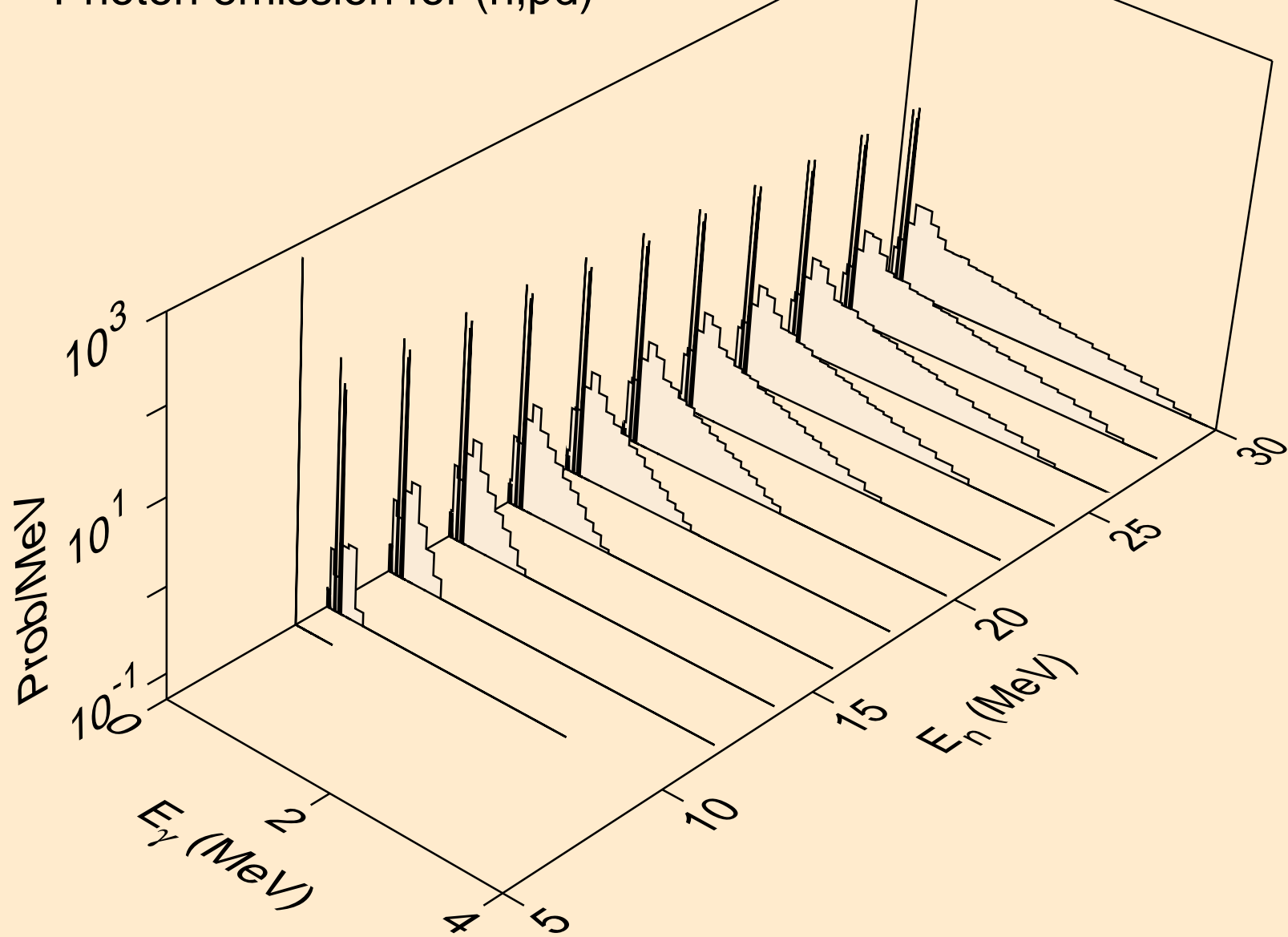

SB110 NEUTRON ACER TENDL-2024 LIBRARY; T=0.K  
Photon emission for (n,pt)

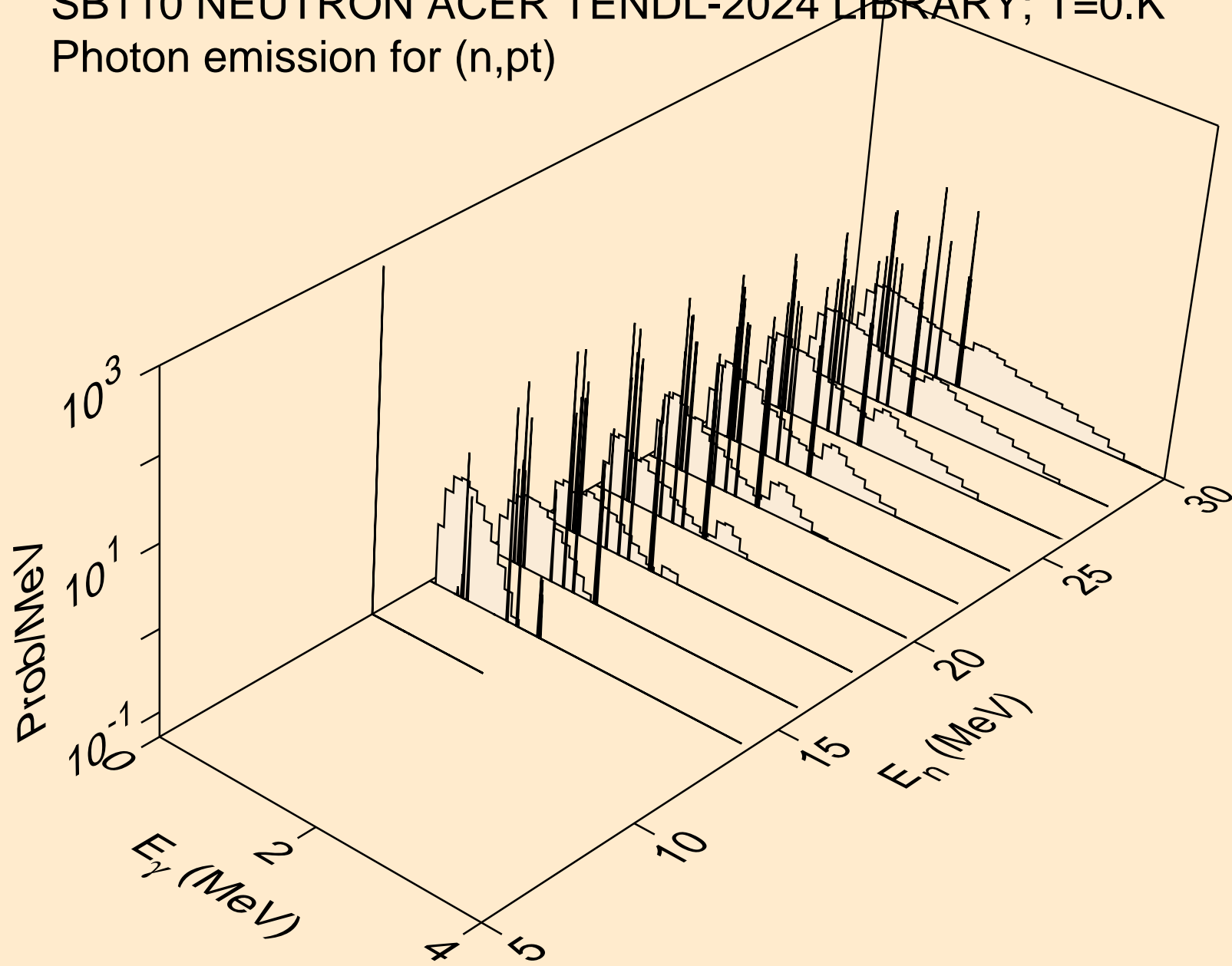

SB110 NEUTRON ACER TENDL-2024 LIBRARY; T=0.K  
Photon emission for (n,da)

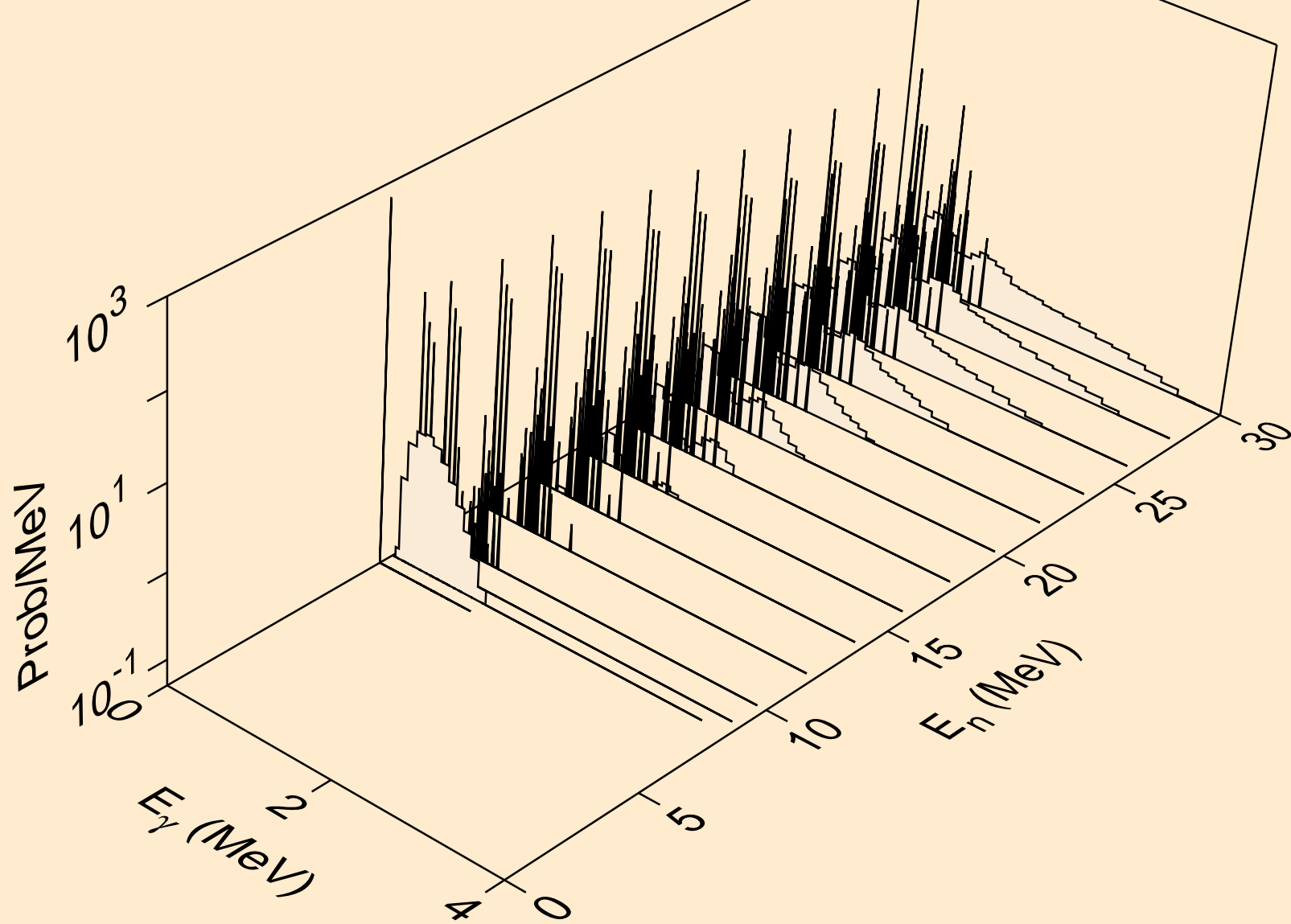



SB110 NEUTRON ACER TENDL-2024 LIBRARY; T=0.K  
thermal capture photon spectrum

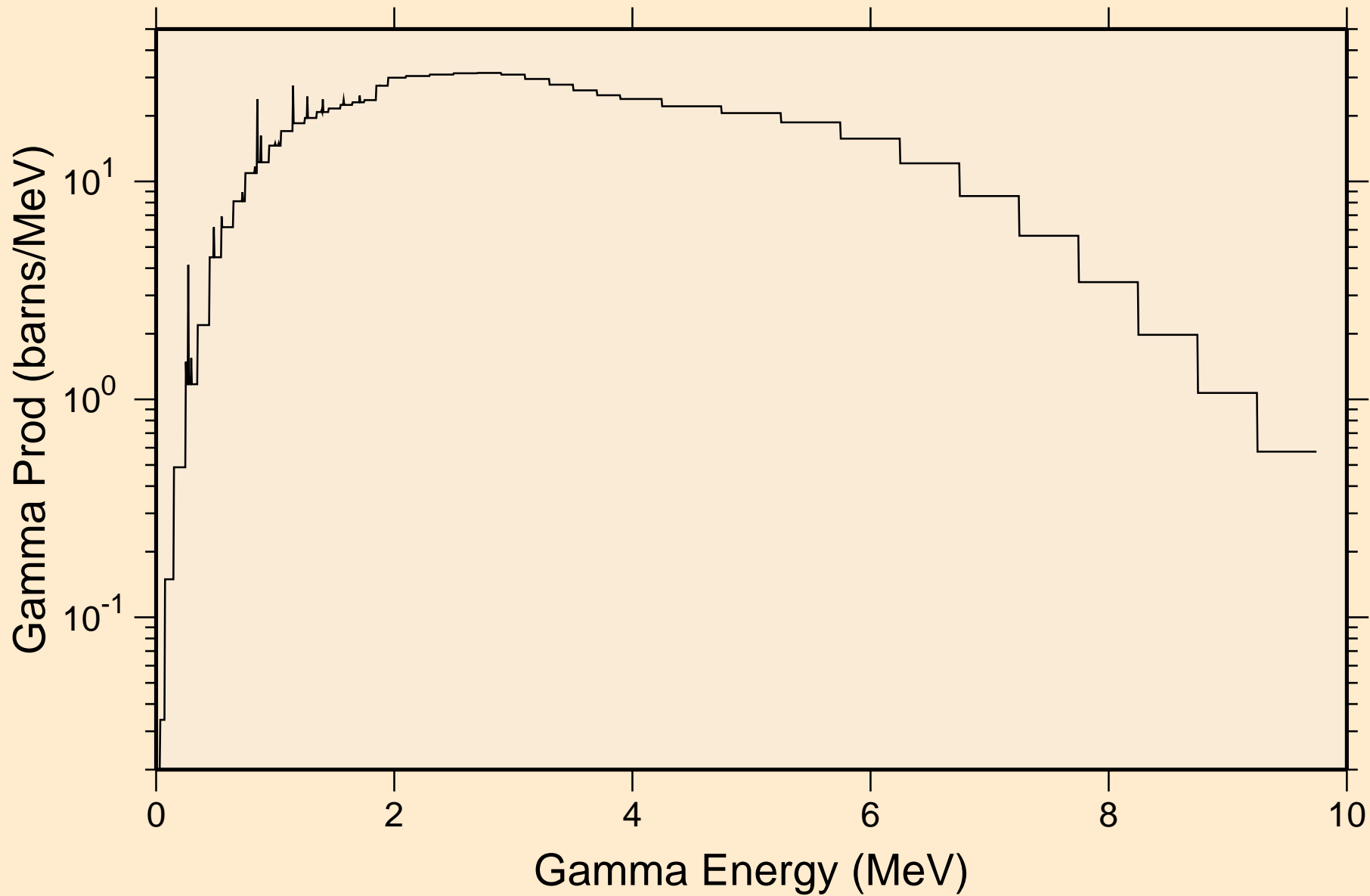

SB110 NEUTRON ACER TENDL-2024 LIBRARY; T=0.K  
14 MeV photon spectrum

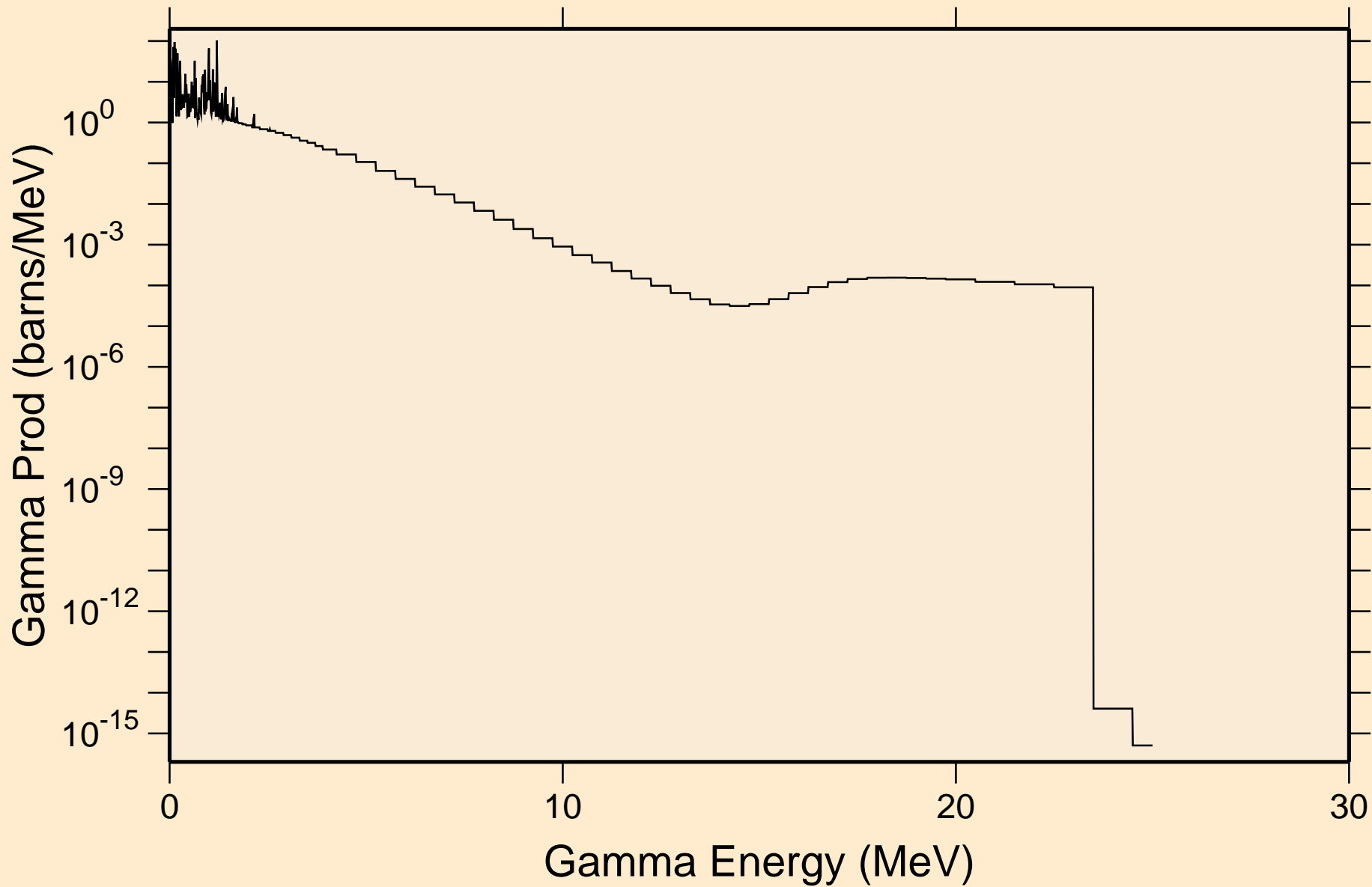

# SB110 NEUTRON ACER TENDL-2024 LIBRARY; T=0.K

## Particle heating contributions

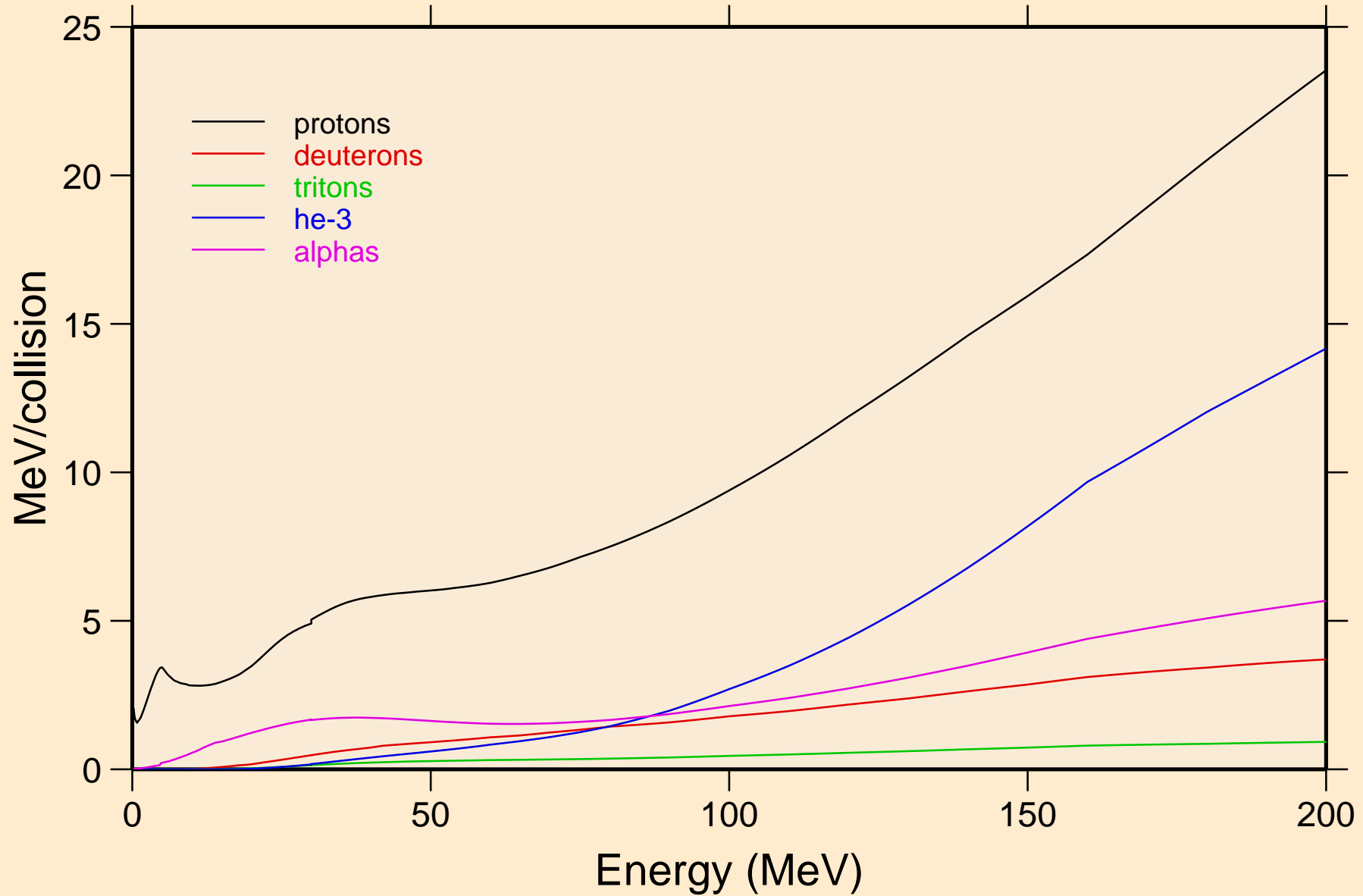

SB110 NEUTRON ACER TENDL-2024 LIBRARY; T=0.K  
Recoil Heating

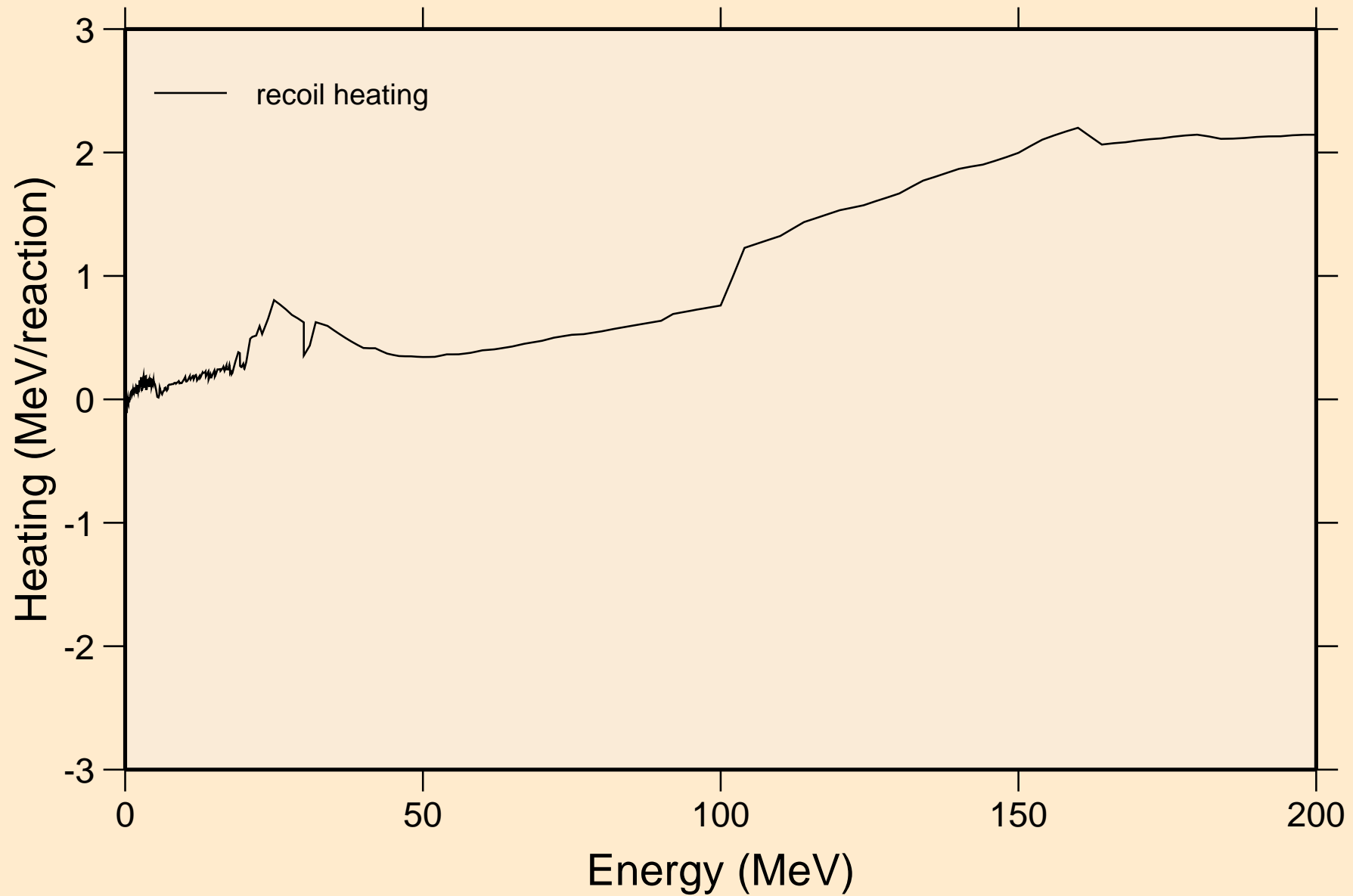

# SB110 NEUTRON ACER TENDL-2024 LIBRARY; T=0.K

## Particle production cross sections

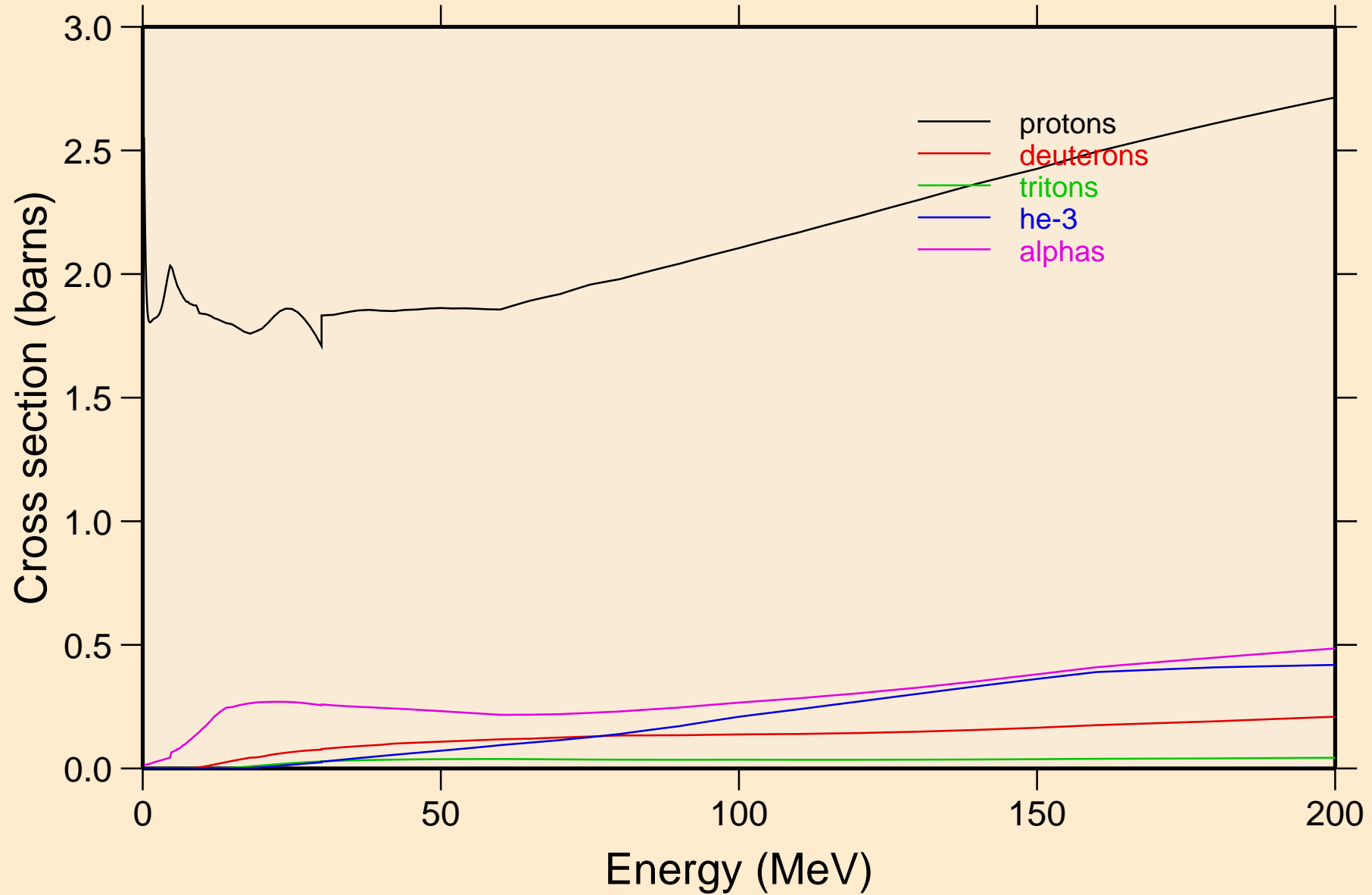

SB110 NEUTRON ACER TENDL-2024 LIBRARY; T=0.K  
protons from (n,x)

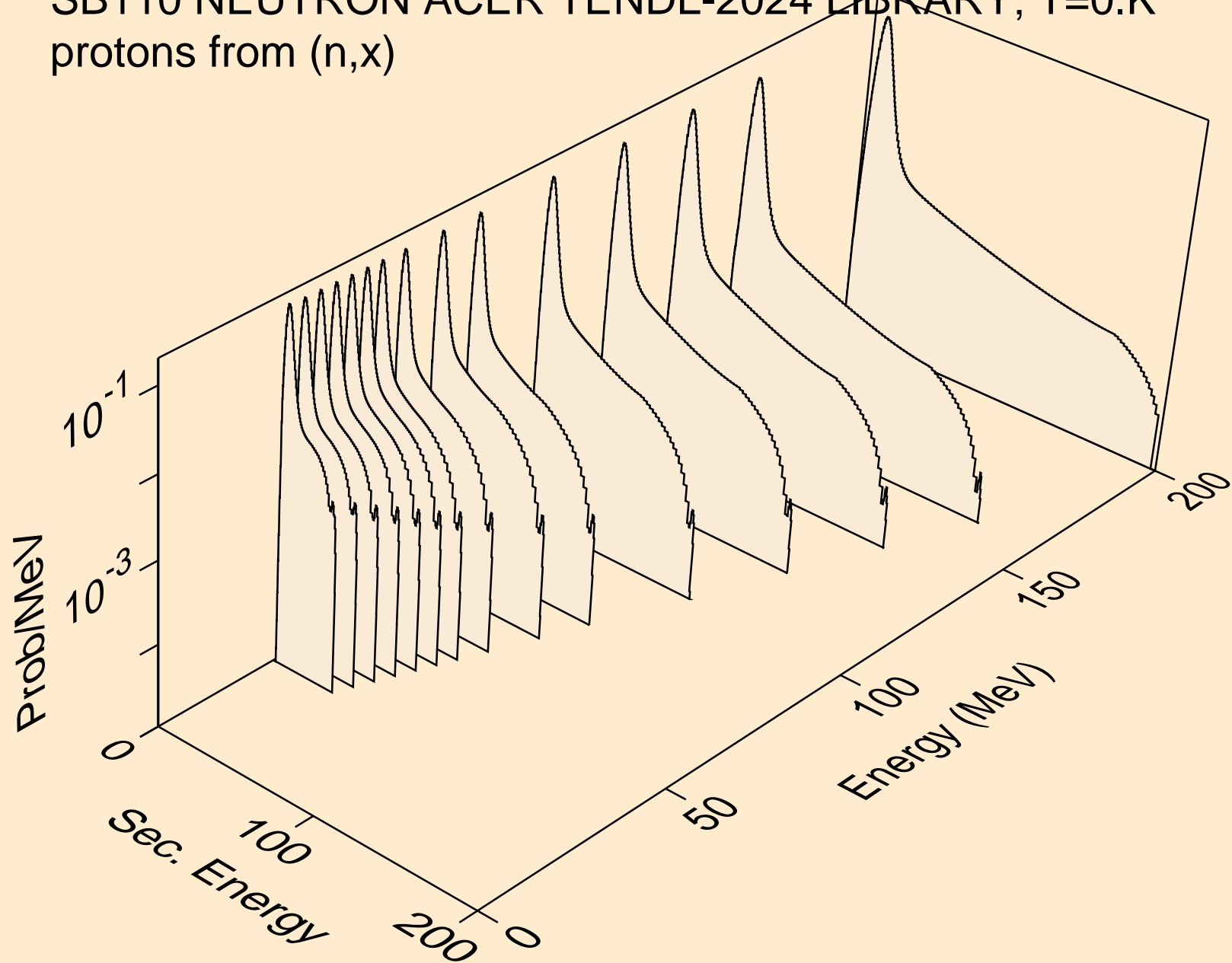

SB110 NEUTRON ACER TENDL-2024 LIBRARY; T=0.K  
protons from (n,n\*)p

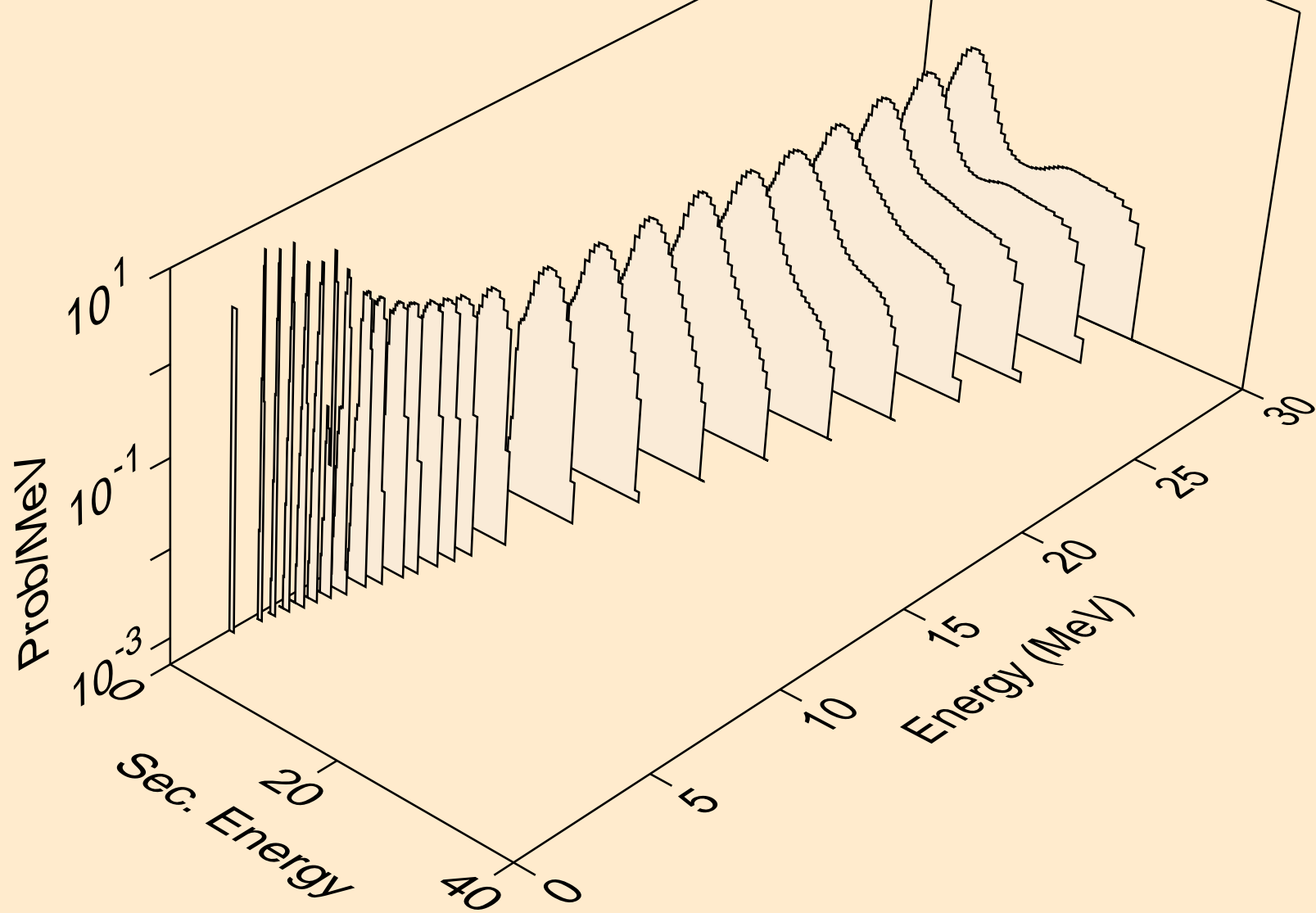

SB110 NEUTRON ACER TENDL-2024 LIBRARY; T=0.K  
protons from (n,2np)

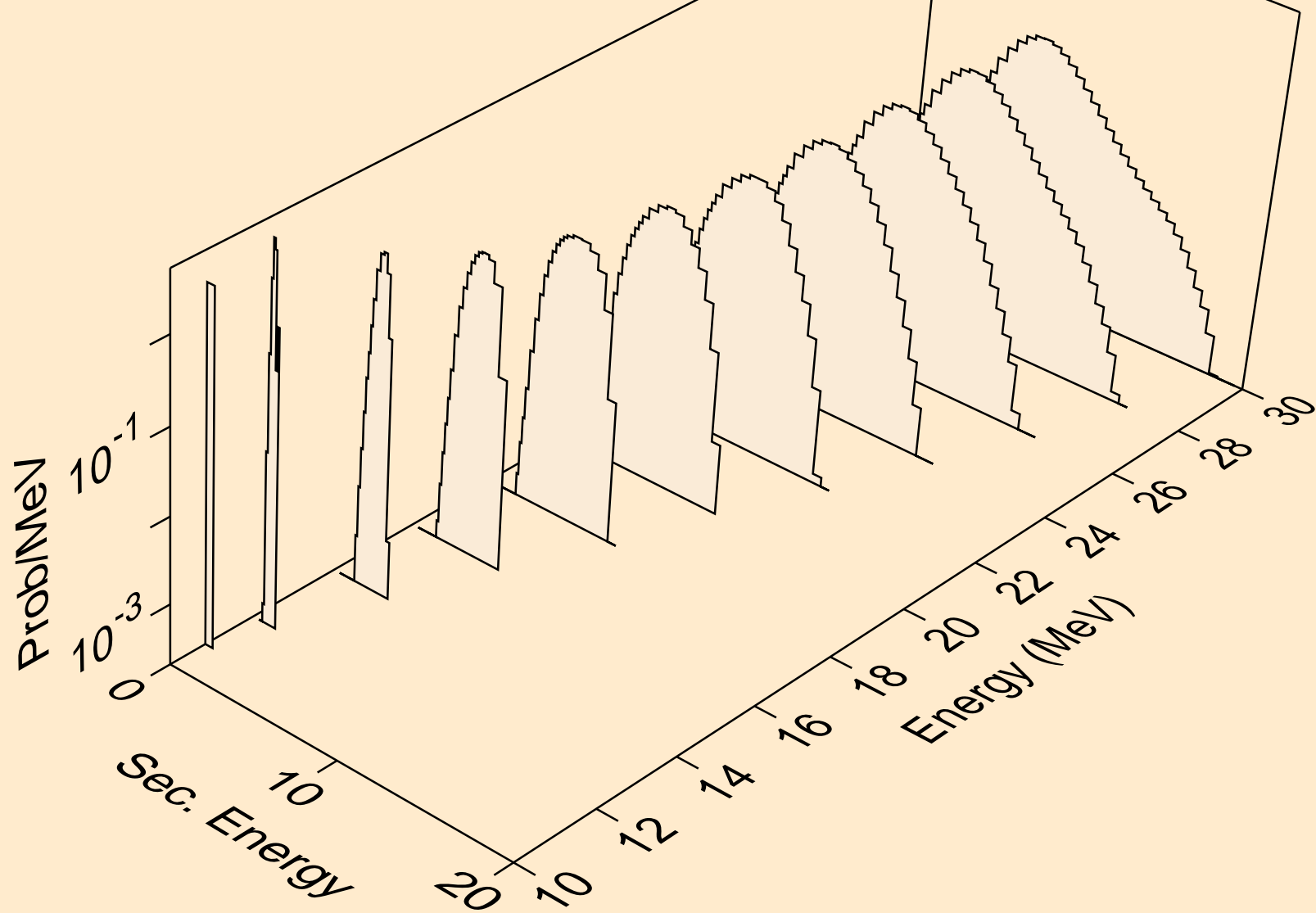



SB110 NEUTRON ACER TENDL-2024 LIBRARY; T=0.K  
protons from (n,3np)

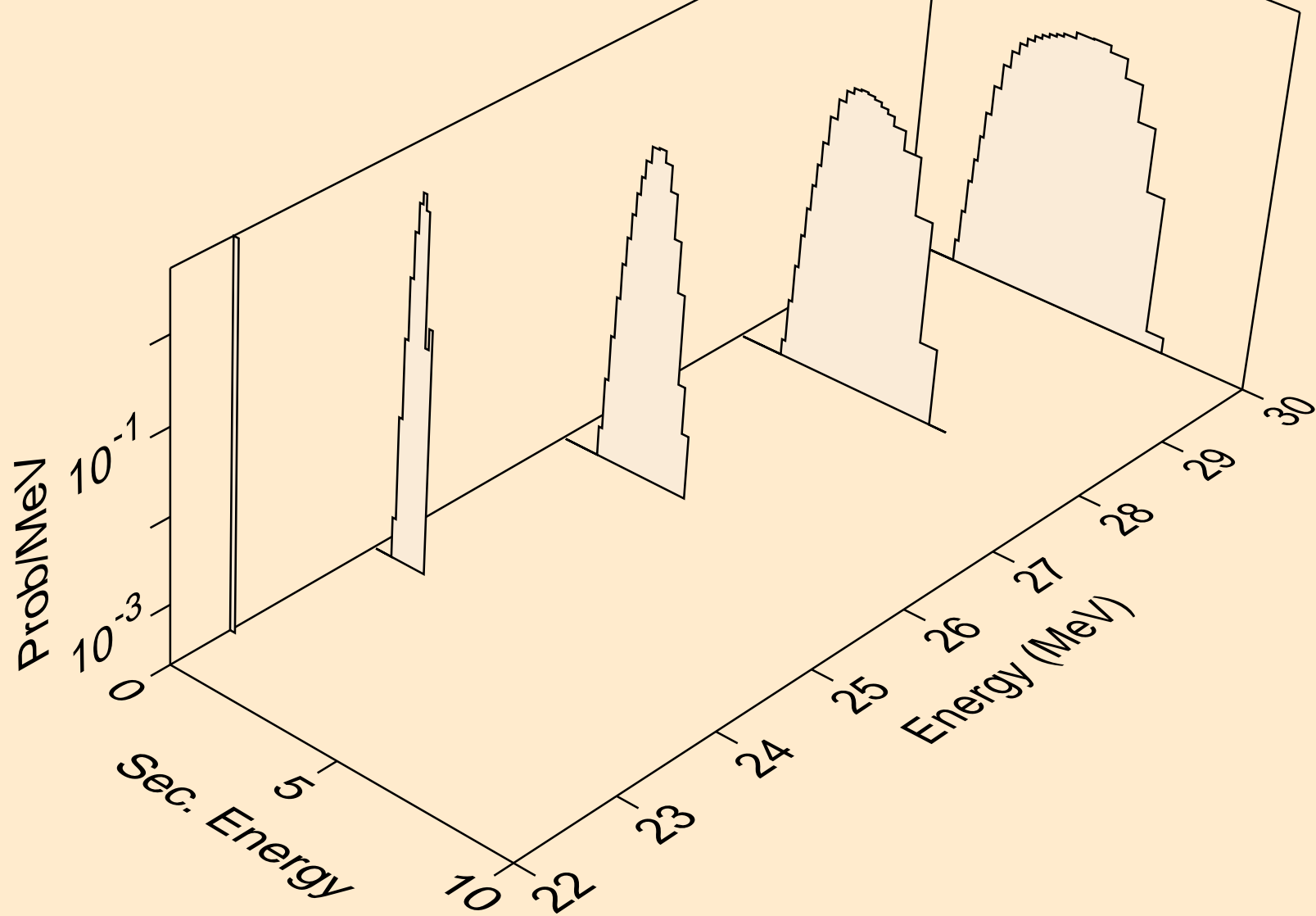

SB110 NEUTRON ACER TENDL-2024 LIBRARY; T=0.K  
protons from (n,n2p)

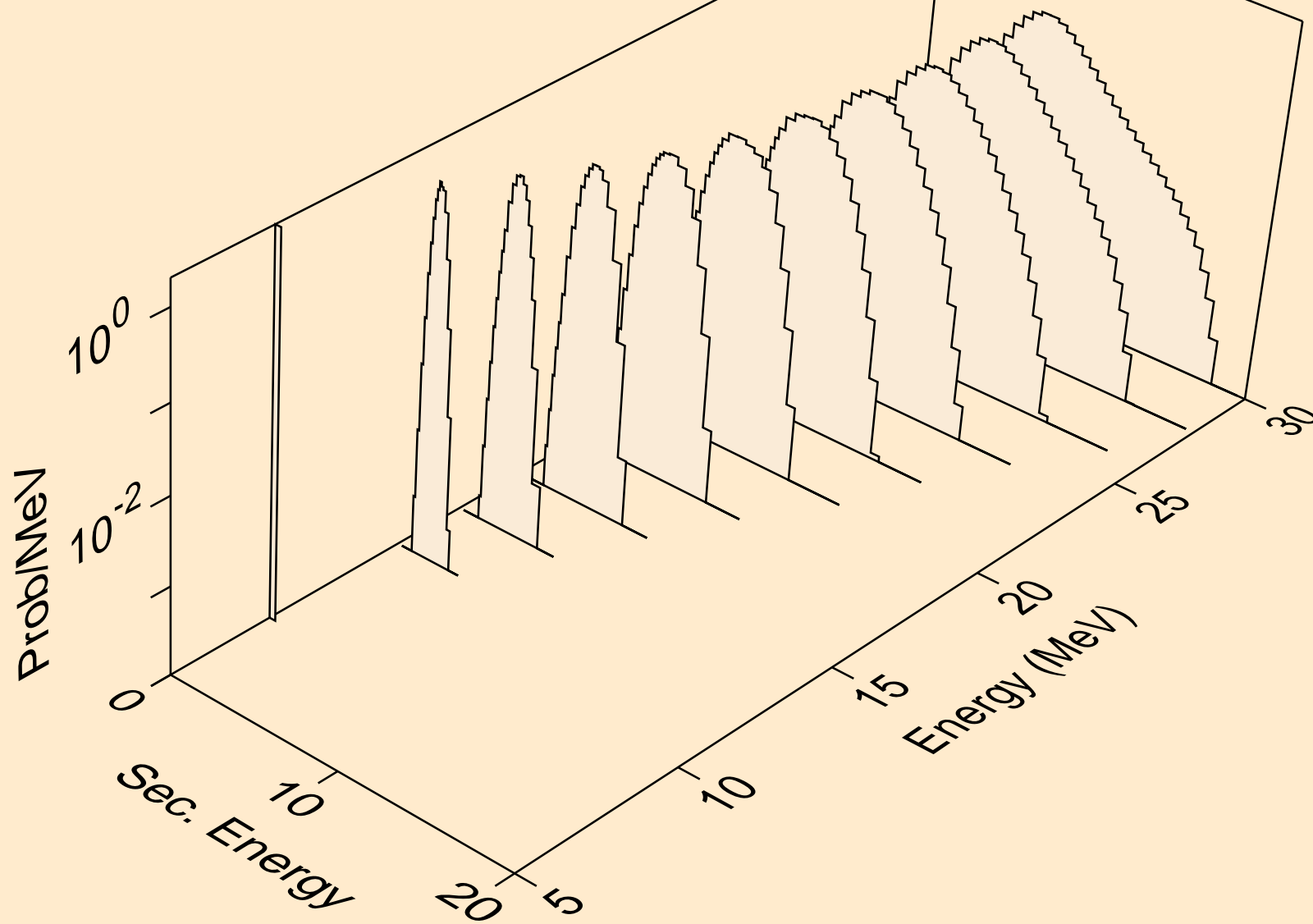

SB110 NEUTRON ACER TENDL-2024 LIBRARY; T=0.K  
protons from (n,npa)

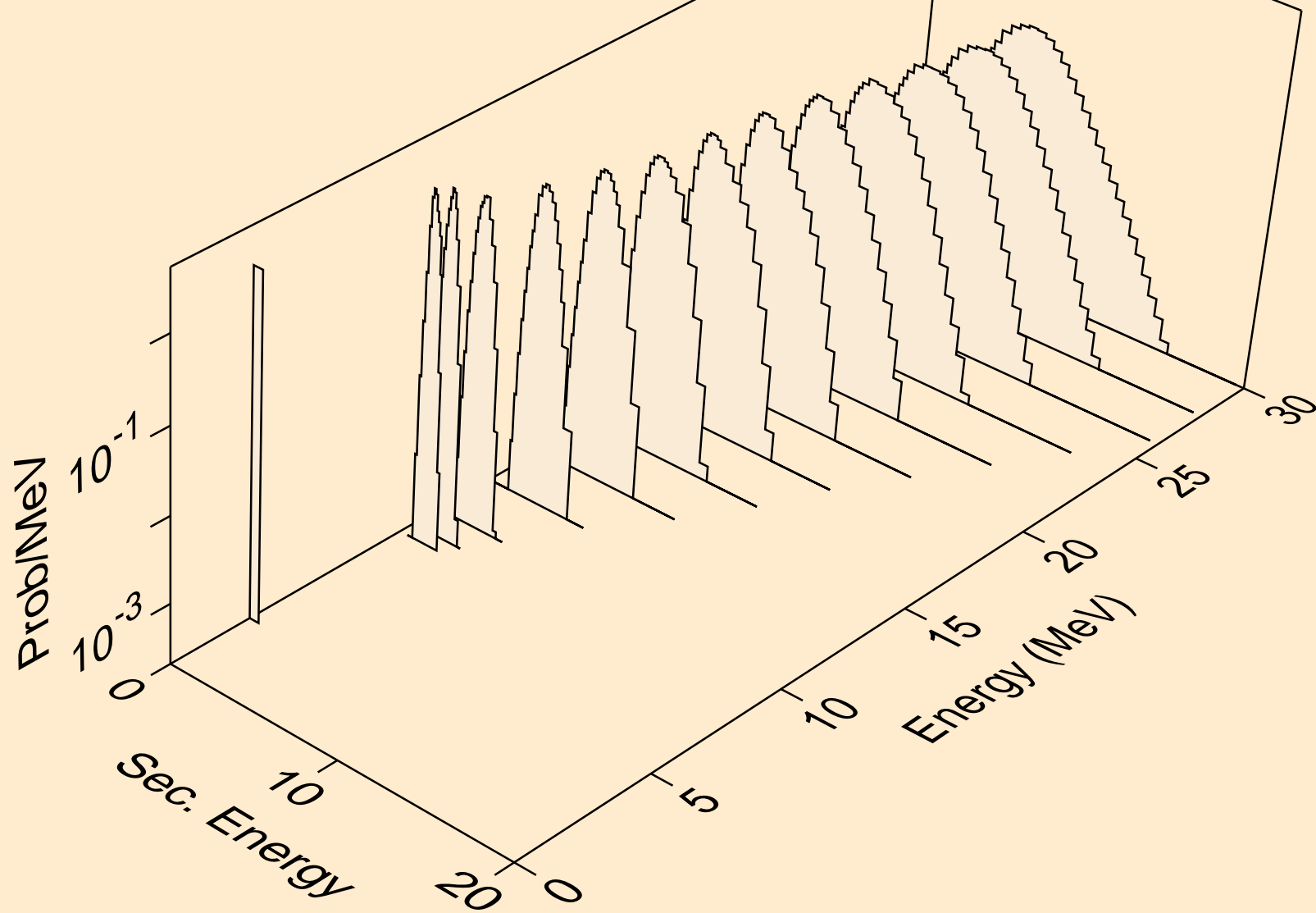

SB110 NEUTRON ACER TENDL-2024 LIBRARY; T=0.K  
protons from (n,p)

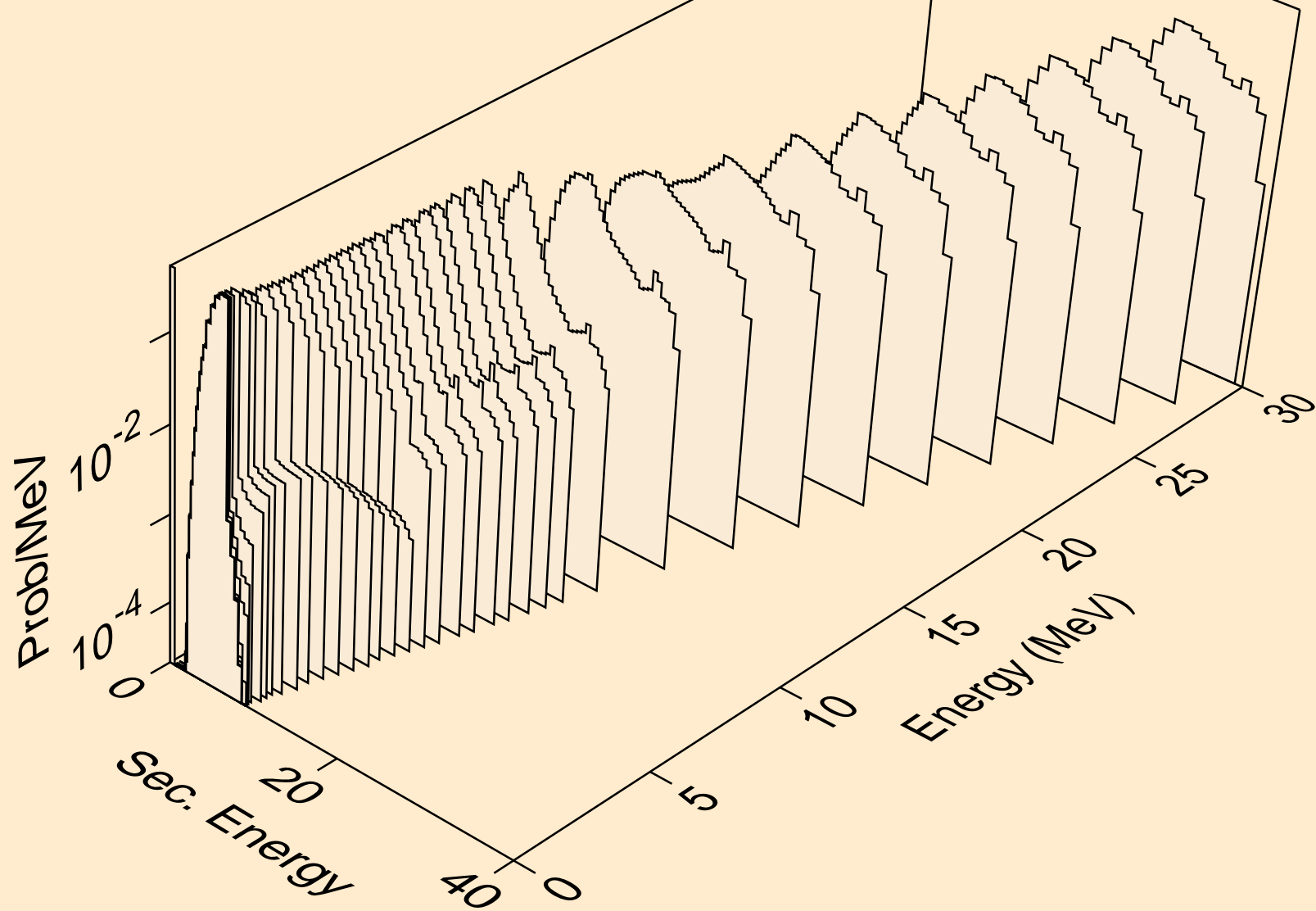

SB110 NEUTRON ACER TENDL-2024 LIBRARY; T=0.K  
protons from (n,2p)

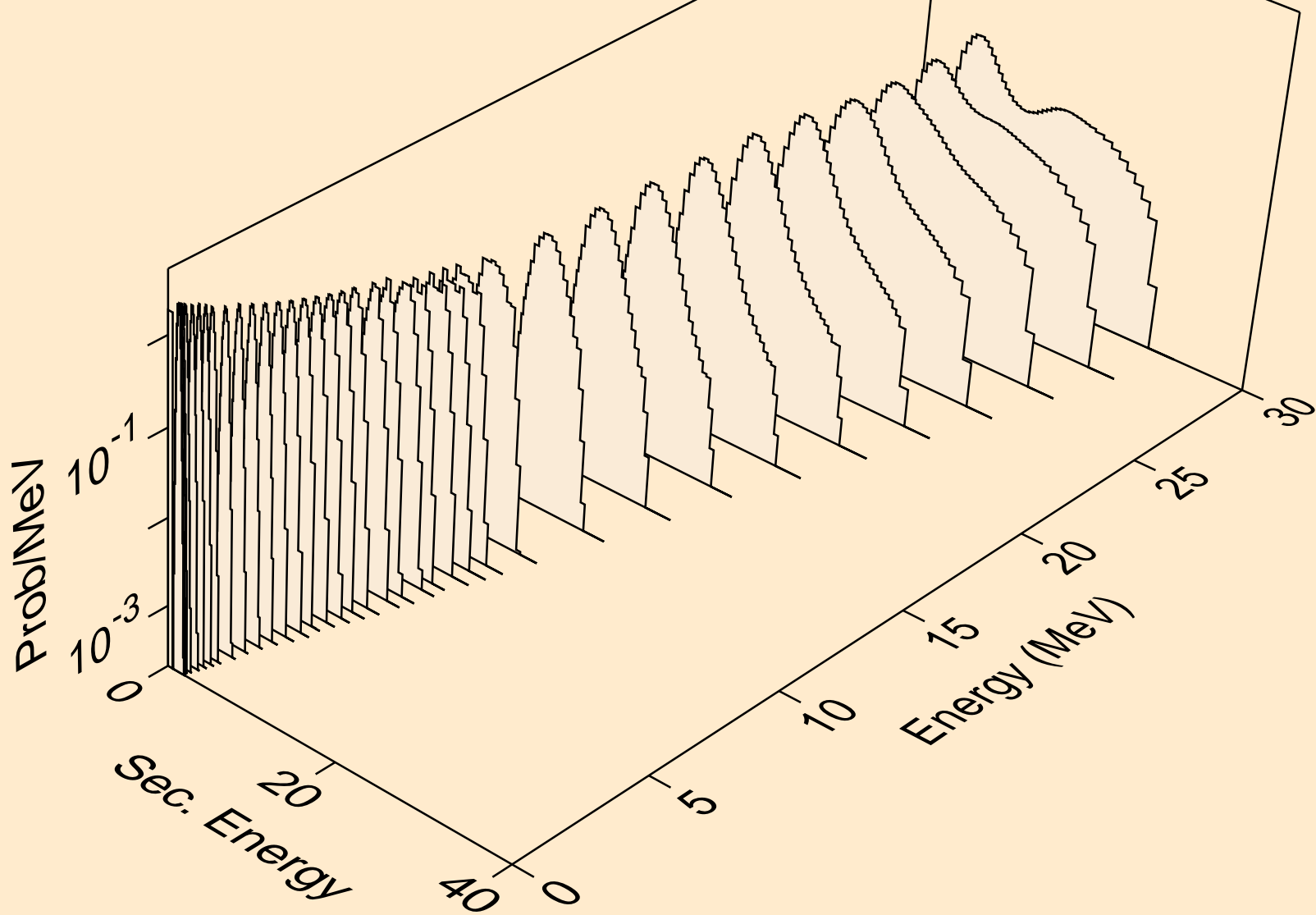

SB110 NEUTRON ACER TENDL-2024 LIBRARY; T=0.K  
protons from (n,p)

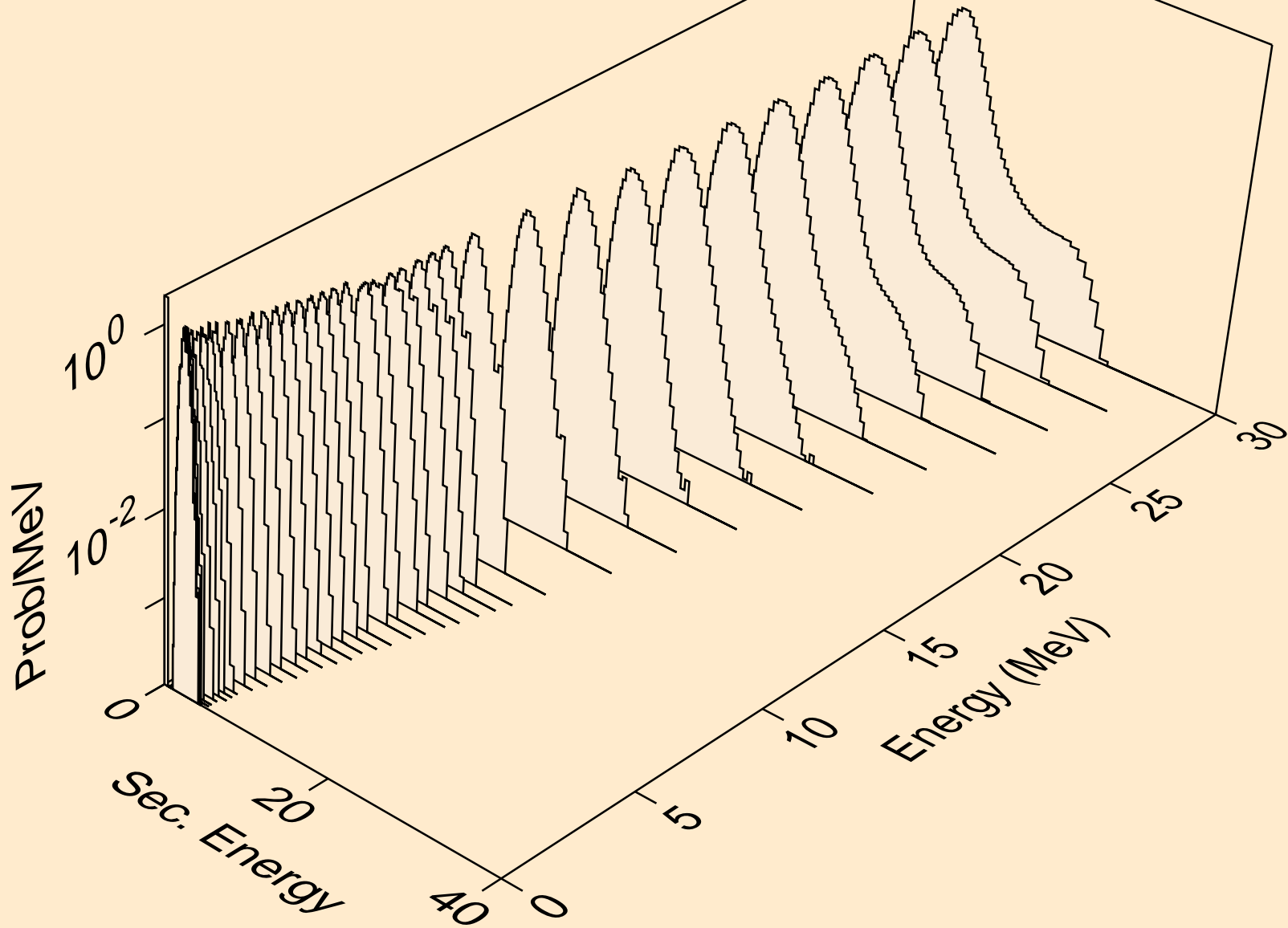

SB110 NEUTRON ACER TENDL-2024 LIBRARY; T=0.K  
protons from (n,pd)

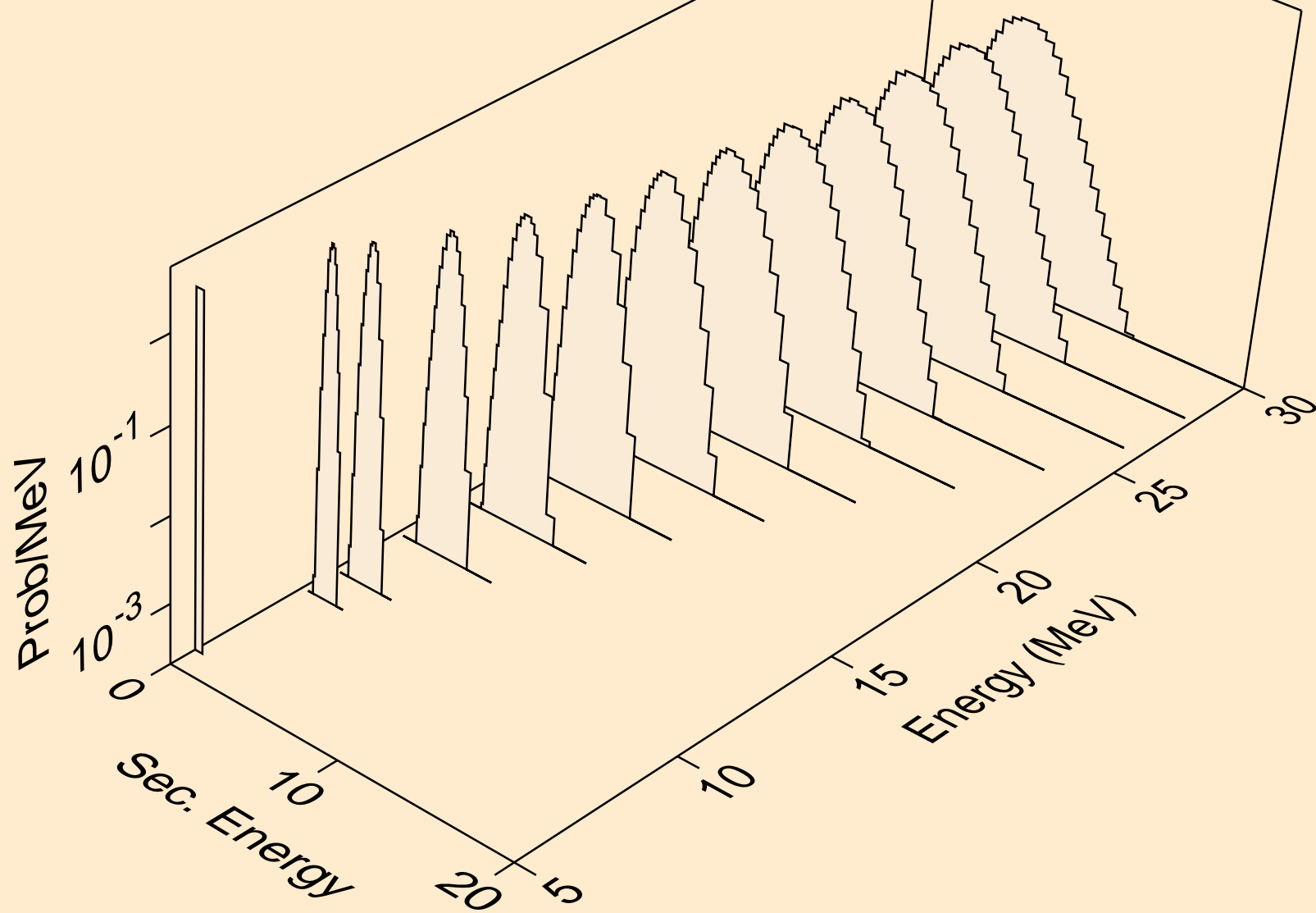

SB110 NEUTRON ACER TENDL-2024 LIBRARY; T=0.K  
protons from (n,pt)

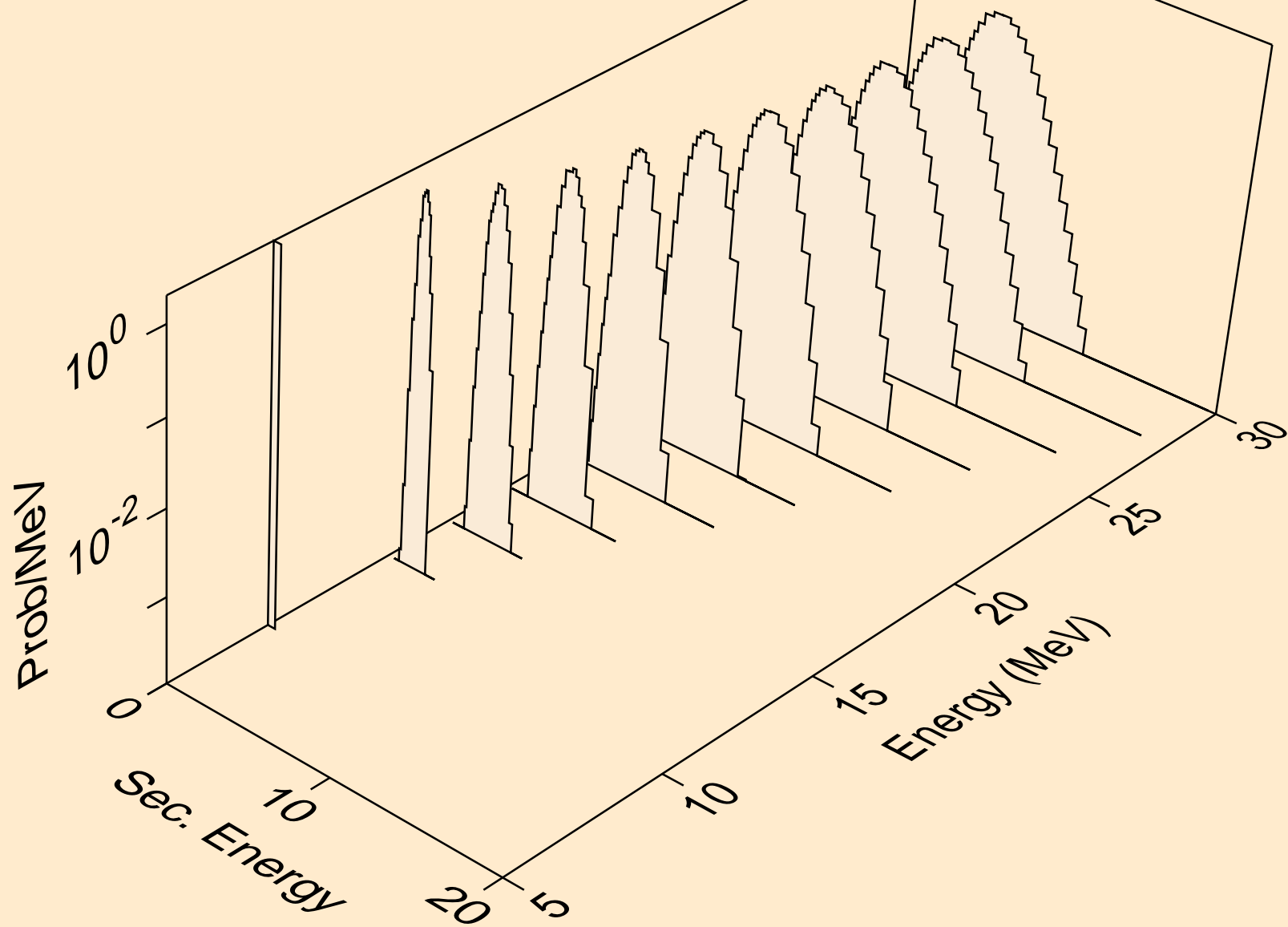



SB110 NEUTRON ACER TENDL-2024 LIBRARY; T=0.K  
deuterons from (n,x)

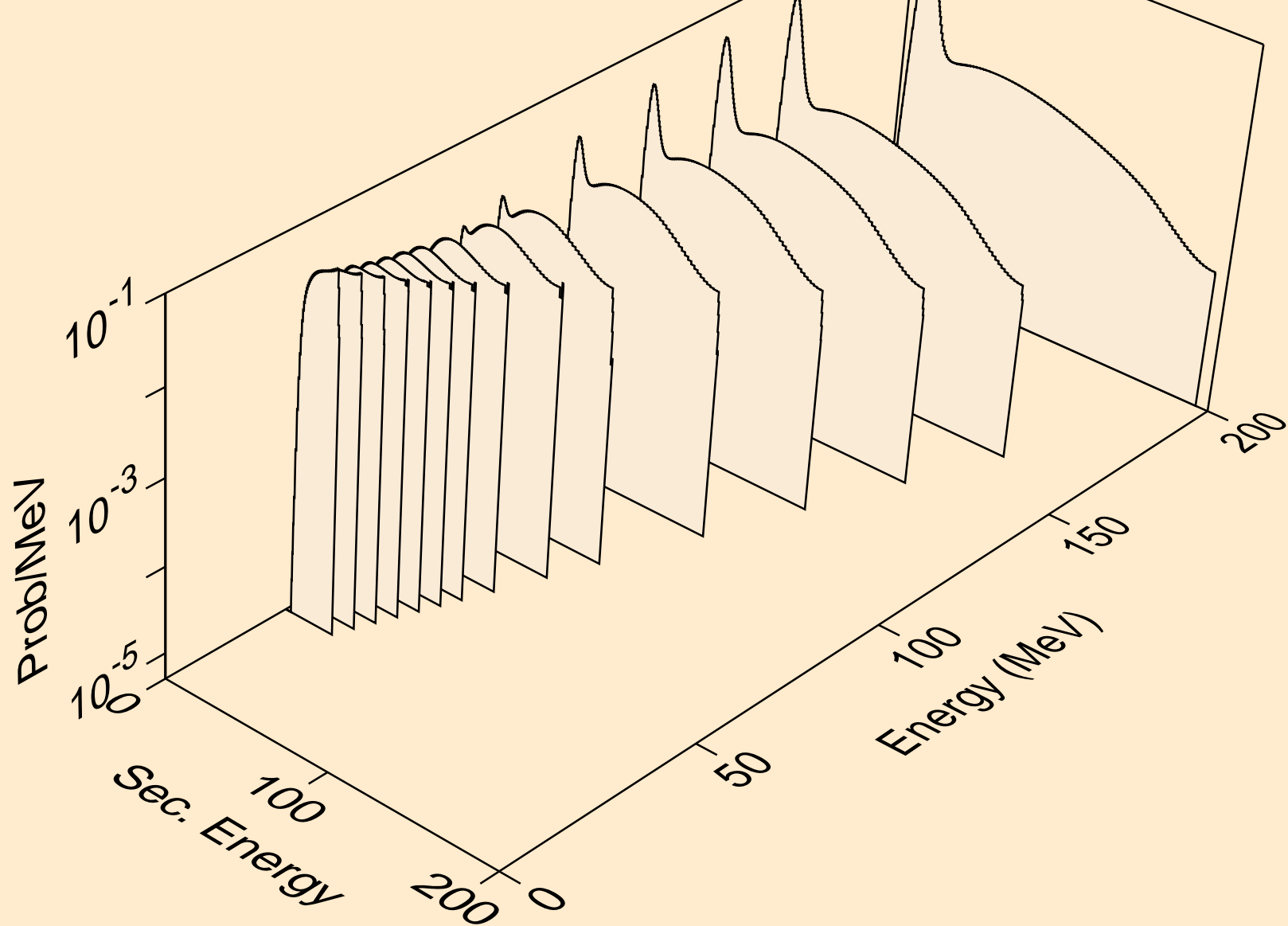

SB110 NEUTRON ACER TENDL-2024 LIBRARY; T=0.K  
deuterons from (n,2nd)

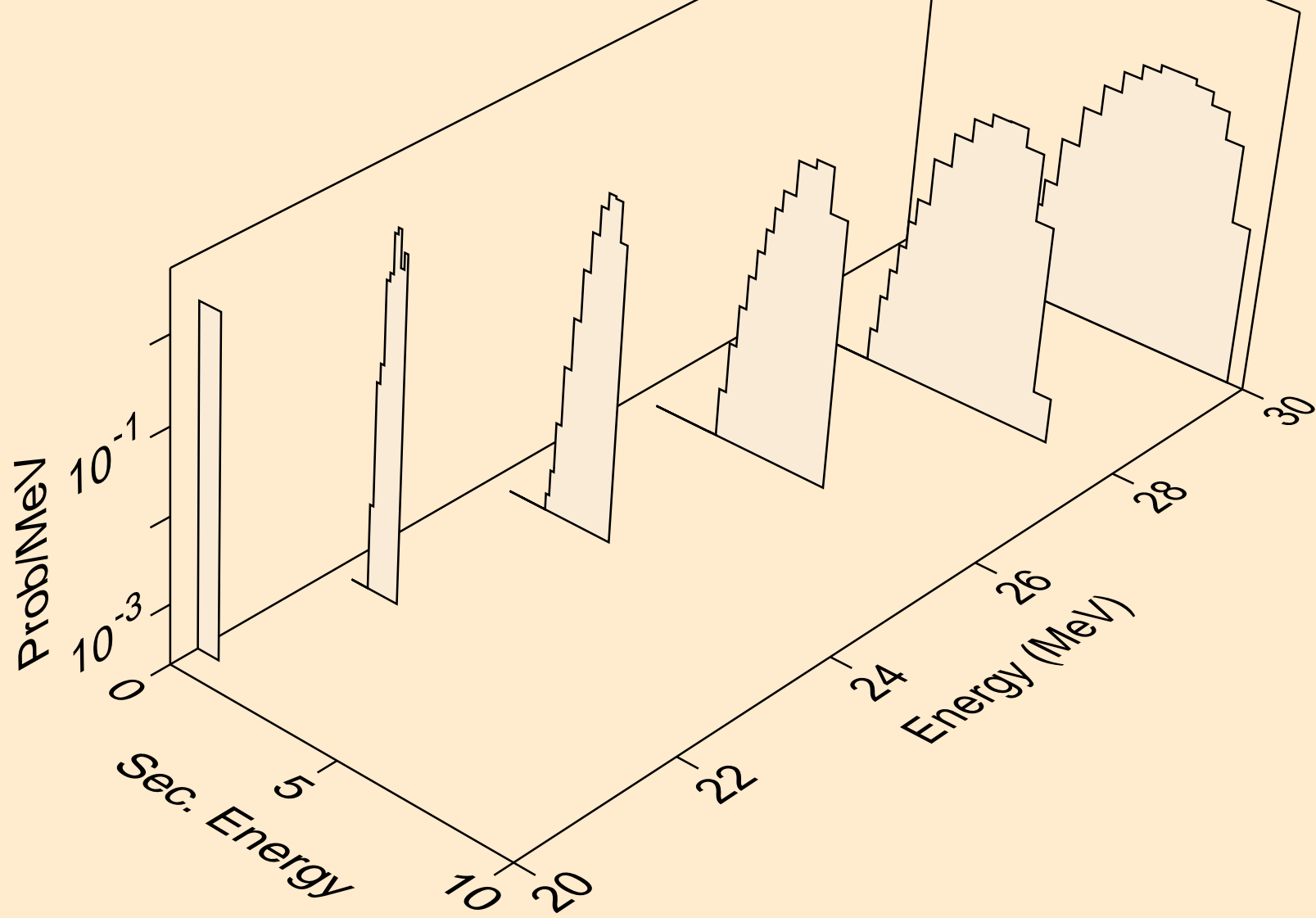

SB110 NEUTRON ACER TENDL-2024 LIBRARY; T=0.K  
deuterons from (n,n\*)d

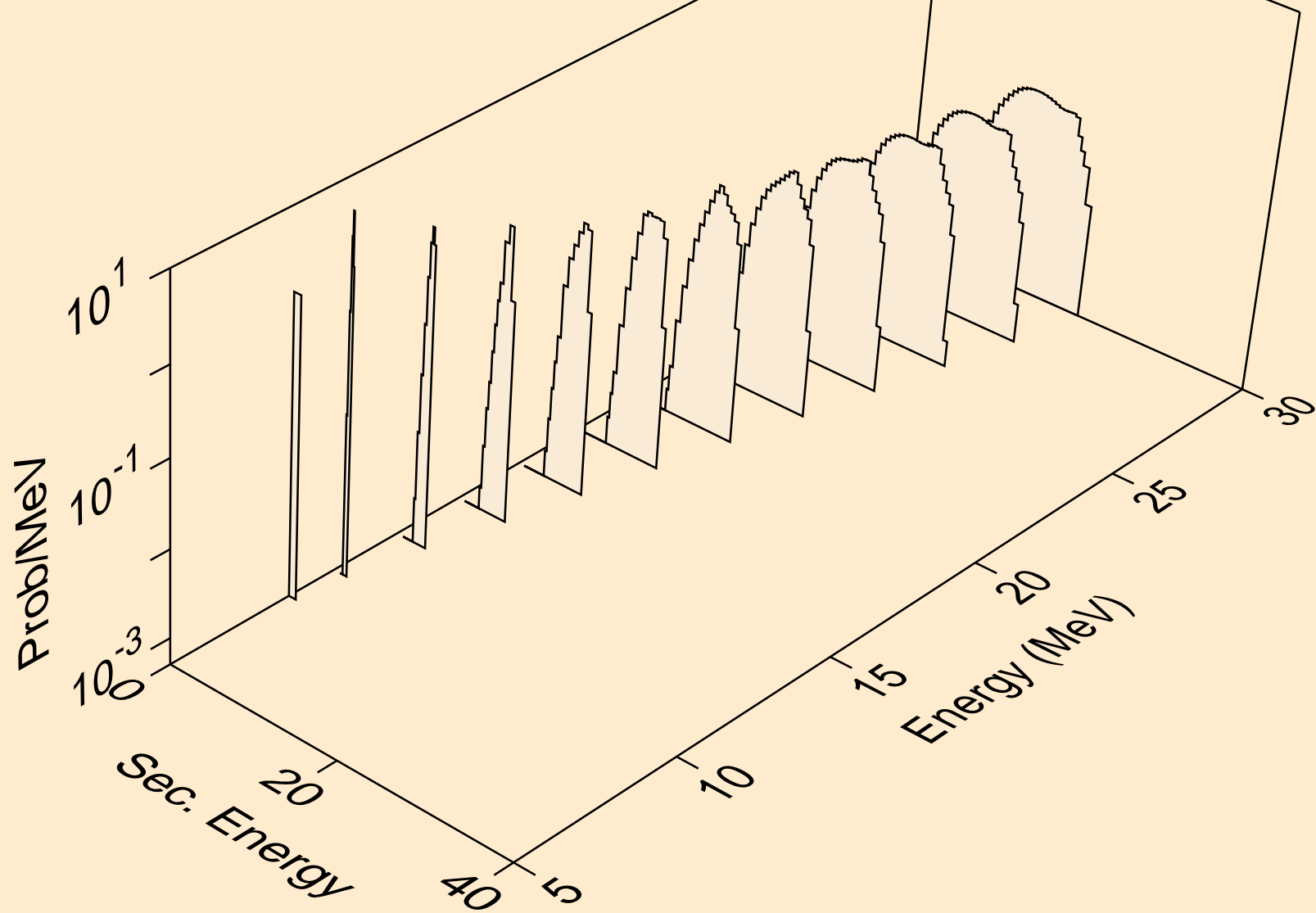

SB110 NEUTRON ACER TENDL-2024 LIBRARY; T=0.K  
deuterons from (n,d)

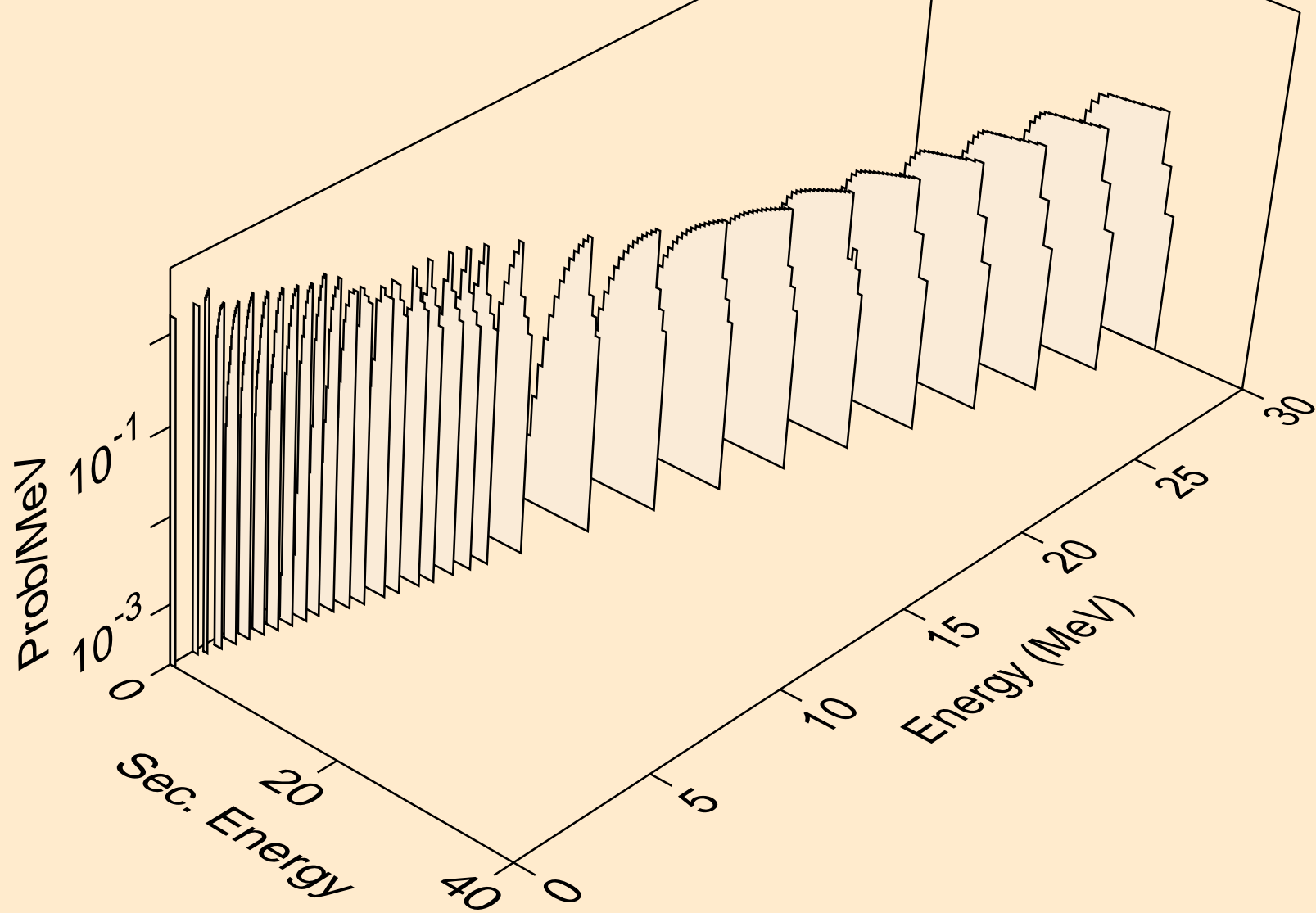

SB110 NEUTRON ACER TENDL-2024 LIBRARY; T=0.K  
deuterons from (n,d2a)

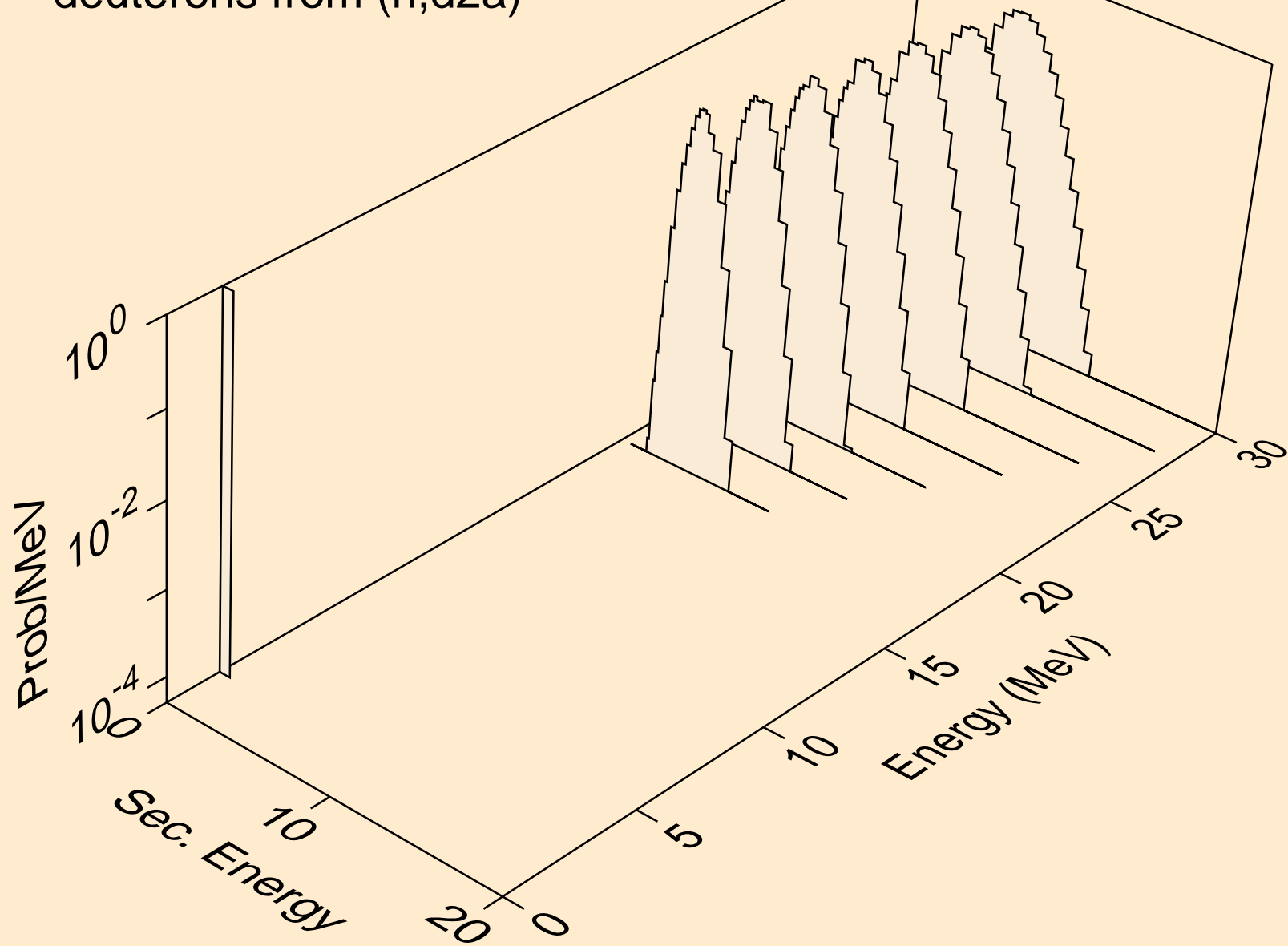

SB110 NEUTRON ACER TENDL-2024 LIBRARY; T=0.K  
deuterons from (n,pd)

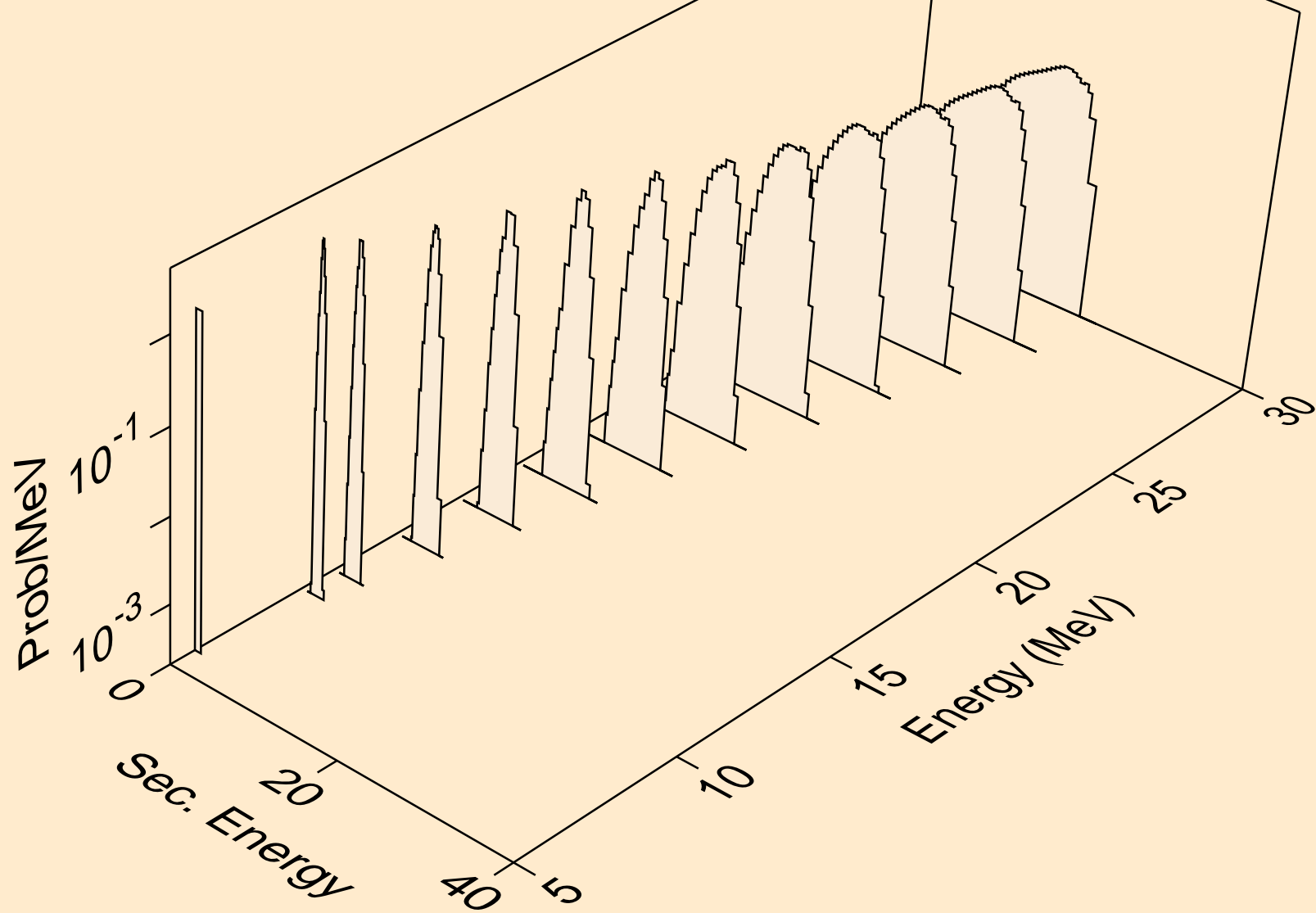

SB110 NEUTRON ACER TENDL-2024 LIBRARY; T=0.K  
deuterons from (n,da)

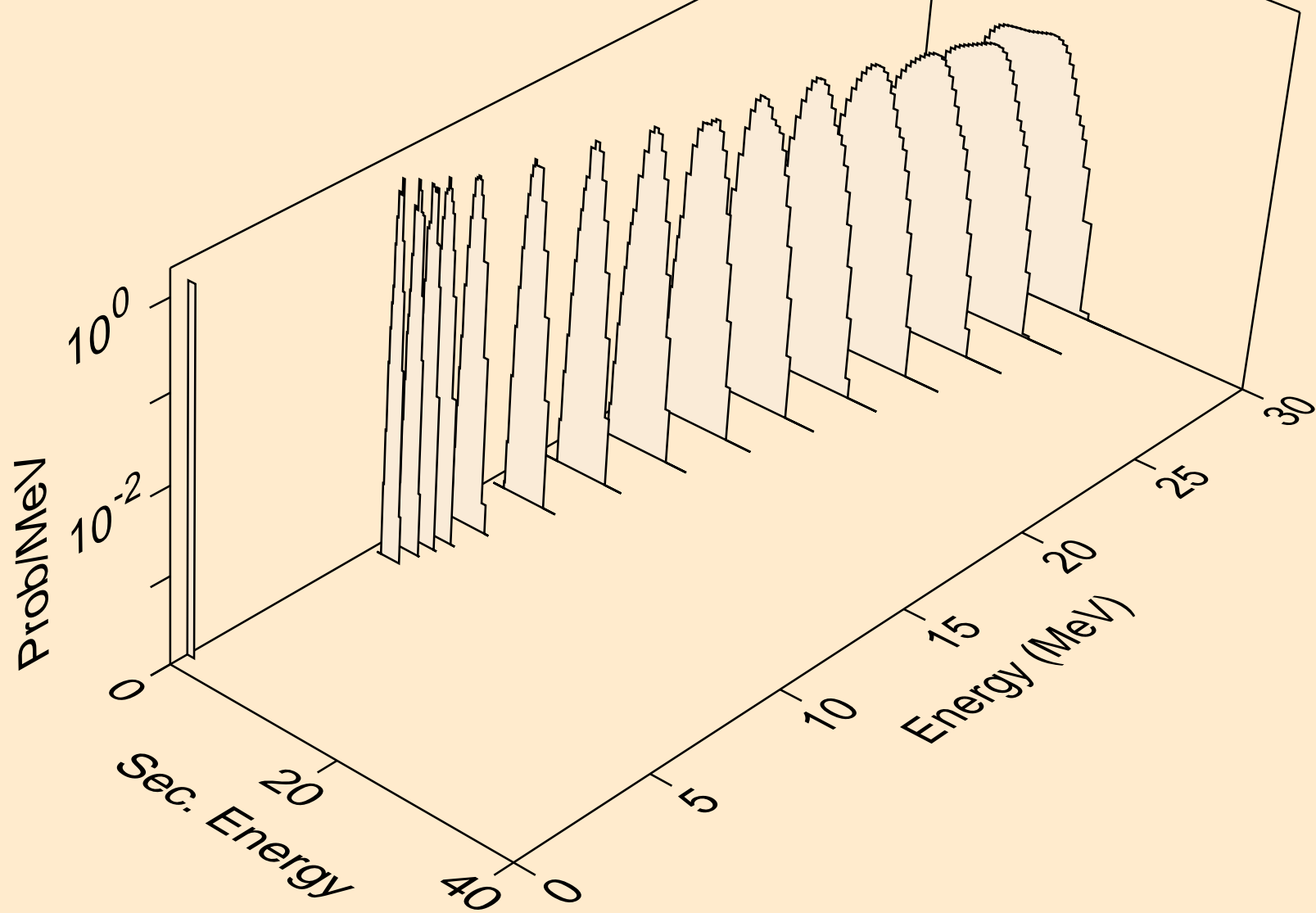

SB110 NEUTRON ACER TENDL-2024 LIBRARY; T=0.K  
tritons from (n,x)

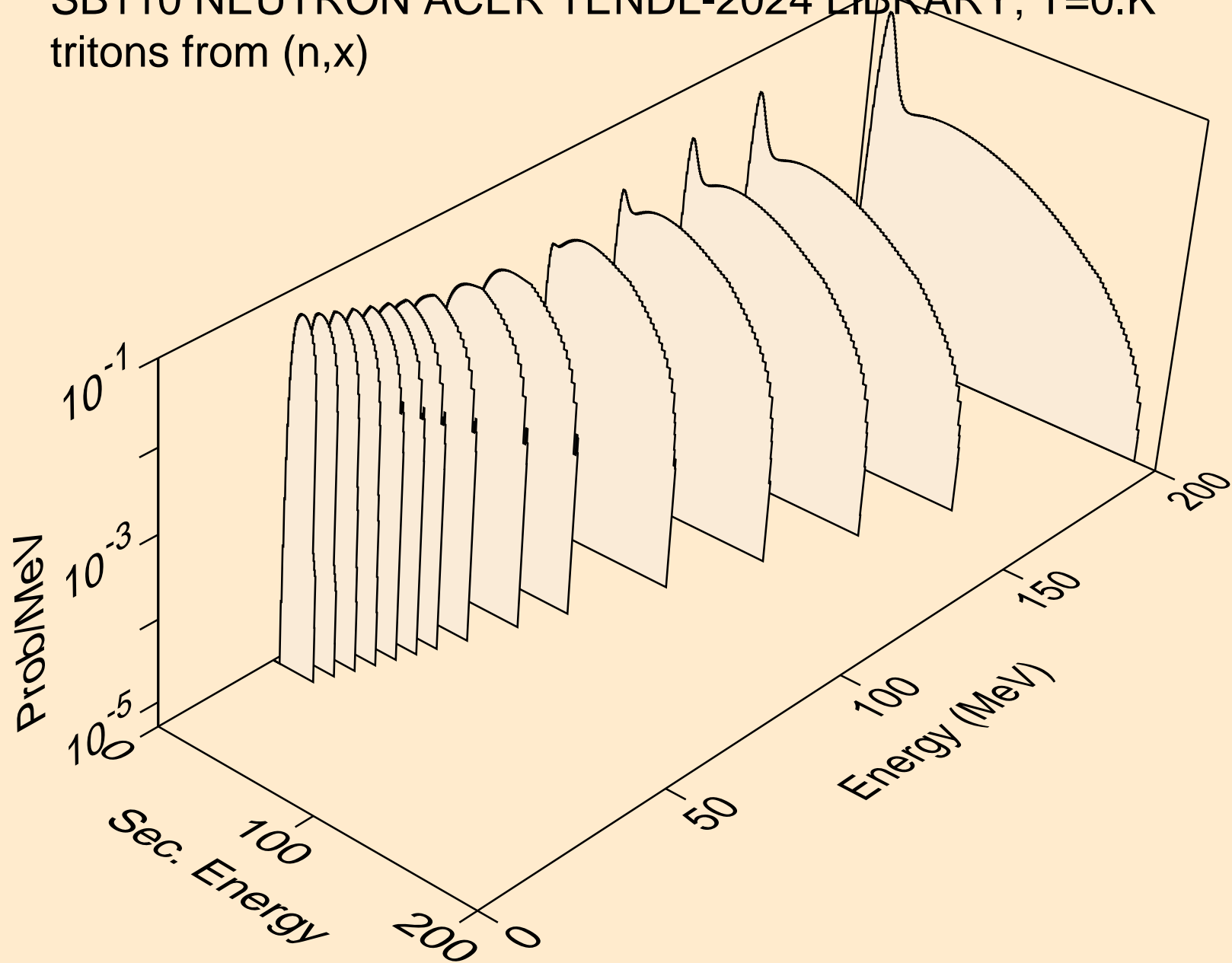



SB110 NEUTRON ACER TENDL-2024 LIBRARY; T=0.K  
tritons from (n,n\*)t

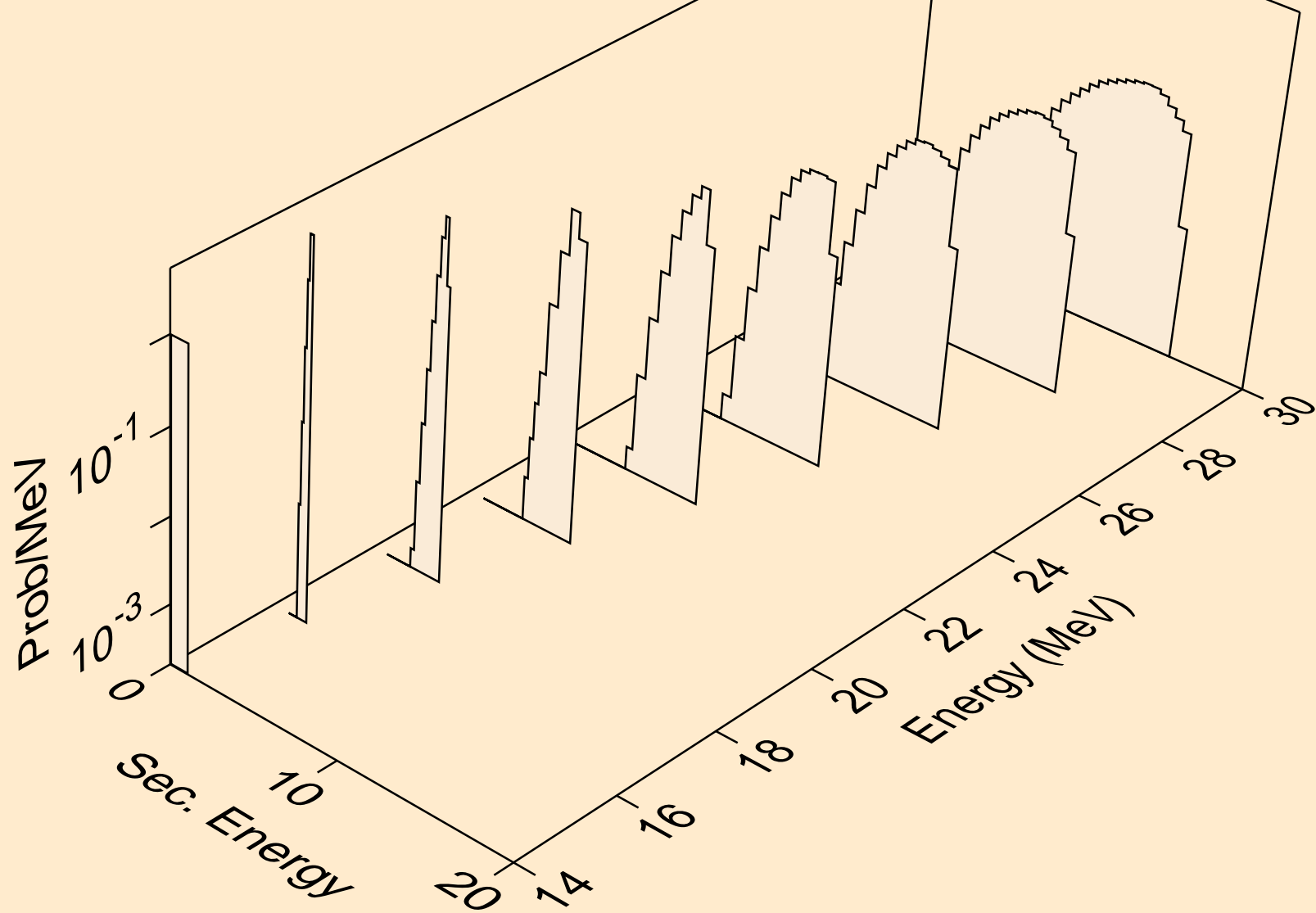

SB110 NEUTRON ACER TENDL-2024 LIBRARY; T=0.K  
tritons from (n,t)

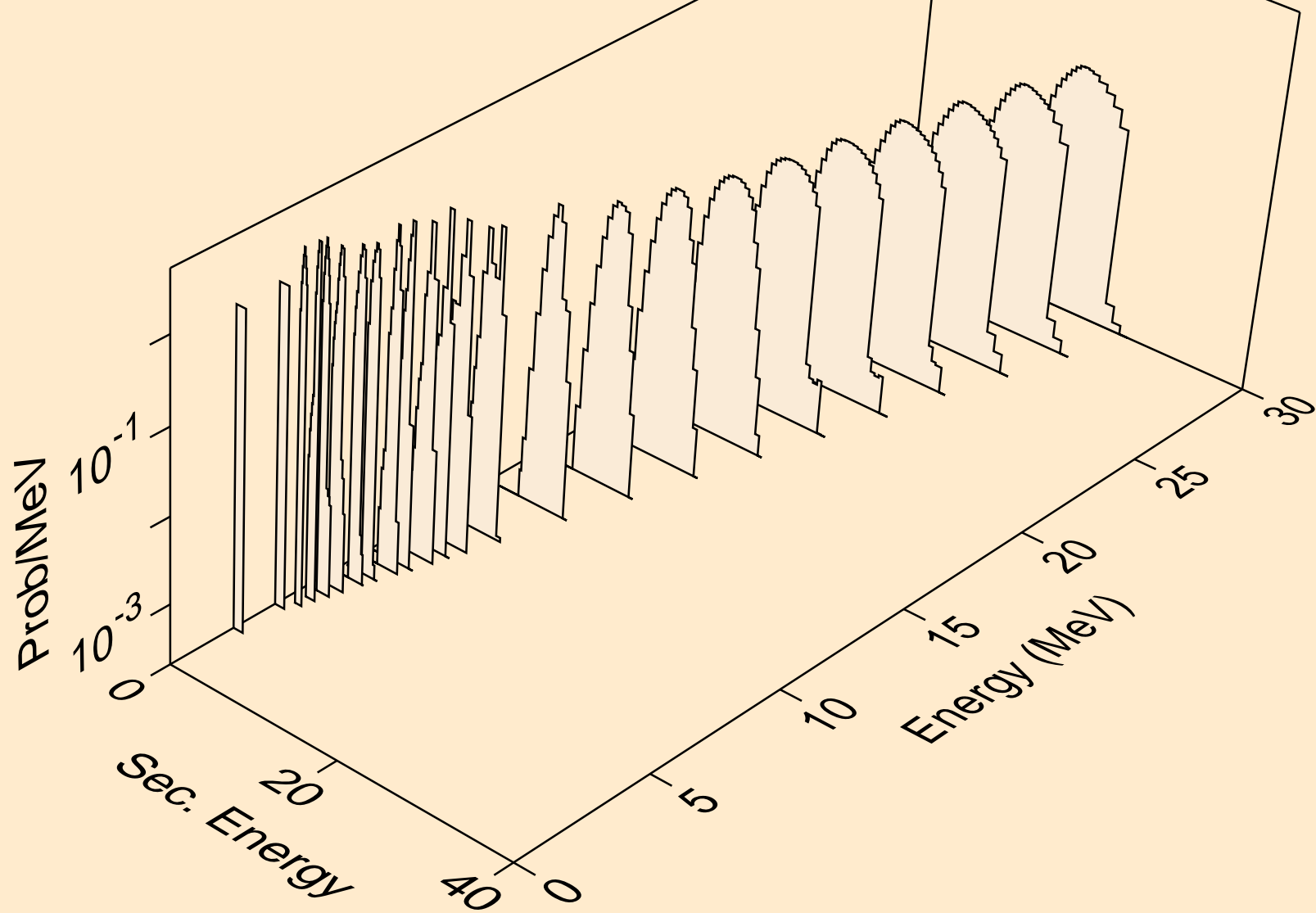

SB110 NEUTRON ACER TENDL-2024 LIBRARY; T=0.K  
tritons from (n,pt)

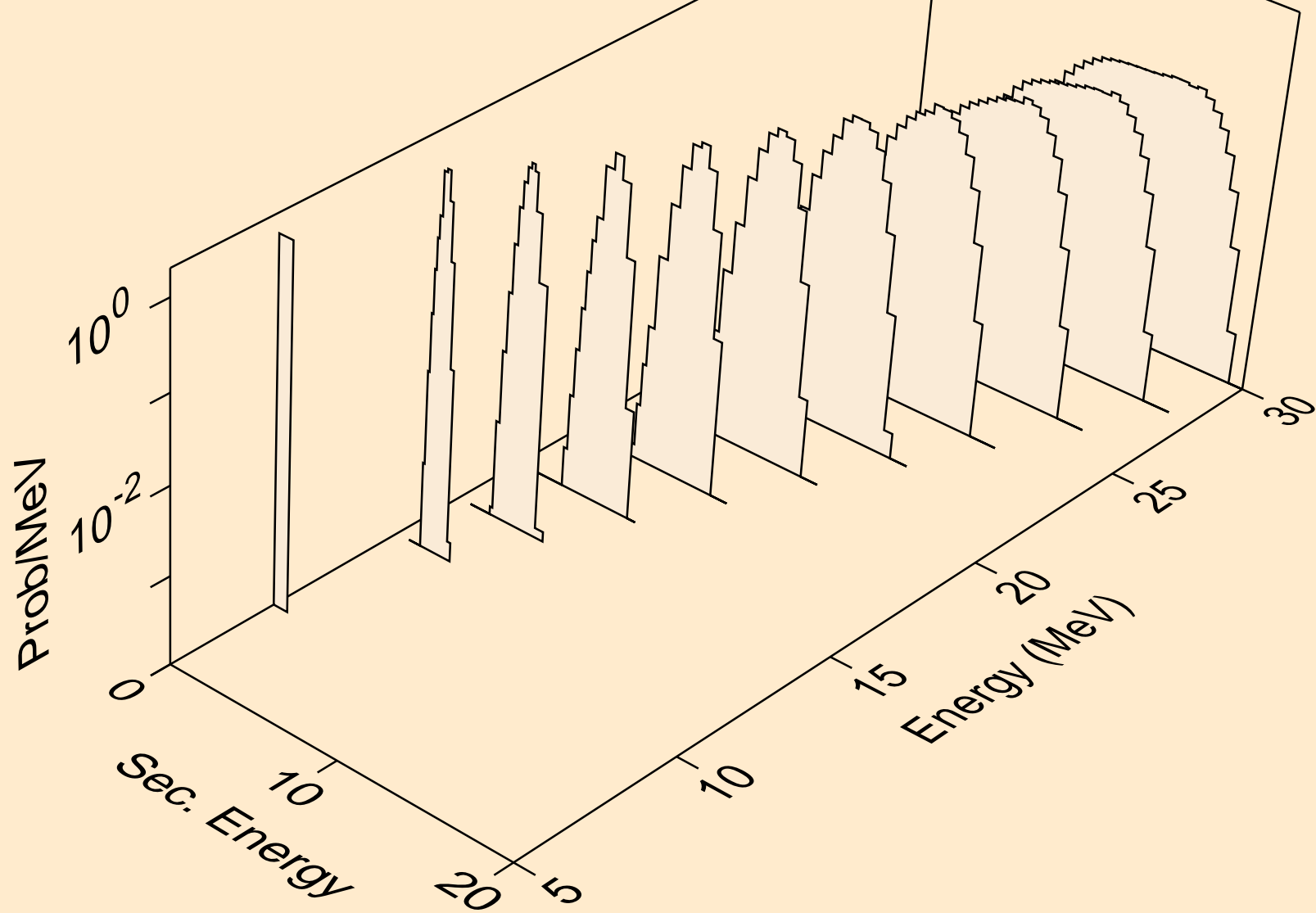

SB110 NEUTRON ACER TENDL-2024 LIBRARY; T=0.K  
he3s from (n,x)

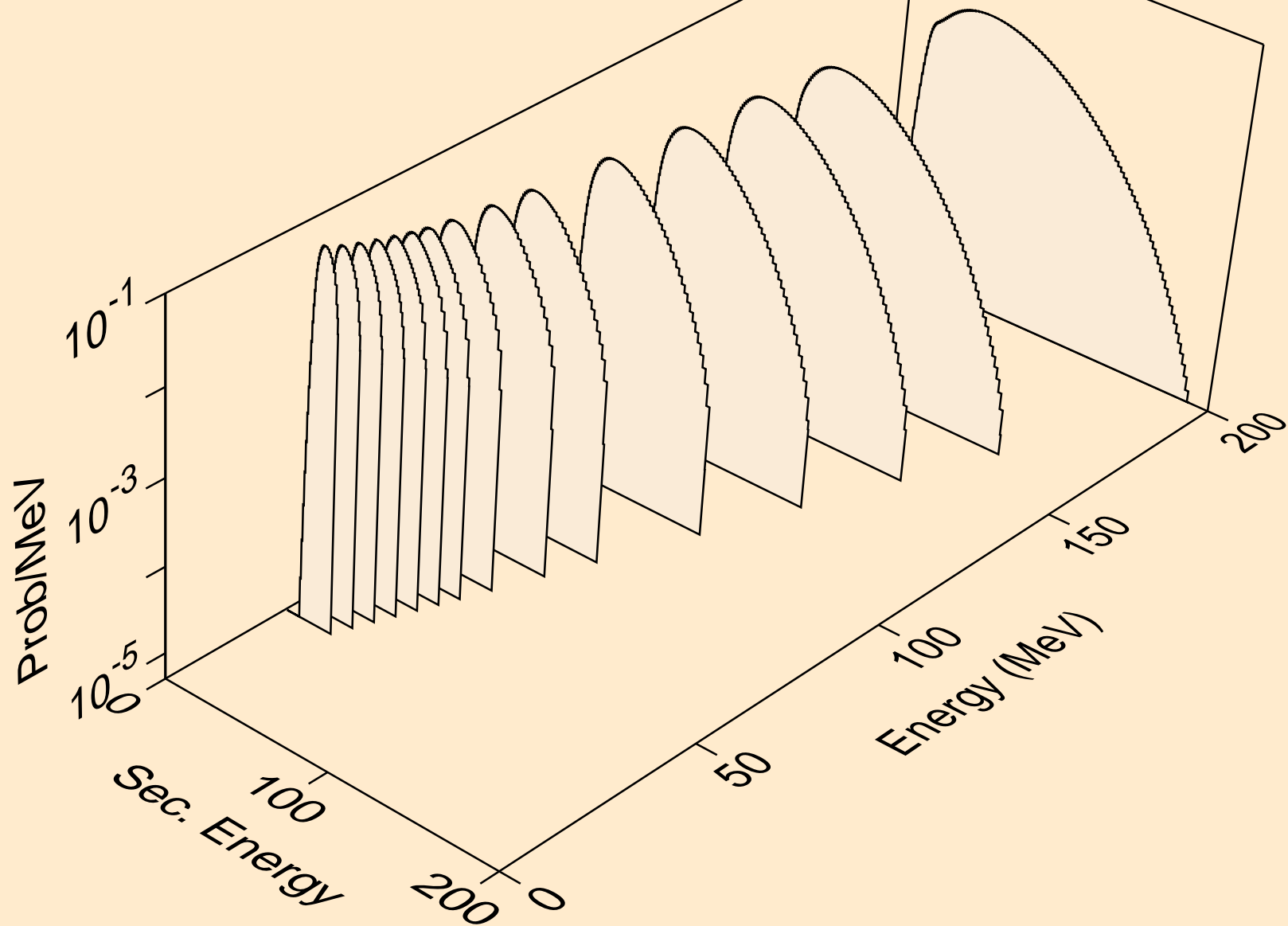

SB110 NEUTRON ACER TENDL-2024 LIBRARY; T=0.K  
he3s from (n,n\*)he3

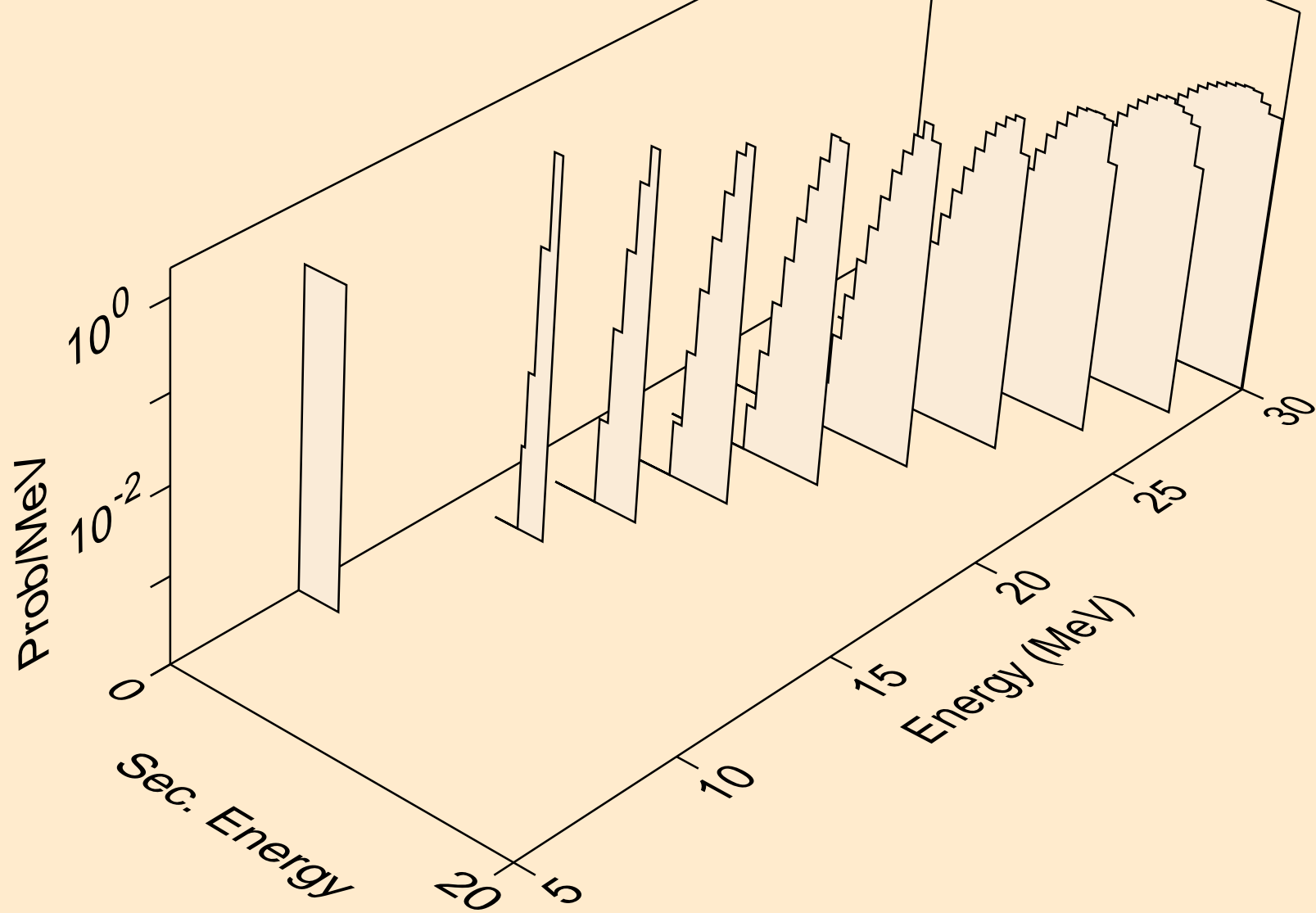

SB110 NEUTRON ACER TENDL-2024 LIBRARY; T=0.K  
he3s from (n,he3)

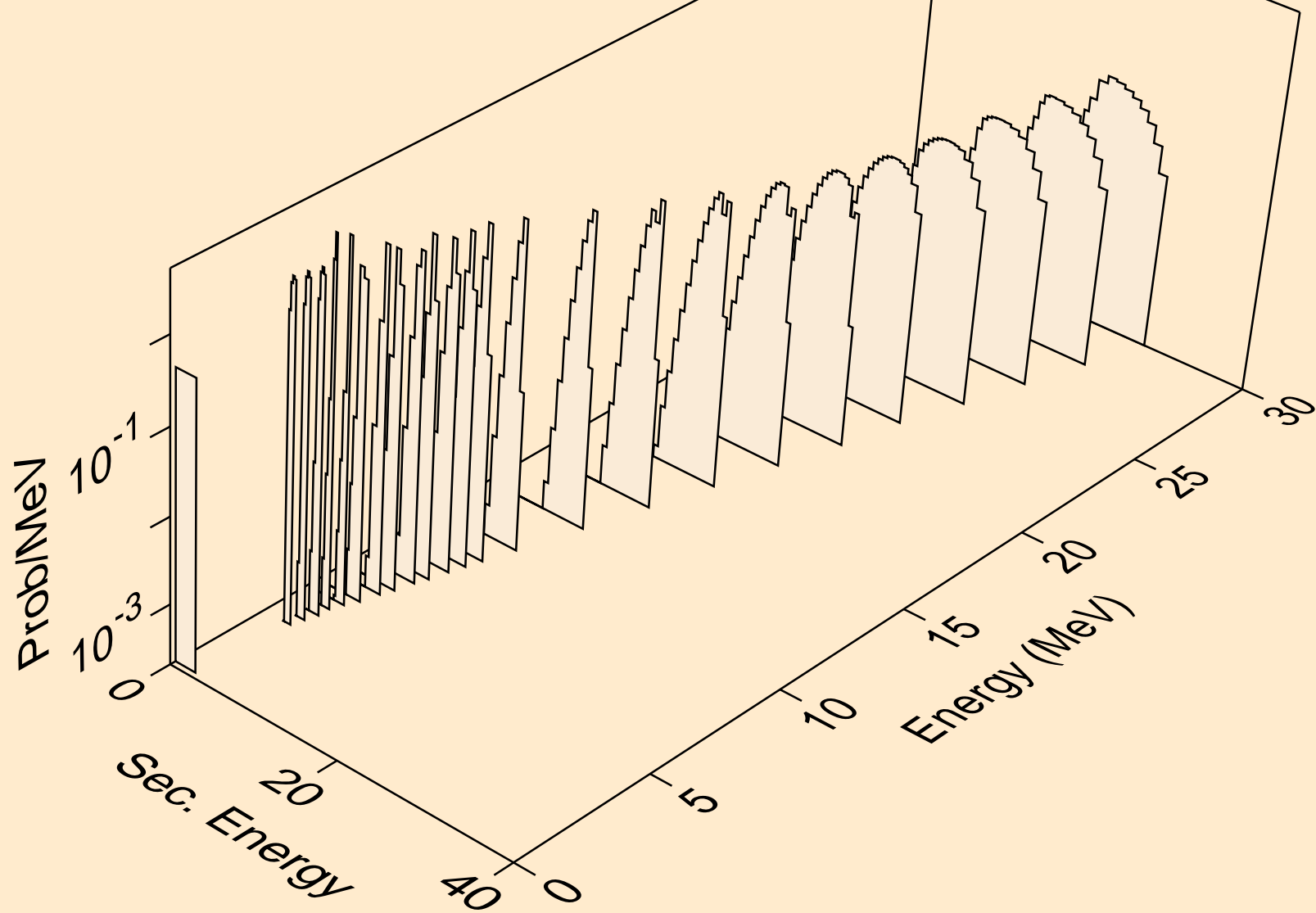

SB110 NEUTRON ACER TENDL-2024 LIBRARY; T=0.K  
alphas from (n,x)

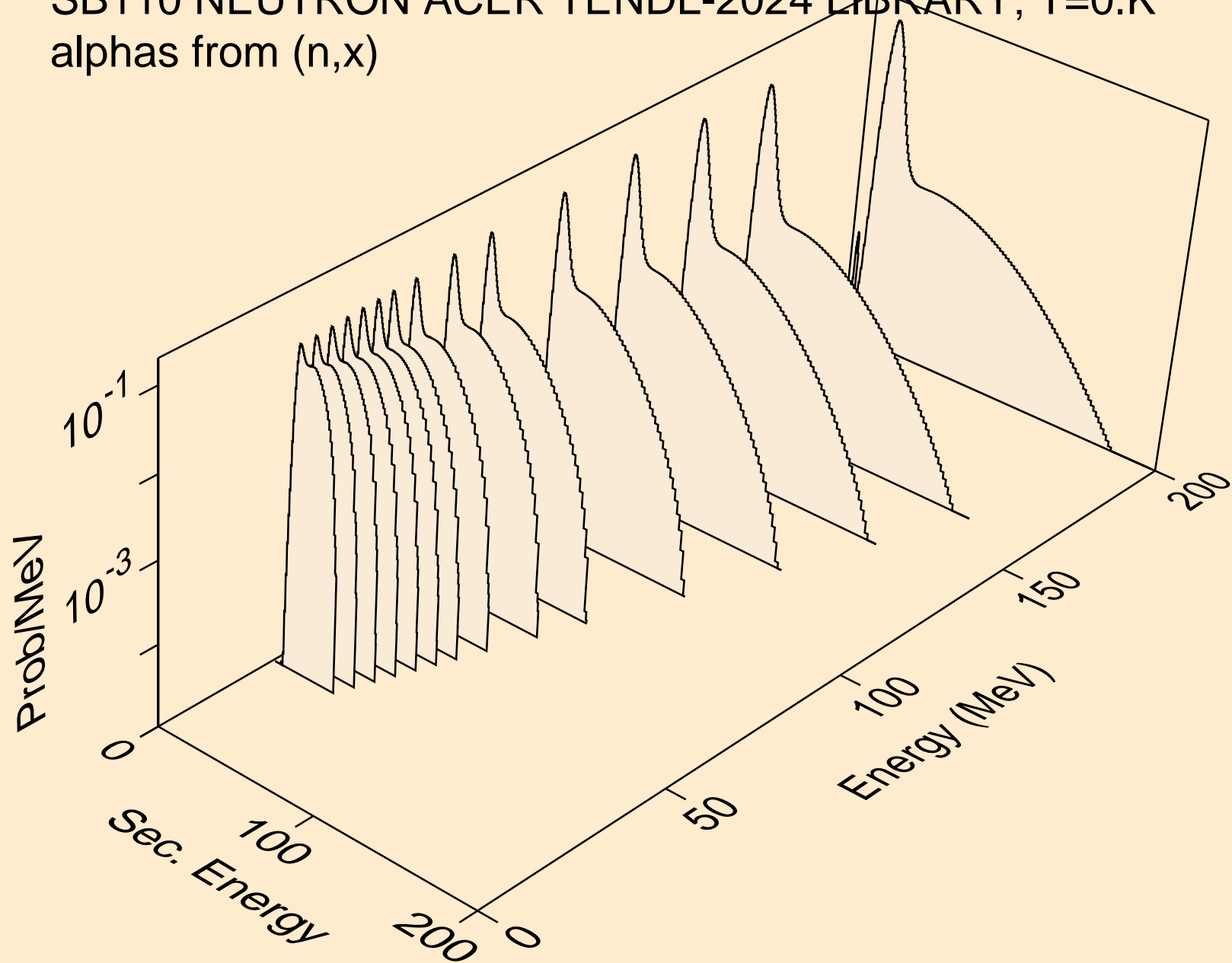

SB110 NEUTRON ACER TENDL-2024 LIBRARY; T=0.K  
alphas from (n,n\*)a

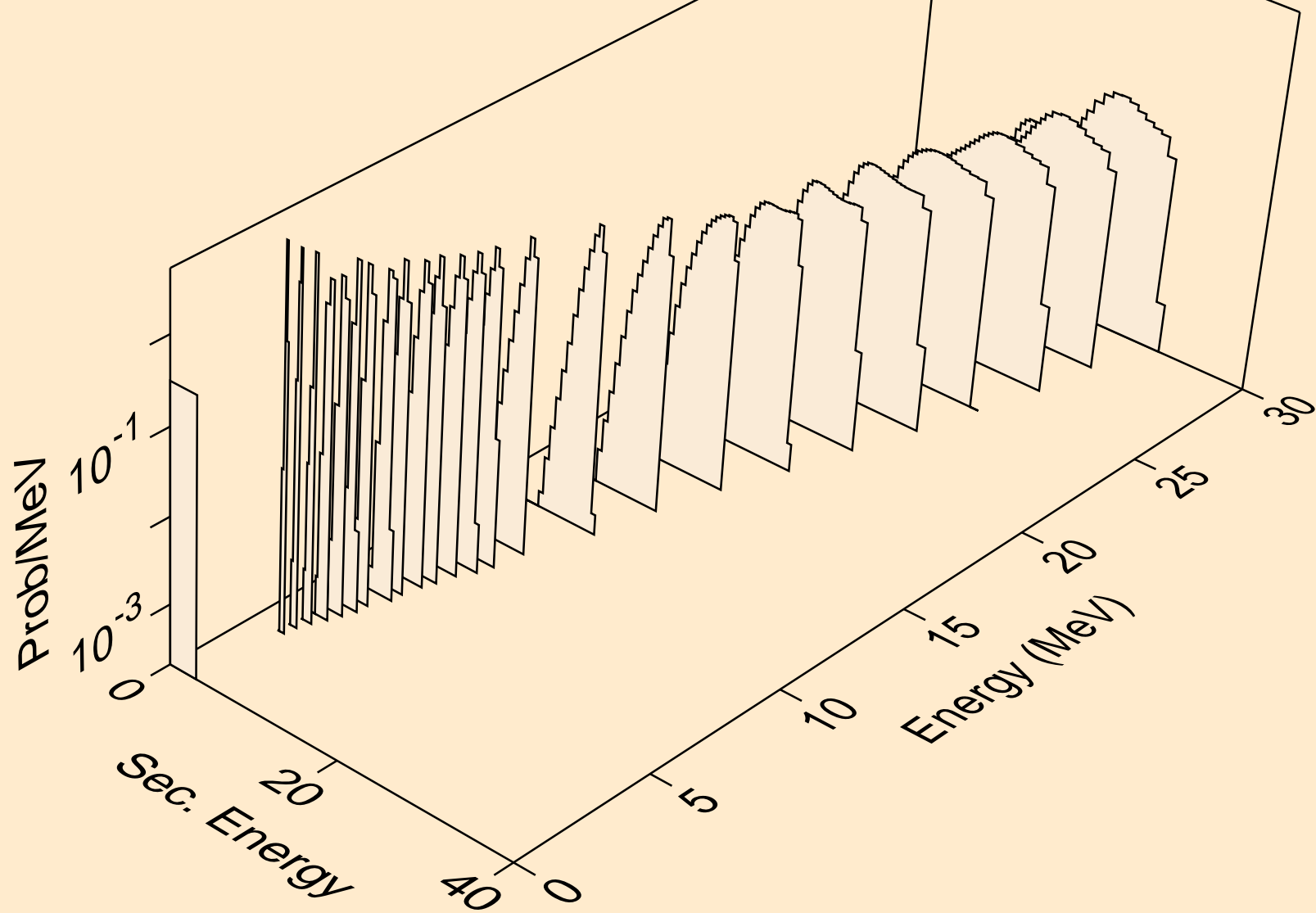



SB110 NEUTRON ACER TENDL-2024 LIBRARY; T=0.K  
alphas from (n,2n)a

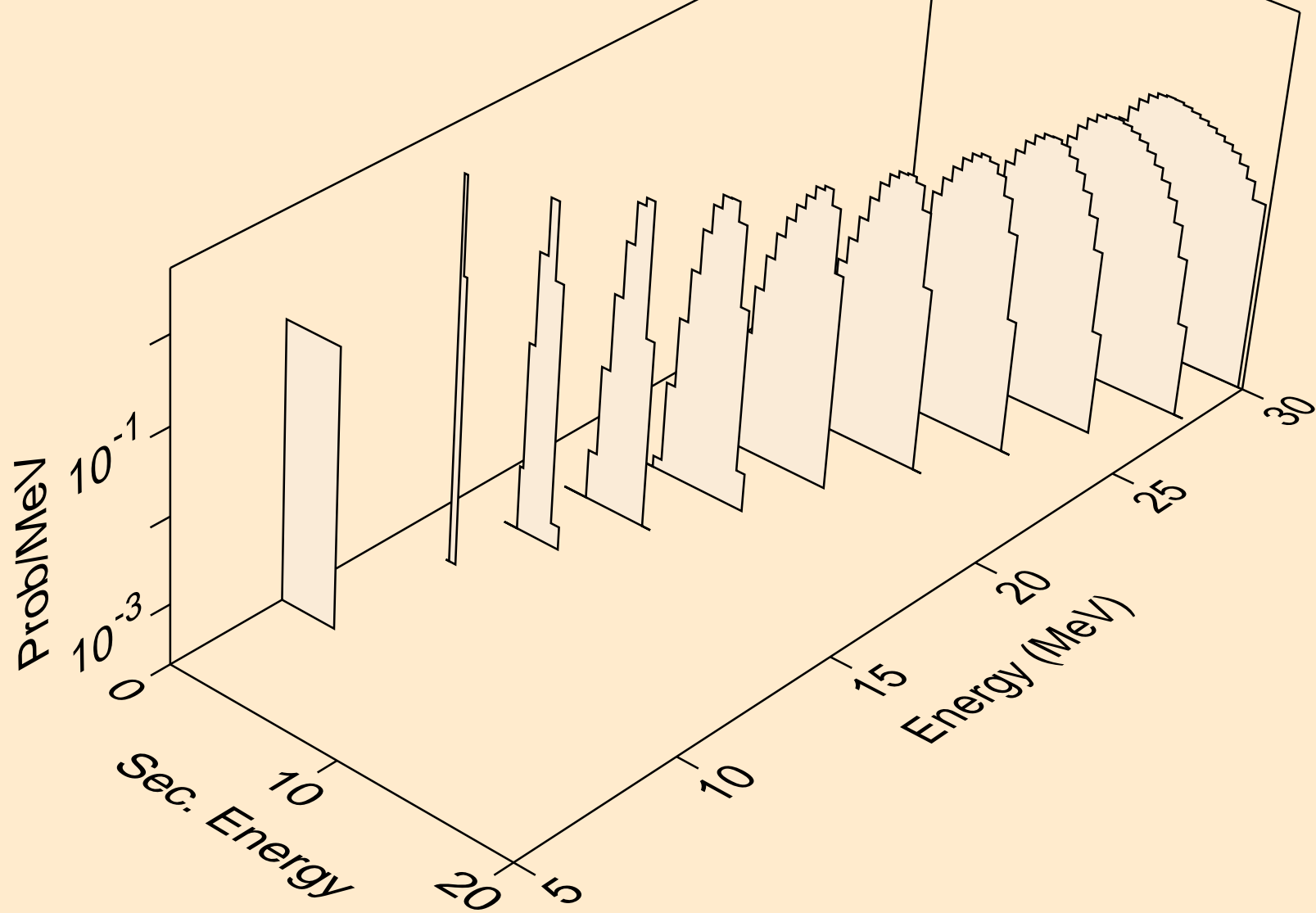

SB110 NEUTRON ACER TENDL-2024 LIBRARY; T=0.K  
alphas from (n,3n)a

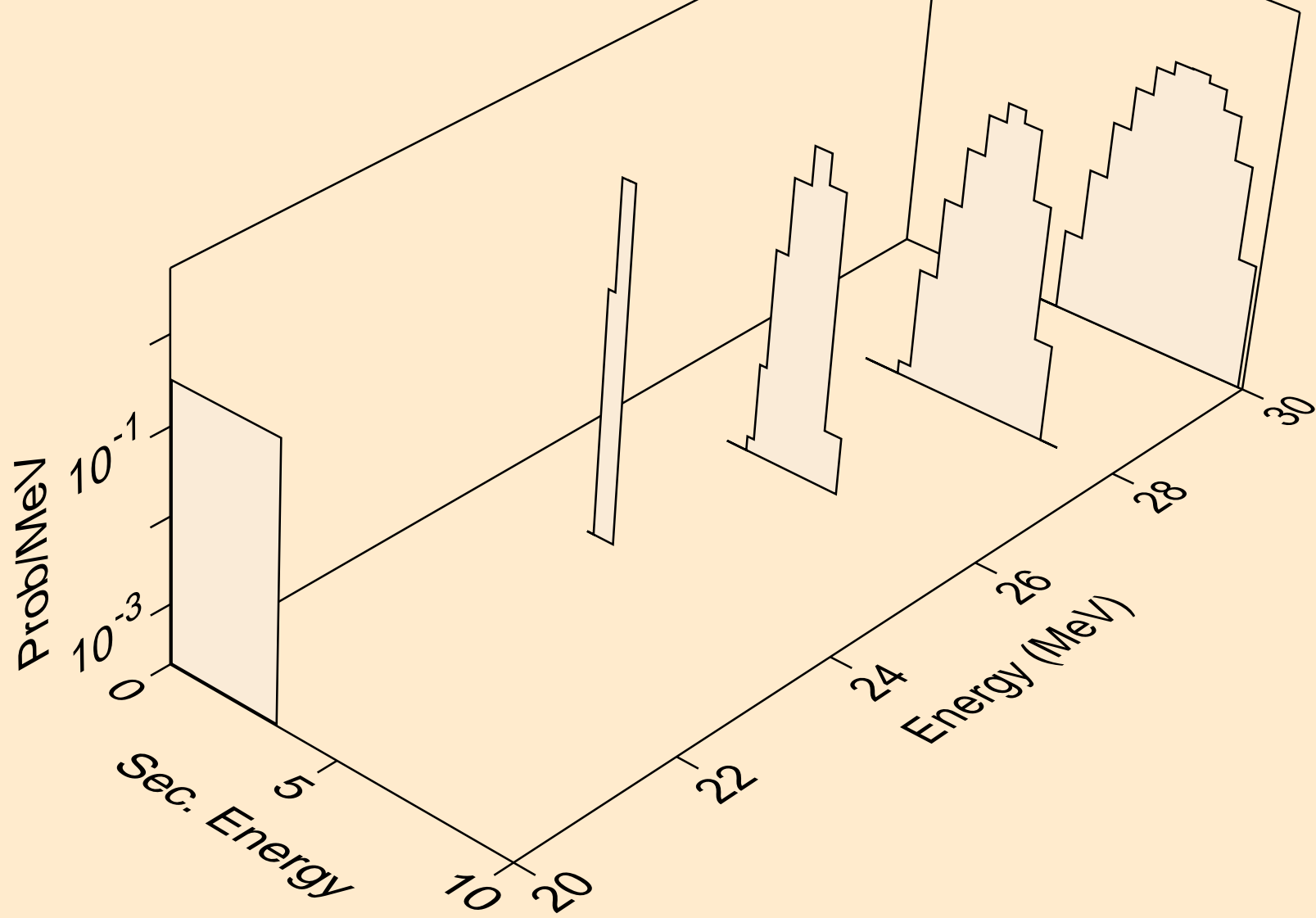

SB110 NEUTRON ACER TENDL-2024 LIBRARY; T=0.K  
alphas from (n,n\*)2a

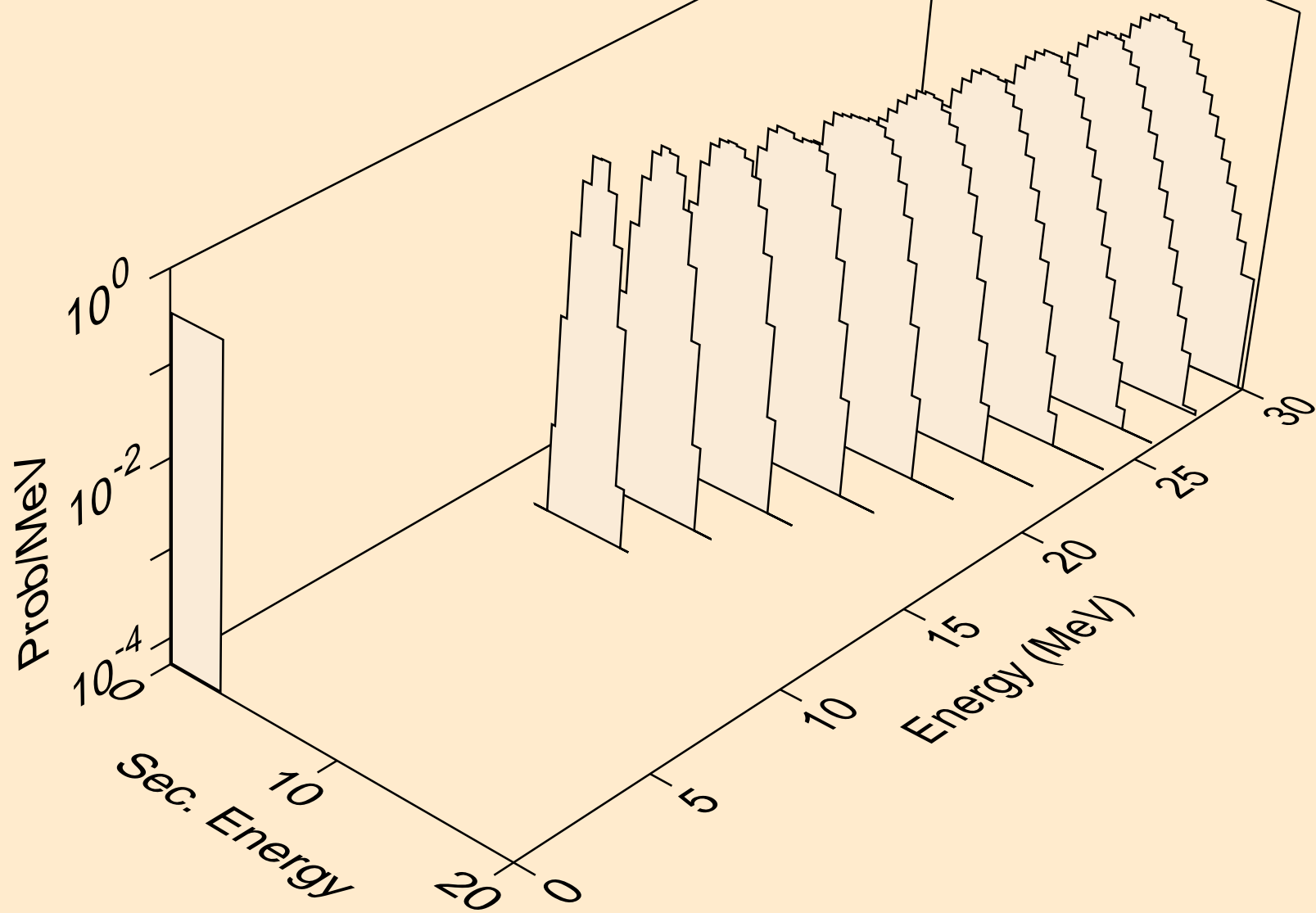

SB110 NEUTRON ACER TENDL-2024 LIBRARY; T=0.K  
alphas from (n,2n)2a

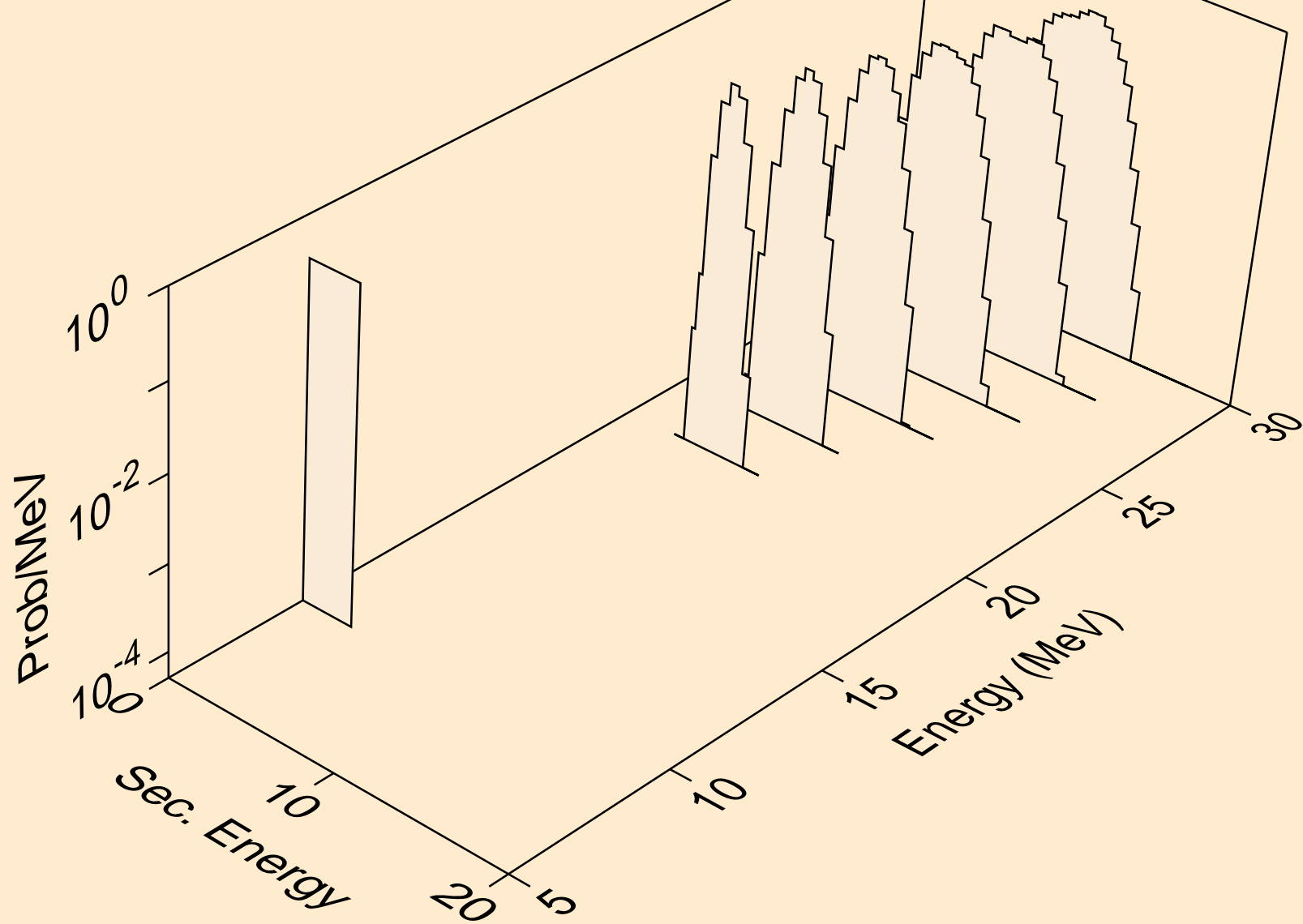

SB110 NEUTRON ACER TENDL-2024 LIBRARY; T=0.K  
alphas from (n,npa)

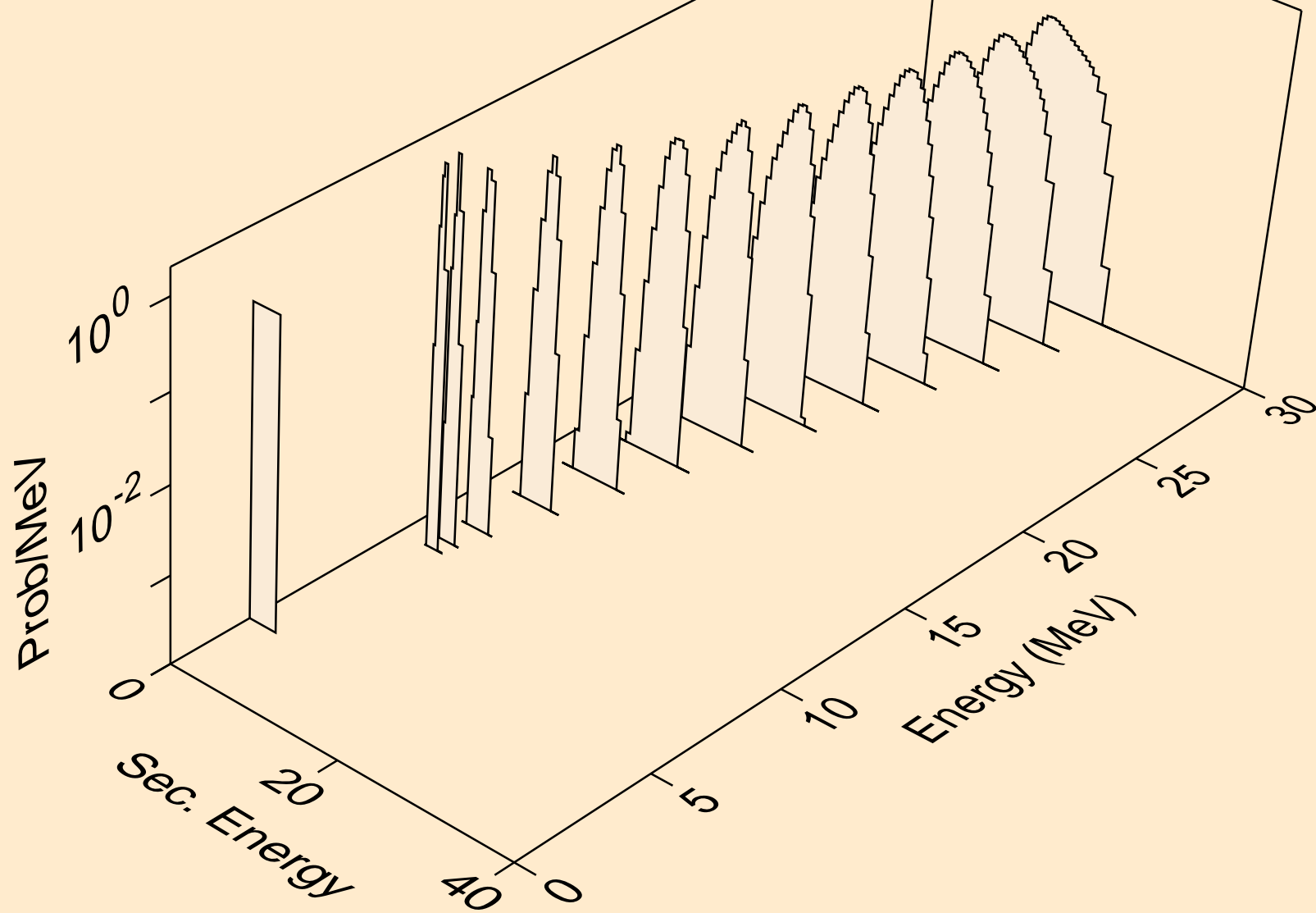

SB110 NEUTRON ACER TENDL-2024 LIBRARY; T=0.K  
alphas from (n,a)

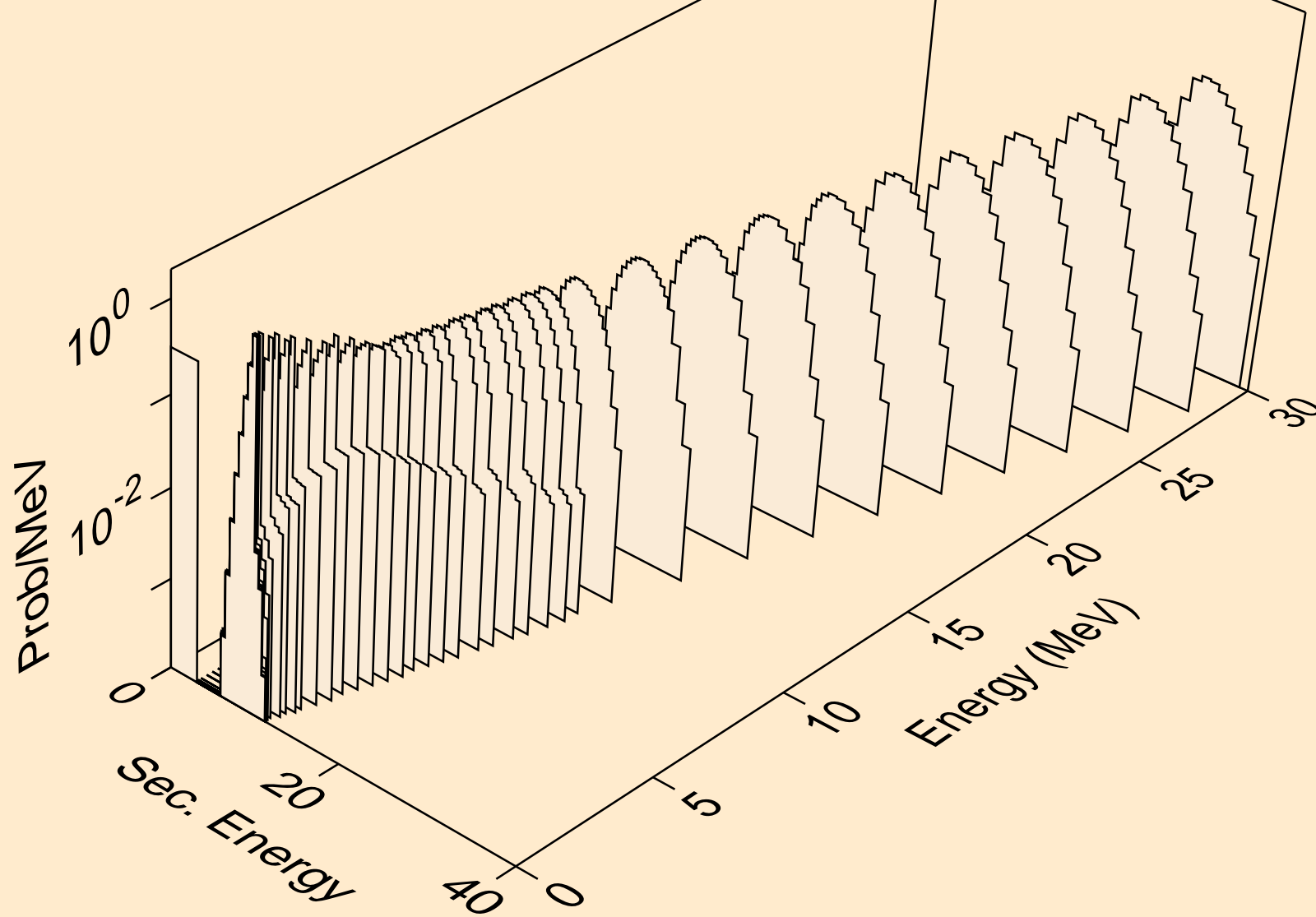

SB110 NEUTRON ACER TENDL-2024 LIBRARY; T=0.K  
alphas from (n,2a)

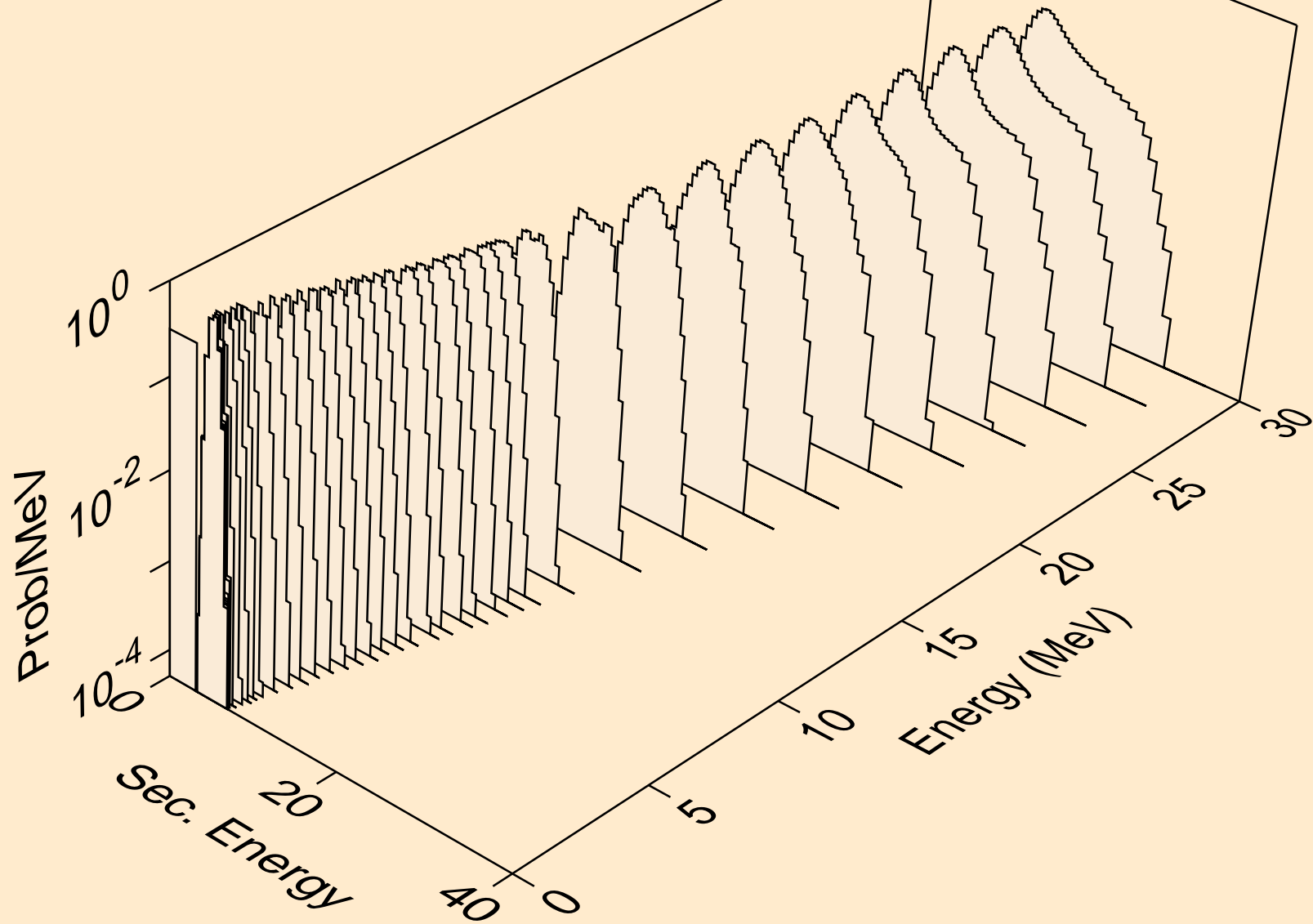

SB110 NEUTRON ACER TENDL-2024 LIBRARY; T=0.K  
alphas from (n,3a)

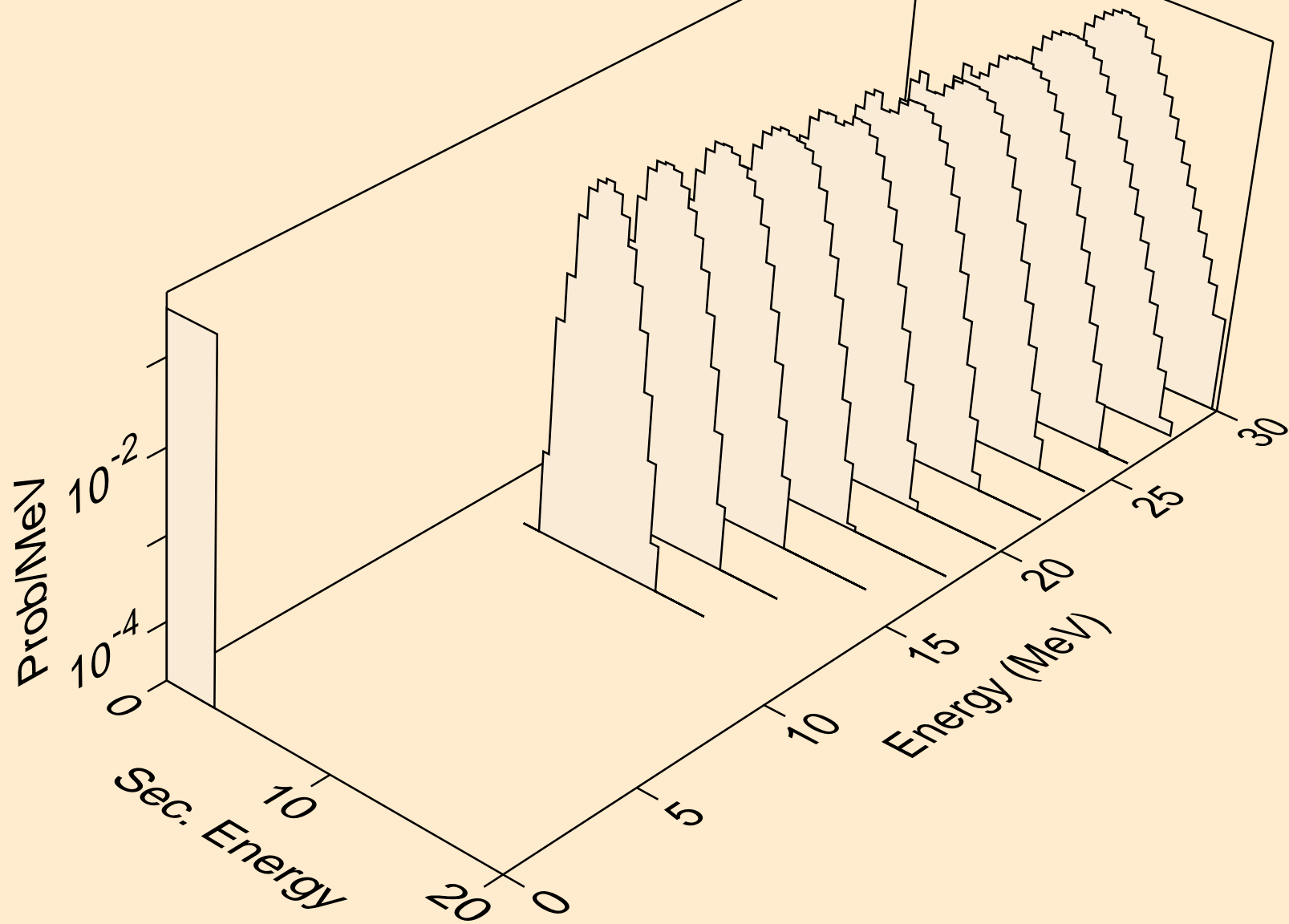



SB110 NEUTRON ACER TENDL-2024 LIBRARY; T=0.K  
alphas from (n,pa)

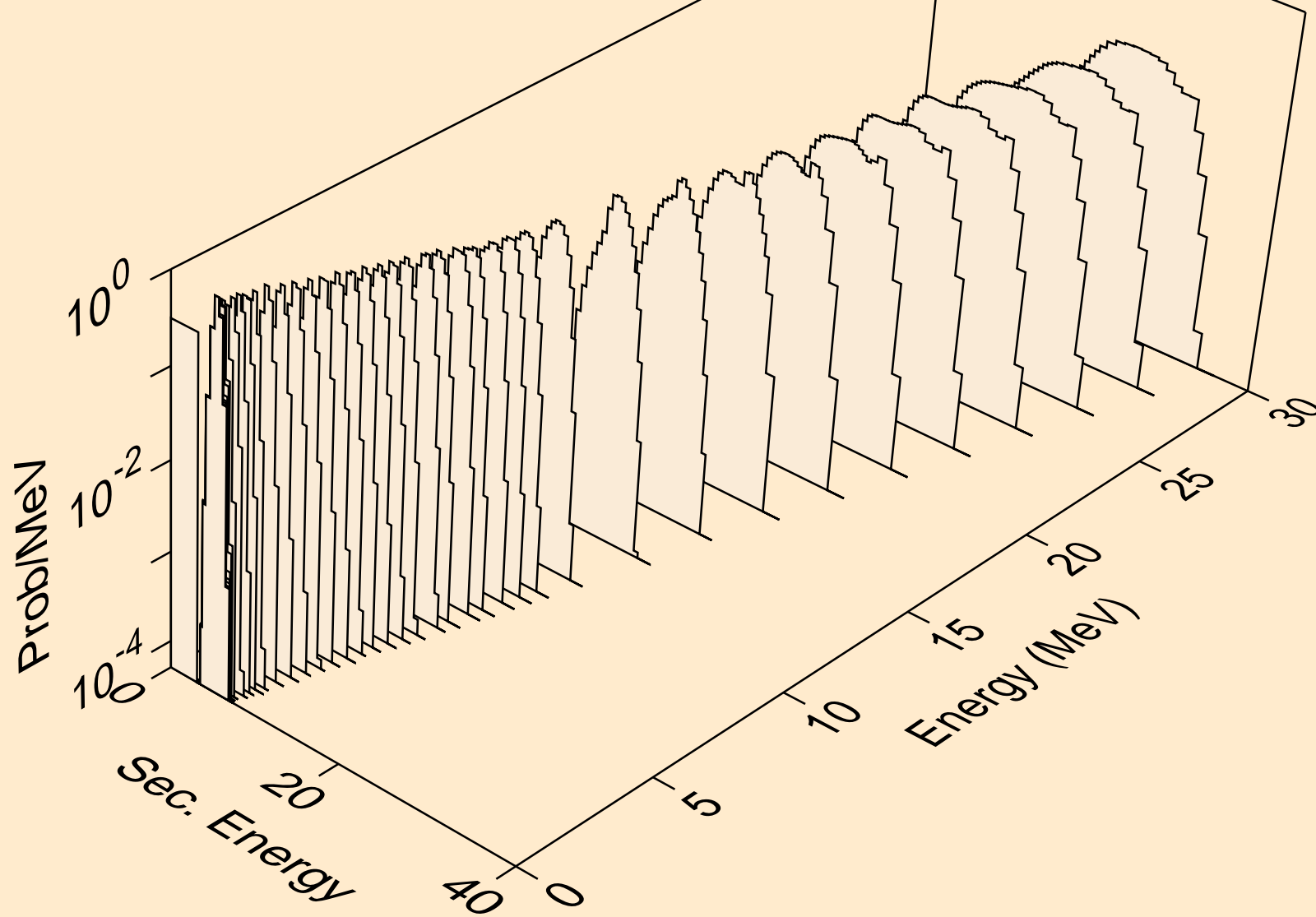

SB110 NEUTRON ACER TENDL-2024 LIBRARY; T=0.K  
alphas from (n,d2a)

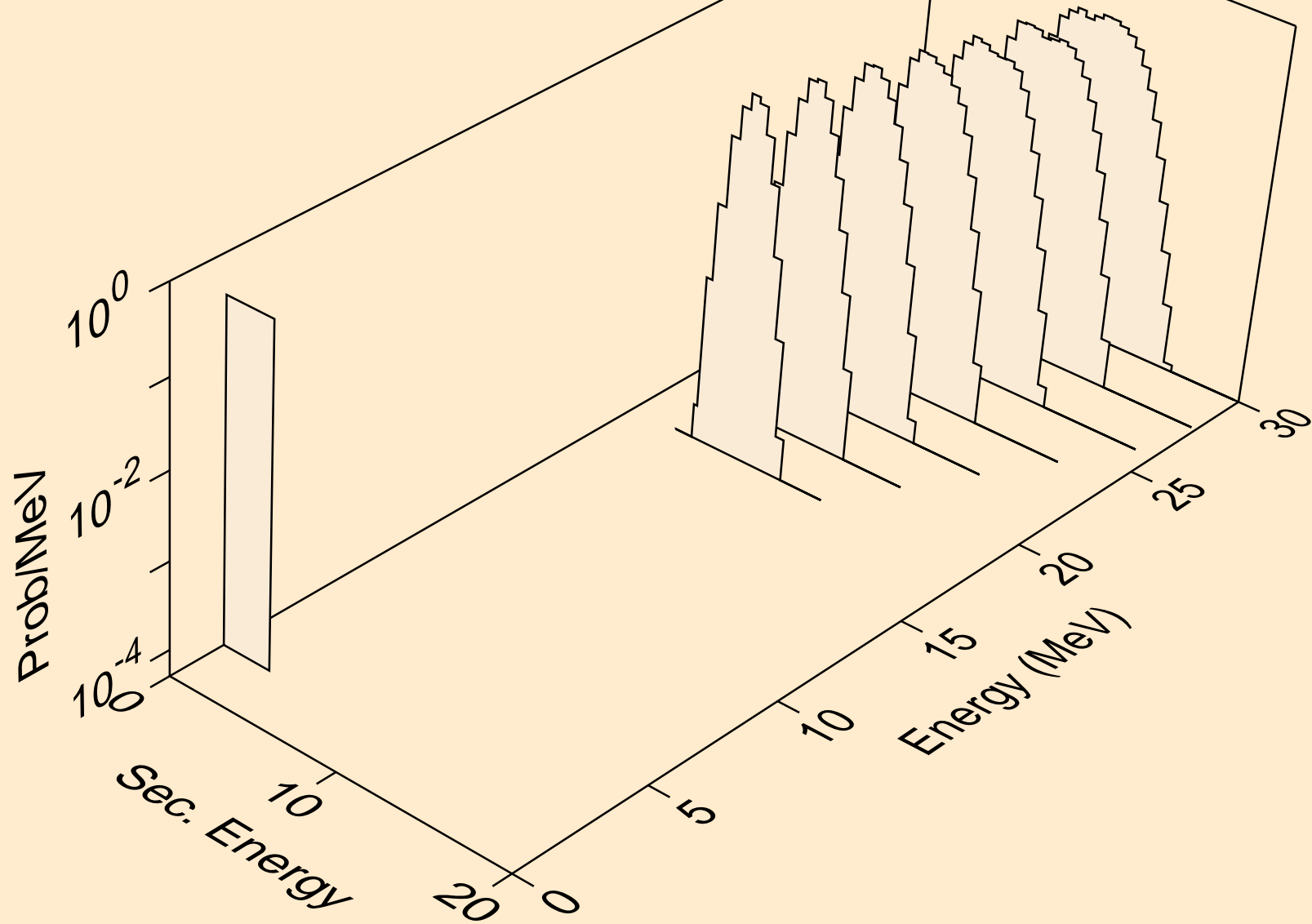

SB110 NEUTRON ACER TENDL-2024 LIBRARY; T=0.K  
alphas from (n,da)

