

SB114 NEUTRON ACER TENDL-2024 LIBRARY; T=0.K

Principal cross sections

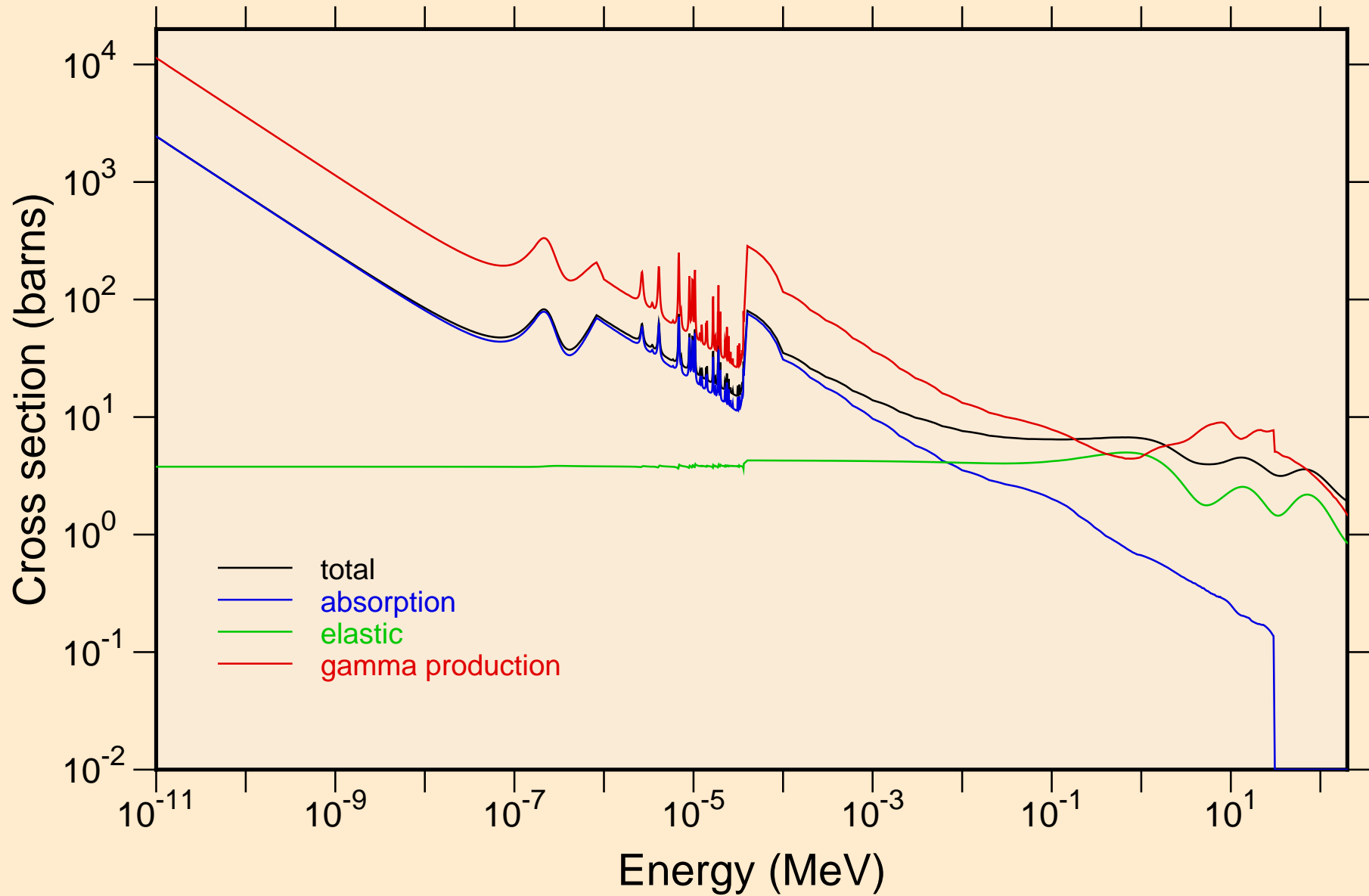

SB114 NEUTRON ACER TENDL-2024 LIBRARY; T=0.K
resonance total cross section

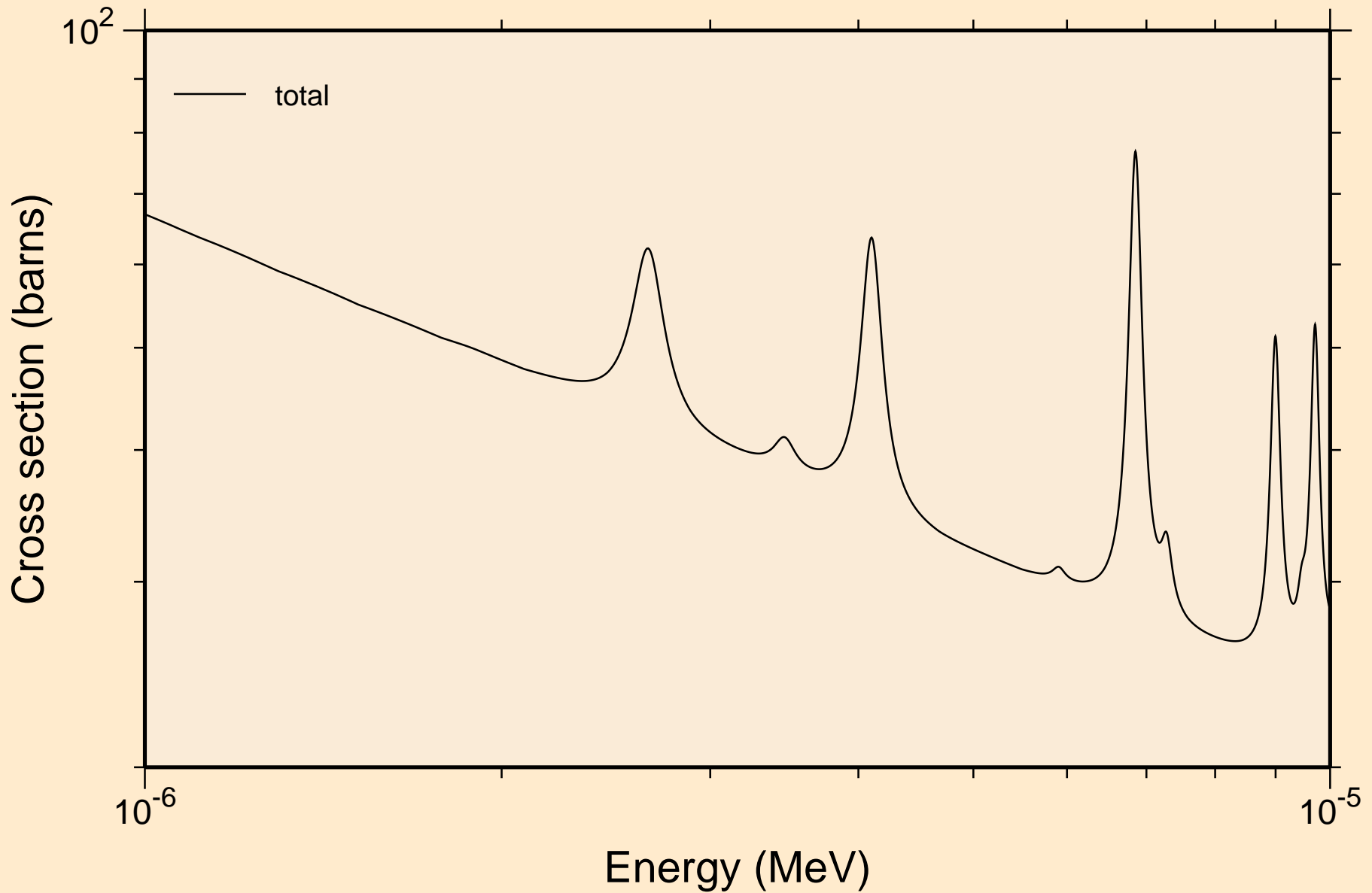

SB114 NEUTRON ACER TENDL-2024 LIBRARY; T=0.K
resonance total cross section

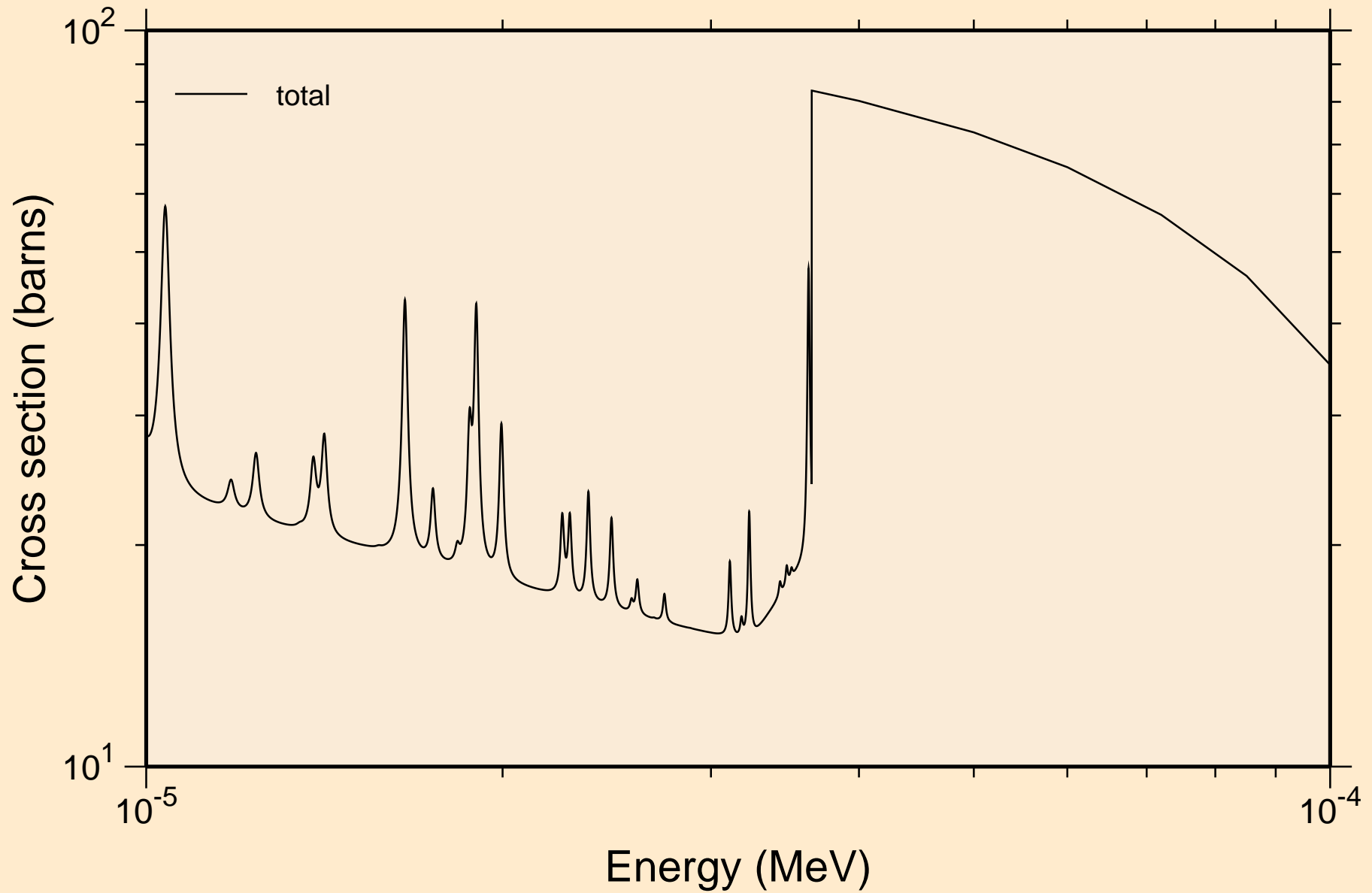

S_B114 NEUTRON ACER TENDL-2024 LIBRARY; T=0.K
resonance total cross section

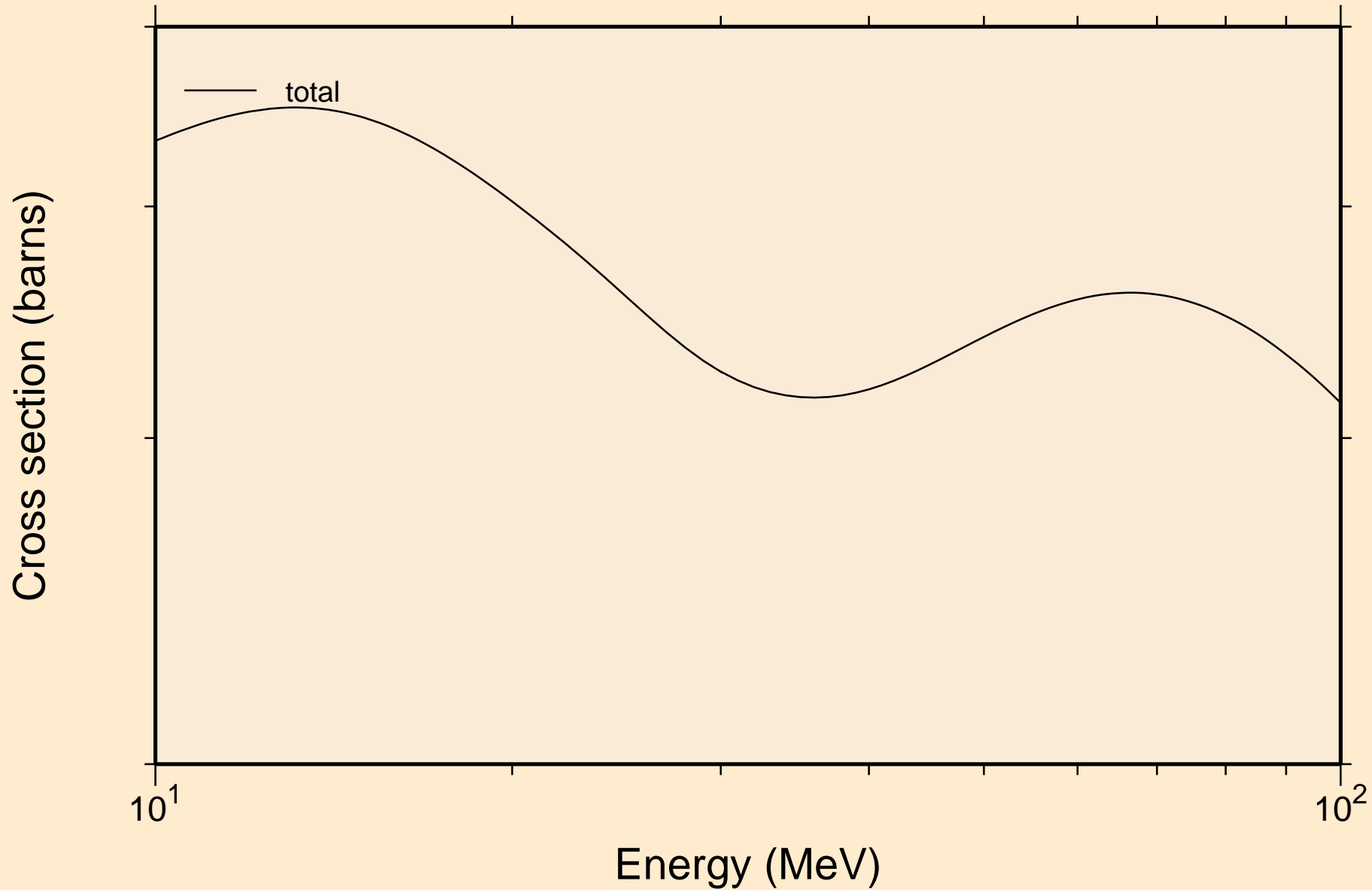

SB114 NEUTRON ACER TENDL-2024 LIBRARY; T=0.K
resonance absorption cross sections

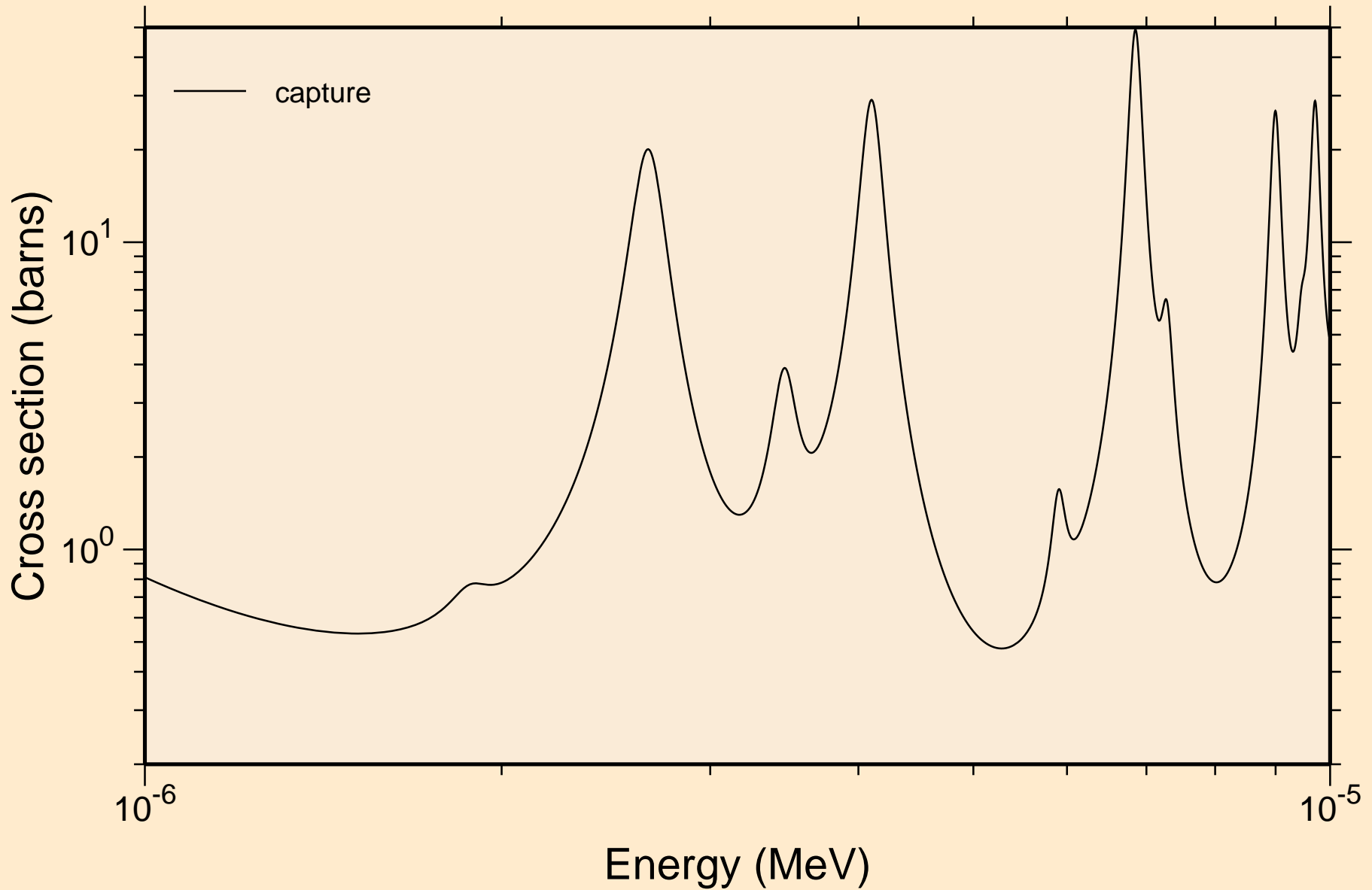

SB114 NEUTRON ACER TENDL-2024 LIBRARY; T=0.K
resonance absorption cross sections

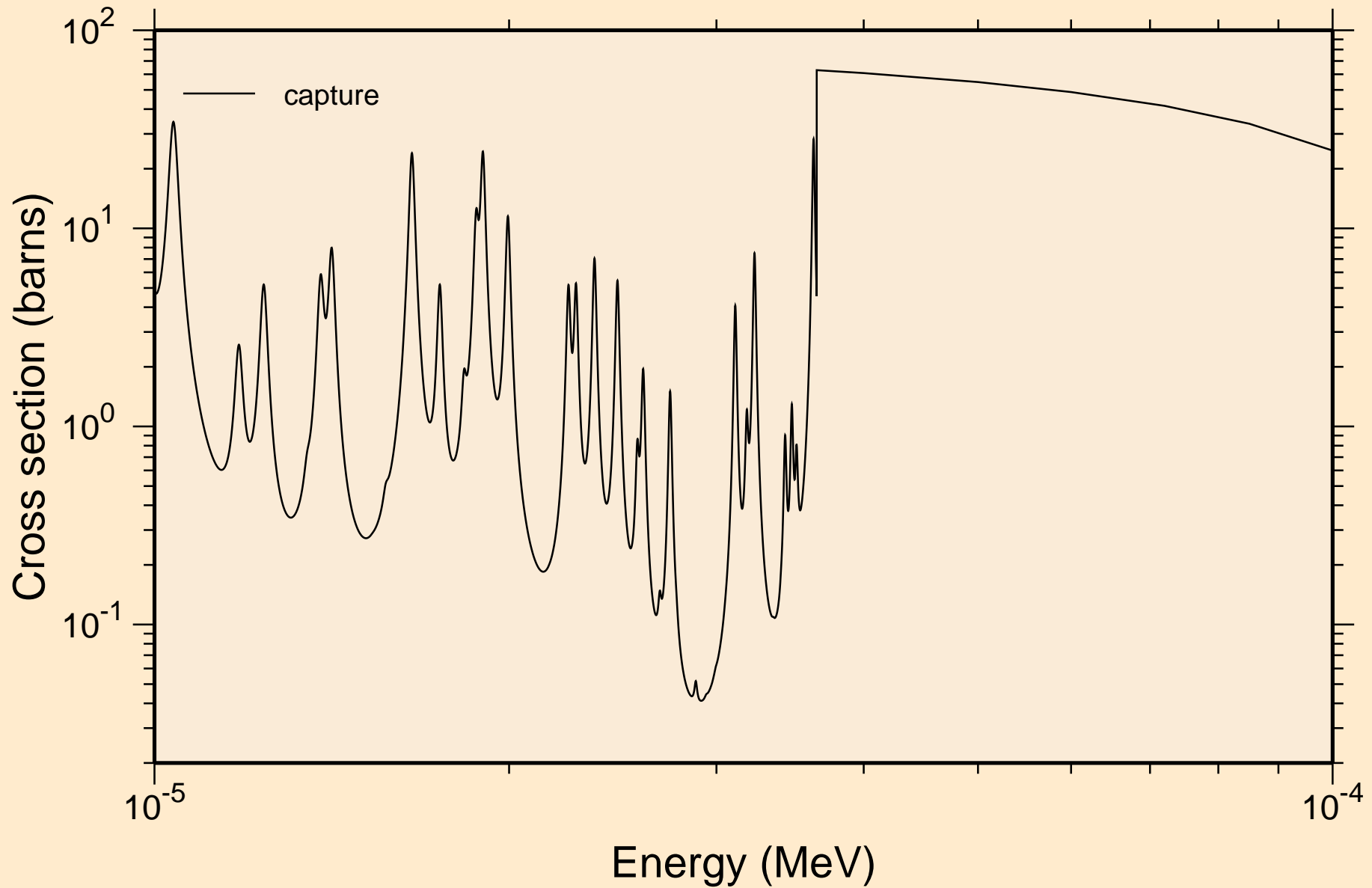

SB114 NEUTRON ACER TENDL-2024 LIBRARY; T=0.K
resonance absorption cross sections

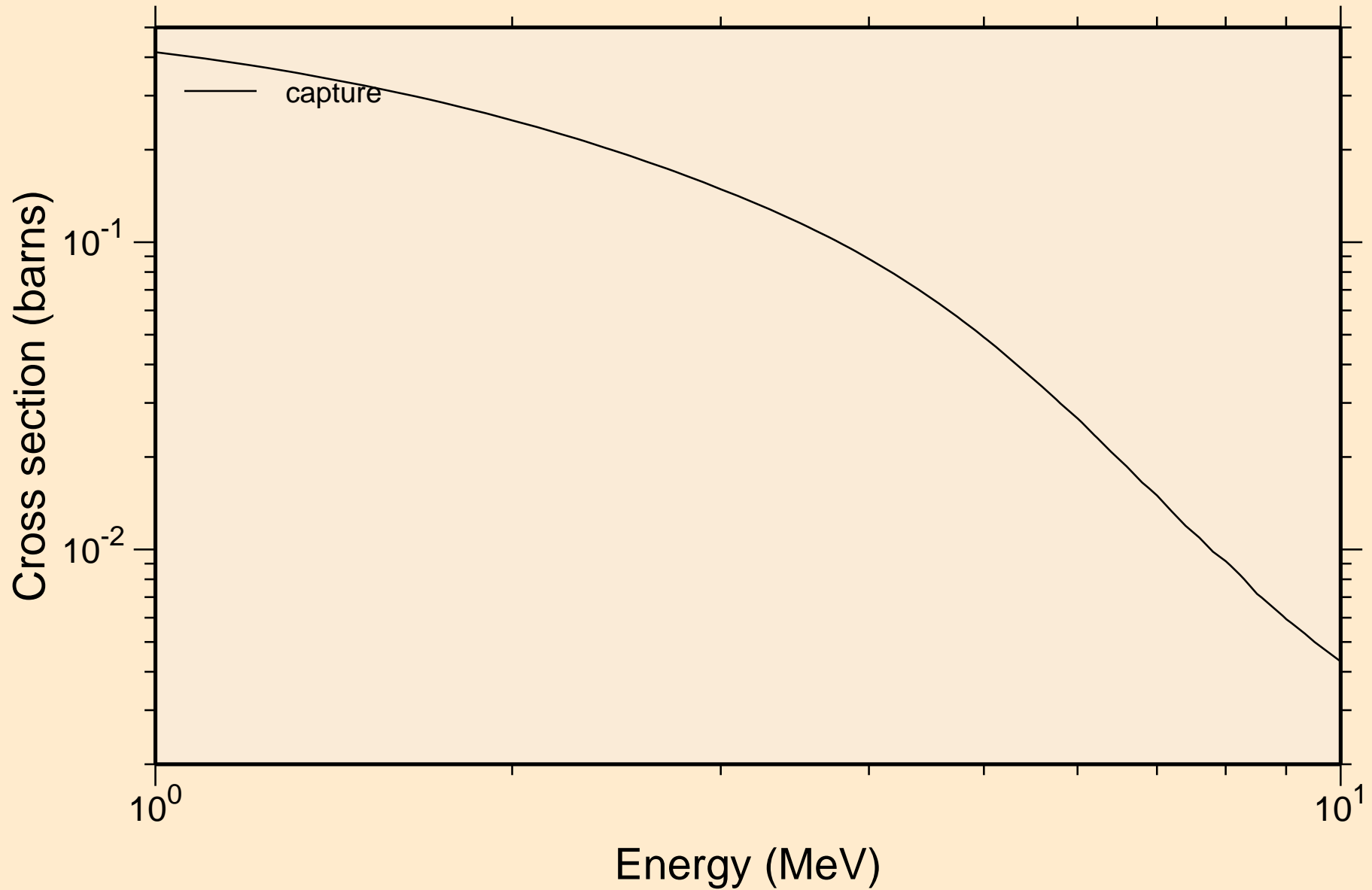

SB114 NEUTRON ACER TENDL-2024 LIBRARY; T=0.K

Heating

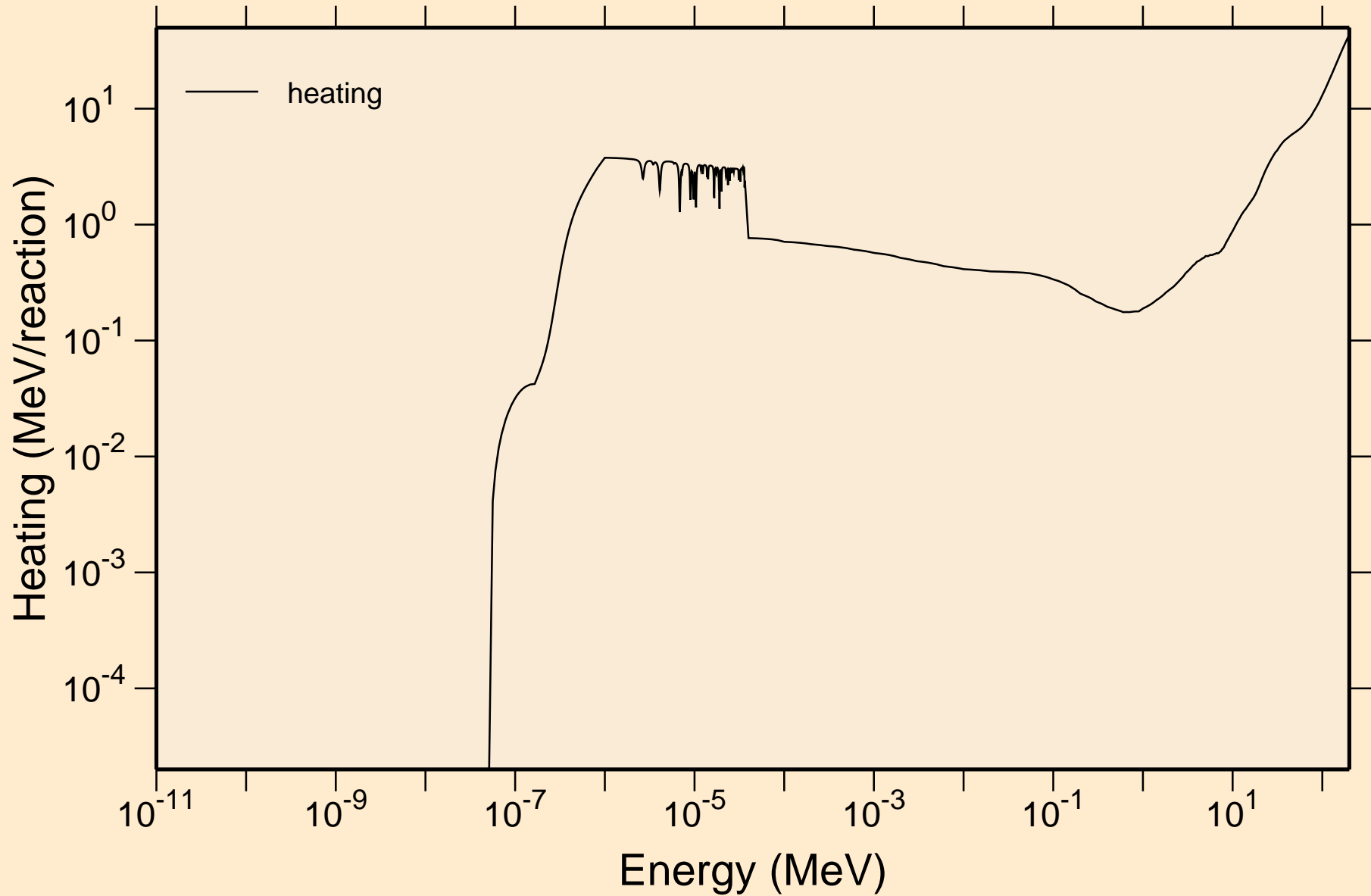

SB114 NEUTRON ACER TENDL-2024 LIBRARY; T=0.K
Damage

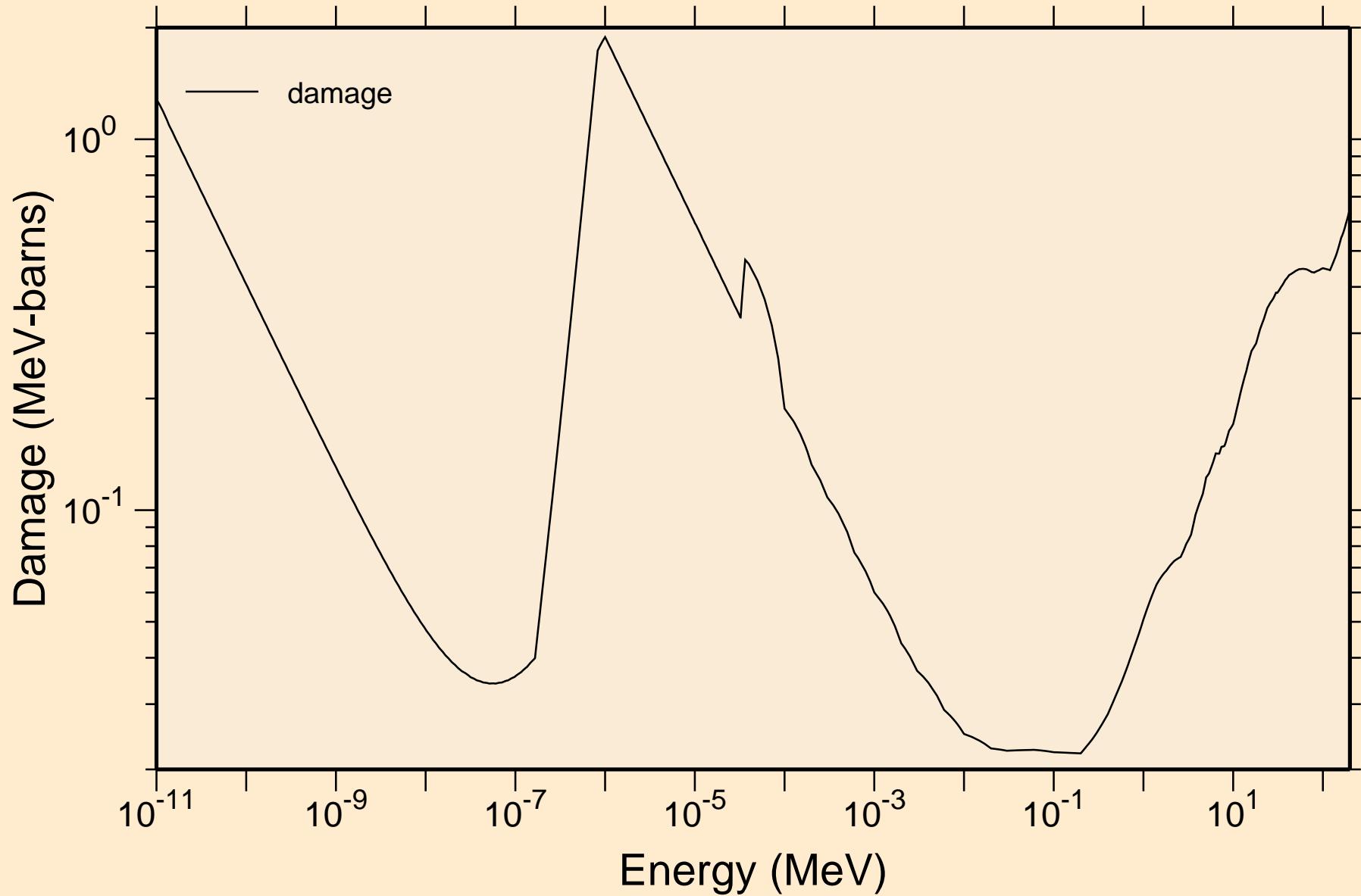

SB114 NEUTRON ACER TENDL-2024 LIBRARY; T=0.K

Non-threshold reactions

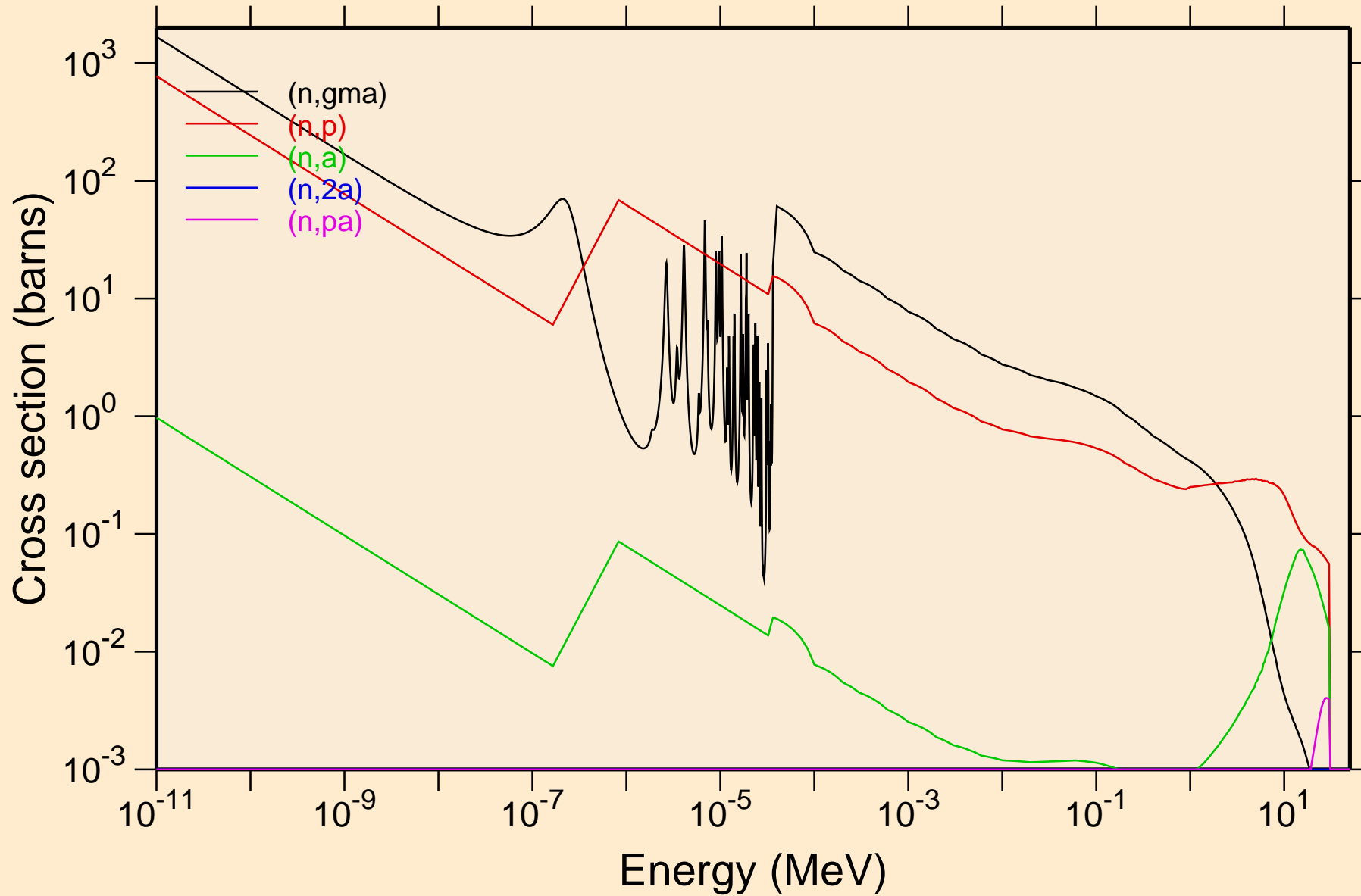

SB114 NEUTRON ACER TENDL-2024 LIBRARY; T=0.K

Non-threshold reactions

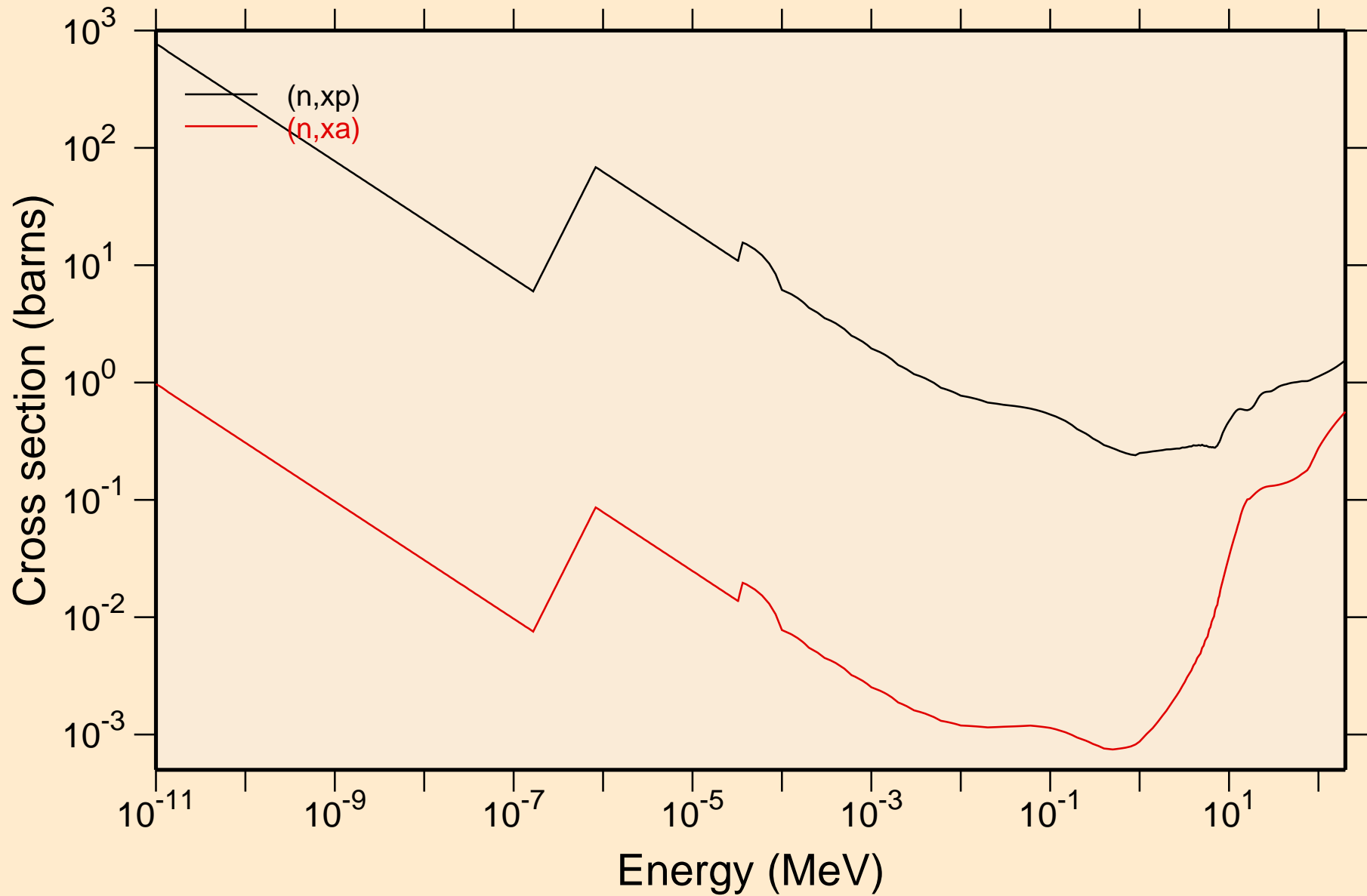

SB114 NEUTRON ACER TENDL-2024 LIBRARY; T=0.K

Principal cross sections

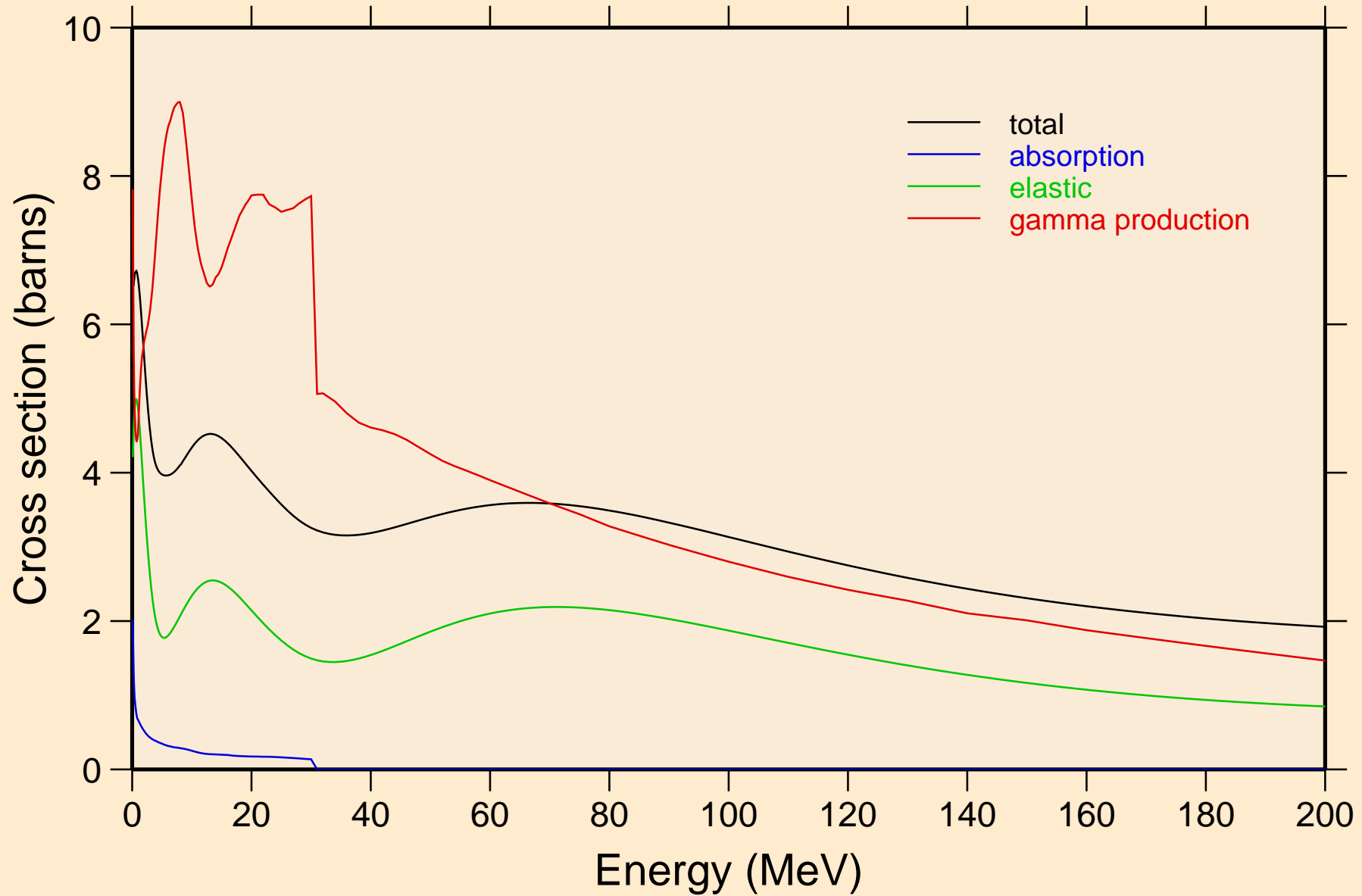

SB114 NEUTRON ACER TENDL-2024 LIBRARY; T=0.K

Heating

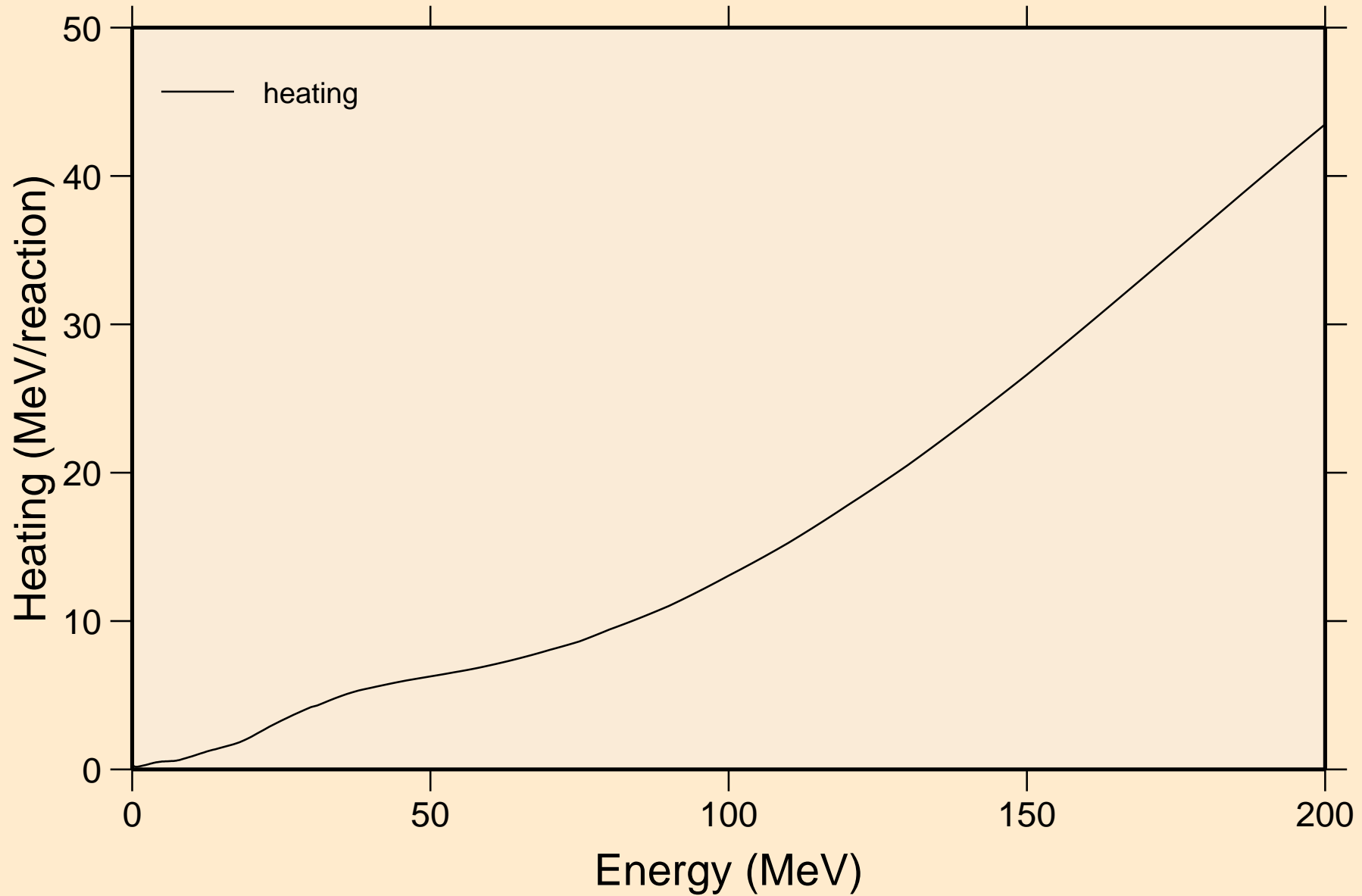

SB114 NEUTRON ACER TENDL-2024 LIBRARY; T=0.K

Damage

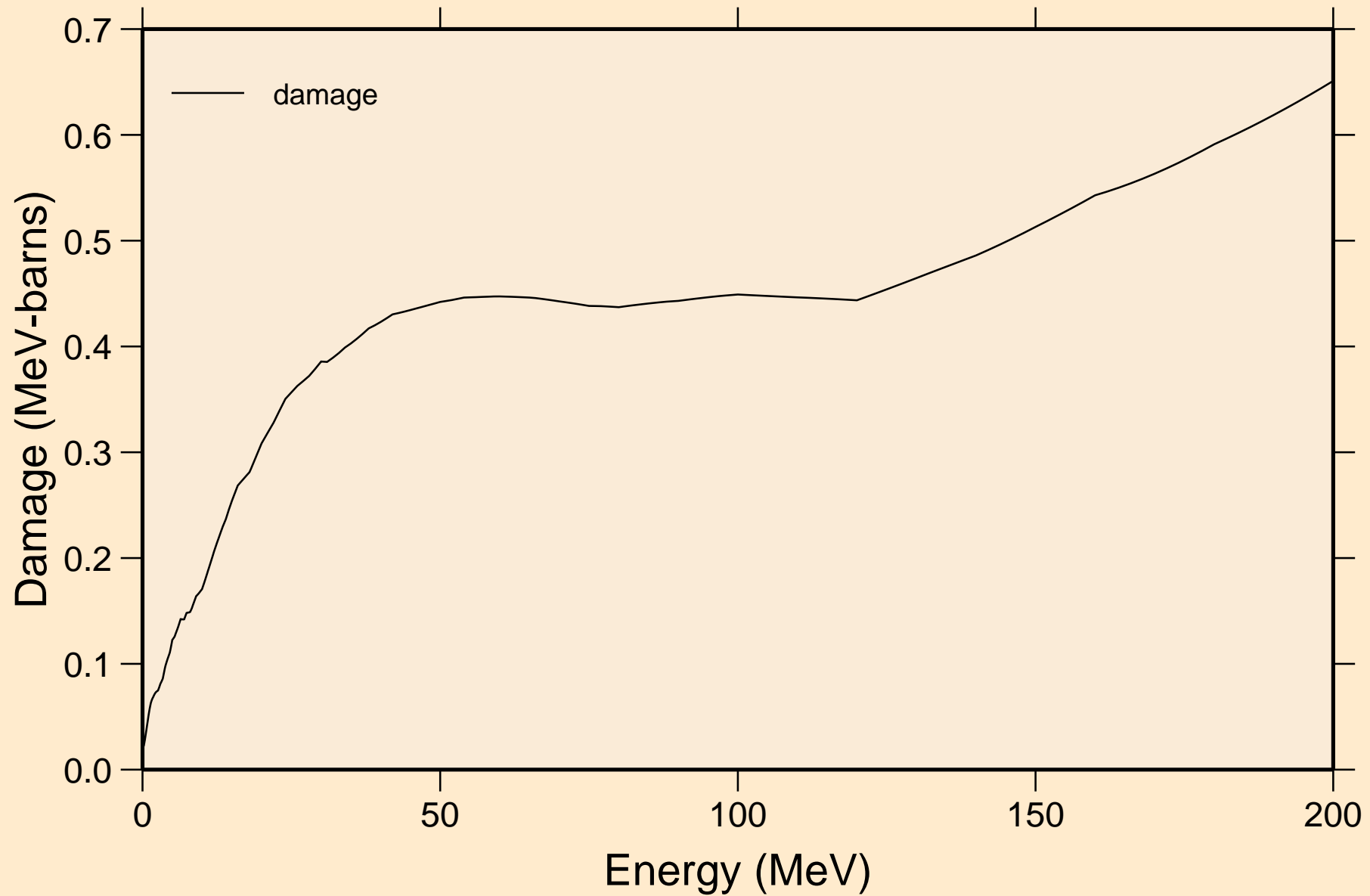

SB114 NEUTRON ACER TENDL-2024 LIBRARY; T=0.K

Non-threshold reactions

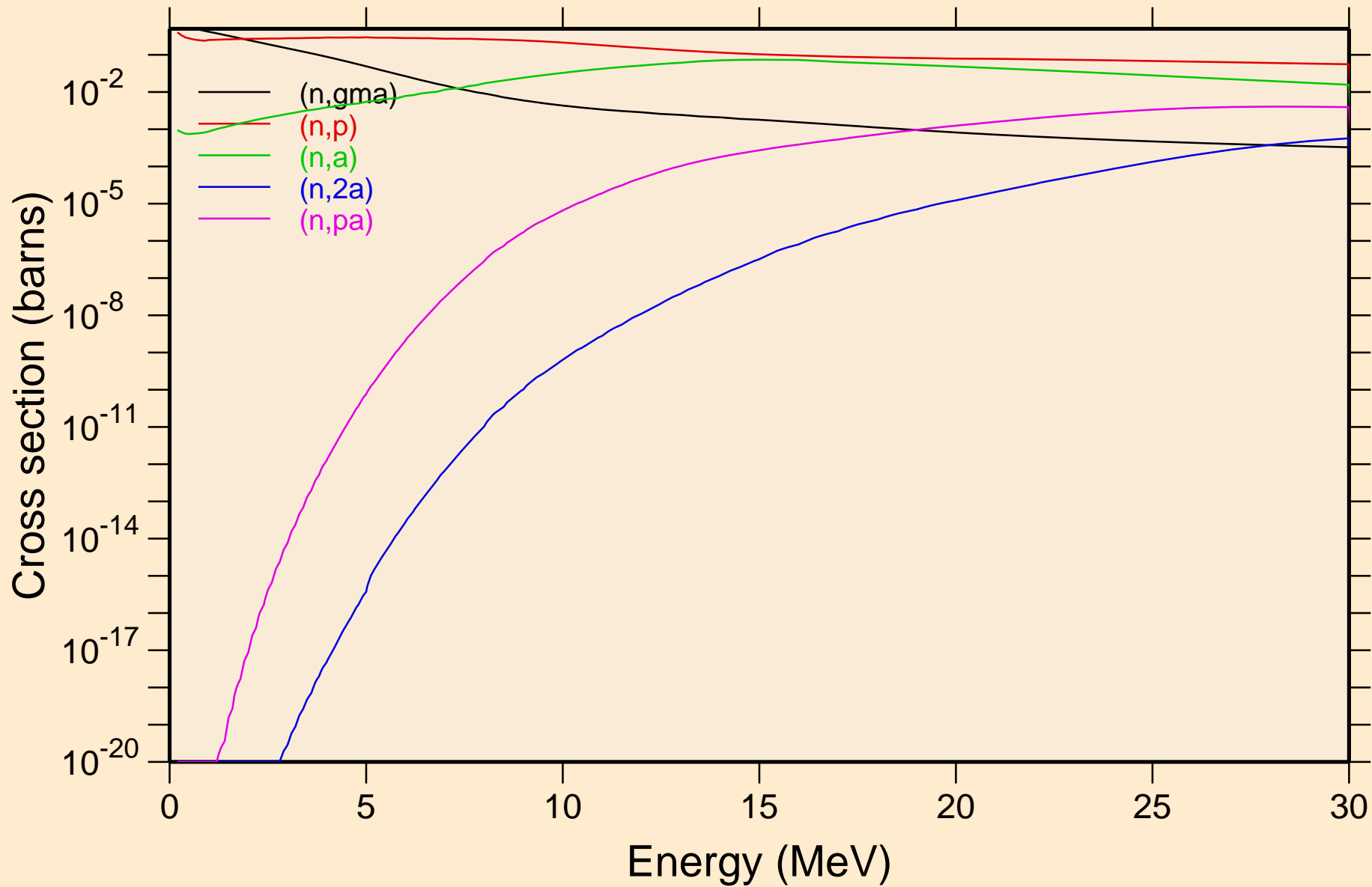

SB114 NEUTRON ACER TENDL-2024 LIBRARY; T=0.K
Non-threshold reactions

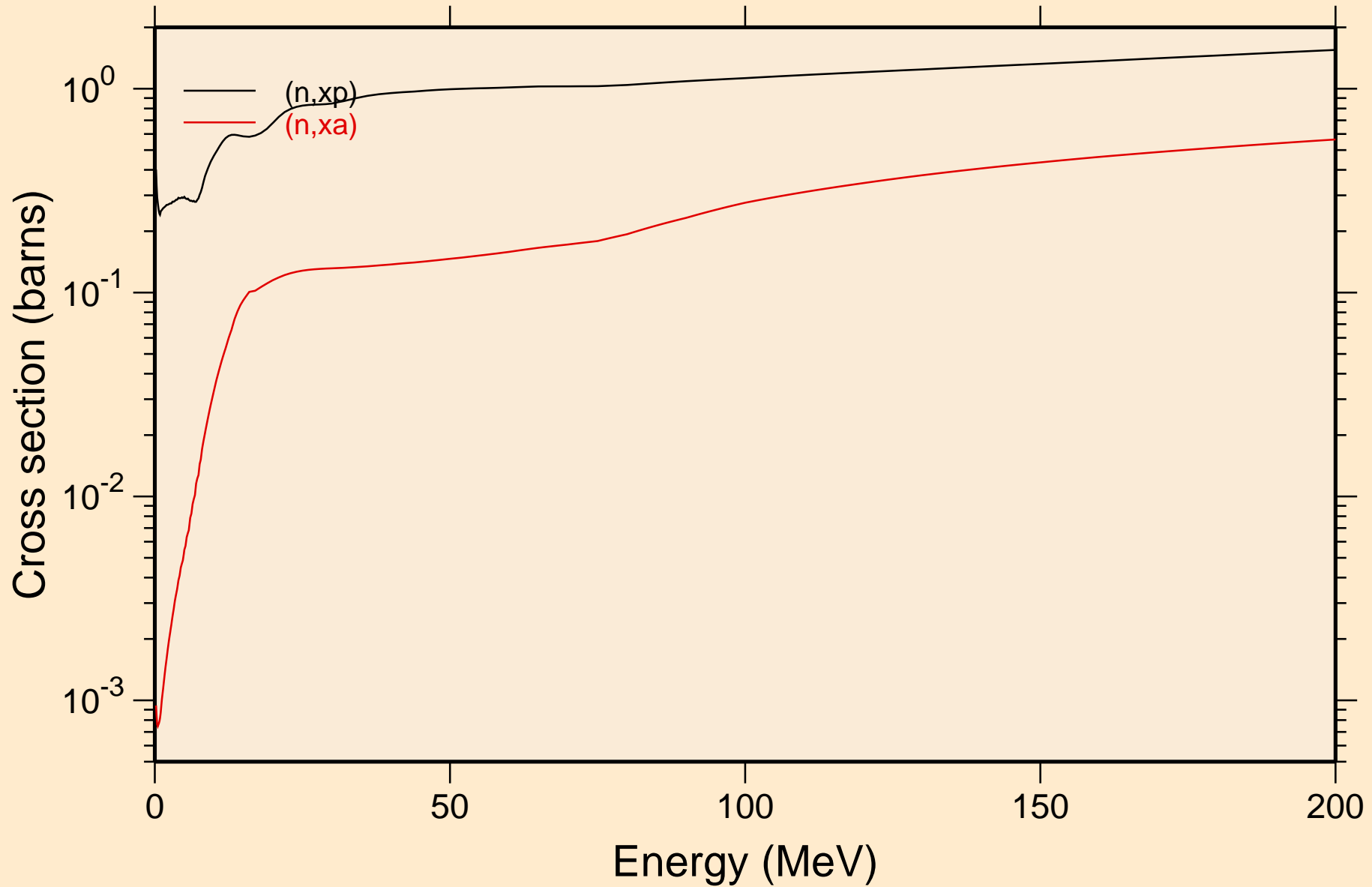

SB114 NEUTRON ACER TENDL-2024 LIBRARY; T=0.K
Inelastic levels

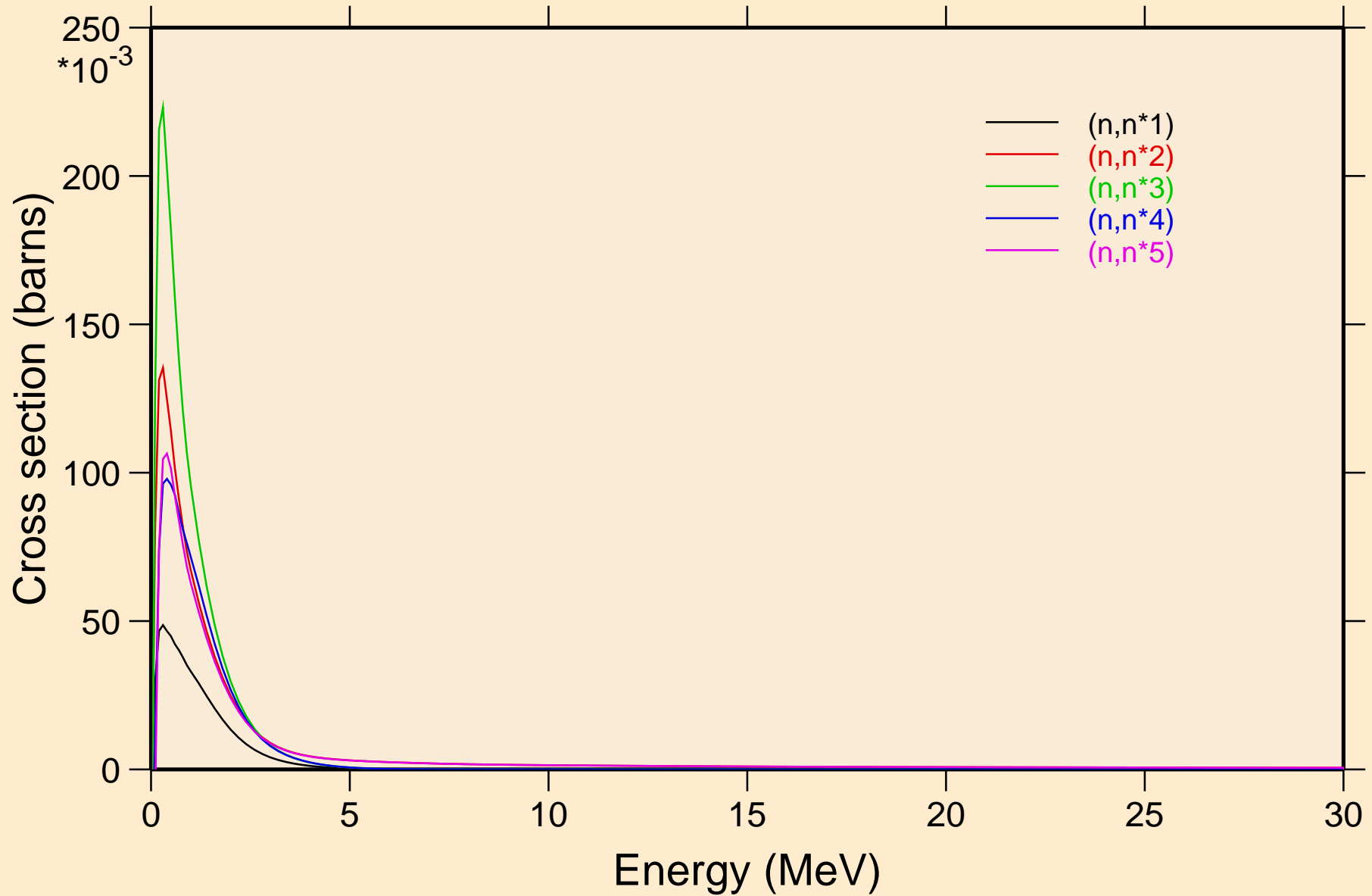

SB114 NEUTRON ACER TENDL-2024 LIBRARY; T=0.K

Inelastic levels

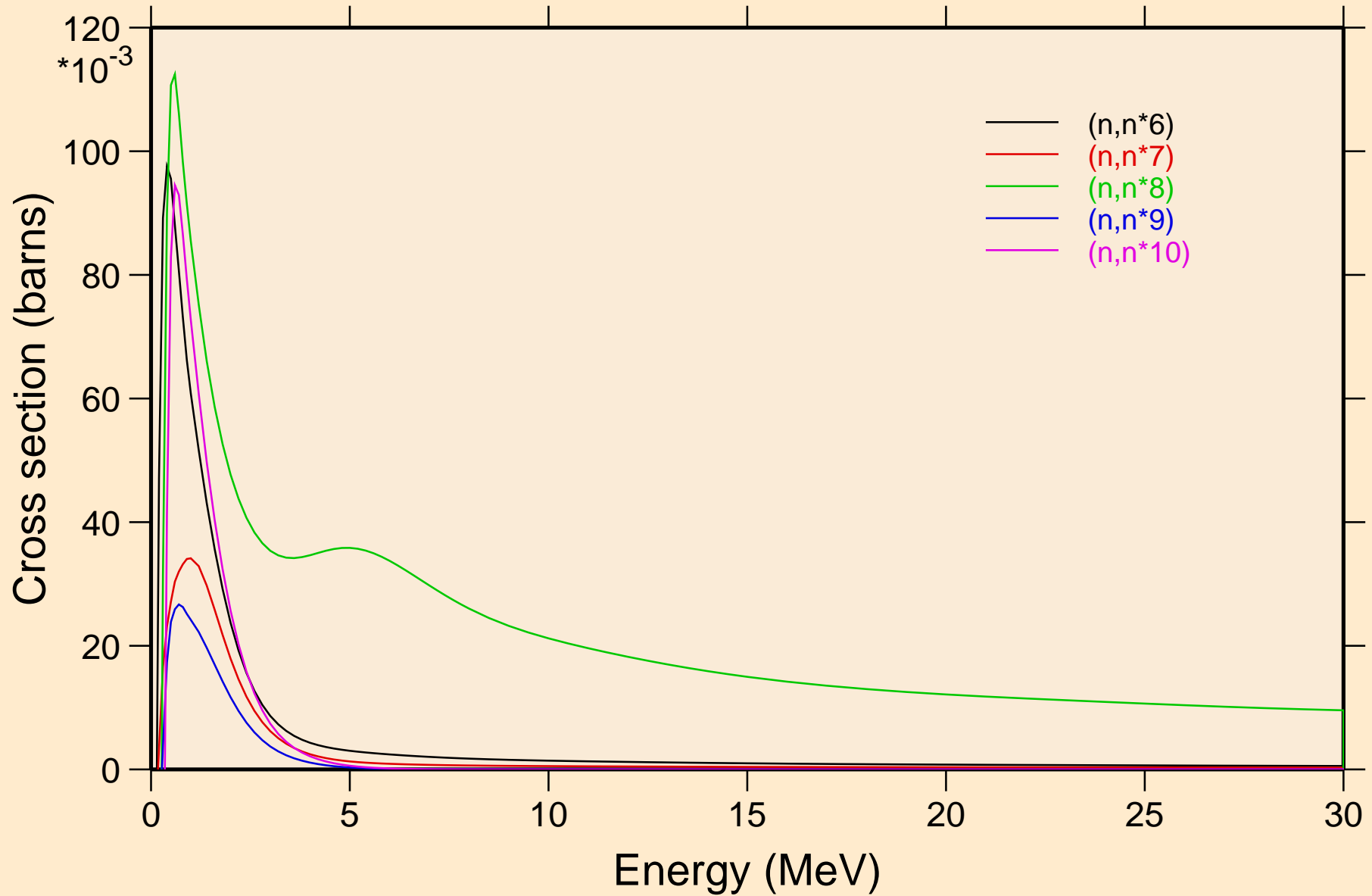

SB114 NEUTRON ACER TENDL-2024 LIBRARY; T=0.K
Inelastic levels

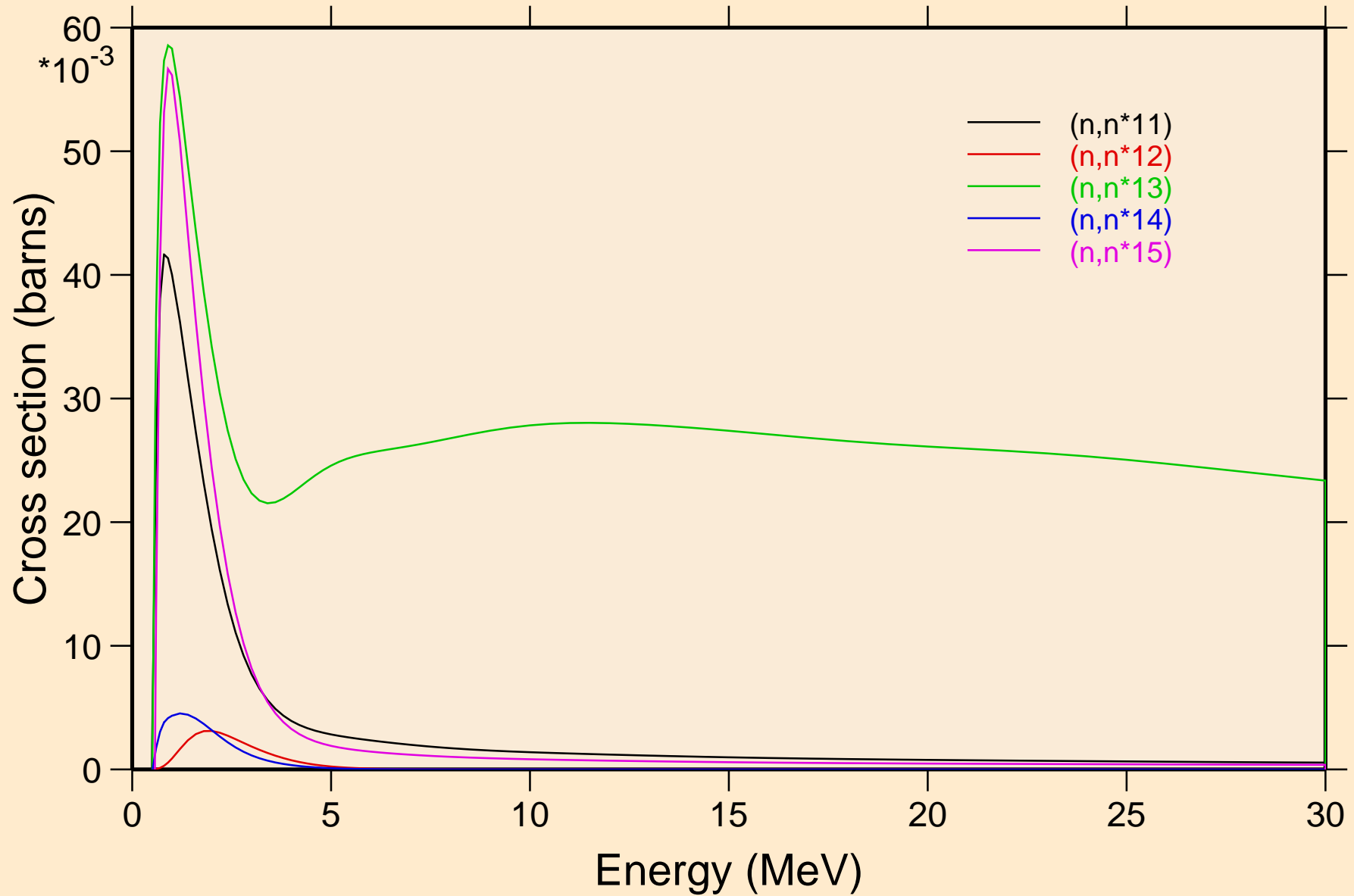

SB114 NEUTRON ACER TENDL-2024 LIBRARY; T=0.K

Inelastic levels

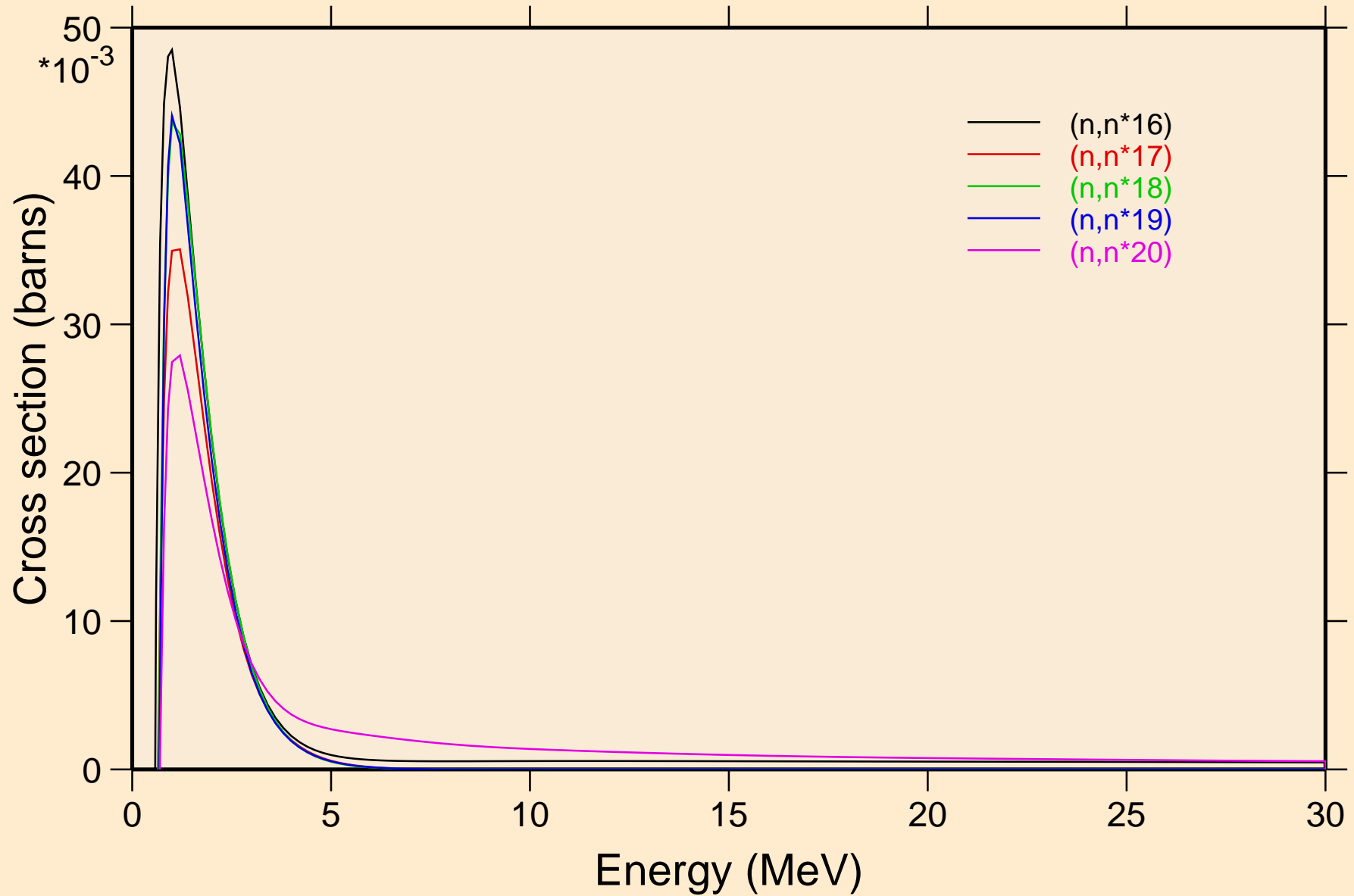

SB114 NEUTRON ACER TENDL-2024 LIBRARY; T=0.K

Inelastic levels

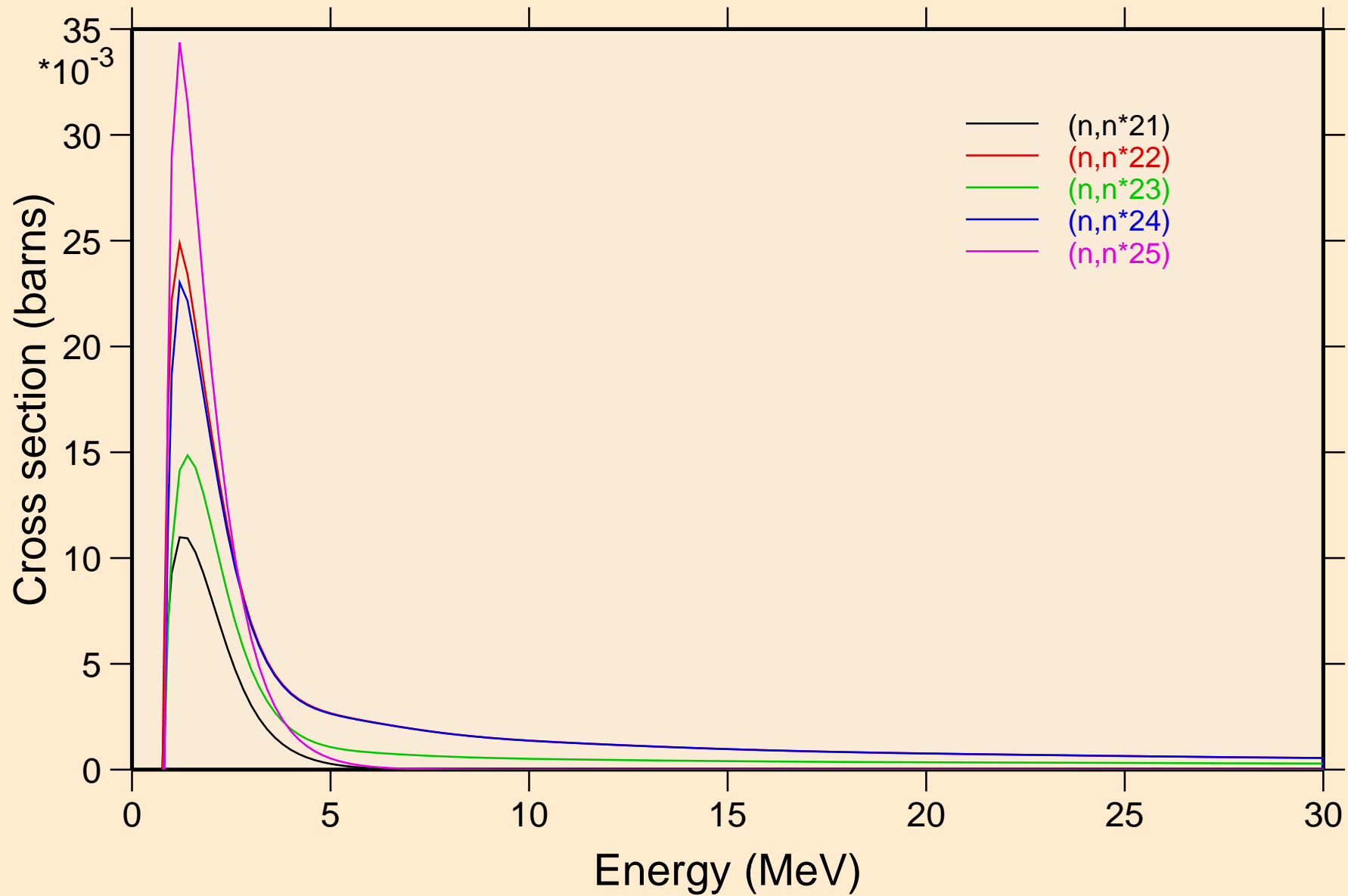

SB114 NEUTRON ACER TENDL-2024 LIBRARY; T=0.K
Inelastic levels

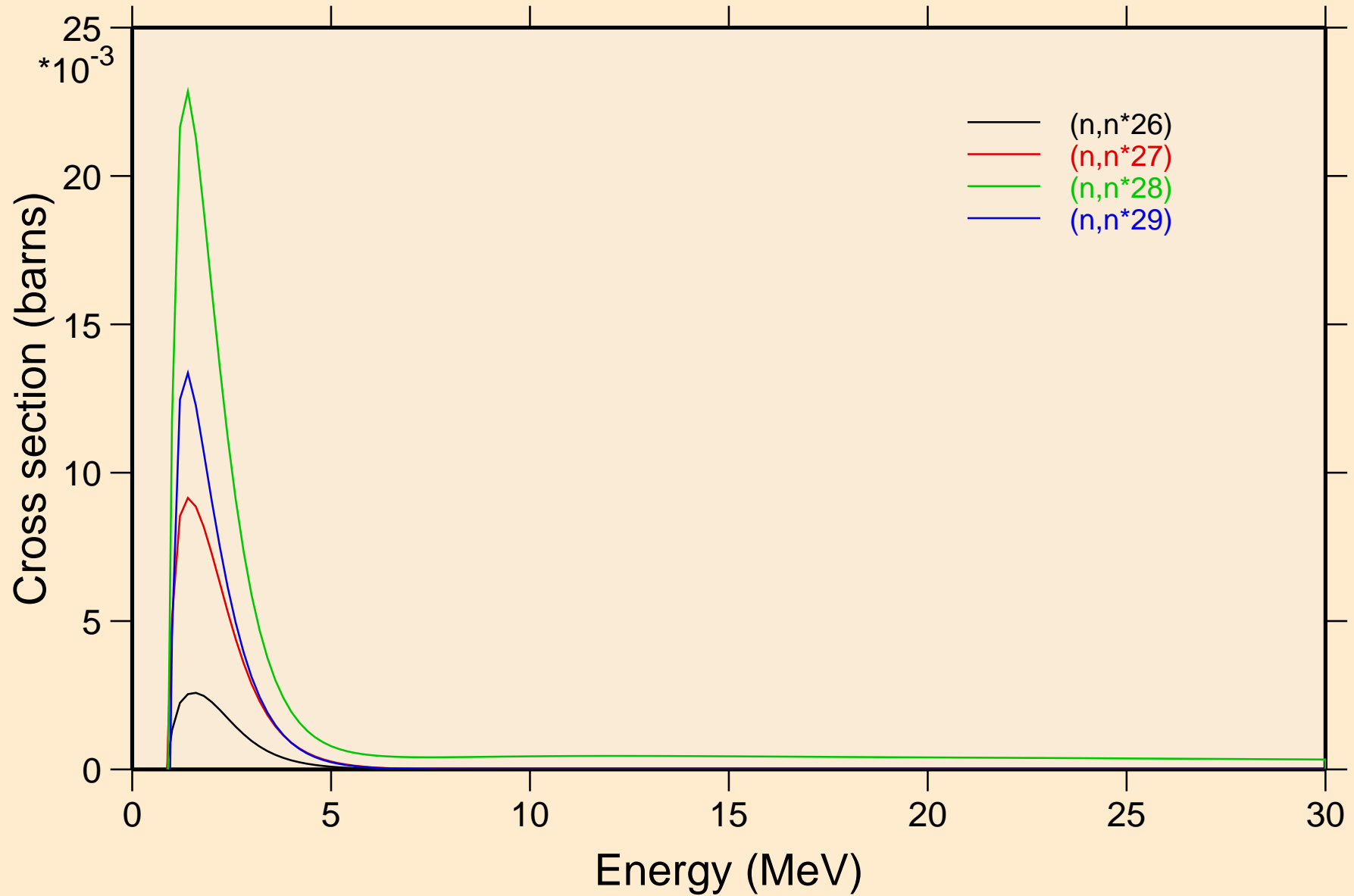

SB114 NEUTRON ACER TENDL-2024 LIBRARY; T=0.K

Threshold reactions

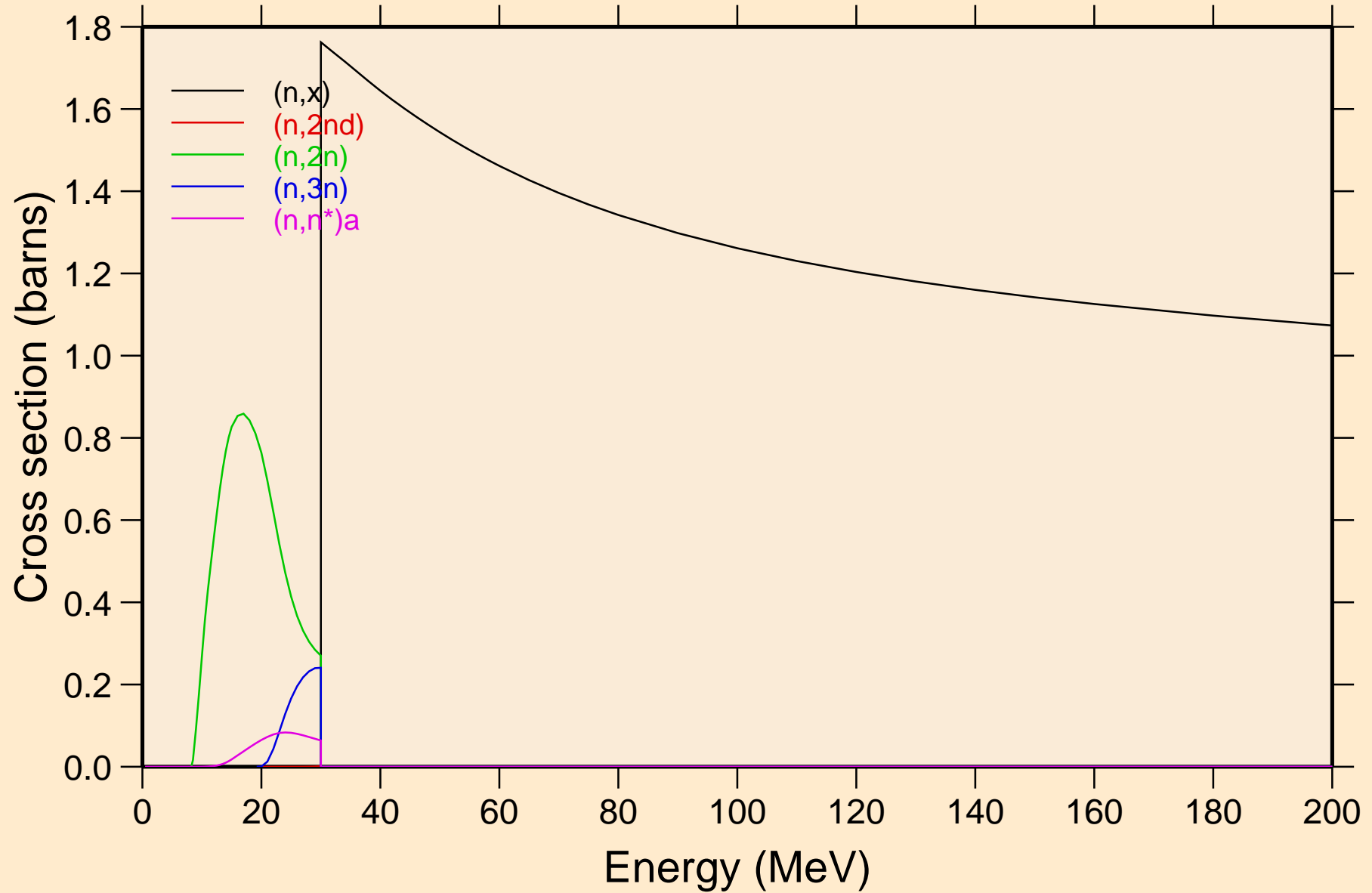

SB114 NEUTRON ACER TENDL-2024 LIBRARY; T=0.K
Threshold reactions

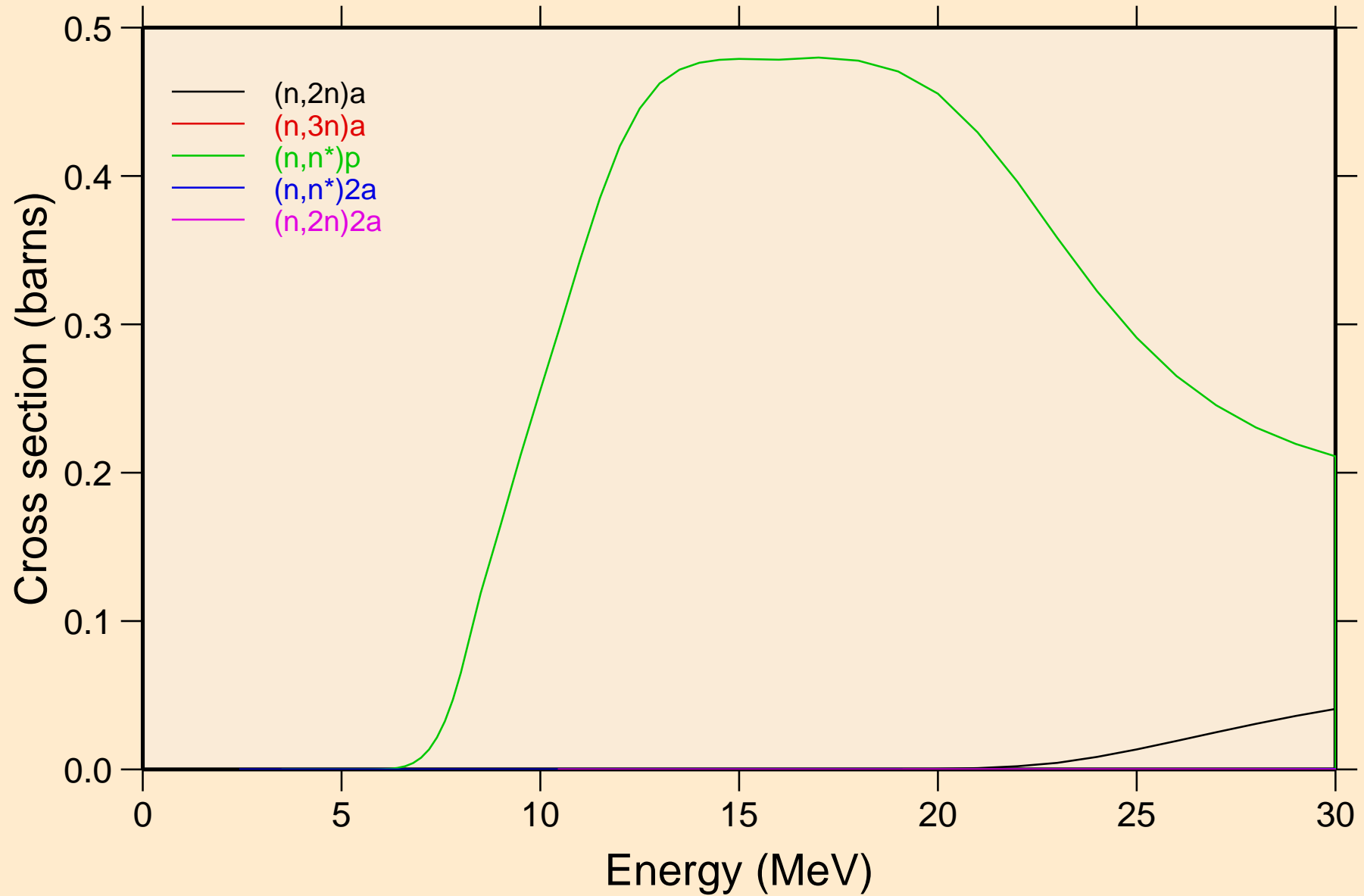

SB114 NEUTRON ACER TENDL-2024 LIBRARY; T=0.K

Threshold reactions

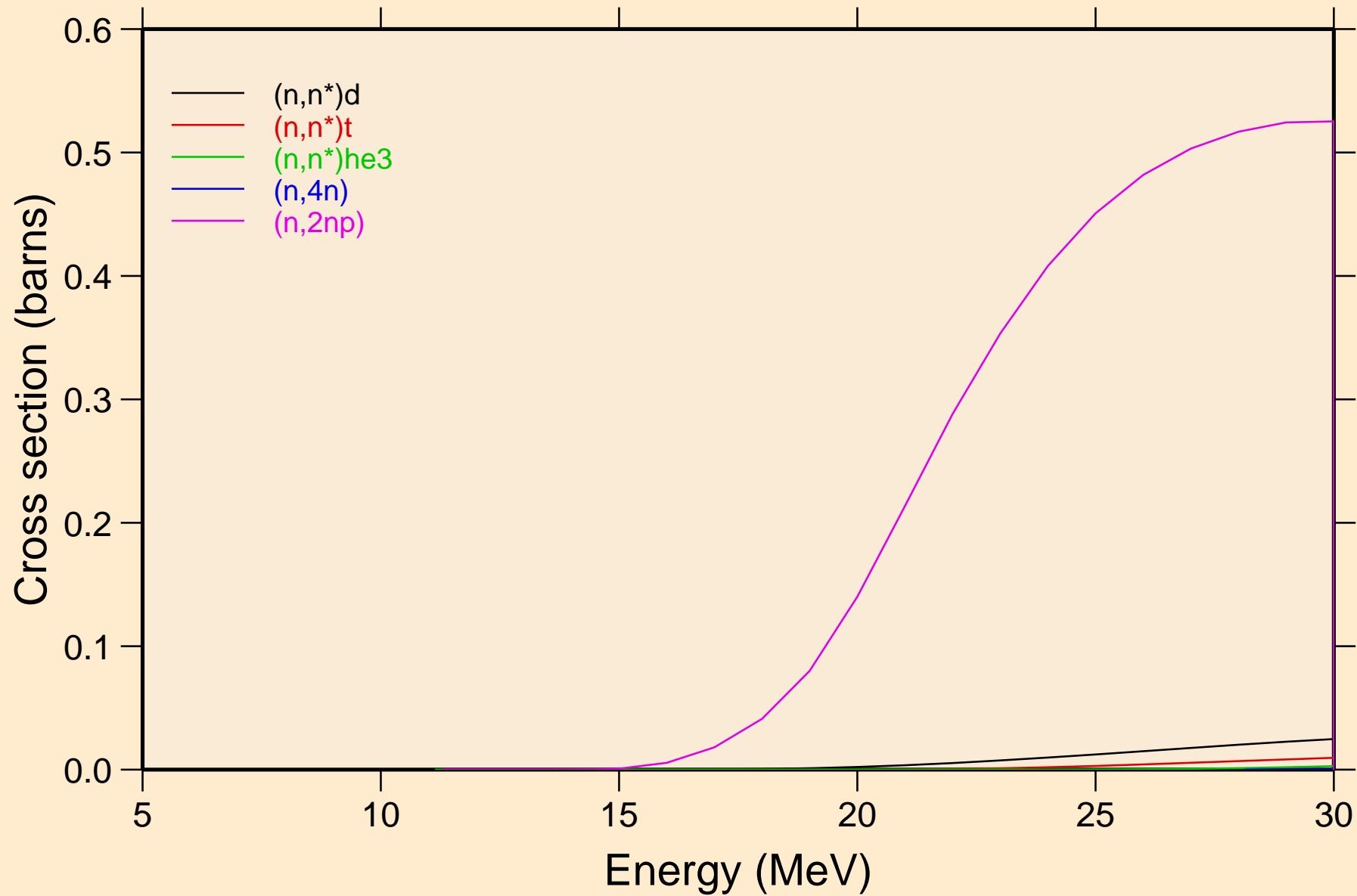

SB114 NEUTRON ACER TENDL-2024 LIBRARY; T=0.K

Threshold reactions

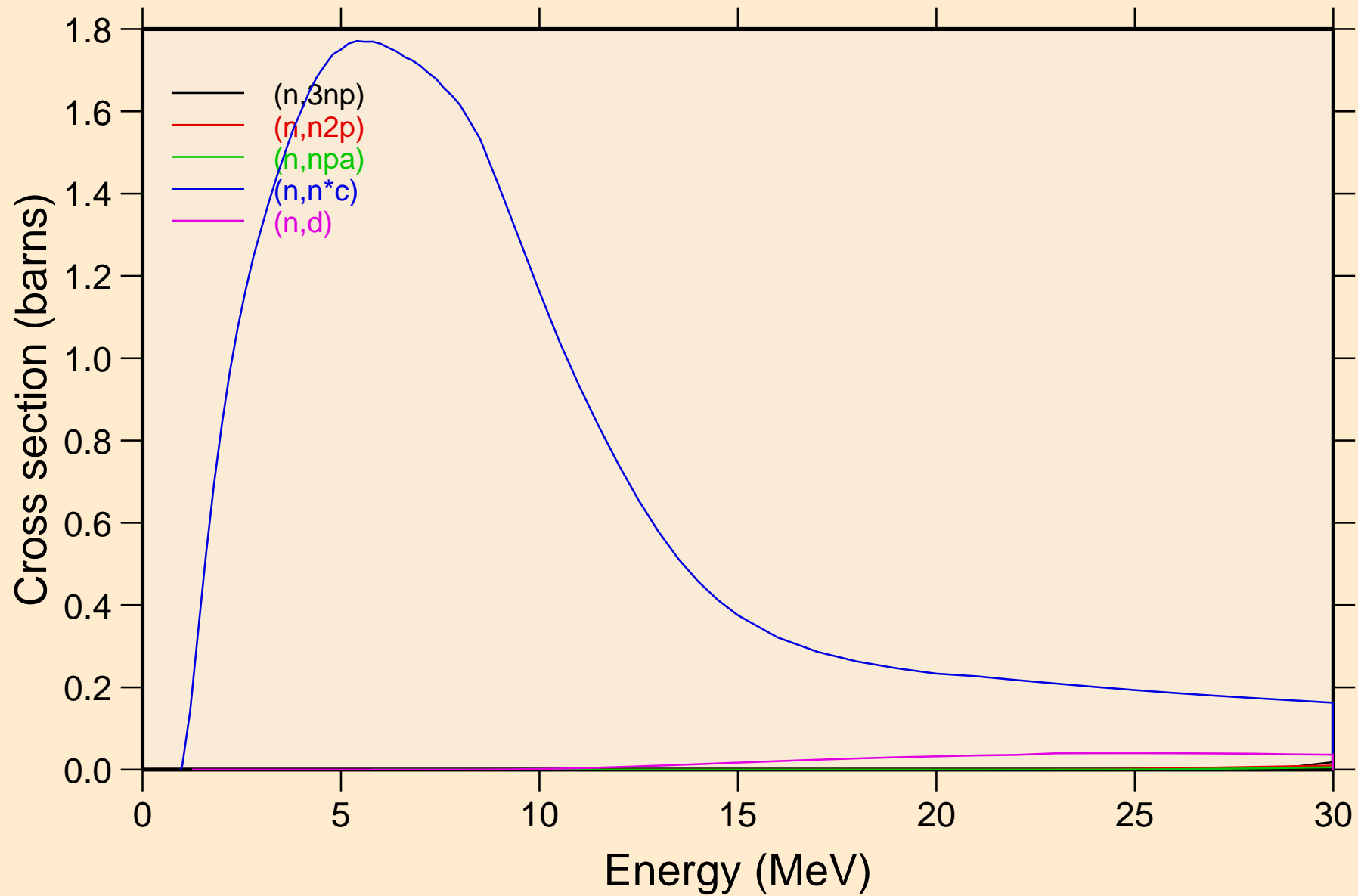

SB114 NEUTRON ACER TENDL-2024 LIBRARY; T=0.K
Threshold reactions

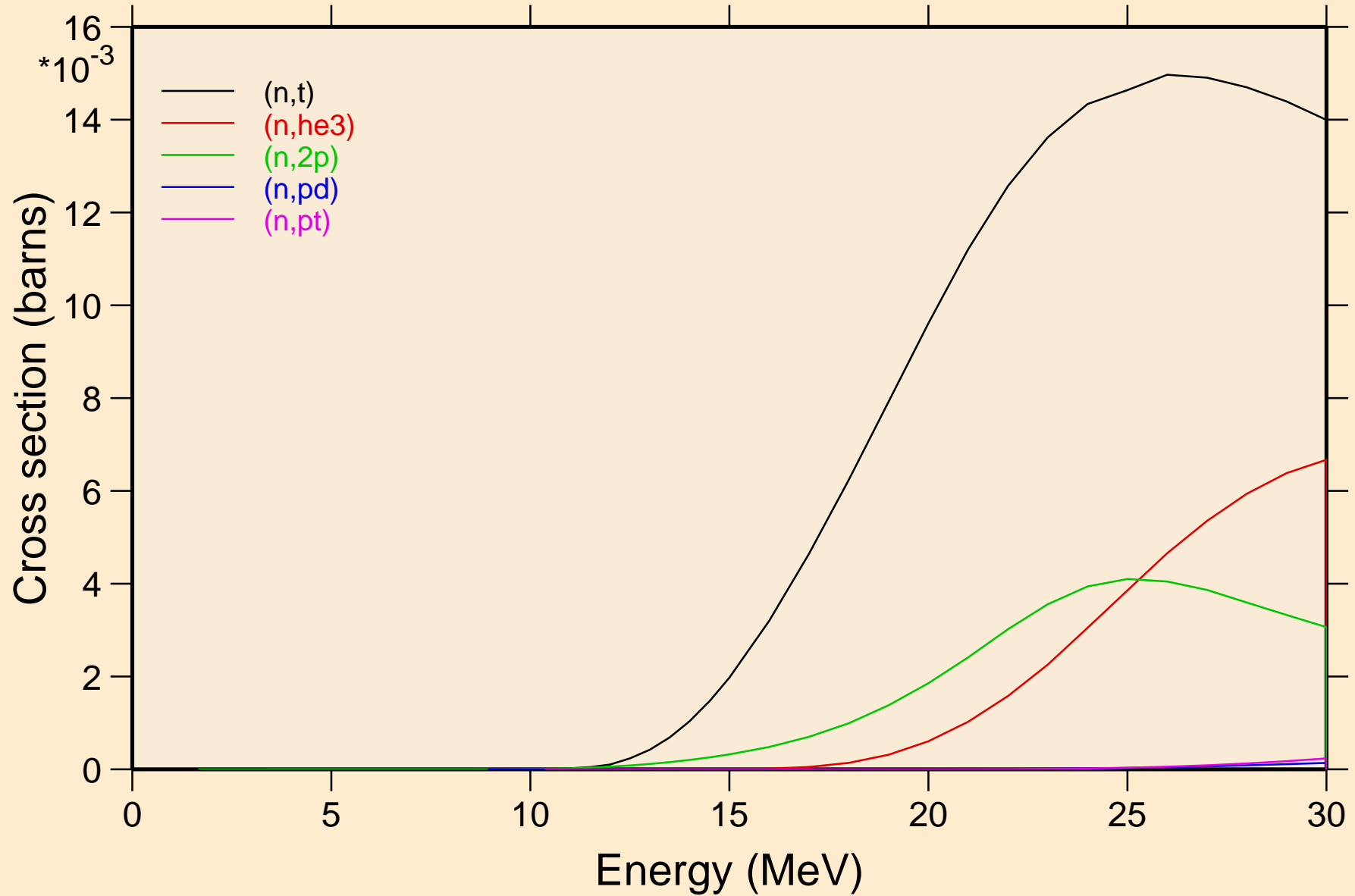

SB114 NEUTRON ACER TENDL-2024 LIBRARY; T=0.K
Threshold reactions

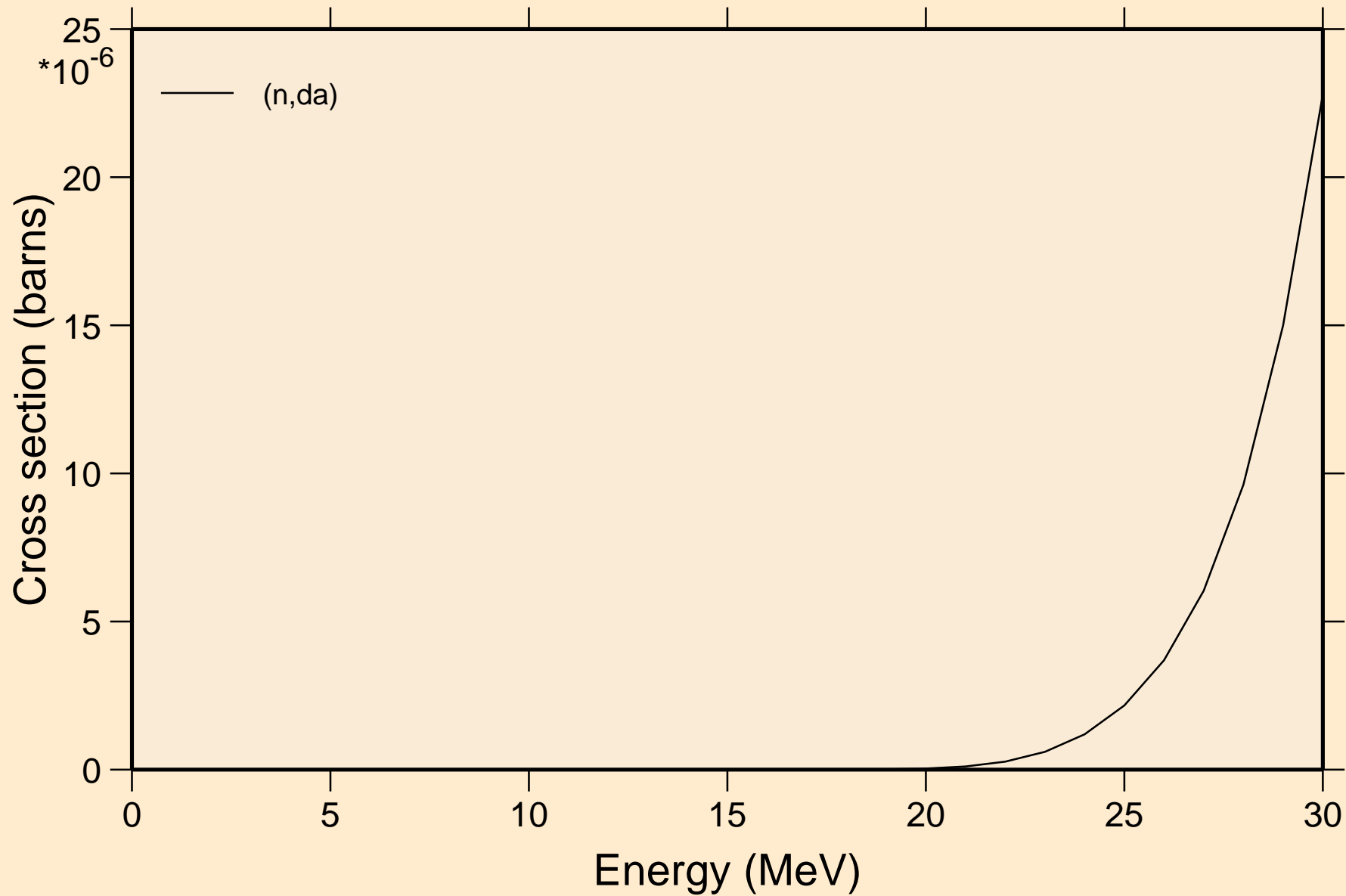

SB114 NEUTRON ACER TENDL-2024 LIBRARY; T=0.K

Threshold reactions

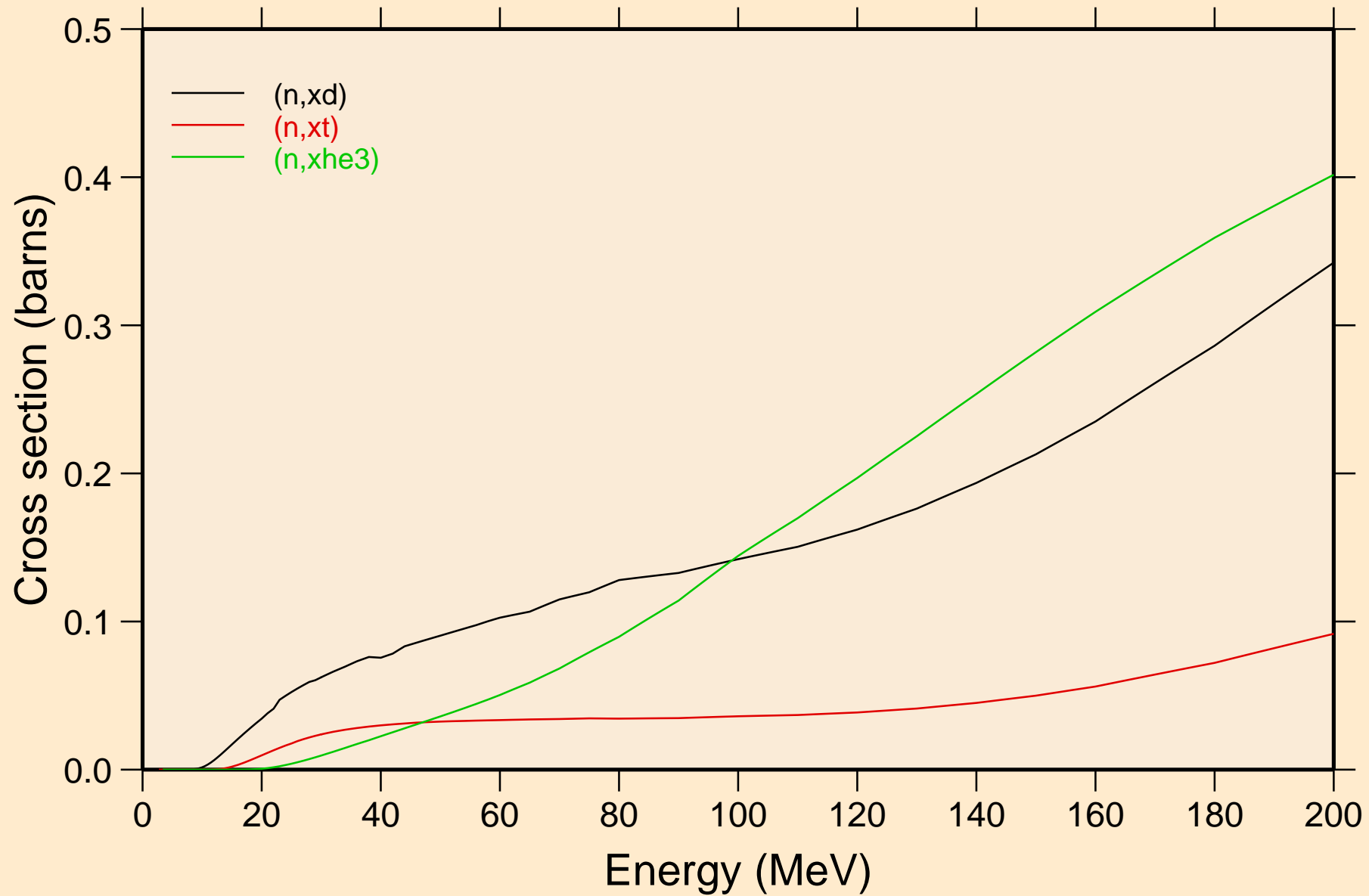

SB114 NEUTRON ACER TENDL-2024 LIBRARY; T=0.K
angular distribution for elastic

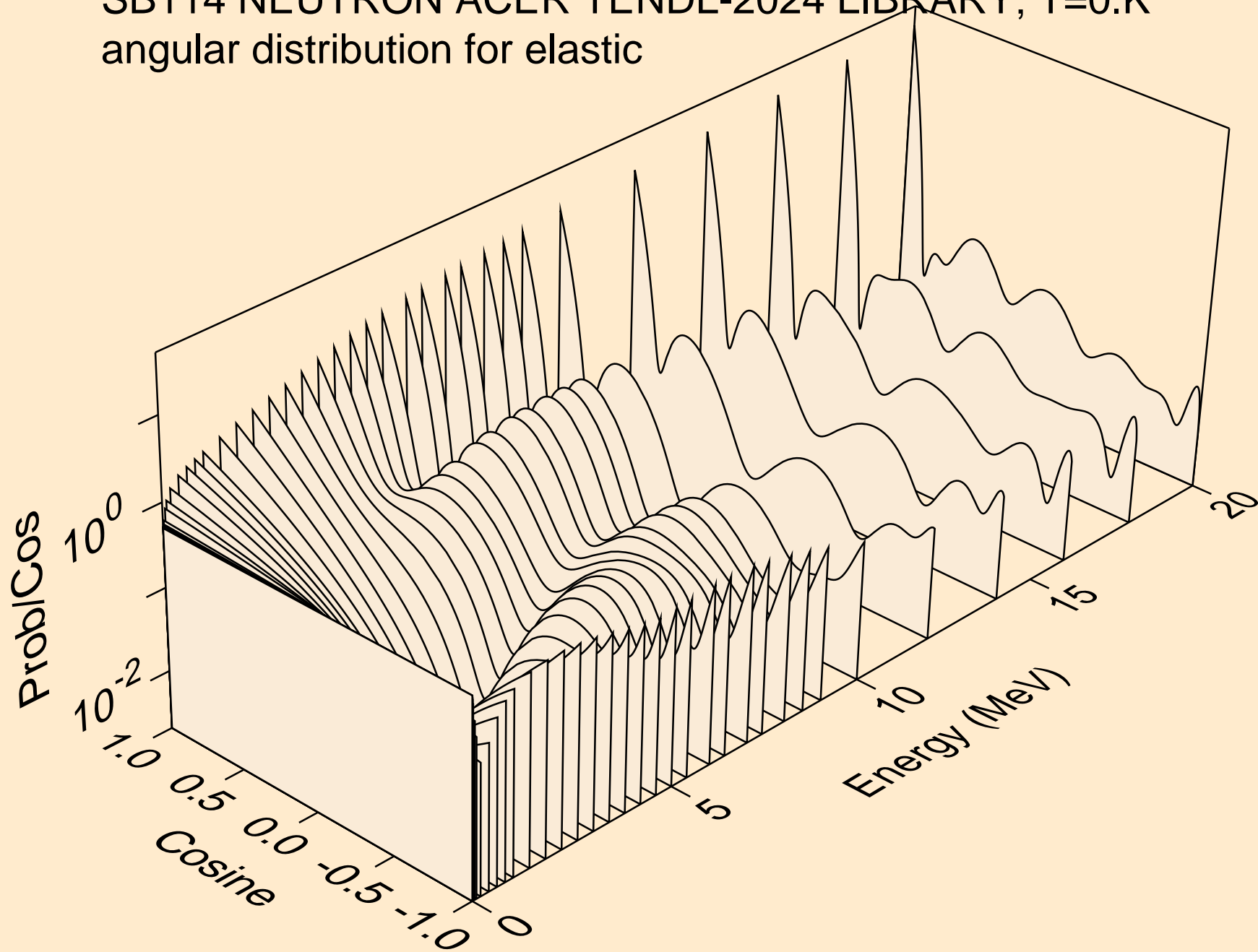

SB114 NEUTRON ACER TENDL-2024 LIBRARY; T=0.K
angular distribution for elastic

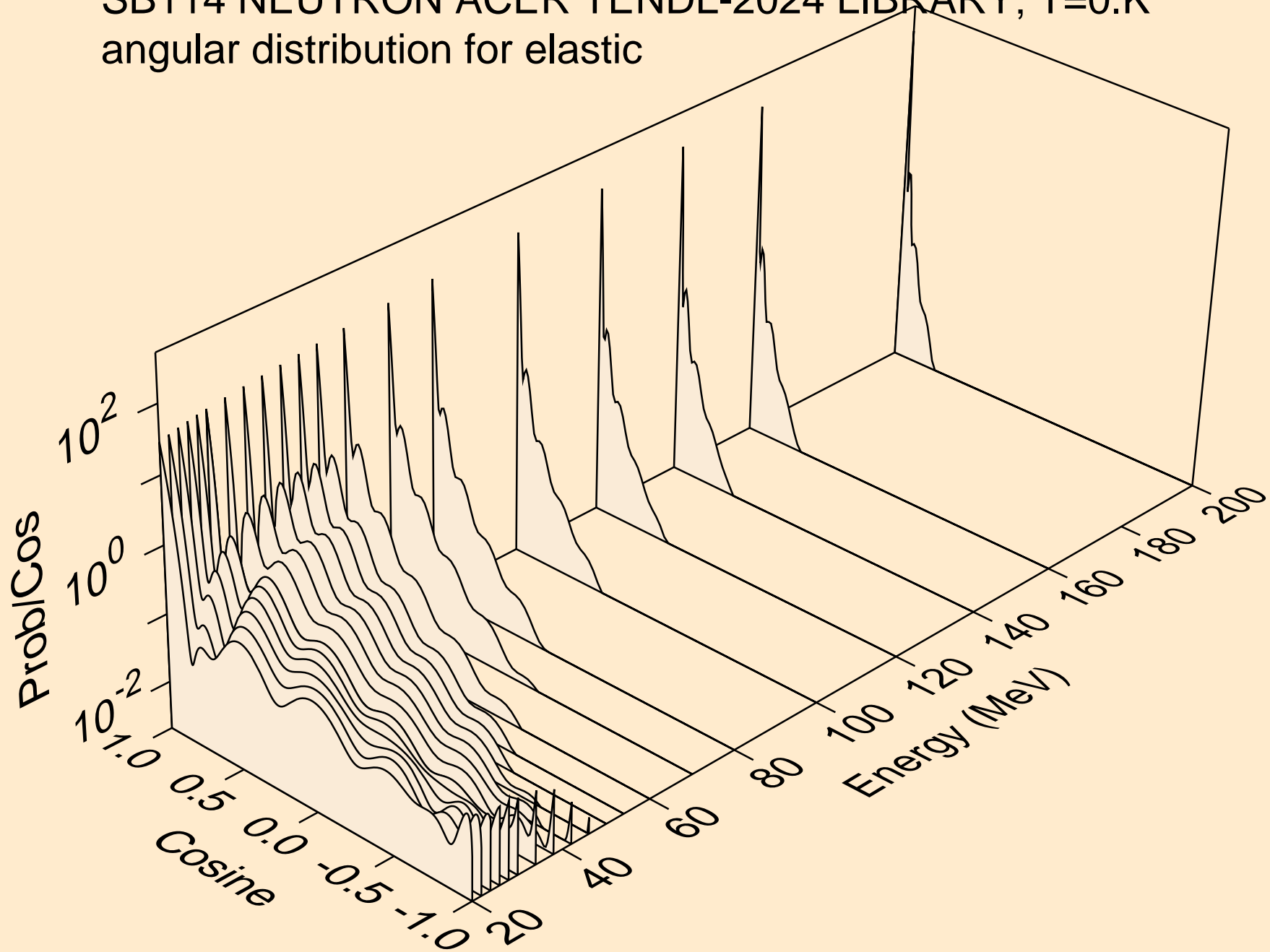

SB114 NEUTRON ACER TENDL-2024 LIBRARY; T=0.K
angular distribution for (n,n*1)

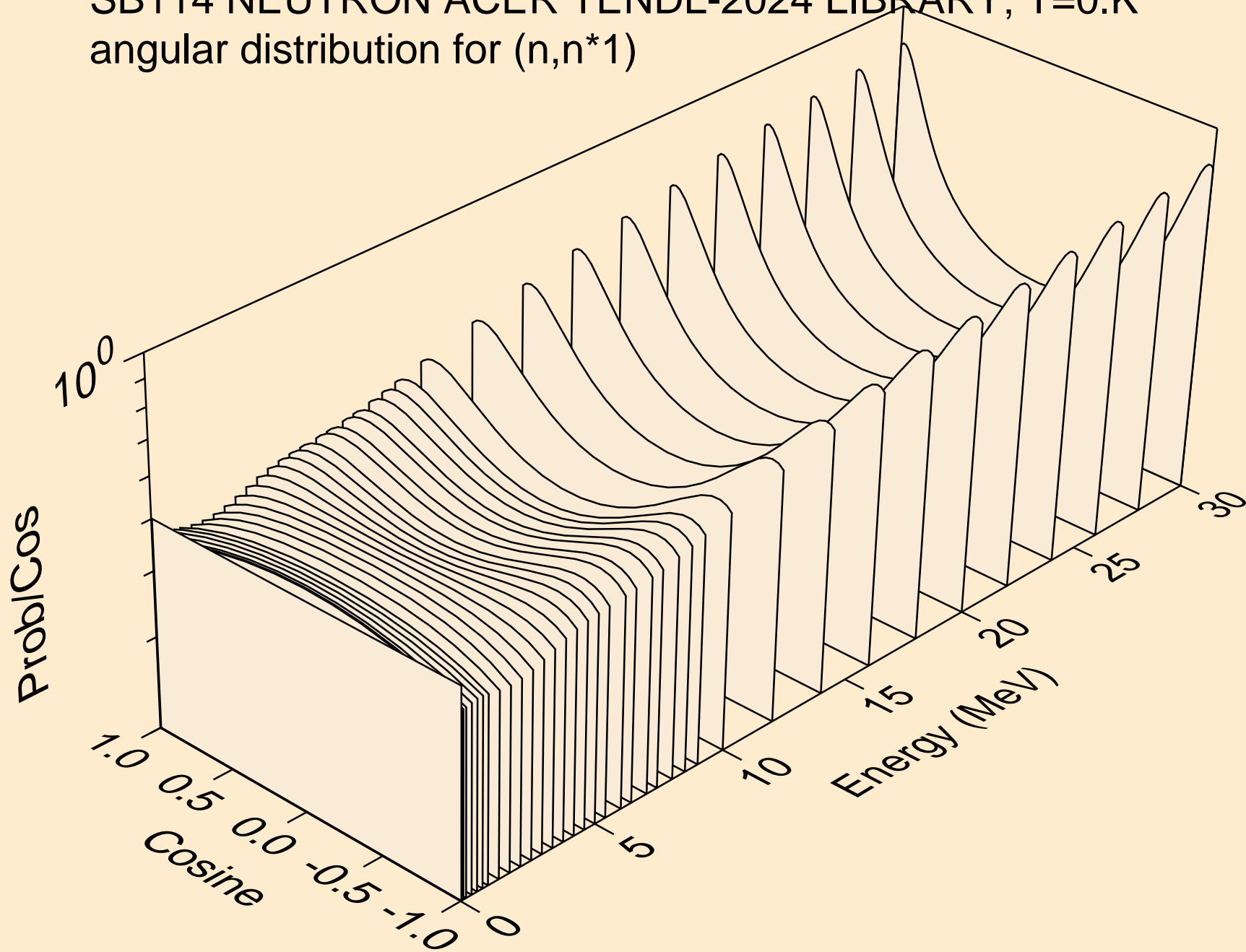

SB114 NEUTRON ACER TENDL-2024 LIBRARY; T=0.K
angular distribution for (n,n*2)

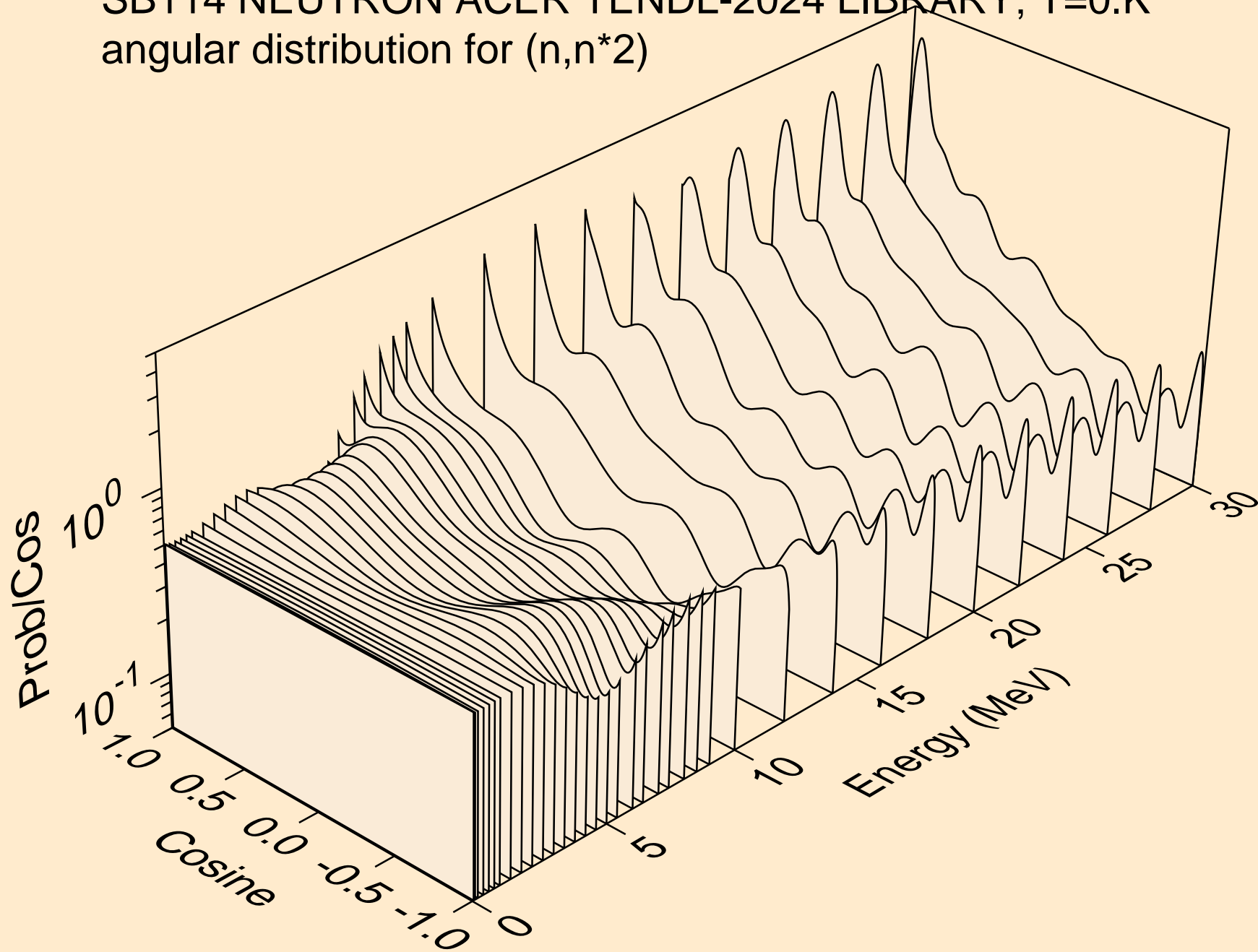

SB114 NEUTRON ACER TENDL-2024 LIBRARY; T=0.K
angular distribution for (n,n*3)

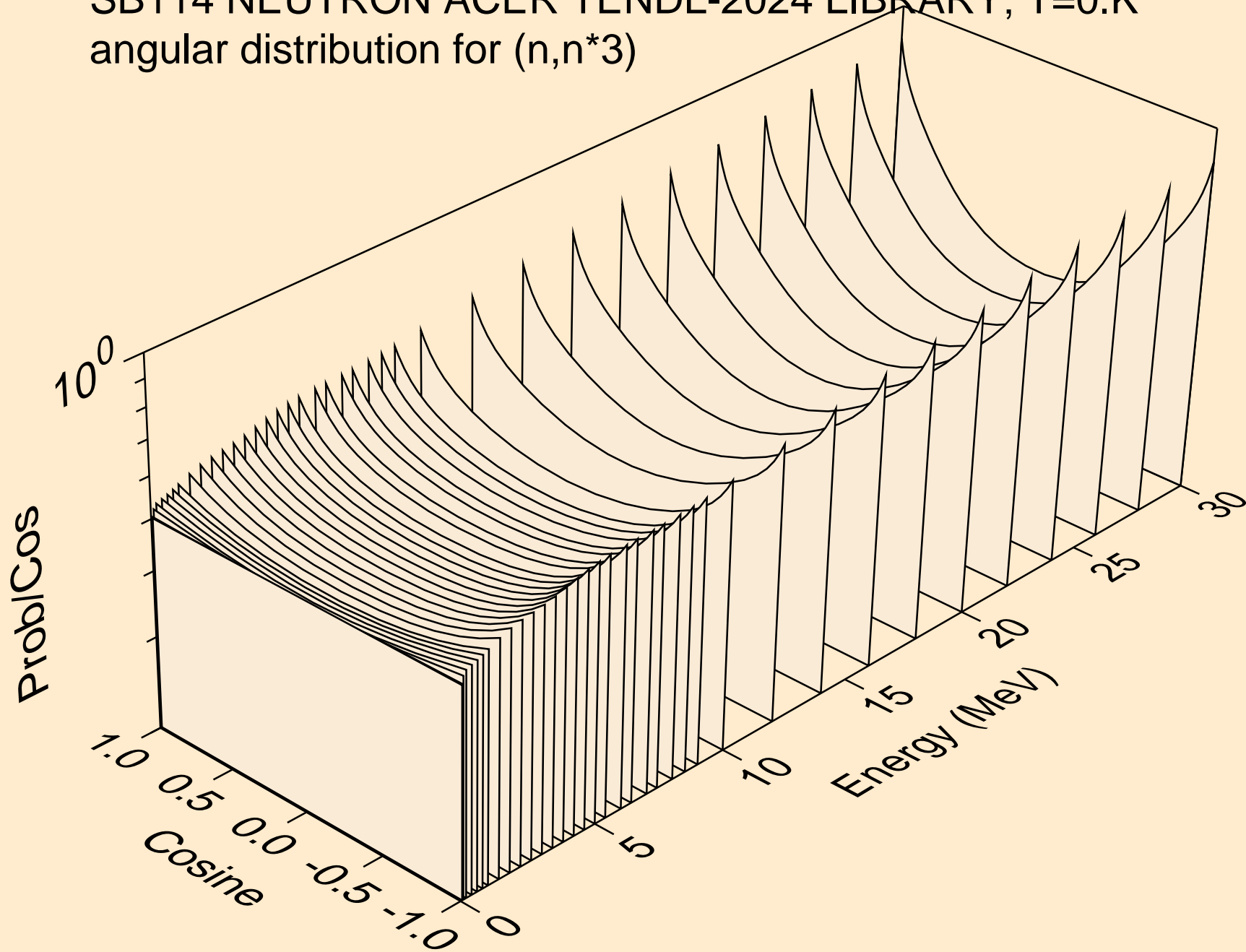

SB114 NEUTRON ACER TENDL-2024 LIBRARY; T=0.K
angular distribution for (n,n*4)

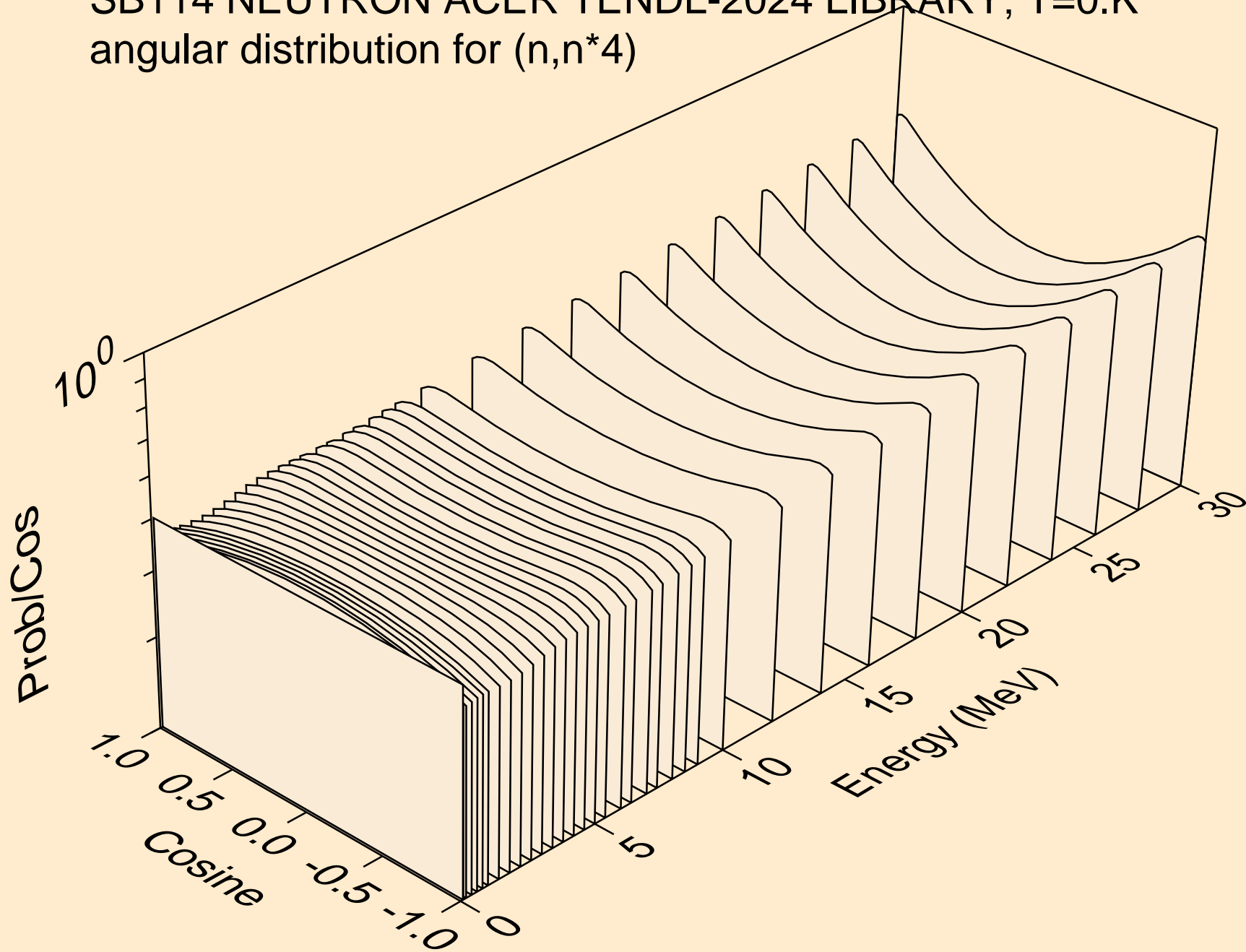

SB114 NEUTRON ACER TENDL-2024 LIBRARY; T=0.K
angular distribution for (n,n*5)

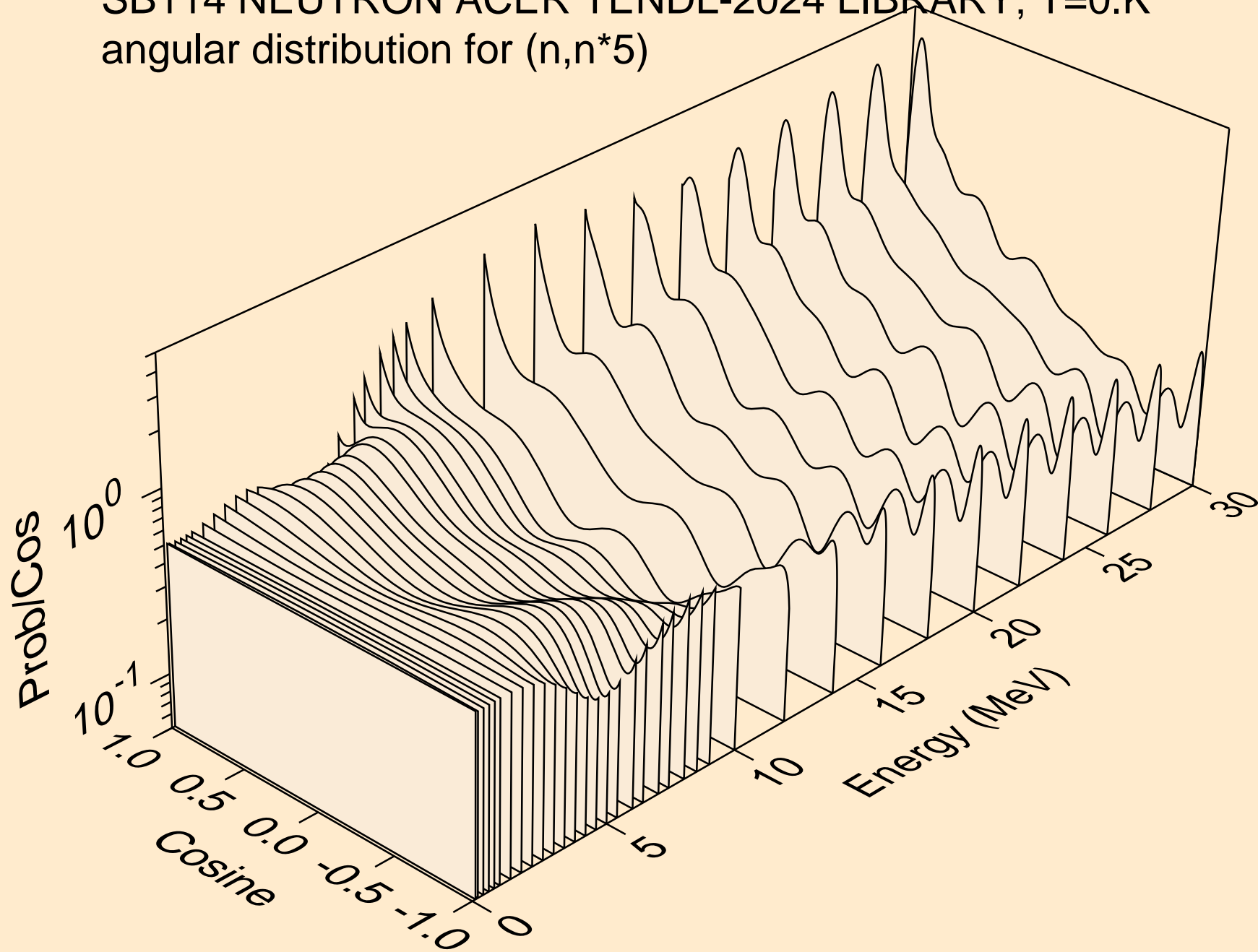

SB114 NEUTRON ACER TENDL-2024 LIBRARY; T=0.K
angular distribution for (n,n*6)

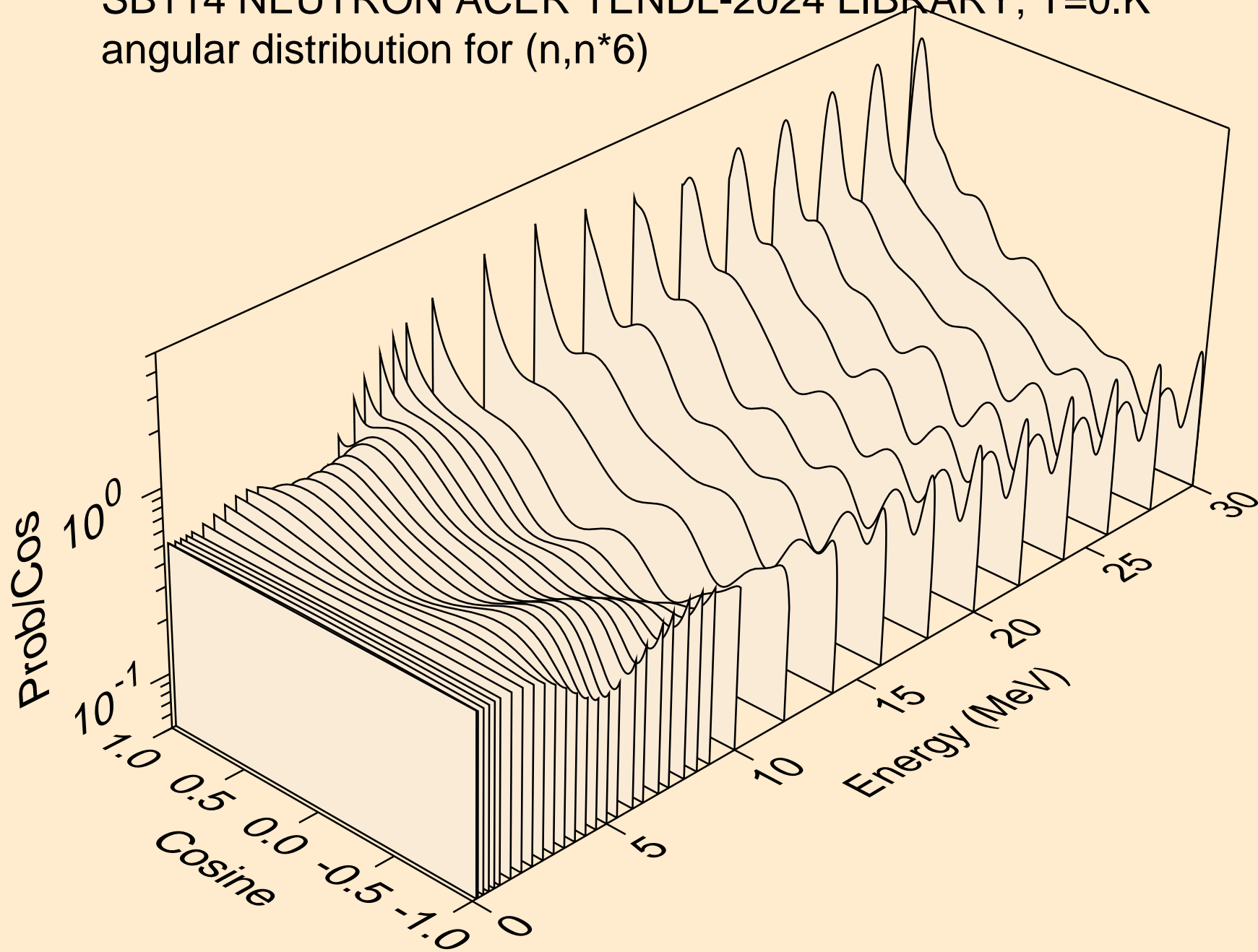

SB114 NEUTRON ACER TENDL-2024 LIBRARY; T=0.K
angular distribution for (n,n*7)

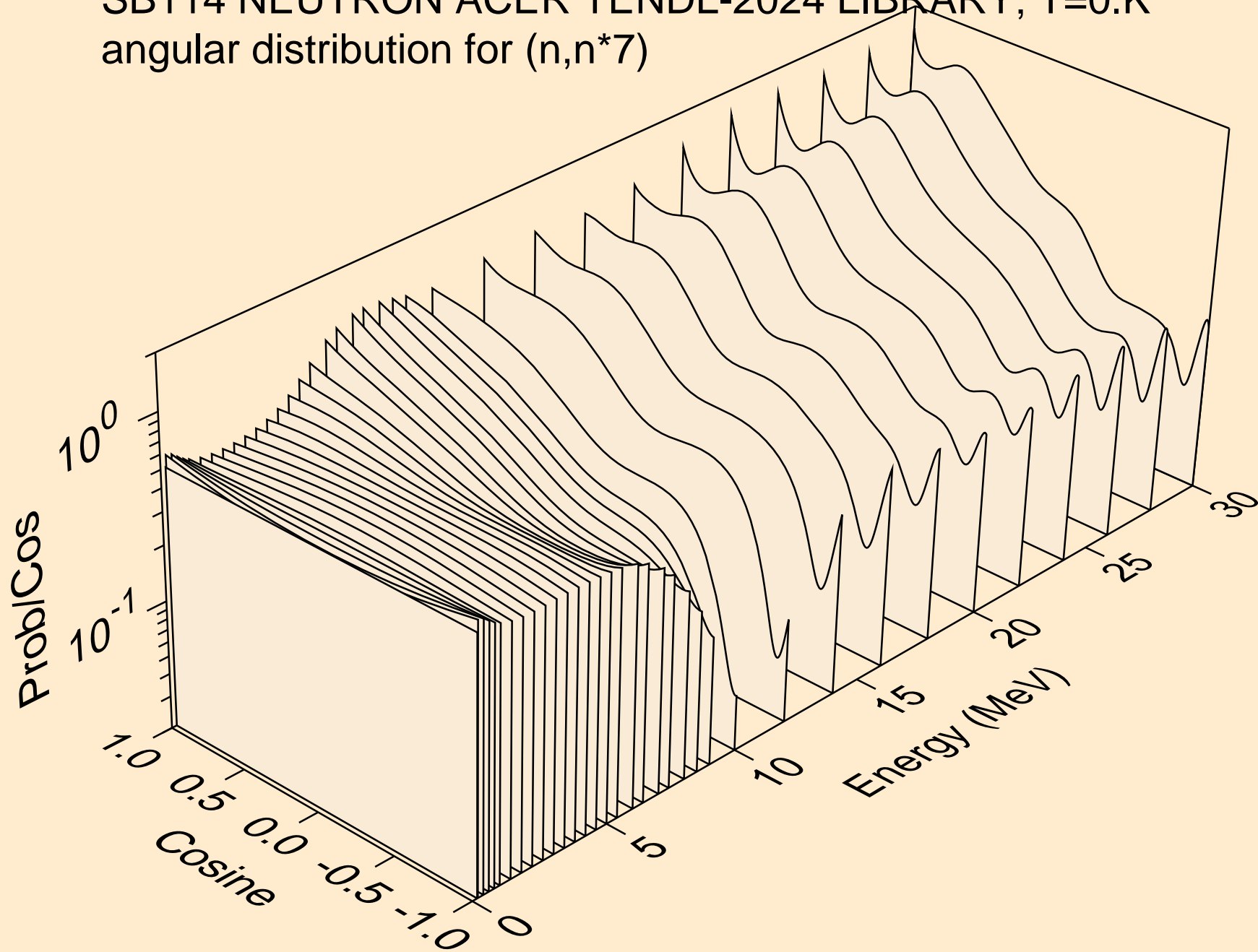

SB114 NEUTRON ACER TENDL-2024 LIBRARY; T=0.K
angular distribution for (n,n*8)

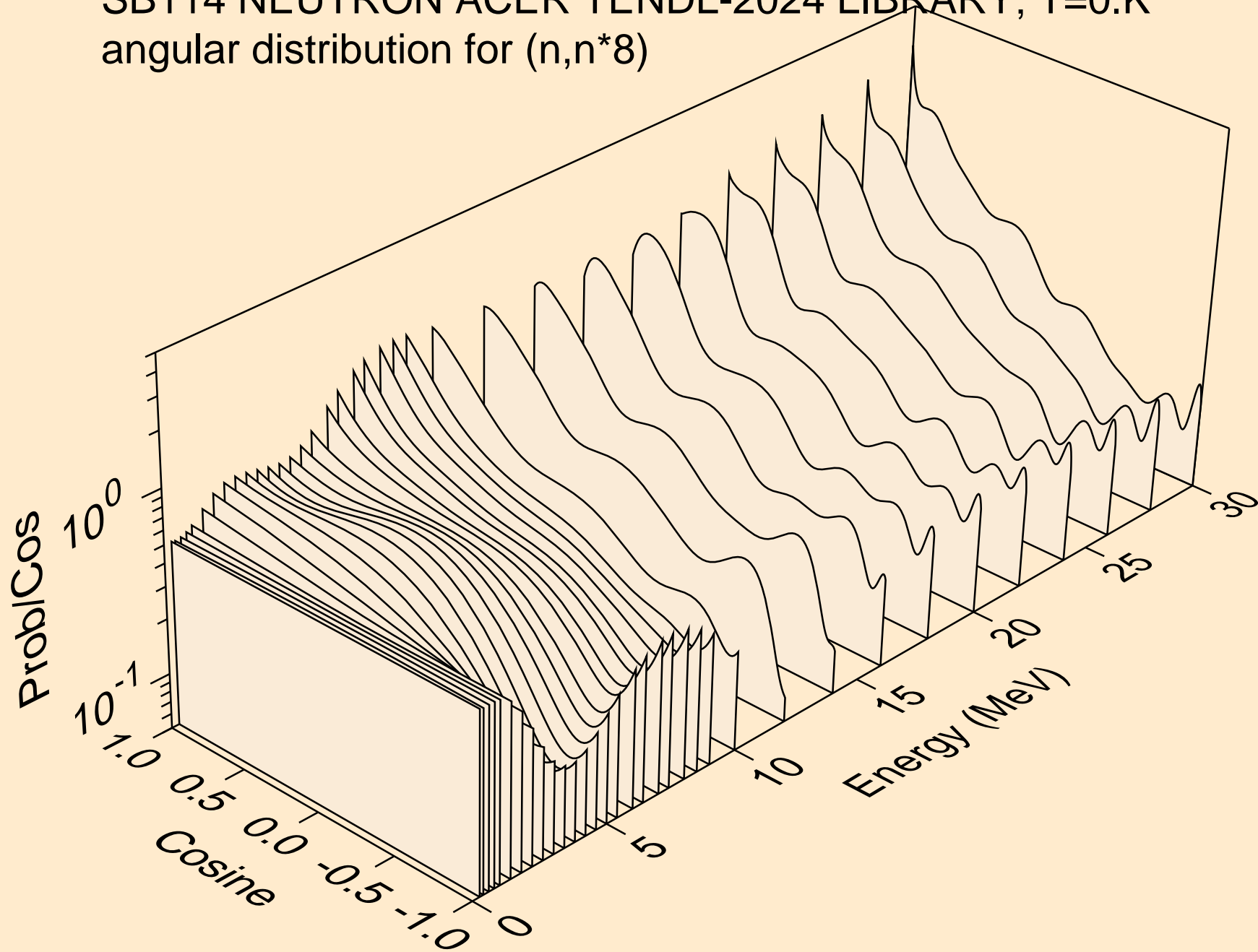

SB114 NEUTRON ACER TENDL-2024 LIBRARY; T=0.K
angular distribution for (n,n*9)

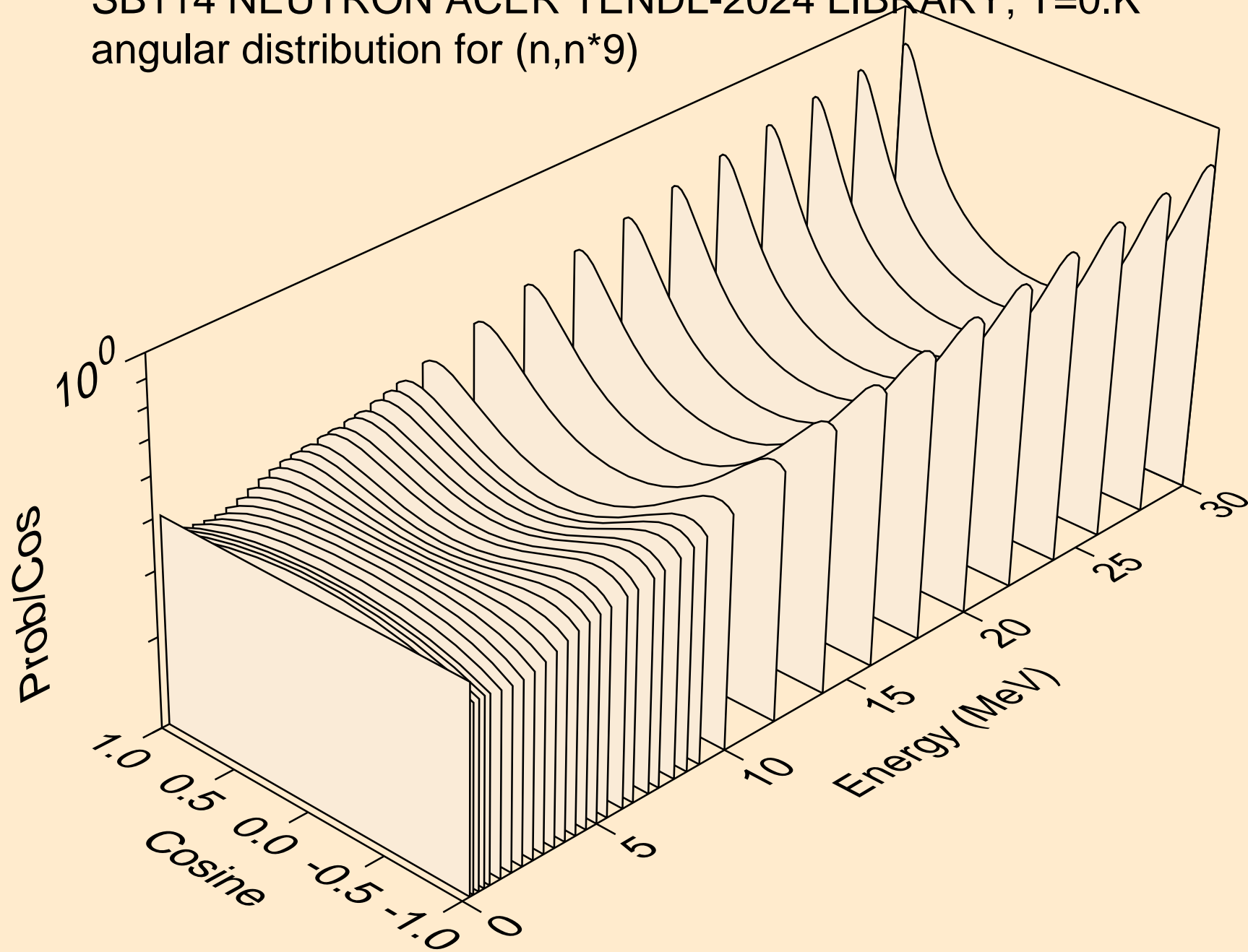

SB114 NEUTRON ACER TENDL-2024 LIBRARY; T=0.K
angular distribution for (n,n*10)

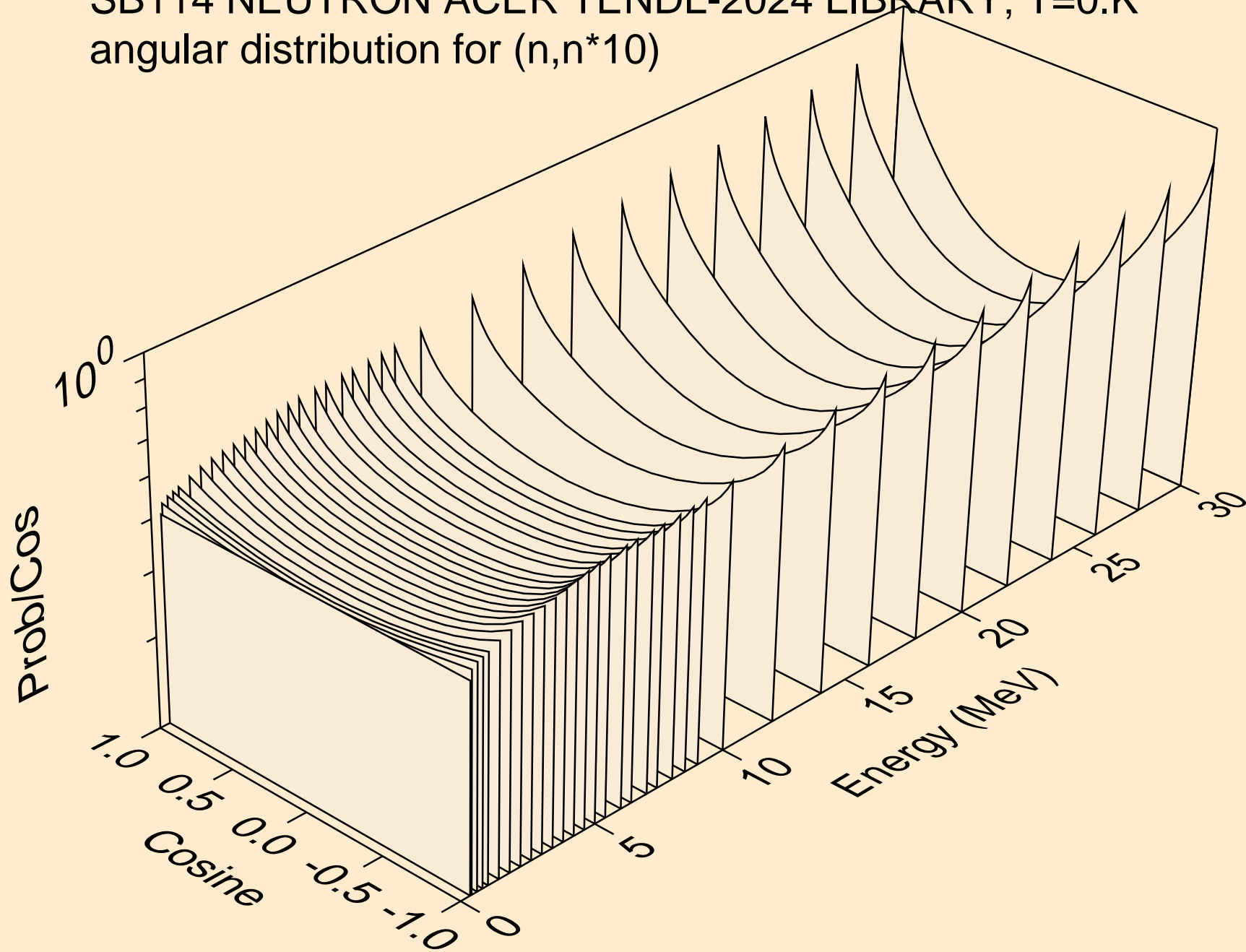

SB114 NEUTRON ACER TENDL-2024 LIBRARY; T=0.K
angular distribution for (n,n*11)

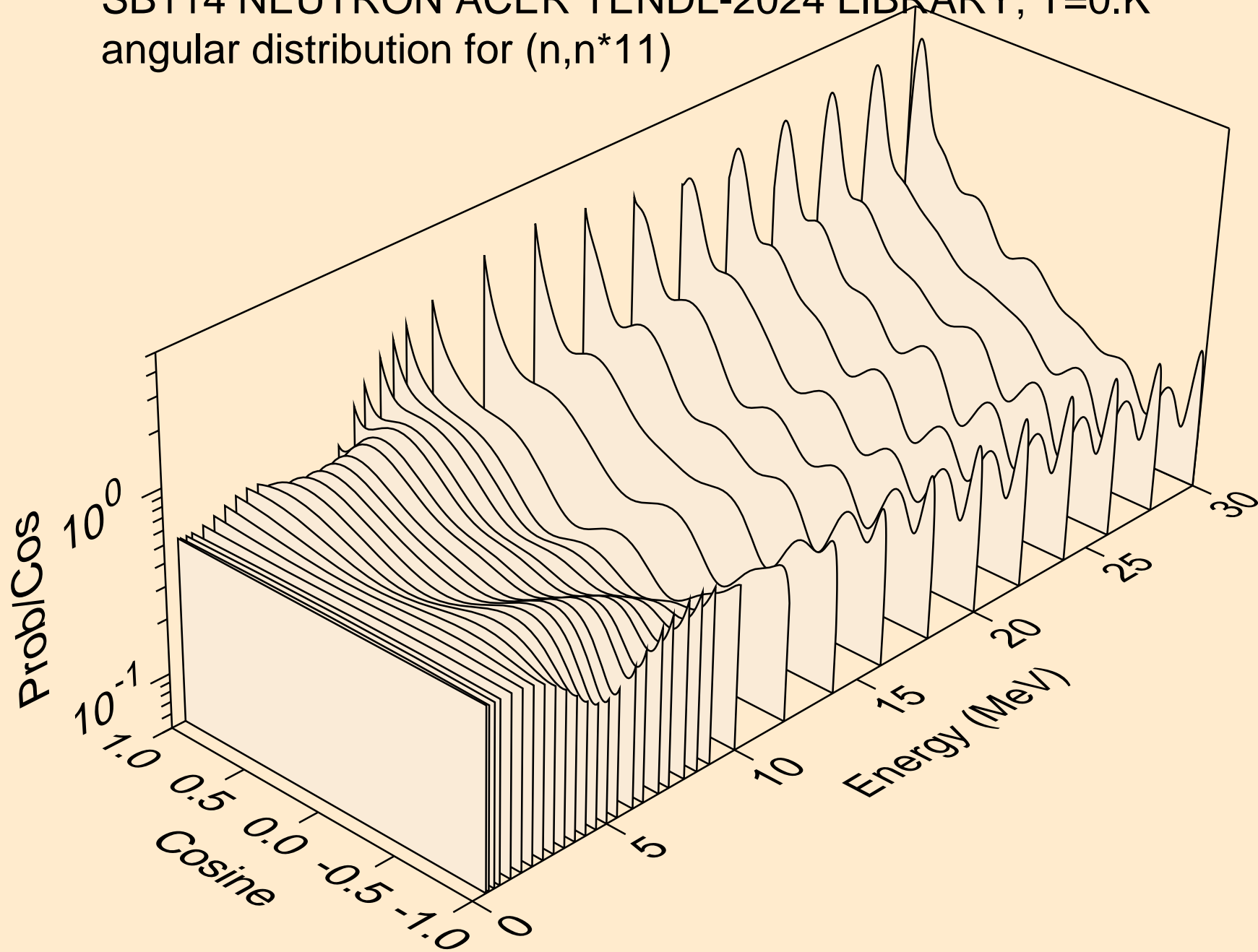

SB114 NEUTRON ACER TENDL-2024 LIBRARY; T=0.K
angular distribution for (n,n*12)

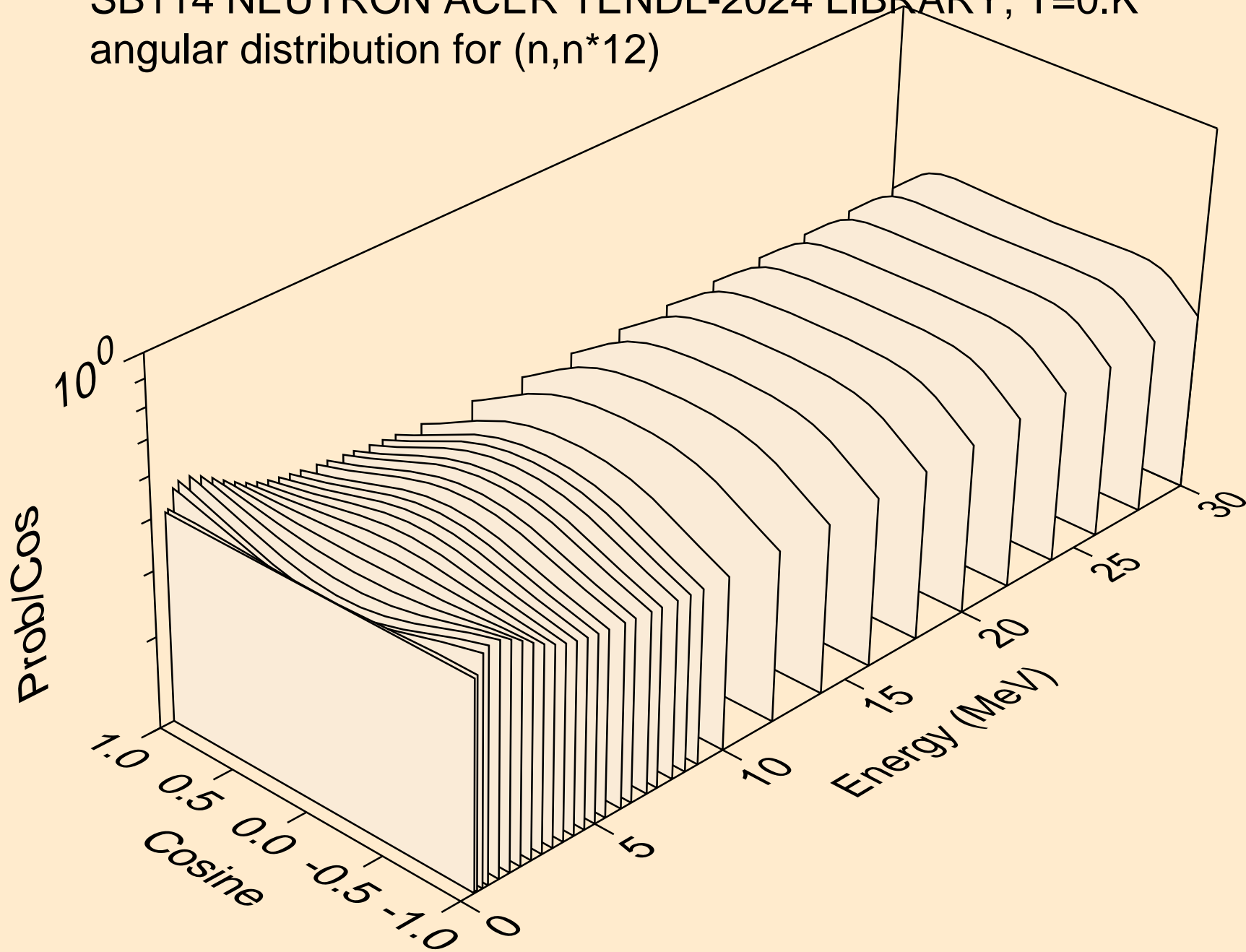

SB114 NEUTRON ACER TENDL-2024 LIBRARY; T=0.K
angular distribution for (n,n*13)

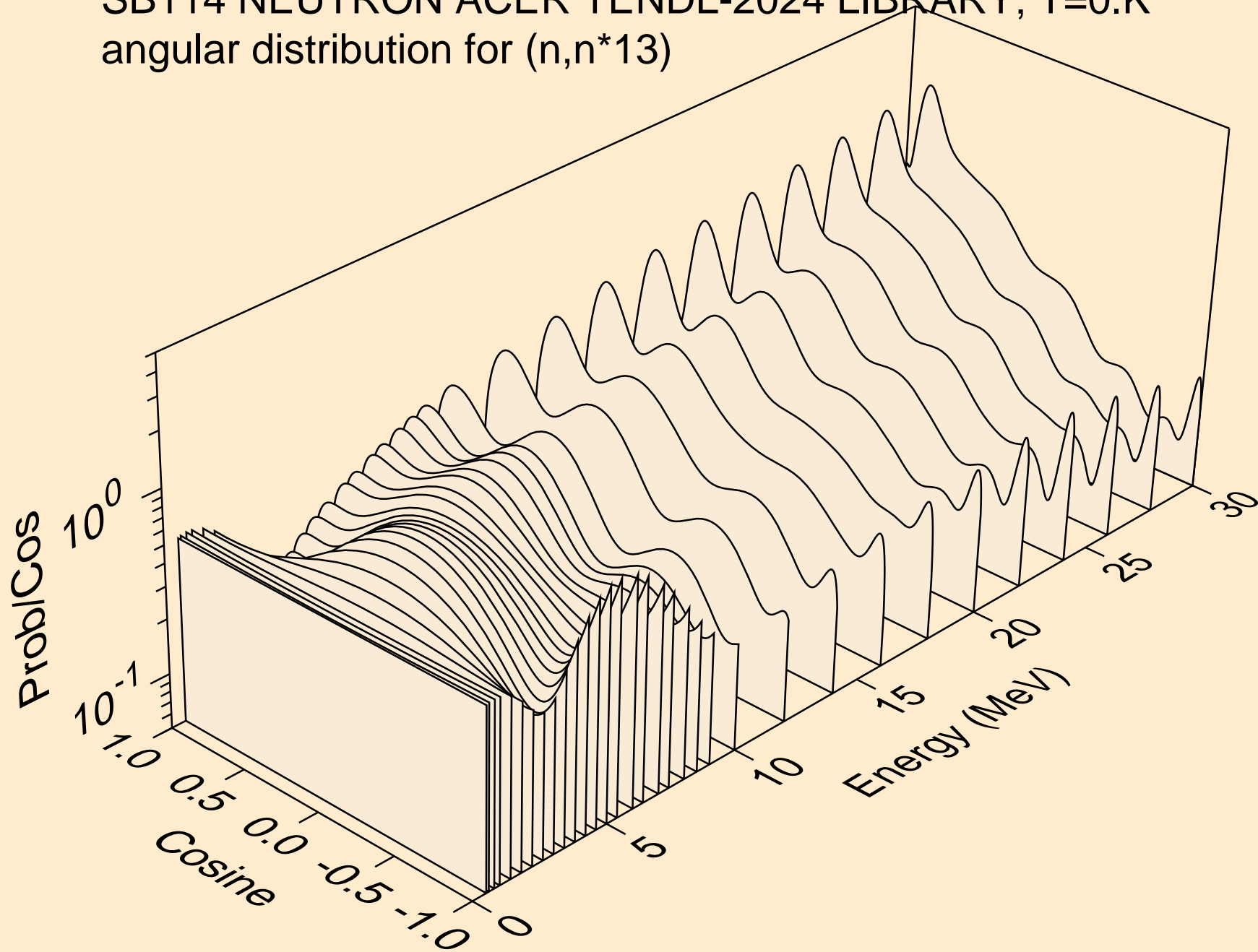

SB114 NEUTRON ACER TENDL-2024 LIBRARY; T=0.K
angular distribution for (n,n*14)

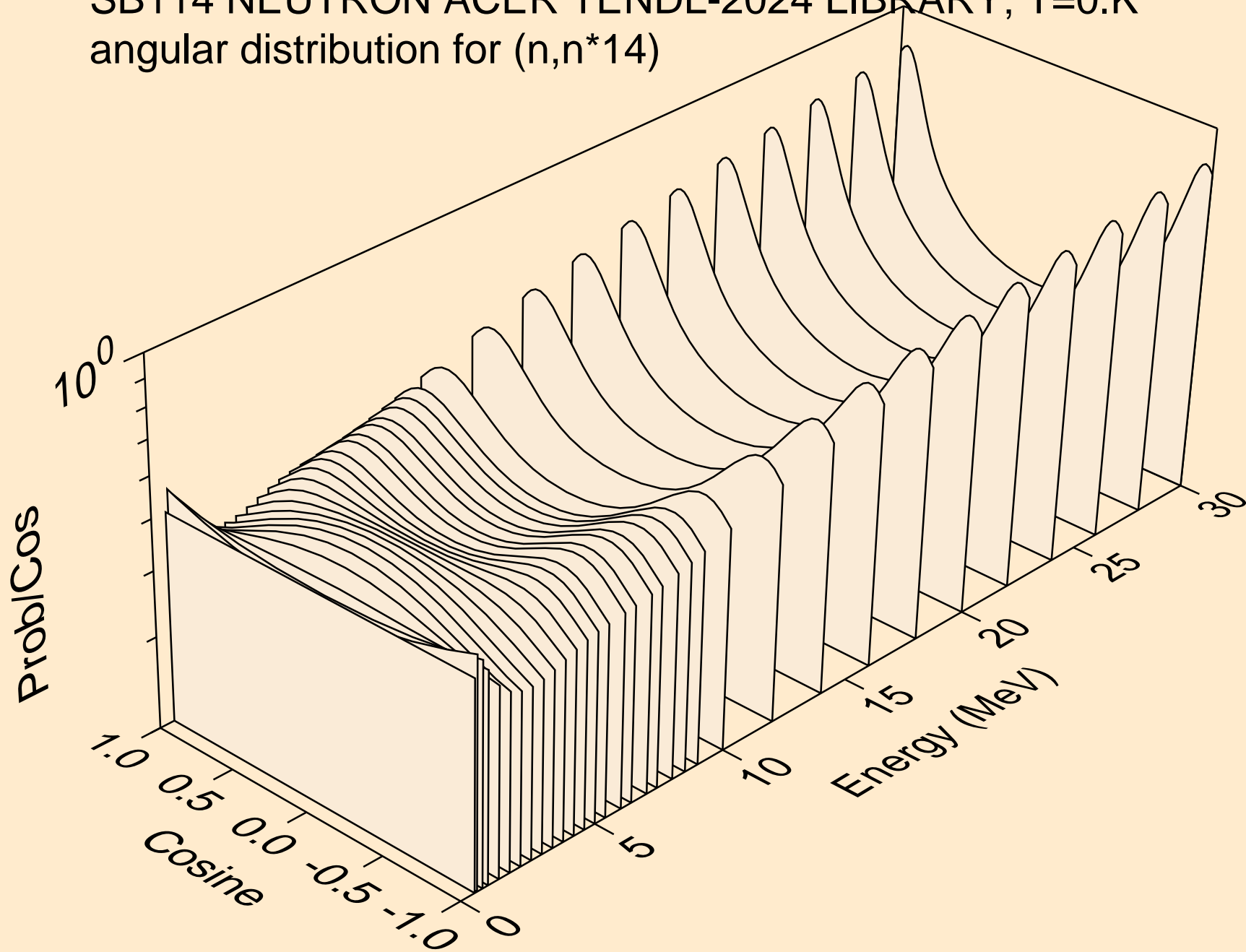

SB114 NEUTRON ACER TENDL-2024 LIBRARY; T=0.K
angular distribution for (n,n*15)

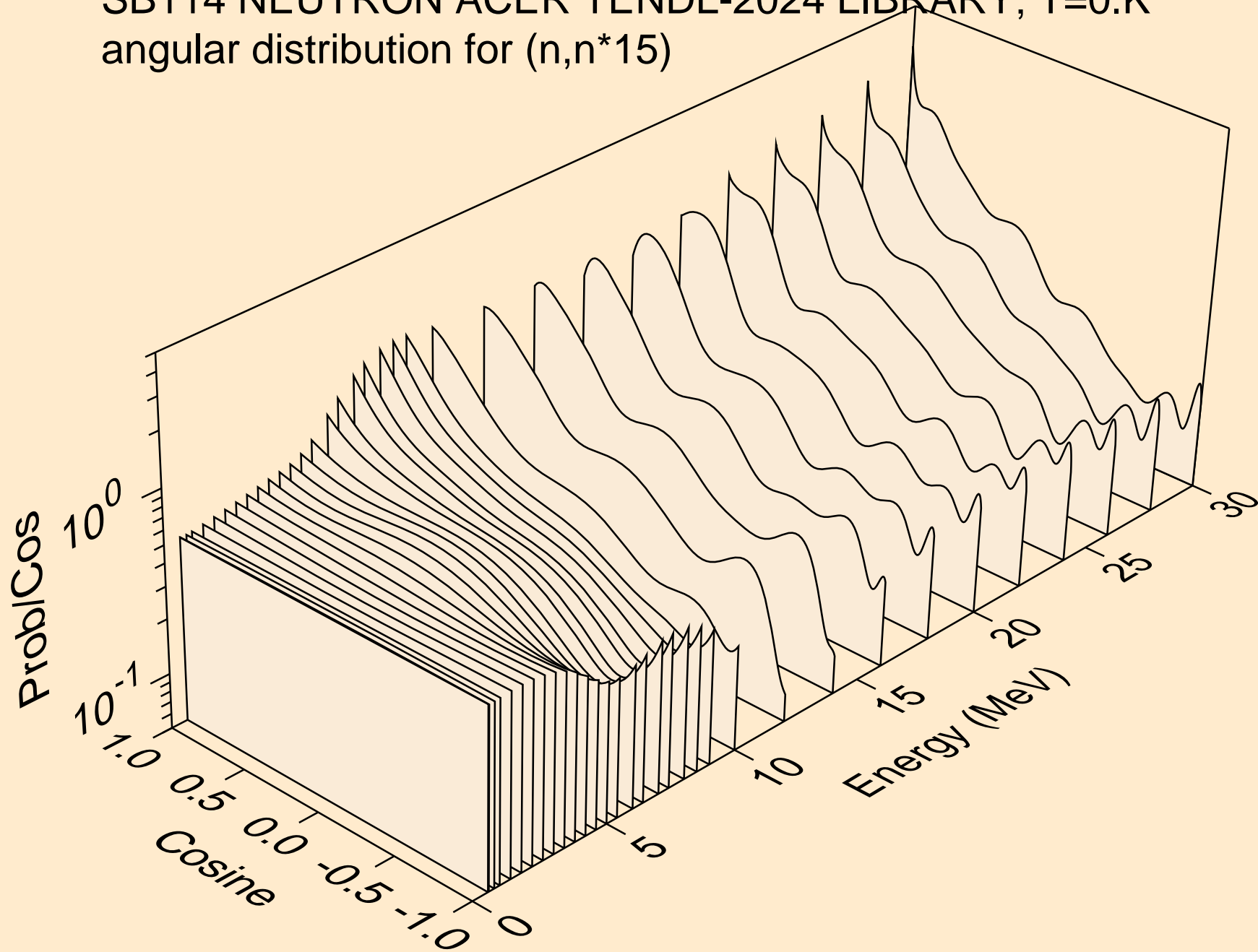

SB114 NEUTRON ACER TENDL-2024 LIBRARY; T=0.K
angular distribution for (n,n*16)

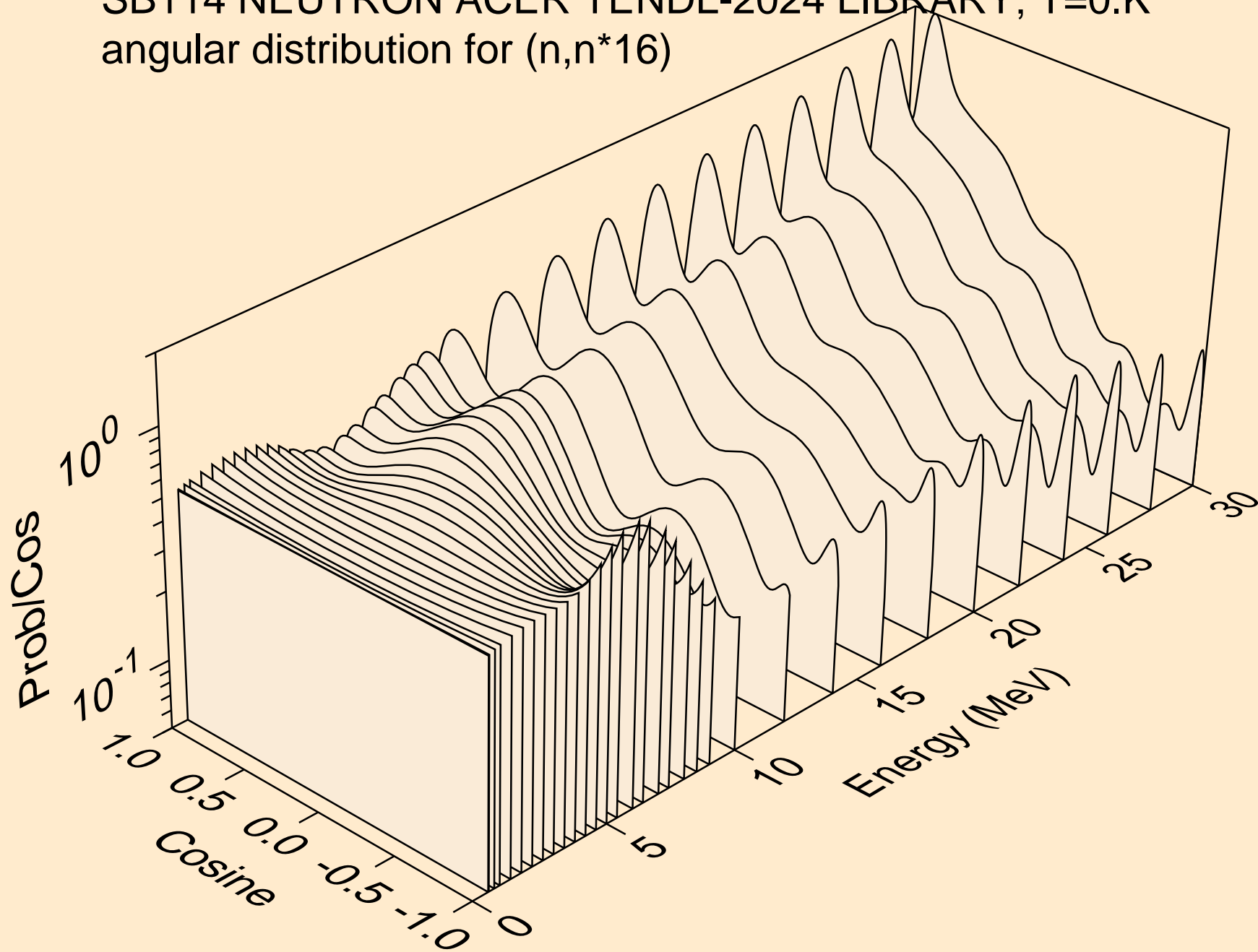

SB114 NEUTRON ACER TENDL-2024 LIBRARY; T=0.K
angular distribution for (n,n*17)

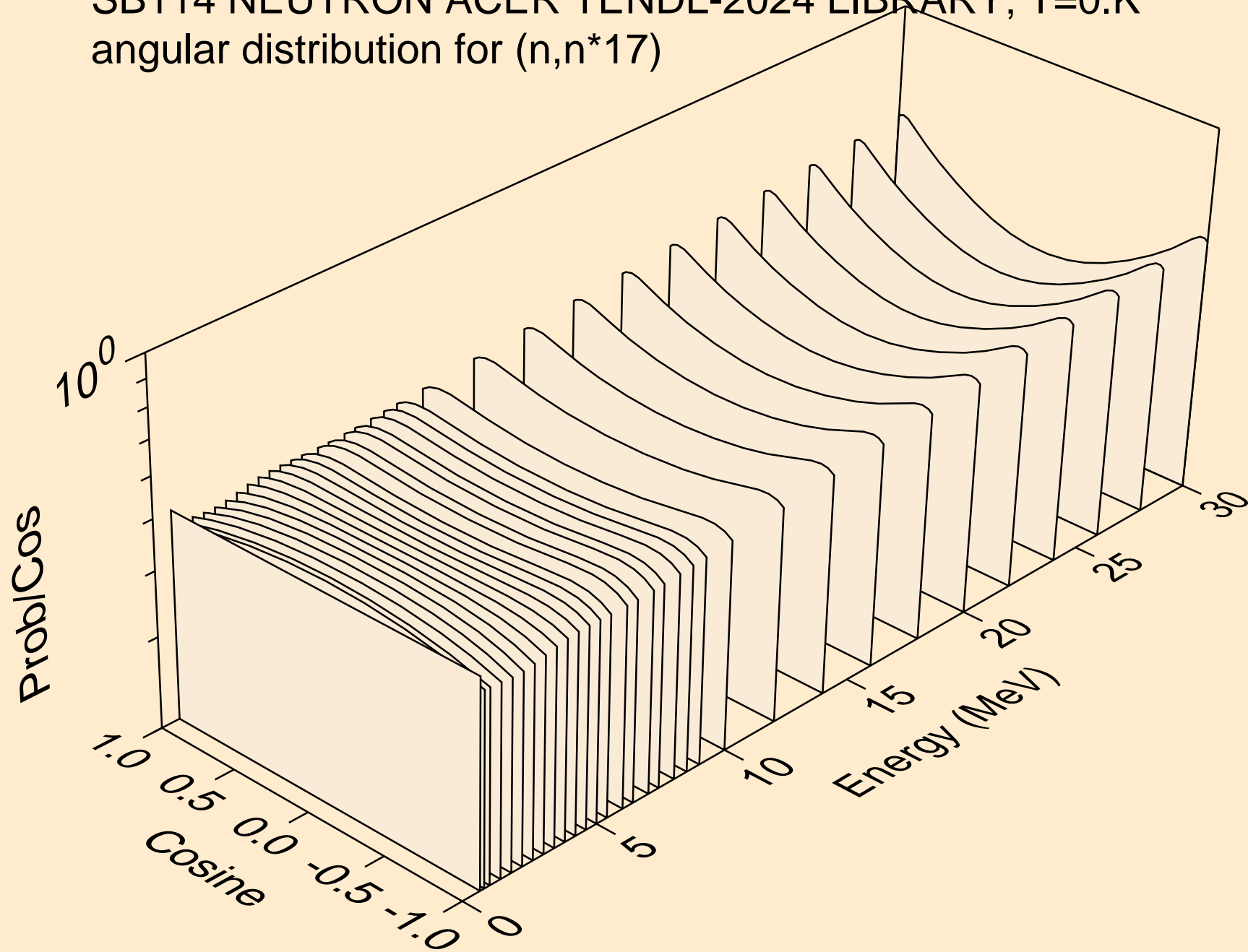

SB114 NEUTRON ACER TENDL-2024 LIBRARY; T=0.K
angular distribution for (n,n*18)

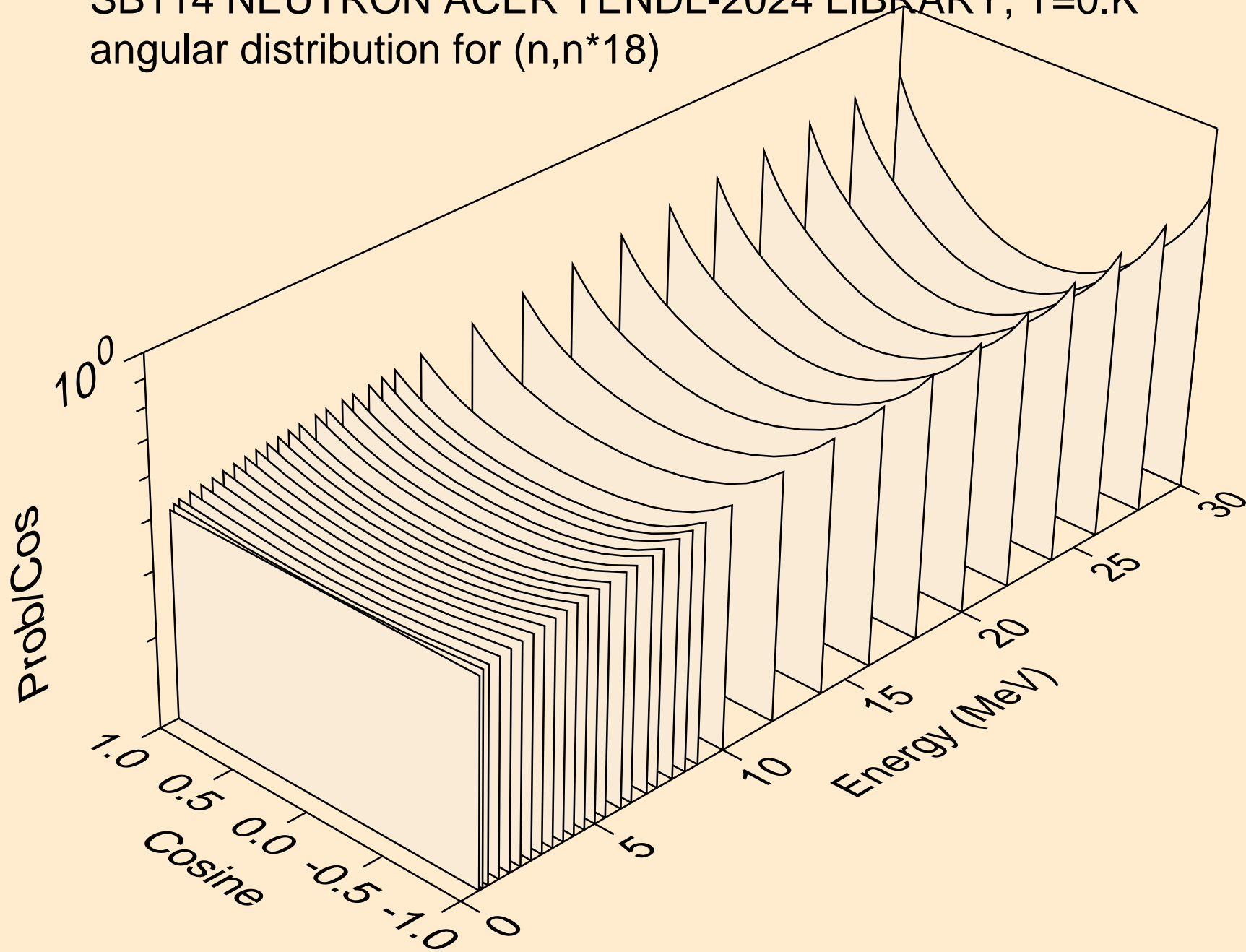

SB114 NEUTRON ACER TENDL-2024 LIBRARY; T=0.K
angular distribution for (n,n*19)

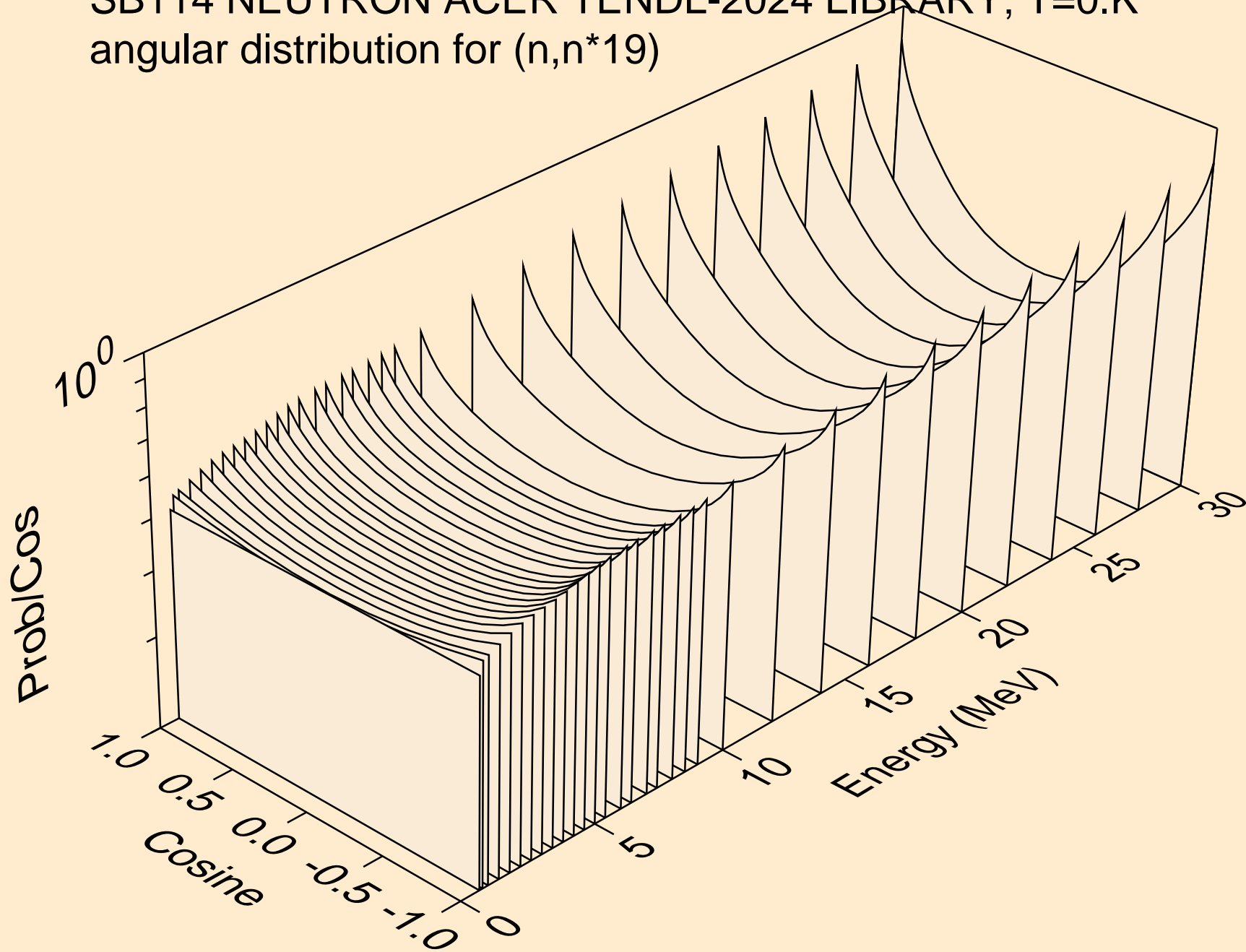

SB114 NEUTRON ACER TENDL-2024 LIBRARY; T=0.K
angular distribution for (n,n*20)

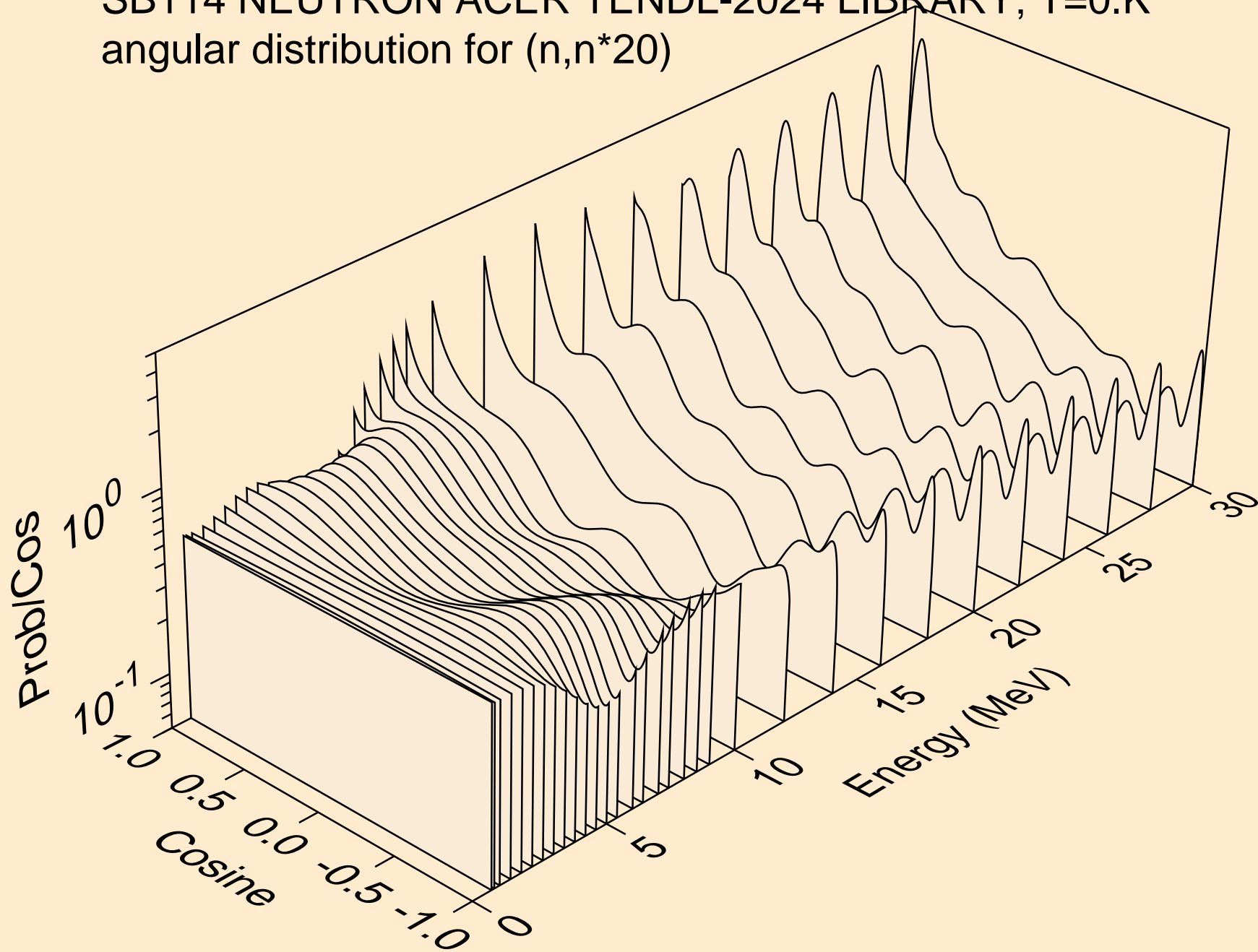

SB114 NEUTRON ACER TENDL-2024 LIBRARY; T=0.K
angular distribution for (n,n*21)

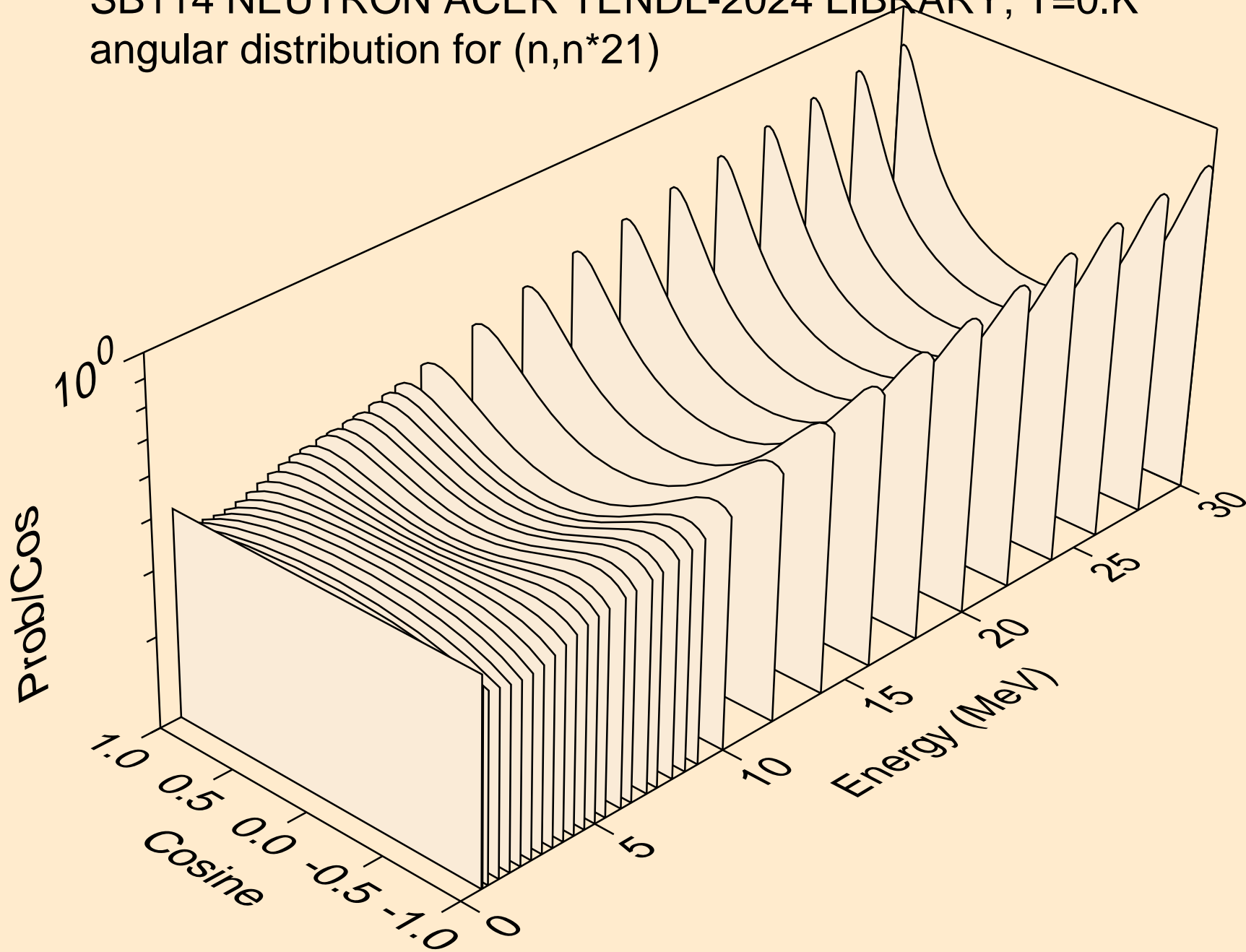

SB114 NEUTRON ACER TENDL-2024 LIBRARY; T=0.K
angular distribution for (n,n*22)

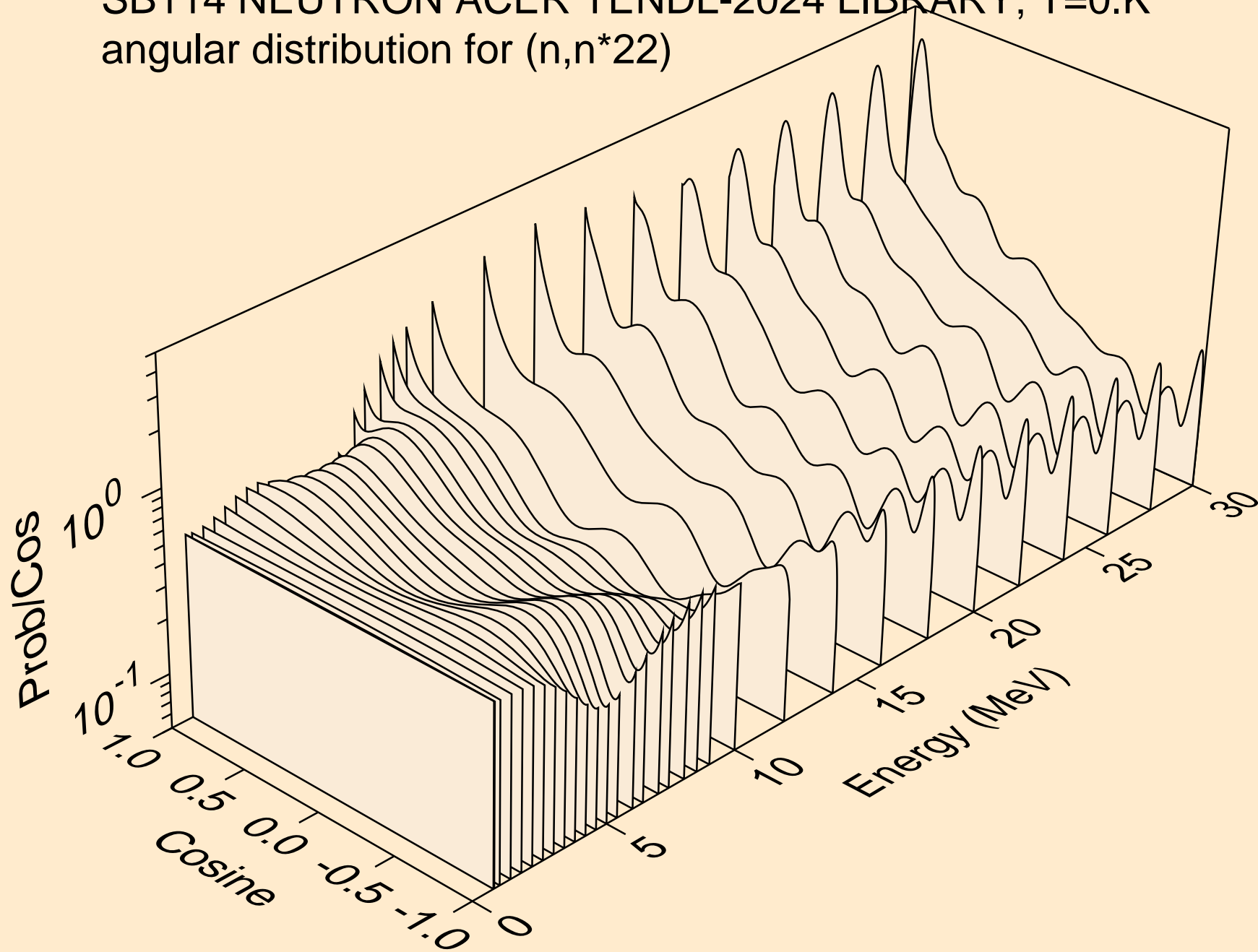

SB114 NEUTRON ACER TENDL-2024 LIBRARY; T=0.K
angular distribution for (n,n*23)

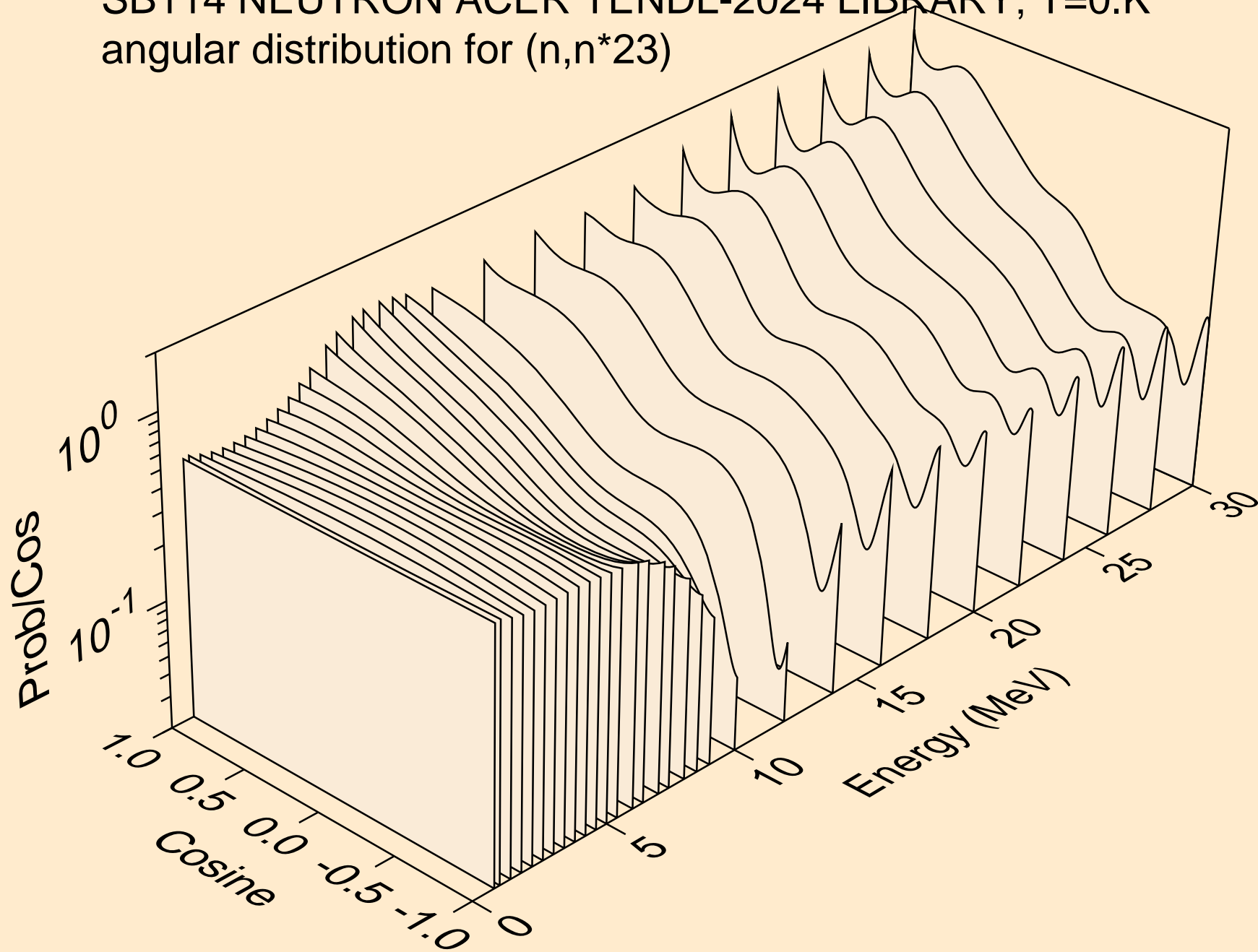

SB114 NEUTRON ACER TENDL-2024 LIBRARY; T=0.K
angular distribution for (n,n*24)

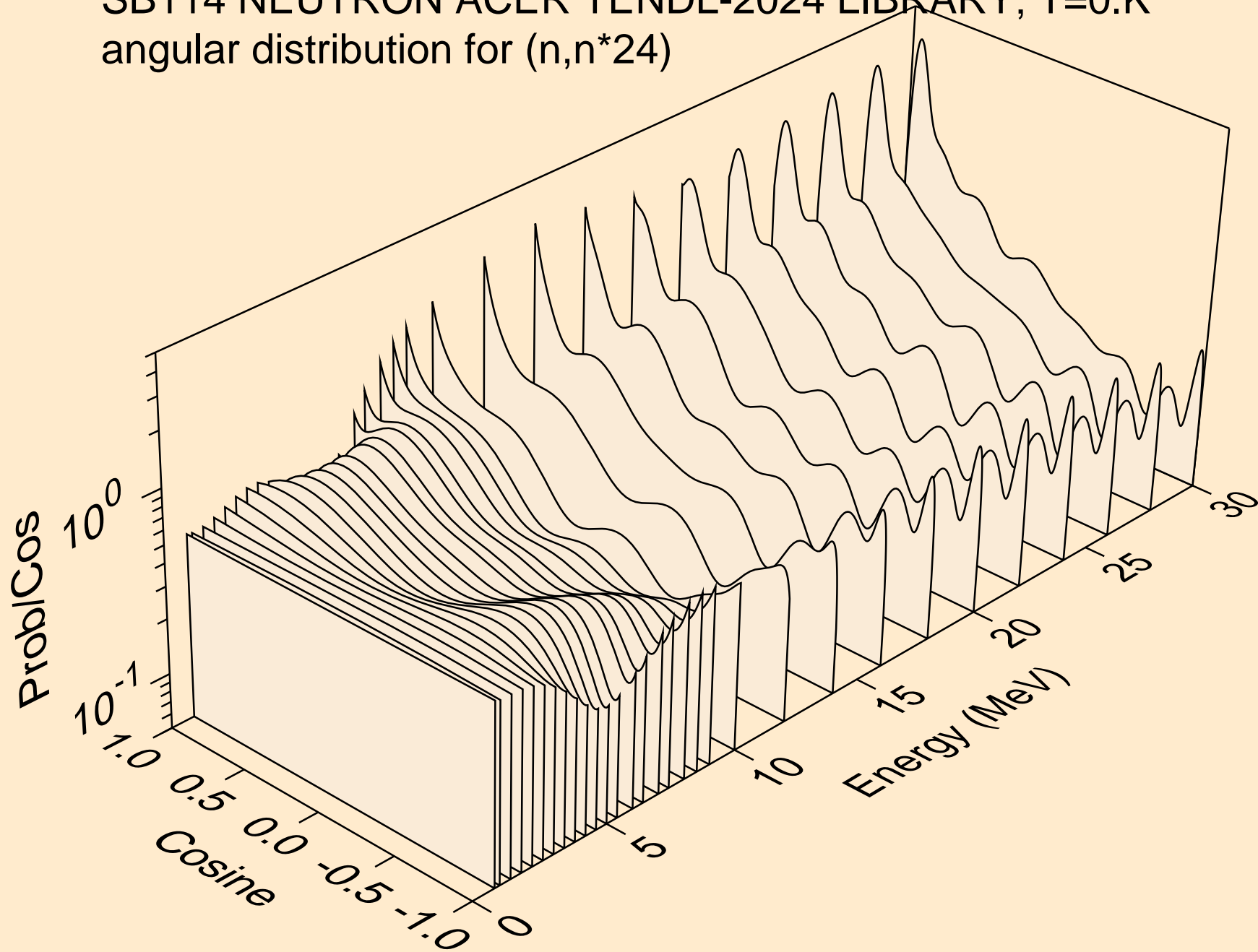

SB114 NEUTRON ACER TENDL-2024 LIBRARY; T=0.K
angular distribution for (n,n*25)

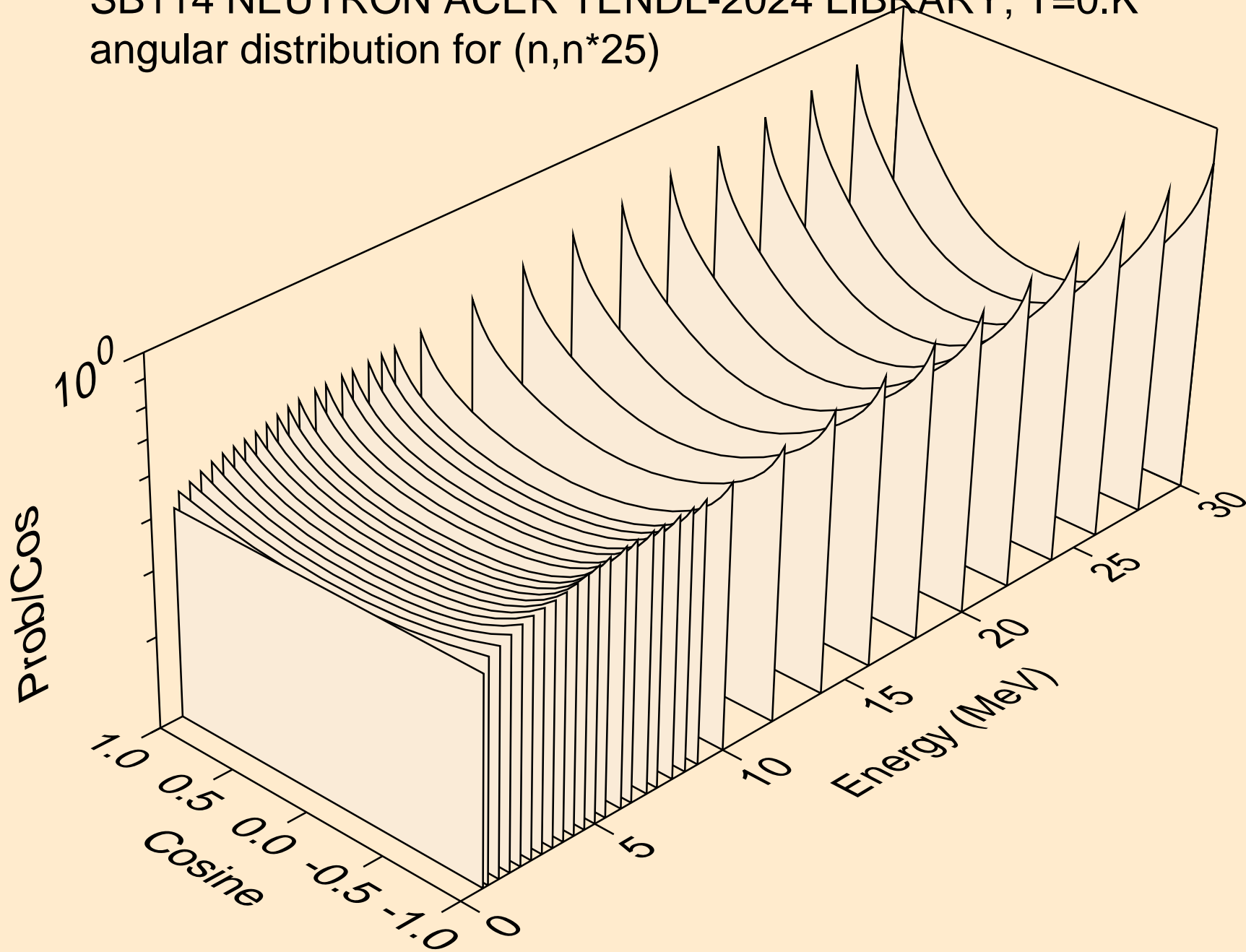

SB114 NEUTRON ACER TENDL-2024 LIBRARY; T=0.K
angular distribution for (n,n*26)

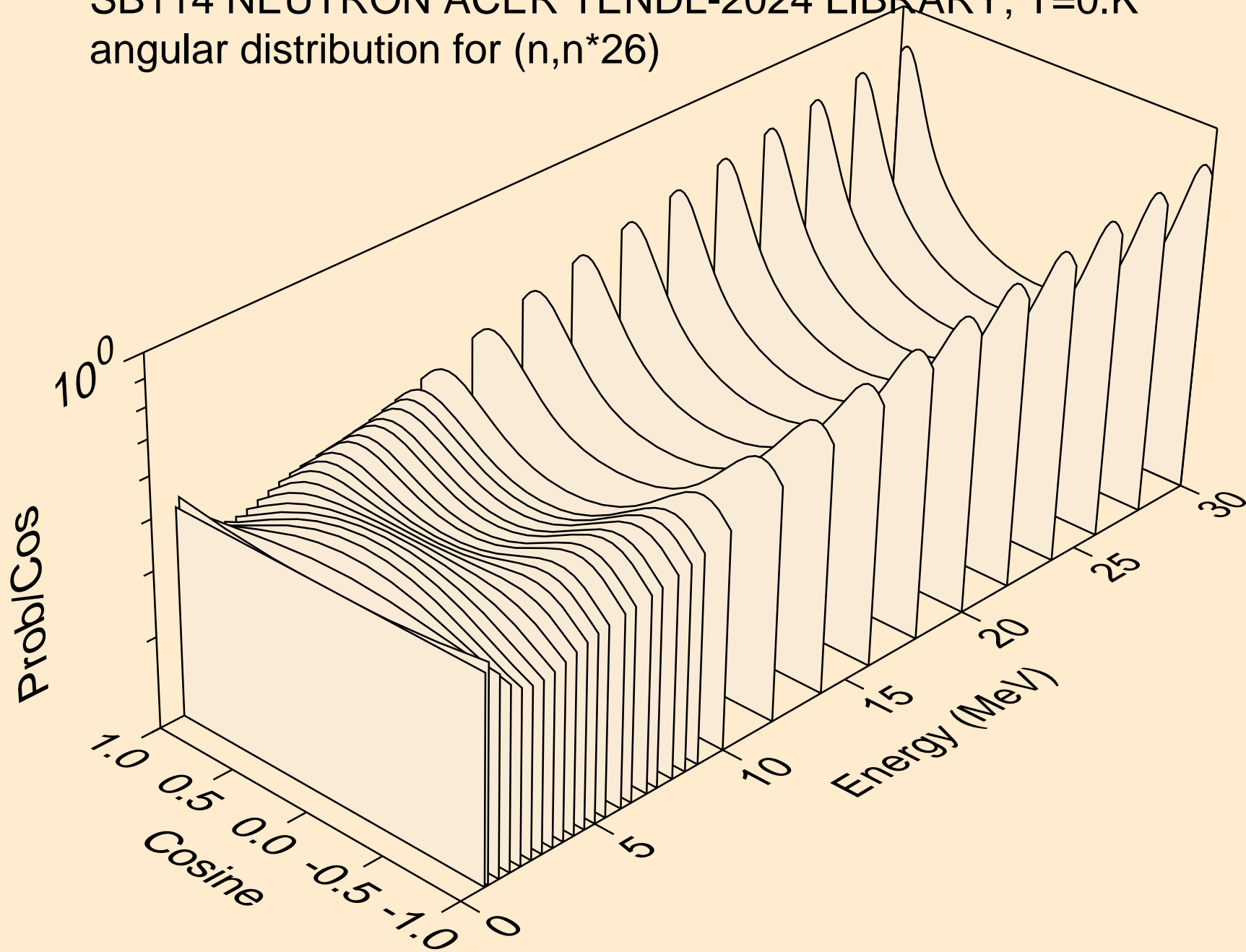

SB114 NEUTRON ACER TENDL-2024 LIBRARY; T=0.K
angular distribution for (n,n*27)

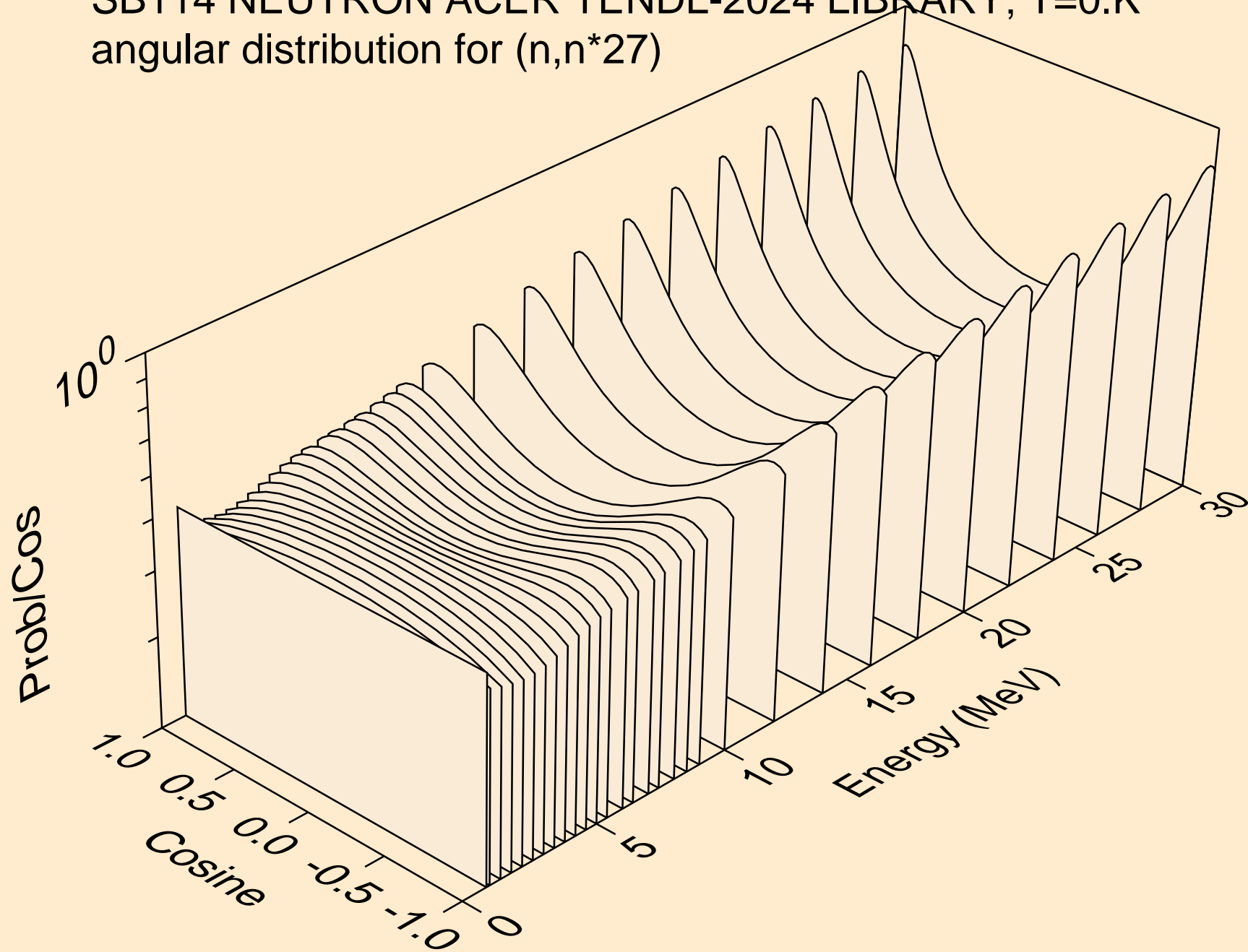

SB114 NEUTRON ACER TENDL-2024 LIBRARY; T=0.K
angular distribution for (n,n*28)

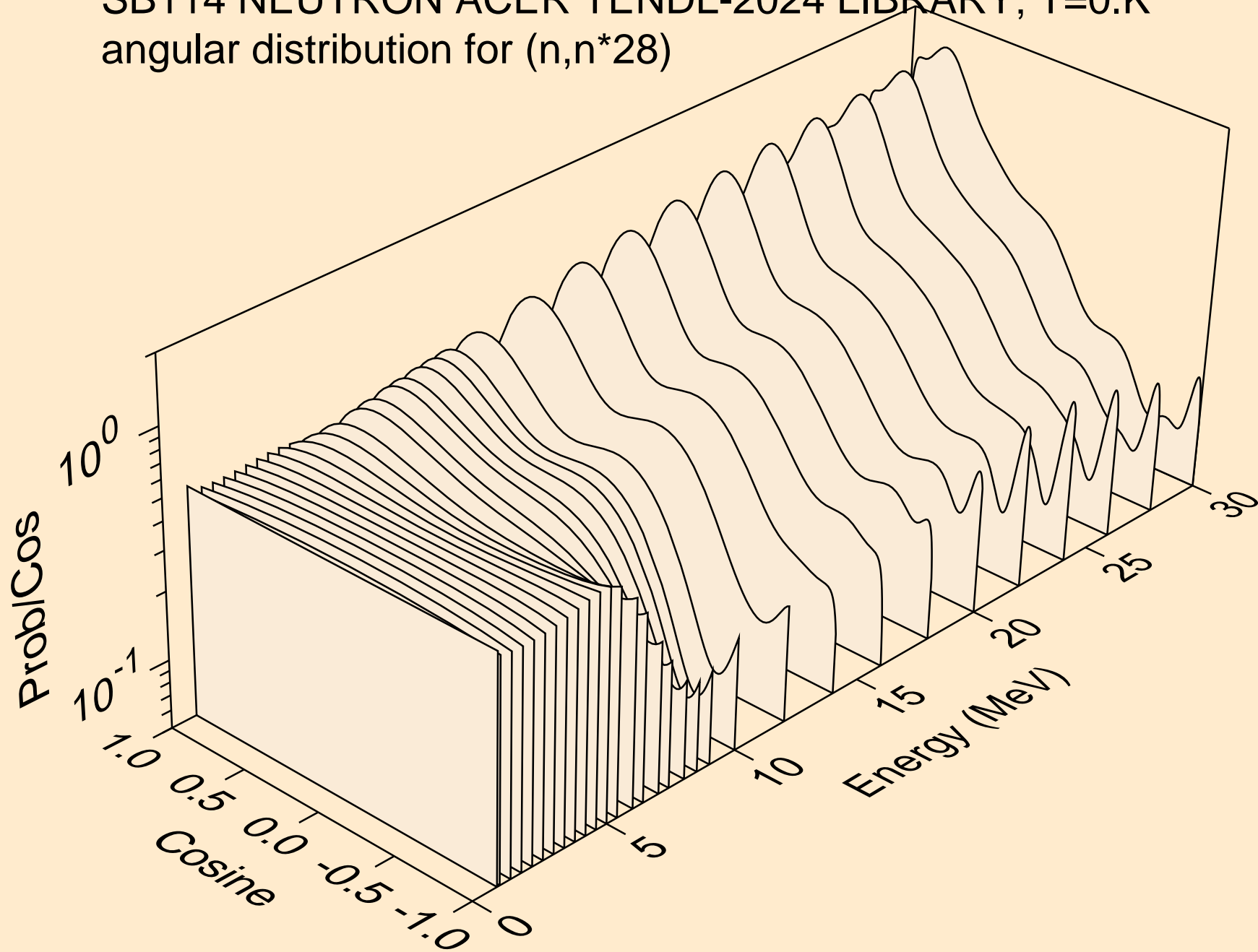

SB114 NEUTRON ACER TENDL-2024 LIBRARY; T=0.K
angular distribution for (n,n*29)

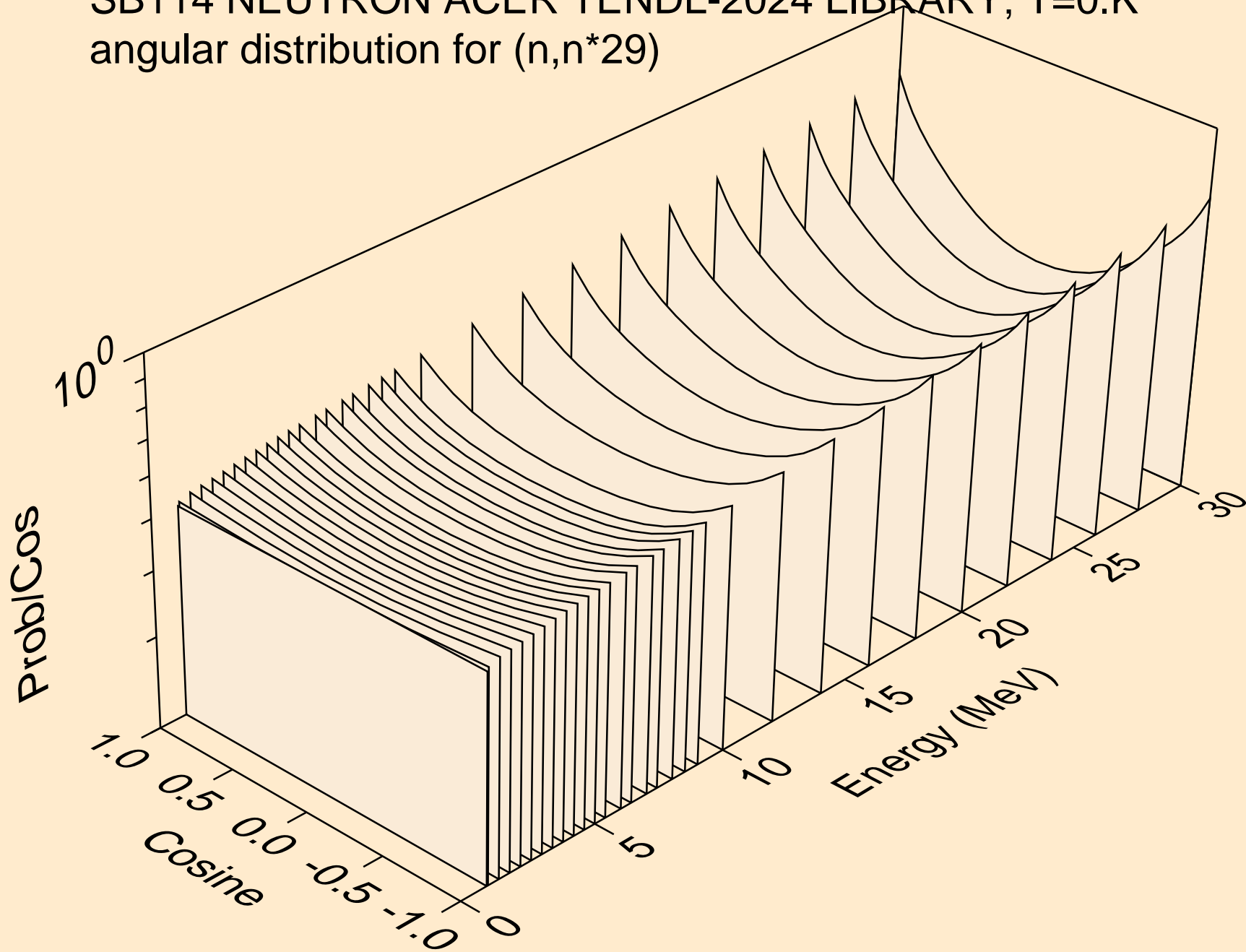

SB114 NEUTRON ACER TENDL-2024 LIBRARY; T=0.K
Neutron emission for (n,x)

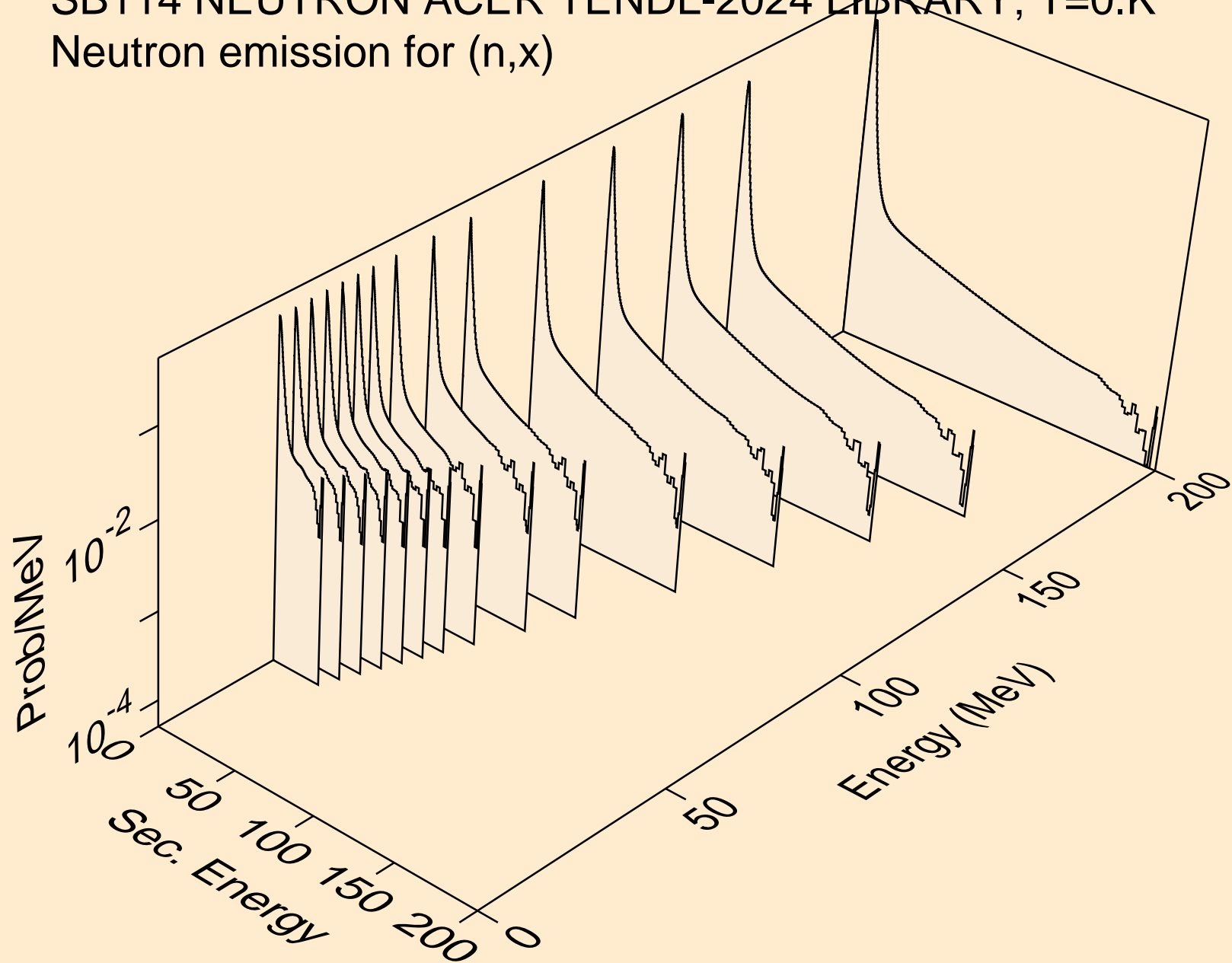

SB114 NEUTRON ACER TENDL-2024 LIBRARY; T=0.K
Neutron emission for (n,2nd)

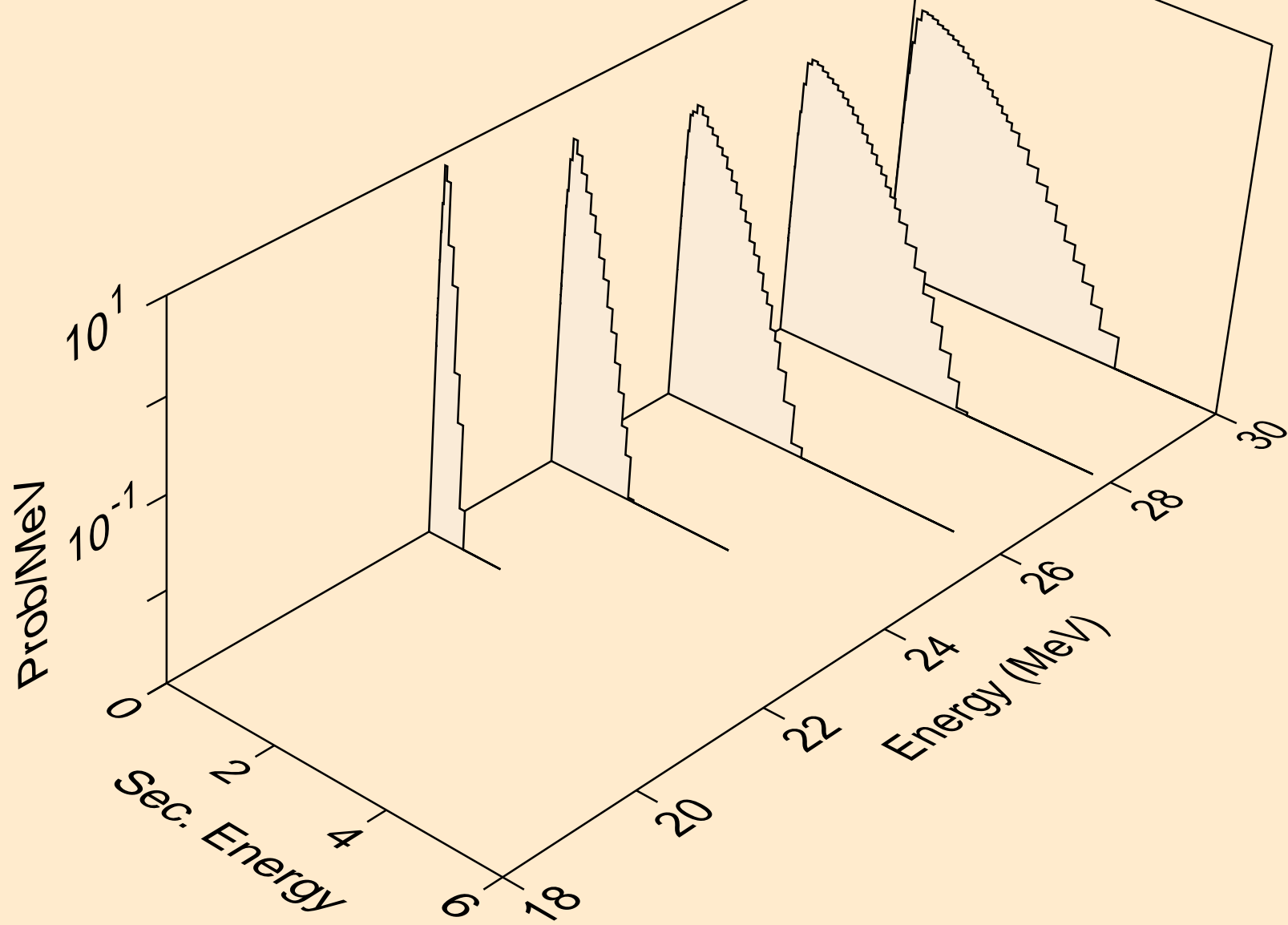

SB114 NEUTRON ACER TENDL-2024 LIBRARY; T=0.K
Neutron emission for (n,2n)

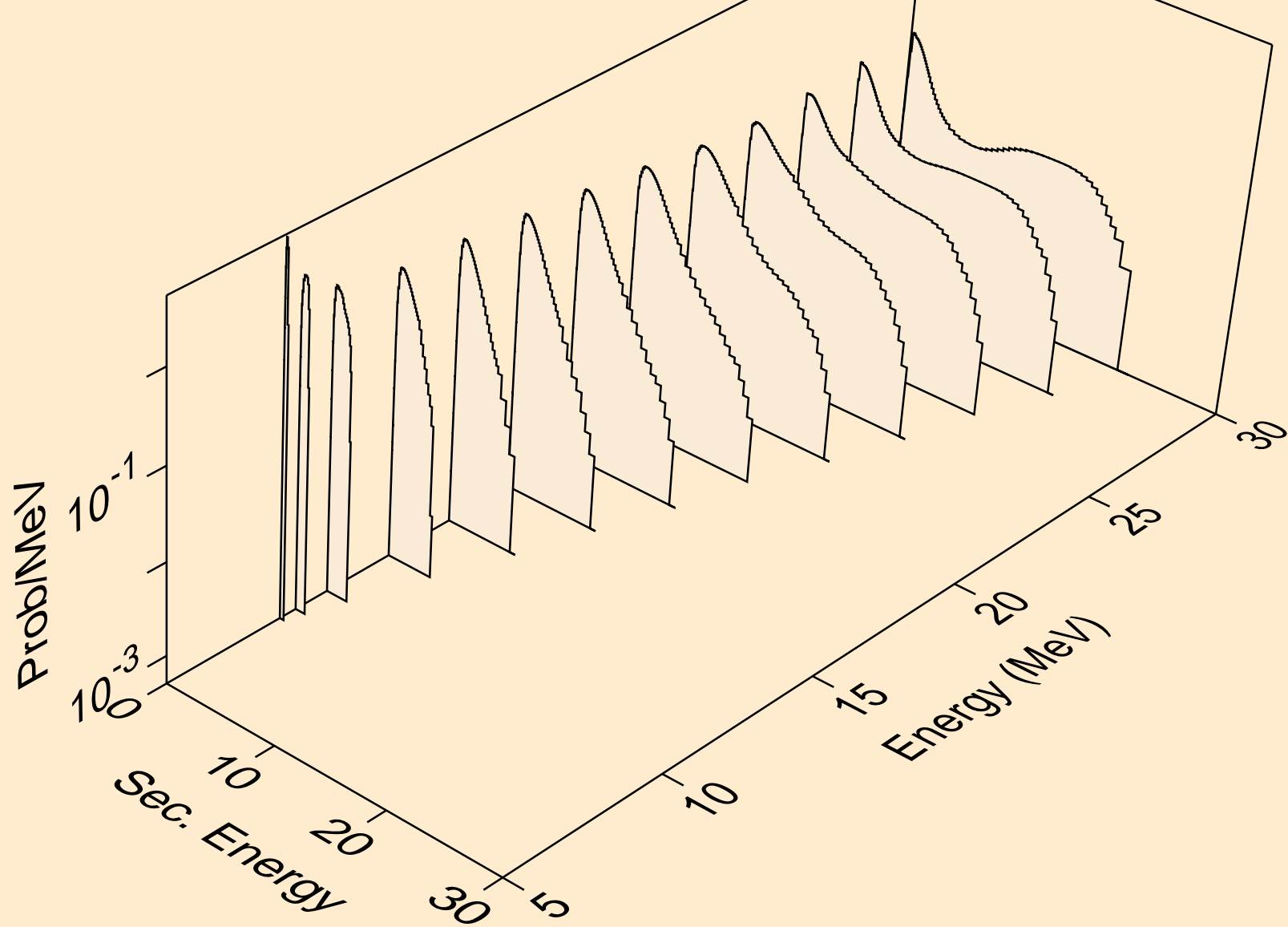

SB114 NEUTRON ACER TENDL-2024 LIBRARY; T=0.K
Neutron emission for (n,3n)

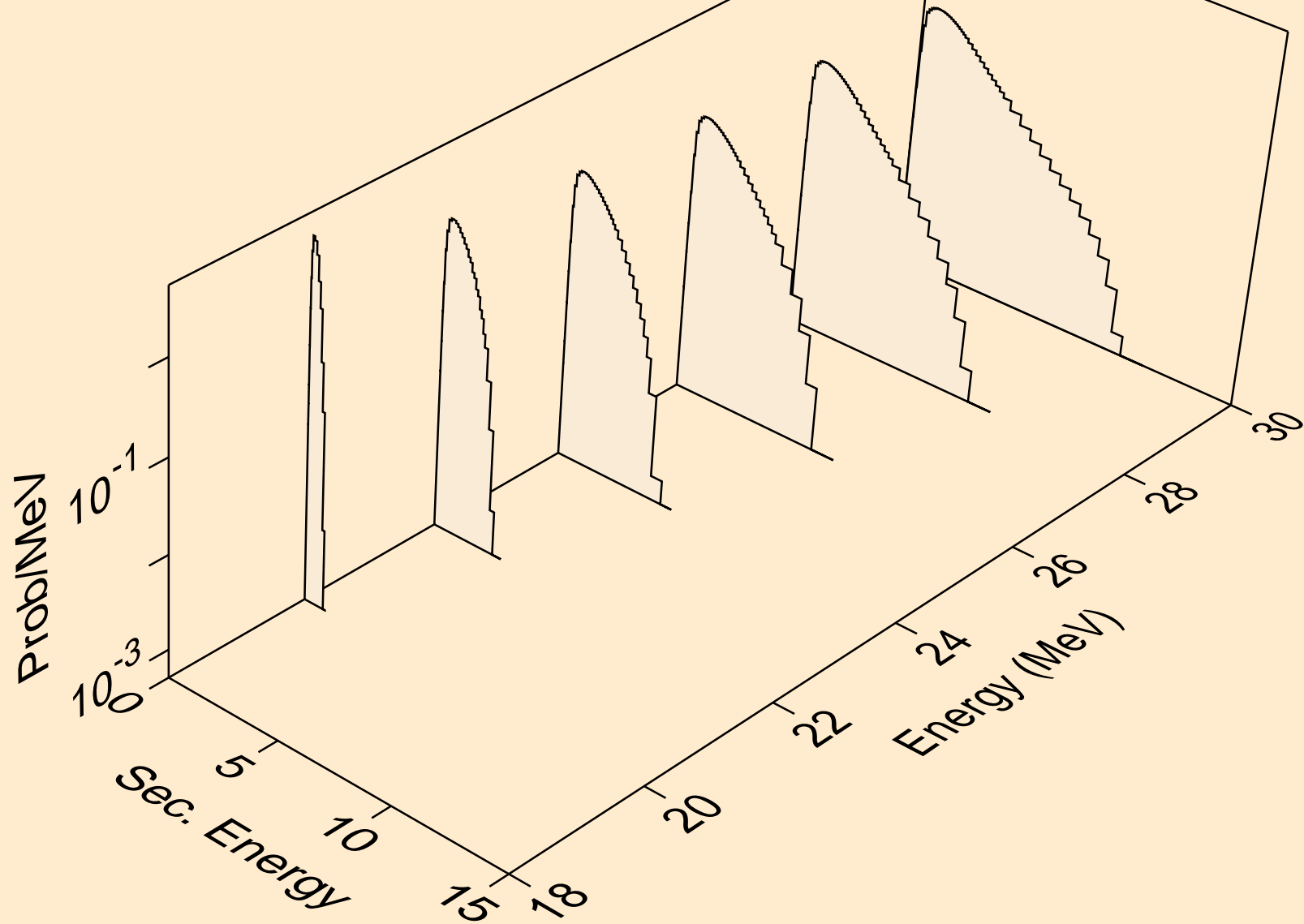

SB114 NEUTRON ACER TENDL-2024 LIBRARY; T=0.K
Neutron emission for (n,n*)a

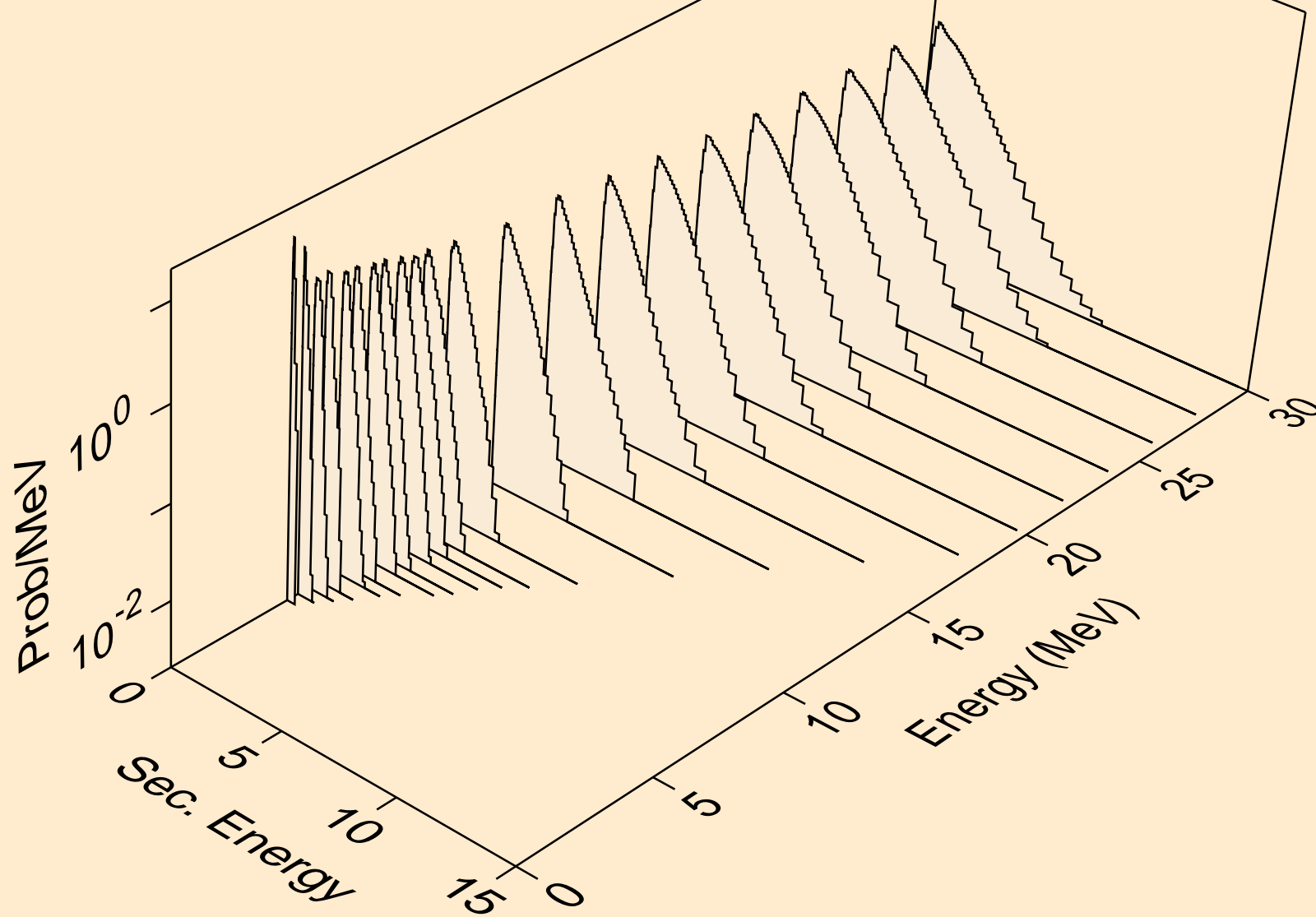

SB114 NEUTRON ACER TENDL-2024 LIBRARY; T=0.K
Neutron emission for (n,2n)_a

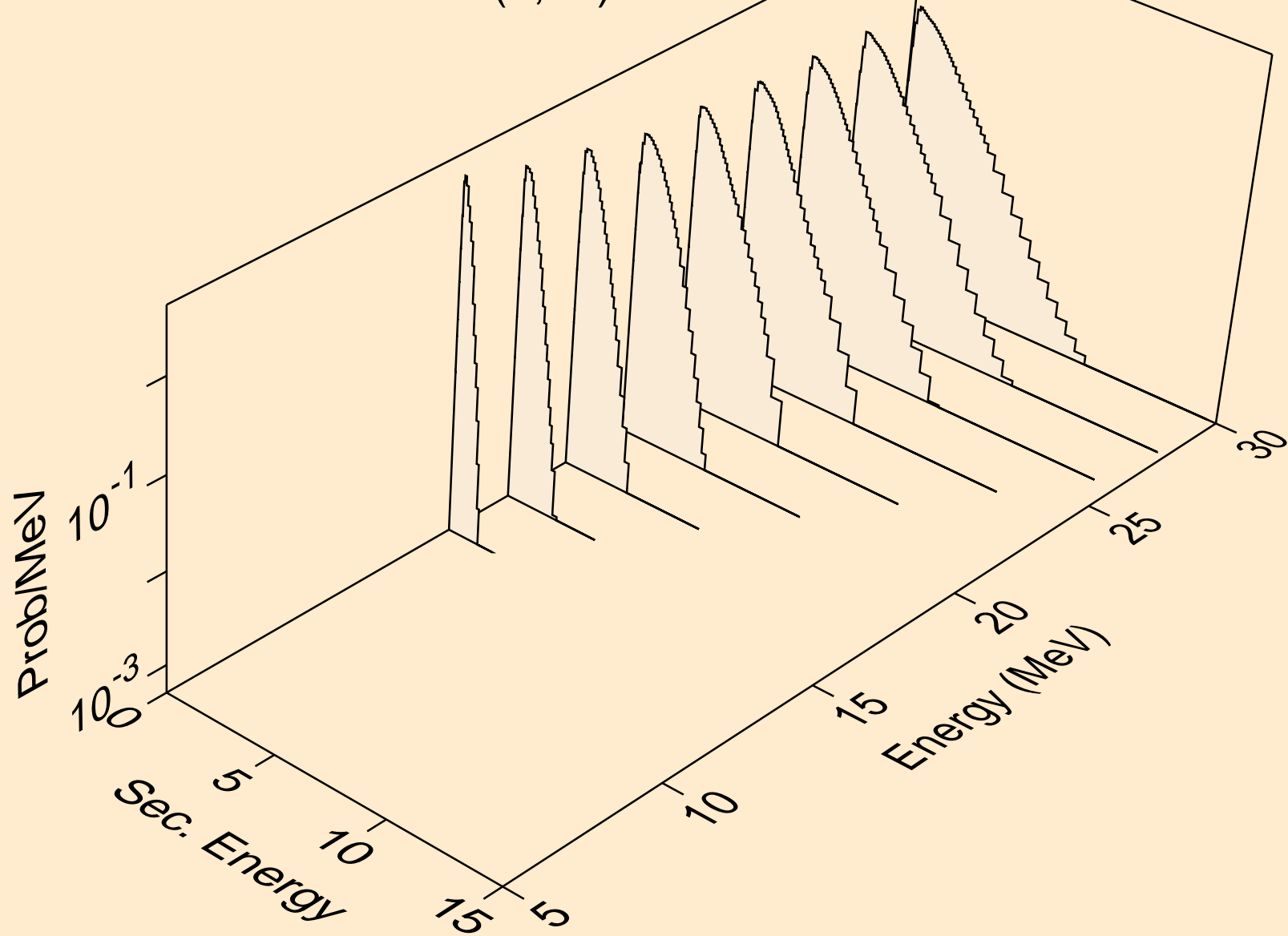

SB114 NEUTRON ACER TENDL-2024 LIBRARY; T=0.K
Neutron emission for (n,3n)a

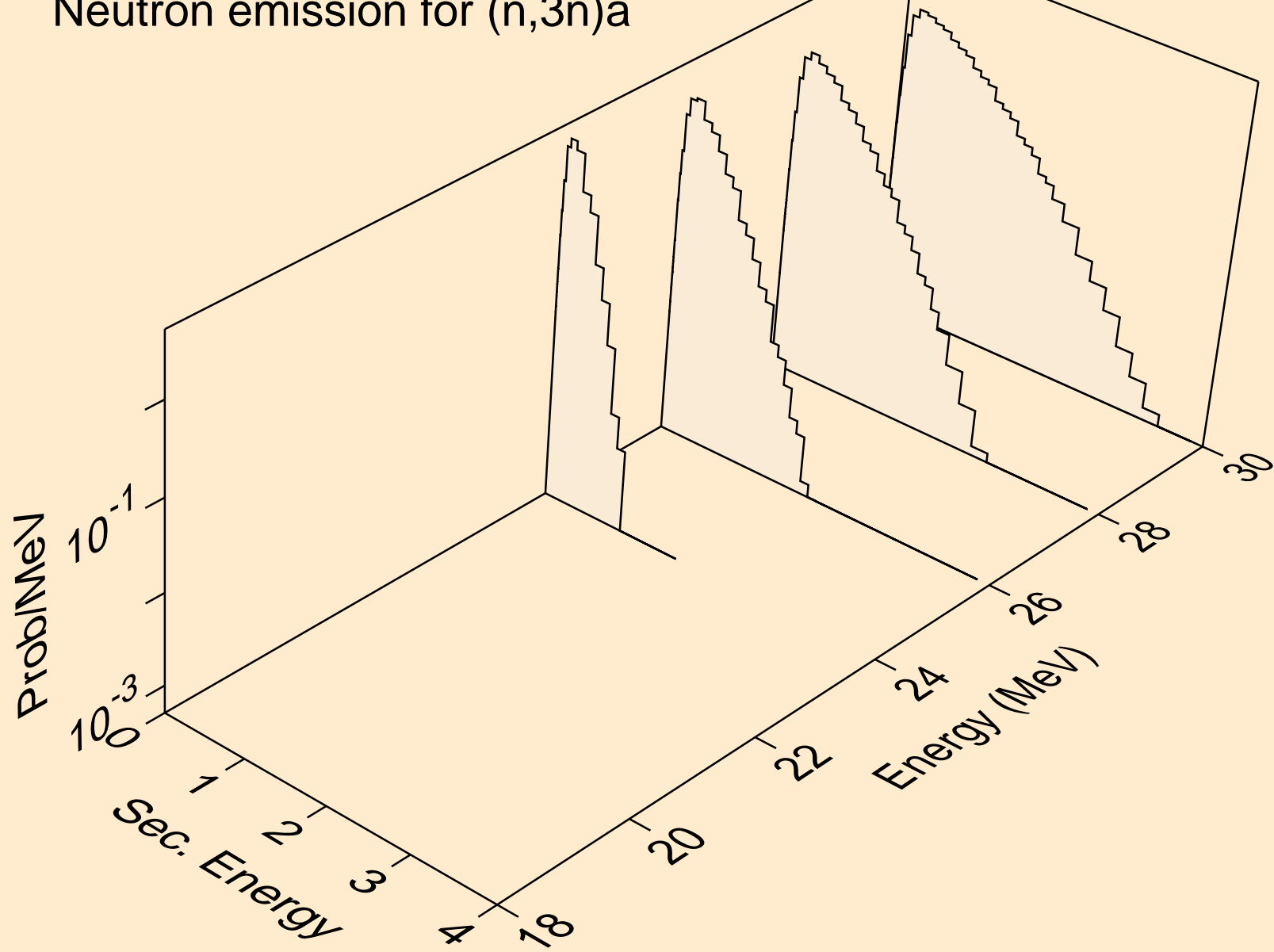

SB114 NEUTRON ACER TENDL-2024 LIBRARY; T=0.K
Neutron emission for (n,n*)p

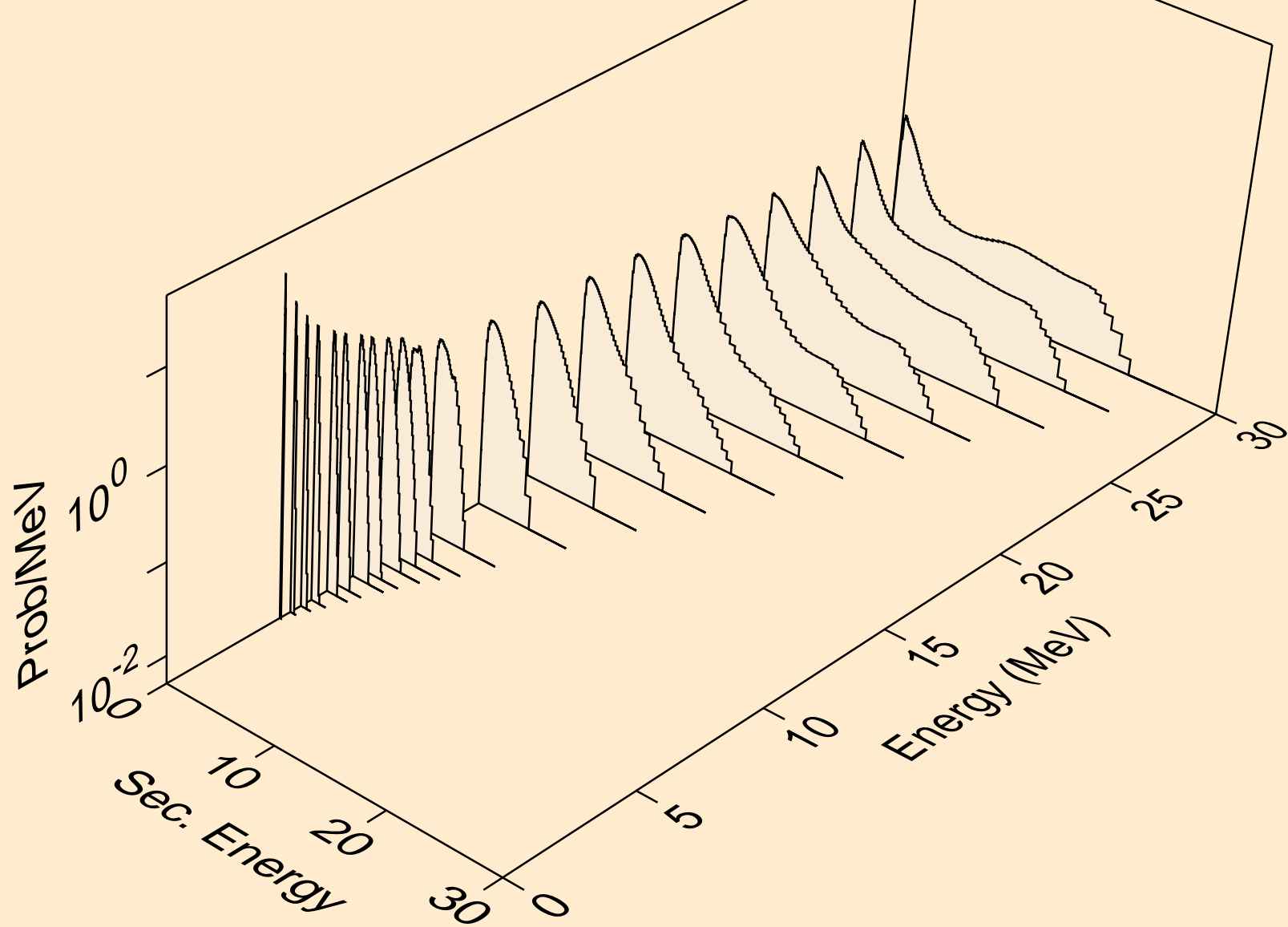

SB114 NEUTRON ACER TENDL-2024 LIBRARY; T=0.K
Neutron emission for (n,n*)2a

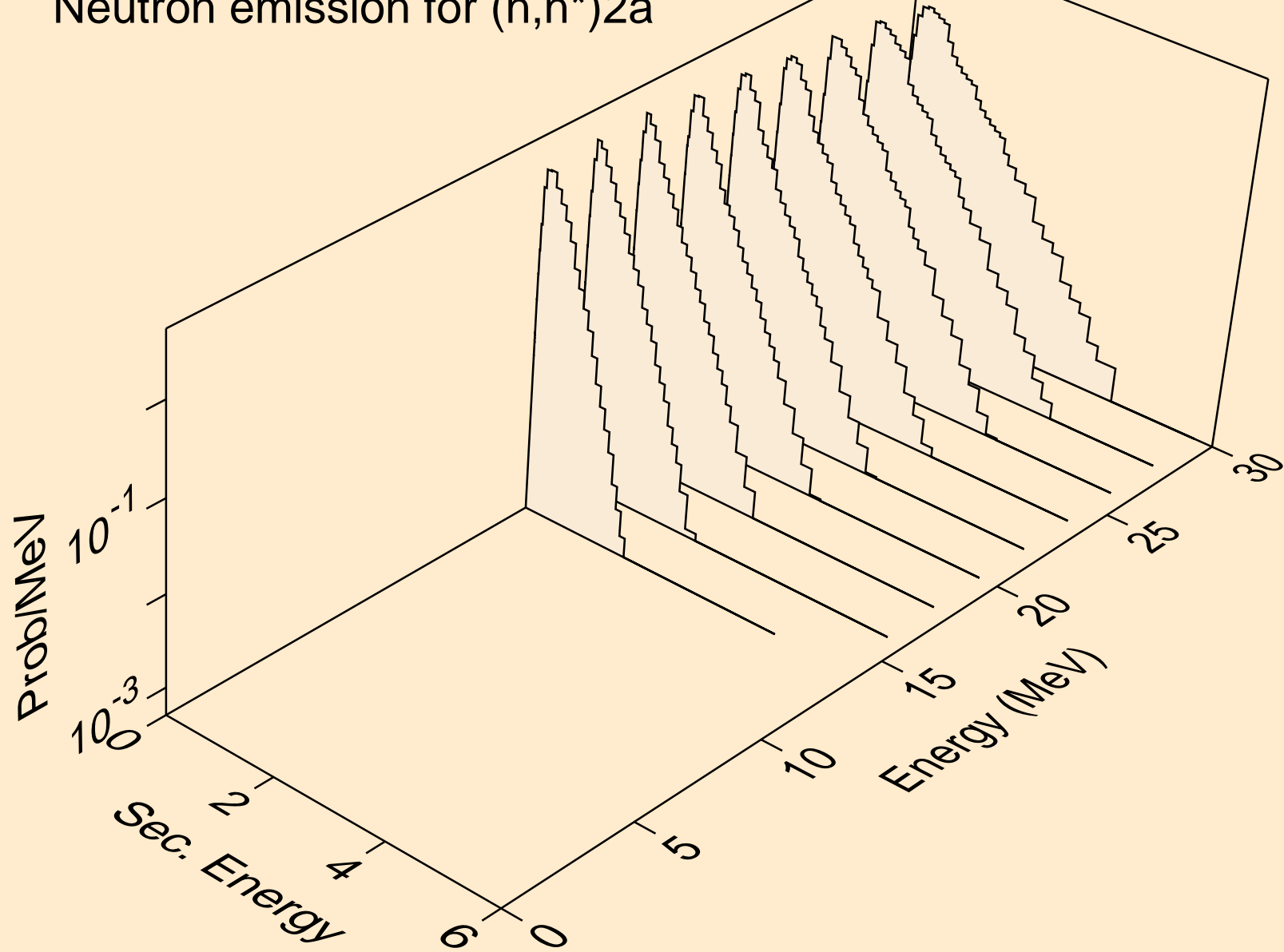

SB114 NEUTRON ACER TENDL-2024 LIBRARY; T=0.K
Neutron emission for (n,2n)2a

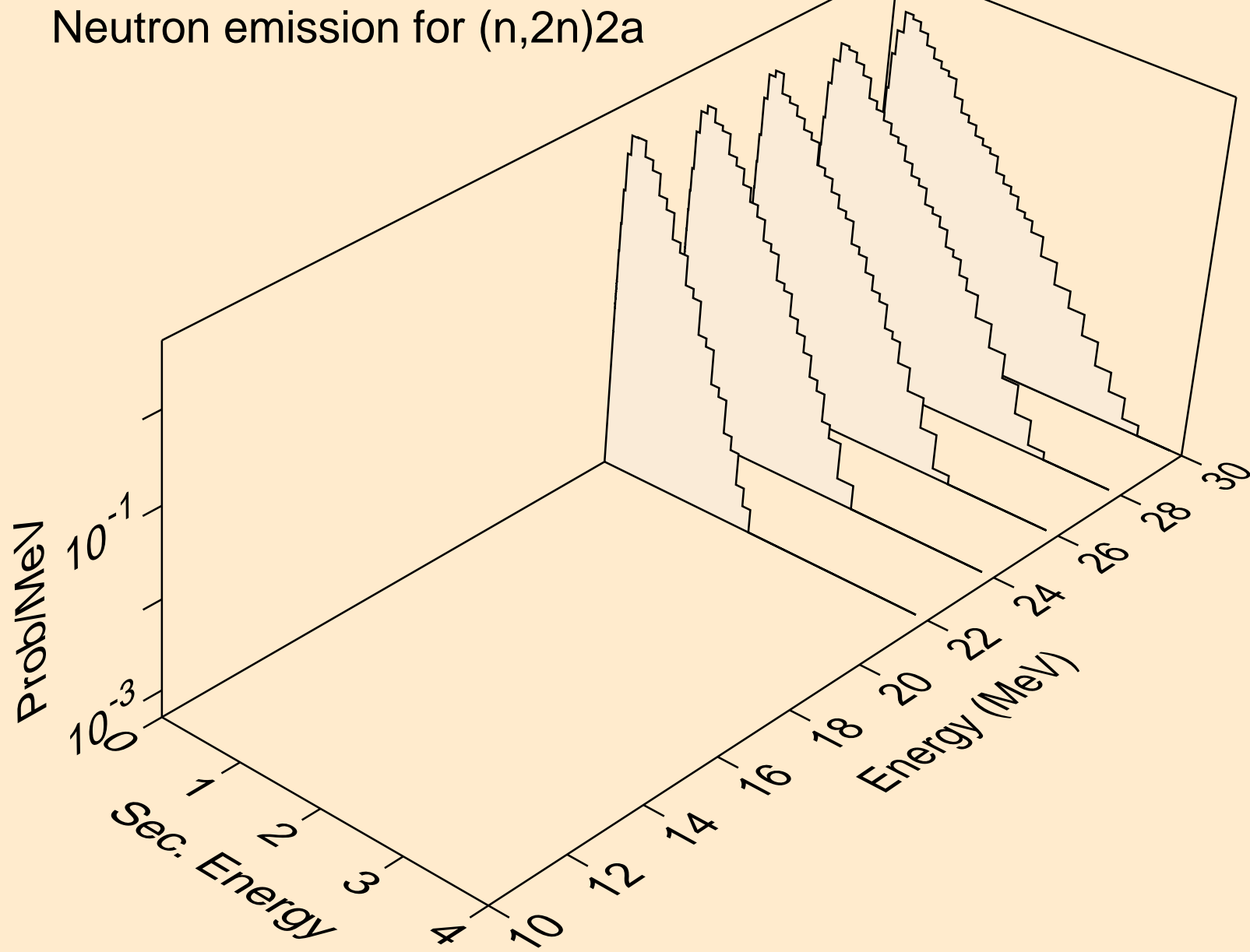

SB114 NEUTRON ACER TENDL-2024 LIBRARY; T=0.K
Neutron emission for (n,n*)d

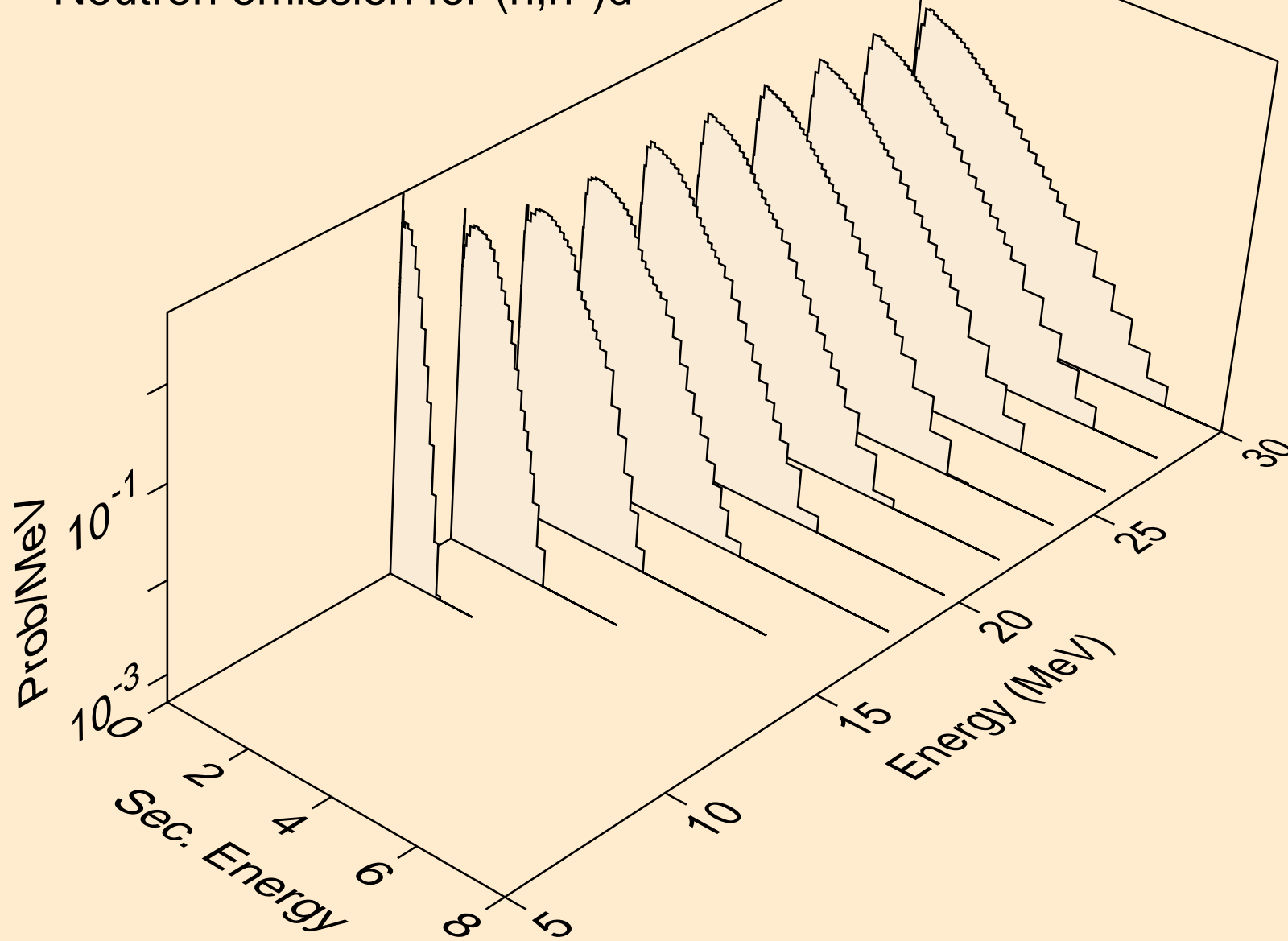

SB114 NEUTRON ACER TENDL-2024 LIBRARY; T=0.K
Neutron emission for (n,n*)t

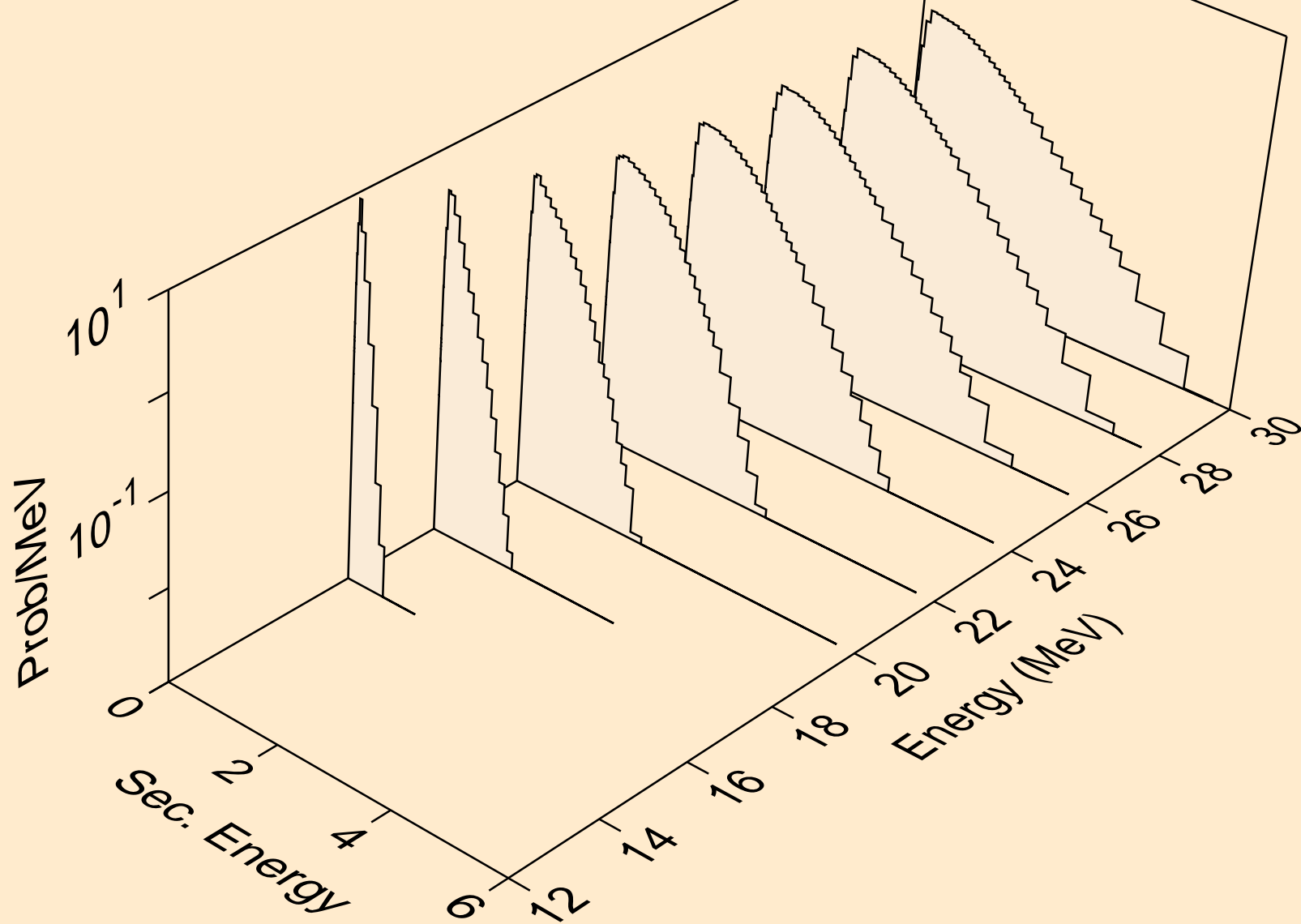

SB114 NEUTRON ACER TENDL-2024 LIBRARY; T=0.K
Neutron emission for (n,n*)he3

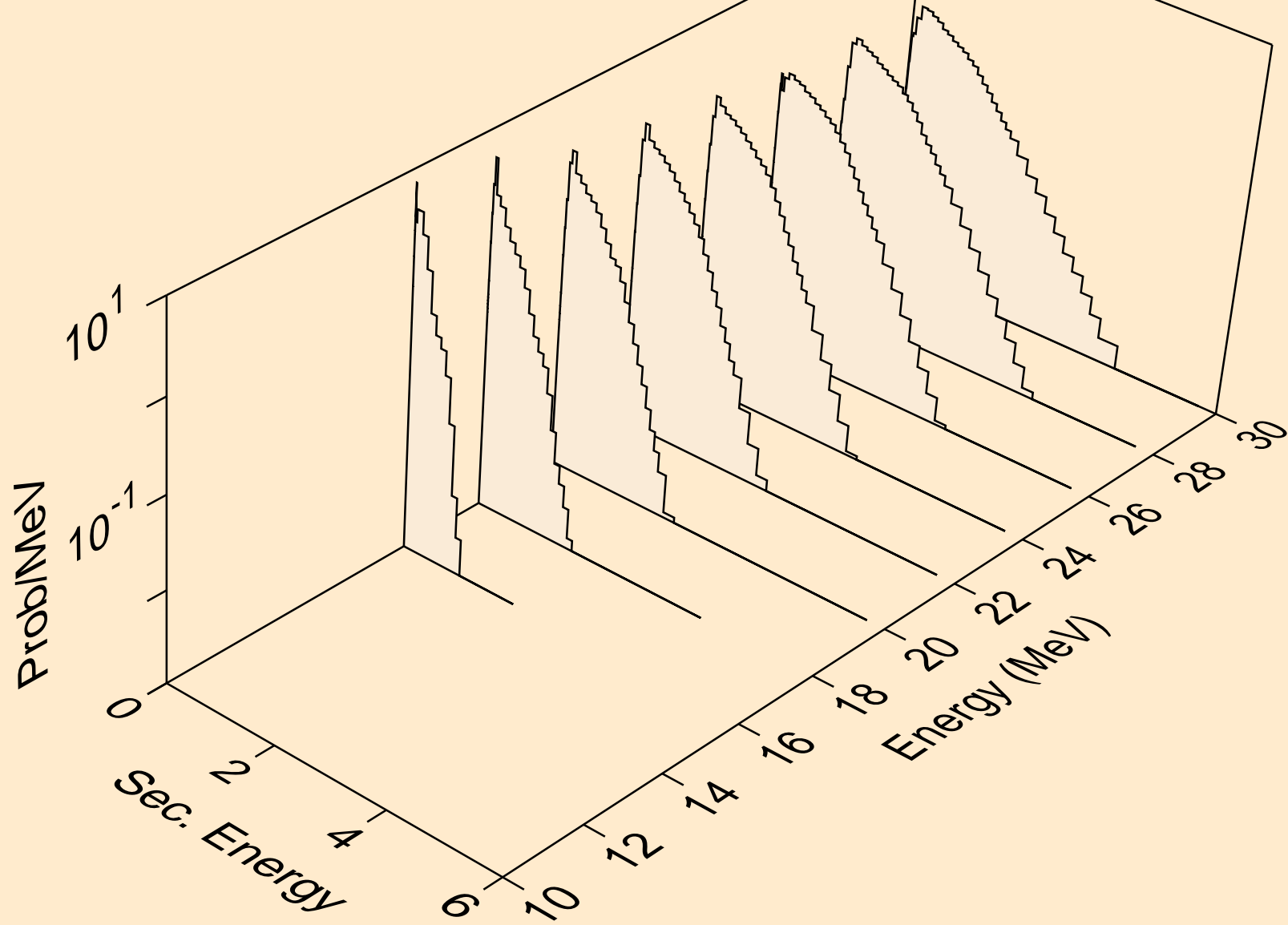

SB114 NEUTRON ACER TENDL-2024 LIBRARY; T=0.K
Neutron emission for (n,4n)

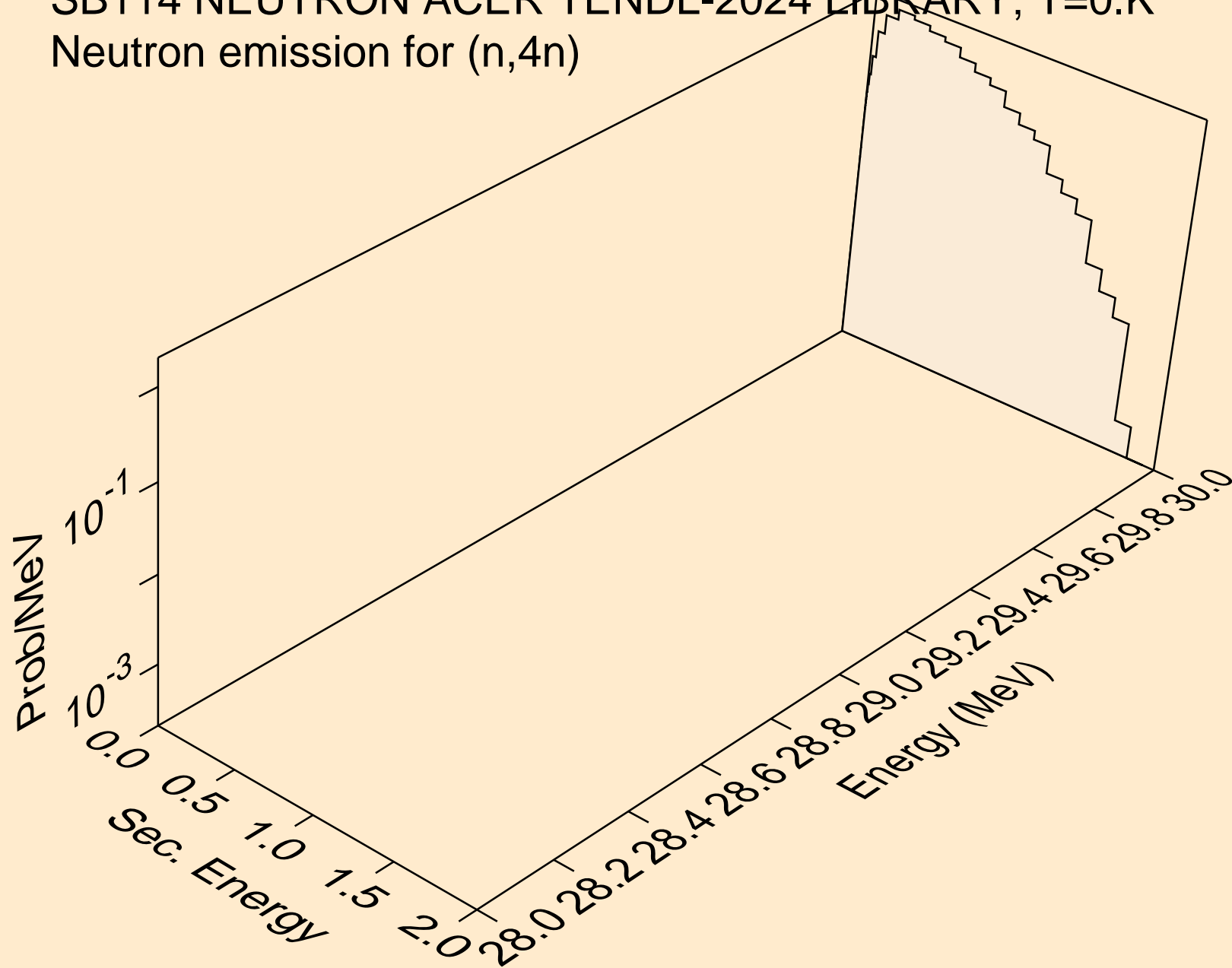

SB114 NEUTRON ACER TENDL-2024 LIBRARY; T=0.K
Neutron emission for (n,2np)

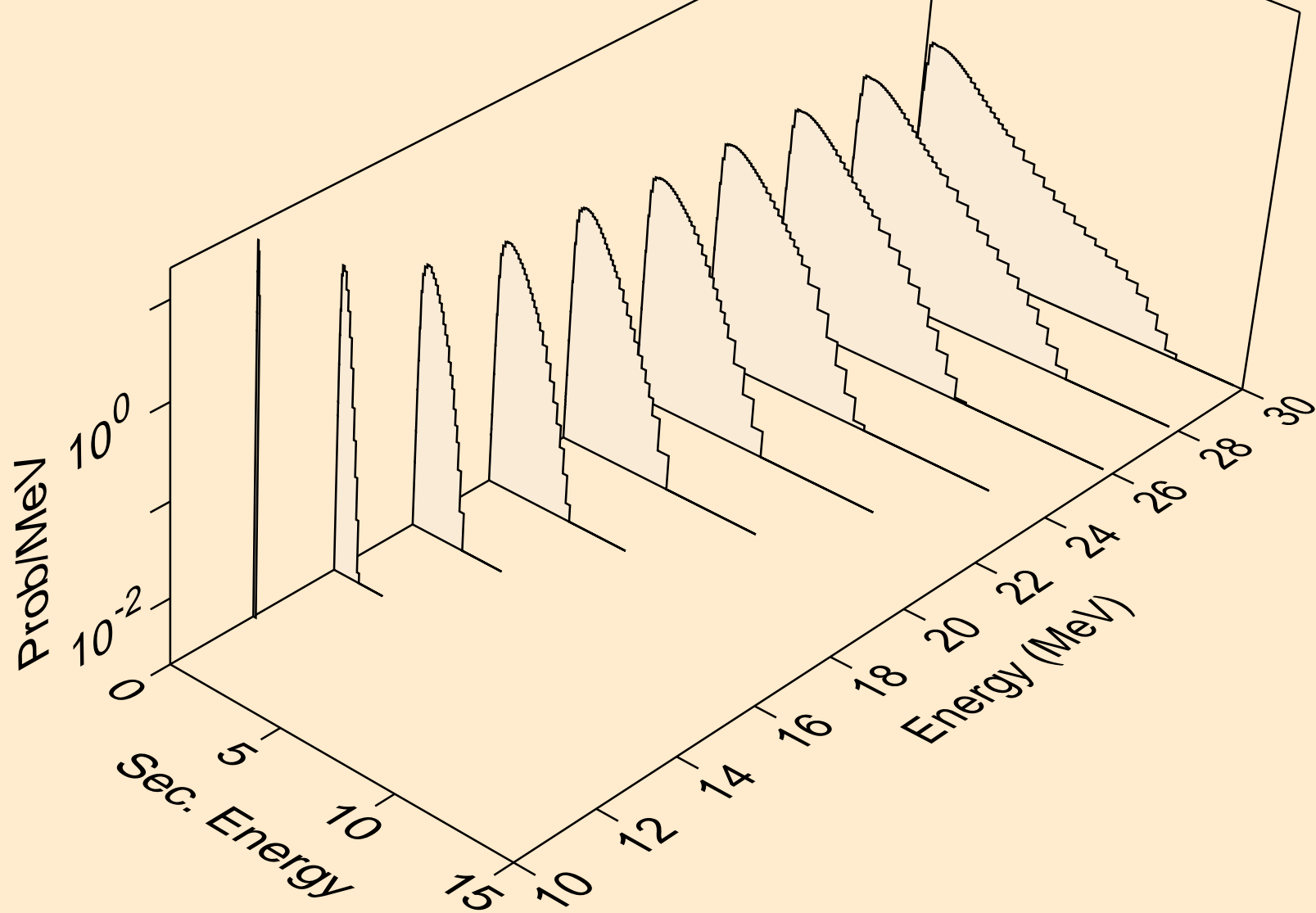

SB114 NEUTRON ACER TENDL-2024 LIBRARY; T=0.K
Neutron emission for (n,3np)

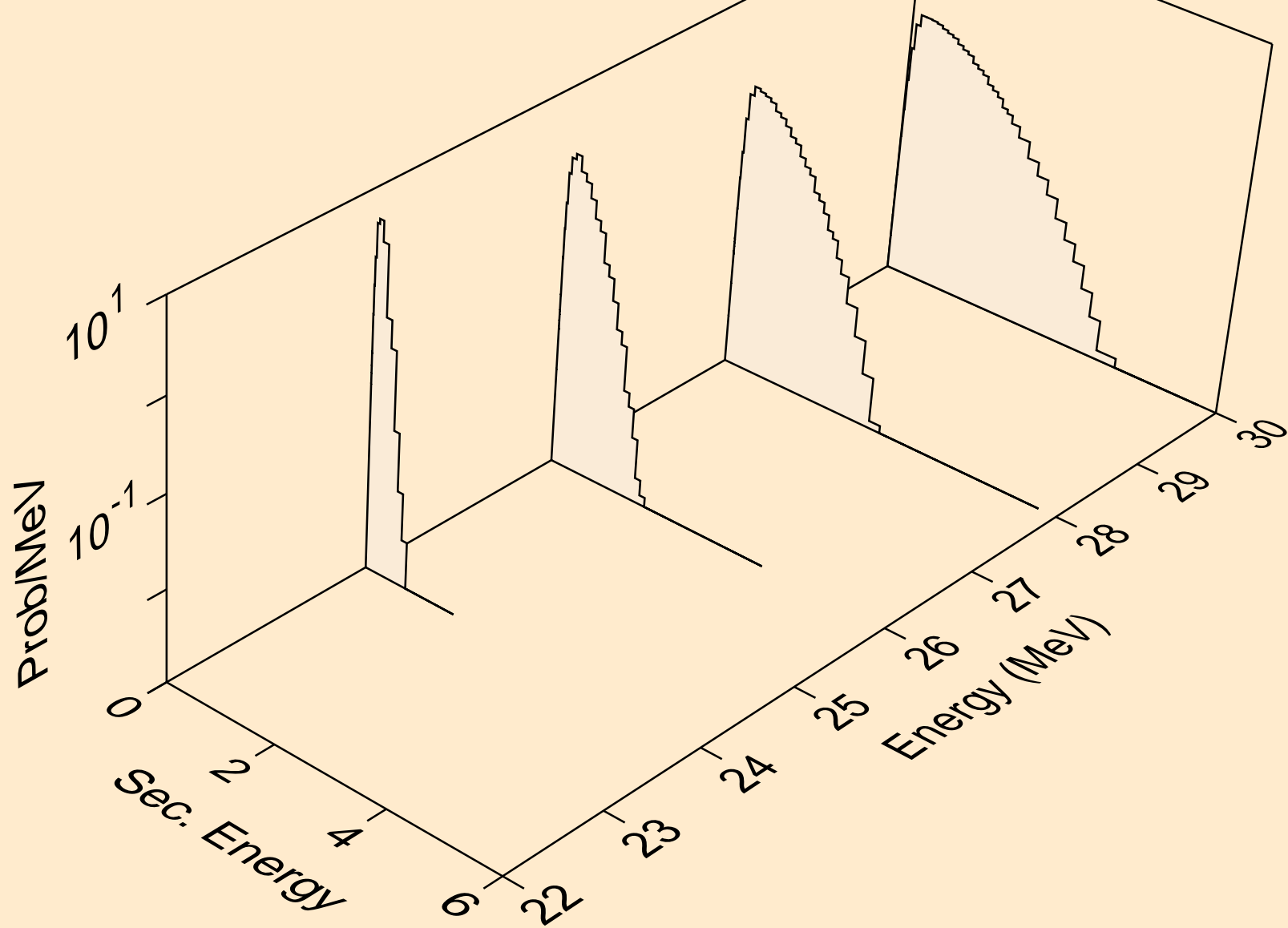

SB114 NEUTRON ACER TENDL-2024 LIBRARY; T=0.K
Neutron emission for (n,n2p)

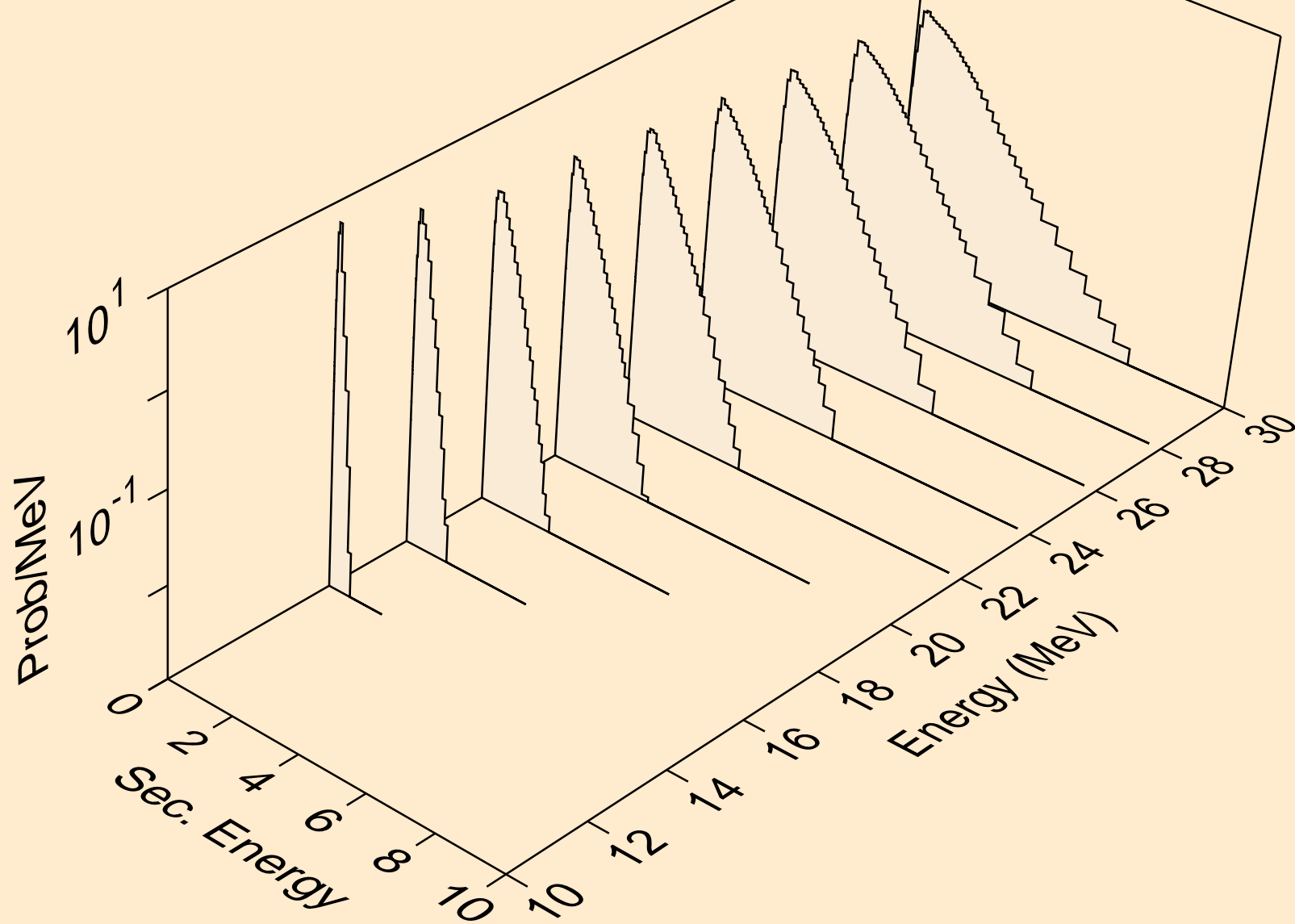

SB114 NEUTRON ACER TENDL-2024 LIBRARY; T=0.K
Neutron emission for (n,npa)

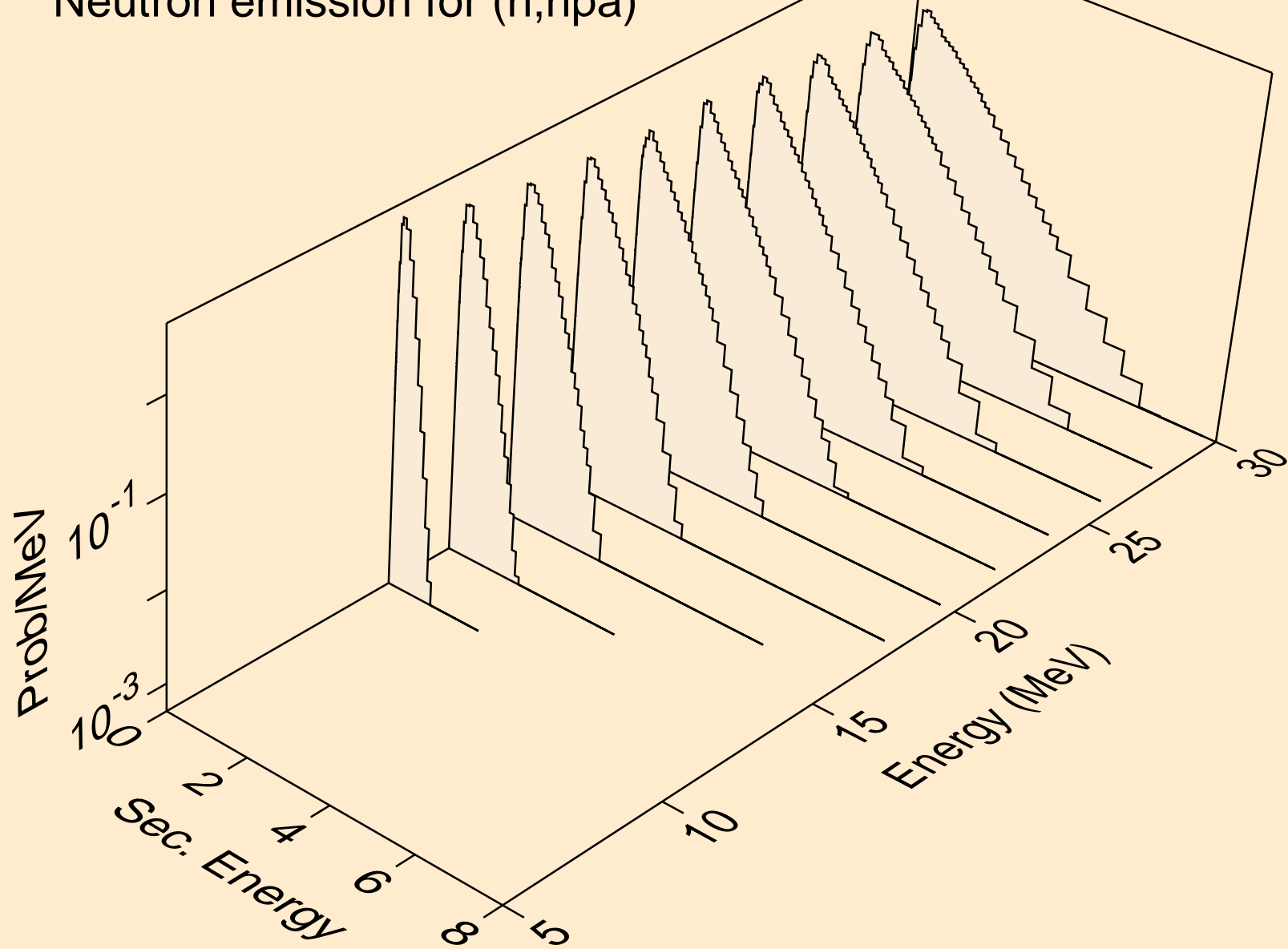

SB114 NEUTRON ACER TENDL-2024 LIBRARY; T=0.K
Neutron emission for (n,n*c)

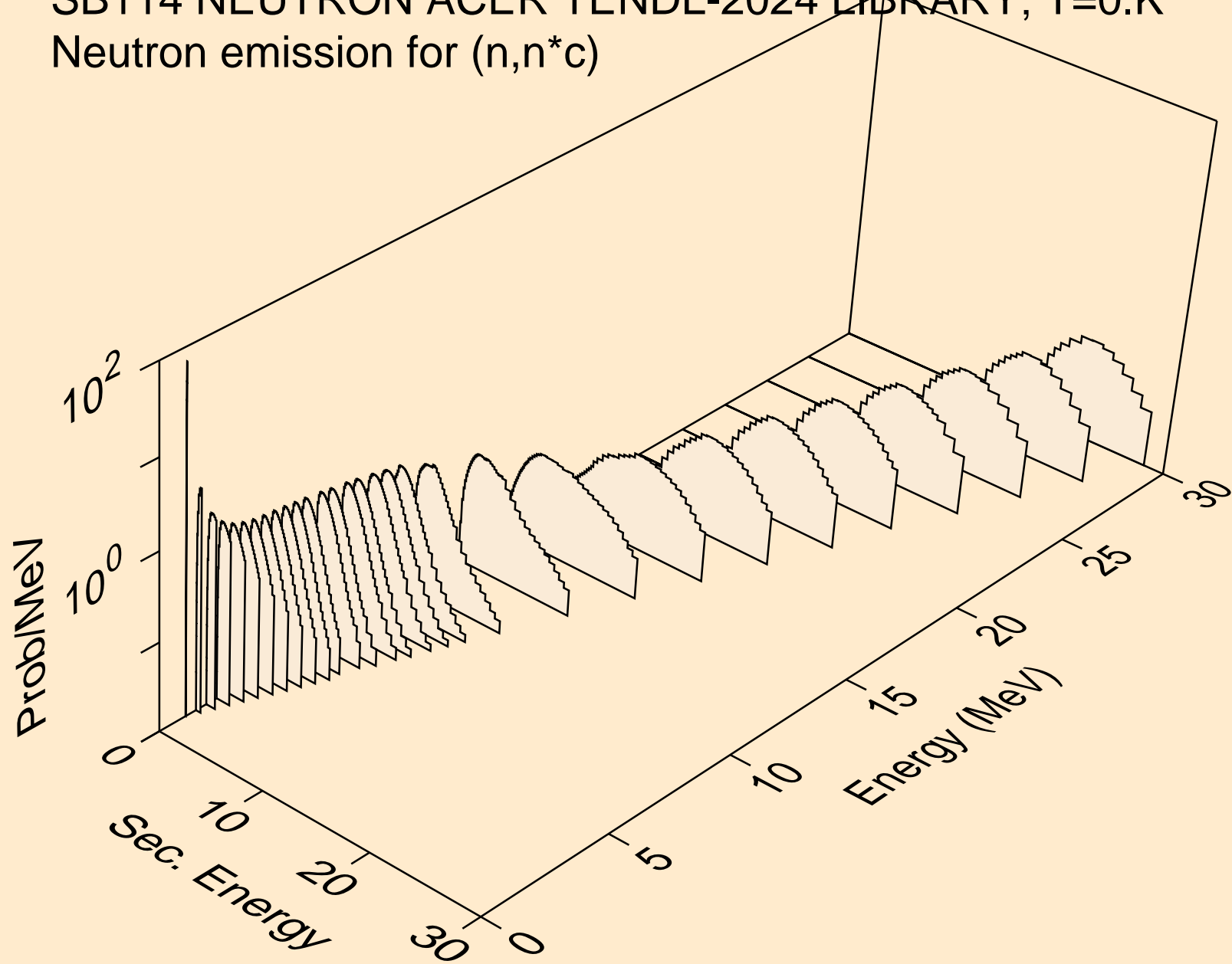

SB114 NEUTRON ACER TENDL-2024 LIBRARY; T=0.K
Photon emission for (n,x)

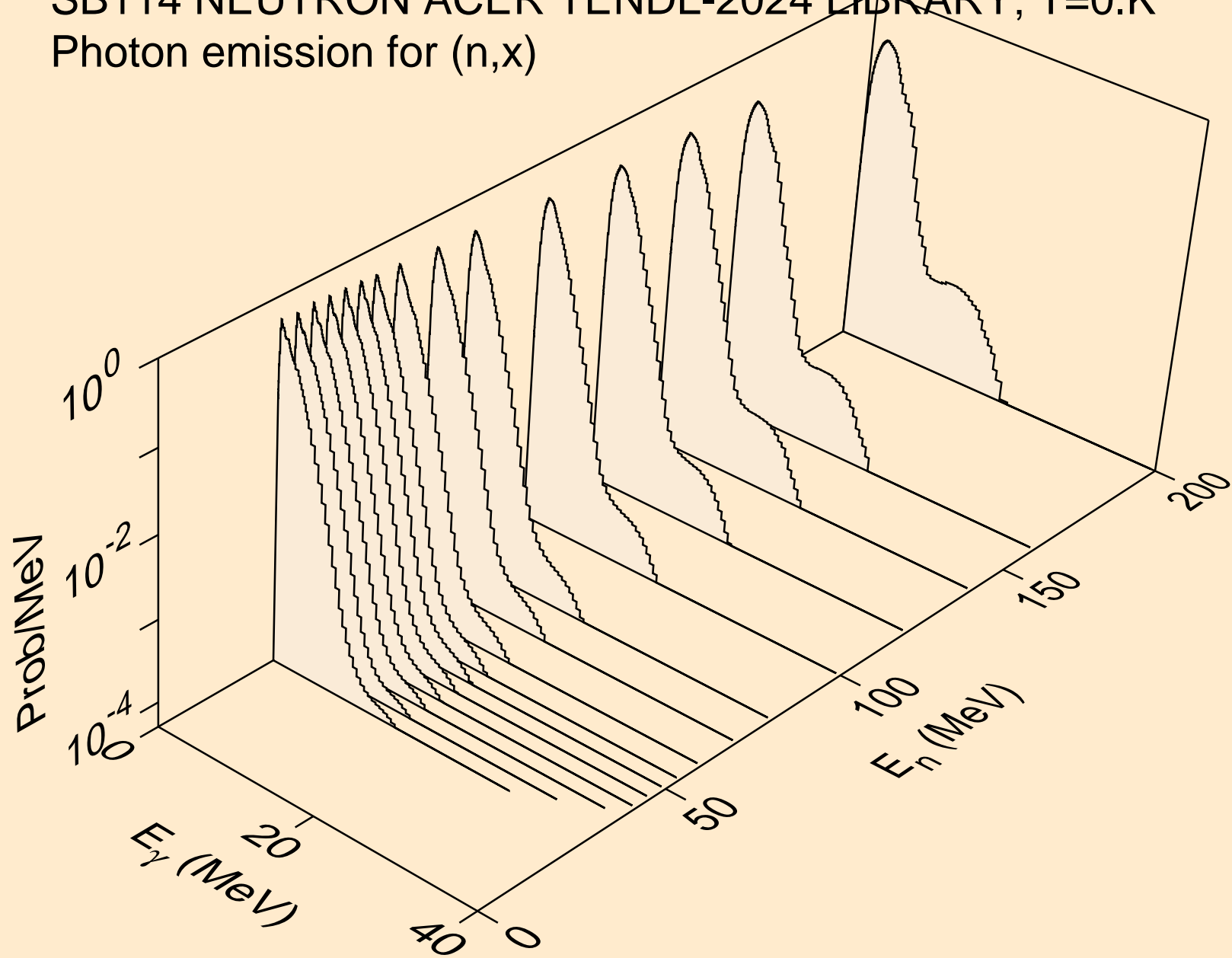

SB114 NEUTRON ACER TENDL-2024 LIBRARY; T=0.K
Photon emission for (n,2nd)

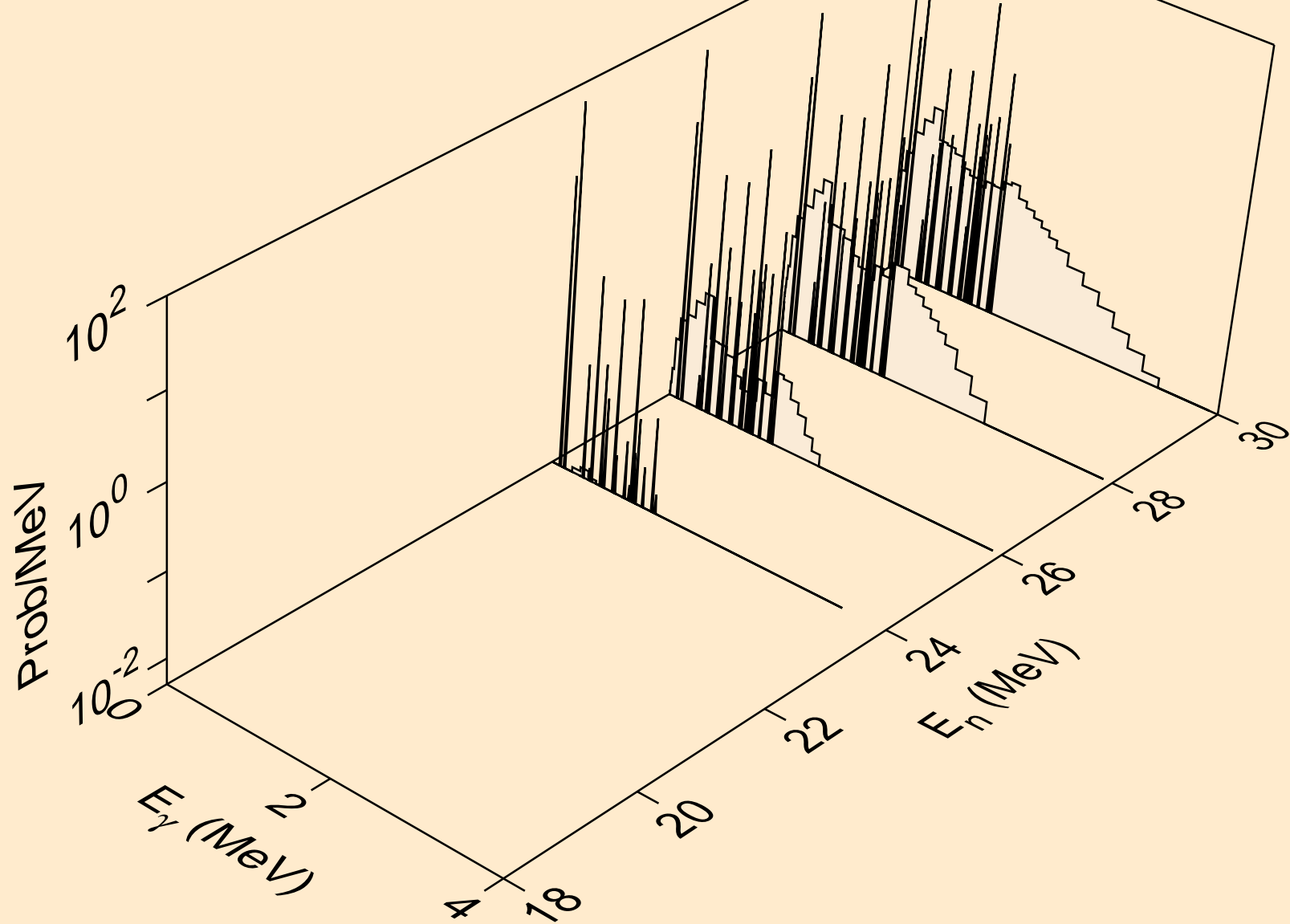

SB114 NEUTRON ACER TENDL-2024 LIBRARY; T=0.K
Photon emission for (n,2n)

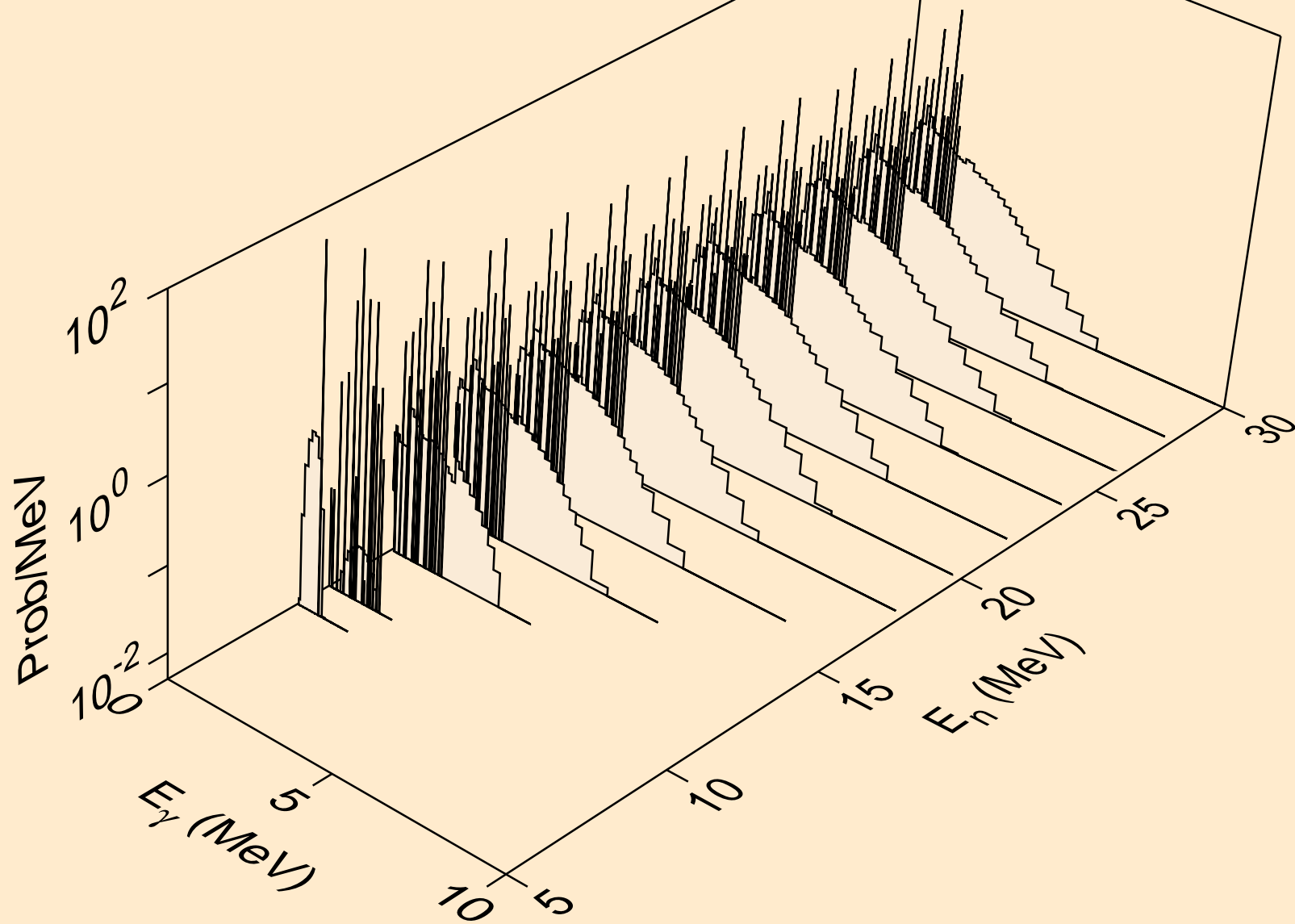

SB114 NEUTRON ACER TENDL-2024 LIBRARY; T=0.K
Photon emission for (n,3n)

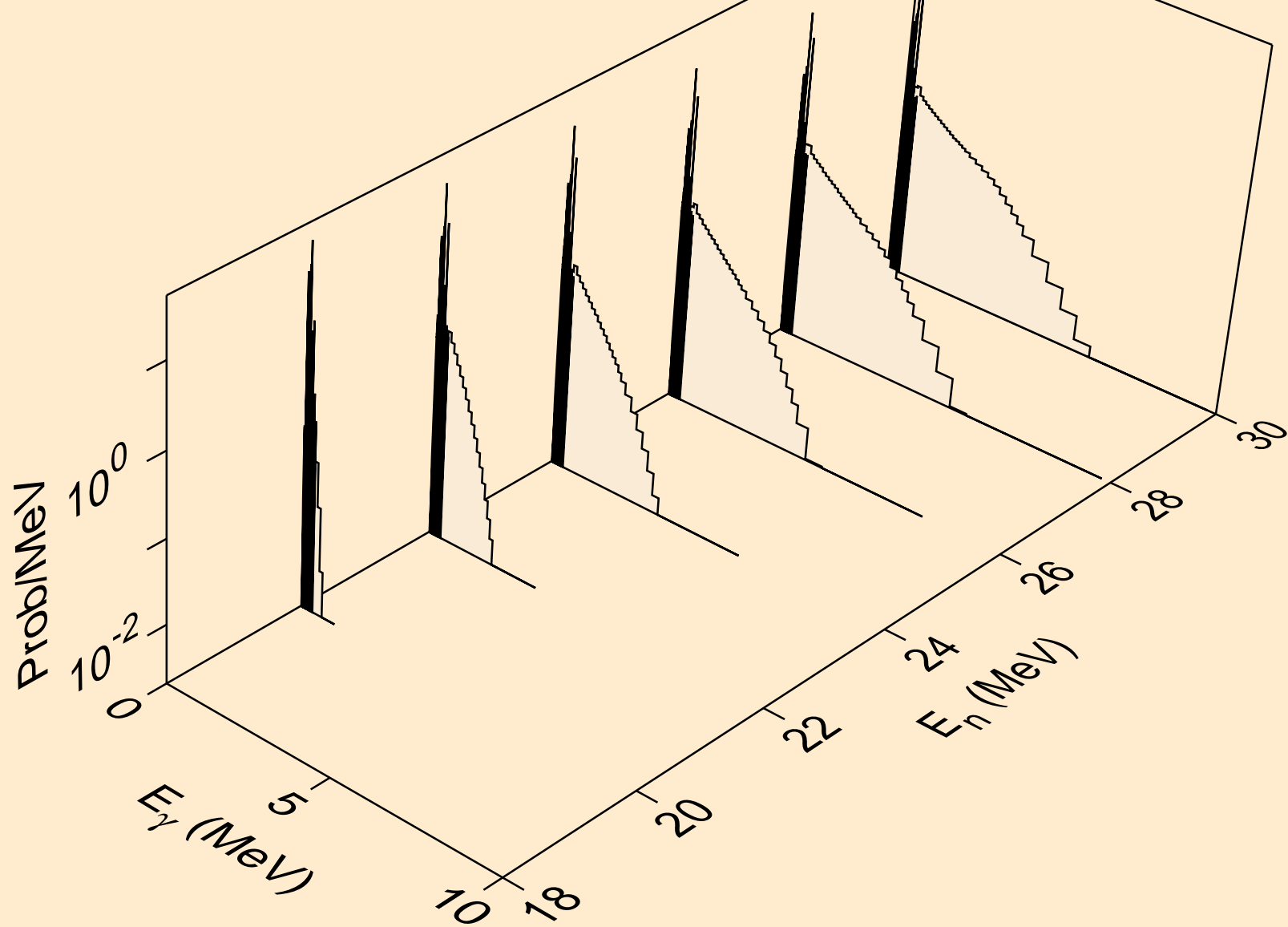

SB114 NEUTRON ACER TENDL-2024 LIBRARY; T=0.K
Photon emission for (n,n*)a

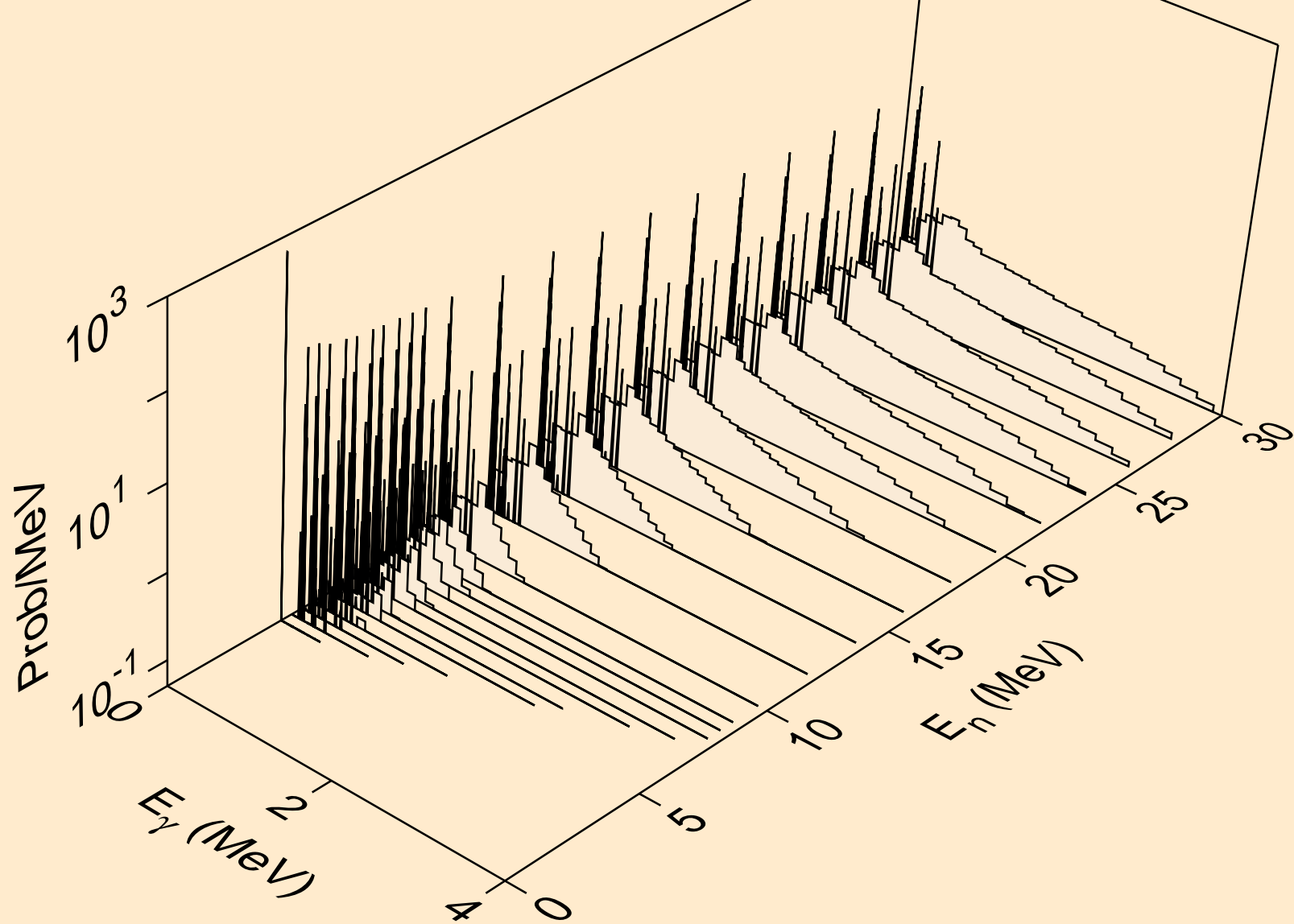

SB114 NEUTRON ACER TENDL-2024 LIBRARY; T=0.K
Photon emission for (n,2n)a

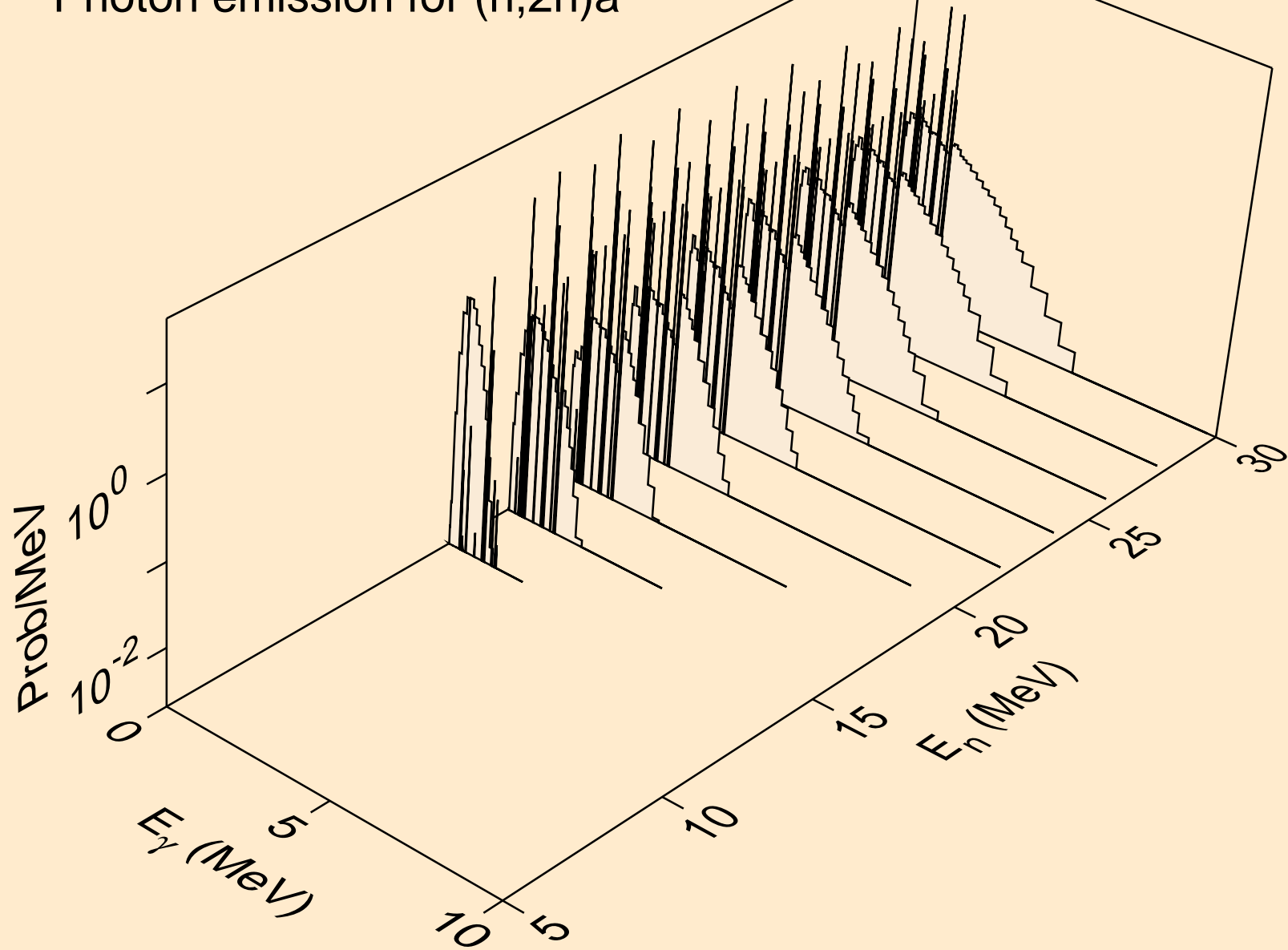

SB114 NEUTRON ACER TENDL-2024 LIBRARY; T=0.K
Photon emission for (n,3n)a

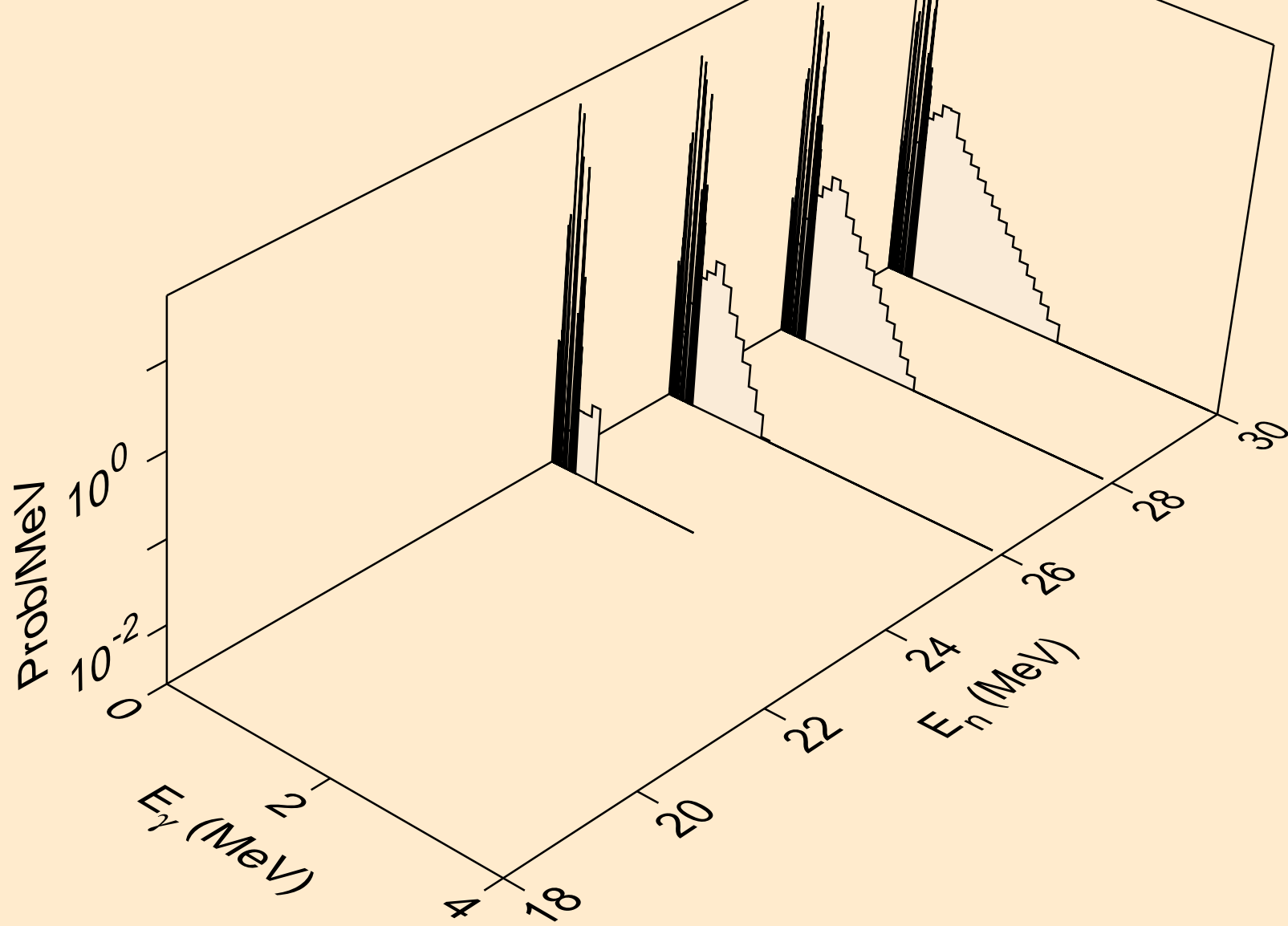

SB114 NEUTRON ACER TENDL-2024 LIBRARY; T=0.K
Photon emission for (n,n*)p

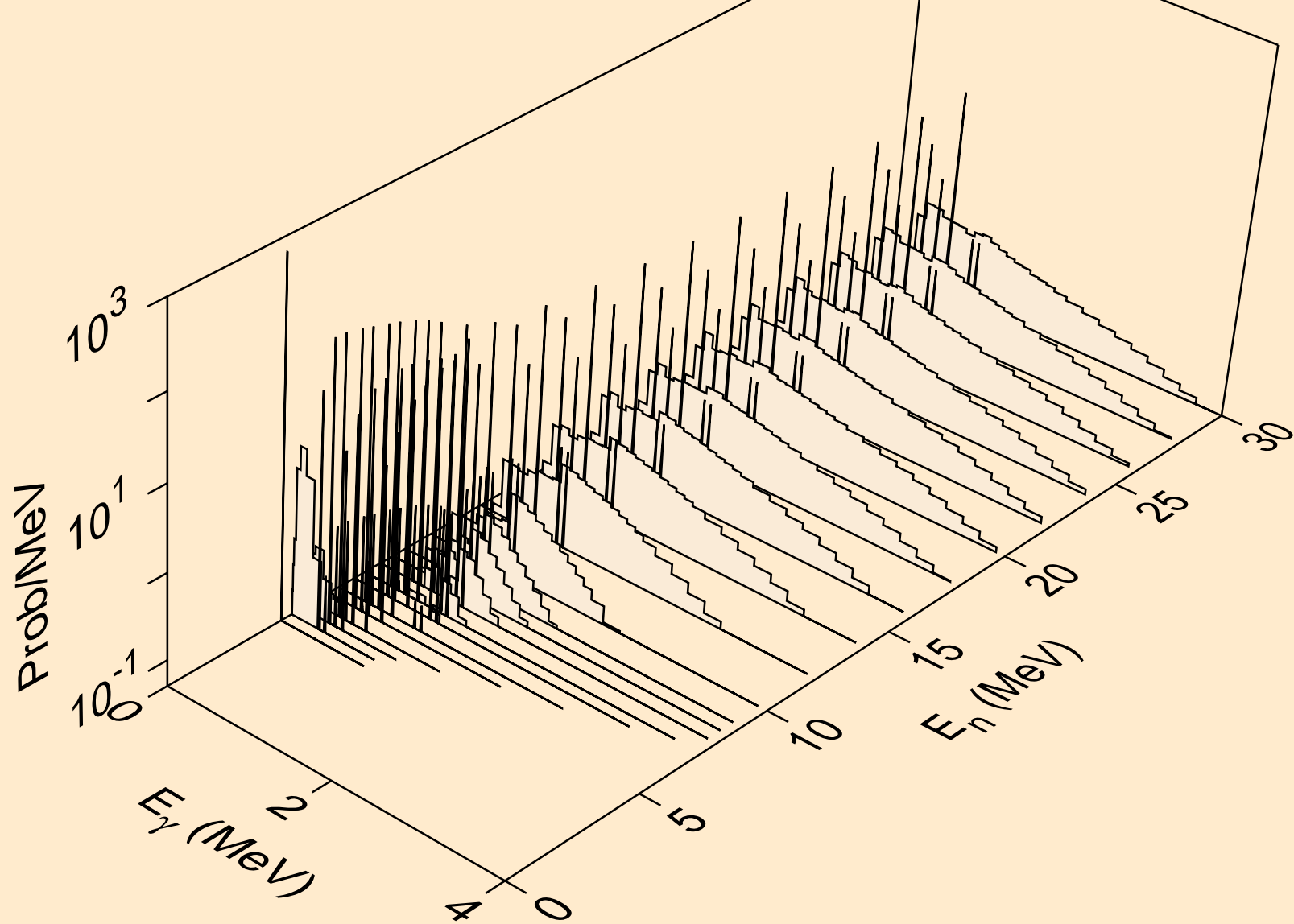

SB114 NEUTRON ACER TENDL-2024 LIBRARY; T=0.K
Photon emission for (n,n*)2a

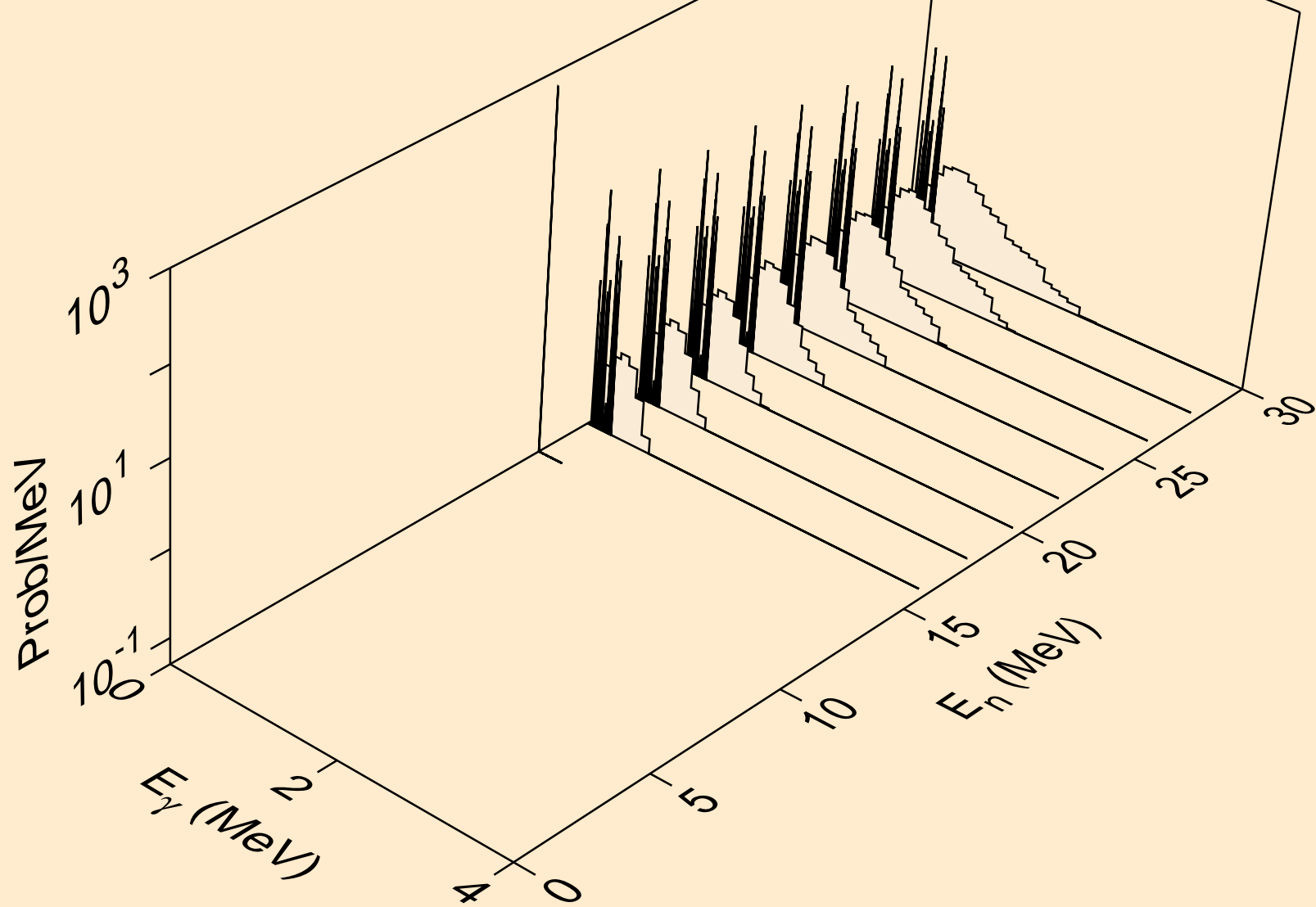

SB114 NEUTRON ACER TENDL-2024 LIBRARY; T=0.K
Photon emission for (n,2n)2a

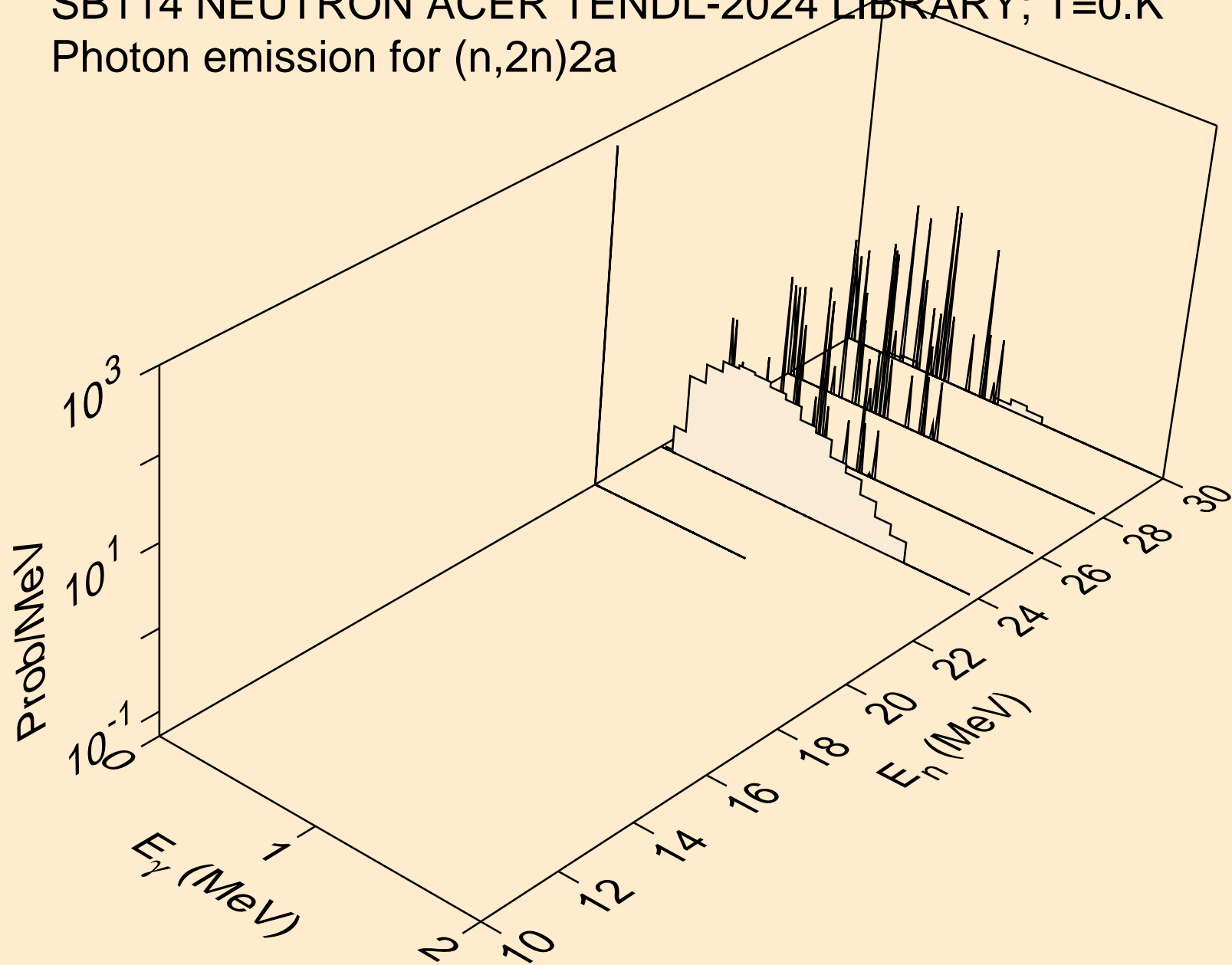

SB114 NEUTRON ACER TENDL-2024 LIBRARY; T=0.K
Photon emission for (n,n*)d

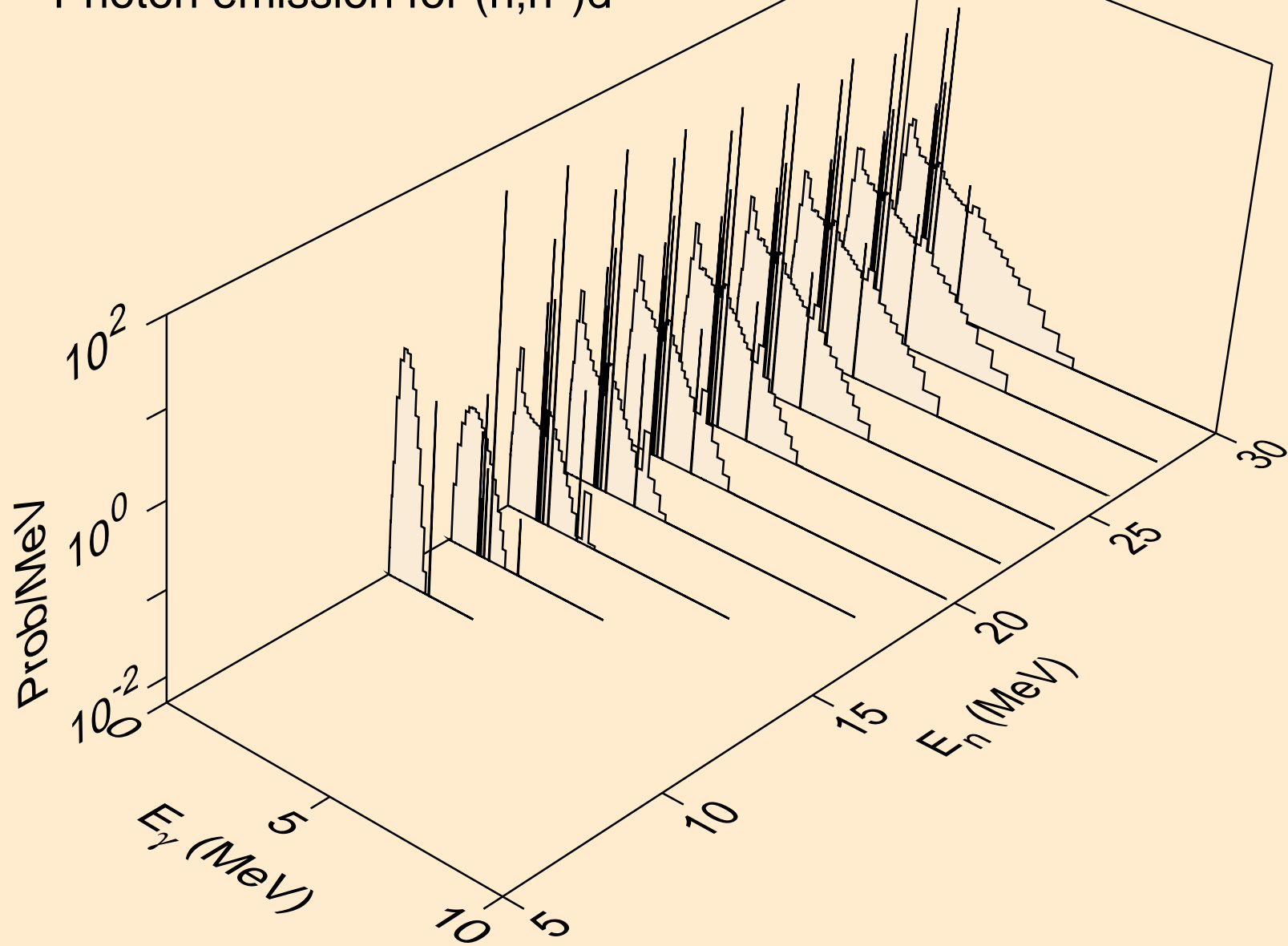

SB114 NEUTRON ACER TENDL-2024 LIBRARY; T=0.K
Photon emission for (n,n*)t

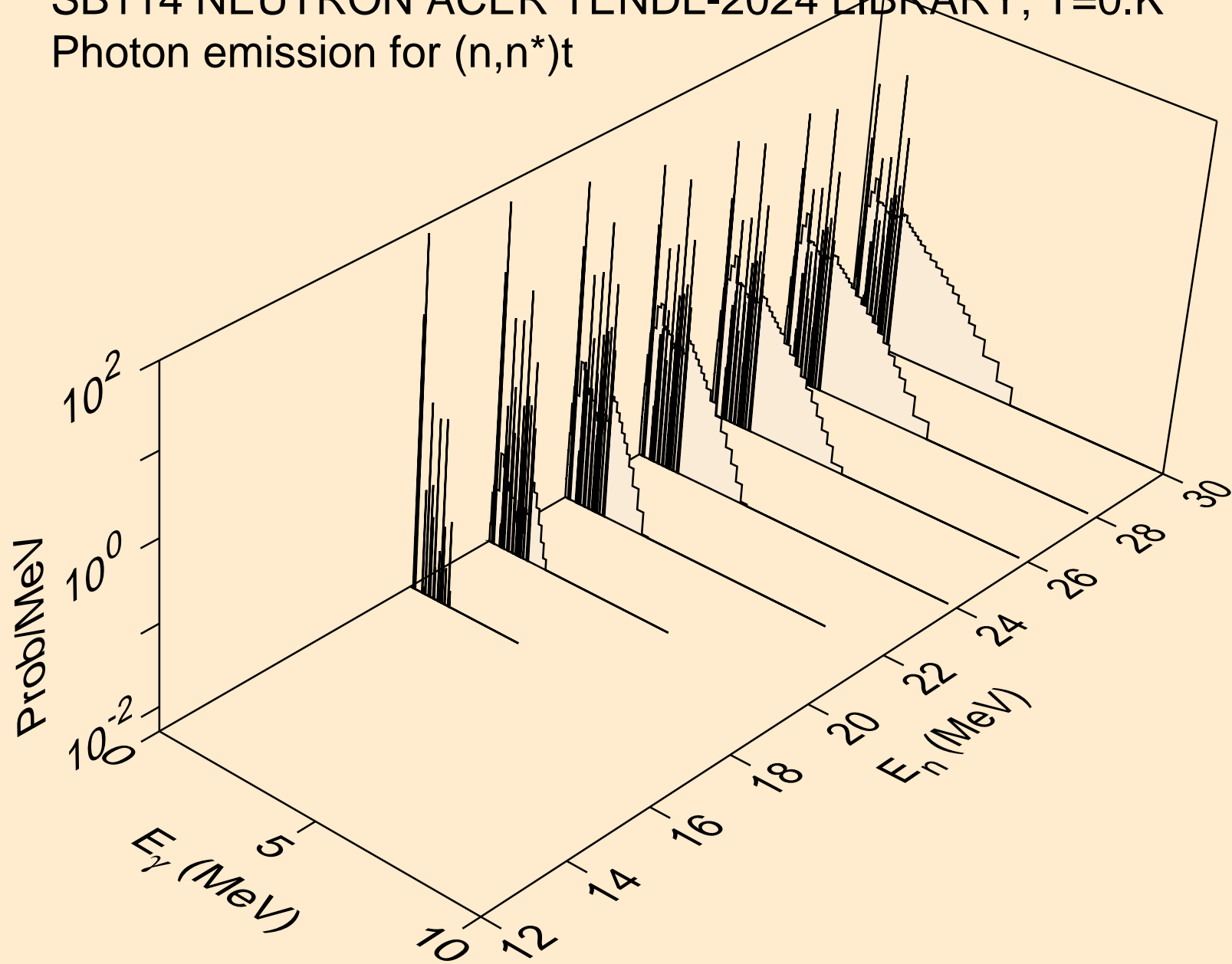

SB114 NEUTRON ACER TENDL-2024 LIBRARY; T=0.K
Photon emission for (n,n*)he3

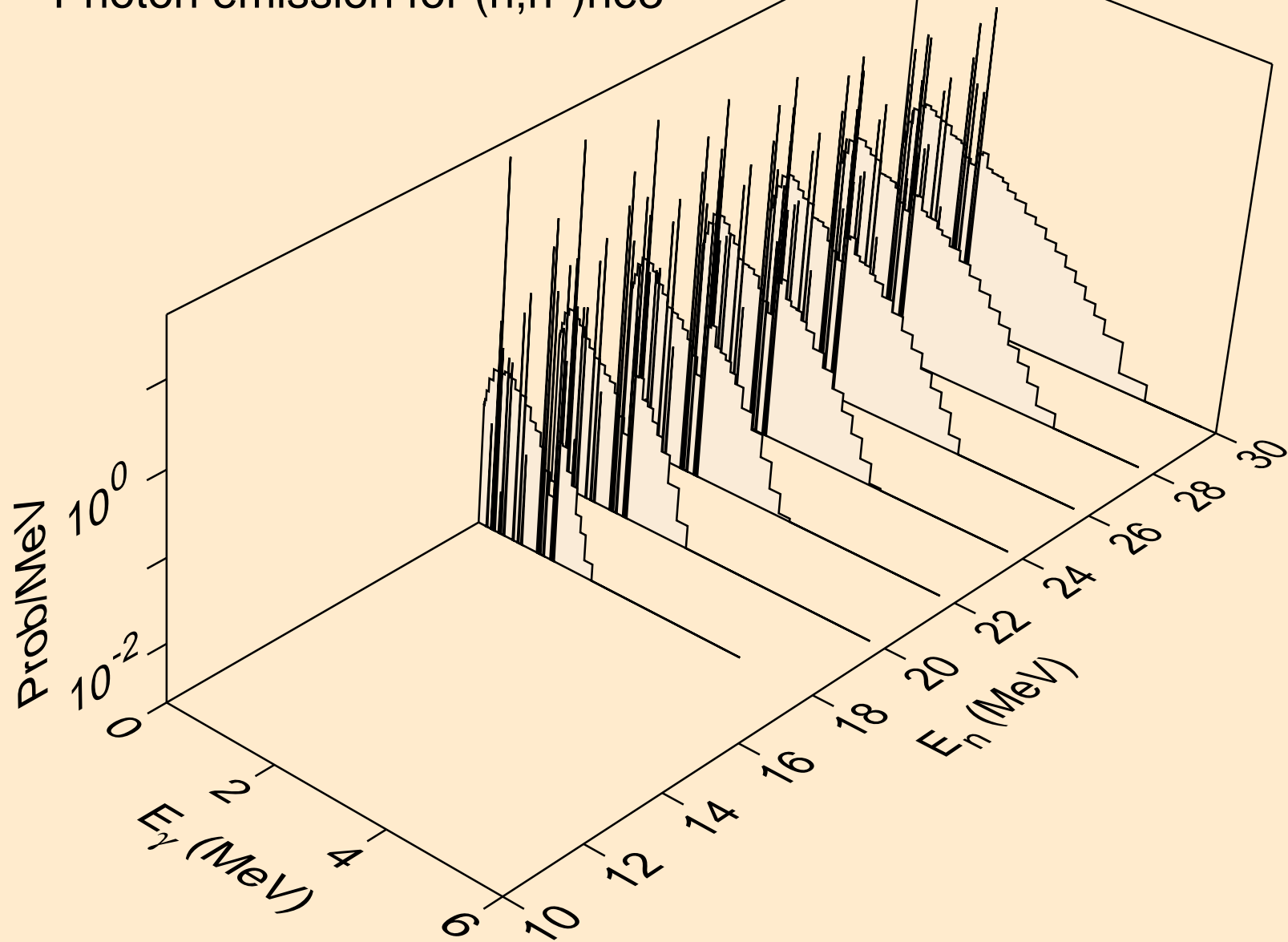

SB114 NEUTRON ACER TENDL-2024 LIBRARY; T=0.K
Photon emission for (n,4n)

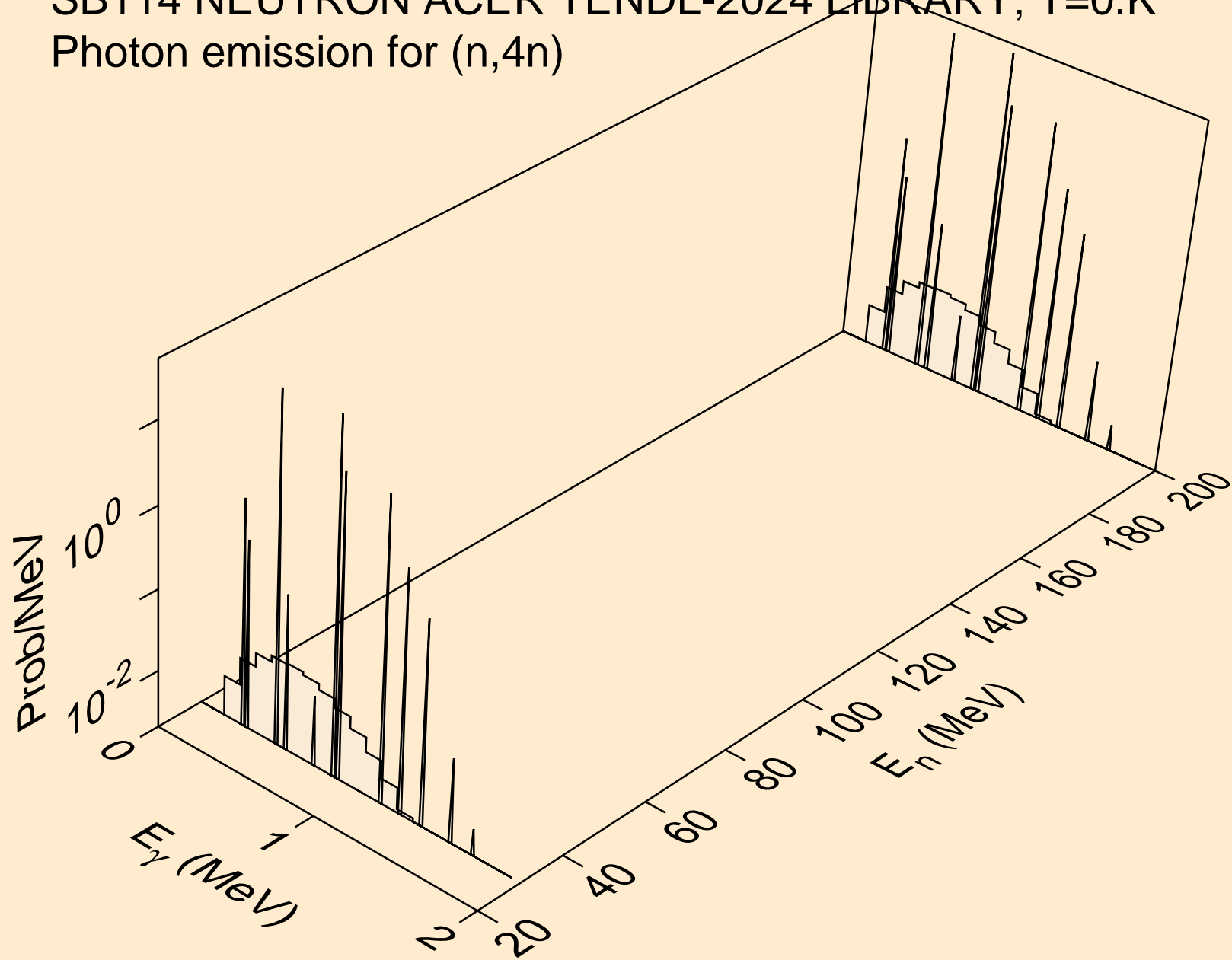

SB114 NEUTRON ACER TENDL-2024 LIBRARY; T=0.K
Photon emission for (n,2np)

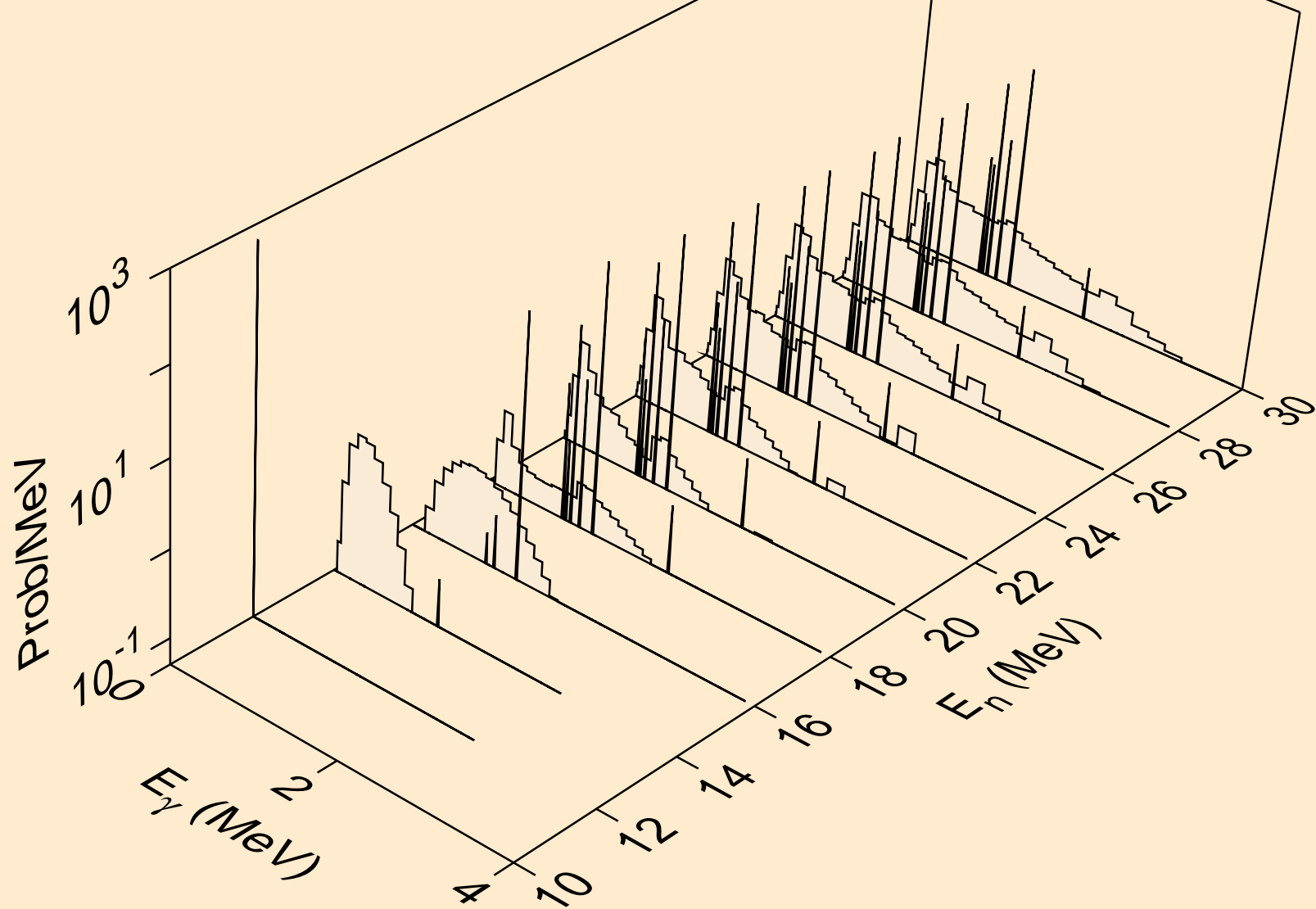

SB114 NEUTRON ACER TENDL-2024 LIBRARY; T=0.K
Photon emission for (n,3np)

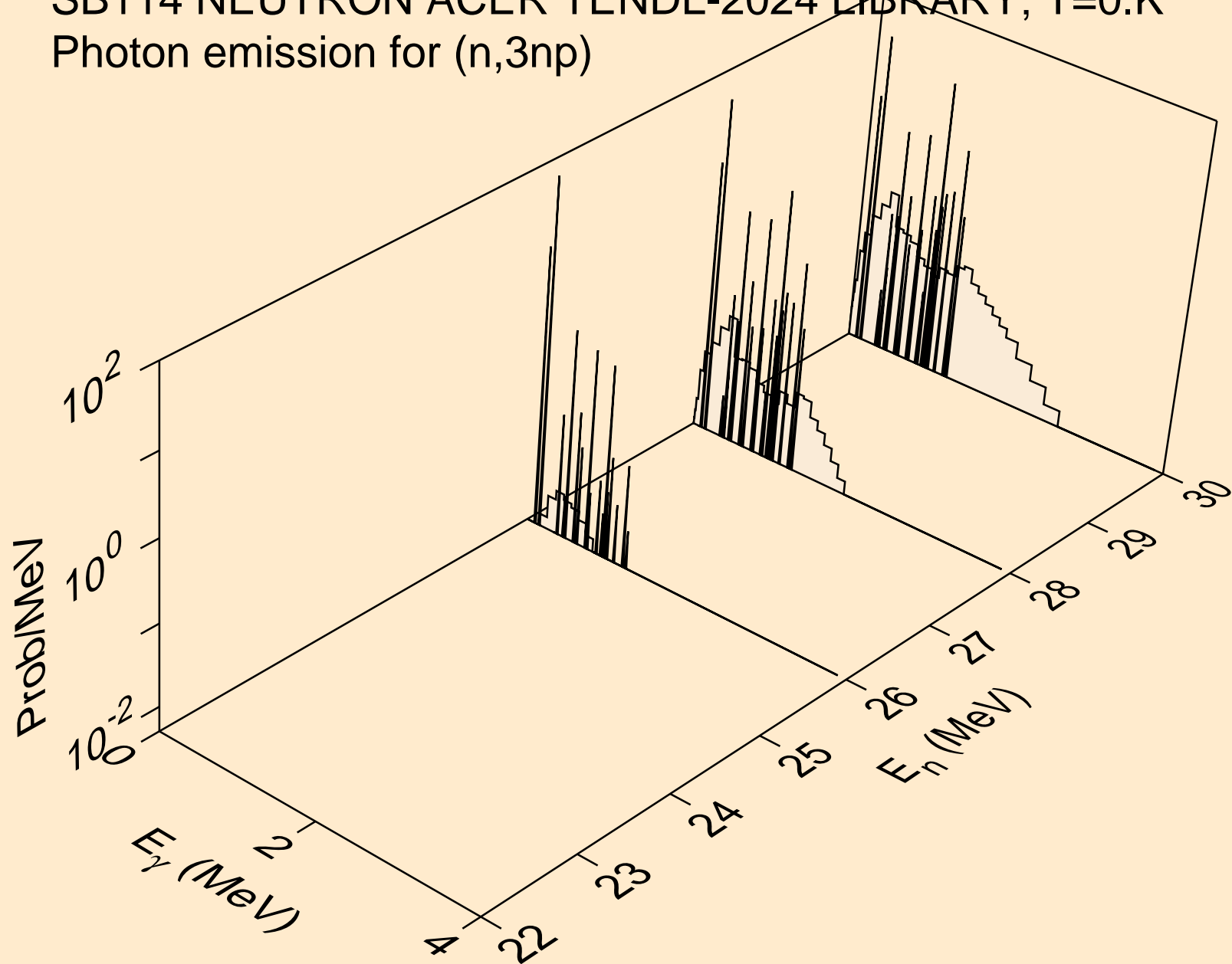

SB114 NEUTRON ACER TENDL-2024 LIBRARY; T=0.K
Photon emission for (n,n2p)

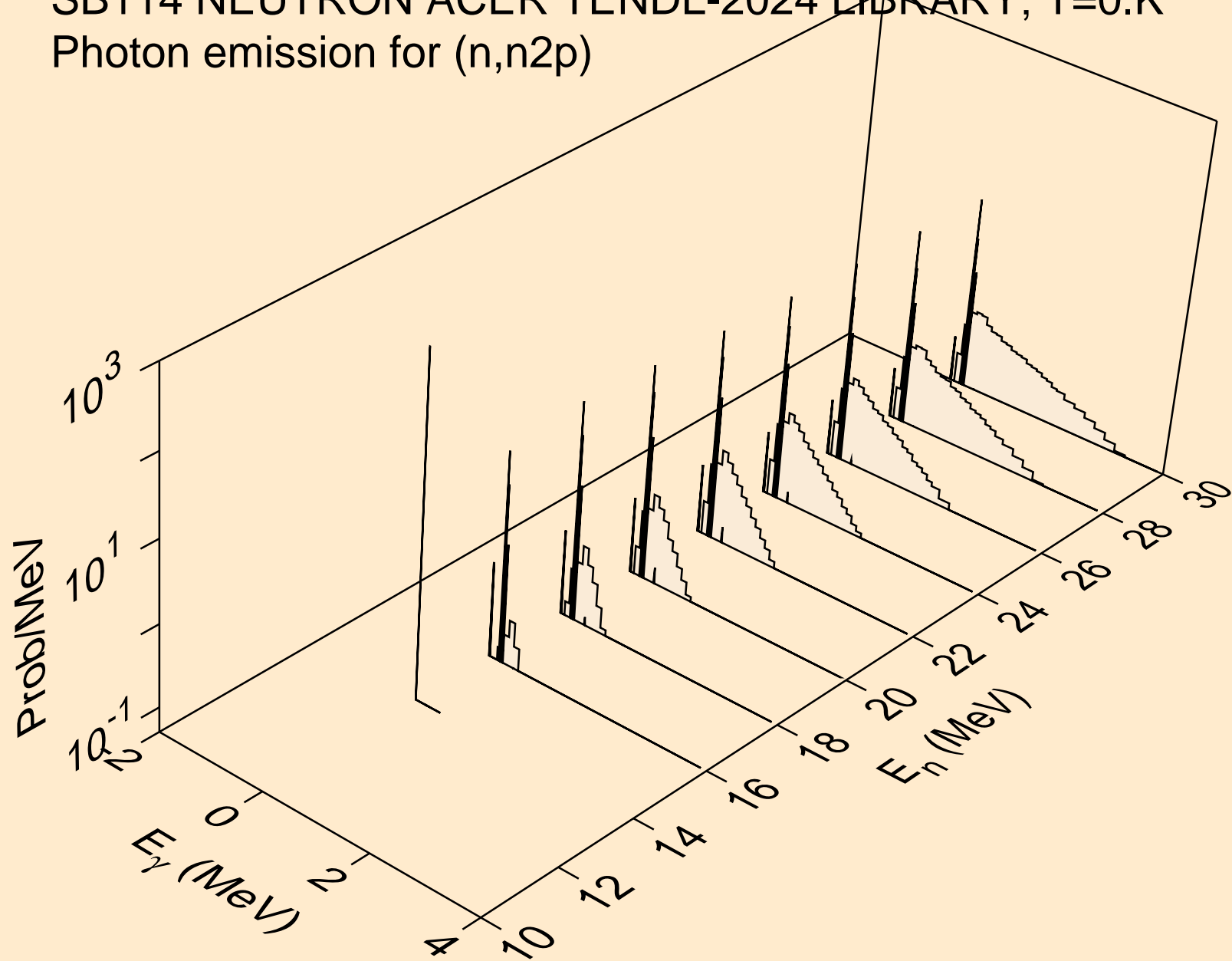

SB114 NEUTRON ACER TENDL-2024 LIBRARY; T=0.K
Photon emission for (n,npa)

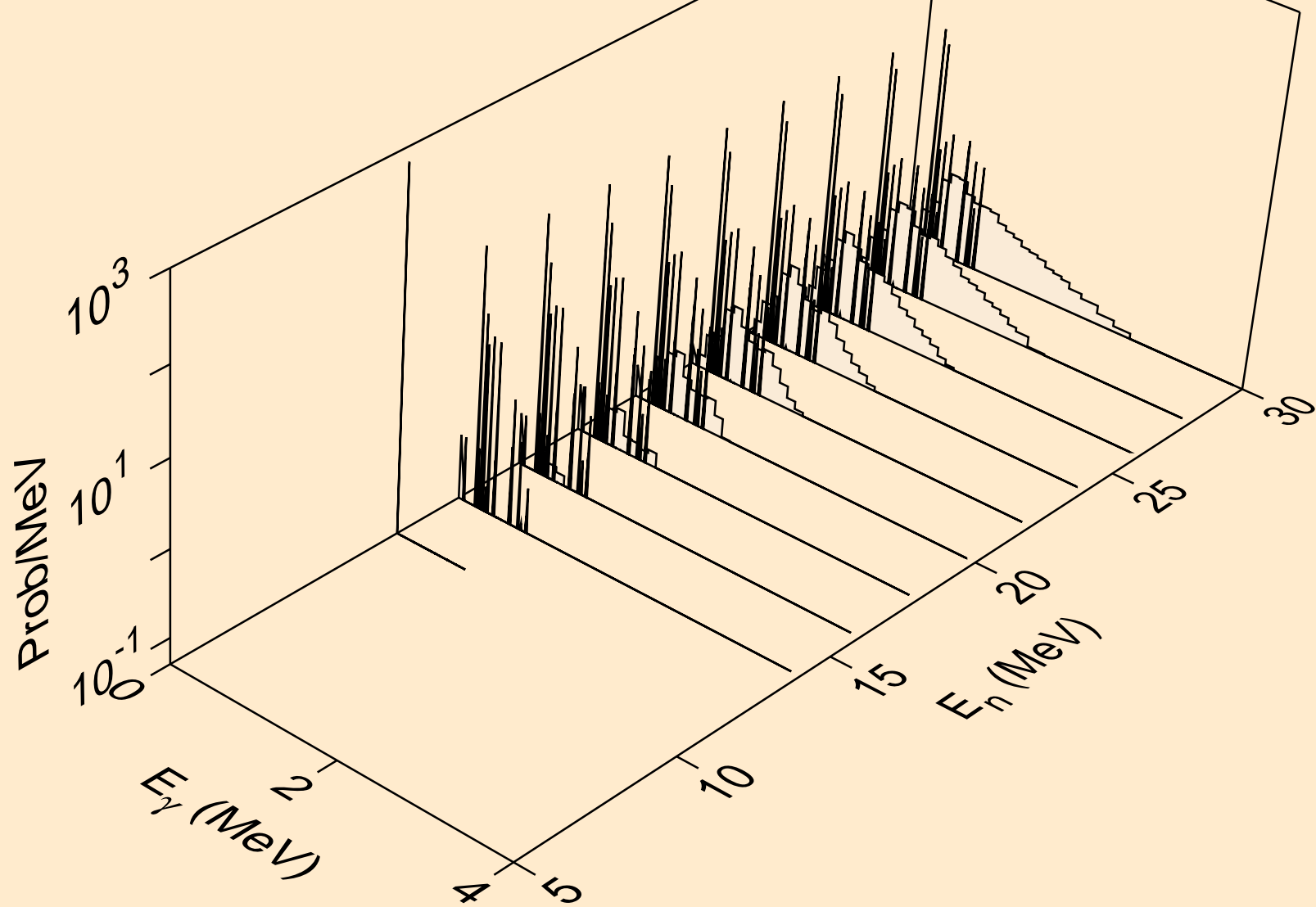

SB114 NEUTRON ACER TENDL-2024 LIBRARY; T=0.K
Photon emission for (n,n*c)

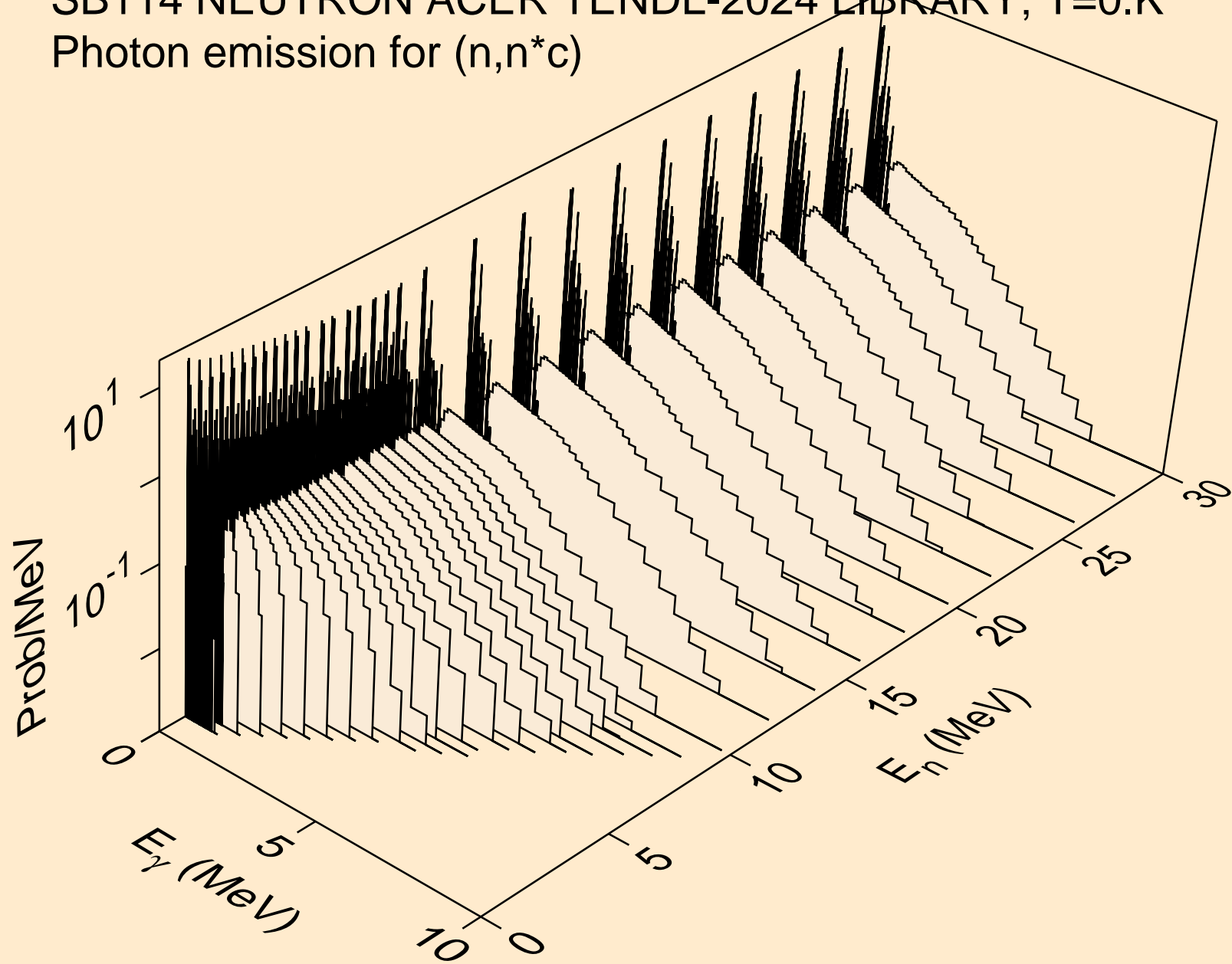

SB114 NEUTRON ACER TENDL-2024 LIBRARY; T=0.K
Photon emission for (n,gma)

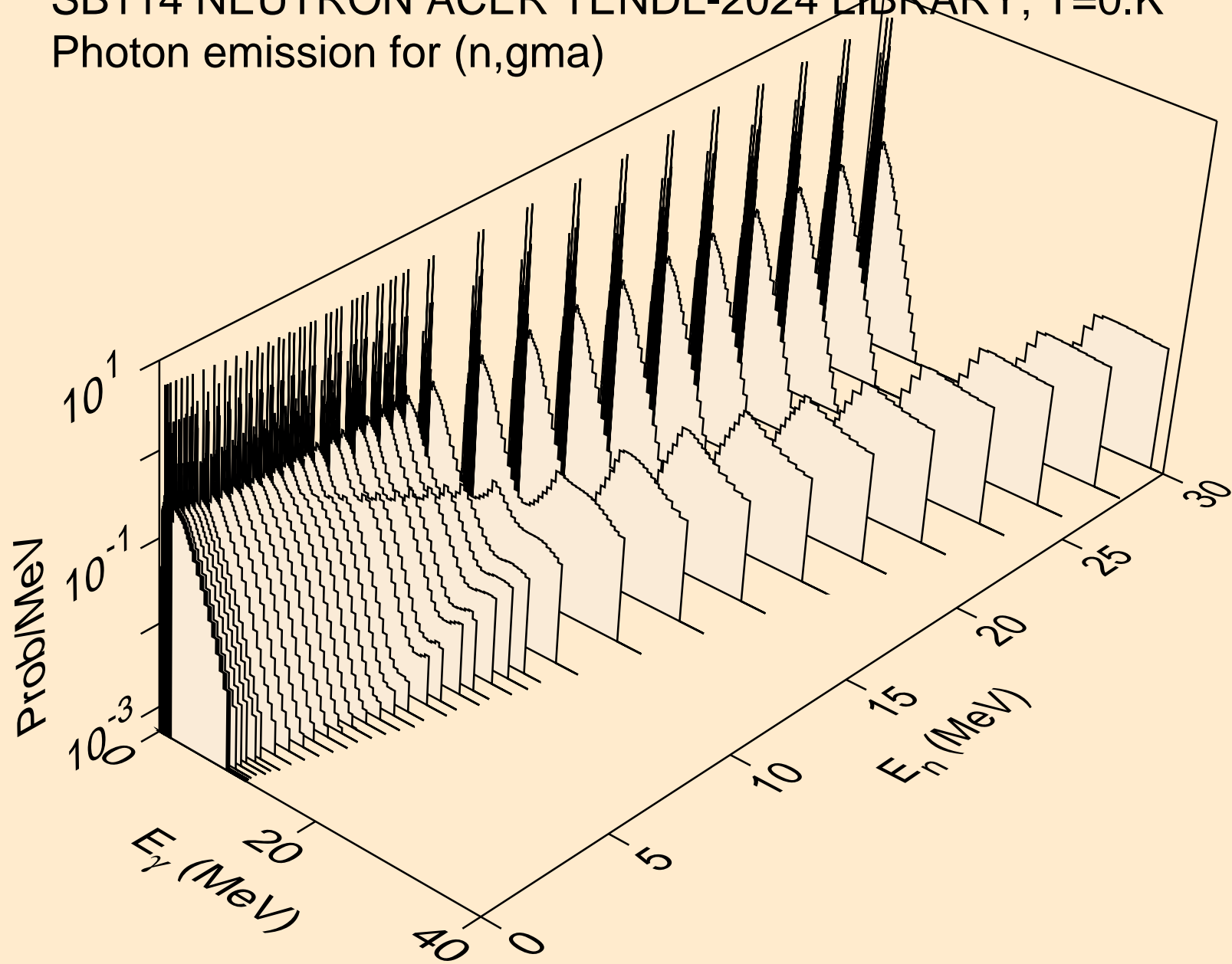

SB114 NEUTRON ACER TENDL-2024 LIBRARY; T=0.K
Photon emission for (n,p)

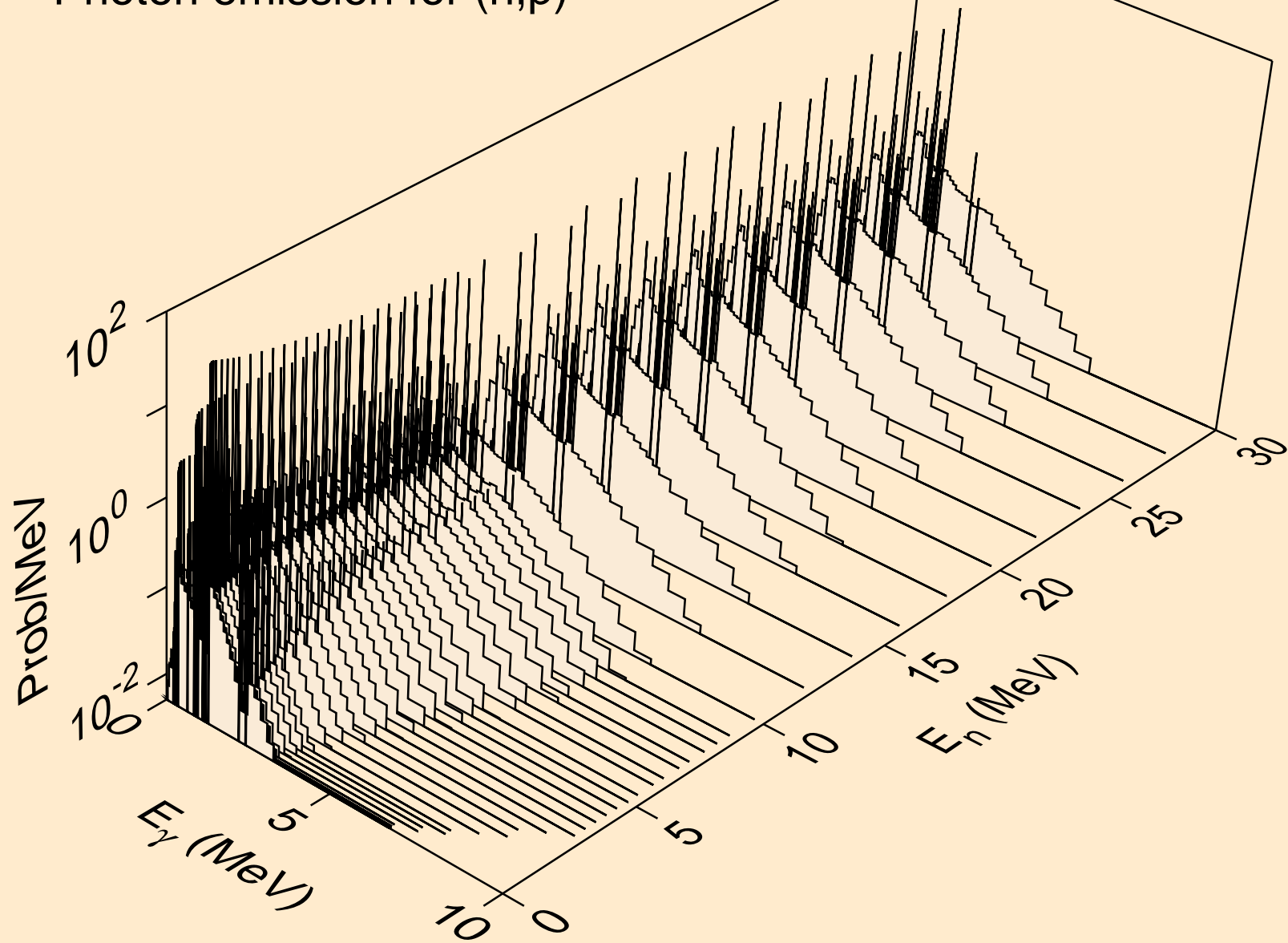

SB114 NEUTRON ACER TENDL-2024 LIBRARY; T=0.K
Photon emission for (n,d)

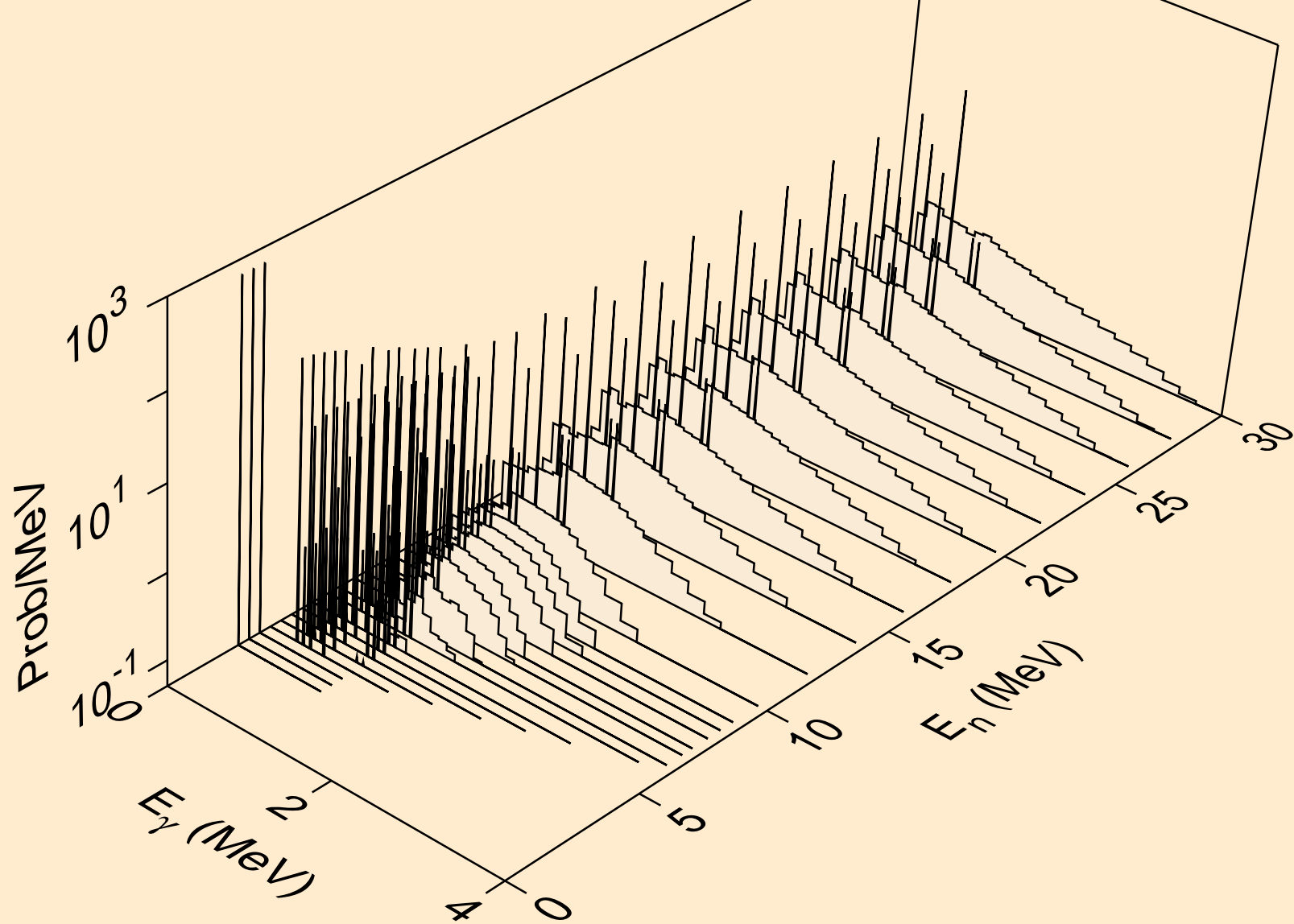

SB114 NEUTRON ACER TENDL-2024 LIBRARY; T=0.K
Photon emission for (n,t)

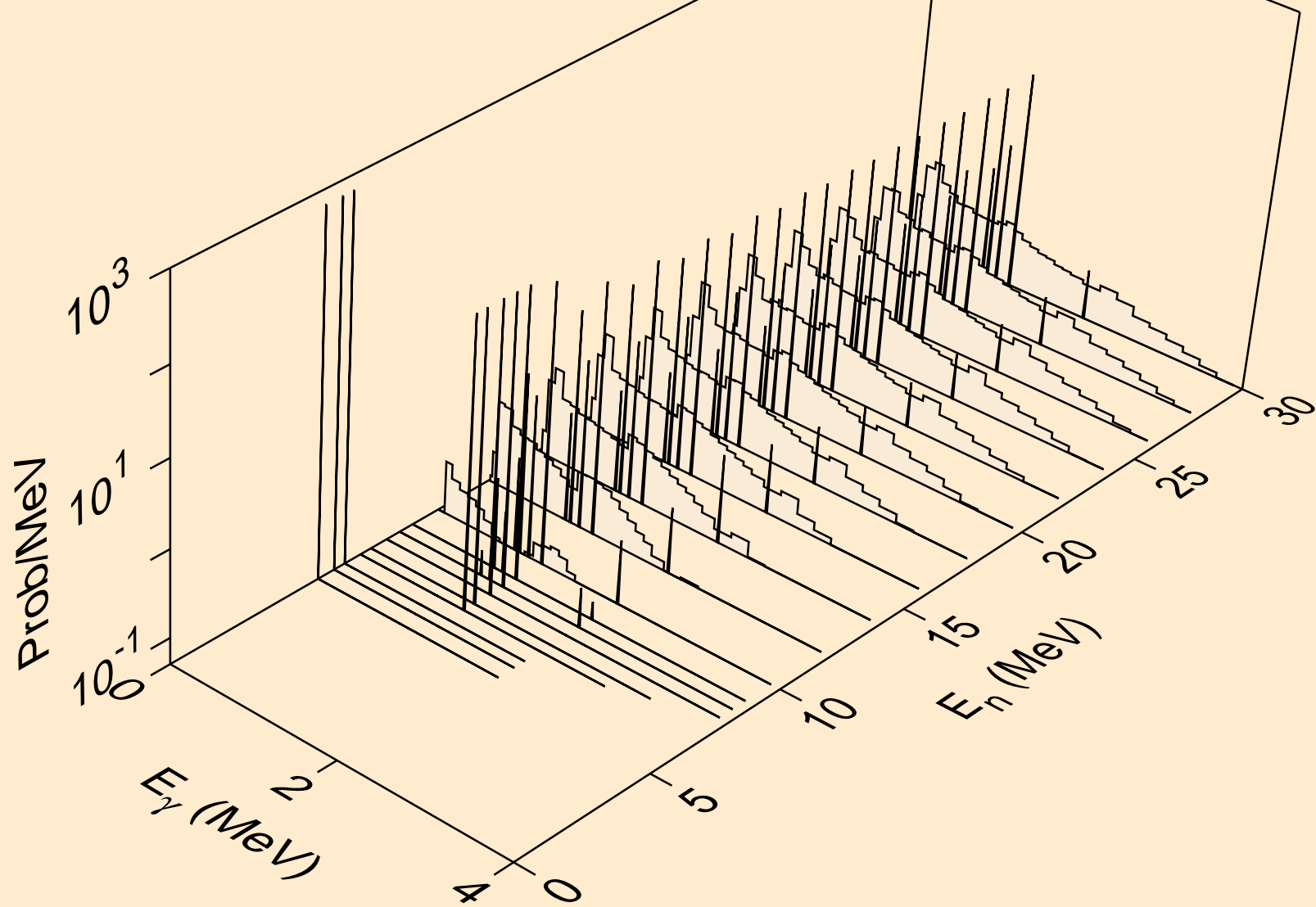

SB114 NEUTRON ACER TENDL-2024 LIBRARY; T=0.K
Photon emission for (n,he3)

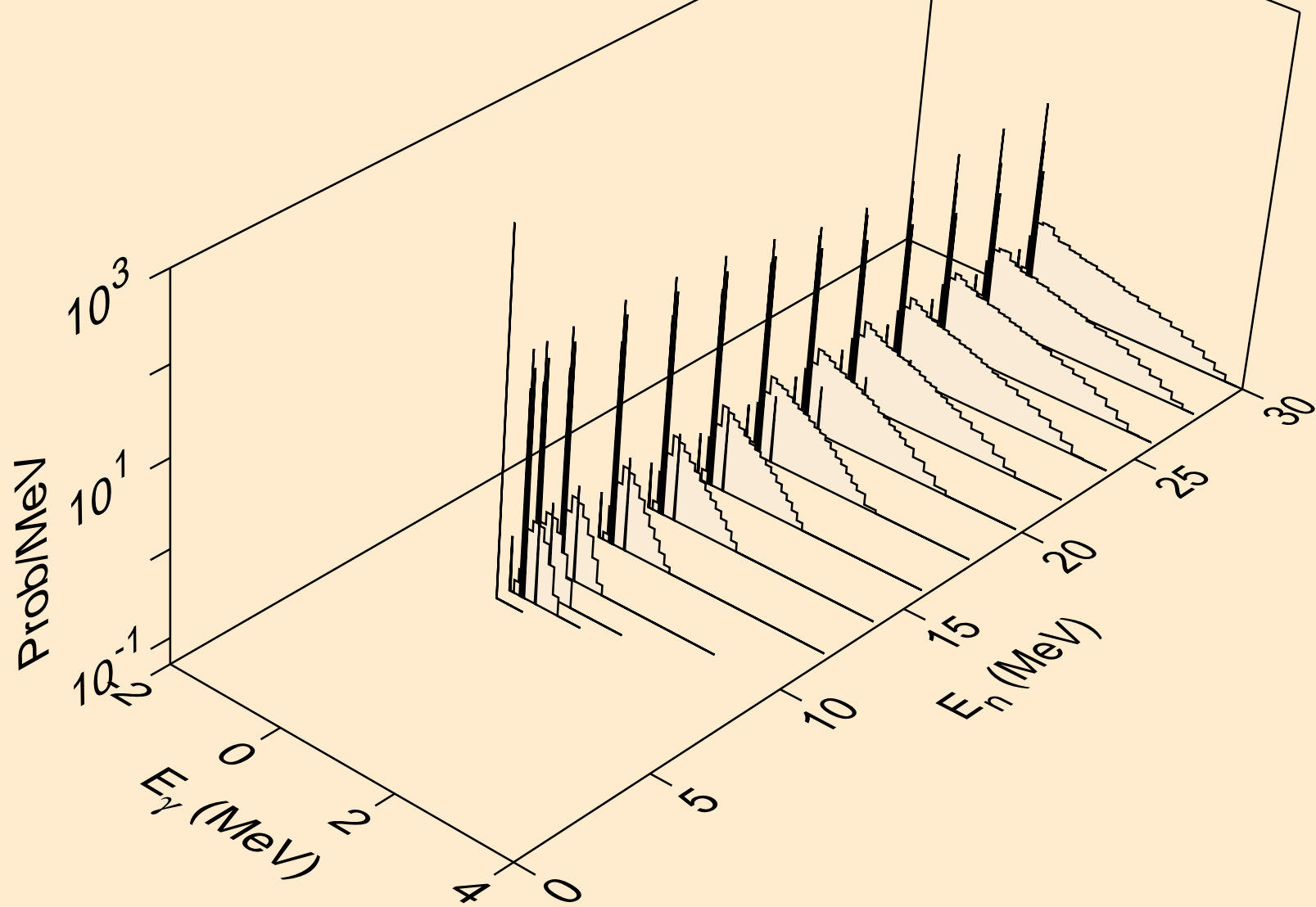

SB114 NEUTRON ACER TENDL-2024 LIBRARY; T=0.K
Photon emission for (n,a)

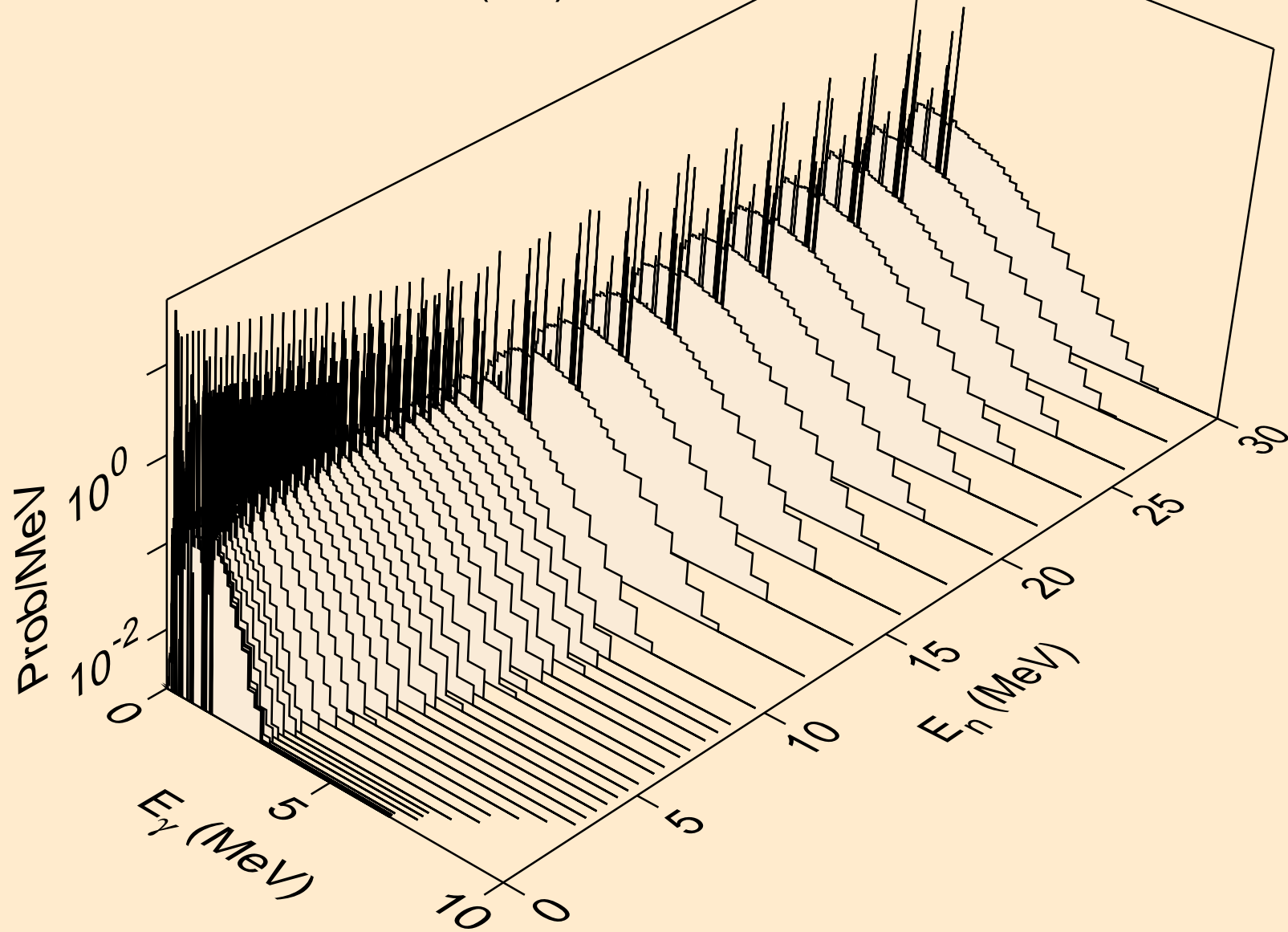

SB114 NEUTRON ACER TENDL-2024 LIBRARY; T=0.K
Photon emission for (n,2a)

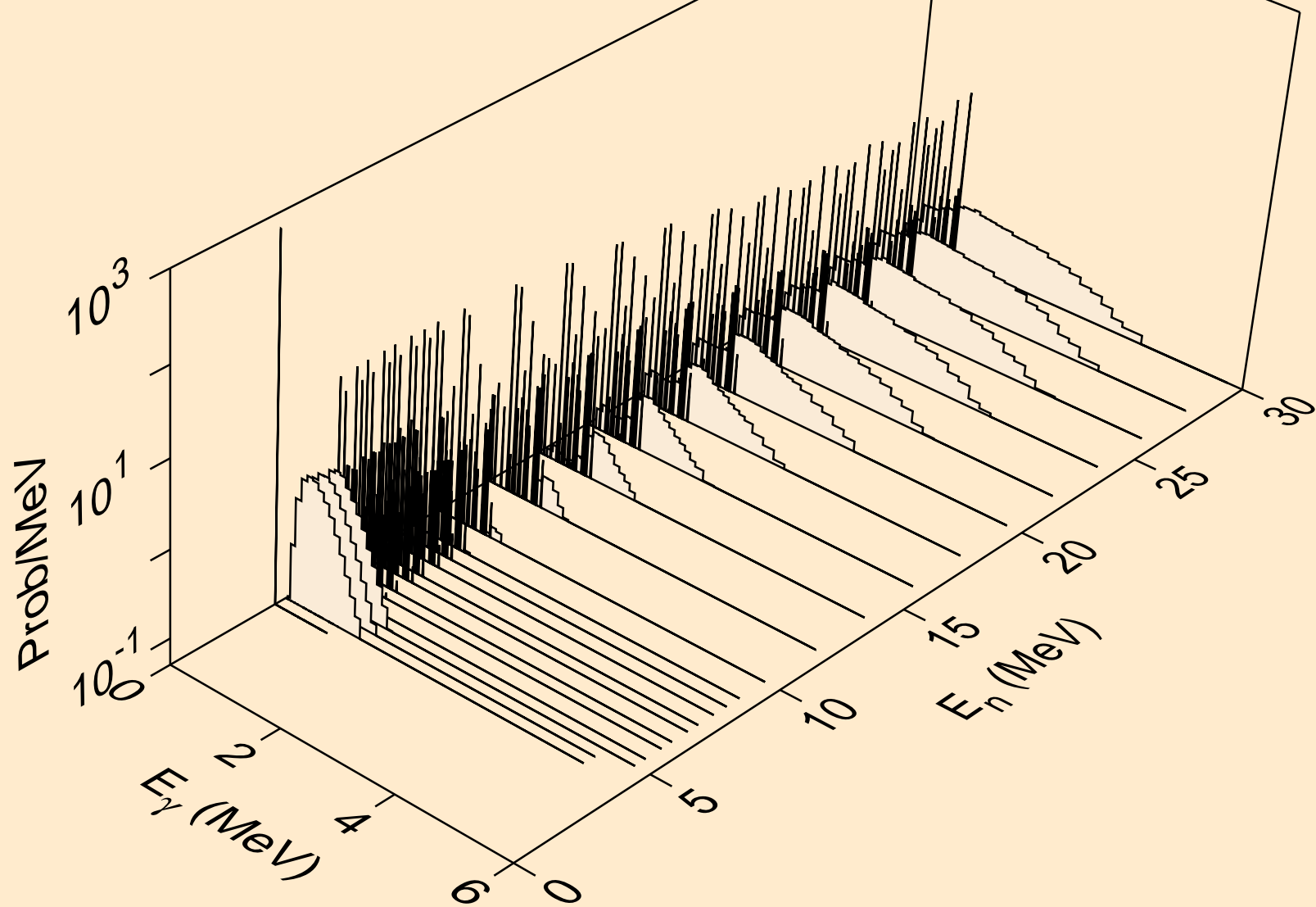

SB114 NEUTRON ACER TENDL-2024 LIBRARY; T=0.K
Photon emission for (n,2p)

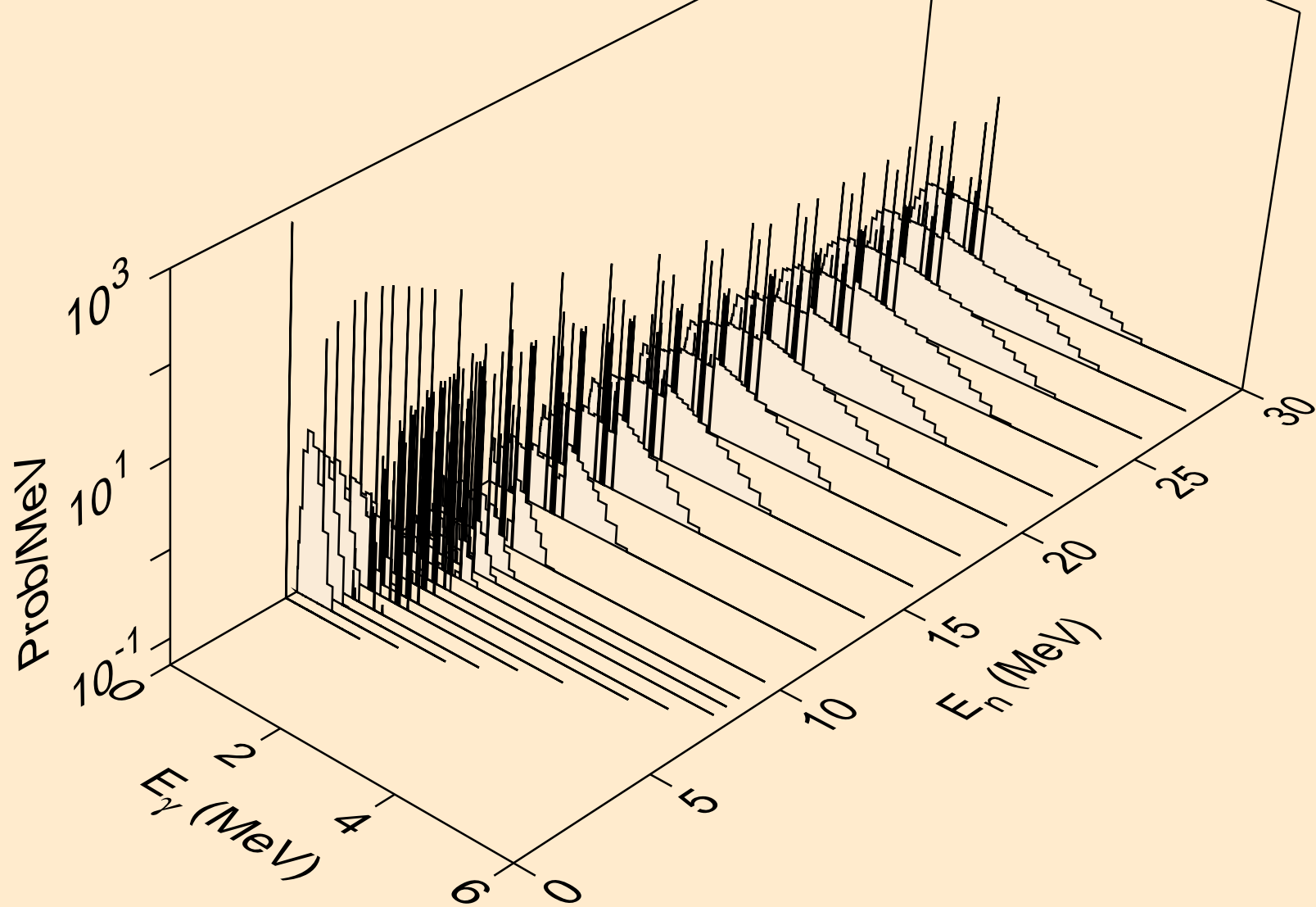

SB114 NEUTRON ACER TENDL-2024 LIBRARY; T=0.K
Photon emission for (n,p α)

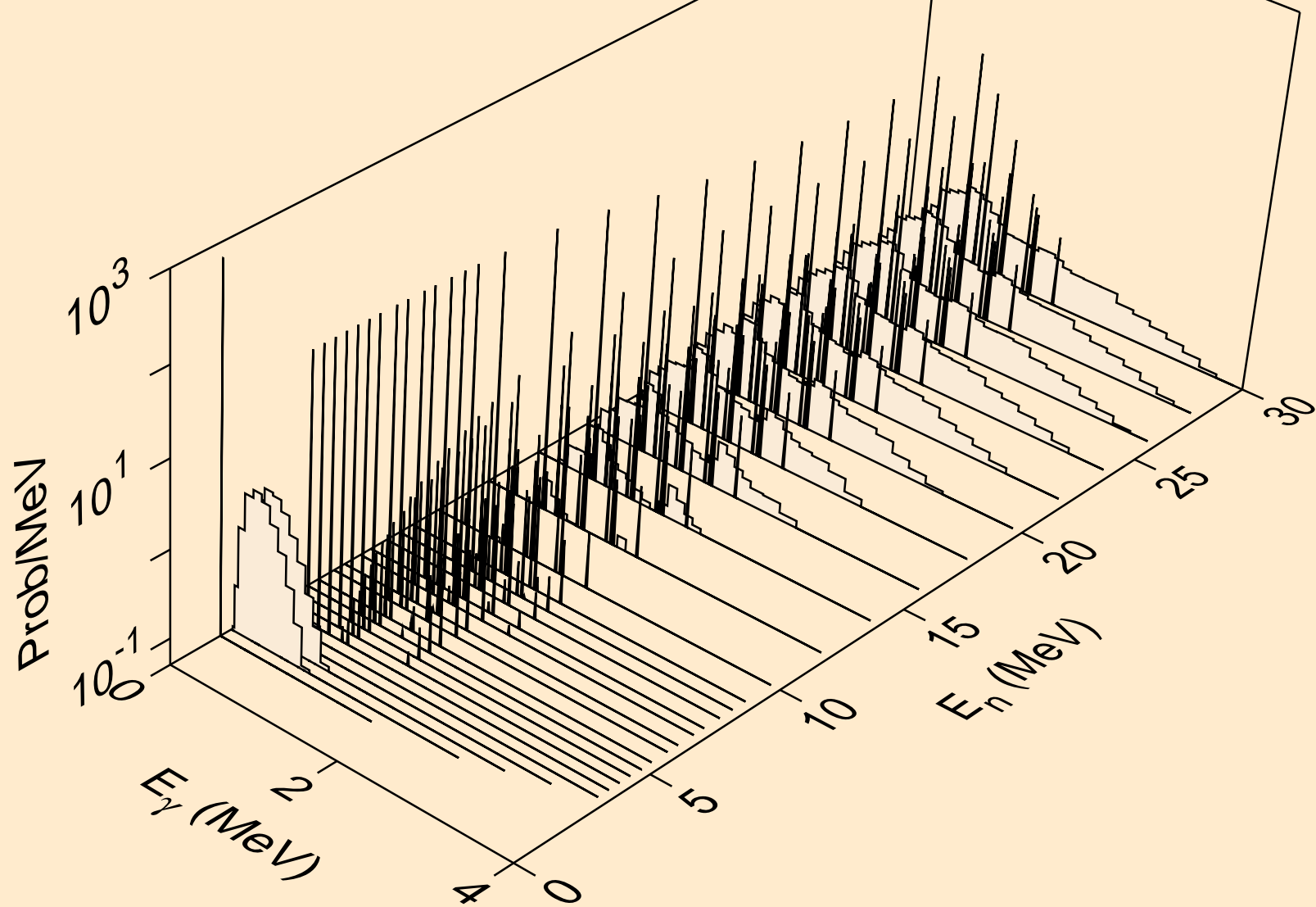

SB114 NEUTRON ACER TENDL-2024 LIBRARY; T=0.K
Photon emission for (n,pd)

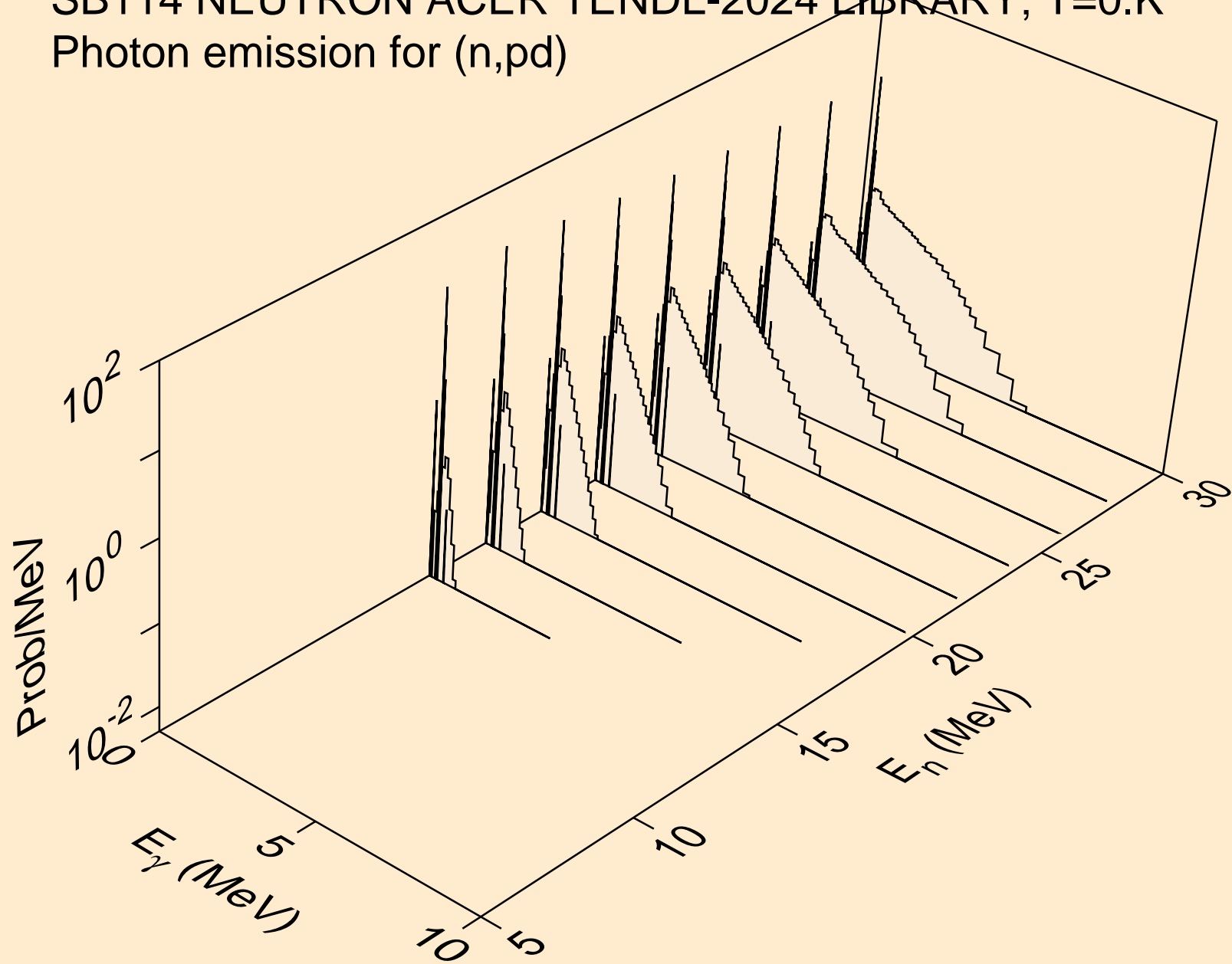

SB114 NEUTRON ACER TENDL-2024 LIBRARY; T=0.K
Photon emission for (n,pt)

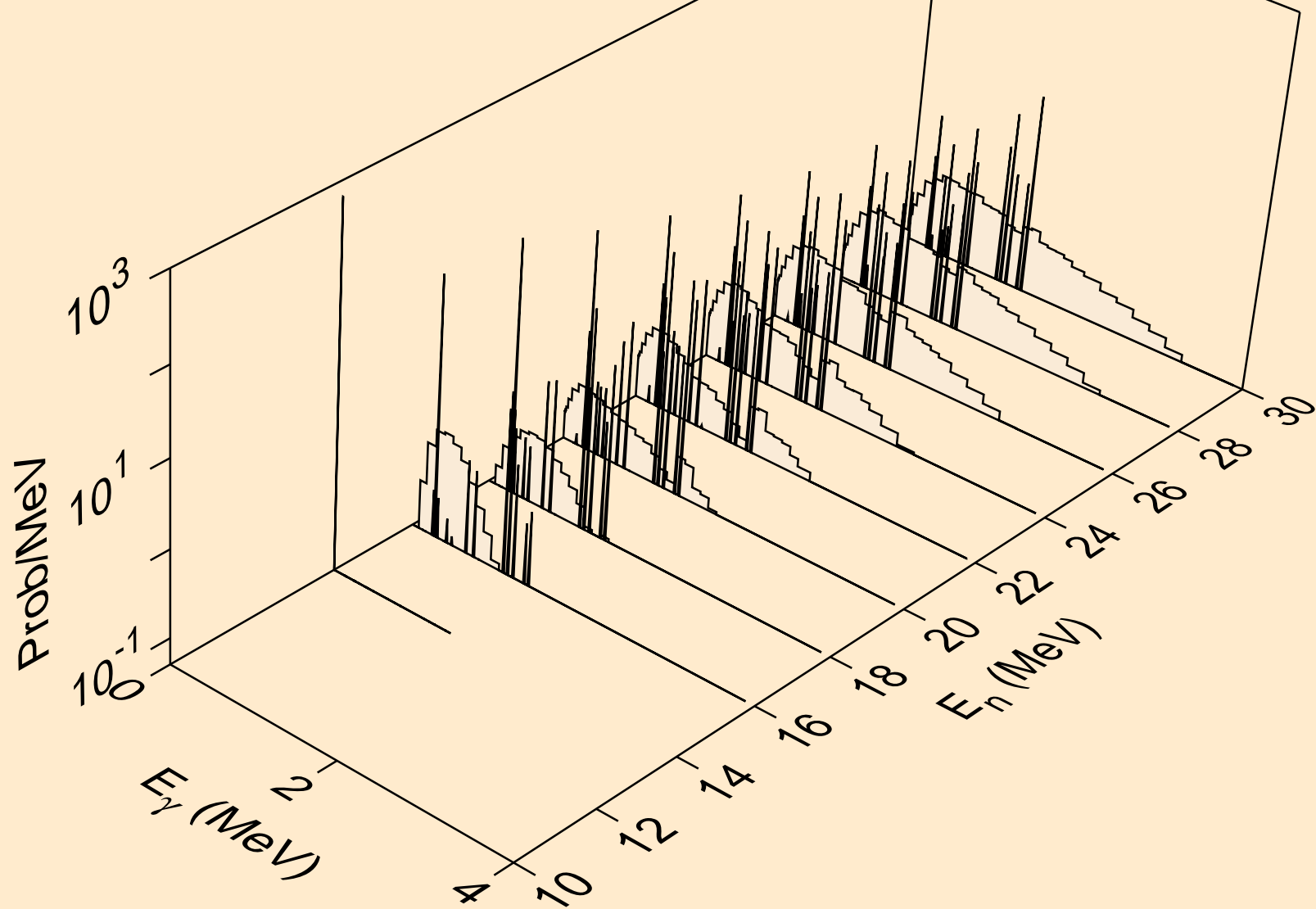

SB114 NEUTRON ACER TENDL-2024 LIBRARY; T=0.K
Photon emission for (n,da)

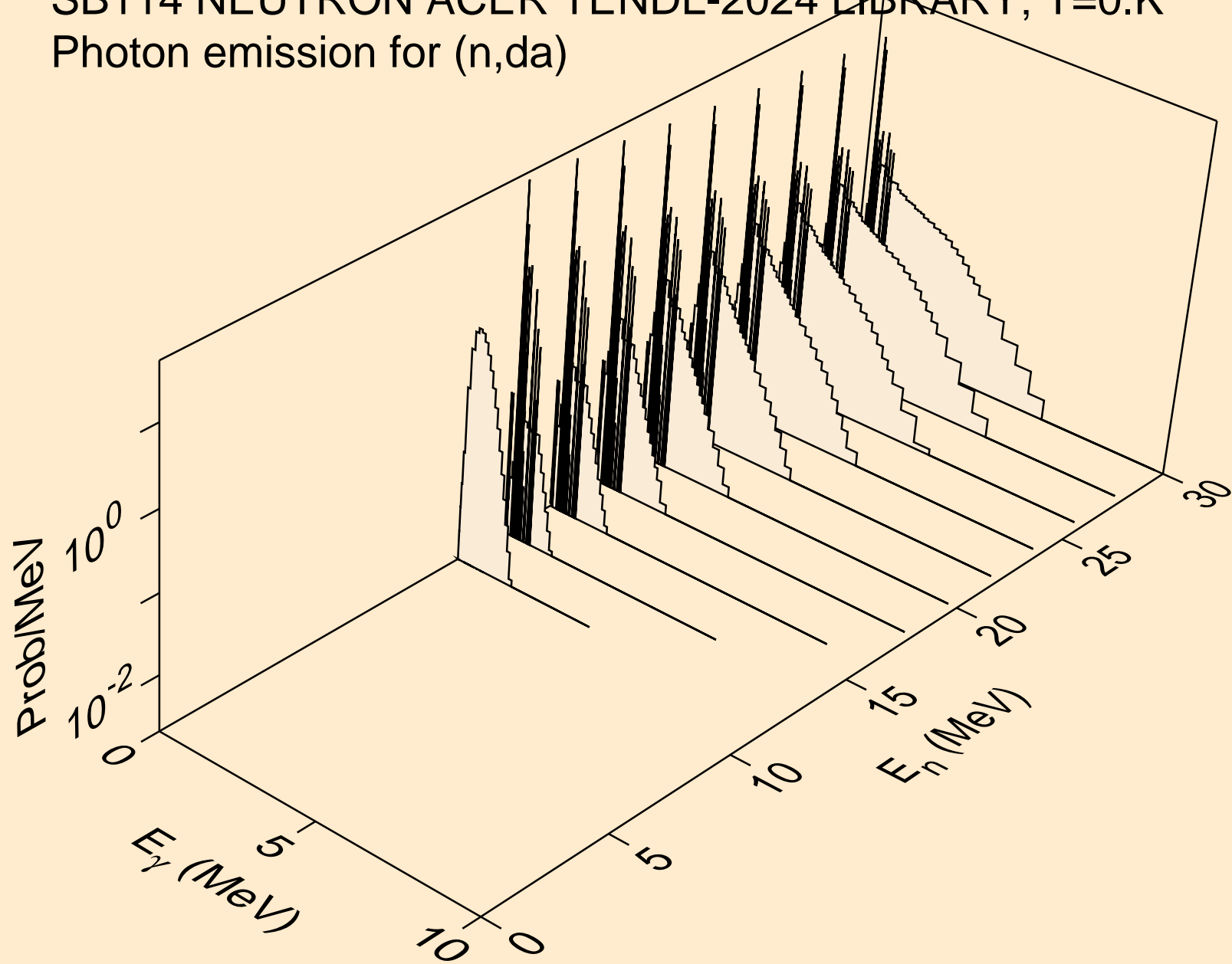

SB114 NEUTRON ACER TENDL-2024 LIBRARY; T=0.K
thermal capture photon spectrum

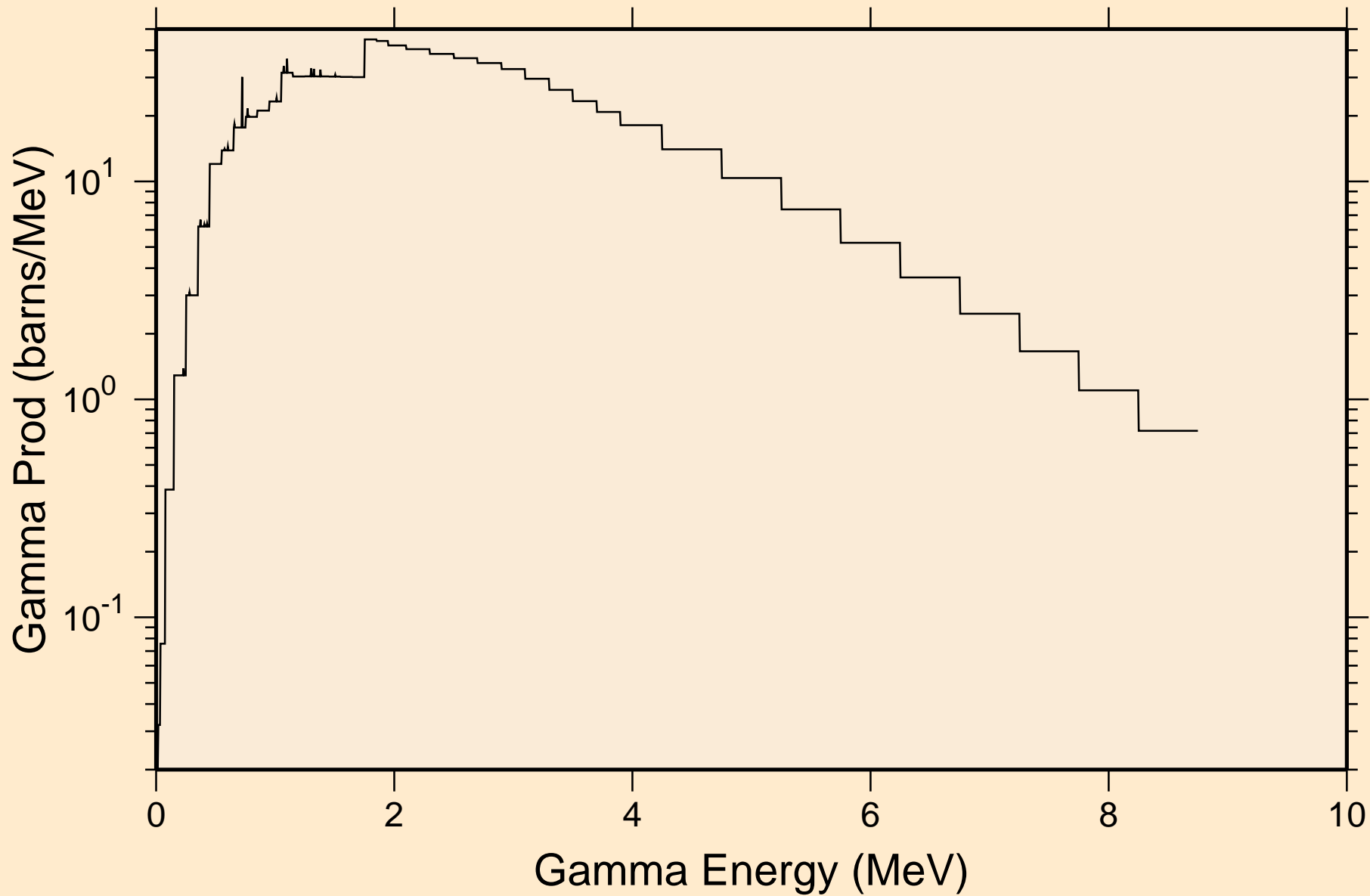

SB114 NEUTRON ACER TENDL-2024 LIBRARY; T=0.K
14 MeV photon spectrum

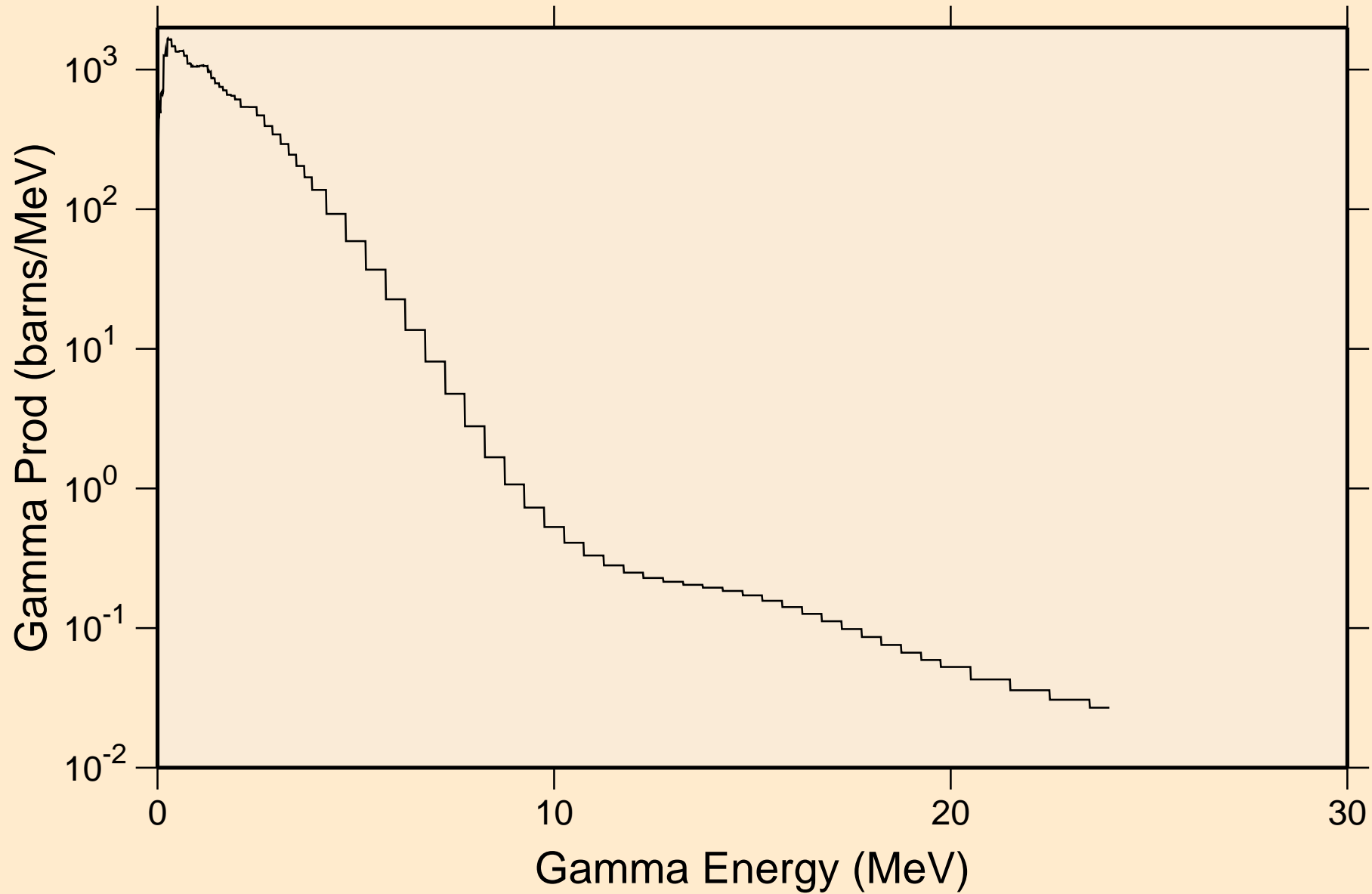

SB114 NEUTRON ACER TENDL-2024 LIBRARY; T=0.K

Particle heating contributions

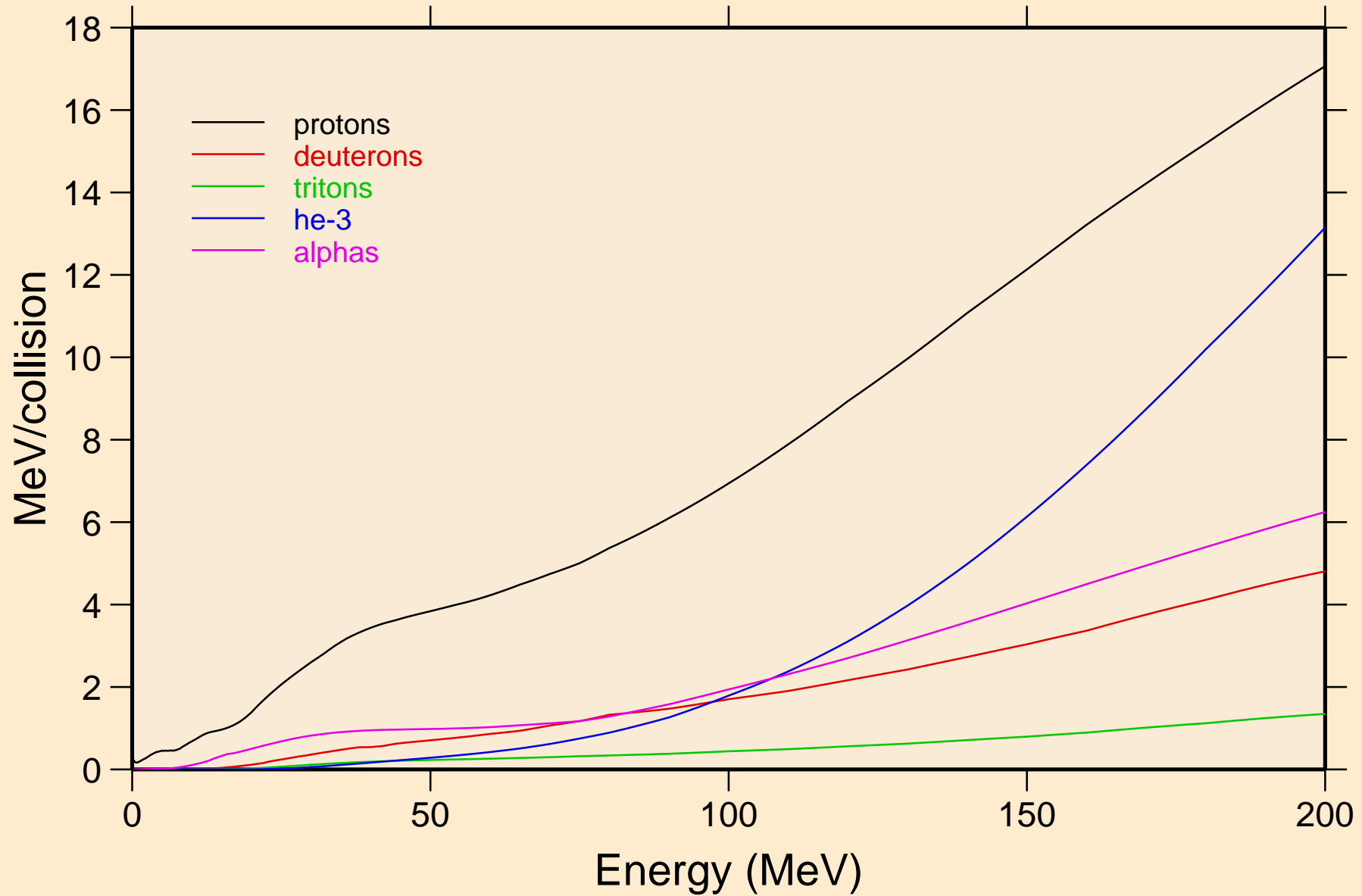

SB114 NEUTRON ACER TENDL-2024 LIBRARY; T=0.K

Recoil Heating

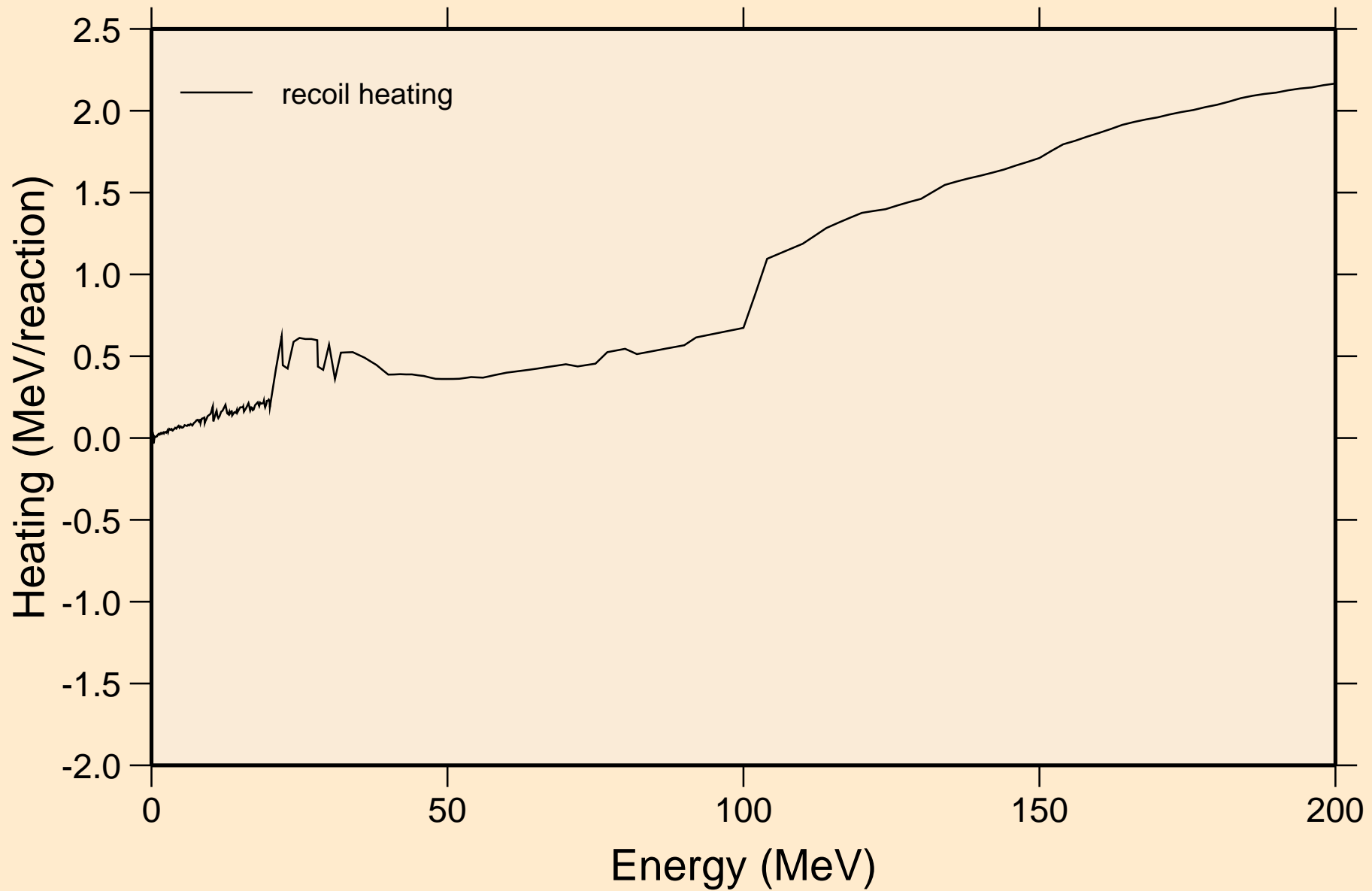

SB114 NEUTRON ACER TENDL-2024 LIBRARY; T=0.K

Particle production cross sections

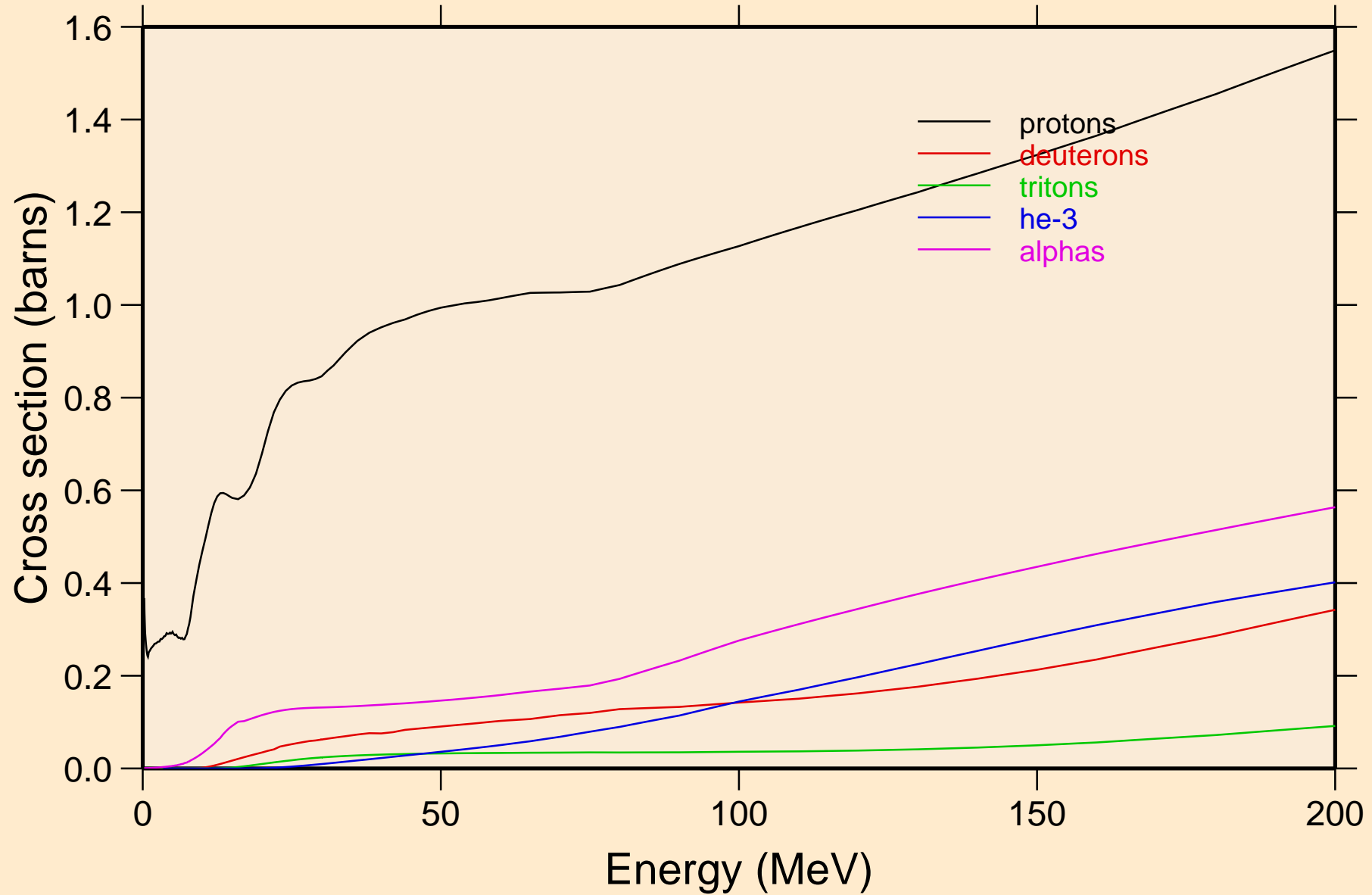

SB114 NEUTRON ACER TENDL-2024 LIBRARY; T=0.K
protons from (n,x)

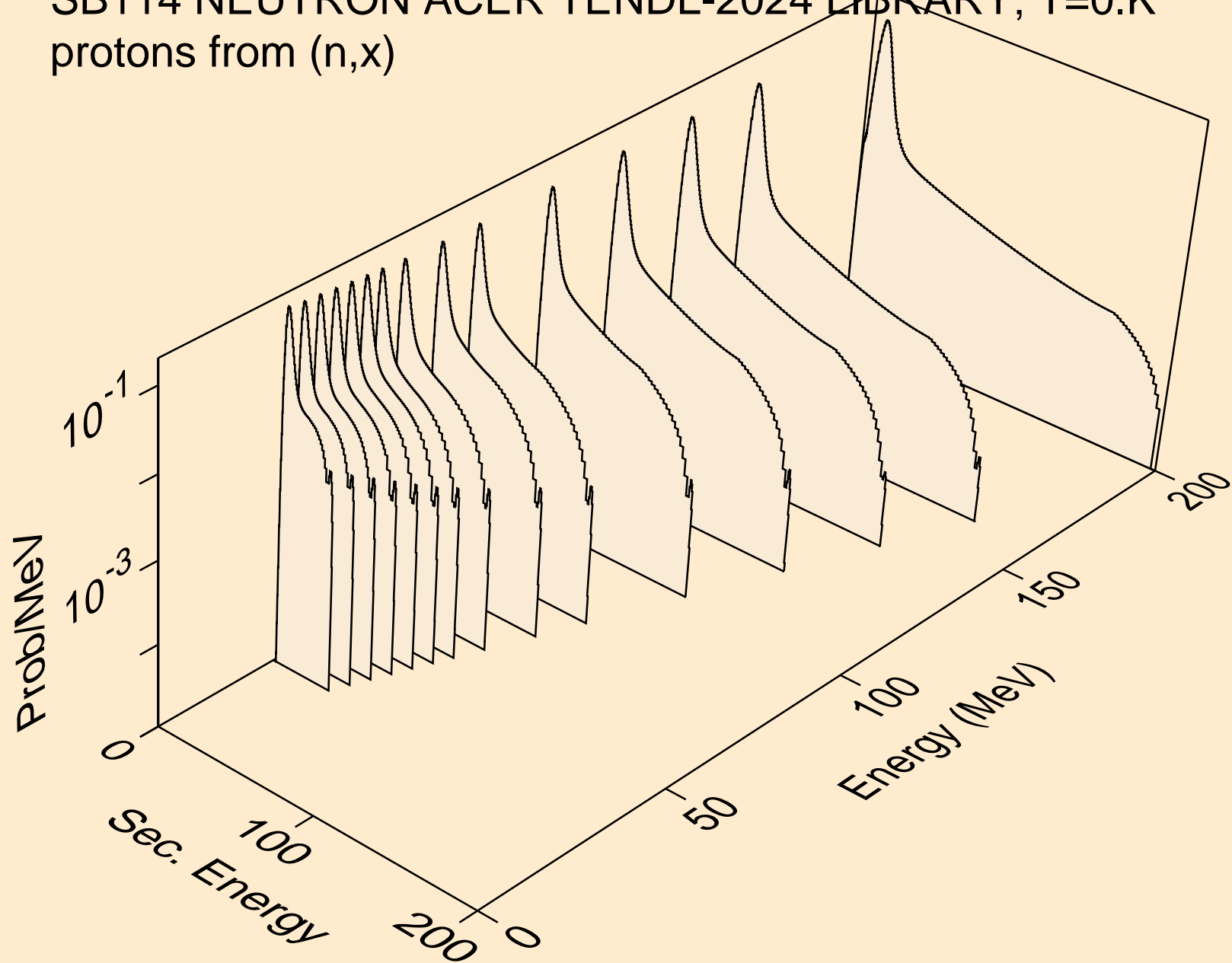

SB114 NEUTRON ACER TENDL-2024 LIBRARY; T=0.K
protons from (n,n*)p

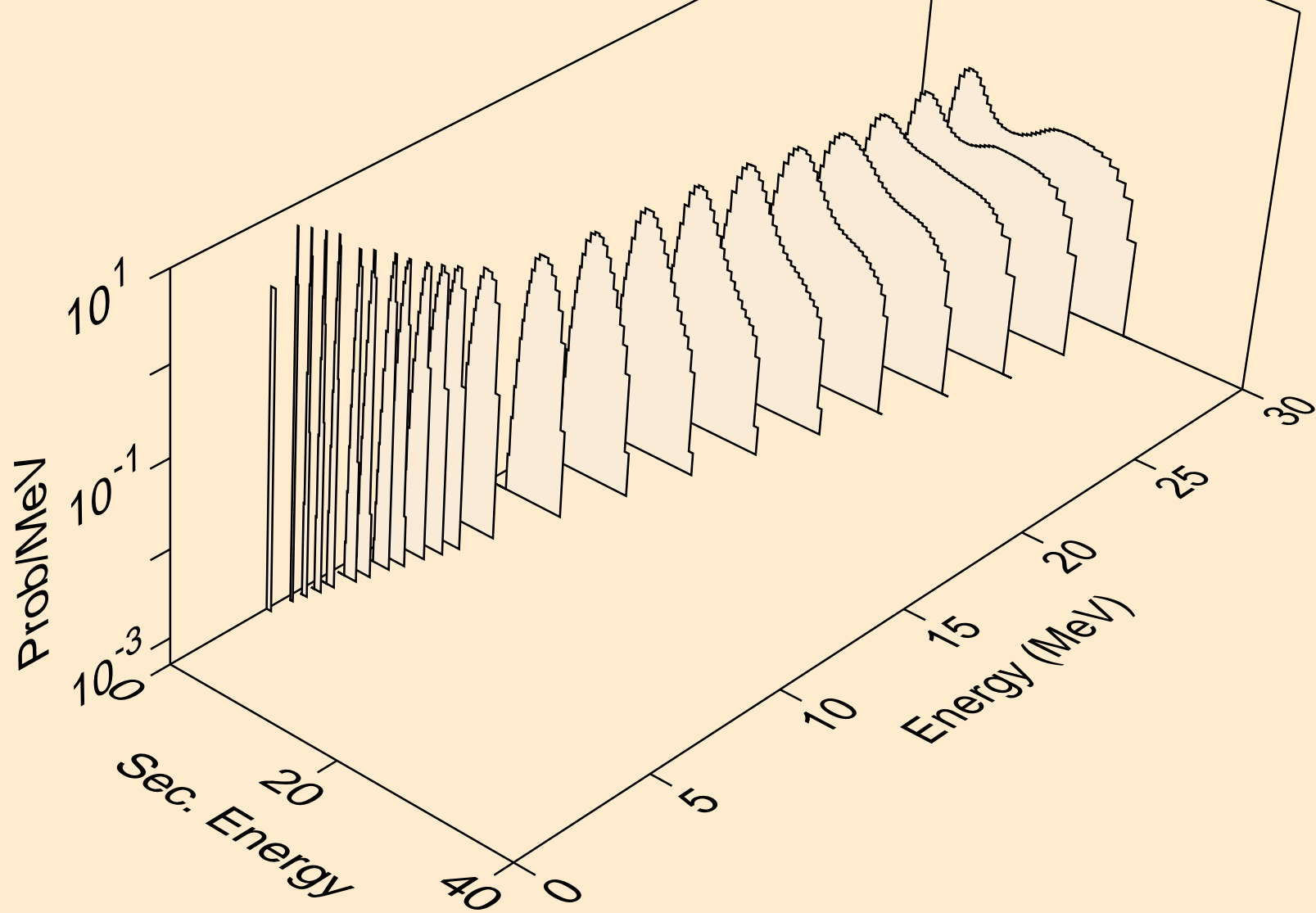

SB114 NEUTRON ACER TENDL-2024 LIBRARY; T=0.K
protons from (n,2np)

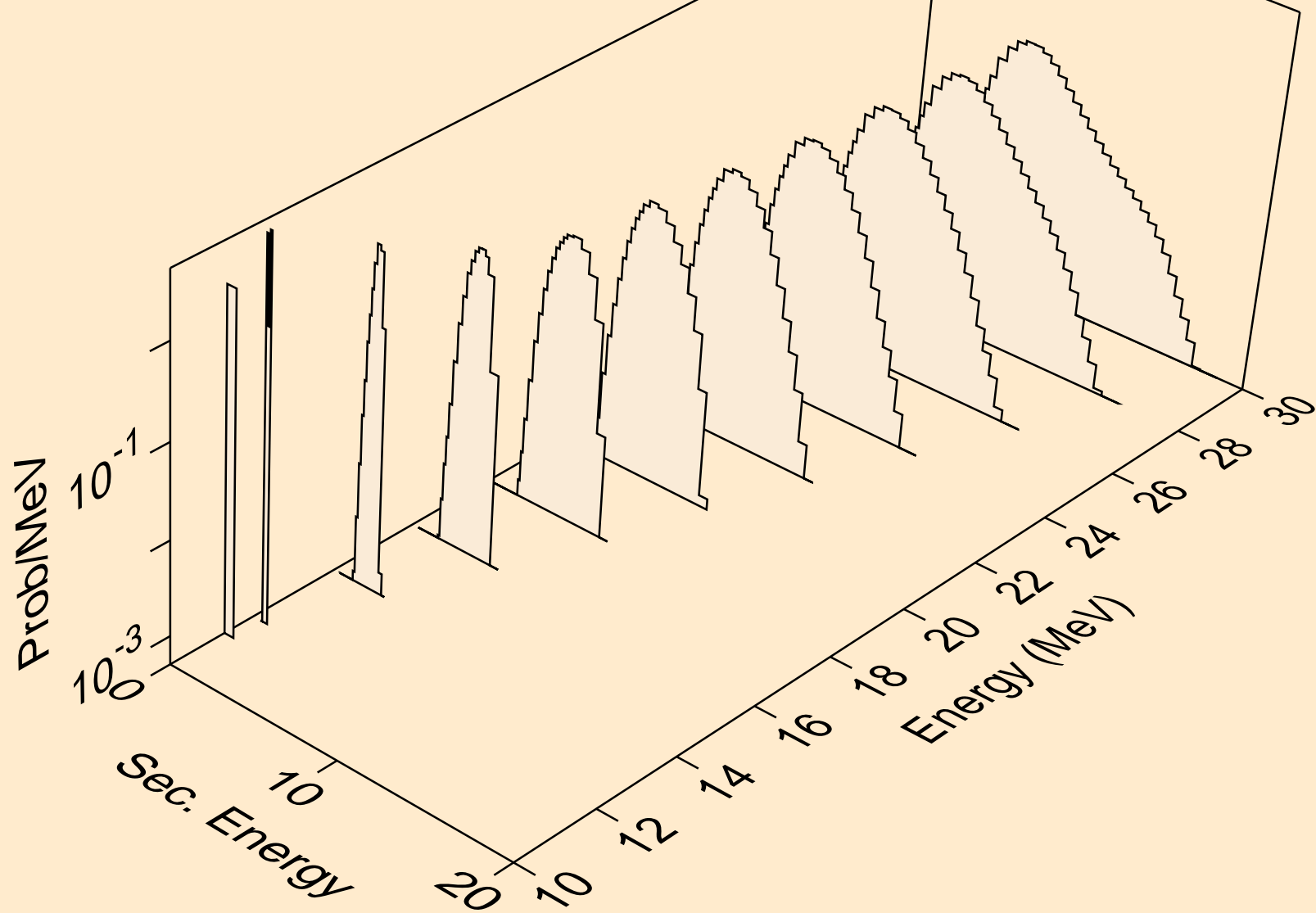

SB114 NEUTRON ACER TENDL-2024 LIBRARY; T=0.K
protons from (n,3np)

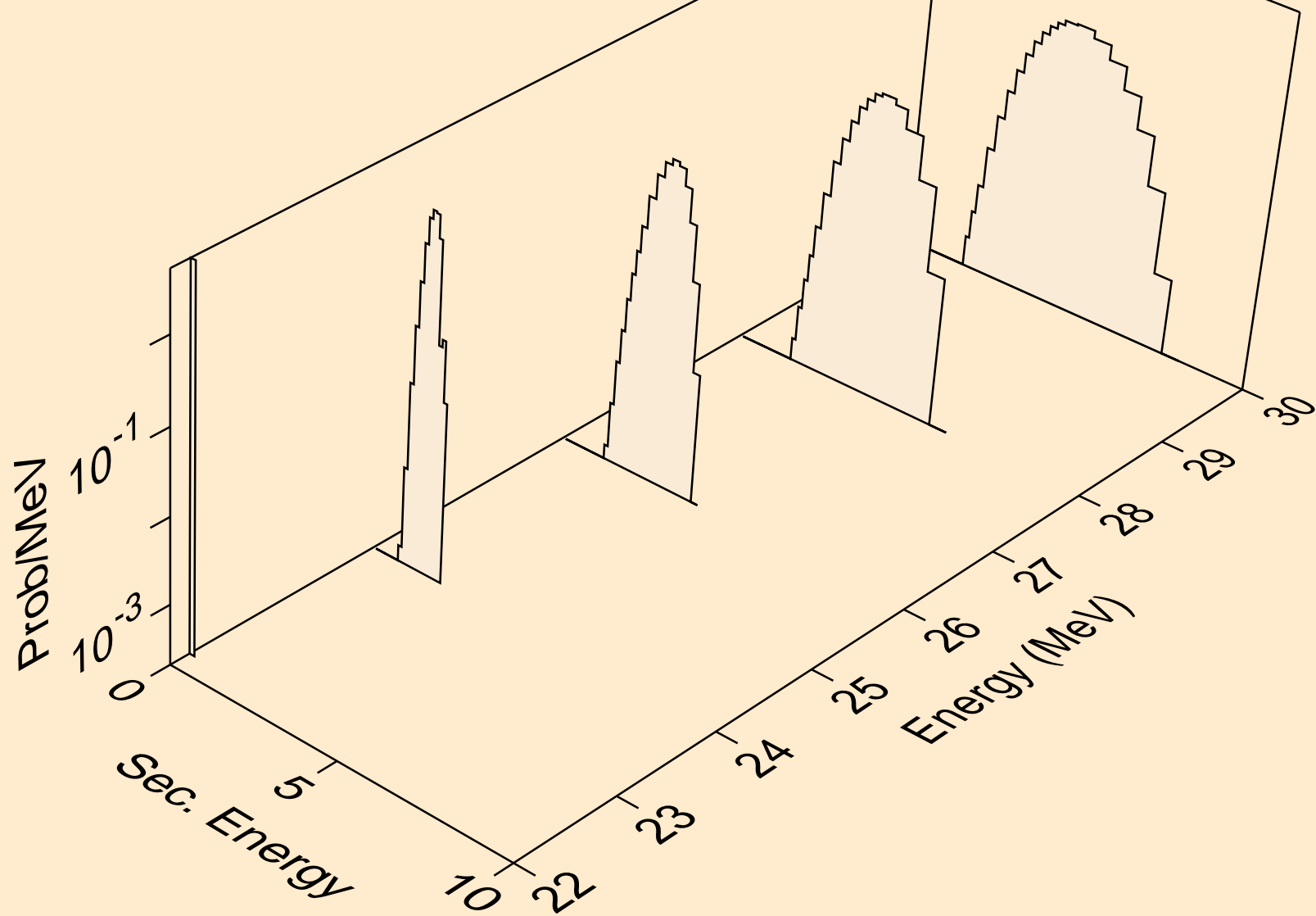

SB114 NEUTRON ACER TENDL-2024 LIBRARY; T=0.K
protons from (n,n2p)

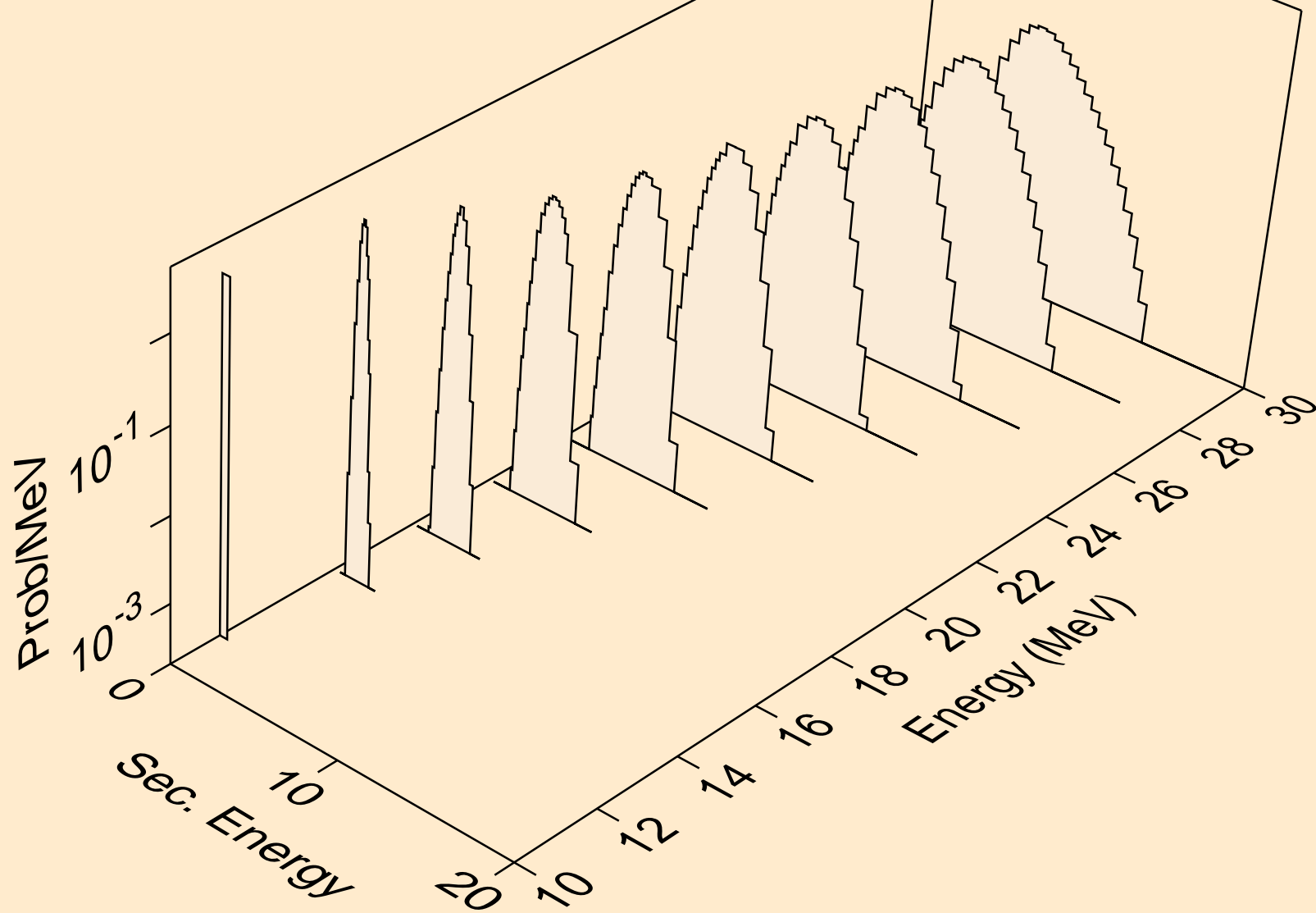

SB114 NEUTRON ACER TENDL-2024 LIBRARY; T=0.K
protons from (n,npa)

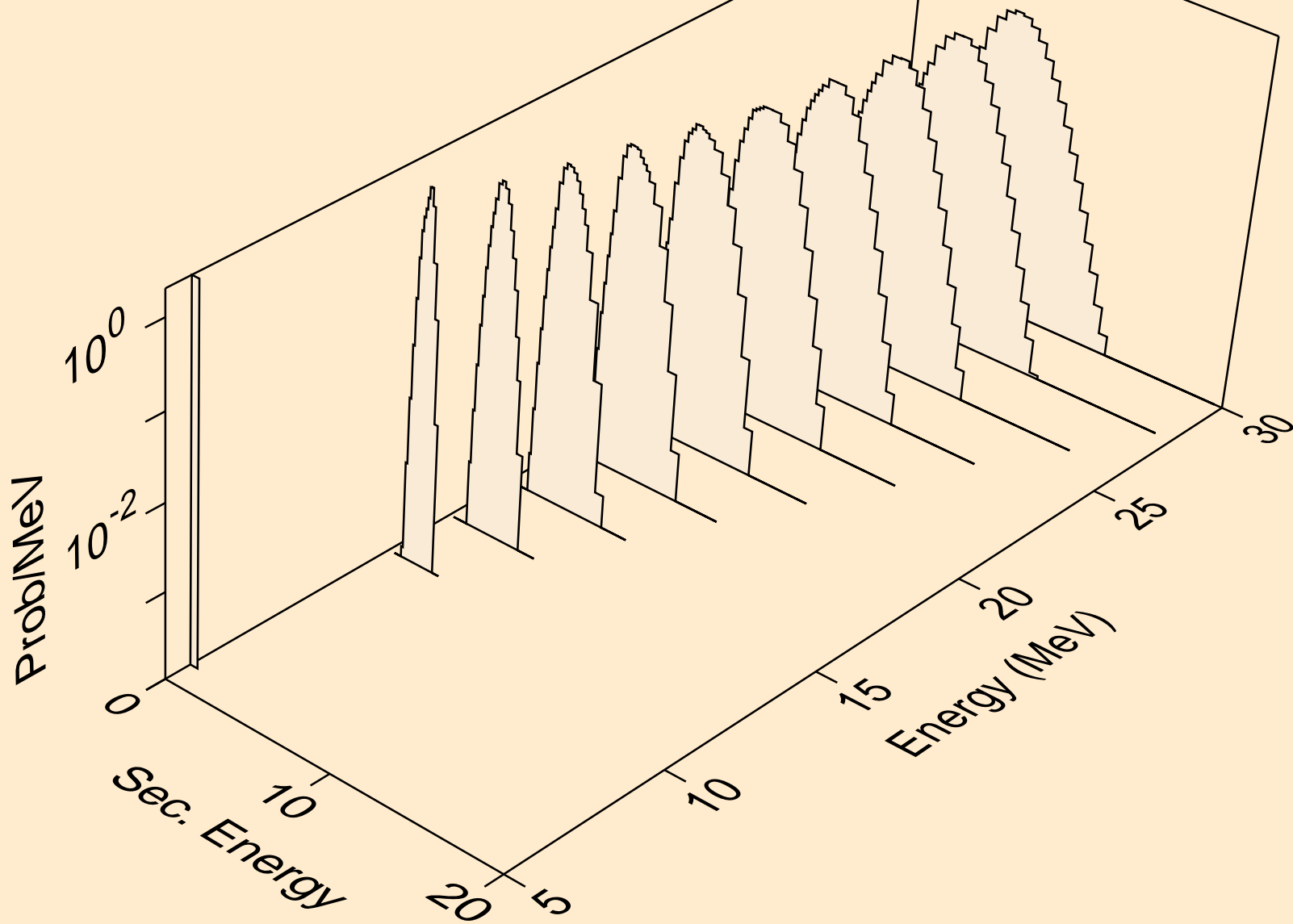

SB114 NEUTRON ACER TENDL-2024 LIBRARY; T=0.K
protons from (n,p)

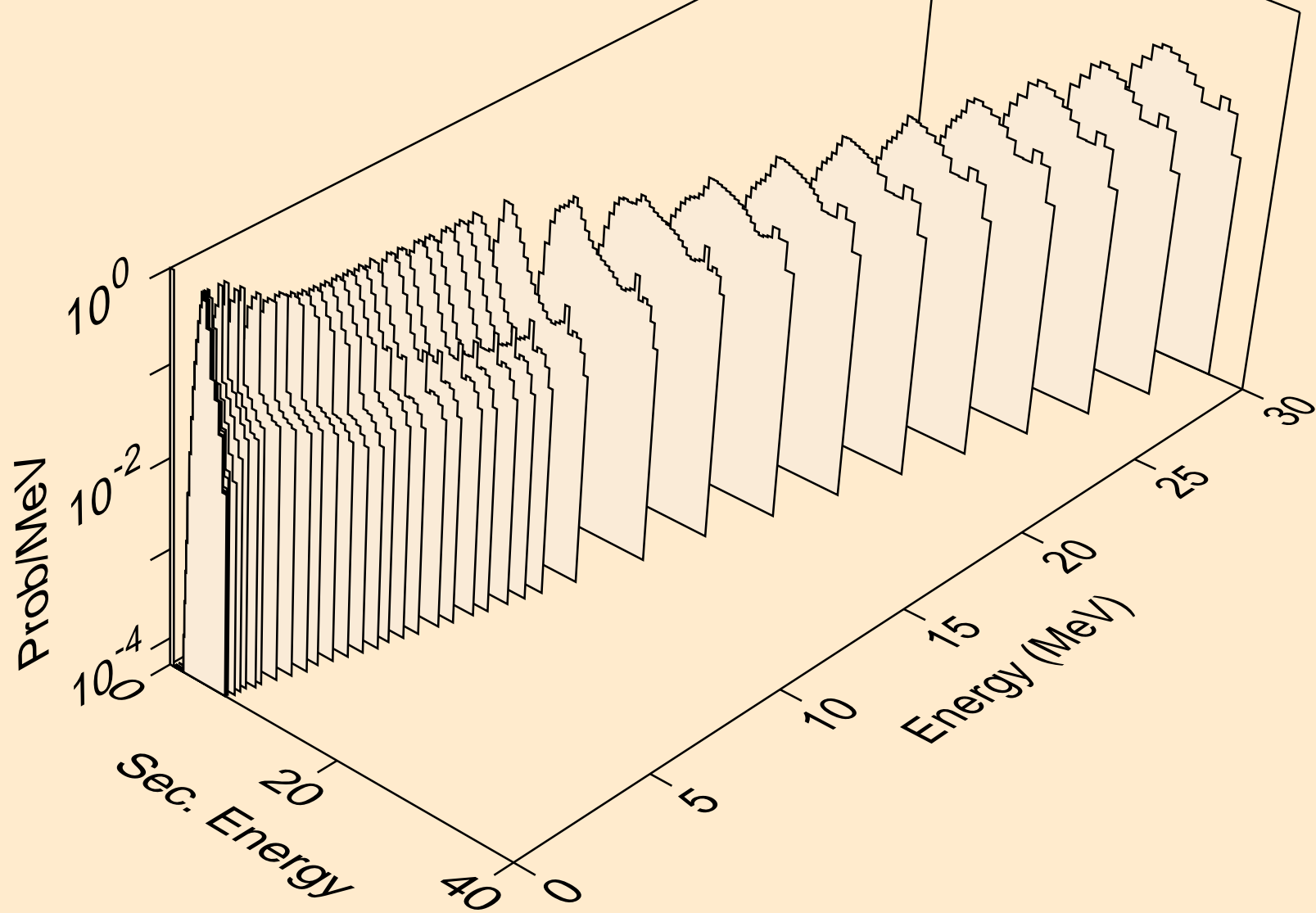

SB114 NEUTRON ACER TENDL-2024 LIBRARY; T=0.K
protons from (n,2p)

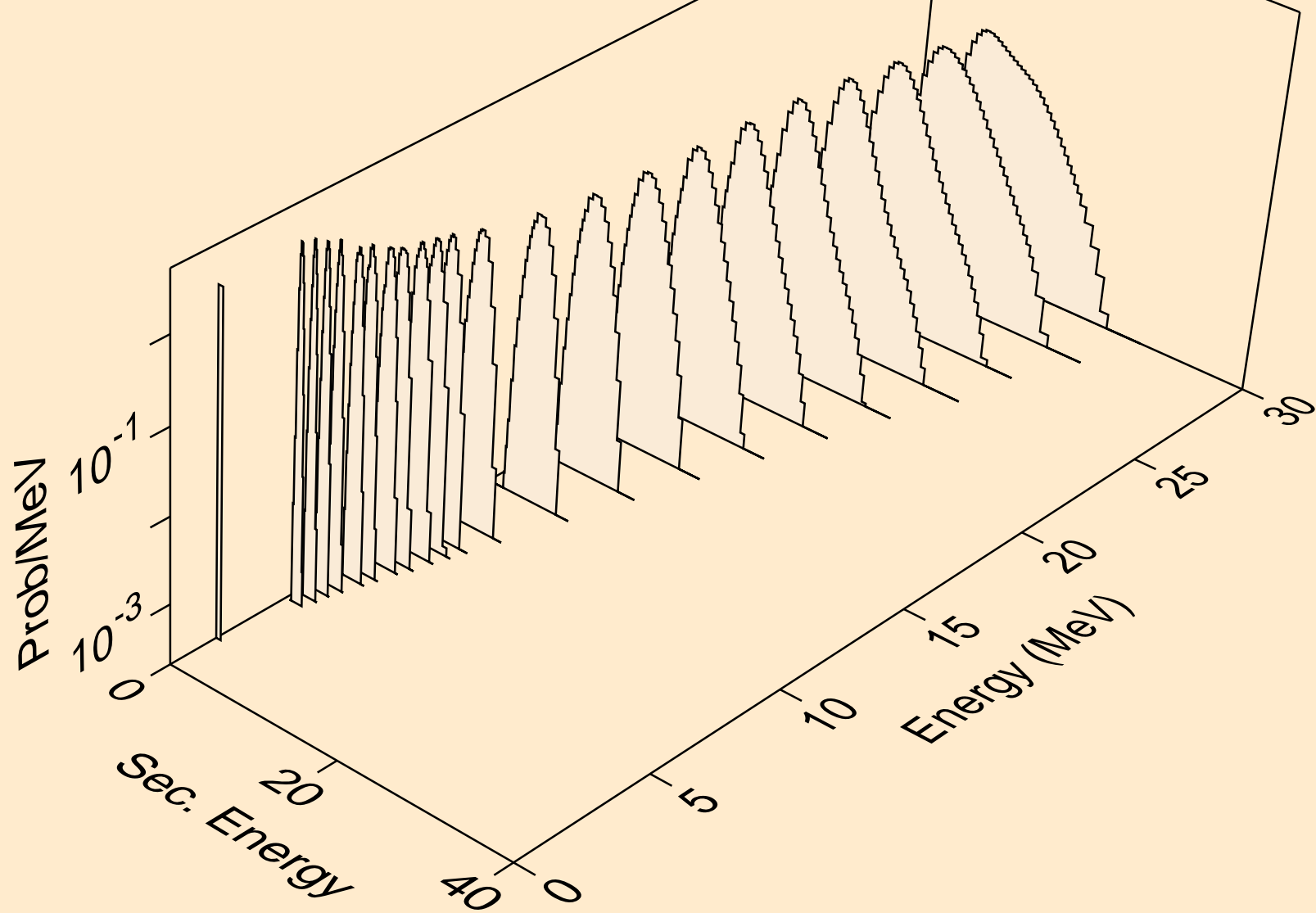

SB114 NEUTRON ACER TENDL-2024 LIBRARY; T=0.K
protons from (n,p)

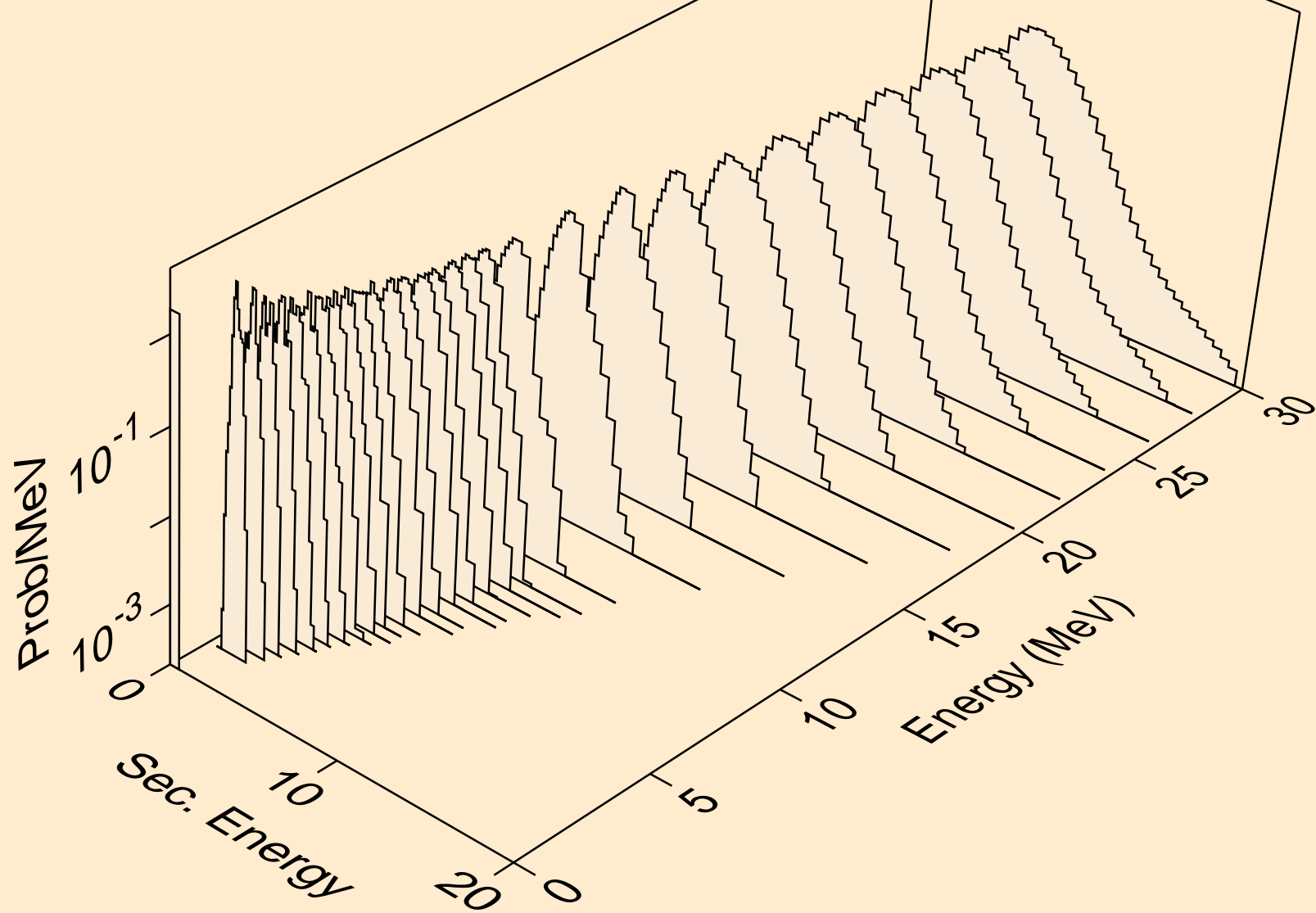

SB114 NEUTRON ACER TENDL-2024 LIBRARY; T=0.K
protons from (n,pd)

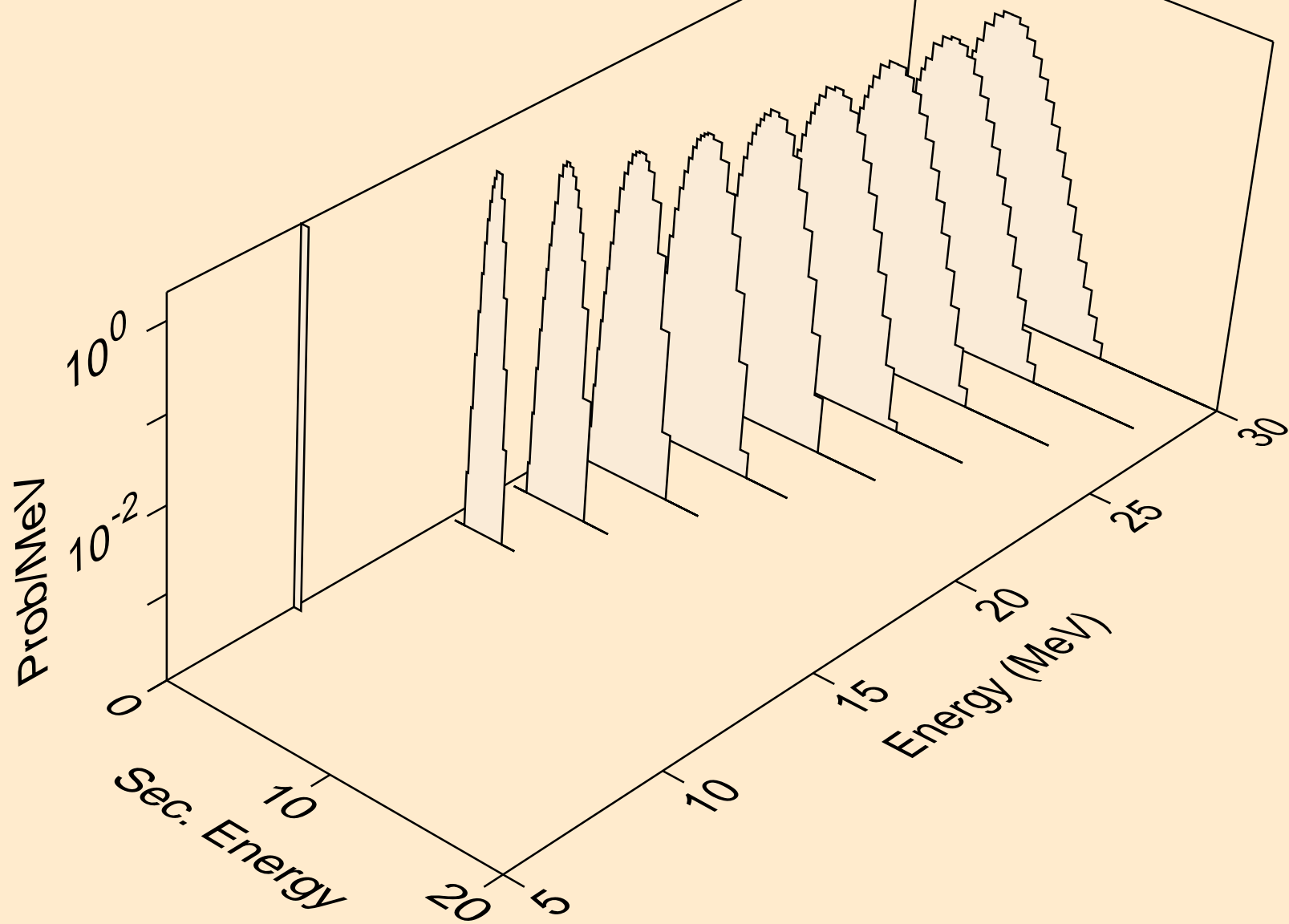

SB114 NEUTRON ACER TENDL-2024 LIBRARY; T=0.K
protons from (n,pt)

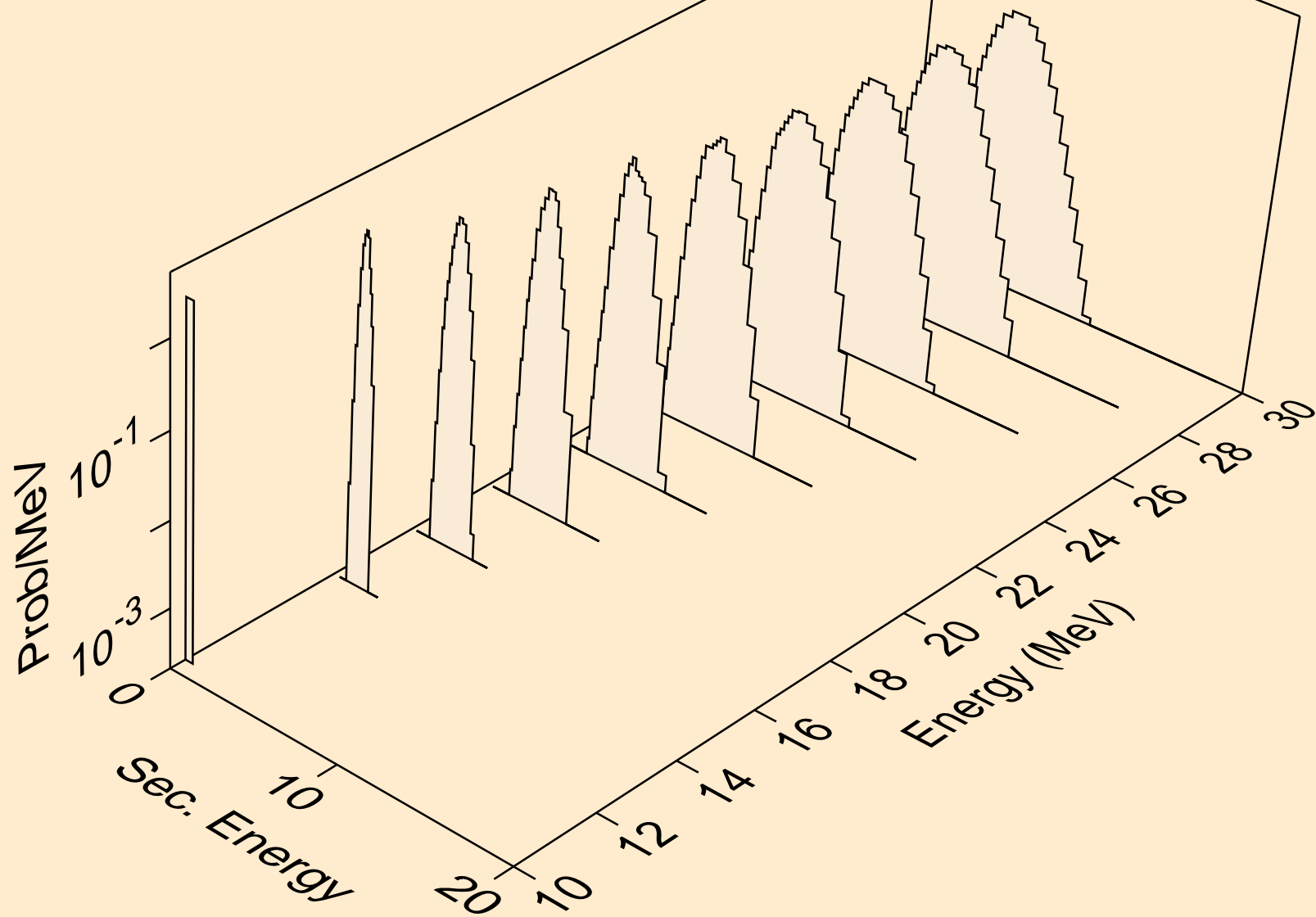

SB114 NEUTRON ACER TENDL-2024 LIBRARY; T=0.K
deuterons from (n,x)

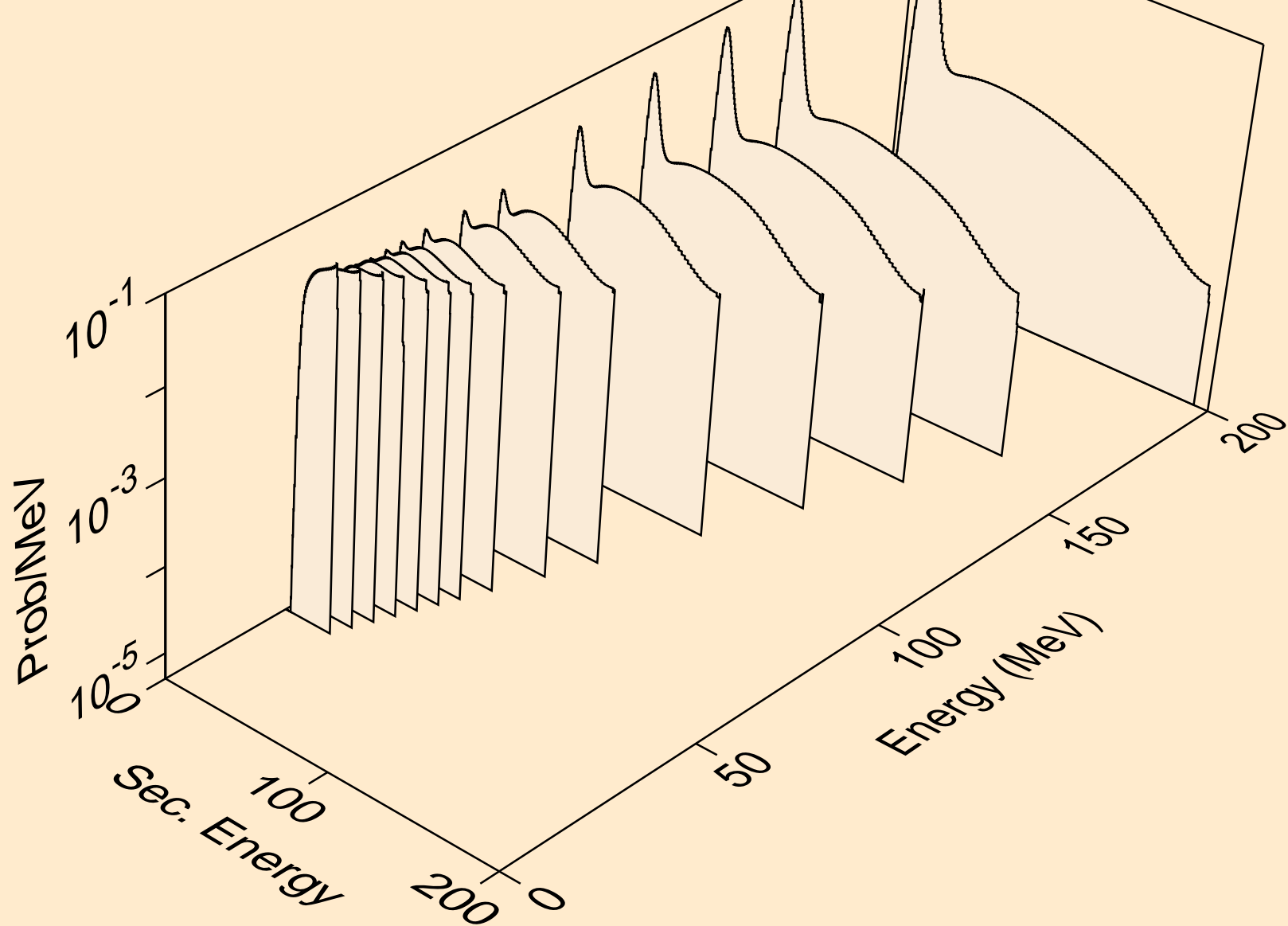

SB114 NEUTRON ACER TENDL-2024 LIBRARY; T=0.K
deuterons from (n,2nd)

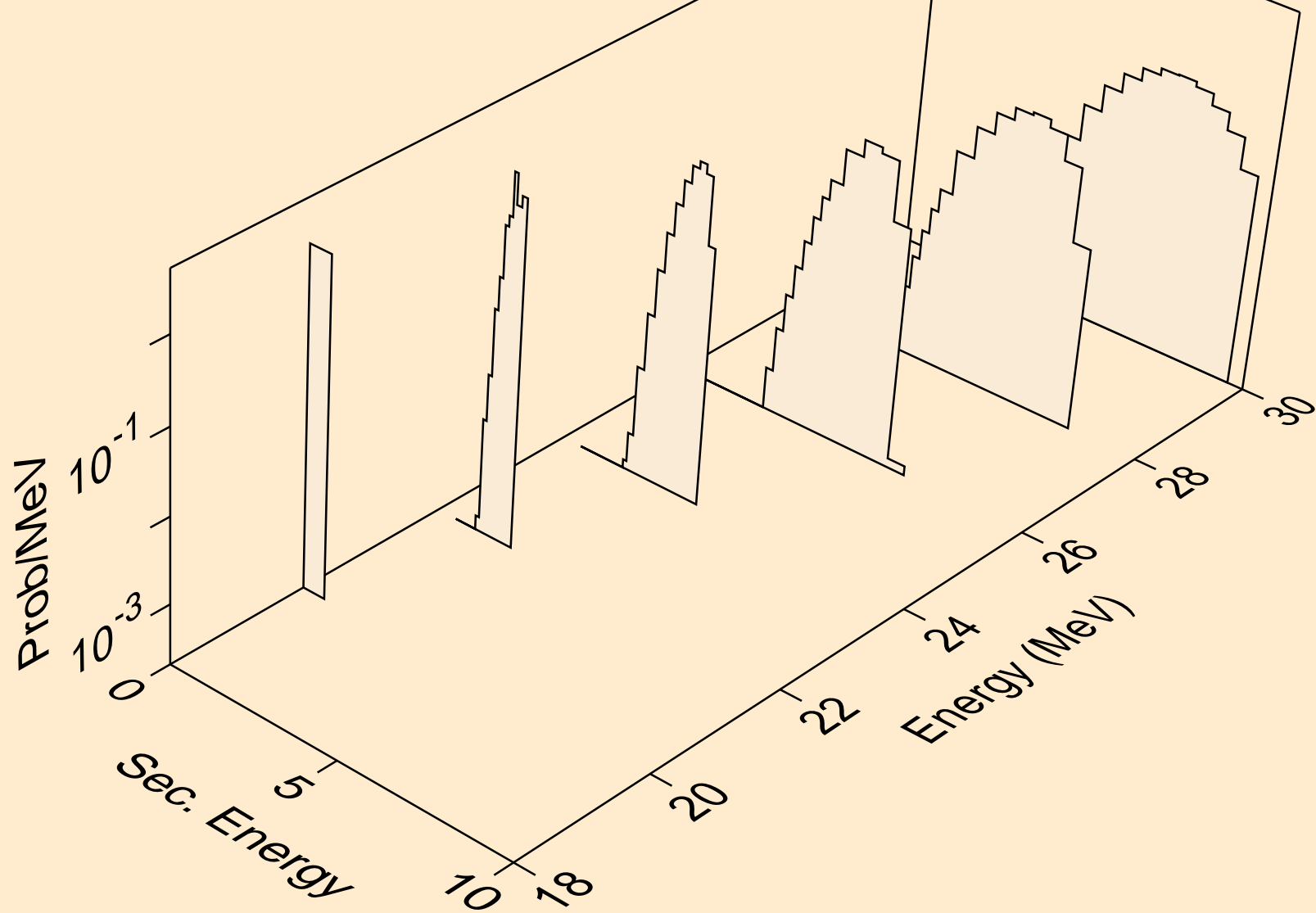

SB114 NEUTRON ACER TENDL-2024 LIBRARY; T=0.K
deuterons from (n,n*)d

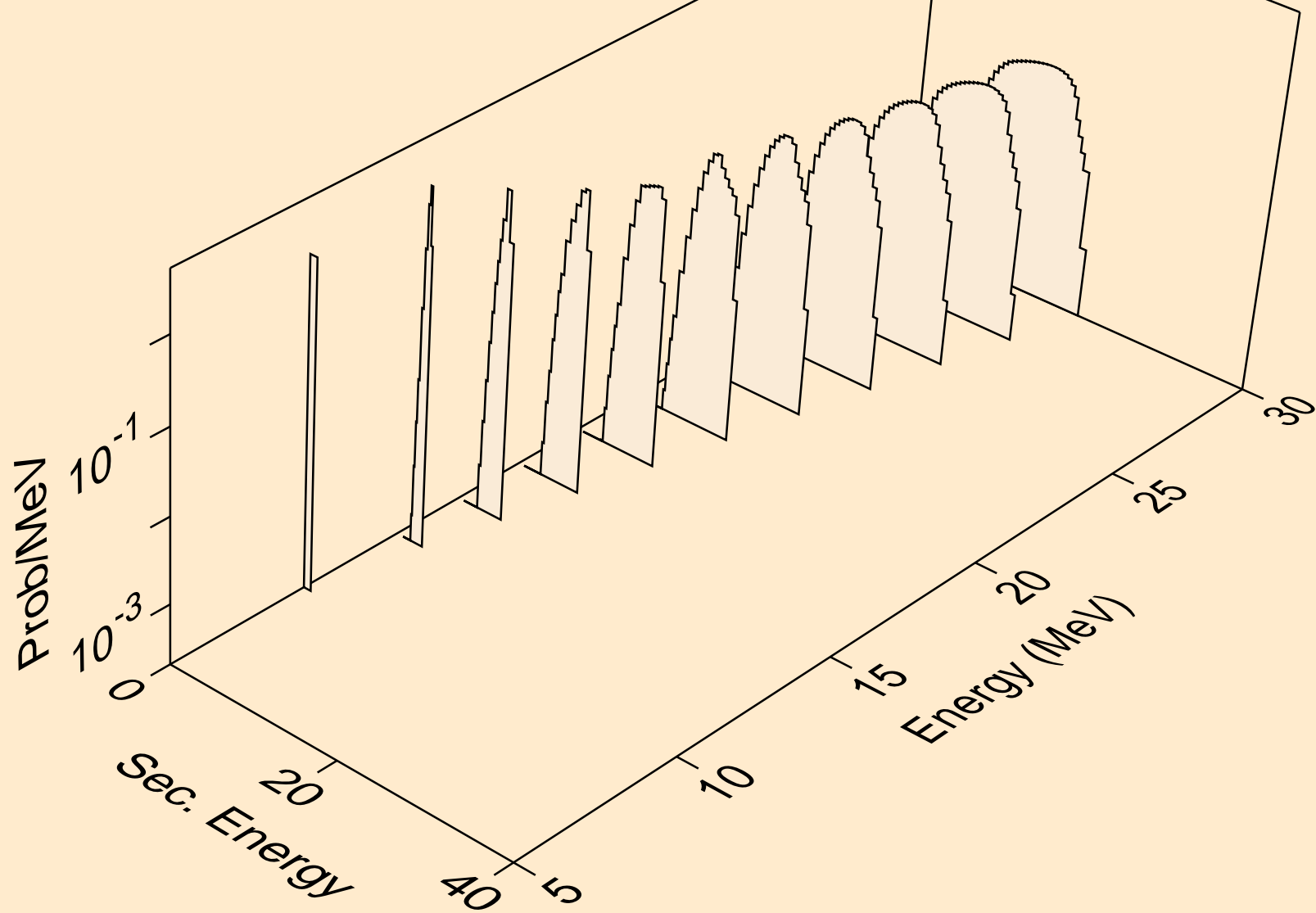

SB114 NEUTRON ACER TENDL-2024 LIBRARY; T=0.K
deuterons from (n,d)

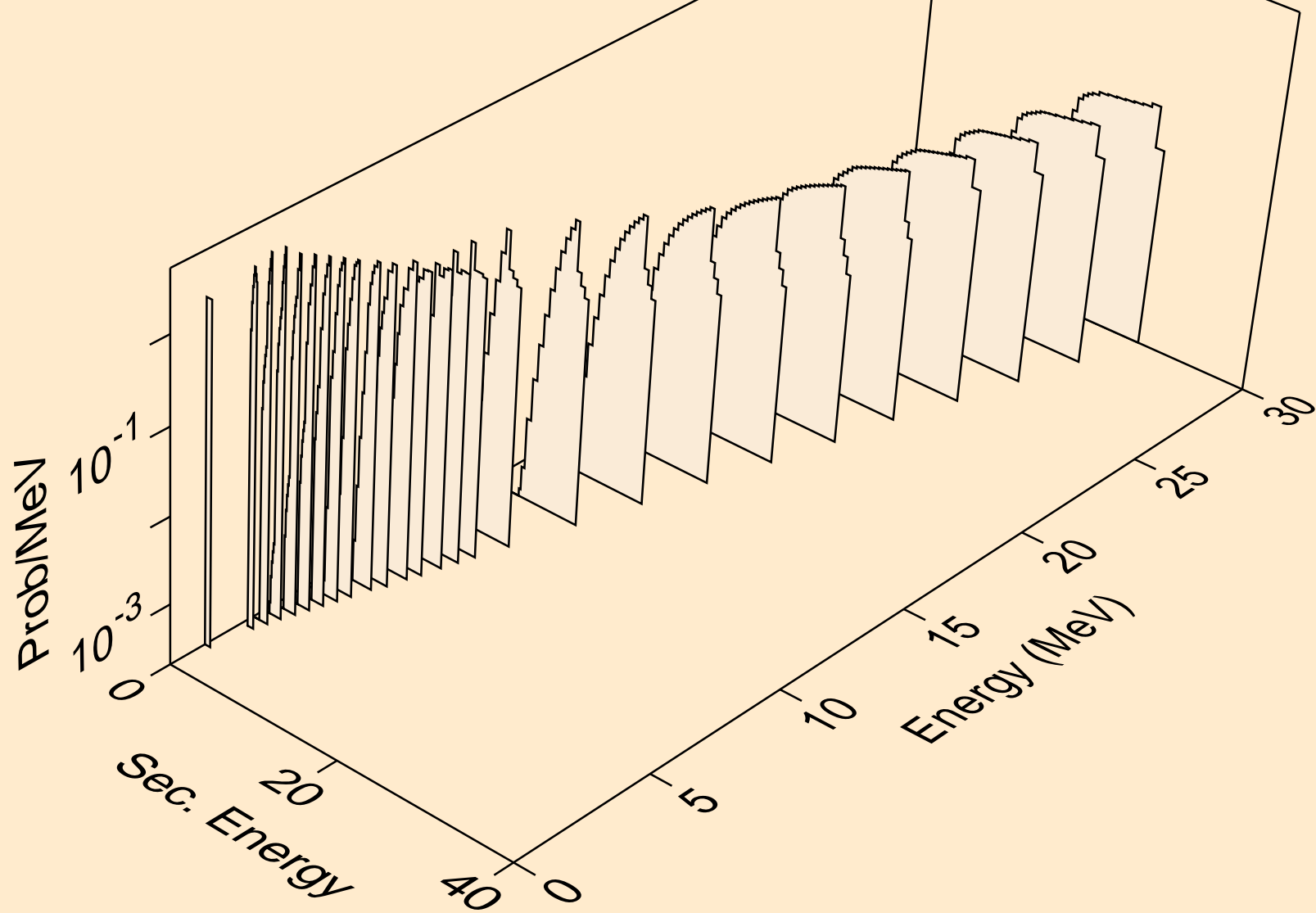

SB114 NEUTRON ACER TENDL-2024 LIBRARY; T=0.K
deuterons from (n,pd)

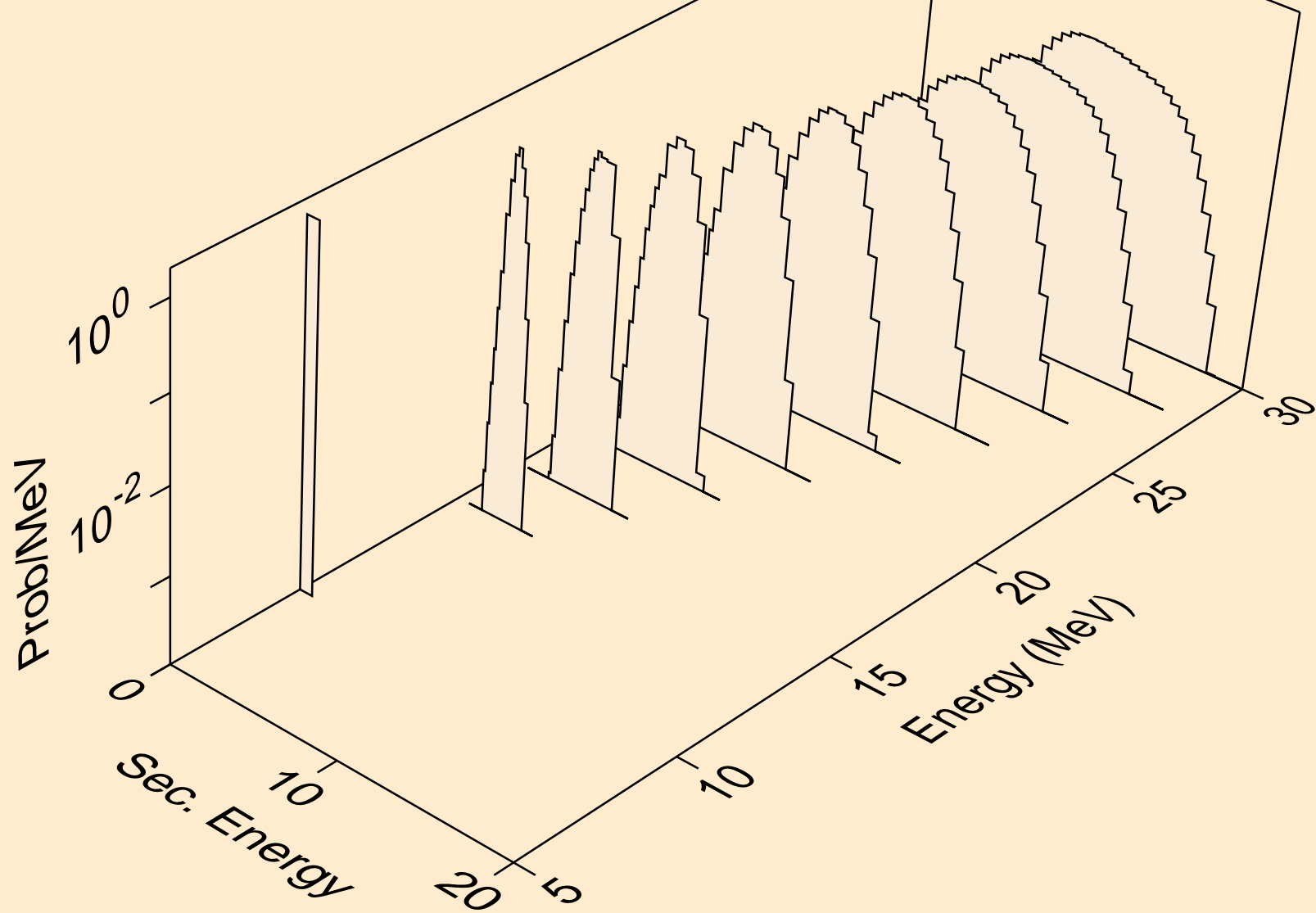

SB114 NEUTRON ACER TENDL-2024 LIBRARY; T=0.K
deuterons from (n,da)

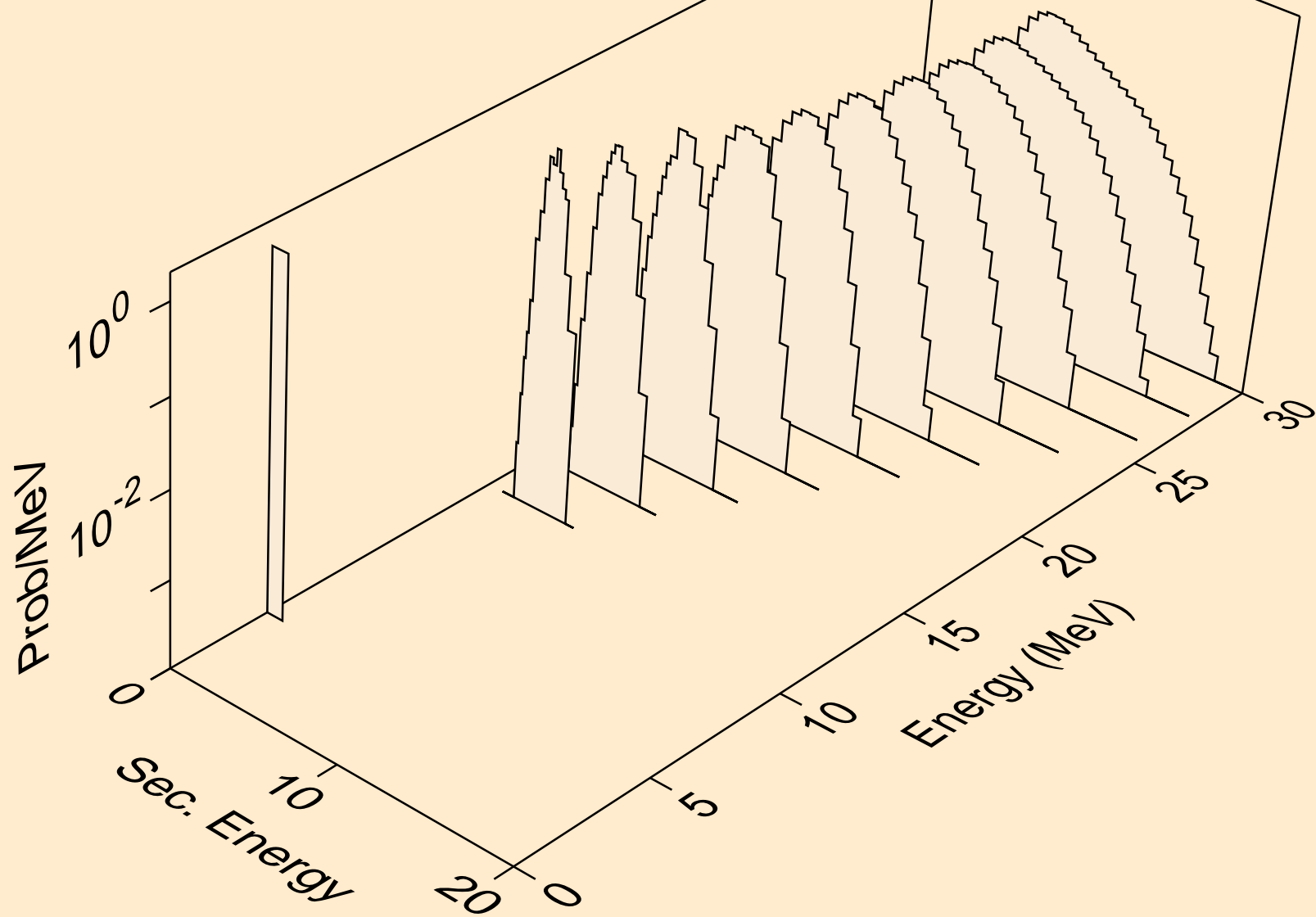

SB114 NEUTRON ACER TENDL-2024 LIBRARY; T=0.K
tritons from (n,x)

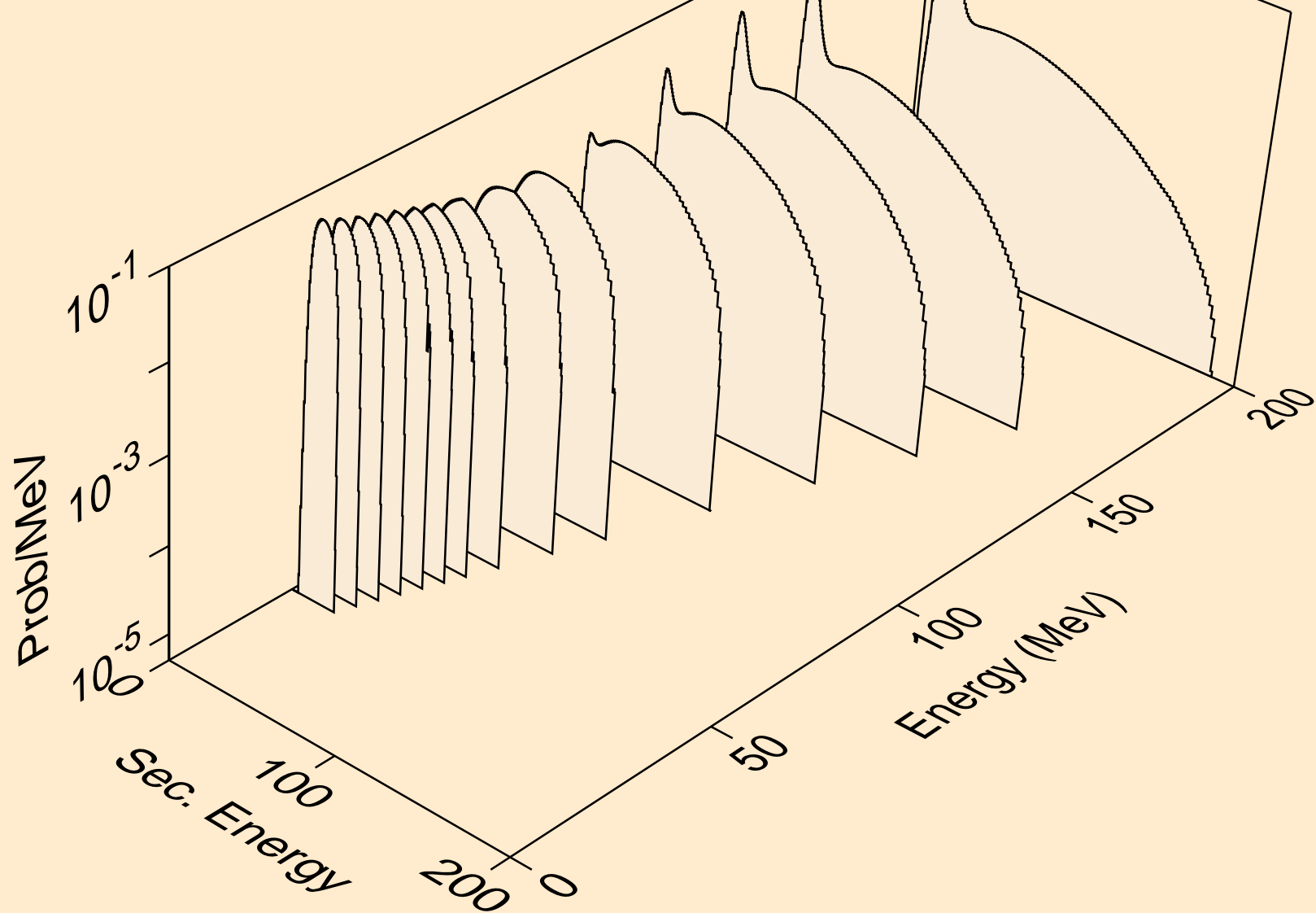

SB114 NEUTRON ACER TENDL-2024 LIBRARY; T=0.K
tritons from (n,n*)t

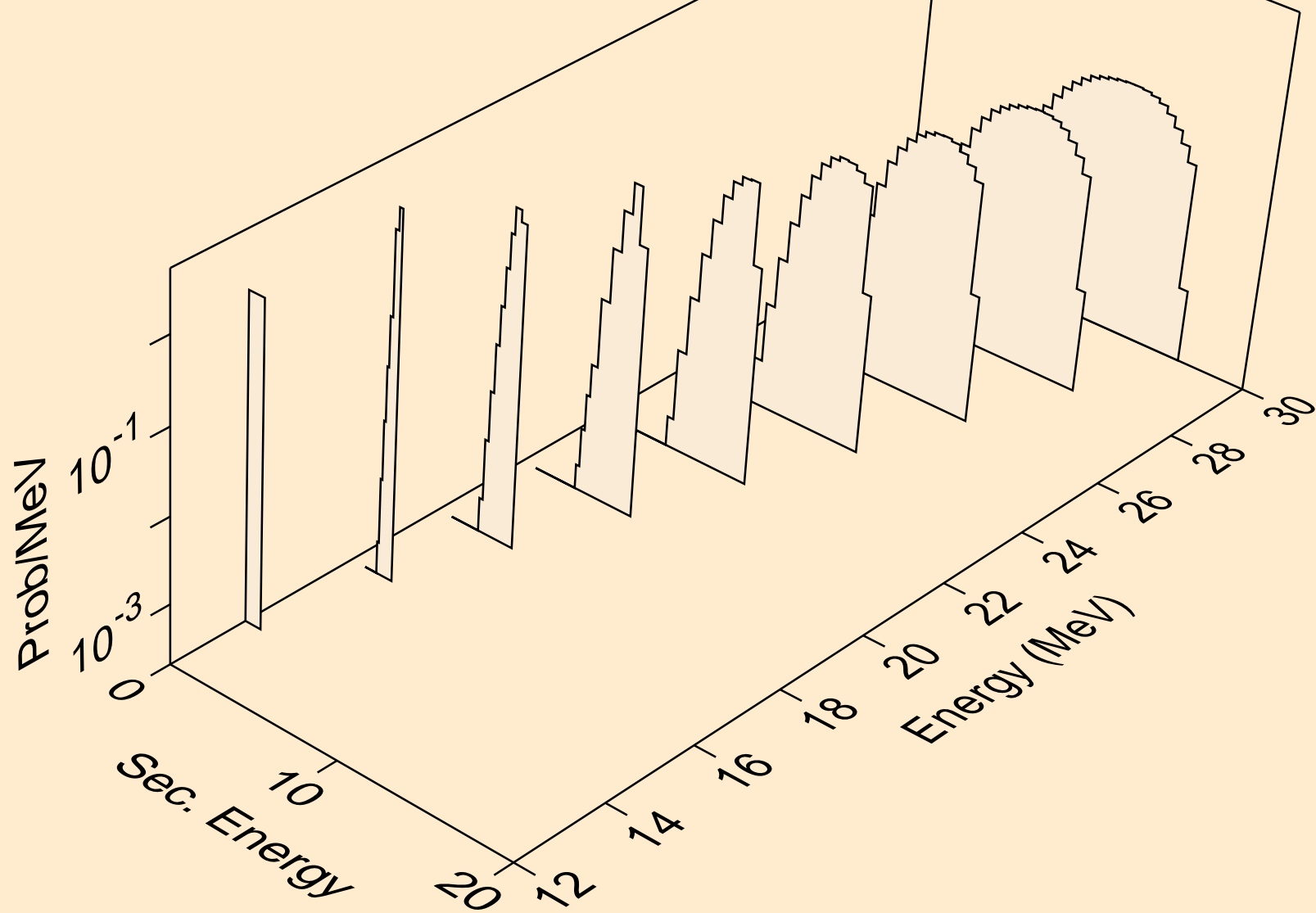

SB114 NEUTRON ACER TENDL-2024 LIBRARY; T=0.K
tritons from (n,t)

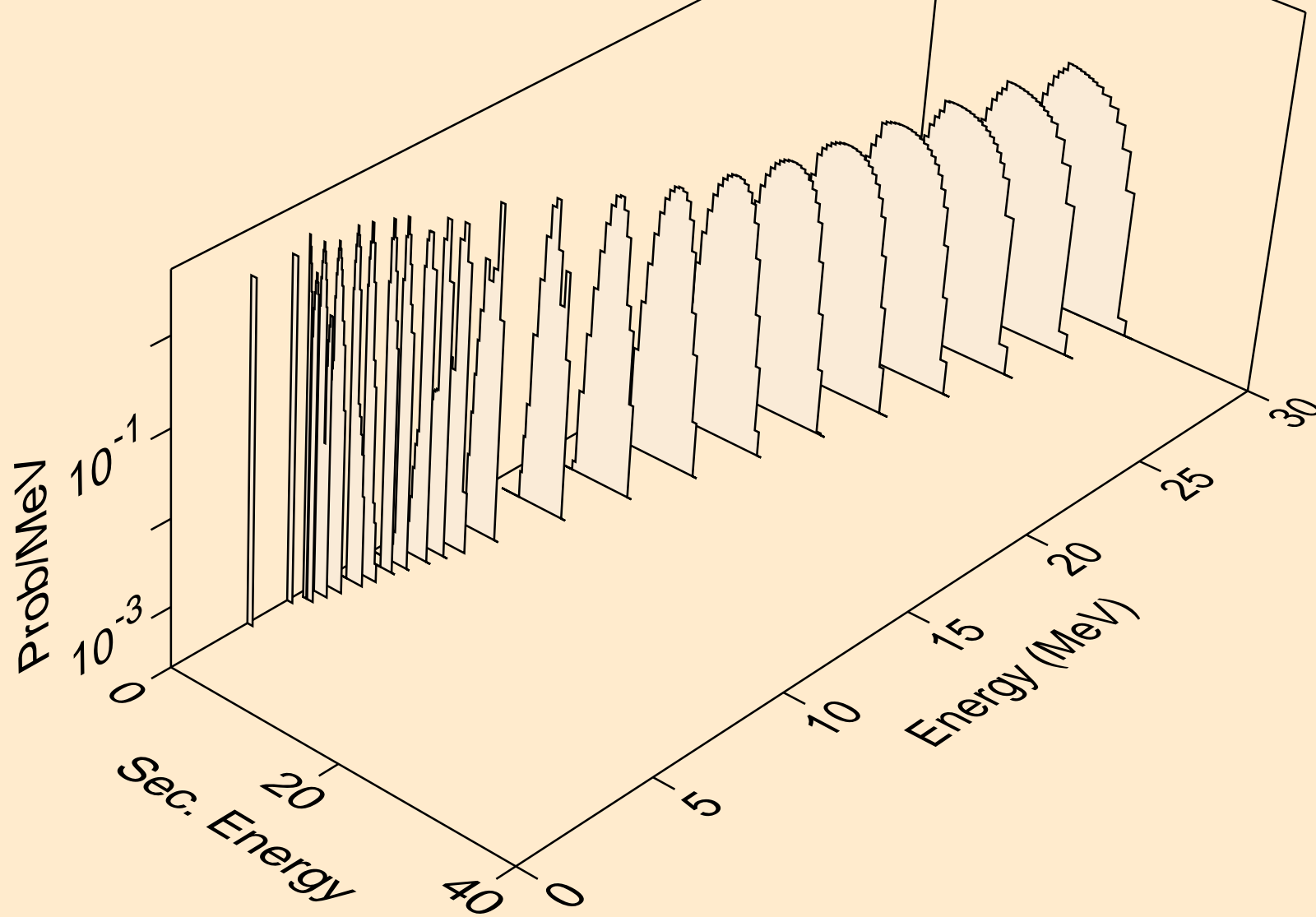

SB114 NEUTRON ACER TENDL-2024 LIBRARY; T=0.K
tritons from (n,pt)

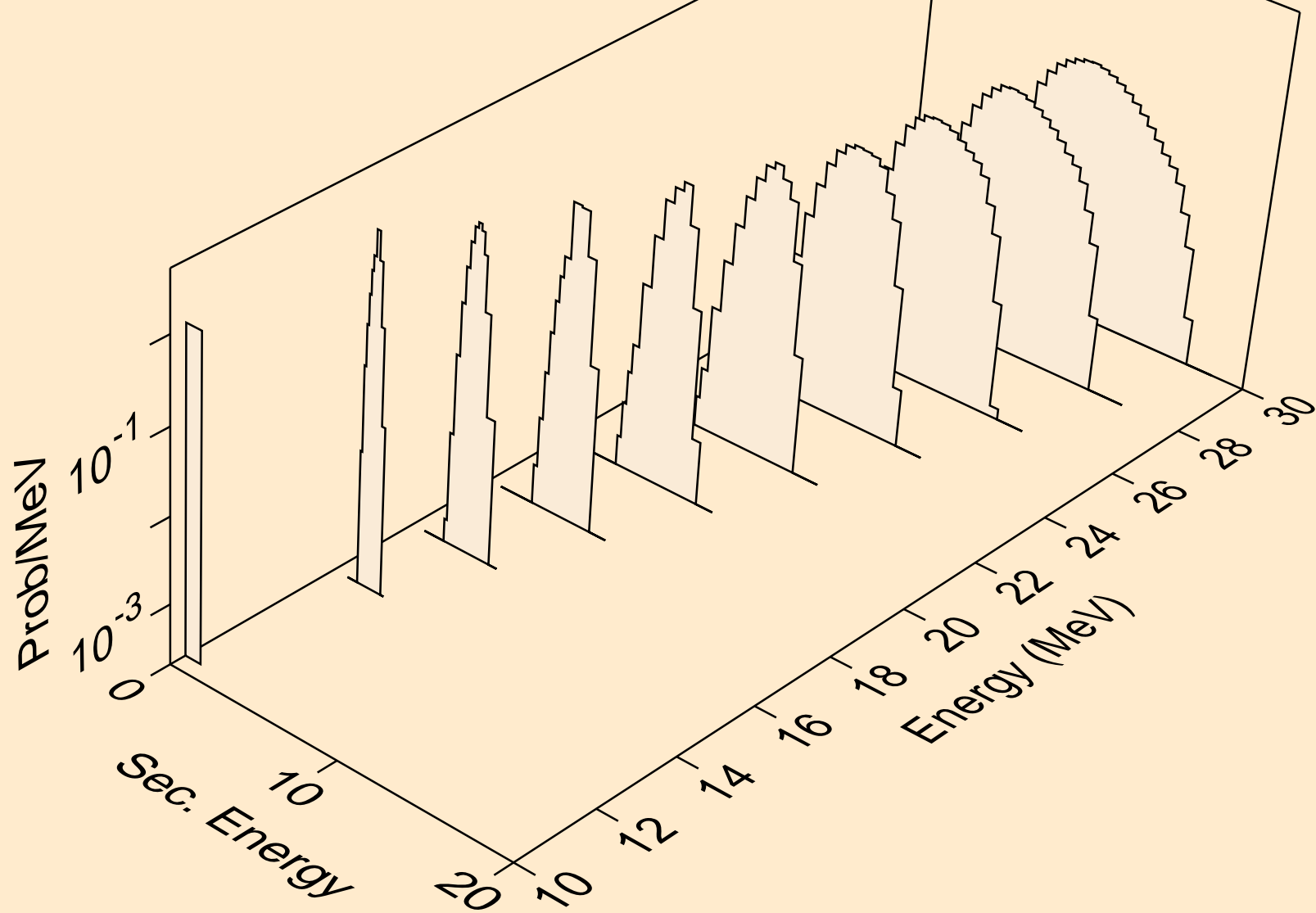

SB114 NEUTRON ACER TENDL-2024 LIBRARY; T=0.K
he3s from (n,x)

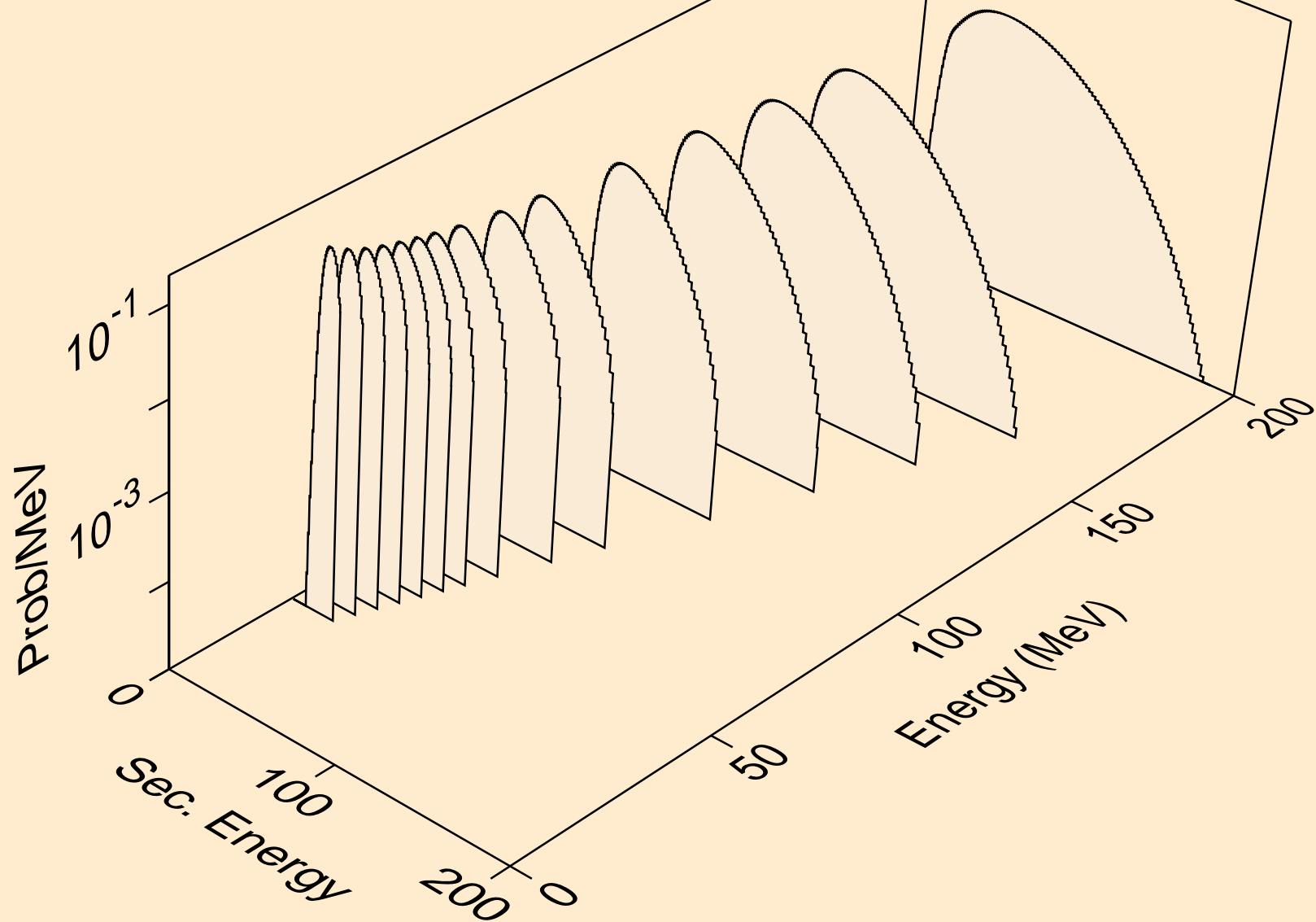

SB114 NEUTRON ACER TENDL-2024 LIBRARY; T=0.K
he3s from (n,n*)he3

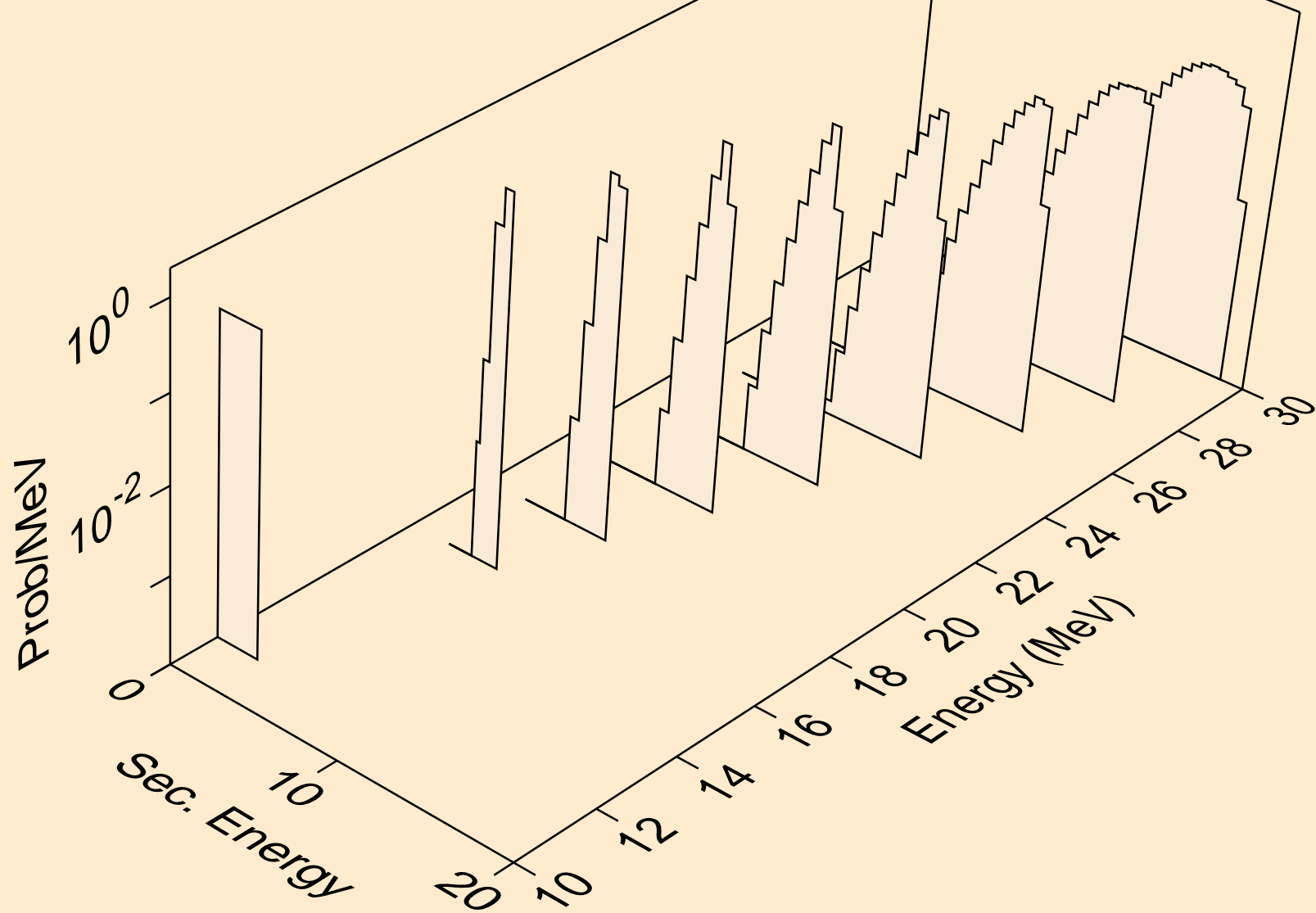

SB114 NEUTRON ACER TENDL-2024 LIBRARY; T=0.K
he3s from (n,he3)

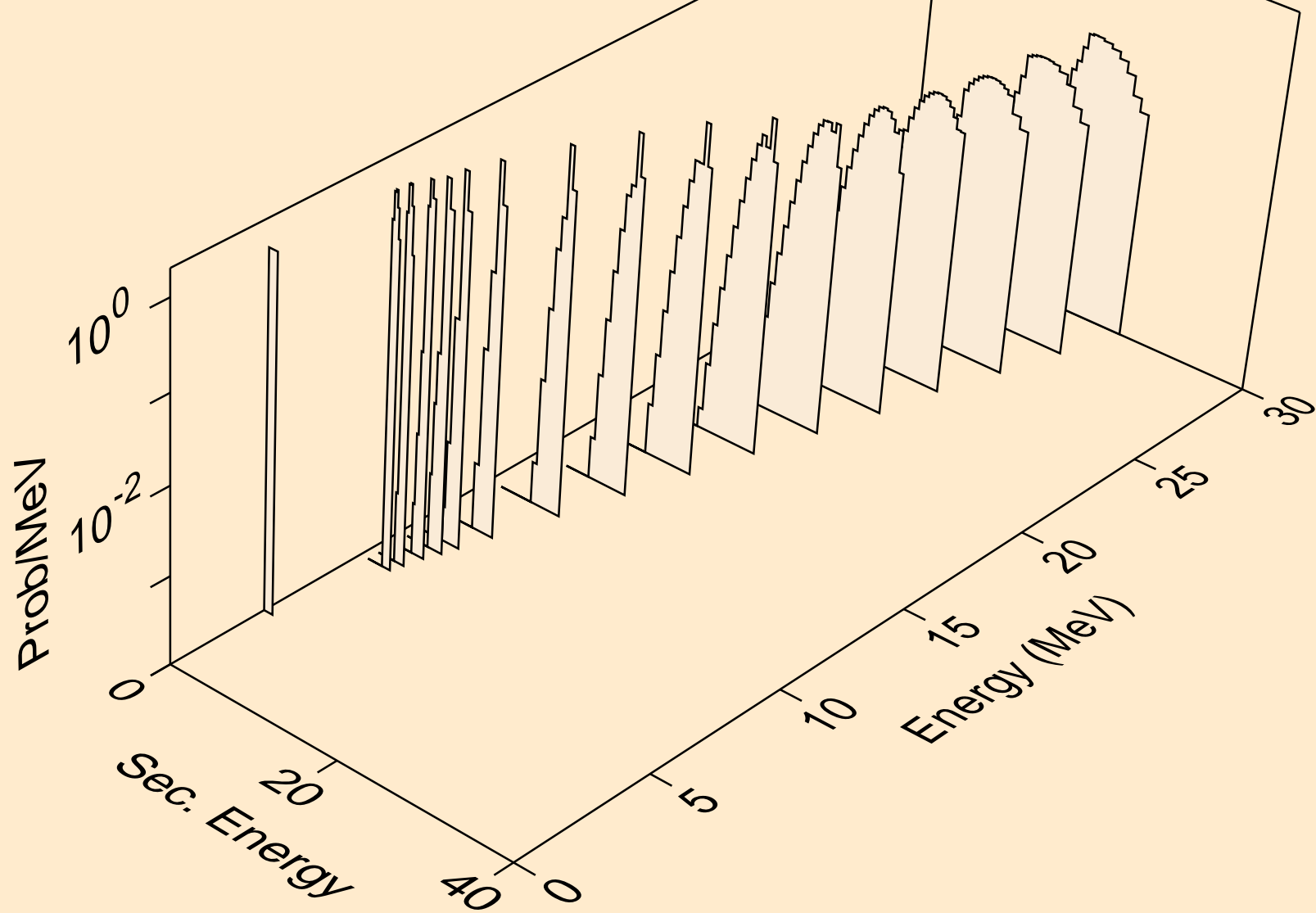

SB114 NEUTRON ACER TENDL-2024 LIBRARY; T=0.K
alphas from (n,x)

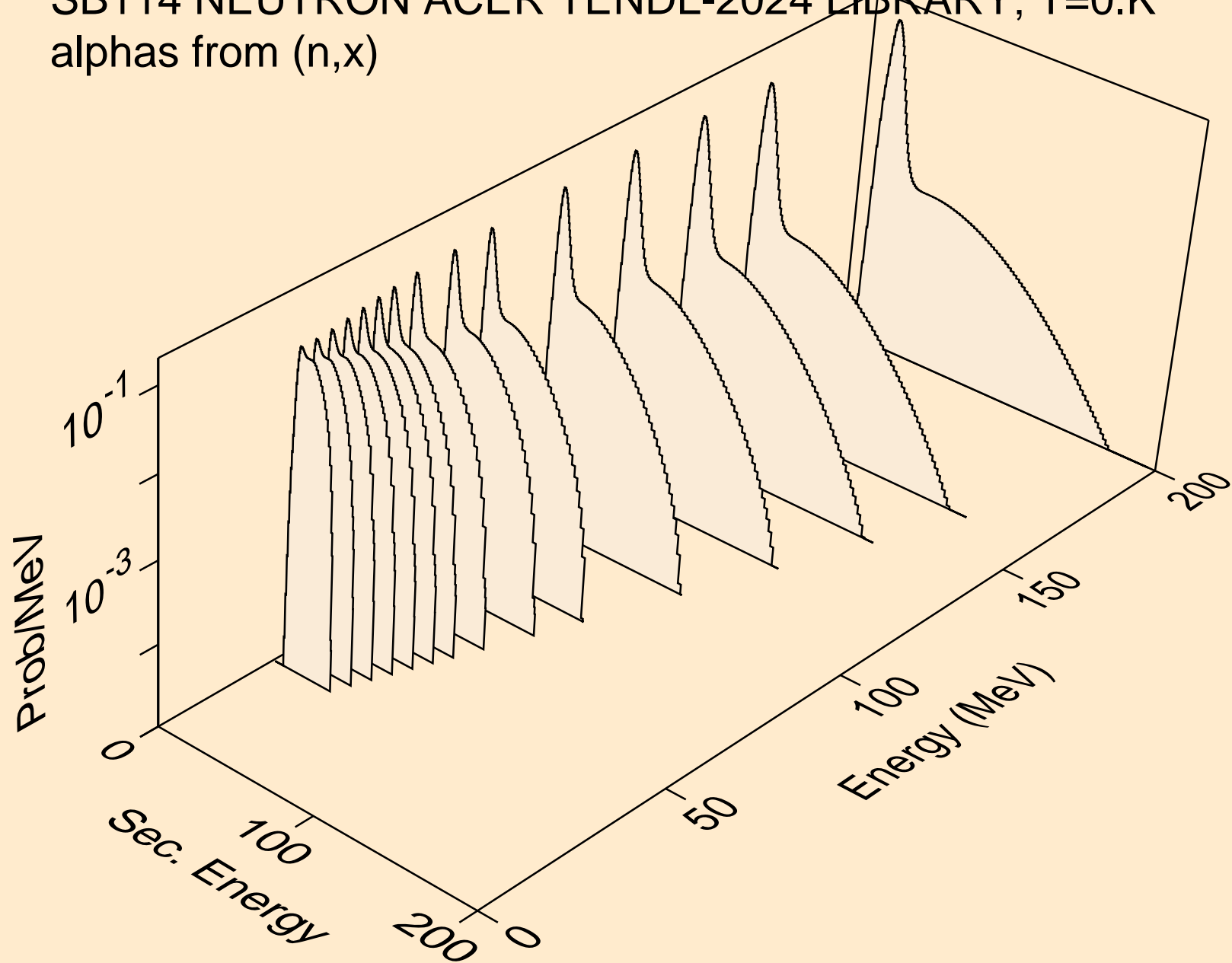

SB114 NEUTRON ACER TENDL-2024 LIBRARY; T=0.K
alphas from (n,n*)a

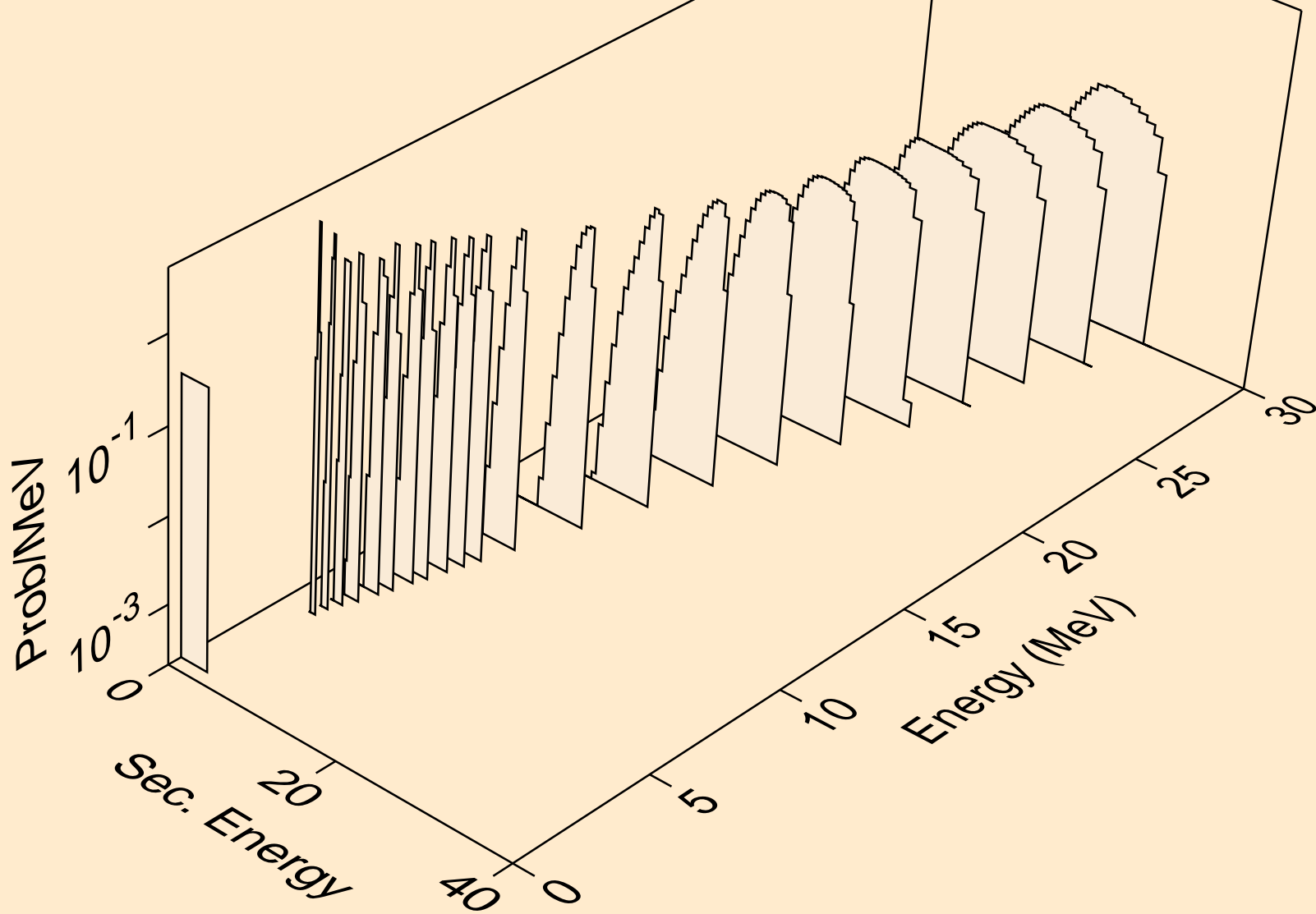

SB114 NEUTRON ACER TENDL-2024 LIBRARY; T=0.K
alphas from (n,2n)a

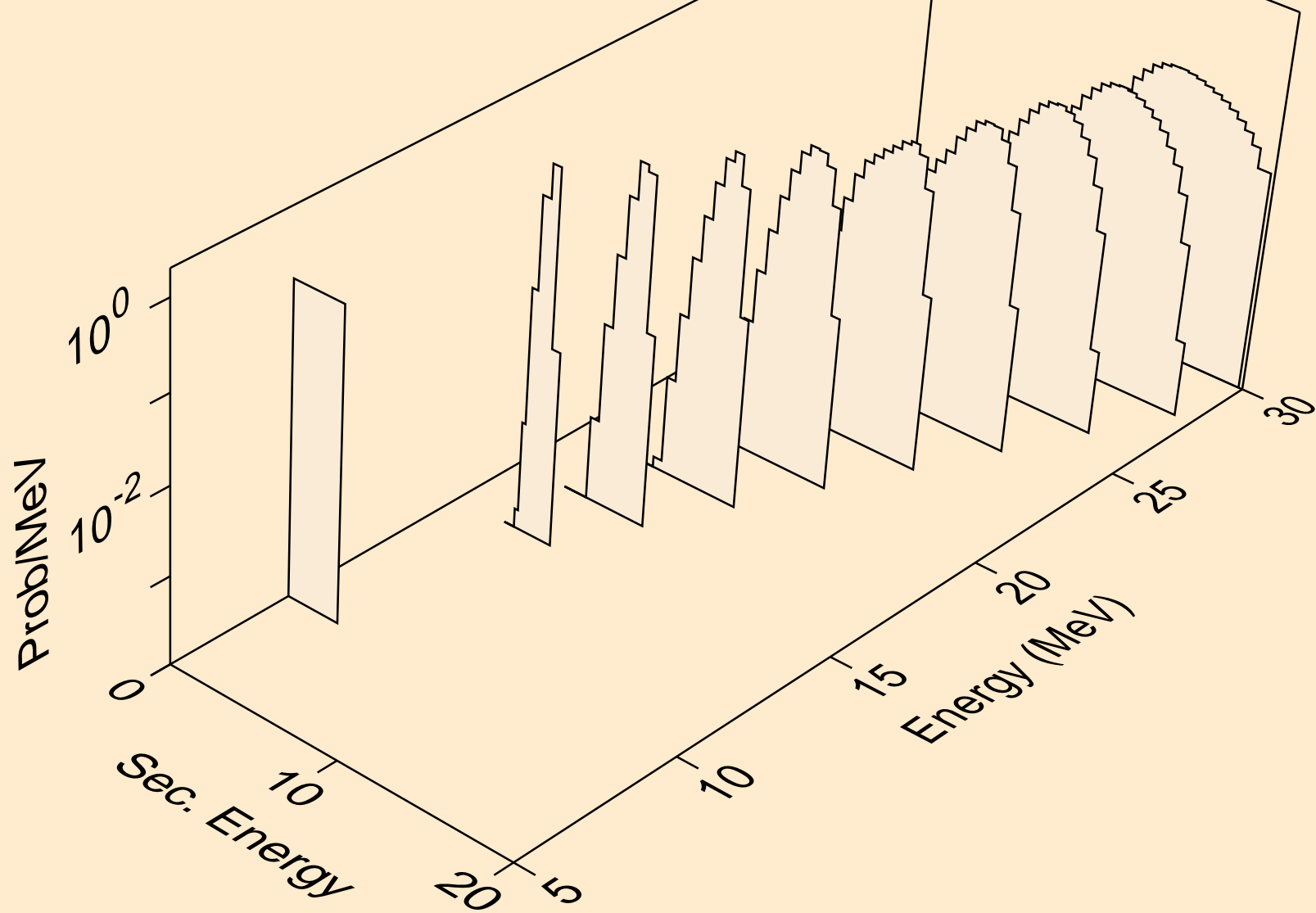

SB114 NEUTRON ACER TENDL-2024 LIBRARY; T=0.K
alphas from (n,3n)a

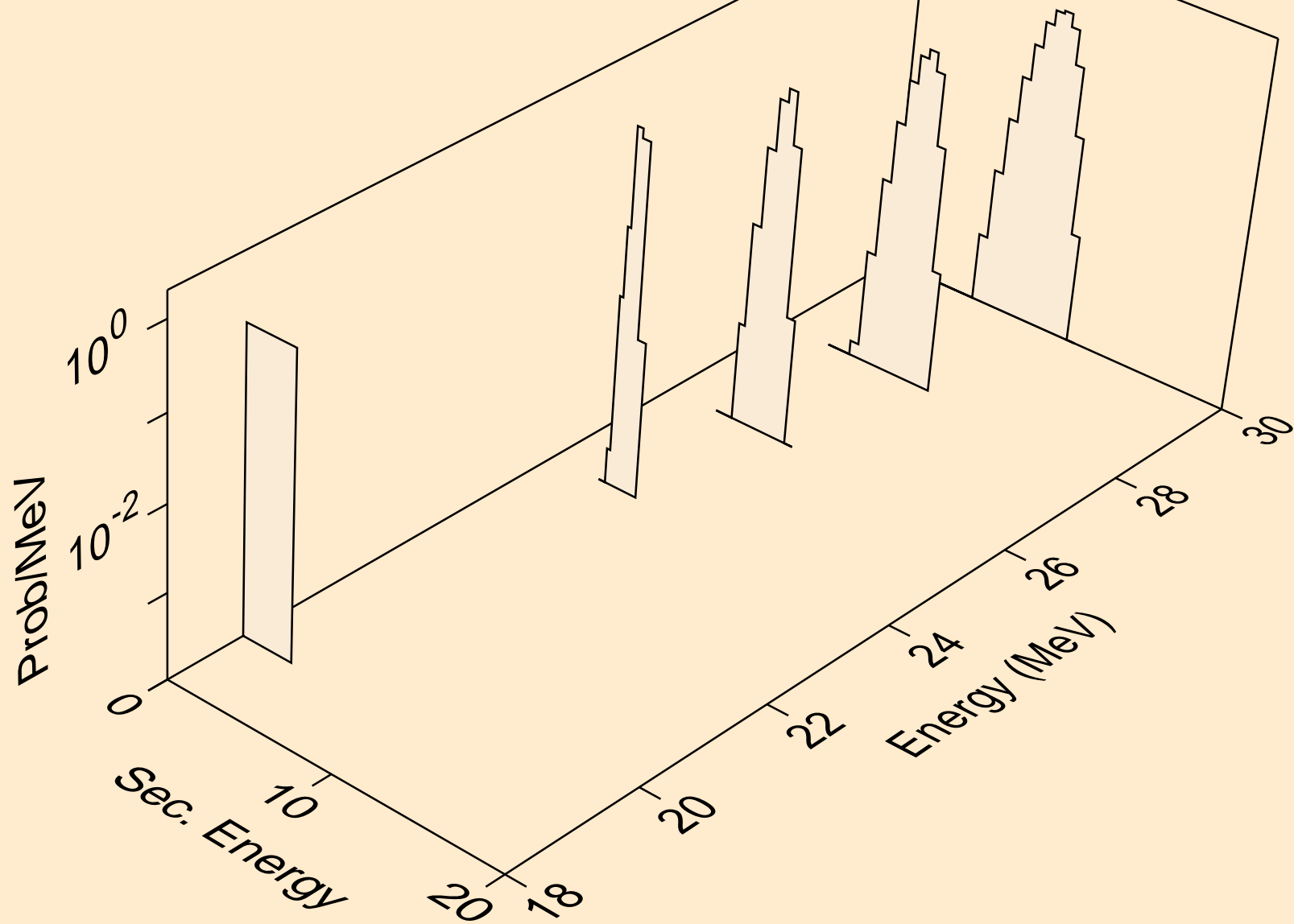

SB114 NEUTRON ACER TENDL-2024 LIBRARY; T=0.K
alphas from (n,n*)2a

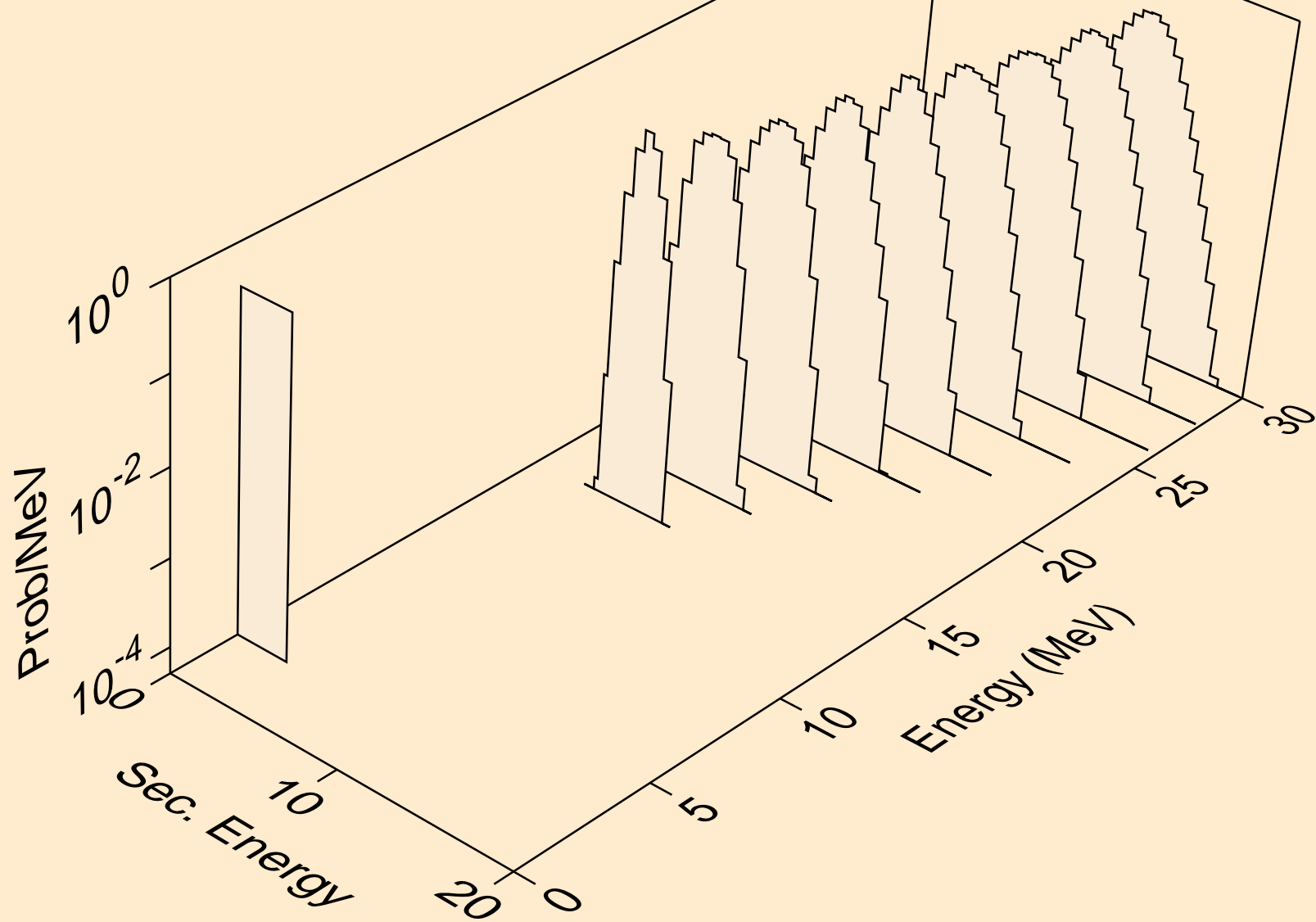

SB114 NEUTRON ACER TENDL-2024 LIBRARY; T=0.K
alphas from (n,2n)2a

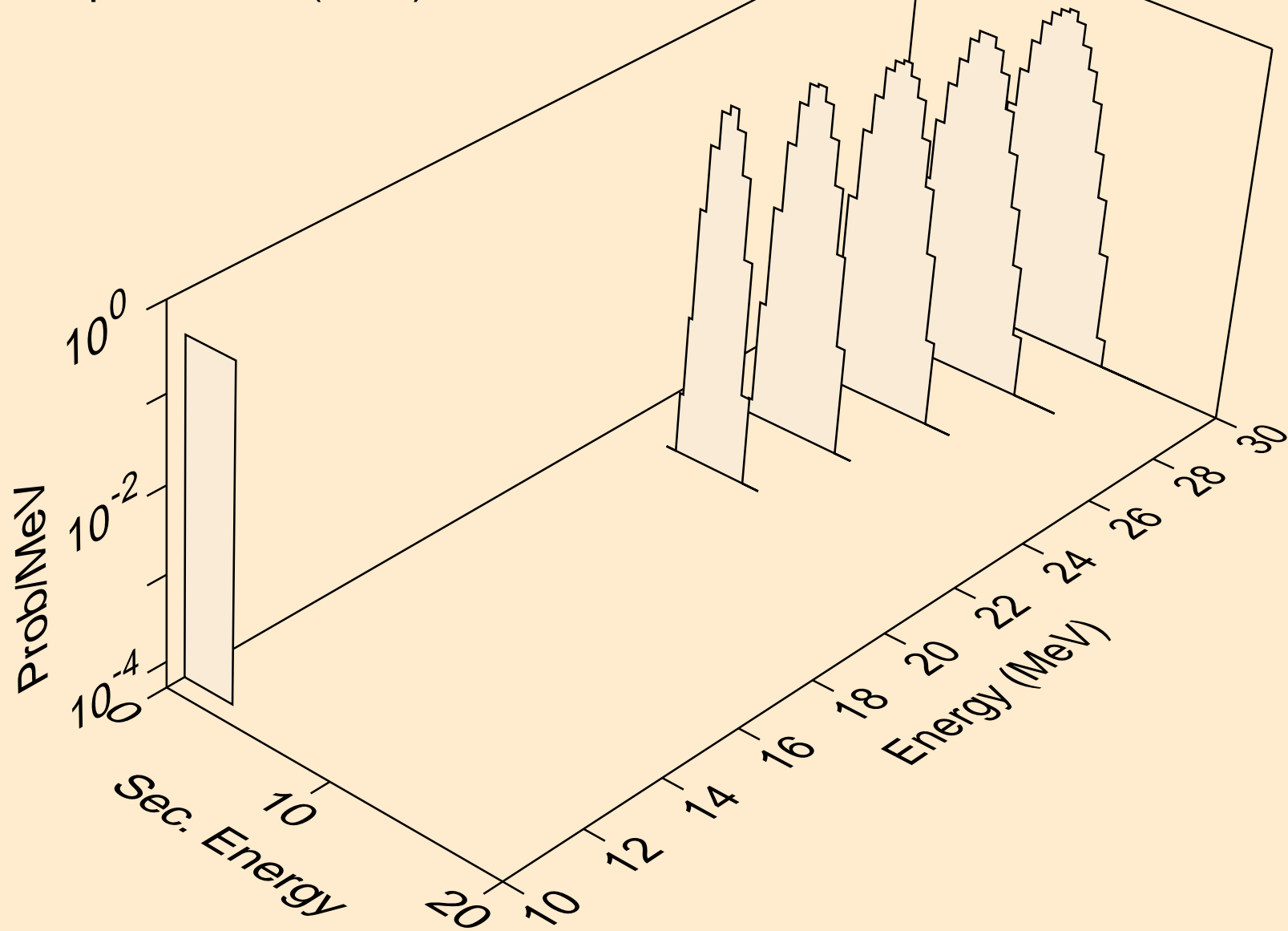

SB114 NEUTRON ACER TENDL-2024 LIBRARY; T=0.K
alphas from (n,npa)

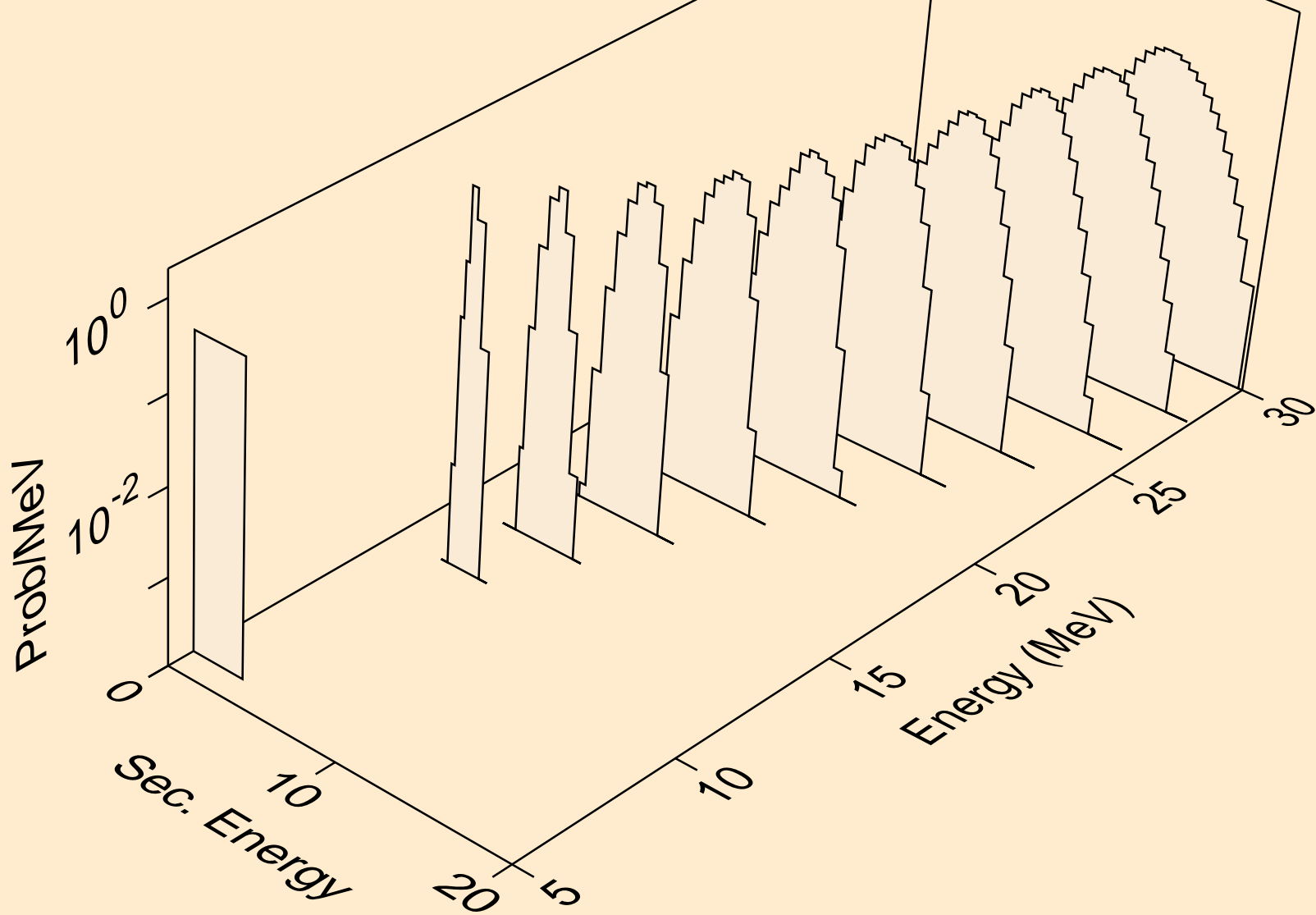

SB114 NEUTRON ACER TENDL-2024 LIBRARY; T=0.K
alphas from (n,a)

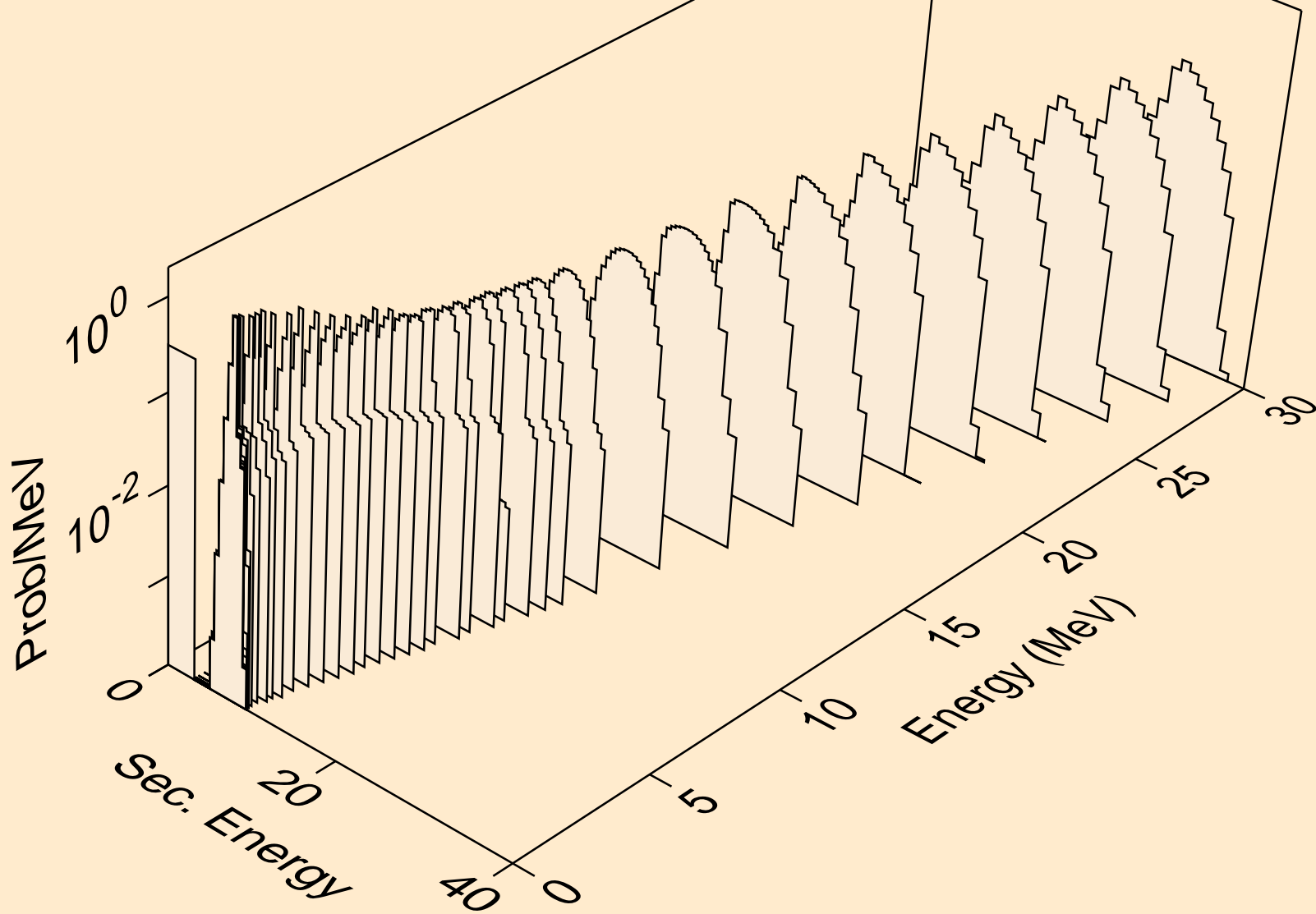

SB114 NEUTRON ACER TENDL-2024 LIBRARY; T=0.K
alphas from (n,2a)

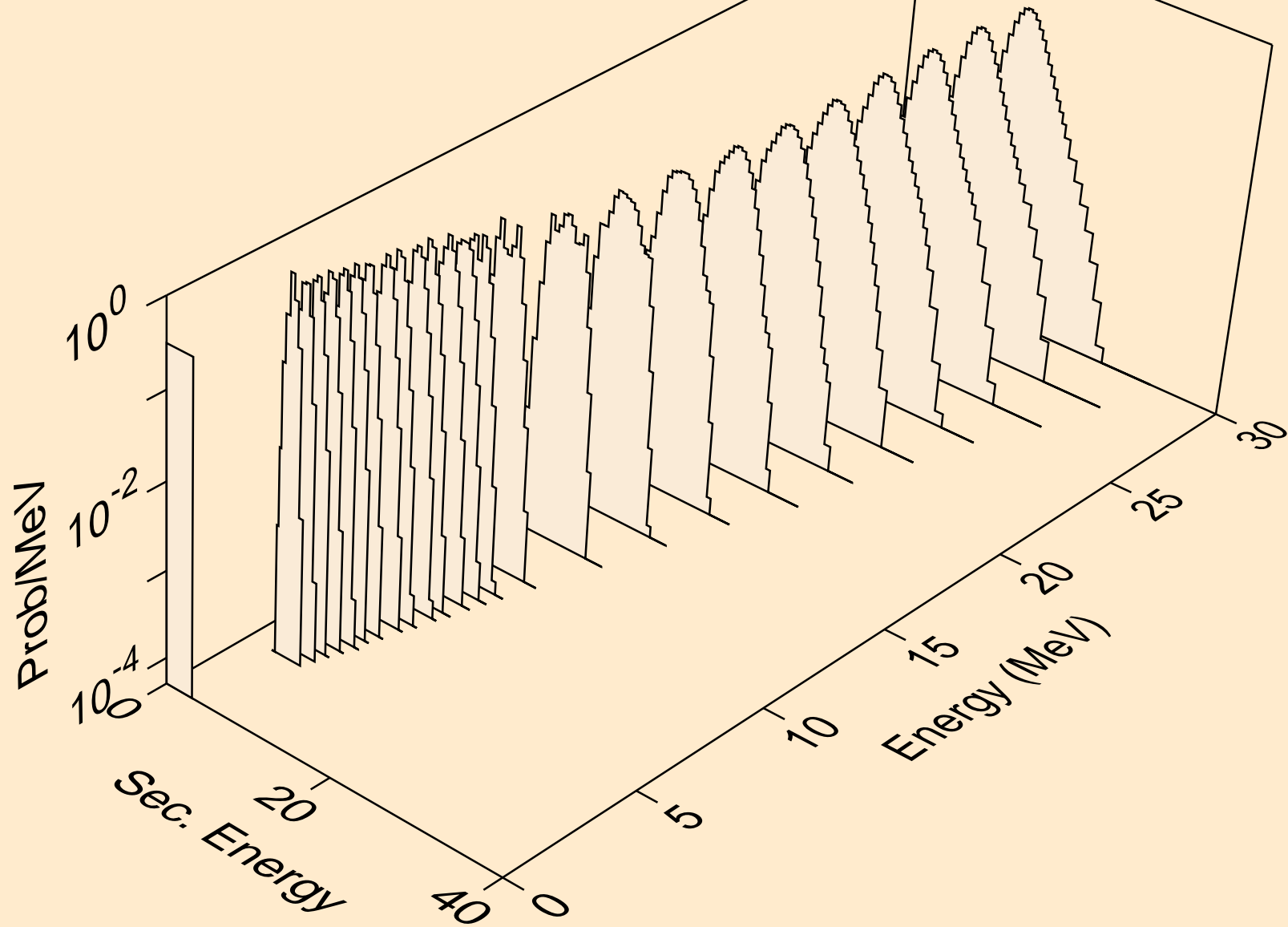

SB114 NEUTRON ACER TENDL-2024 LIBRARY; T=0.K
alphas from (n,pa)

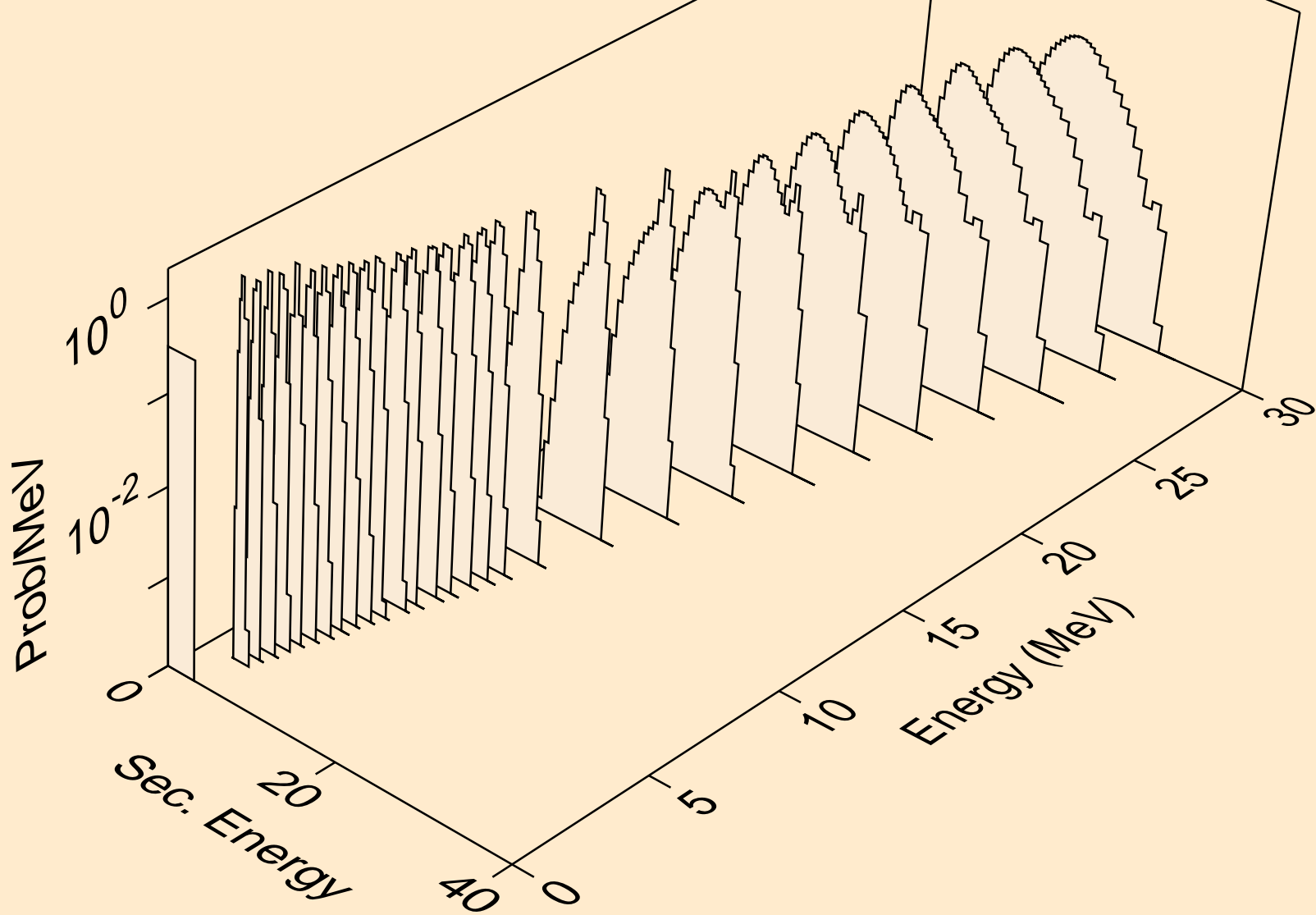

SB114 NEUTRON ACER TENDL-2024 LIBRARY; T=0.K
alphas from (n,da)

