

# SB124N NEUTRON ACER TENDL-2024 LIBRARY; T=0.K

## Principal cross sections

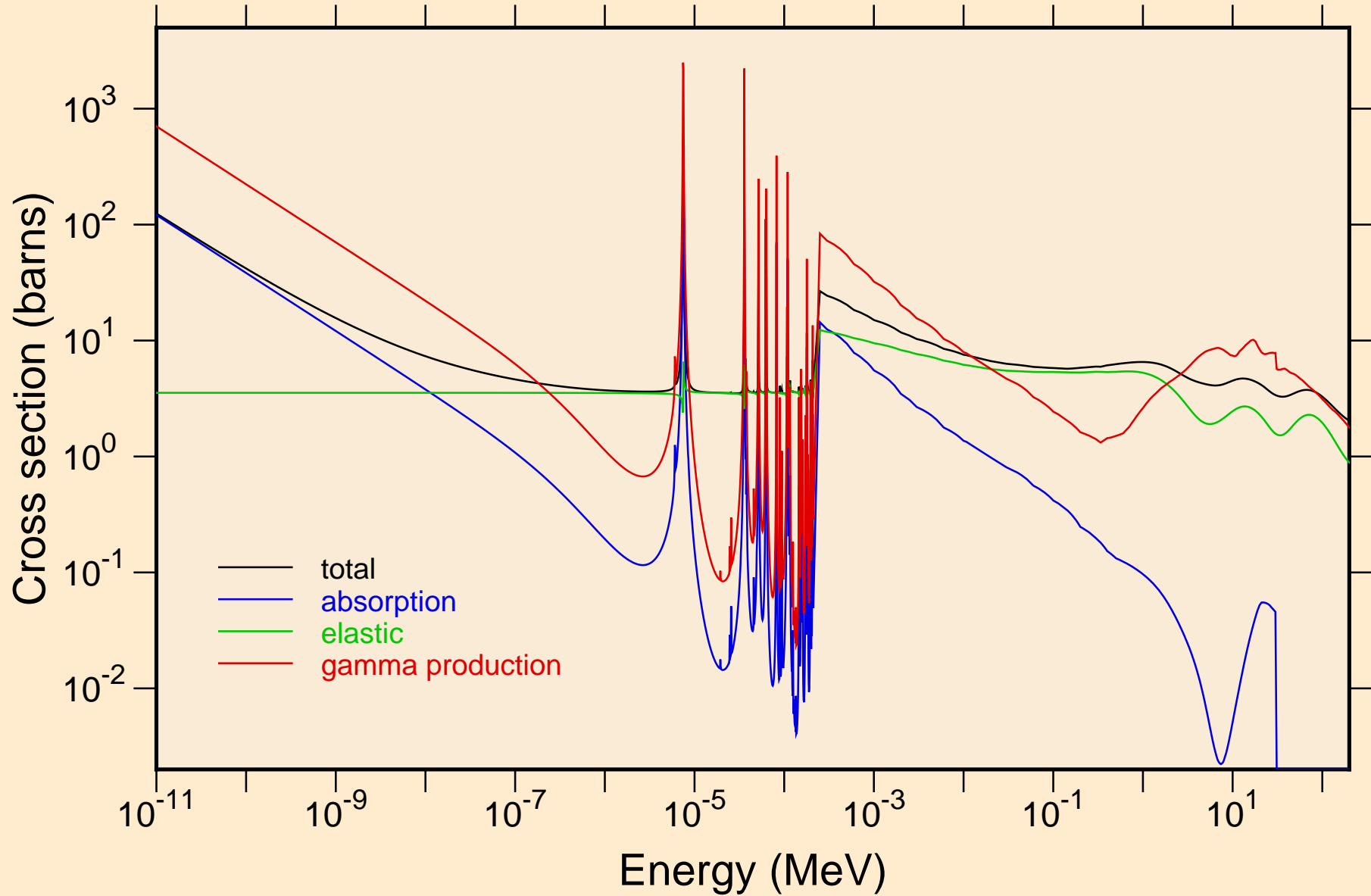

SB124N NEUTRON ACER TENDL-2024 LIBRARY; T=0.K  
resonance total cross section

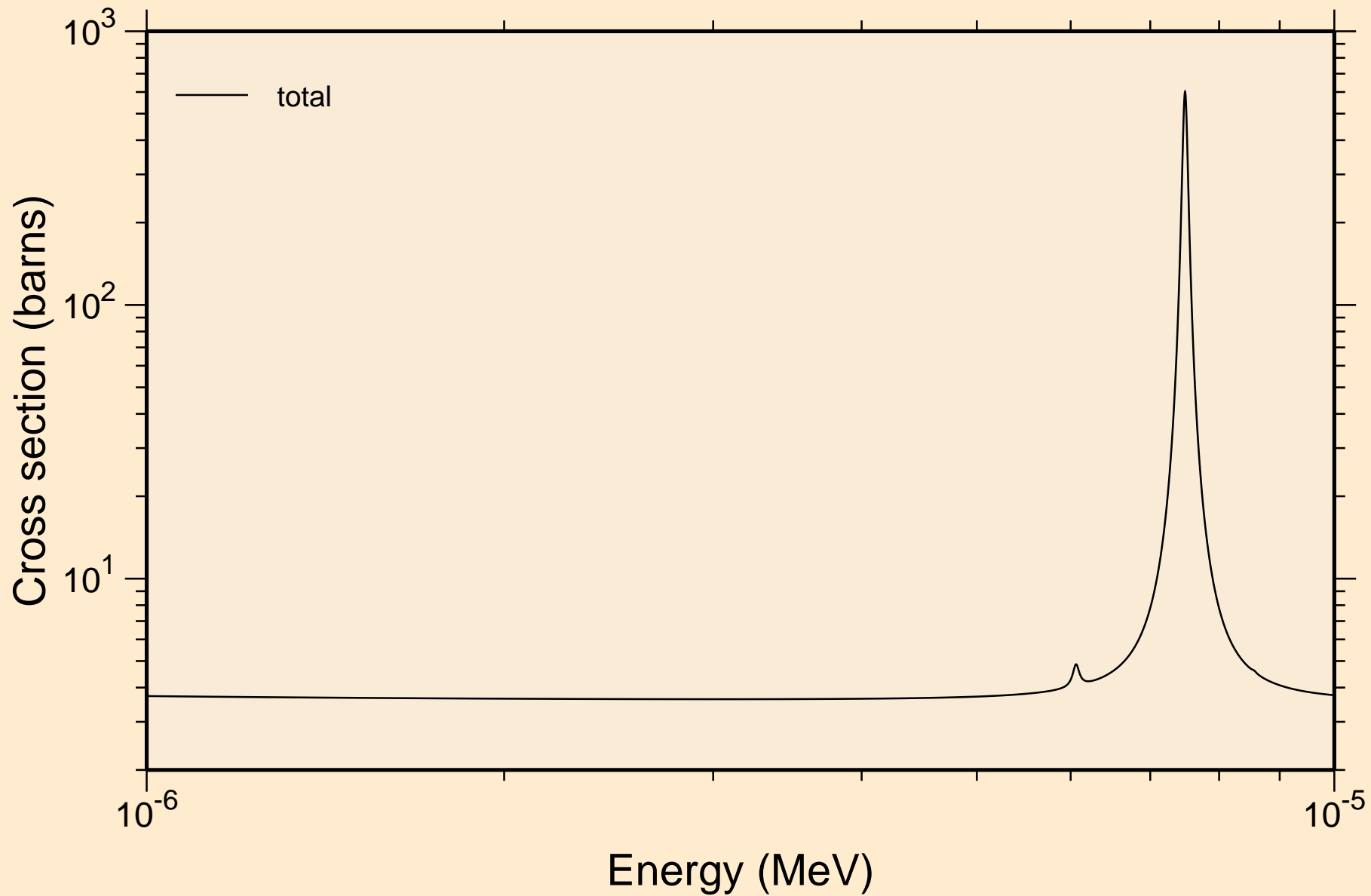

SB124N NEUTRON ACER TENDL-2024 LIBRARY; T=0.K  
resonance total cross section

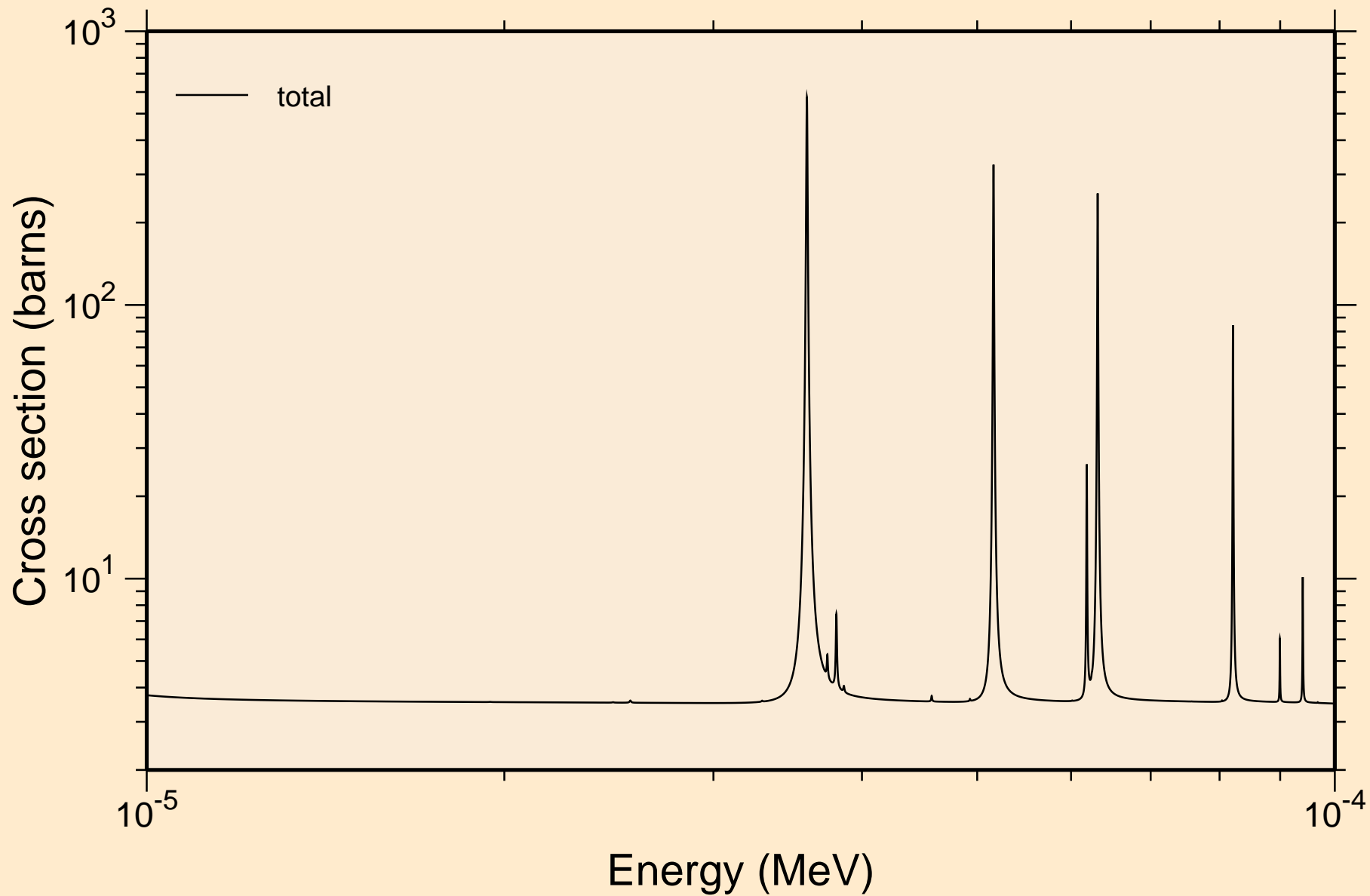

SB124N NEUTRON ACER TENDL-2024 LIBRARY; T=0.K  
resonance total cross section

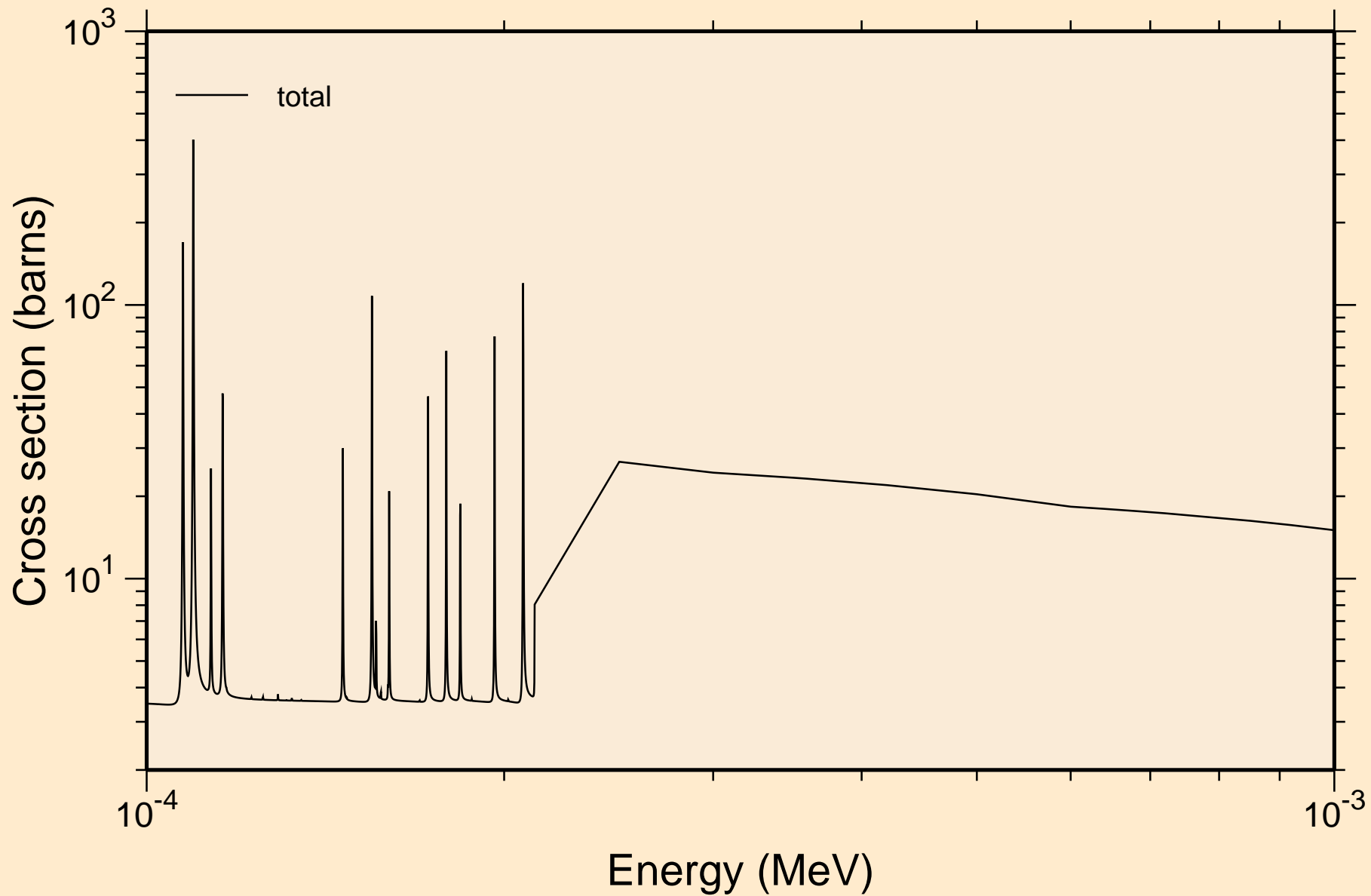

S<sup>124</sup>N NEUTRON ACER TENDL-2024 LIBRARY; T=0.K  
resonance total cross section

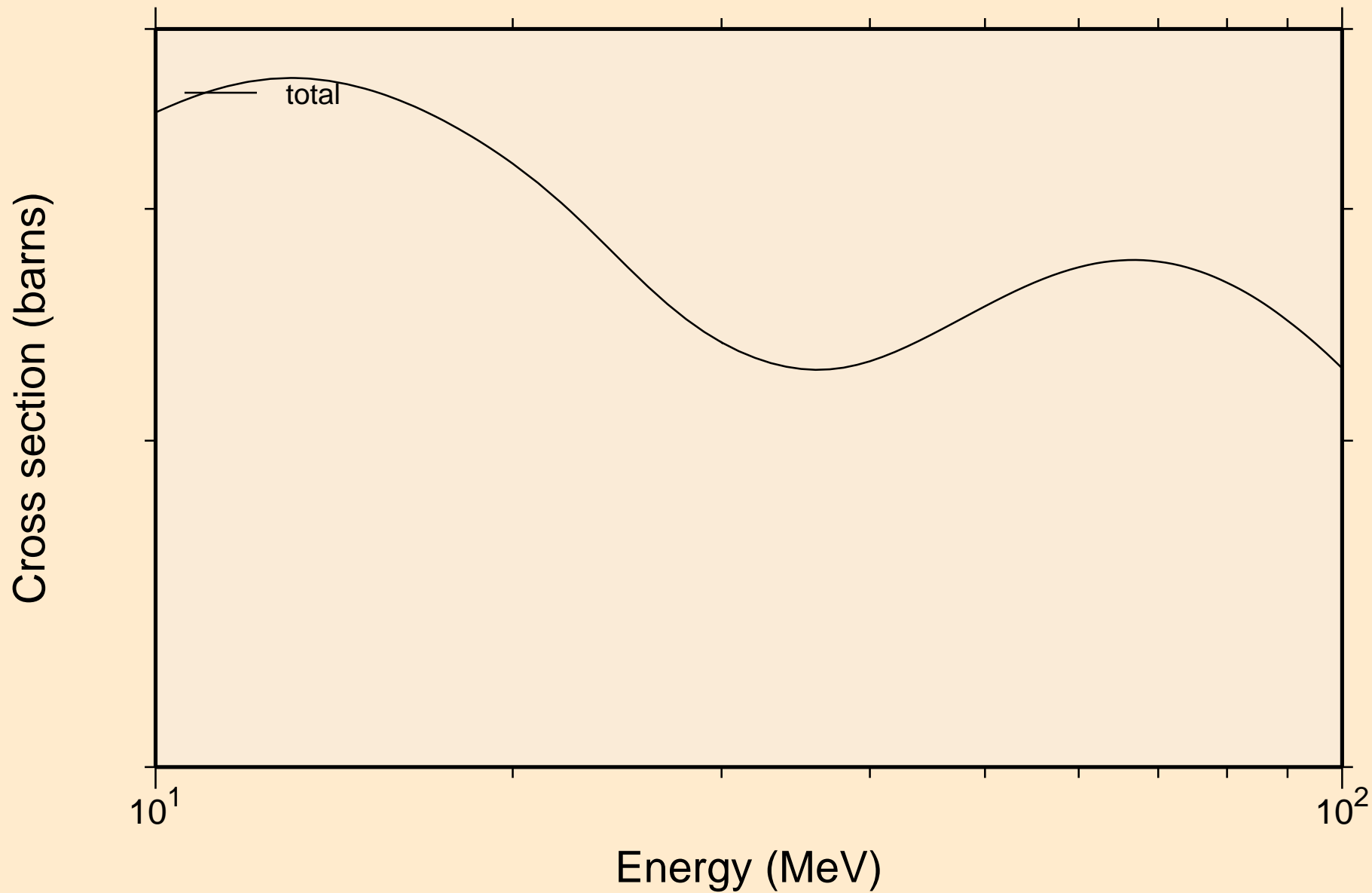

SB124N NEUTRON ACER TENDL-2024 LIBRARY; T=0.K  
resonance absorption cross sections

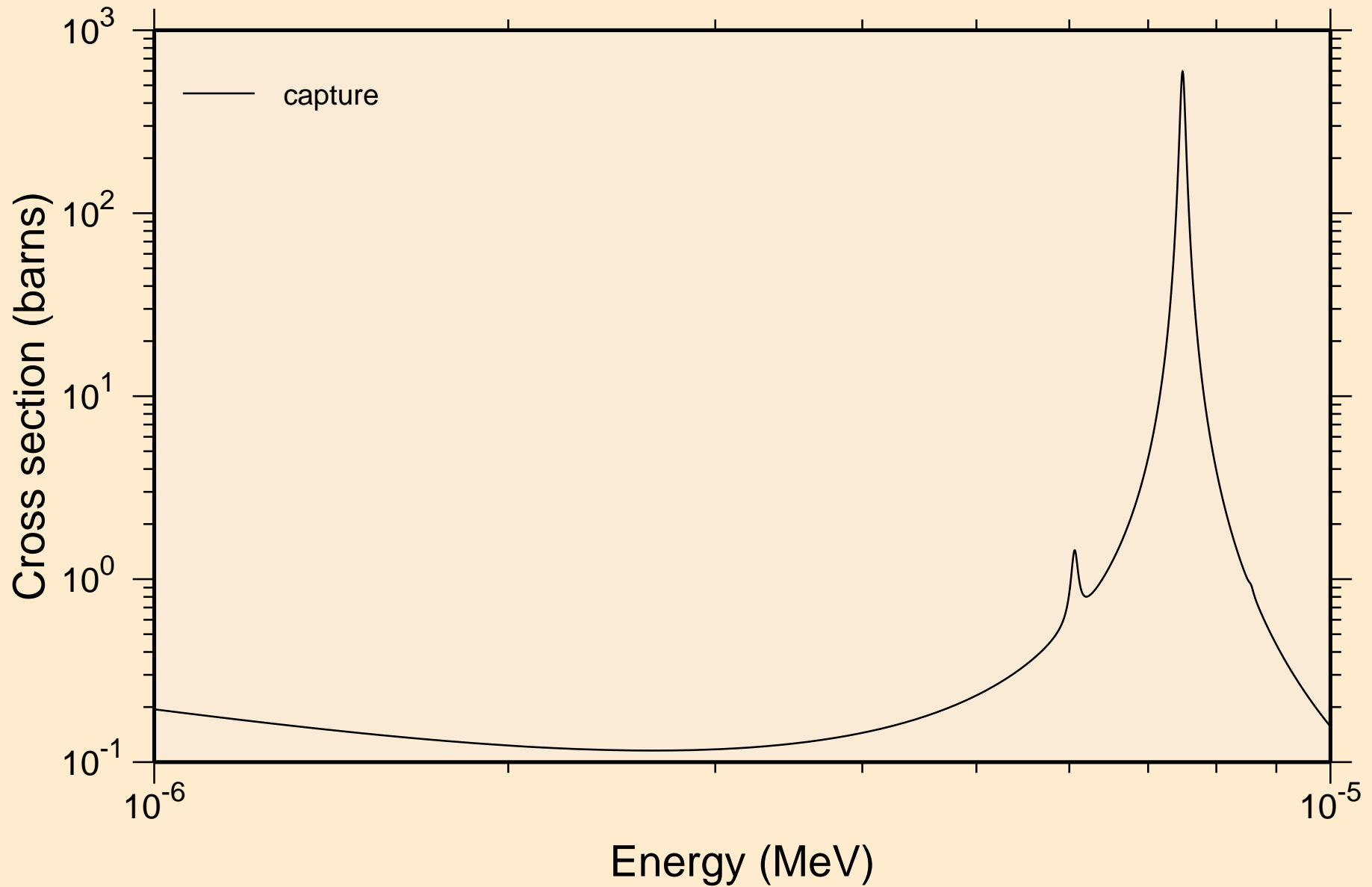

SB124N NEUTRON ACER TENDL-2024 LIBRARY; T=0.K  
resonance absorption cross sections

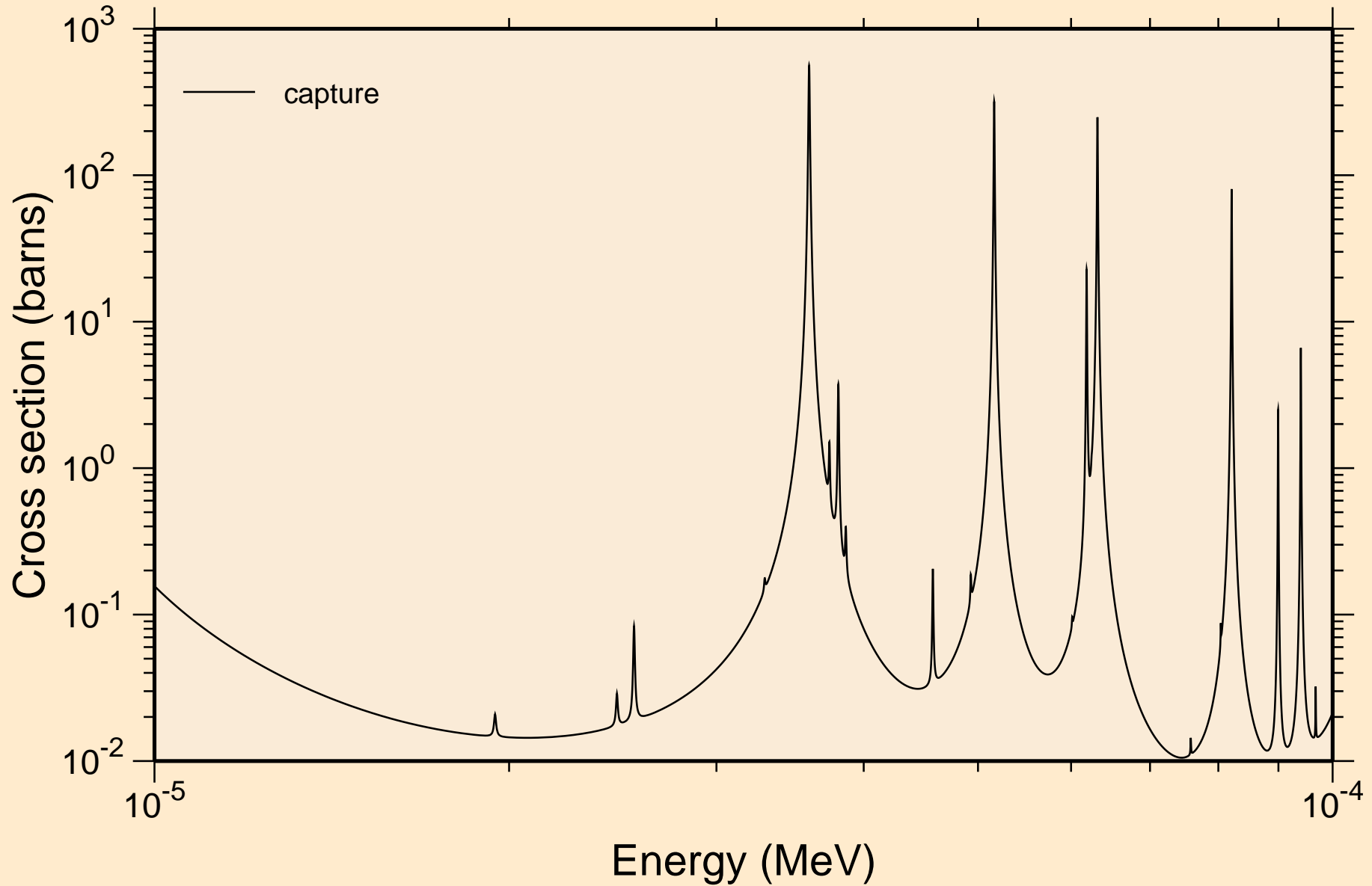

SB124N NEUTRON ACER TENDL-2024 LIBRARY; T=0.K  
resonance absorption cross sections

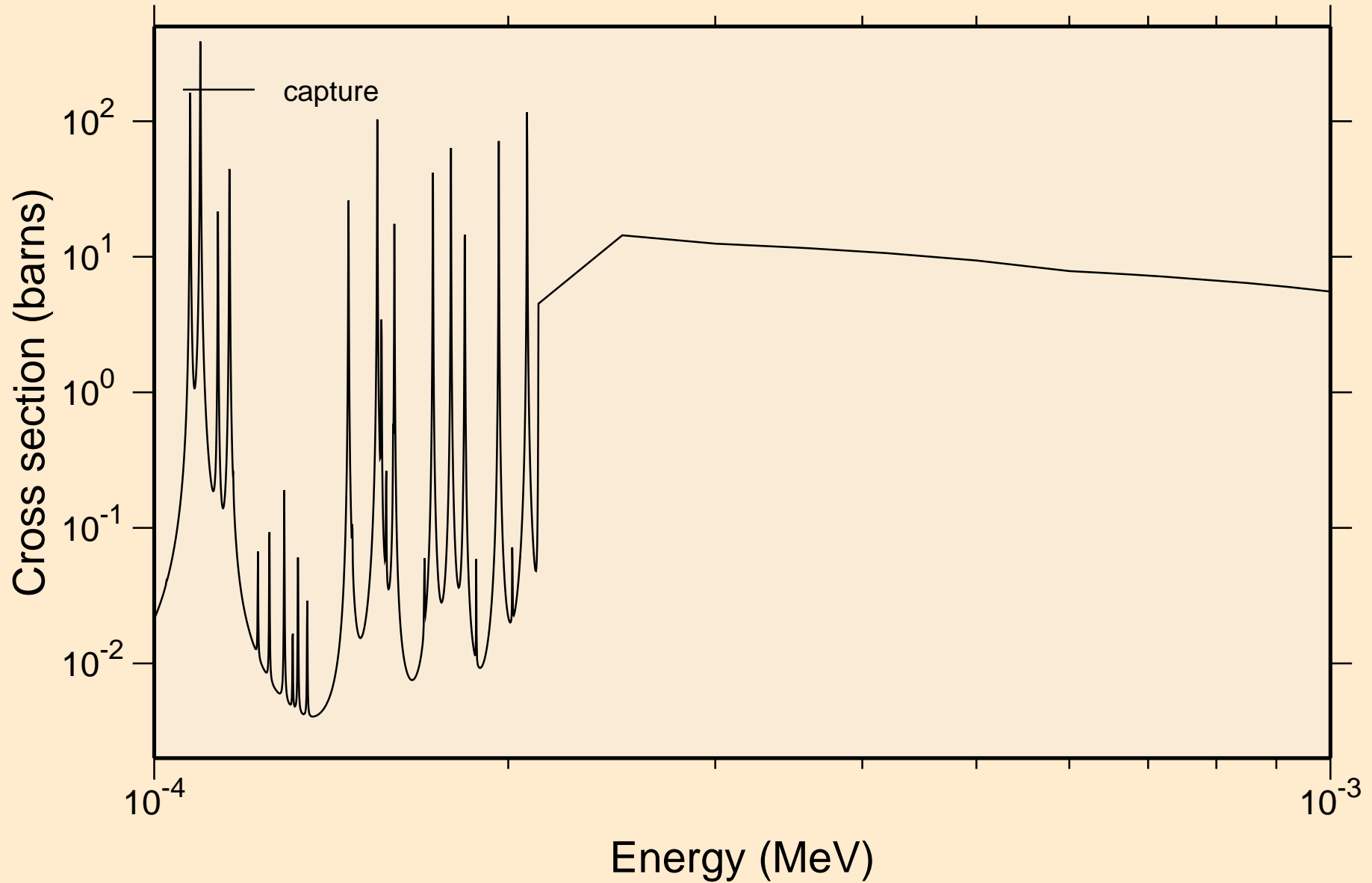



SB124N NEUTRON ACER TENDL-2024 LIBRARY; T=0.K  
resonance absorption cross sections

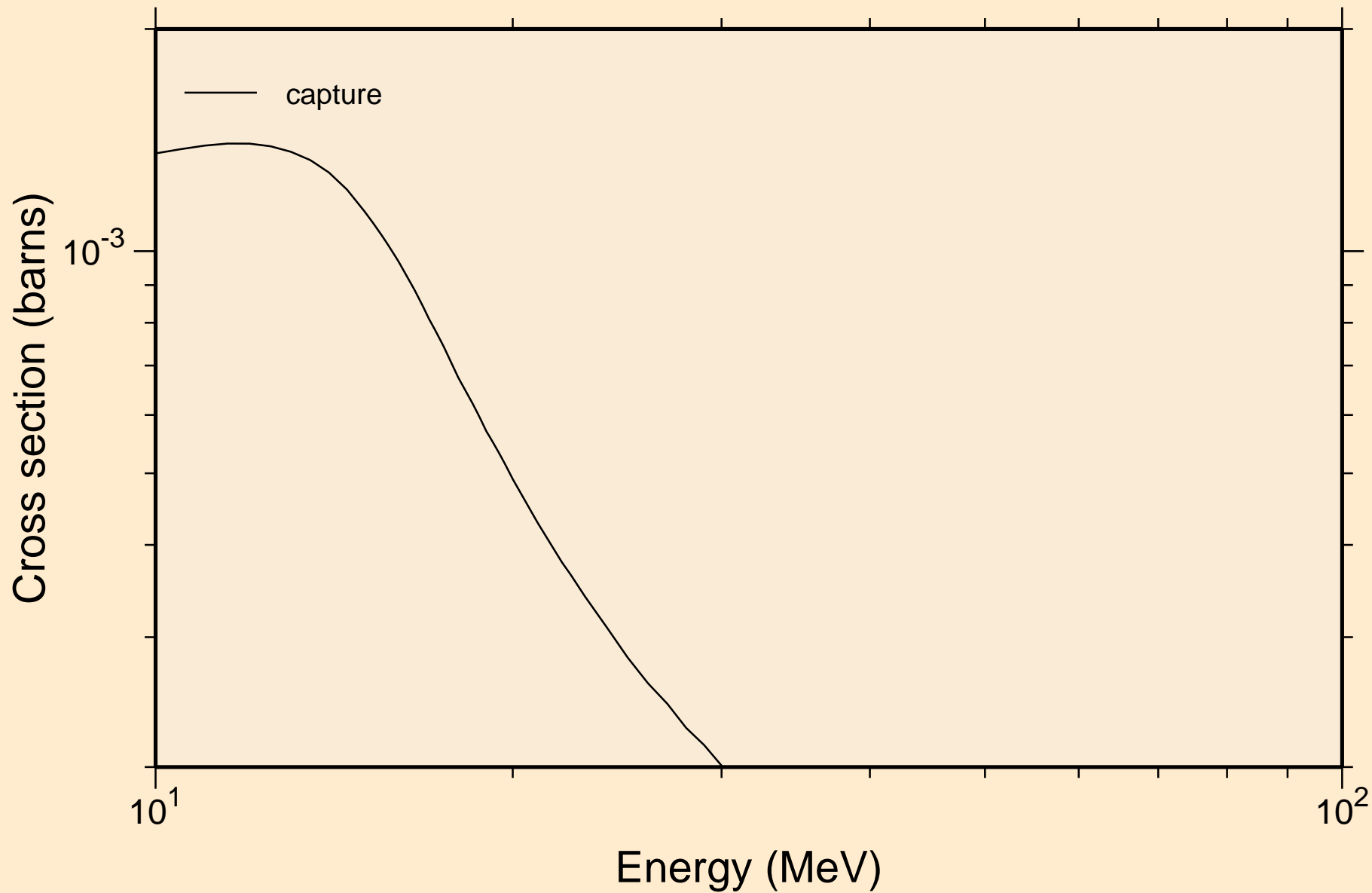

SB124N NEUTRON ACER TENDL-2024 LIBRARY; T=0.K  
Heating

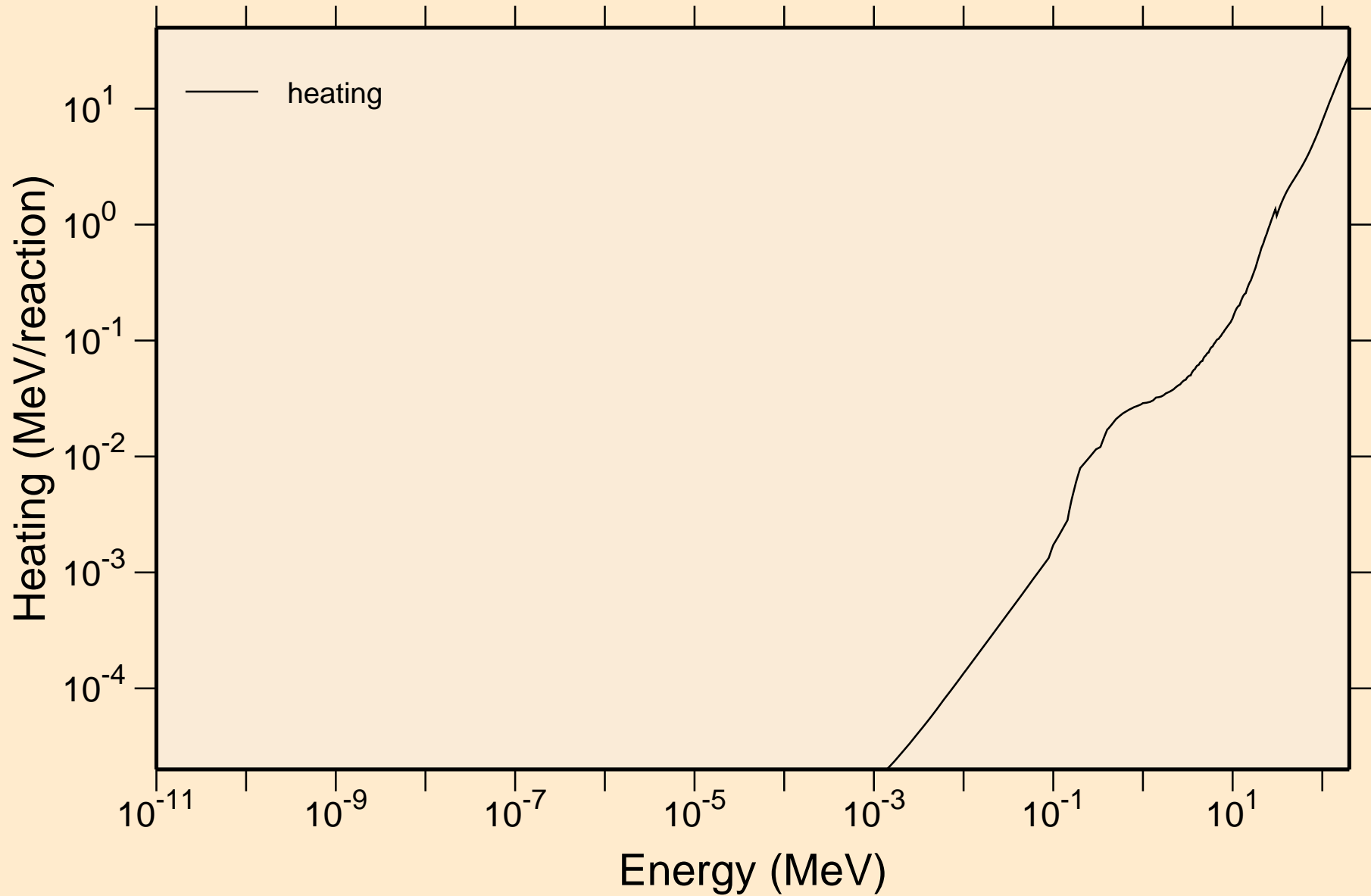

# SB124N NEUTRON ACER TENDL-2024 LIBRARY; T=0.K

## Damage

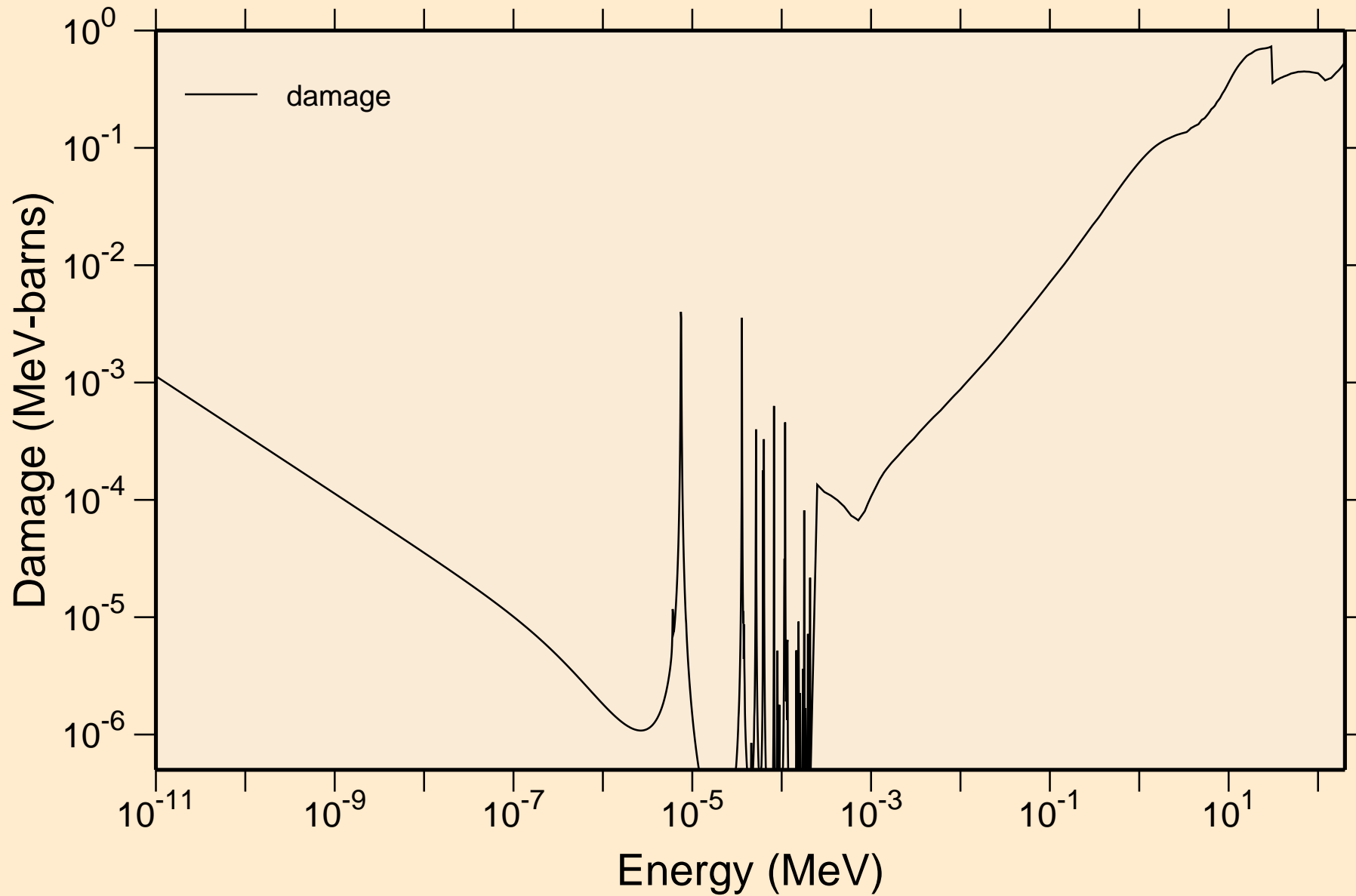

# SB124N NEUTRON ACER TENDL-2024 LIBRARY; T=0.K

## Non-threshold reactions

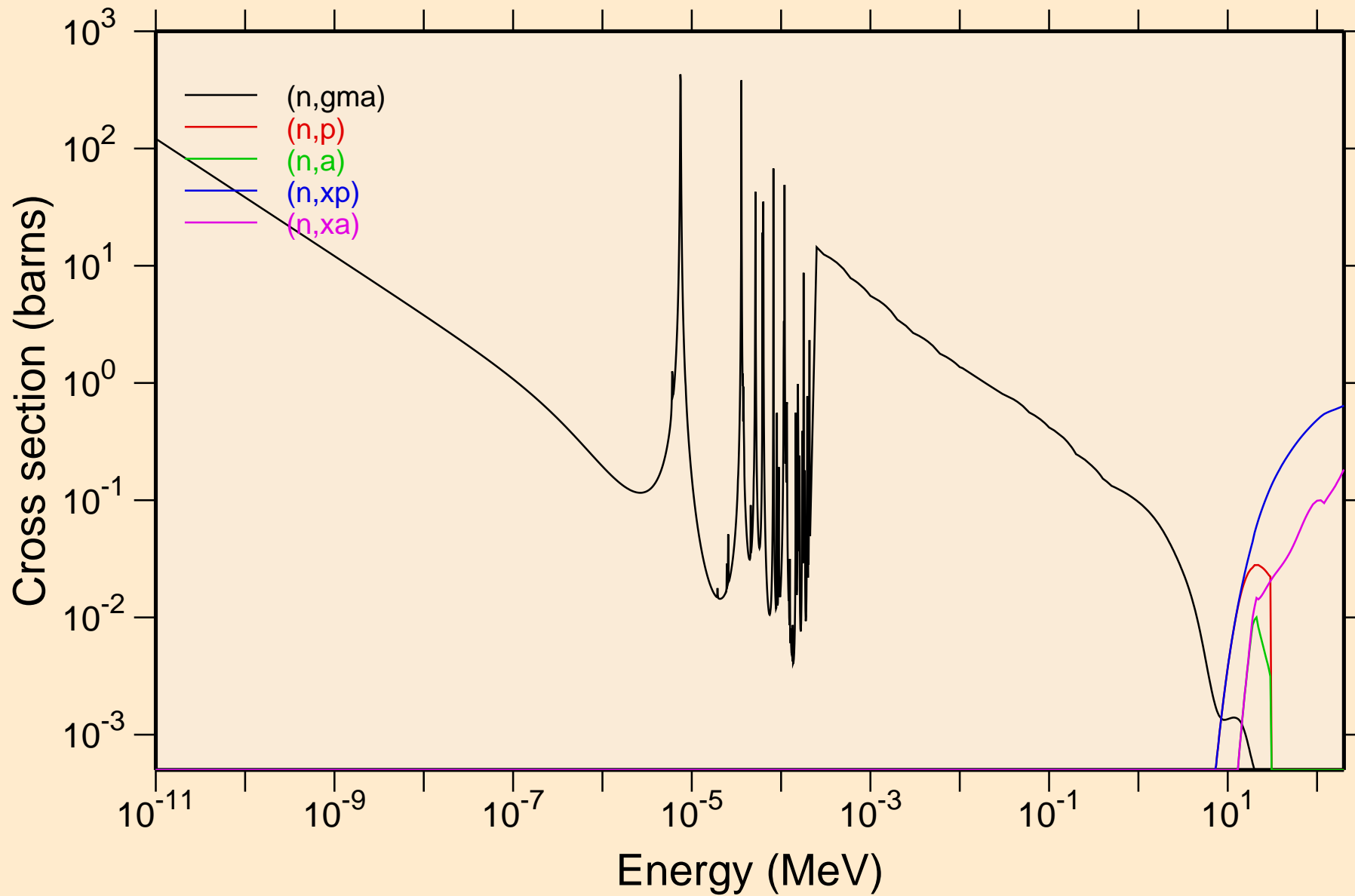

# SB124N NEUTRON ACER TENDL-2024 LIBRARY; T=0.K

## Principal cross sections

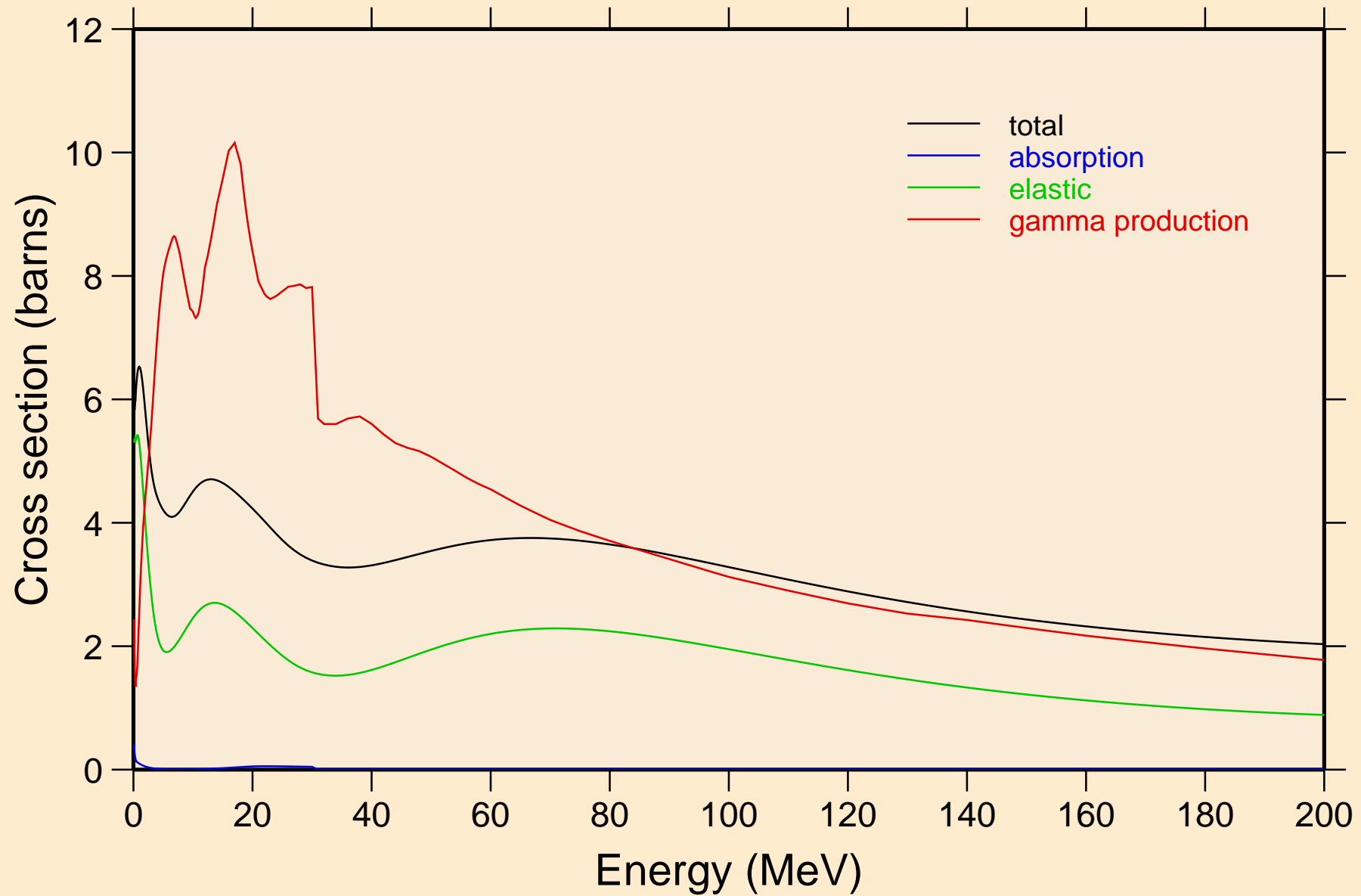

# SB124N NEUTRON ACER TENDL-2024 LIBRARY; T=0.K

## Heating

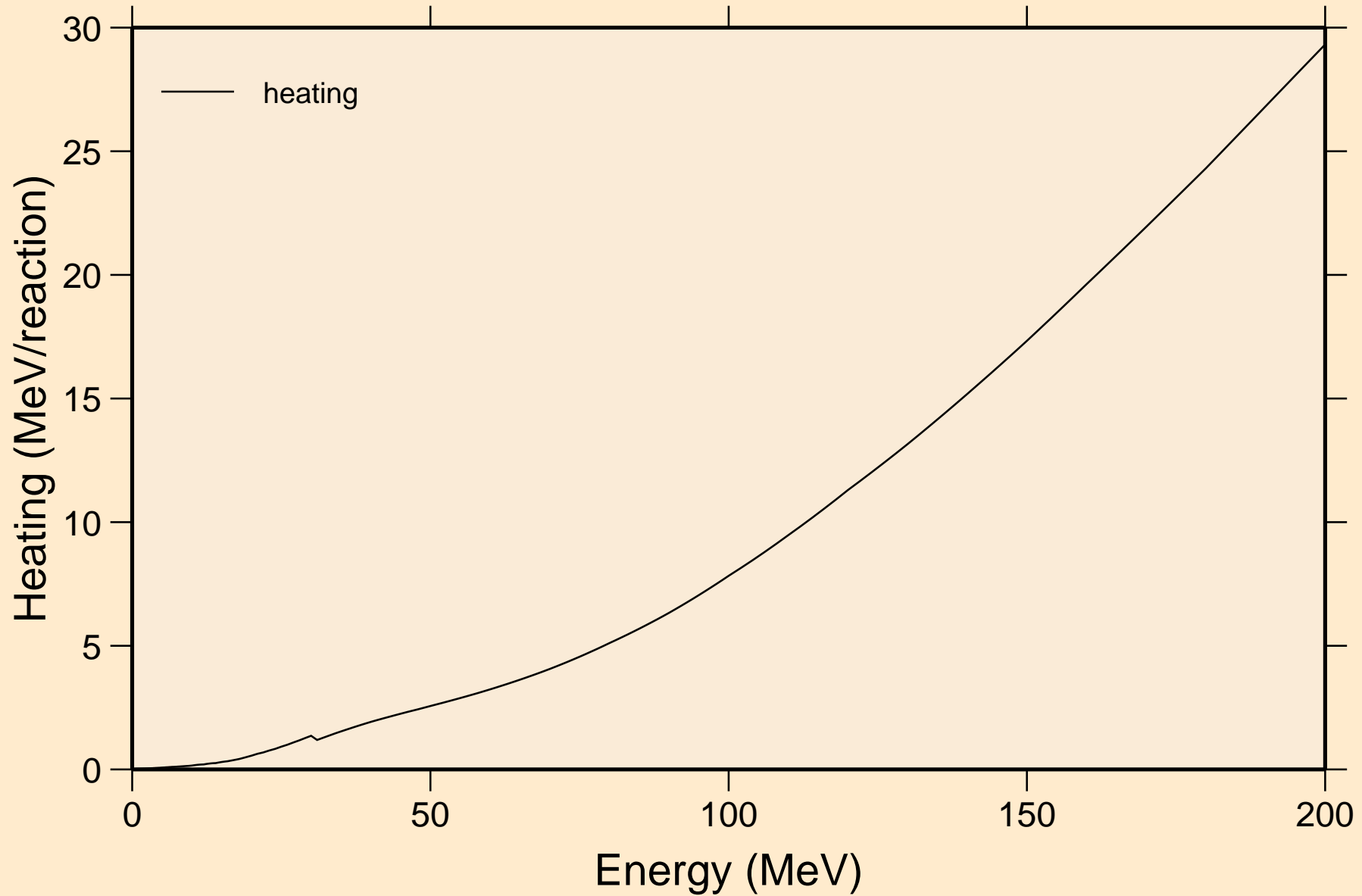

# SB124N NEUTRON ACER TENDL-2024 LIBRARY; T=0.K

## Damage

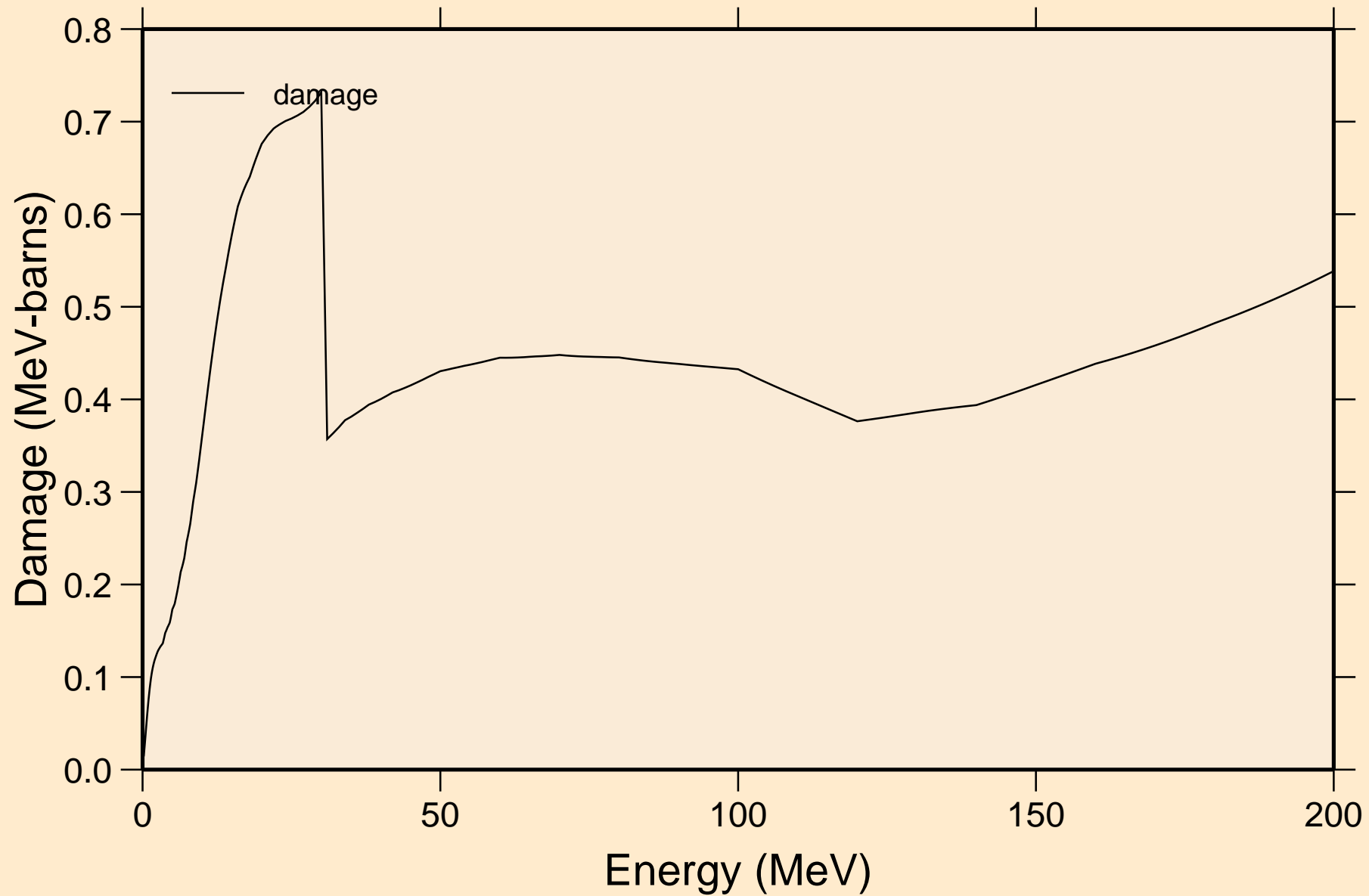

# SB124N NEUTRON ACER TENDL-2024 LIBRARY; T=0.K

## Non-threshold reactions

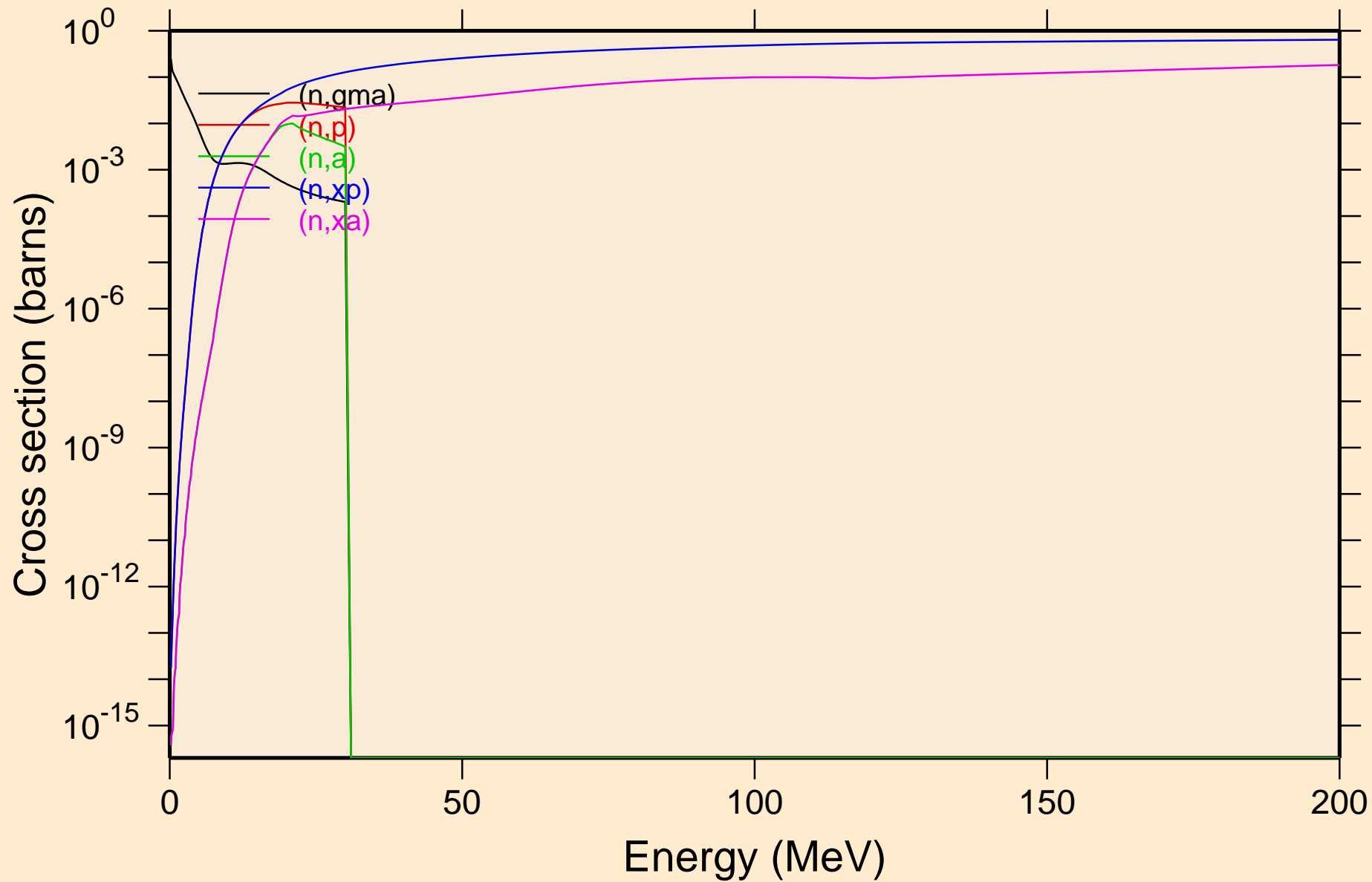



SB124N NEUTRON ACER TENDL-2024 LIBRARY; T=0.K  
Inelastic levels

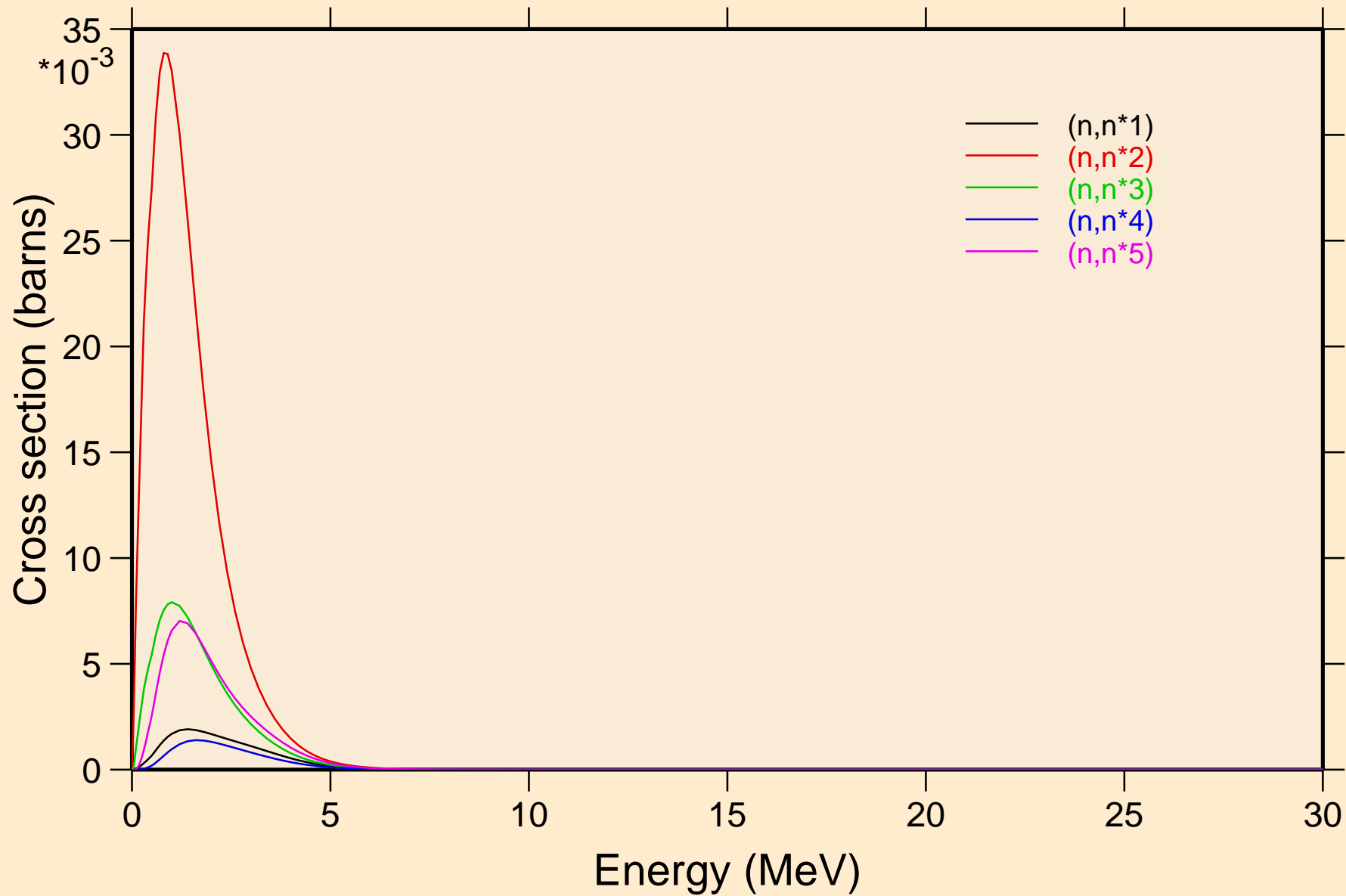

SB124N NEUTRON ACER TENDL-2024 LIBRARY; T=0.K  
Inelastic levels

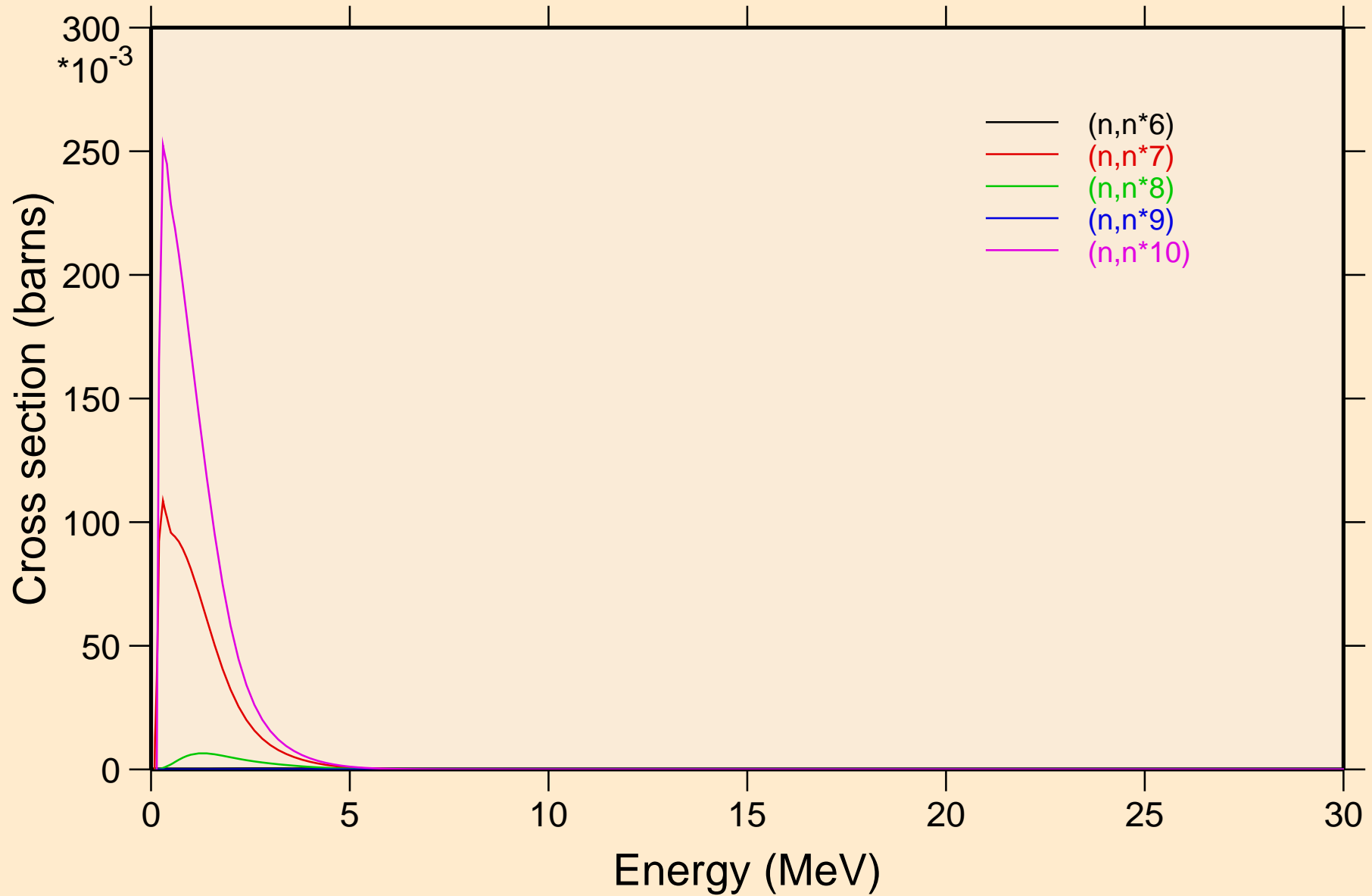

SB124N NEUTRON ACER TENDL-2024 LIBRARY; T=0.K  
Inelastic levels

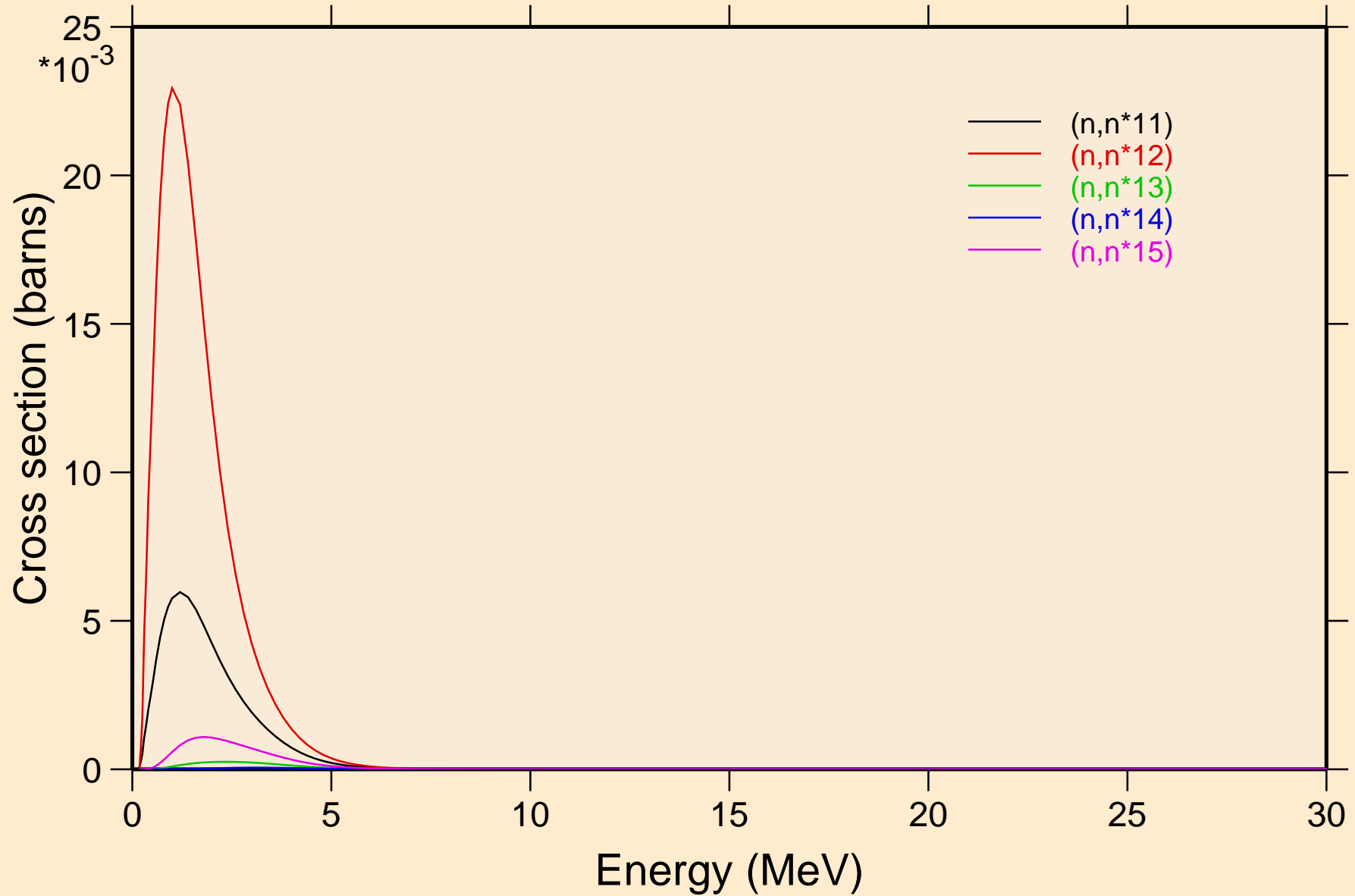

# SB124N NEUTRON ACER TENDL-2024 LIBRARY; T=0.K

## Inelastic levels

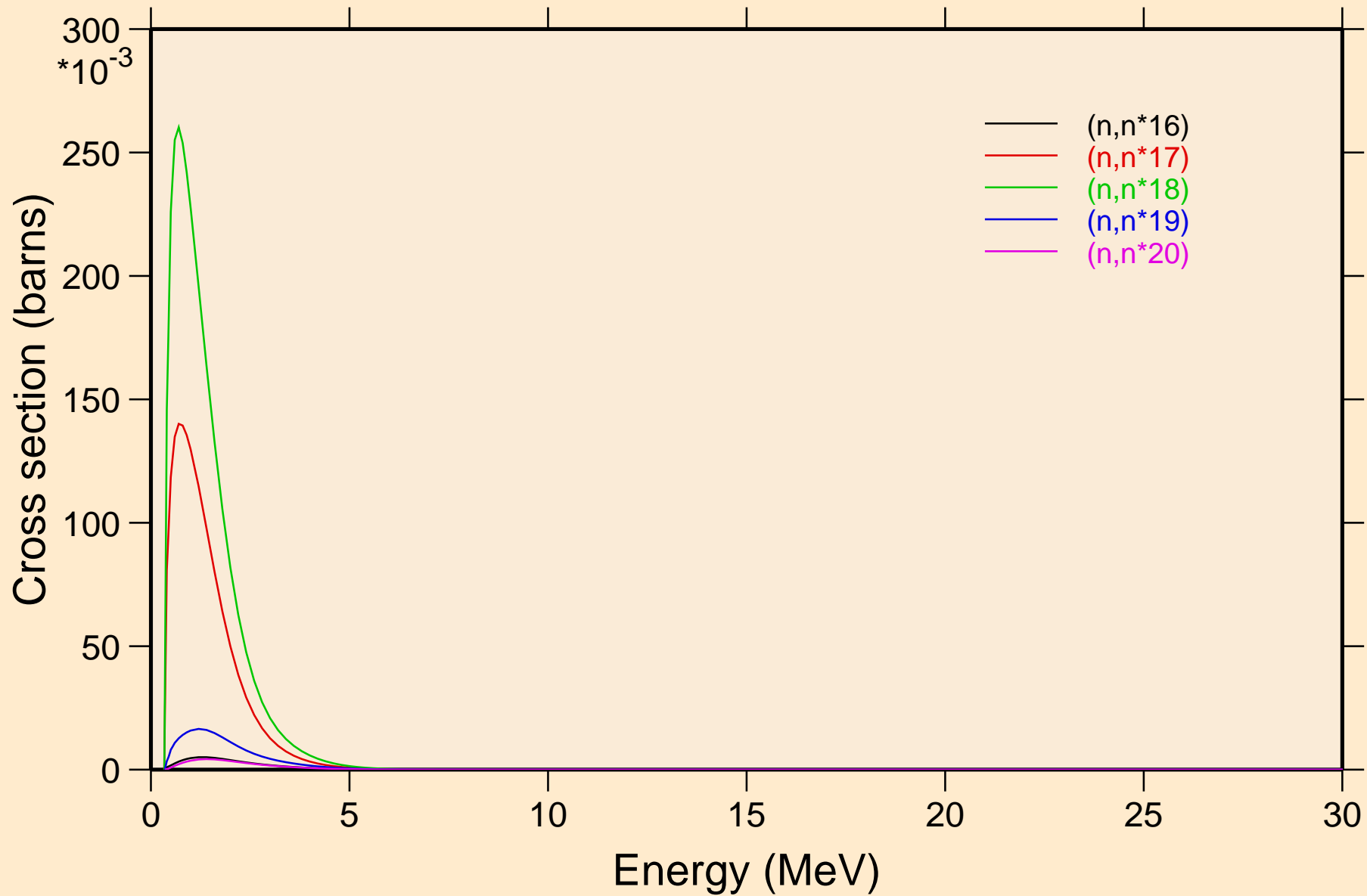

SB124N NEUTRON ACER TENDL-2024 LIBRARY; T=0.K  
Inelastic levels

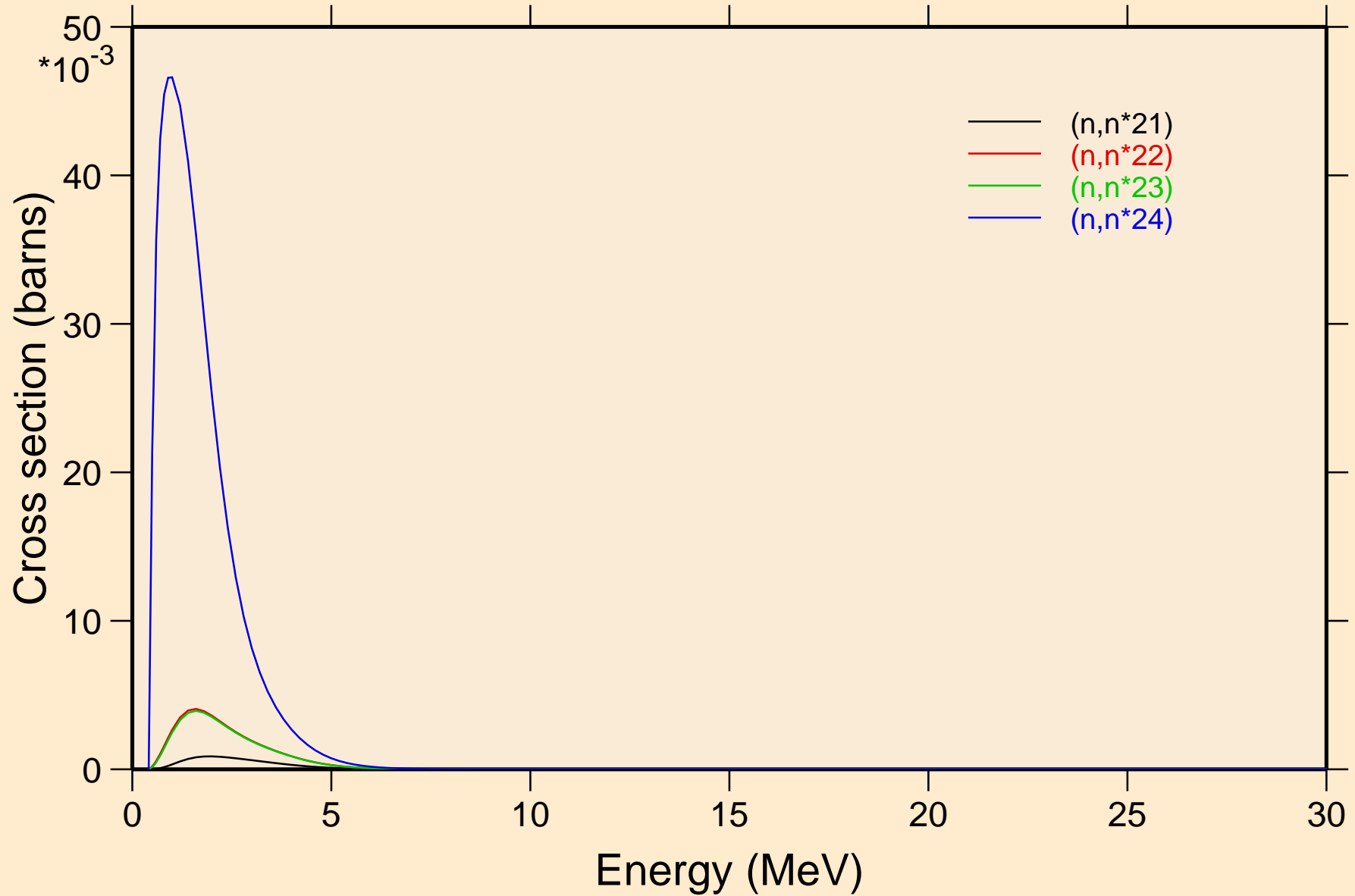

# SB124N NEUTRON ACER TENDL-2024 LIBRARY; T=0.K

## Threshold reactions

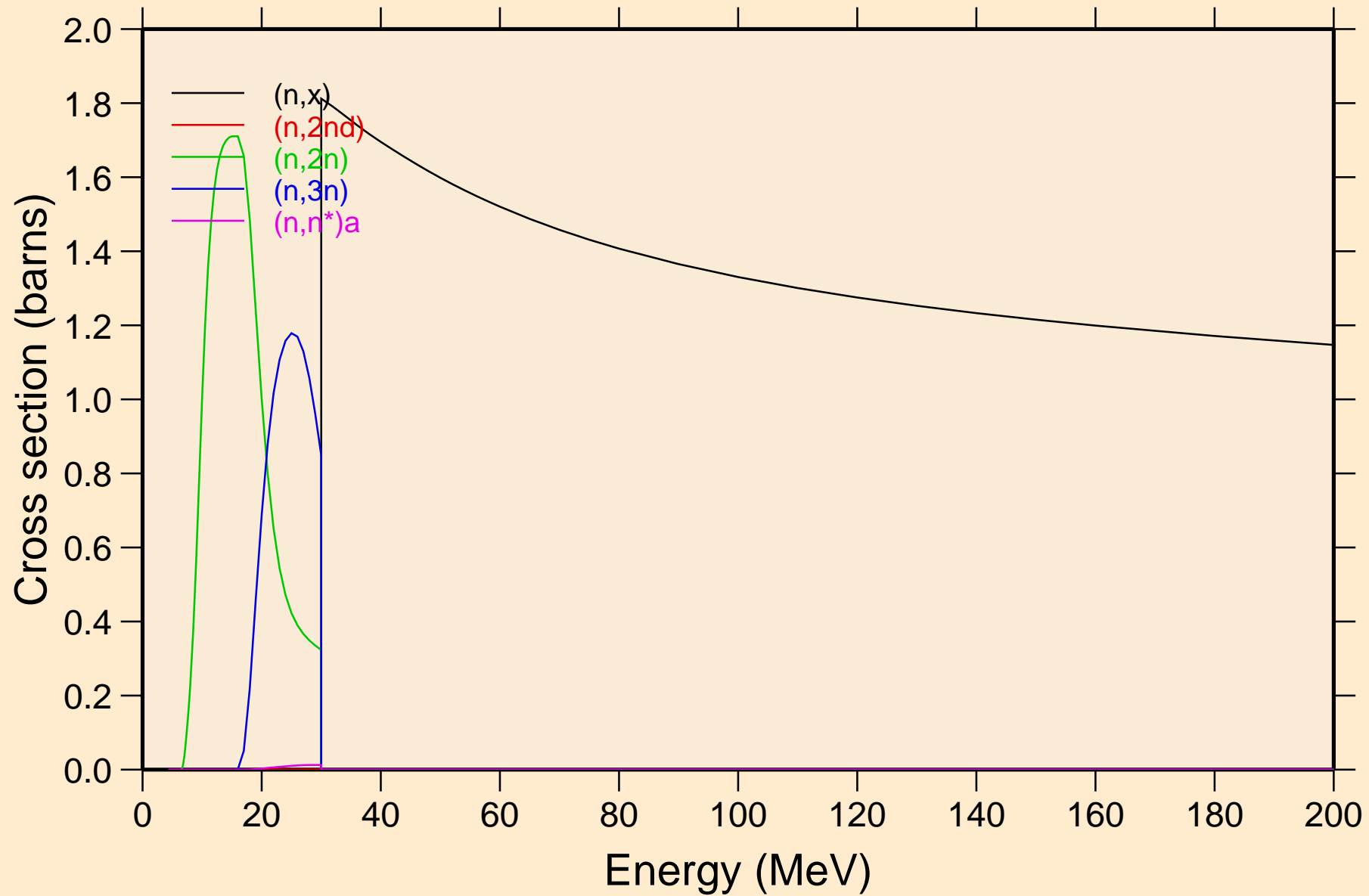

# SB124N NEUTRON ACER TENDL-2024 LIBRARY; T=0.K

## Threshold reactions

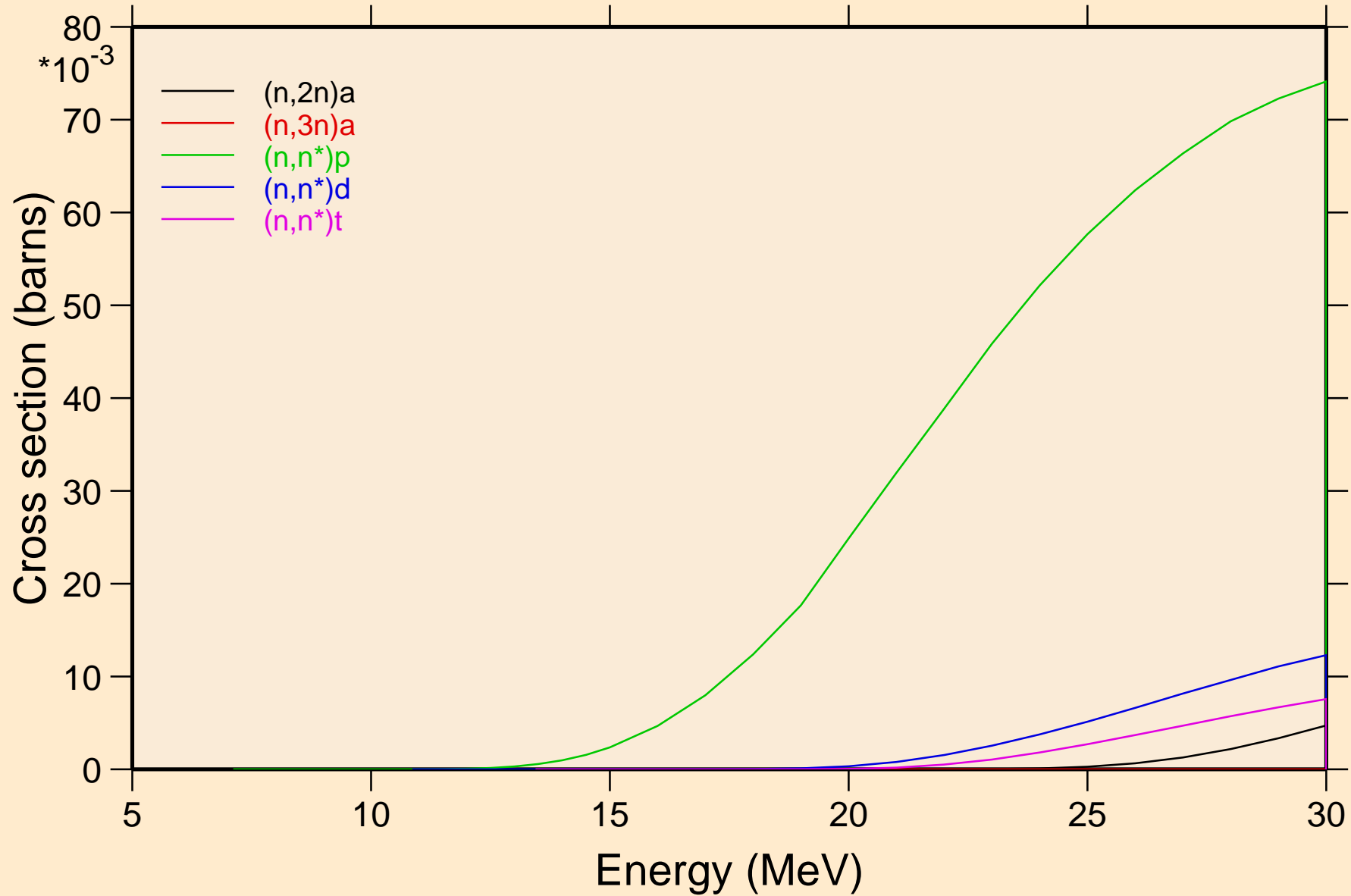

# SB124N NEUTRON ACER TENDL-2024 LIBRARY; T=0.K

## Threshold reactions

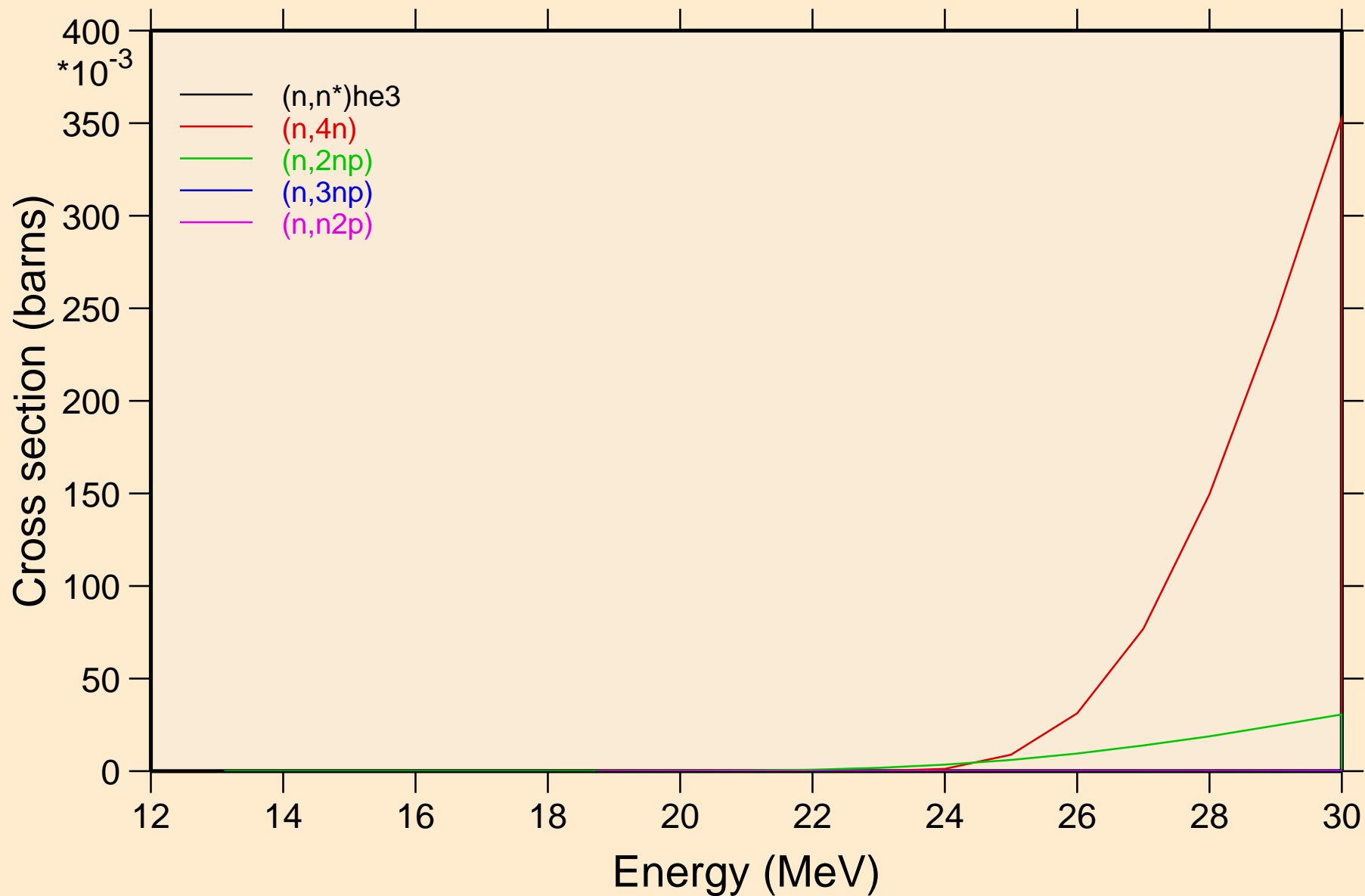



# SB124N NEUTRON ACER TENDL-2024 LIBRARY; T=0.K

## Threshold reactions

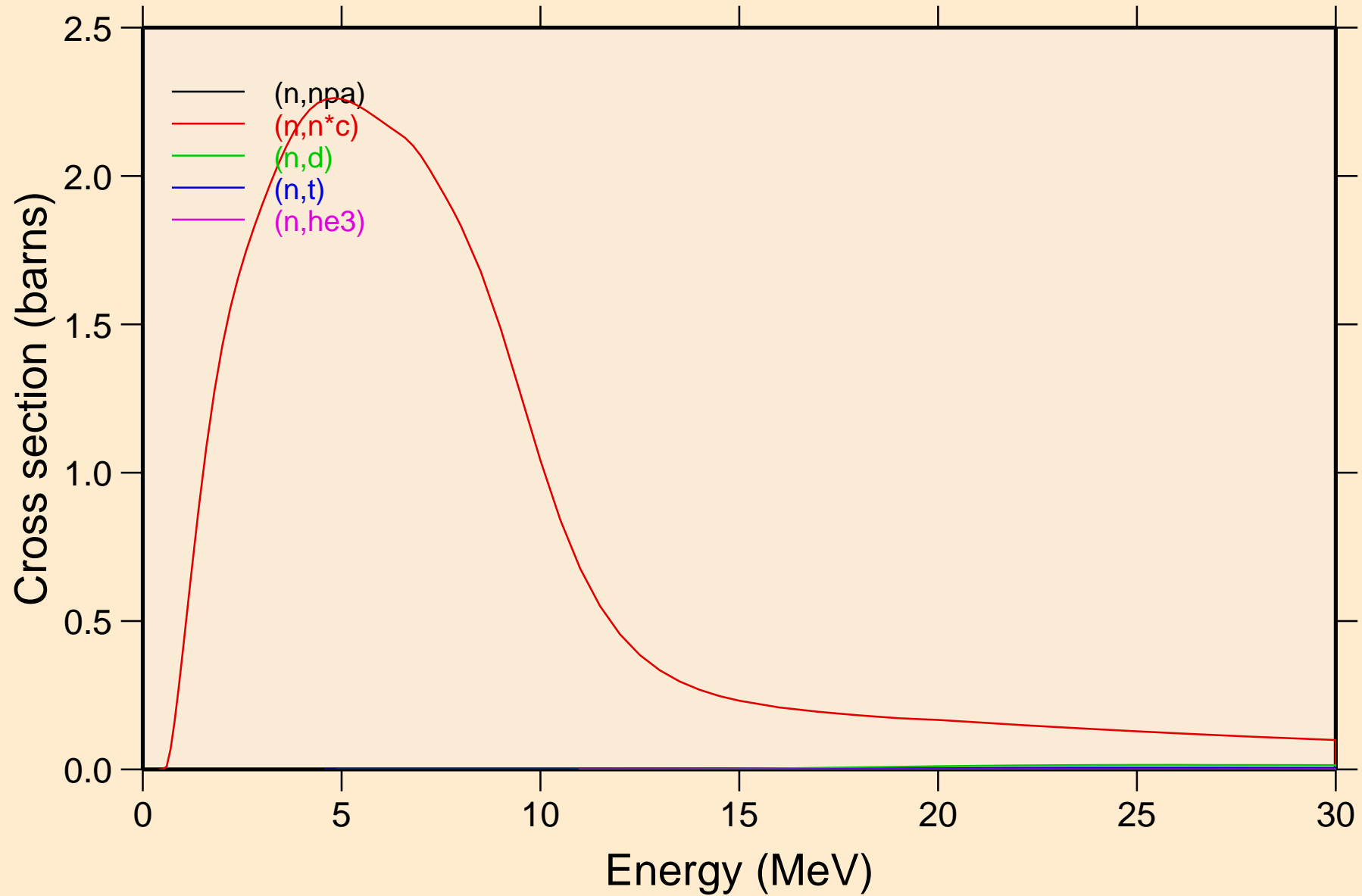

# SB124N NEUTRON ACER TENDL-2024 LIBRARY; T=0.K

## Threshold reactions

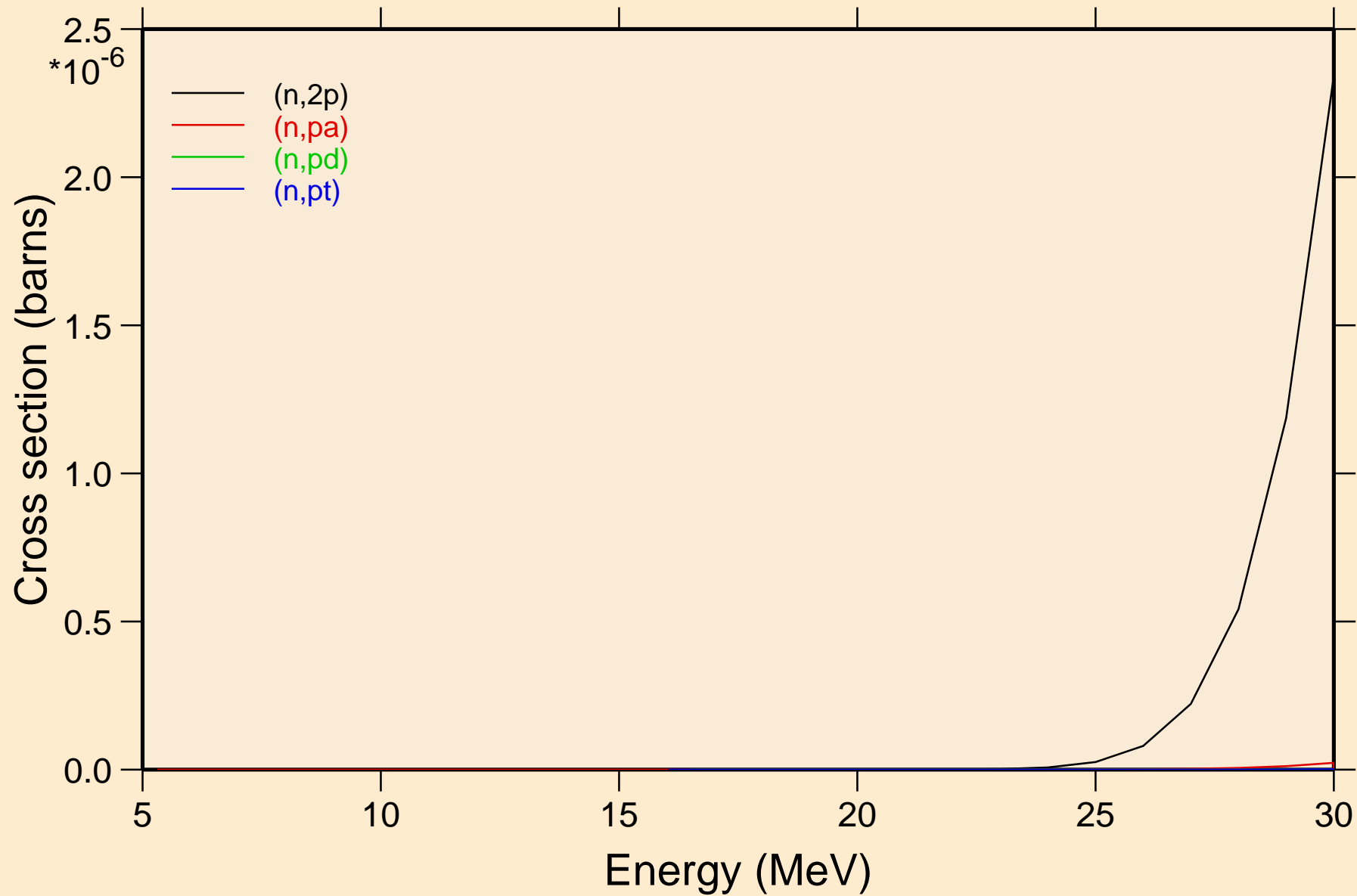

# SB124N NEUTRON ACER TENDL-2024 LIBRARY; T=0.K

## Threshold reactions

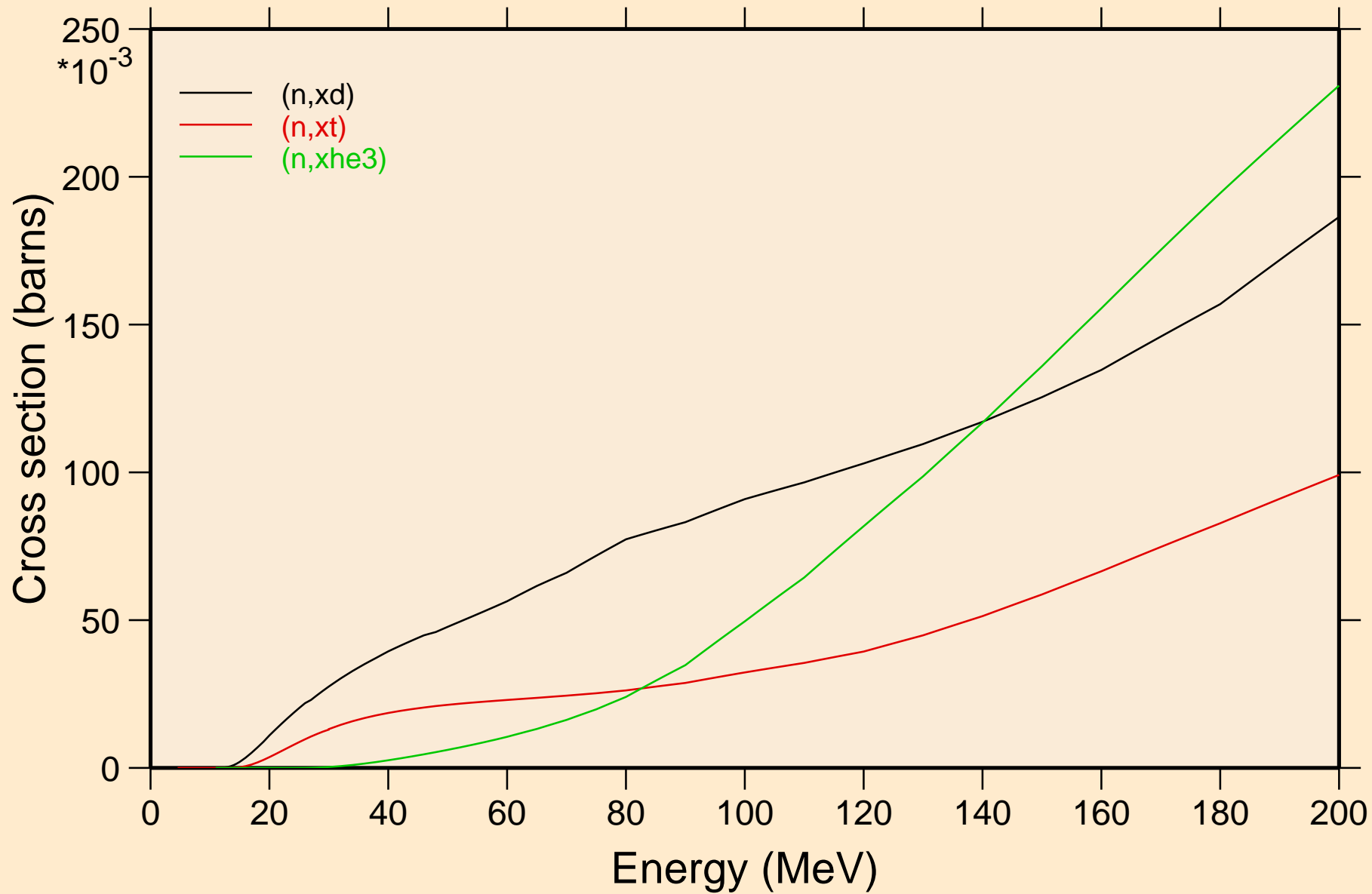

SB124N NEUTRON ACER TENDL-2024 LIBRARY; T=0.K  
angular distribution for elastic

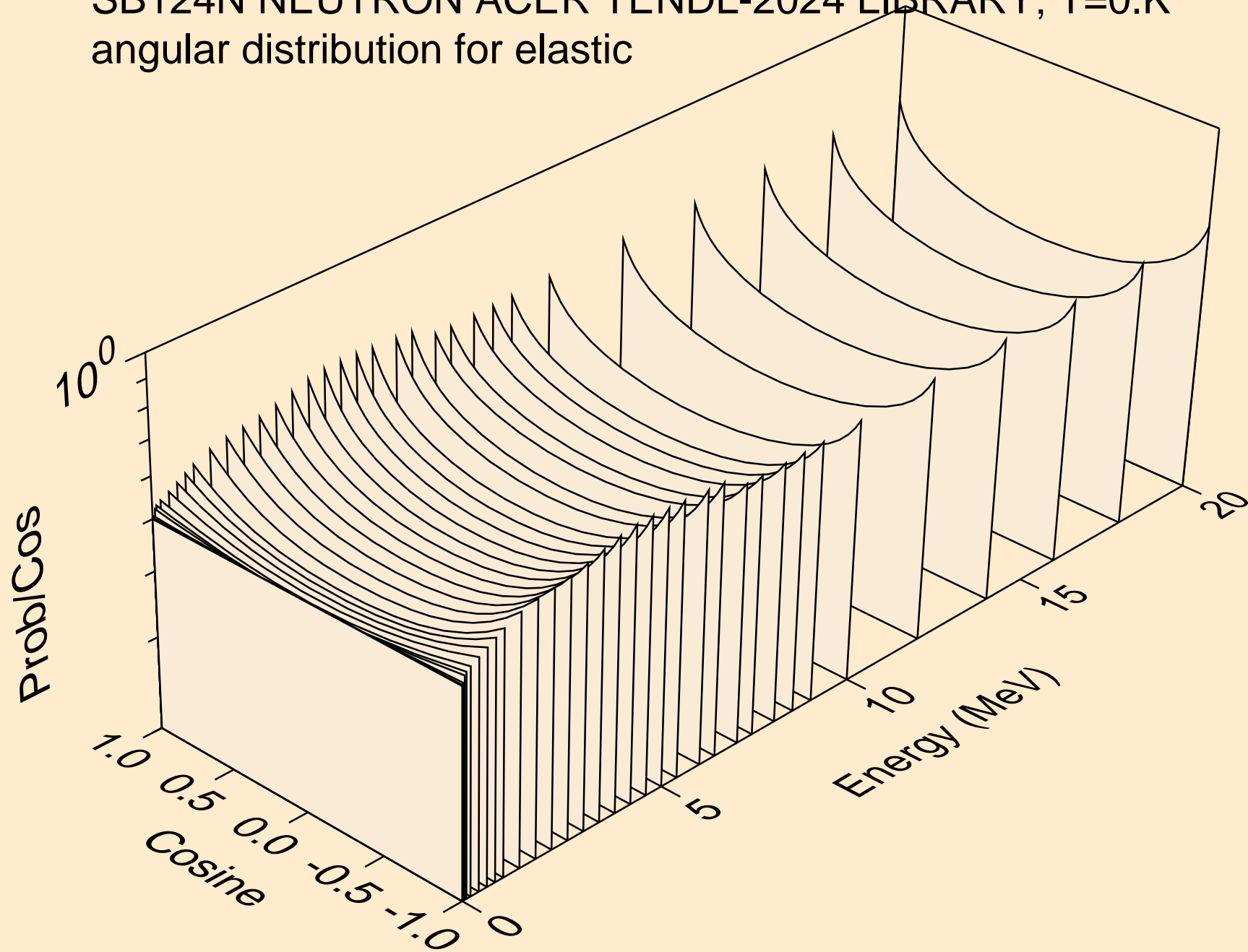

SB124N NEUTRON ACER TENDL-2024 LIBRARY; T=0.K  
angular distribution for elastic

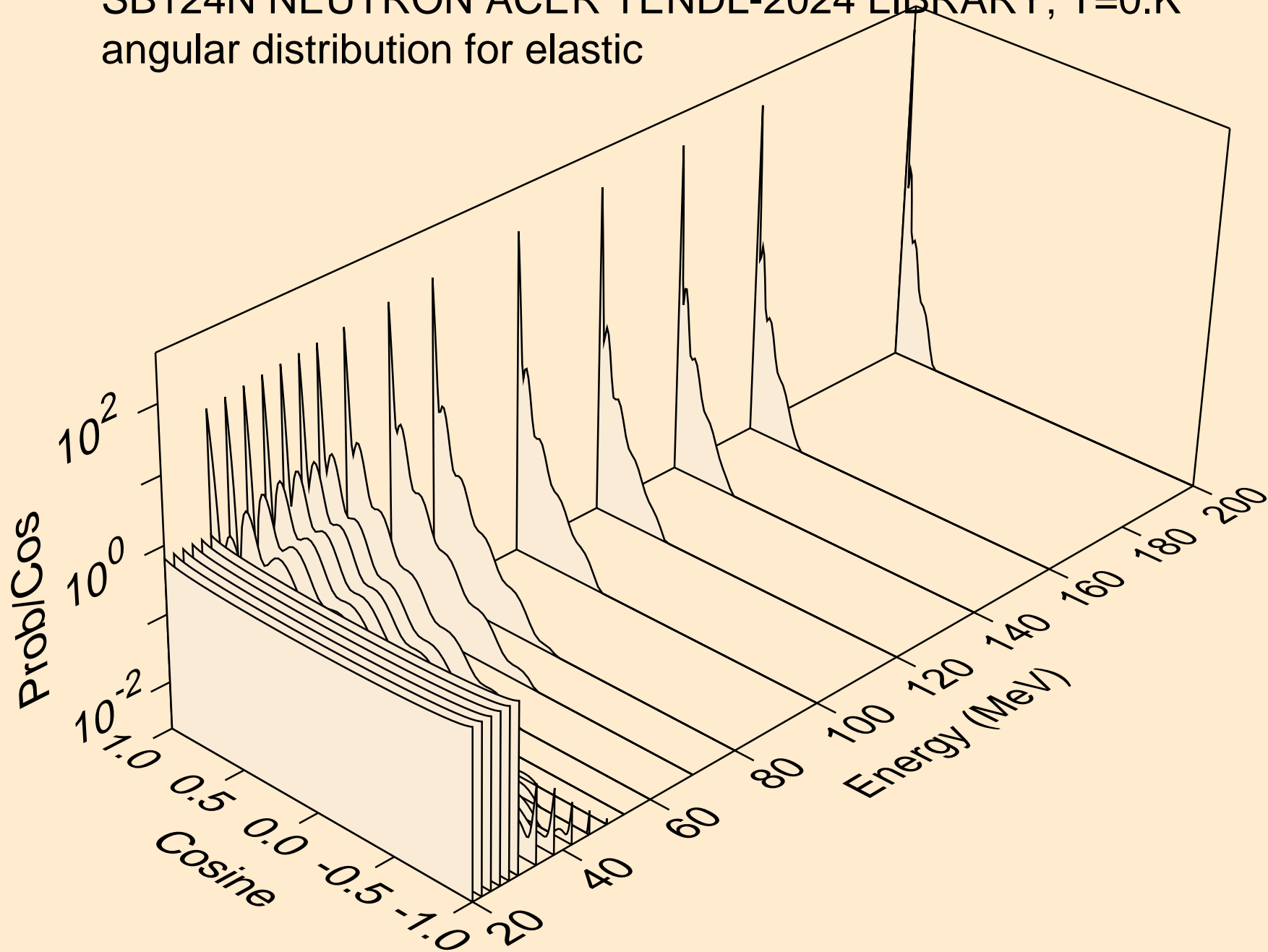

SB124N NEUTRON ACER TENDL-2024 LIBRARY; T=0.K  
angular distribution for (n,n\*1)

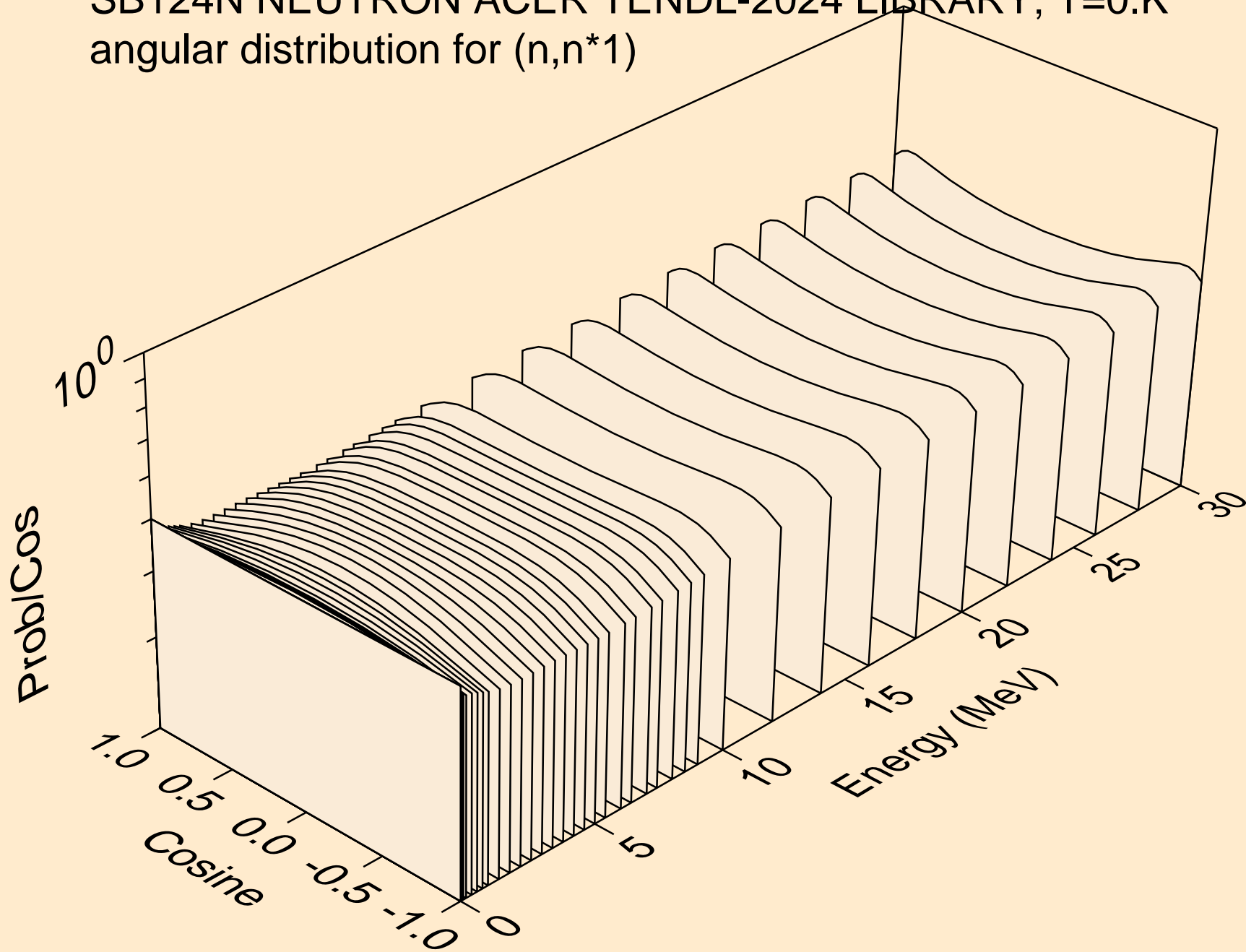

SB124N NEUTRON ACER TENDL-2024 LIBRARY; T=0.K  
angular distribution for (n,n\*2)

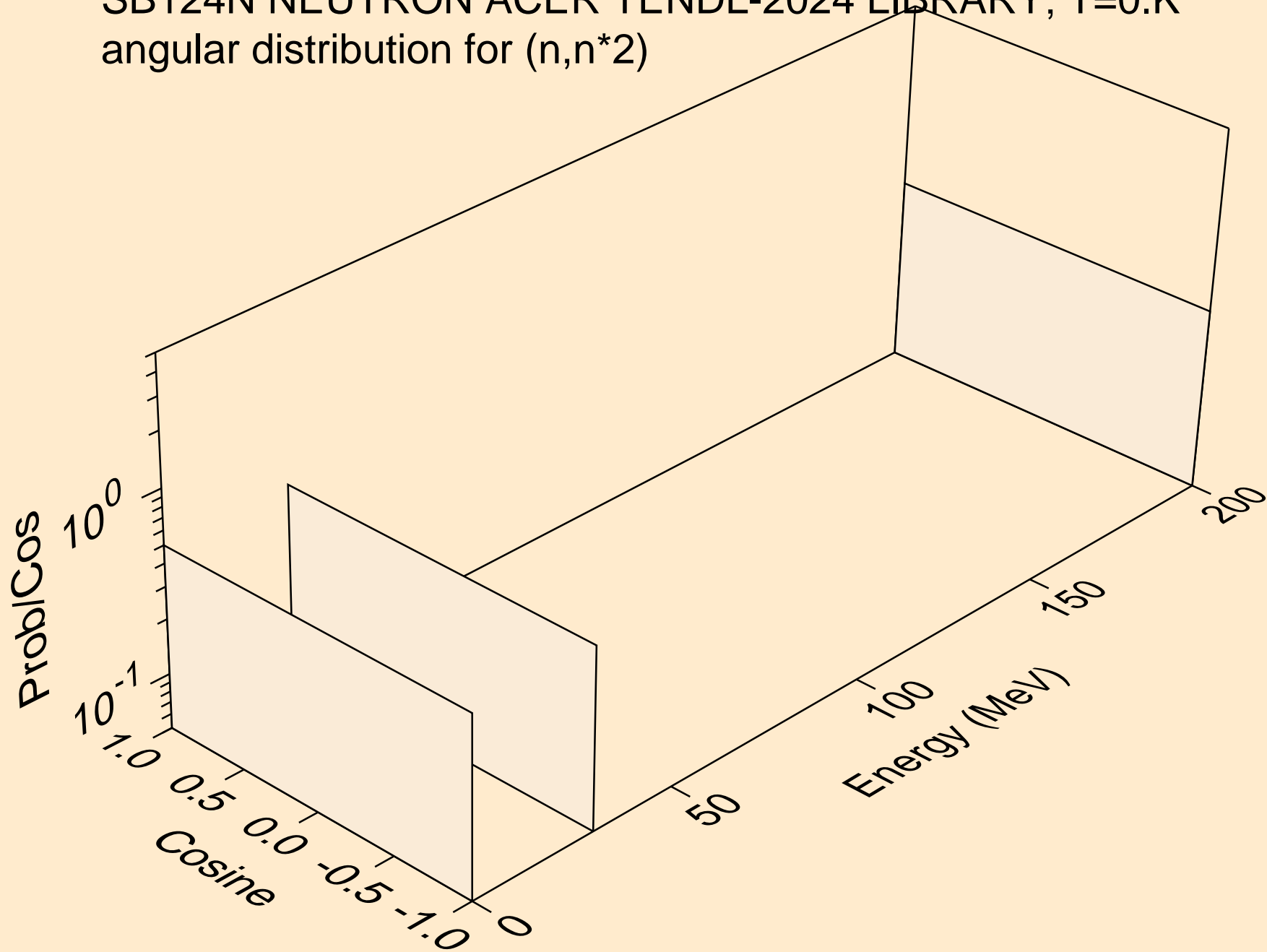

SB124N NEUTRON ACER TENDL-2024 LIBRARY; T=0.K  
angular distribution for (n,n\*3)

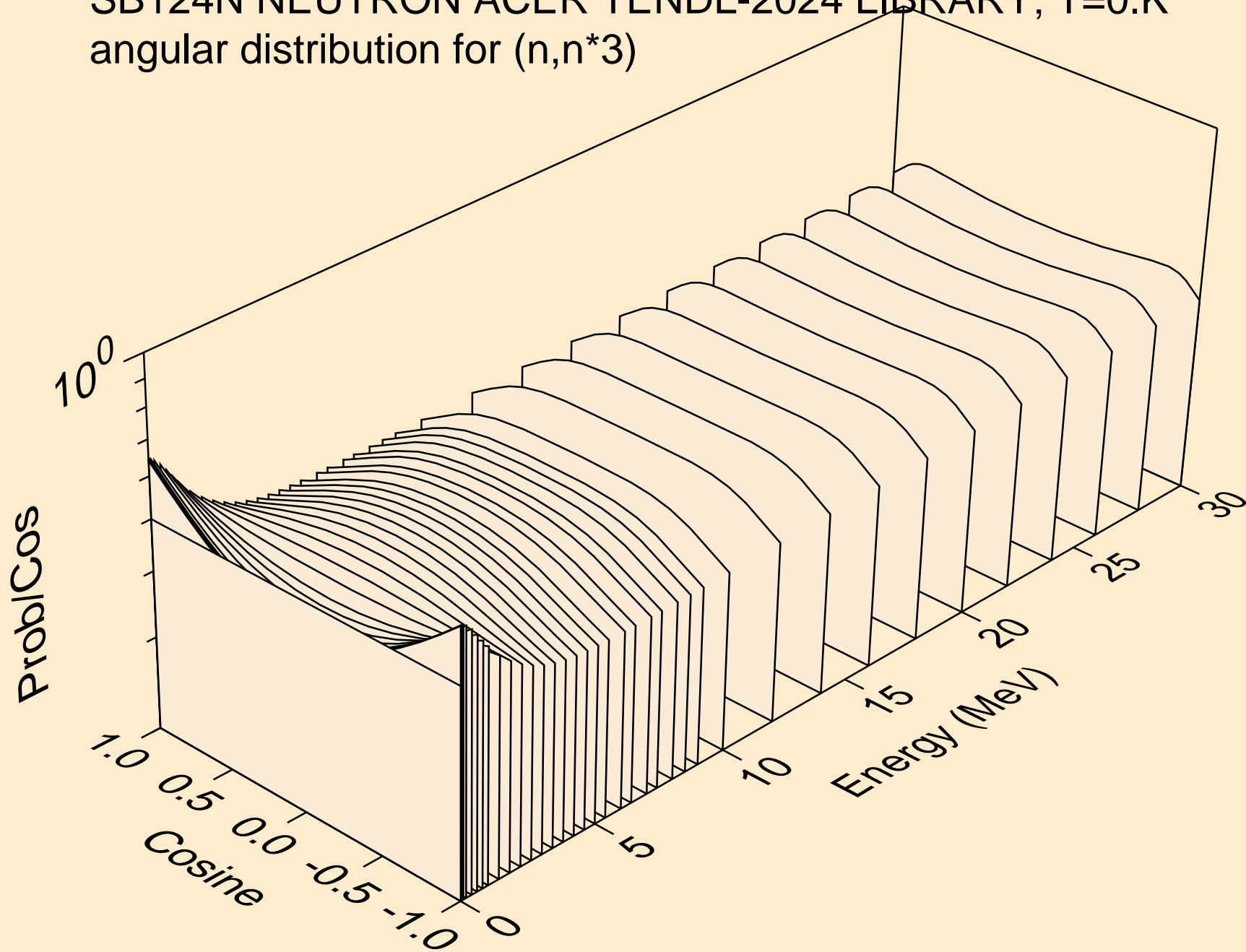



SB124N NEUTRON ACER TENDL-2024 LIBRARY; T=0.K  
angular distribution for (n,n\*4)

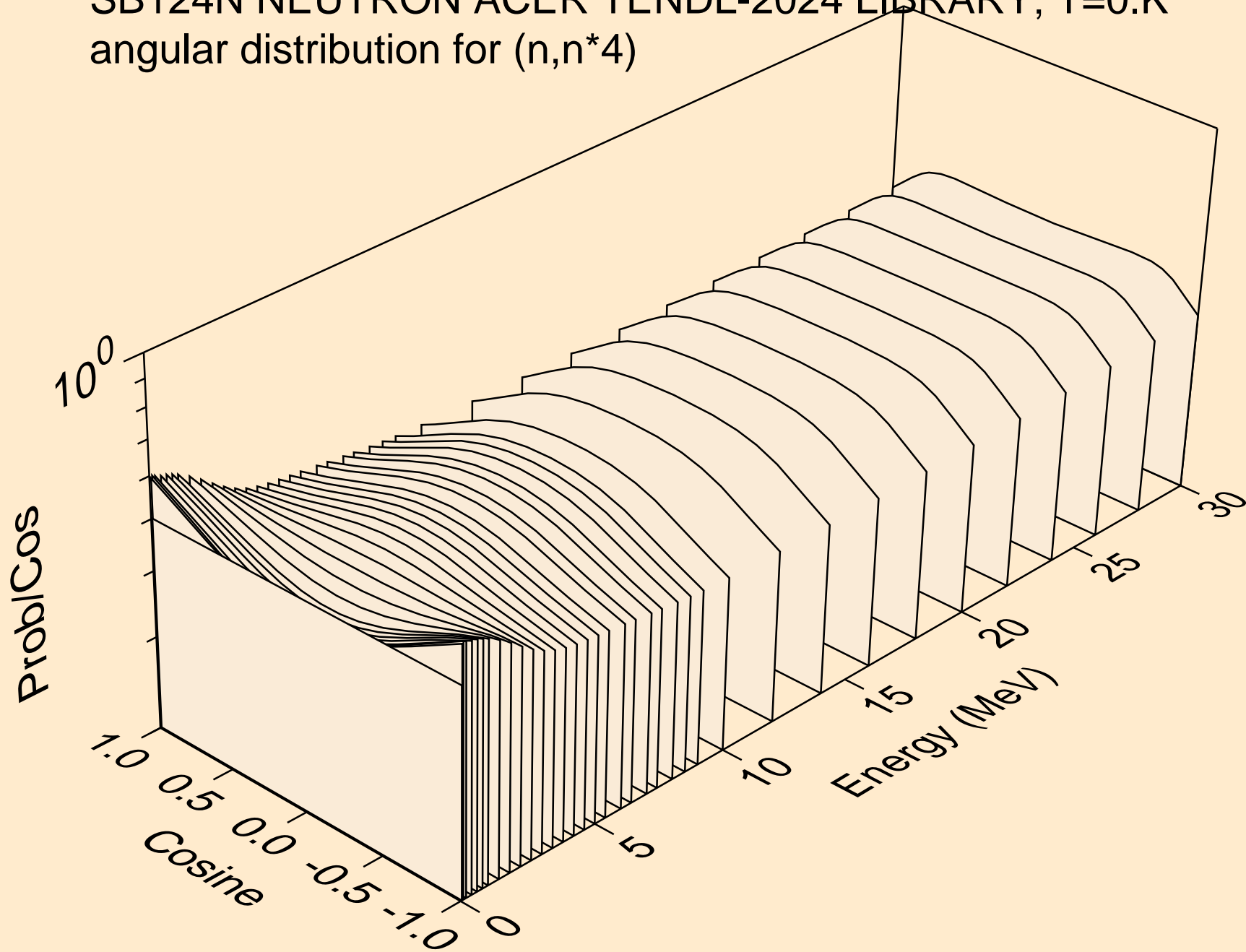

SB124N NEUTRON ACER TENDL-2024 LIBRARY; T=0.K  
angular distribution for (n,n\*5)

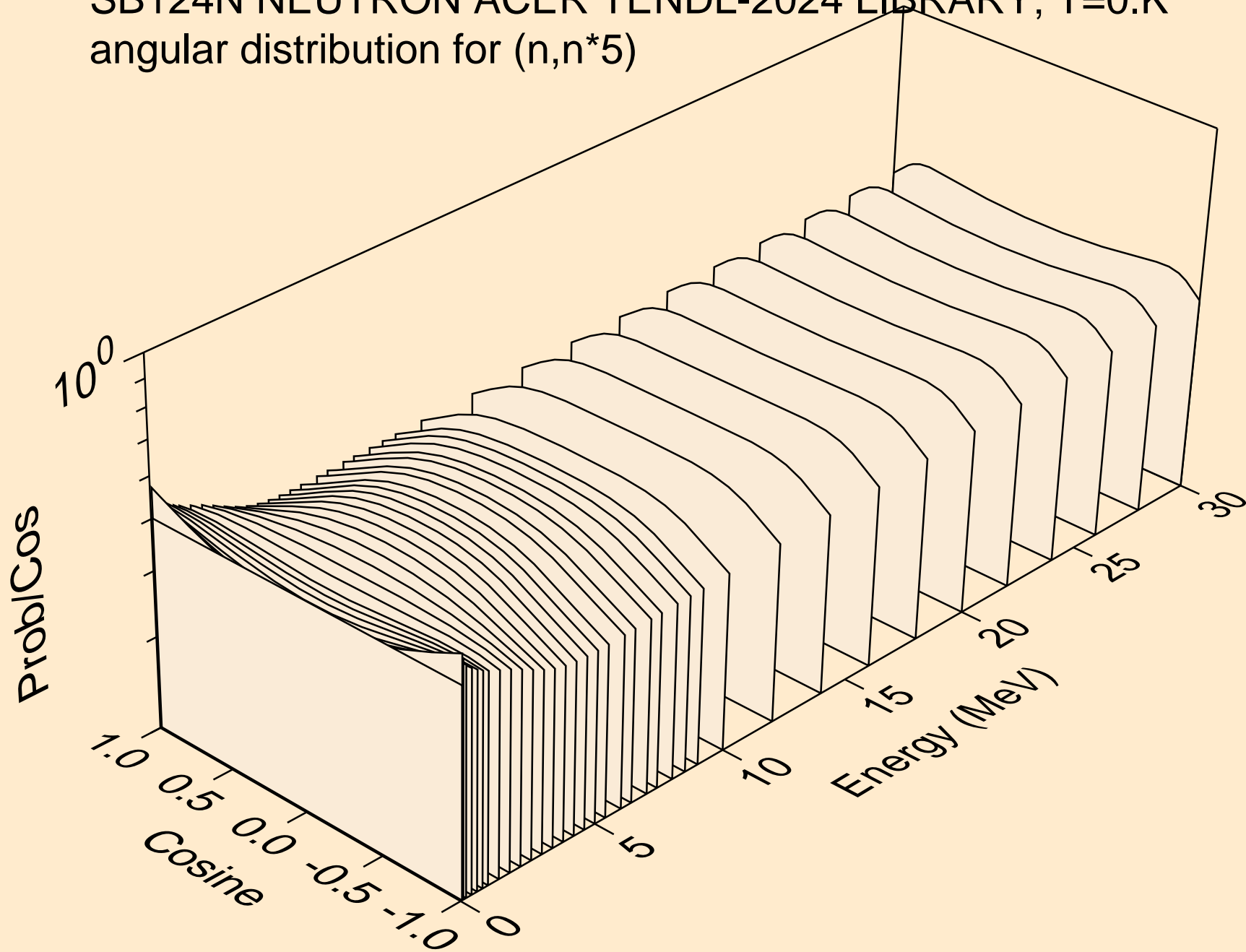

SB124N NEUTRON ACER TENDL-2024 LIBRARY; T=0.K  
angular distribution for (n,n\*6)

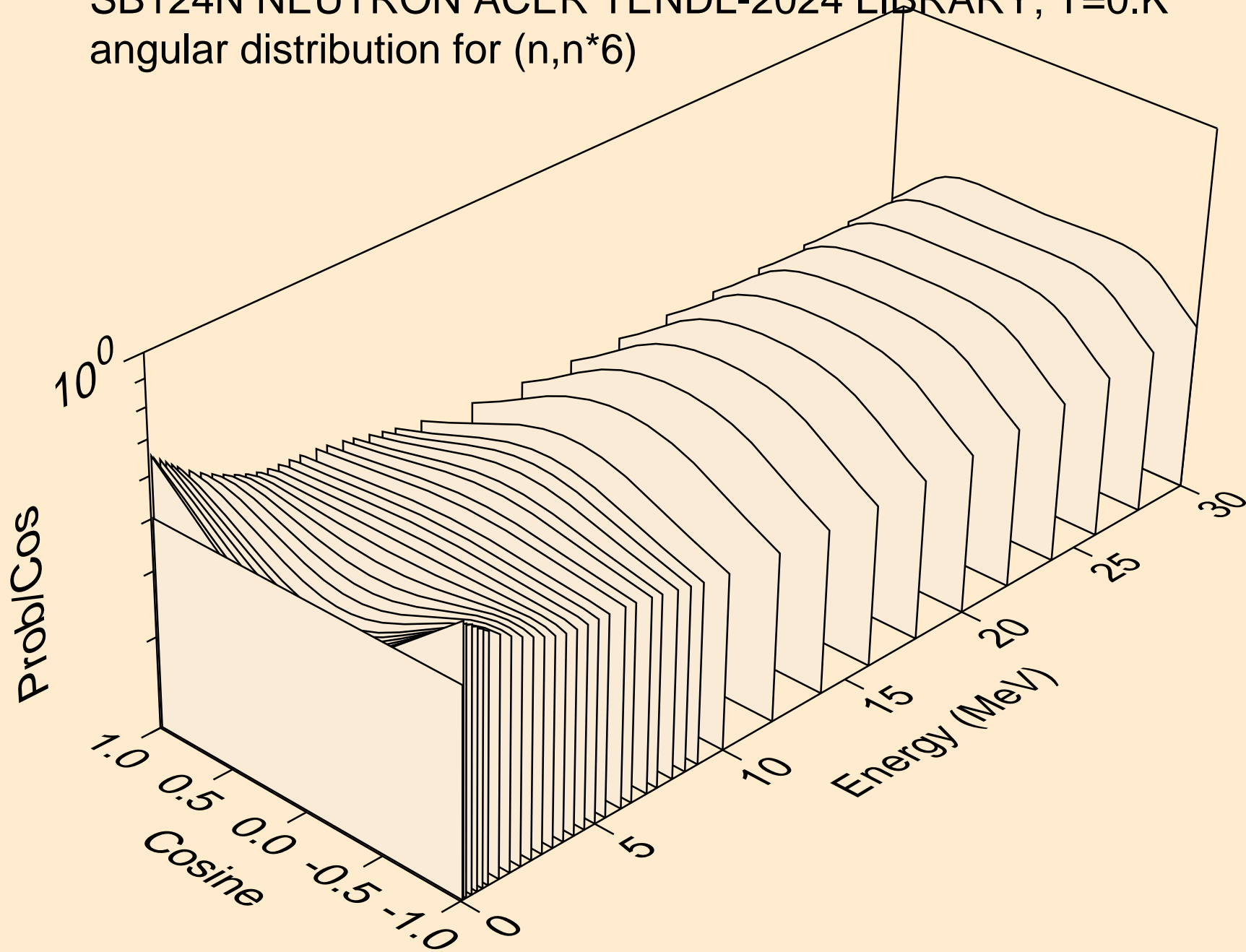

SB124N NEUTRON ACER TENDL-2024 LIBRARY; T=0.K  
angular distribution for (n,n\*7)

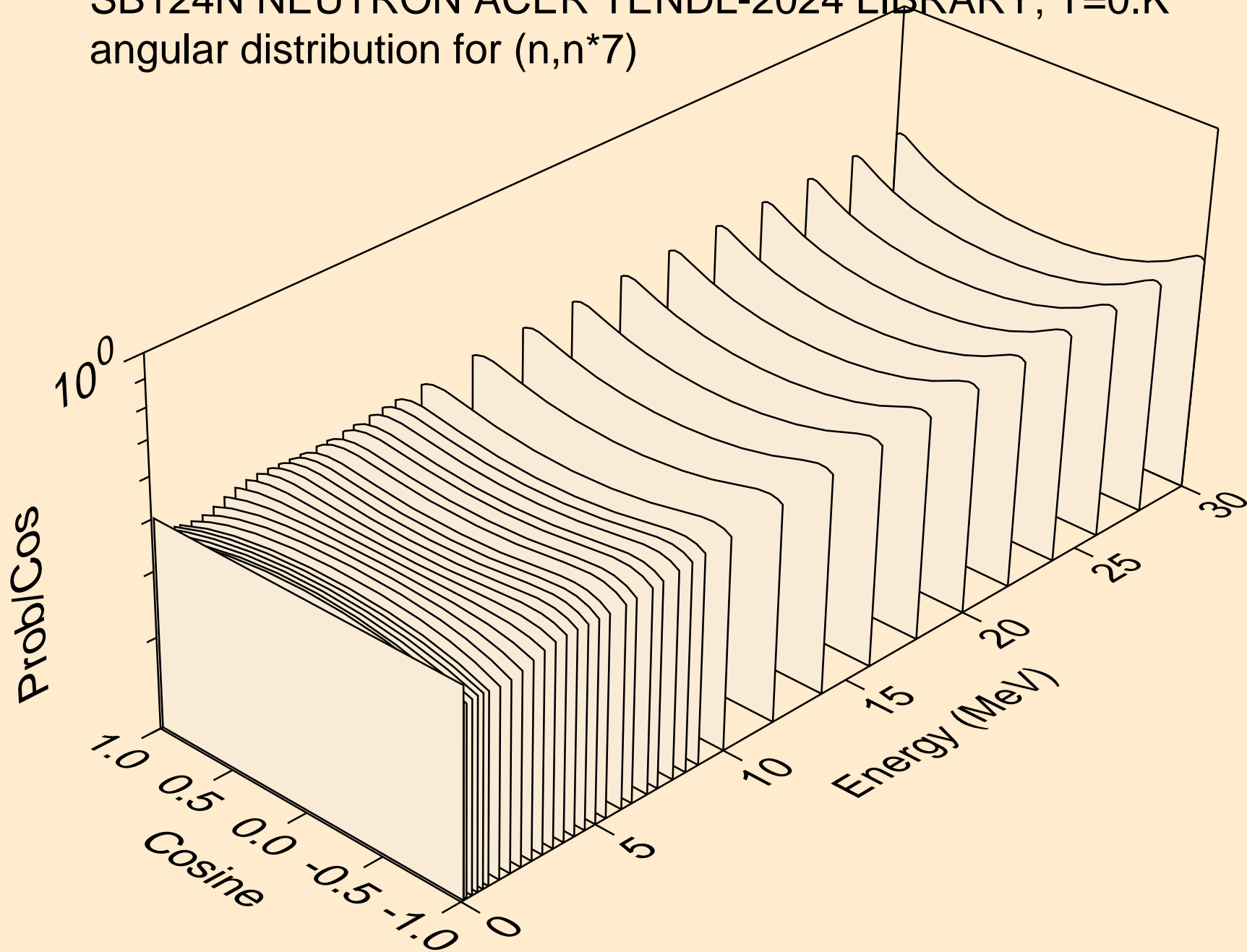

SB124N NEUTRON ACER TENDL-2024 LIBRARY; T=0.K  
angular distribution for (n,n\*8)

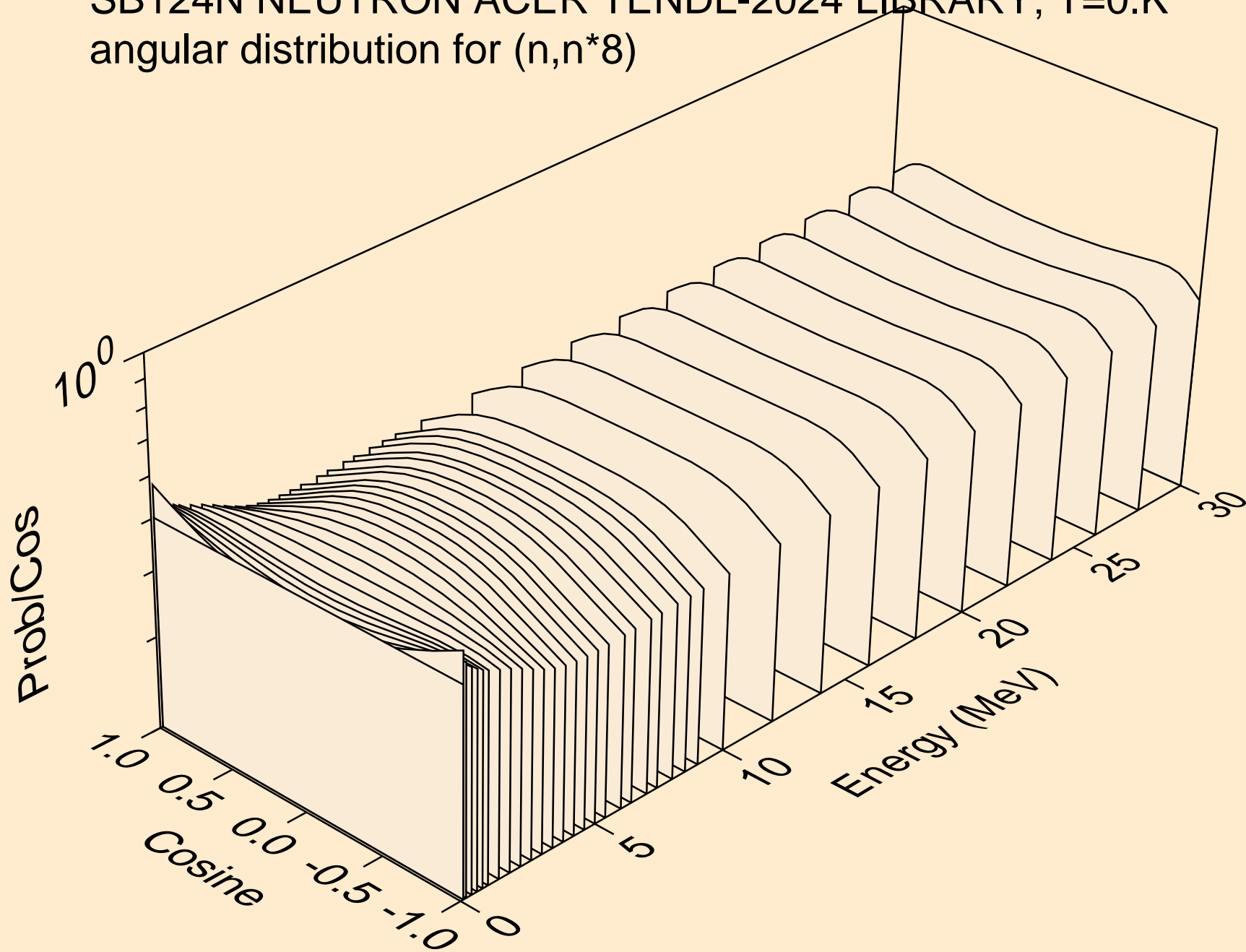

SB124N NEUTRON ACER TENDL-2024 LIBRARY; T=0.K  
angular distribution for (n,n\*9)

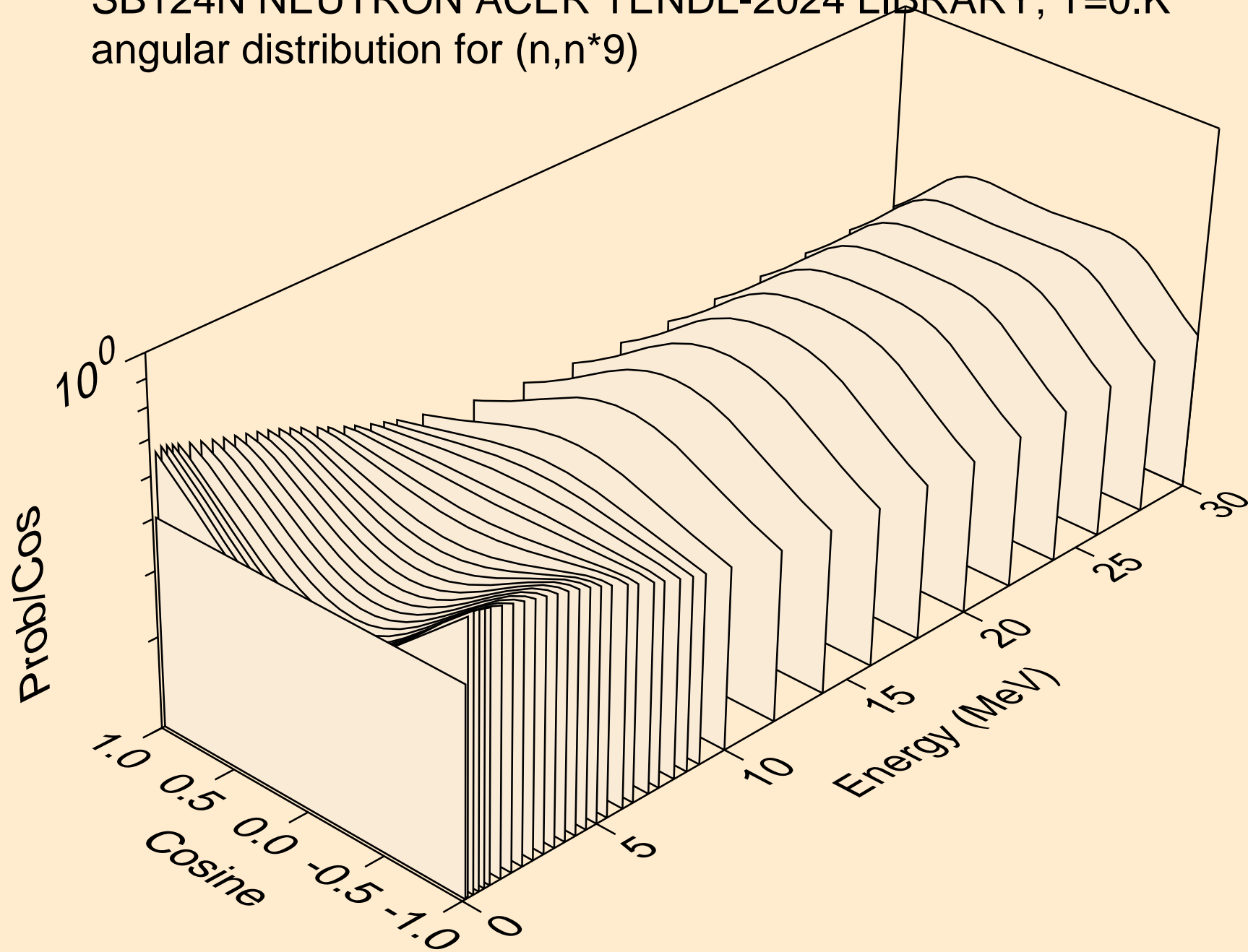

SB124N NEUTRON ACER TENDL-2024 LIBRARY; T=0.K  
angular distribution for (n,n\*10)

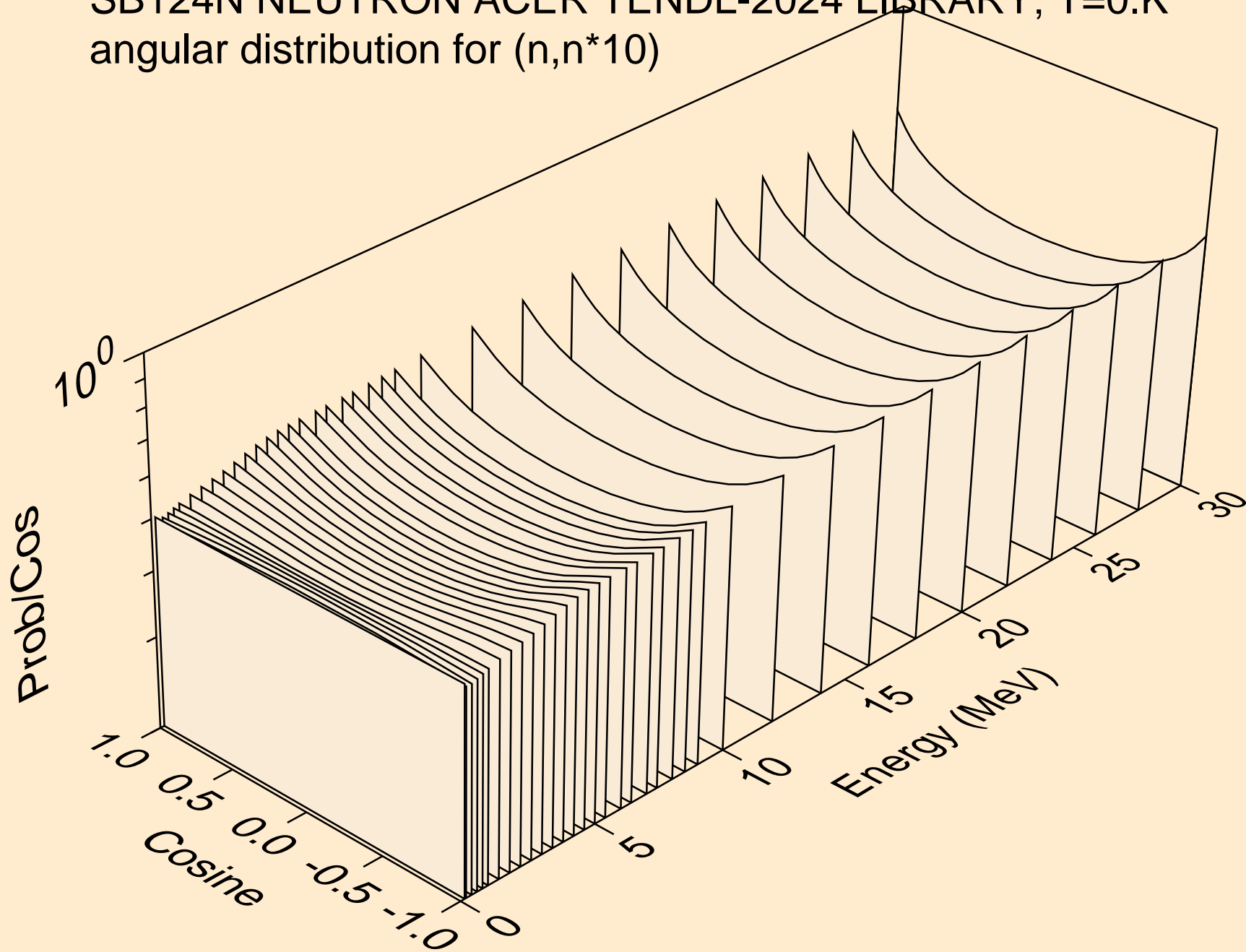

SB124N NEUTRON ACER TENDL-2024 LIBRARY; T=0.K  
angular distribution for (n,n\*11)

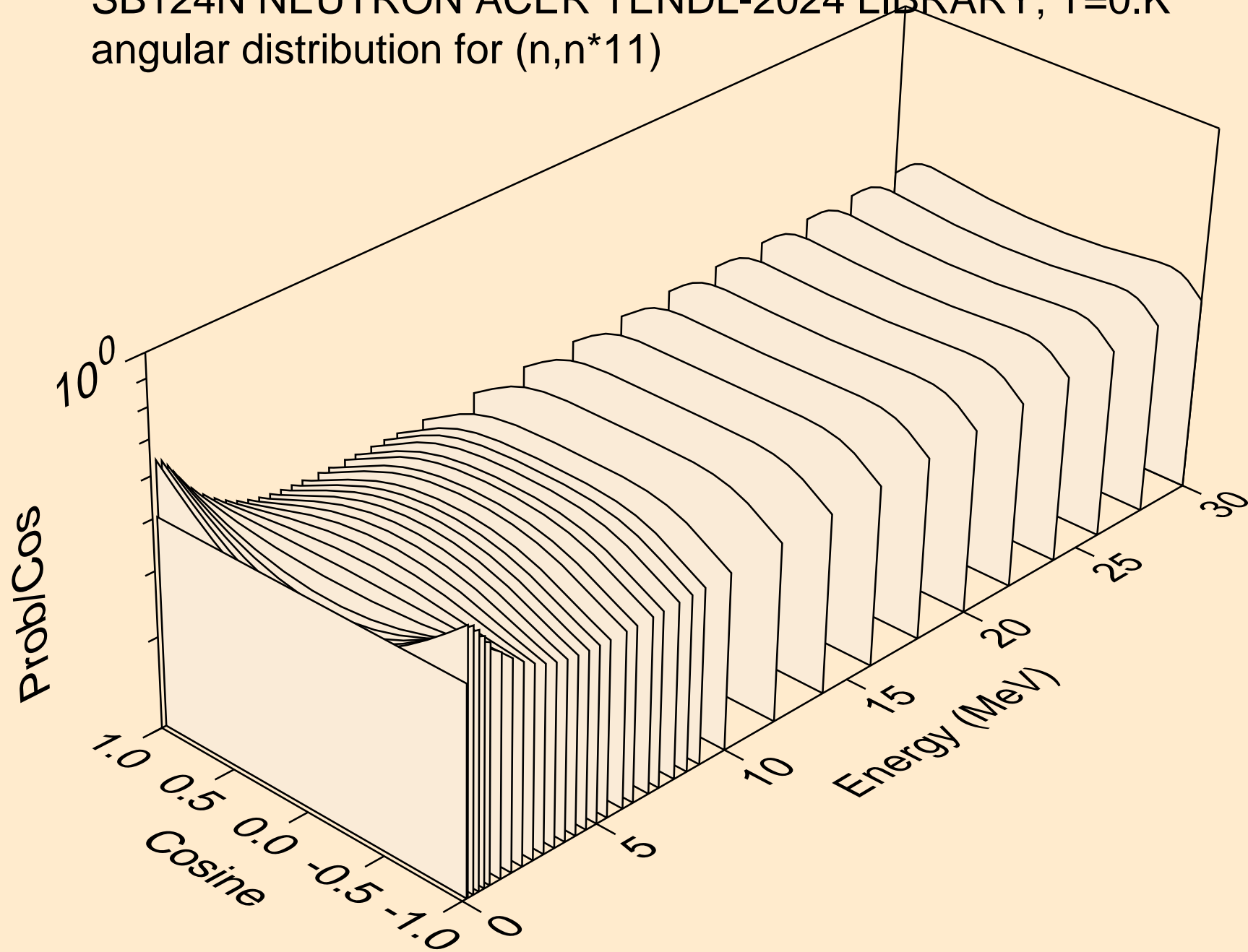



SB124N NEUTRON ACER TENDL-2024 LIBRARY; T=0.K  
angular distribution for (n,n\*12)

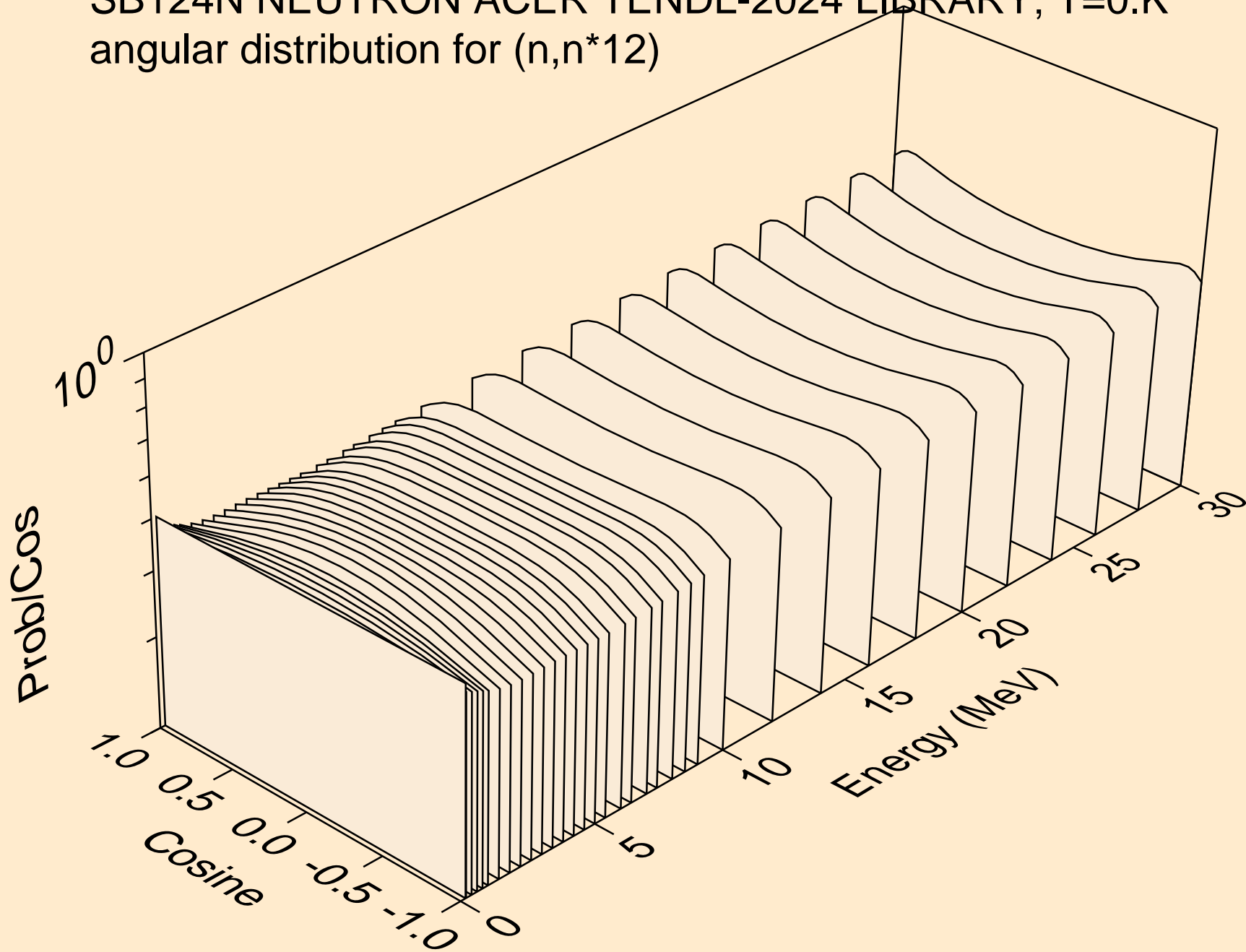

SB124N NEUTRON ACER TENDL-2024 LIBRARY; T=0.K  
angular distribution for (n,n\*13)

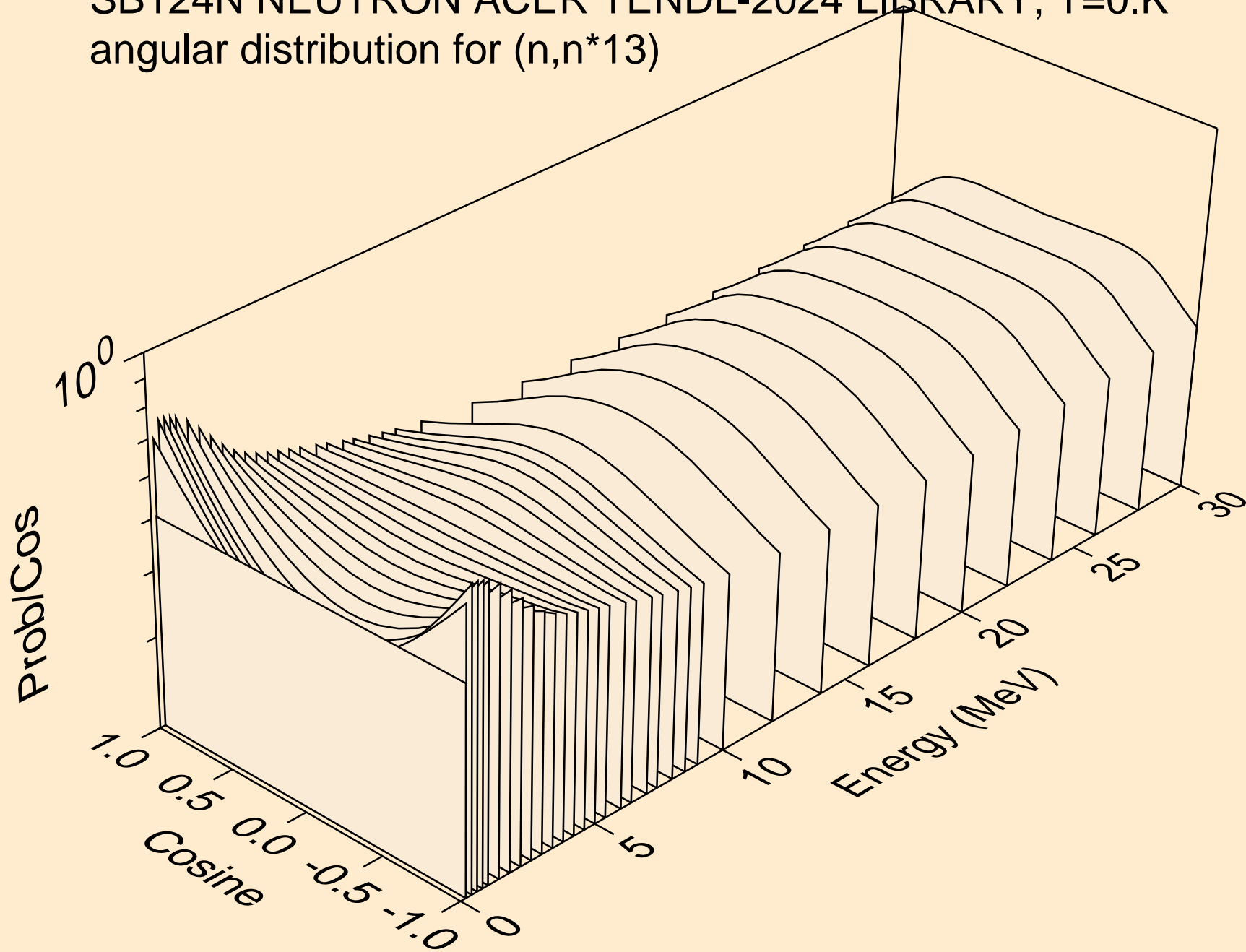

SB124N NEUTRON ACER TENDL-2024 LIBRARY; T=0.K  
angular distribution for (n,n\*14)

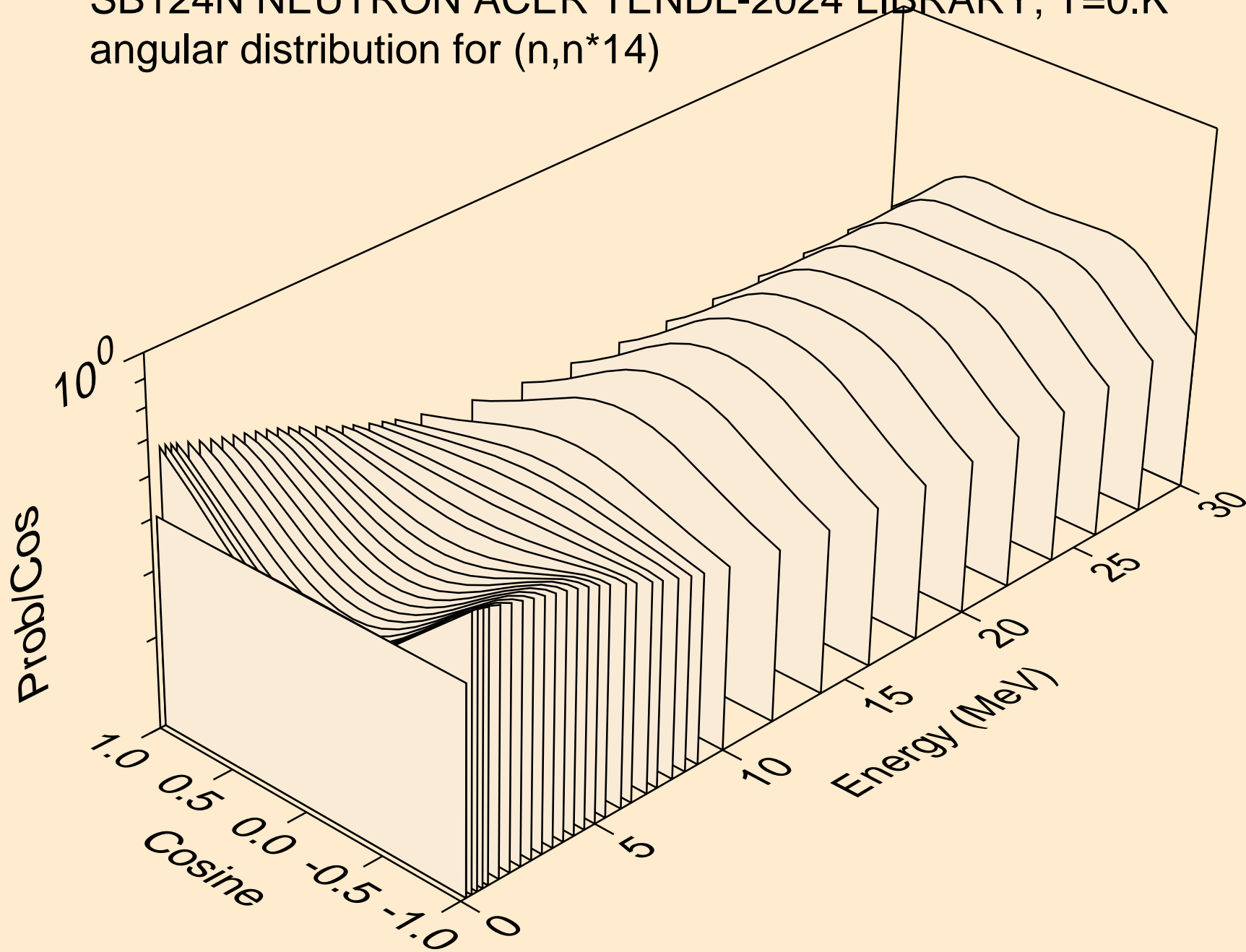

SB124N NEUTRON ACER TENDL-2024 LIBRARY; T=0.K  
angular distribution for (n,n\*15)

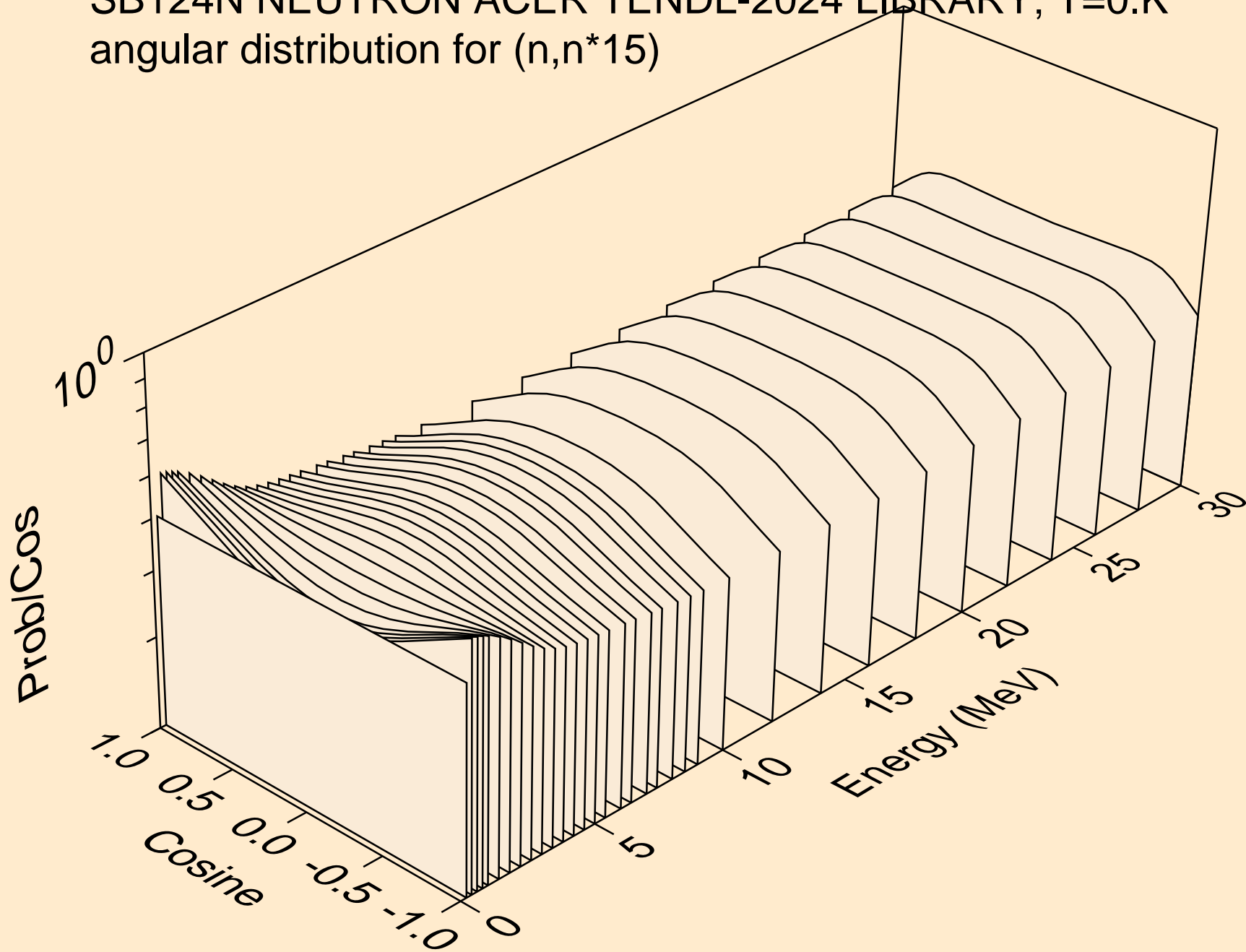

SB124N NEUTRON ACER TENDL-2024 LIBRARY; T=0.K  
angular distribution for (n,n\*16)

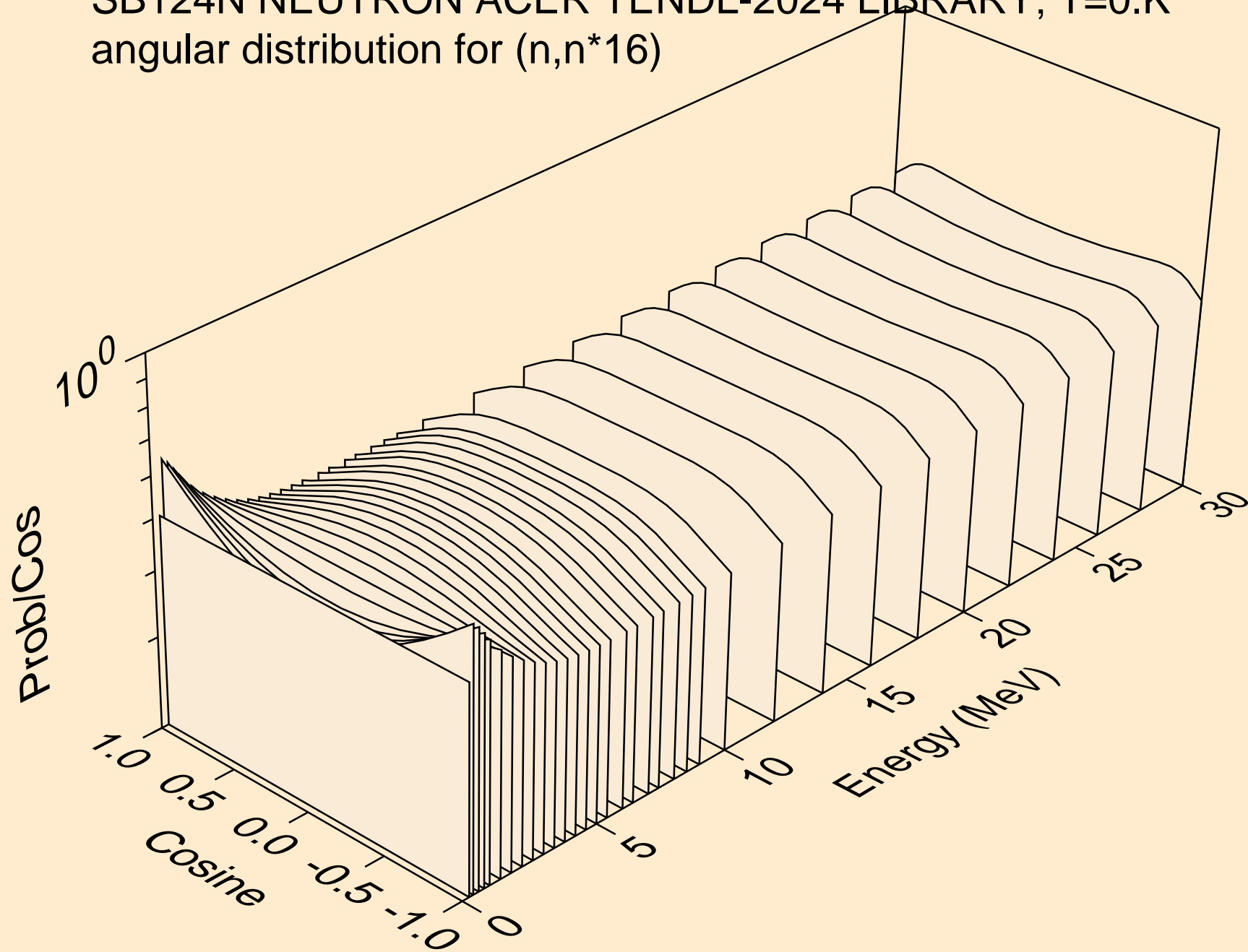

SB124N NEUTRON ACER TENDL-2024 LIBRARY; T=0.K  
angular distribution for (n,n\*17)

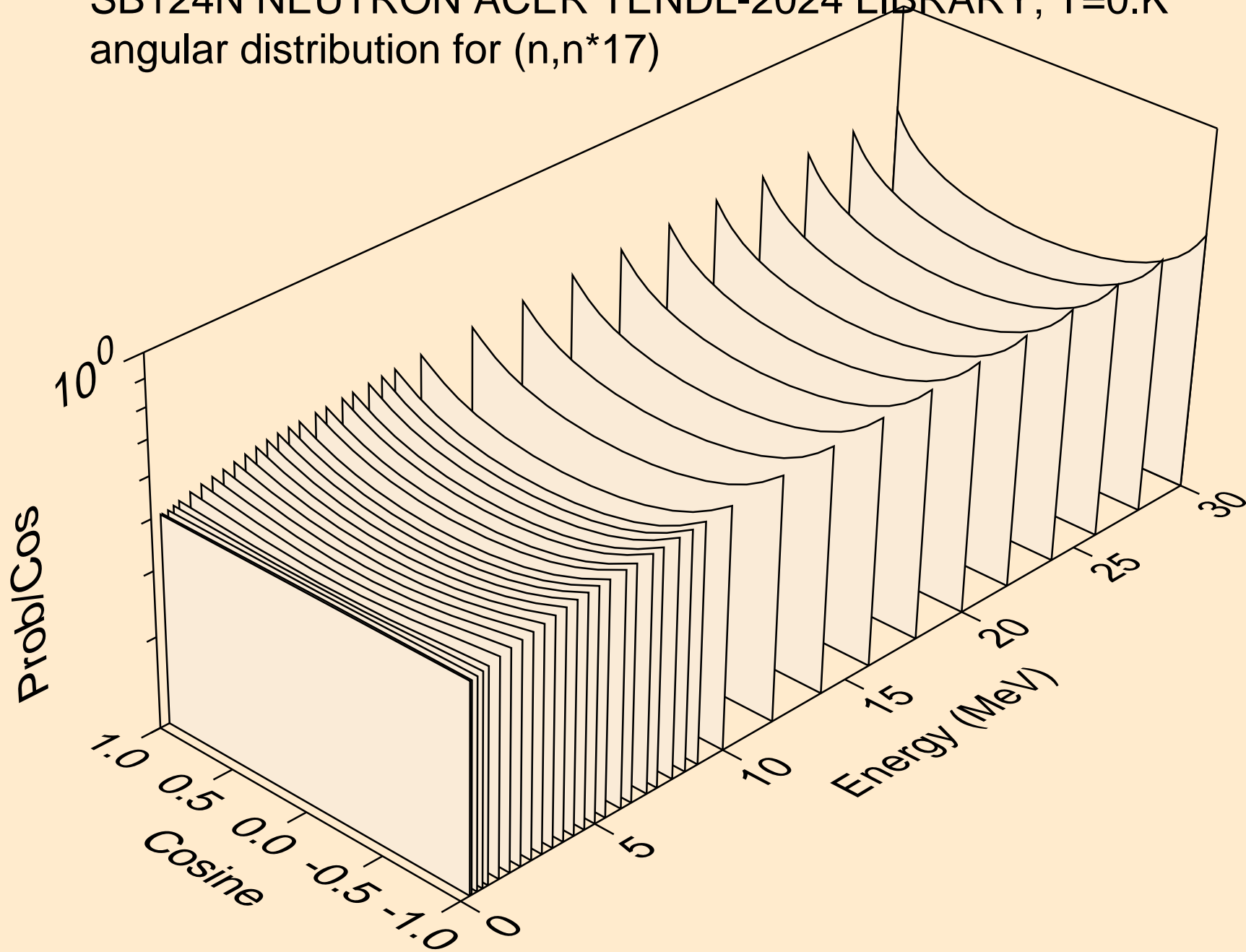

SB124N NEUTRON ACER TENDL-2024 LIBRARY; T=0.K  
angular distribution for (n,n\*18)

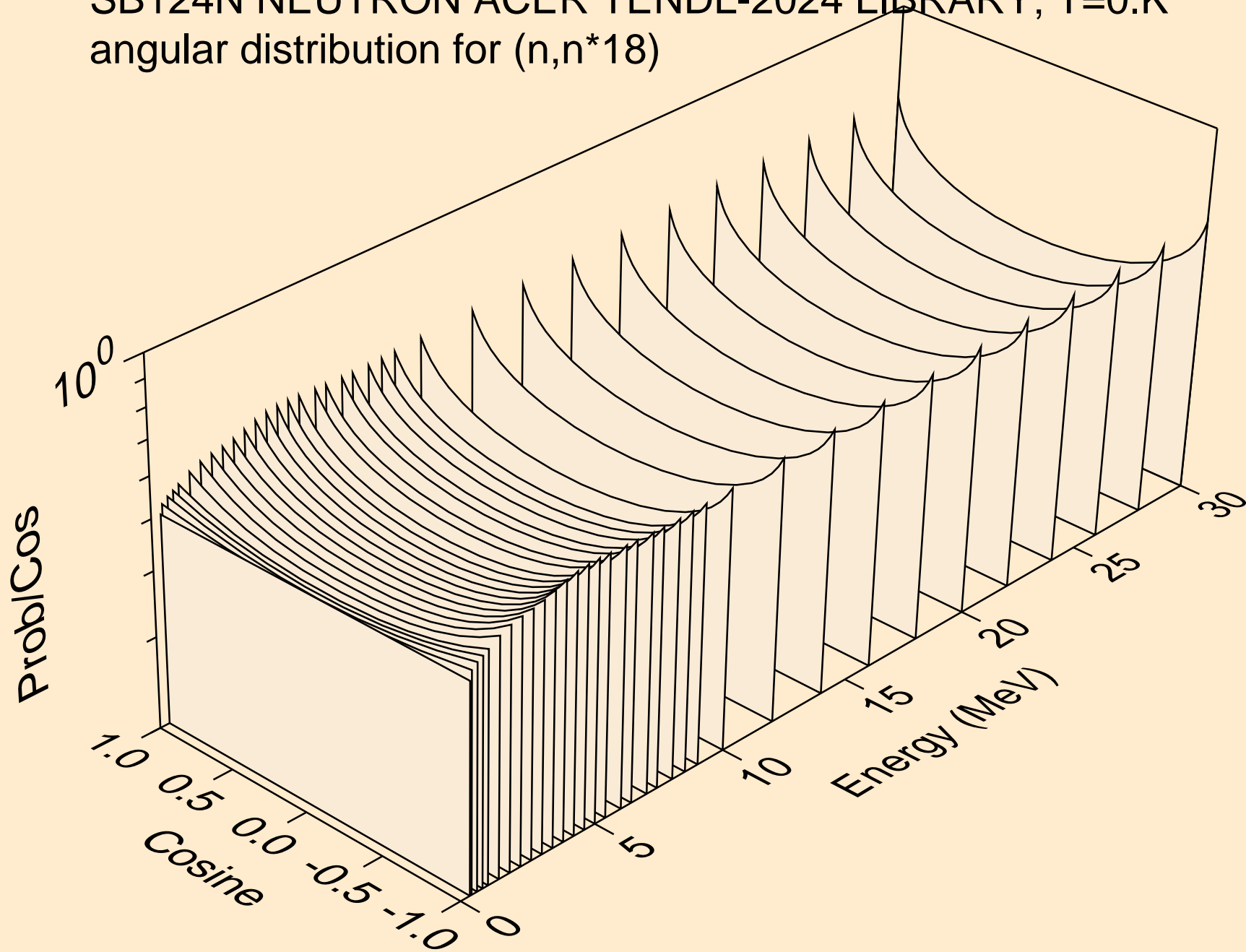

SB124N NEUTRON ACER TENDL-2024 LIBRARY; T=0.K  
angular distribution for (n,n\*19)

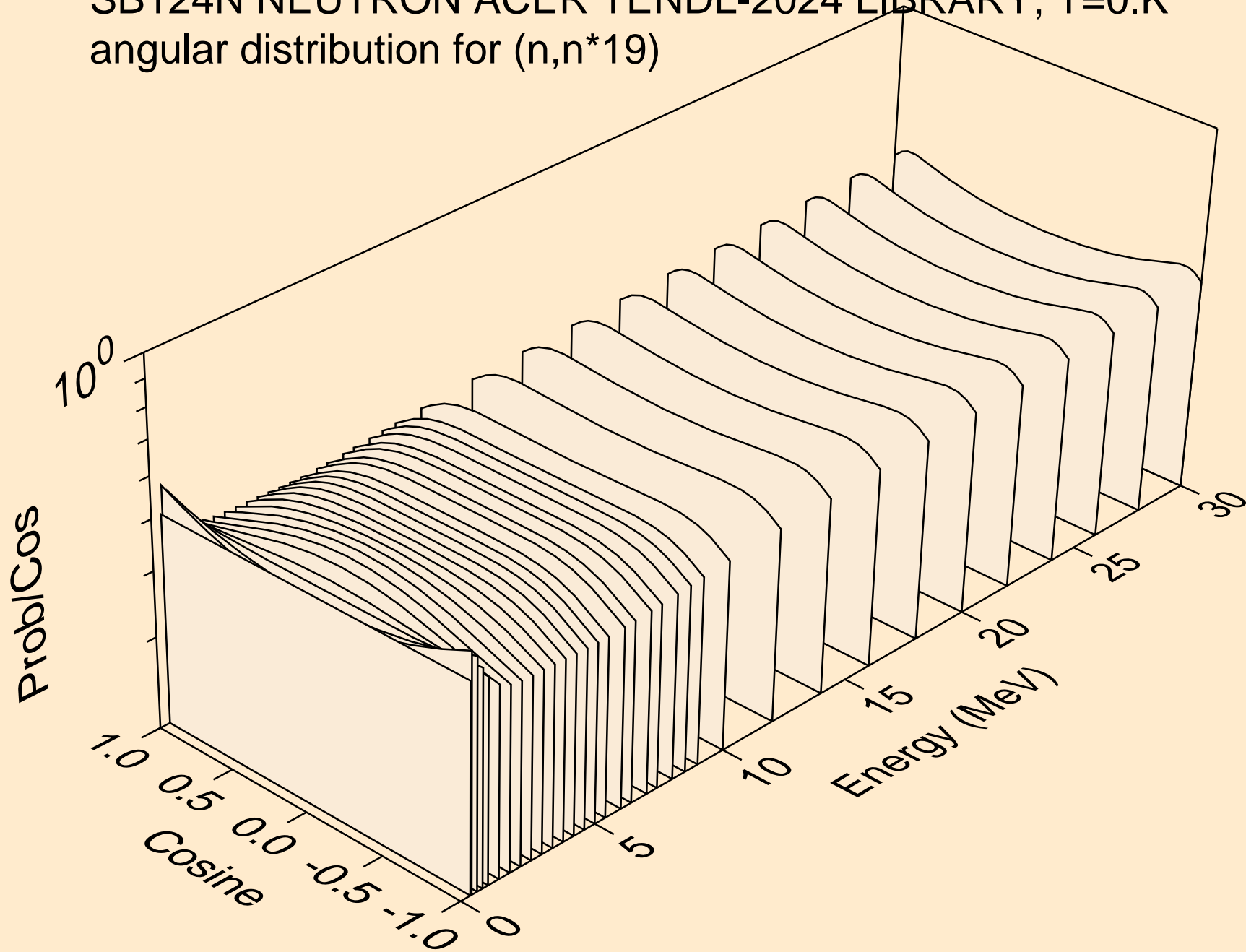



SB124N NEUTRON ACER TENDL-2024 LIBRARY; T=0.K  
angular distribution for (n,n\*20)

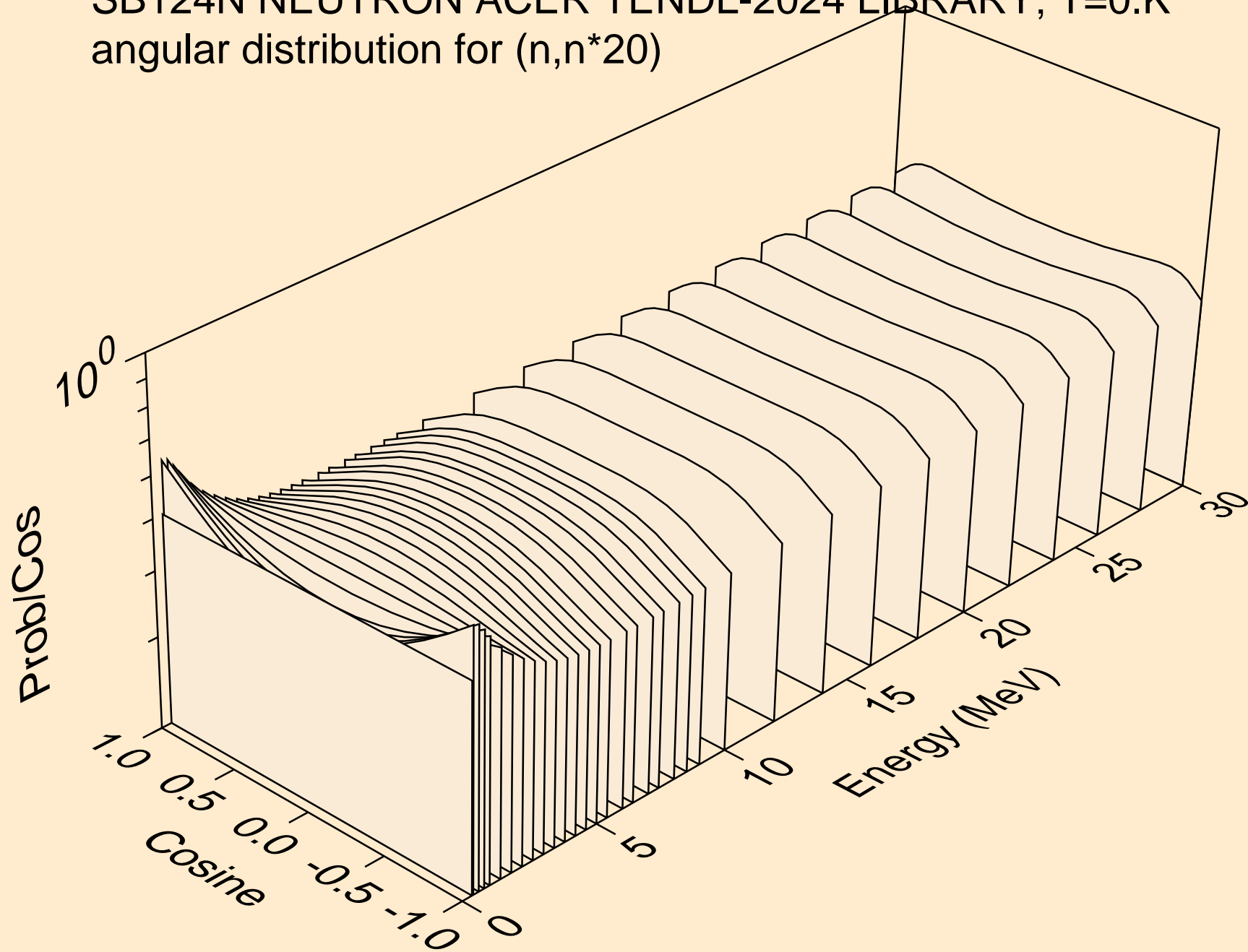

SB124N NEUTRON ACER TENDL-2024 LIBRARY; T=0.K  
angular distribution for (n,n\*21)

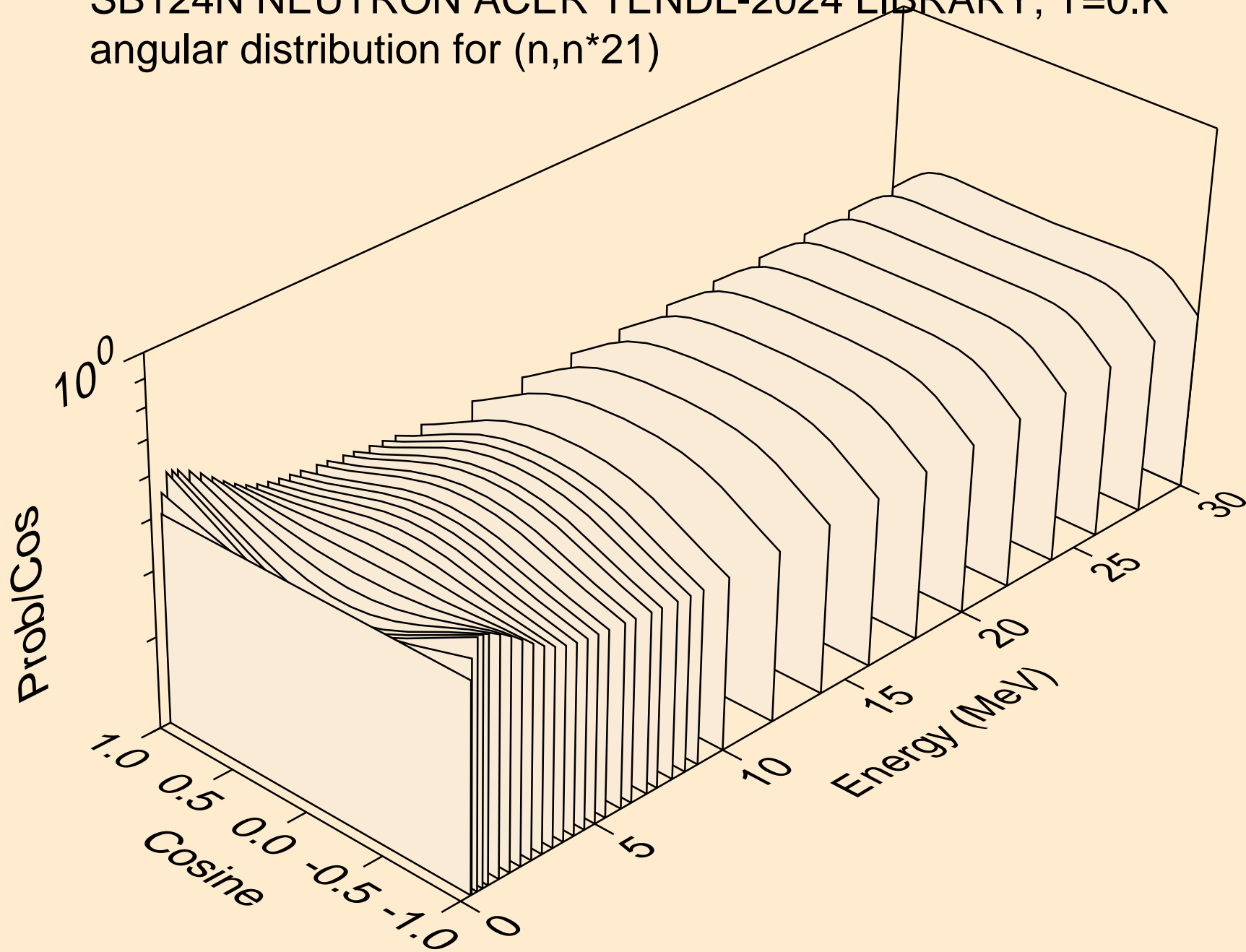

SB124N NEUTRON ACER TENDL-2024 LIBRARY; T=0.K  
angular distribution for (n,n\*22)

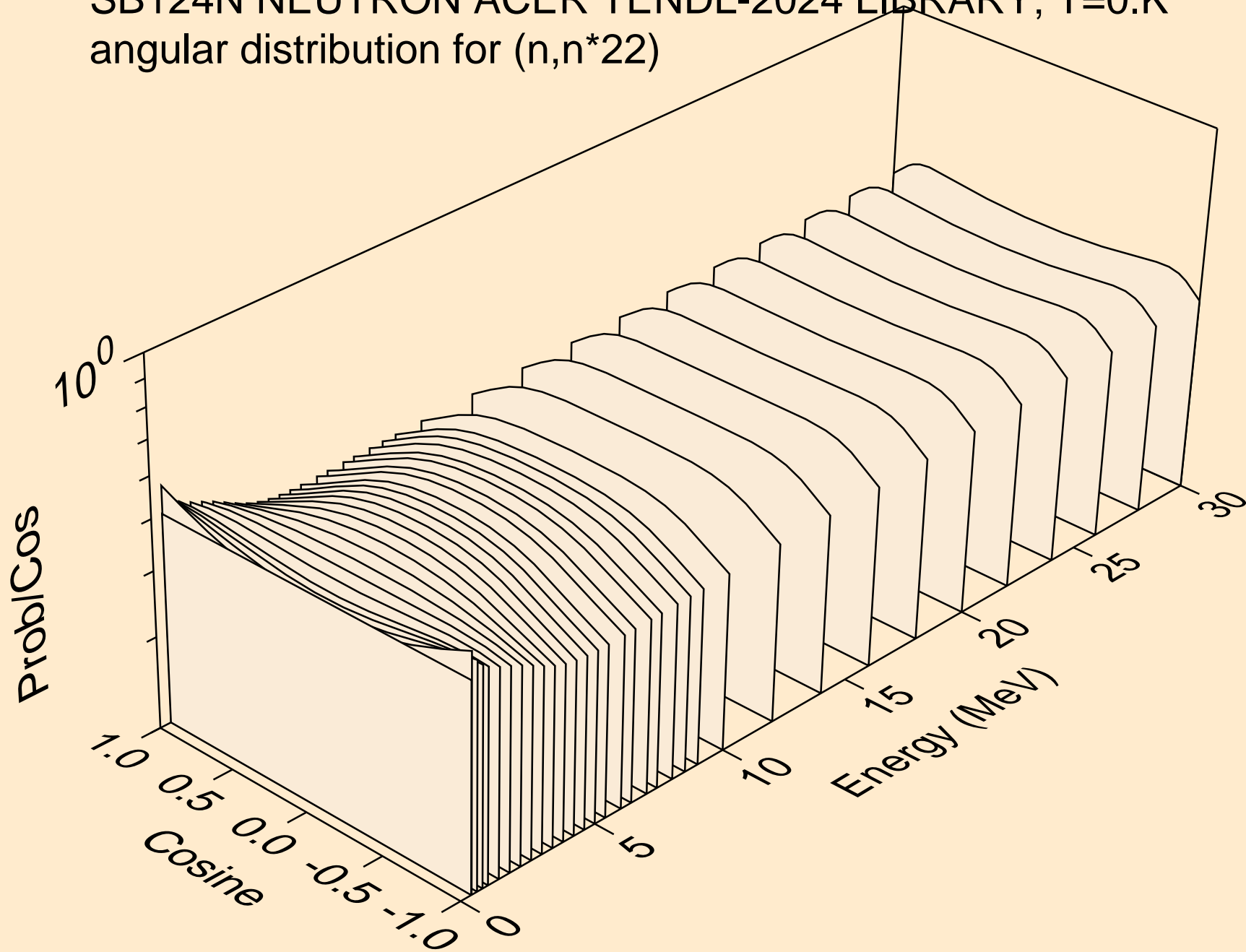

SB124N NEUTRON ACER TENDL-2024 LIBRARY; T=0.K  
angular distribution for (n,n\*23)

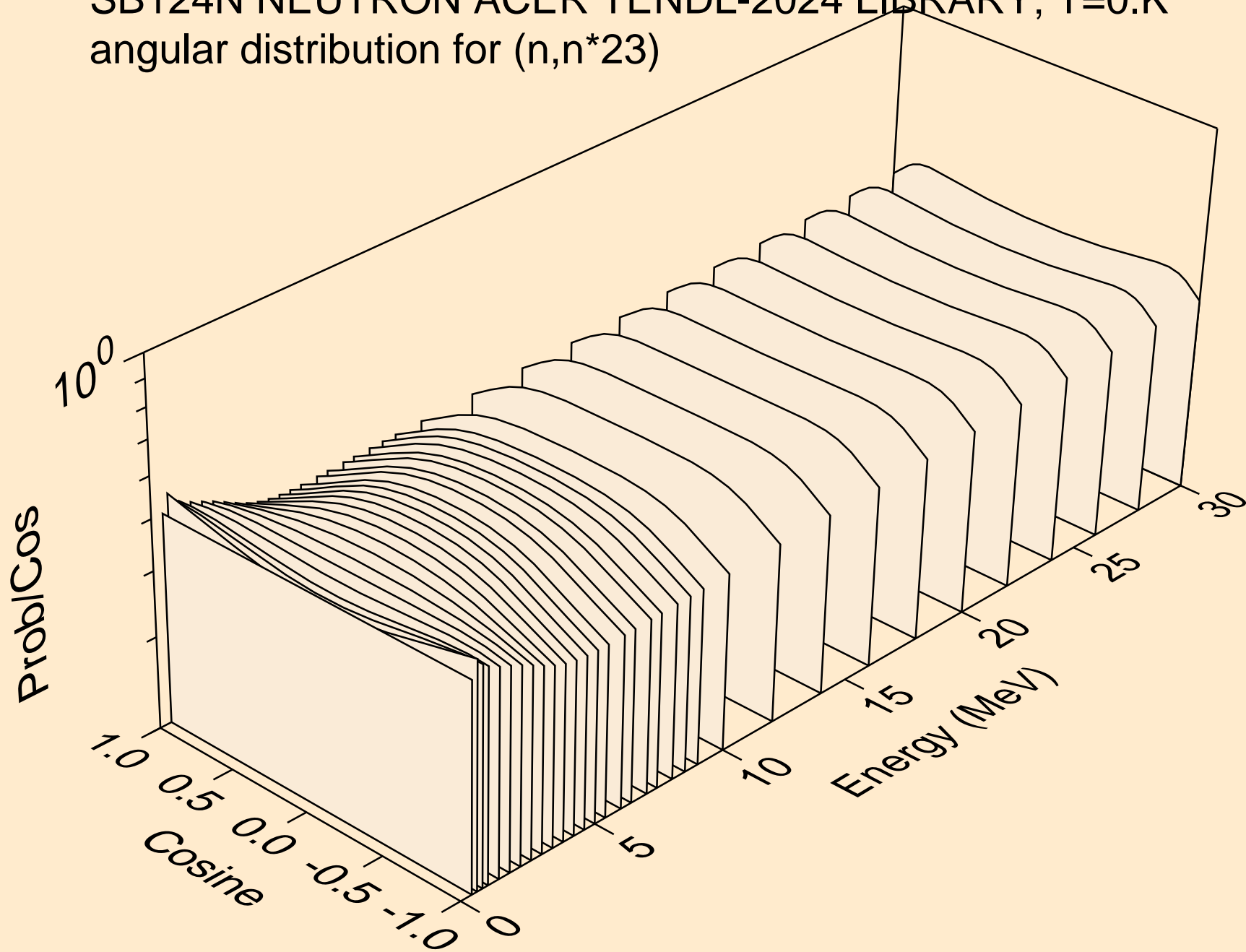

SB124N NEUTRON ACER TENDL-2024 LIBRARY; T=0.K  
angular distribution for (n,n\*24)

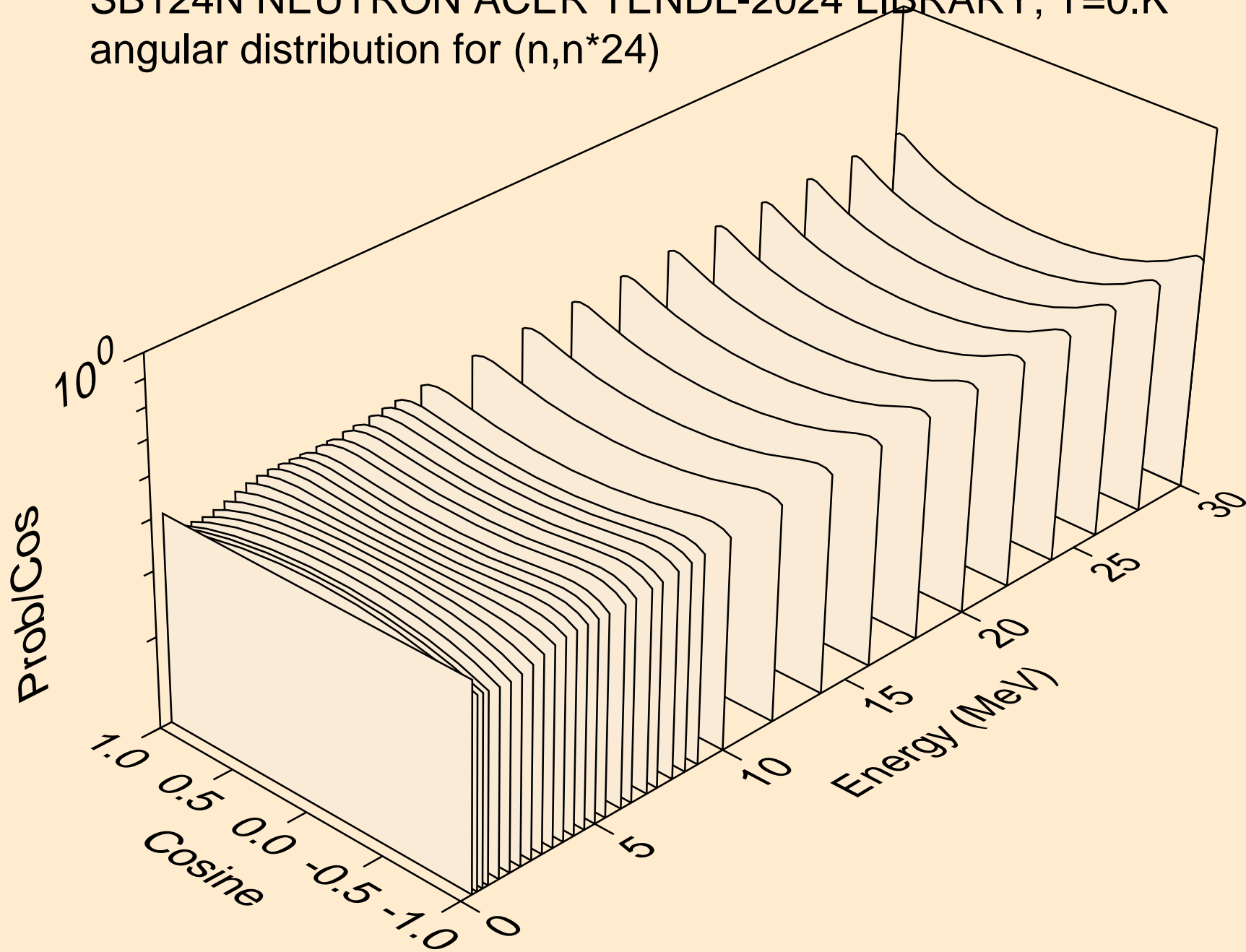

SB124N NEUTRON ACER TENDL-2024 LIBRARY; T=0.K  
Neutron emission for (n,x)

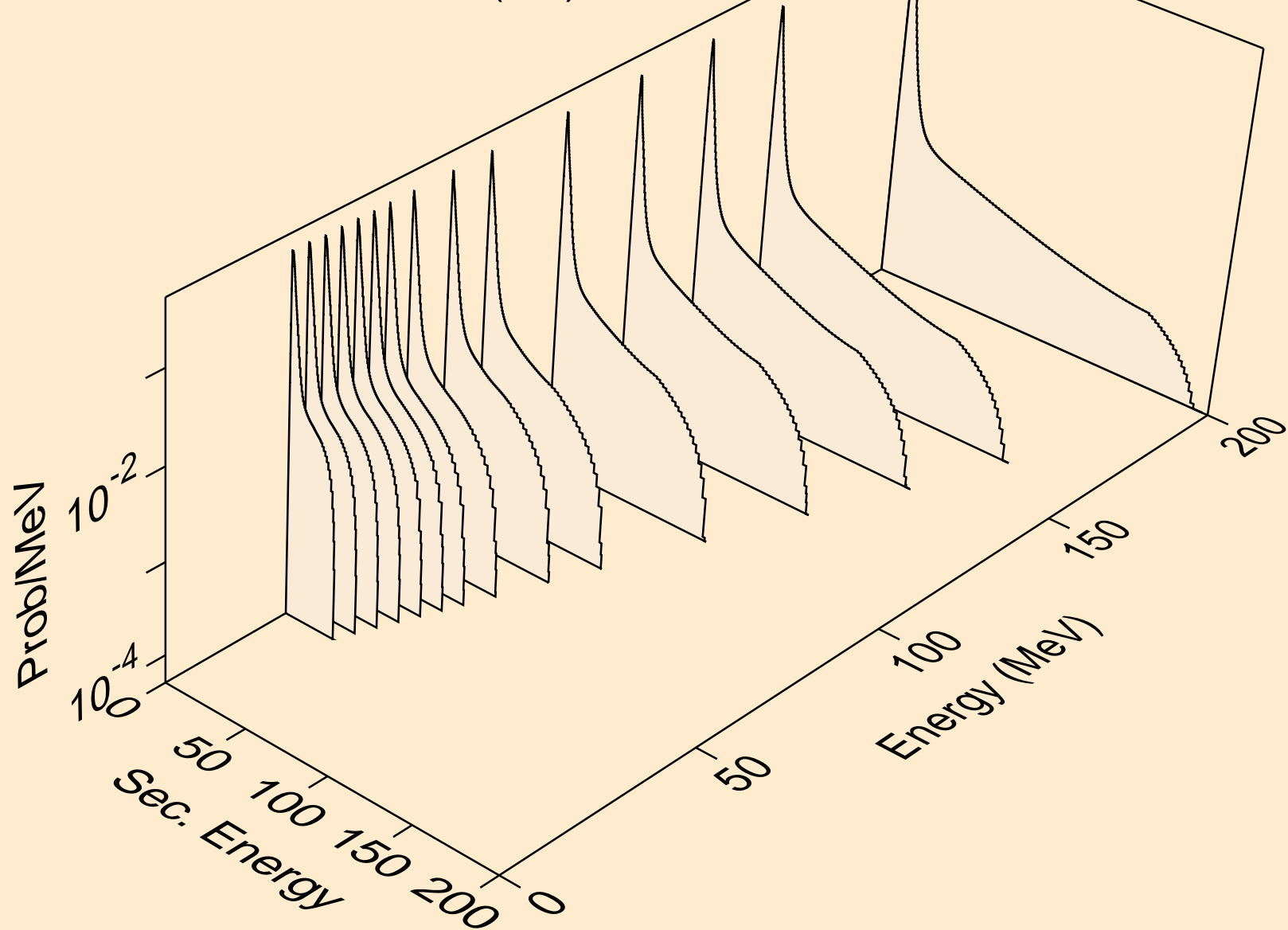

SB124N NEUTRON ACER TENDL-2024 LIBRARY; T=0.K  
Neutron emission for (n,2nd)

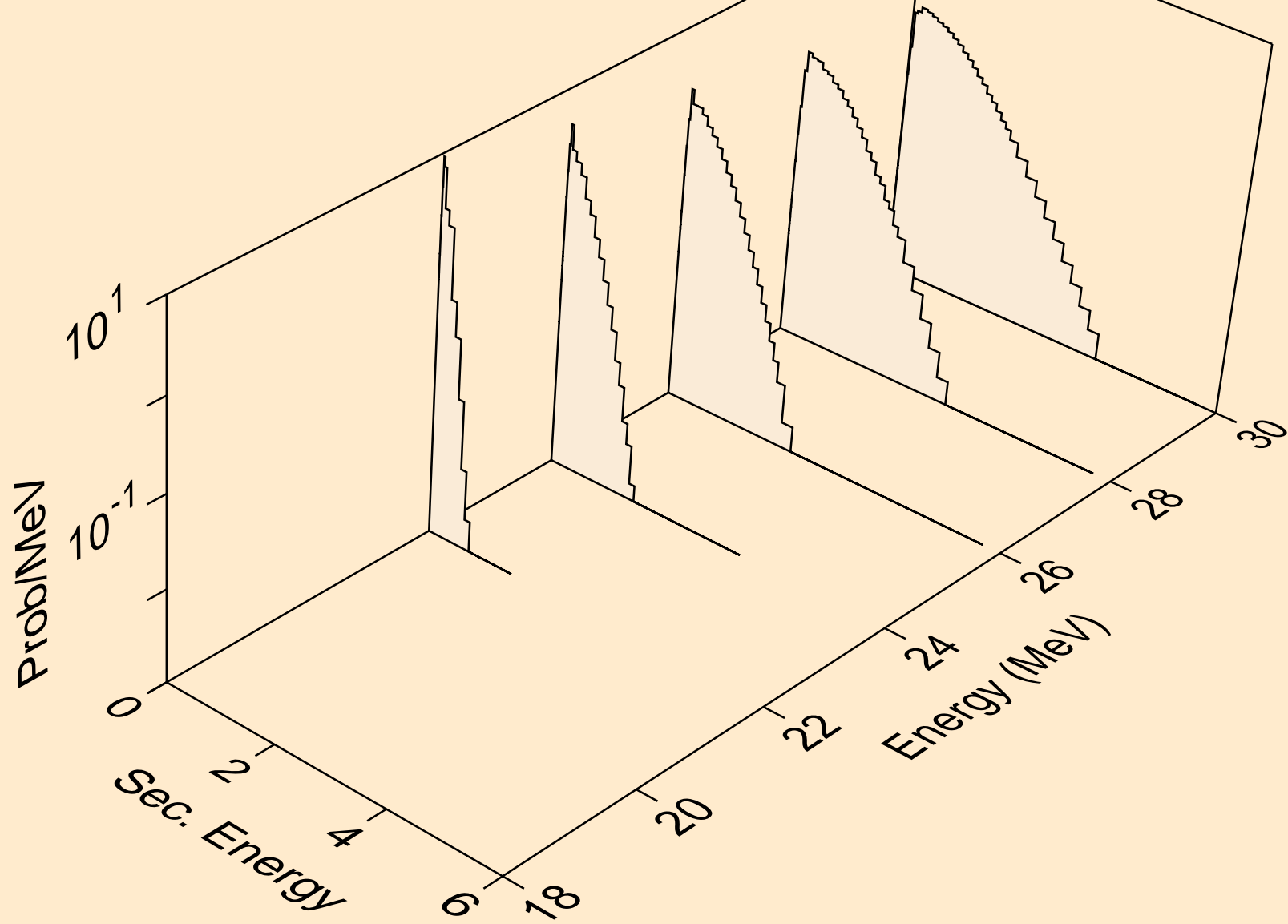

SB124N NEUTRON ACER TENDL-2024 LIBRARY; T=0.K  
Neutron emission for (n,2n)

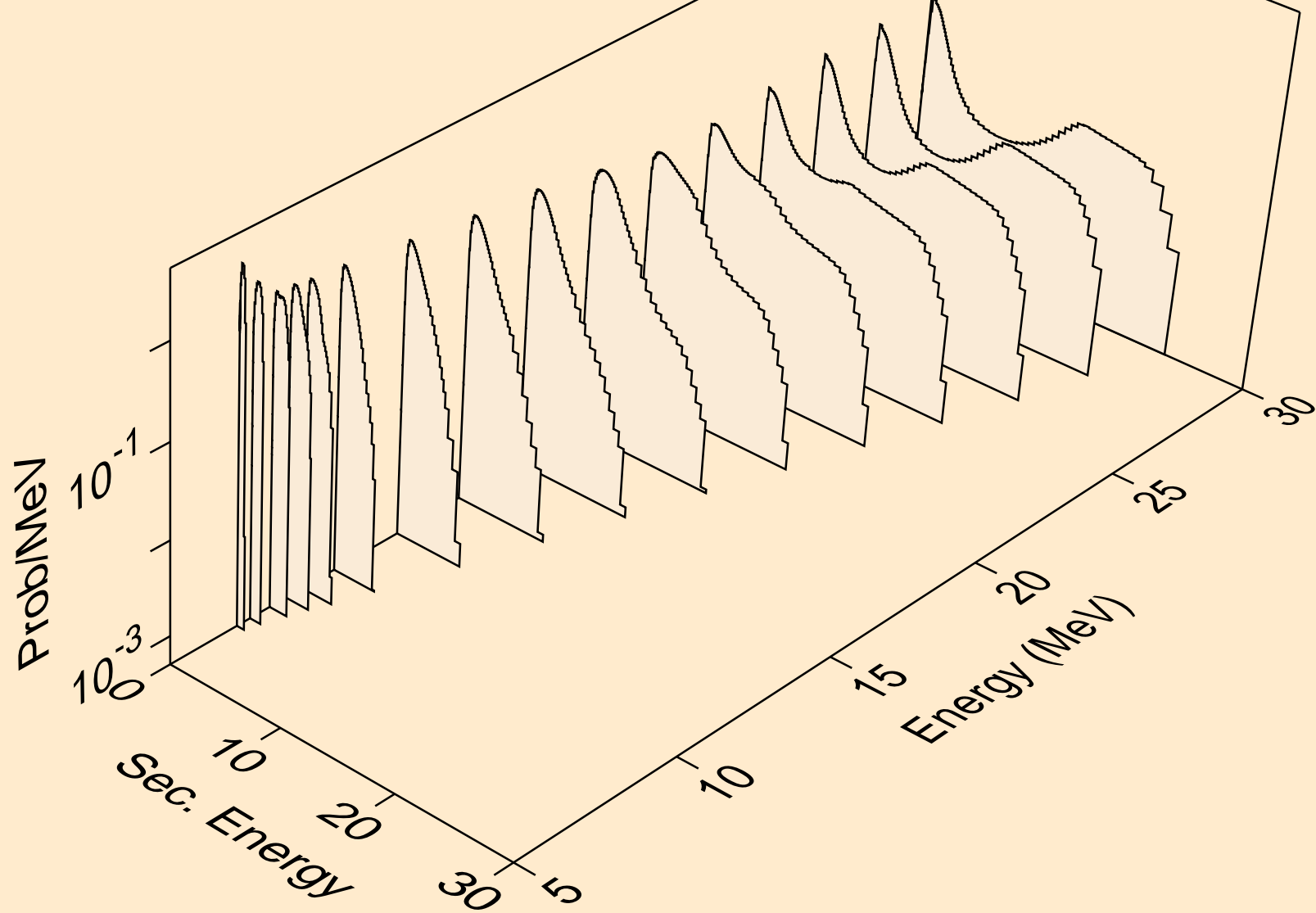



SB124N NEUTRON ACER TENDL-2024 LIBRARY; T=0.K  
Neutron emission for (n,3n)

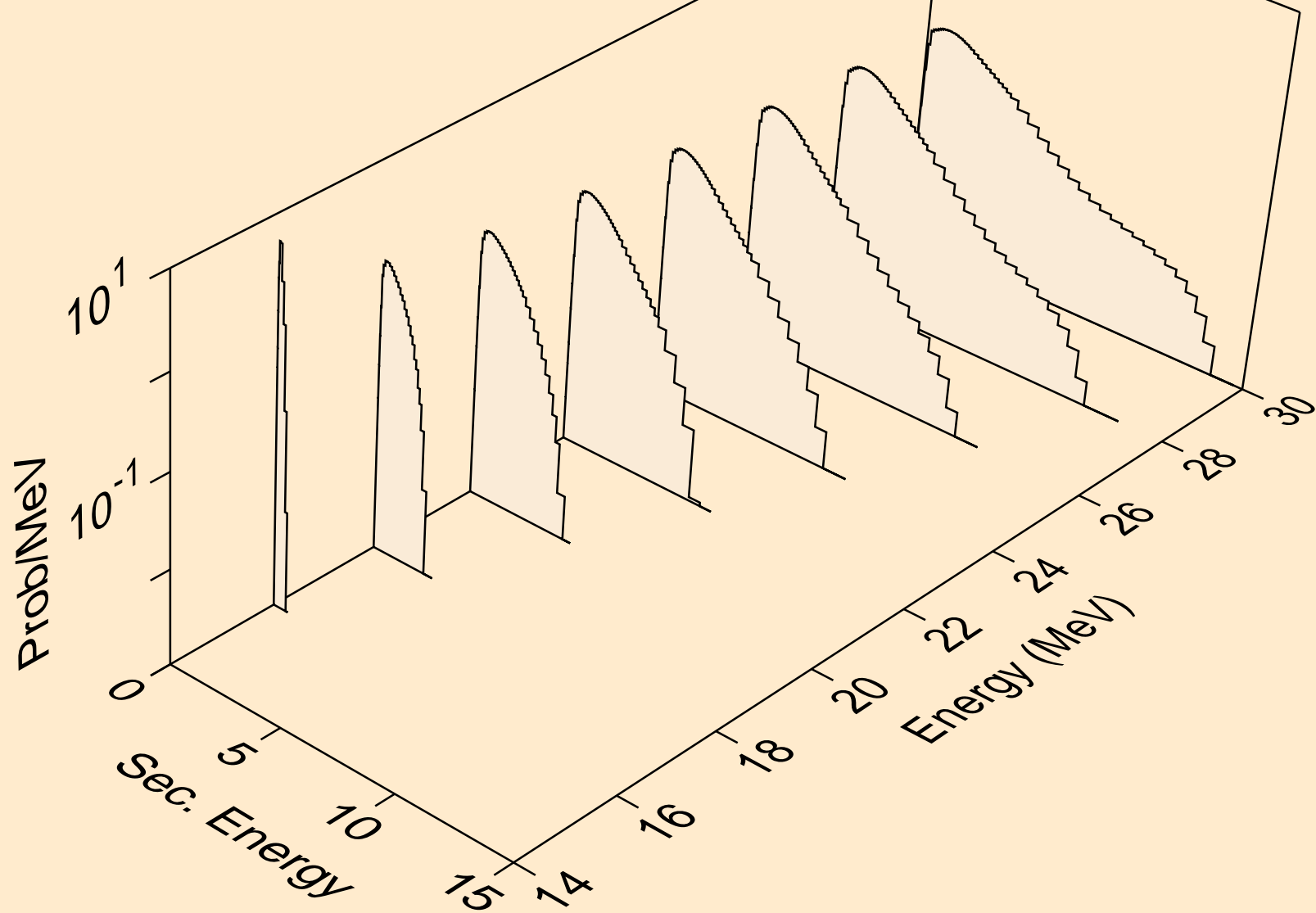

SB124N NEUTRON ACER TENDL-2024 LIBRARY; T=0.K  
Neutron emission for (n,n\*)a

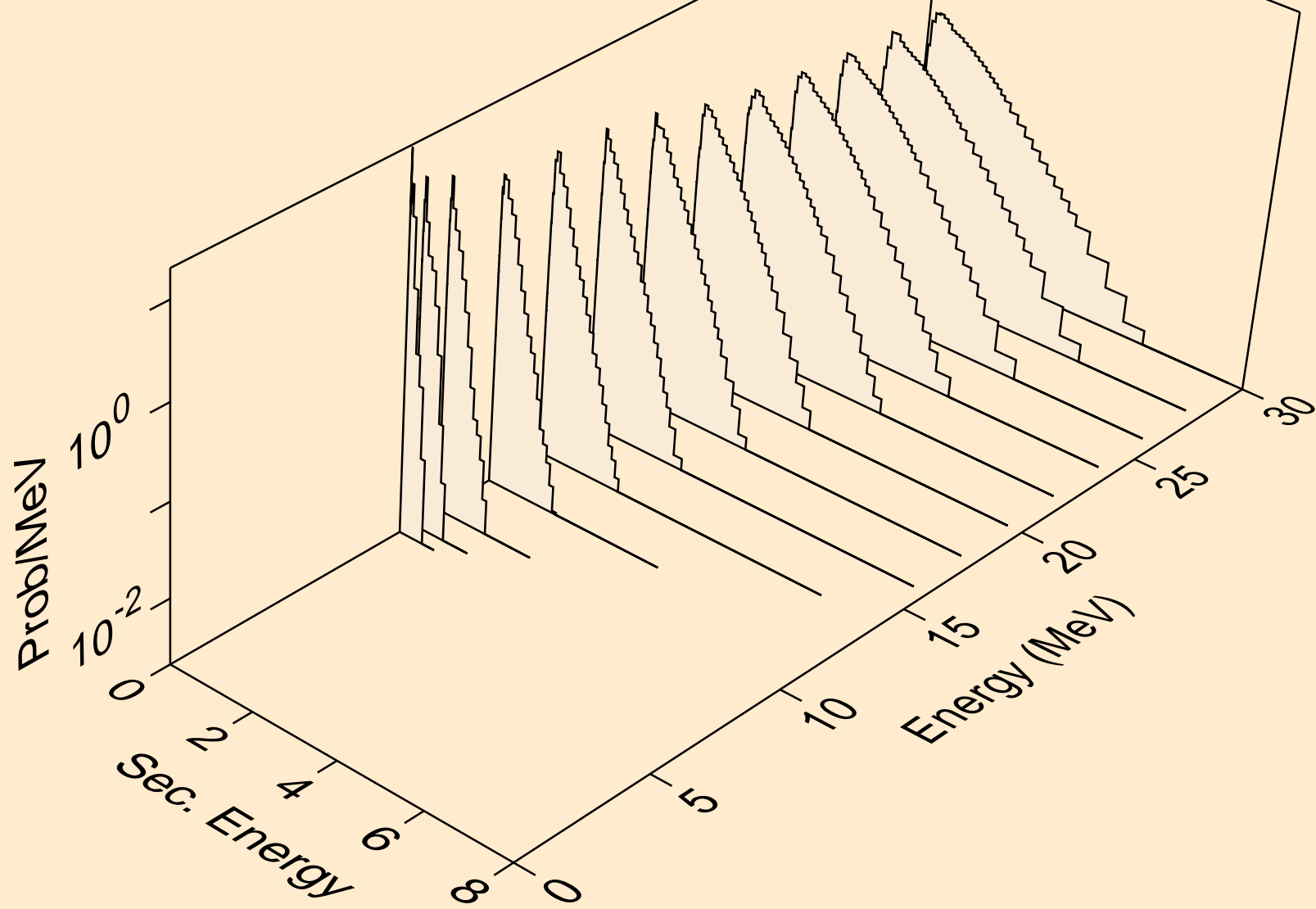

SB124N NEUTRON ACER TENDL-2024 LIBRARY; T=0.K  
Neutron emission for (n,2n)a

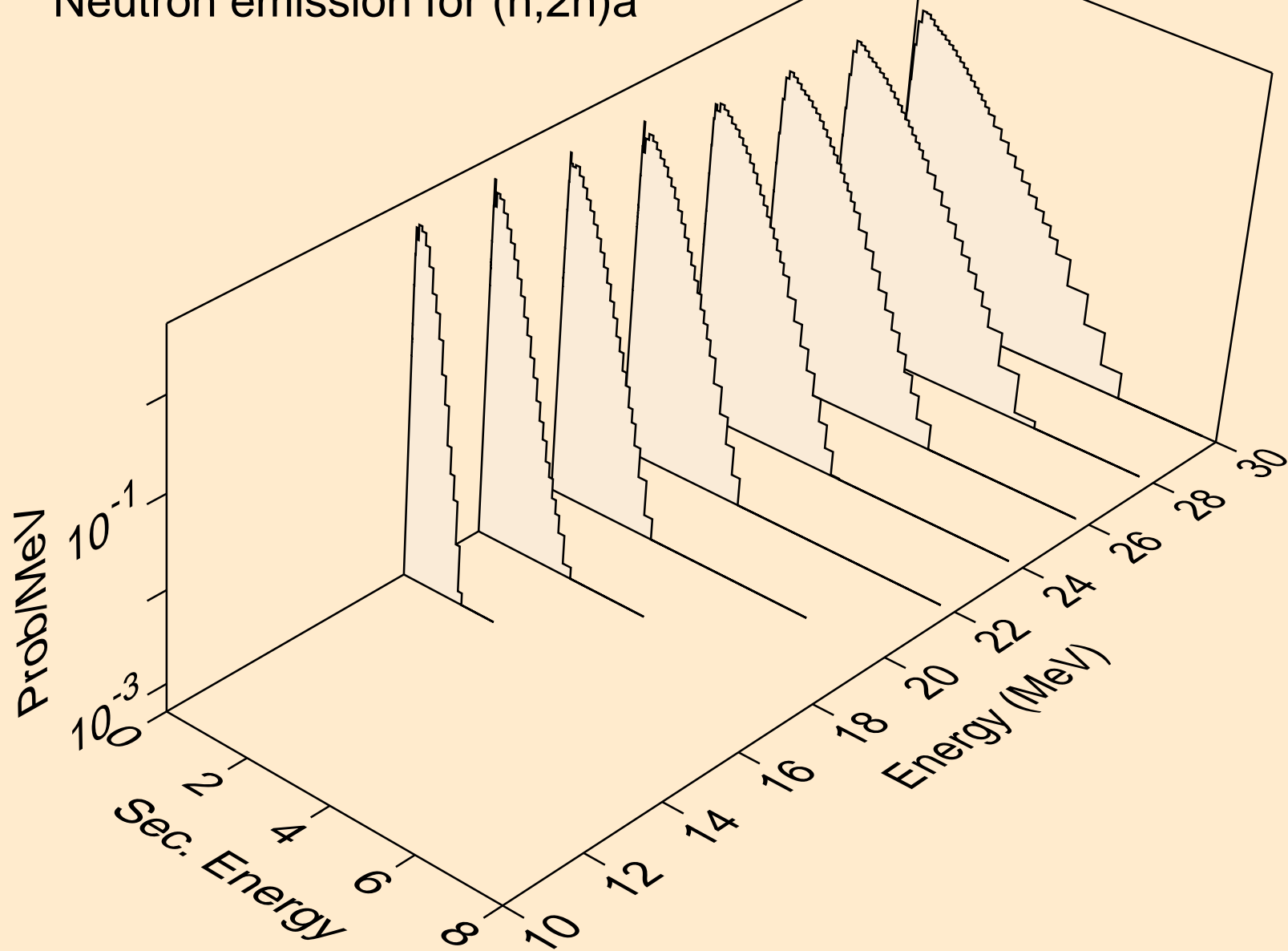

SB124N NEUTRON ACER TENDL-2024 LIBRARY; T=0.K  
Neutron emission for (n,3n)a

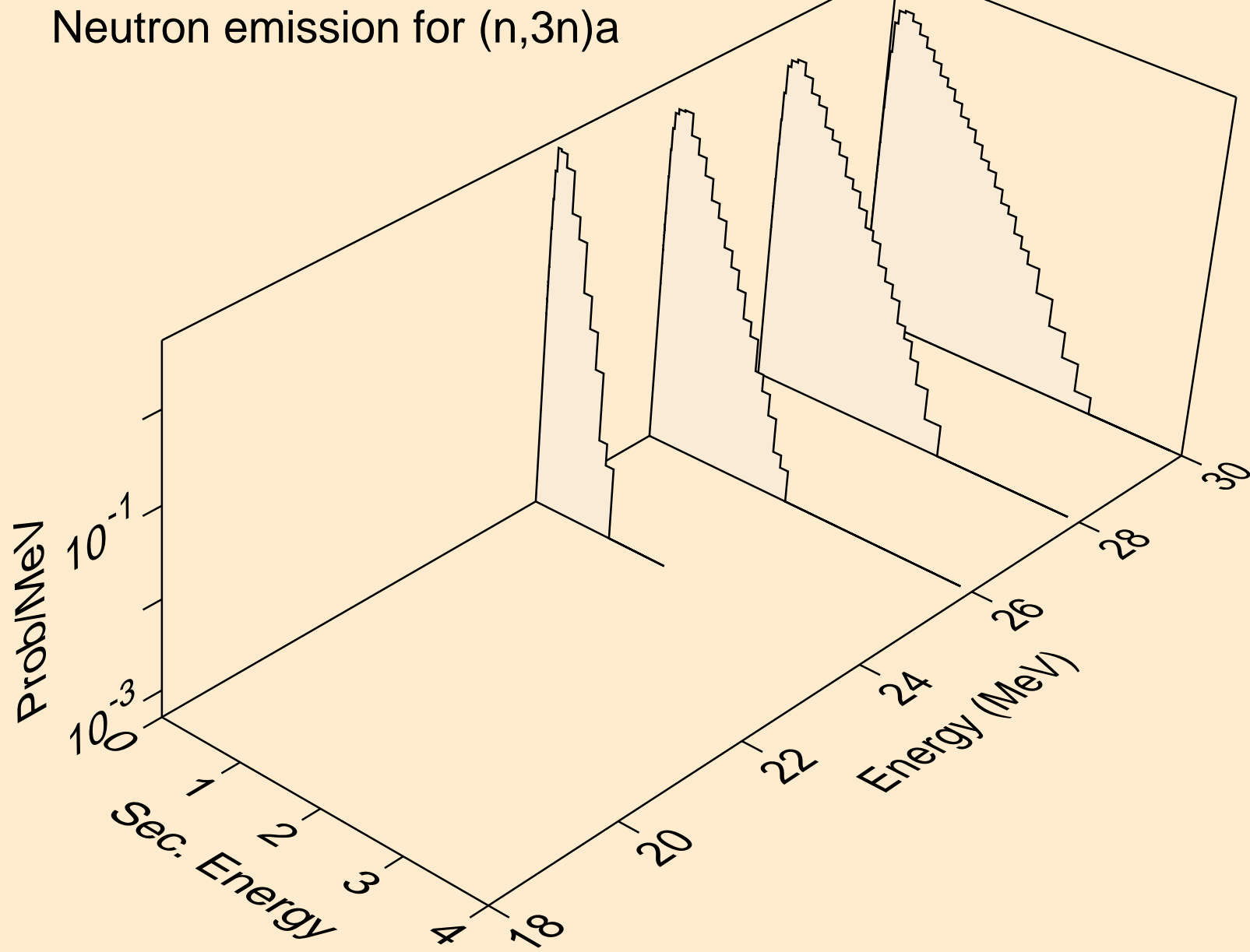

SB124N NEUTRON ACER TENDL-2024 LIBRARY; T=0.K  
Neutron emission for (n,n\*)p

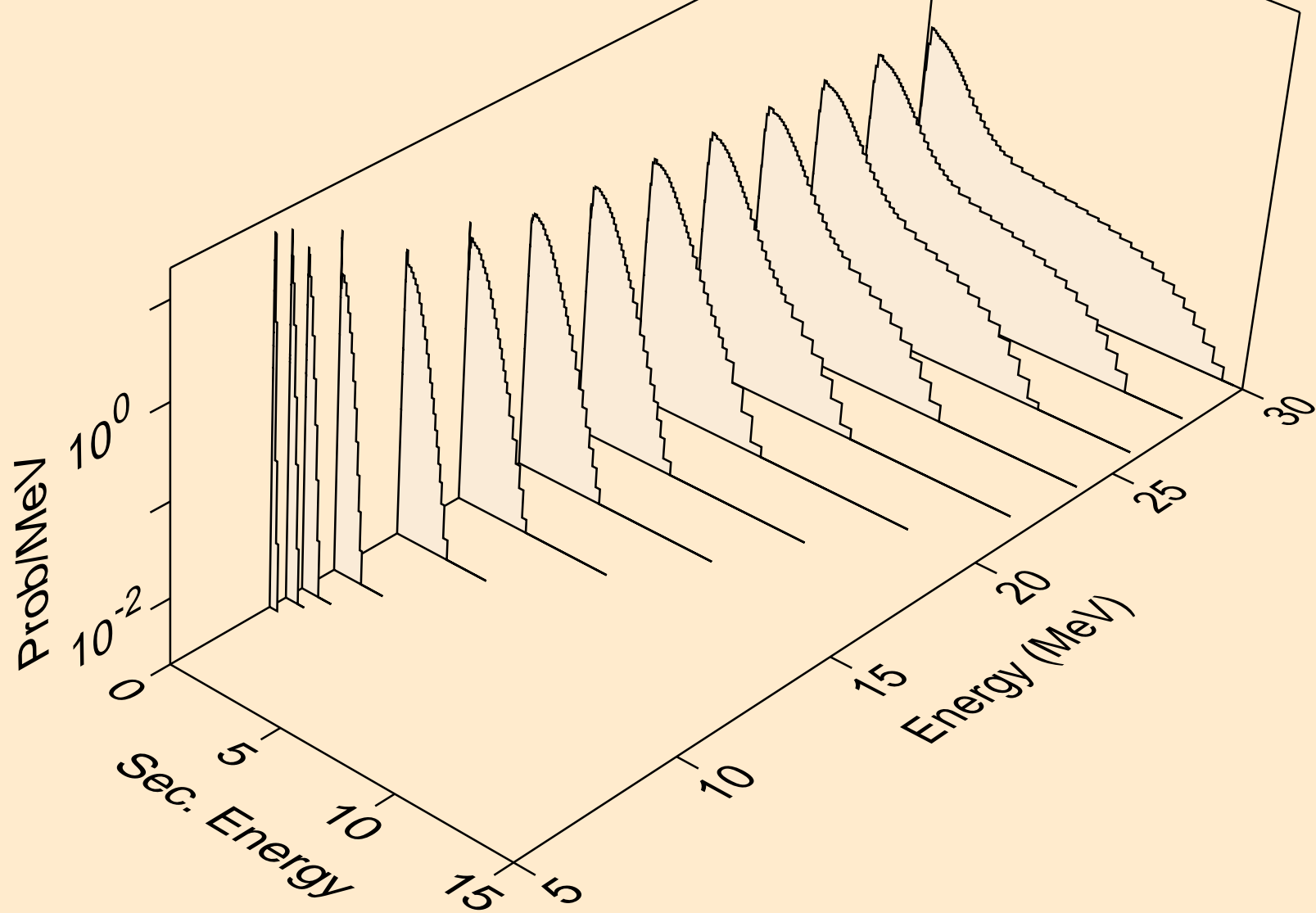

SB124N NEUTRON ACER TENDL-2024 LIBRARY; T=0.K  
Neutron emission for (n,n\*)d

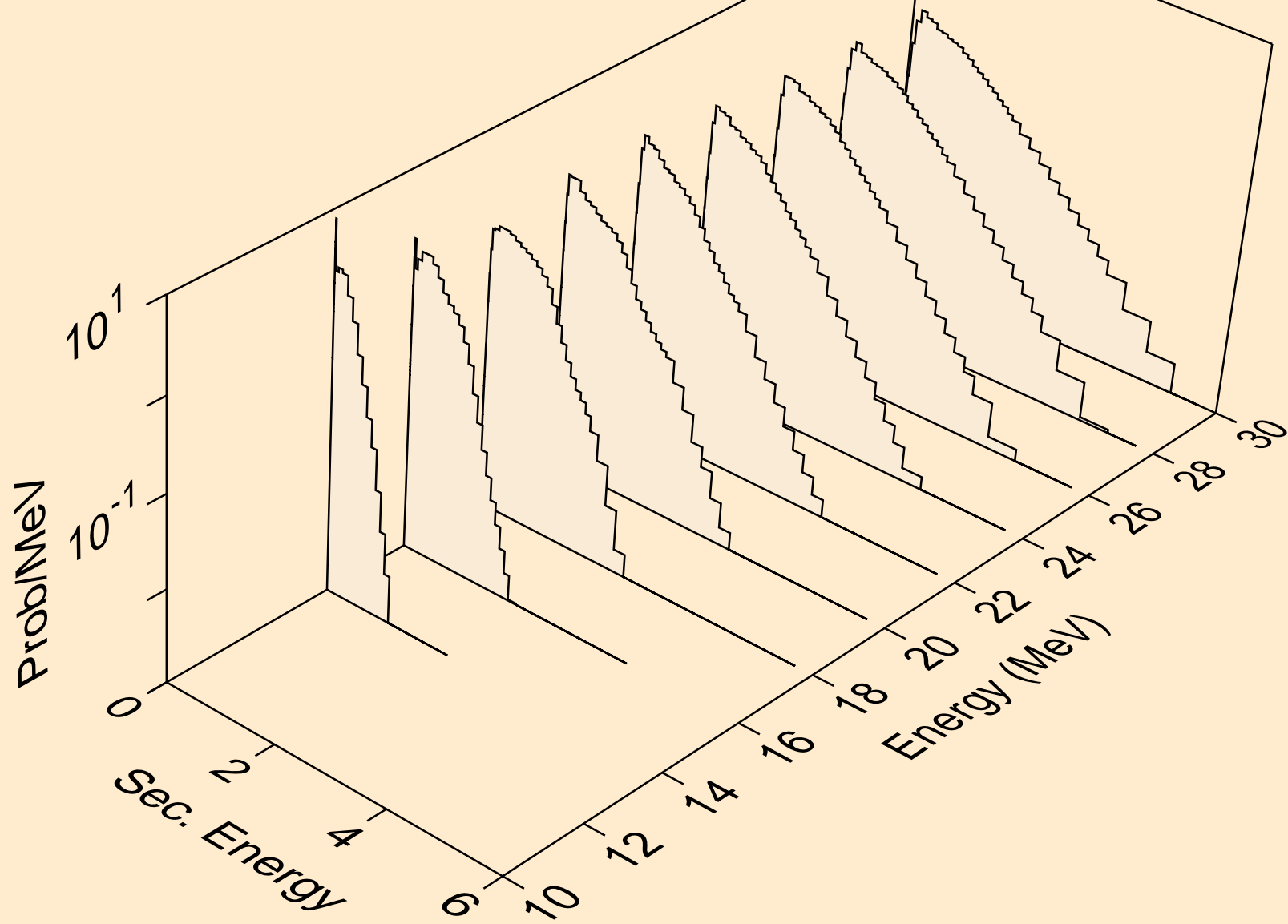

SB124N NEUTRON ACER TENDL-2024 LIBRARY; T=0.K  
Neutron emission for (n,n\*)t

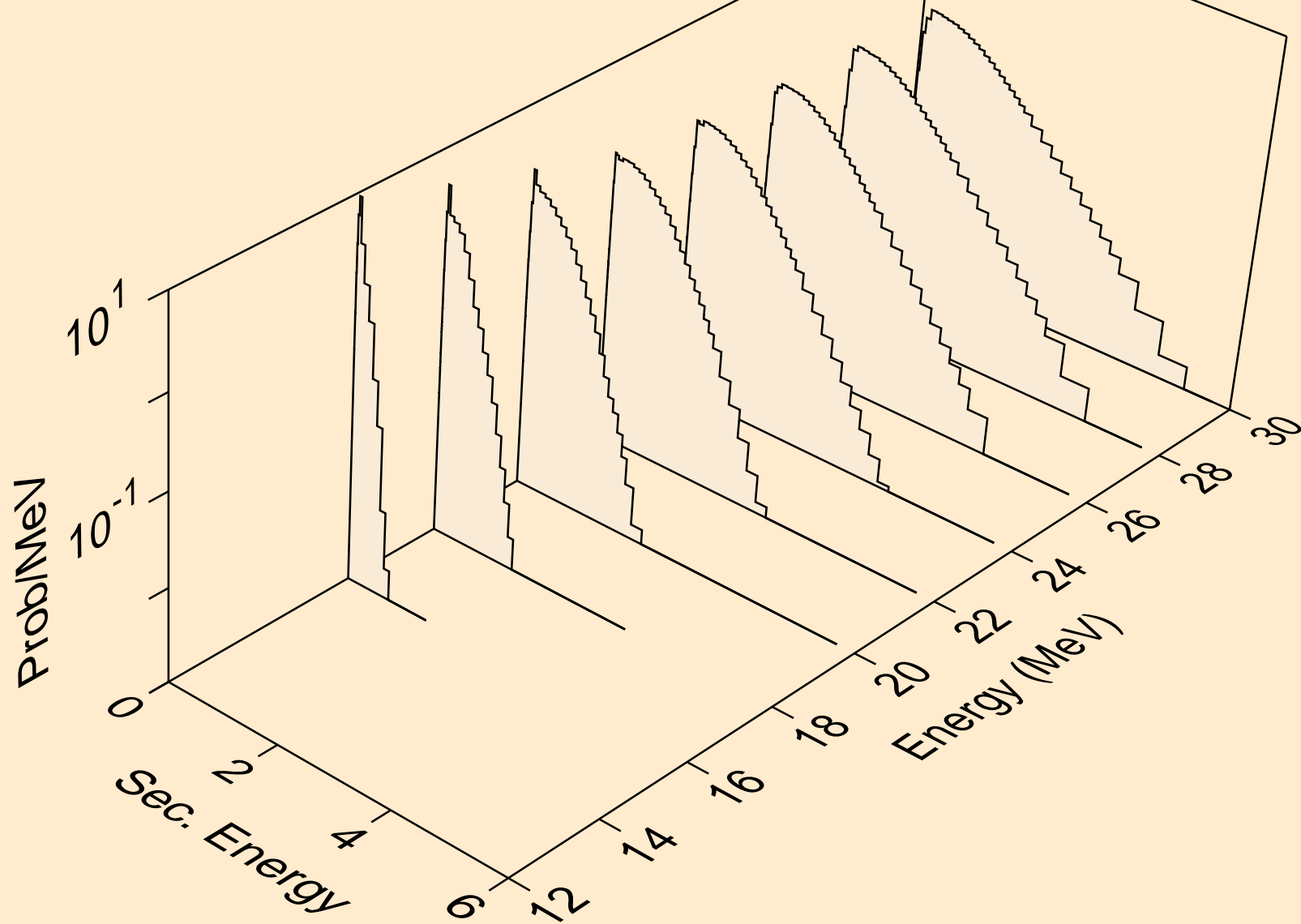

SB124N NEUTRON ACER TENDL-2024 LIBRARY; T=0.K  
Neutron emission for (n,n\*)he3

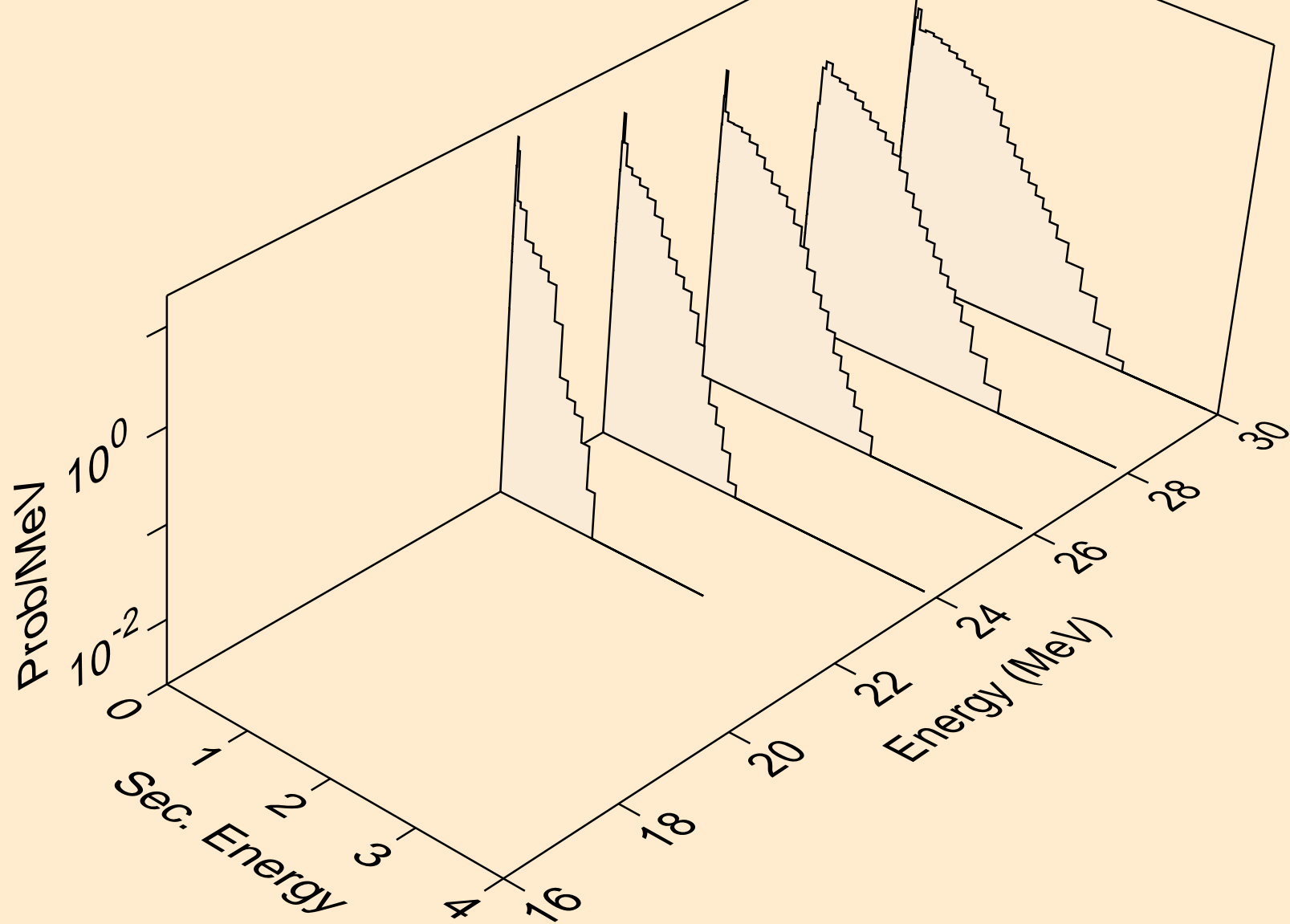



SB124N NEUTRON ACER TENDL-2024 LIBRARY; T=0.K  
Neutron emission for (n,4n)

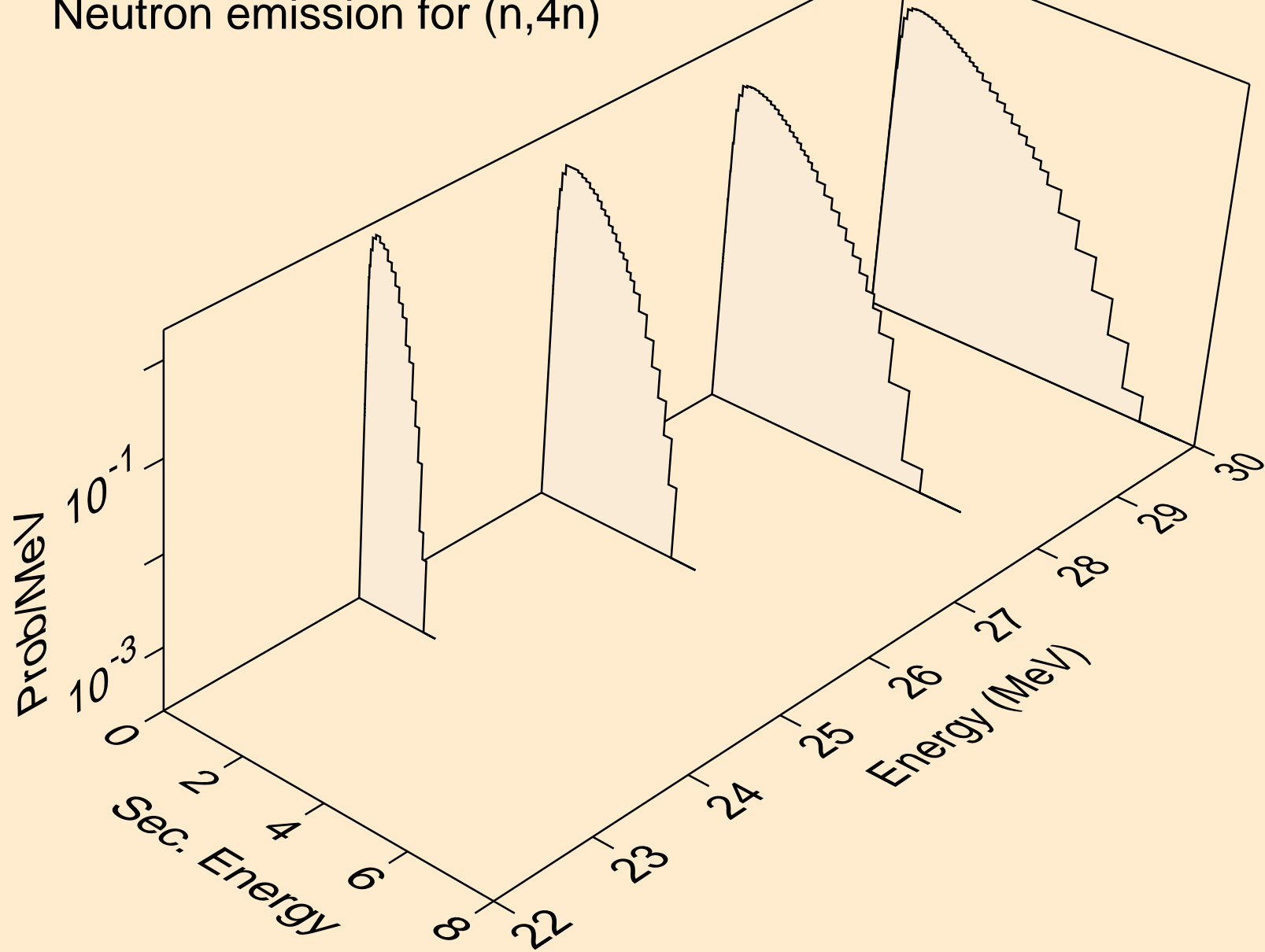

SB124N NEUTRON ACER TENDL-2024 LIBRARY; T=0.K  
Neutron emission for (n,2np)

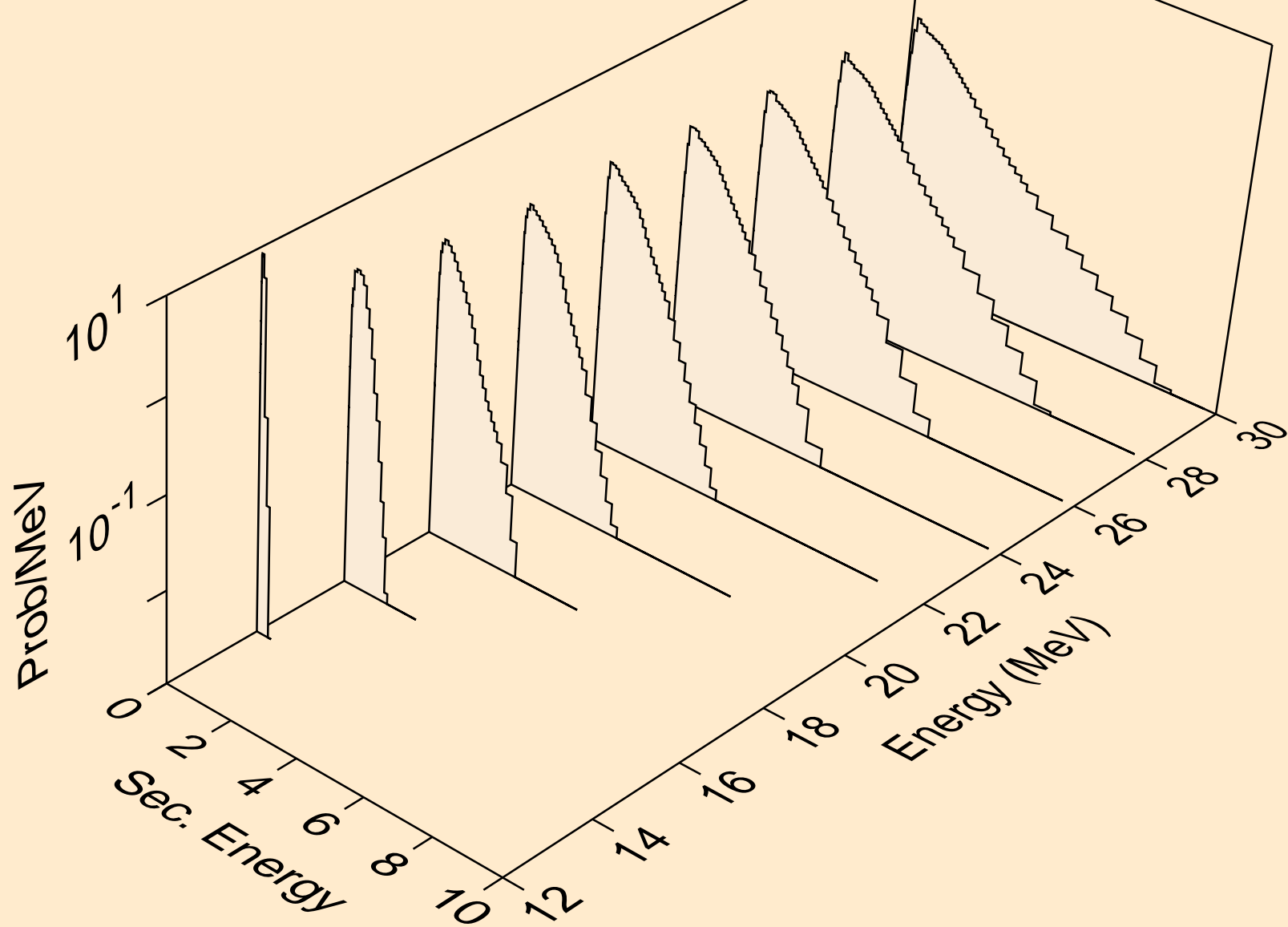

SB124N NEUTRON ACER TENDL-2024 LIBRARY; T=0.K  
Neutron emission for (n,3np)

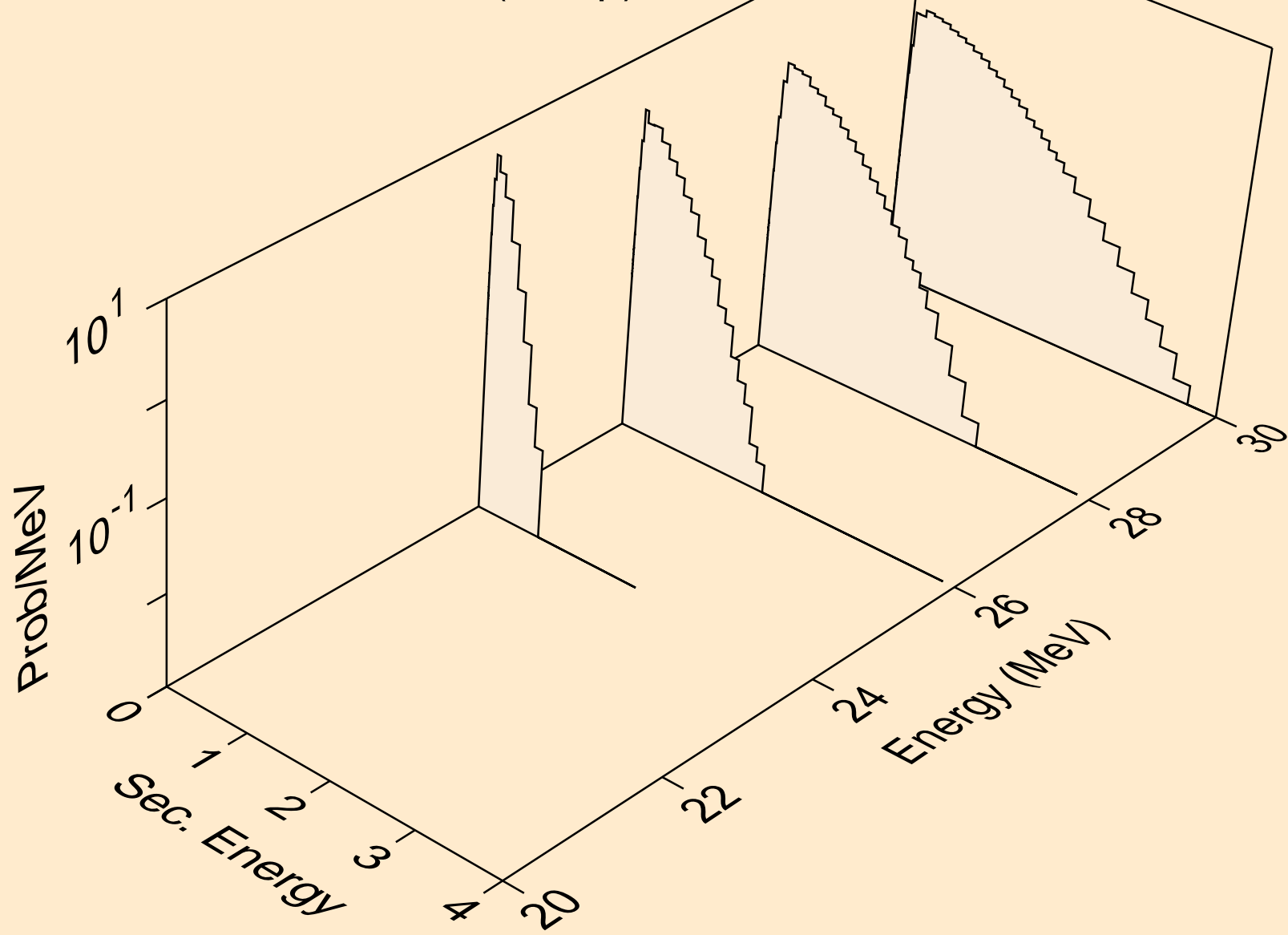

SB124N NEUTRON ACER TENDL-2024 LIBRARY; T=0.K  
Neutron emission for (n,n2p)

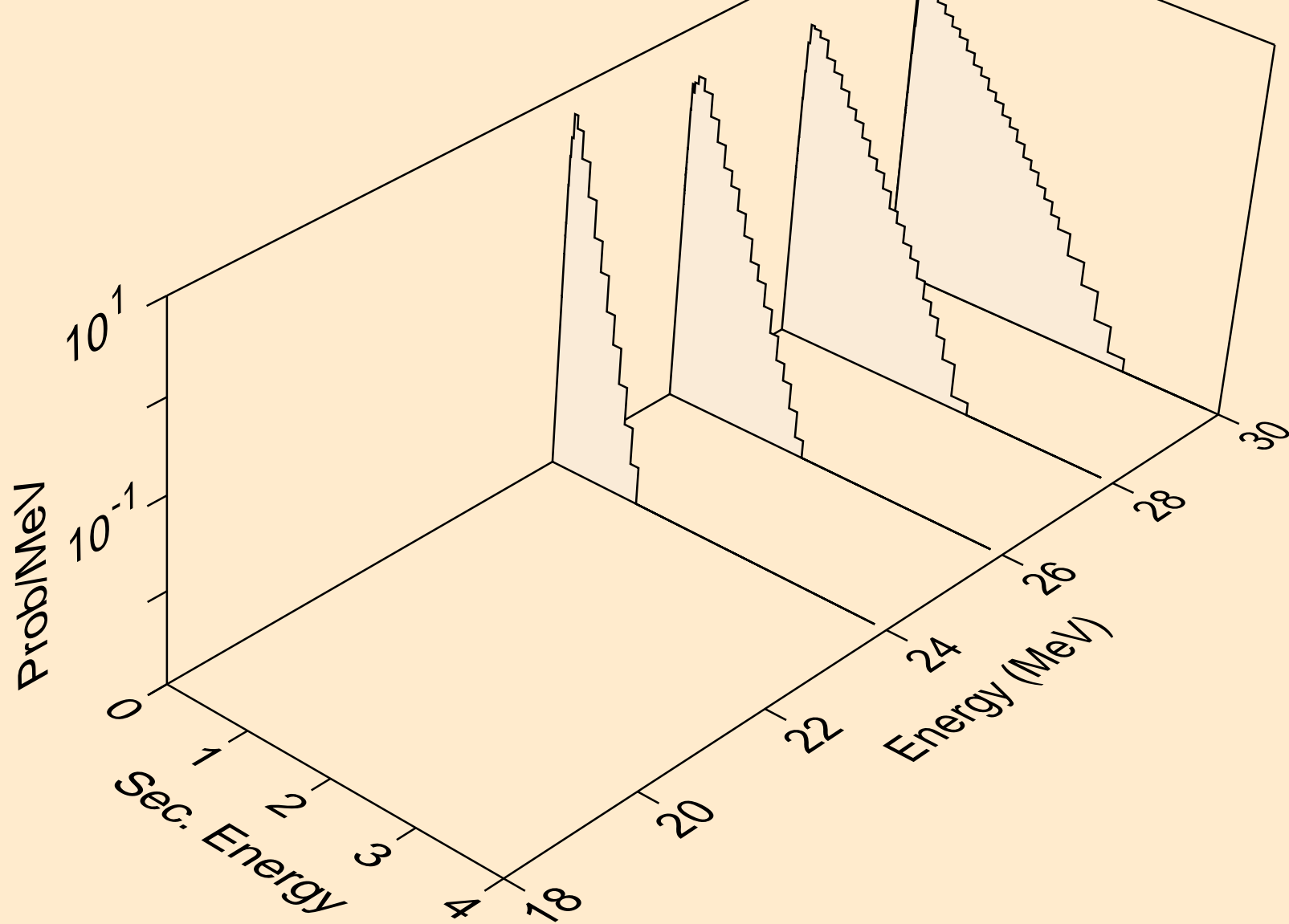

SB124N NEUTRON ACER TENDL-2024 LIBRARY; T=0.K  
Neutron emission for (n,npa)

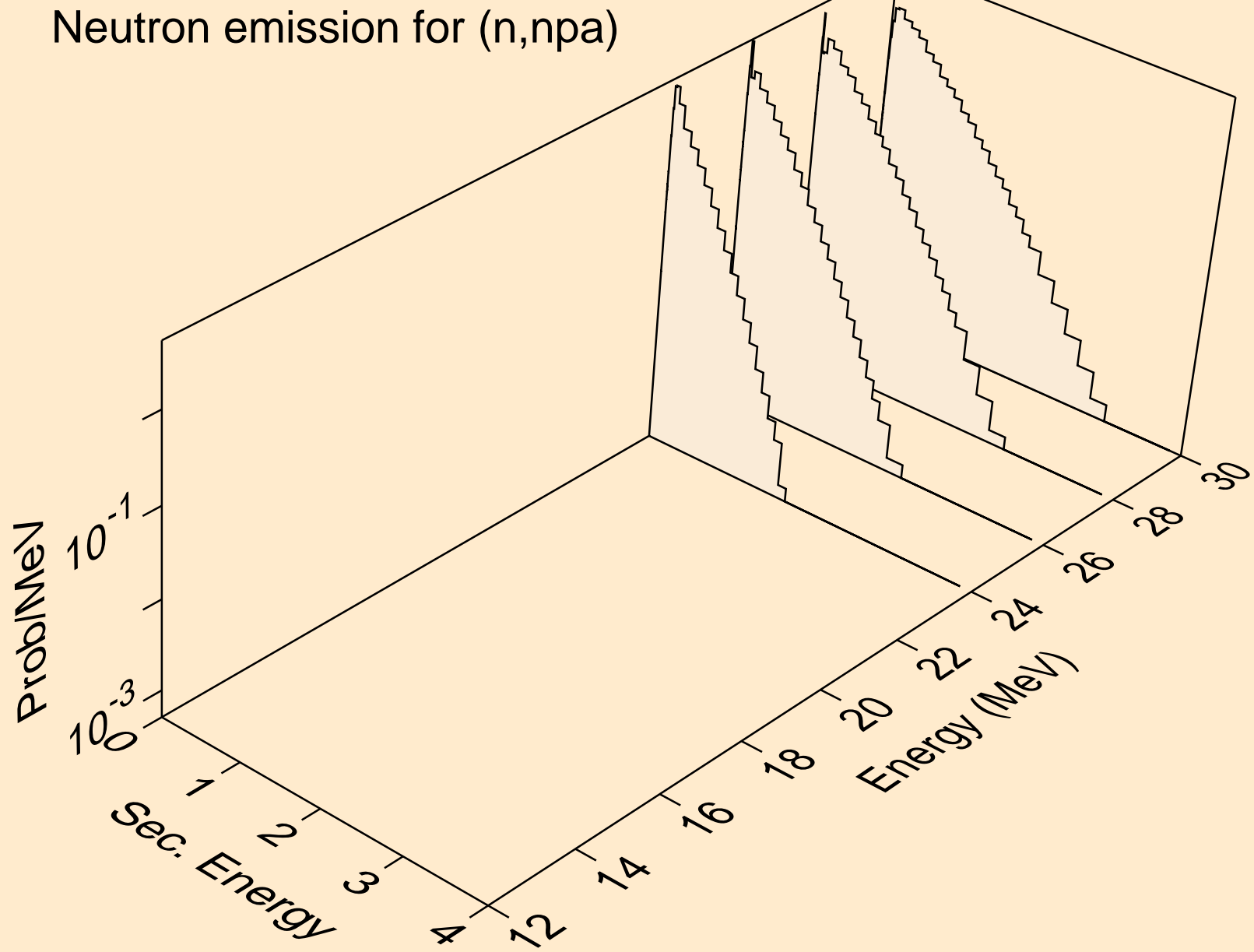

SB124N NEUTRON ACER TENDL-2024 LIBRARY; T=0.K  
Neutron emission for (n,n\*c)

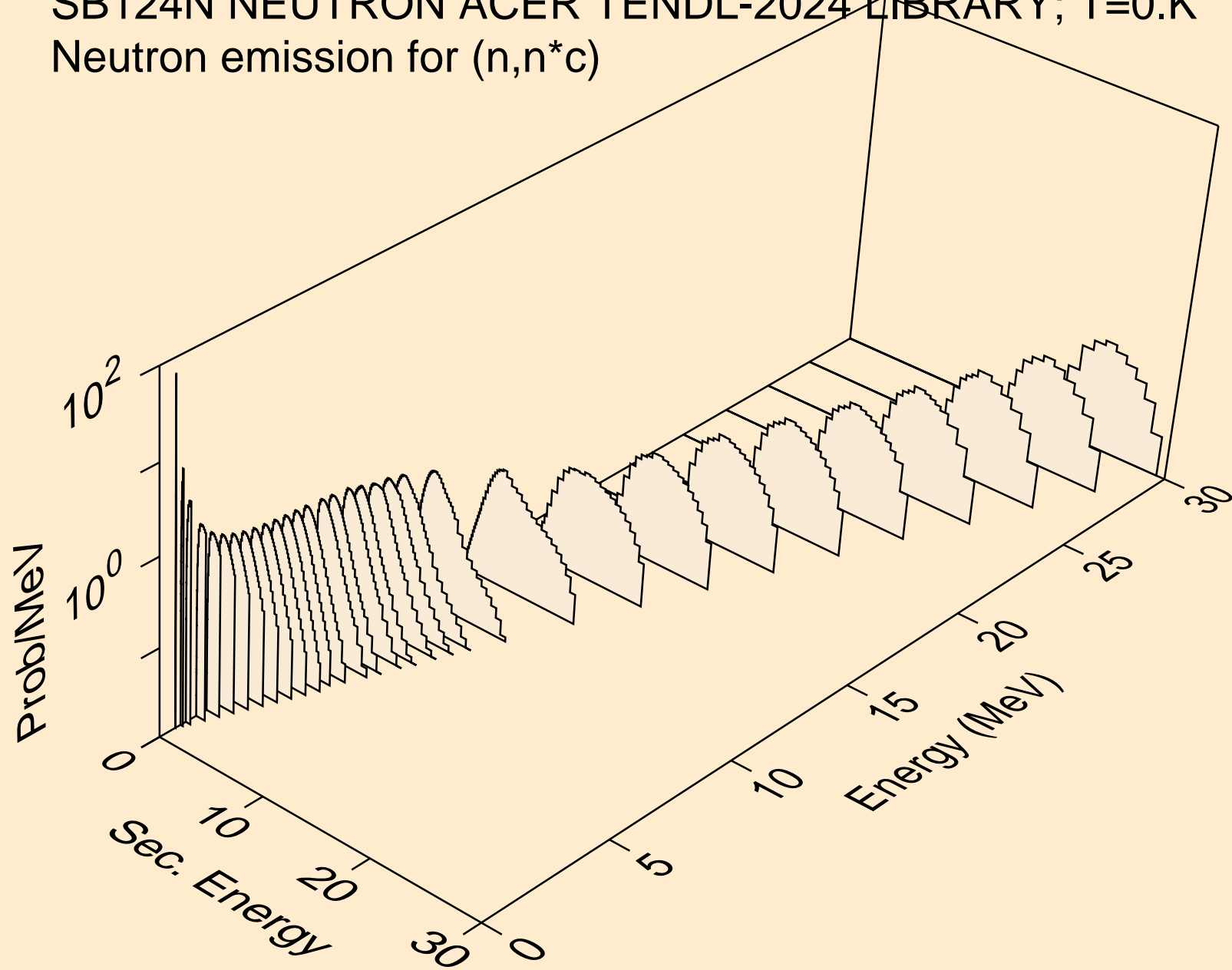

SB124N NEUTRON ACER TENDL-2024 LIBRARY; T=0.K  
Photon emission for (n,x)

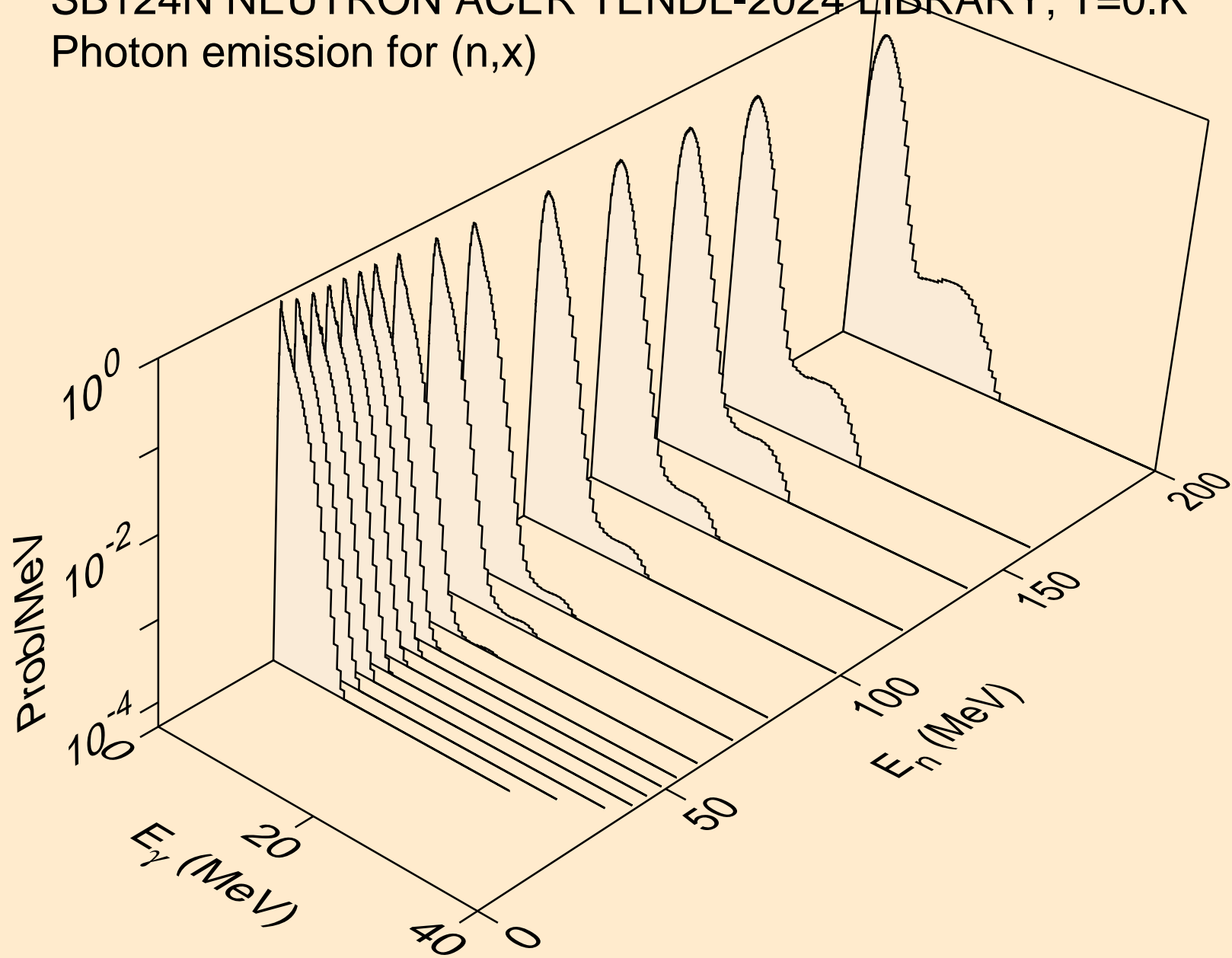

SB124N NEUTRON ACER TENDL-2024 LIBRARY; T=0.K  
Photon emission for (n,2nd)

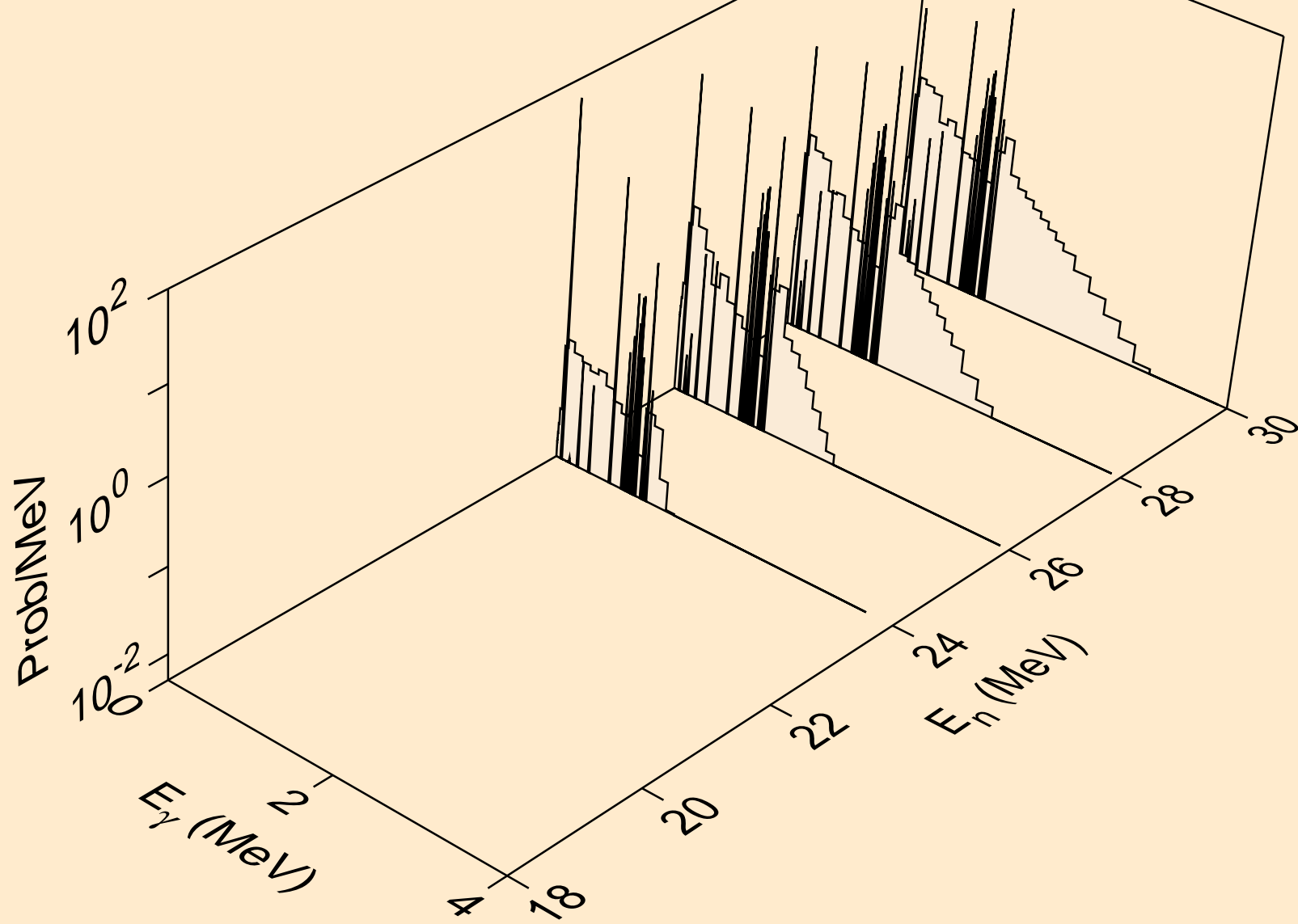



SB124N NEUTRON ACER TENDL-2024 LIBRARY; T=0.K  
Photon emission for (n,2n)

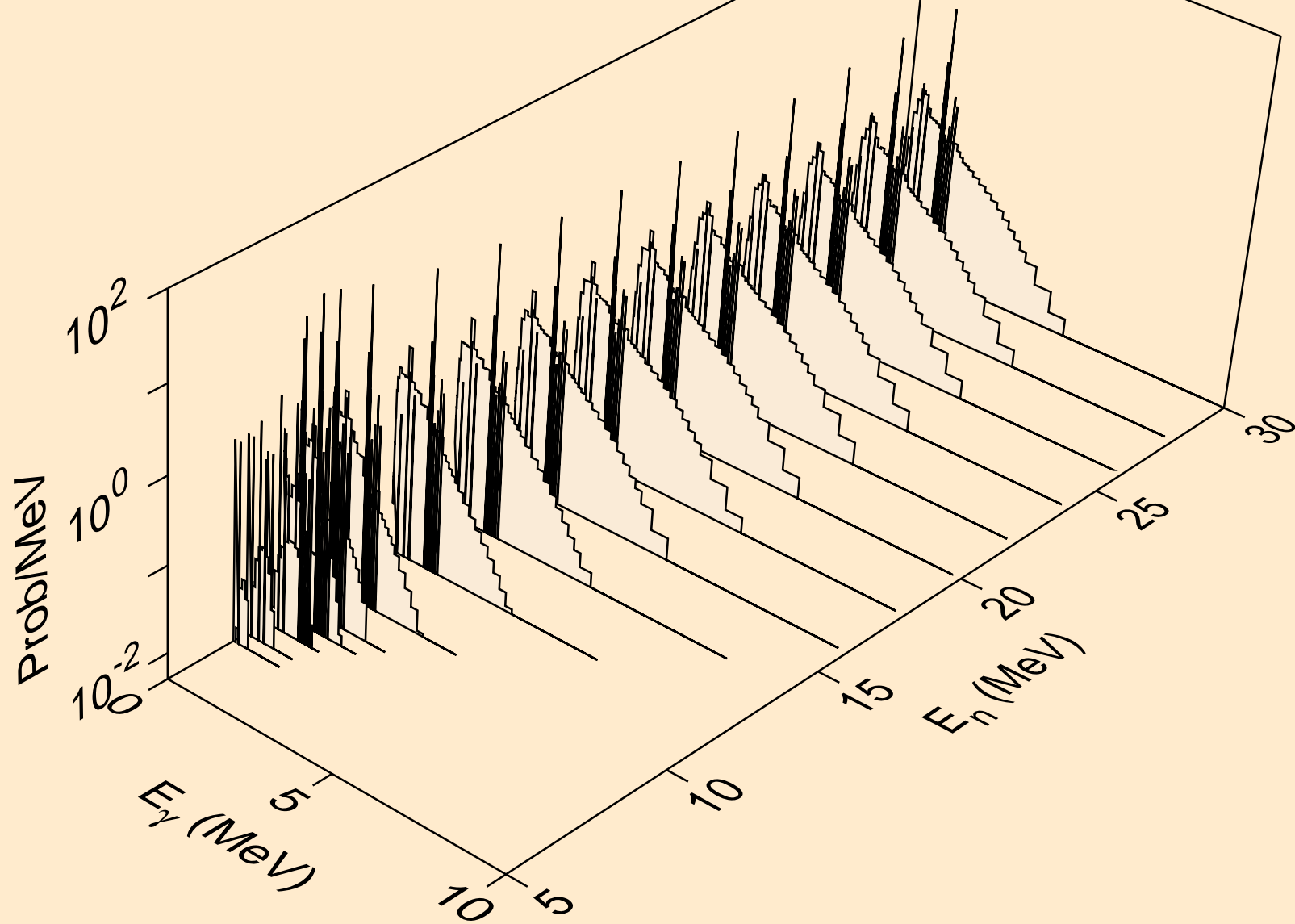

SB124N NEUTRON ACER TENDL-2024 LIBRARY; T=0.K  
Photon emission for (n,3n)

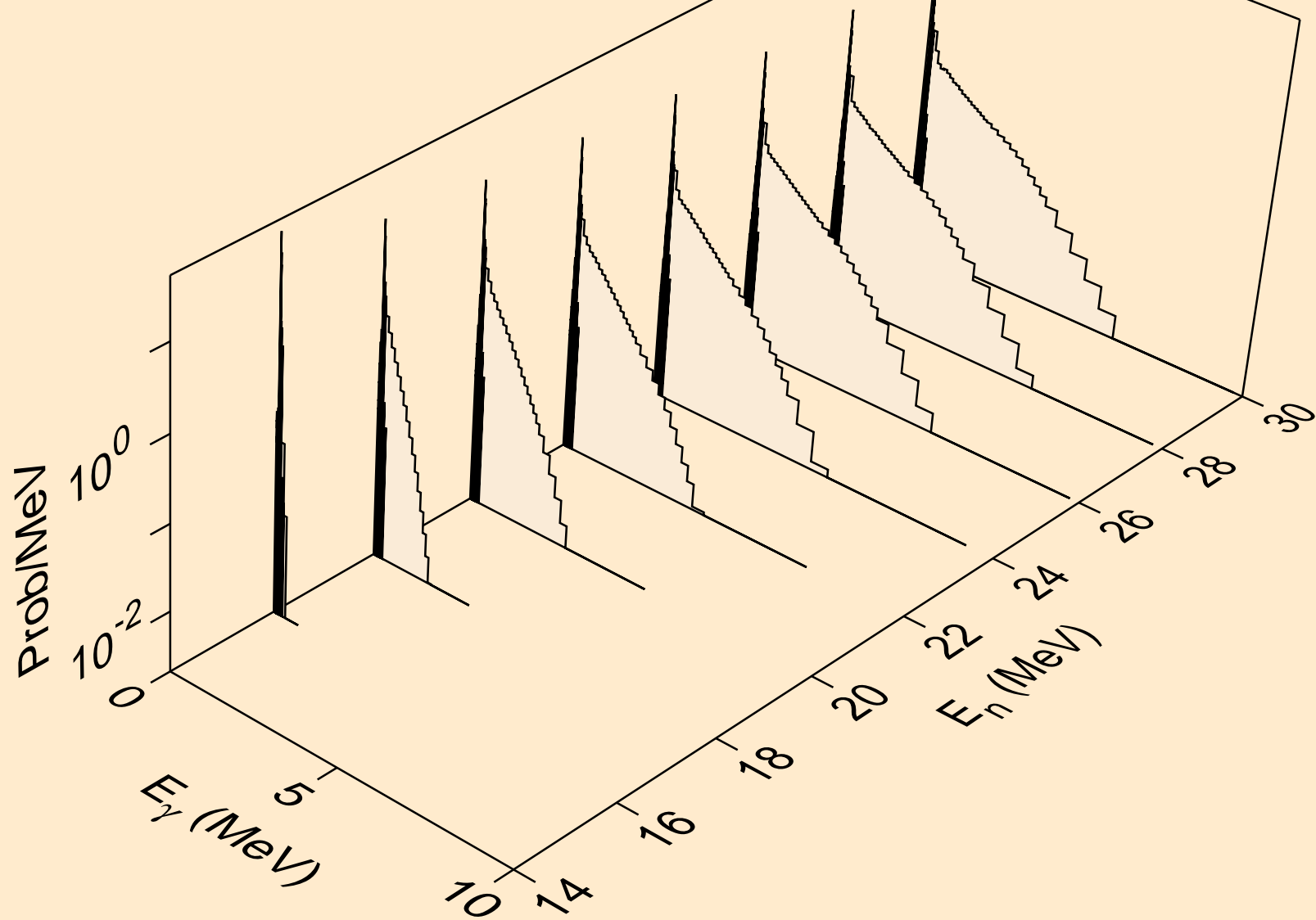

SB124N NEUTRON ACER TENDL-2024 LIBRARY; T=0.K  
Photon emission for (n,n\*)a

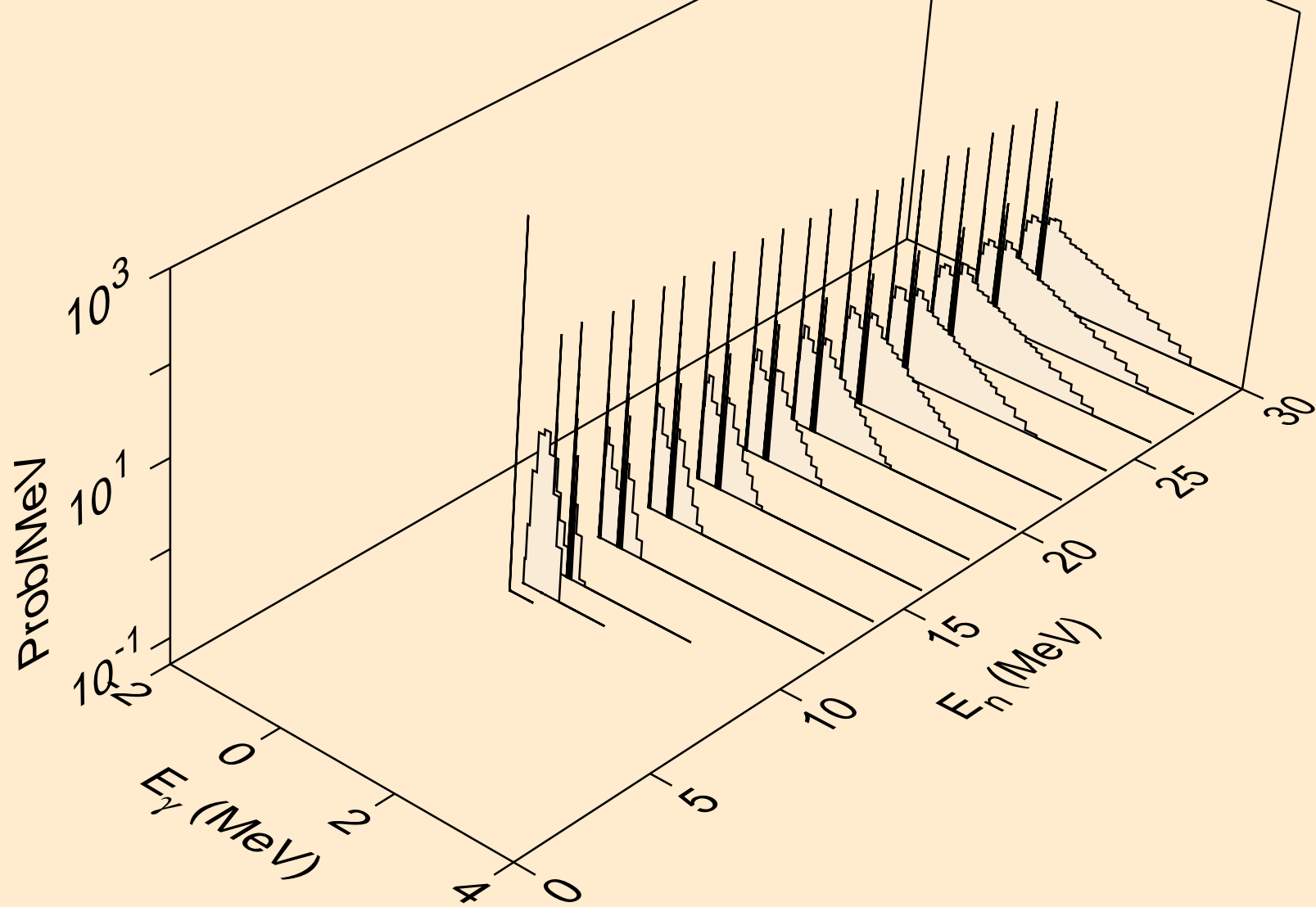

SB124N NEUTRON ACER TENDL-2024 LIBRARY; T=0.K  
Photon emission for (n,2n)a

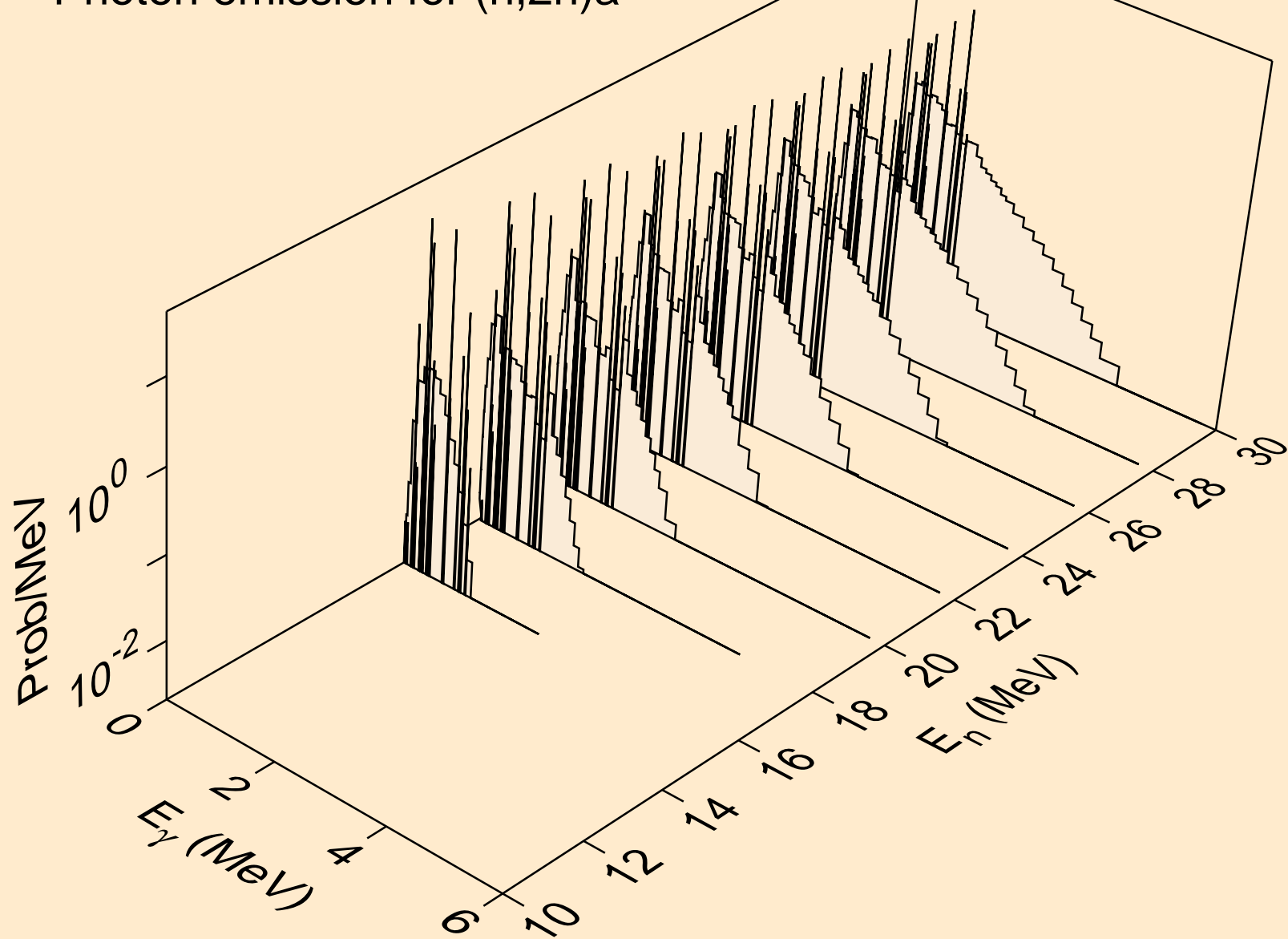

SB124N NEUTRON ACER TENDL-2024 LIBRARY; T=0.K  
Photon emission for (n,3n)a

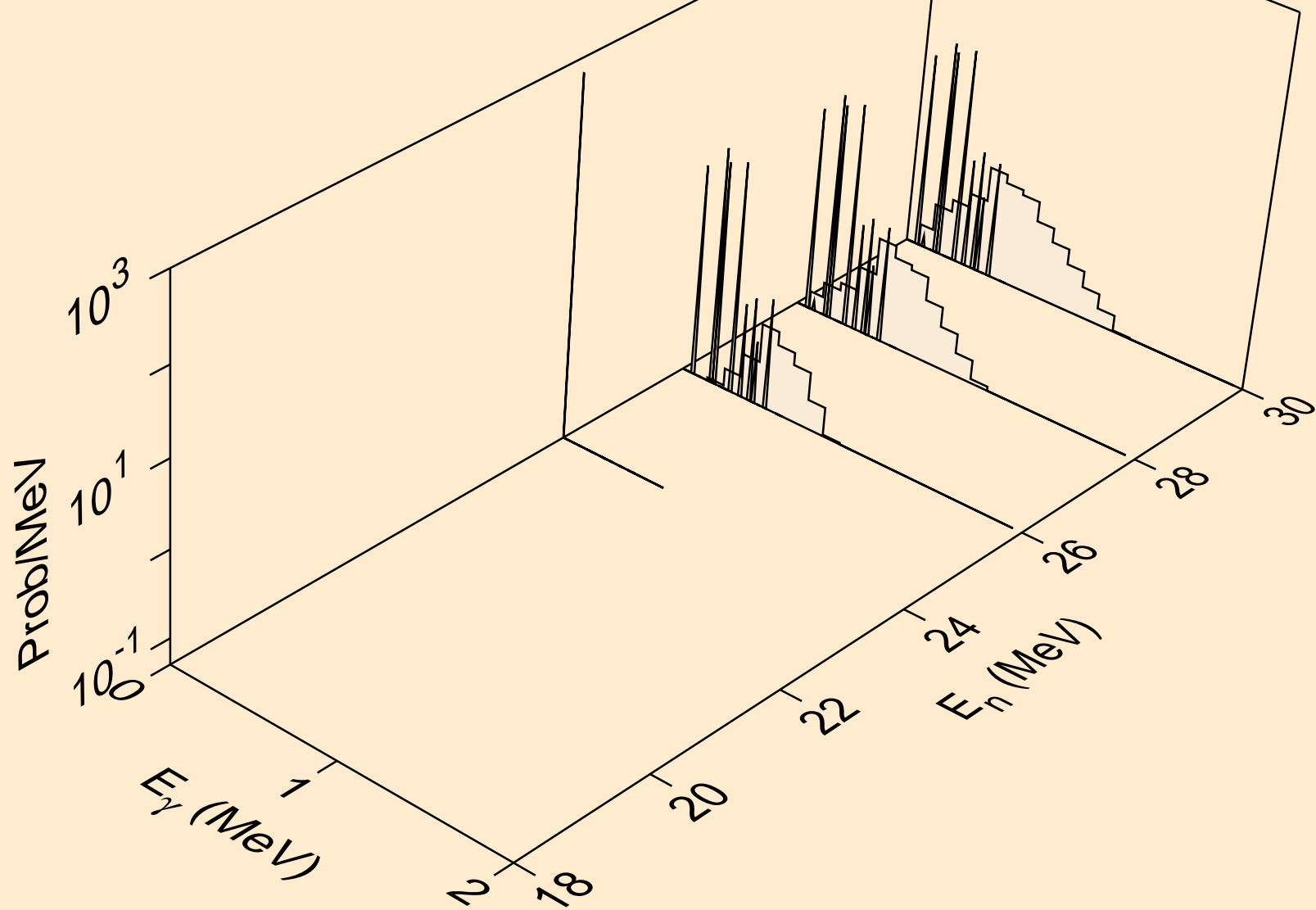

SB124N NEUTRON ACER TENDL-2024 LIBRARY; T=0.K  
Photon emission for (n,n\*)p

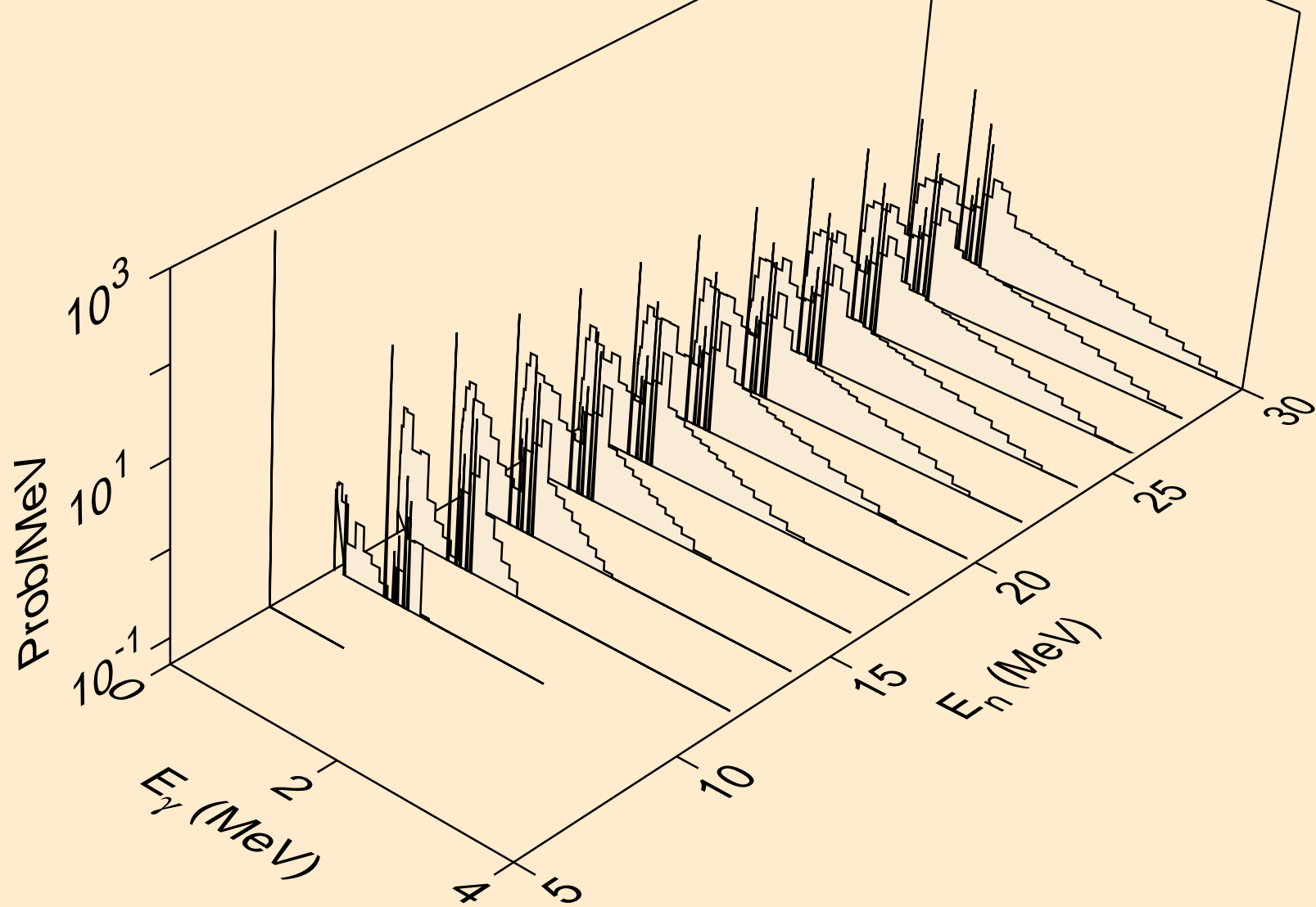

SB124N NEUTRON ACER TENDL-2024 LIBRARY; T=0.K  
Photon emission for (n,n\*)d

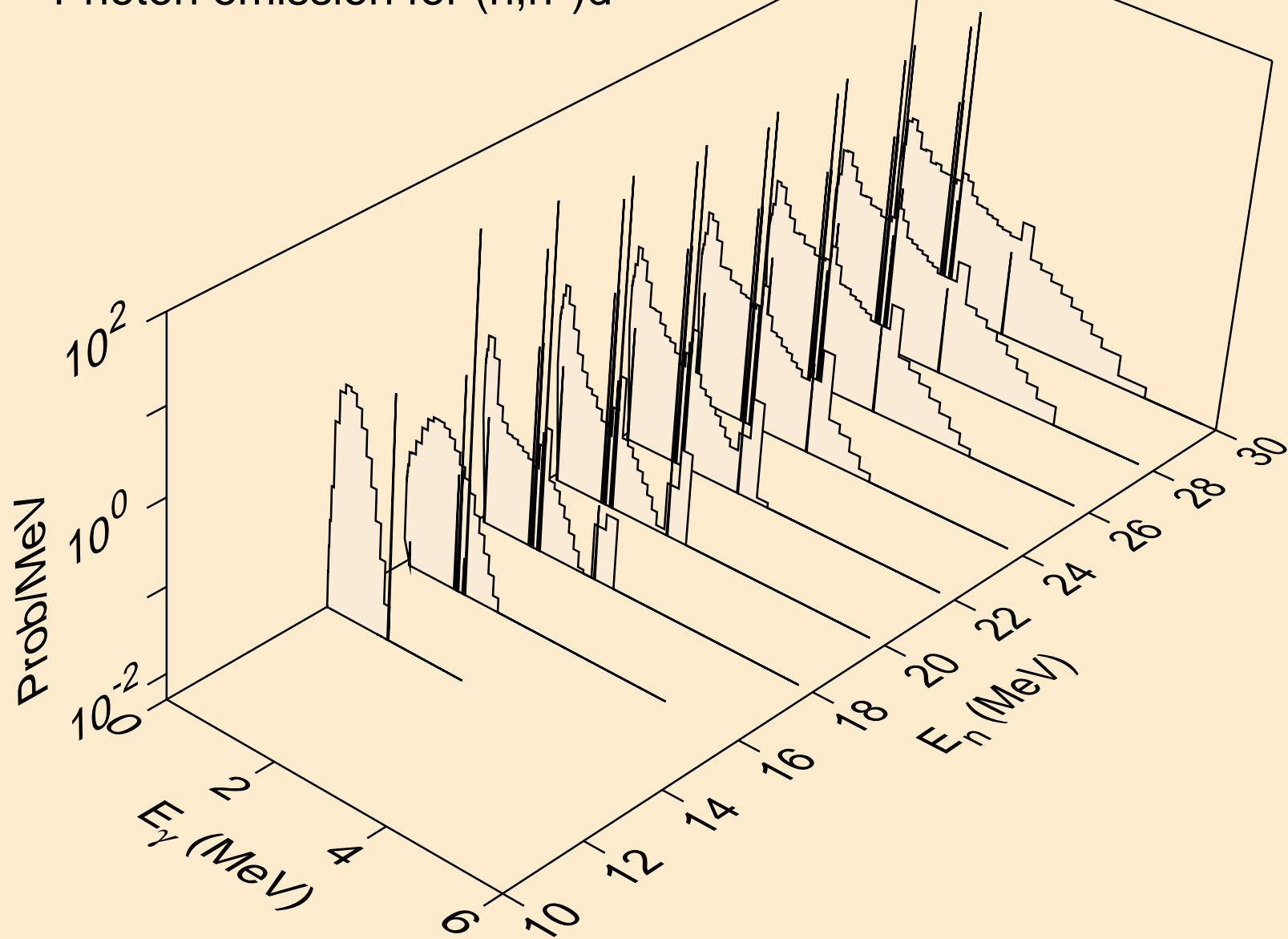

SB124N NEUTRON ACER TENDL-2024 LIBRARY; T=0.K  
Photon emission for (n,n\*)t

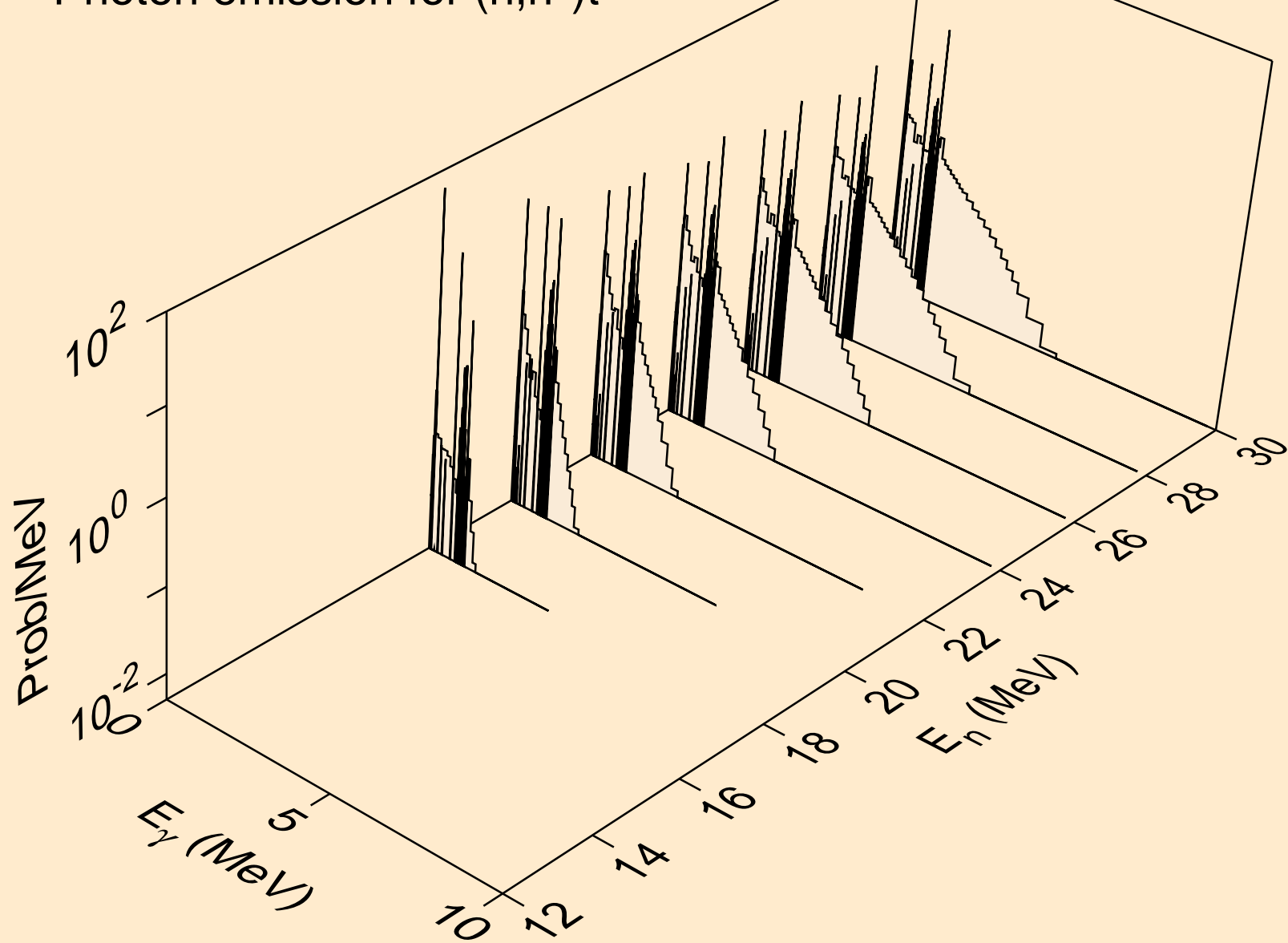



SB124N NEUTRON ACER TENDL-2024 LIBRARY; T=0.K  
Photon emission for (n,n\*)he3

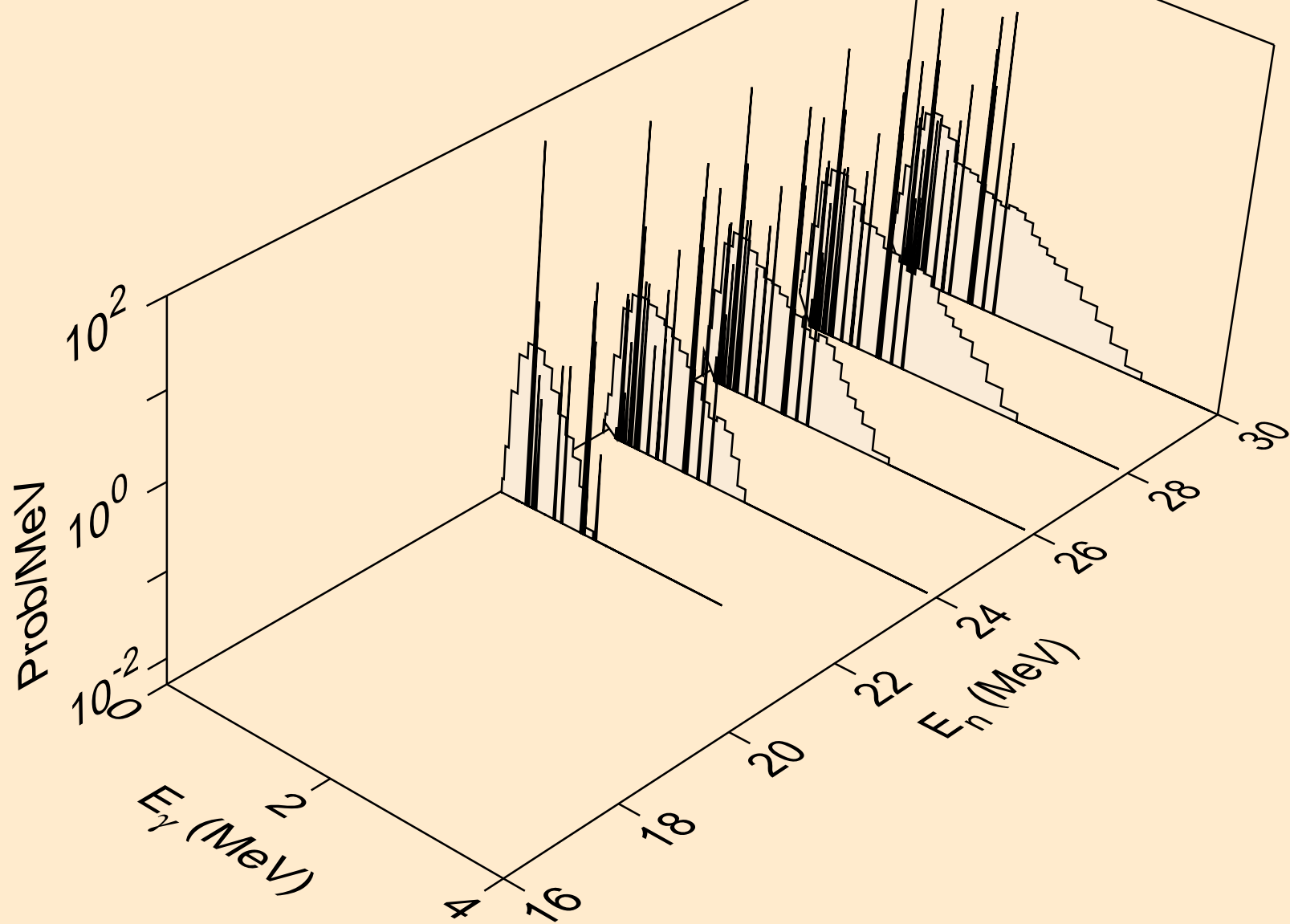

SB124N NEUTRON ACER TENDL-2024 LIBRARY; T=0.K  
Photon emission for (n,4n)

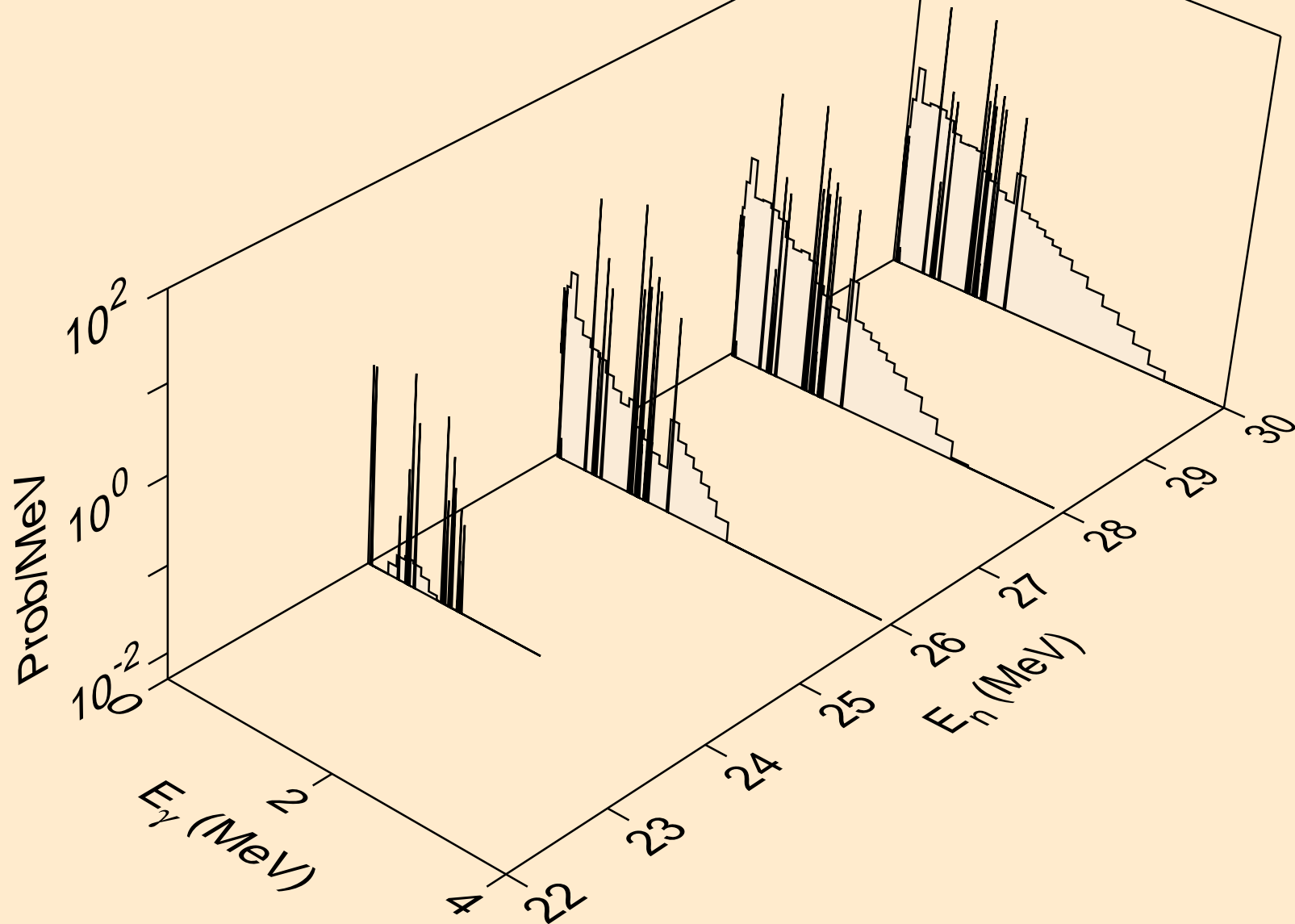

SB124N NEUTRON ACER TENDL-2024 LIBRARY; T=0.K  
Photon emission for (n,2np)

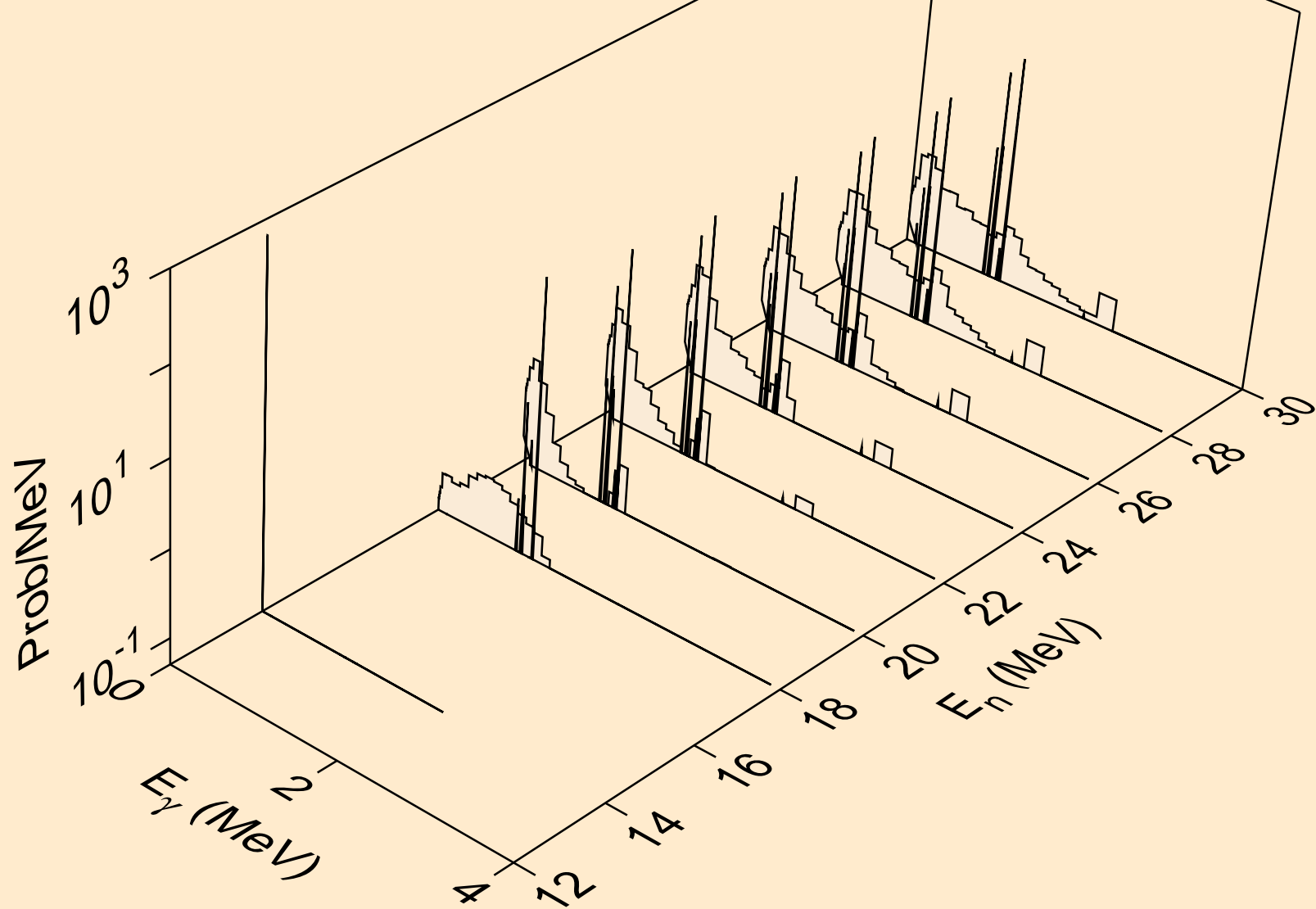

SB124N NEUTRON ACER TENDL-2024 LIBRARY; T=0.K  
Photon emission for (n,3np)

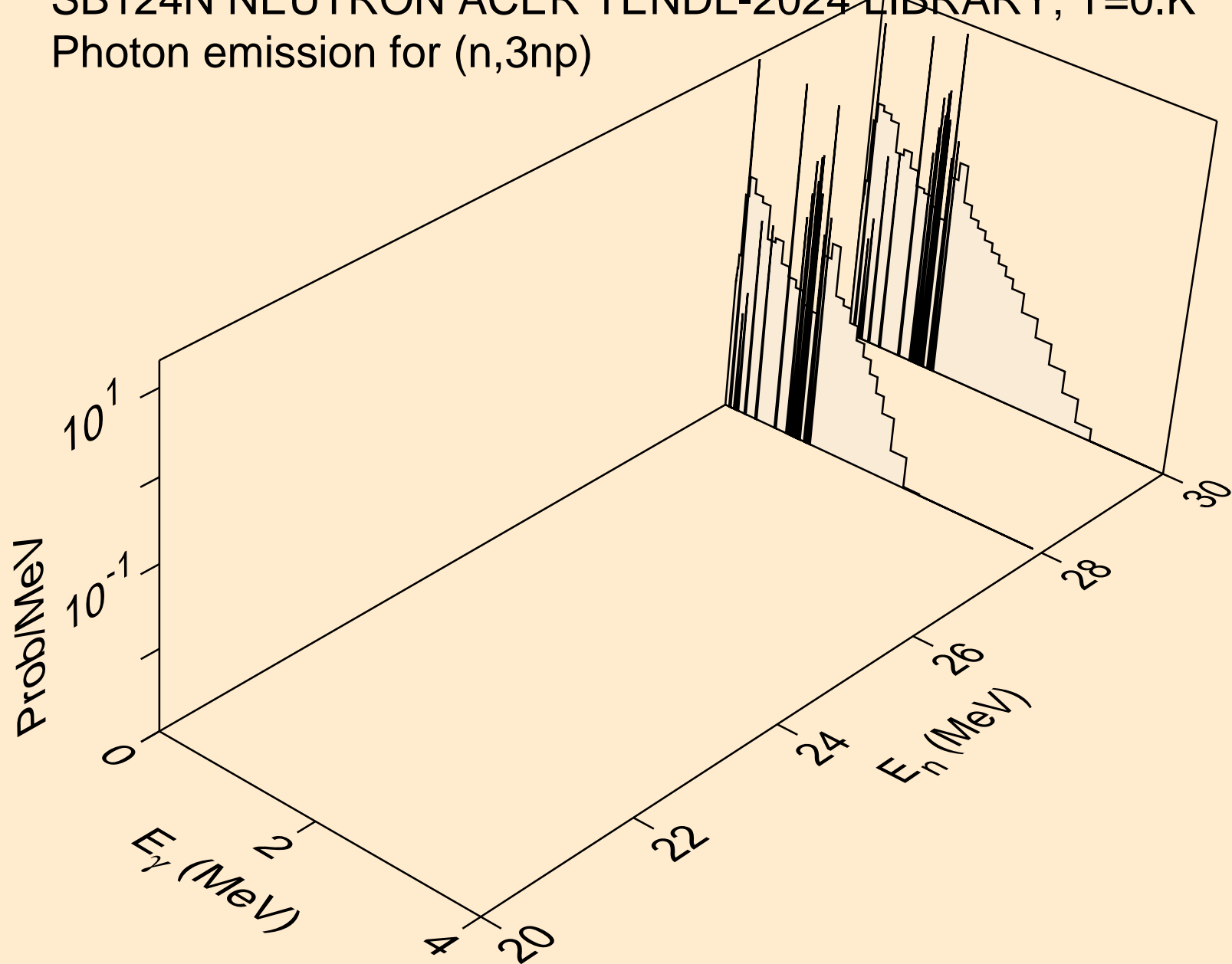

SB124N NEUTRON ACER TENDL-2024 LIBRARY; T=0.K  
Photon emission for (n,n2p)

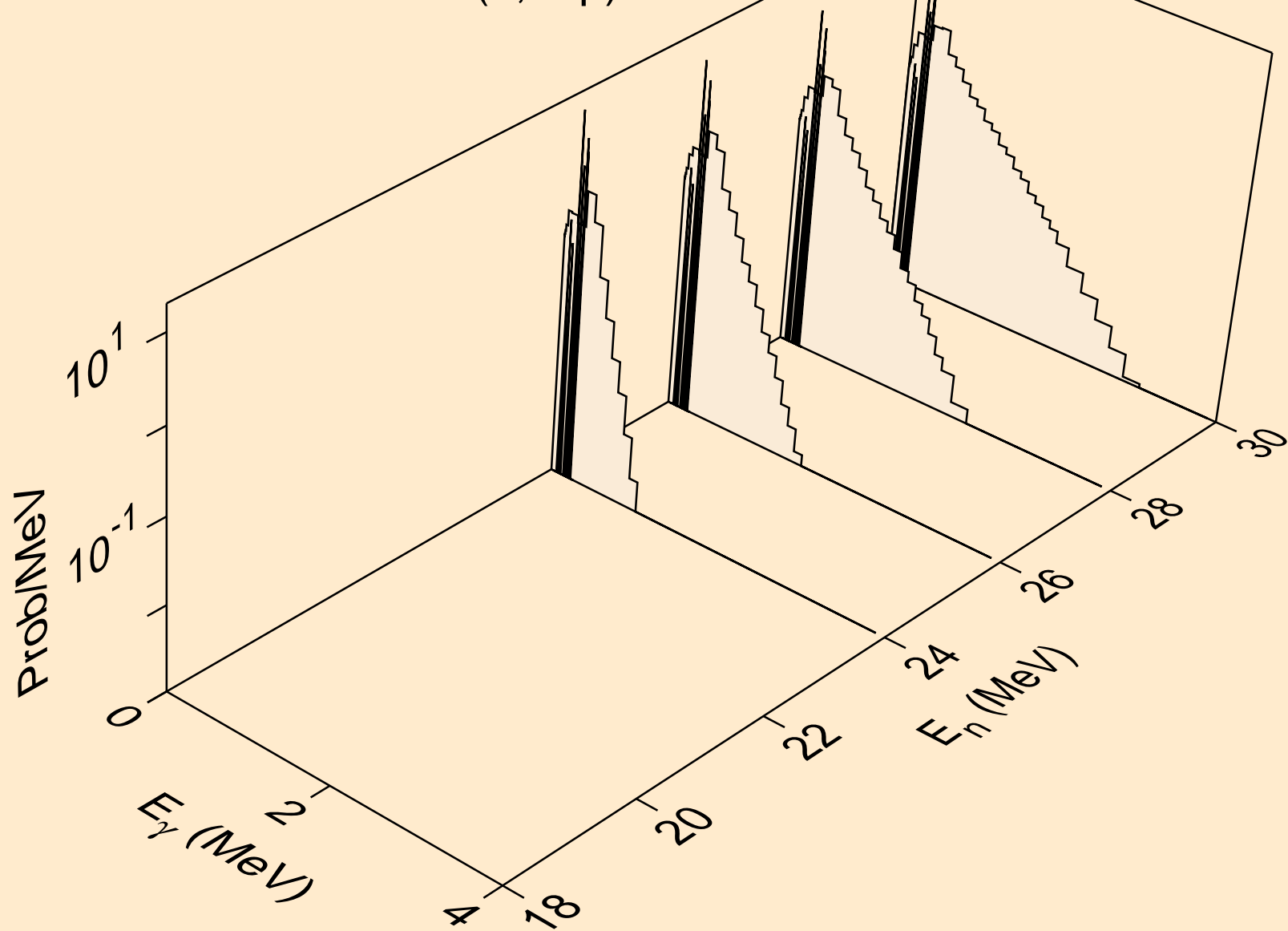

SB124N NEUTRON ACER TENDL-2024 LIBRARY; T=0.K  
Photon emission for (n,npa)

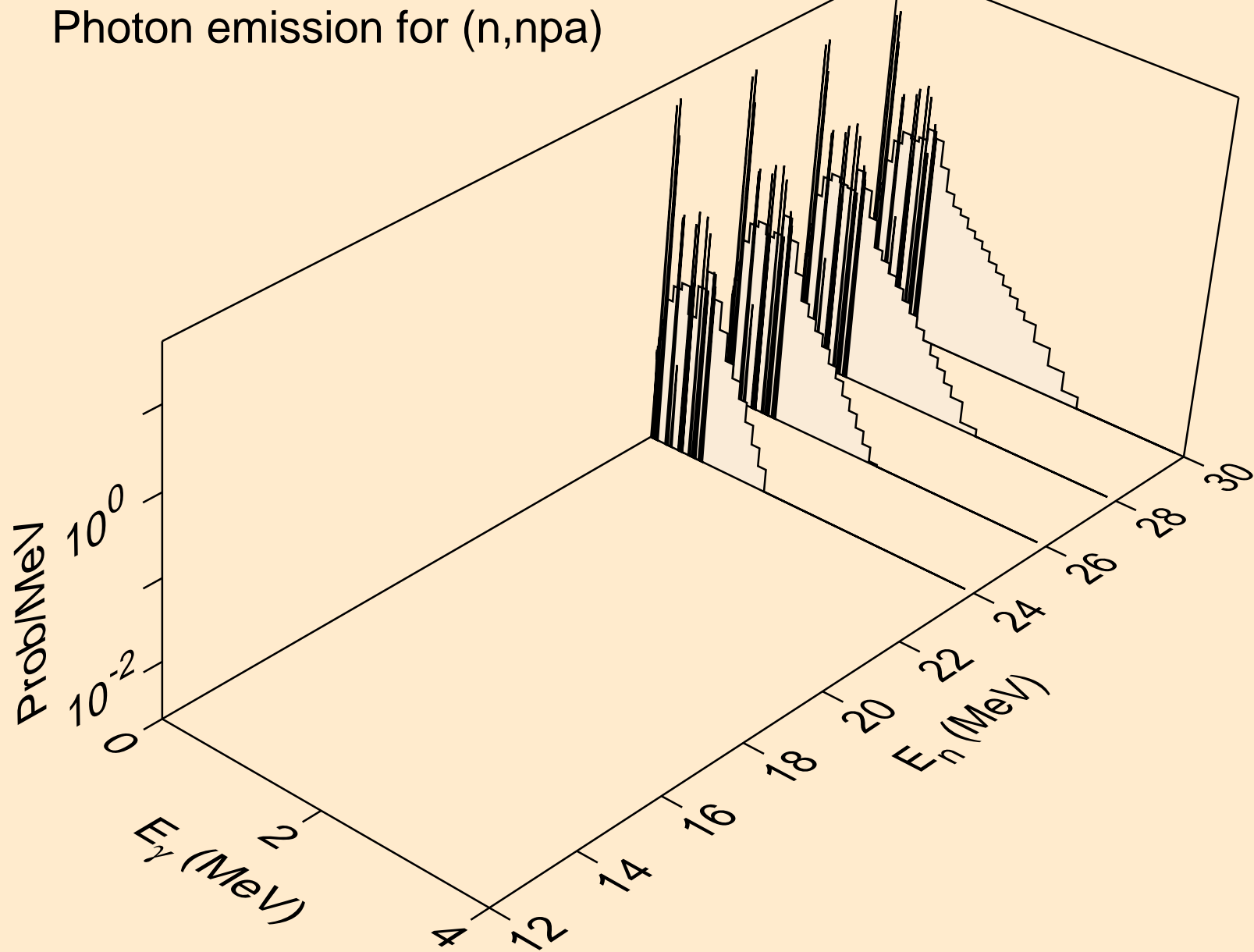

SB124N NEUTRON ACER TENDL-2024 LIBRARY; T=0.K  
Photon emission for (n,n\*3)

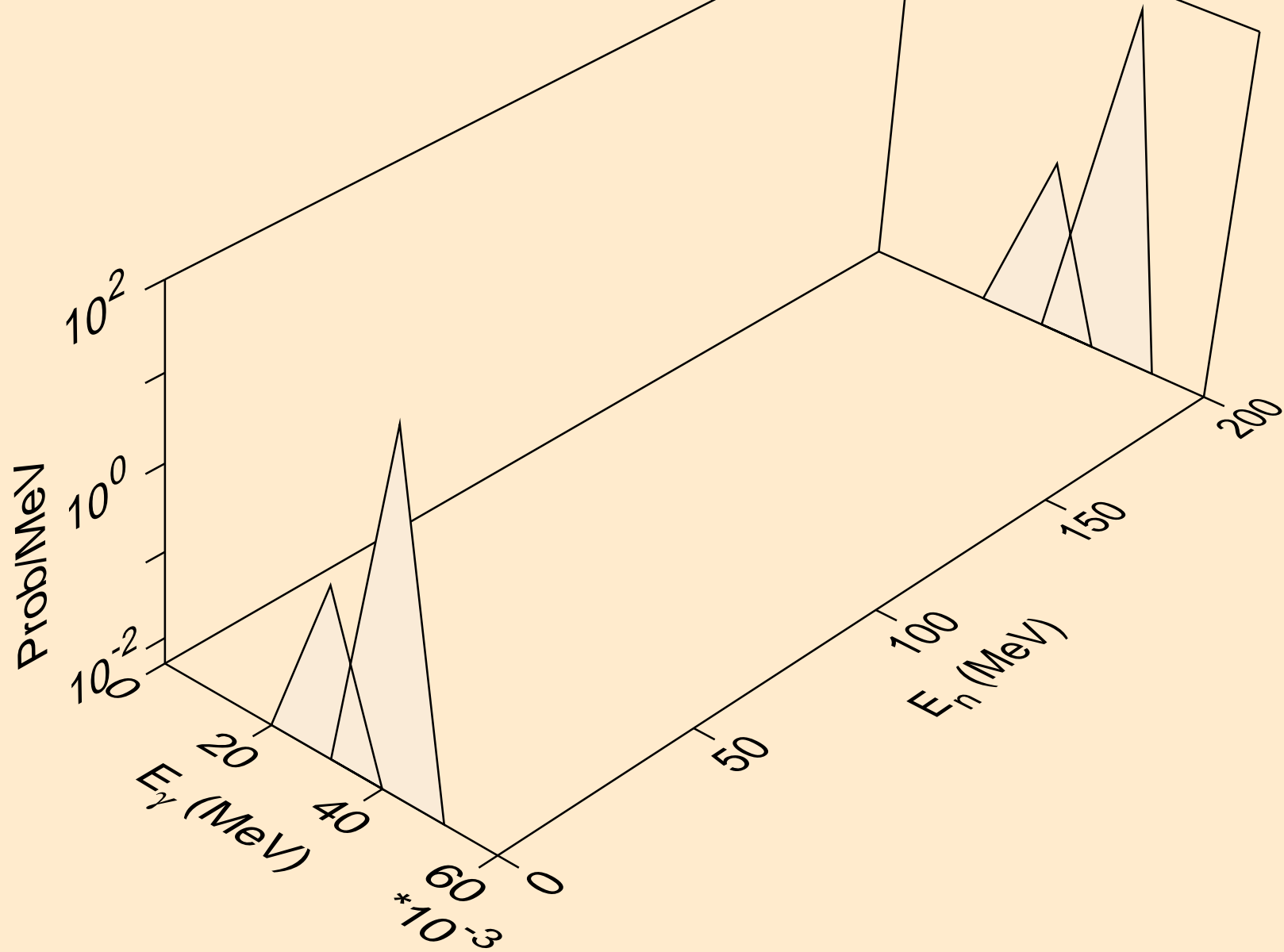

SB124N NEUTRON ACER TENDL-2024 LIBRARY; T=0.K  
Photon emission for (n,n\*4)

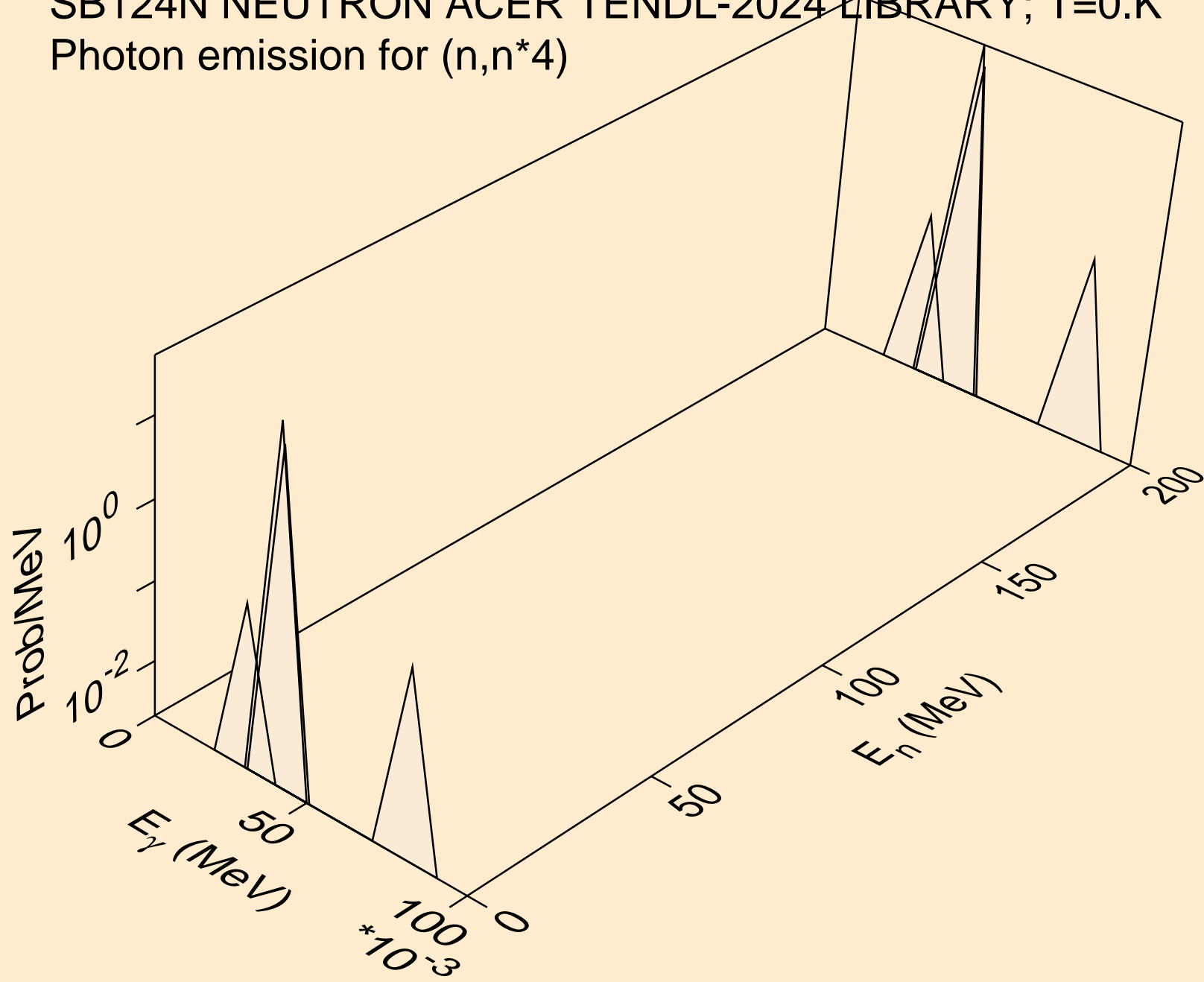



SB124N NEUTRON ACER TENDL-2024 LIBRARY; T=0.K  
Photon emission for (n,n\*5)

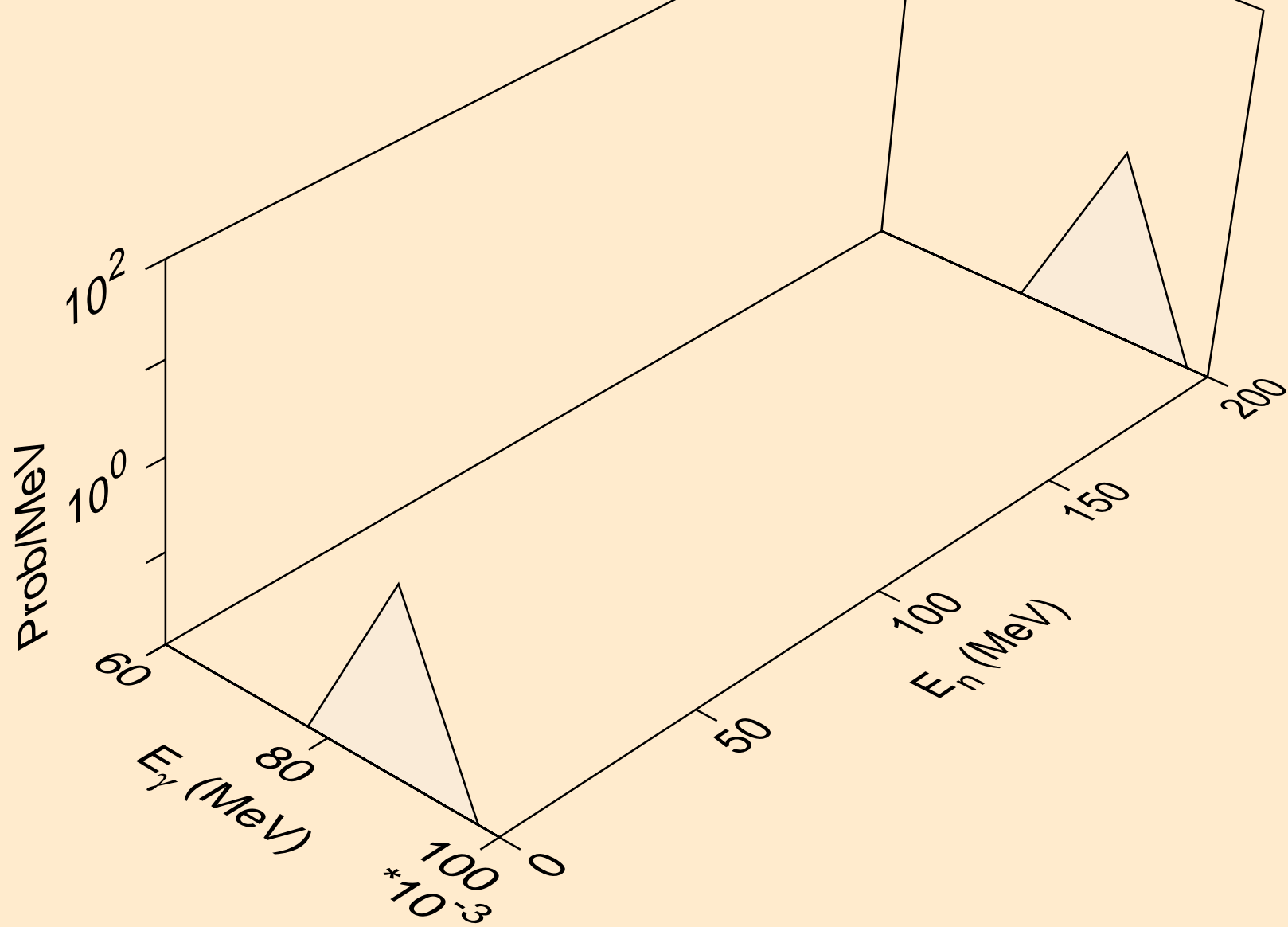

SB124N NEUTRON ACER TENDL-2024 LIBRARY; T=0.K  
Photon emission for (n,n\*6)

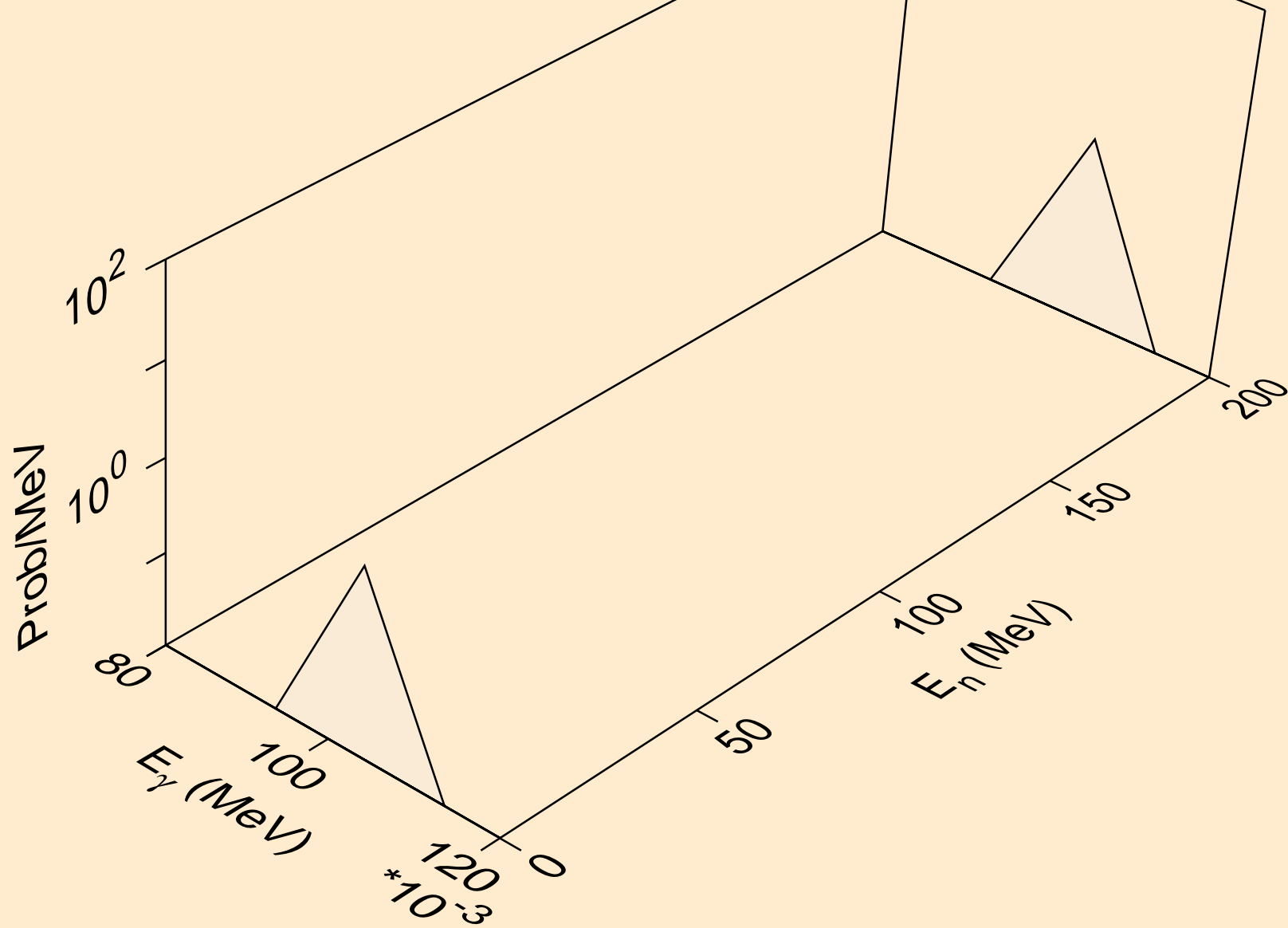

SB124N NEUTRON ACER TENDL-2024 LIBRARY; T=0.K  
Photon emission for (n,n\*7)

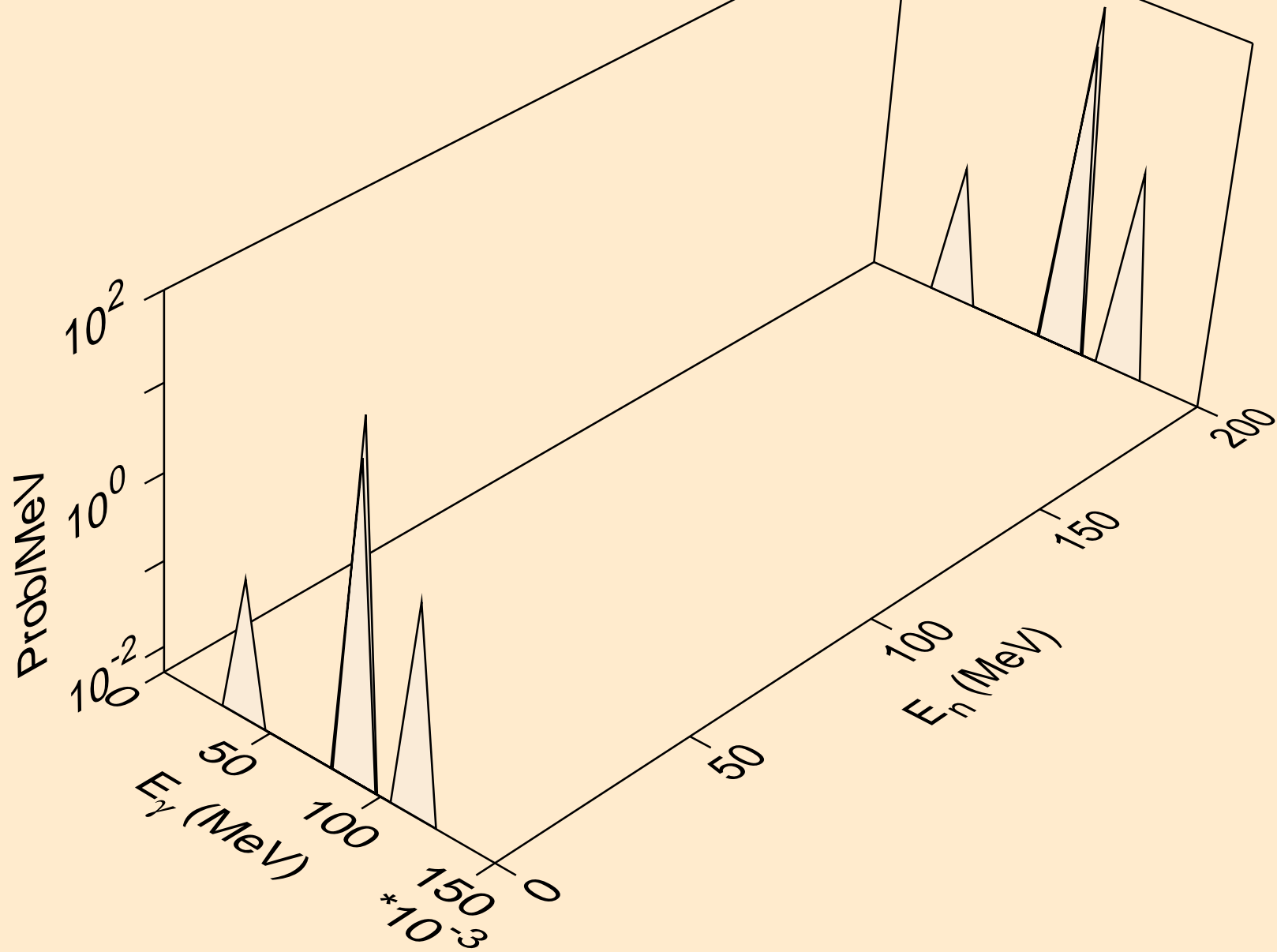

SB124N NEUTRON ACER TENDL-2024 LIBRARY; T=0.K  
Photon emission for (n,n\*8)

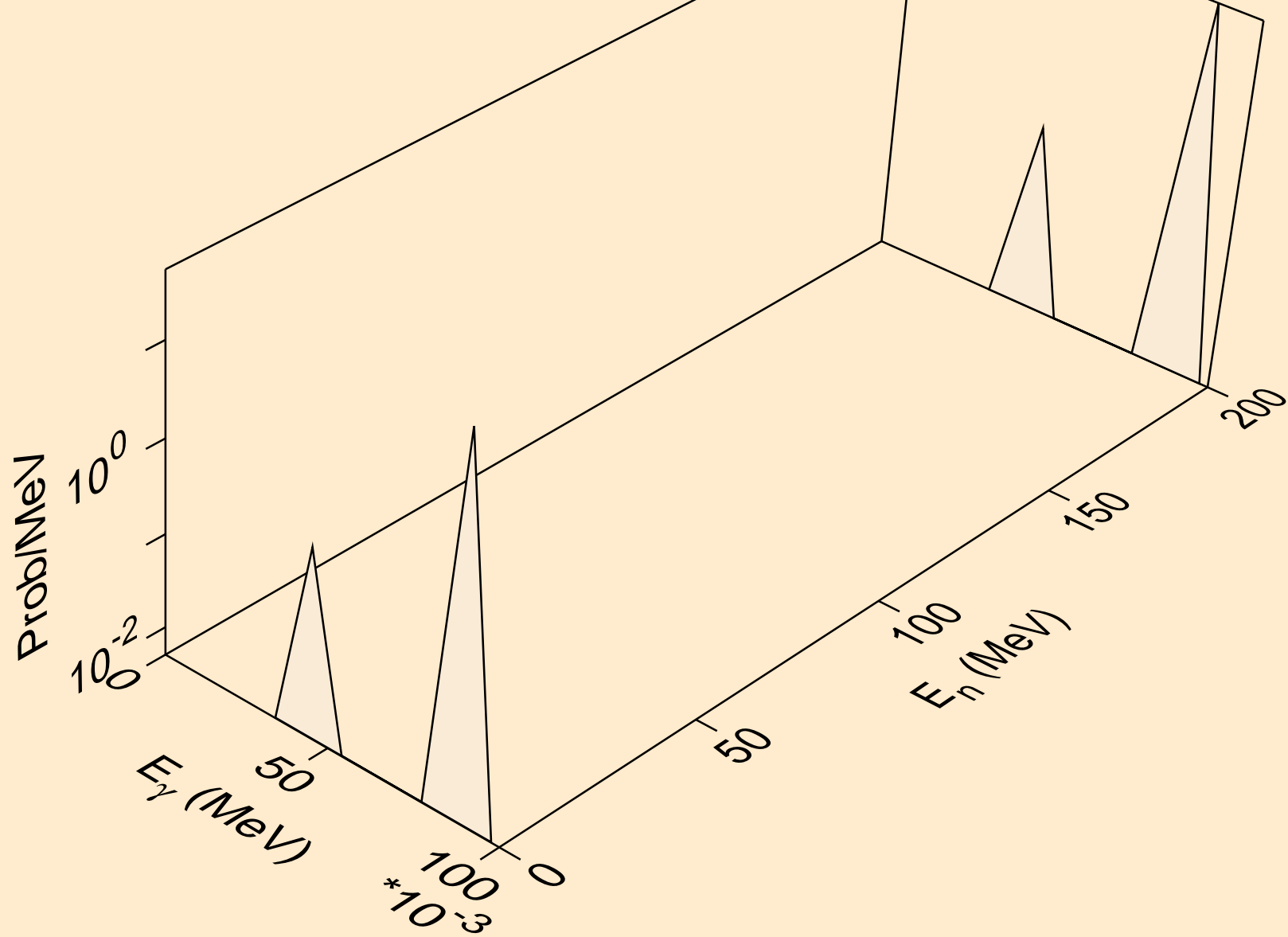

SB124N NEUTRON ACER TENDL-2024 LIBRARY; T=0.K  
Photon emission for (n,n\*9)

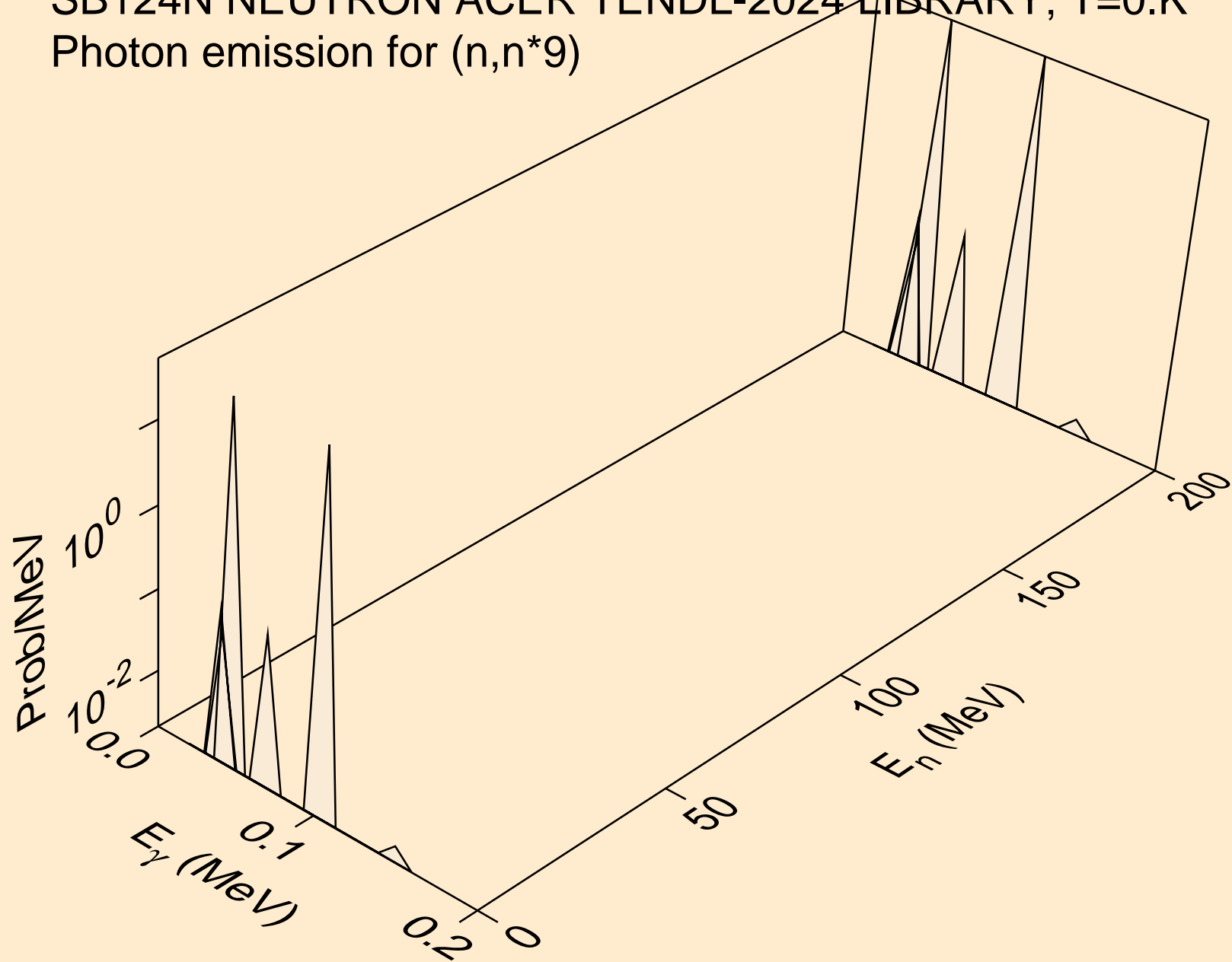

SB124N NEUTRON ACER TENDL-2024 LIBRARY; T=0.K  
Photon emission for (n,n\*10)

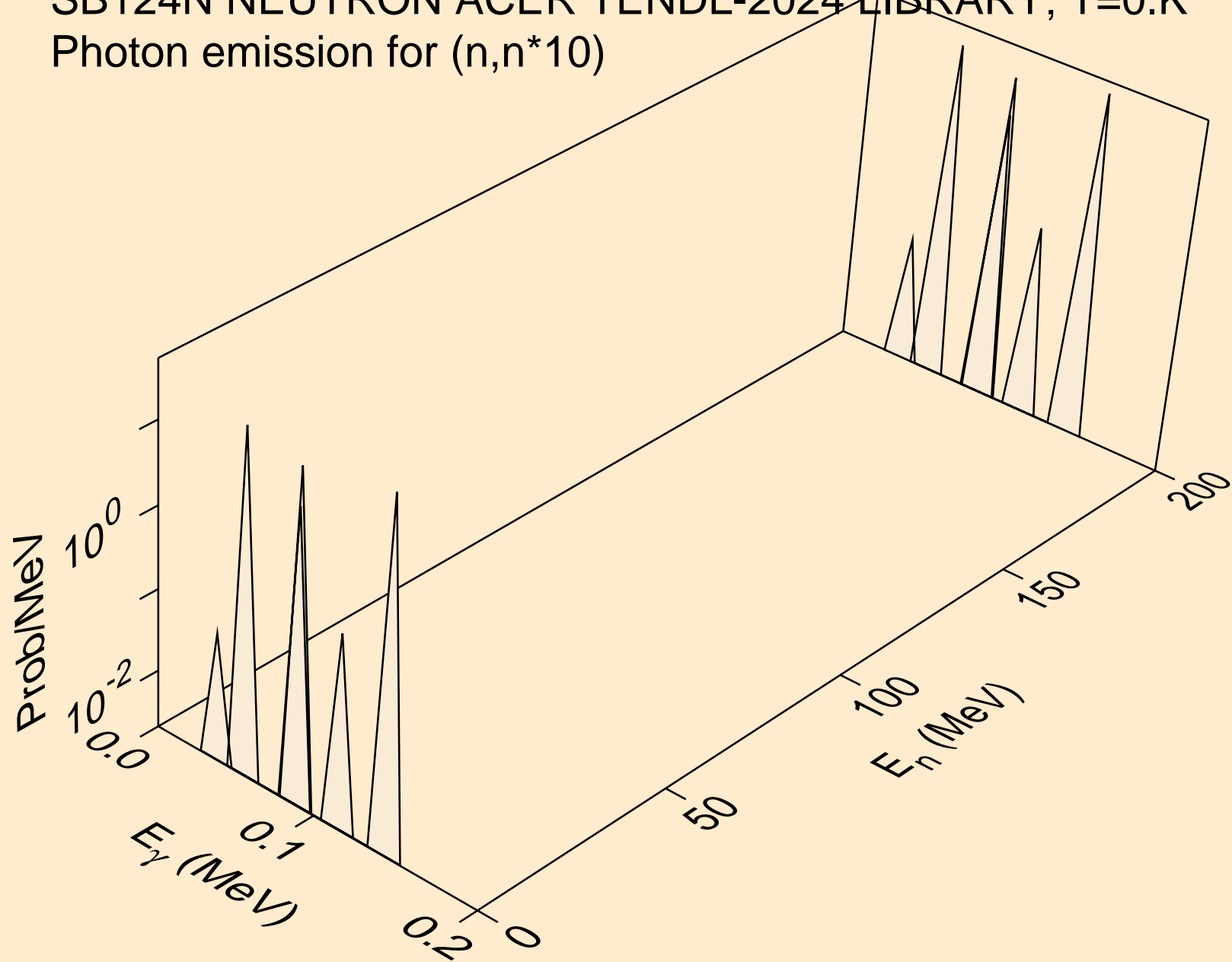

SB124N NEUTRON ACER TENDL-2024 LIBRARY; T=0.K  
Photon emission for (n,n\*11)

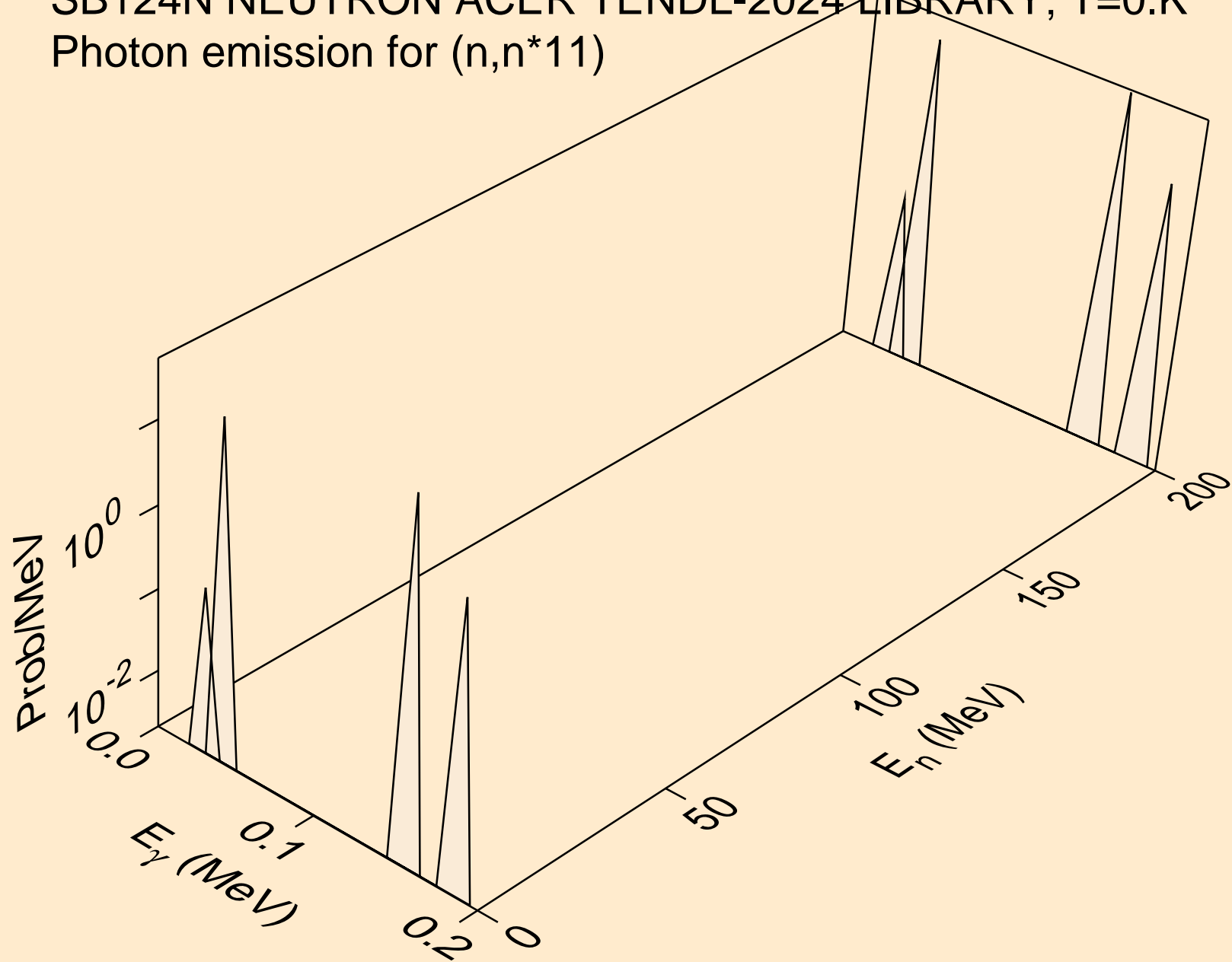

SB124N NEUTRON ACER TENDL-2024 LIBRARY; T=0.K  
Photon emission for (n,n\*12)

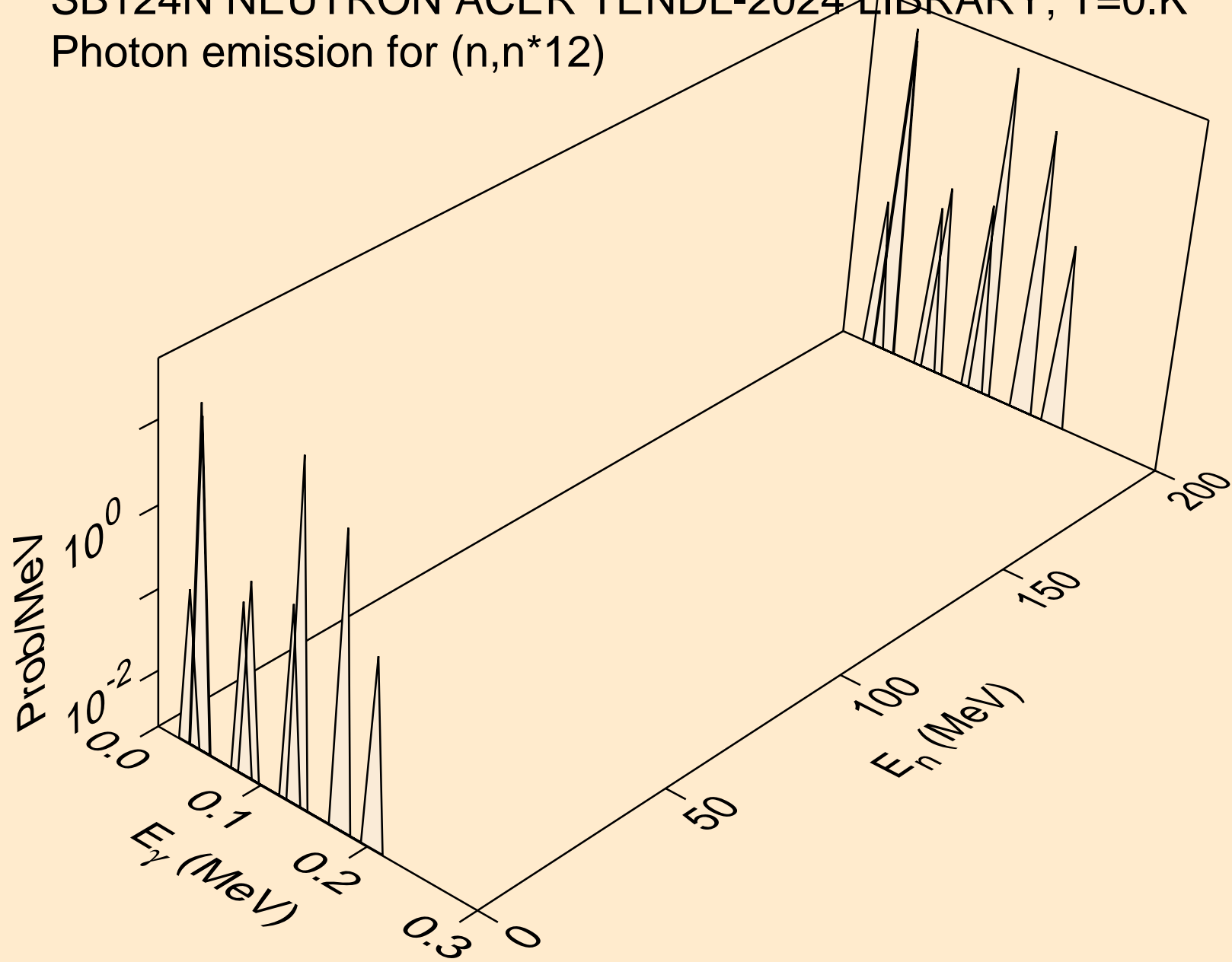



SB124N NEUTRON ACER TENDL-2024 LIBRARY; T=0.K  
Photon emission for (n,n\*13)

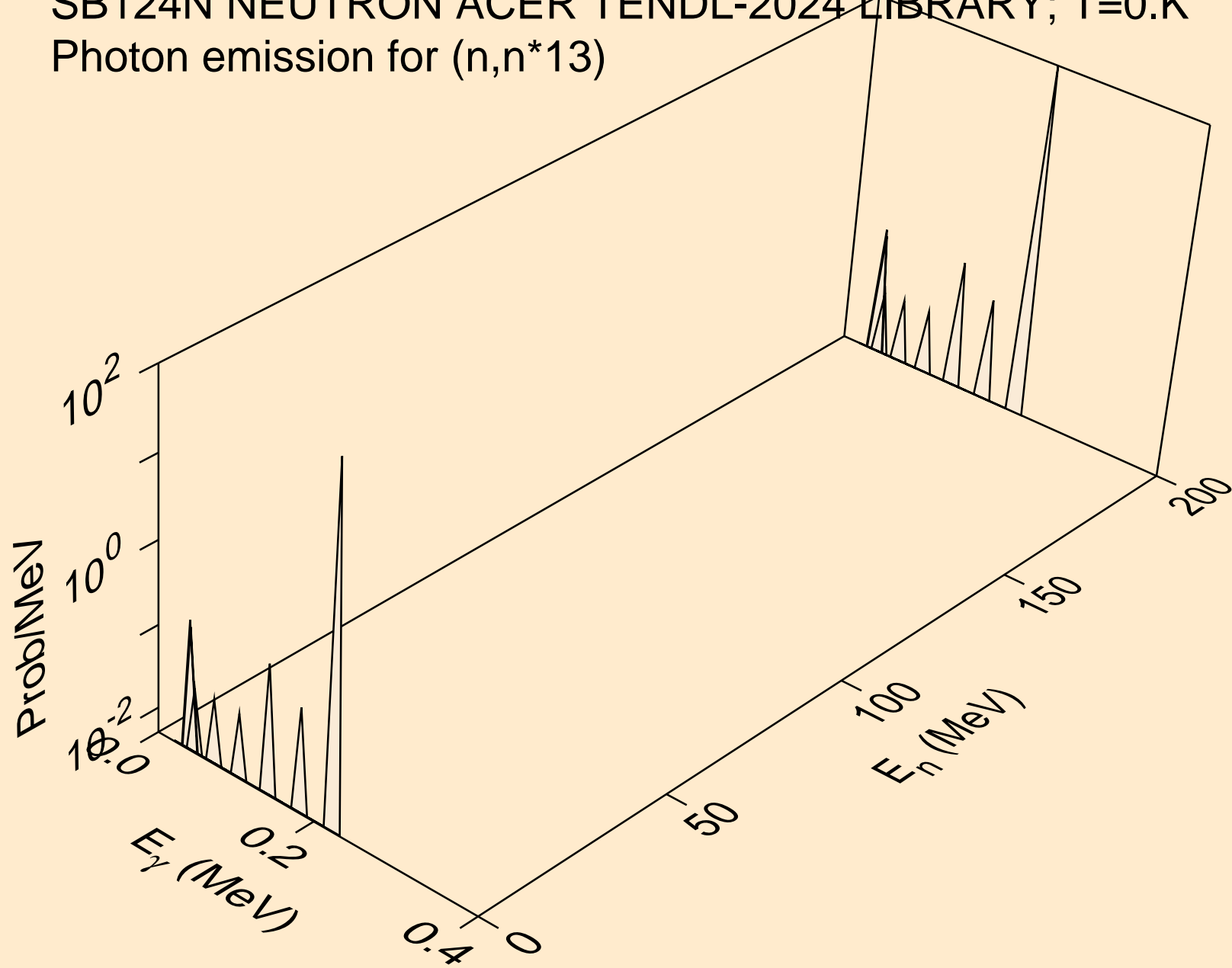

SB124N NEUTRON ACER TENDL-2024 LIBRARY; T=0.K  
Photon emission for (n,n\*14)

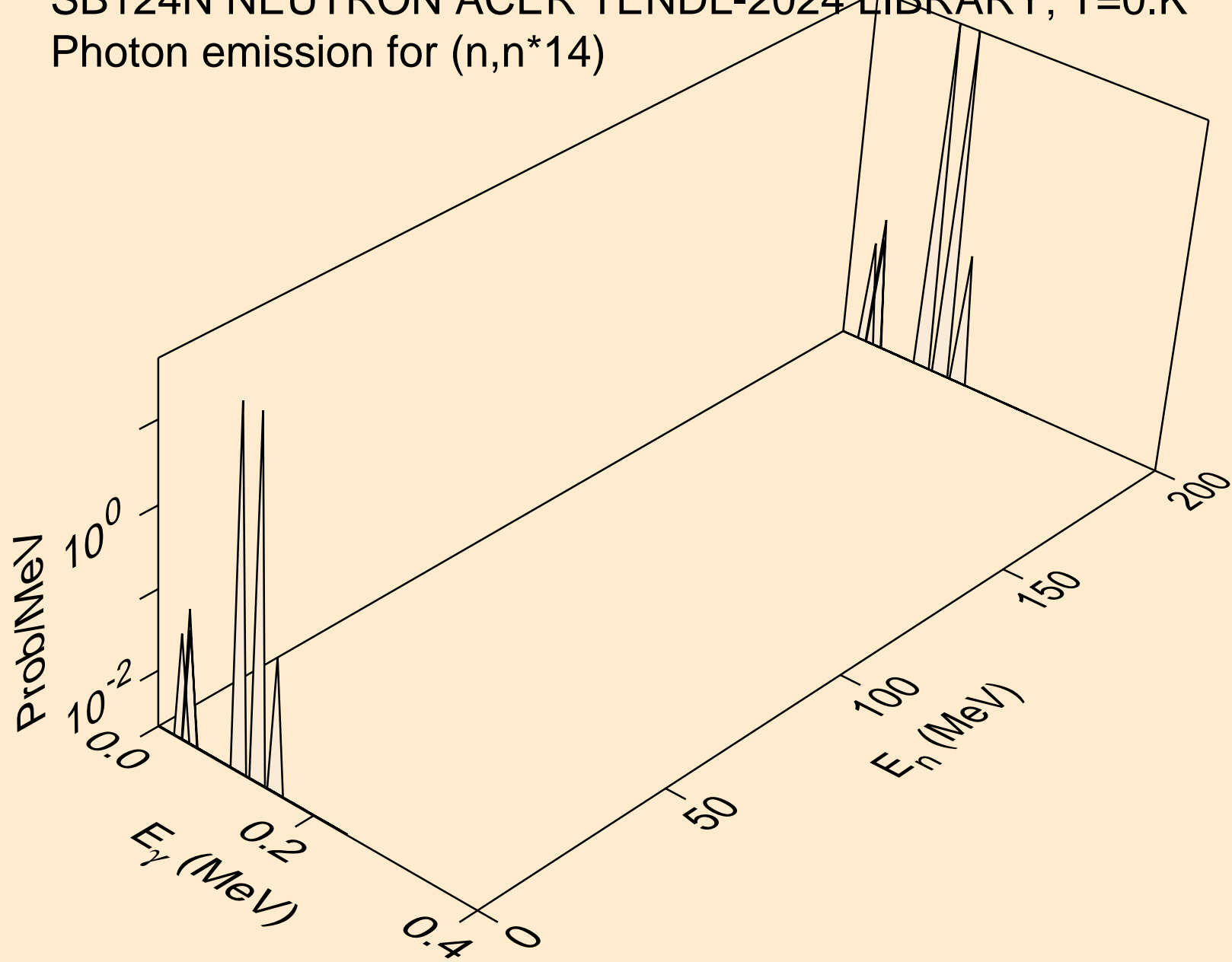

SB124N NEUTRON ACER TENDL-2024 LIBRARY; T=0.K  
Photon emission for (n,n\*15)

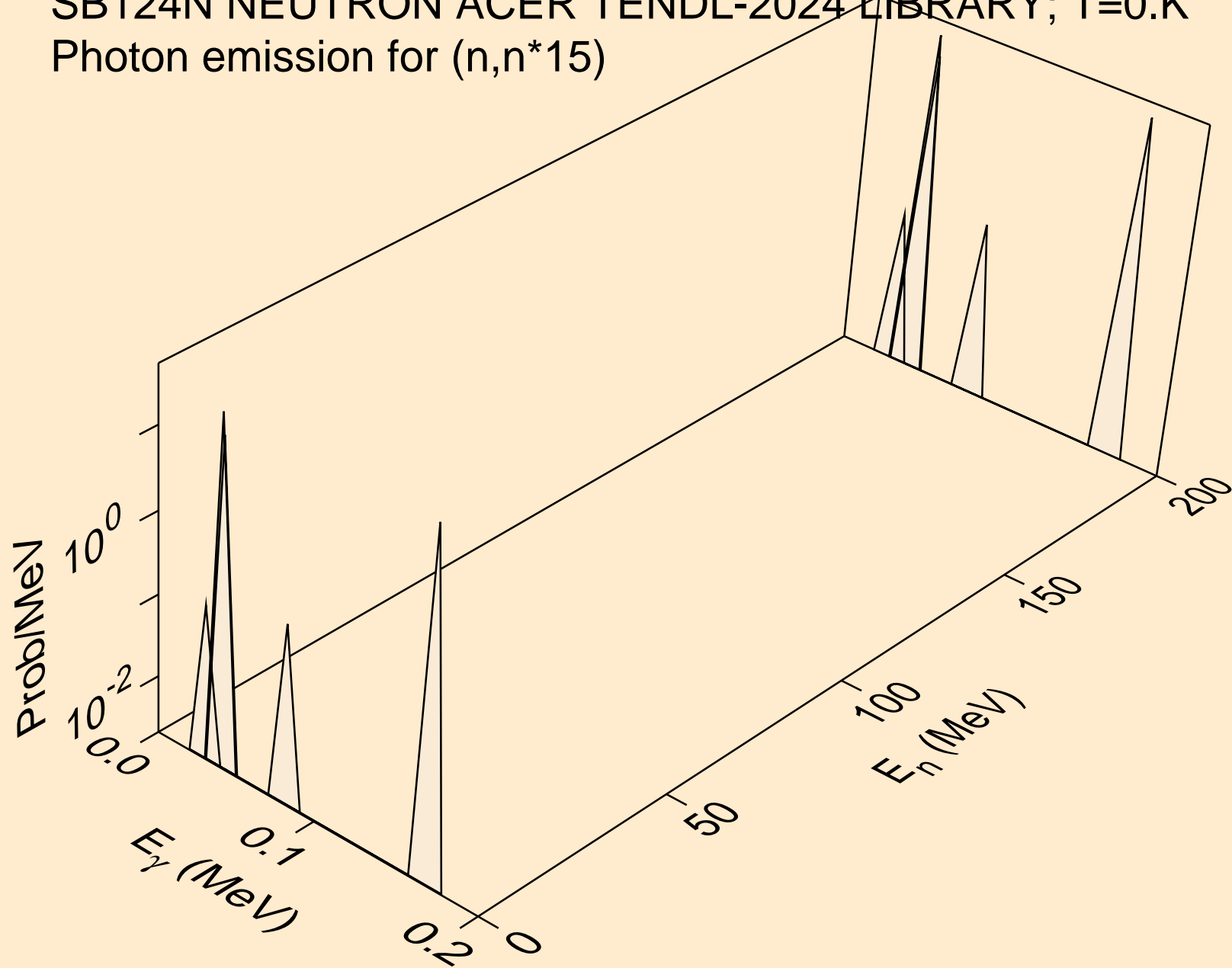

SB124N NEUTRON ACER TENDL-2024 LIBRARY; T=0.K  
Photon emission for (n,n\*16)

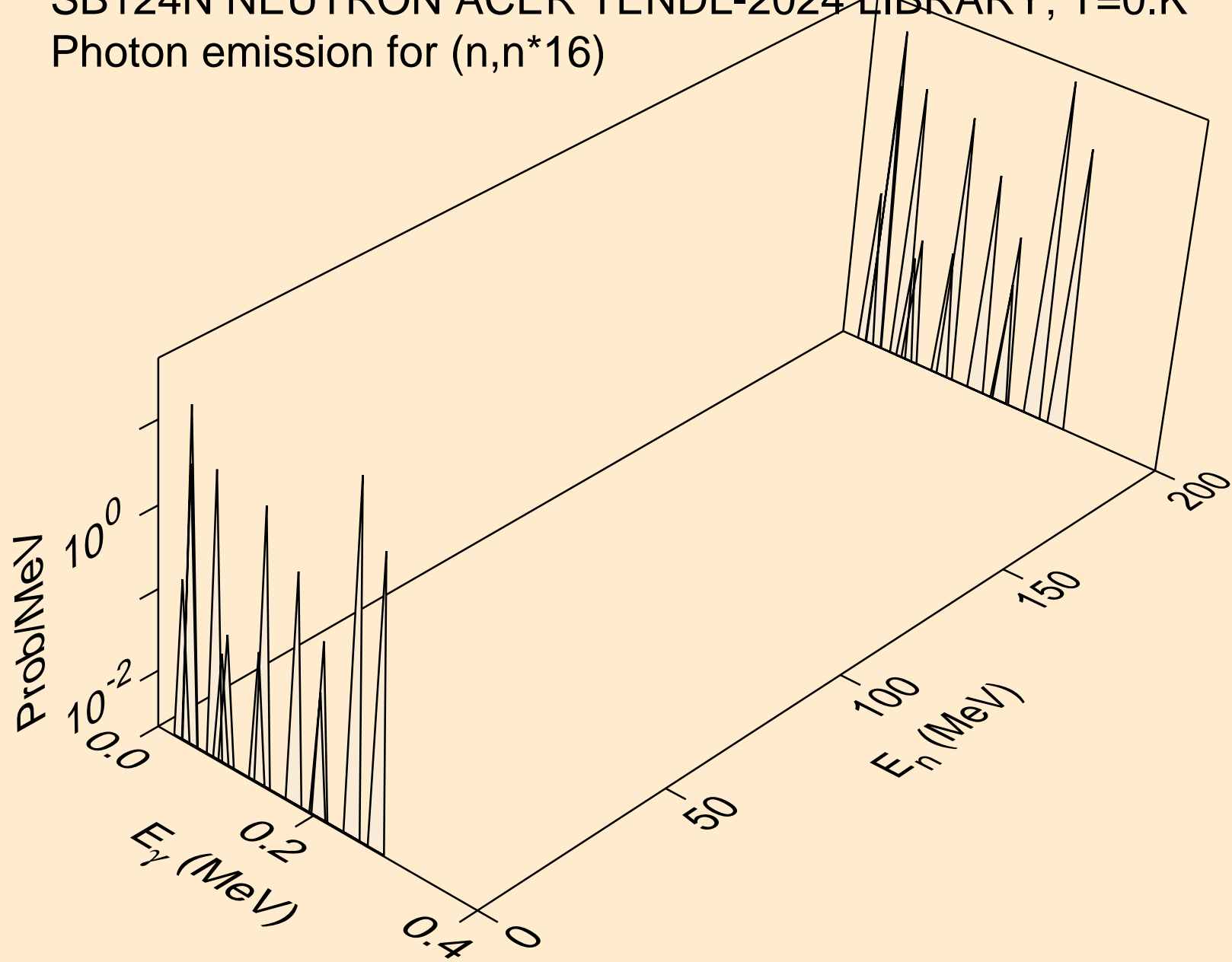

SB124N NEUTRON ACER TENDL-2024 LIBRARY; T=0.K  
Photon emission for (n,n\*17)

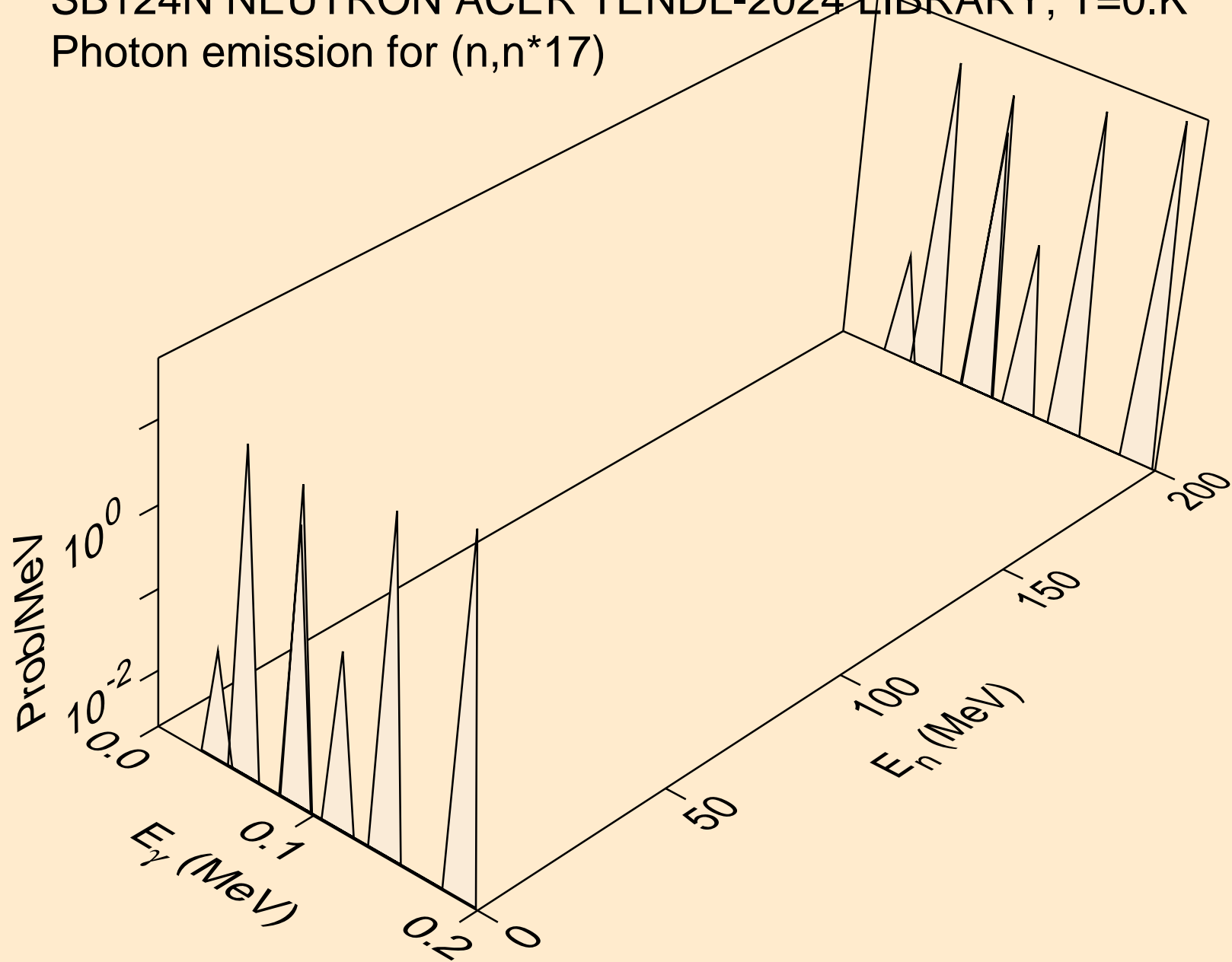

SB124N NEUTRON ACER TENDL-2024 LIBRARY; T=0.K  
Photon emission for (n,n\*18)

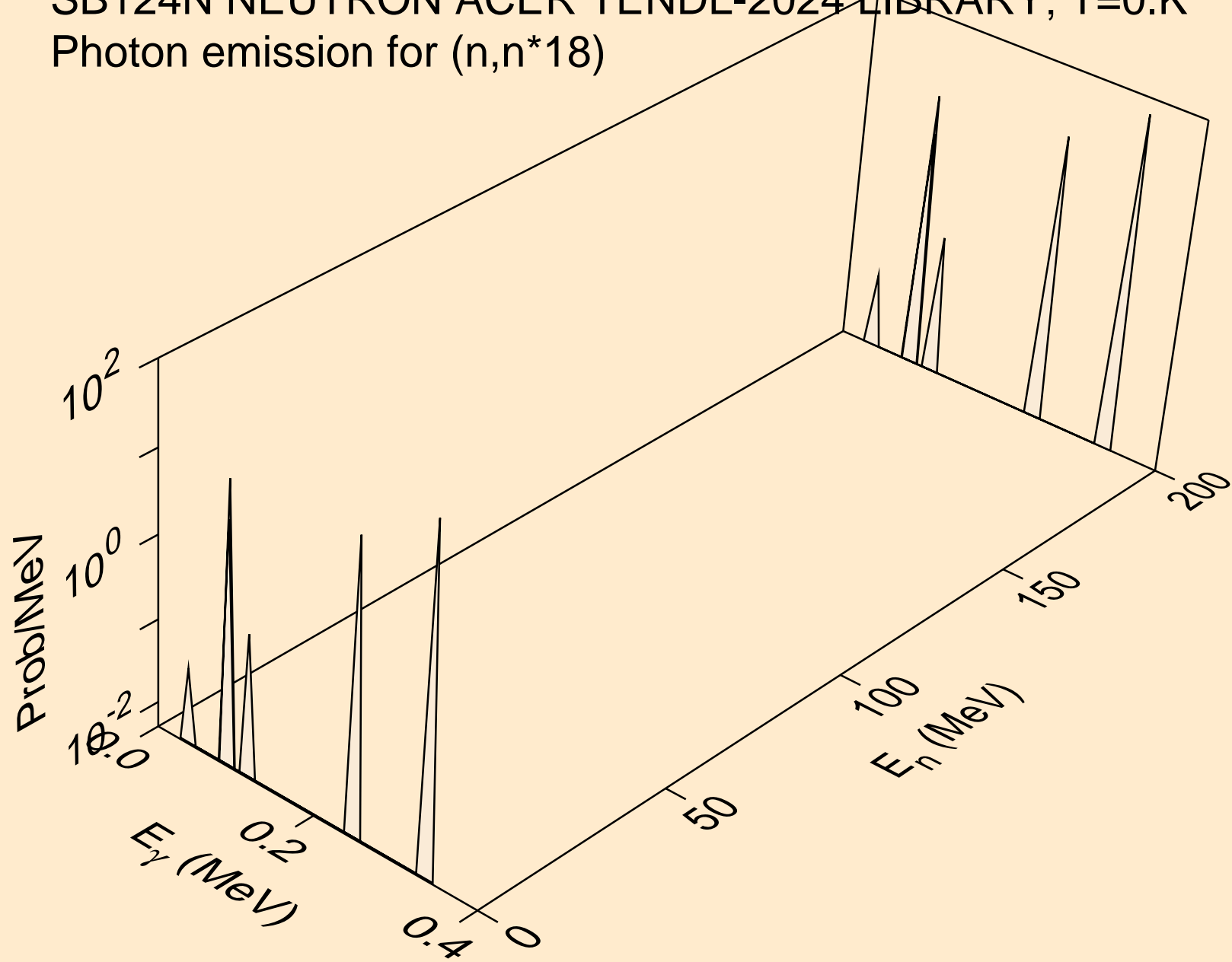

SB124N NEUTRON ACER TENDL-2024 LIBRARY; T=0.K  
Photon emission for (n,n\*19)

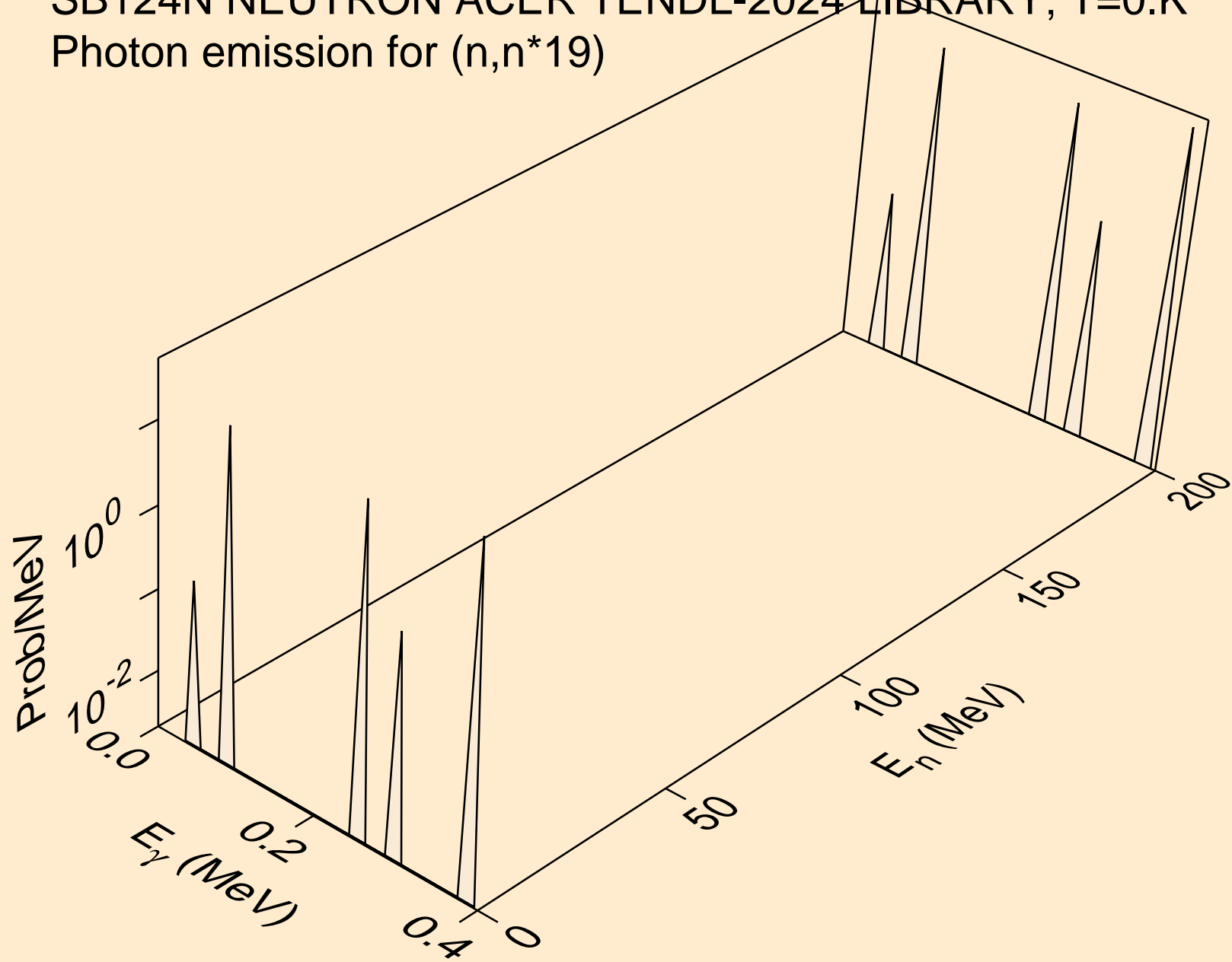

SB124N NEUTRON ACER TENDL-2024 LIBRARY; T=0.K  
Photon emission for (n,n\*20)

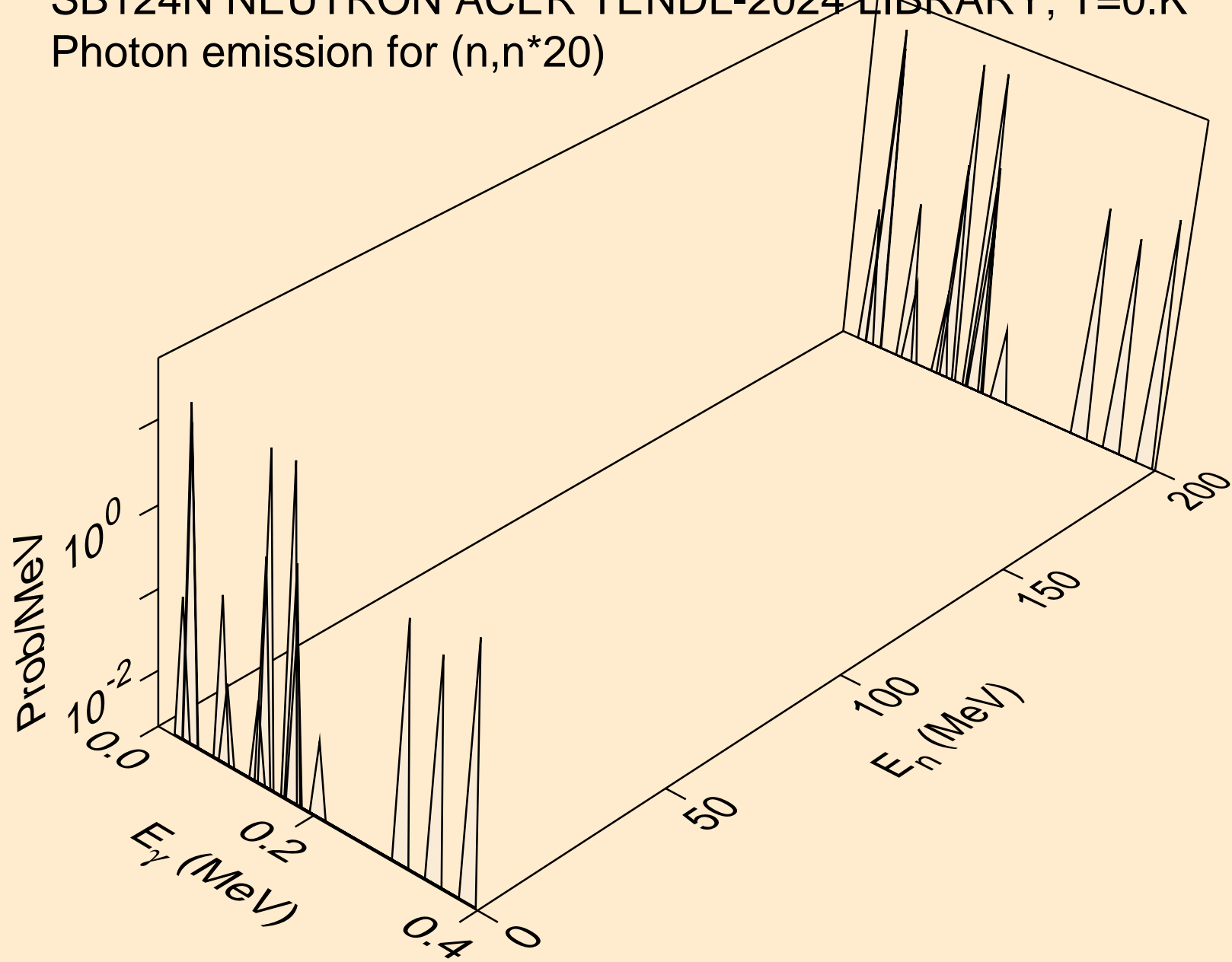



SB124N NEUTRON ACER TENDL-2024 LIBRARY; T=0.K  
Photon emission for (n,n\*21)

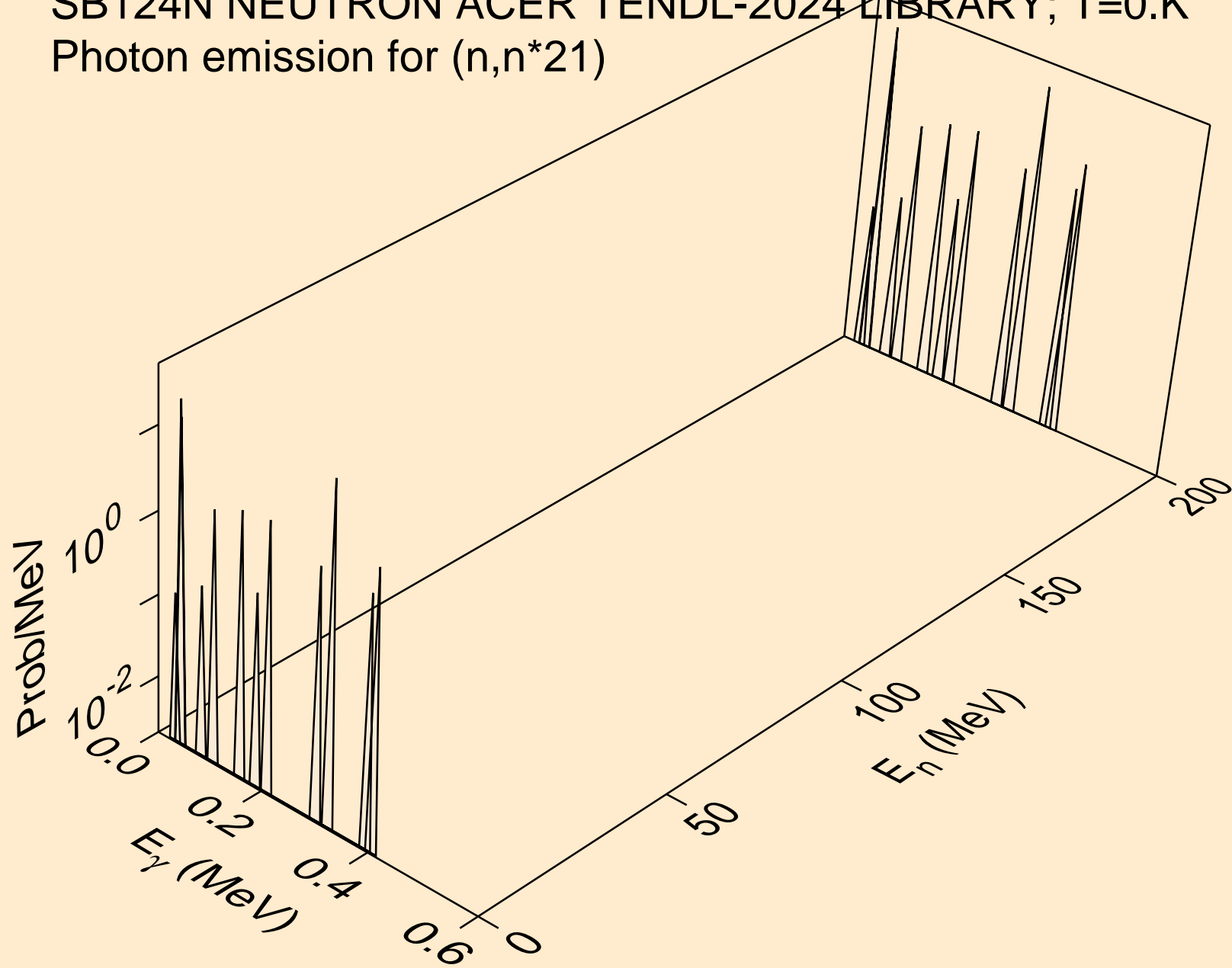

SB124N NEUTRON ACER TENDL-2024 LIBRARY; T=0.K  
Photon emission for (n,n\*22)

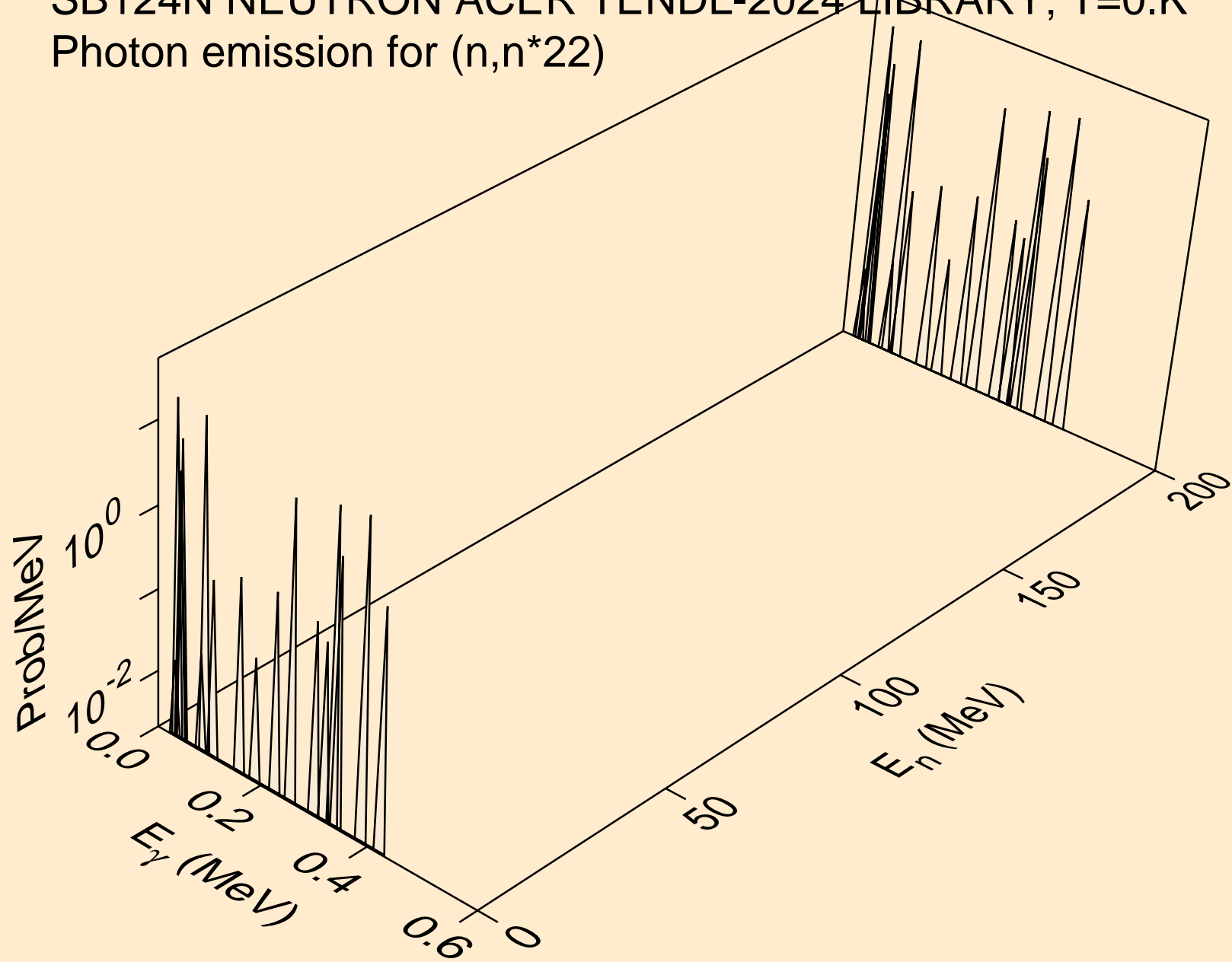

SB124N NEUTRON ACER TENDL-2024 LIBRARY; T=0.K  
Photon emission for (n,n\*23)

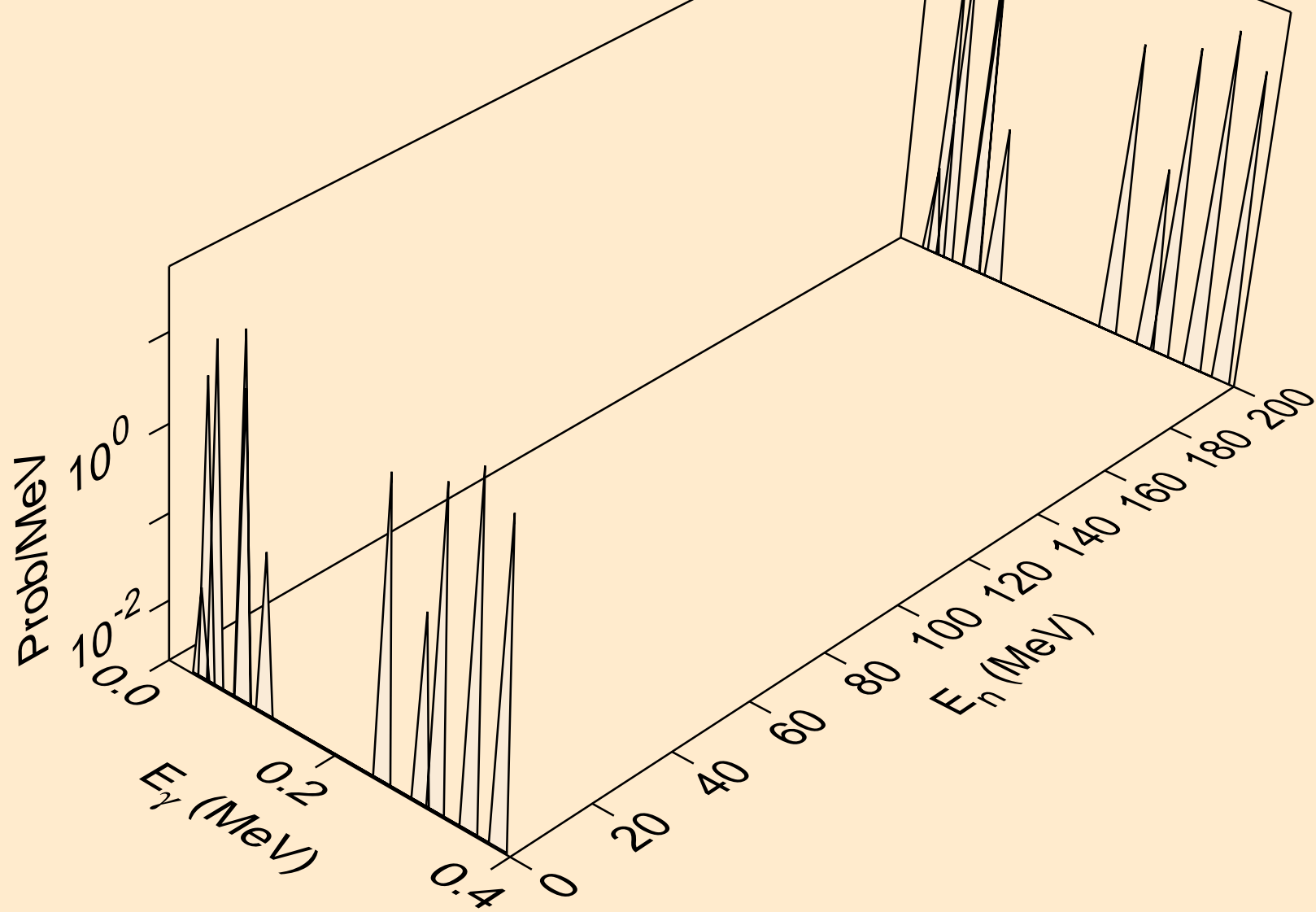

SB124N NEUTRON ACER TENDL-2024 LIBRARY; T=0.K  
Photon emission for (n,n\*24)

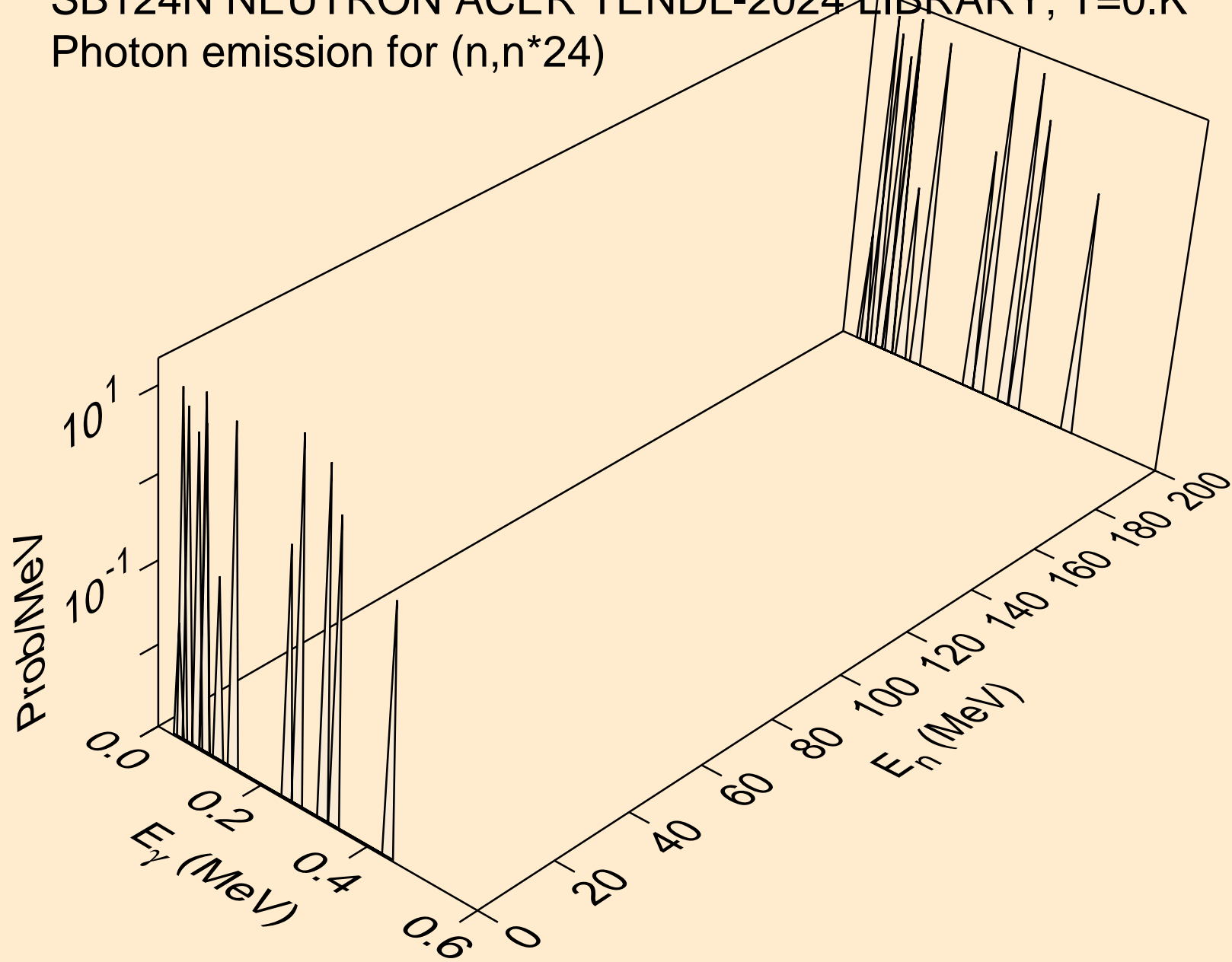

SB124N NEUTRON ACER TENDL-2024 LIBRARY; T=0.K  
Photon emission for (n,n\*c)

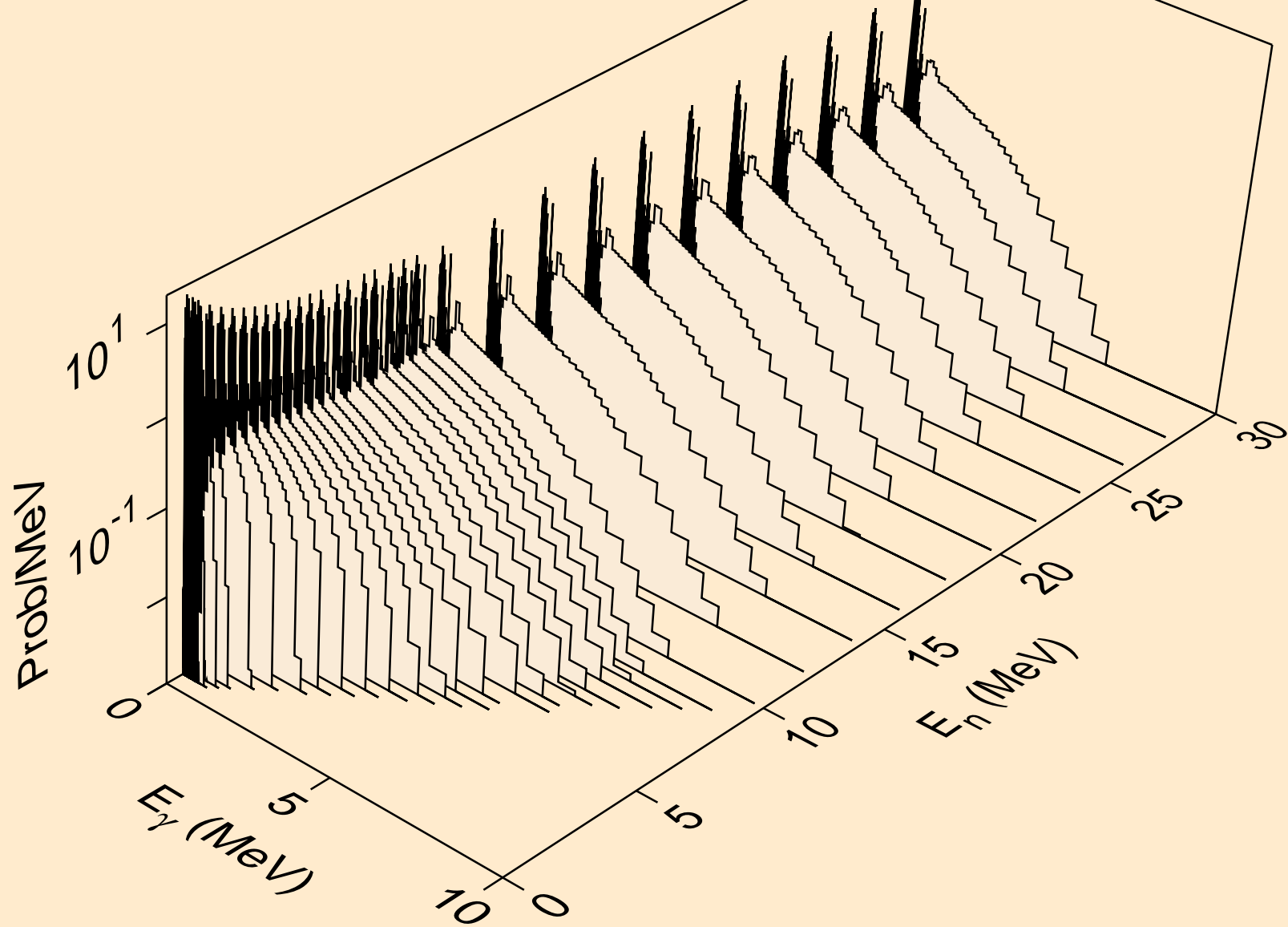

SB124N NEUTRON ACER TENDL-2024 LIBRARY; T=0.K  
Photon emission for (n,gma)

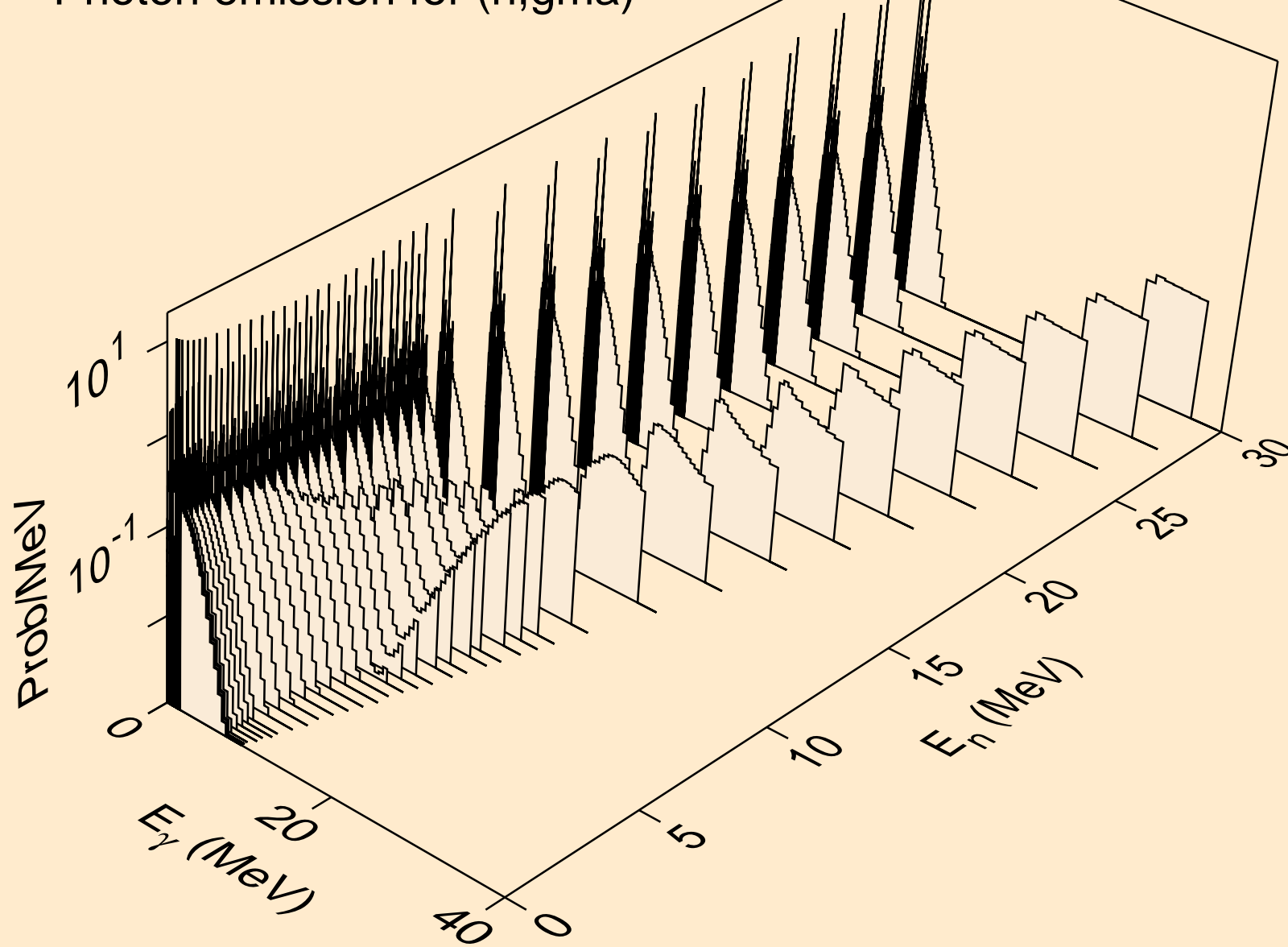

SB124N NEUTRON ACER TENDL-2024 LIBRARY; T=0.K  
Photon emission for (n,p)

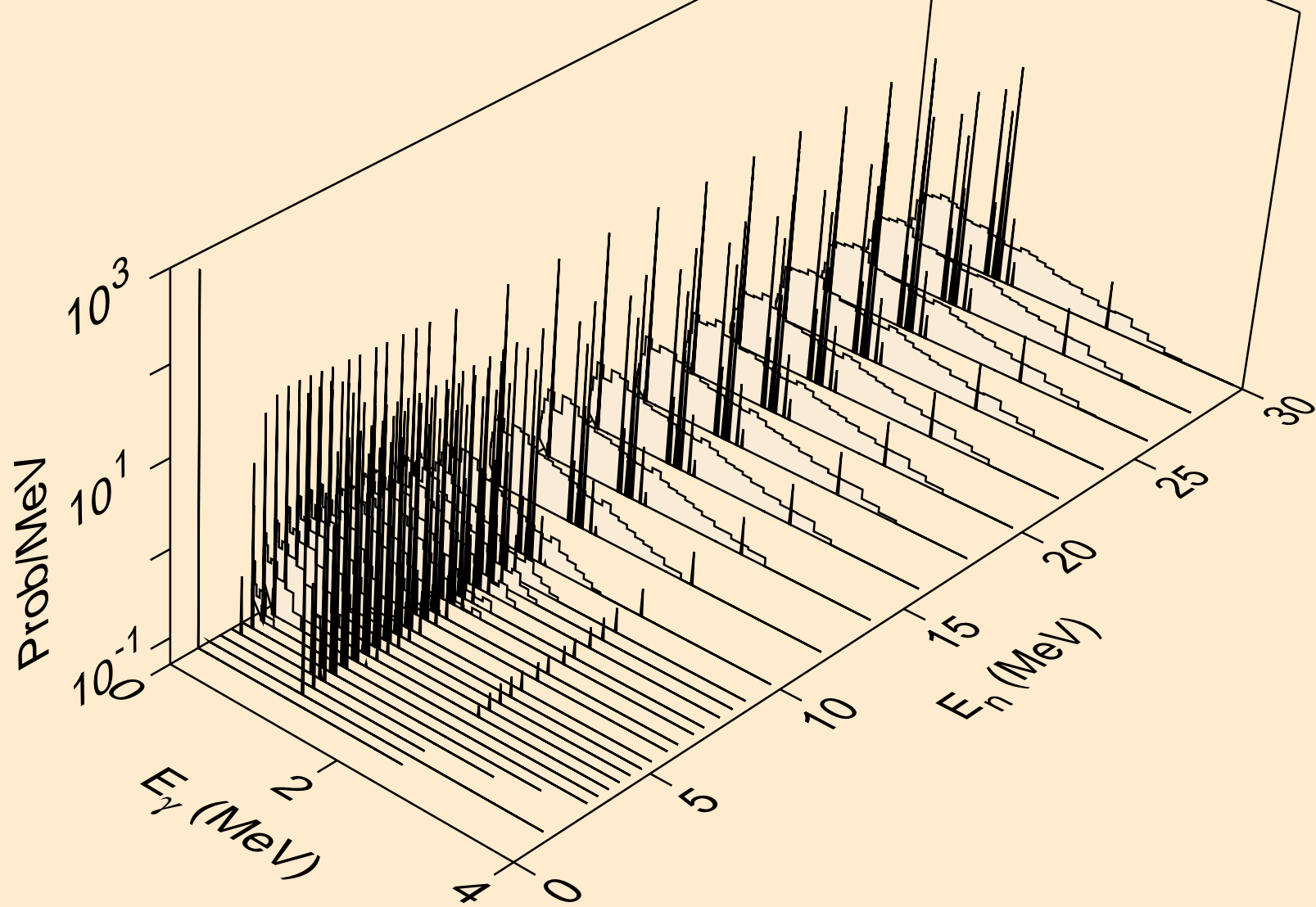

SB124N NEUTRON ACER TENDL-2024 LIBRARY; T=0.K  
Photon emission for (n,d)

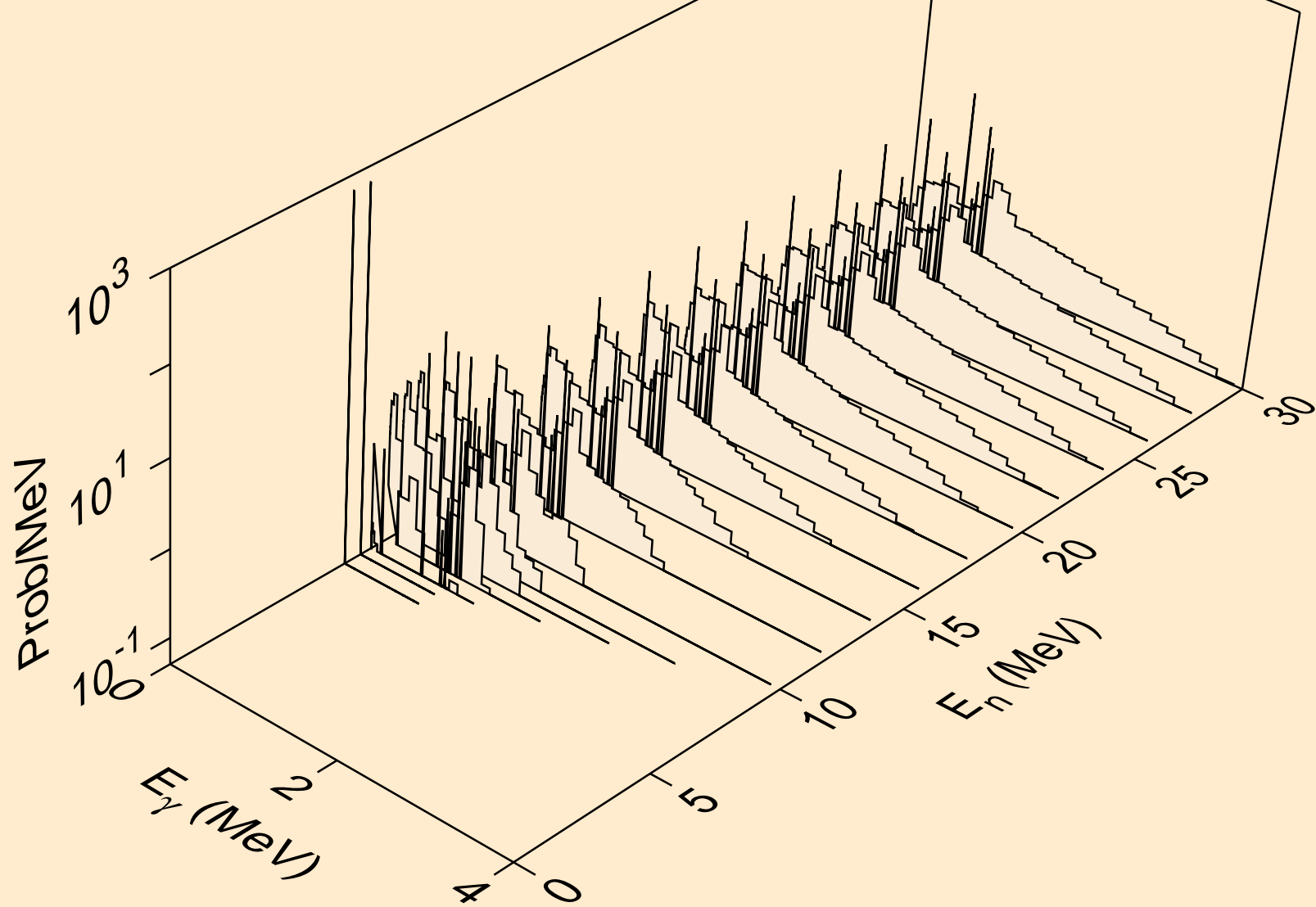



SB124N NEUTRON ACER TENDL-2024 LIBRARY; T=0.K  
Photon emission for (n,t)

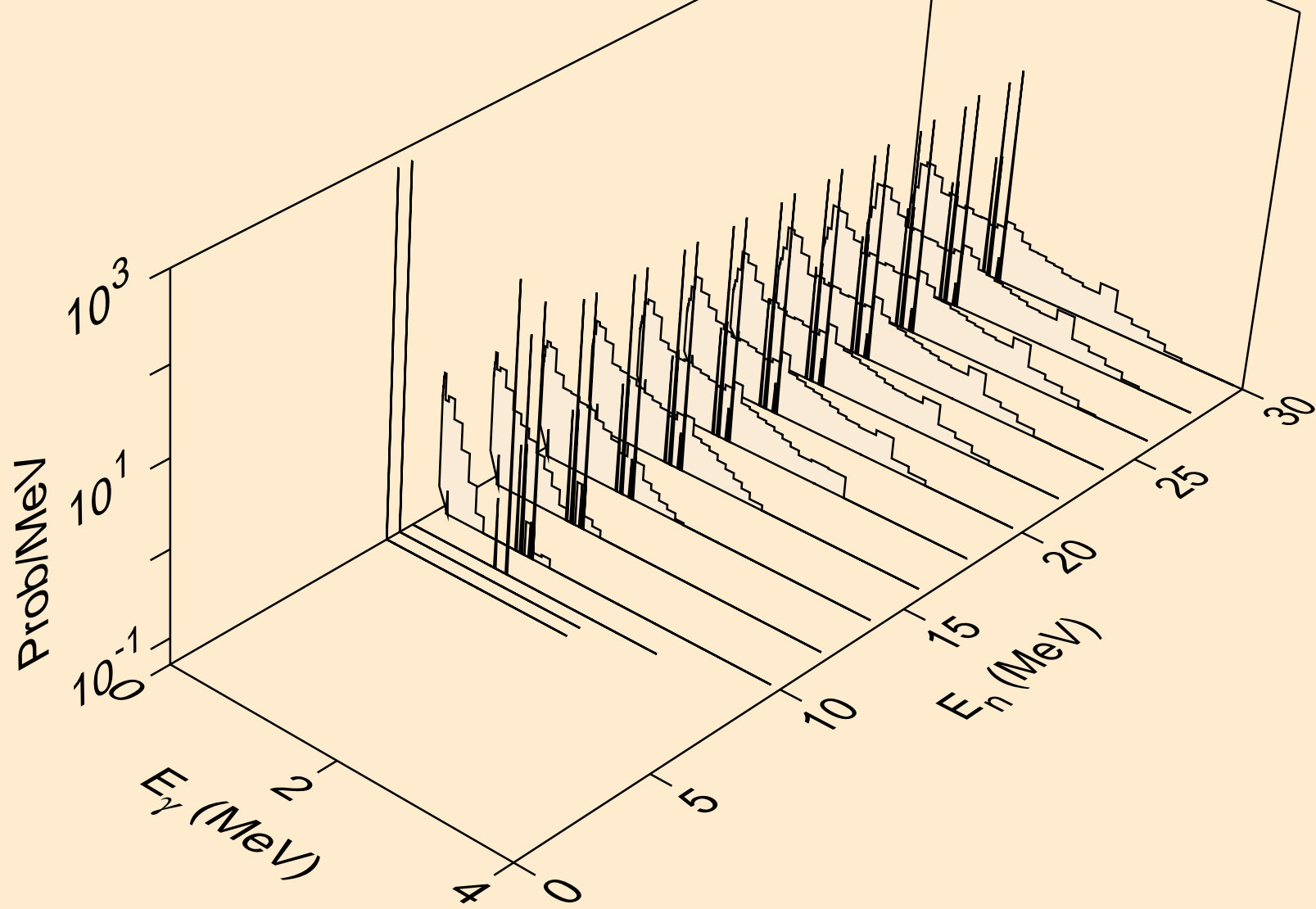

SB124N NEUTRON ACER TENDL-2024 LIBRARY; T=0.K  
Photon emission for (n,he3)

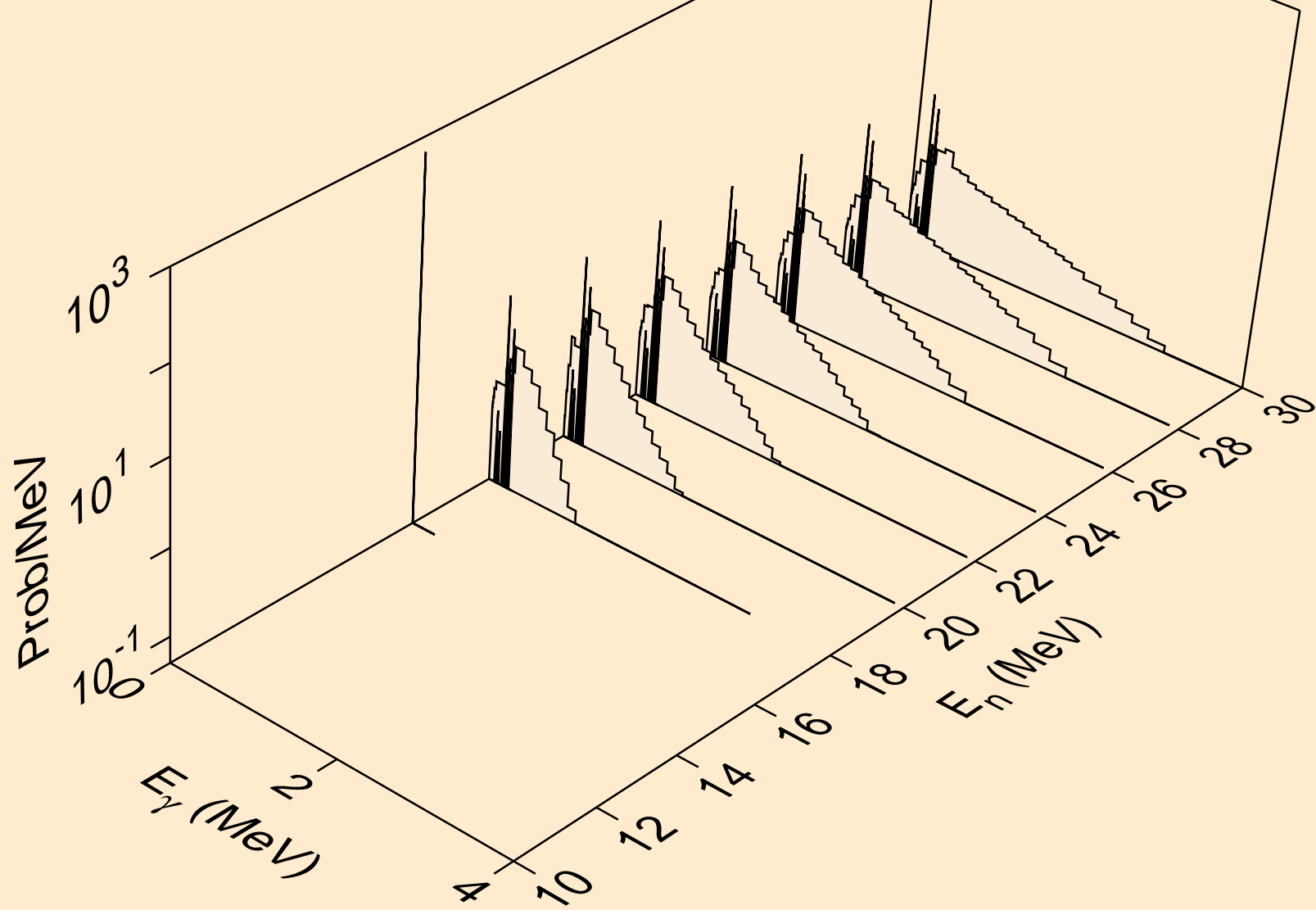

SB124N NEUTRON ACER TENDL-2024 LIBRARY; T=0.K  
Photon emission for (n,a)

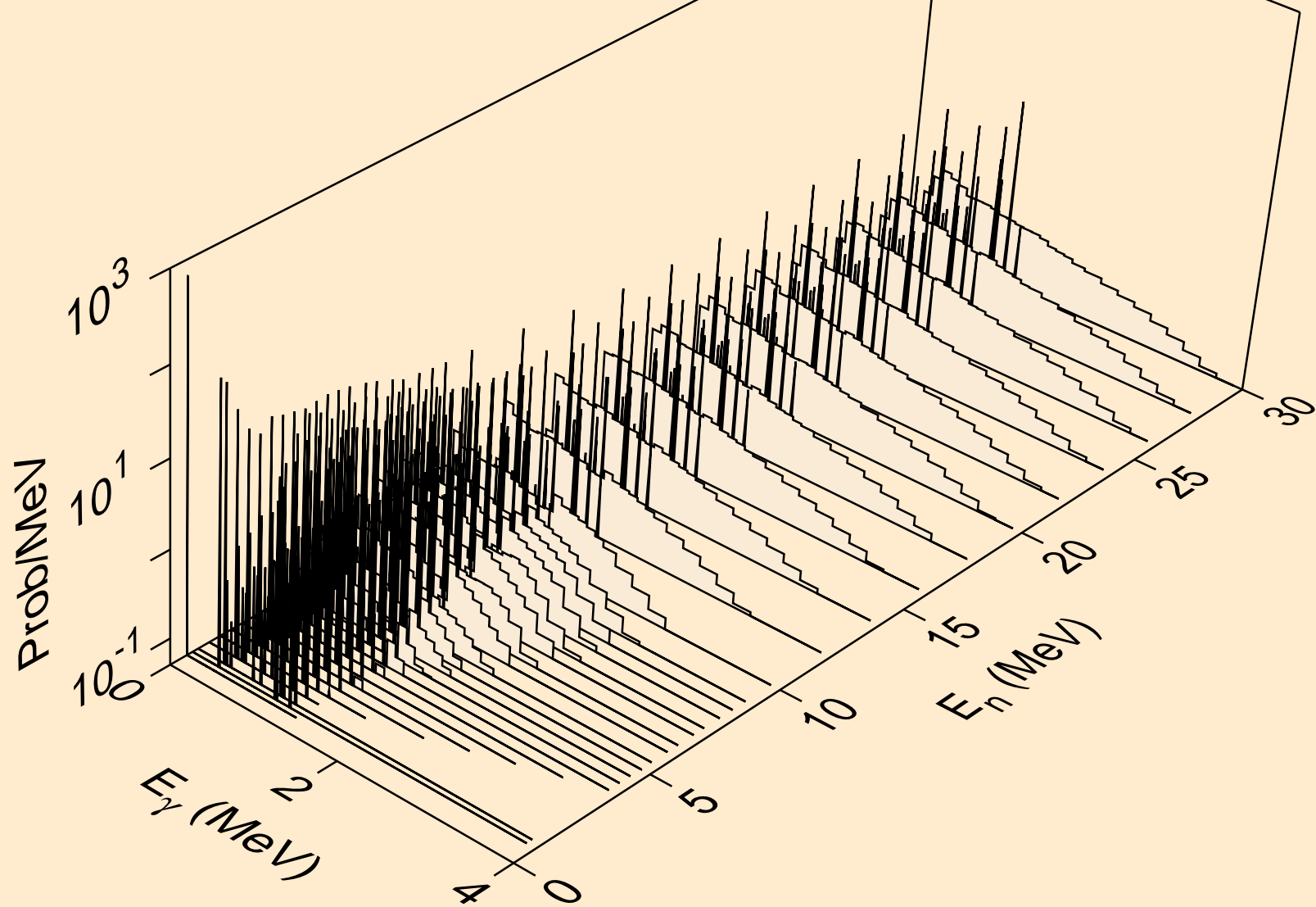

SB124N NEUTRON ACER TENDL-2024 LIBRARY; T=0.K  
Photon emission for (n,2p)

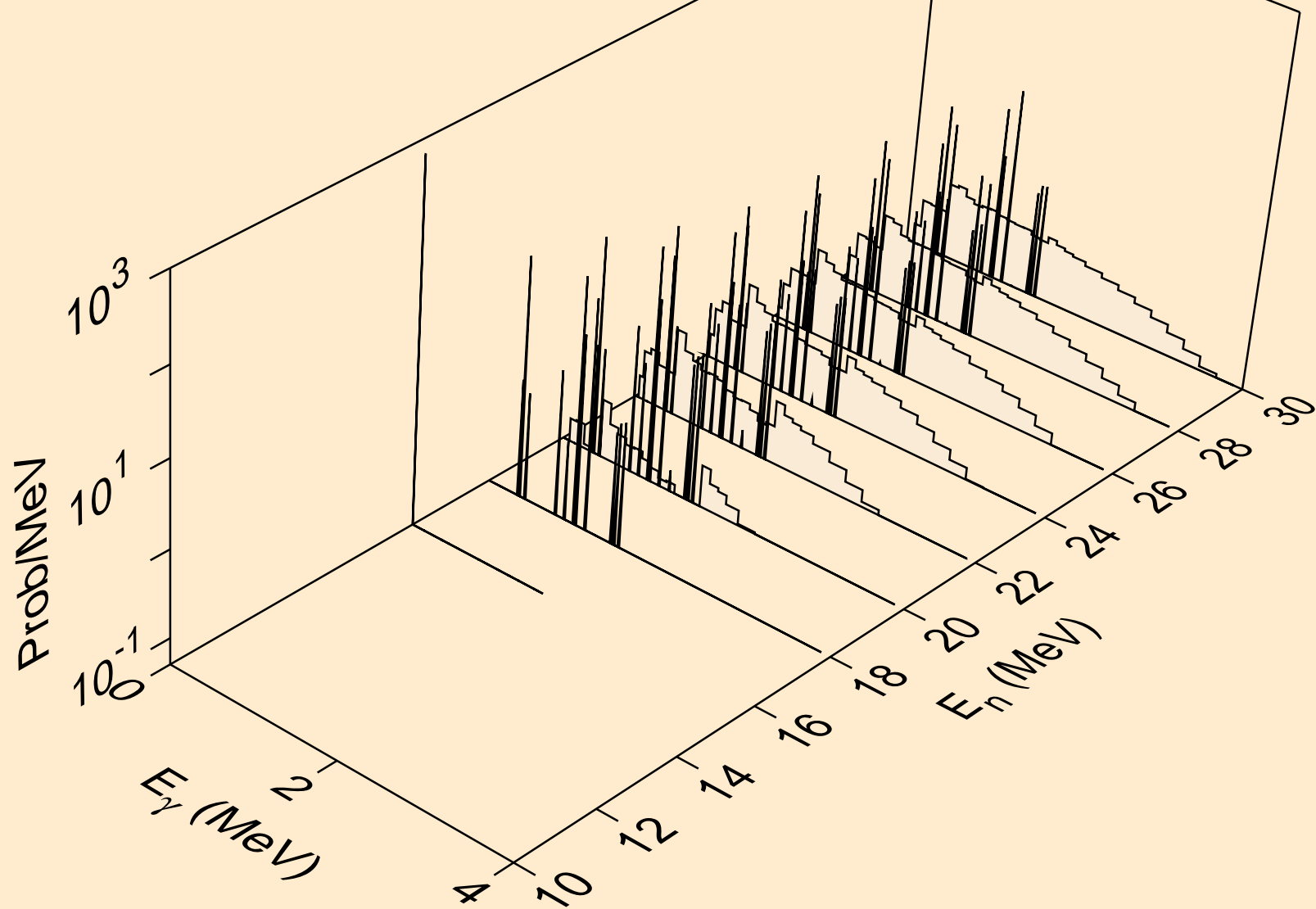

SB124N NEUTRON ACER TENDL-2024 LIBRARY; T=0.K  
Photon emission for (n,p $\alpha$ )

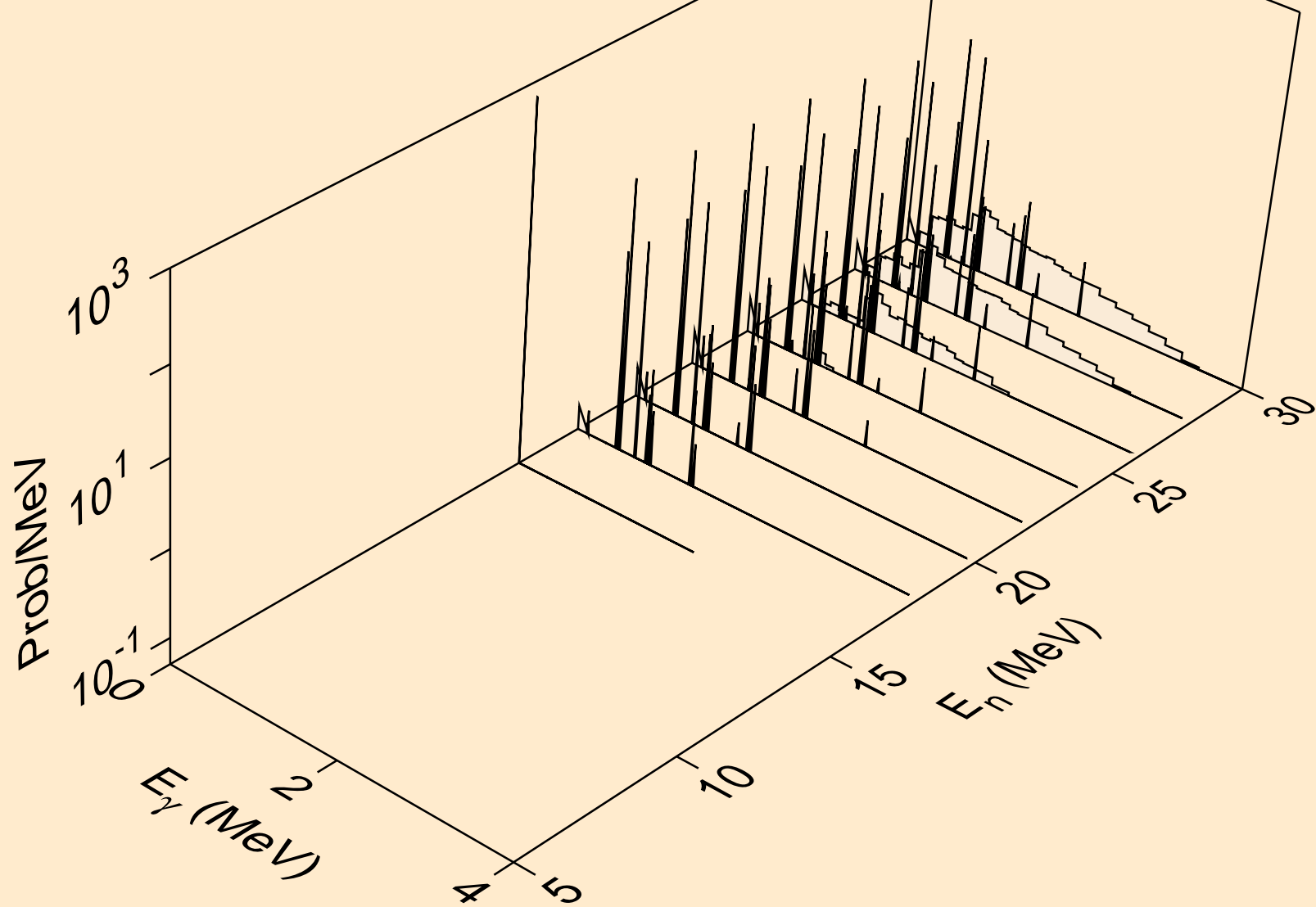

SB124N NEUTRON ACER TENDL-2024 LIBRARY; T=0.K  
Photon emission for (n,pd)

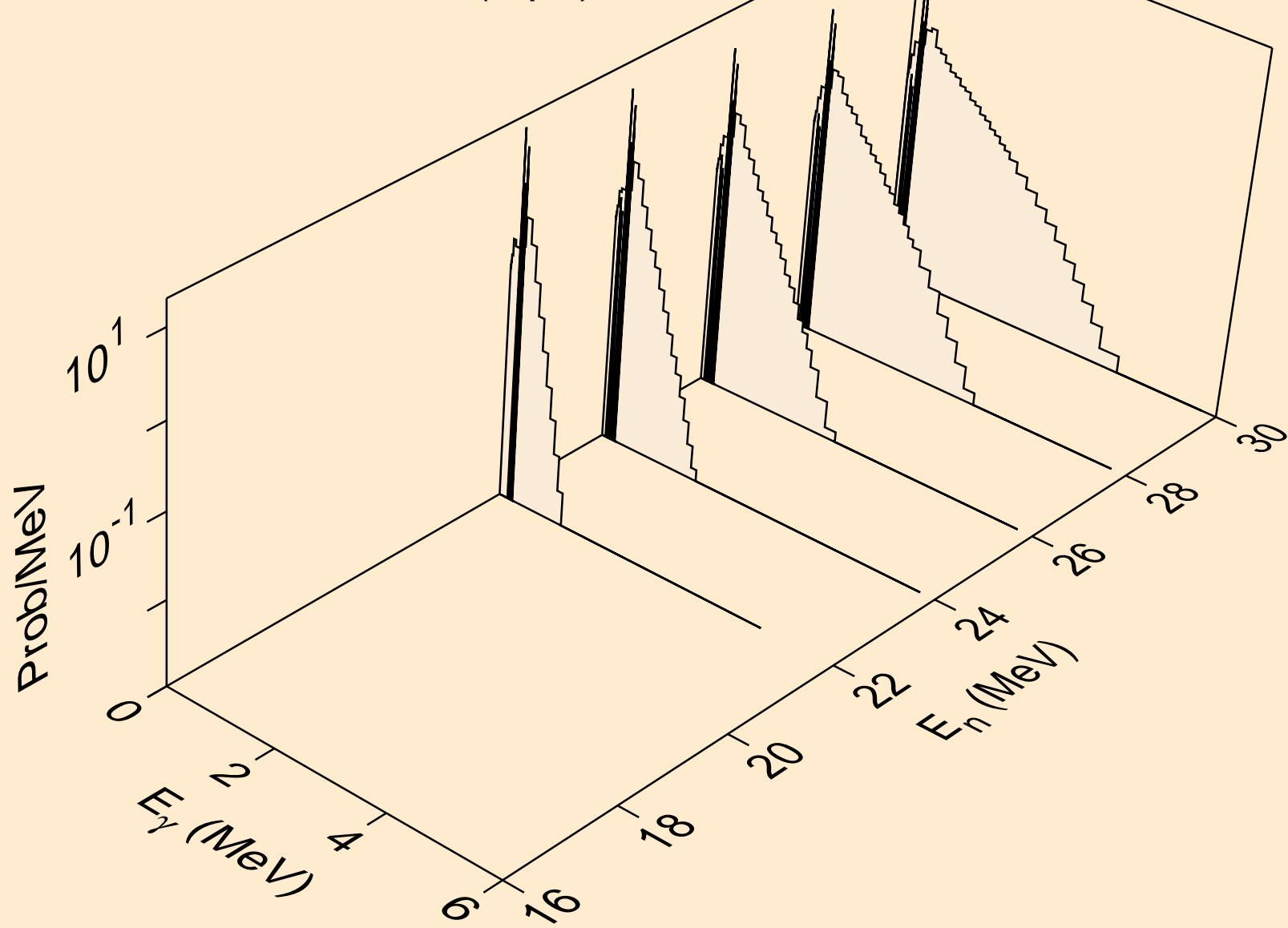

SB124N NEUTRON ACER TENDL-2024 LIBRARY; T=0.K  
Photon emission for (n,pt)

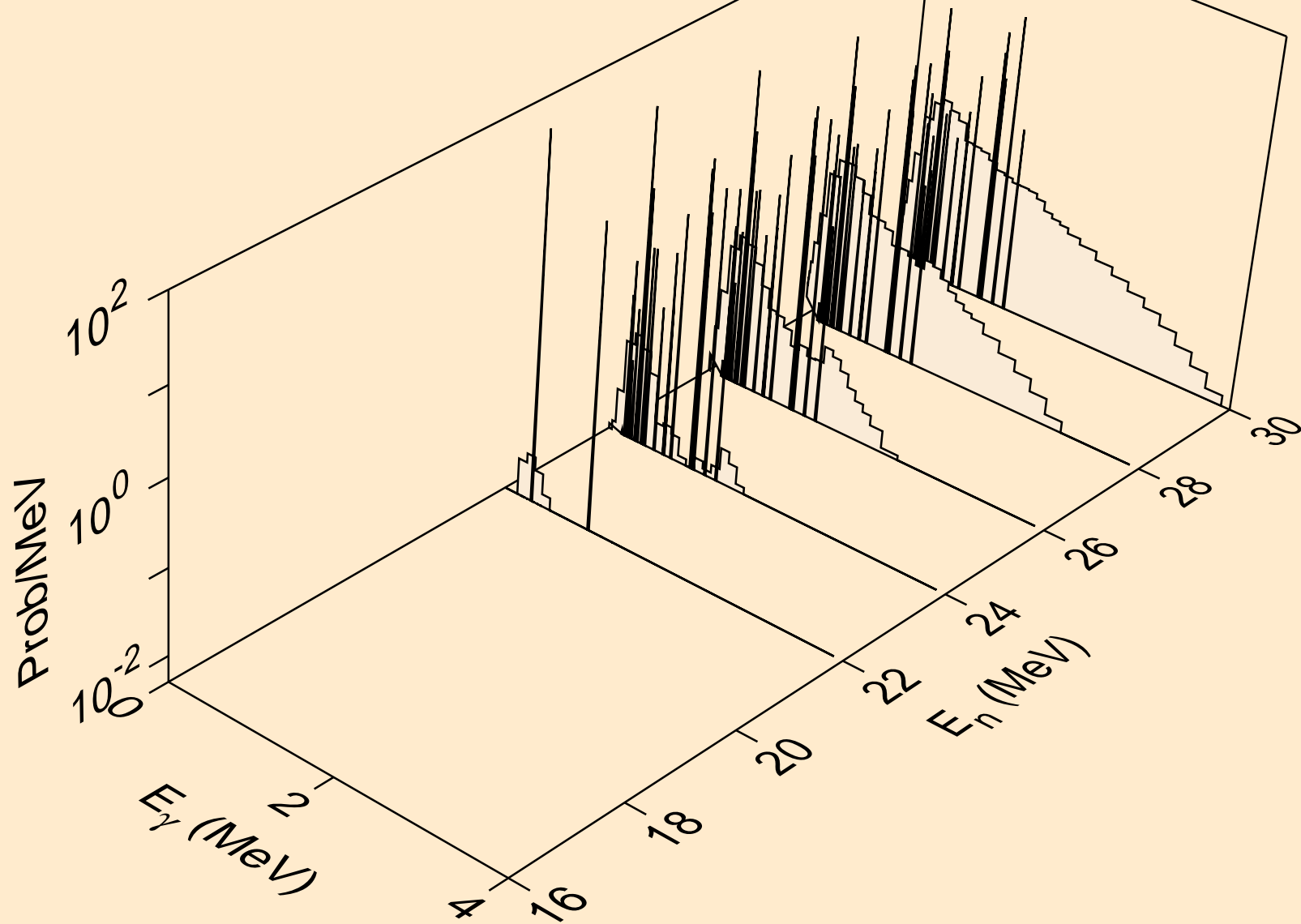

SB124N NEUTRON ACER TENDL-2024 LIBRARY; T=0.K  
thermal capture photon spectrum

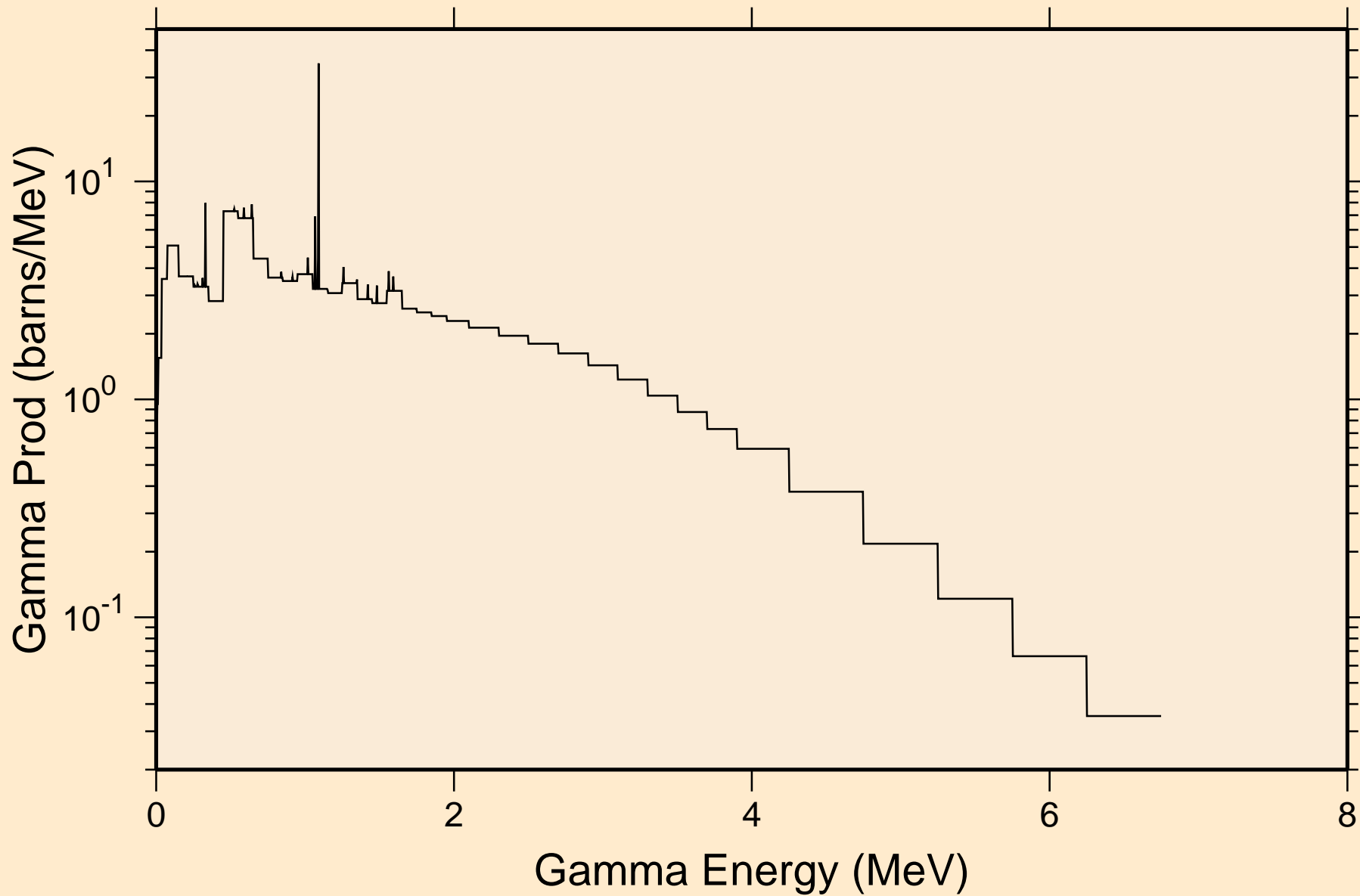



SB124N NEUTRON ACER TENDL-2024 LIBRARY; T=0.K  
14 MeV photon spectrum

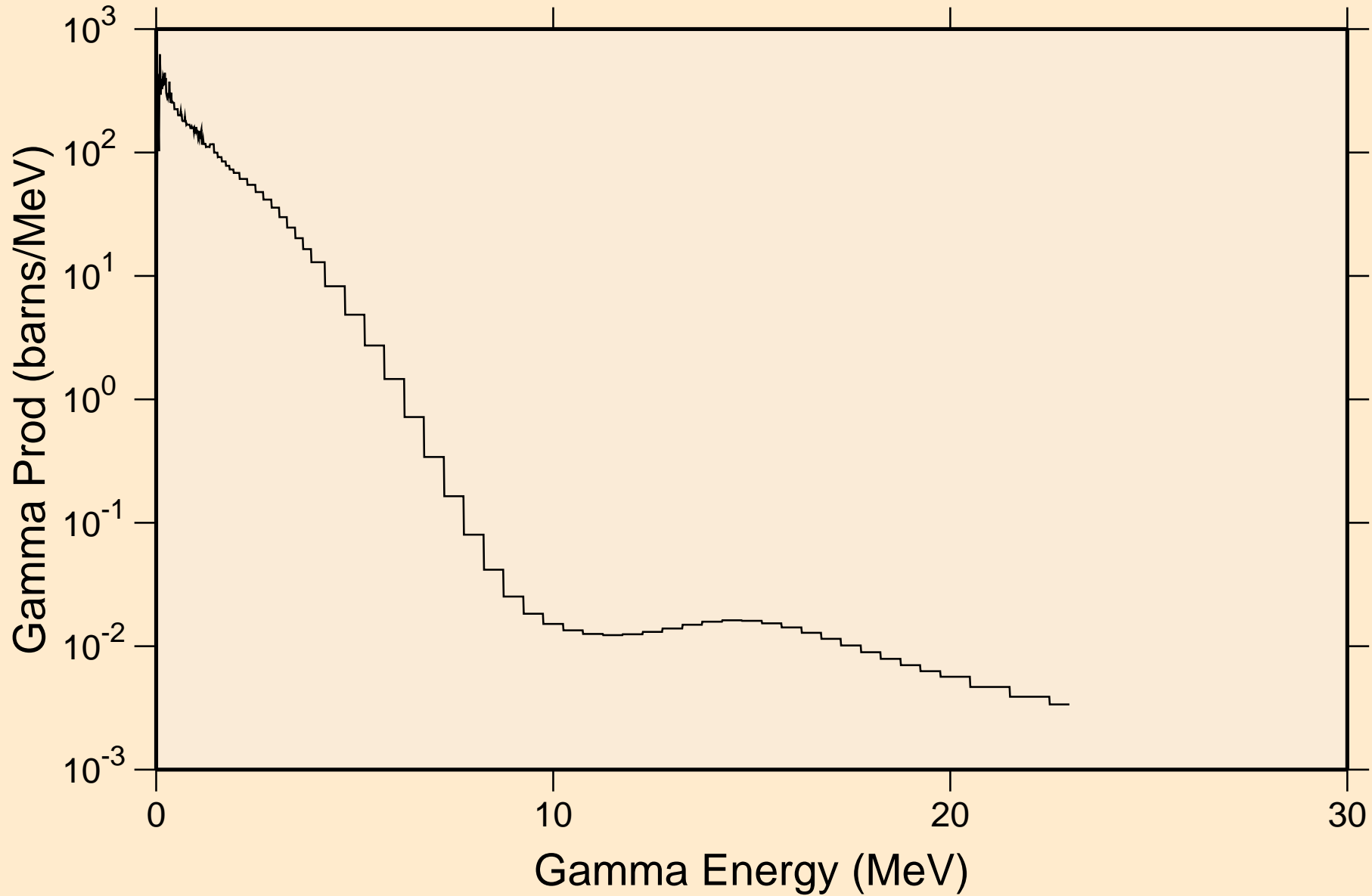

# SB124N NEUTRON ACER TENDL-2024 LIBRARY; T=0.K

## Particle heating contributions

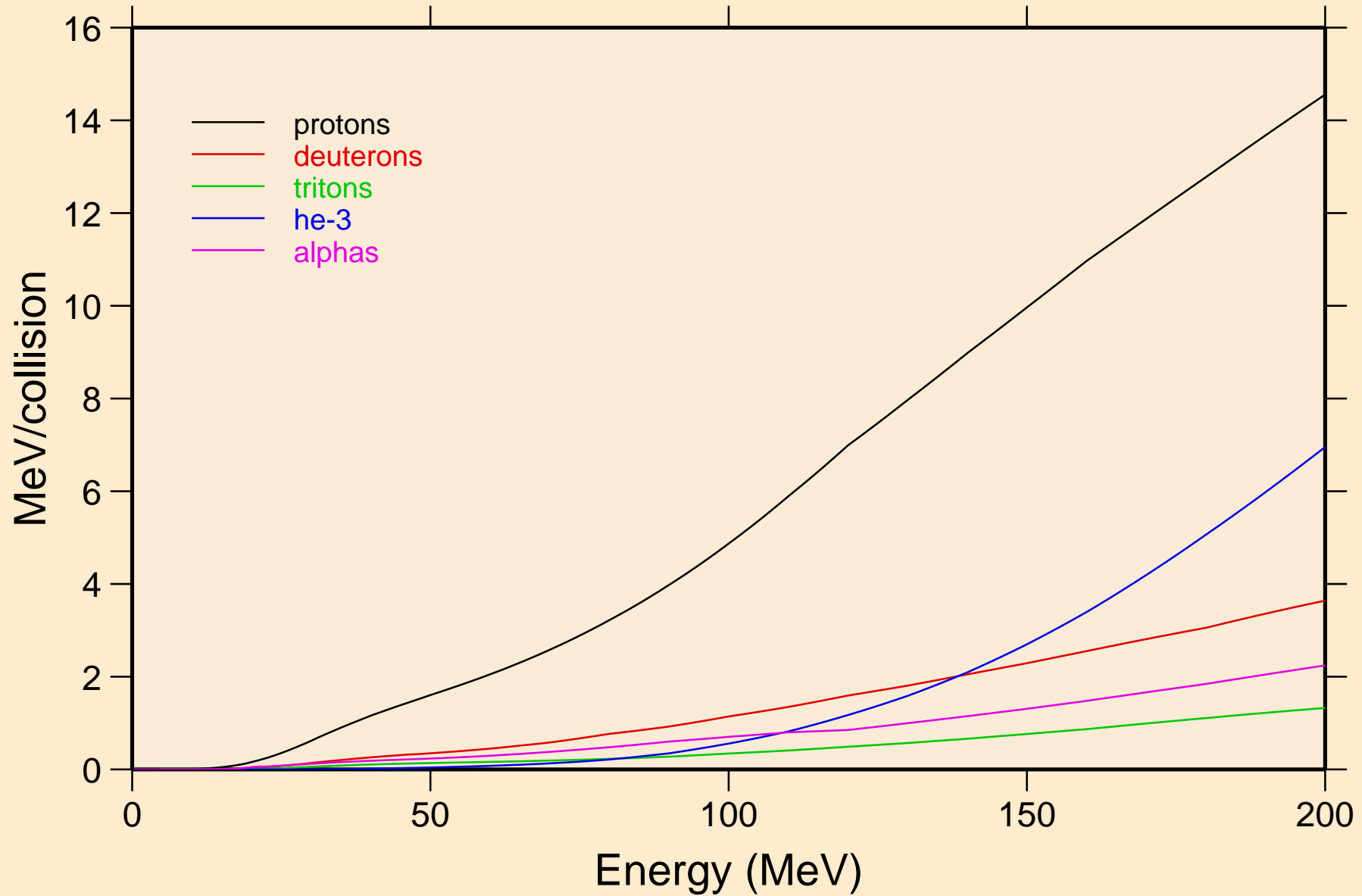

SB124N NEUTRON ACER TENDL-2024 LIBRARY; T=0.K  
Recoil Heating

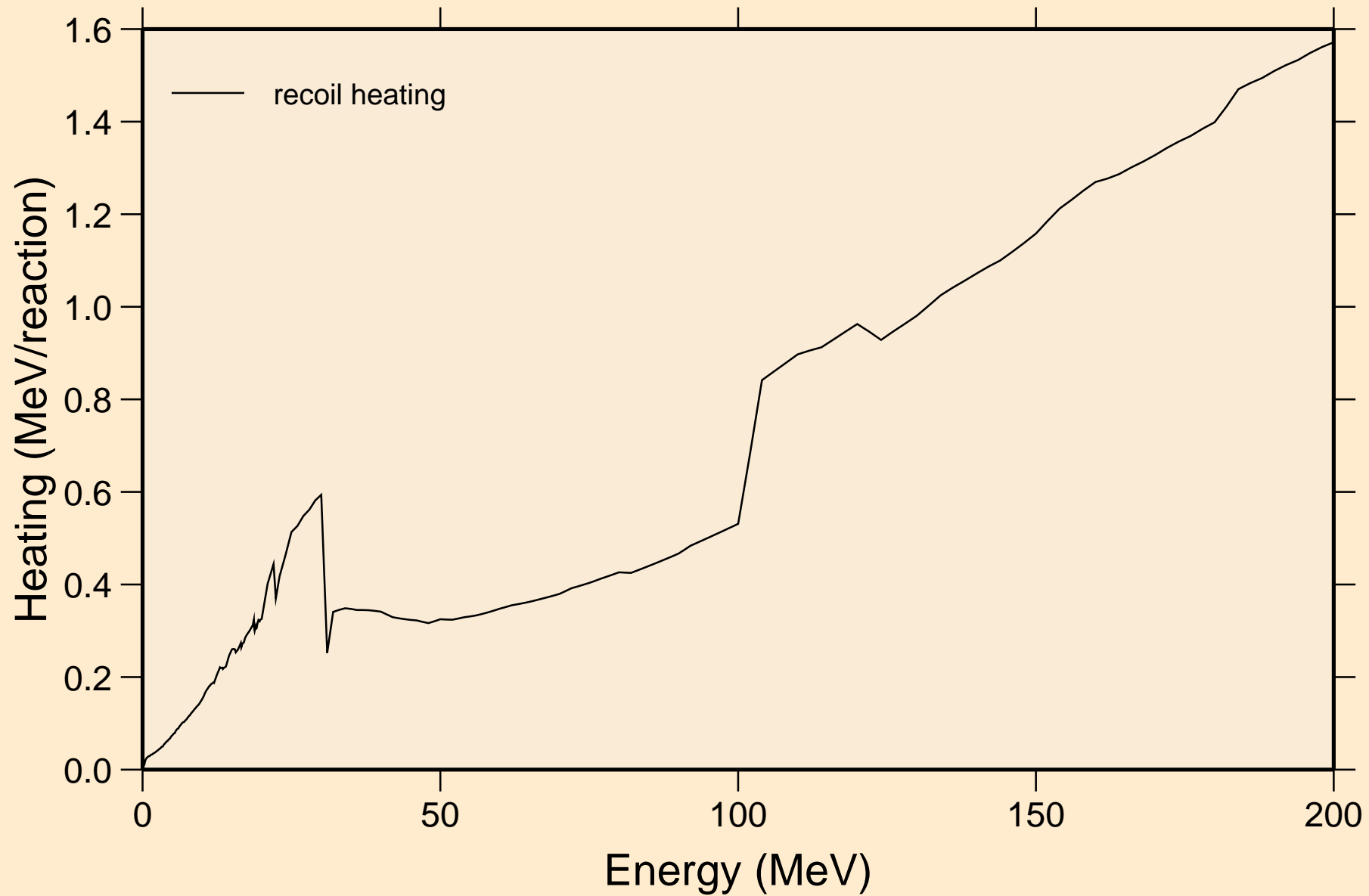

SB124N NEUTRON ACER TENDL-2024 LIBRARY; T=0.K  
Particle production cross sections

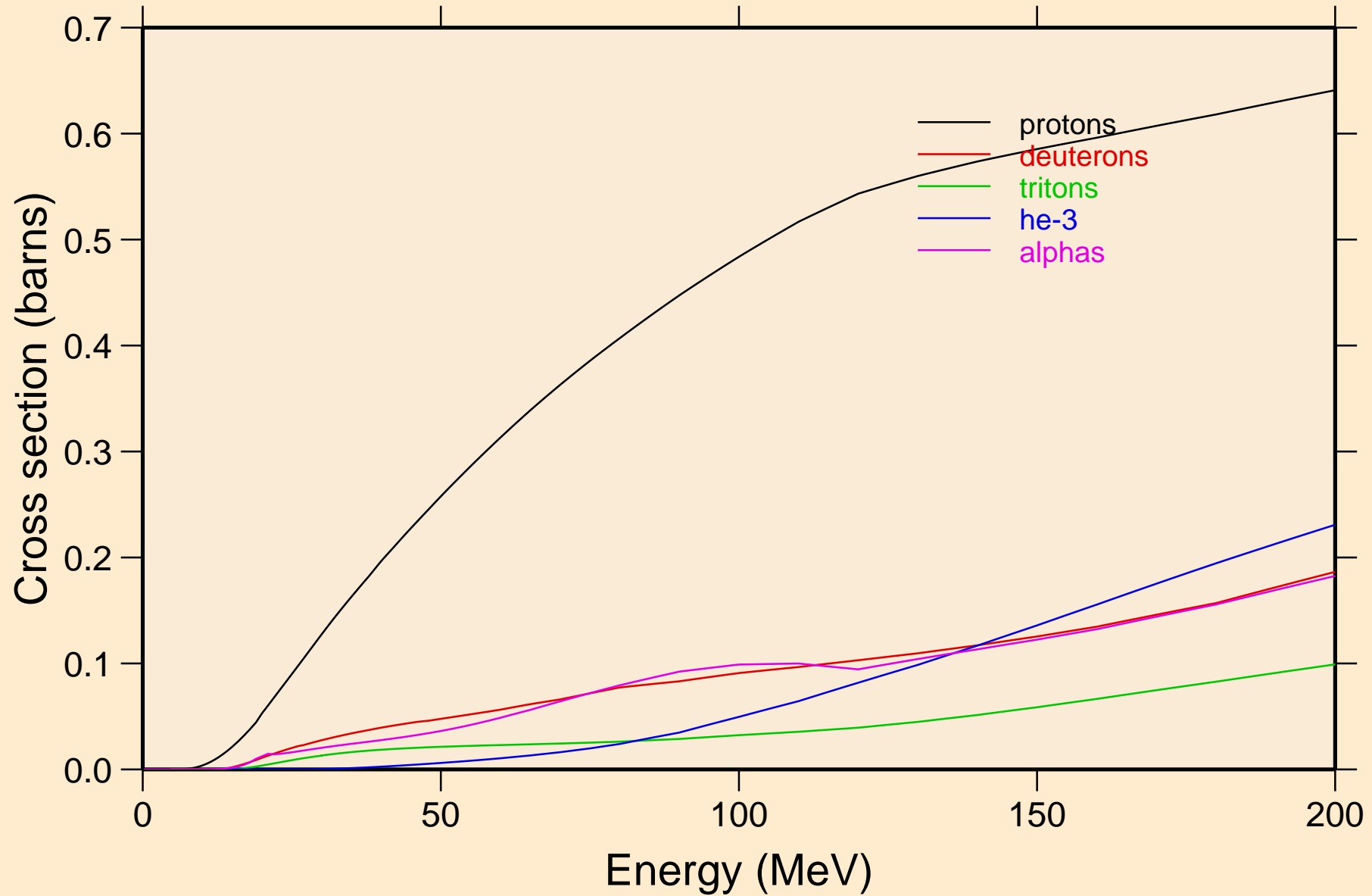

SB124N NEUTRON ACER TENDL-2024 LIBRARY; T=0.K  
protons from (n,x)

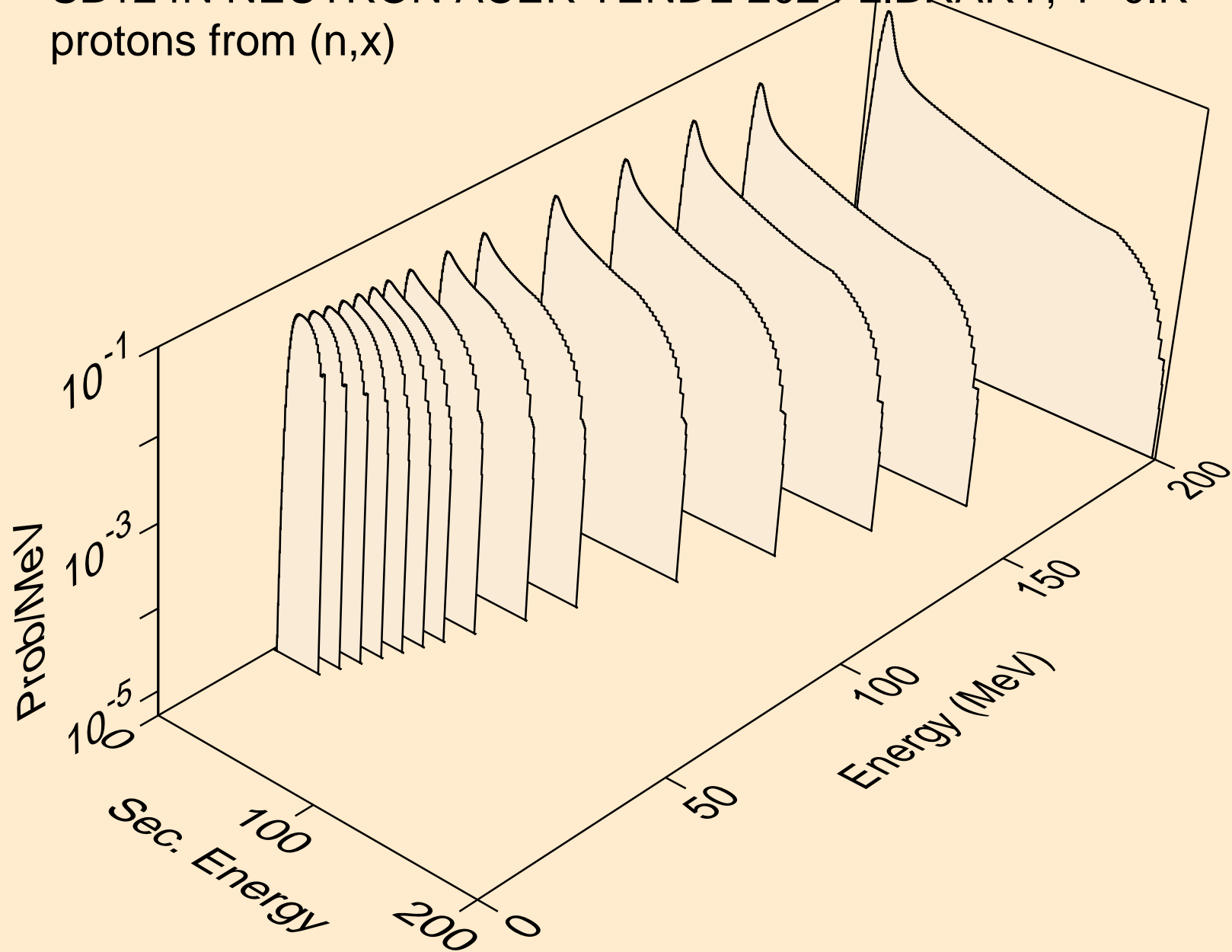

SB124N NEUTRON ACER TENDL-2024 LIBRARY; T=0.K  
protons from (n,n\*)p

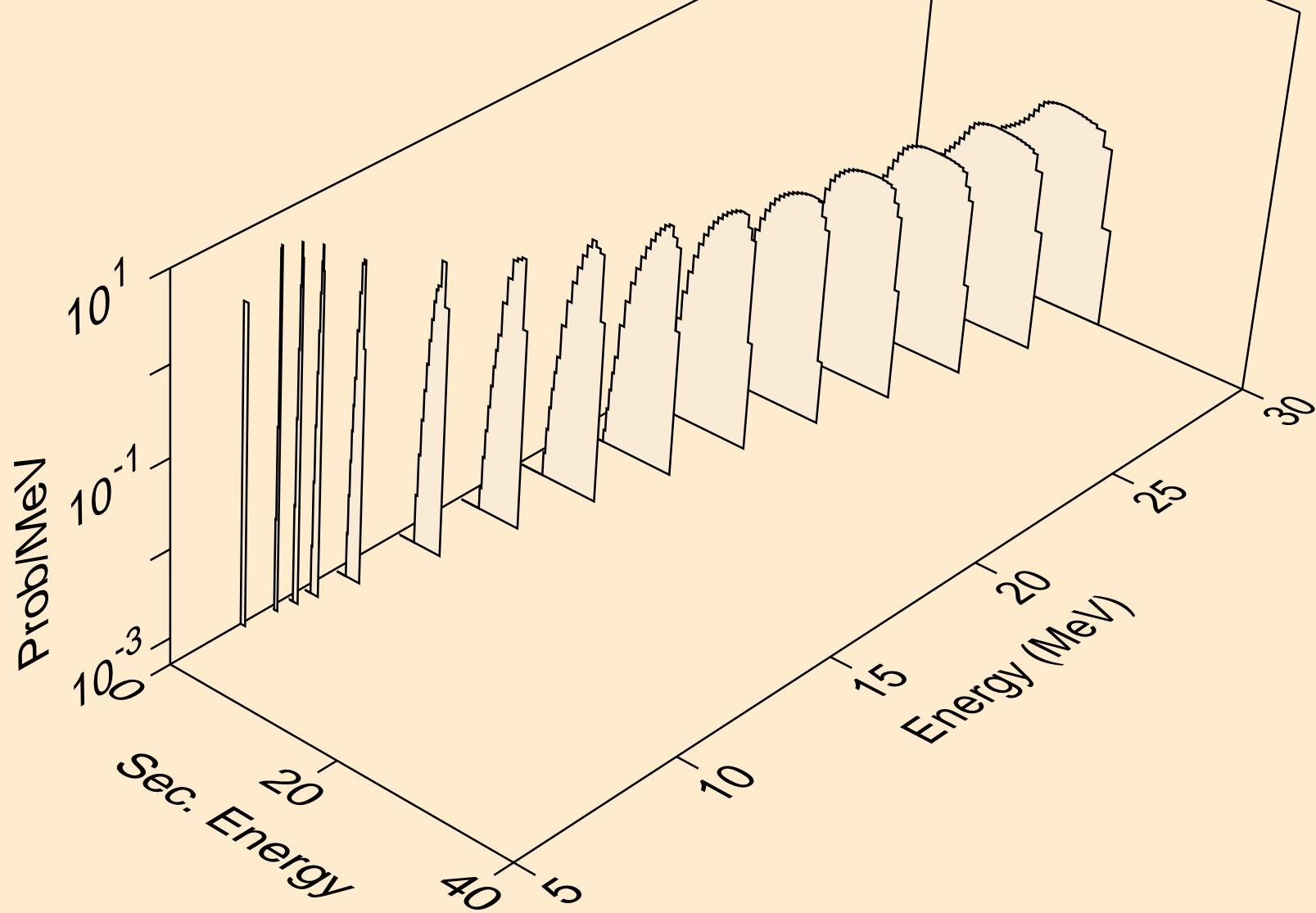

SB124N NEUTRON ACER TENDL-2024 LIBRARY; T=0.K  
protons from (n,2np)

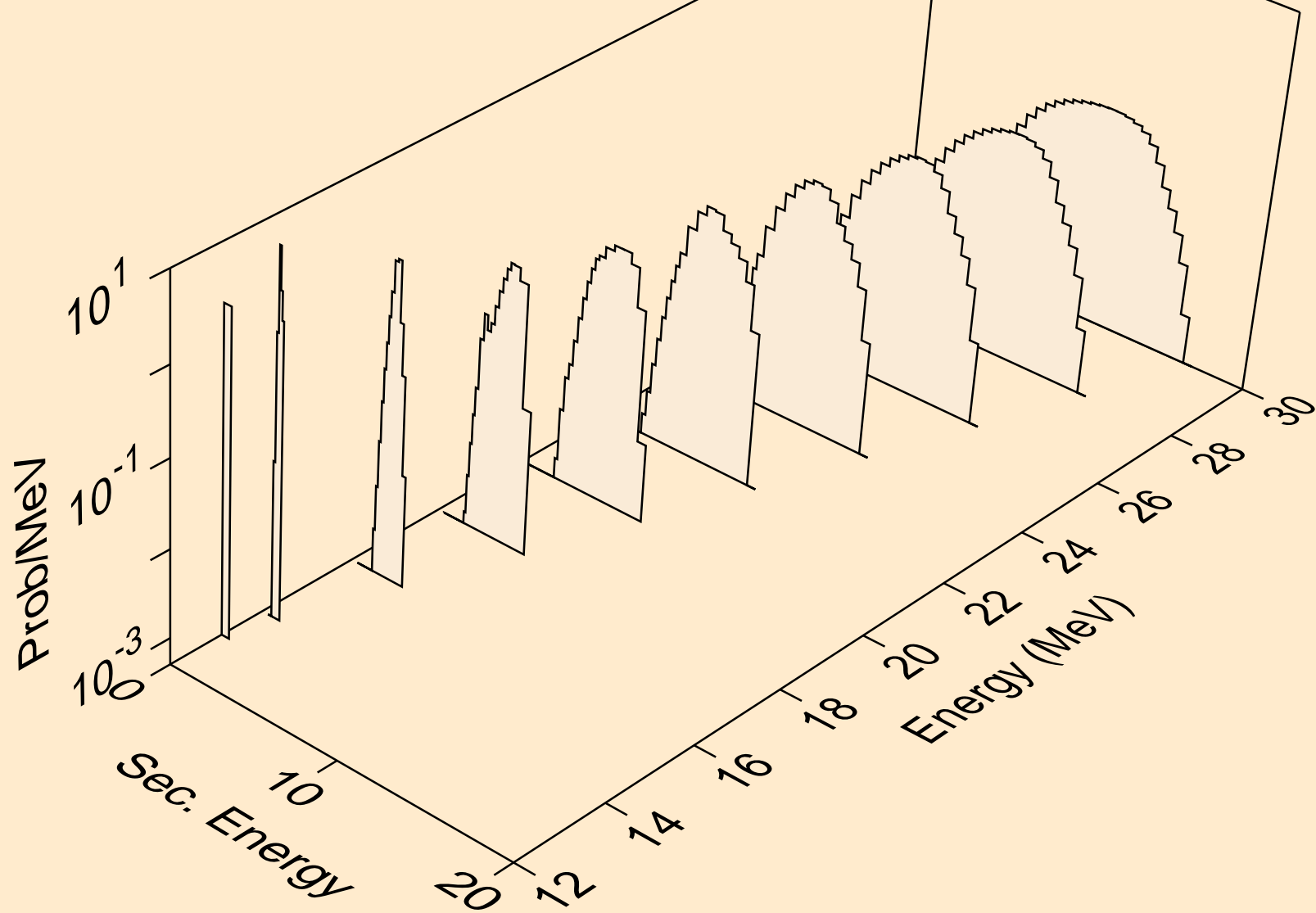

SB124N NEUTRON ACER TENDL-2024 LIBRARY; T=0.K  
protons from (n,3np)

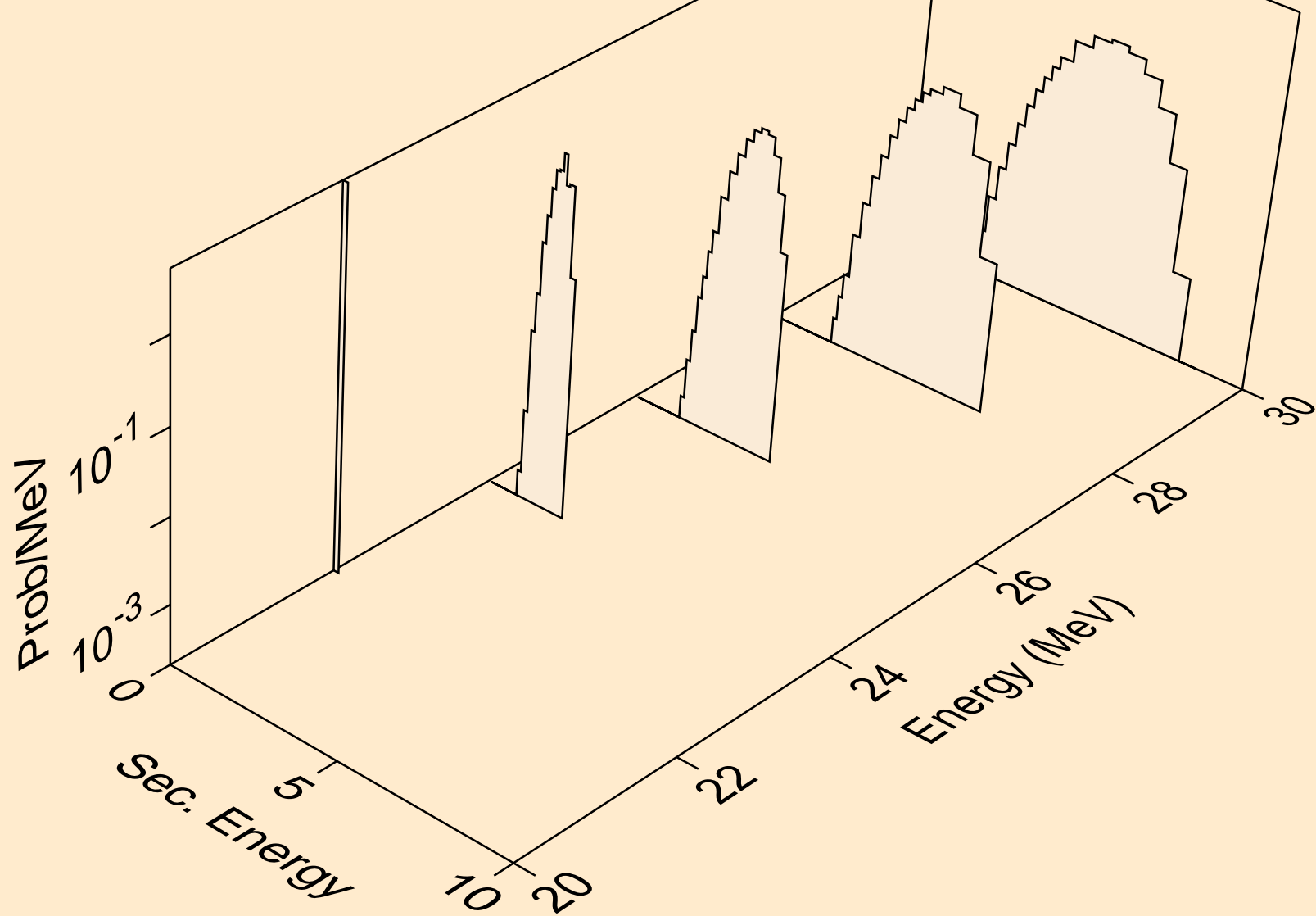



SB124N NEUTRON ACER TENDL-2024 LIBRARY; T=0.K  
protons from (n,n2p)

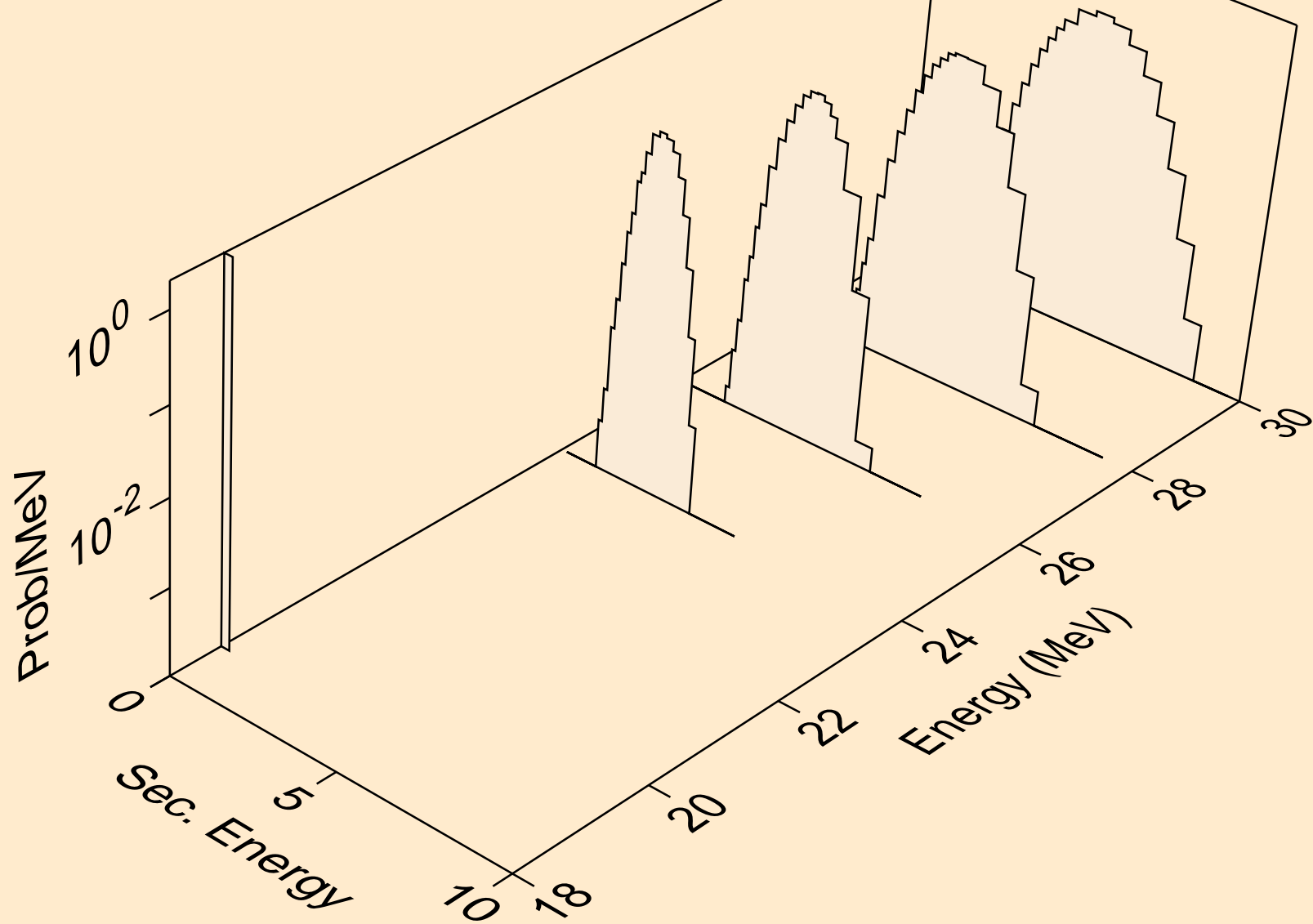

SB124N NEUTRON ACER TENDL-2024 LIBRARY; T=0.K  
protons from (n,npa)

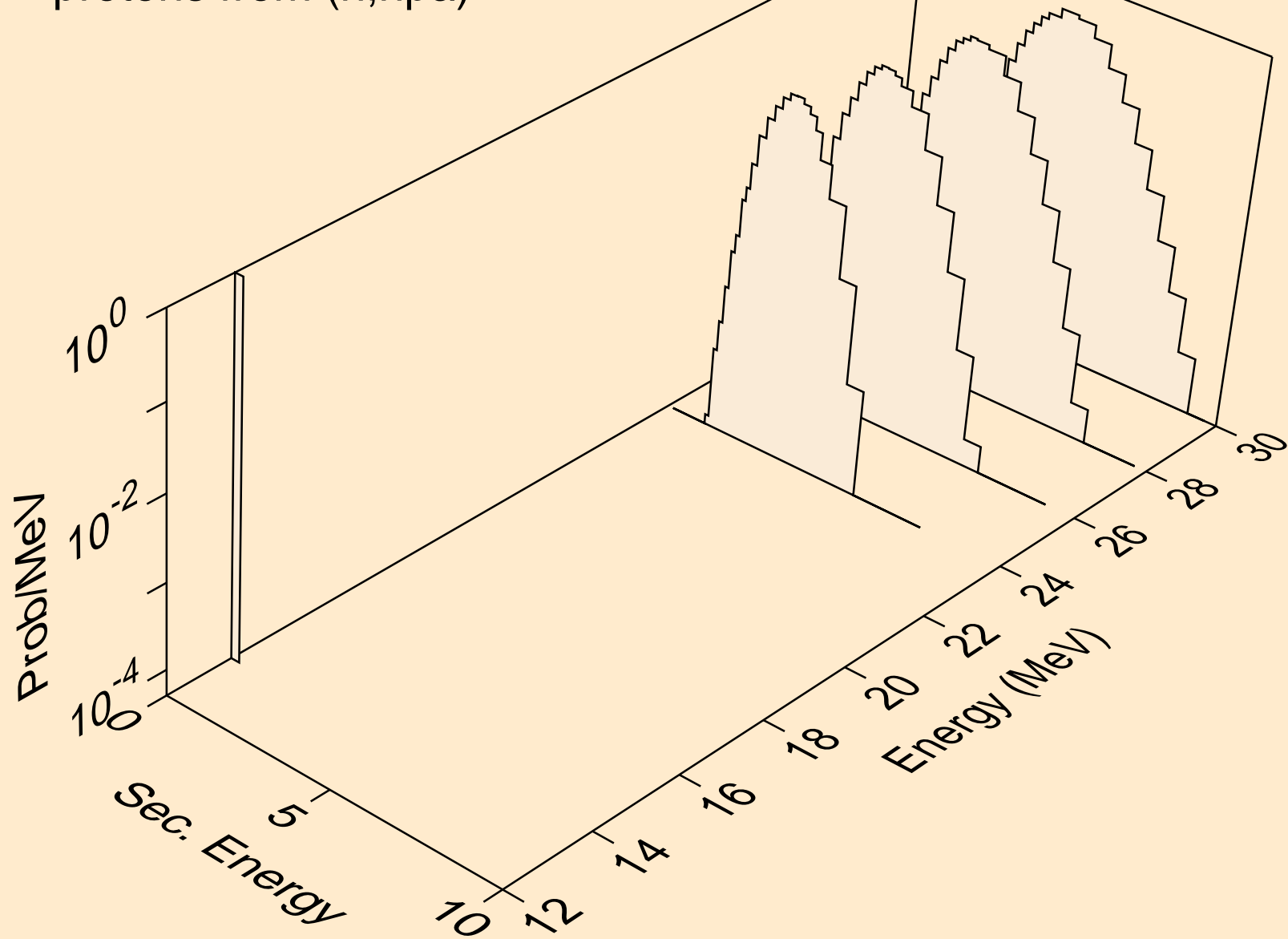

SB124N NEUTRON ACER TENDL-2024 LIBRARY; T=0.K  
protons from (n,p)

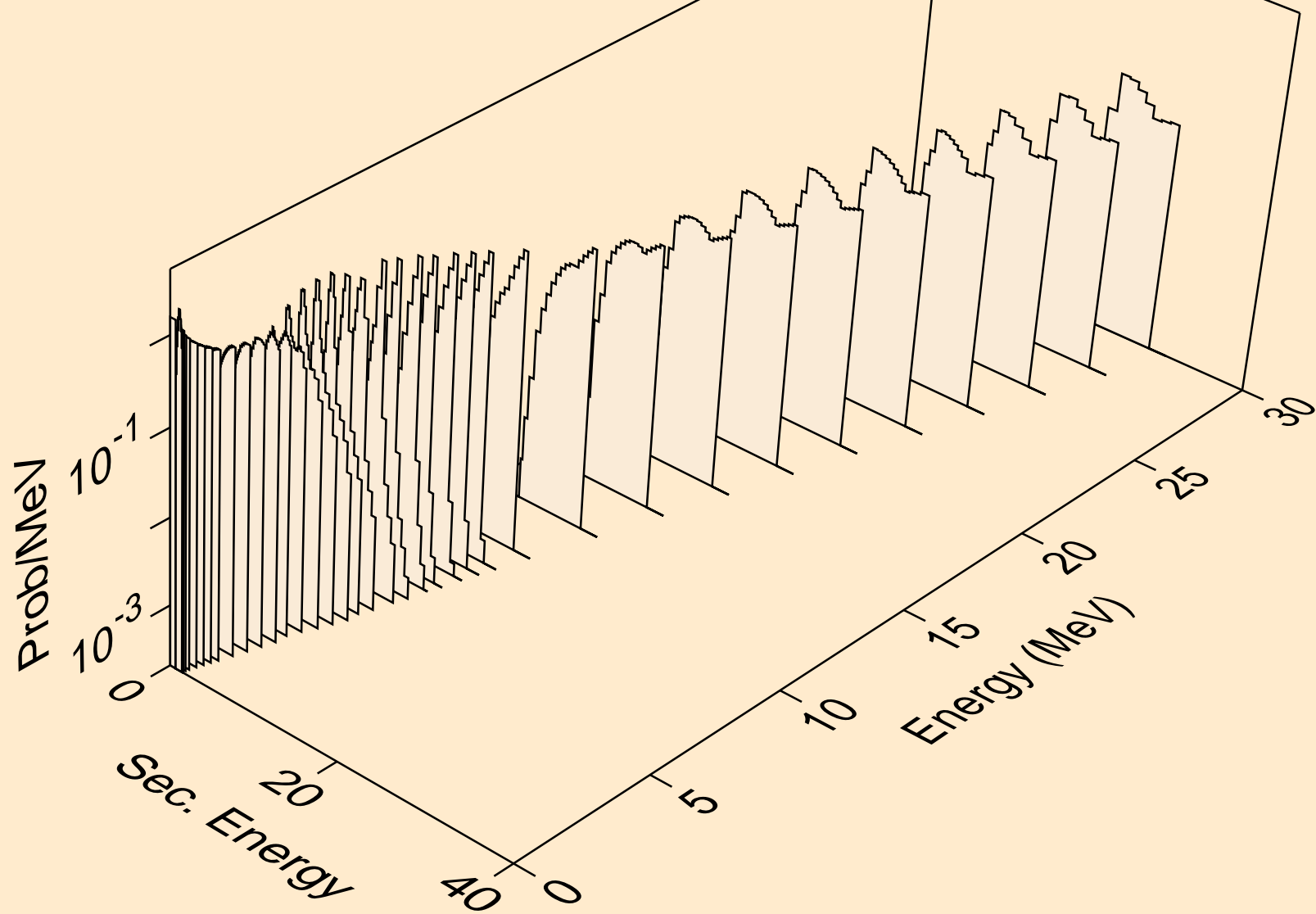

SB124N NEUTRON ACER TENDL-2024 LIBRARY; T=0.K  
protons from (n,2p)

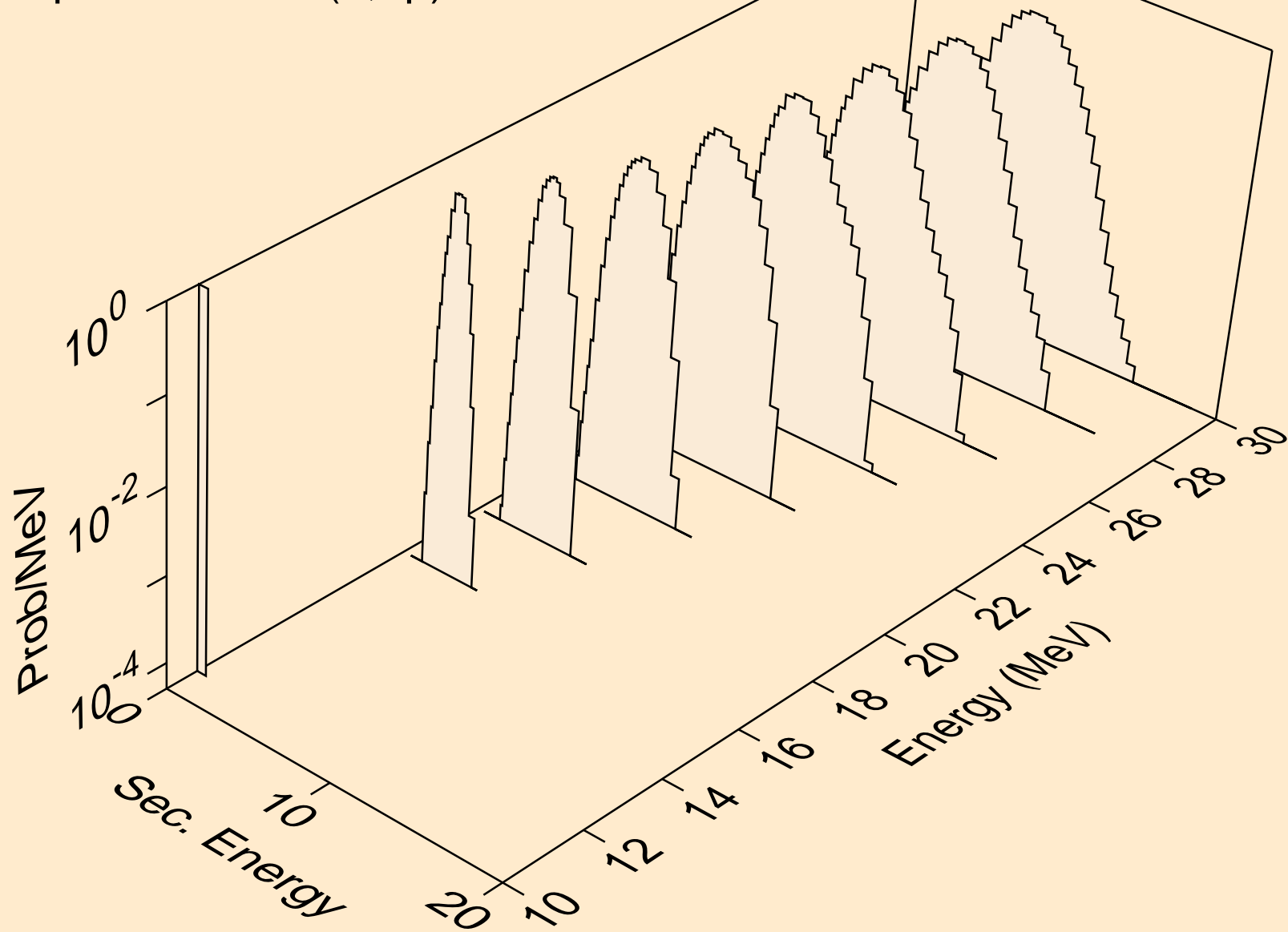

SB124N NEUTRON ACER TENDL-2024 LIBRARY; T=0.K  
protons from (n,pa)

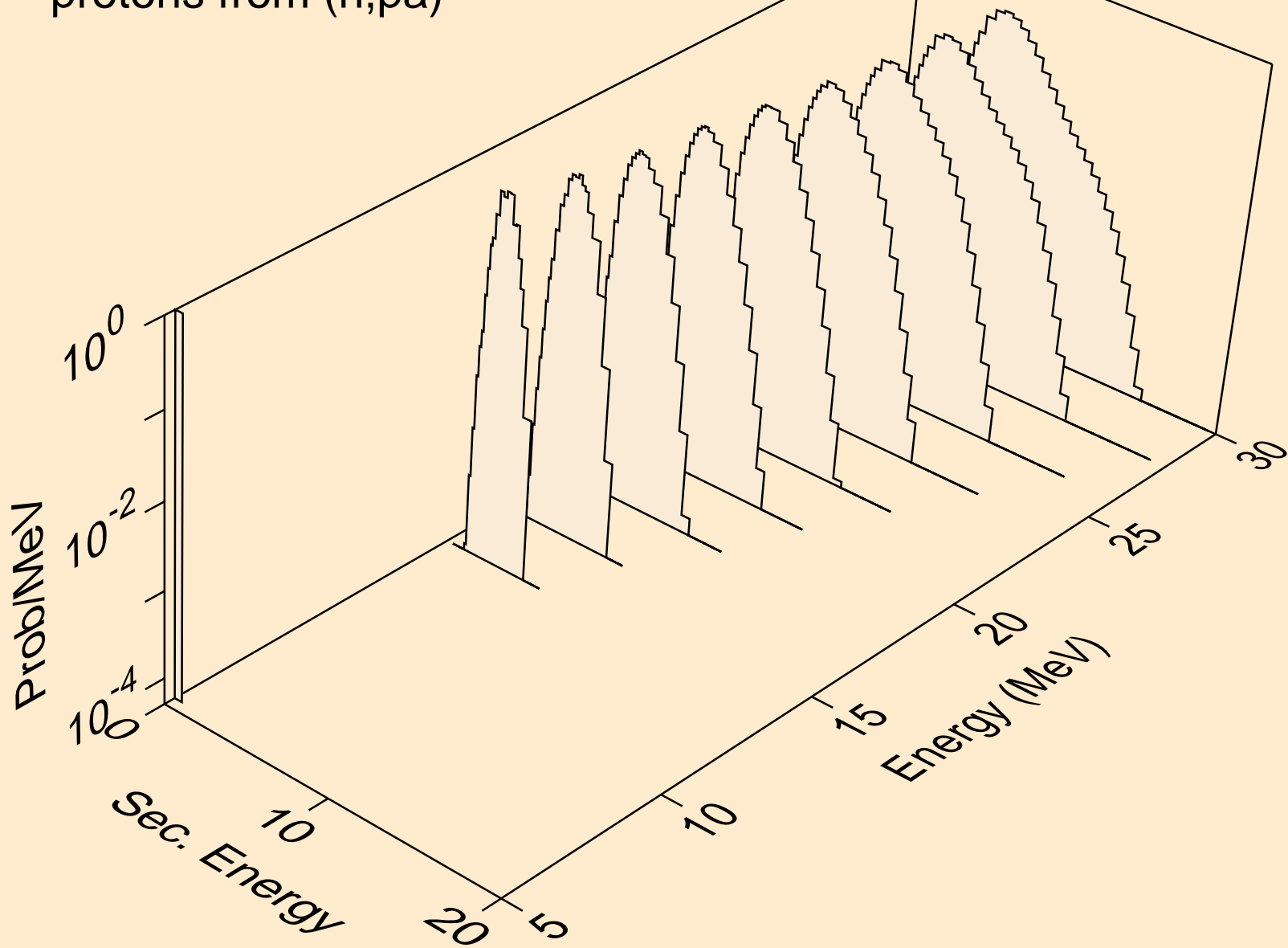

SB124N NEUTRON ACER TENDL-2024 LIBRARY; T=0.K  
protons from (n,pd)

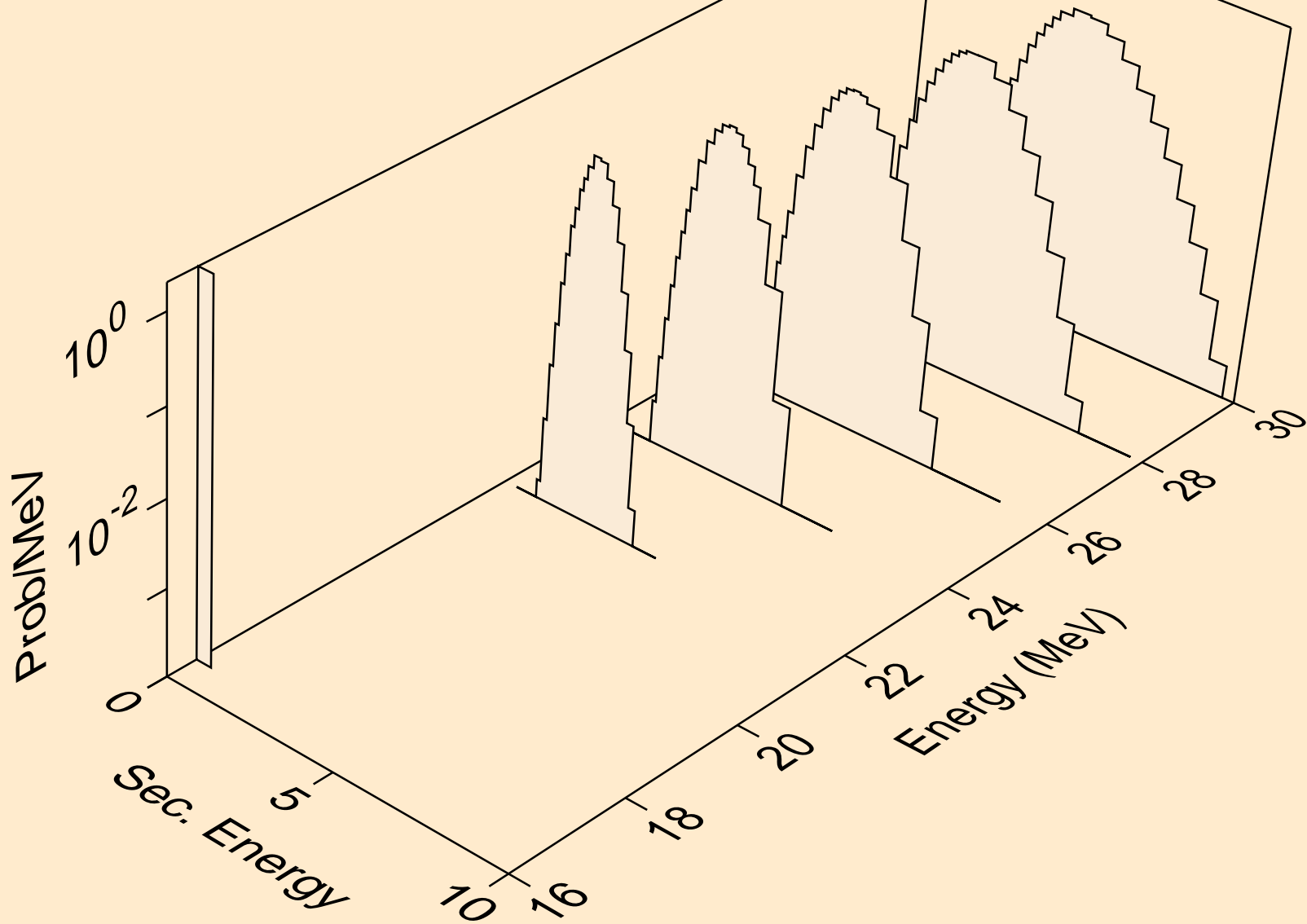

SB124N NEUTRON ACER TENDL-2024 LIBRARY; T=0.K  
protons from (n,pt)

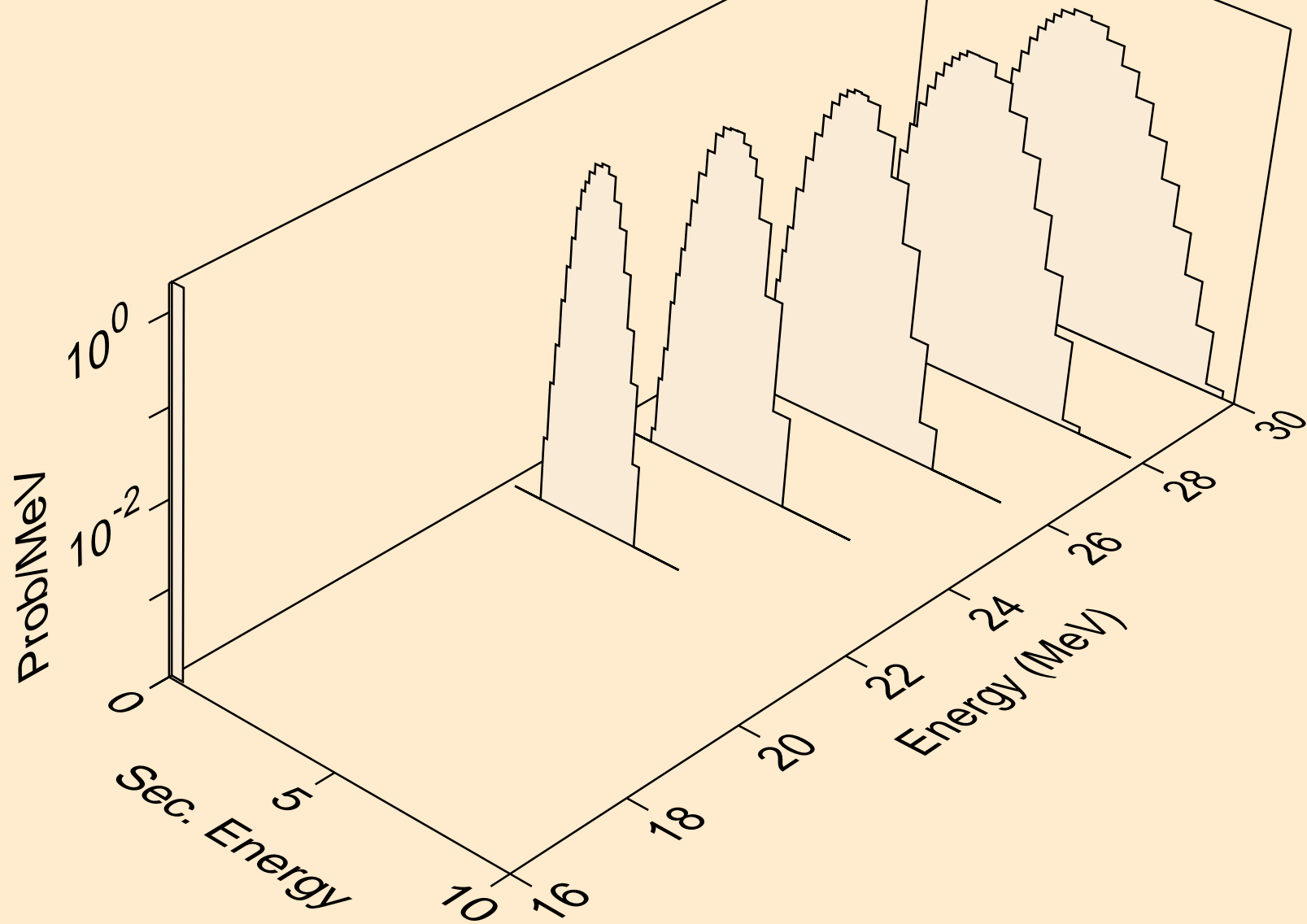

SB124N NEUTRON ACER TENDL-2024 LIBRARY; T=0.K  
deuterons from (n,x)

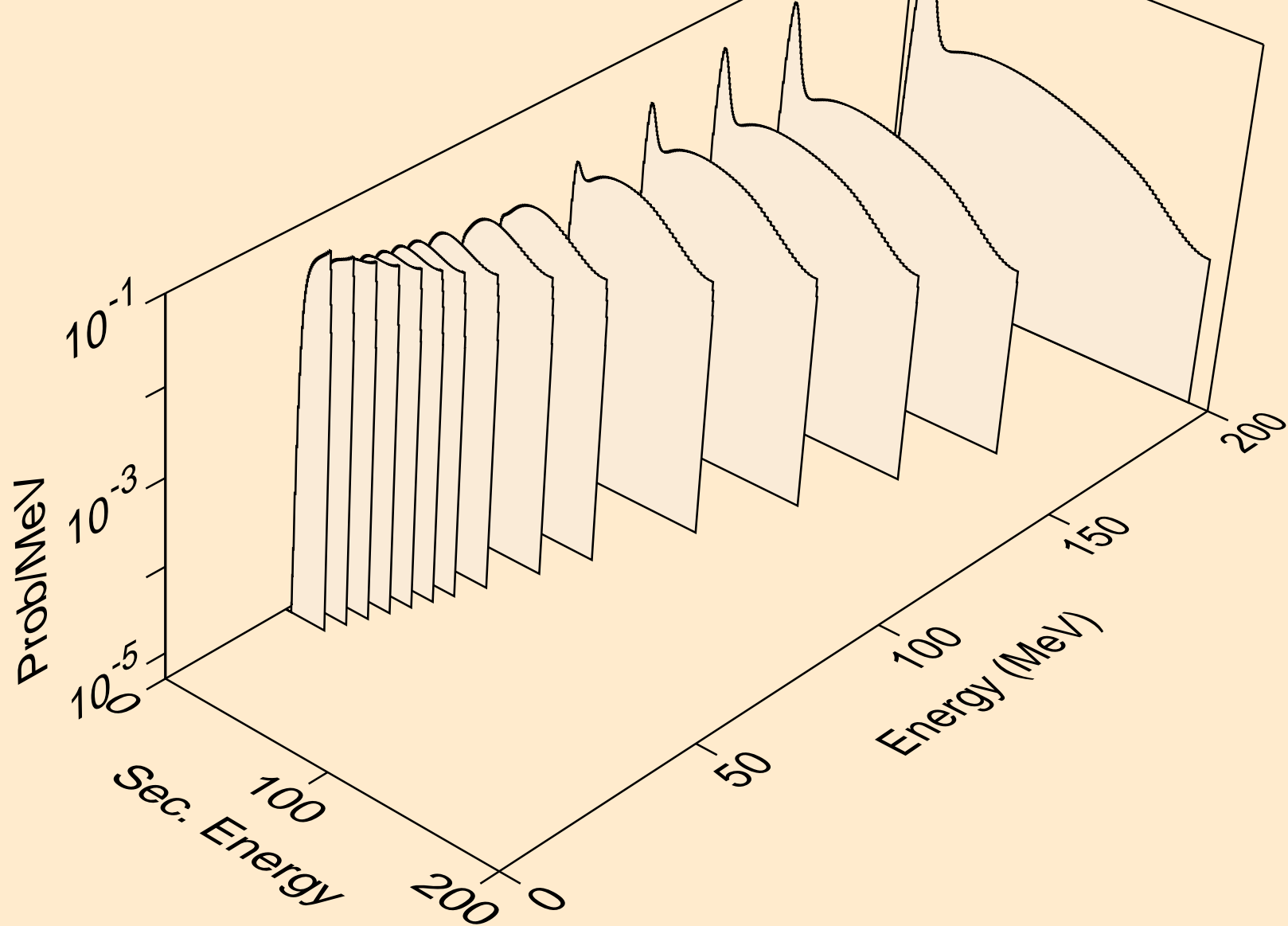



SB124N NEUTRON ACER TENDL-2024 LIBRARY; T=0.K  
deuterons from (n,2nd)

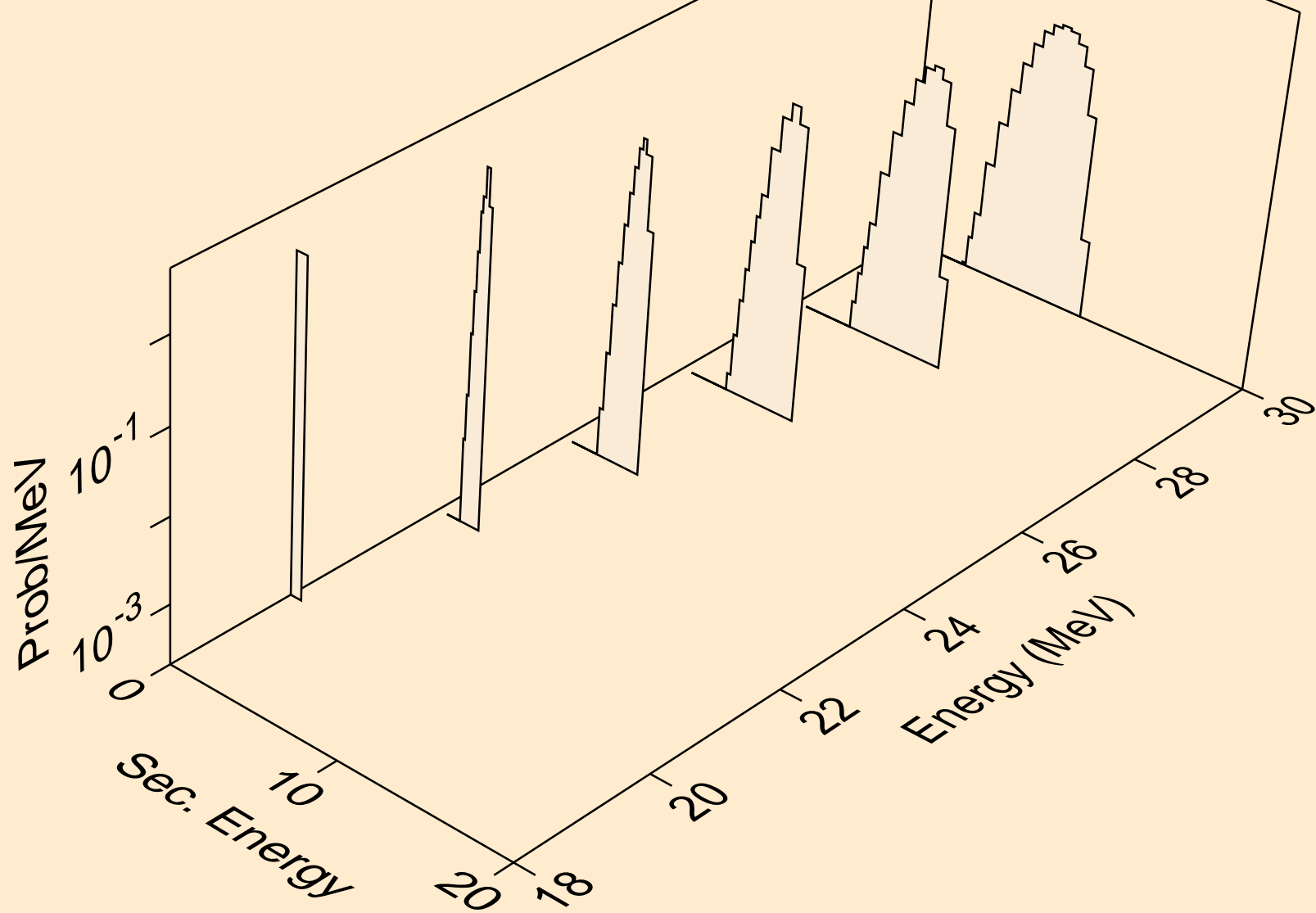

SB124N NEUTRON ACER TENDL-2024 LIBRARY; T=0.K  
deuterons from (n,n\*)d

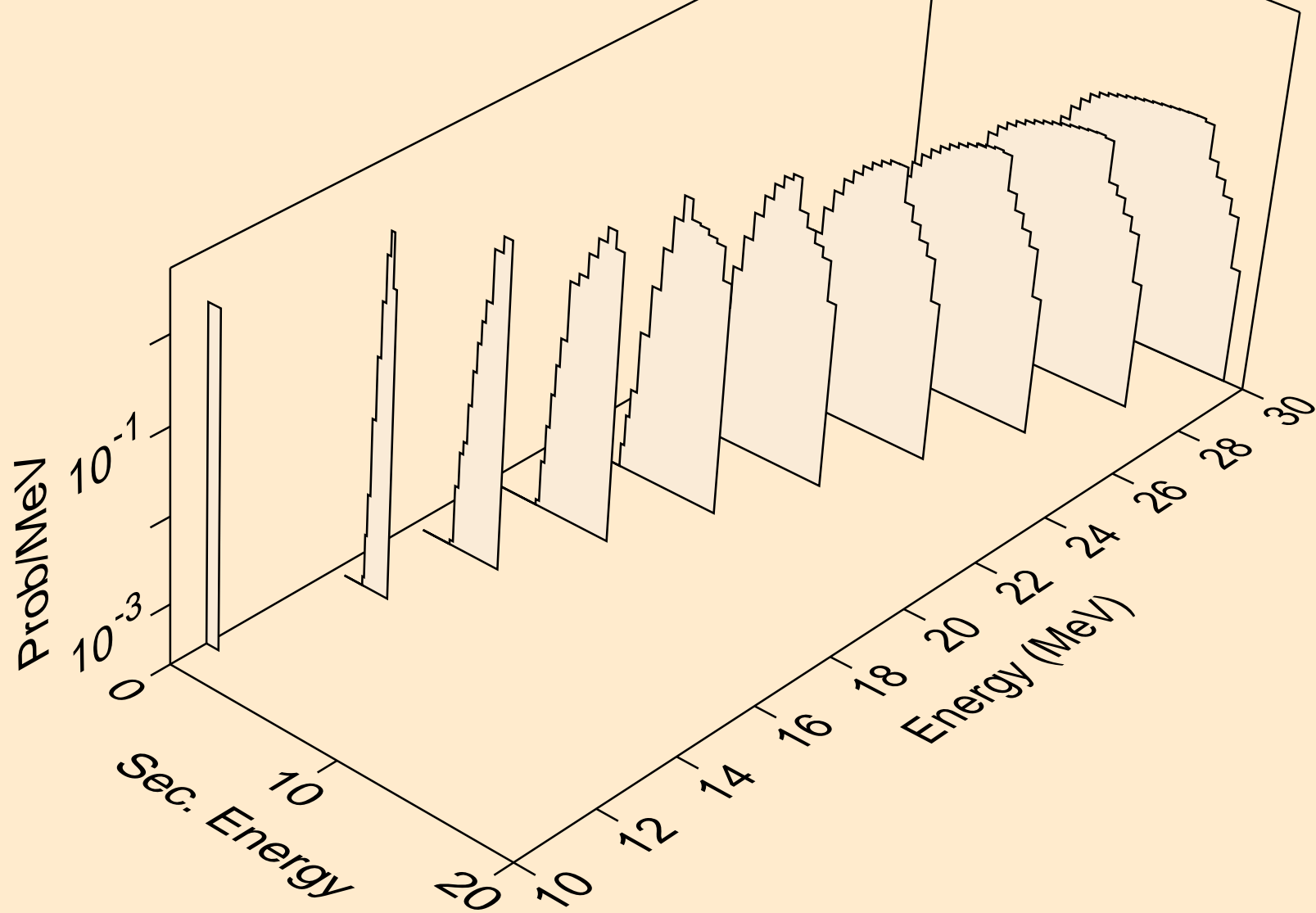

SB124N NEUTRON ACER TENDL-2024 LIBRARY; T=0.K  
deuterons from (n,d)

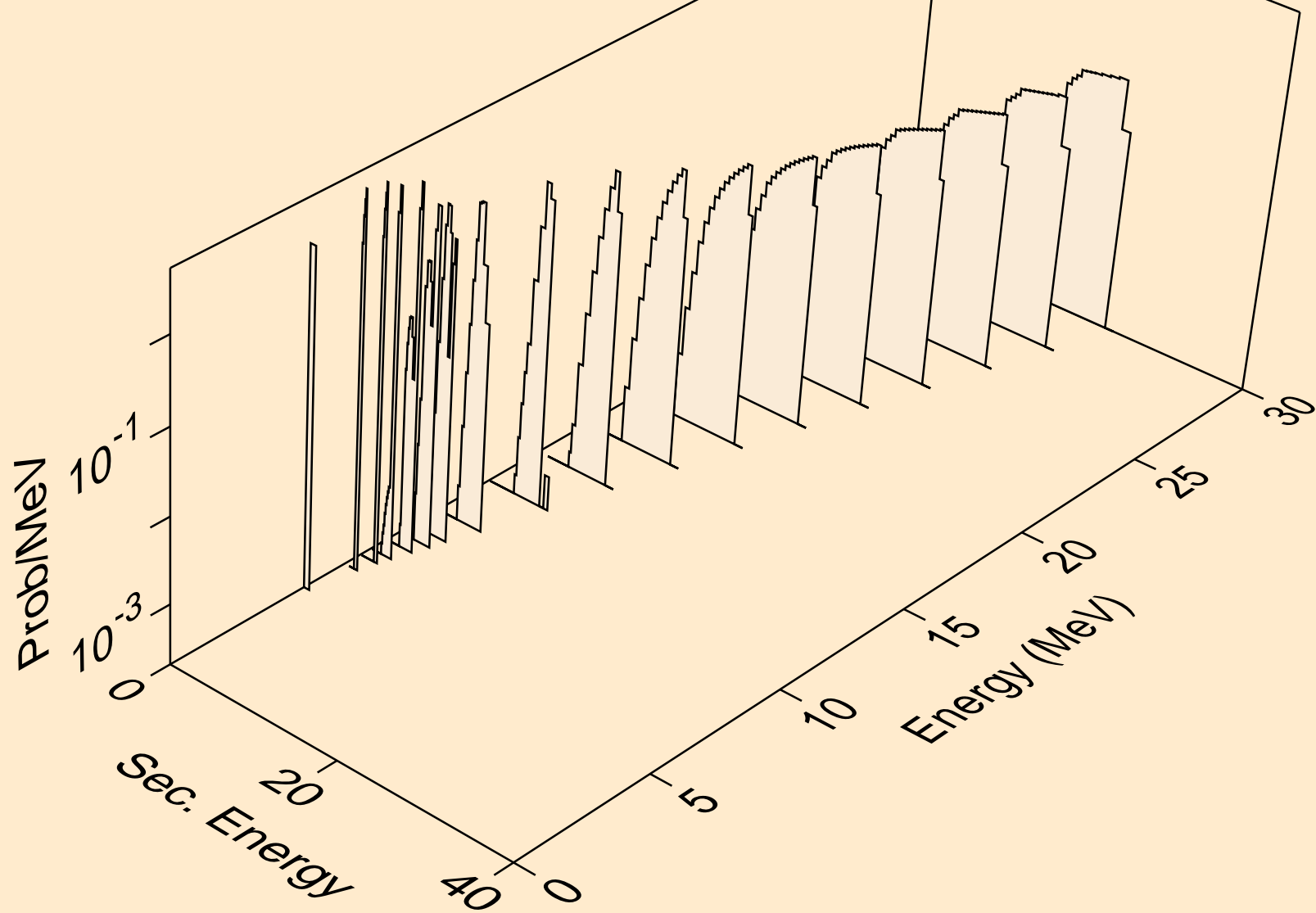

SB124N NEUTRON ACER TENDL-2024 LIBRARY; T=0.K  
deuterons from (n,pd)

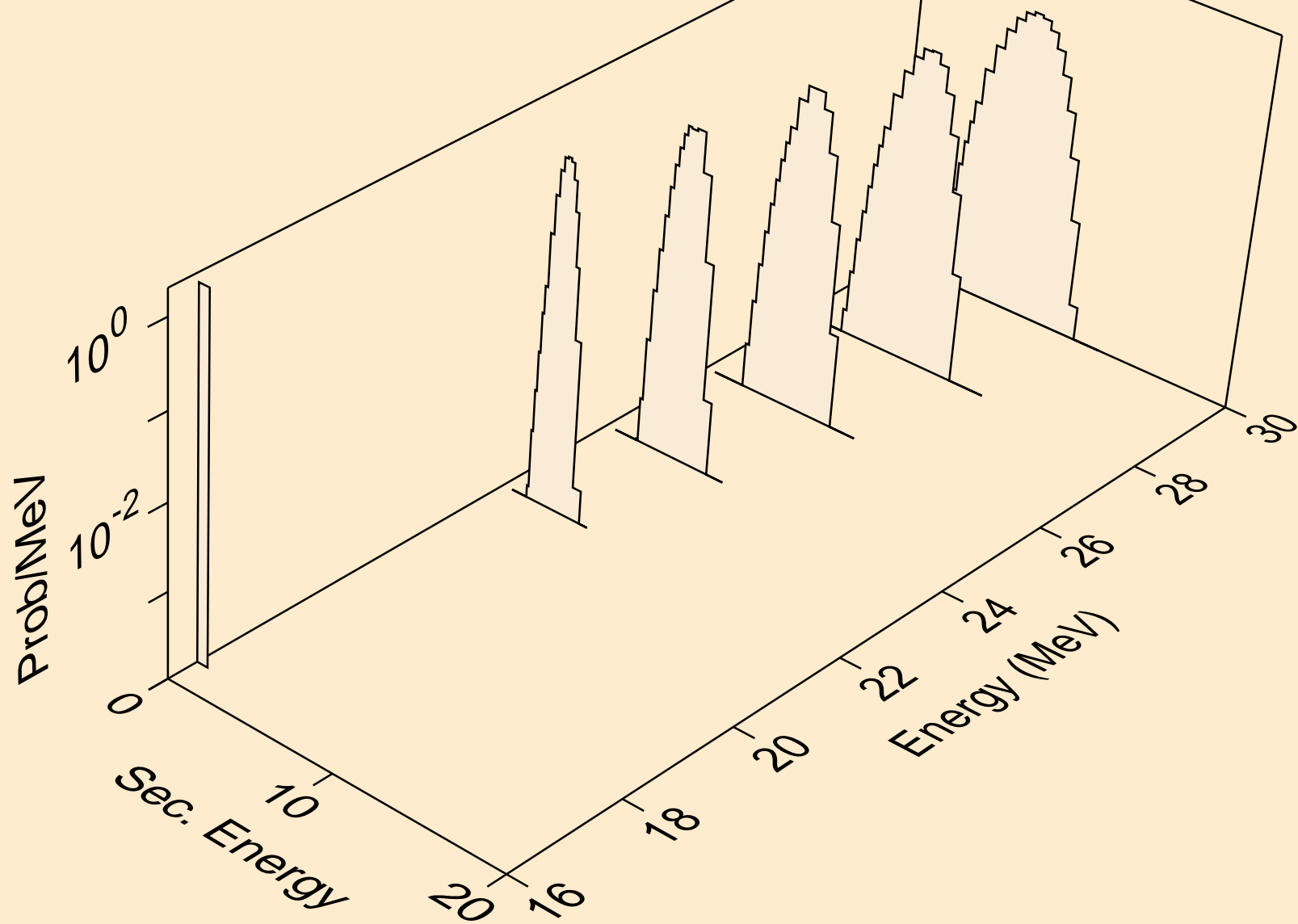

SB124N NEUTRON ACER TENDL-2024 LIBRARY; T=0.K  
tritons from (n,x)

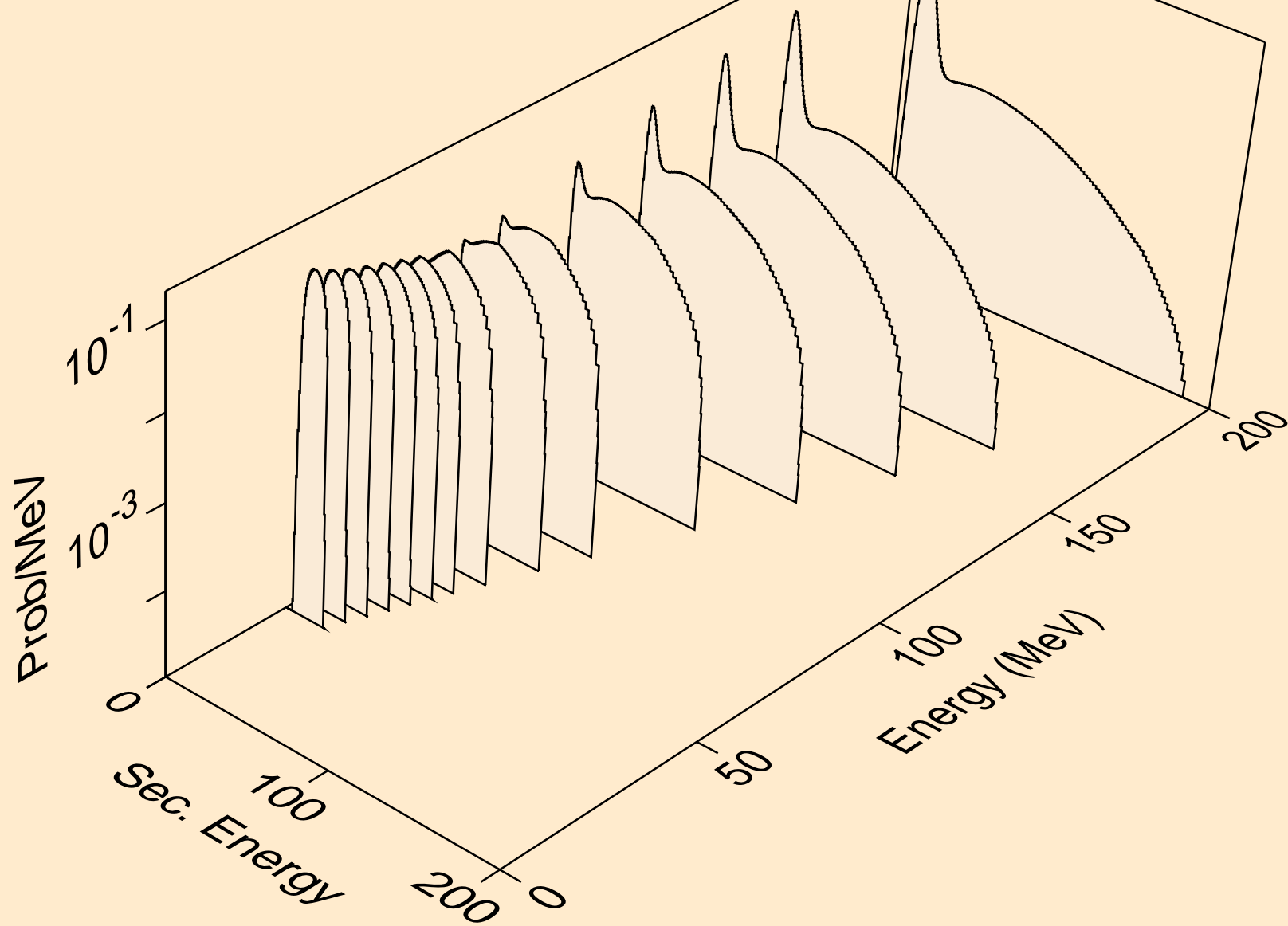

SB124N NEUTRON ACER TENDL-2024 LIBRARY; T=0.K  
tritons from (n,n\*)t

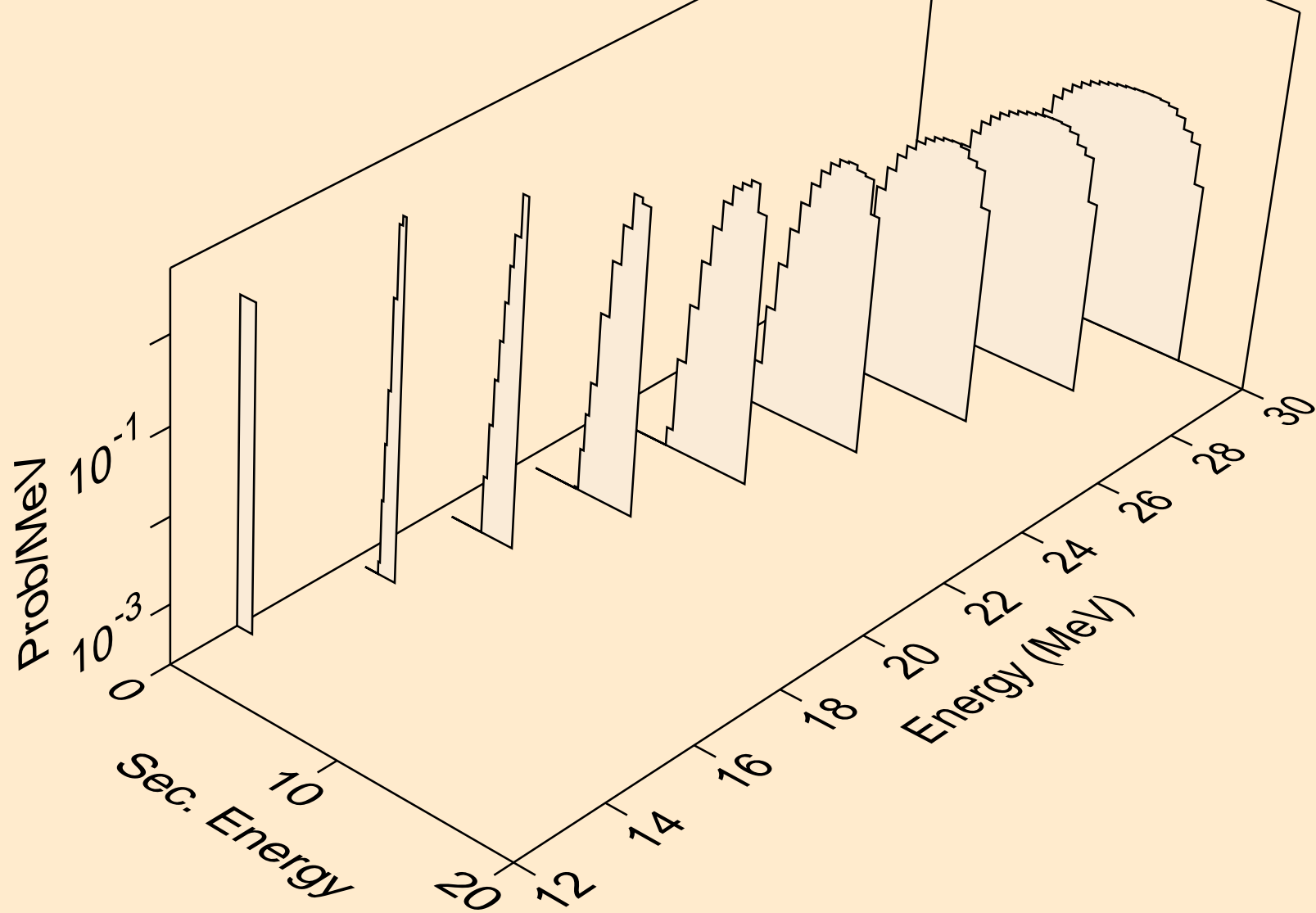

SB124N NEUTRON ACER TENDL-2024 LIBRARY; T=0.K  
tritons from (n,t)

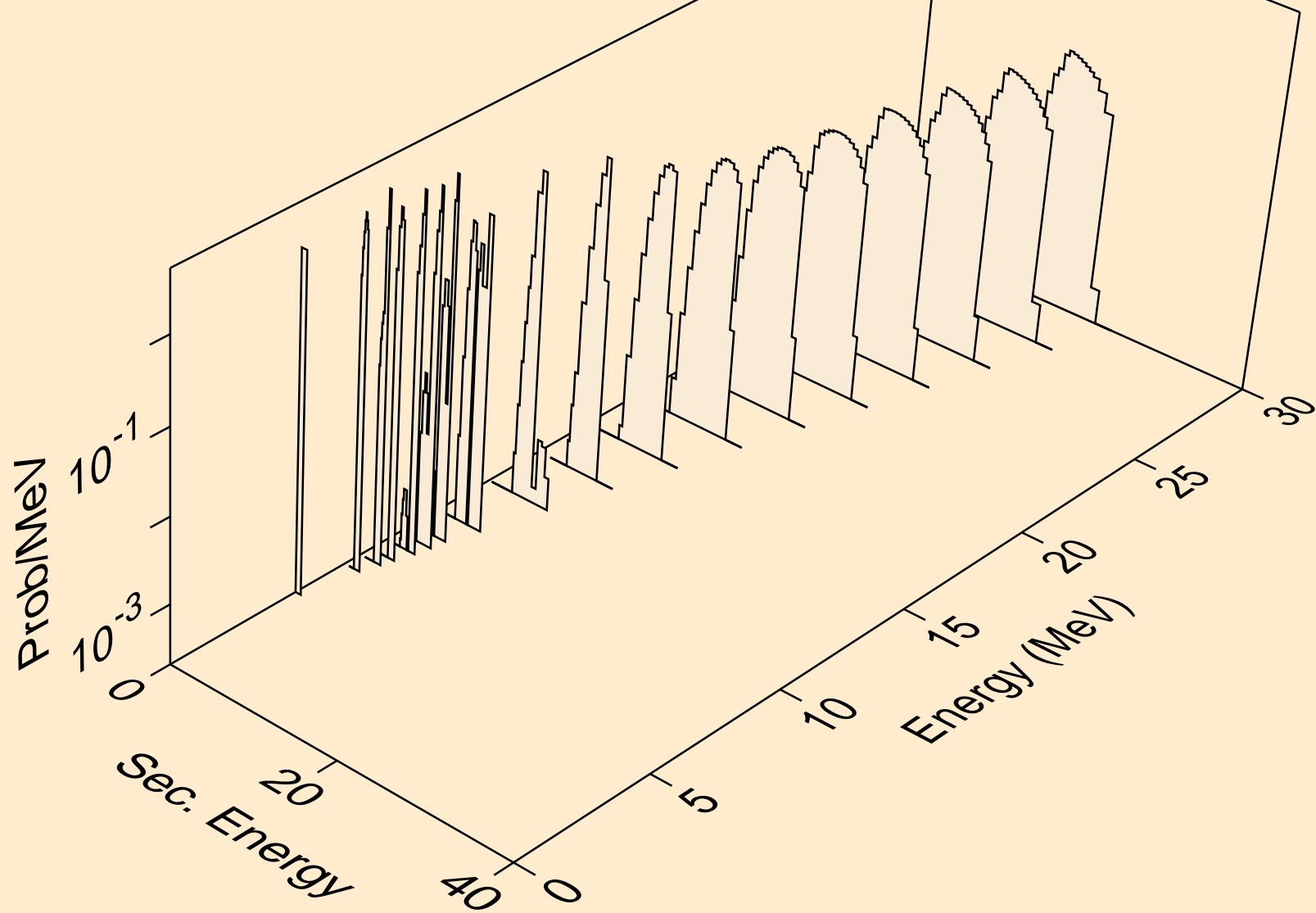

SB124N NEUTRON ACER TENDL-2024 LIBRARY; T=0.K  
tritons from (n,pt)

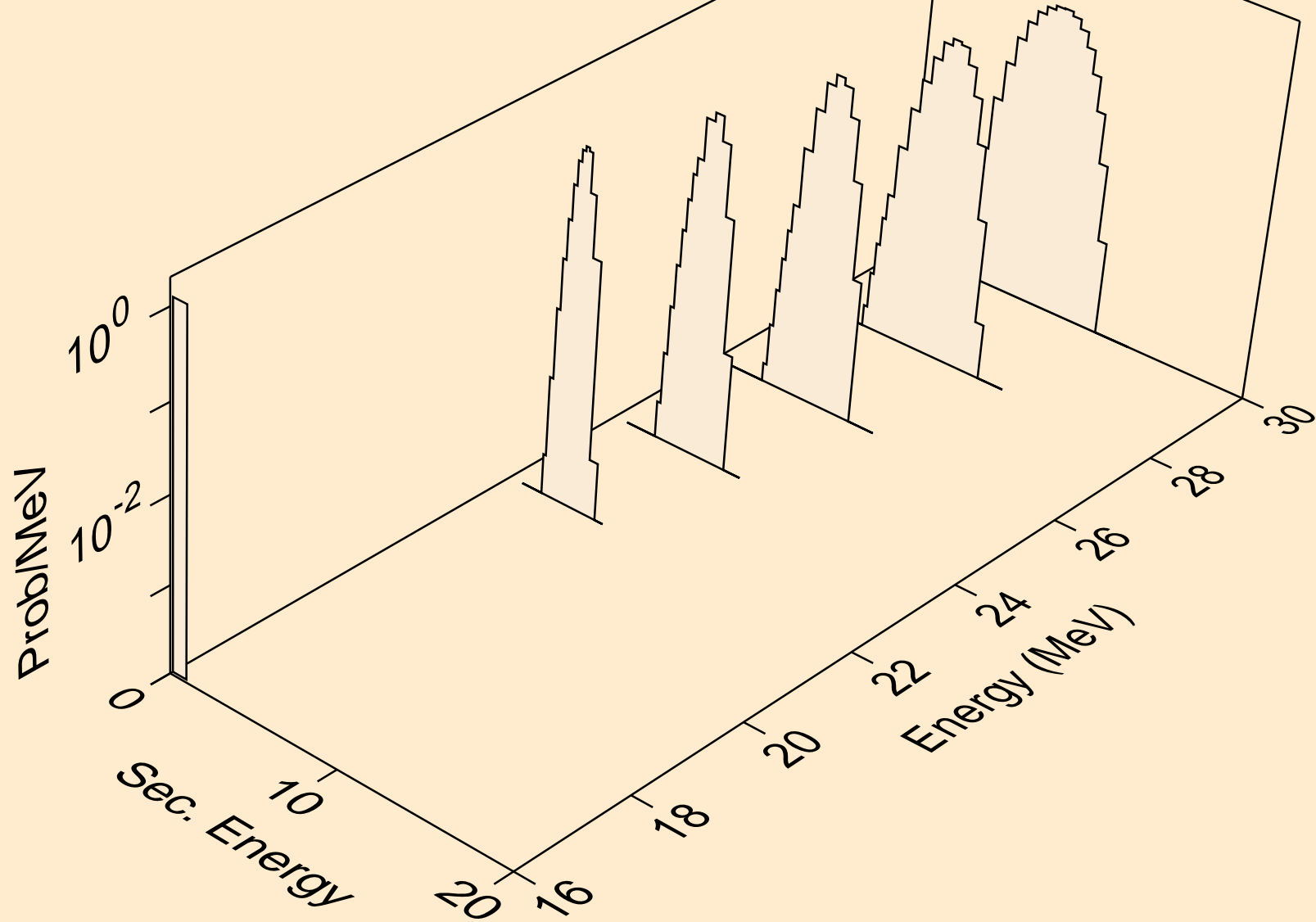



SB124N NEUTRON ACER TENDL-2024 LIBRARY; T=0.K  
he3s from (n,x)

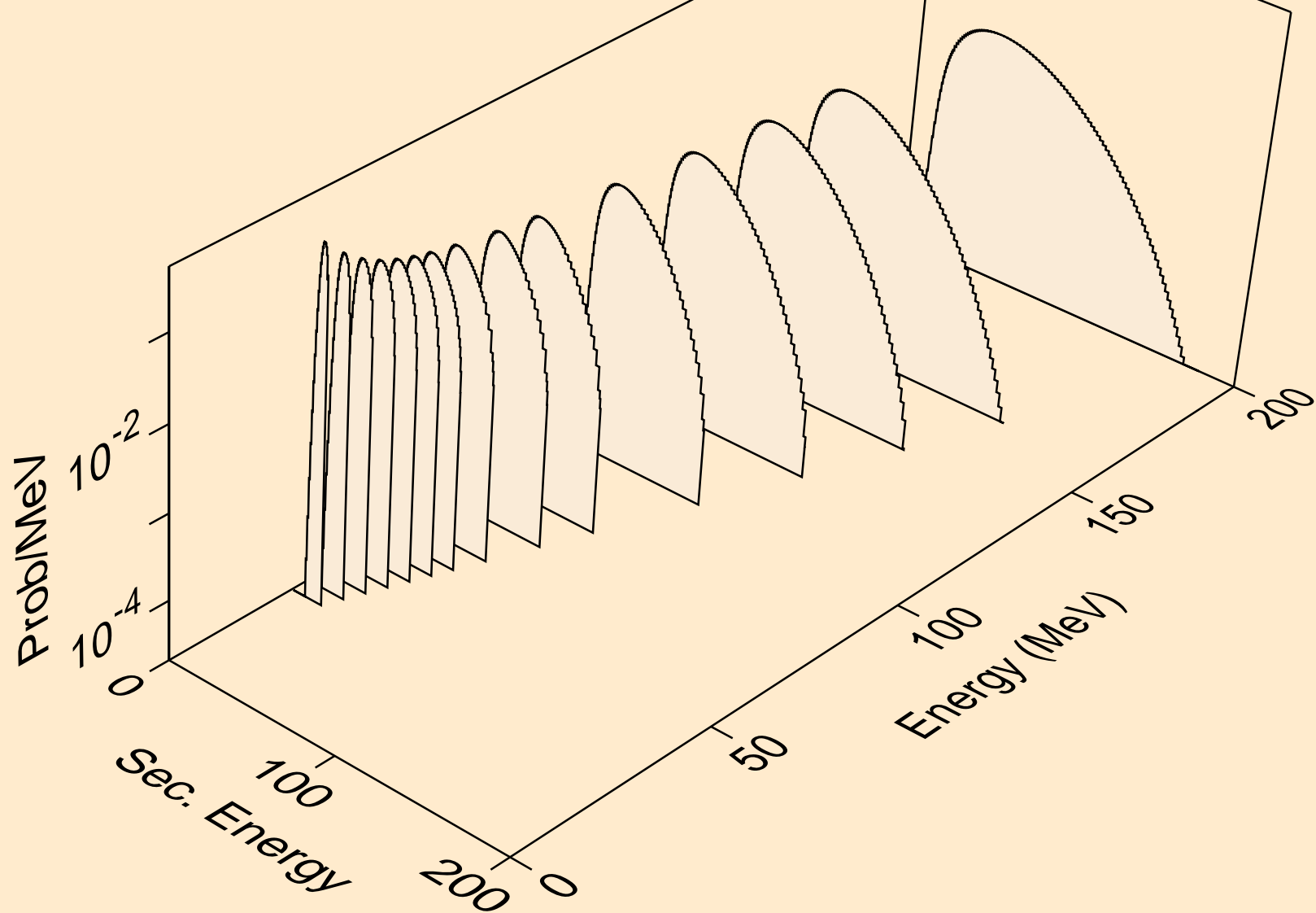

SB124N NEUTRON ACER TENDL-2024 LIBRARY; T=0.K  
he3s from (n,n\*)he3

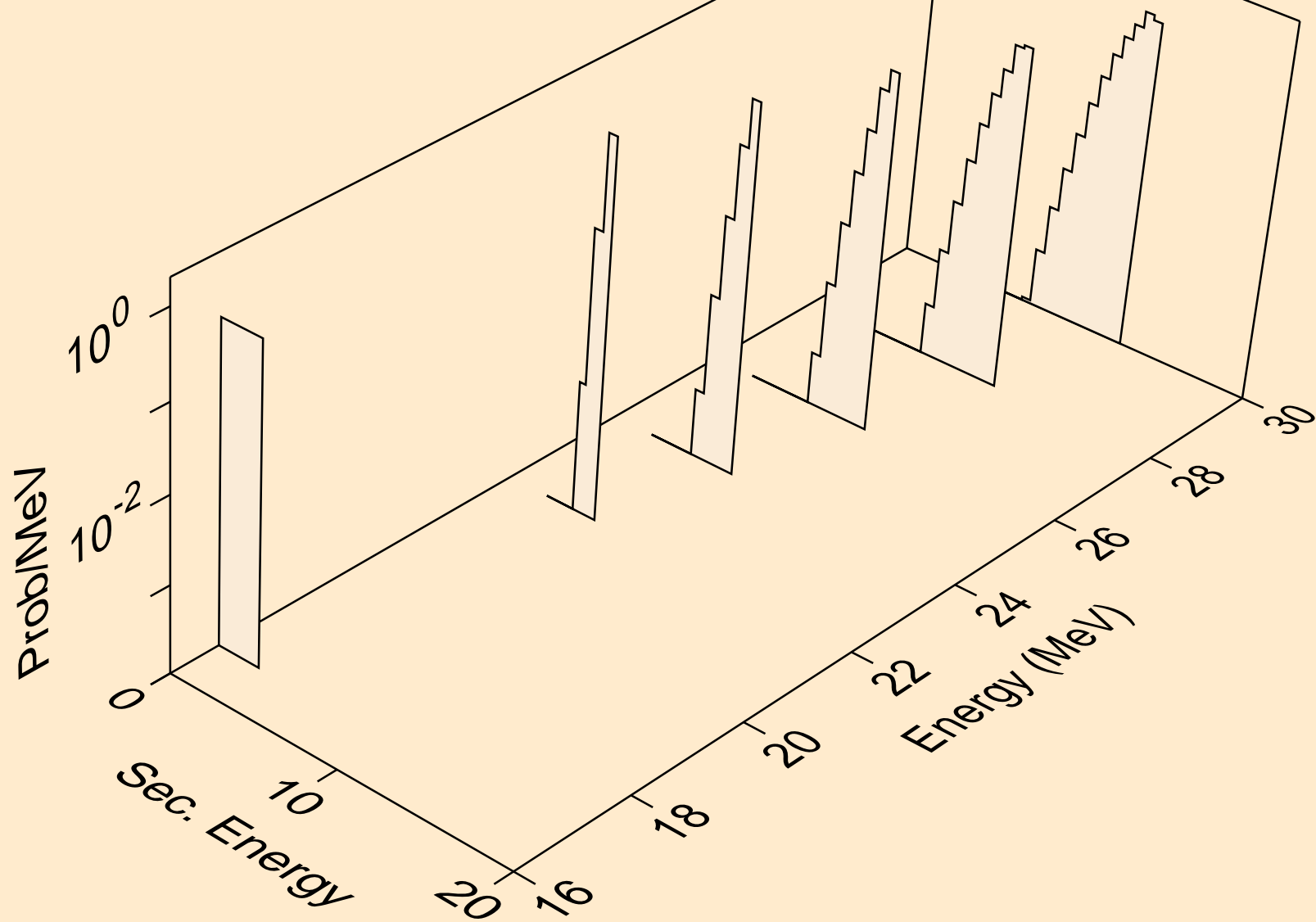

SB124N NEUTRON ACER TENDL-2024 LIBRARY; T=0.K  
he3s from (n,he3)

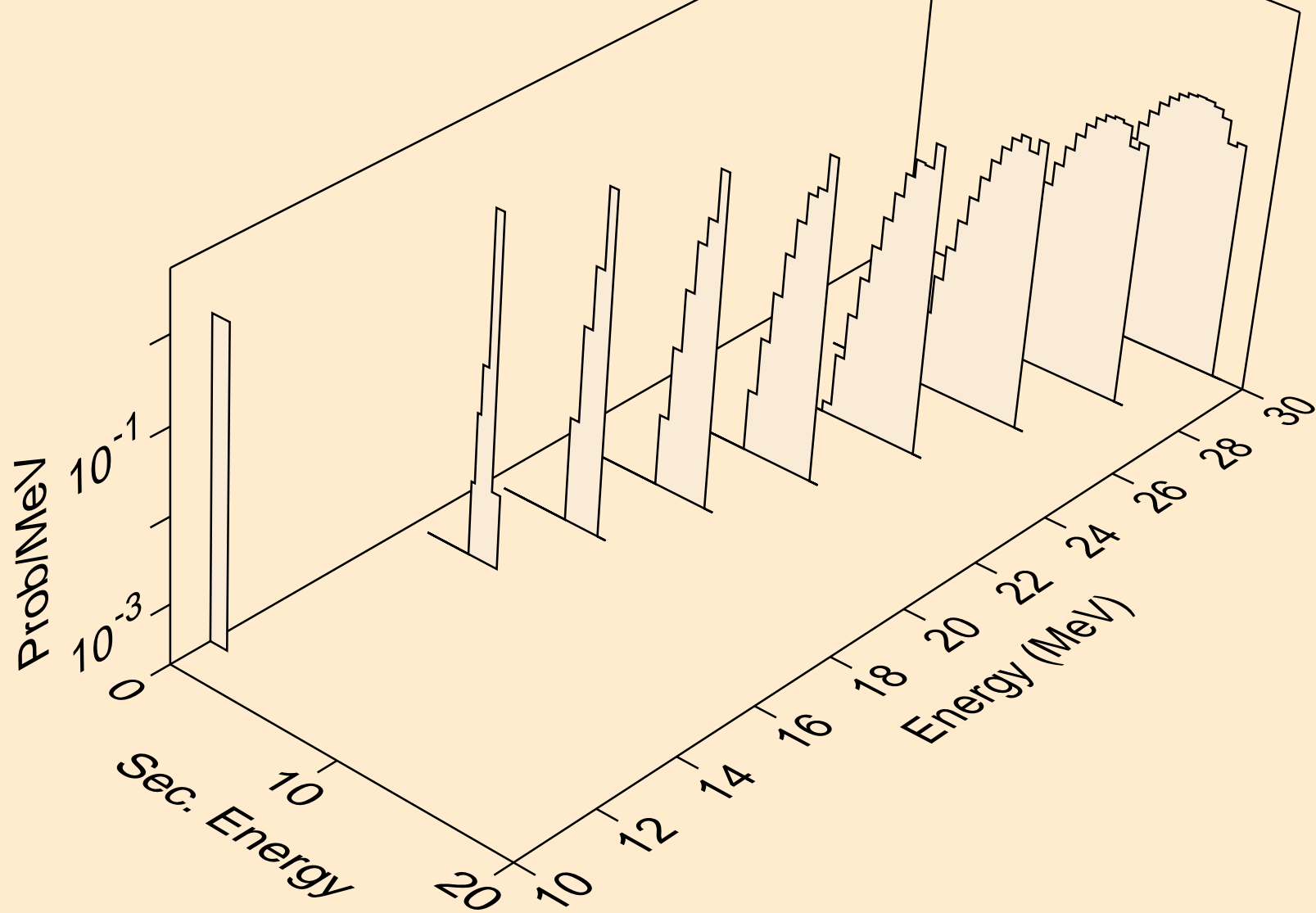

SB124N NEUTRON ACER TENDL-2024 LIBRARY; T=0.K  
alphas from (n,x)

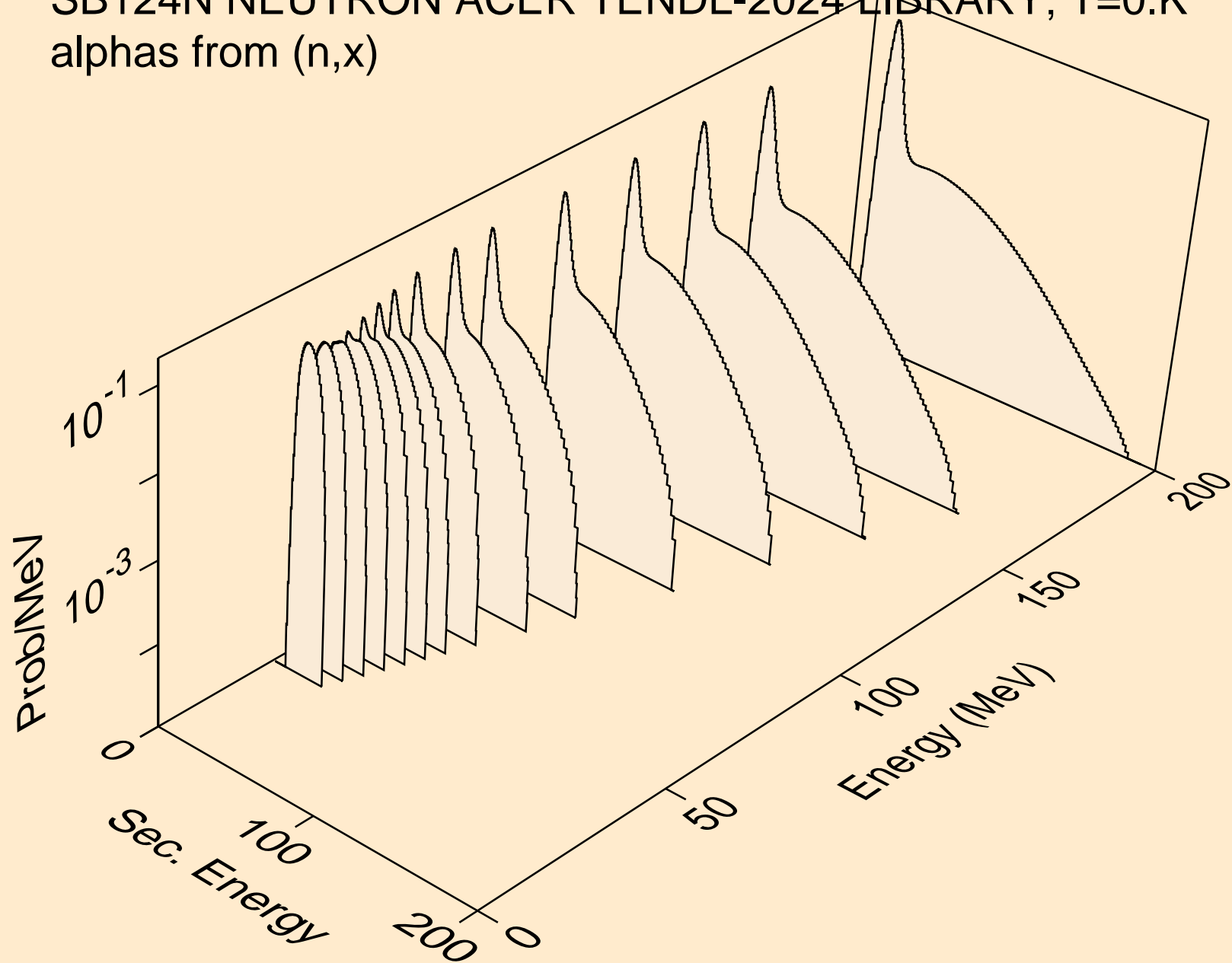

SB124N NEUTRON ACER TENDL-2024 LIBRARY; T=0.K  
alphas from (n,n\*)a

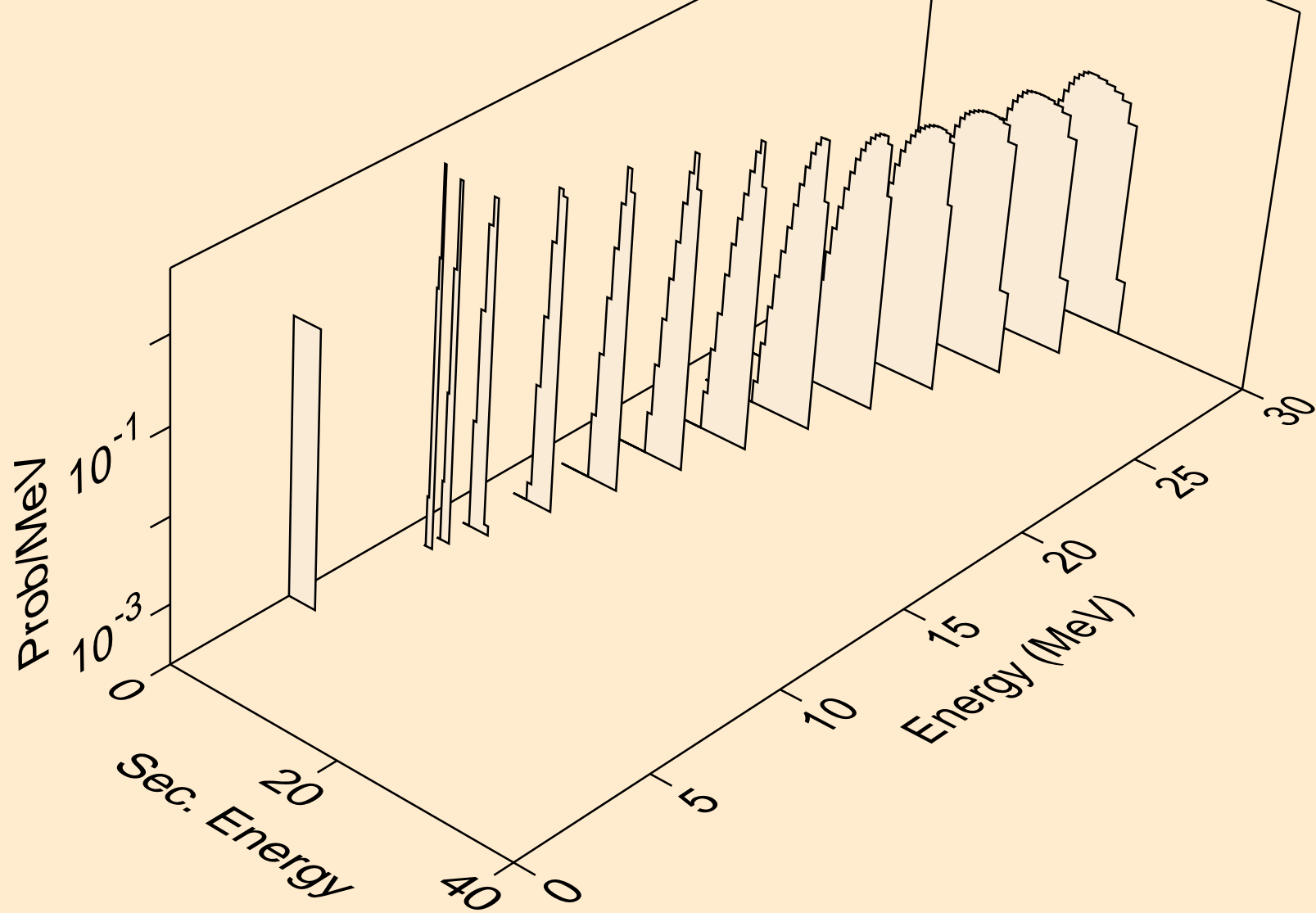

SB124N NEUTRON ACER TENDL-2024 LIBRARY; T=0.K  
alphas from (n,2n)a

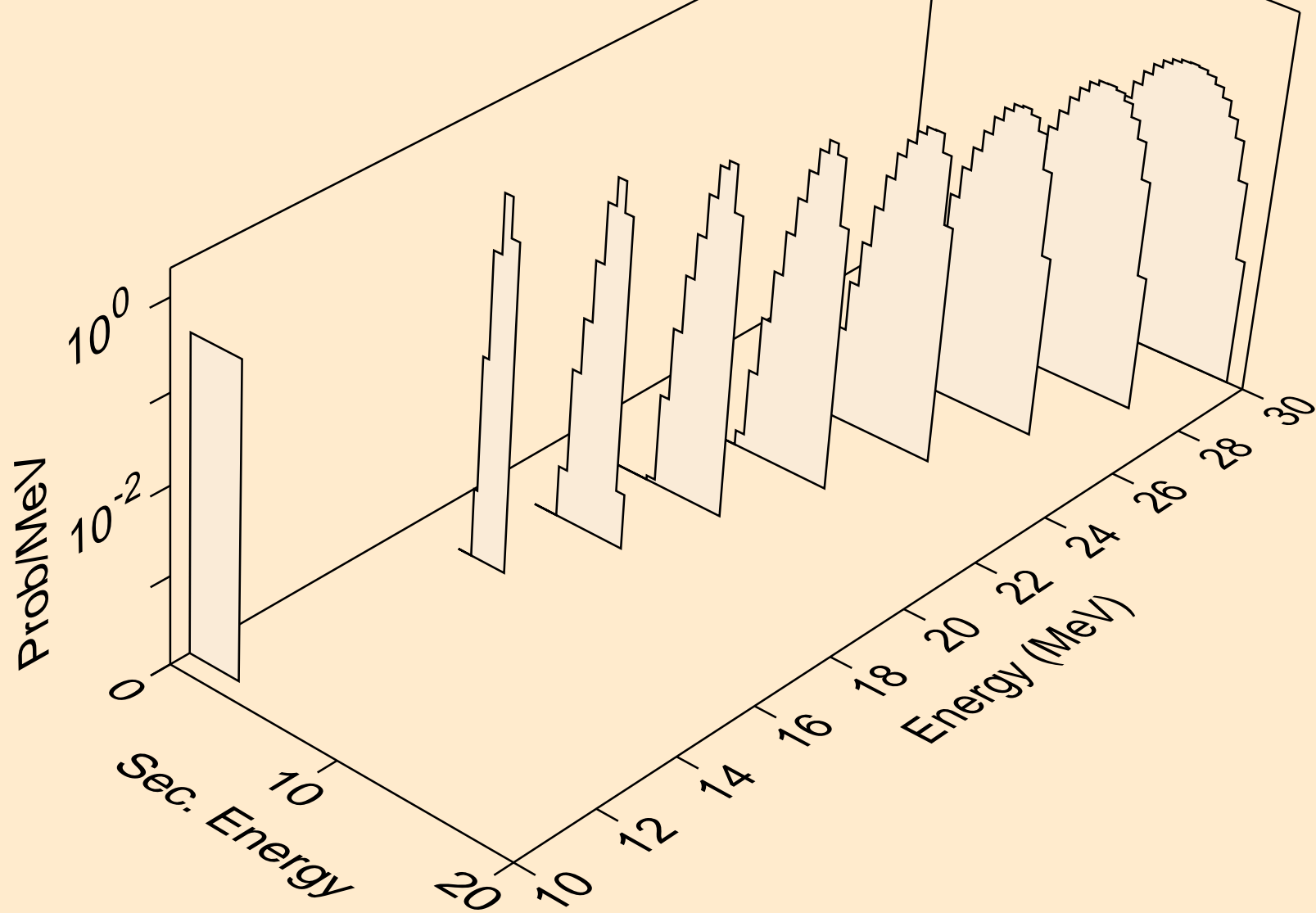

SB124N NEUTRON ACER TENDL-2024 LIBRARY; T=0.K  
alphas from (n,3n)a

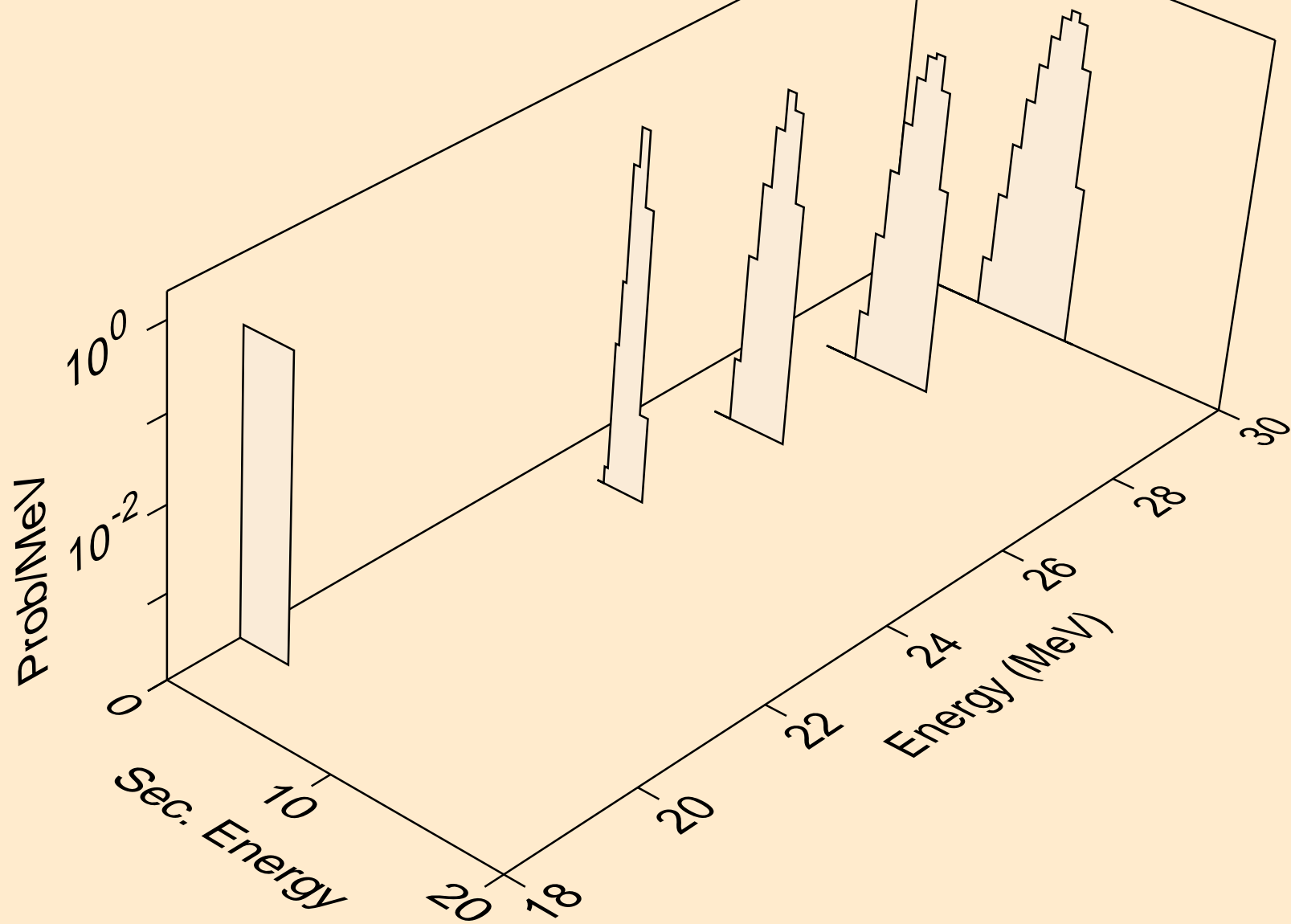

SB124N NEUTRON ACER TENDL-2024 LIBRARY; T=0.K  
alphas from (n,npa)

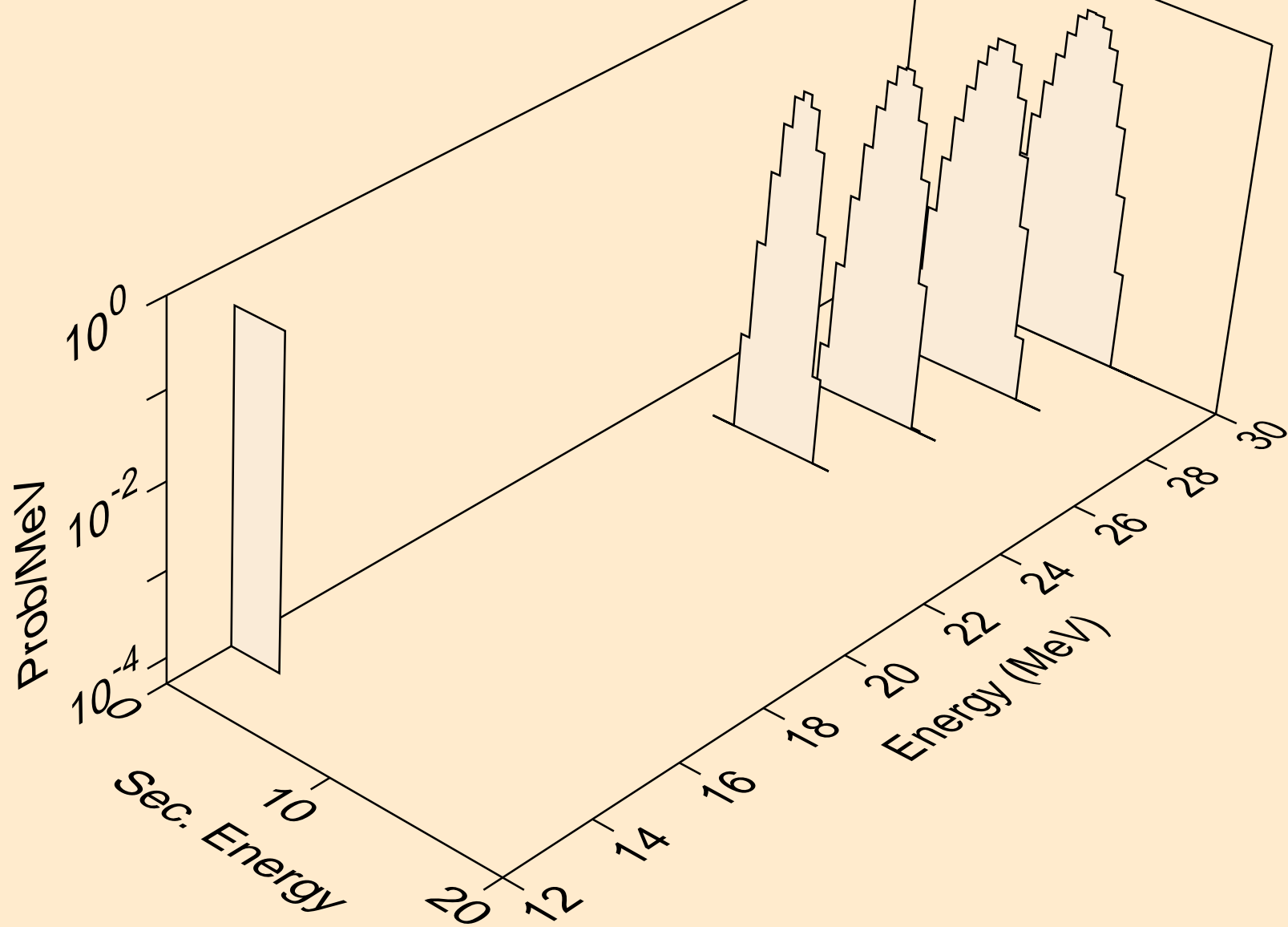



SB124N NEUTRON ACER TENDL-2024 LIBRARY; T=0.K  
alphas from (n,a)

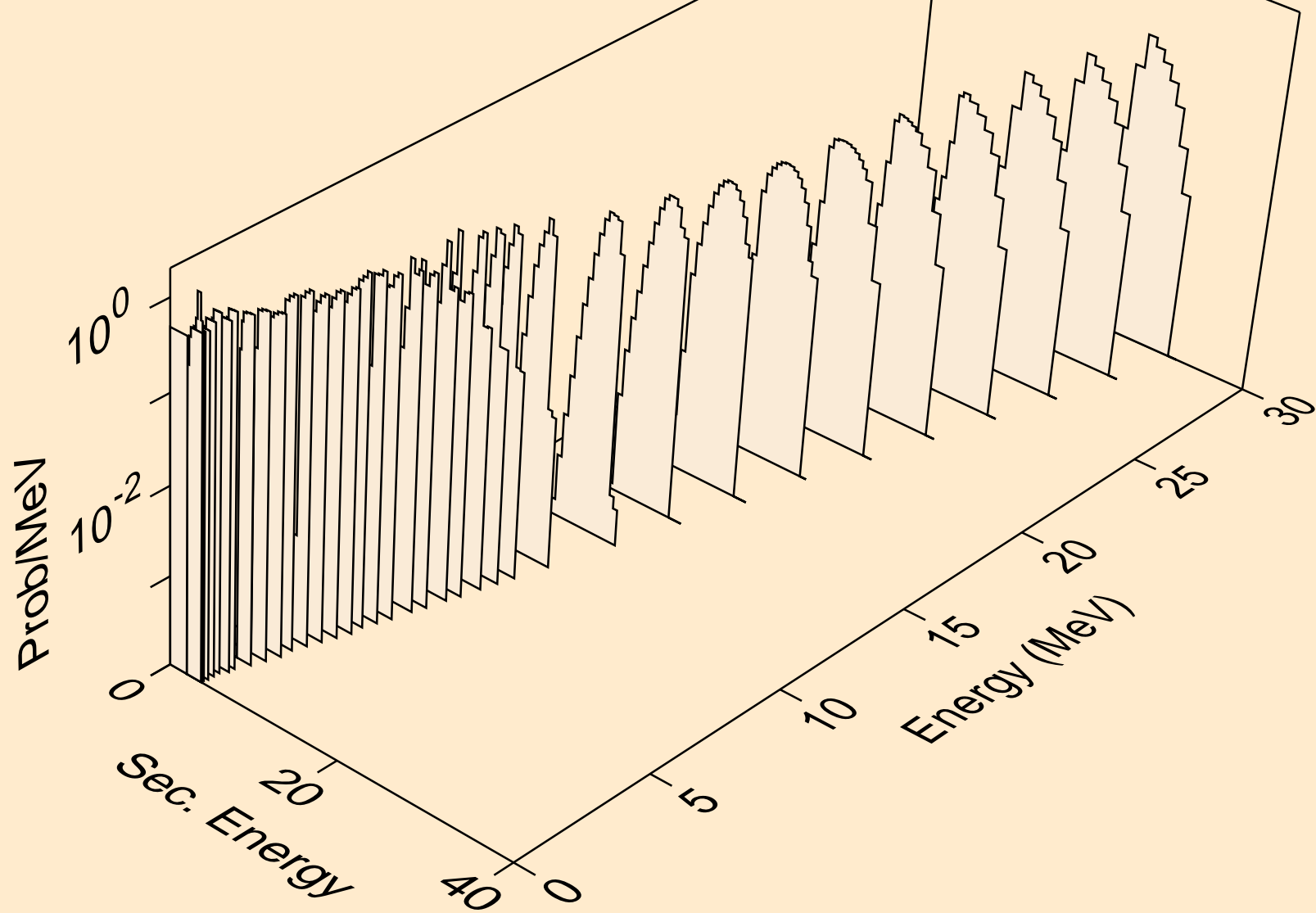

SB124N NEUTRON ACER TENDL-2024 LIBRARY; T=0.K  
alphas from (n,pa)

