

SB129M NEUTRON ACER TENDL-2024 LIBRARY; T=0.K

Principal cross sections

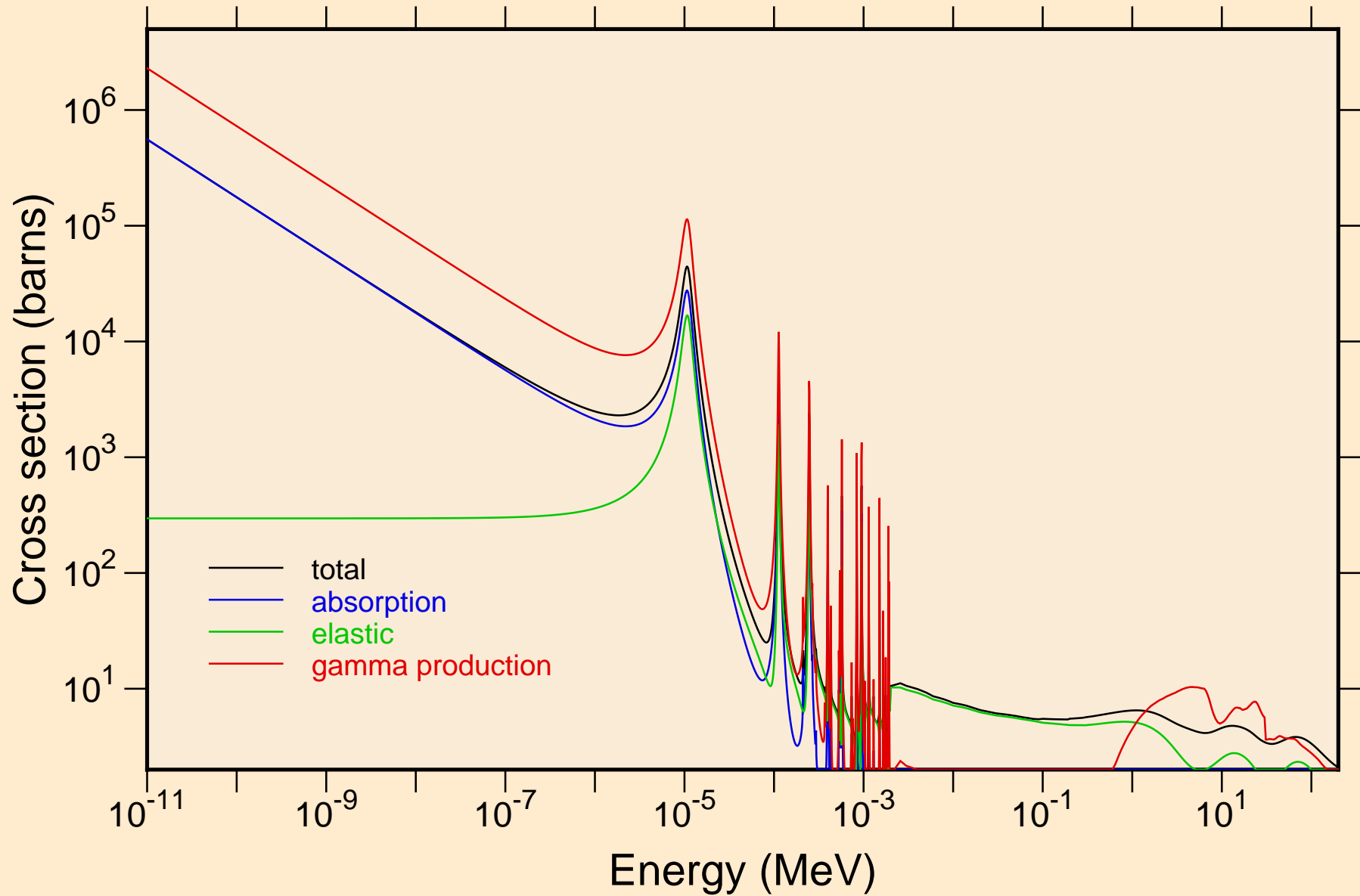

SB129M NEUTRON ACER TENDL-2024 LIBRARY; T=0.K
resonance total cross section

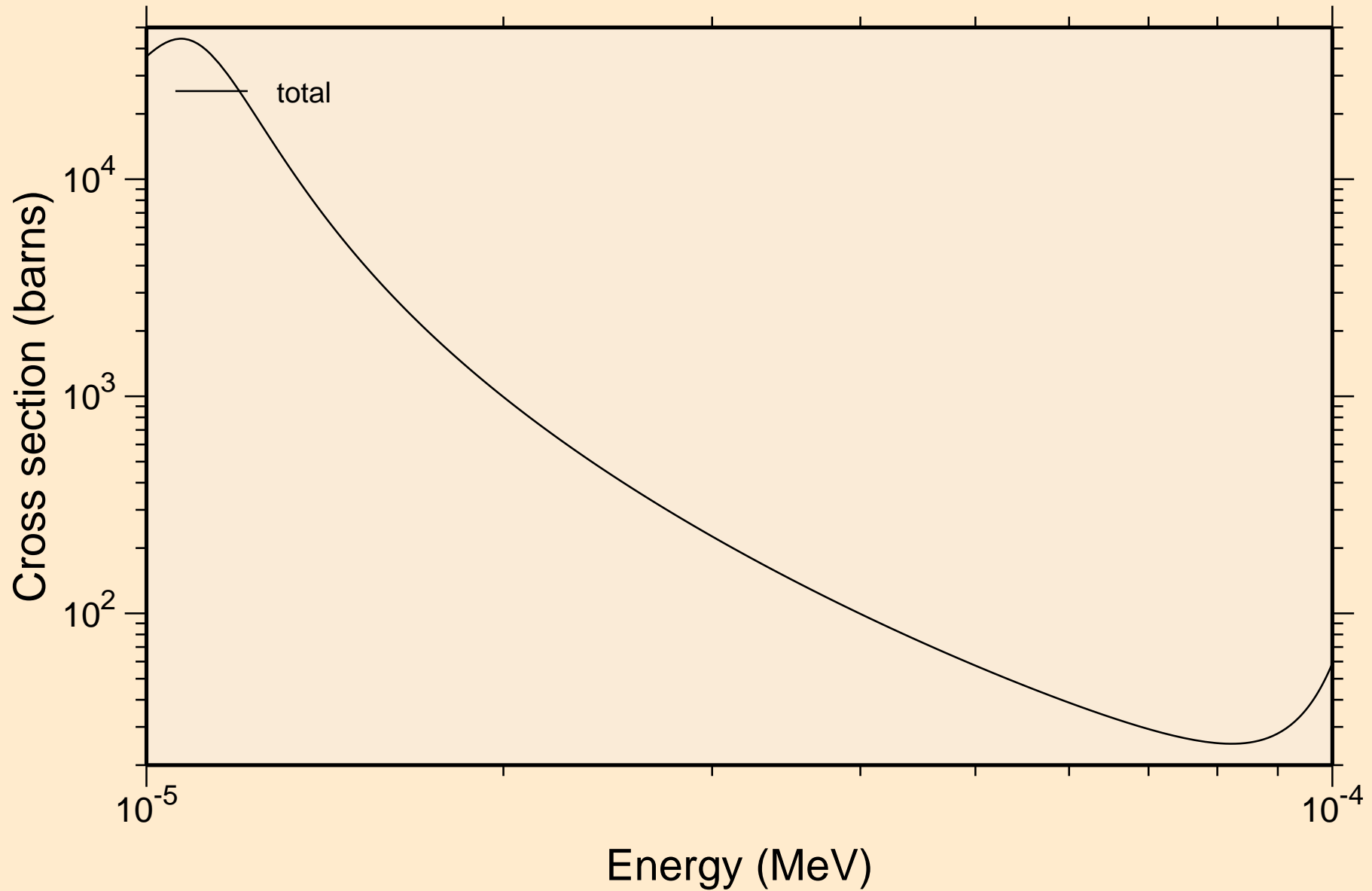

SB129M NEUTRON ACER TENDL-2024 LIBRARY; T=0.K
resonance total cross section

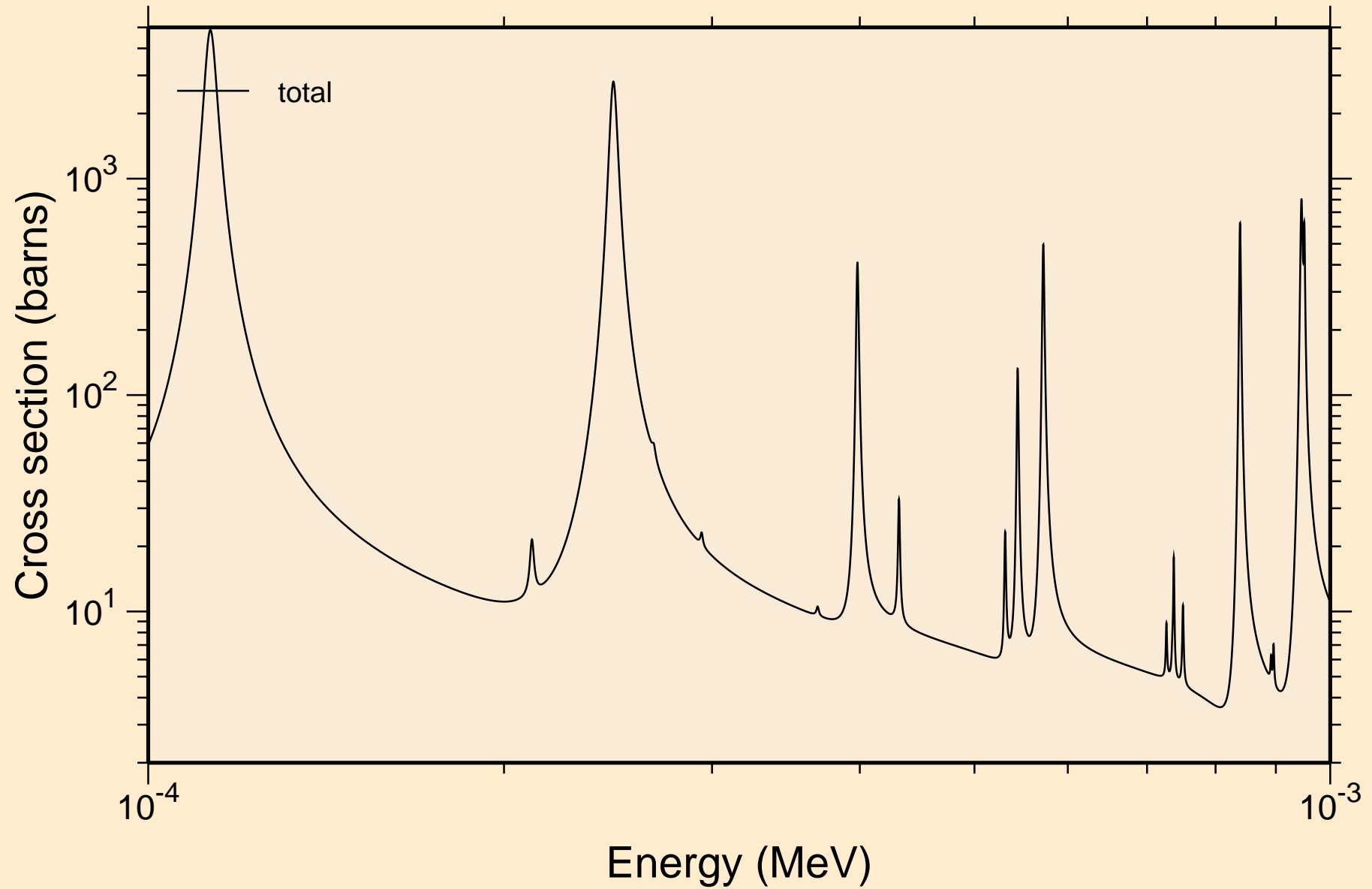

SB129M NEUTRON ACER TENDL-2024 LIBRARY; T=0.K
resonance total cross section

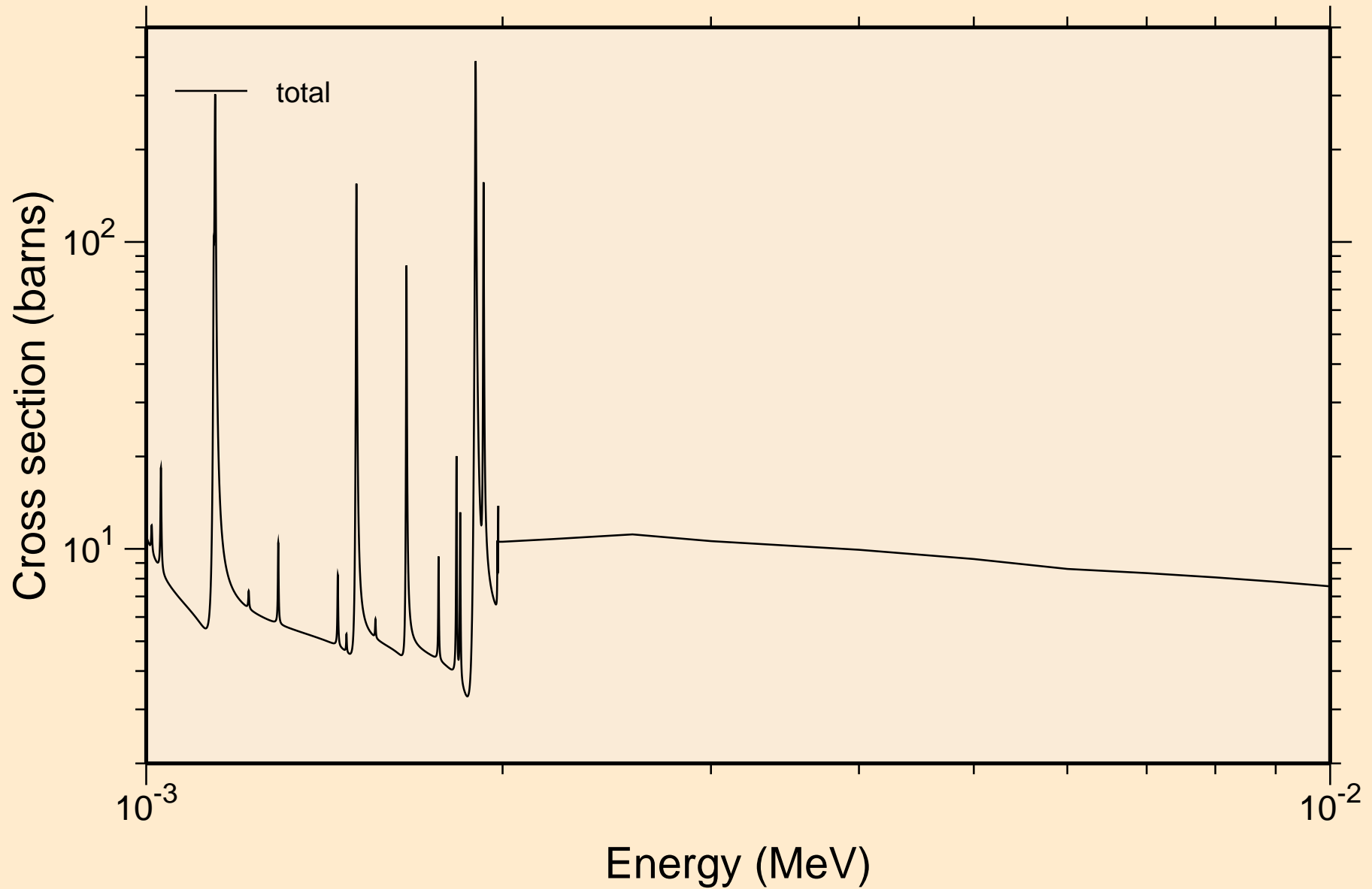

S \bar{B} 129M NEUTRON ACER TENDL-2024 LIBRARY; T=0.K
resonance total cross section

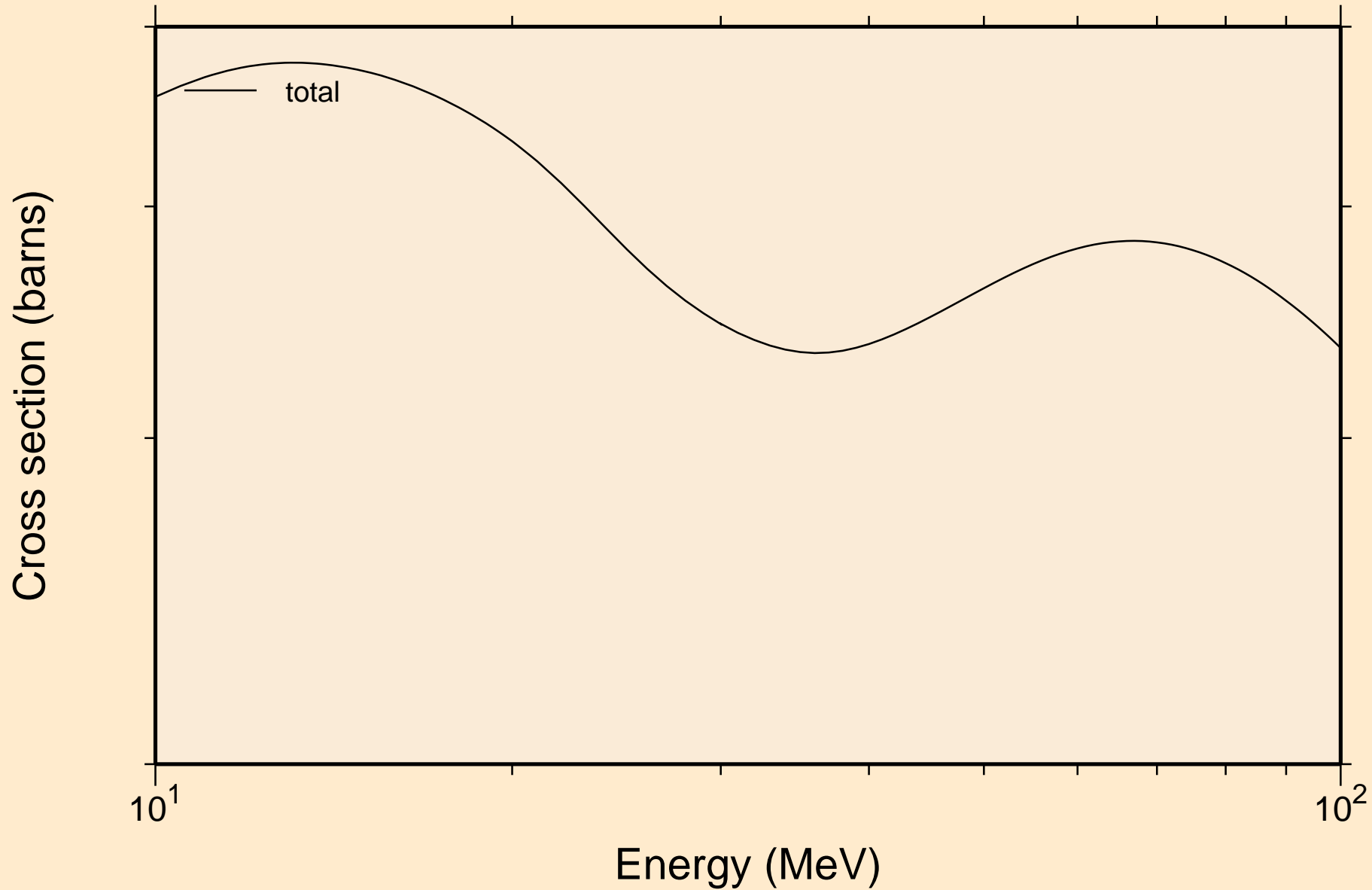

SB129M NEUTRON ACER TENDL-2024 LIBRARY; T=0.K
resonance absorption cross sections

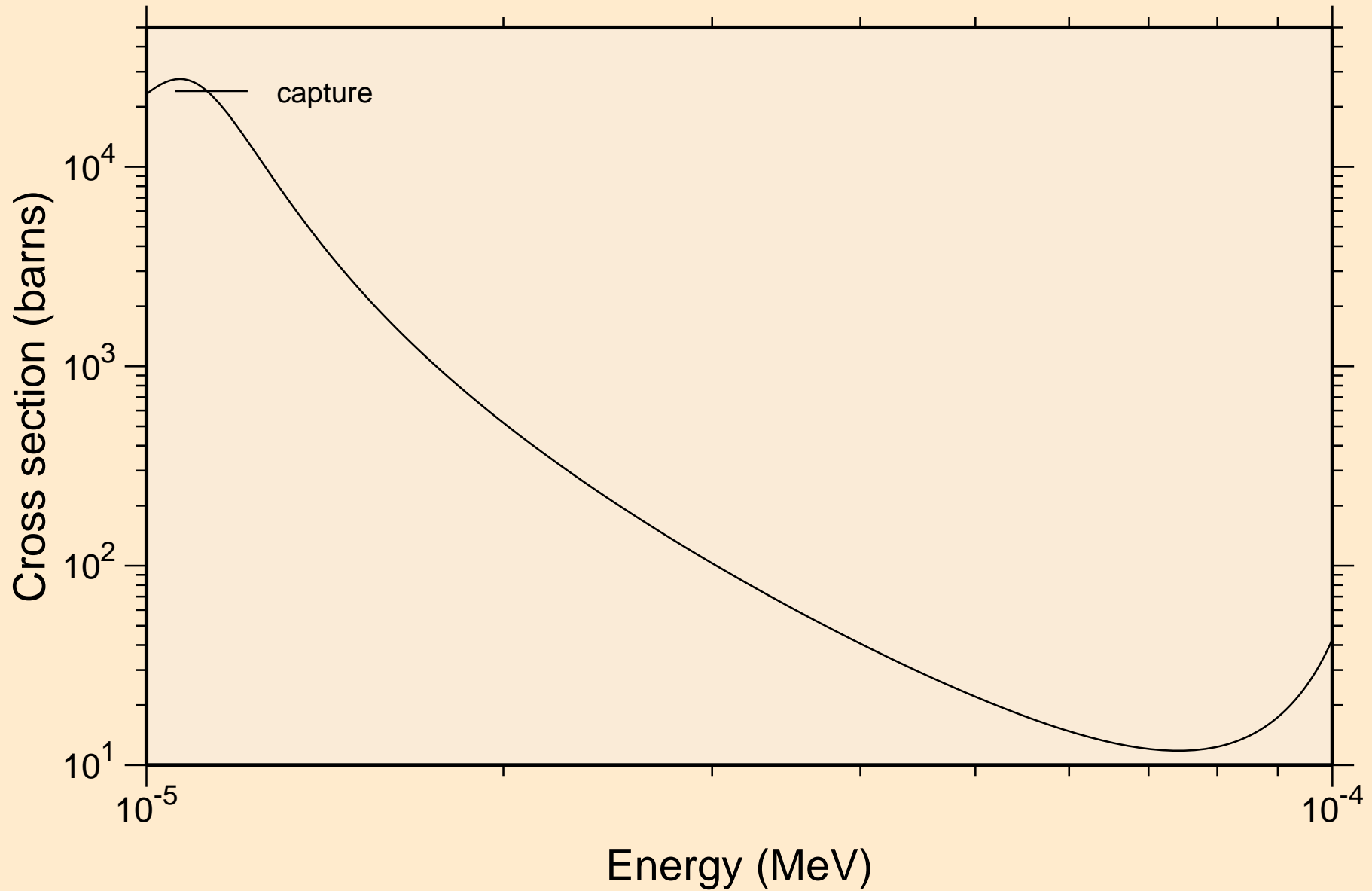

SB129M NEUTRON ACER TENDL-2024 LIBRARY; T=0.K
resonance absorption cross sections

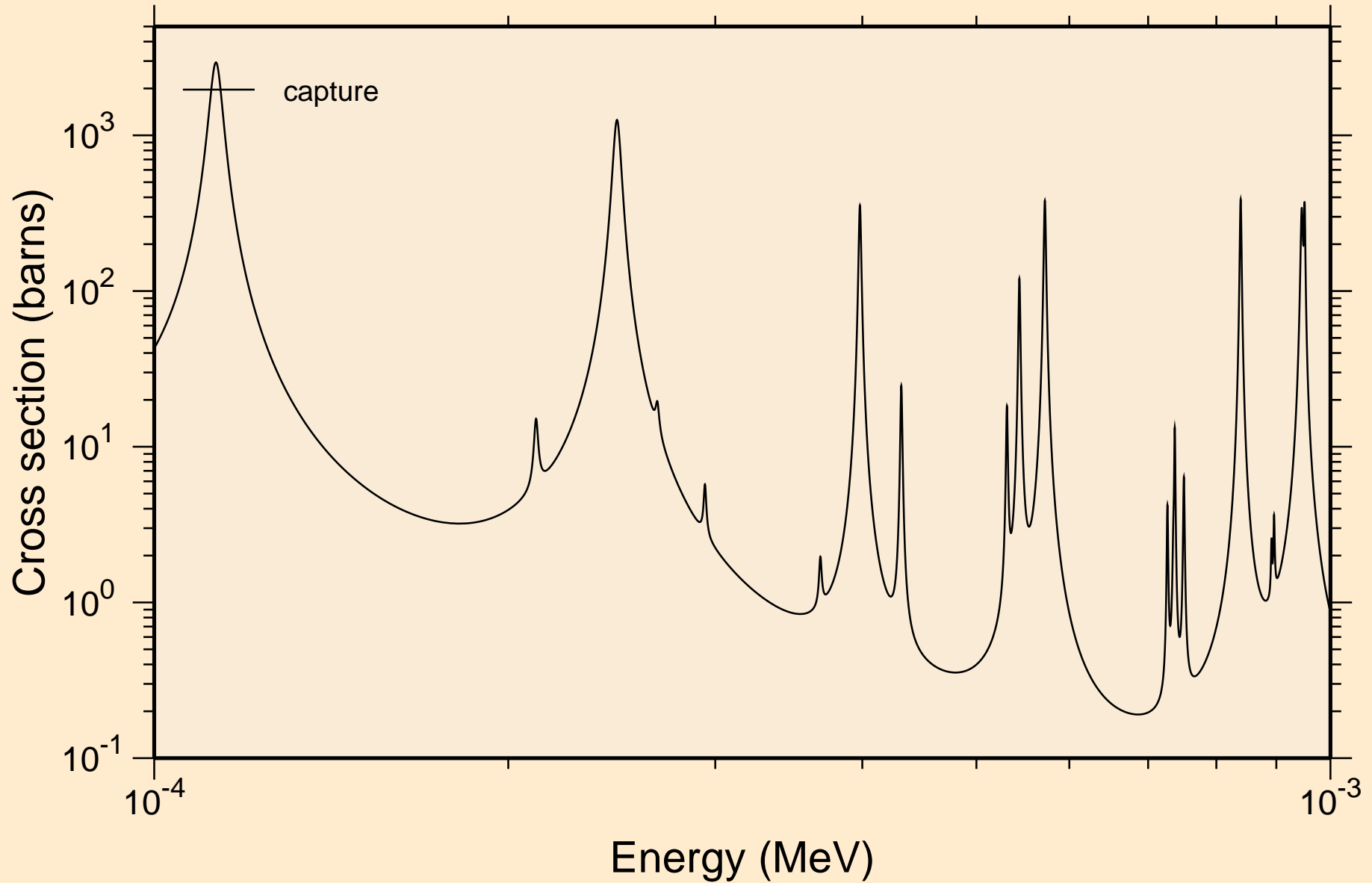

SB129M NEUTRON ACER TENDL-2024 LIBRARY; T=0.K
resonance absorption cross sections

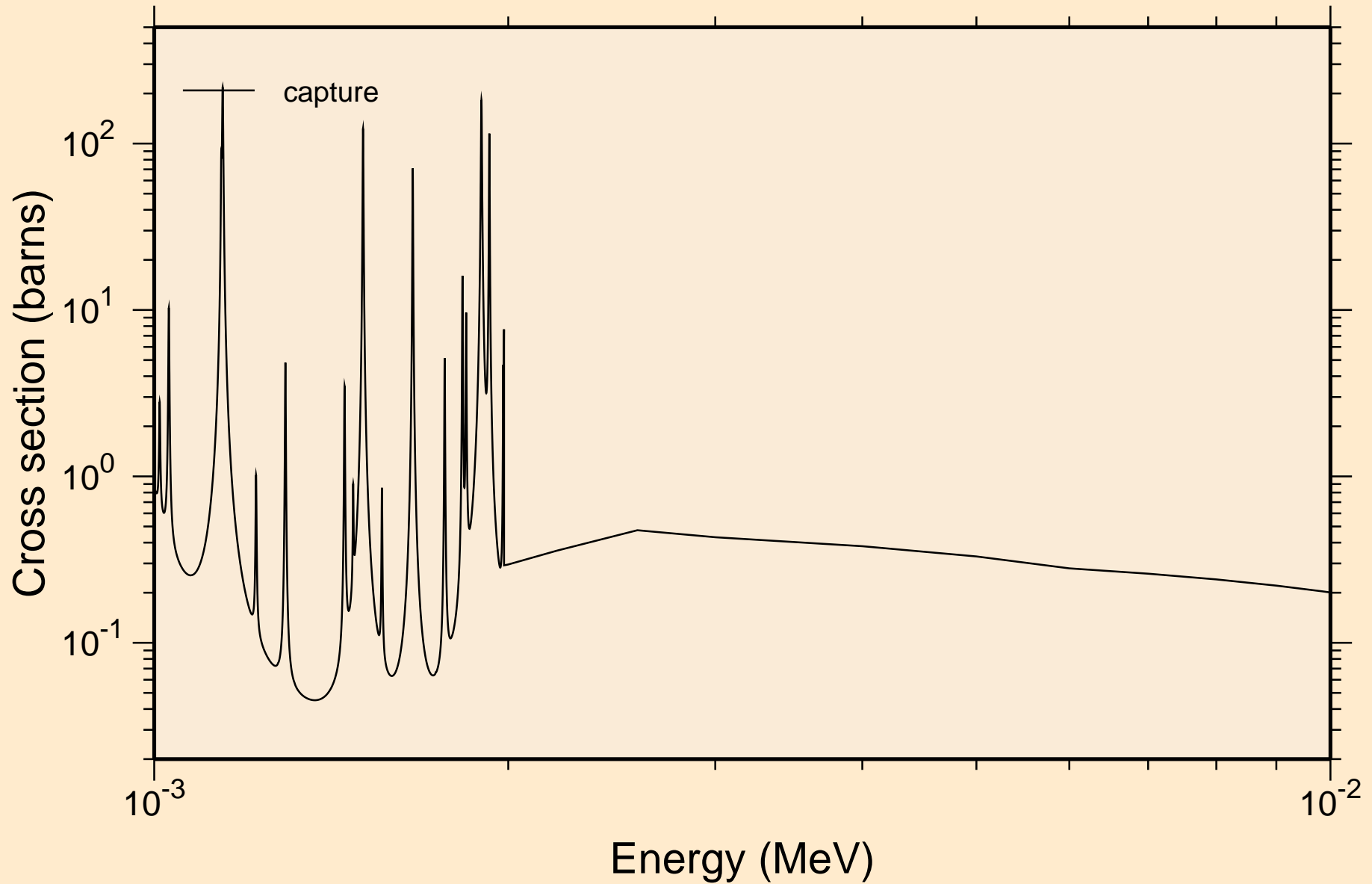

SB129M NEUTRON ACER TENDL-2024 LIBRARY; T=0.K
resonance absorption cross sections

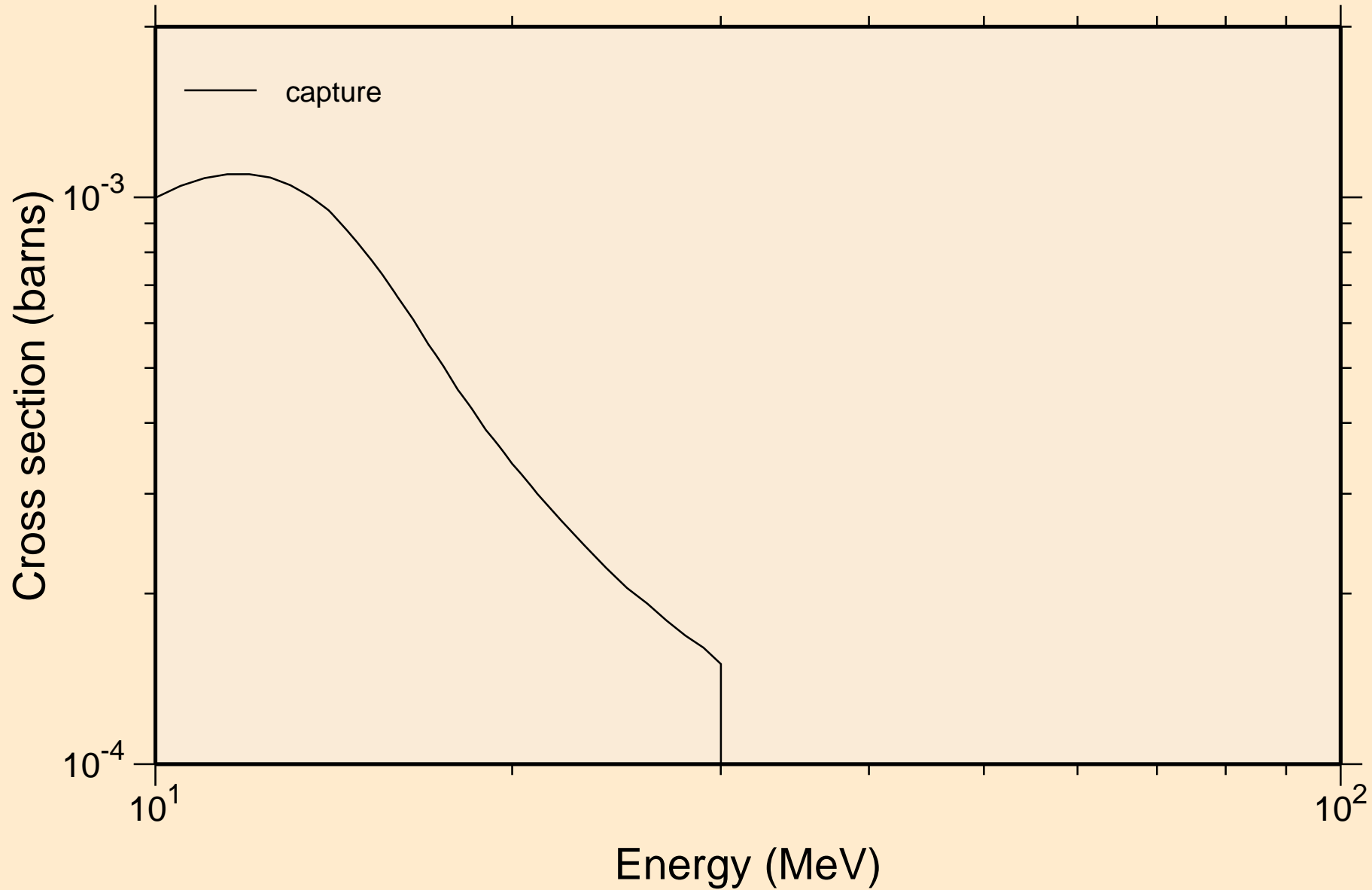

SB129M NEUTRON ACER TENDL-2024 LIBRARY; T=0.K

Heating

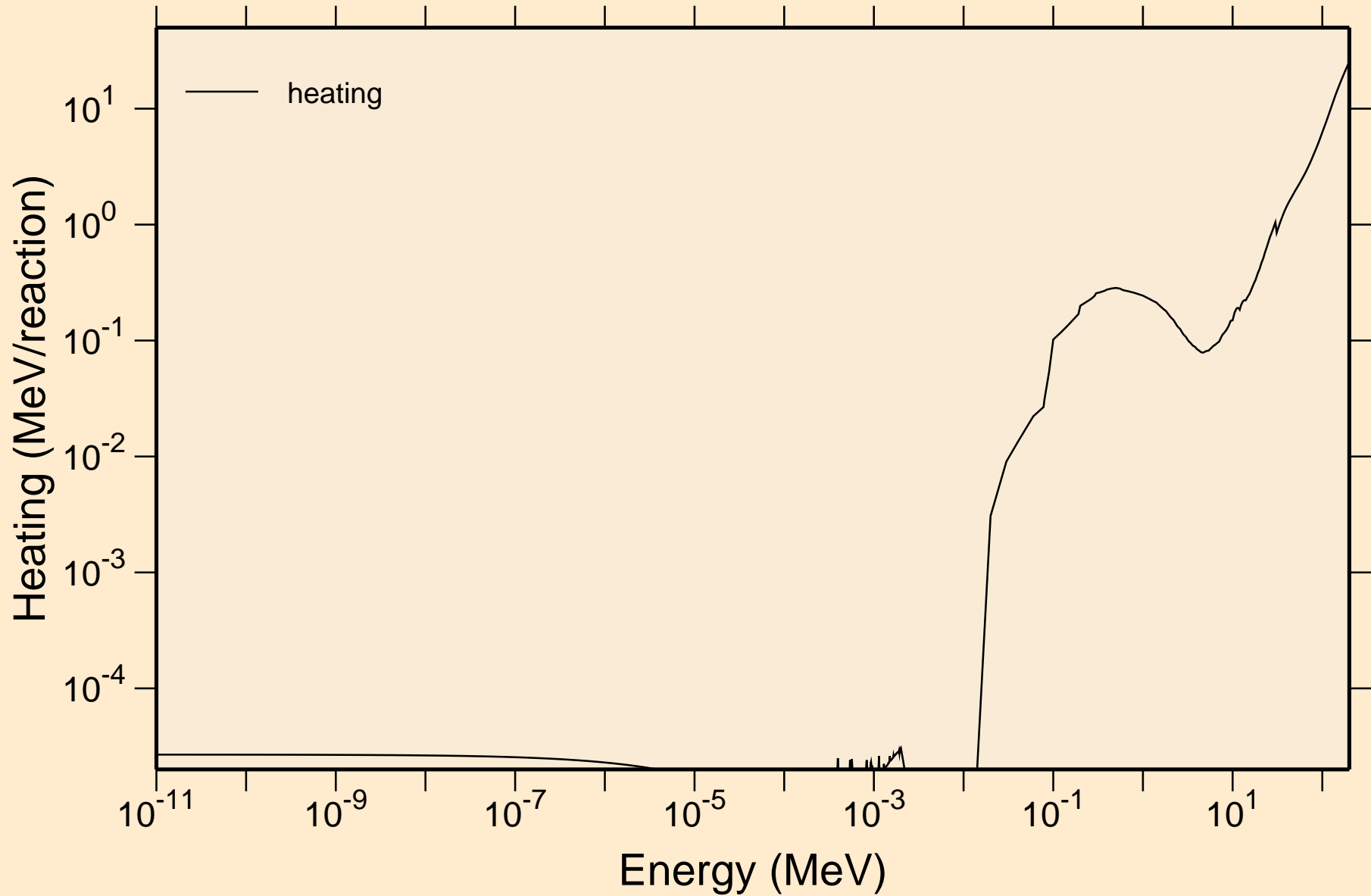

SB129M NEUTRON ACER TENDL-2024 LIBRARY; T=0.K

Damage

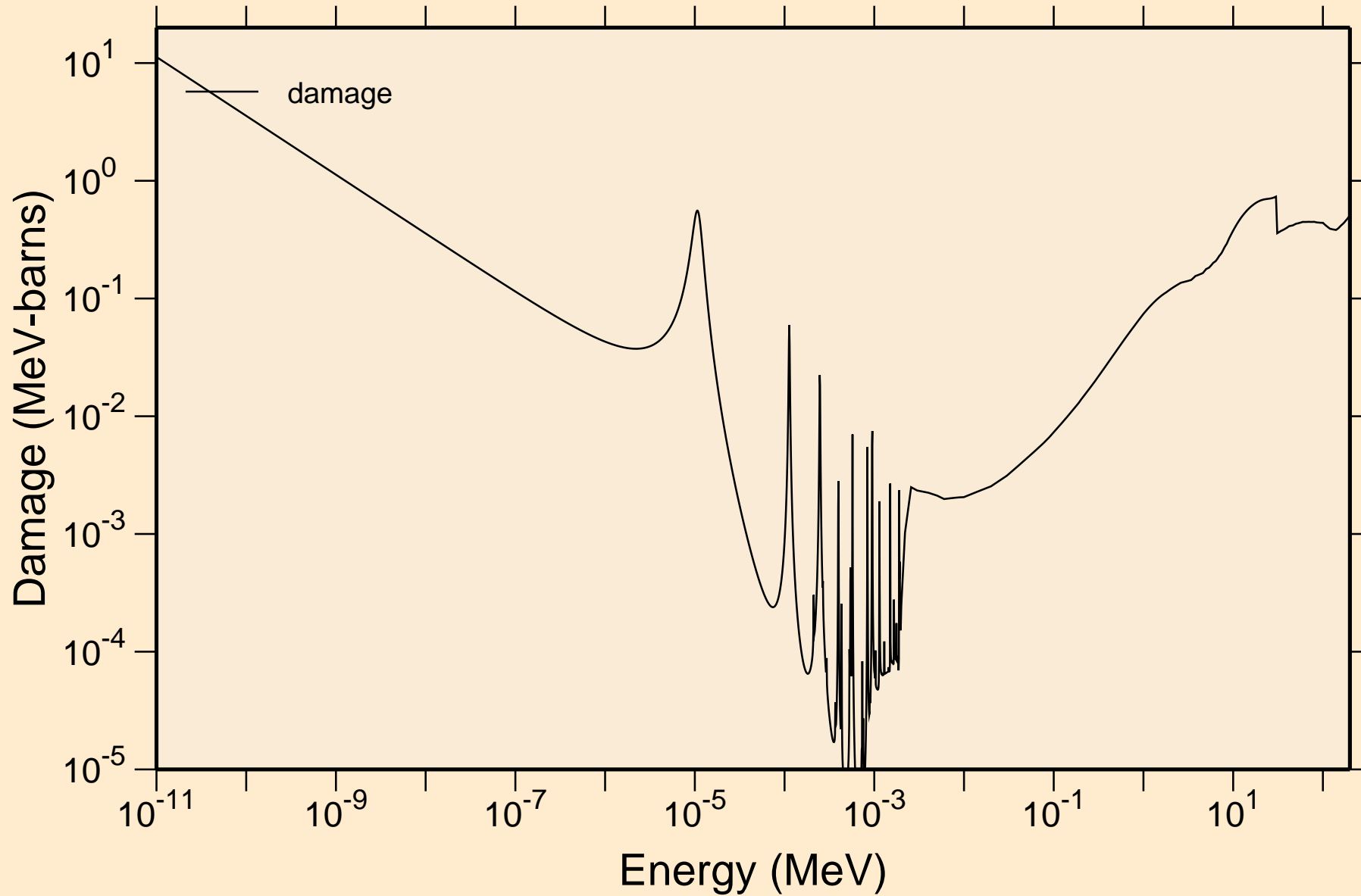

SB129M NEUTRON ACER TENDL-2024 LIBRARY; T=0.K
Non-threshold reactions

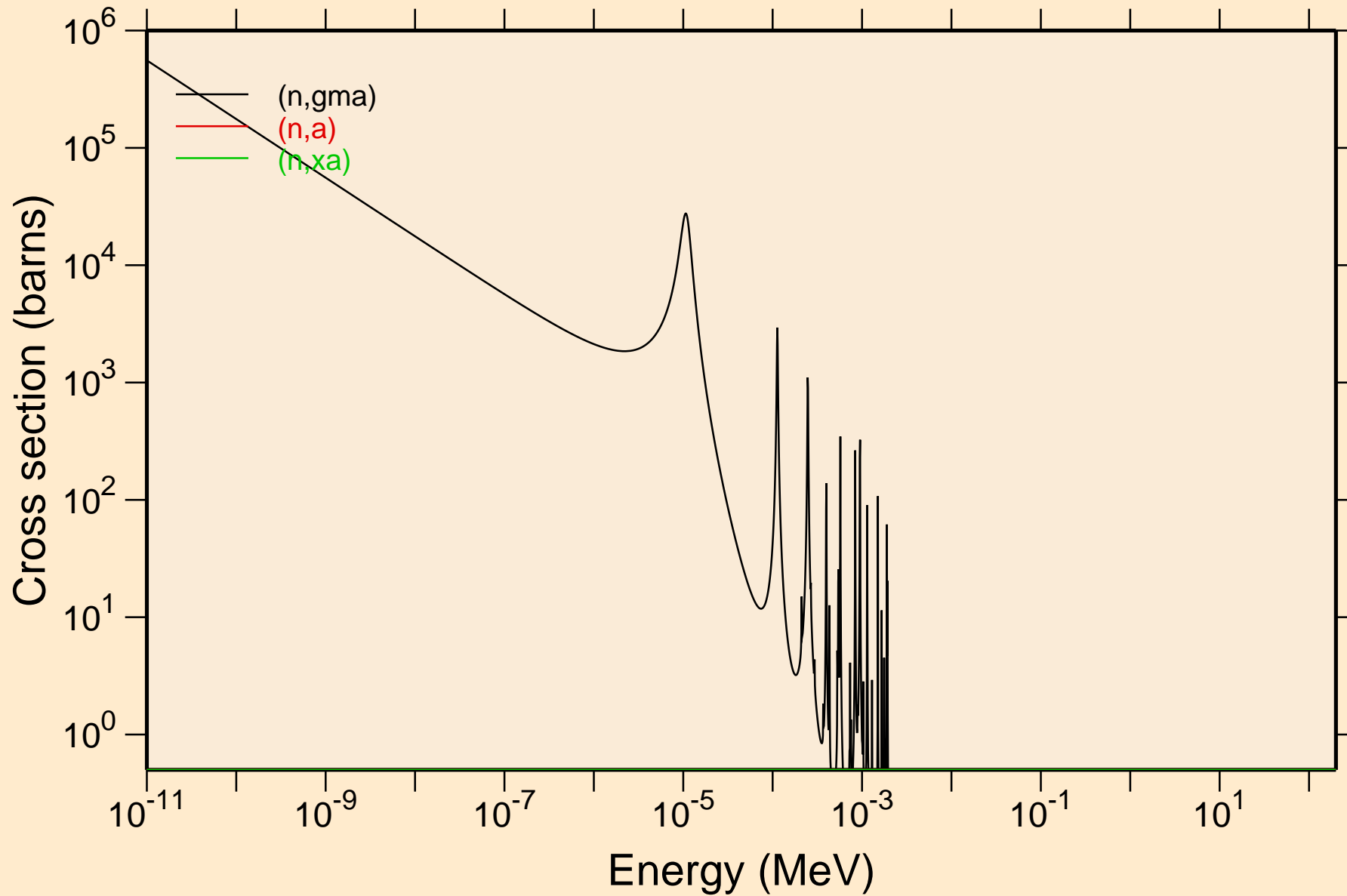

SB129M NEUTRON ACER TENDL-2024 LIBRARY; T=0.K

Principal cross sections

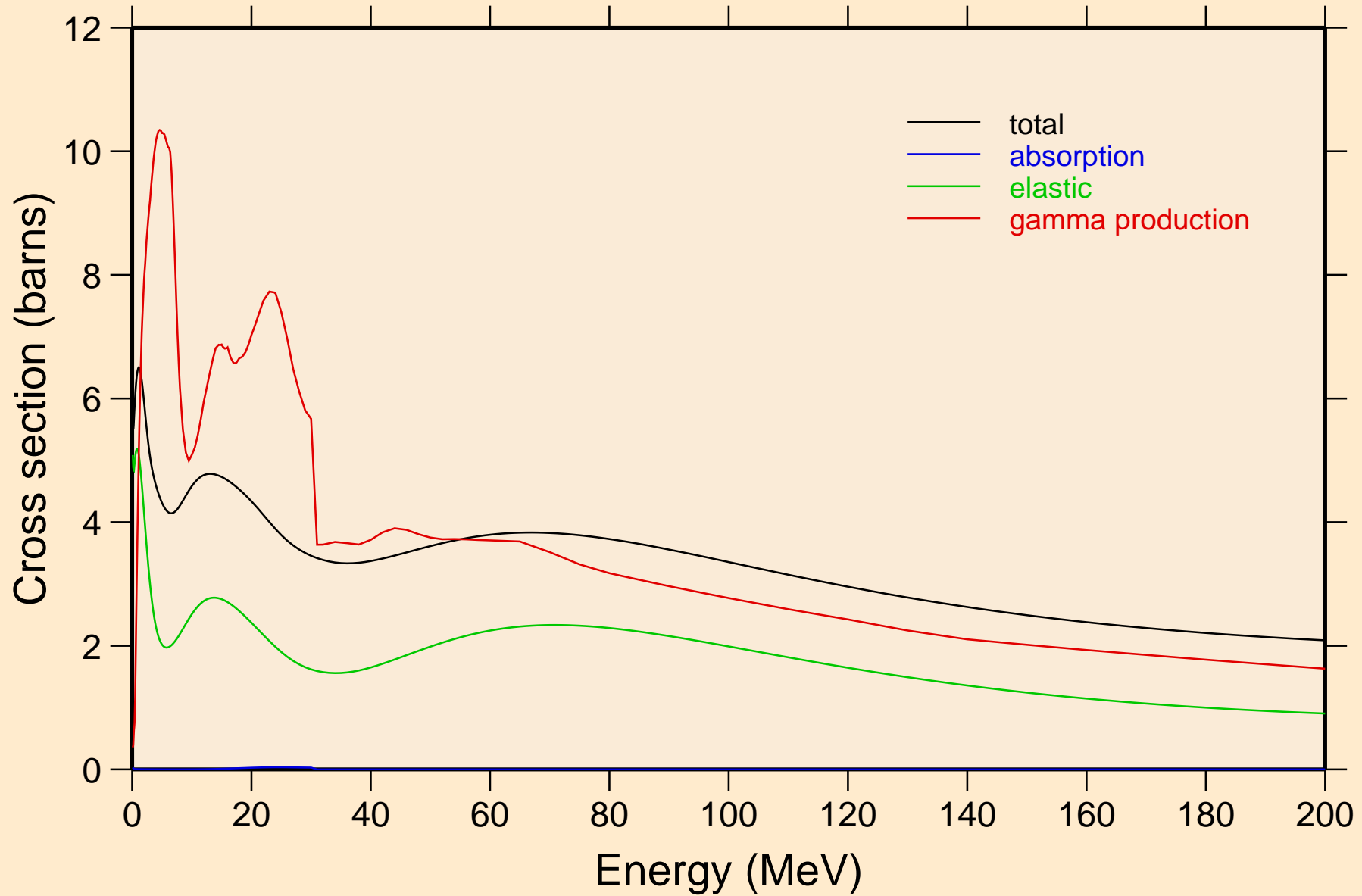

SB129M NEUTRON ACER TENDL-2024 LIBRARY; T=0.K

Heating

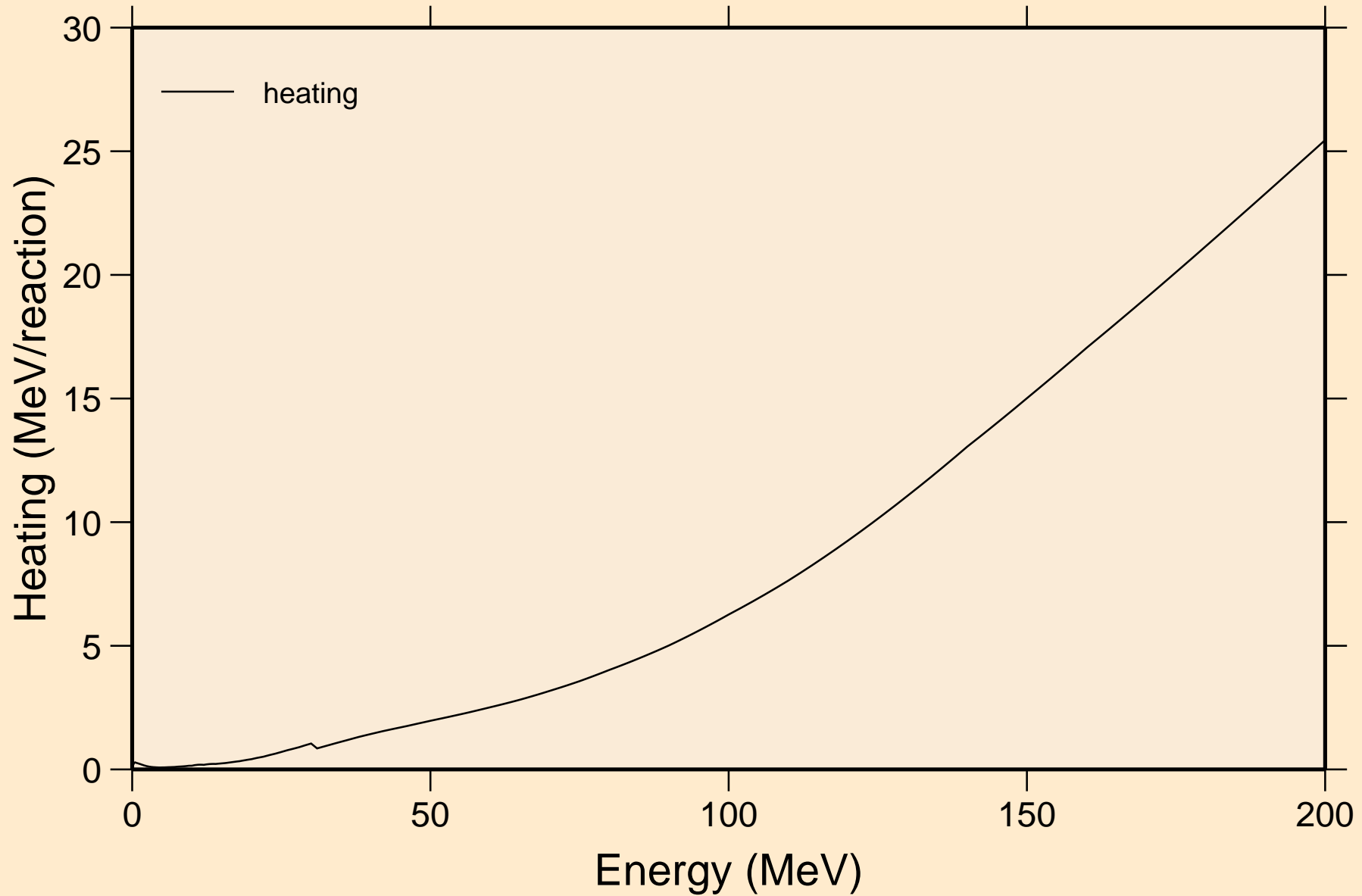

SB129M NEUTRON ACER TENDL-2024 LIBRARY; T=0.K

Damage

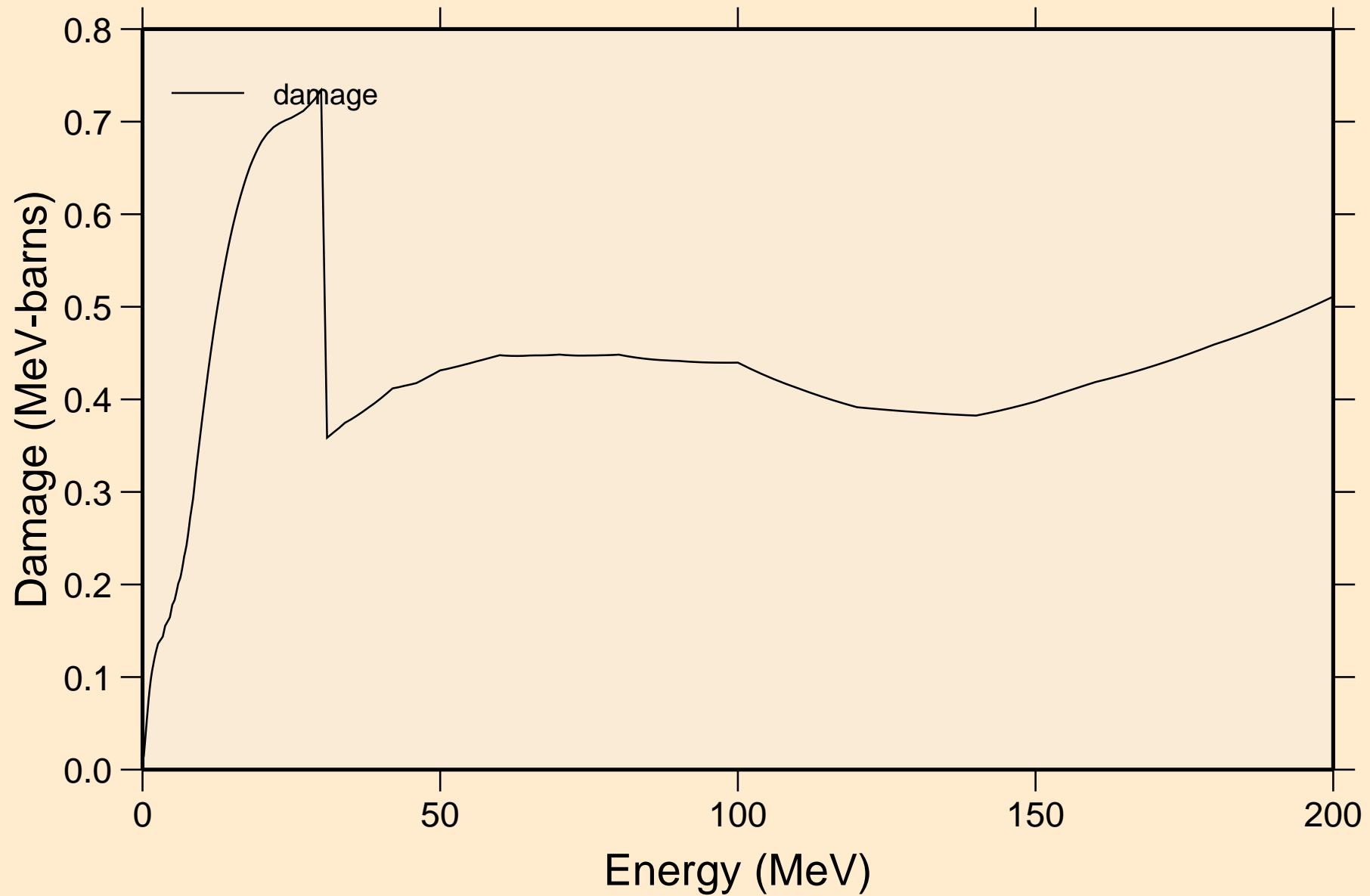

SB129M NEUTRON ACER TENDL-2024 LIBRARY; T=0.K
Non-threshold reactions

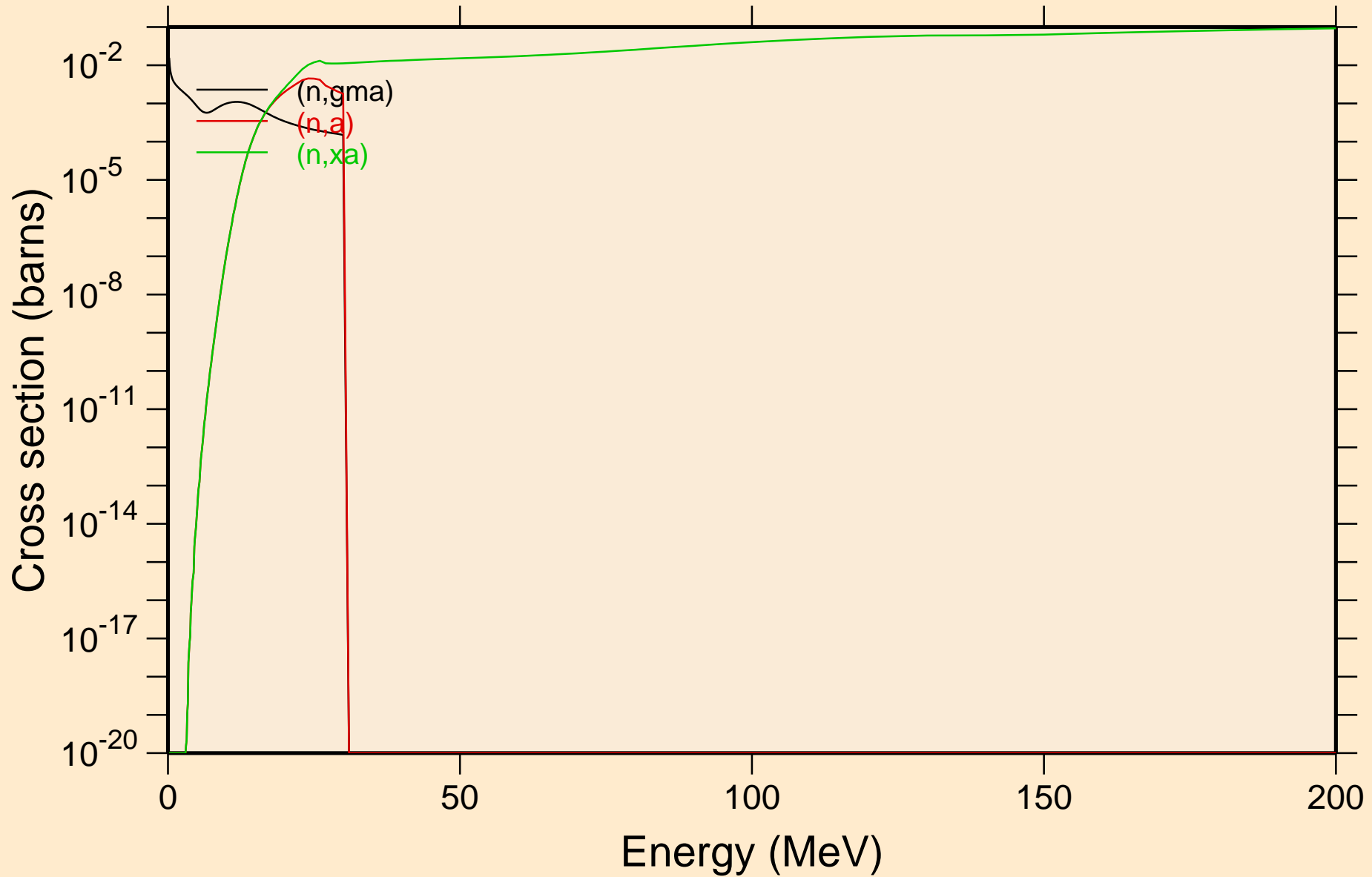

SB129M NEUTRON ACER TENDL-2024 LIBRARY; T=0.K

Inelastic levels

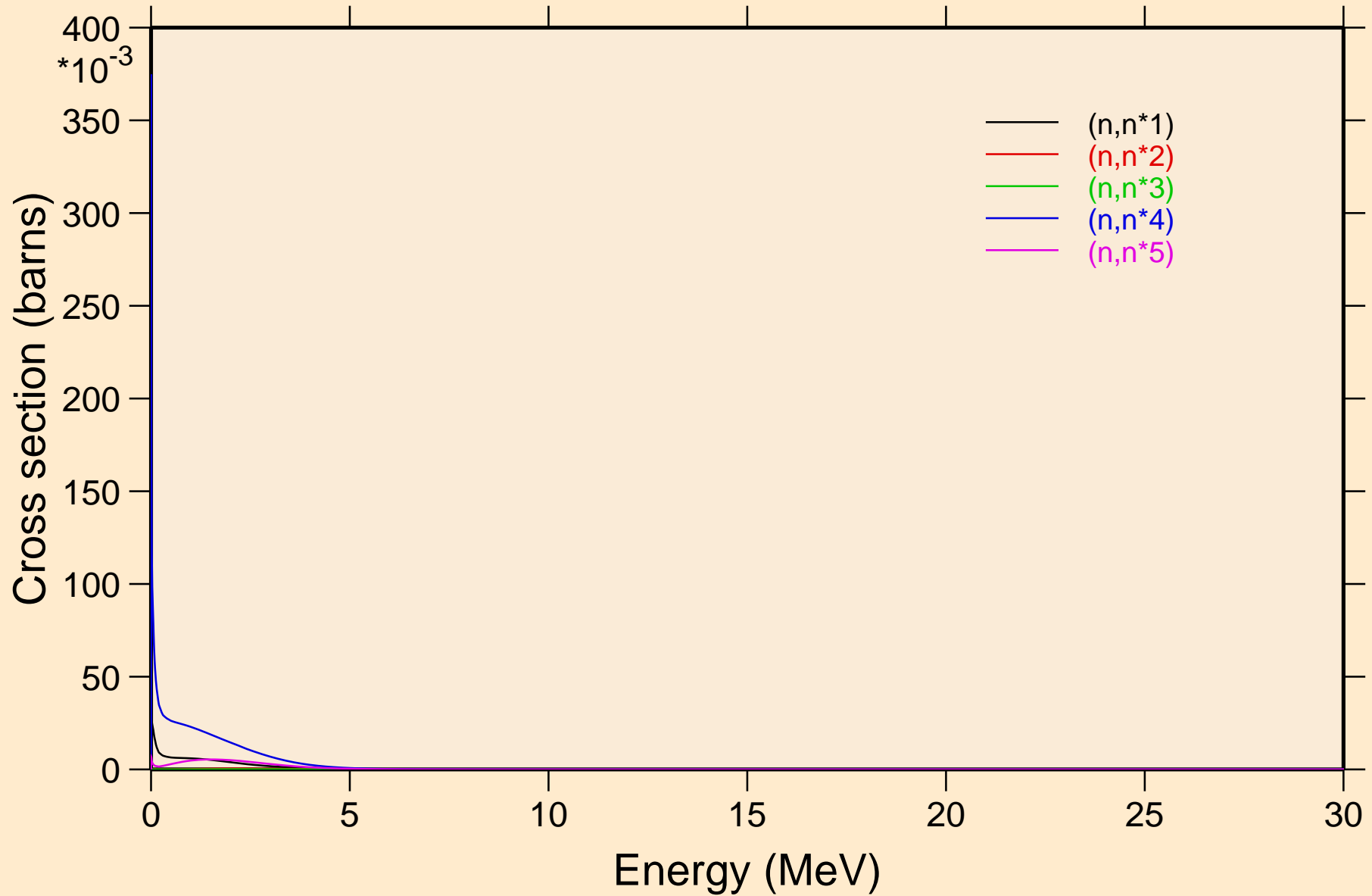

SB129M NEUTRON ACER TENDL-2024 LIBRARY; T=0.K
Inelastic levels

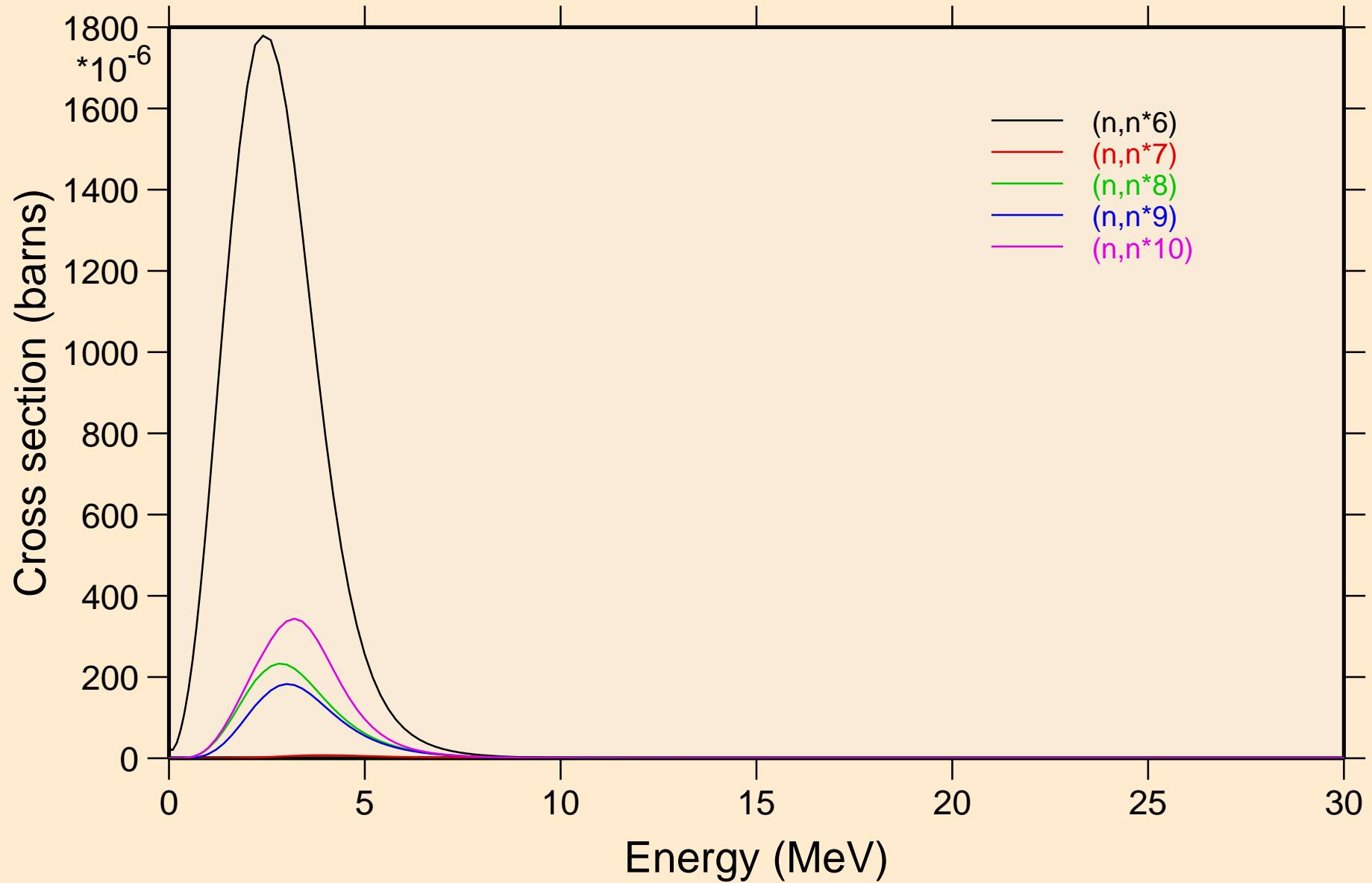

SB129M NEUTRON ACER TENDL-2024 LIBRARY; T=0.K
Inelastic levels

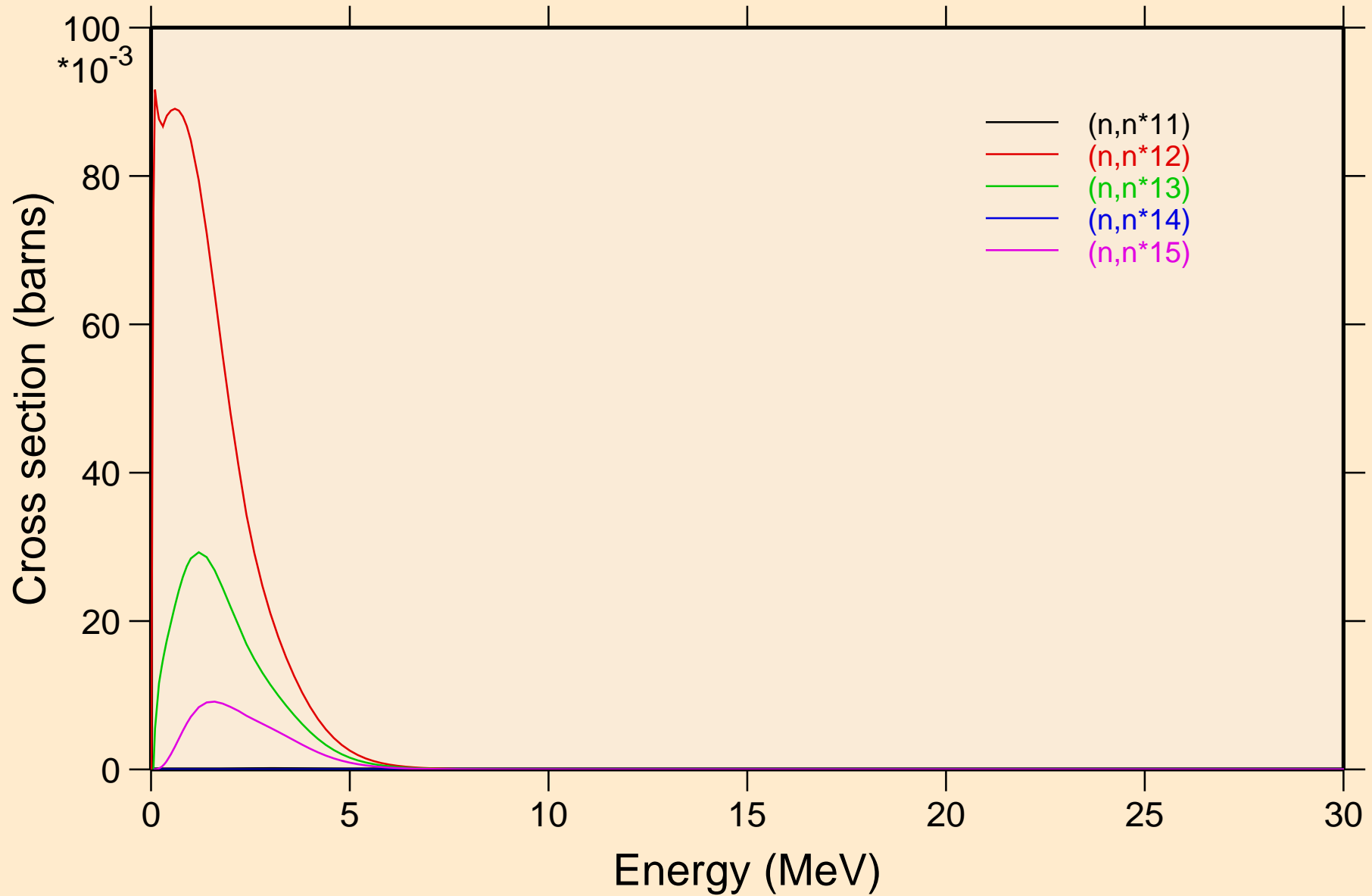

SB129M NEUTRON ACER TENDL-2024 LIBRARY; T=0.K
Inelastic levels

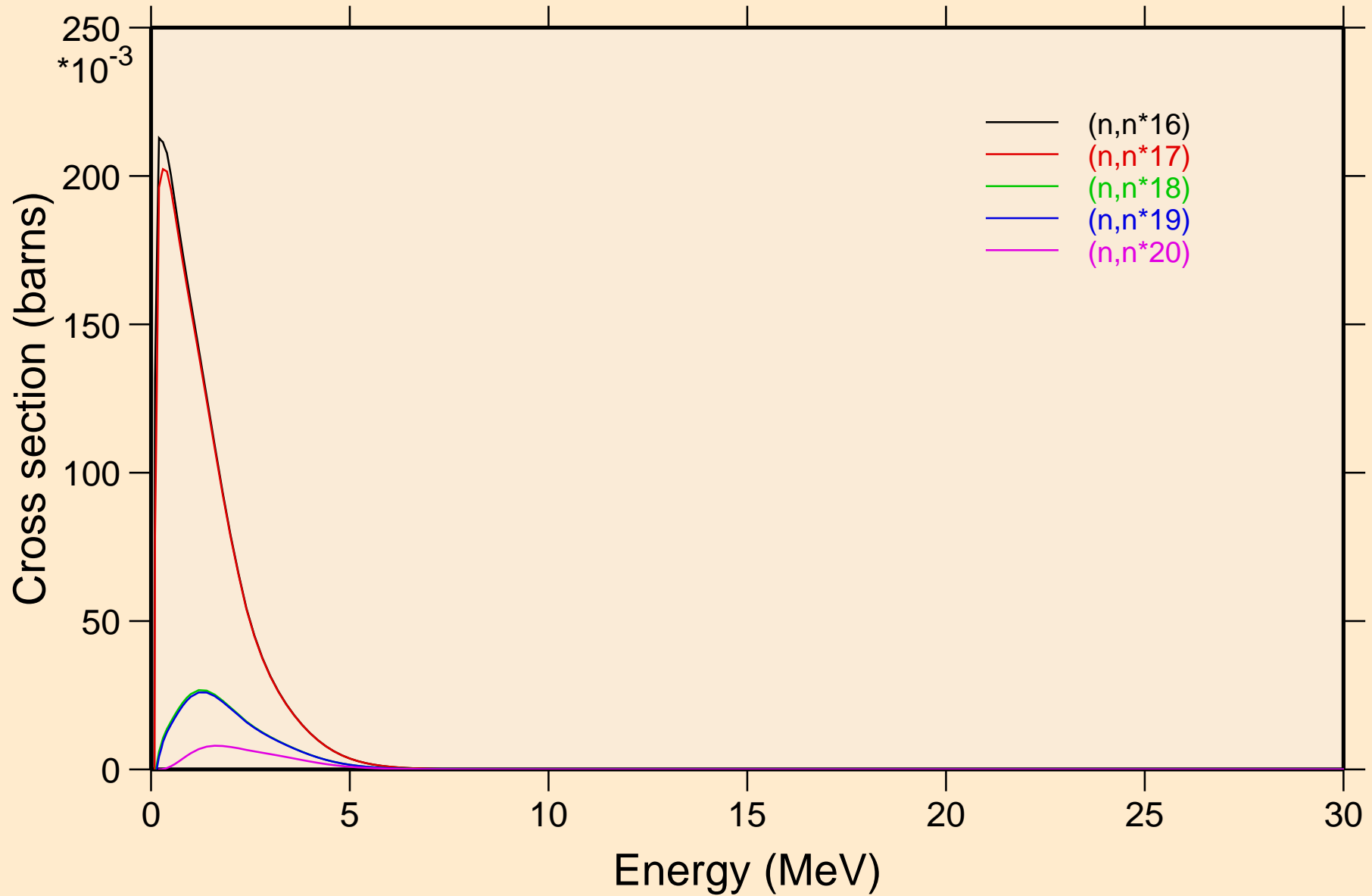

SB129M NEUTRON ACER TENDL-2024 LIBRARY; T=0.K
Inelastic levels

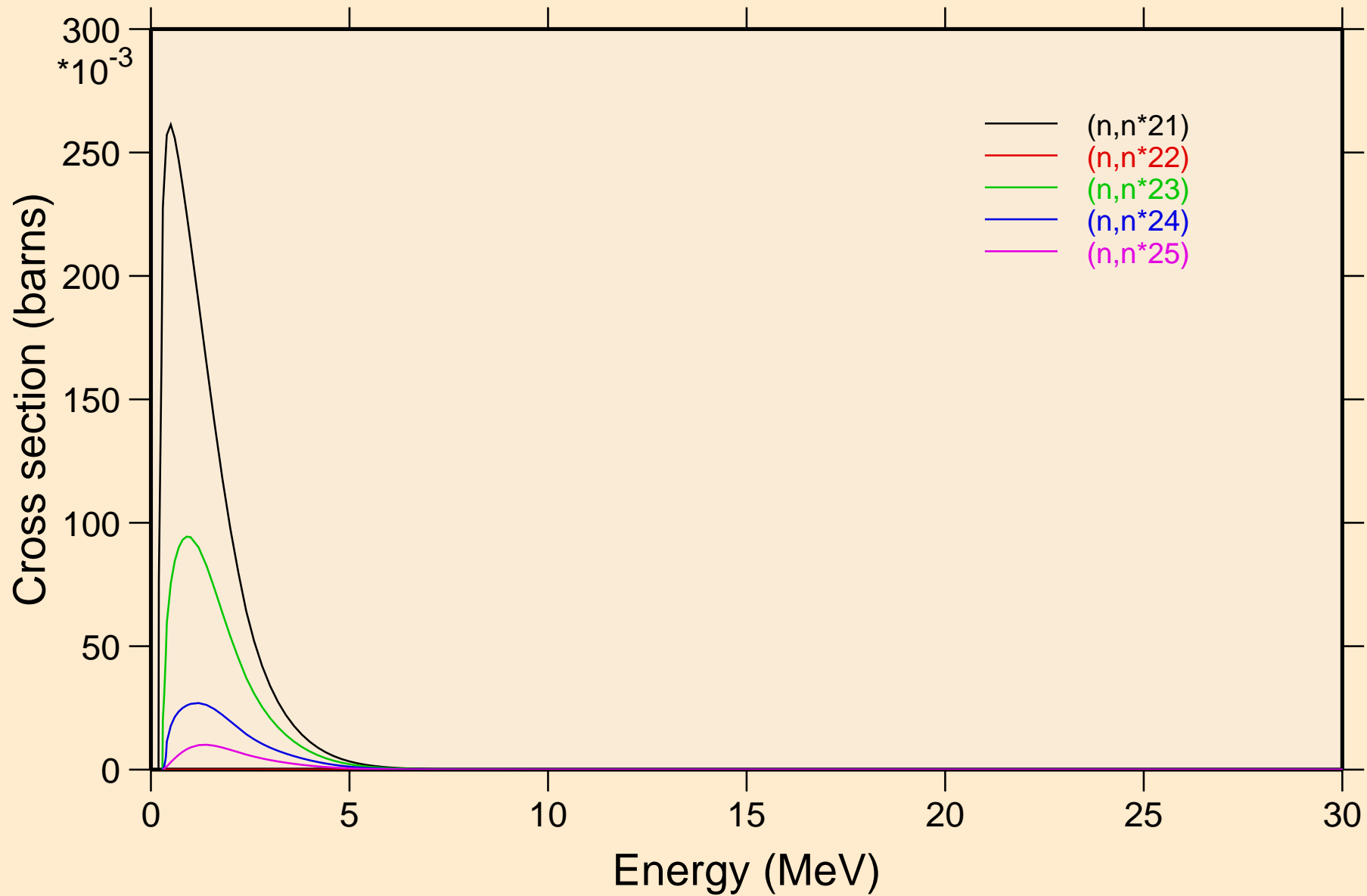

SB129M NEUTRON ACER TENDL-2024 LIBRARY; T=0.K
Inelastic levels

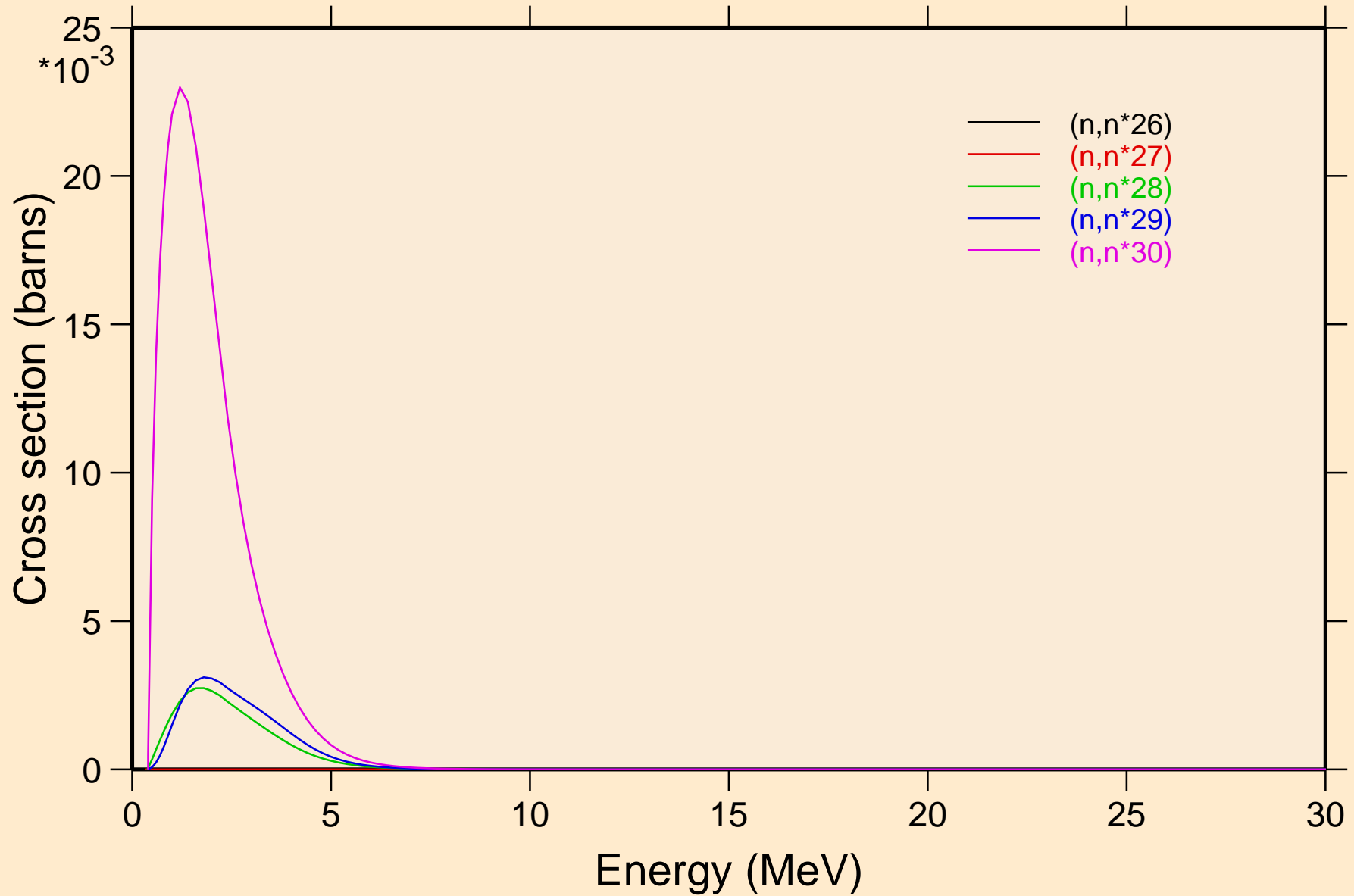

SB129M NEUTRON ACER TENDL-2024 LIBRARY; T=0.K

Threshold reactions

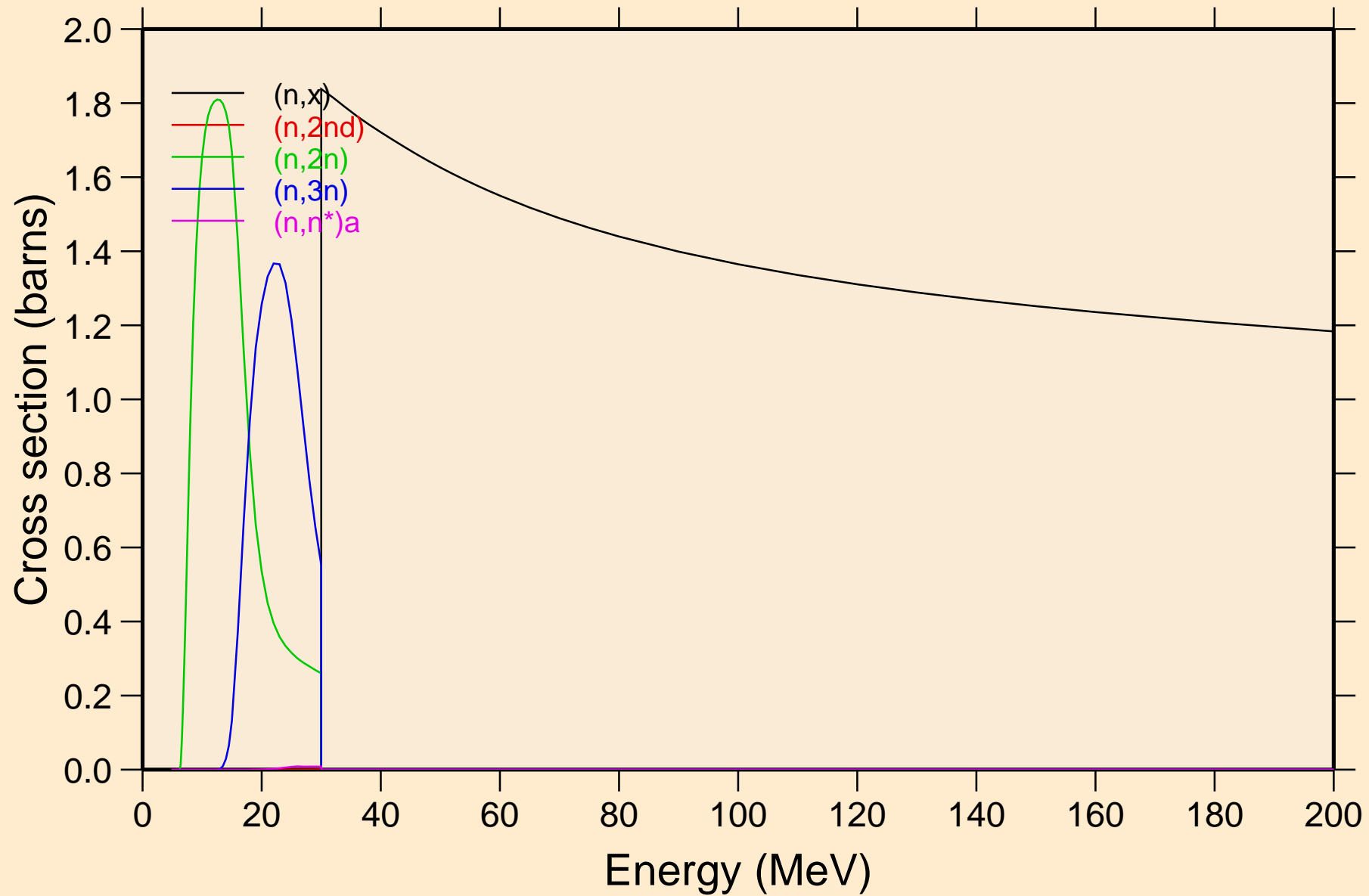

SB129M NEUTRON ACER TENDL-2024 LIBRARY; T=0.K

Threshold reactions

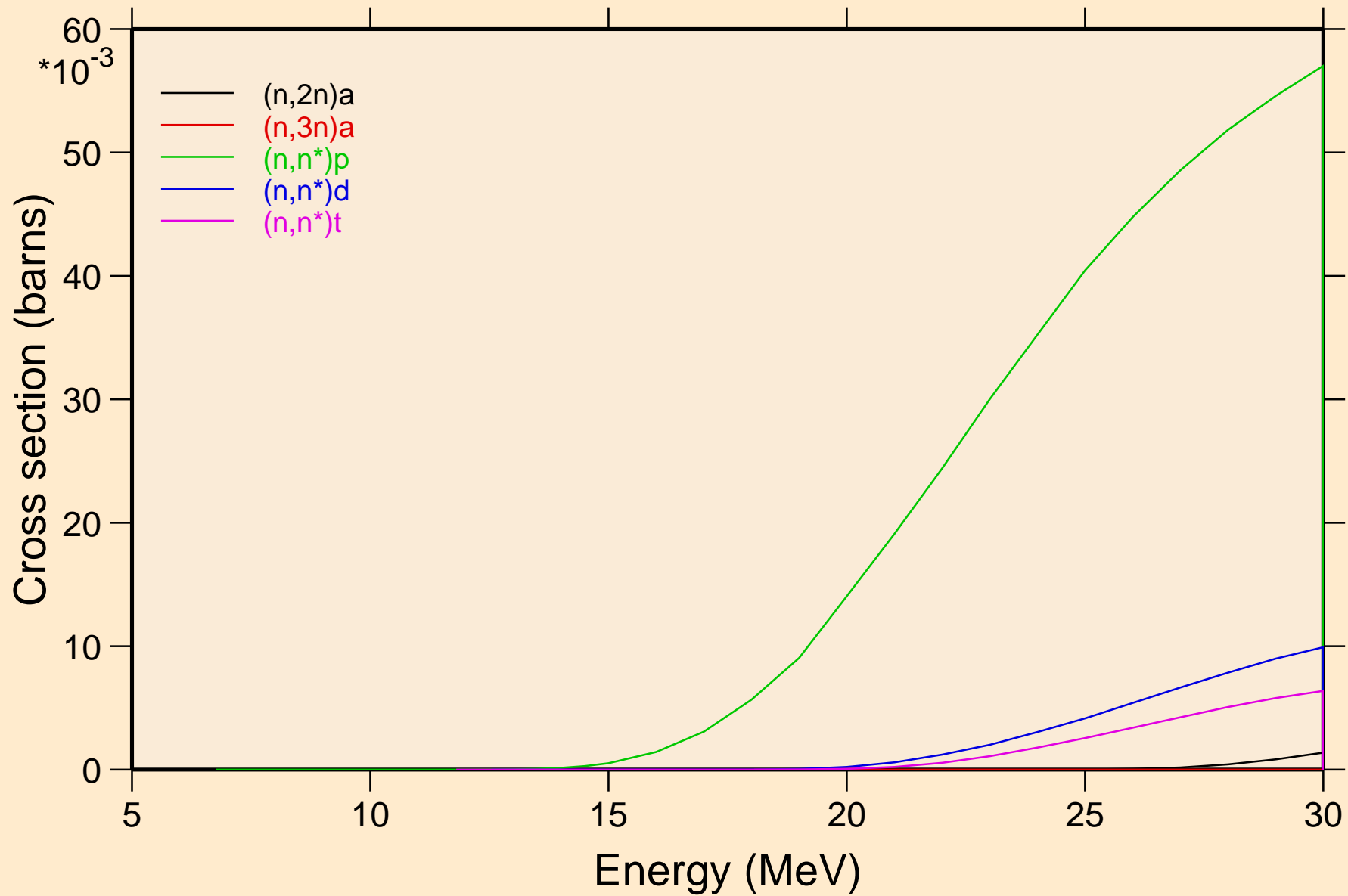

SB129M NEUTRON ACER TENDL-2024 LIBRARY; T=0.K
Threshold reactions

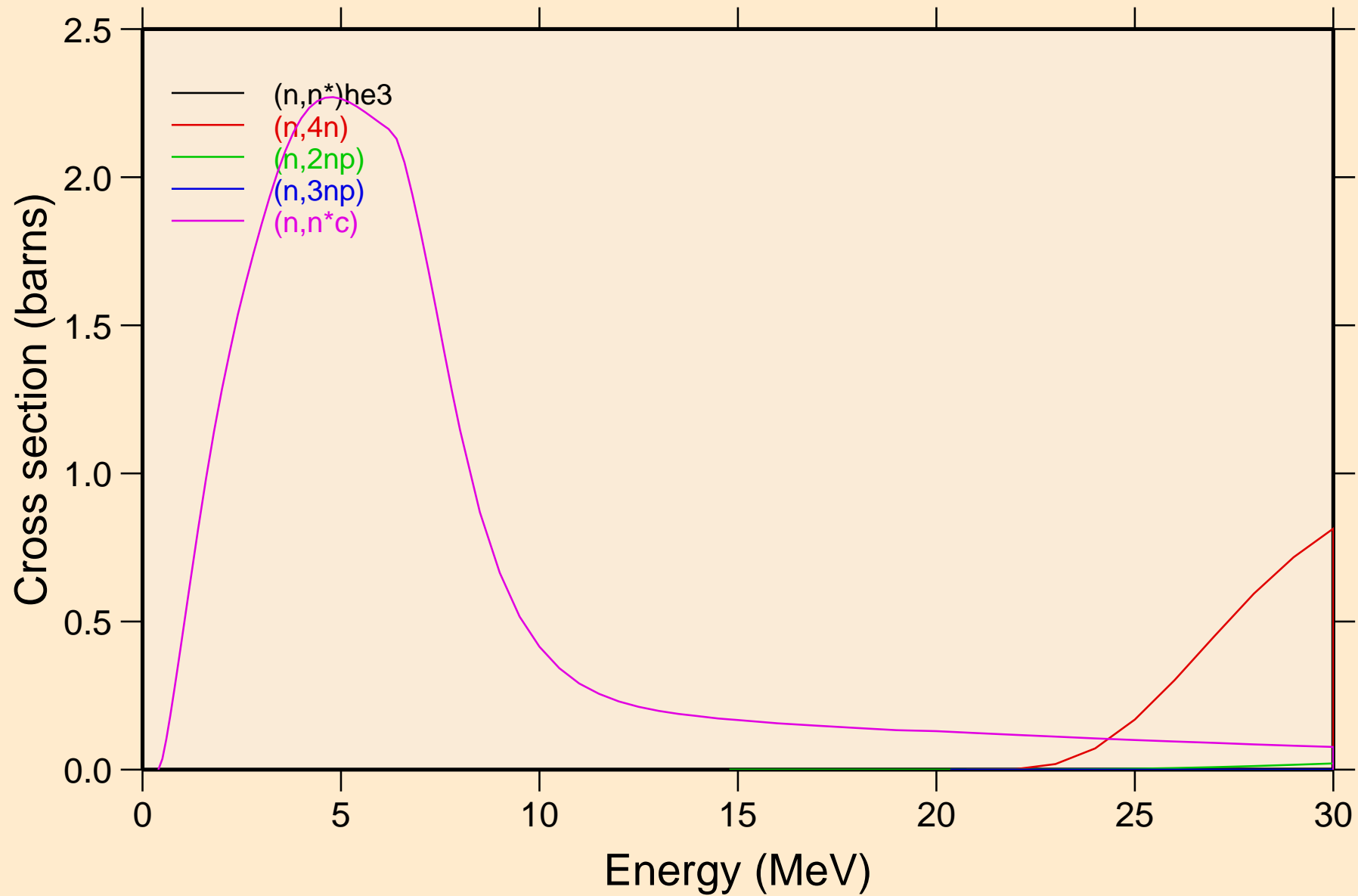

SB129M NEUTRON ACER TENDL-2024 LIBRARY; T=0.K

Threshold reactions

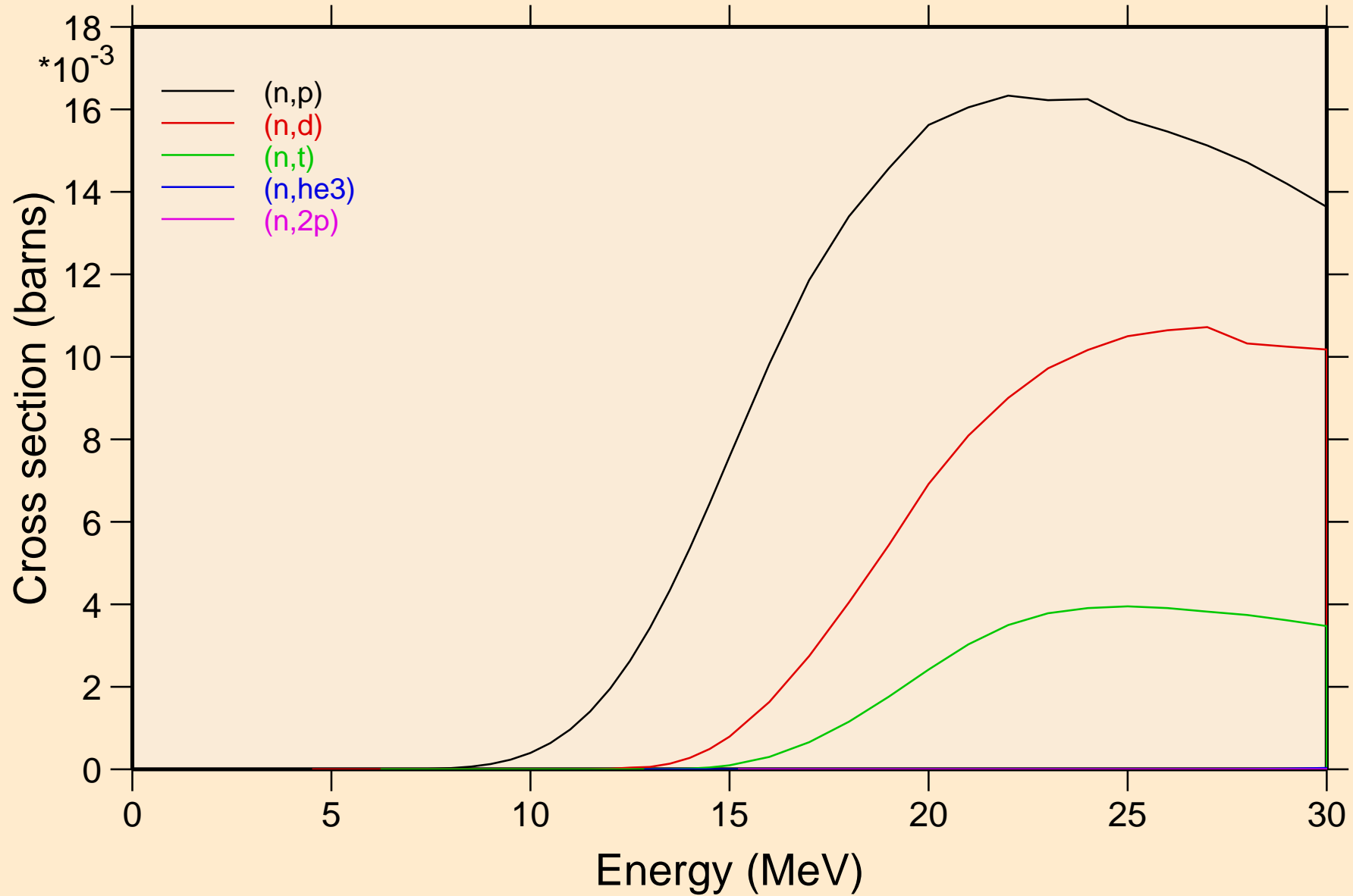

SB129M NEUTRON ACER TENDL-2024 LIBRARY; T=0.K

Threshold reactions

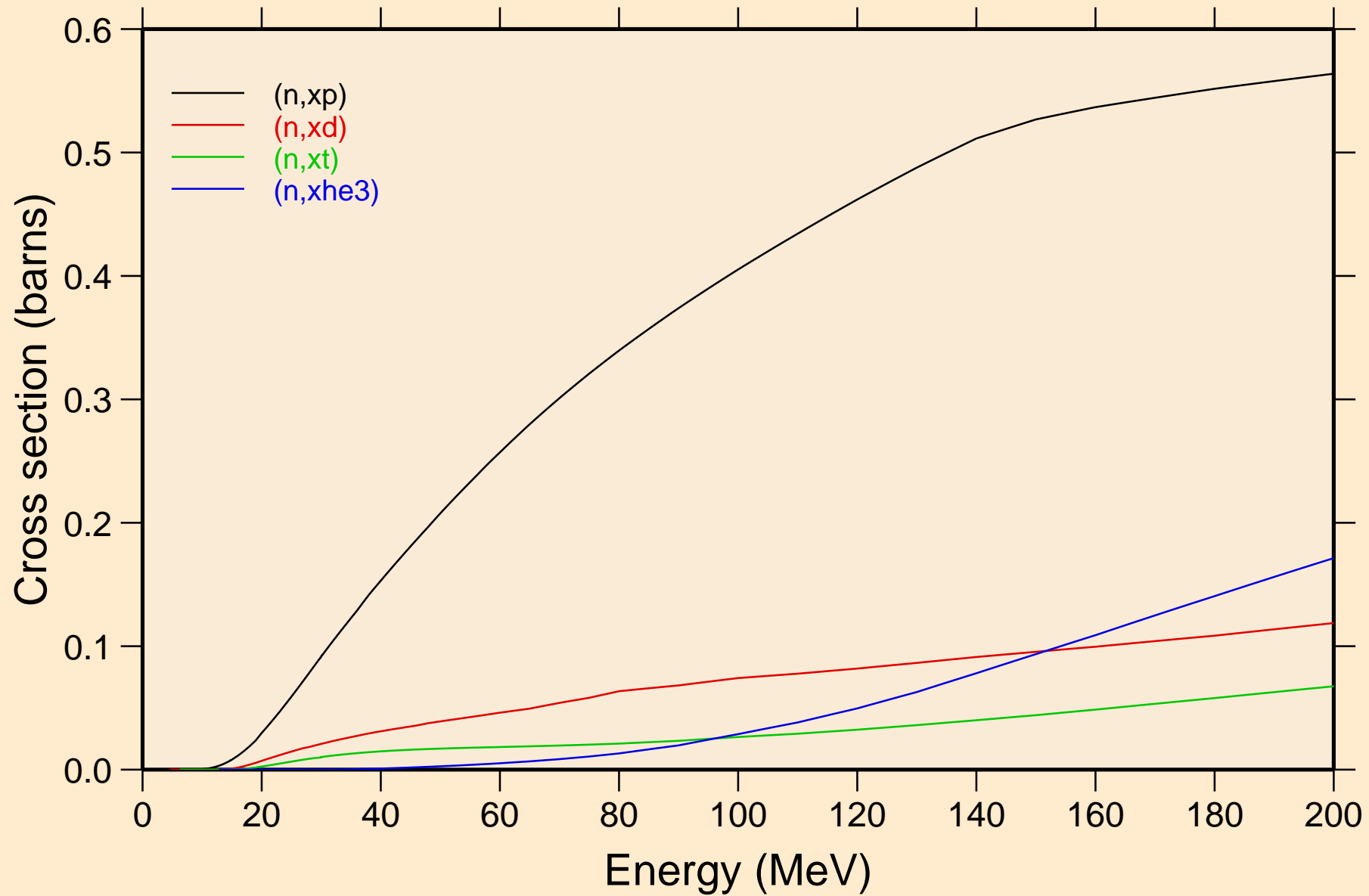

SB129M NEUTRON ACER TENDL-2024 LIBRARY; T=0.K
angular distribution for elastic

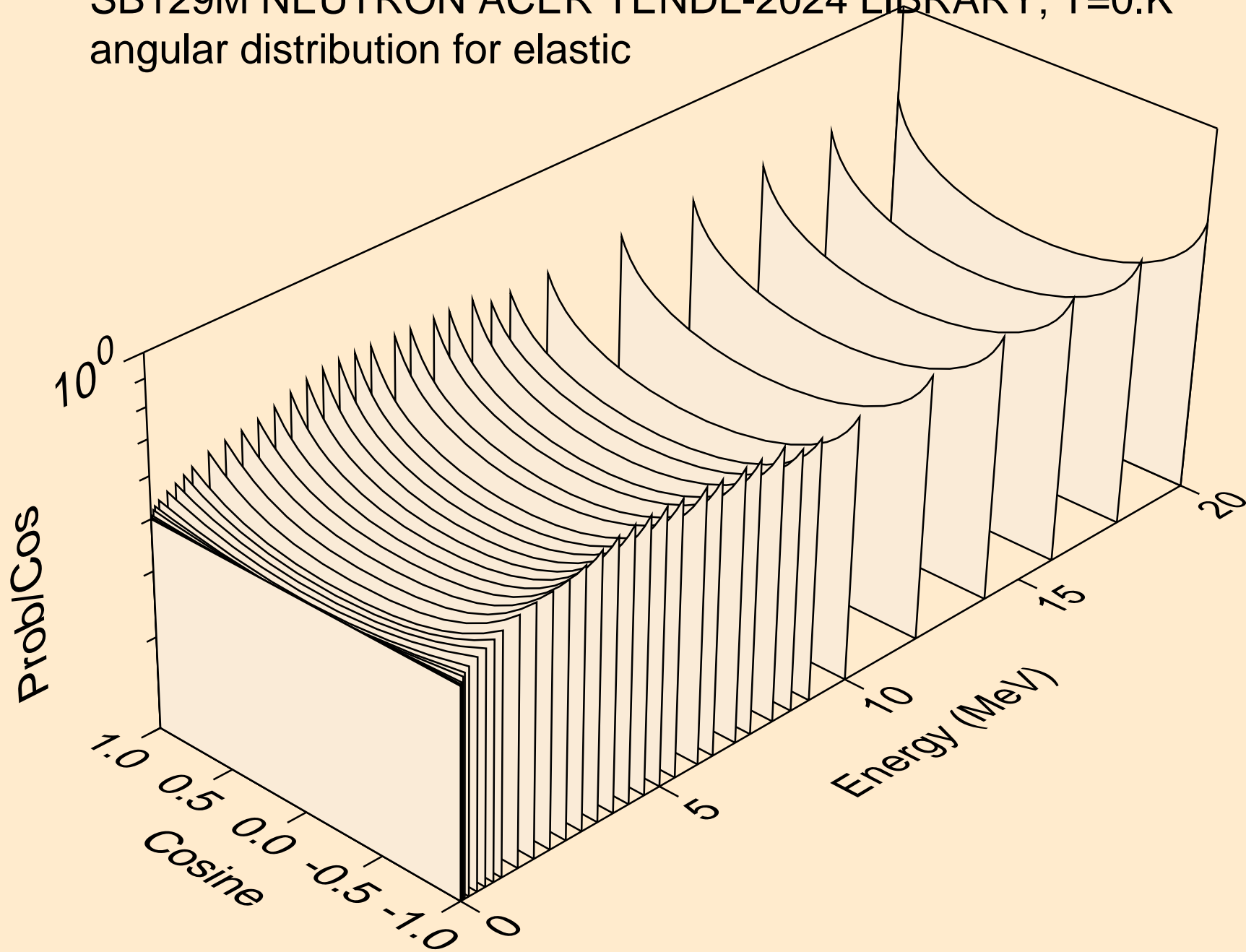

SB129M NEUTRON ACER TENDL-2024 LIBRARY; T=0.K
angular distribution for elastic

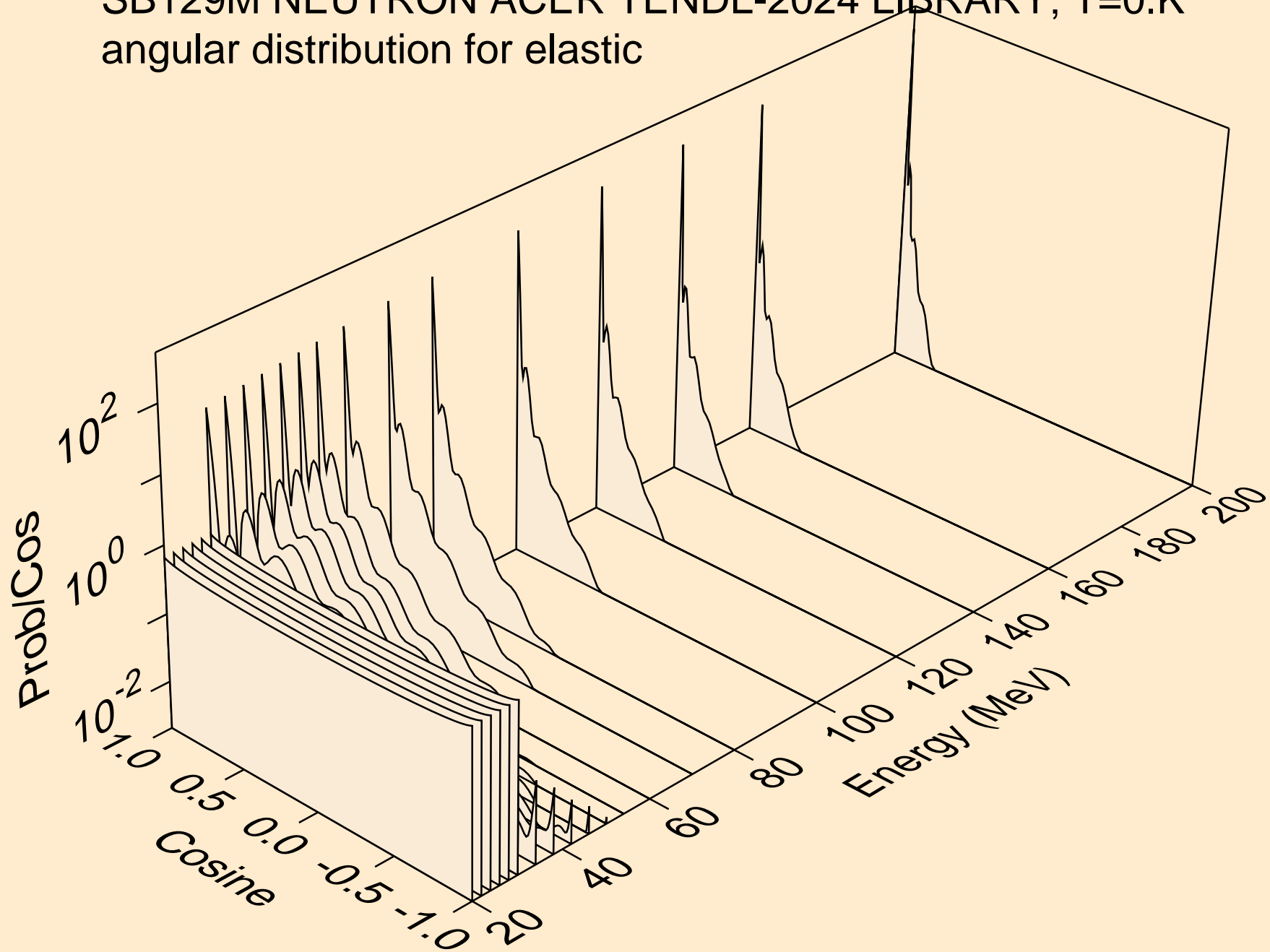

SB129M NEUTRON ACER TENDL-2024 LIBRARY; T=0.K
angular distribution for (n,n*1)

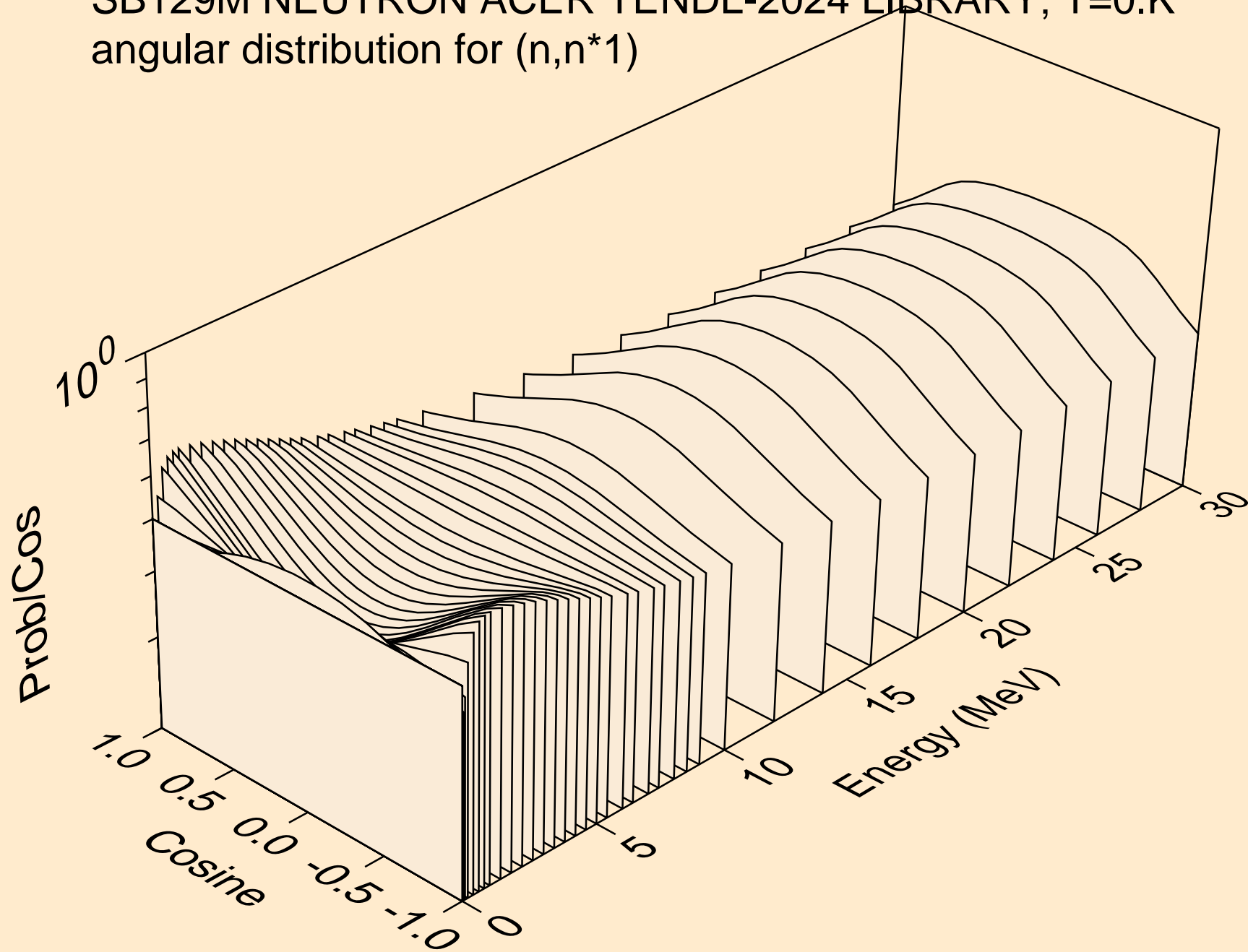

SB129M NEUTRON ACER TENDL-2024 LIBRARY; T=0.K
angular distribution for (n,n*2)

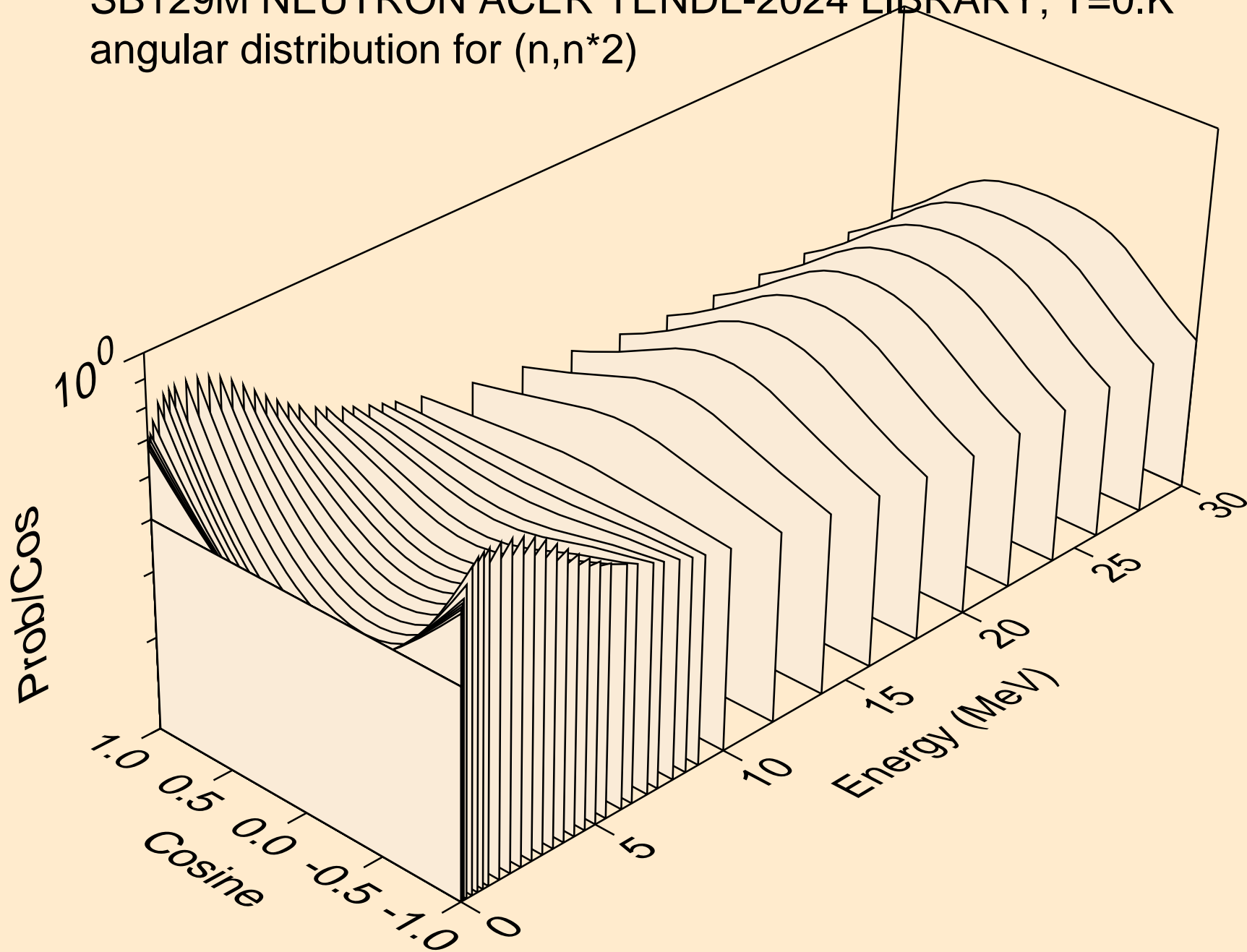

SB129M NEUTRON ACER TENDL-2024 LIBRARY; T=0.K
angular distribution for (n,n*3)

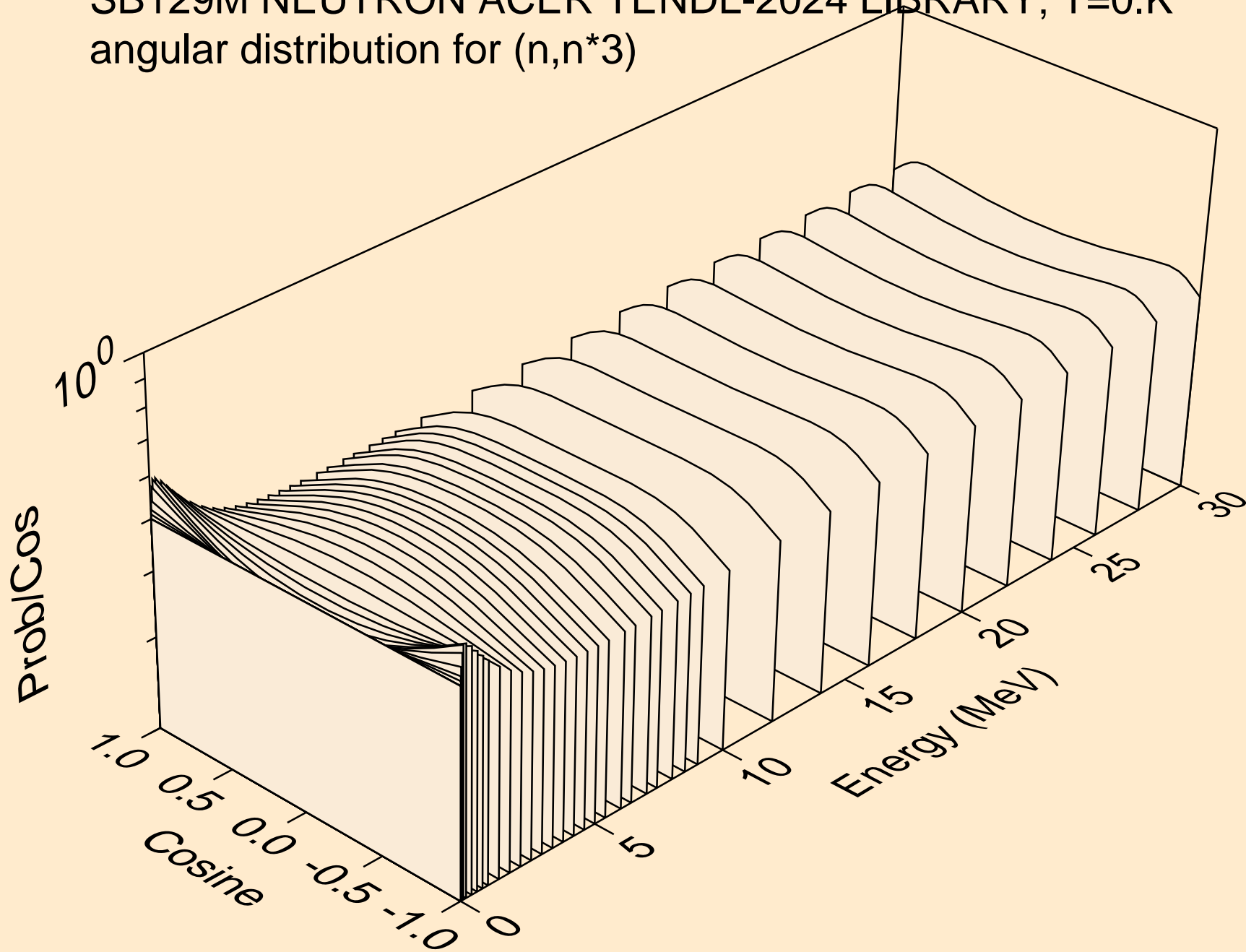

SB129M NEUTRON ACER TENDL-2024 LIBRARY; T=0.K
angular distribution for (n,n*4)

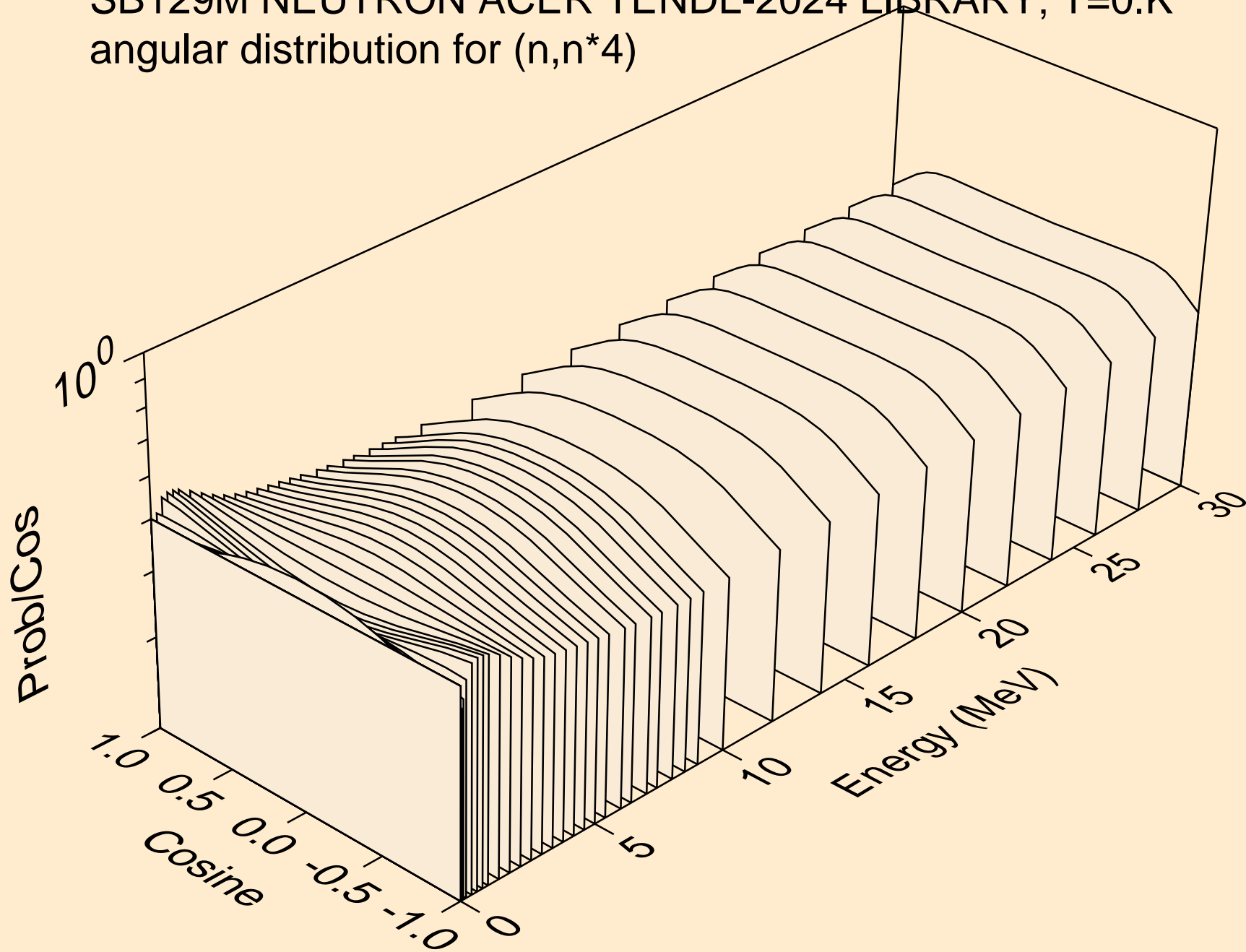

SB129M NEUTRON ACER TENDL-2024 LIBRARY; T=0.K
angular distribution for (n,n*5)

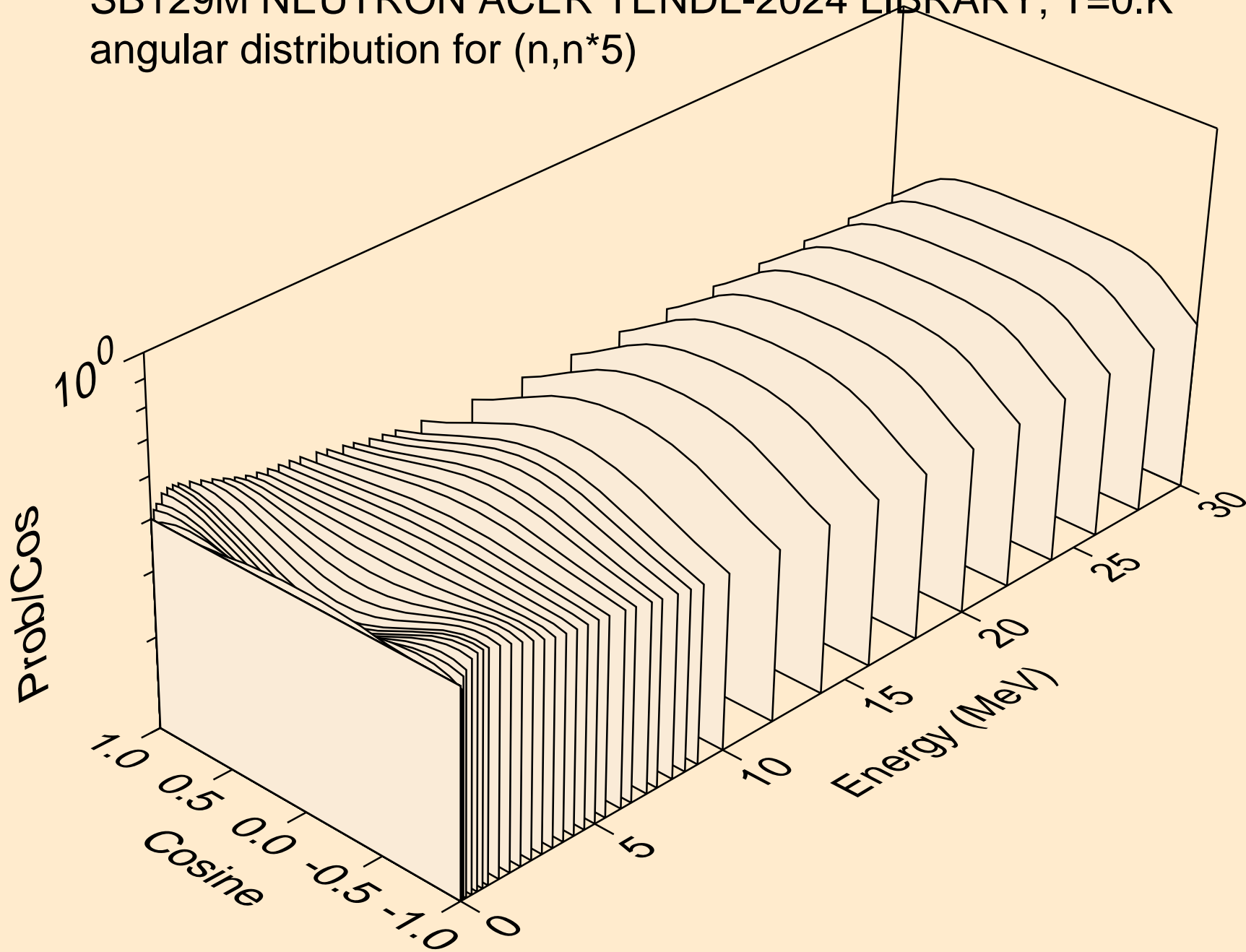

SB129M NEUTRON ACER TENDL-2024 LIBRARY; T=0.K
angular distribution for (n,n*6)

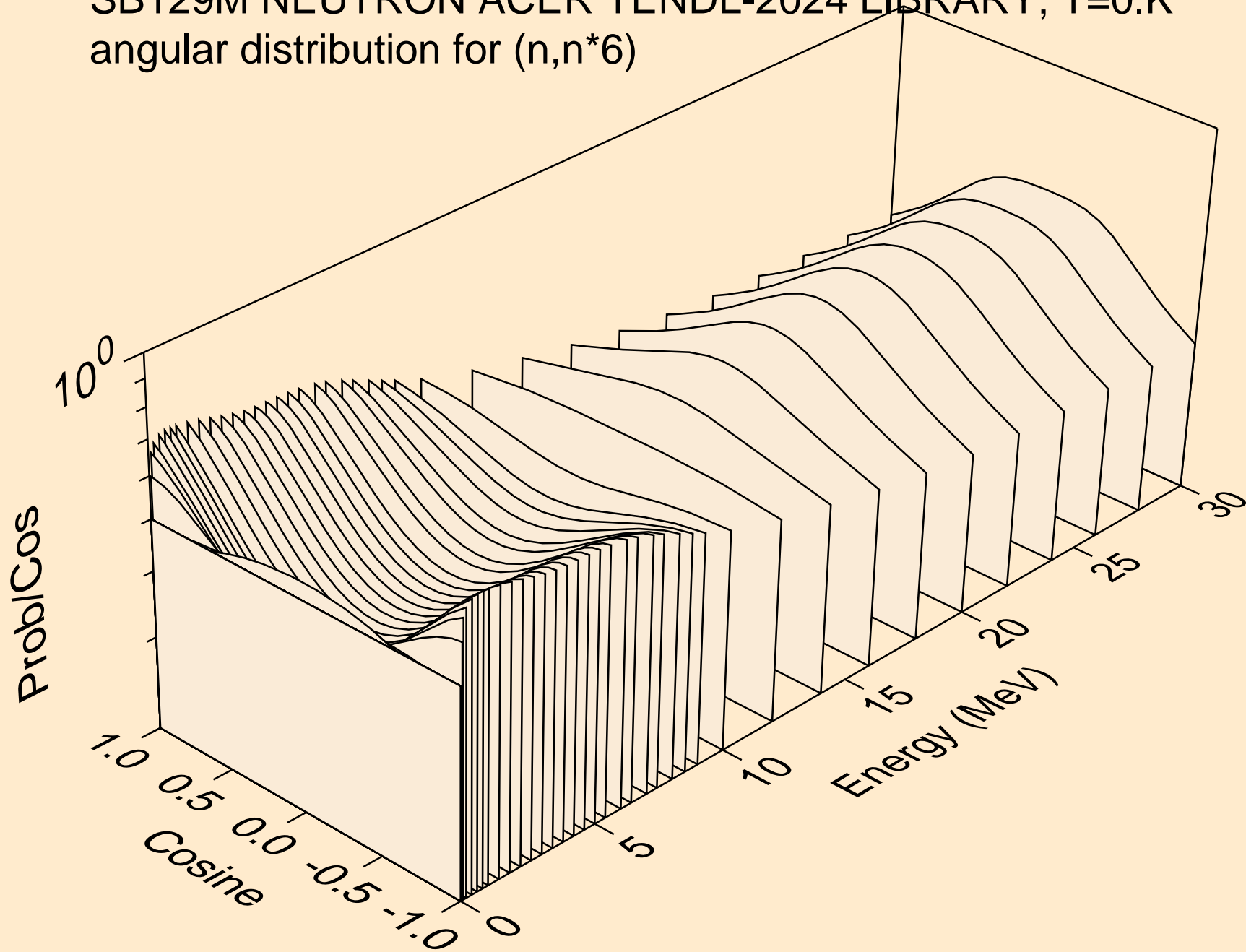

SB129M NEUTRON ACER TENDL-2024 LIBRARY; T=0.K
angular distribution for (n,n*7)

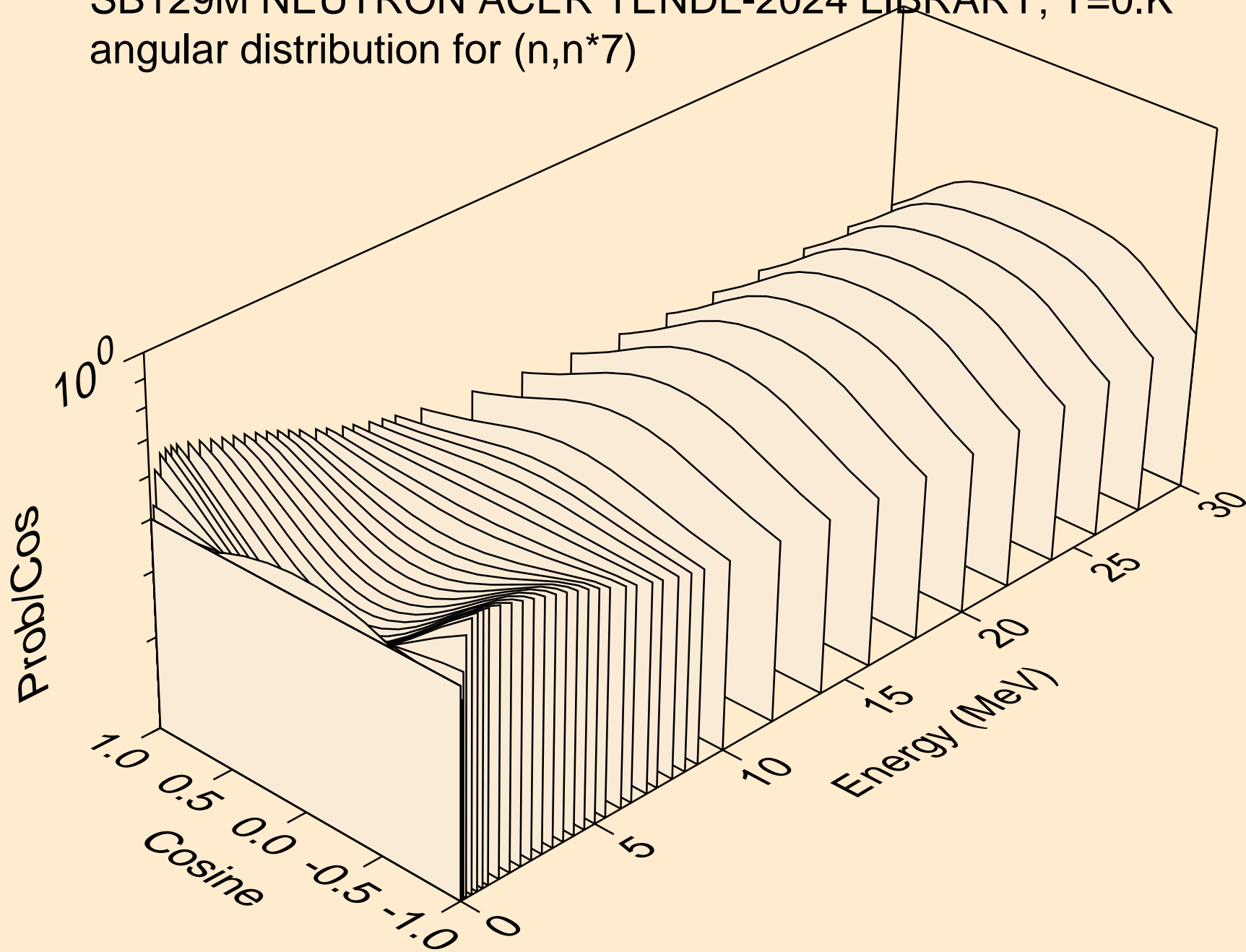

SB129M NEUTRON ACER TENDL-2024 LIBRARY; T=0.K
angular distribution for (n,n*8)

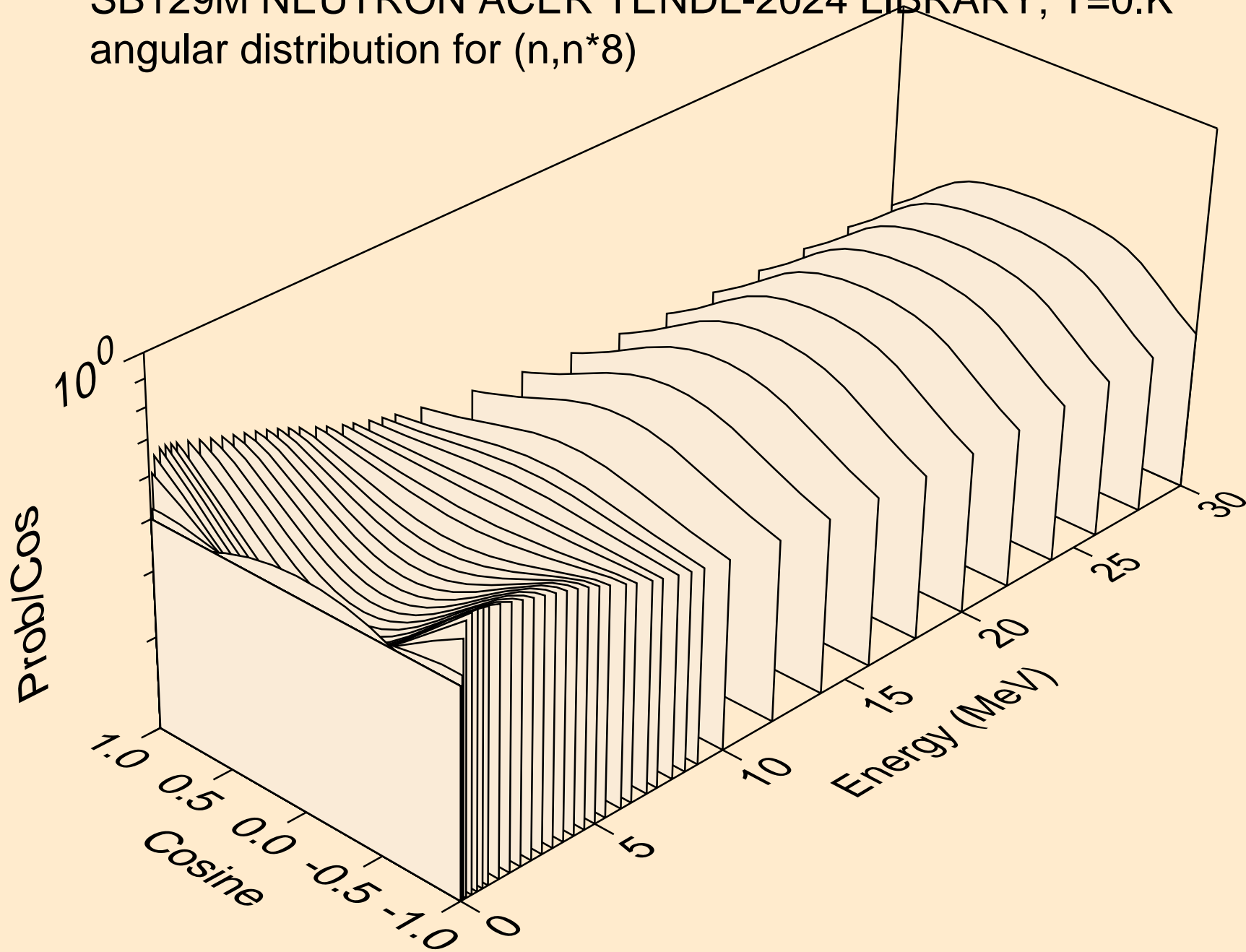

SB129M NEUTRON ACER TENDL-2024 LIBRARY; T=0.K
angular distribution for (n,n*9)

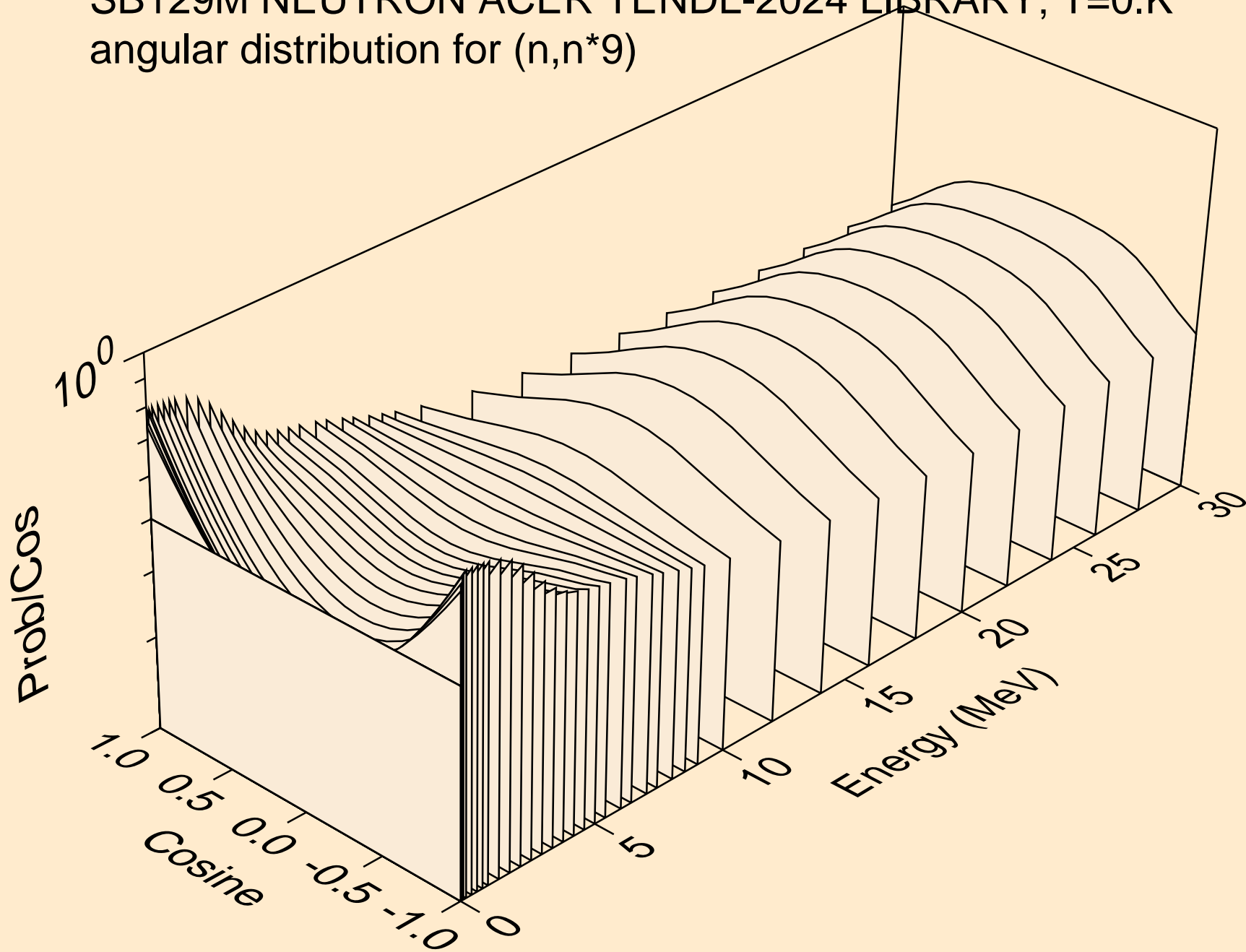

SB129M NEUTRON ACER TENDL-2024 LIBRARY; T=0.K
angular distribution for (n,n*10)

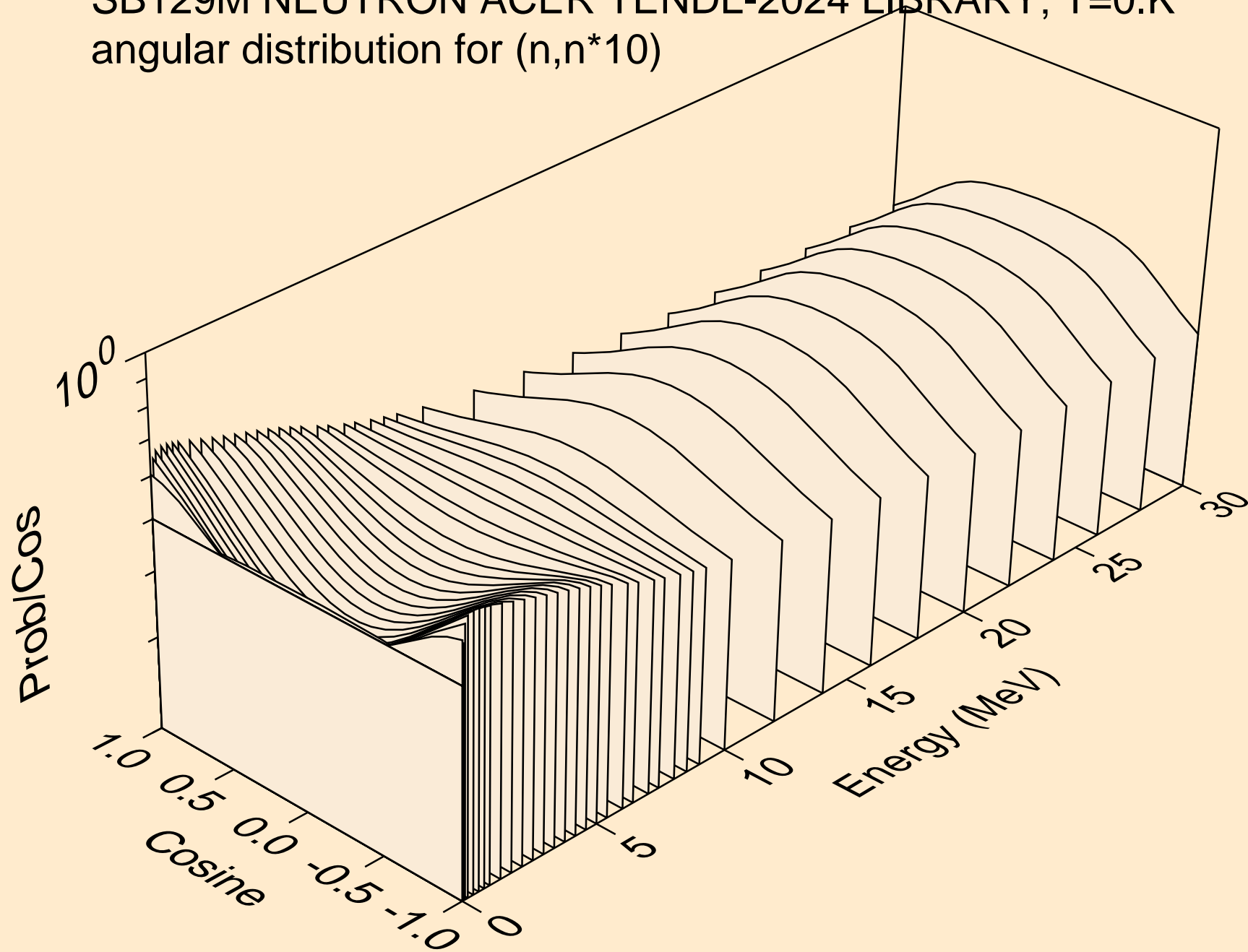

SB129M NEUTRON ACER TENDL-2024 LIBRARY; T=0.K
angular distribution for (n,n*11)

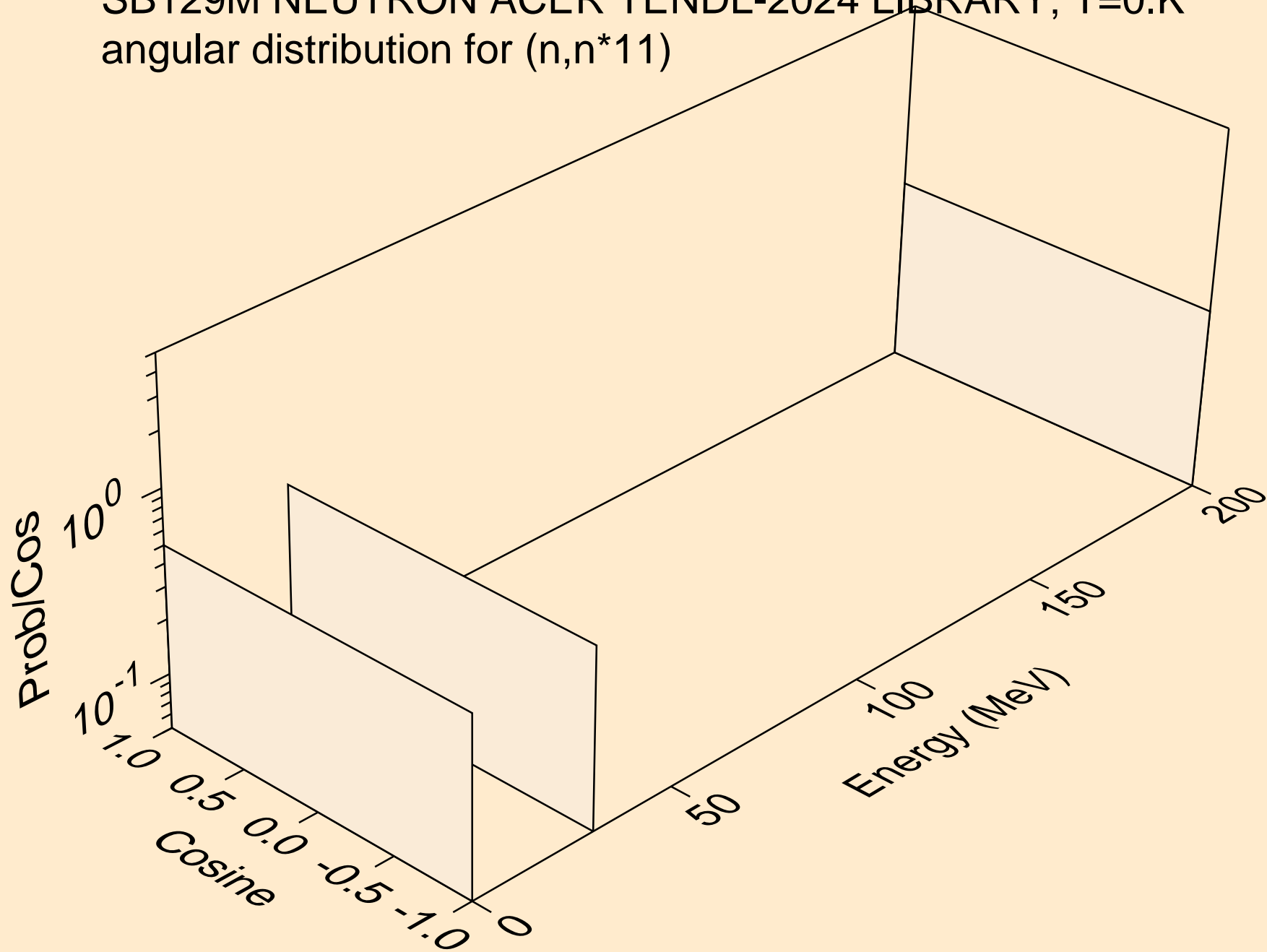

SB129M NEUTRON ACER TENDL-2024 LIBRARY; T=0.K
angular distribution for (n,n*12)

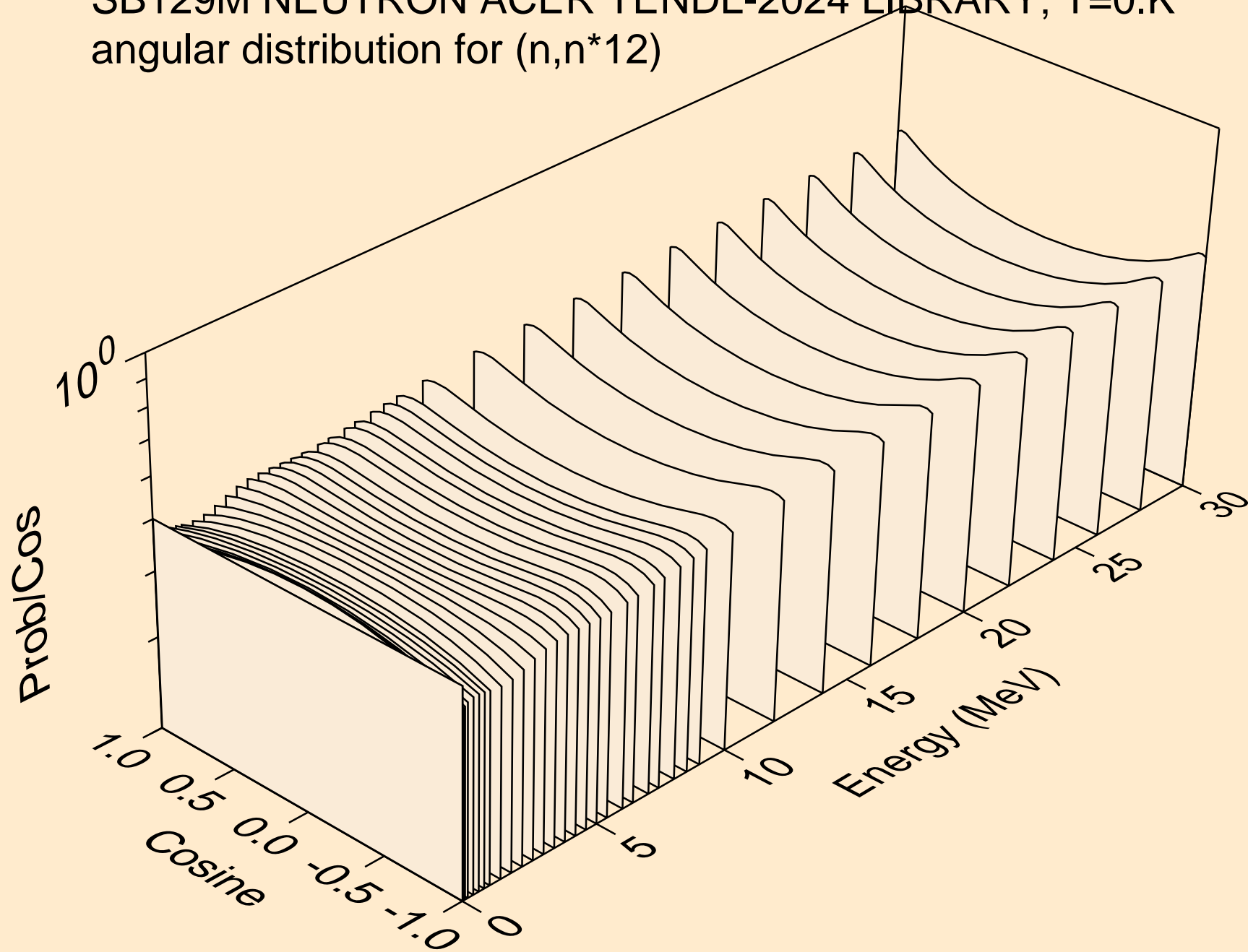

SB129M NEUTRON ACER TENDL-2024 LIBRARY; T=0.K
angular distribution for (n,n*13)

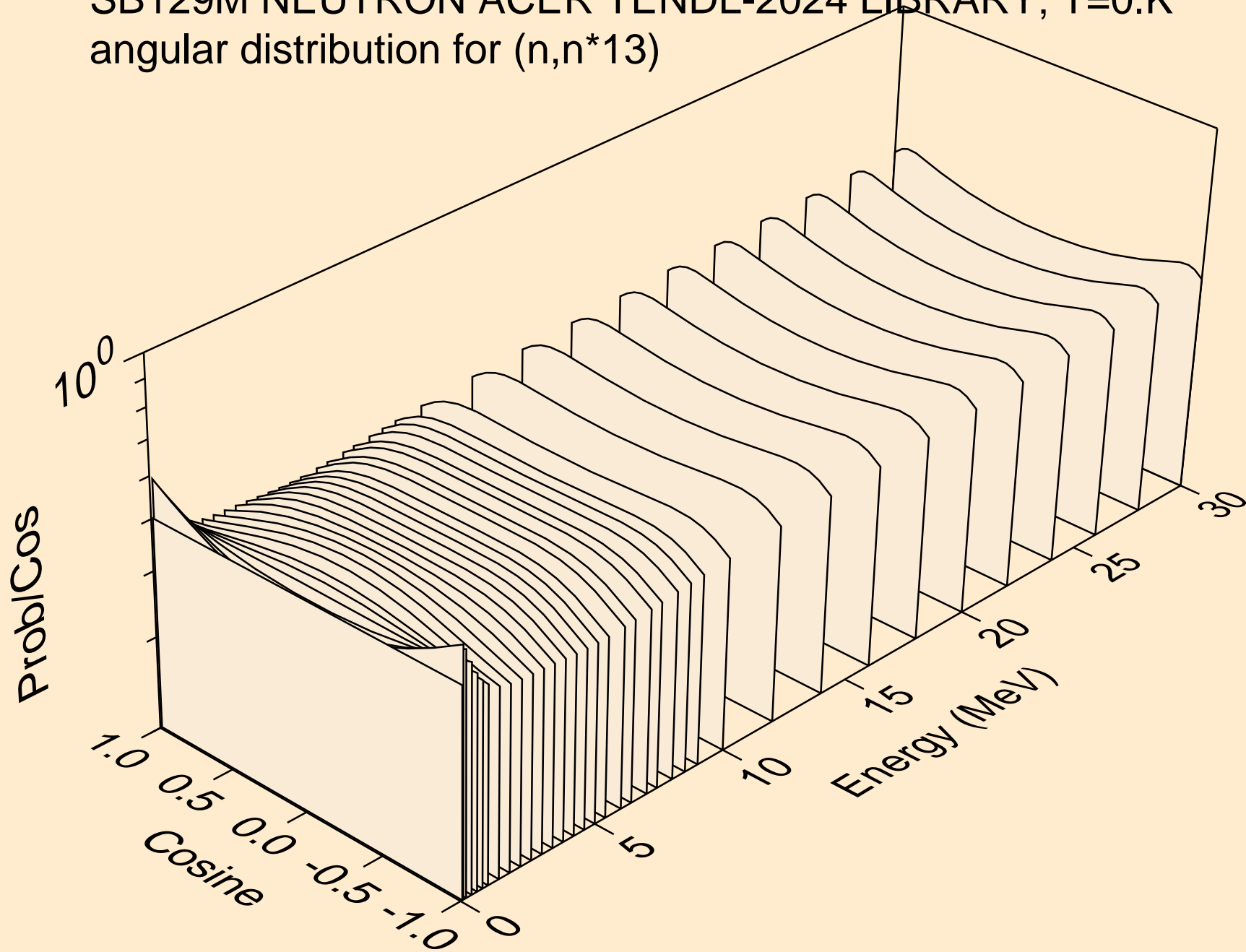

SB129M NEUTRON ACER TENDL-2024 LIBRARY; T=0.K
angular distribution for (n,n*14)

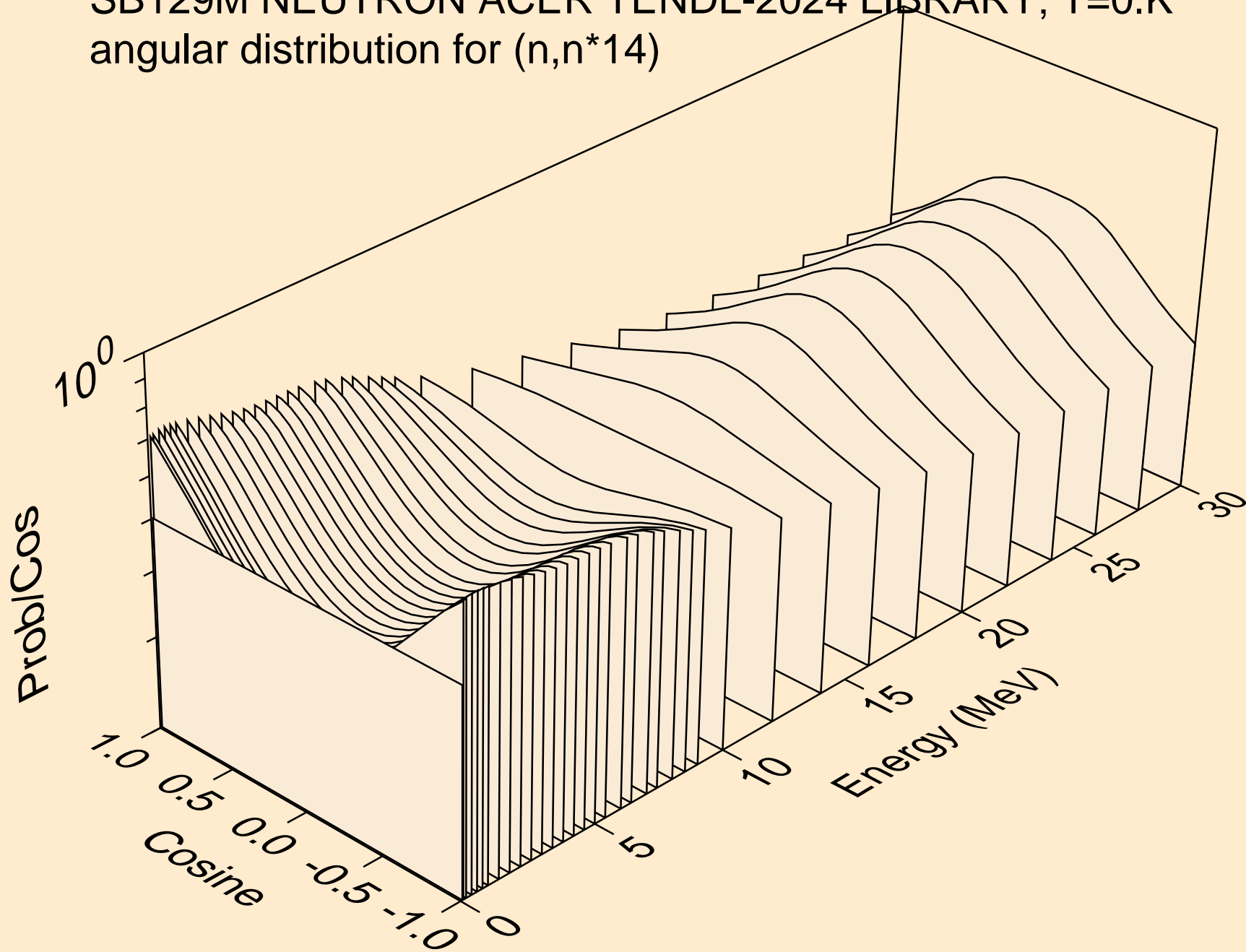

SB129M NEUTRON ACER TENDL-2024 LIBRARY; T=0.K
angular distribution for (n,n*15)

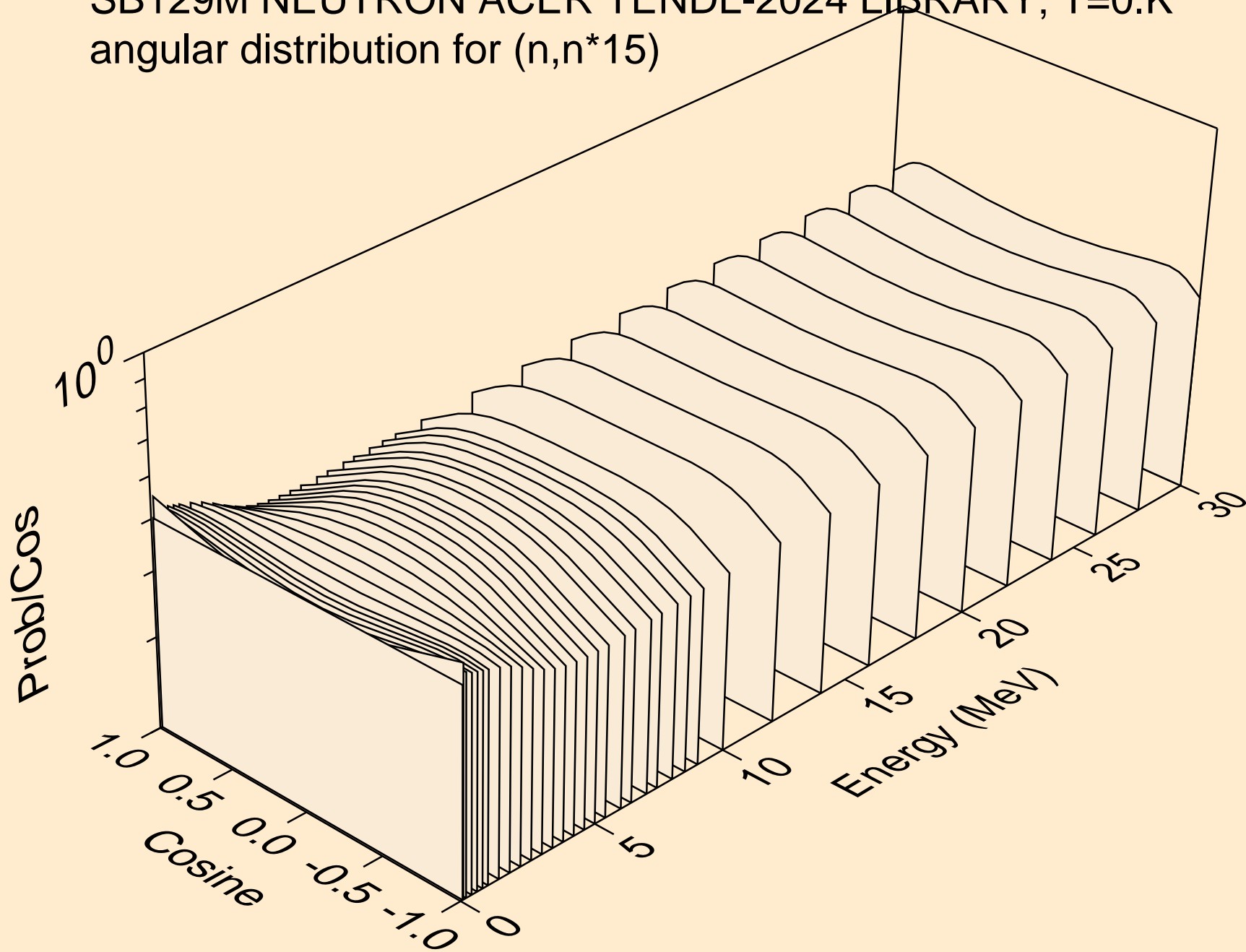

SB129M NEUTRON ACER TENDL-2024 LIBRARY; T=0.K
angular distribution for (n,n*16)

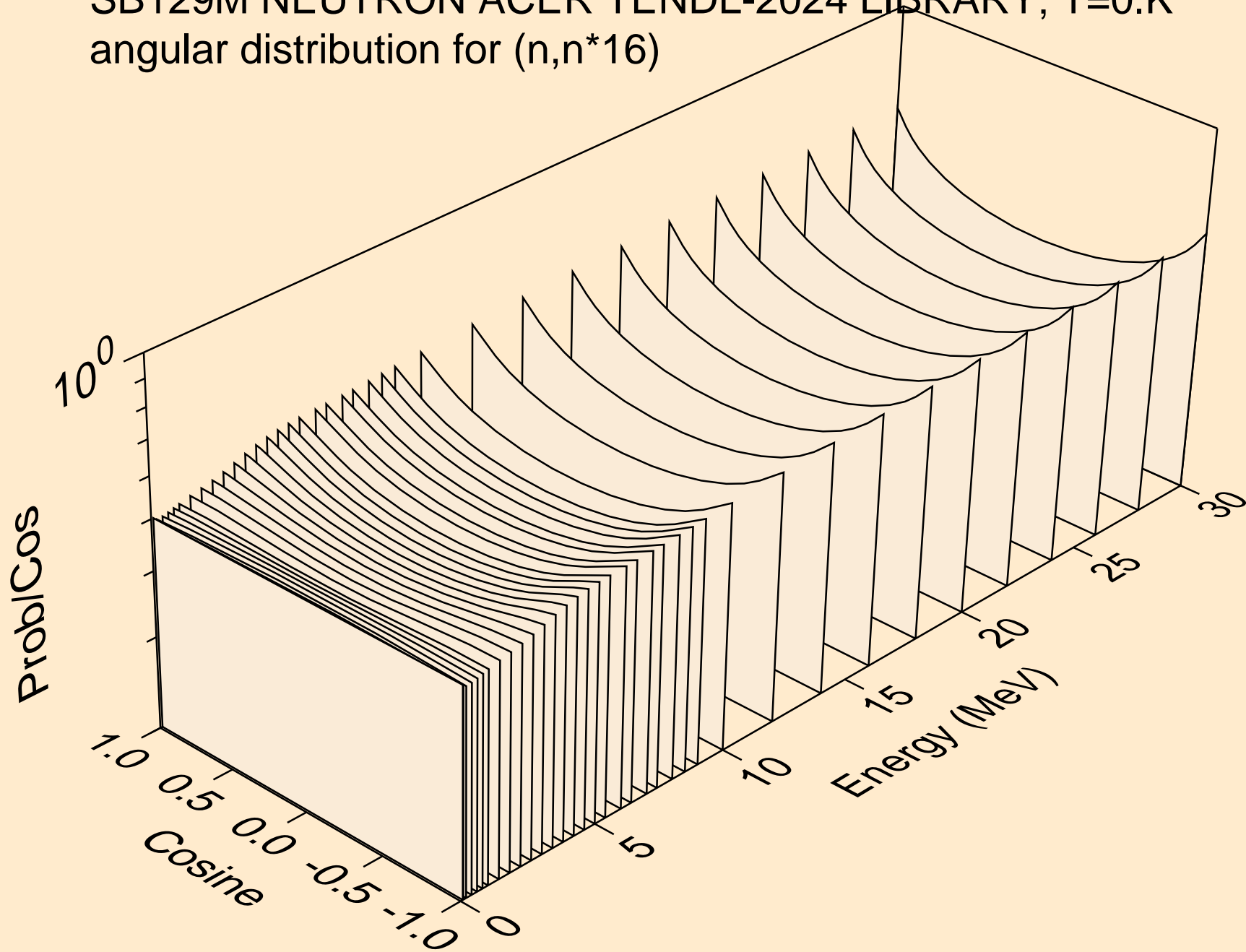

SB129M NEUTRON ACER TENDL-2024 LIBRARY; T=0.K
angular distribution for (n,n*17)

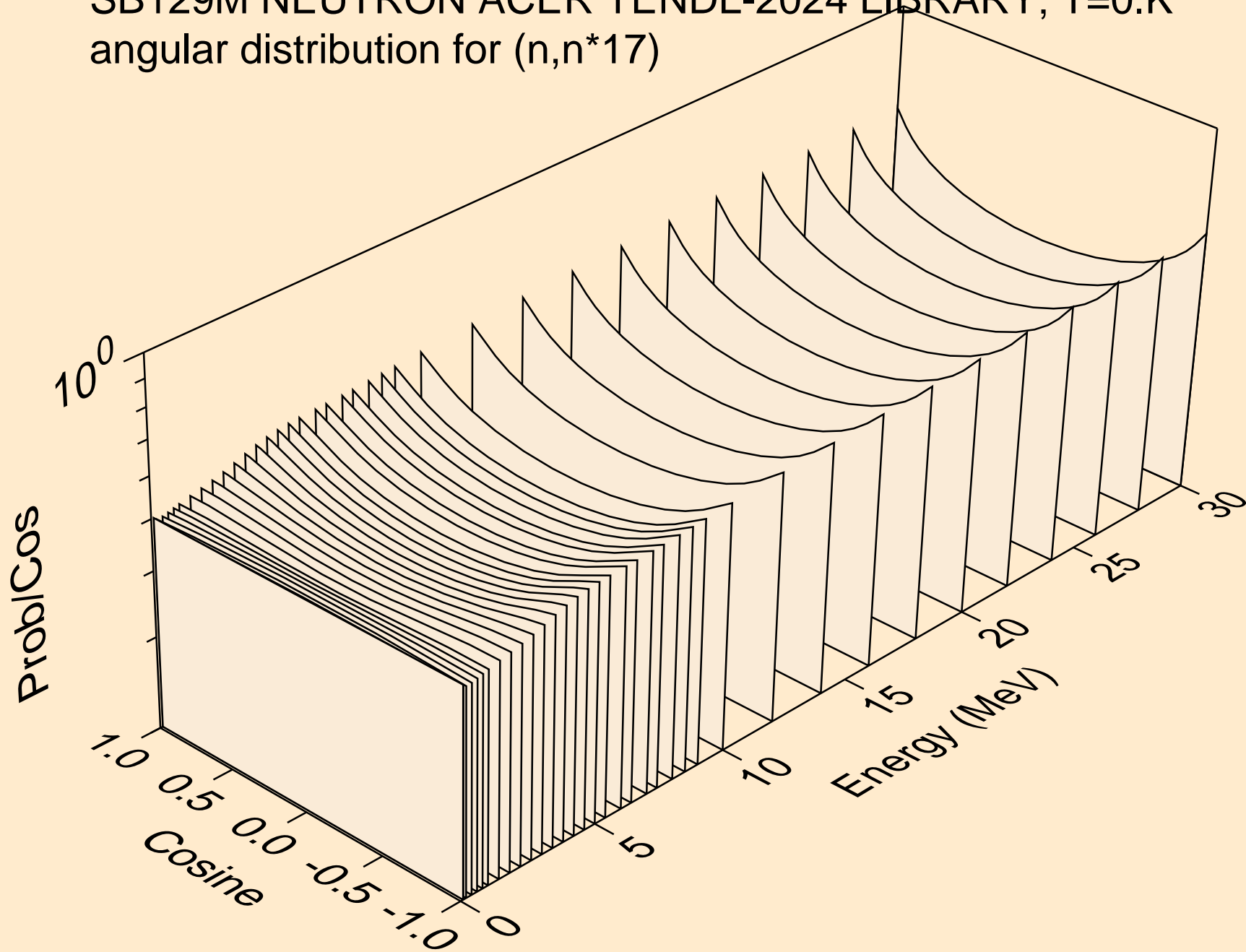

SB129M NEUTRON ACER TENDL-2024 LIBRARY; T=0.K
angular distribution for (n,n*18)

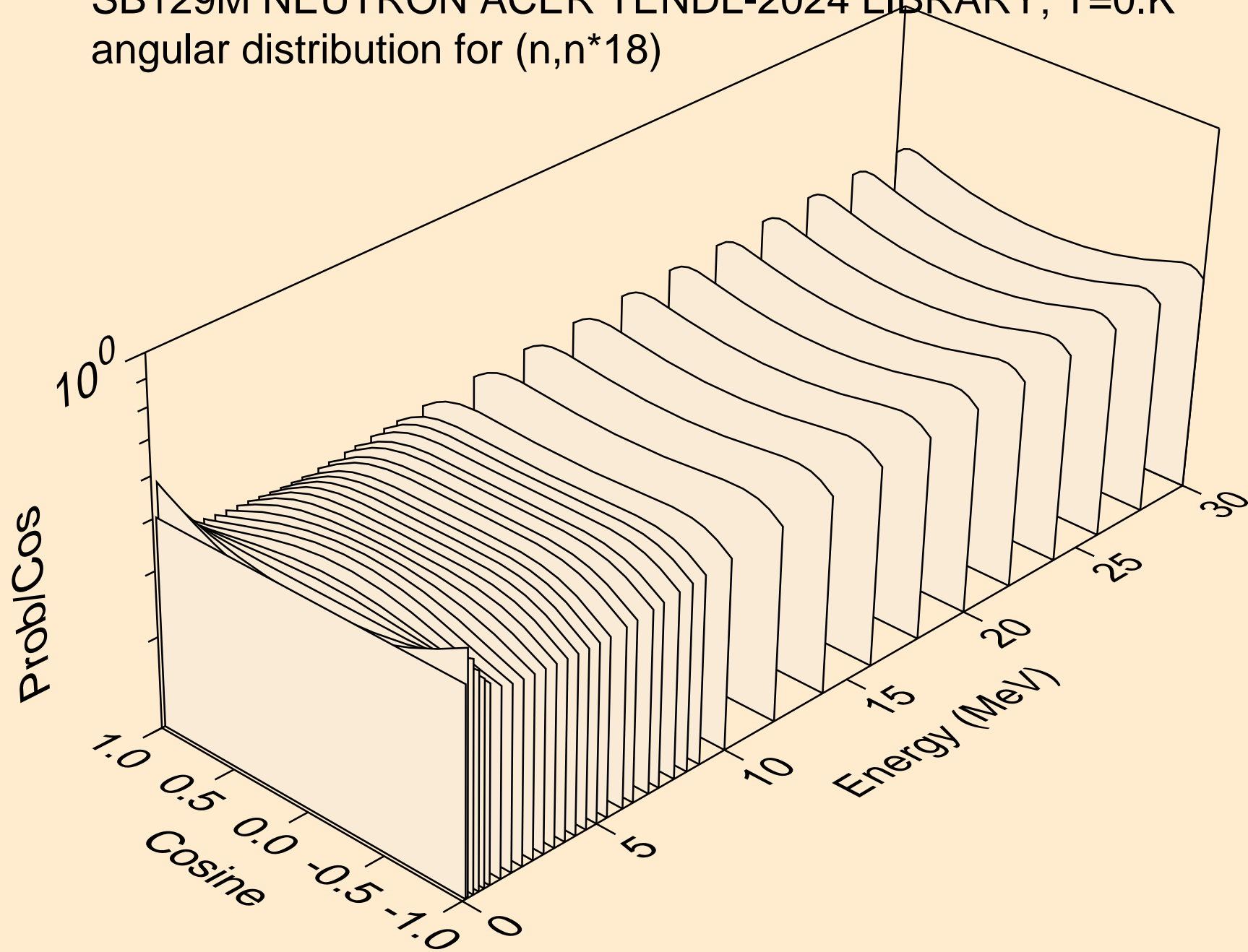

SB129M NEUTRON ACER TENDL-2024 LIBRARY; T=0.K
angular distribution for (n,n*19)

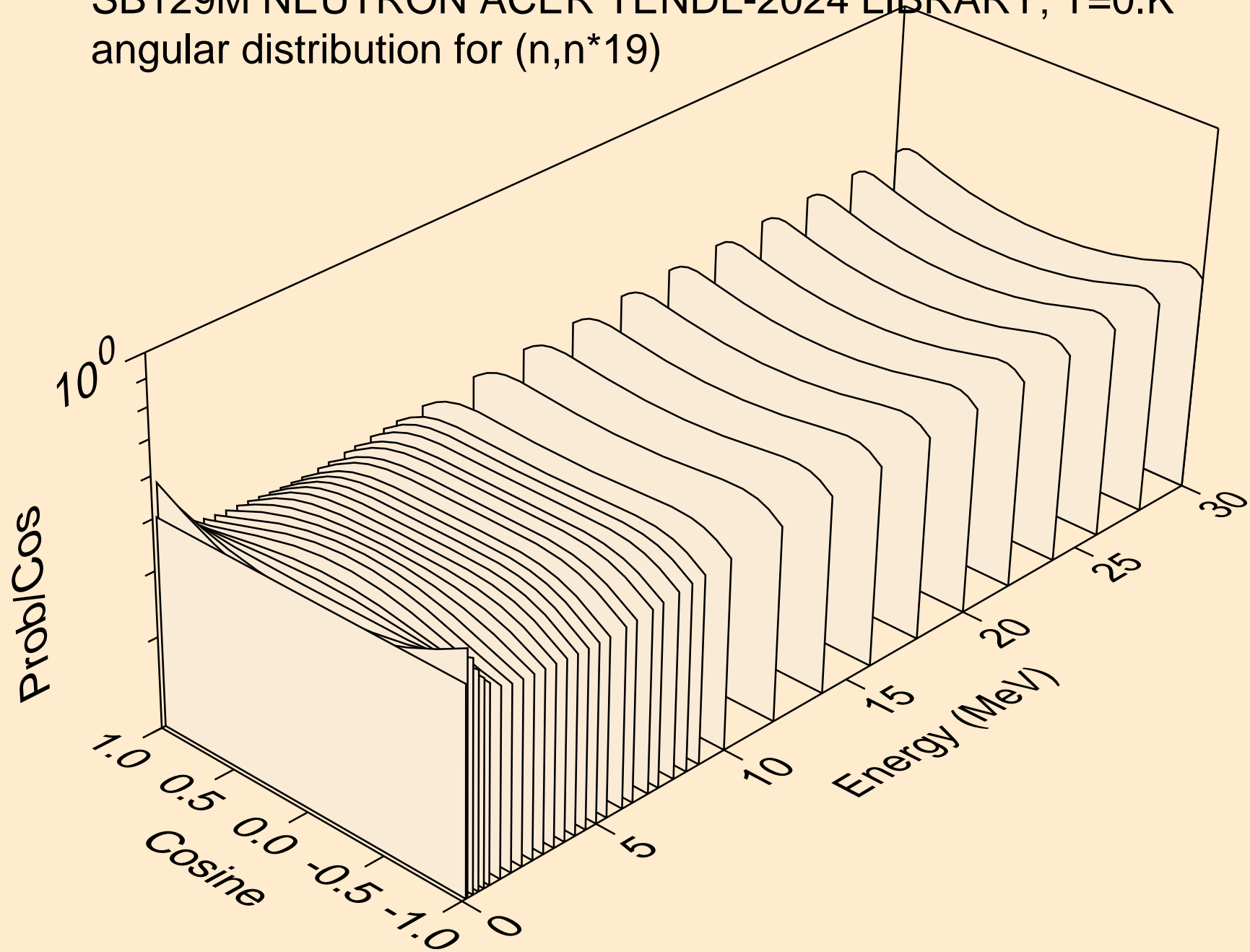

SB129M NEUTRON ACER TENDL-2024 LIBRARY; T=0.K
angular distribution for (n,n*20)

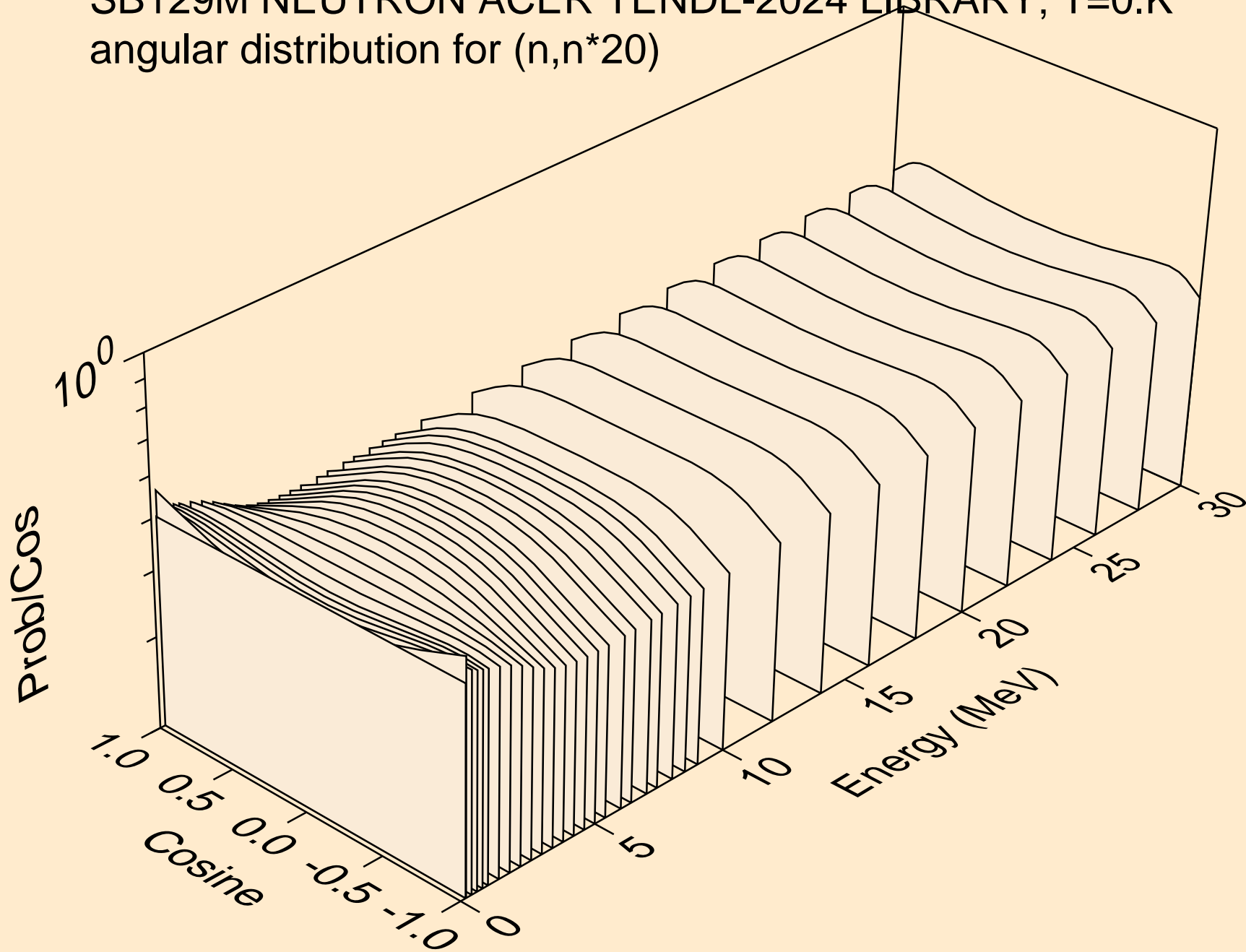

SB129M NEUTRON ACER TENDL-2024 LIBRARY; T=0.K
angular distribution for (n,n*21)

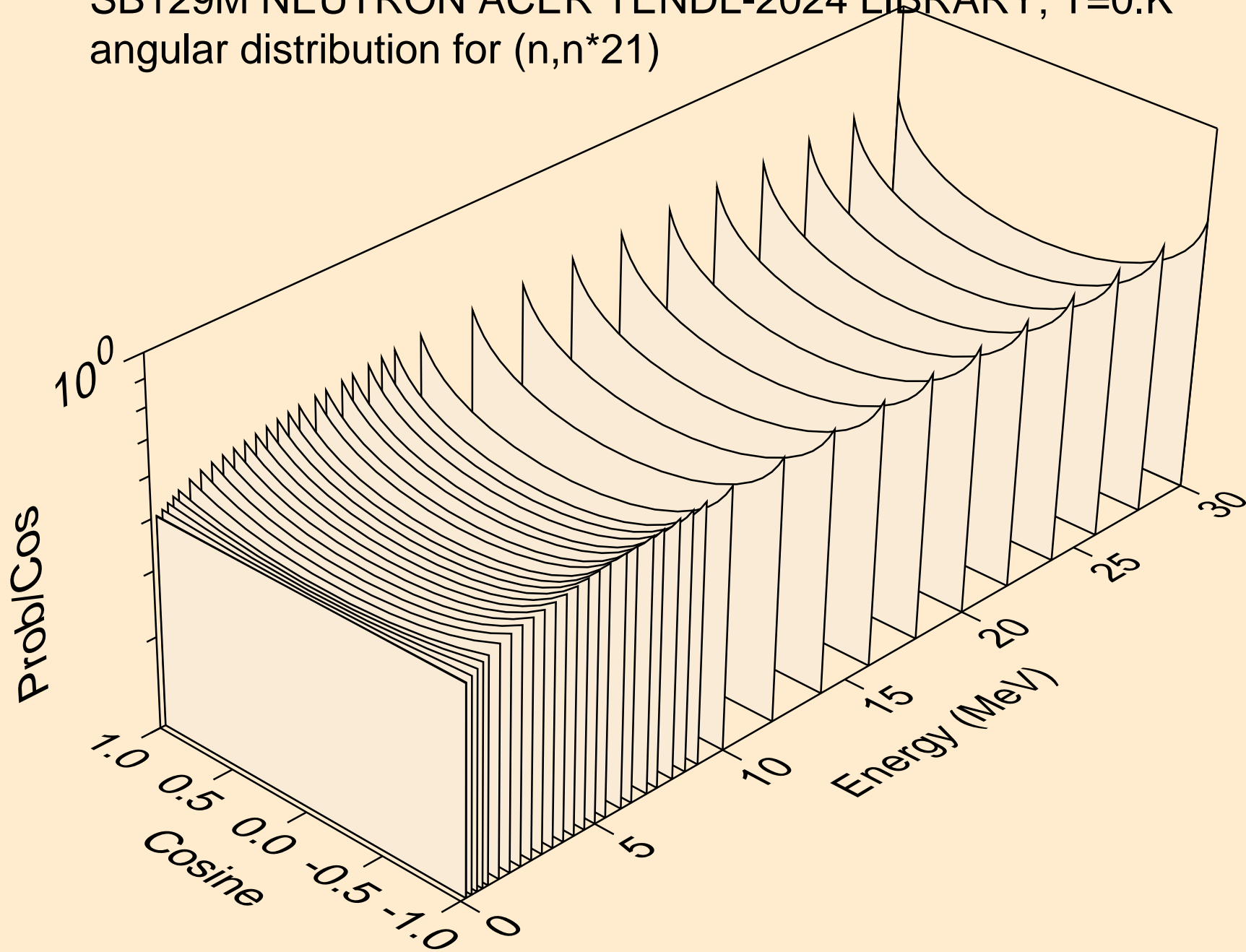

SB129M NEUTRON ACER TENDL-2024 LIBRARY; T=0.K
angular distribution for (n,n*22)

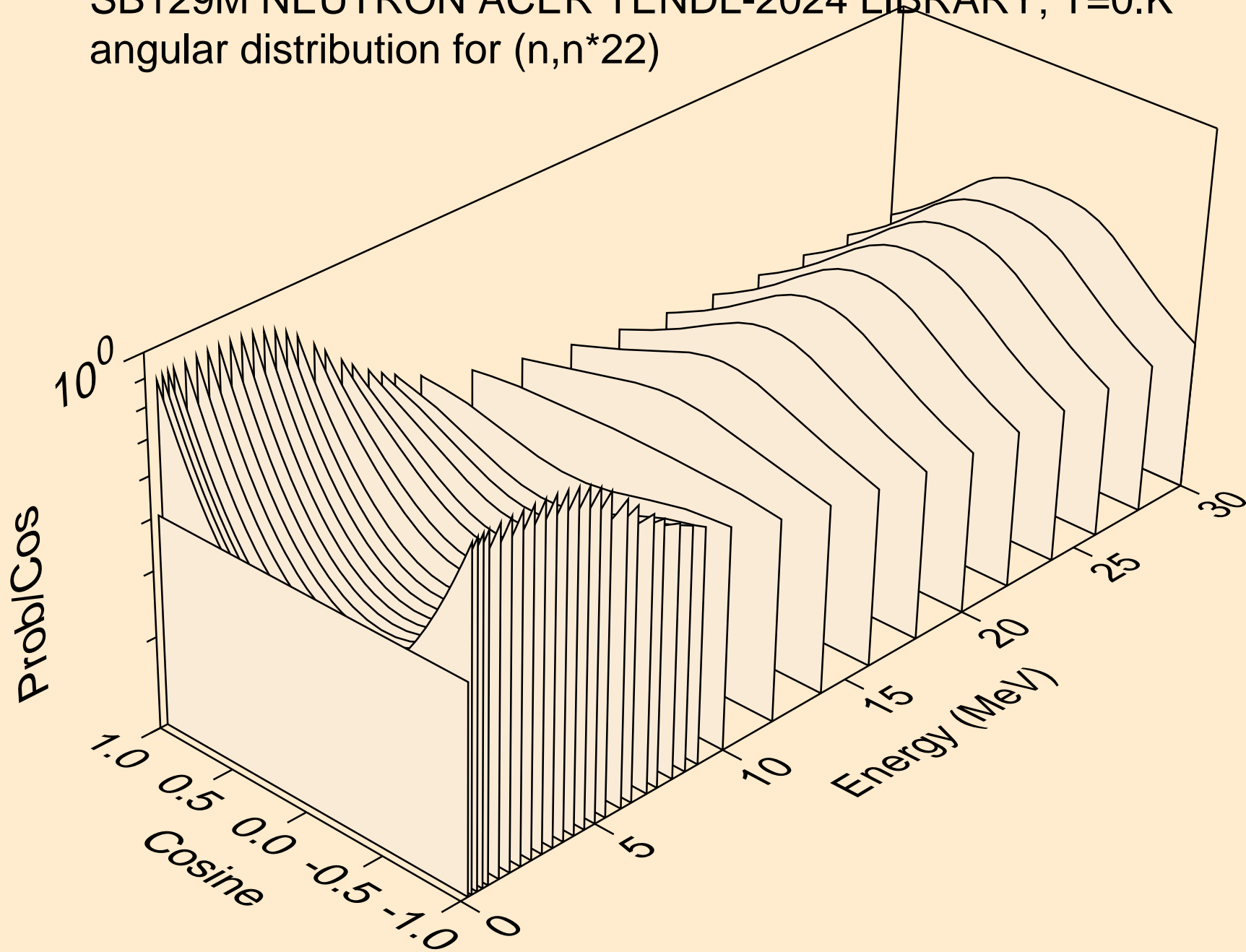

SB129M NEUTRON ACER TENDL-2024 LIBRARY; T=0.K
angular distribution for (n,n*23)

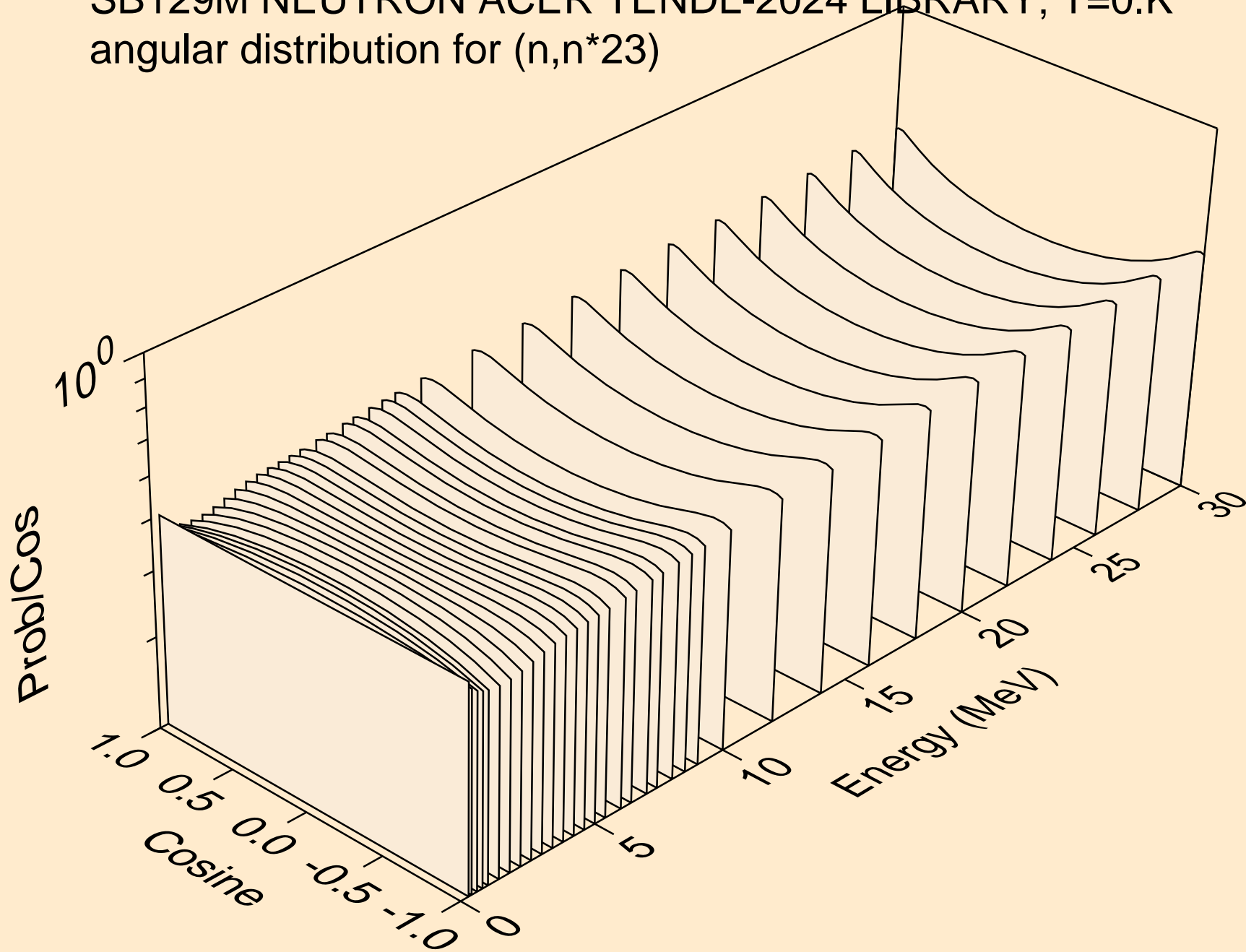

SB129M NEUTRON ACER TENDL-2024 LIBRARY; T=0.K
angular distribution for (n,n*24)

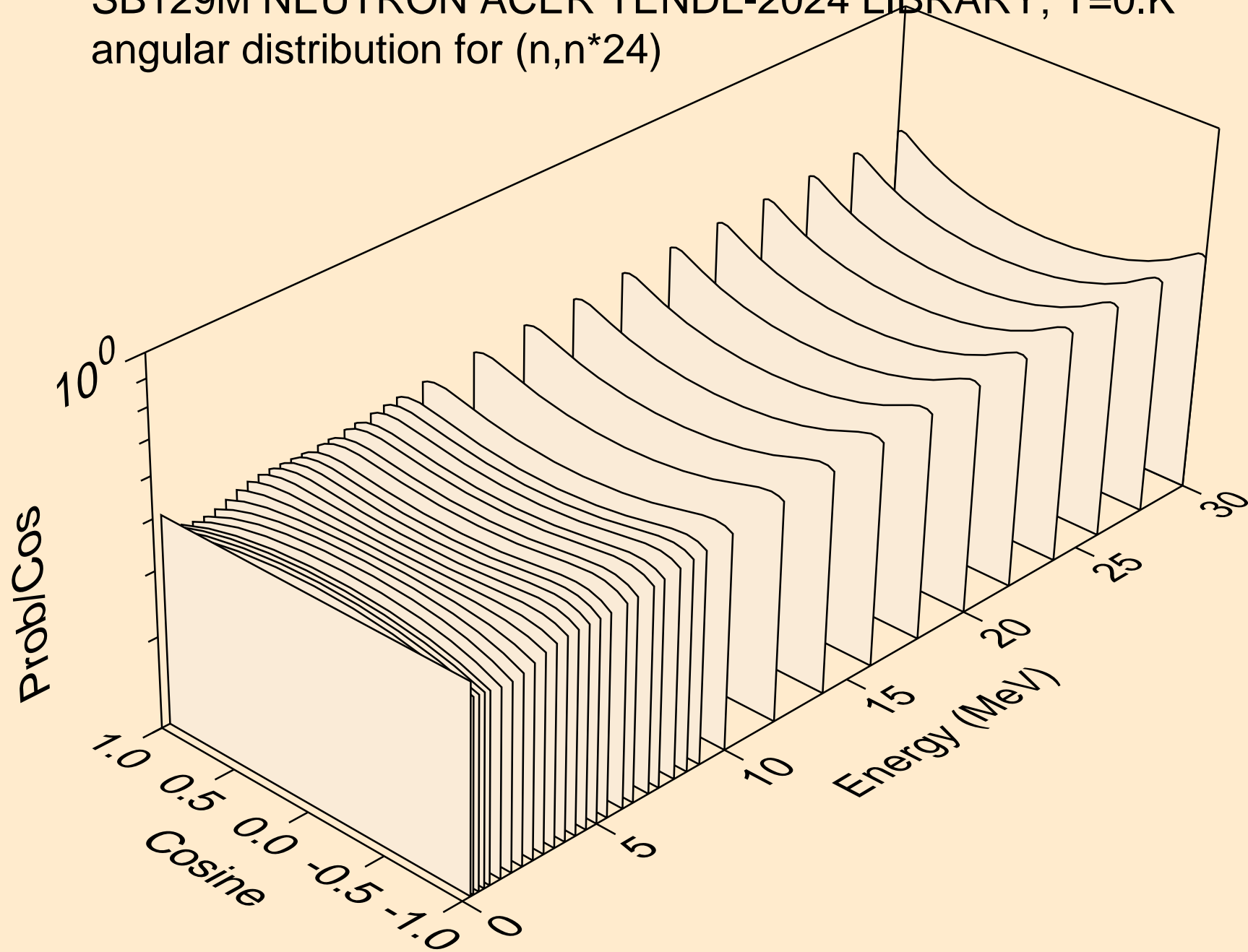

SB129M NEUTRON ACER TENDL-2024 LIBRARY; T=0.K
angular distribution for (n,n*25)

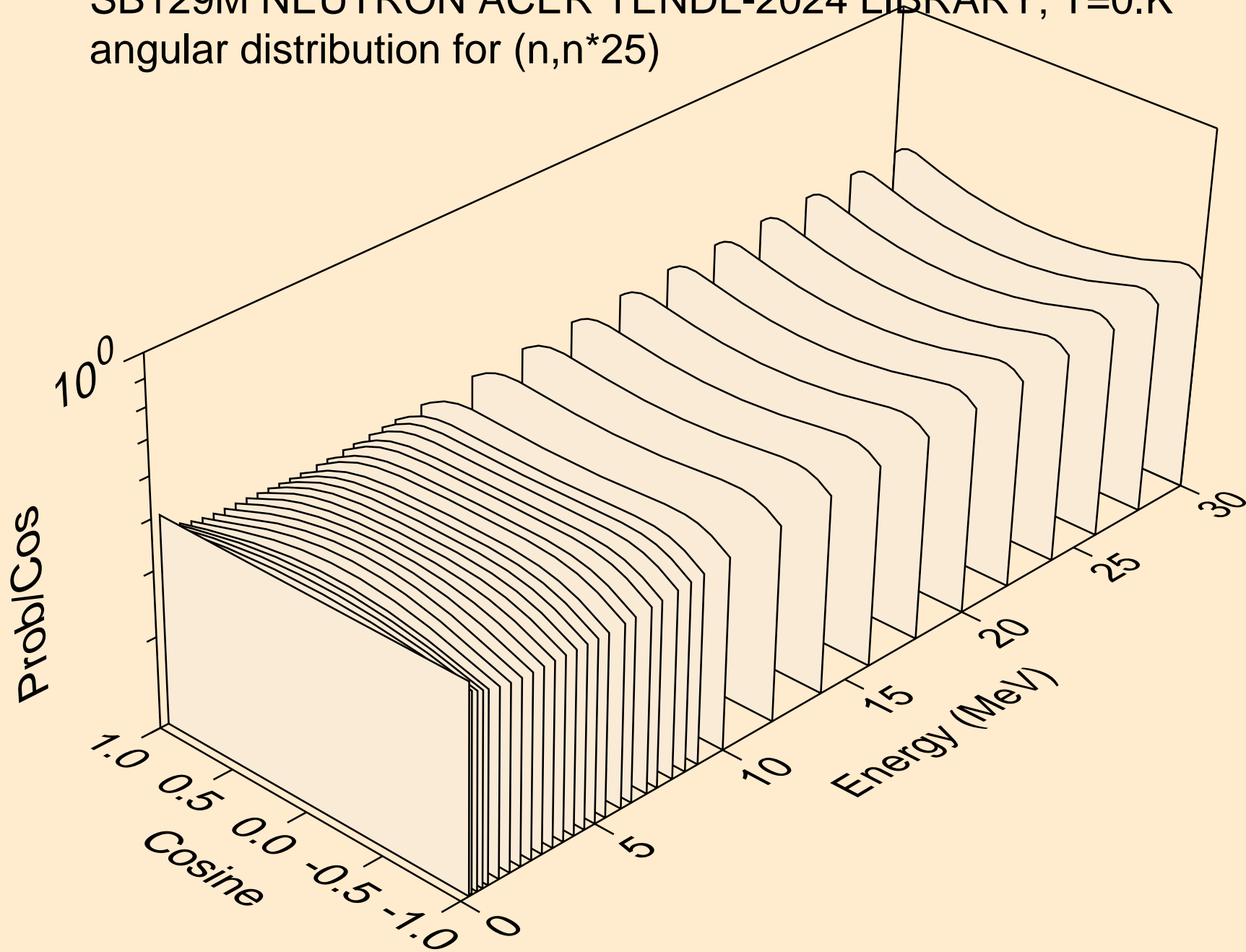

SB129M NEUTRON ACER TENDL-2024 LIBRARY; T=0.K
angular distribution for (n,n*26)

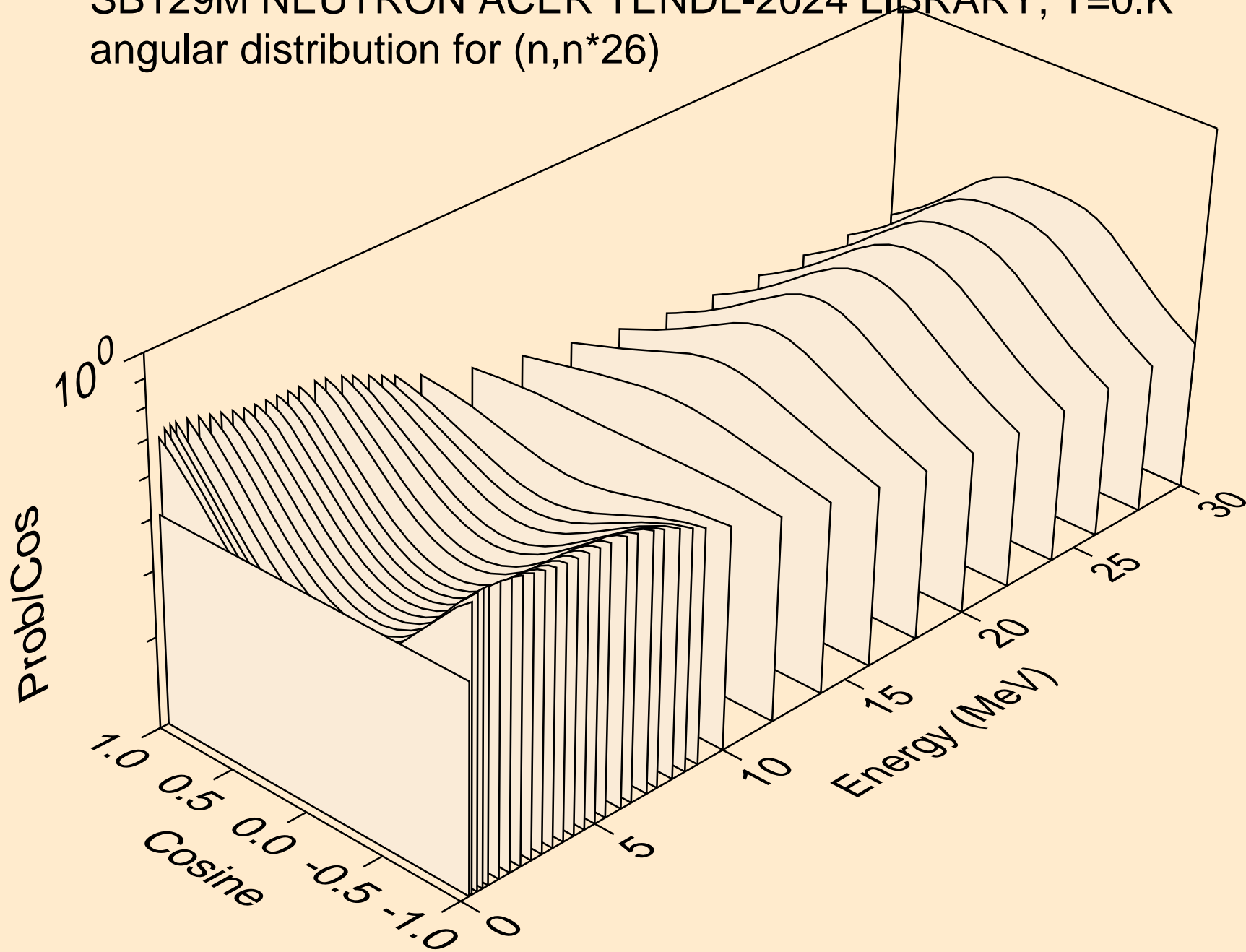

SB129M NEUTRON ACER TENDL-2024 LIBRARY; T=0.K
angular distribution for (n,n*27)

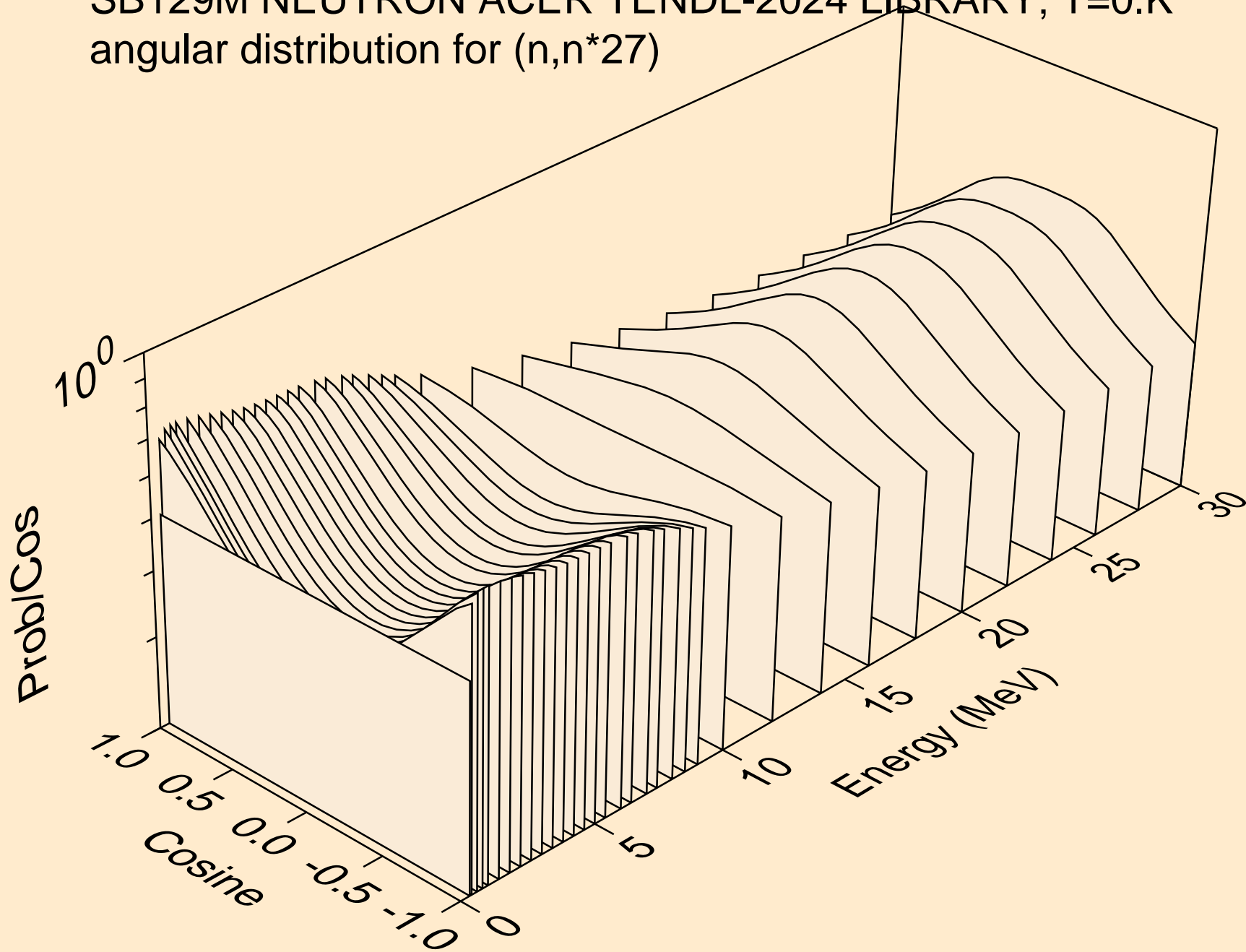

SB129M NEUTRON ACER TENDL-2024 LIBRARY; T=0.K
angular distribution for (n,n*28)

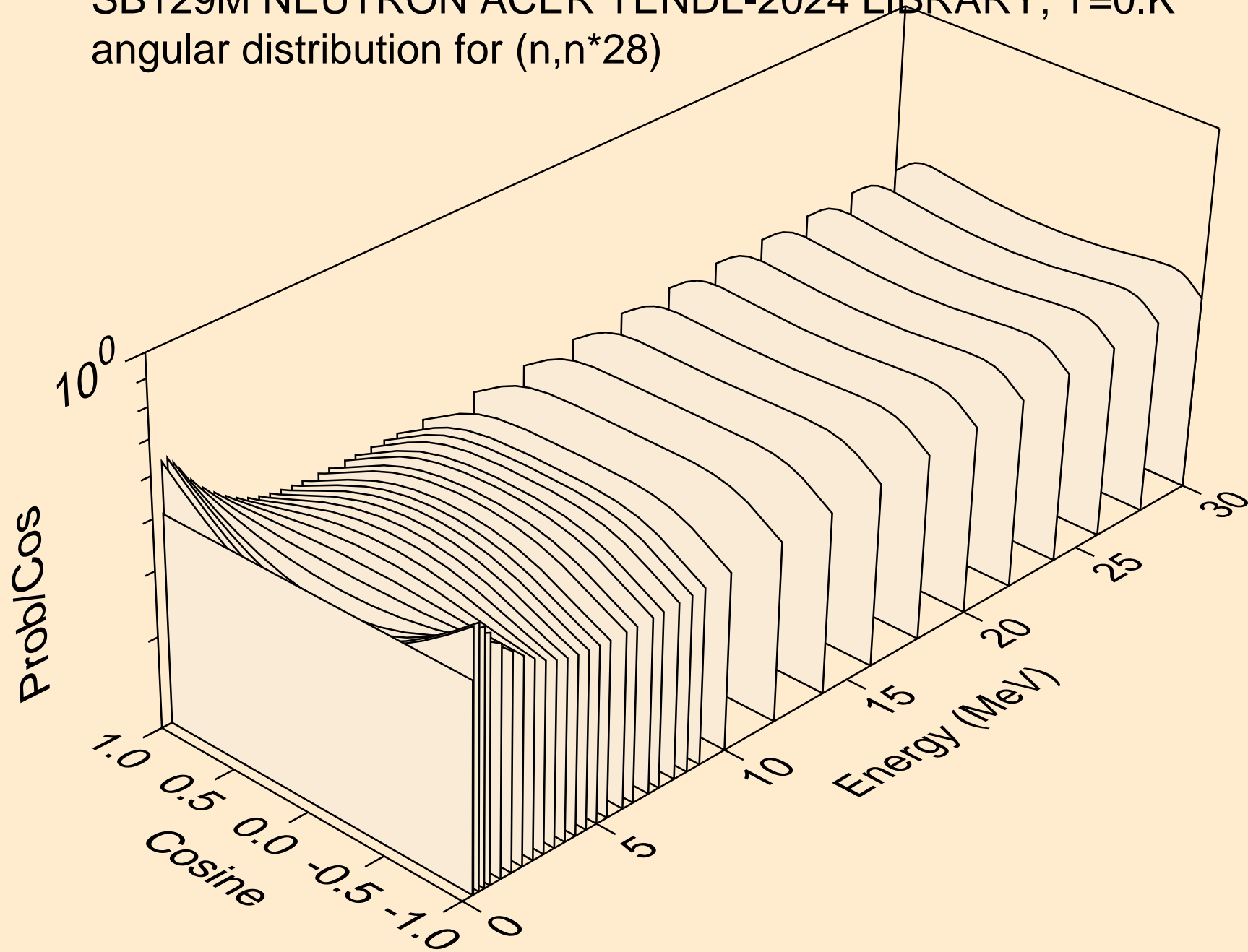

SB129M NEUTRON ACER TENDL-2024 LIBRARY; T=0.K
angular distribution for (n,n*29)

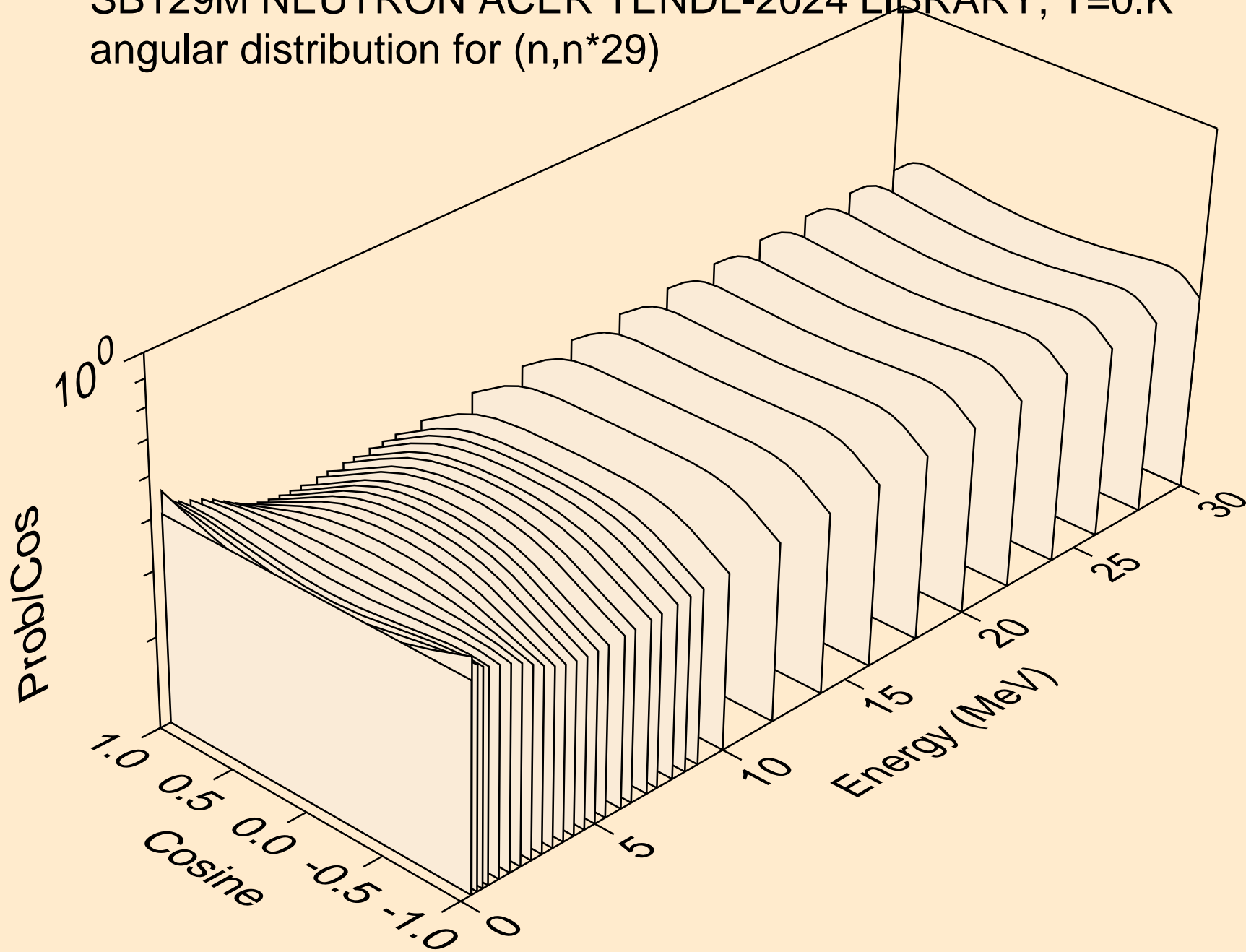

SB129M NEUTRON ACER TENDL-2024 LIBRARY; T=0.K
angular distribution for (n,n*30)

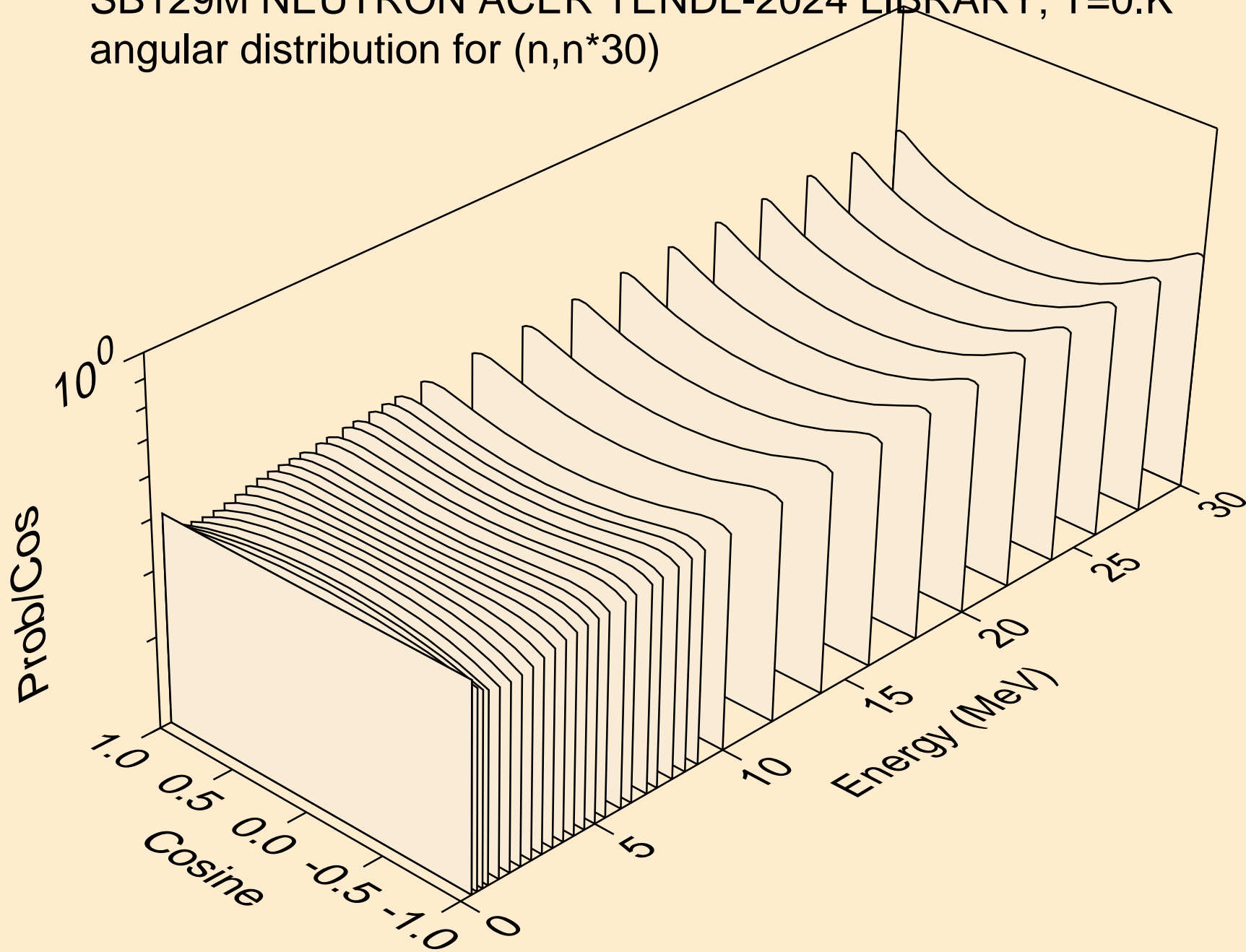

SB129M NEUTRON ACER TENDL-2024 LIBRARY; T=0.K
Neutron emission for (n,x)

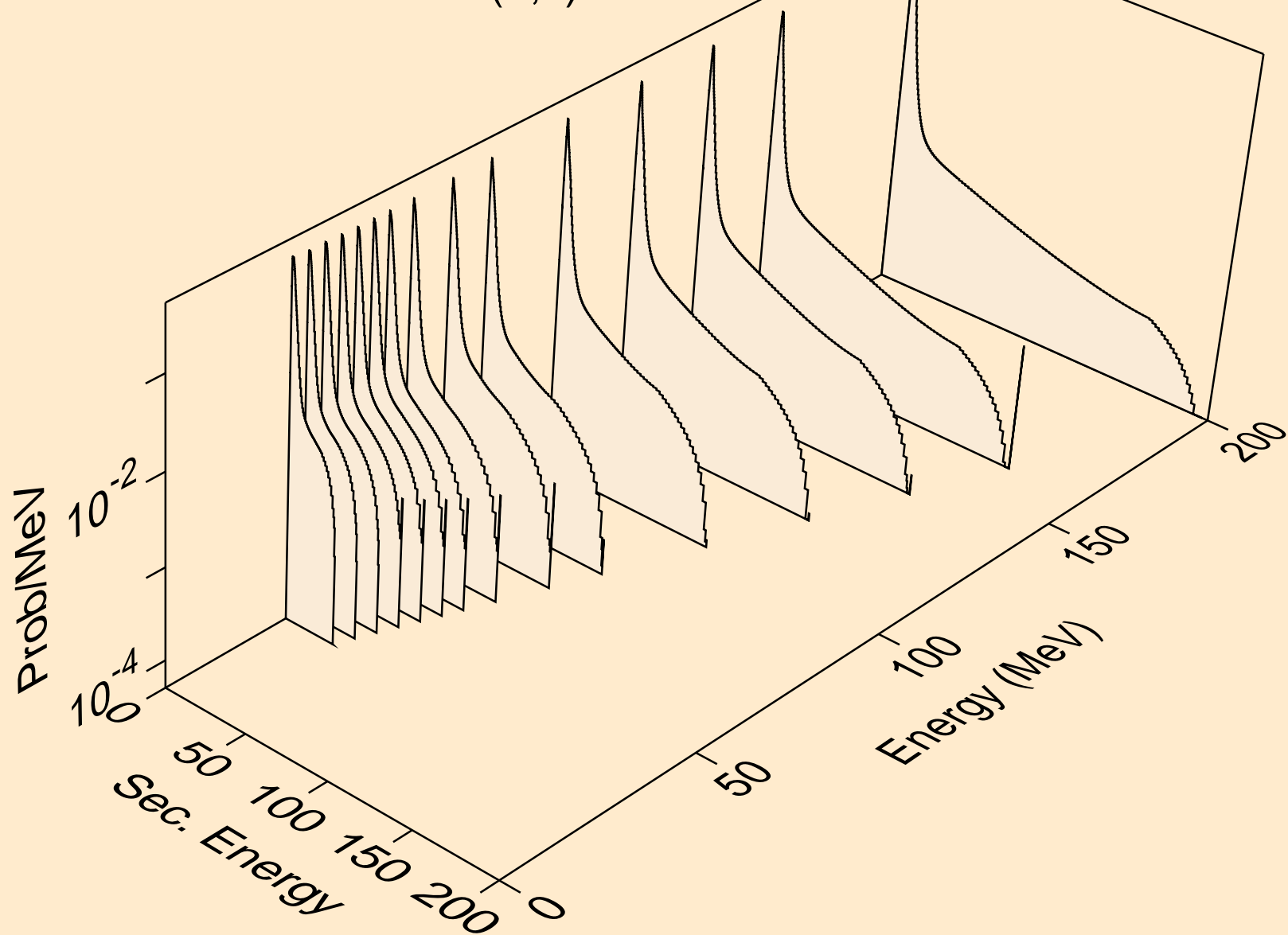

SB129M NEUTRON ACER TENDL-2024 LIBRARY; T=0.K
Neutron emission for (n,2nd)

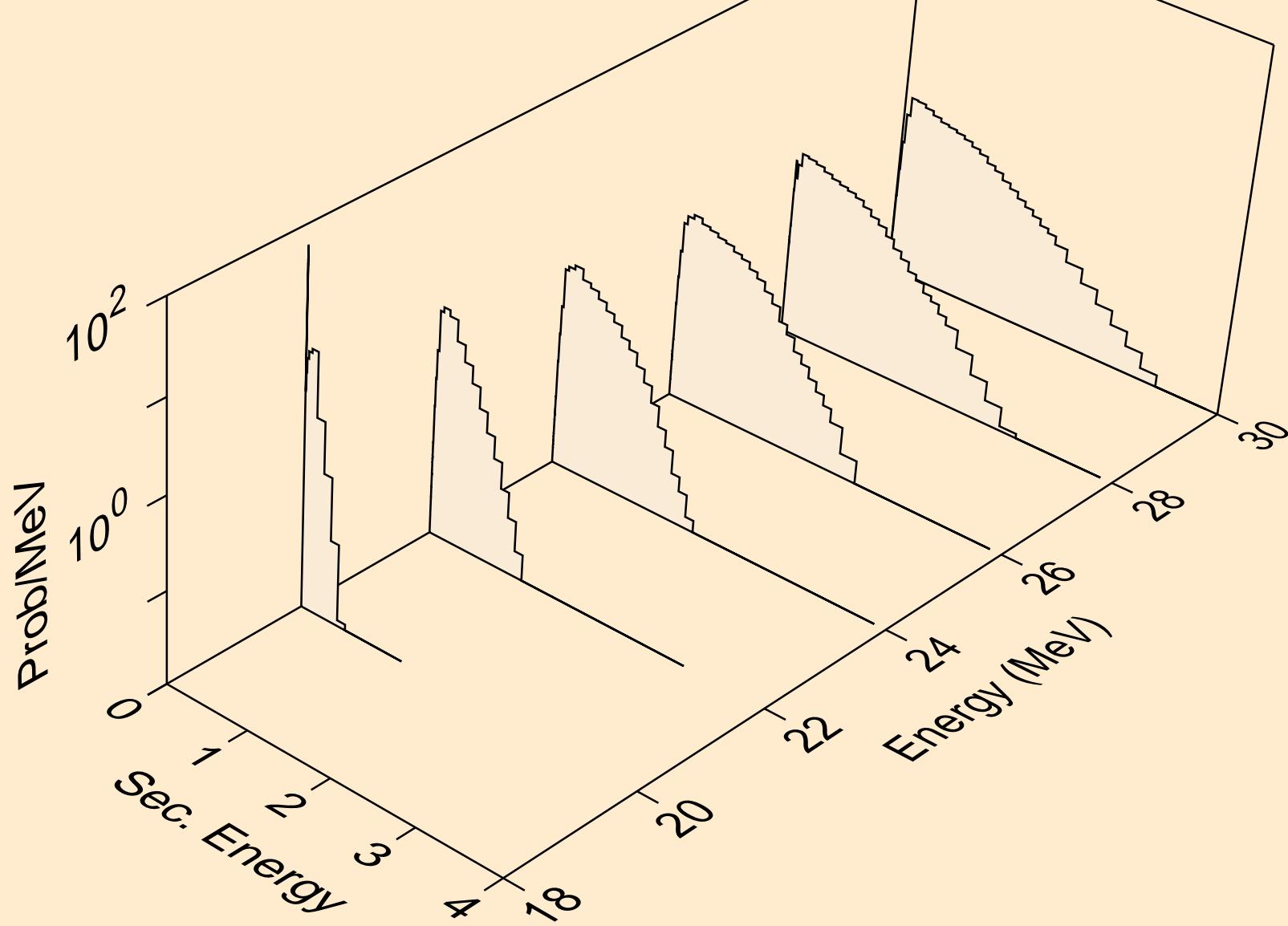

SB129M NEUTRON ACER TENDL-2024 LIBRARY; T=0.K
Neutron emission for (n,2n)

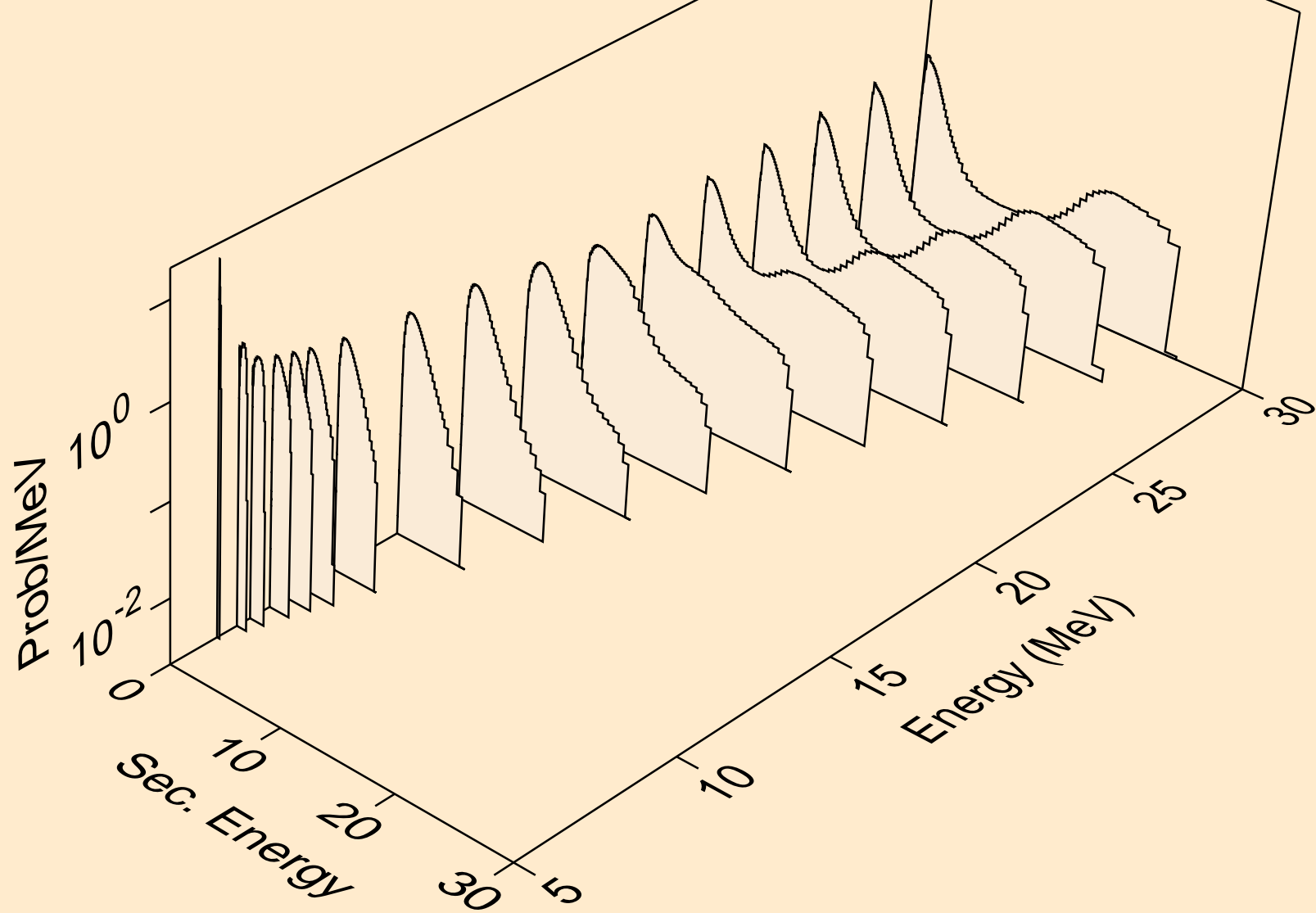

SB129M NEUTRON ACER TENDL-2024 LIBRARY; T=0.K
Neutron emission for (n,3n)

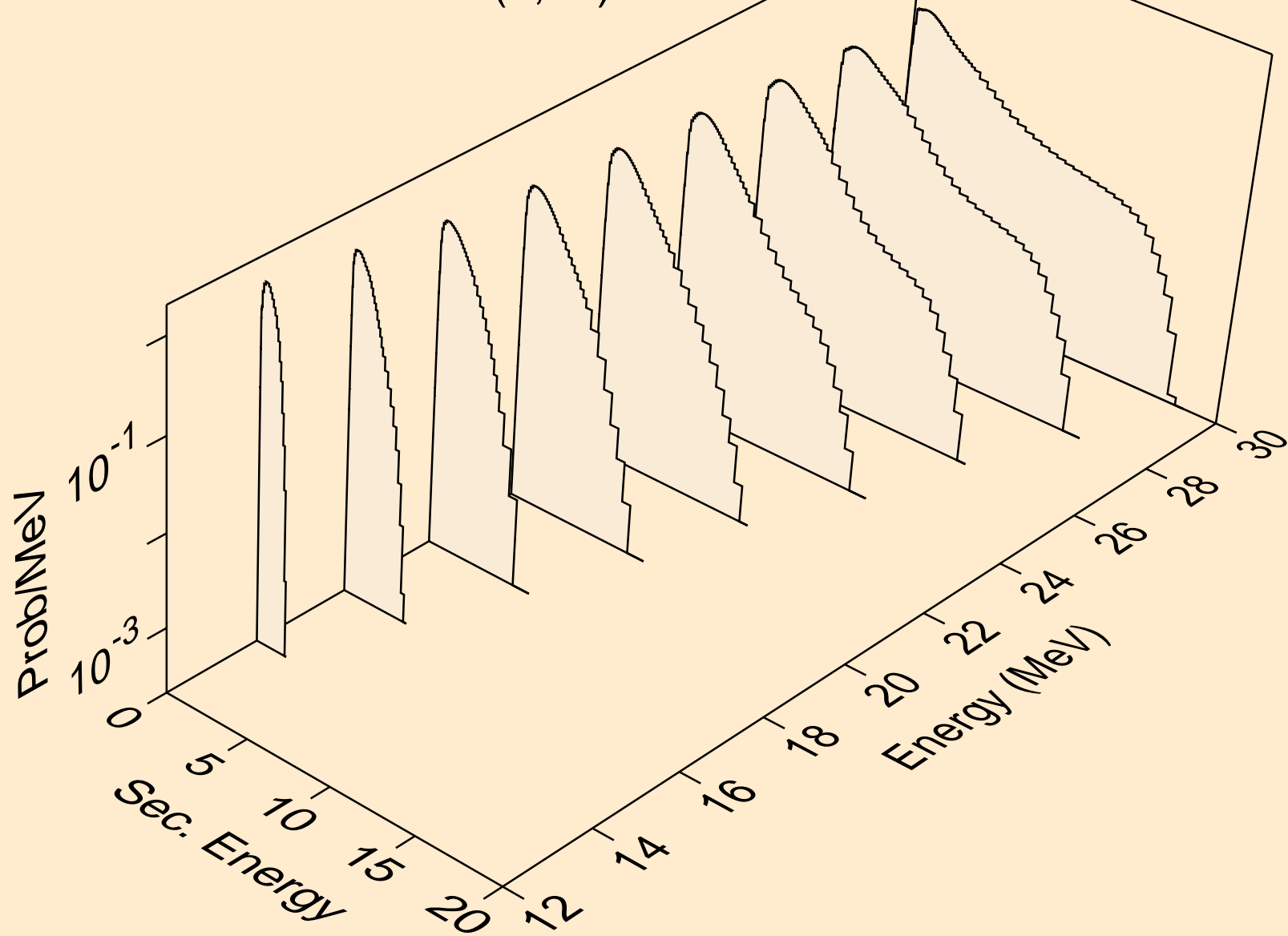

SB129M NEUTRON ACER TENDL-2024 LIBRARY; T=0.K
Neutron emission for (n,n*)a

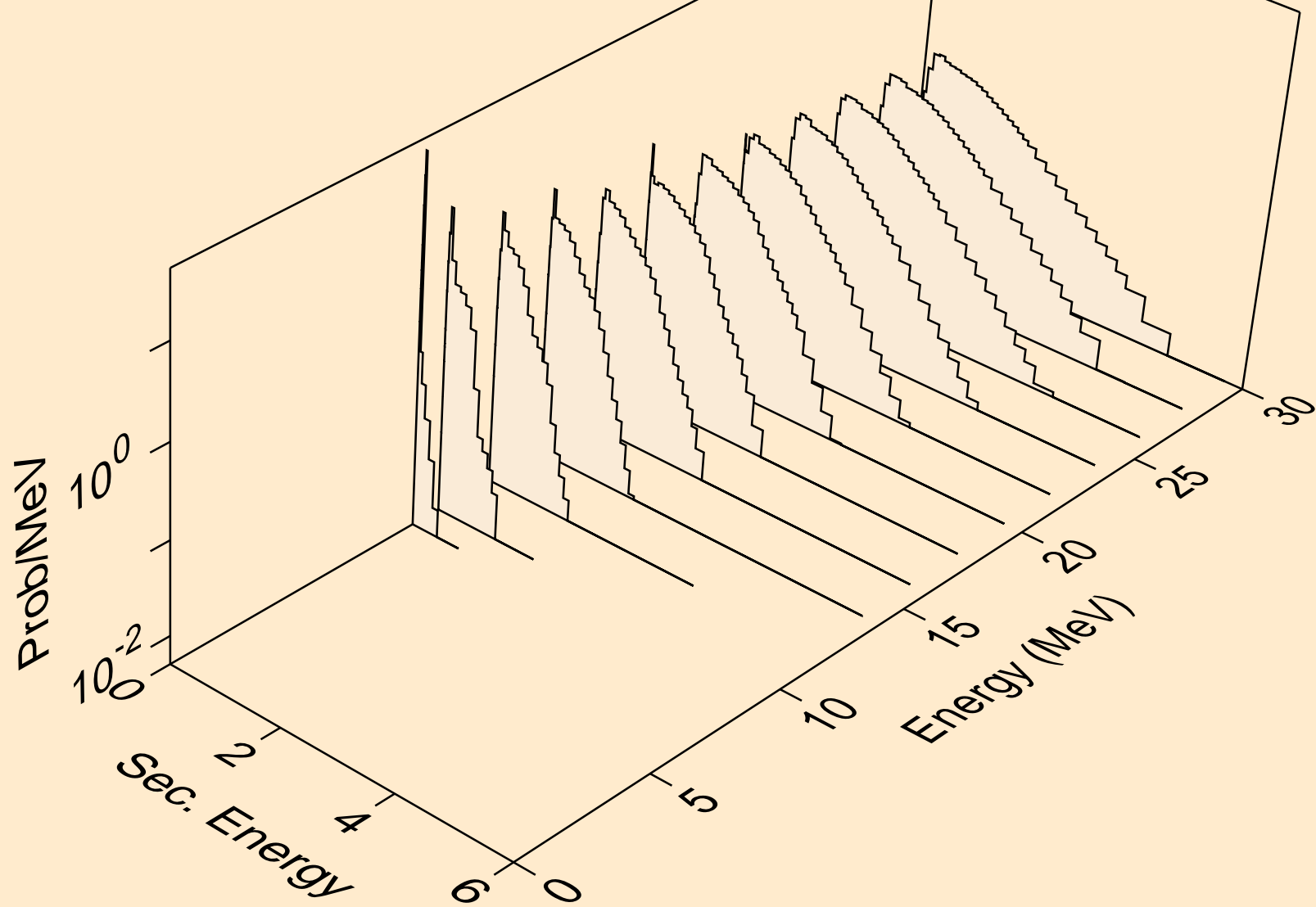

SB129M NEUTRON ACER TENDL-2024 LIBRARY; T=0.K
Neutron emission for (n,2n)a

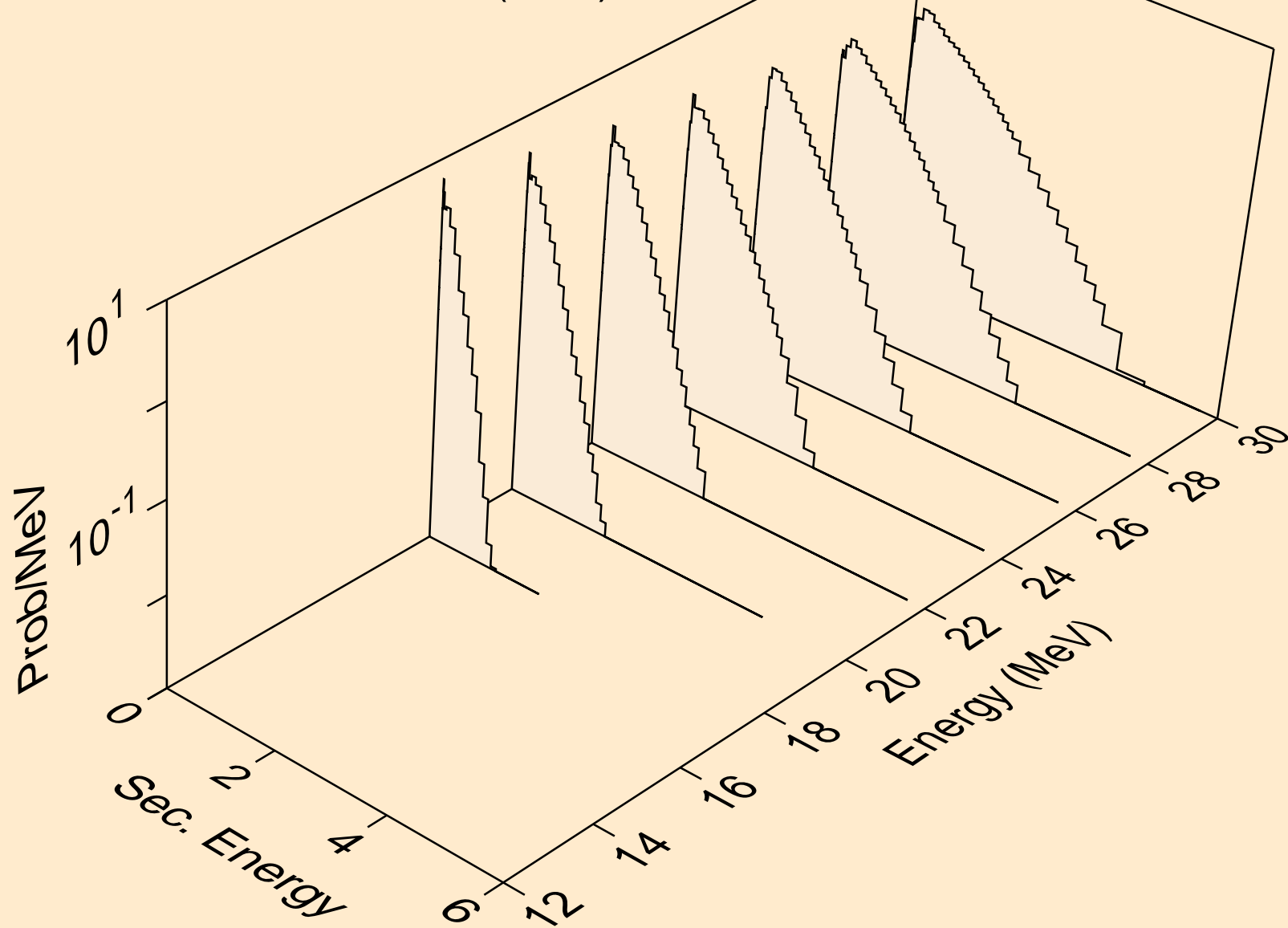

SB129M NEUTRON ACER TENDL-2024 LIBRARY; T=0.K
Neutron emission for (n,3n)a

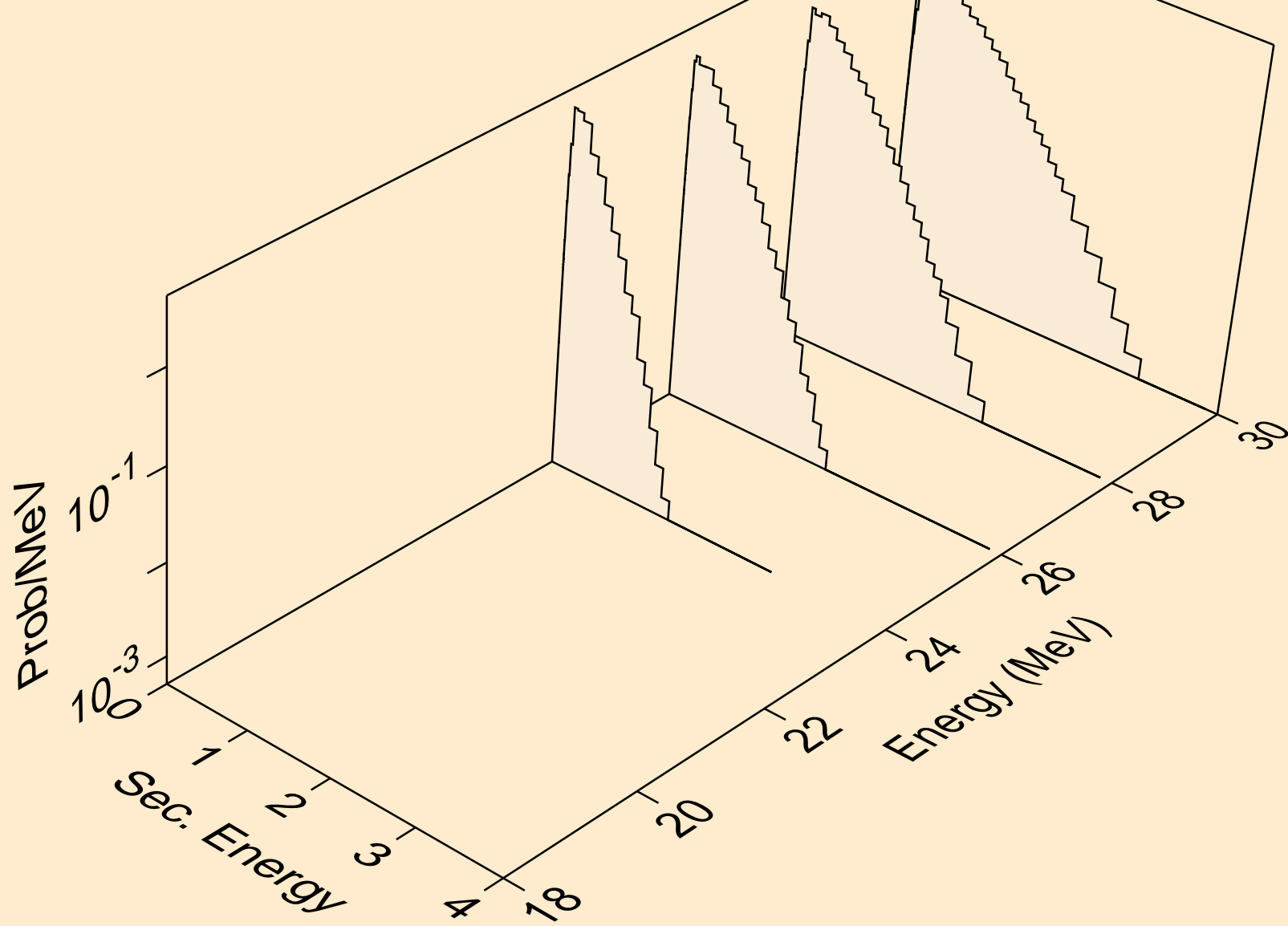

SB129M NEUTRON ACER TENDL-2024 LIBRARY; T=0.K
Neutron emission for (n,n*)p

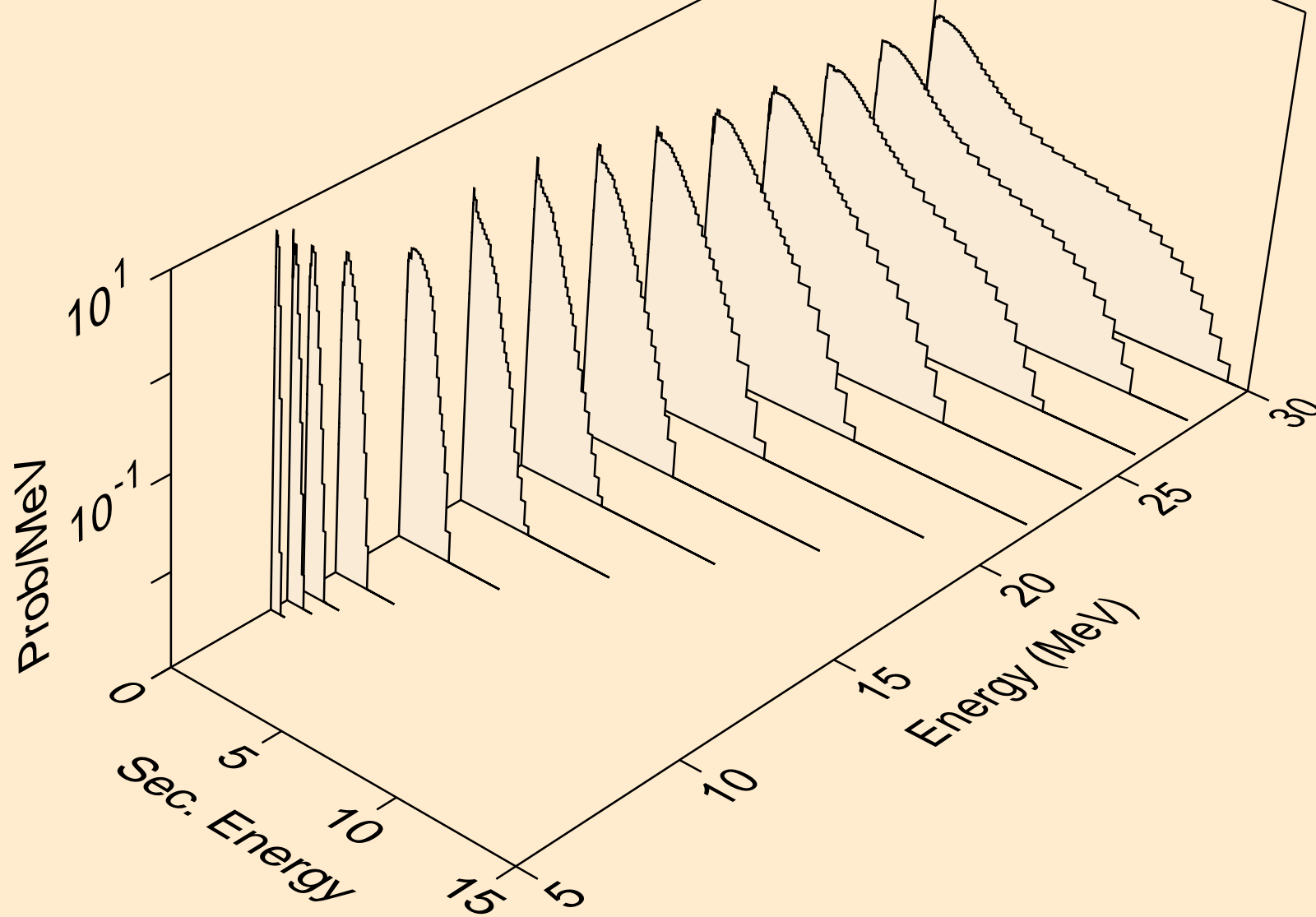

SB129M NEUTRON ACER TENDL-2024 LIBRARY; T=0.K
Neutron emission for (n,n*)d

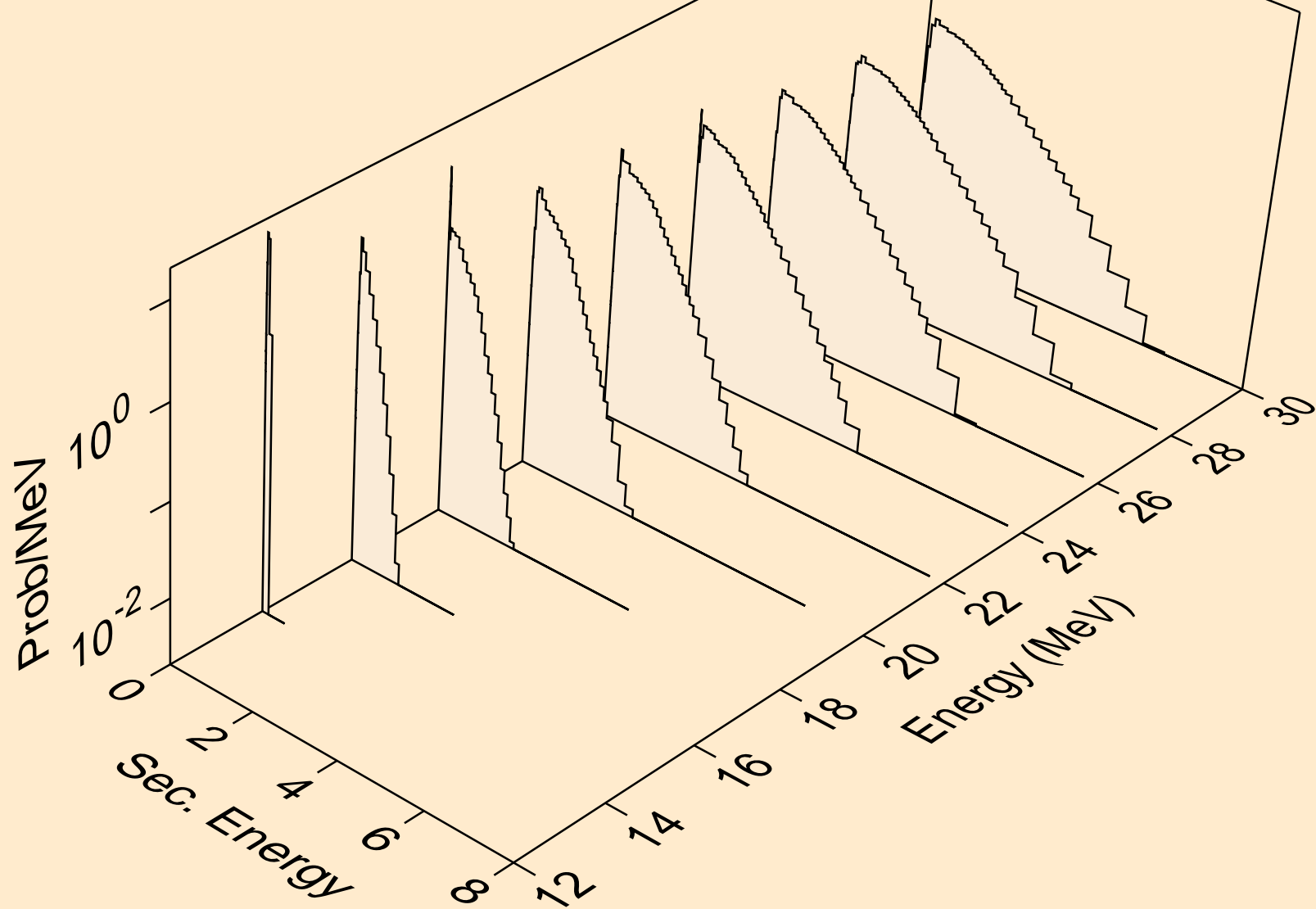

SB129M NEUTRON ACER TENDL-2024 LIBRARY; T=0.K
Neutron emission for (n,n*)t

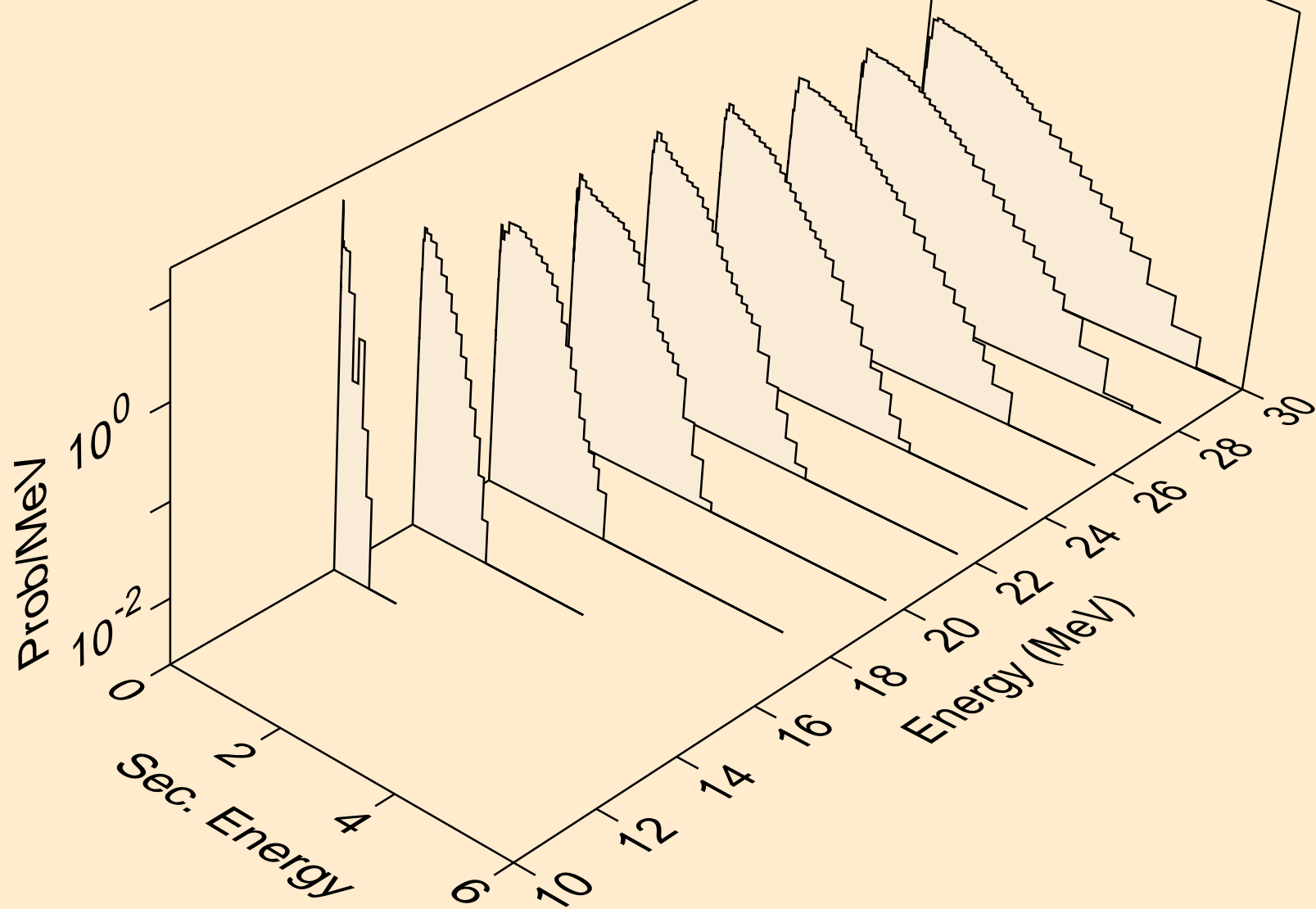

SB129M NEUTRON ACER TENDL-2024 LIBRARY; T=0.K
Neutron emission for (n,n*)he3

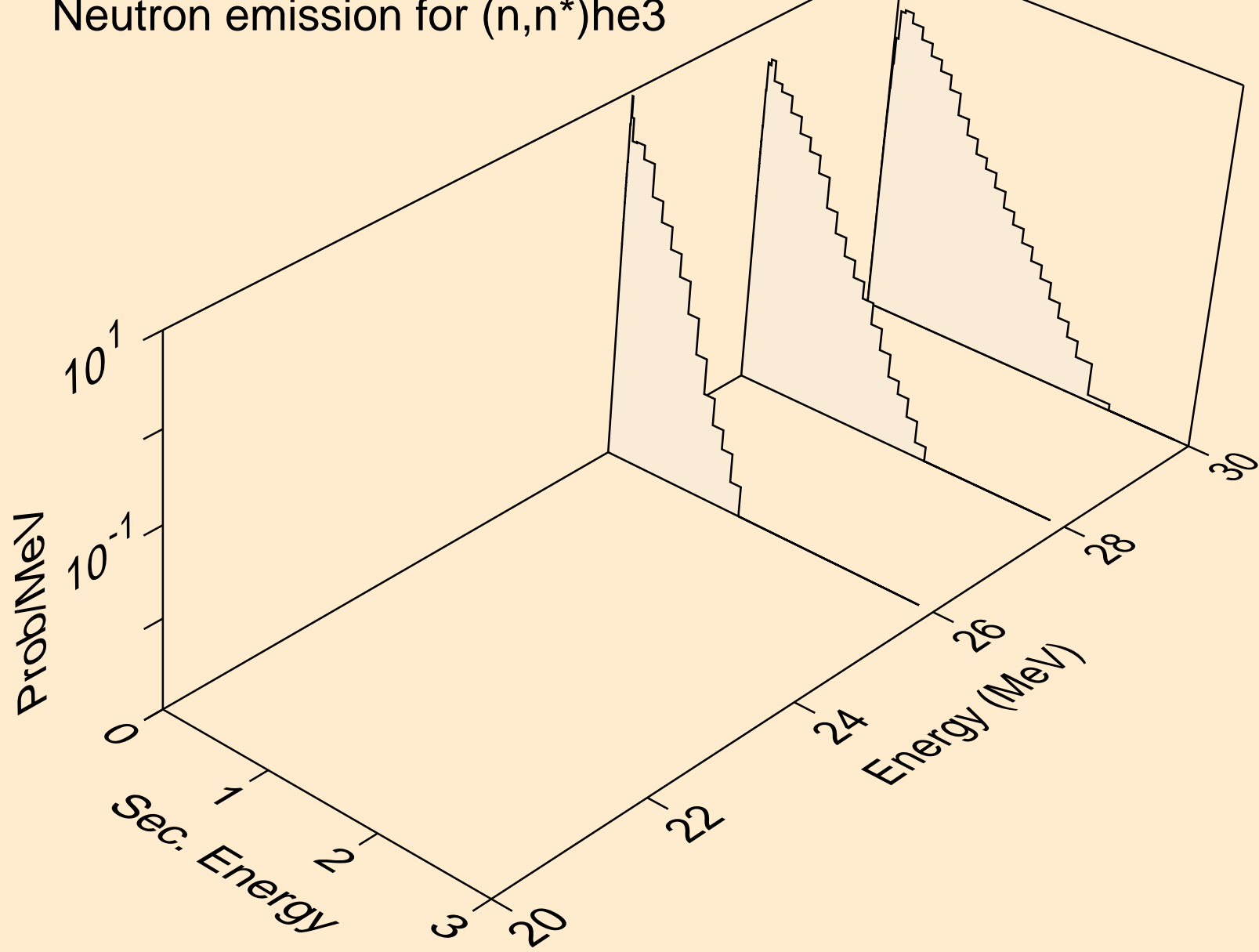

SB129M NEUTRON ACER TENDL-2024 LIBRARY; T=0.K
Neutron emission for (n,4n)

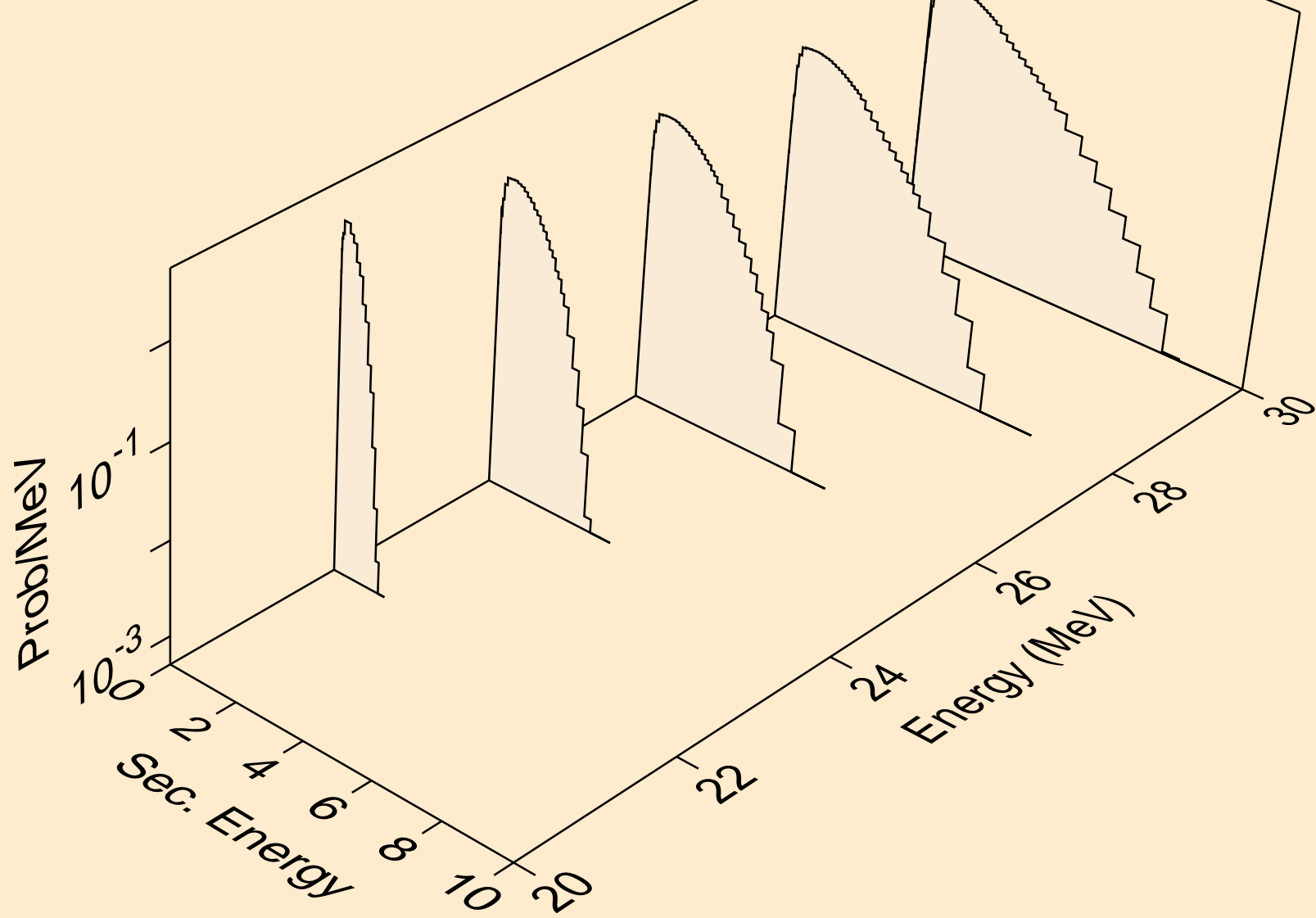

SB129M NEUTRON ACER TENDL-2024 LIBRARY; T=0.K
Neutron emission for (n,2np)

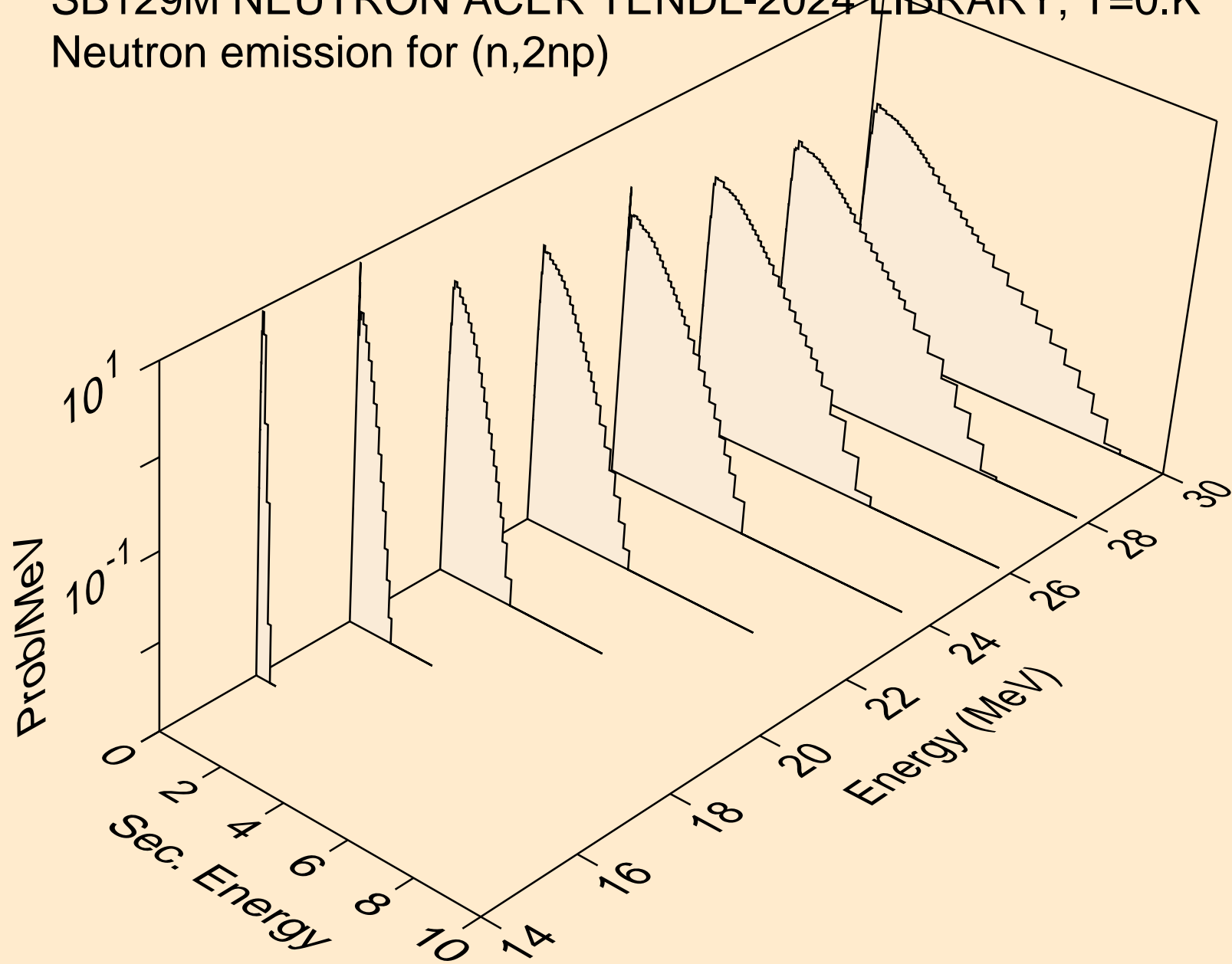

SB129M NEUTRON ACER TENDL-2024 LIBRARY; T=0.K
Neutron emission for (n,3np)

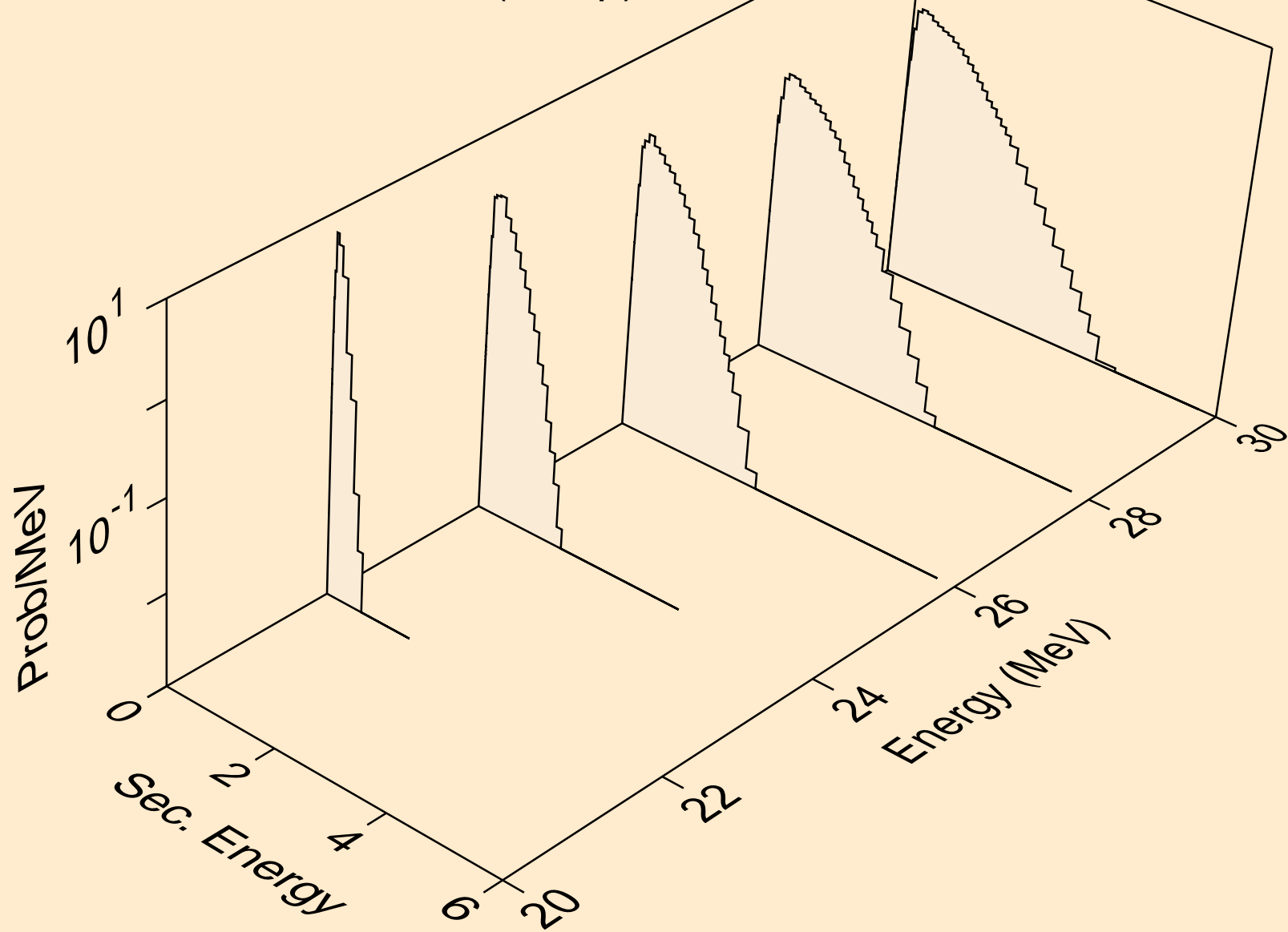

SB129M NEUTRON ACER TENDL-2024 LIBRARY; T=0.K
Neutron emission for (n,n*c)

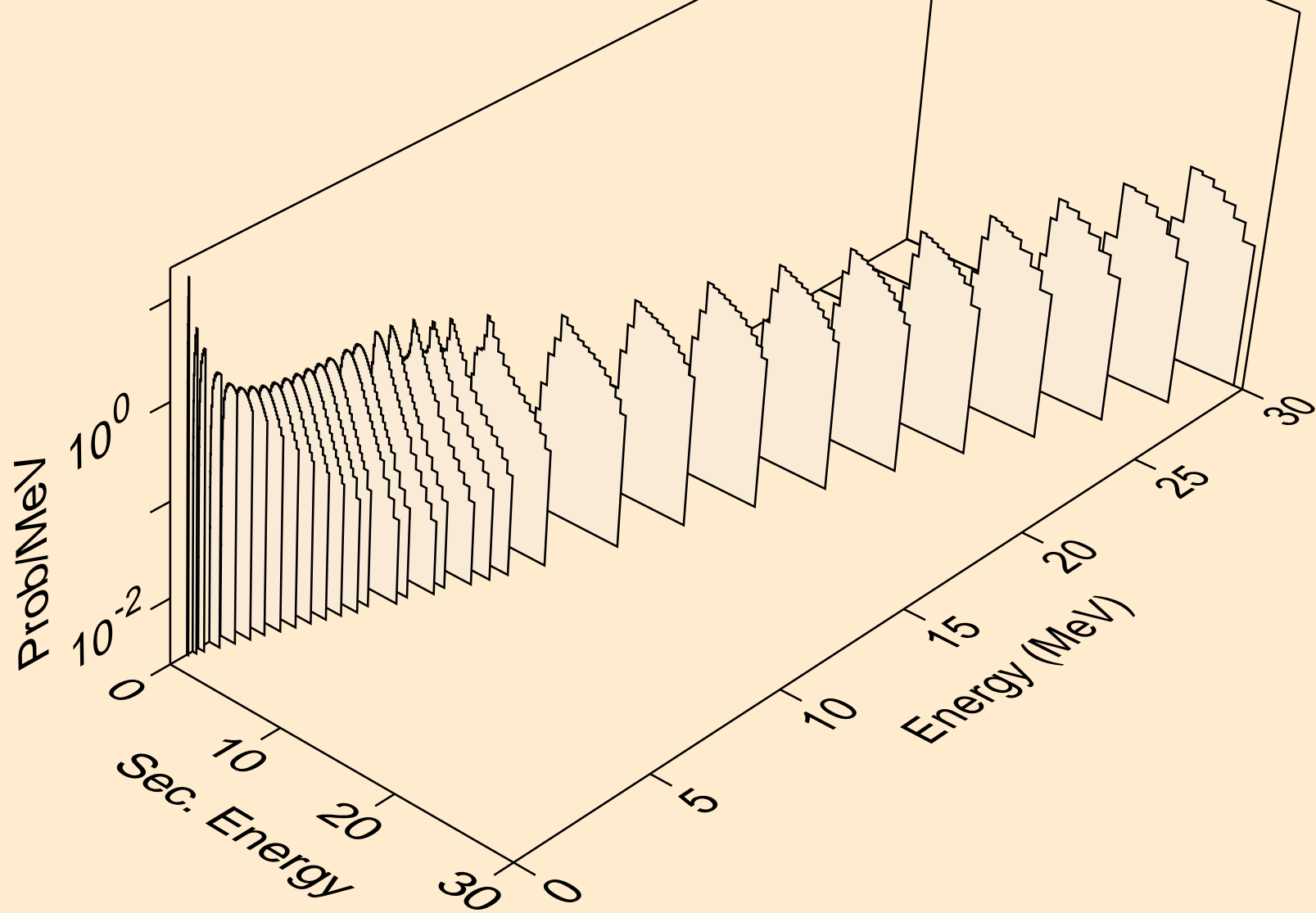

SB129M NEUTRON ACER TENDL-2024 LIBRARY; T=0.K
Photon emission for (n,x)

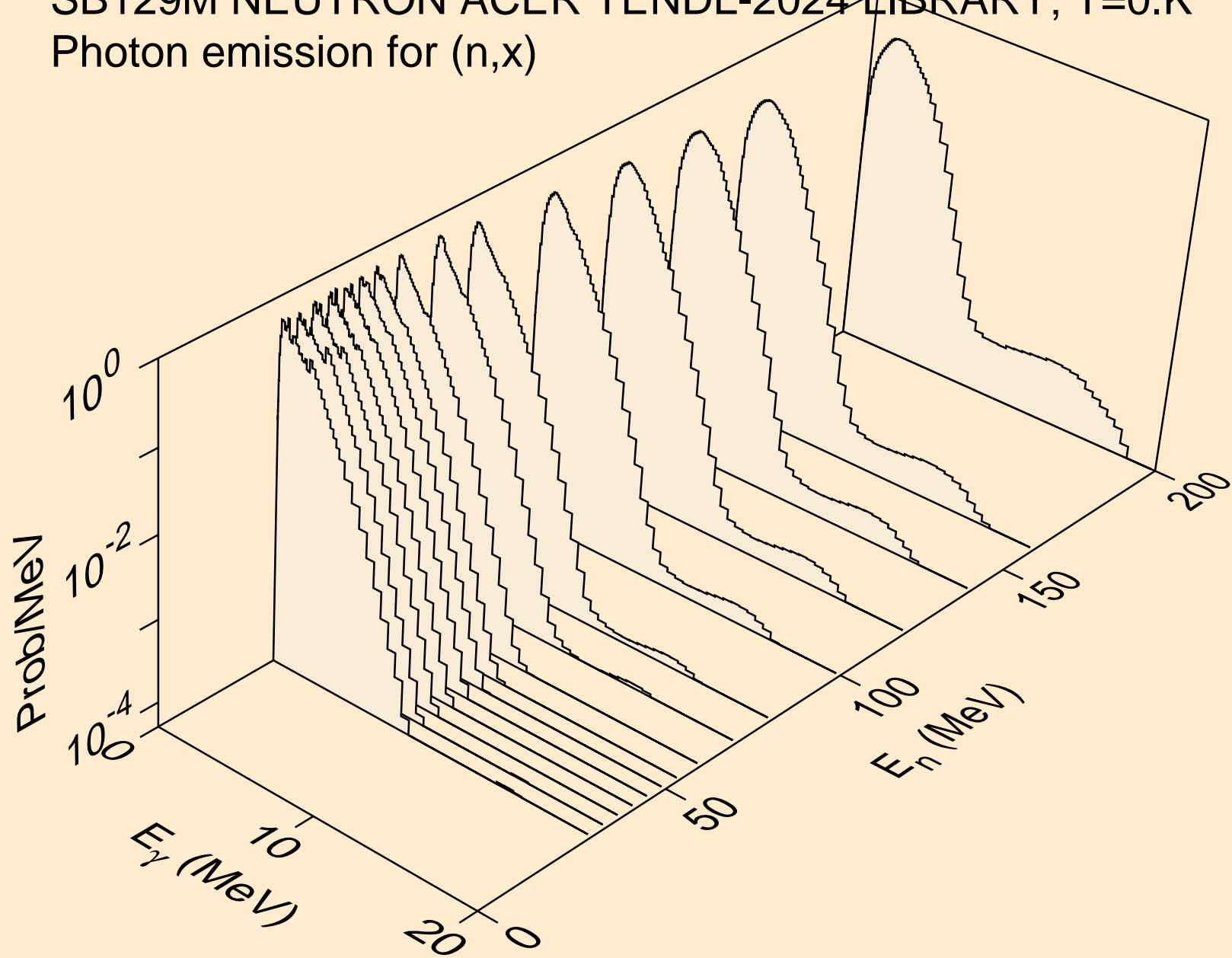

SB129M NEUTRON ACER TENDL-2024 LIBRARY; T=0.K
Photon emission for (n,2nd)

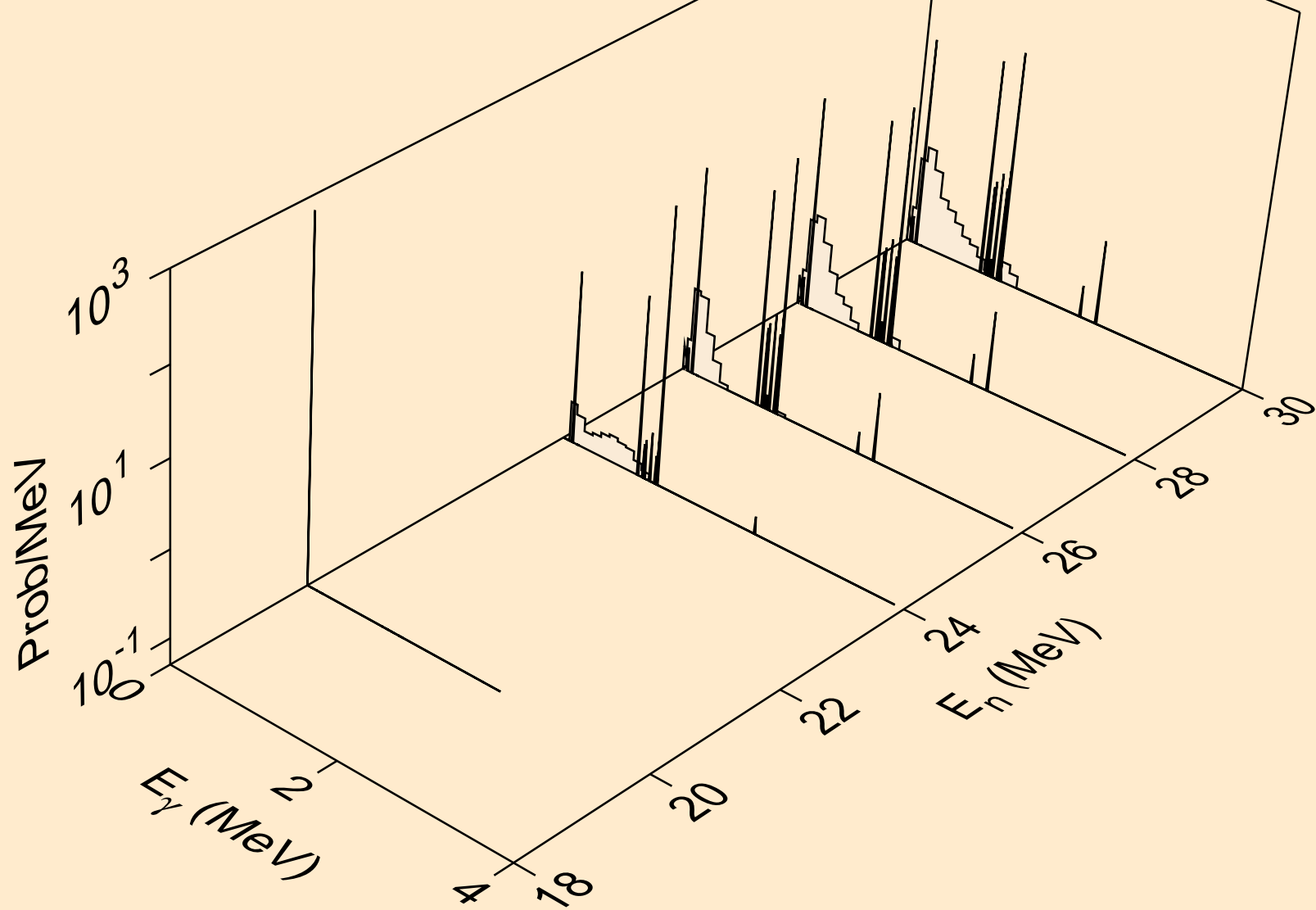

SB129M NEUTRON ACER TENDL-2024 LIBRARY; T=0.K
Photon emission for (n,2n)

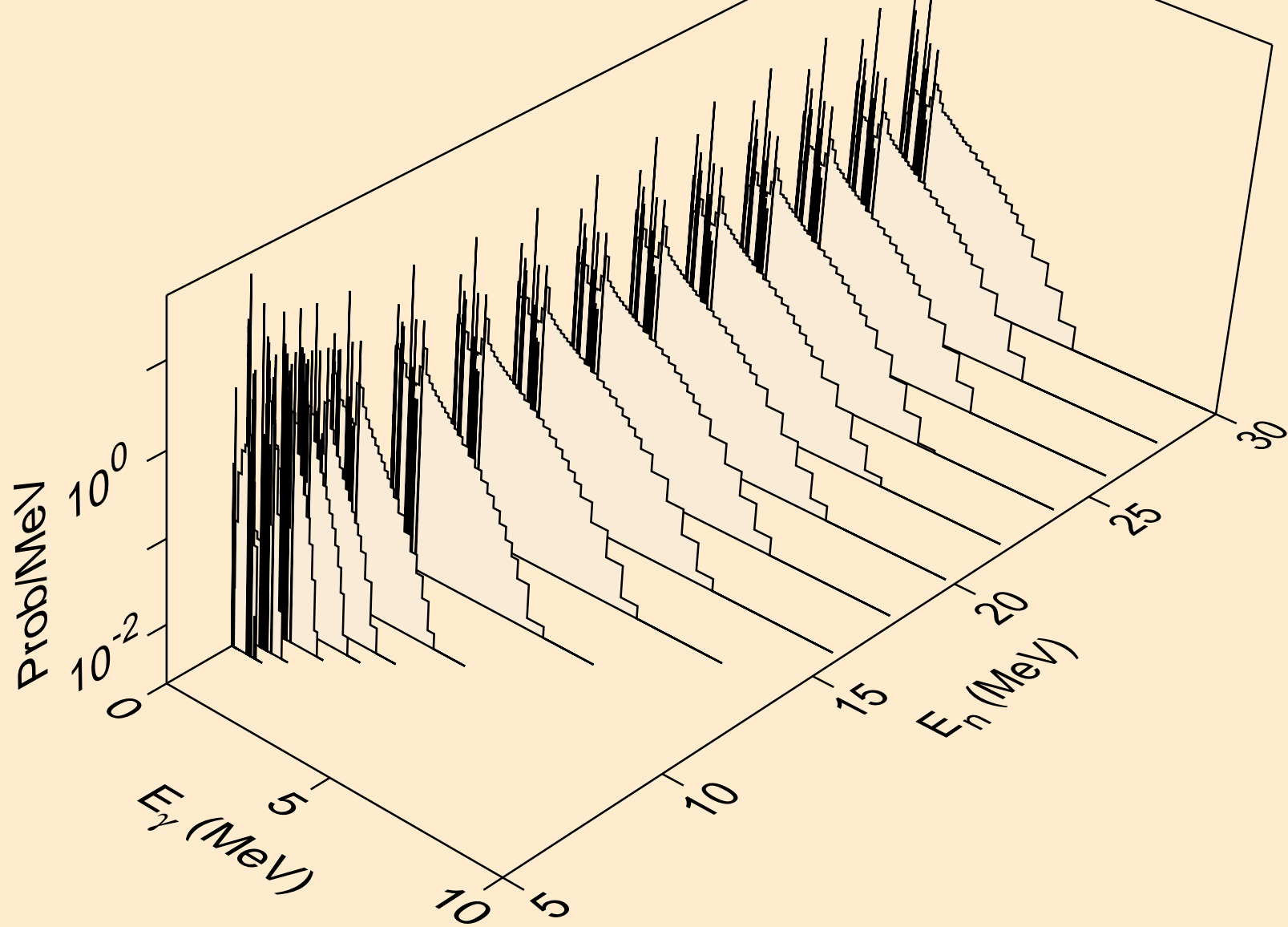

SB129M NEUTRON ACER TENDL-2024 LIBRARY; T=0.K
Photon emission for (n,3n)

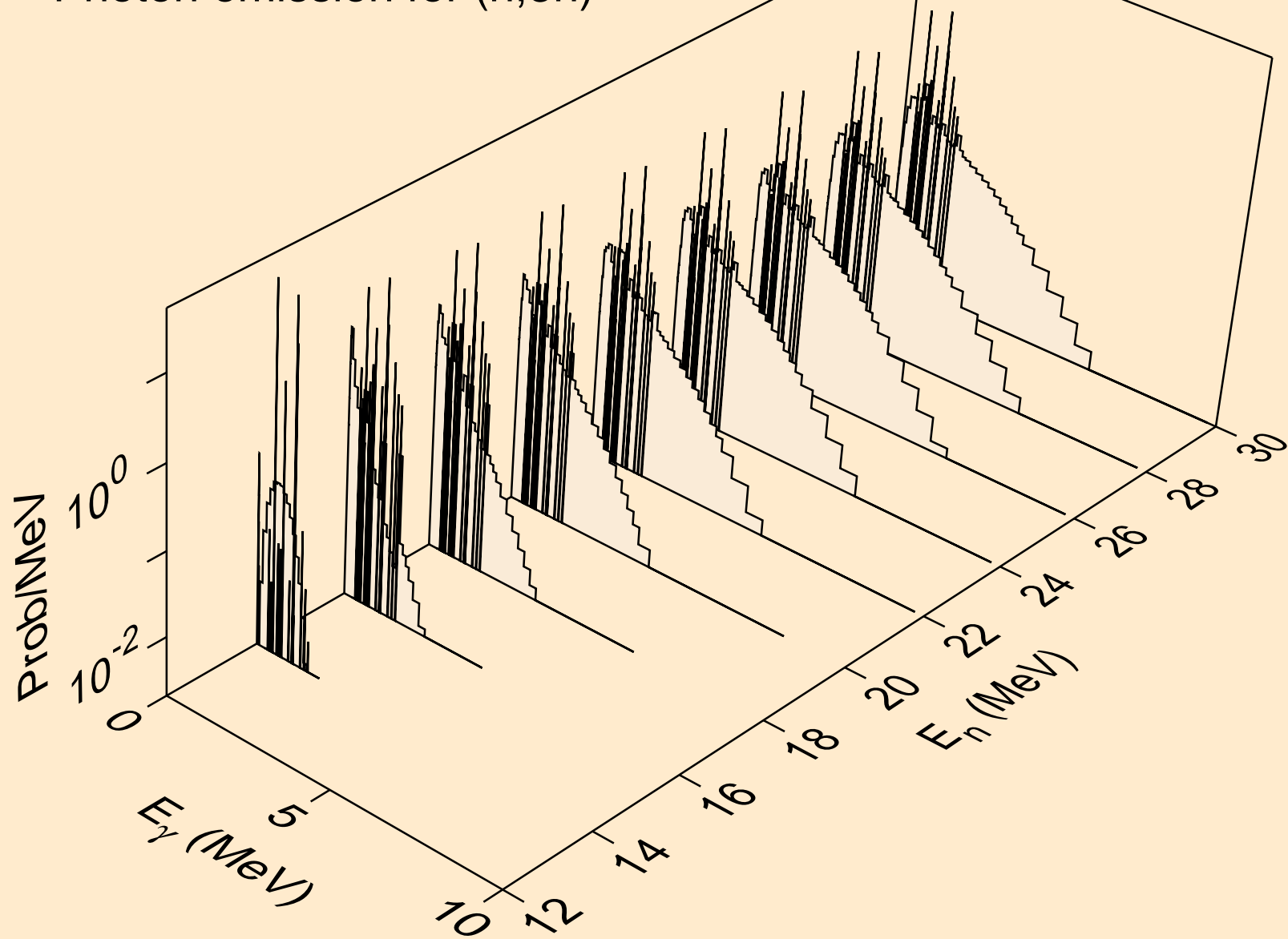

SB129M NEUTRON ACER TENDL-2024 LIBRARY; T=0.K
Photon emission for (n,n*)a

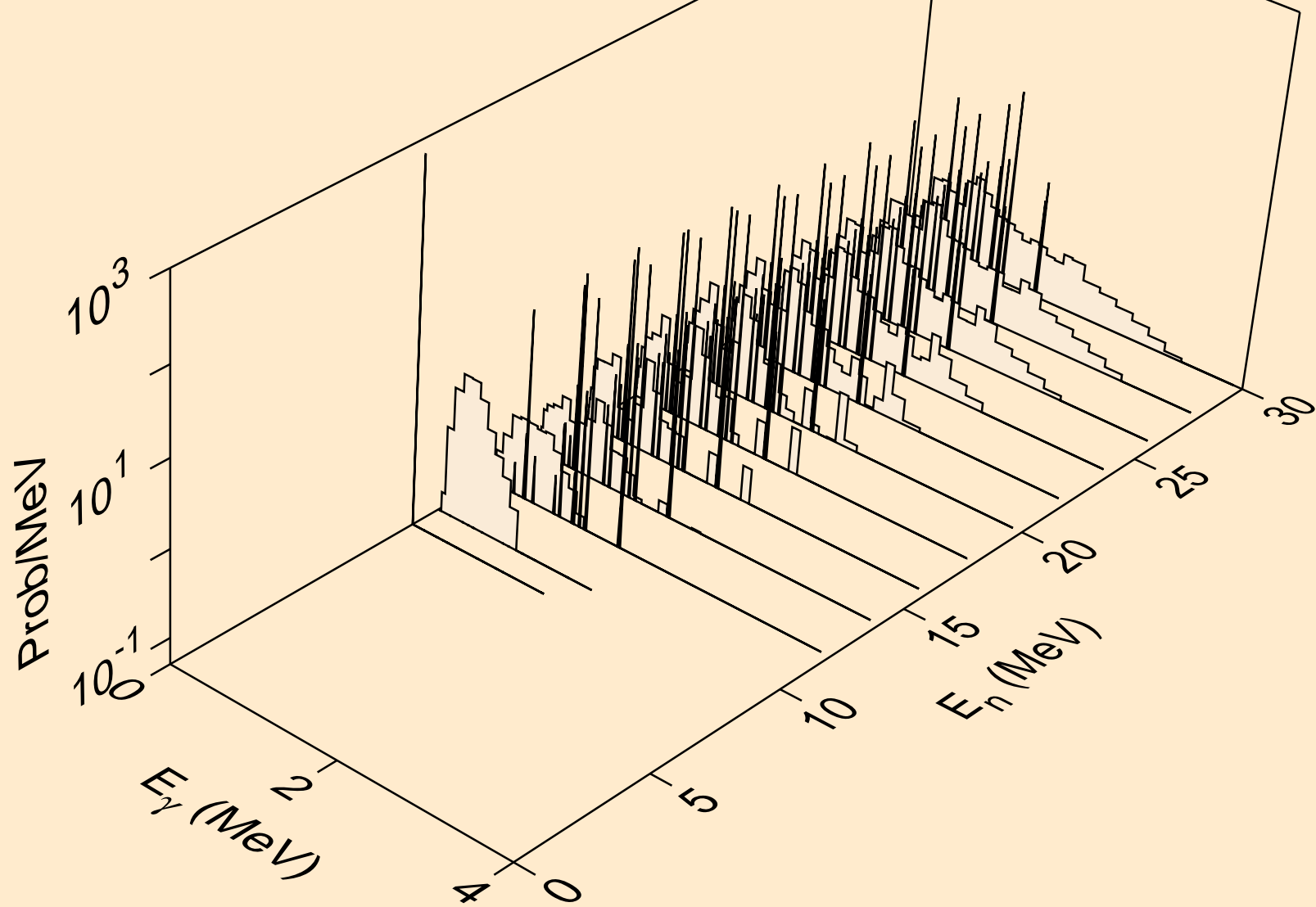

SB129M NEUTRON ACER TENDL-2024 LIBRARY; T=0.K
Photon emission for (n,2n)a

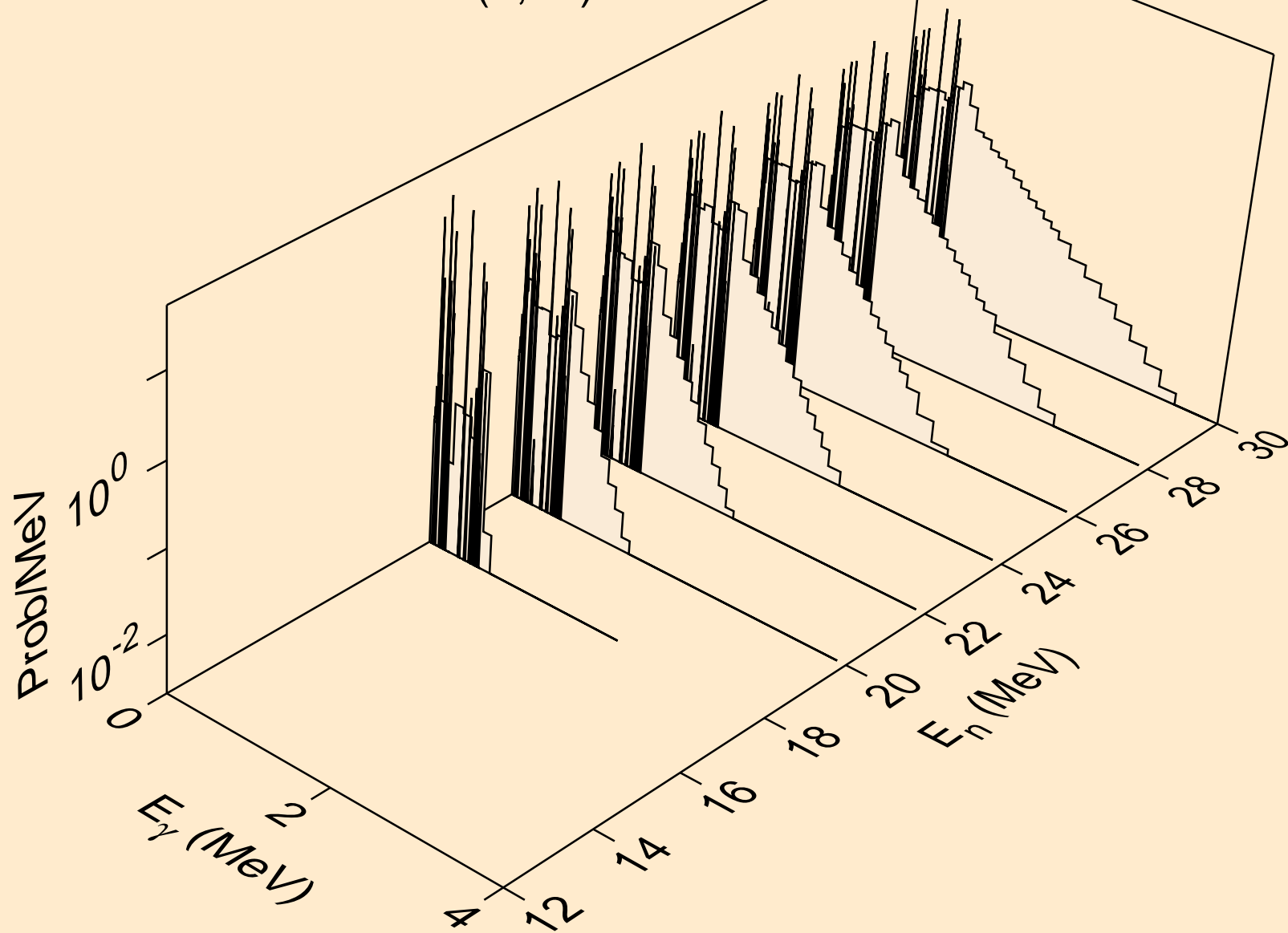

SB129M NEUTRON ACER TENDL-2024 LIBRARY; T=0.K
Photon emission for (n,3n)a

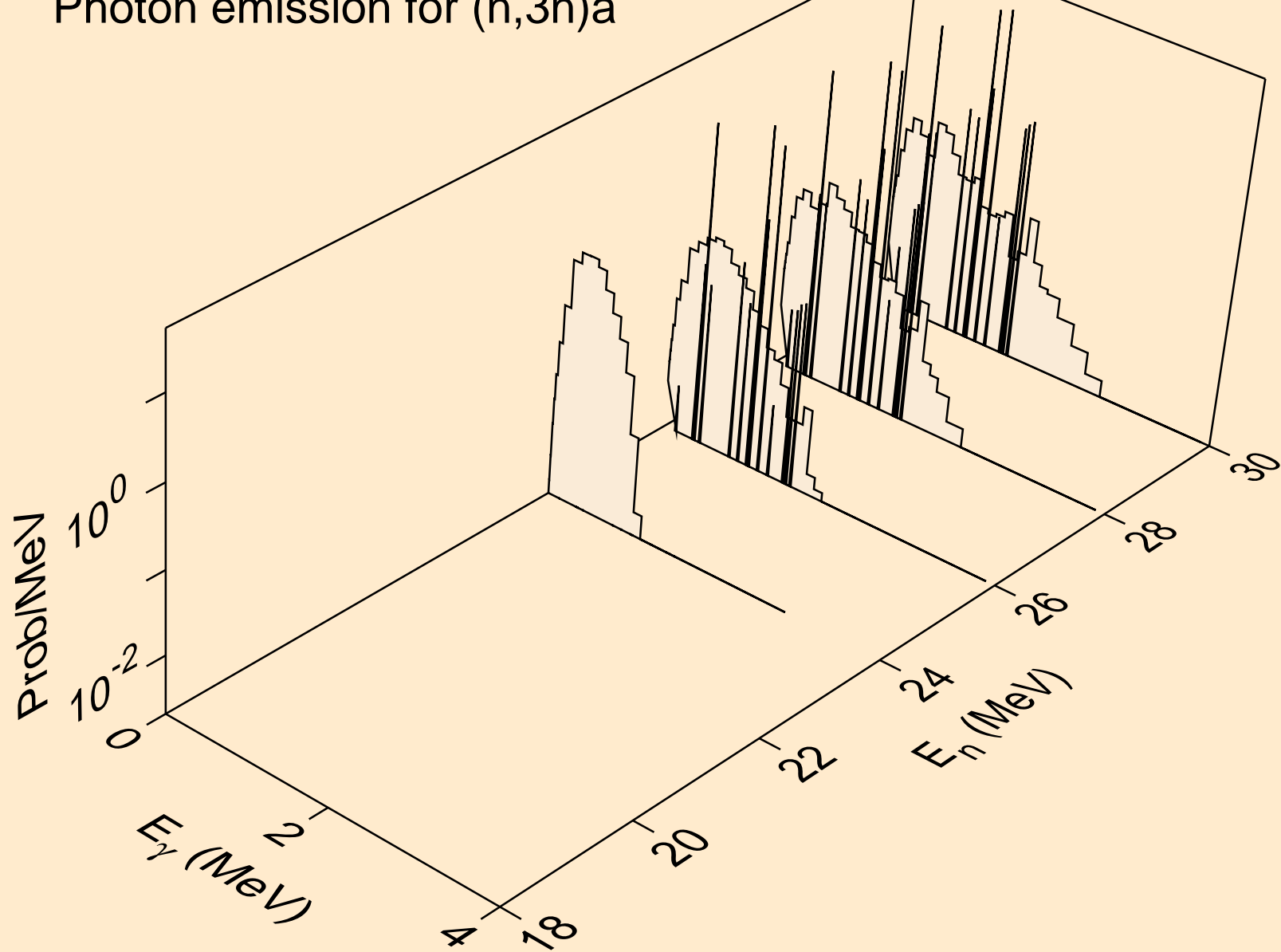

SB129M NEUTRON ACER TENDL-2024 LIBRARY; T=0.K
Photon emission for (n,n*)p

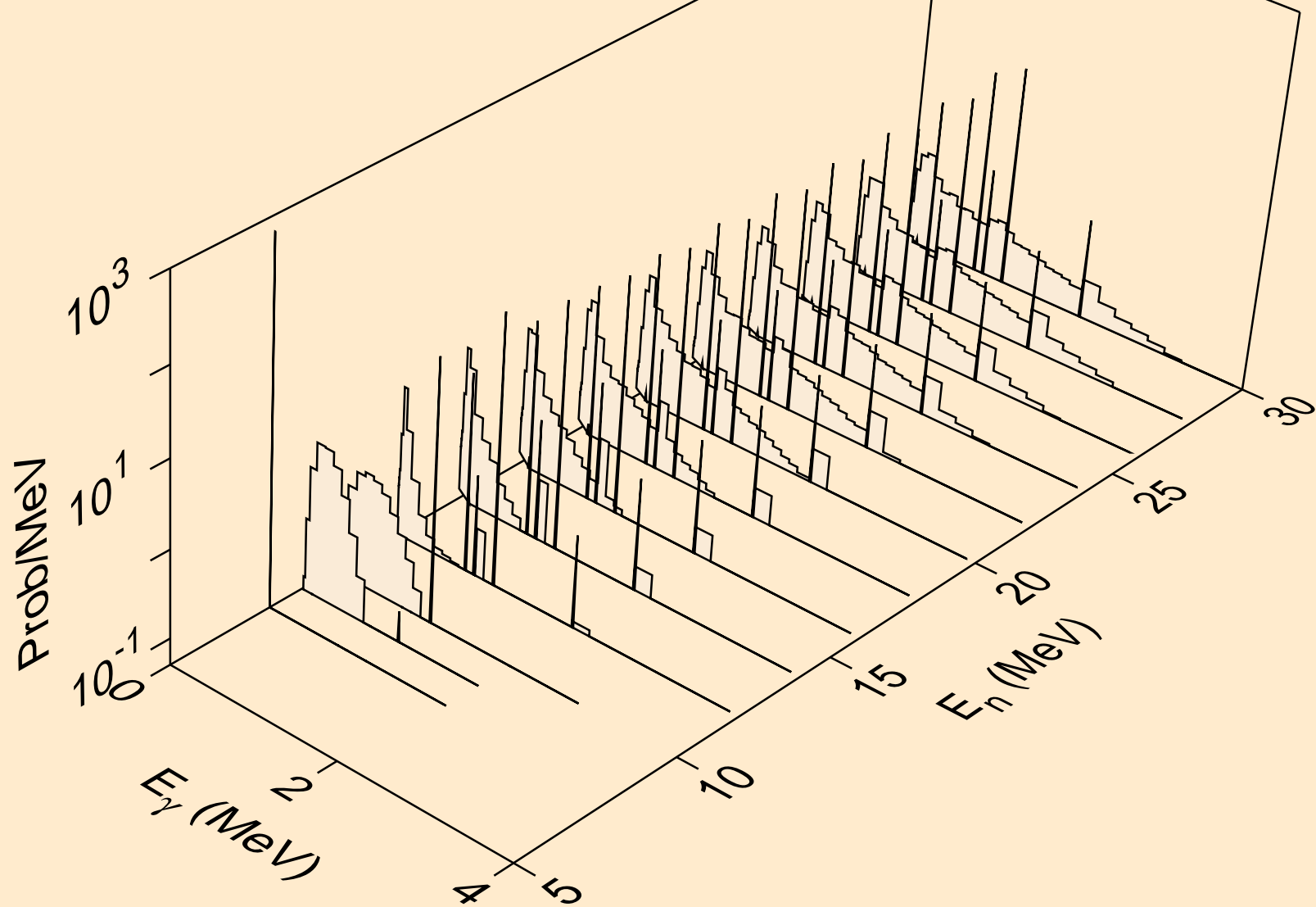

SB129M NEUTRON ACER TENDL-2024 LIBRARY; T=0.K
Photon emission for (n,n*)d

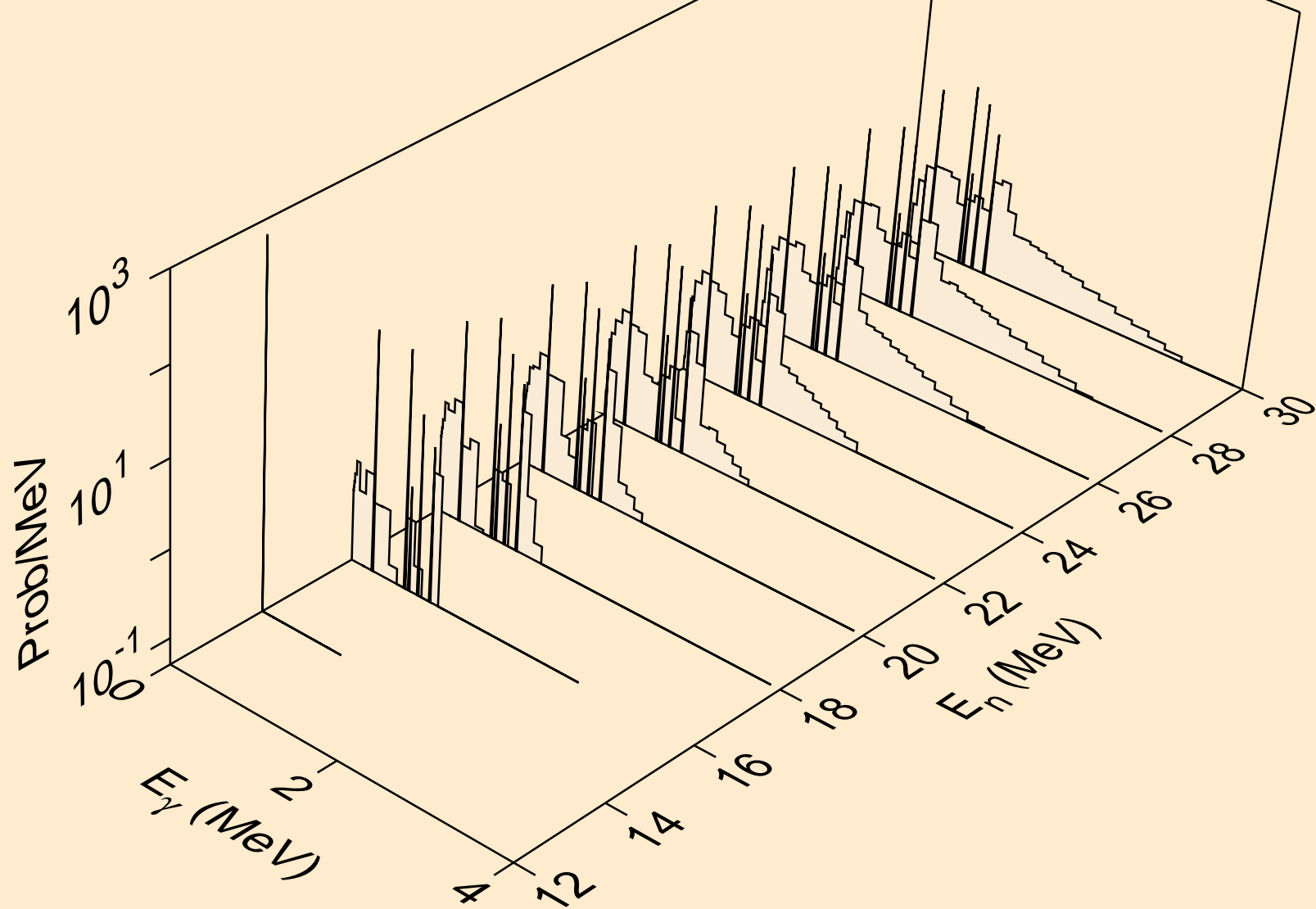

SB129M NEUTRON ACER TENDL-2024 LIBRARY; T=0.K
Photon emission for (n,n*)t

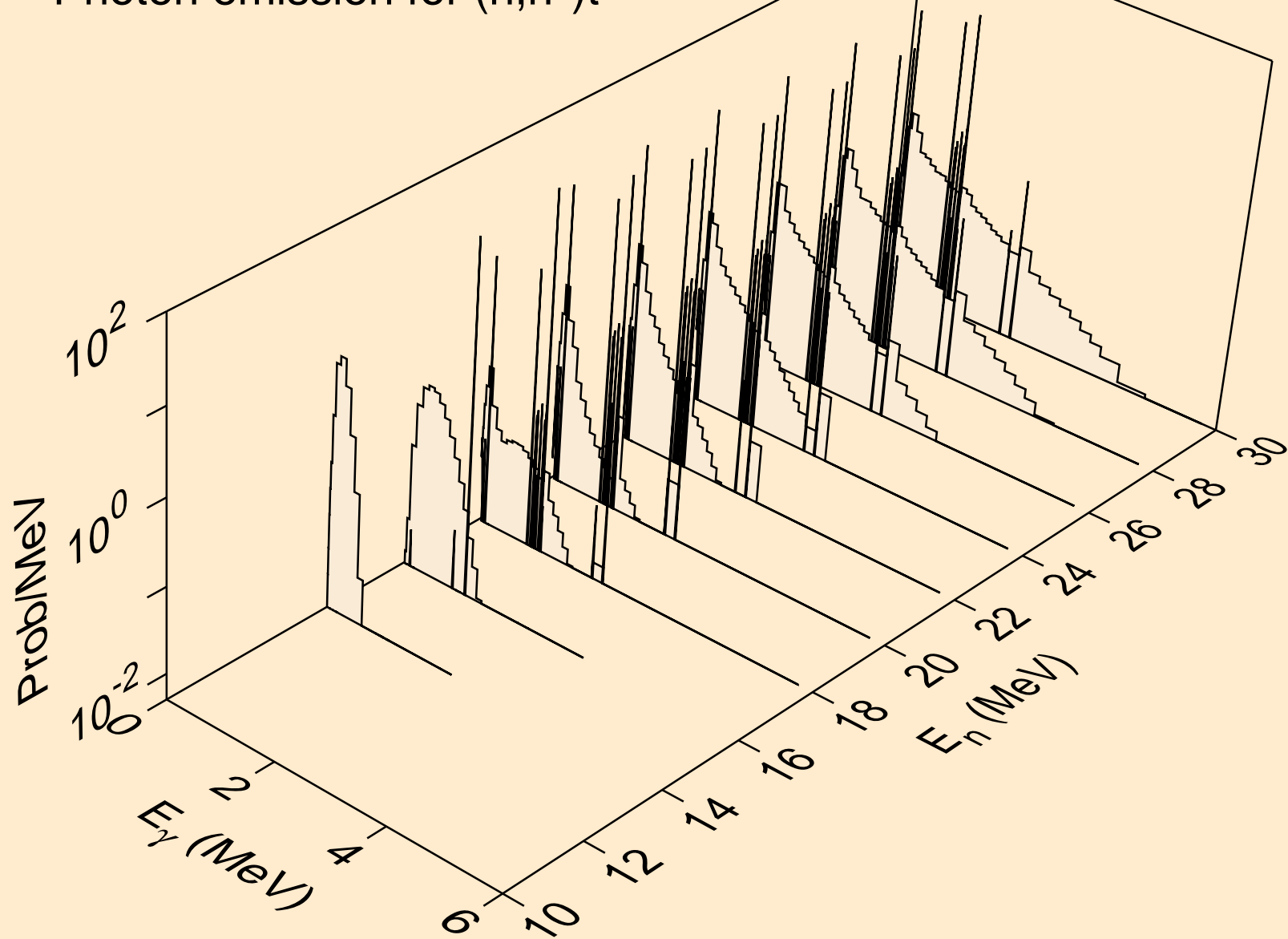

SB129M NEUTRON ACER TENDL-2024 LIBRARY; T=0.K
Photon emission for (n,n*)he3

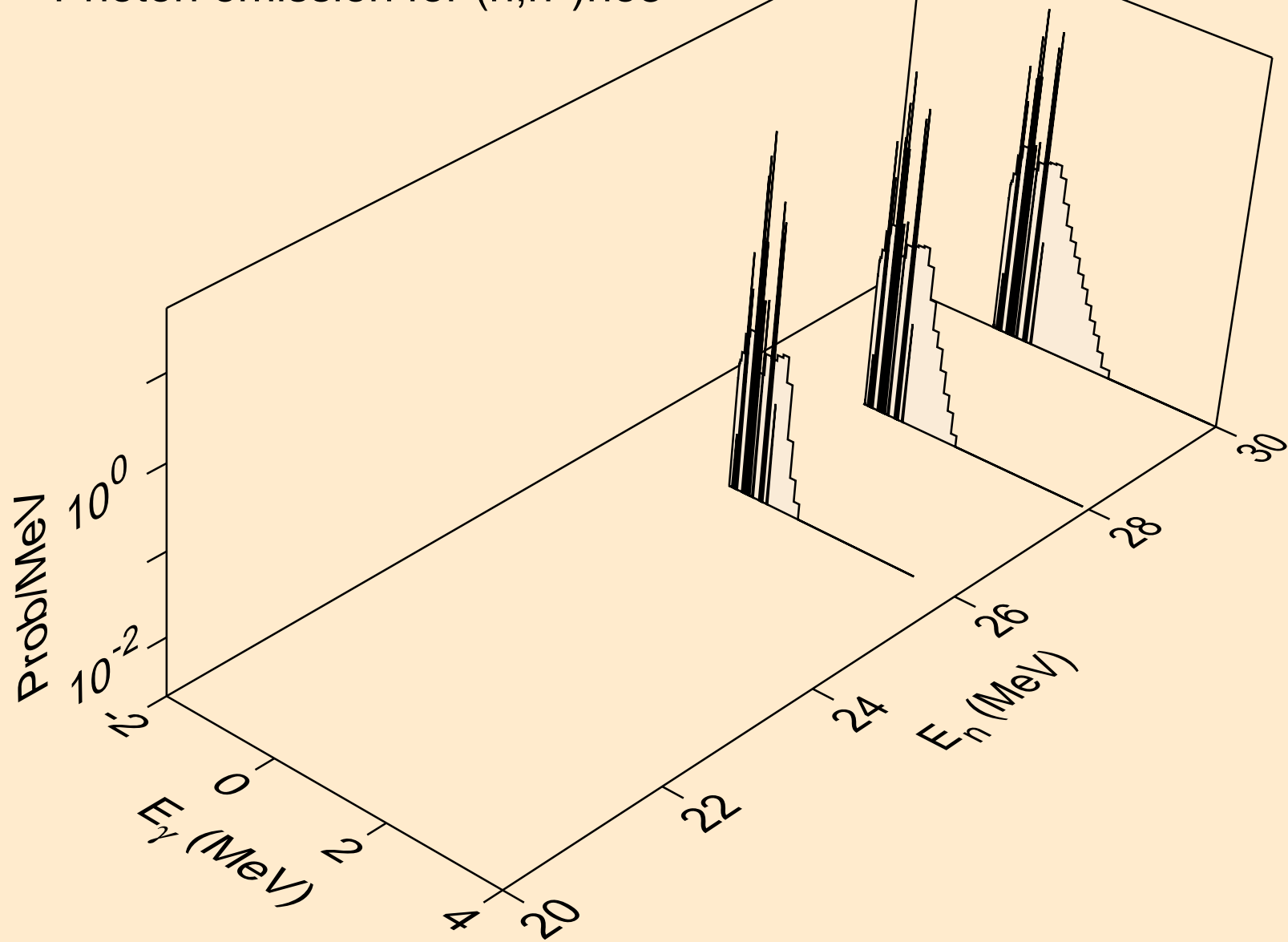

SB129M NEUTRON ACER TENDL-2024 LIBRARY; T=0.K
Photon emission for (n,4n)

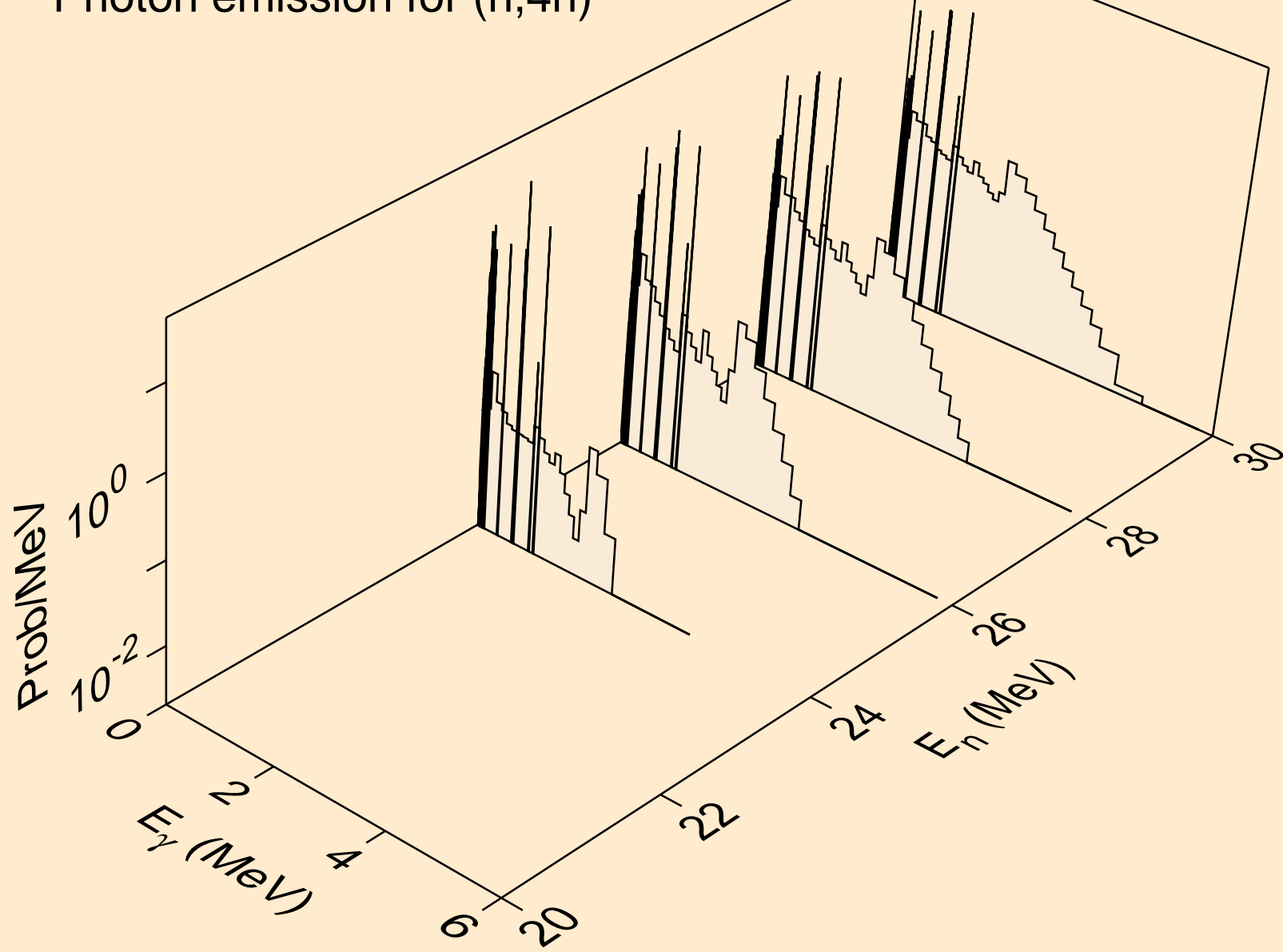

SB129M NEUTRON ACER TENDL-2024 LIBRARY; T=0.K
Photon emission for (n,2np)

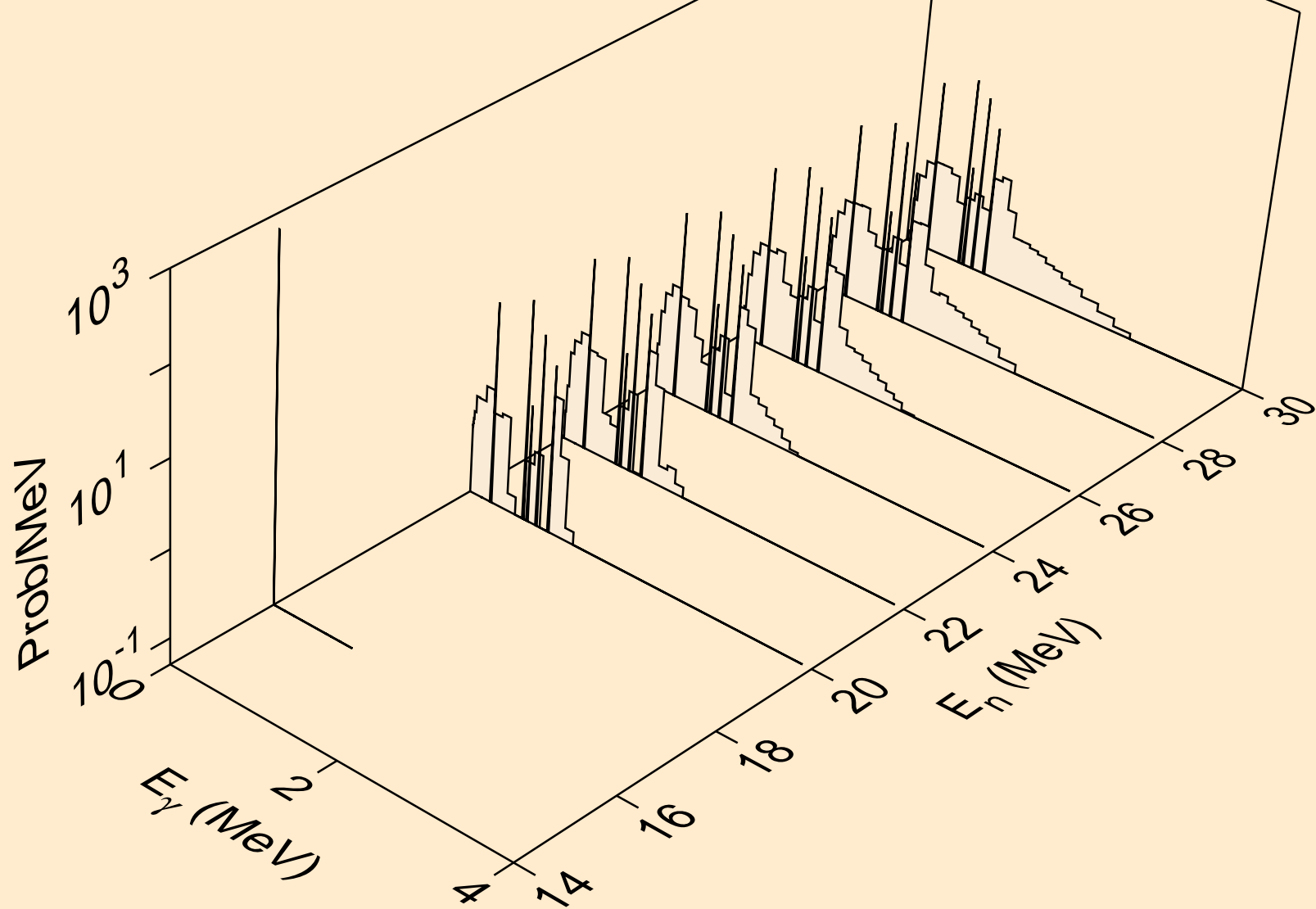

SB129M NEUTRON ACER TENDL-2024 LIBRARY; T=0.K
Photon emission for (n,3np)

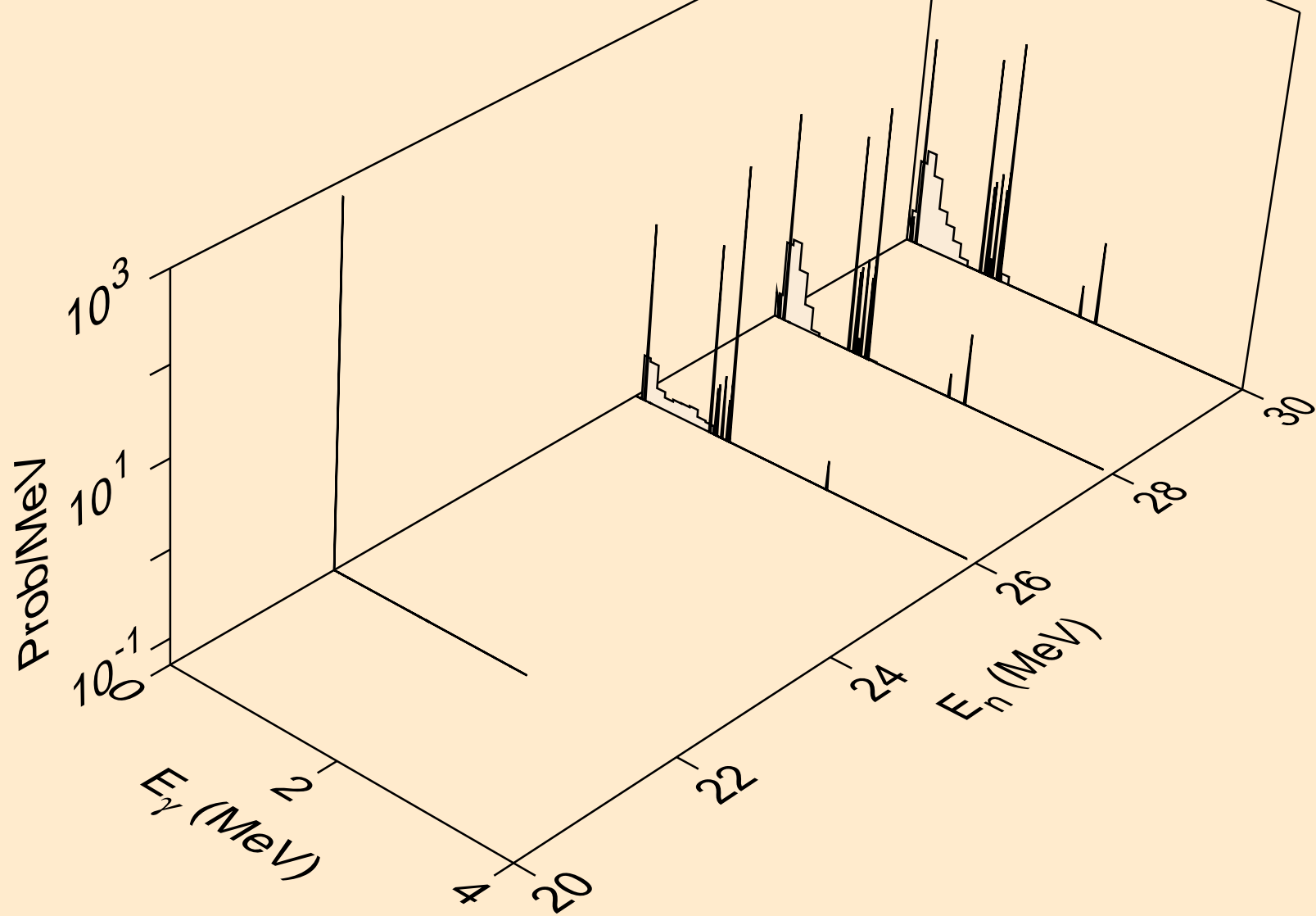

SB129M NEUTRON ACER TENDL-2024 LIBRARY; T=0.K
Photon emission for (n,n*1)

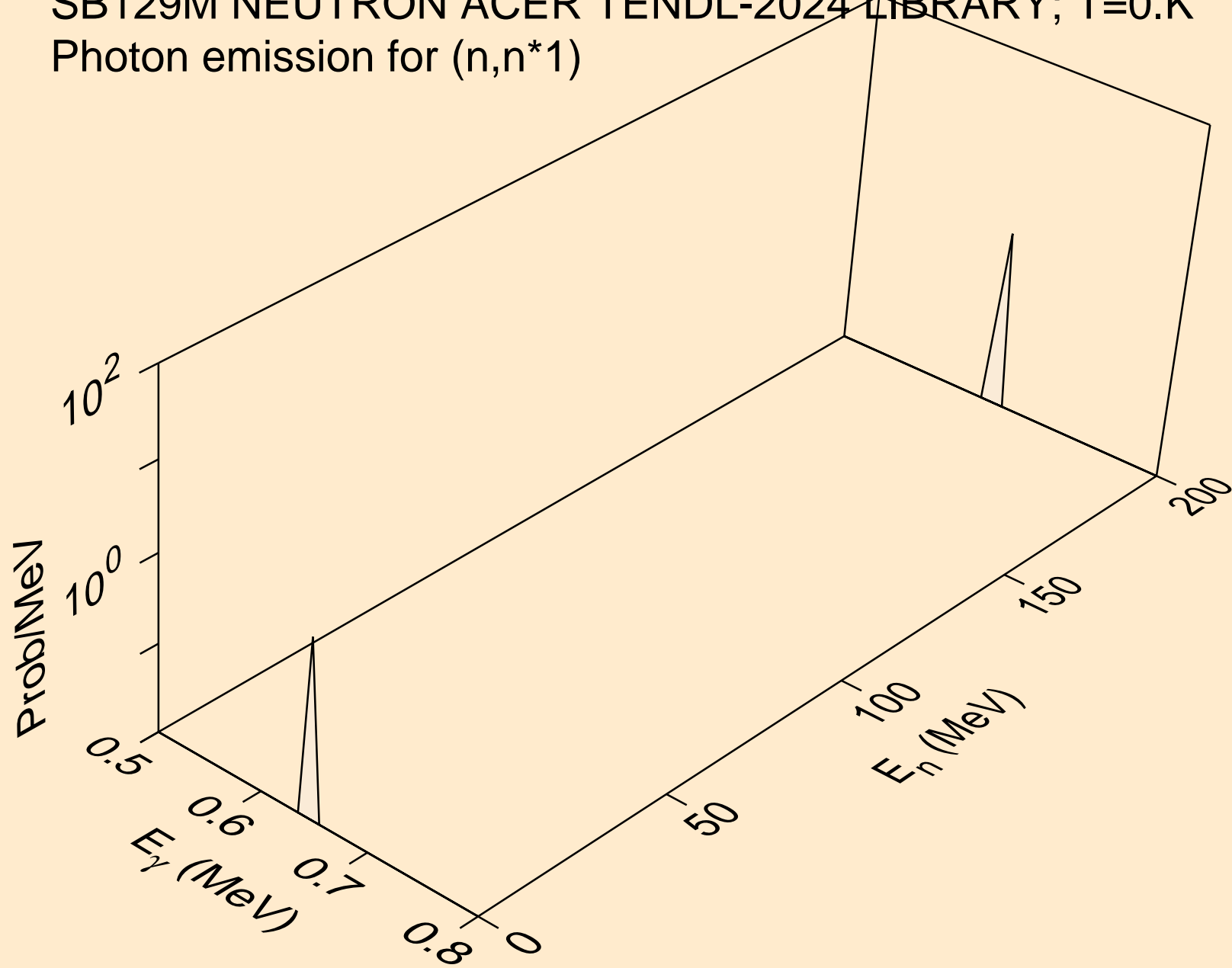

SB129M NEUTRON ACER TENDL-2024 LIBRARY; T=0.K
Photon emission for (n,n*2)

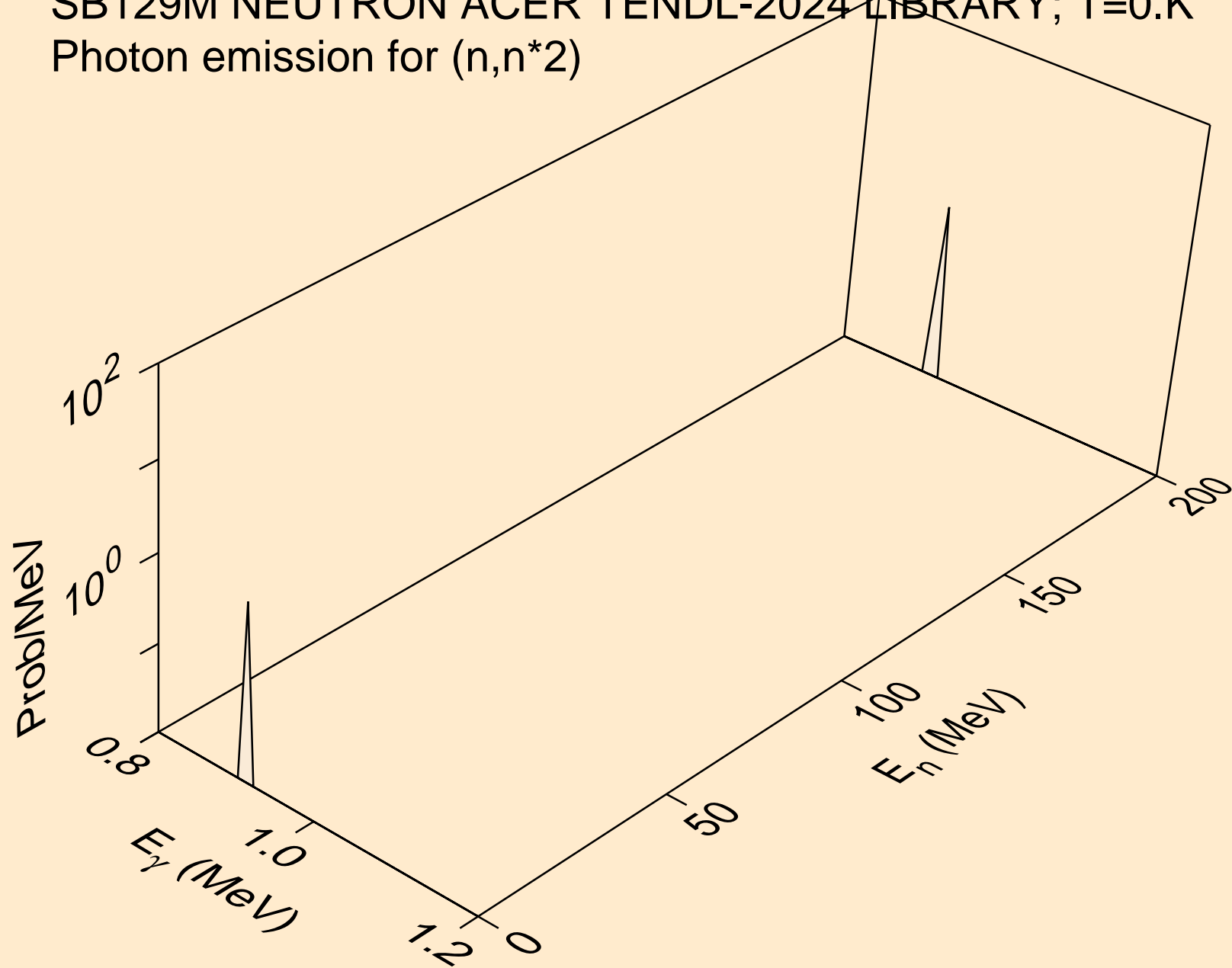

SB129M NEUTRON ACER TENDL-2024 LIBRARY; T=0.K
Photon emission for (n,n*3)

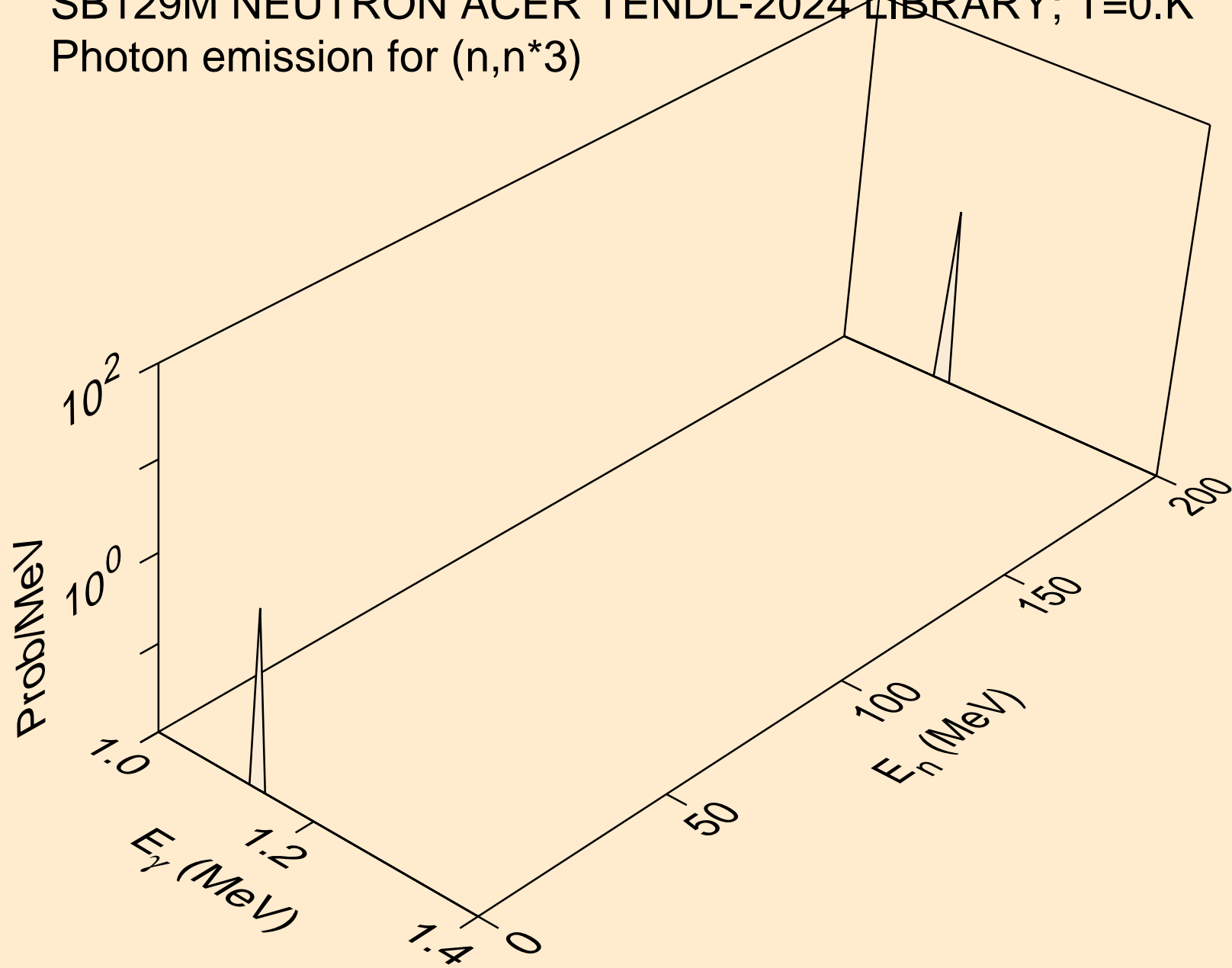

SB129M NEUTRON ACER TENDL-2024 LIBRARY; T=0.K
Photon emission for (n,n*4)

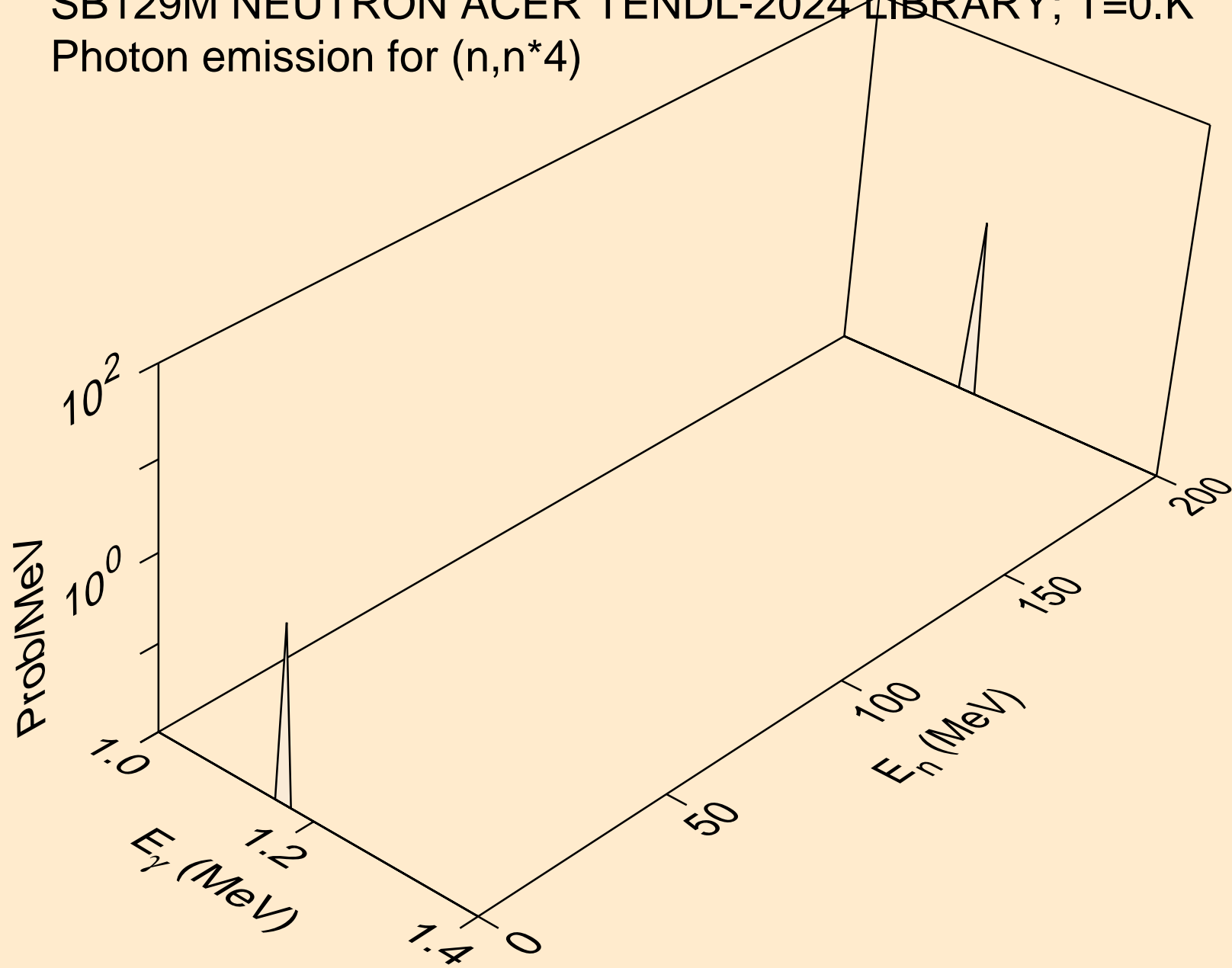

SB129M NEUTRON ACER TENDL-2024 LIBRARY; T=0.K
Photon emission for (n,n*5)

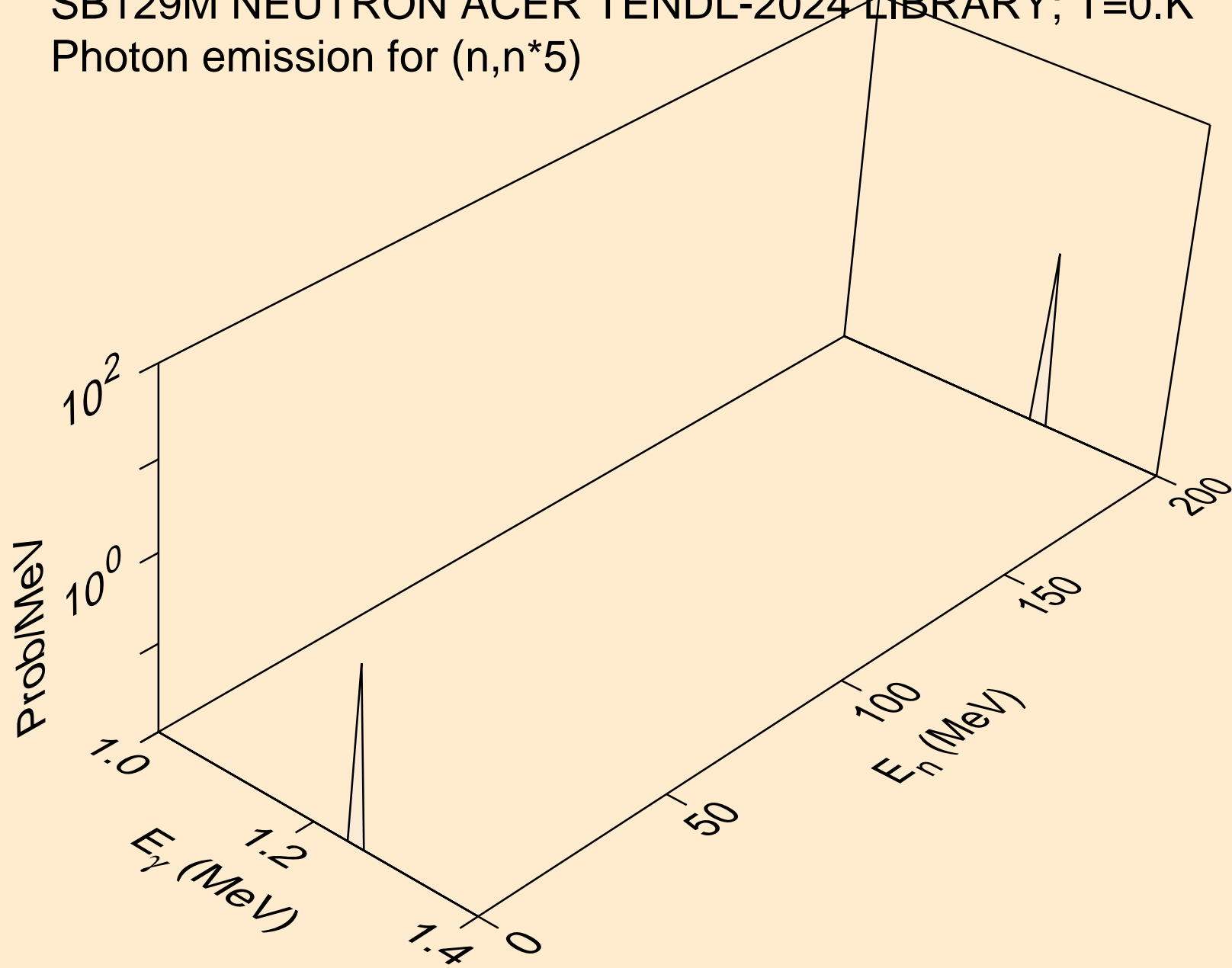

SB129M NEUTRON ACER TENDL-2024 LIBRARY; T=0.K
Photon emission for (n,n*6)

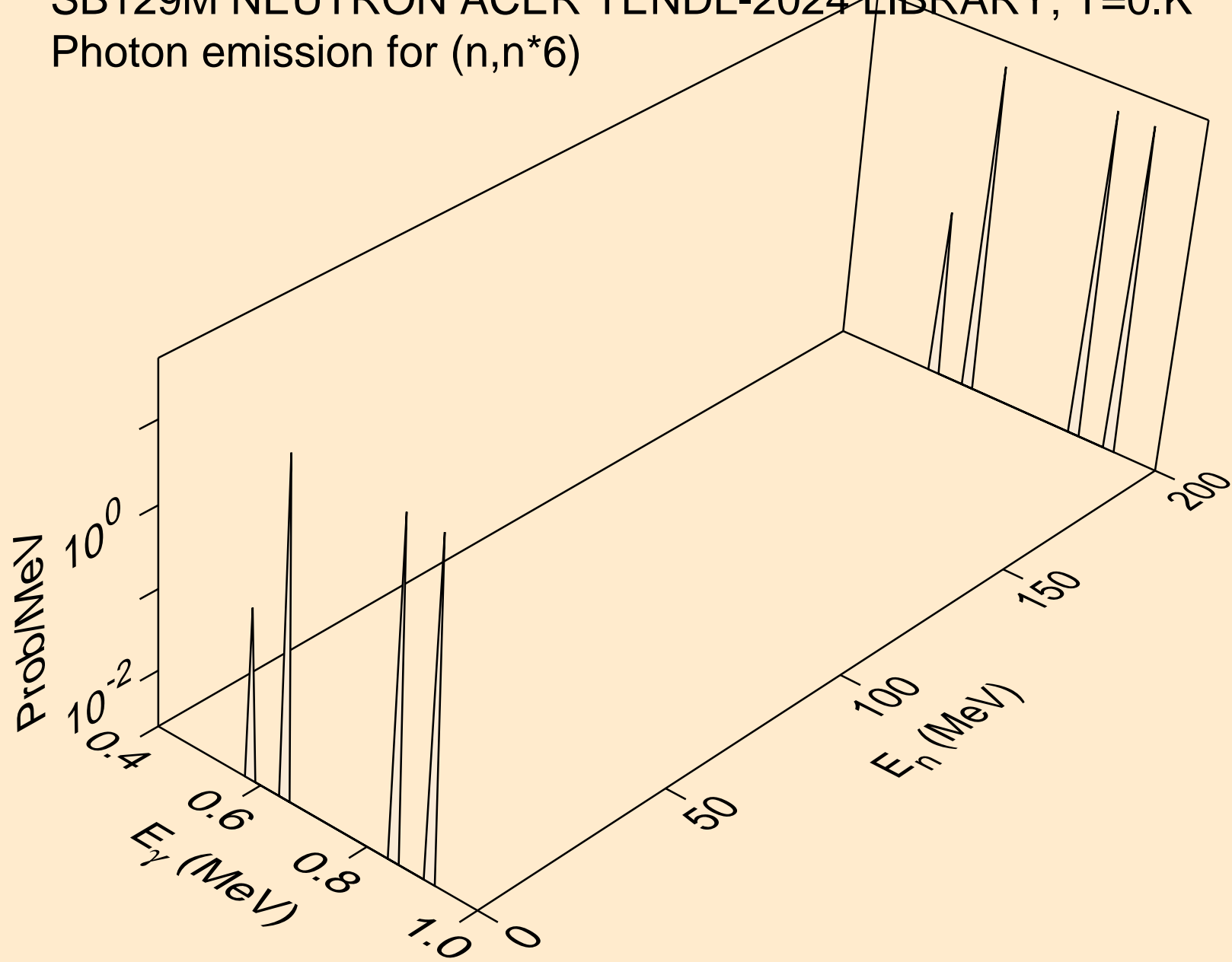

SB129M NEUTRON ACER TENDL-2024 LIBRARY; T=0.K
Photon emission for (n,n*7)

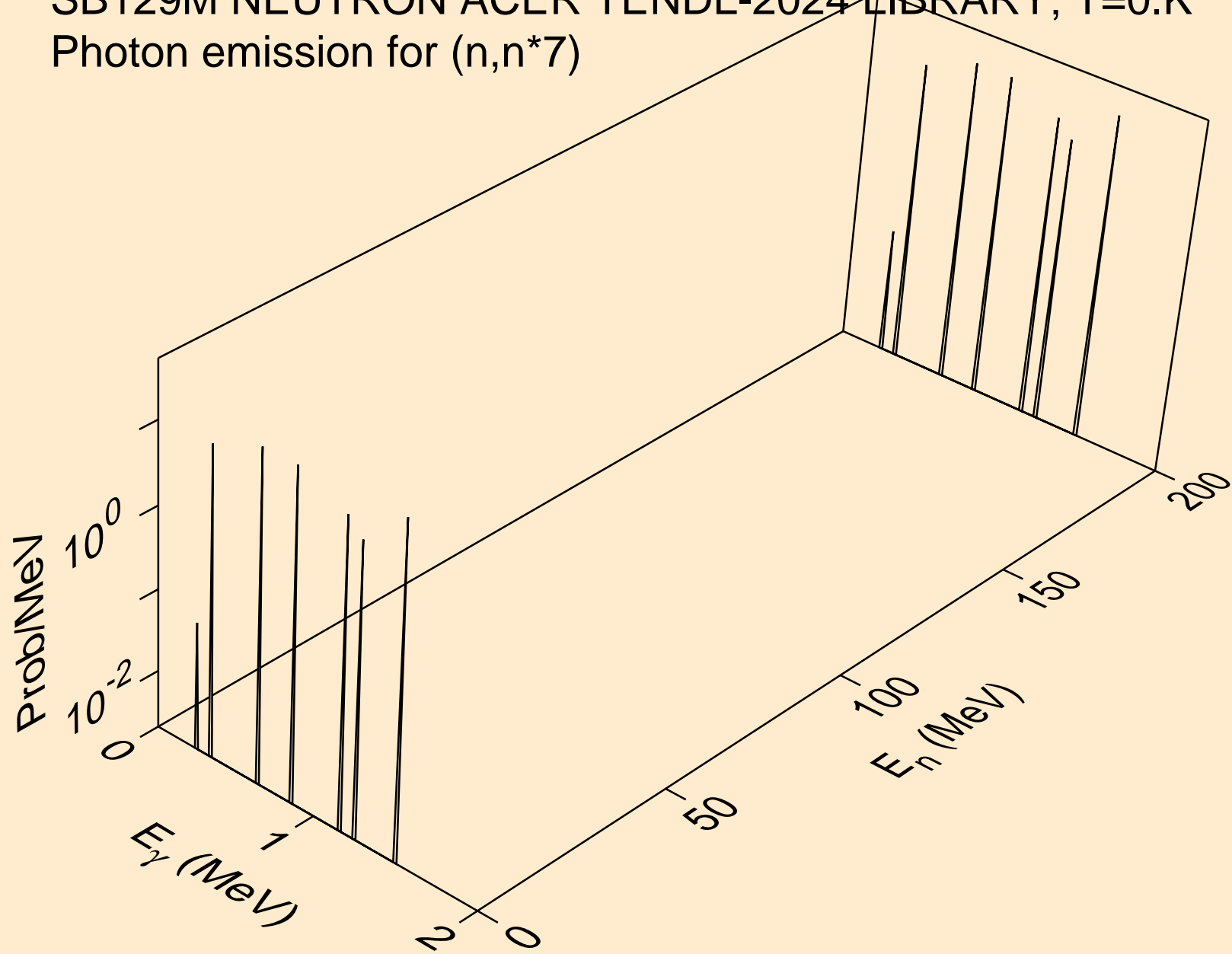

SB129M NEUTRON ACER TENDL-2024 LIBRARY; T=0.K
Photon emission for (n,n*8)

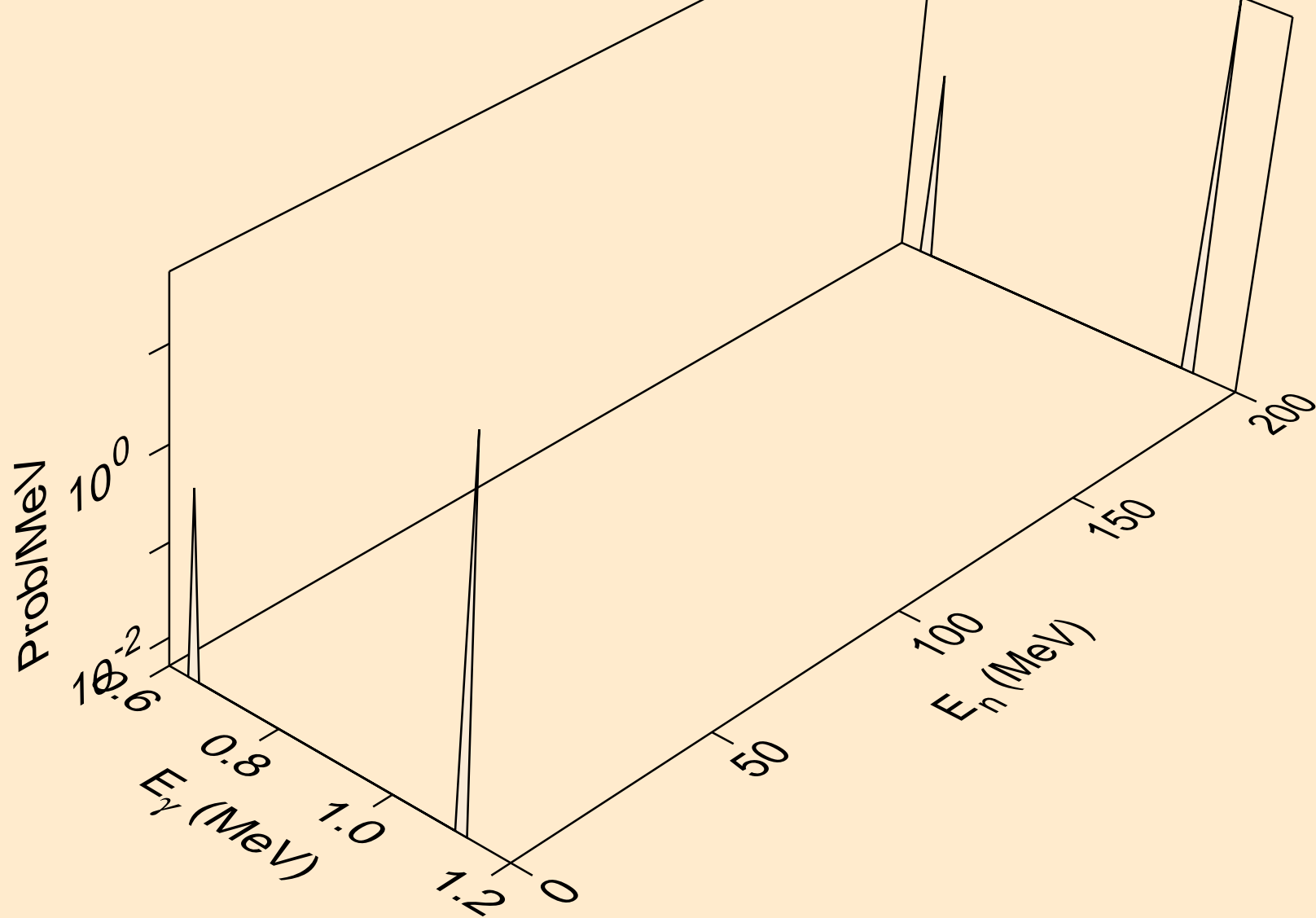

SB129M NEUTRON ACER TENDL-2024 LIBRARY; T=0.K
Photon emission for (n,n*9)

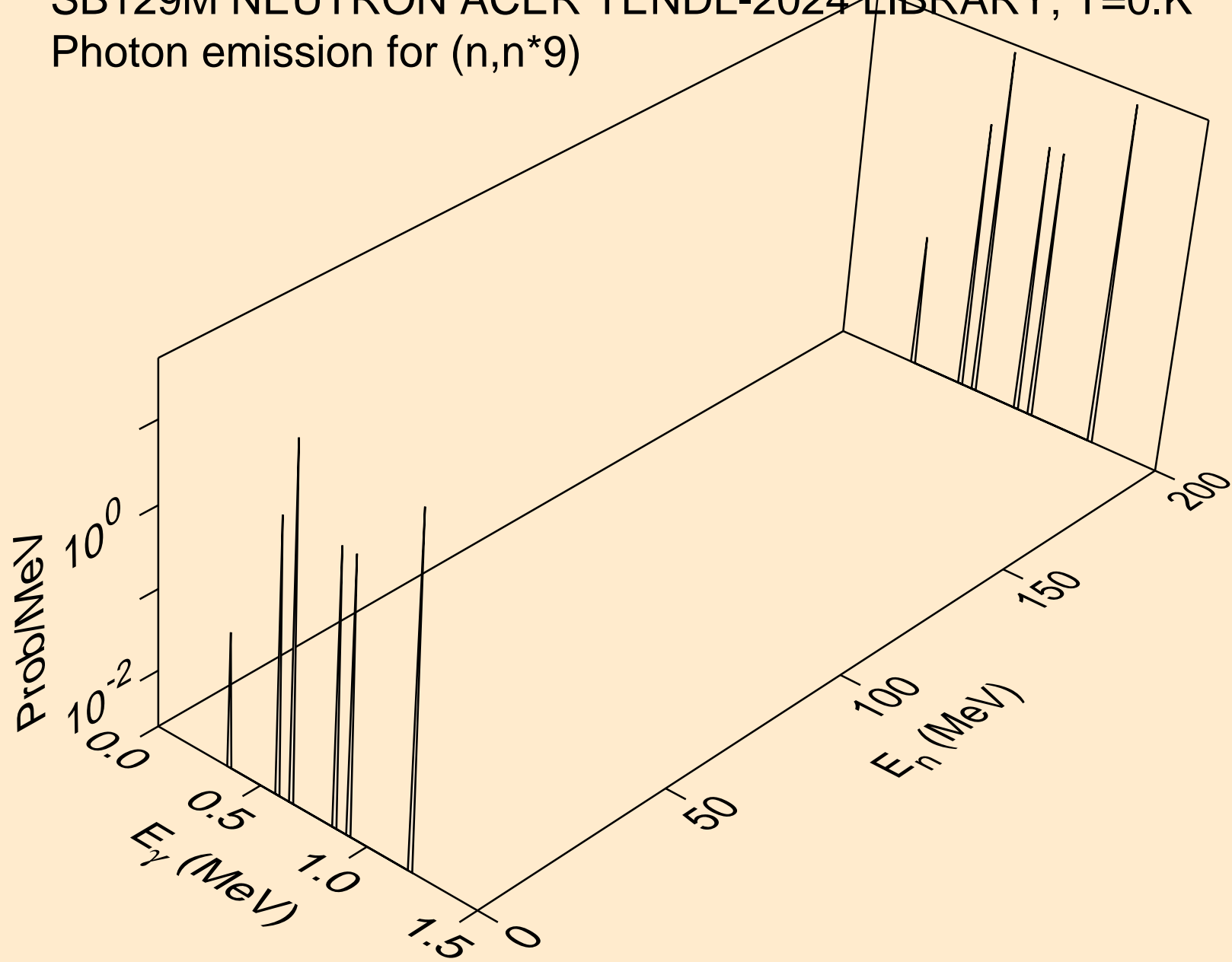

SB129M NEUTRON ACER TENDL-2024 LIBRARY; T=0.K
Photon emission for (n,n*10)

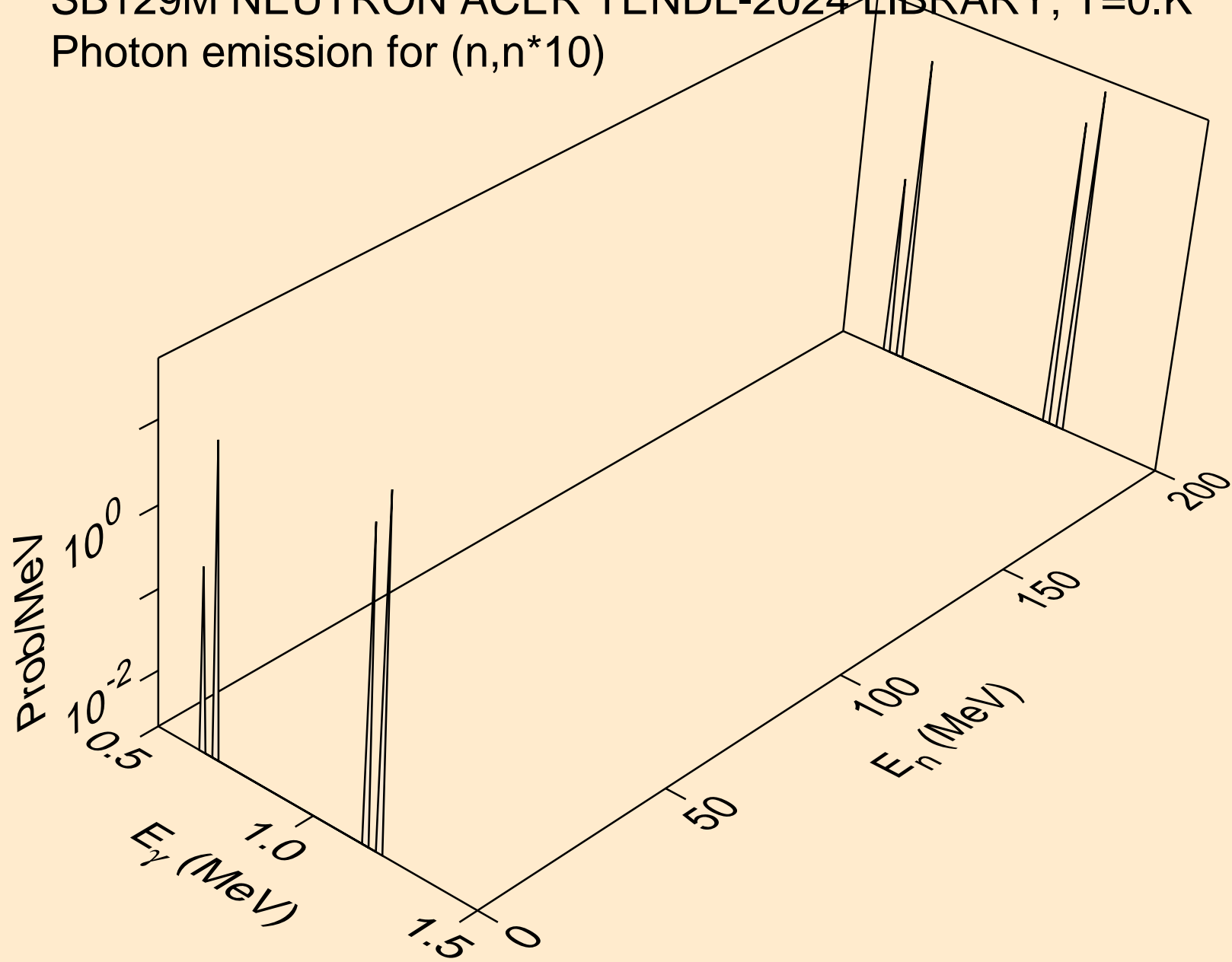

SB129M NEUTRON ACER TENDL-2024 LIBRARY; T=0.K
Photon emission for (n,n*12)

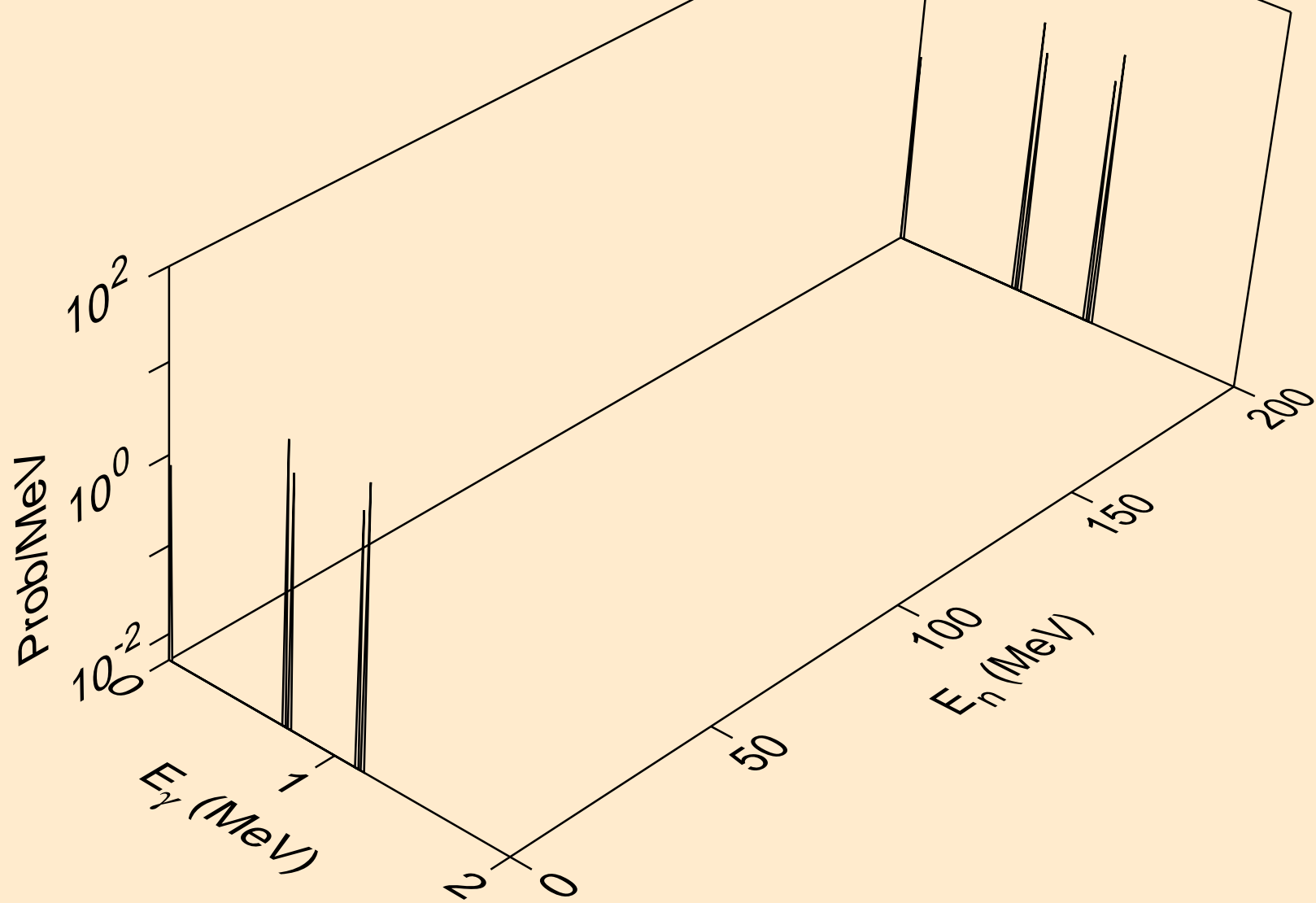

SB129M NEUTRON ACER TENDL-2024 LIBRARY; T=0.K
Photon emission for (n,n*13)

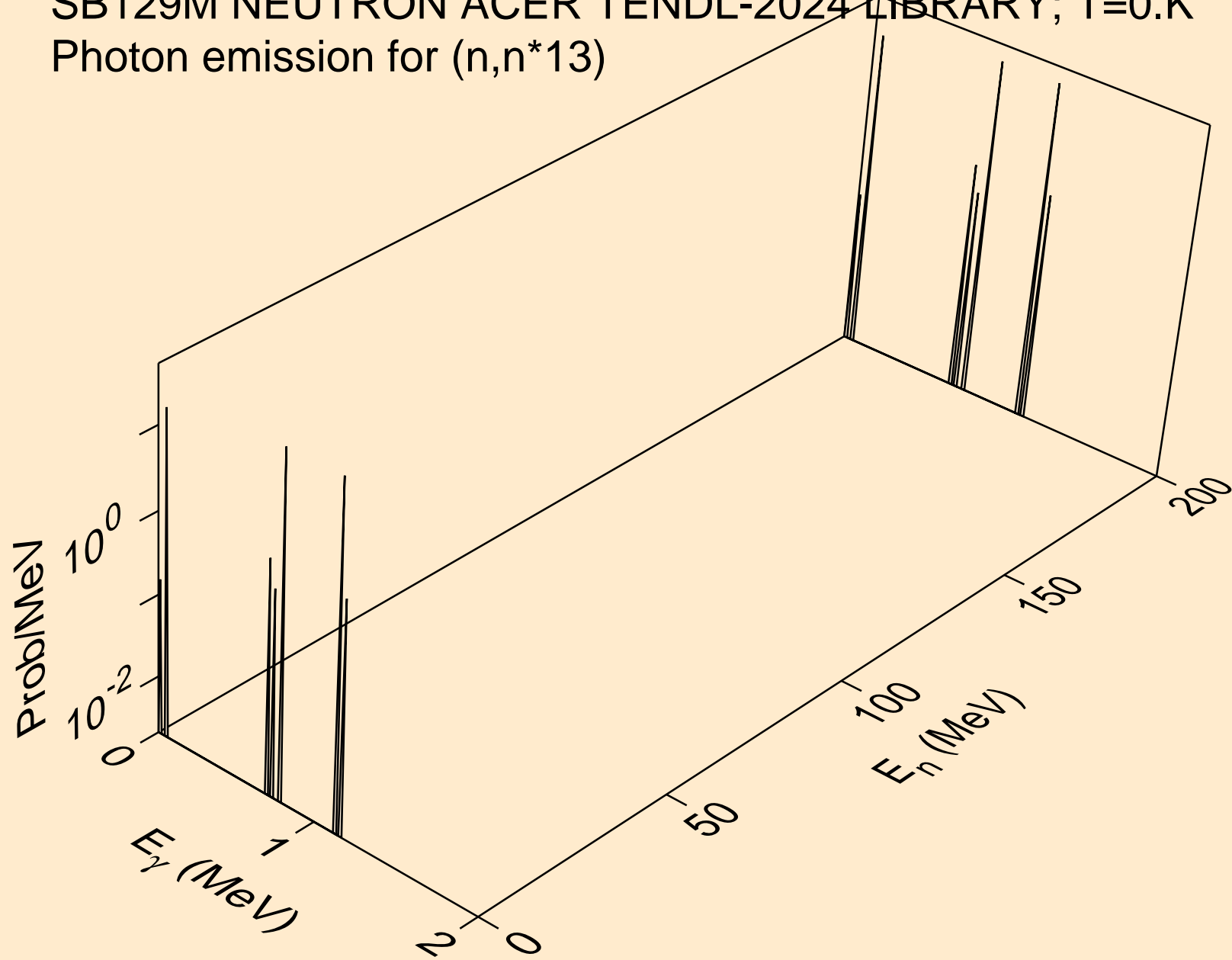

SB129M NEUTRON ACER TENDL-2024 LIBRARY; T=0.K
Photon emission for (n,n*14)

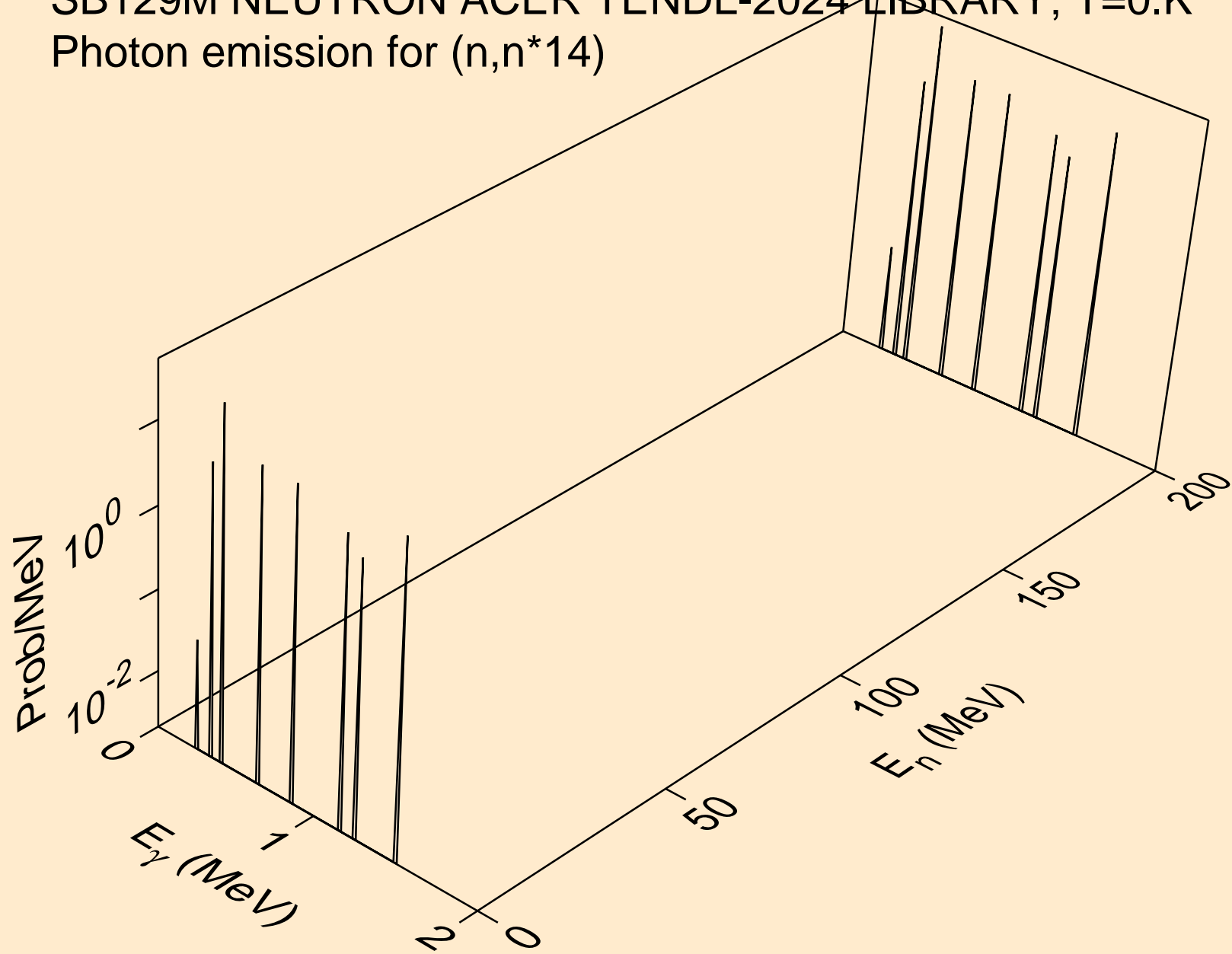

SB129M NEUTRON ACER TENDL-2024 LIBRARY; T=0.K
Photon emission for (n,n*15)

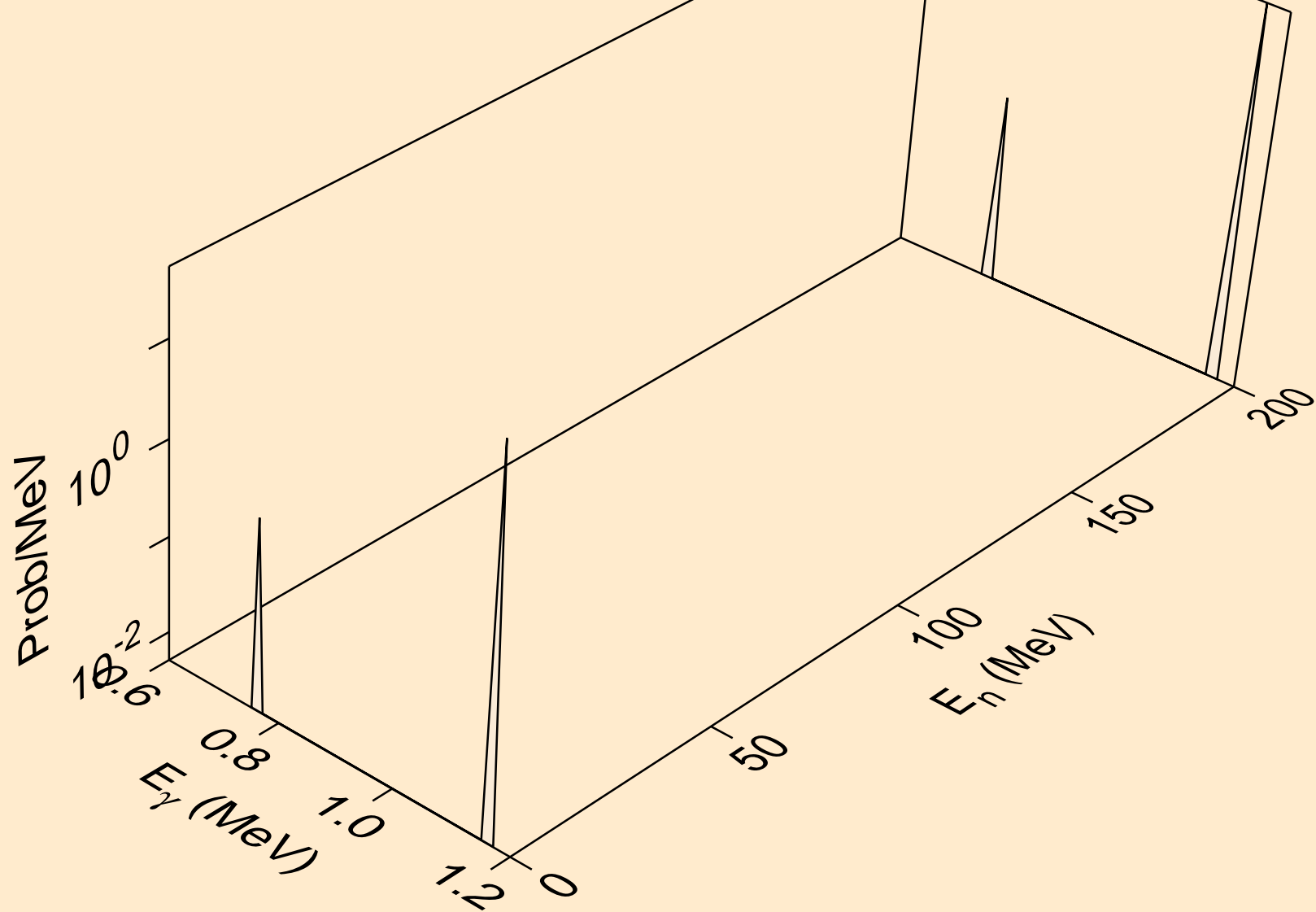

SB129M NEUTRON ACER TENDL-2024 LIBRARY; T=0.K
Photon emission for (n,n*16)

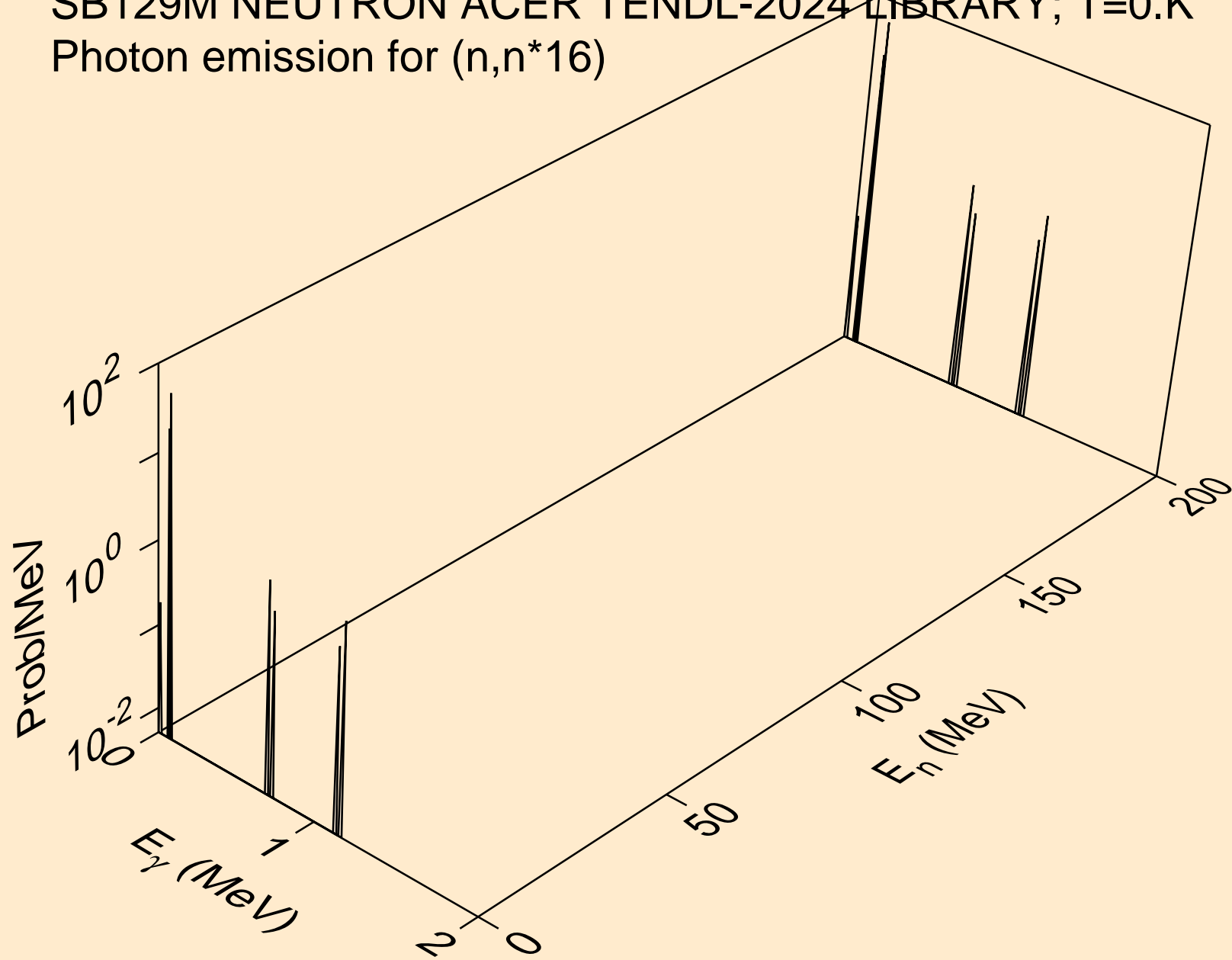

SB129M NEUTRON ACER TENDL-2024 LIBRARY; T=0.K
Photon emission for (n,n*17)

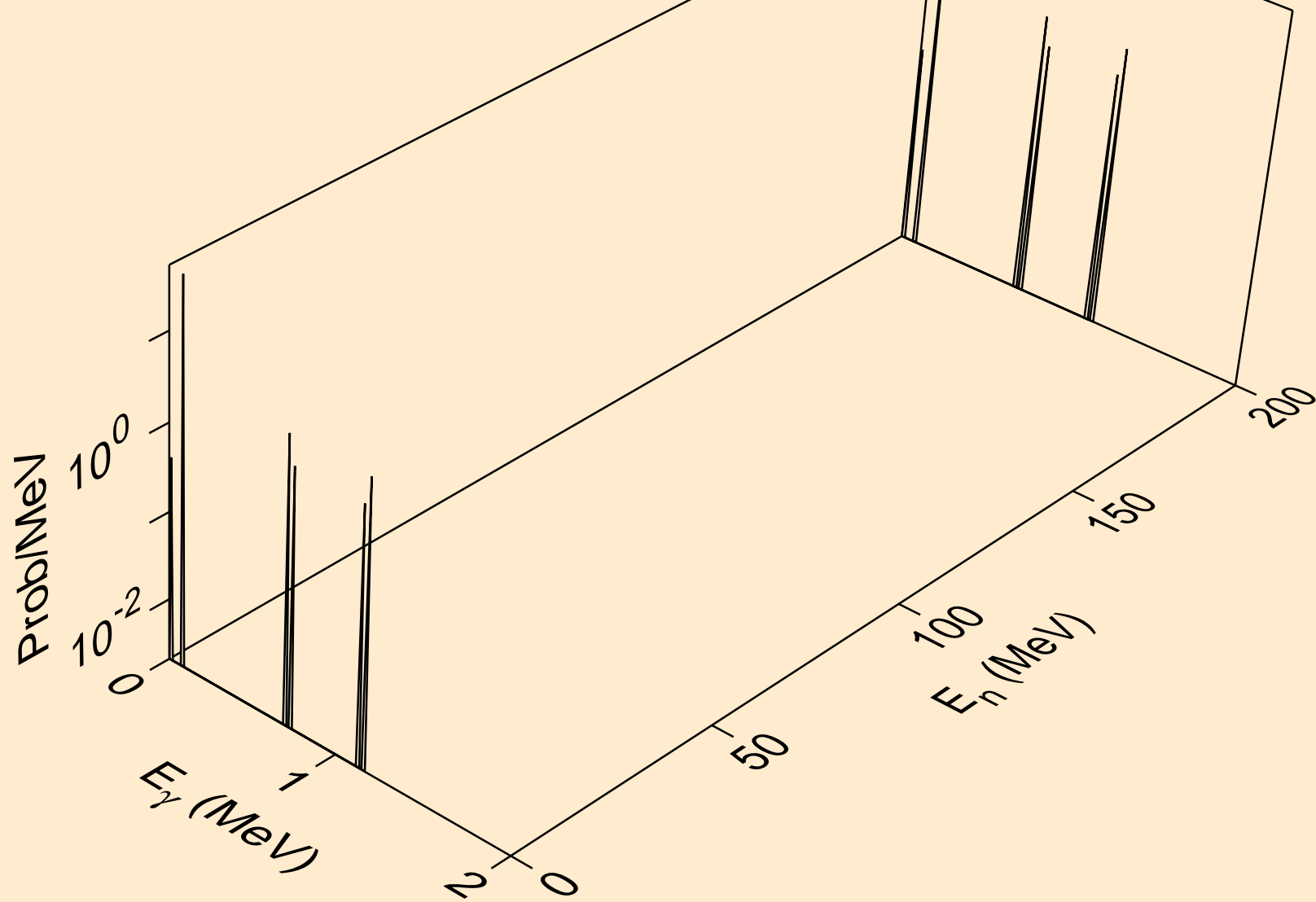

SB129M NEUTRON ACER TENDL-2024 LIBRARY; T=0.K
Photon emission for (n,n*18)

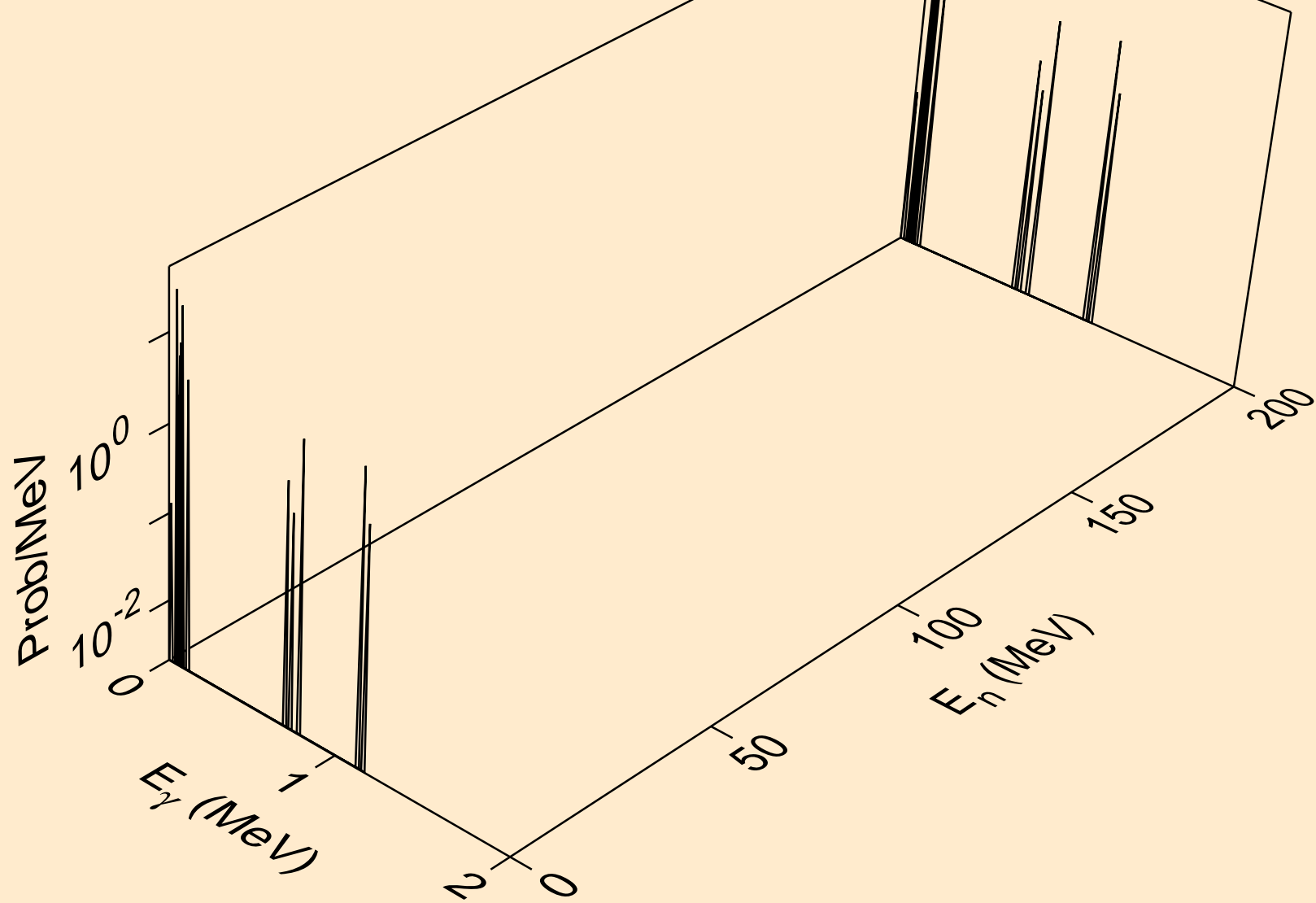

SB129M NEUTRON ACER TENDL-2024 LIBRARY; T=0.K
Photon emission for (n,n*19)

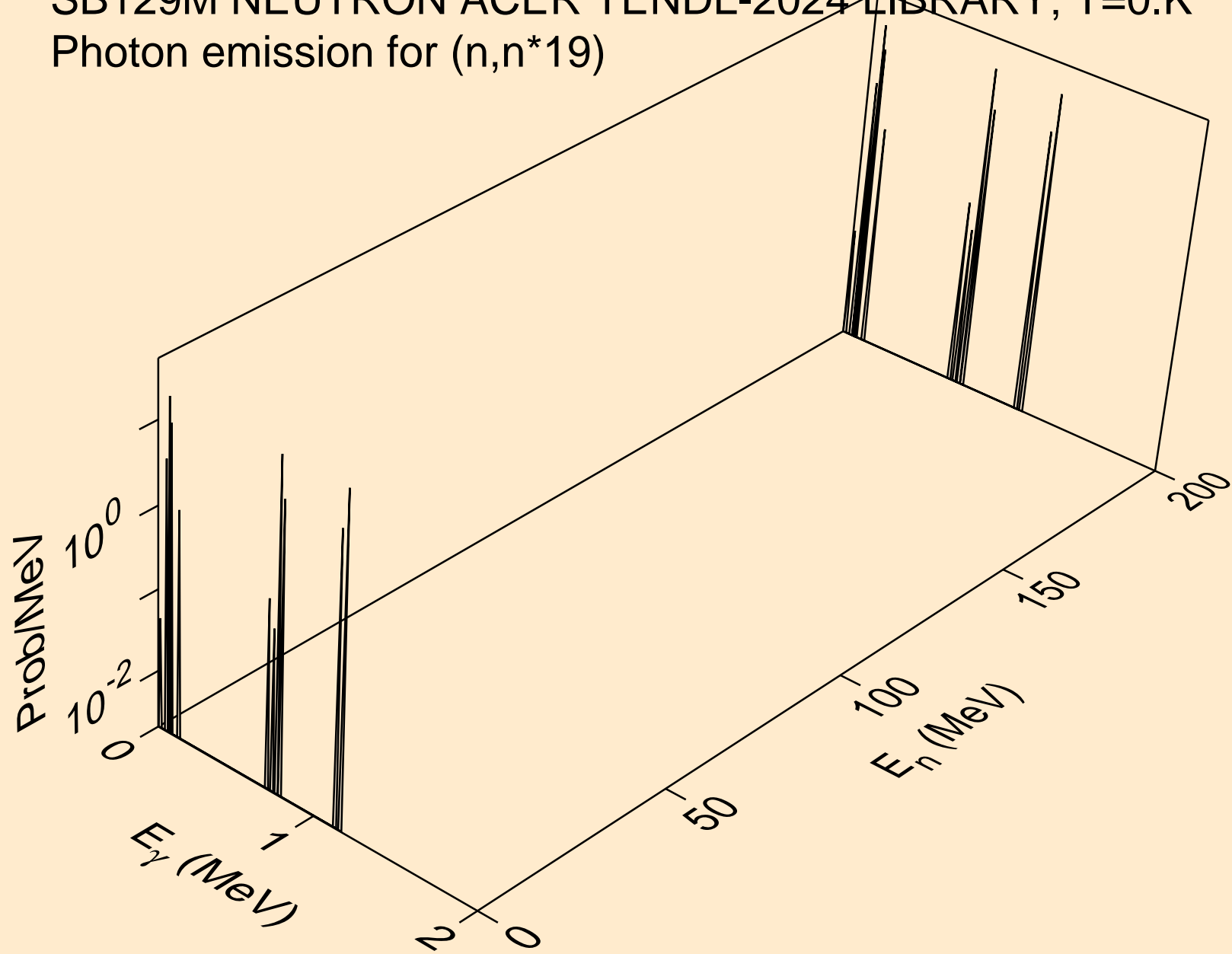

SB129M NEUTRON ACER TENDL-2024 LIBRARY; T=0.K
Photon emission for (n,n*20)

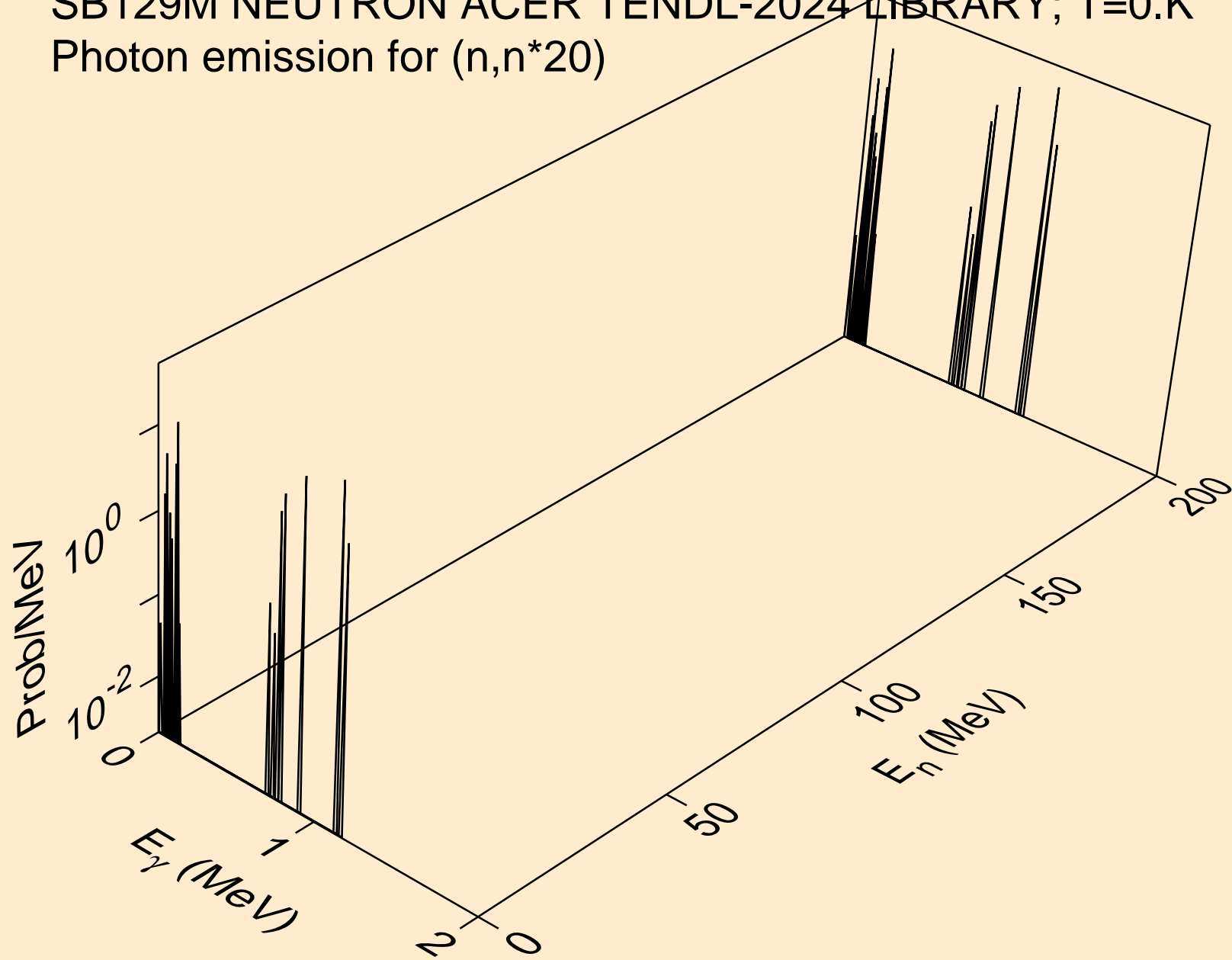

SB129M NEUTRON ACER TENDL-2024 LIBRARY; T=0.K
Photon emission for (n,n*21)

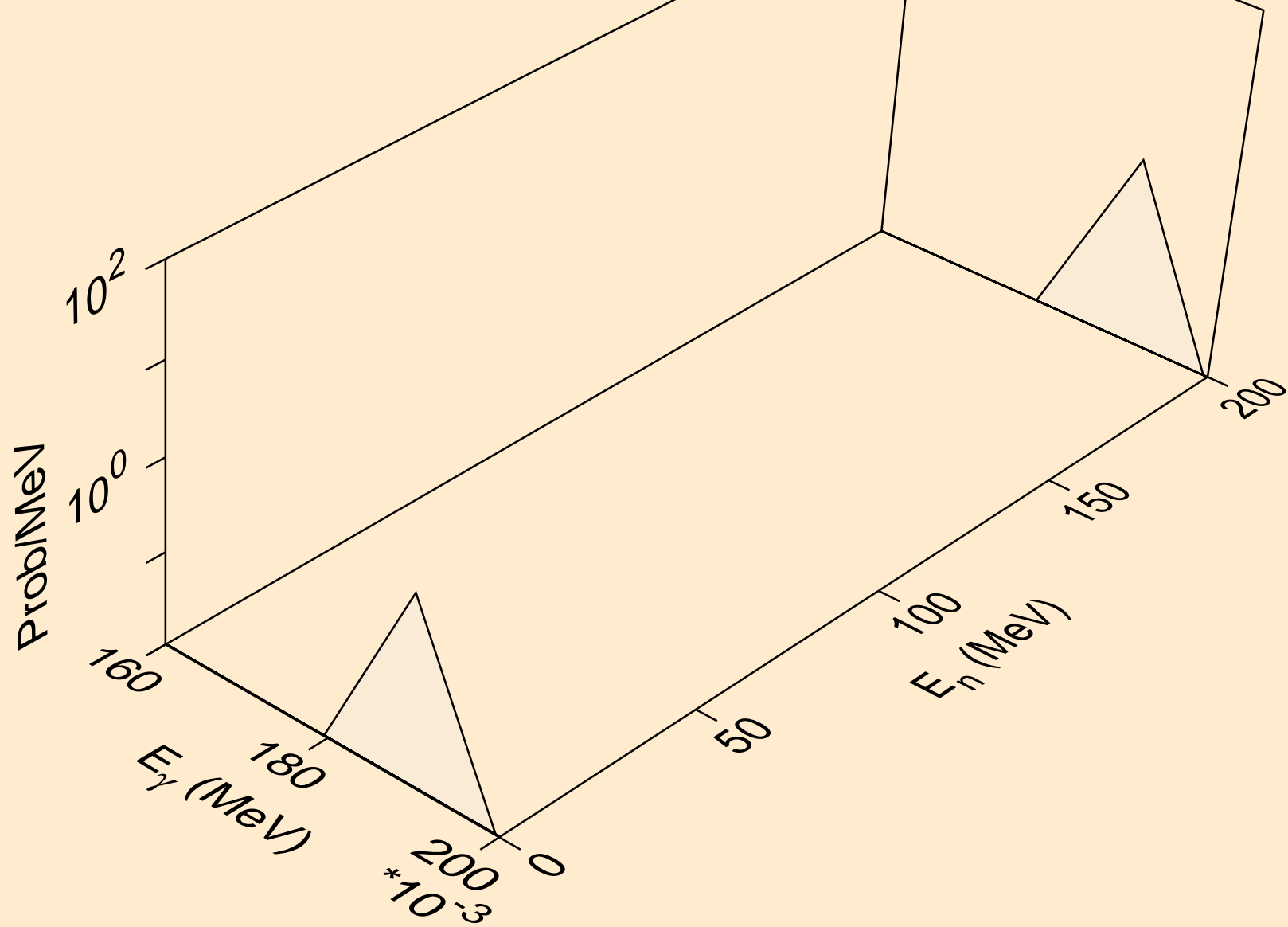

SB129M NEUTRON ACER TENDL-2024 LIBRARY; T=0.K
Photon emission for (n,n*22)

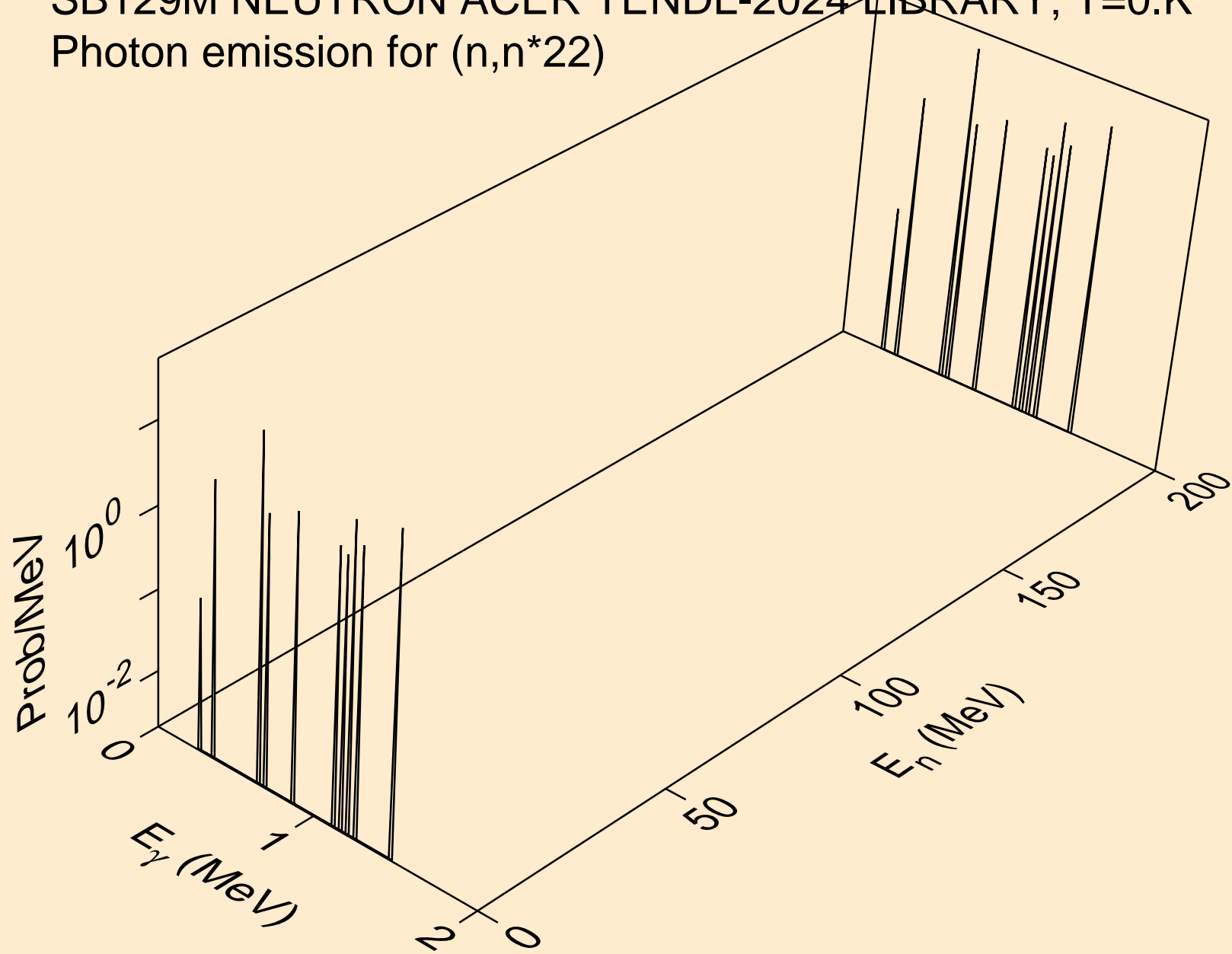

SB129M NEUTRON ACER TENDL-2024 LIBRARY; T=0.K
Photon emission for (n,n*23)

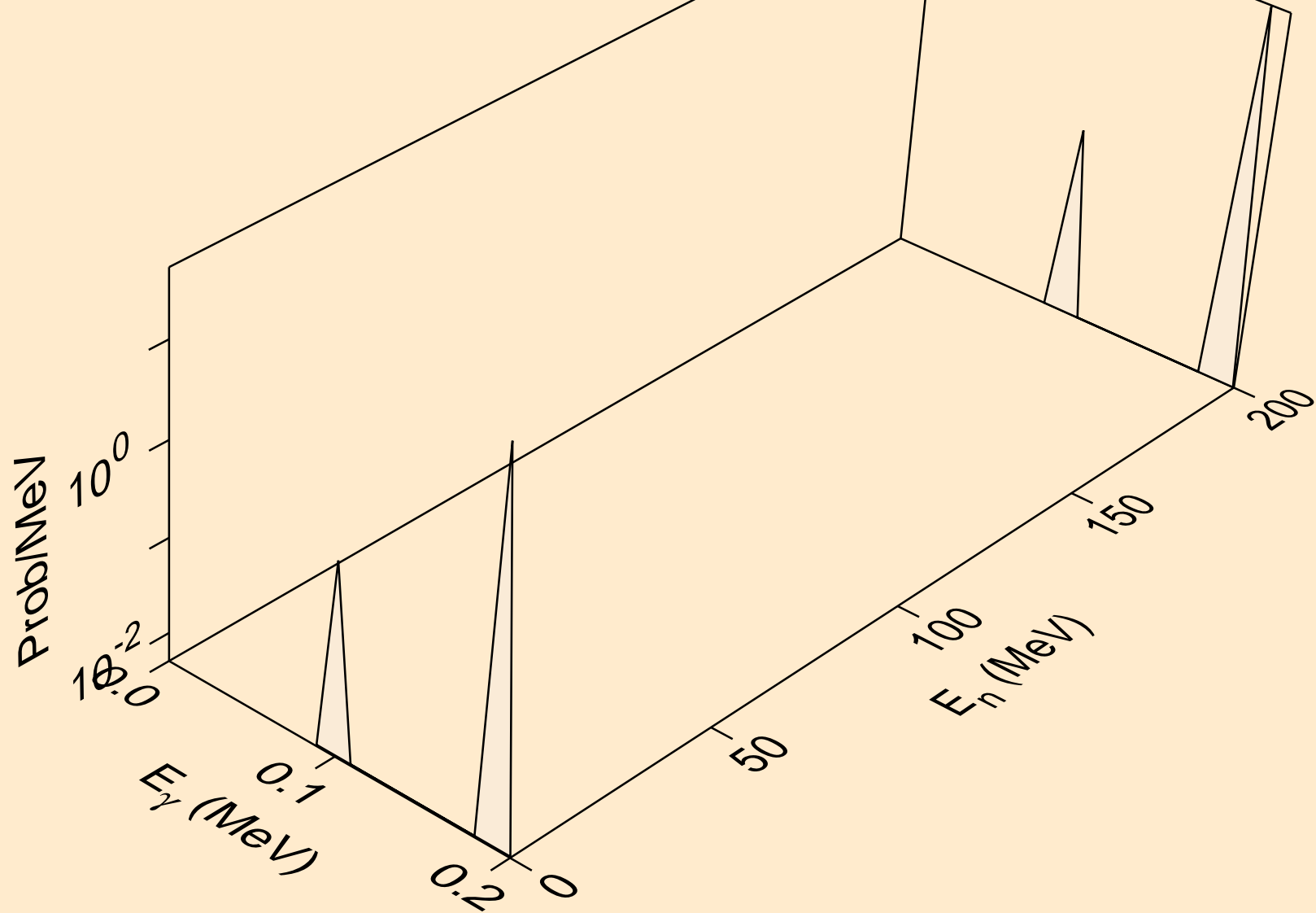

SB129M NEUTRON ACER TENDL-2024 LIBRARY; T=0.K
Photon emission for (n,n*24)

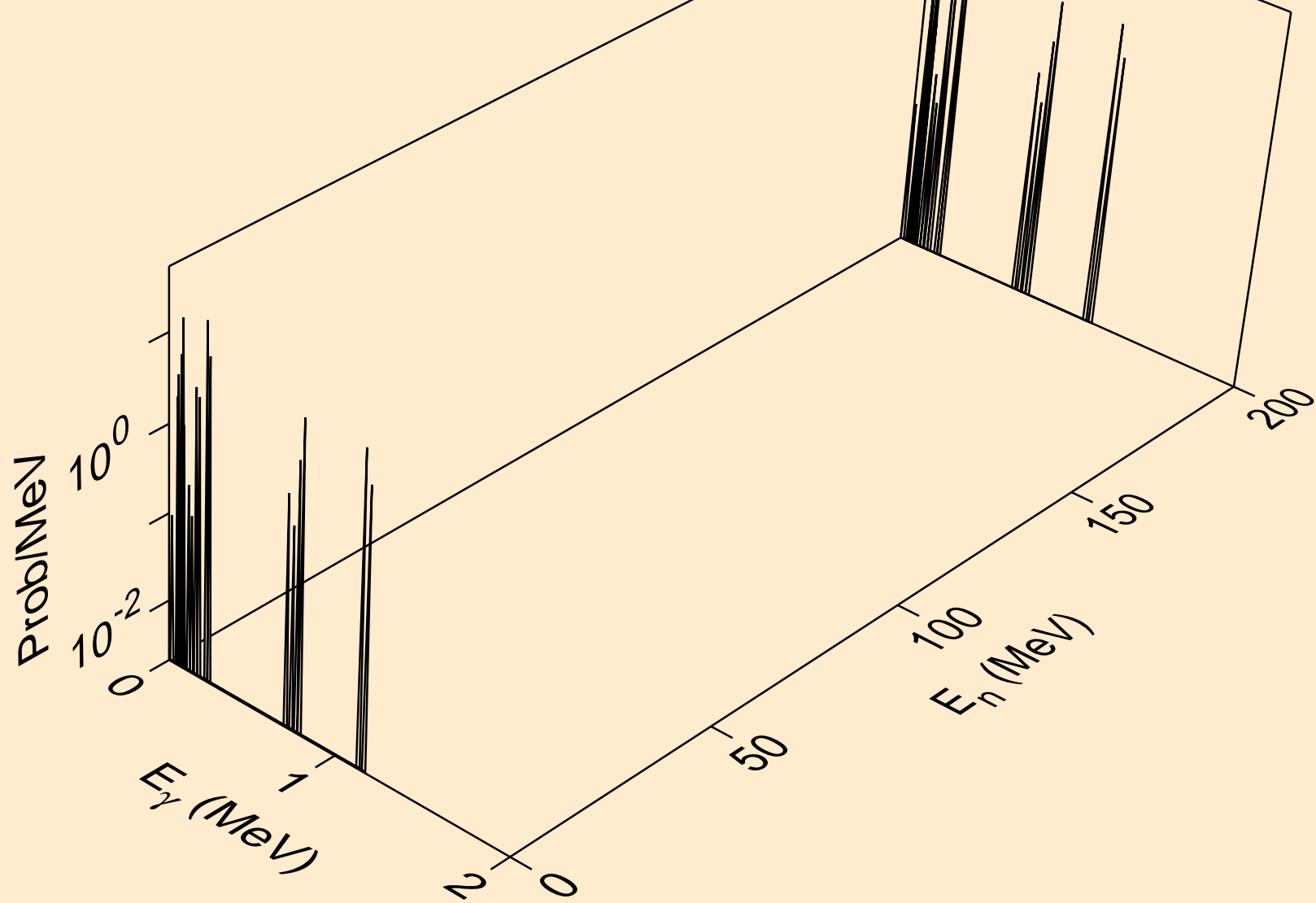

SB129M NEUTRON ACER TENDL-2024 LIBRARY; T=0.K
Photon emission for (n,n*25)

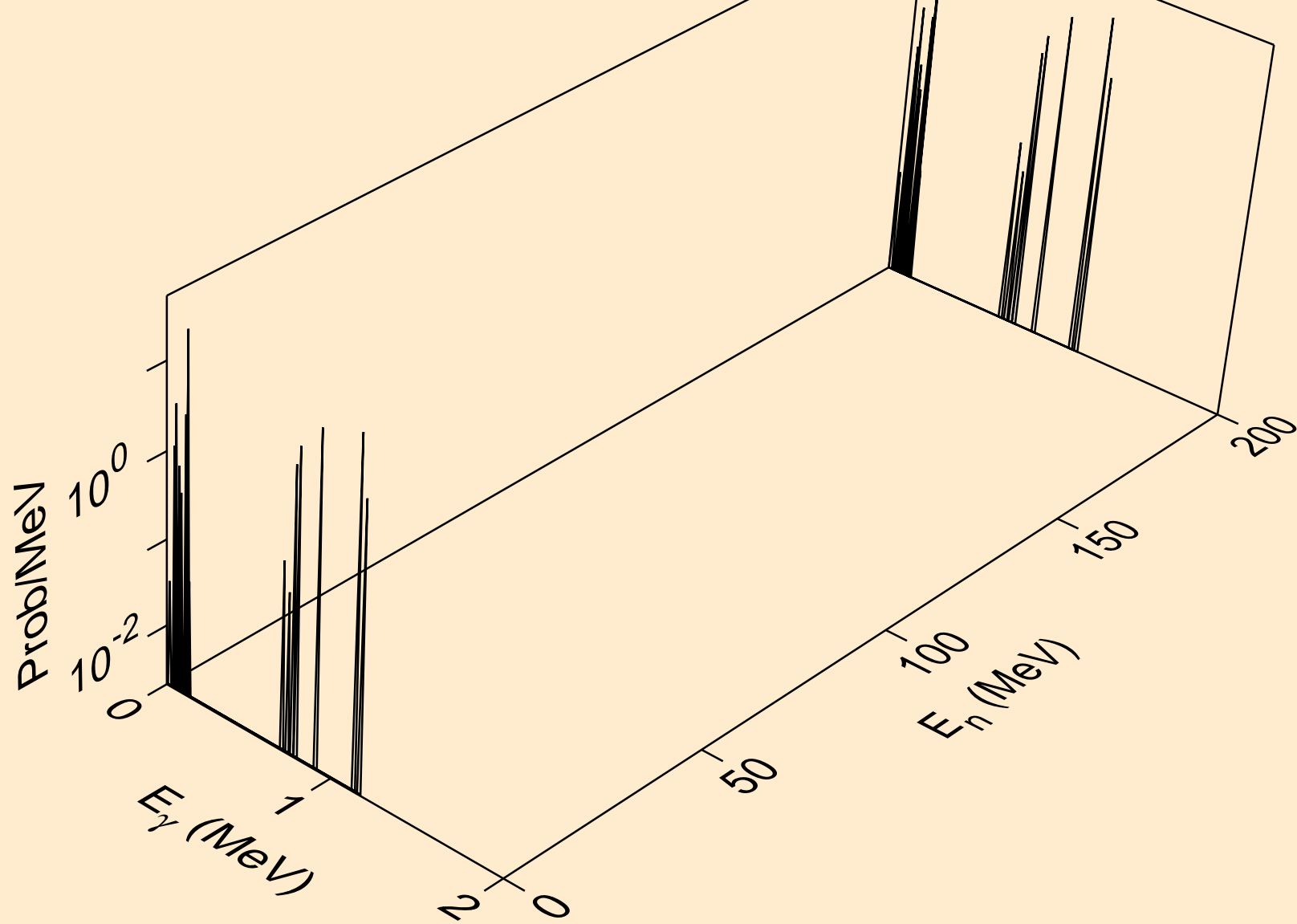

SB129M NEUTRON ACER TENDL-2024 LIBRARY; T=0.K
Photon emission for (n,n*26)

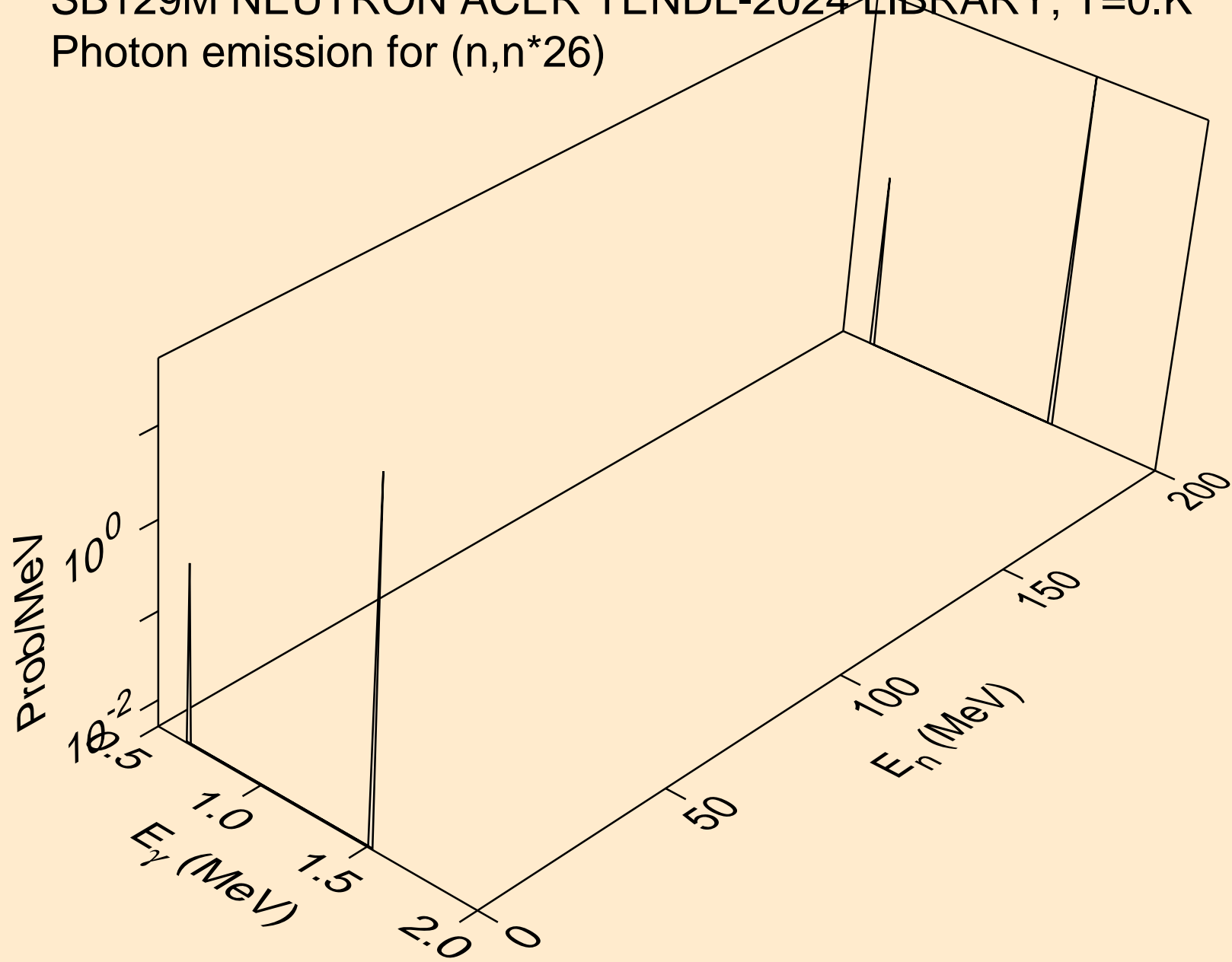

SB129M NEUTRON ACER TENDL-2024 LIBRARY; T=0.K
Photon emission for (n,n*27)

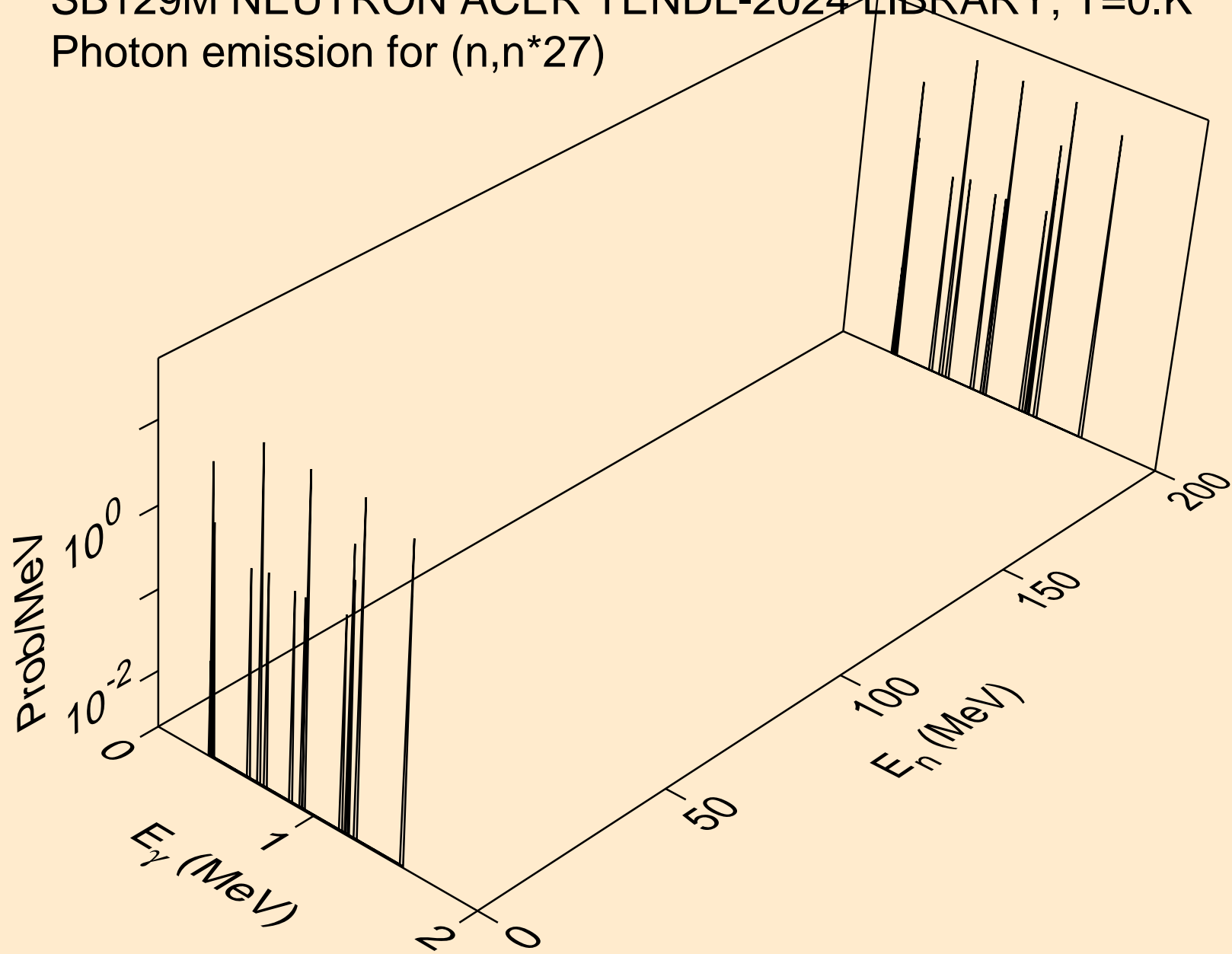

SB129M NEUTRON ACER TENDL-2024 LIBRARY; T=0.K
Photon emission for (n,n*28)

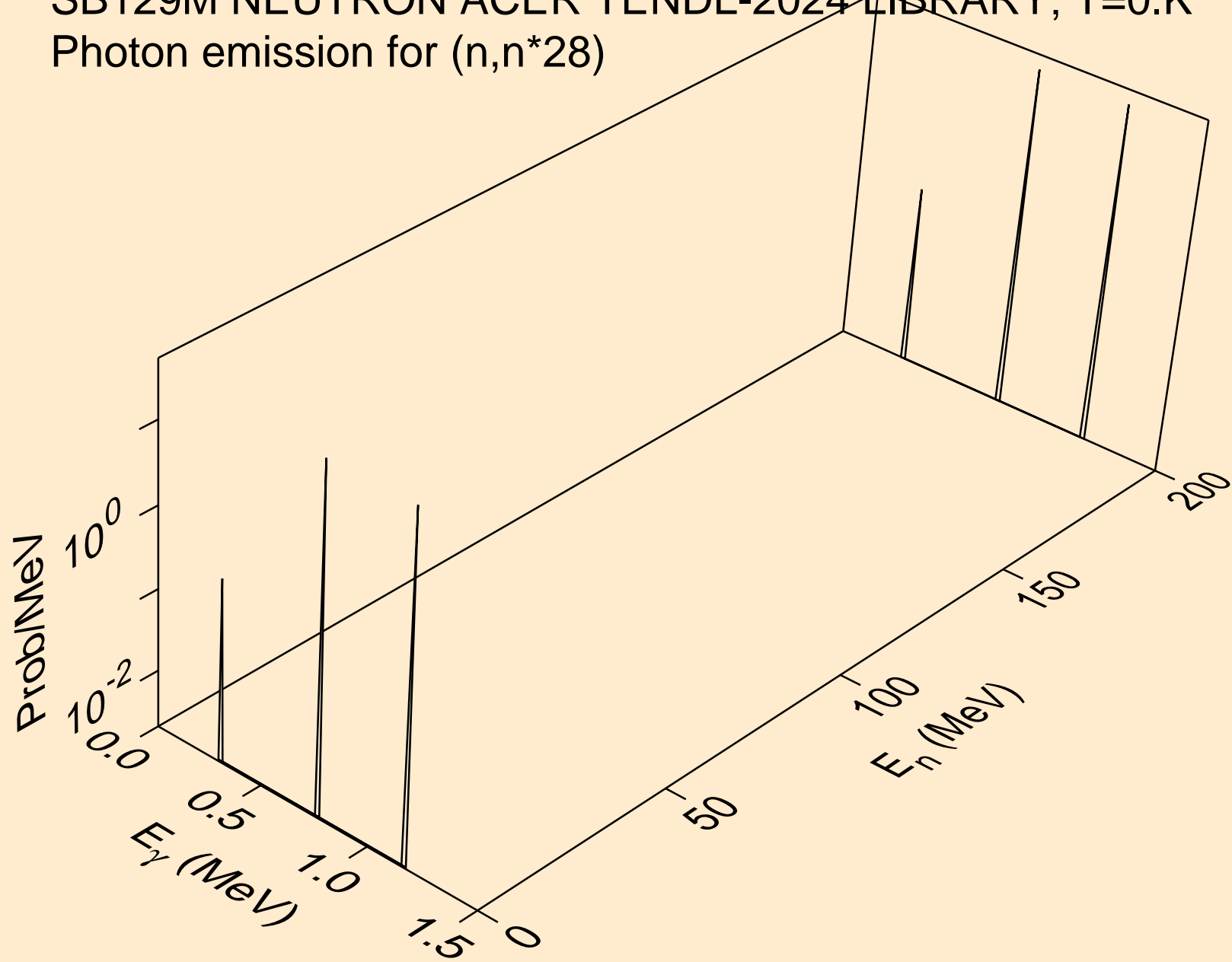

SB129M NEUTRON ACER TENDL-2024 LIBRARY; T=0.K
Photon emission for (n,n*29)

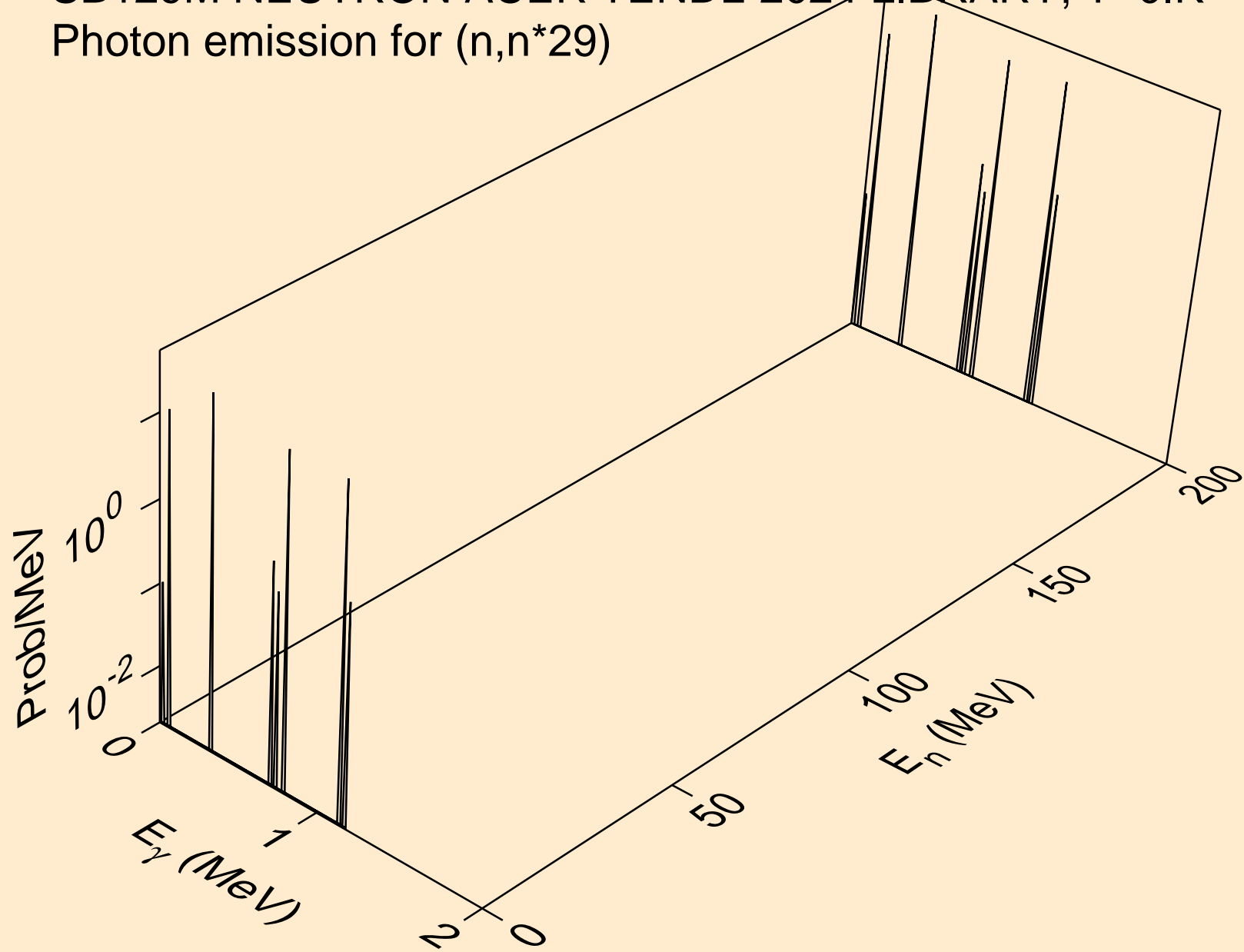

SB129M NEUTRON ACER TENDL-2024 LIBRARY; T=0.K
Photon emission for (n,n*30)

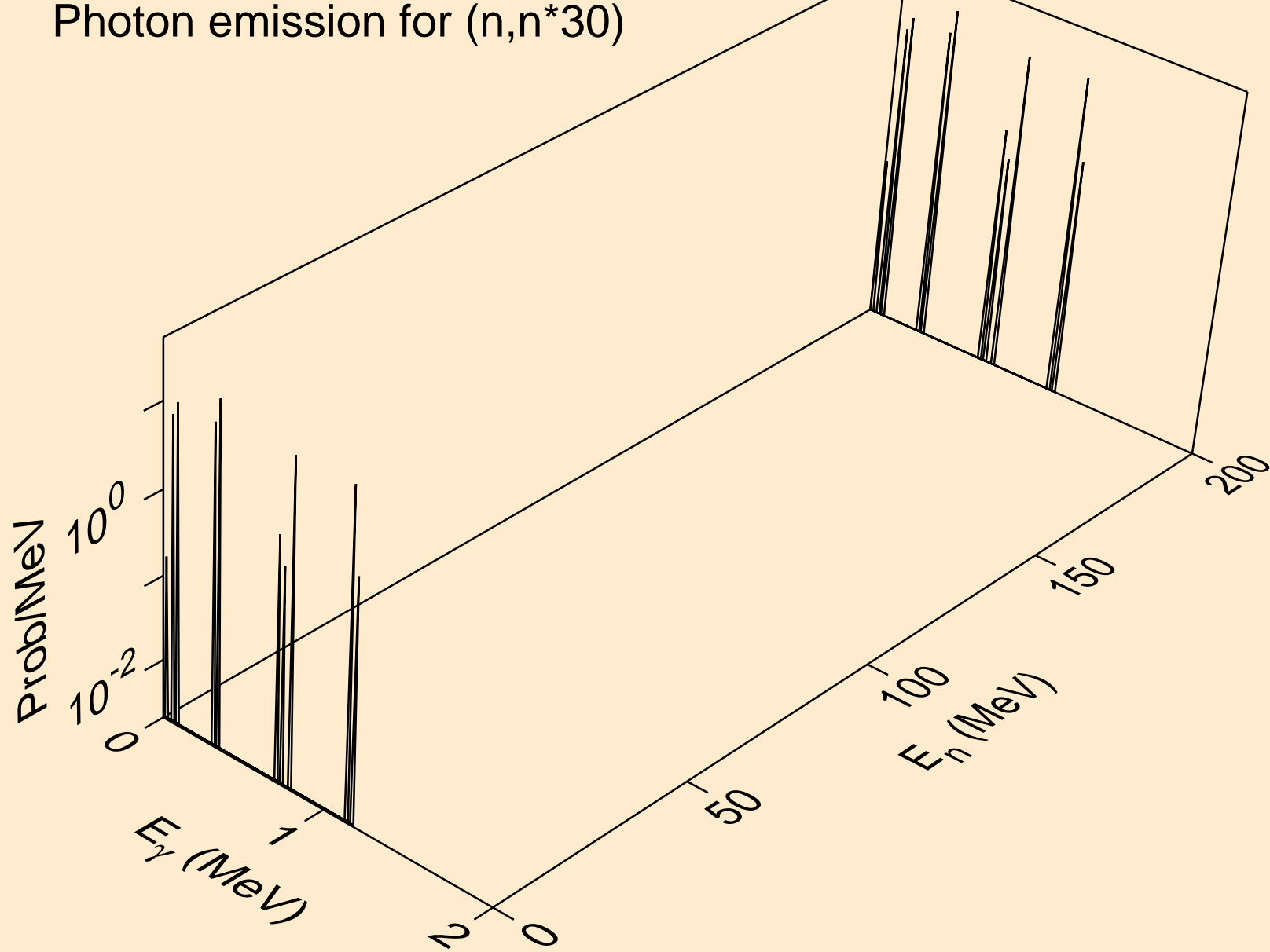

SB129M NEUTRON ACER TENDL-2024 LIBRARY; T=0.K
Photon emission for (n,n*c)

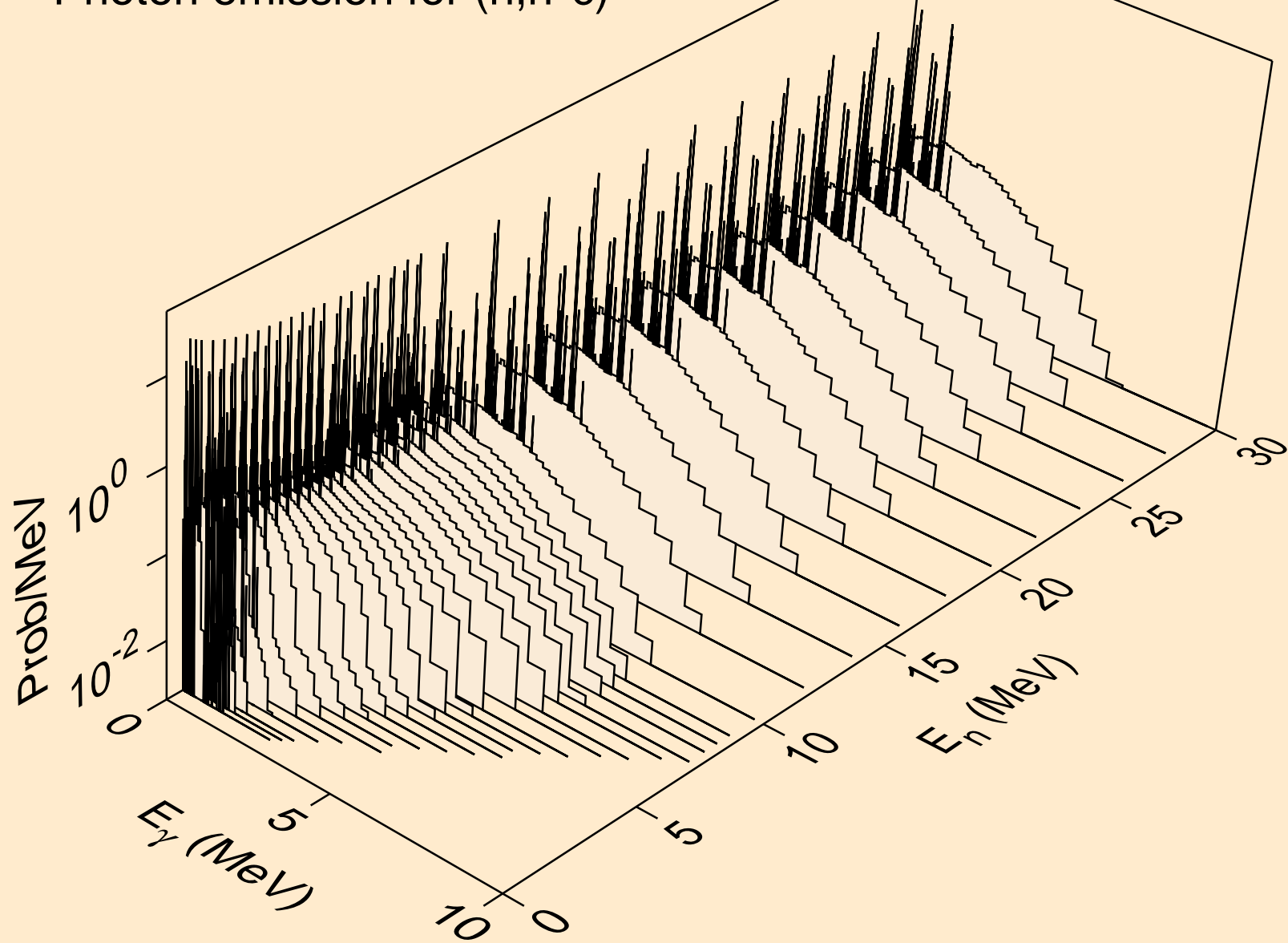

SB129M NEUTRON ACER TENDL-2024 LIBRARY; T=0.K
Photon emission for (n,gma)

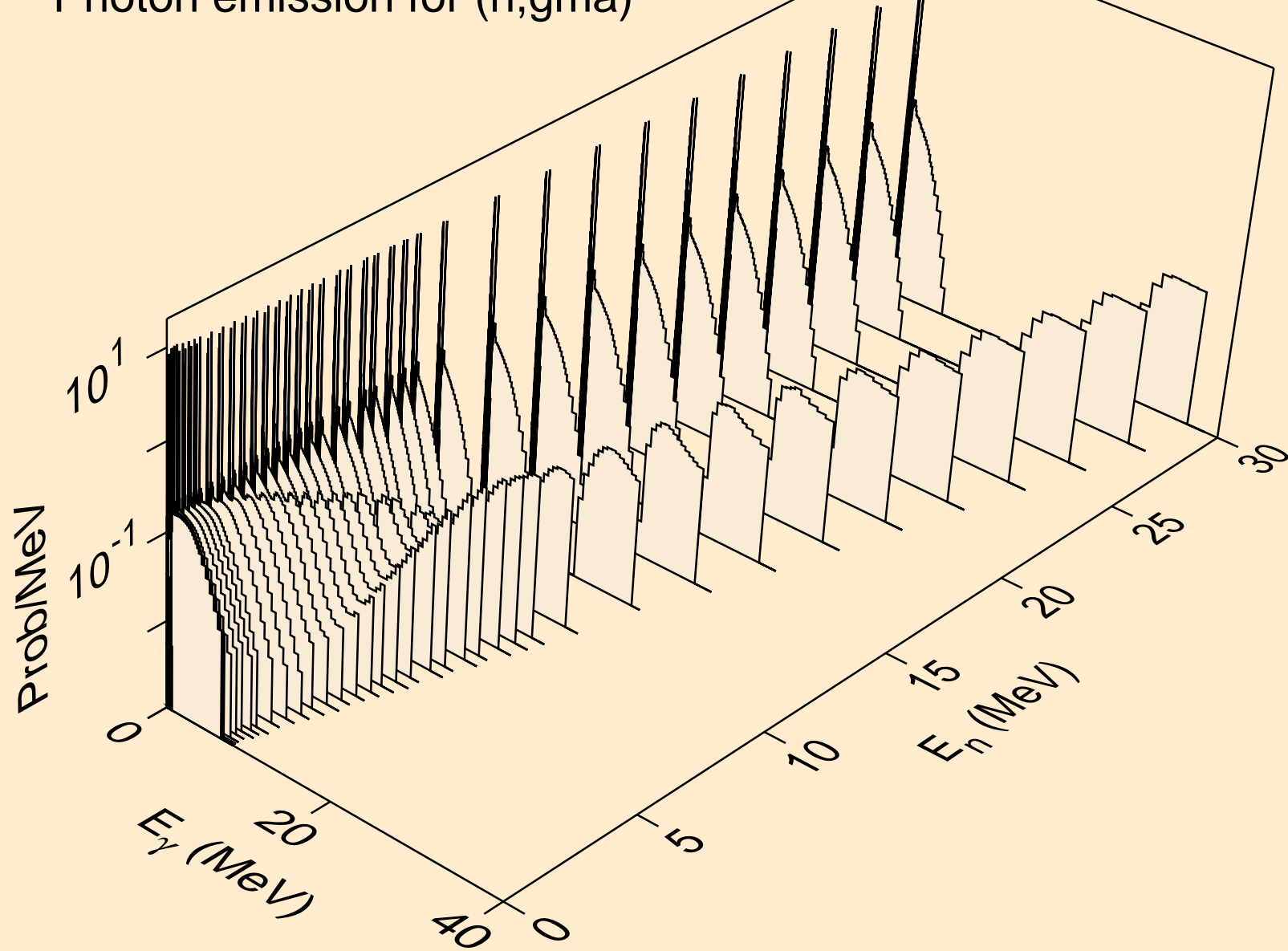

SB129M NEUTRON ACER TENDL-2024 LIBRARY; T=0.K
Photon emission for (n,p)

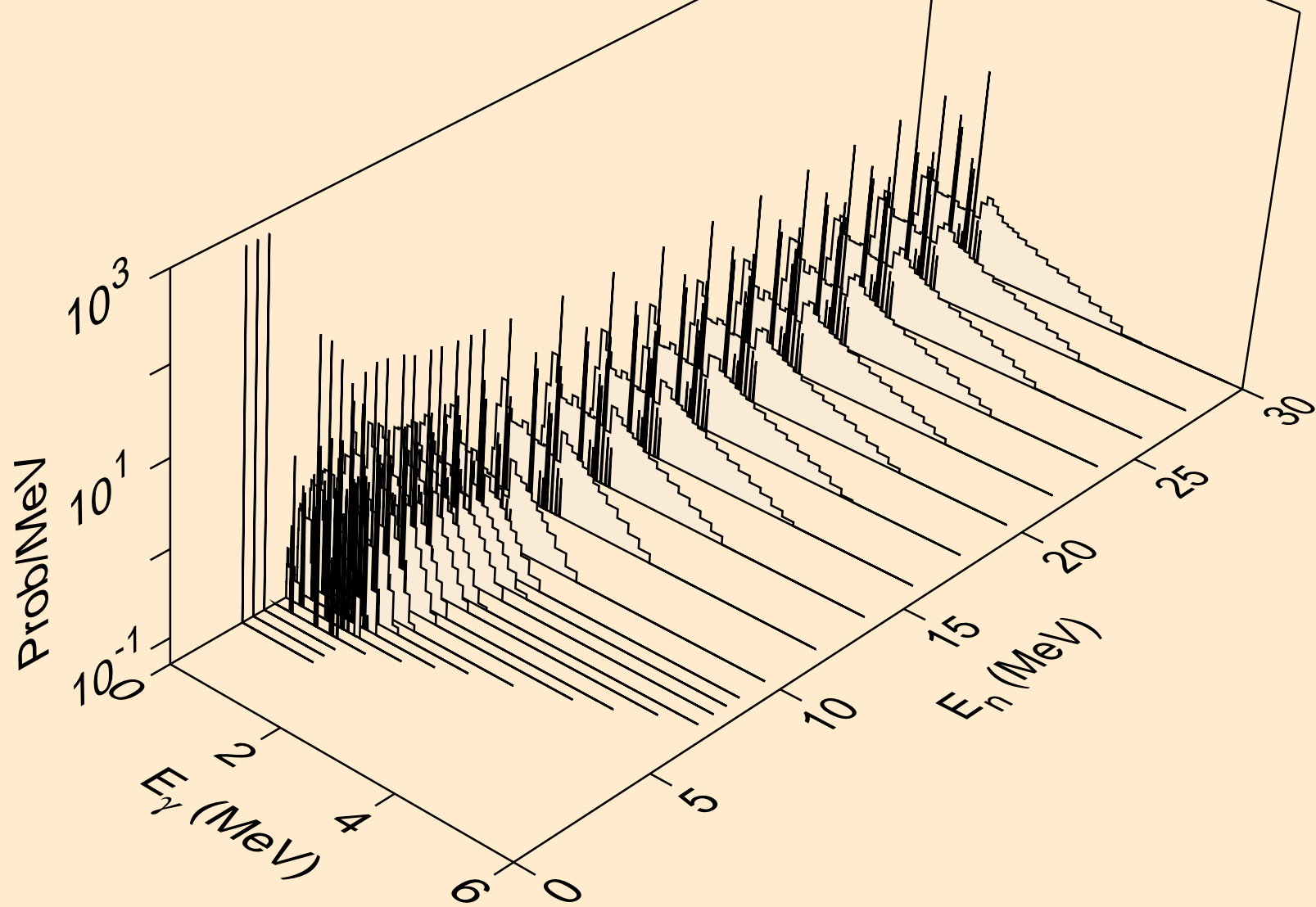

SB129M NEUTRON ACER TENDL-2024 LIBRARY; T=0.K
Photon emission for (n,d)

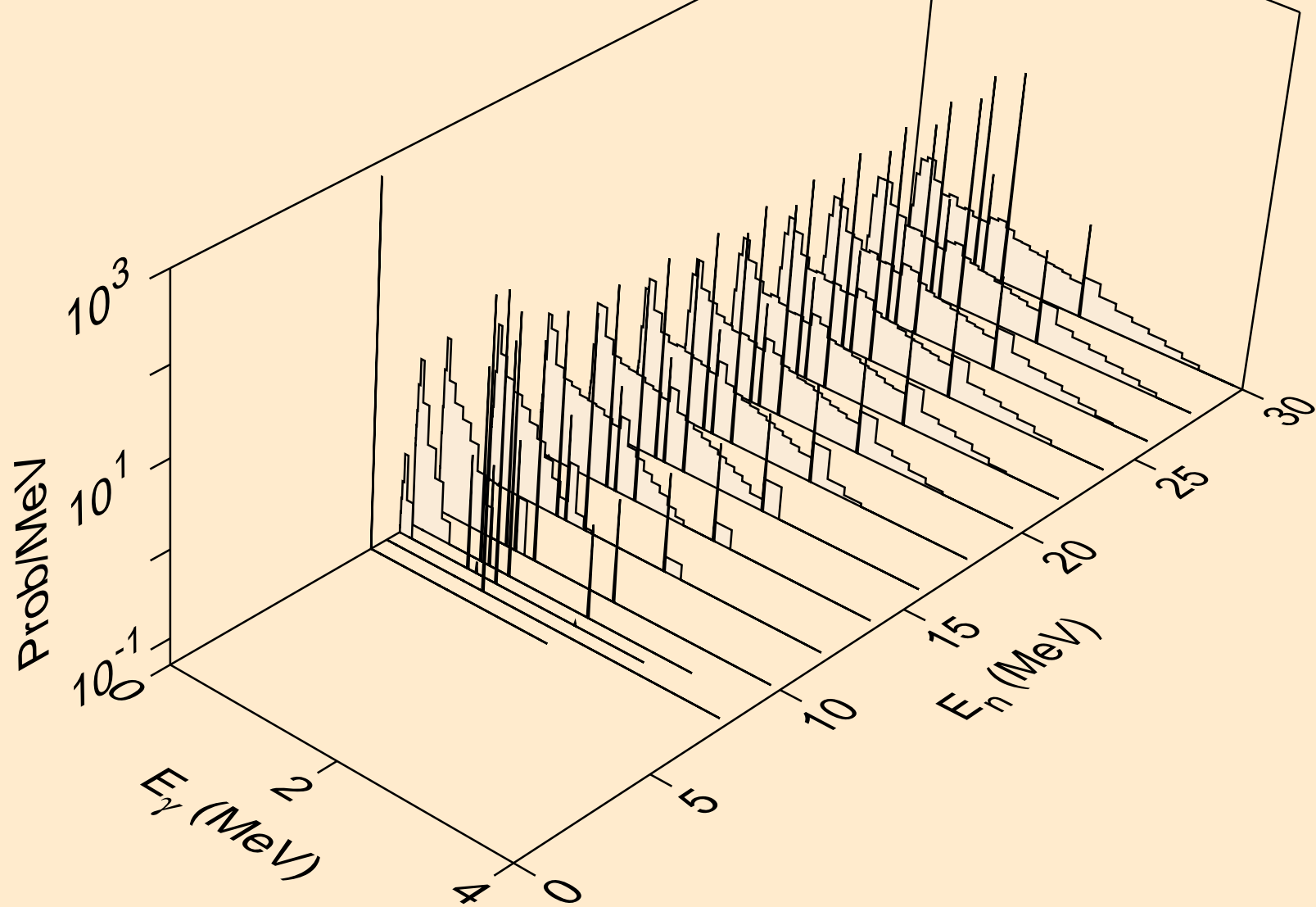

SB129M NEUTRON ACER TENDL-2024 LIBRARY; T=0.K
Photon emission for (n,t)

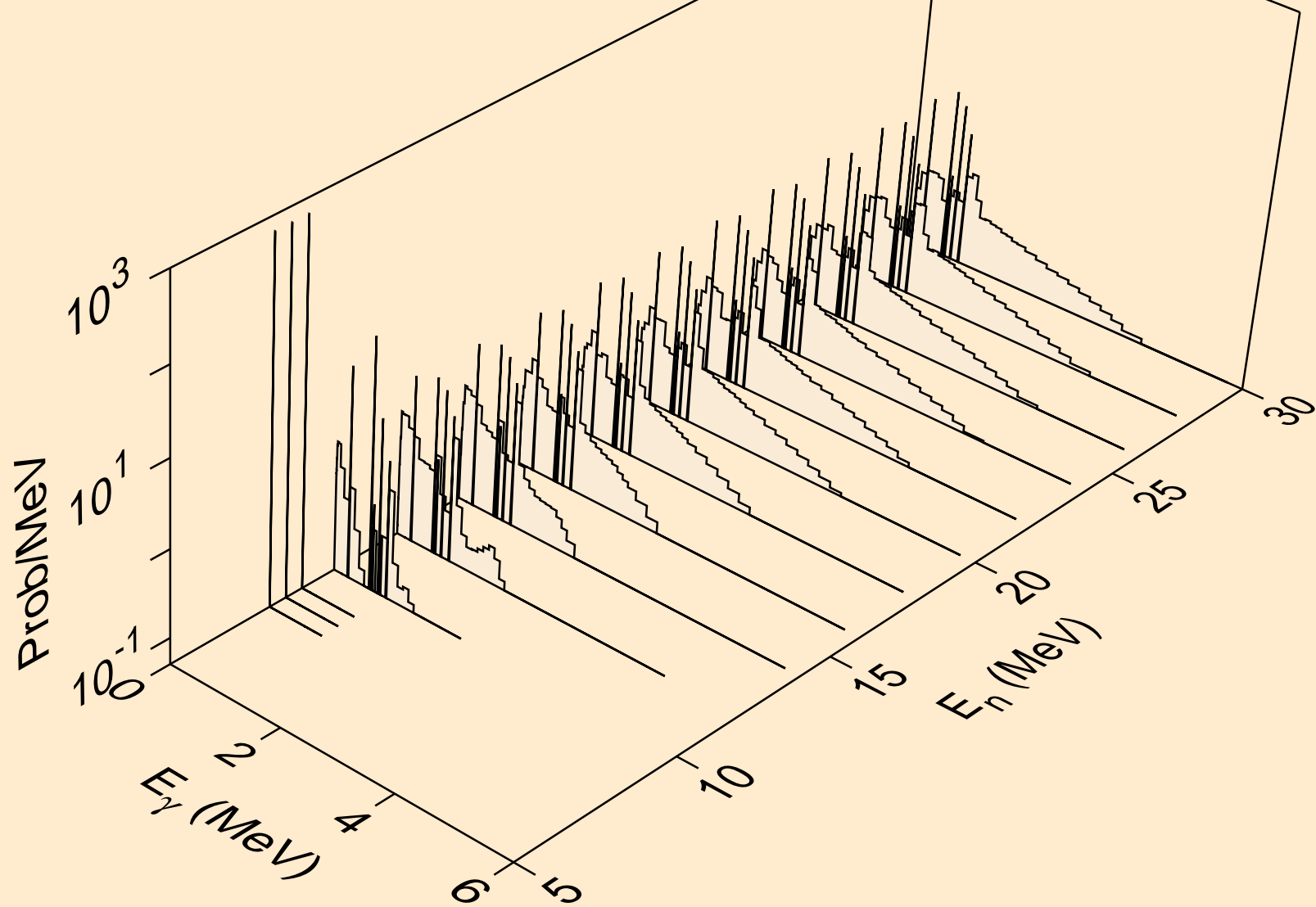

SB129M NEUTRON ACER TENDL-2024 LIBRARY; T=0.K
Photon emission for (n,he3)

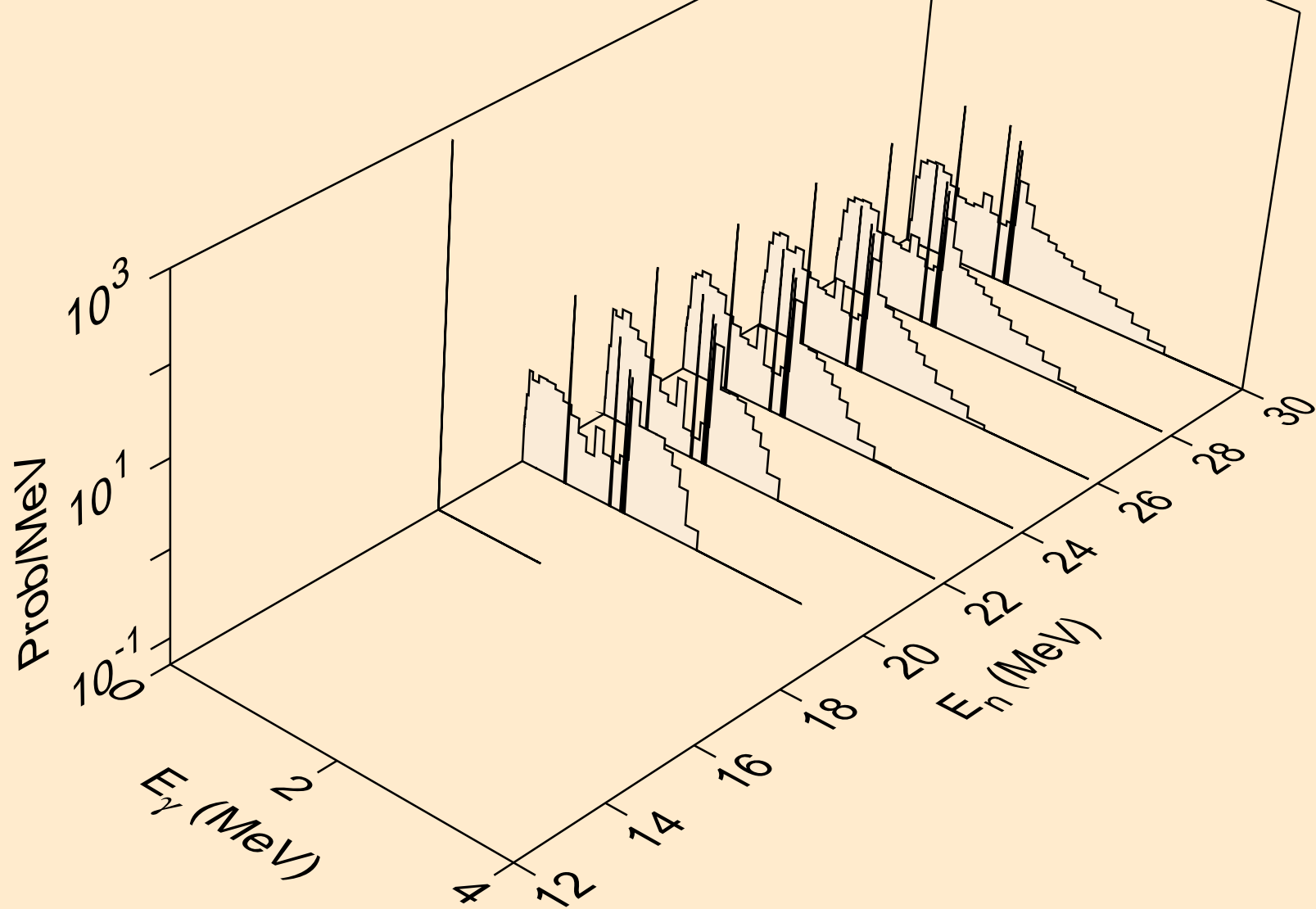

SB129M NEUTRON ACER TENDL-2024 LIBRARY; T=0.K
Photon emission for (n,a)

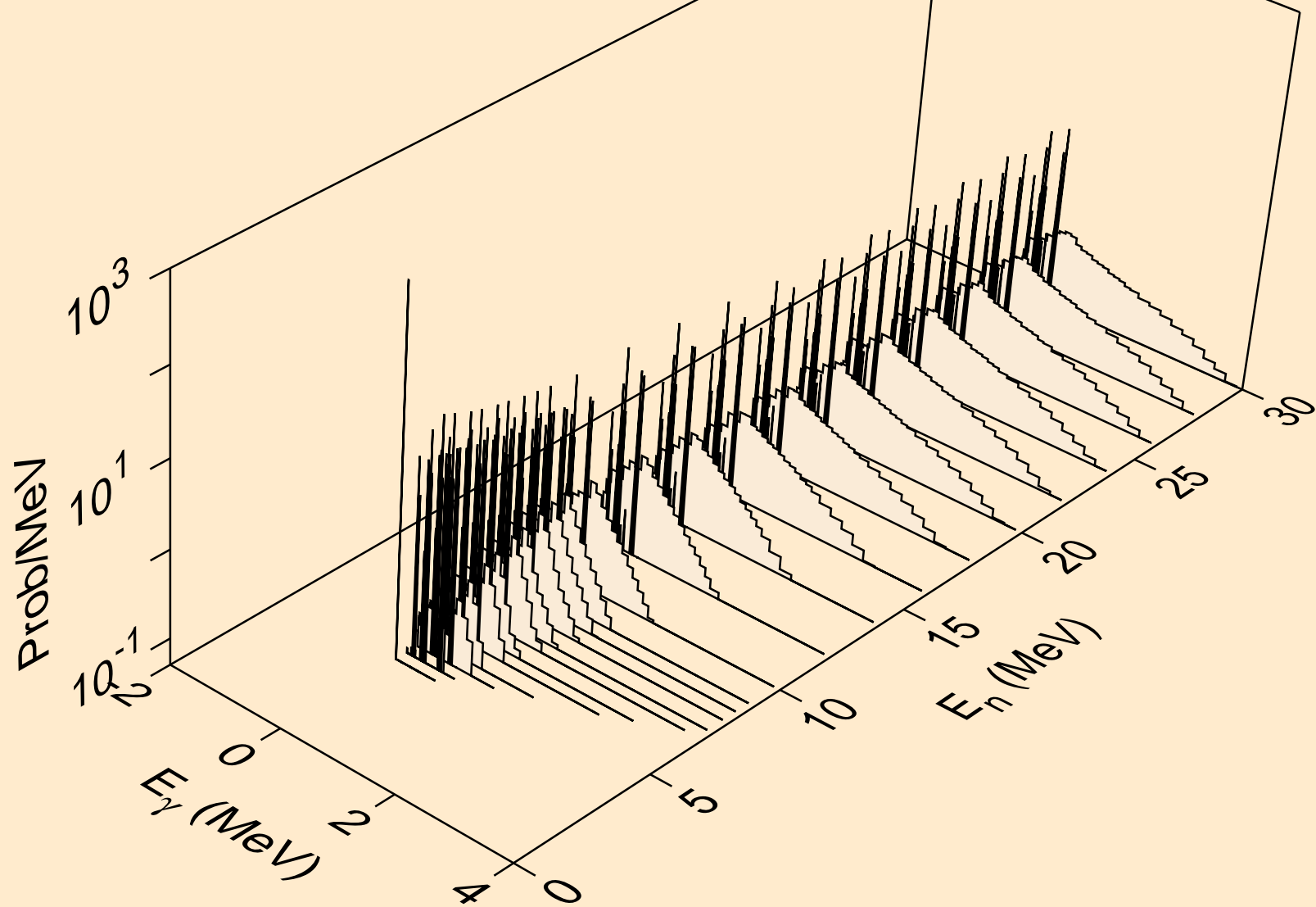

SB129M NEUTRON ACER TENDL-2024 LIBRARY; T=0.K
Photon emission for (n,2p)

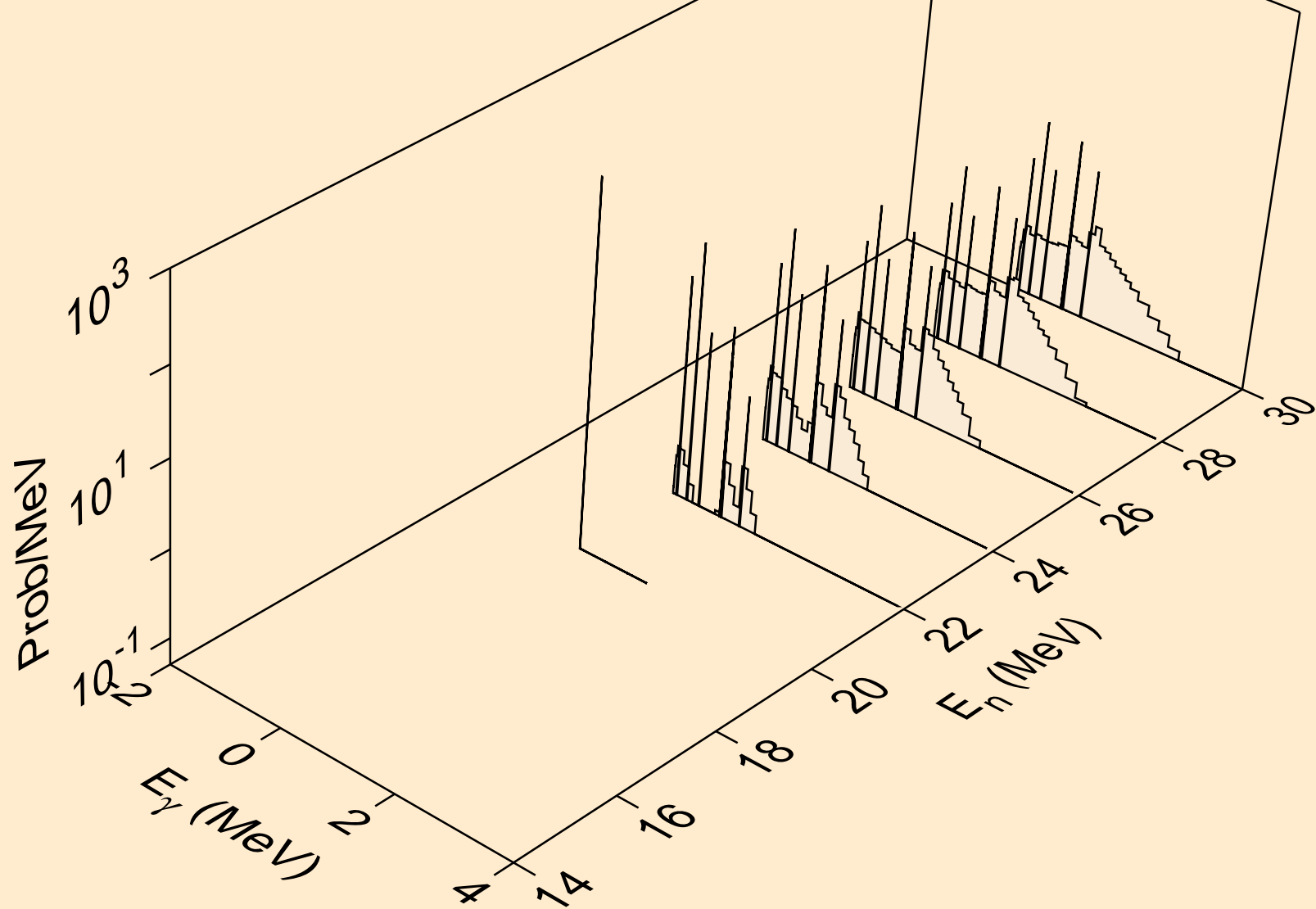

SB129M NEUTRON ACER TENDL-2024 LIBRARY; T=0.K
thermal capture photon spectrum

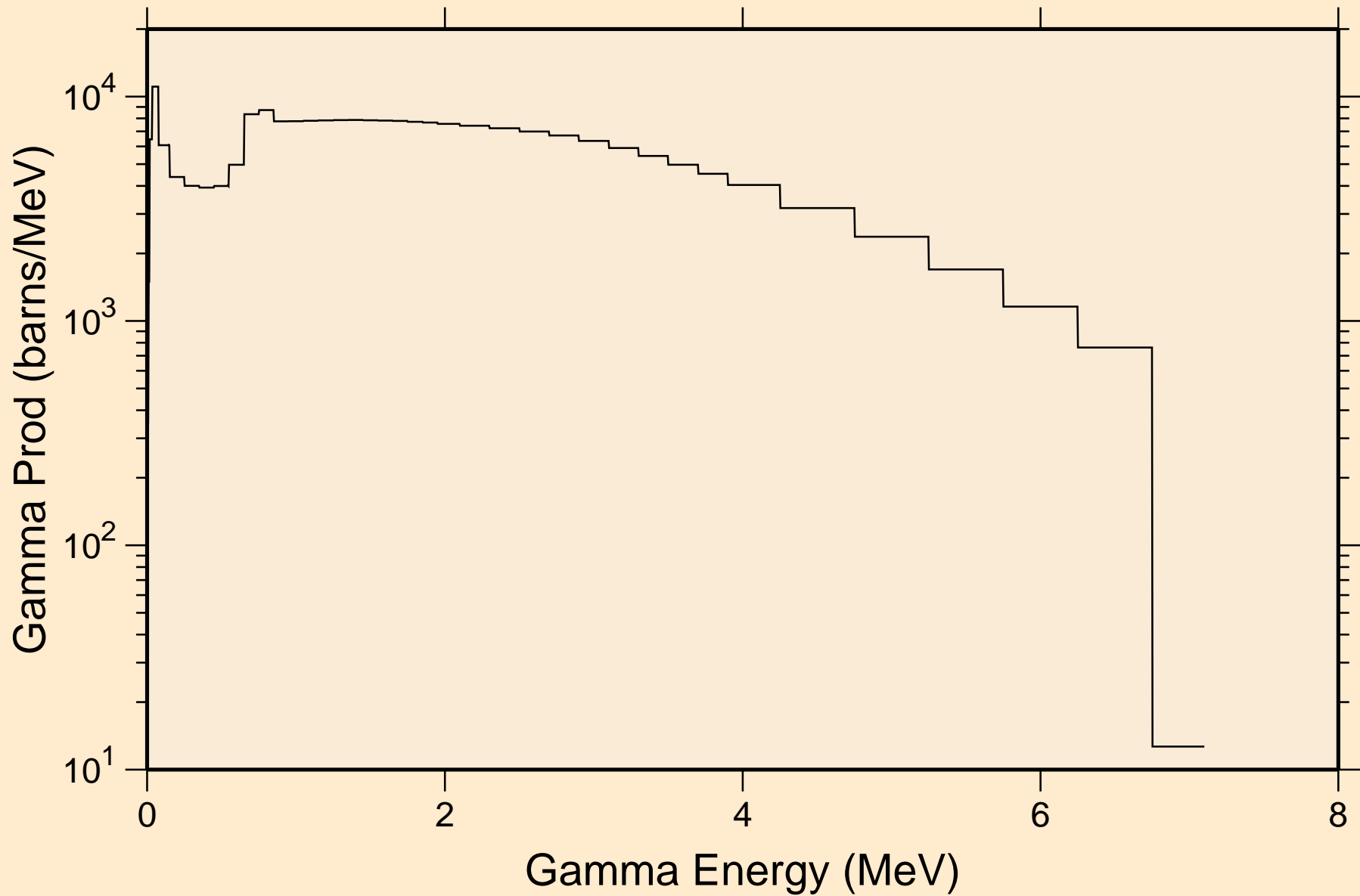

SB129M NEUTRON ACER TENDL-2024 LIBRARY; T=0.K
14 MeV photon spectrum

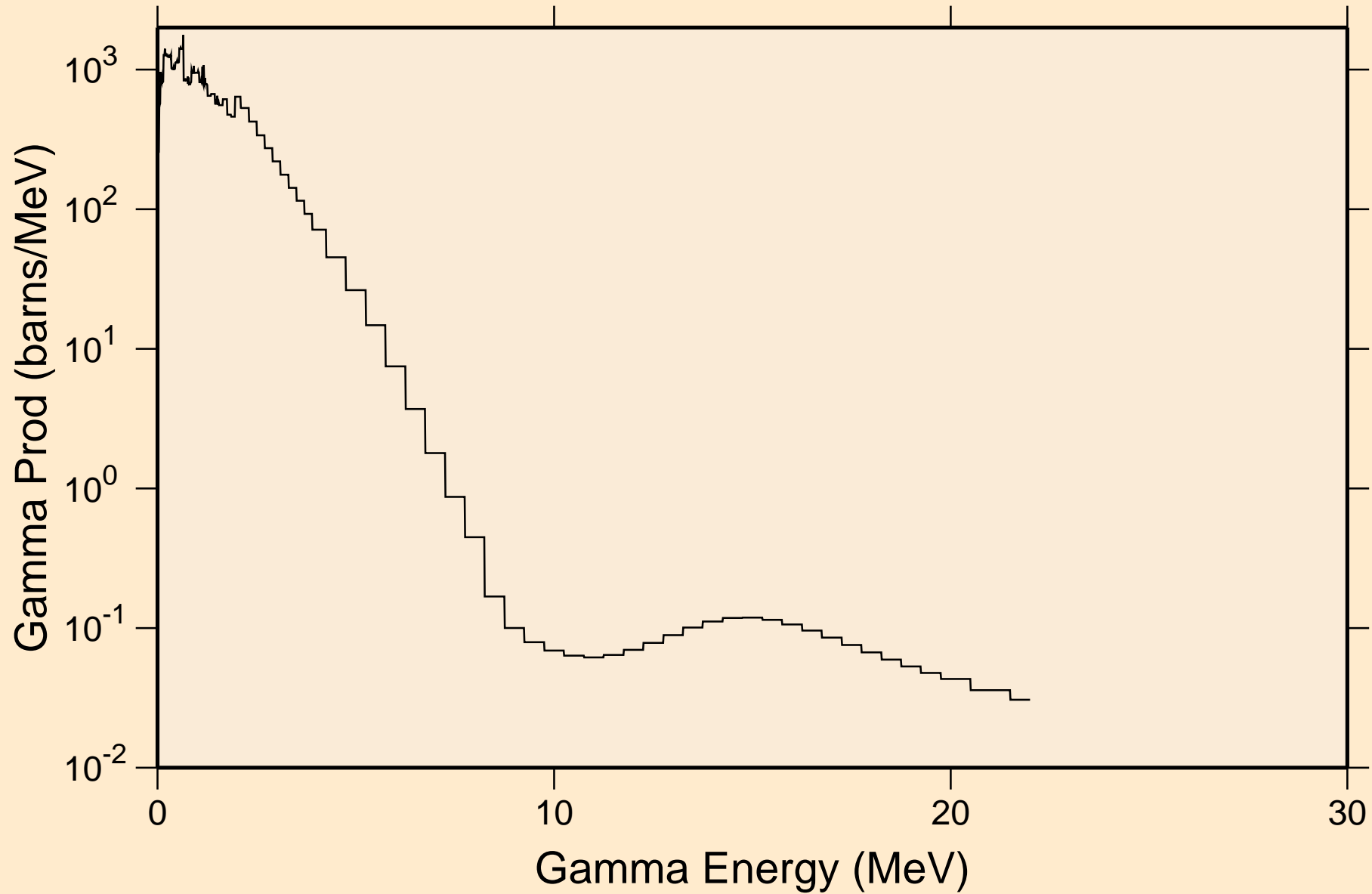

SB129M NEUTRON ACER TENDL-2024 LIBRARY; T=0.K
Particle heating contributions

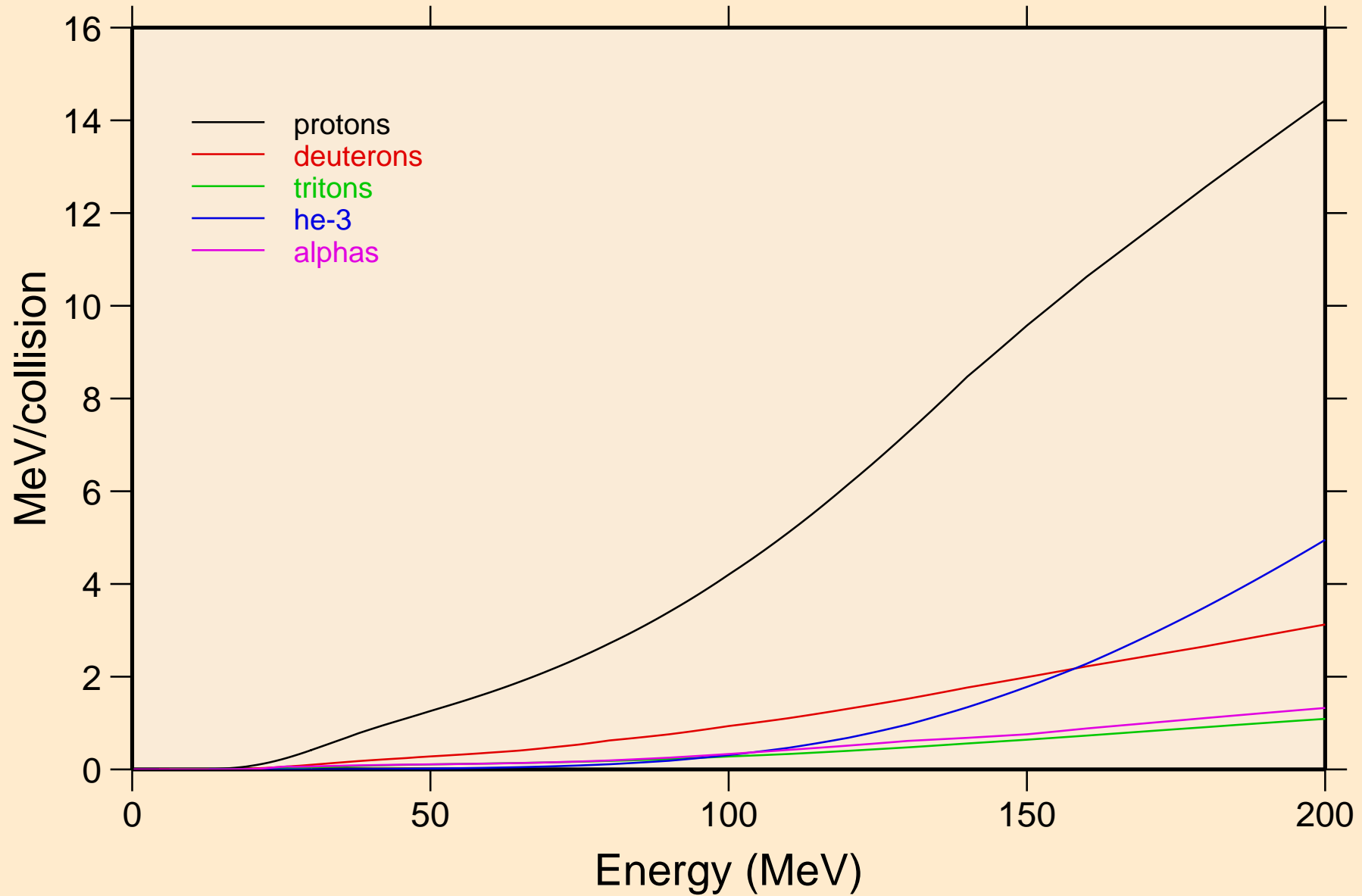

SB129M NEUTRON ACER TENDL-2024 LIBRARY; T=0.K
Recoil Heating

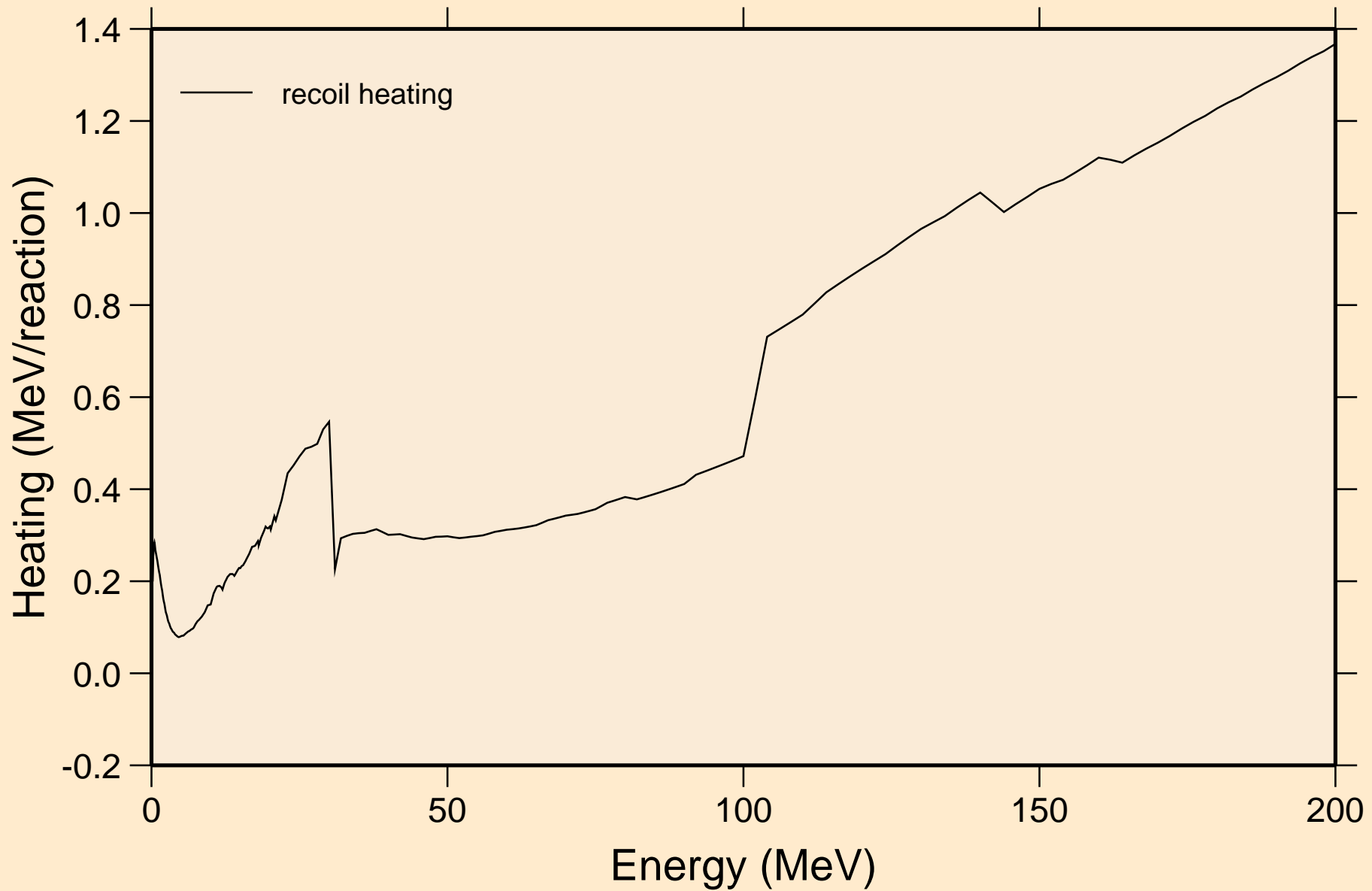

SB129M NEUTRON ACER TENDL-2024 LIBRARY; T=0.K

Particle production cross sections

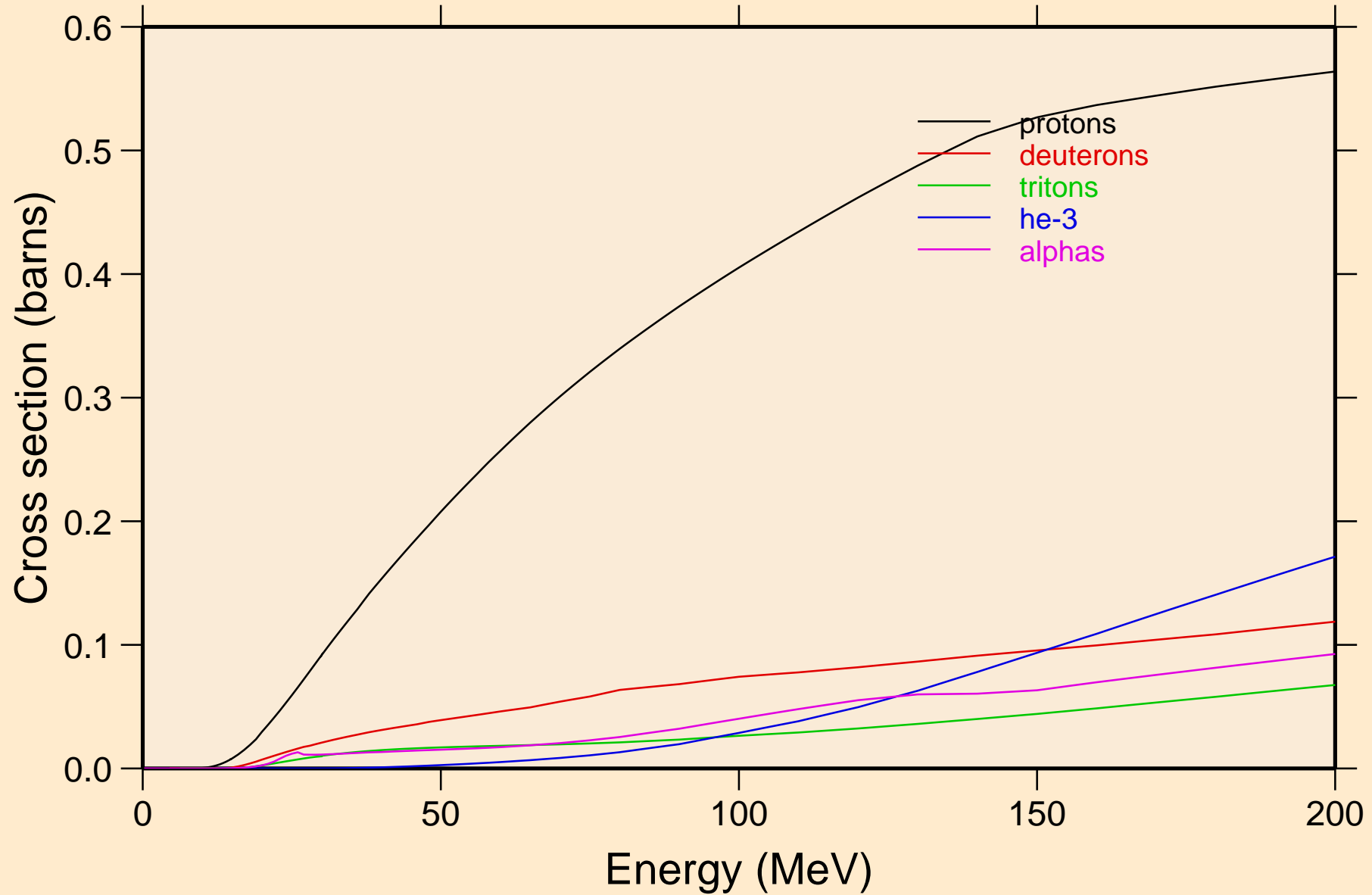

SB129M NEUTRON ACER TENDL-2024 LIBRARY; T=0.K
protons from (n,x)

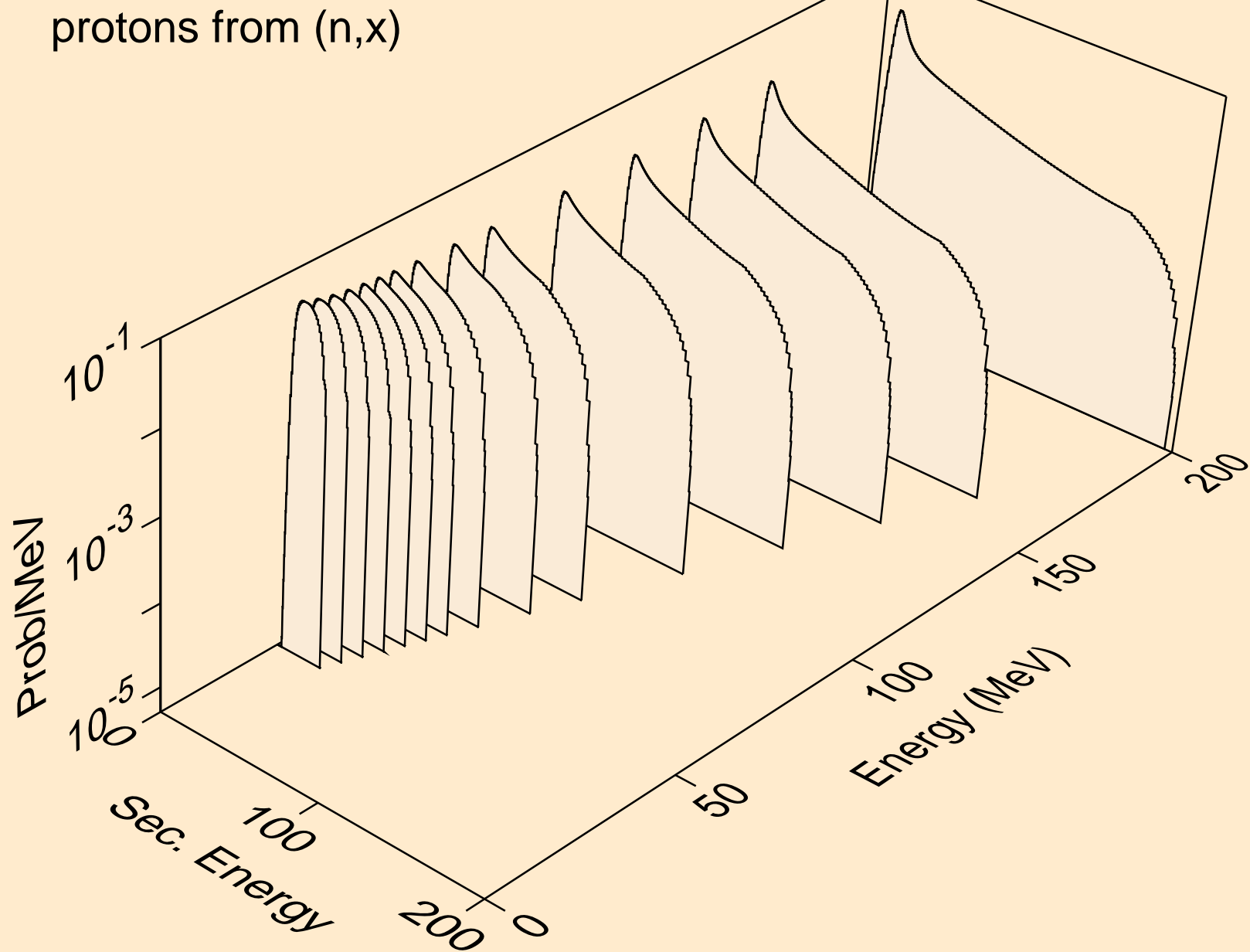

SB129M NEUTRON ACER TENDL-2024 LIBRARY; T=0.K
protons from (n,n*)p

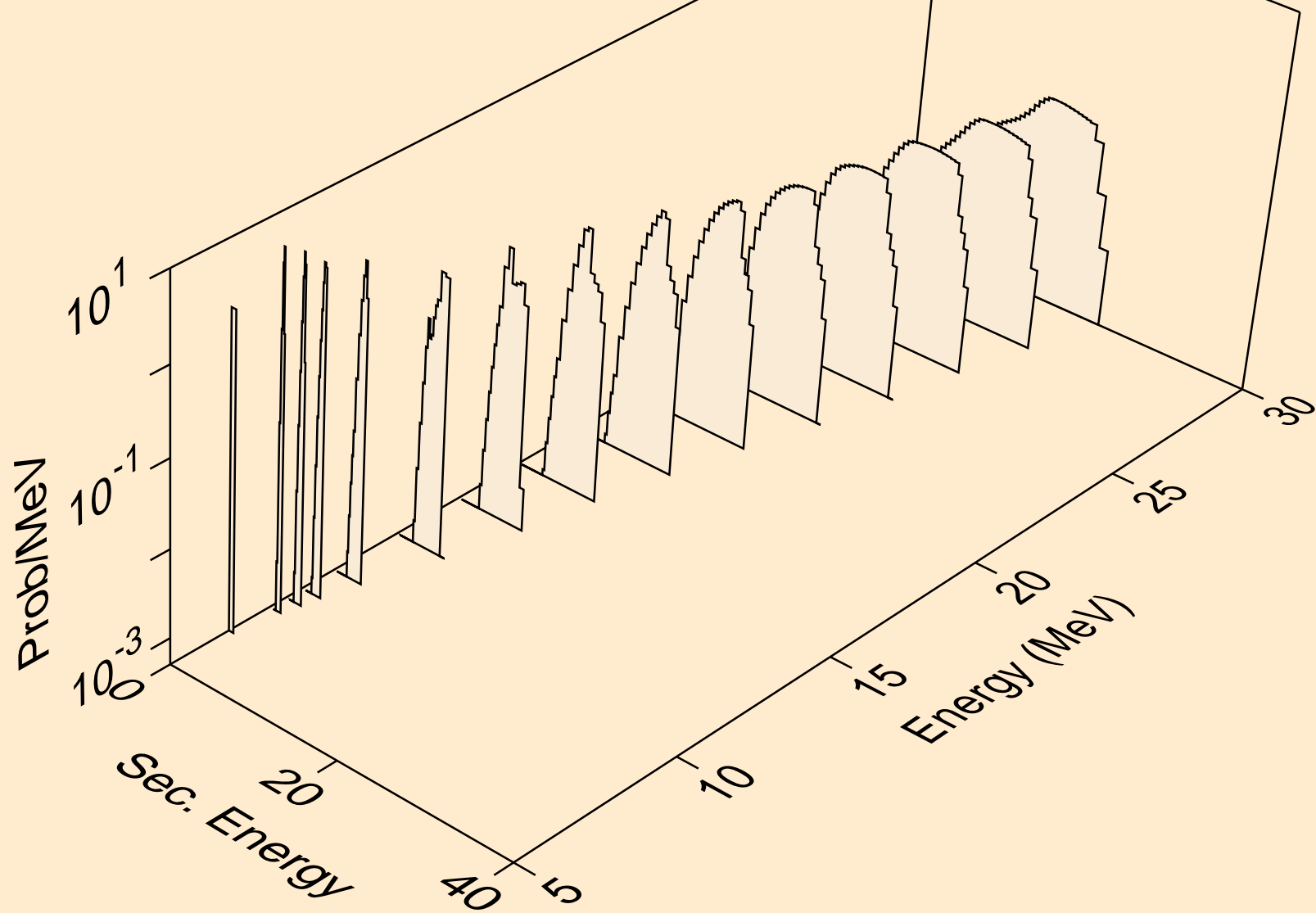

SB129M NEUTRON ACER TENDL-2024 LIBRARY; T=0.K
protons from (n,2np)

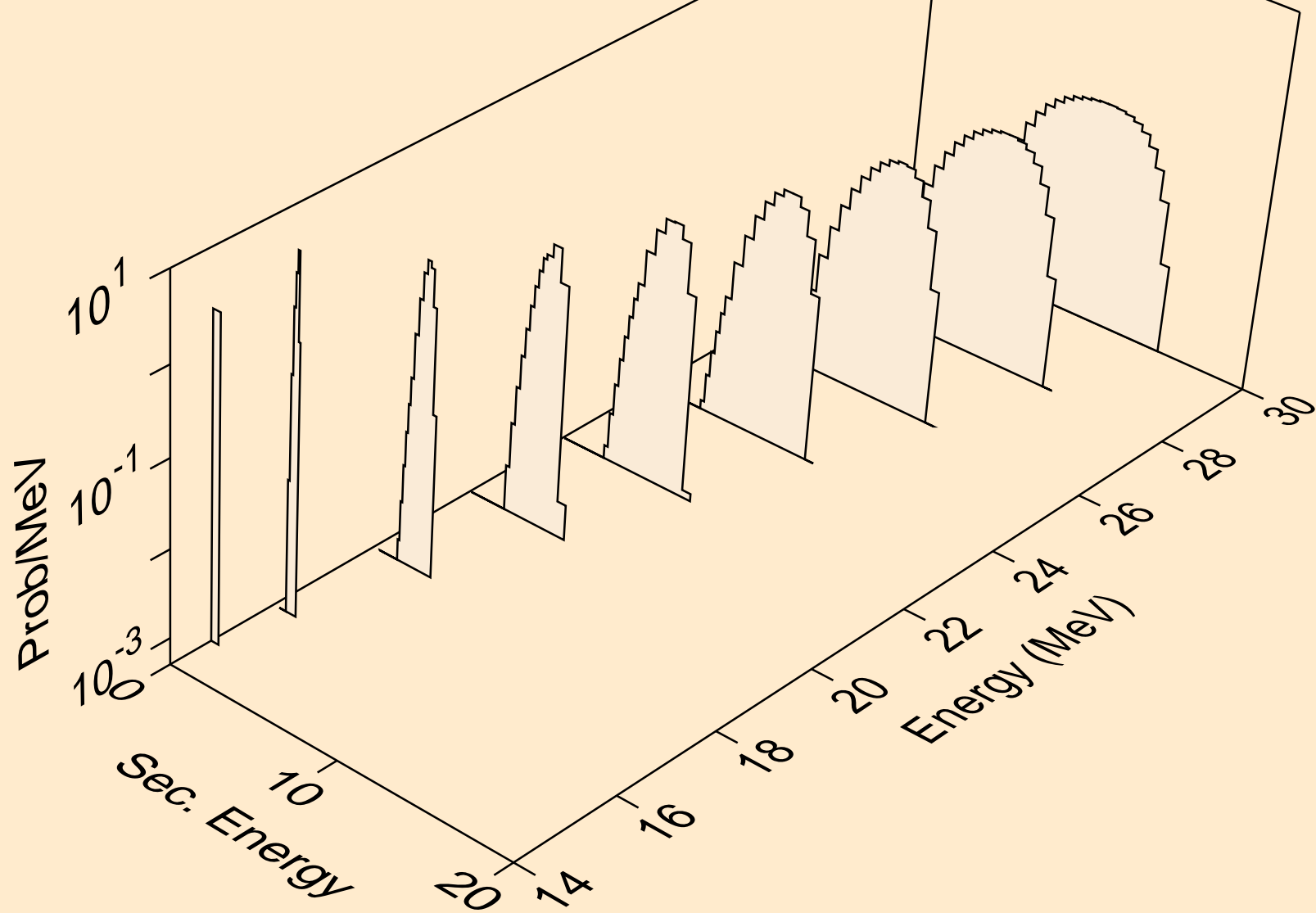

SB129M NEUTRON ACER TENDL-2024 LIBRARY; T=0.K
protons from (n,3np)

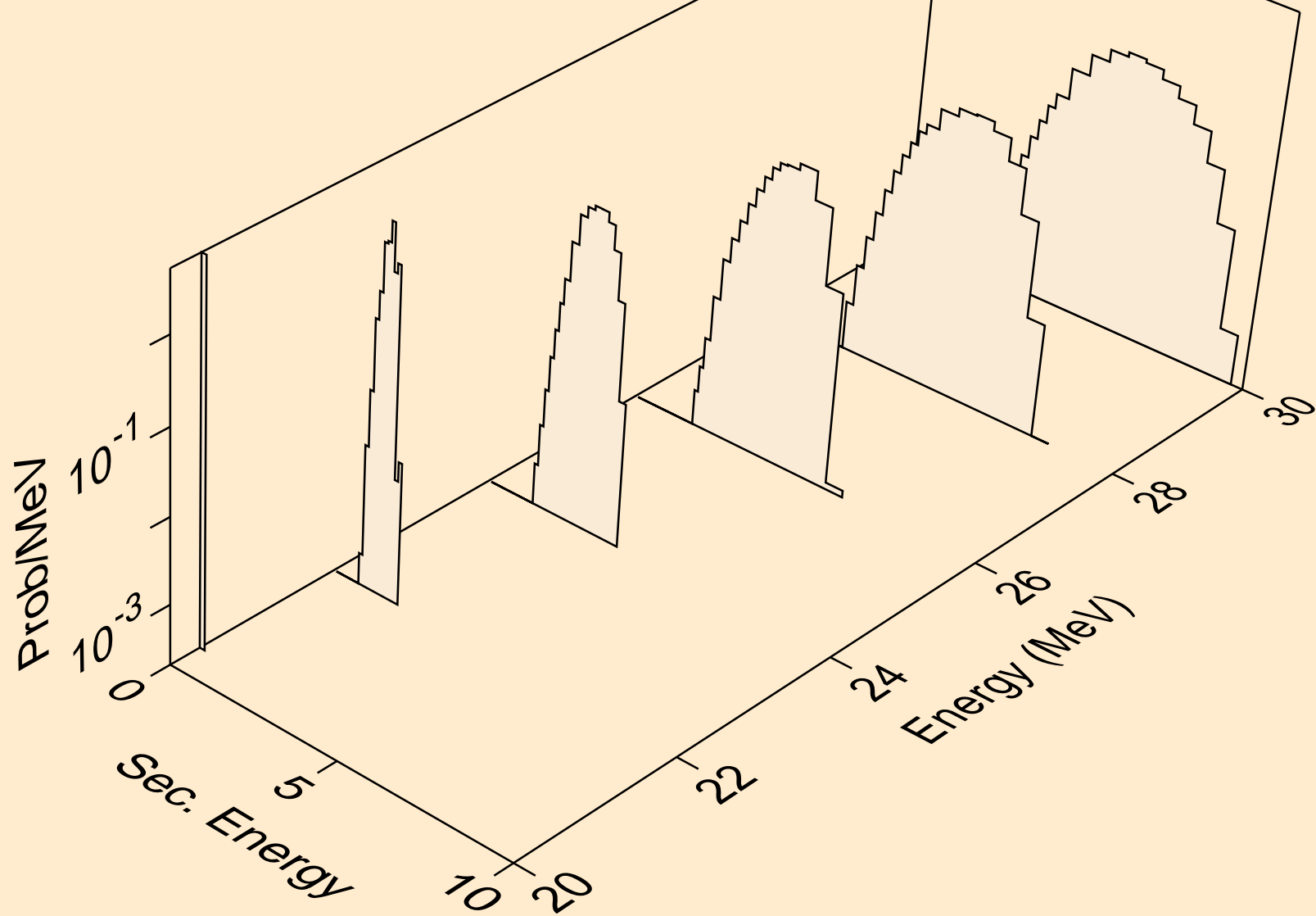

SB129M NEUTRON ACER TENDL-2024 LIBRARY; T=0.K
protons from (n,p)

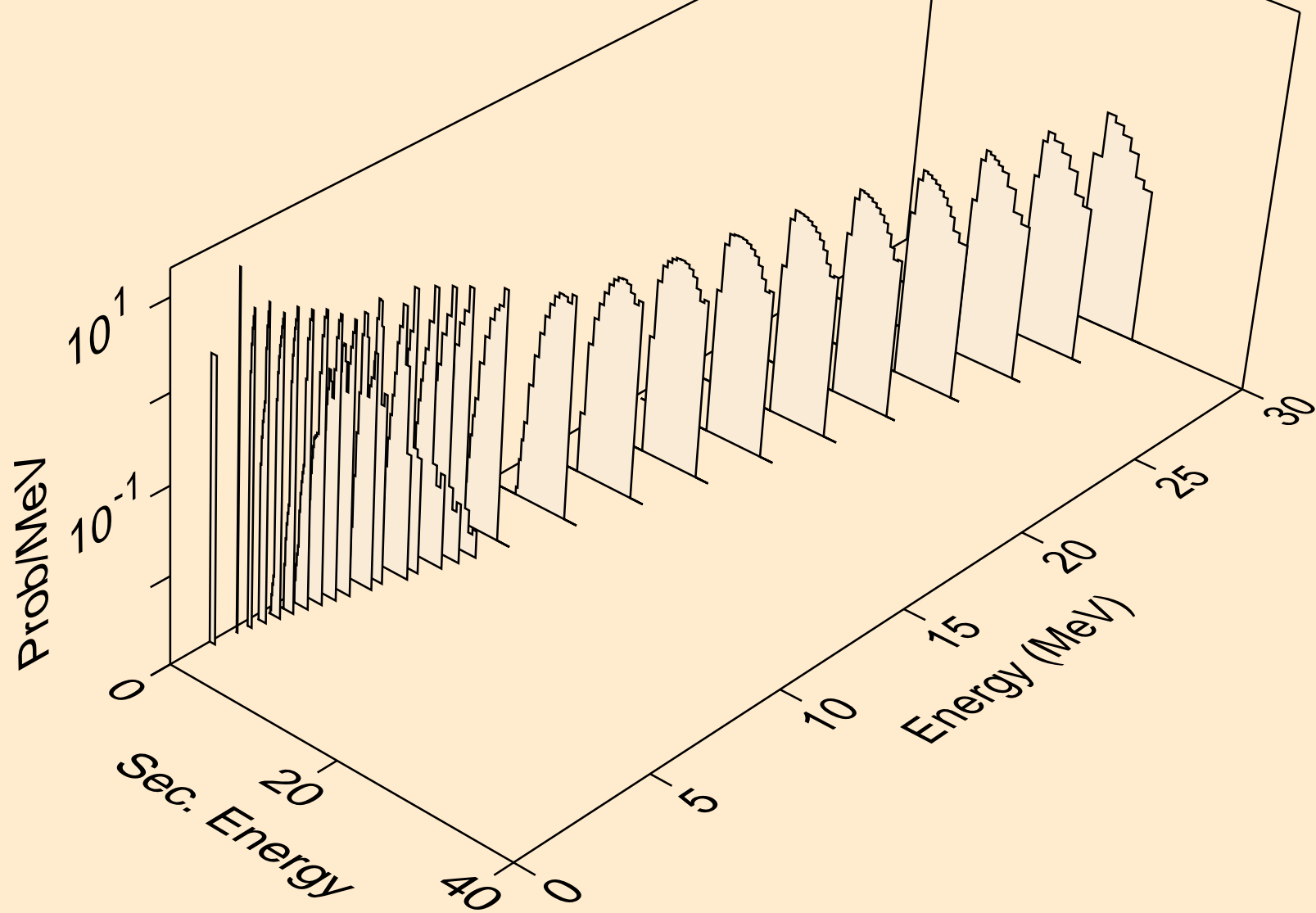

SB129M NEUTRON ACER TENDL-2024 LIBRARY; T=0.K
protons from (n,2p)

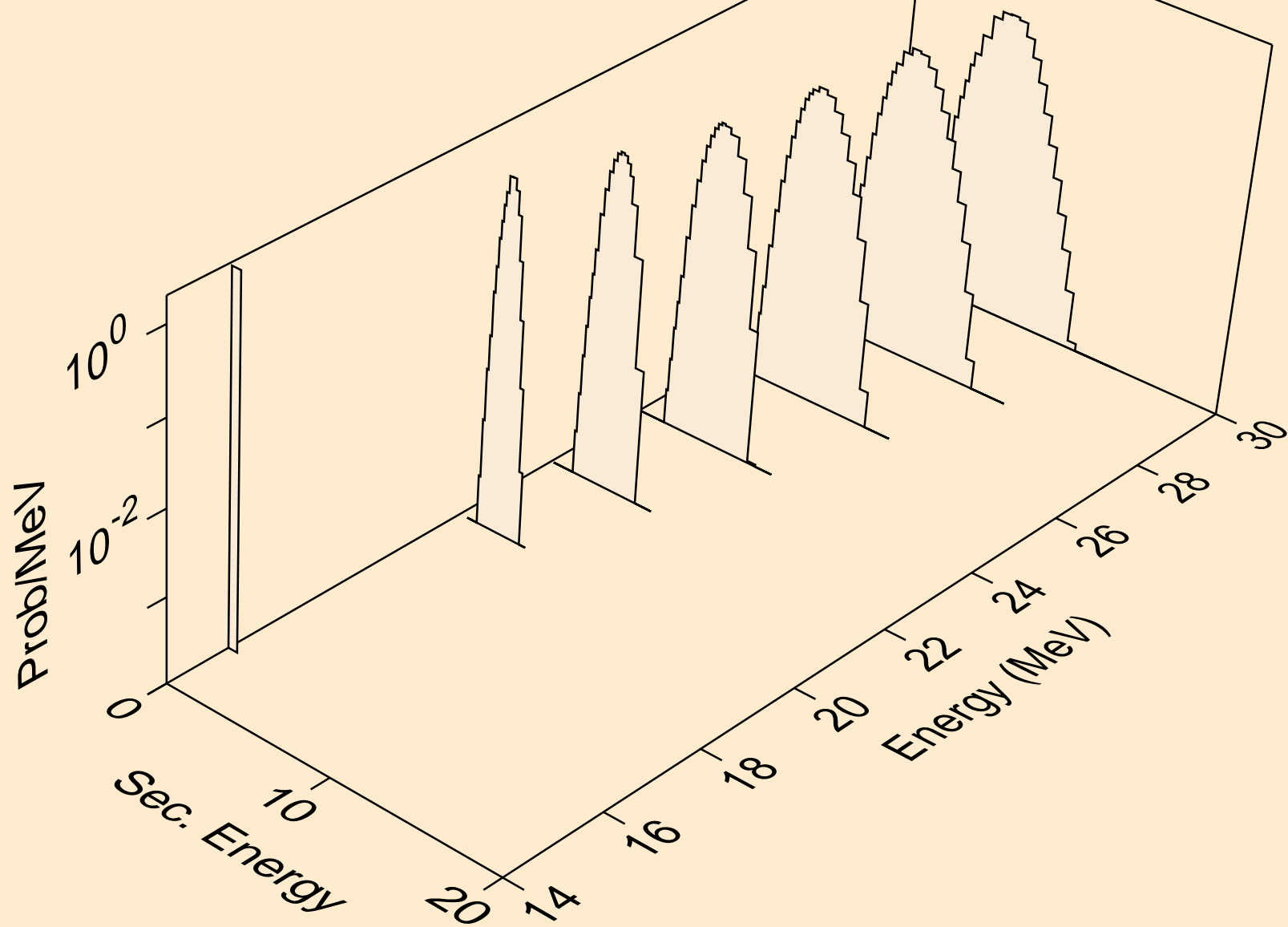

SB129M NEUTRON ACER TENDL-2024 LIBRARY; T=0.K
deuterons from (n,x)

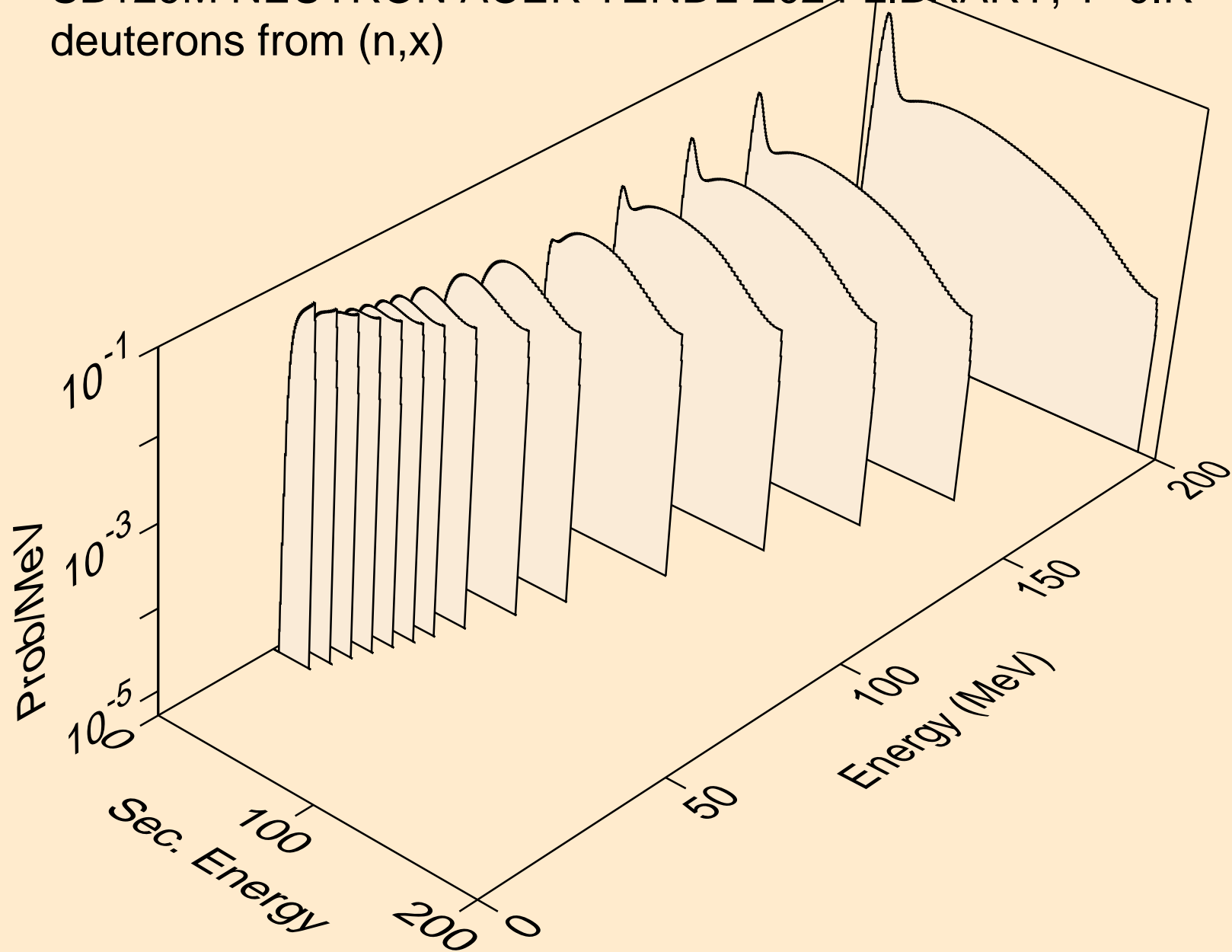

SB129M NEUTRON ACER TENDL-2024 LIBRARY; T=0.K
deuterons from (n,2nd)

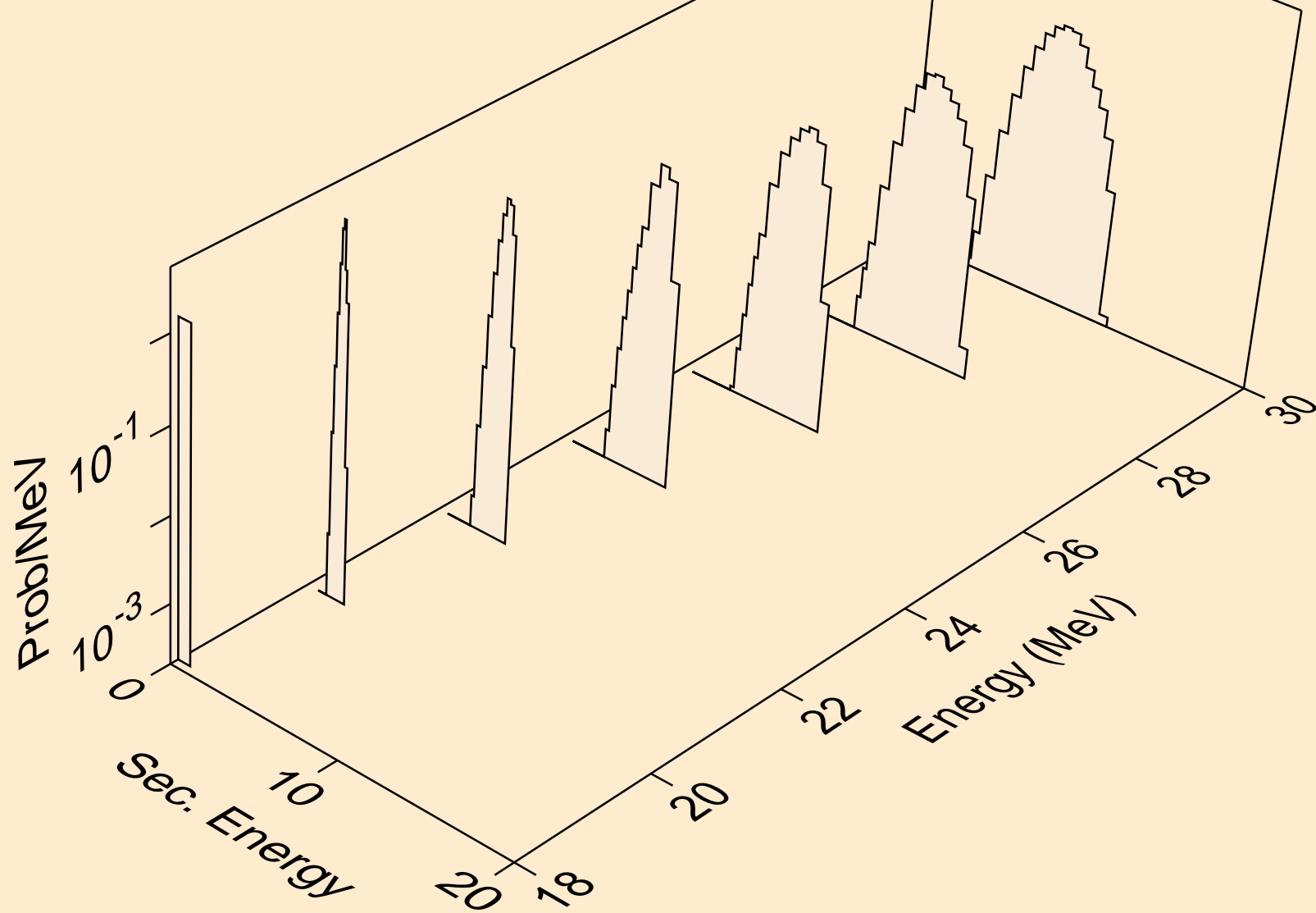

SB129M NEUTRON ACER TENDL-2024 LIBRARY; T=0.K
deuterons from (n,n*)d

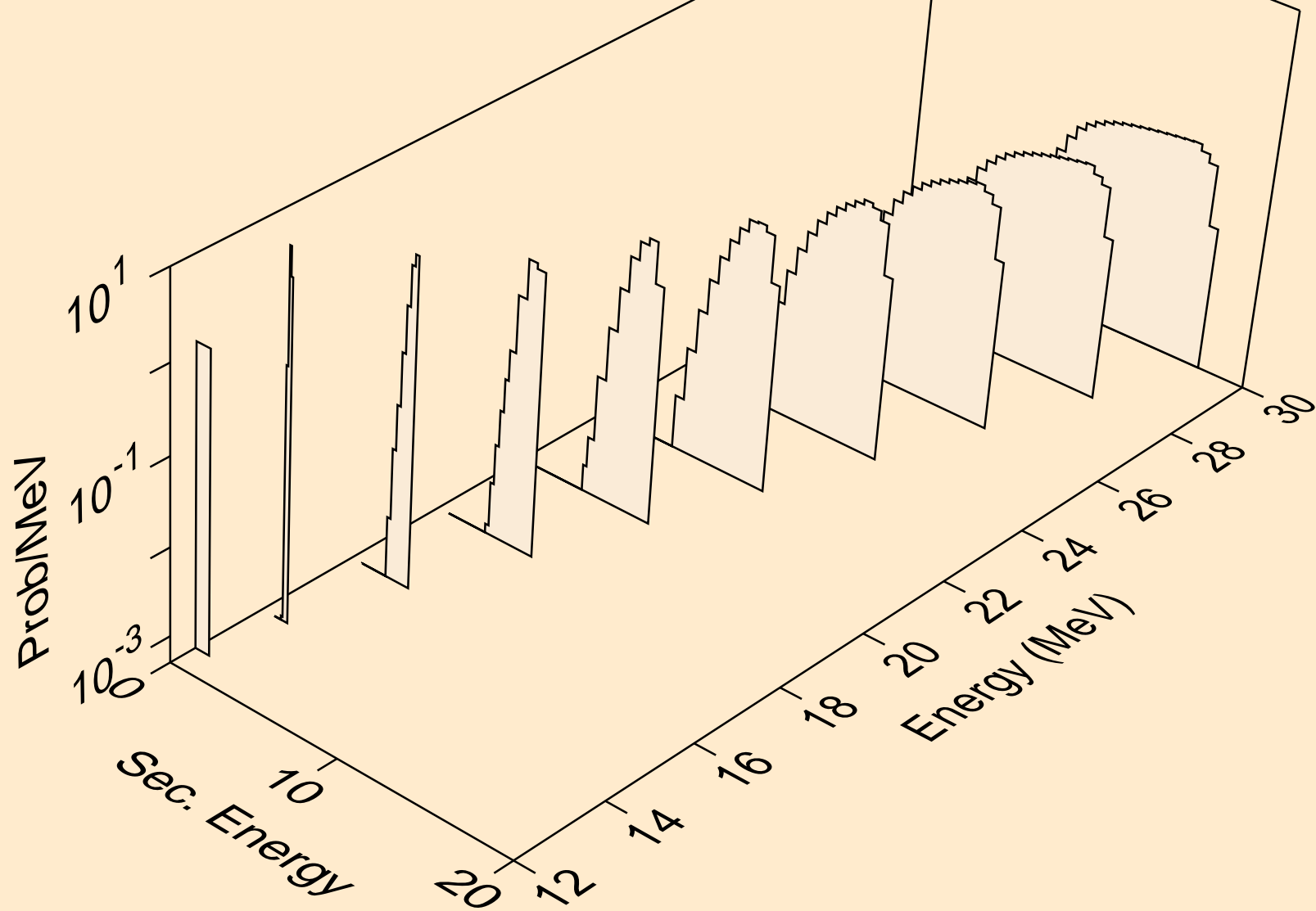

SB129M NEUTRON ACER TENDL-2024 LIBRARY; T=0.K
deuterons from (n,d)

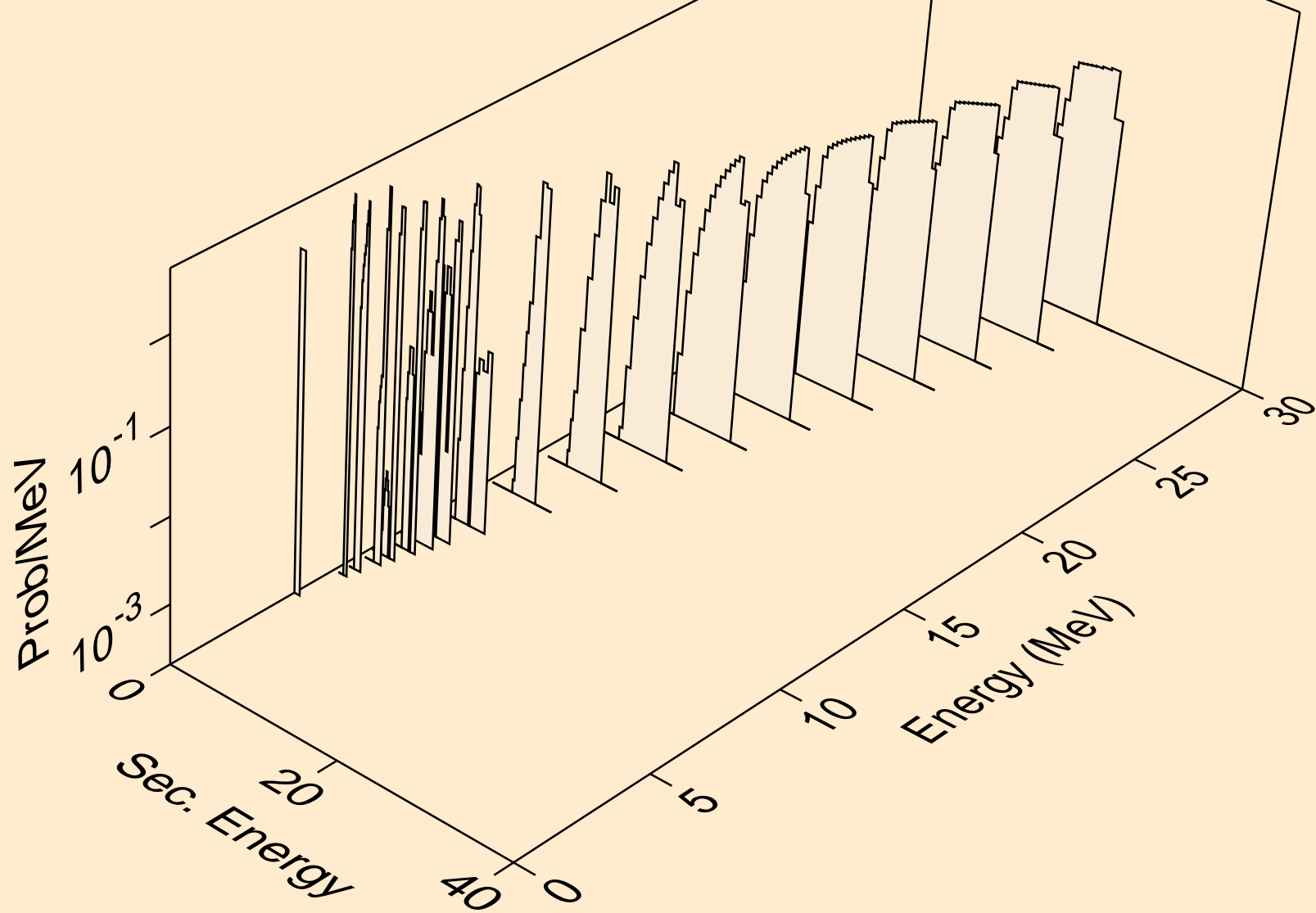

SB129M NEUTRON ACER TENDL-2024 LIBRARY; T=0.K
tritons from (n,x)

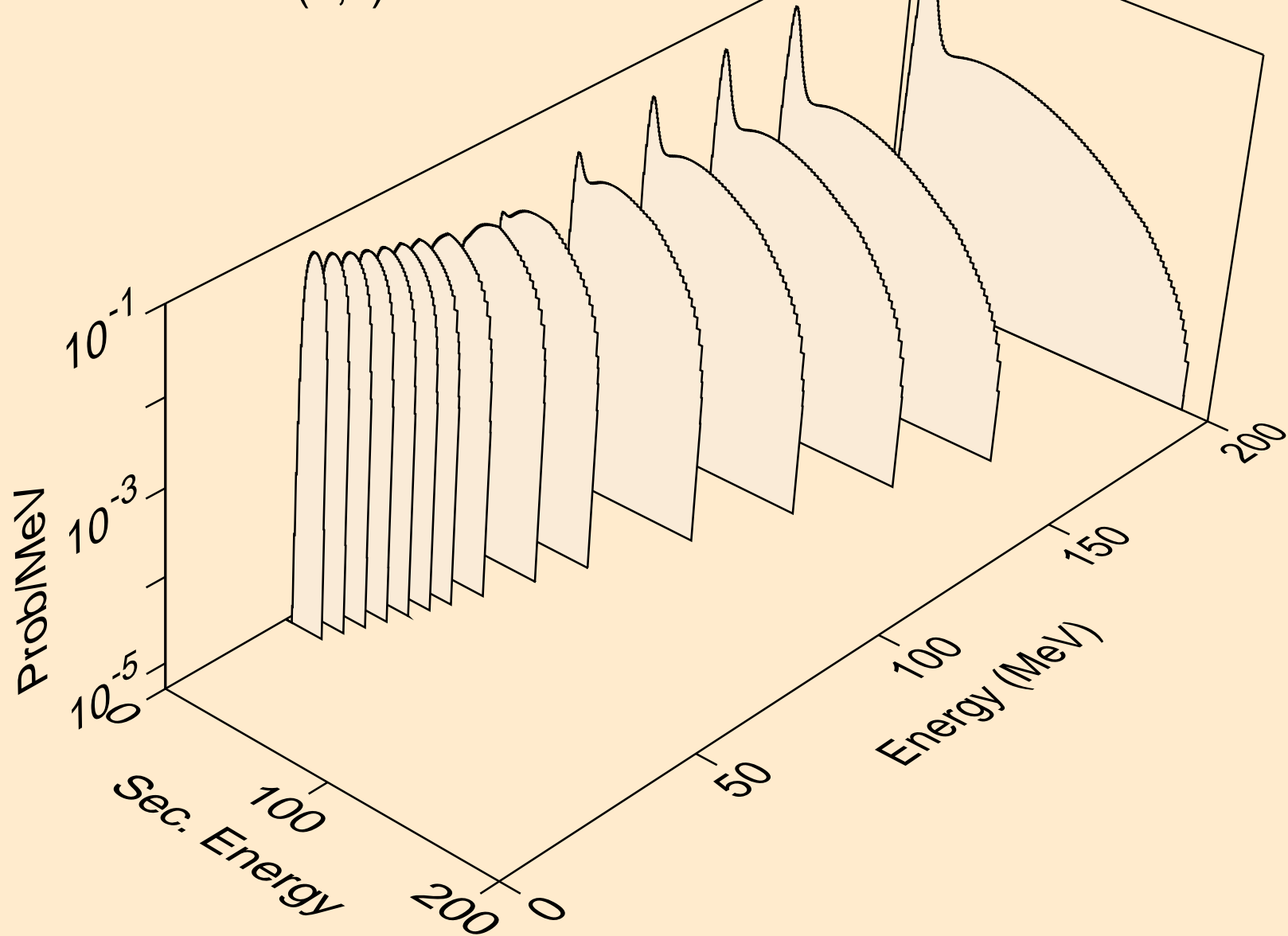

SB129M NEUTRON ACER TENDL-2024 LIBRARY; T=0.K
tritons from (n,n*)t

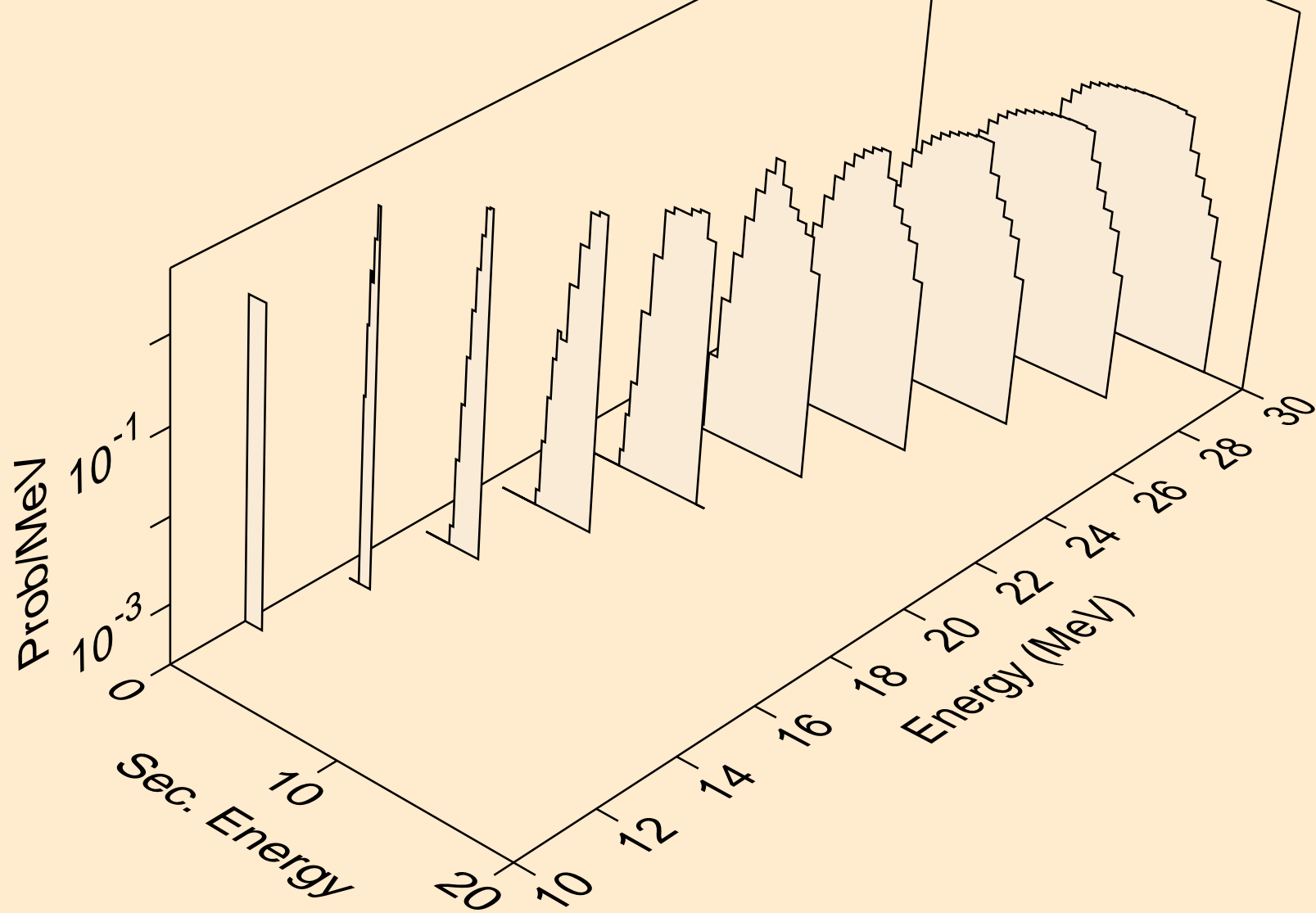

SB129M NEUTRON ACER TENDL-2024 LIBRARY; T=0.K
tritons from (n,t)

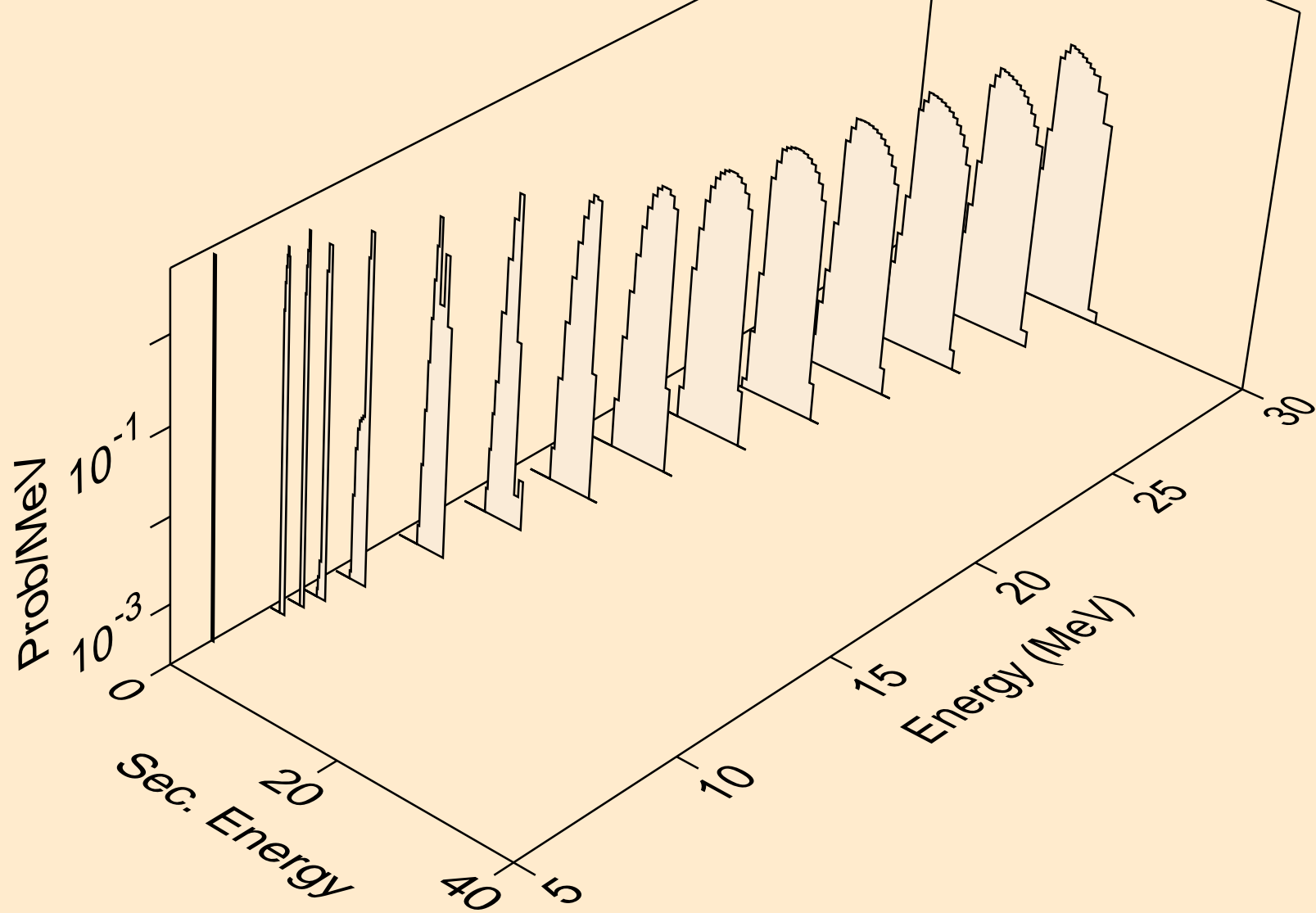

SB129M NEUTRON ACER TENDL-2024 LIBRARY; T=0.K
he3s from (n,x)

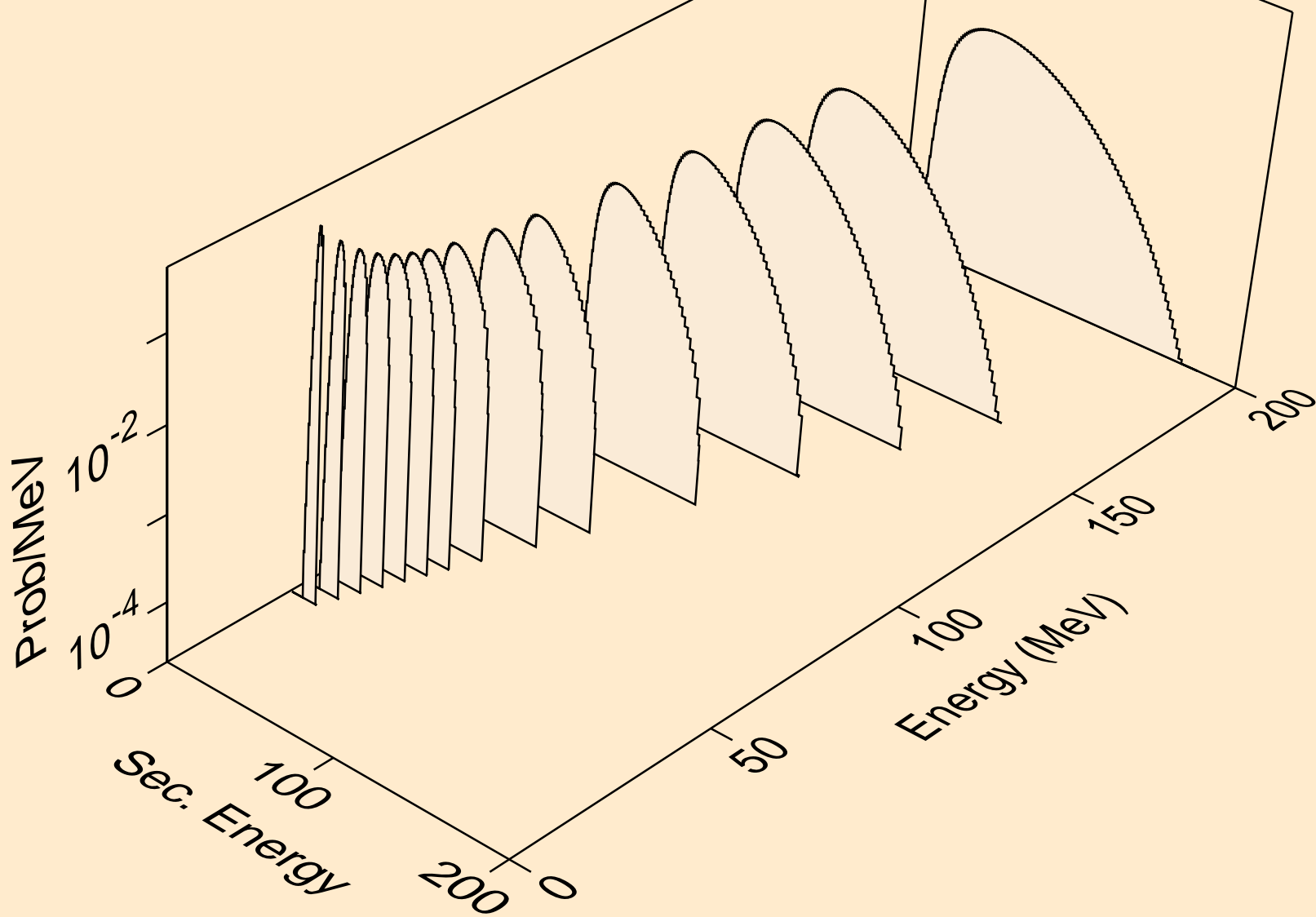

SB129M NEUTRON ACER TENDL-2024 LIBRARY; T=0.K
he3s from (n,n*)he3

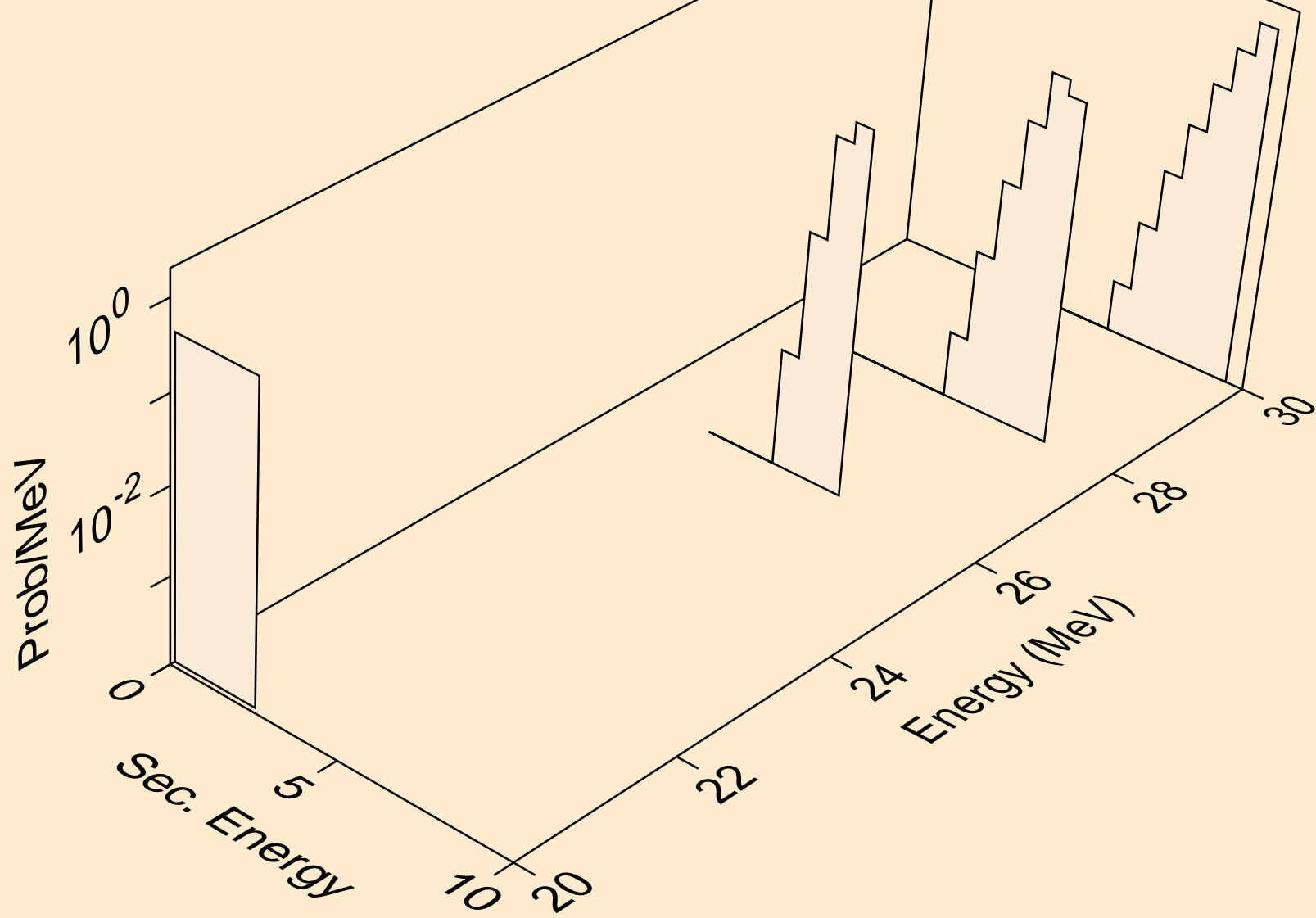

SB129M NEUTRON ACER TENDL-2024 LIBRARY; T=0.K
he3s from (n,he3)

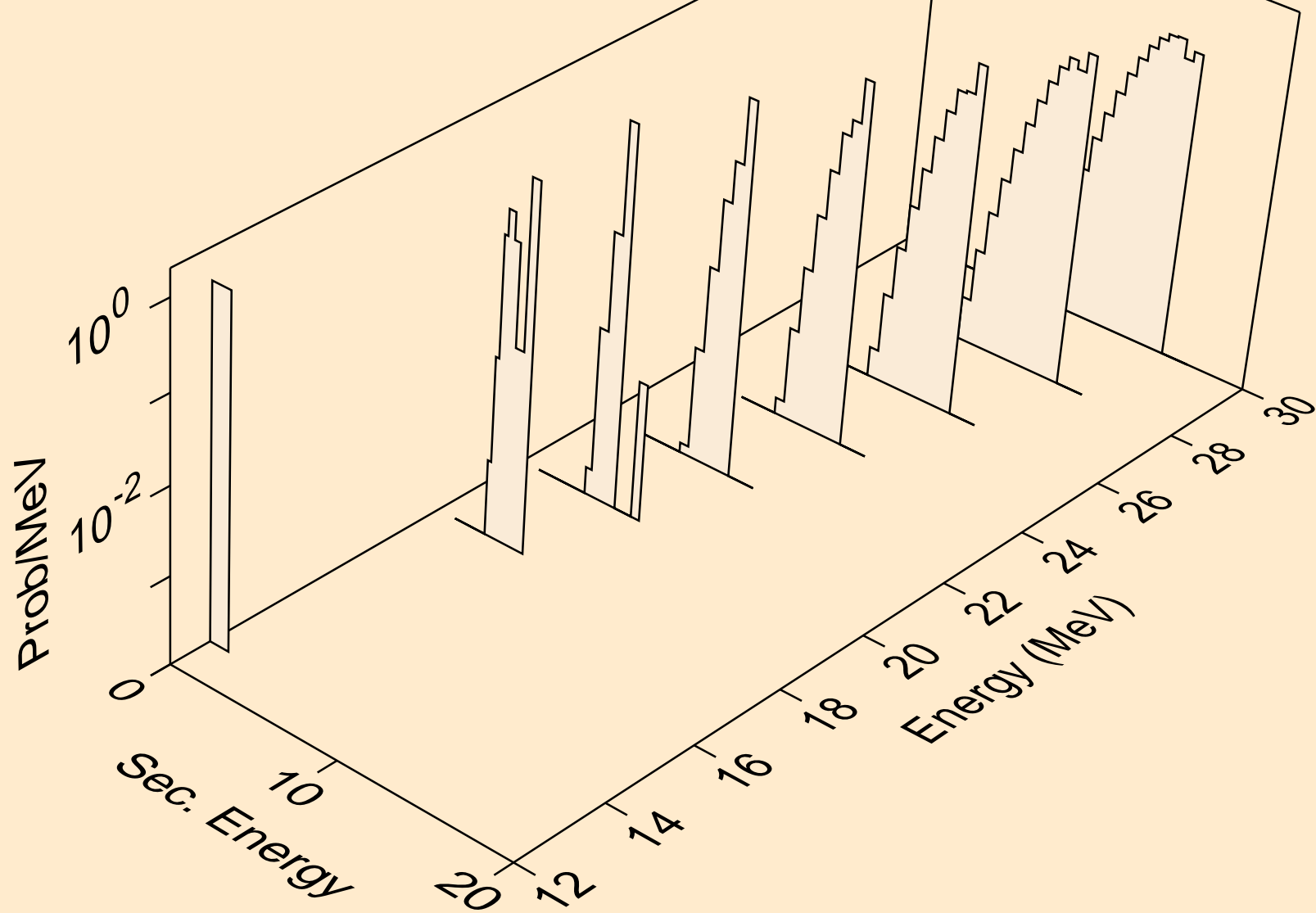

SB129M NEUTRON ACER TENDL-2024 LIBRARY; T=0.K
alphas from (n,x)

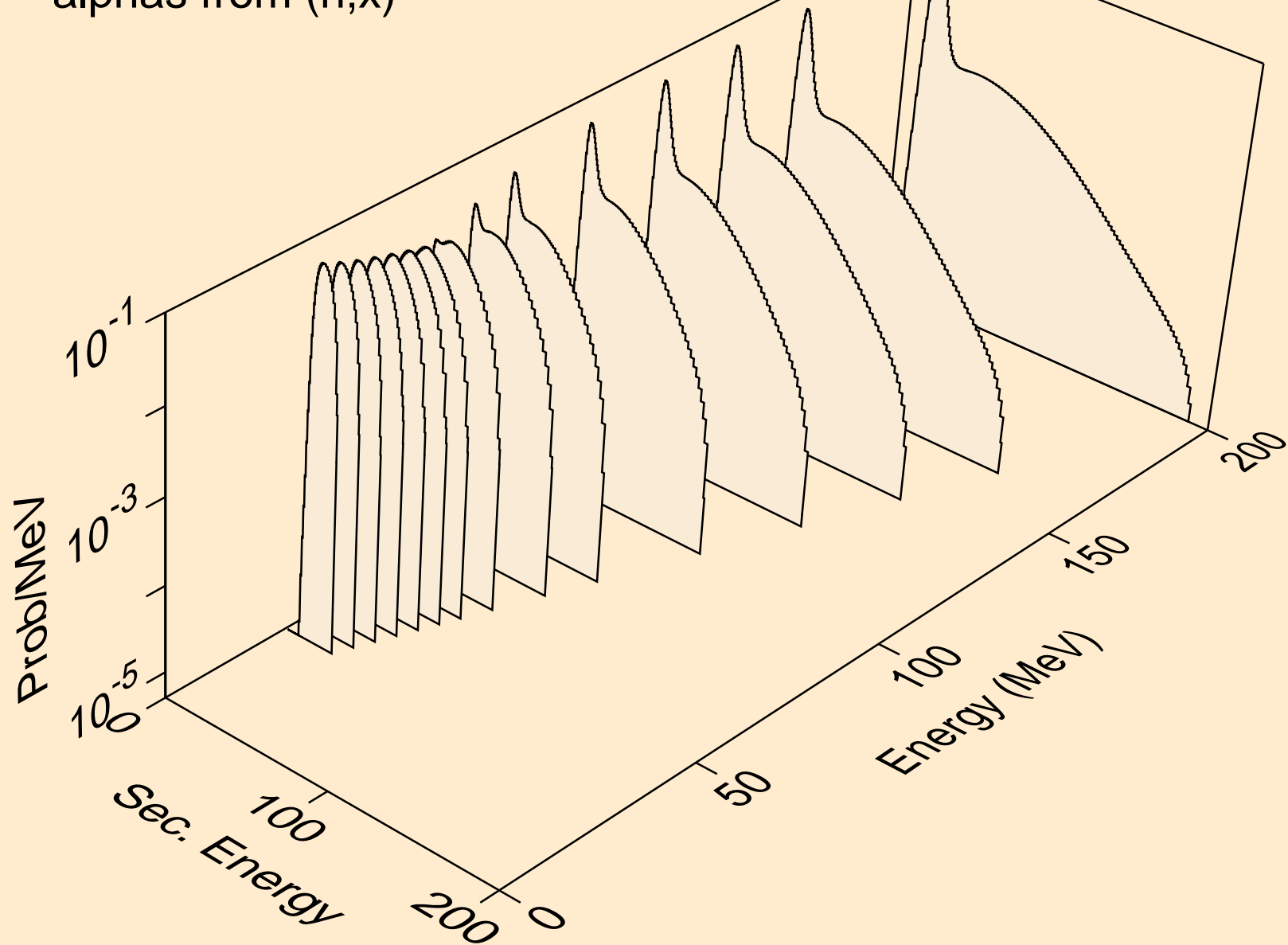

SB129M NEUTRON ACER TENDL-2024 LIBRARY; T=0.K
alphas from (n,n*)a

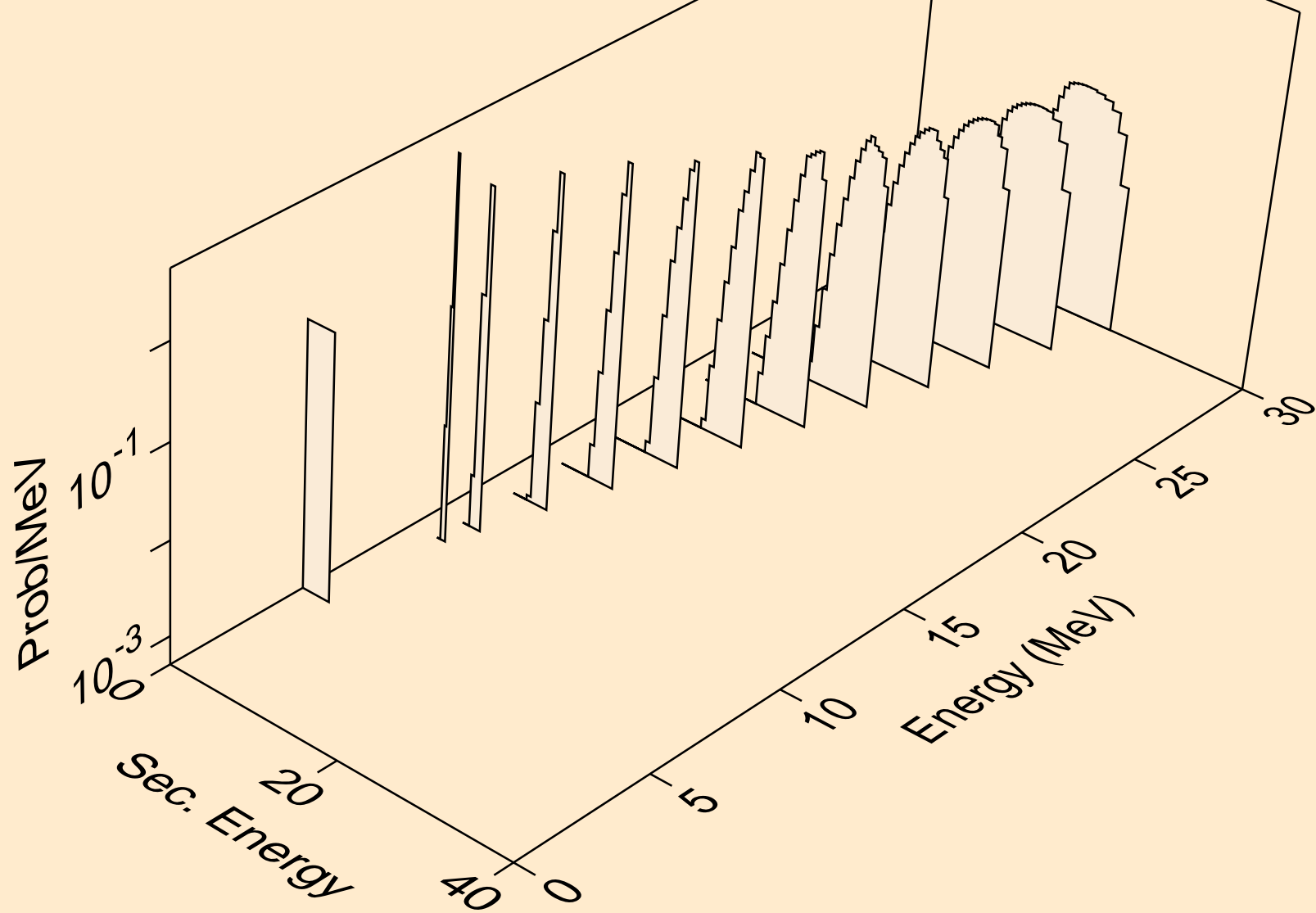

SB129M NEUTRON ACER TENDL-2024 LIBRARY; T=0.K
alphas from (n,2n)a

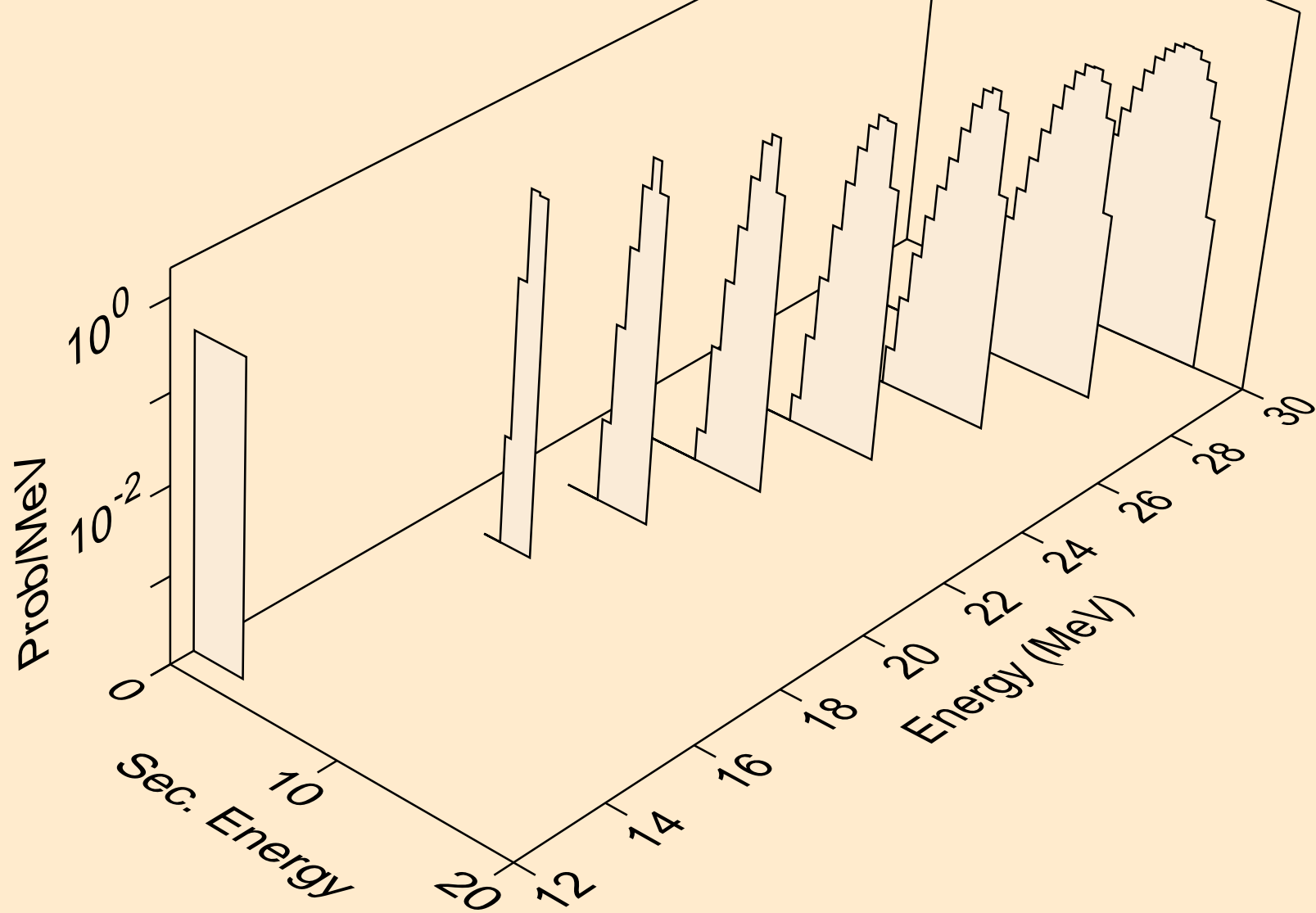

SB129M NEUTRON ACER TENDL-2024 LIBRARY; T=0.K
alphas from (n,3n)a

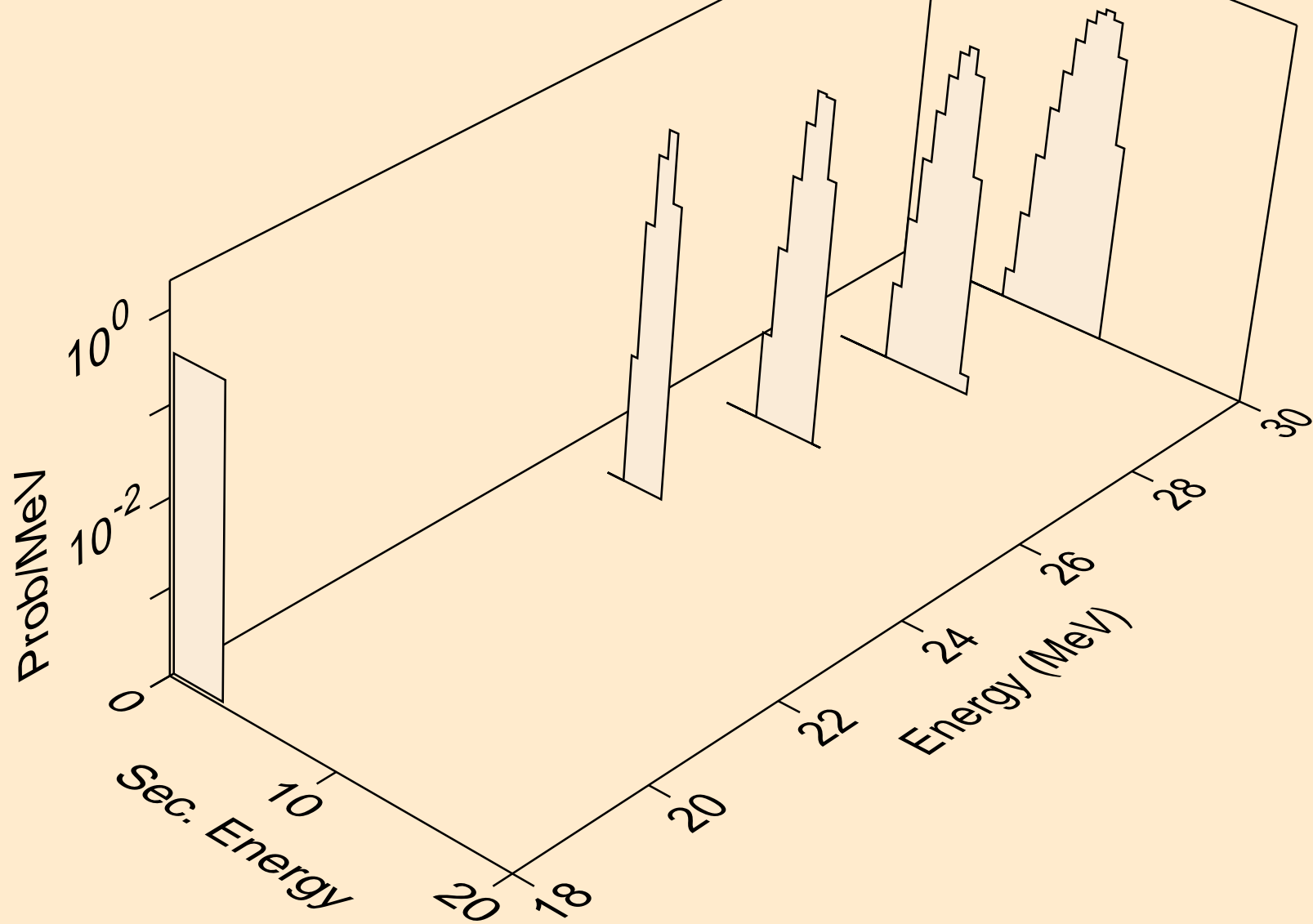

SB129M NEUTRON ACER TENDL-2024 LIBRARY; T=0.K
alphas from (n,a)

