

# SC053 NEUTRON ACER TENDL-2024 LIBRARY; T=0.K

## Principal cross sections

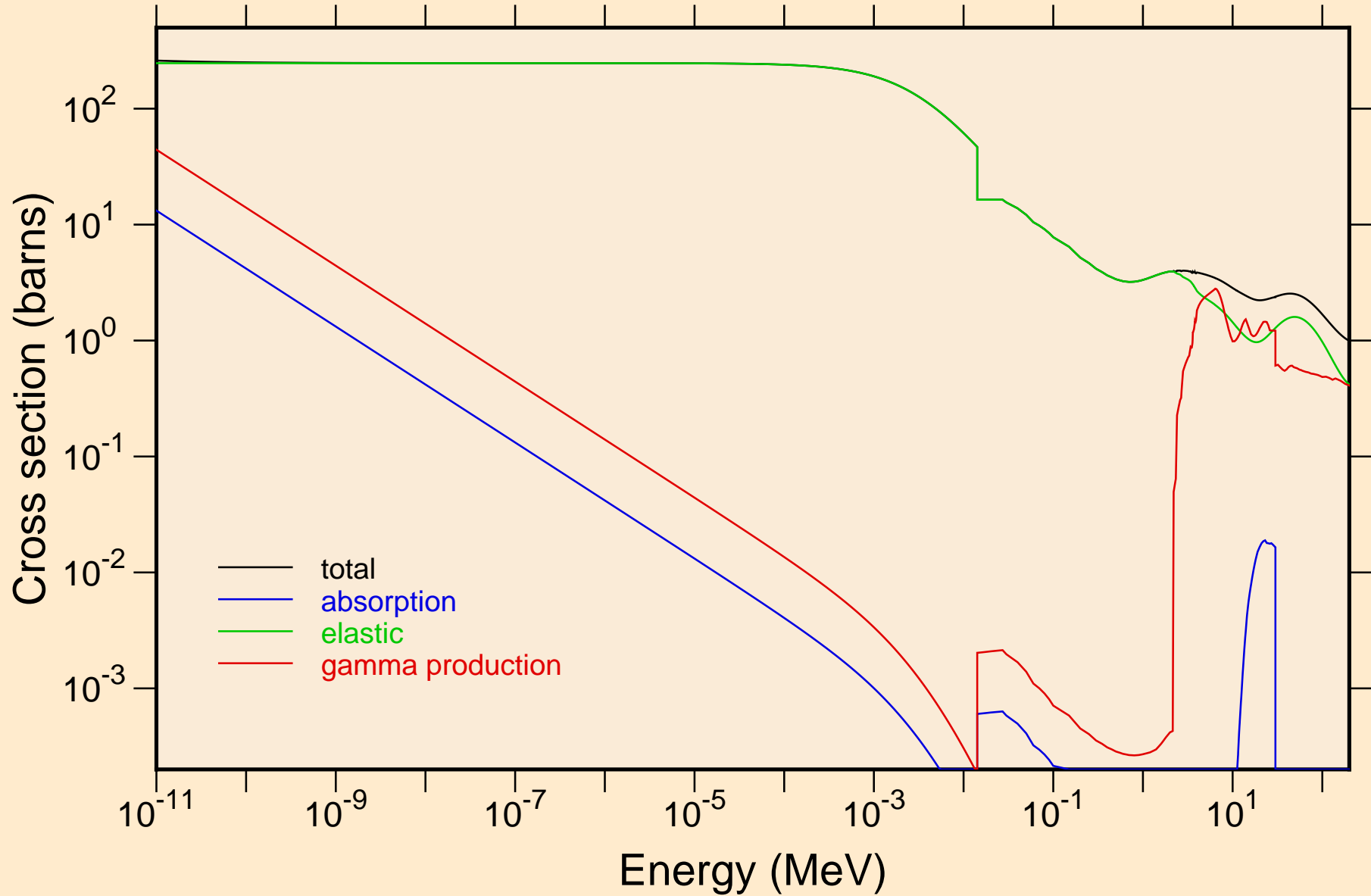

# SC053 NEUTRON ACER TENDL-2024 LIBRARY; T=0.K

## Heating

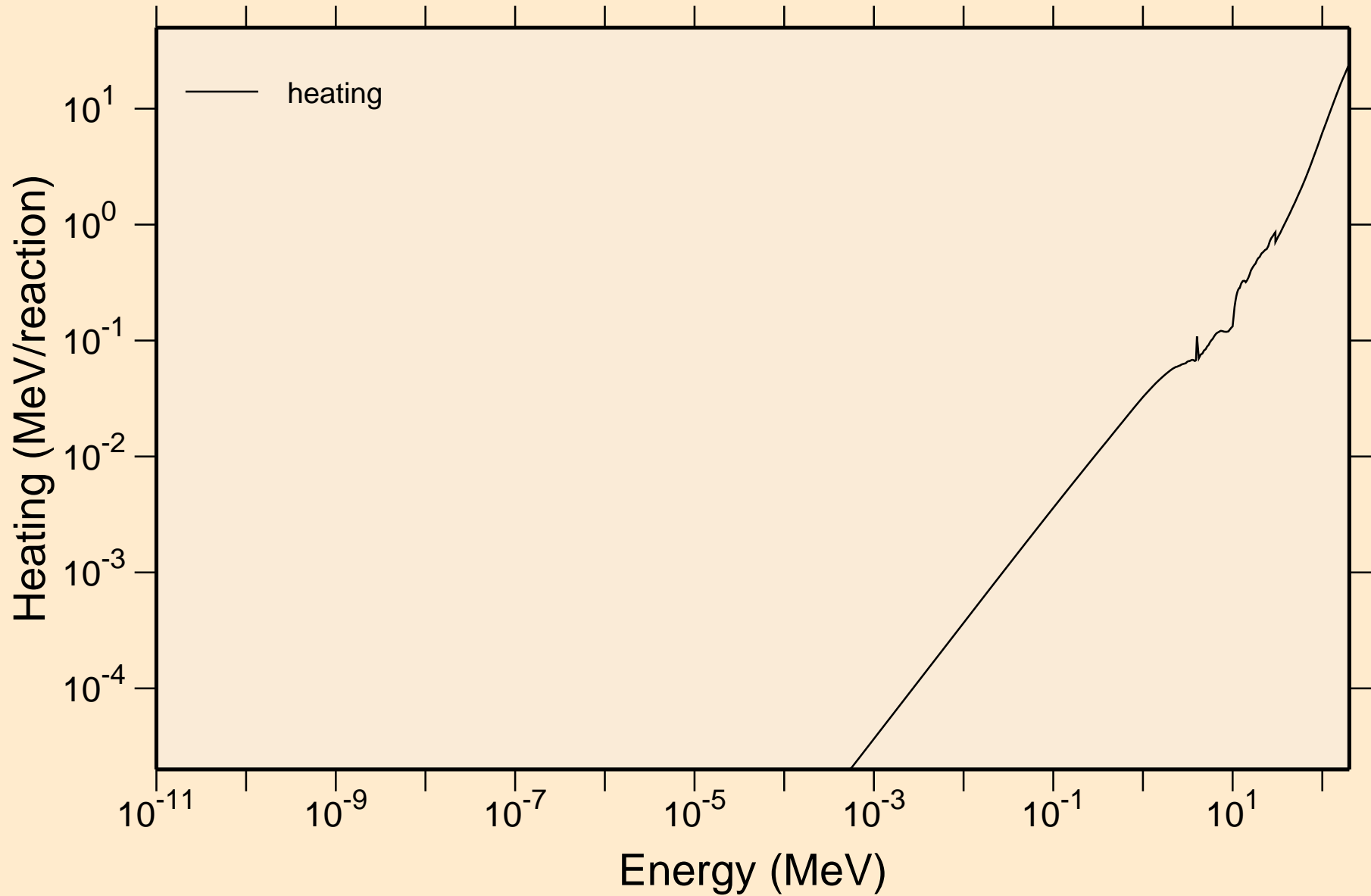

# SC053 NEUTRON ACER TENDL-2024 LIBRARY; T=0.K

## Damage

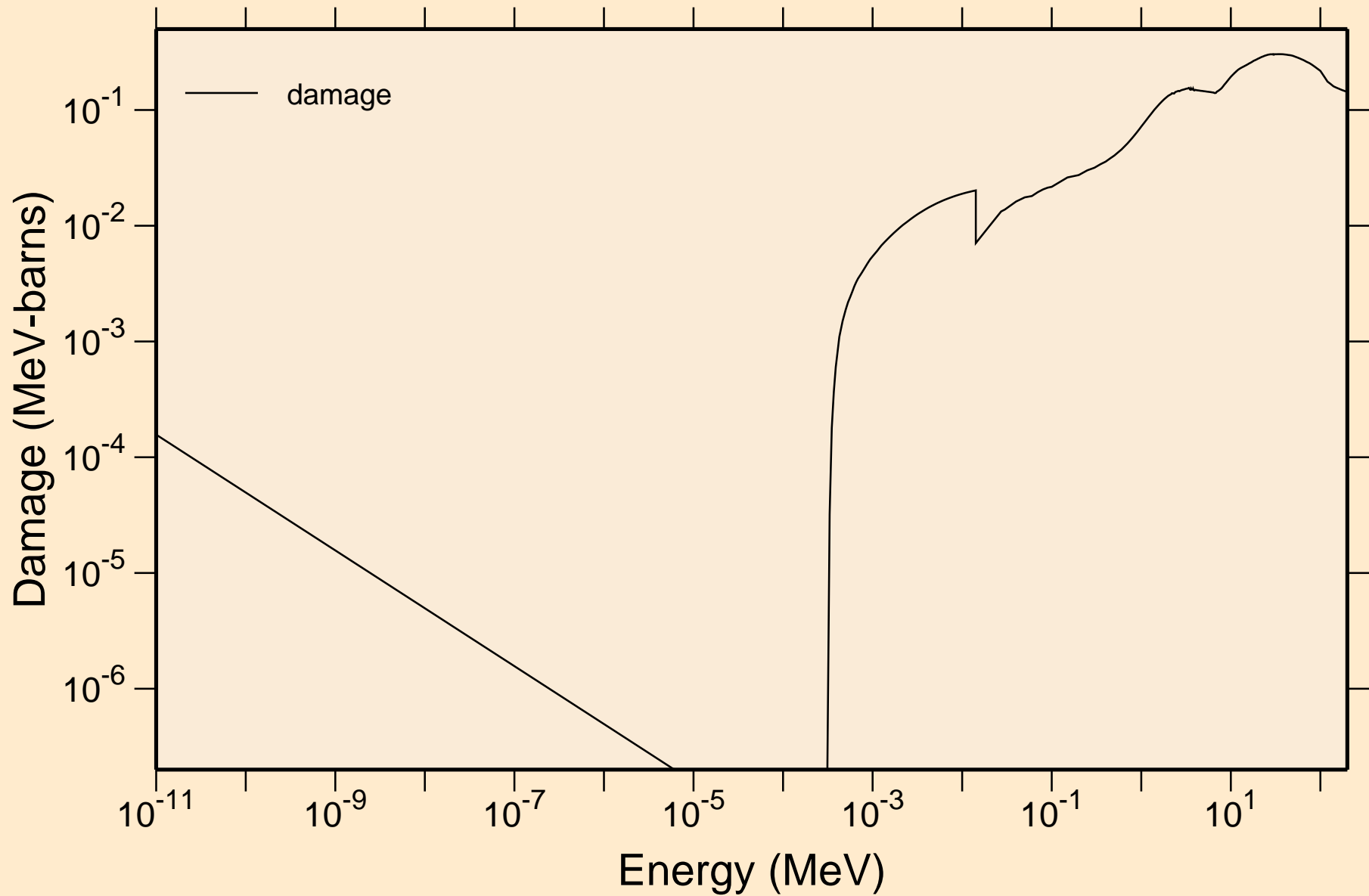

SC053 NEUTRON ACER TENDL-2024 LIBRARY; T=0.K  
Non-threshold reactions

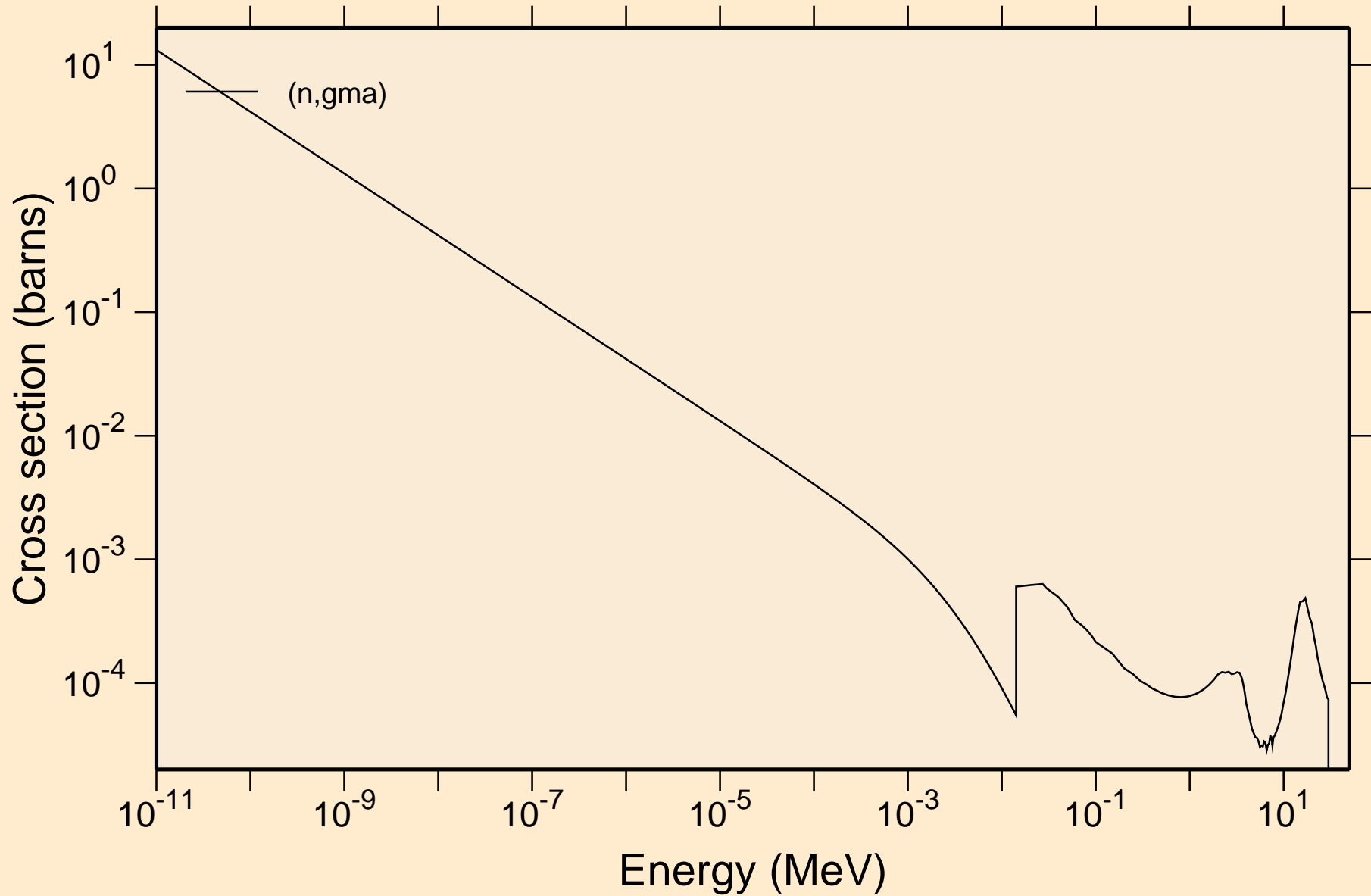

# SC053 NEUTRON ACER TENDL-2024 LIBRARY; T=0.K

## Principal cross sections

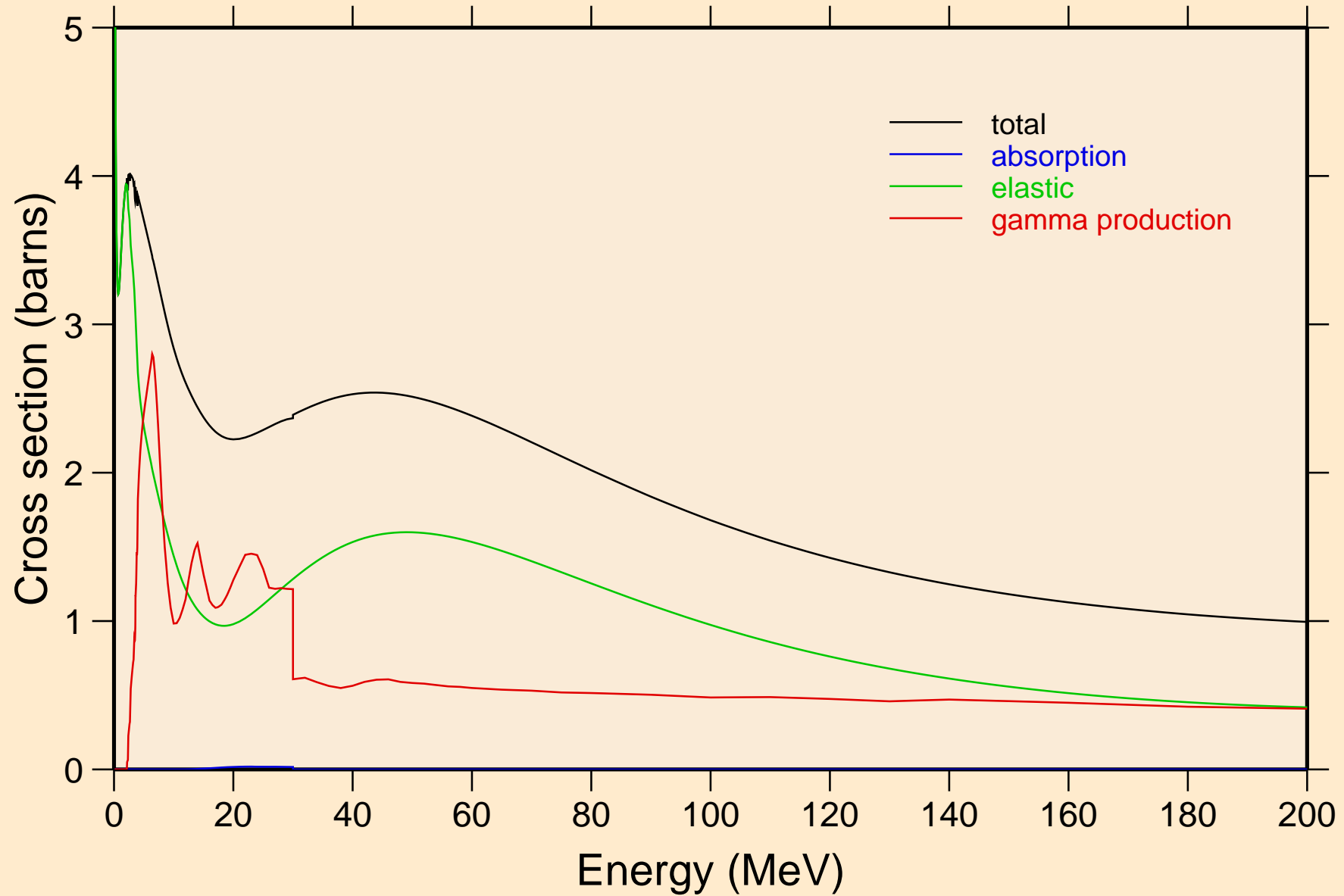

# SC053 NEUTRON ACER TENDL-2024 LIBRARY; T=0.K

## Heating

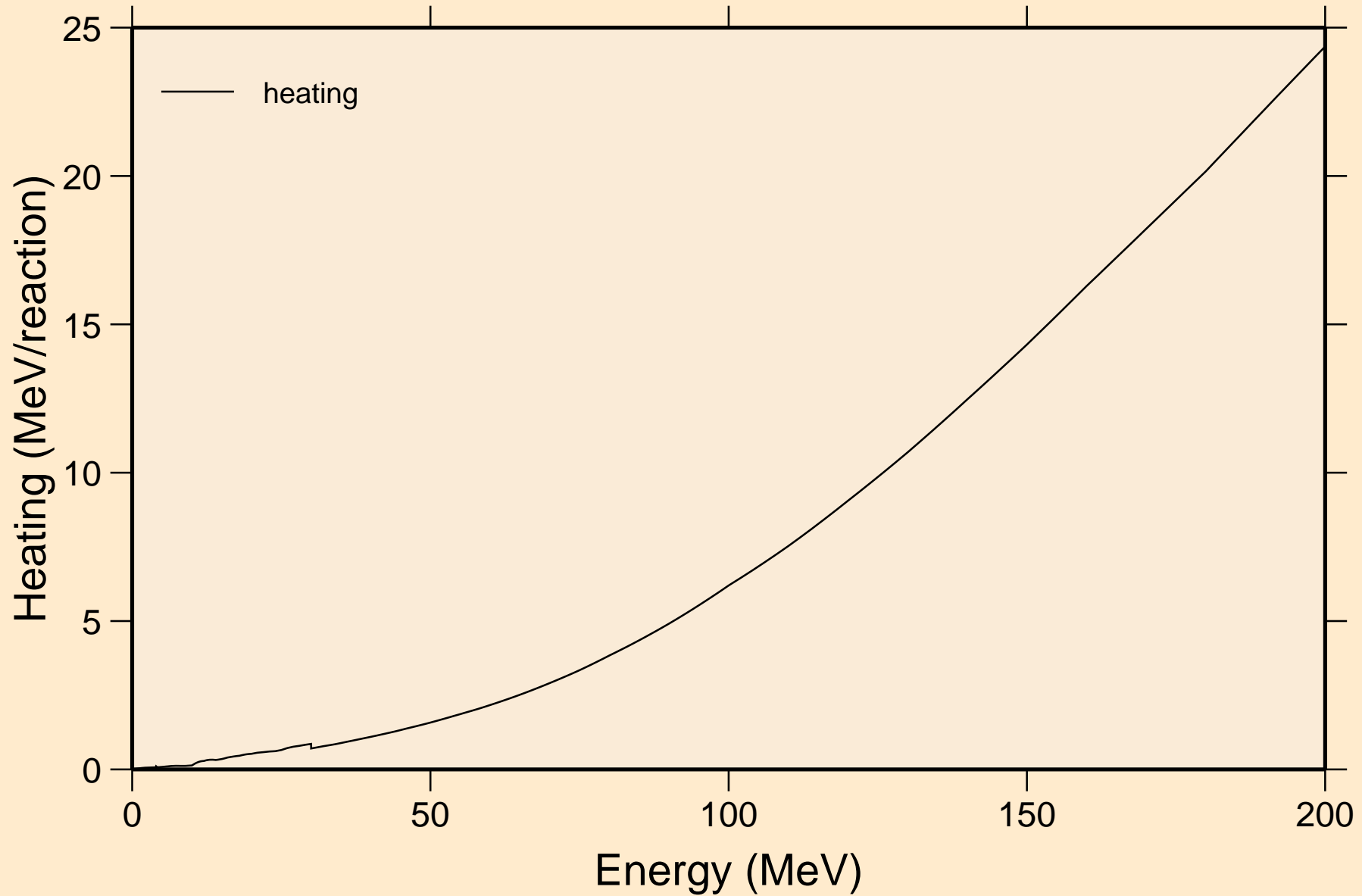

# SC053 NEUTRON ACER TENDL-2024 LIBRARY; T=0.K

## Damage

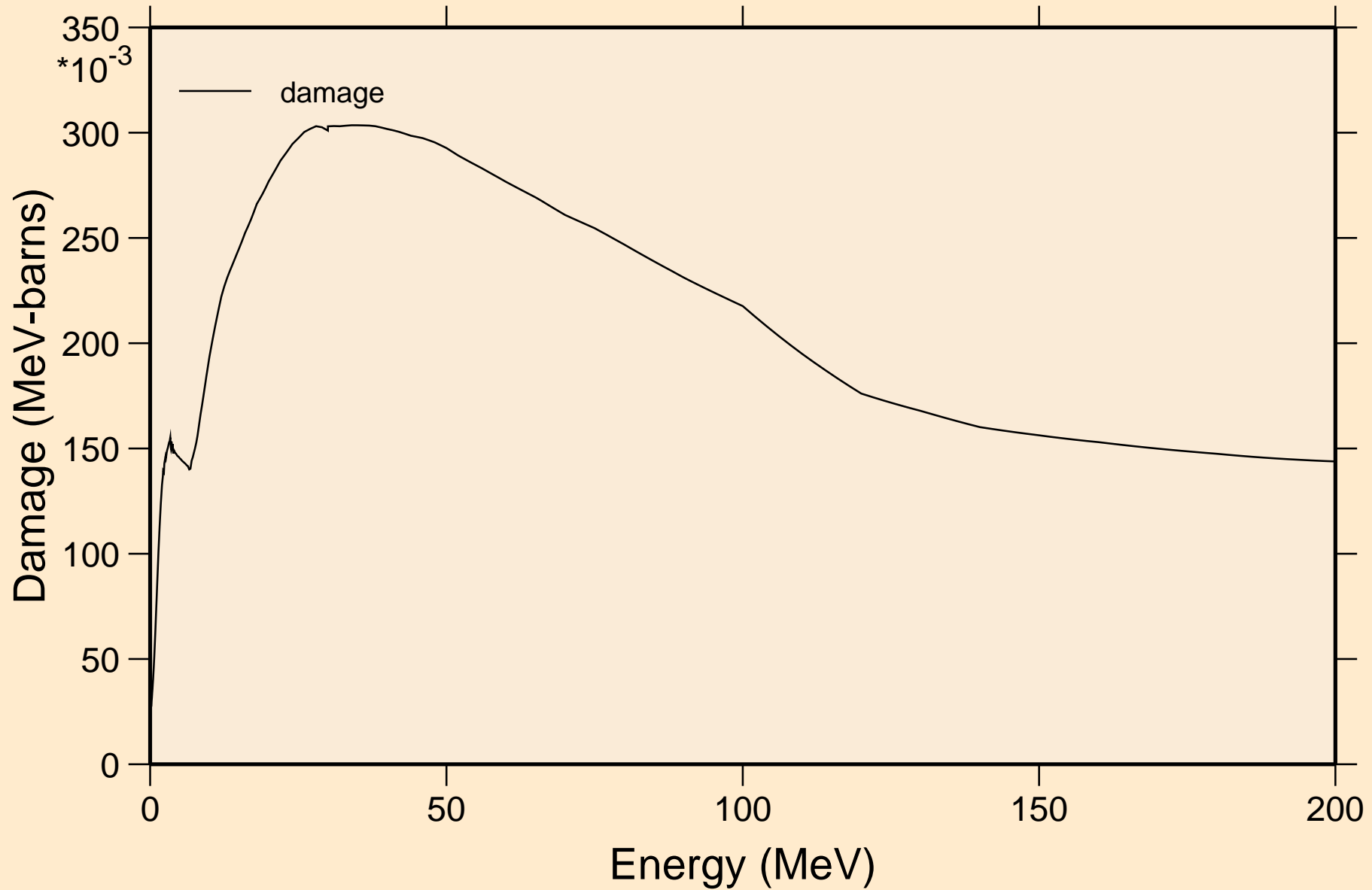

SC053 NEUTRON ACER TENDL-2024 LIBRARY; T=0.K  
Non-threshold reactions

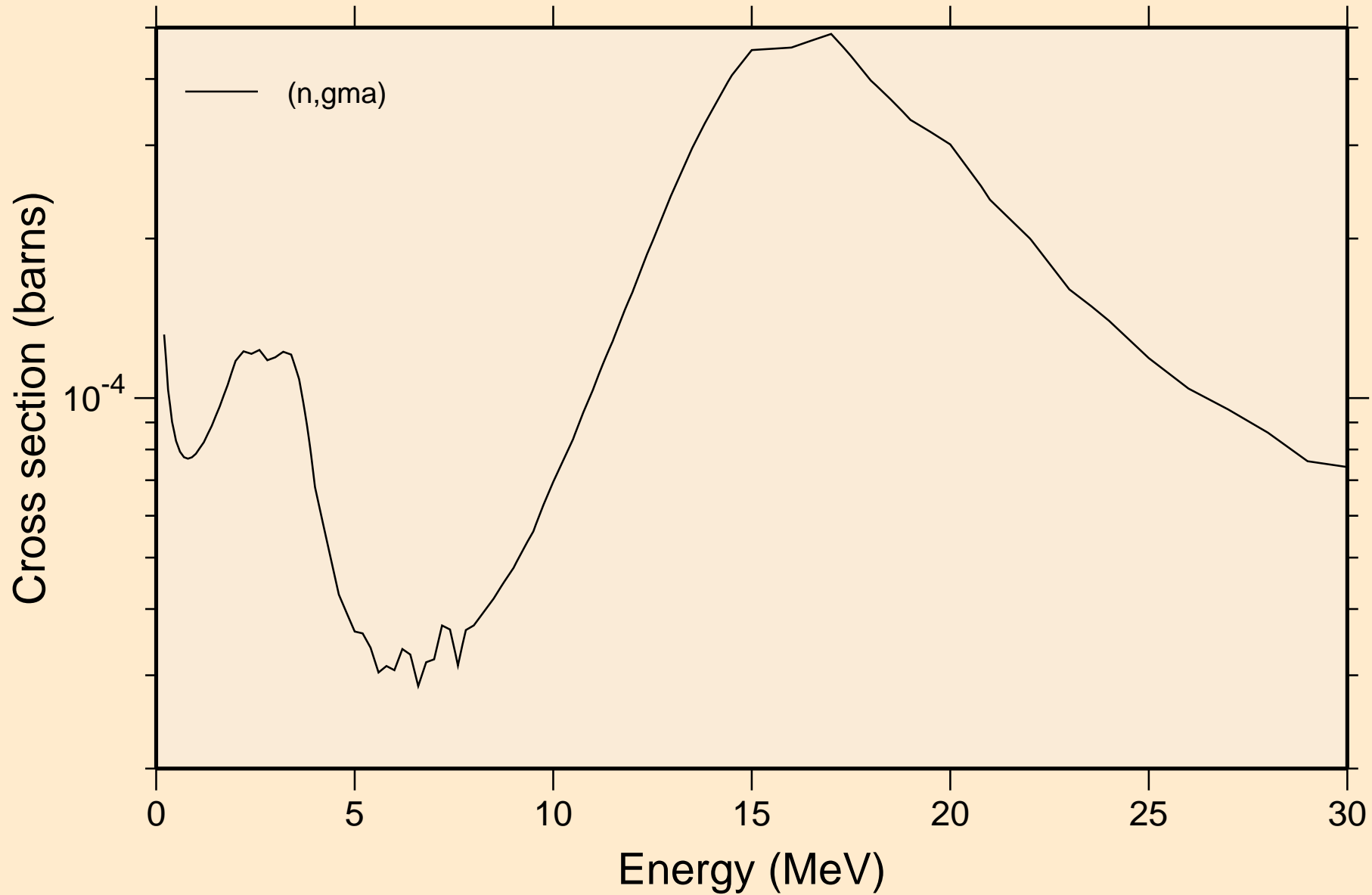



# SC053 NEUTRON ACER TENDL-2024 LIBRARY; T=0.K

## Inelastic levels

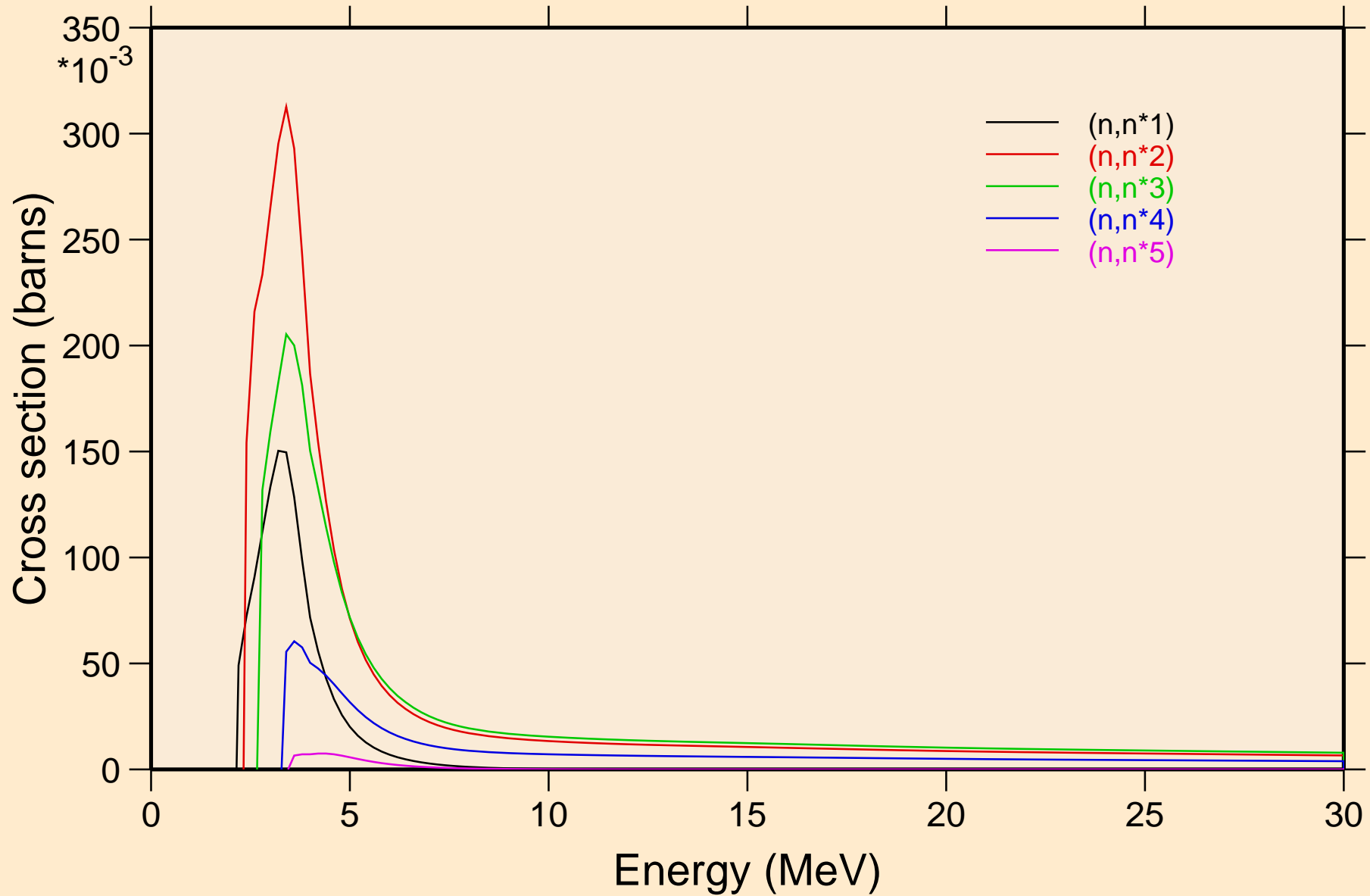

SC053 NEUTRON ACER TENDL-2024 LIBRARY; T=0.K  
Inelastic levels

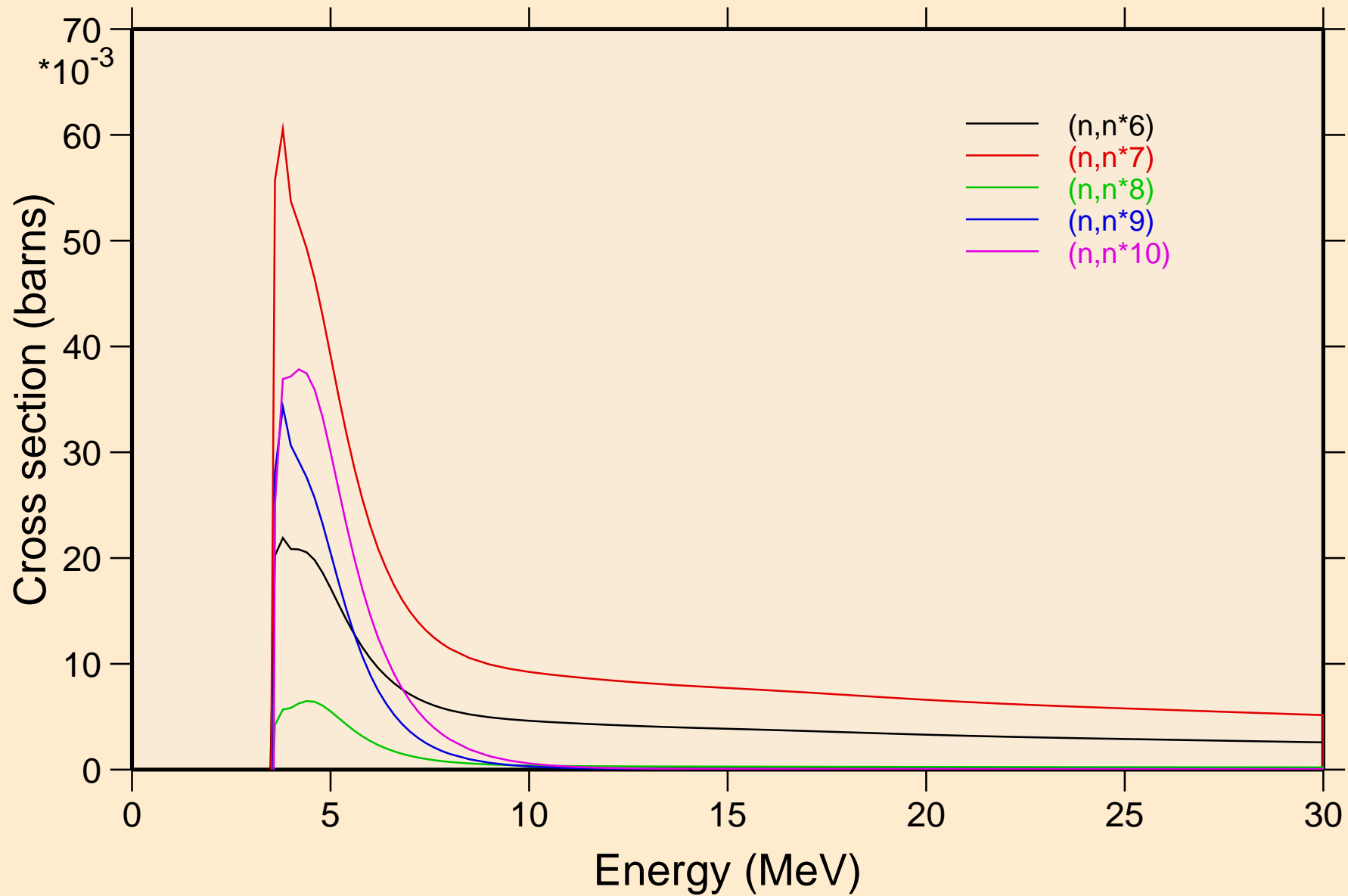

SC053 NEUTRON ACER TENDL-2024 LIBRARY; T=0.K  
Inelastic levels

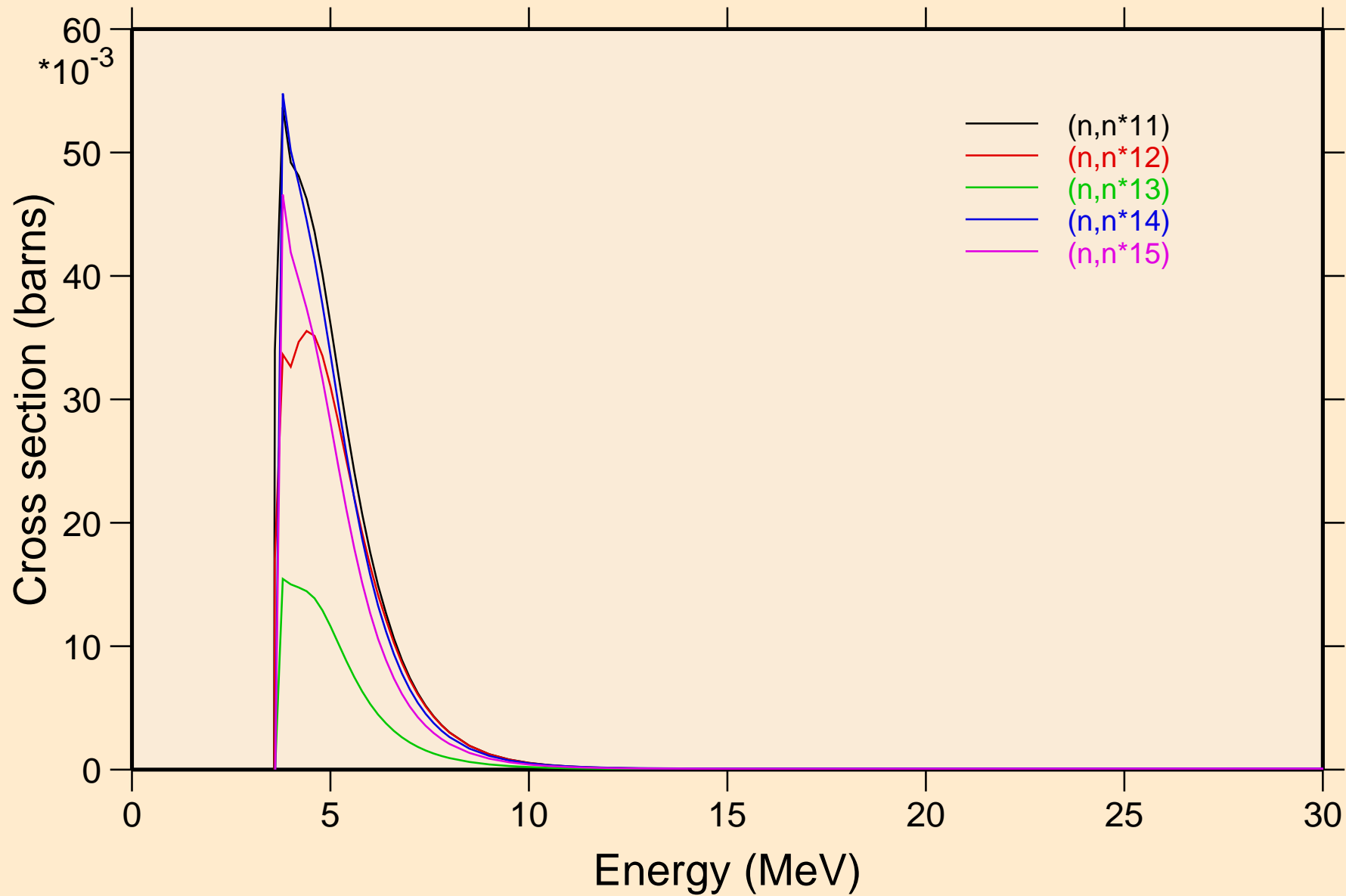

# SC053 NEUTRON ACER TENDL-2024 LIBRARY; T=0.K

## Inelastic levels

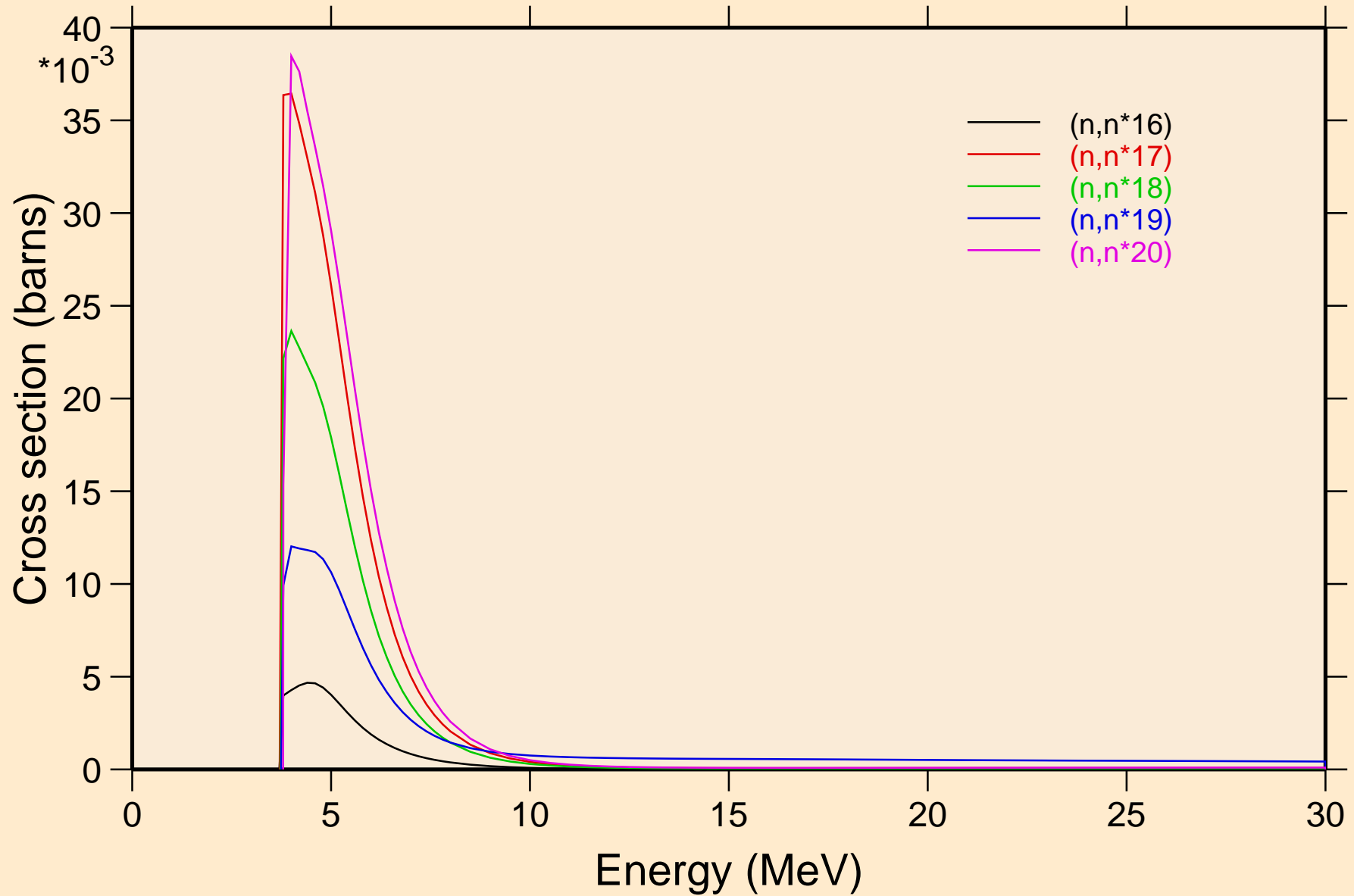

SC053 NEUTRON ACER TENDL-2024 LIBRARY; T=0.K  
Inelastic levels

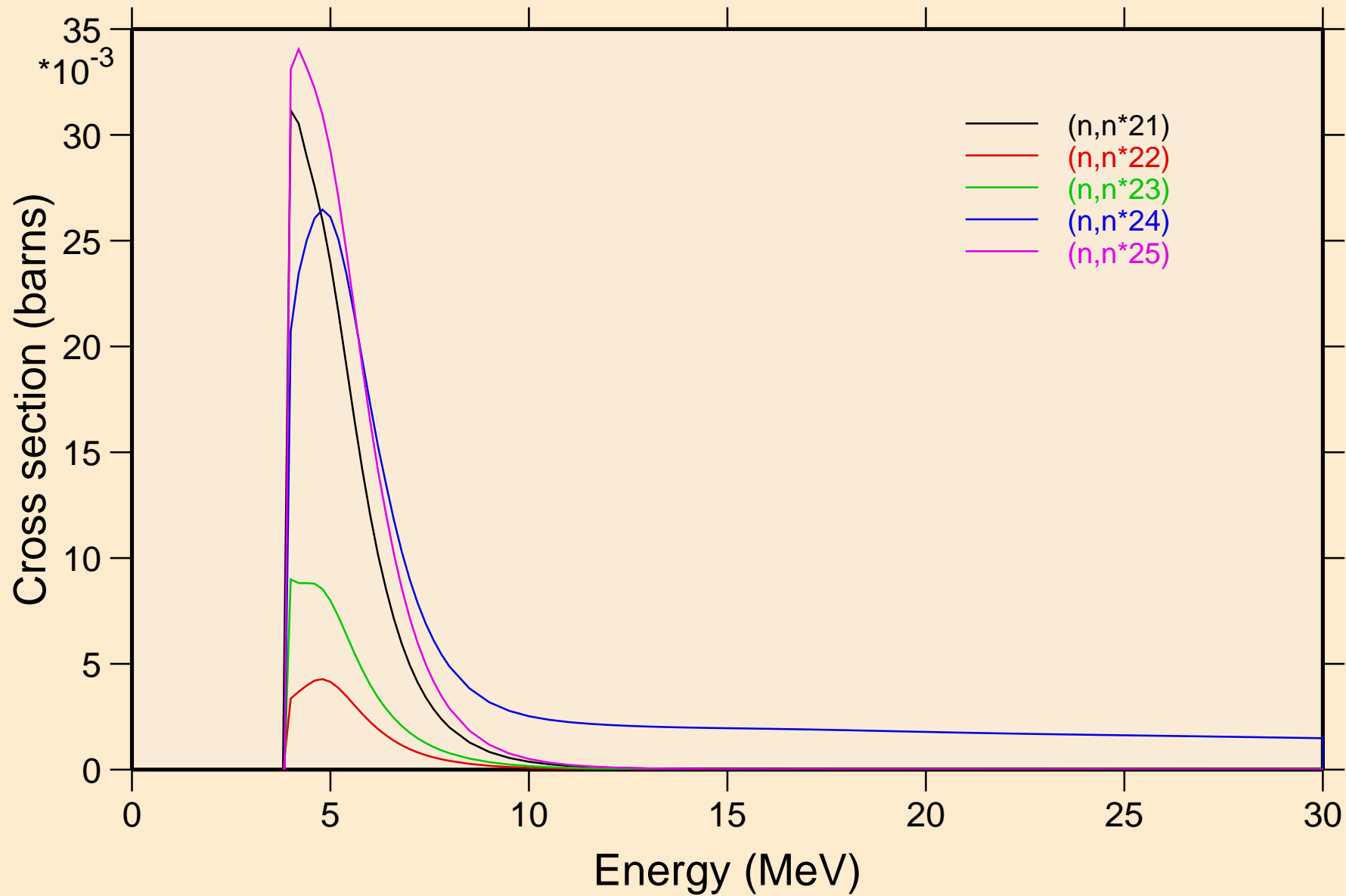

# SC053 NEUTRON ACER TENDL-2024 LIBRARY; T=0.K

## Inelastic levels

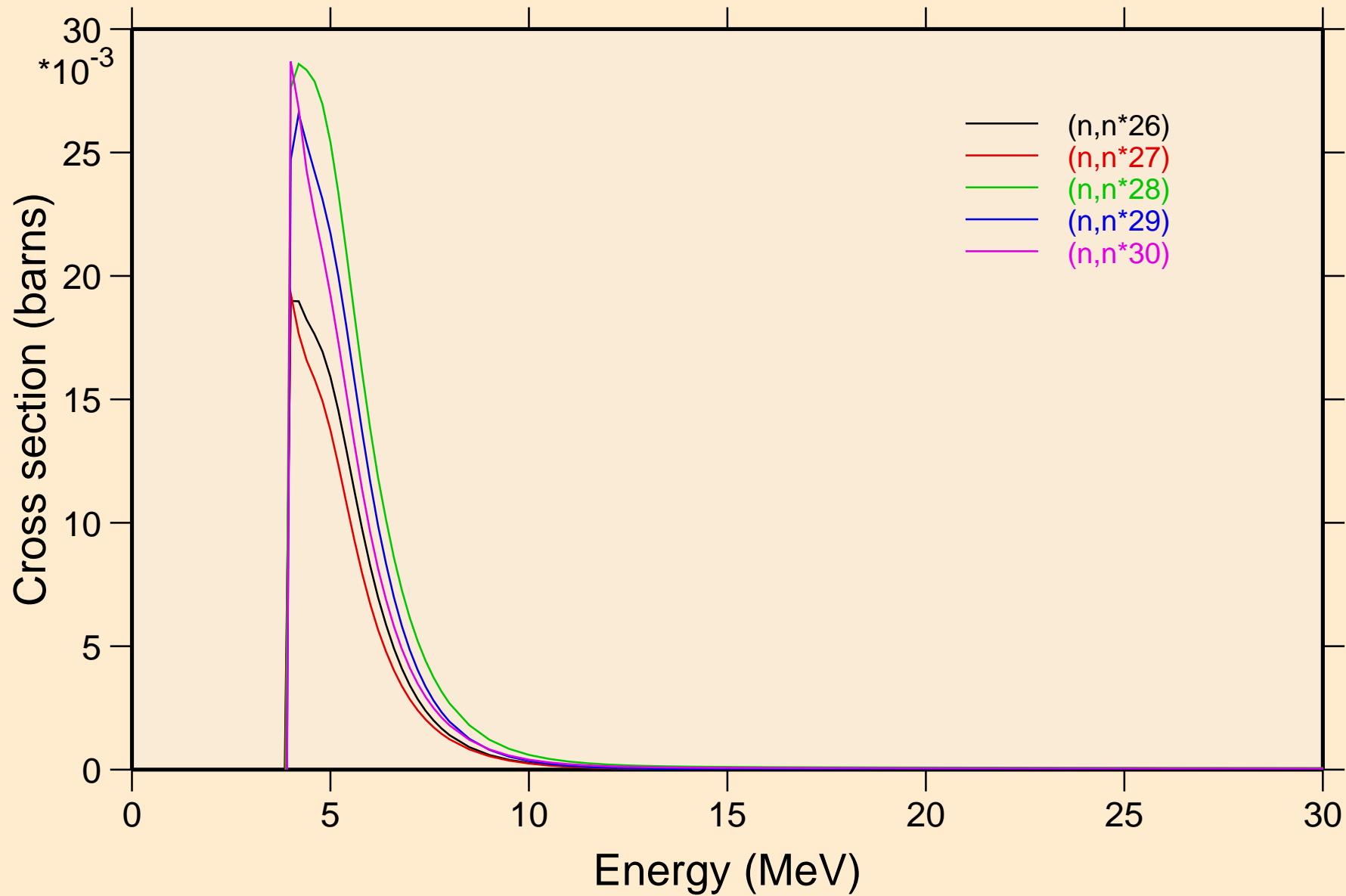

SC053 NEUTRON ACER TENDL-2024 LIBRARY; T=0.K  
Threshold reactions

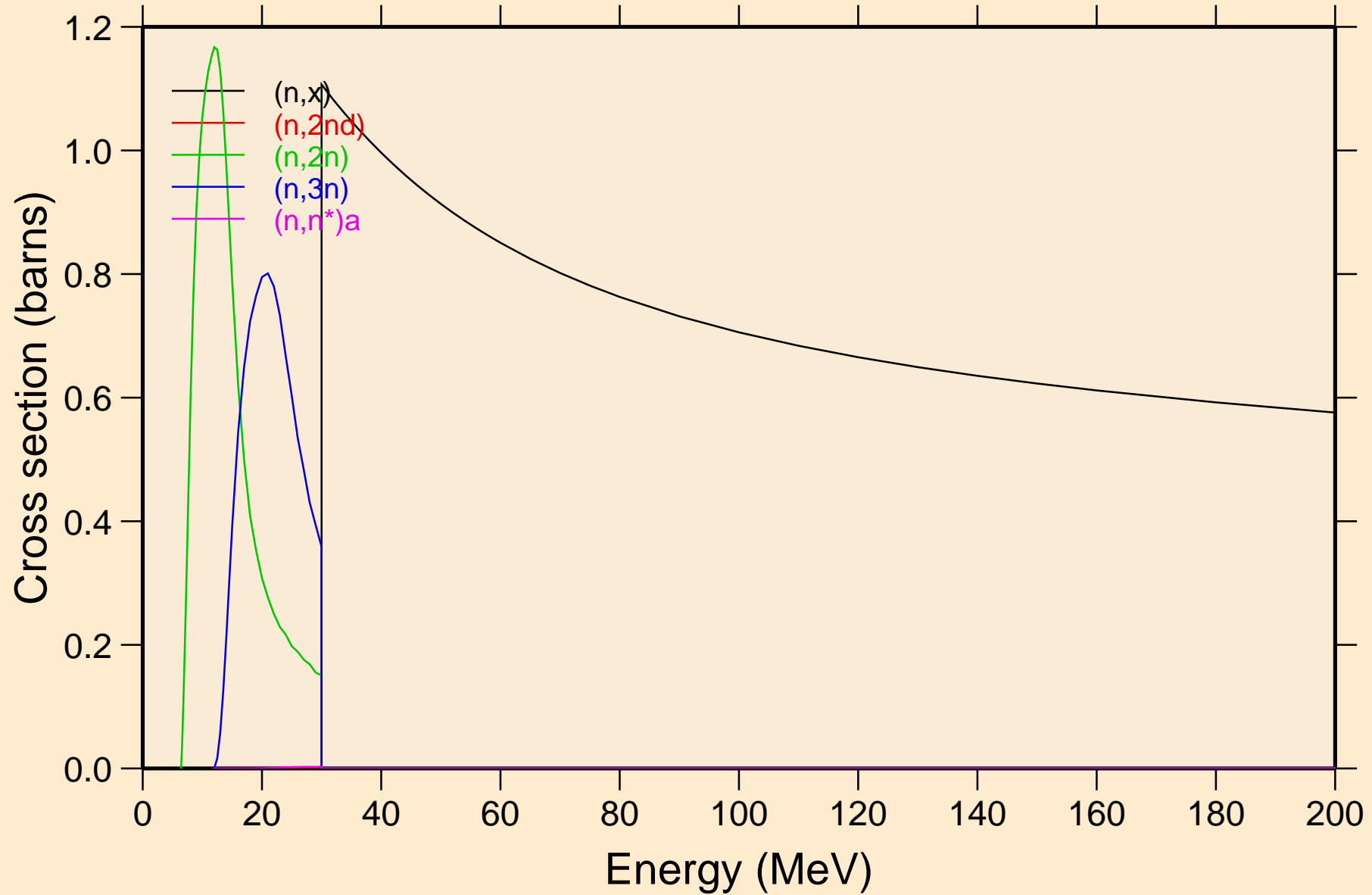

SC053 NEUTRON ACER TENDL-2024 LIBRARY; T=0.K  
Threshold reactions

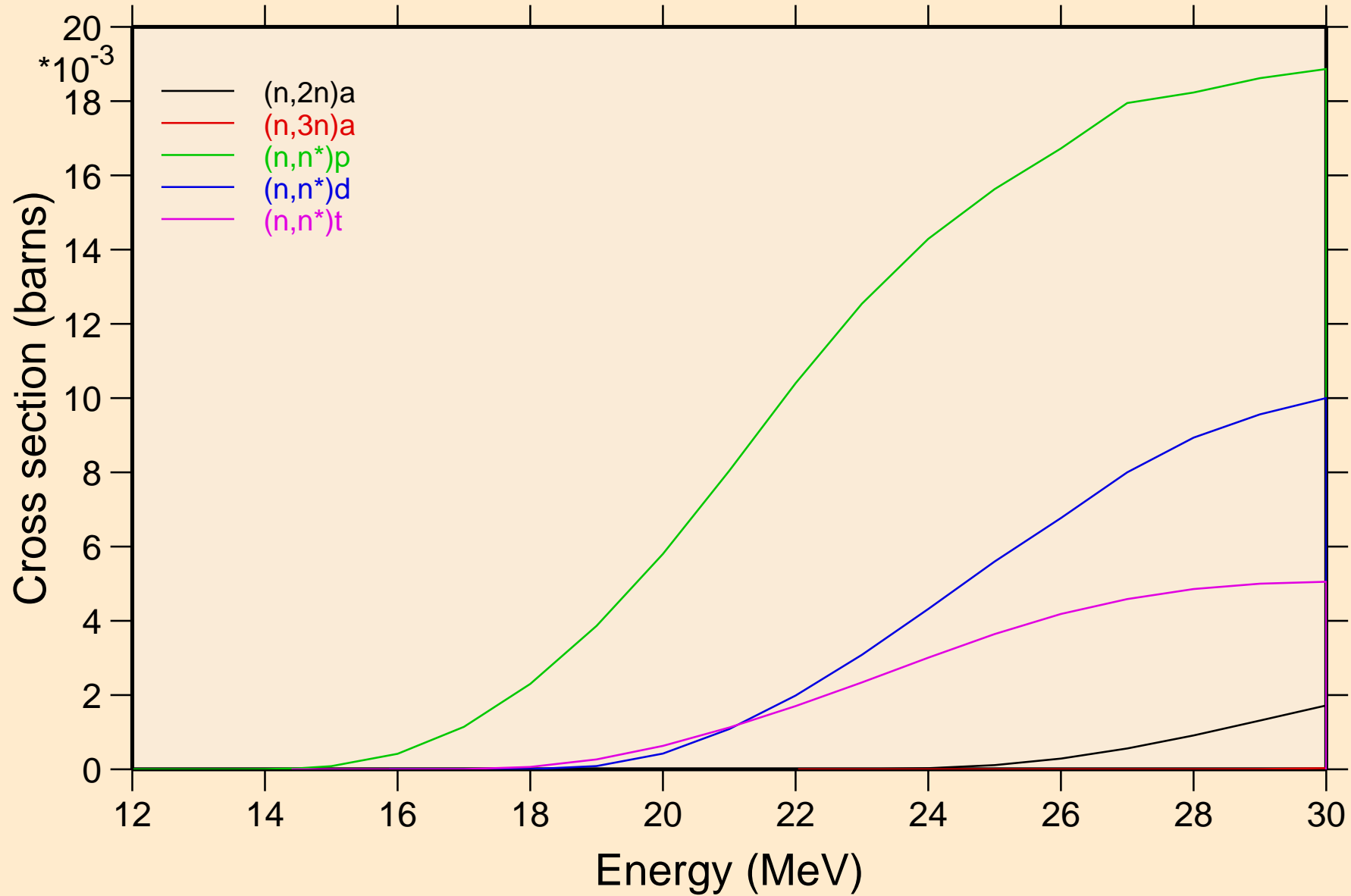



SC053 NEUTRON ACER TENDL-2024 LIBRARY; T=0.K  
Threshold reactions

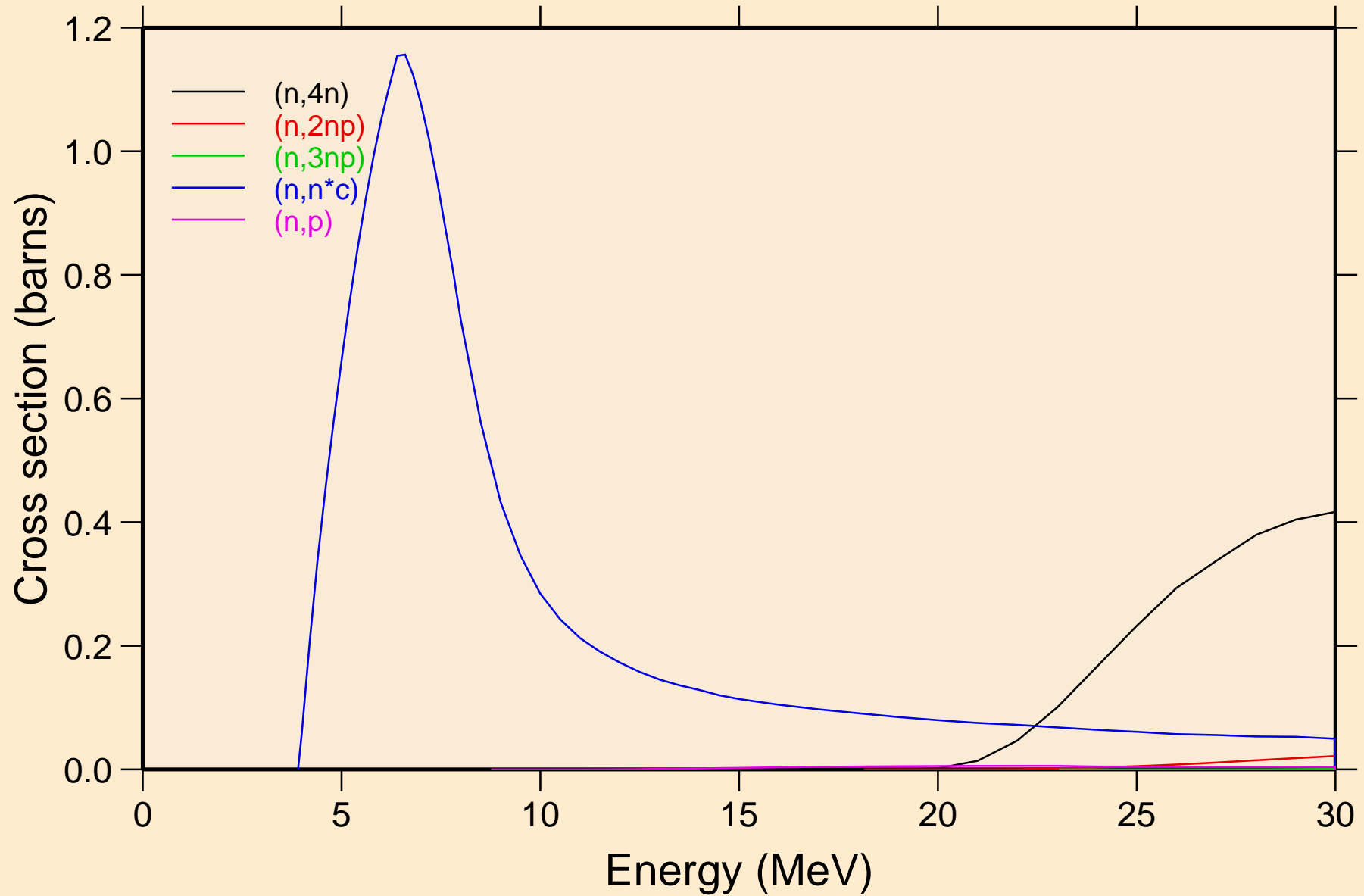

SC053 NEUTRON ACER TENDL-2024 LIBRARY; T=0.K  
Threshold reactions

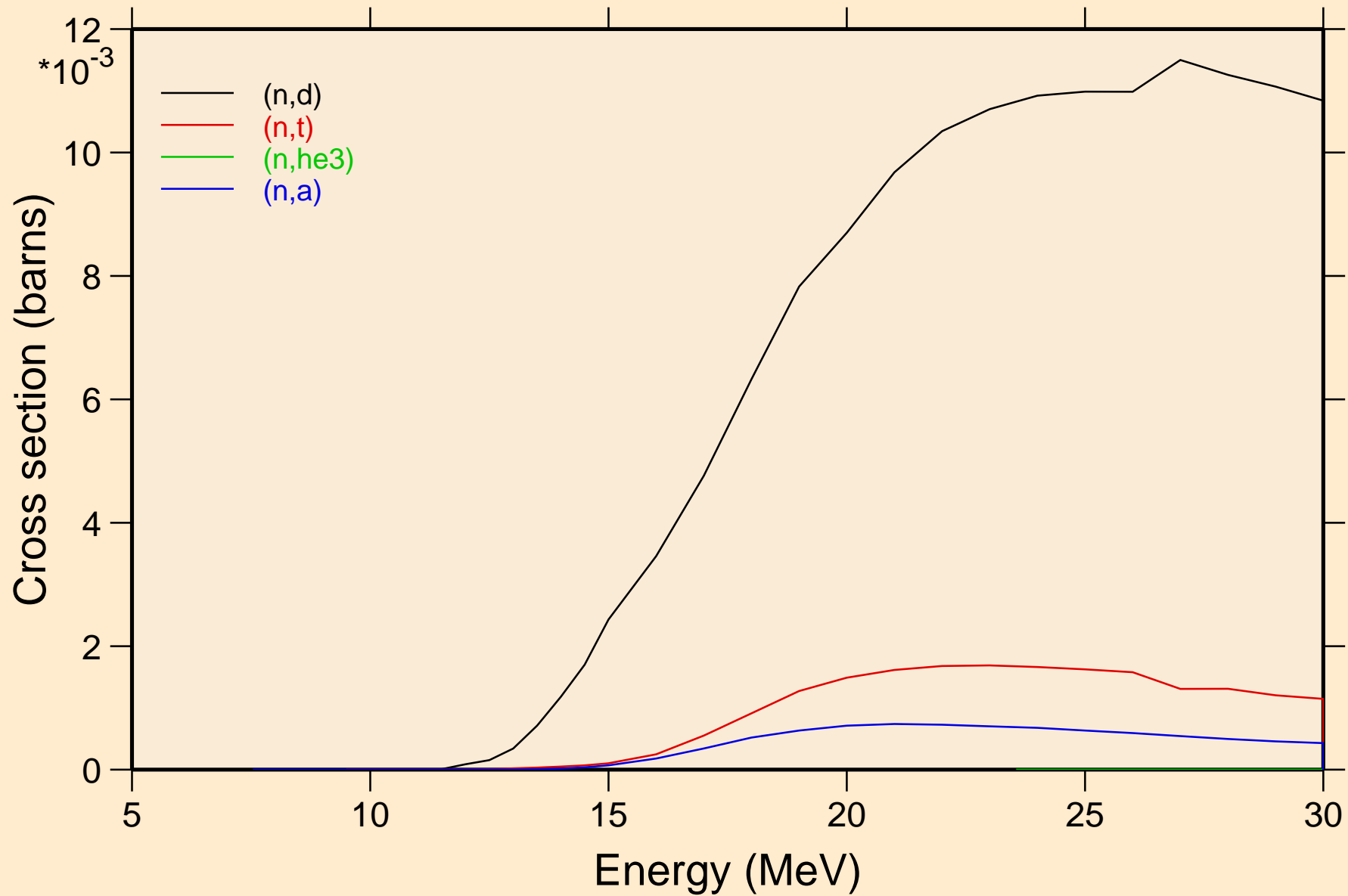

# SC053 NEUTRON ACER TENDL-2024 LIBRARY; T=0.K

## Threshold reactions

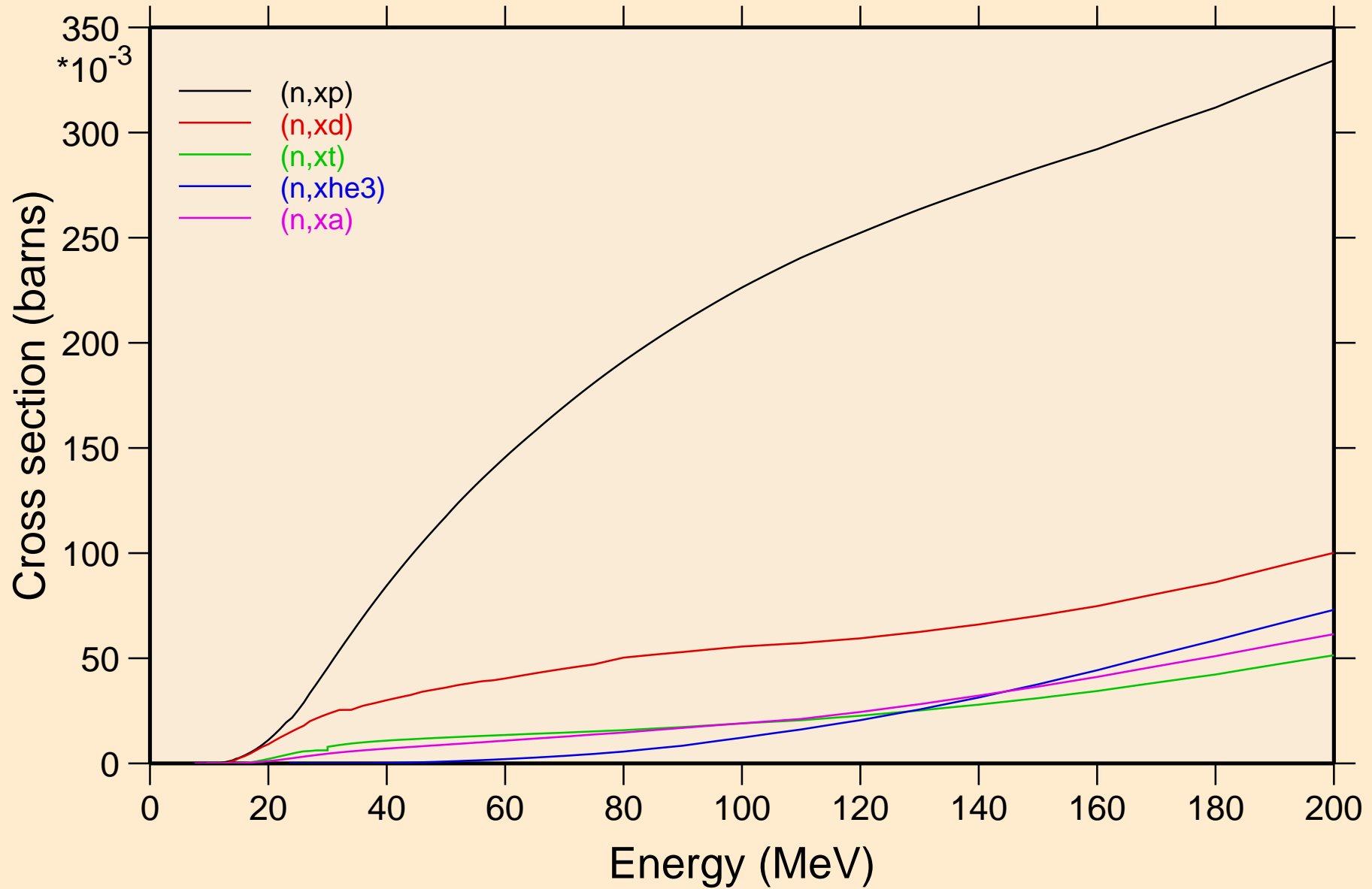

SC053 NEUTRON ACER TENDL-2024 LIBRARY; T=0.K  
angular distribution for elastic

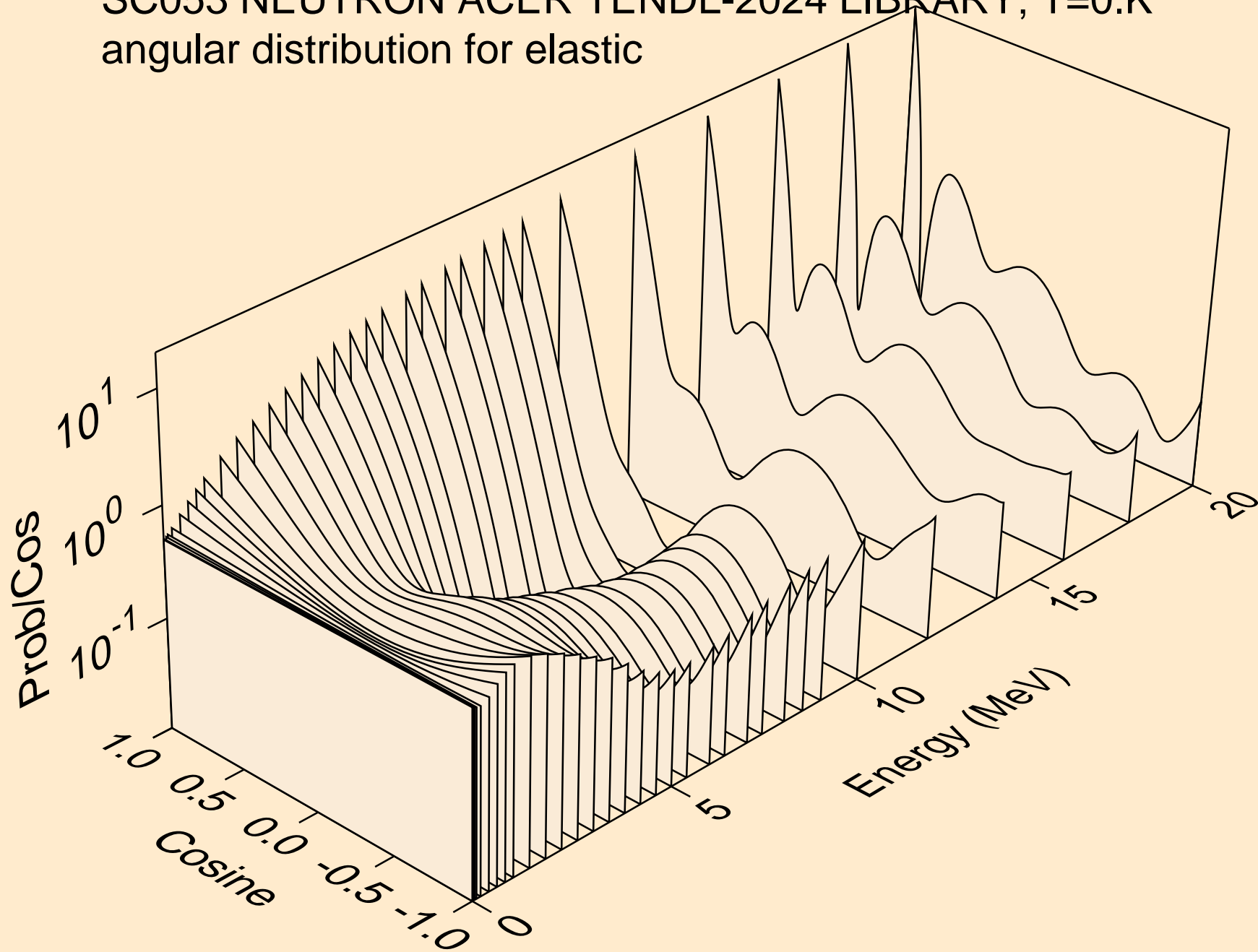

SC053 NEUTRON ACER TENDL-2024 LIBRARY; T=0.K  
angular distribution for elastic

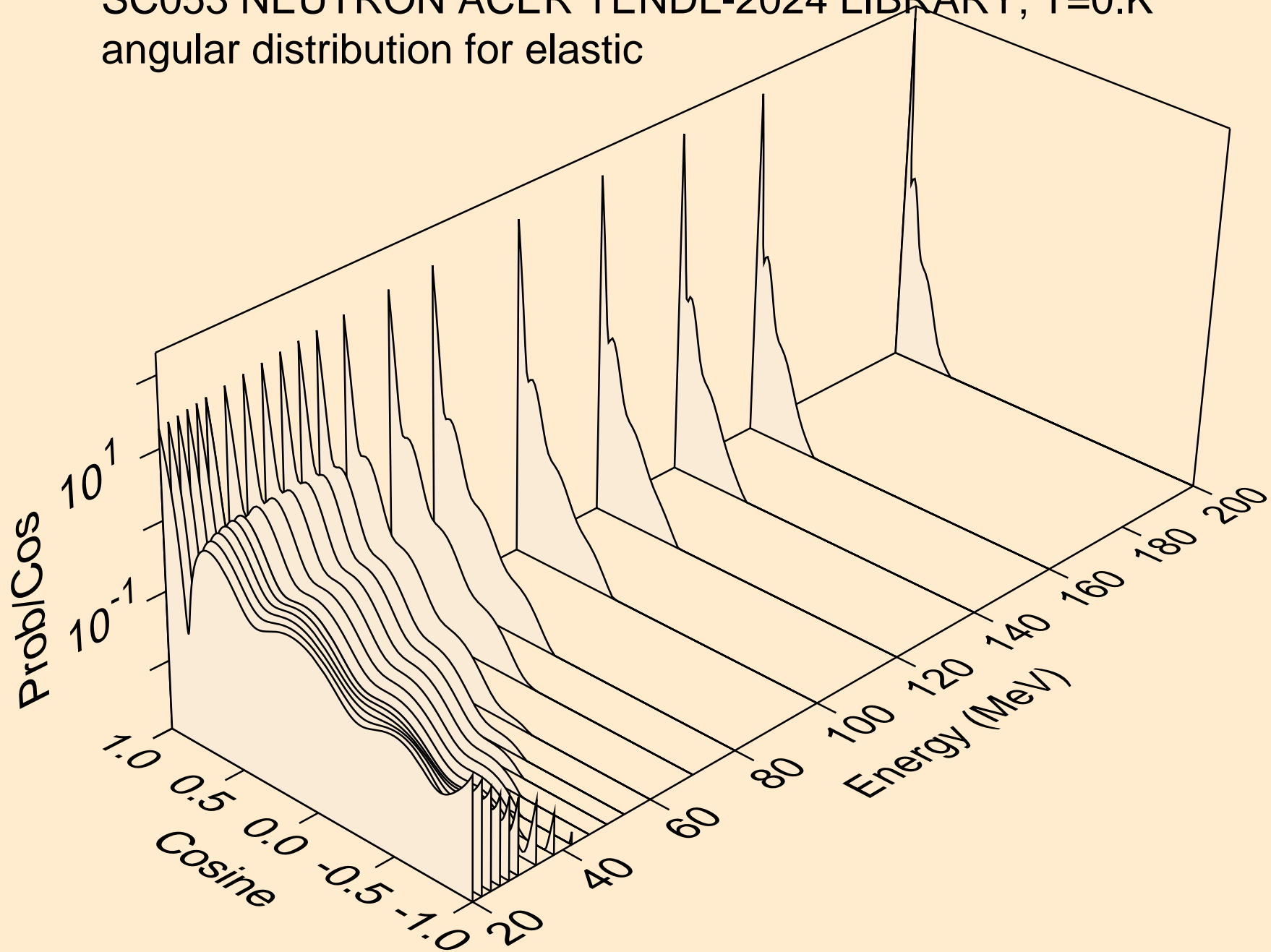

SC053 NEUTRON ACER TENDL-2024 LIBRARY; T=0.K  
angular distribution for (n,n\*1)

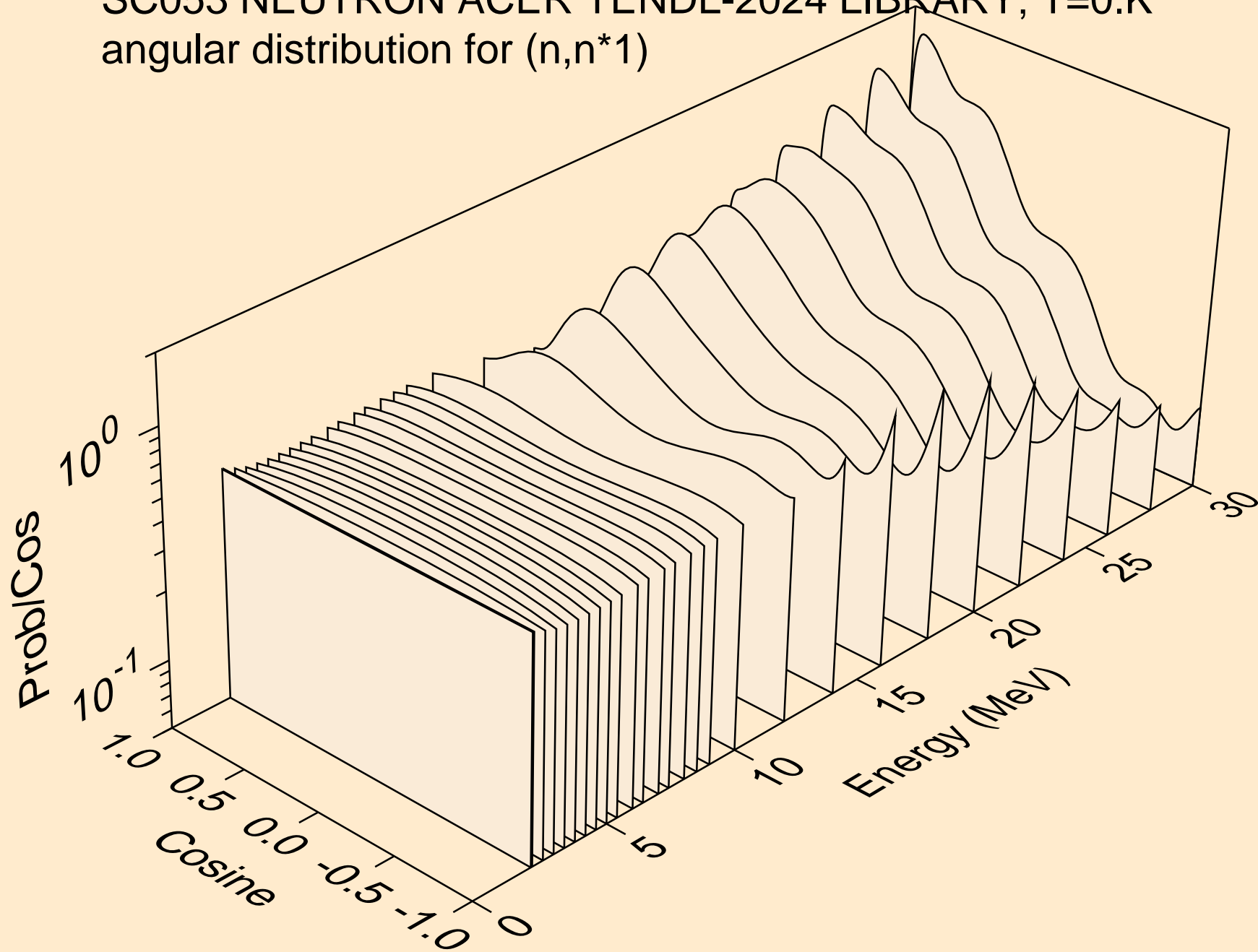

SC053 NEUTRON ACER TENDL-2024 LIBRARY; T=0.K  
angular distribution for (n,n\*2)

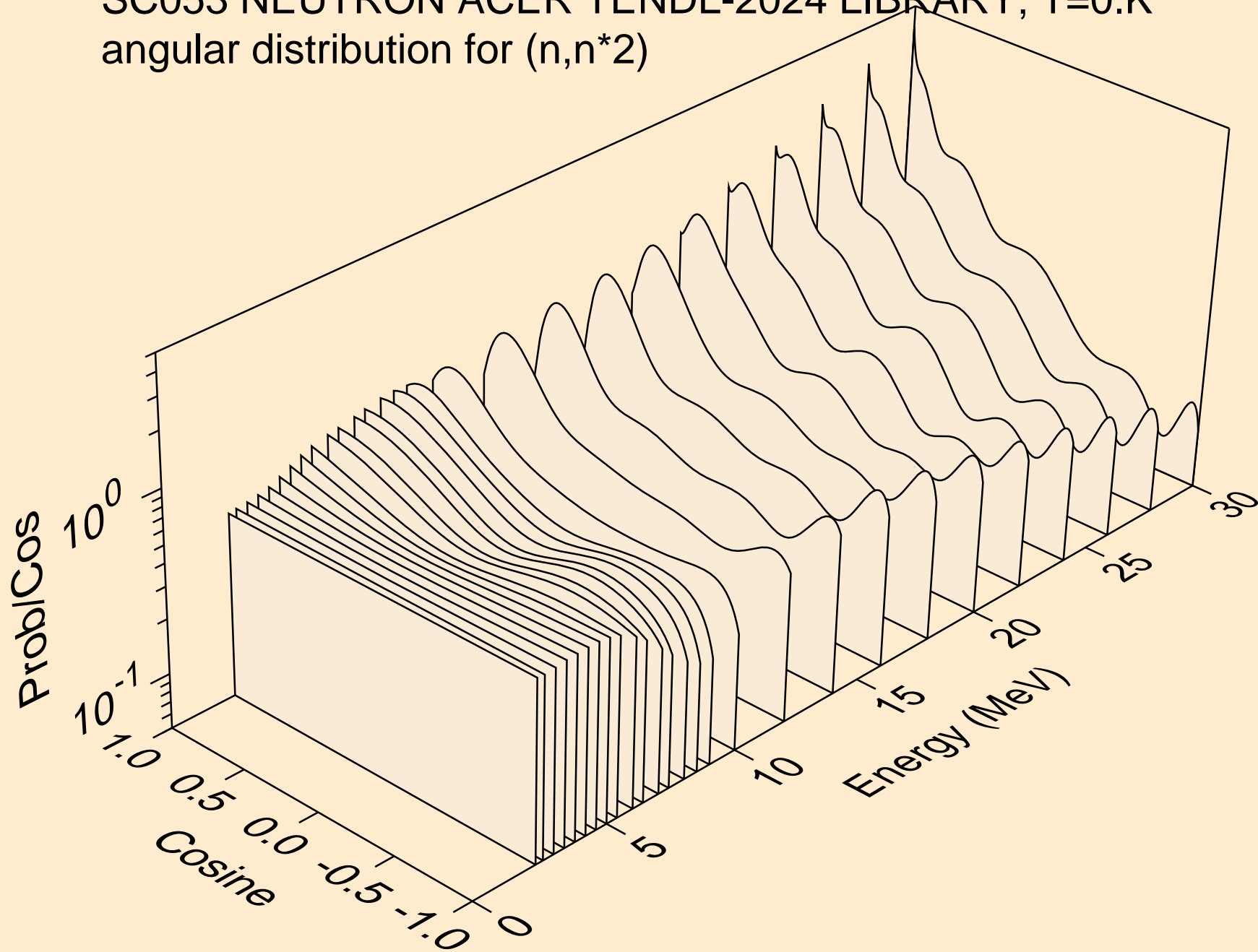

SC053 NEUTRON ACER TENDL-2024 LIBRARY; T=0.K  
angular distribution for (n,n\*3)

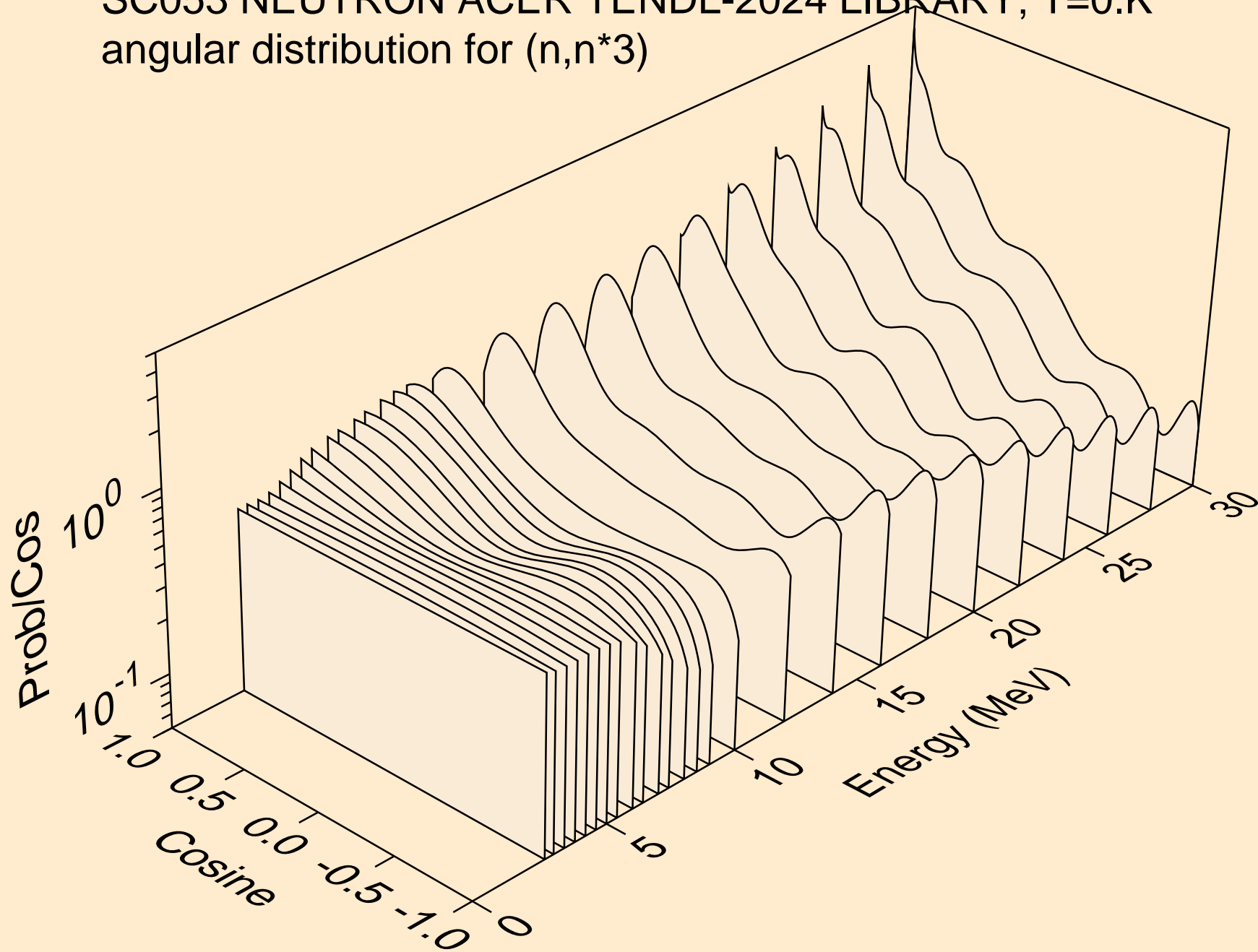



SC053 NEUTRON ACER TENDL-2024 LIBRARY; T=0.K  
angular distribution for (n,n\*4)

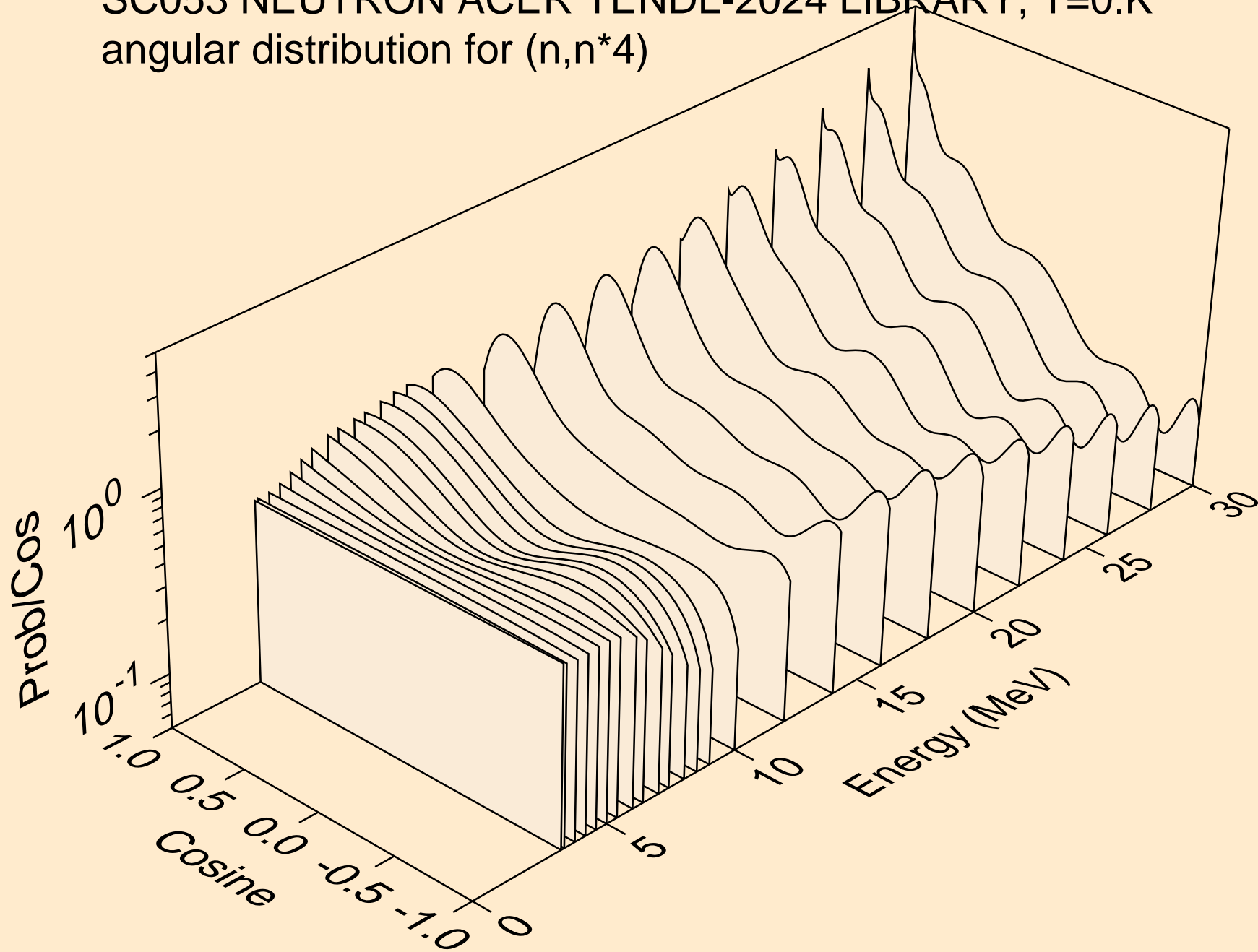

SC053 NEUTRON ACER TENDL-2024 LIBRARY; T=0.K  
angular distribution for (n,n\*5)

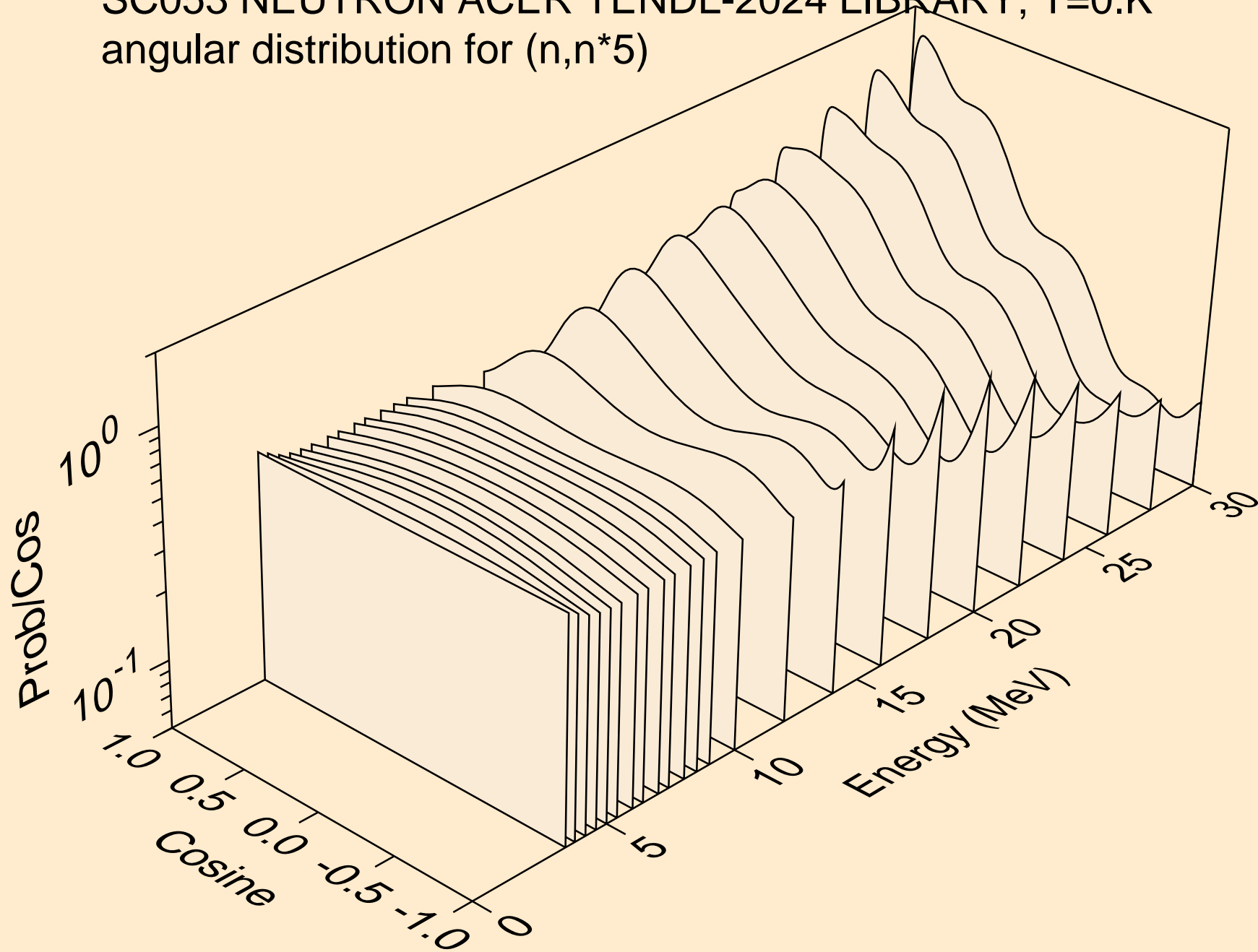

SC053 NEUTRON ACER TENDL-2024 LIBRARY; T=0.K  
angular distribution for (n,n\*6)

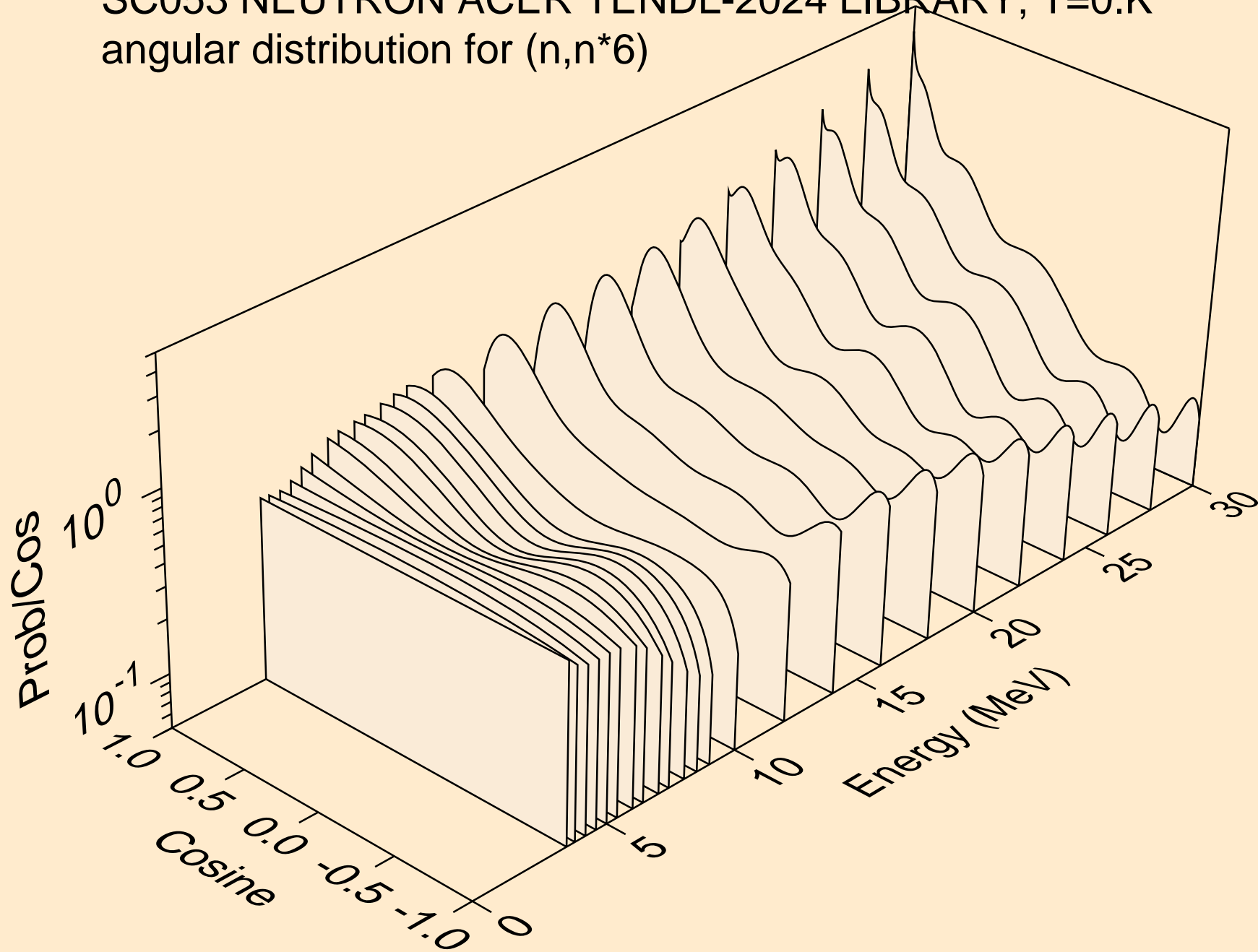

SC053 NEUTRON ACER TENDL-2024 LIBRARY; T=0.K  
angular distribution for (n,n\*7)

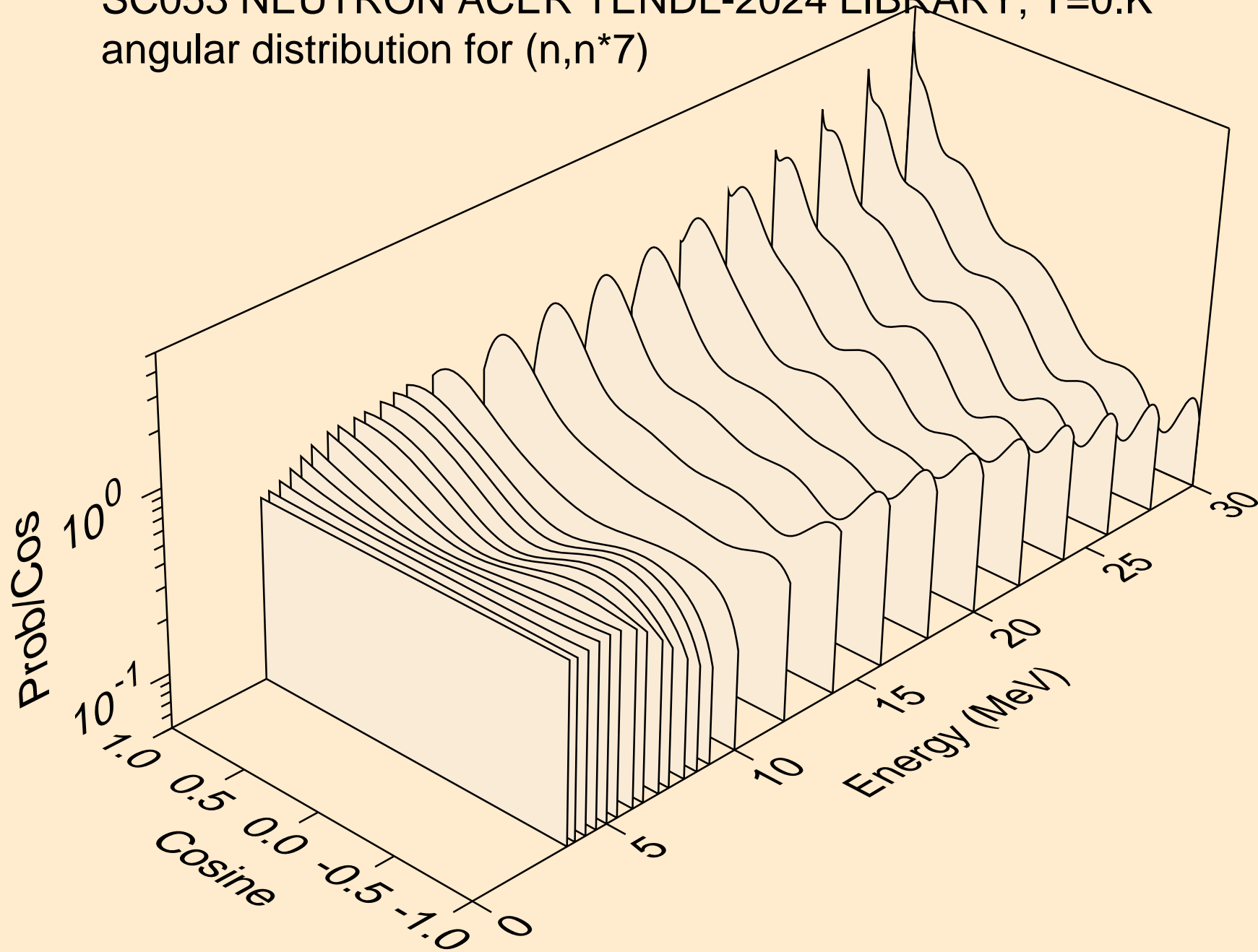

SC053 NEUTRON ACER TENDL-2024 LIBRARY; T=0.K  
angular distribution for (n,n\*8)

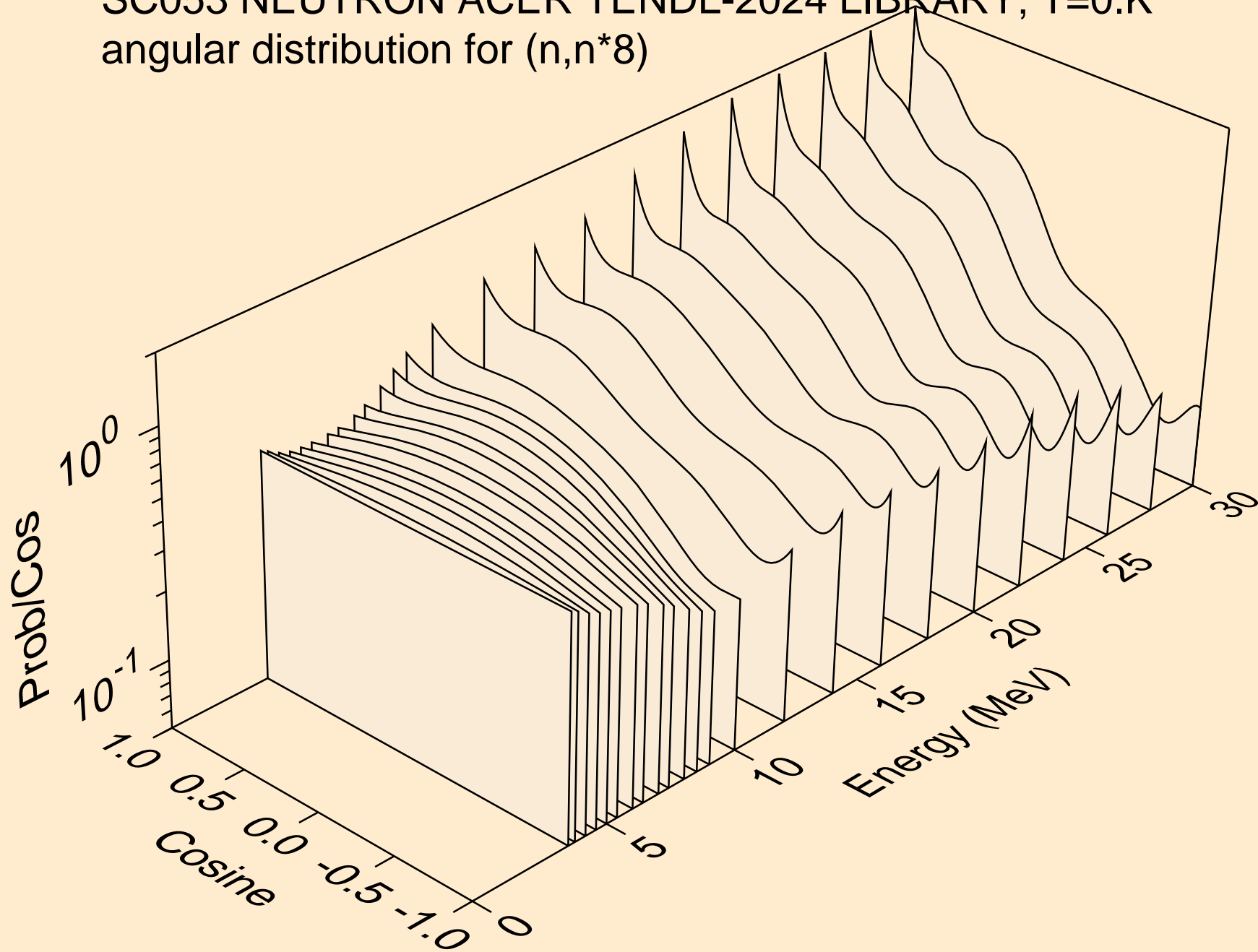

SC053 NEUTRON ACER TENDL-2024 LIBRARY; T=0.K  
angular distribution for (n,n\*9)

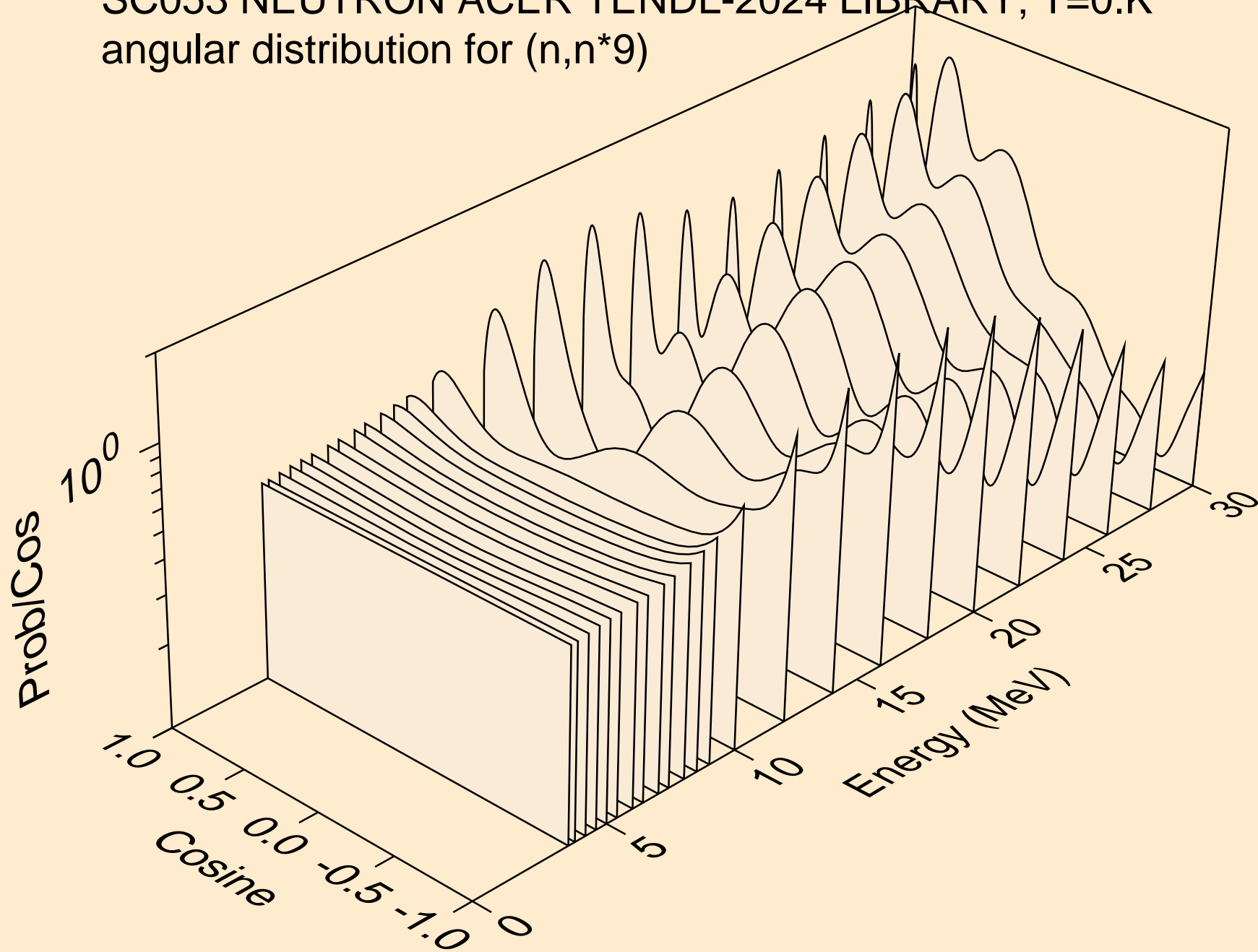

SC053 NEUTRON ACER TENDL-2024 LIBRARY; T=0.K  
angular distribution for (n,n\*10)

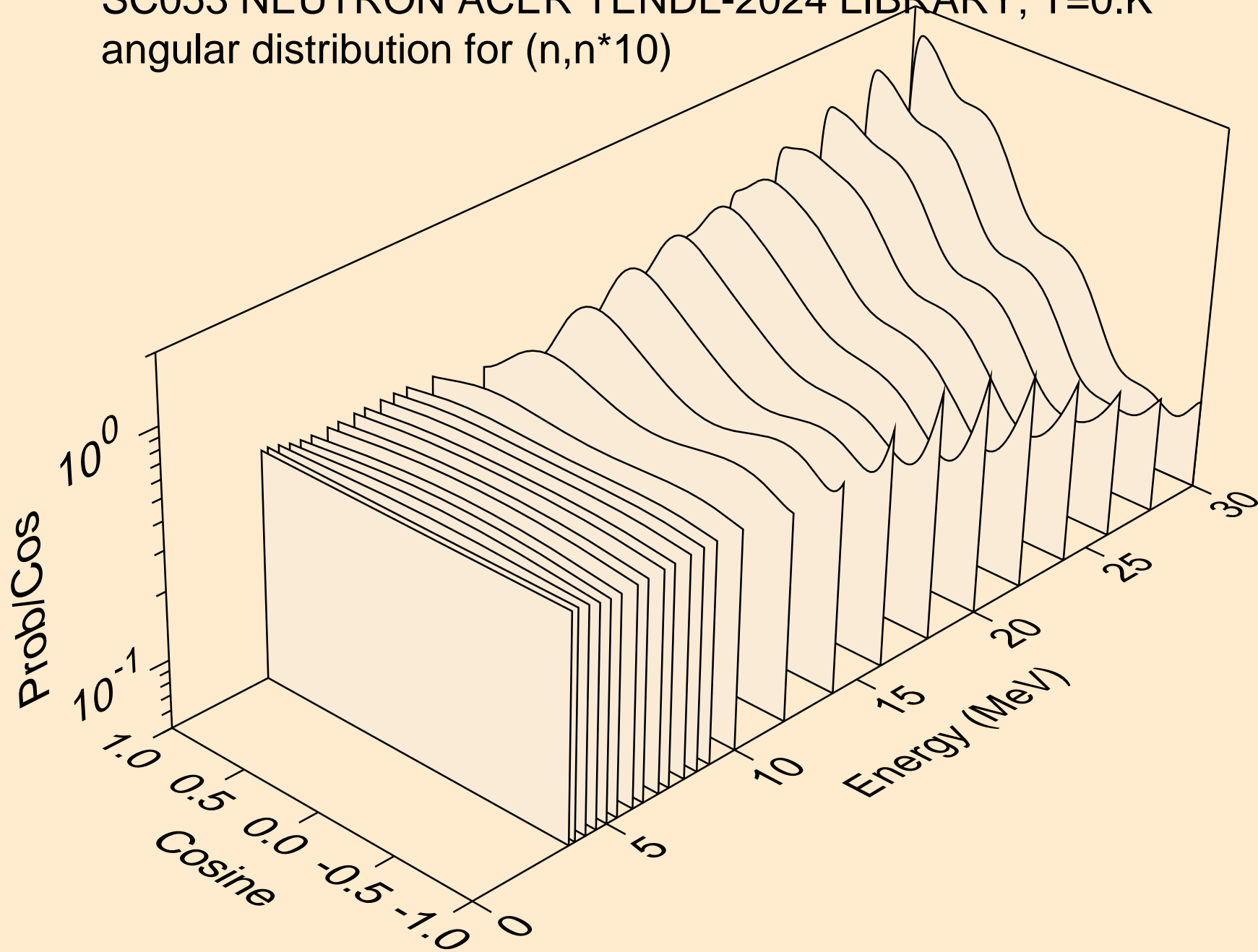

SC053 NEUTRON ACER TENDL-2024 LIBRARY; T=0.K  
angular distribution for (n,n\*11)

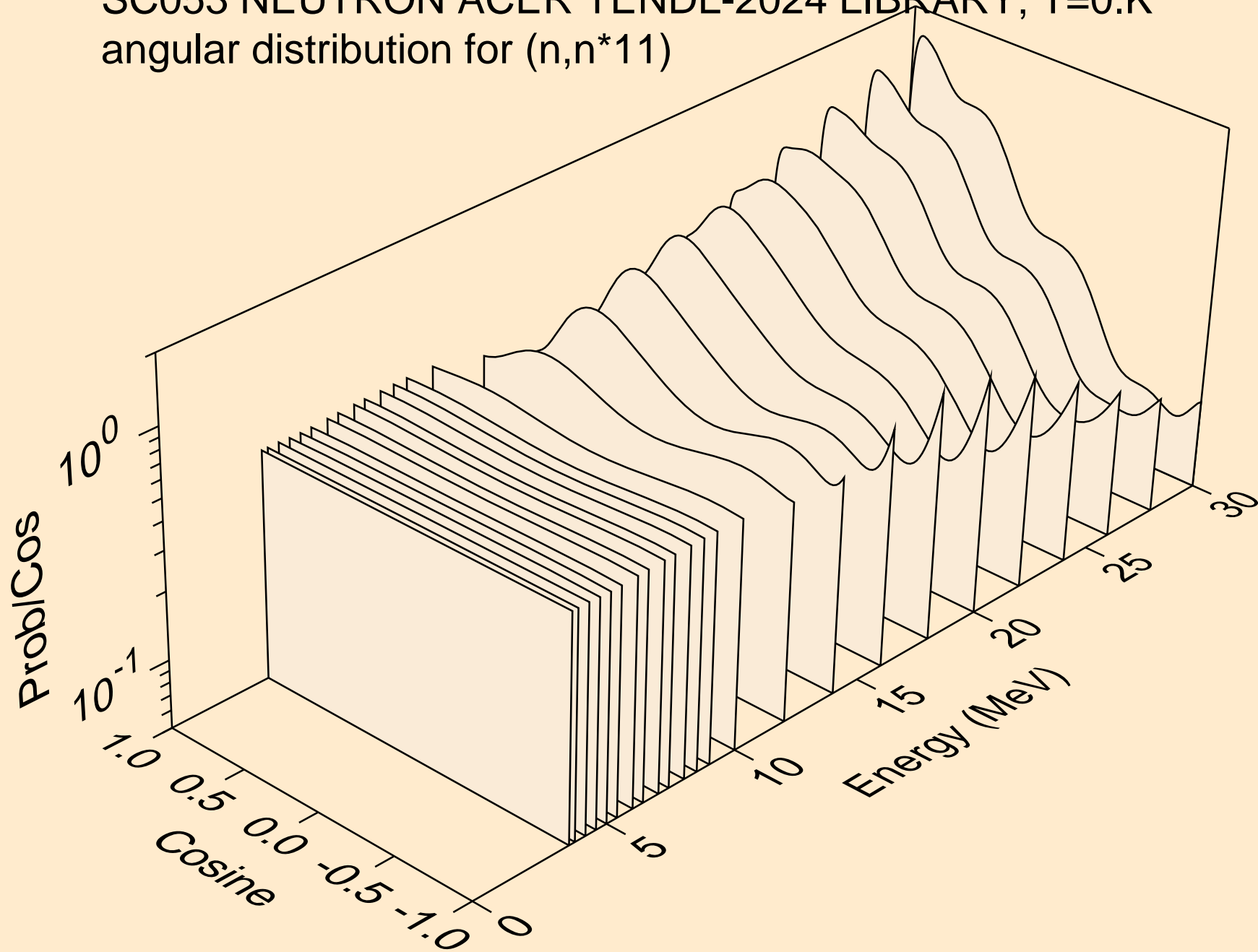



SC053 NEUTRON ACER TENDL-2024 LIBRARY; T=0.K  
angular distribution for (n,n\*12)

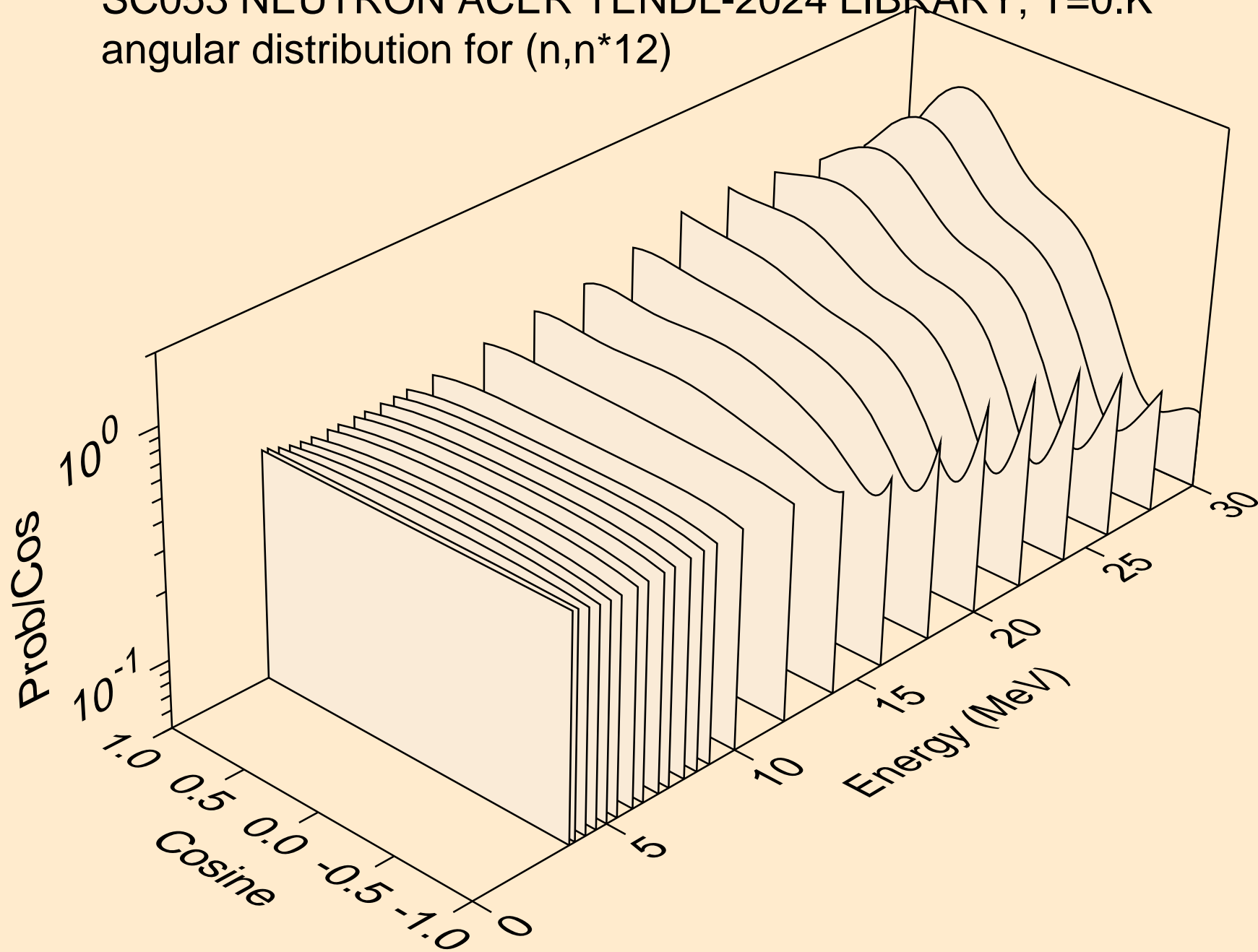

SC053 NEUTRON ACER TENDL-2024 LIBRARY; T=0.K  
angular distribution for (n,n\*13)

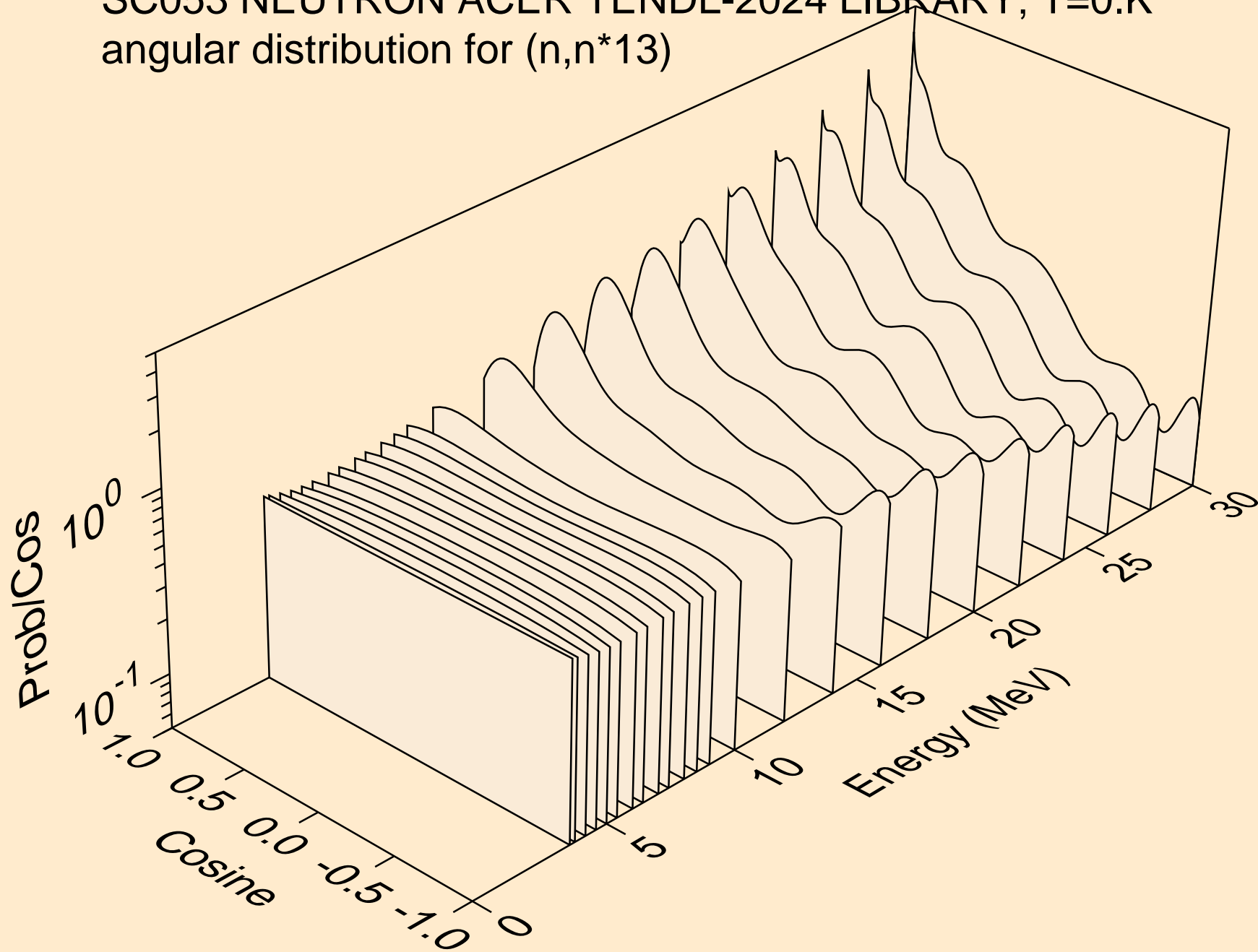

SC053 NEUTRON ACER TENDL-2024 LIBRARY; T=0.K  
angular distribution for (n,n\*14)

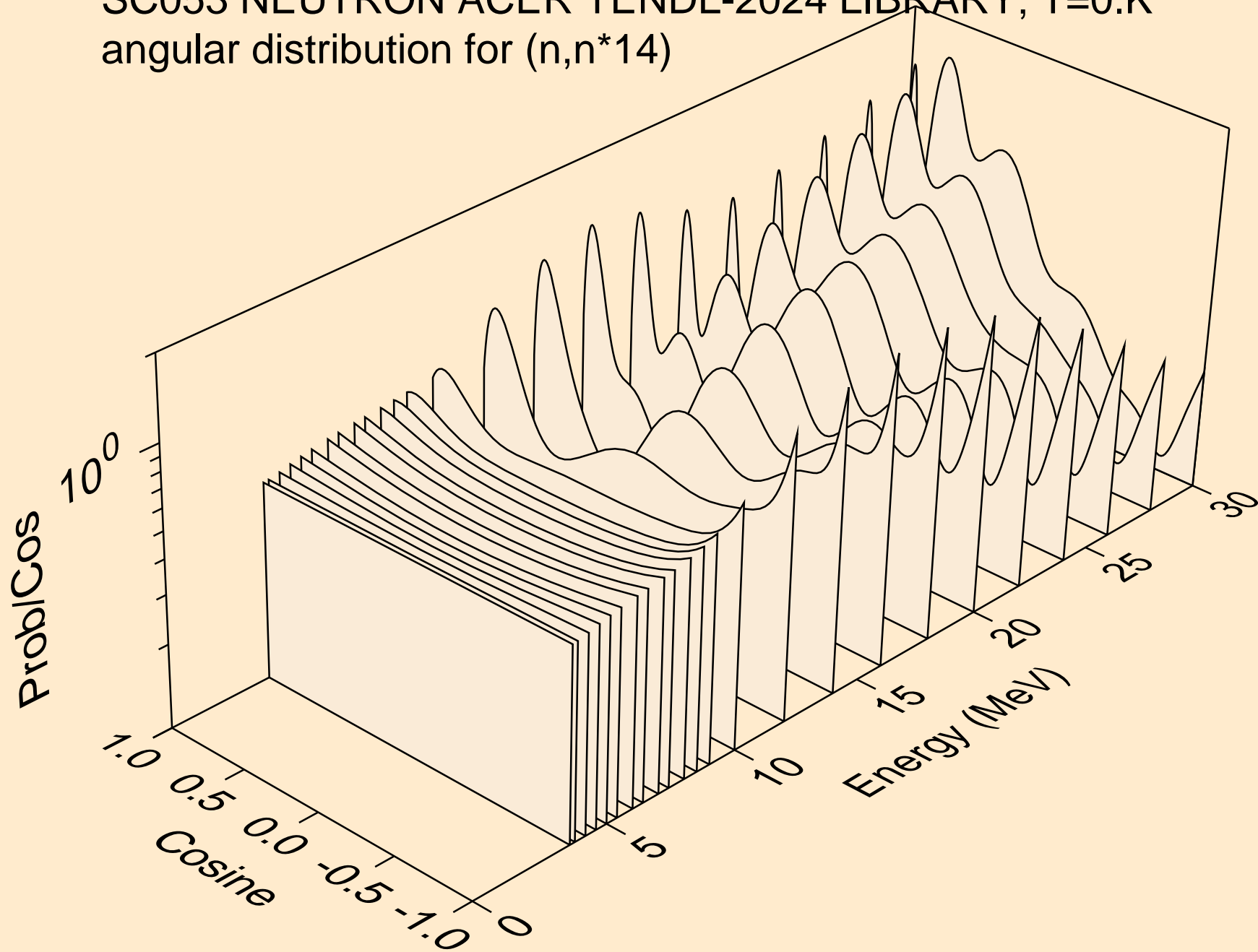

SC053 NEUTRON ACER TENDL-2024 LIBRARY; T=0.K  
angular distribution for (n,n\*15)

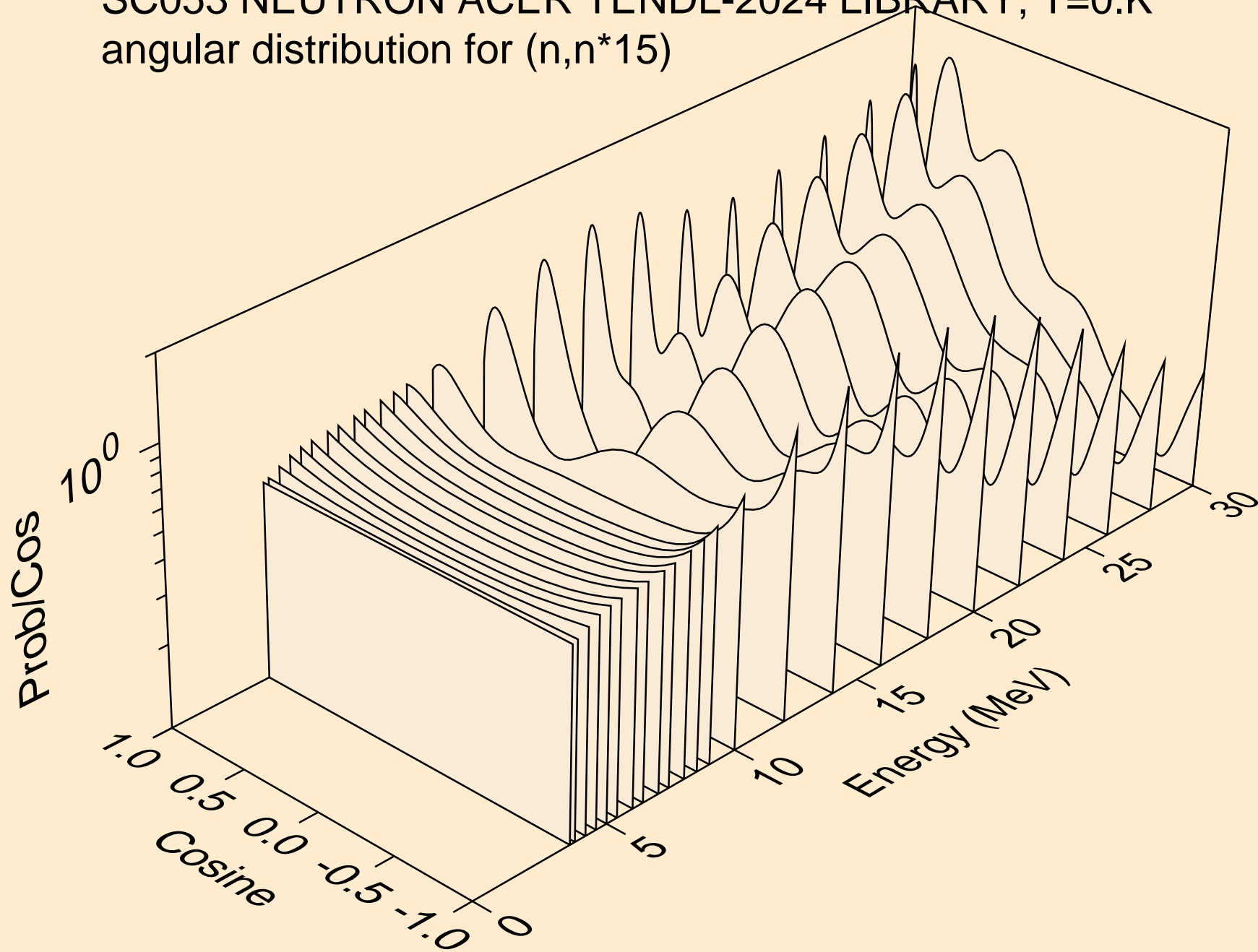

SC053 NEUTRON ACER TENDL-2024 LIBRARY; T=0.K  
angular distribution for (n,n\*16)

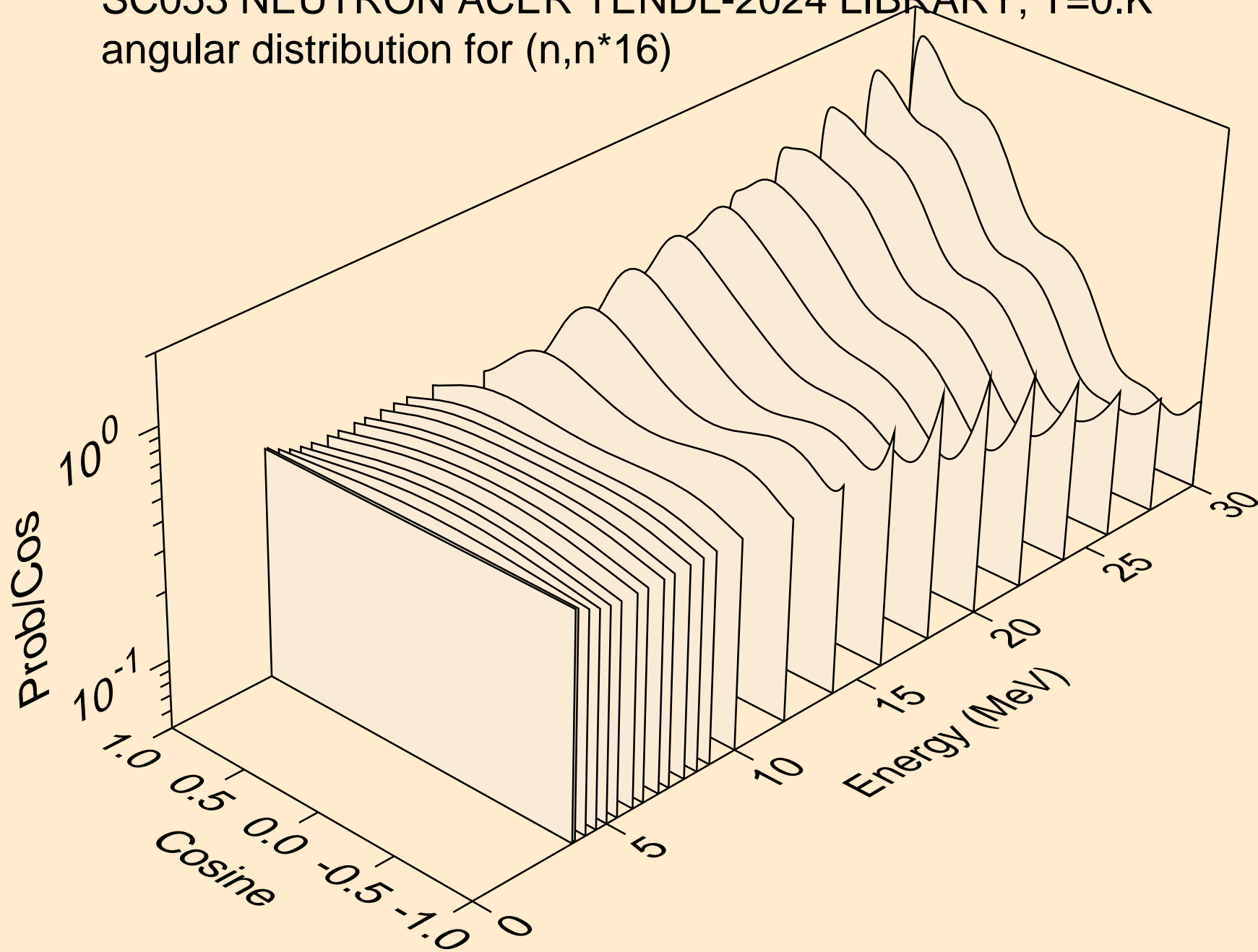

SC053 NEUTRON ACER TENDL-2024 LIBRARY; T=0.K  
angular distribution for (n,n\*17)

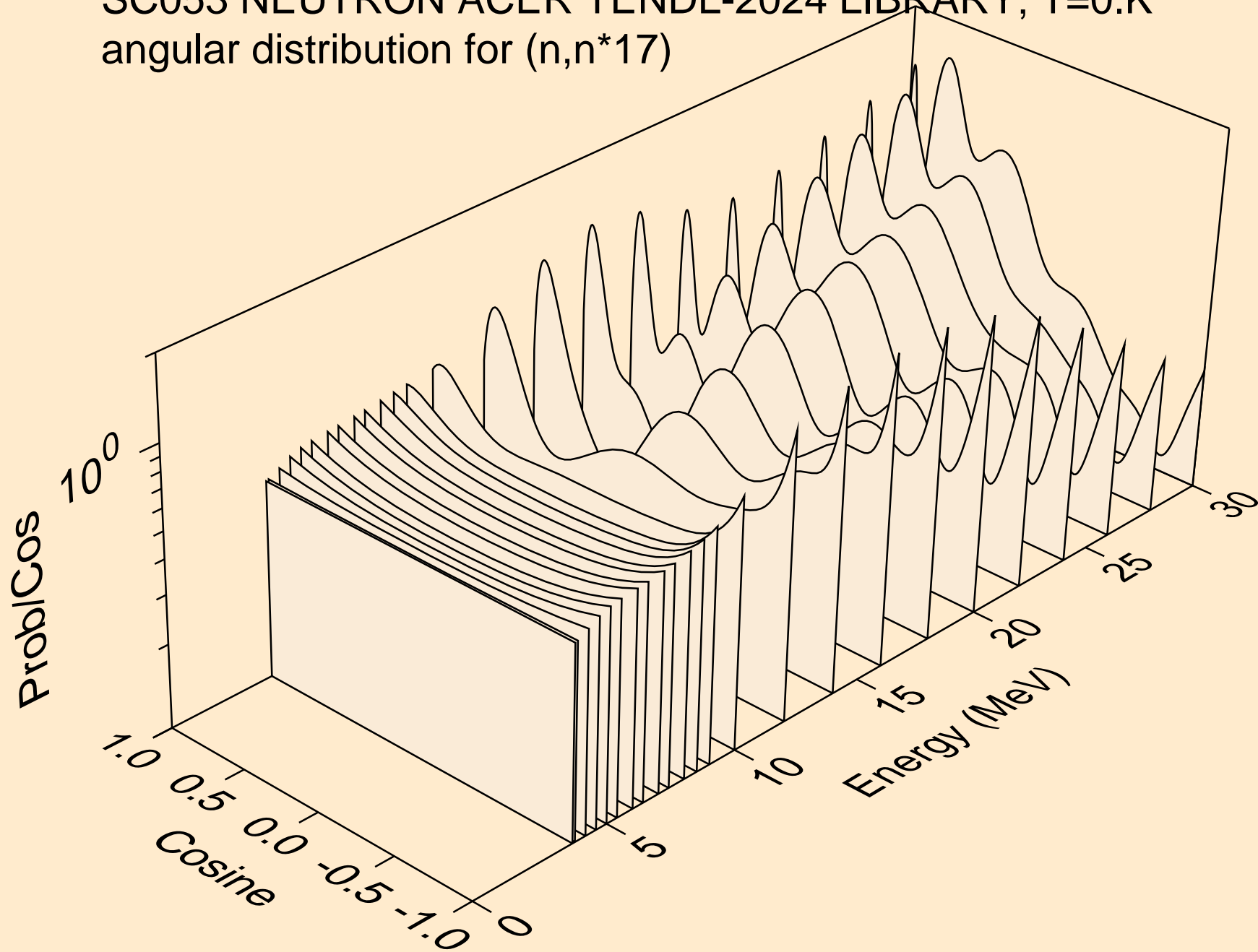

SC053 NEUTRON ACER TENDL-2024 LIBRARY; T=0.K  
angular distribution for (n,n\*18)

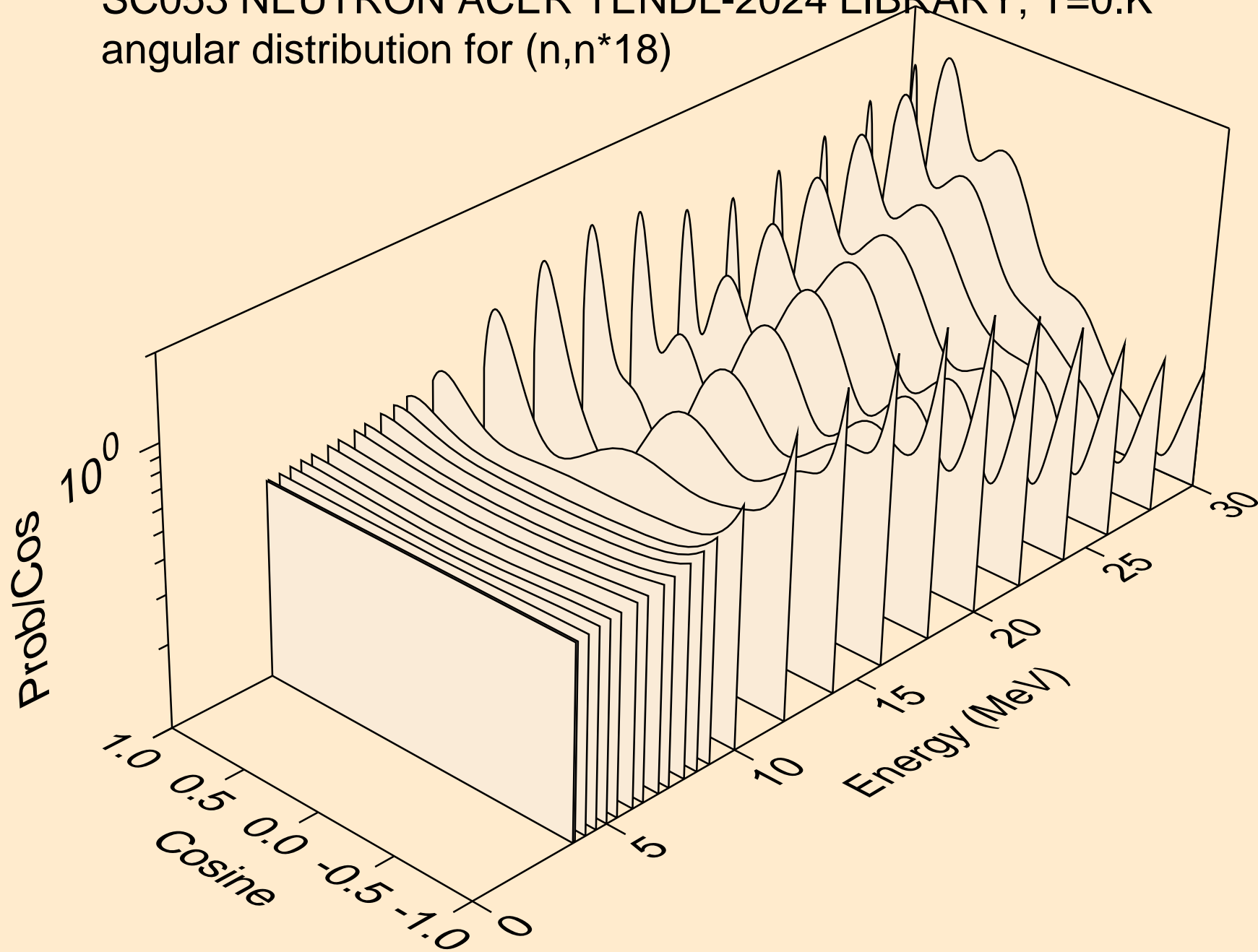

SC053 NEUTRON ACER TENDL-2024 LIBRARY; T=0.K  
angular distribution for (n,n\*19)

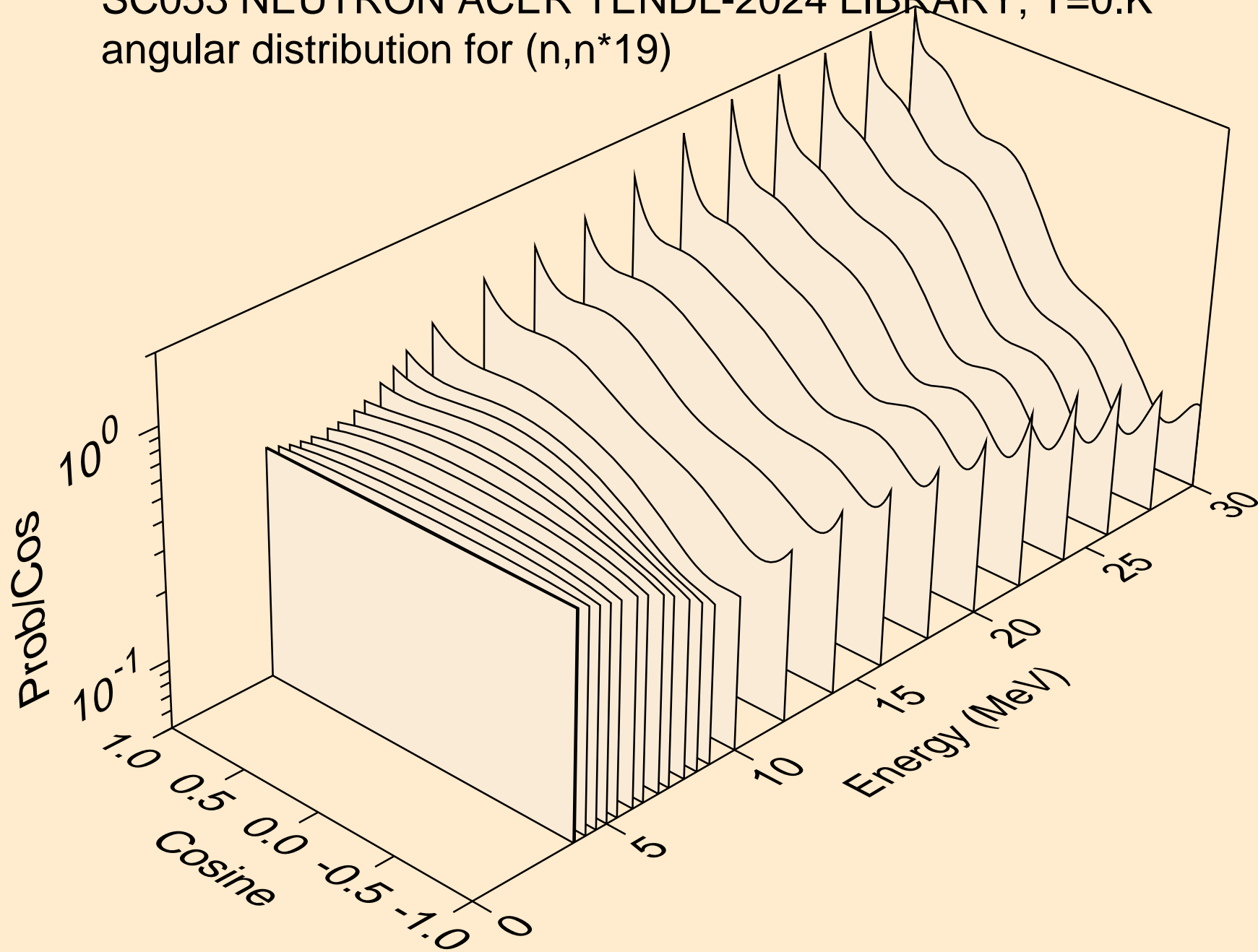



SC053 NEUTRON ACER TENDL-2024 LIBRARY; T=0.K  
angular distribution for (n,n\*20)

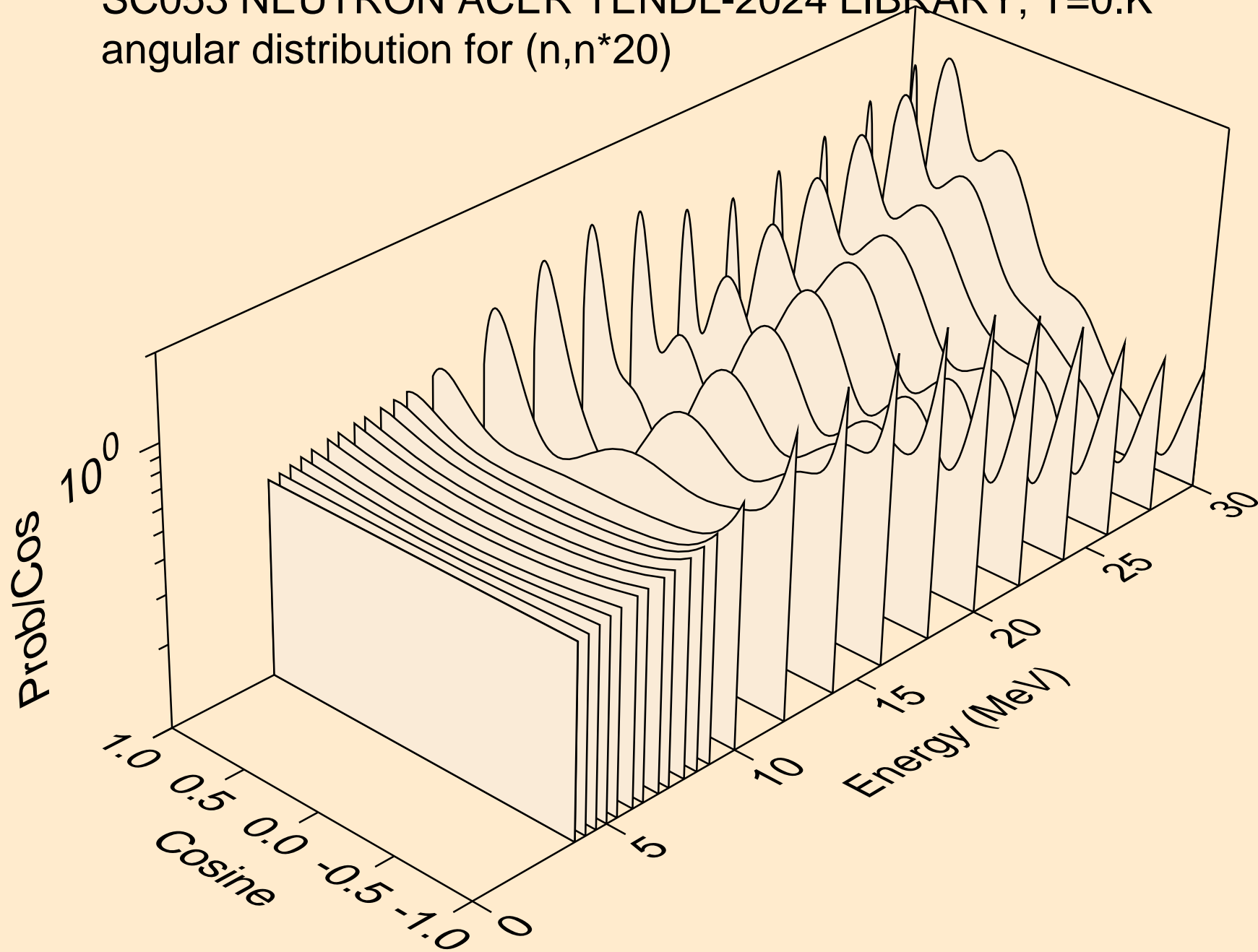

SC053 NEUTRON ACER TENDL-2024 LIBRARY; T=0.K  
angular distribution for (n,n\*21)

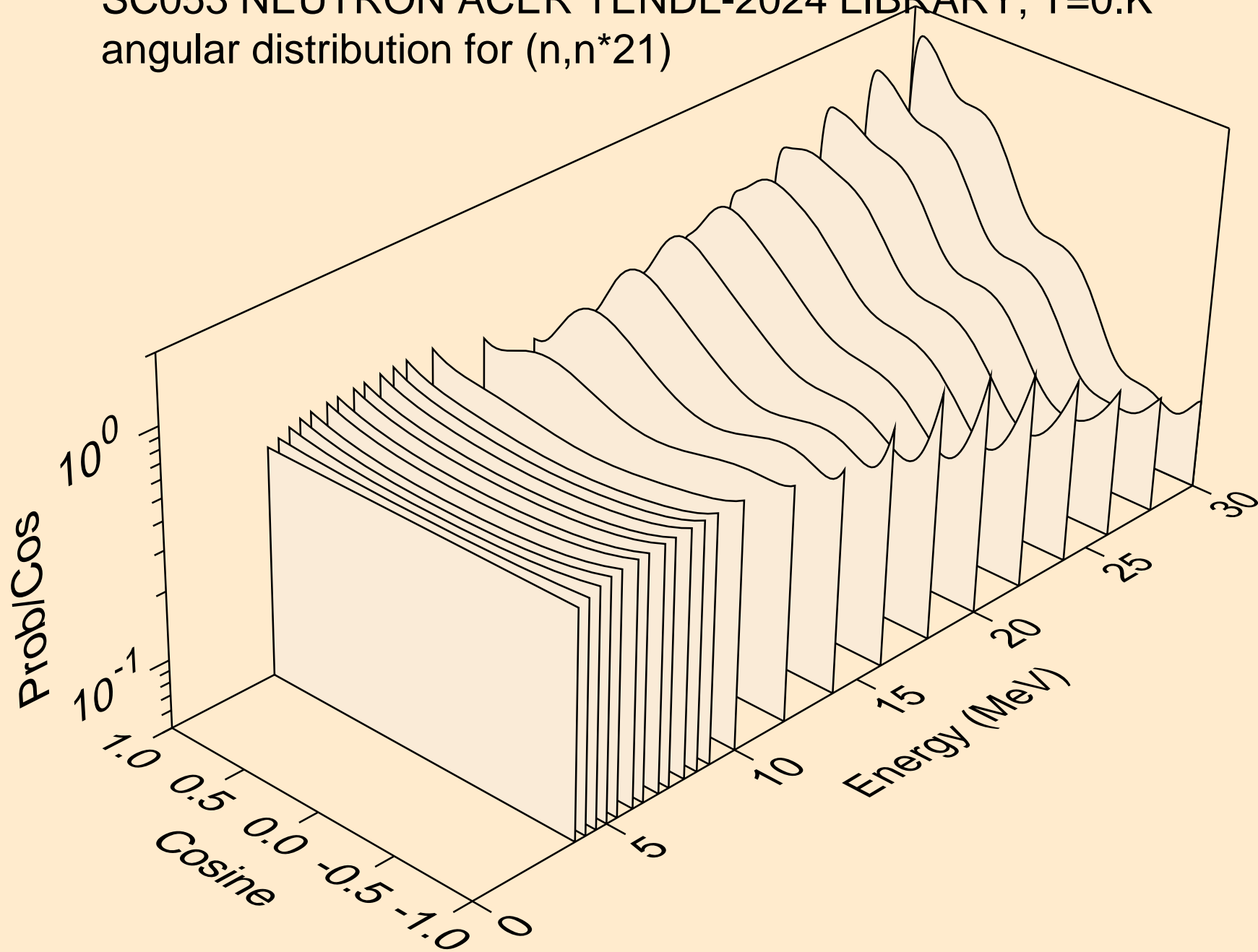

SC053 NEUTRON ACER TENDL-2024 LIBRARY; T=0.K  
angular distribution for (n,n\*22)

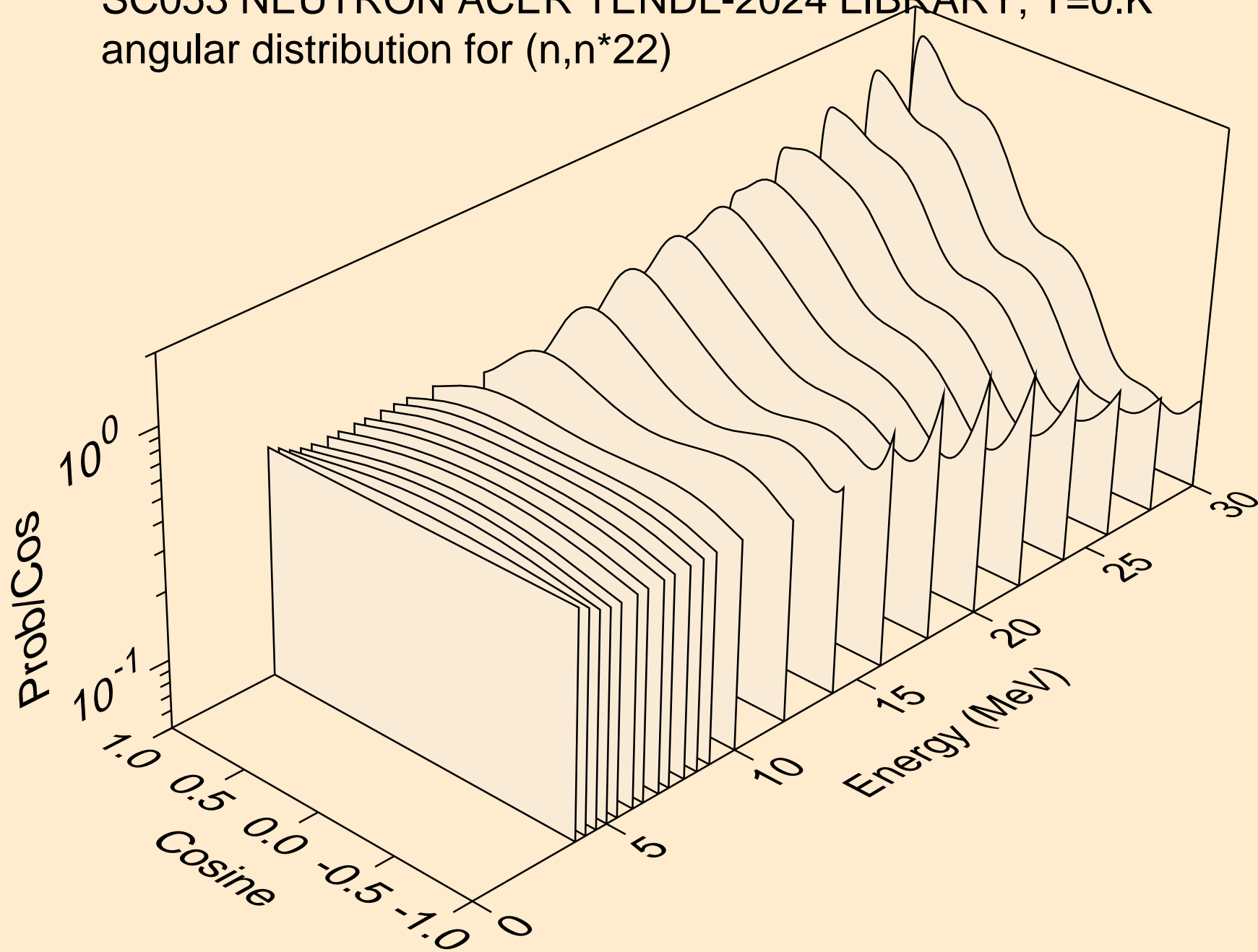

SC053 NEUTRON ACER TENDL-2024 LIBRARY; T=0.K  
angular distribution for (n,n\*23)

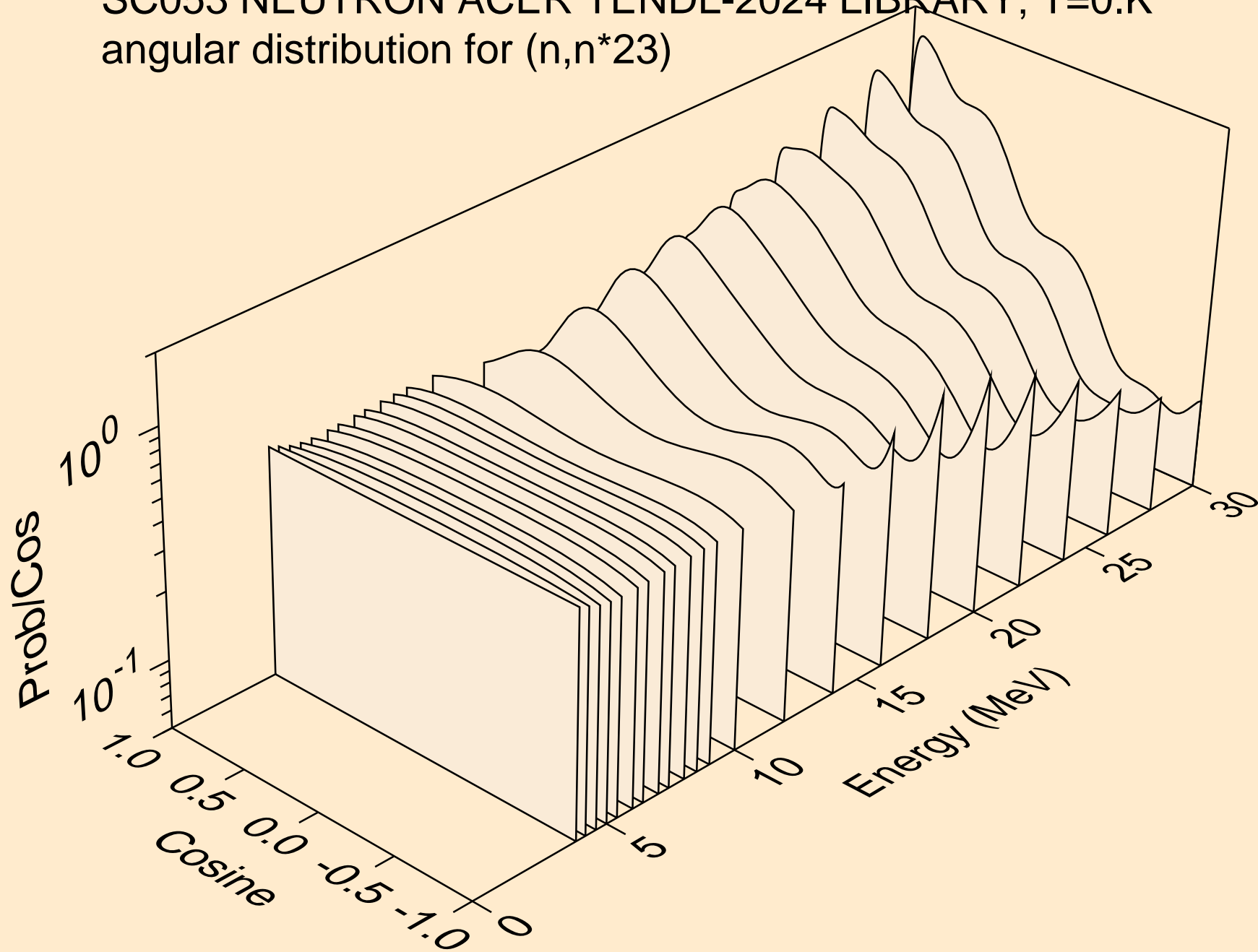

SC053 NEUTRON ACER TENDL-2024 LIBRARY; T=0.K  
angular distribution for (n,n\*24)

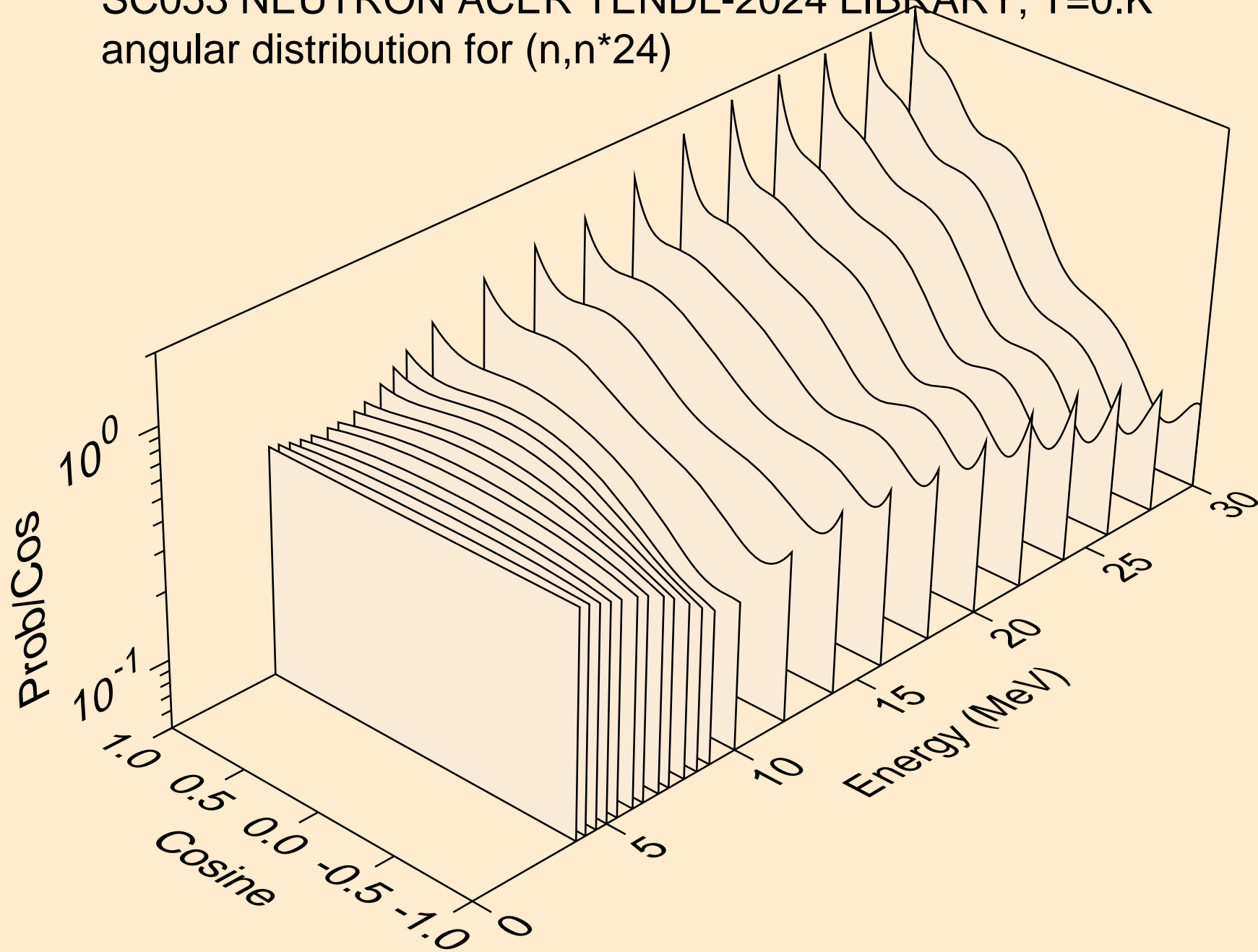

SC053 NEUTRON ACER TENDL-2024 LIBRARY; T=0.K  
angular distribution for (n,n\*25)

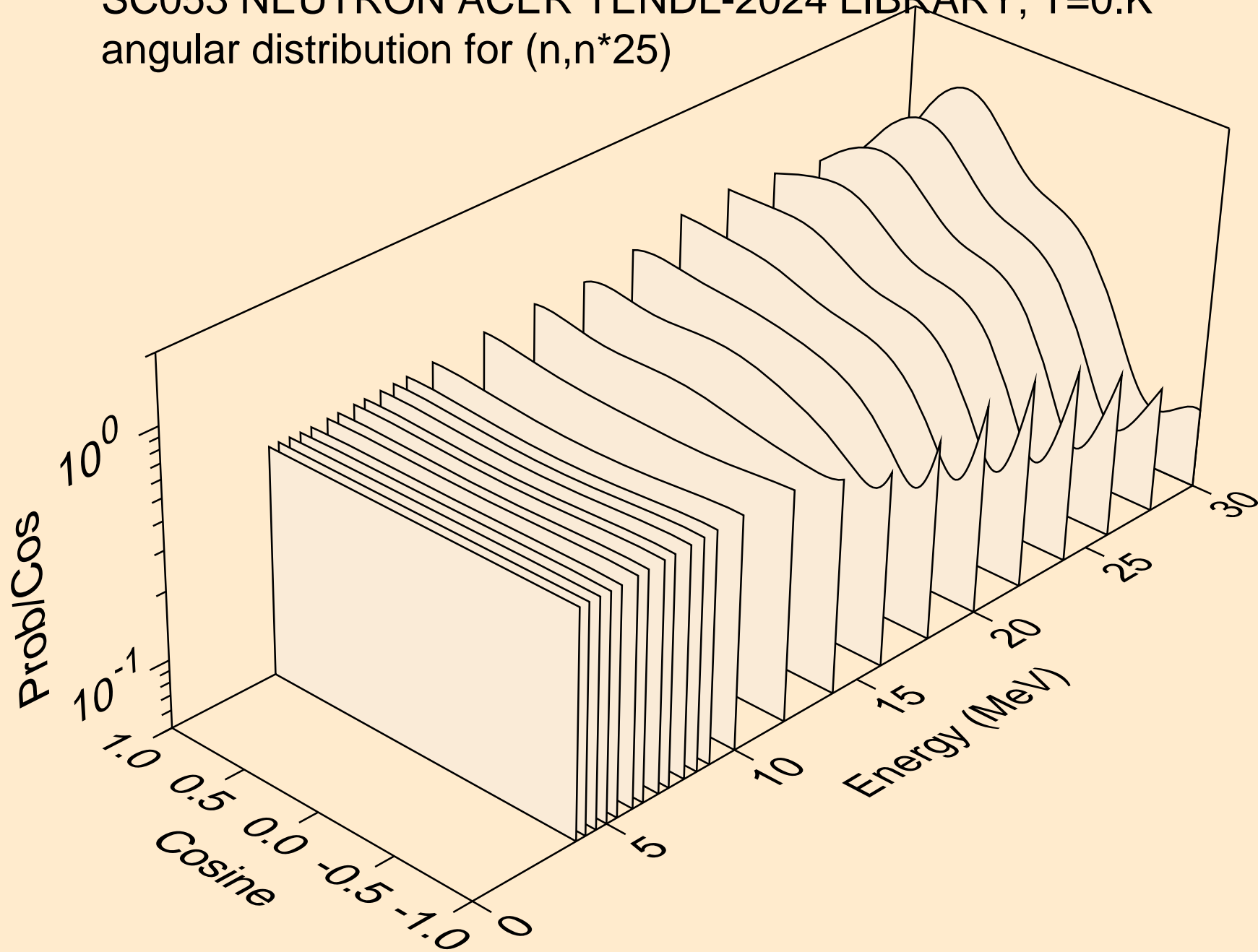

SC053 NEUTRON ACER TENDL-2024 LIBRARY; T=0.K  
angular distribution for (n,n\*26)

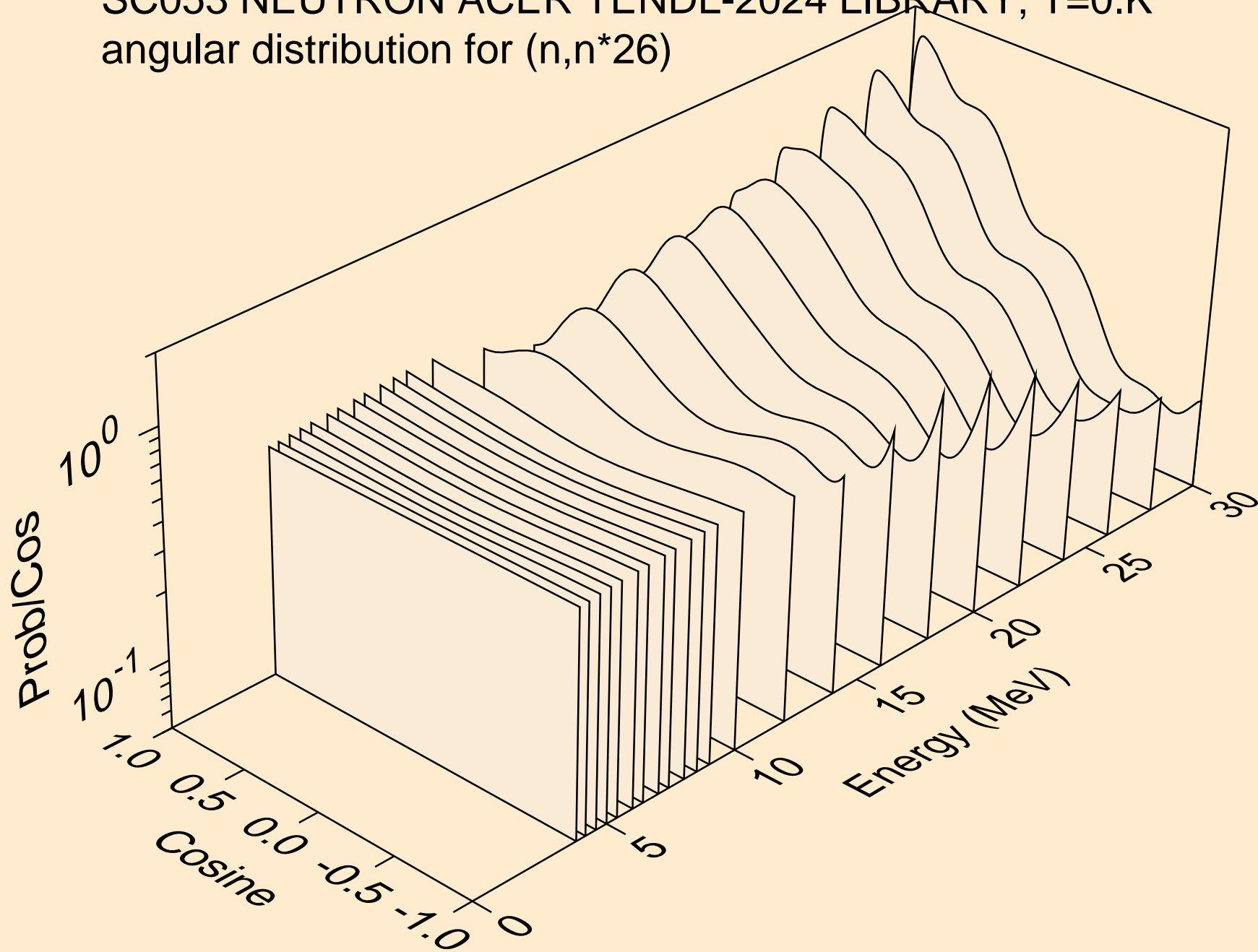

SC053 NEUTRON ACER TENDL-2024 LIBRARY; T=0.K  
angular distribution for (n,n\*27)

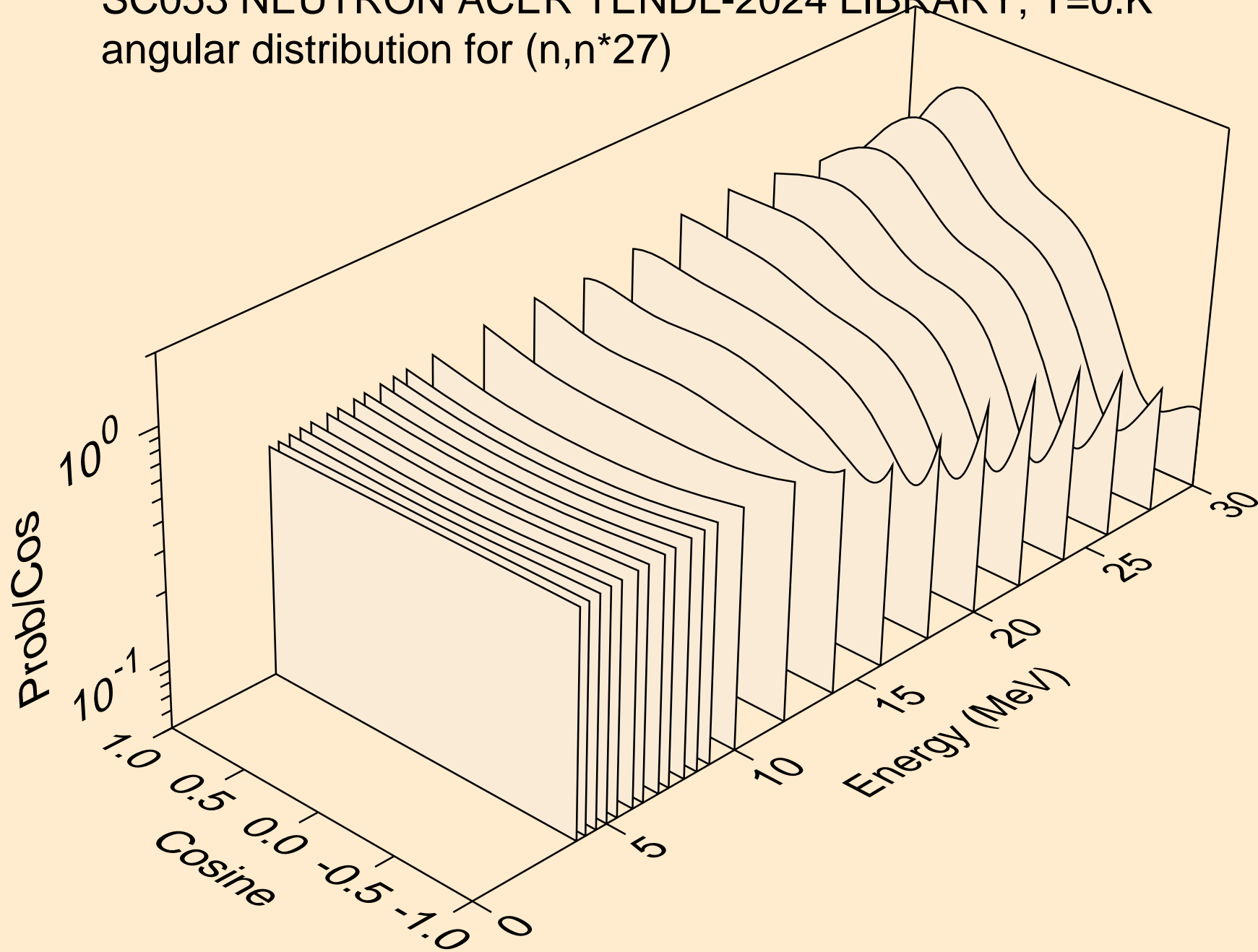



SC053 NEUTRON ACER TENDL-2024 LIBRARY; T=0.K  
angular distribution for (n,n\*28)

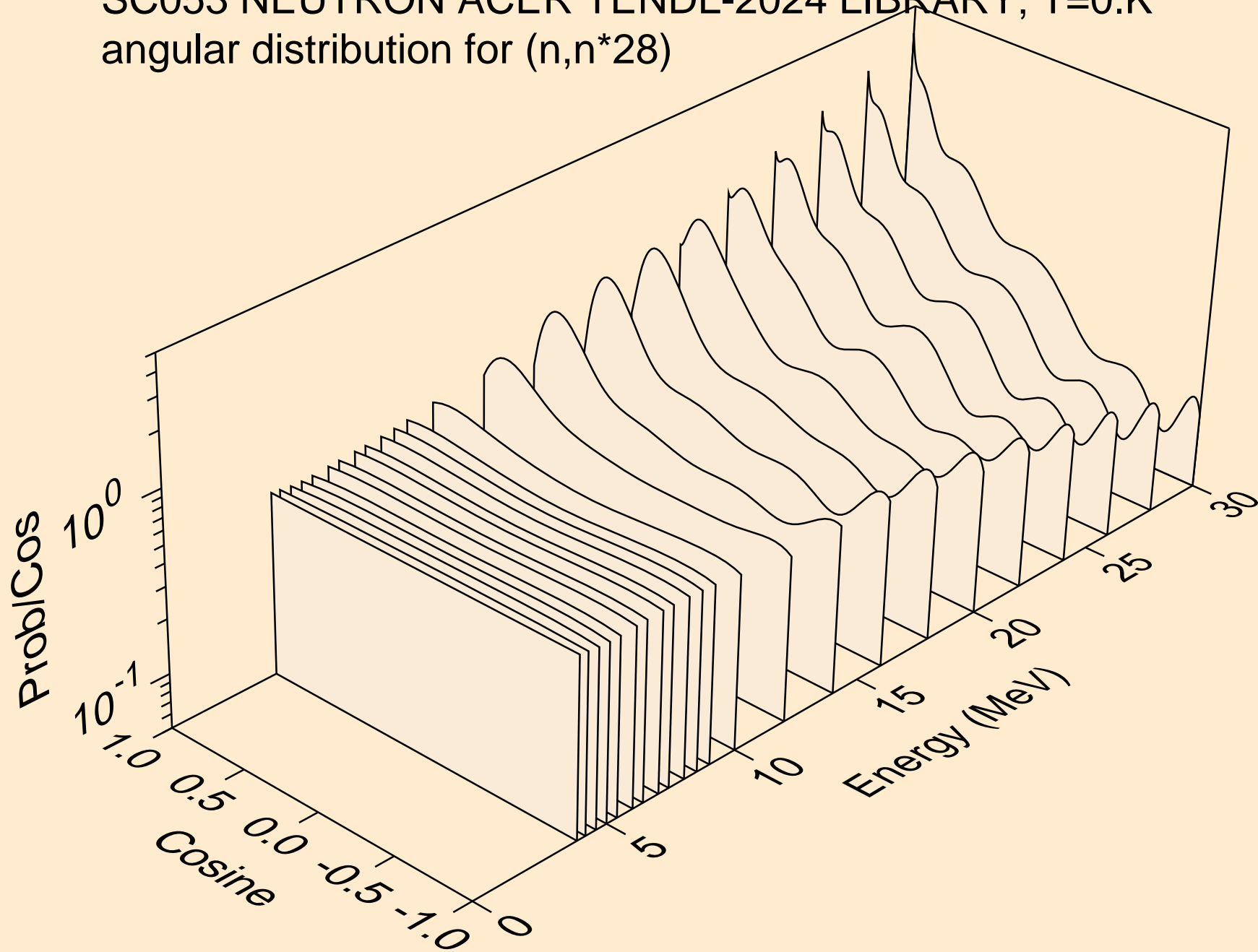

SC053 NEUTRON ACER TENDL-2024 LIBRARY; T=0.K  
angular distribution for (n,n\*29)

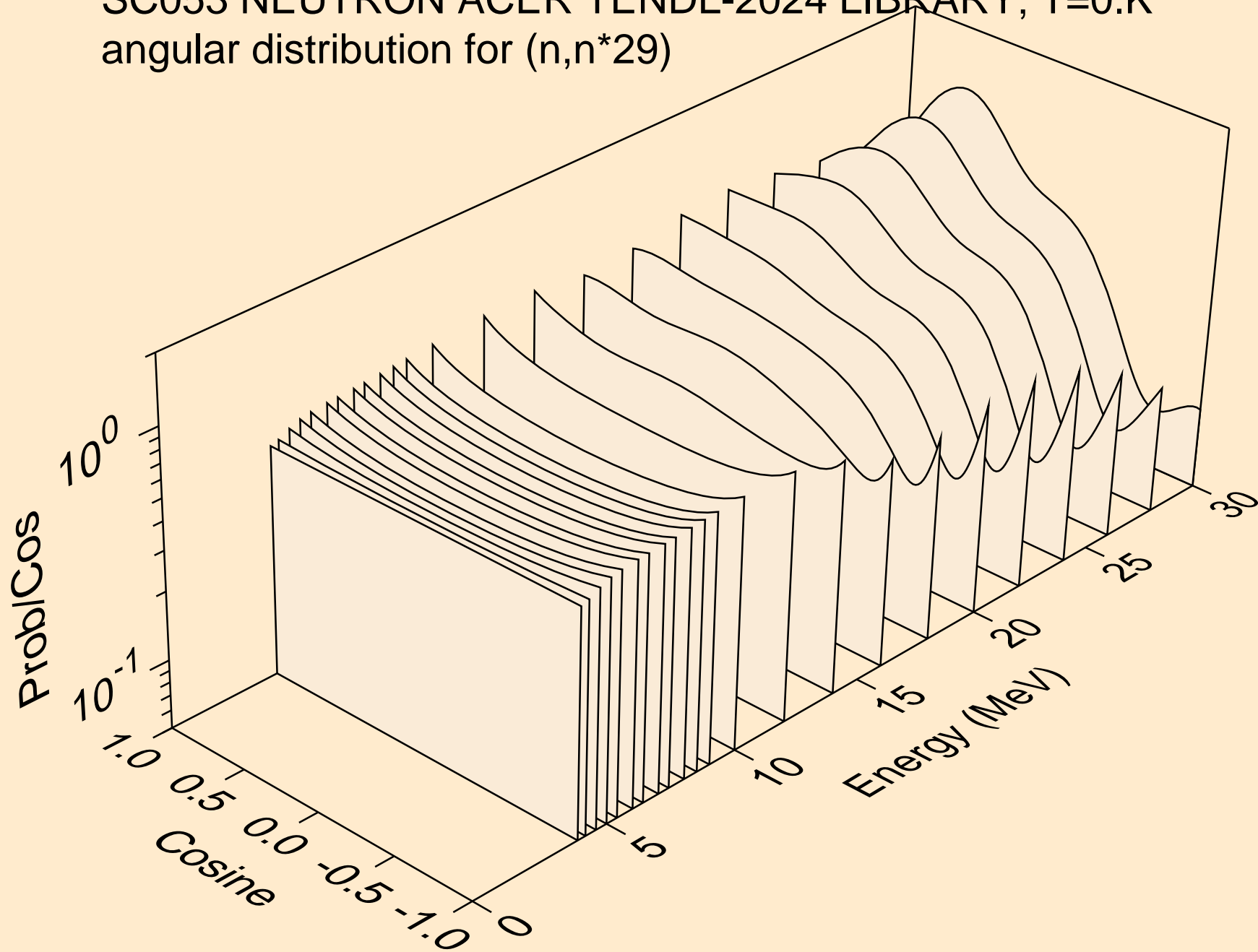

SC053 NEUTRON ACER TENDL-2024 LIBRARY; T=0.K  
angular distribution for (n,n\*30)

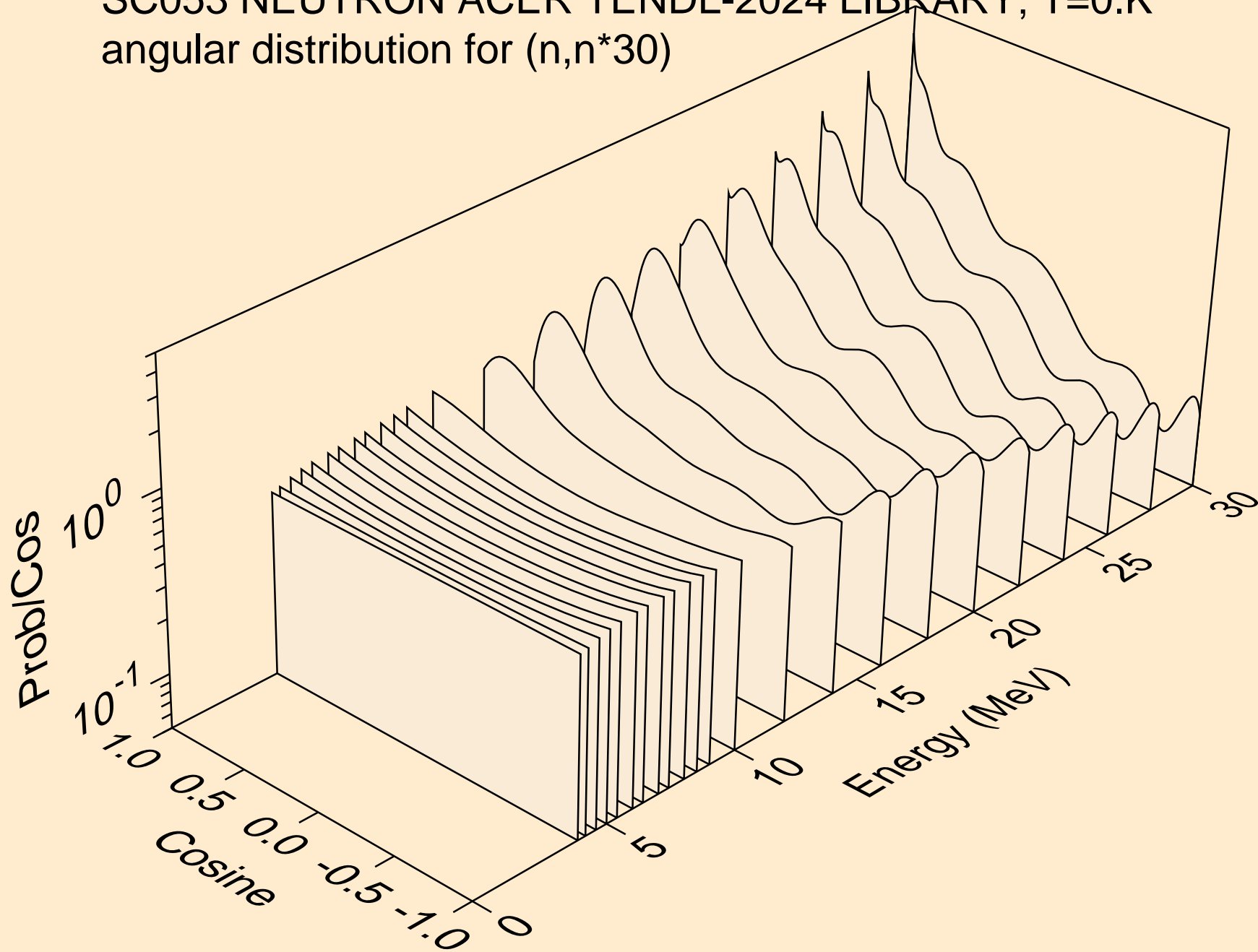

SC053 NEUTRON ACER TENDL-2024 LIBRARY; T=0.K  
Neutron emission for (n,x)

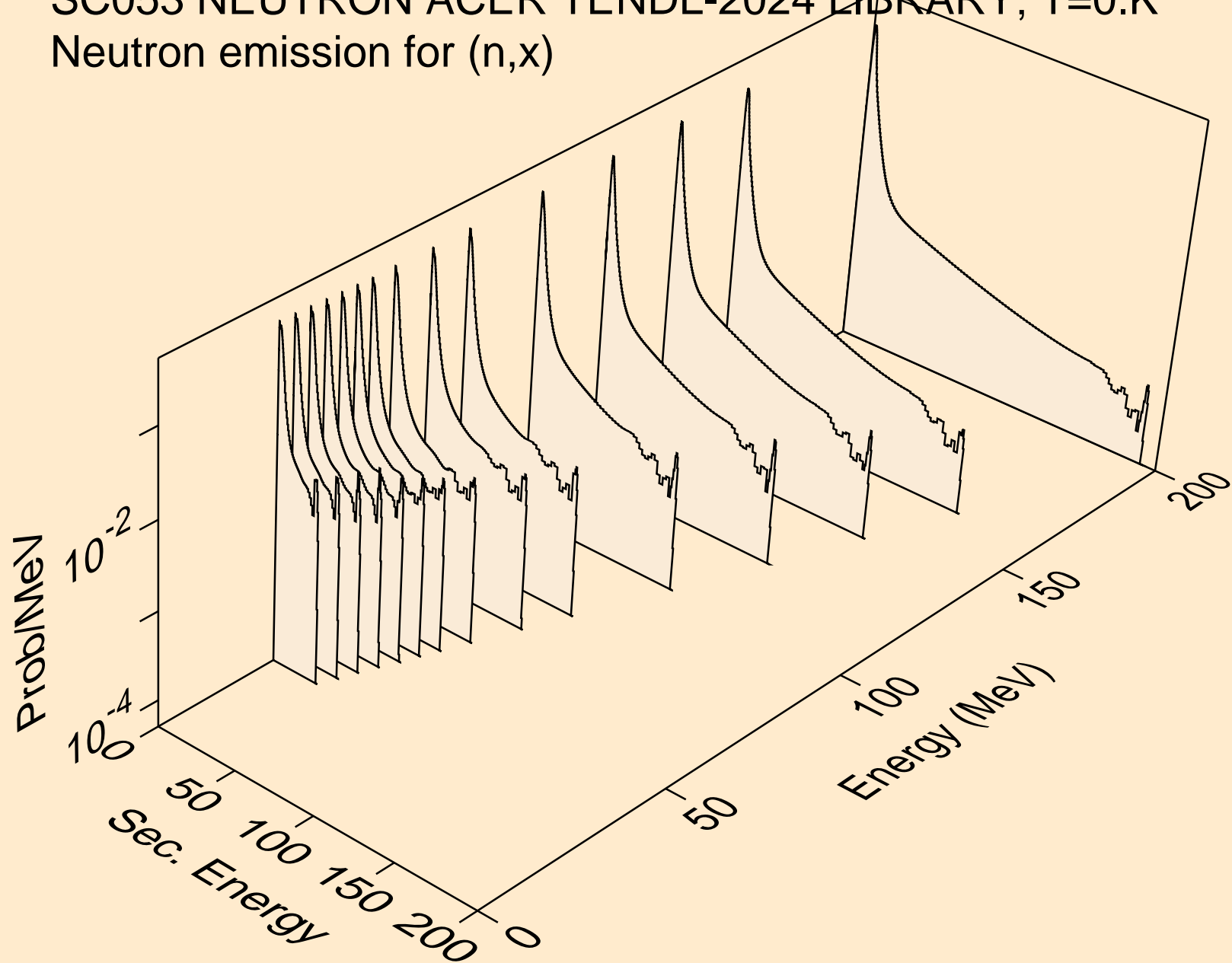

SC053 NEUTRON ACER TENDL-2024 LIBRARY; T=0.K  
Neutron emission for (n,2nd)

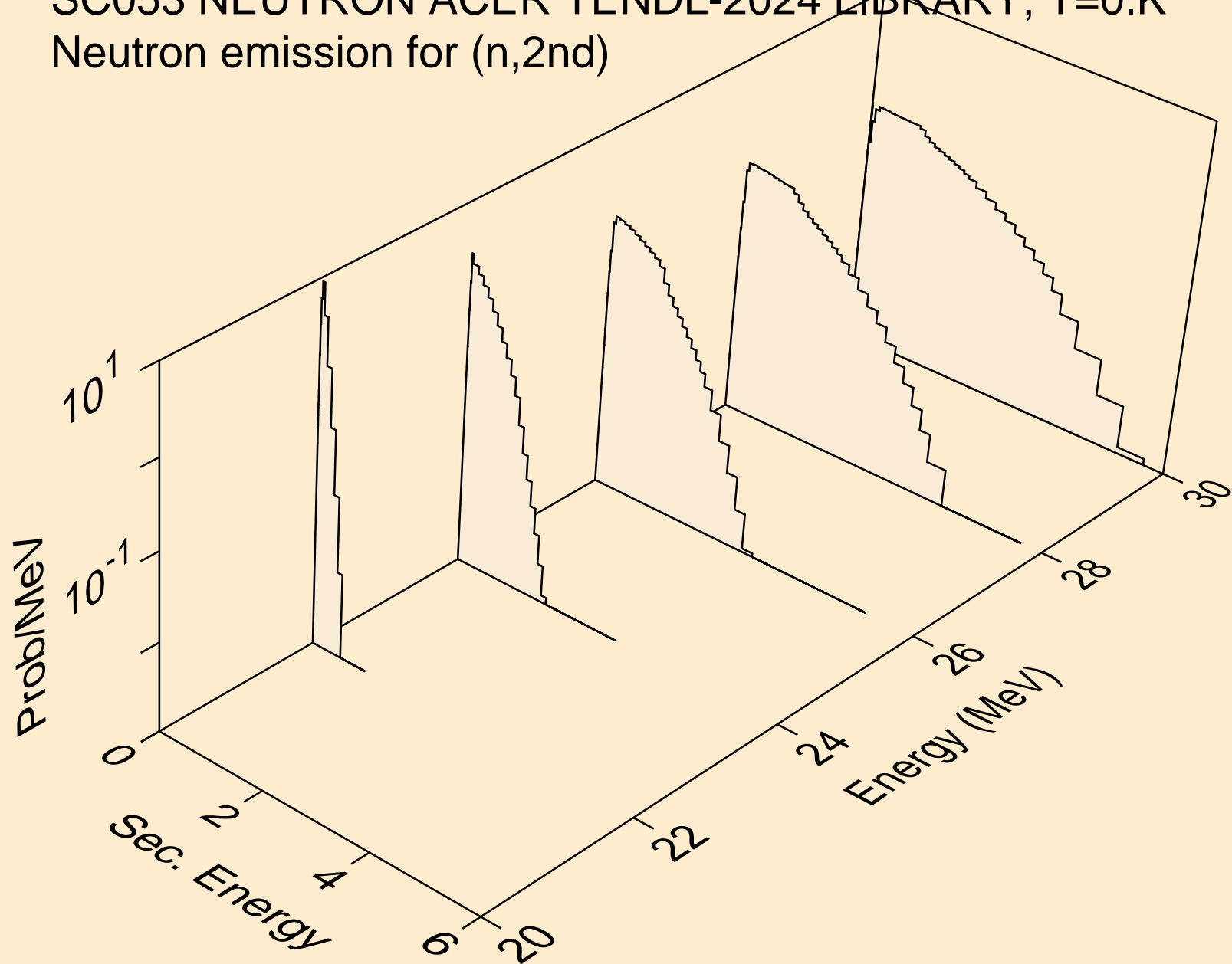

SC053 NEUTRON ACER TENDL-2024 LIBRARY; T=0.K  
Neutron emission for (n,2n)

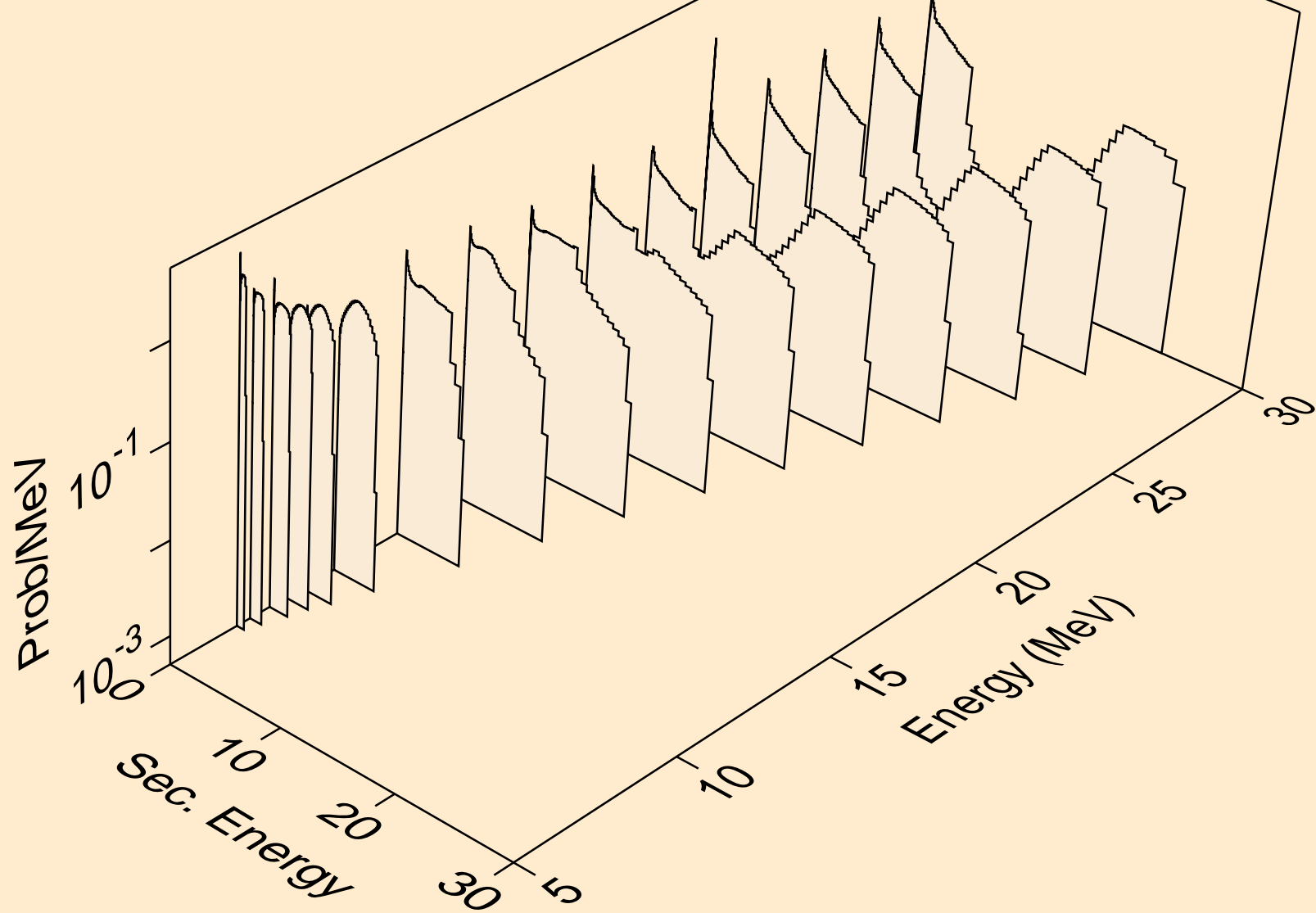

SC053 NEUTRON ACER TENDL-2024 LIBRARY; T=0.K  
Neutron emission for (n,3n)

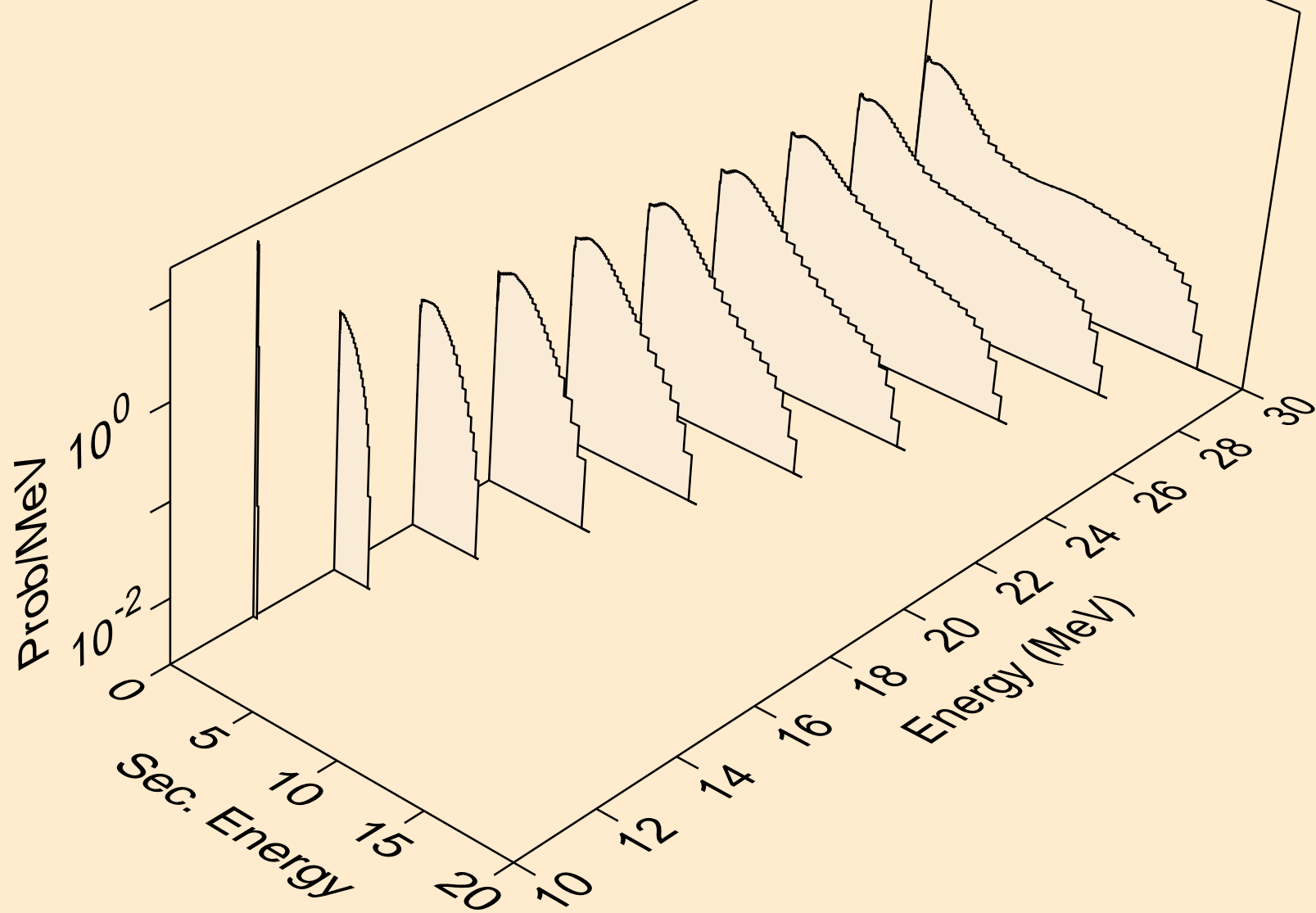

SC053 NEUTRON ACER TENDL-2024 LIBRARY; T=0.K  
Neutron emission for (n,n\*)a

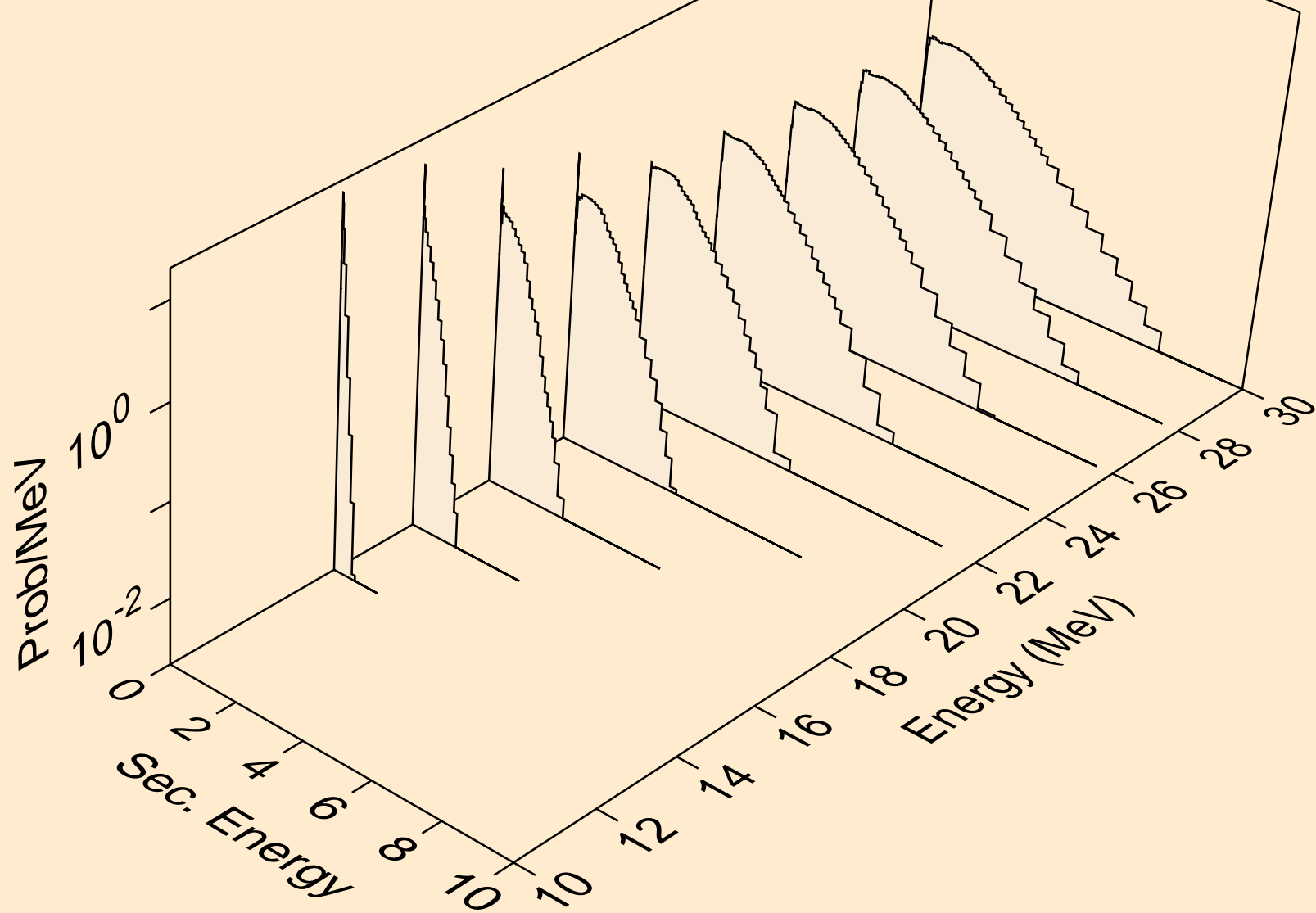



SC053 NEUTRON ACER TENDL-2024 LIBRARY; T=0.K  
Neutron emission for (n,2n)a

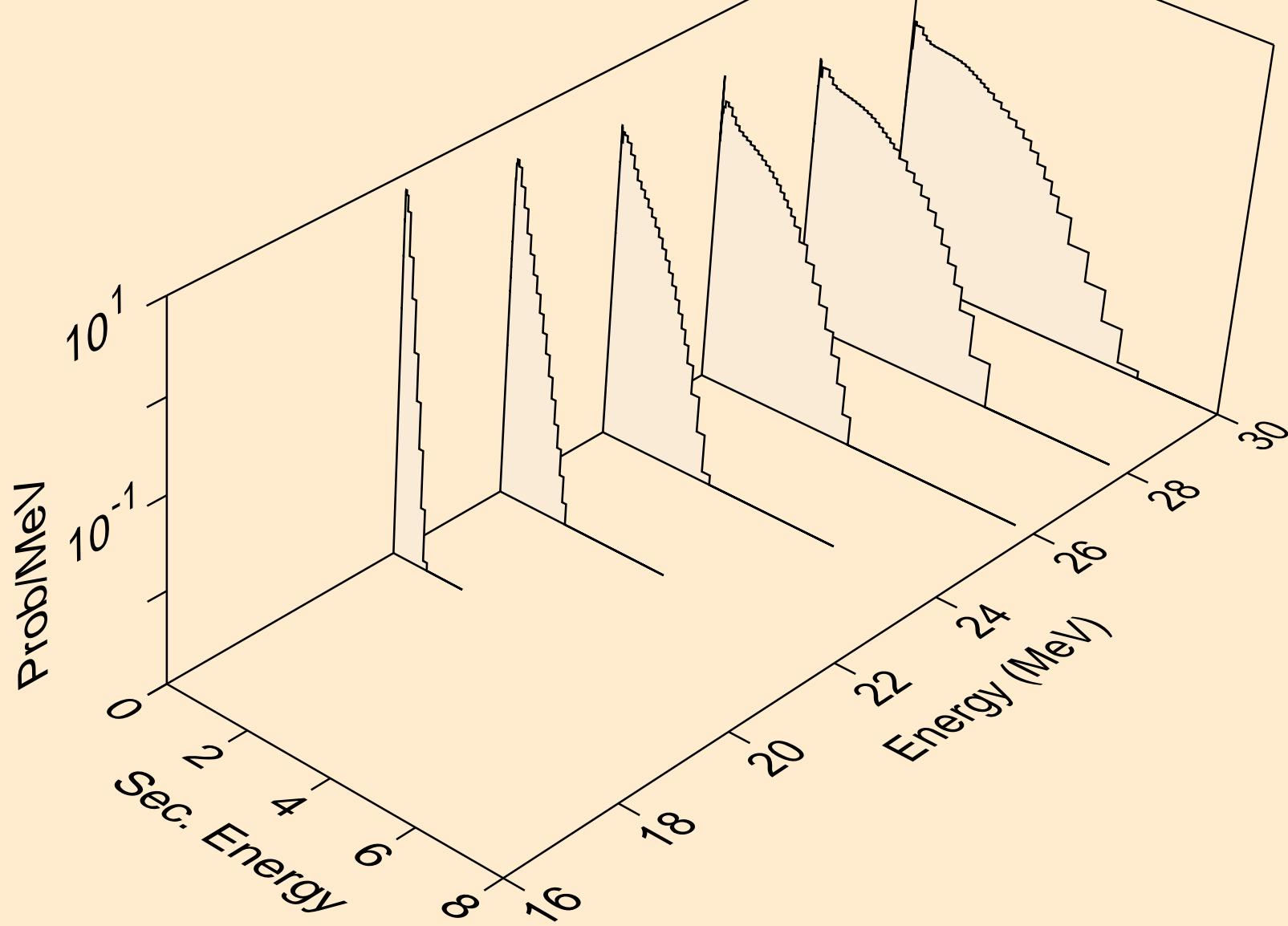

SC053 NEUTRON ACER TENDL-2024 LIBRARY; T=0.K  
Neutron emission for (n,3n)a

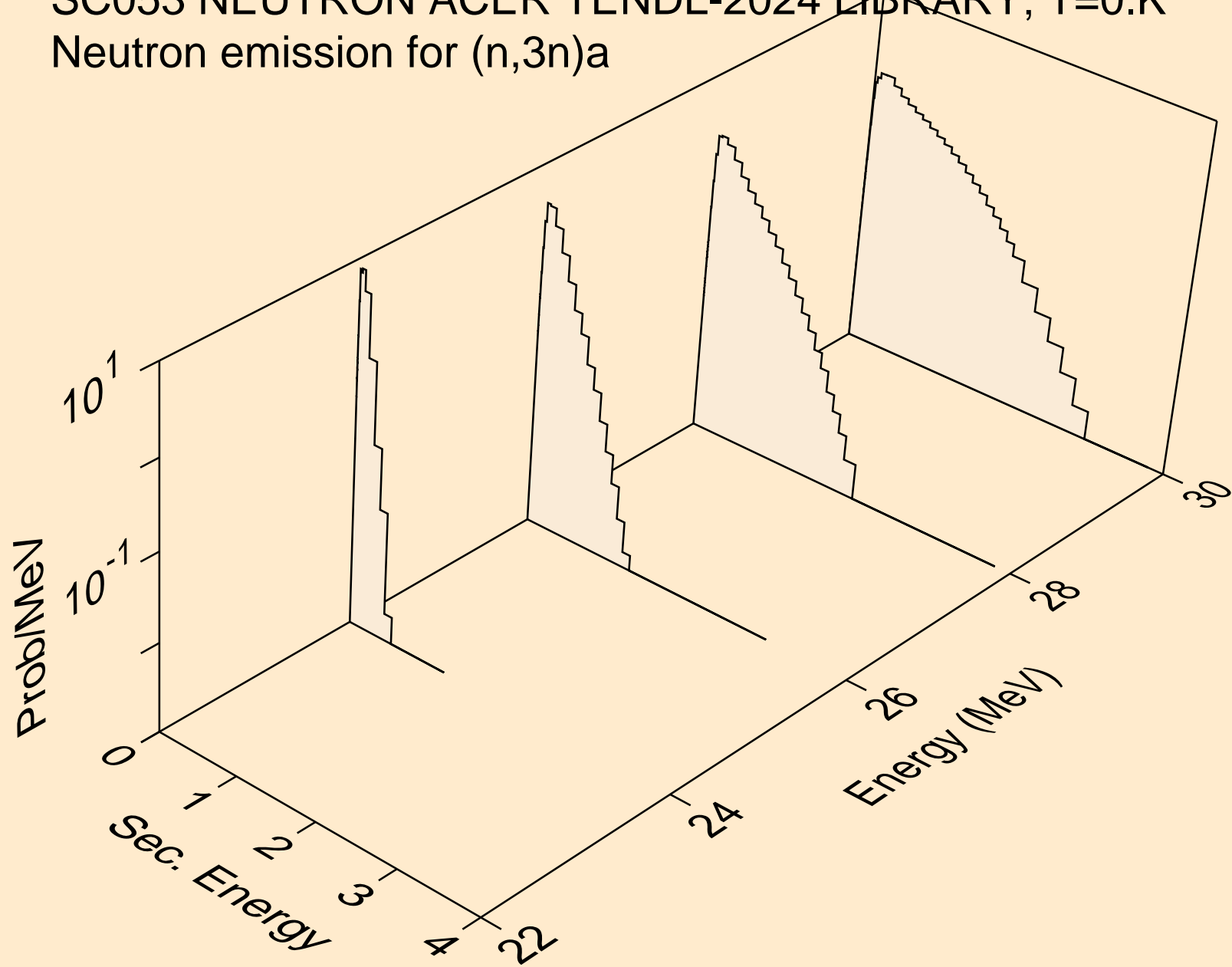

SC053 NEUTRON ACER TENDL-2024 LIBRARY; T=0.K  
Neutron emission for (n,n\*)p

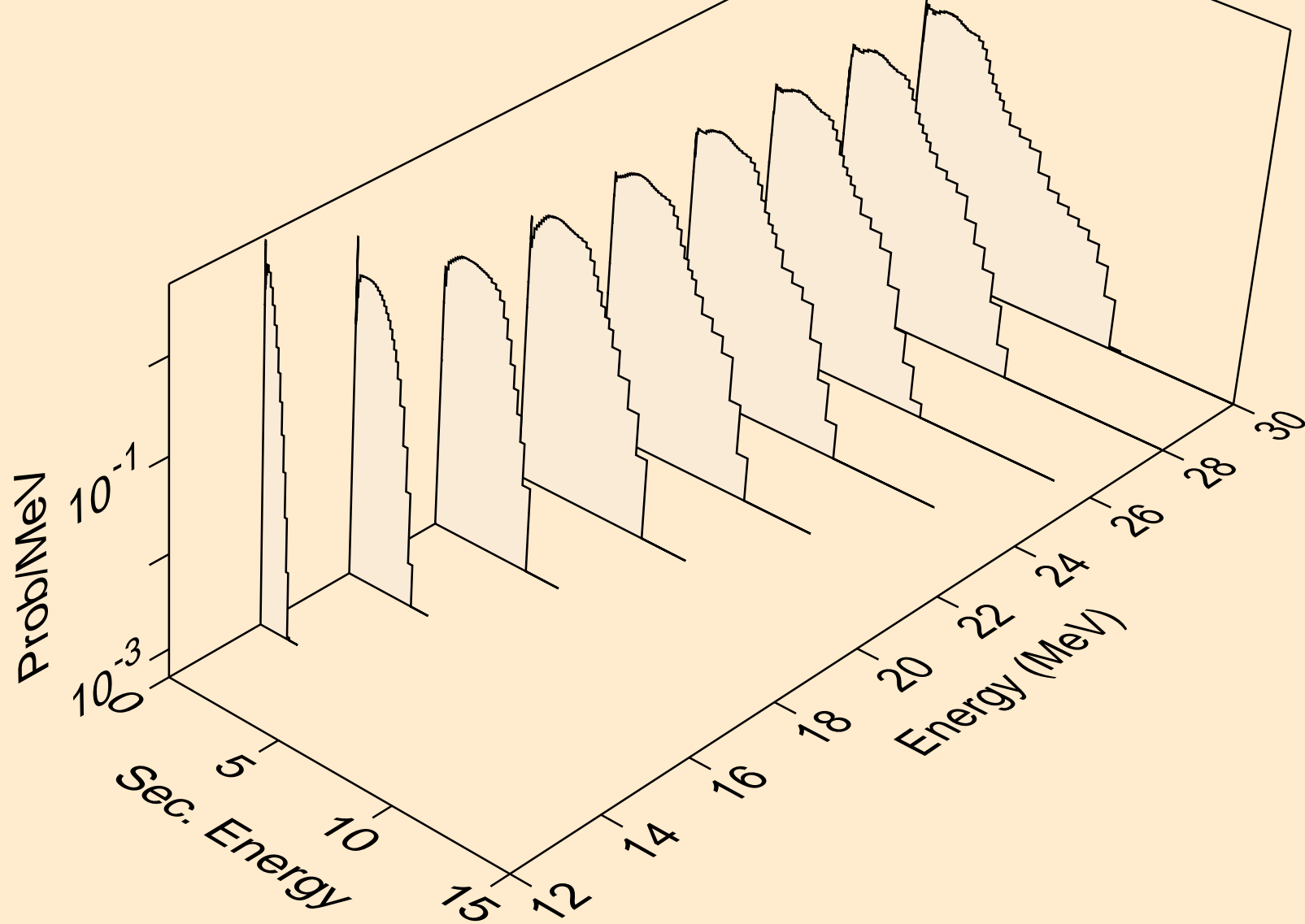

SC053 NEUTRON ACER TENDL-2024 LIBRARY; T=0.K  
Neutron emission for (n,n\*)d

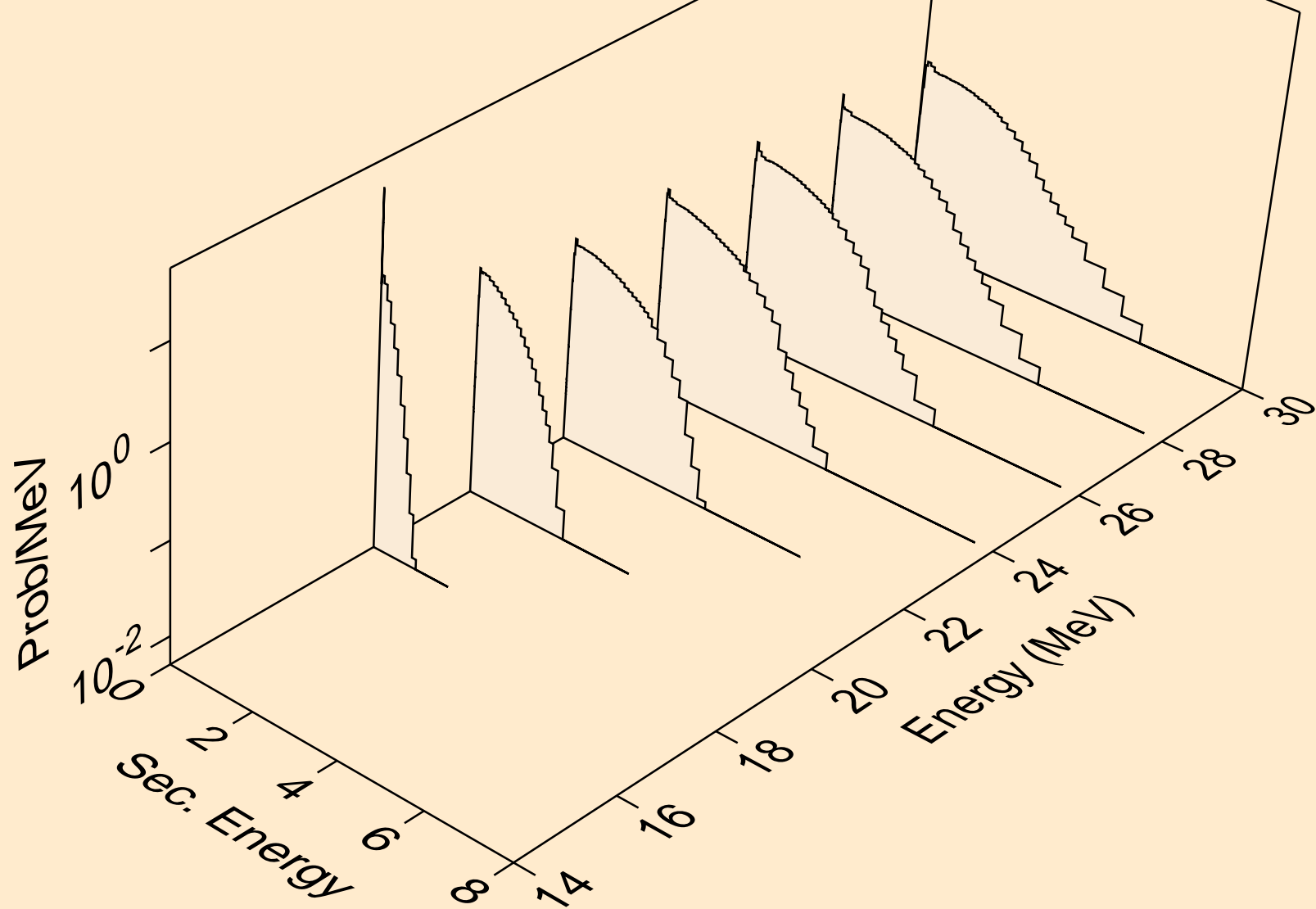

SC053 NEUTRON ACER TENDL-2024 LIBRARY; T=0.K  
Neutron emission for (n,n\*)t

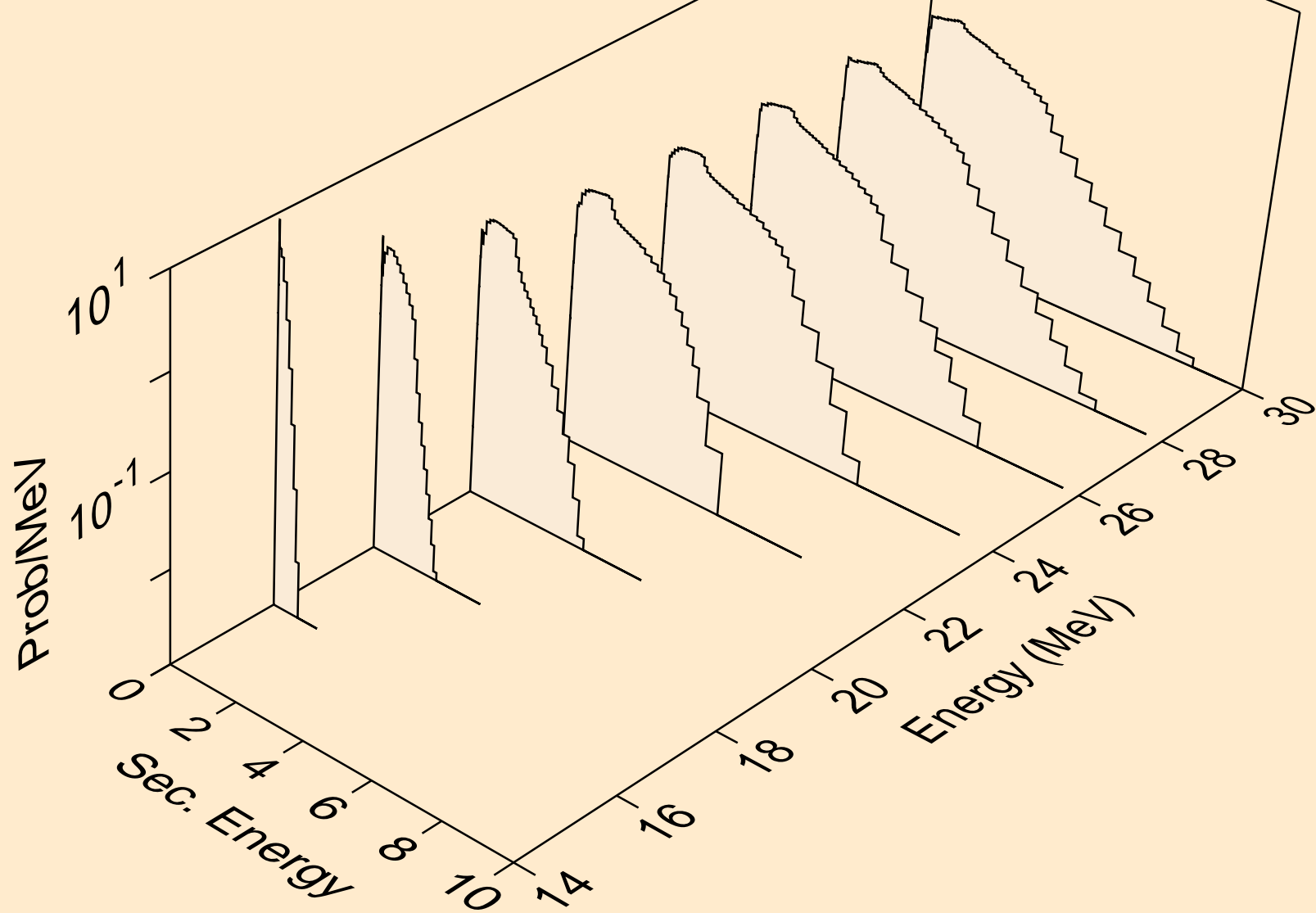

SC053 NEUTRON ACER TENDL-2024 LIBRARY; T=0.K  
Neutron emission for (n,4n)

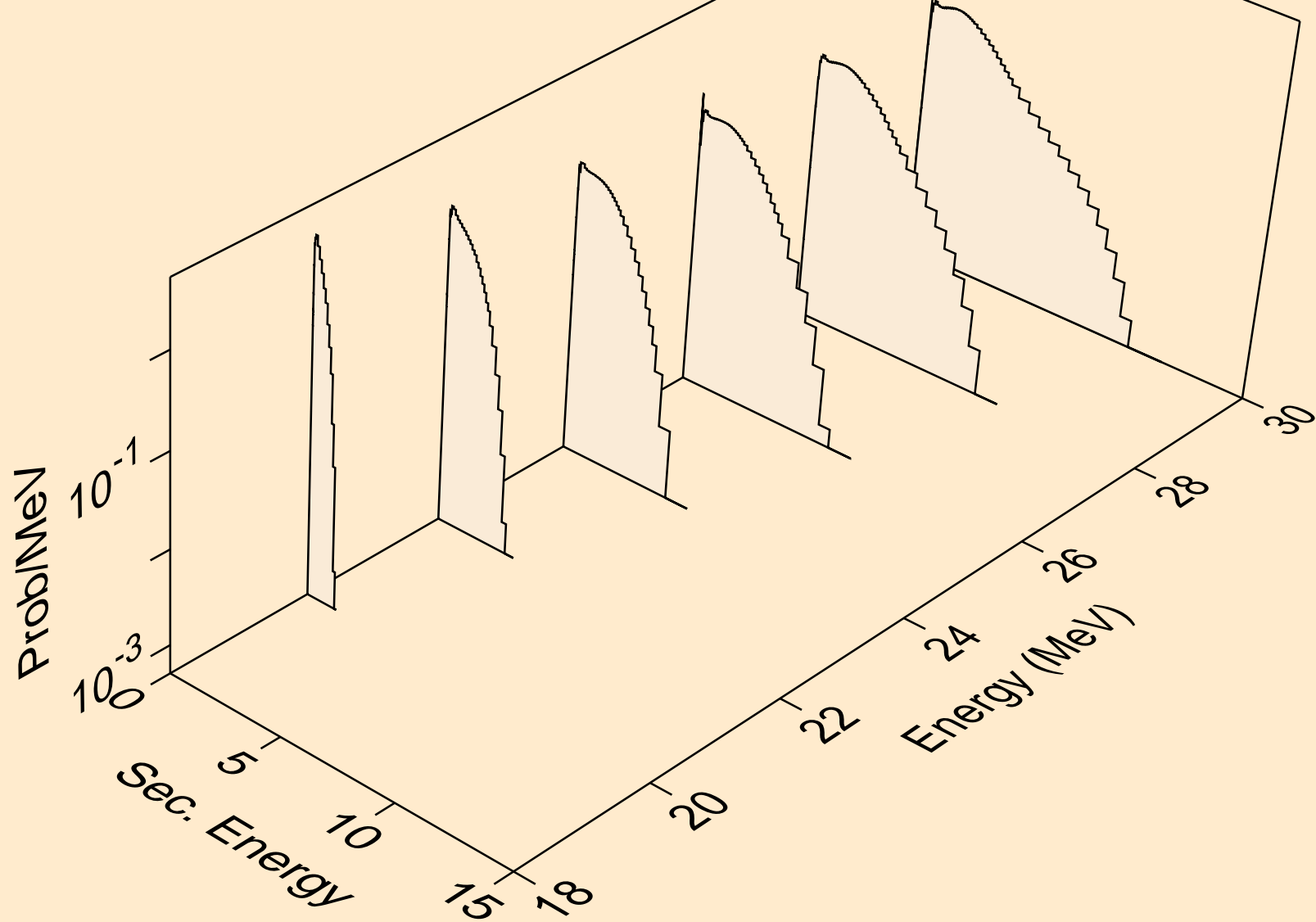

SC053 NEUTRON ACER TENDL-2024 LIBRARY; T=0.K  
Neutron emission for (n,2np)

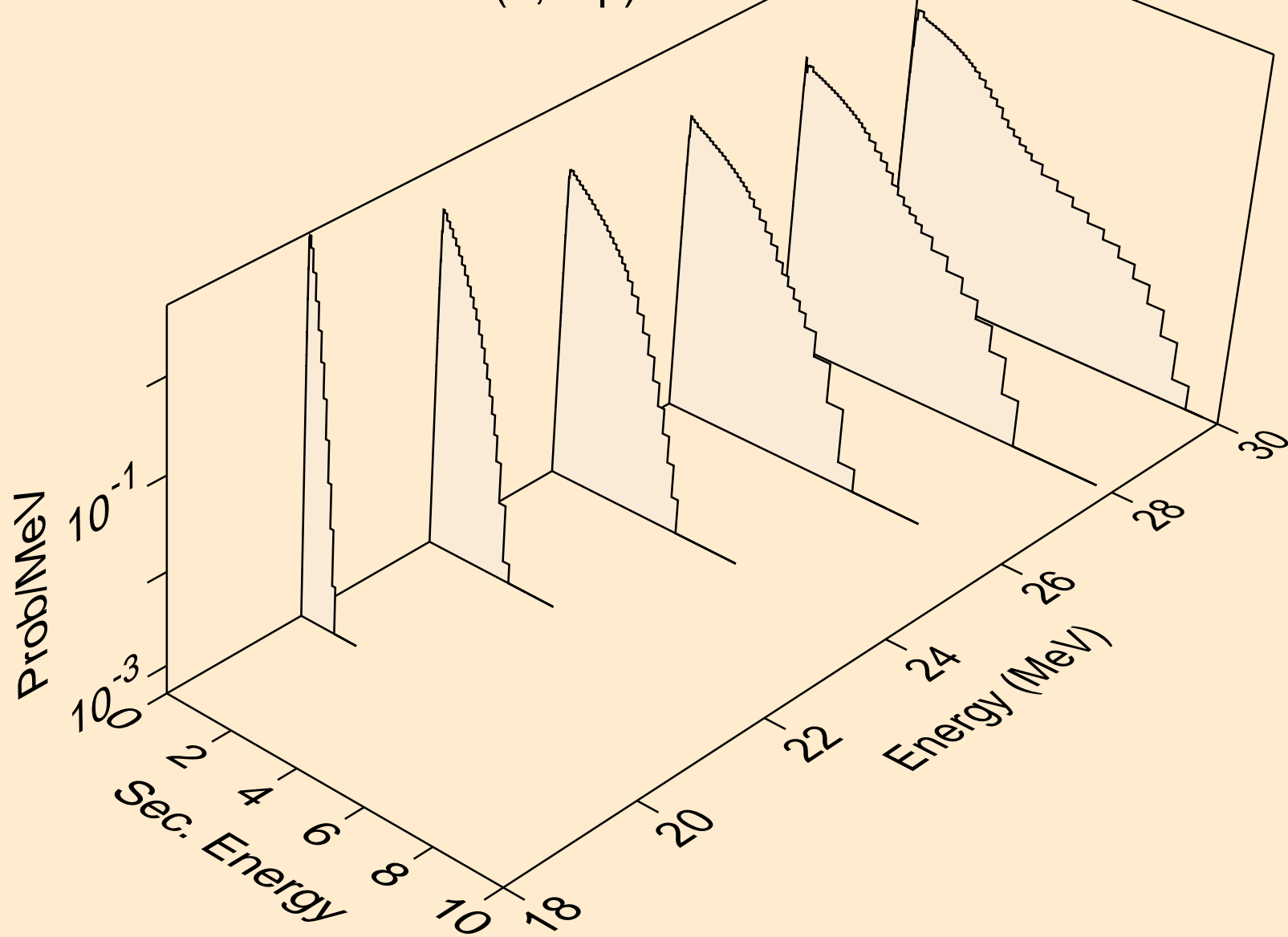

SC053 NEUTRON ACER TENDL-2024 LIBRARY; T=0.K  
Neutron emission for (n,3np)

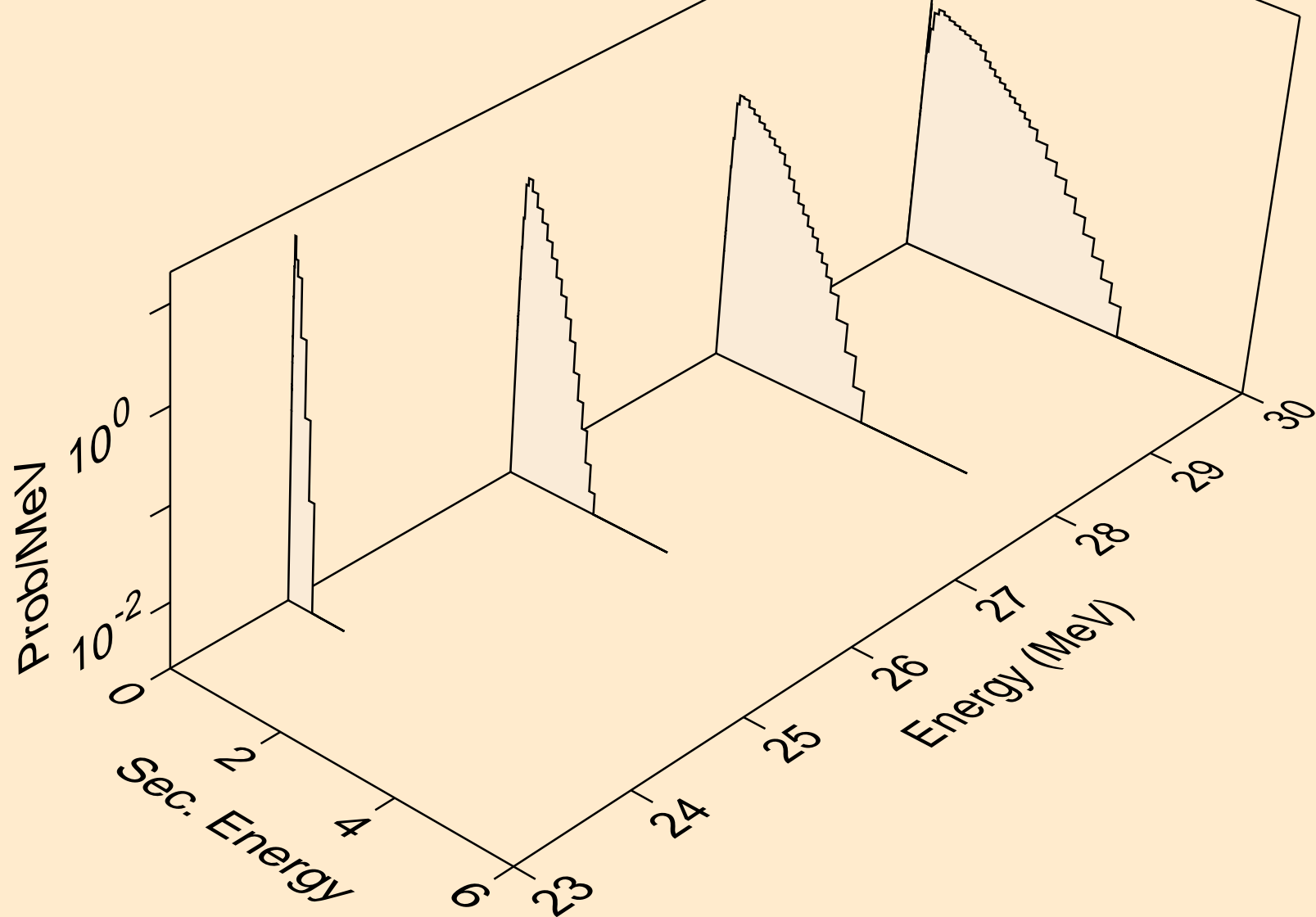



SC053 NEUTRON ACER TENDL-2024 LIBRARY; T=0.K  
Neutron emission for (n,n\*c)

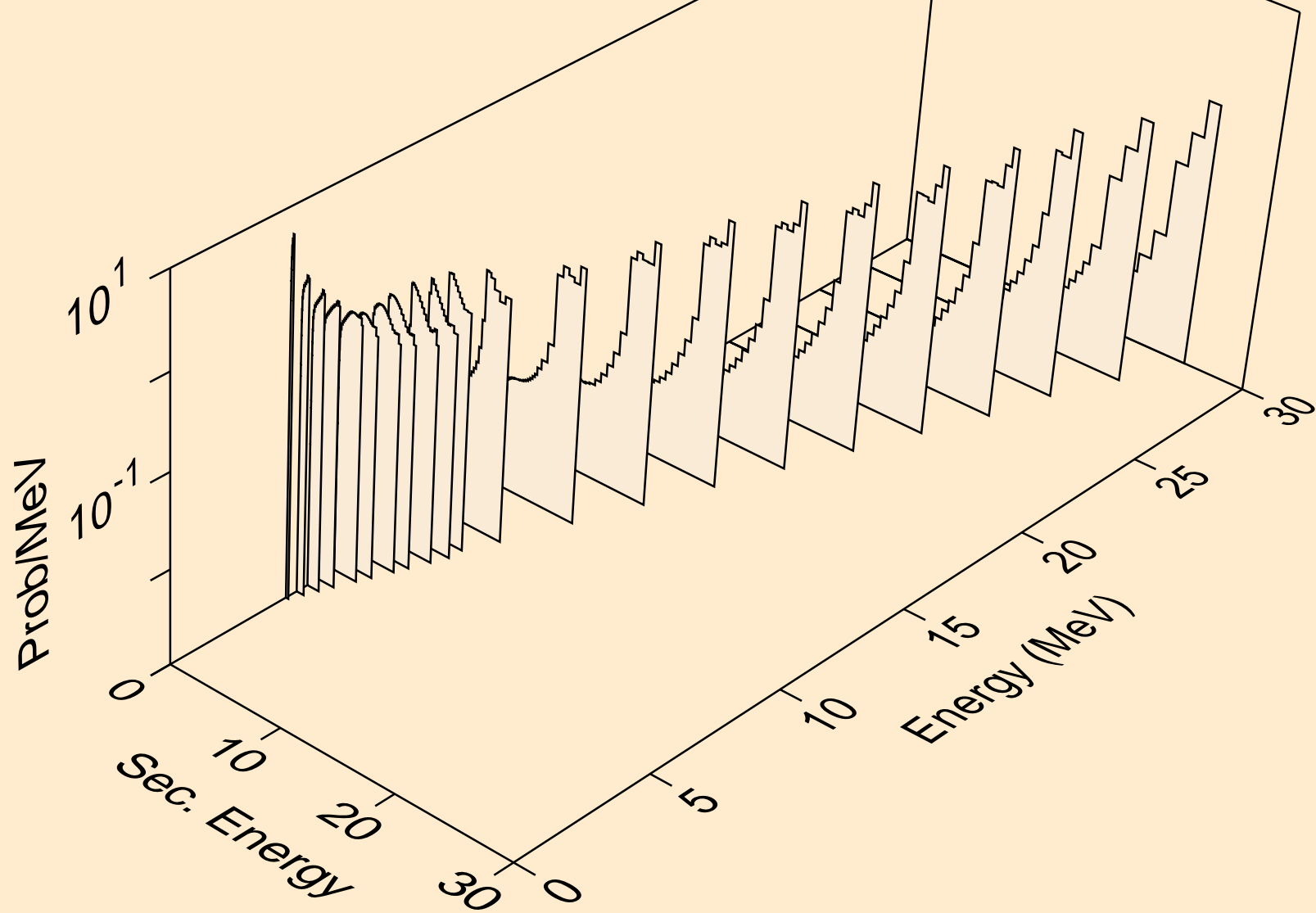

SC053 NEUTRON ACER TENDL-2024 LIBRARY; T=0.K  
Photon emission for (n,x)

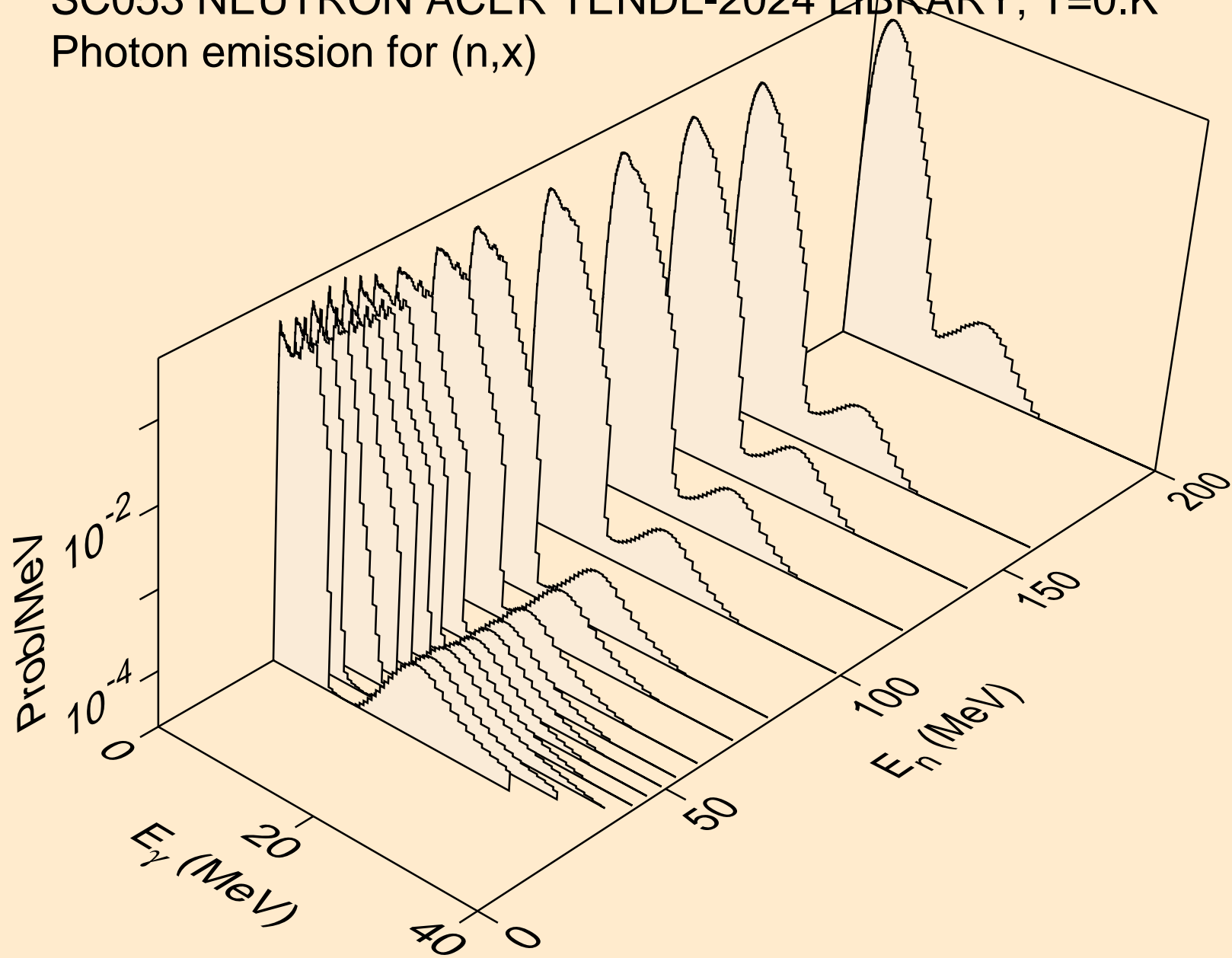

SC053 NEUTRON ACER TENDL-2024 LIBRARY; T=0.K  
Photon emission for (n,2nd)

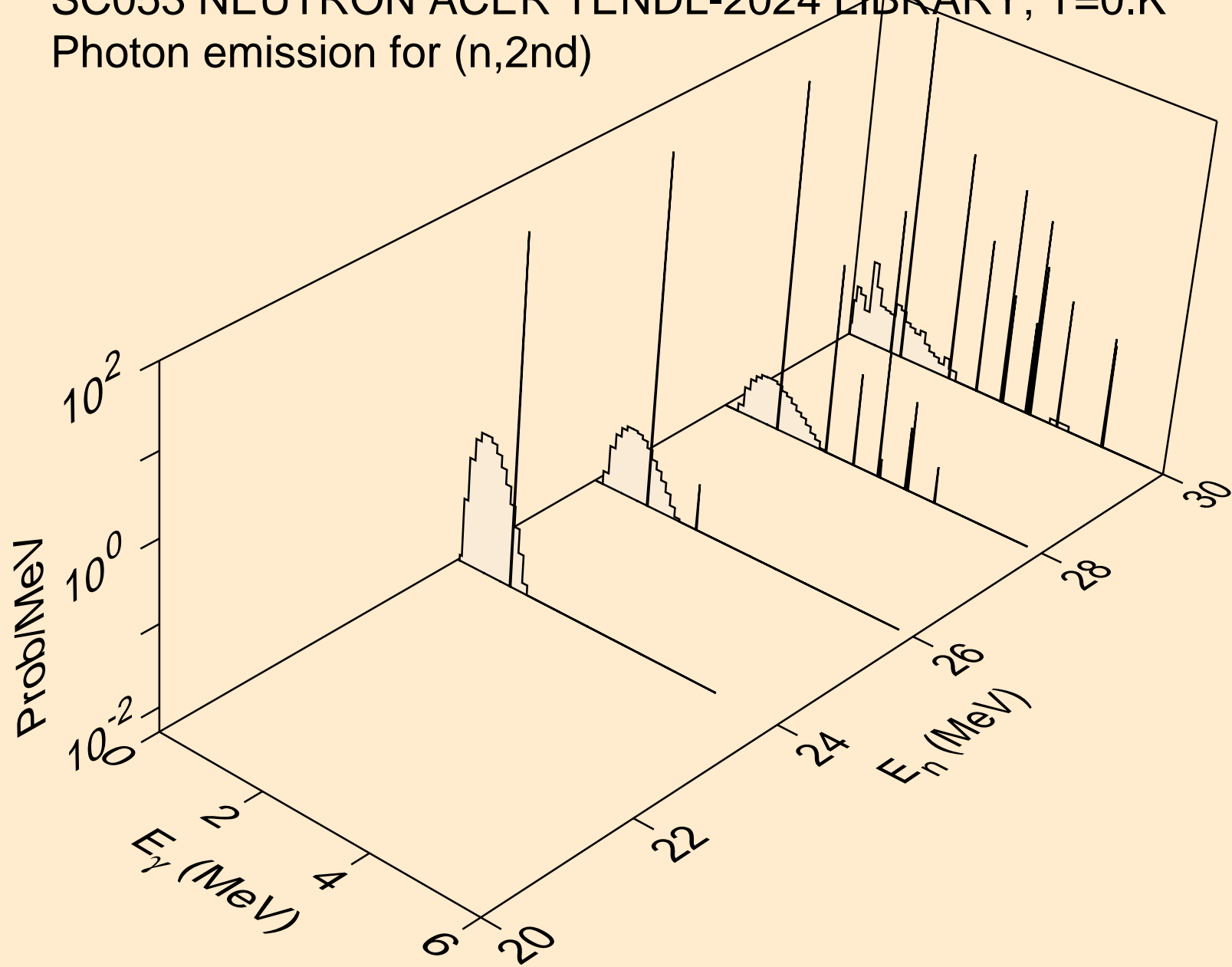

SC053 NEUTRON ACER TENDL-2024 LIBRARY; T=0.K  
Photon emission for (n,2n)

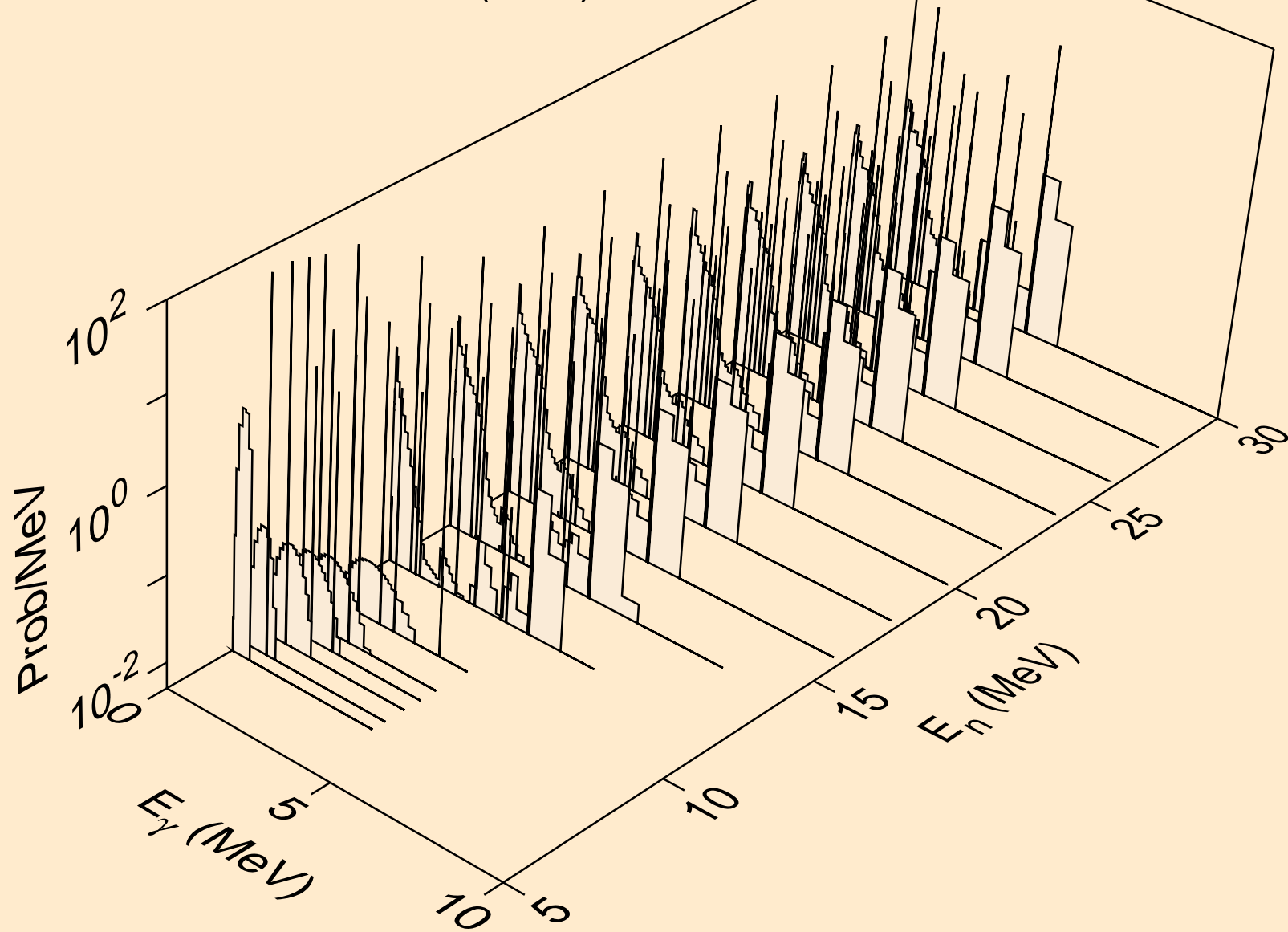

SC053 NEUTRON ACER TENDL-2024 LIBRARY; T=0.K  
Photon emission for (n,3n)

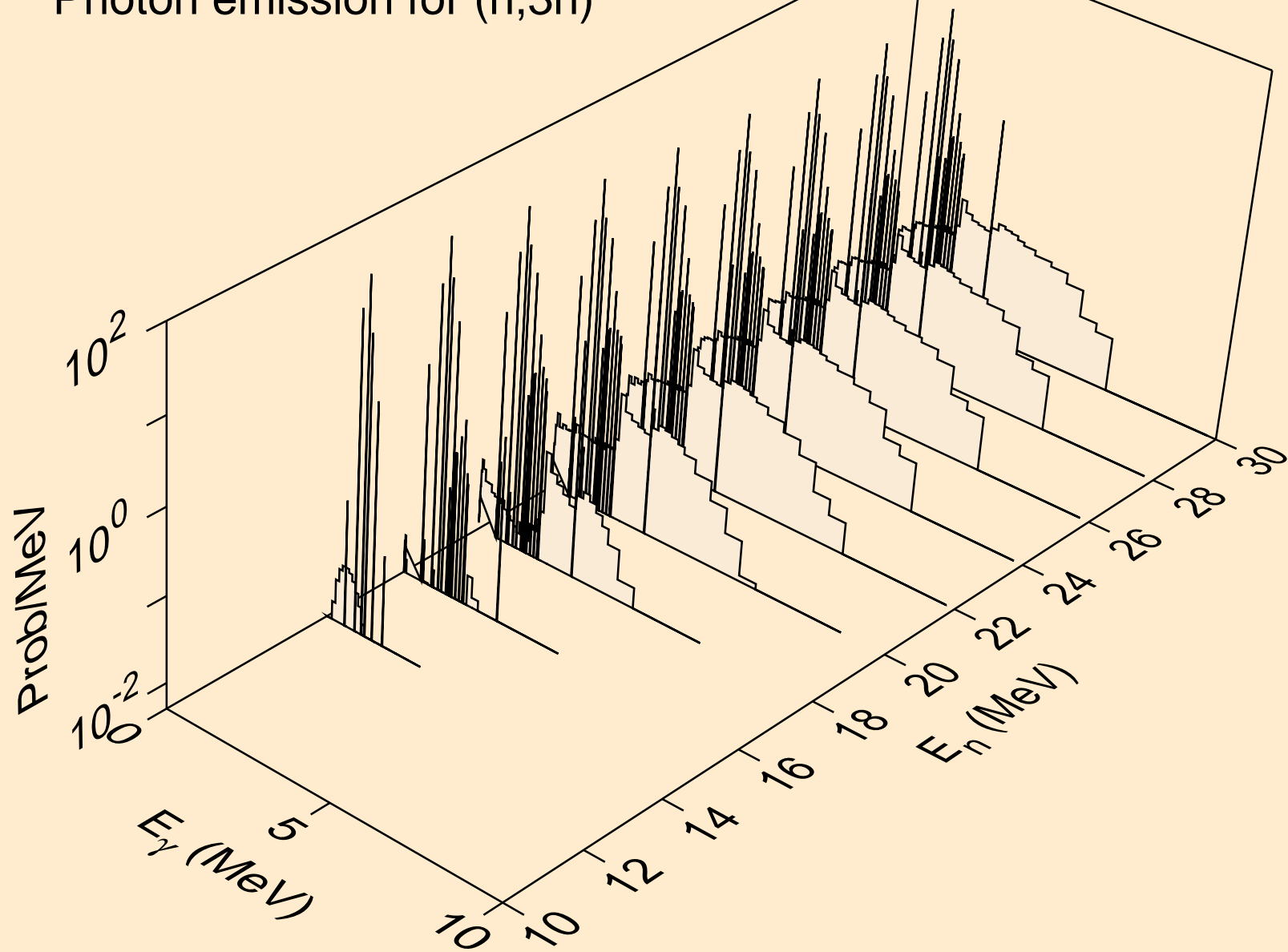

SC053 NEUTRON ACER TENDL-2024 LIBRARY; T=0.K  
Photon emission for (n,n\*)a

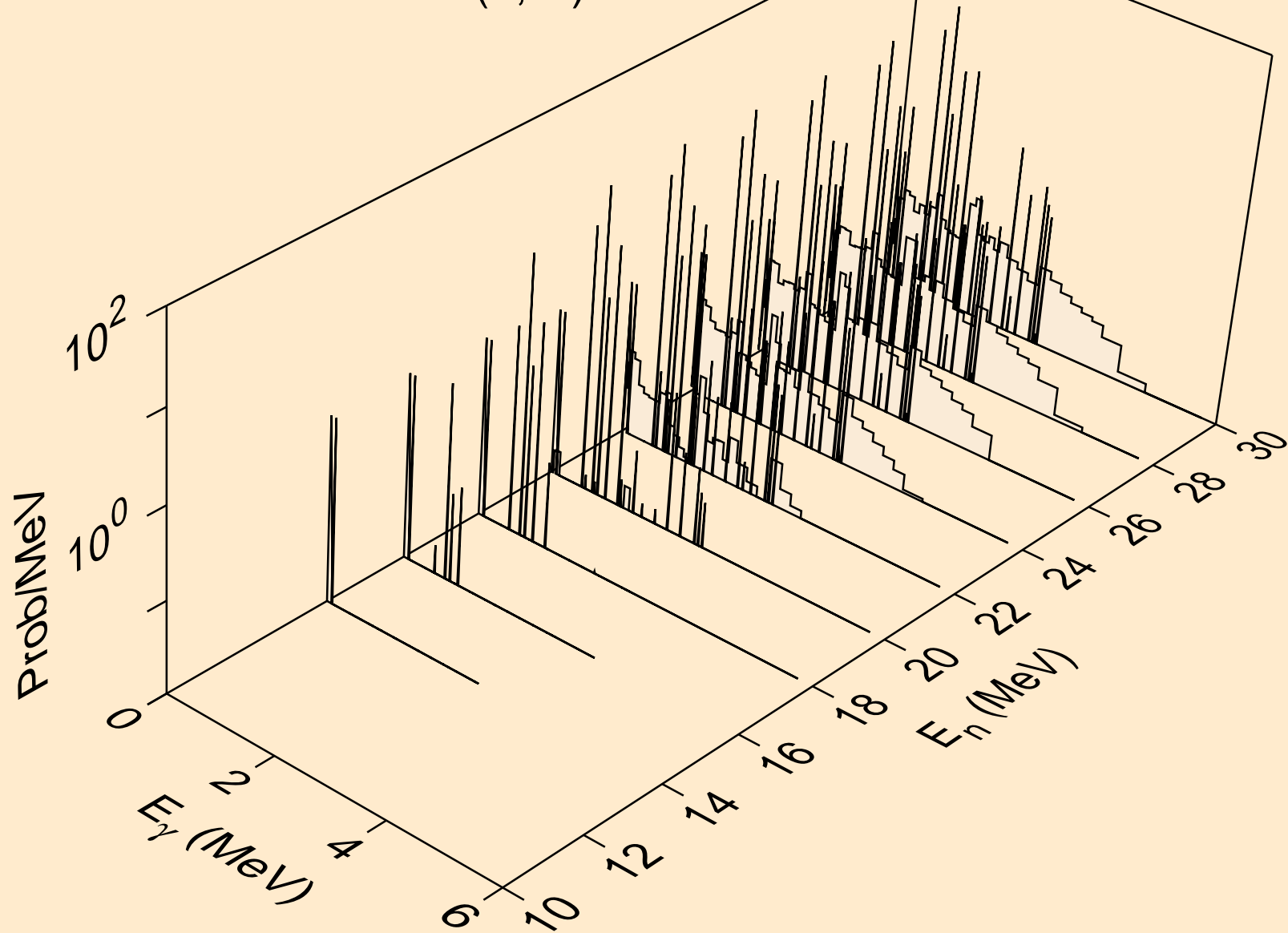

SC053 NEUTRON ACER TENDL-2024 LIBRARY; T=0.K  
Photon emission for (n,2n)a

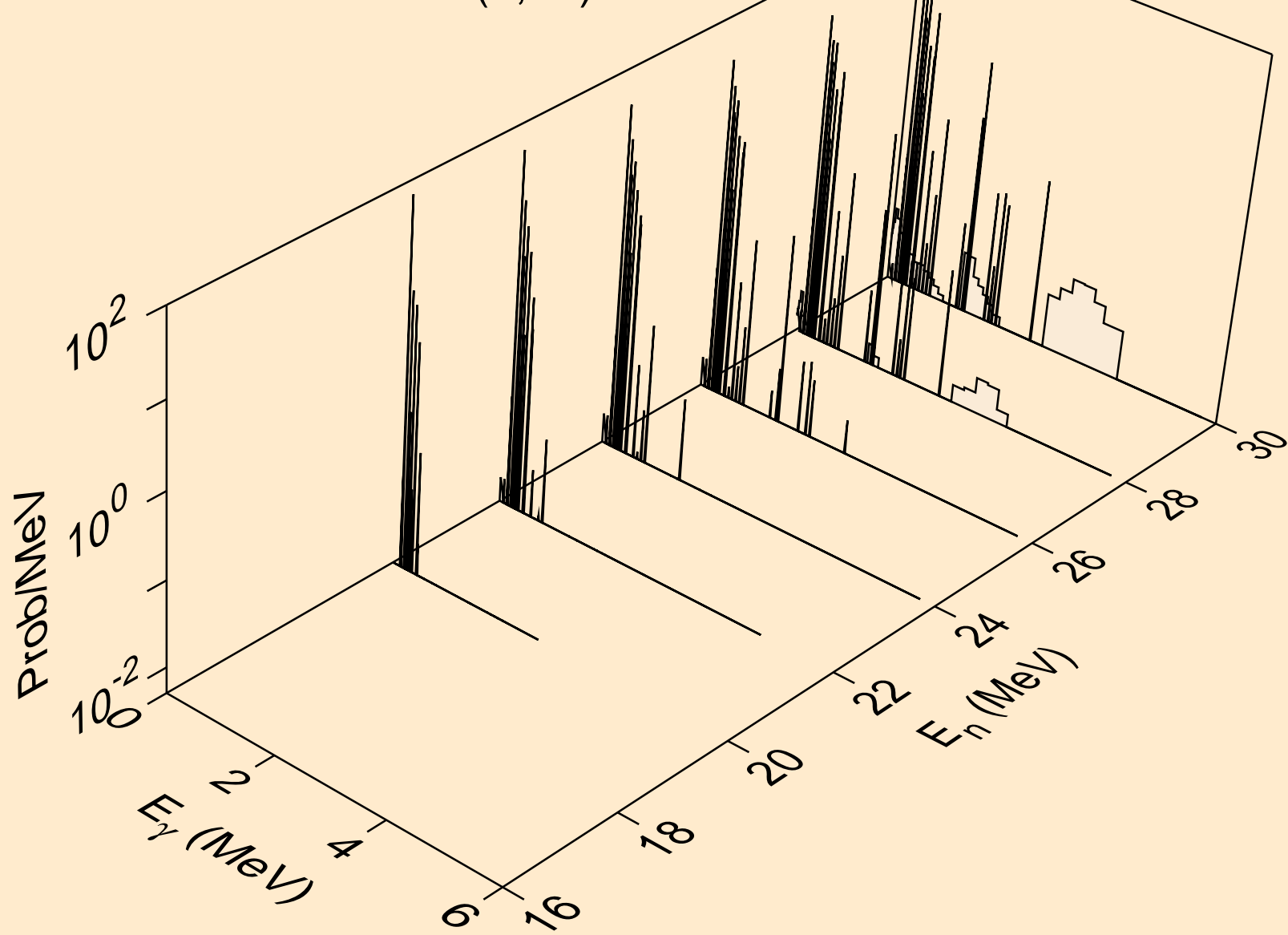

SC053 NEUTRON ACER TENDL-2024 LIBRARY; T=0.K  
Photon emission for (n,3n)a

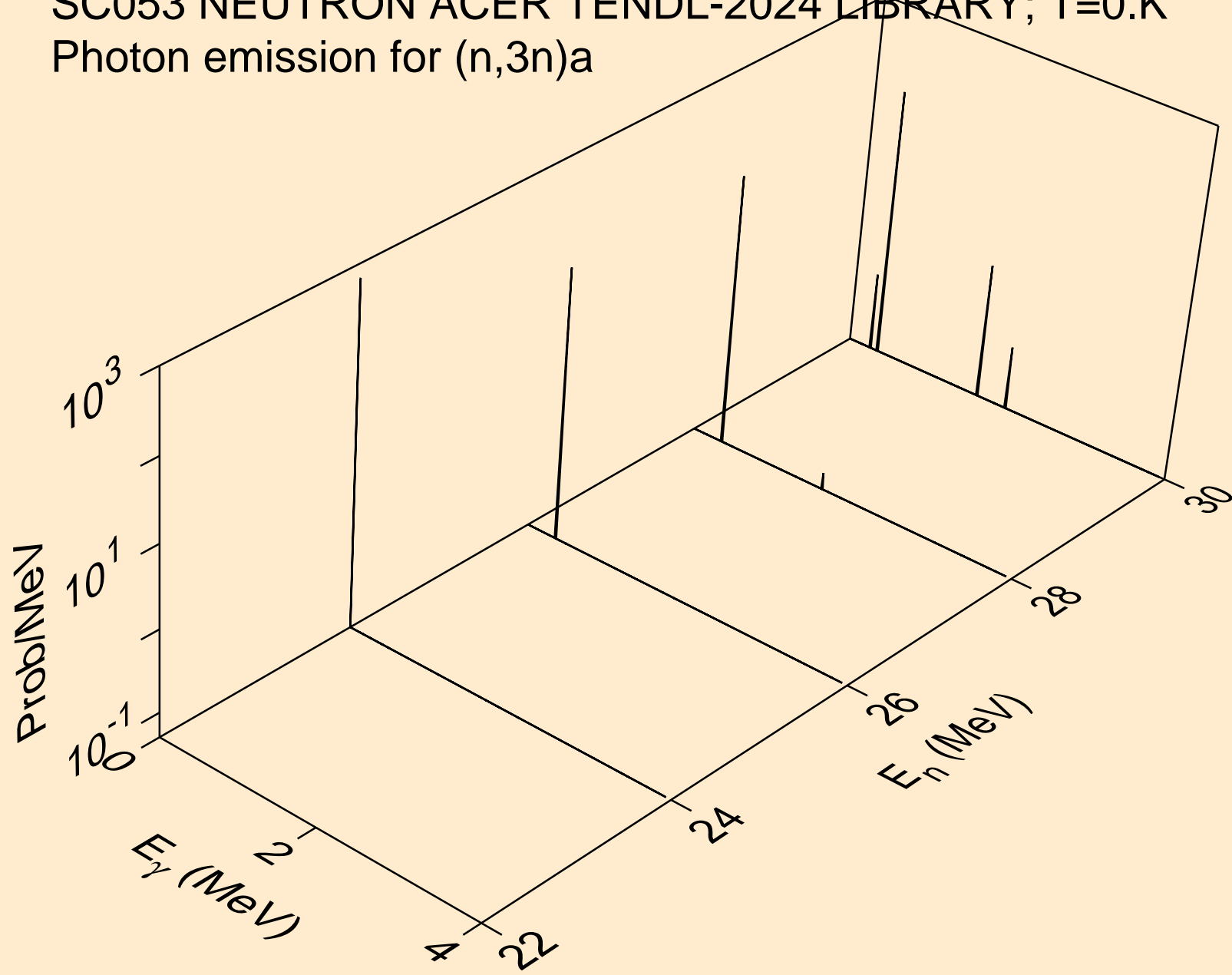



SC053 NEUTRON ACER TENDL-2024 LIBRARY; T=0.K  
Photon emission for (n,n\*)p

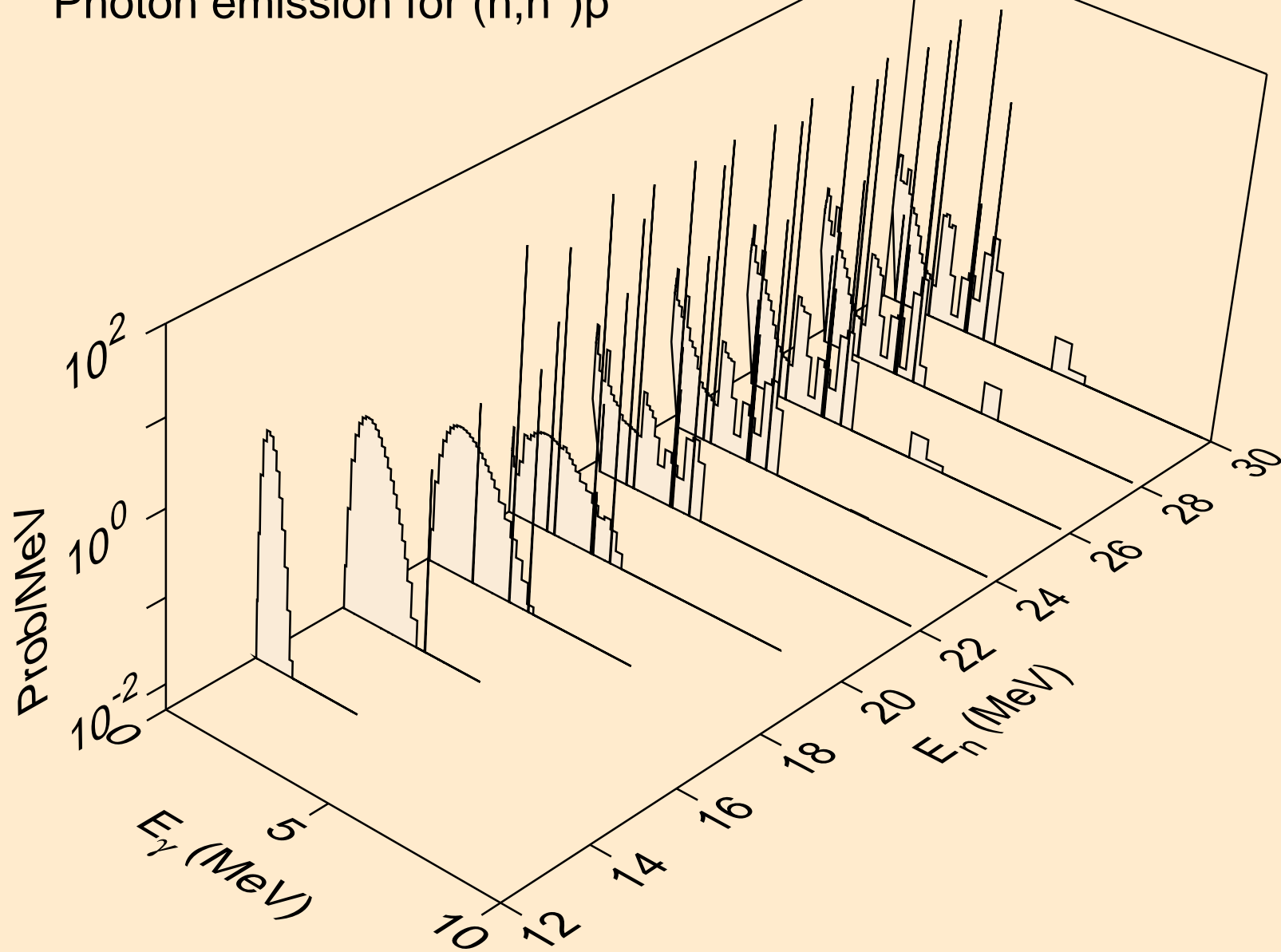

SC053 NEUTRON ACER TENDL-2024 LIBRARY; T=0.K  
Photon emission for (n,n\*)d

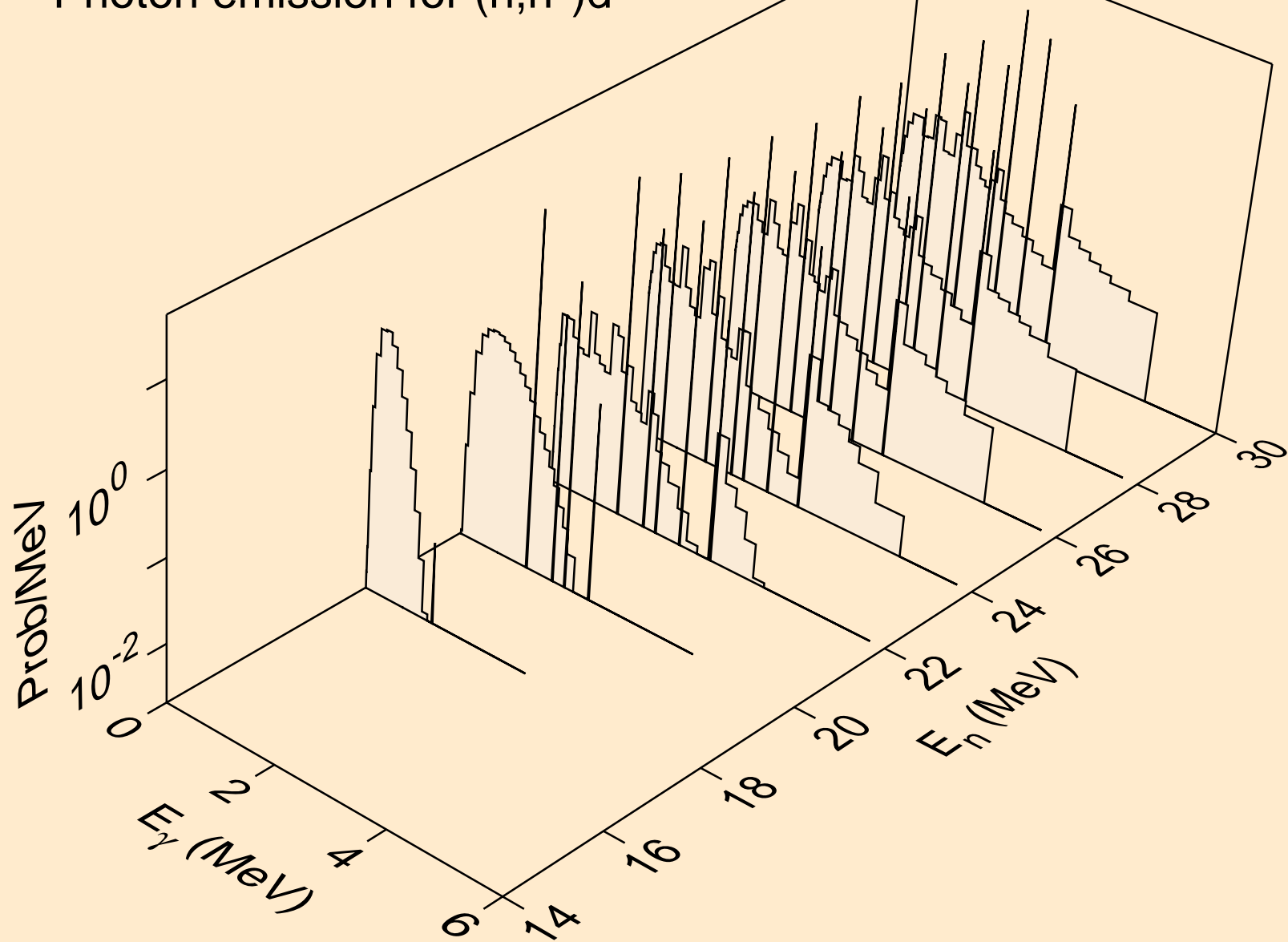

SC053 NEUTRON ACER TENDL-2024 LIBRARY; T=0.K  
Photon emission for (n,n\*)t

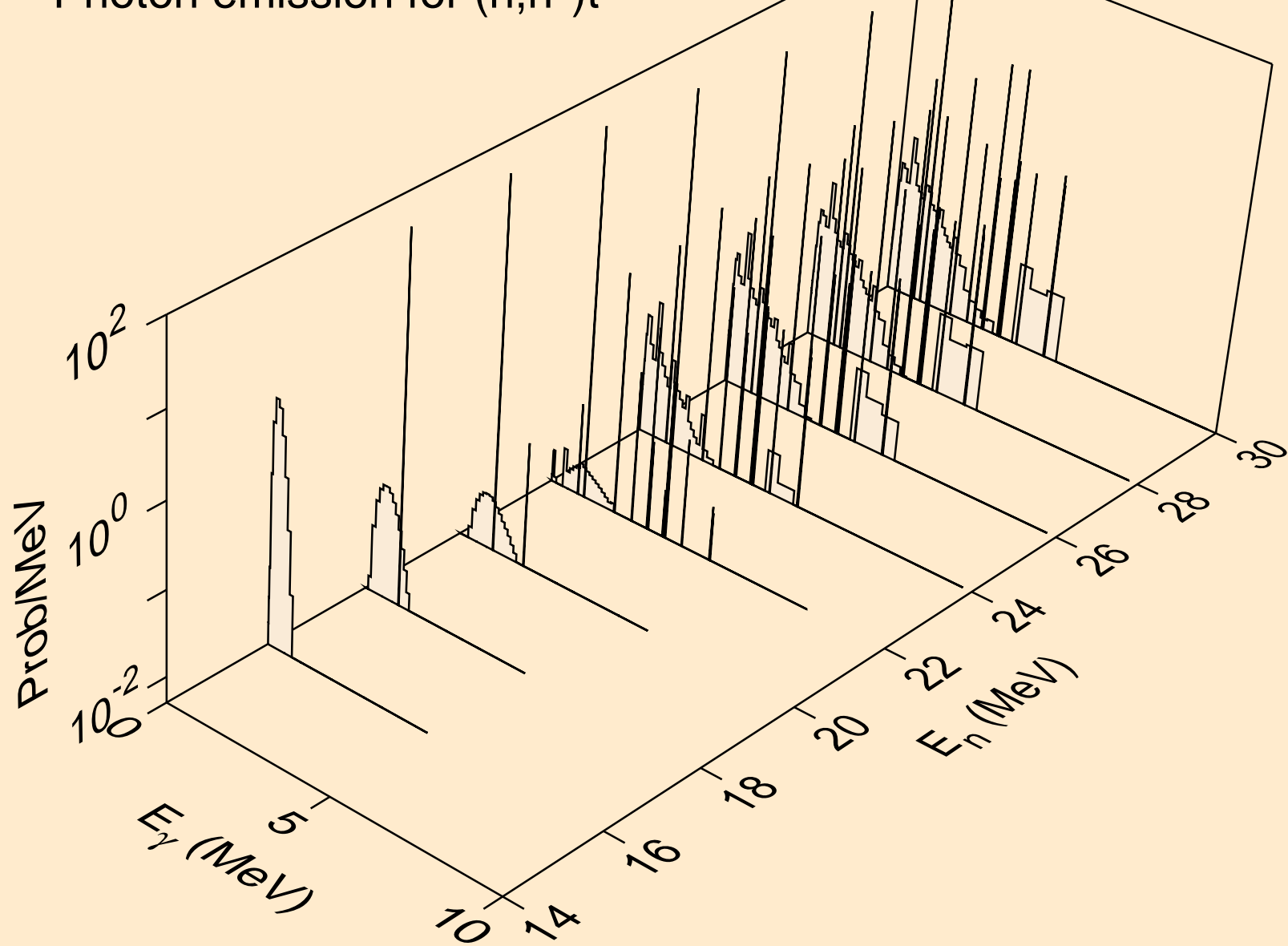

SC053 NEUTRON ACER TENDL-2024 LIBRARY; T=0.K  
Photon emission for (n,4n)

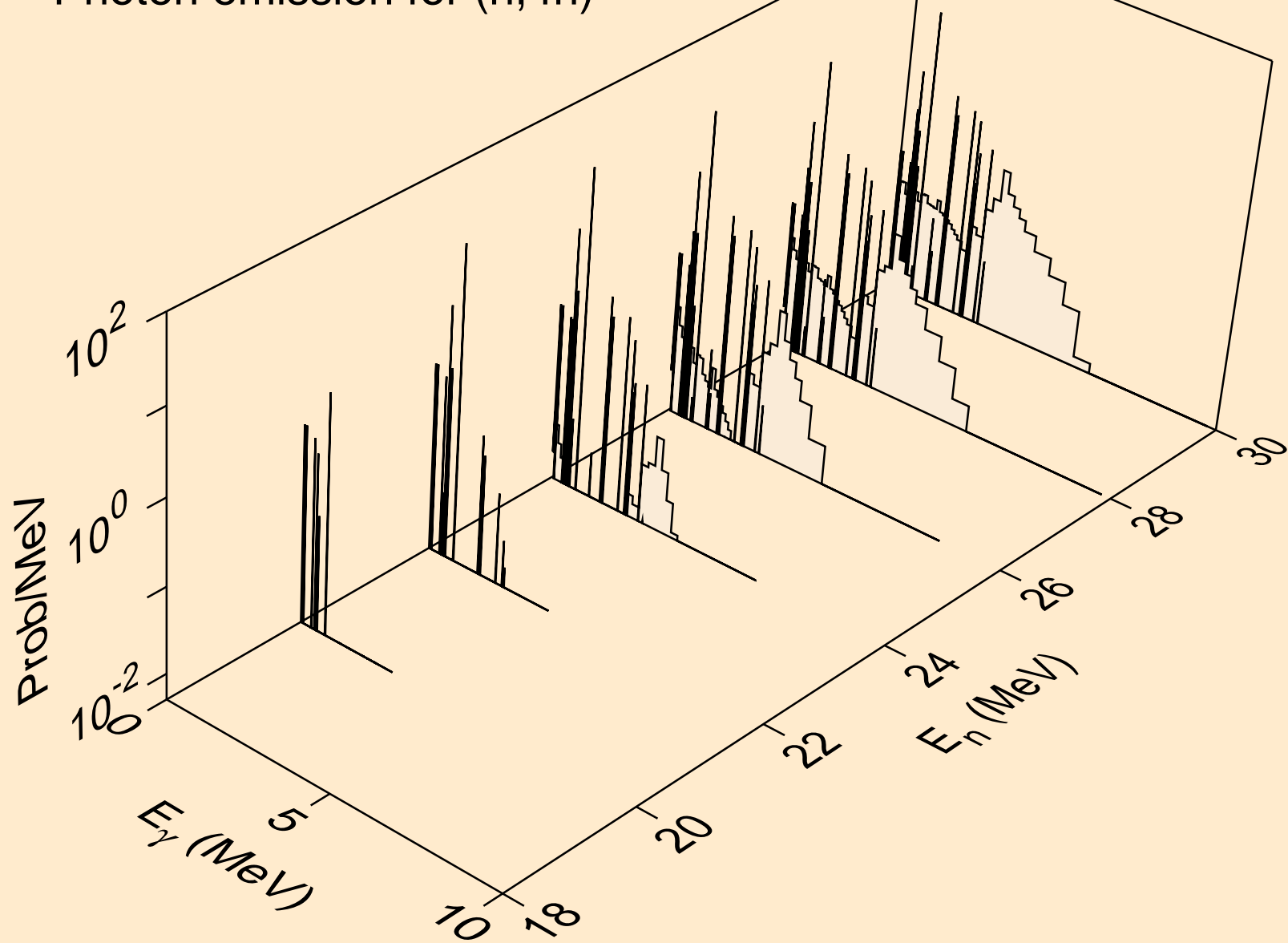

SC053 NEUTRON ACER TENDL-2024 LIBRARY; T=0.K  
Photon emission for (n,2np)

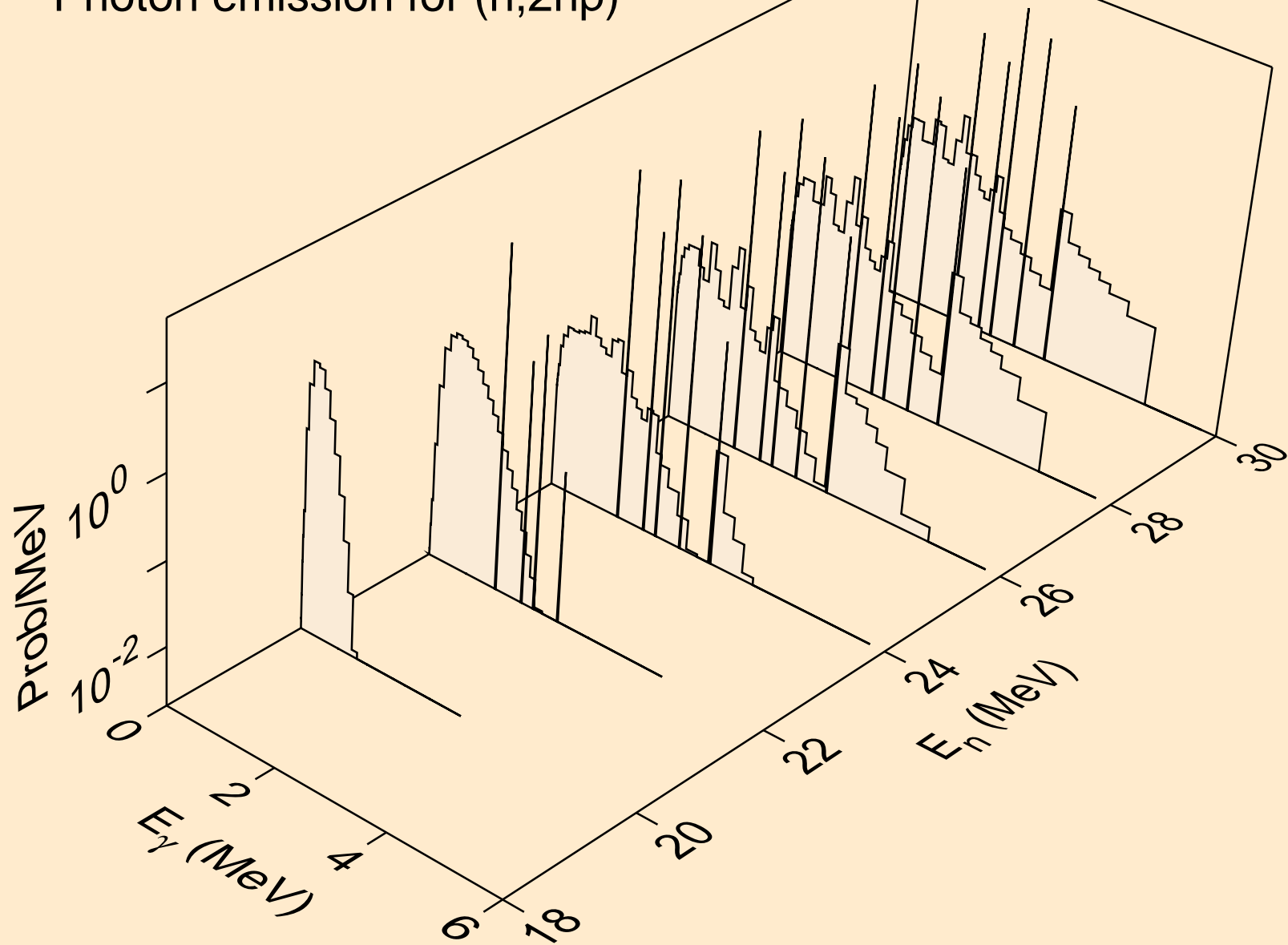

SC053 NEUTRON ACER TENDL-2024 LIBRARY; T=0.K  
Photon emission for (n,3np)

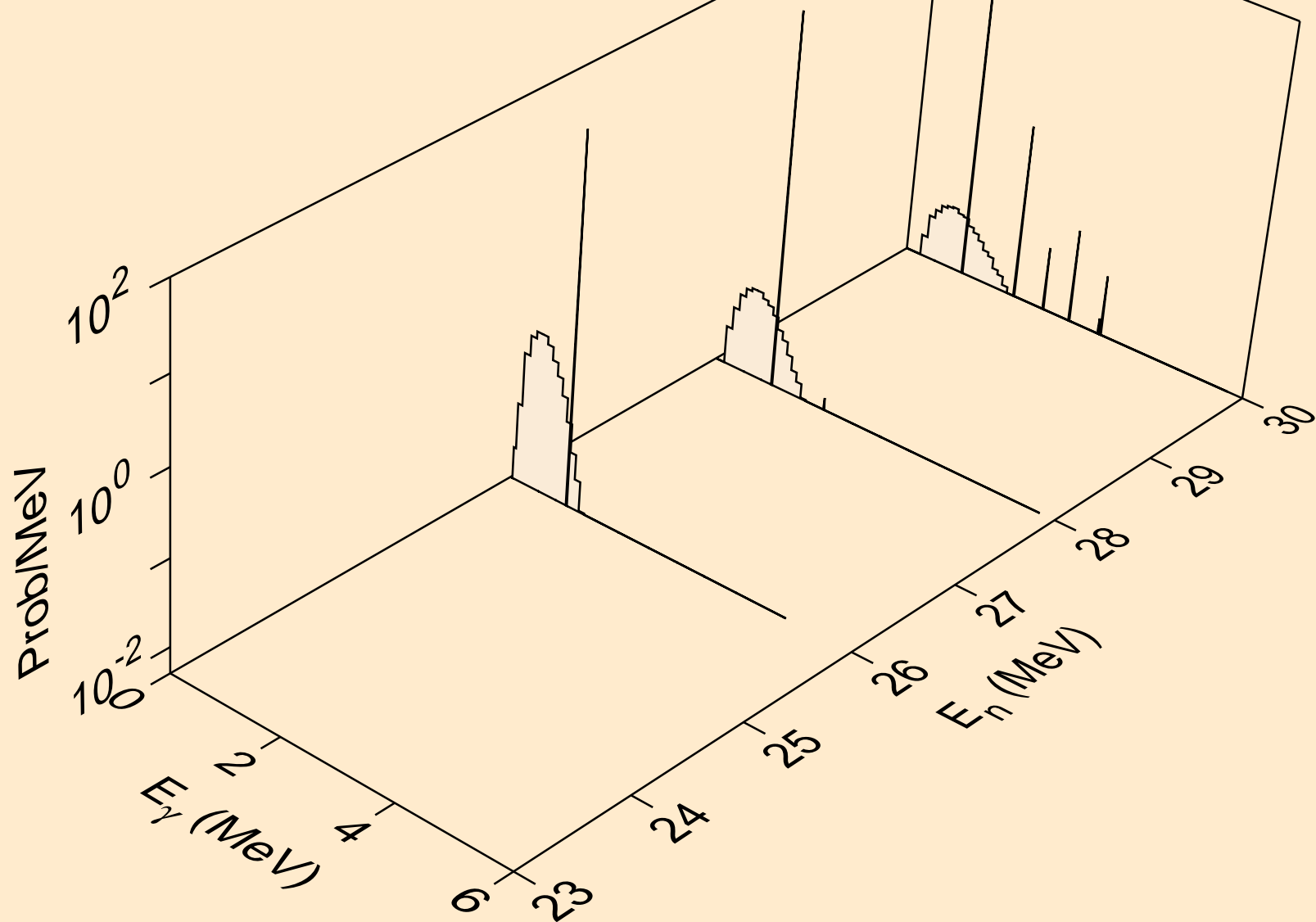

SC053 NEUTRON ACER TENDL-2024 LIBRARY; T=0.K  
Photon emission for (n,n\*c)

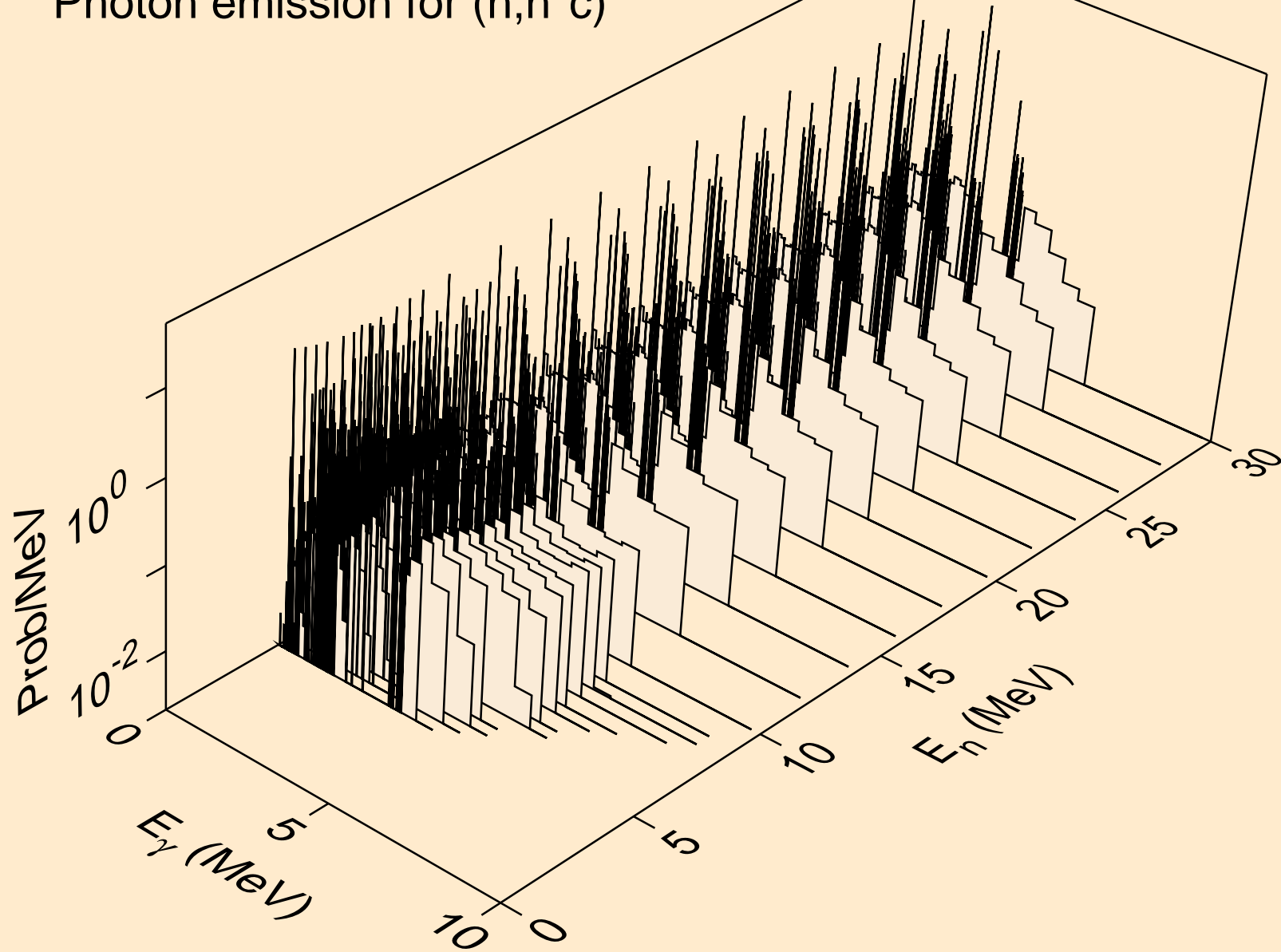

SC053 NEUTRON ACER TENDL-2024 LIBRARY; T=0.K  
Photon emission for (n,gma)

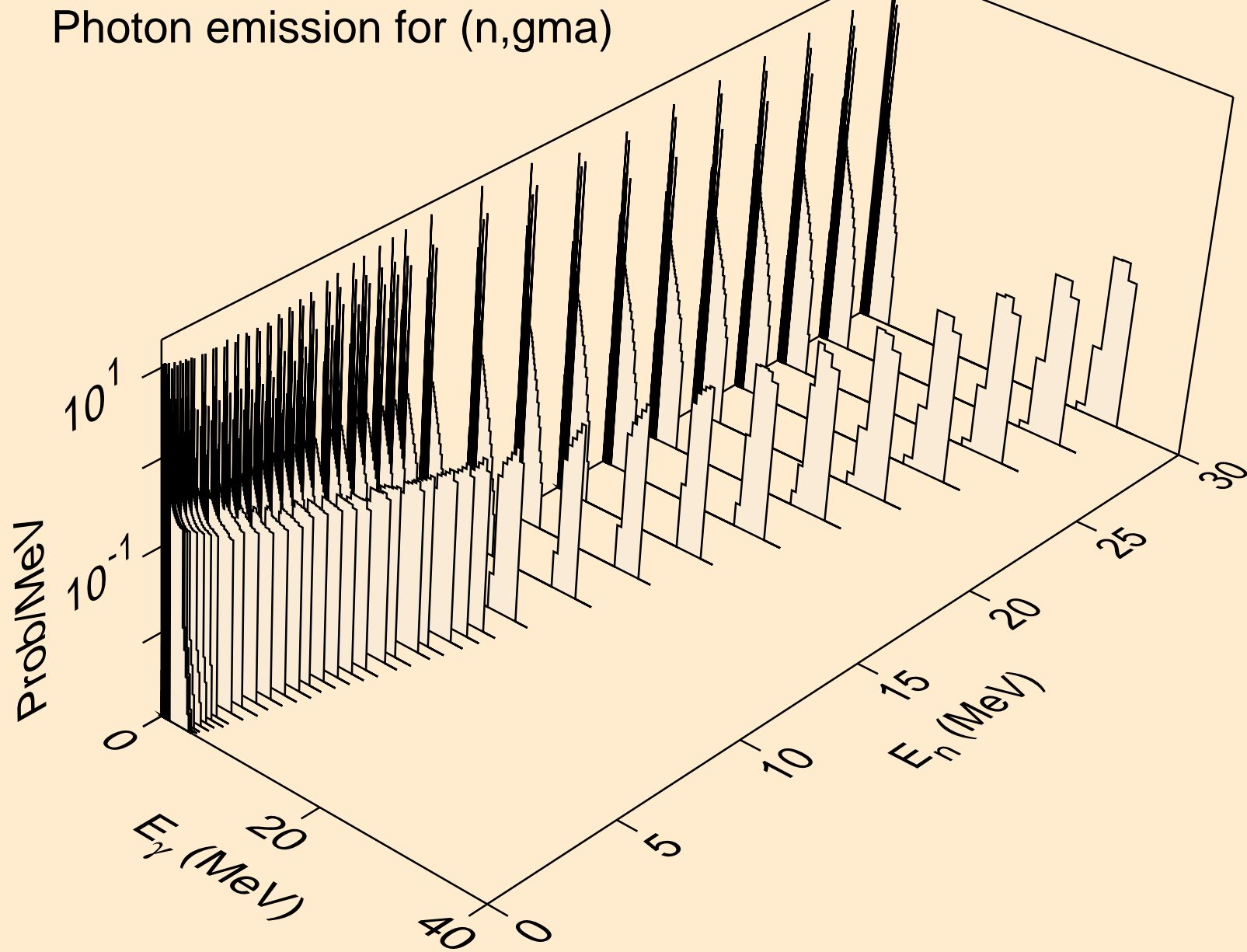



SC053 NEUTRON ACER TENDL-2024 LIBRARY; T=0.K  
Photon emission for (n,p)

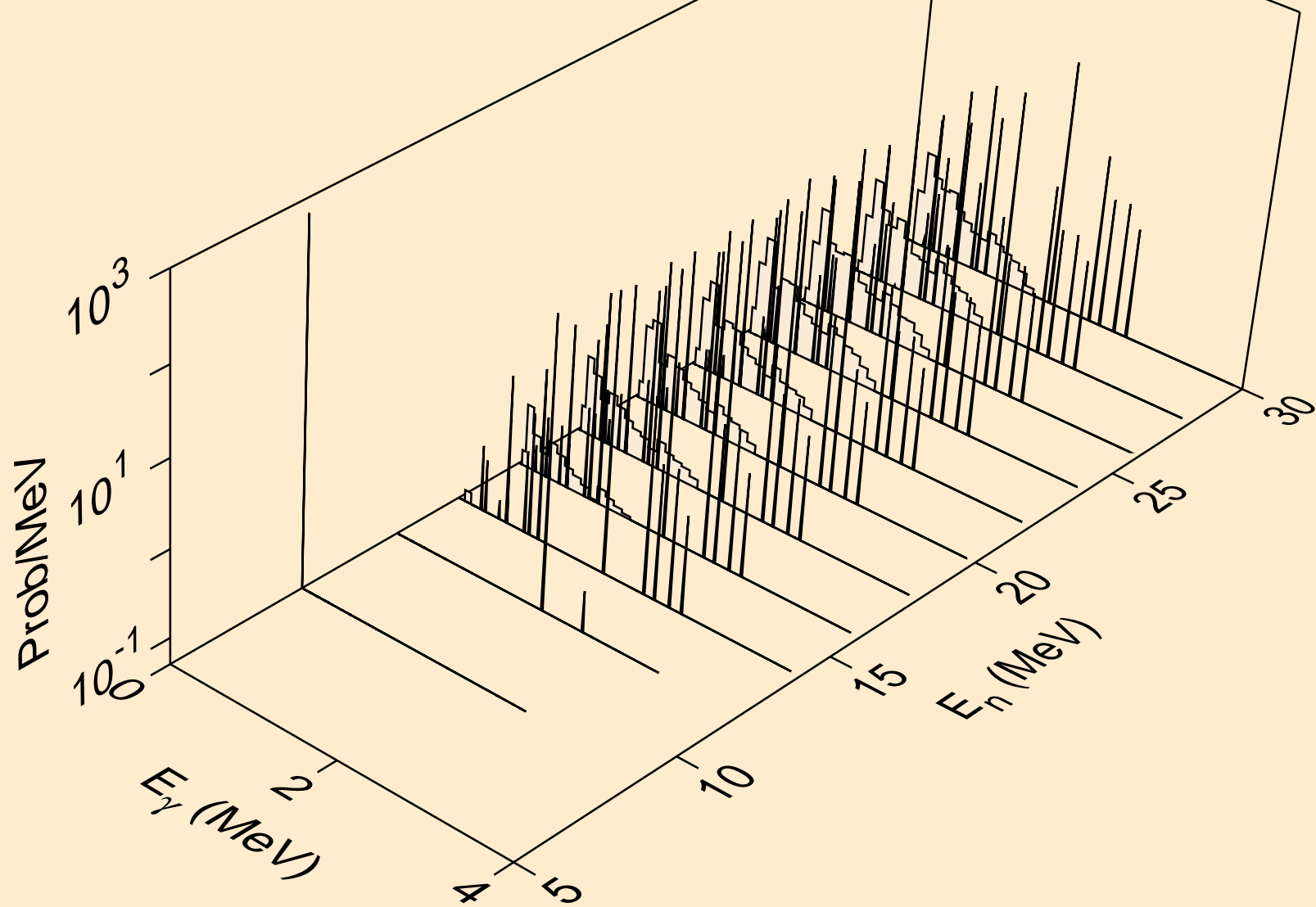

SC053 NEUTRON ACER TENDL-2024 LIBRARY; T=0.K  
Photon emission for (n,d)

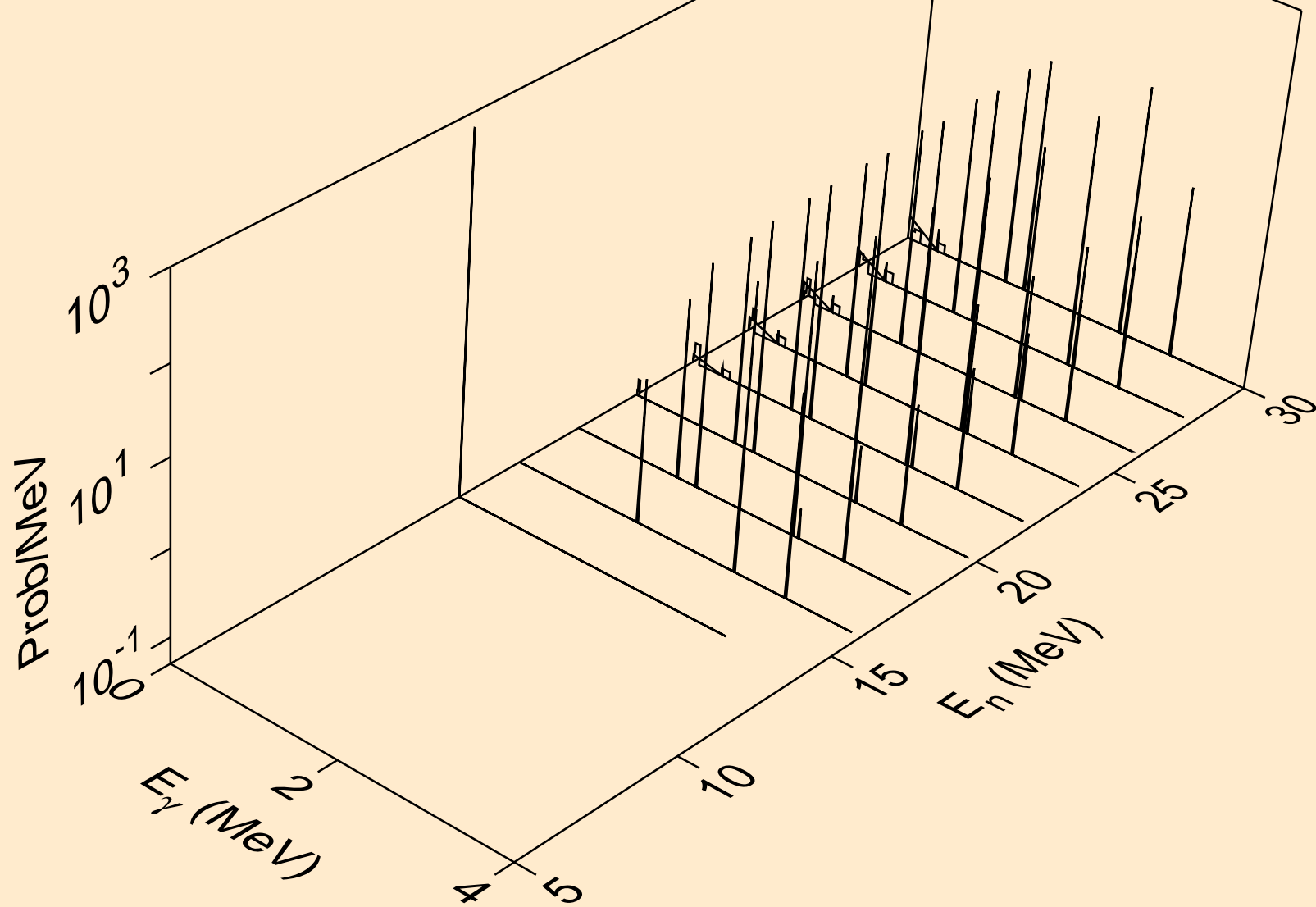

SC053 NEUTRON ACER TENDL-2024 LIBRARY; T=0.K  
Photon emission for (n,t)

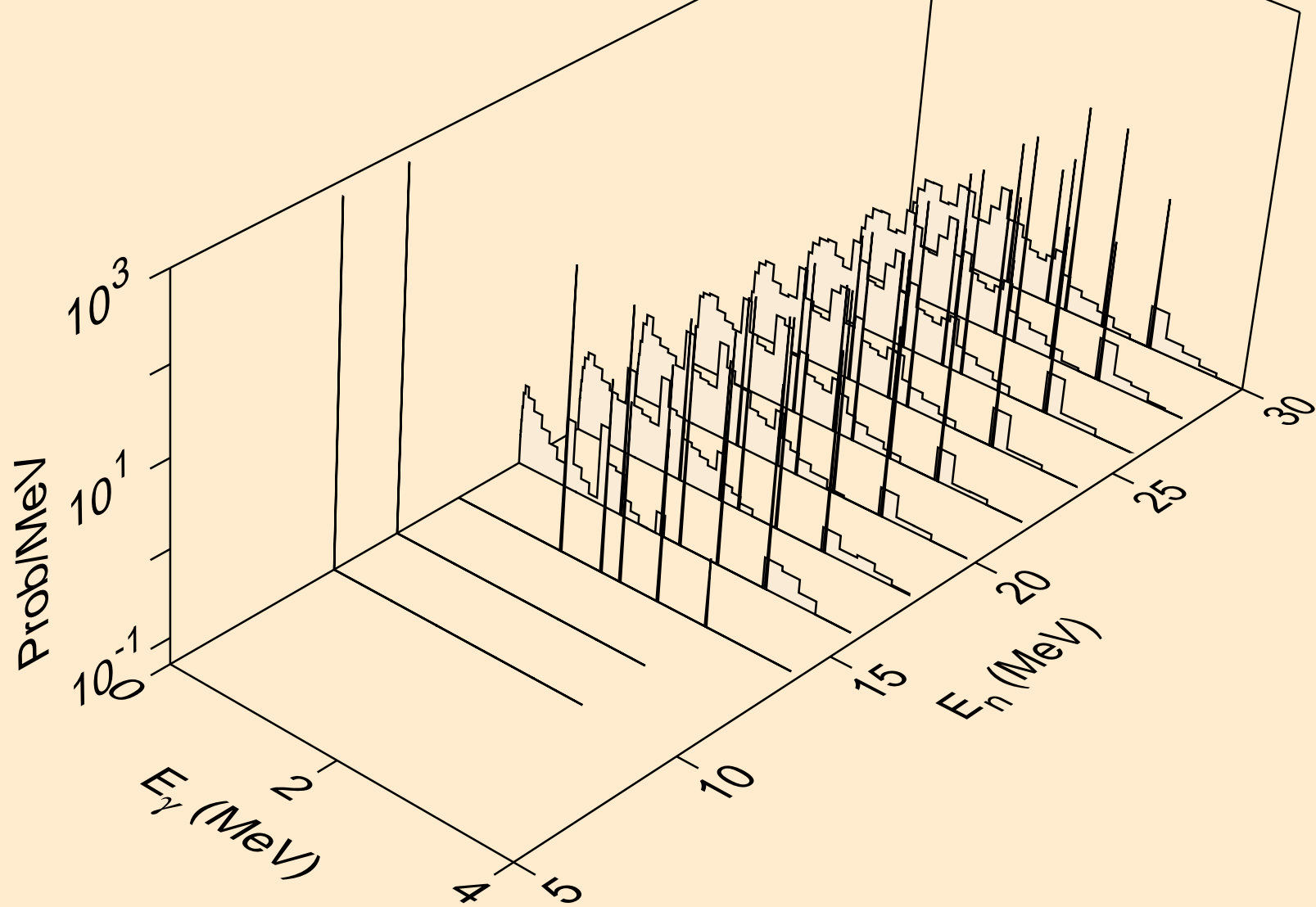

SC053 NEUTRON ACER TENDL-2024 LIBRARY; T=0.K  
Photon emission for (n,he3)

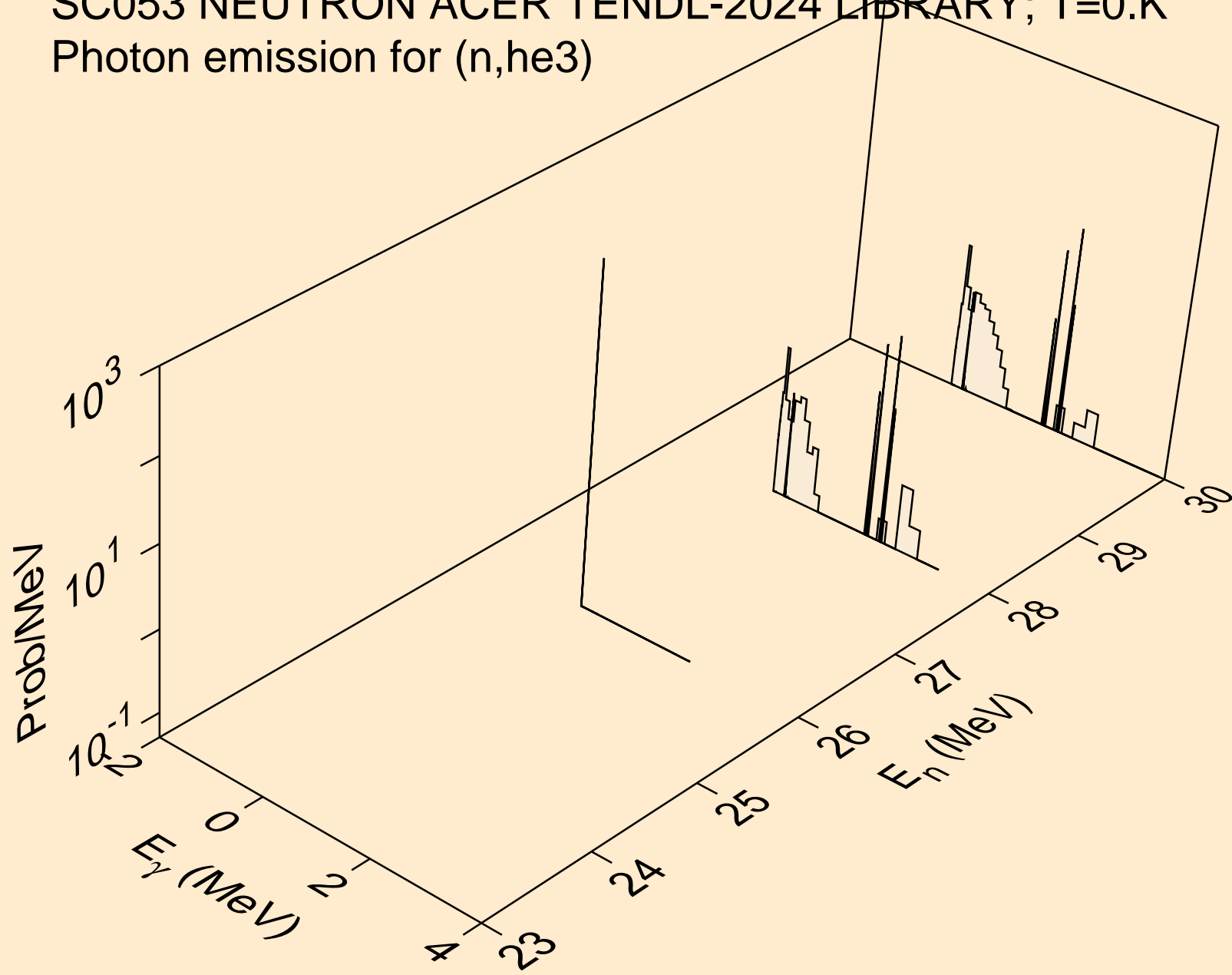

SC053 NEUTRON ACER TENDL-2024 LIBRARY; T=0.K  
Photon emission for (n,a)

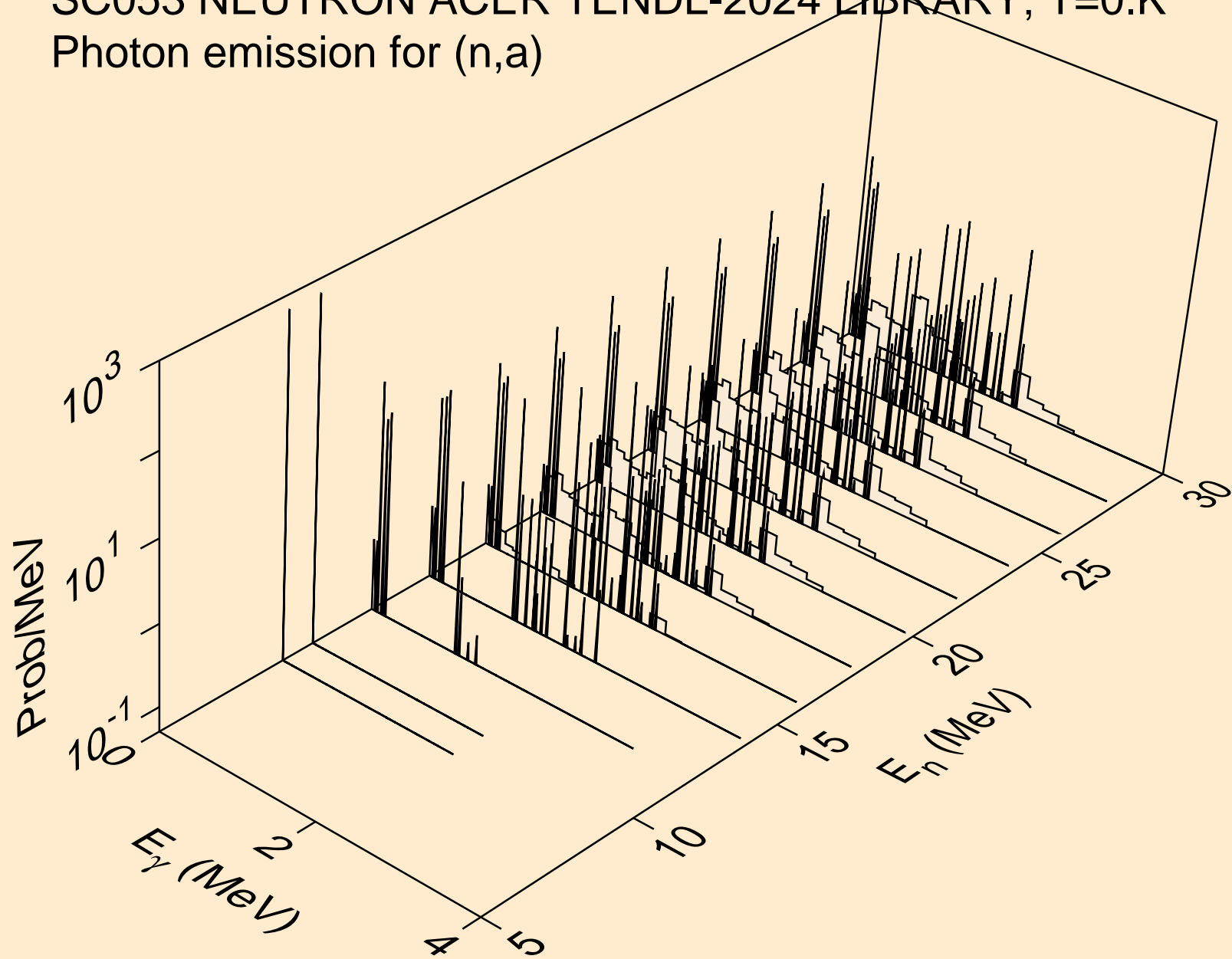

SC053 NEUTRON ACER TENDL-2024 LIBRARY; T=0.K  
thermal capture photon spectrum

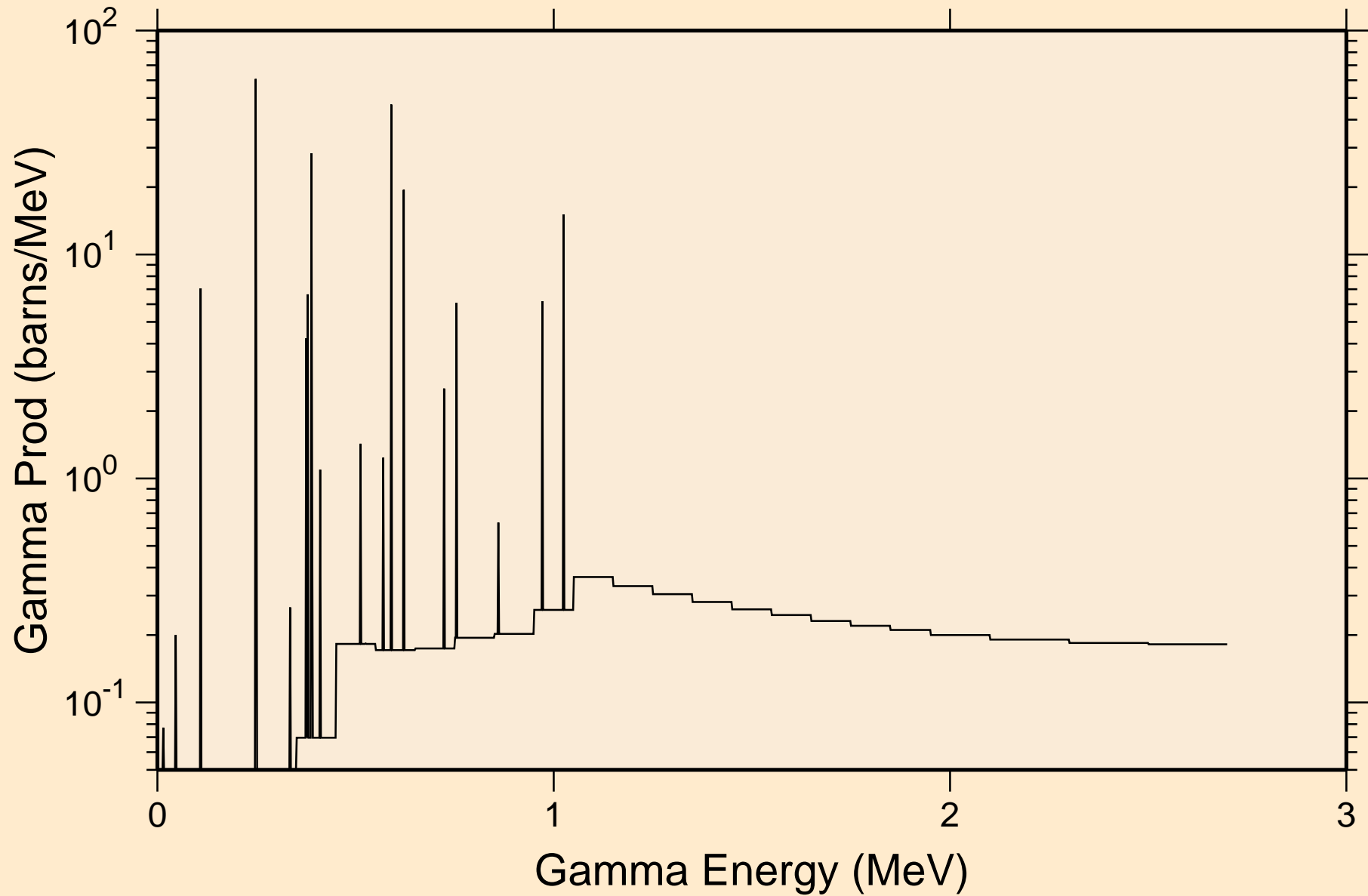

SC053 NEUTRON ACER TENDL-2024 LIBRARY; T=0.K  
14 MeV photon spectrum

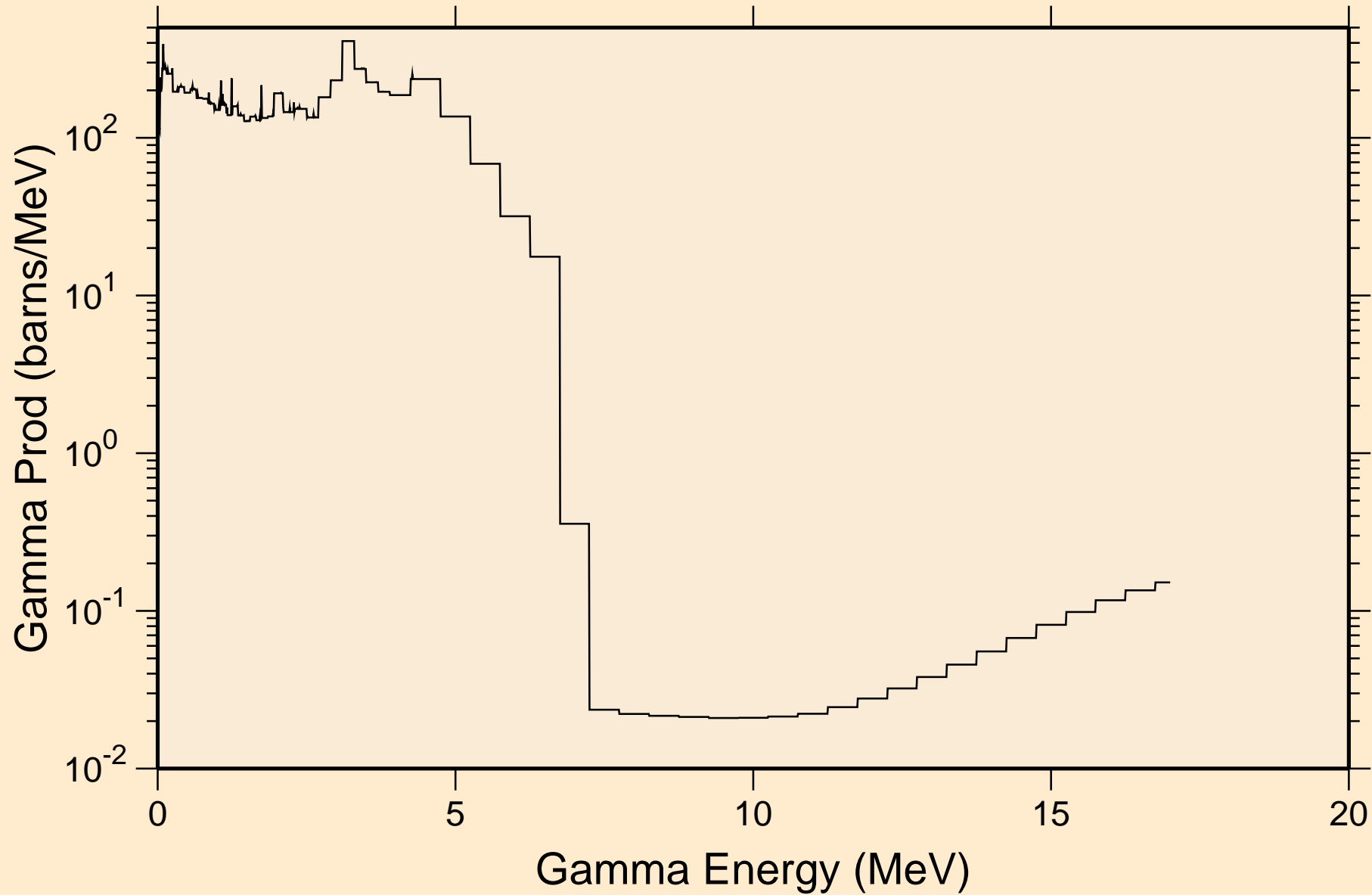

# SC053 NEUTRON ACER TENDL-2024 LIBRARY; T=0.K

## Particle heating contributions

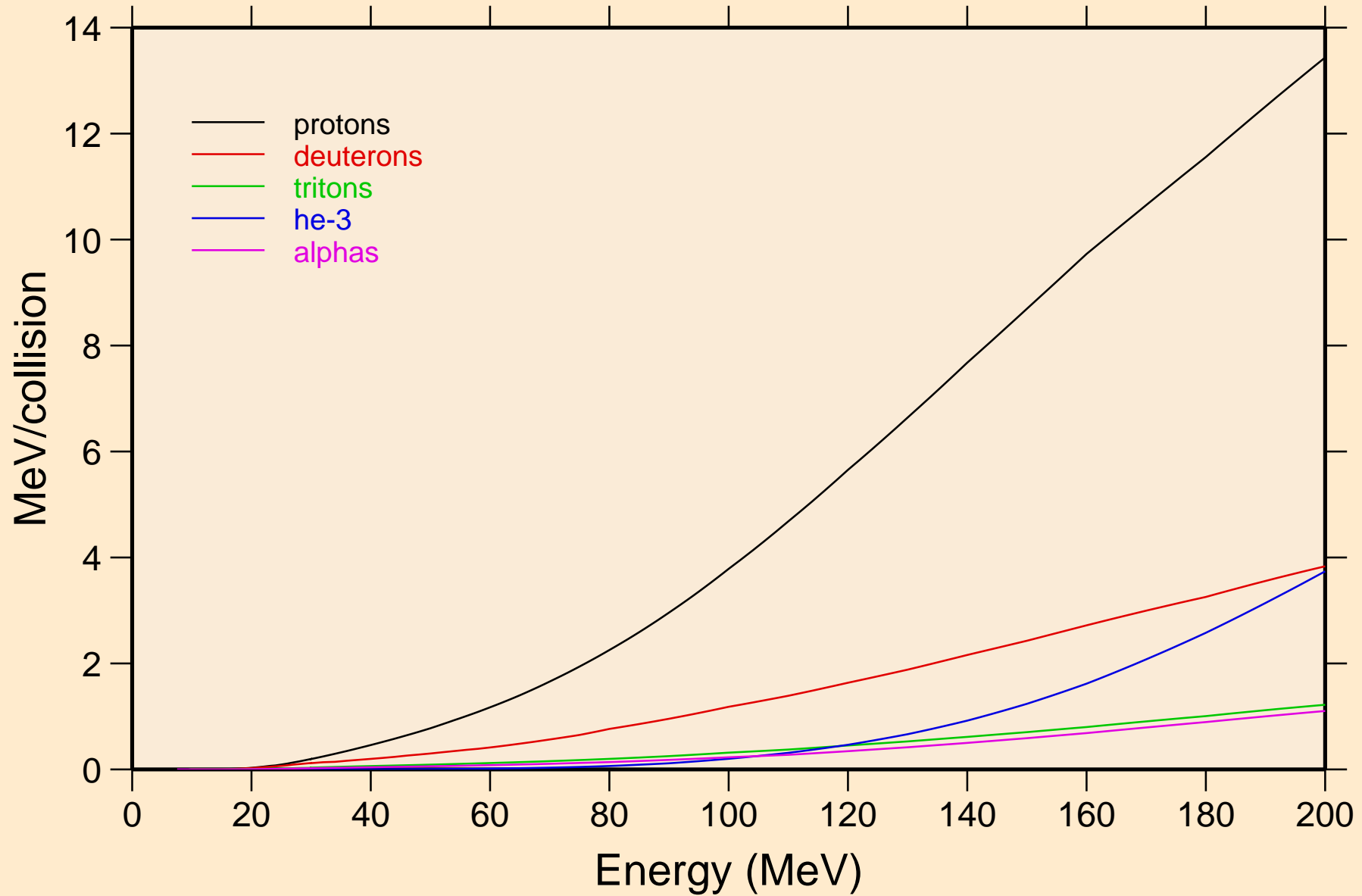



SC053 NEUTRON ACER TENDL-2024 LIBRARY; T=0.K  
Recoil Heating

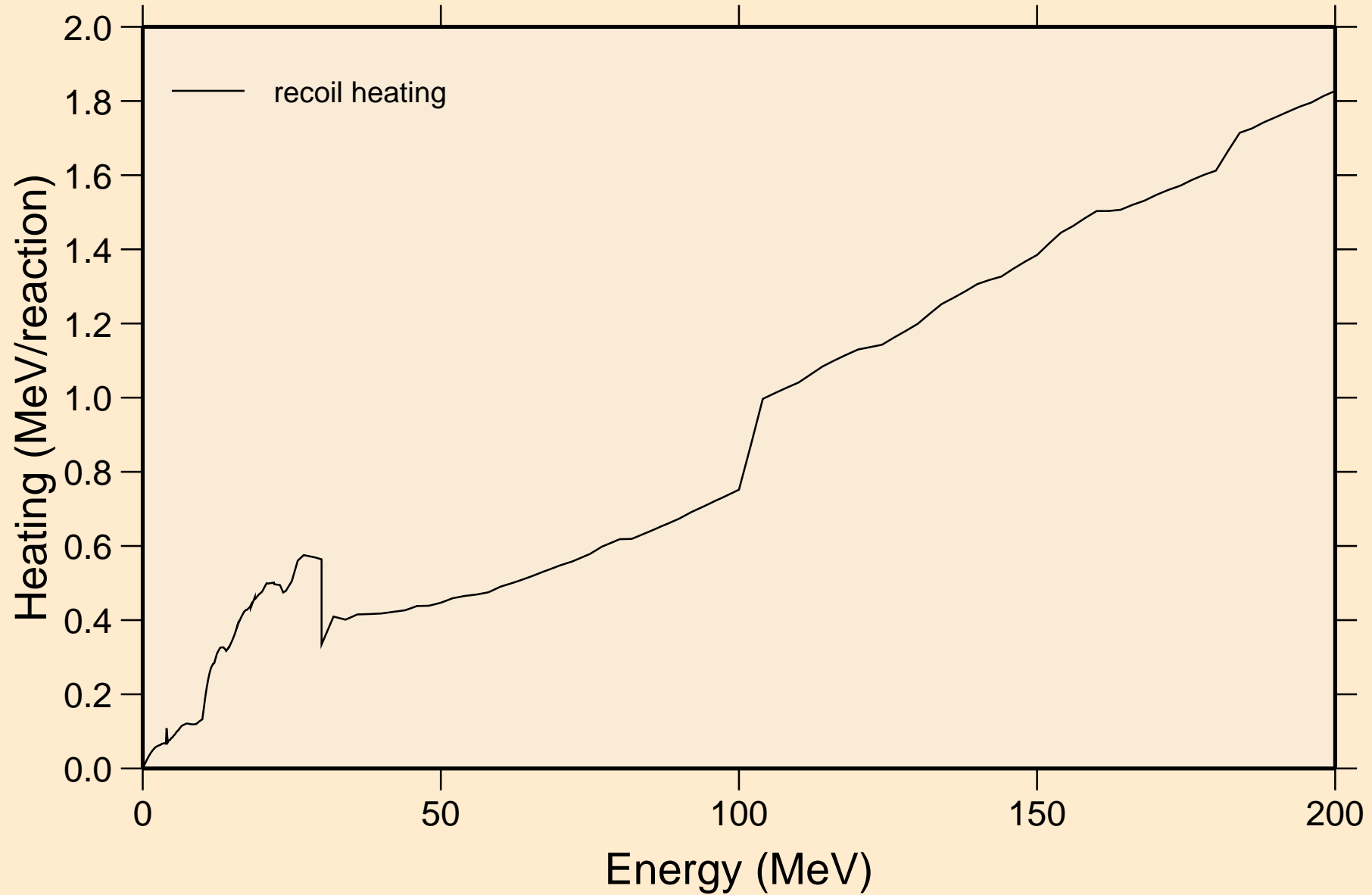

SC053 NEUTRON ACER TENDL-2024 LIBRARY; T=0.K  
Particle production cross sections

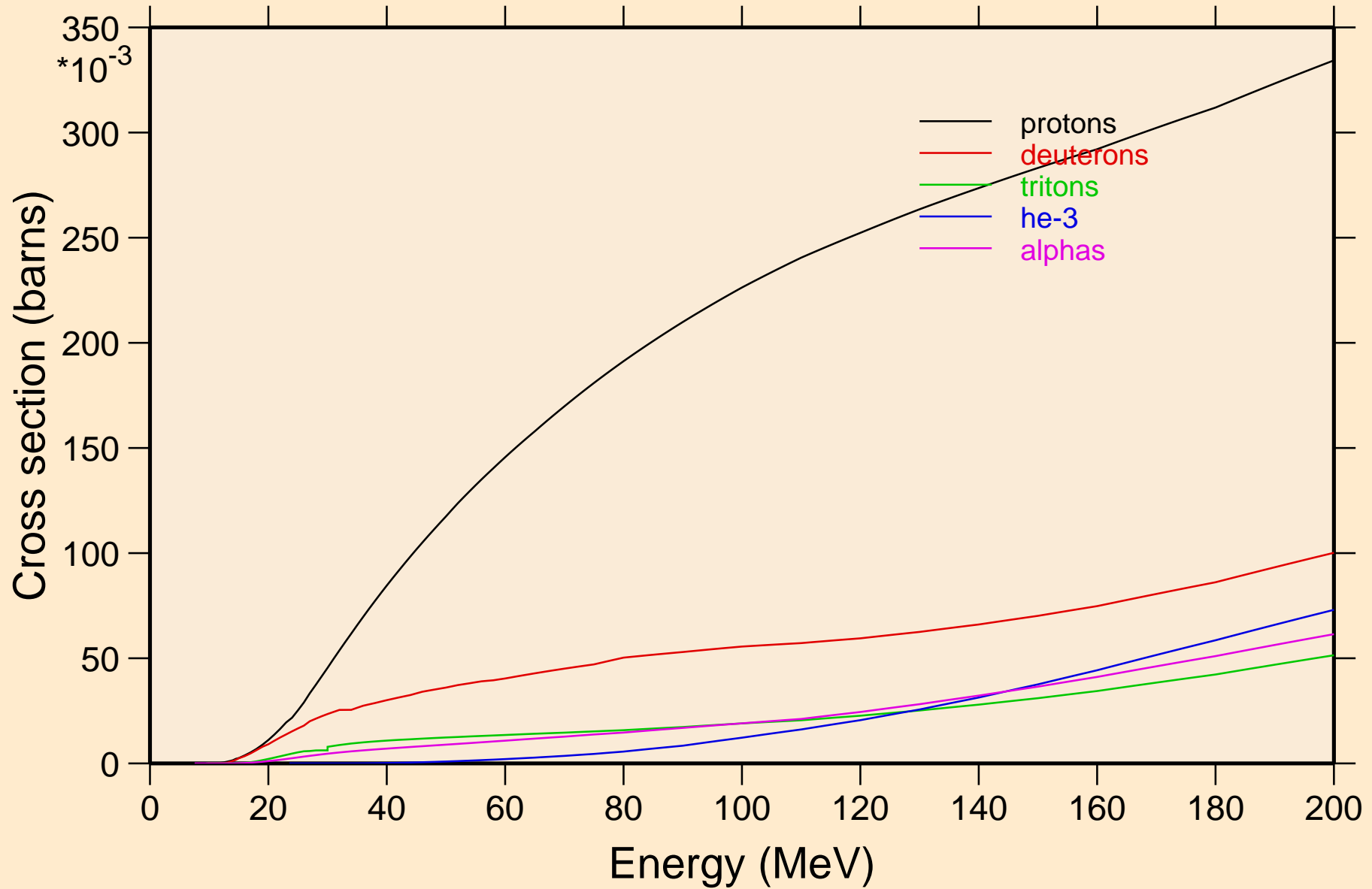

SC053 NEUTRON ACER TENDL-2024 LIBRARY; T=0.K  
protons from (n,x)

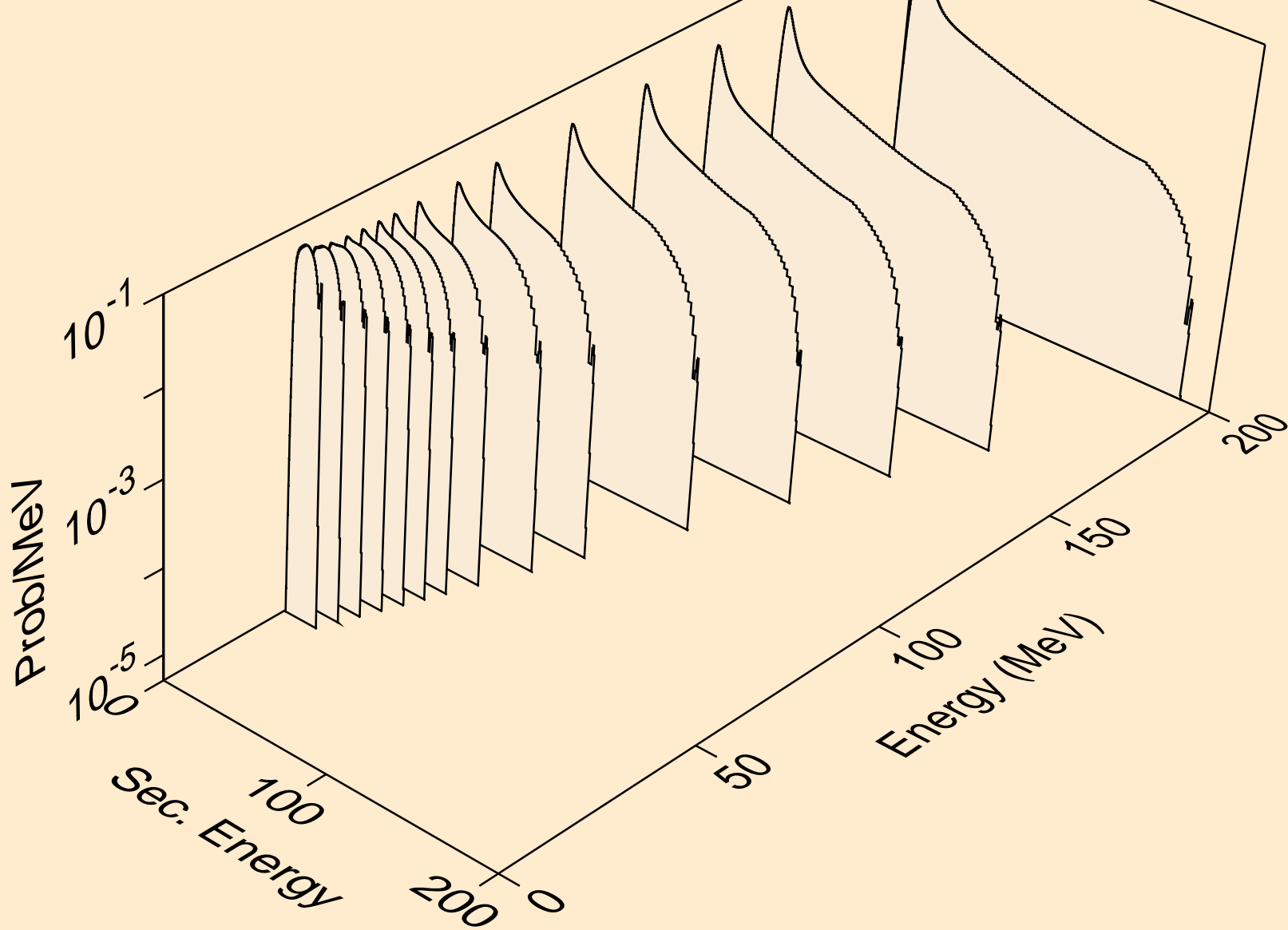

SC053 NEUTRON ACER TENDL-2024 LIBRARY; T=0.K  
protons from (n,n\*)p

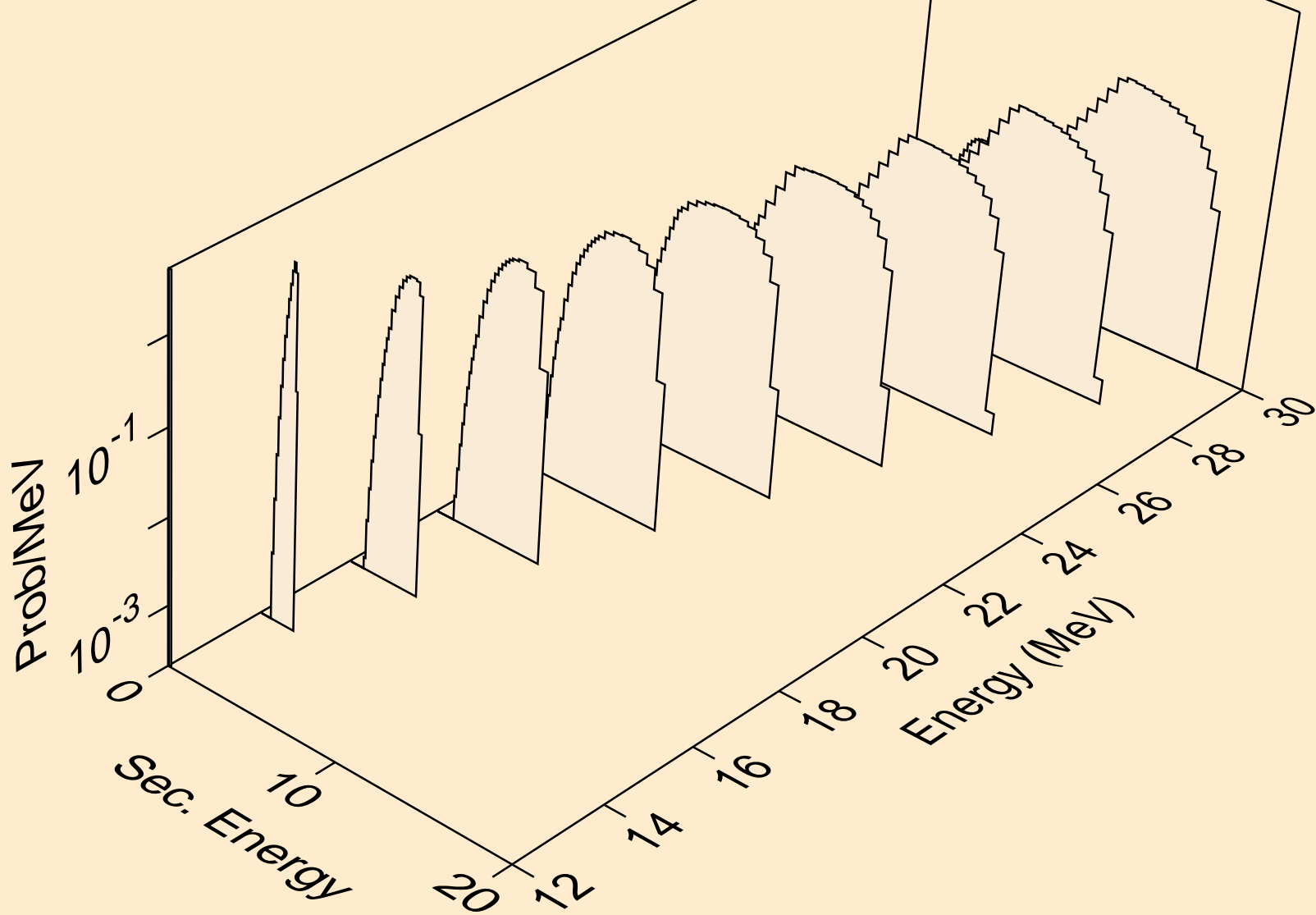

SC053 NEUTRON ACER TENDL-2024 LIBRARY; T=0.K  
protons from (n,2np)

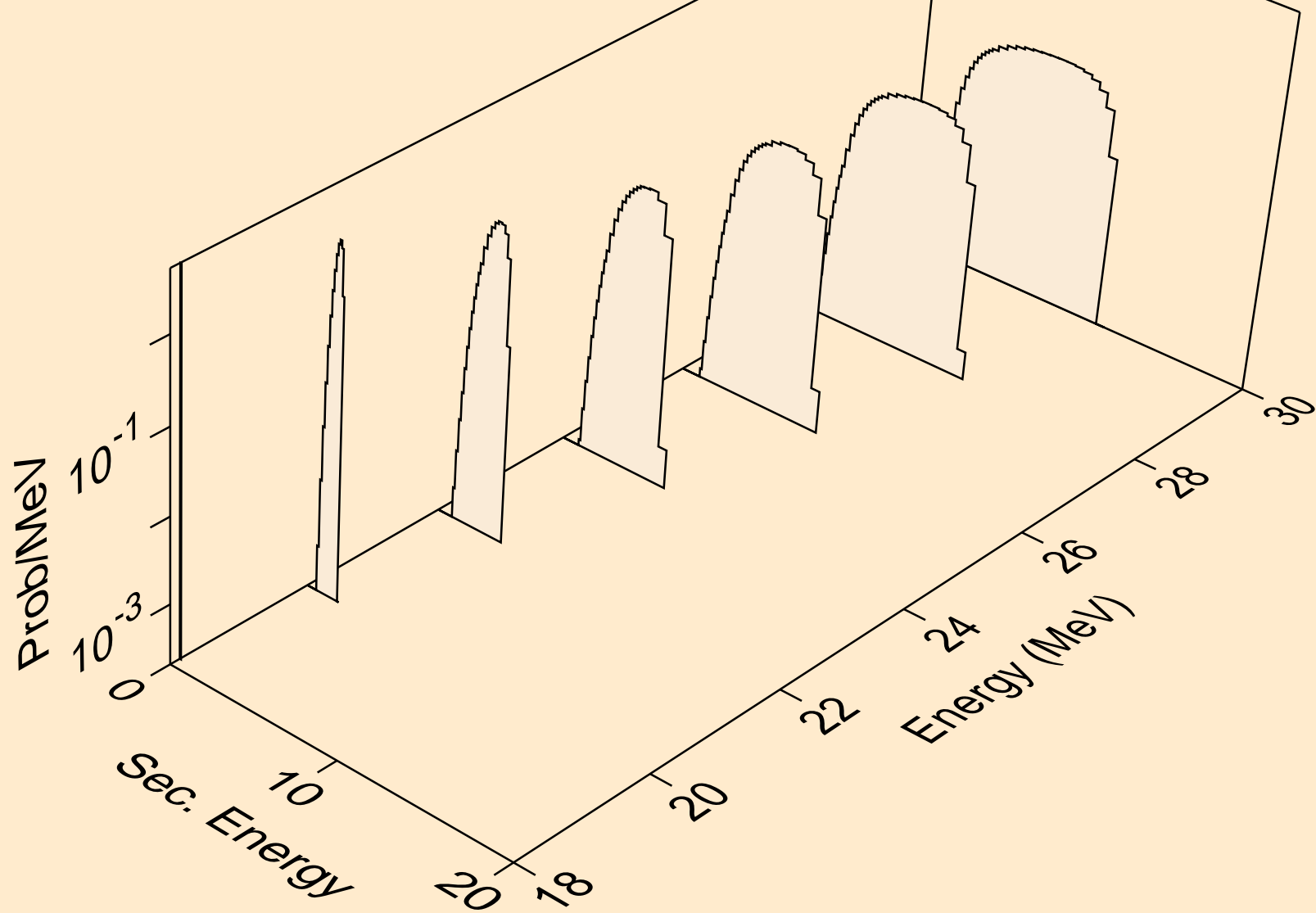

SC053 NEUTRON ACER TENDL-2024 LIBRARY; T=0.K  
protons from (n,3np)

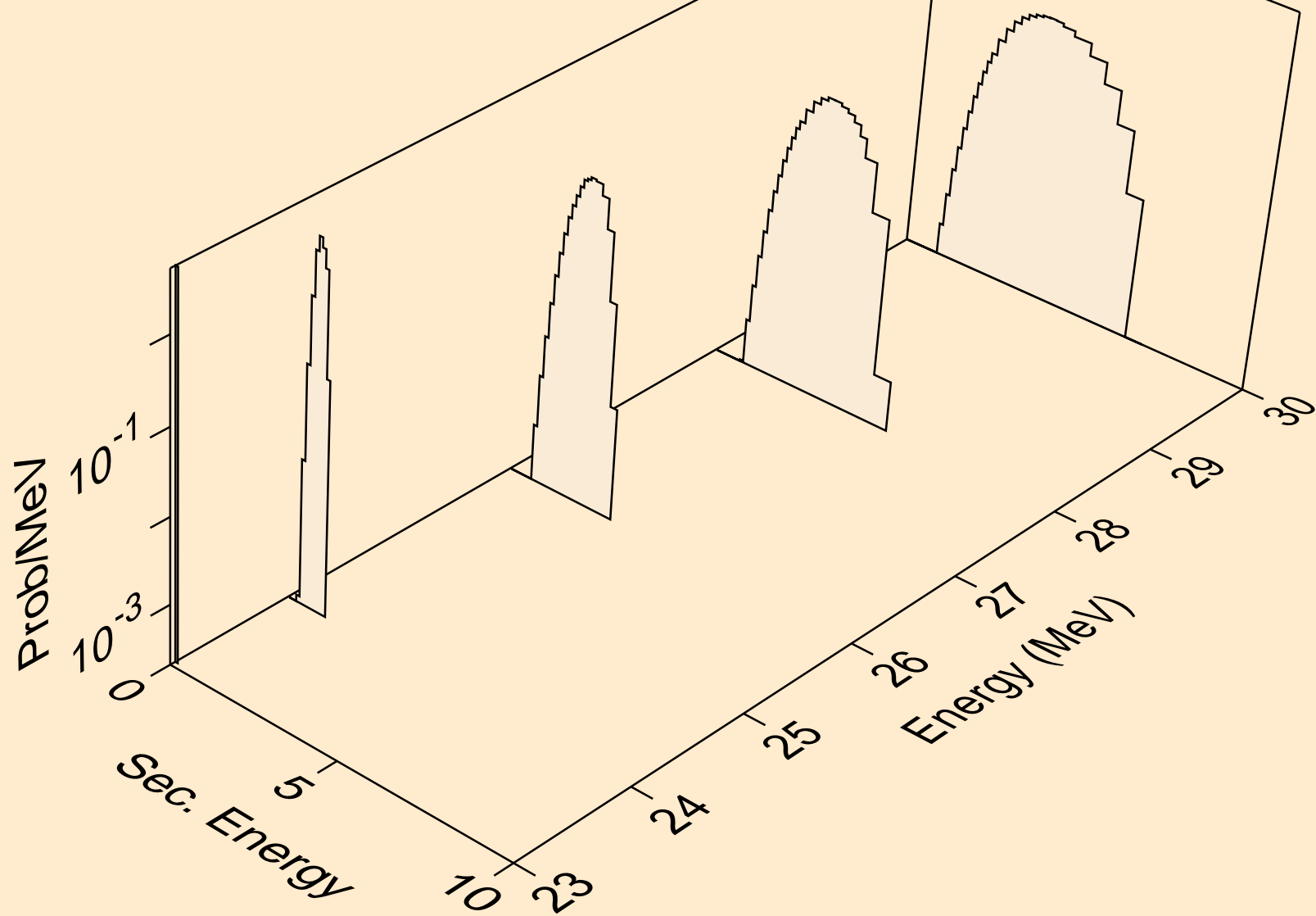

SC053 NEUTRON ACER TENDL-2024 LIBRARY; T=0.K  
protons from (n,p)

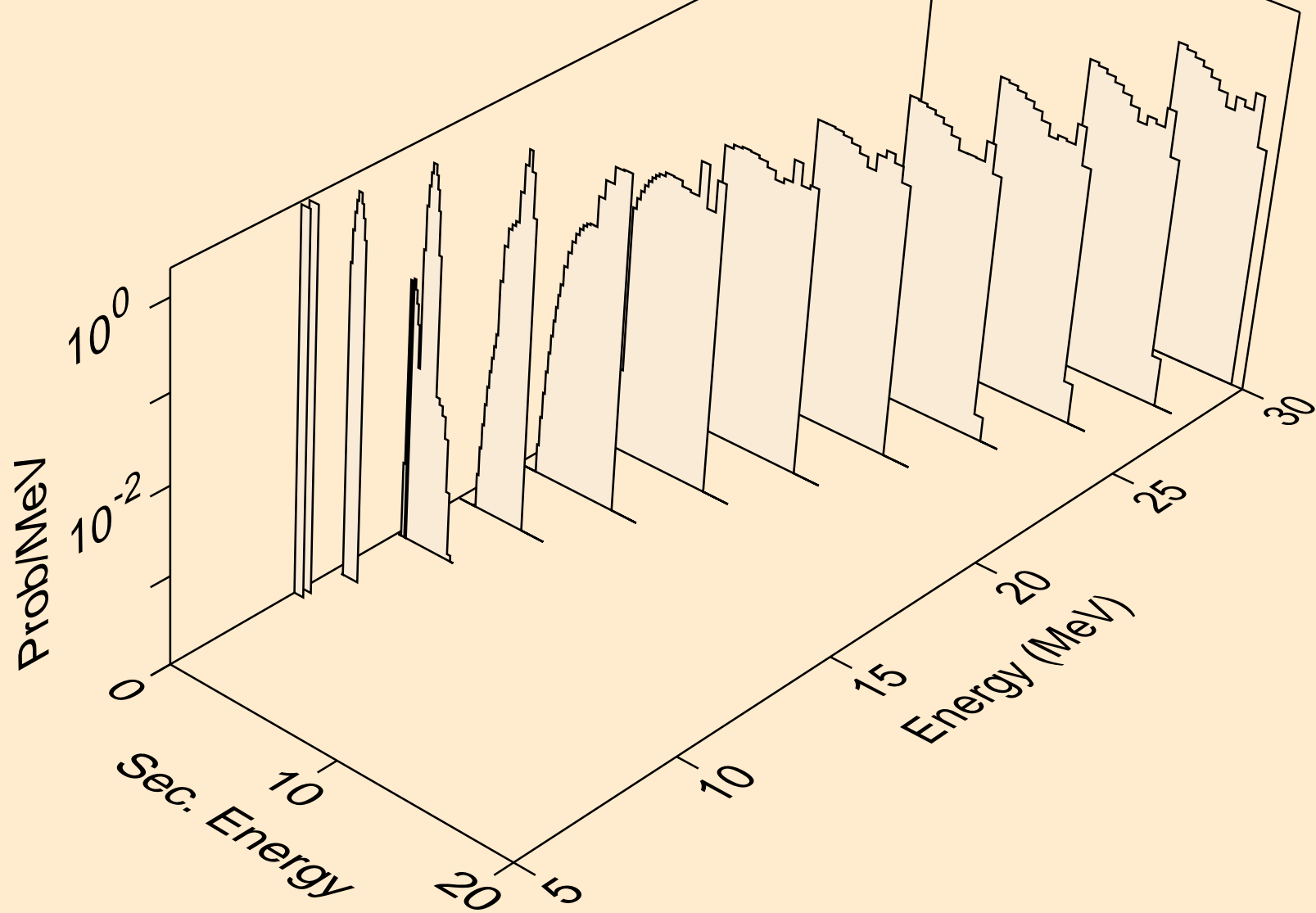

SC053 NEUTRON ACER TENDL-2024 LIBRARY; T=0.K  
deuterons from (n,x)

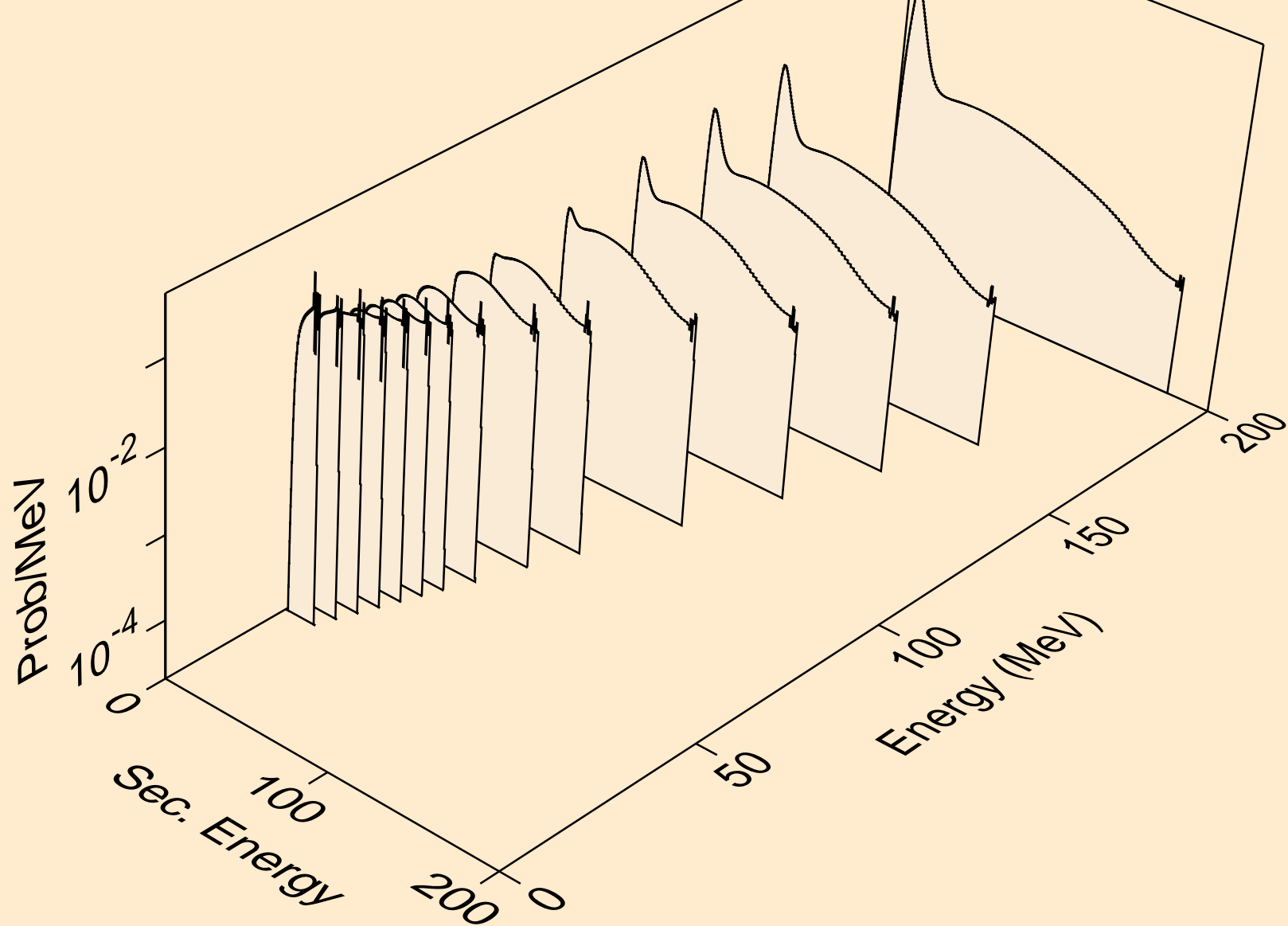



SC053 NEUTRON ACER TENDL-2024 LIBRARY; T=0.K  
deuterons from (n,2nd)

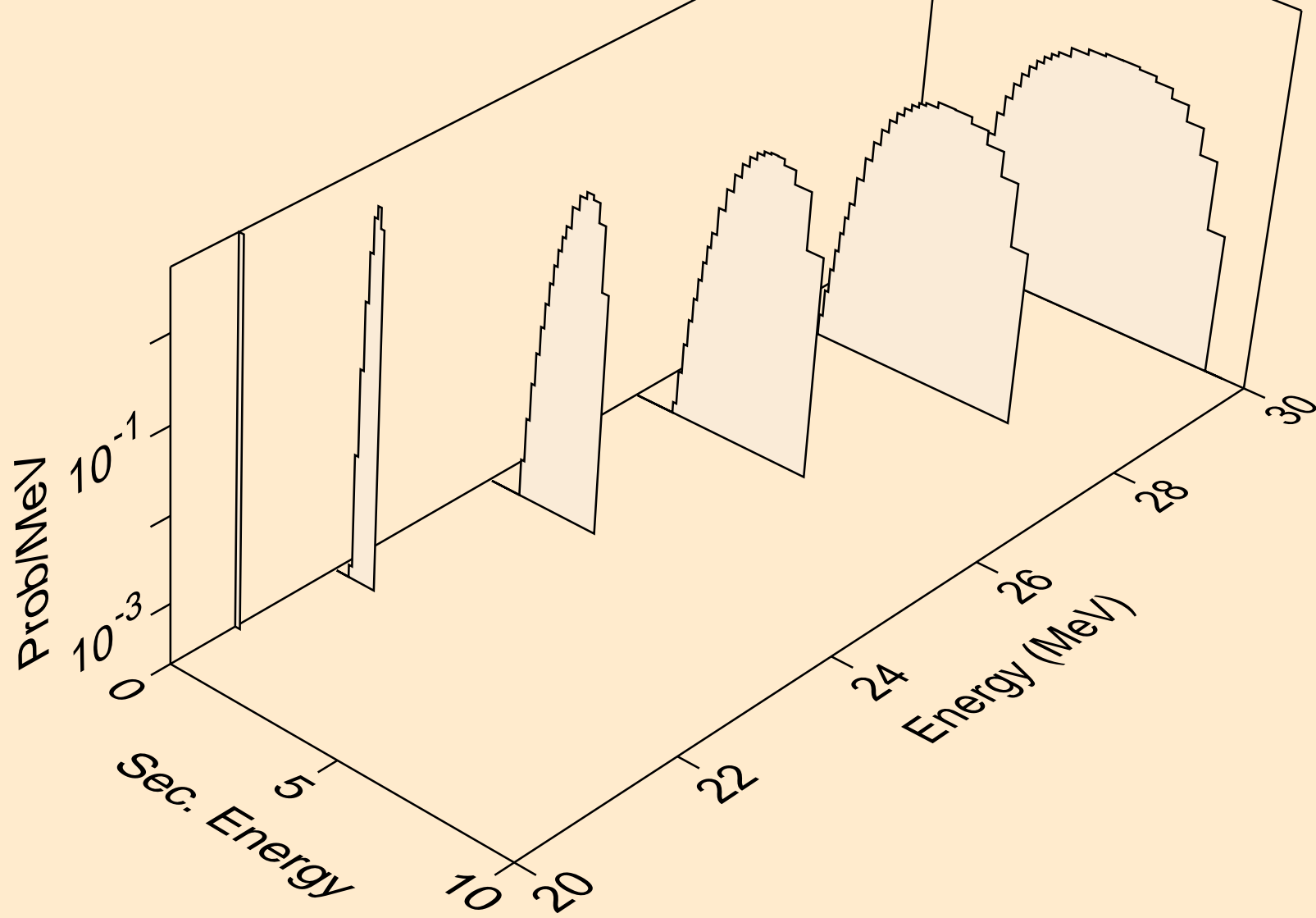

SC053 NEUTRON ACER TENDL-2024 LIBRARY; T=0.K  
deuterons from (n,n\*)d

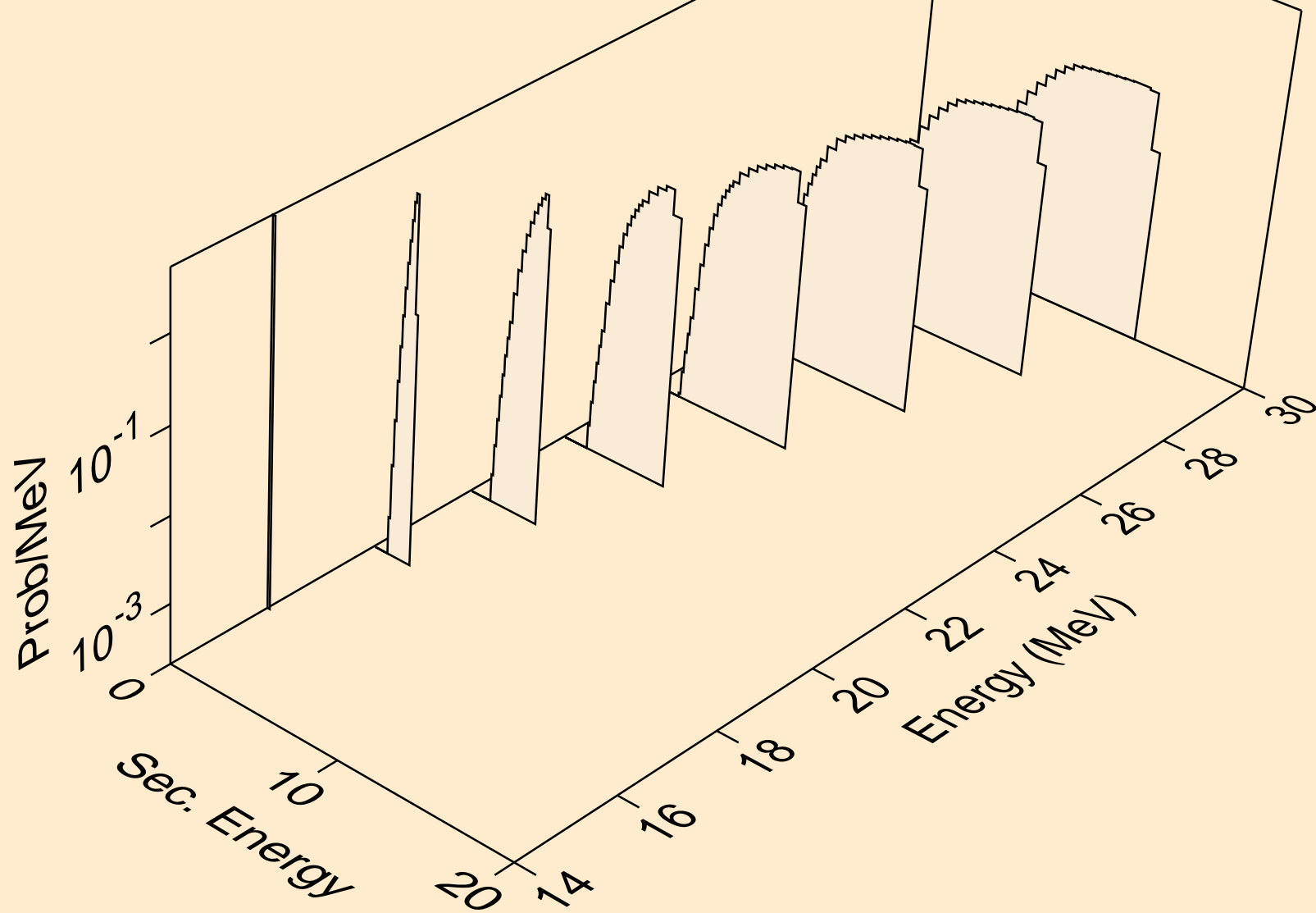

SC053 NEUTRON ACER TENDL-2024 LIBRARY; T=0.K  
deuterons from (n,d)

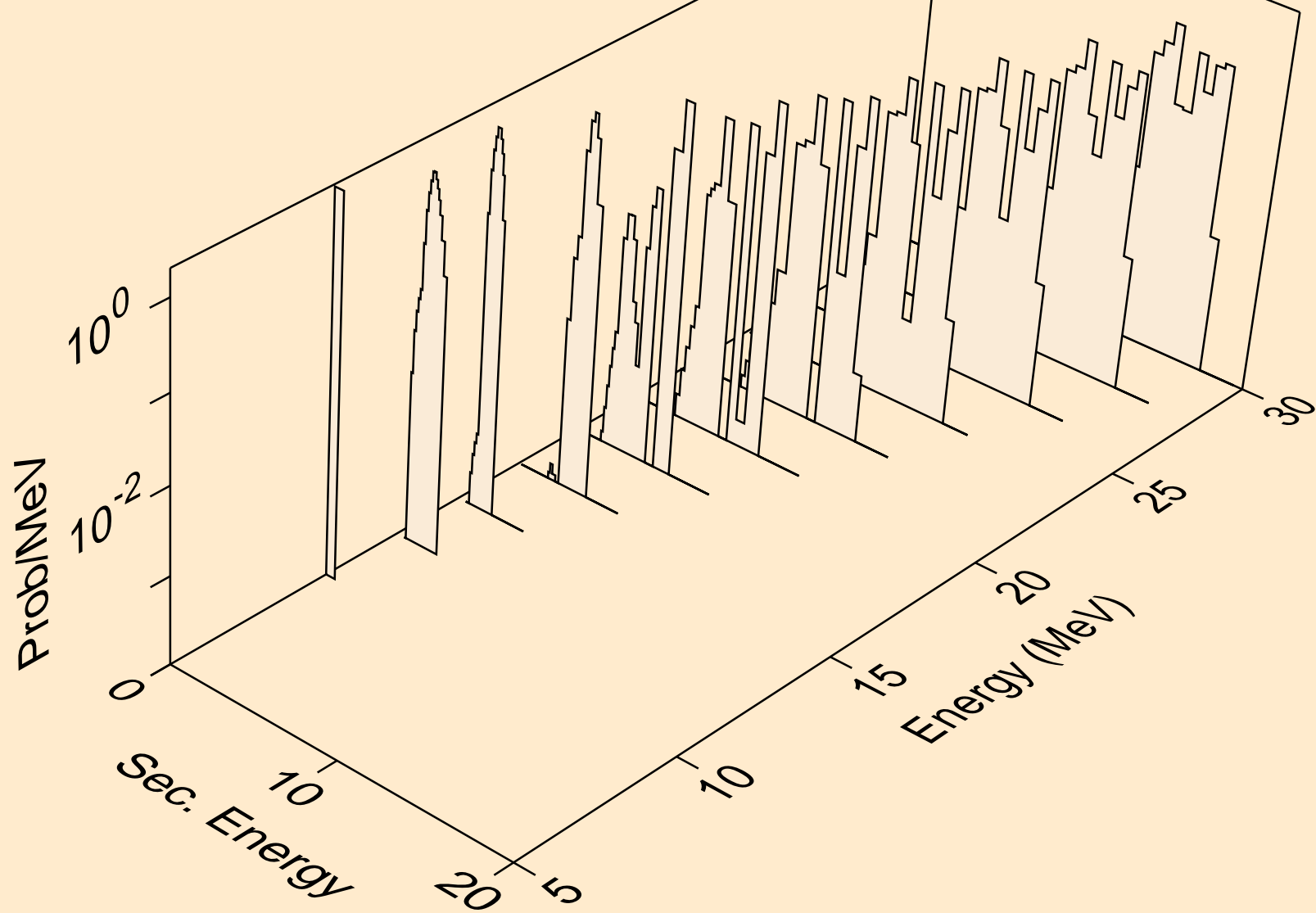

SC053 NEUTRON ACER TENDL-2024 LIBRARY; T=0.K  
tritons from (n,x)

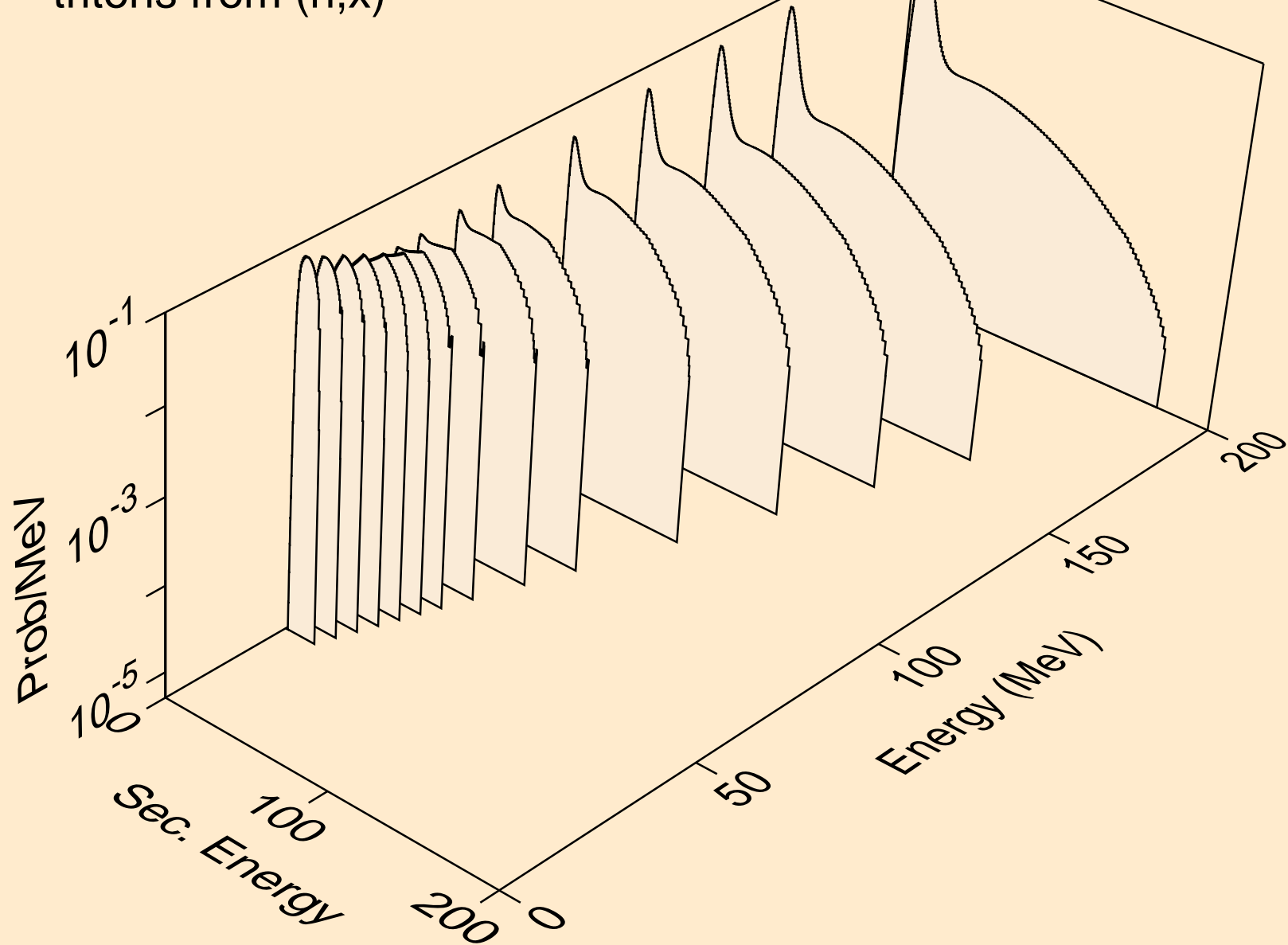

SC053 NEUTRON ACER TENDL-2024 LIBRARY; T=0.K  
tritons from (n,n\*)t

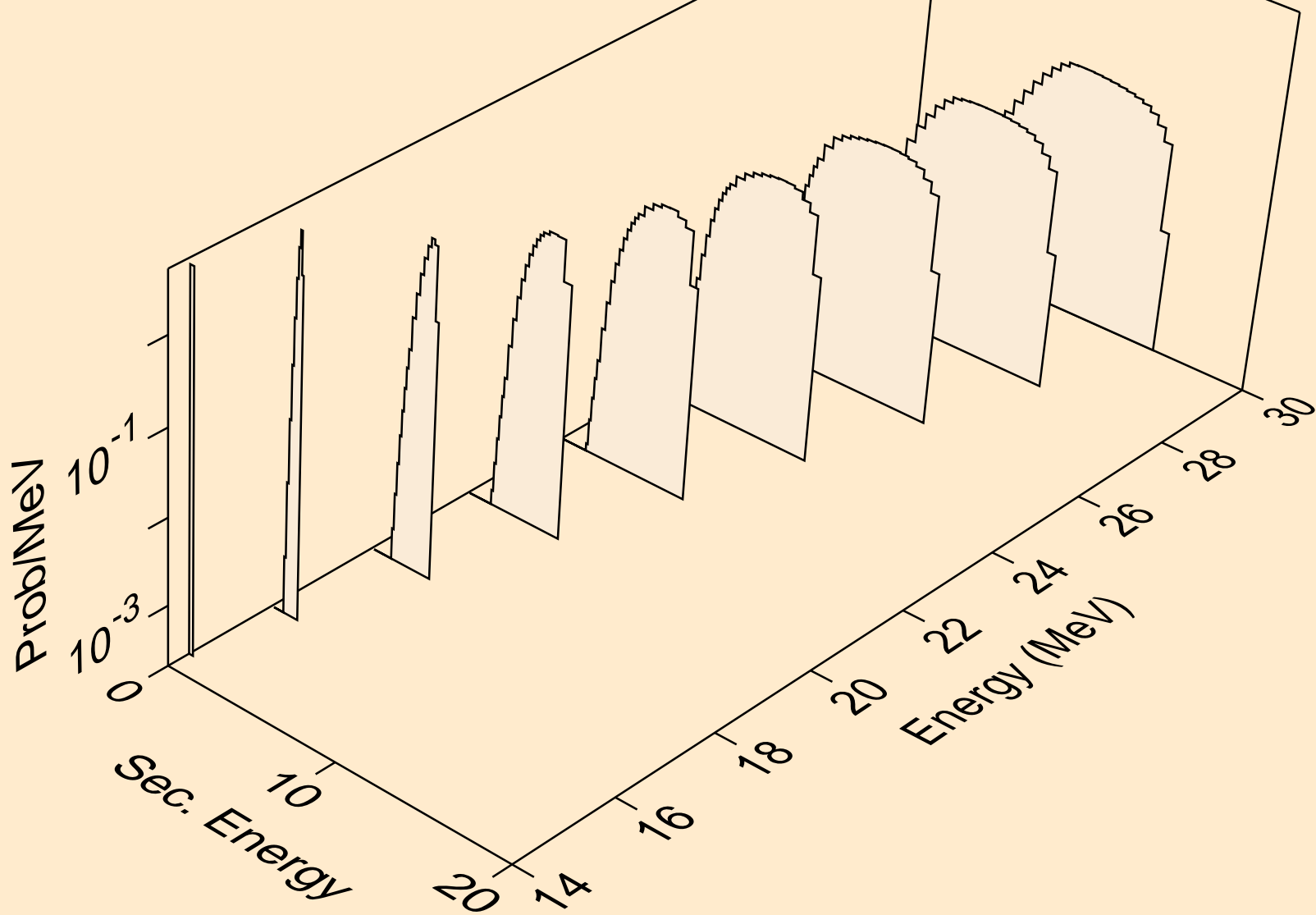

SC053 NEUTRON ACER TENDL-2024 LIBRARY; T=0.K  
tritons from (n,t)

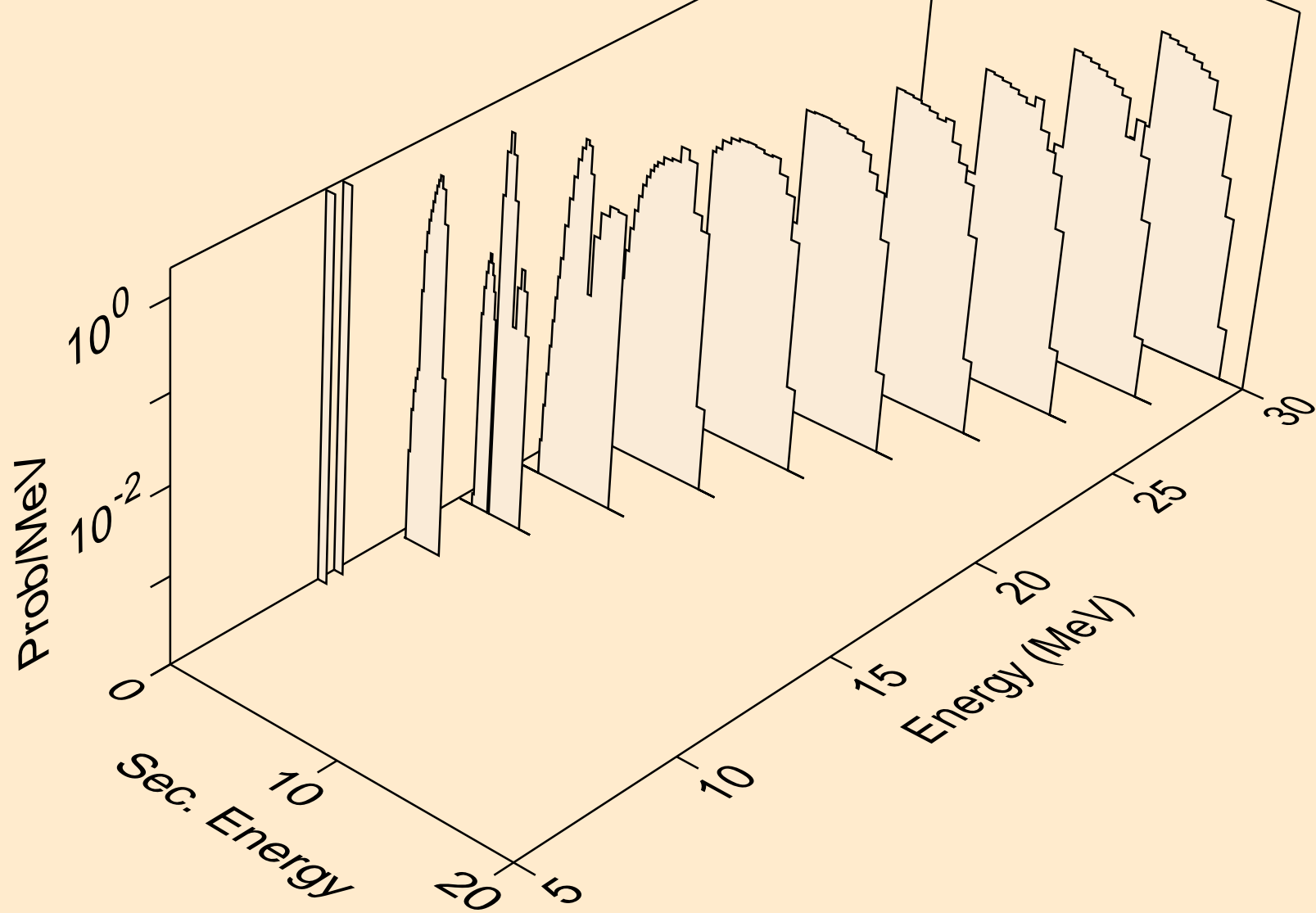

SC053 NEUTRON ACER TENDL-2024 LIBRARY; T=0.K  
he3s from (n,x)

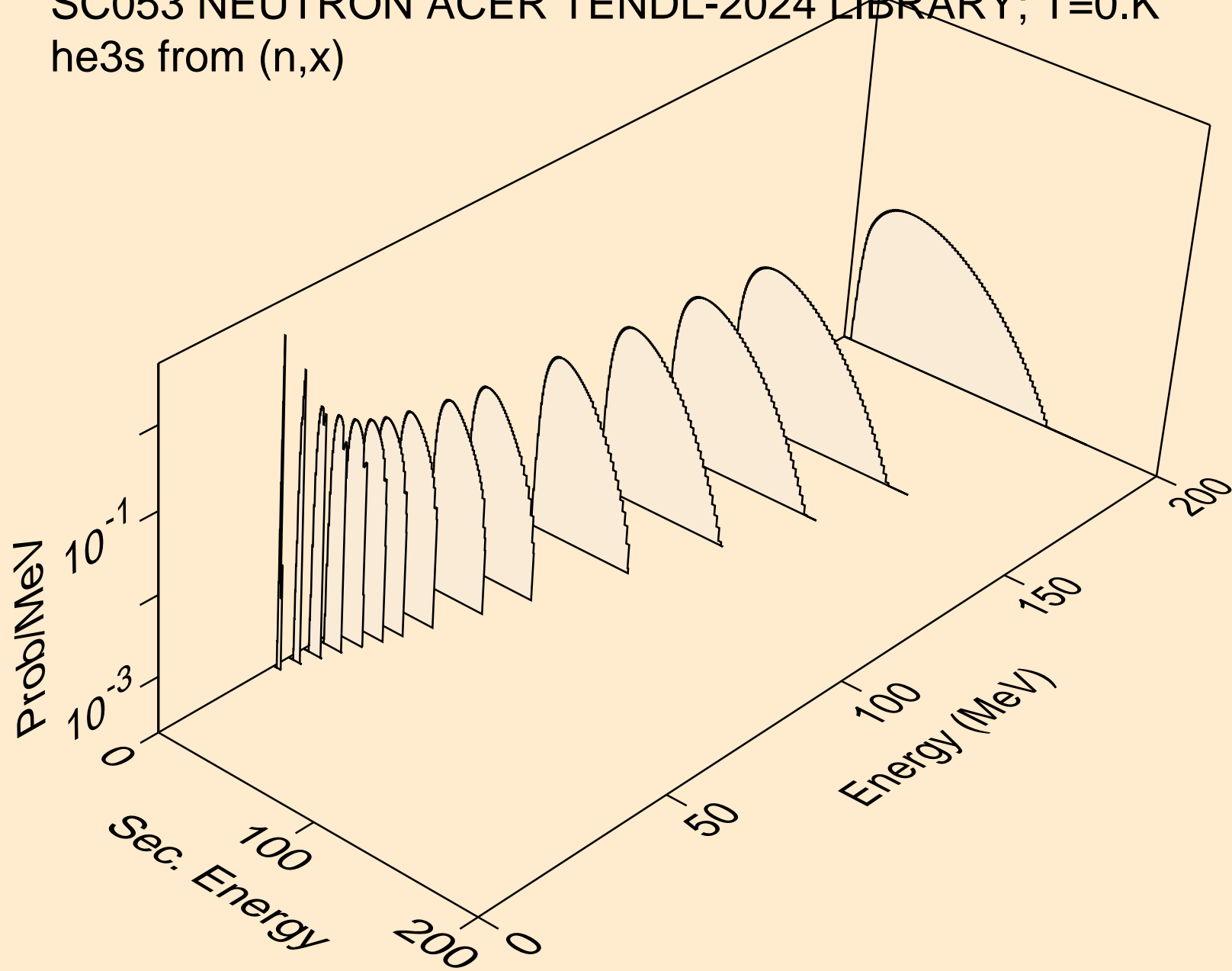

SC053 NEUTRON ACER TENDL-2024 LIBRARY; T=0.K  
he3s from (n,he3)

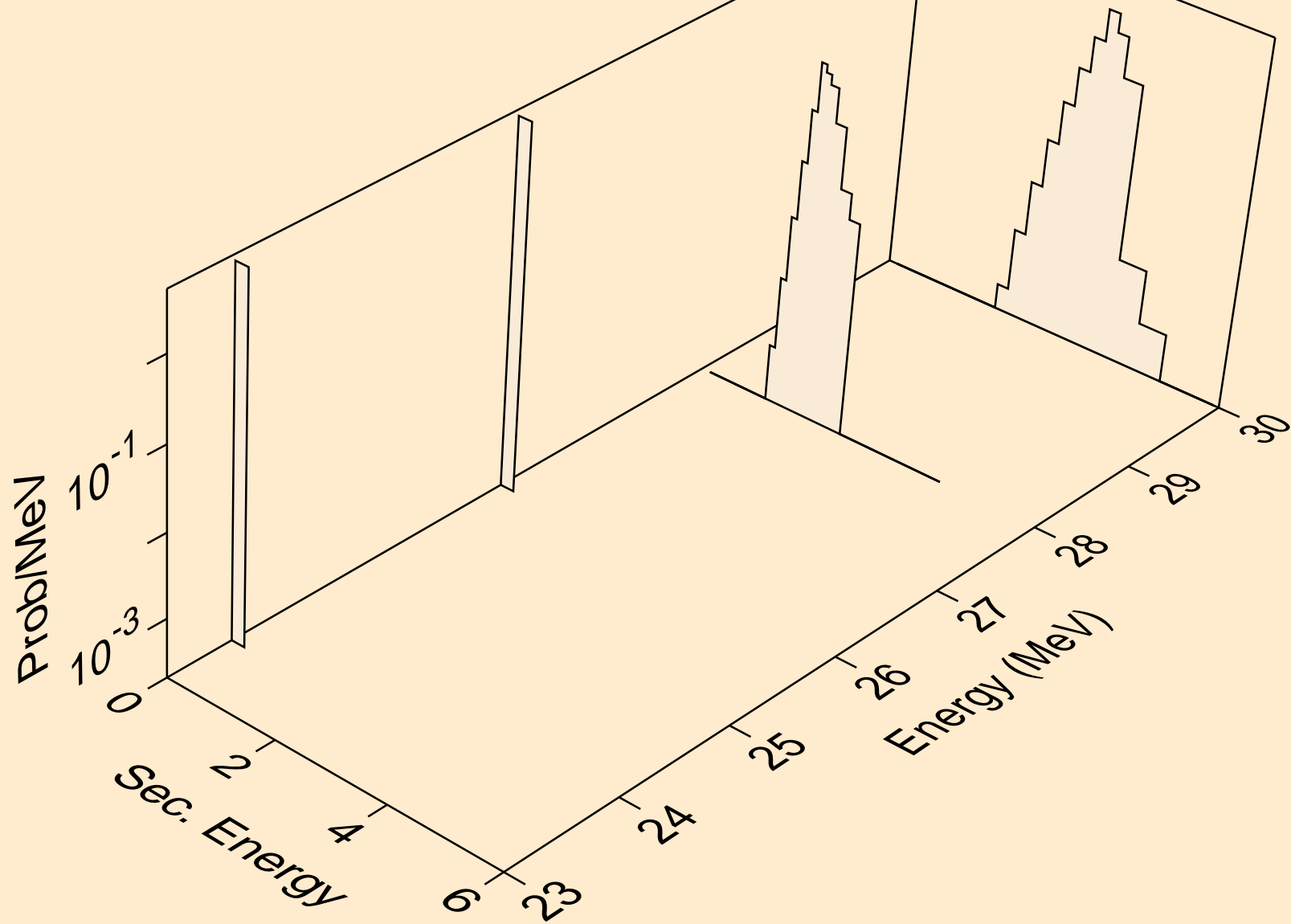



SC053 NEUTRON ACER TENDL-2024 LIBRARY; T=0.K  
alphas from (n,x)

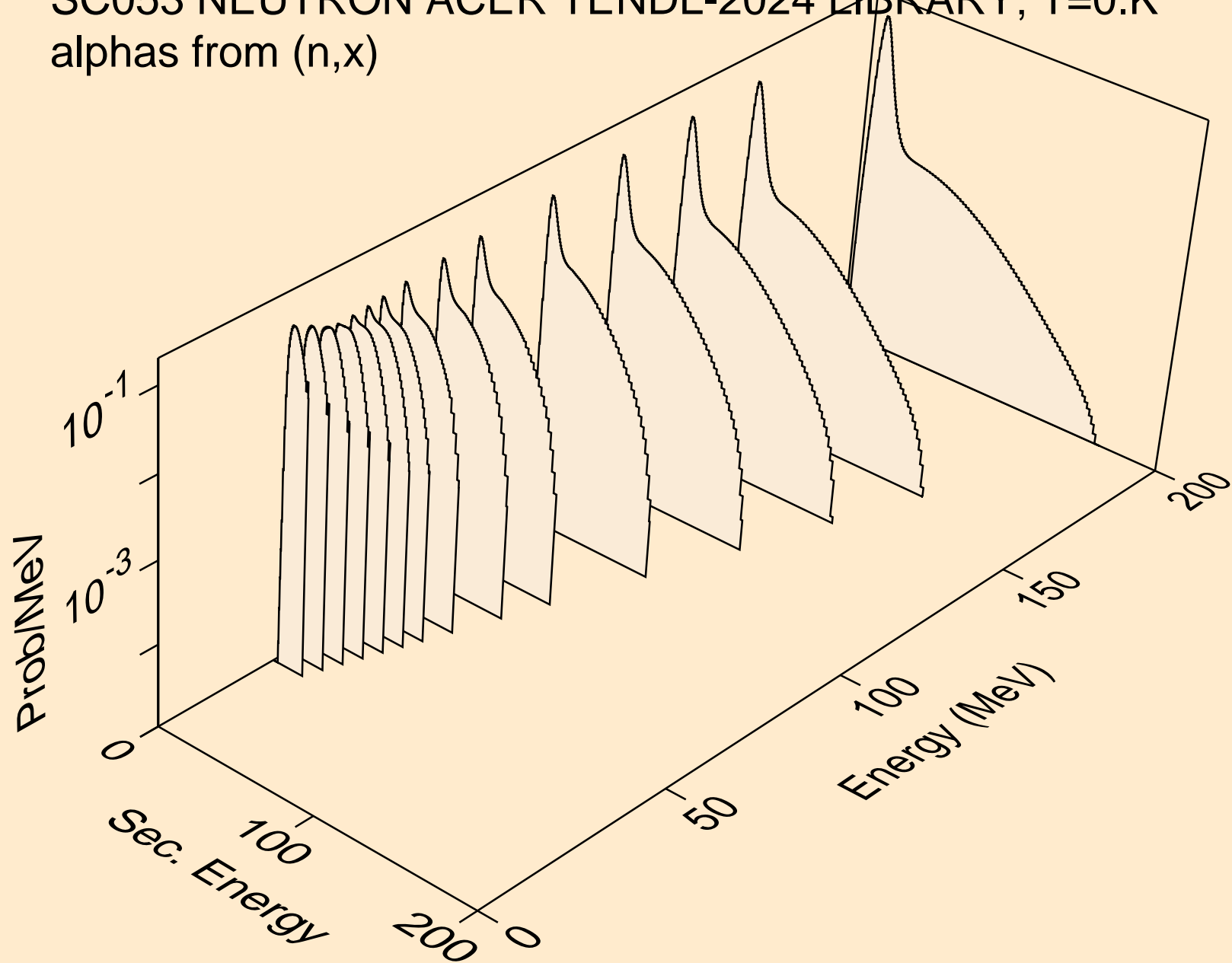

SC053 NEUTRON ACER TENDL-2024 LIBRARY; T=0.K  
alphas from (n,n\*)a

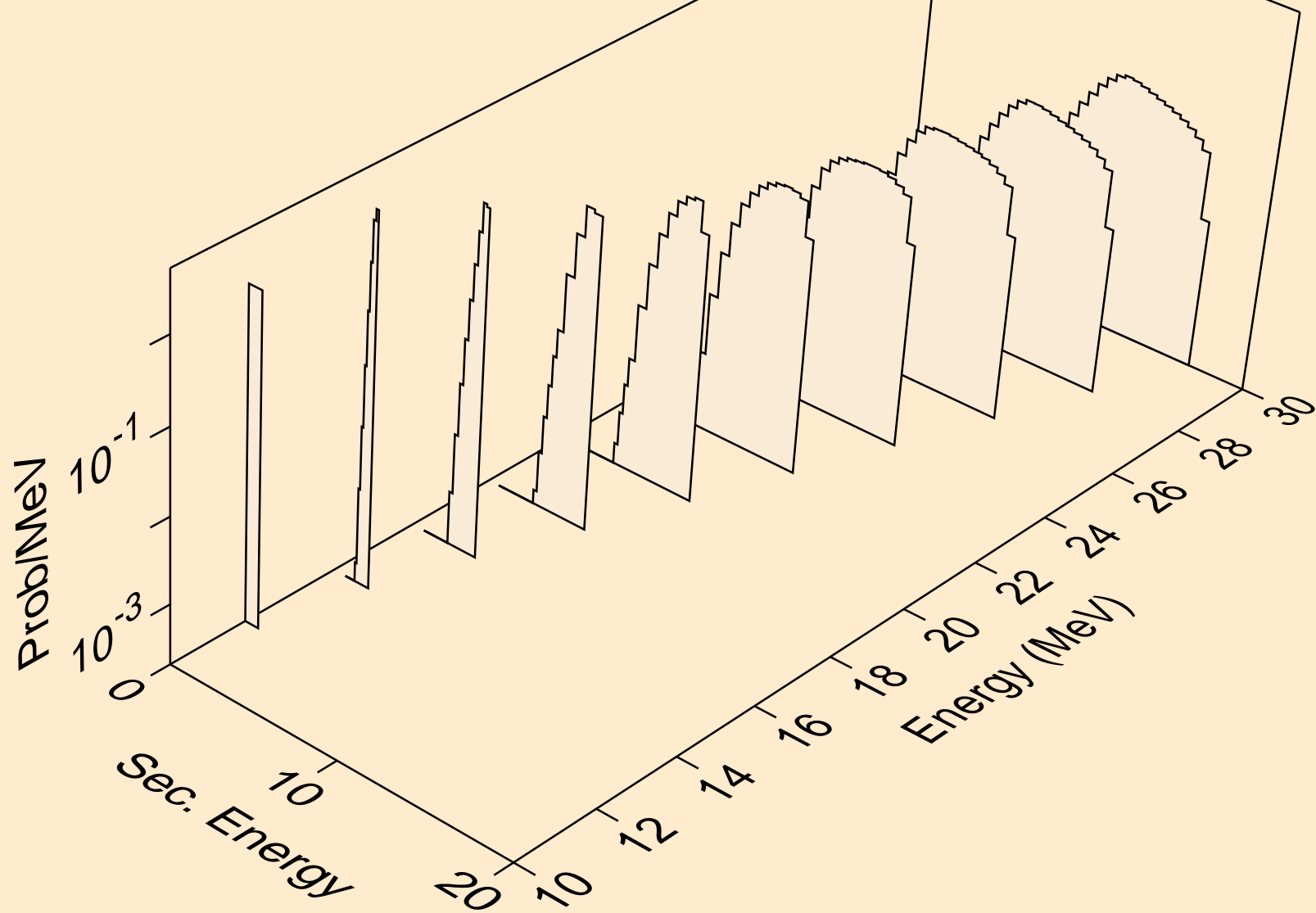

SC053 NEUTRON ACER TENDL-2024 LIBRARY; T=0.K  
alphas from (n,2n)a

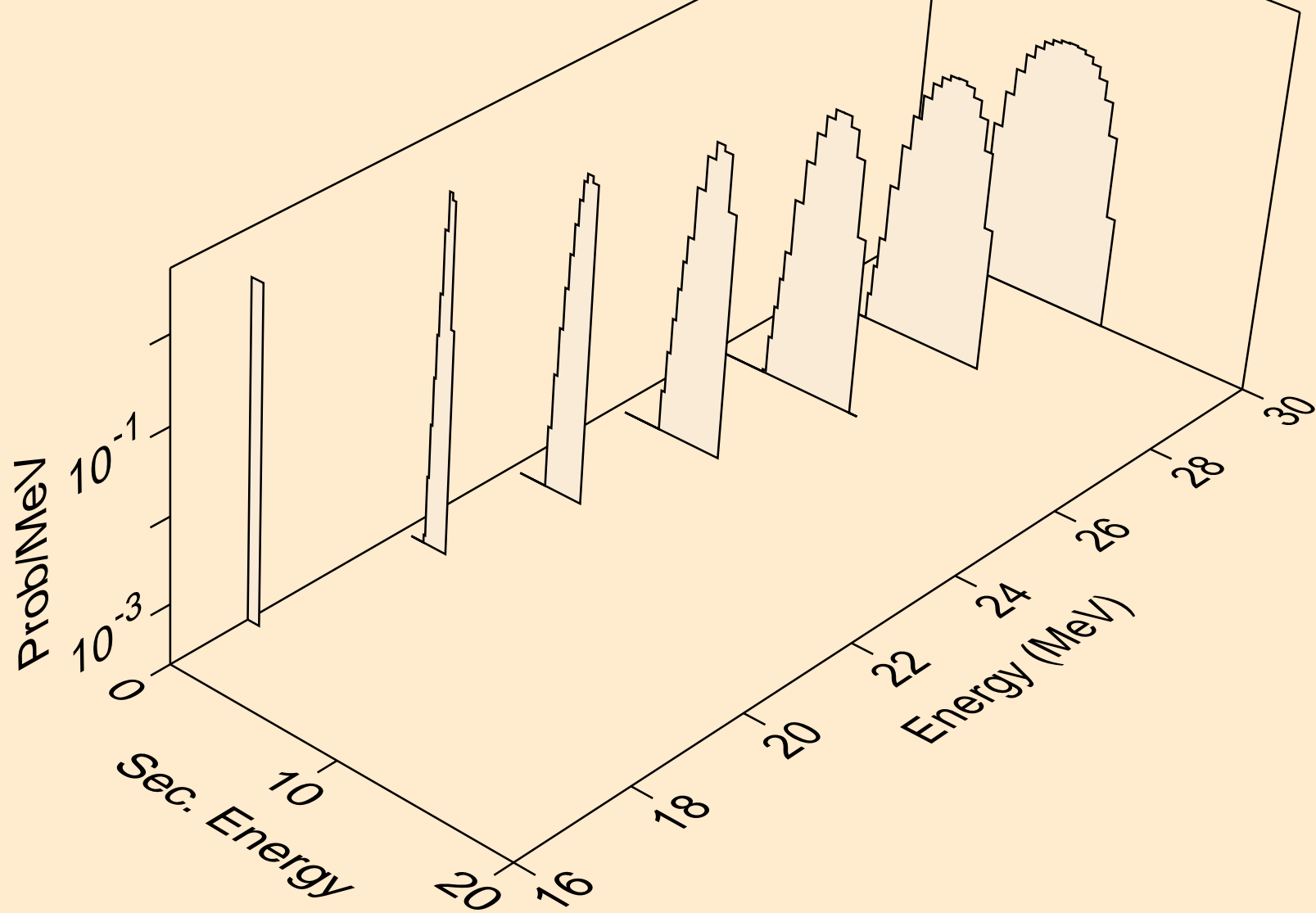

SC053 NEUTRON ACER TENDL-2024 LIBRARY; T=0.K  
alphas from (n,3n)a

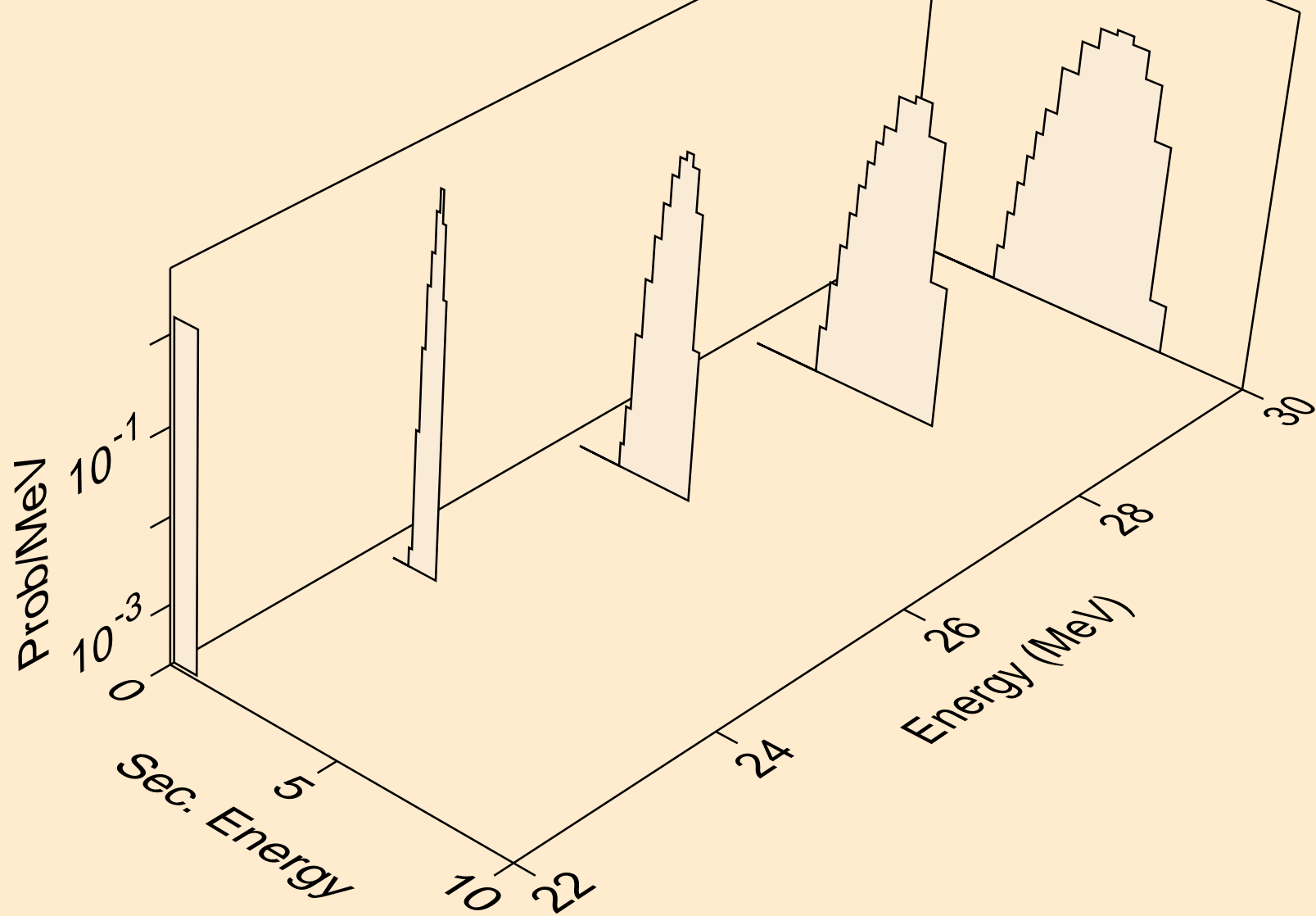

SC053 NEUTRON ACER TENDL-2024 LIBRARY; T=0.K  
alphas from (n,a)

