

SI029 NEUTRON ACER TENDL-2024 LIBRARY; T=0.K  
Principal cross sections

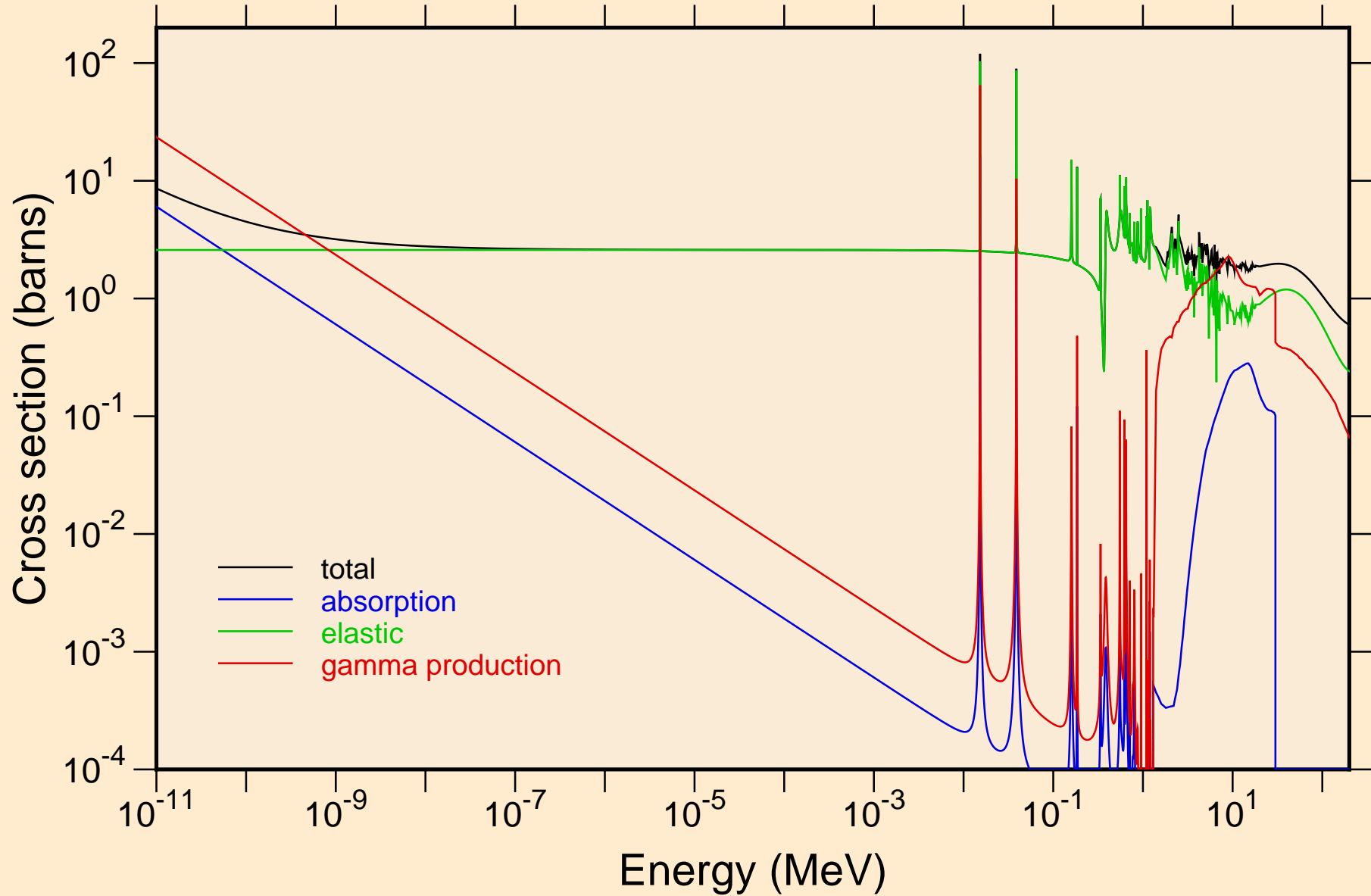

SI029 NEUTRON ACER TENDL-2024 LIBRARY; T=0.K  
resonance total cross section

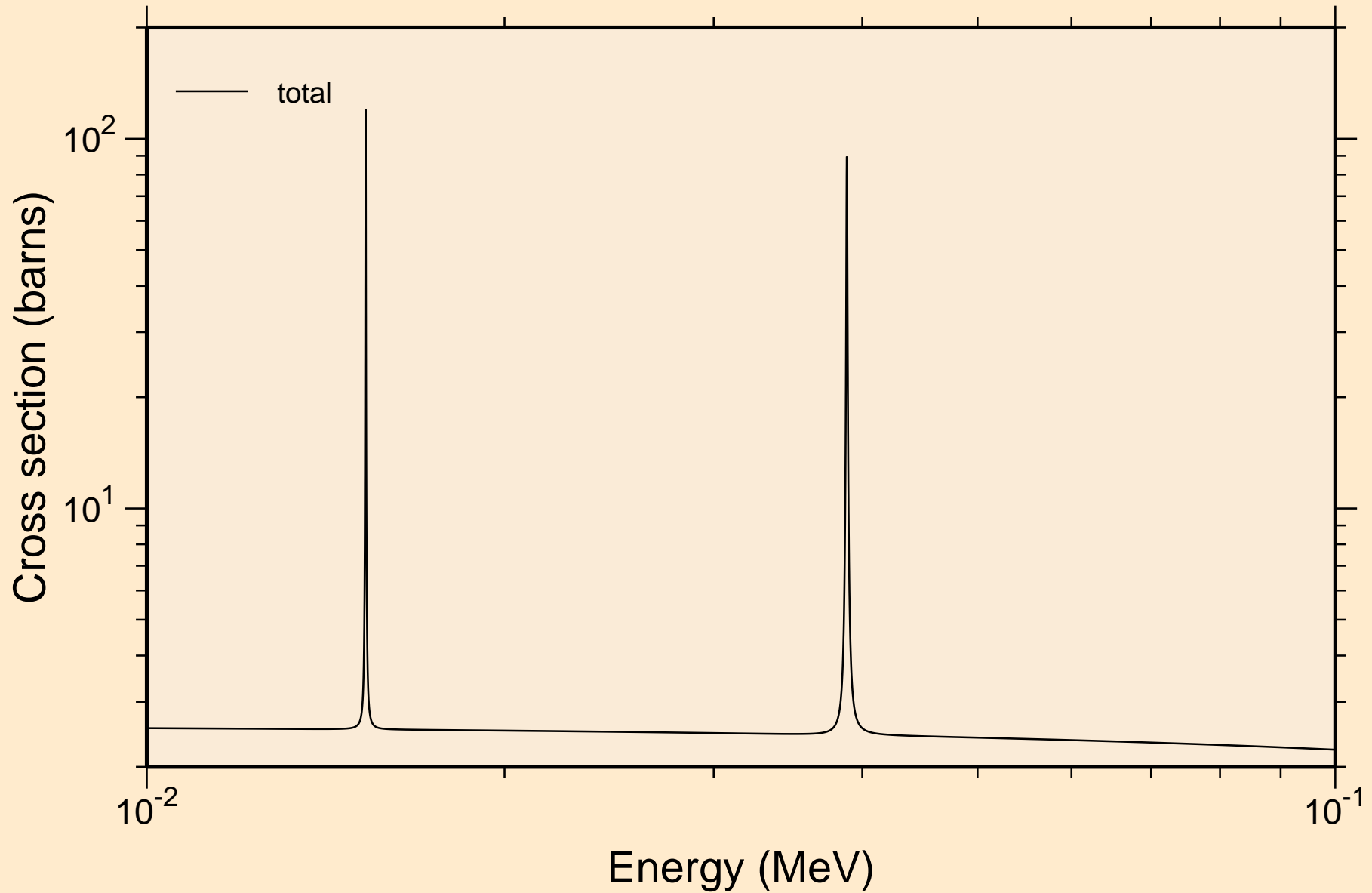

SI029 NEUTRON ACER TENDL-2024 LIBRARY; T=0.K  
resonance total cross section

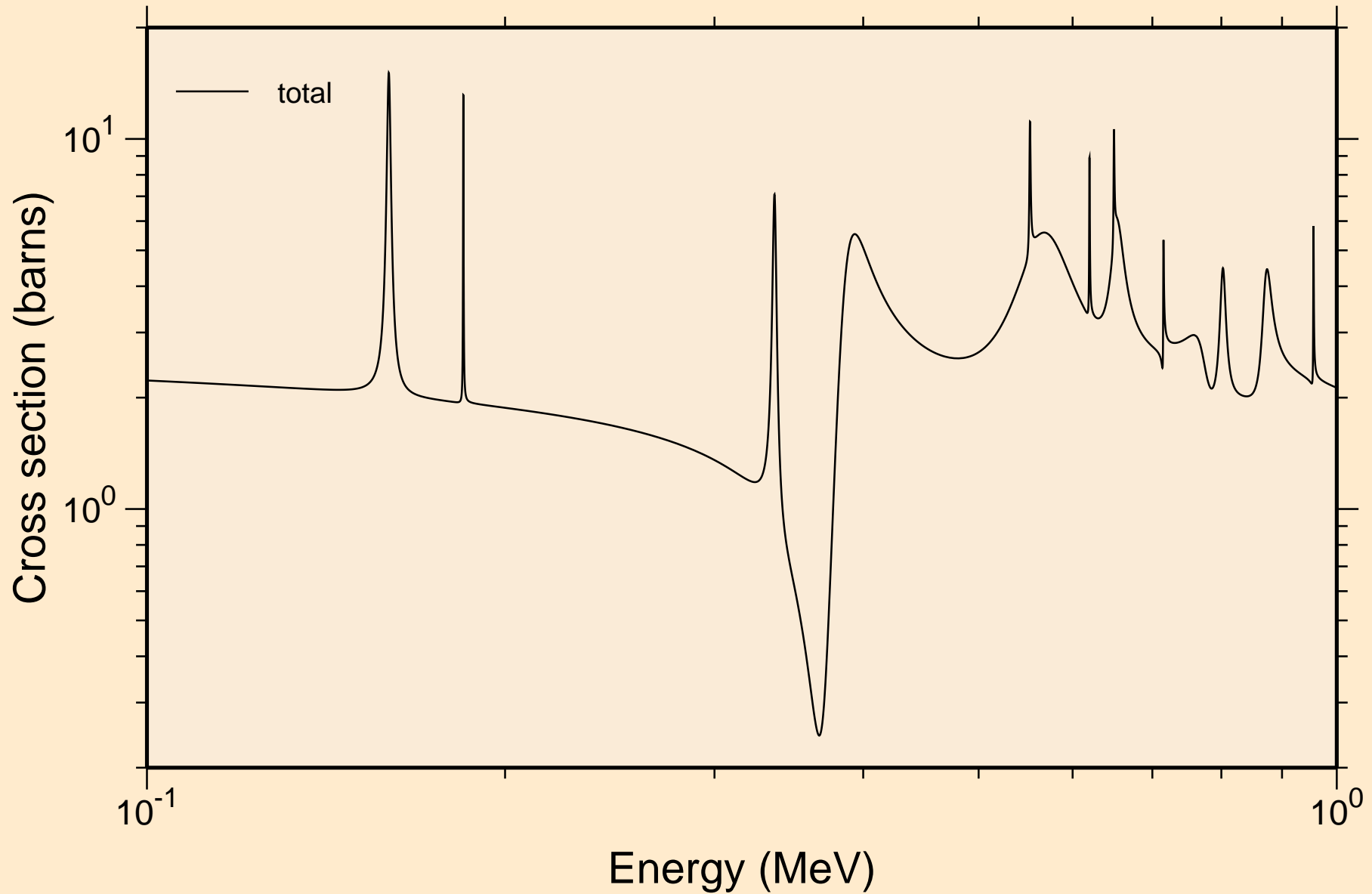

SI029 NEUTRON ACER TENDL-2024 LIBRARY; T=0.K  
resonance total cross section

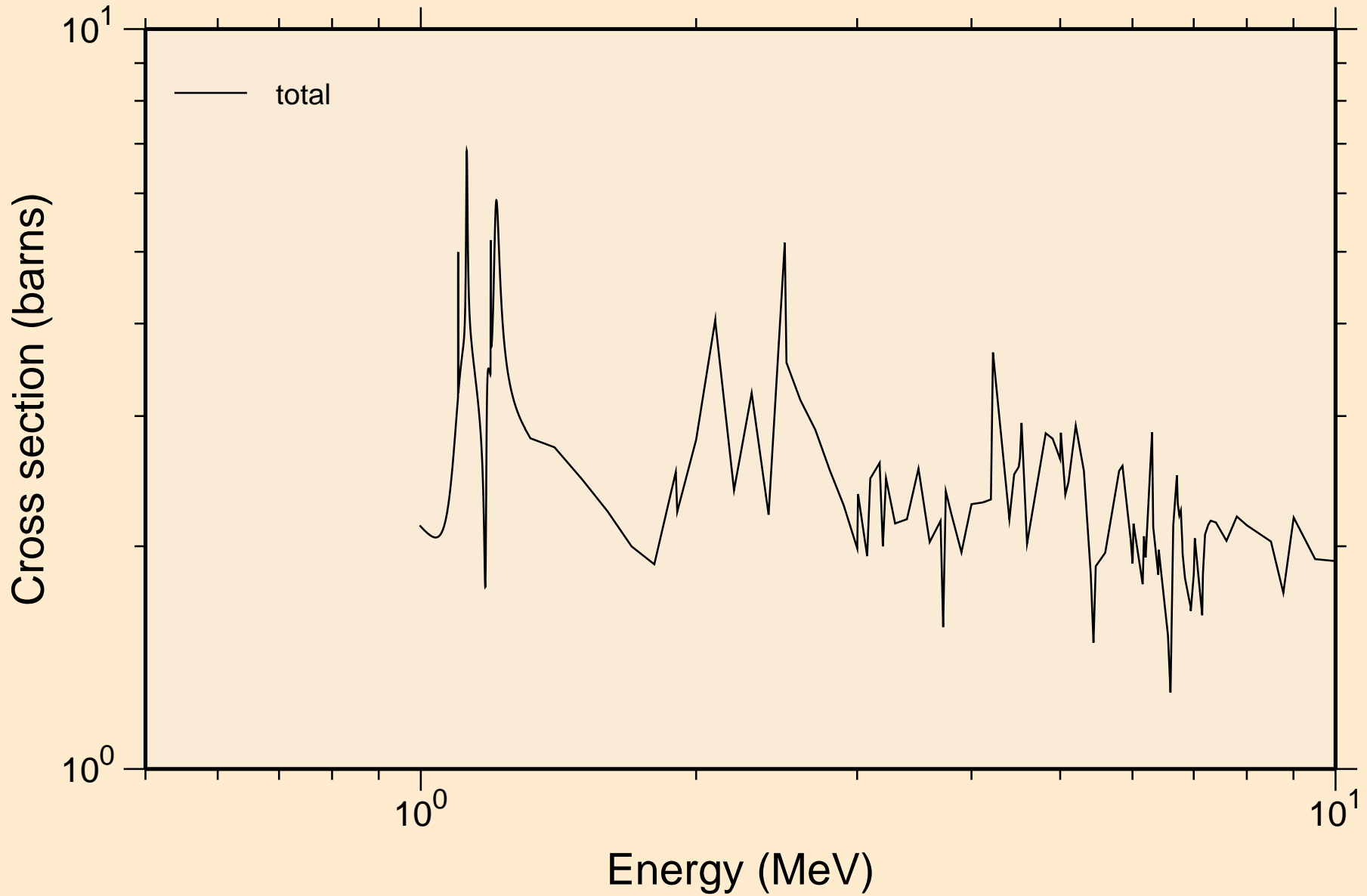

SI029 NEUTRON ACER TENDL-2024 LIBRARY; T=0.K  
resonance absorption cross sections

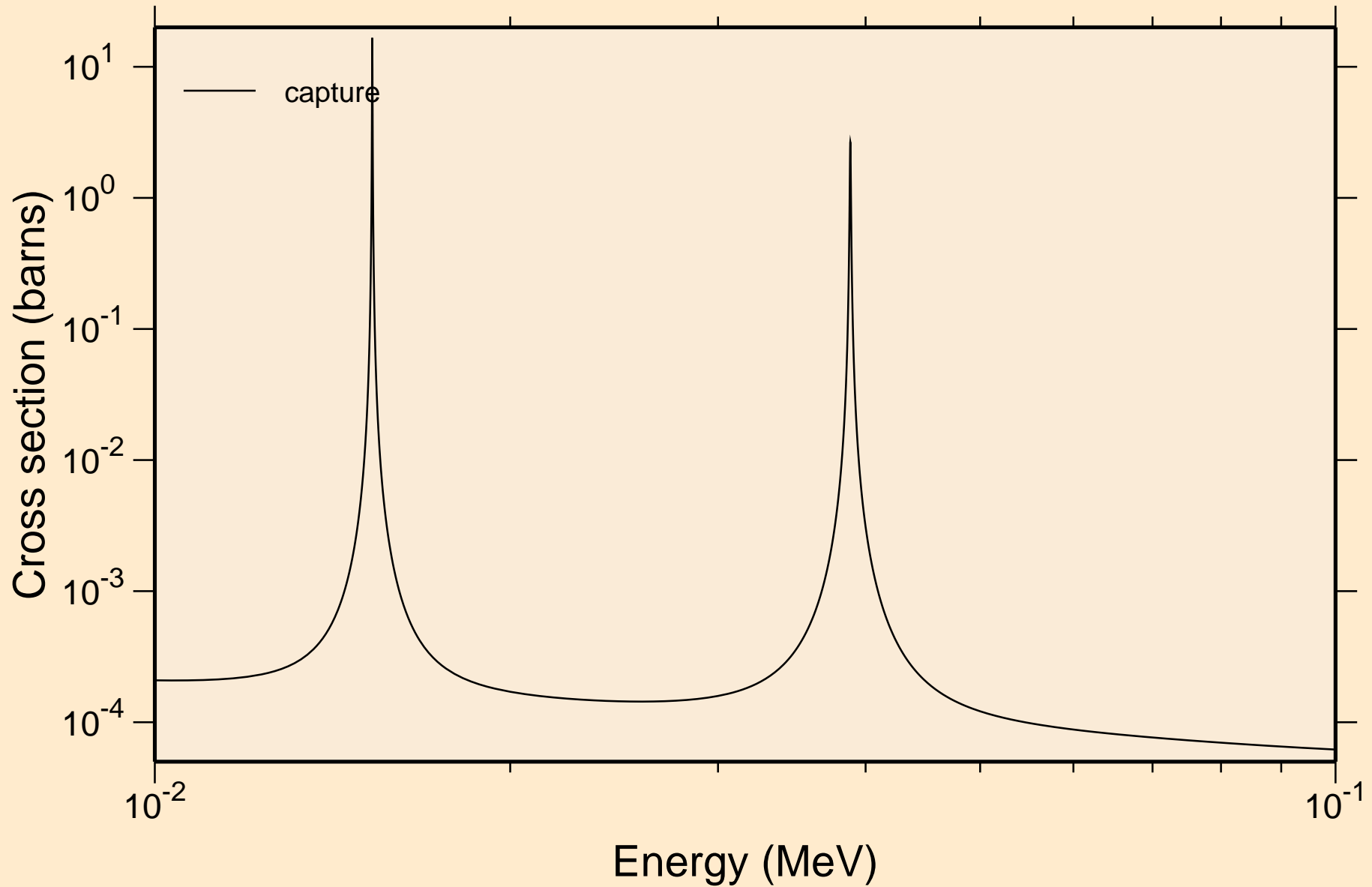

SI029 NEUTRON ACER TENDL-2024 LIBRARY; T=0.K  
resonance absorption cross sections

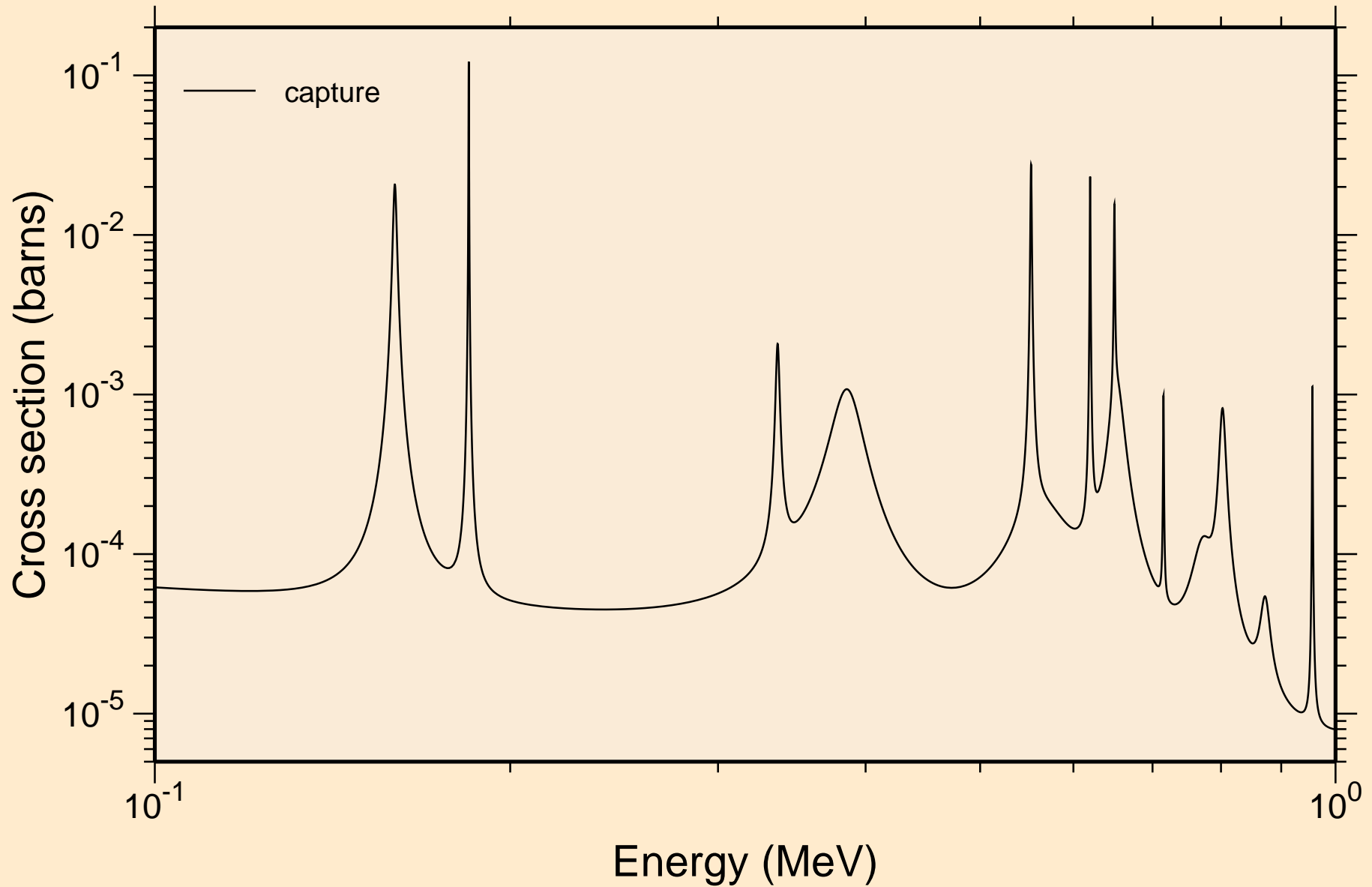

SI029 NEUTRON ACER TENDL-2024 LIBRARY; T=0.K  
resonance absorption cross sections

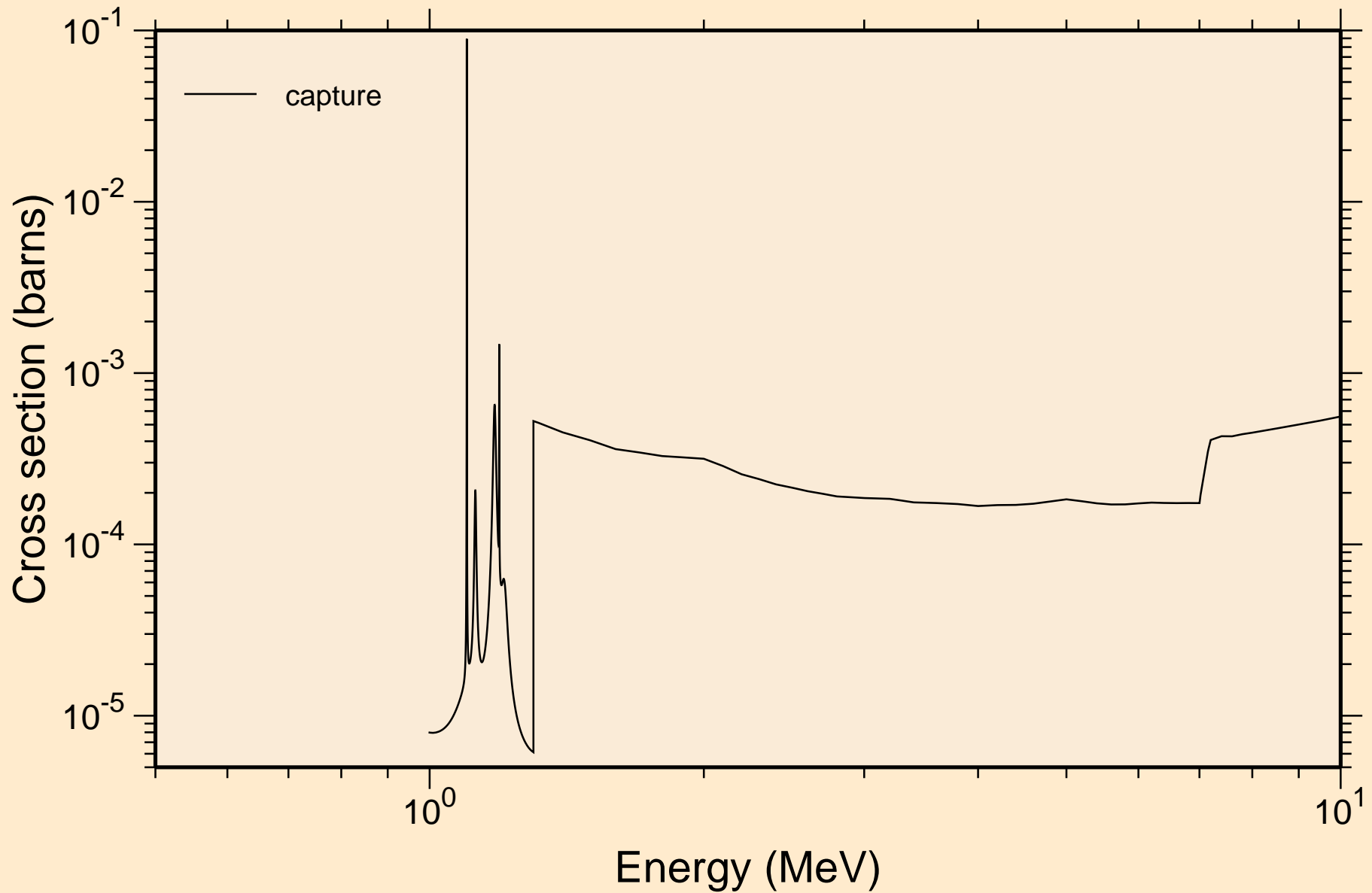

# SI029 NEUTRON ACER TENDL-2024 LIBRARY; T=0.K

## Heating

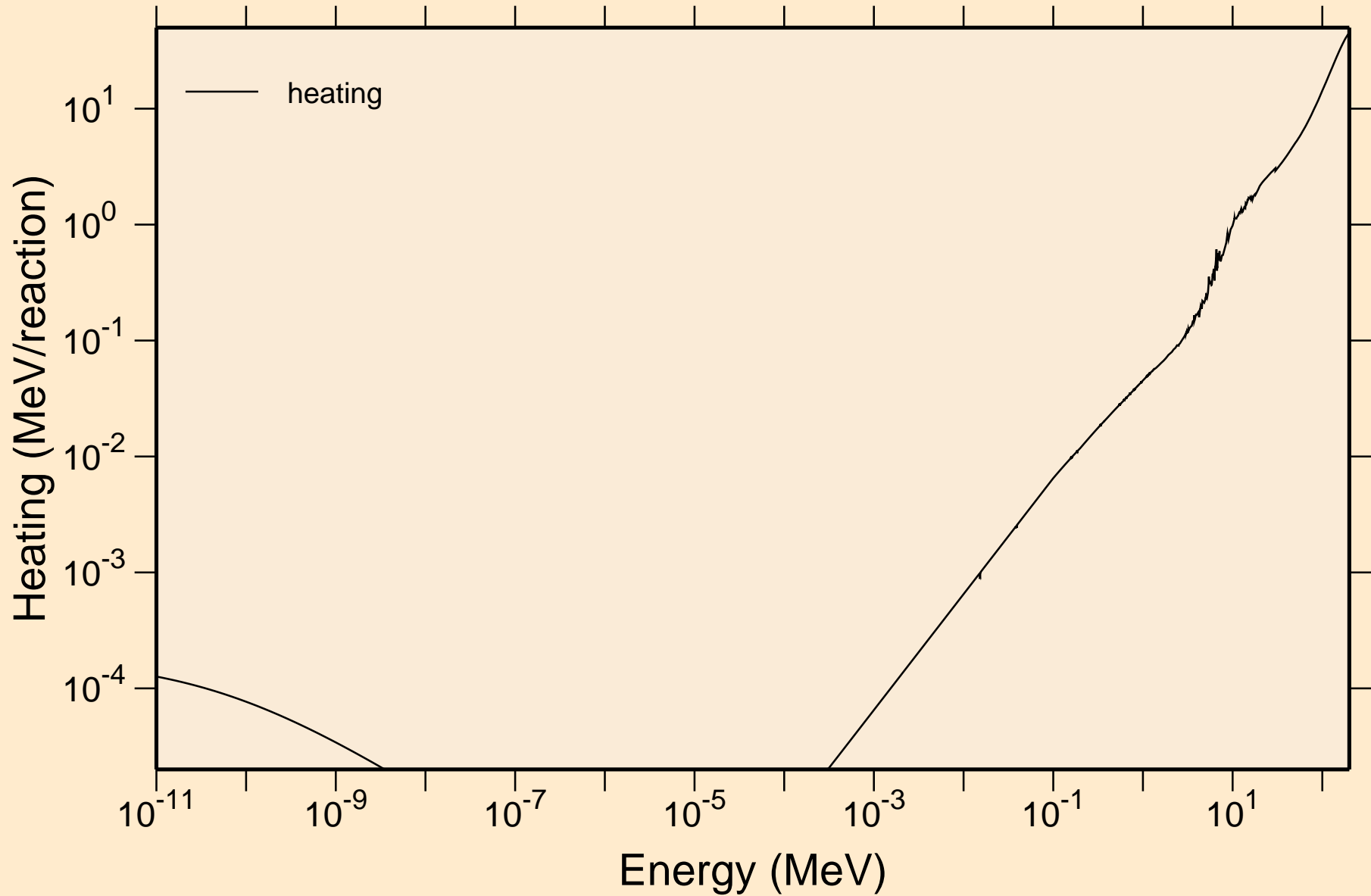



SI029 NEUTRON ACER TENDL-2024 LIBRARY; T=0.K  
Damage

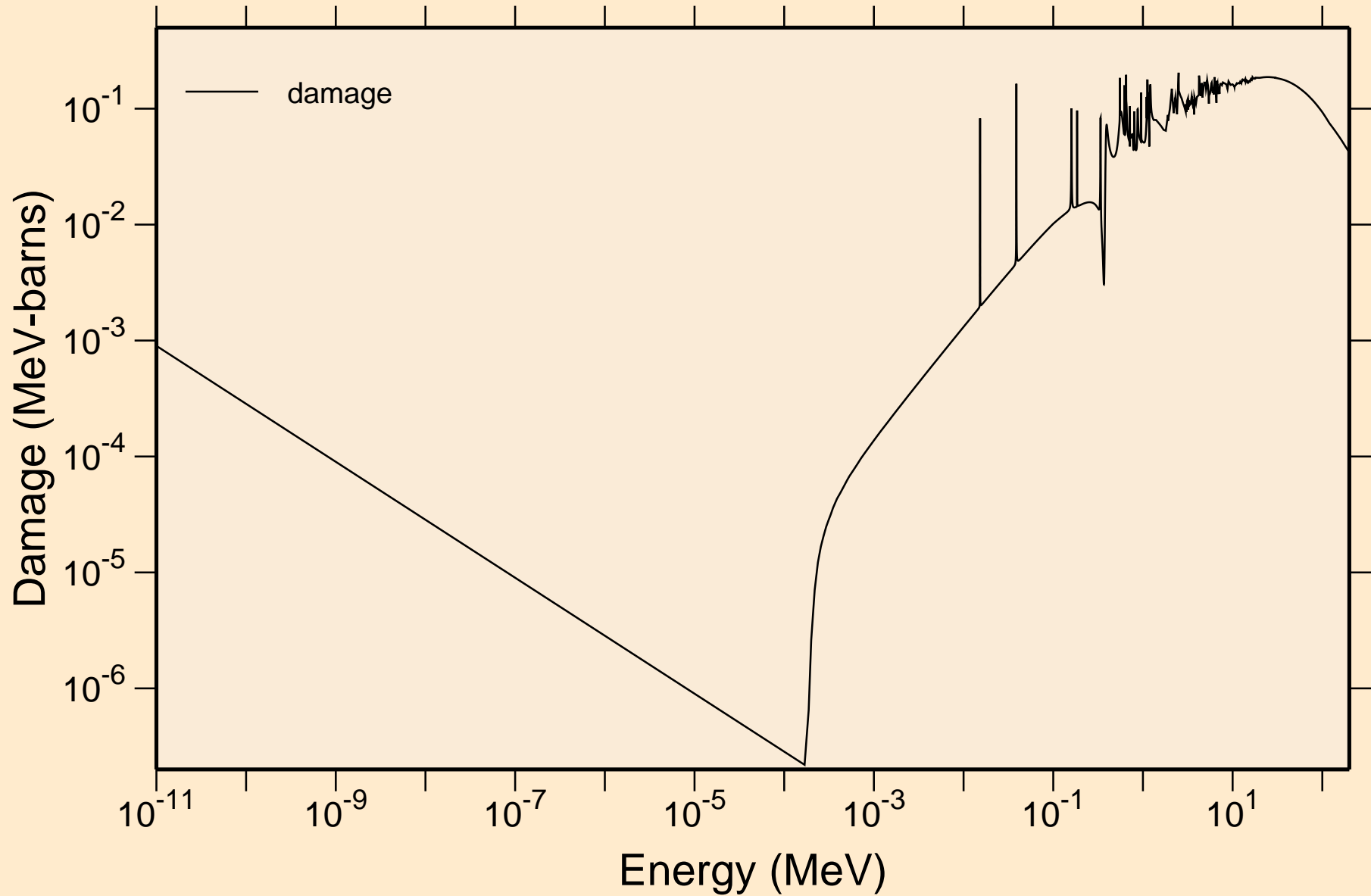

SI029 NEUTRON ACER TENDL-2024 LIBRARY; T=0.K  
Non-threshold reactions

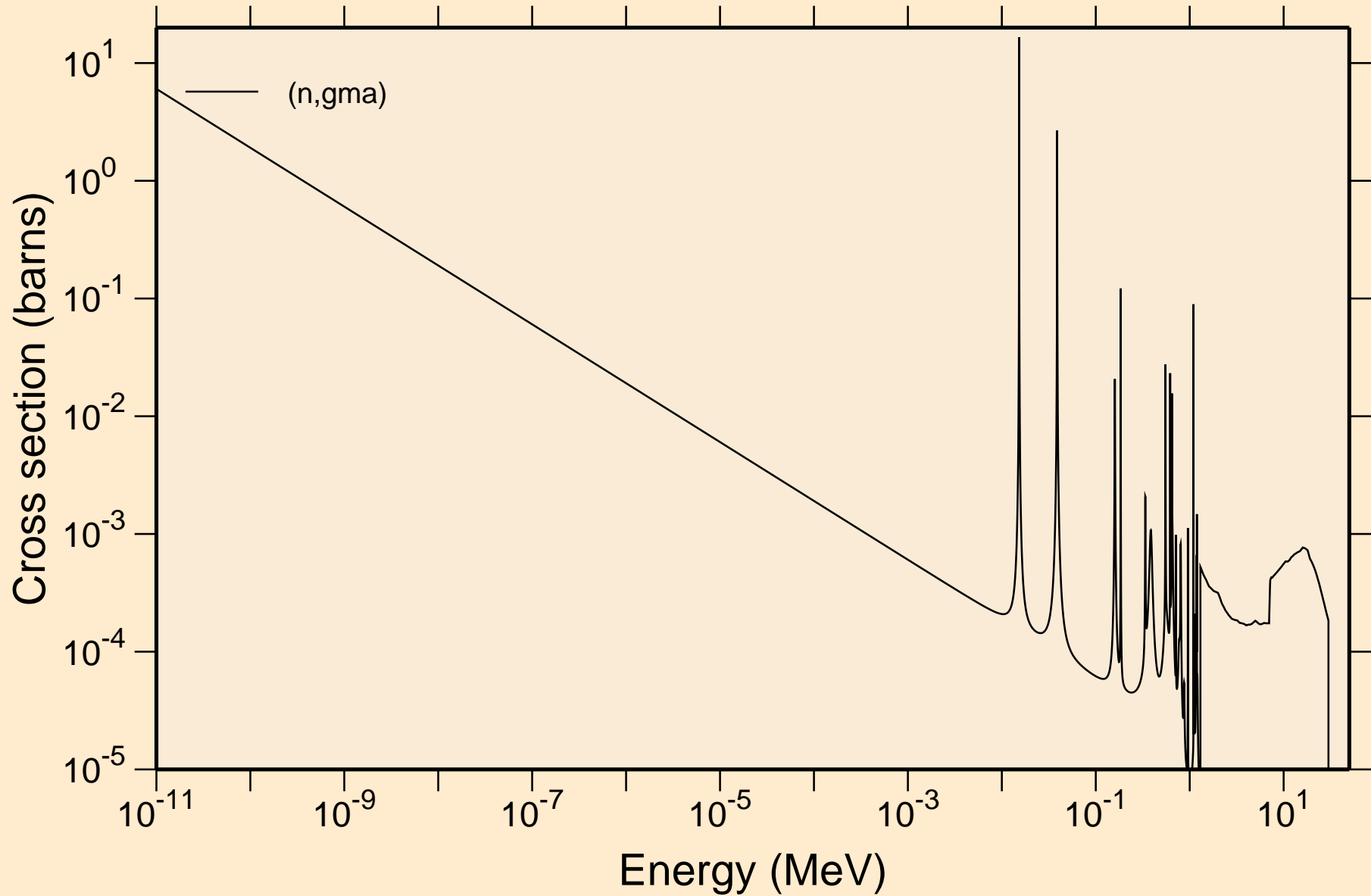

# SI029 NEUTRON ACER TENDL-2024 LIBRARY; T=0.K

## Principal cross sections

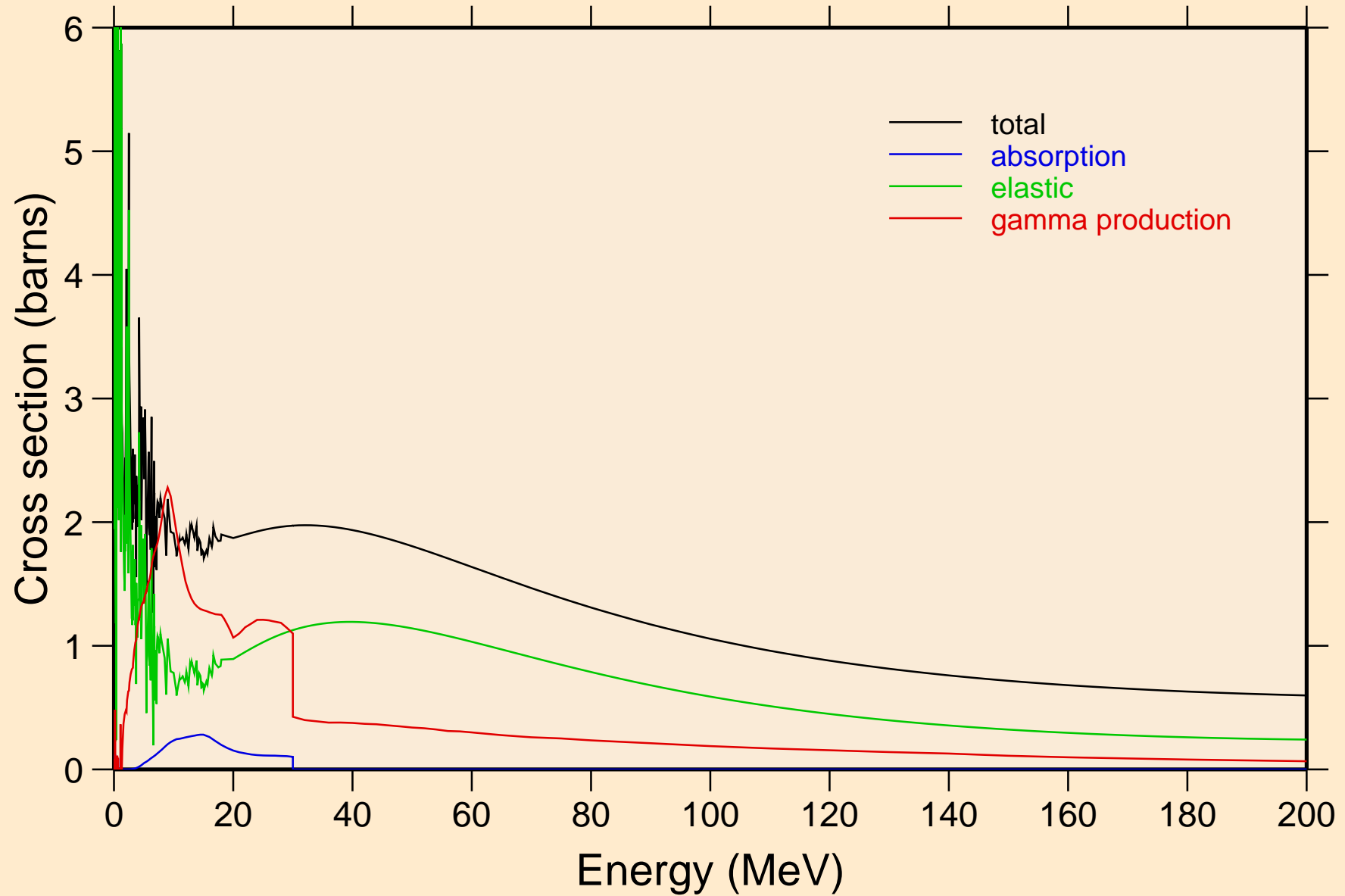

# SI029 NEUTRON ACER TENDL-2024 LIBRARY; T=0.K

## Heating

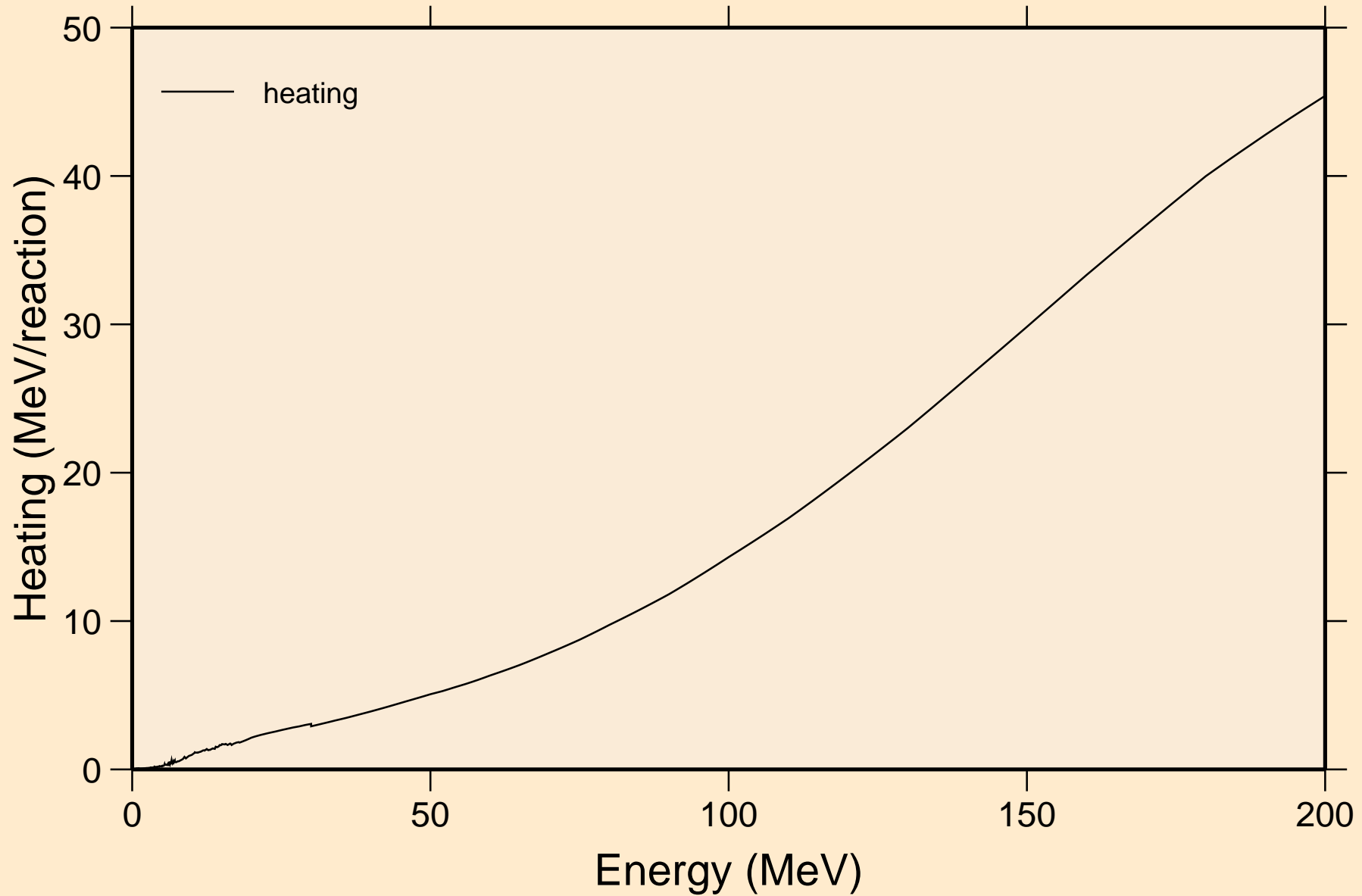

# SI029 NEUTRON ACER TENDL-2024 LIBRARY; T=0.K

## Damage

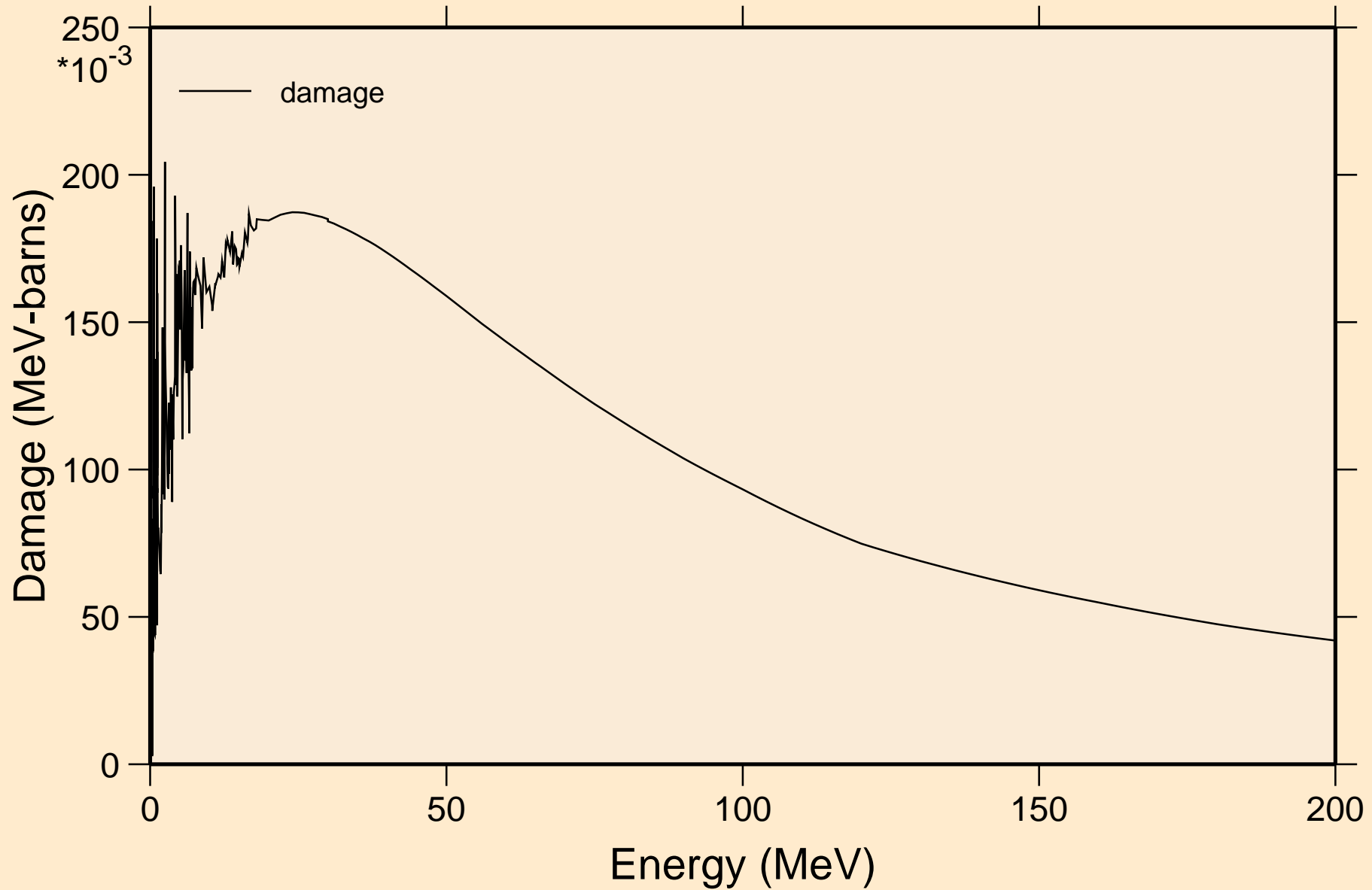

SI029 NEUTRON ACER TENDL-2024 LIBRARY; T=0.K  
Non-threshold reactions

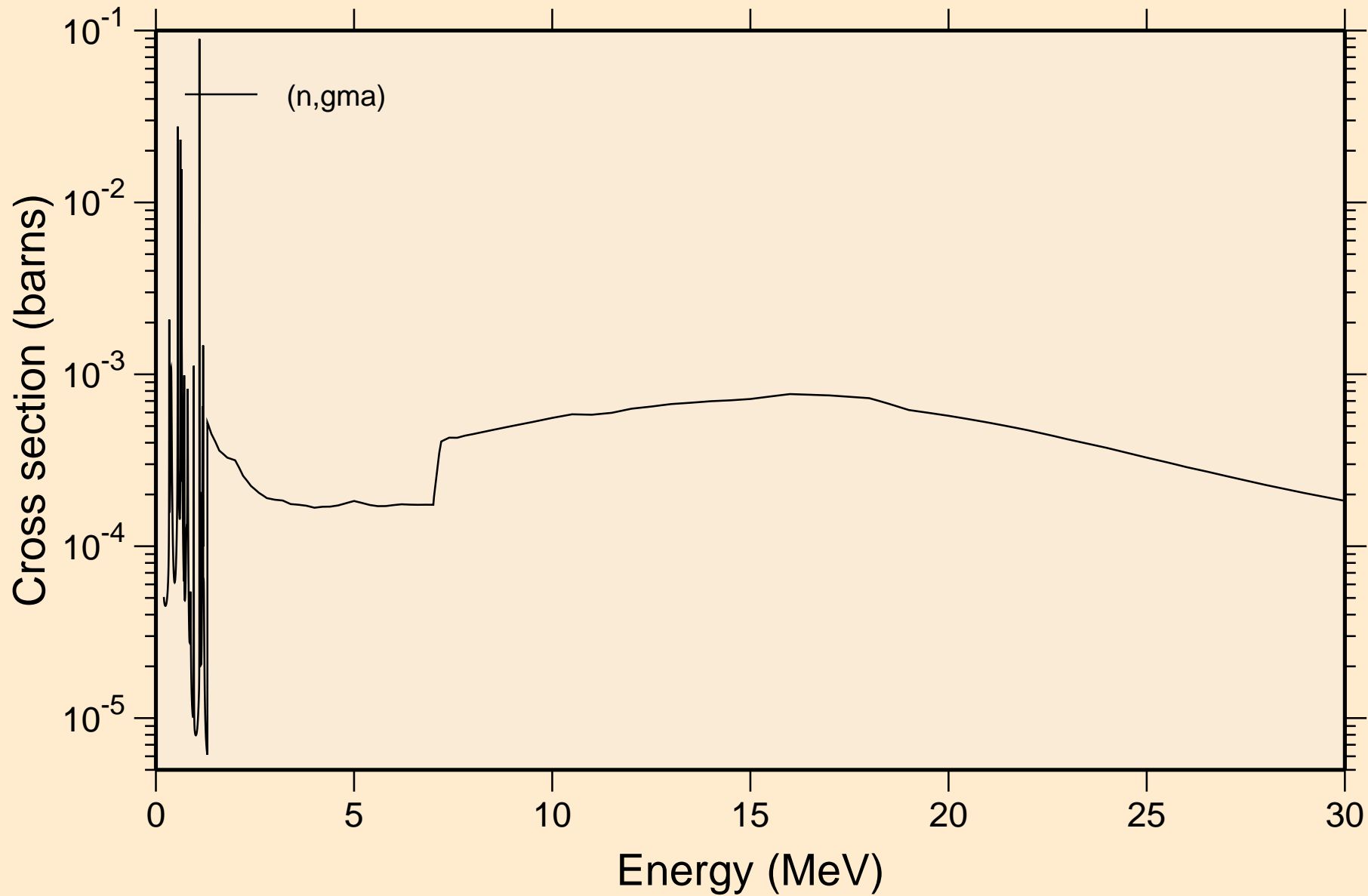

SI029 NEUTRON ACER TENDL-2024 LIBRARY; T=0.K  
Inelastic levels

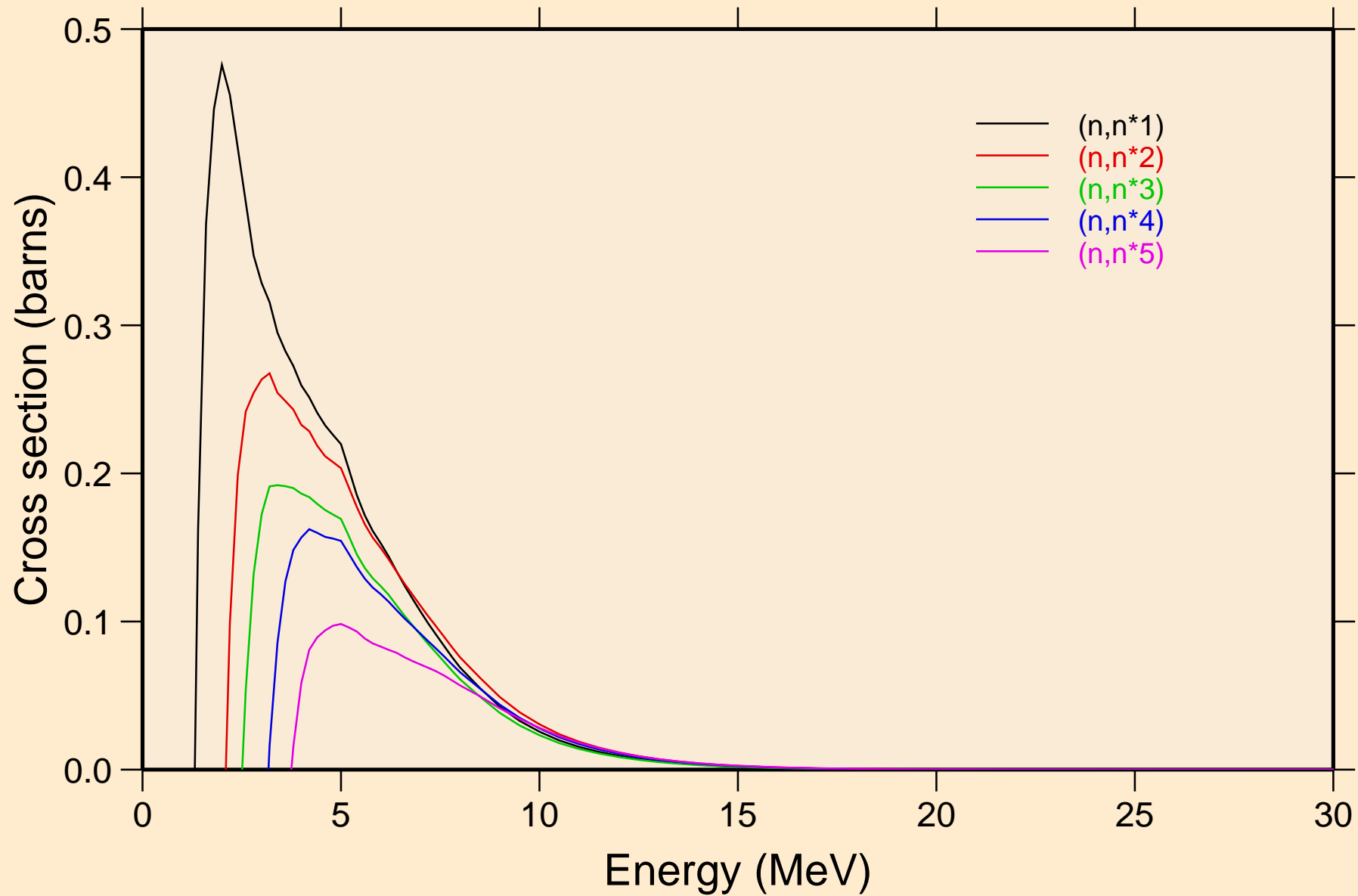

SI029 NEUTRON ACER TENDL-2024 LIBRARY; T=0.K  
Inelastic levels

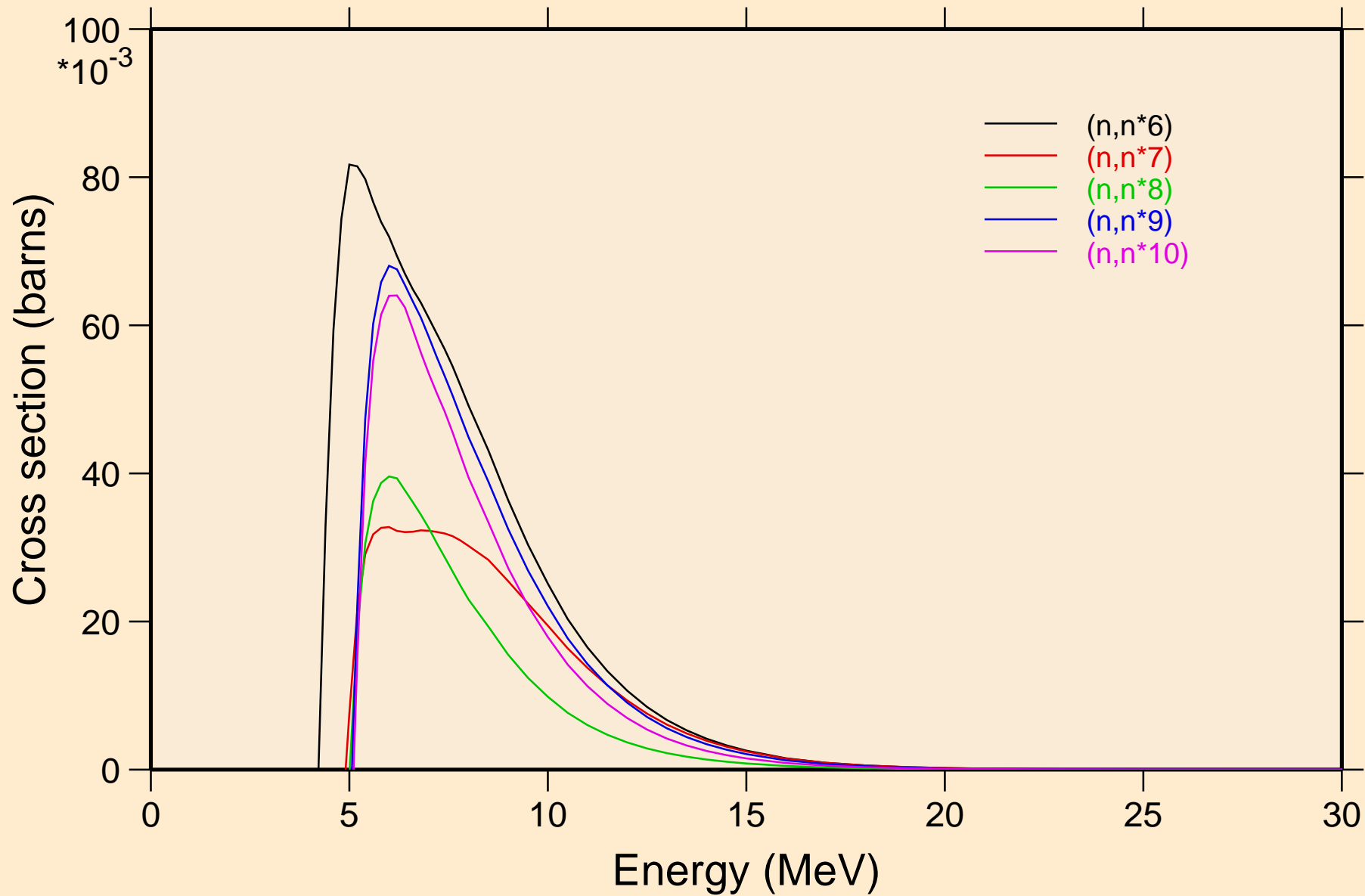



SI029 NEUTRON ACER TENDL-2024 LIBRARY; T=0.K  
Inelastic levels

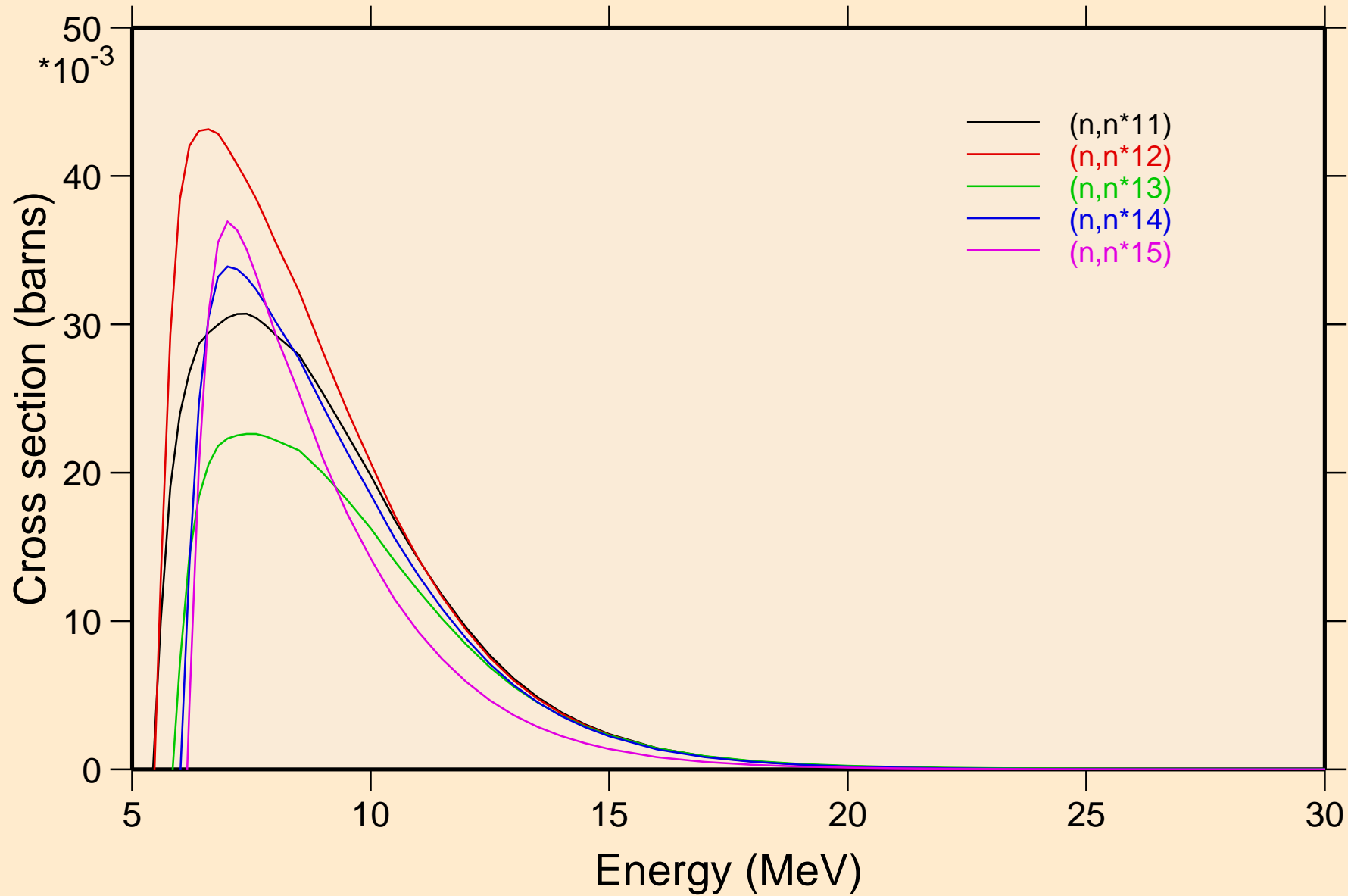

SI029 NEUTRON ACER TENDL-2024 LIBRARY; T=0.K  
Inelastic levels

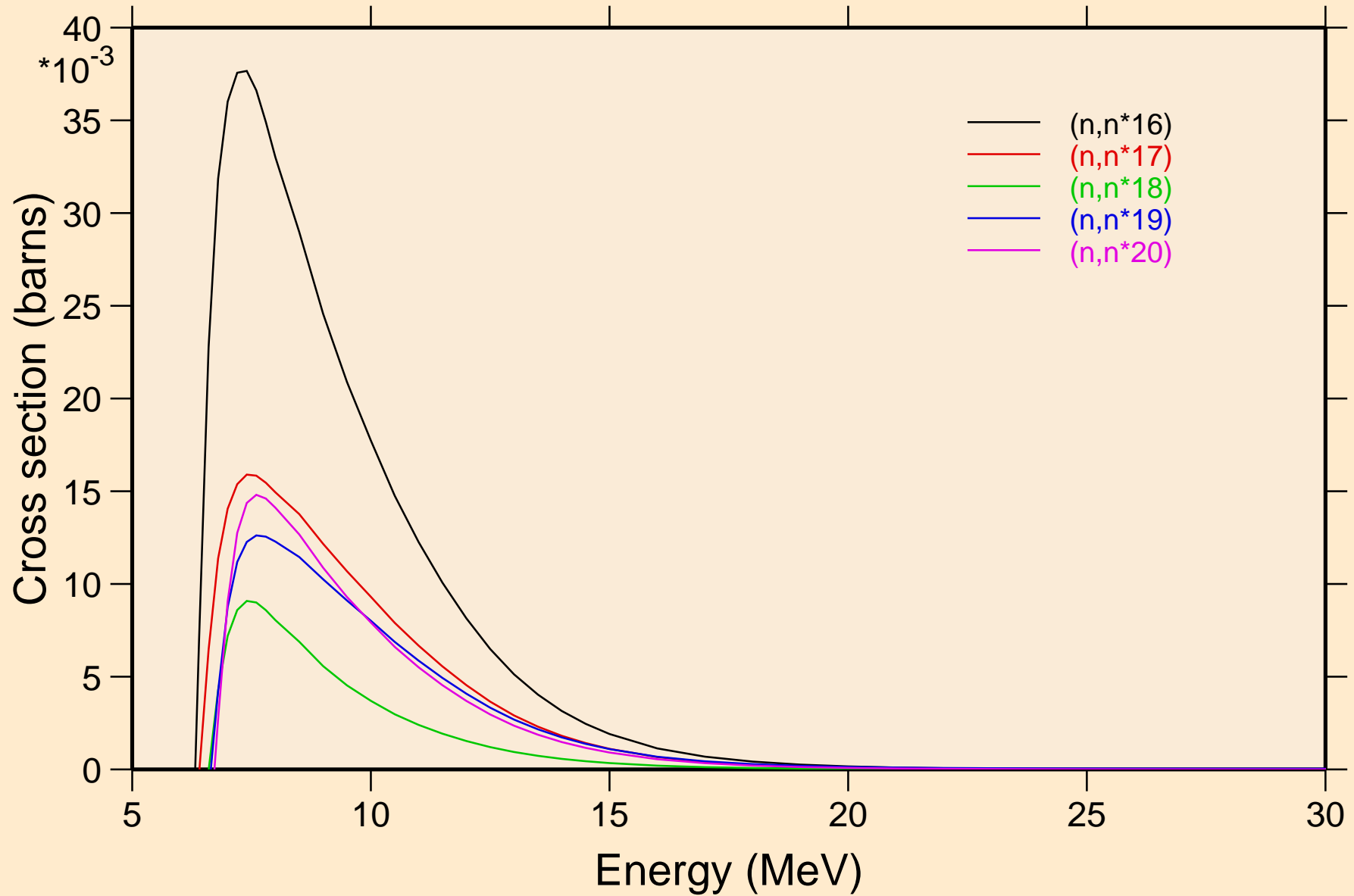

SI029 NEUTRON ACER TENDL-2024 LIBRARY; T=0.K  
Inelastic levels

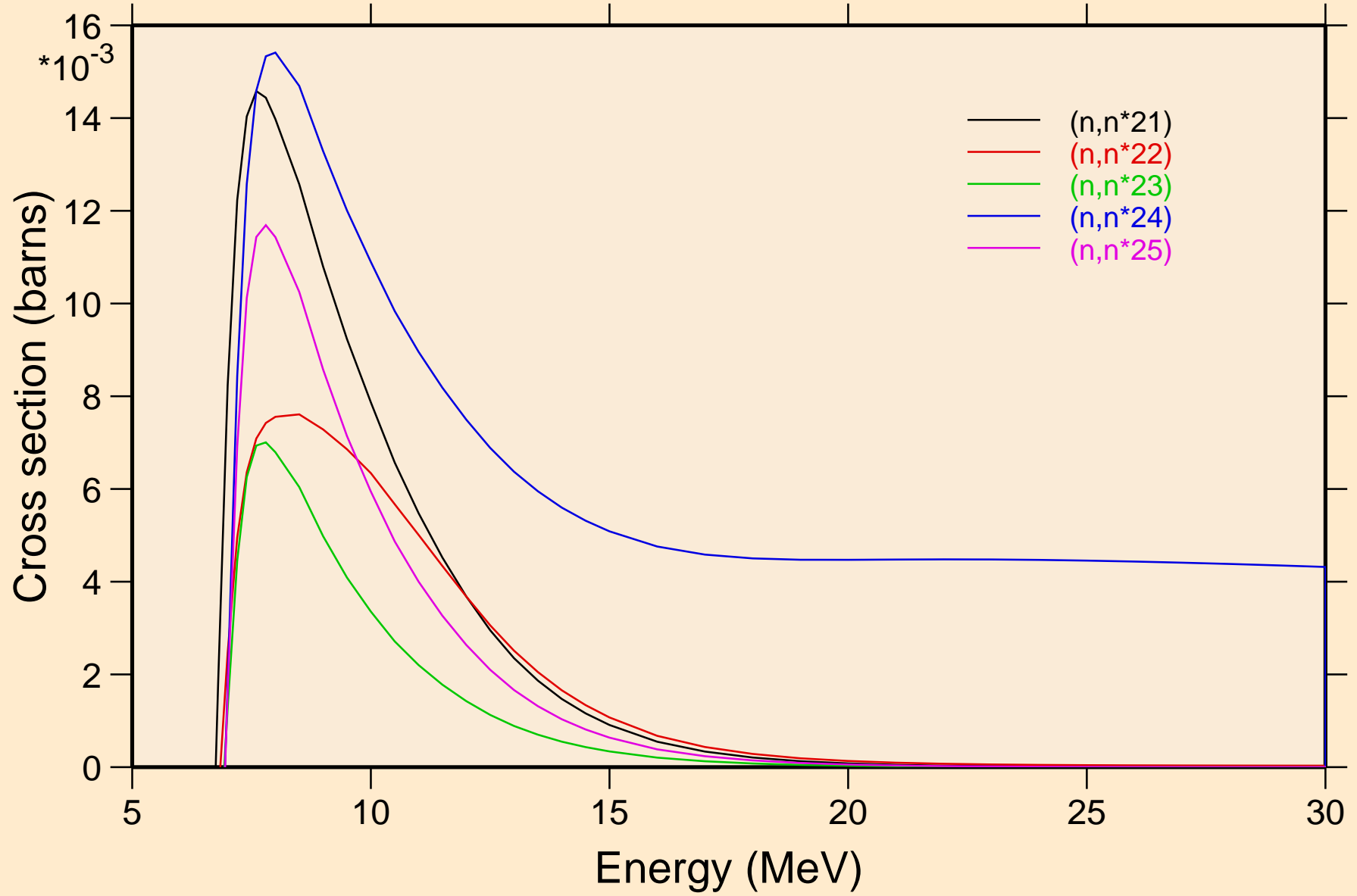

SI029 NEUTRON ACER TENDL-2024 LIBRARY; T=0.K  
Inelastic levels

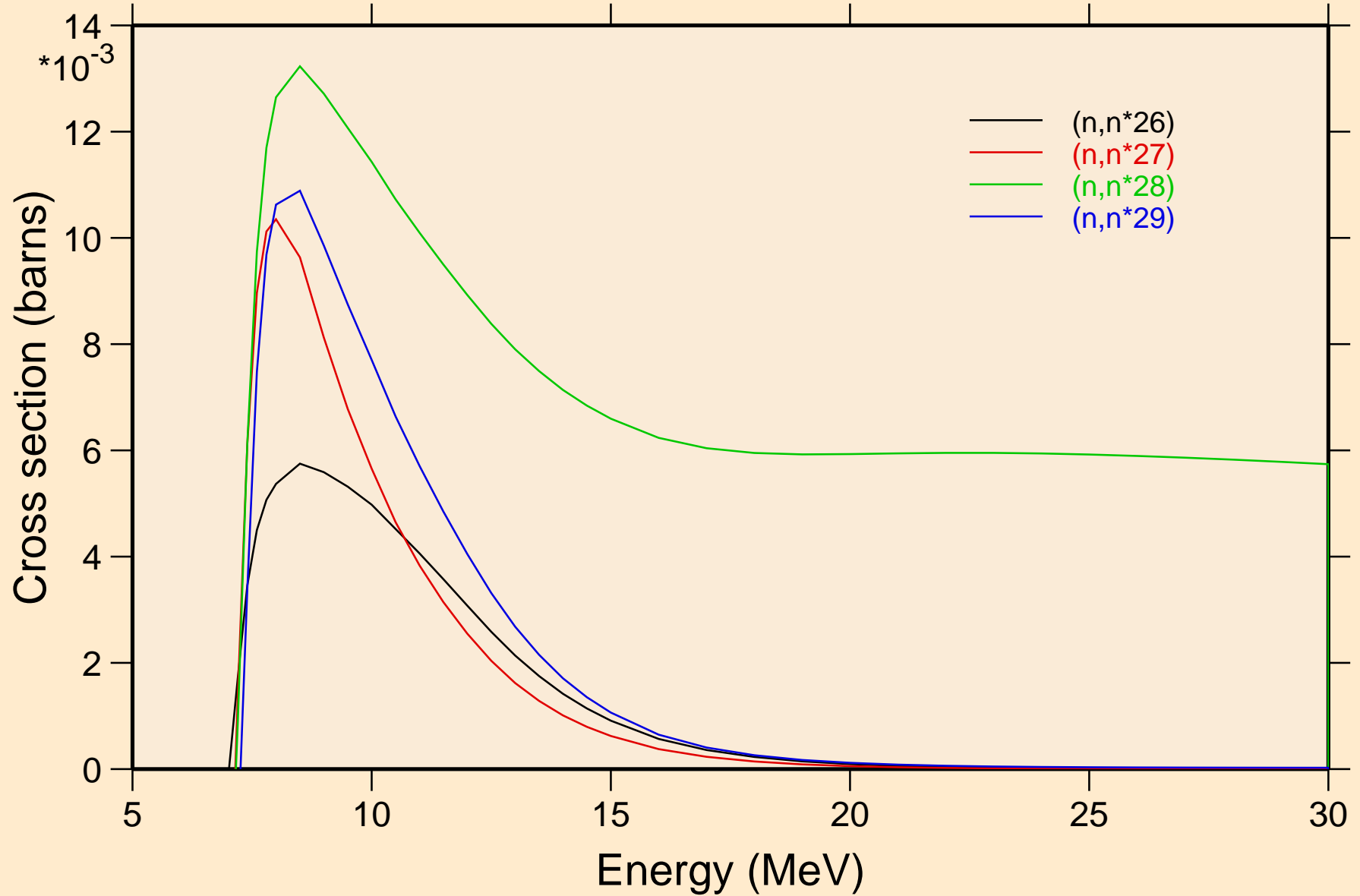

SI029 NEUTRON ACER TENDL-2024 LIBRARY; T=0.K  
Threshold reactions

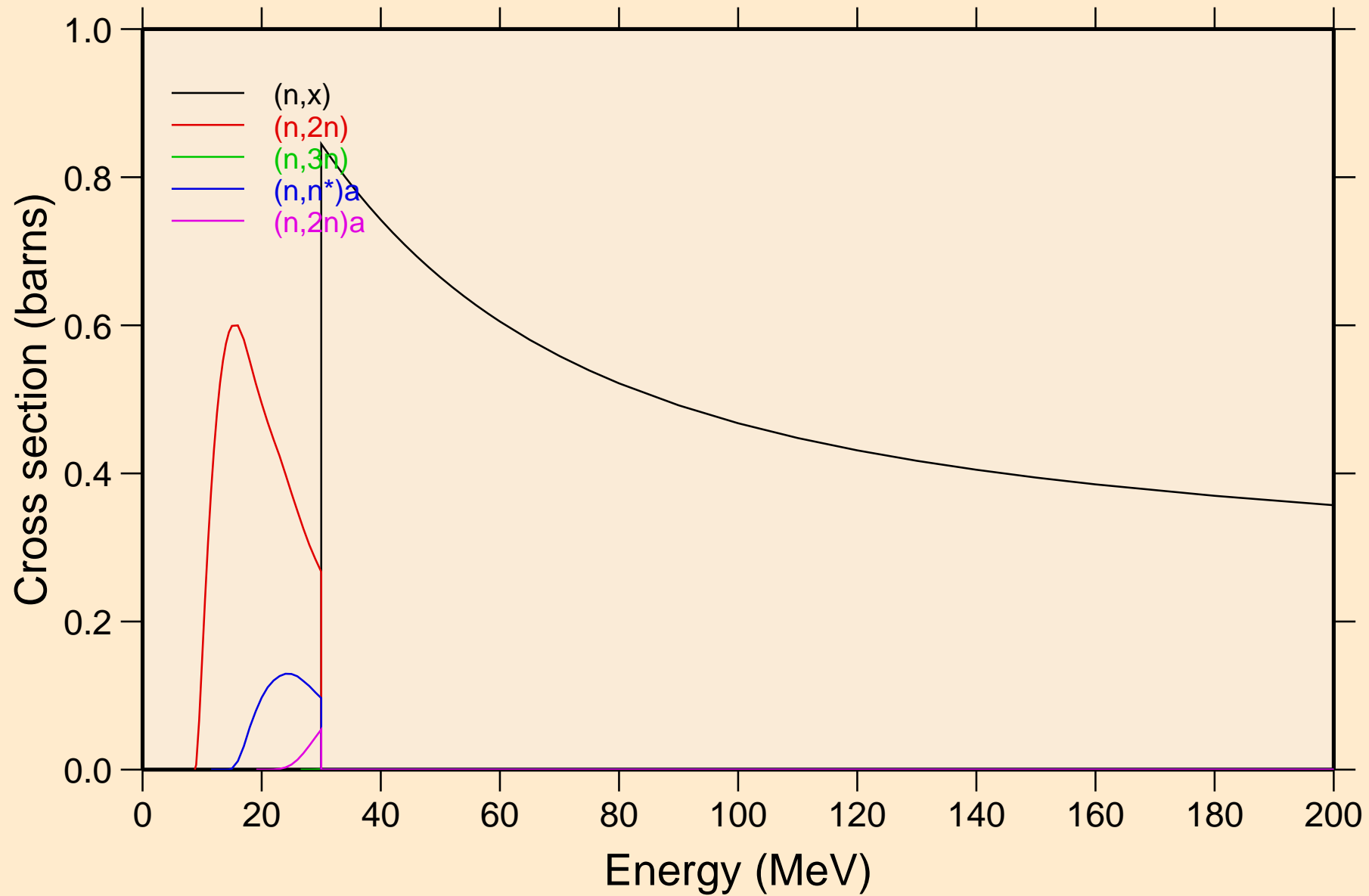

# SI029 NEUTRON ACER TENDL-2024 LIBRARY; T=0.K

## Threshold reactions

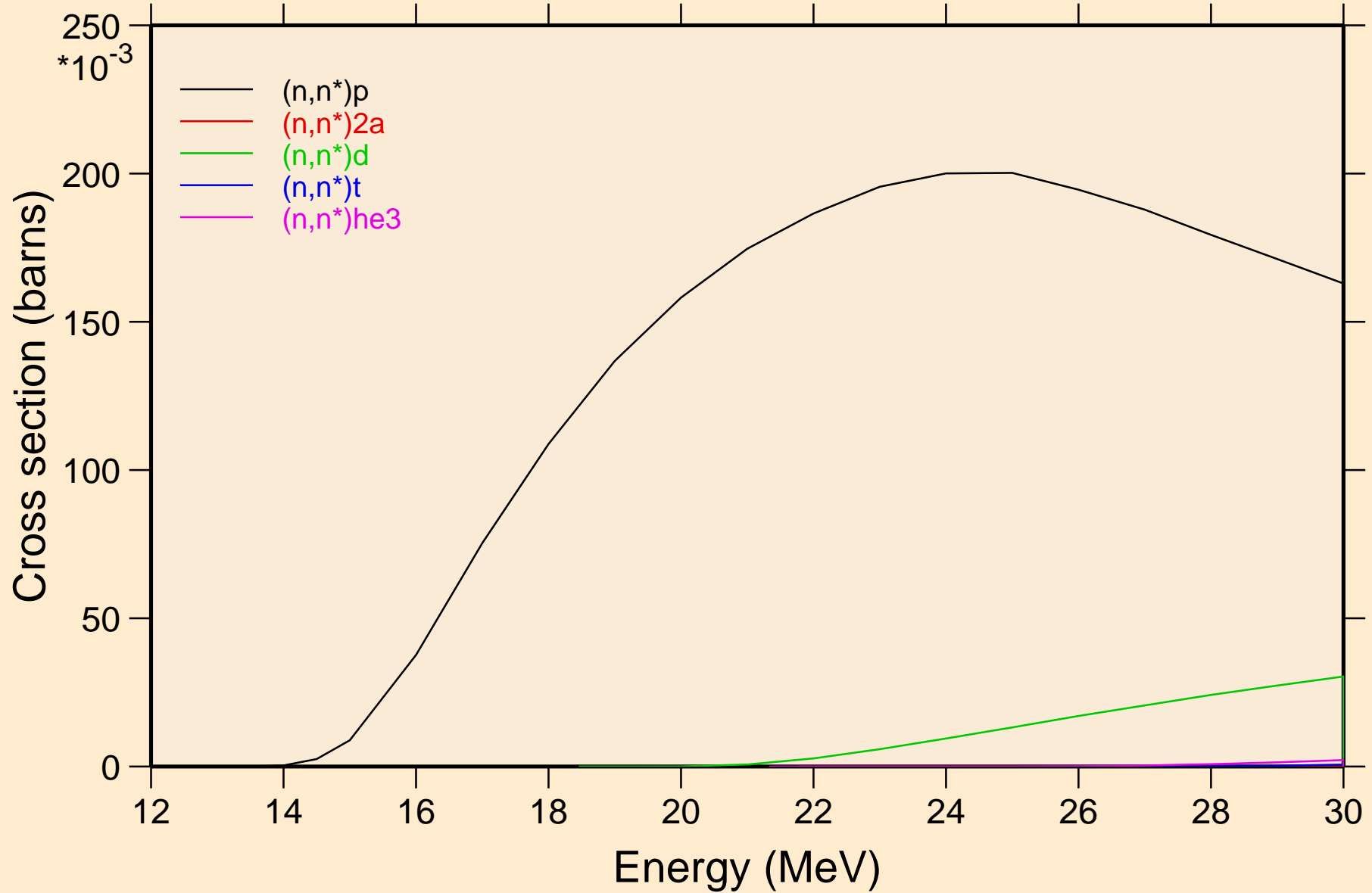

# SI029 NEUTRON ACER TENDL-2024 LIBRARY; T=0.K

## Threshold reactions

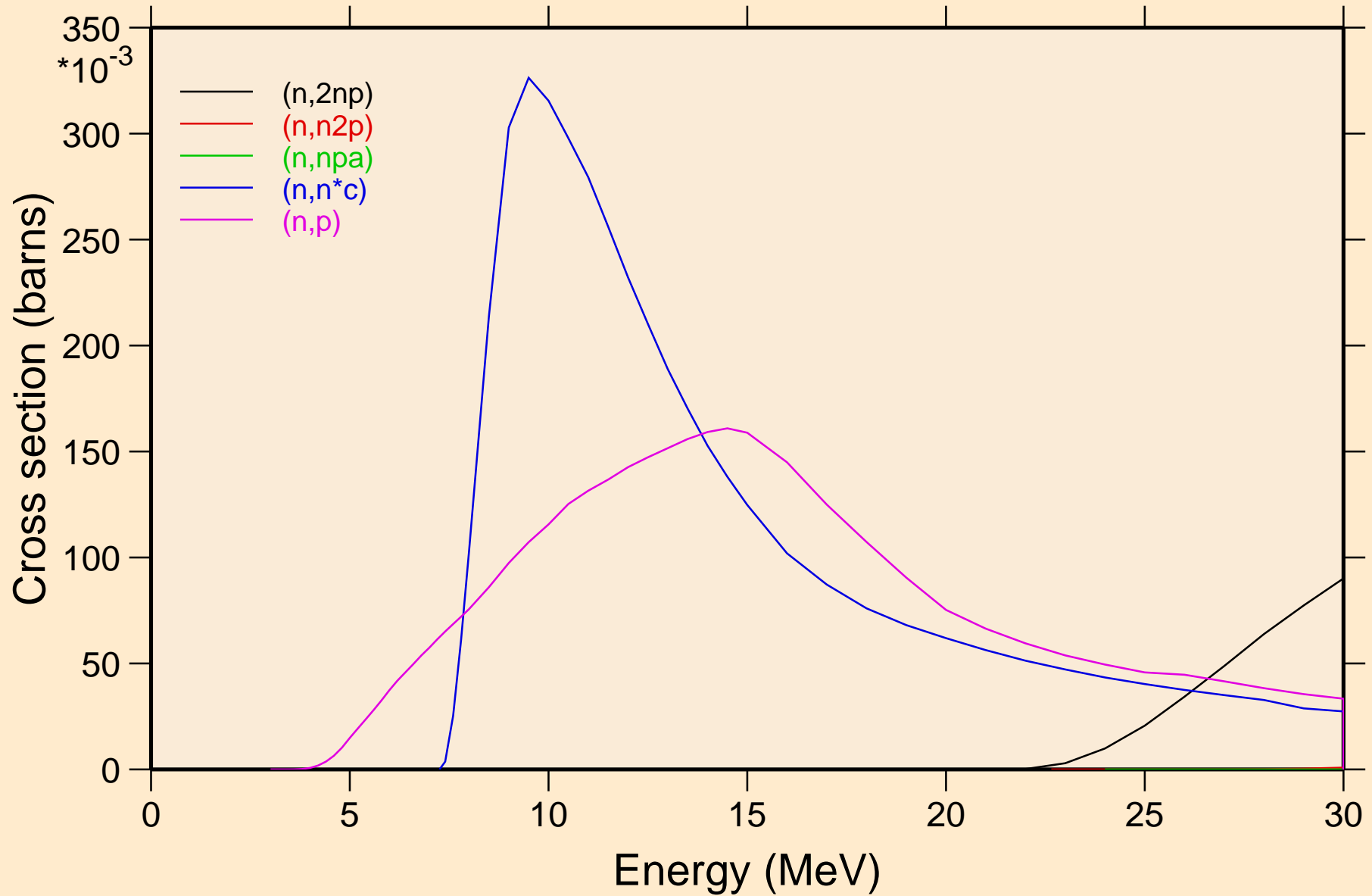

# SI029 NEUTRON ACER TENDL-2024 LIBRARY; T=0.K

## Threshold reactions

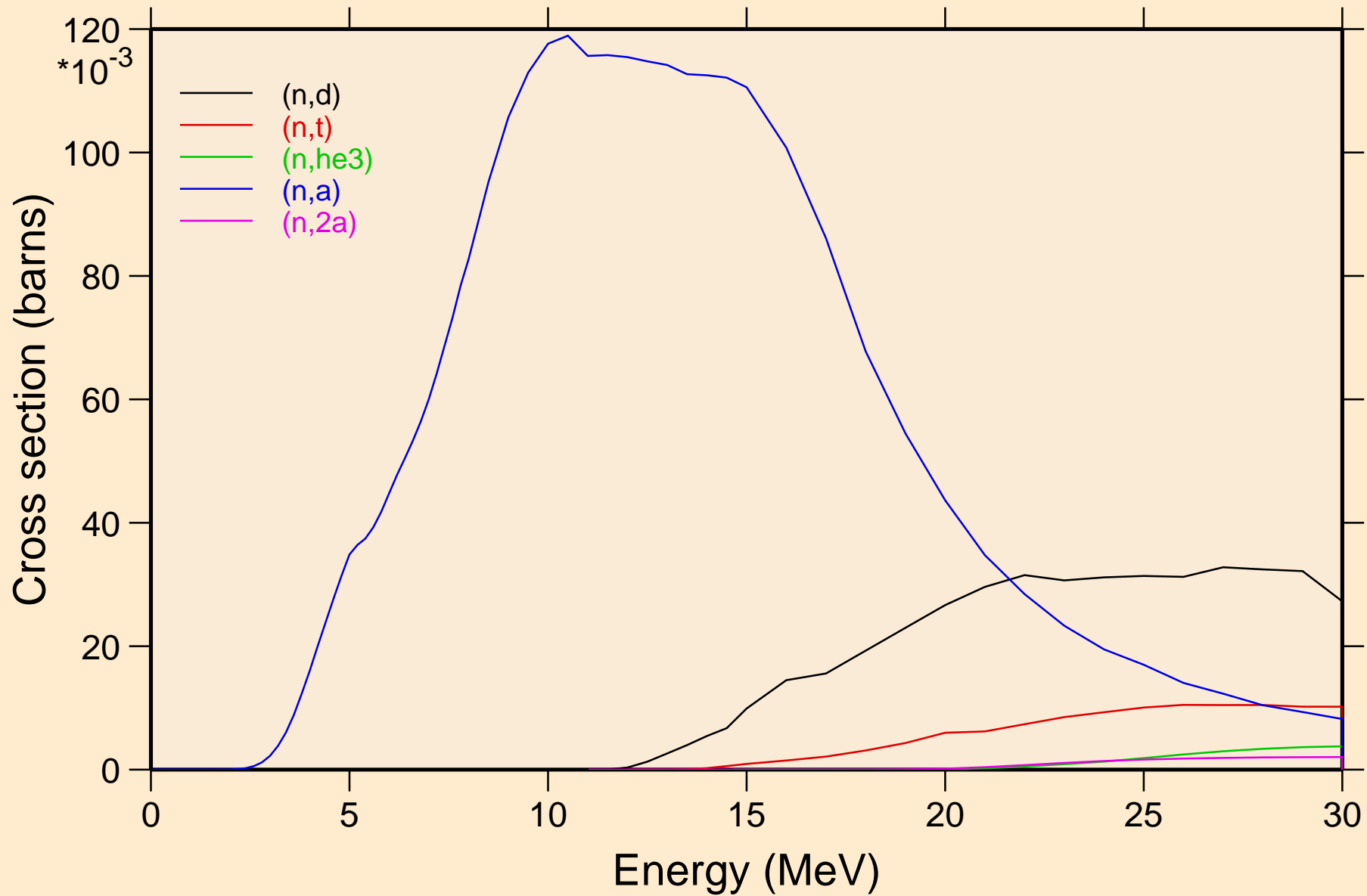



# SI029 NEUTRON ACER TENDL-2024 LIBRARY; T=0.K

## Threshold reactions

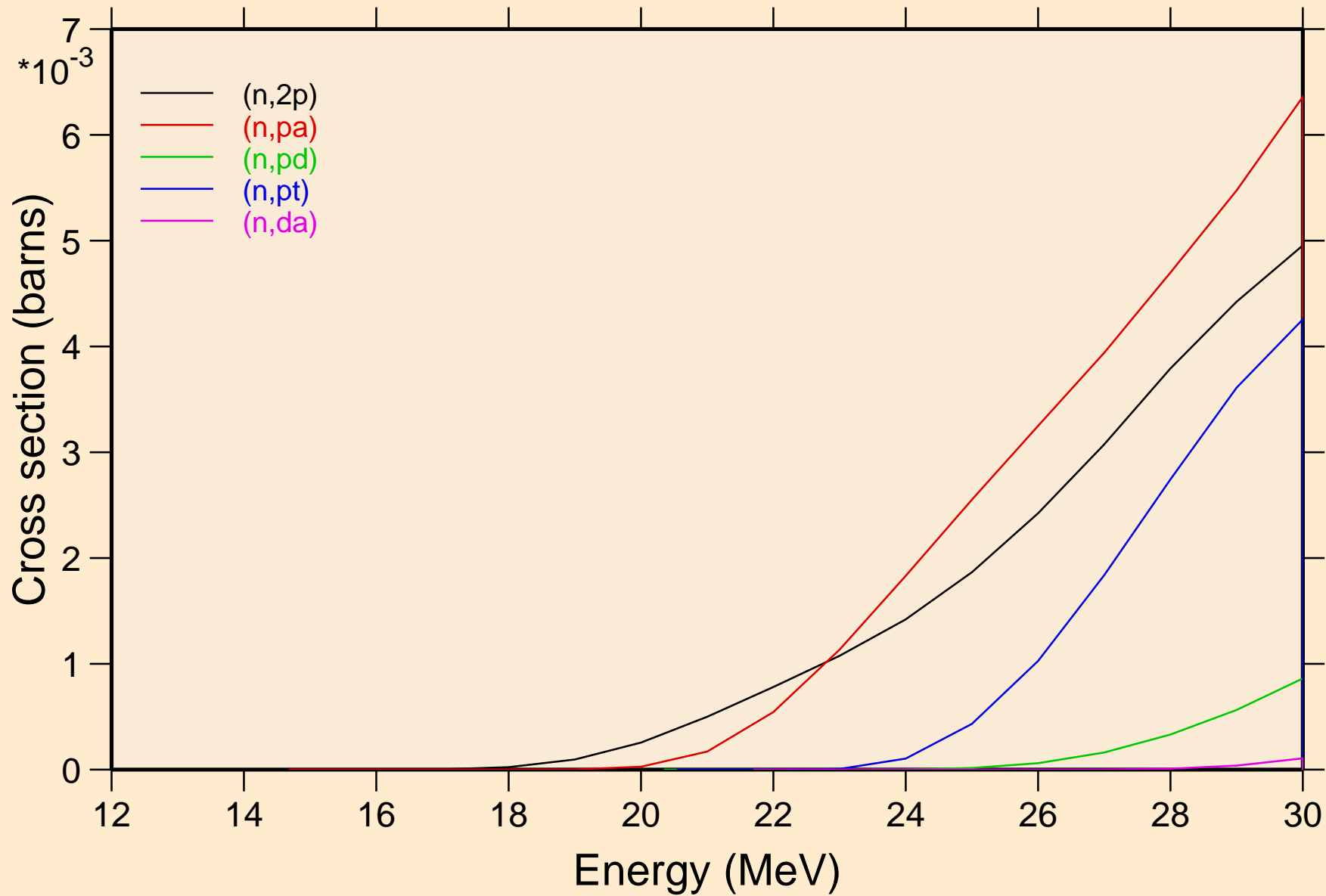

# SI029 NEUTRON ACER TENDL-2024 LIBRARY; T=0.K

## Threshold reactions

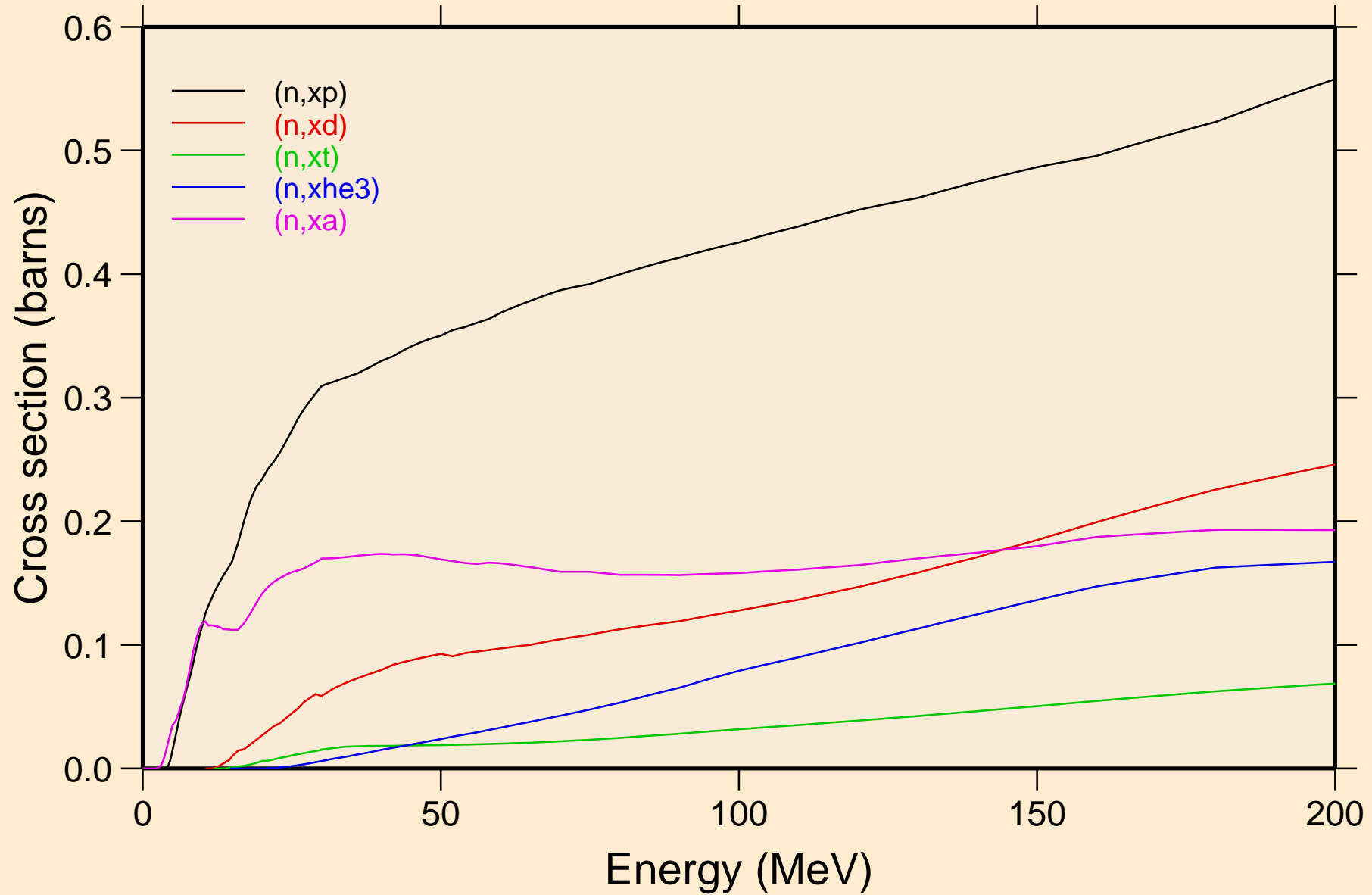

SI029 NEUTRON ACER TENDL-2024 LIBRARY; T=0.K  
angular distribution for elastic

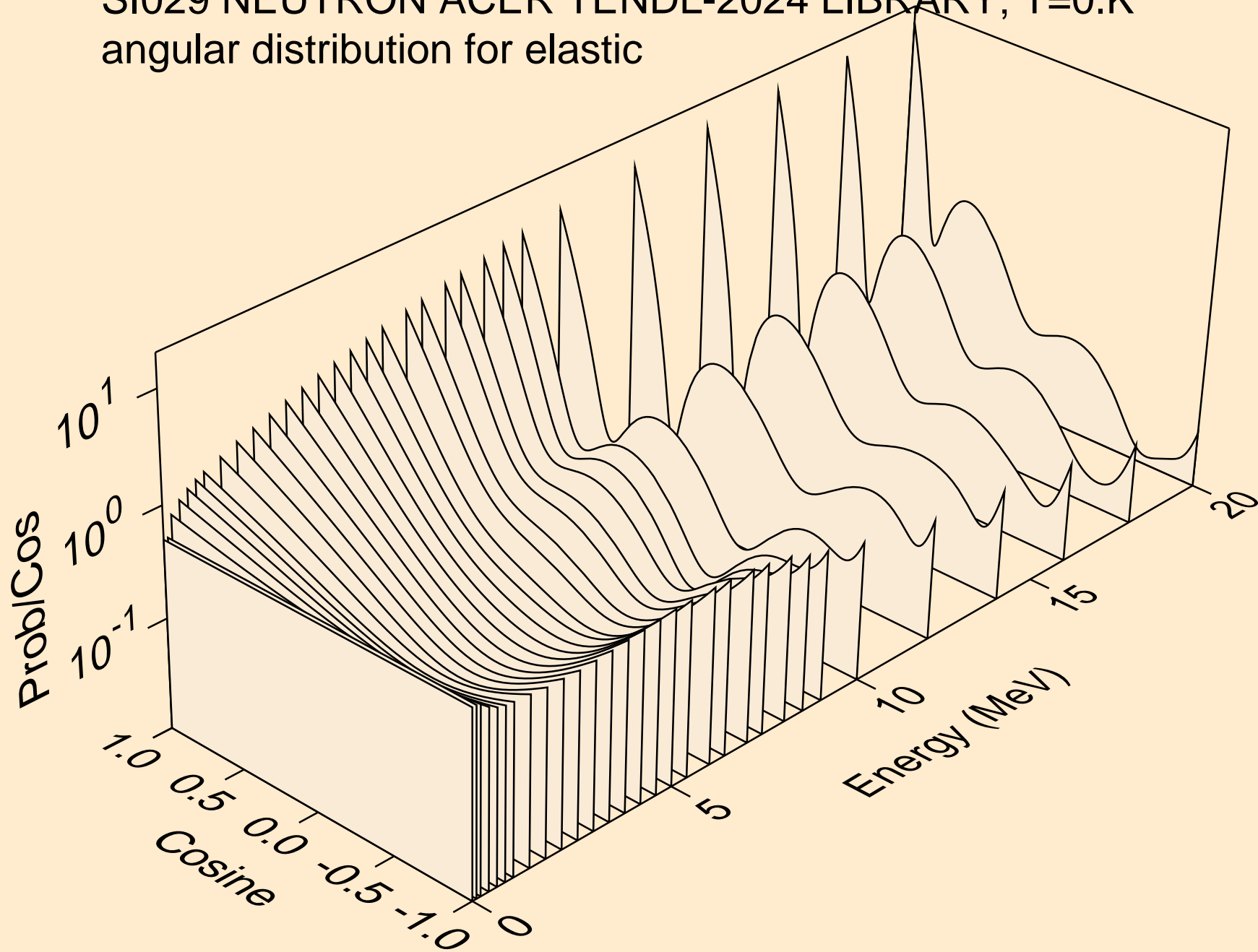

SI029 NEUTRON ACER TENDL-2024 LIBRARY; T=0.K  
angular distribution for elastic

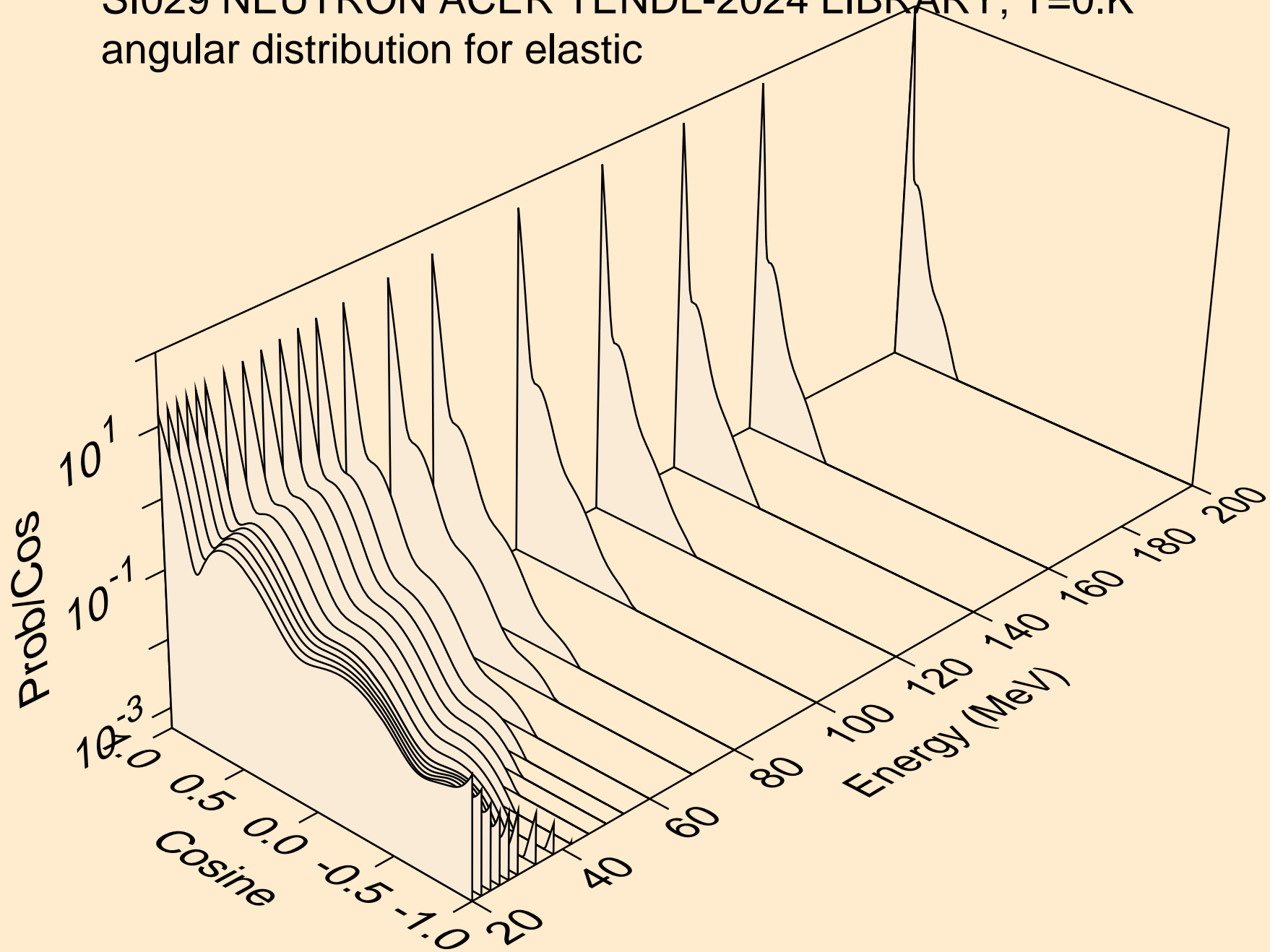

SI029 NEUTRON ACER TENDL-2024 LIBRARY; T=0.K  
angular distribution for (n,n\*1)

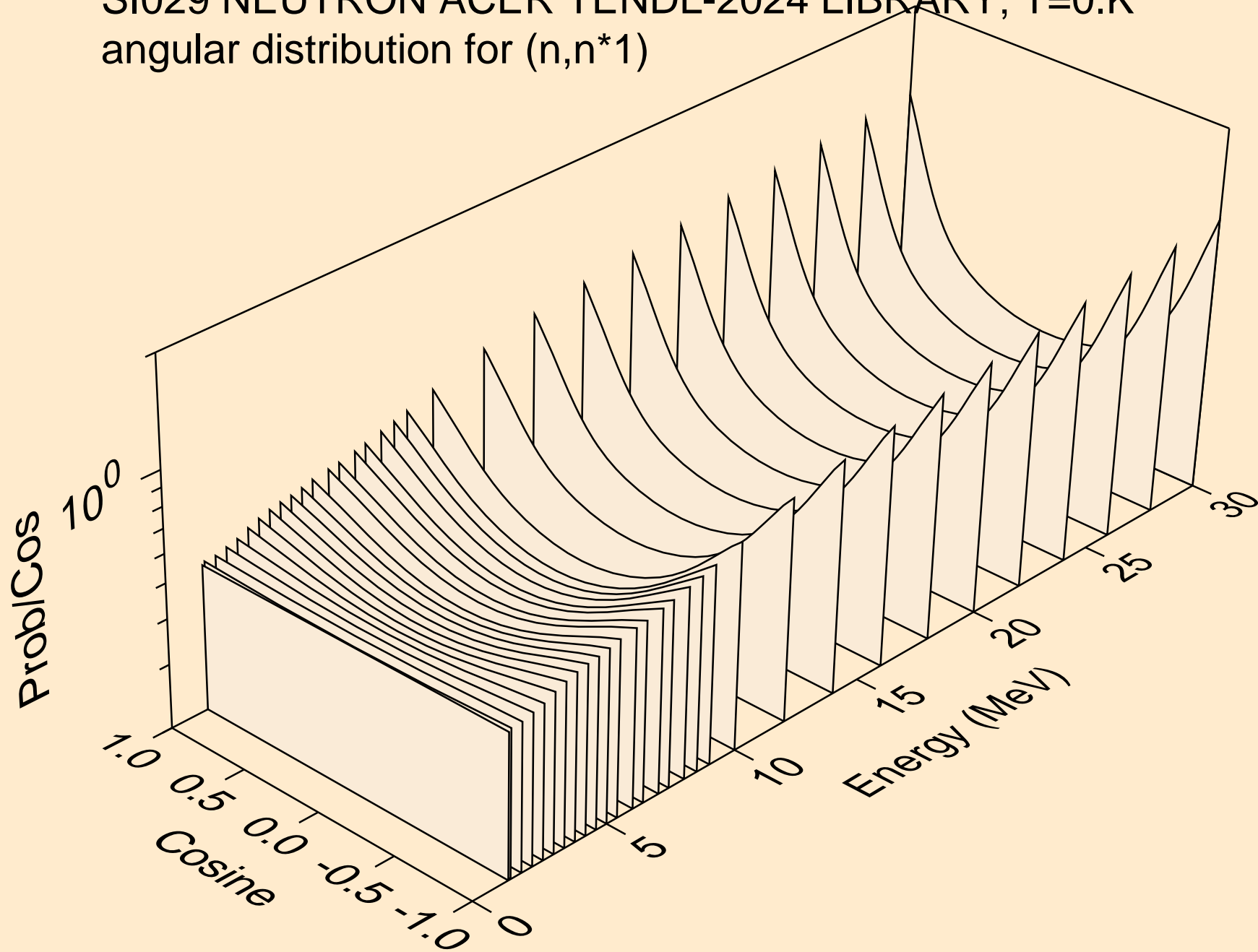

SI029 NEUTRON ACER TENDL-2024 LIBRARY; T=0.K  
angular distribution for (n,n\*2)

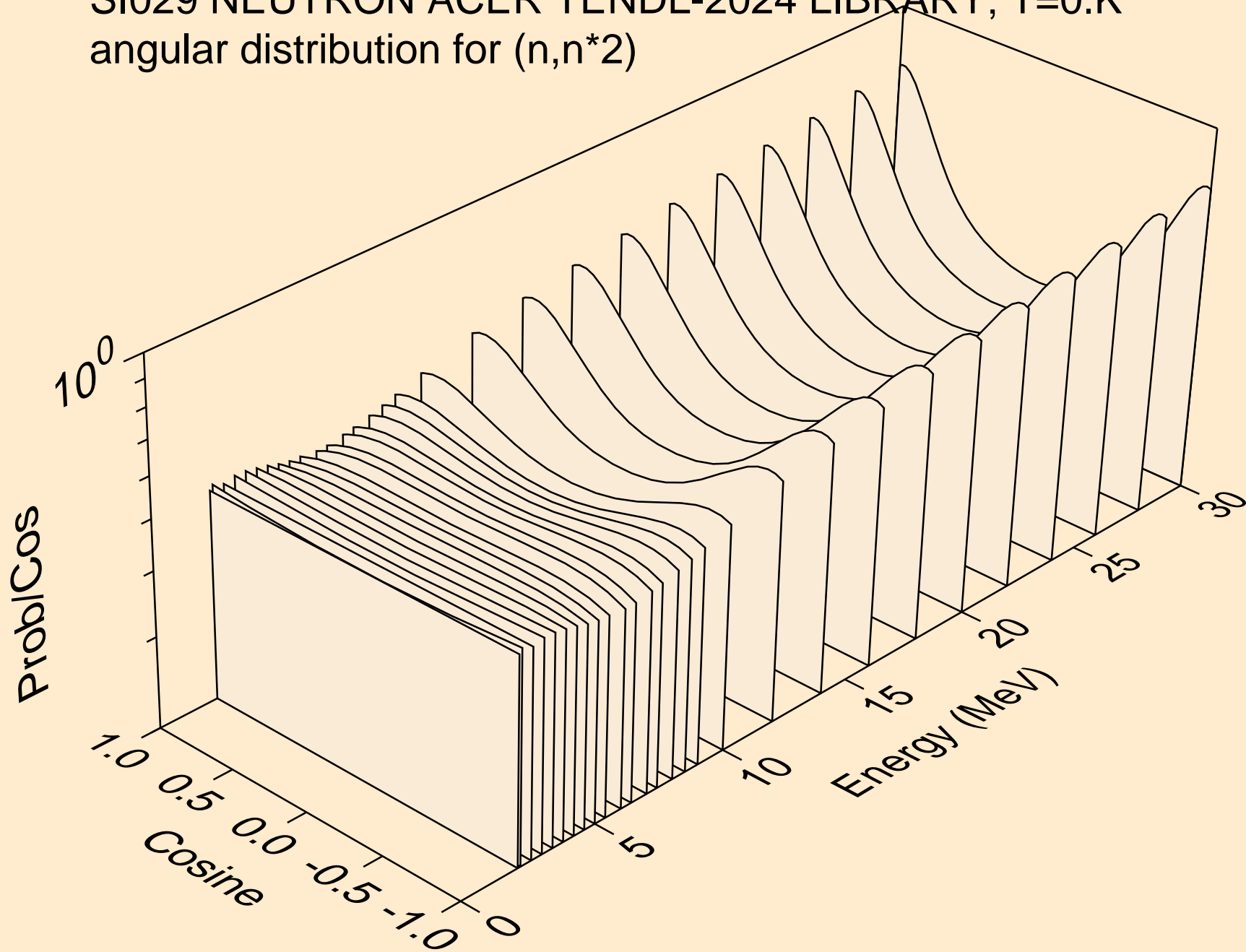

SI029 NEUTRON ACER TENDL-2024 LIBRARY; T=0.K  
angular distribution for (n,n\*3)

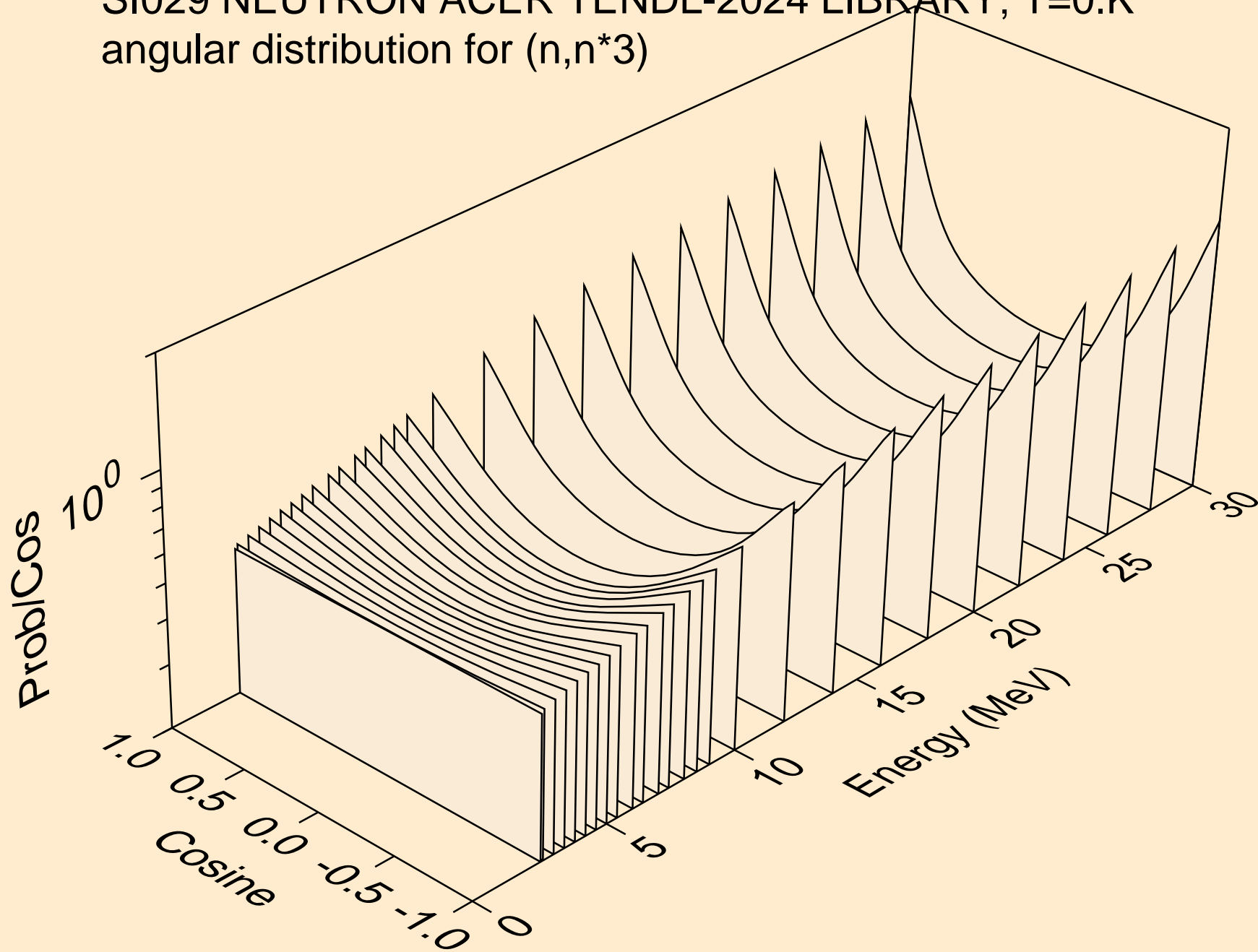

SI029 NEUTRON ACER TENDL-2024 LIBRARY; T=0.K  
angular distribution for (n,n\*4)

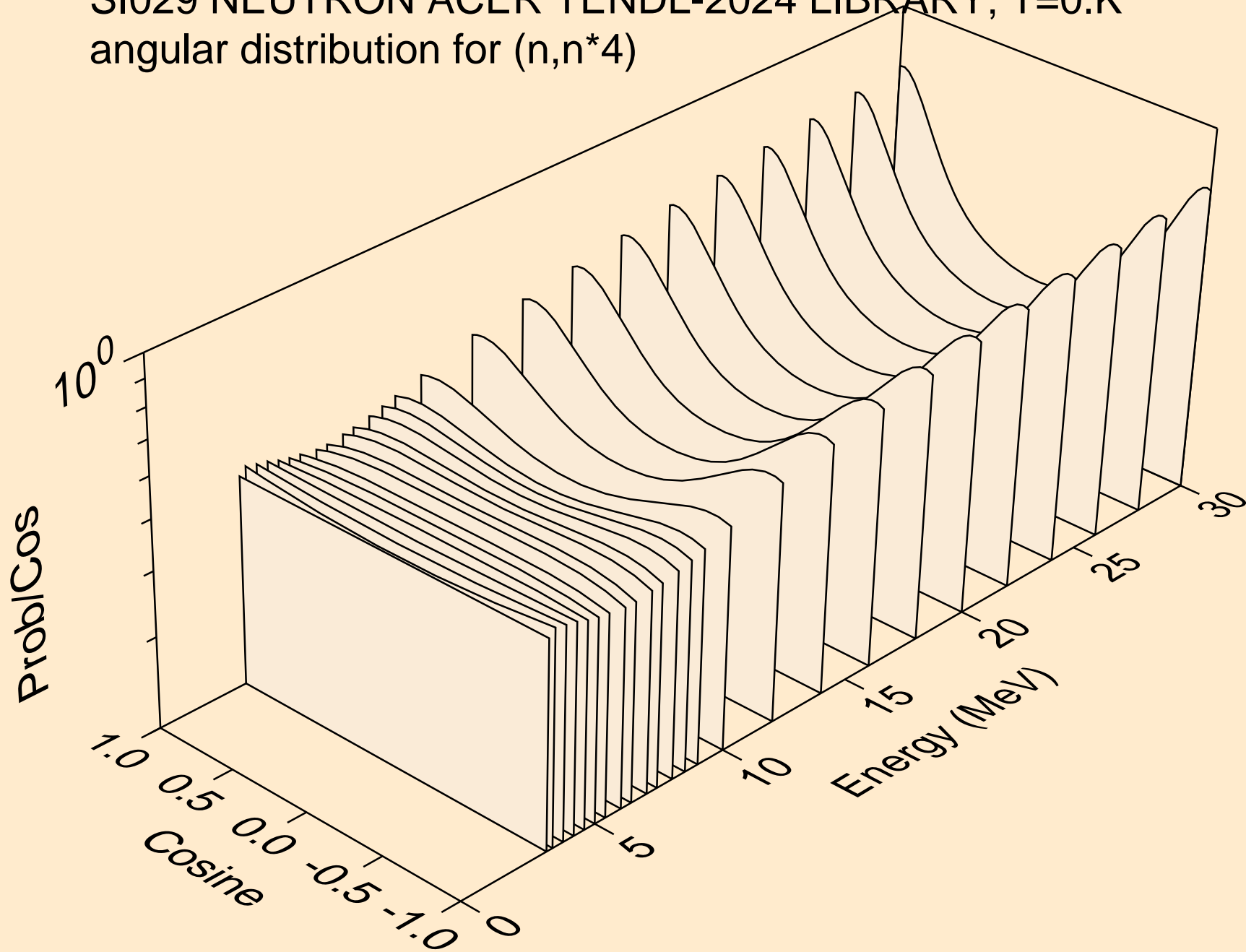



SI029 NEUTRON ACER TENDL-2024 LIBRARY; T=0.K  
angular distribution for (n,n\*5)

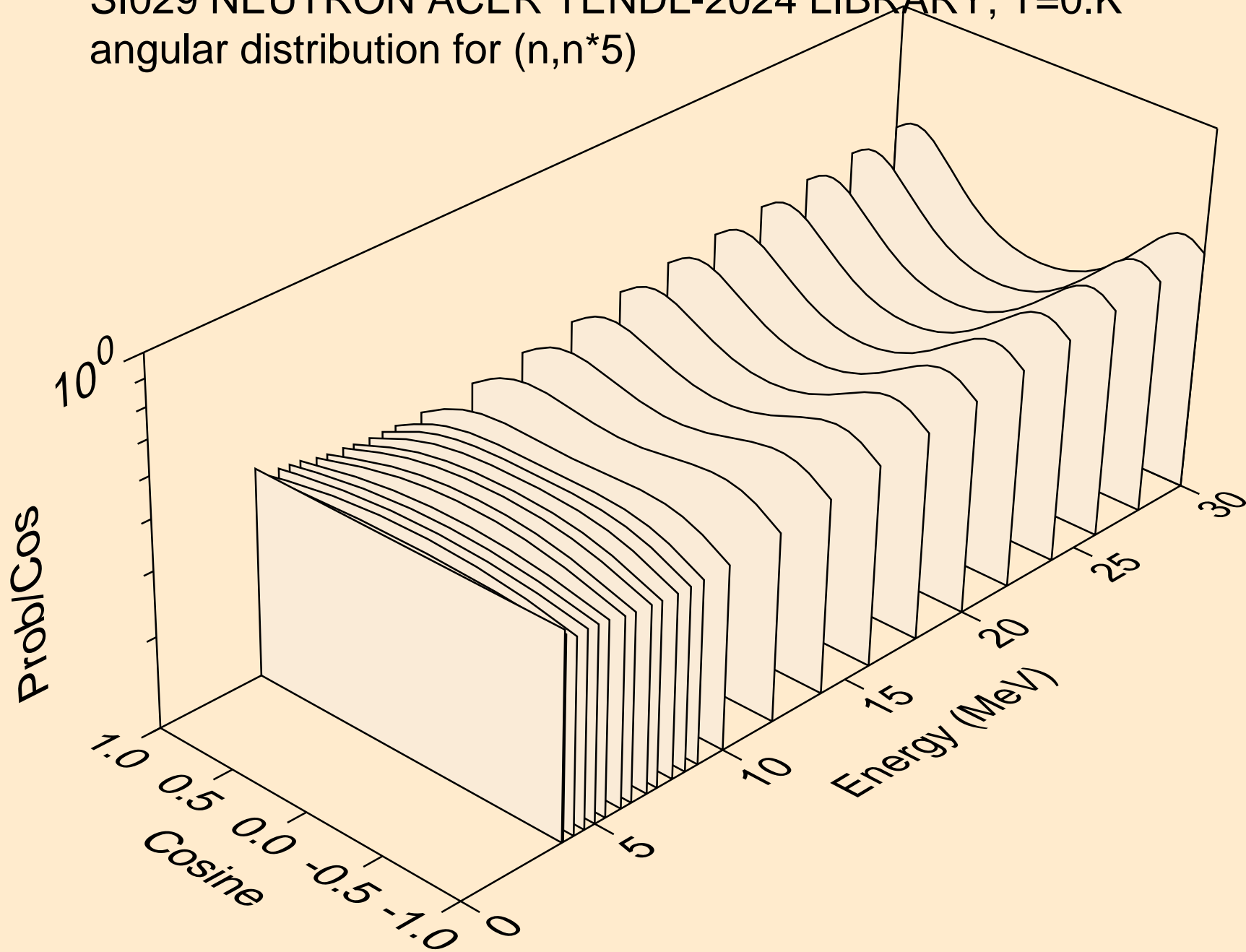

SI029 NEUTRON ACER TENDL-2024 LIBRARY; T=0.K  
angular distribution for (n,n\*6)

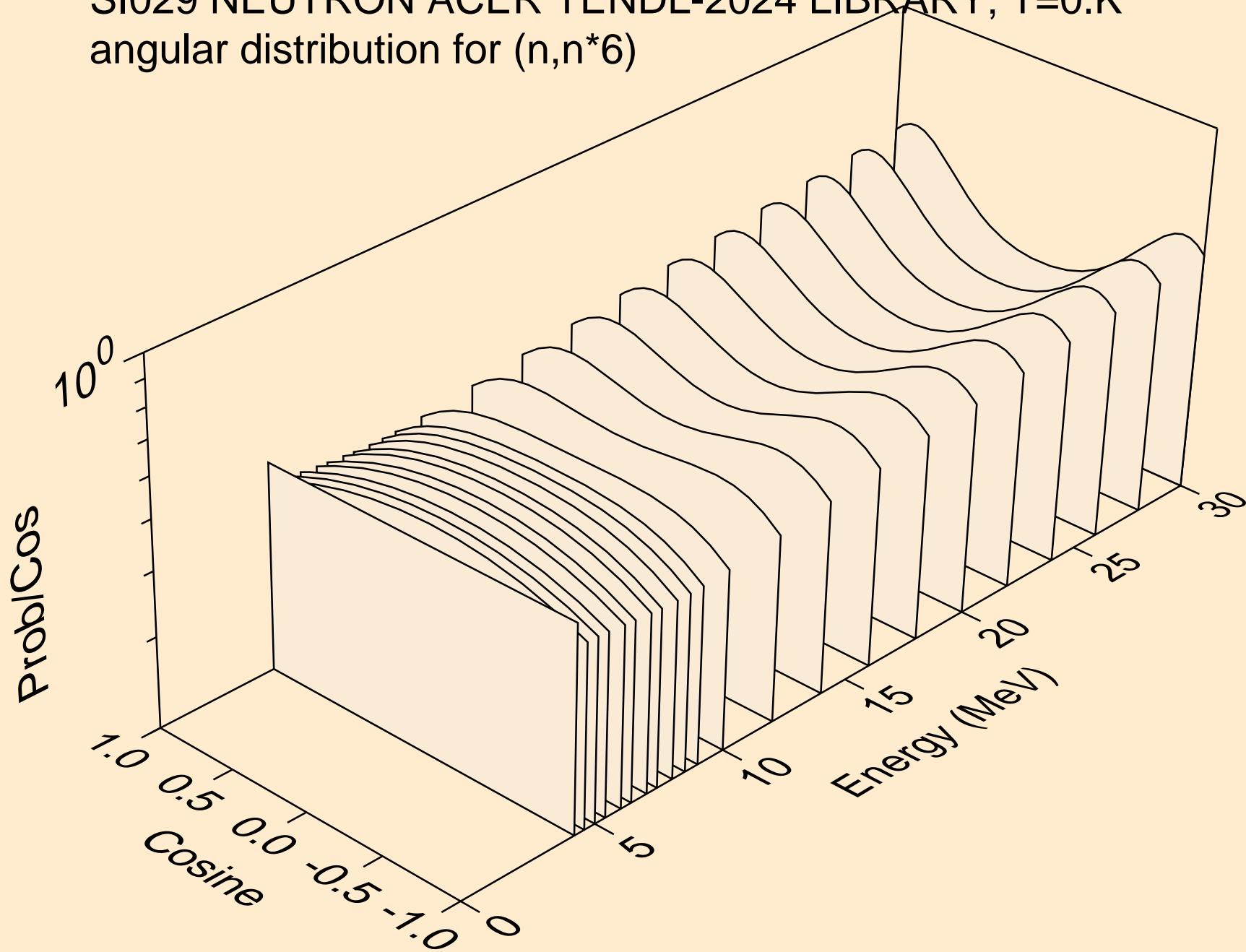

SI029 NEUTRON ACER TENDL-2024 LIBRARY; T=0.K  
angular distribution for (n,n\*7)

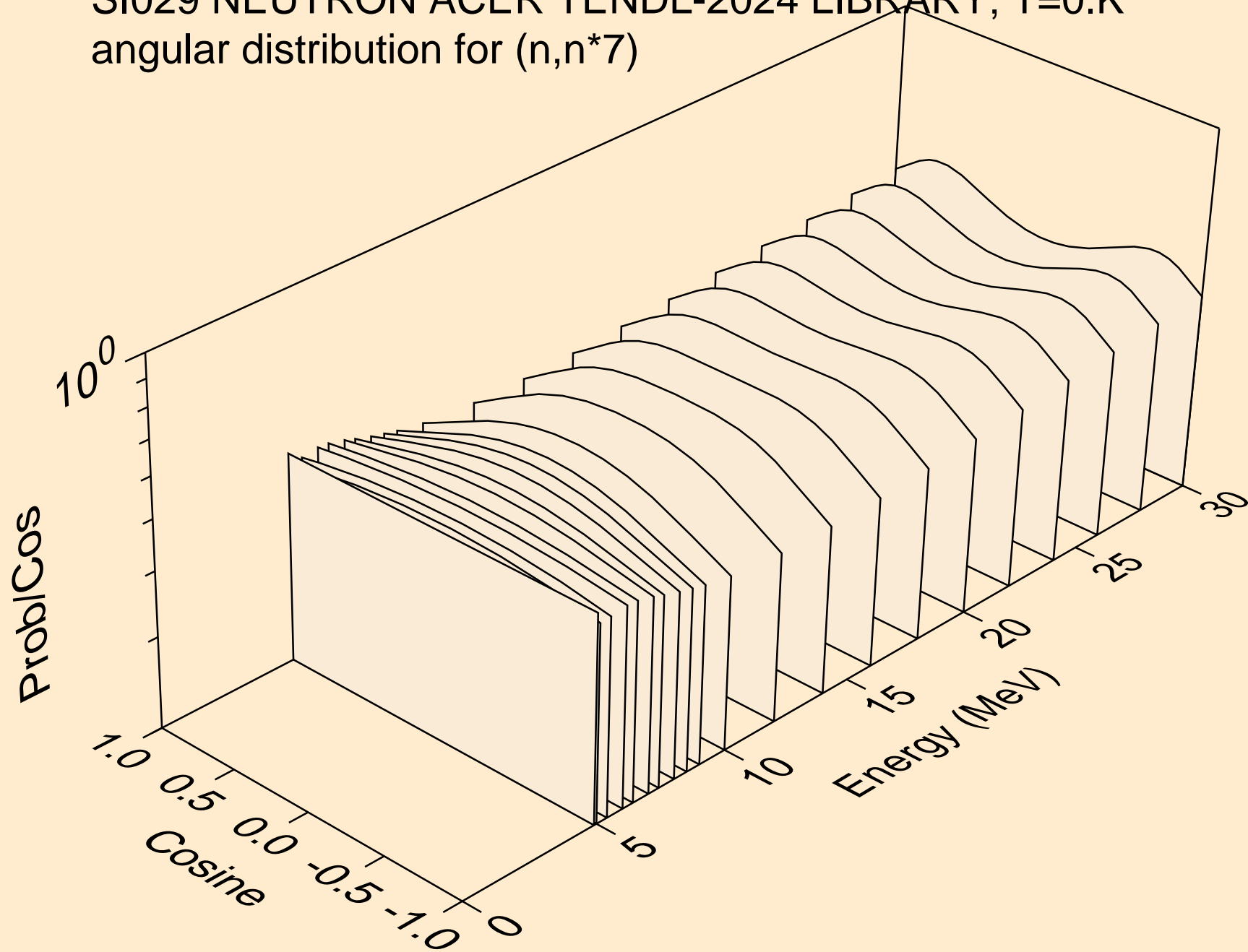

SI029 NEUTRON ACER TENDL-2024 LIBRARY; T=0.K  
angular distribution for (n,n\*8)

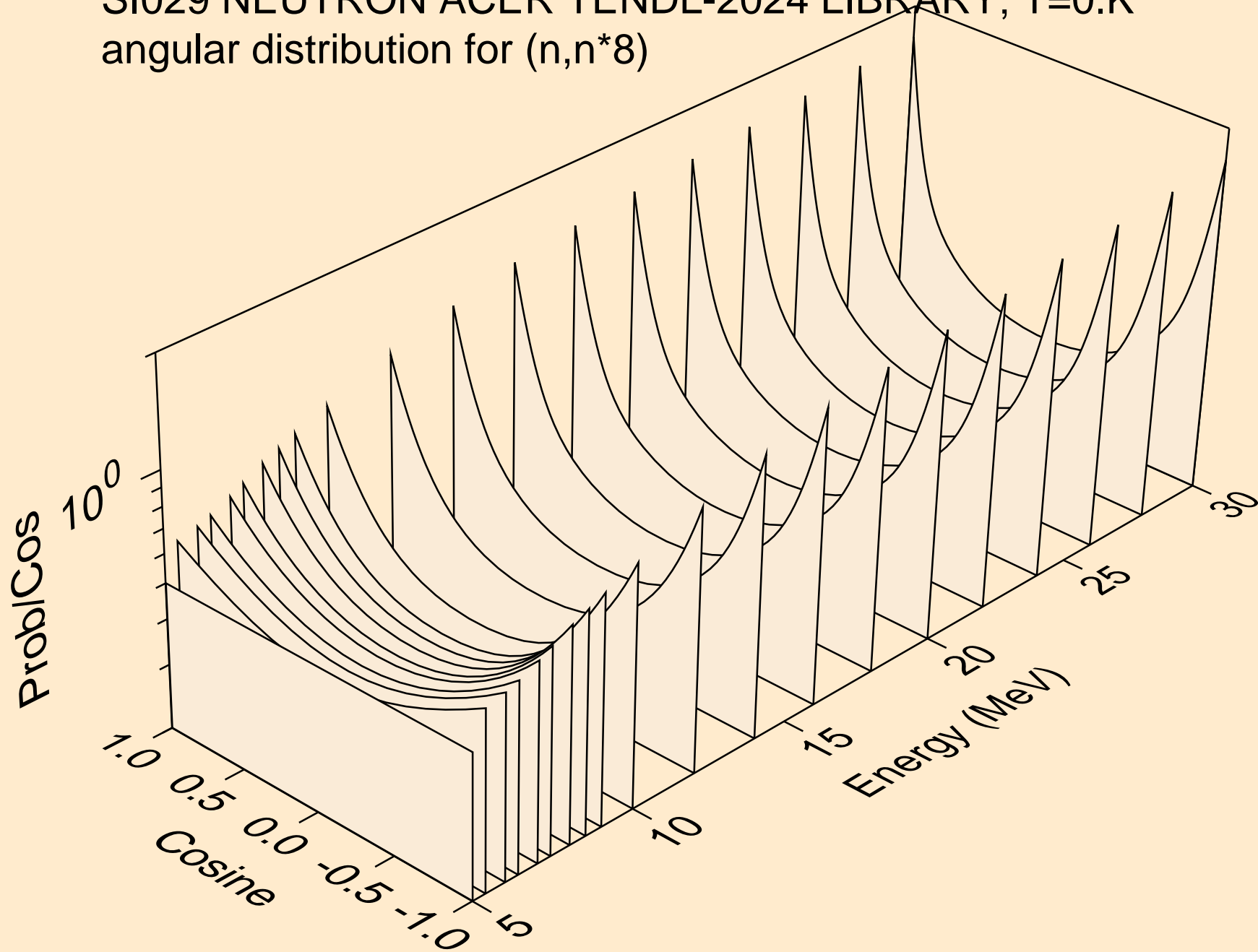

SI029 NEUTRON ACER TENDL-2024 LIBRARY; T=0.K  
angular distribution for (n,n\*9)

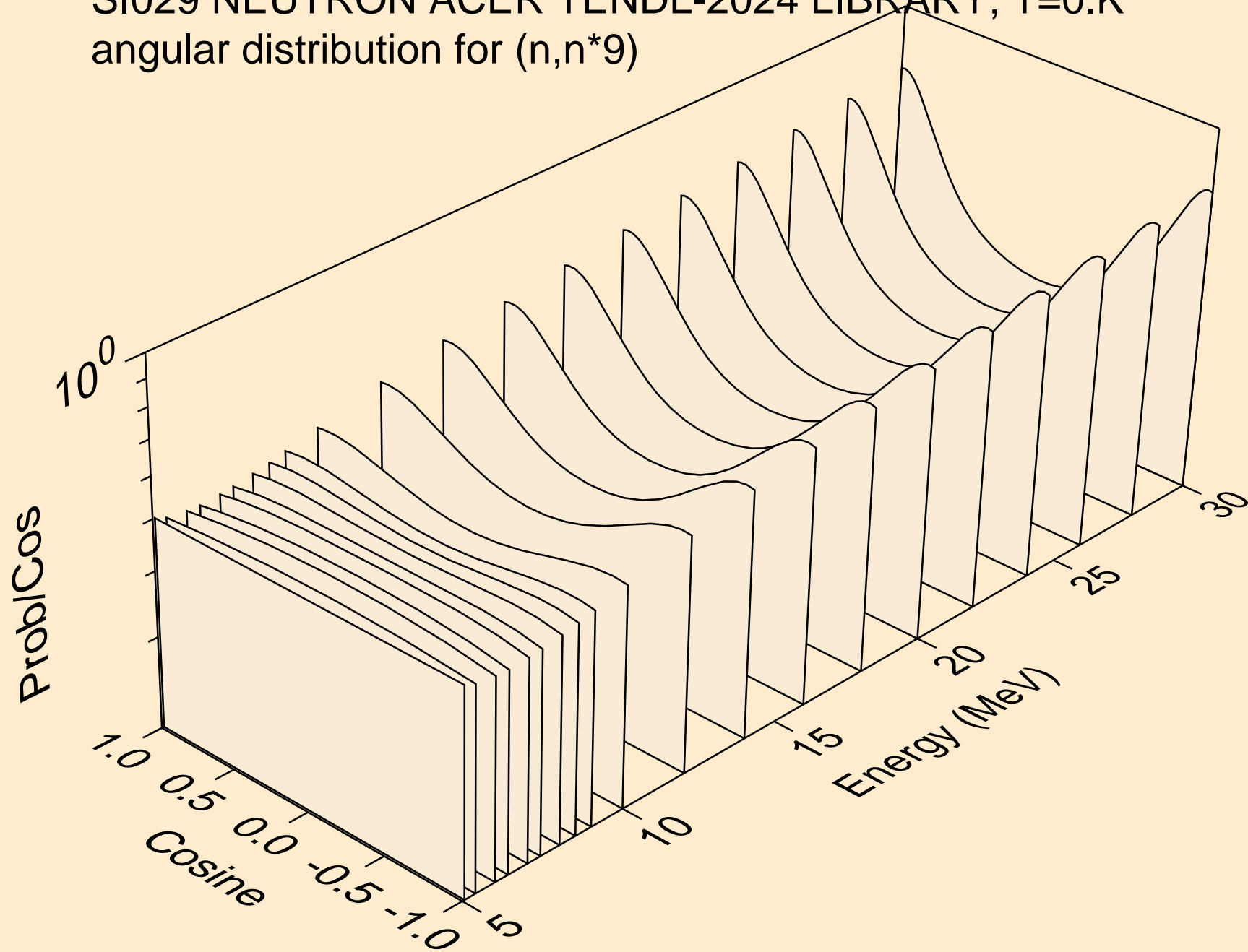

SI029 NEUTRON ACER TENDL-2024 LIBRARY; T=0.K  
angular distribution for (n,n\*10)

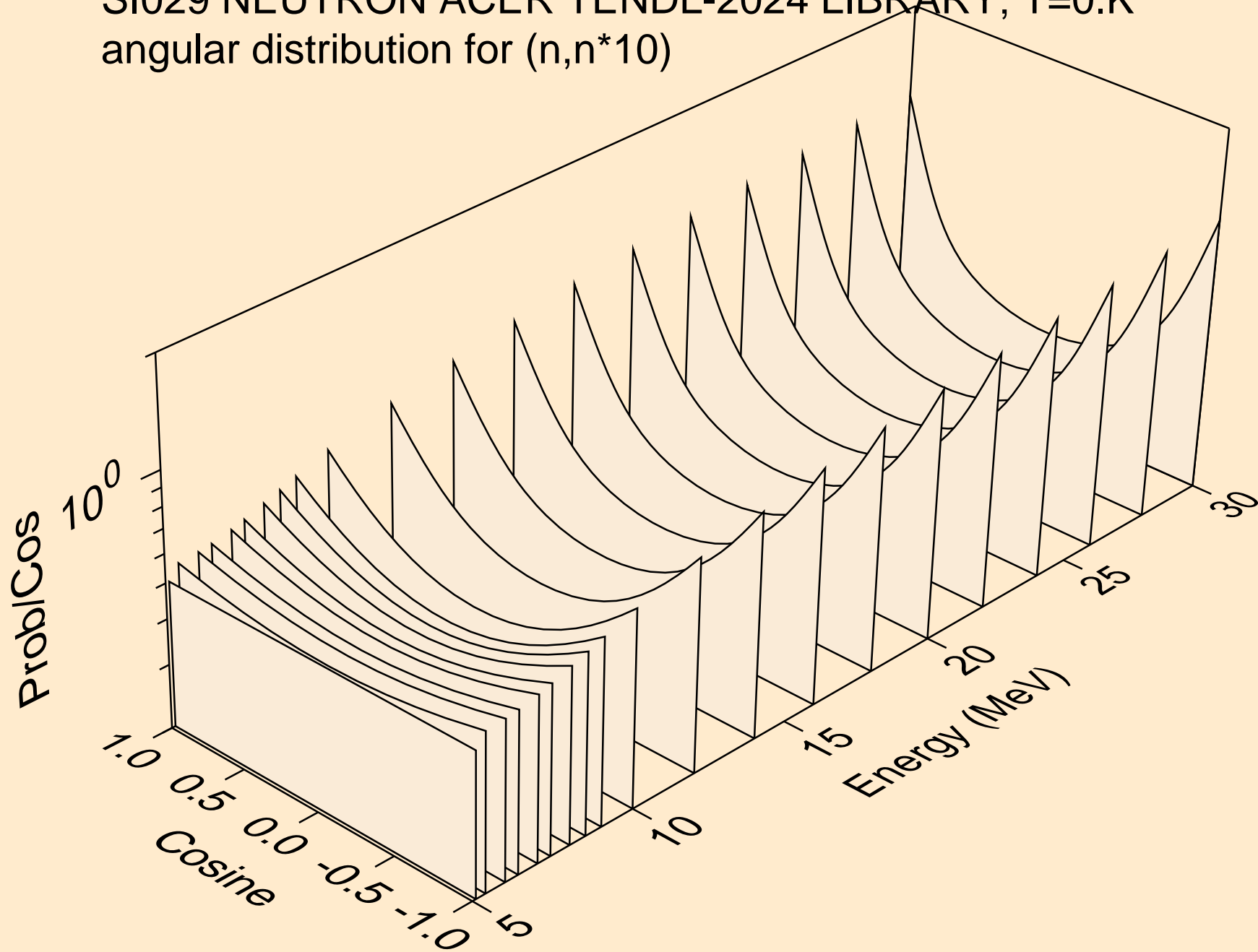

SI029 NEUTRON ACER TENDL-2024 LIBRARY; T=0.K  
angular distribution for (n,n\*11)

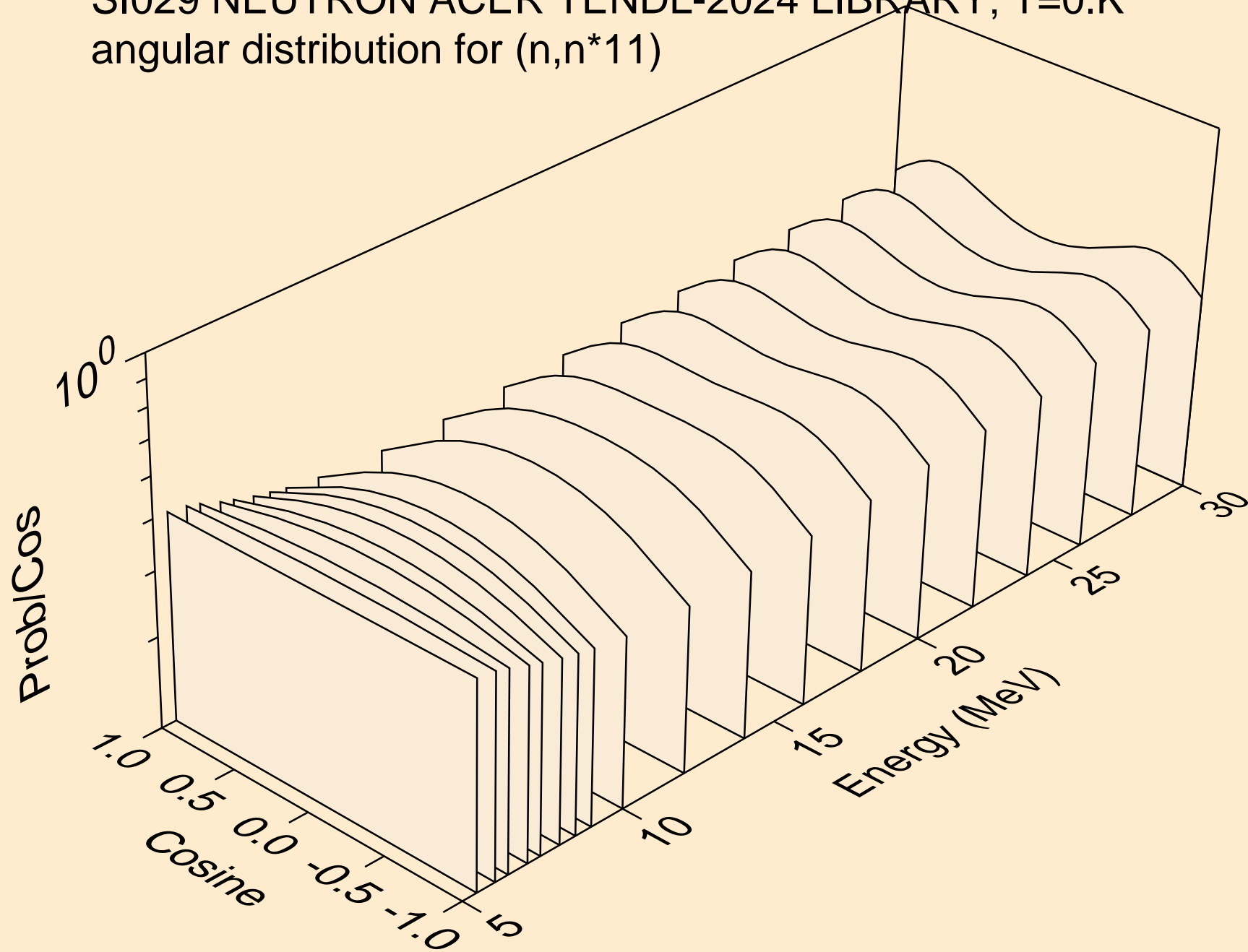

SI029 NEUTRON ACER TENDL-2024 LIBRARY; T=0.K  
angular distribution for (n,n\*12)

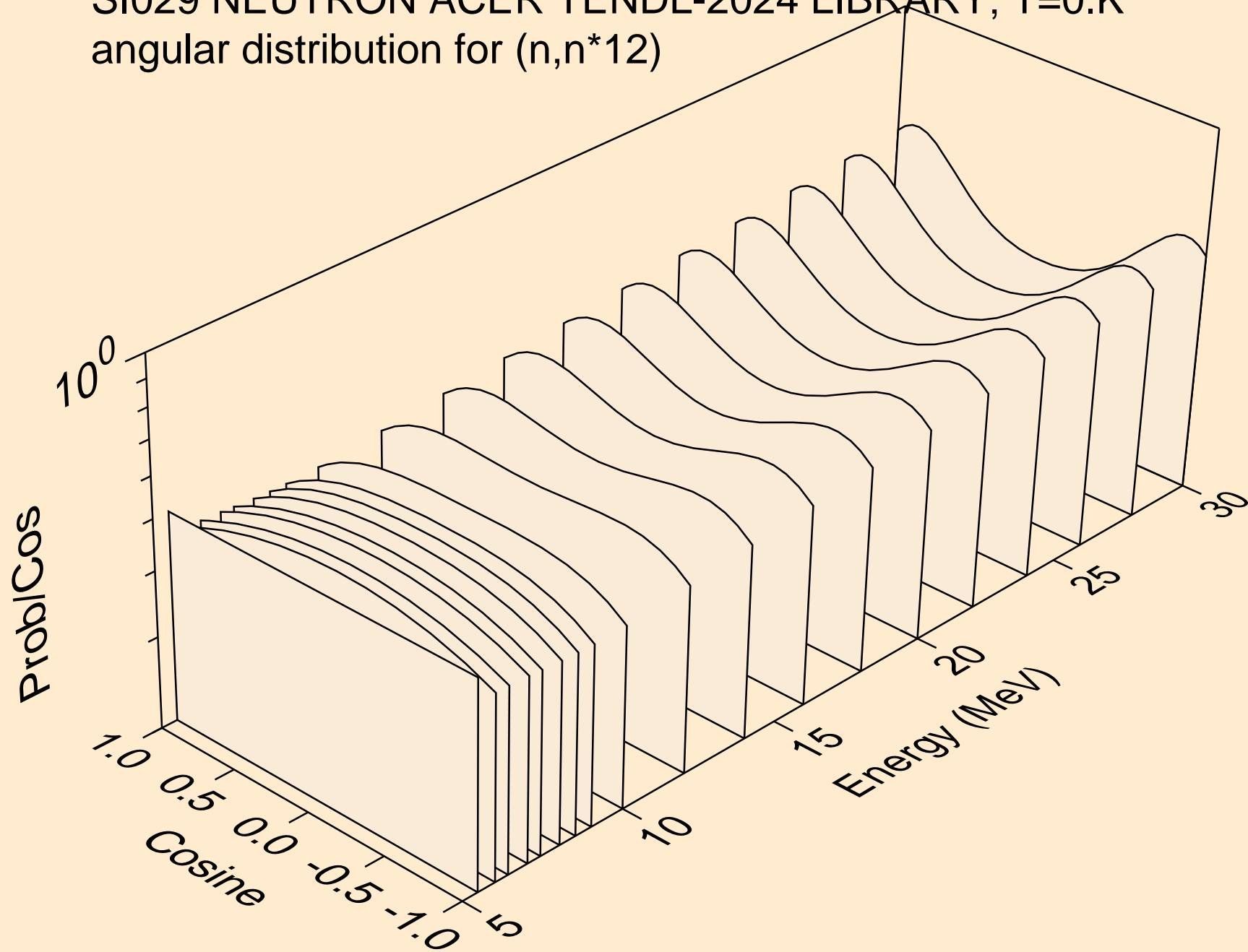



SI029 NEUTRON ACER TENDL-2024 LIBRARY; T=0.K  
angular distribution for (n,n\*13)

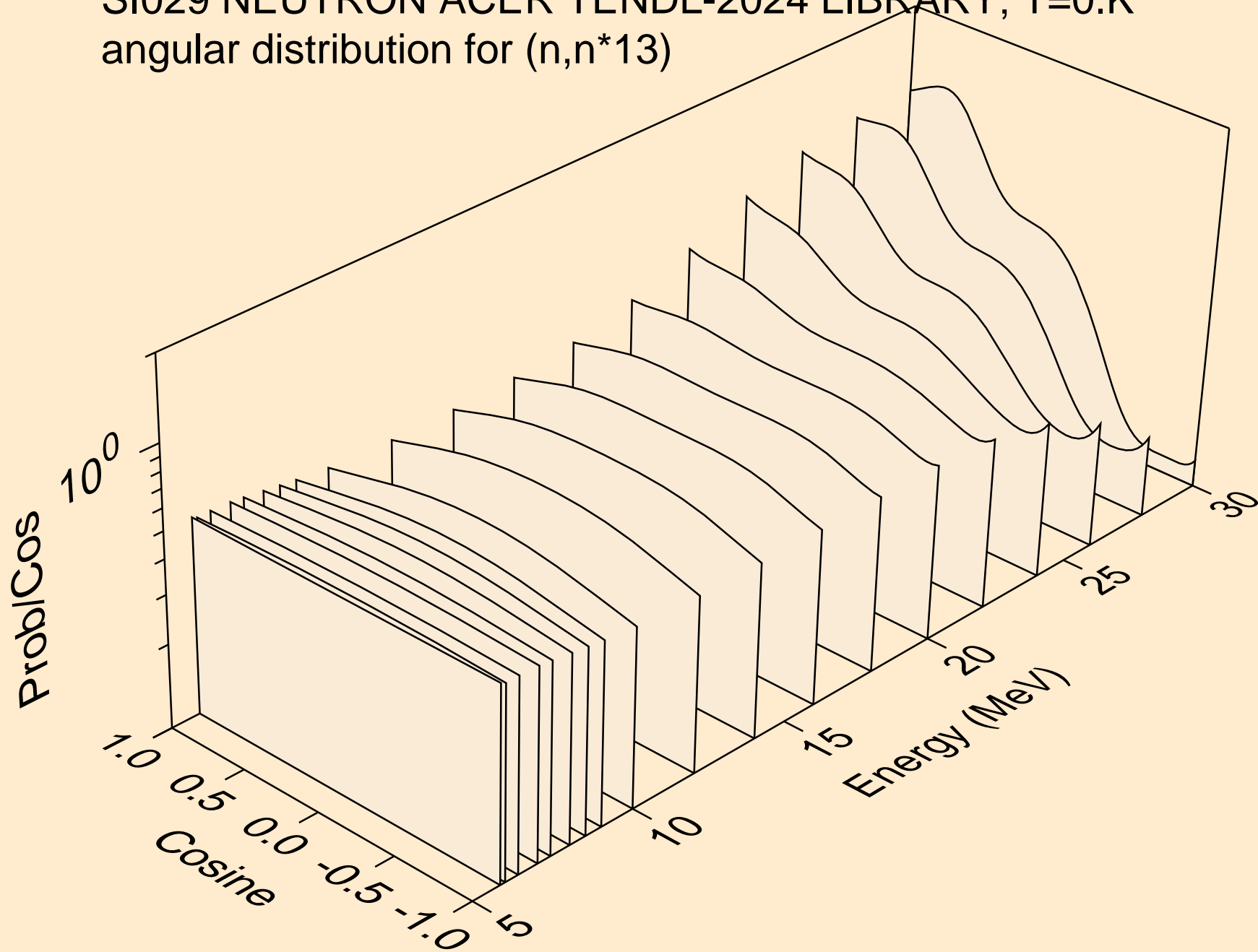

SI029 NEUTRON ACER TENDL-2024 LIBRARY; T=0.K  
angular distribution for (n,n\*14)

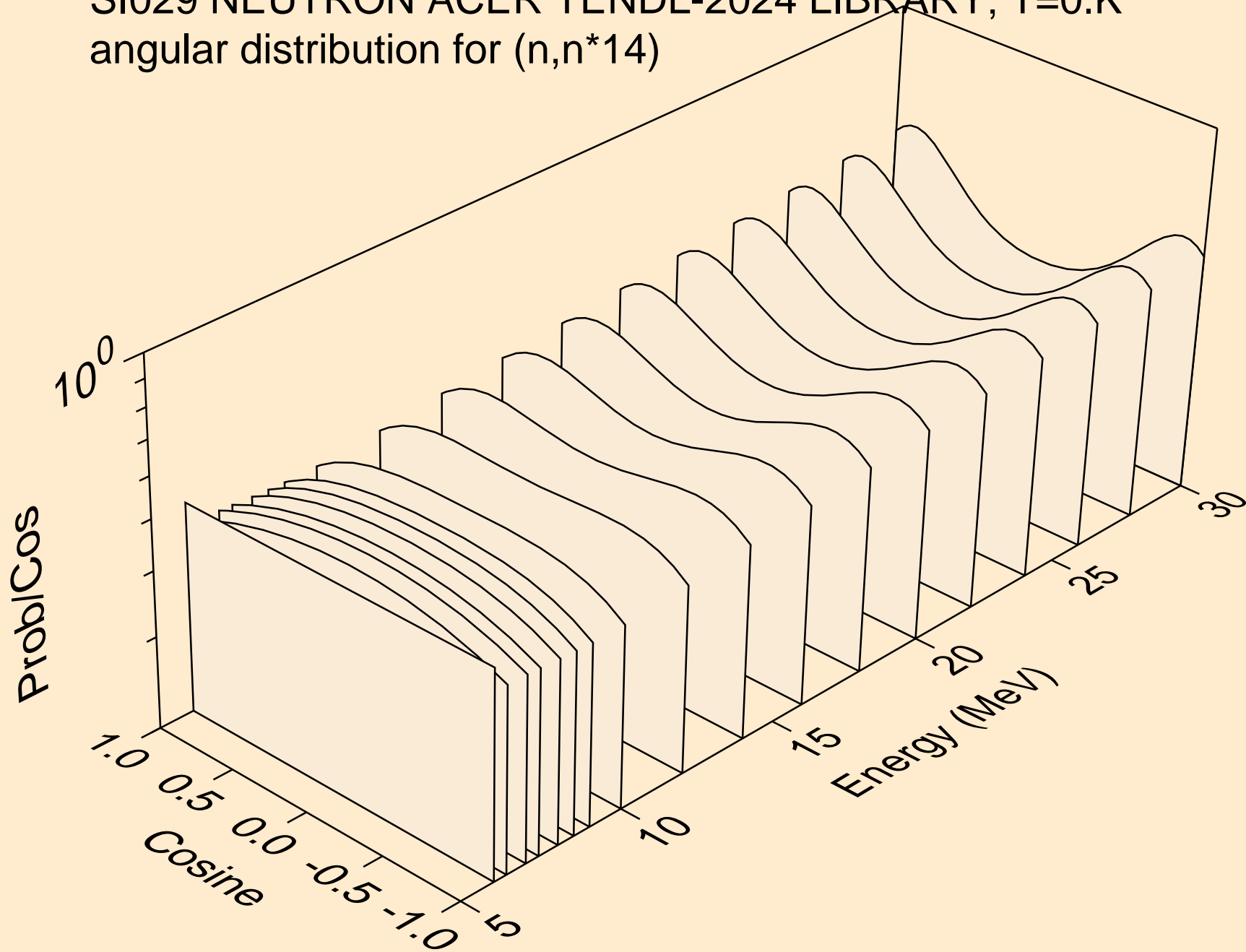

SI029 NEUTRON ACER TENDL-2024 LIBRARY; T=0.K  
angular distribution for (n,n\*15)

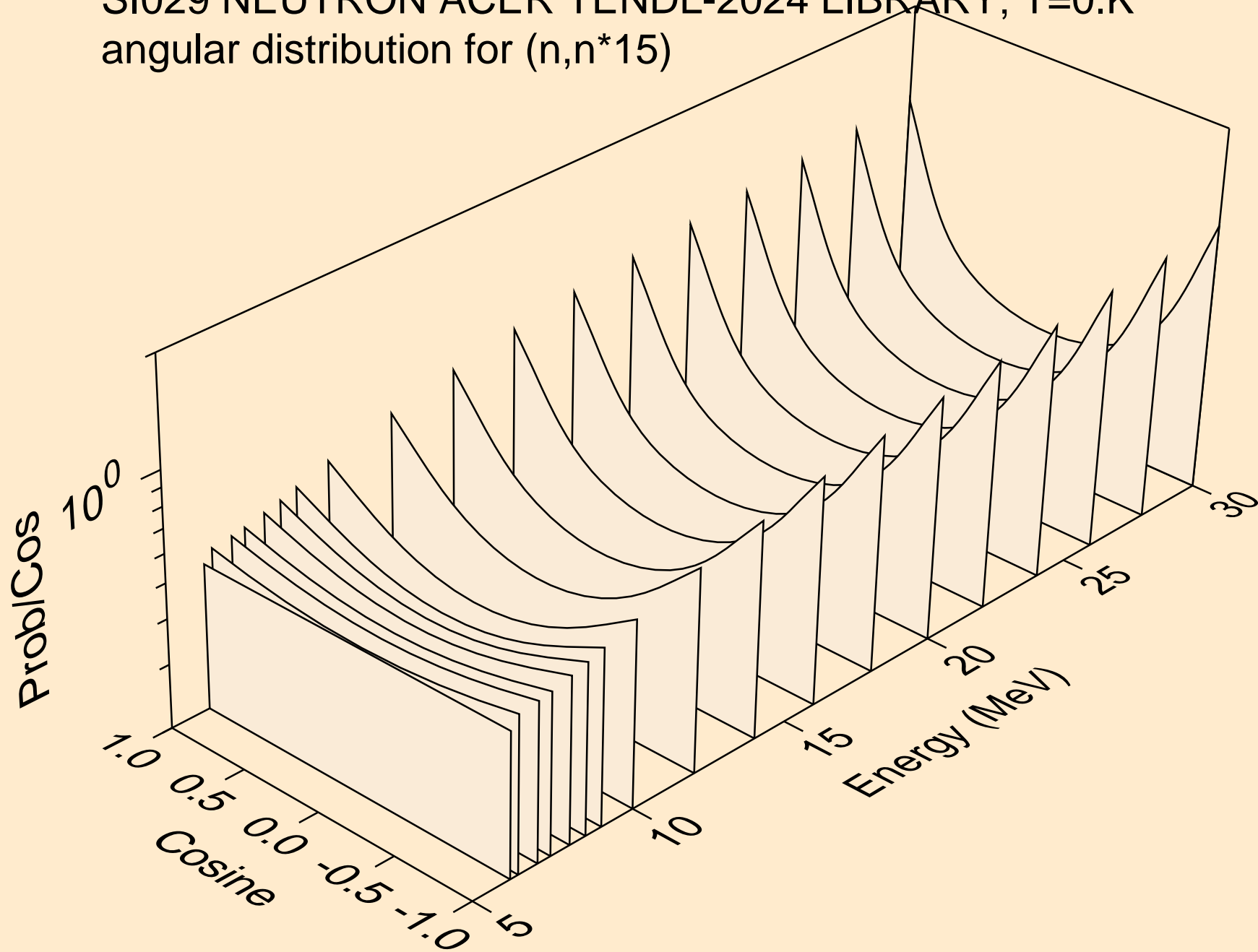

SI029 NEUTRON ACER TENDL-2024 LIBRARY; T=0.K  
angular distribution for (n,n\*16)

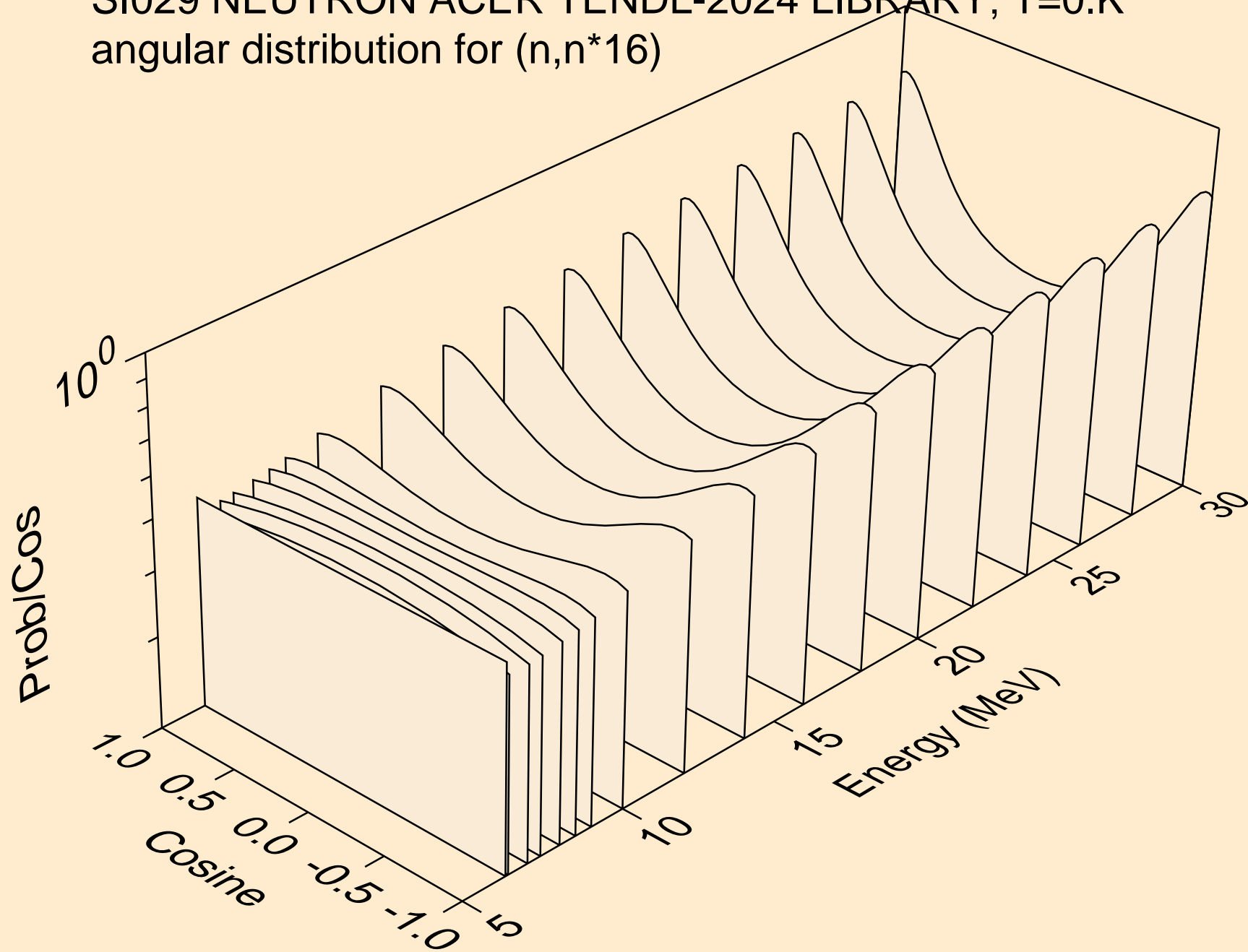

SI029 NEUTRON ACER TENDL-2024 LIBRARY; T=0.K  
angular distribution for (n,n\*17)

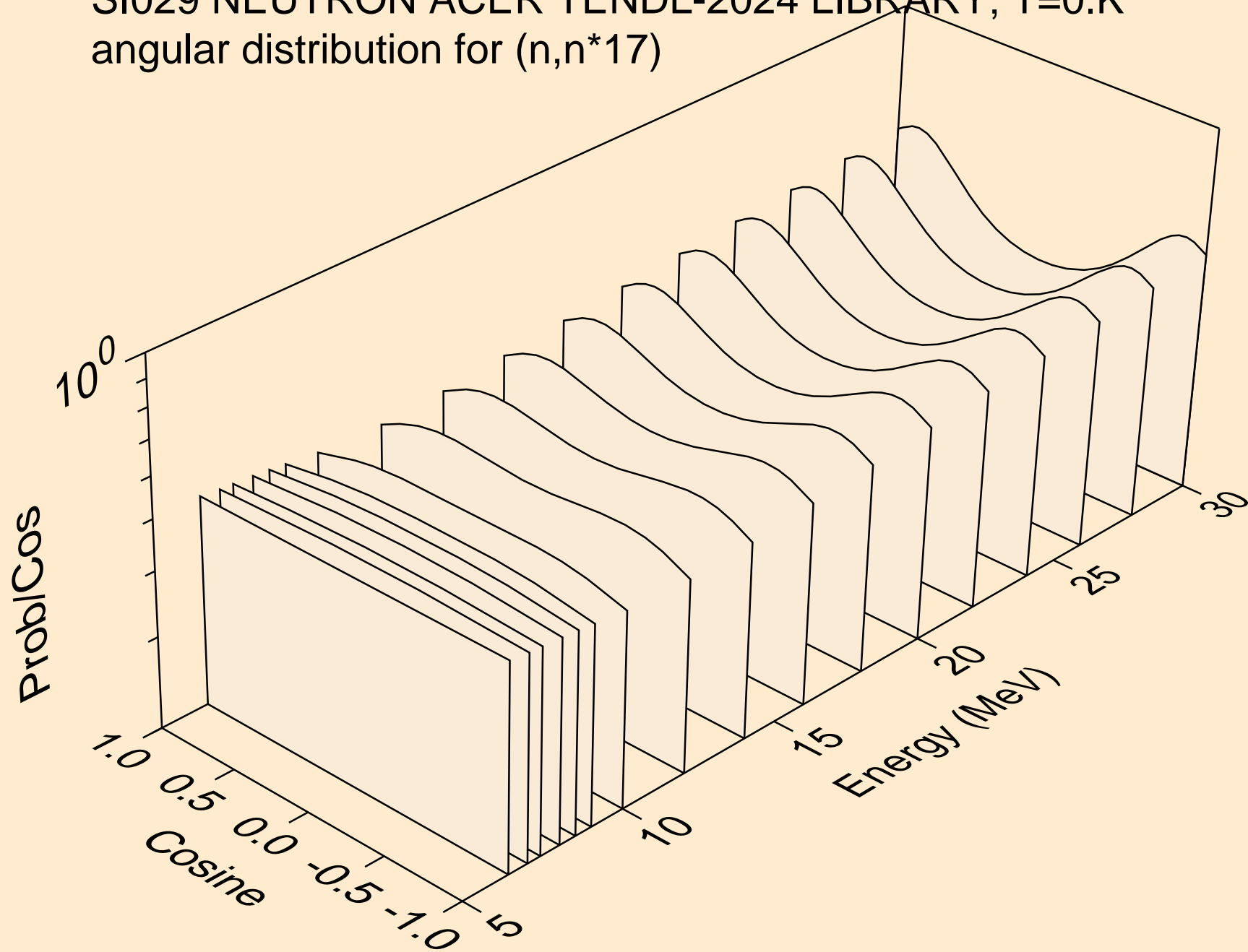

SI029 NEUTRON ACER TENDL-2024 LIBRARY; T=0.K  
angular distribution for (n,n\*18)

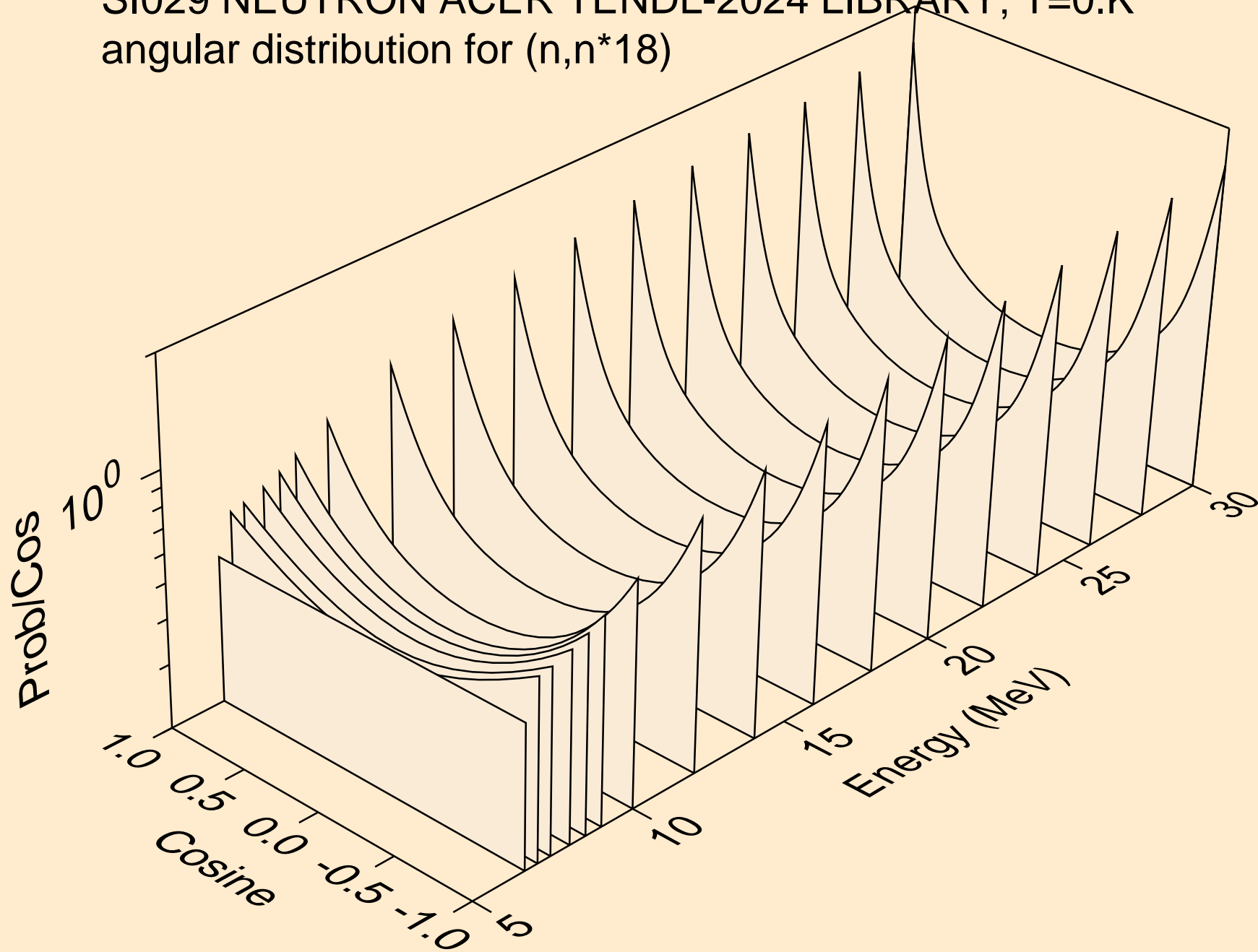

SI029 NEUTRON ACER TENDL-2024 LIBRARY; T=0.K  
angular distribution for (n,n\*19)

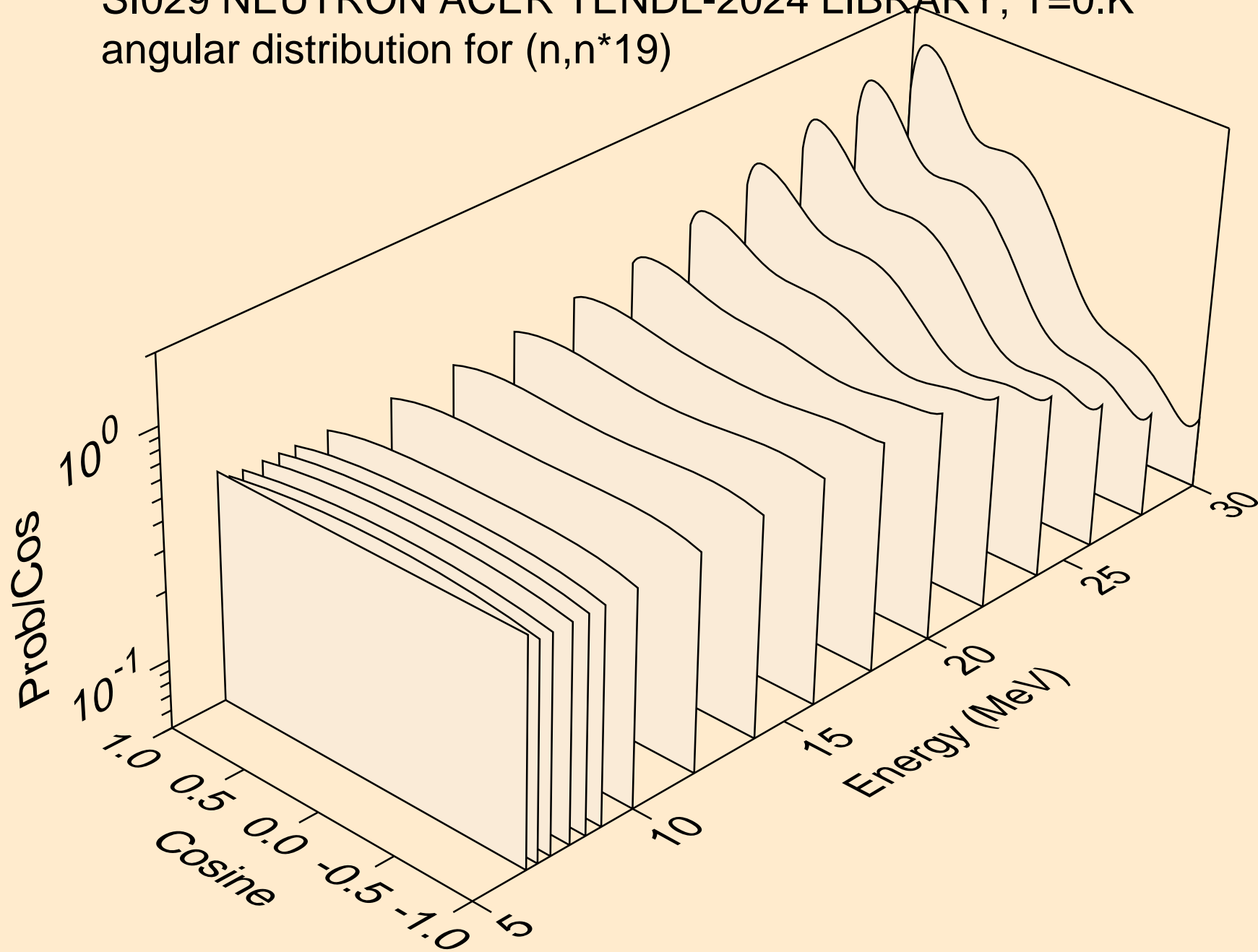

SI029 NEUTRON ACER TENDL-2024 LIBRARY; T=0.K  
angular distribution for (n,n\*20)

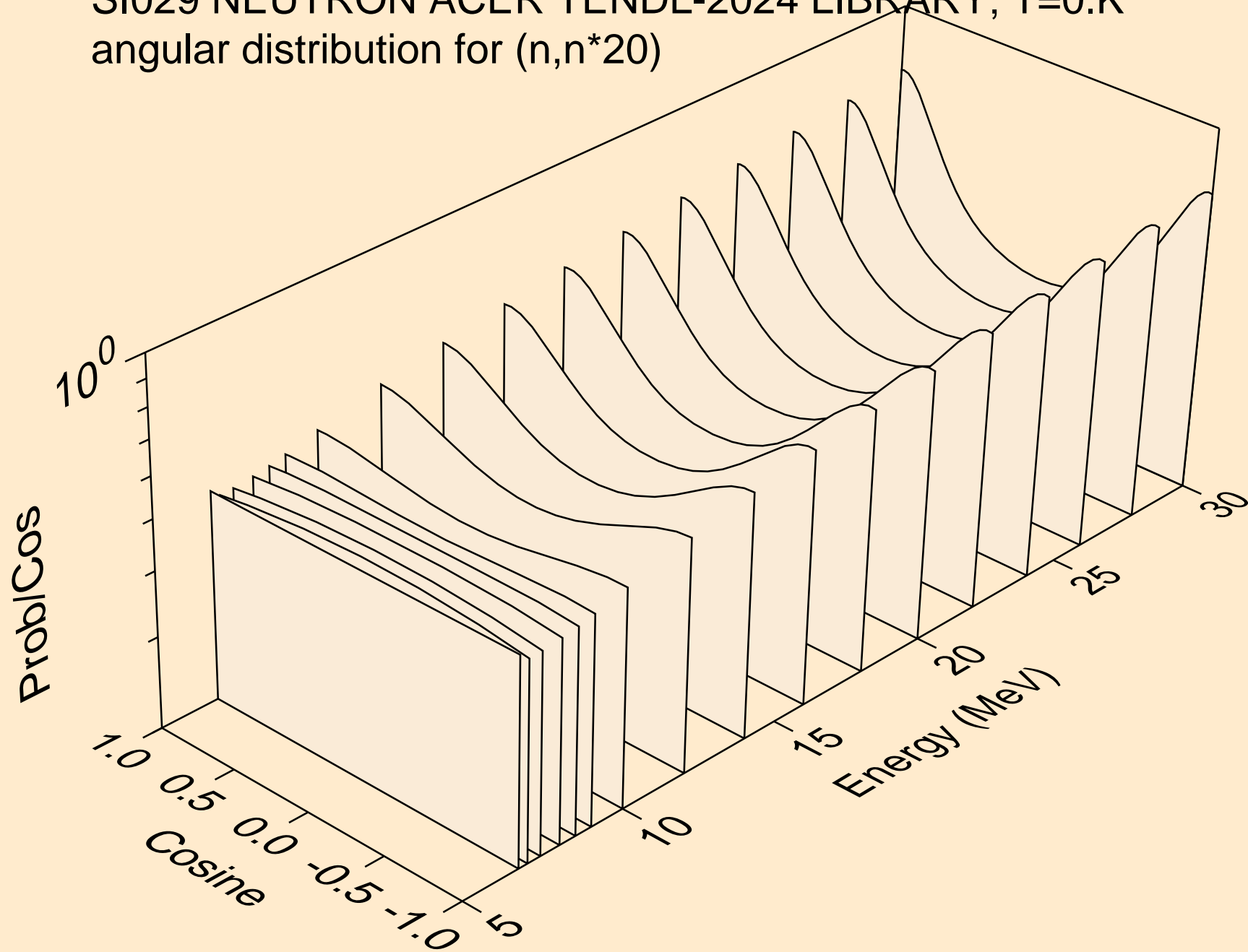



SI029 NEUTRON ACER TENDL-2024 LIBRARY; T=0.K  
angular distribution for (n,n\*21)

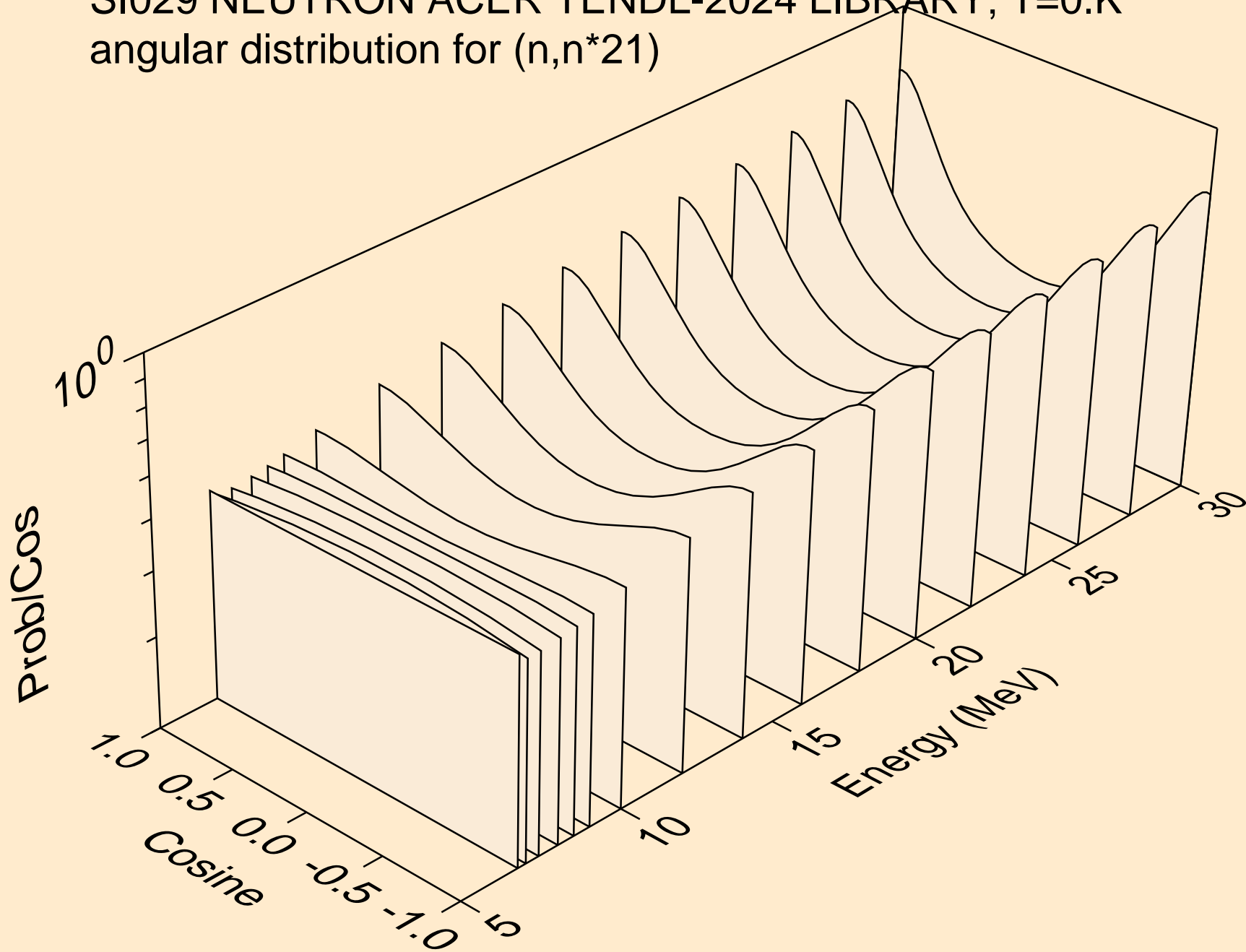

SI029 NEUTRON ACER TENDL-2024 LIBRARY; T=0.K  
angular distribution for (n,n\*22)

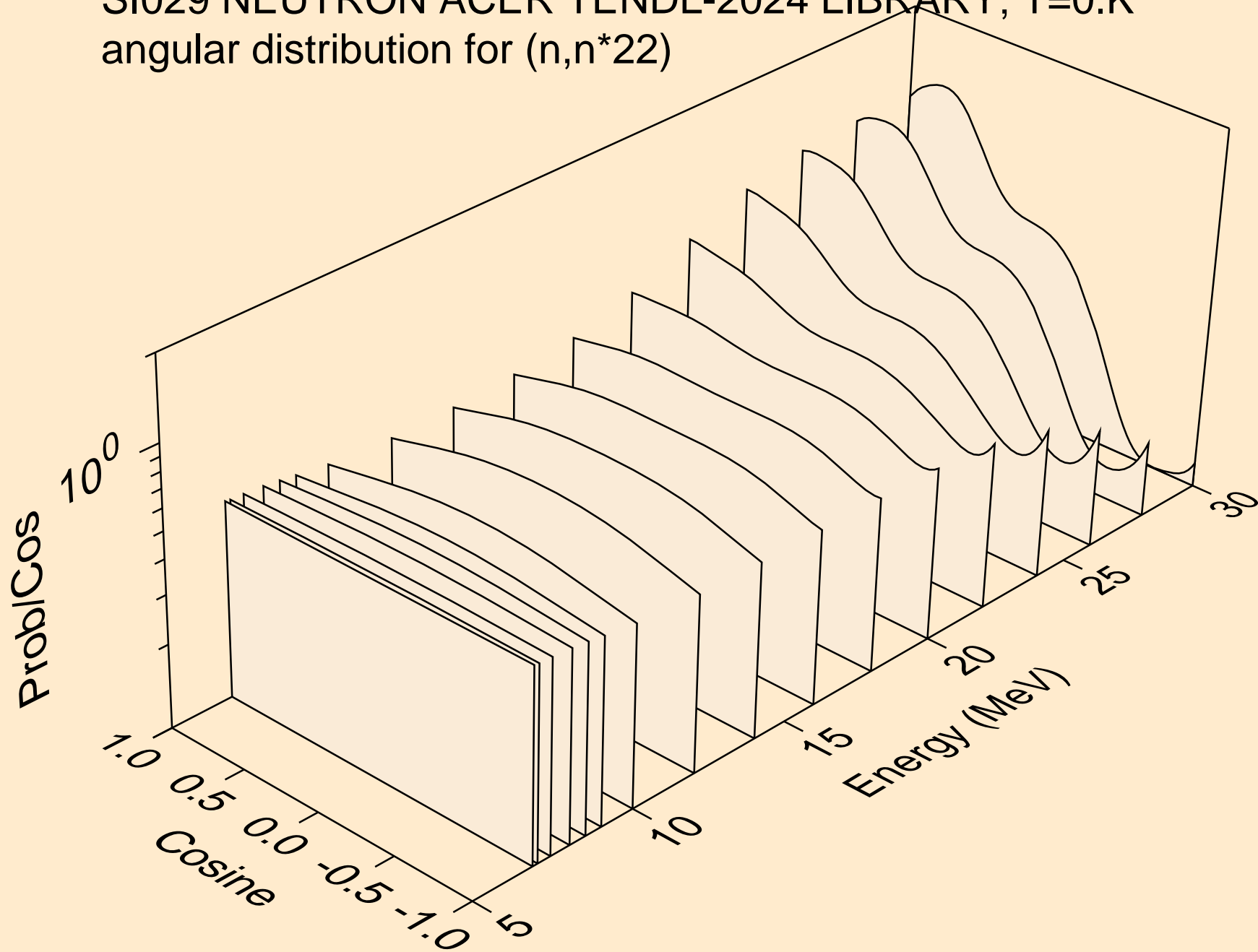

SI029 NEUTRON ACER TENDL-2024 LIBRARY; T=0.K  
angular distribution for (n,n\*23)

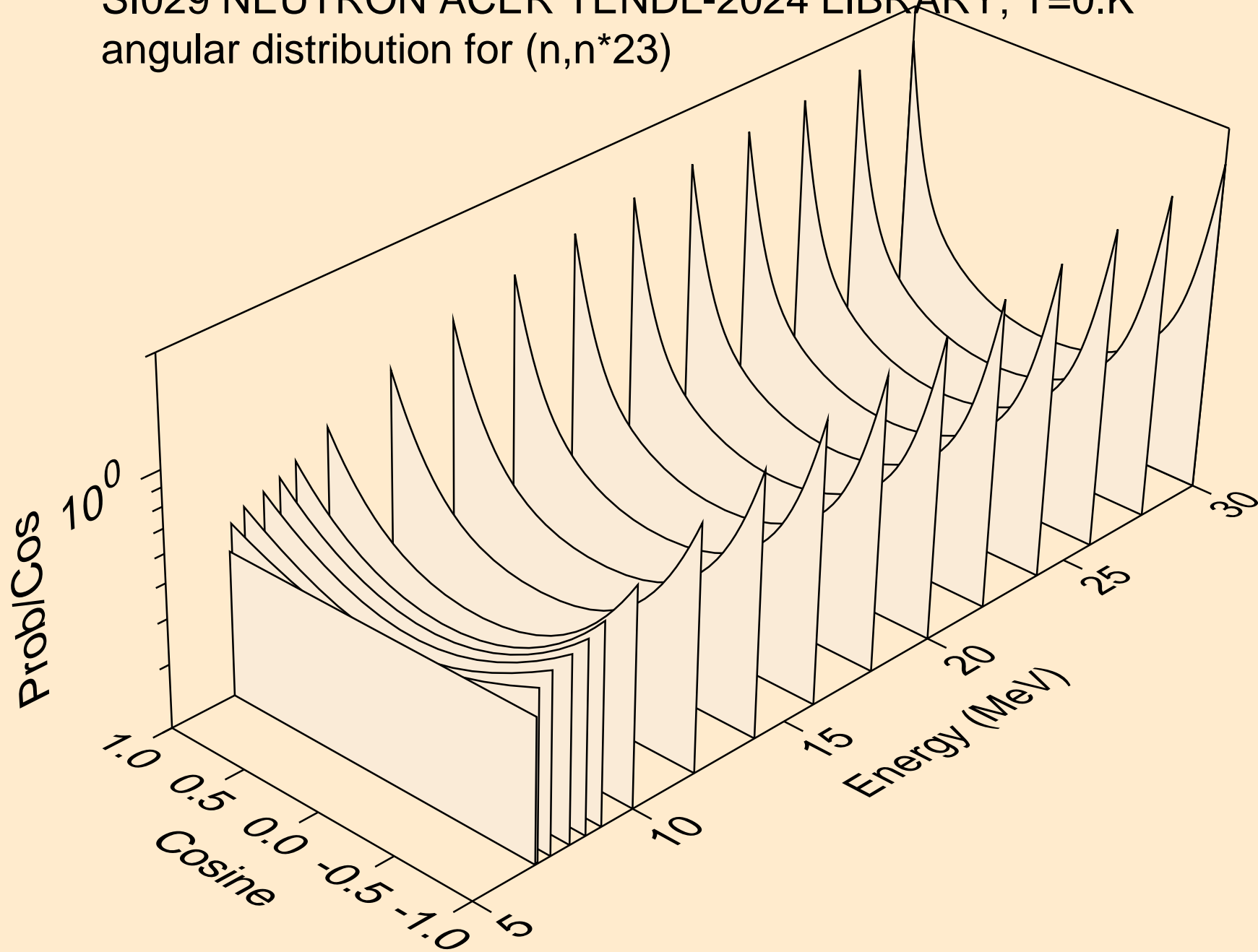

SI029 NEUTRON ACER TENDL-2024 LIBRARY; T=0.K  
angular distribution for (n,n\*24)

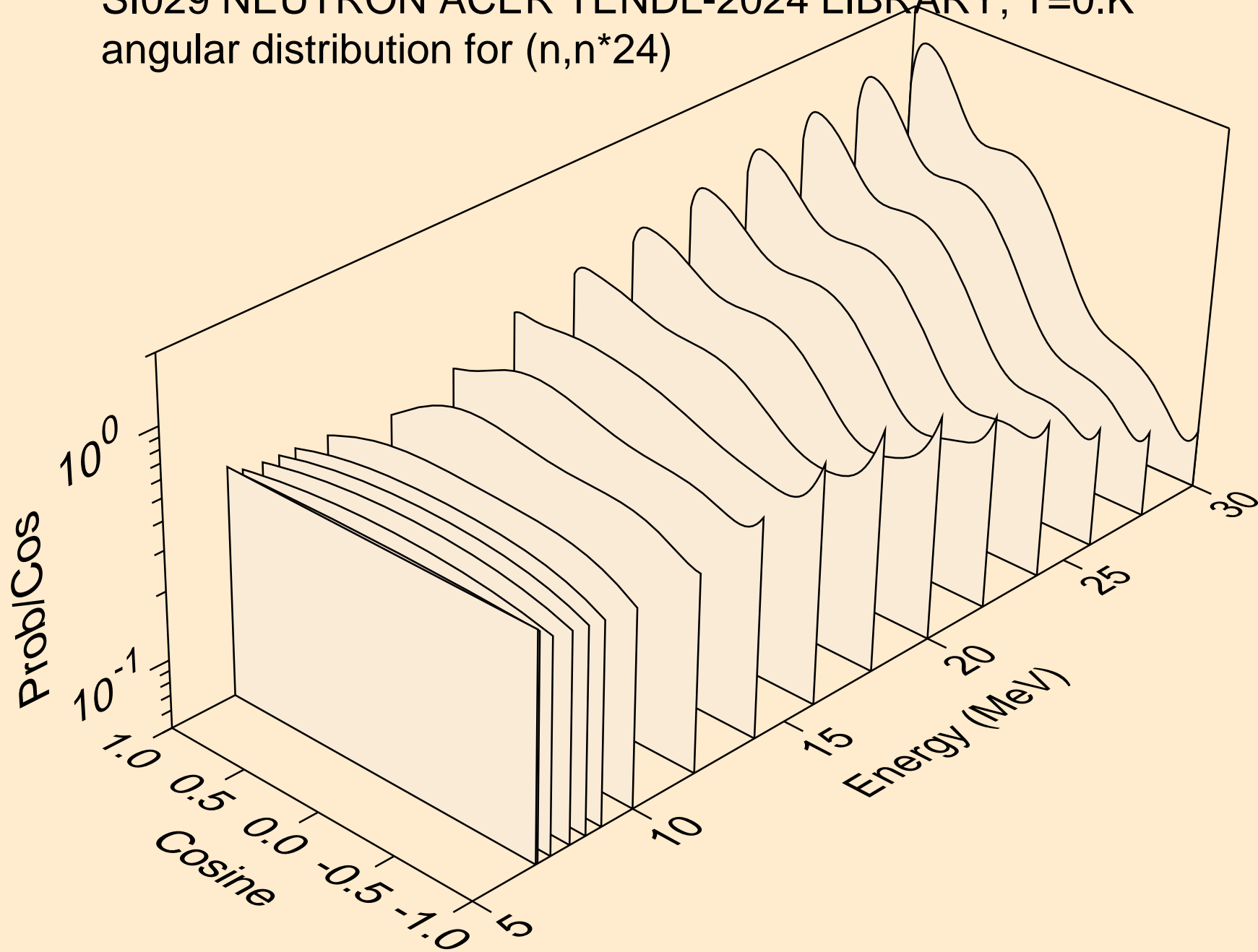

SI029 NEUTRON ACER TENDL-2024 LIBRARY; T=0.K  
angular distribution for (n,n\*25)

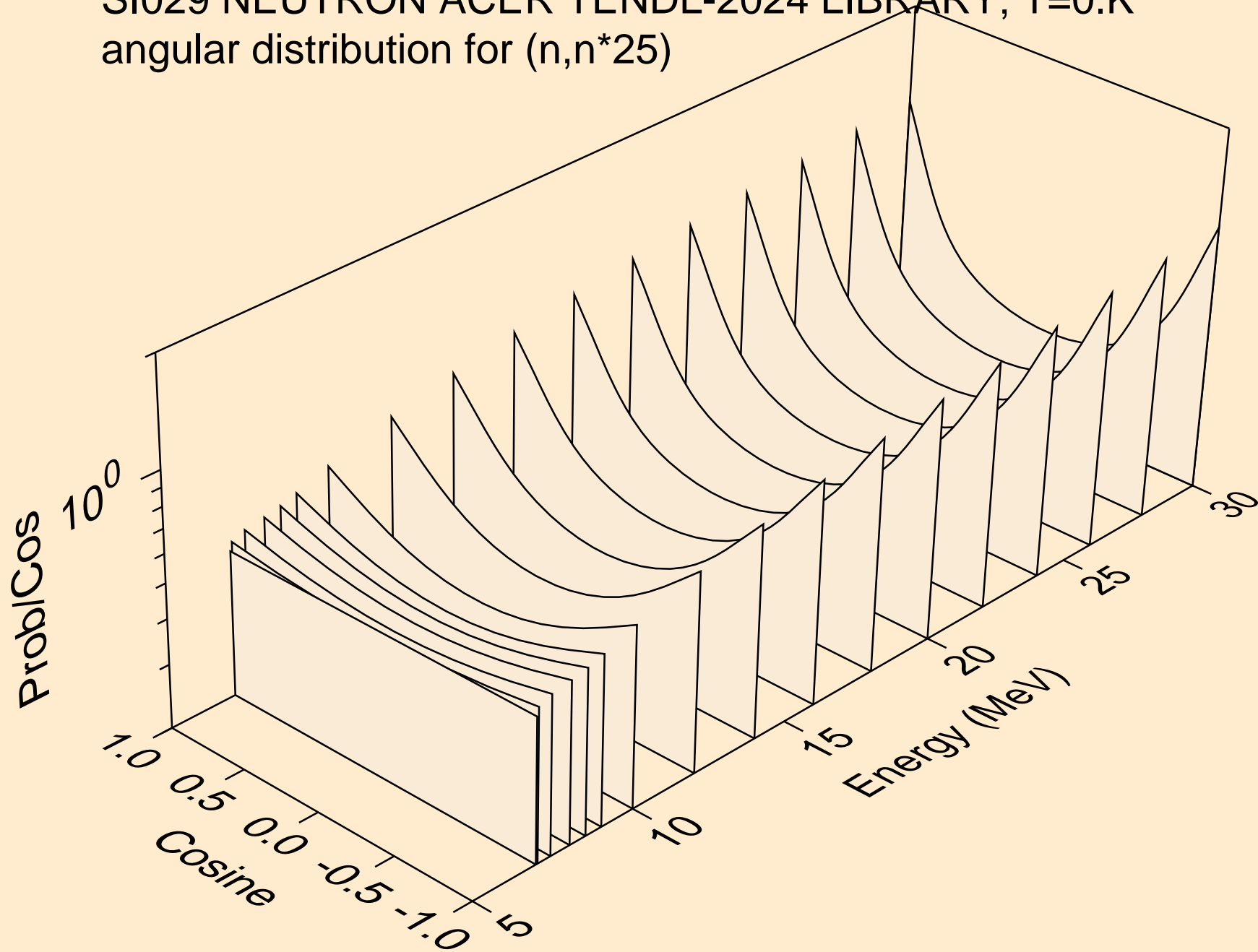

SI029 NEUTRON ACER TENDL-2024 LIBRARY; T=0.K  
angular distribution for (n,n\*26)

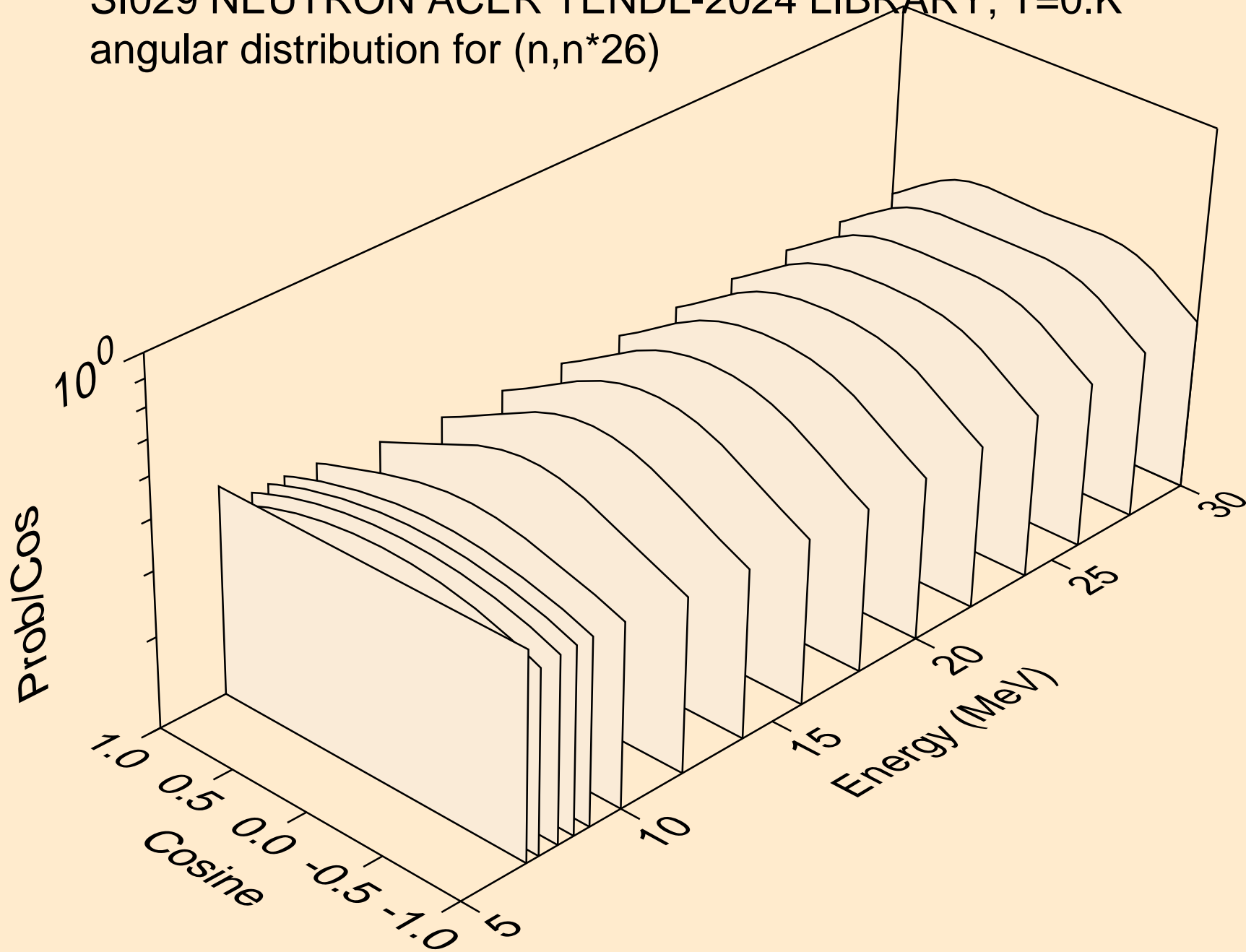

SI029 NEUTRON ACER TENDL-2024 LIBRARY; T=0.K  
angular distribution for (n,n\*27)

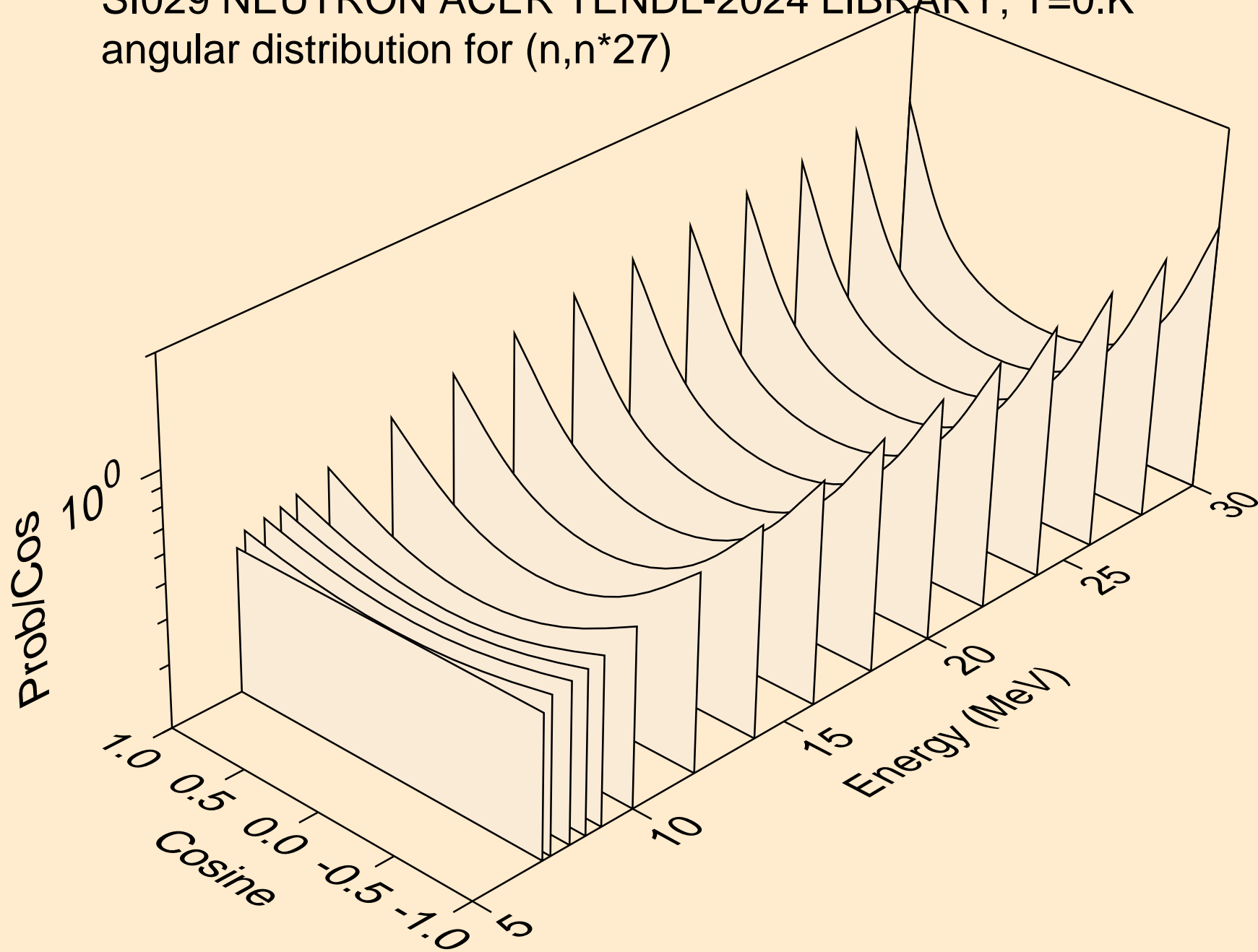

SI029 NEUTRON ACER TENDL-2024 LIBRARY; T=0.K  
angular distribution for (n,n\*28)

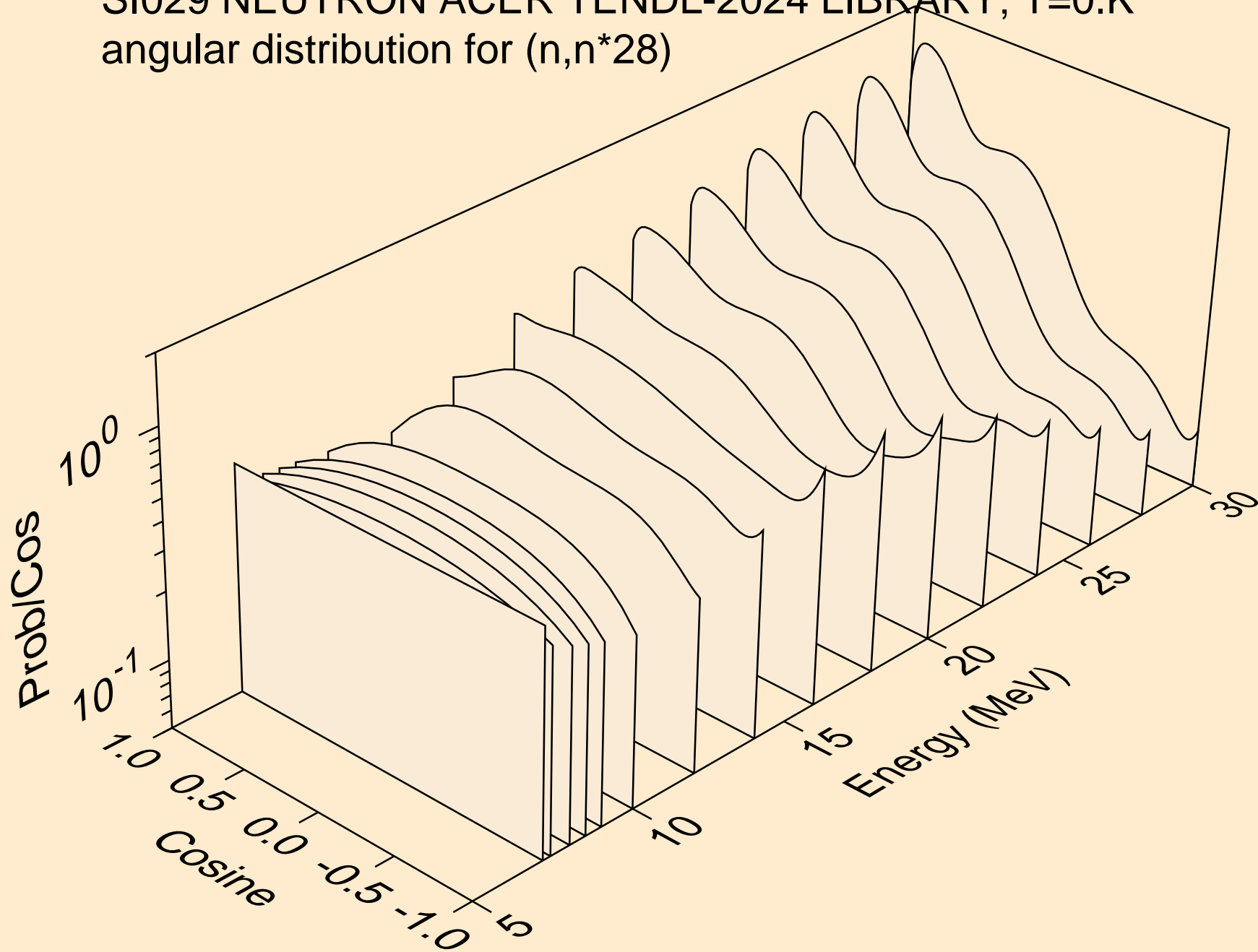



SI029 NEUTRON ACER TENDL-2024 LIBRARY; T=0.K  
angular distribution for (n,n\*29)

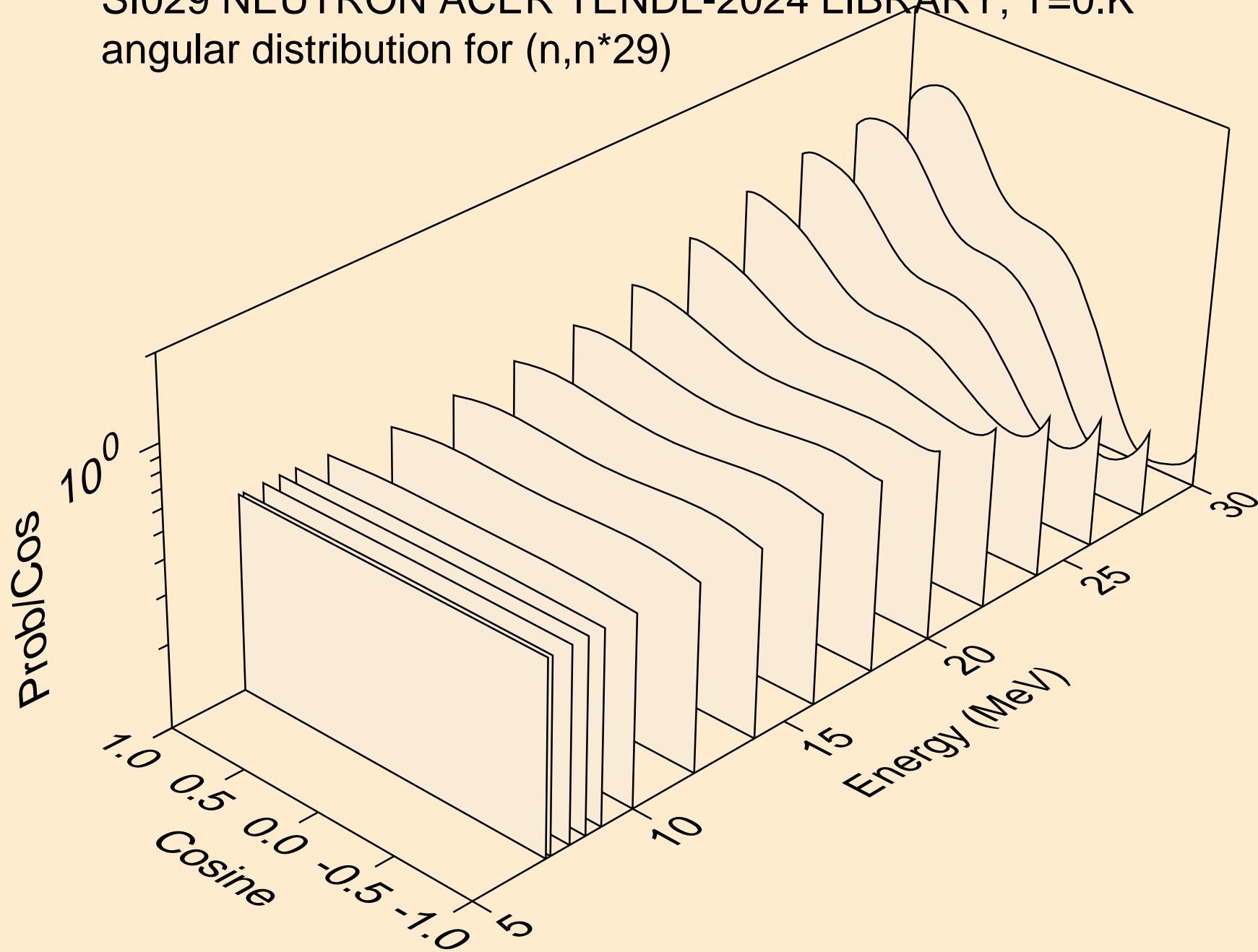

SI029 NEUTRON ACER TENDL-2024 LIBRARY; T=0.K  
Neutron emission for (n,x)

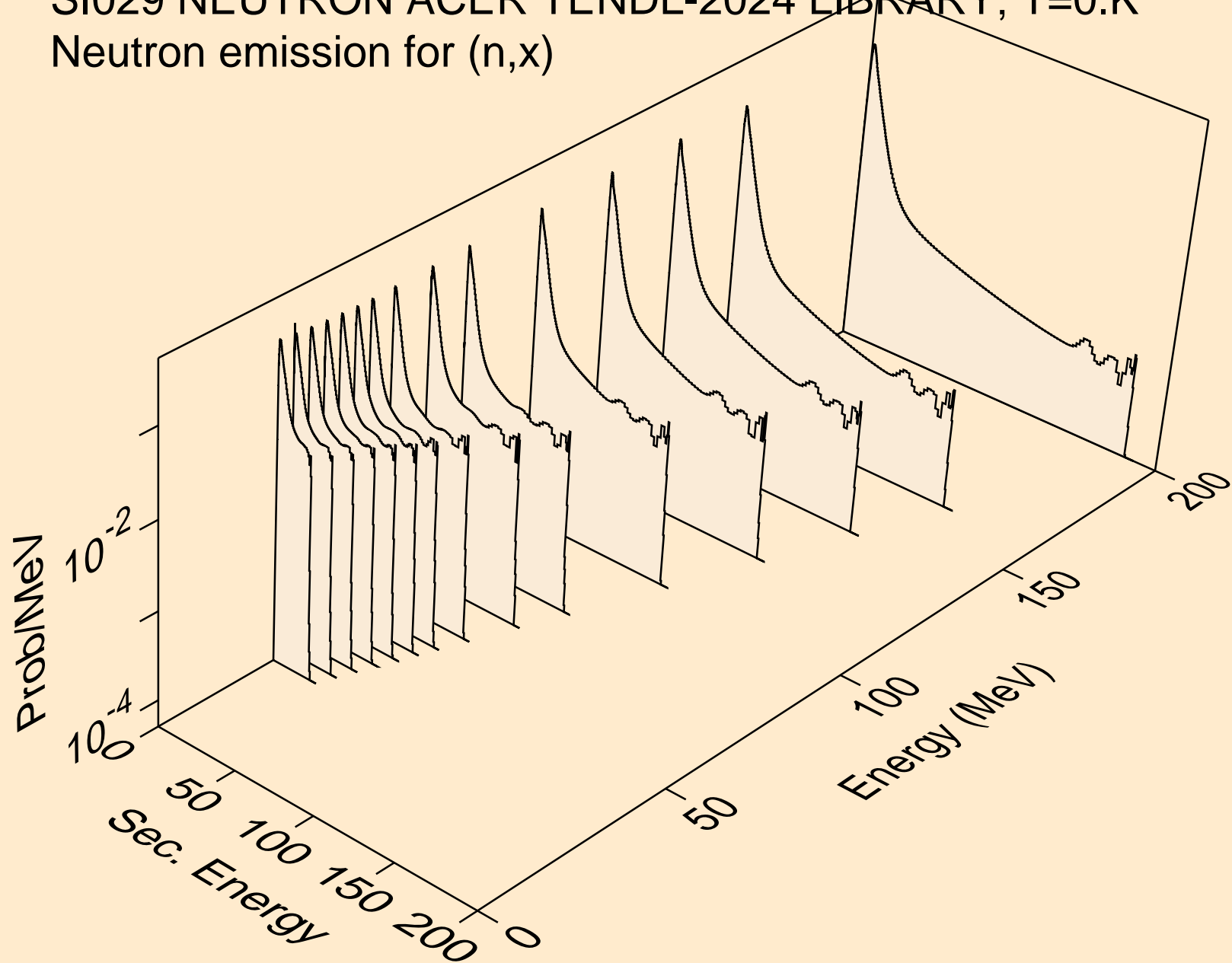

SI029 NEUTRON ACER TENDL-2024 LIBRARY; T=0.K  
Neutron emission for (n,2n)

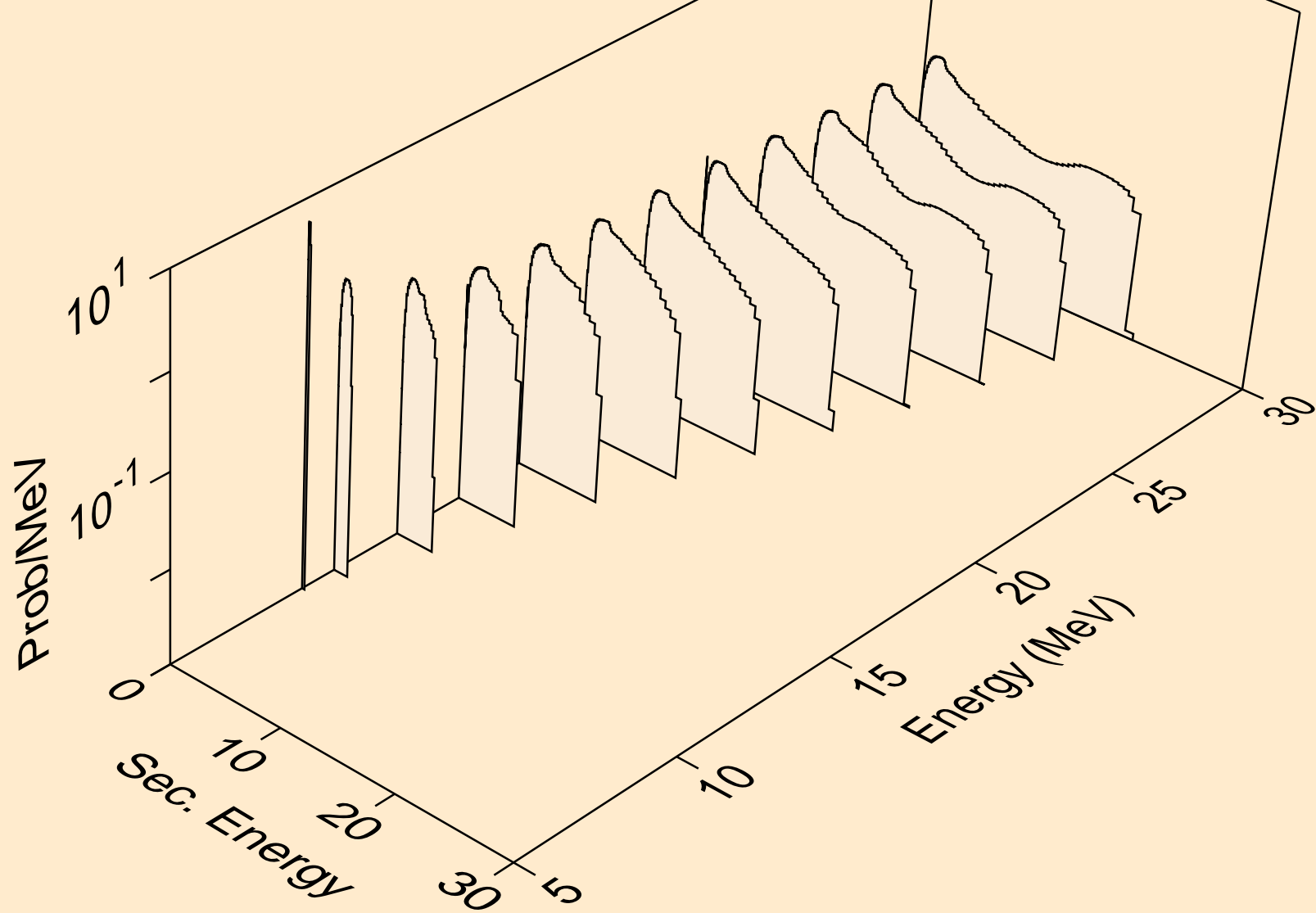

SI029 NEUTRON ACER TENDL-2024 LIBRARY; T=0.K  
Neutron emission for (n,3n)

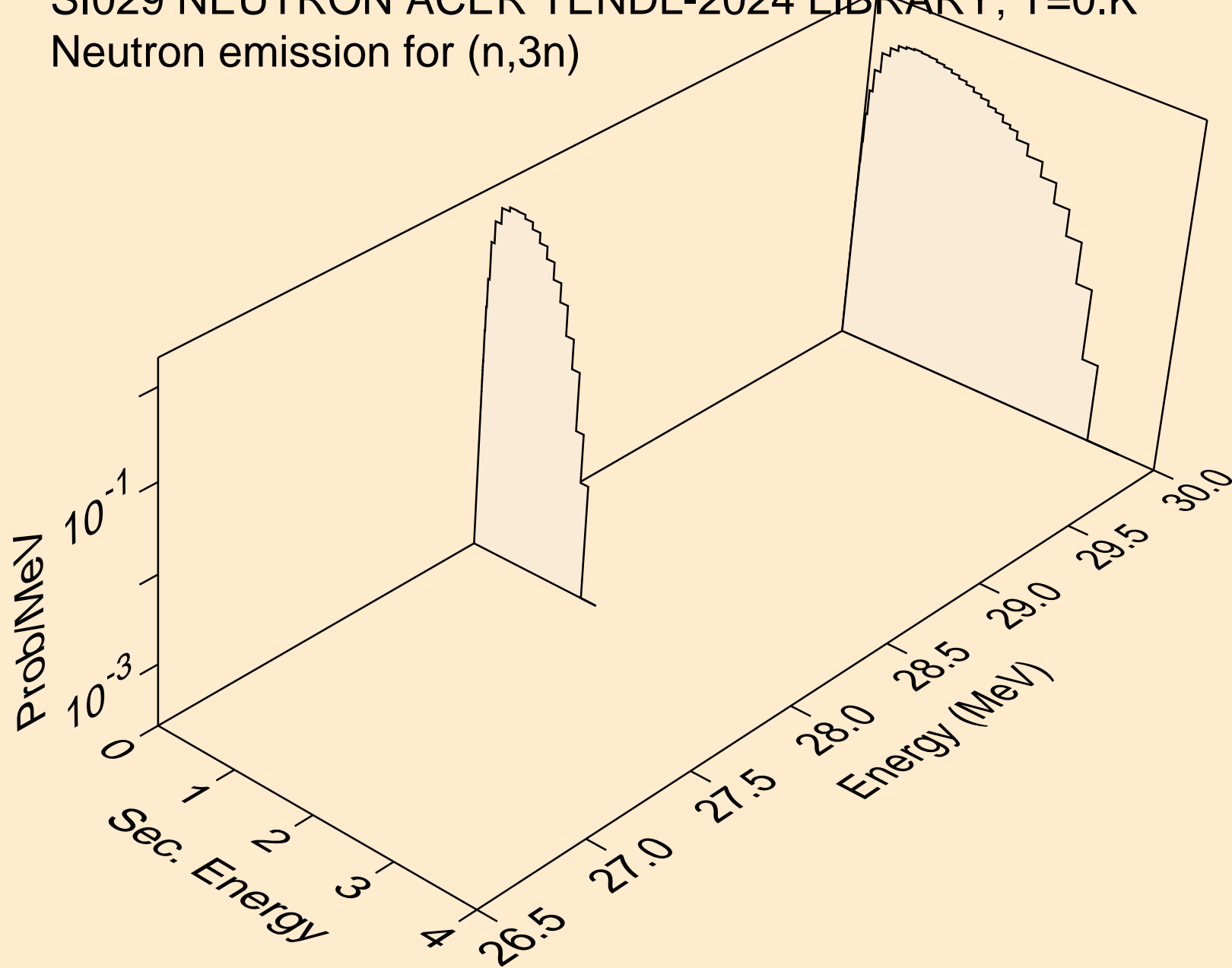

SI029 NEUTRON ACER TENDL-2024 LIBRARY; T=0.K  
Neutron emission for (n,n\*)a

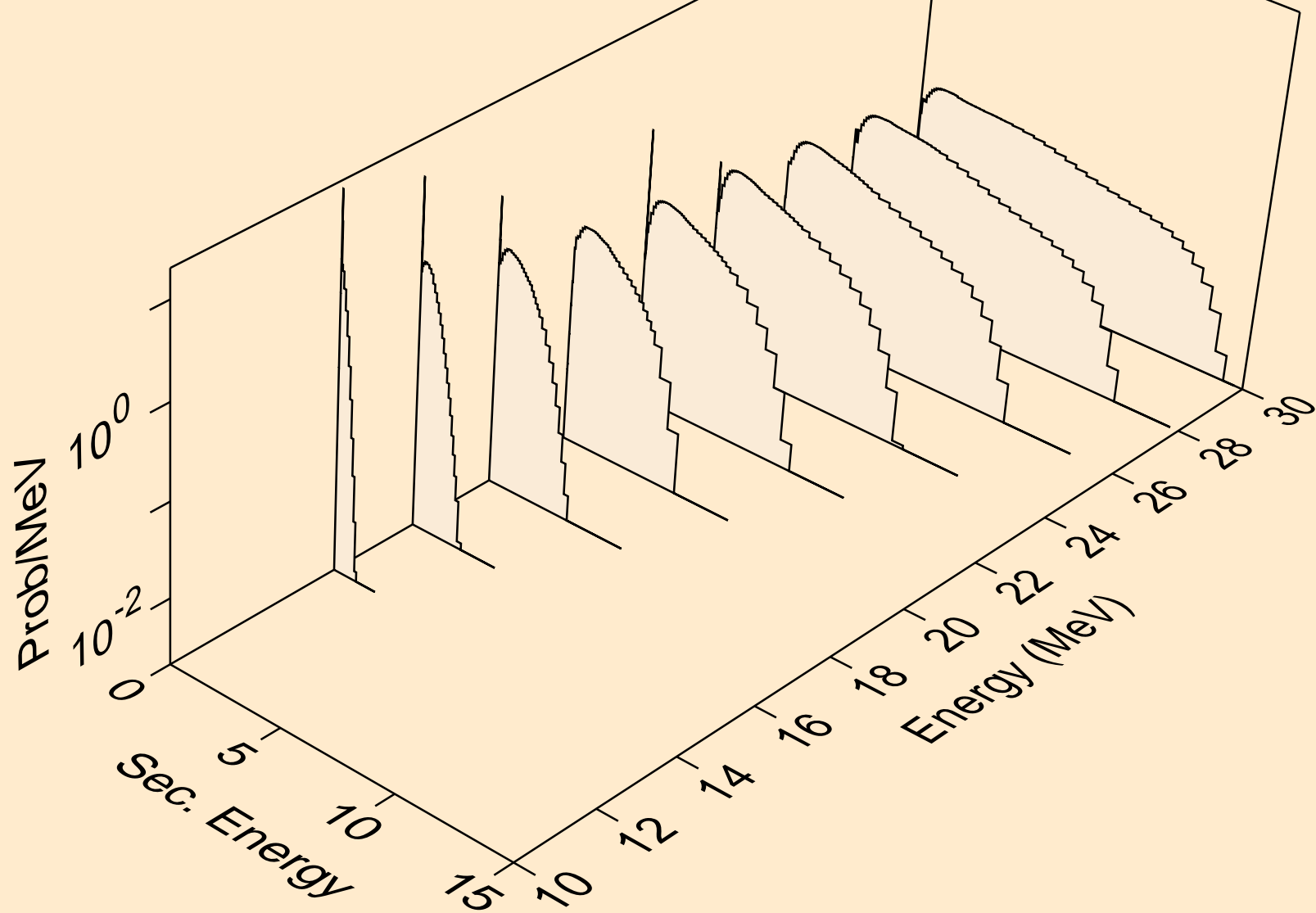

SI029 NEUTRON ACER TENDL-2024 LIBRARY; T=0.K  
Neutron emission for (n,2n)a

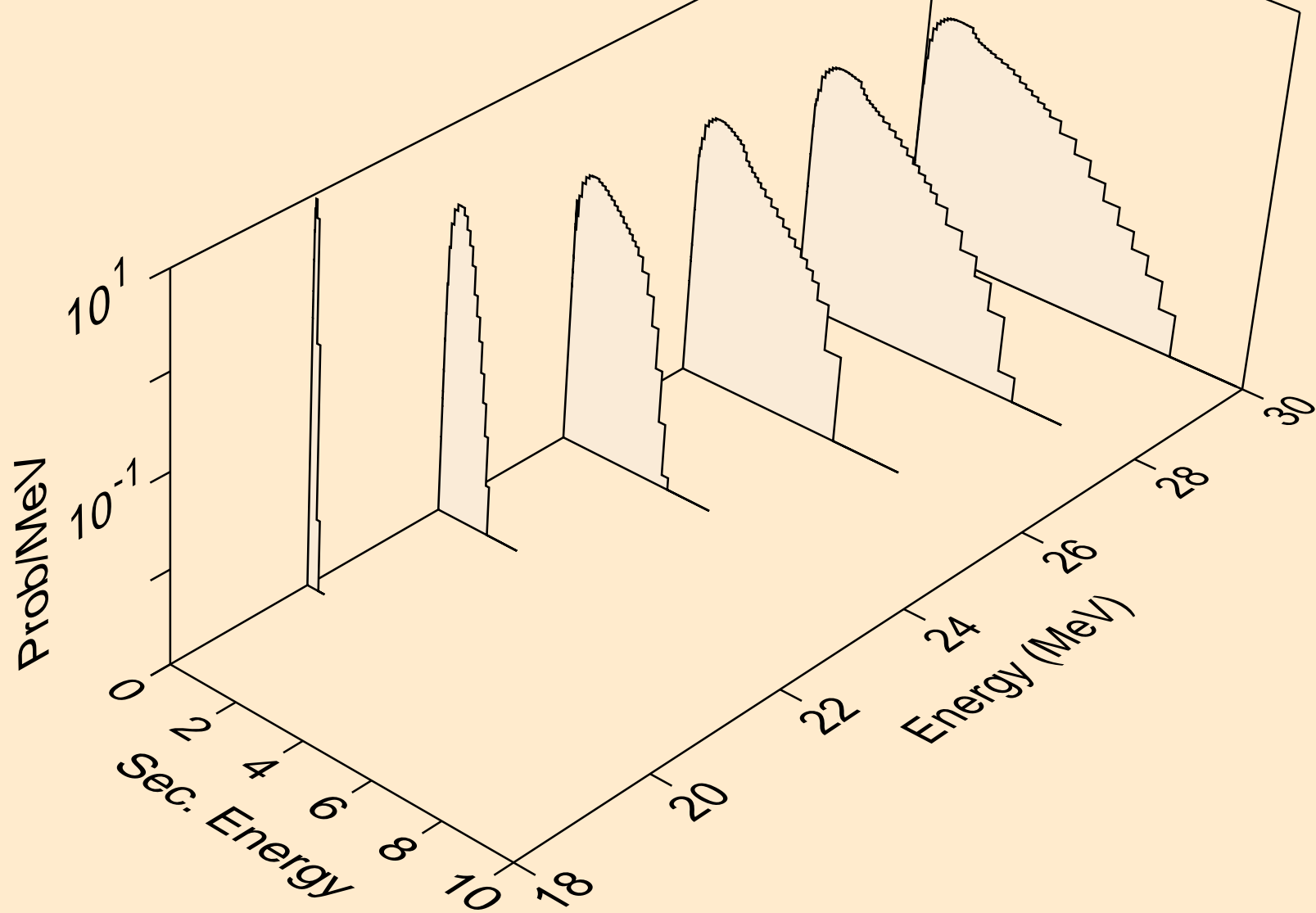

SI029 NEUTRON ACER TENDL-2024 LIBRARY; T=0.K  
Neutron emission for (n,n\*)p

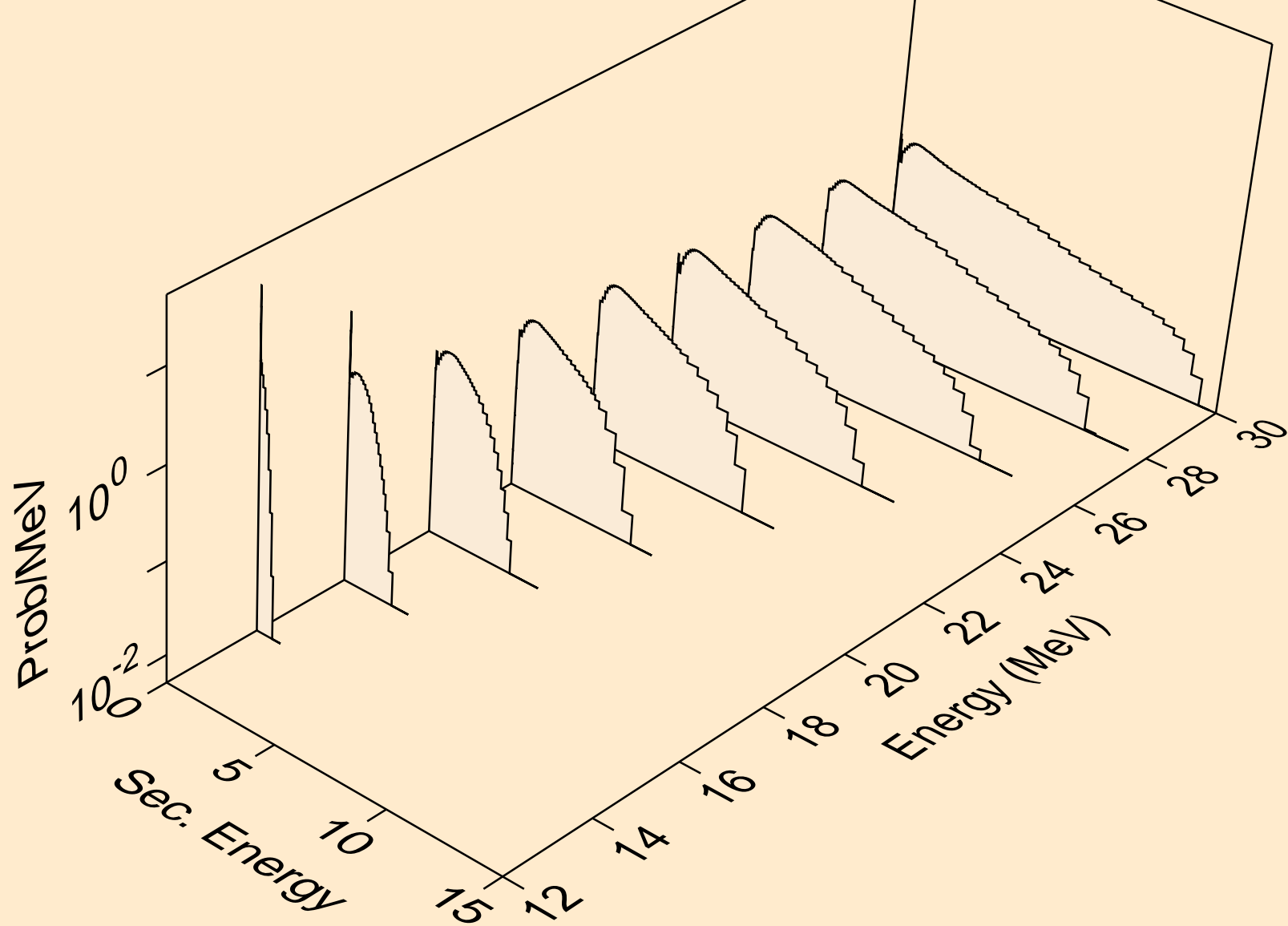

SI029 NEUTRON ACER TENDL-2024 LIBRARY; T=0.K  
Neutron emission for (n,n\*)2a

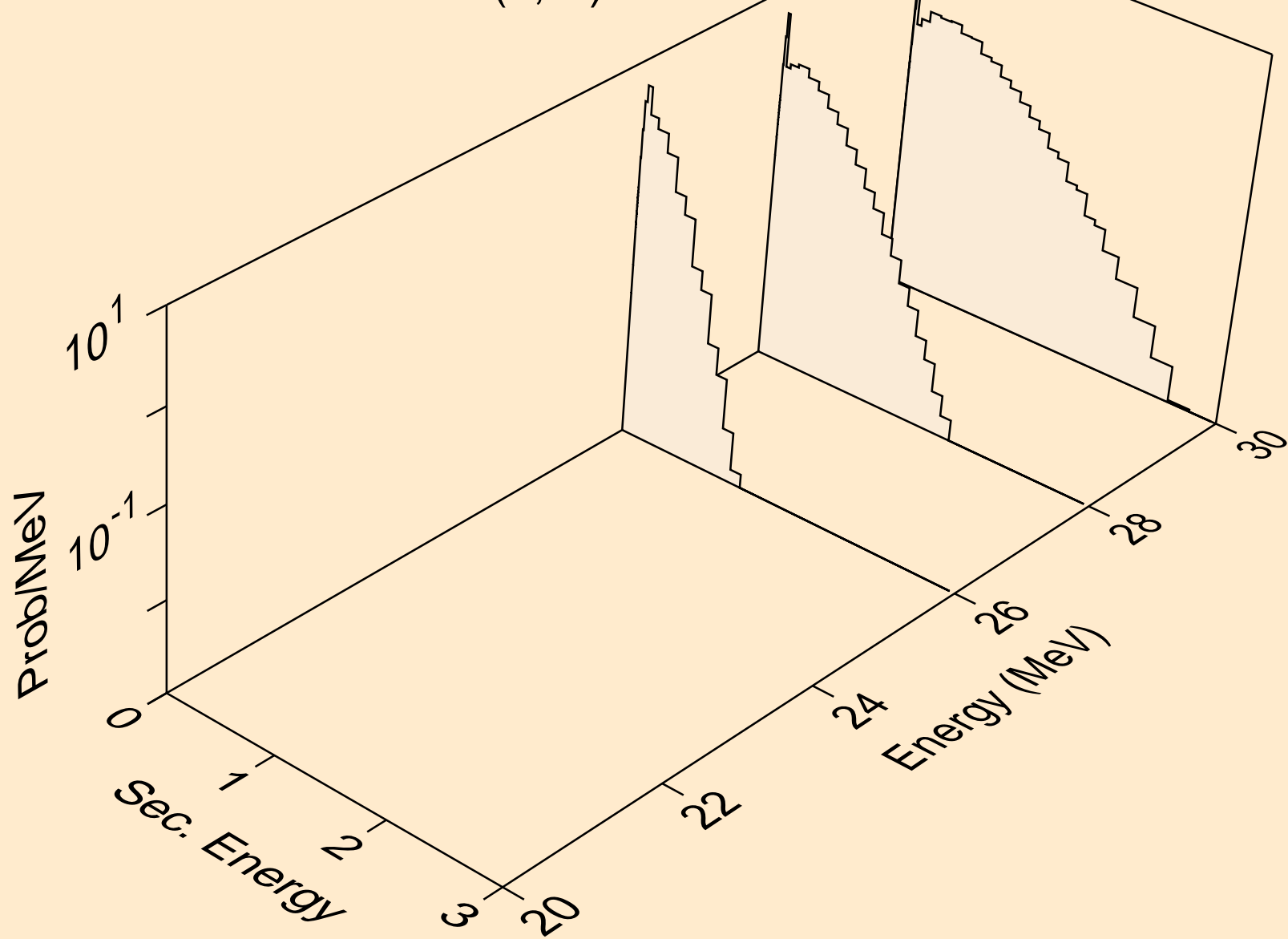



SI029 NEUTRON ACER TENDL-2024 LIBRARY; T=0.K  
Neutron emission for (n,n\*)d

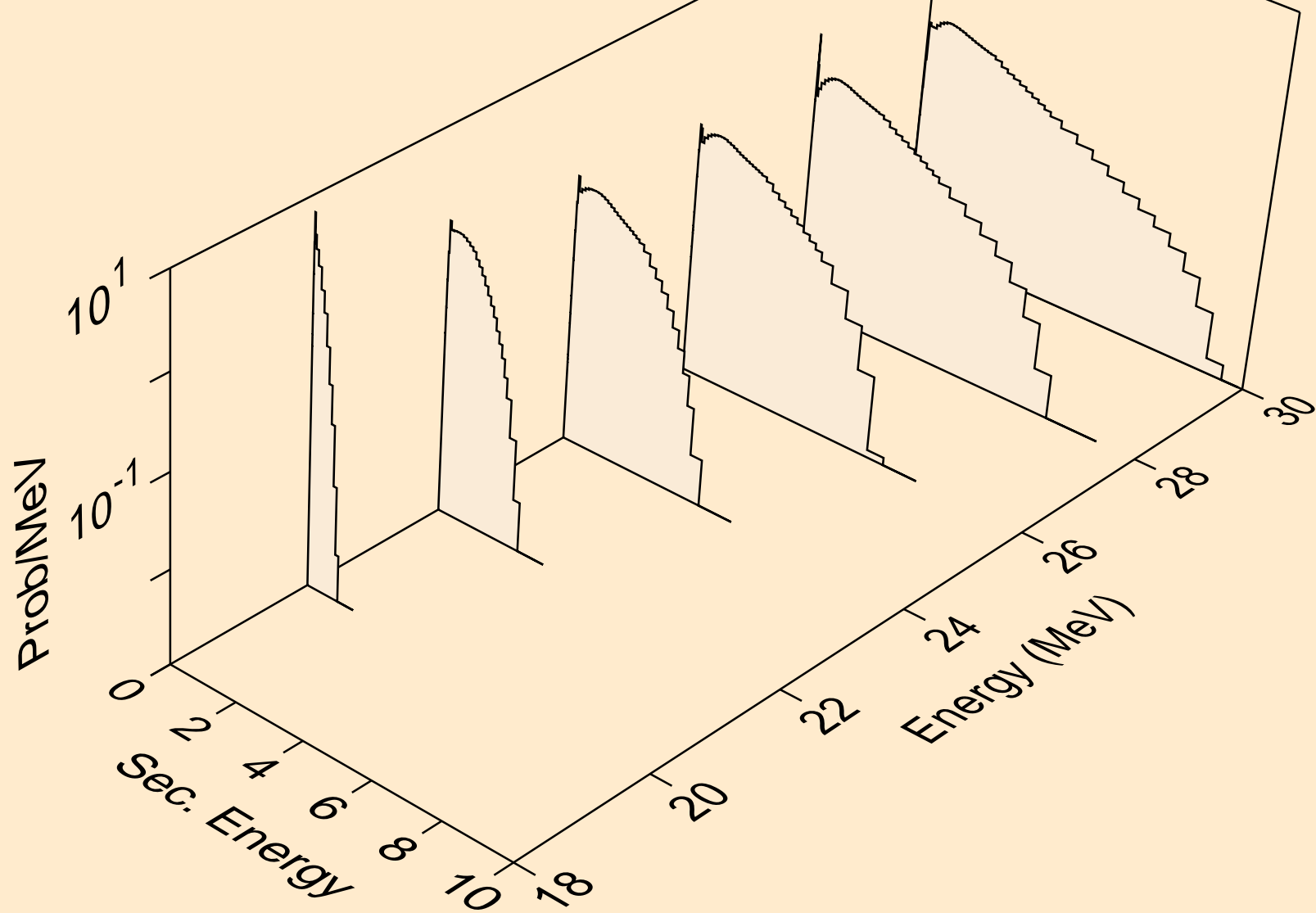

SI029 NEUTRON ACER TENDL-2024 LIBRARY; T=0.K  
Neutron emission for (n,n\*)t

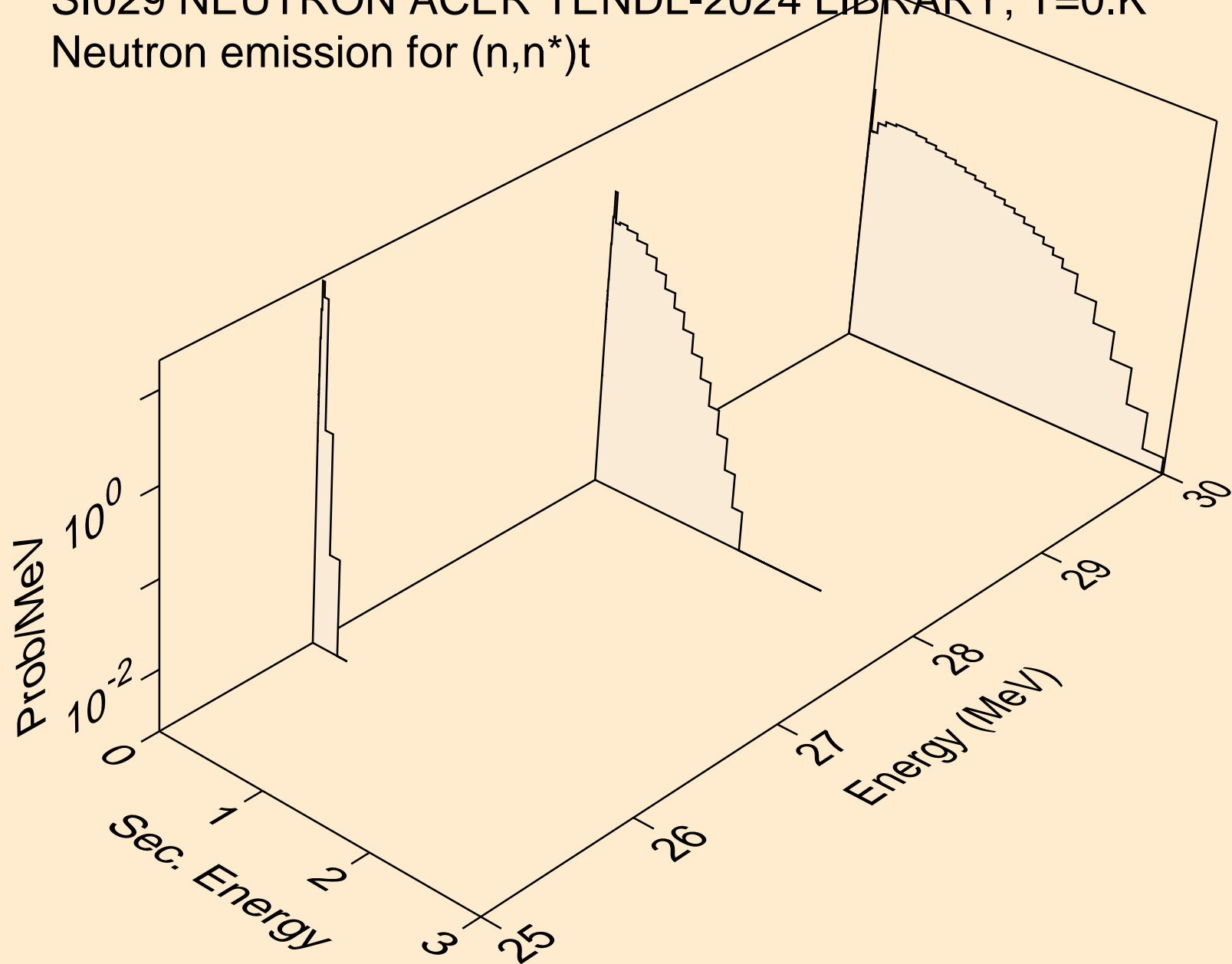

SI029 NEUTRON ACER TENDL-2024 LIBRARY; T=0.K  
Neutron emission for (n,n\*)he3

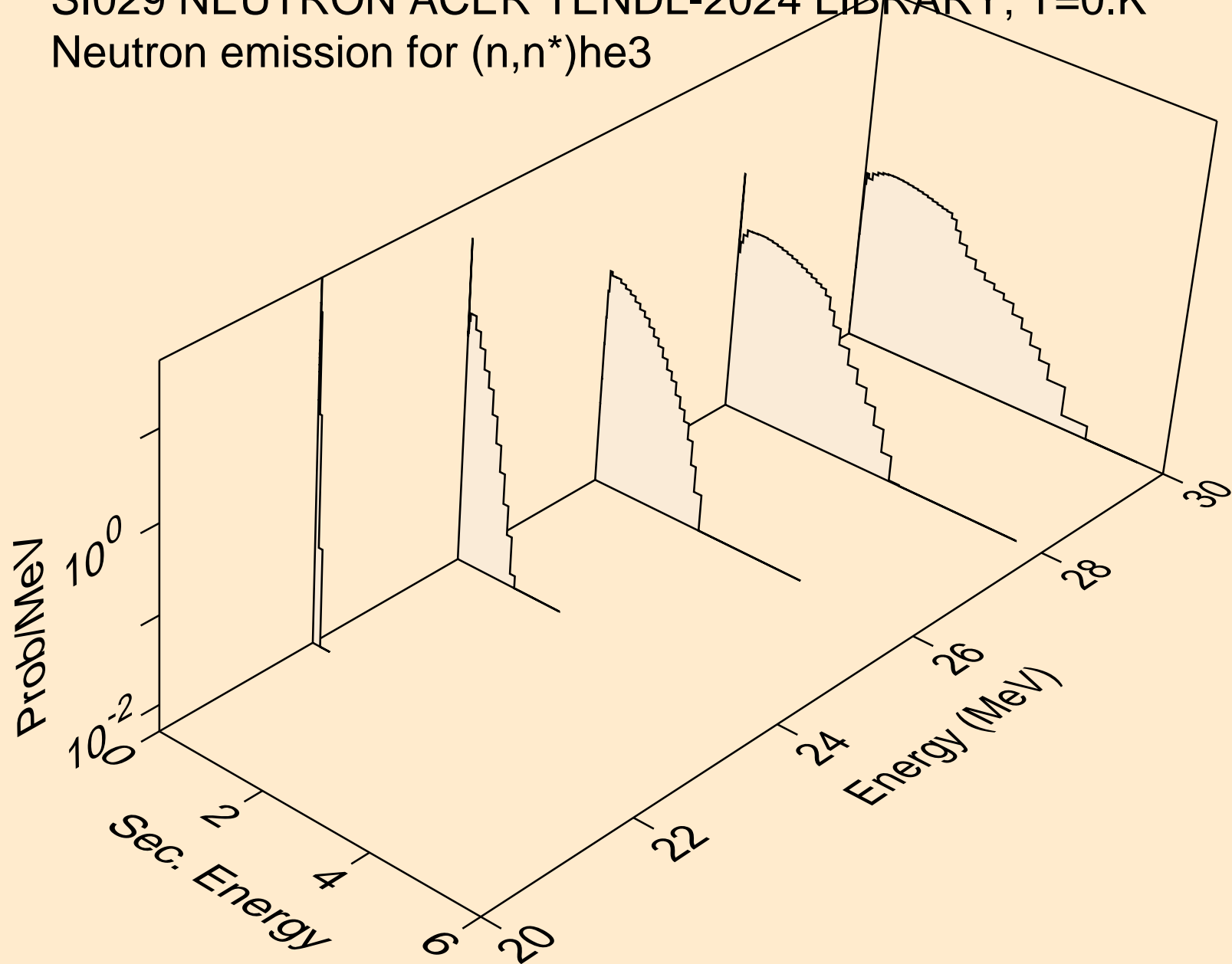

SI029 NEUTRON ACER TENDL-2024 LIBRARY; T=0.K  
Neutron emission for (n,2np)

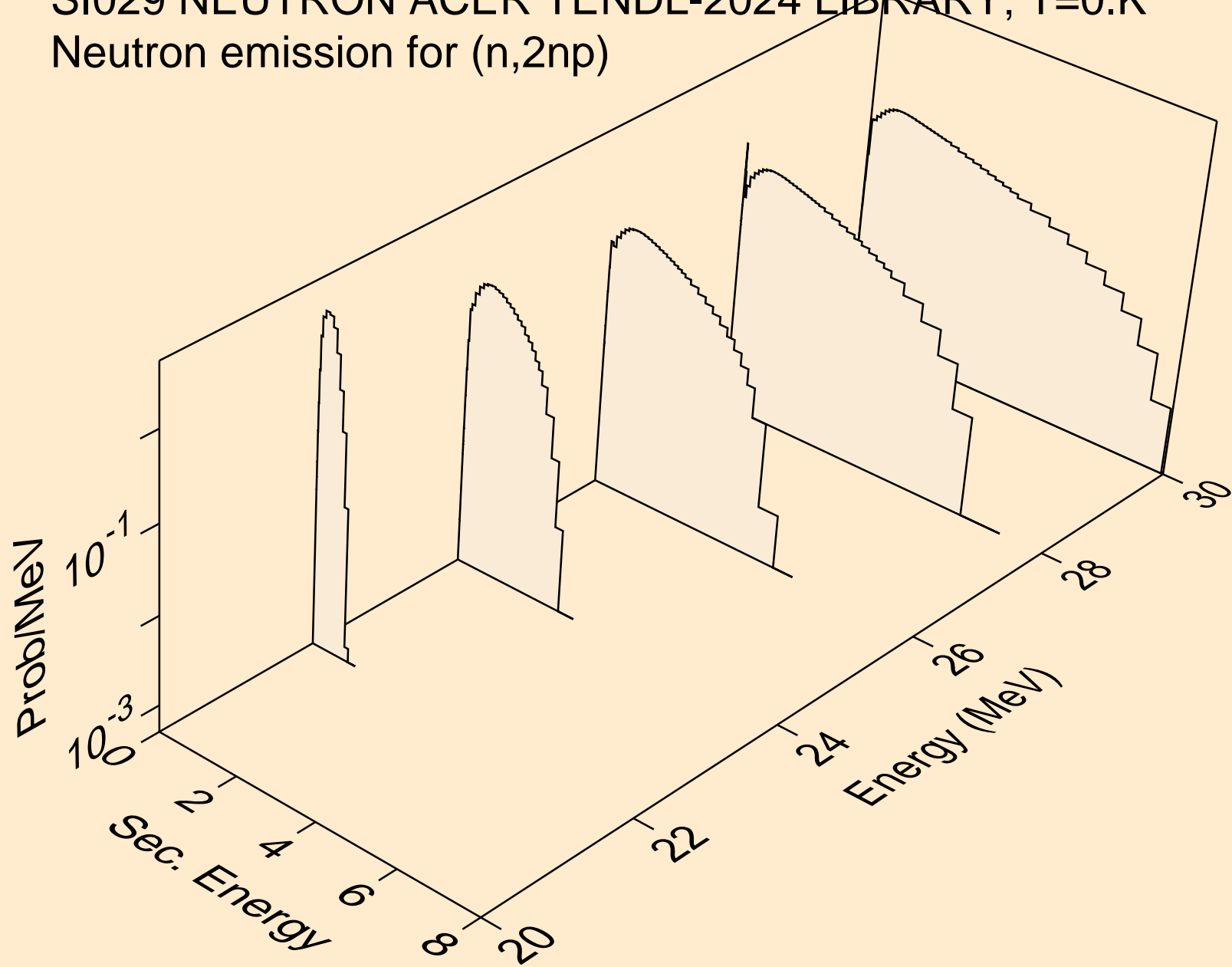

SI029 NEUTRON ACER TENDL-2024 LIBRARY; T=0.K  
Neutron emission for (n,n2p)

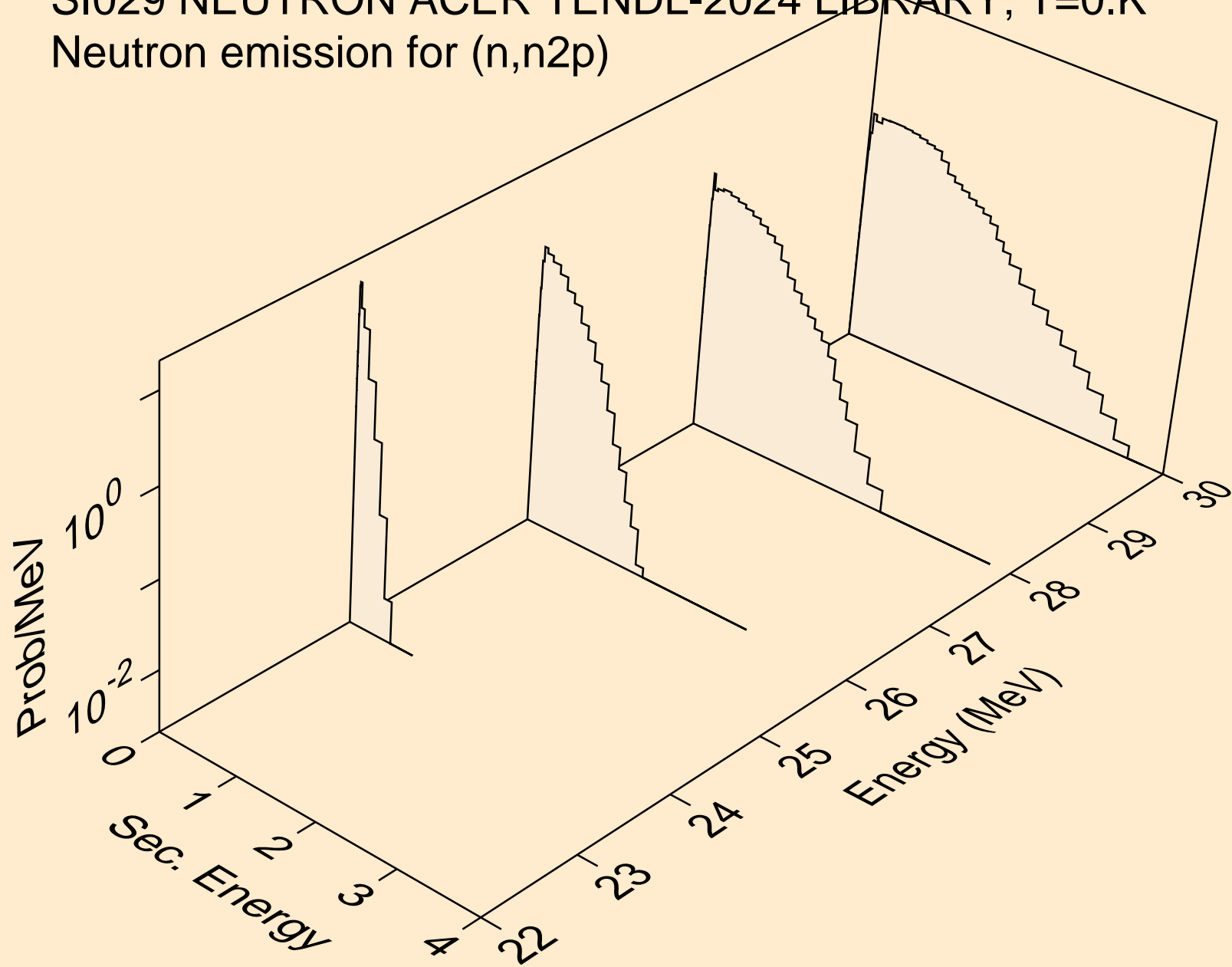

SI029 NEUTRON ACER TENDL-2024 LIBRARY; T=0.K  
Neutron emission for (n,npa)

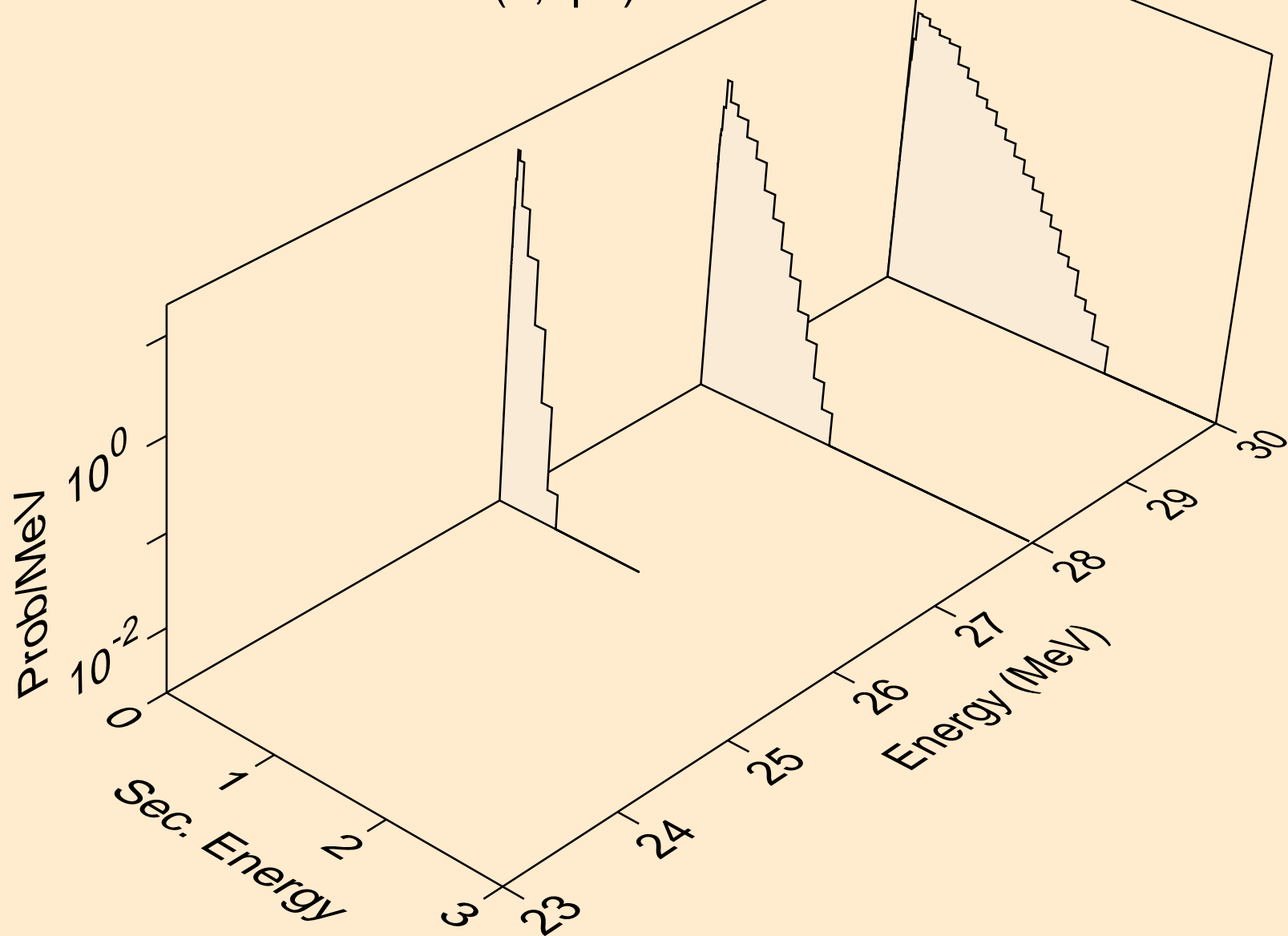

SI029 NEUTRON ACER TENDL-2024 LIBRARY; T=0.K  
Neutron emission for (n,n\*c)

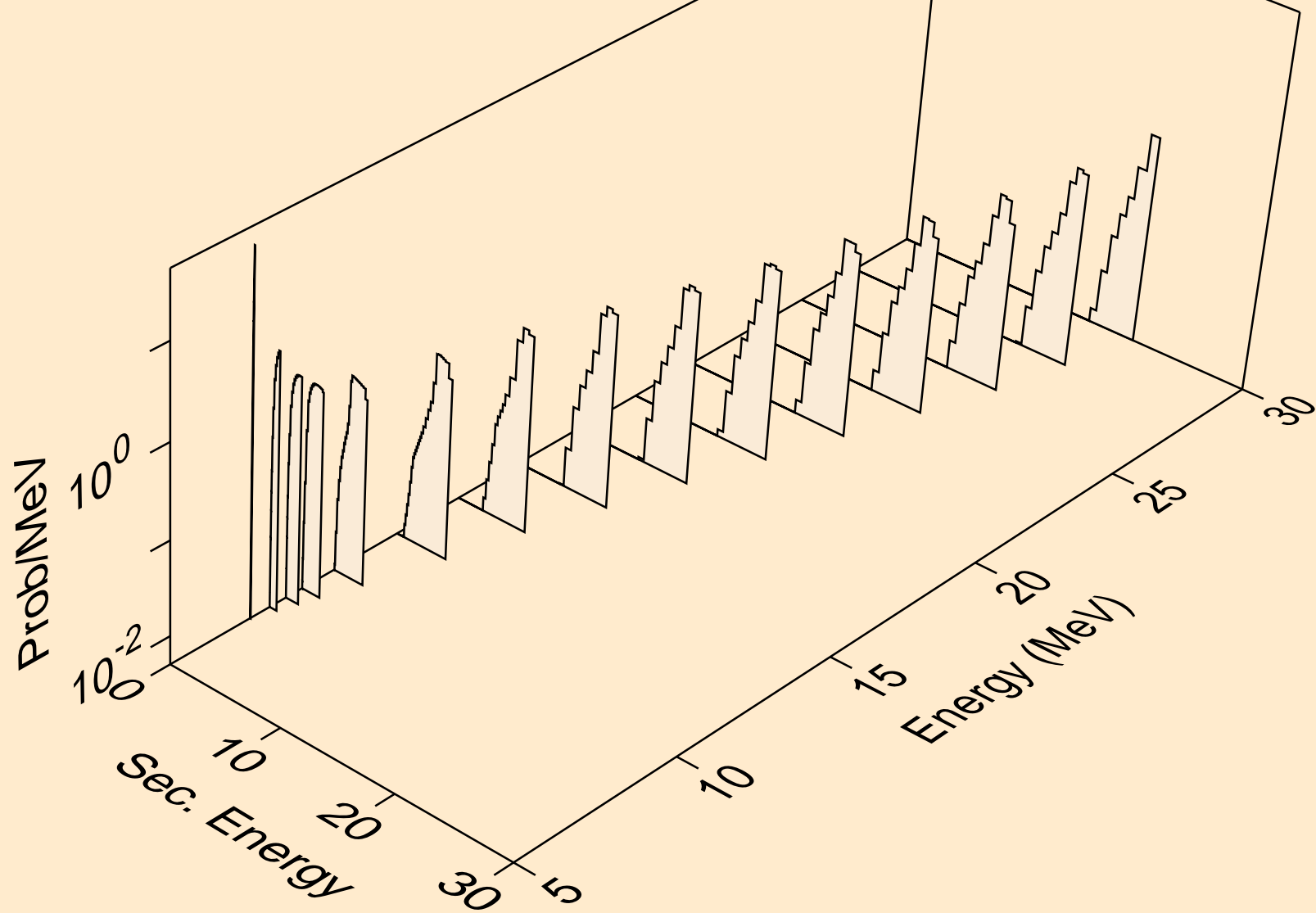

SI029 NEUTRON ACER TENDL-2024 LIBRARY; T=0.K  
Photon emission for (n,x)

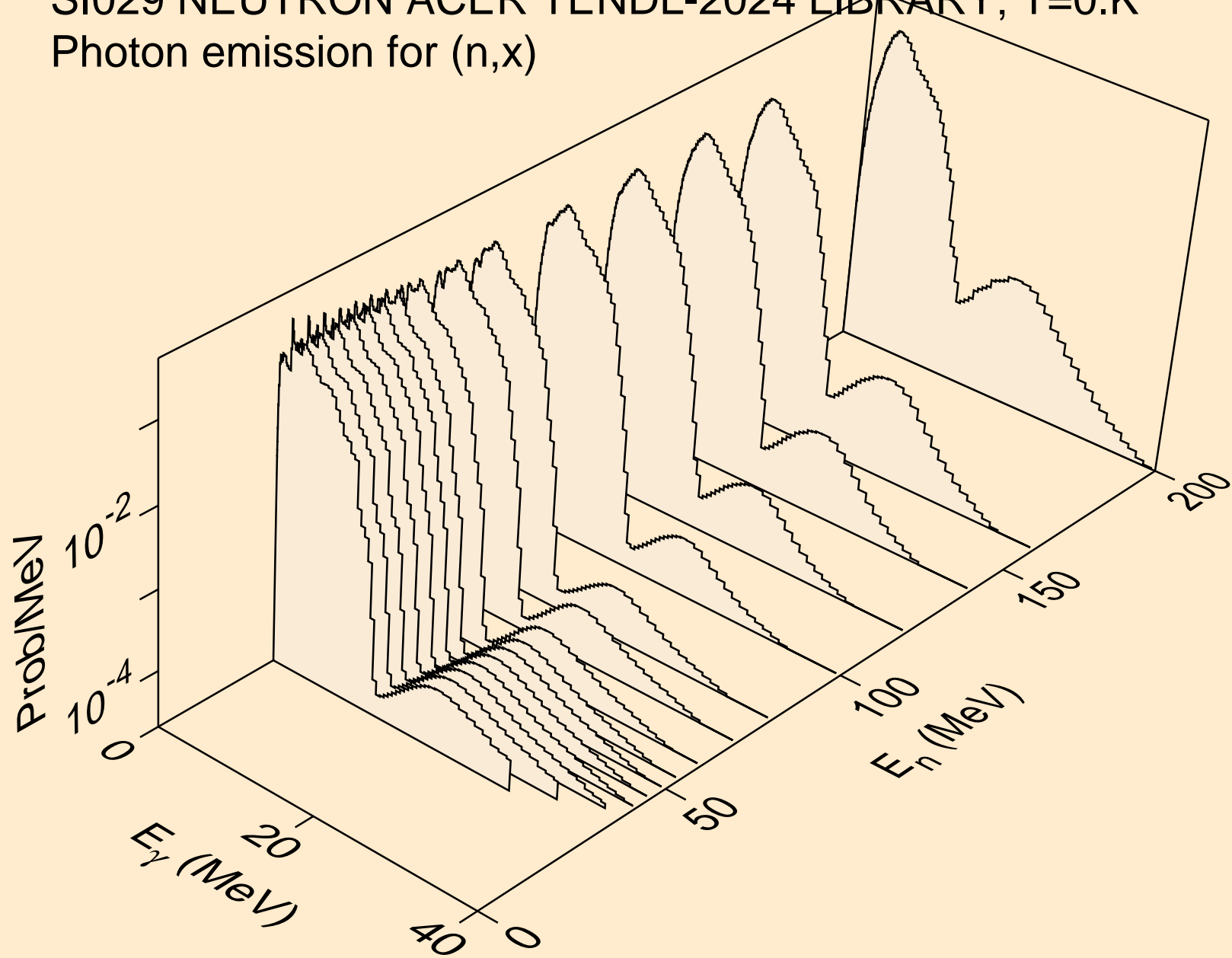



SI029 NEUTRON ACER TENDL-2024 LIBRARY; T=0.K  
Photon emission for (n,2n)

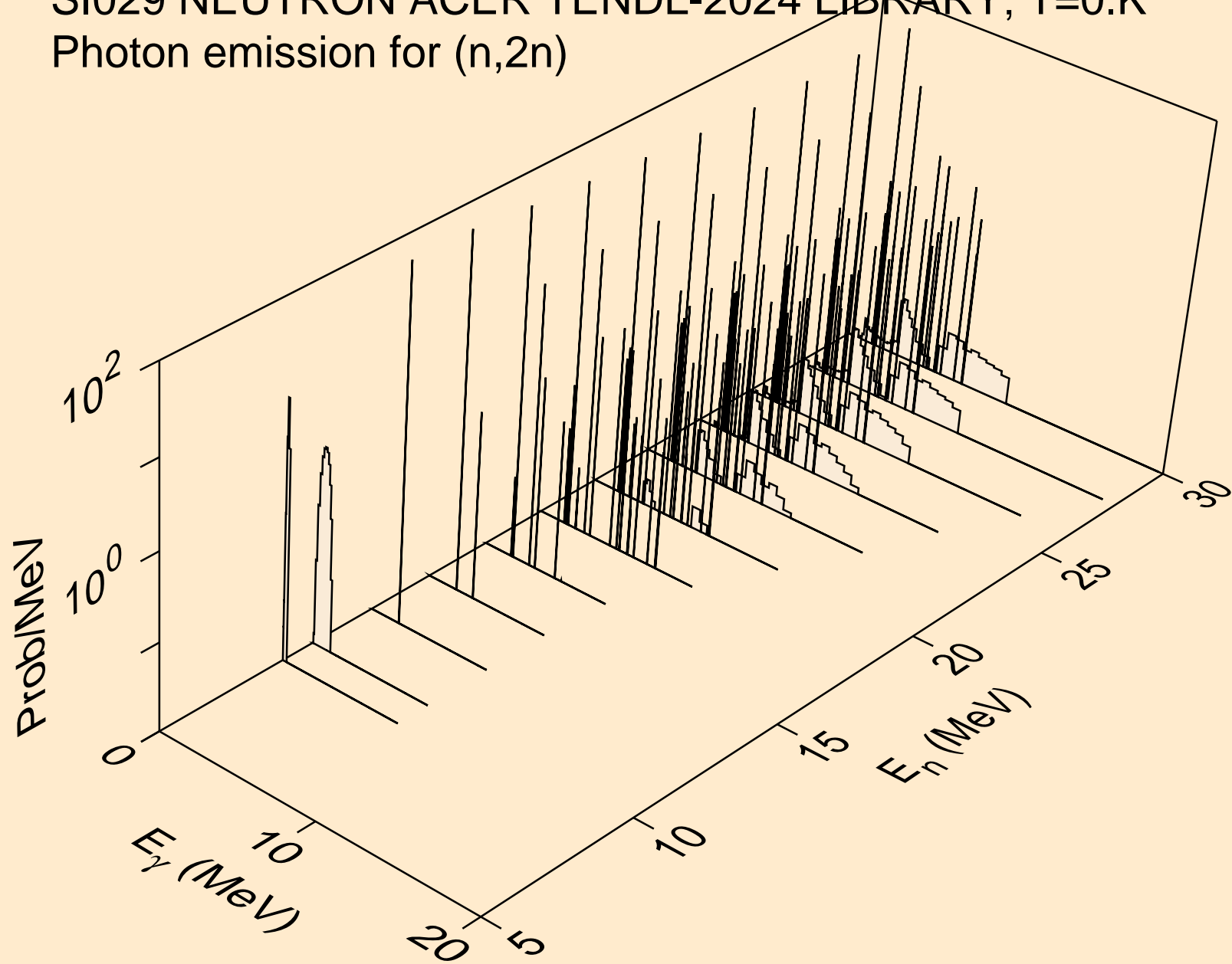

SI029 NEUTRON ACER TENDL-2024 LIBRARY; T=0.K  
Photon emission for (n,3n)

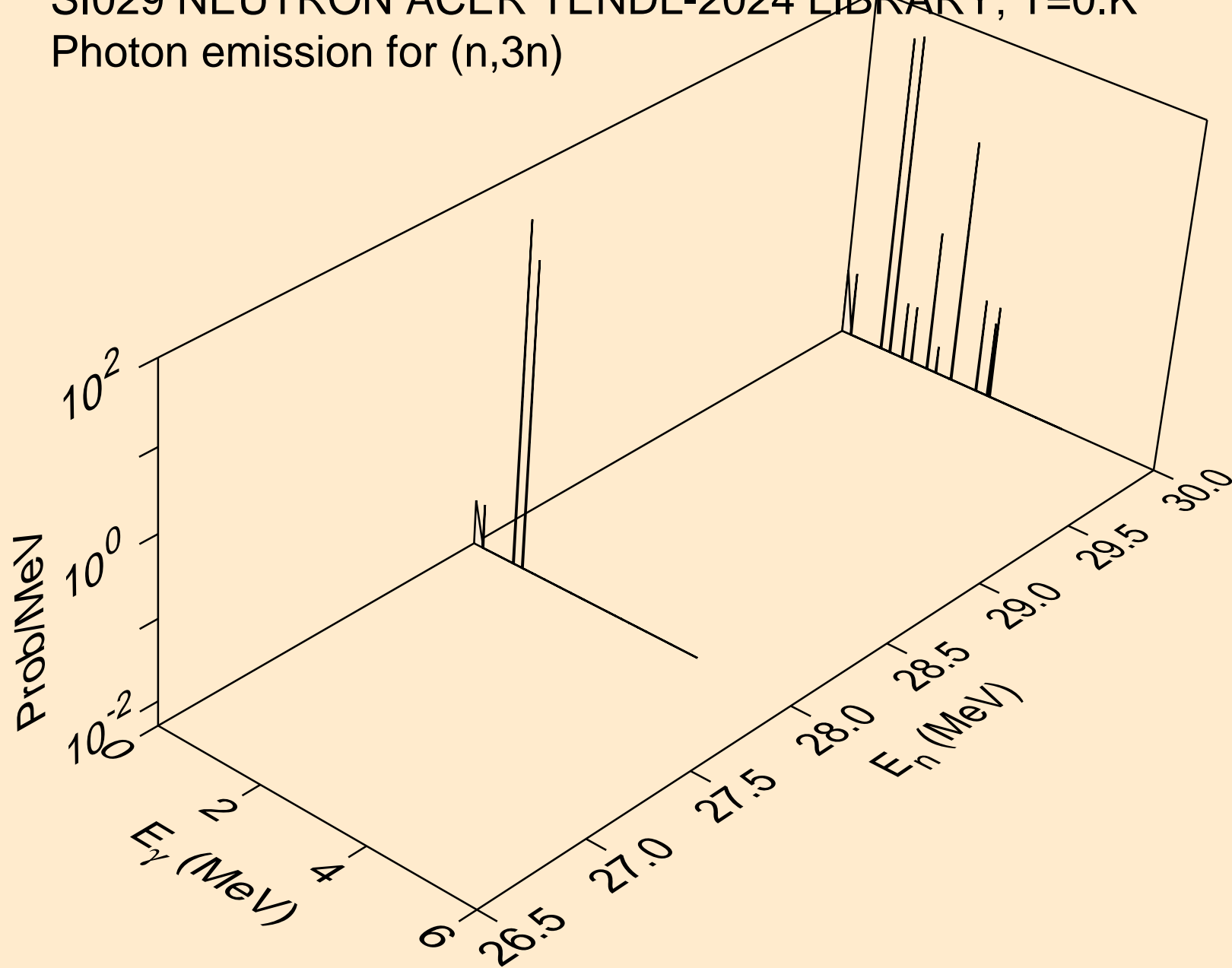

SI029 NEUTRON ACER TENDL-2024 LIBRARY; T=0.K  
Photon emission for (n,n\*)a

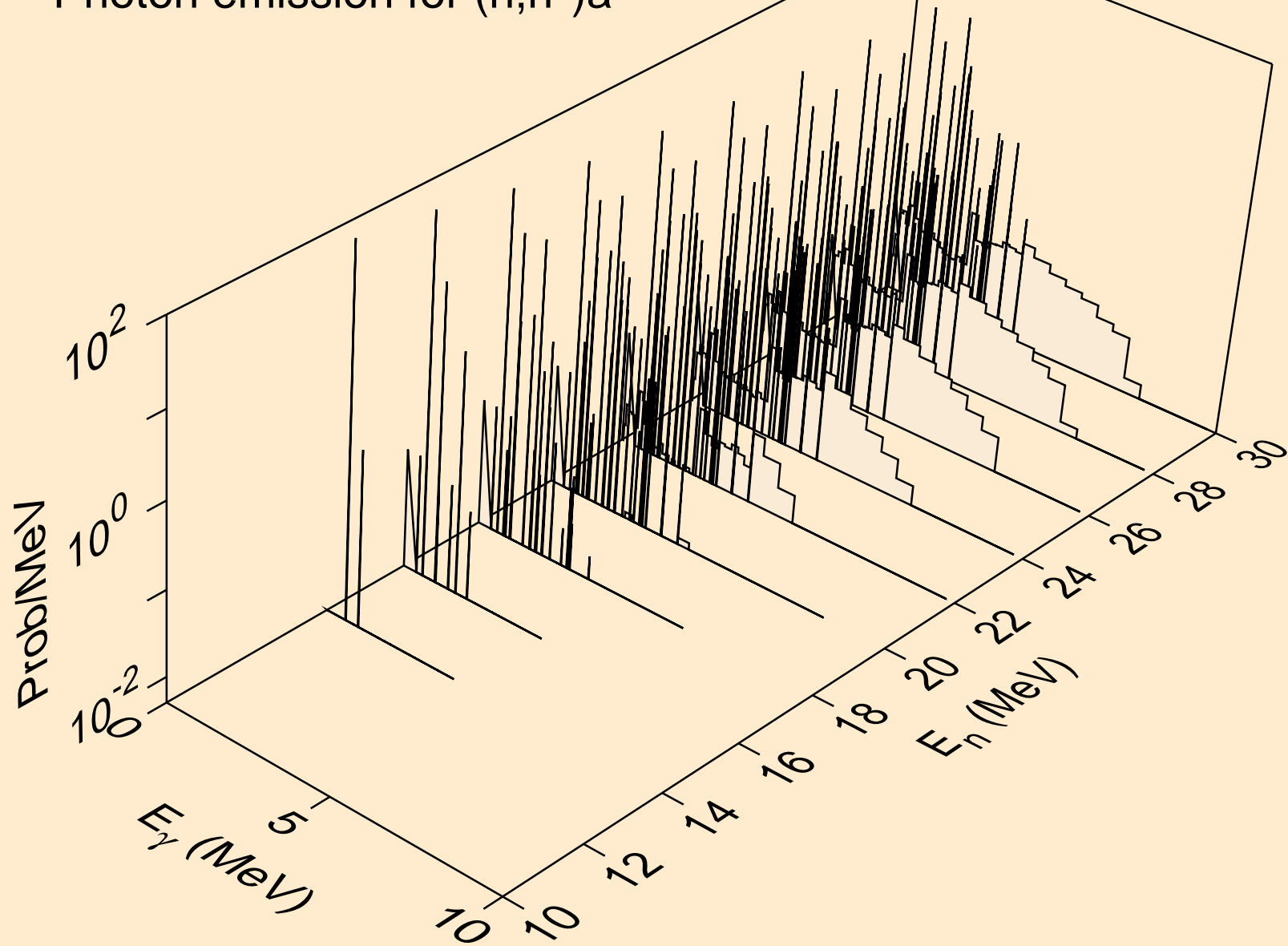

SI029 NEUTRON ACER TENDL-2024 LIBRARY; T=0.K  
Photon emission for (n,2n)a

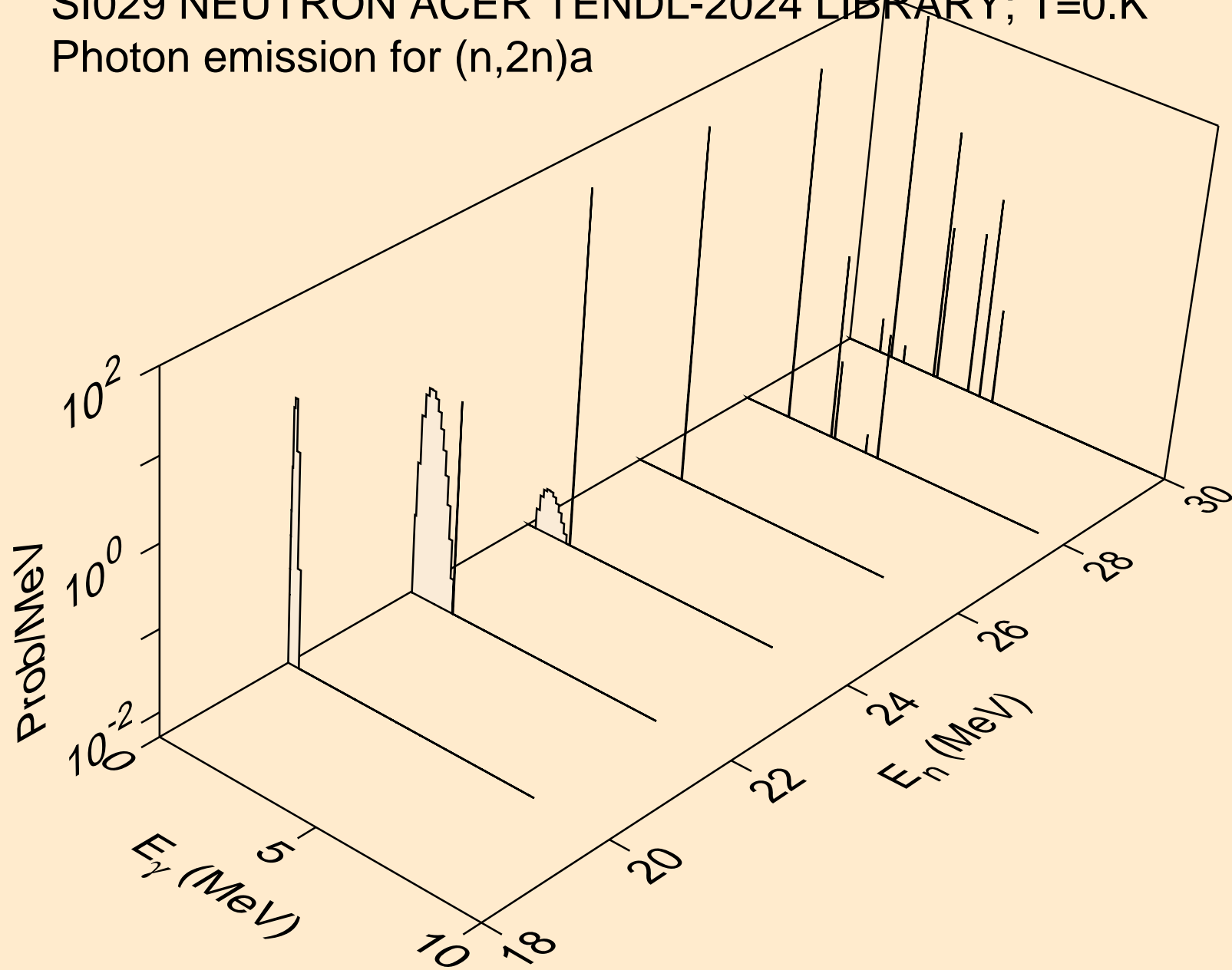

SI029 NEUTRON ACER TENDL-2024 LIBRARY; T=0.K  
Photon emission for (n,n\*)p

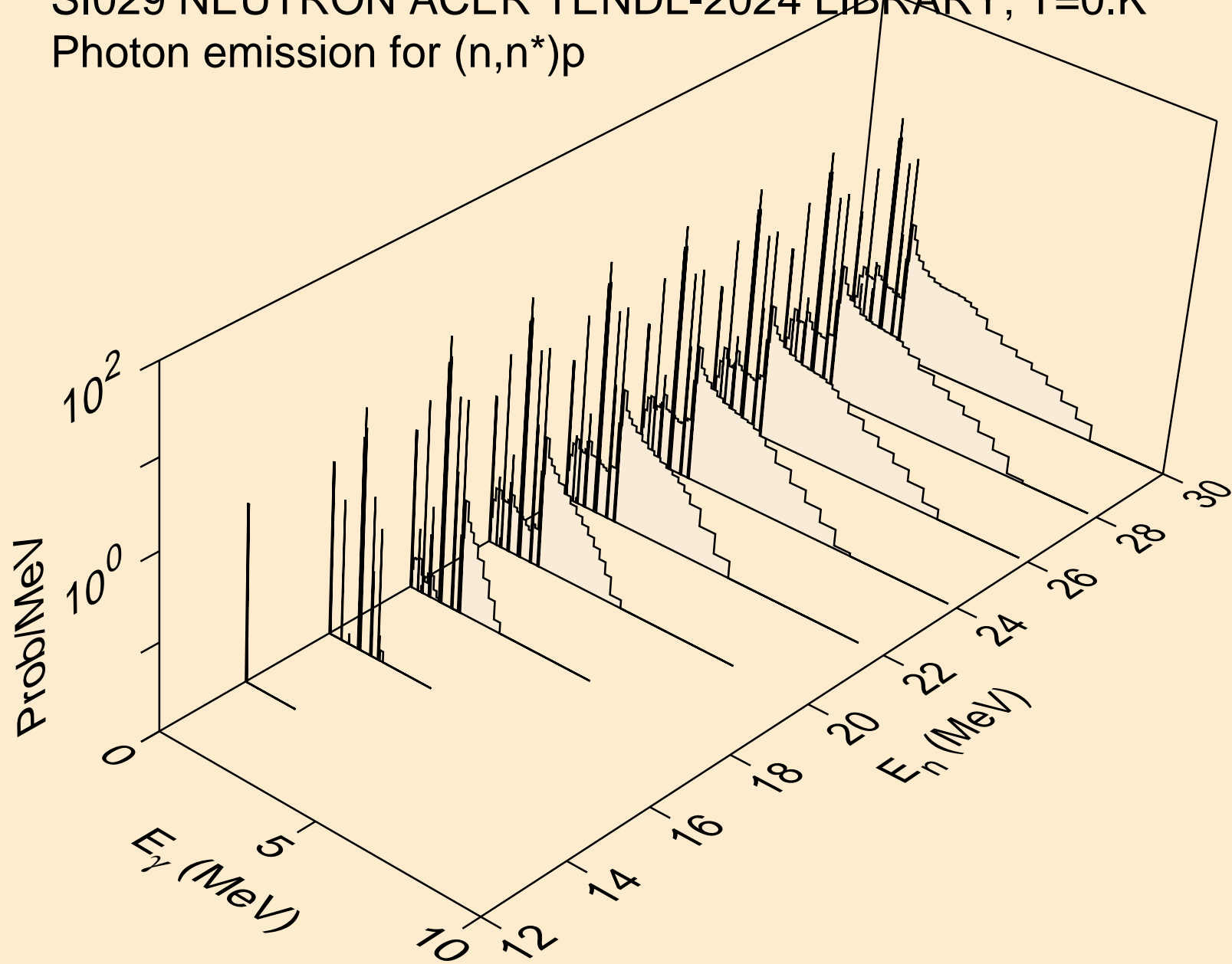

SI029 NEUTRON ACER TENDL-2024 LIBRARY; T=0.K  
Photon emission for (n,n\*)2a

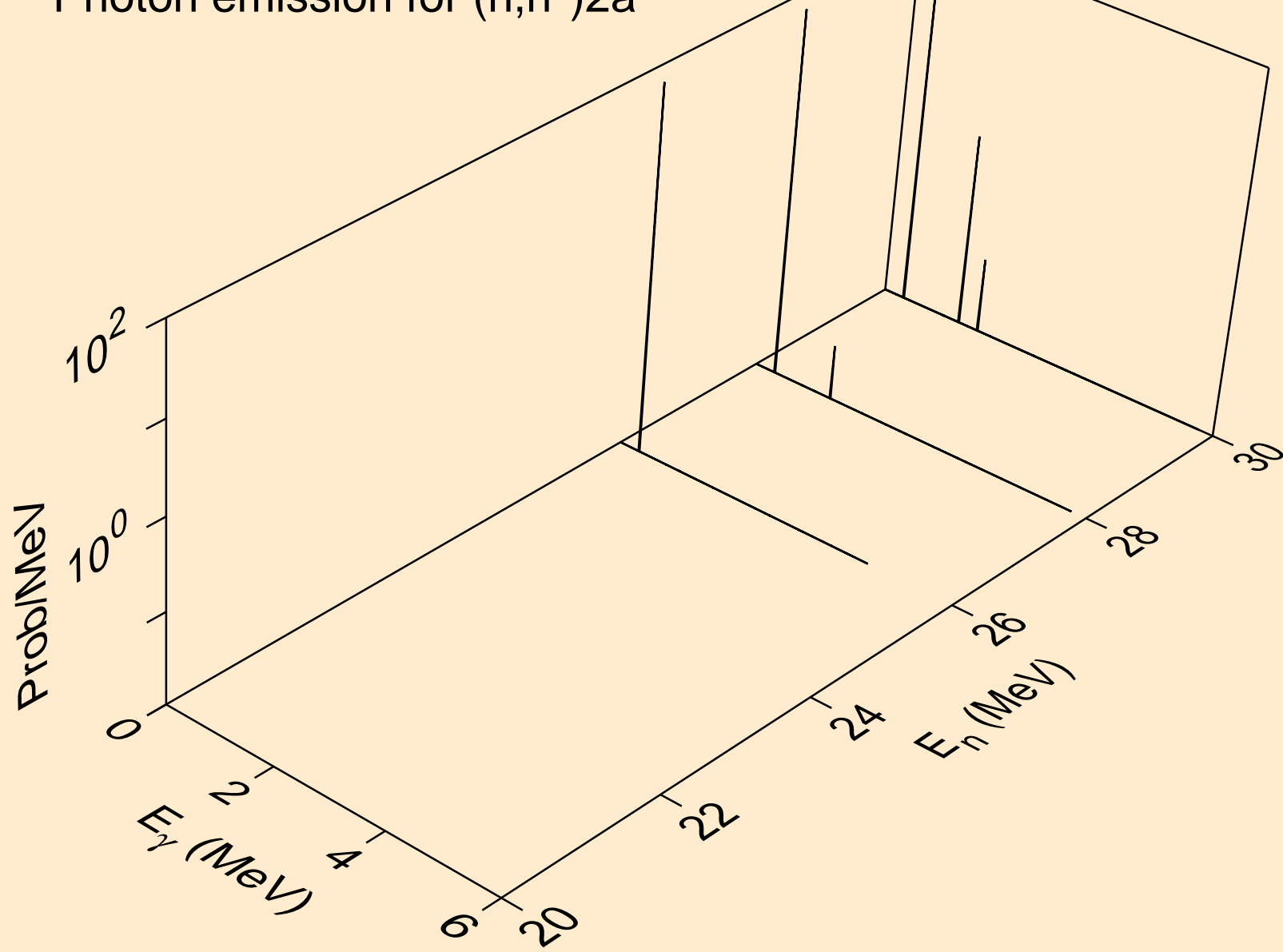

SI029 NEUTRON ACER TENDL-2024 LIBRARY; T=0.K  
Photon emission for (n,n\*)d

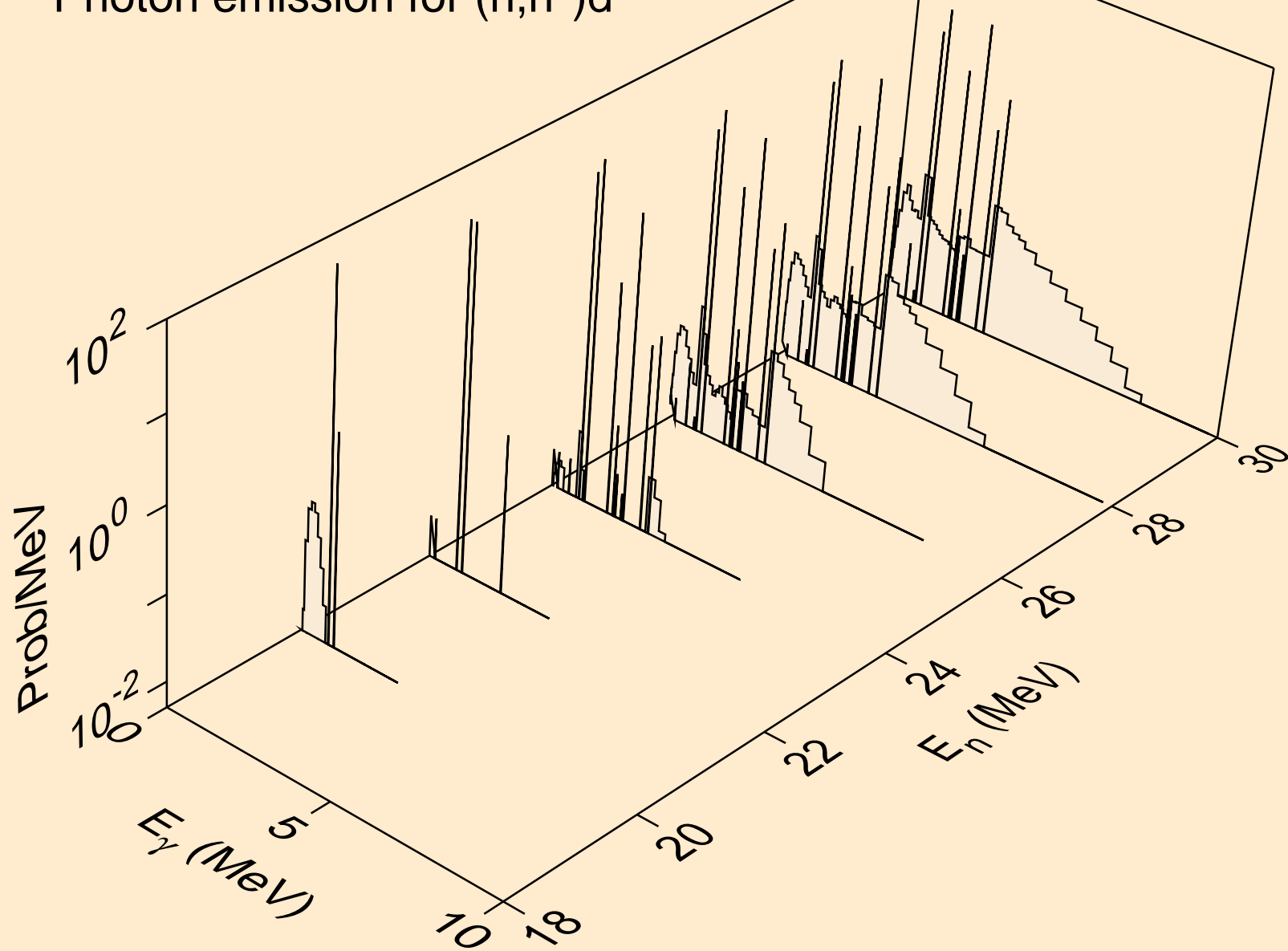

SI029 NEUTRON ACER TENDL-2024 LIBRARY; T=0.K  
Photon emission for (n,n\*)t

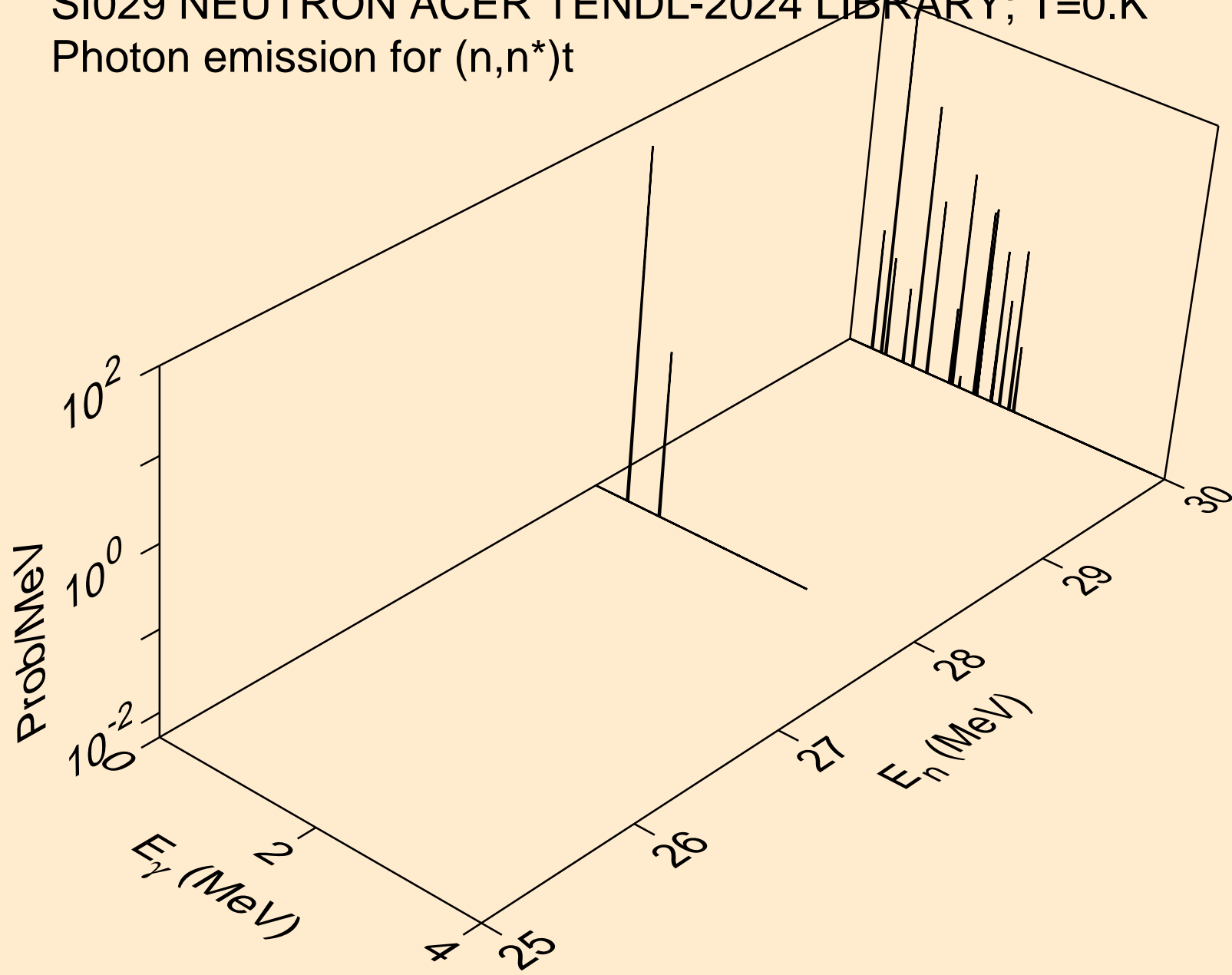



SI029 NEUTRON ACER TENDL-2024 LIBRARY; T=0.K  
Photon emission for (n,n\*)he3

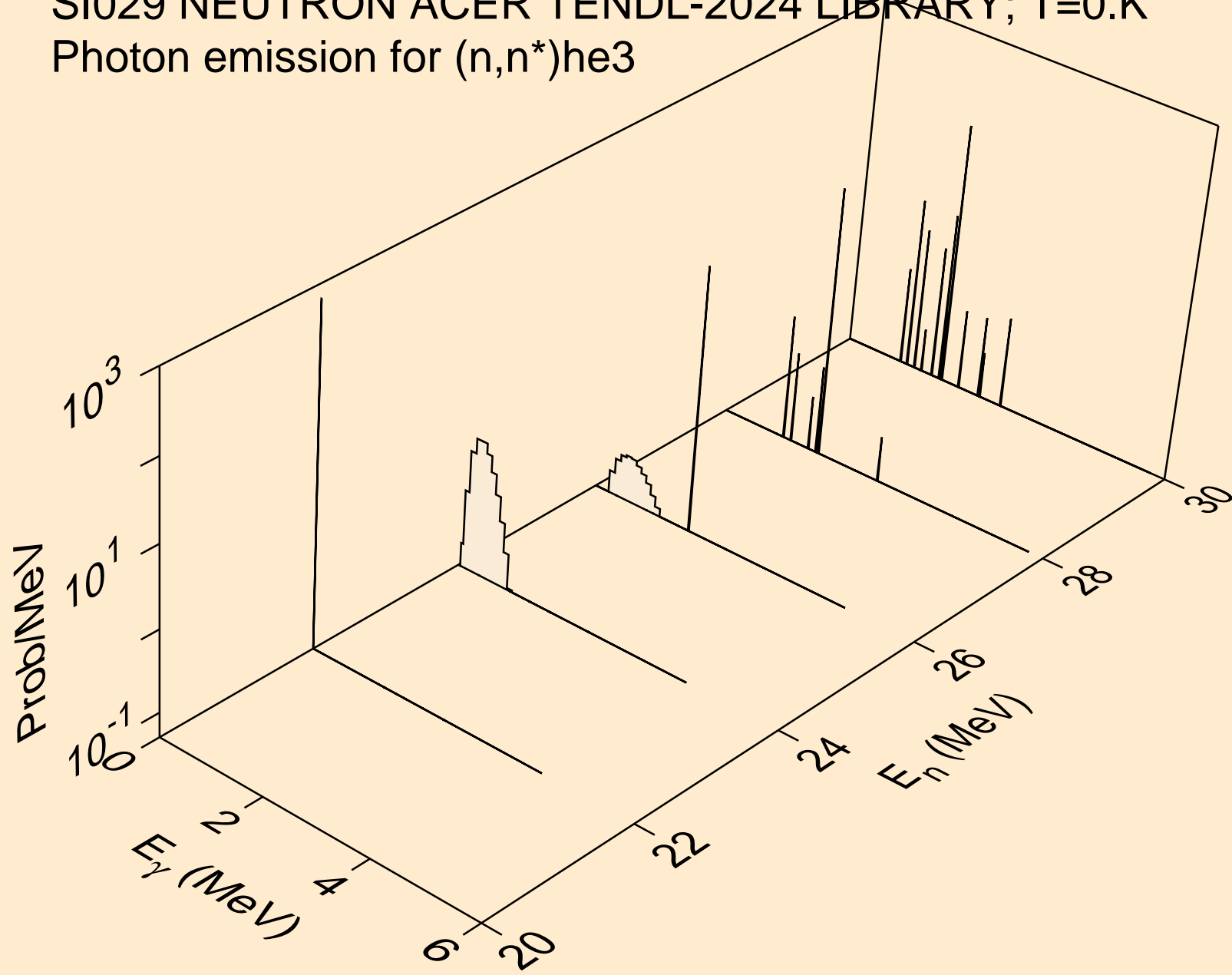

SI029 NEUTRON ACER TENDL-2024 LIBRARY; T=0.K  
Photon emission for (n,2np)

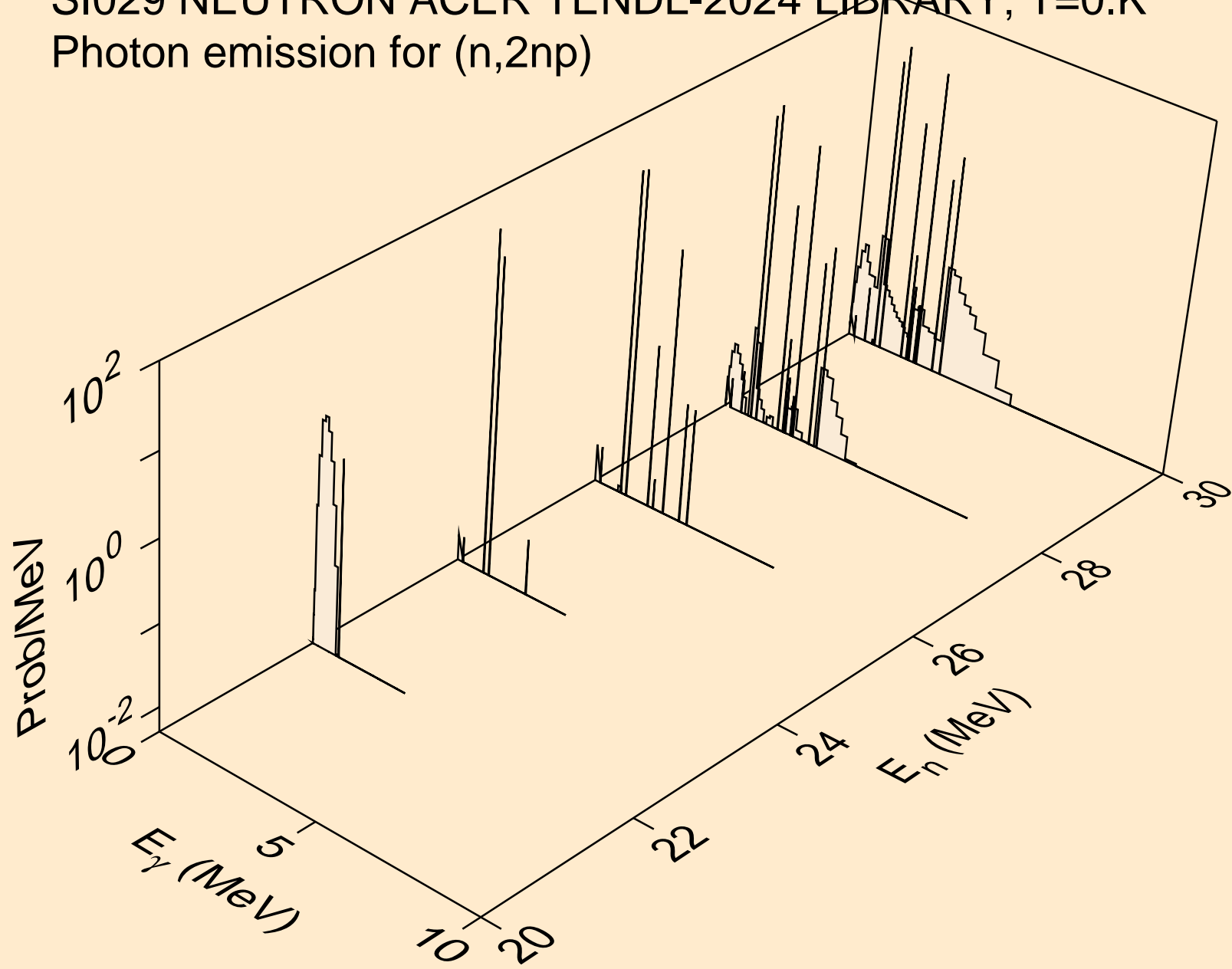

SI029 NEUTRON ACER TENDL-2024 LIBRARY; T=0.K  
Photon emission for (n,n2p)

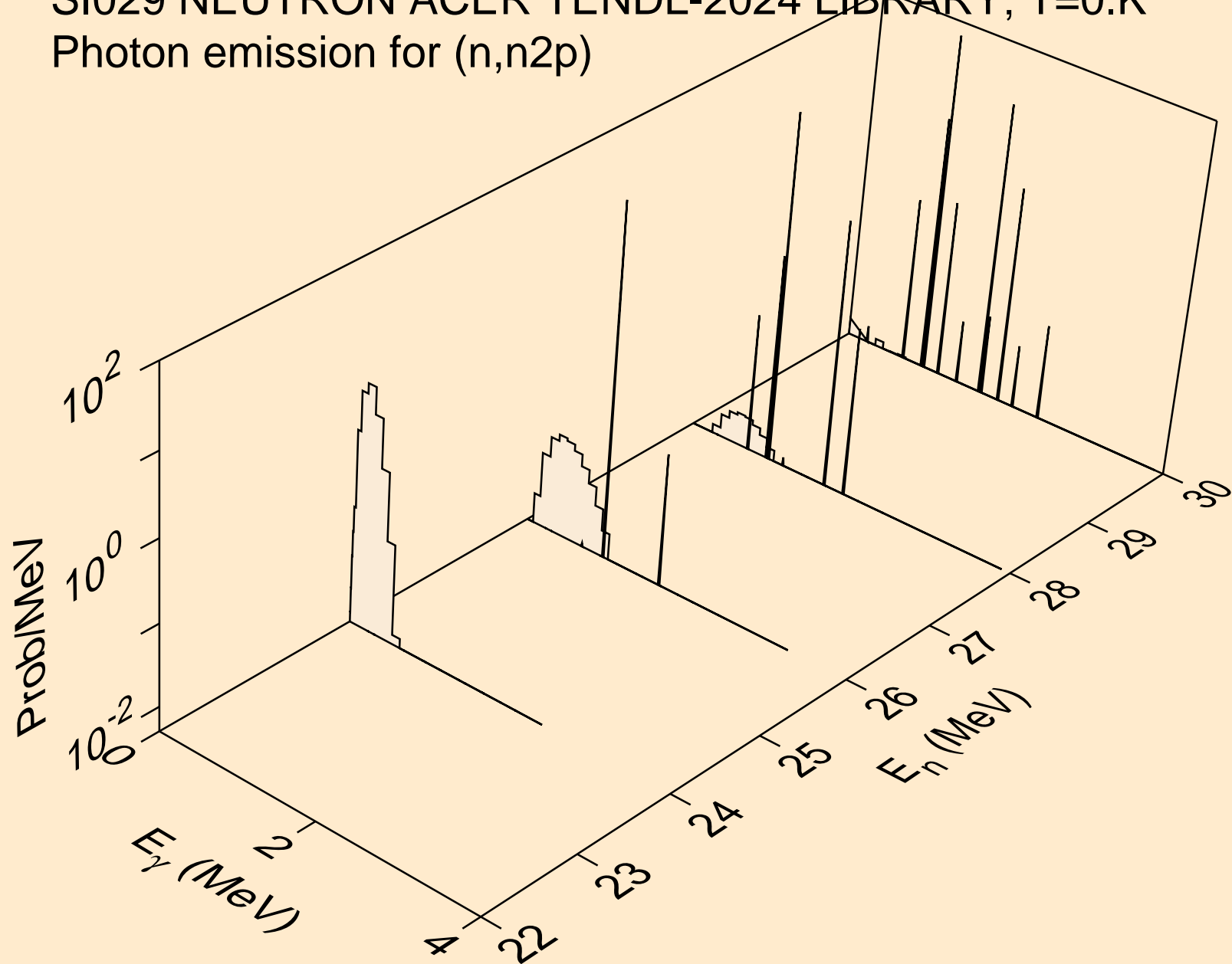

SI029 NEUTRON ACER TENDL-2024 LIBRARY; T=0.K  
Photon emission for (n,npa)

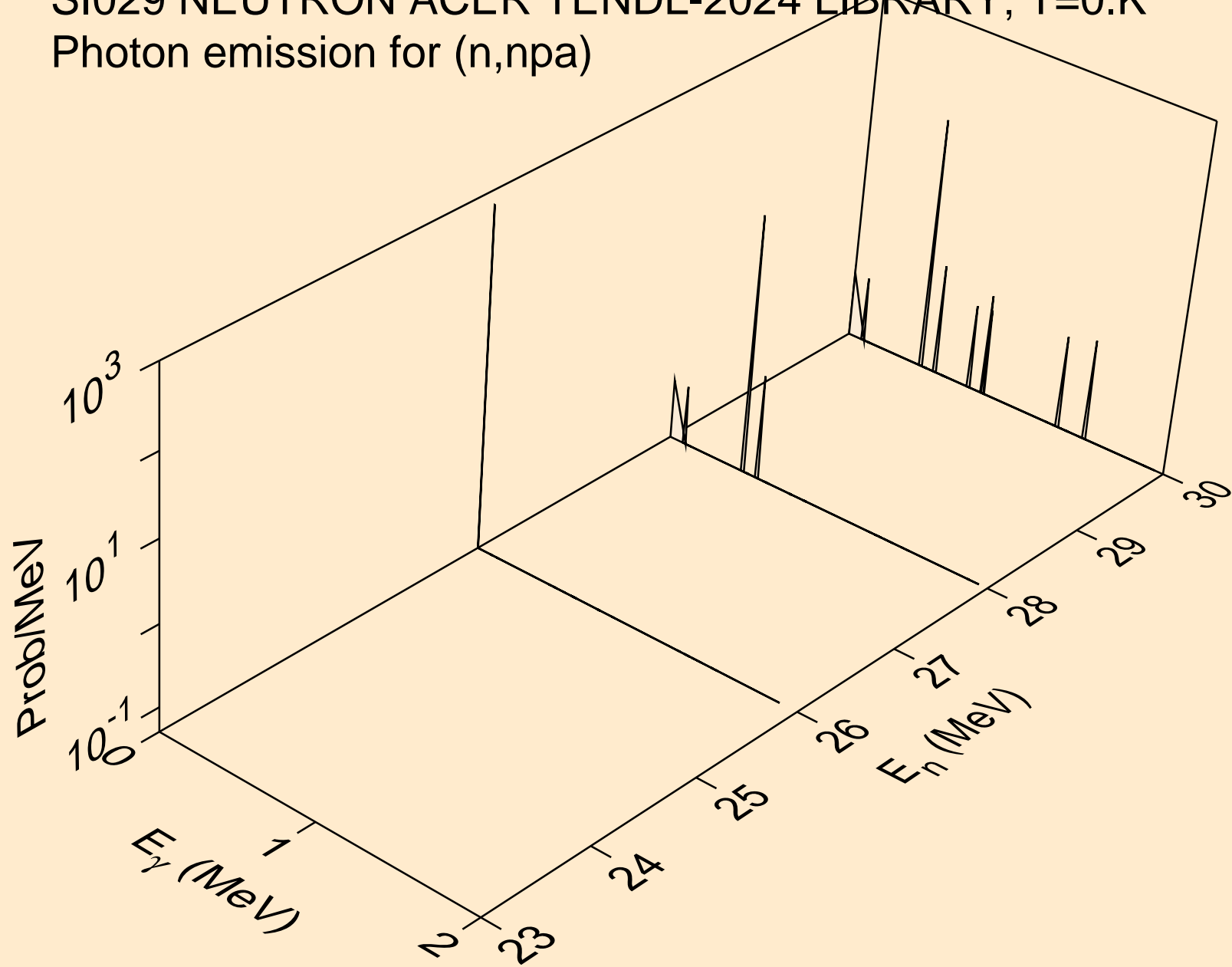

SI029 NEUTRON ACER TENDL-2024 LIBRARY; T=0.K  
Photon emission for (n,n\*c)

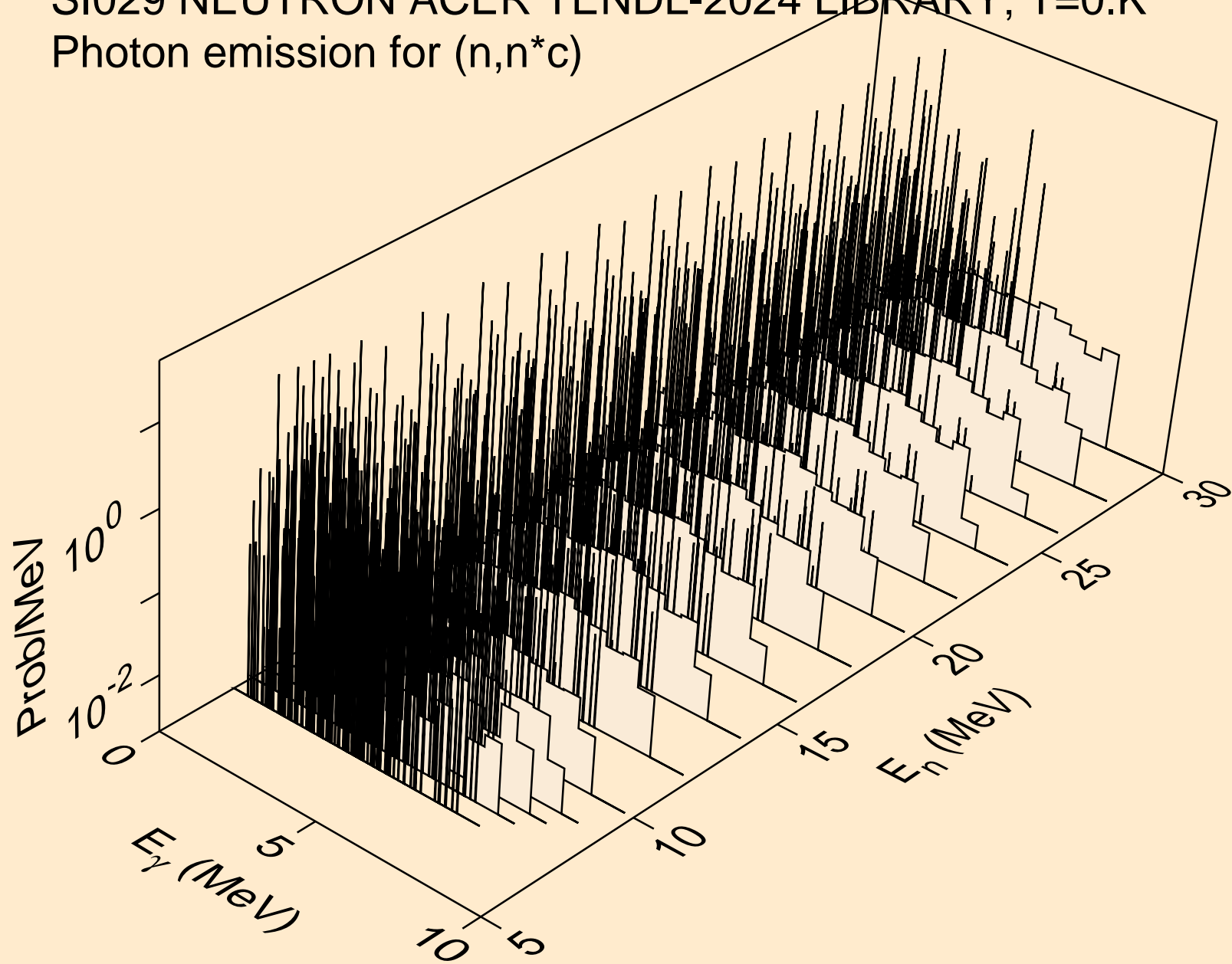

SI029 NEUTRON ACER TENDL-2024 LIBRARY; T=0.K  
Photon emission for (n,gma)

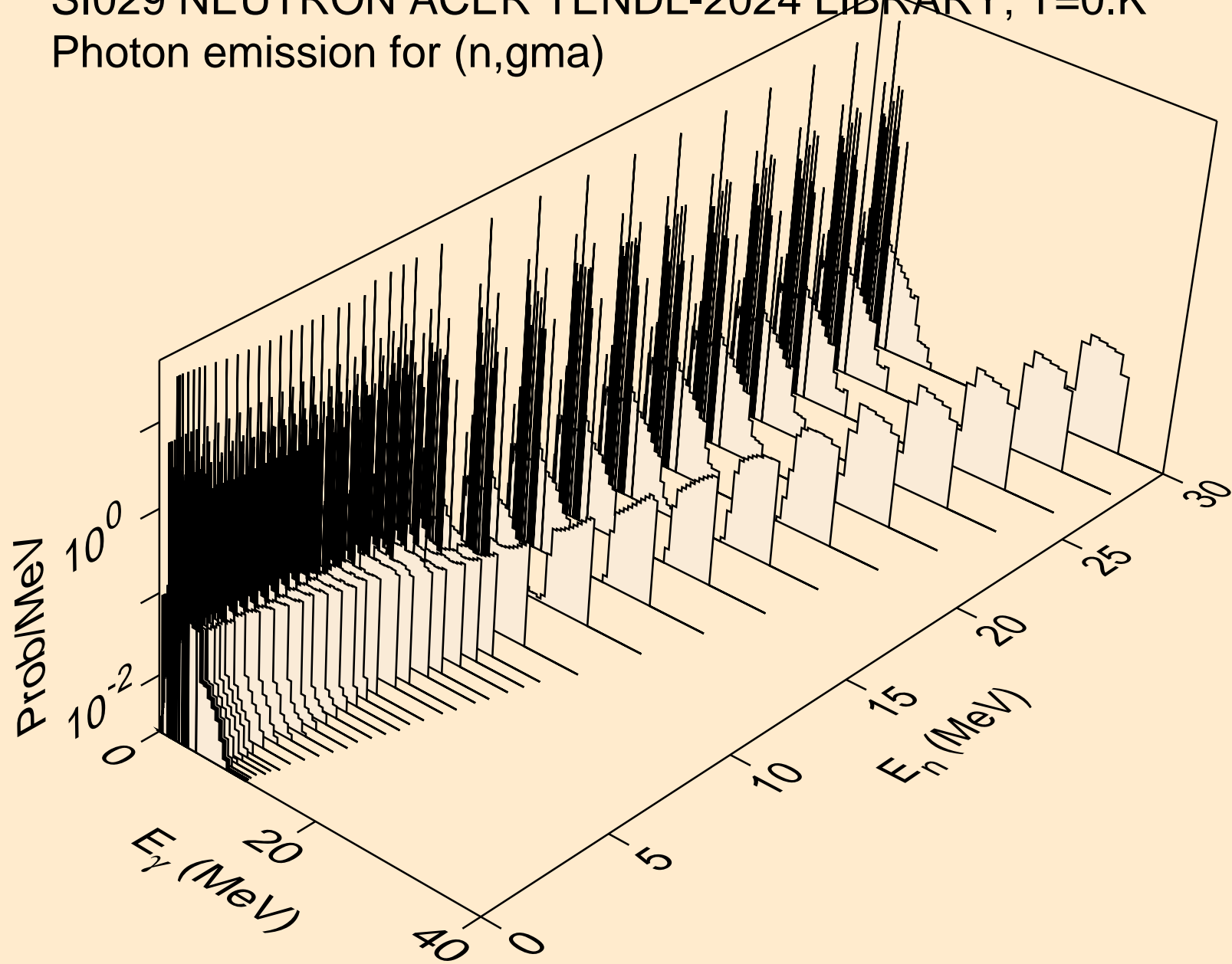

SI029 NEUTRON ACER TENDL-2024 LIBRARY; T=0.K  
Photon emission for (n,p)

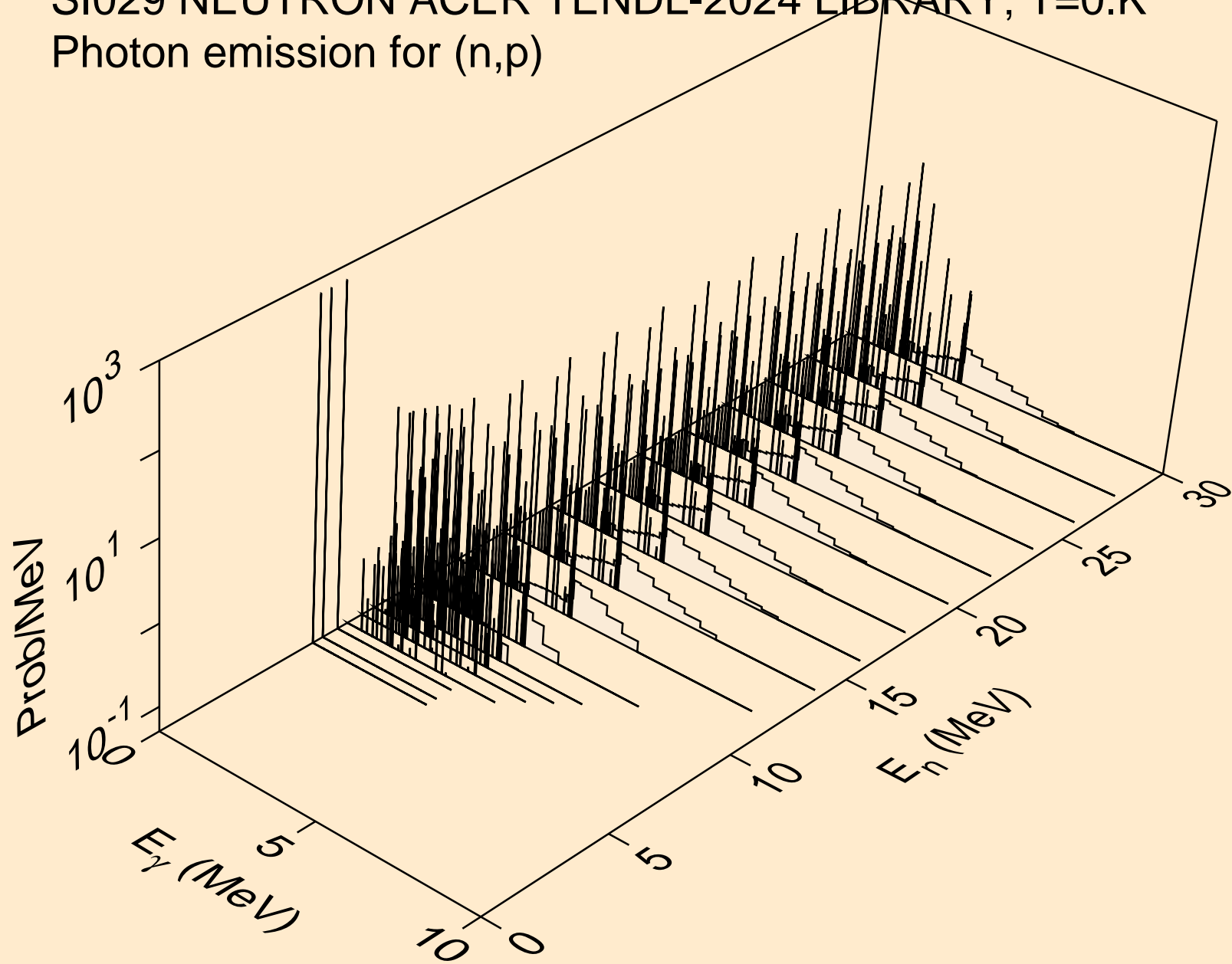

SI029 NEUTRON ACER TENDL-2024 LIBRARY; T=0.K  
Photon emission for (n,d)

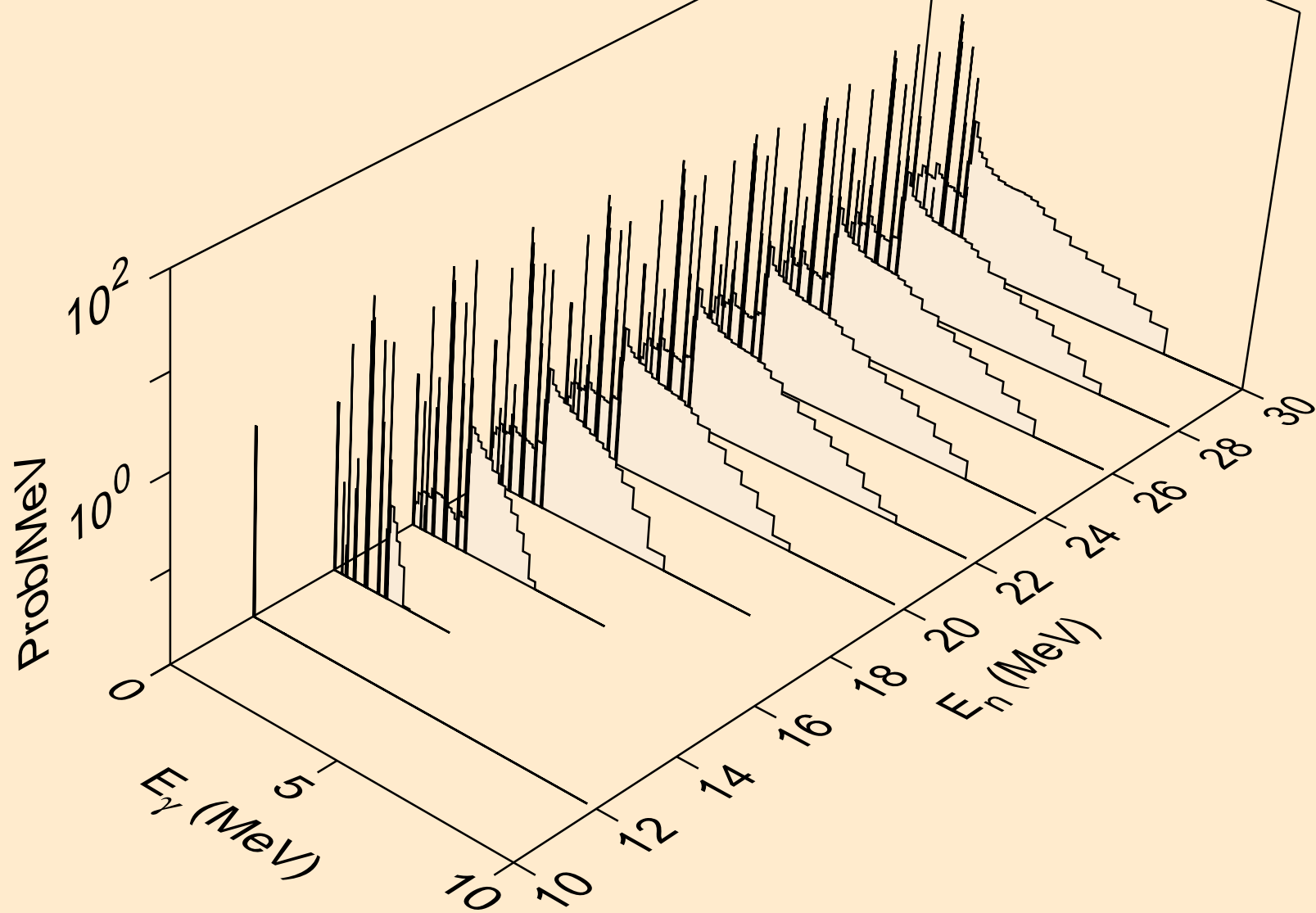



SI029 NEUTRON ACER TENDL-2024 LIBRARY; T=0.K  
Photon emission for (n,t)

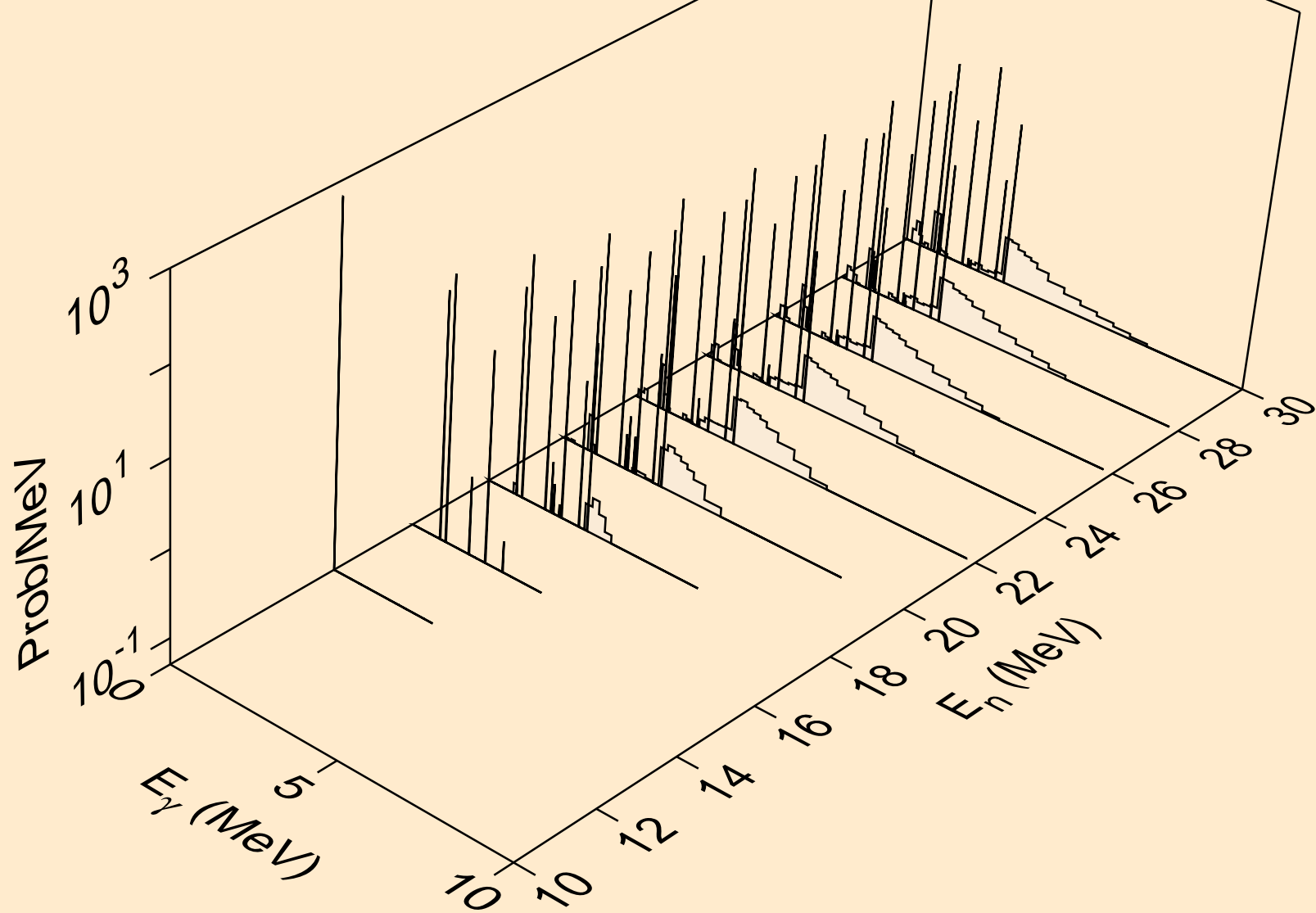

SI029 NEUTRON ACER TENDL-2024 LIBRARY; T=0.K  
Photon emission for (n,he3)

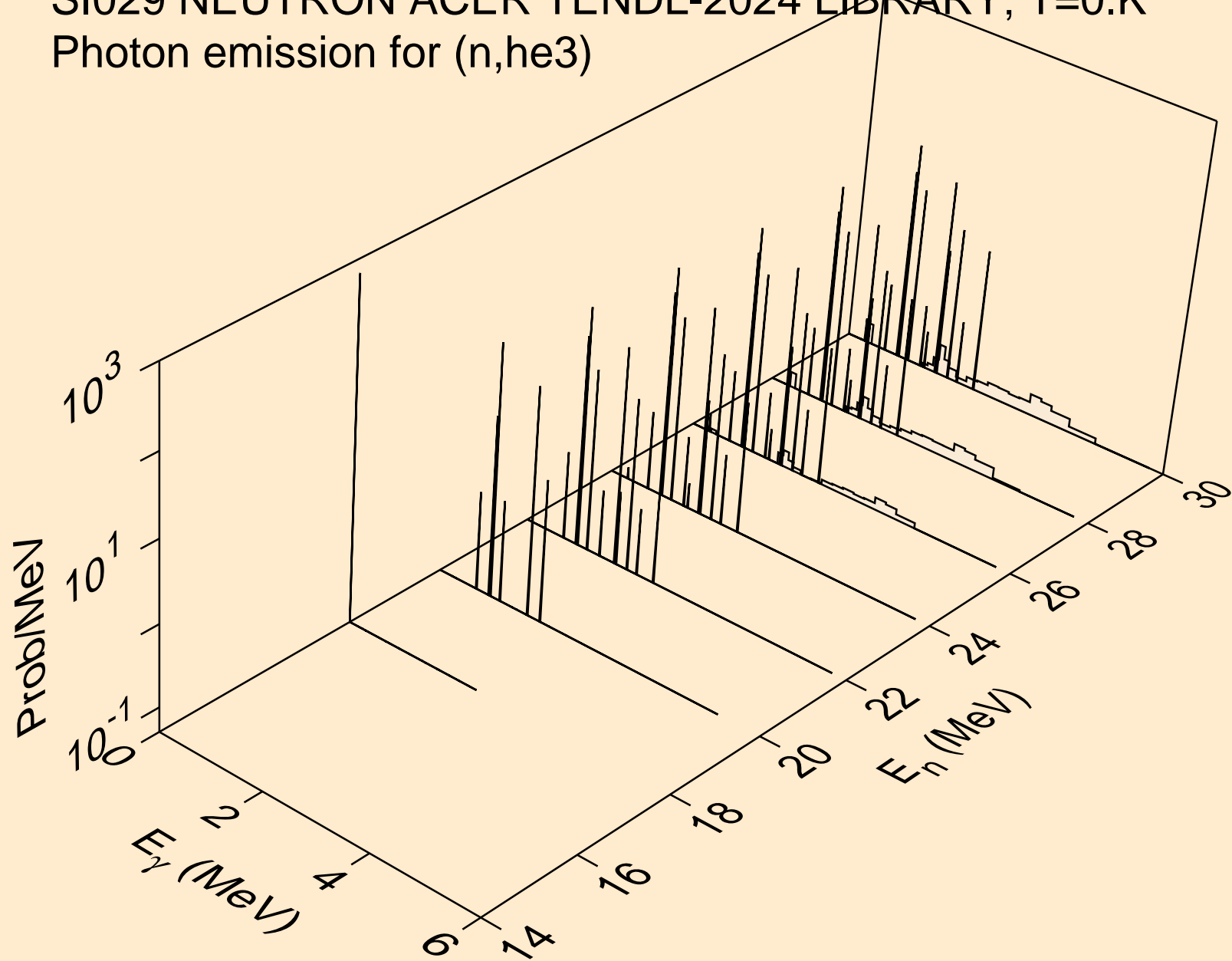

SI029 NEUTRON ACER TENDL-2024 LIBRARY; T=0.K  
Photon emission for (n,a)

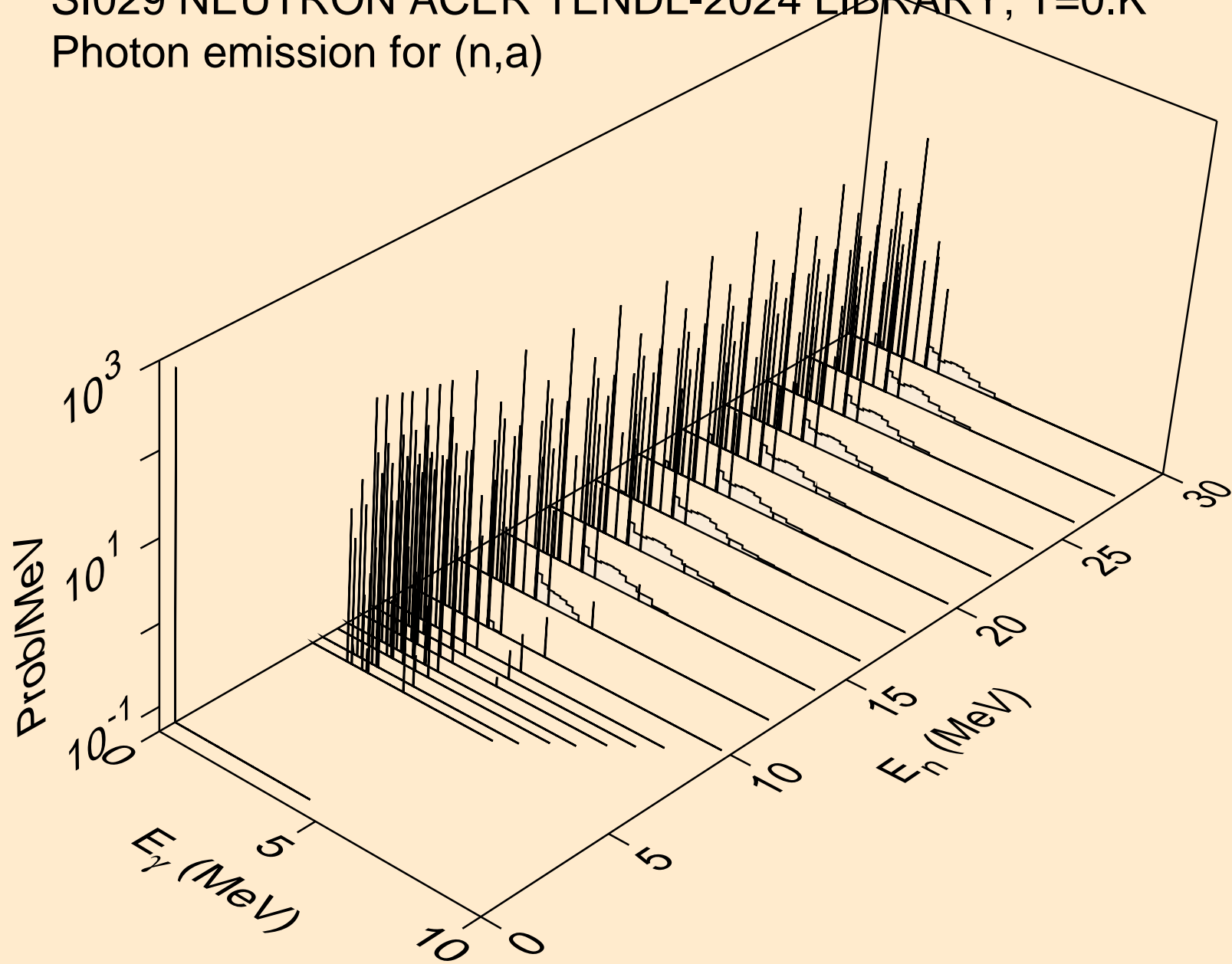

SI029 NEUTRON ACER TENDL-2024 LIBRARY; T=0.K  
Photon emission for (n,2a)

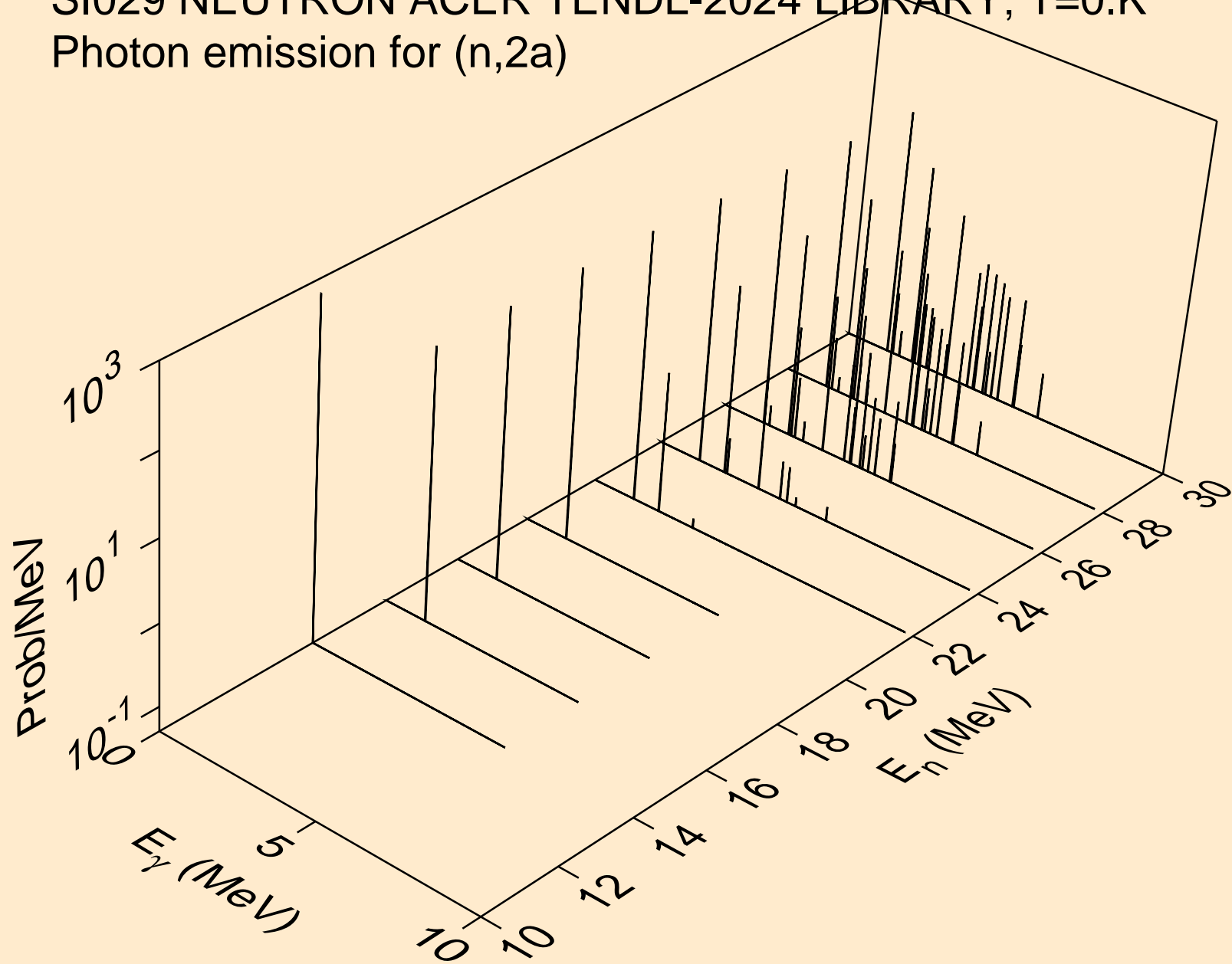

SI029 NEUTRON ACER TENDL-2024 LIBRARY; T=0.K  
Photon emission for (n,2p)

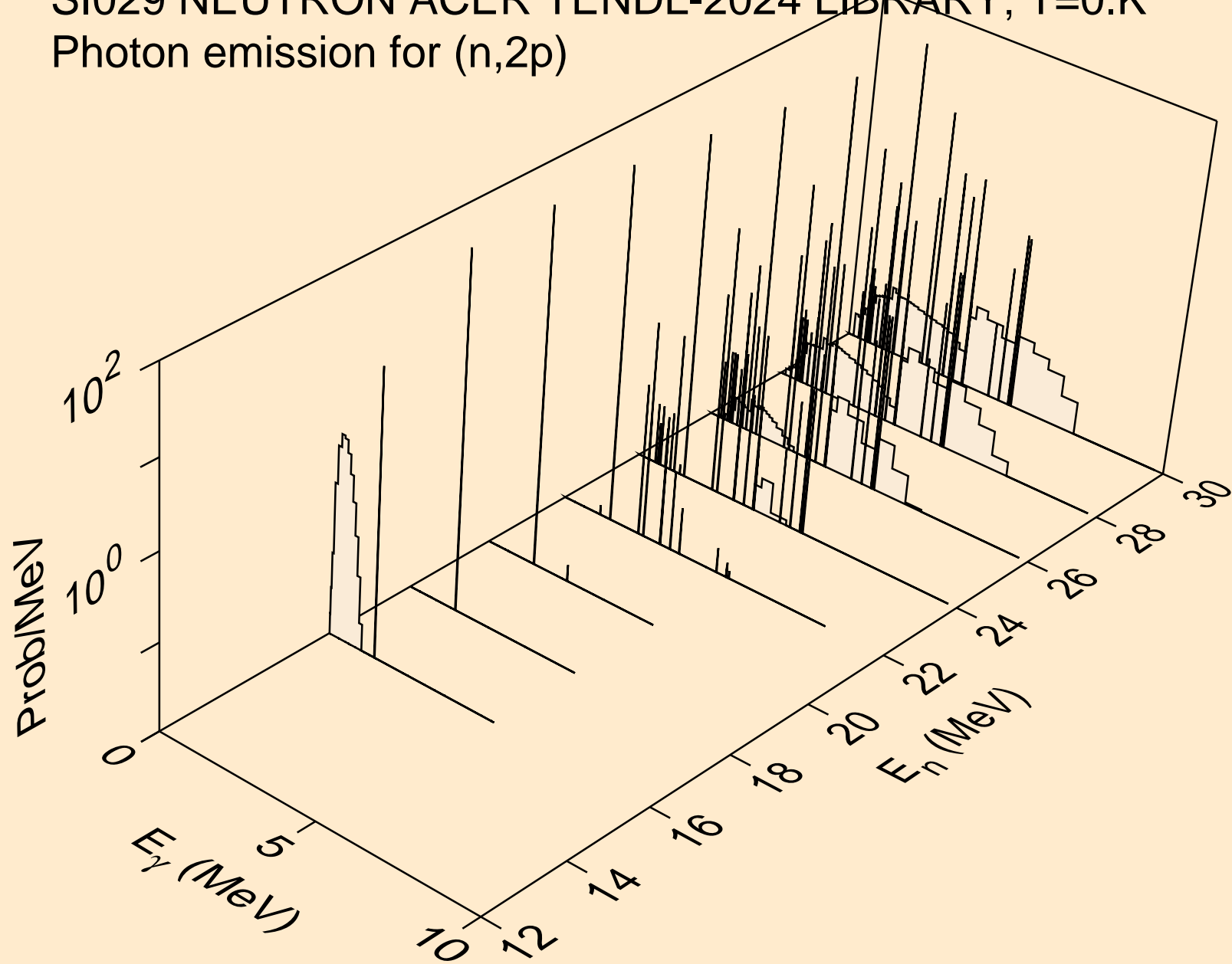

SI029 NEUTRON ACER TENDL-2024 LIBRARY; T=0.K  
Photon emission for (n,p $\alpha$ )

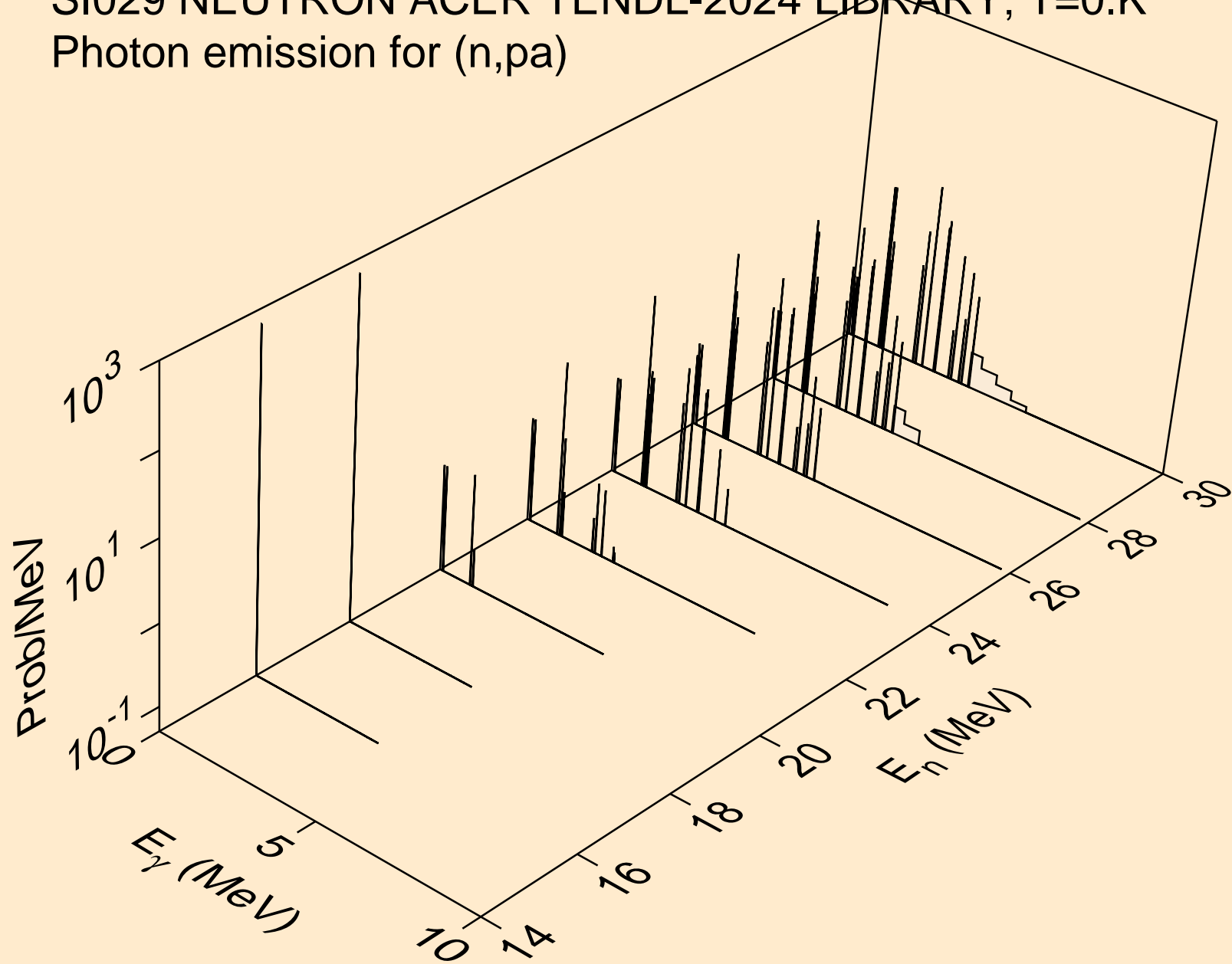

SI029 NEUTRON ACER TENDL-2024 LIBRARY; T=0.K  
Photon emission for (n,pd)

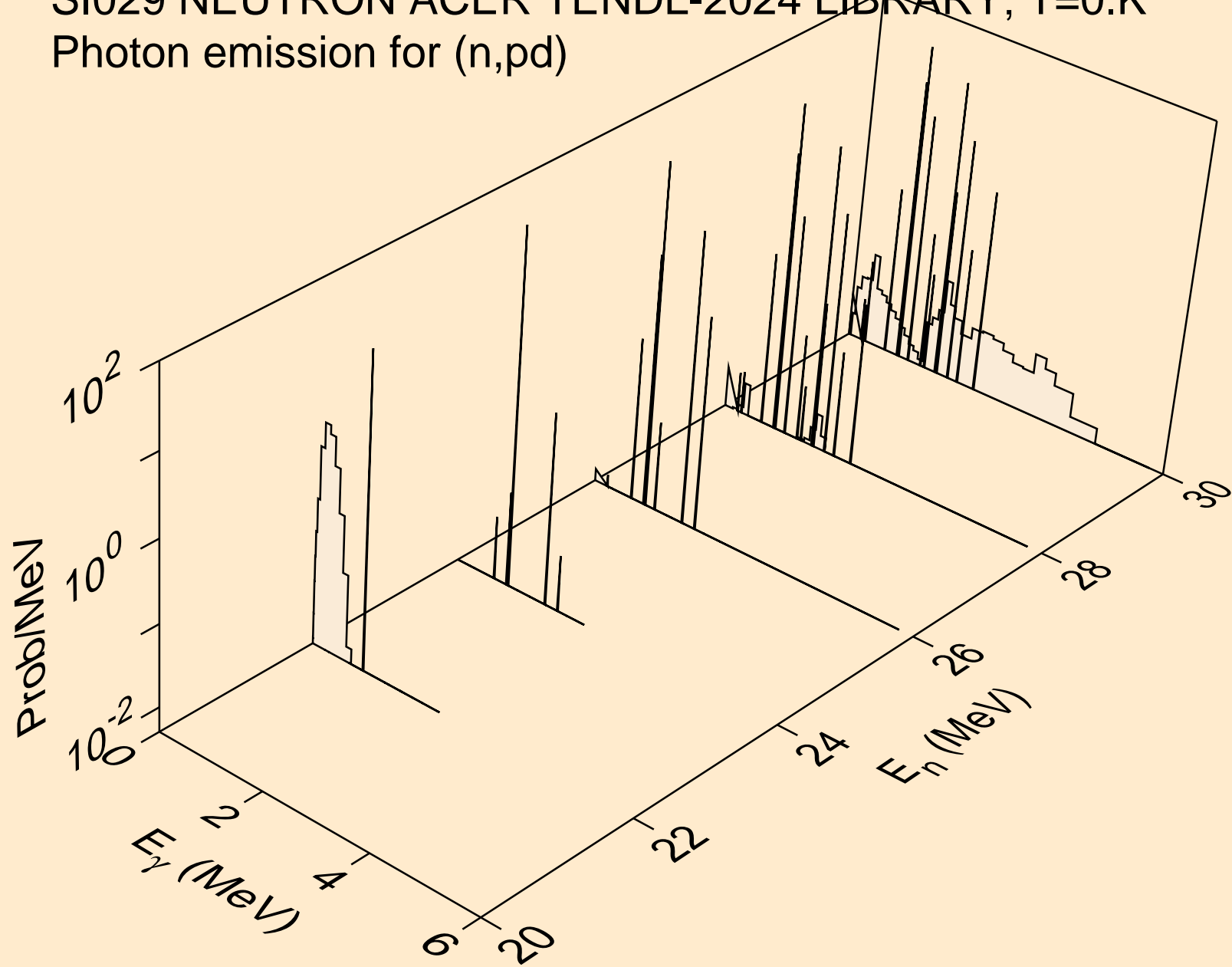

SI029 NEUTRON ACER TENDL-2024 LIBRARY; T=0.K  
Photon emission for (n,pt)

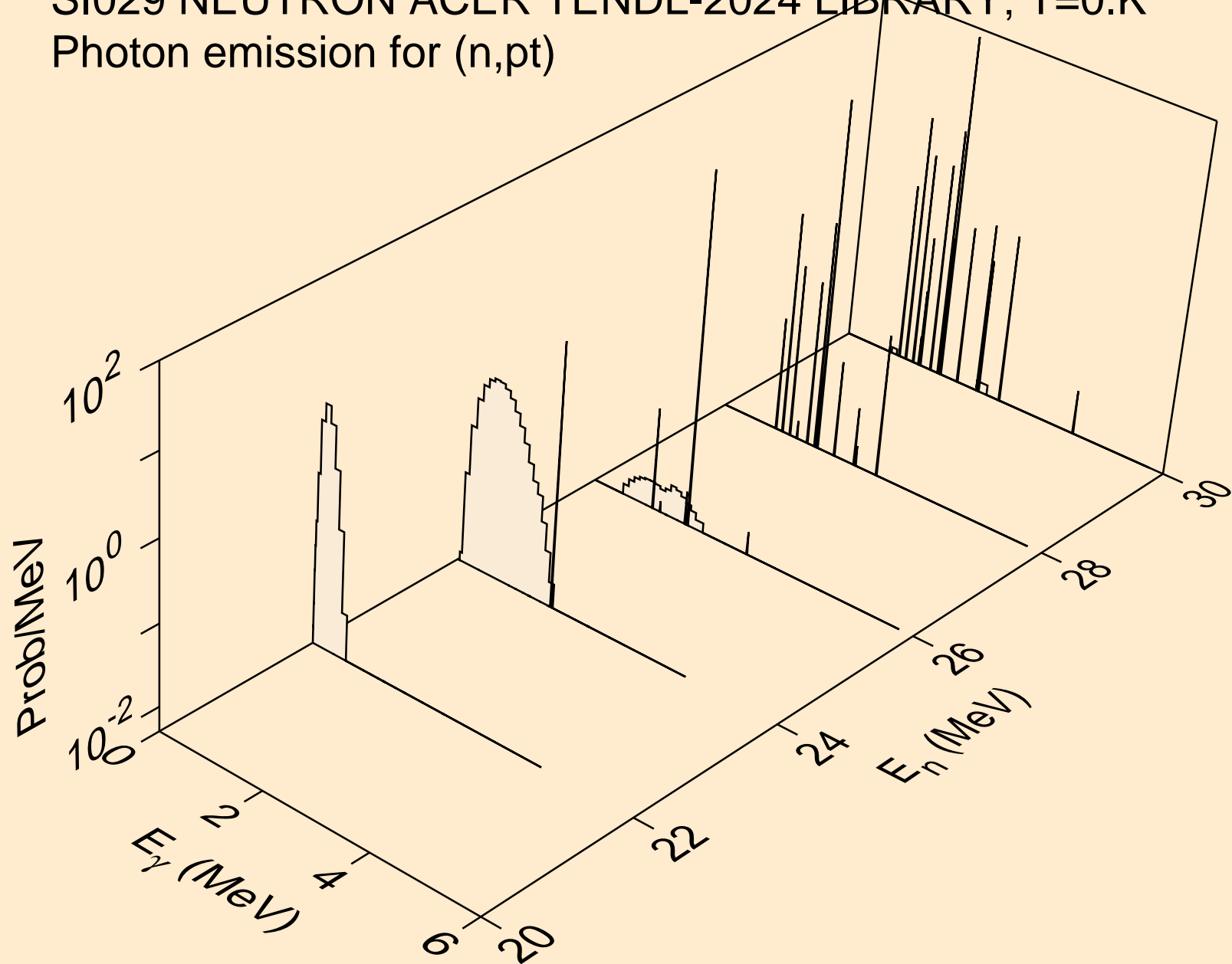



SI029 NEUTRON ACER TENDL-2024 LIBRARY; T=0.K  
Photon emission for (n,da)

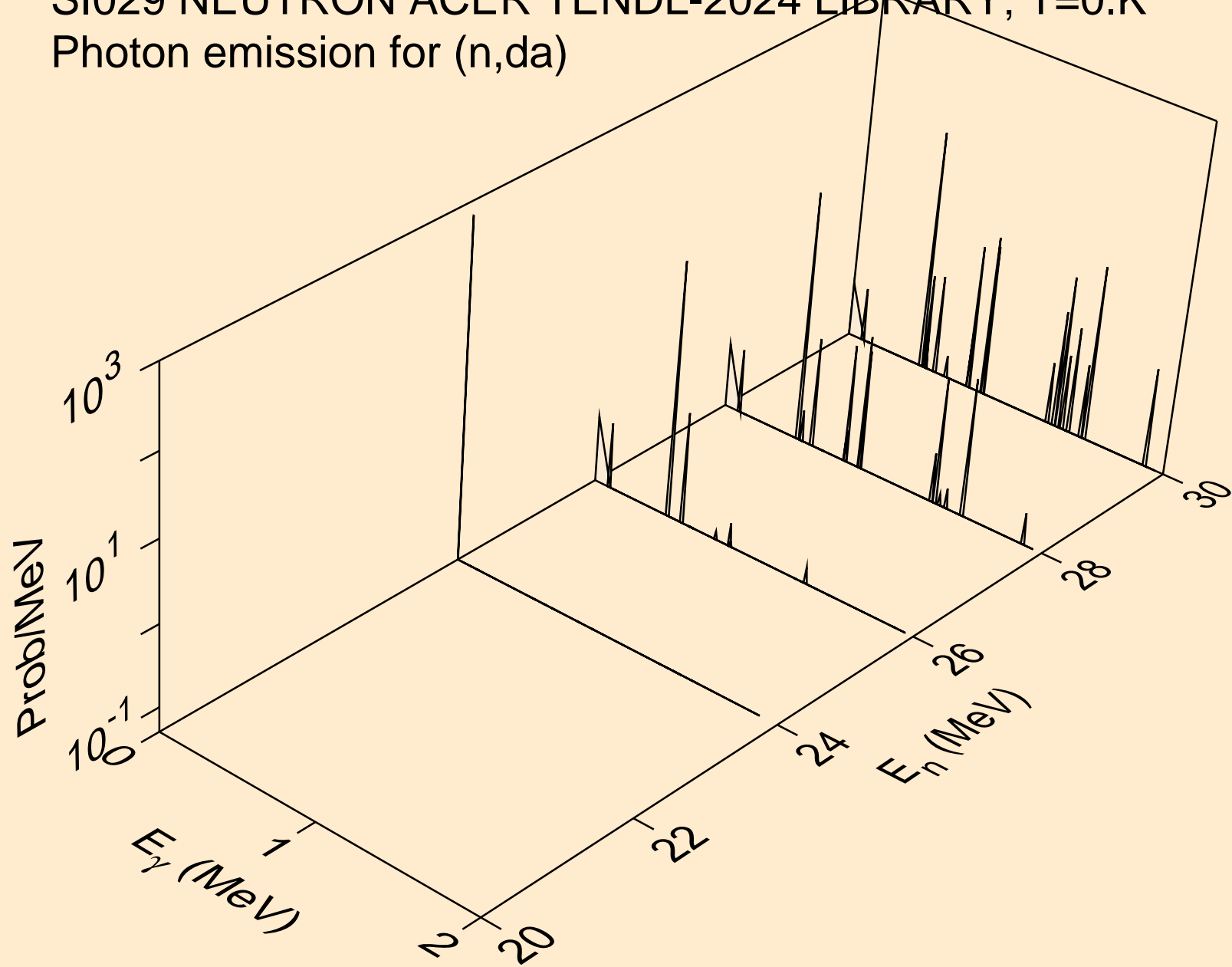

SI029 NEUTRON ACER TENDL-2024 LIBRARY; T=0.K  
thermal capture photon spectrum

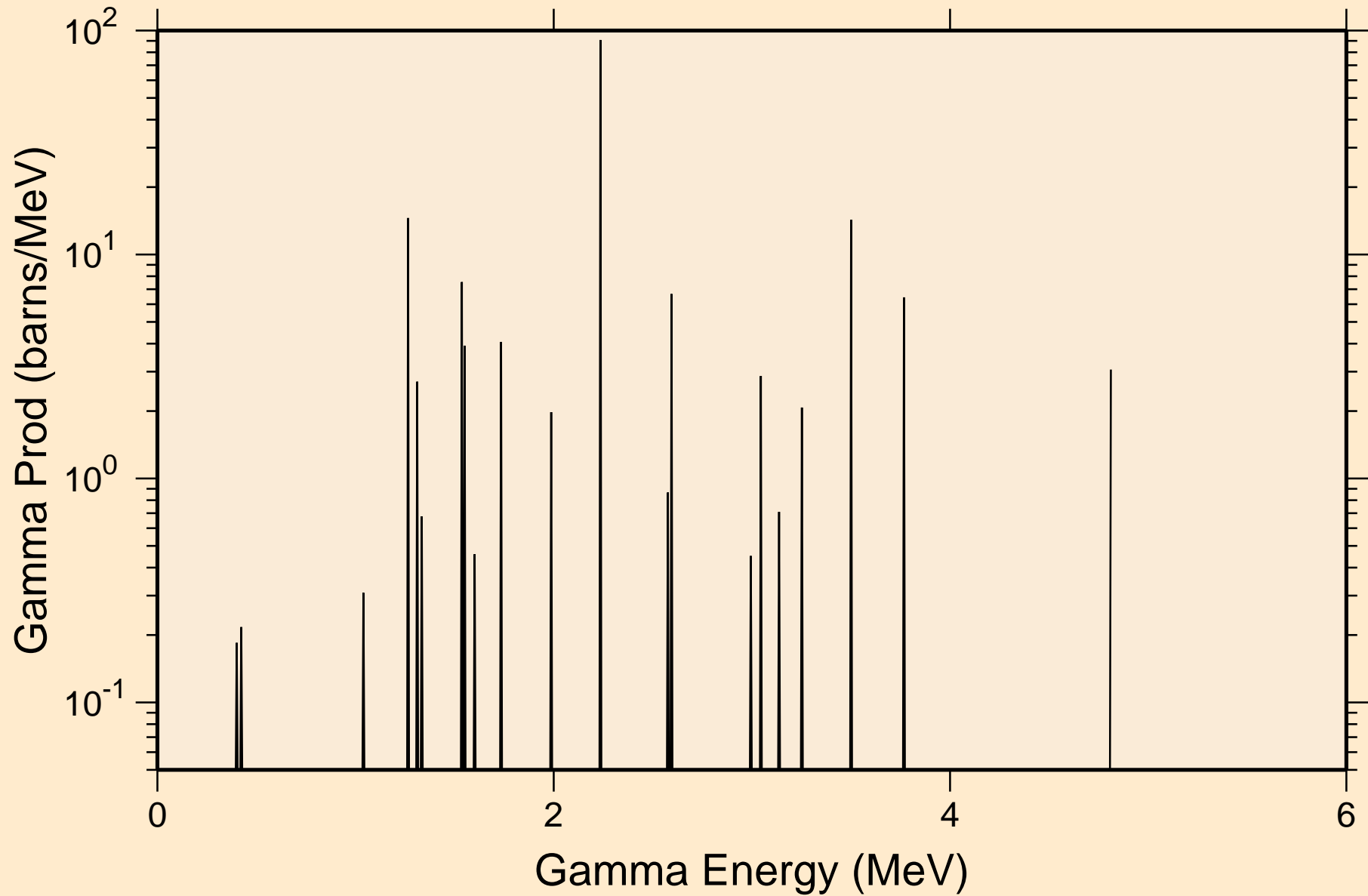

SI029 NEUTRON ACER TENDL-2024 LIBRARY; T=0.K  
14 MeV photon spectrum

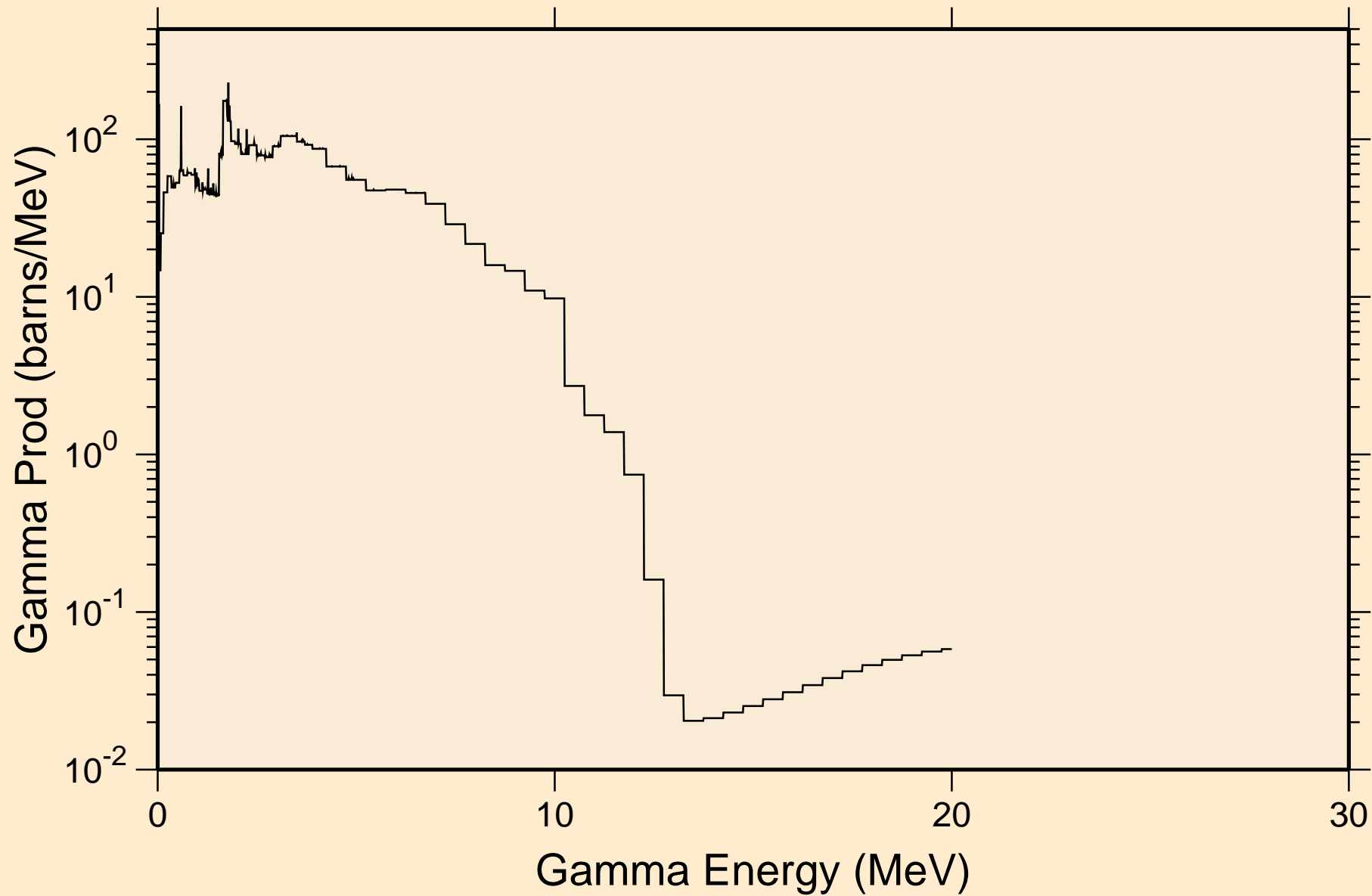

# SI029 NEUTRON ACER TENDL-2024 LIBRARY; T=0.K

## Particle heating contributions

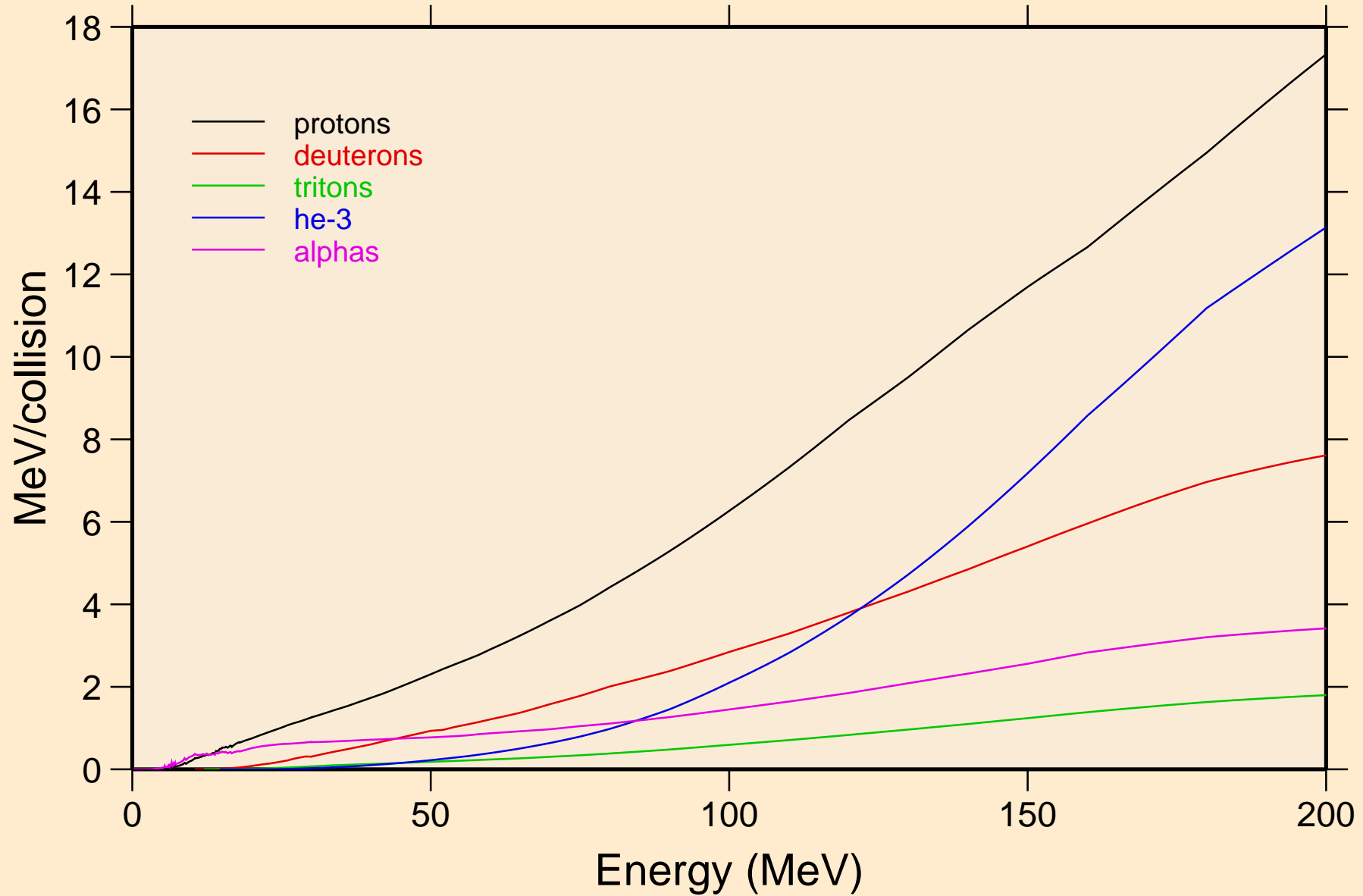

SI029 NEUTRON ACER TENDL-2024 LIBRARY; T=0.K  
Recoil Heating

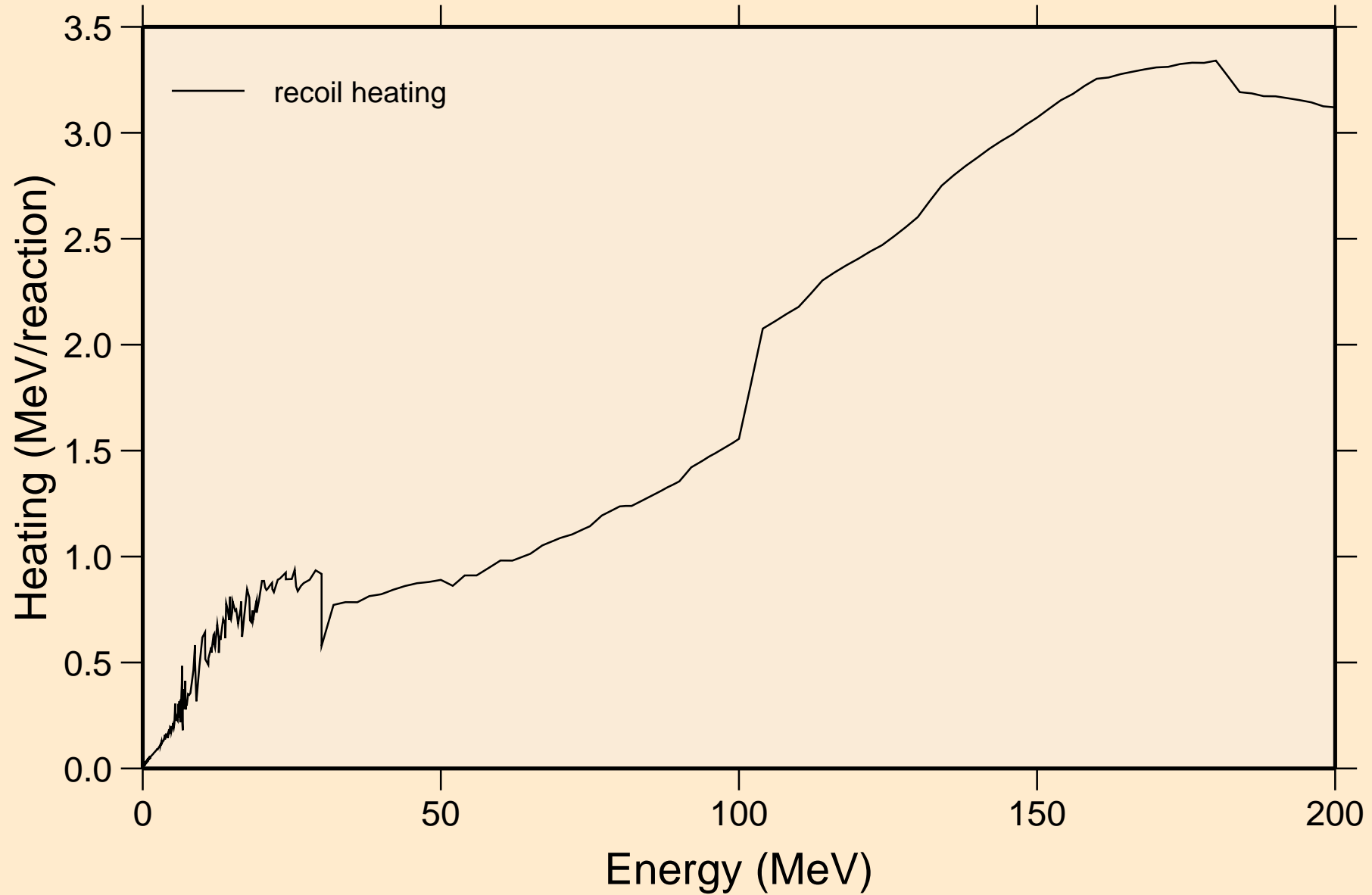

SI029 NEUTRON ACER TENDL-2024 LIBRARY; T=0.K  
Particle production cross sections

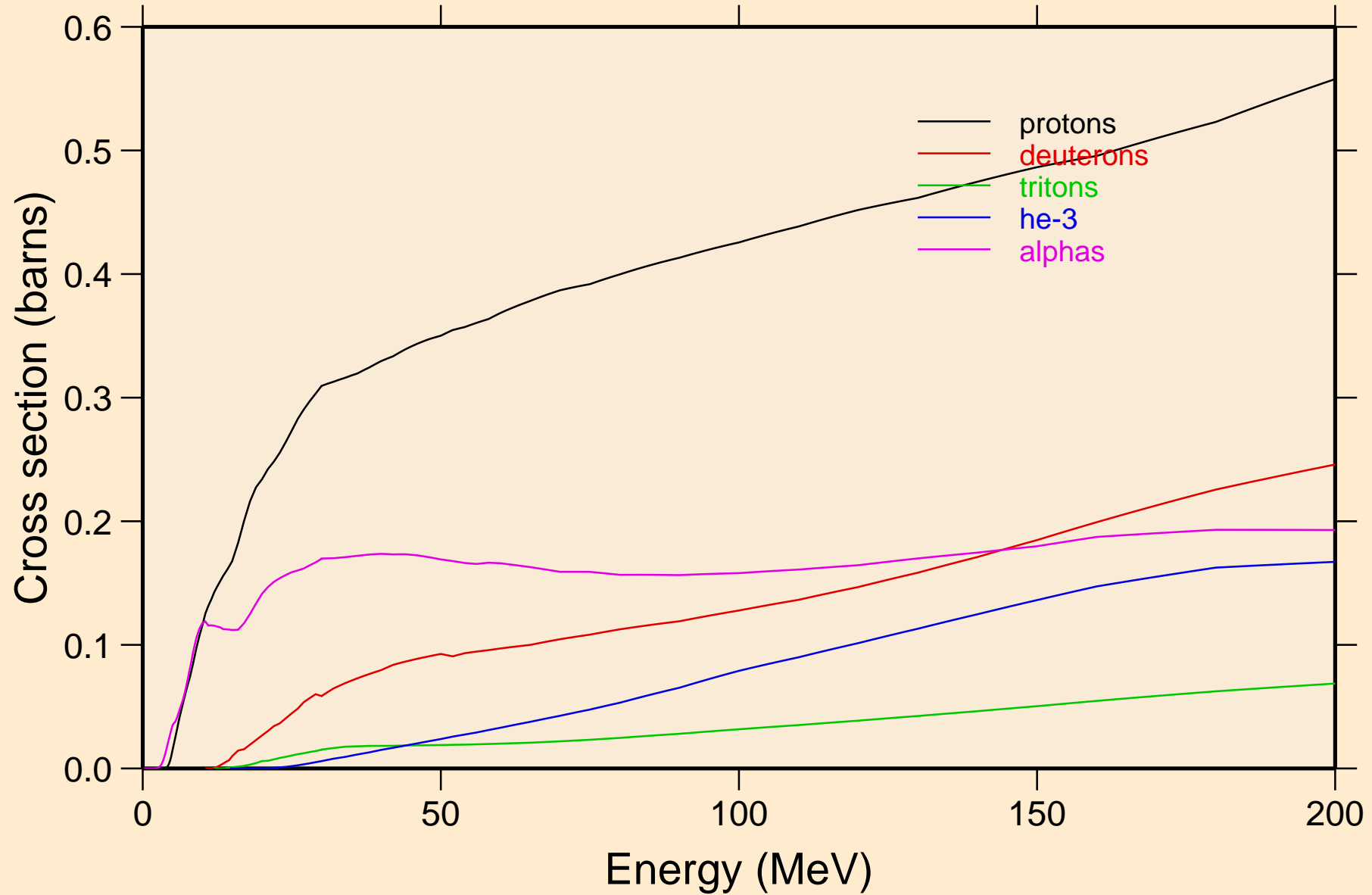

SI029 NEUTRON ACER TENDL-2024 LIBRARY; T=0.K  
protons from (n,x)

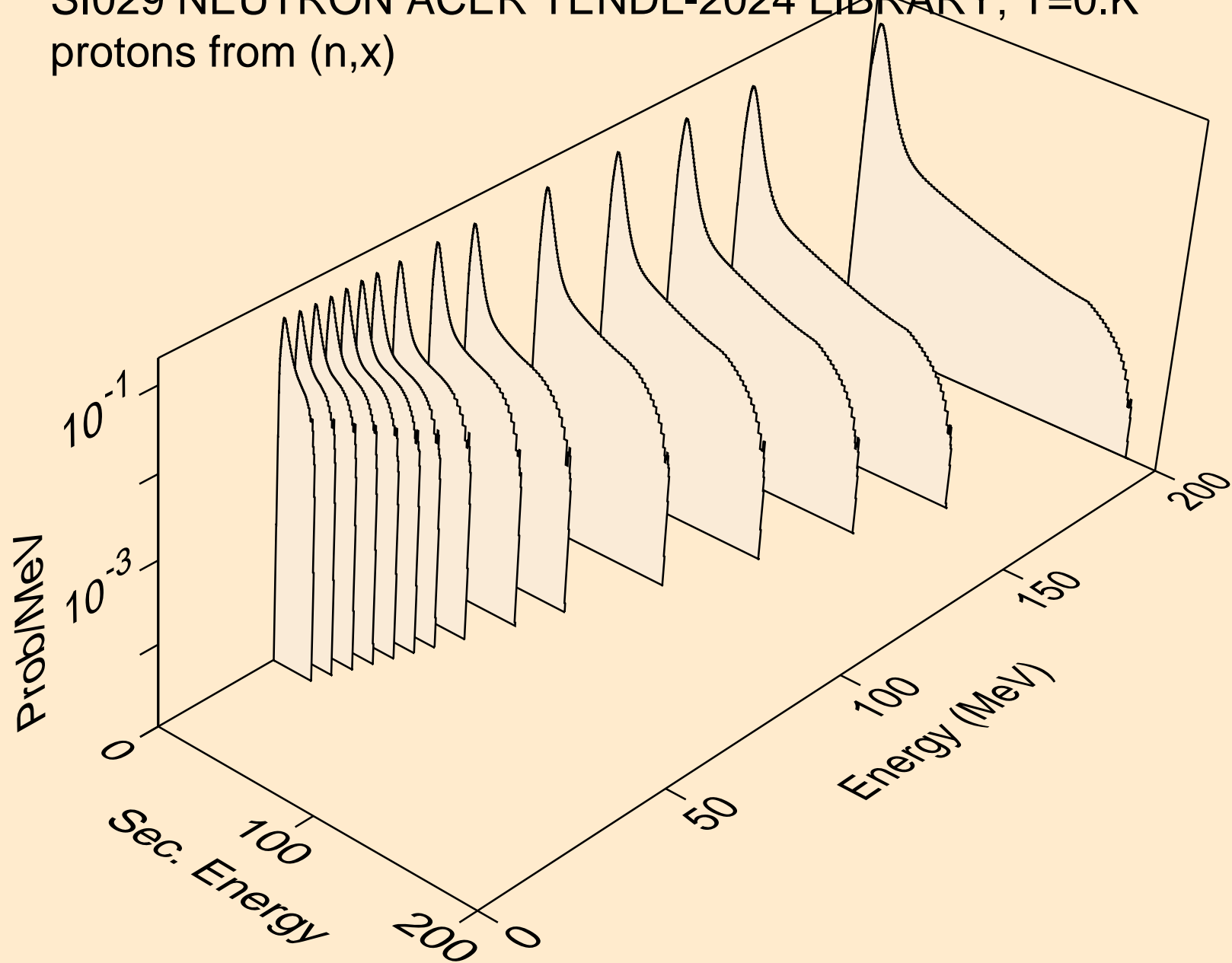

SI029 NEUTRON ACER TENDL-2024 LIBRARY; T=0.K  
protons from (n,n\*)p

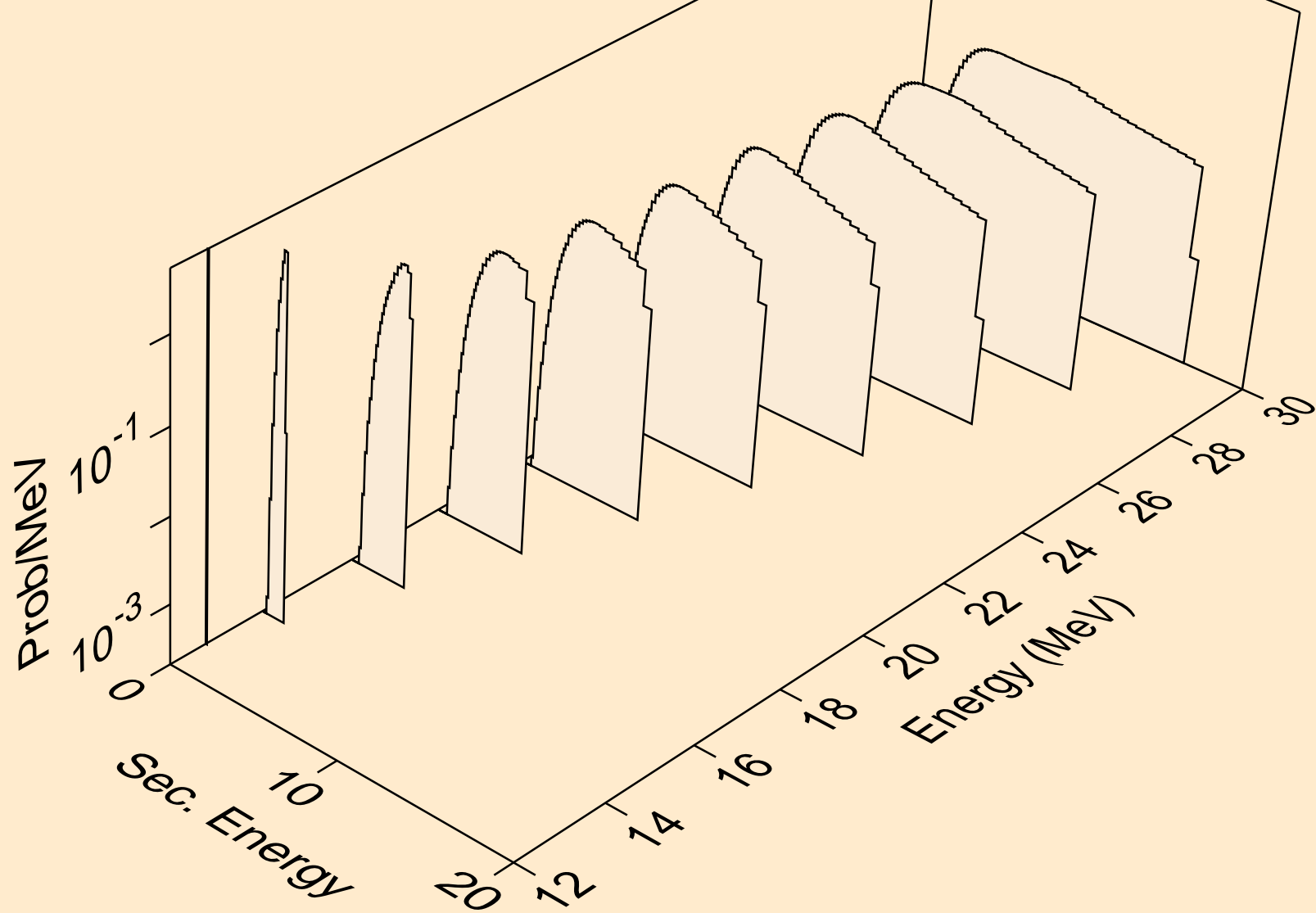



SI029 NEUTRON ACER TENDL-2024 LIBRARY; T=0.K  
protons from (n,2np)

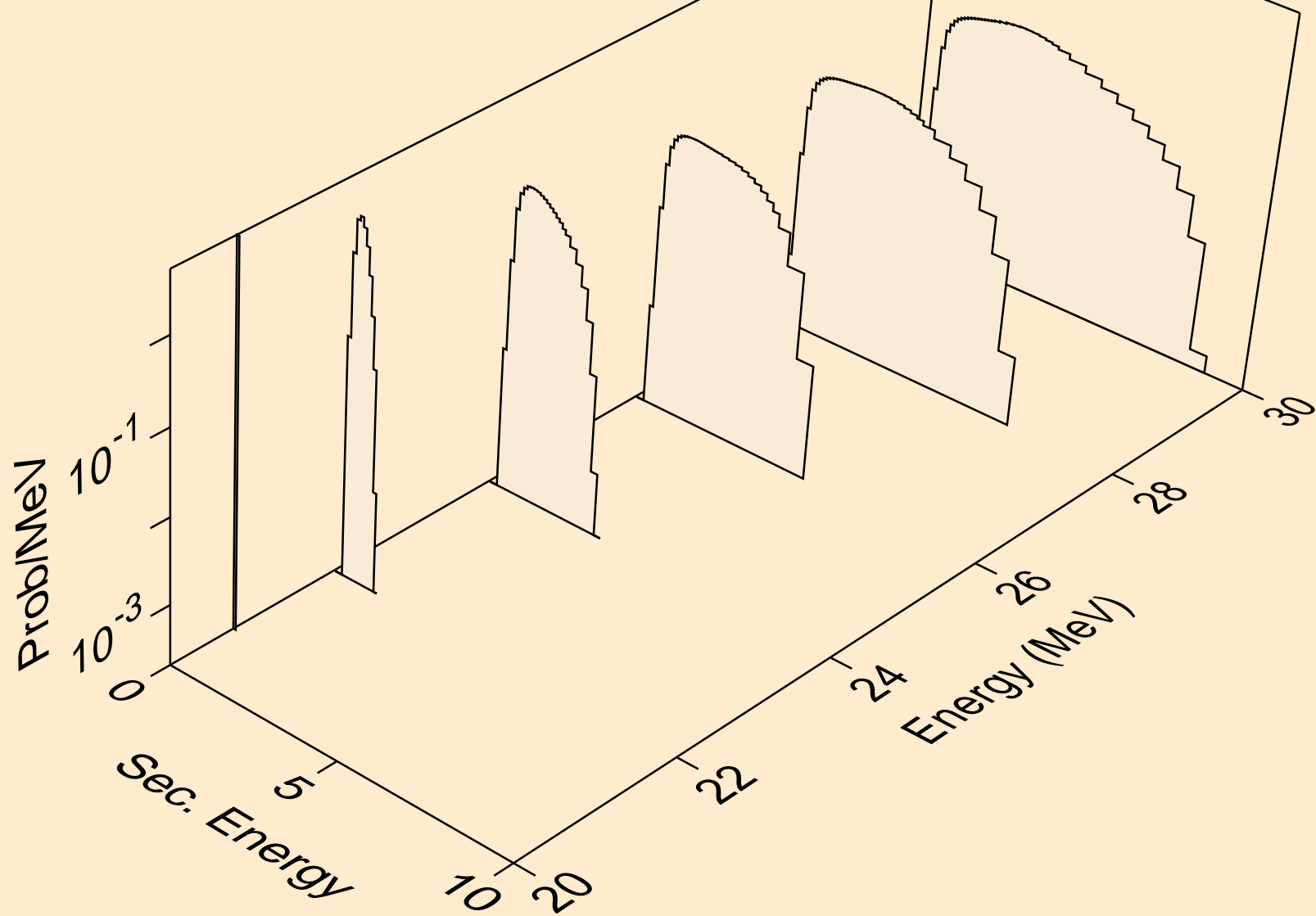

SI029 NEUTRON ACER TENDL-2024 LIBRARY; T=0.K  
protons from (n,n2p)

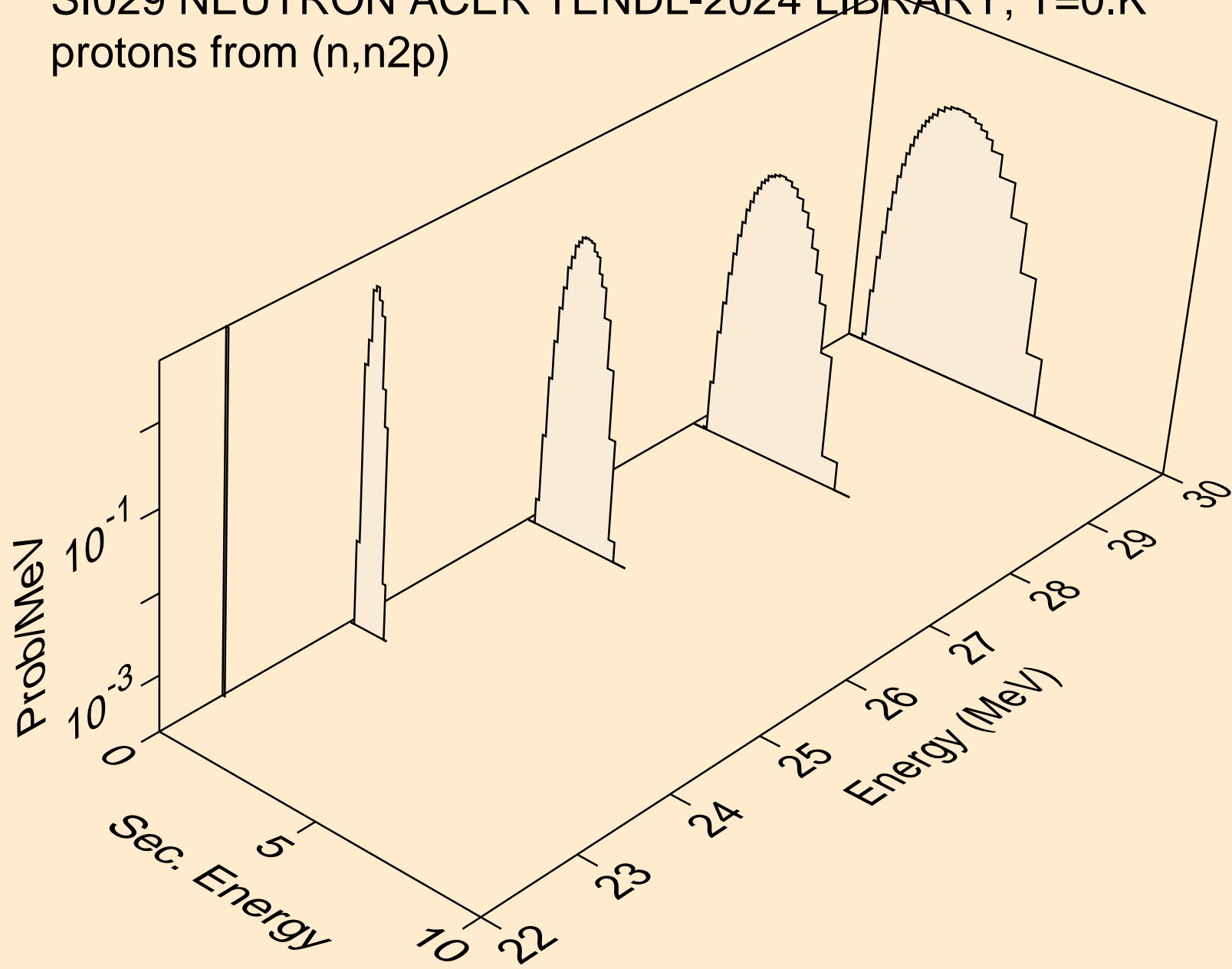

SI029 NEUTRON ACER TENDL-2024 LIBRARY; T=0.K  
protons from (n,npa)

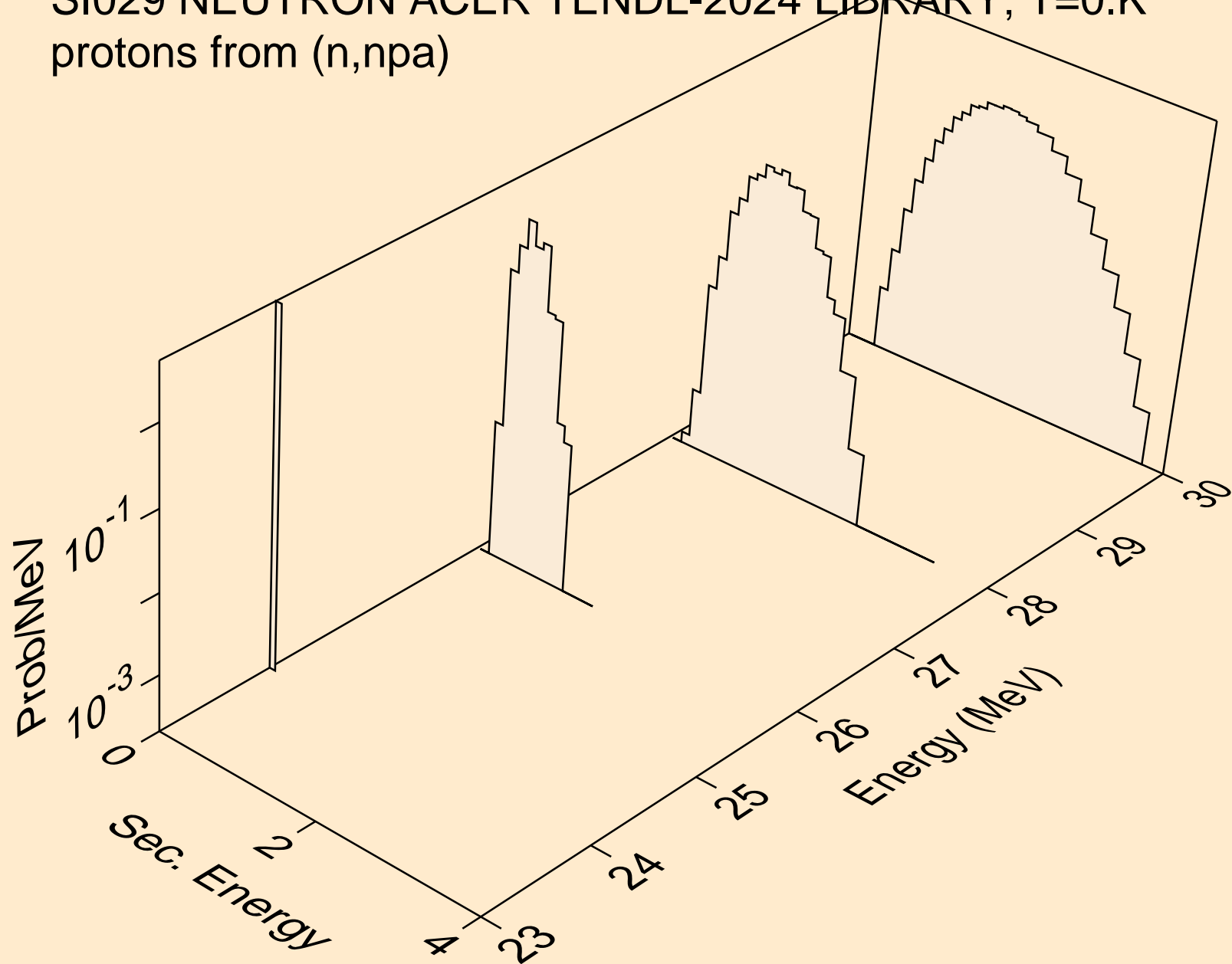

SI029 NEUTRON ACER TENDL-2024 LIBRARY; T=0.K  
protons from (n,p)

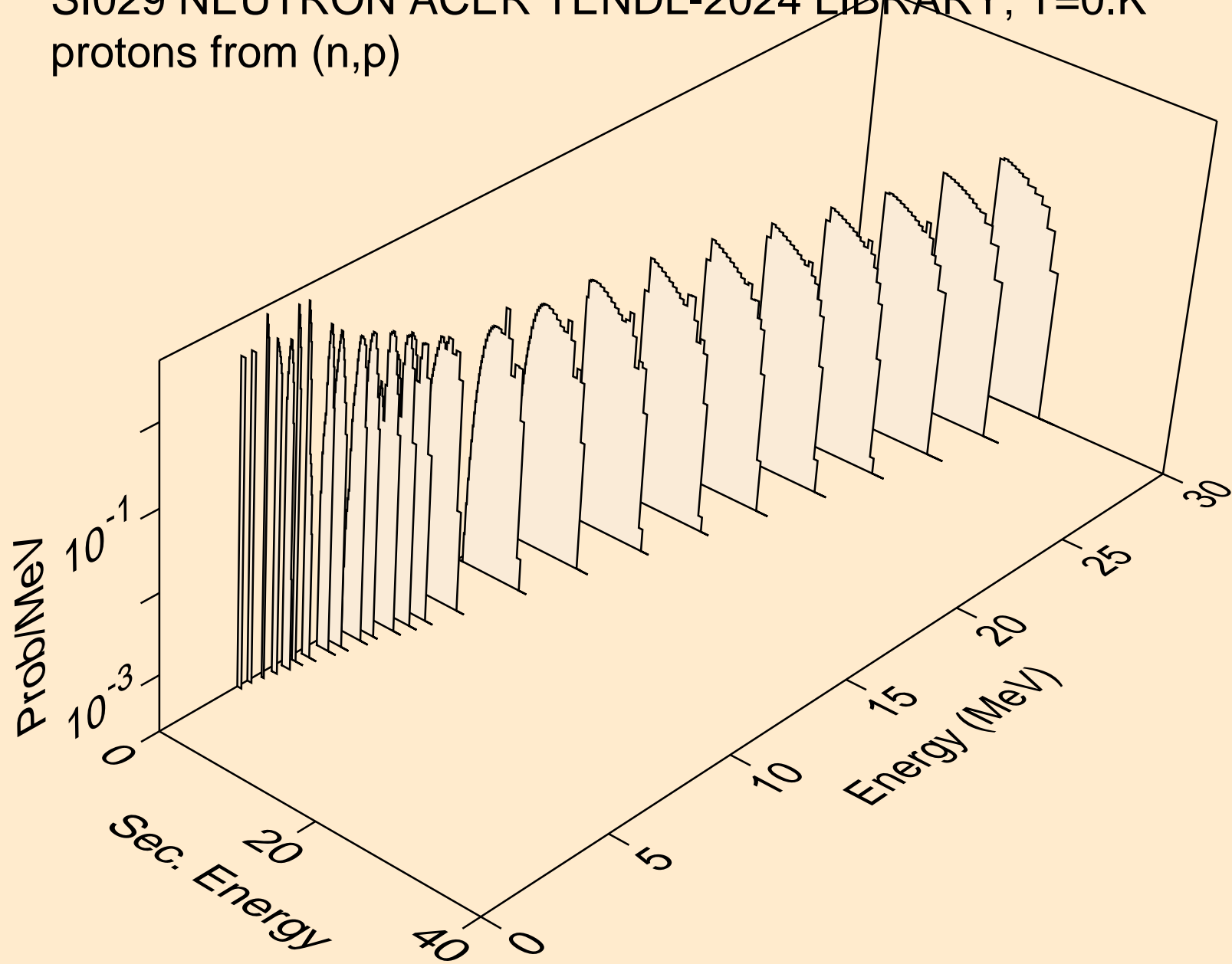

SI029 NEUTRON ACER TENDL-2024 LIBRARY; T=0.K  
protons from (n,2p)

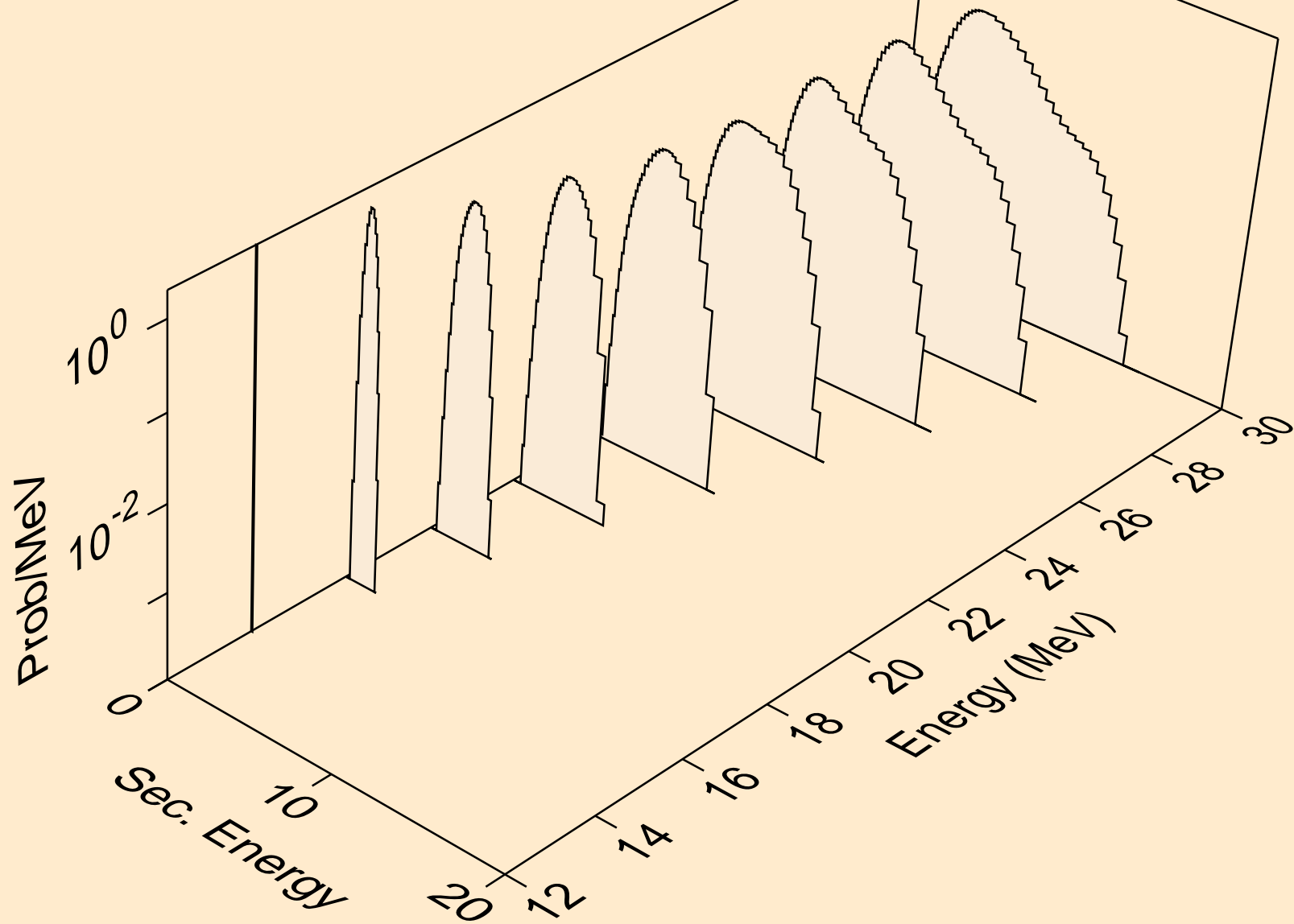

SI029 NEUTRON ACER TENDL-2024 LIBRARY; T=0.K  
protons from (n,p)

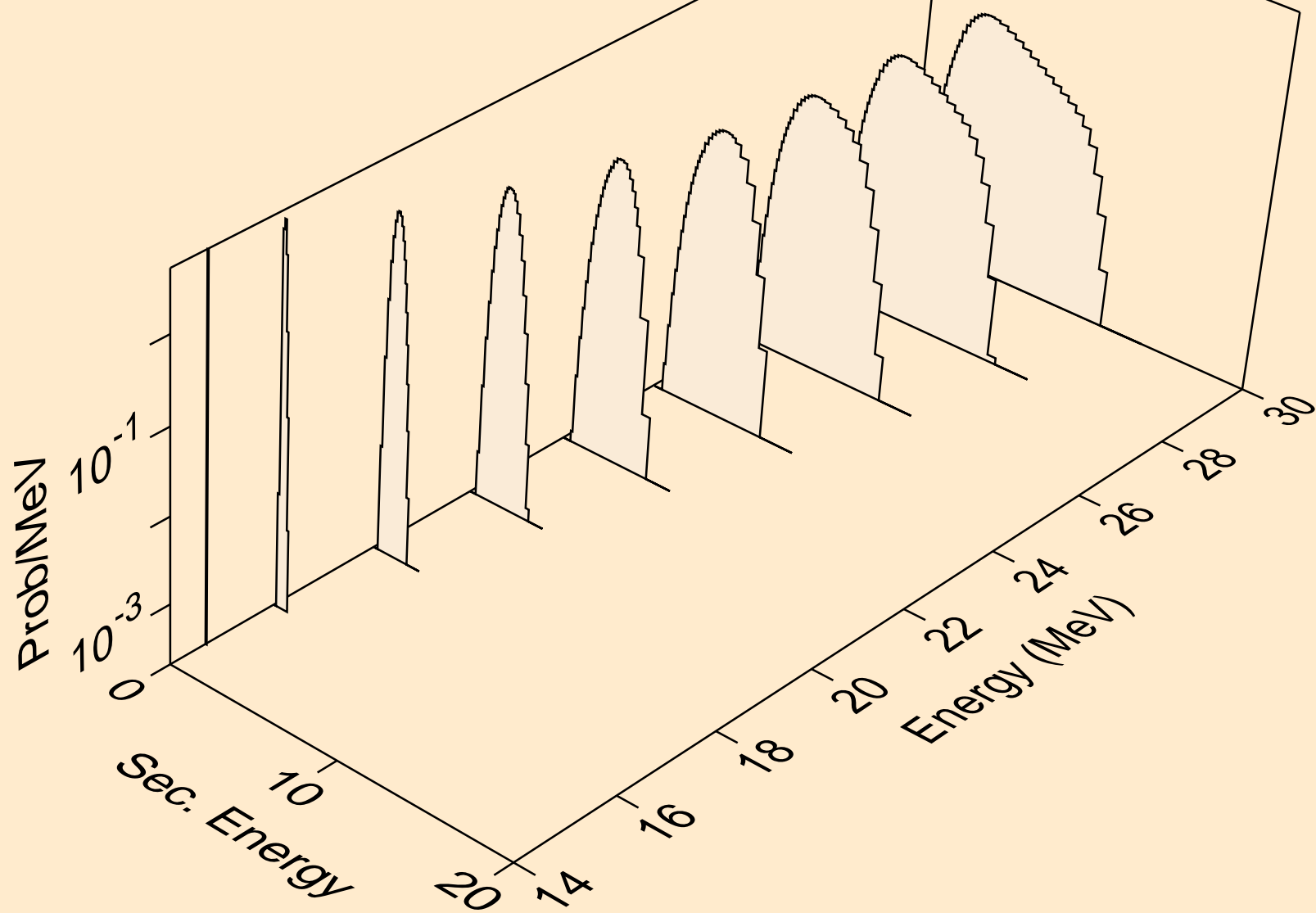

SI029 NEUTRON ACER TENDL-2024 LIBRARY; T=0.K  
protons from (n,pd)

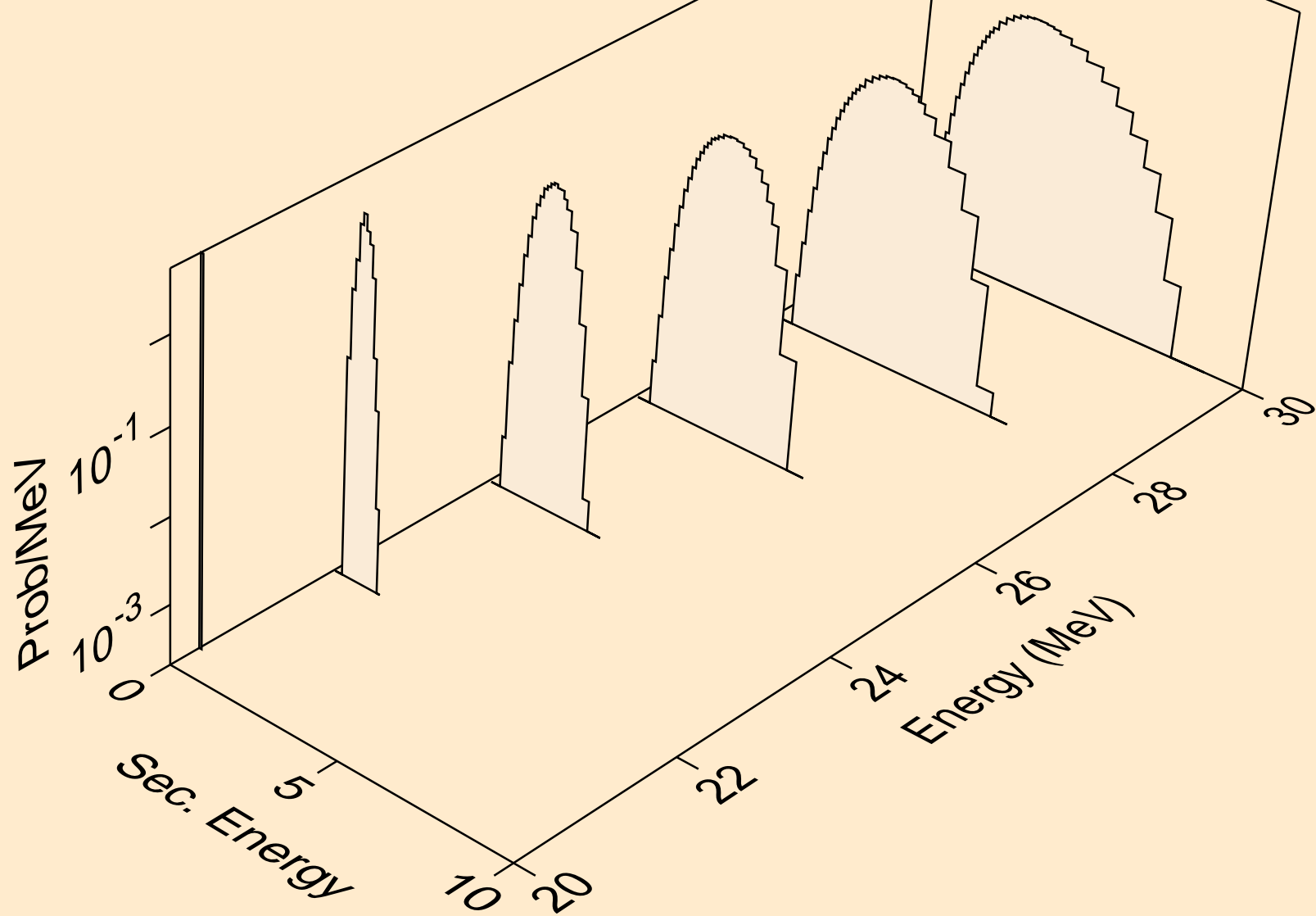

SI029 NEUTRON ACER TENDL-2024 LIBRARY; T=0.K  
protons from (n,pt)

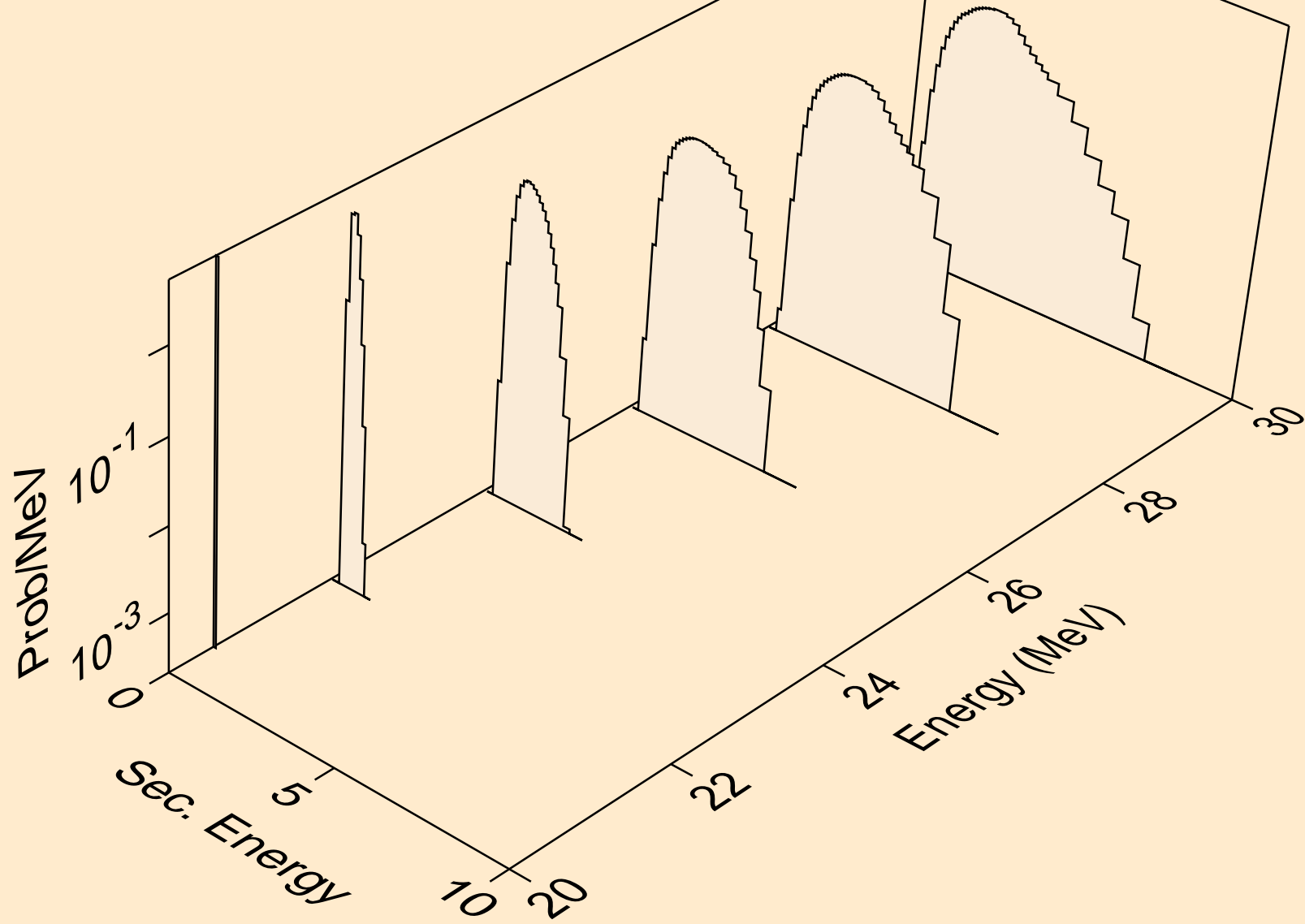



SI029 NEUTRON ACER TENDL-2024 LIBRARY; T=0.K  
deuterons from (n,x)

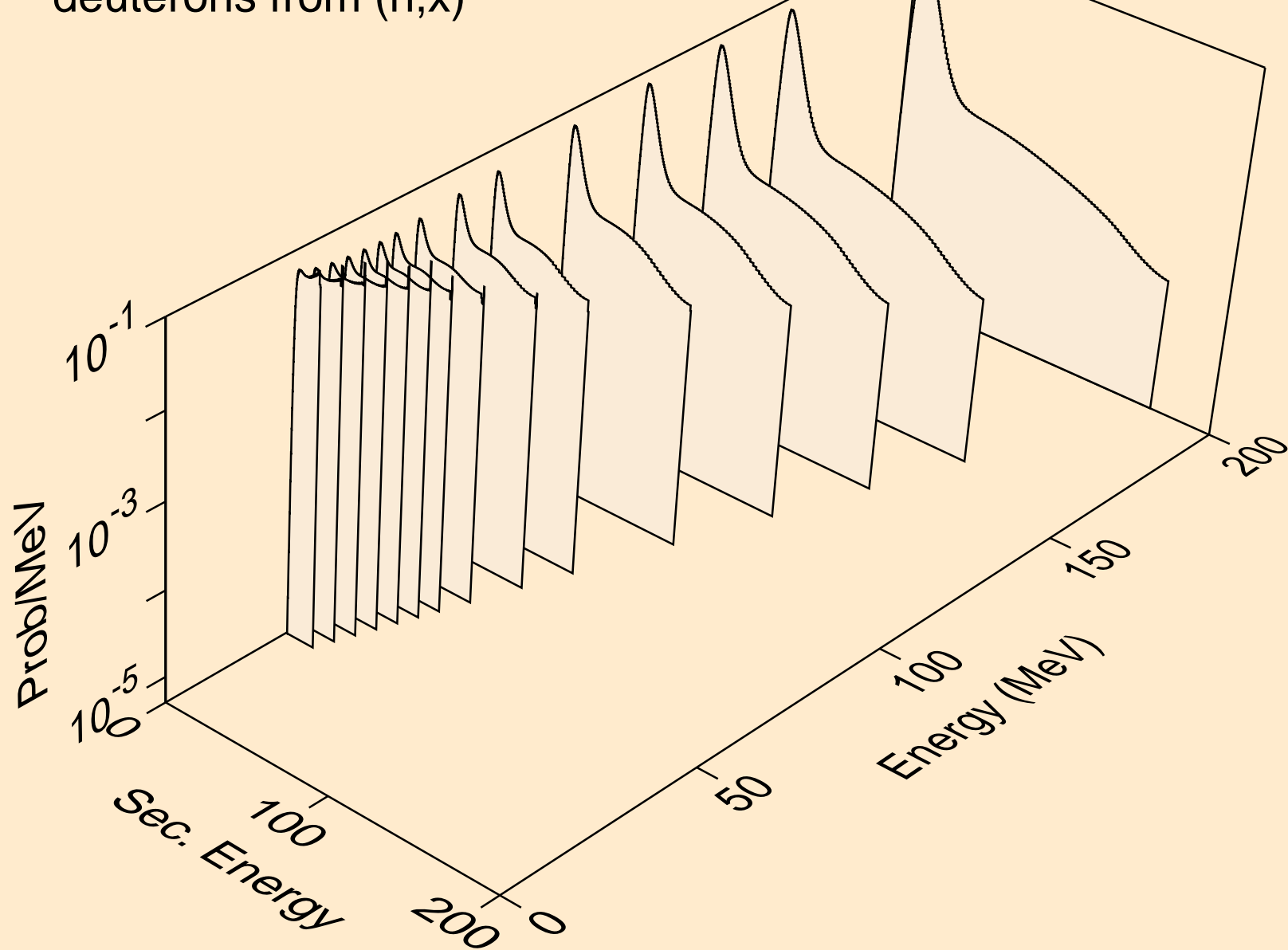

SI029 NEUTRON ACER TENDL-2024 LIBRARY; T=0.K  
deuterons from (n,n\*)d

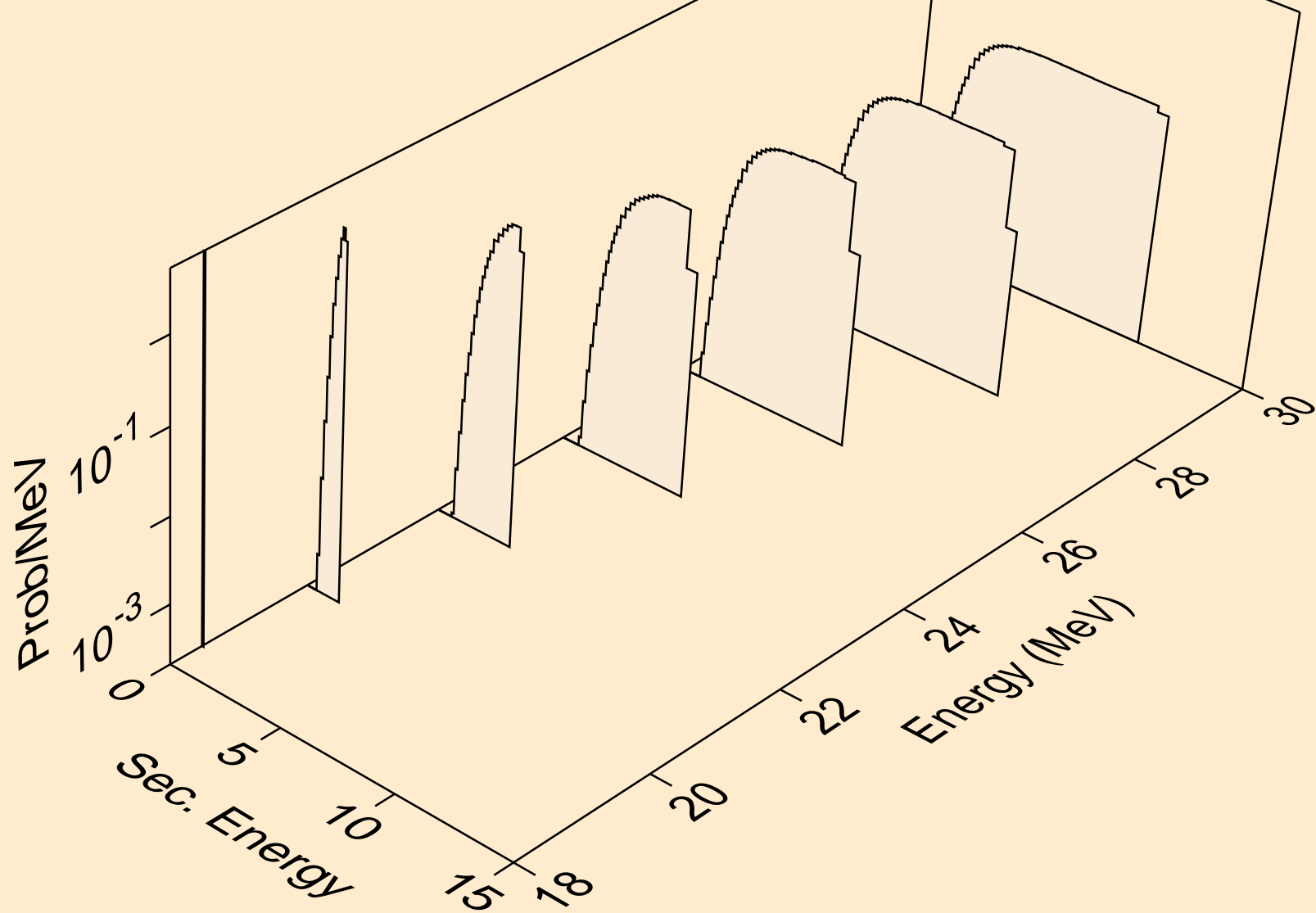

SI029 NEUTRON ACER TENDL-2024 LIBRARY; T=0.K  
deuterons from (n,d)

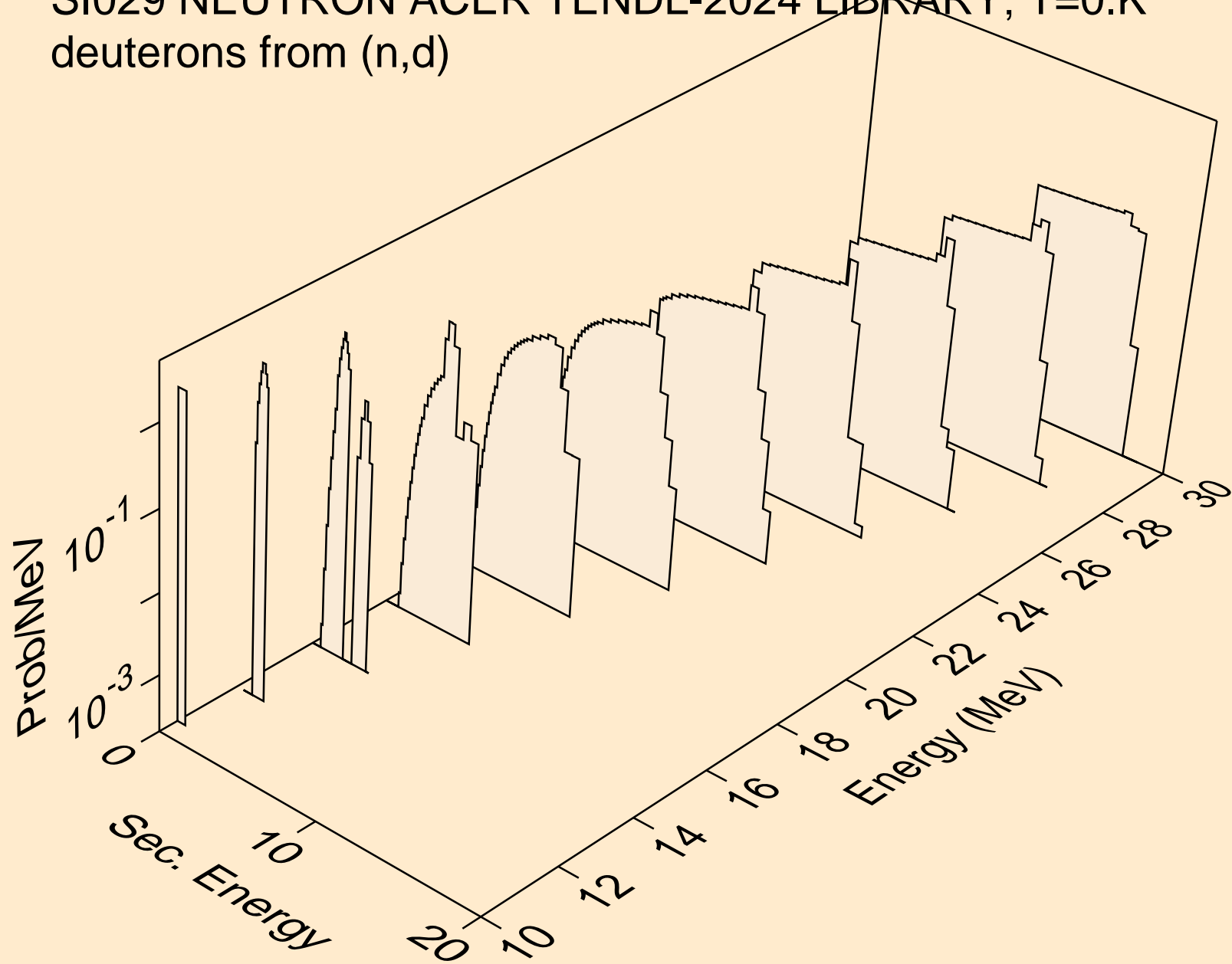

SI029 NEUTRON ACER TENDL-2024 LIBRARY; T=0.K  
deuterons from (n,pd)

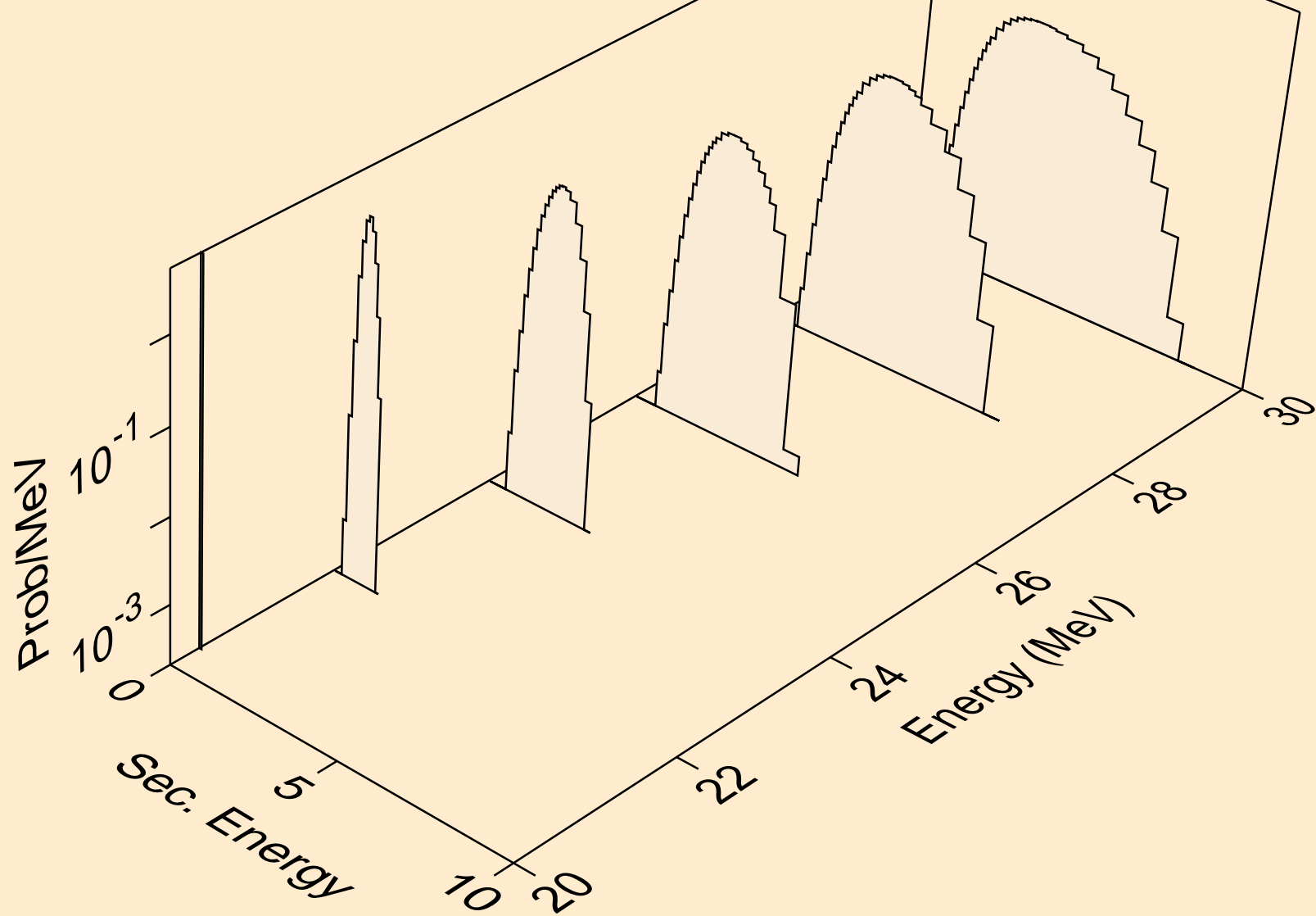

SI029 NEUTRON ACER TENDL-2024 LIBRARY; T=0.K  
deuterons from (n,da)

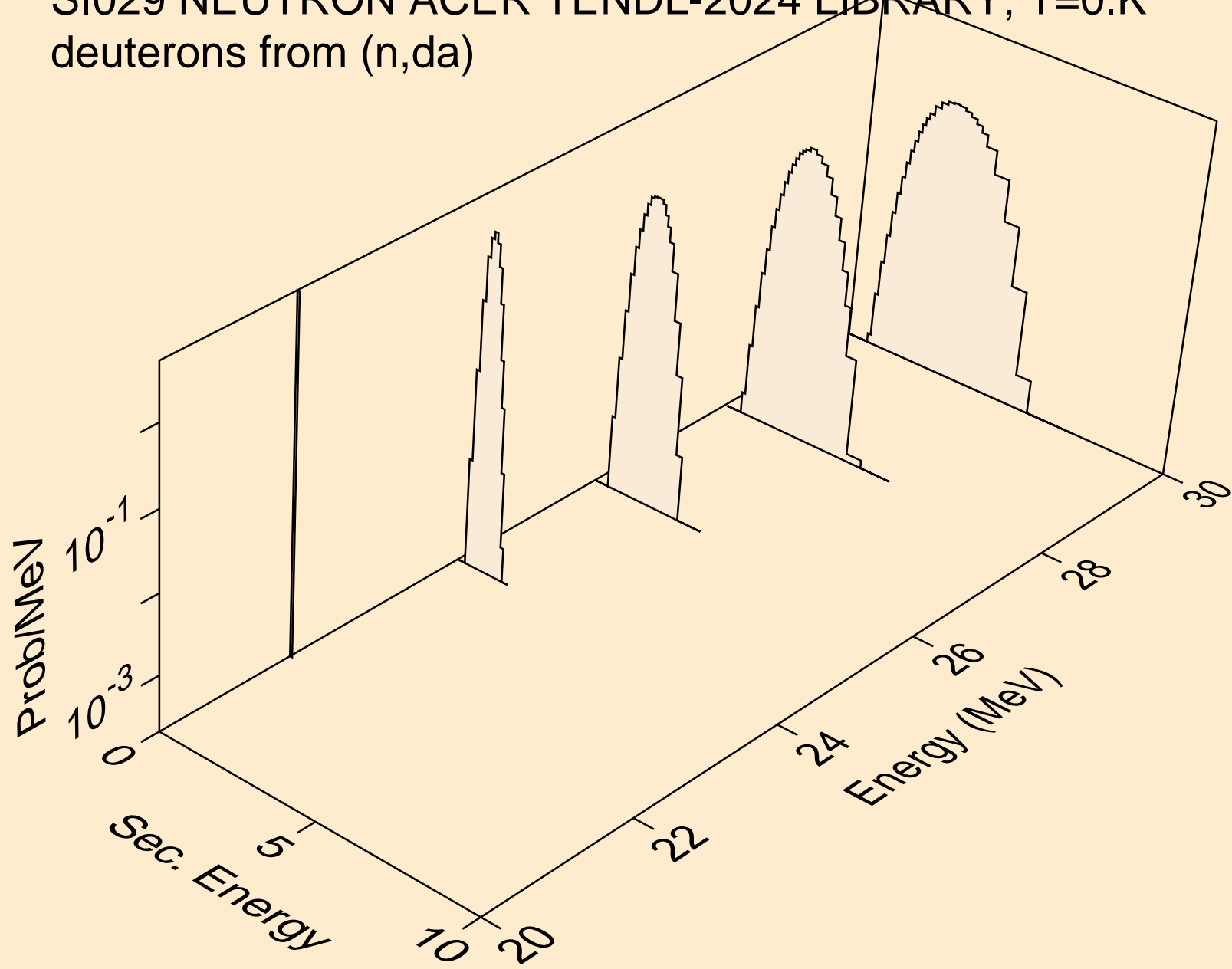

SI029 NEUTRON ACER TENDL-2024 LIBRARY; T=0.K  
tritons from (n,x)

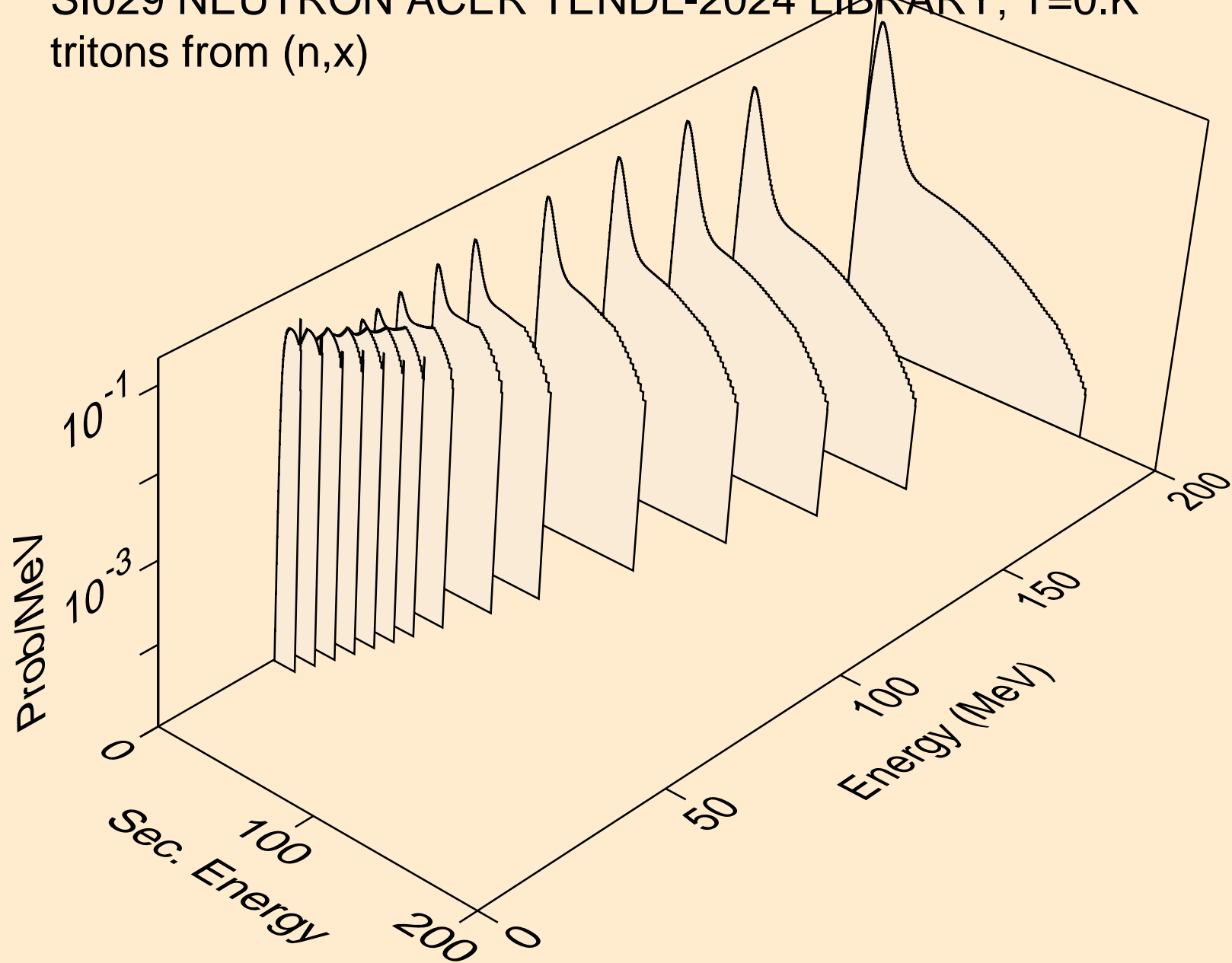

SI029 NEUTRON ACER TENDL-2024 LIBRARY; T=0.K  
tritons from (n,n\*)t

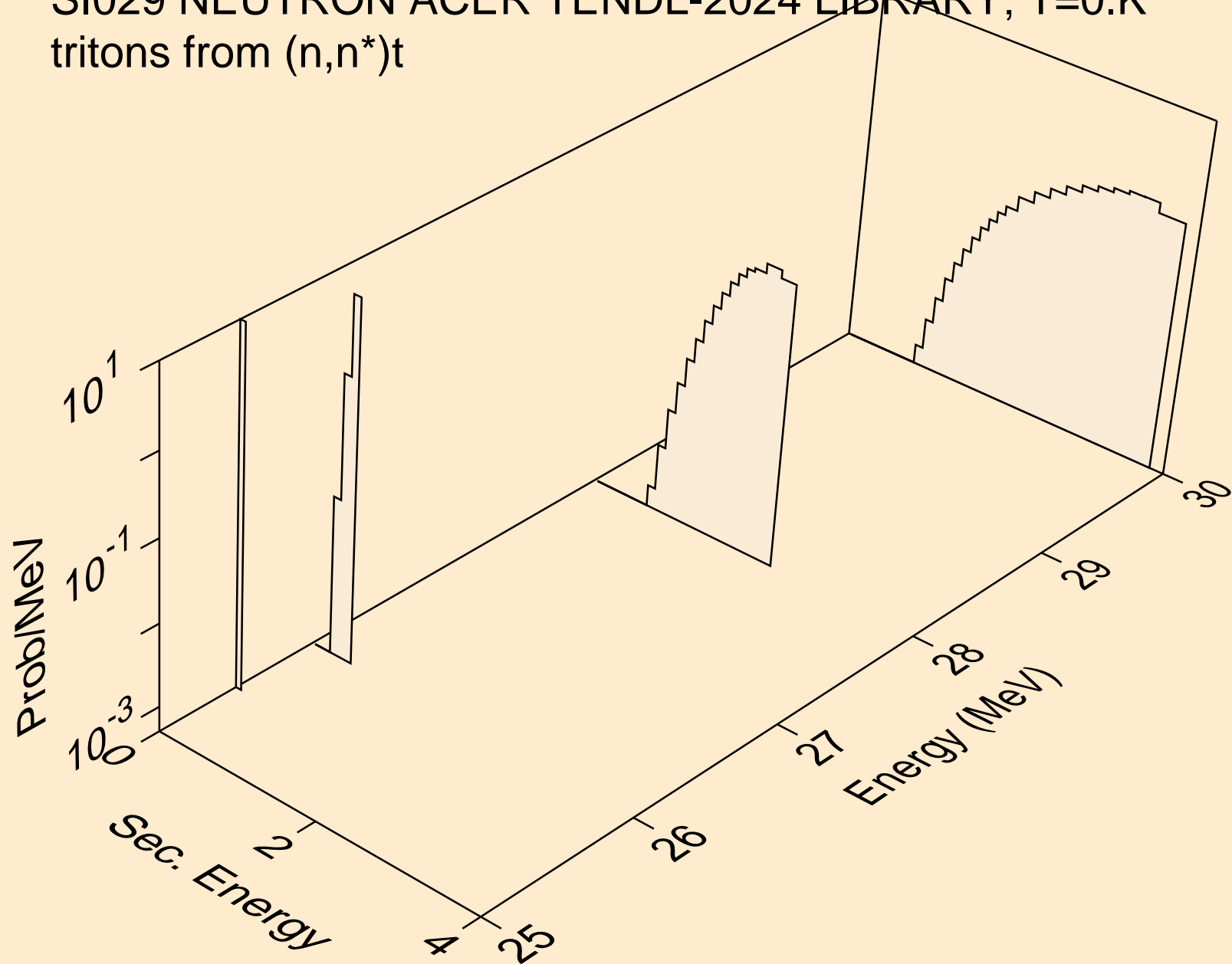

SI029 NEUTRON ACER TENDL-2024 LIBRARY; T=0.K  
tritons from (n,t)

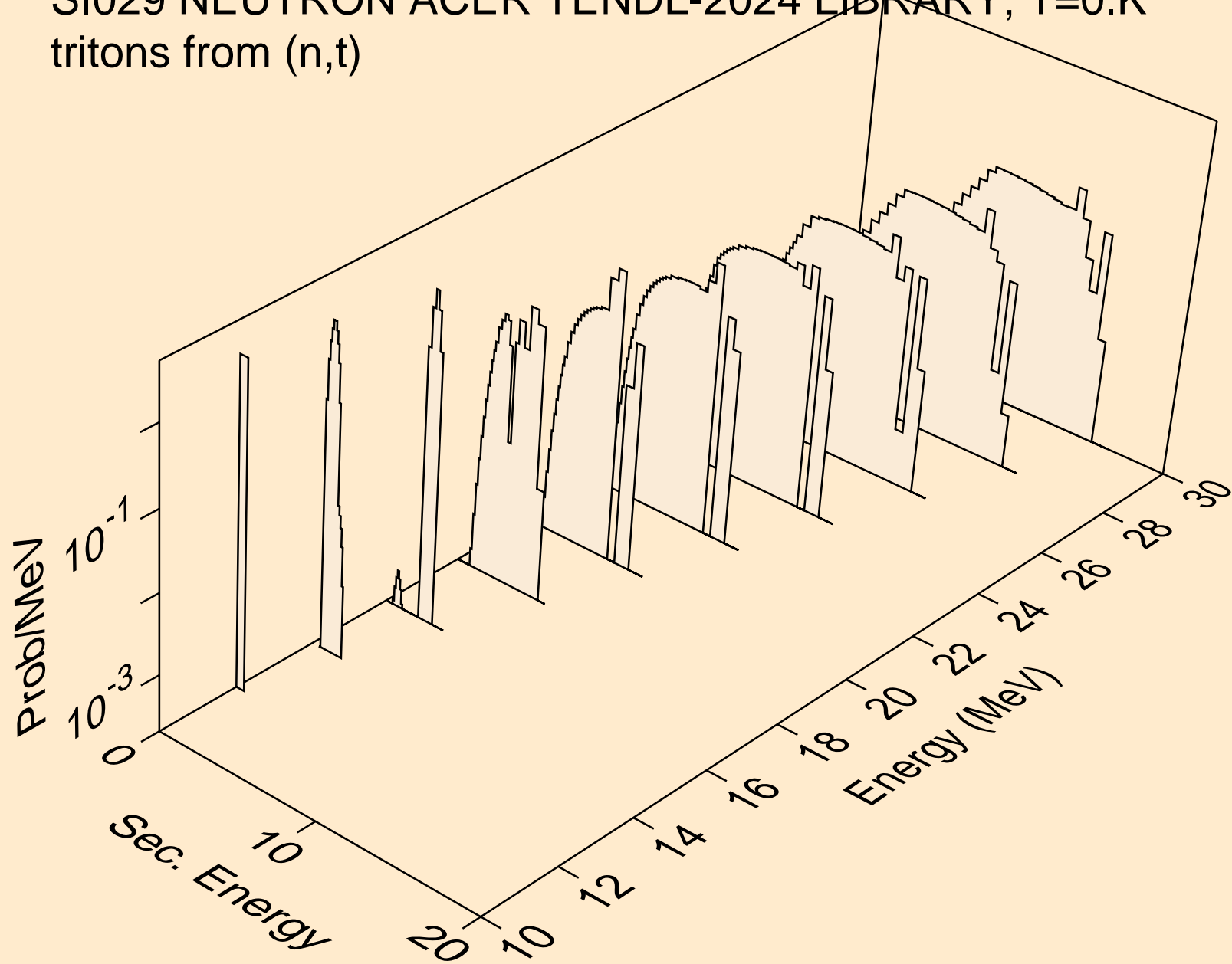



SI029 NEUTRON ACER TENDL-2024 LIBRARY; T=0.K  
tritons from (n,pt)

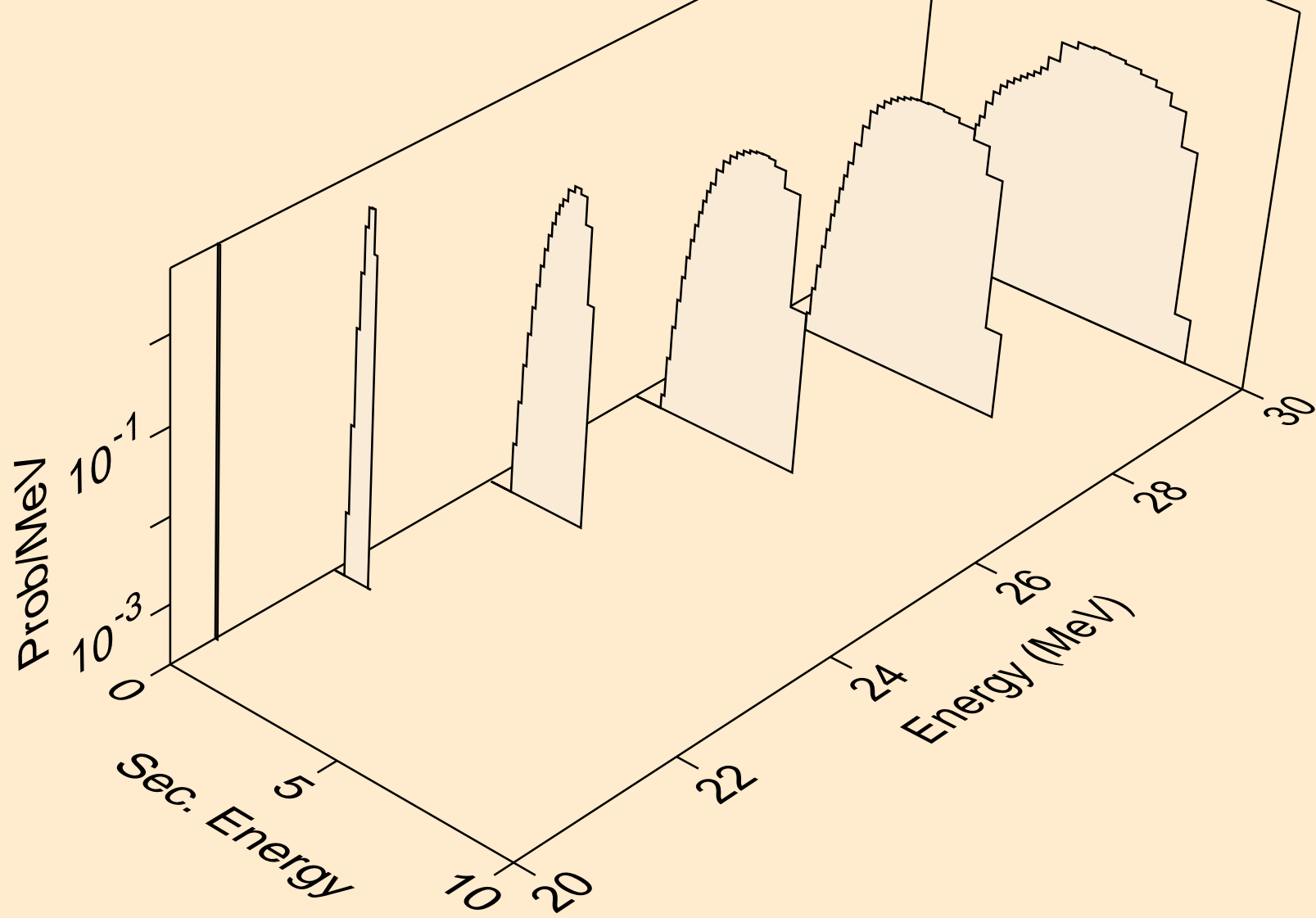

SI029 NEUTRON ACER TENDL-2024 LIBRARY; T=0.K  
he3s from (n,x)

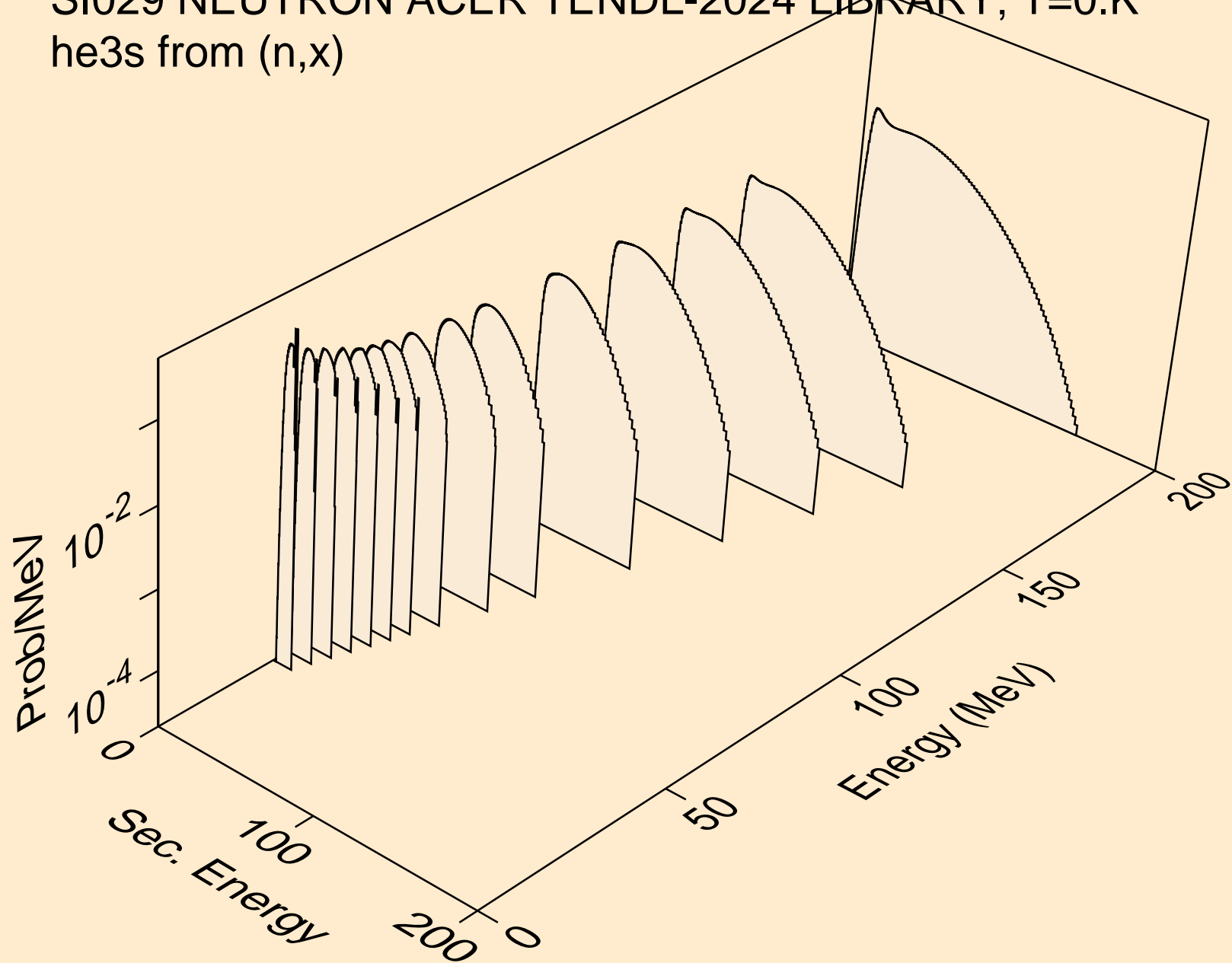

SI029 NEUTRON ACER TENDL-2024 LIBRARY; T=0.K  
he3s from (n,n\*)he3

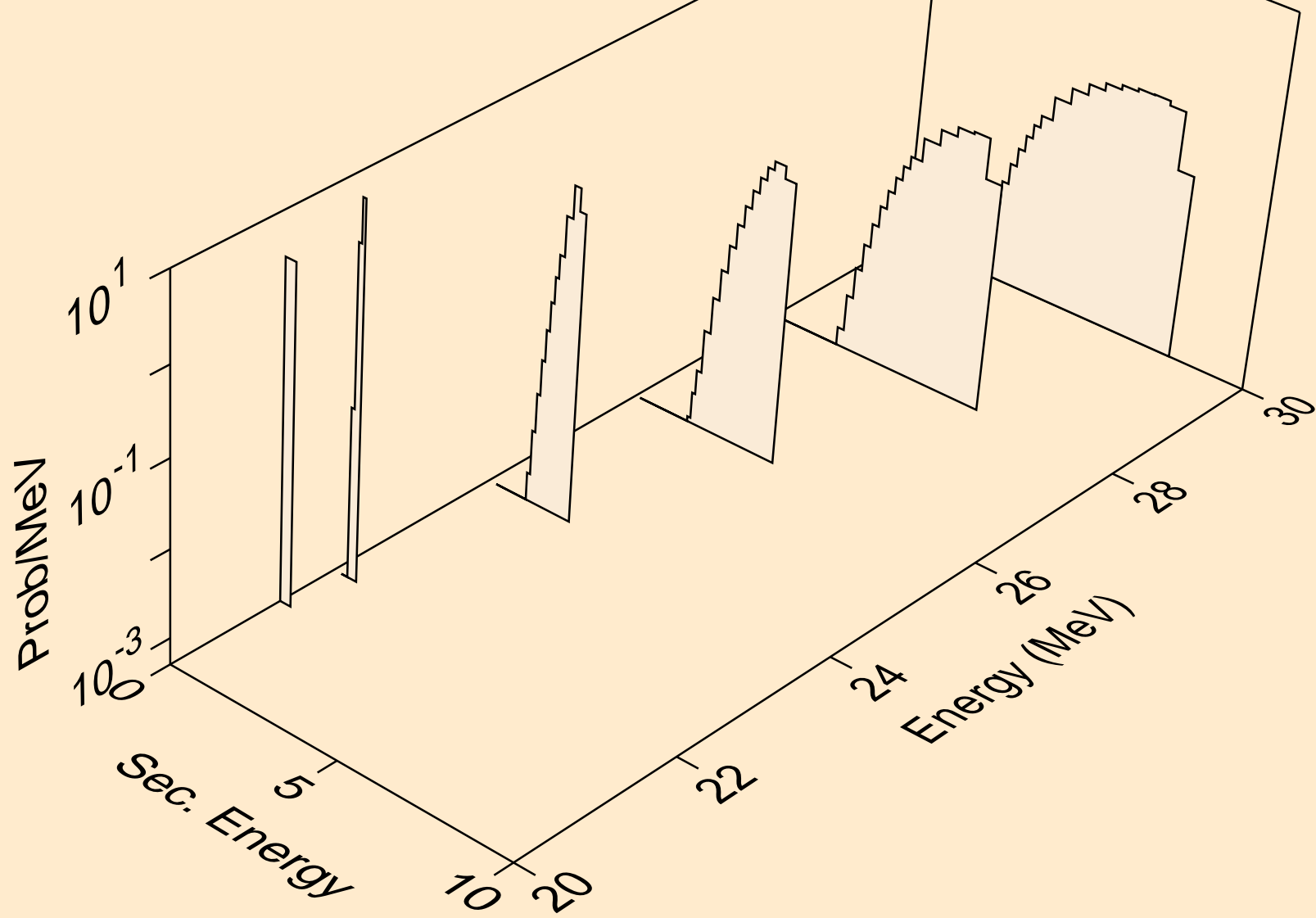

SI029 NEUTRON ACER TENDL-2024 LIBRARY; T=0.K  
he3s from (n,he3)

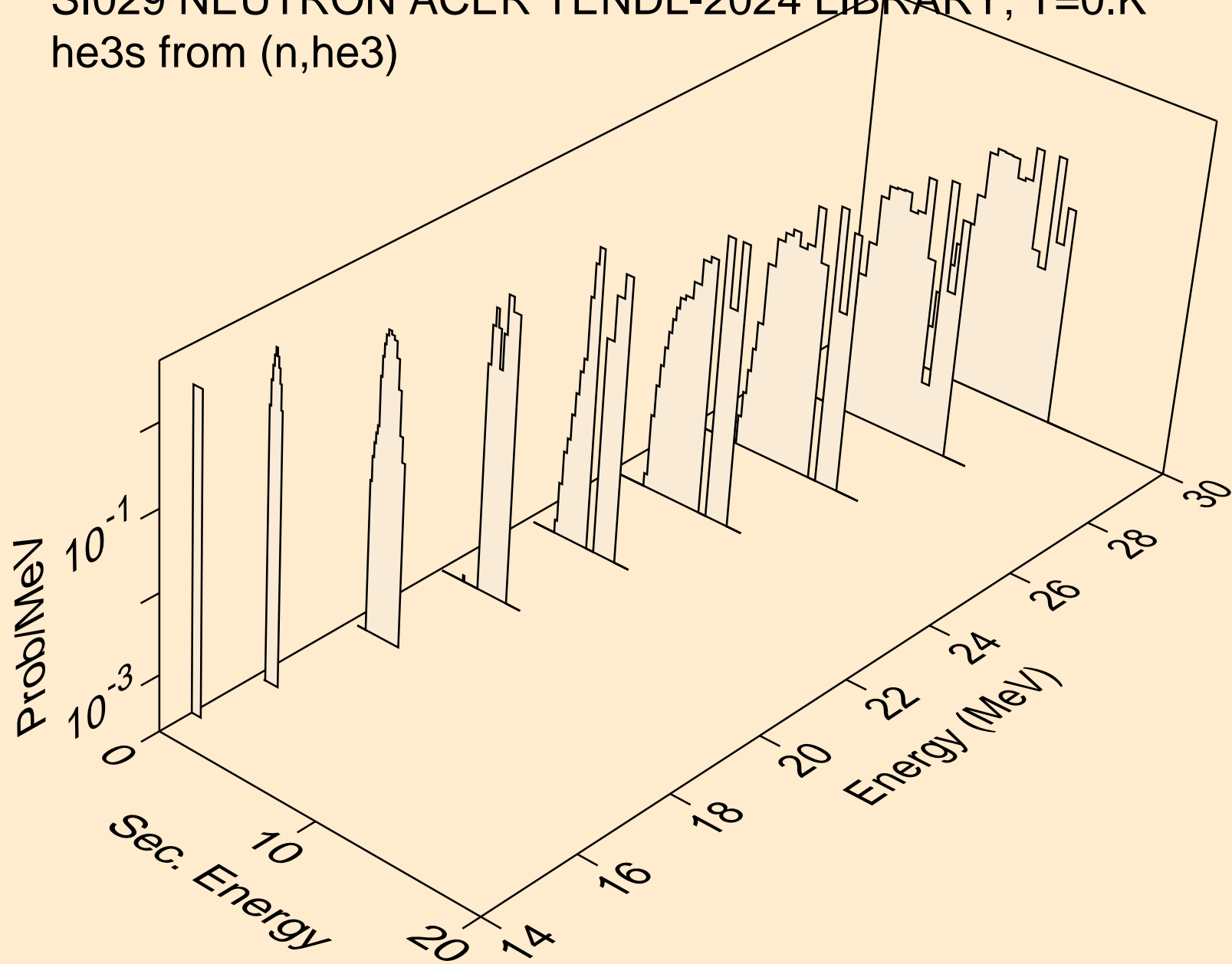

SI029 NEUTRON ACER TENDL-2024 LIBRARY; T=0.K  
alphas from (n,x)

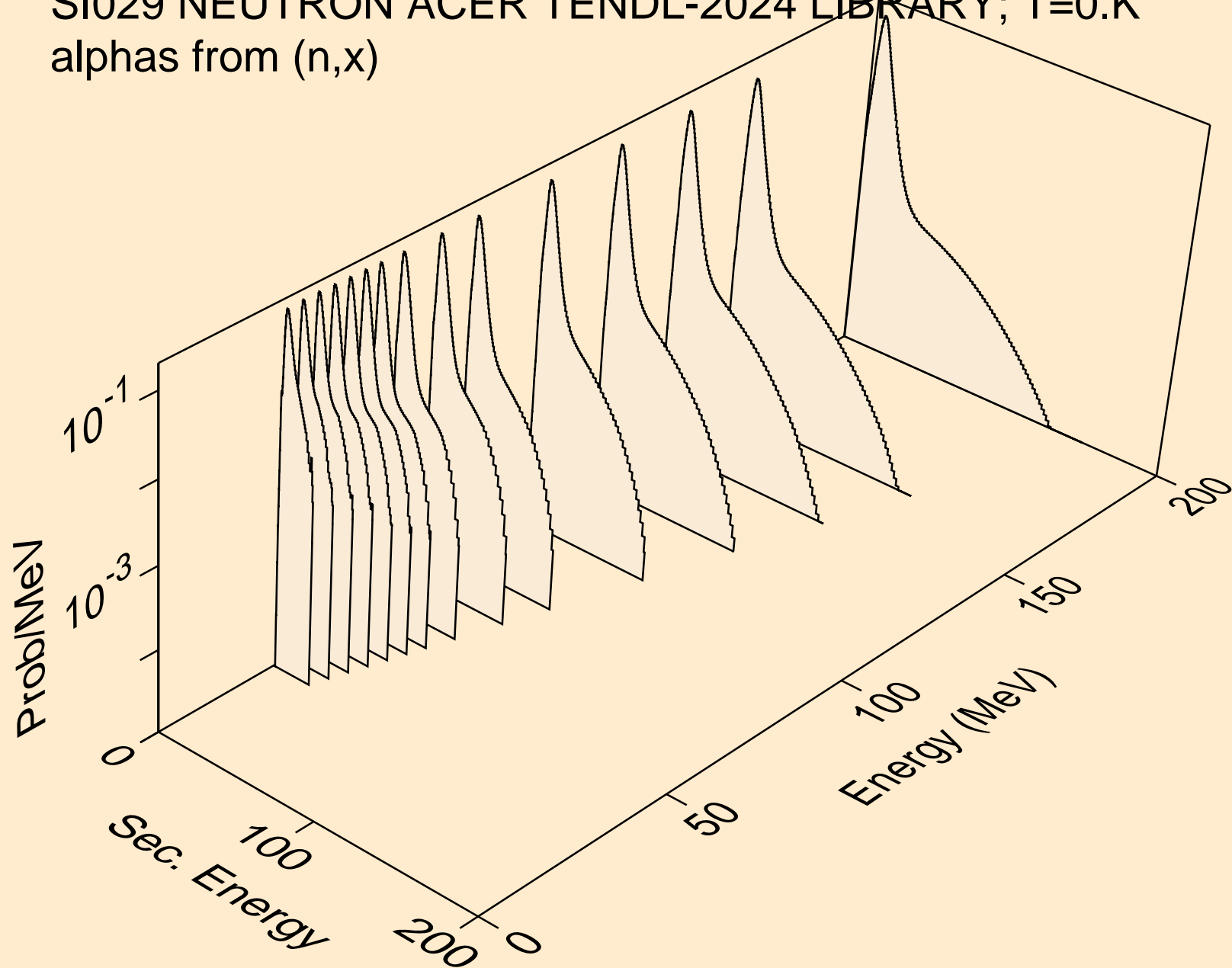

SI029 NEUTRON ACER TENDL-2024 LIBRARY; T=0.K  
alphas from (n,n\*)a

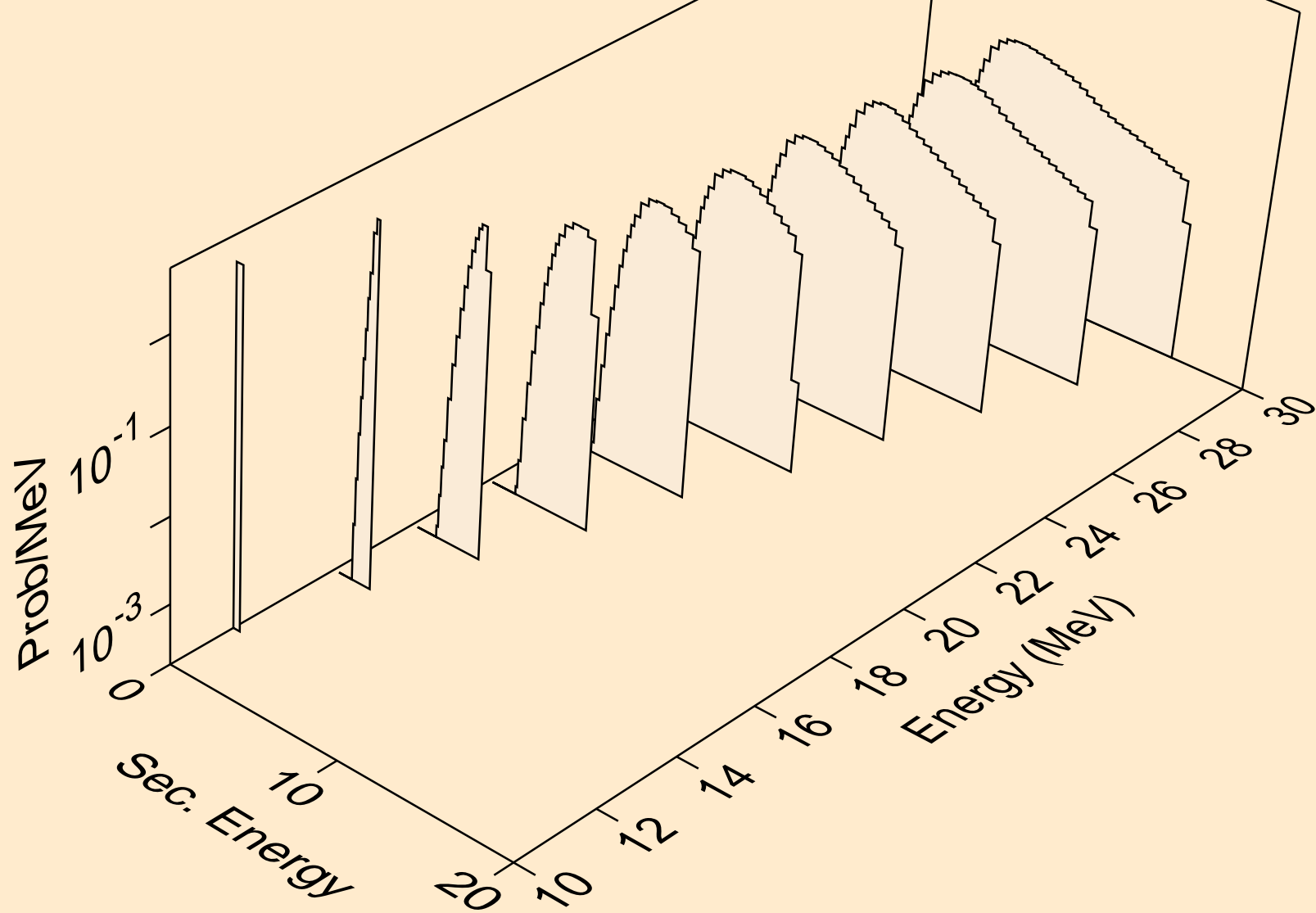

SI029 NEUTRON ACER TENDL-2024 LIBRARY; T=0.K  
alphas from (n,2n)a

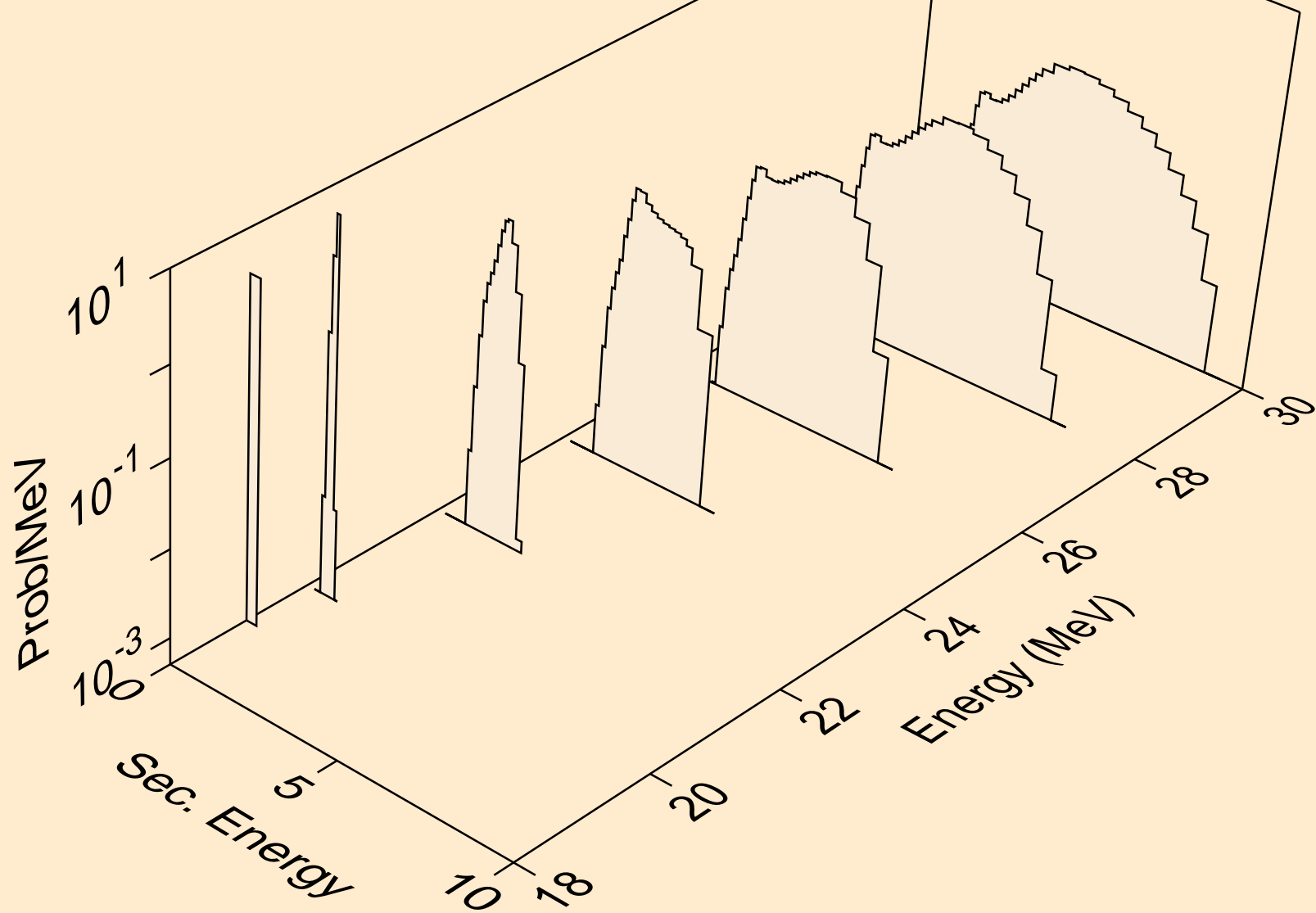

SI029 NEUTRON ACER TENDL-2024 LIBRARY; T=0.K  
alphas from (n,n\*)2a

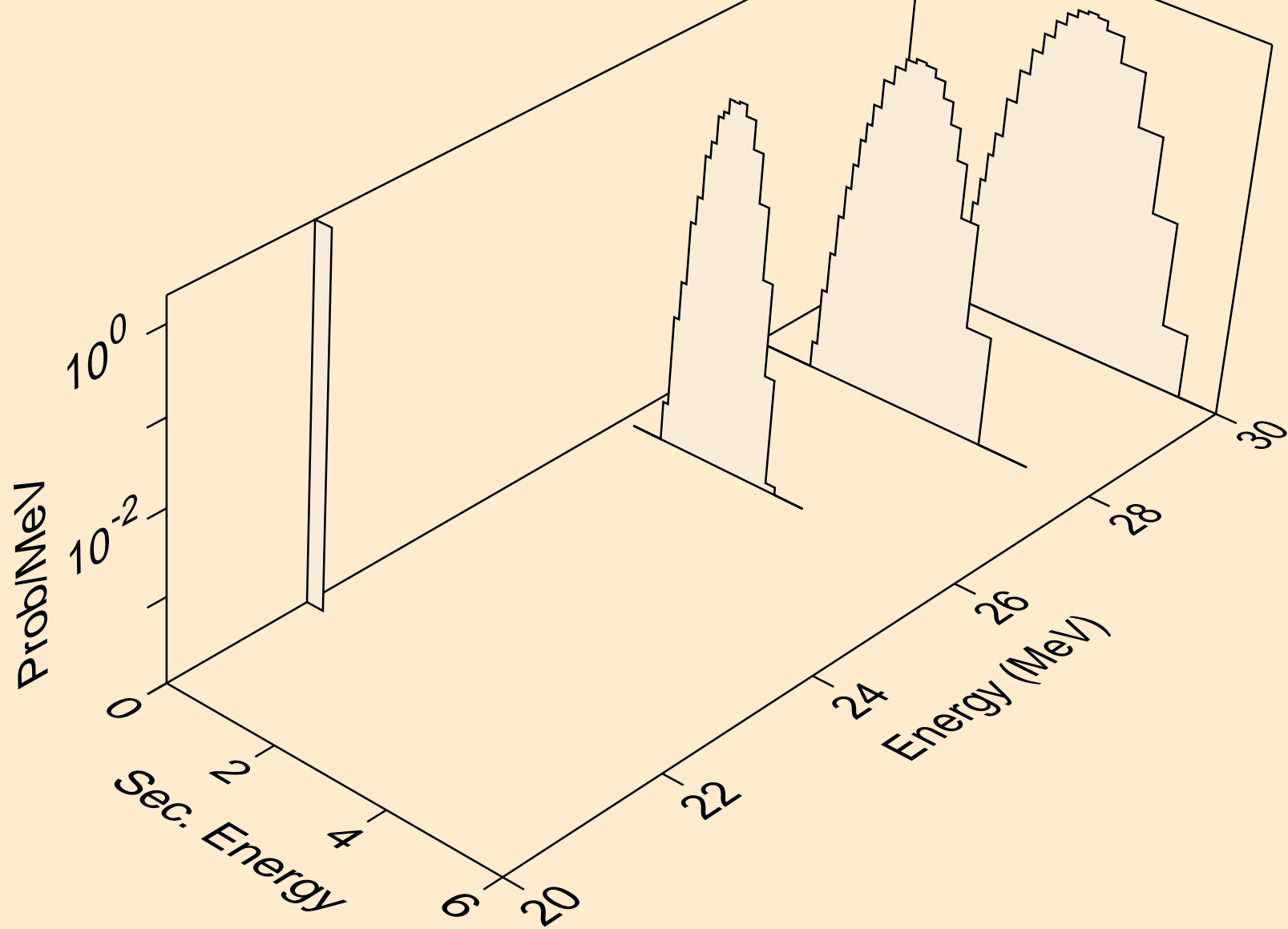



SI029 NEUTRON ACER TENDL-2024 LIBRARY; T=0.K  
alphas from (n,npa)

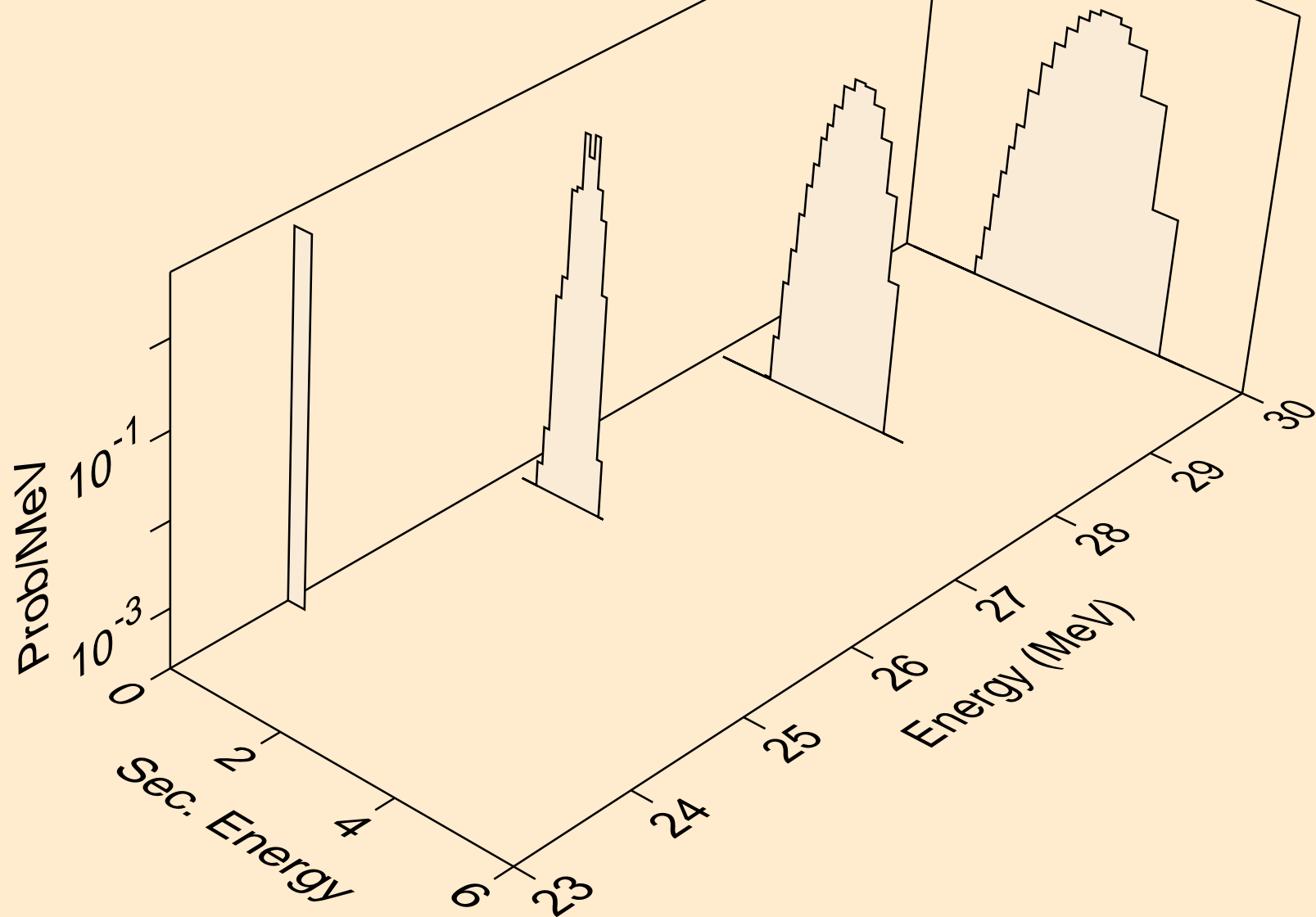

SI029 NEUTRON ACER TENDL-2024 LIBRARY; T=0.K  
alphas from (n,a)

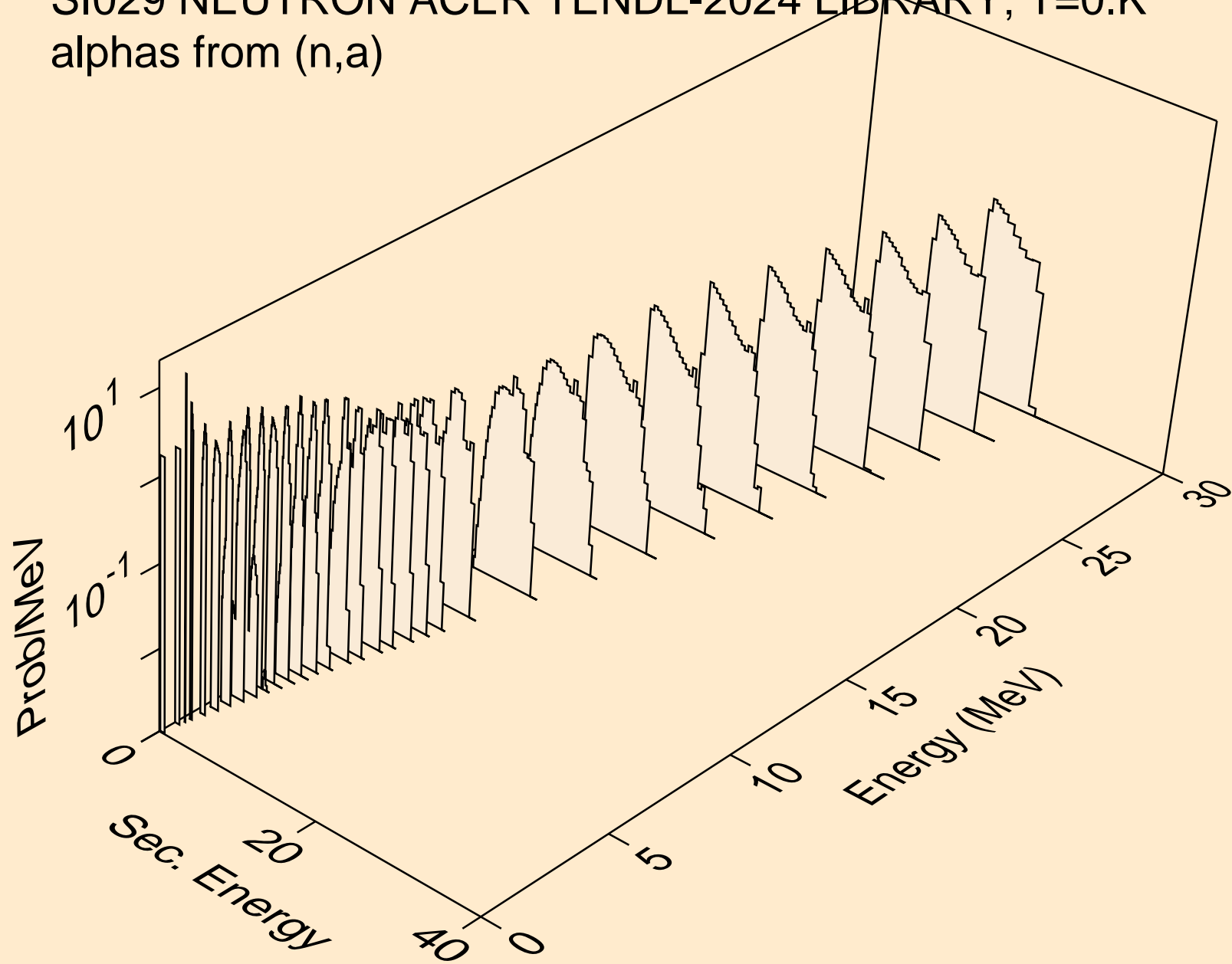

SI029 NEUTRON ACER TENDL-2024 LIBRARY; T=0.K  
alphas from (n,2a)

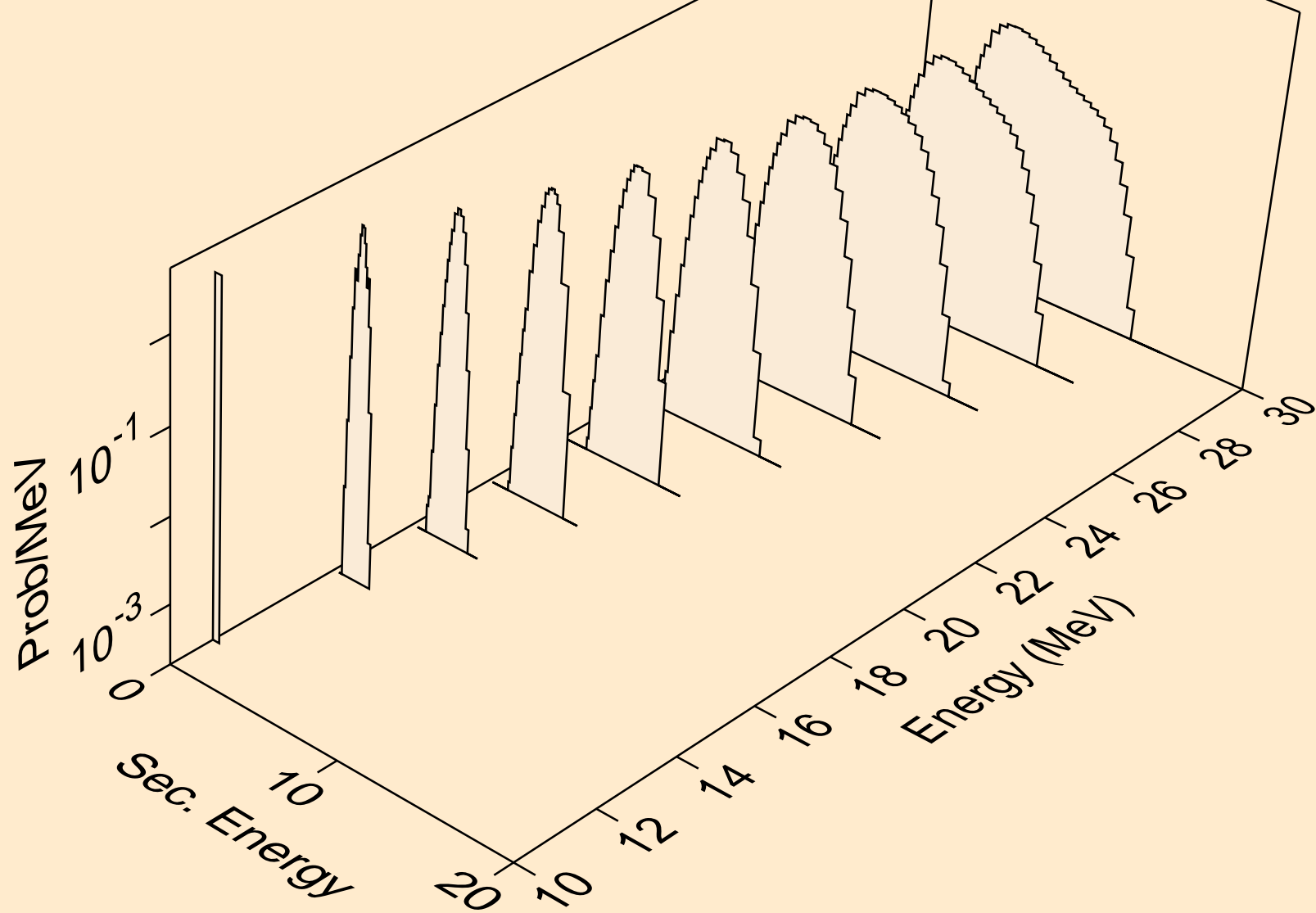

SI029 NEUTRON ACER TENDL-2024 LIBRARY; T=0.K  
alphas from (n,pa)

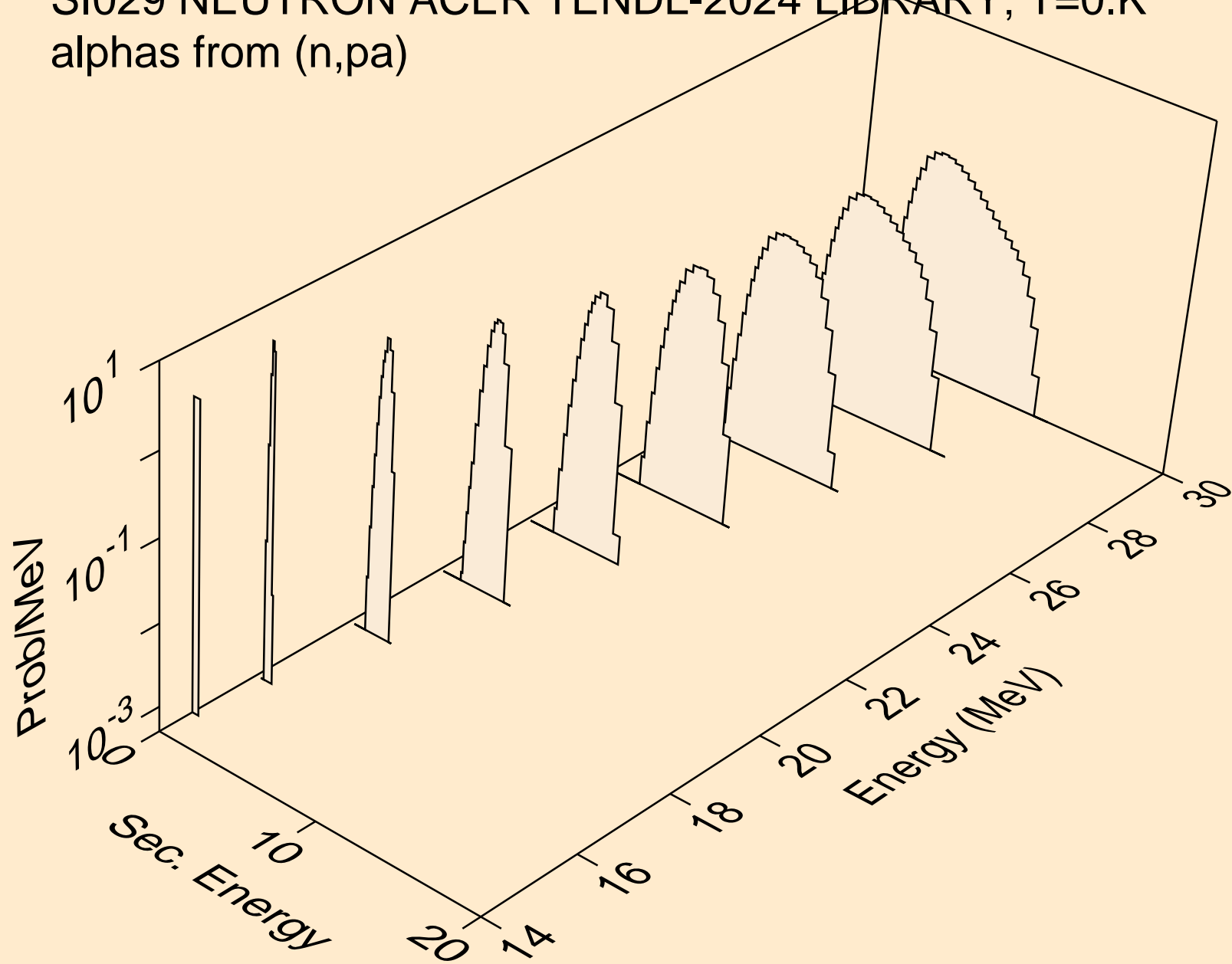

SI029 NEUTRON ACER TENDL-2024 LIBRARY; T=0.K  
alphas from (n,da)

