

SI031 NEUTRON ACER TENDL-2024 LIBRARY; T=0.K

Principal cross sections

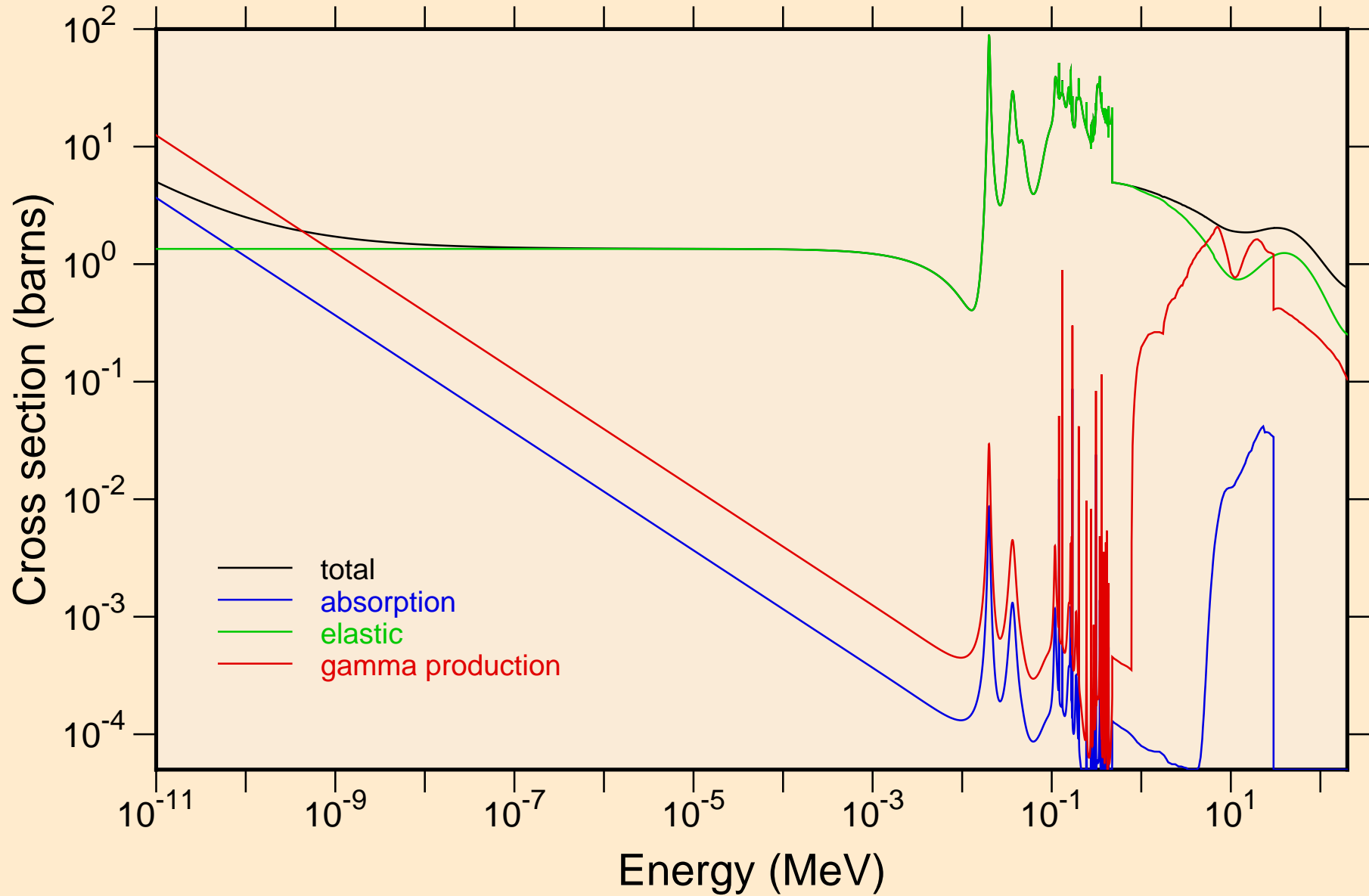

SI031 NEUTRON ACER TENDL-2024 LIBRARY; T=0.K
resonance total cross section

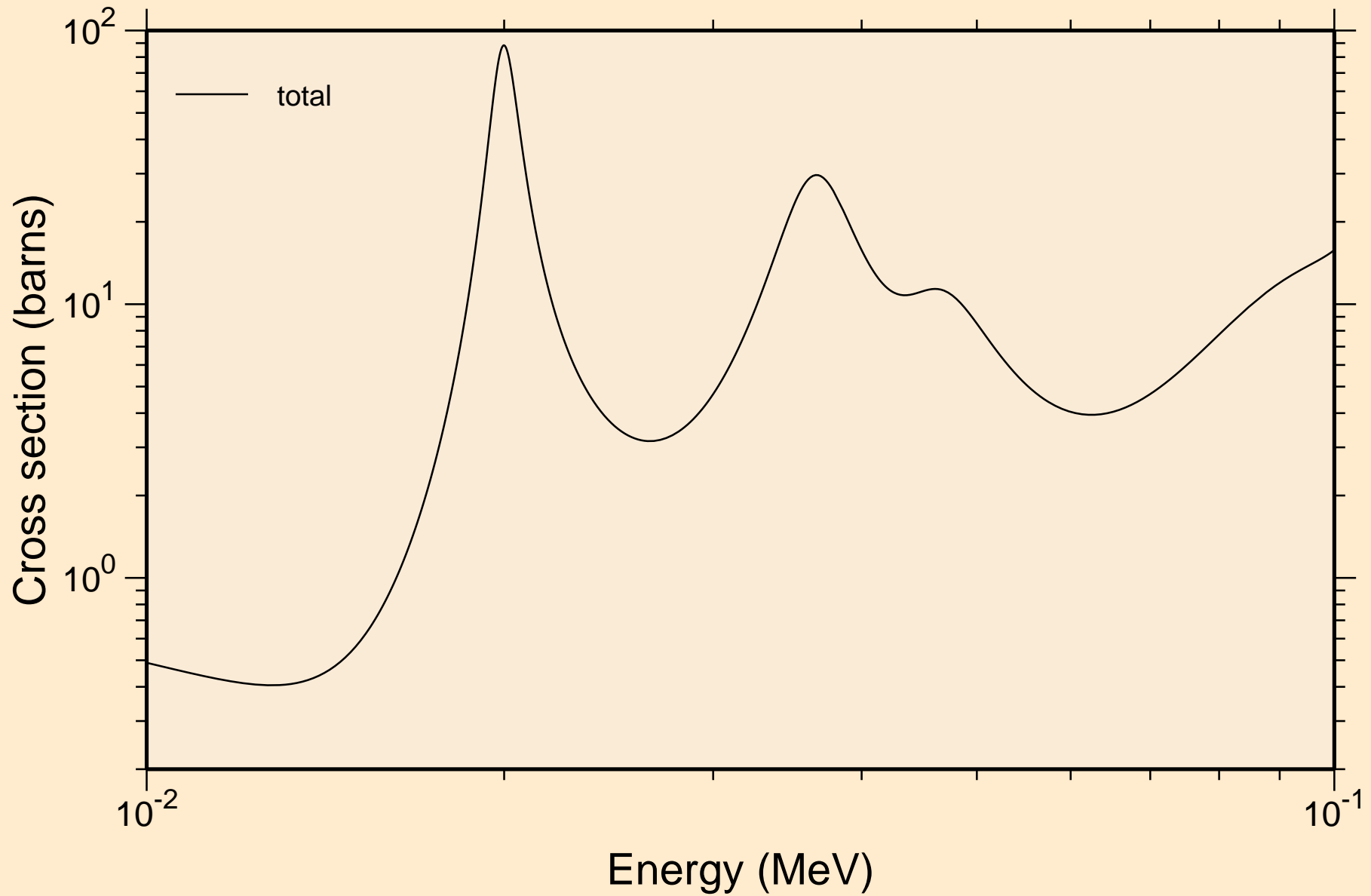

SI031 NEUTRON ACER TENDL-2024 LIBRARY; T=0.K
resonance total cross section

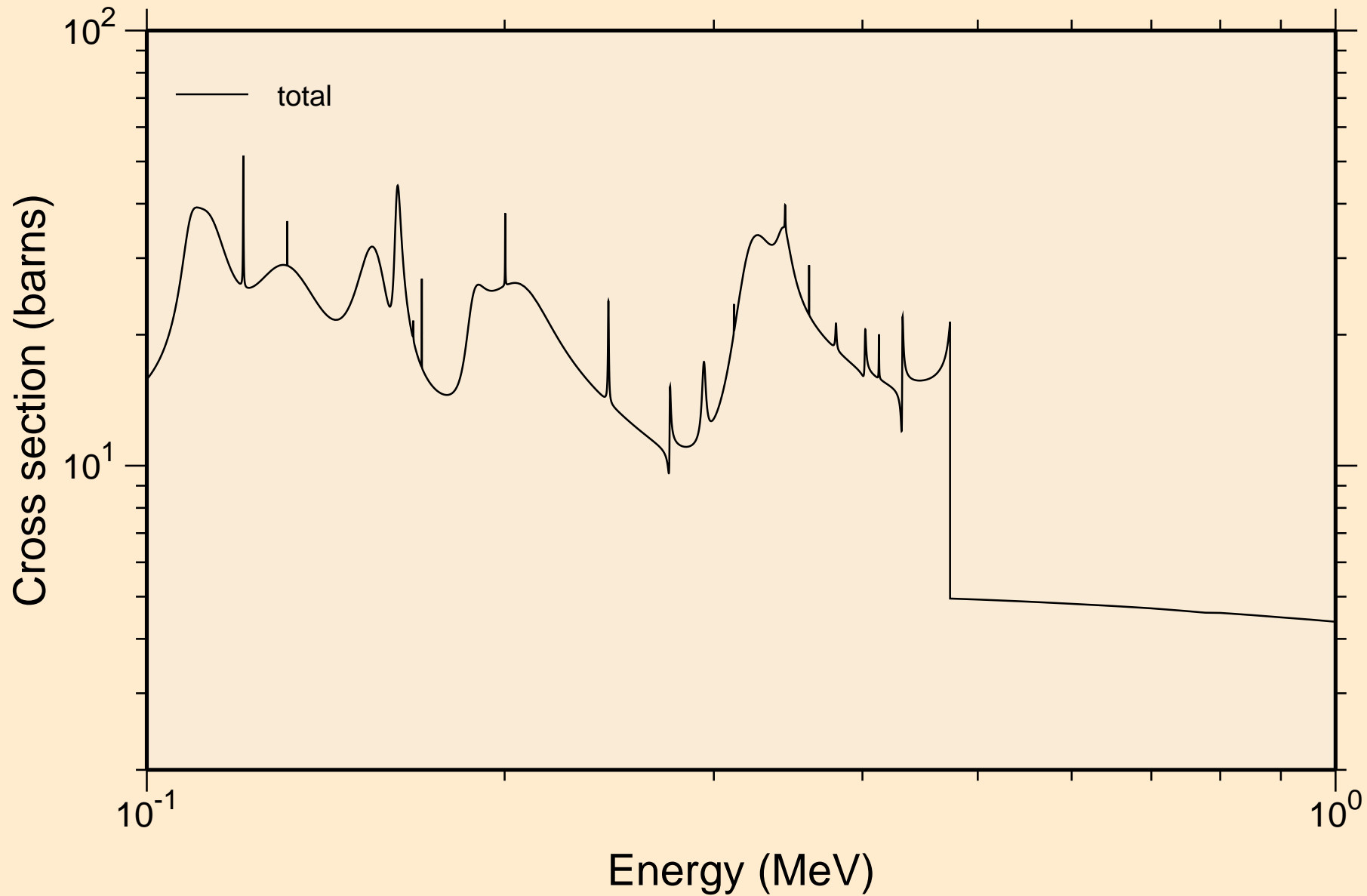

SI031 NEUTRON ACER TENDL-2024 LIBRARY; T=0.K
resonance total cross section

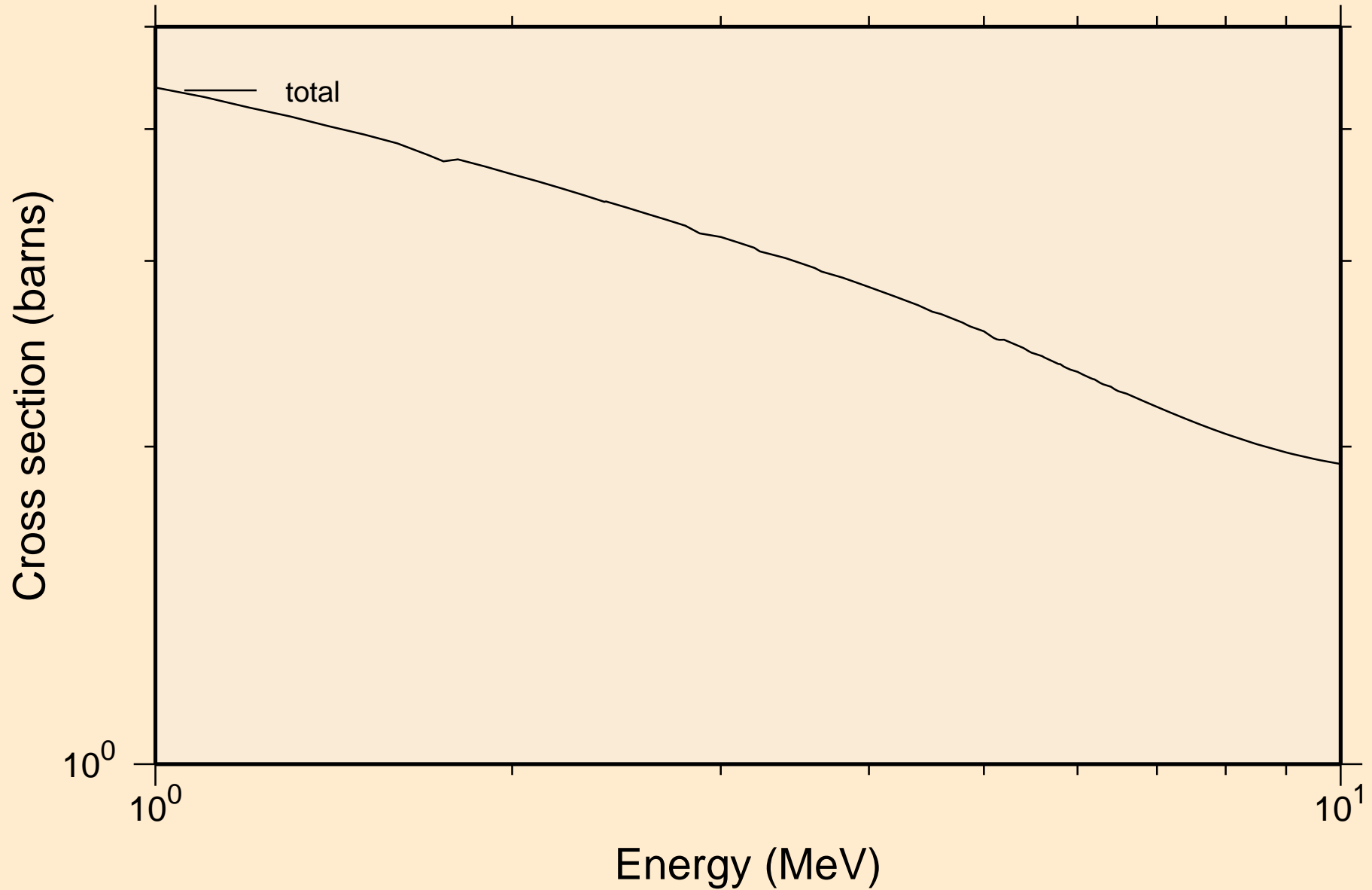

SI031 NEUTRON ACER TENDL-2024 LIBRARY; T=0.K
resonance absorption cross sections

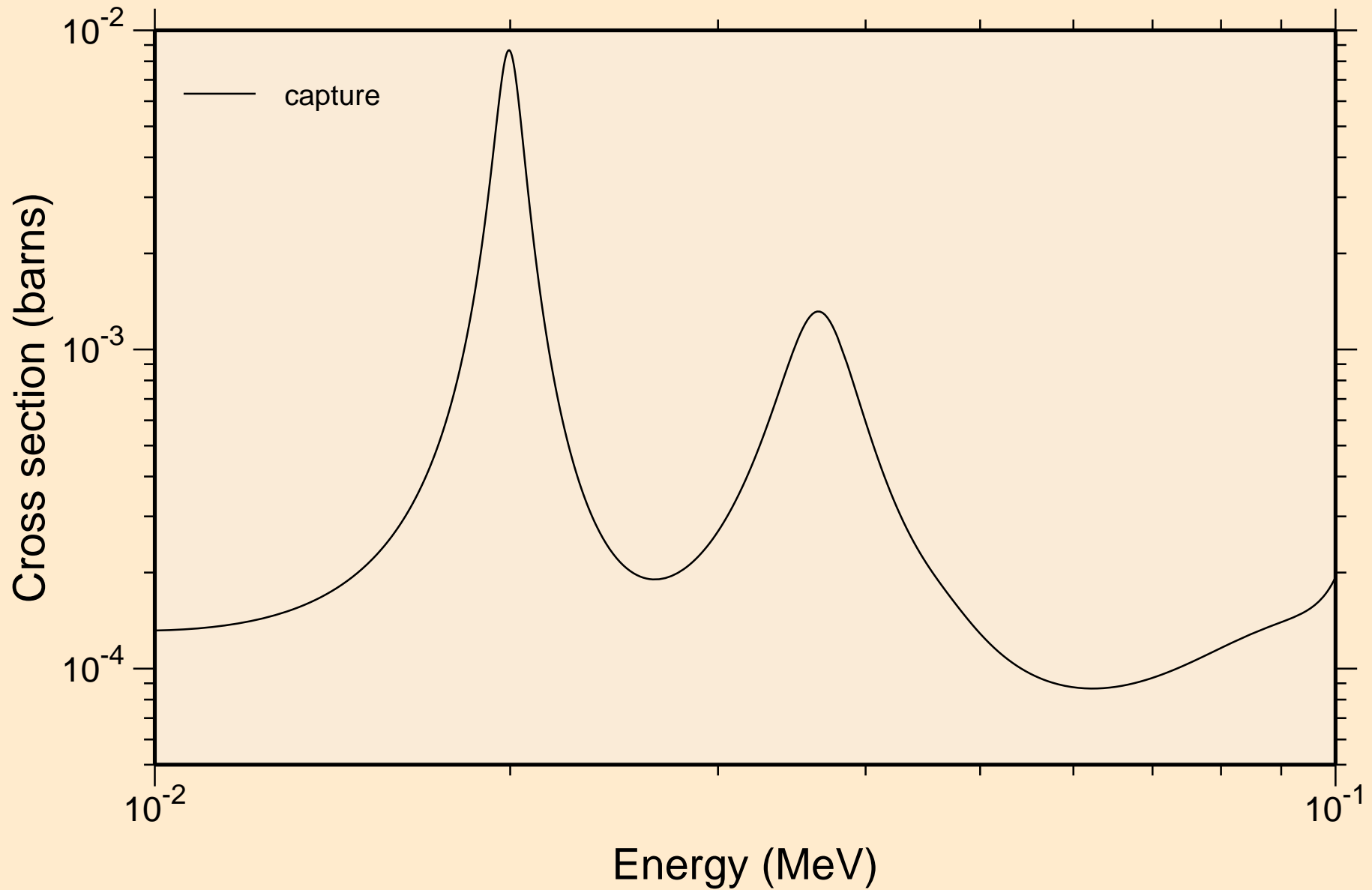

SI031 NEUTRON ACER TENDL-2024 LIBRARY; T=0.K
resonance absorption cross sections

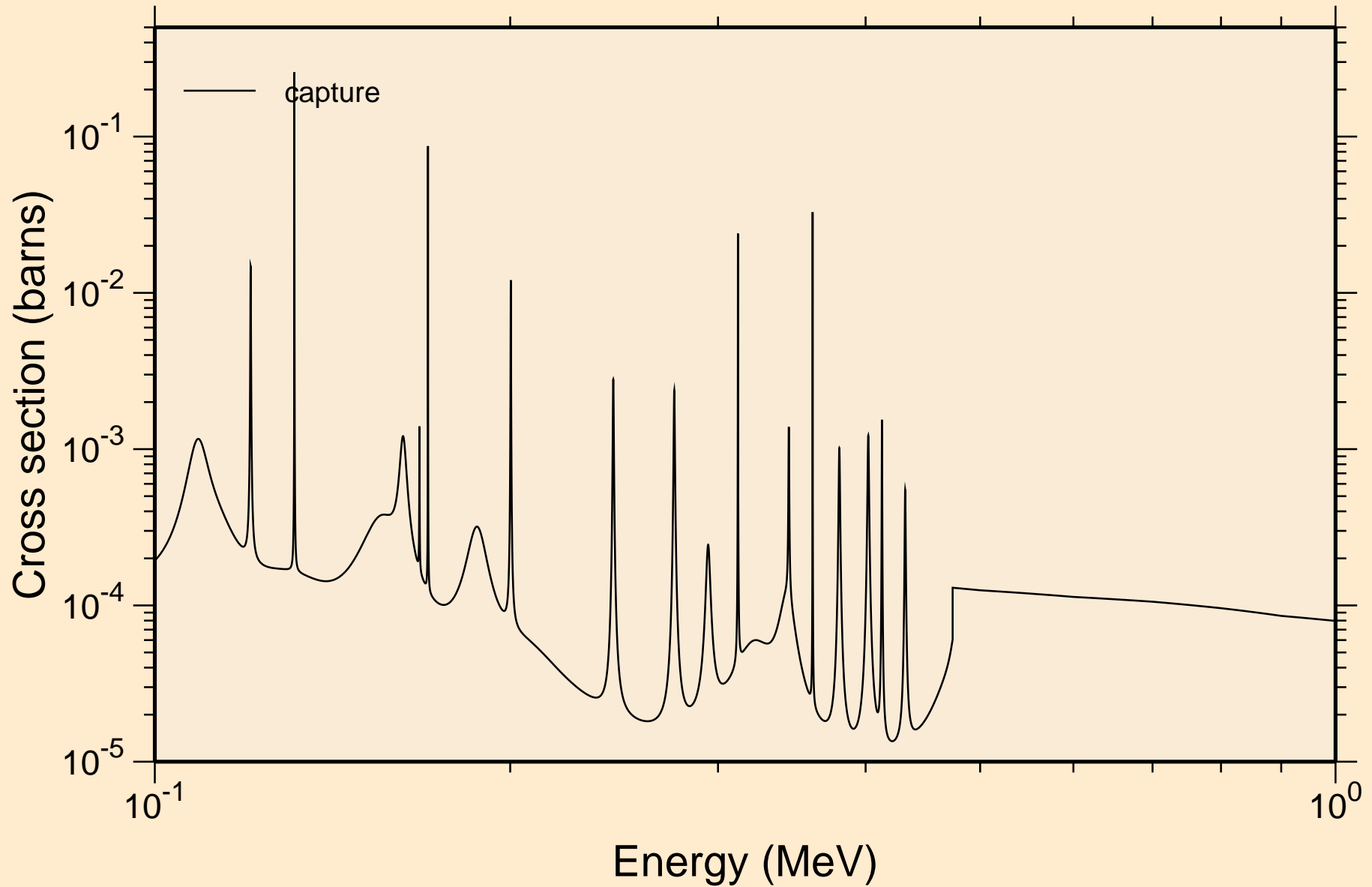

SI031 NEUTRON ACER TENDL-2024 LIBRARY; T=0.K
resonance absorption cross sections

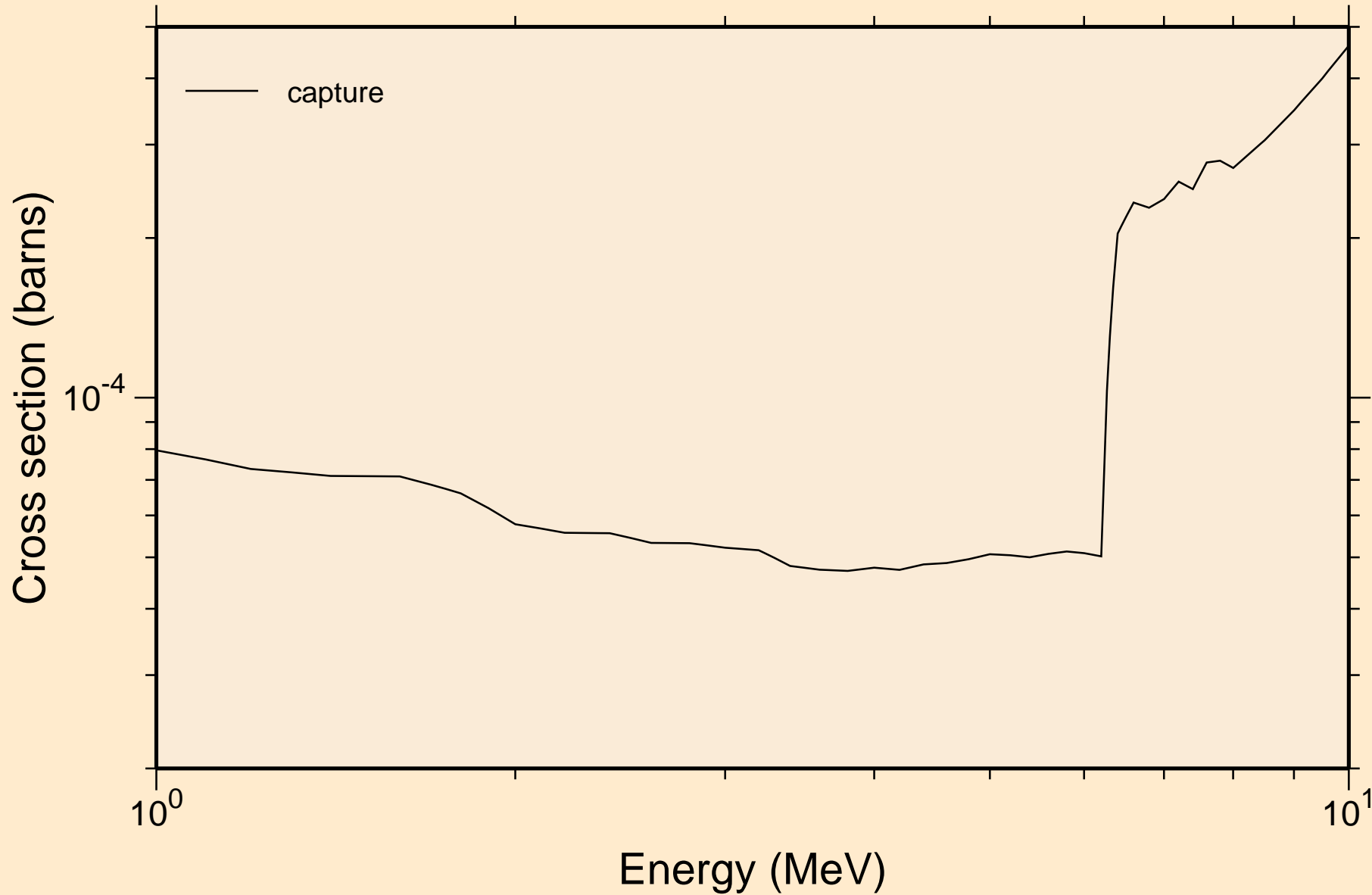

SI031 NEUTRON ACER TENDL-2024 LIBRARY; T=0.K

Heating

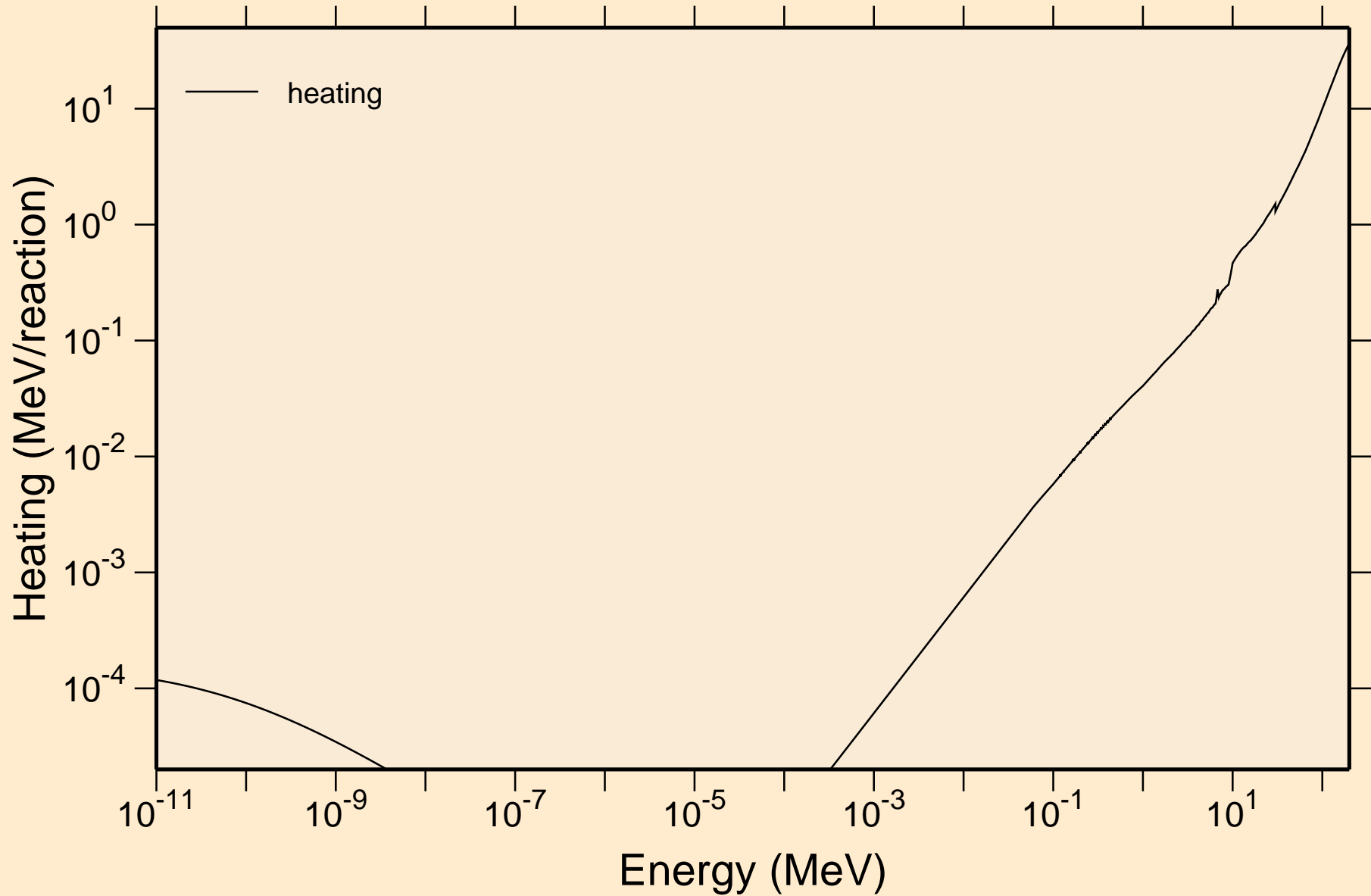

SI031 NEUTRON ACER TENDL-2024 LIBRARY; T=0.K
Damage

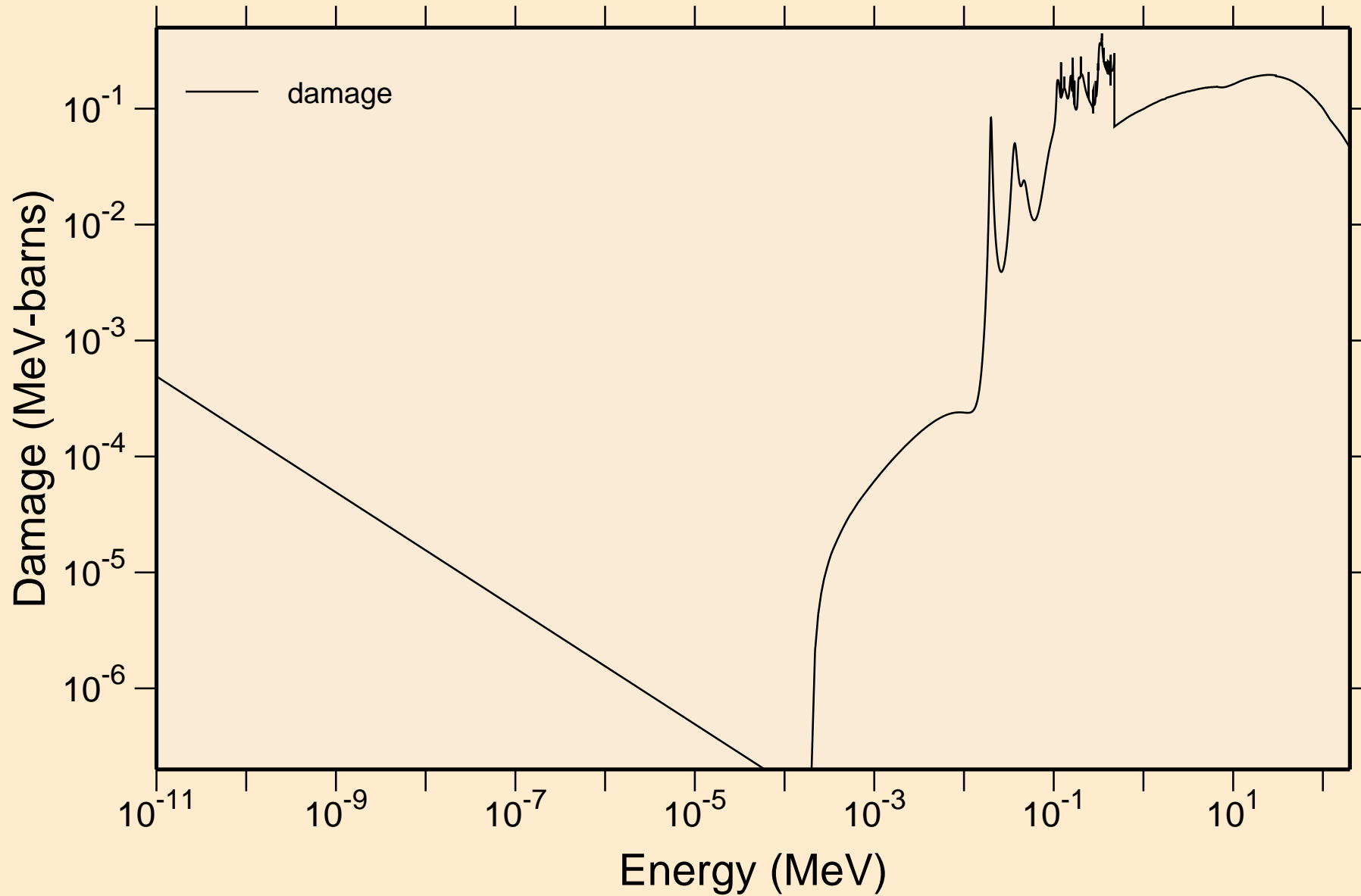

SI031 NEUTRON ACER TENDL-2024 LIBRARY; T=0.K
Non-threshold reactions

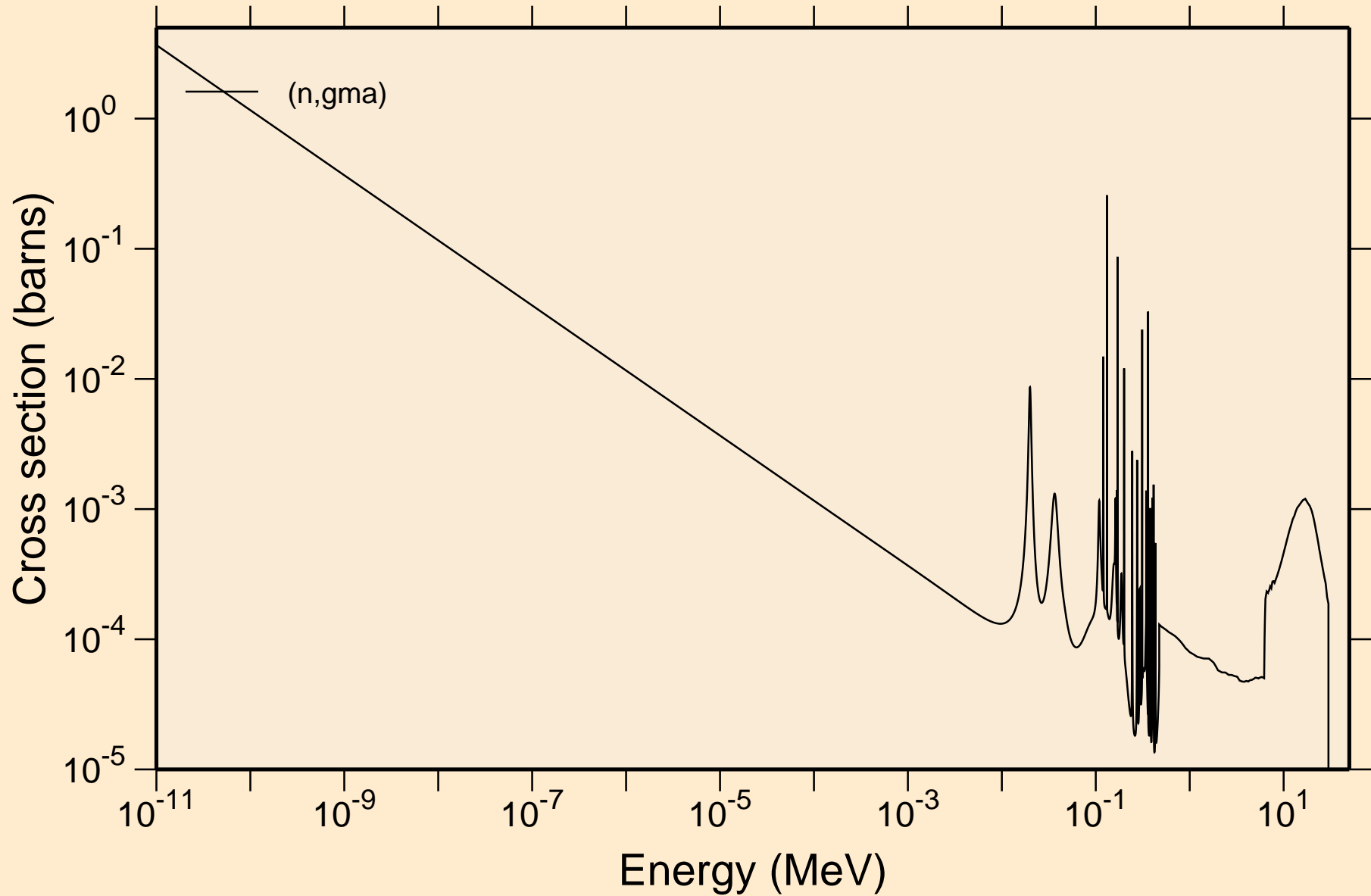

SI031 NEUTRON ACER TENDL-2024 LIBRARY; T=0.K

Principal cross sections

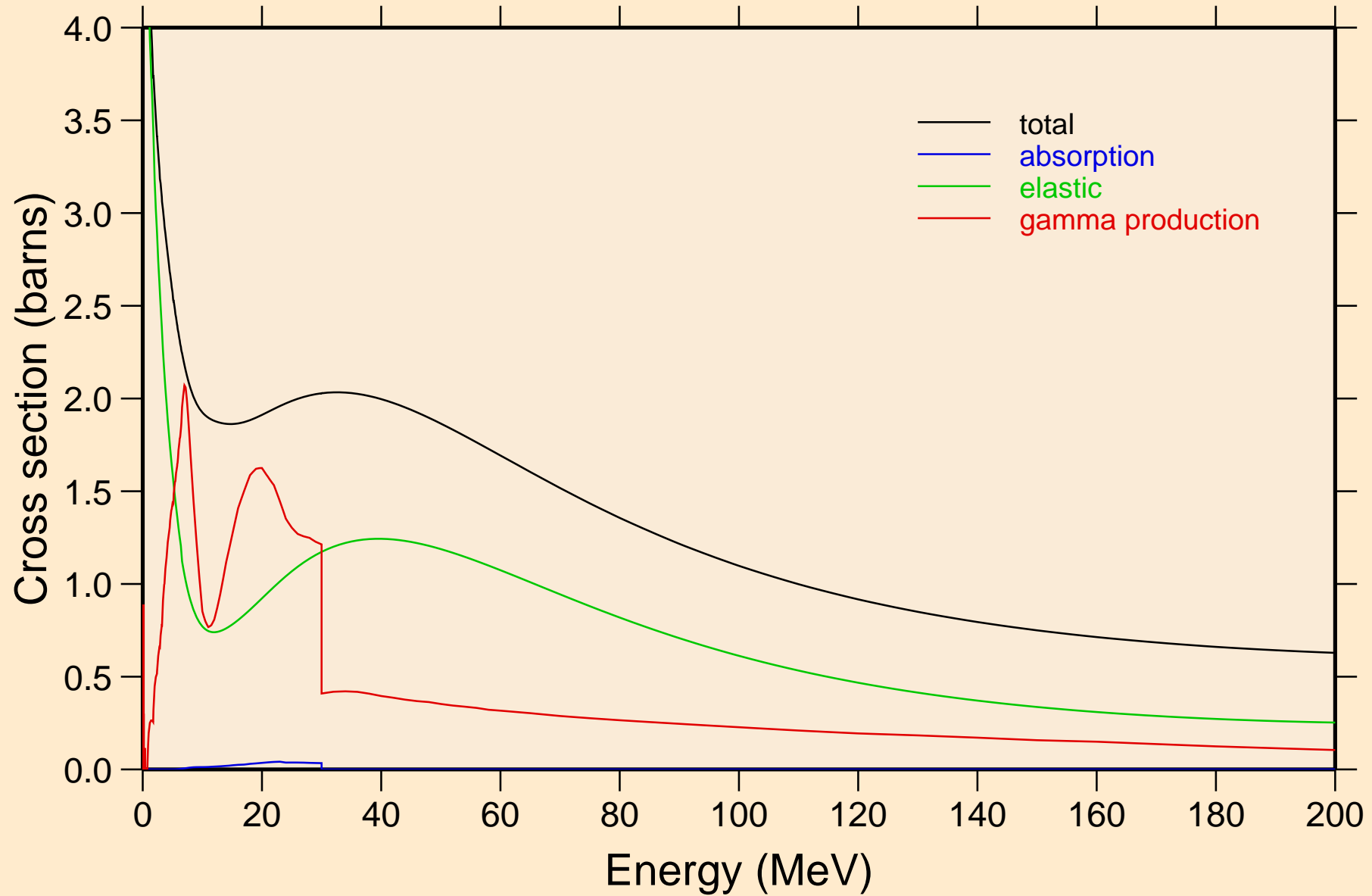

SI031 NEUTRON ACER TENDL-2024 LIBRARY; T=0.K

Heating

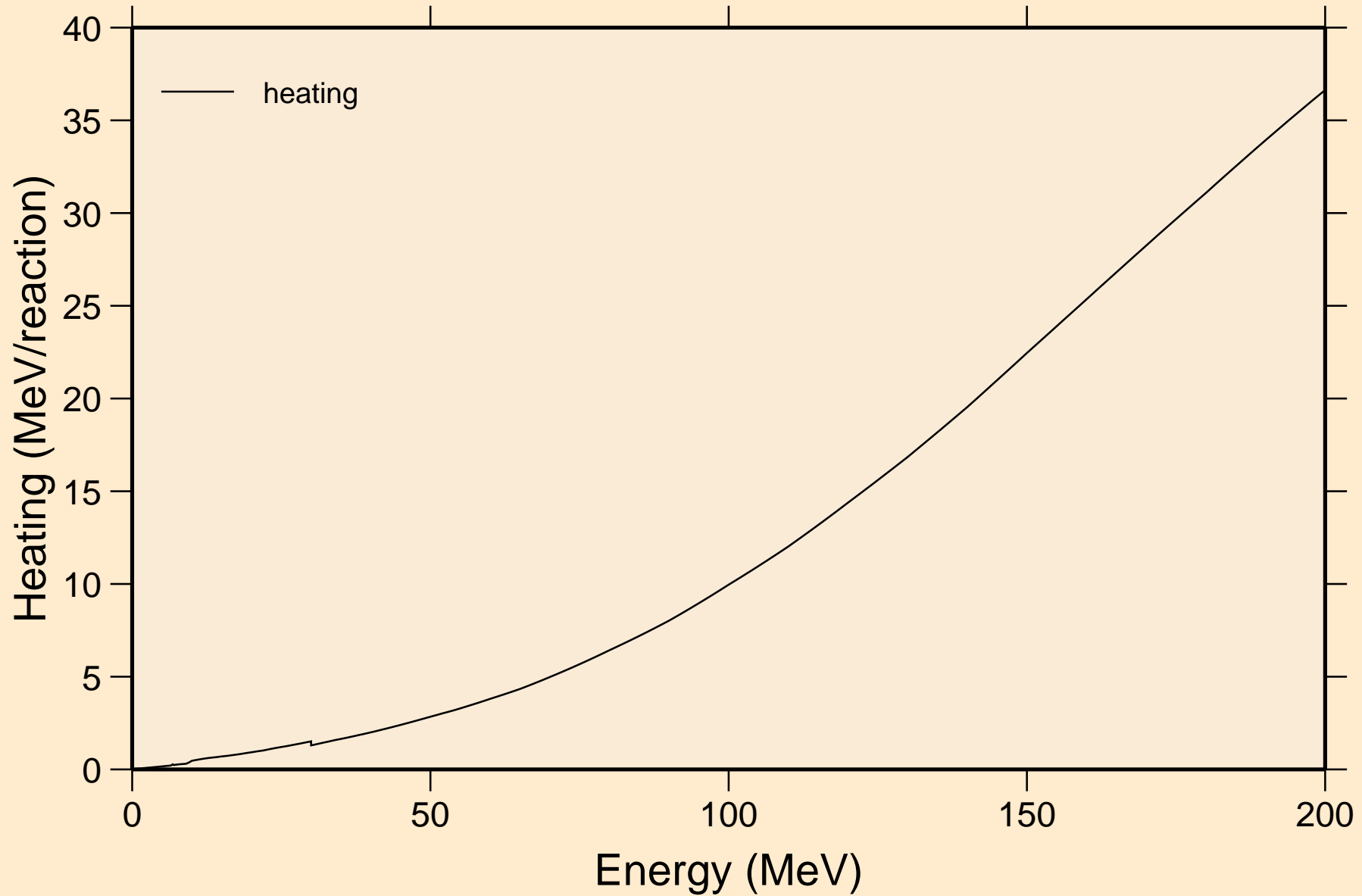

SI031 NEUTRON ACER TENDL-2024 LIBRARY; T=0.K

Damage

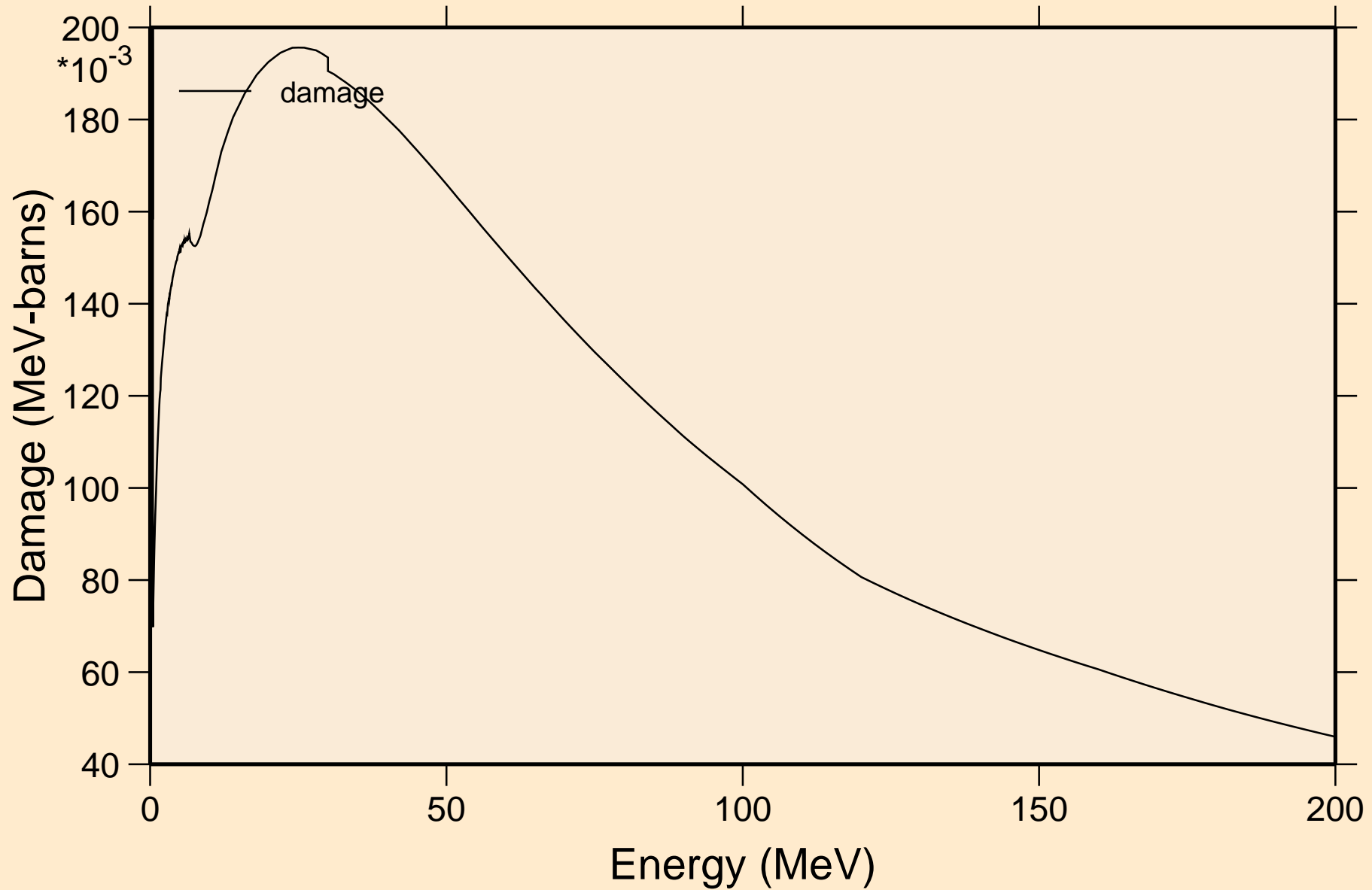

SI031 NEUTRON ACER TENDL-2024 LIBRARY; T=0.K
Non-threshold reactions

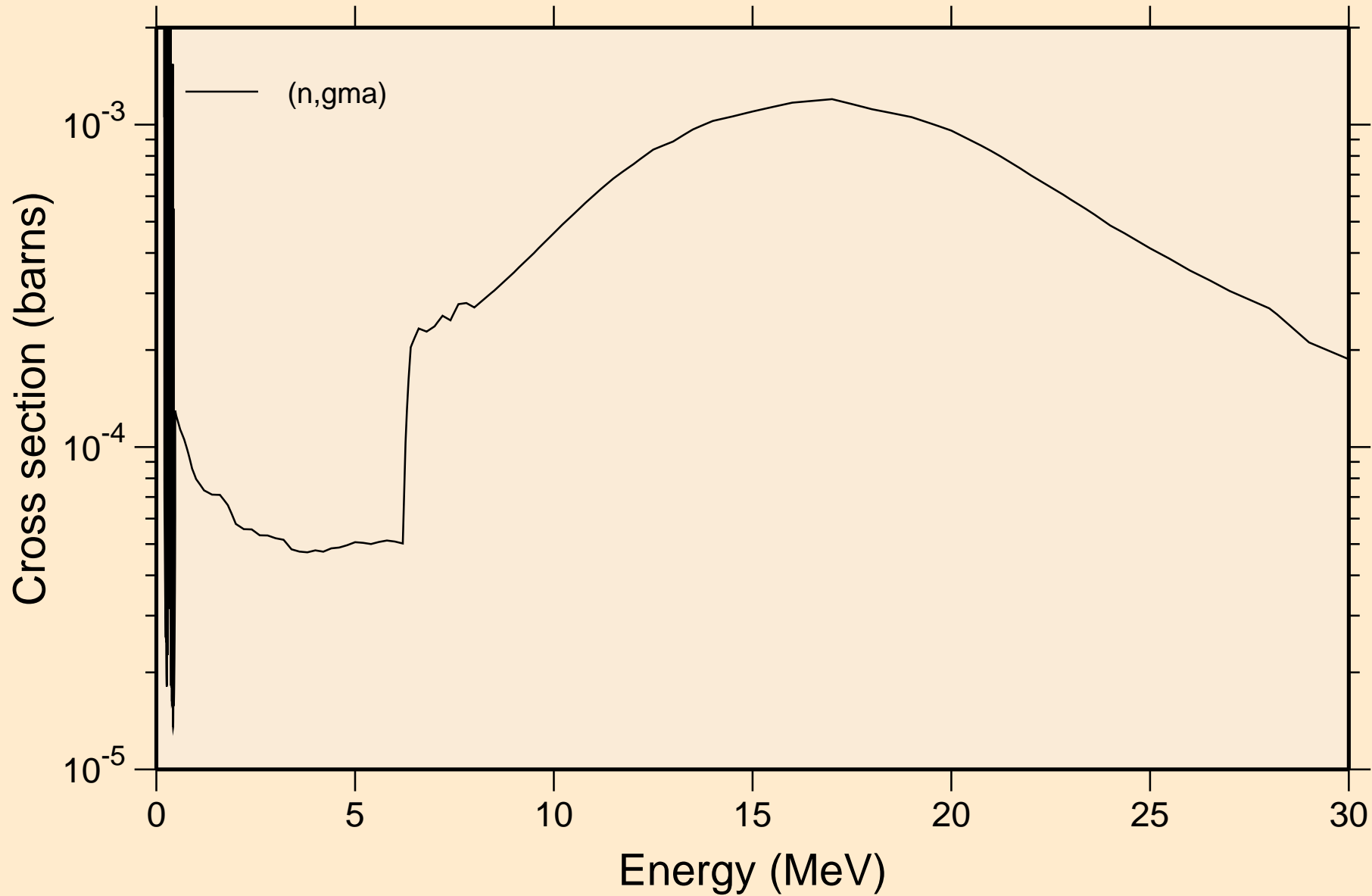

SI031 NEUTRON ACER TENDL-2024 LIBRARY; T=0.K
Inelastic levels

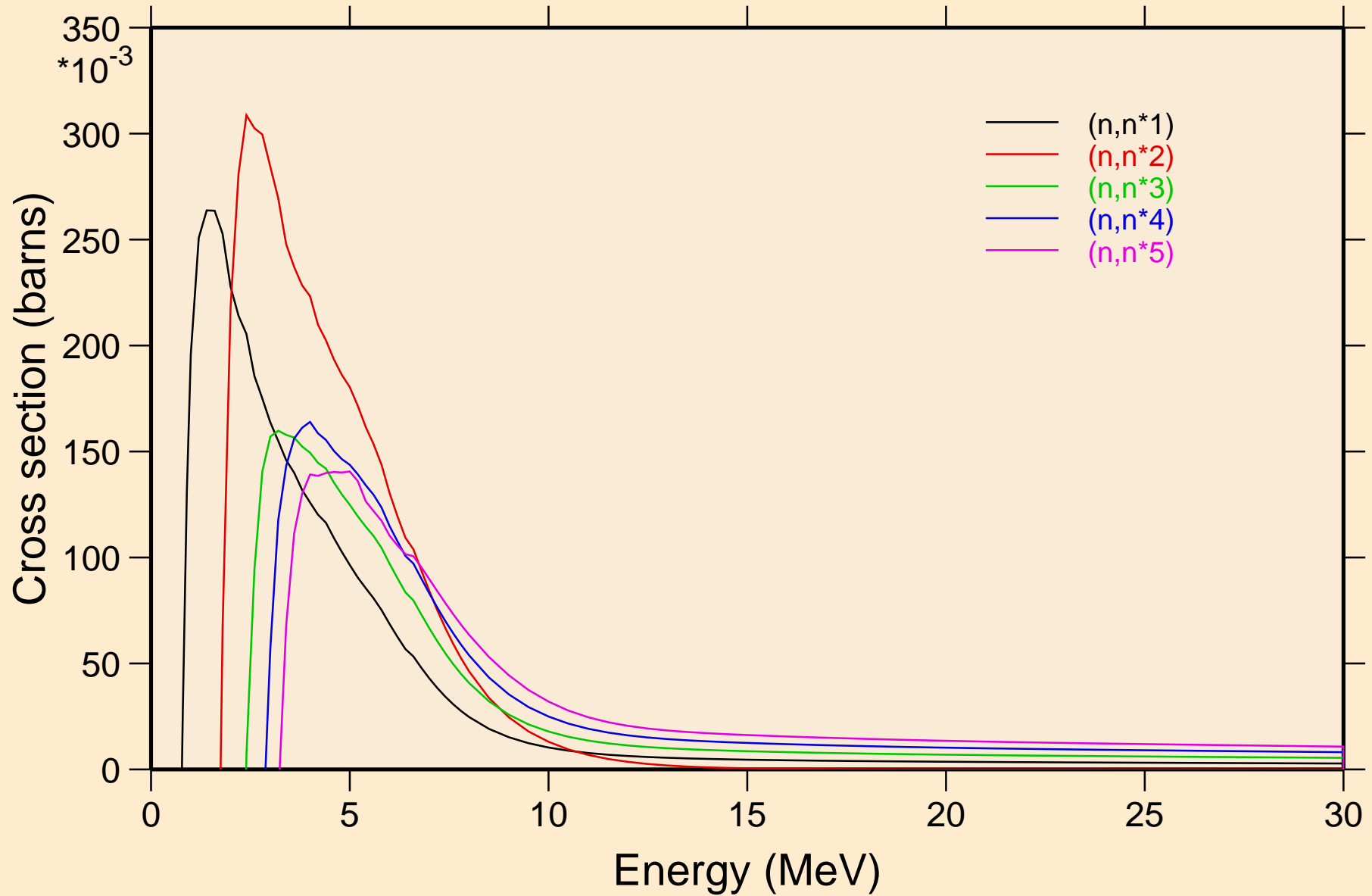

SI031 NEUTRON ACER TENDL-2024 LIBRARY; T=0.K
Inelastic levels

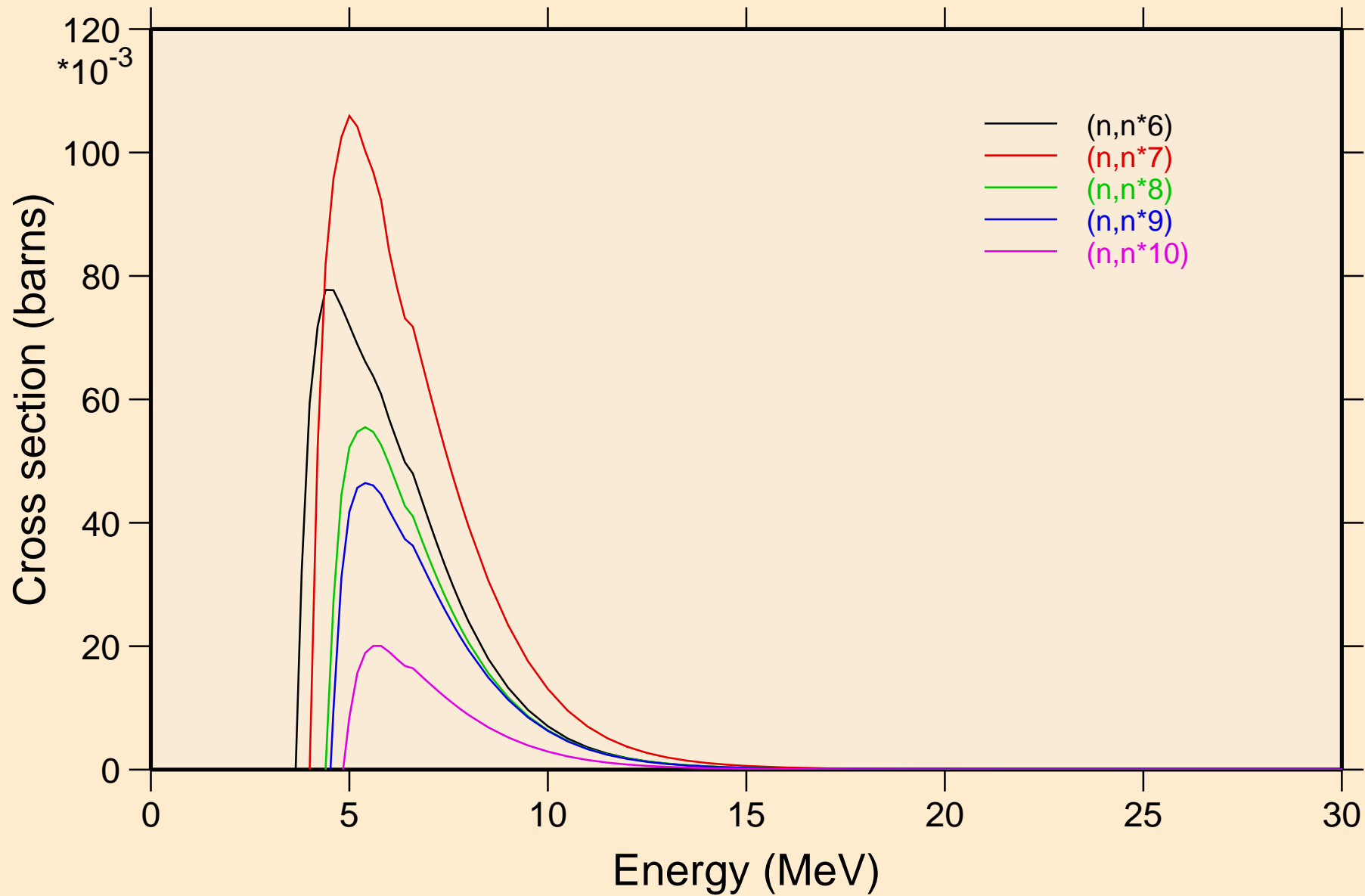

SI031 NEUTRON ACER TENDL-2024 LIBRARY; T=0.K
Inelastic levels

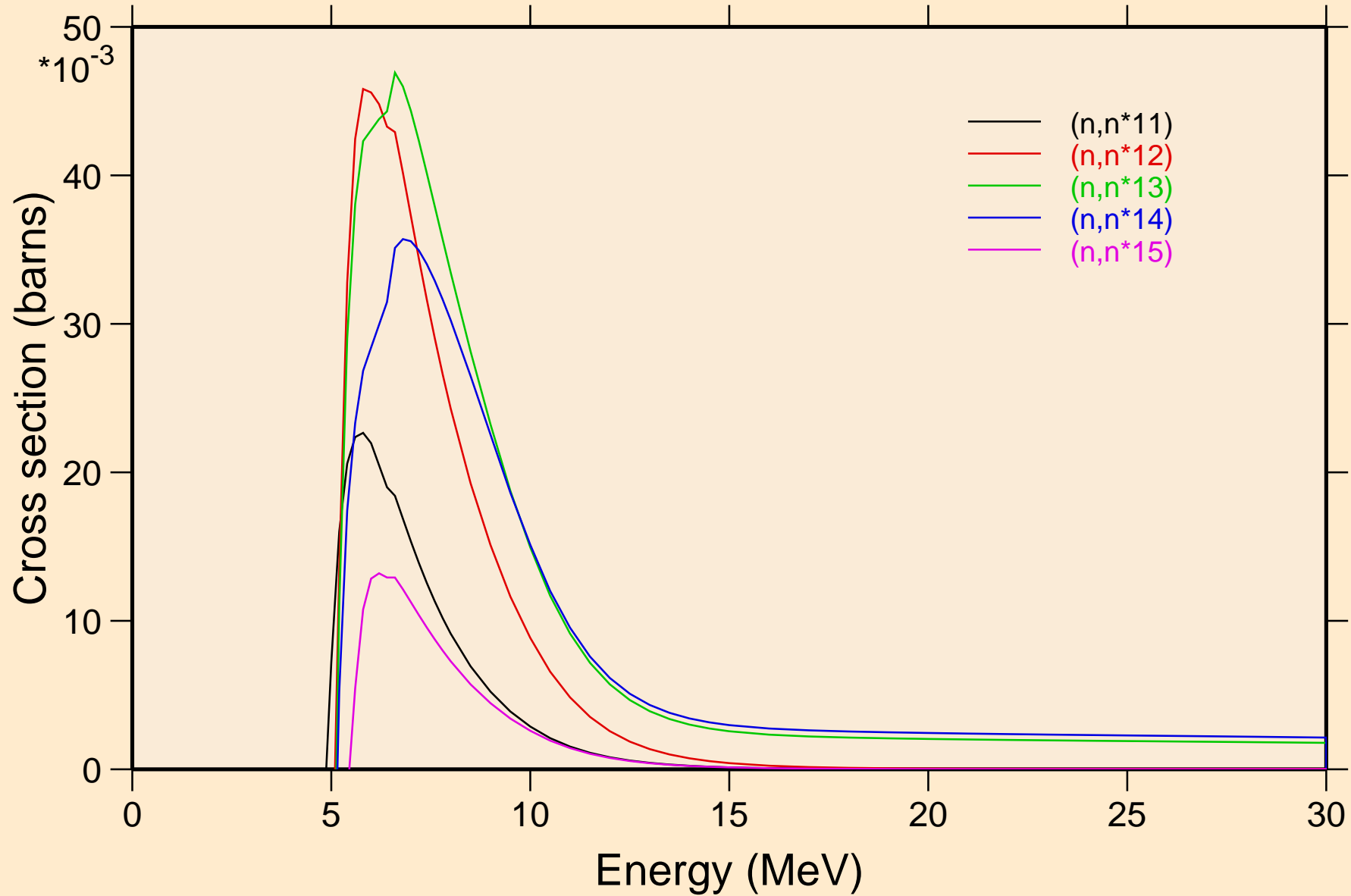

SI031 NEUTRON ACER TENDL-2024 LIBRARY; T=0.K
Inelastic levels

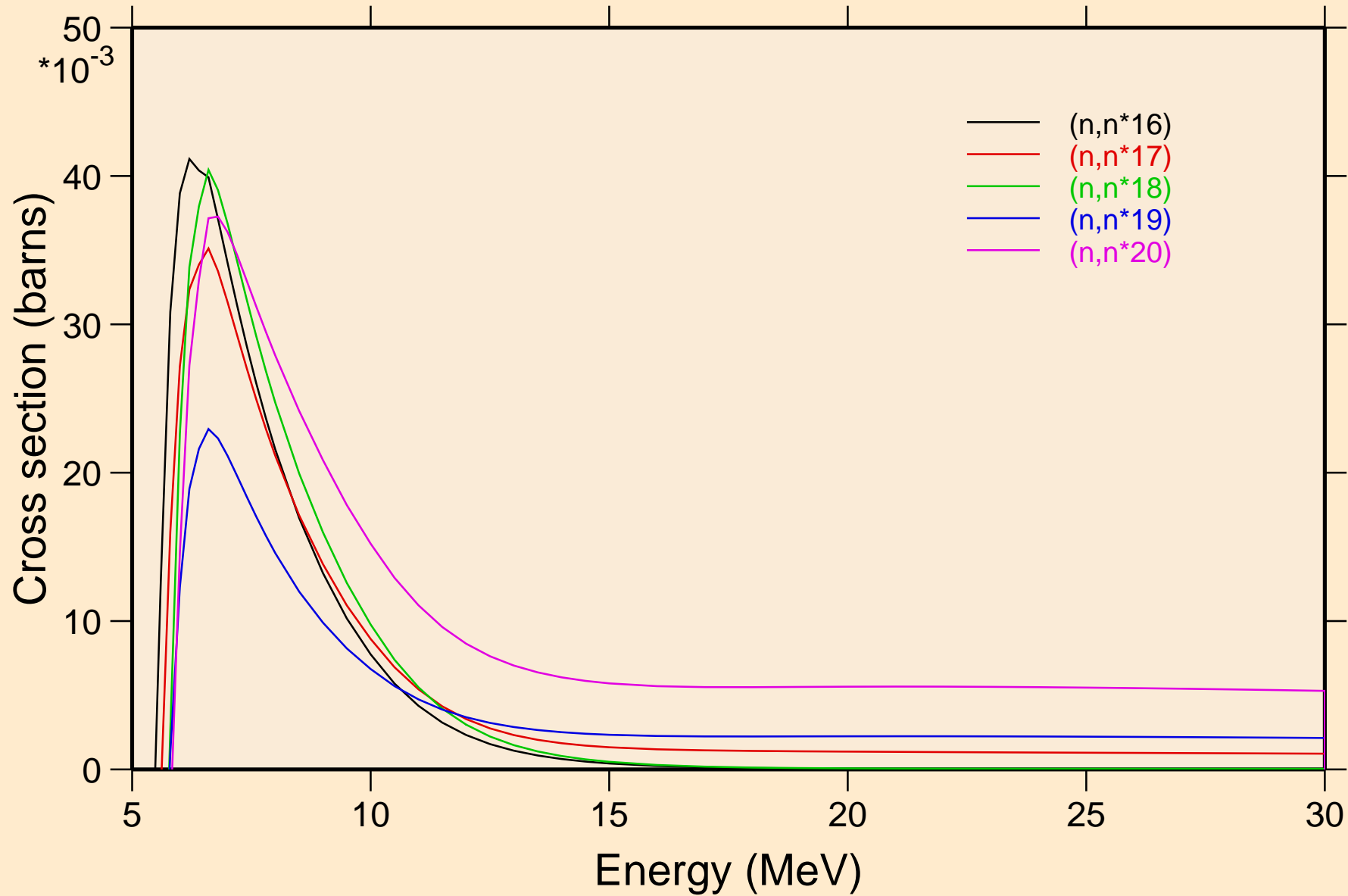

SI031 NEUTRON ACER TENDL-2024 LIBRARY; T=0.K
Inelastic levels

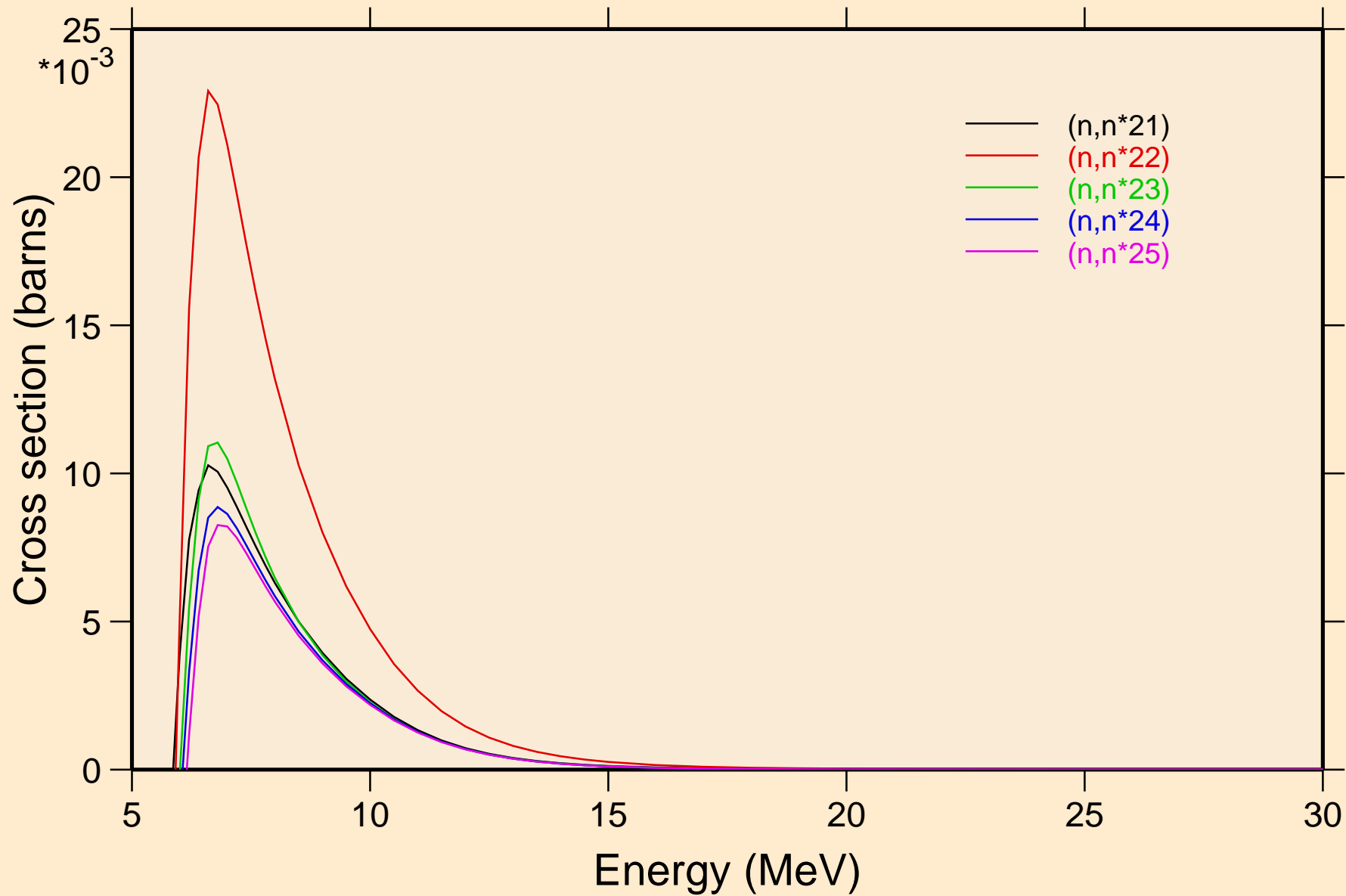

SI031 NEUTRON ACER TENDL-2024 LIBRARY; T=0.K
Inelastic levels

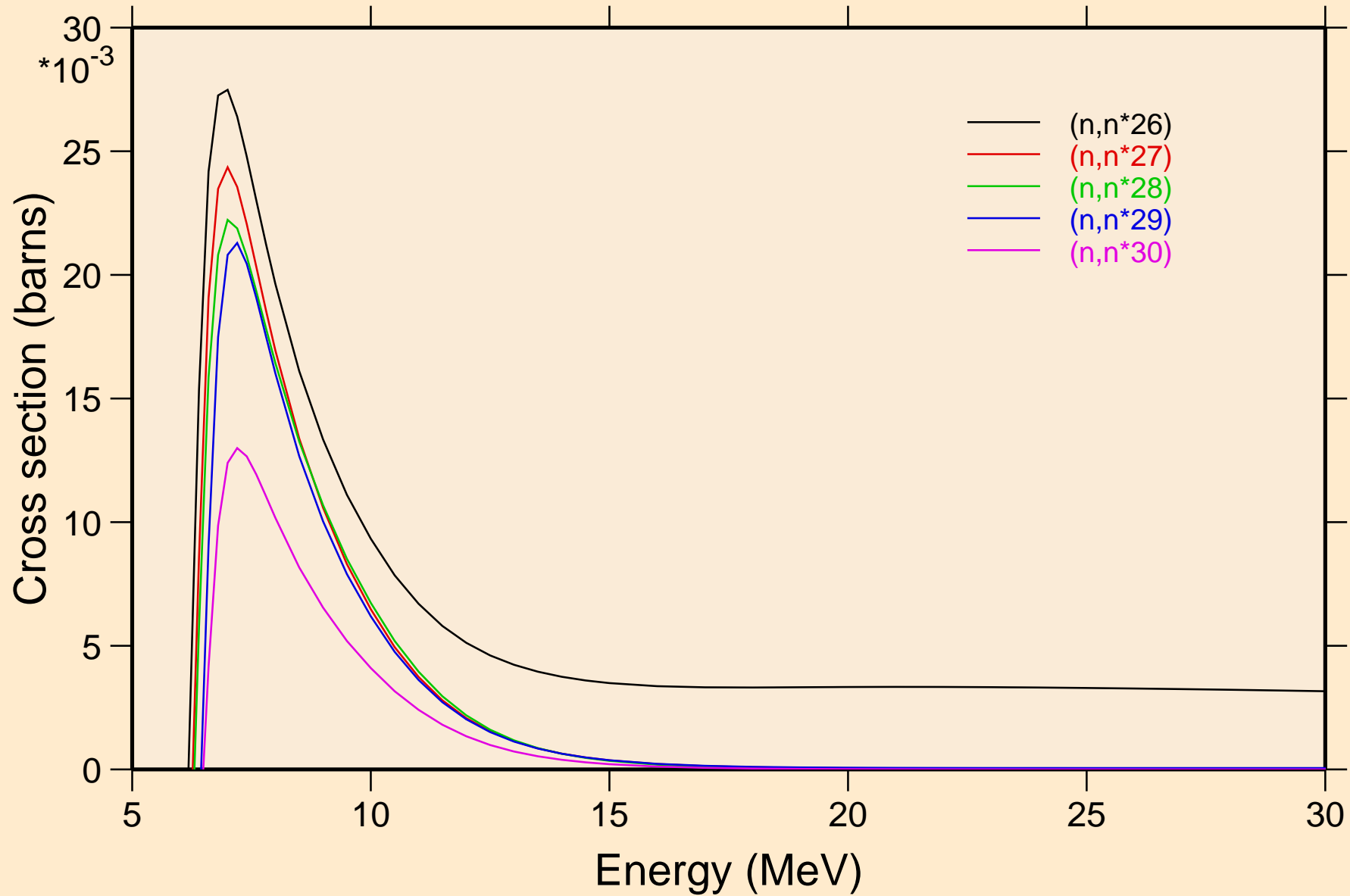

SI031 NEUTRON ACER TENDL-2024 LIBRARY; T=0.K
Threshold reactions

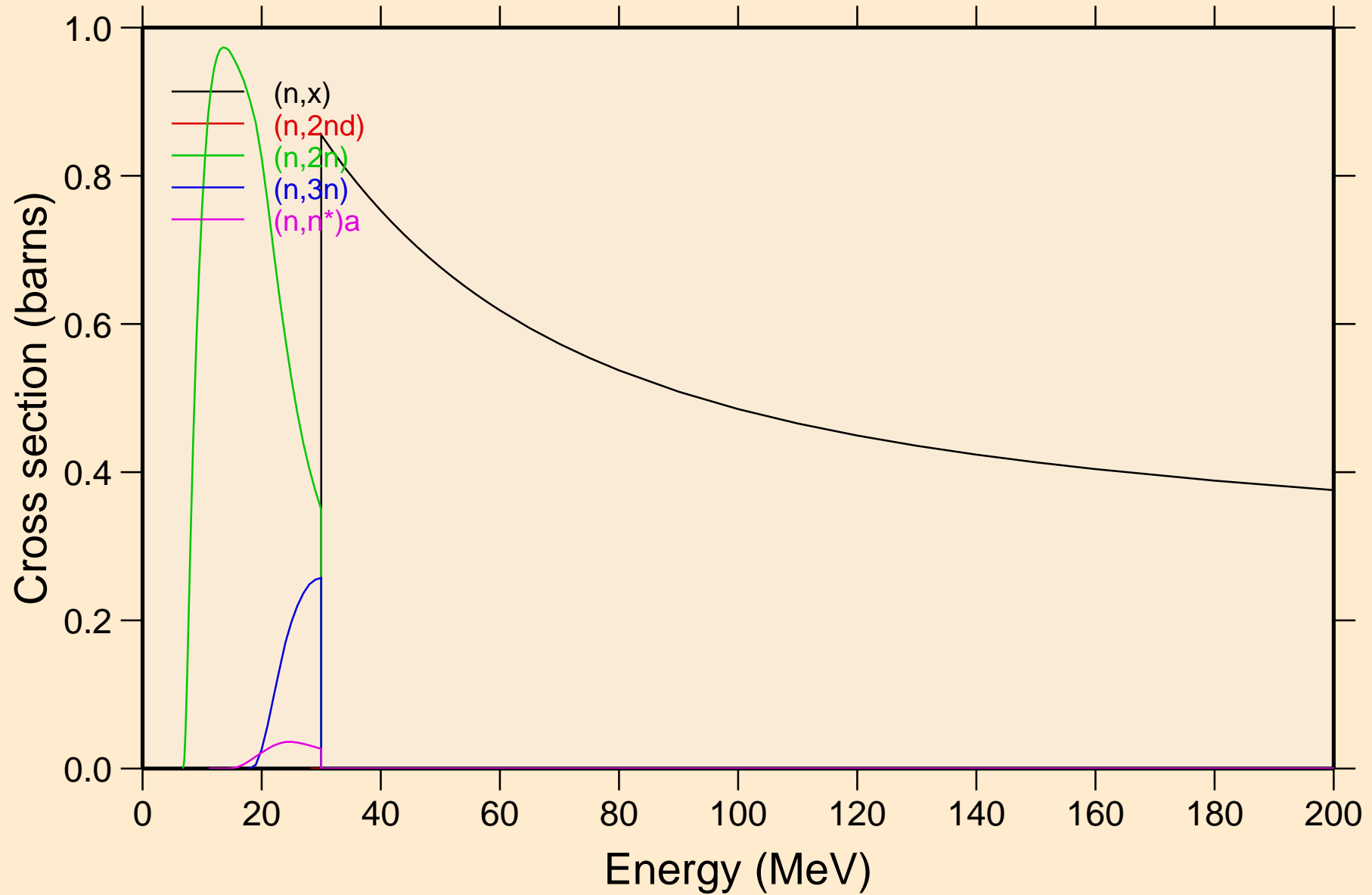

SI031 NEUTRON ACER TENDL-2024 LIBRARY; T=0.K

Threshold reactions

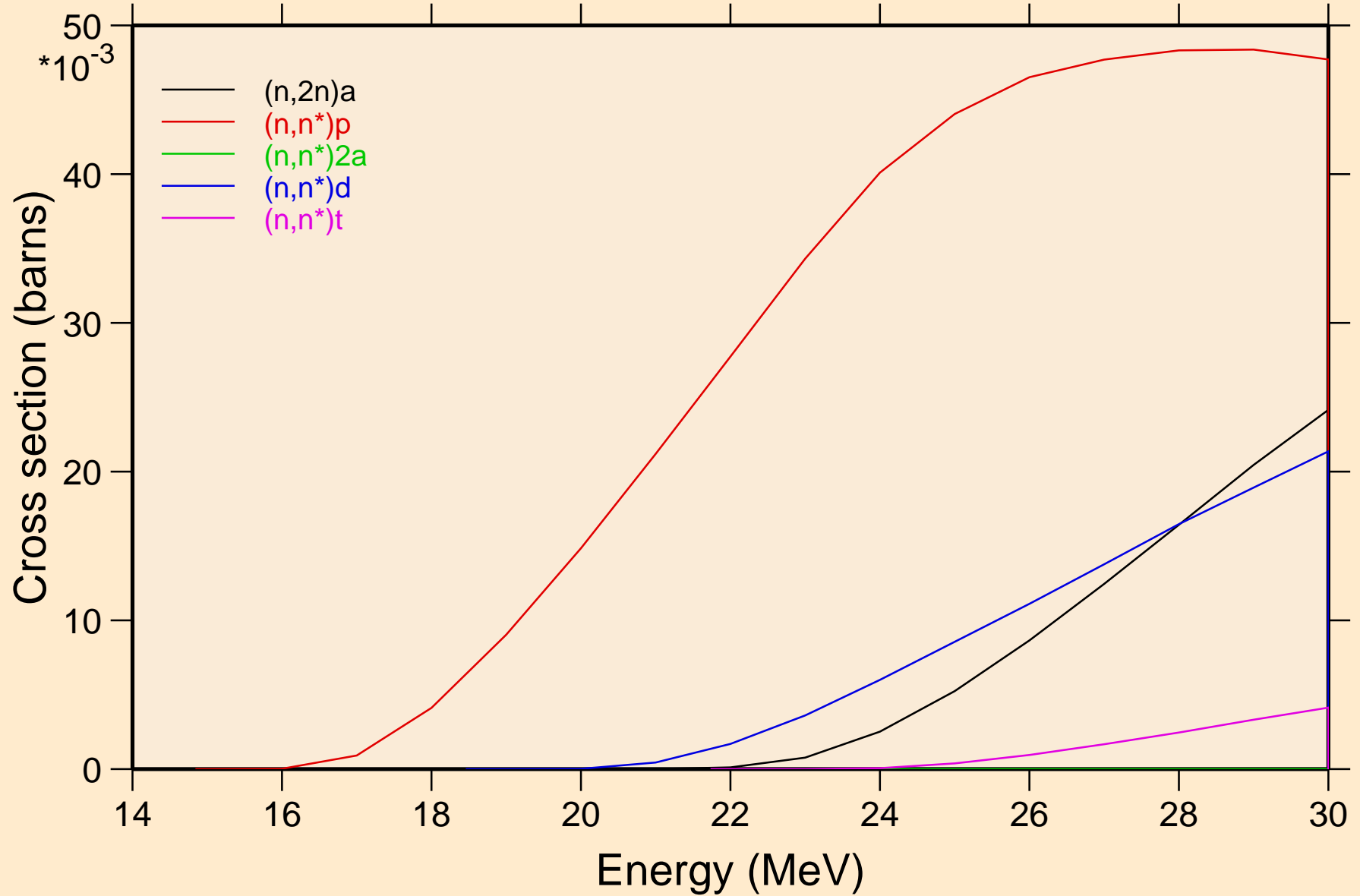

SI031 NEUTRON ACER TENDL-2024 LIBRARY; T=0.K

Threshold reactions

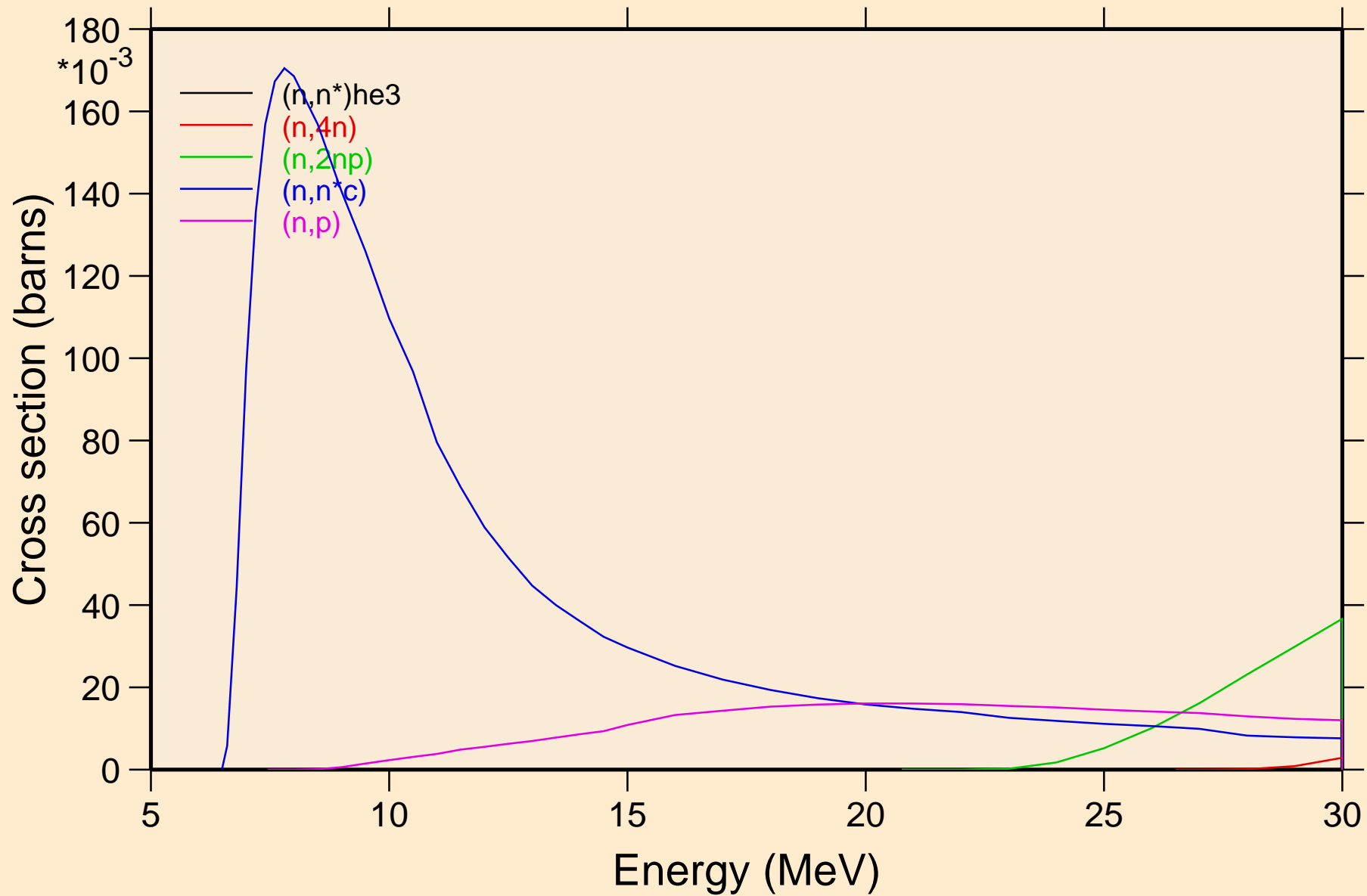

SI031 NEUTRON ACER TENDL-2024 LIBRARY; T=0.K
Threshold reactions

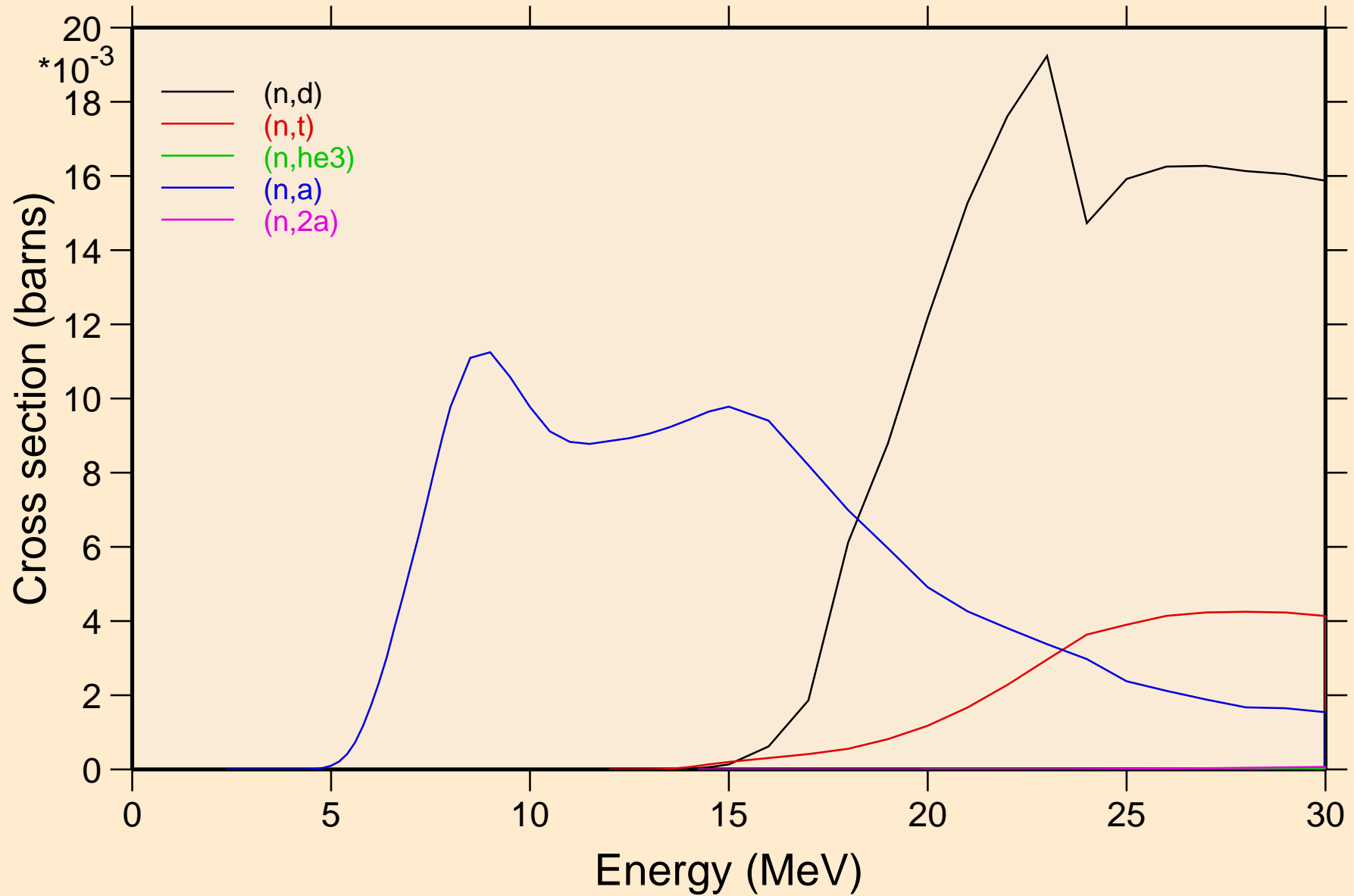

SI031 NEUTRON ACER TENDL-2024 LIBRARY; T=0.K

Threshold reactions

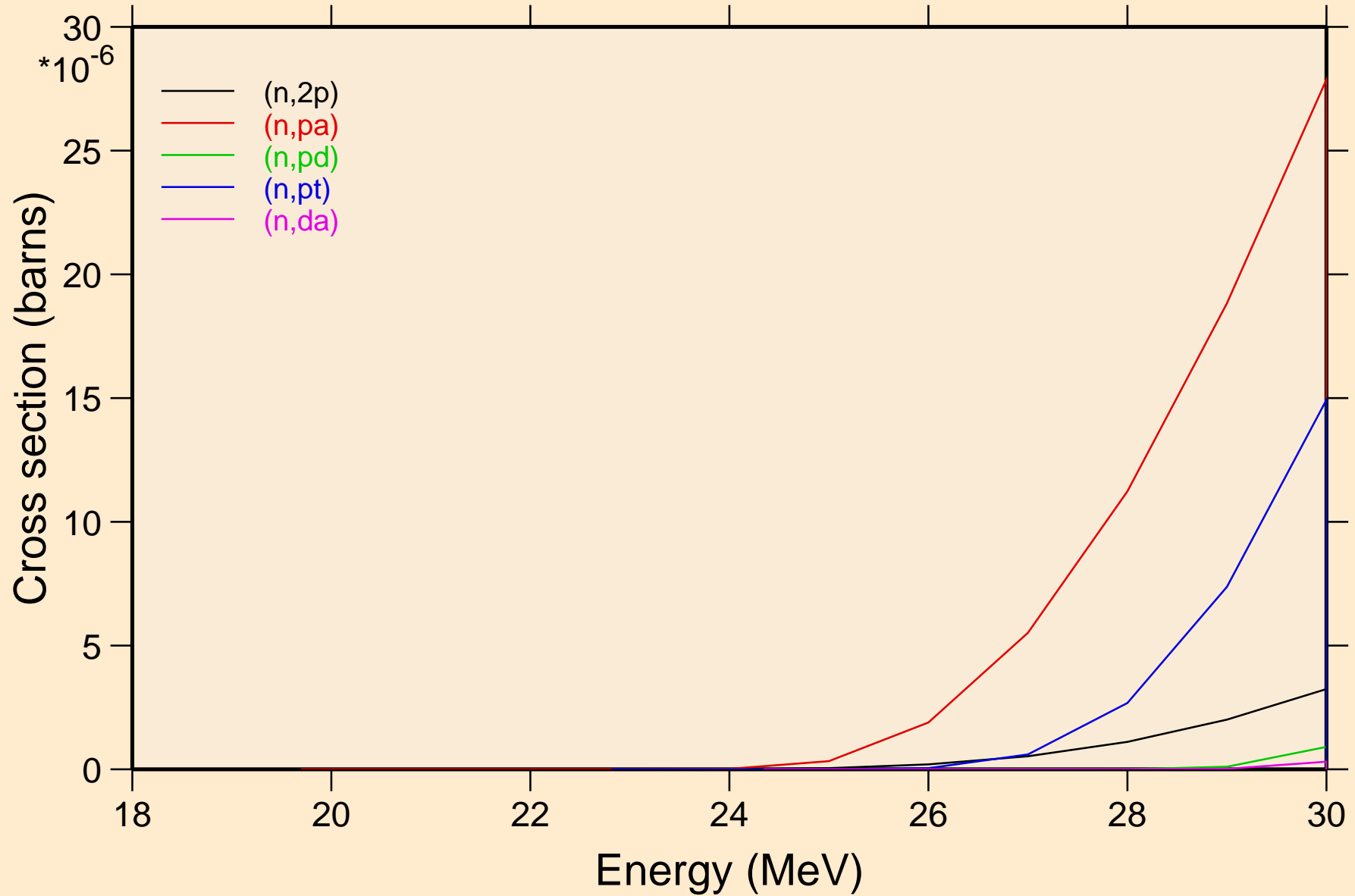

SI031 NEUTRON ACER TENDL-2024 LIBRARY; T=0.K
Threshold reactions

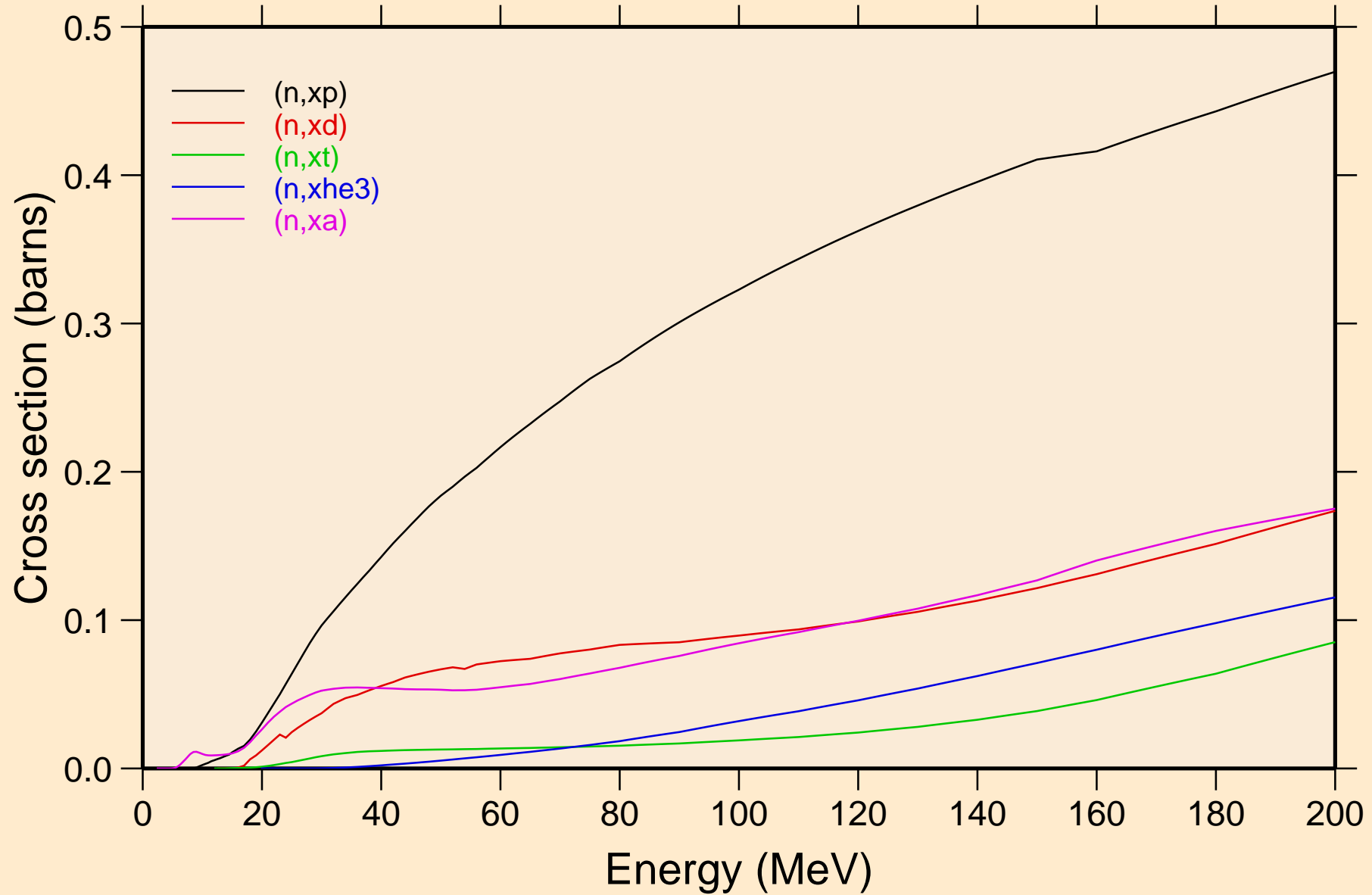

SI031 NEUTRON ACER TENDL-2024 LIBRARY; T=0.K
angular distribution for elastic

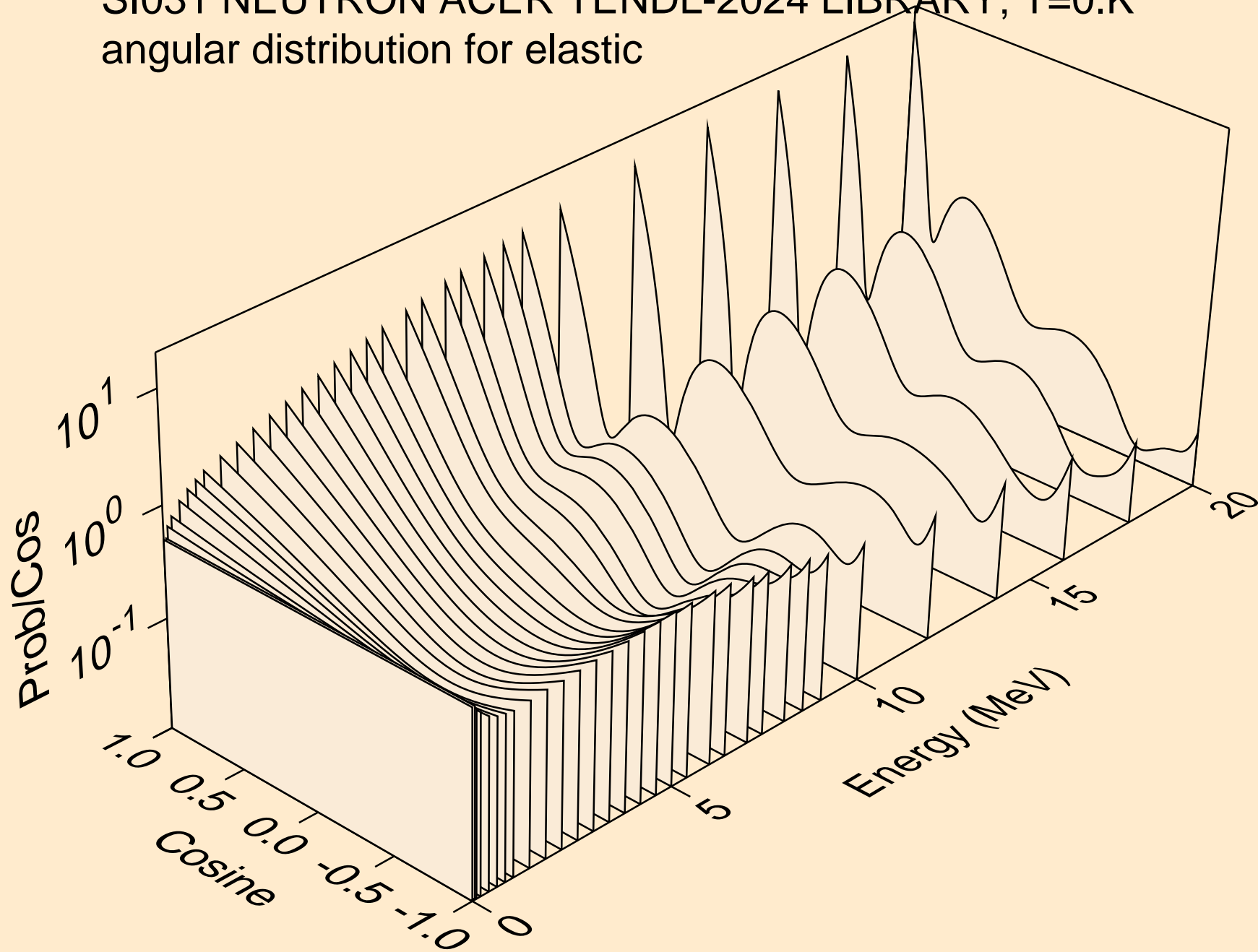

SI031 NEUTRON ACER TENDL-2024 LIBRARY; T=0.K
angular distribution for elastic

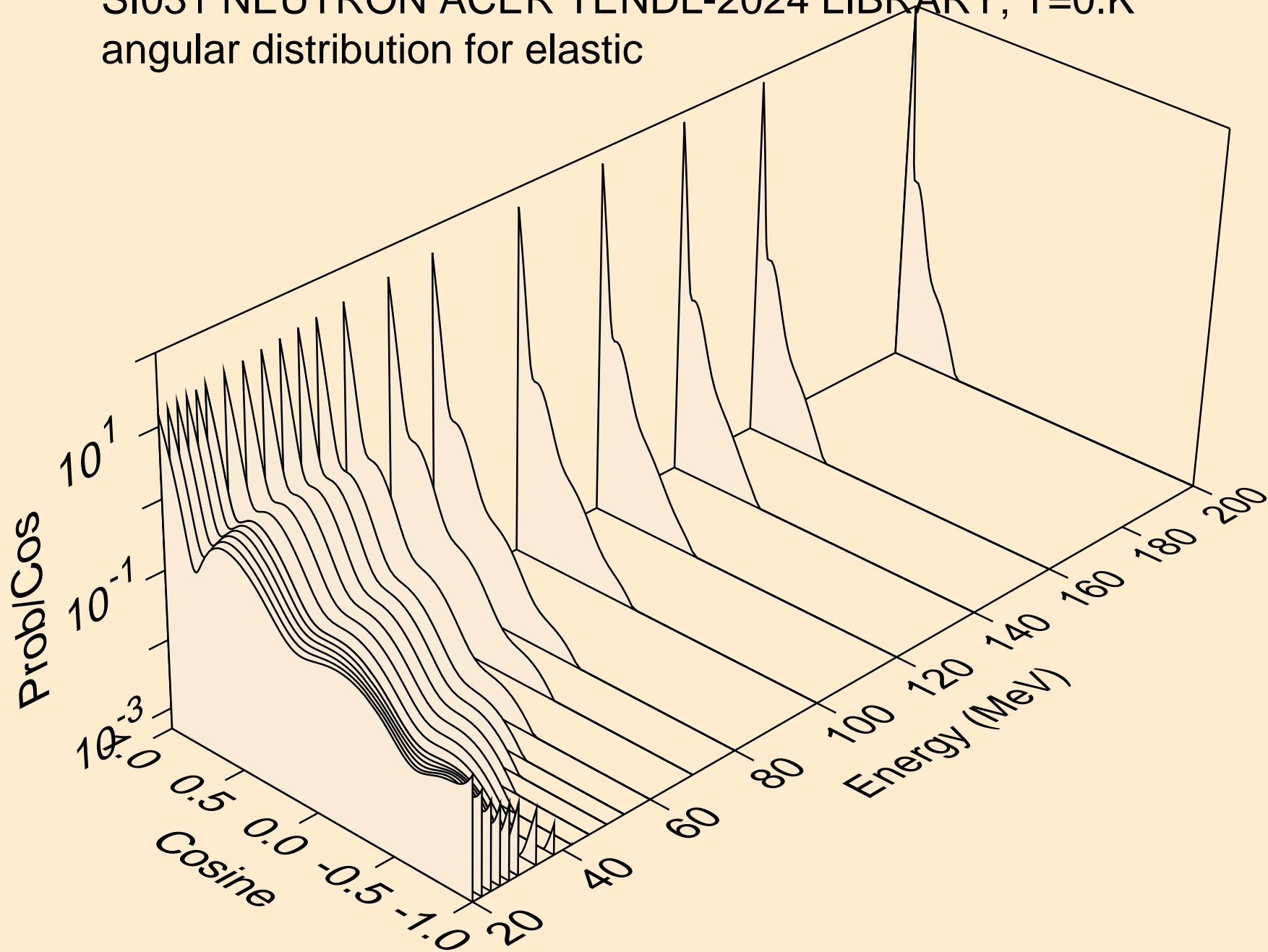

SI031 NEUTRON ACER TENDL-2024 LIBRARY; T=0.K
angular distribution for (n,n*1)

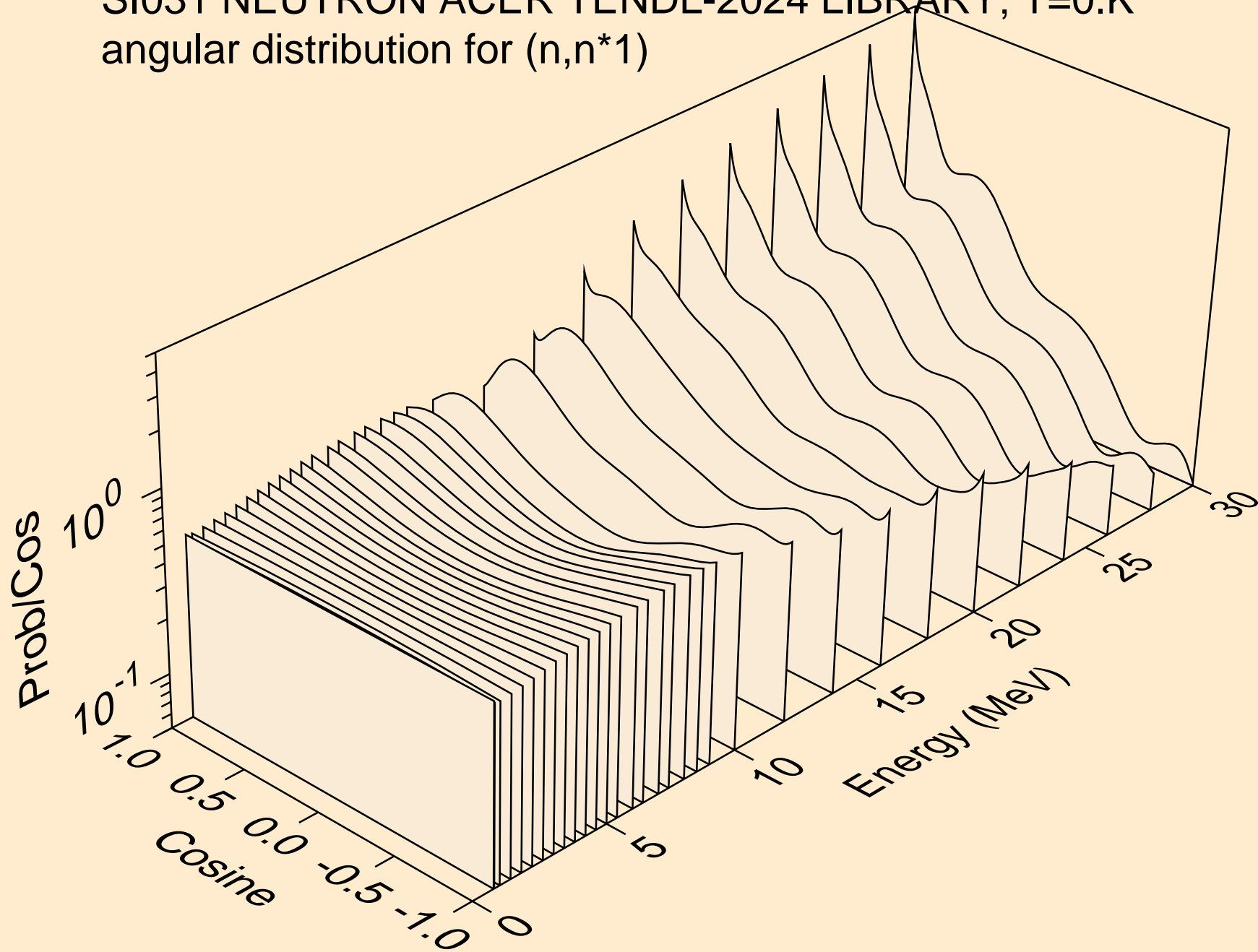

SI031 NEUTRON ACER TENDL-2024 LIBRARY; T=0.K
angular distribution for (n,n*2)

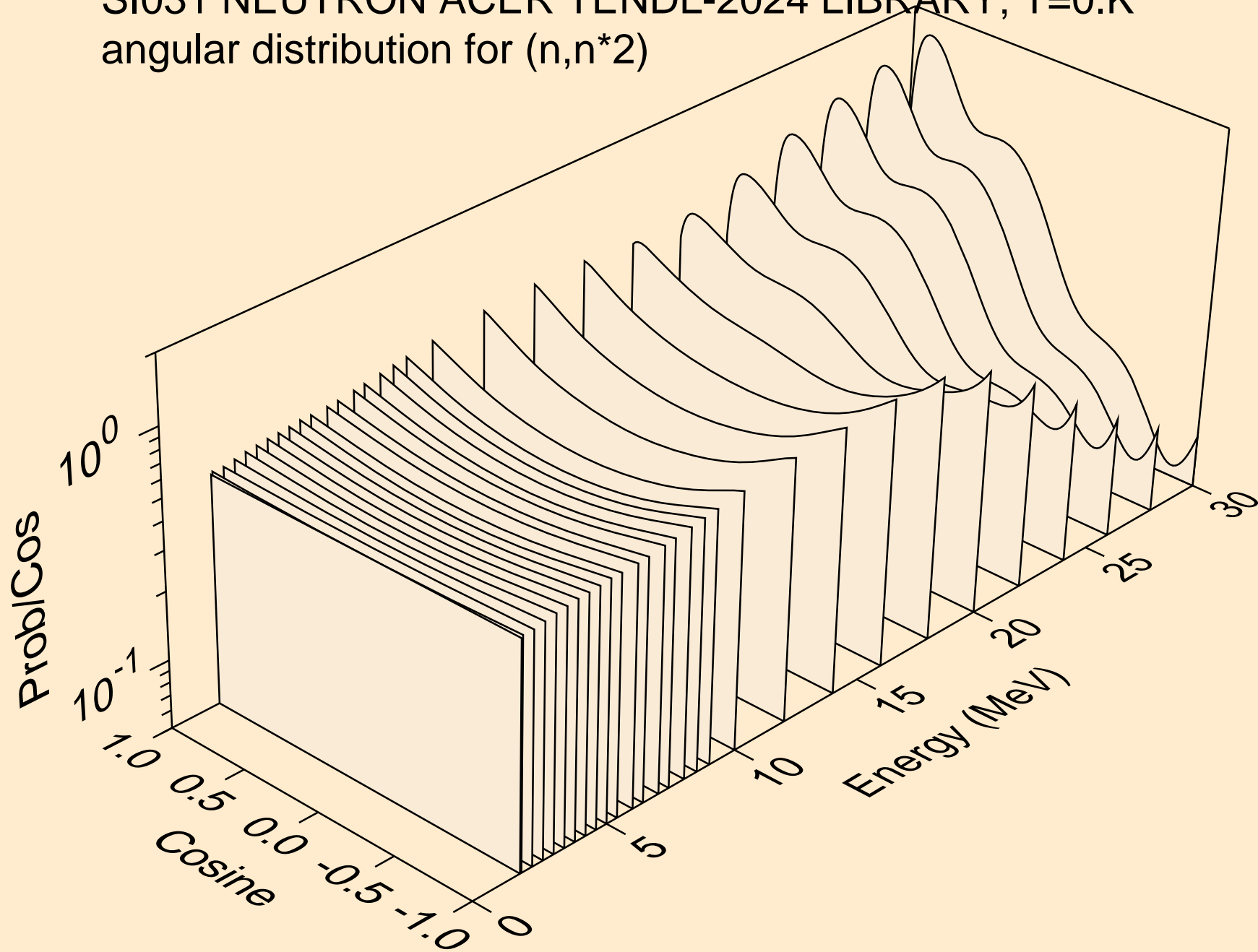

SI031 NEUTRON ACER TENDL-2024 LIBRARY; T=0.K
angular distribution for (n,n*3)

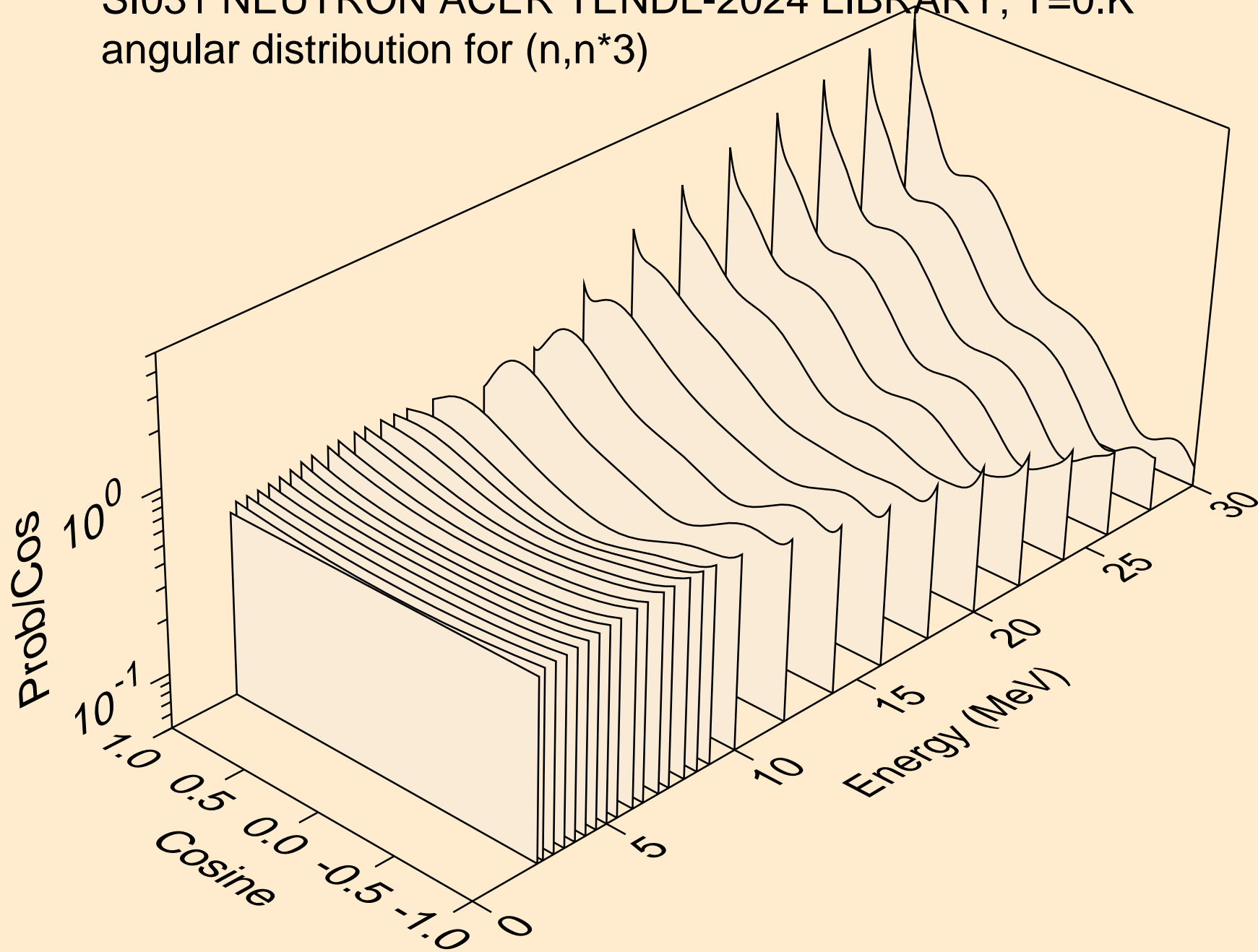

SI031 NEUTRON ACER TENDL-2024 LIBRARY; T=0.K
angular distribution for (n,n*4)

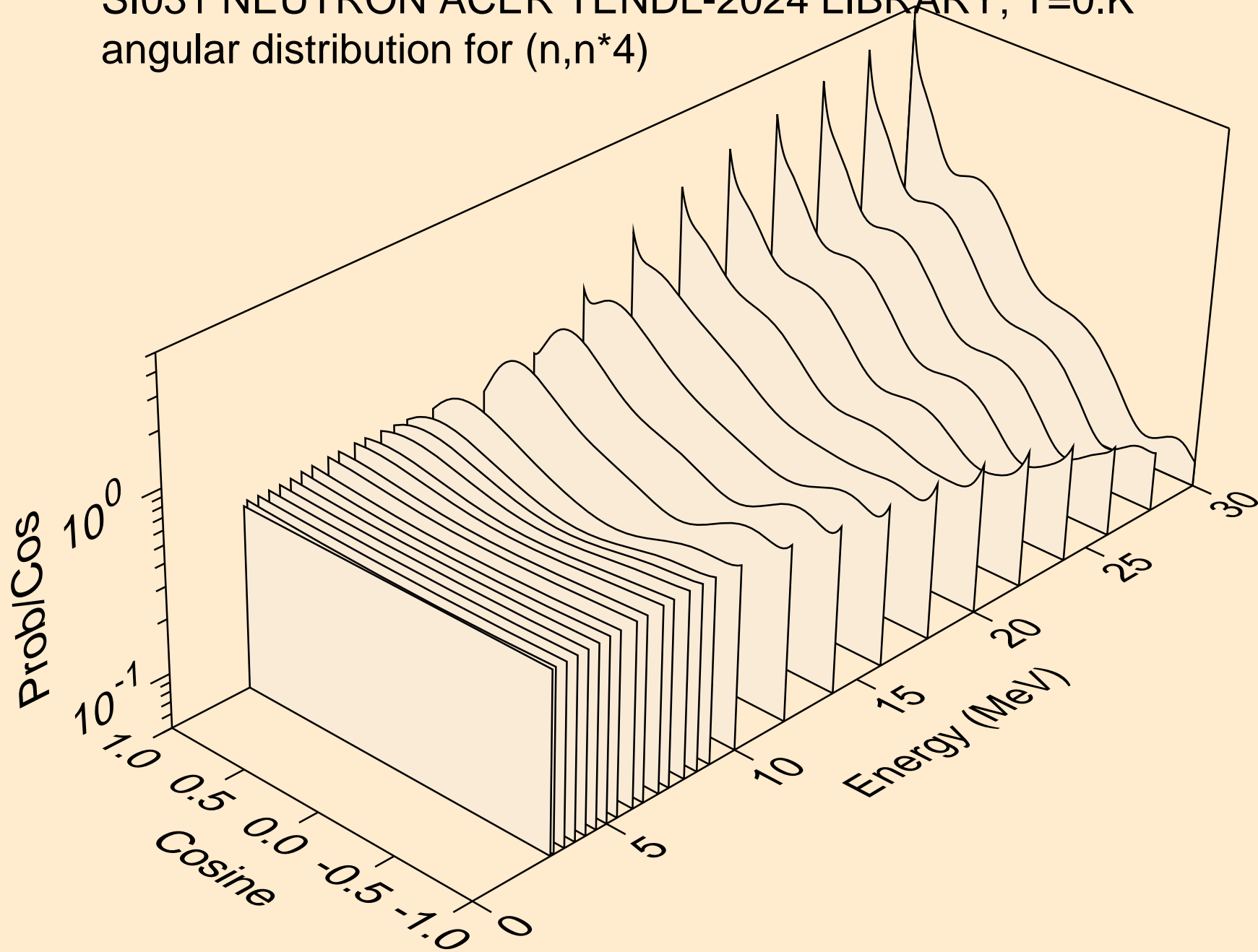

SI031 NEUTRON ACER TENDL-2024 LIBRARY; T=0.K
angular distribution for (n,n*5)

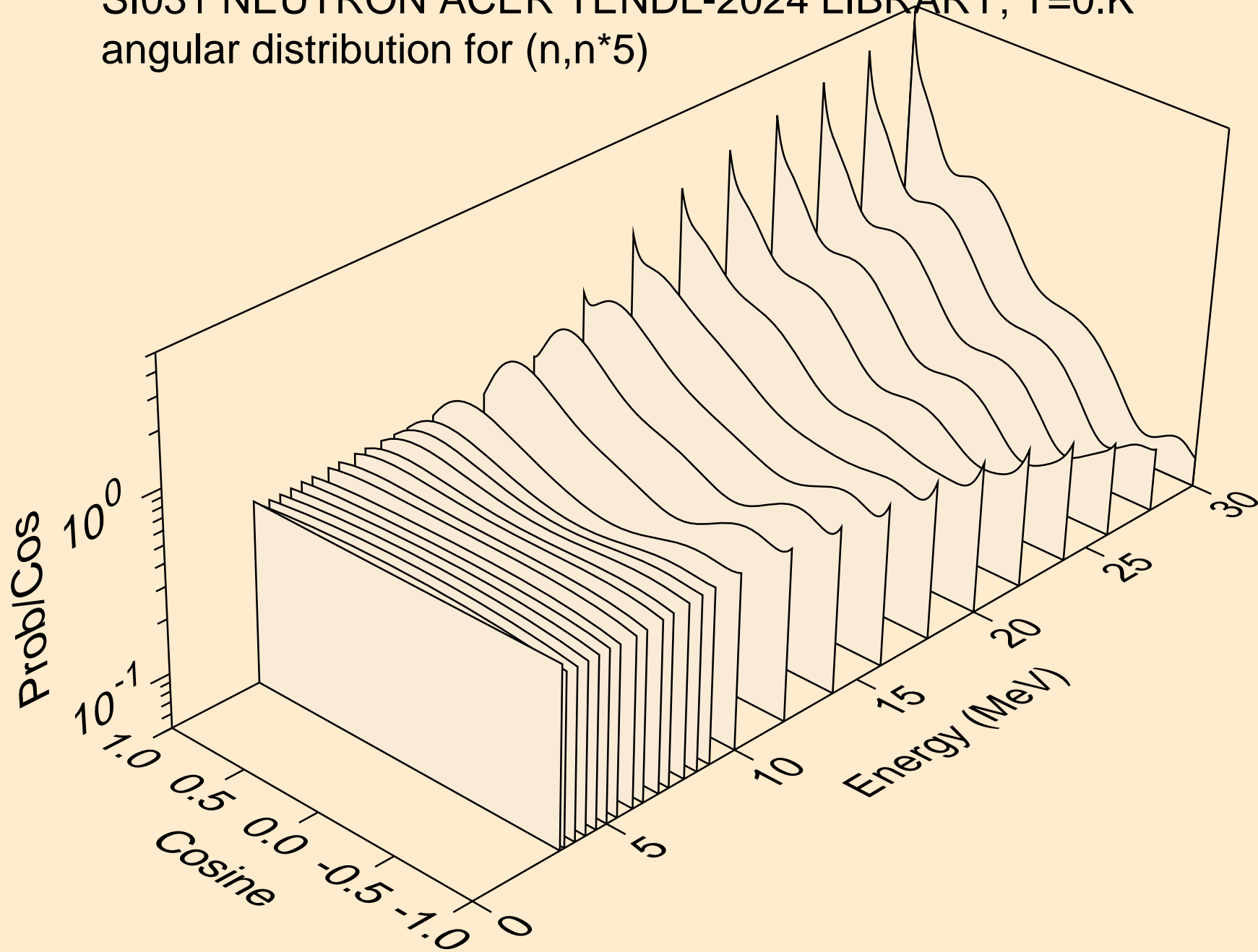

SI031 NEUTRON ACER TENDL-2024 LIBRARY; T=0.K
angular distribution for (n,n*6)

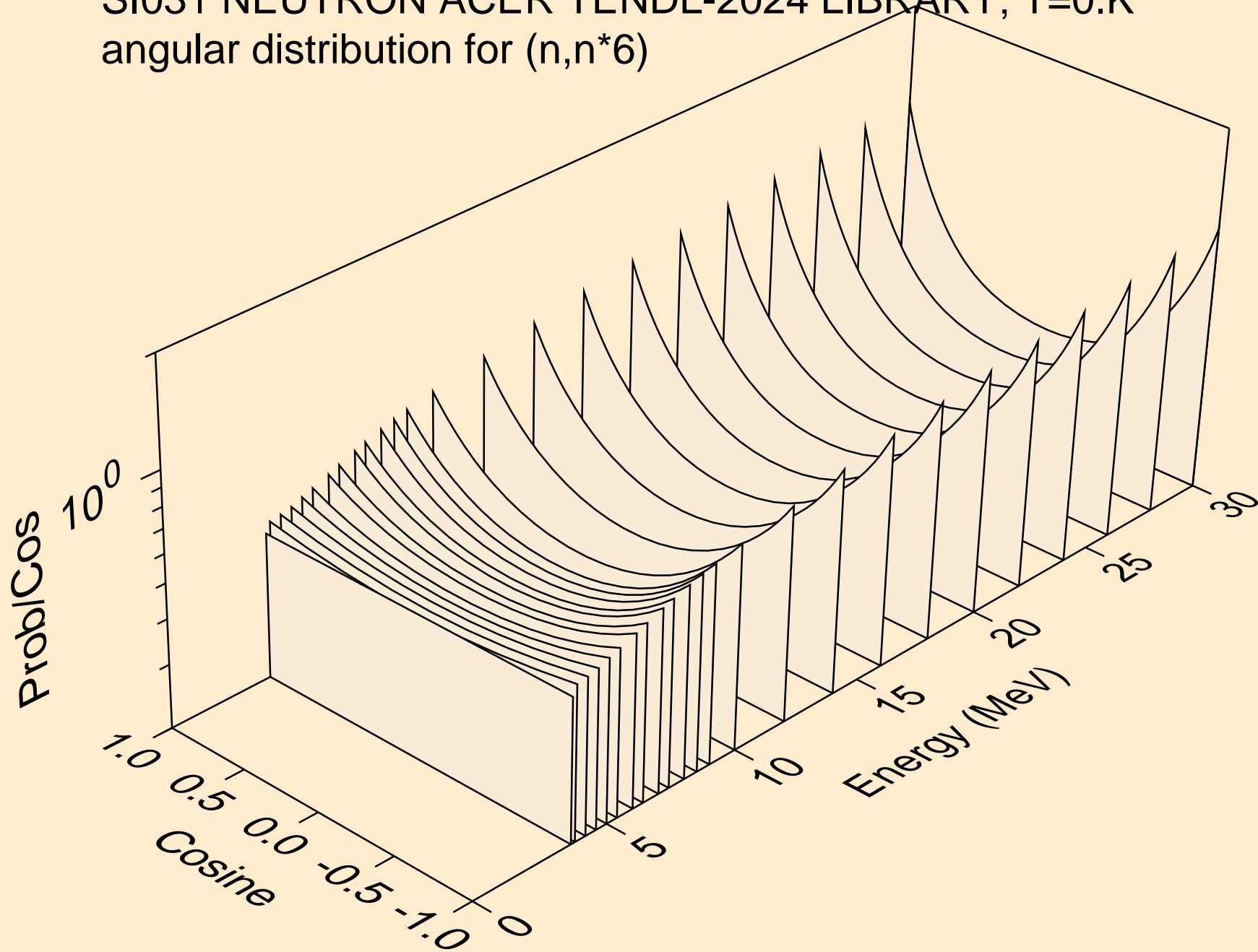

SI031 NEUTRON ACER TENDL-2024 LIBRARY; T=0.K
angular distribution for (n,n*7)

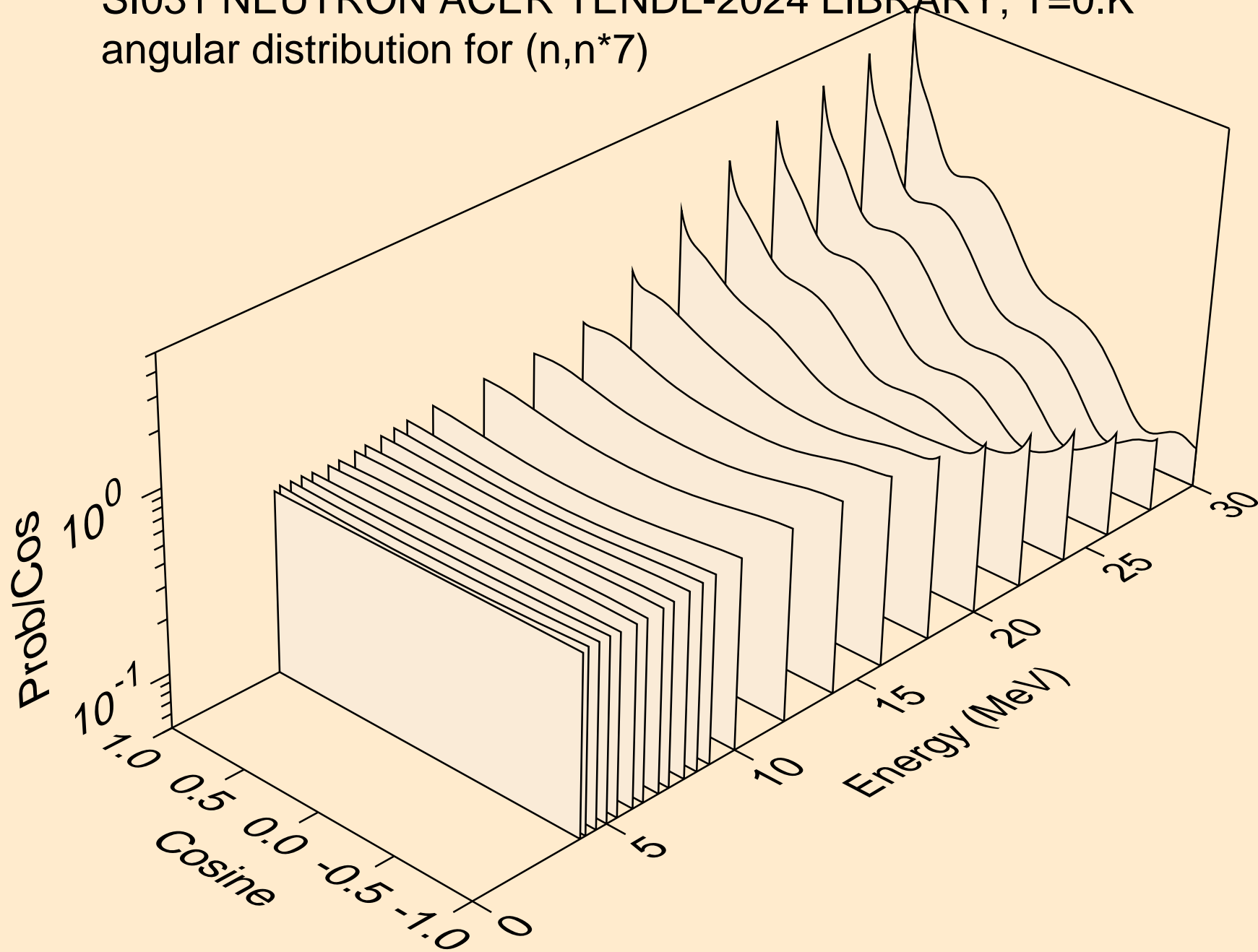

SI031 NEUTRON ACER TENDL-2024 LIBRARY; T=0.K
angular distribution for (n,n*8)

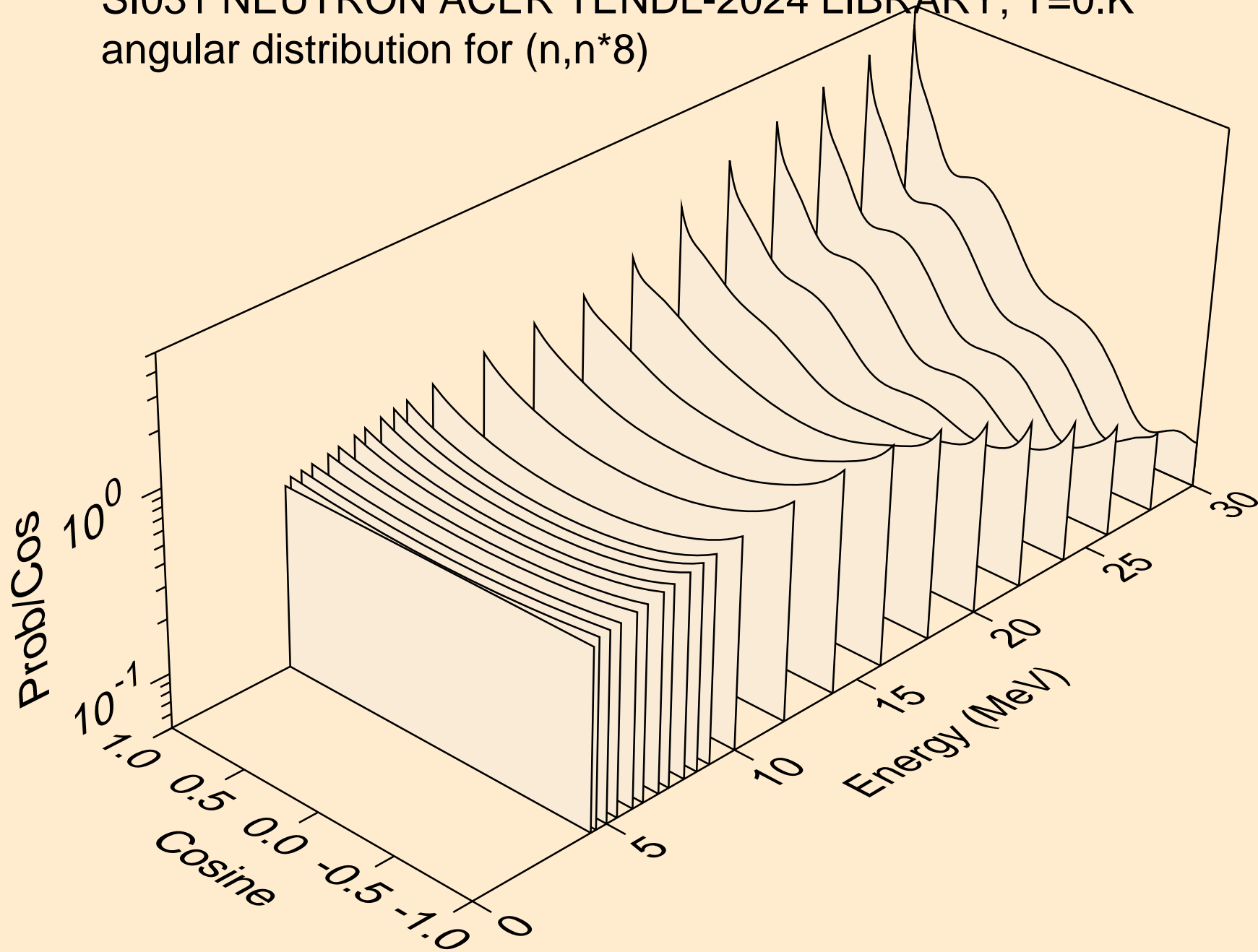

SI031 NEUTRON ACER TENDL-2024 LIBRARY; T=0.K
angular distribution for (n,n*9)

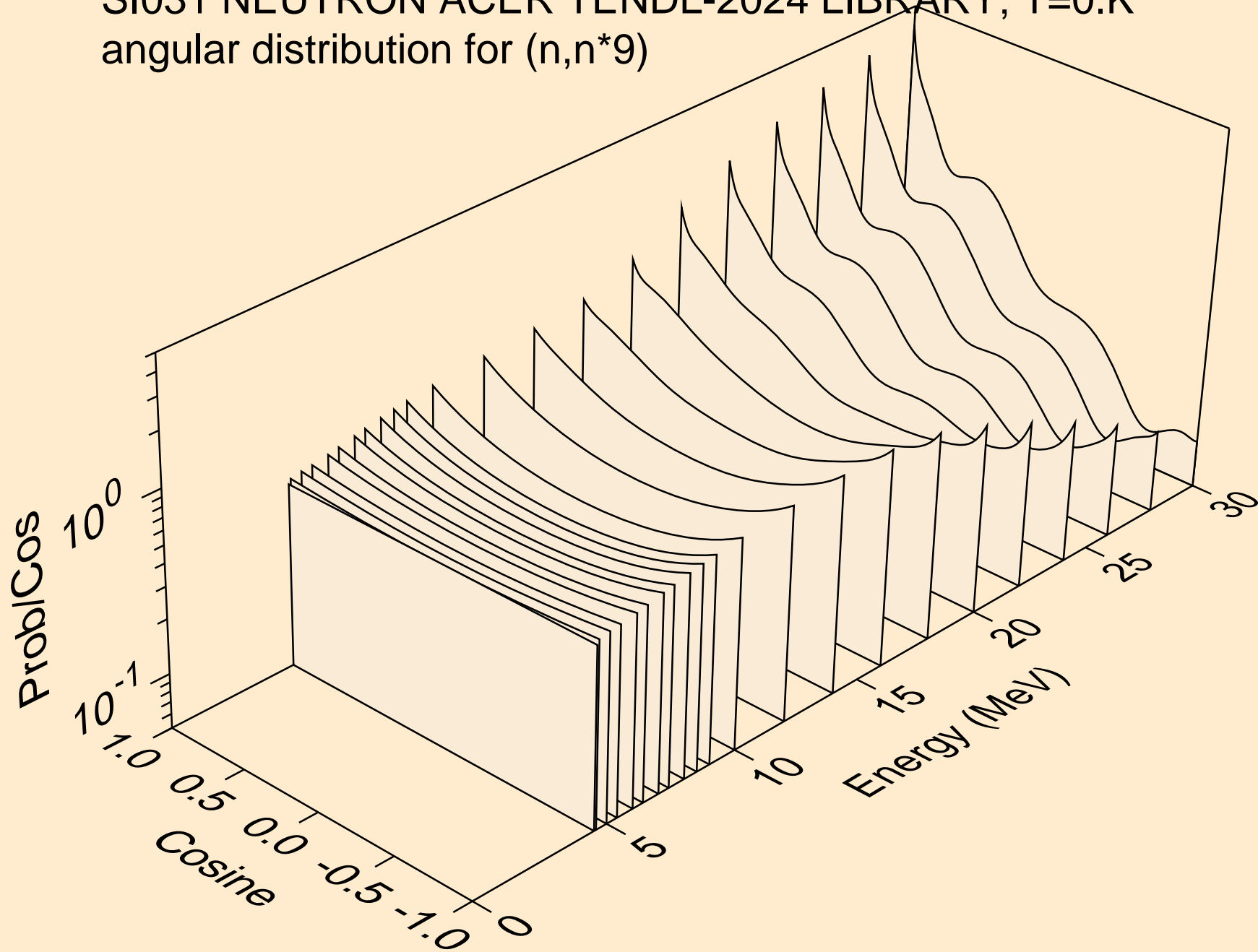

SI031 NEUTRON ACER TENDL-2024 LIBRARY; T=0.K
angular distribution for (n,n*10)

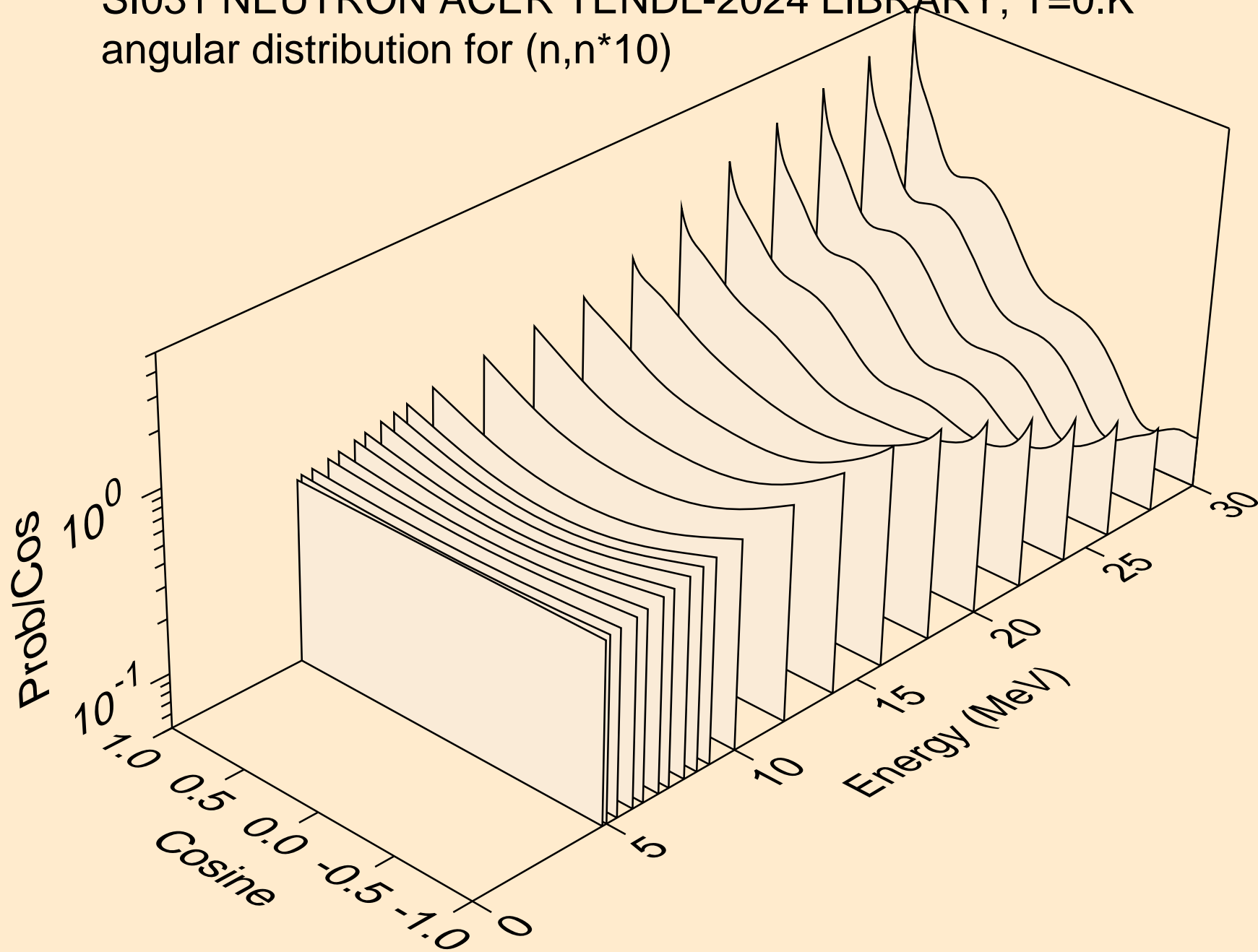

SI031 NEUTRON ACER TENDL-2024 LIBRARY; T=0.K
angular distribution for (n,n*11)

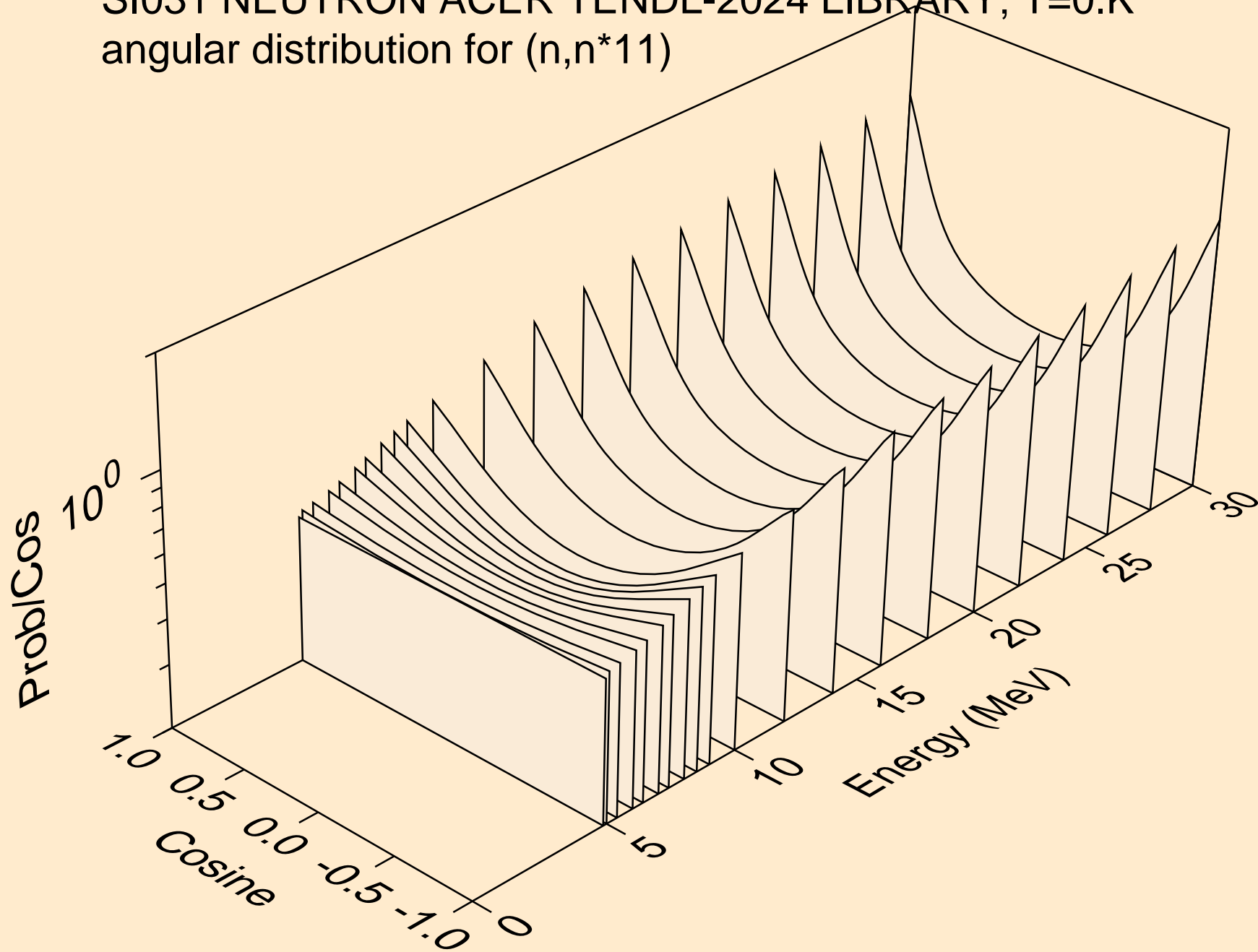

SI031 NEUTRON ACER TENDL-2024 LIBRARY; T=0.K
angular distribution for (n,n*12)

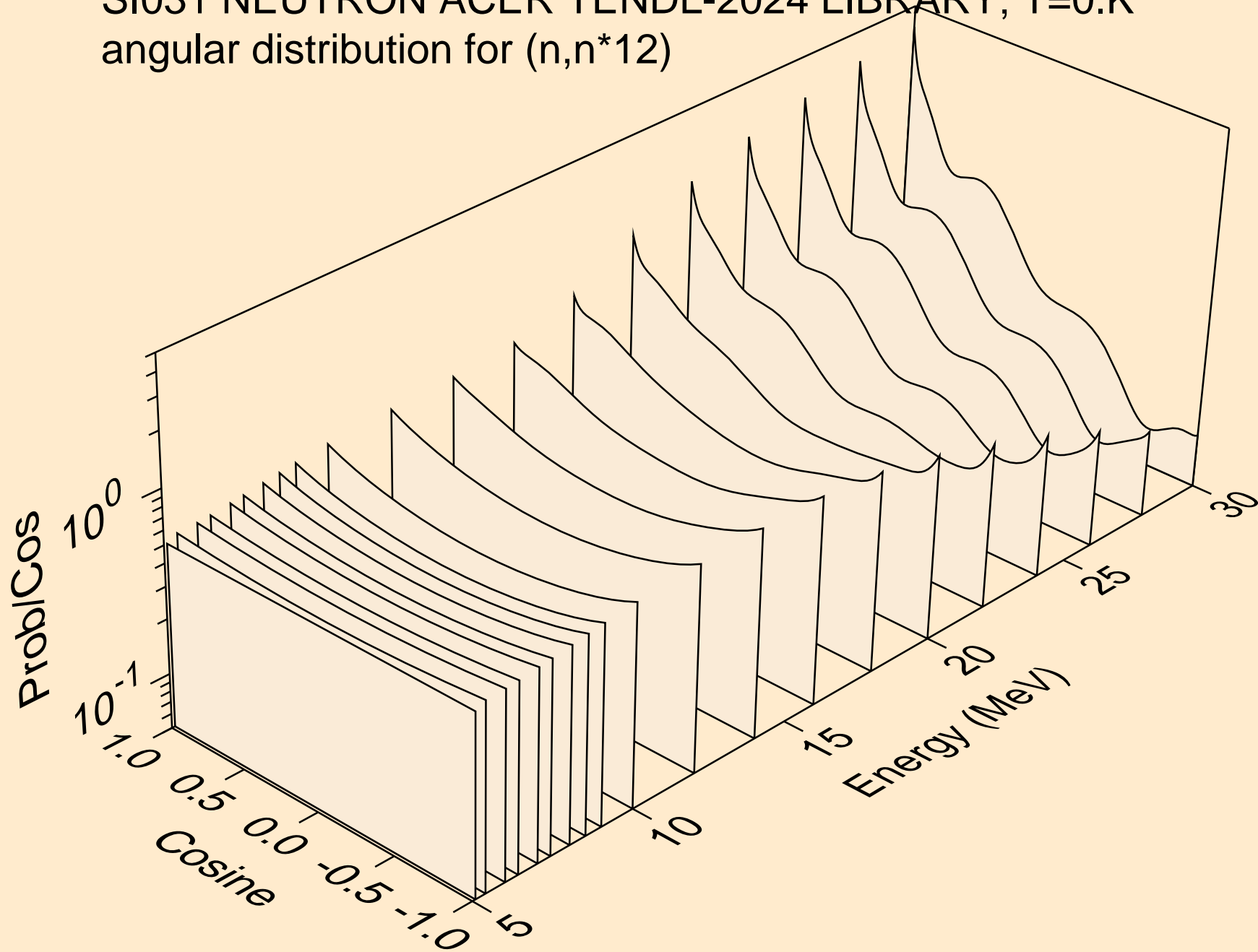

SI031 NEUTRON ACER TENDL-2024 LIBRARY; T=0.K
angular distribution for (n,n*13)

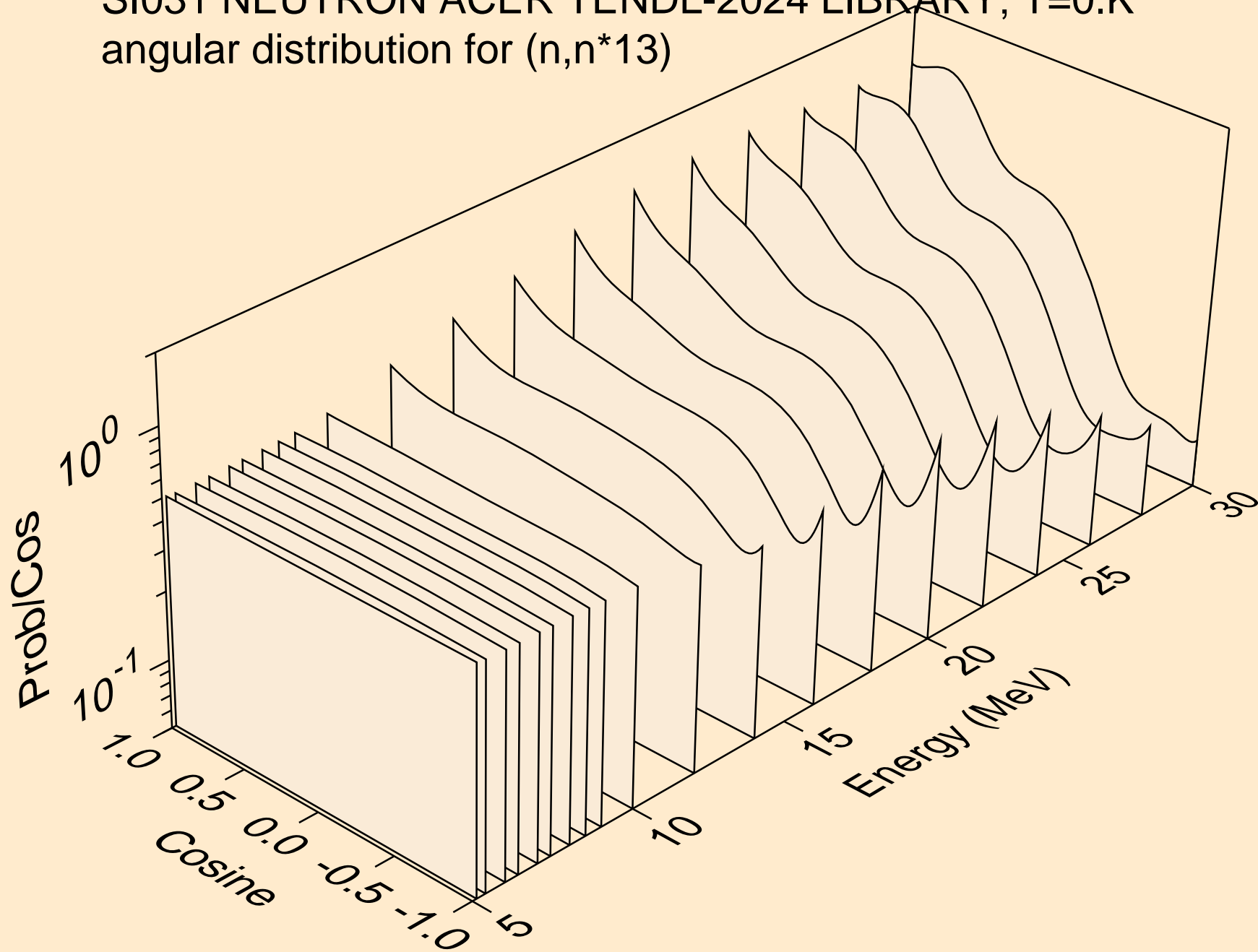

SI031 NEUTRON ACER TENDL-2024 LIBRARY; T=0.K
angular distribution for (n,n*14)

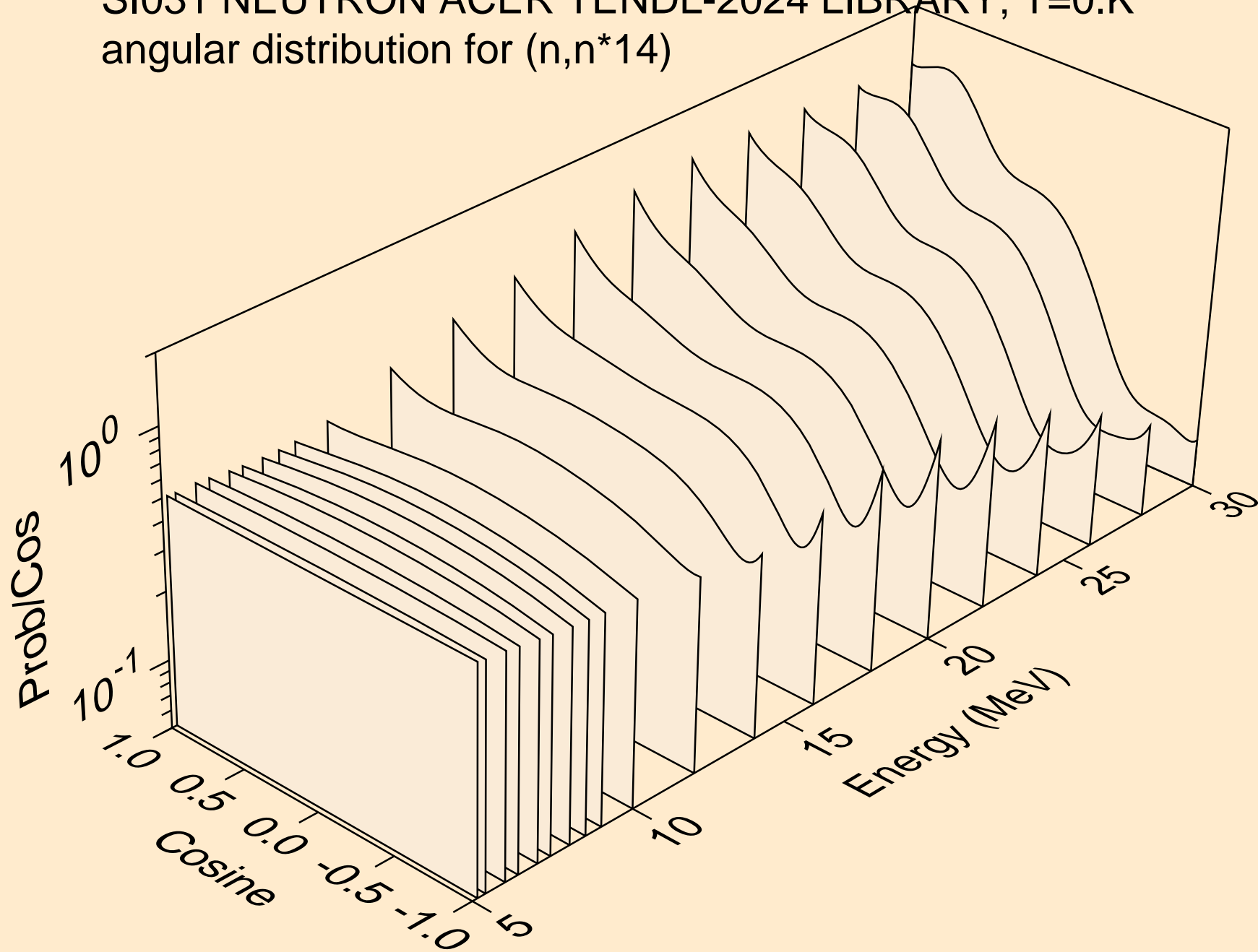

SI031 NEUTRON ACER TENDL-2024 LIBRARY; T=0.K
angular distribution for (n,n*15)

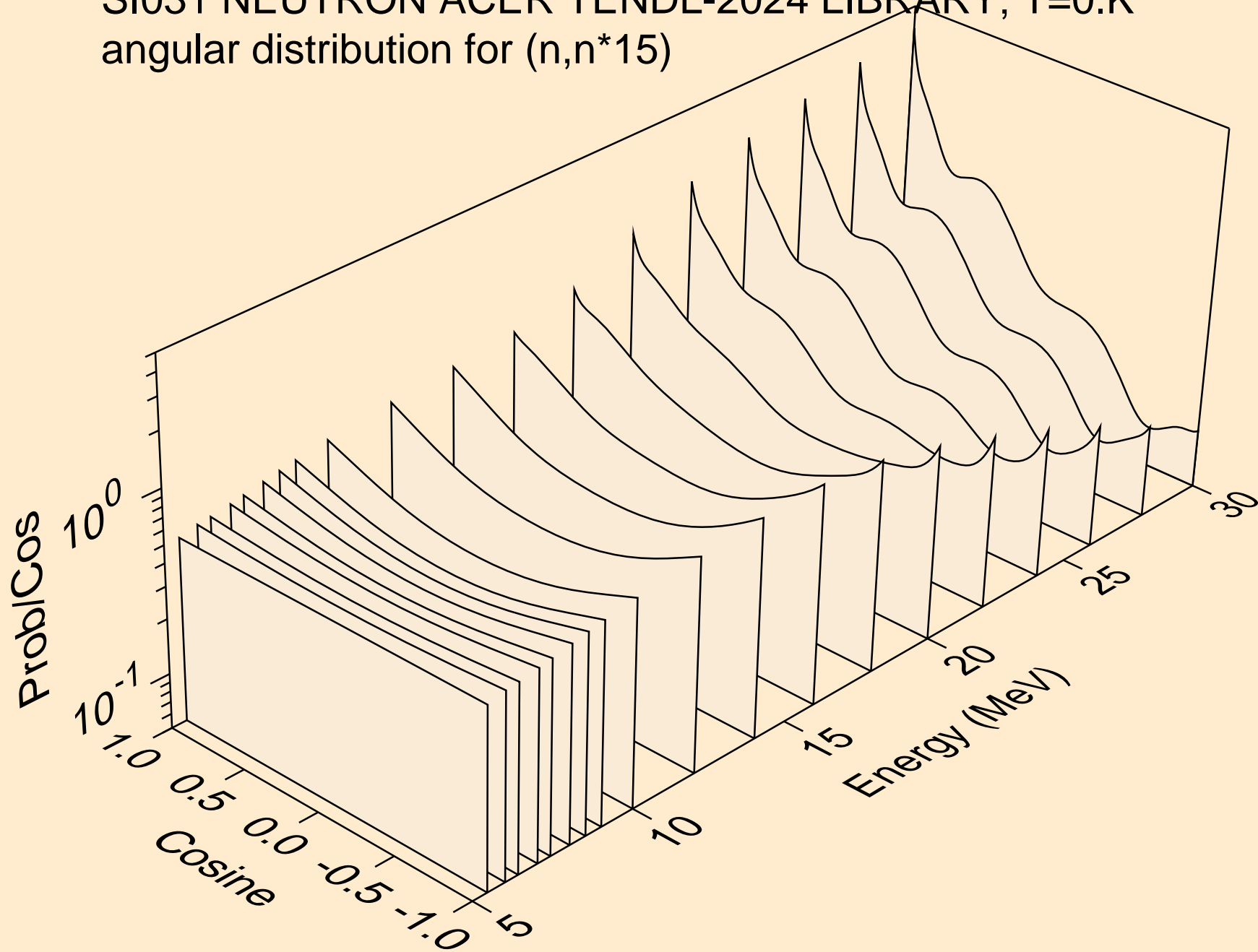

SI031 NEUTRON ACER TENDL-2024 LIBRARY; T=0.K
angular distribution for (n,n*16)

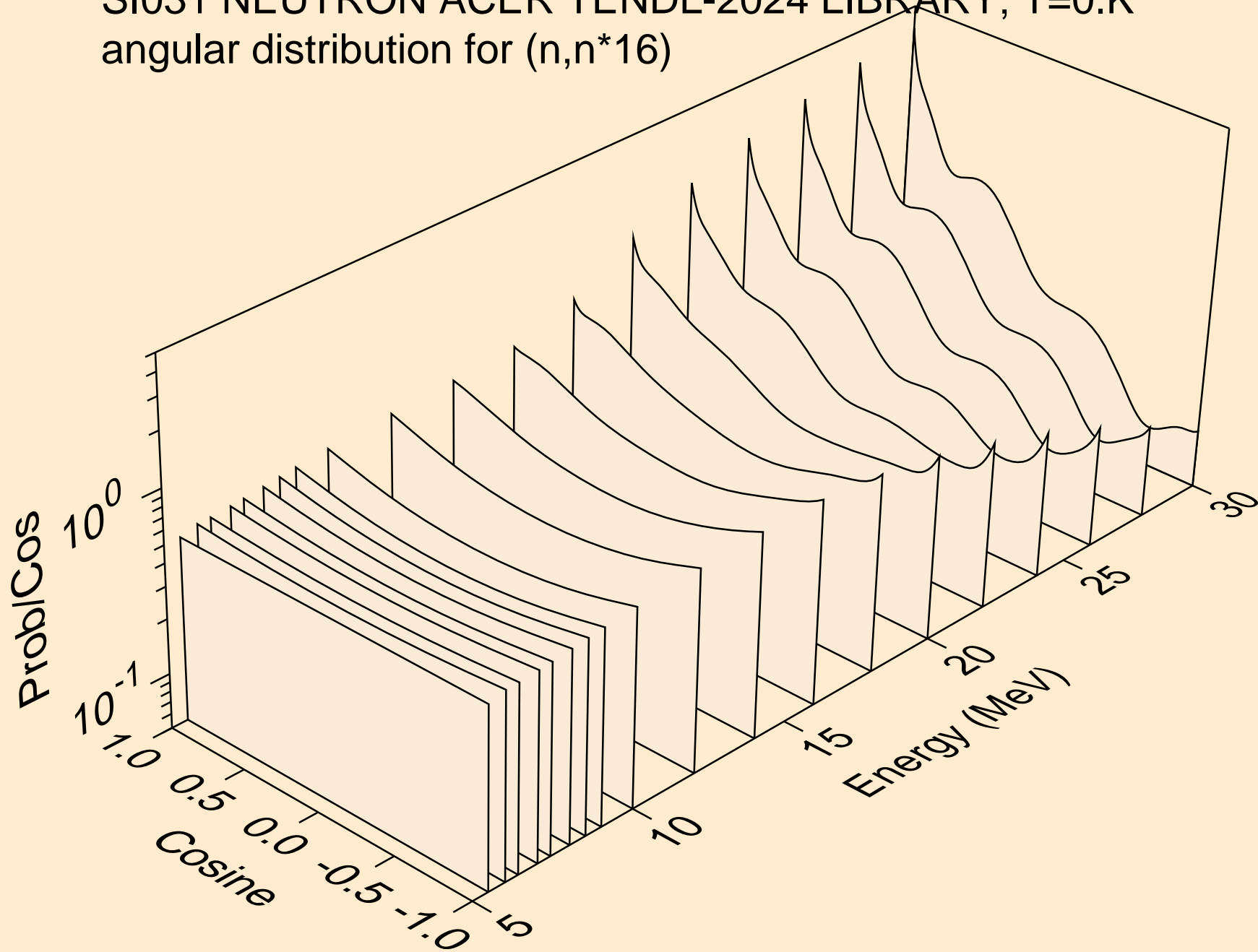

SI031 NEUTRON ACER TENDL-2024 LIBRARY; T=0.K
angular distribution for (n,n*17)

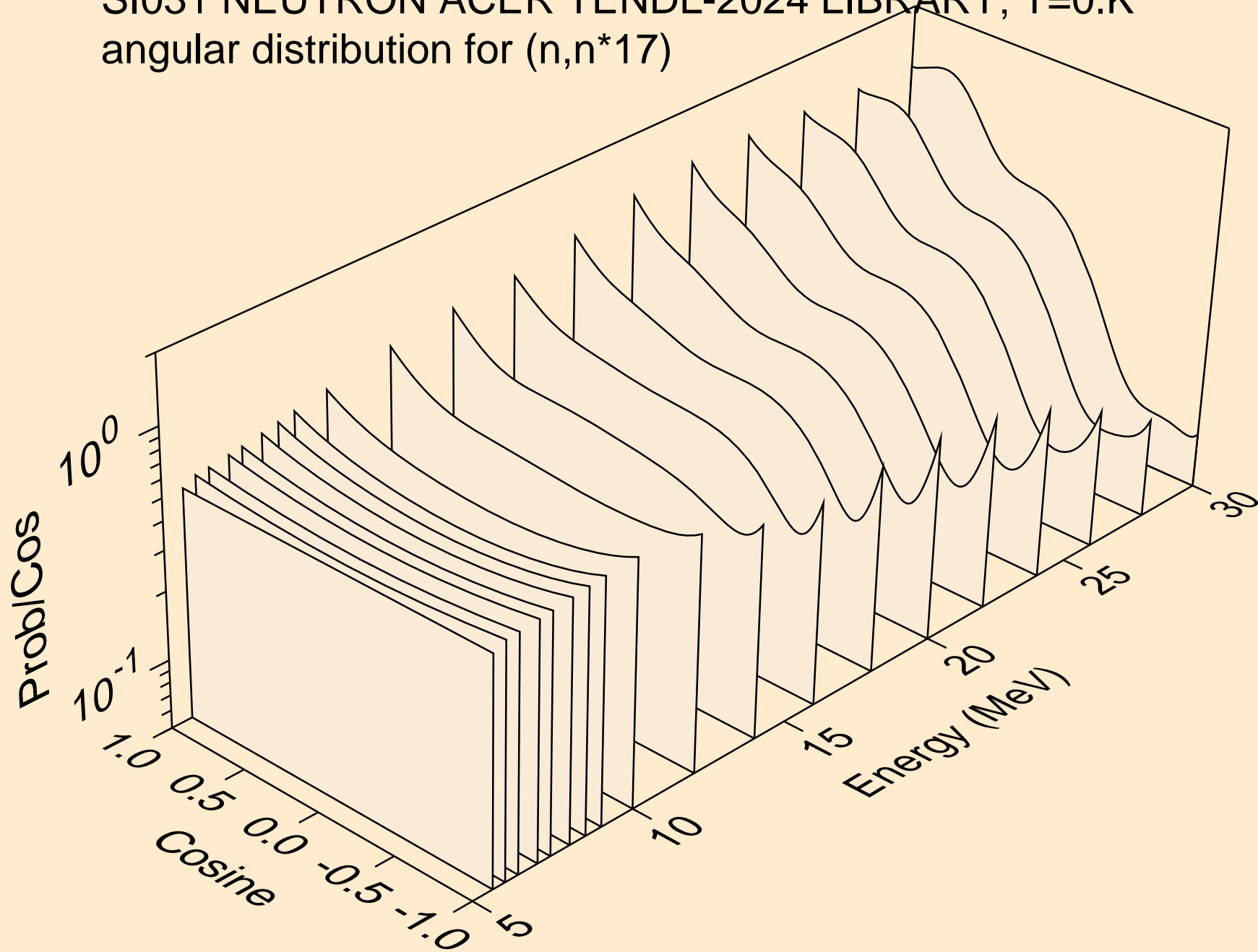

SI031 NEUTRON ACER TENDL-2024 LIBRARY; T=0.K
angular distribution for (n,n*18)

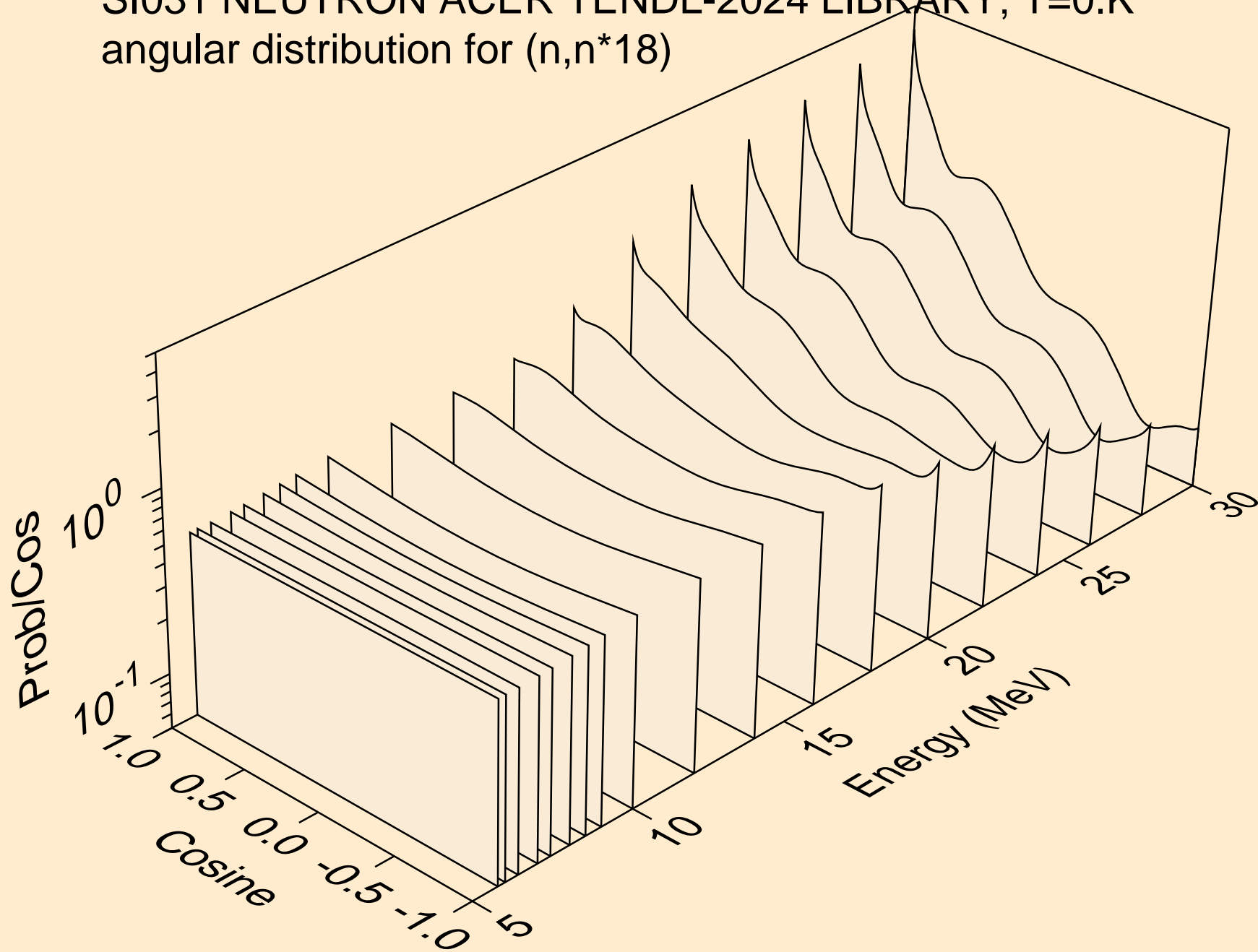

SI031 NEUTRON ACER TENDL-2024 LIBRARY; T=0.K
angular distribution for (n,n*19)

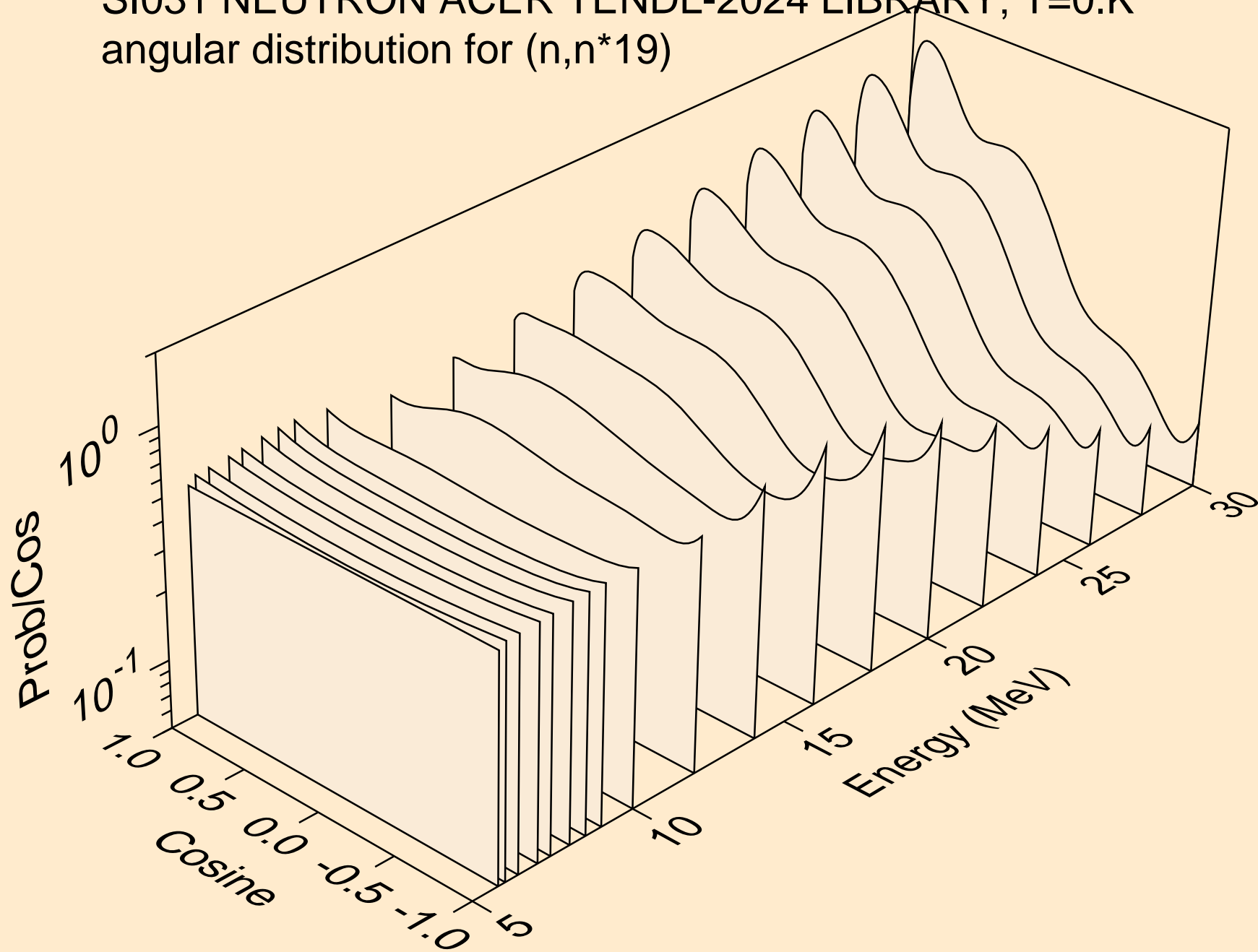

SI031 NEUTRON ACER TENDL-2024 LIBRARY; T=0.K
angular distribution for (n,n*20)

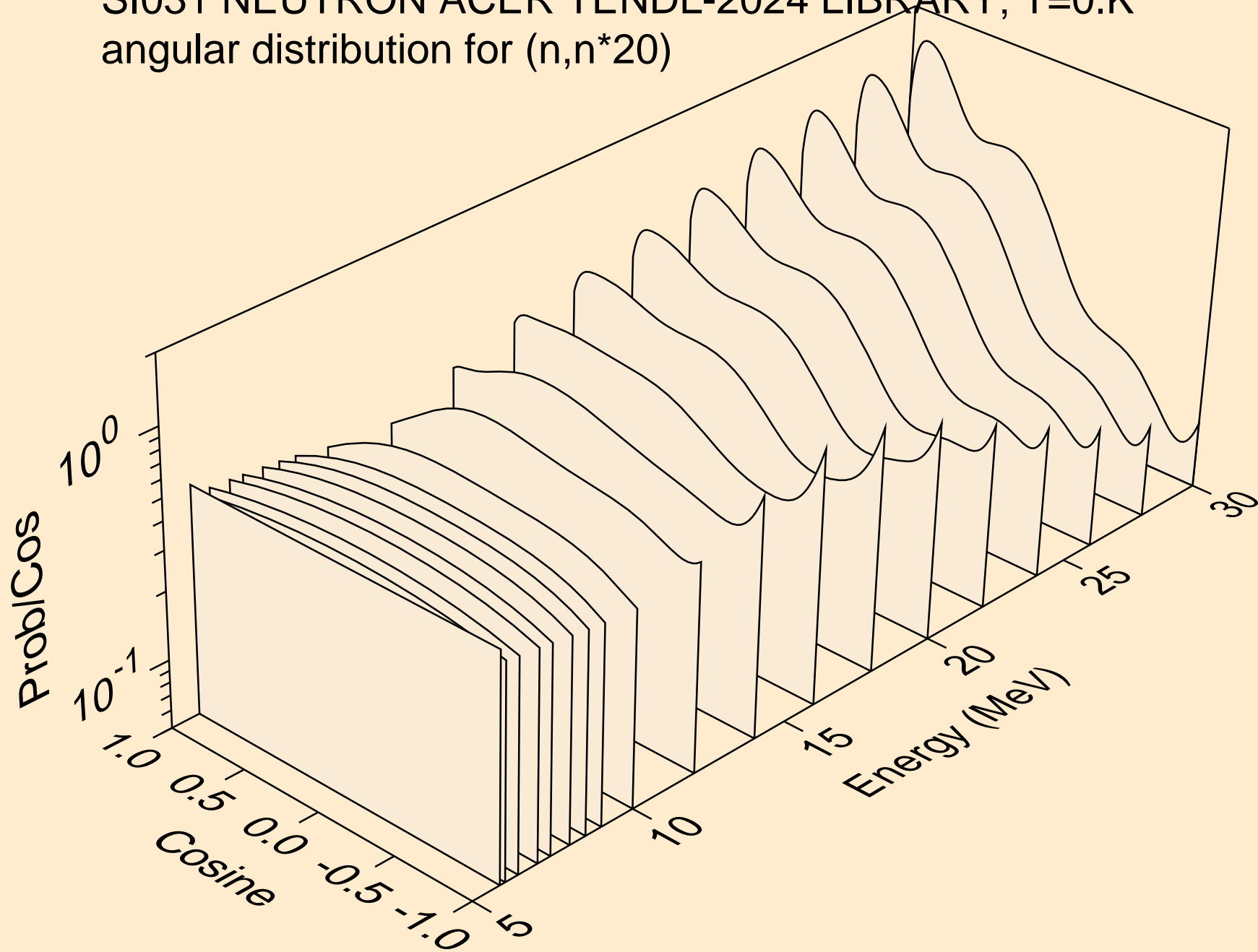

SI031 NEUTRON ACER TENDL-2024 LIBRARY; T=0.K
angular distribution for (n,n*21)

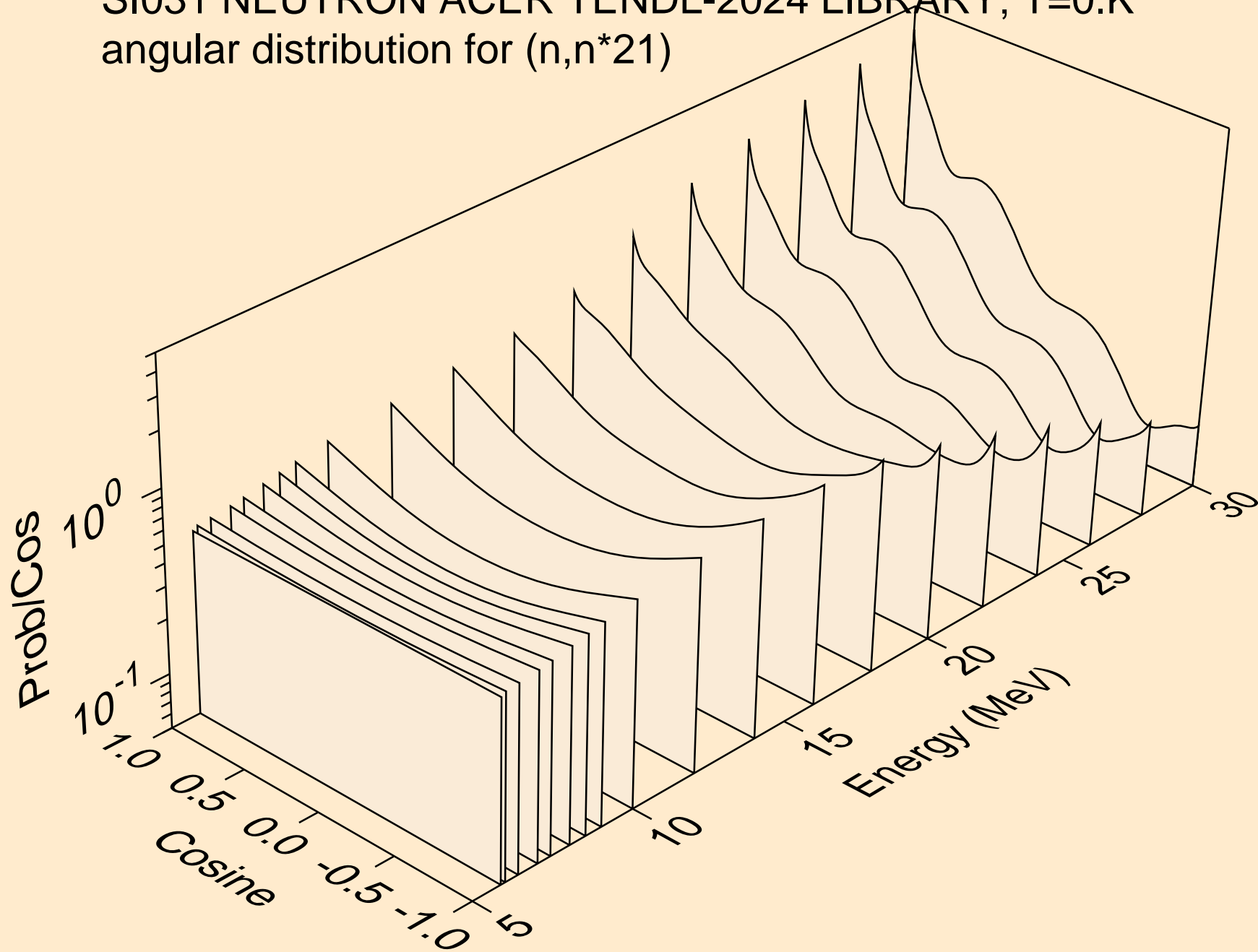

SI031 NEUTRON ACER TENDL-2024 LIBRARY; T=0.K
angular distribution for (n,n*22)

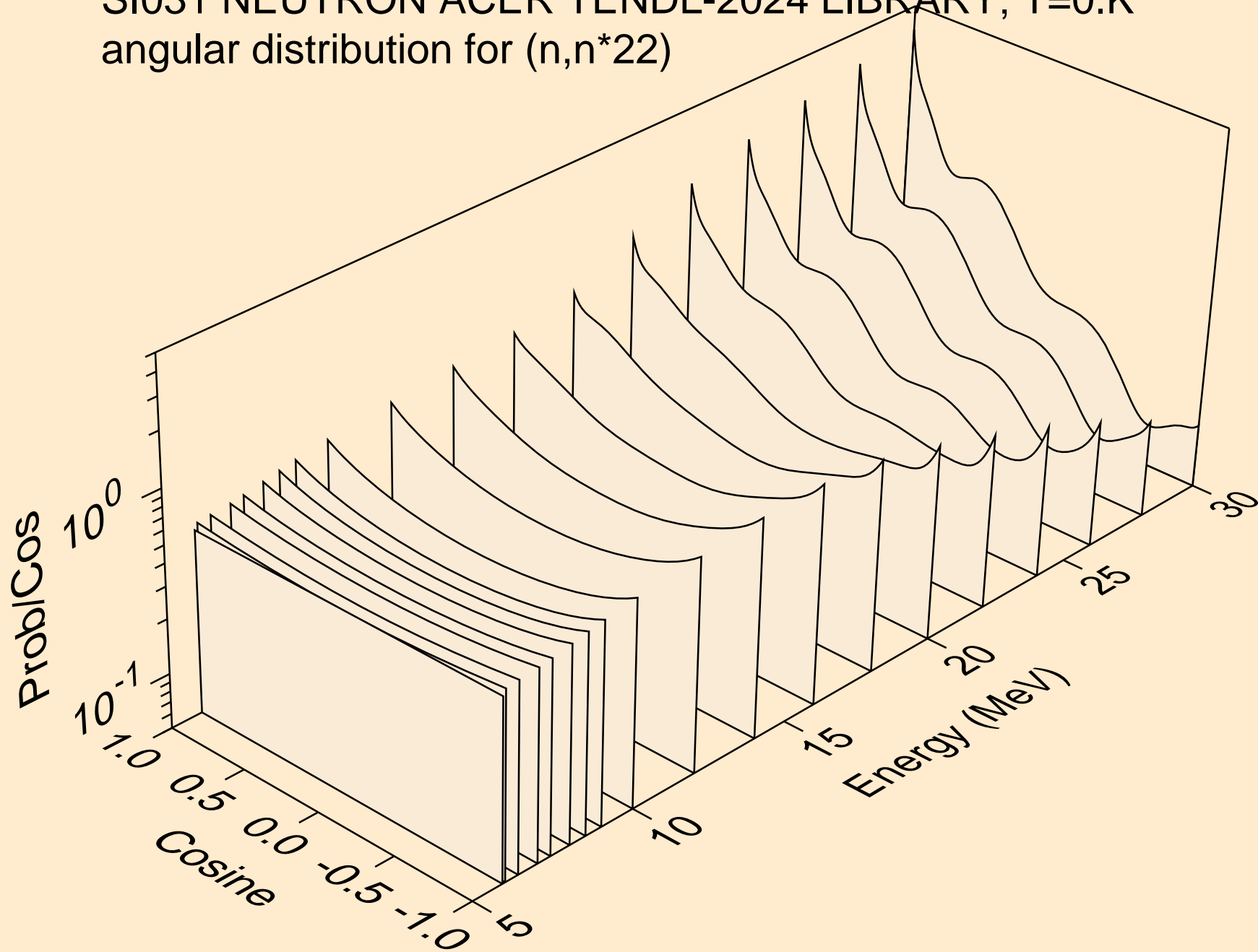

SI031 NEUTRON ACER TENDL-2024 LIBRARY; T=0.K
angular distribution for (n,n*23)

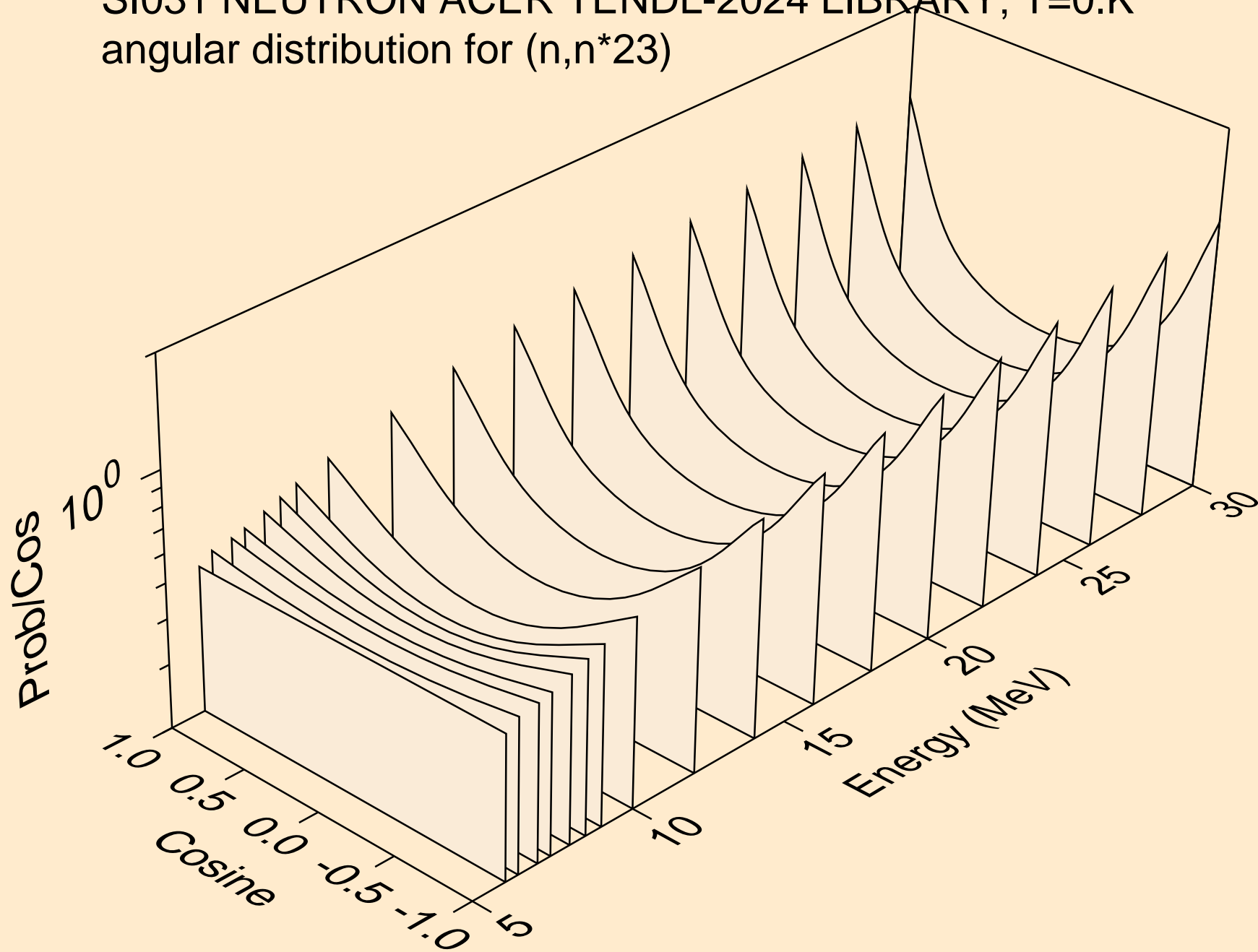

SI031 NEUTRON ACER TENDL-2024 LIBRARY; T=0.K
angular distribution for (n,n*24)

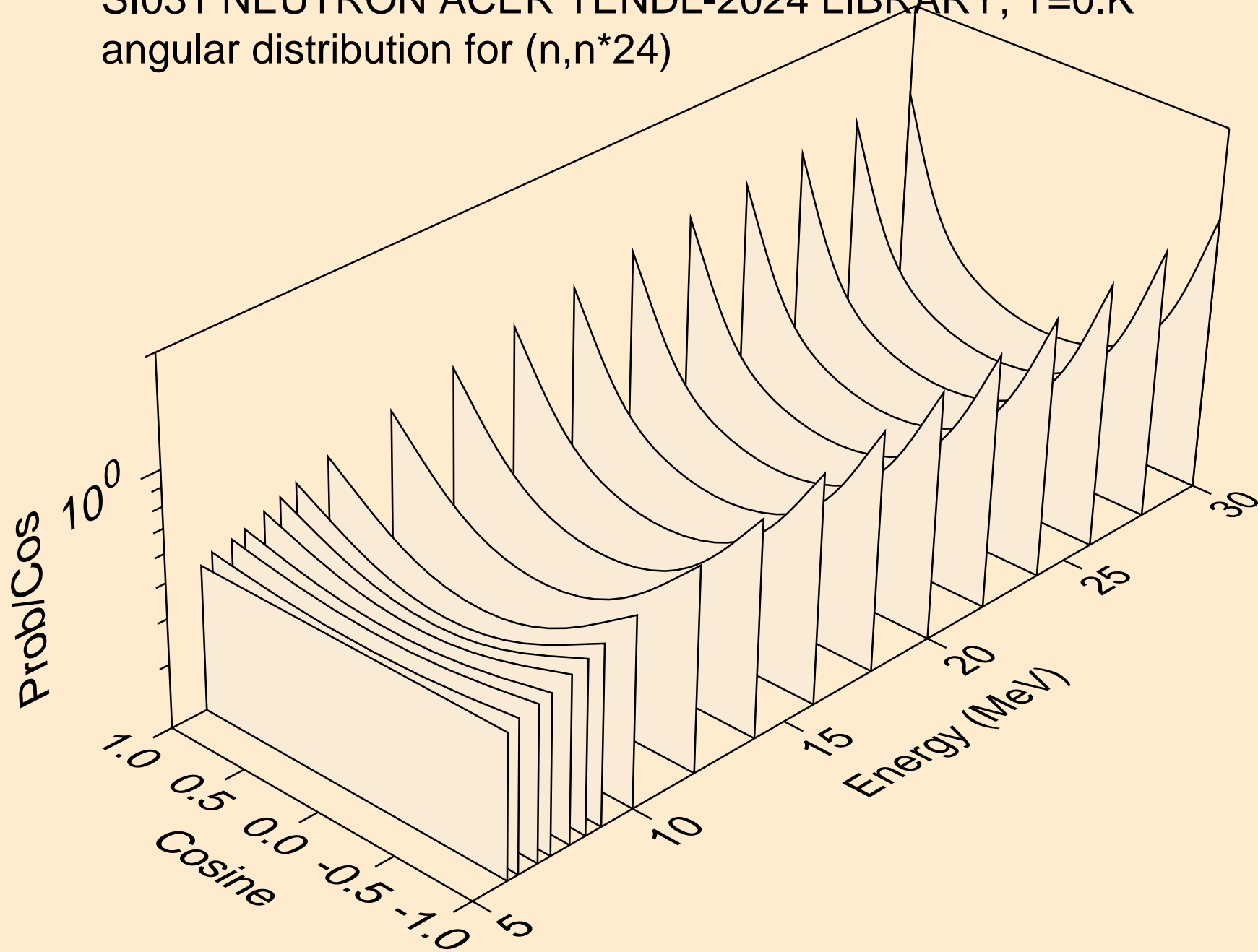

SI031 NEUTRON ACER TENDL-2024 LIBRARY; T=0.K
angular distribution for (n,n*25)

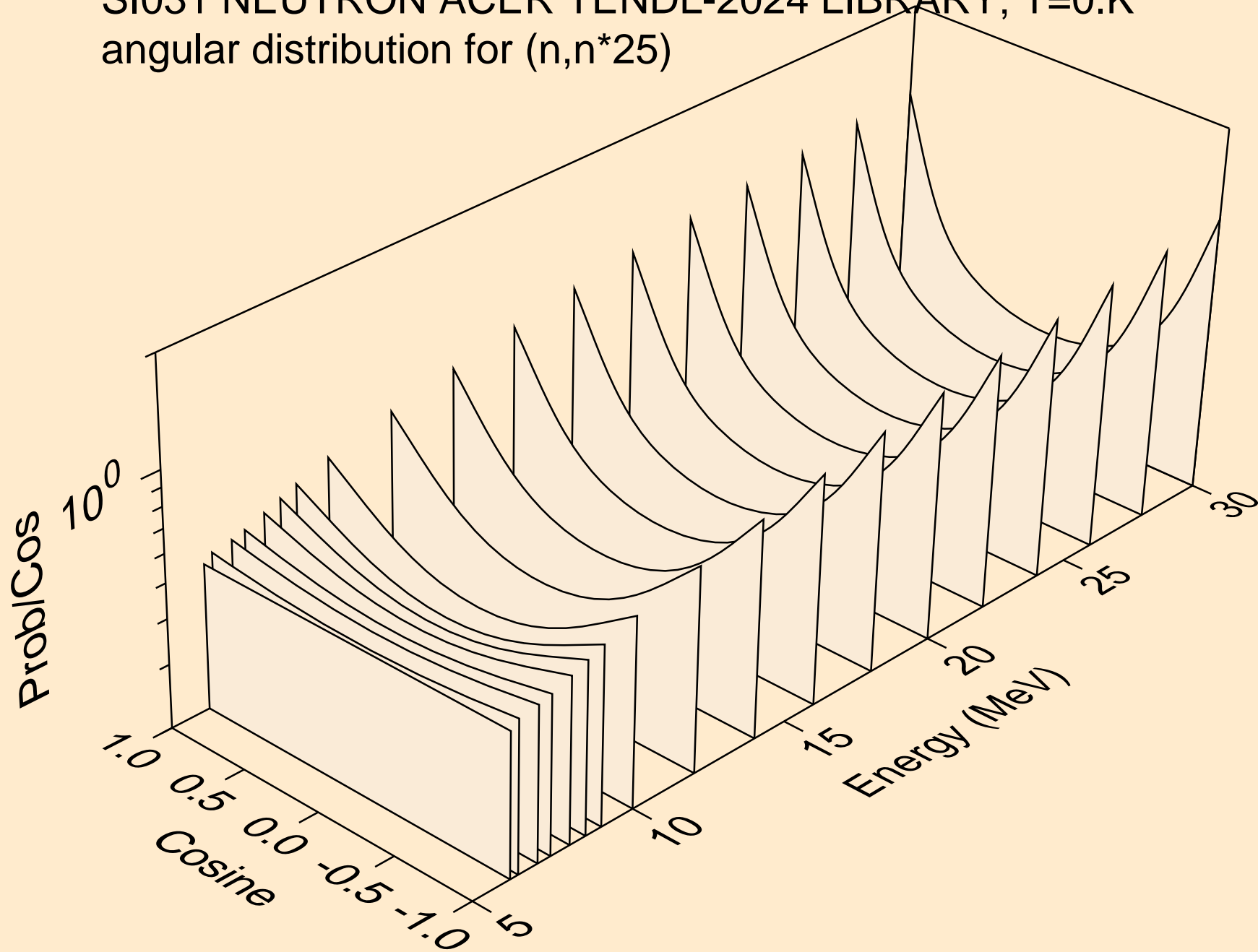

SI031 NEUTRON ACER TENDL-2024 LIBRARY; T=0.K
angular distribution for (n,n*26)

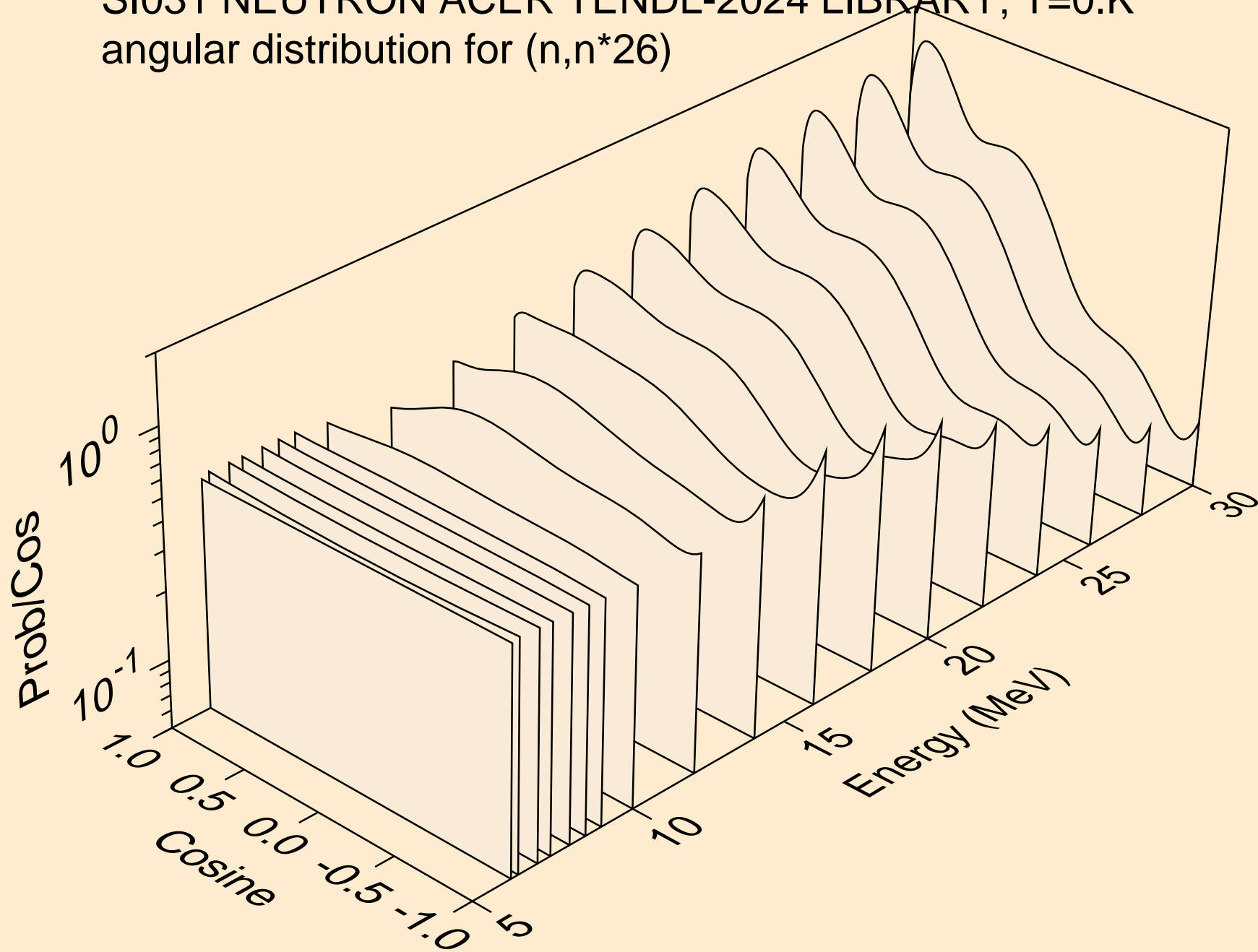

SI031 NEUTRON ACER TENDL-2024 LIBRARY; T=0.K
angular distribution for (n,n*27)

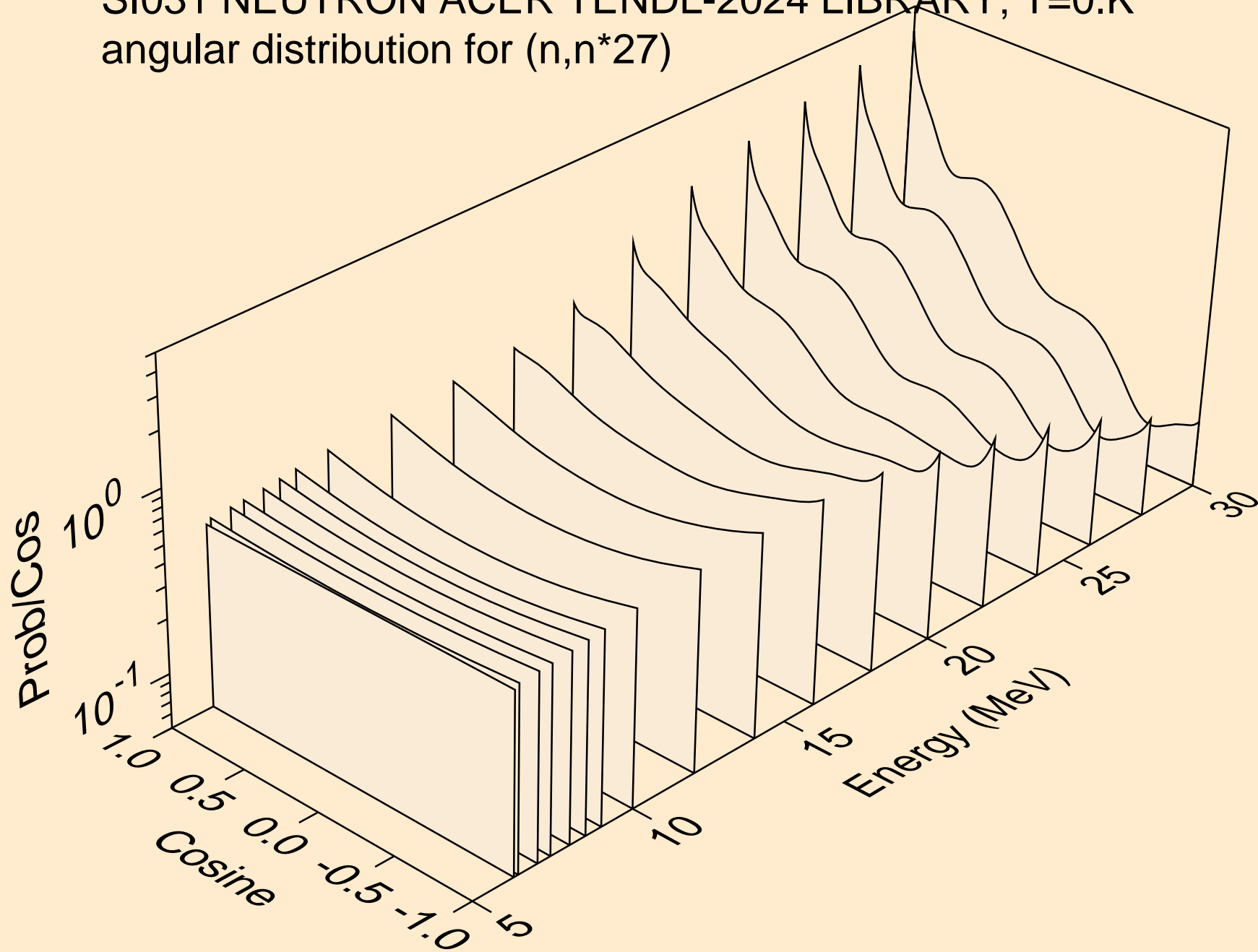

SI031 NEUTRON ACER TENDL-2024 LIBRARY; T=0.K
angular distribution for (n,n*28)

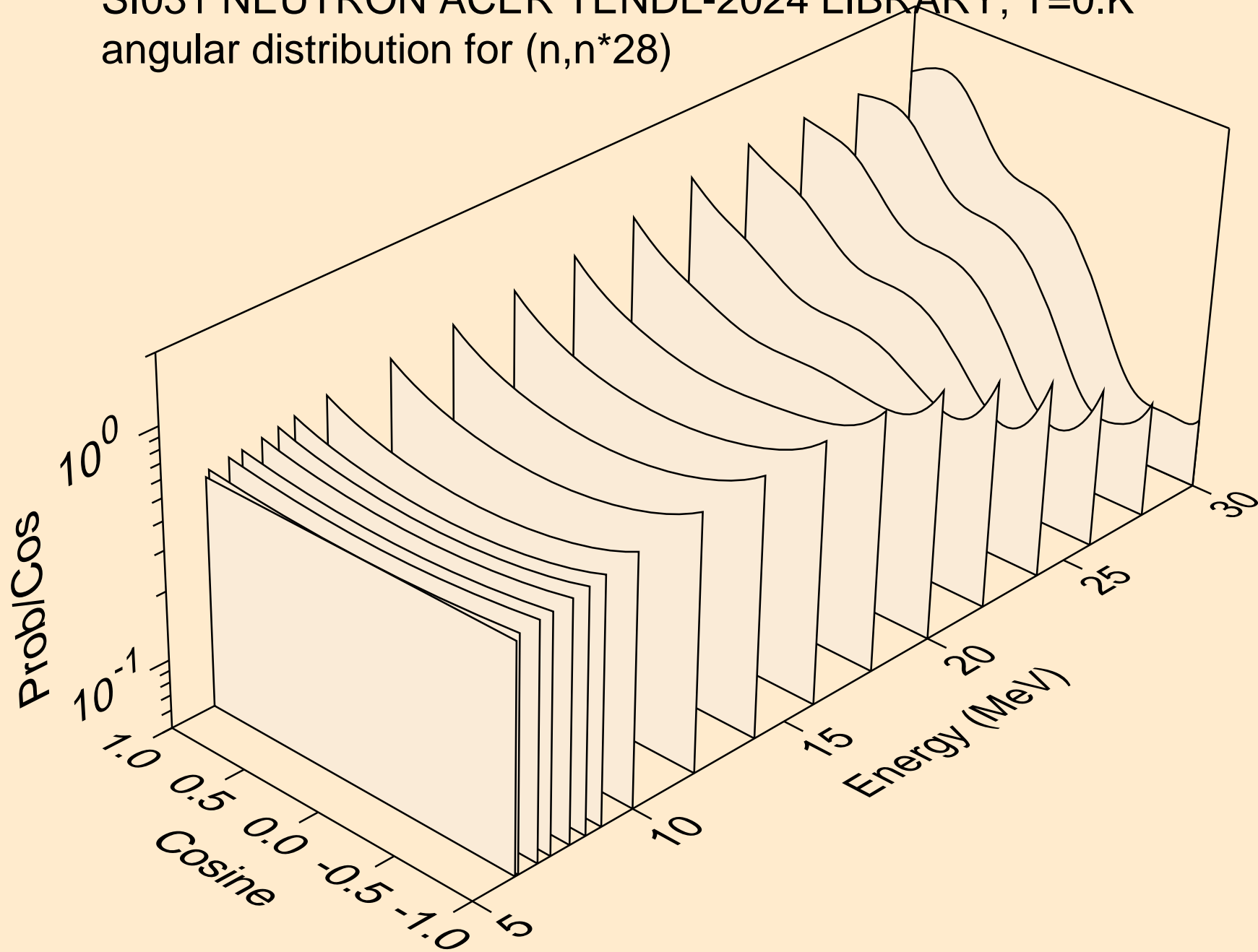

SI031 NEUTRON ACER TENDL-2024 LIBRARY; T=0.K
angular distribution for (n,n*29)

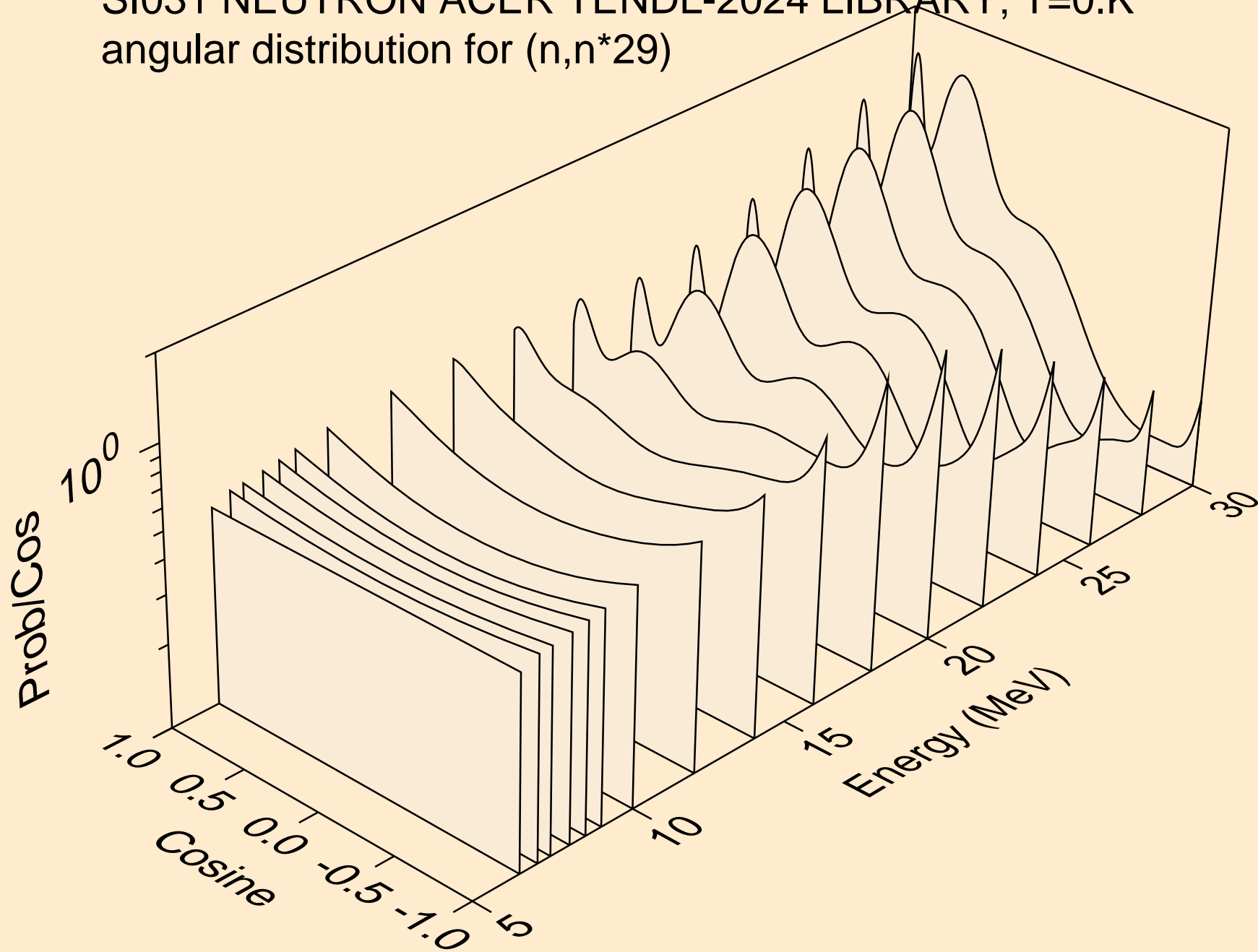

SI031 NEUTRON ACER TENDL-2024 LIBRARY; T=0.K
angular distribution for (n,n*30)

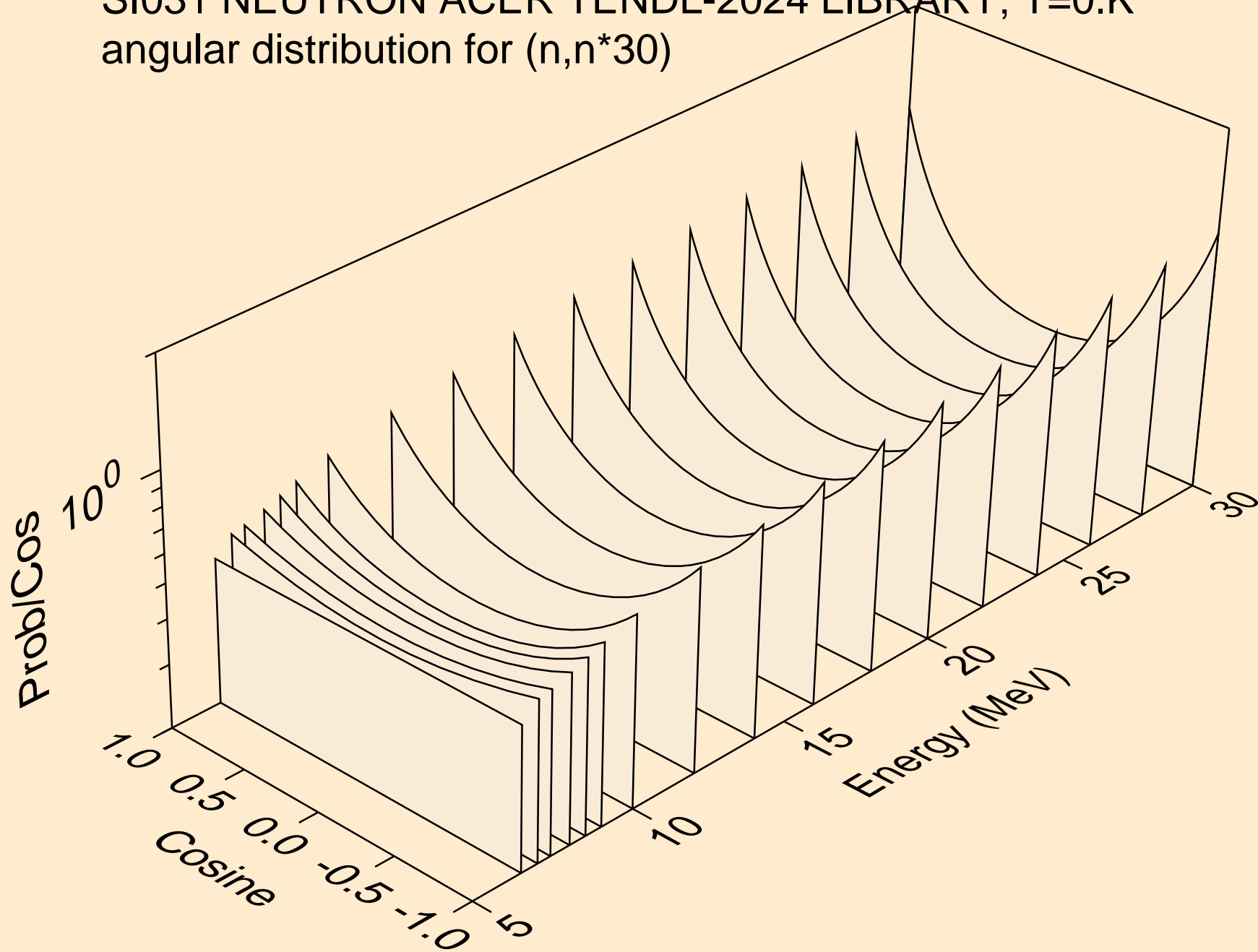

SI031 NEUTRON ACER TENDL-2024 LIBRARY; T=0.K
Neutron emission for (n,x)

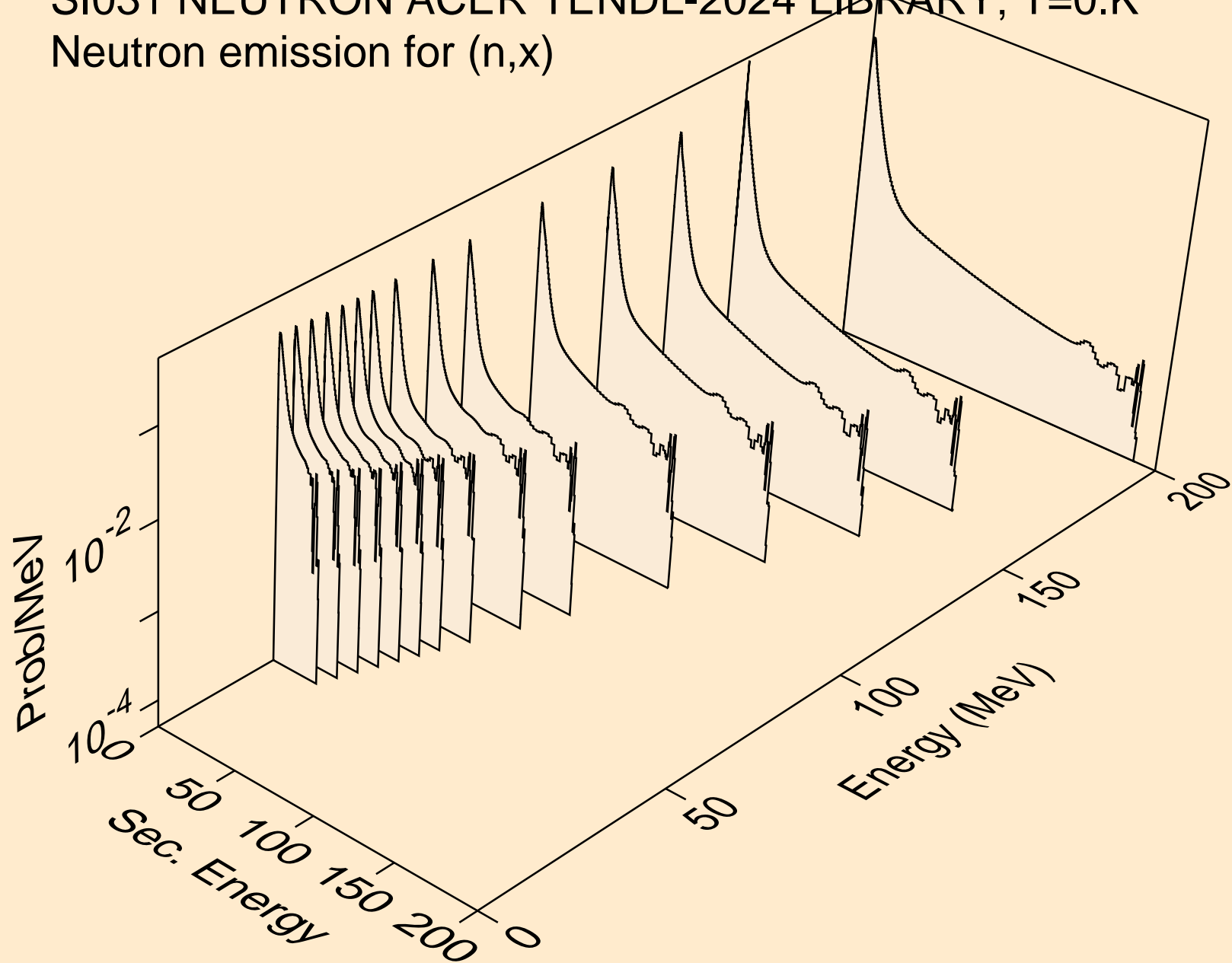

SI031 NEUTRON ACER TENDL-2024 LIBRARY; T=0.K
Neutron emission for (n,2nd)

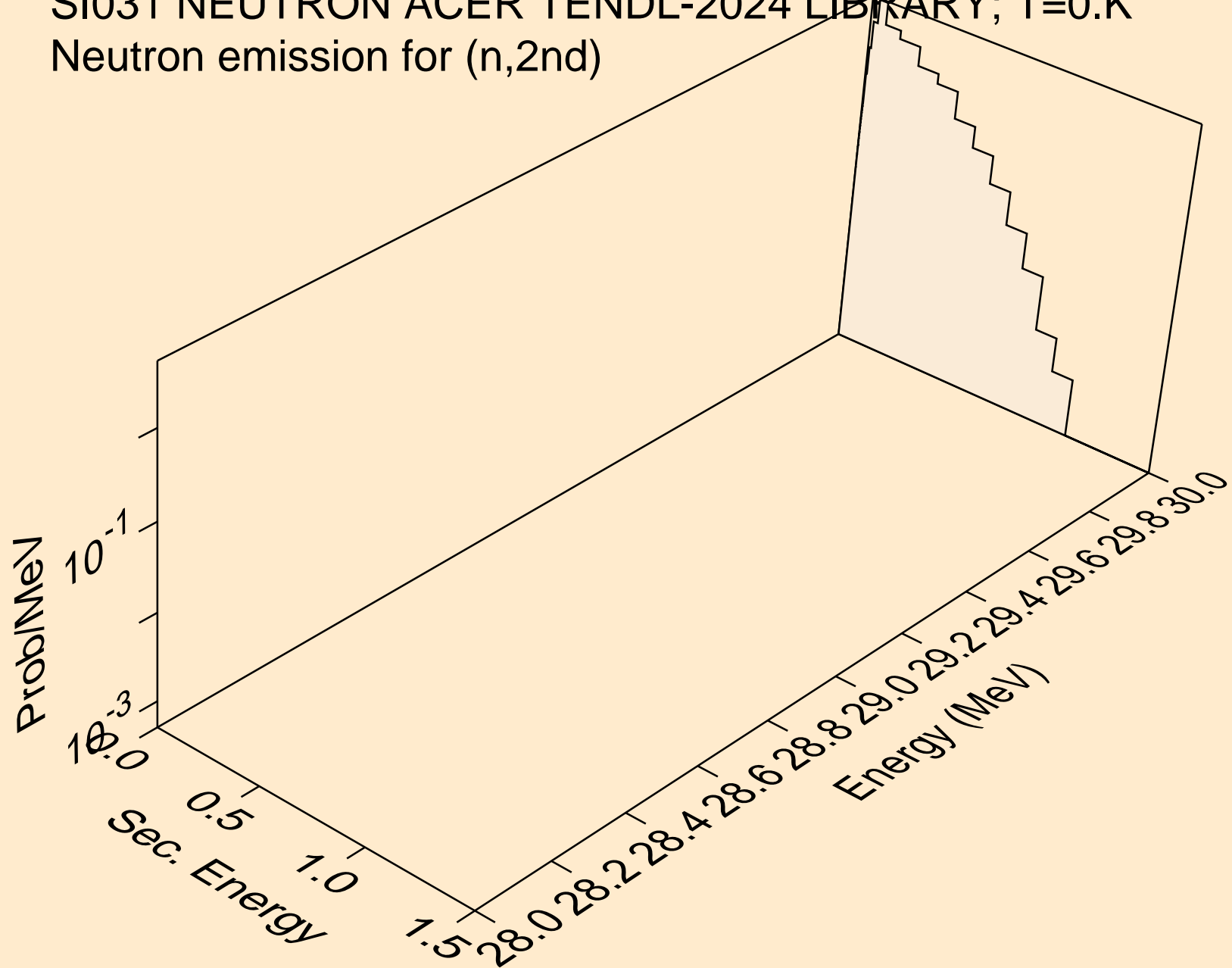

SI031 NEUTRON ACER TENDL-2024 LIBRARY; T=0.K
Neutron emission for (n,2n)

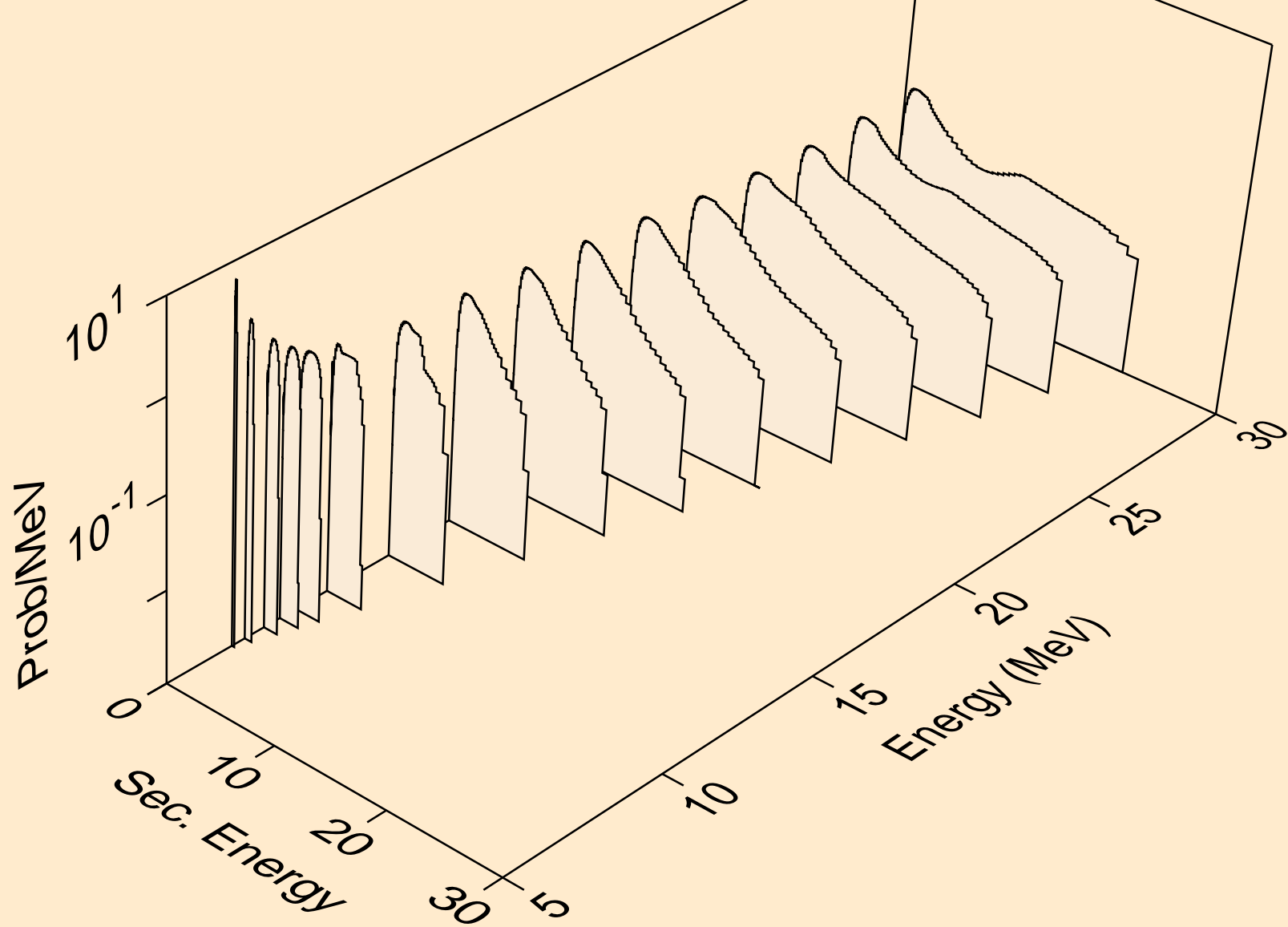

SI031 NEUTRON ACER TENDL-2024 LIBRARY; T=0.K
Neutron emission for (n,3n)

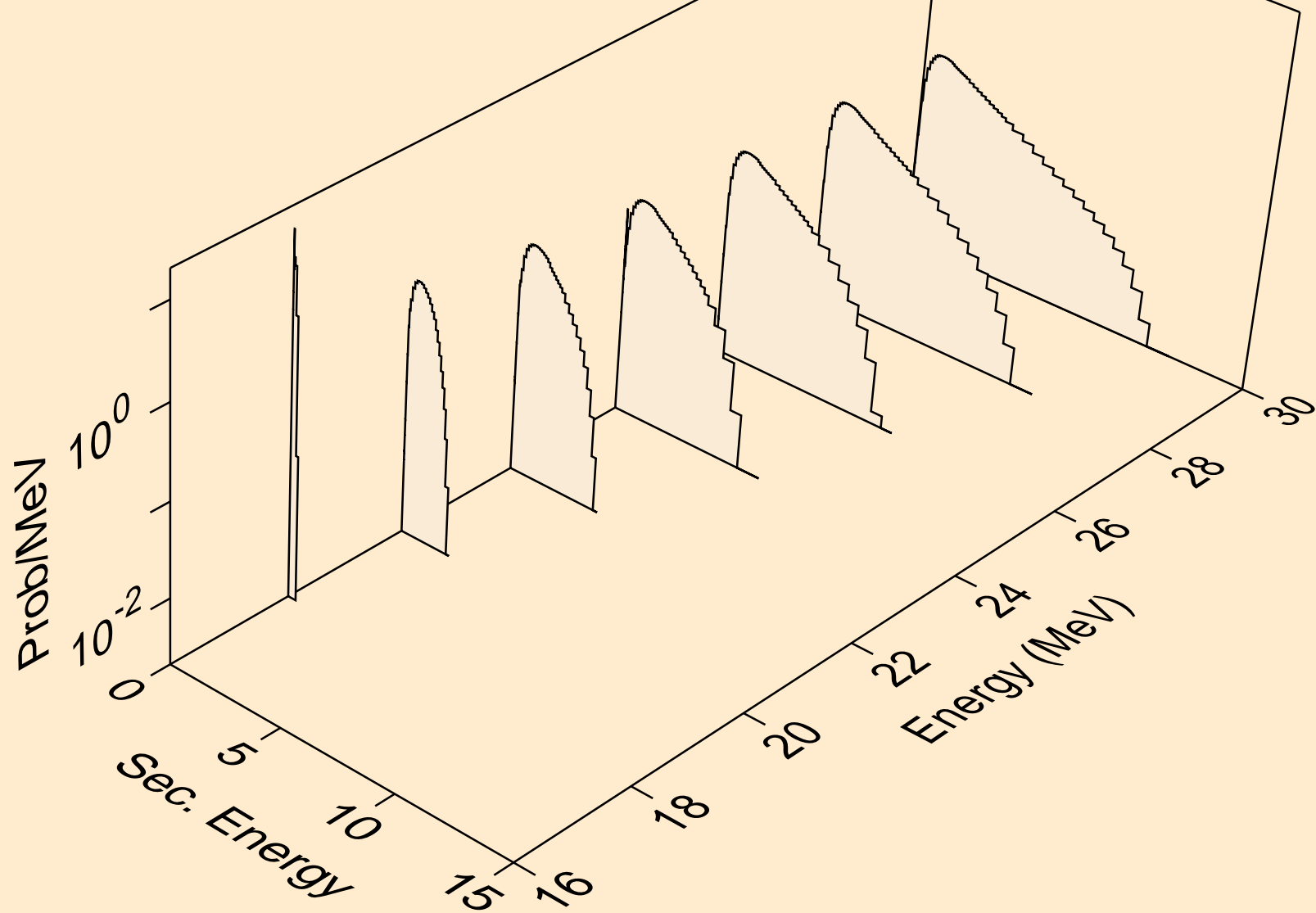

SI031 NEUTRON ACER TENDL-2024 LIBRARY; T=0.K
Neutron emission for (n,n*)a

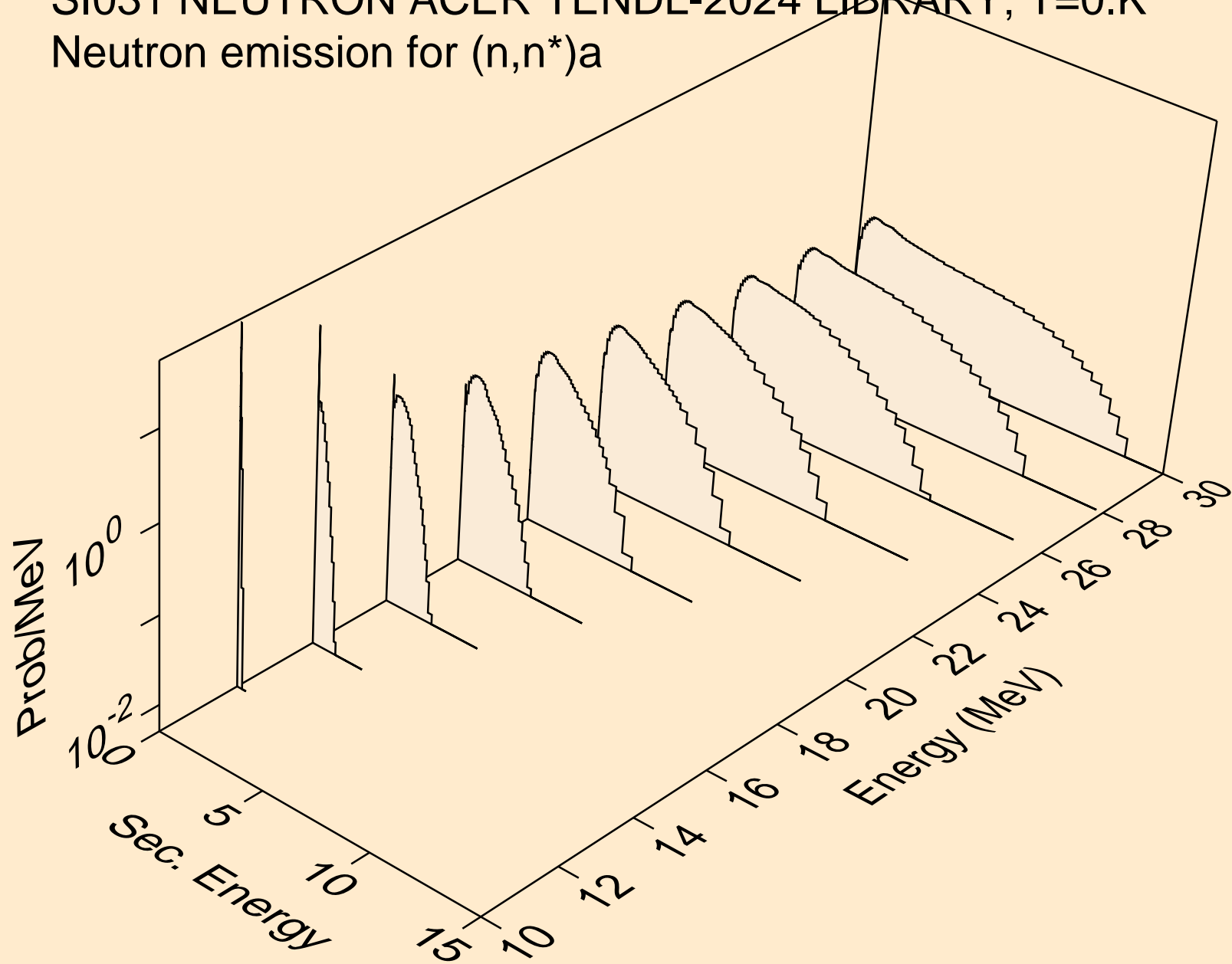

SI031 NEUTRON ACER TENDL-2024 LIBRARY; T=0.K
Neutron emission for (n,2n)a

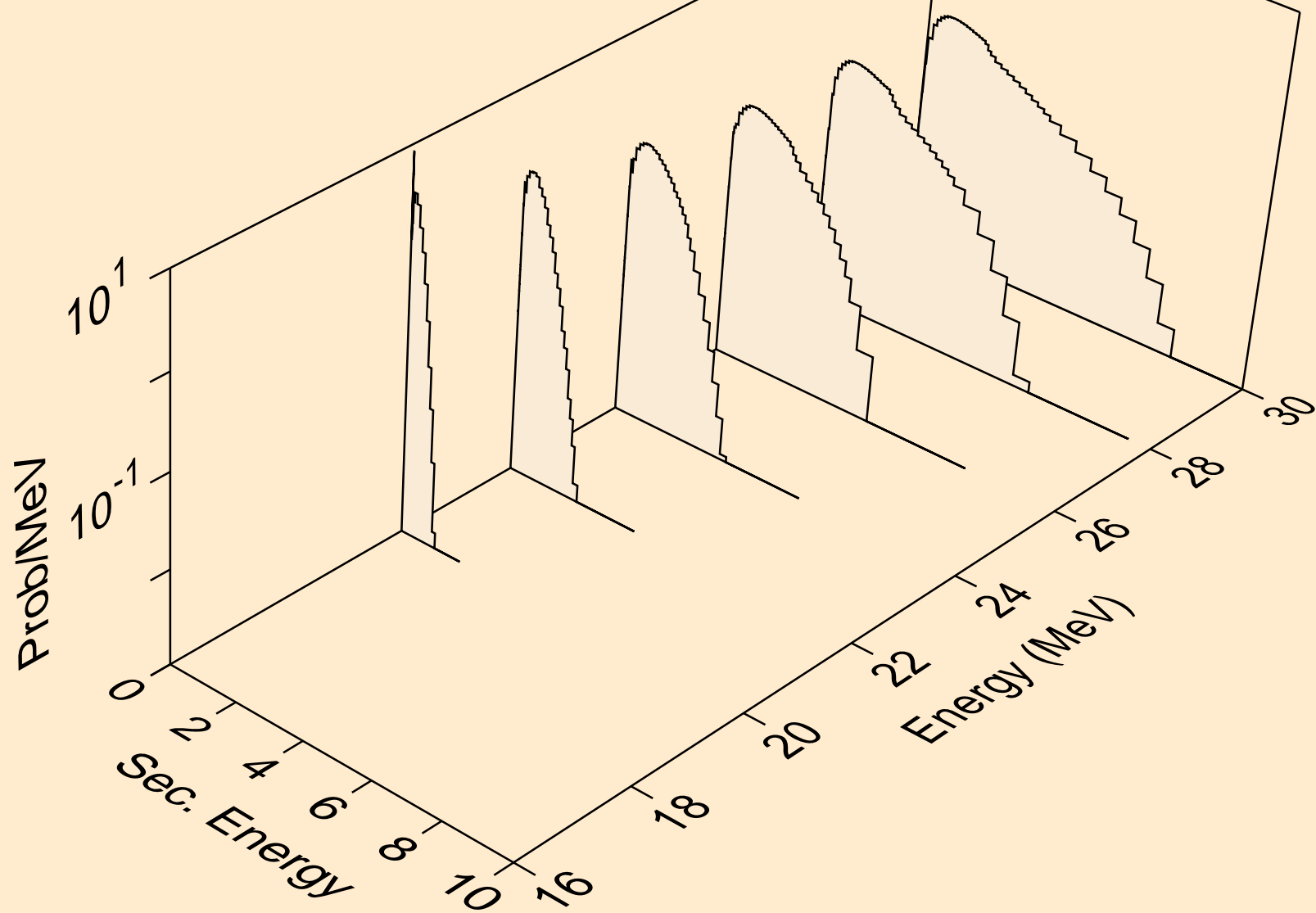

SI031 NEUTRON ACER TENDL-2024 LIBRARY; T=0.K
Neutron emission for (n,n*)p

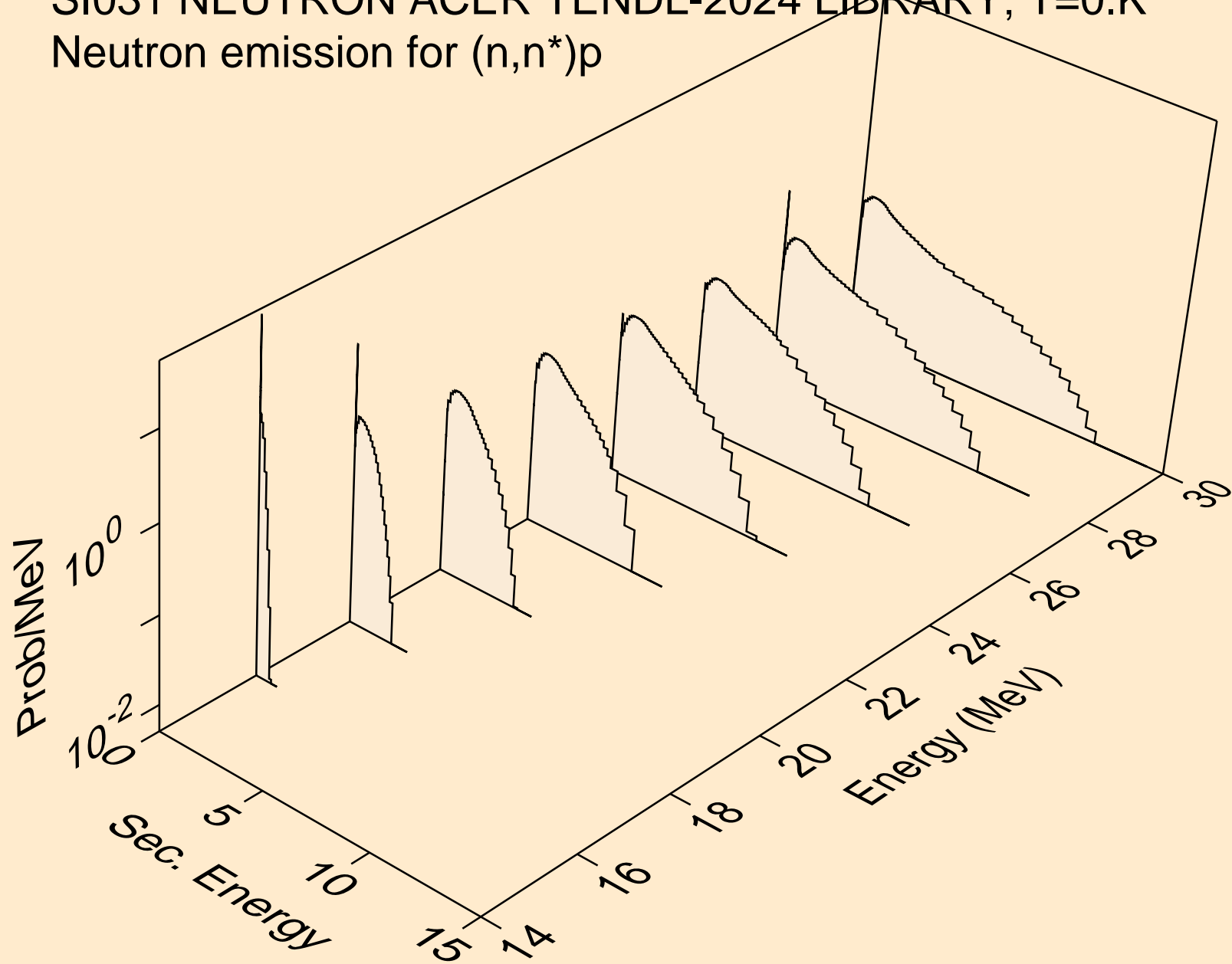

SI031 NEUTRON ACER TENDL-2024 LIBRARY; T=0.K
Neutron emission for (n,n*)2a

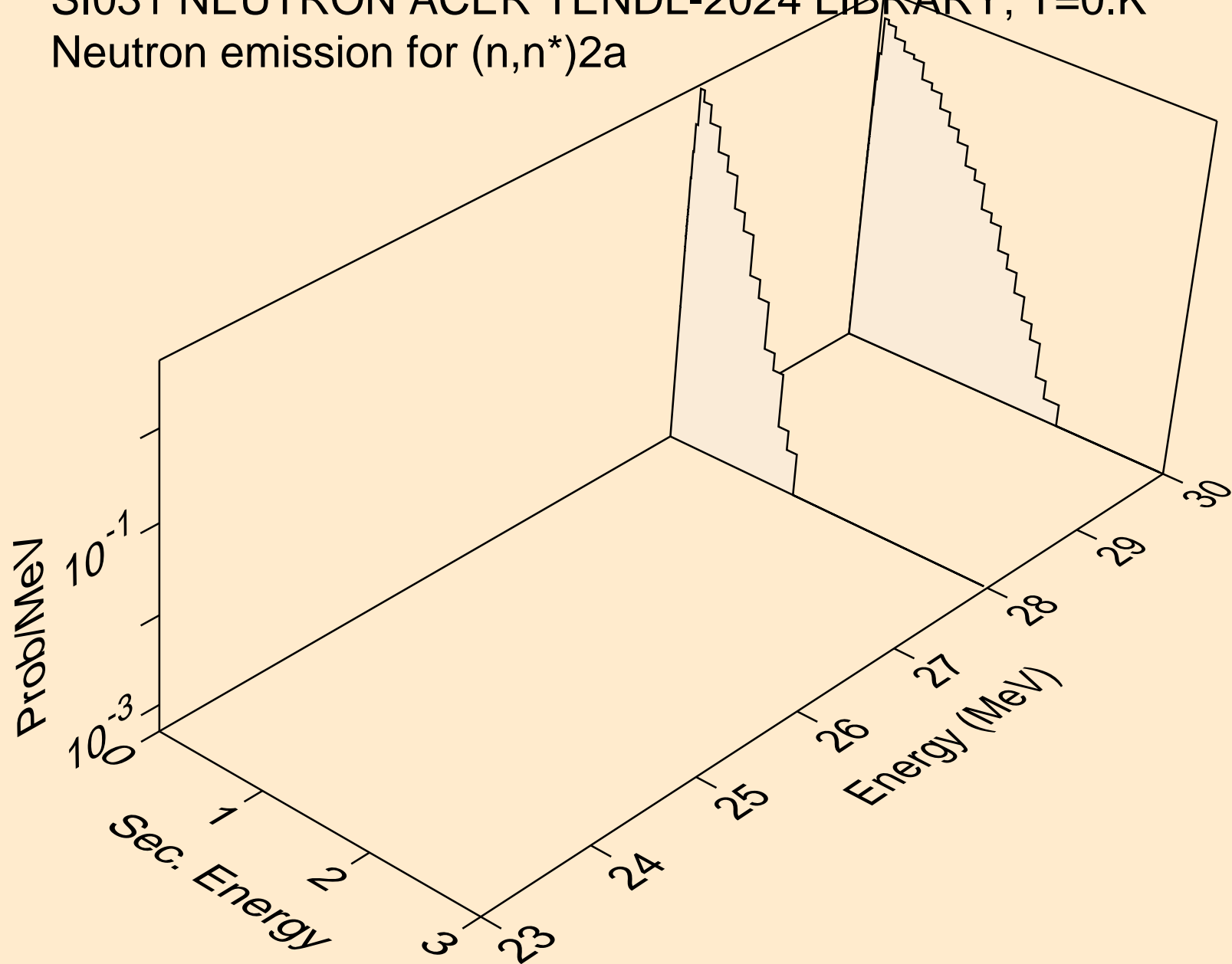

SI031 NEUTRON ACER TENDL-2024 LIBRARY; T=0.K
Neutron emission for (n,n*)d

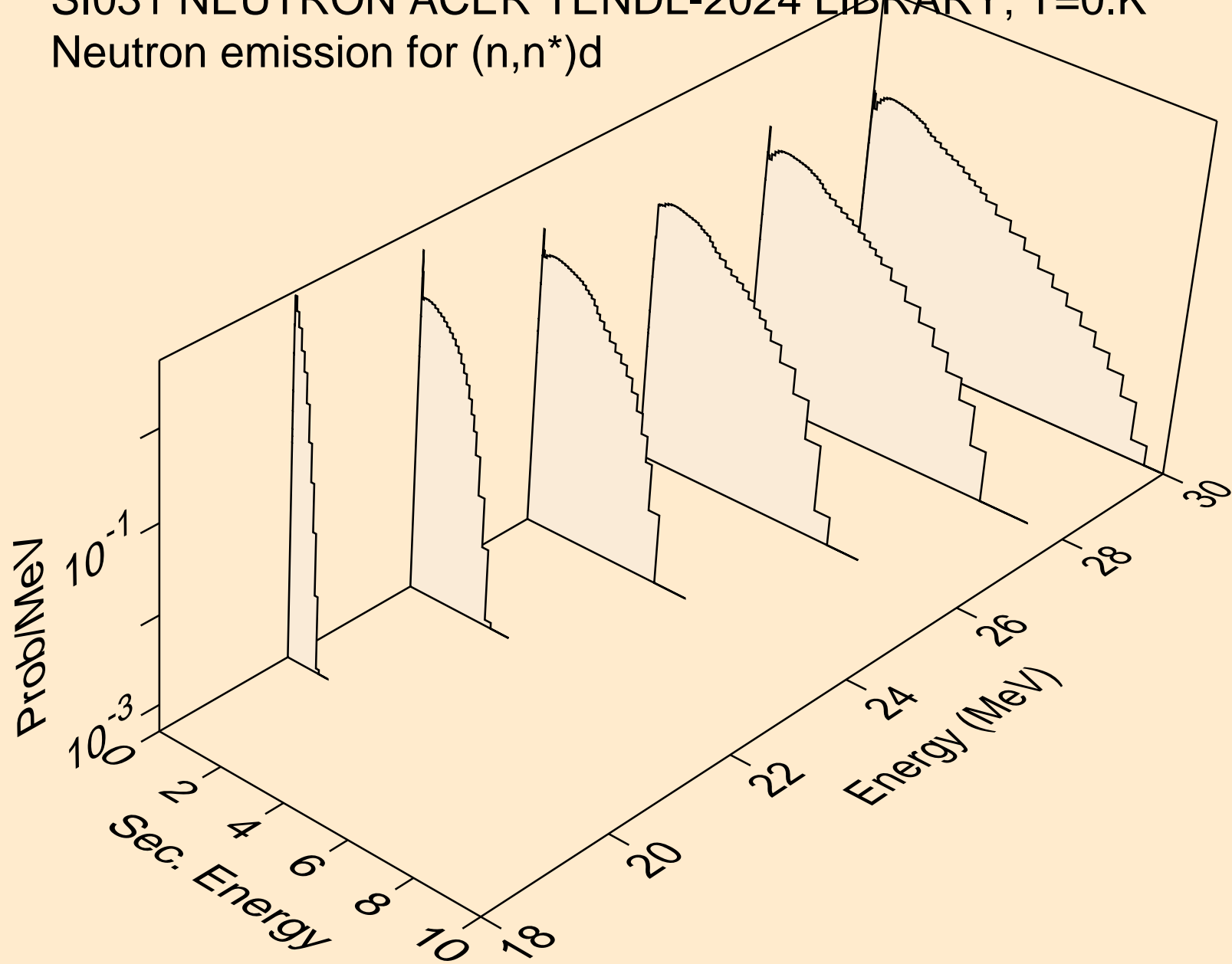

SI031 NEUTRON ACER TENDL-2024 LIBRARY; T=0.K
Neutron emission for (n,n*)t

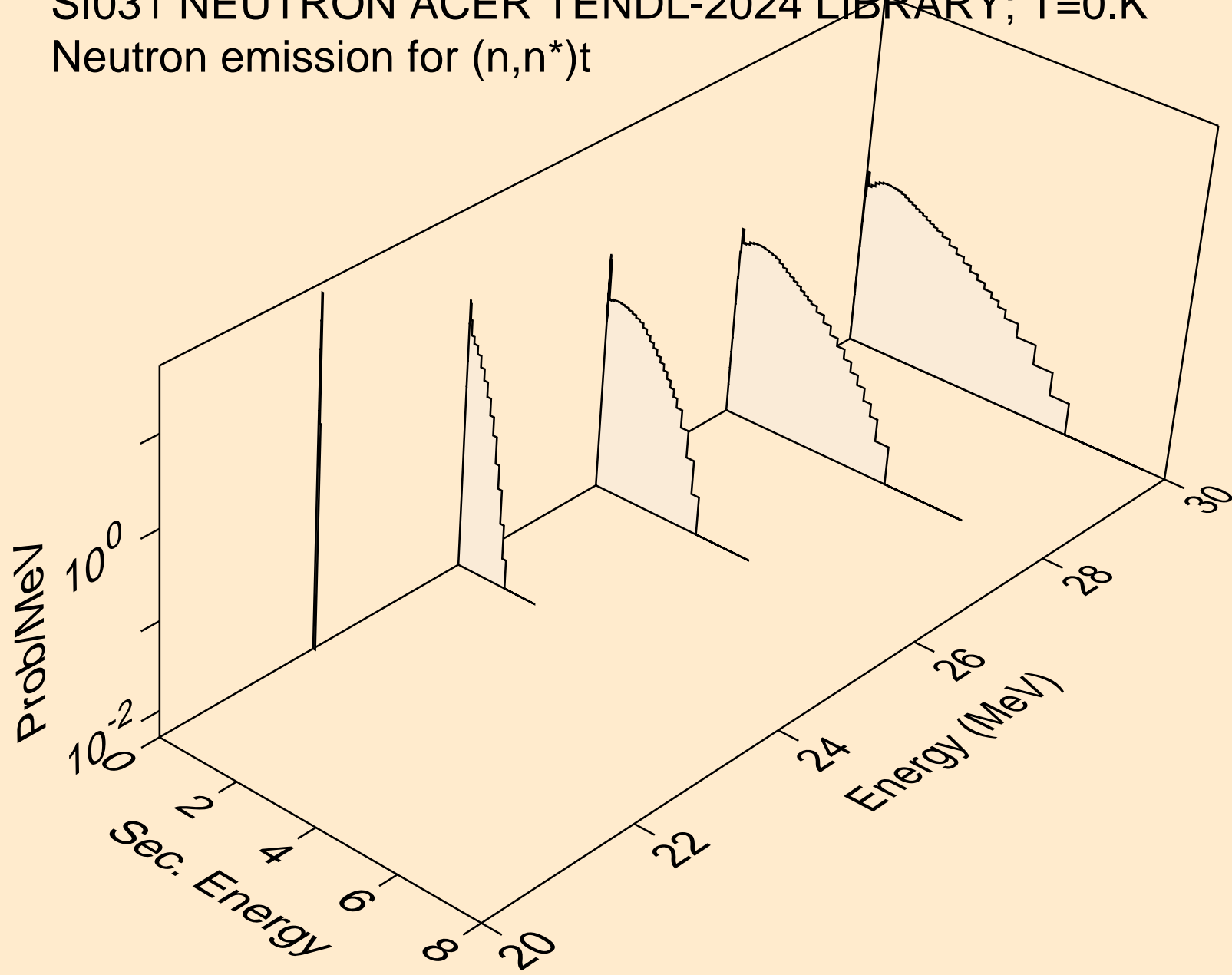

SI031 NEUTRON ACER TENDL-2024 LIBRARY; T=0.K
Neutron emission for (n,n*)he3

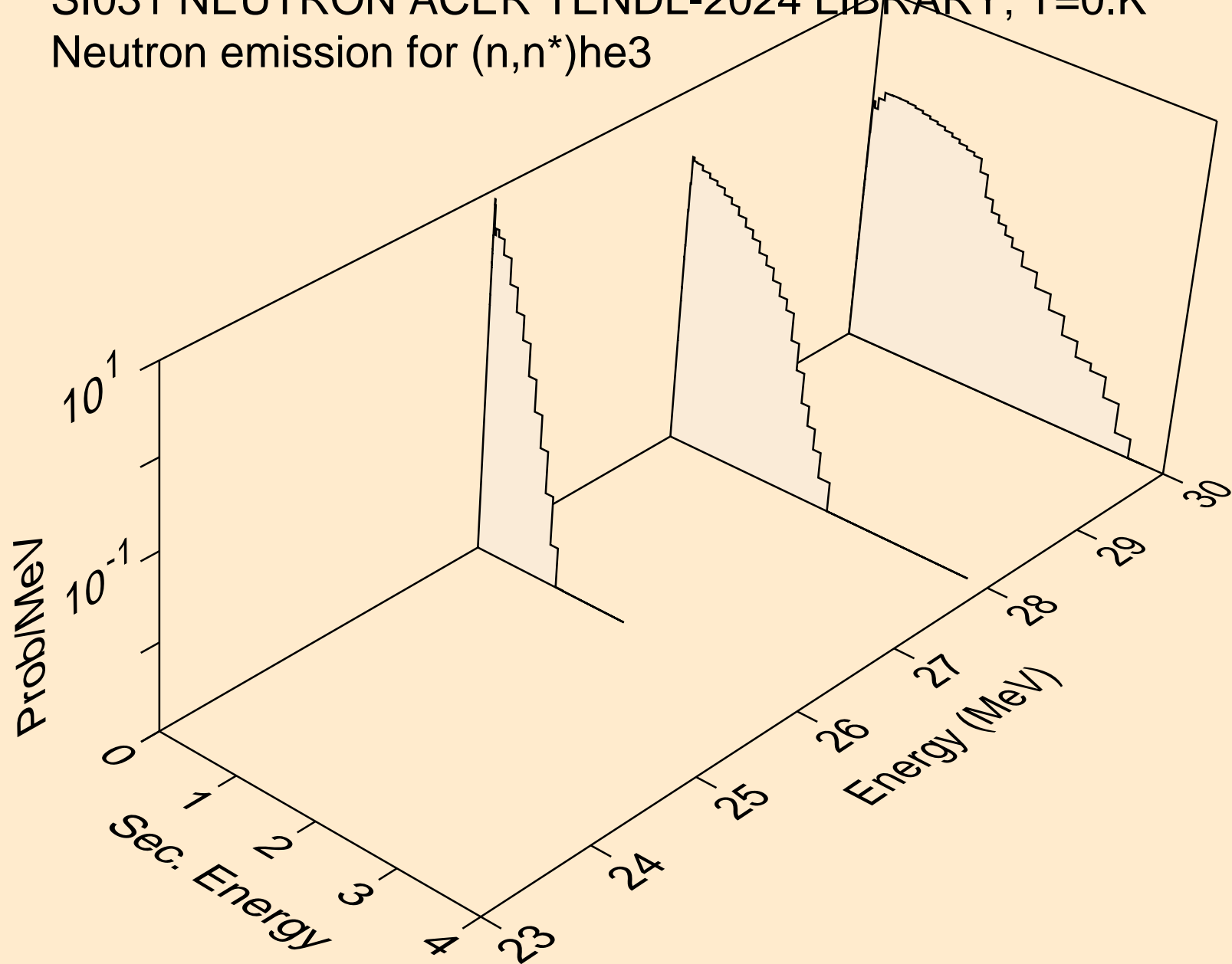

SI031 NEUTRON ACER TENDL-2024 LIBRARY; T=0.K
Neutron emission for (n,4n)

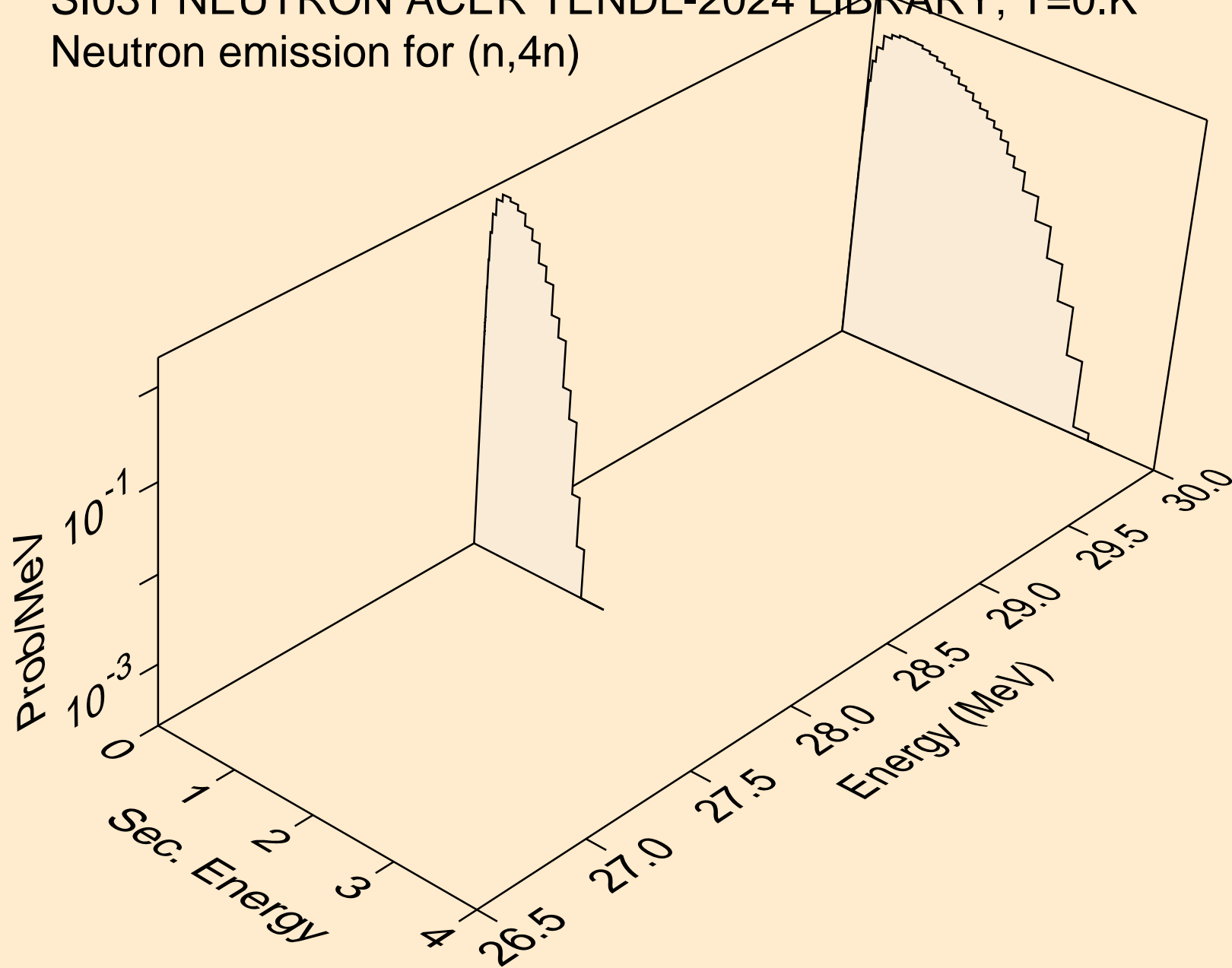

SI031 NEUTRON ACER TENDL-2024 LIBRARY; T=0.K
Neutron emission for (n,2np)

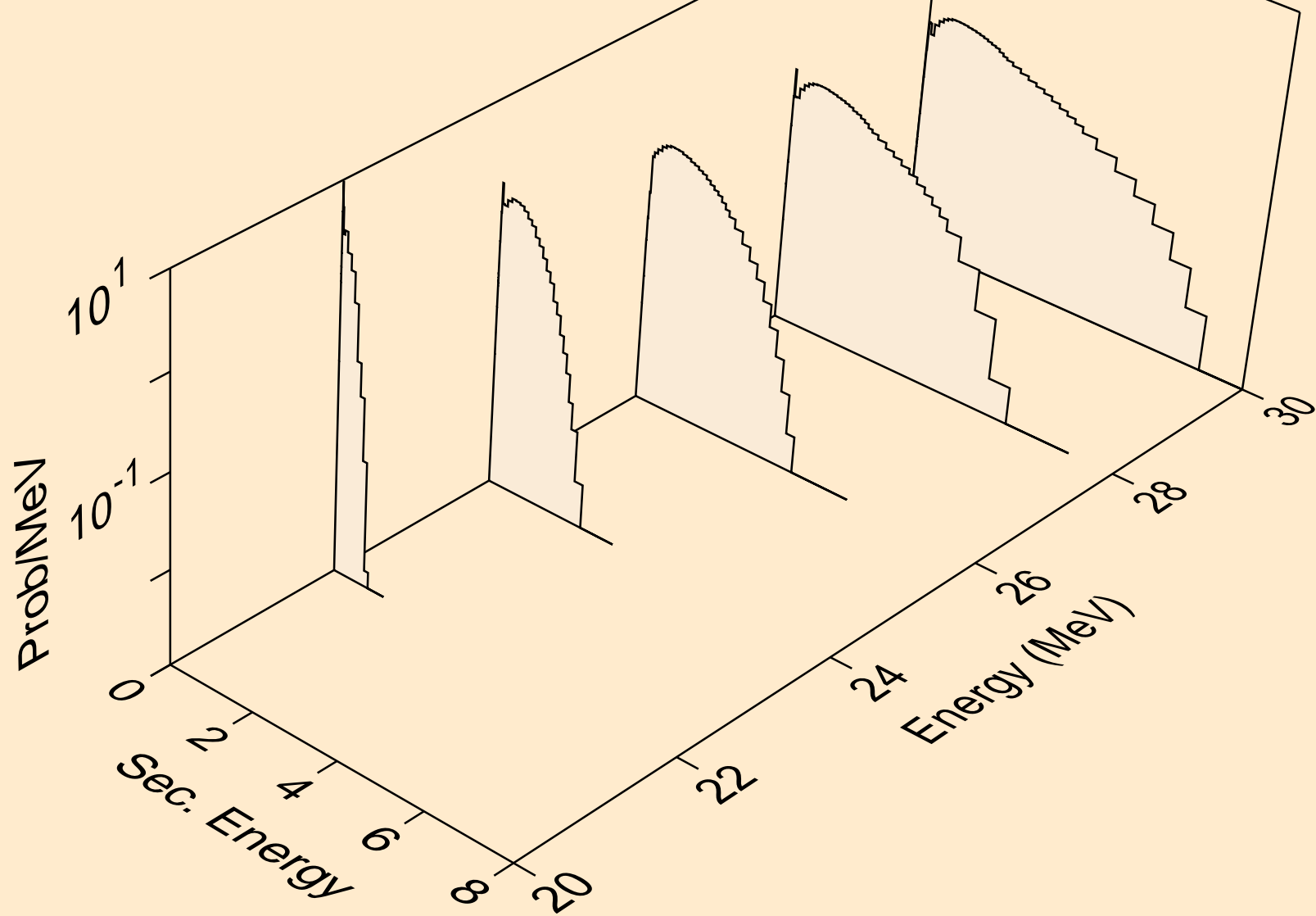

SI031 NEUTRON ACER TENDL-2024 LIBRARY; T=0.K
Neutron emission for (n,n*c)

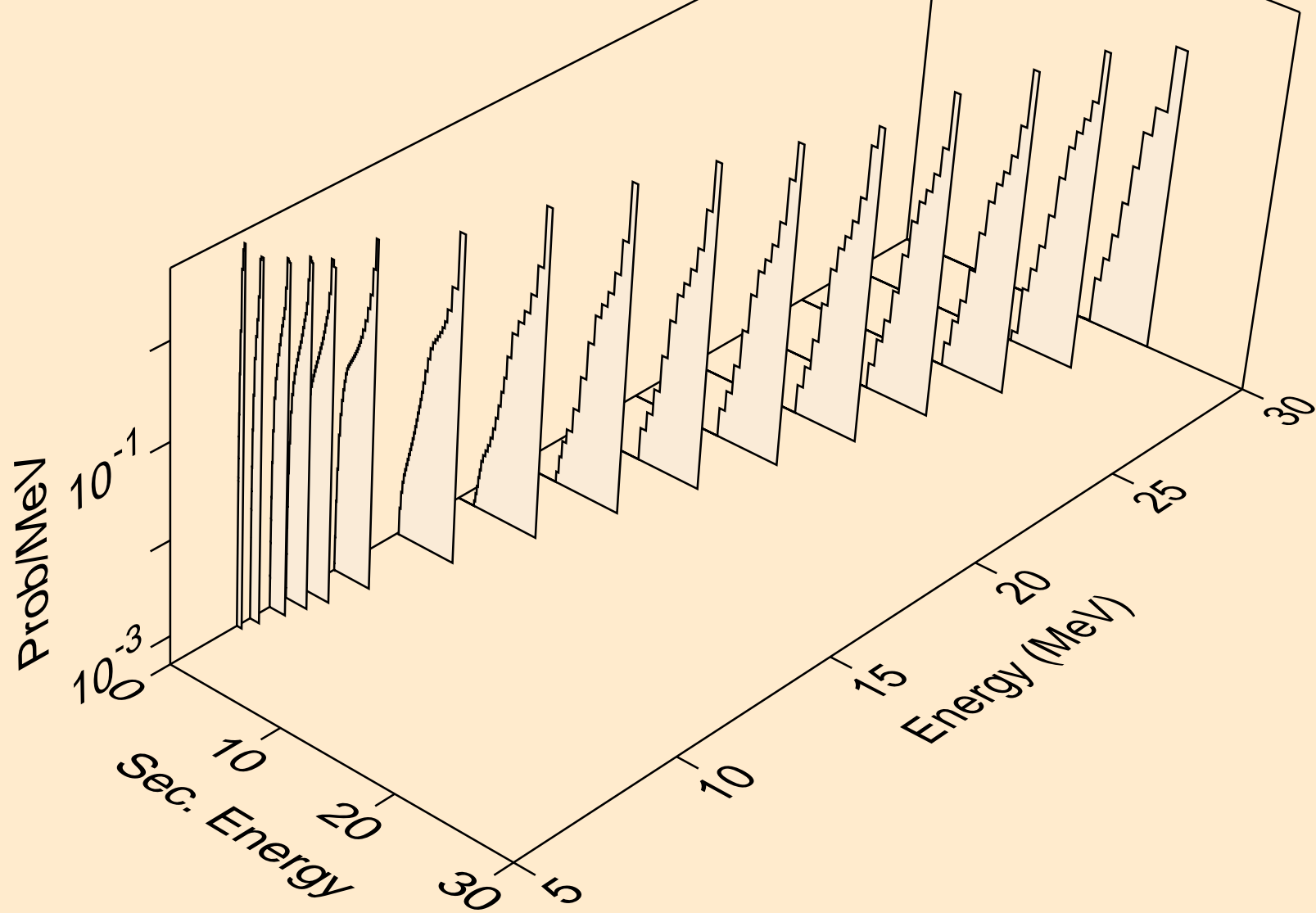

SI031 NEUTRON ACER TENDL-2024 LIBRARY; T=0.K
Photon emission for (n,x)

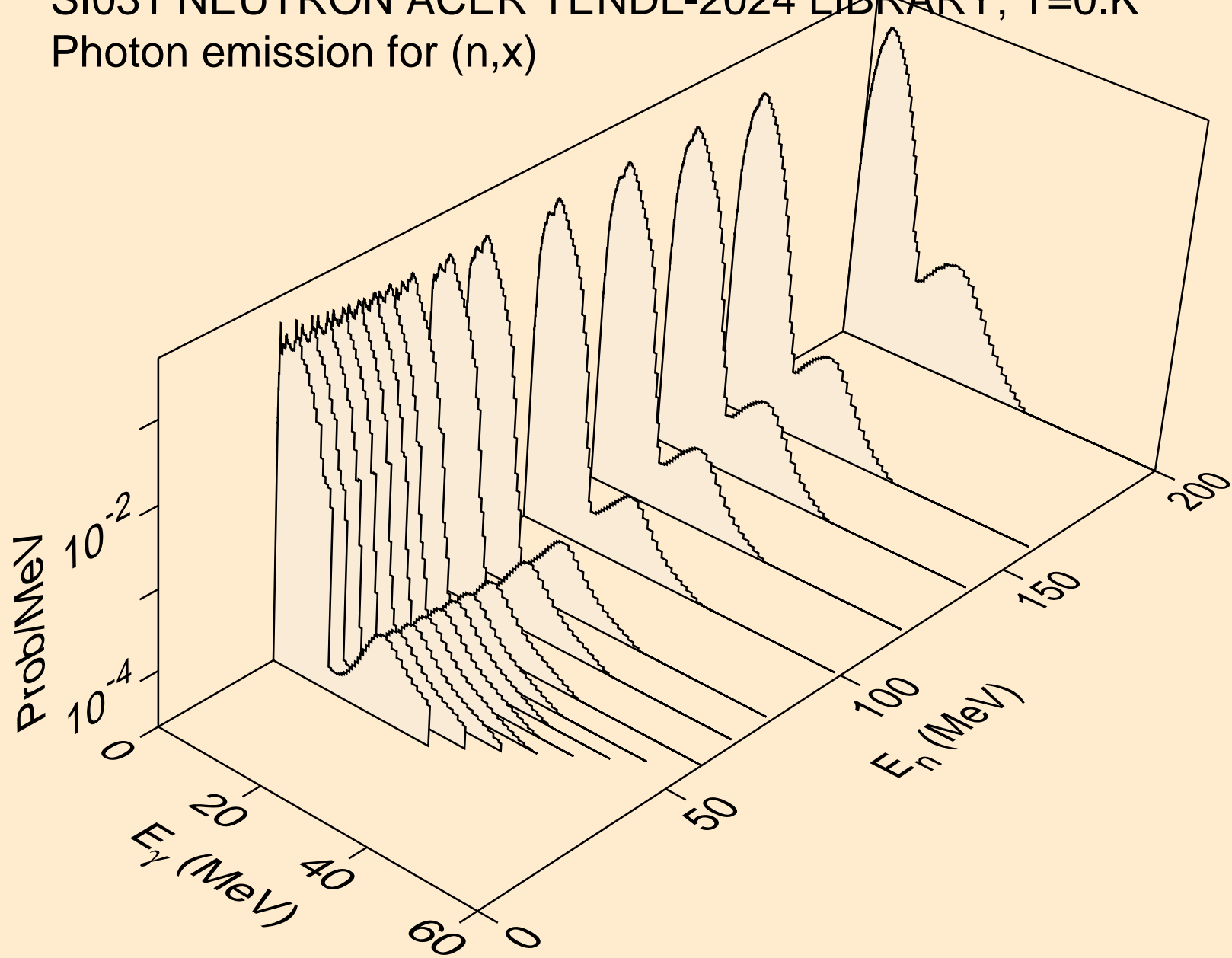

SI031 NEUTRON ACER TENDL-2024 LIBRARY; T=0.K
Photon emission for (n,2nd)

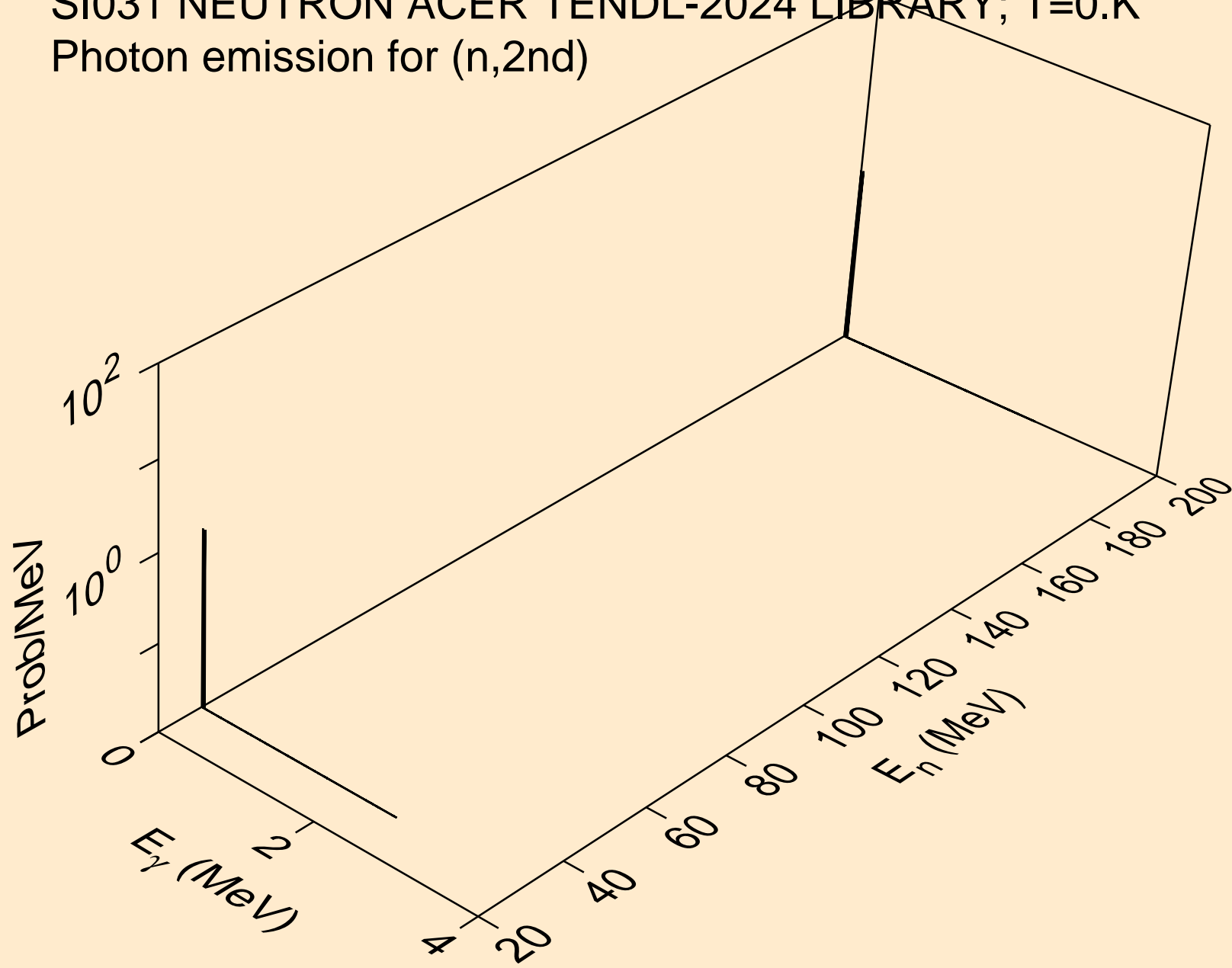

SI031 NEUTRON ACER TENDL-2024 LIBRARY; T=0.K
Photon emission for (n,2n)

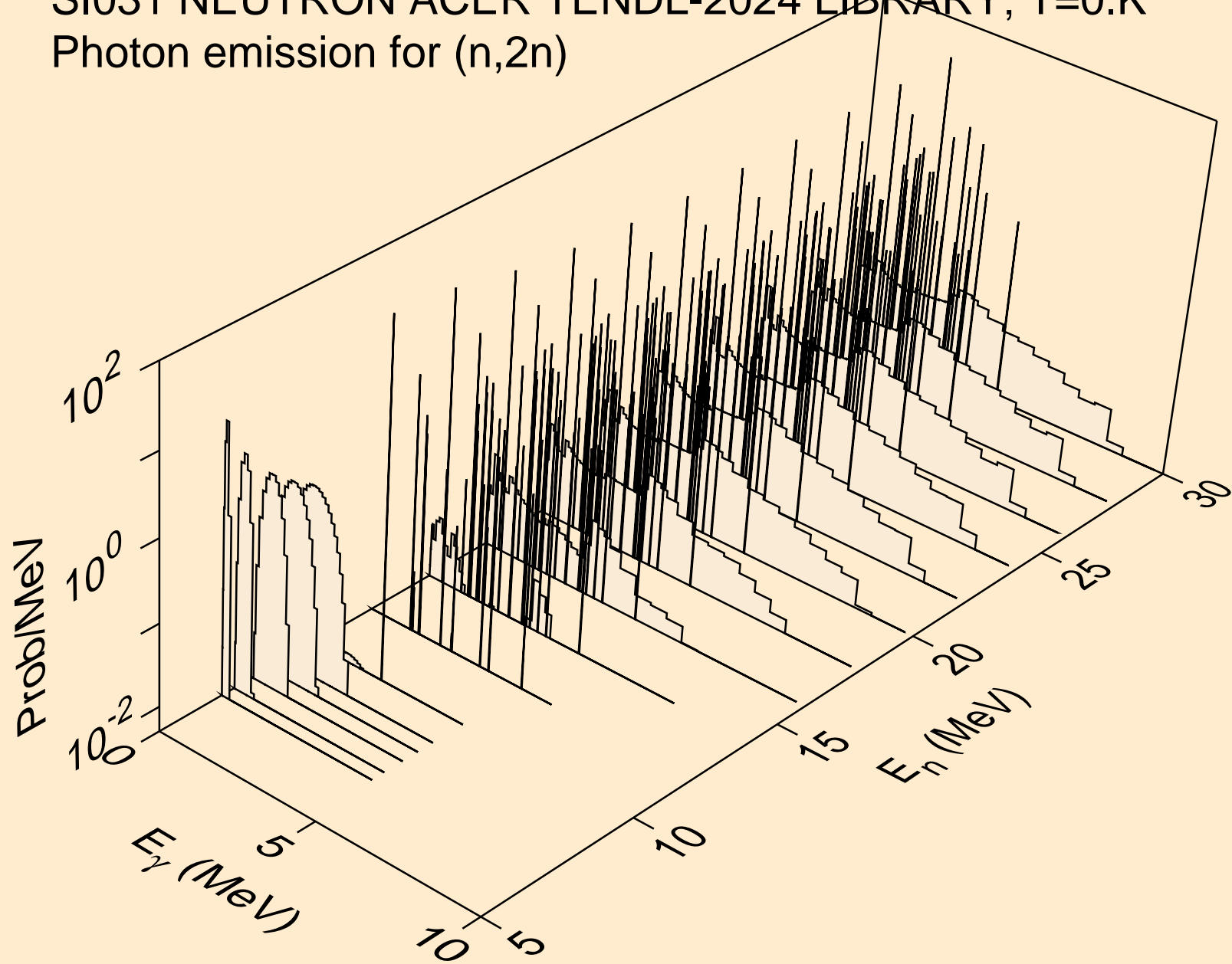

SI031 NEUTRON ACER TENDL-2024 LIBRARY; T=0.K
Photon emission for (n,3n)

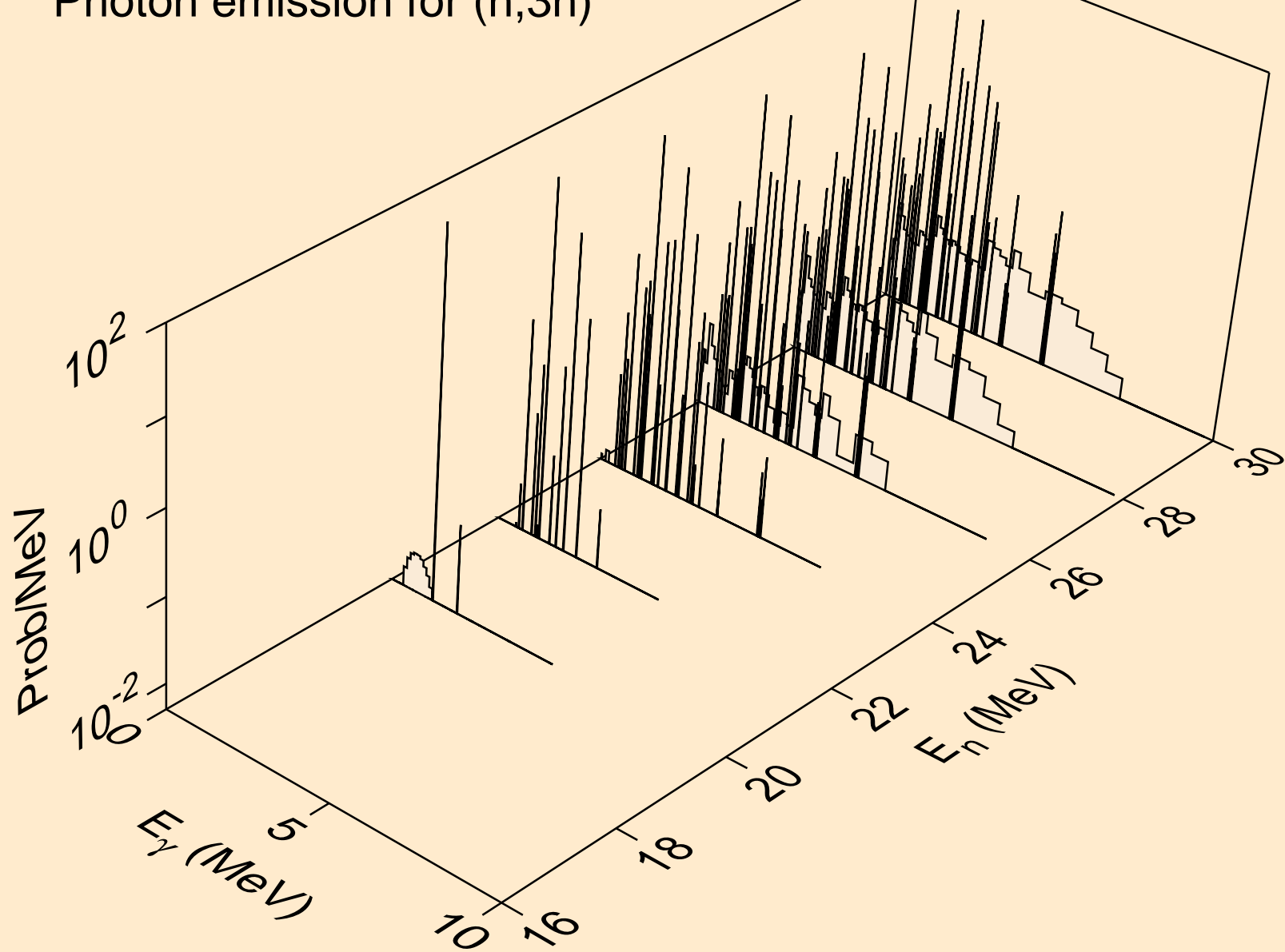

SI031 NEUTRON ACER TENDL-2024 LIBRARY; T=0.K
Photon emission for (n,n*)a

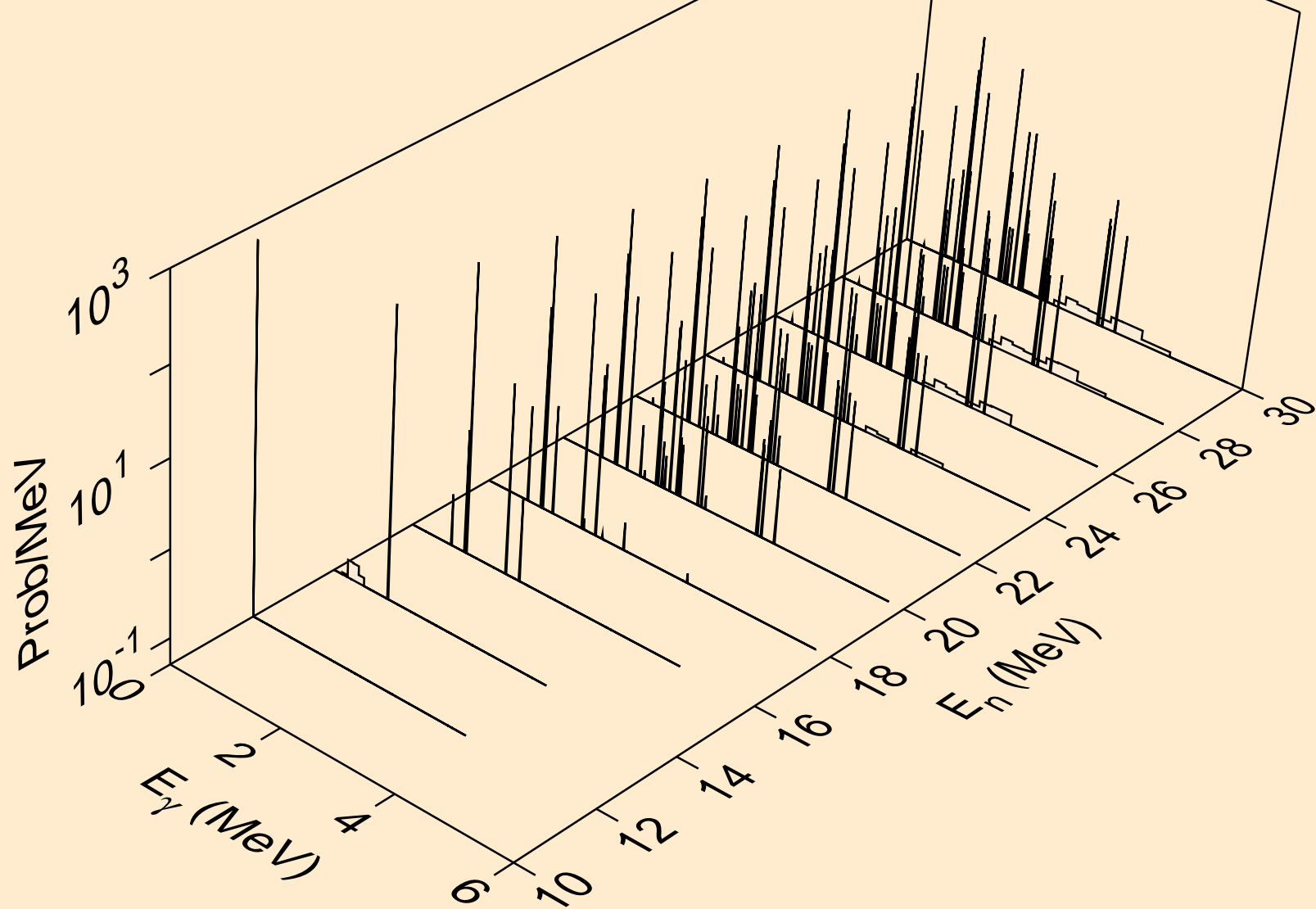

SI031 NEUTRON ACER TENDL-2024 LIBRARY; T=0.K
Photon emission for (n,2n)a

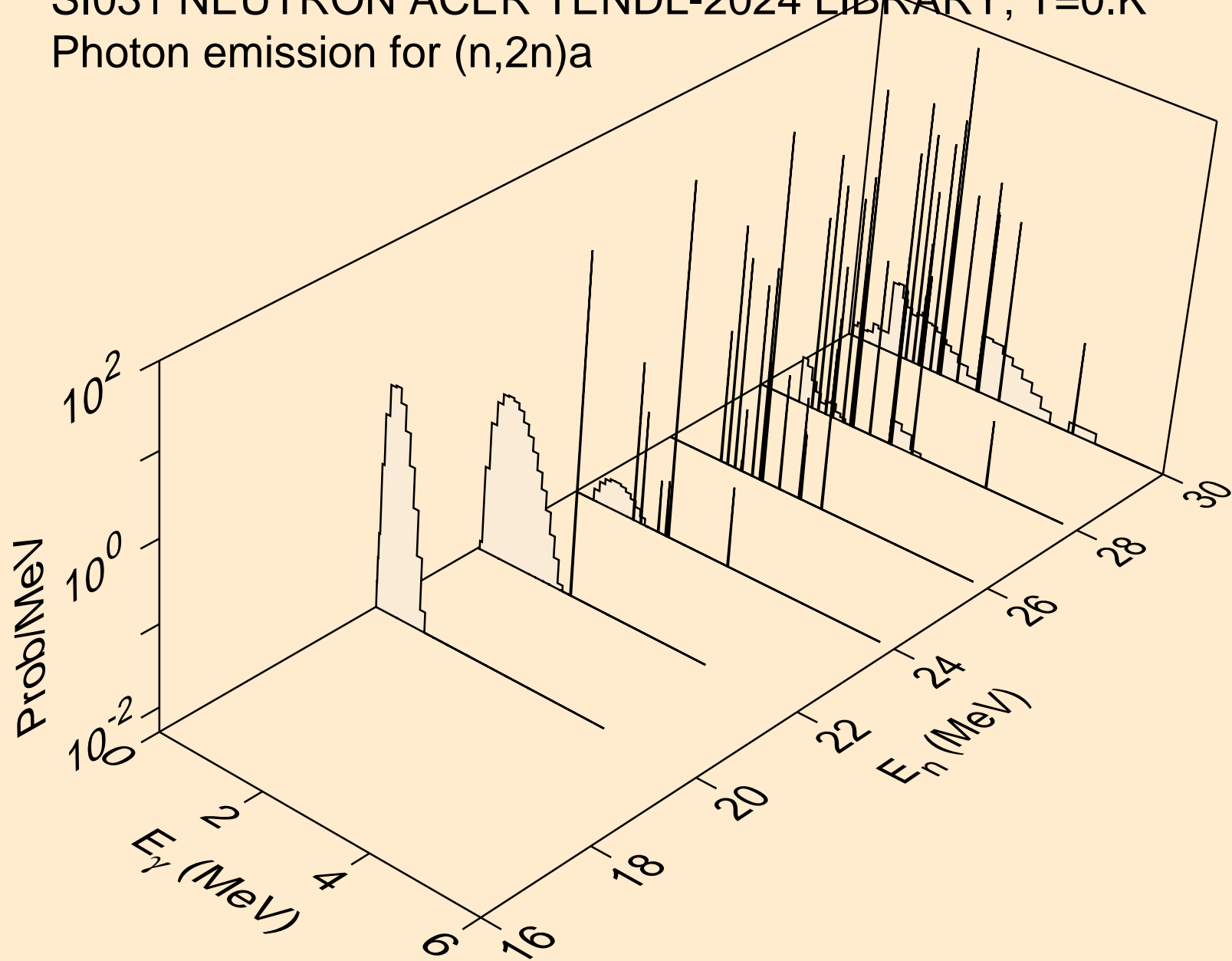

SI031 NEUTRON ACER TENDL-2024 LIBRARY; T=0.K
Photon emission for (n,n*)p

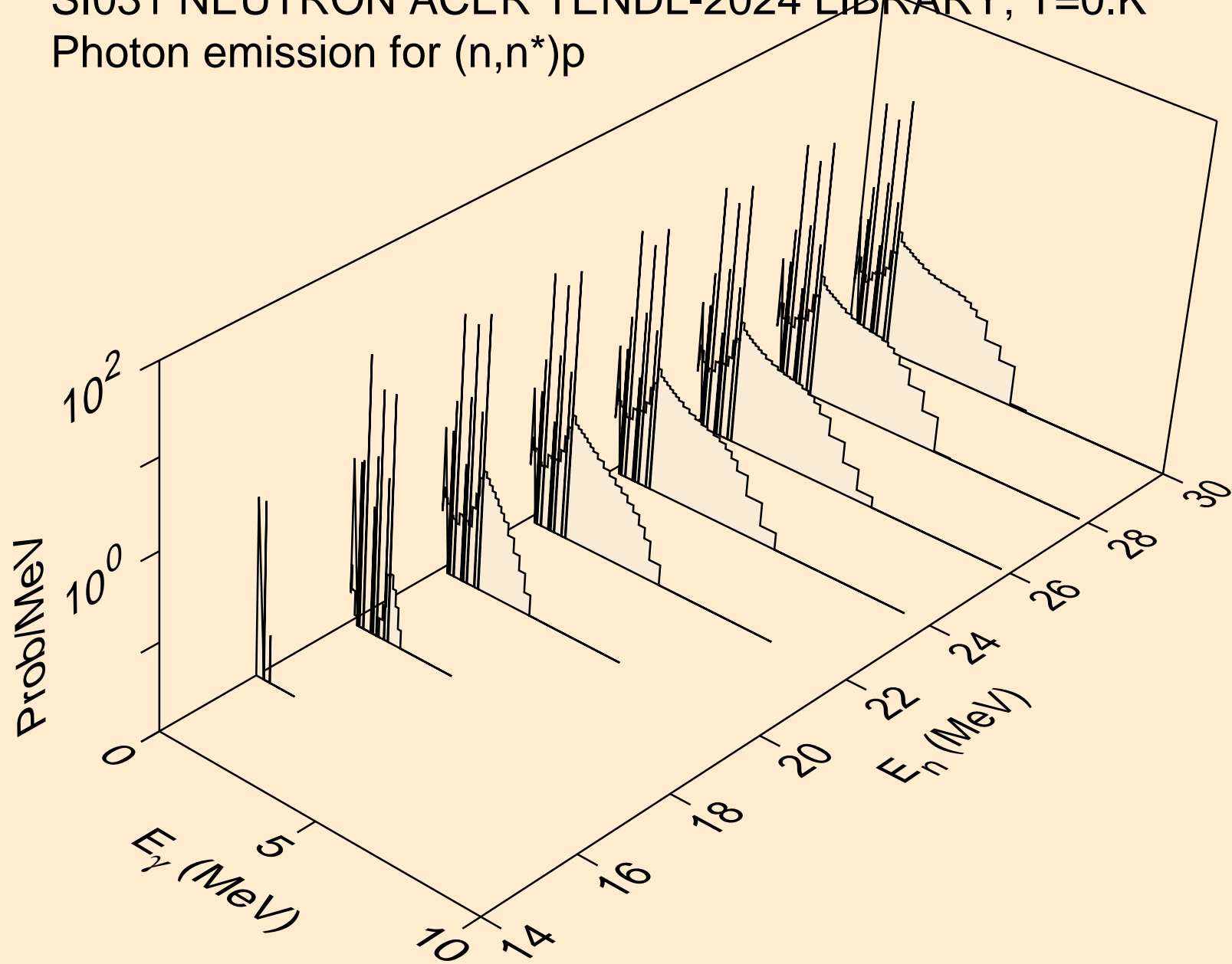

SI031 NEUTRON ACER TENDL-2024 LIBRARY; T=0.K
Photon emission for (n,n*)2a

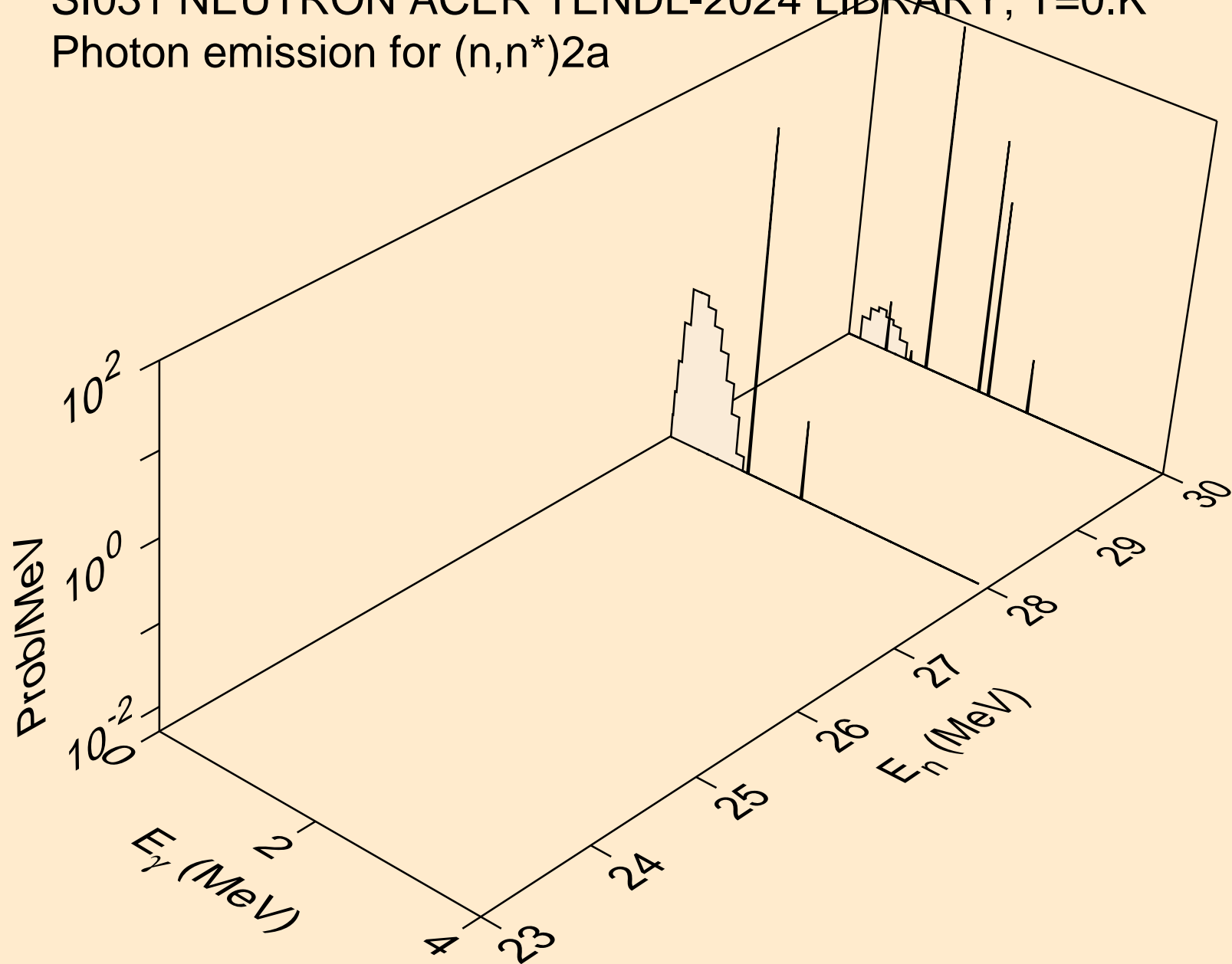

SI031 NEUTRON ACER TENDL-2024 LIBRARY; T=0.K
Photon emission for (n,n*)d

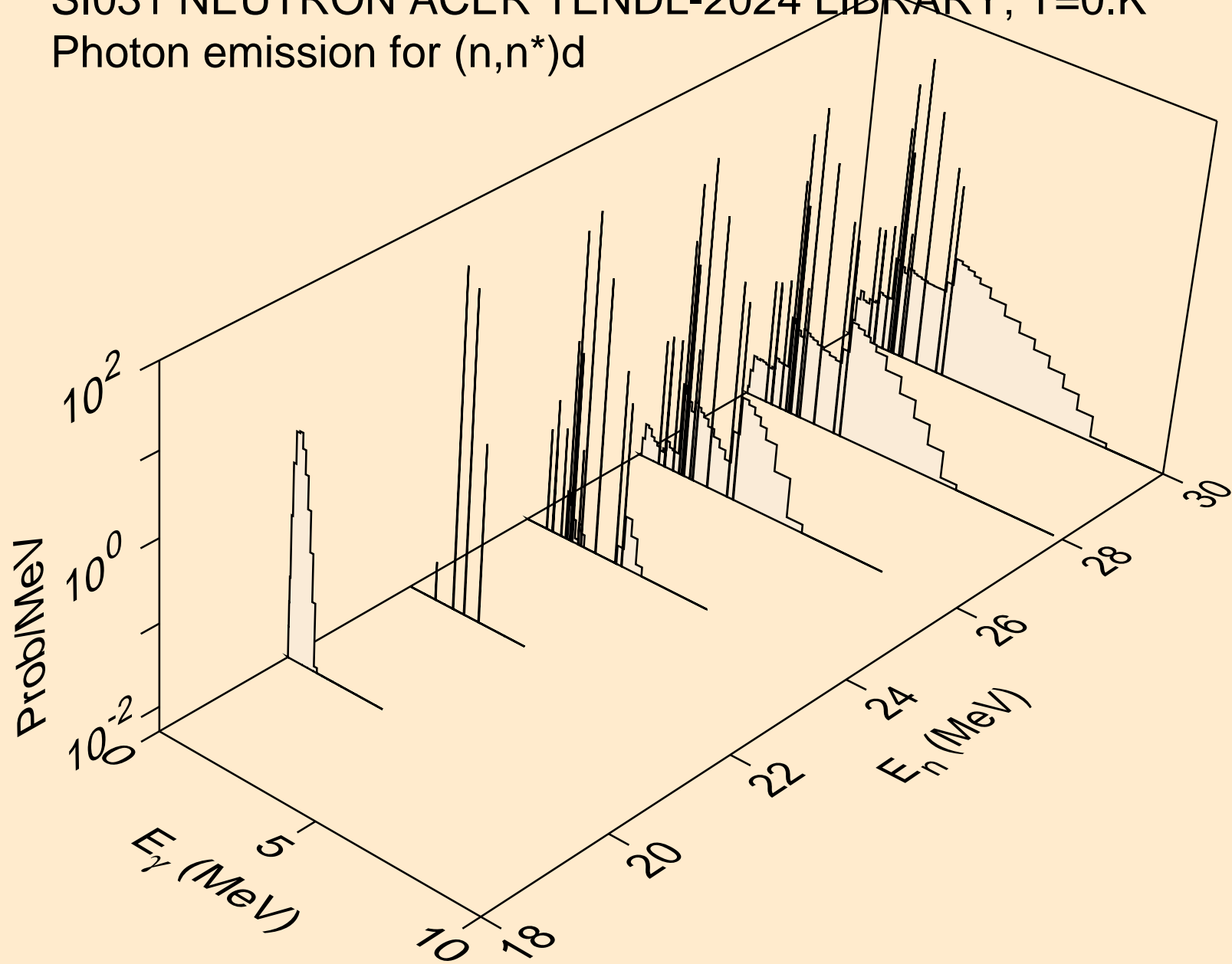

SI031 NEUTRON ACER TENDL-2024 LIBRARY; T=0.K
Photon emission for (n,n*)t

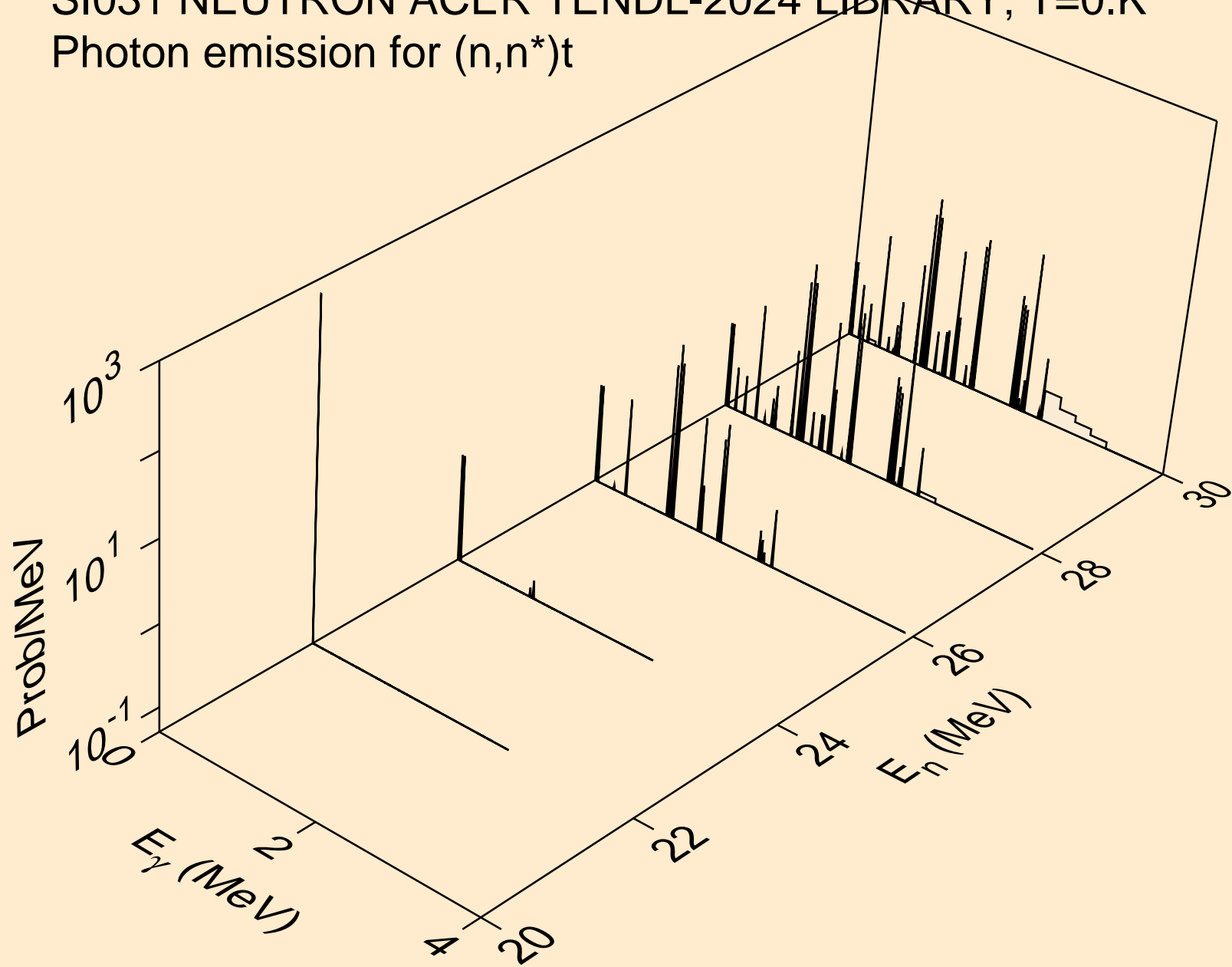

SI031 NEUTRON ACER TENDL-2024 LIBRARY; T=0.K
Photon emission for (n,n*)he3

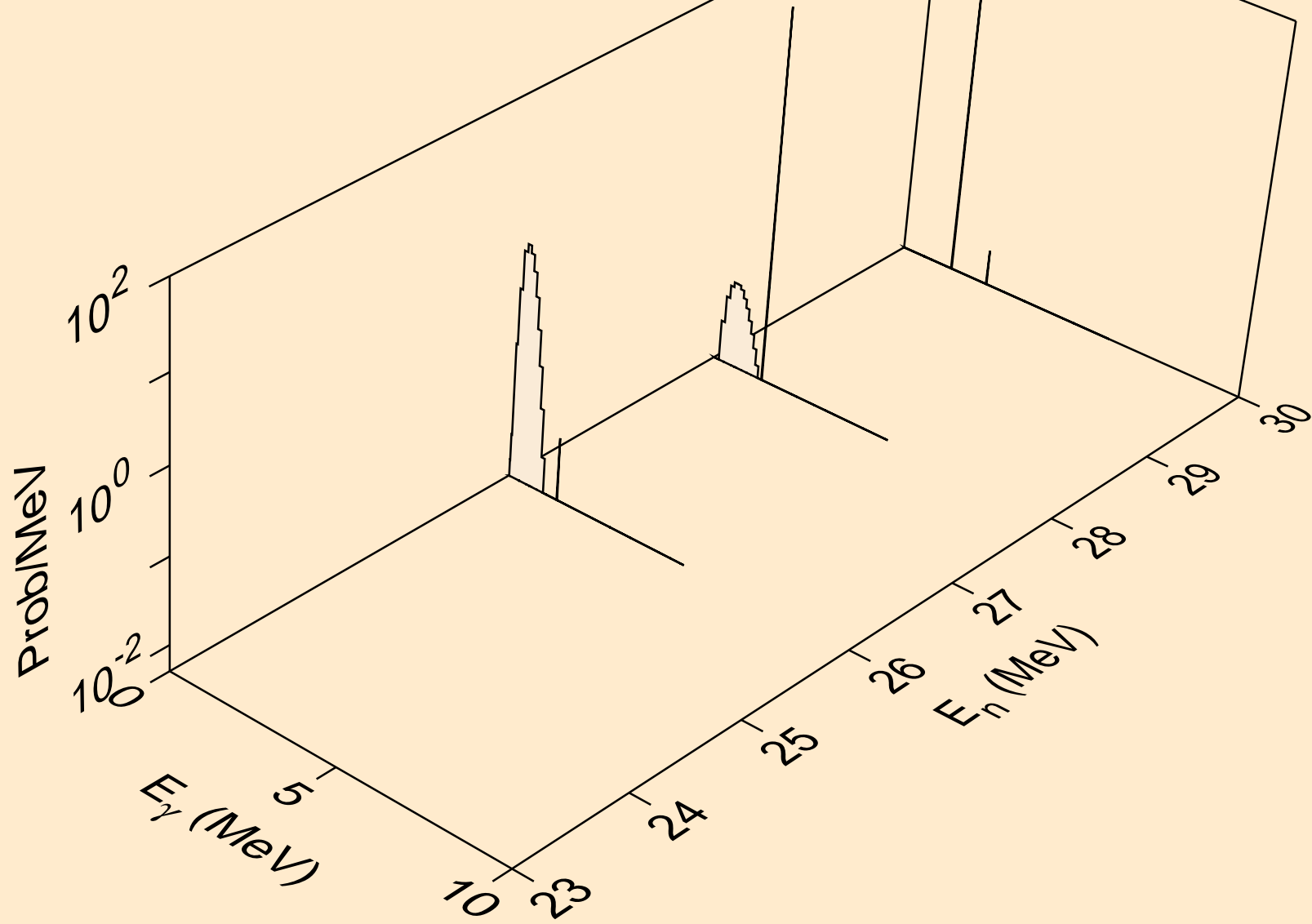

SI031 NEUTRON ACER TENDL-2024 LIBRARY; T=0.K
Photon emission for (n,4n)

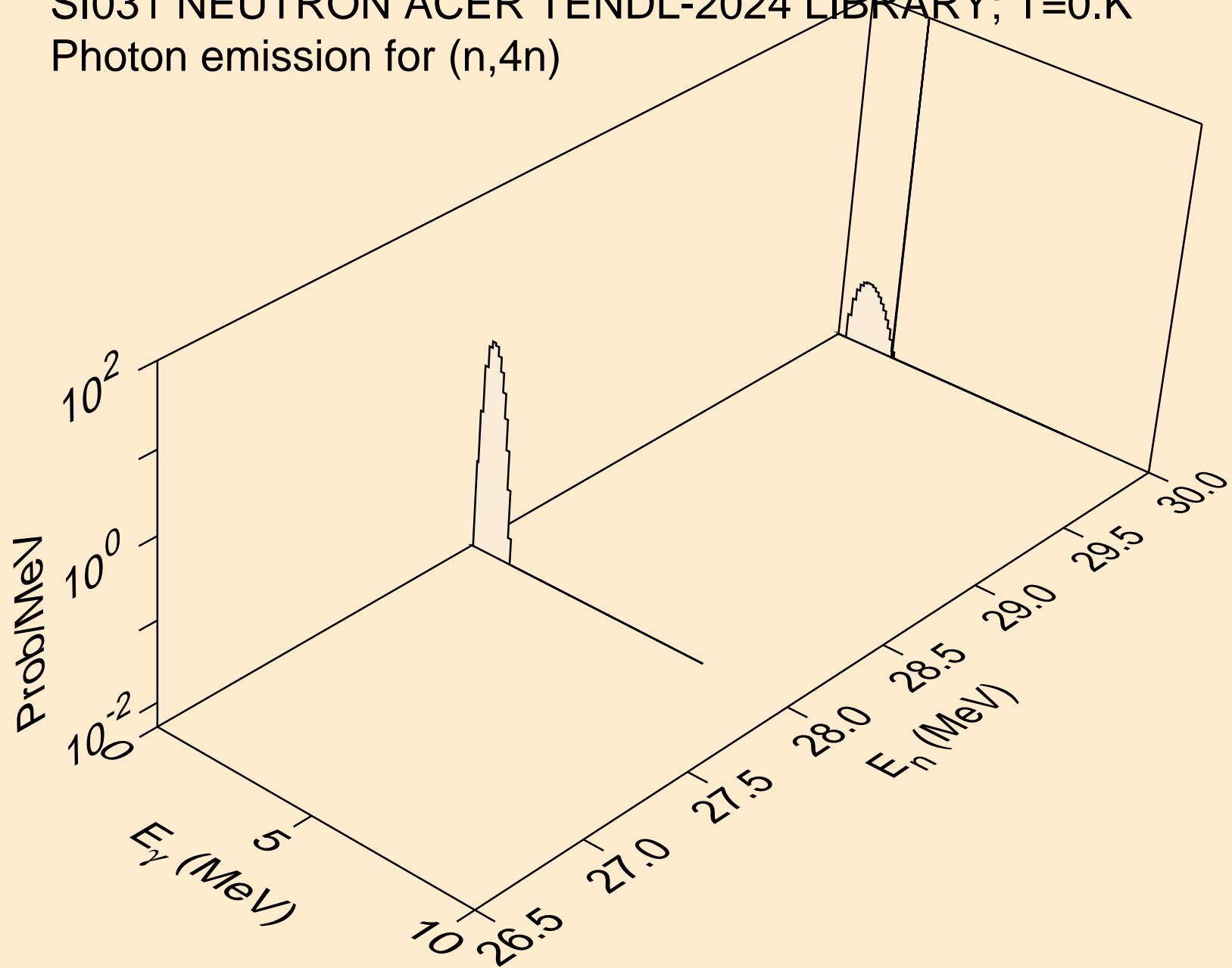

SI031 NEUTRON ACER TENDL-2024 LIBRARY; T=0.K
Photon emission for (n,2np)

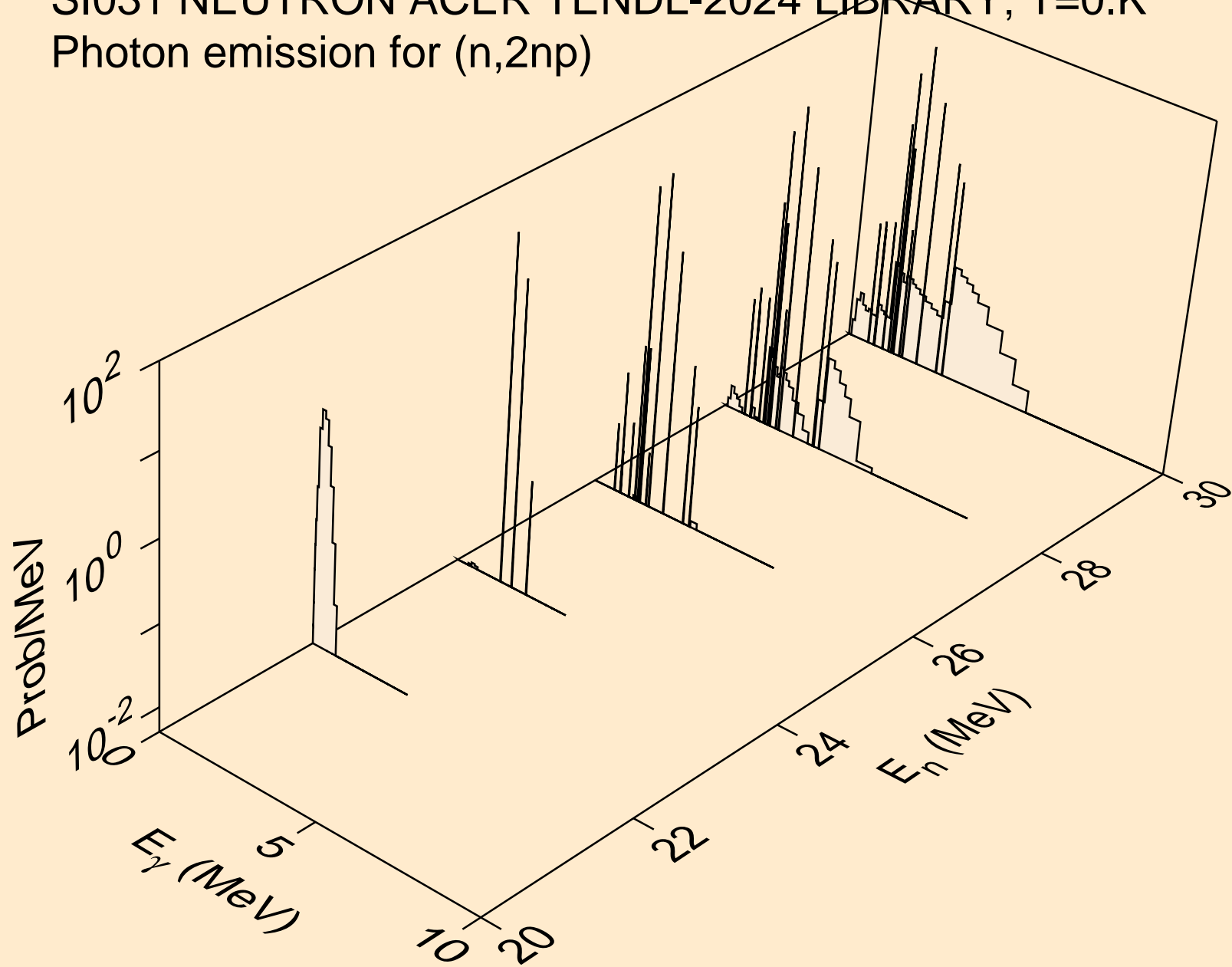

SI031 NEUTRON ACER TENDL-2024 LIBRARY; T=0.K
Photon emission for (n,n*c)

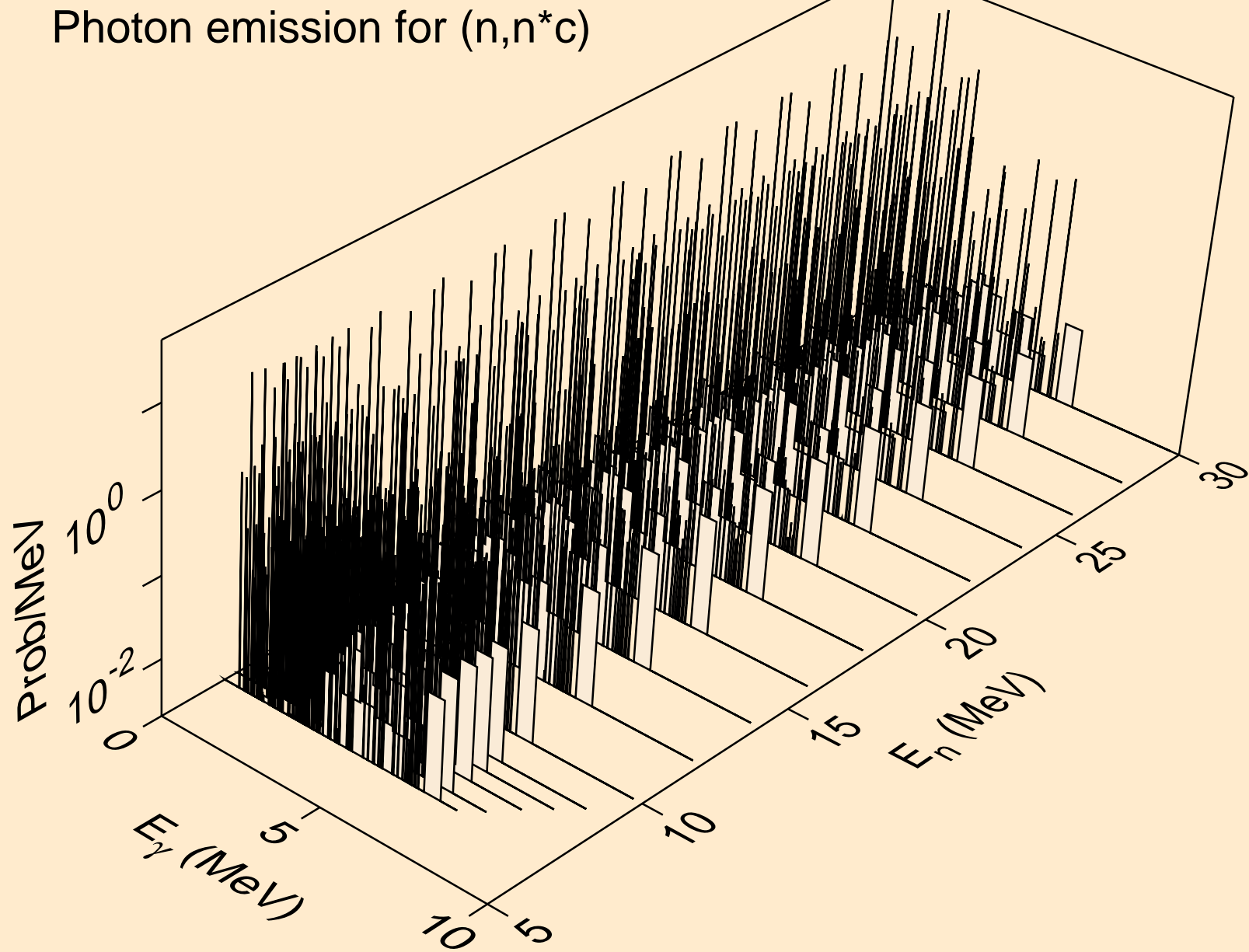

SI031 NEUTRON ACER TENDL-2024 LIBRARY; T=0.K
Photon emission for (n,gma)

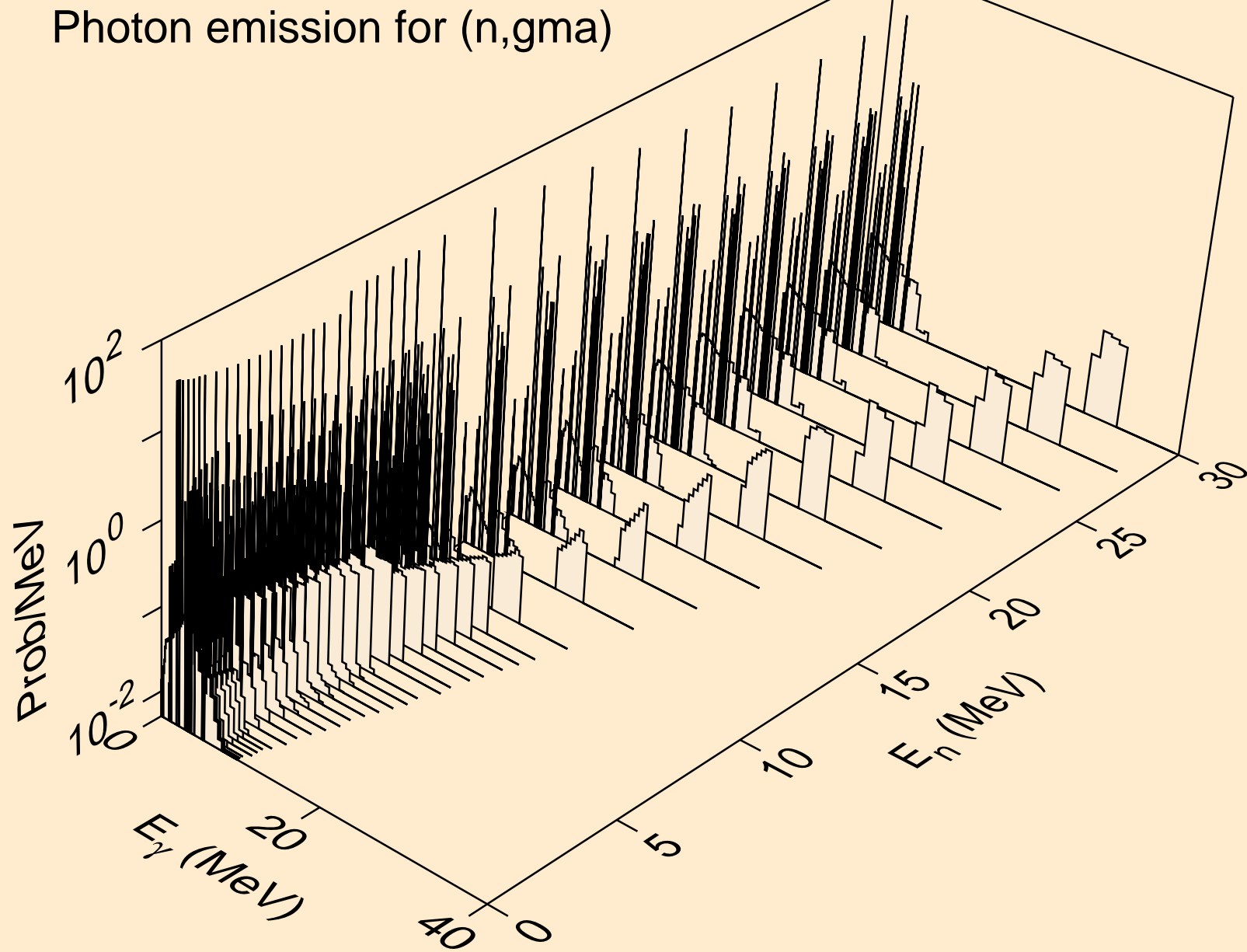

SI031 NEUTRON ACER TENDL-2024 LIBRARY; T=0.K
Photon emission for (n,p)

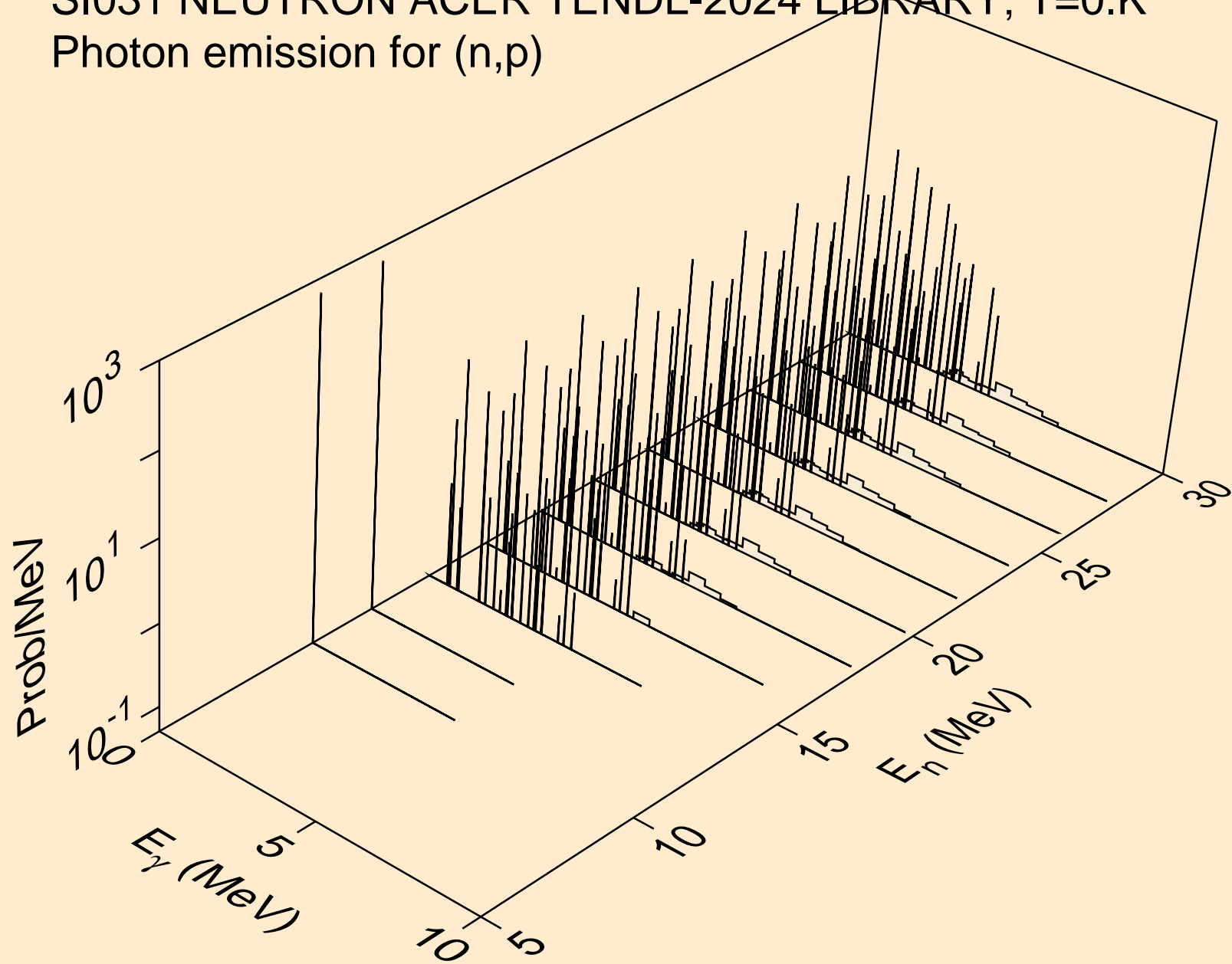

SI031 NEUTRON ACER TENDL-2024 LIBRARY; T=0.K
Photon emission for (n,d)

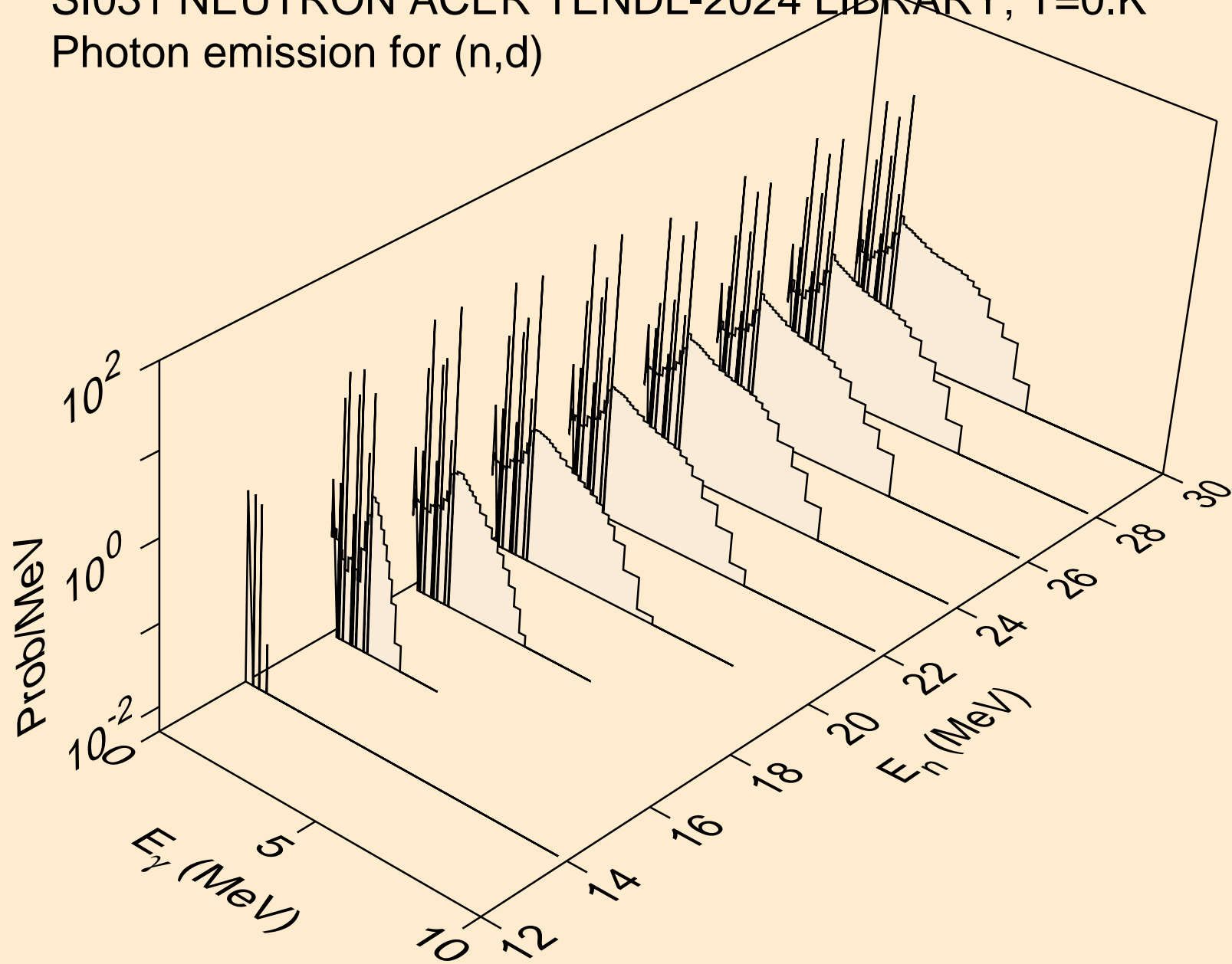

SI031 NEUTRON ACER TENDL-2024 LIBRARY; T=0.K
Photon emission for (n,t)

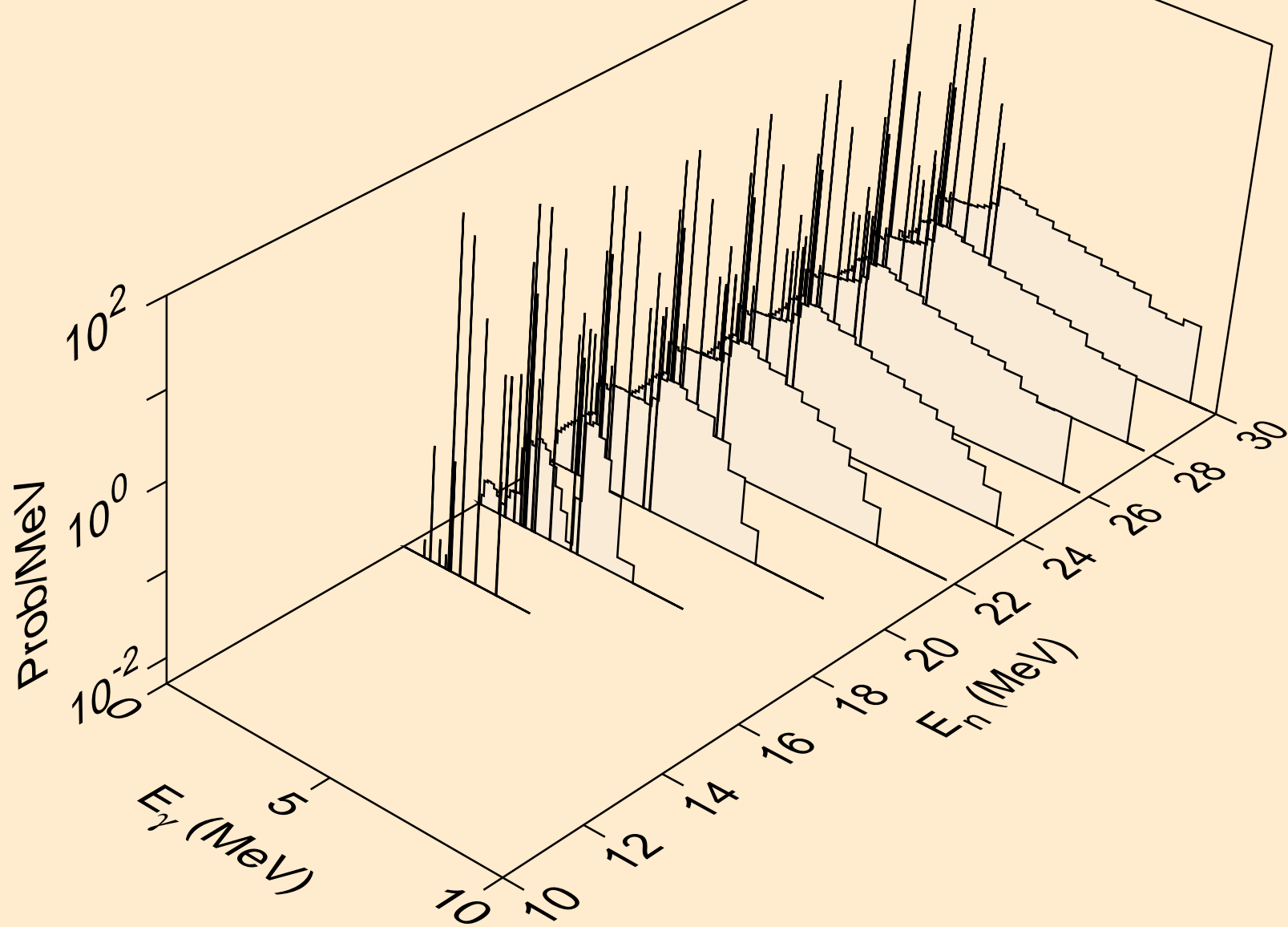

SI031 NEUTRON ACER TENDL-2024 LIBRARY; T=0.K
Photon emission for (n,he3)

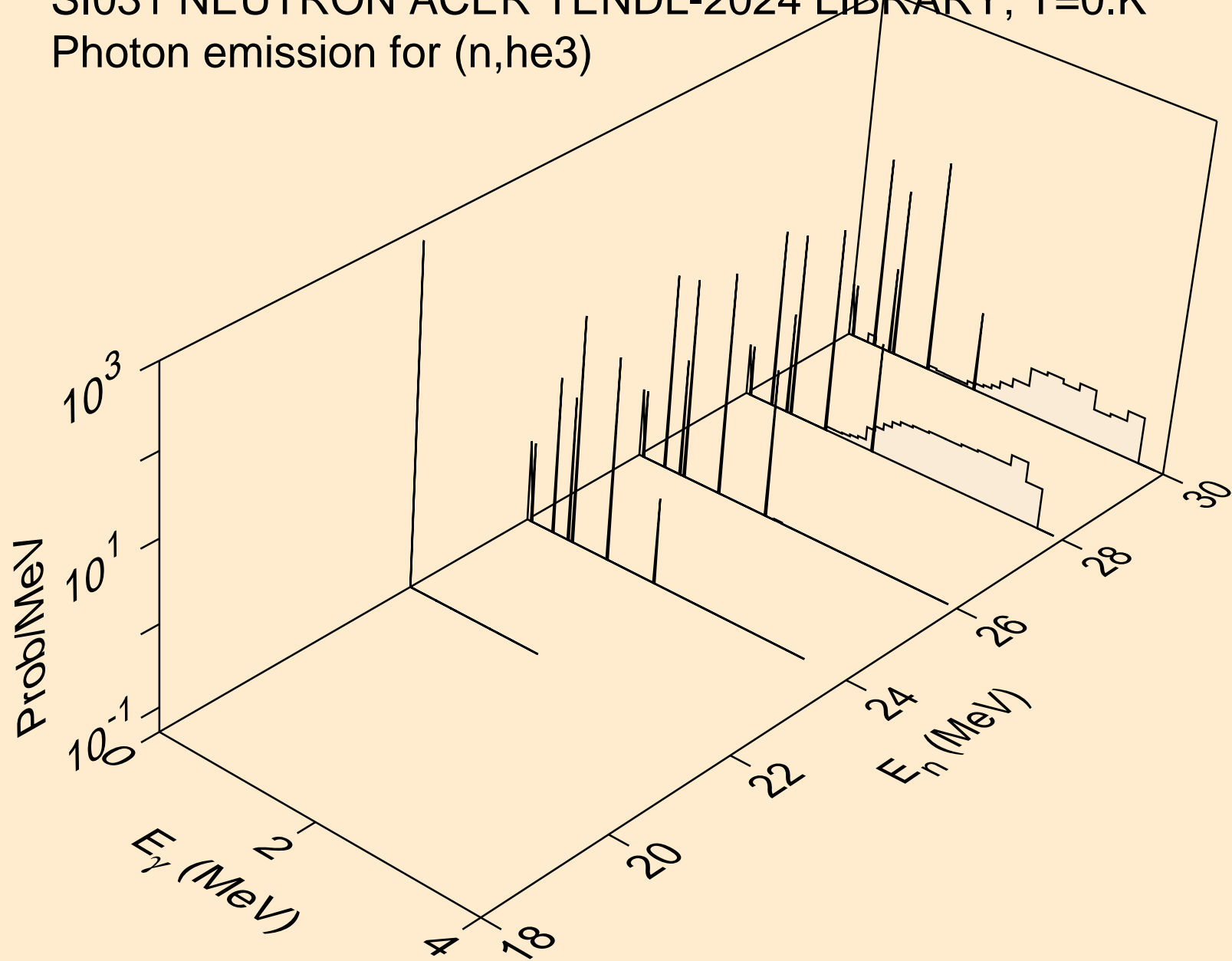

SI031 NEUTRON ACER TENDL-2024 LIBRARY; T=0.K
Photon emission for (n,a)

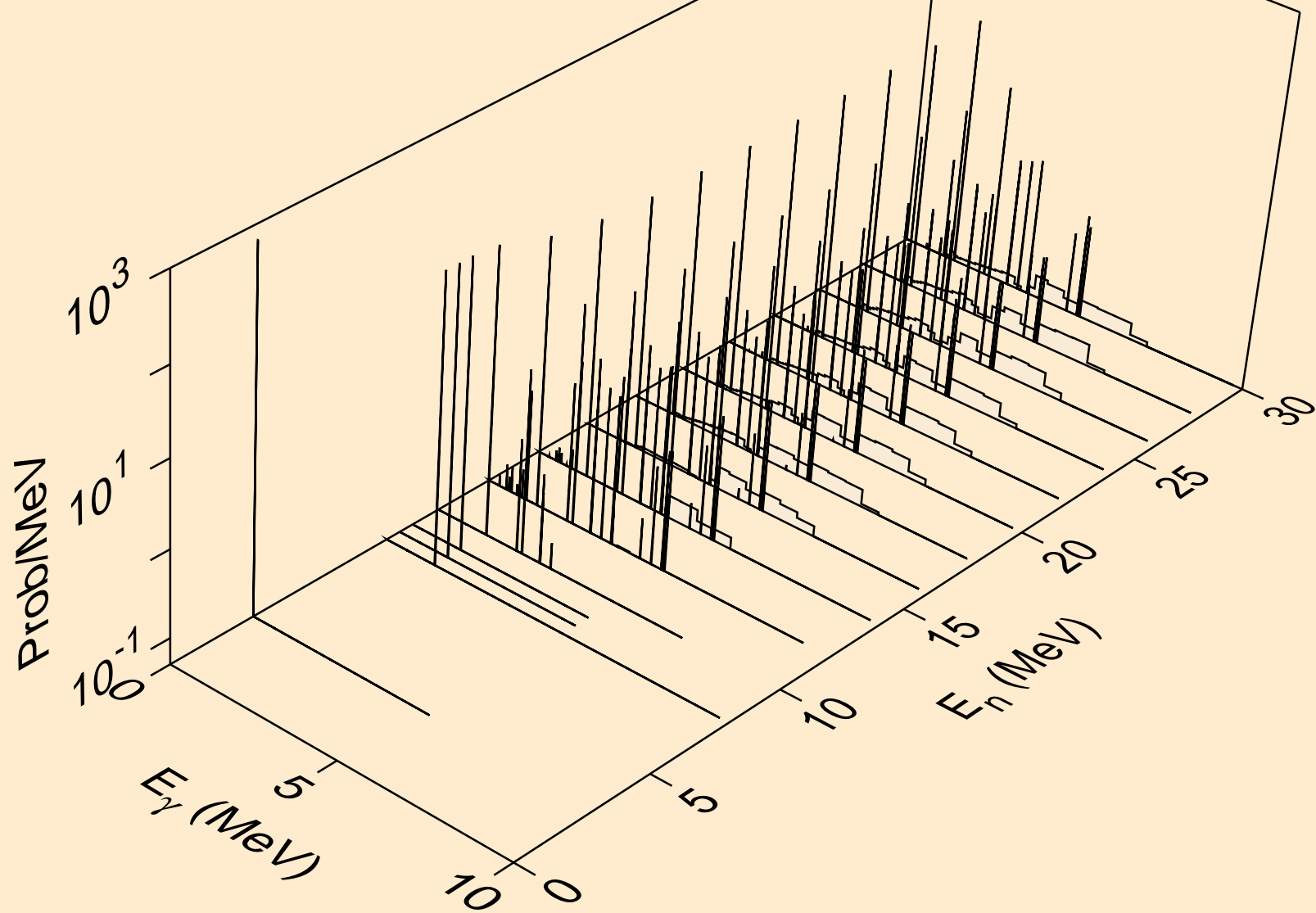

SI031 NEUTRON ACER TENDL-2024 LIBRARY; T=0.K
Photon emission for (n,2a)

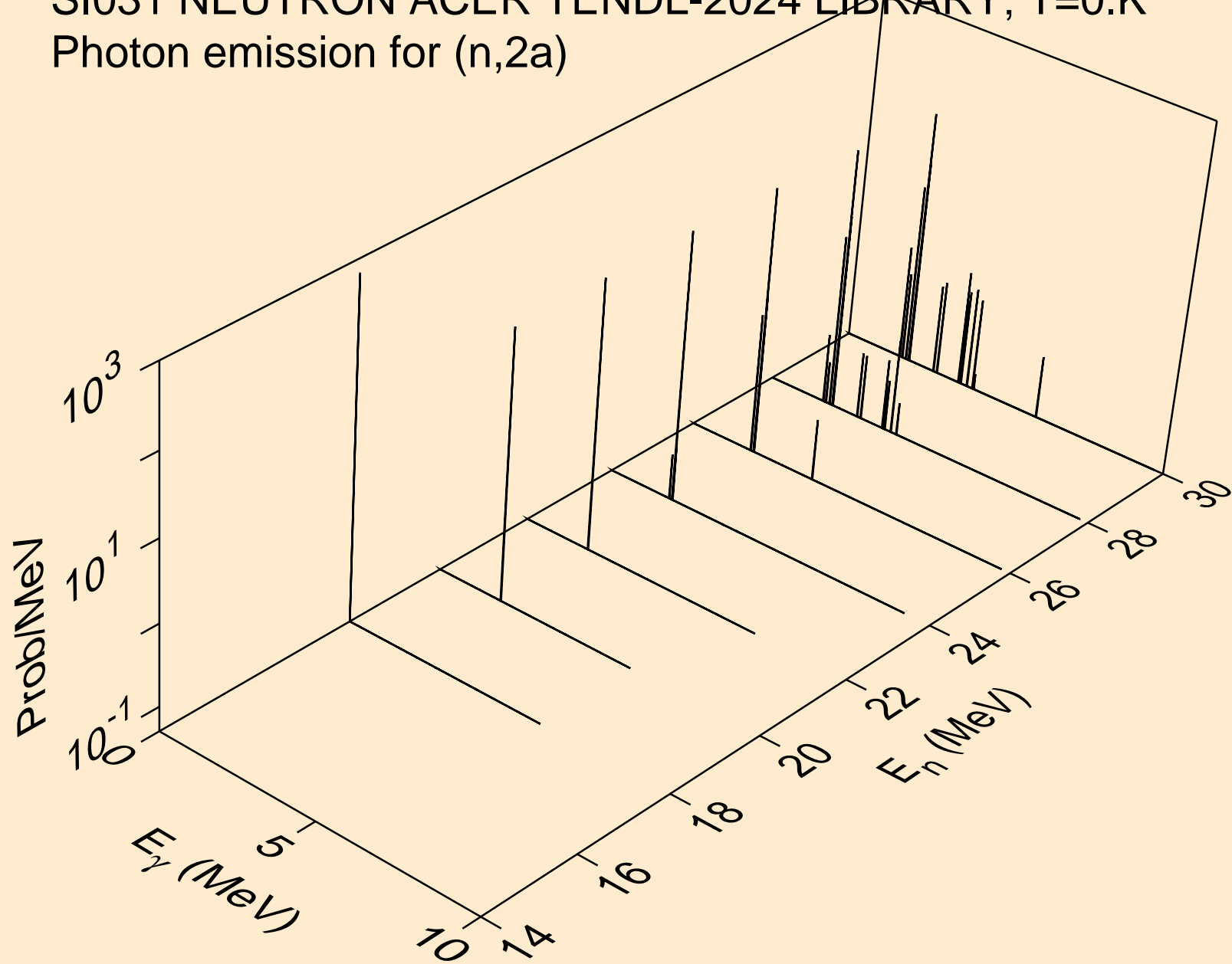

SI031 NEUTRON ACER TENDL-2024 LIBRARY; T=0.K
Photon emission for (n,2p)

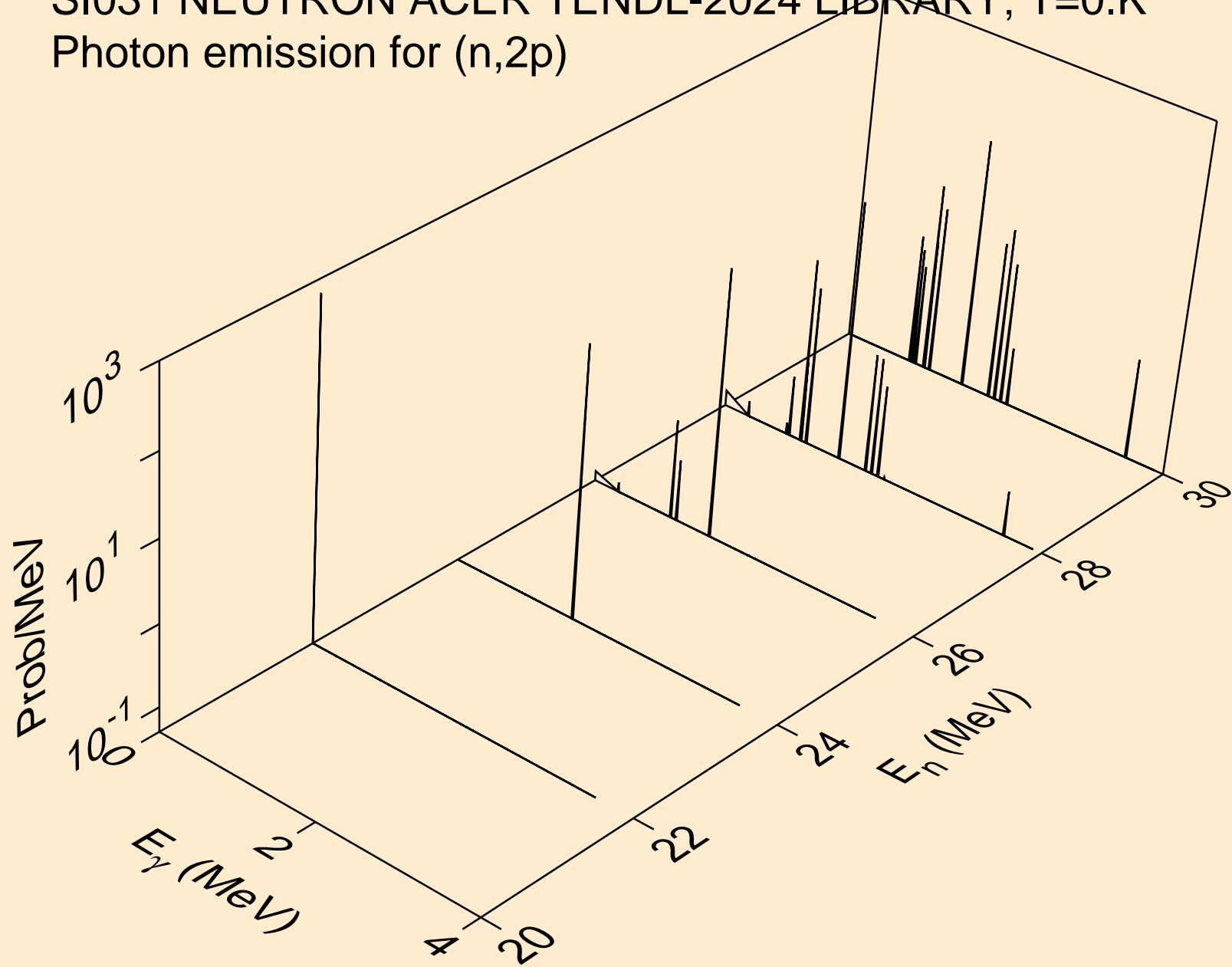

SI031 NEUTRON ACER TENDL-2024 LIBRARY; T=0.K
Photon emission for (n,p α)

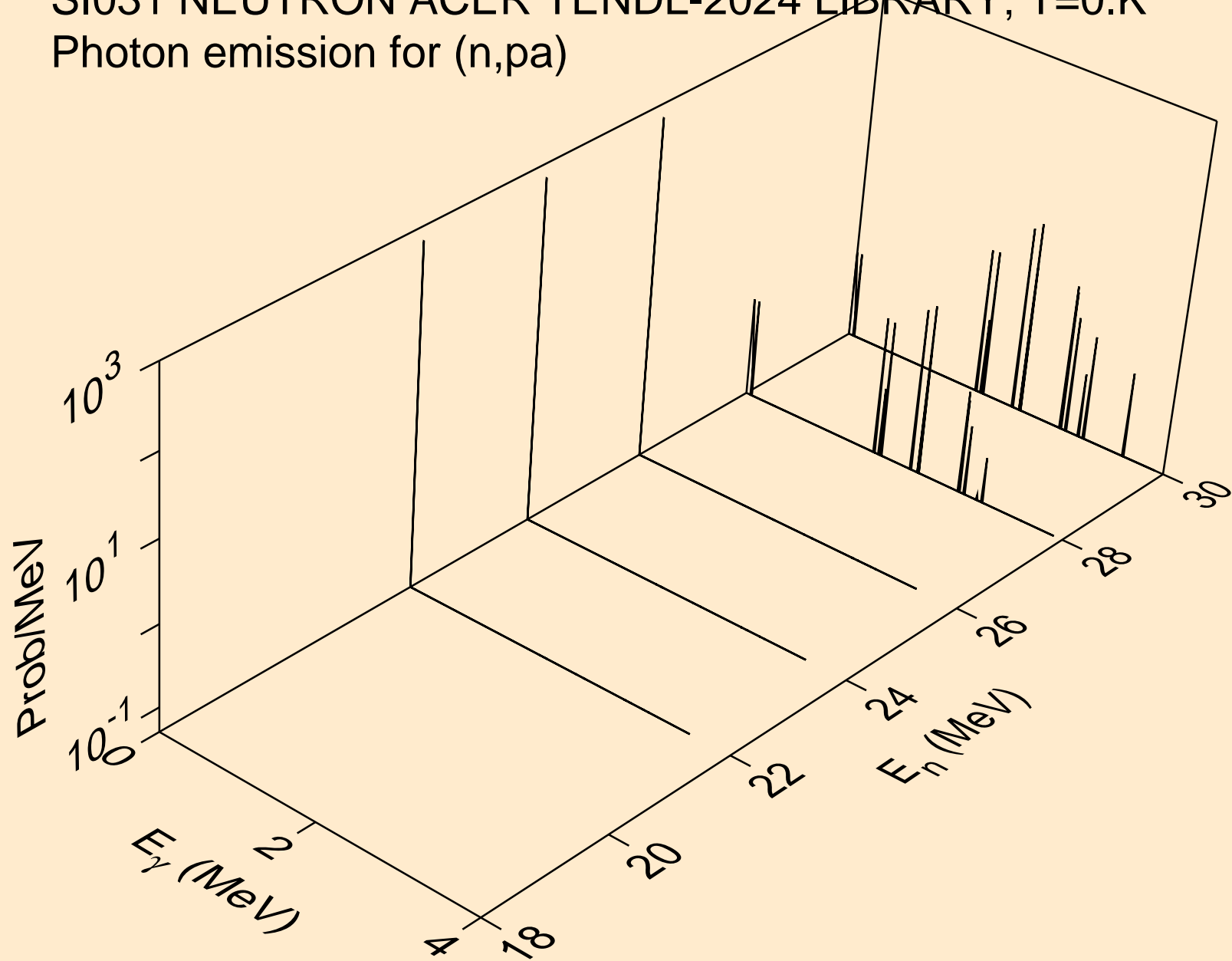

SI031 NEUTRON ACER TENDL-2024 LIBRARY; T=0.K
Photon emission for (n,pd)

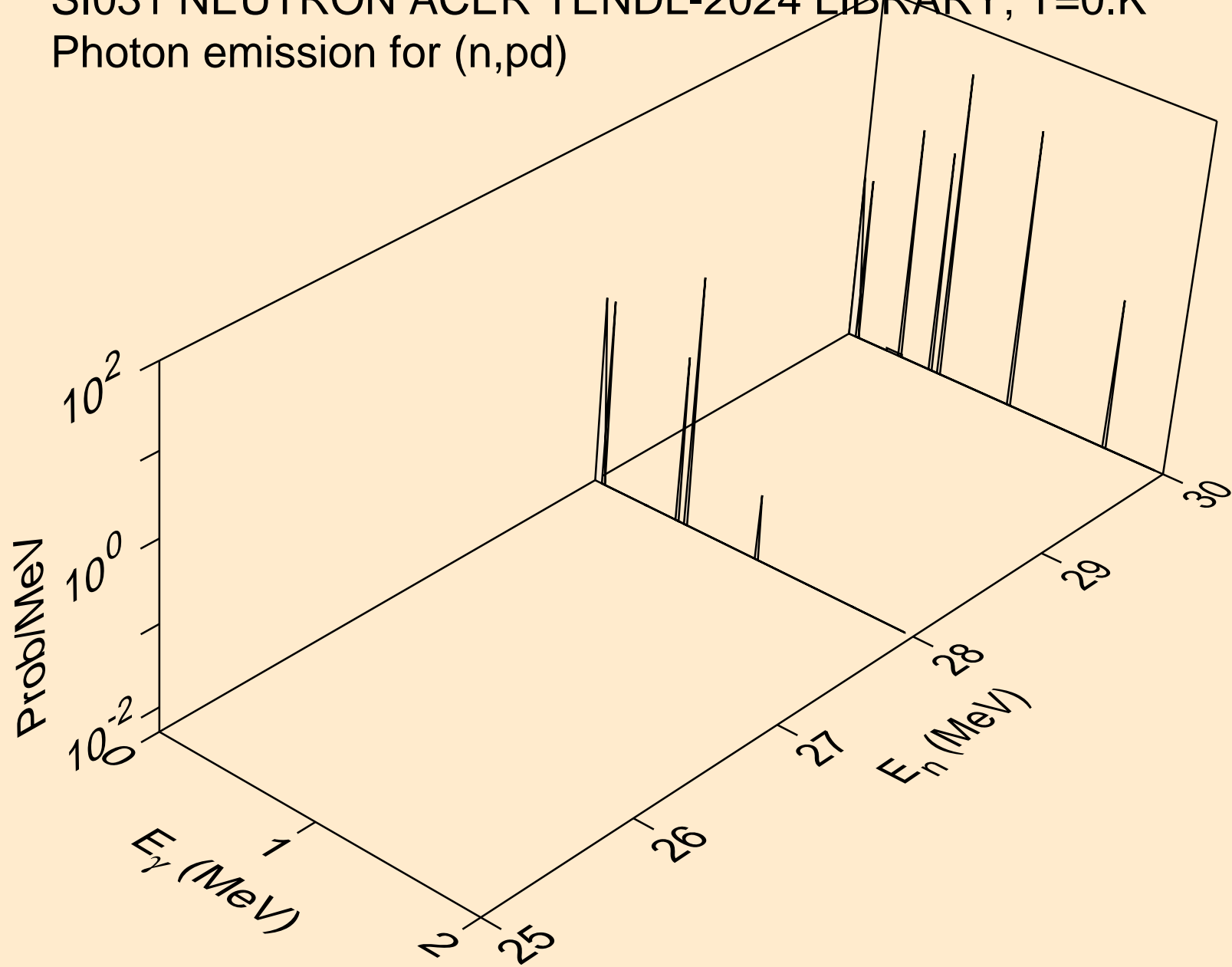

SI031 NEUTRON ACER TENDL-2024 LIBRARY; T=0.K
Photon emission for (n,pt)

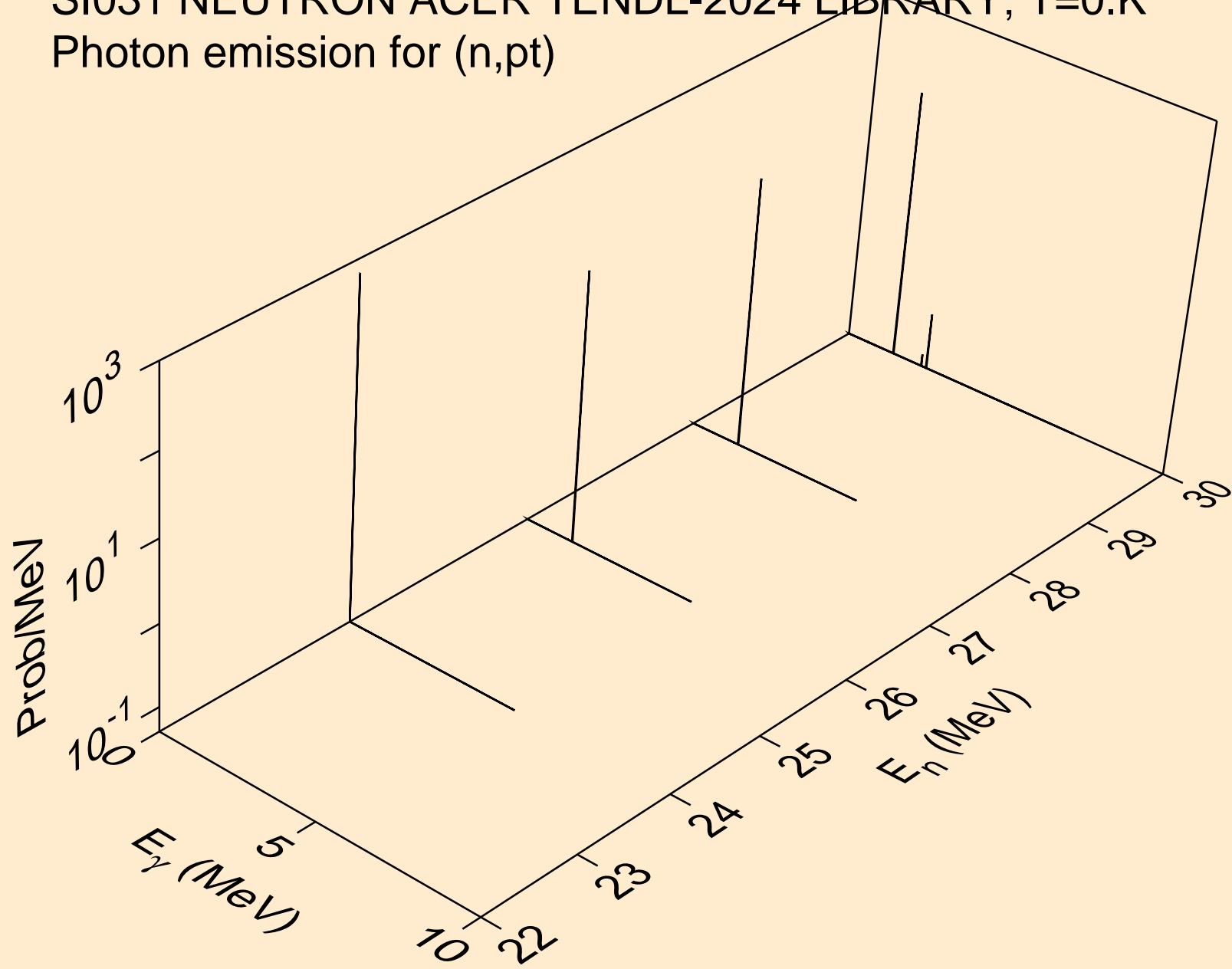

SI031 NEUTRON ACER TENDL-2024 LIBRARY; T=0.K
Photon emission for (n,da)

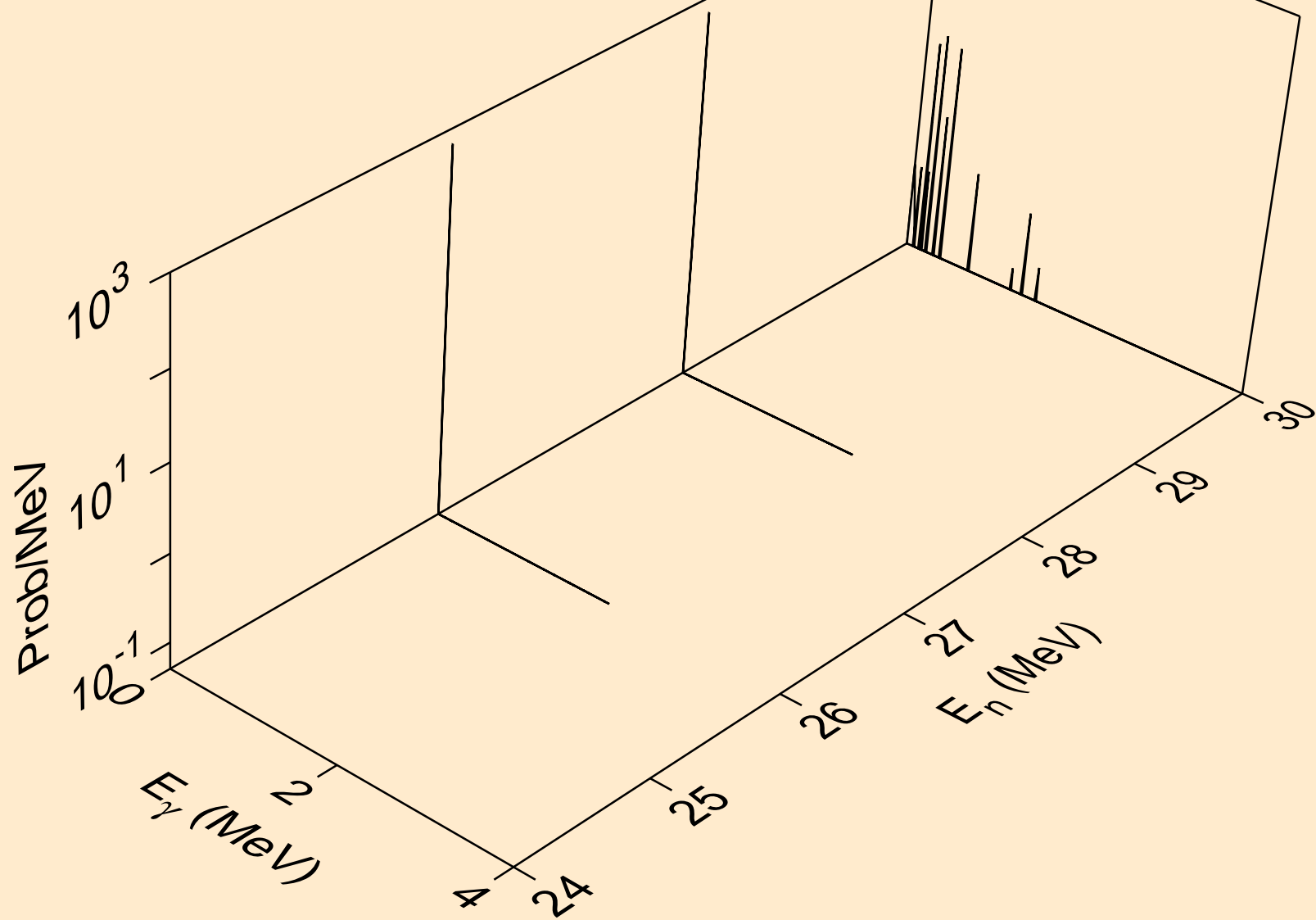

SI031 NEUTRON ACER TENDL-2024 LIBRARY; T=0.K
thermal capture photon spectrum

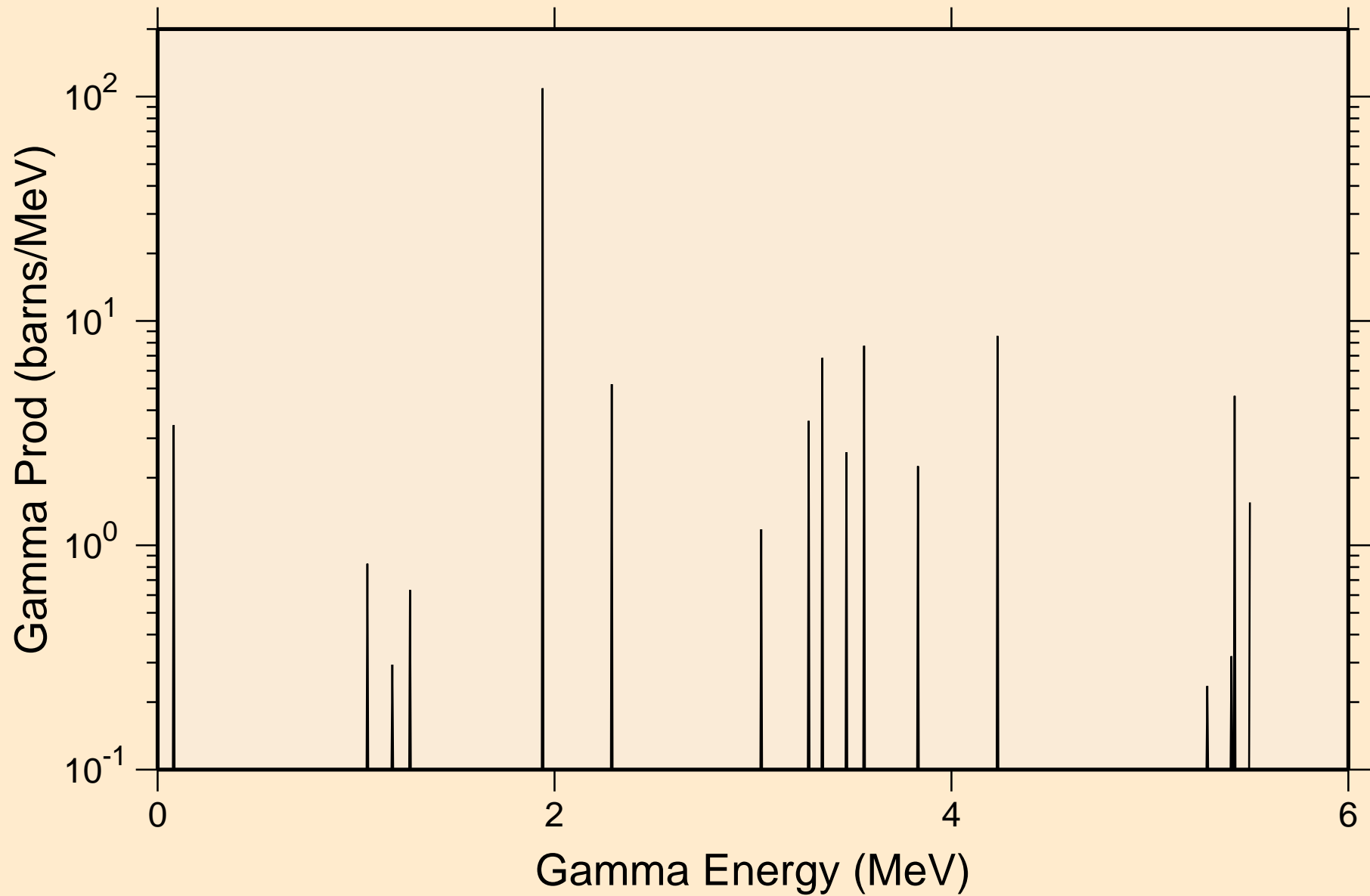

SI031 NEUTRON ACER TENDL-2024 LIBRARY; T=0.K
14 MeV photon spectrum

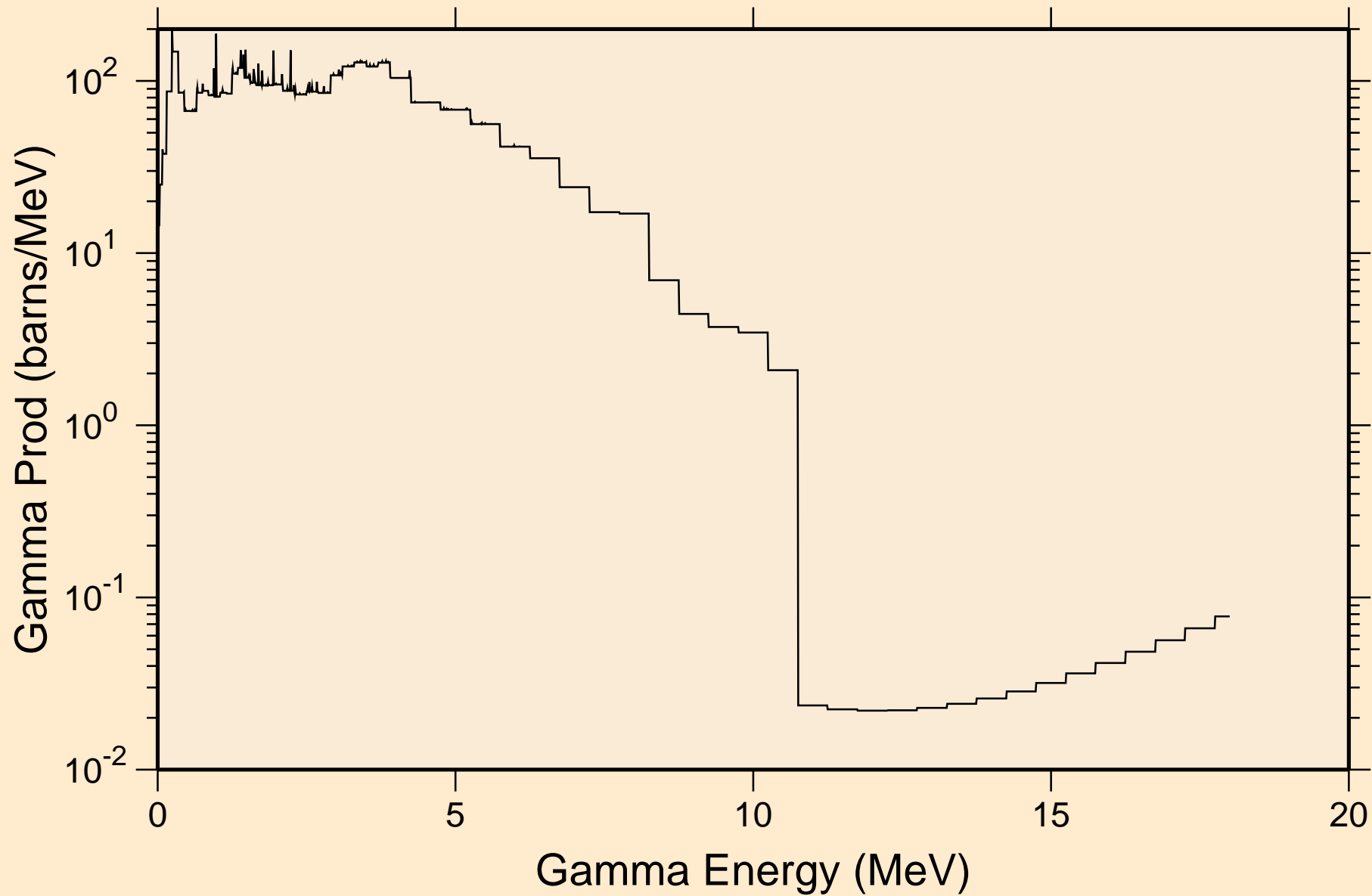

SI031 NEUTRON ACER TENDL-2024 LIBRARY; T=0.K
Particle heating contributions

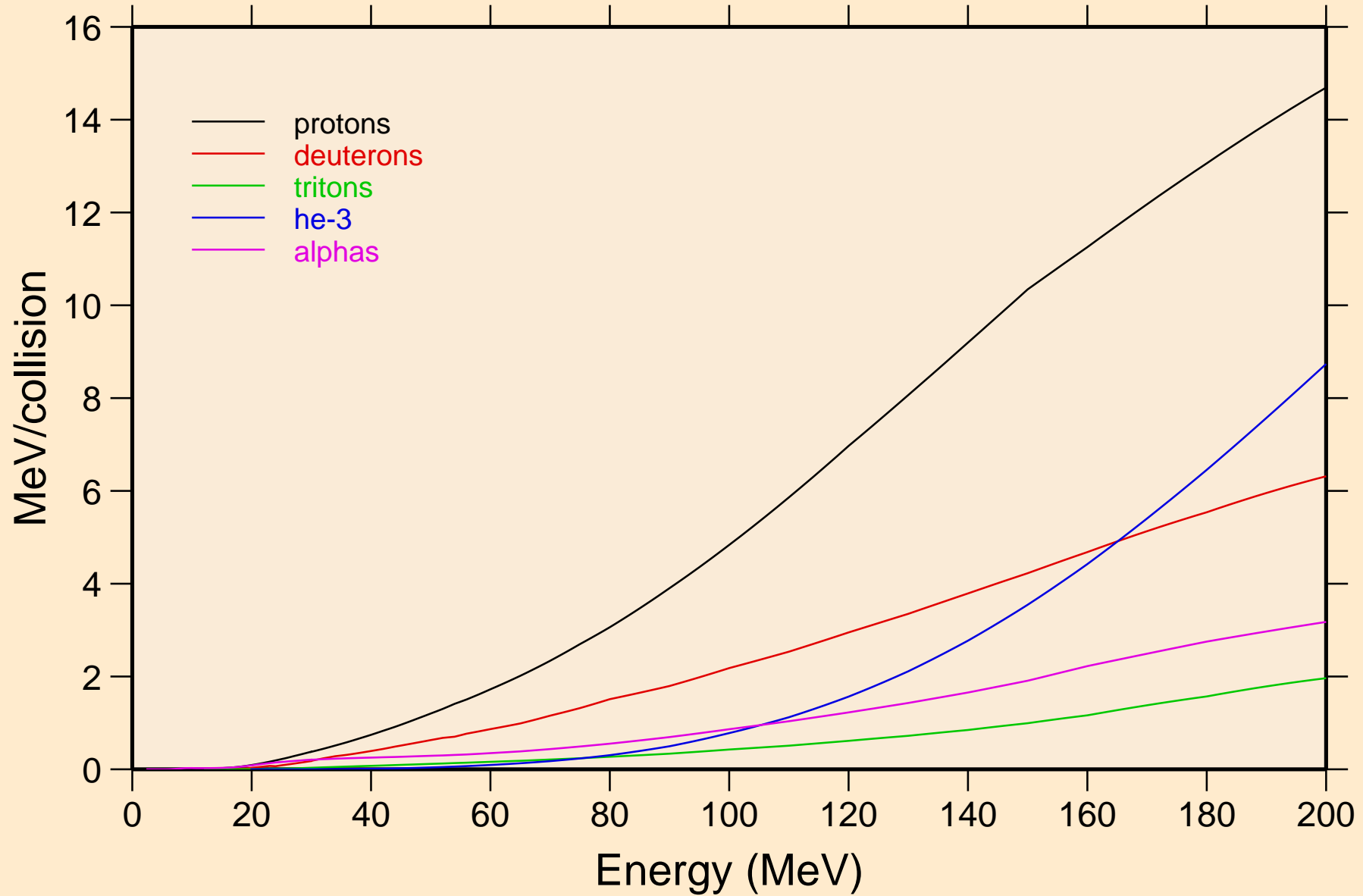

SI031 NEUTRON ACER TENDL-2024 LIBRARY; T=0.K
Recoil Heating

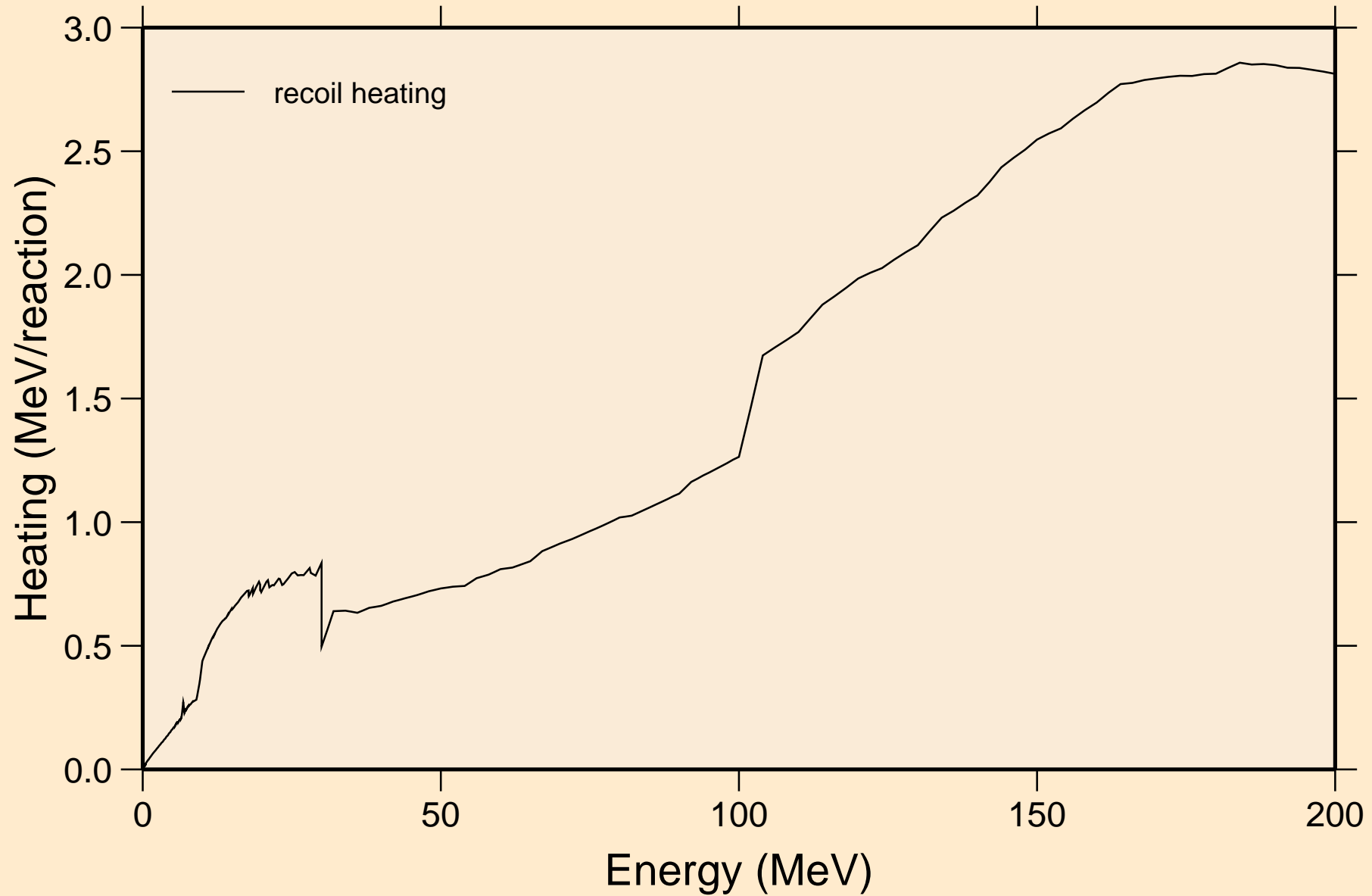

SI031 NEUTRON ACER TENDL-2024 LIBRARY; T=0.K
Particle production cross sections

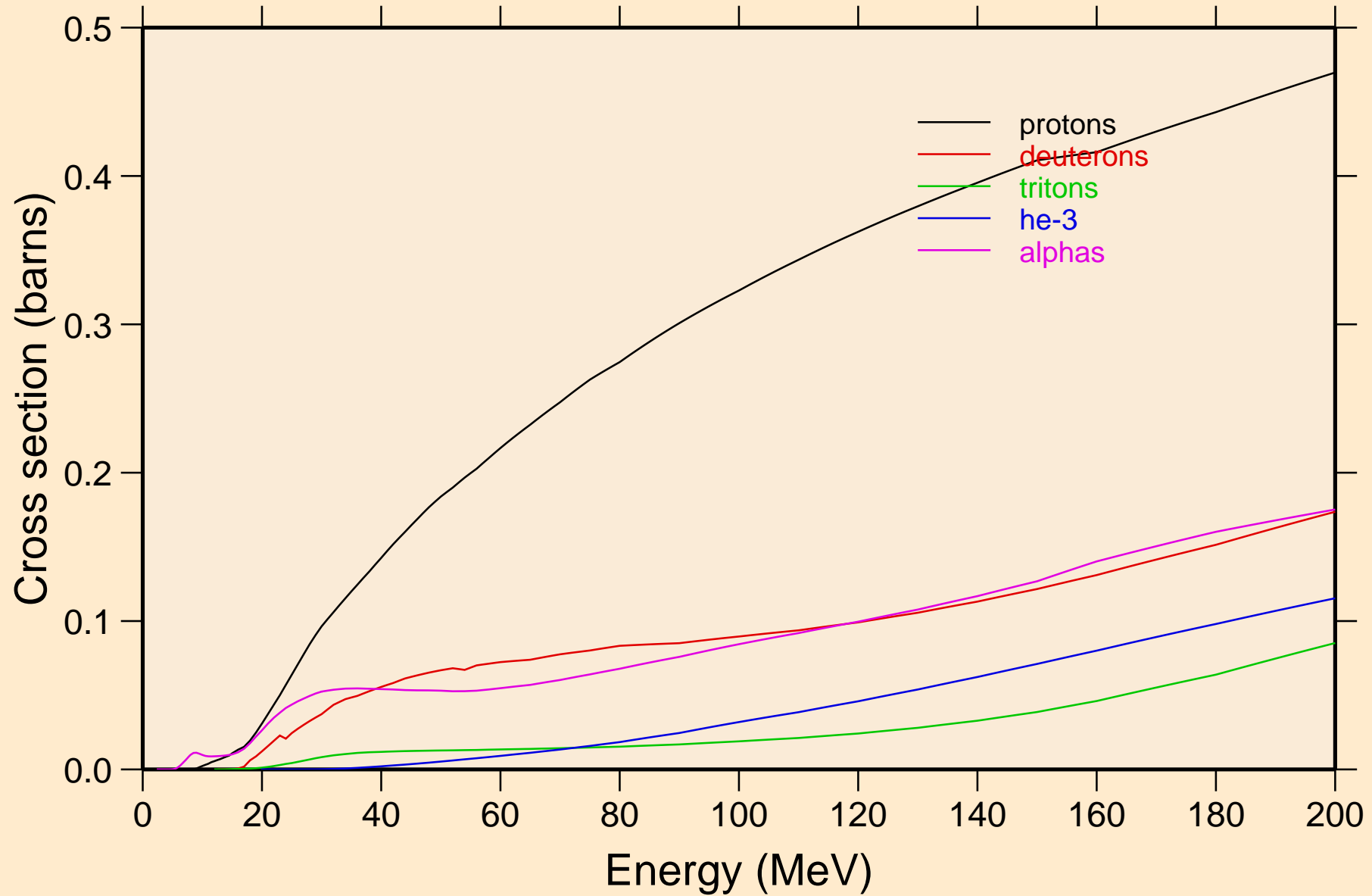

SI031 NEUTRON ACER TENDL-2024 LIBRARY; T=0.K
protons from (n,x)

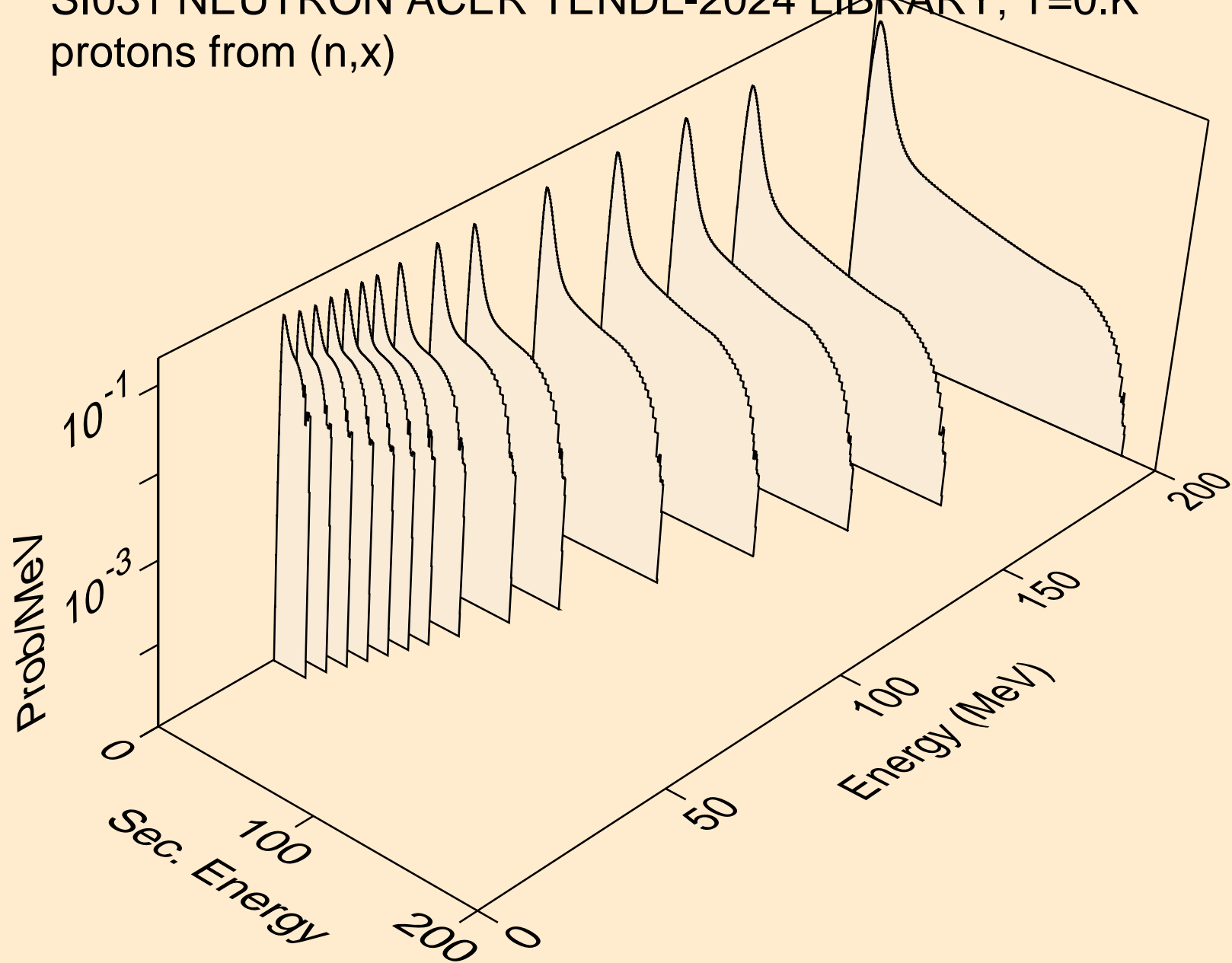

SI031 NEUTRON ACER TENDL-2024 LIBRARY; T=0.K
protons from (n,n*)p

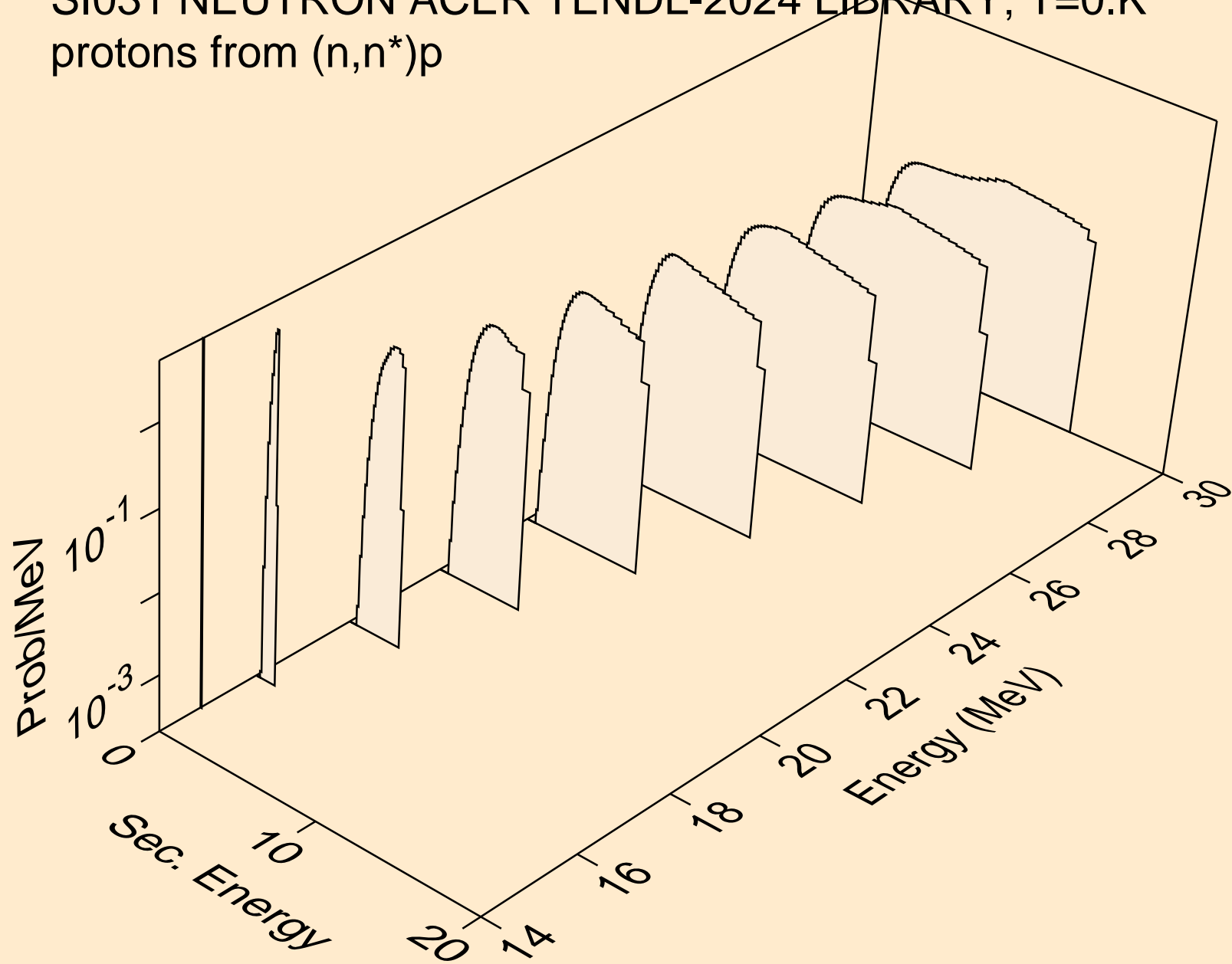

SI031 NEUTRON ACER TENDL-2024 LIBRARY; T=0.K
protons from (n,2np)

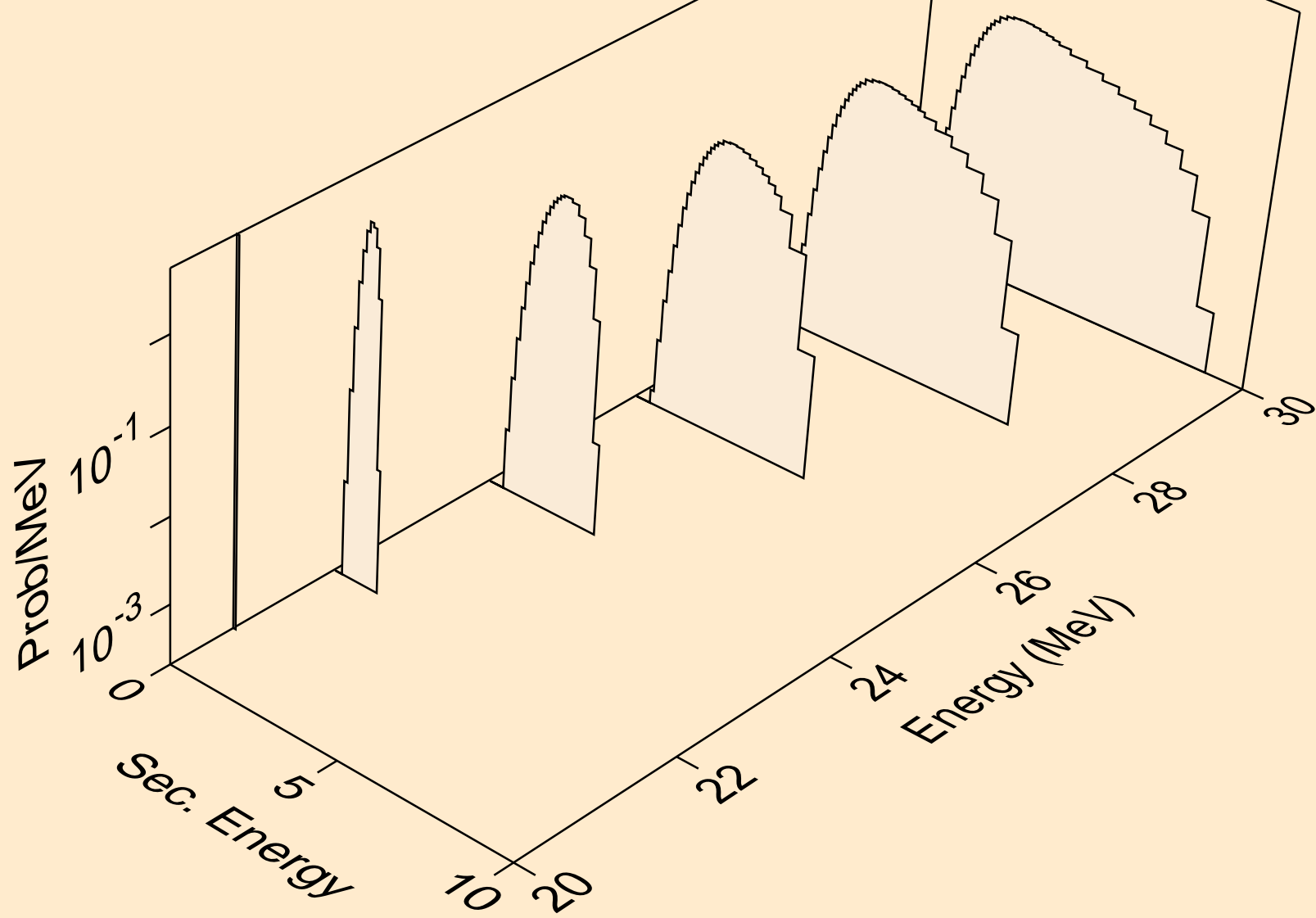

SI031 NEUTRON ACER TENDL-2024 LIBRARY; T=0.K
protons from (n,p)

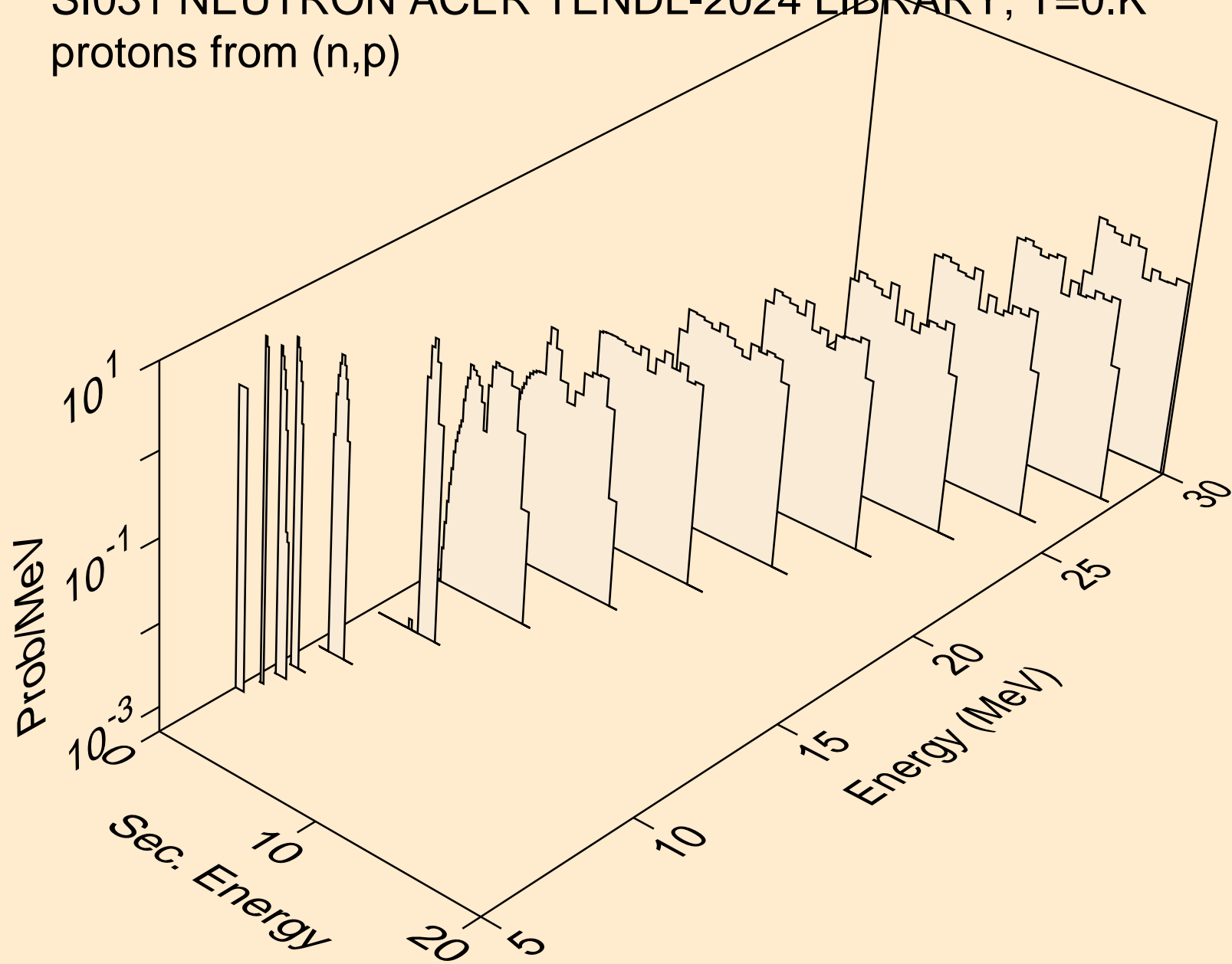

SI031 NEUTRON ACER TENDL-2024 LIBRARY; T=0.K
protons from (n,2p)

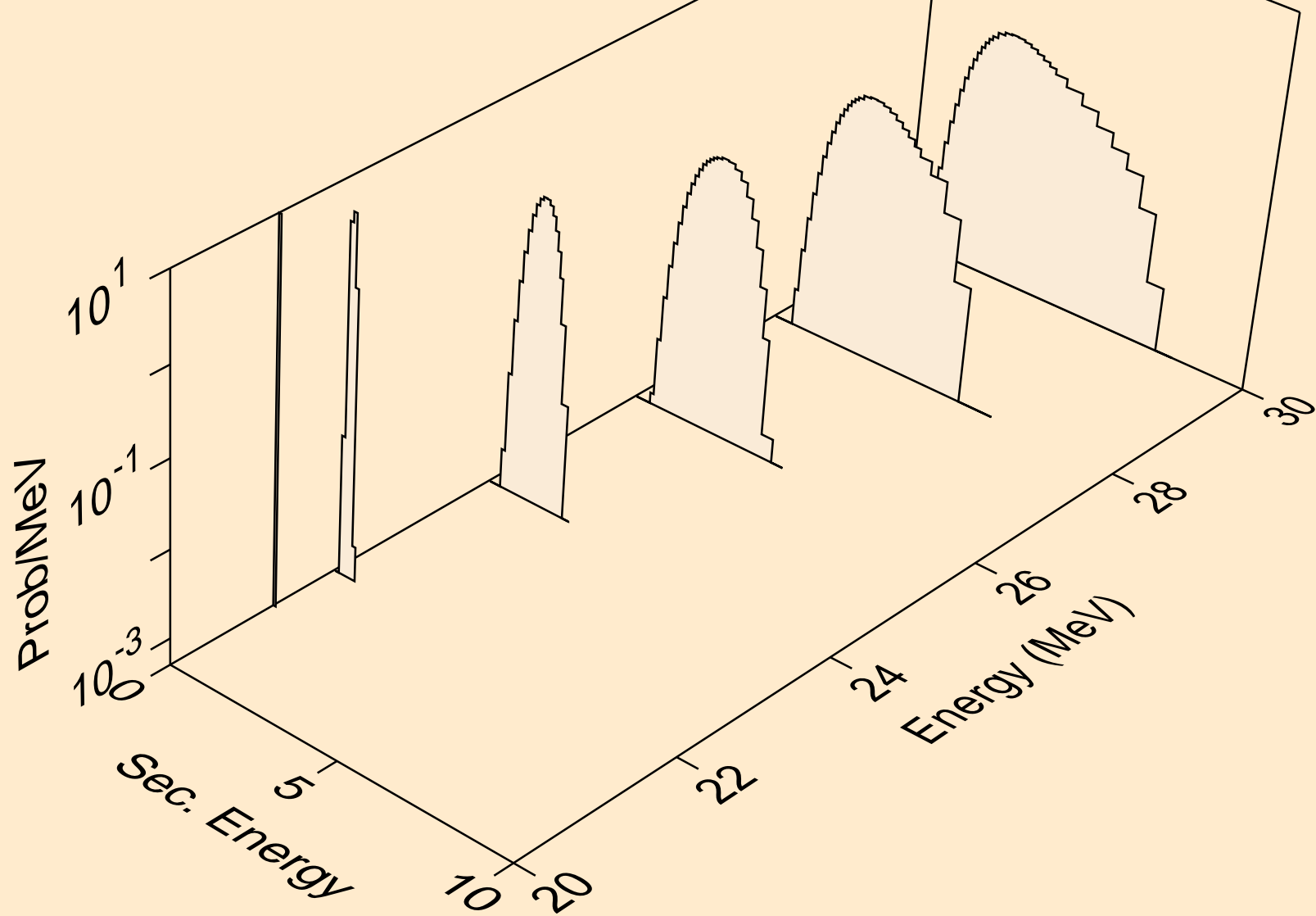

SI031 NEUTRON ACER TENDL-2024 LIBRARY; T=0.K
protons from (n,p)

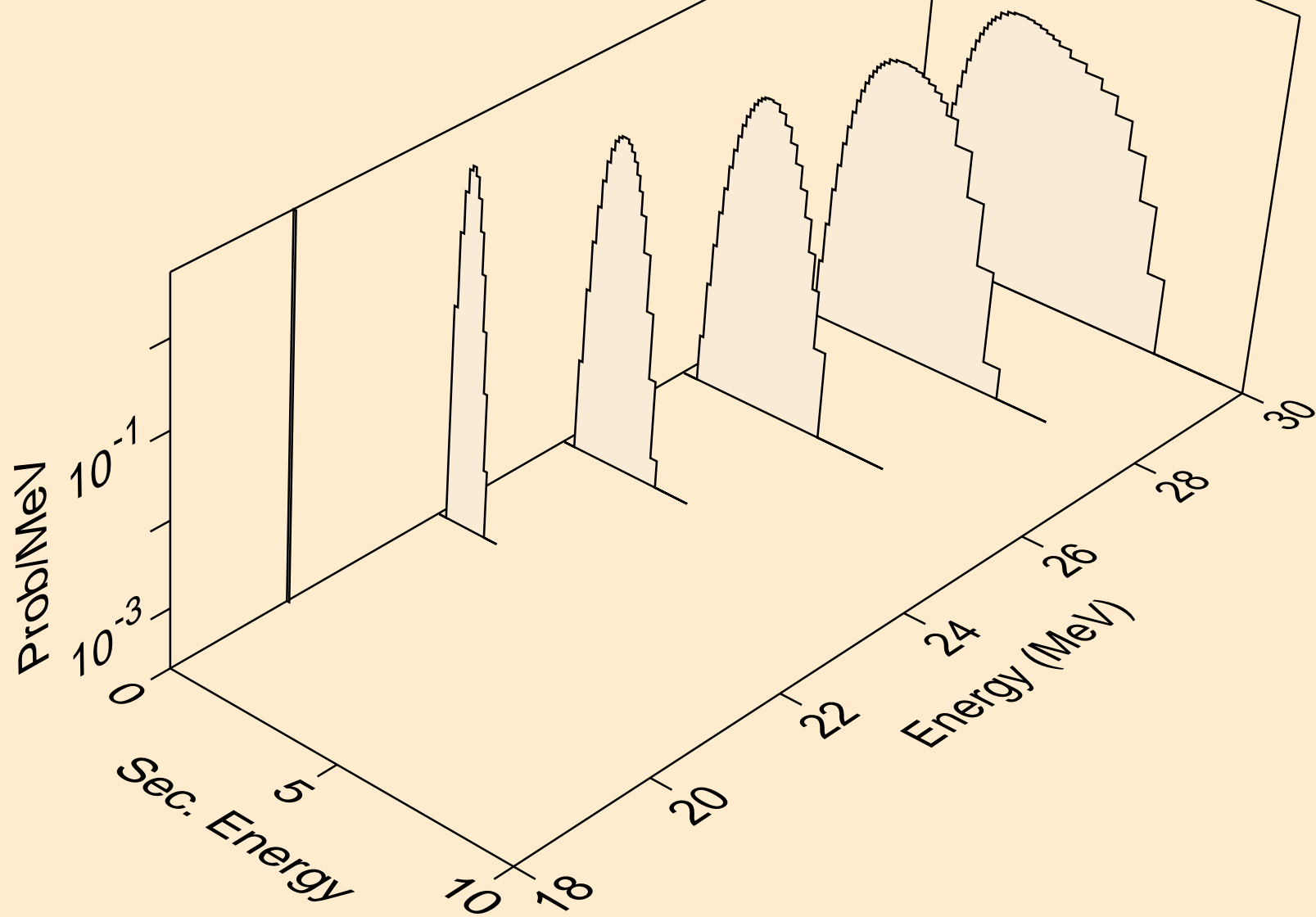

SI031 NEUTRON ACER TENDL-2024 LIBRARY; T=0.K
protons from (n,pd)

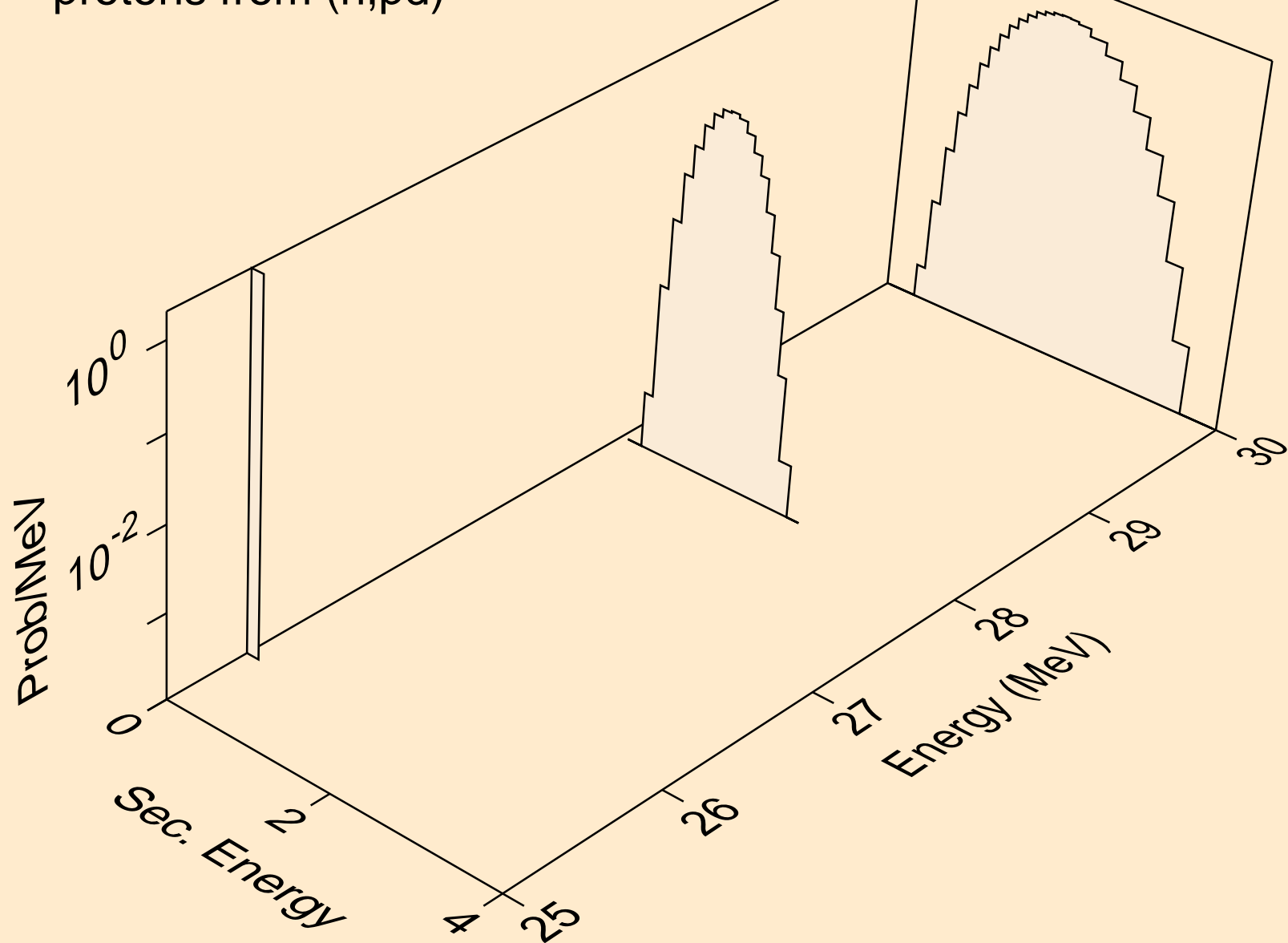

SI031 NEUTRON ACER TENDL-2024 LIBRARY; T=0.K
protons from (n,pt)

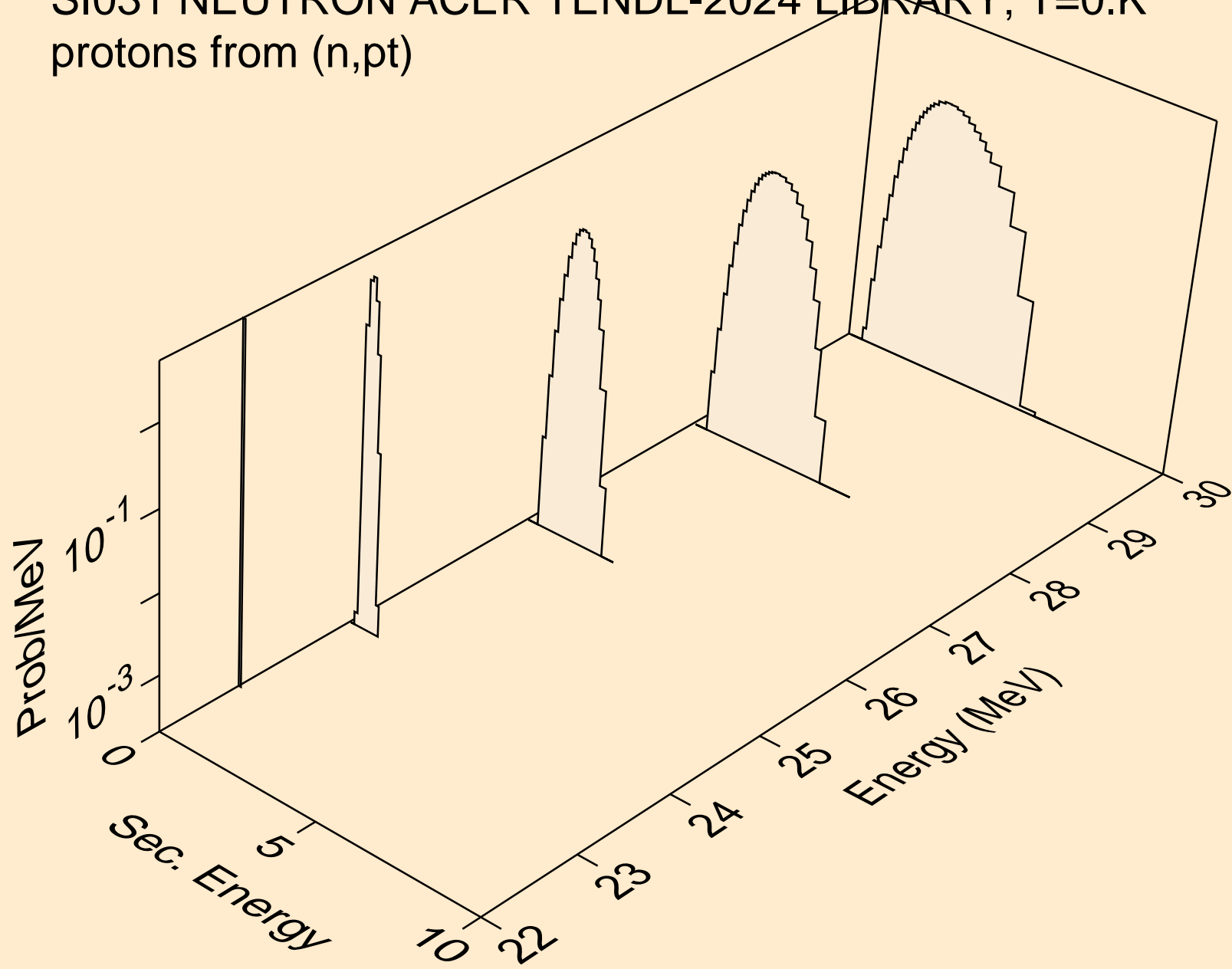

SI031 NEUTRON ACER TENDL-2024 LIBRARY; T=0.K
deuterons from (n,x)

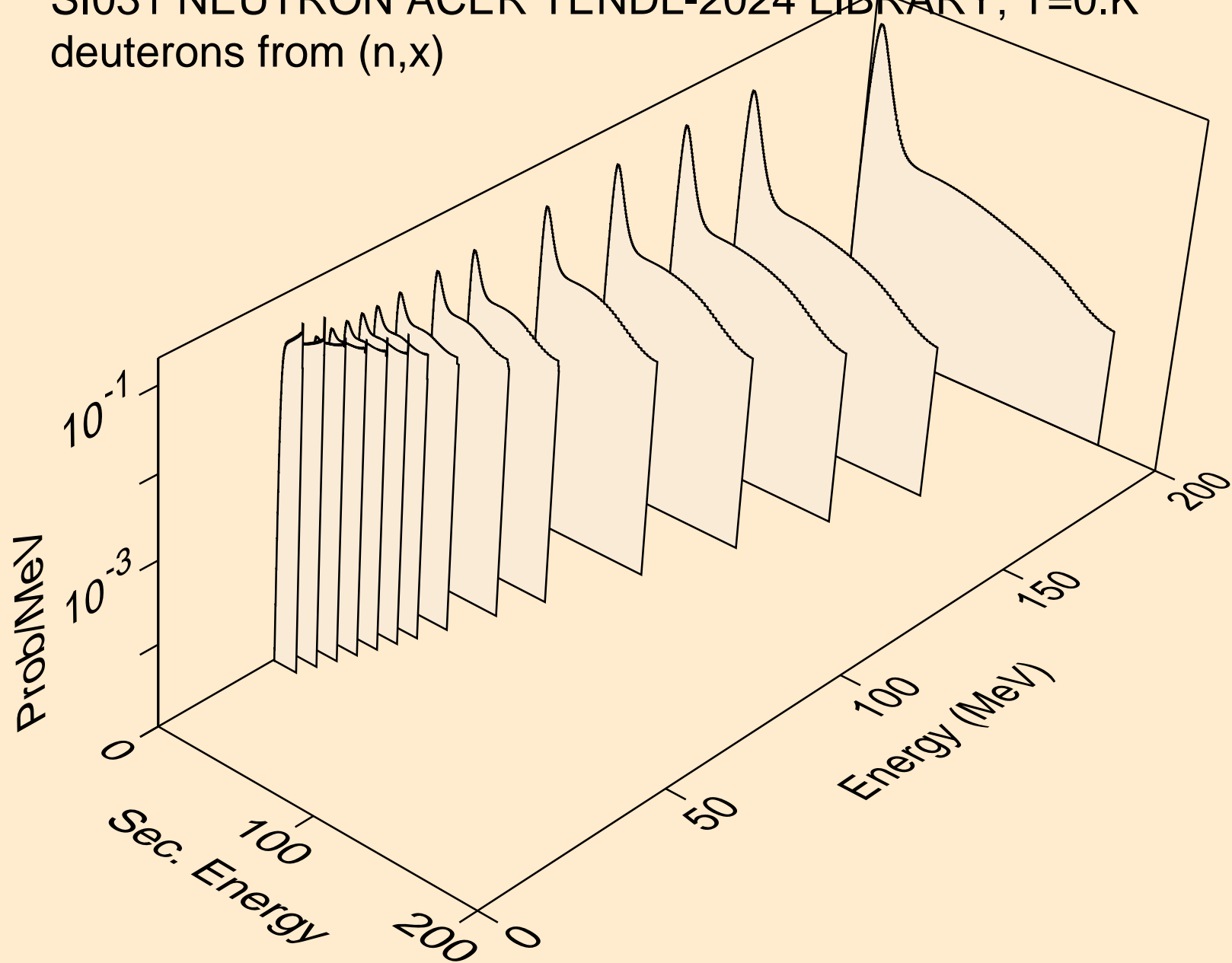

SI031 NEUTRON ACER TENDL-2024 LIBRARY; T=0.K
deuterons from (n,2nd)

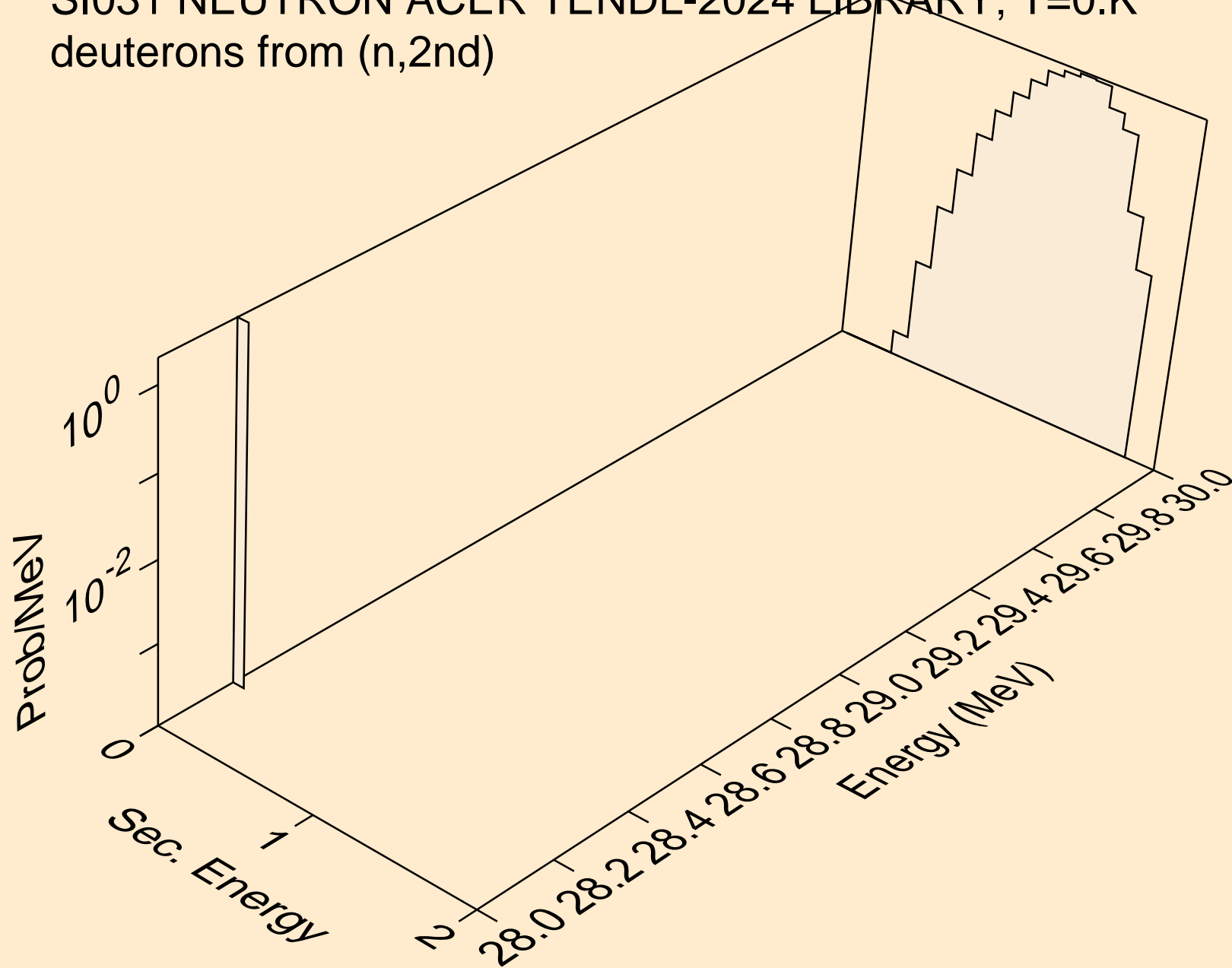

SI031 NEUTRON ACER TENDL-2024 LIBRARY; T=0.K
deuterons from (n,n*)d

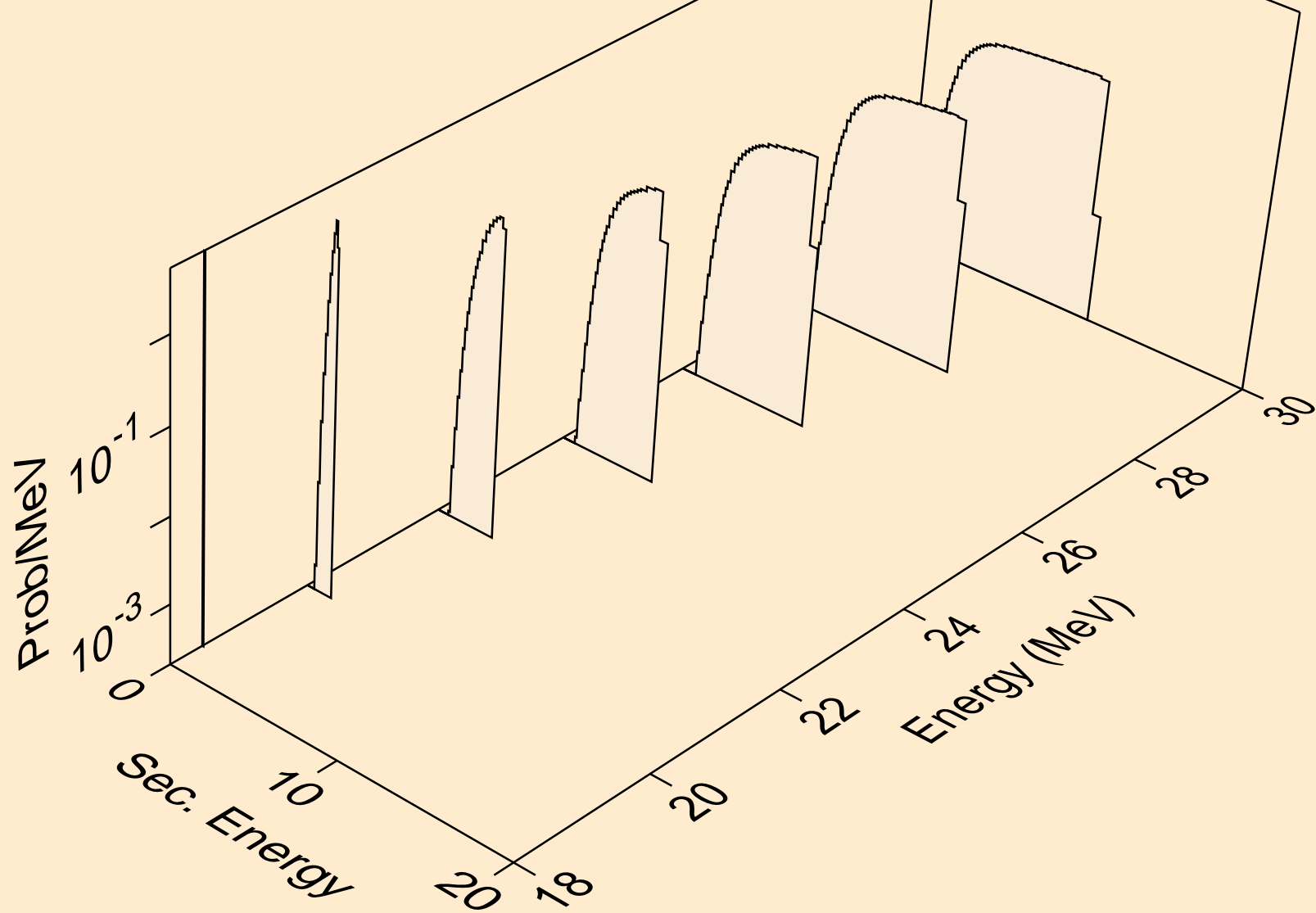

SI031 NEUTRON ACER TENDL-2024 LIBRARY; T=0.K
deuterons from (n,d)

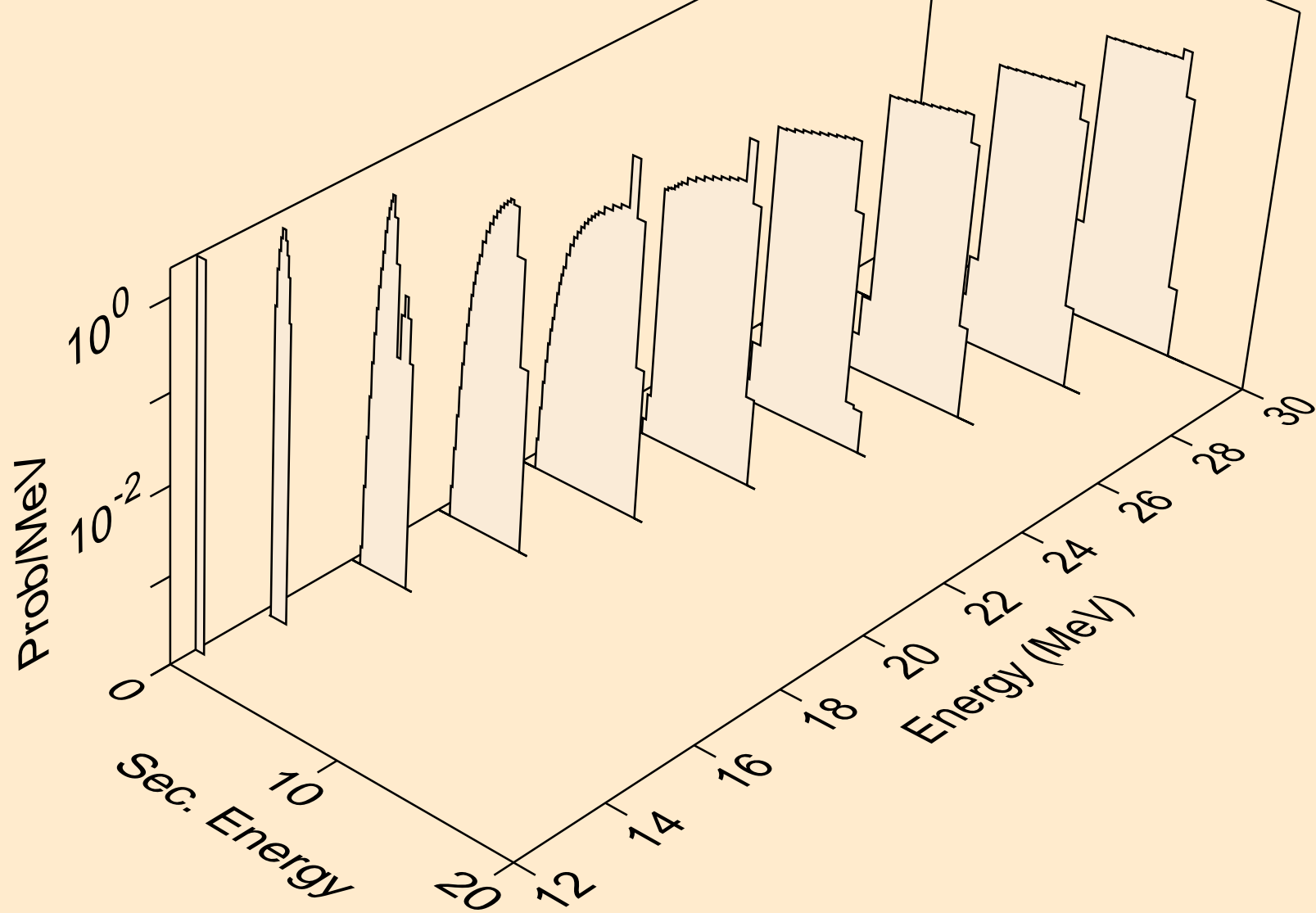

SI031 NEUTRON ACER TENDL-2024 LIBRARY; T=0.K
deuterons from (n,pd)

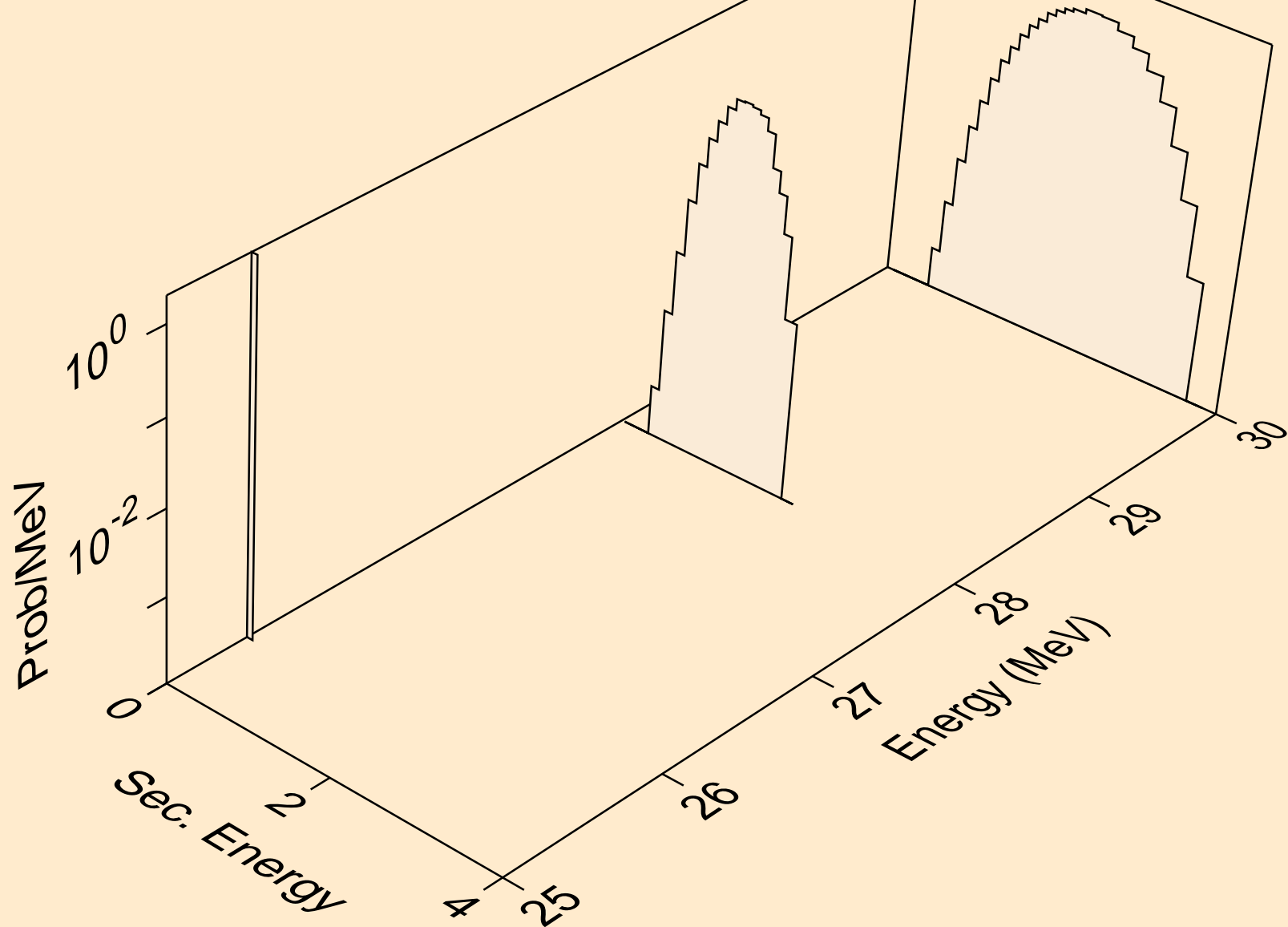

SI031 NEUTRON ACER TENDL-2024 LIBRARY; T=0.K
deuterons from (n,da)

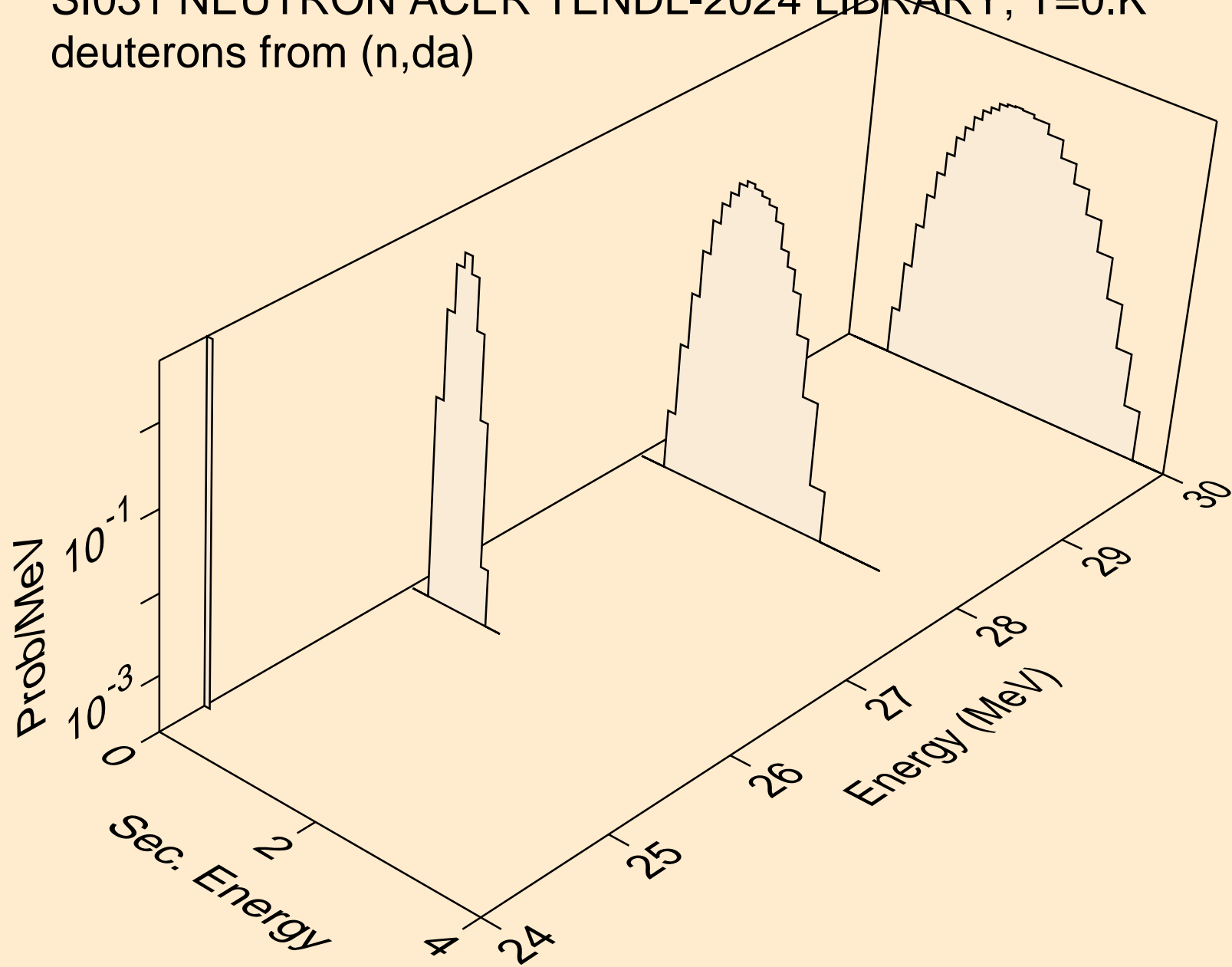

SI031 NEUTRON ACER TENDL-2024 LIBRARY; T=0.K
tritons from (n,x)

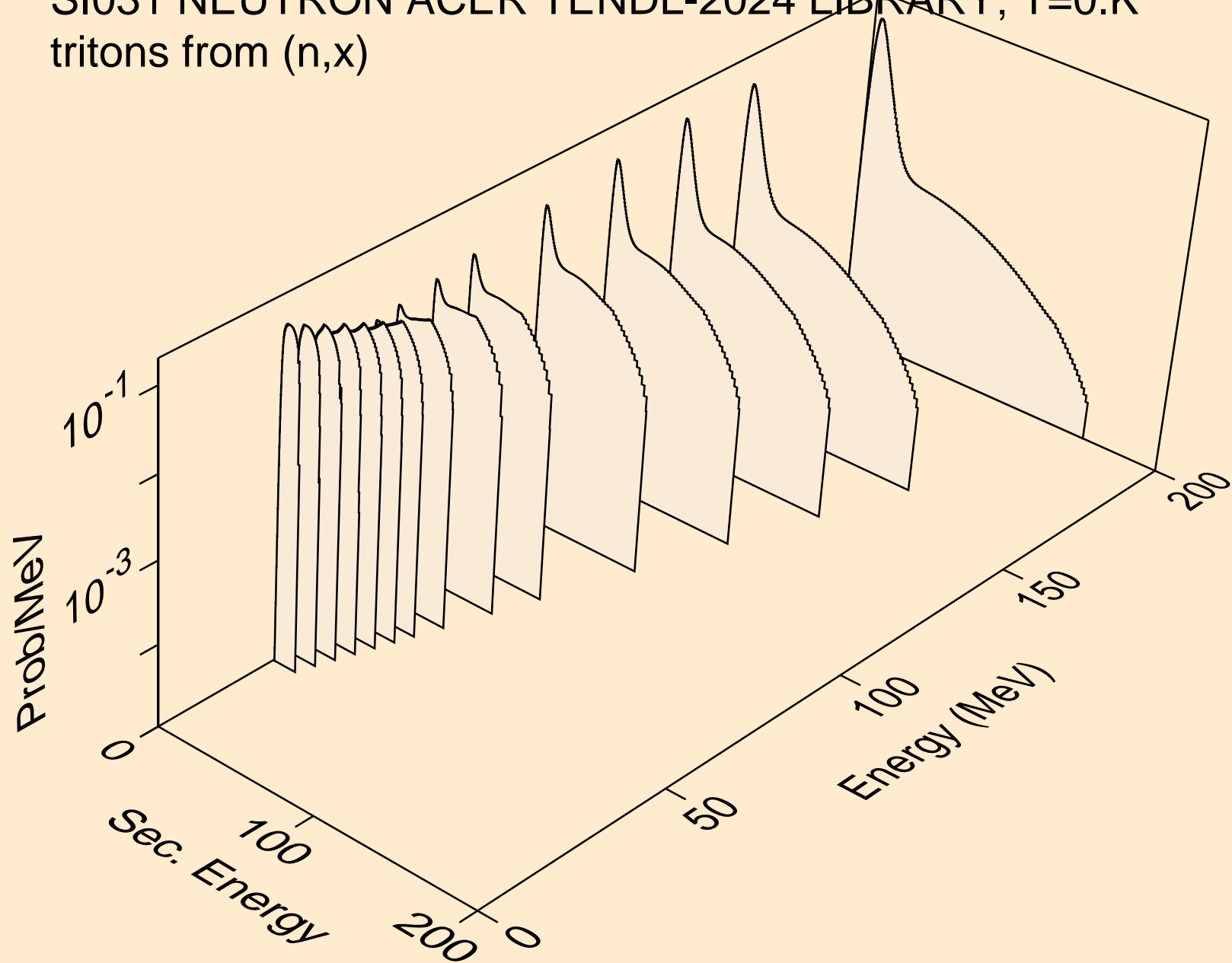

SI031 NEUTRON ACER TENDL-2024 LIBRARY; T=0.K
tritons from (n,n*)t

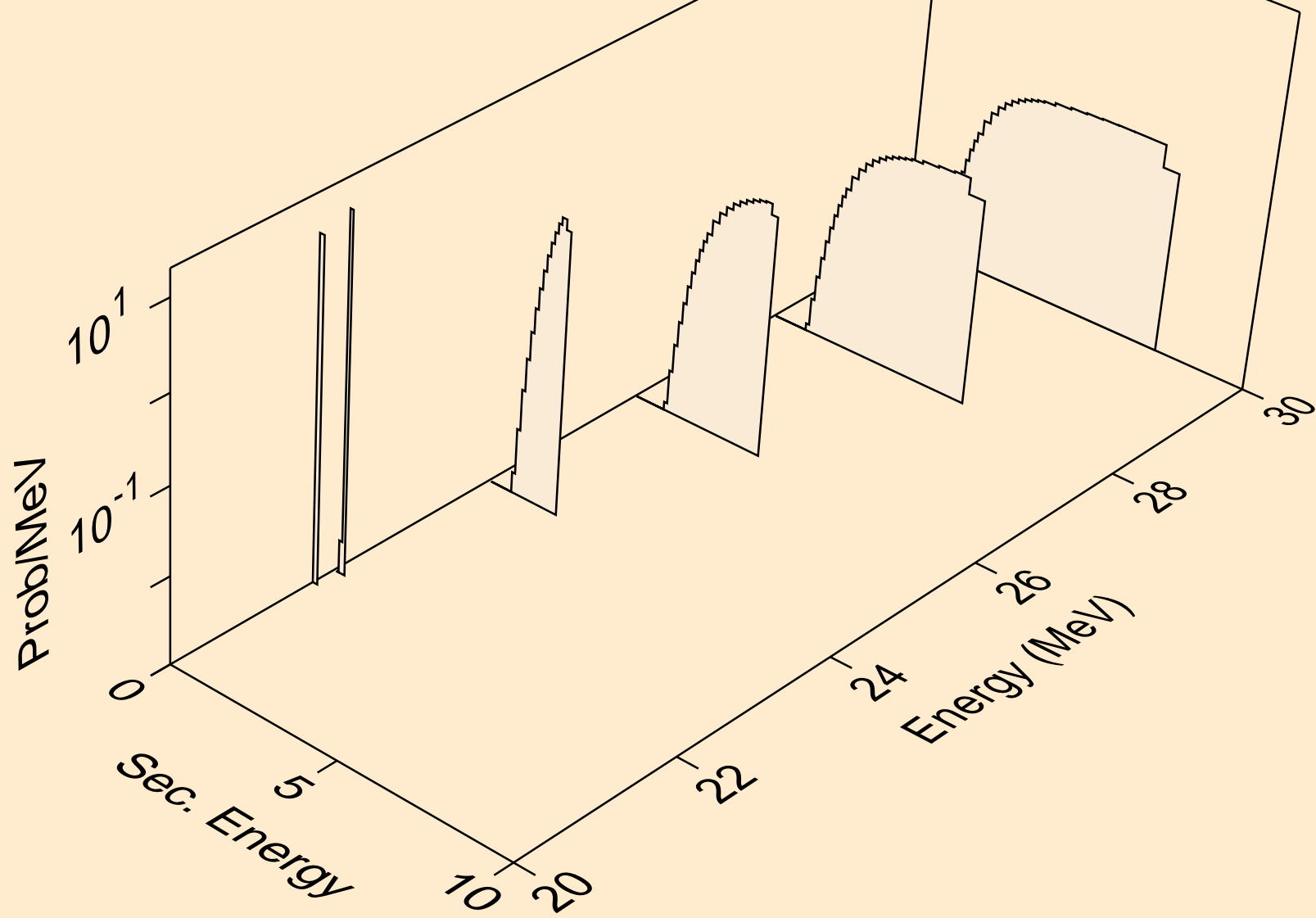

SI031 NEUTRON ACER TENDL-2024 LIBRARY; T=0.K
tritons from (n,t)

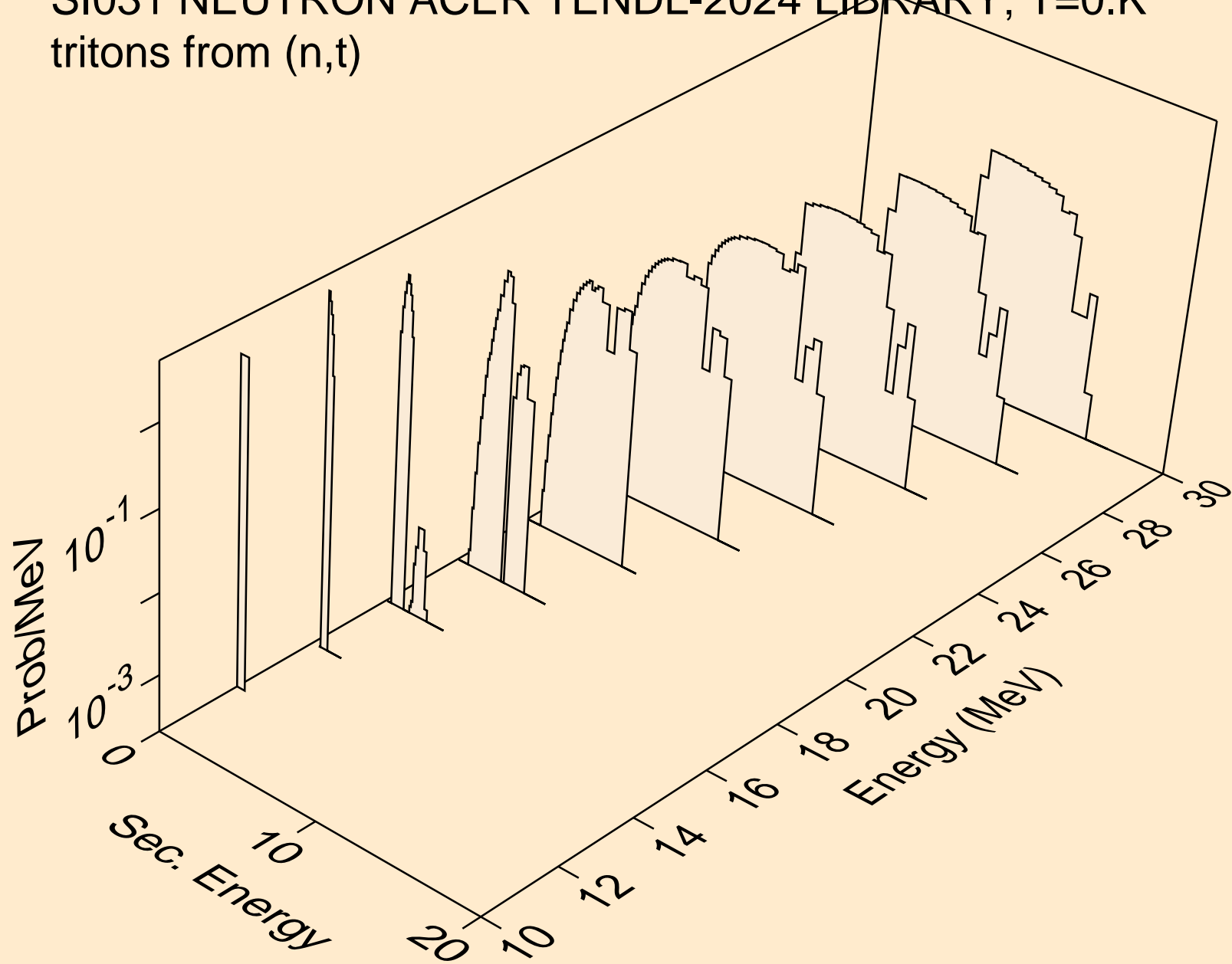

SI031 NEUTRON ACER TENDL-2024 LIBRARY; T=0.K
tritons from (n,pt)

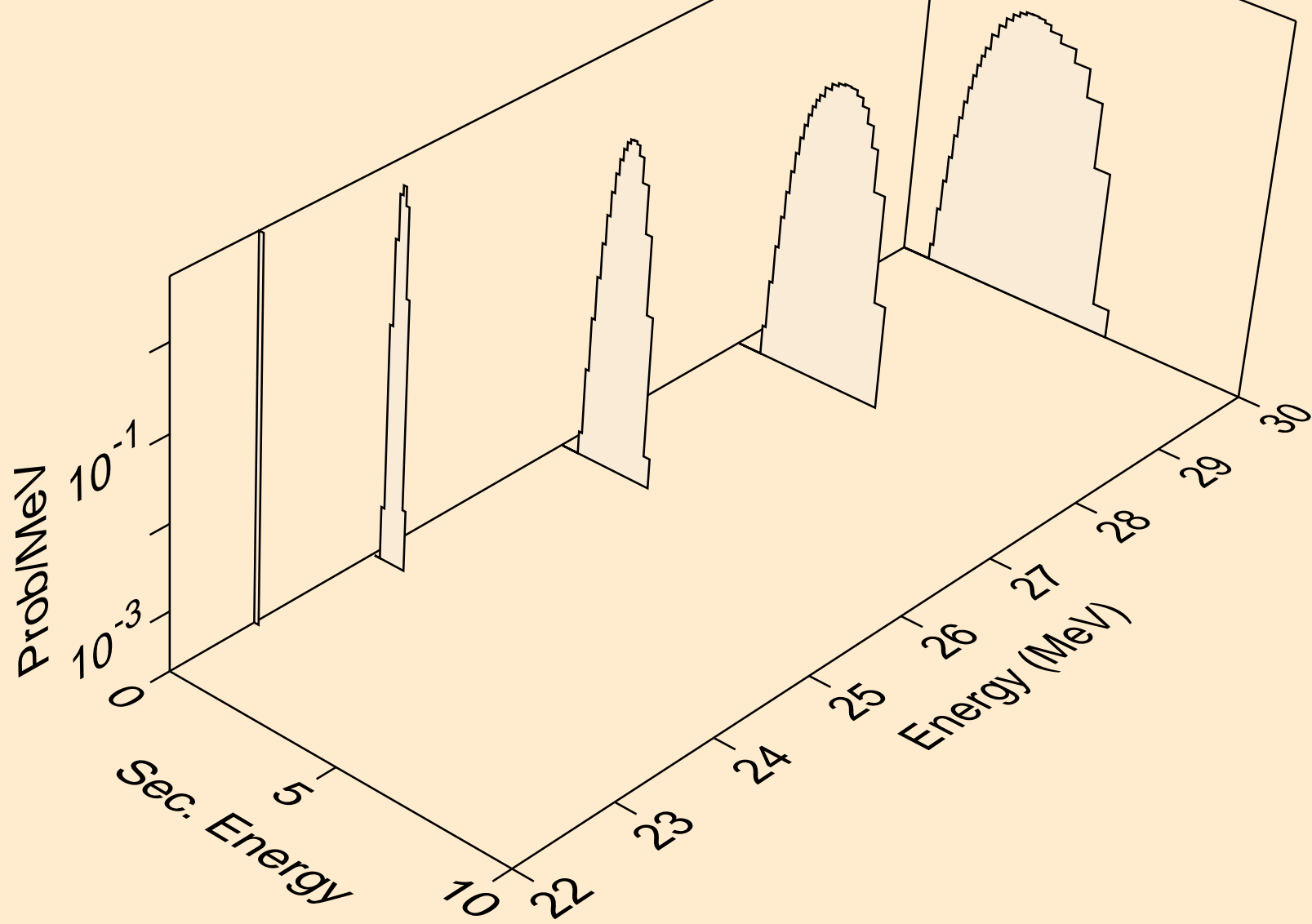

SI031 NEUTRON ACER TENDL-2024 LIBRARY; T=0.K
he3s from (n,x)

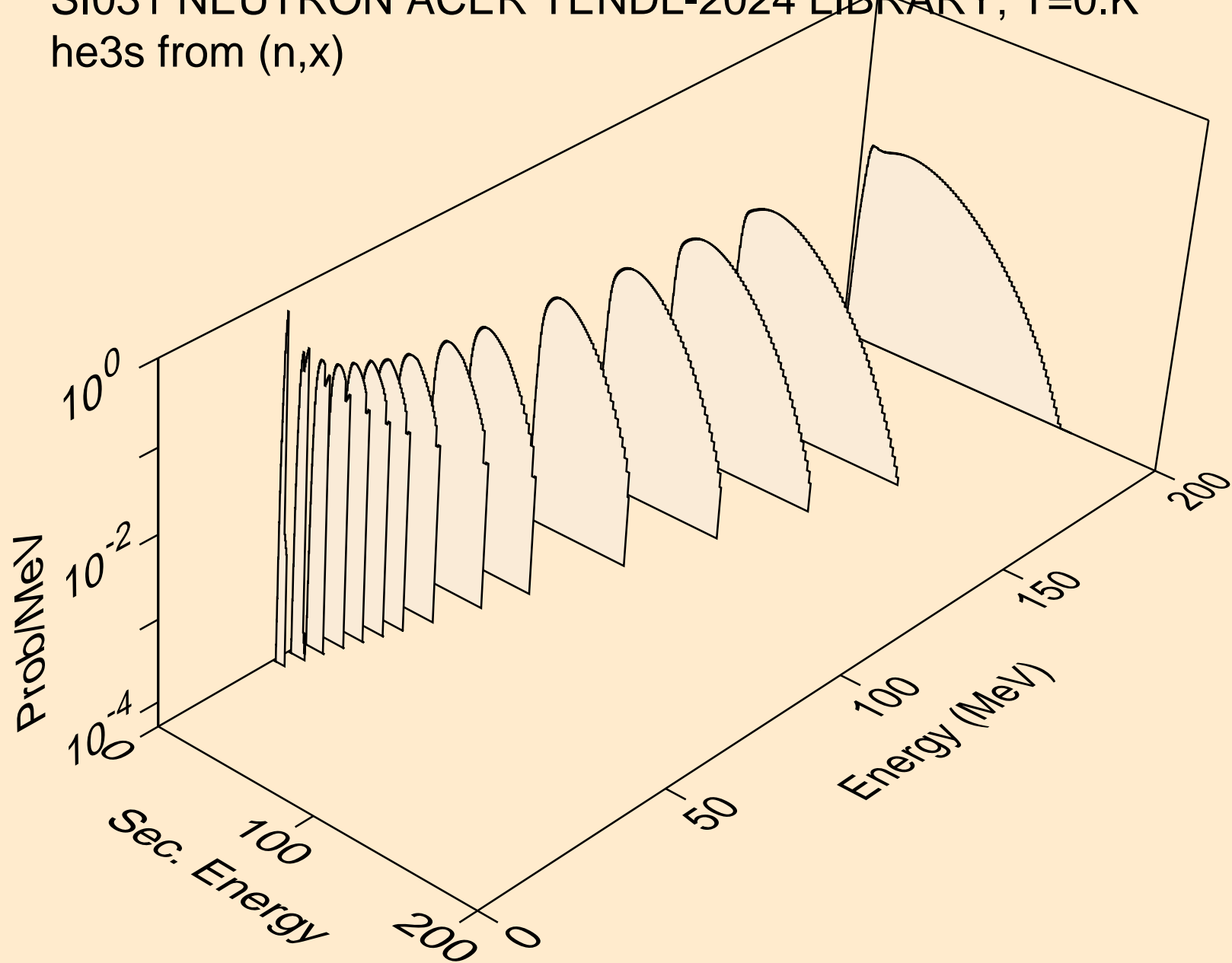

SI031 NEUTRON ACER TENDL-2024 LIBRARY; T=0.K
he3s from (n,n*)he3

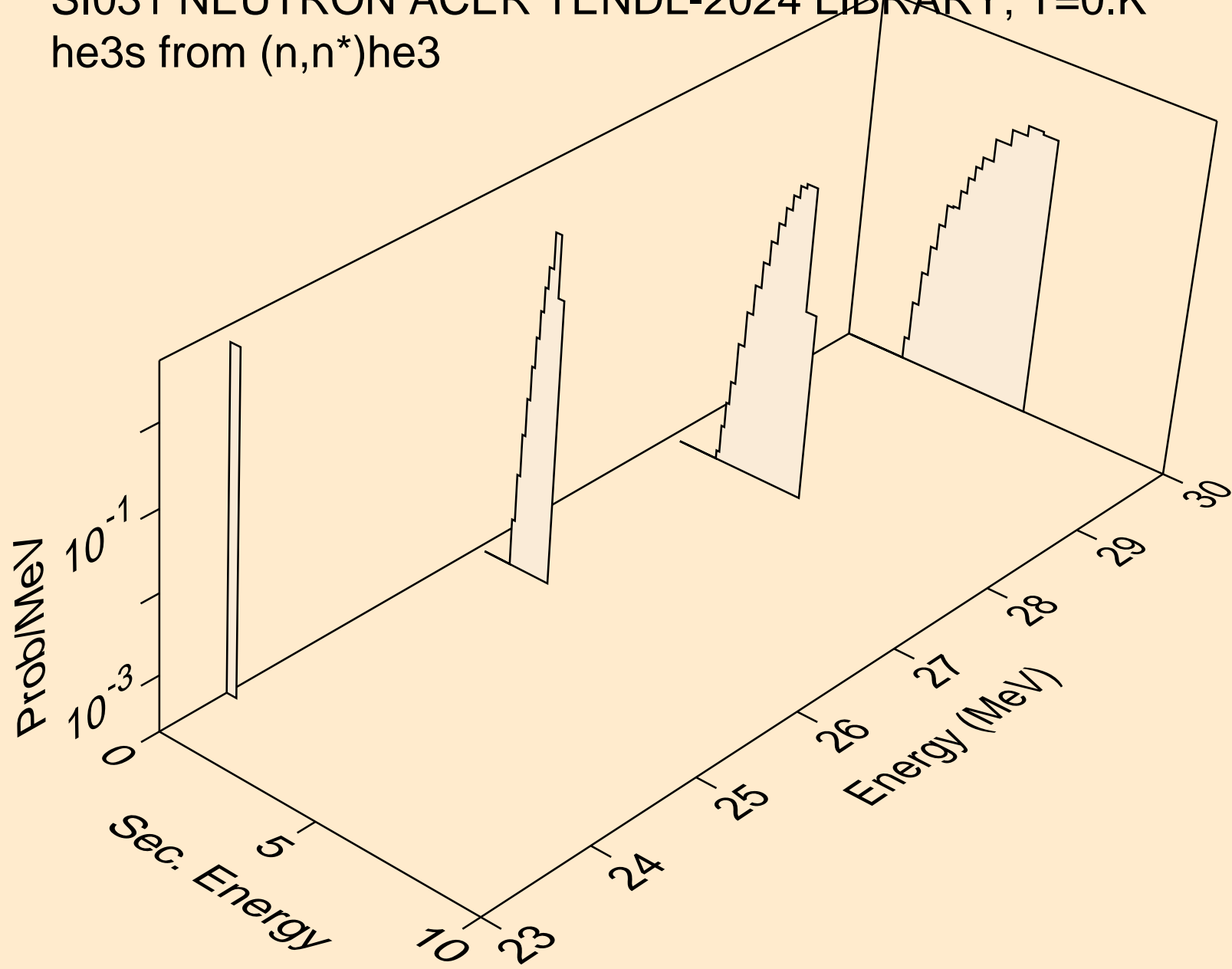

SI031 NEUTRON ACER TENDL-2024 LIBRARY; T=0.K
he3s from (n,he3)

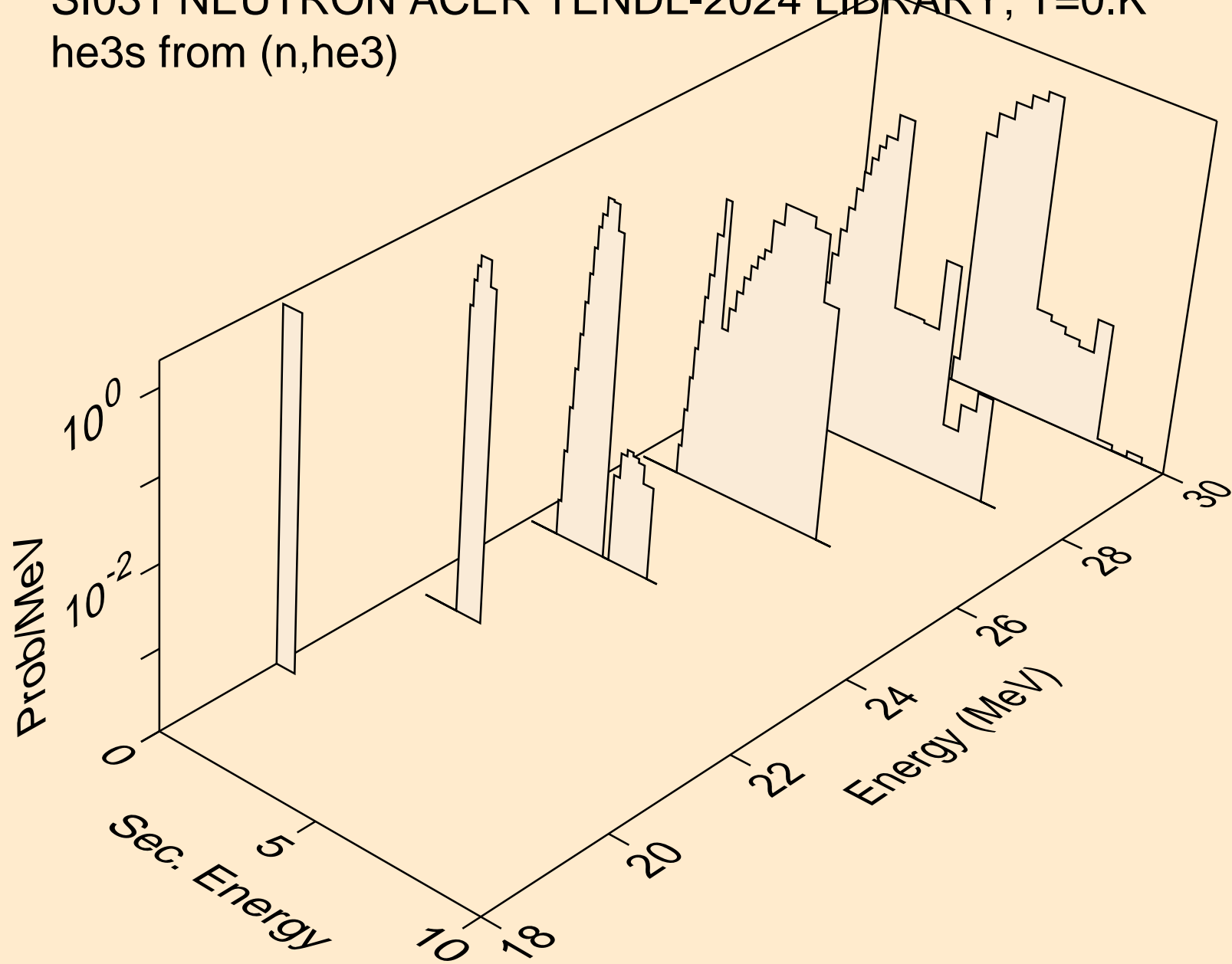

SI031 NEUTRON ACER TENDL-2024 LIBRARY; T=0.K
alphas from (n,x)

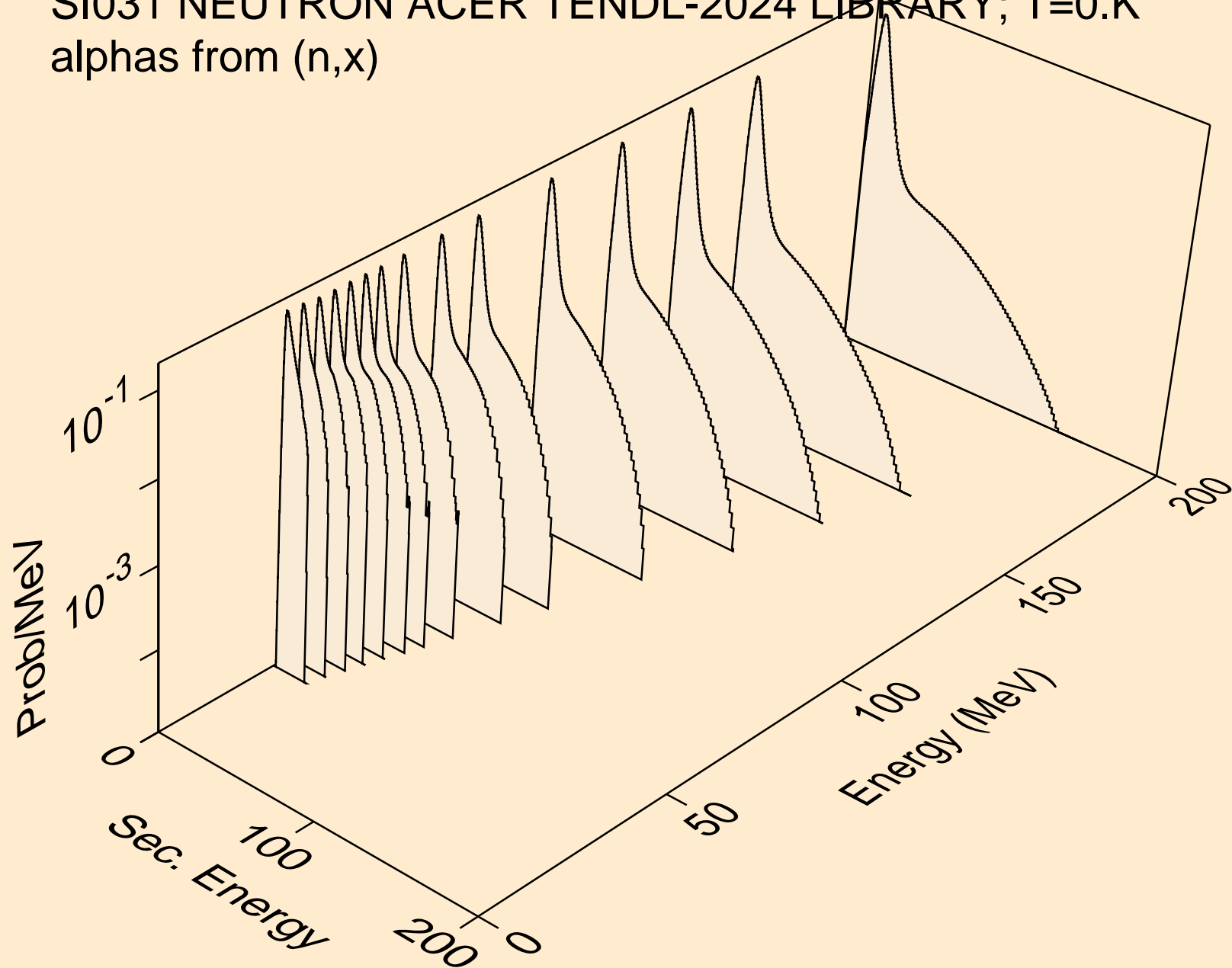

SI031 NEUTRON ACER TENDL-2024 LIBRARY; T=0.K
alphas from (n,n*)a

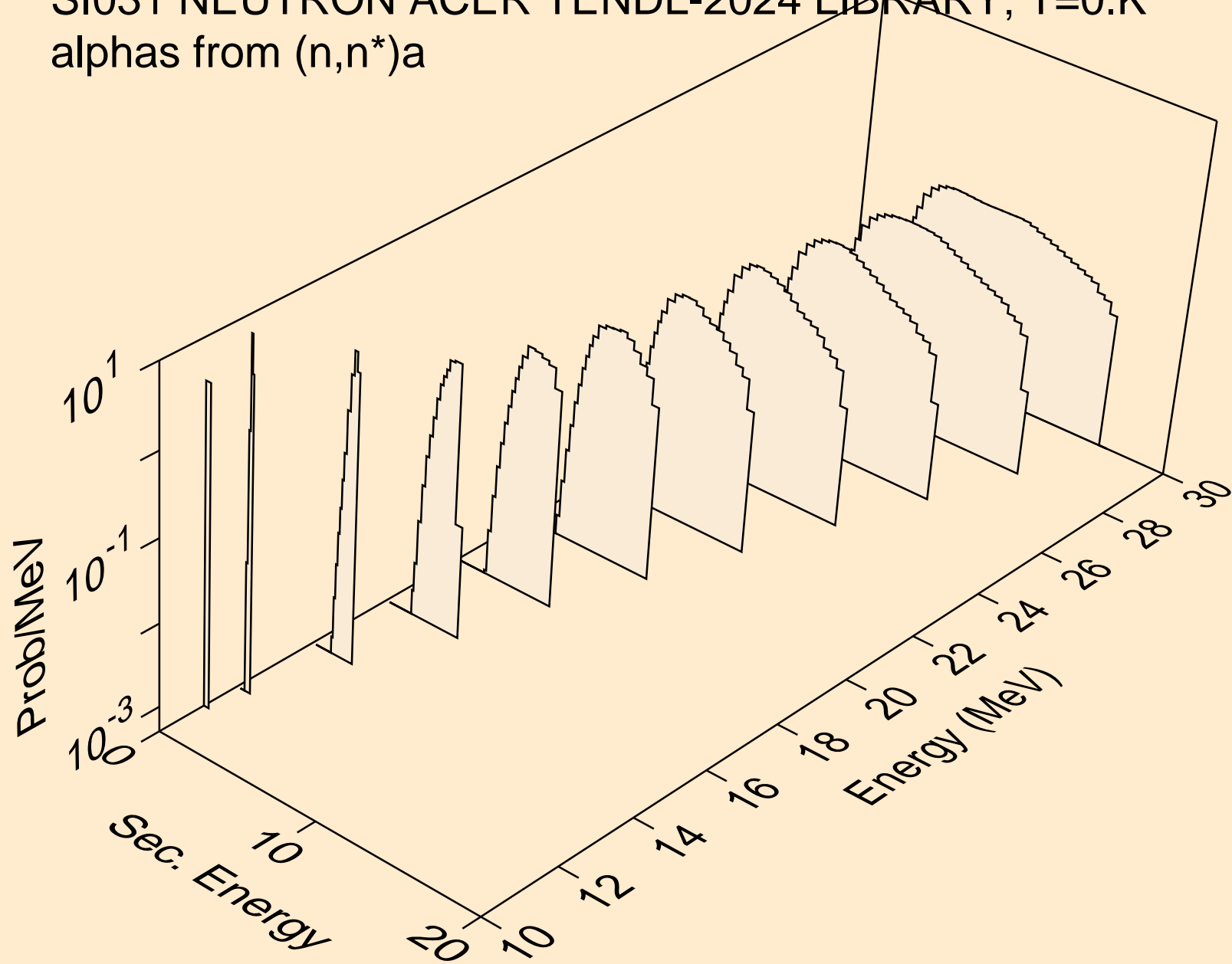

SI031 NEUTRON ACER TENDL-2024 LIBRARY; T=0.K
alphas from (n,2n)a

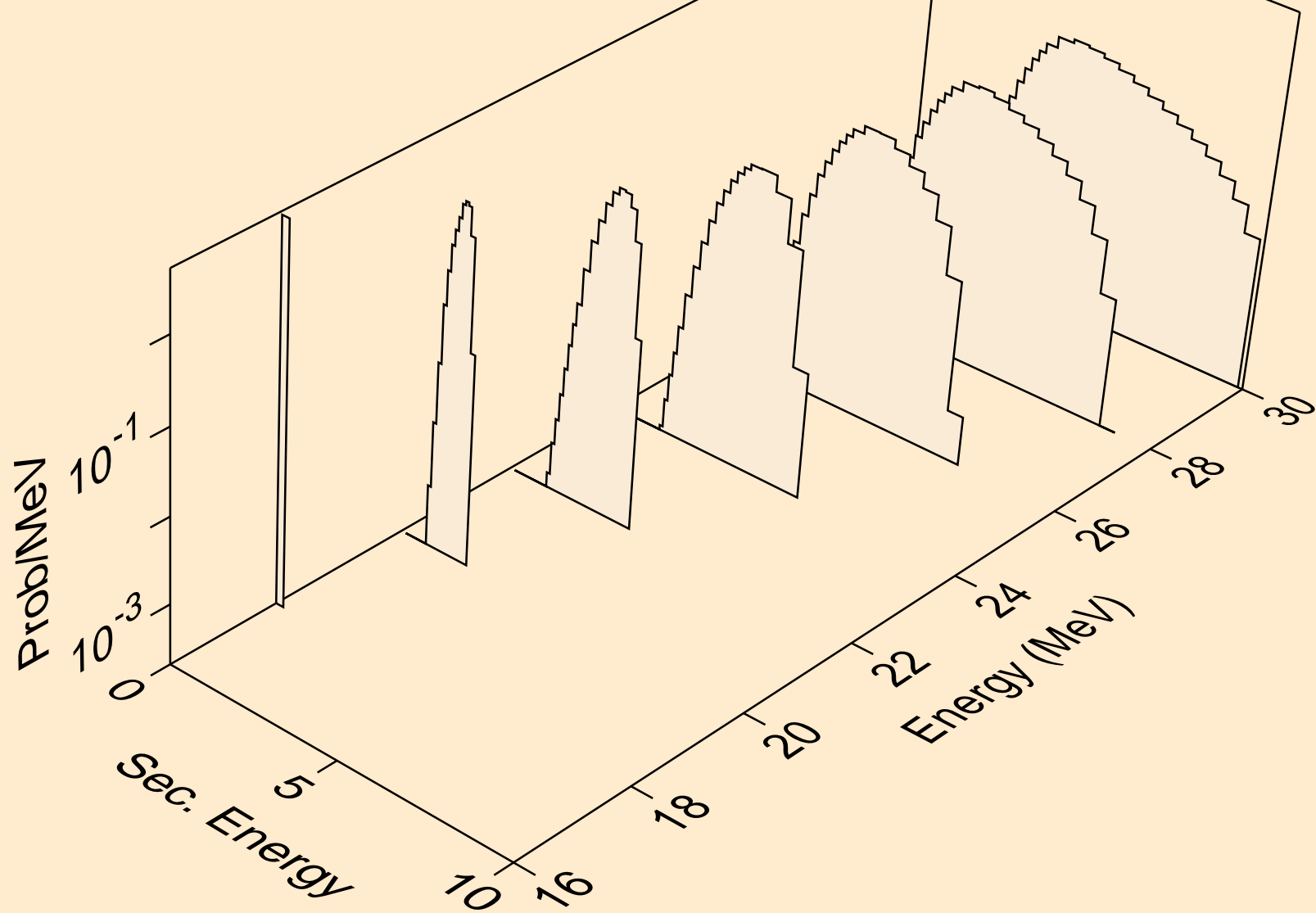

SI031 NEUTRON ACER TENDL-2024 LIBRARY; T=0.K
alphas from (n,n*)2a

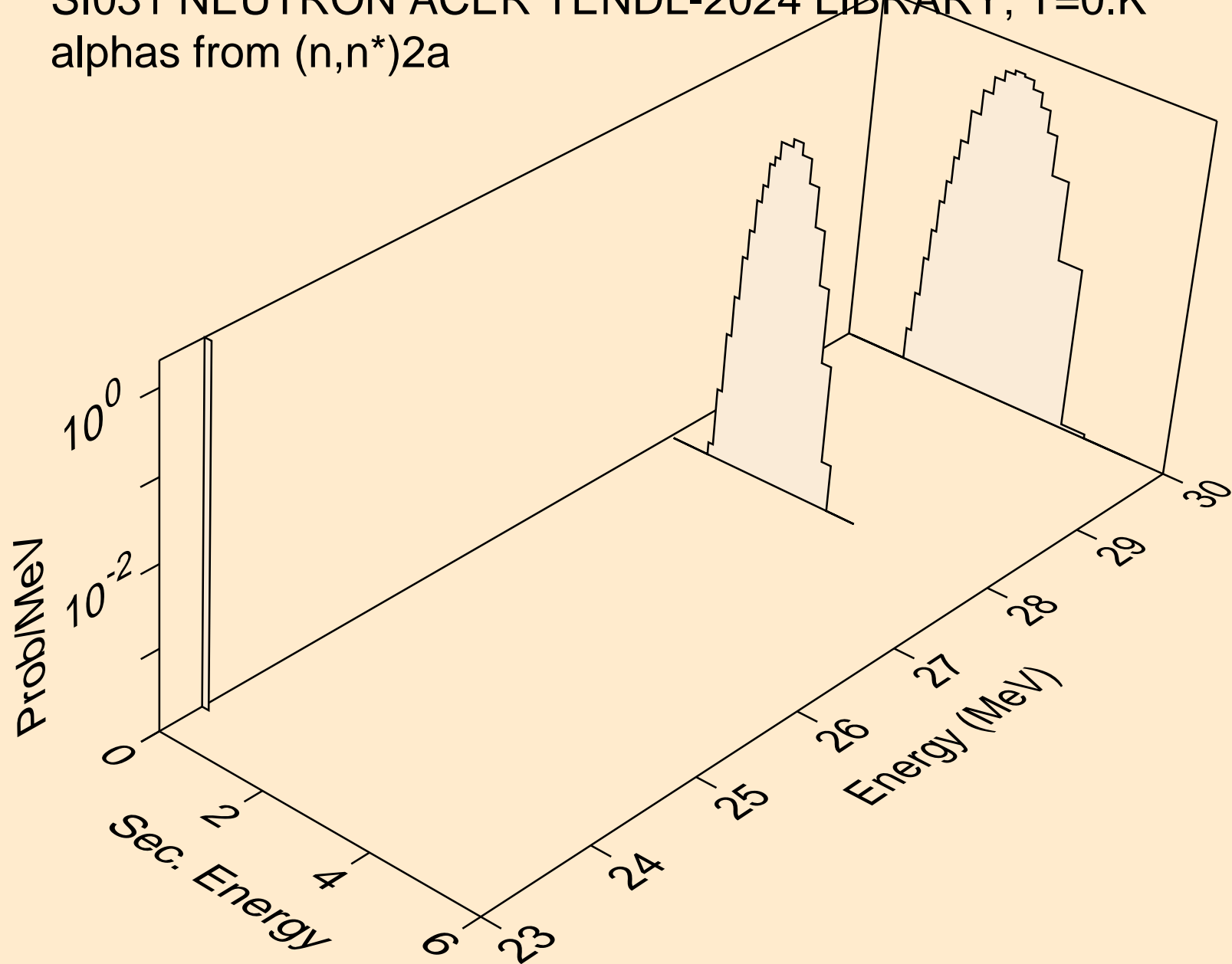

SI031 NEUTRON ACER TENDL-2024 LIBRARY; T=0.K
alphas from (n,a)

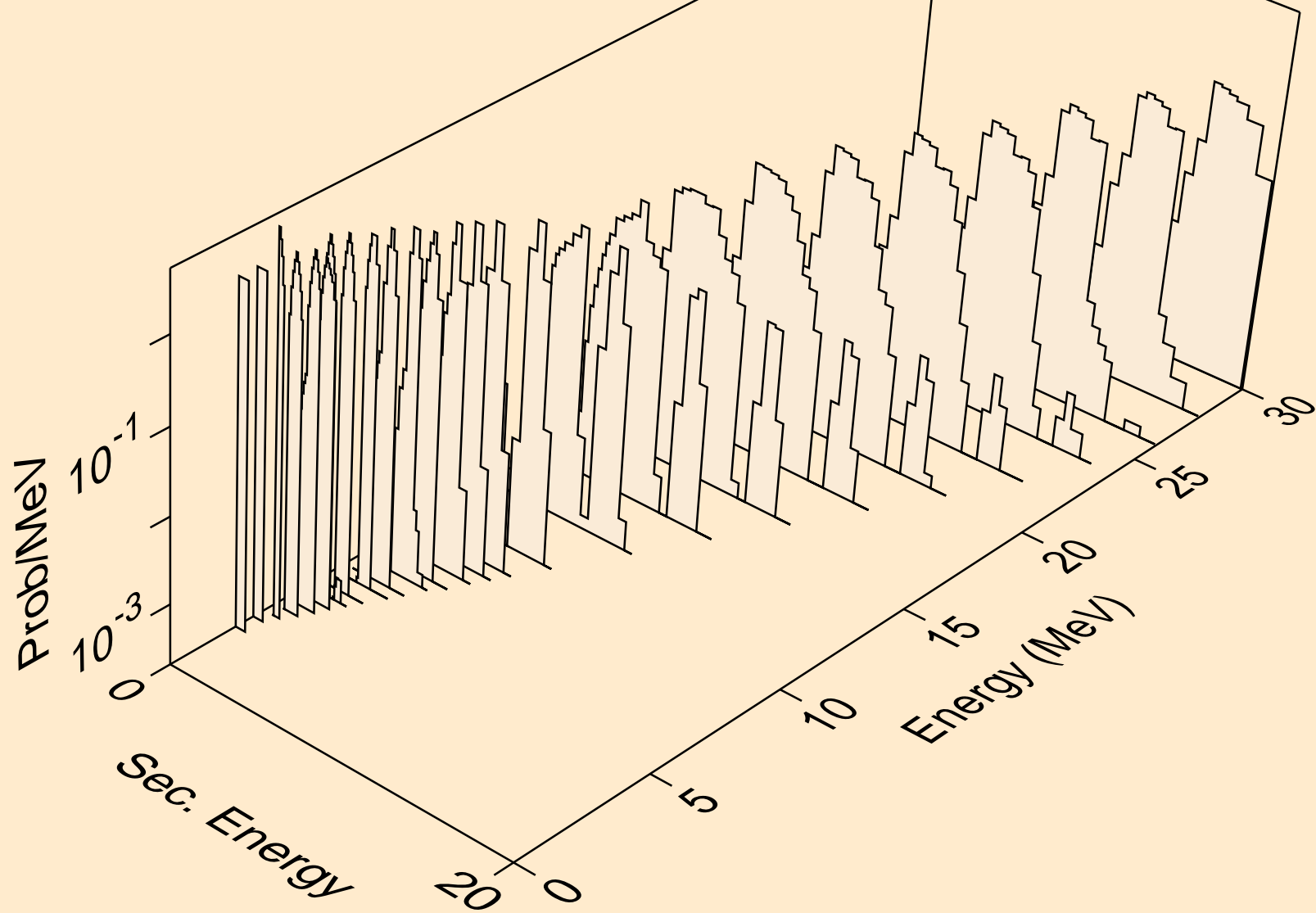

SI031 NEUTRON ACER TENDL-2024 LIBRARY; T=0.K
alphas from (n,2a)

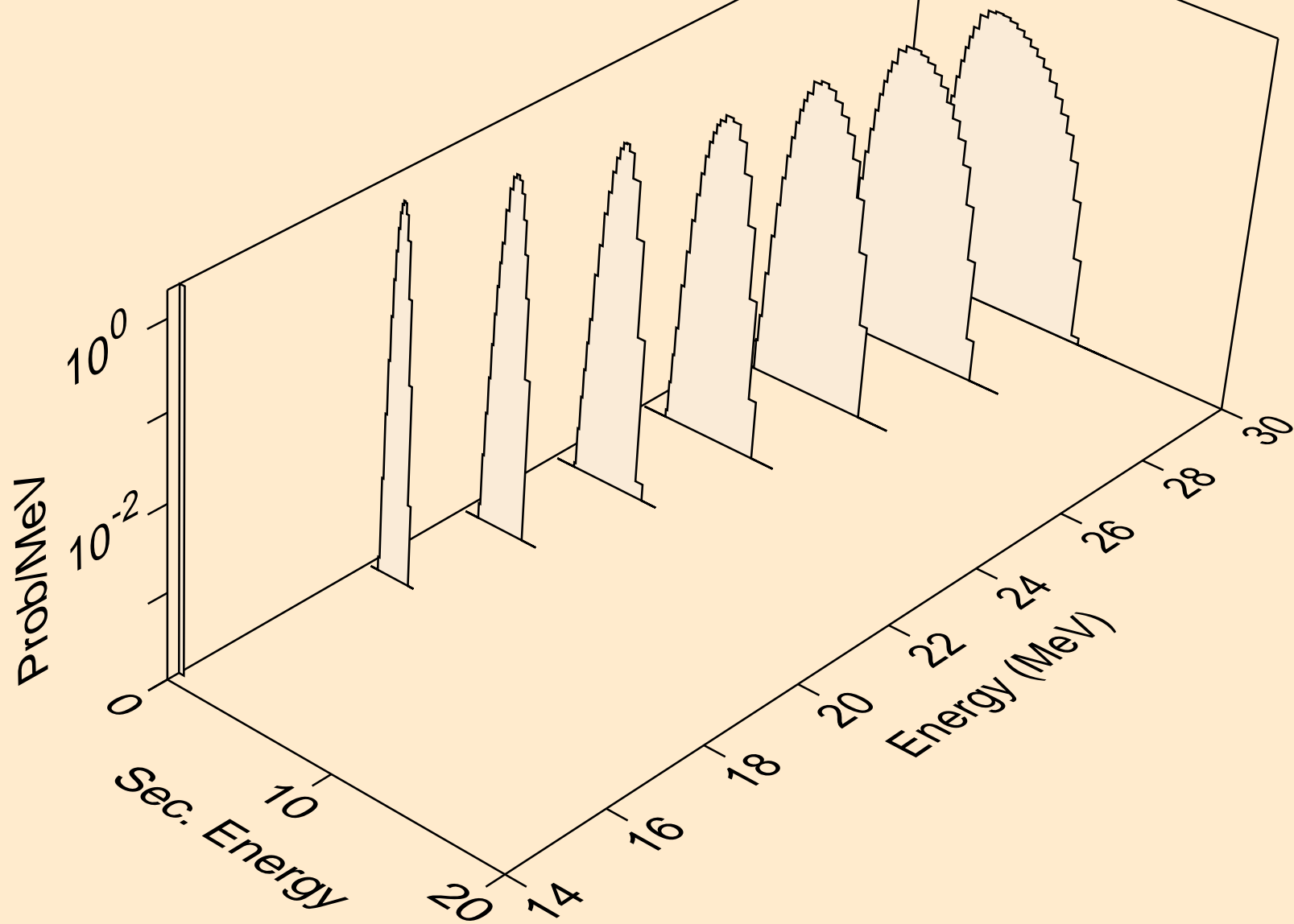

SI031 NEUTRON ACER TENDL-2024 LIBRARY; T=0.K
alphas from (n,pa)

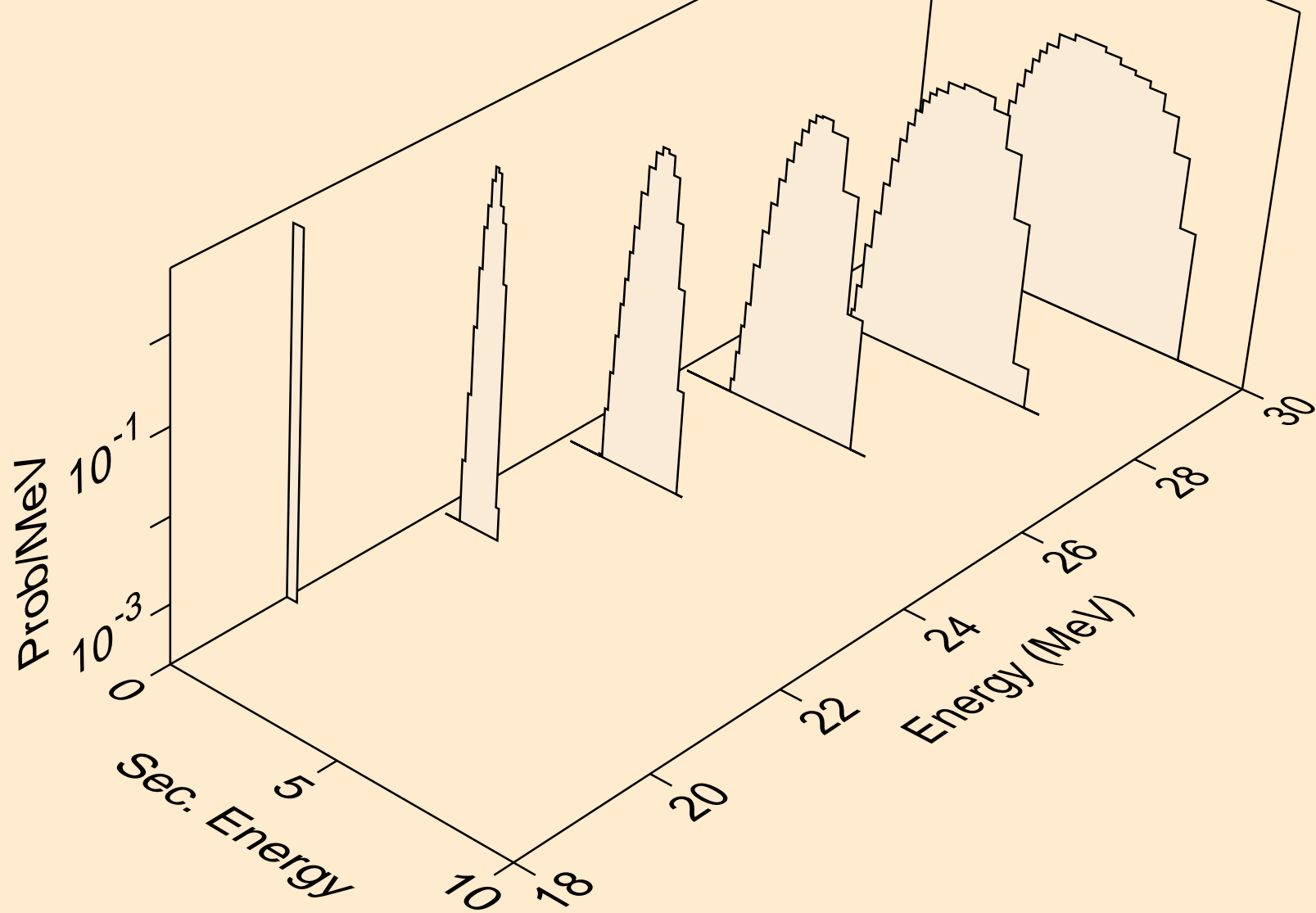

SI031 NEUTRON ACER TENDL-2024 LIBRARY; T=0.K
alphas from (n,da)

