

SN123 NEUTRON ACER TENDL-2024 LIBRARY; T=0.K

Principal cross sections

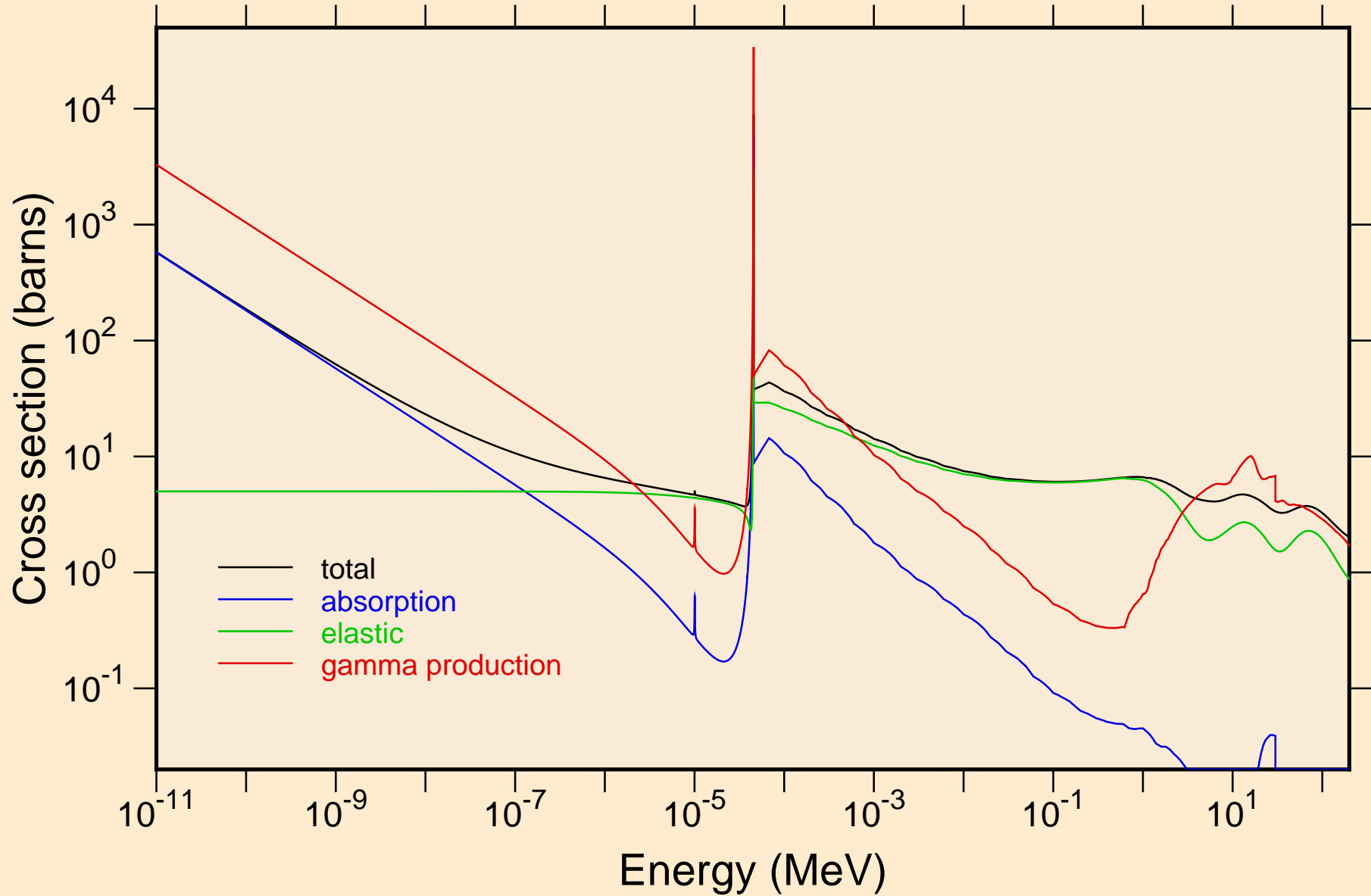

SN123 NEUTRON ACER TENDL-2024 LIBRARY; T=0.K

Heating

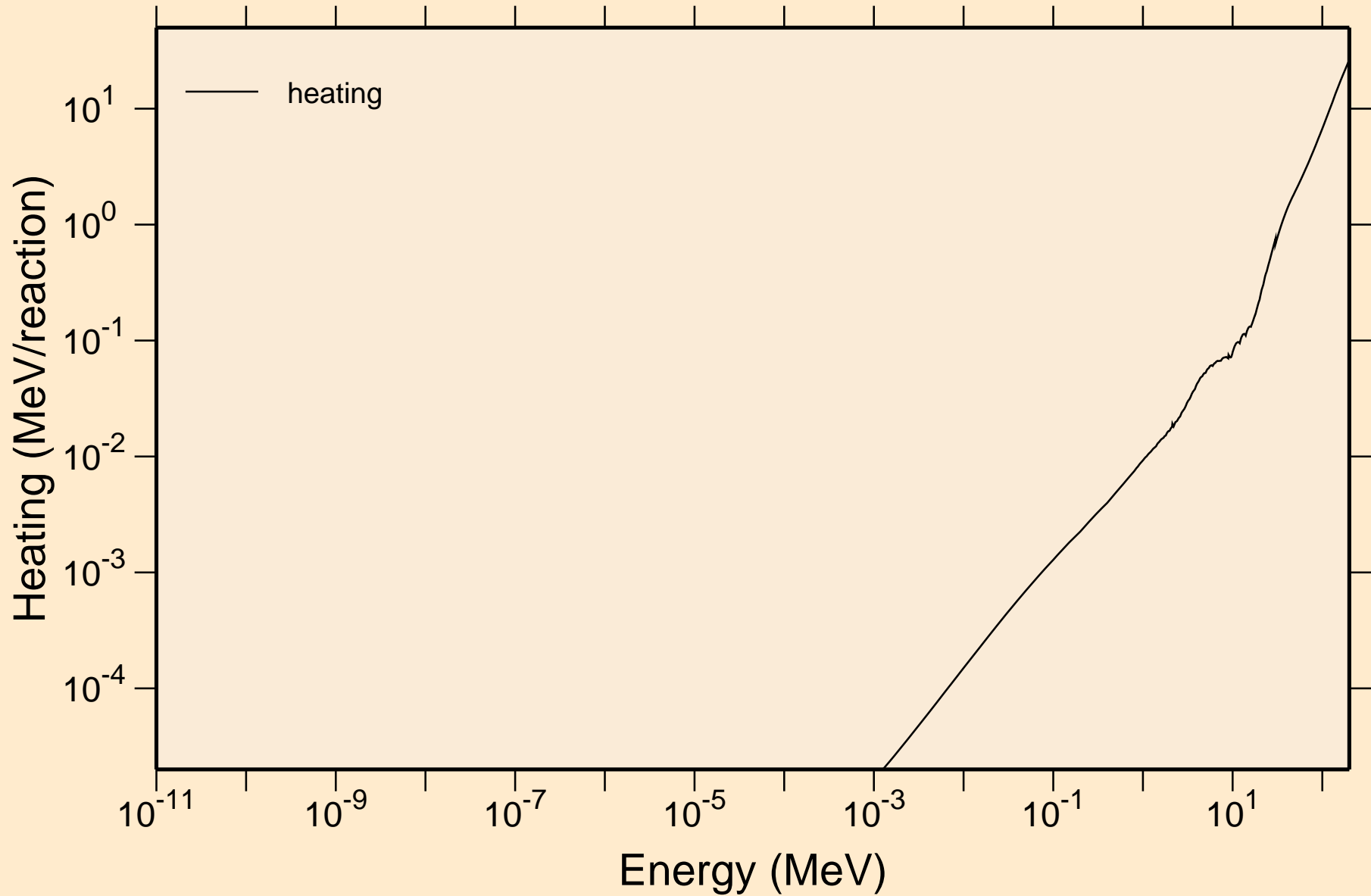

SN123 NEUTRON ACER TENDL-2024 LIBRARY; T=0.K

Damage

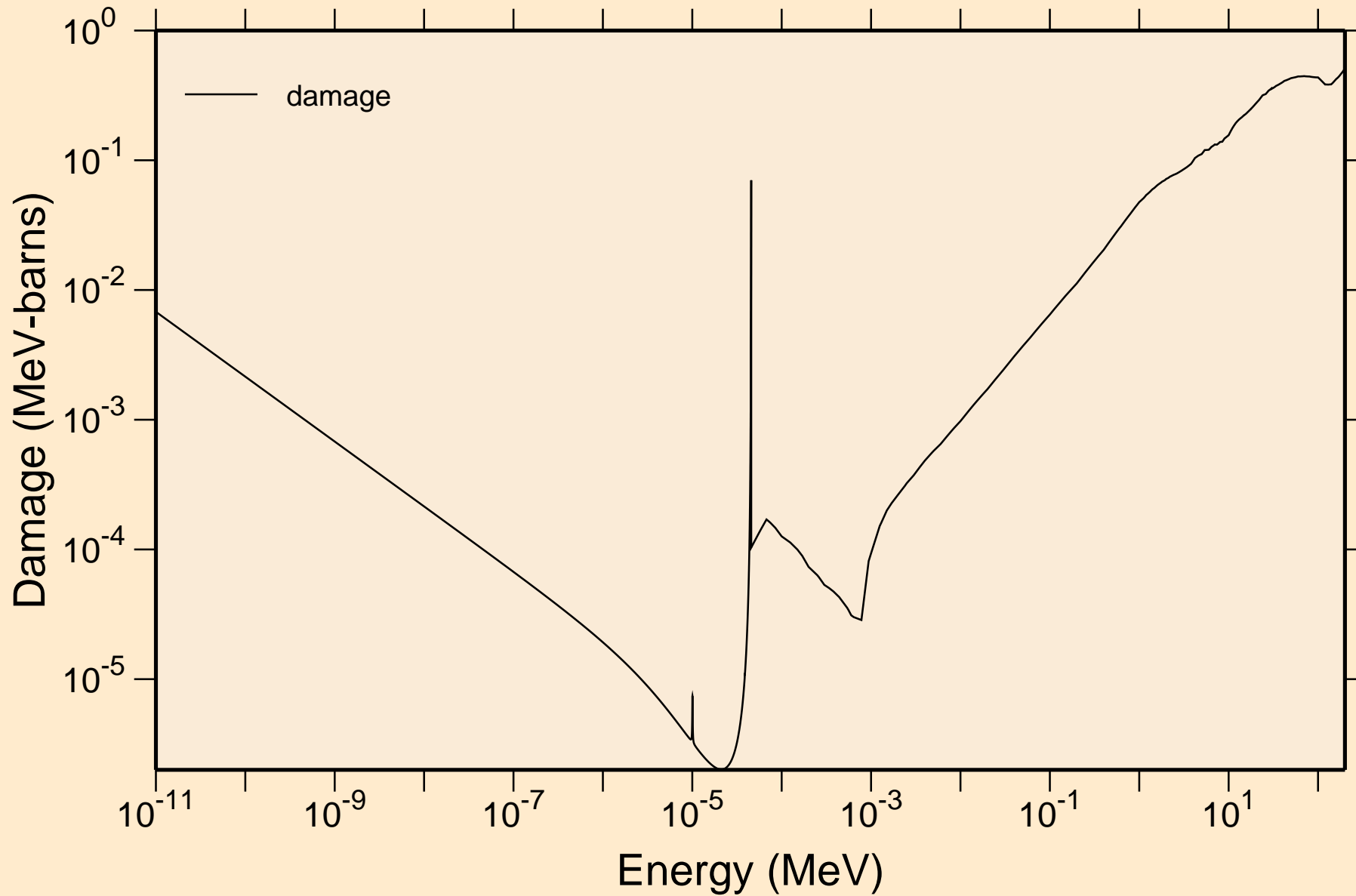

SN123 NEUTRON ACER TENDL-2024 LIBRARY; T=0.K

Non-threshold reactions

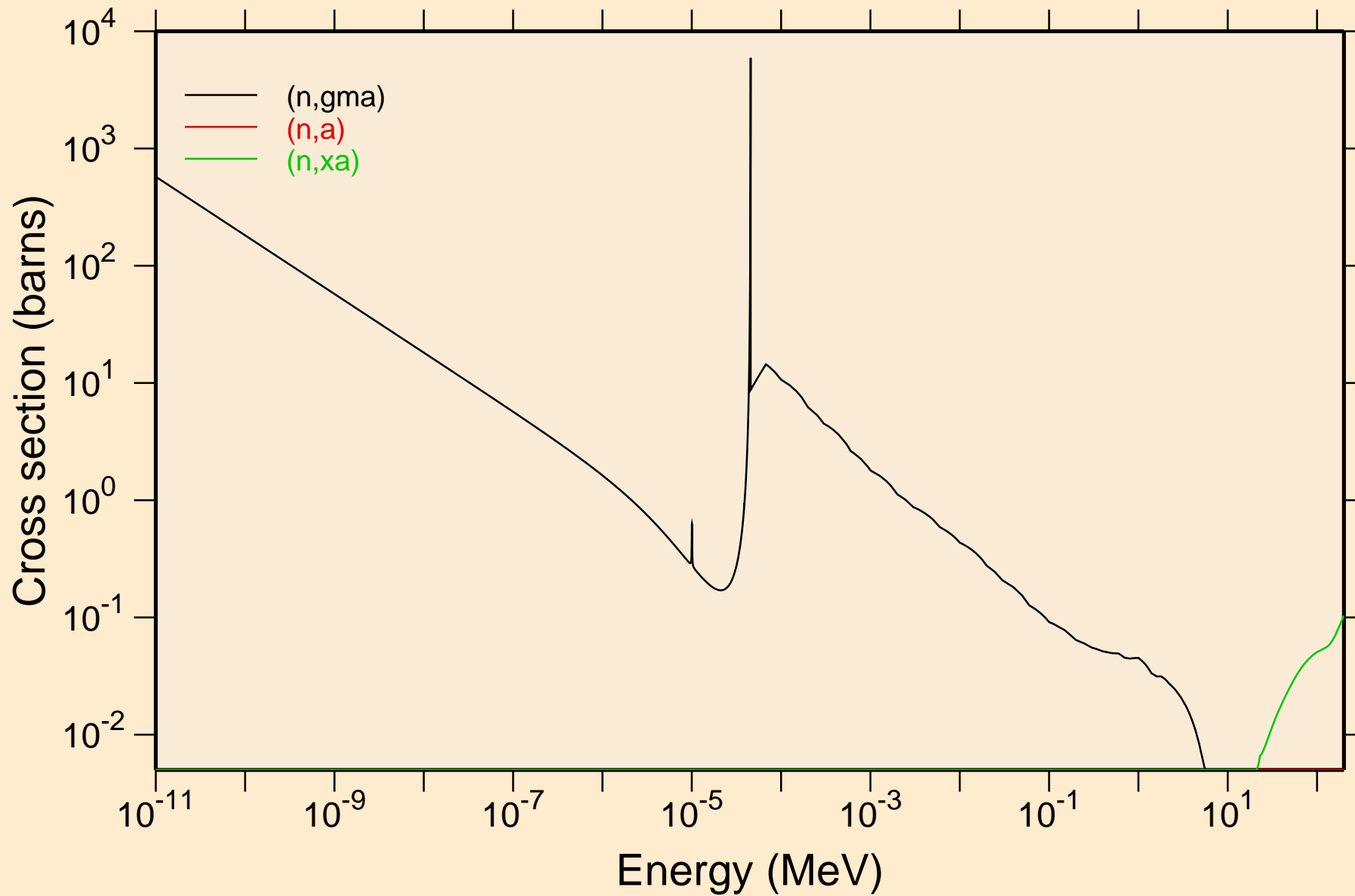

SN123 NEUTRON ACER TENDL-2024 LIBRARY; T=0.K

Principal cross sections

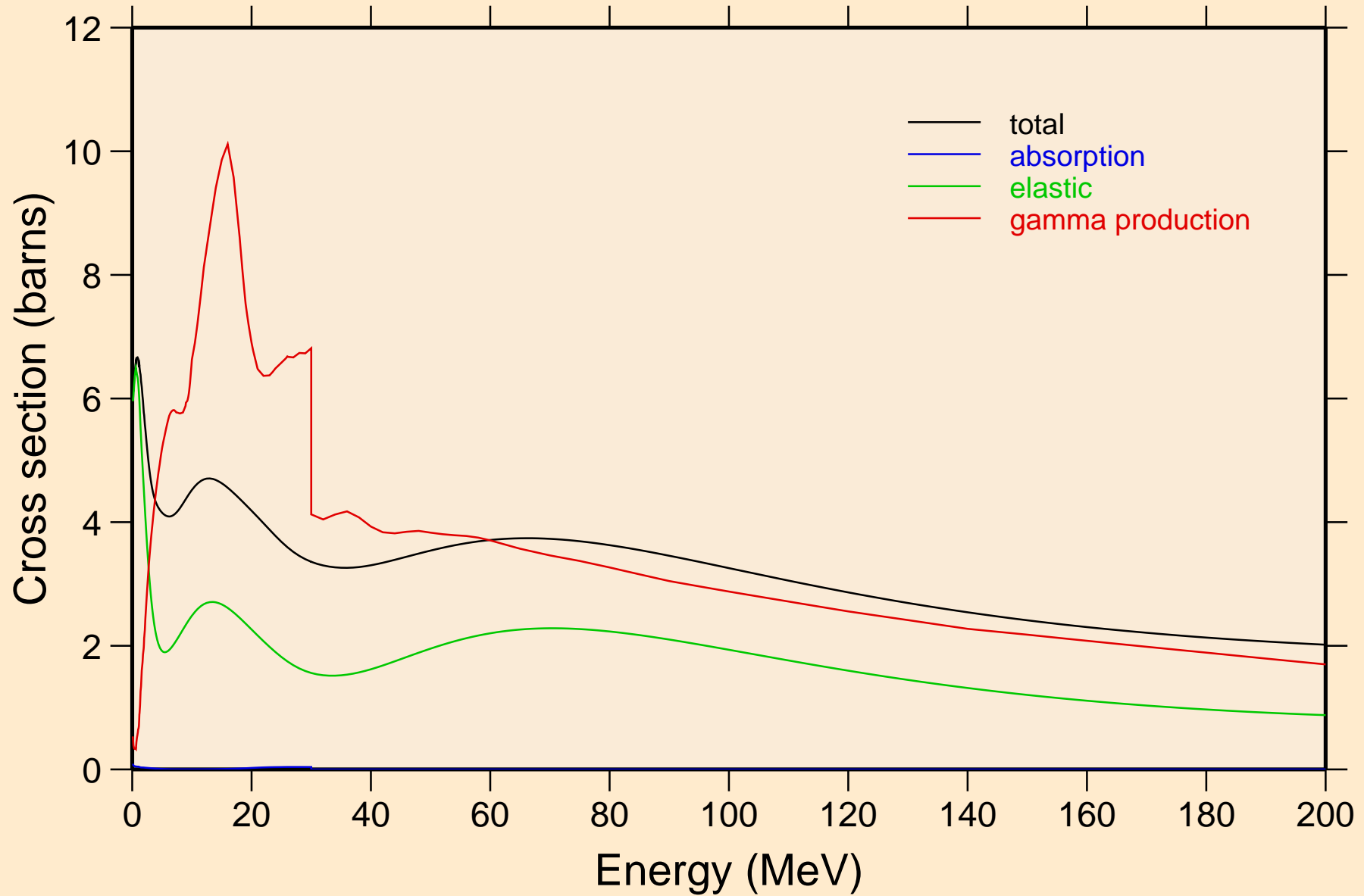

SN123 NEUTRON ACER TENDL-2024 LIBRARY; T=0.K

Heating

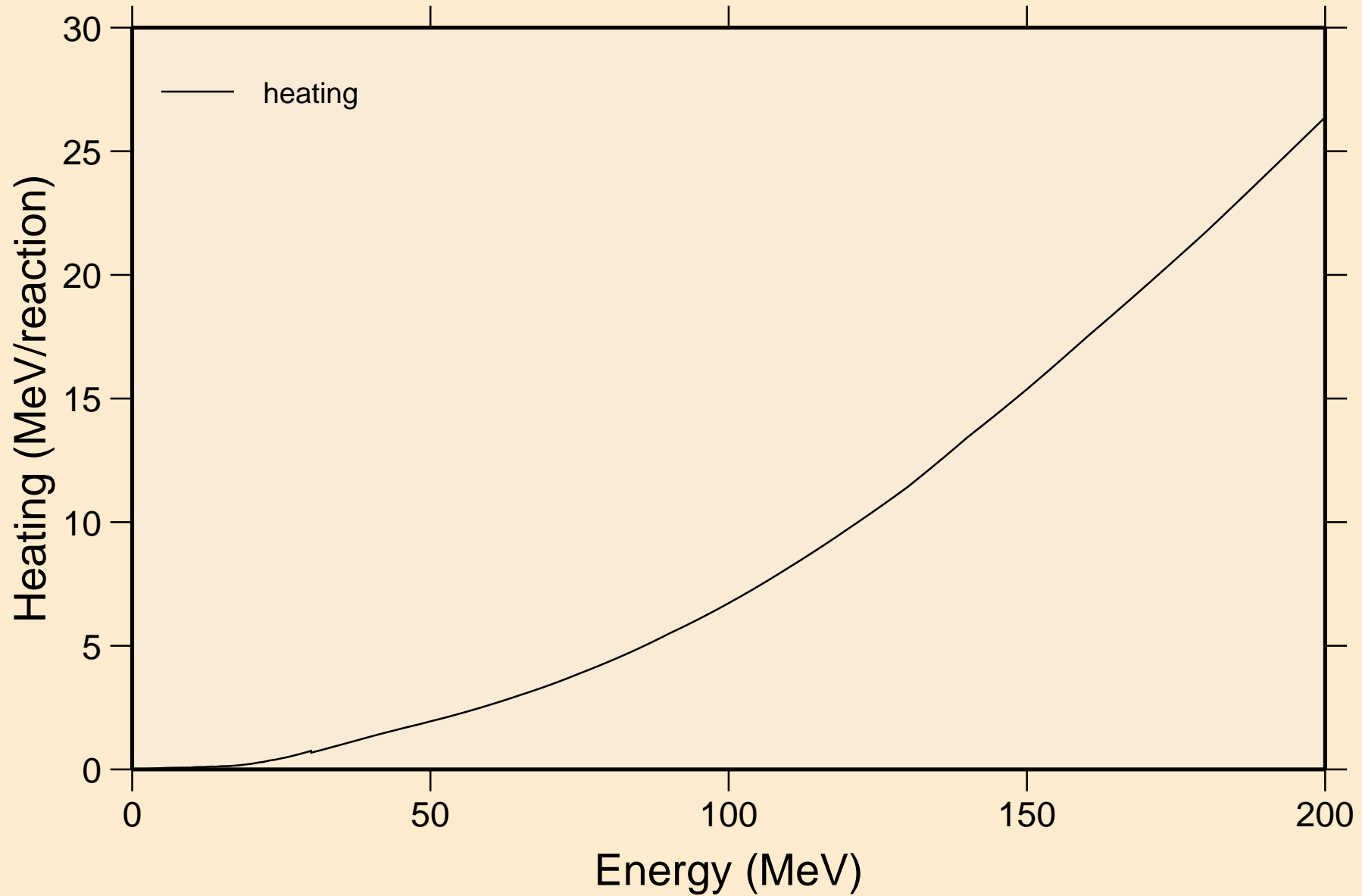

SN123 NEUTRON ACER TENDL-2024 LIBRARY; T=0.K

Damage

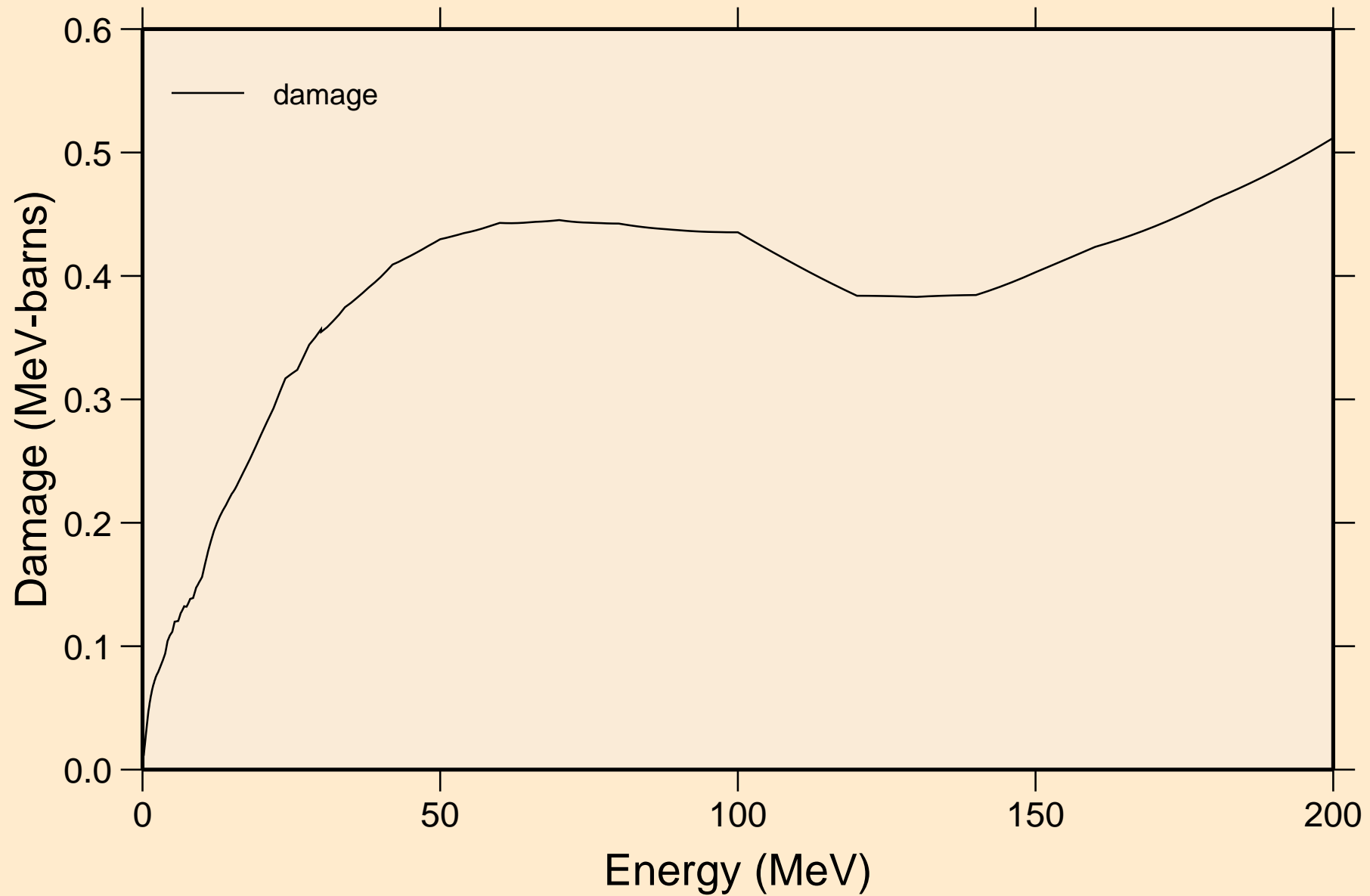

SN123 NEUTRON ACER TENDL-2024 LIBRARY; T=0.K

Non-threshold reactions

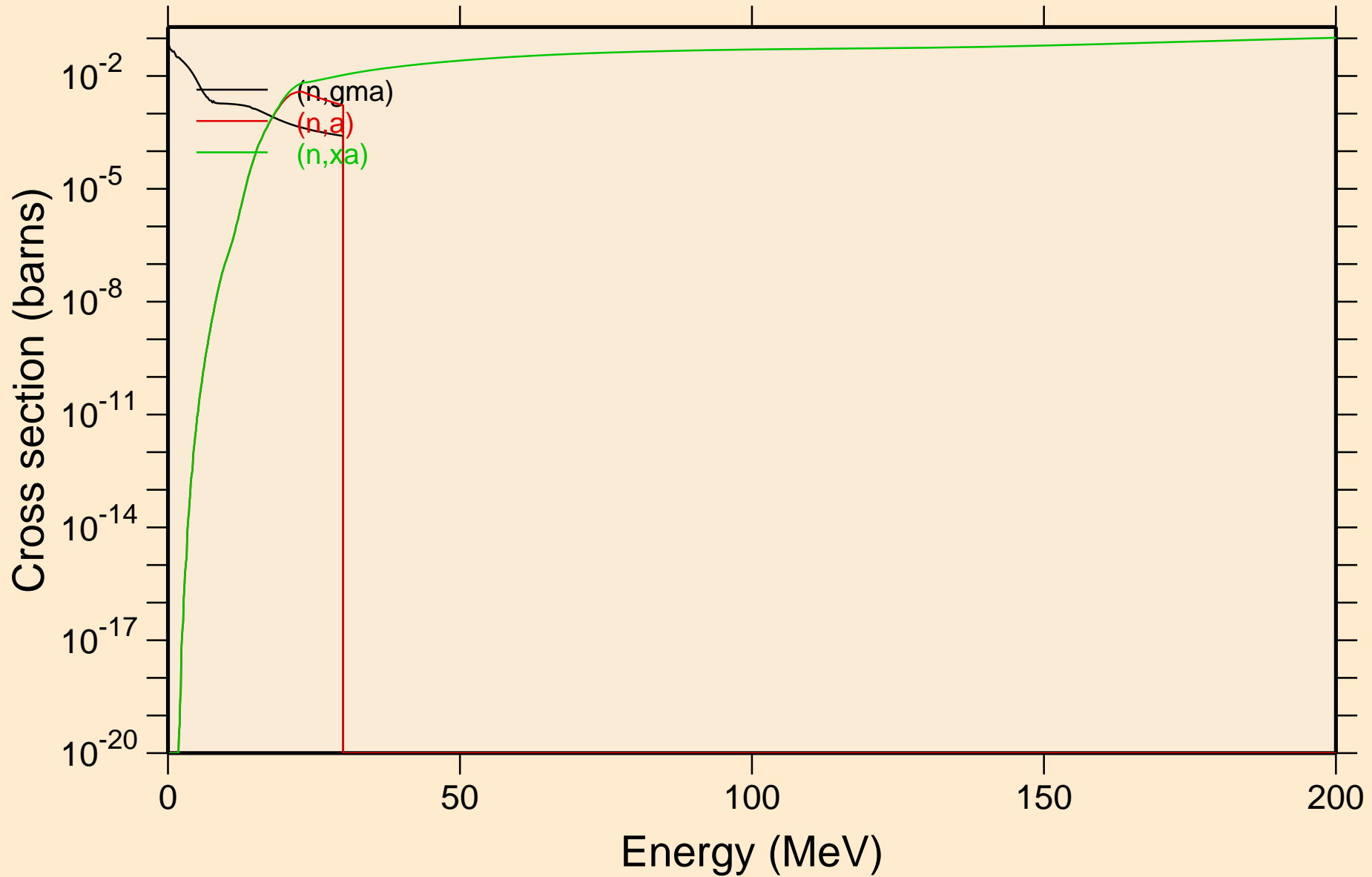

SN123 NEUTRON ACER TENDL-2024 LIBRARY; T=0.K

Inelastic levels

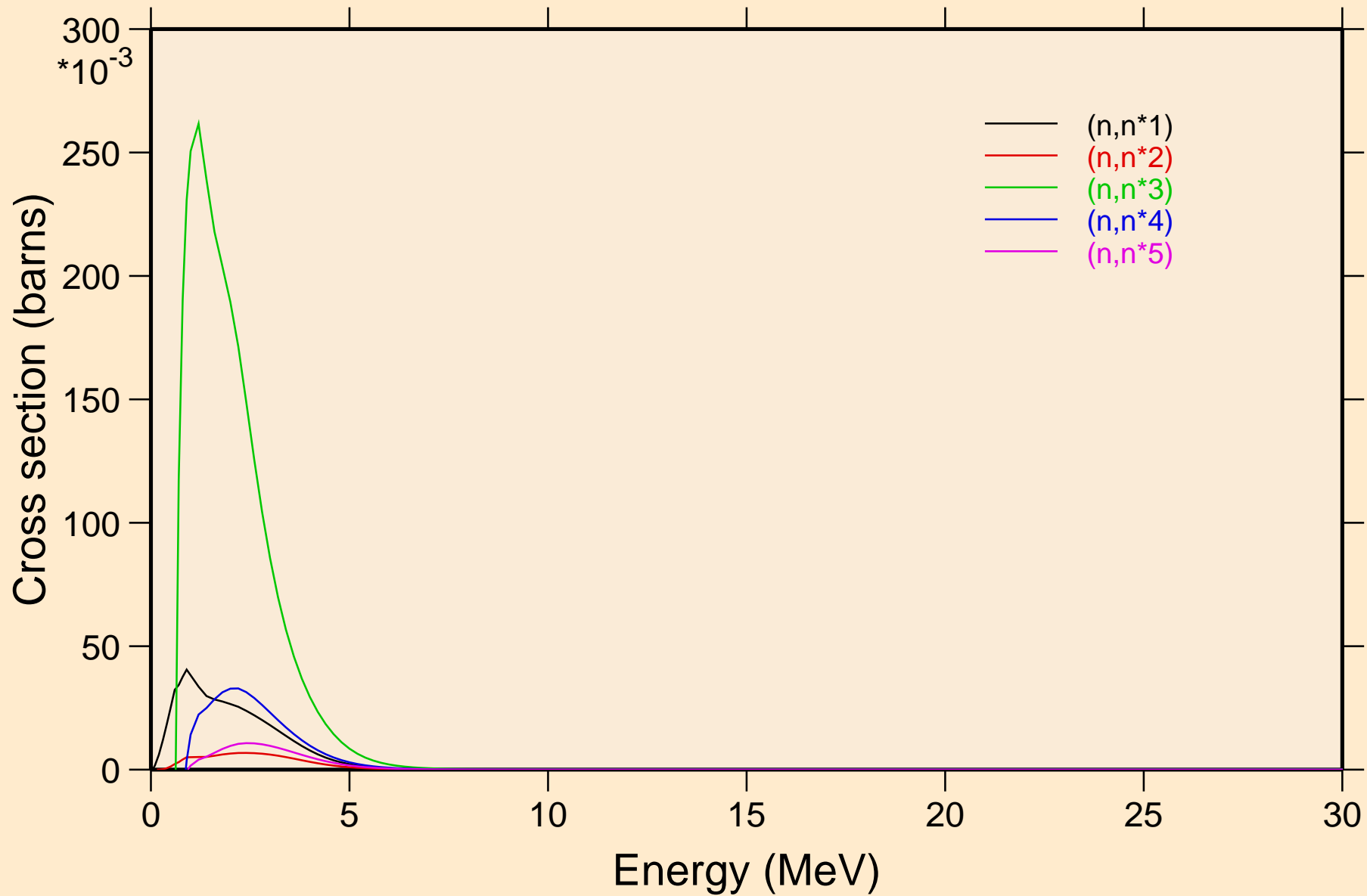

SN123 NEUTRON ACER TENDL-2024 LIBRARY; T=0.K

Inelastic levels

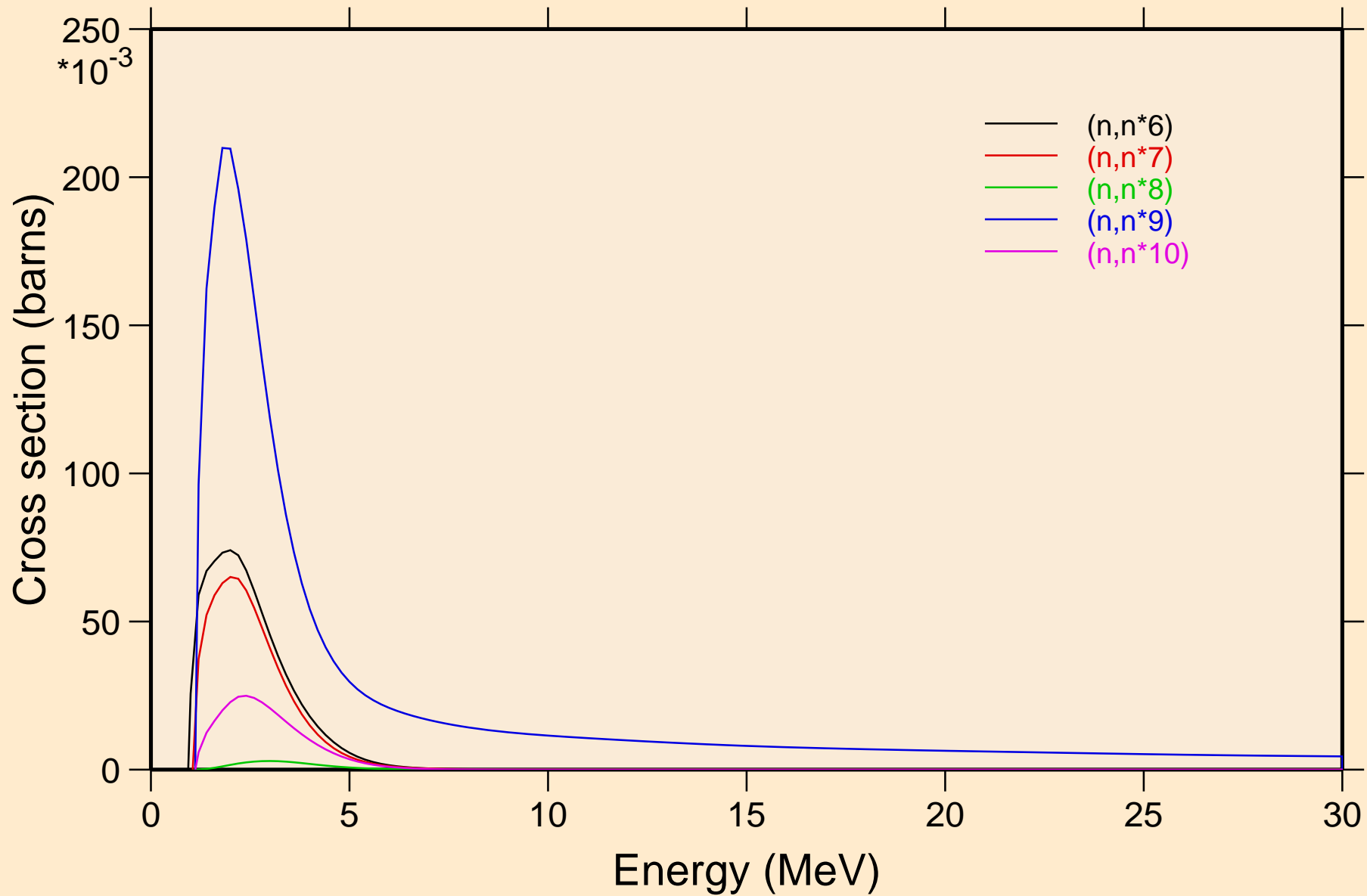

SN123 NEUTRON ACER TENDL-2024 LIBRARY; T=0.K

Inelastic levels

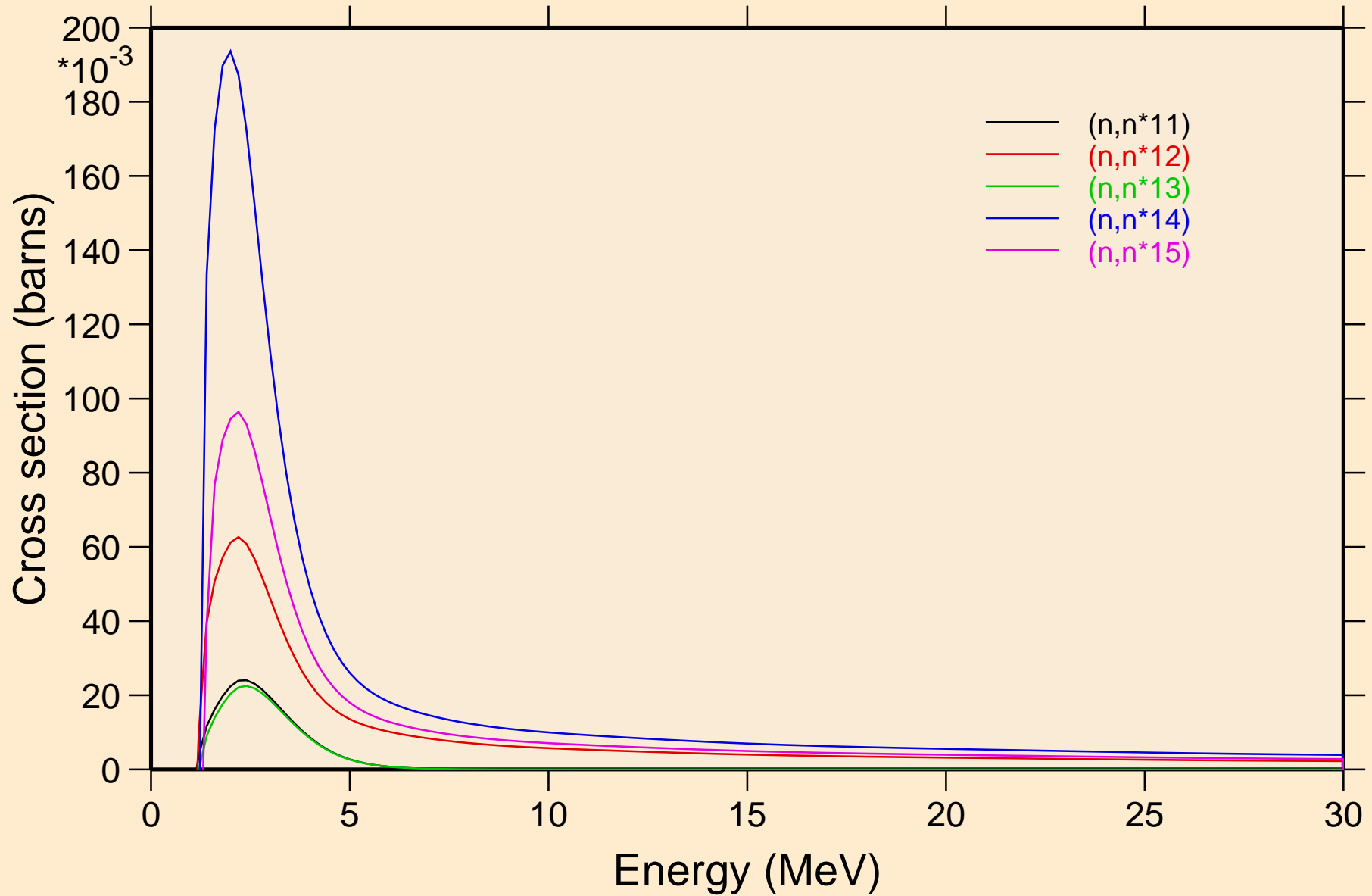

SN123 NEUTRON ACER TENDL-2024 LIBRARY; T=0.K

Inelastic levels

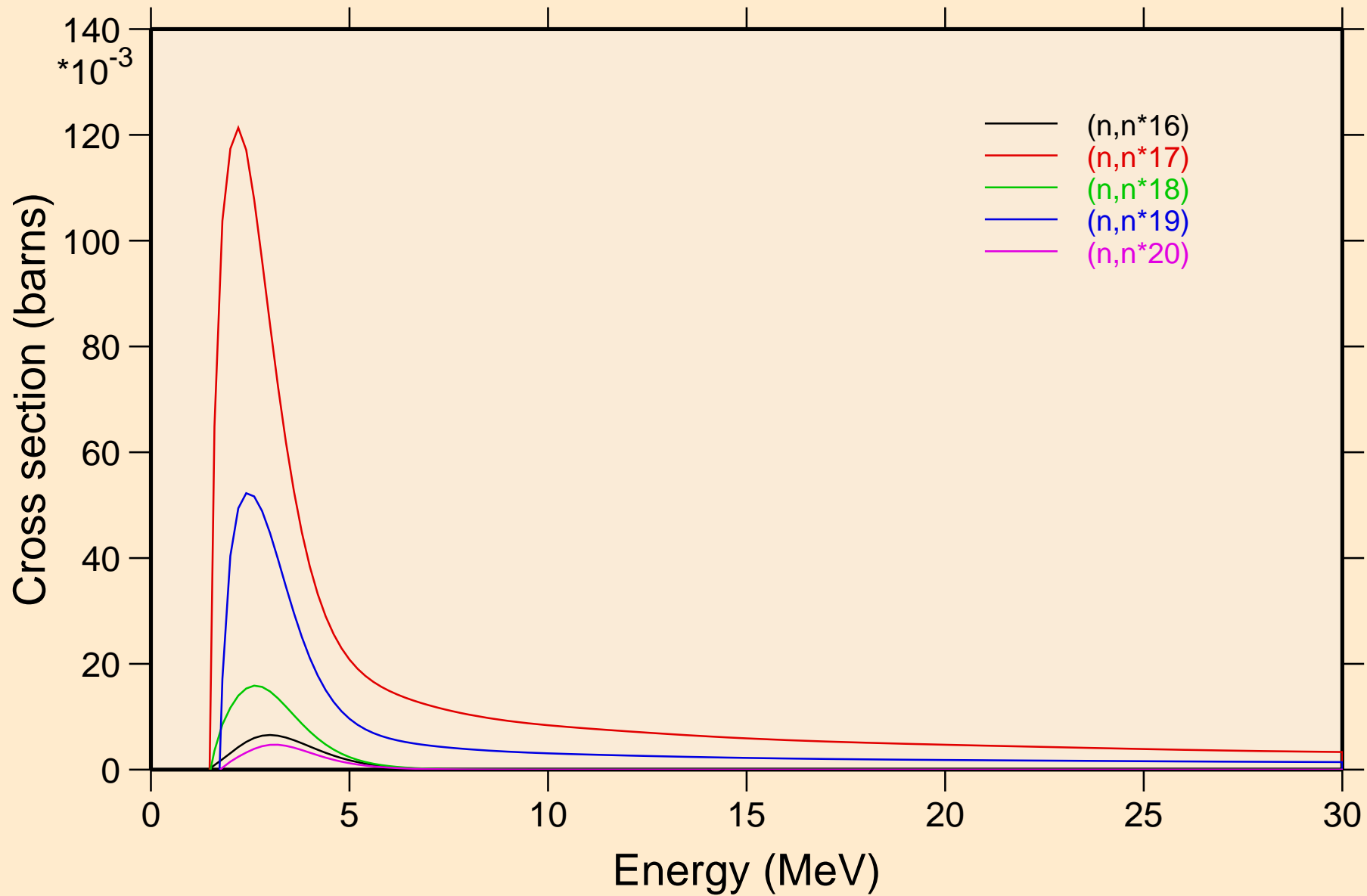

SN123 NEUTRON ACER TENDL-2024 LIBRARY; T=0.K

Inelastic levels

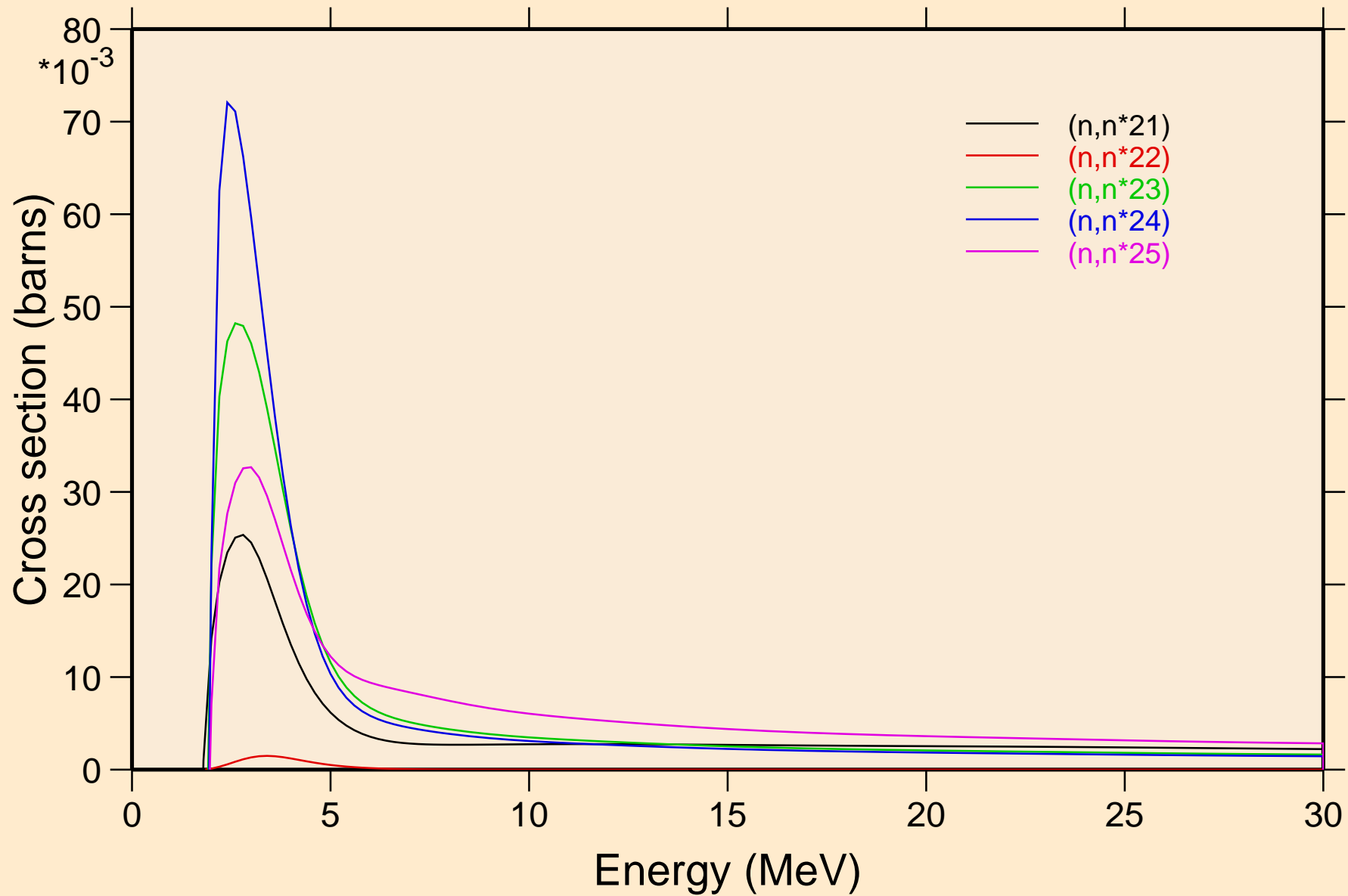

SN123 NEUTRON ACER TENDL-2024 LIBRARY; T=0.K

Inelastic levels

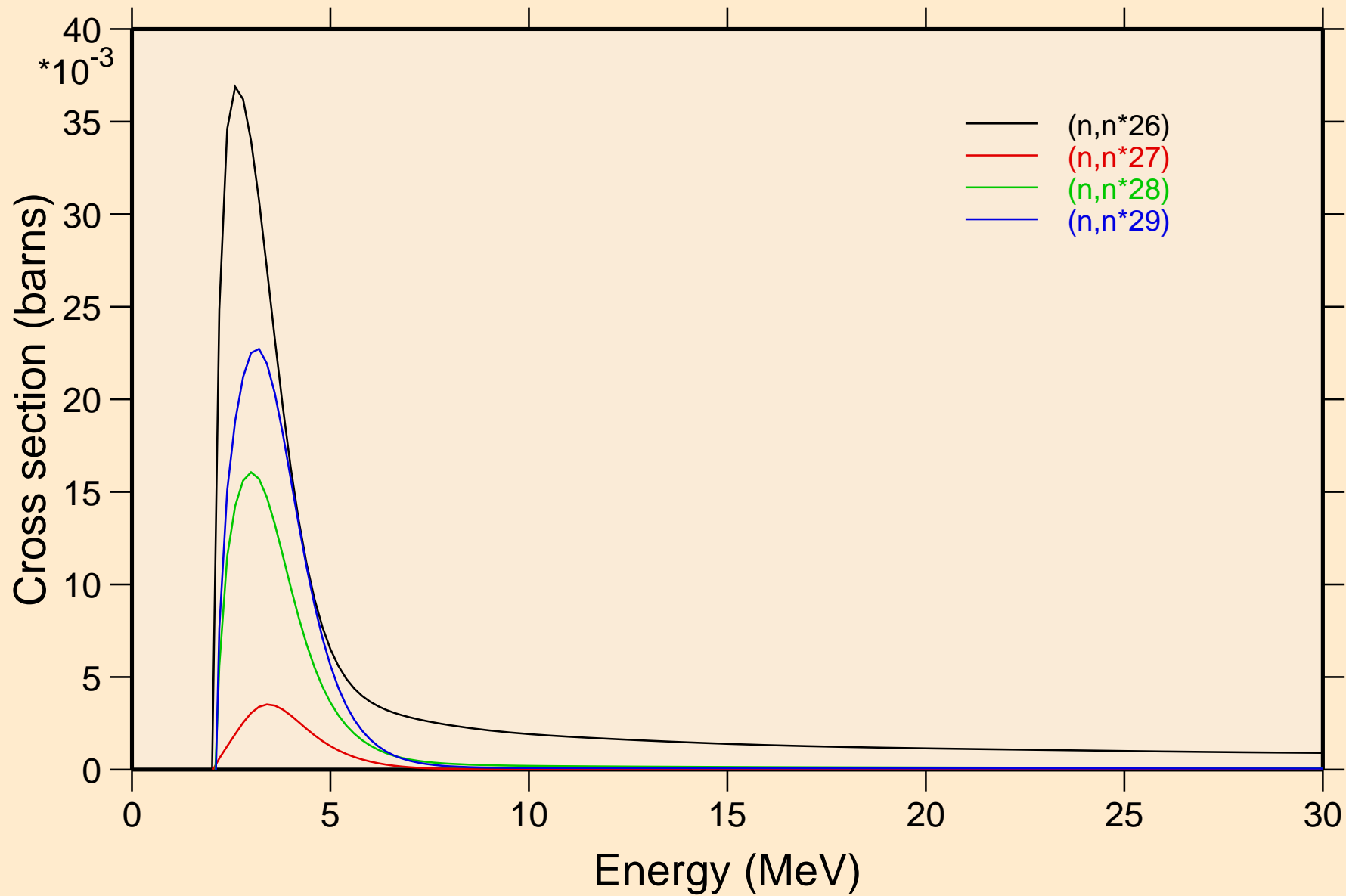

SN123 NEUTRON ACER TENDL-2024 LIBRARY; T=0.K

Threshold reactions

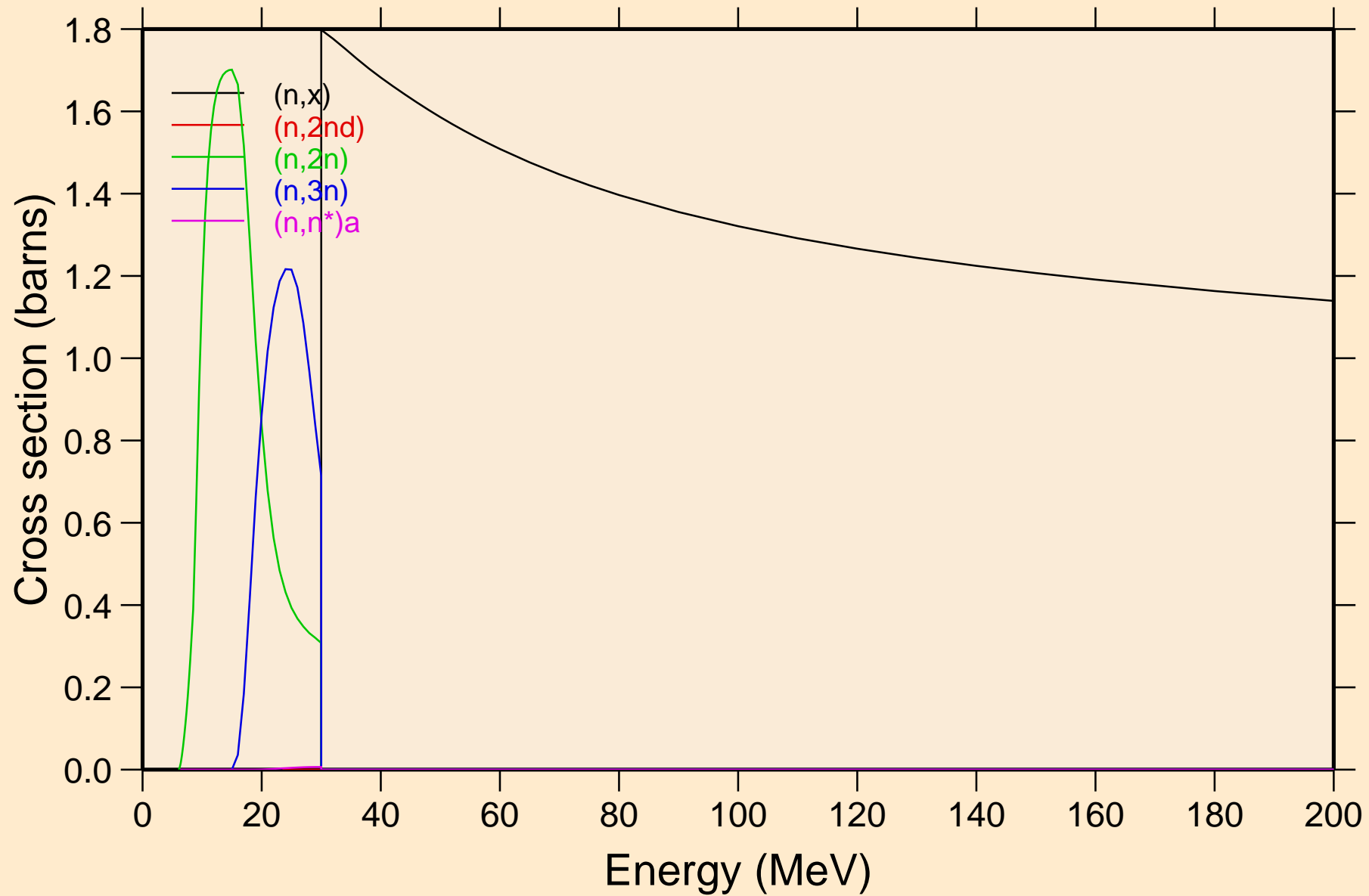

SN123 NEUTRON ACER TENDL-2024 LIBRARY; T=0.K

Threshold reactions

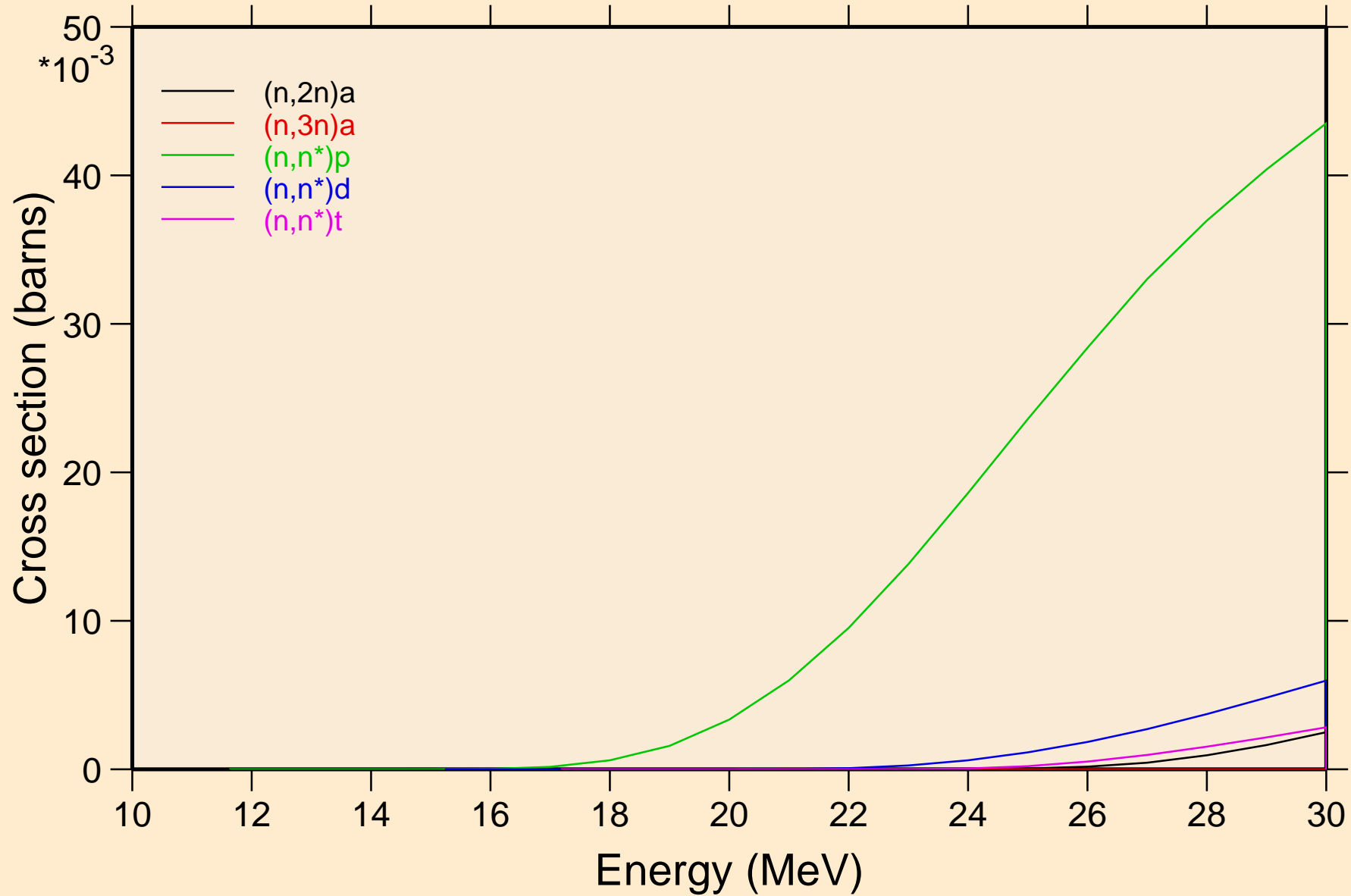

SN123 NEUTRON ACER TENDL-2024 LIBRARY; T=0.K

Threshold reactions

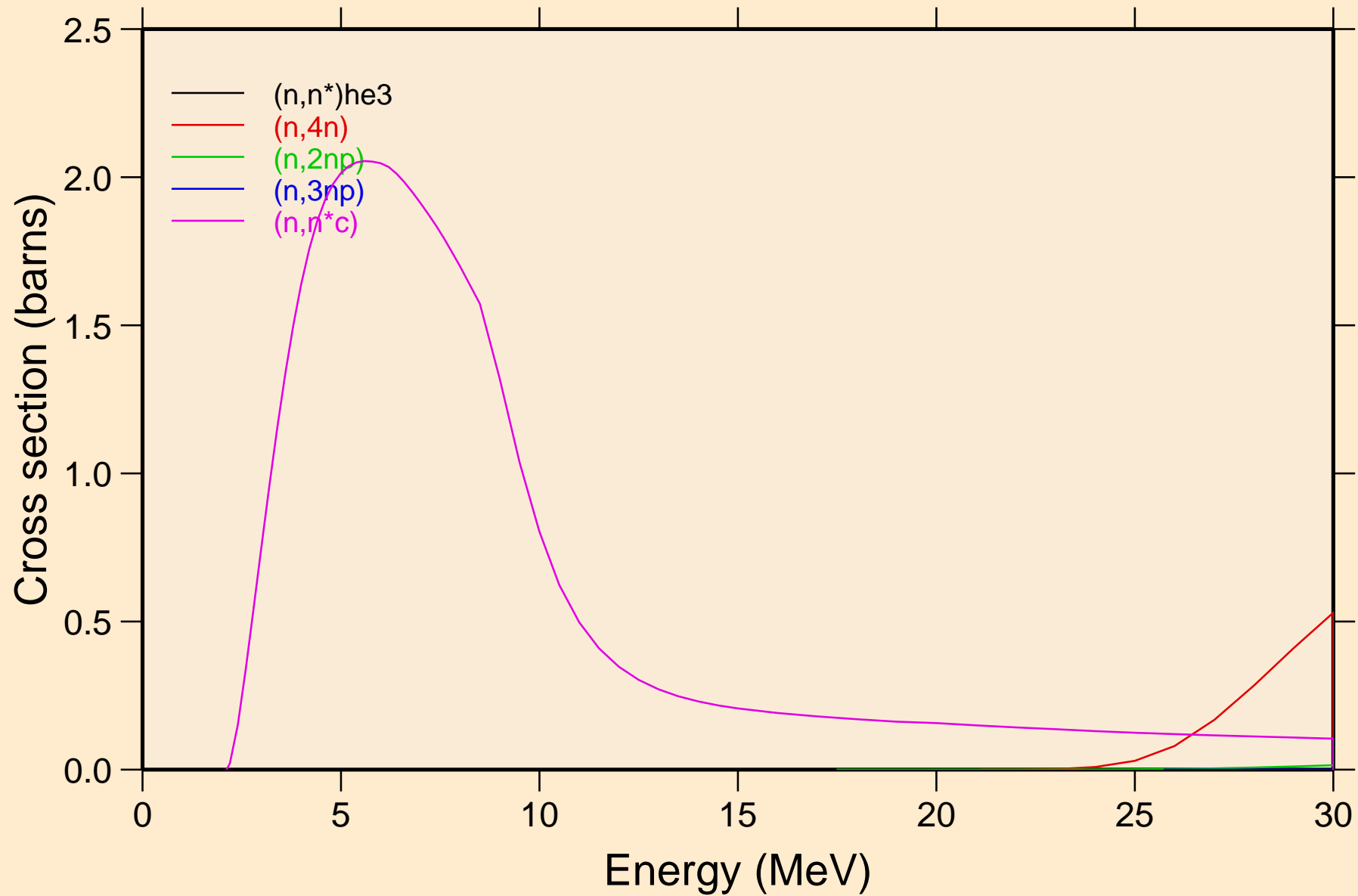

SN123 NEUTRON ACER TENDL-2024 LIBRARY; T=0.K

Threshold reactions

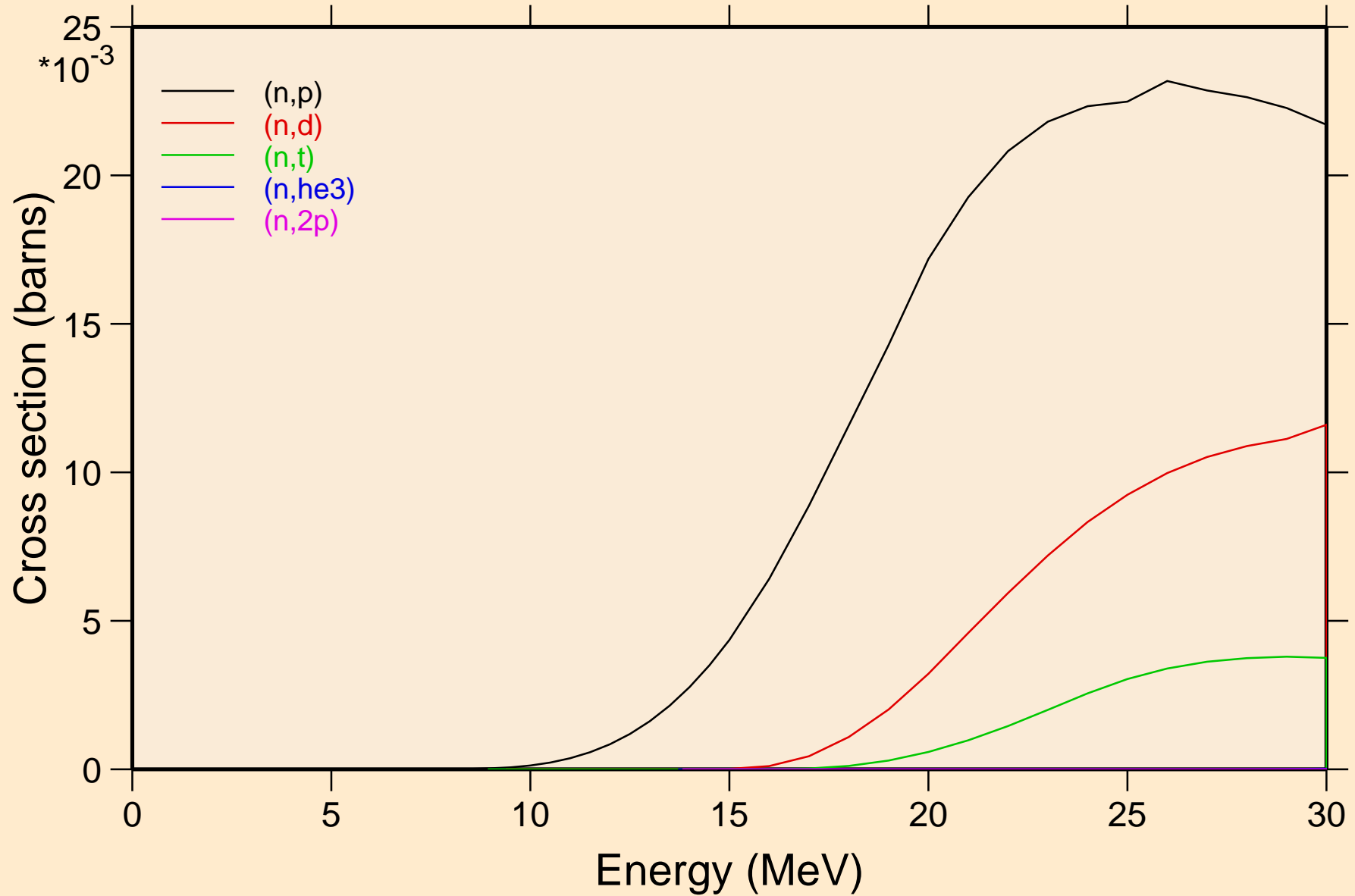

SN123 NEUTRON ACER TENDL-2024 LIBRARY; T=0.K

Threshold reactions

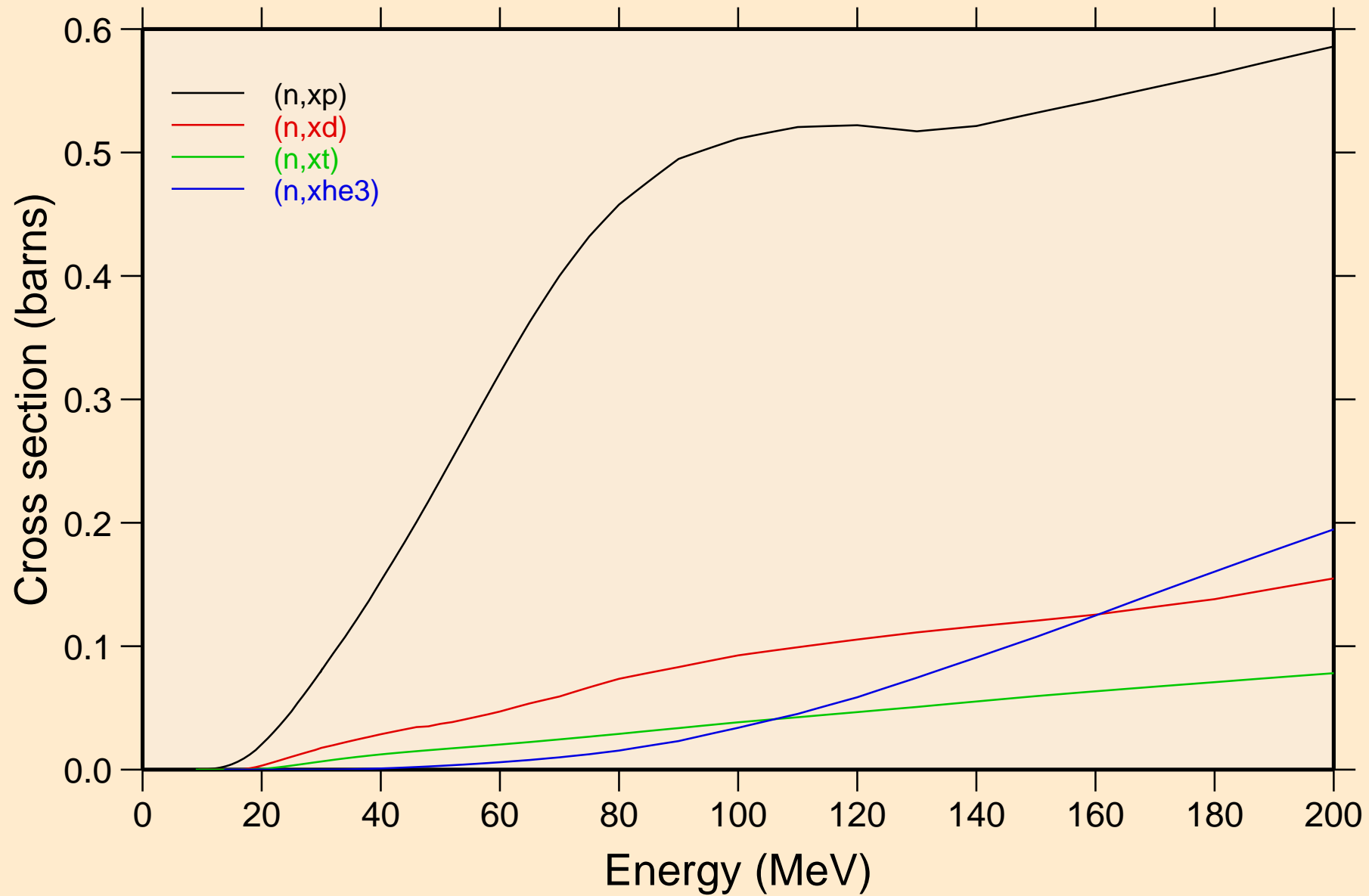

SN123 NEUTRON ACER TENDL-2024 LIBRARY; T=0.K
angular distribution for elastic

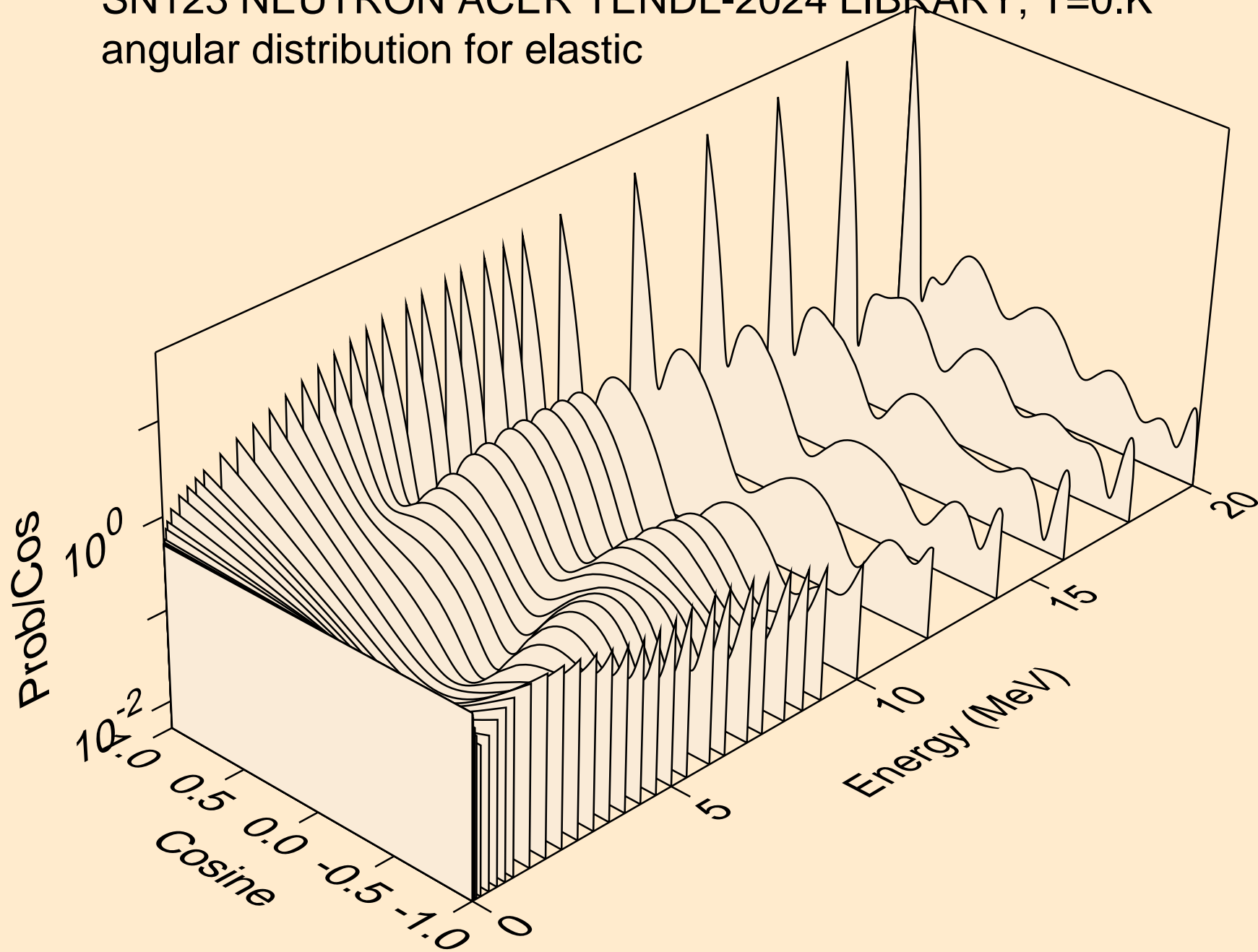

SN123 NEUTRON ACER TENDL-2024 LIBRARY; T=0.K
angular distribution for elastic

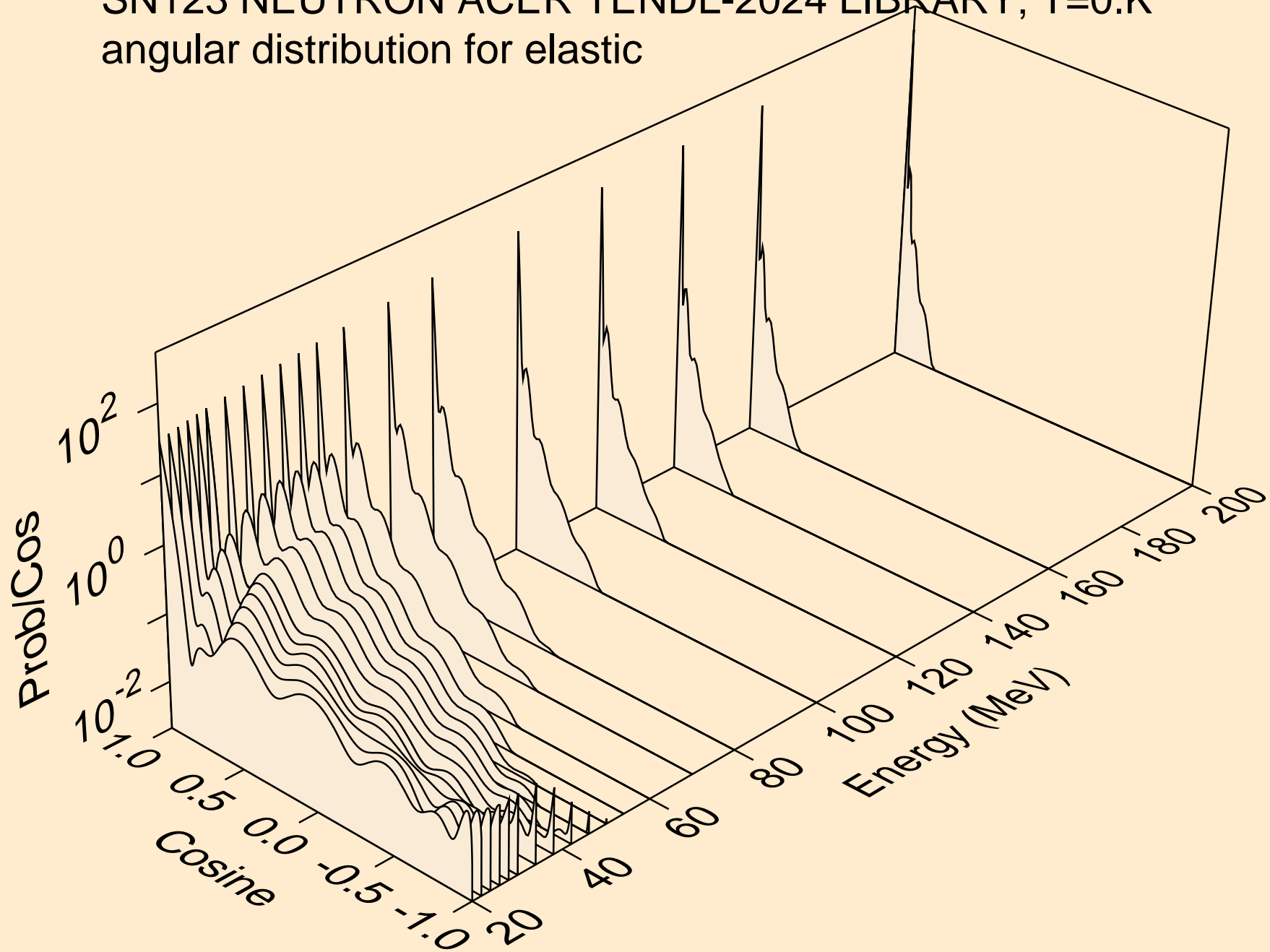

SN123 NEUTRON ACER TENDL-2024 LIBRARY; T=0.K
angular distribution for (n,n*1)

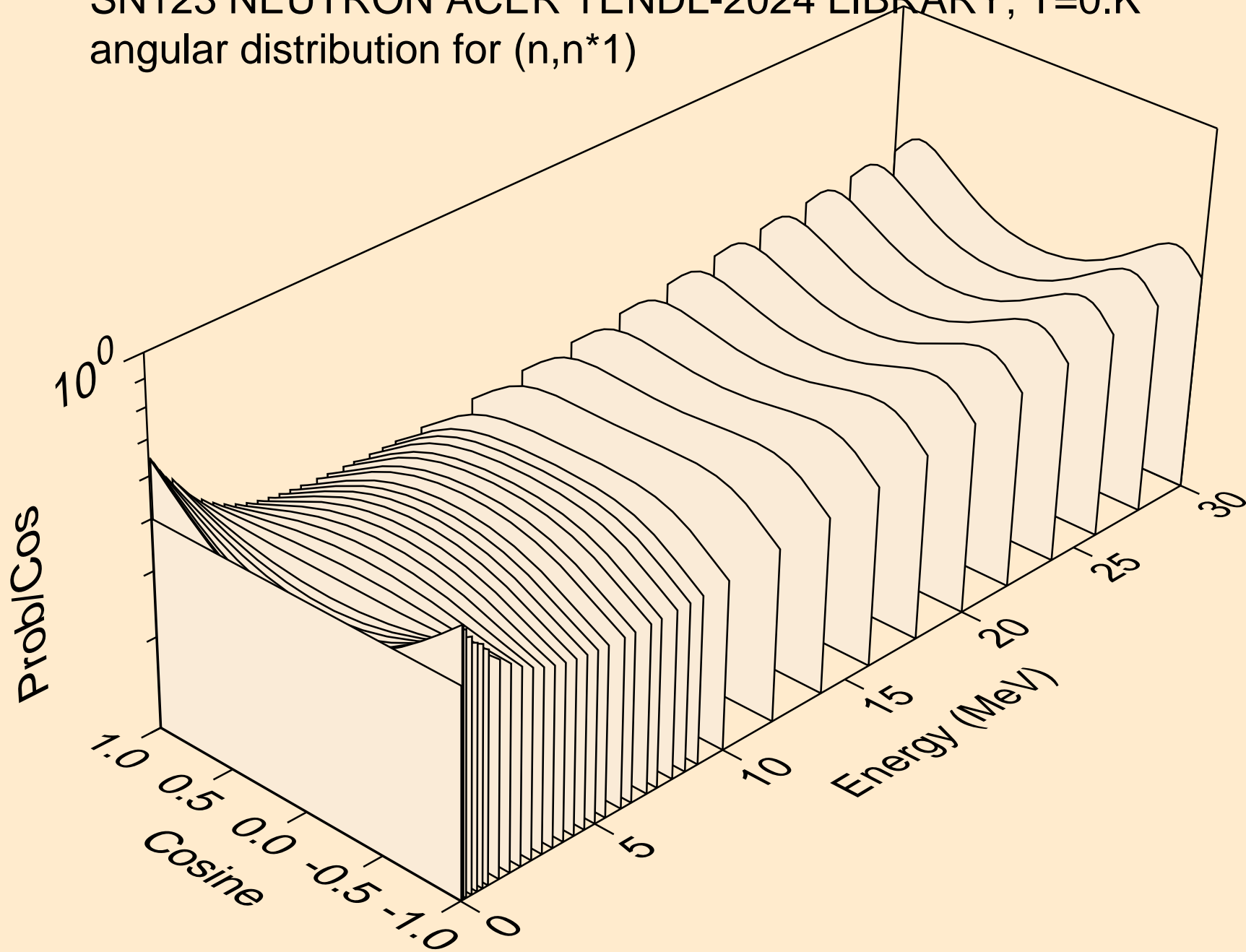

SN123 NEUTRON ACER TENDL-2024 LIBRARY; T=0.K
angular distribution for (n,n*2)

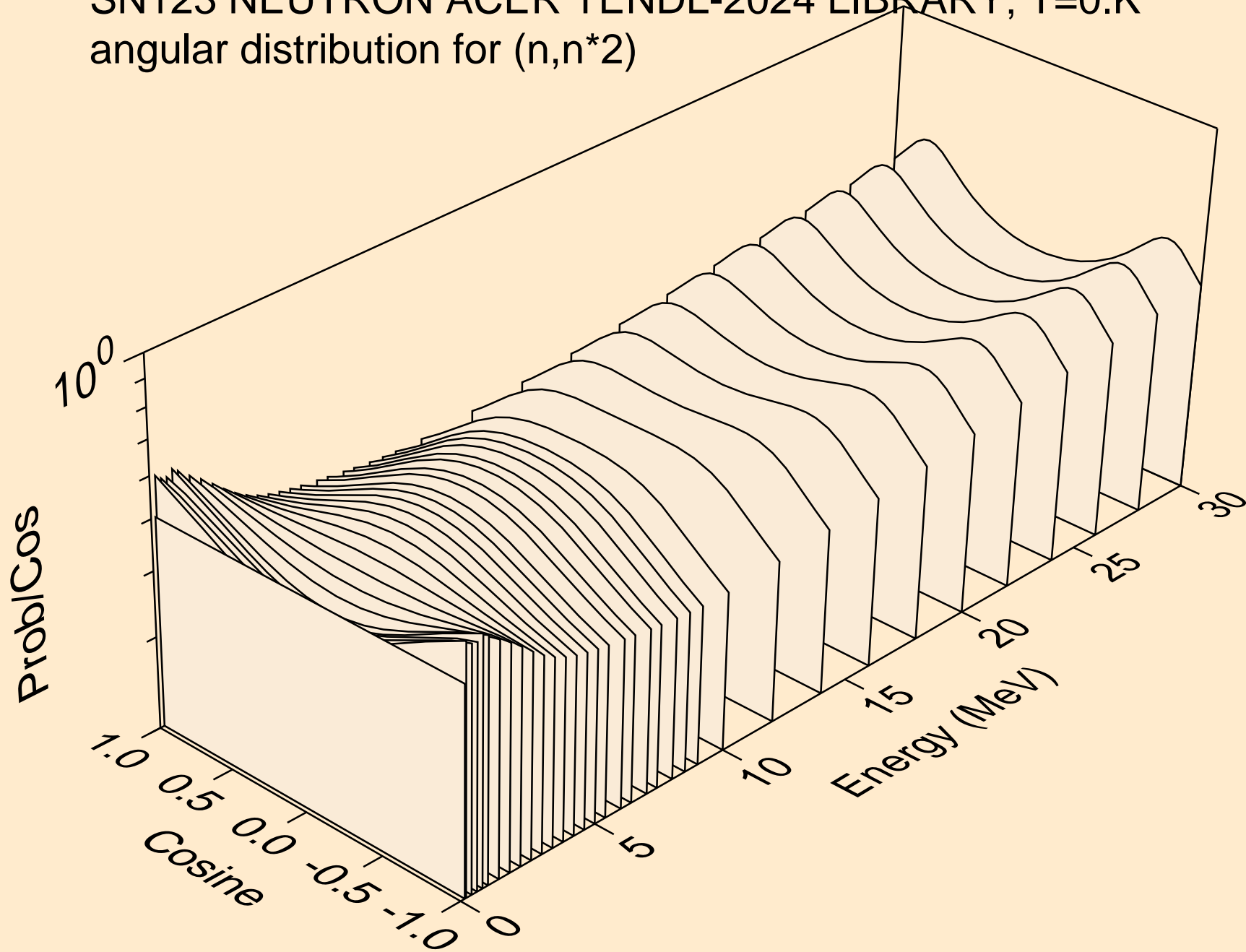

SN123 NEUTRON ACER TENDL-2024 LIBRARY; T=0.K
angular distribution for (n,n*3)

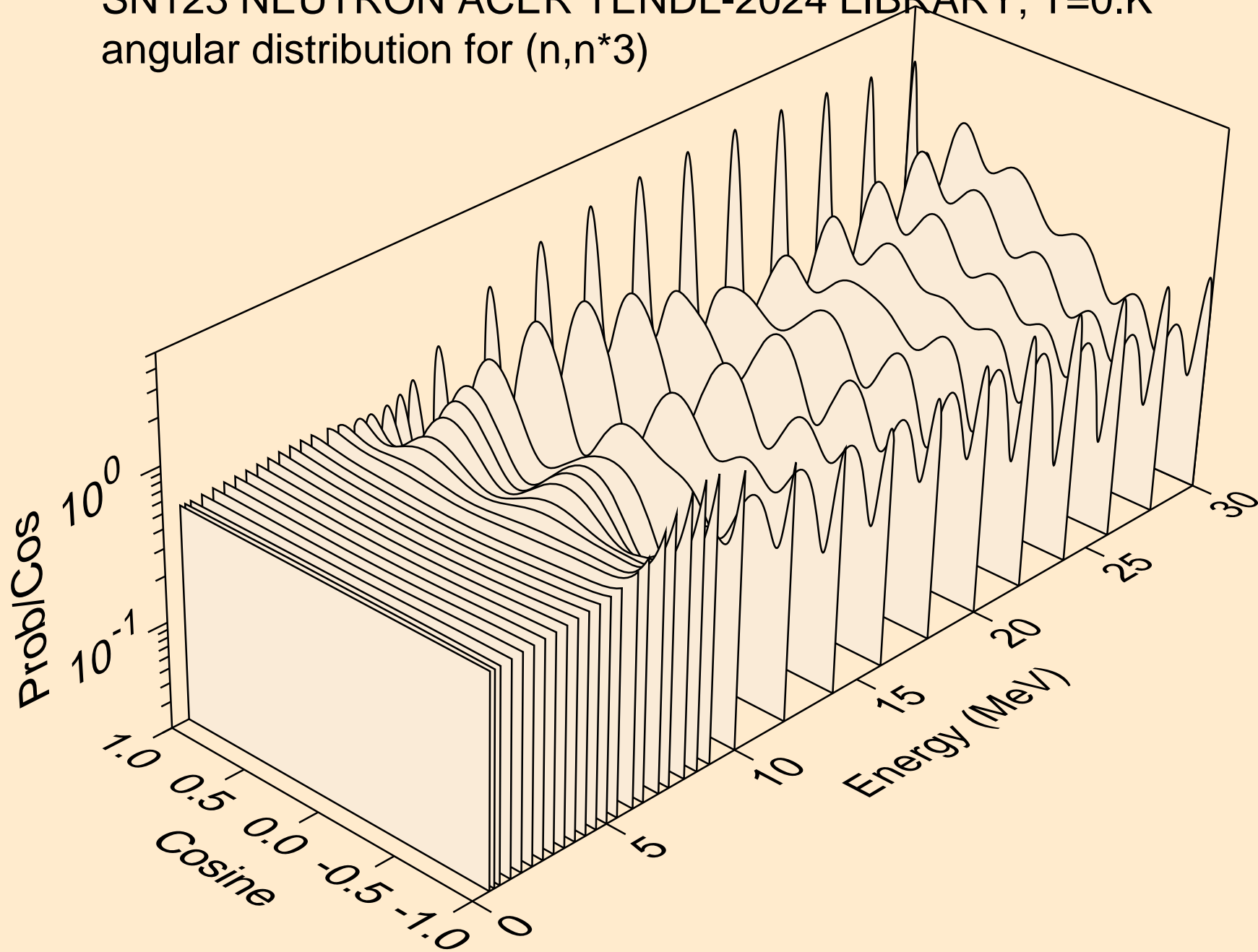

SN123 NEUTRON ACER TENDL-2024 LIBRARY; T=0.K
angular distribution for (n,n*4)

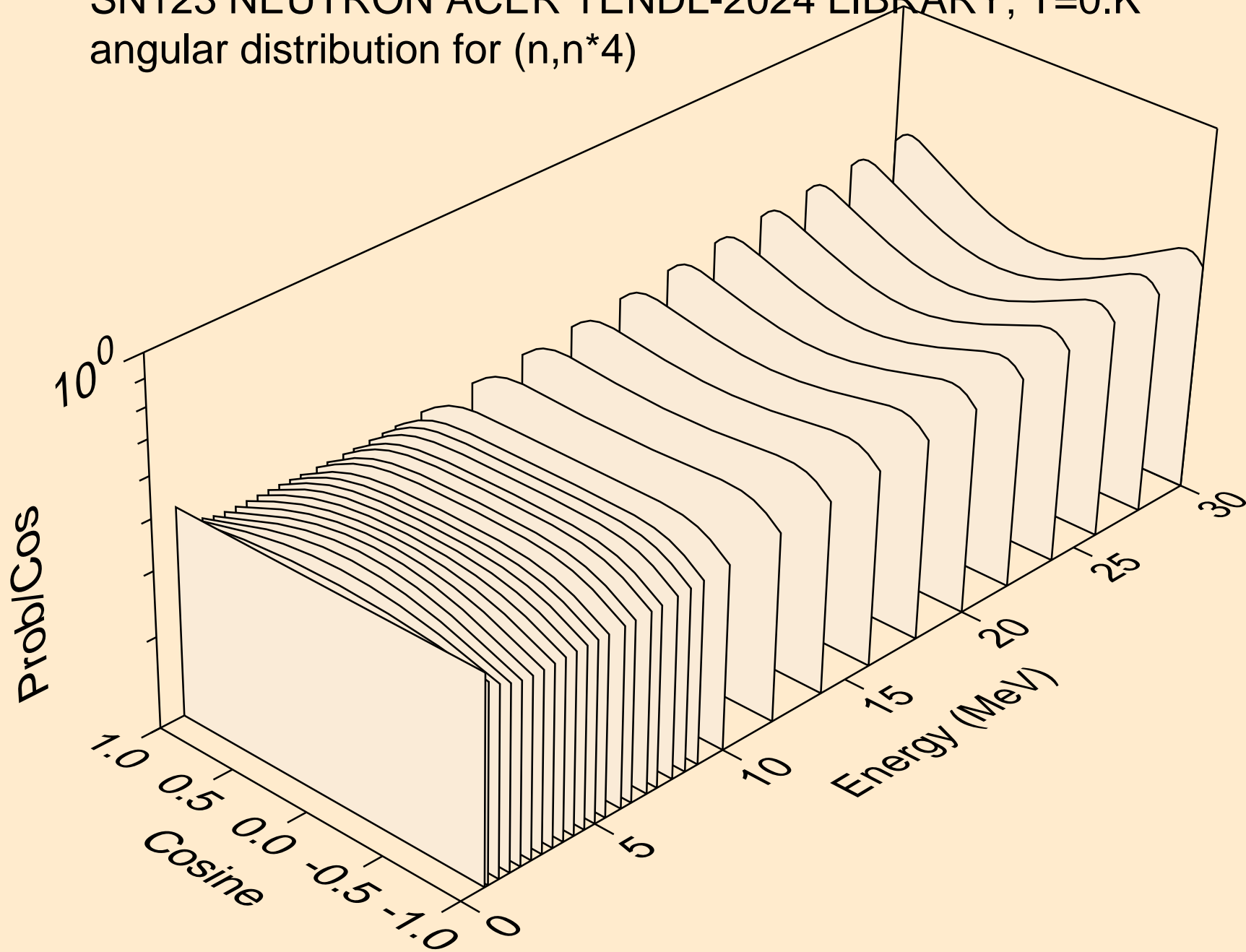

SN123 NEUTRON ACER TENDL-2024 LIBRARY; T=0.K
angular distribution for (n,n*5)

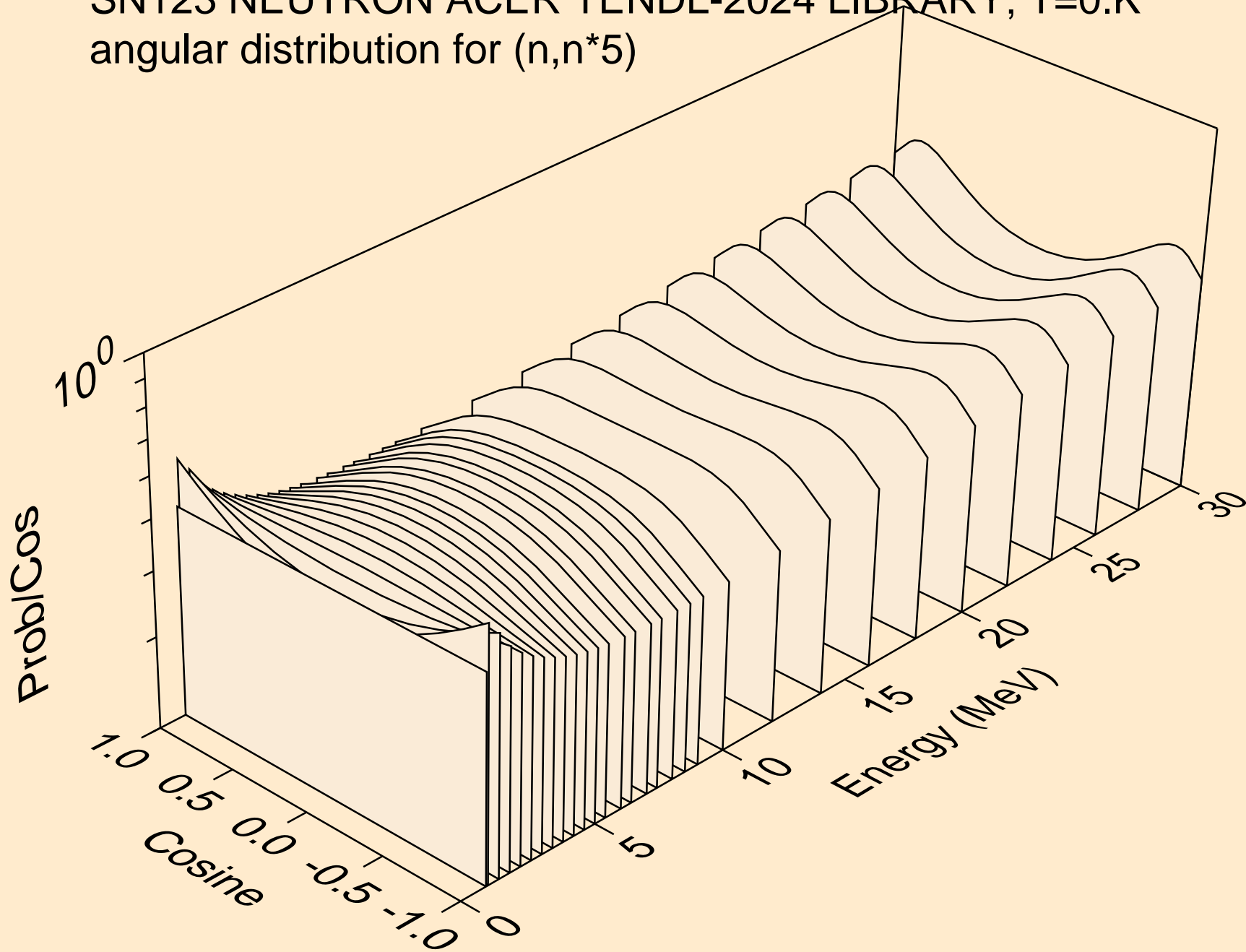

SN123 NEUTRON ACER TENDL-2024 LIBRARY; T=0.K
angular distribution for (n,n*6)

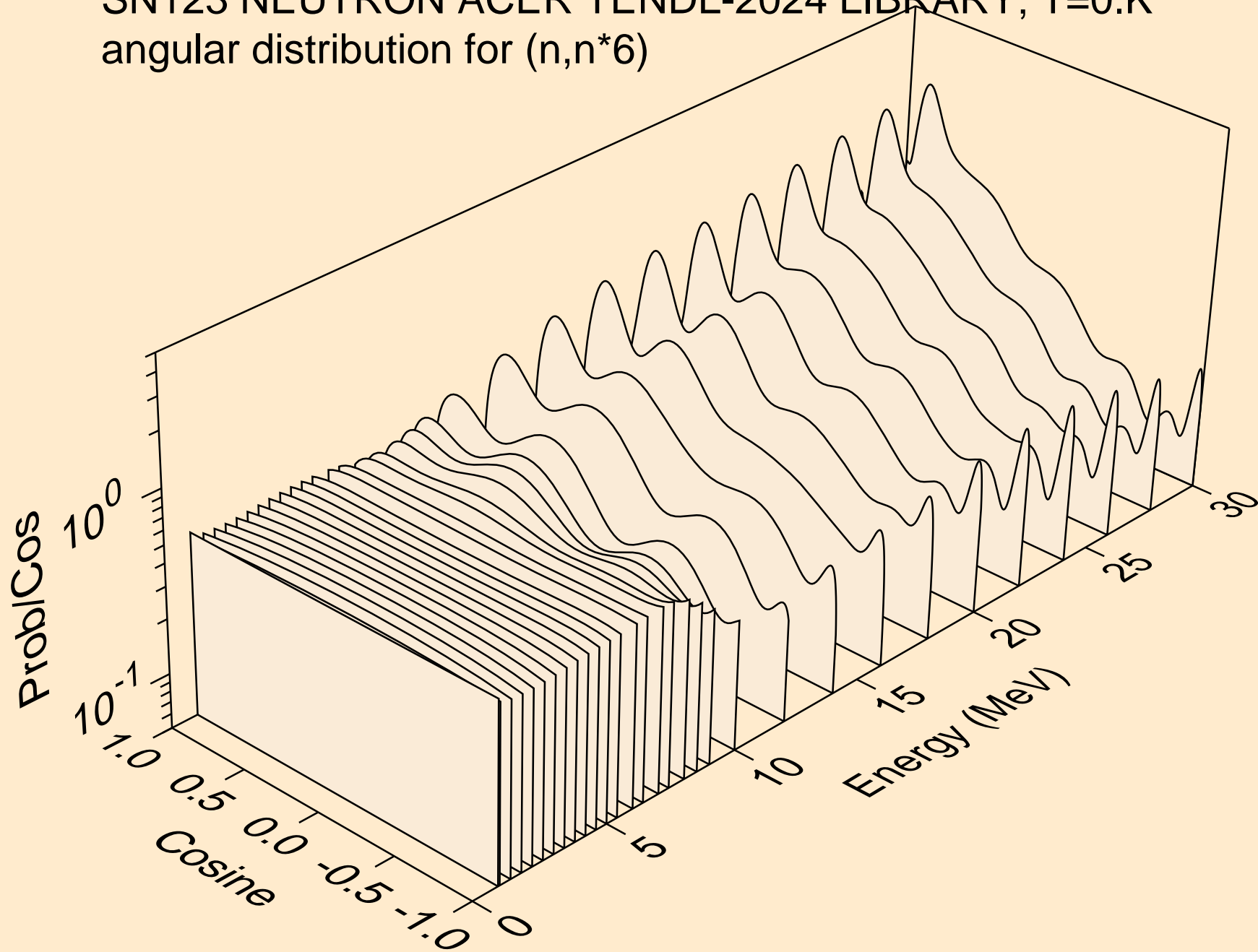

SN123 NEUTRON ACER TENDL-2024 LIBRARY; T=0.K
angular distribution for (n,n*7)

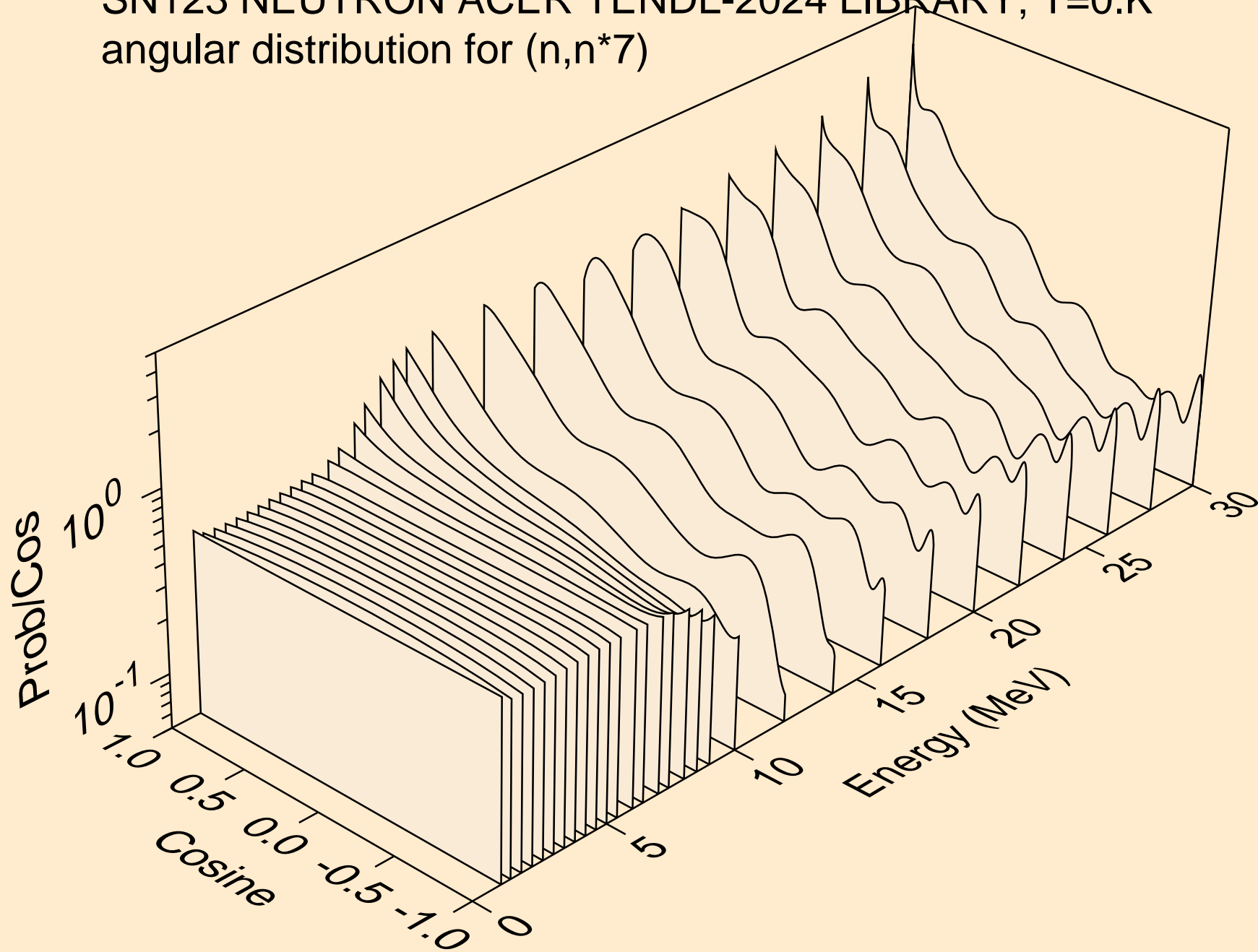

SN123 NEUTRON ACER TENDL-2024 LIBRARY; T=0.K
angular distribution for (n,n*8)

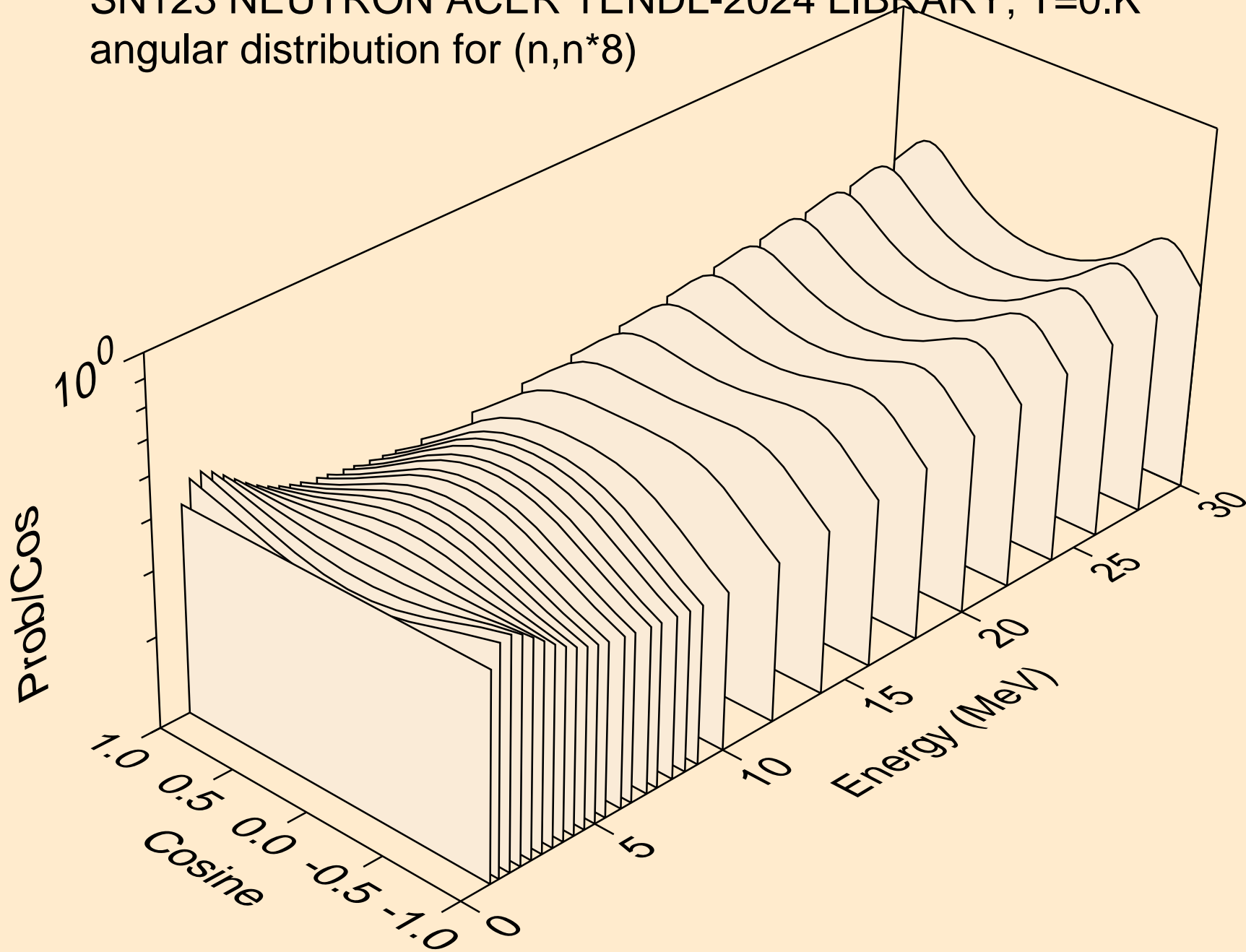

SN123 NEUTRON ACER TENDL-2024 LIBRARY; T=0.K
angular distribution for (n,n*9)

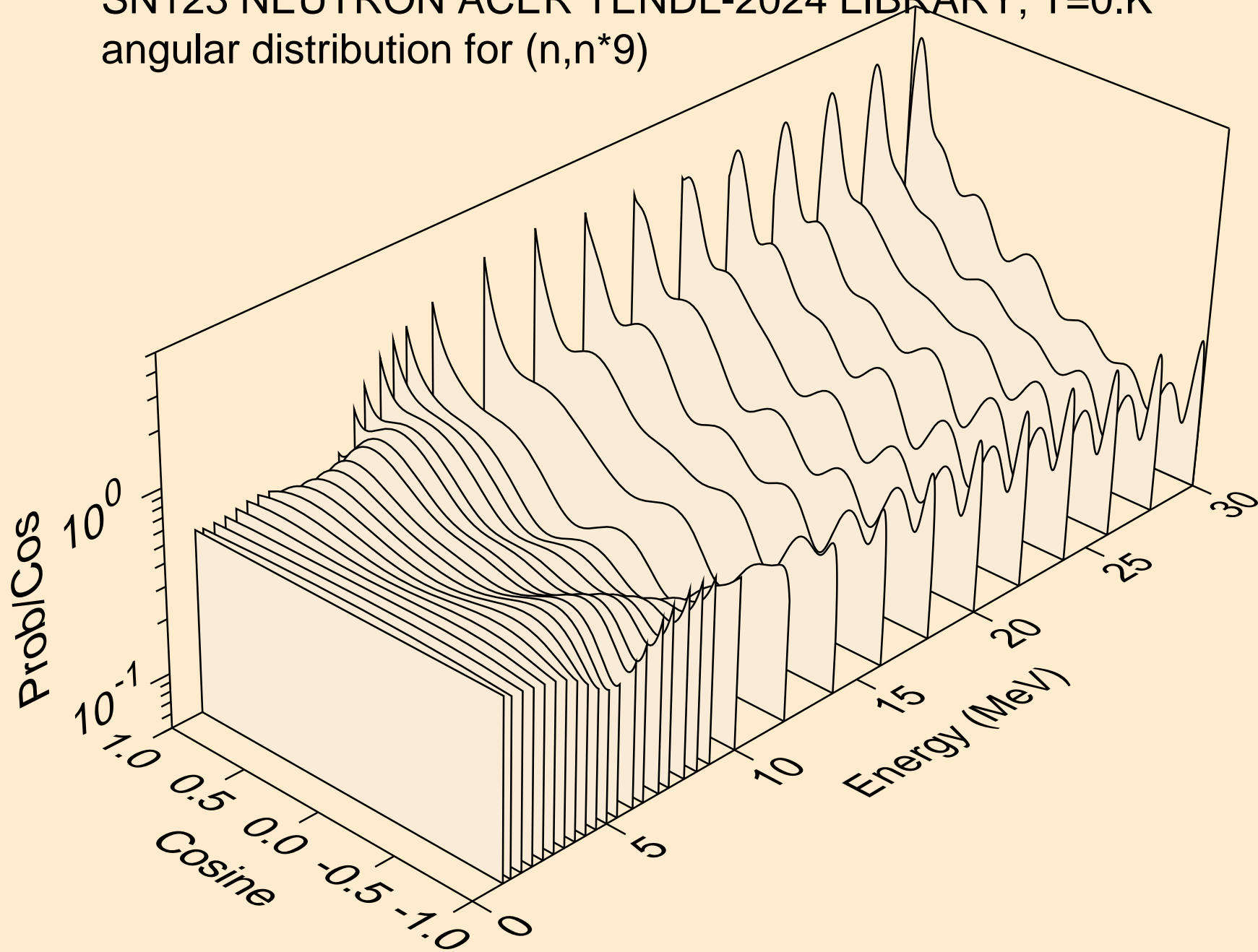

SN123 NEUTRON ACER TENDL-2024 LIBRARY; T=0.K
angular distribution for (n,n*10)

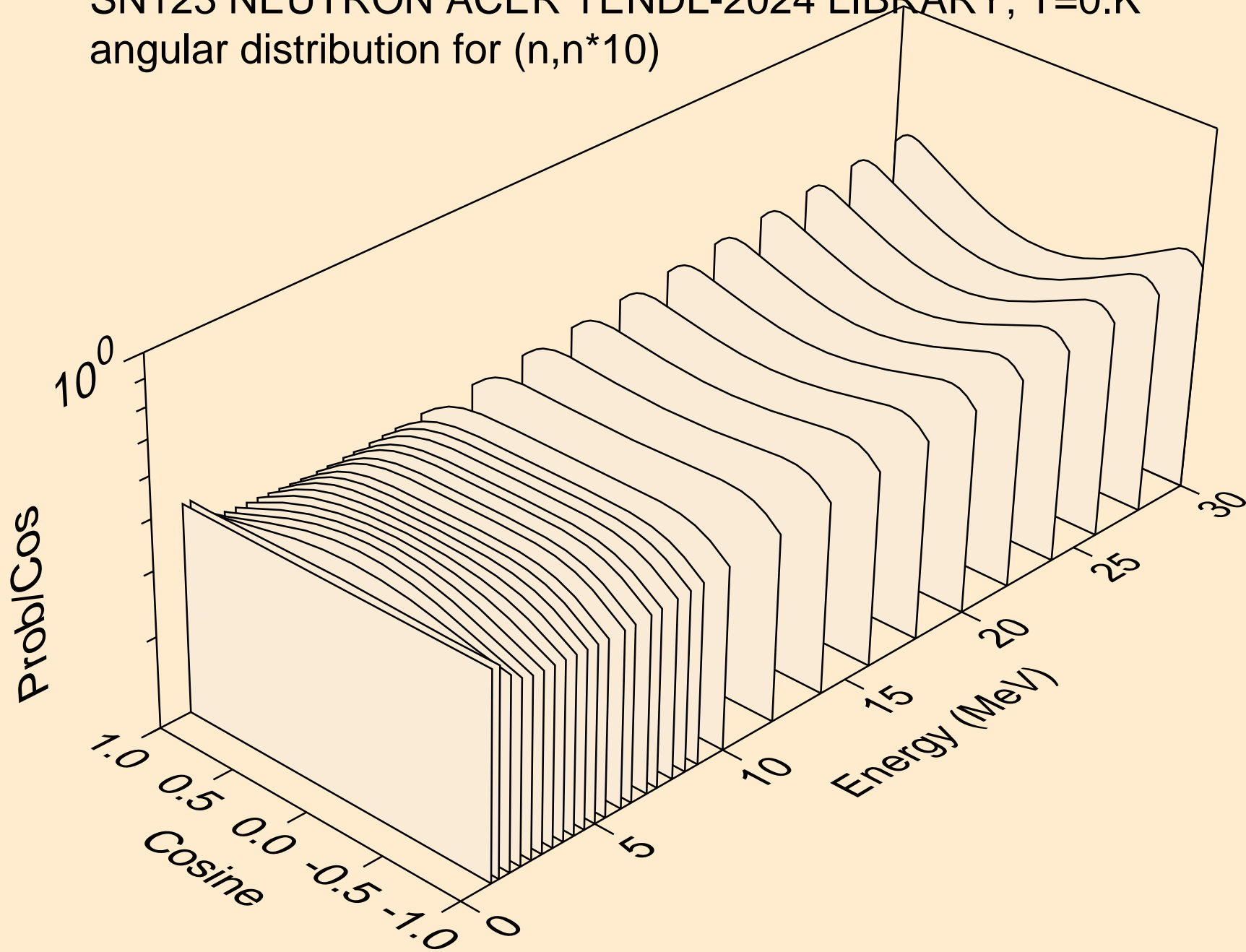

SN123 NEUTRON ACER TENDL-2024 LIBRARY; T=0.K
angular distribution for (n,n*11)

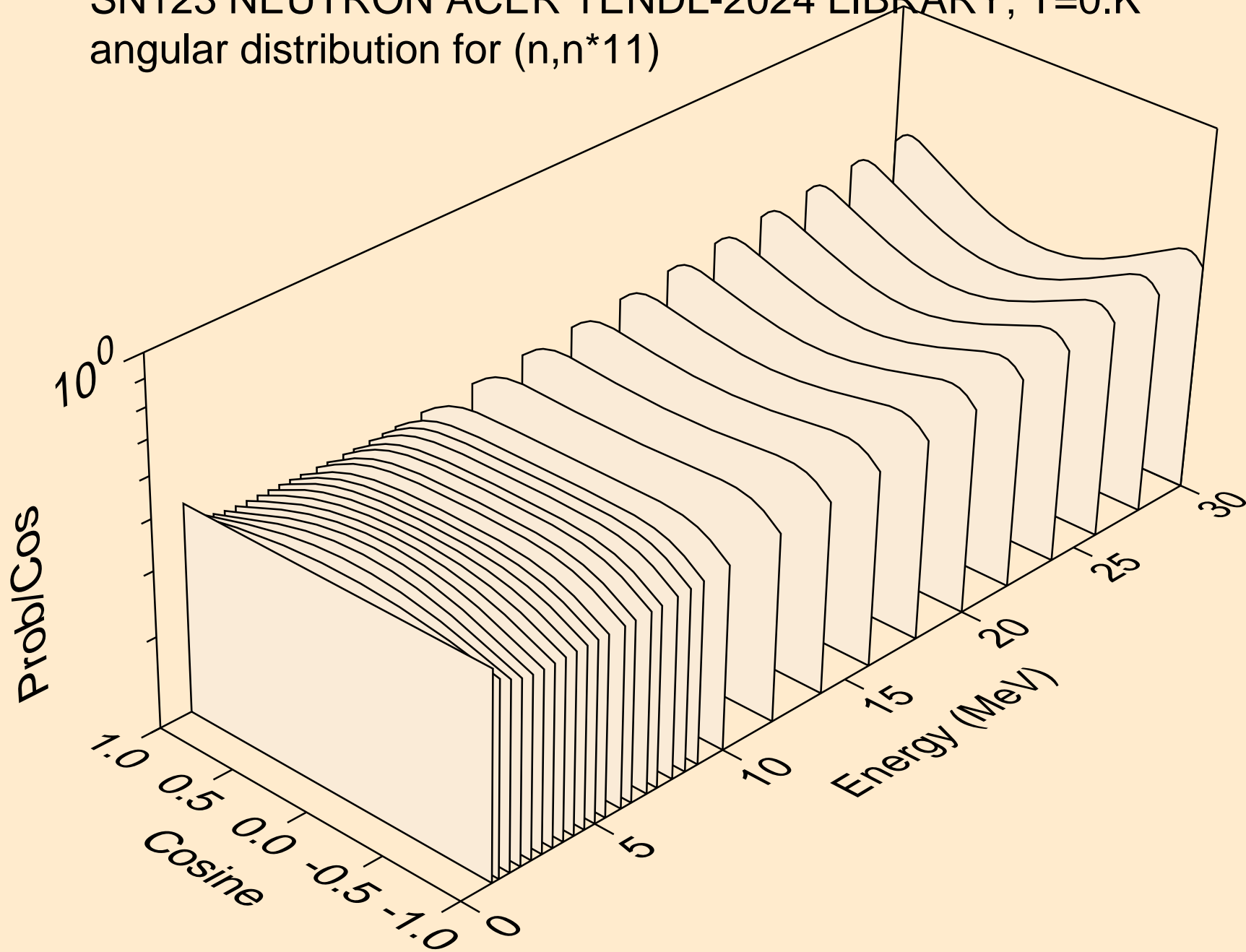

SN123 NEUTRON ACER TENDL-2024 LIBRARY; T=0.K
angular distribution for (n,n*12)

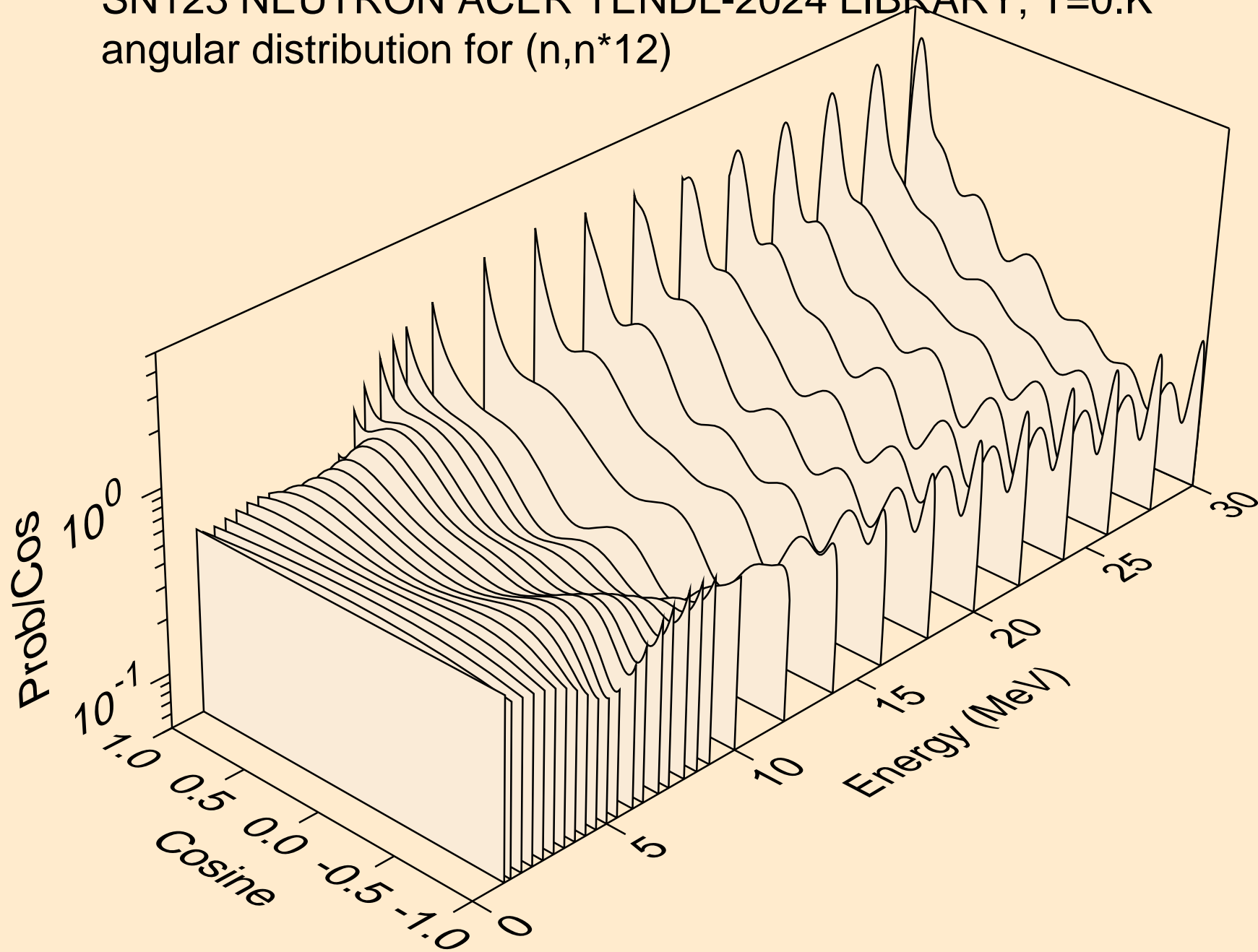

SN123 NEUTRON ACER TENDL-2024 LIBRARY; T=0.K
angular distribution for (n,n*13)

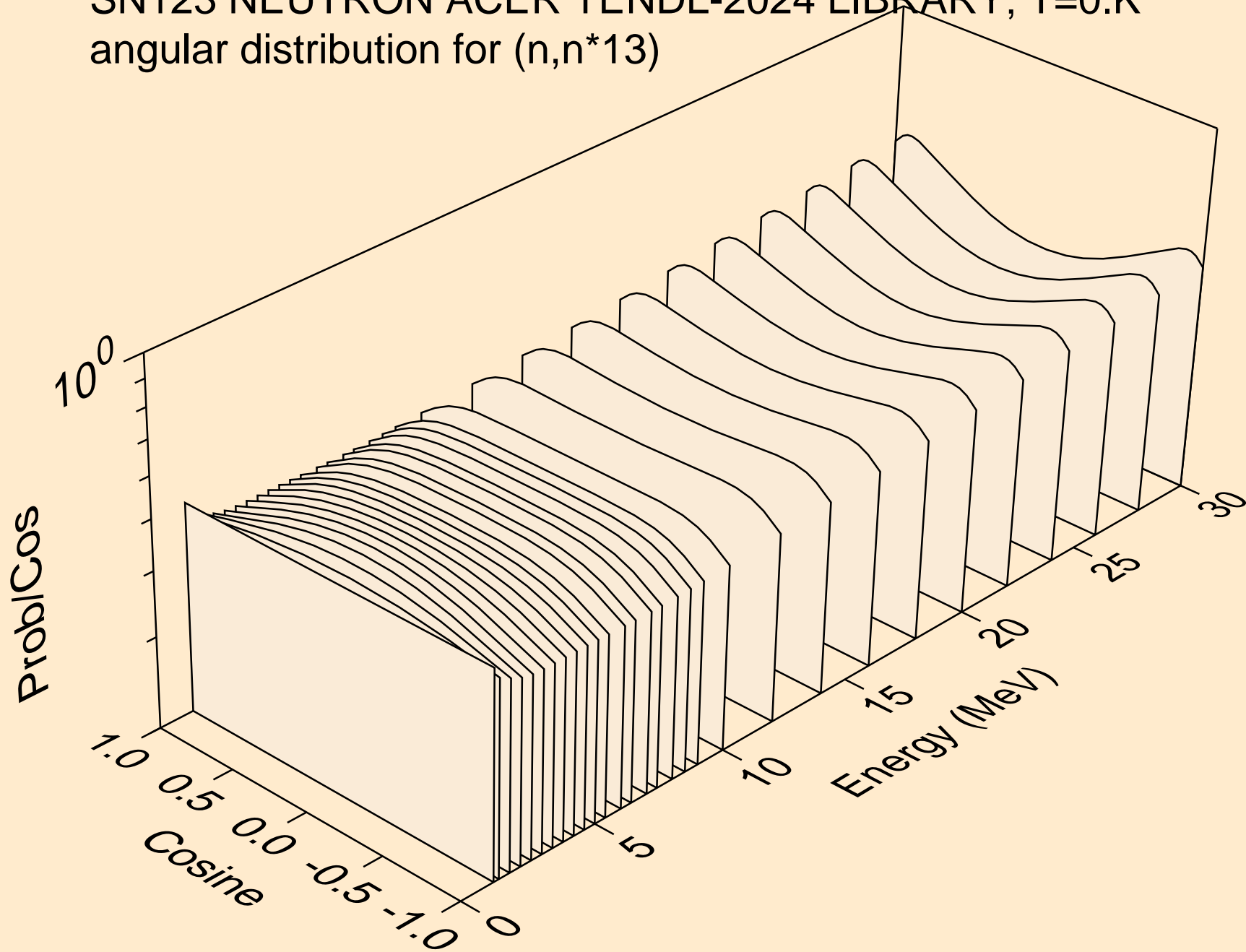

SN123 NEUTRON ACER TENDL-2024 LIBRARY; T=0.K
angular distribution for (n,n*14)

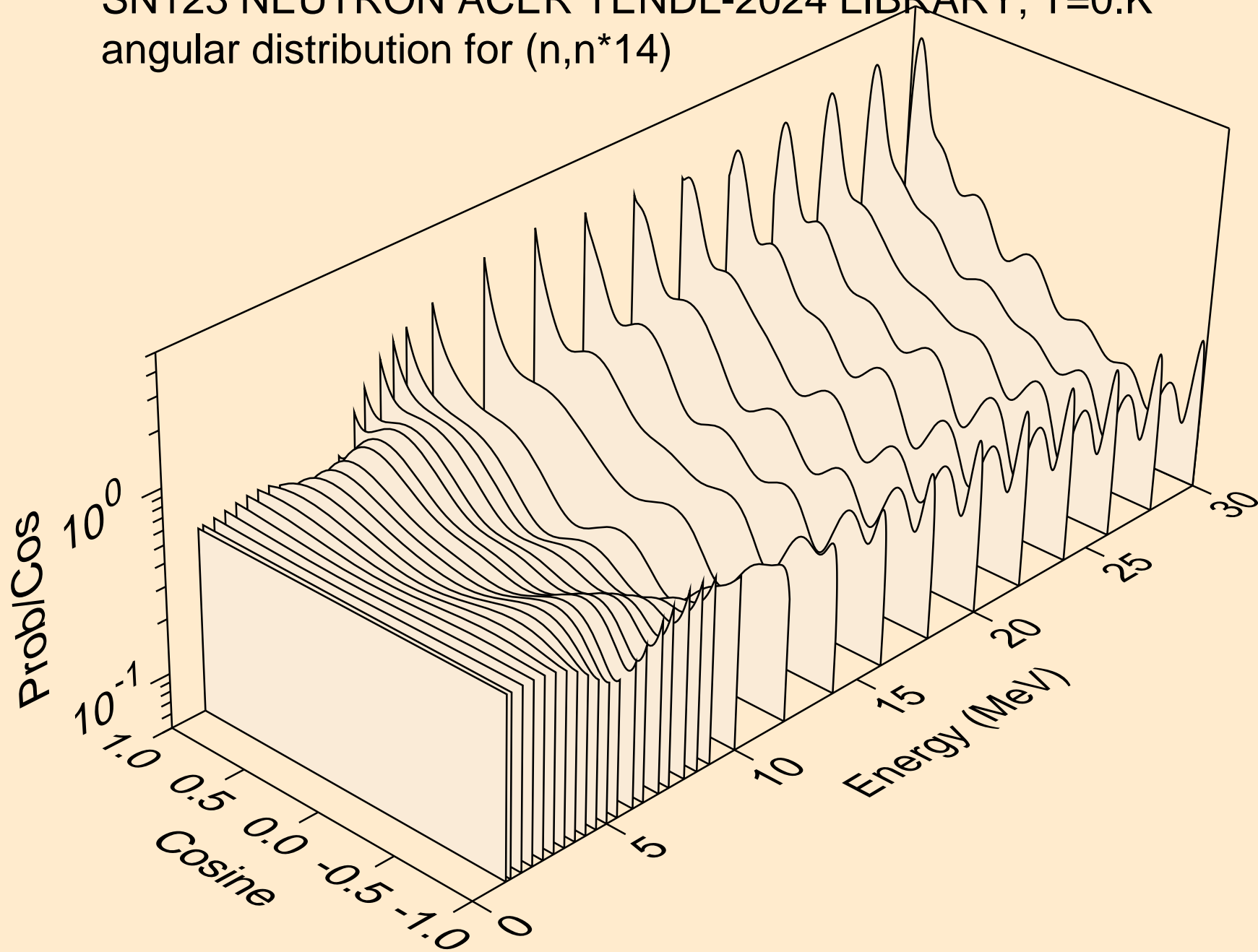

SN123 NEUTRON ACER TENDL-2024 LIBRARY; T=0.K
angular distribution for (n,n*15)

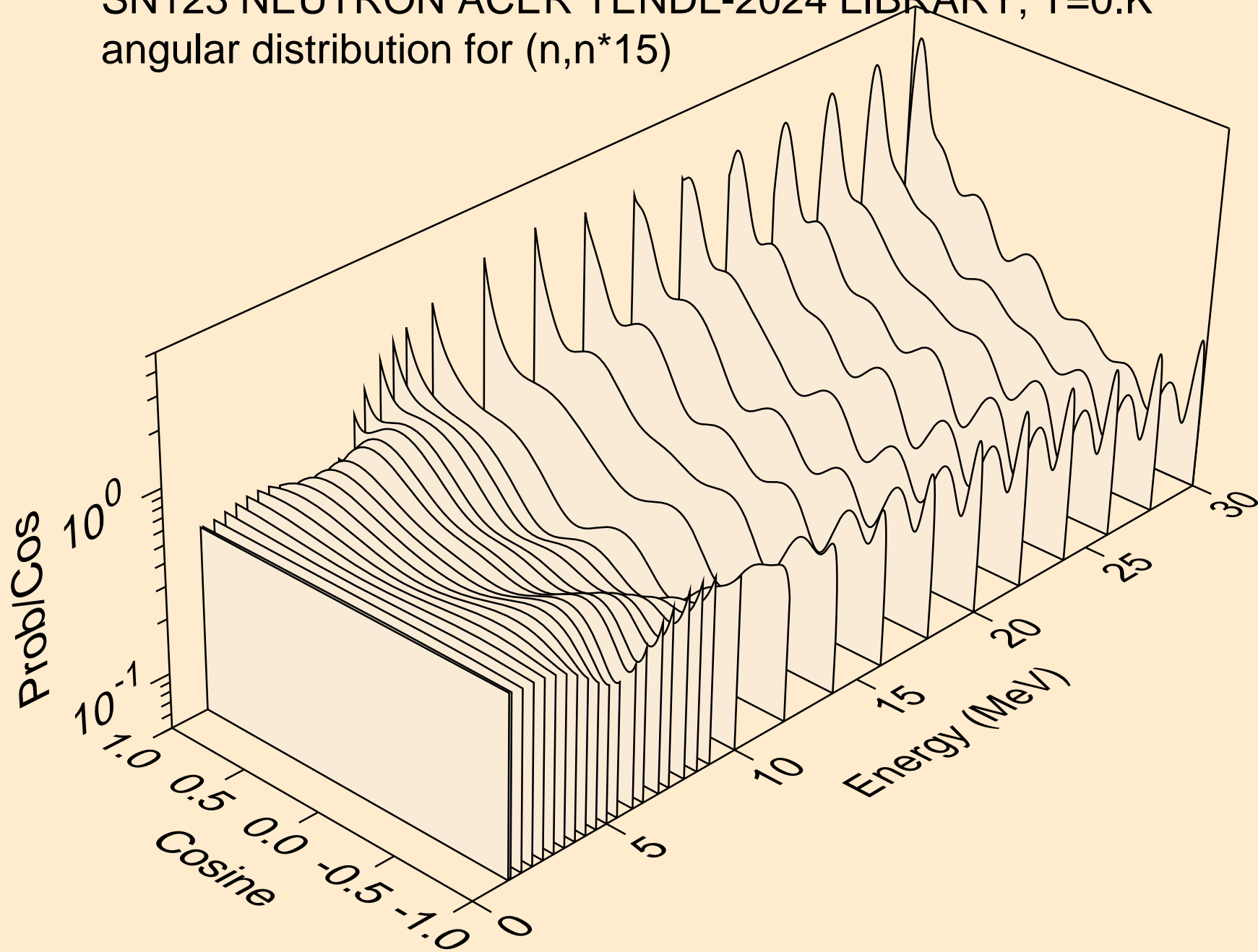

SN123 NEUTRON ACER TENDL-2024 LIBRARY; T=0.K
angular distribution for (n,n*16)

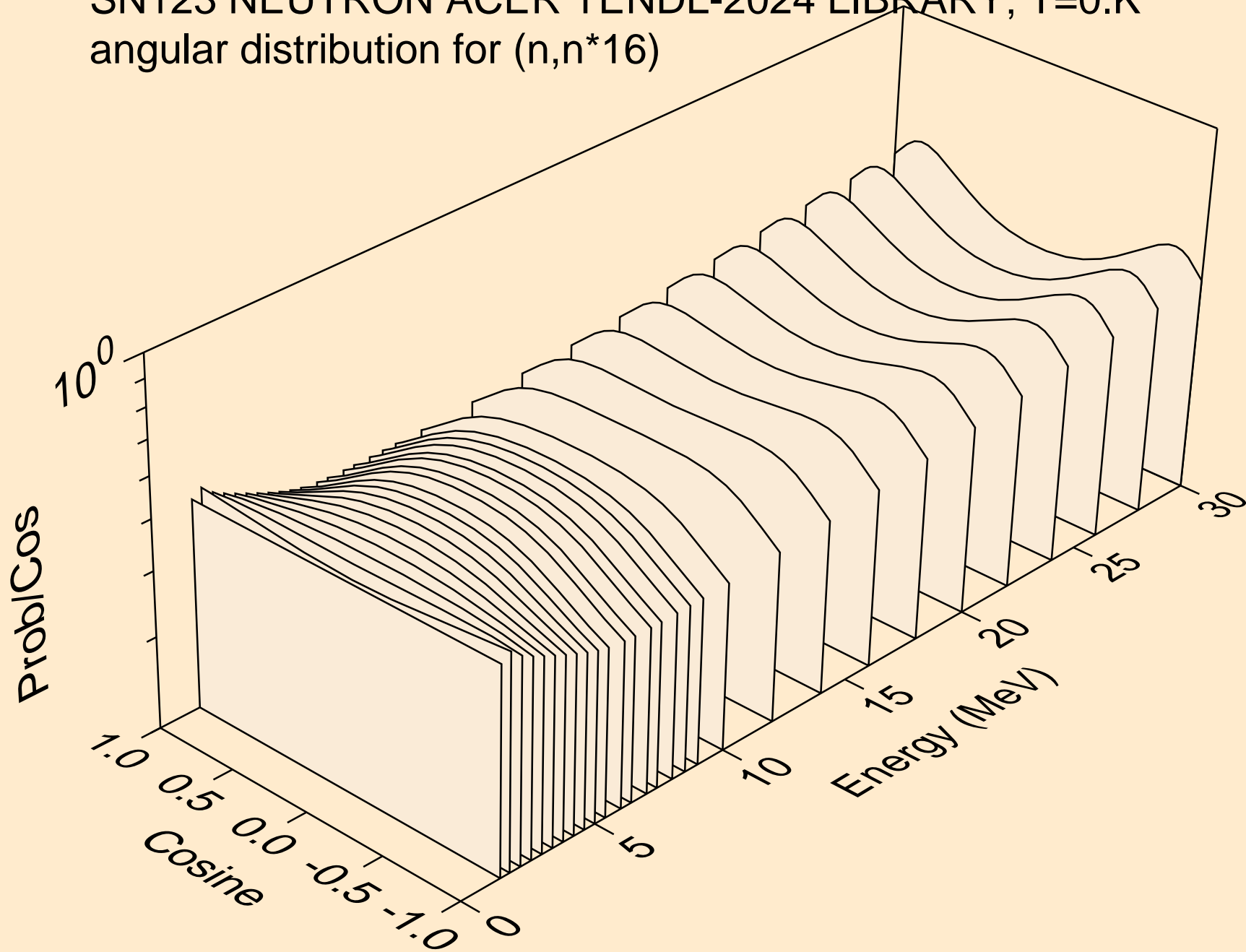

SN123 NEUTRON ACER TENDL-2024 LIBRARY; T=0.K
angular distribution for (n,n*17)

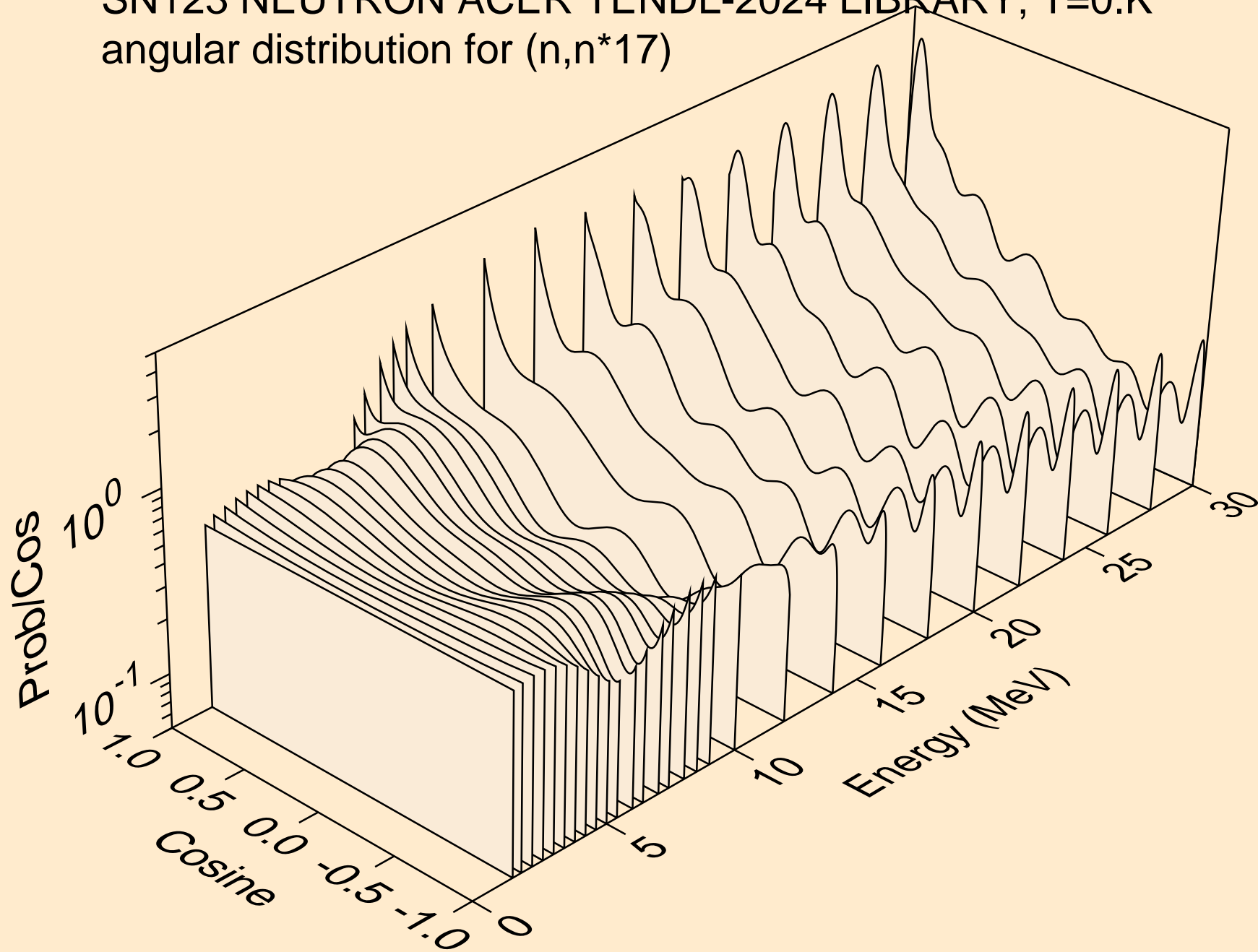

SN123 NEUTRON ACER TENDL-2024 LIBRARY; T=0.K
angular distribution for (n,n*18)

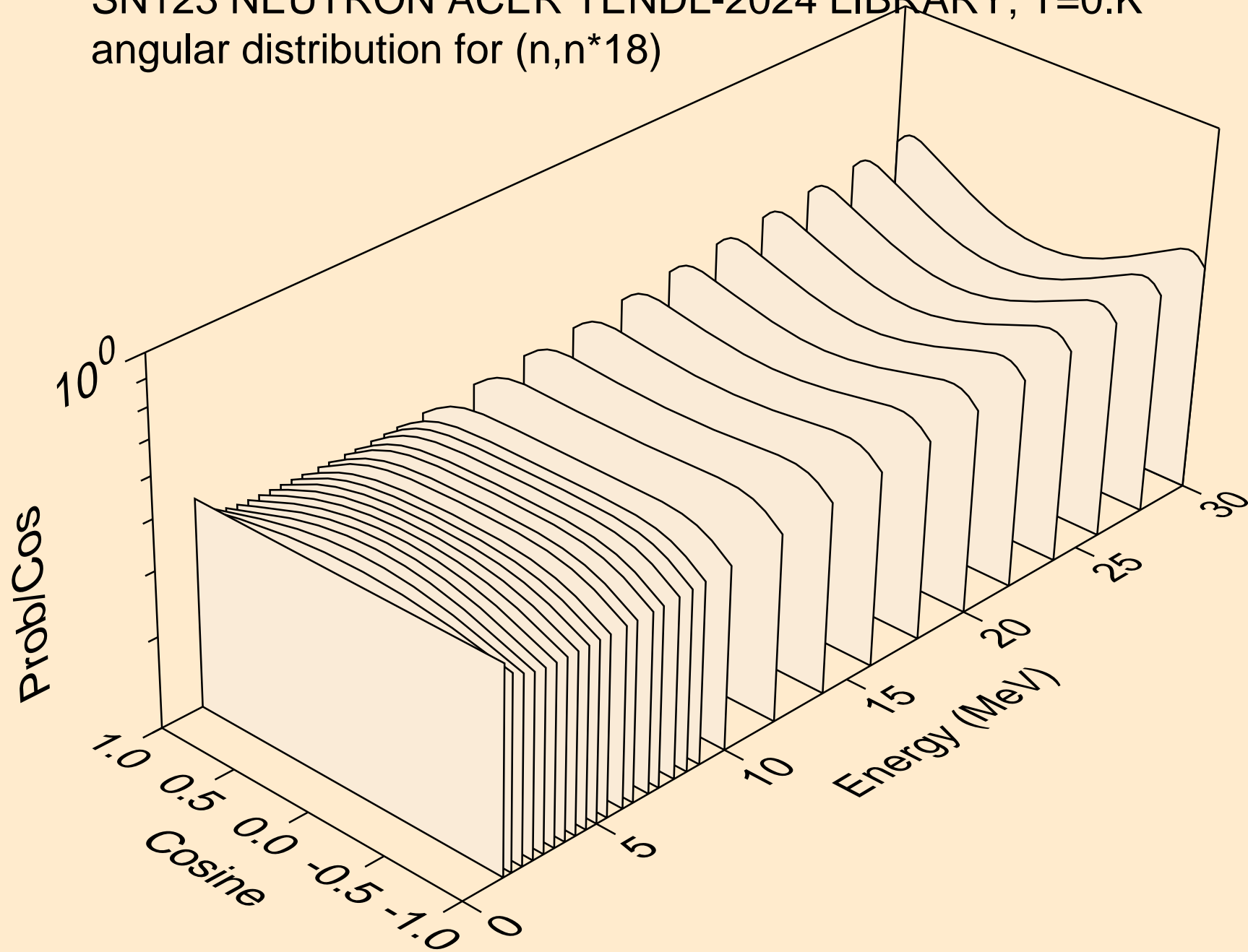

SN123 NEUTRON ACER TENDL-2024 LIBRARY; T=0.K
angular distribution for (n,n*19)

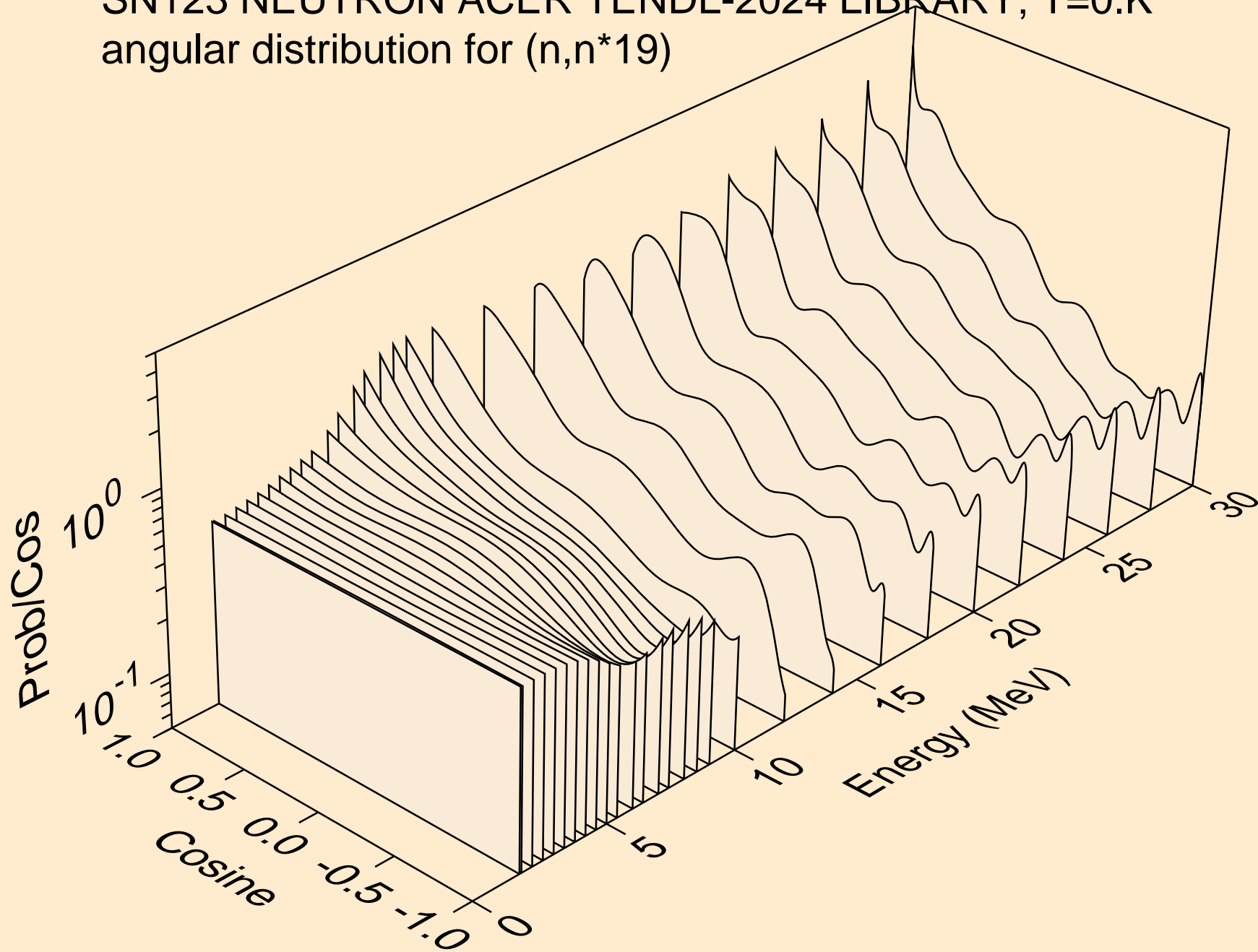

SN123 NEUTRON ACER TENDL-2024 LIBRARY; T=0.K
angular distribution for (n,n*20)

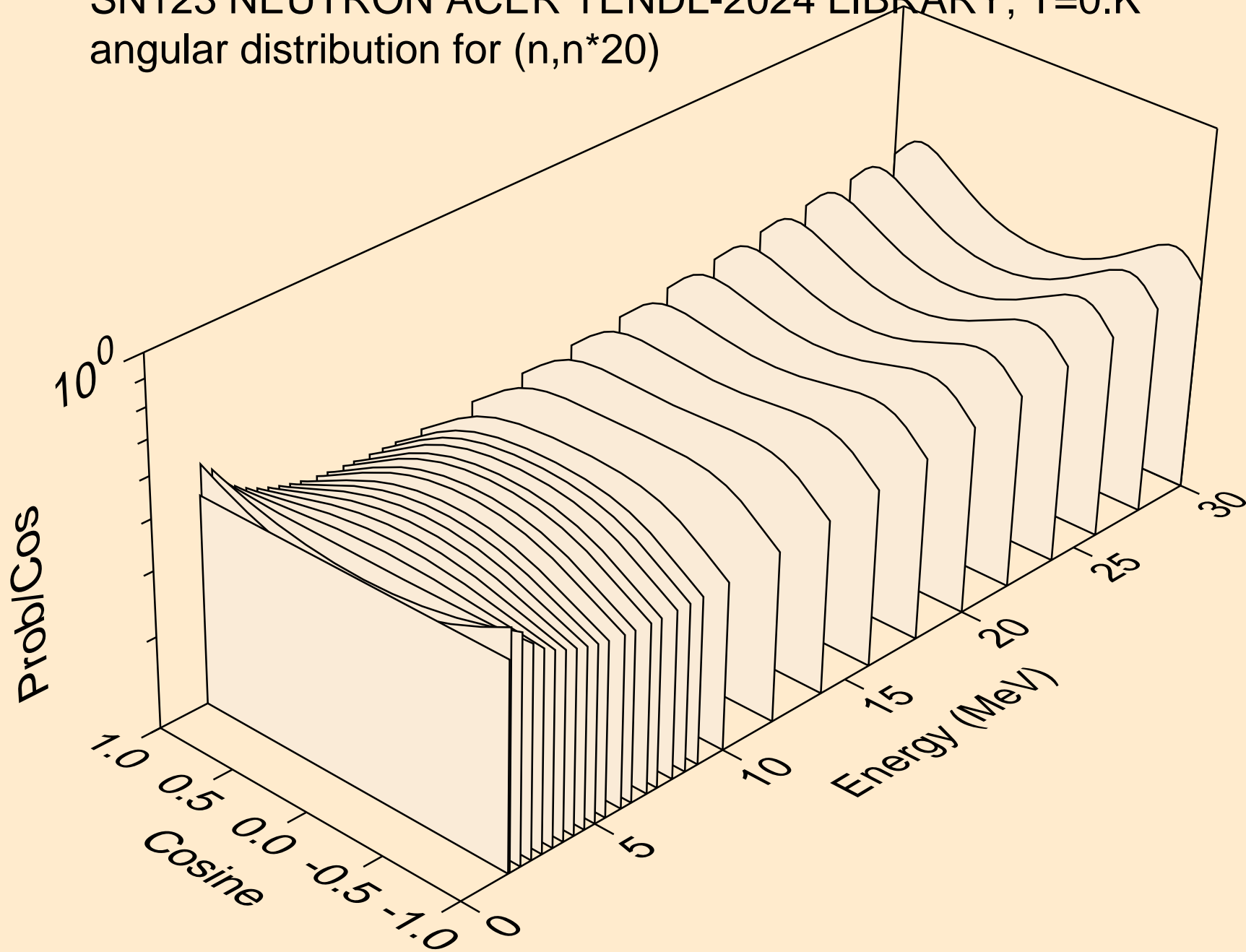

SN123 NEUTRON ACER TENDL-2024 LIBRARY; T=0.K
angular distribution for (n,n*21)

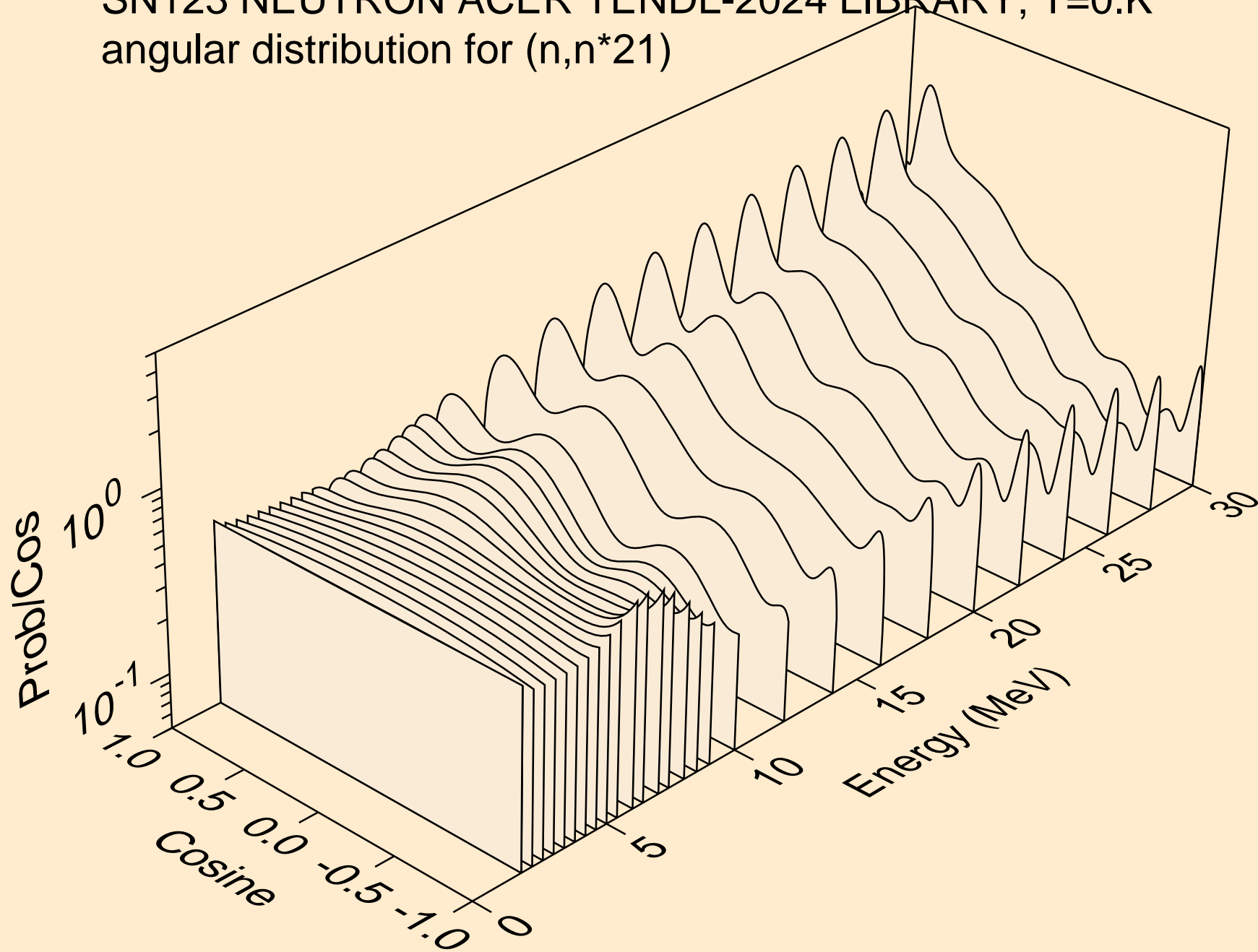

SN123 NEUTRON ACER TENDL-2024 LIBRARY; T=0.K
angular distribution for (n,n*22)

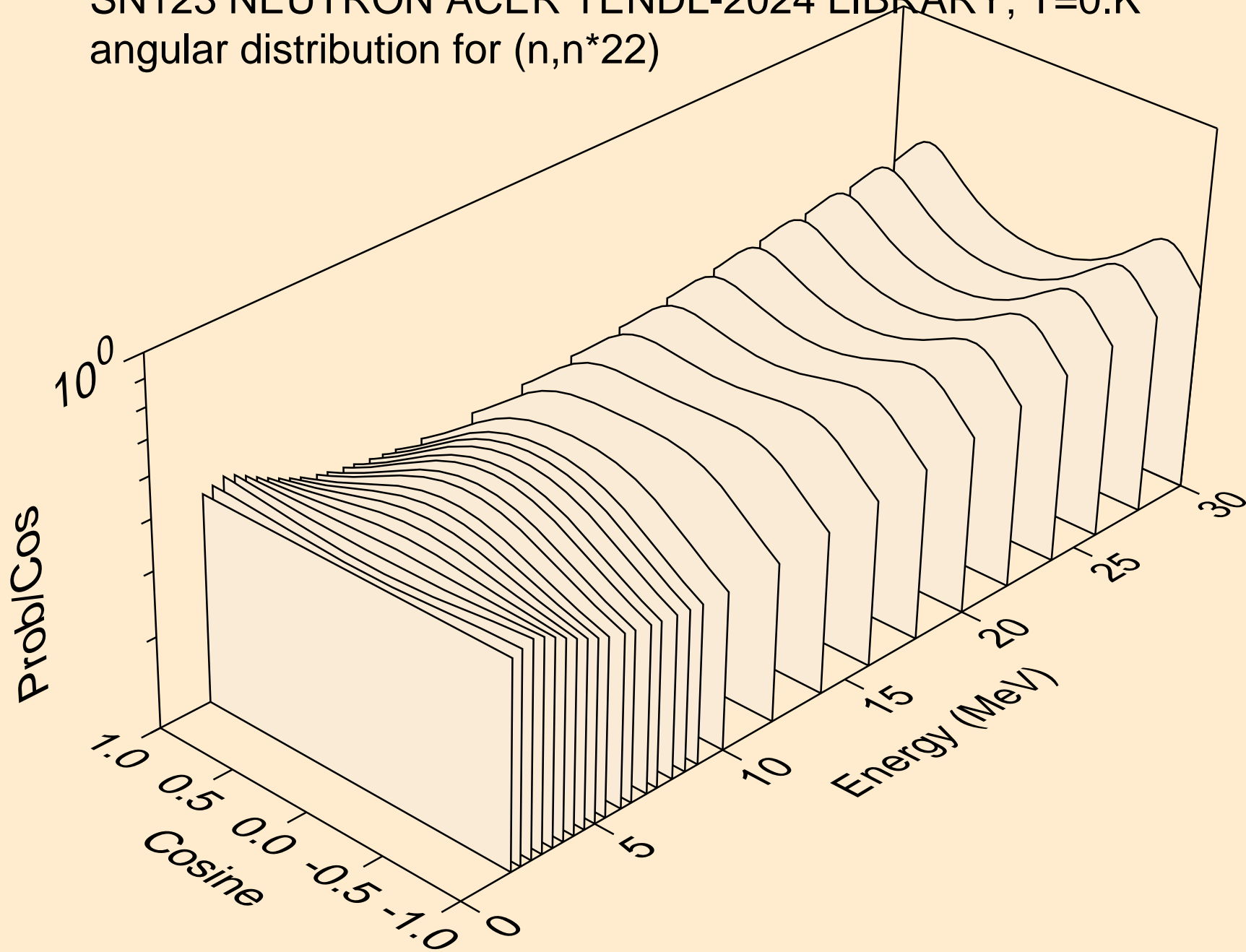

SN123 NEUTRON ACER TENDL-2024 LIBRARY; T=0.K
angular distribution for (n,n*23)

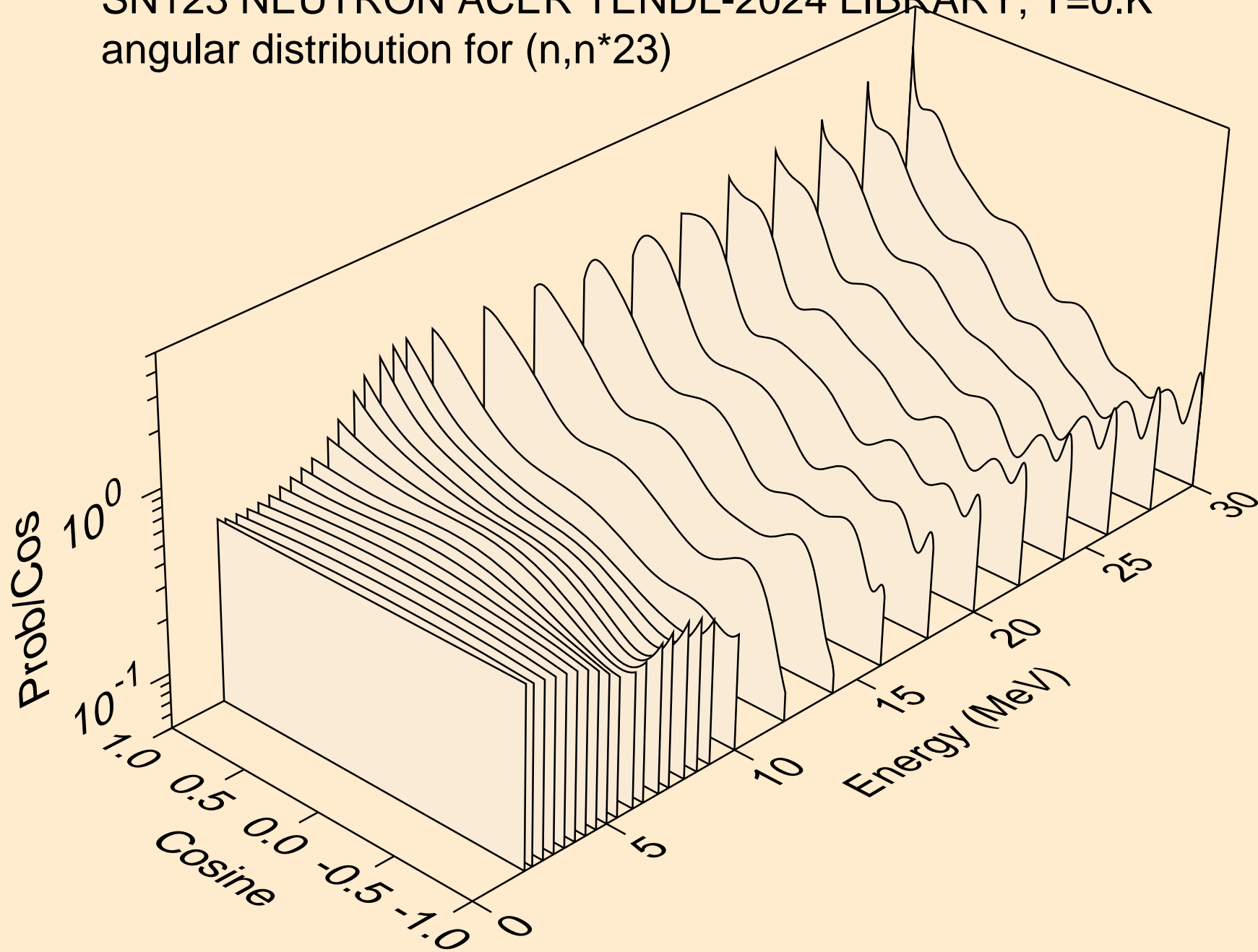

SN123 NEUTRON ACER TENDL-2024 LIBRARY; T=0.K
angular distribution for (n,n*24)

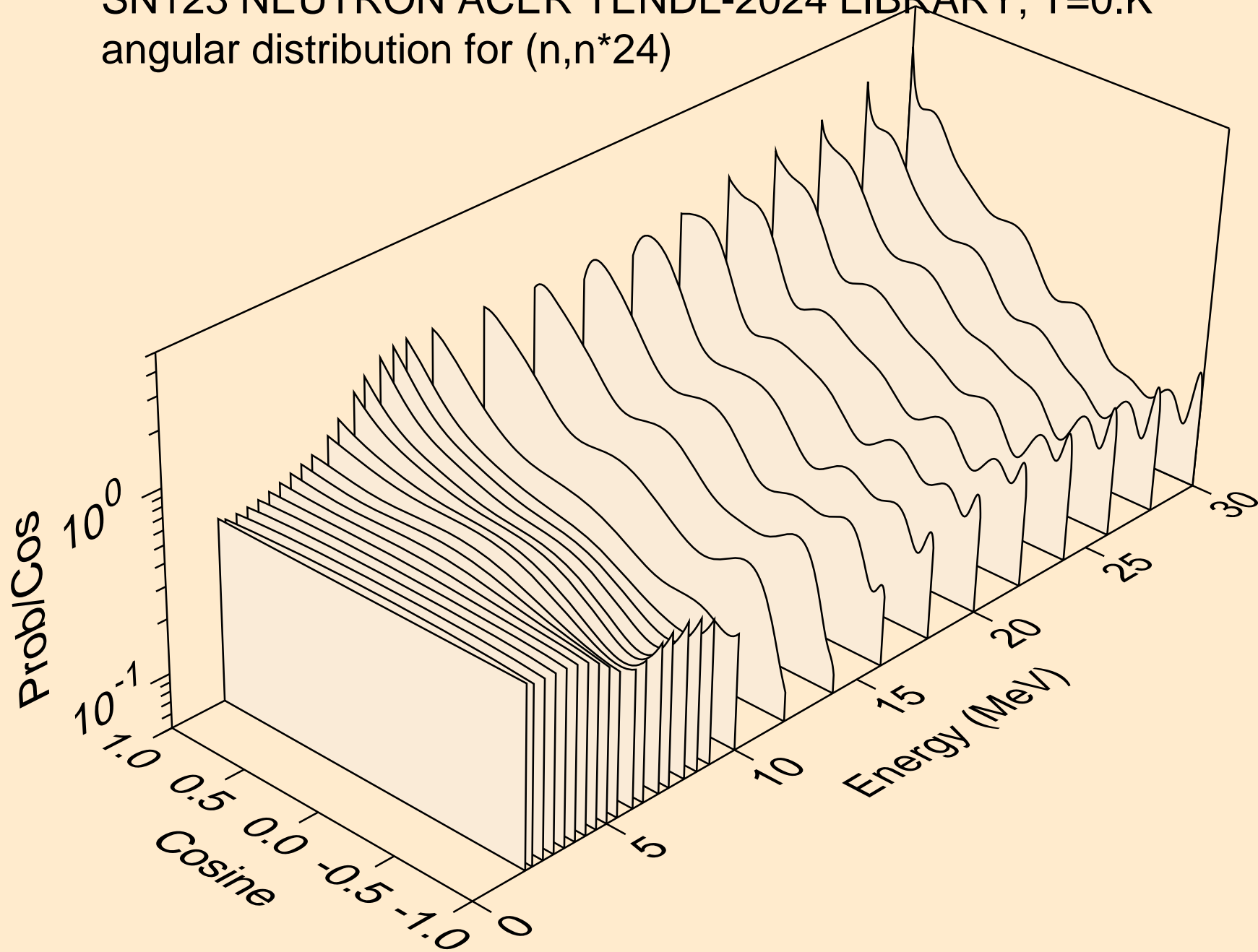

SN123 NEUTRON ACER TENDL-2024 LIBRARY; T=0.K
angular distribution for (n,n*25)

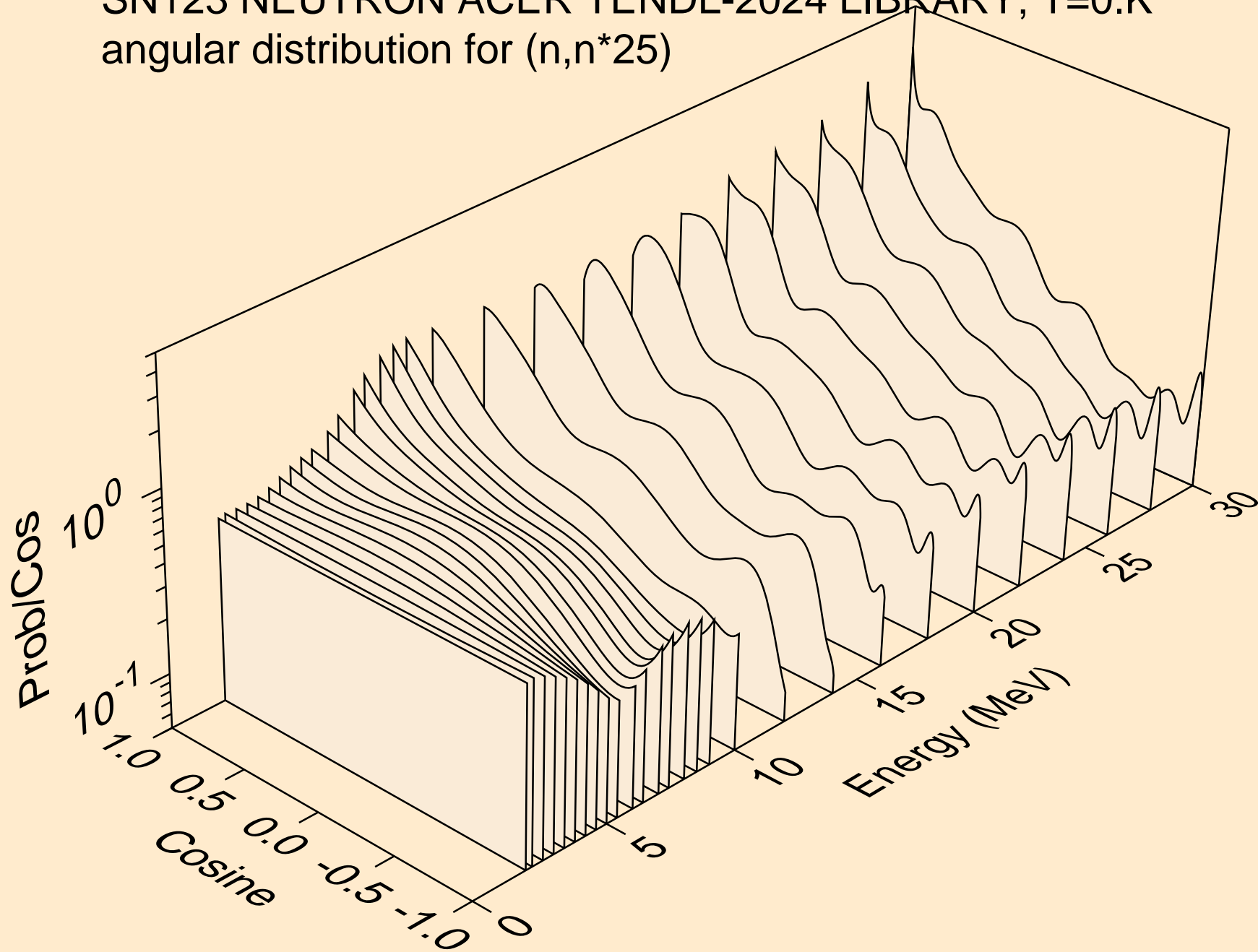

SN123 NEUTRON ACER TENDL-2024 LIBRARY; T=0.K
angular distribution for (n,n*26)

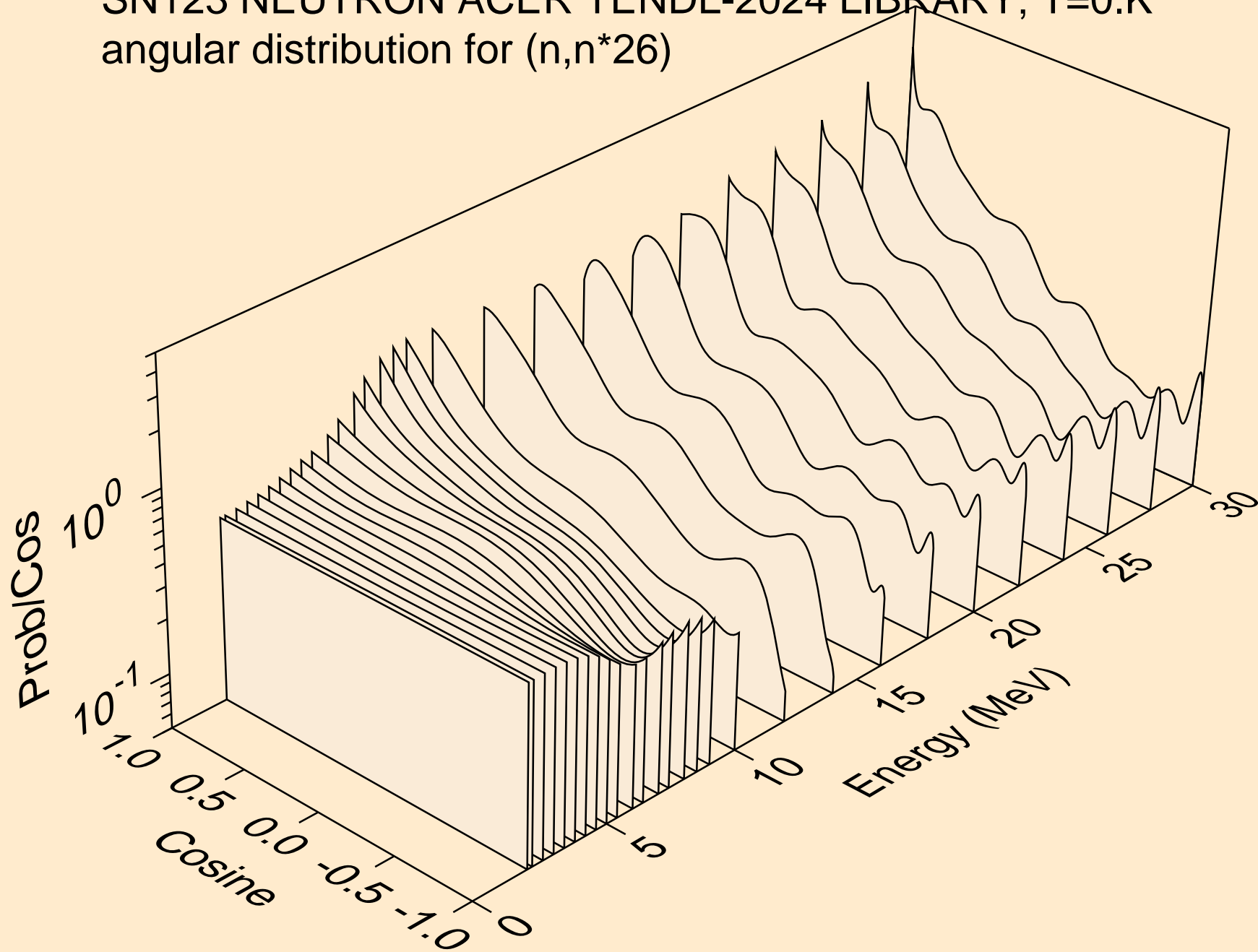

SN123 NEUTRON ACER TENDL-2024 LIBRARY; T=0.K
angular distribution for (n,n*27)

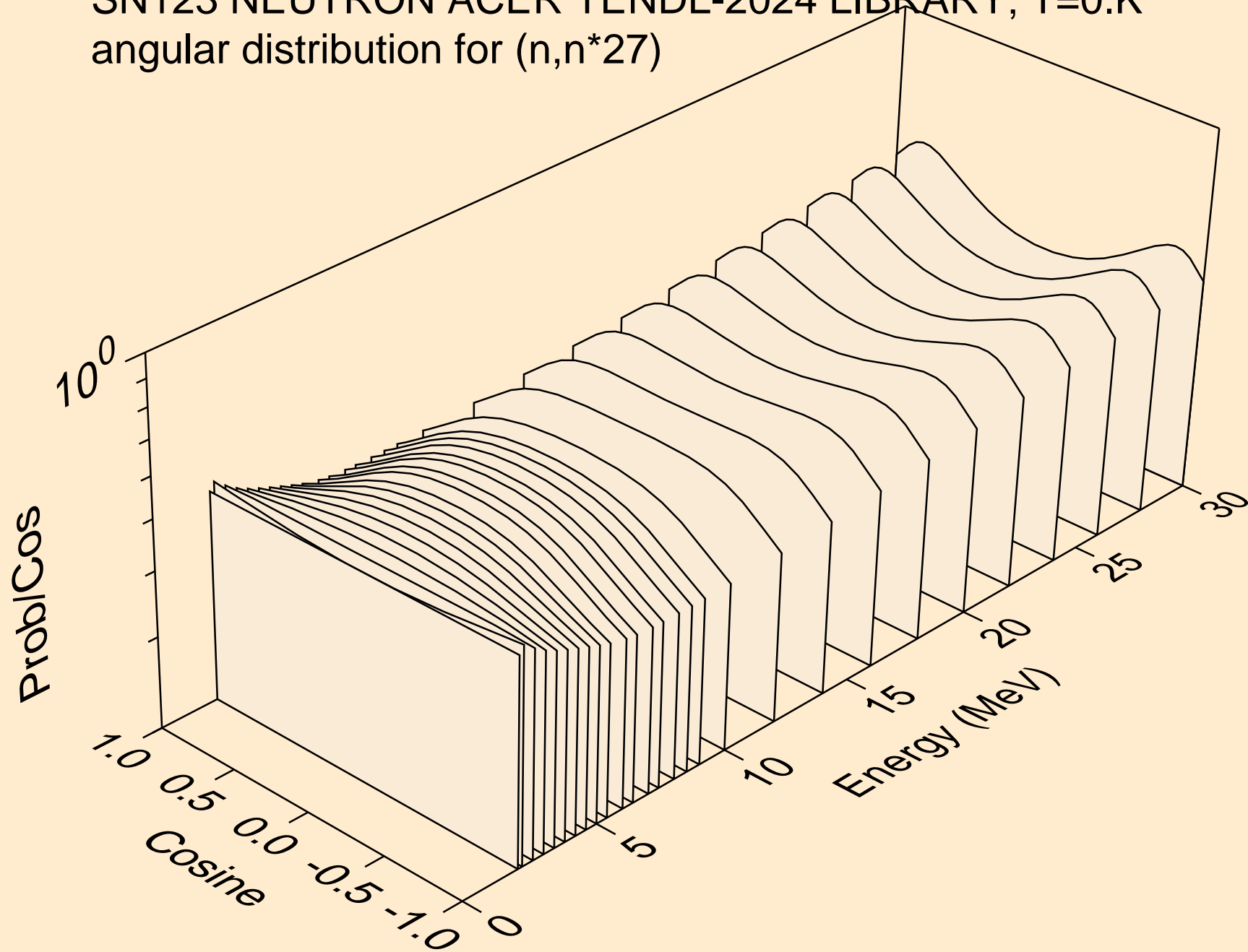

SN123 NEUTRON ACER TENDL-2024 LIBRARY; T=0.K
angular distribution for (n,n*28)

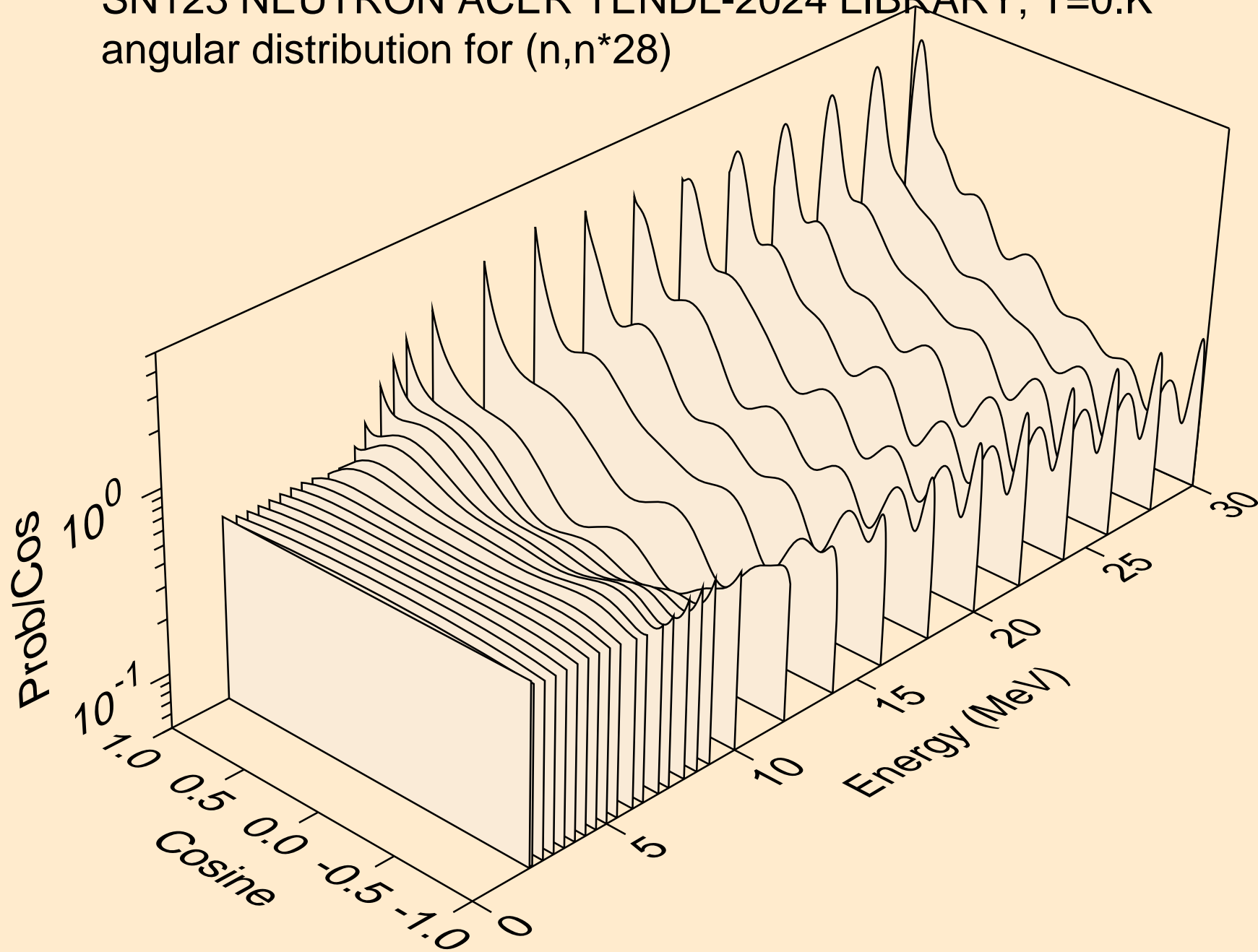

SN123 NEUTRON ACER TENDL-2024 LIBRARY; T=0.K
angular distribution for (n,n*29)

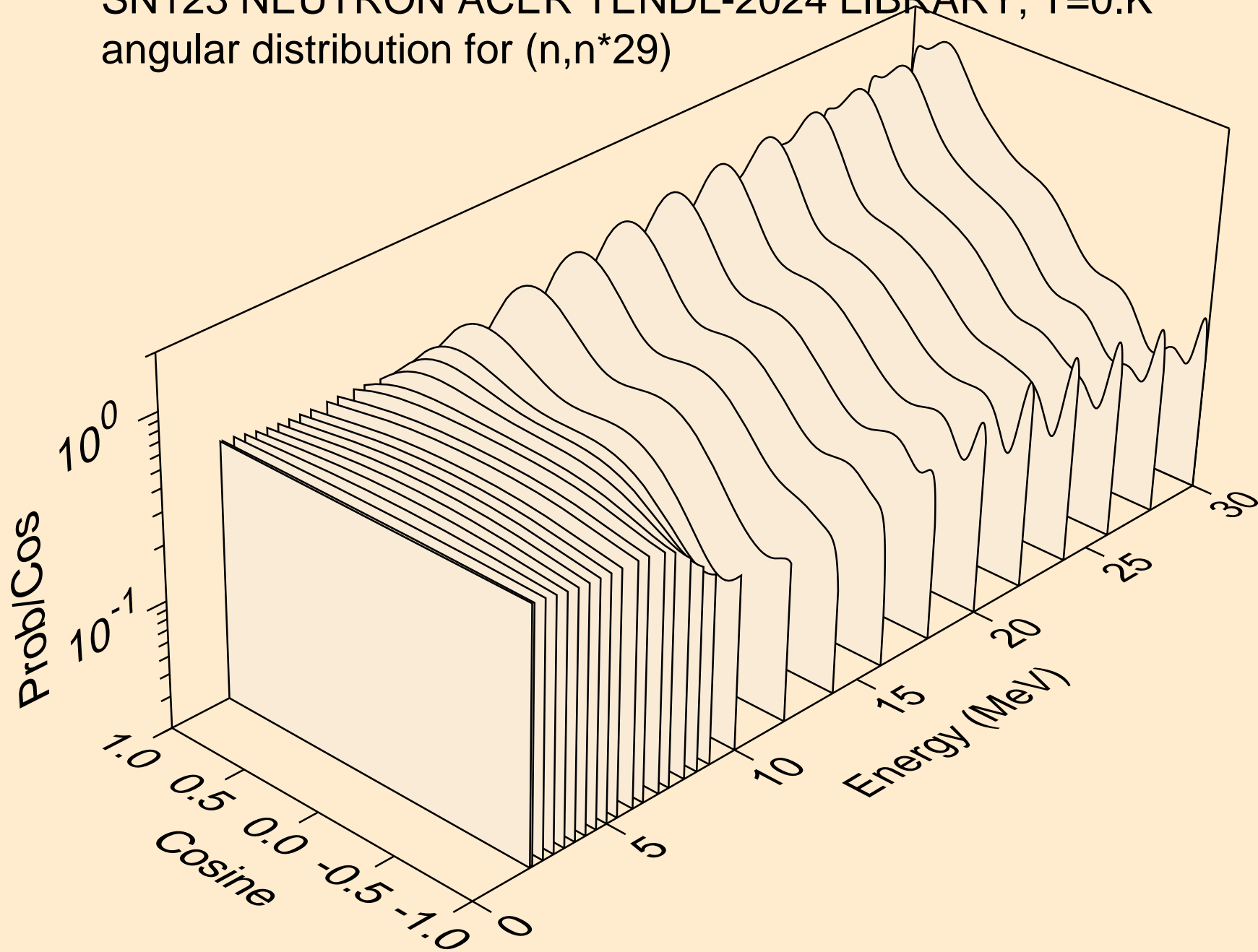

SN123 NEUTRON ACER TENDL-2024 LIBRARY; T=0.K
Neutron emission for (n,x)

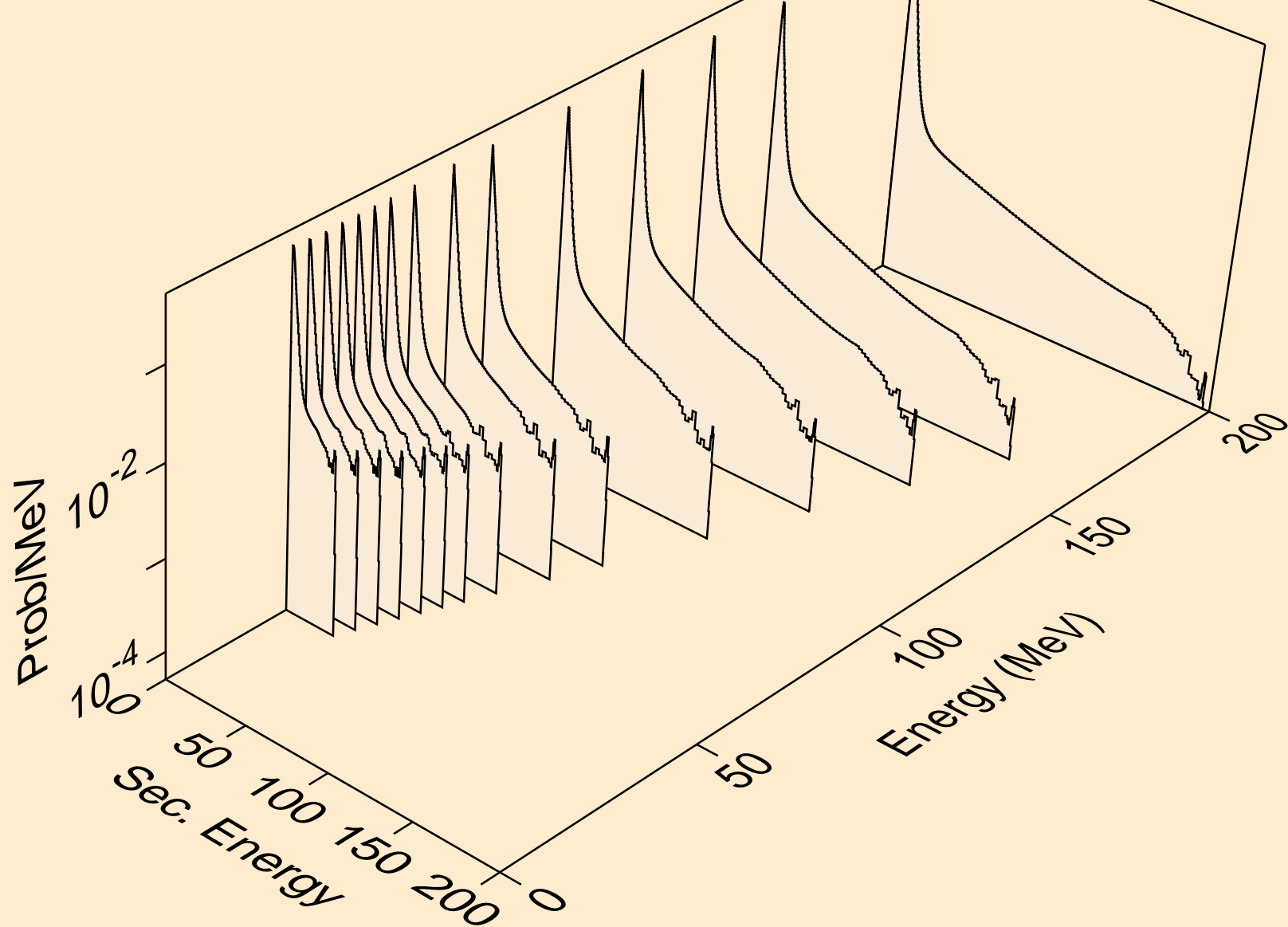

SN123 NEUTRON ACER TENDL-2024 LIBRARY; T=0.K
Neutron emission for (n,2nd)

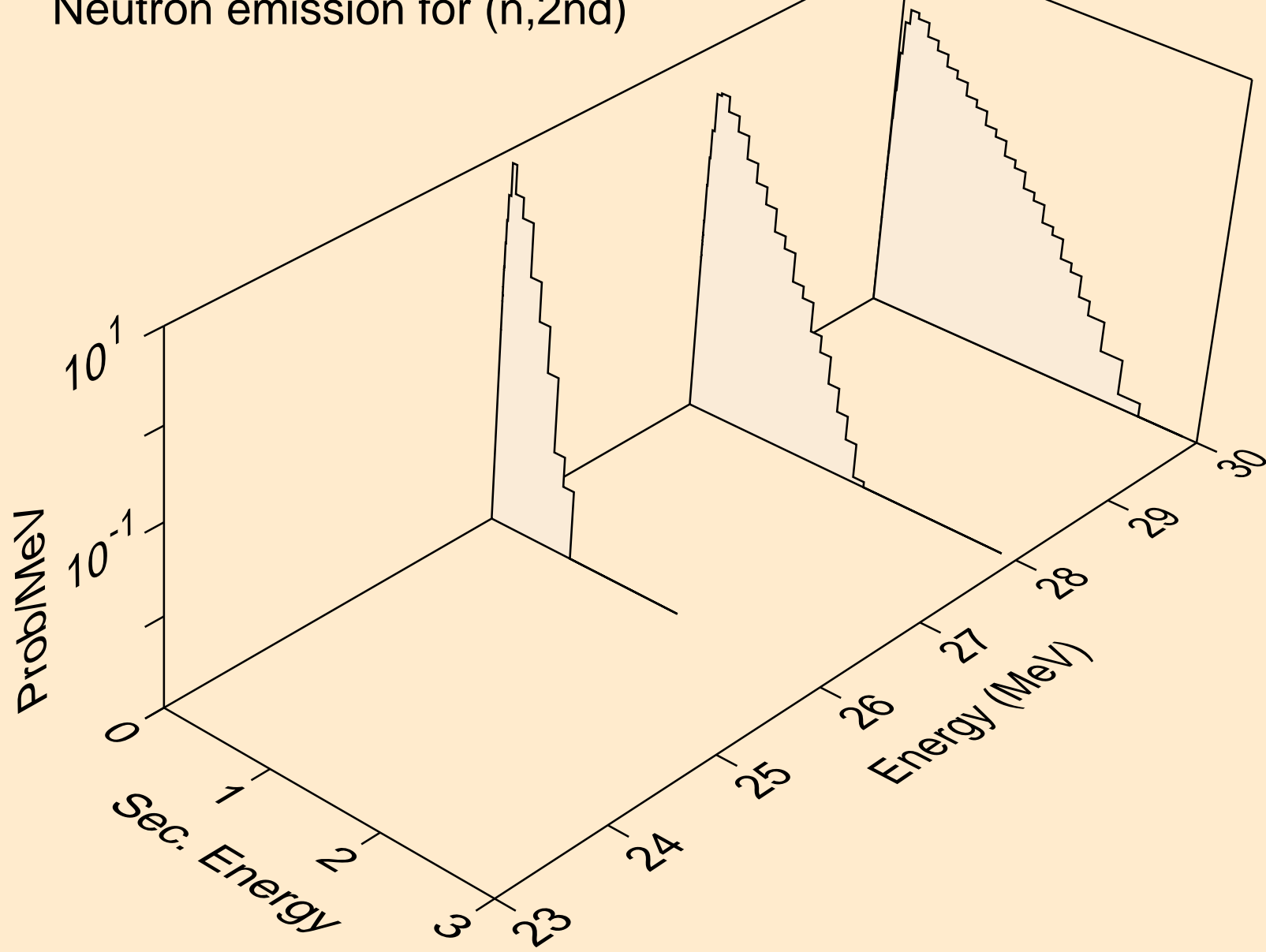

SN123 NEUTRON ACER TENDL-2024 LIBRARY; T=0.K
Neutron emission for (n,2n)

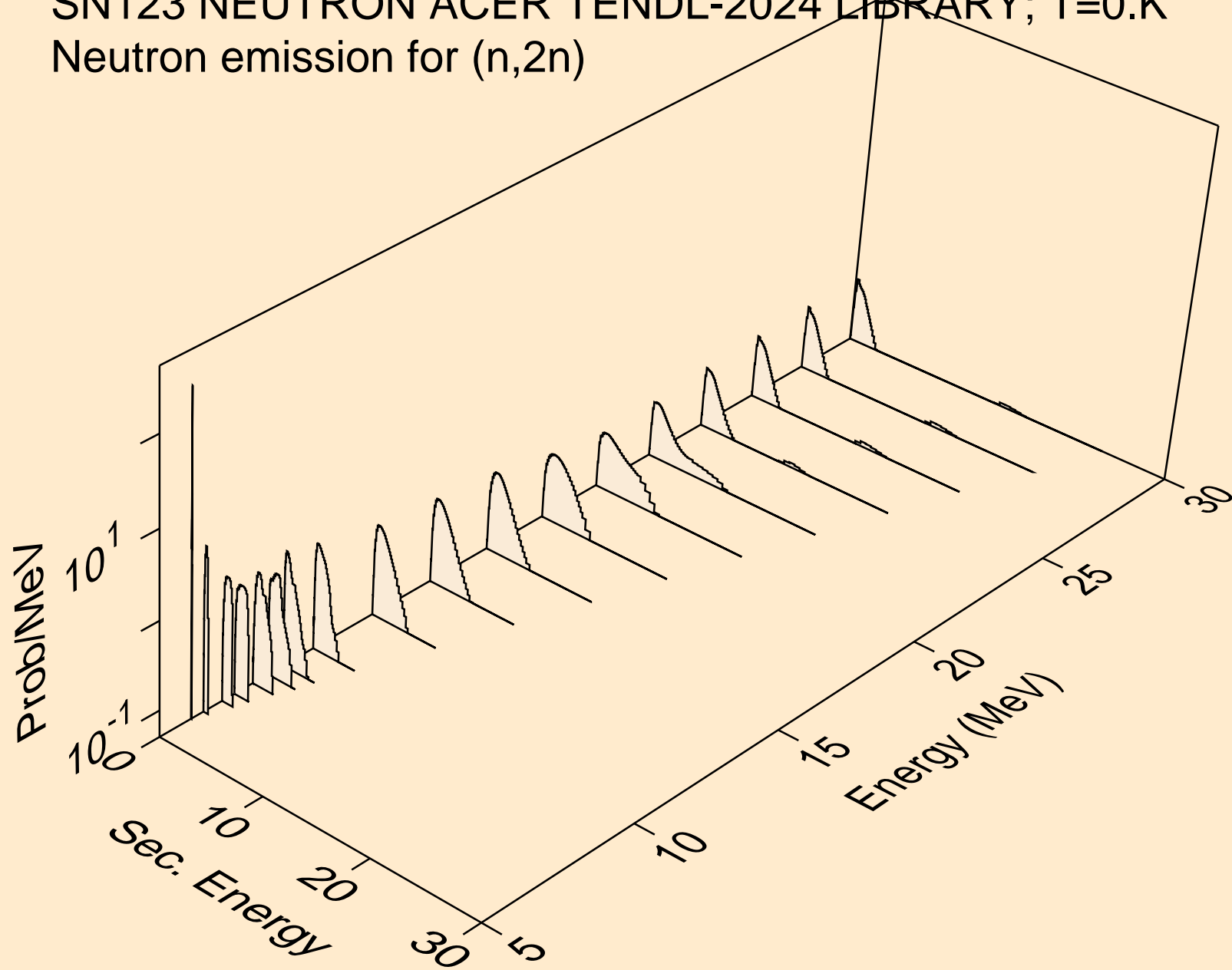

SN123 NEUTRON ACER TENDL-2024 LIBRARY; T=0.K
Neutron emission for (n,3n)

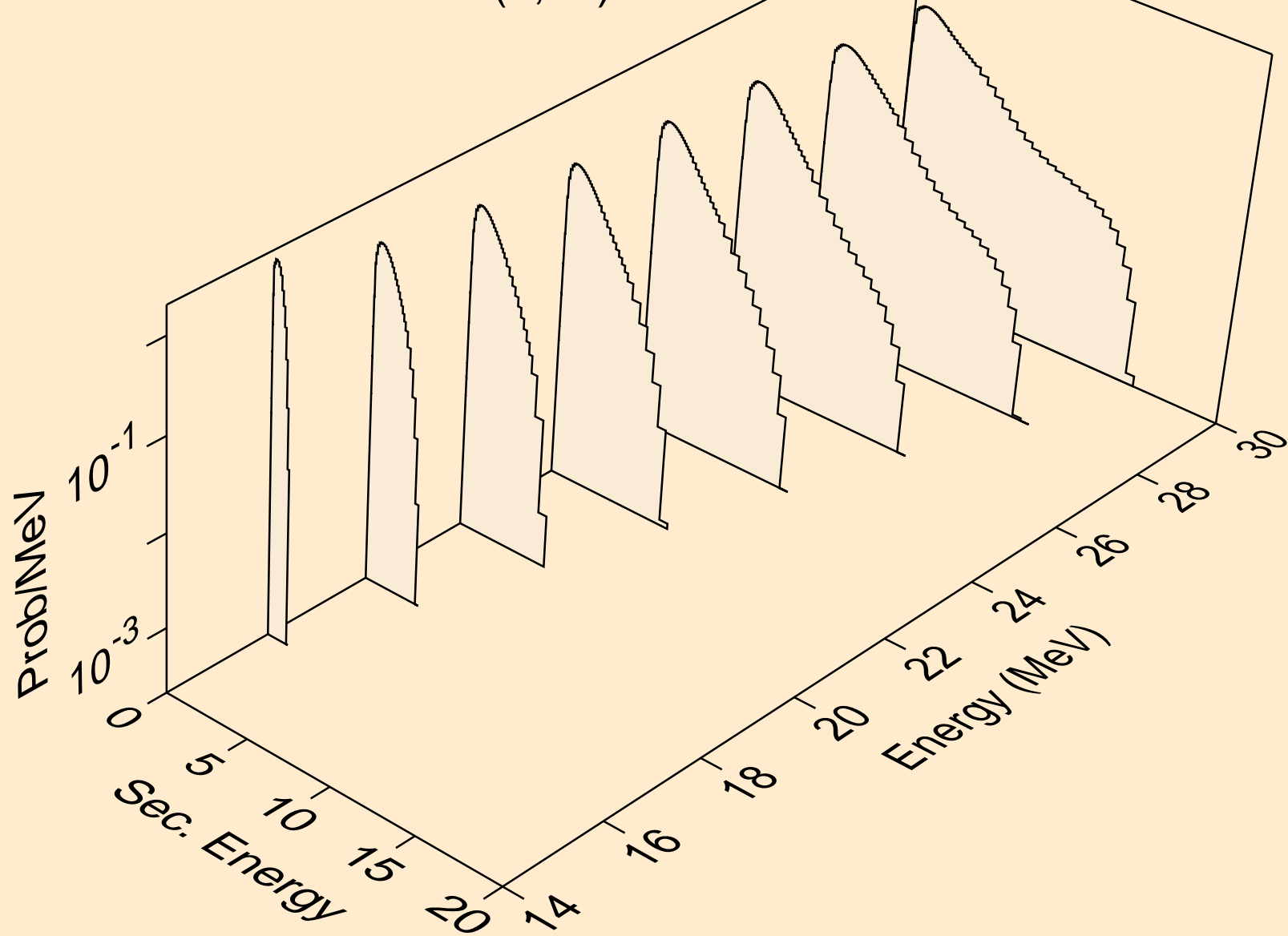

SN123 NEUTRON ACER TENDL-2024 LIBRARY; T=0.K
Neutron emission for (n,n*)a

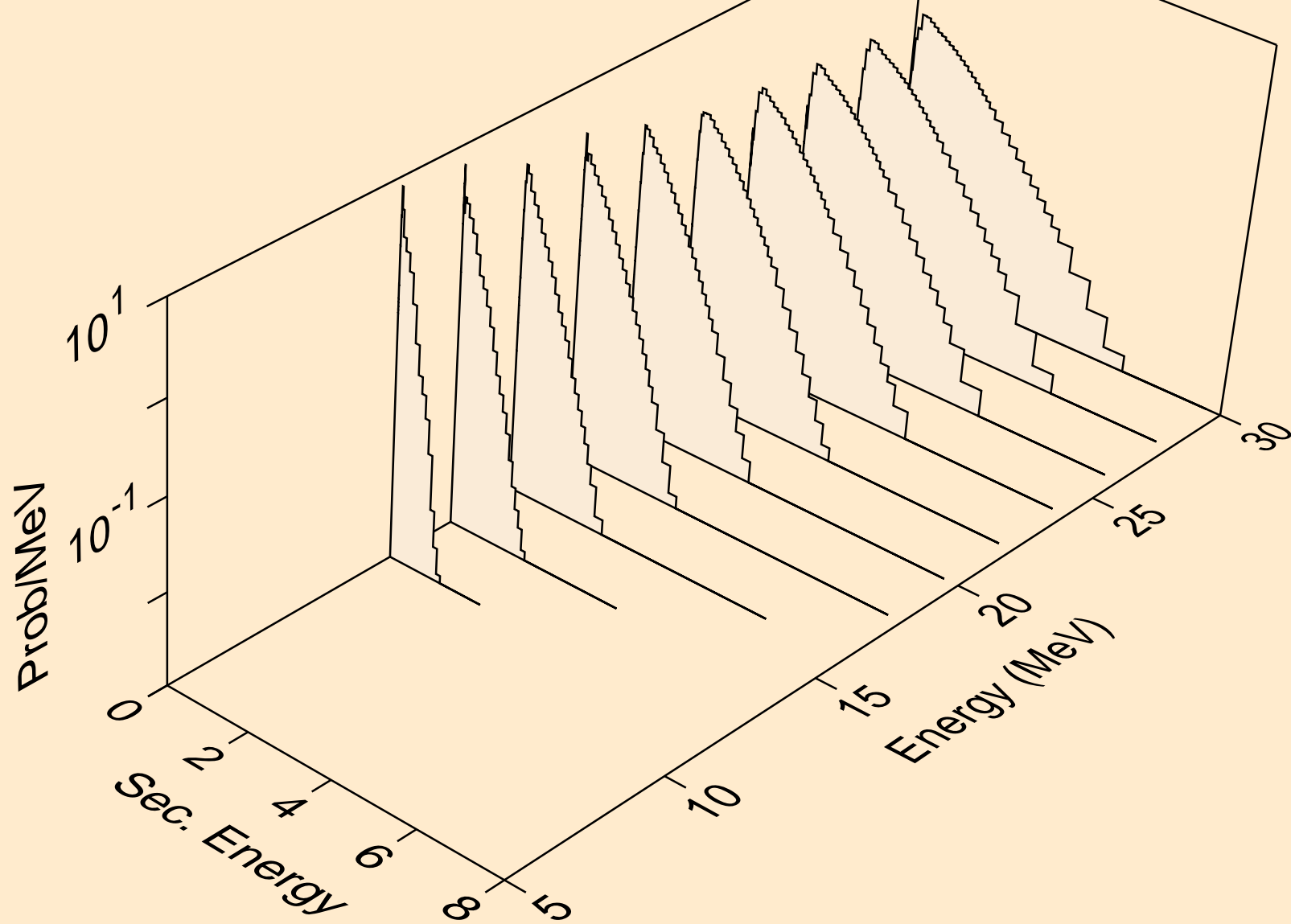

SN123 NEUTRON ACER TENDL-2024 LIBRARY; T=0.K
Neutron emission for (n,2n)a

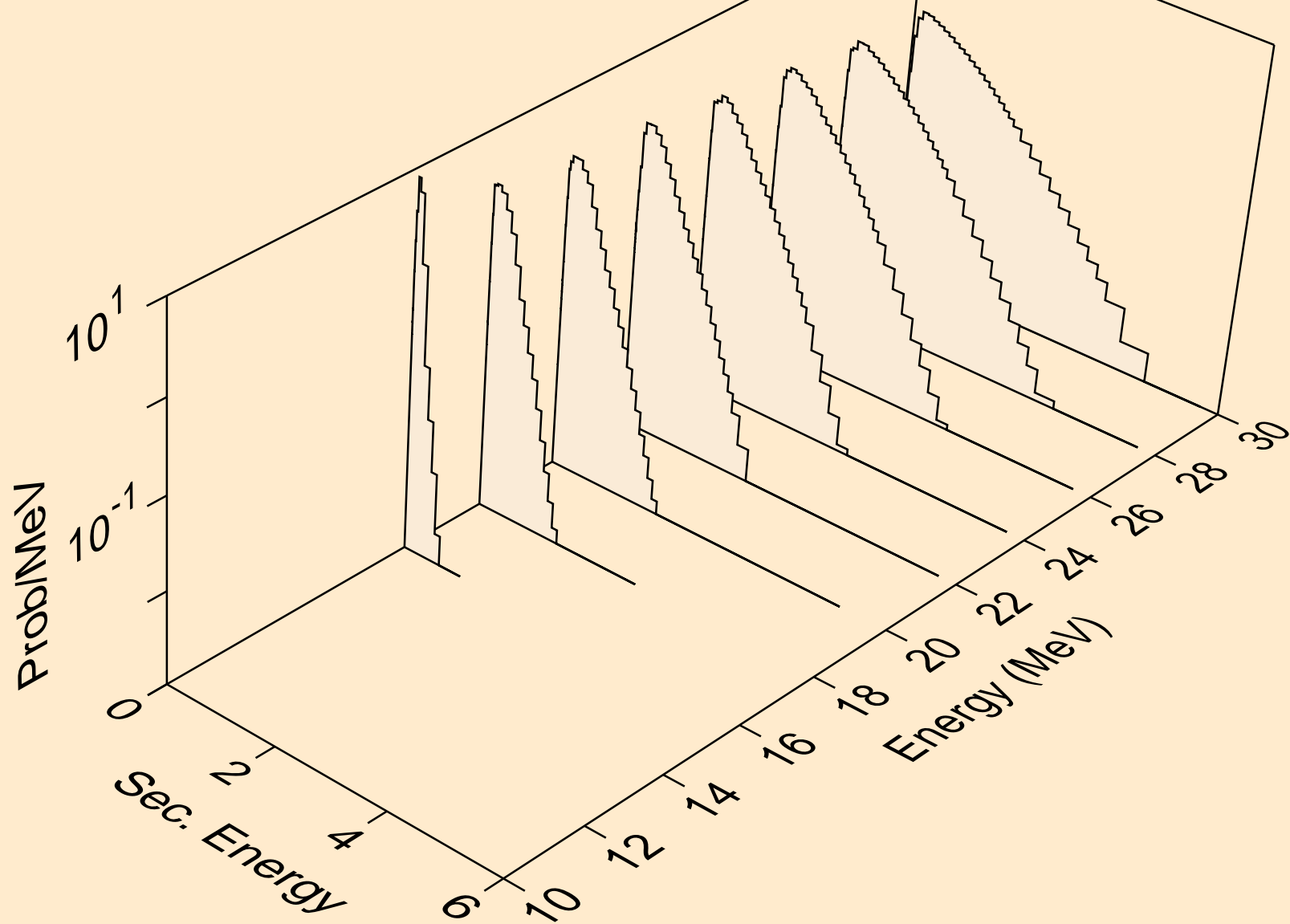

SN123 NEUTRON ACER TENDL-2024 LIBRARY; T=0.K
Neutron emission for (n,3n)a

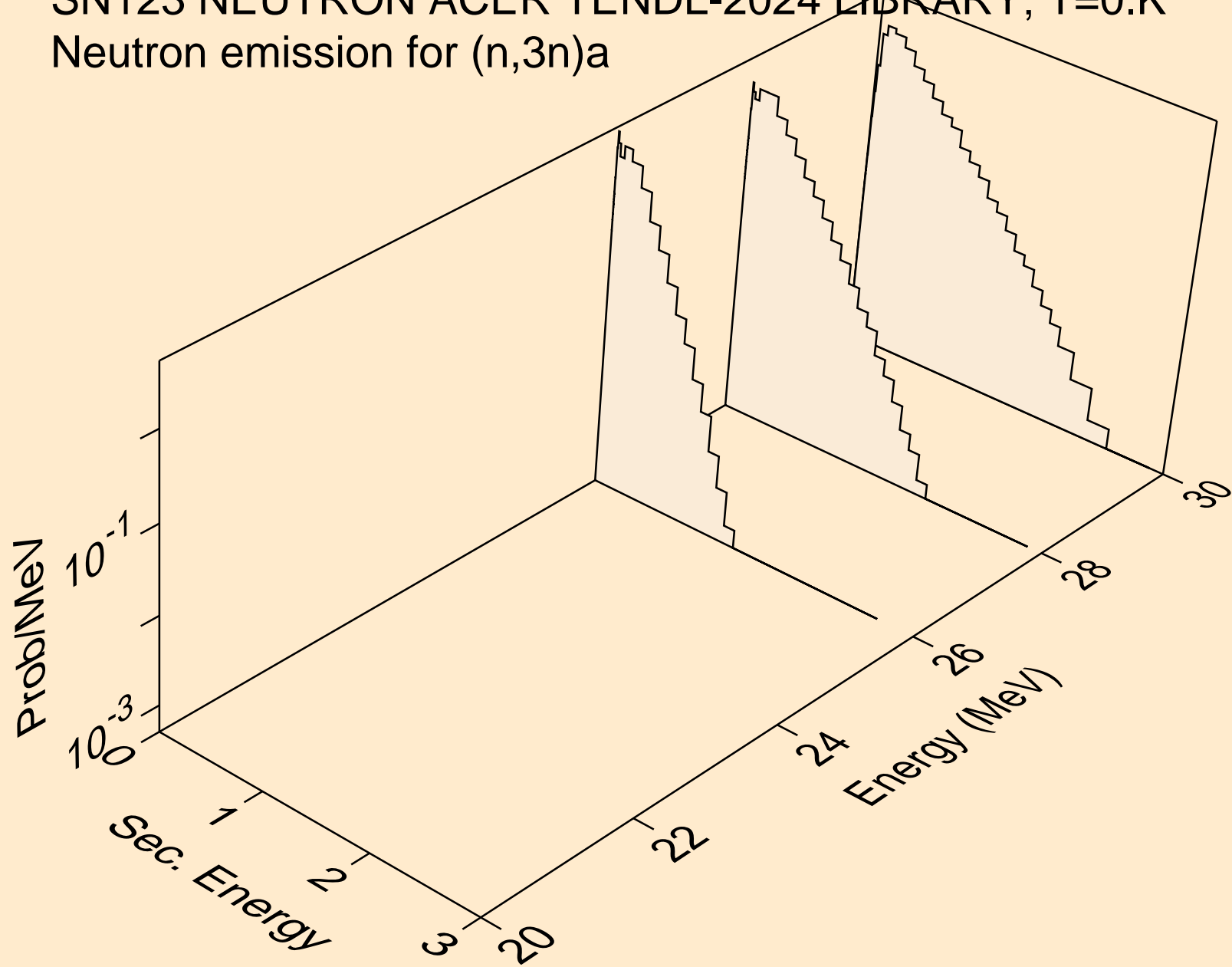

SN123 NEUTRON ACER TENDL-2024 LIBRARY; T=0.K
Neutron emission for (n,n*)p

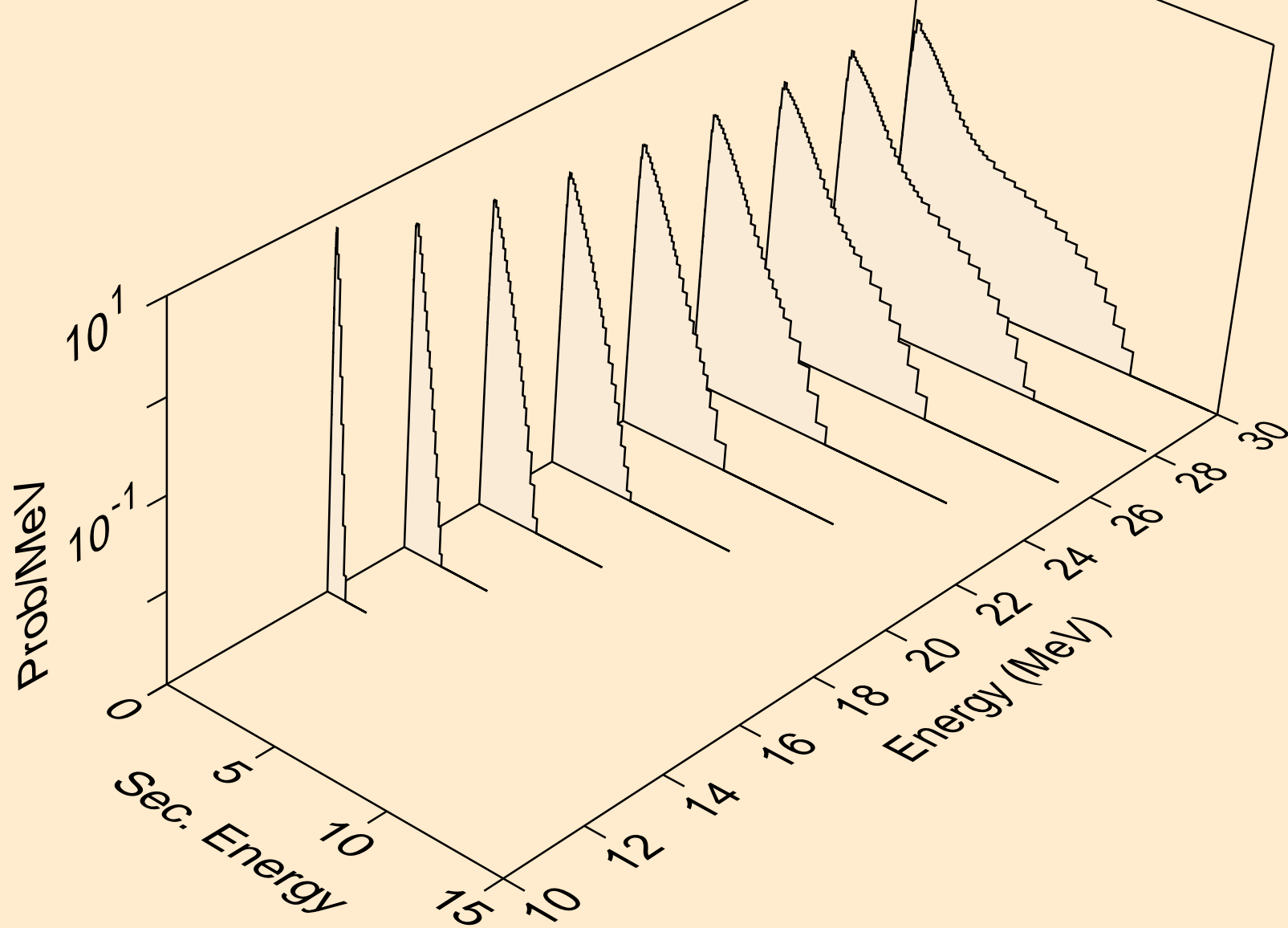

SN123 NEUTRON ACER TENDL-2024 LIBRARY; T=0.K
Neutron emission for (n,n*)d

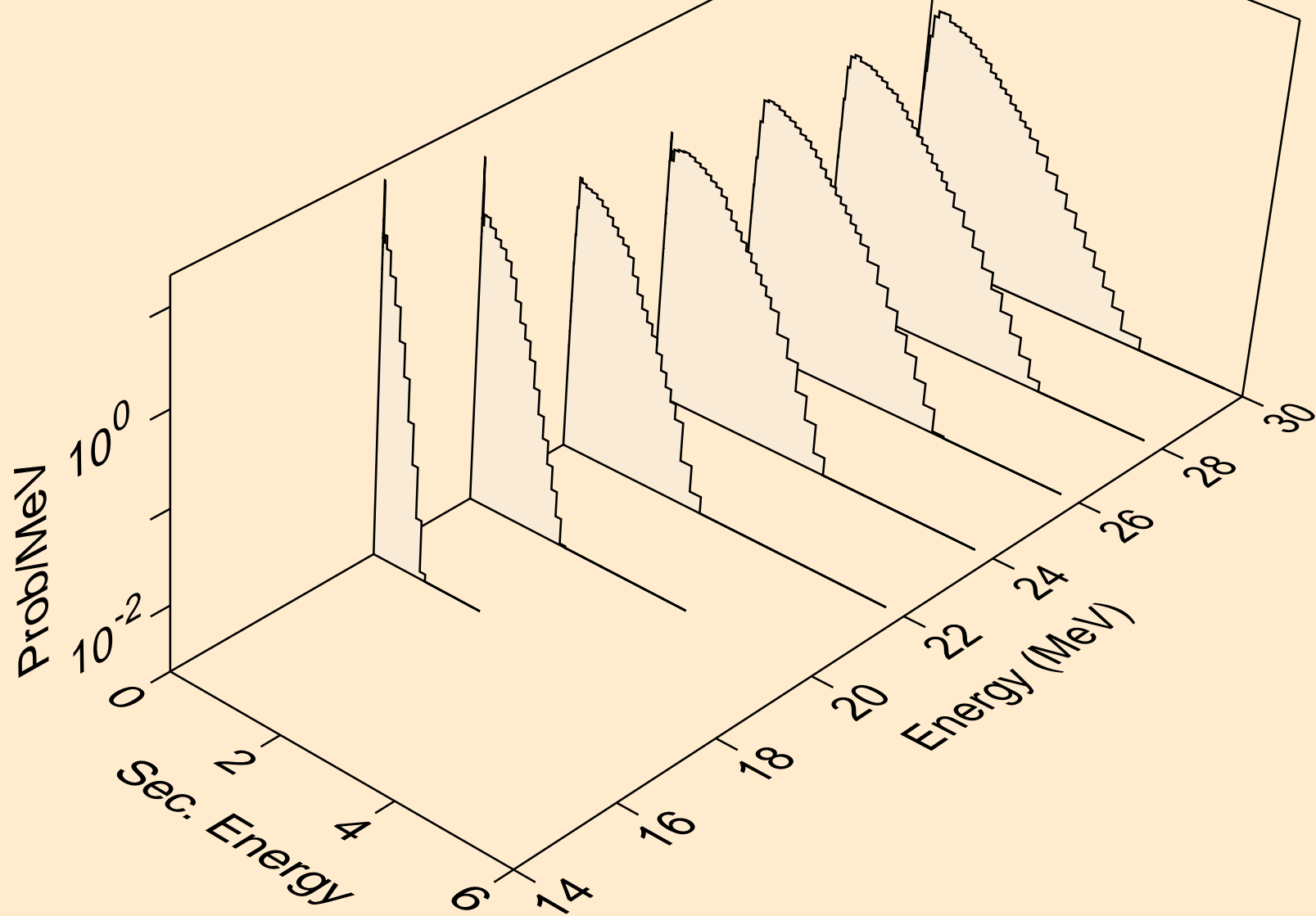

SN123 NEUTRON ACER TENDL-2024 LIBRARY; T=0.K
Neutron emission for (n,n*)t

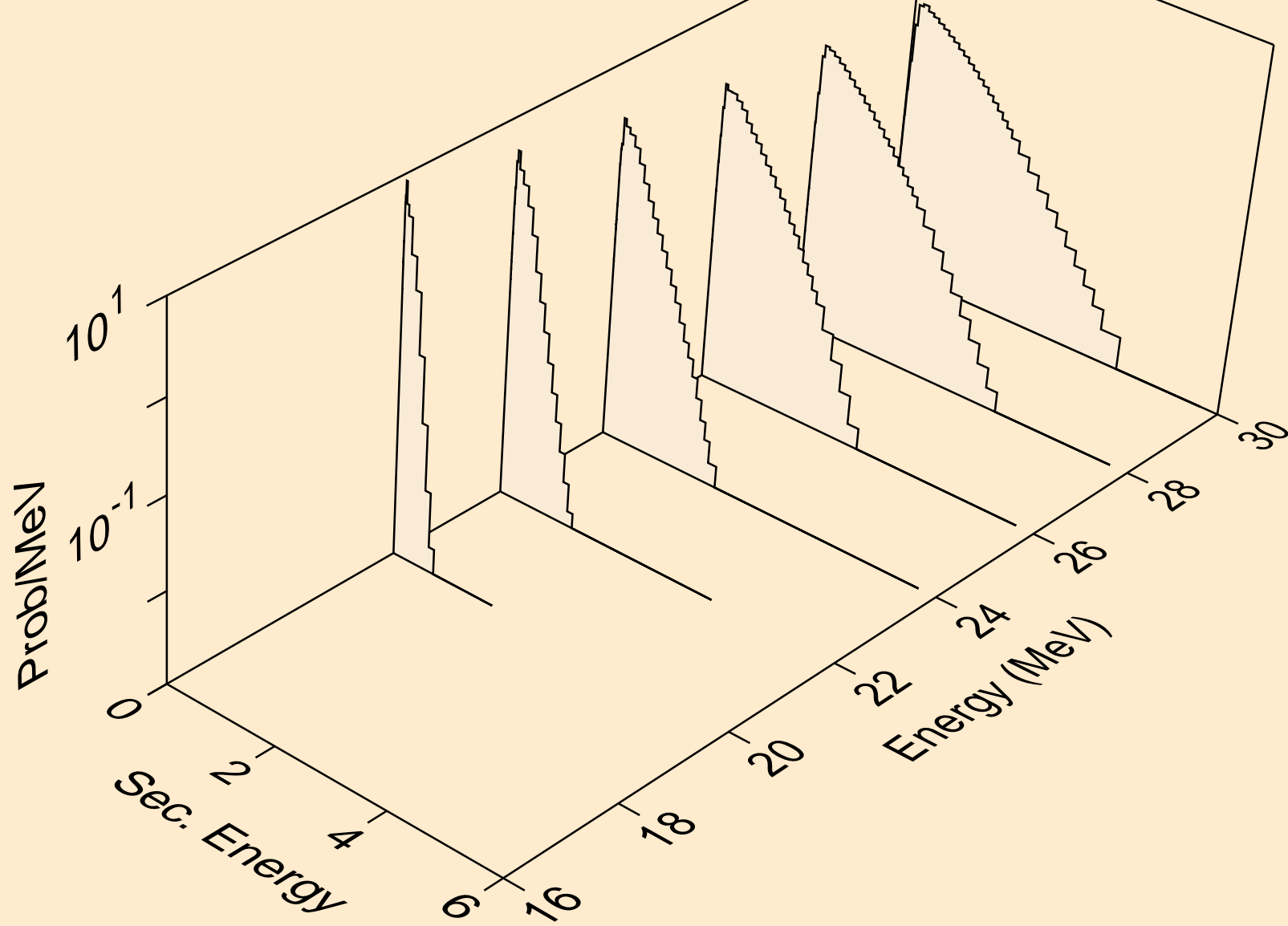

SN123 NEUTRON ACER TENDL-2024 LIBRARY; T=0.K
Neutron emission for (n,n*)he3

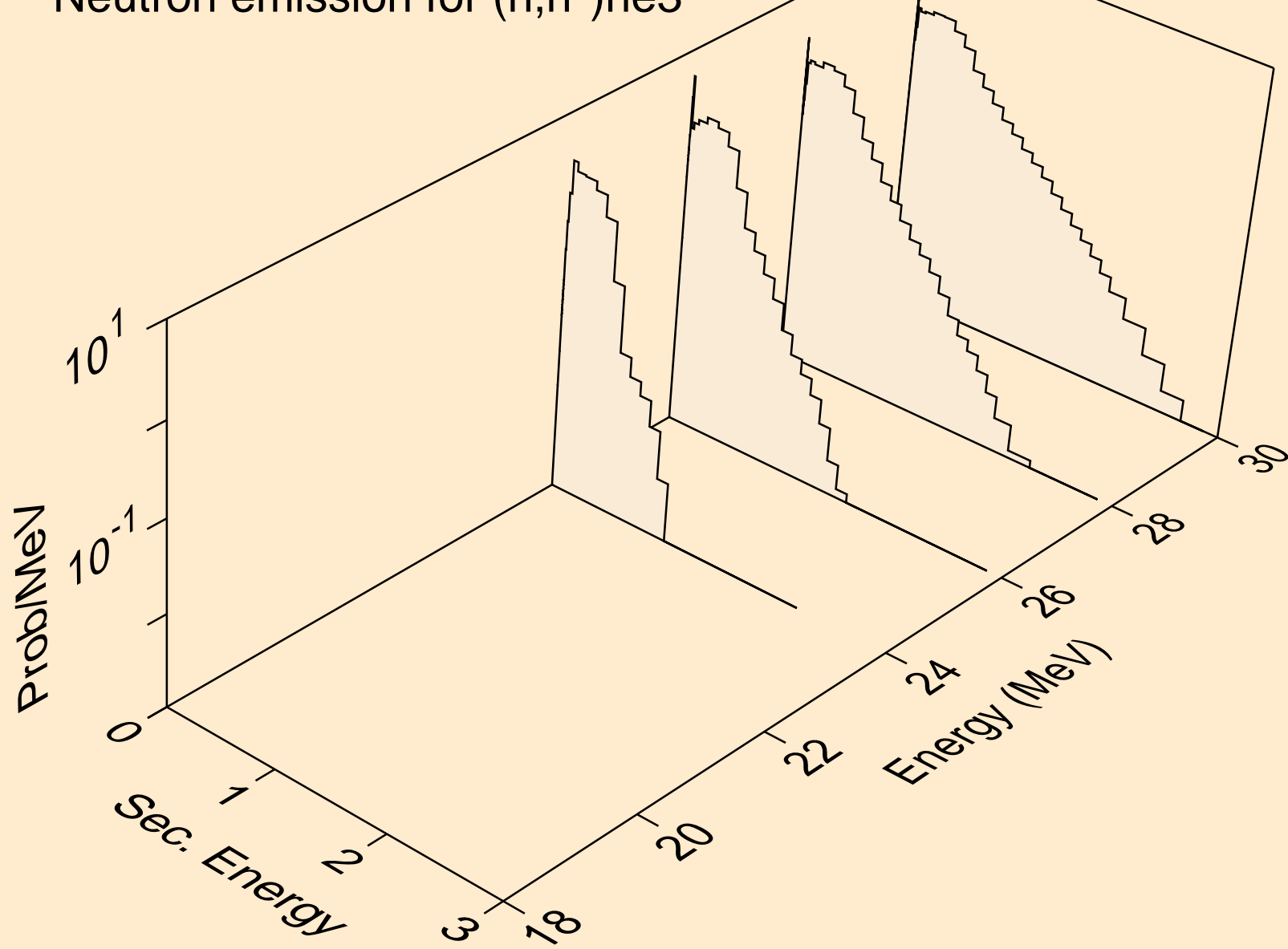

SN123 NEUTRON ACER TENDL-2024 LIBRARY; T=0.K
Neutron emission for (n,4n)

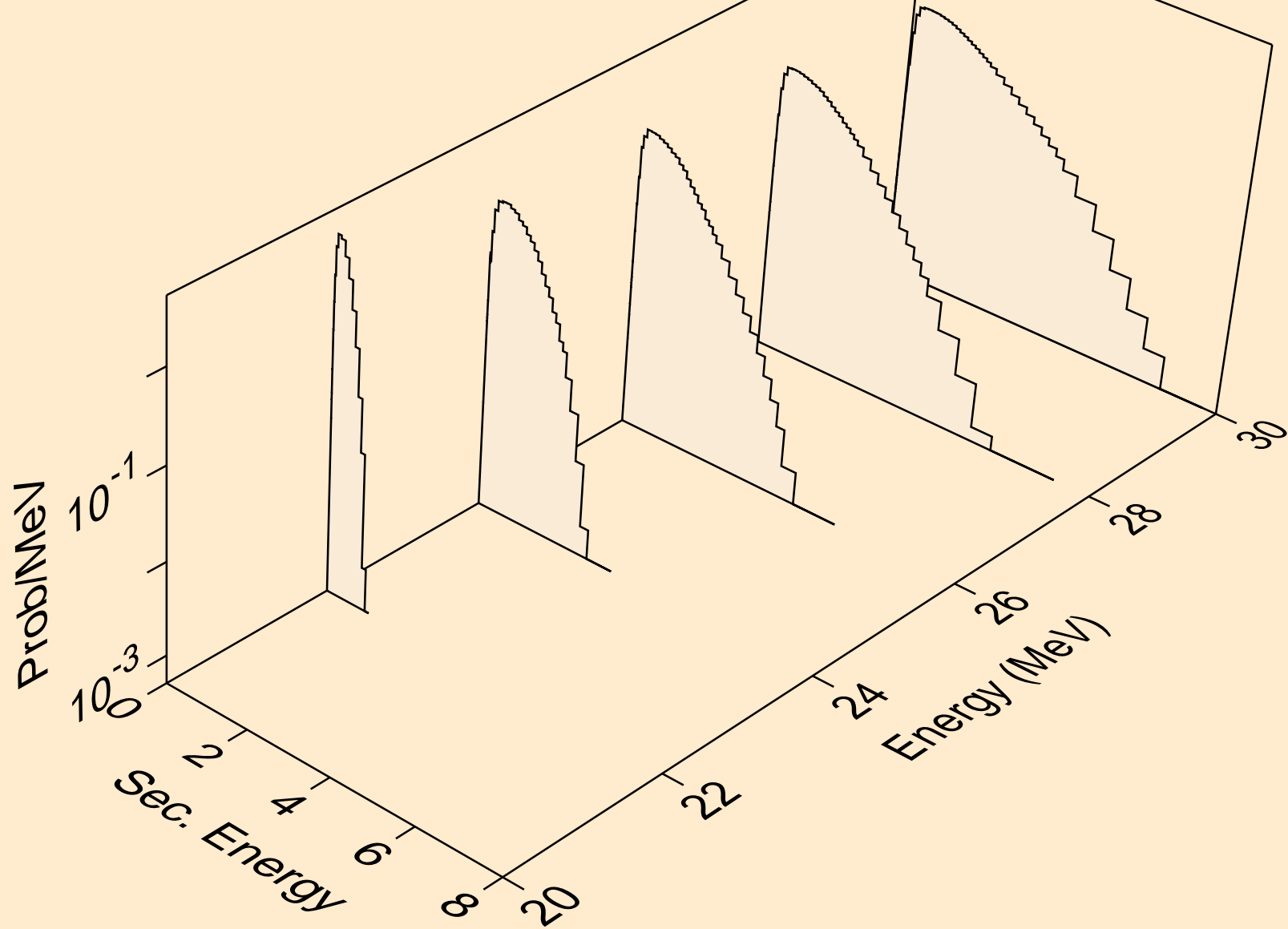

SN123 NEUTRON ACER TENDL-2024 LIBRARY; T=0.K
Neutron emission for (n,2np)

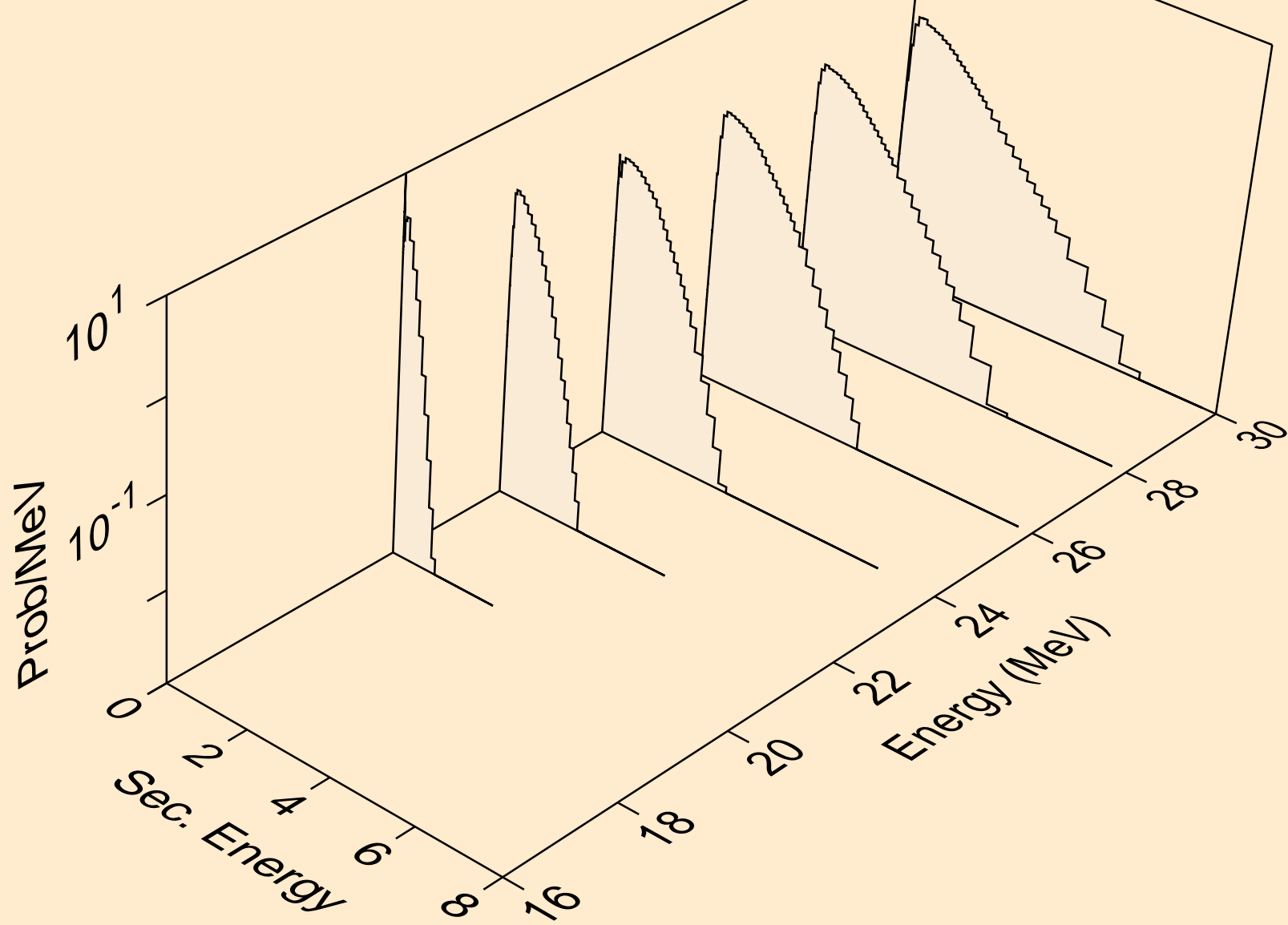

SN123 NEUTRON ACER TENDL-2024 LIBRARY; T=0.K
Neutron emission for (n,3np)

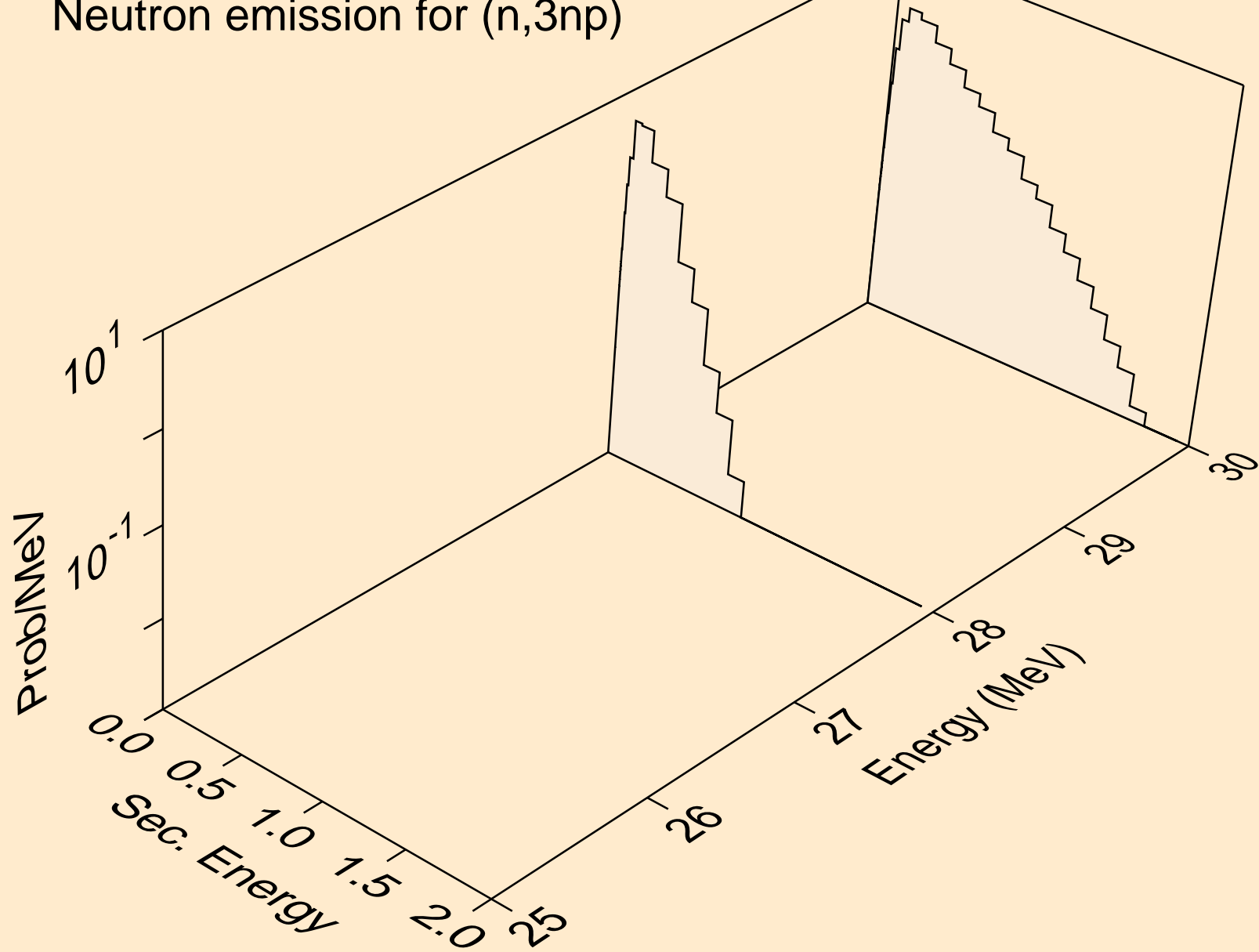

SN123 NEUTRON ACER TENDL-2024 LIBRARY; T=0.K
Neutron emission for (n,n*c)

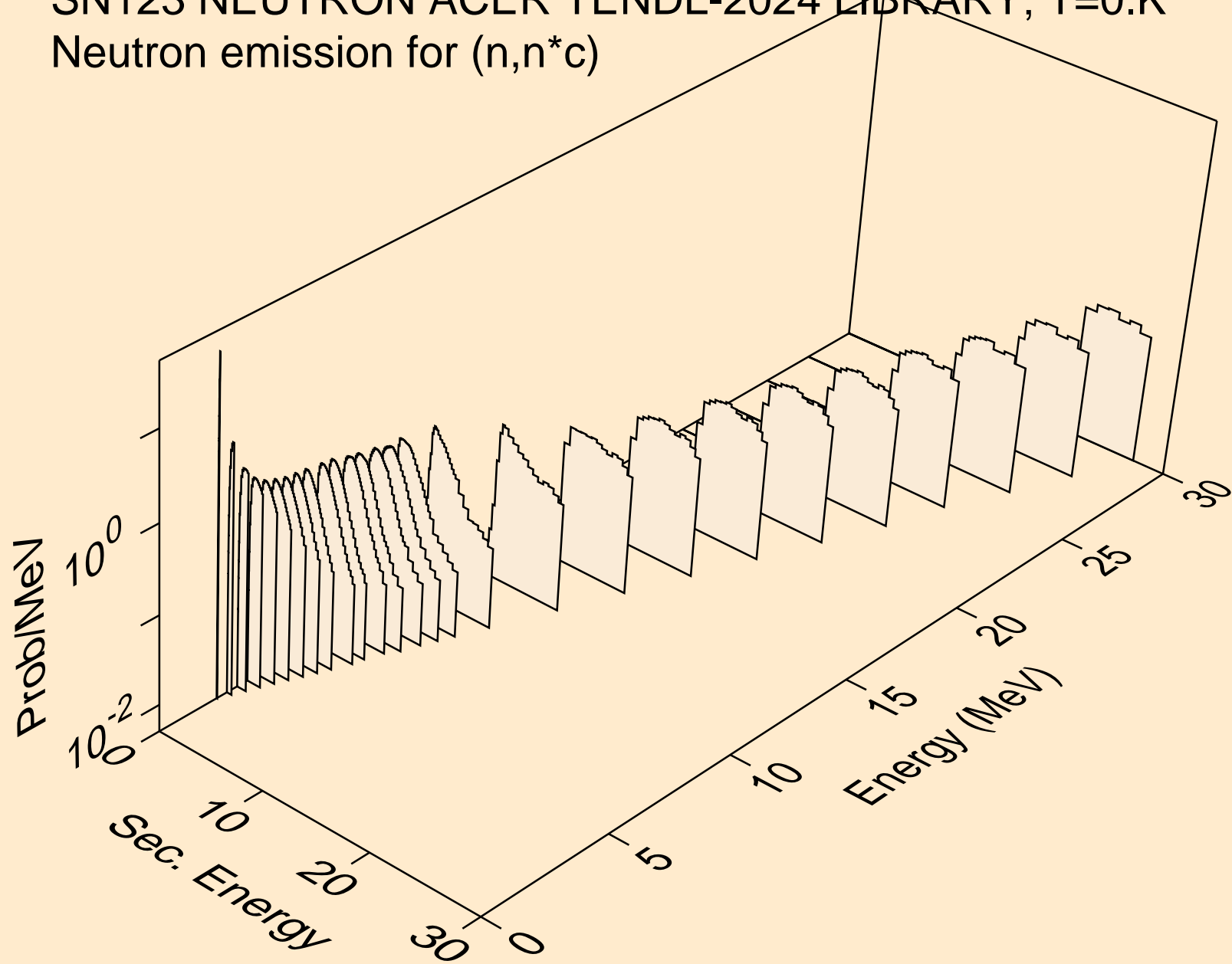

SN123 NEUTRON ACER TENDL-2024 LIBRARY; T=0.K
Photon emission for (n,x)

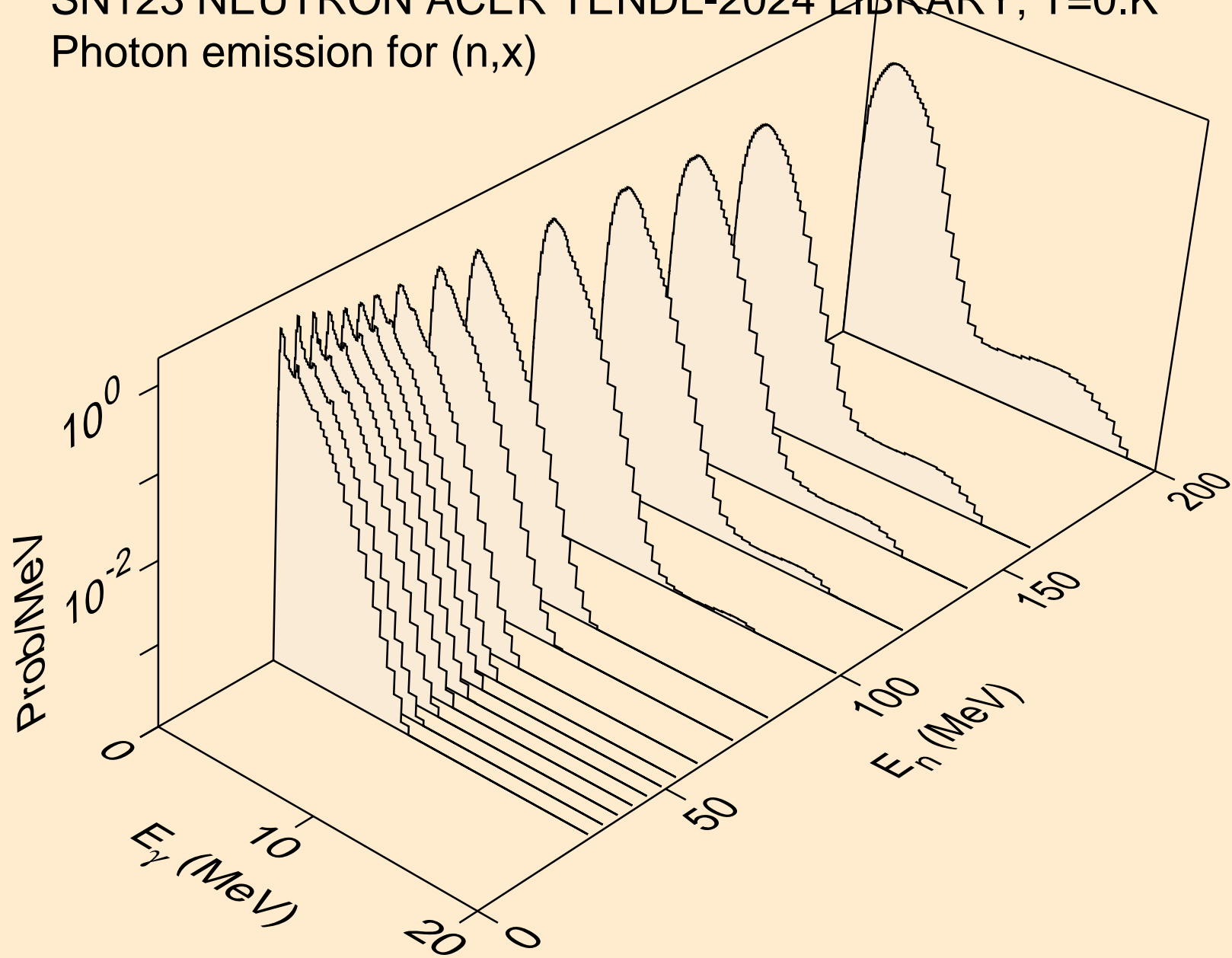

SN123 NEUTRON ACER TENDL-2024 LIBRARY; T=0.K
Photon emission for (n,2nd)

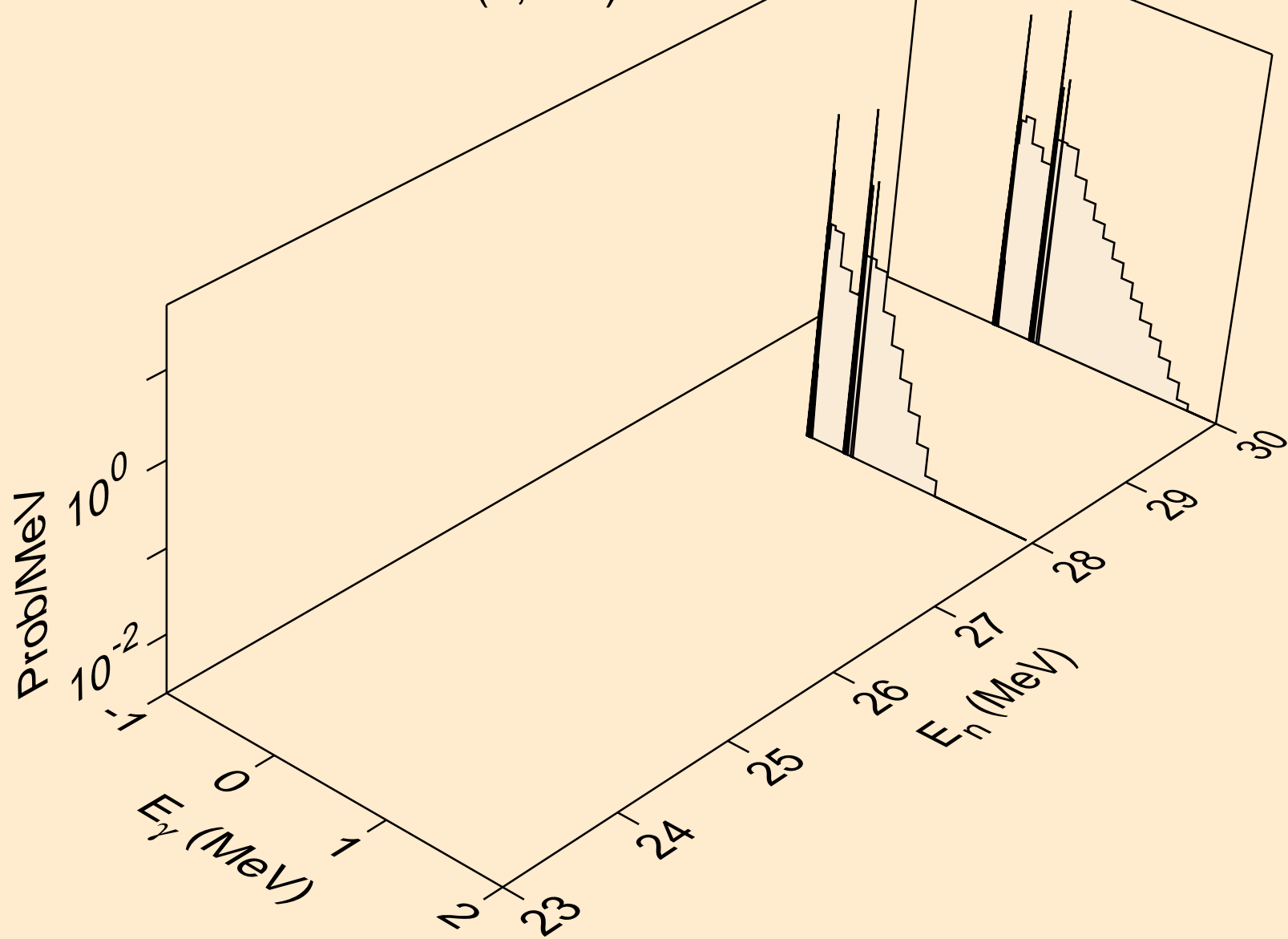

SN123 NEUTRON ACER TENDL-2024 LIBRARY; T=0.K
Photon emission for (n,2n)

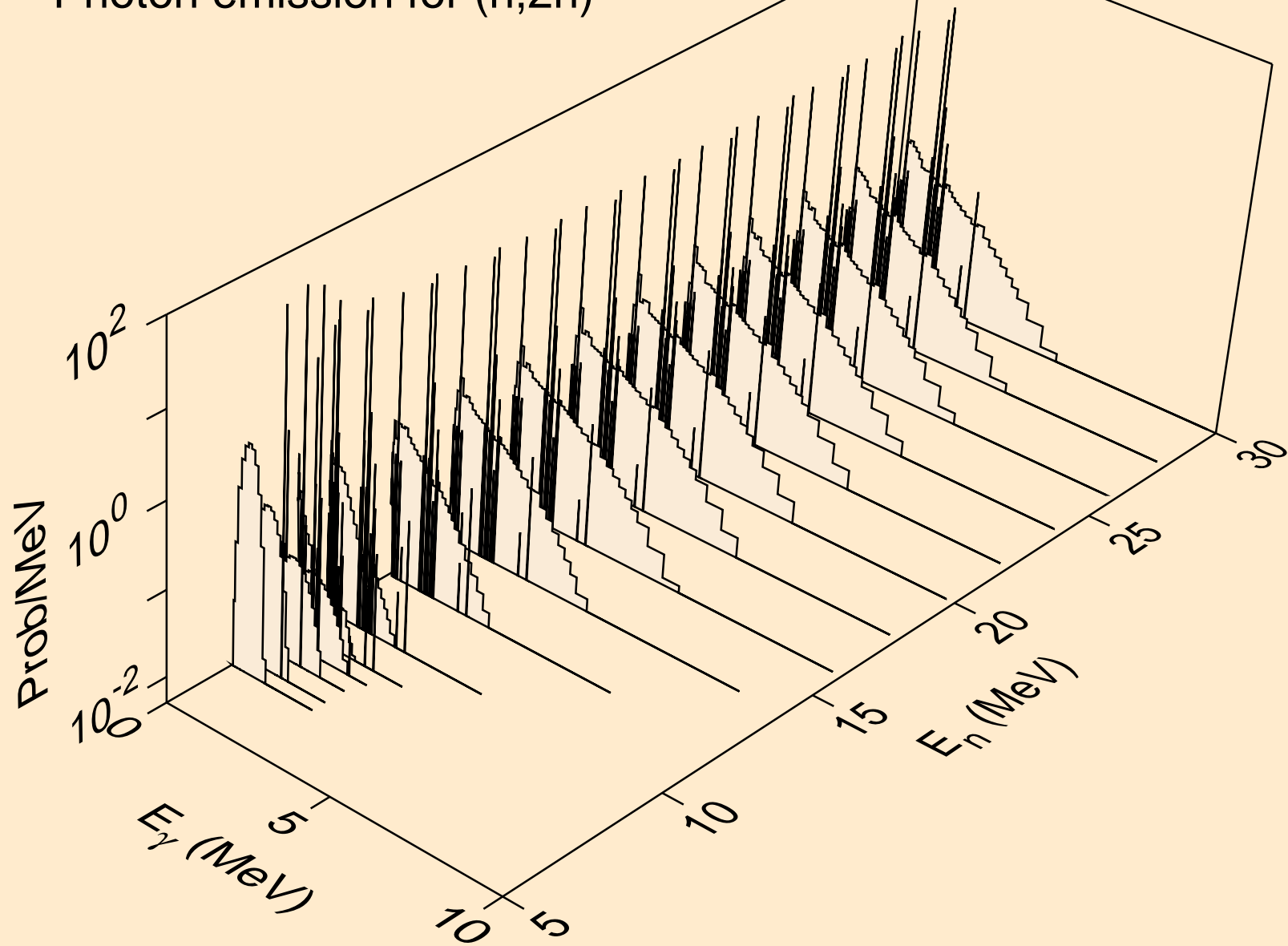

SN123 NEUTRON ACER TENDL-2024 LIBRARY; T=0.K
Photon emission for (n,3n)

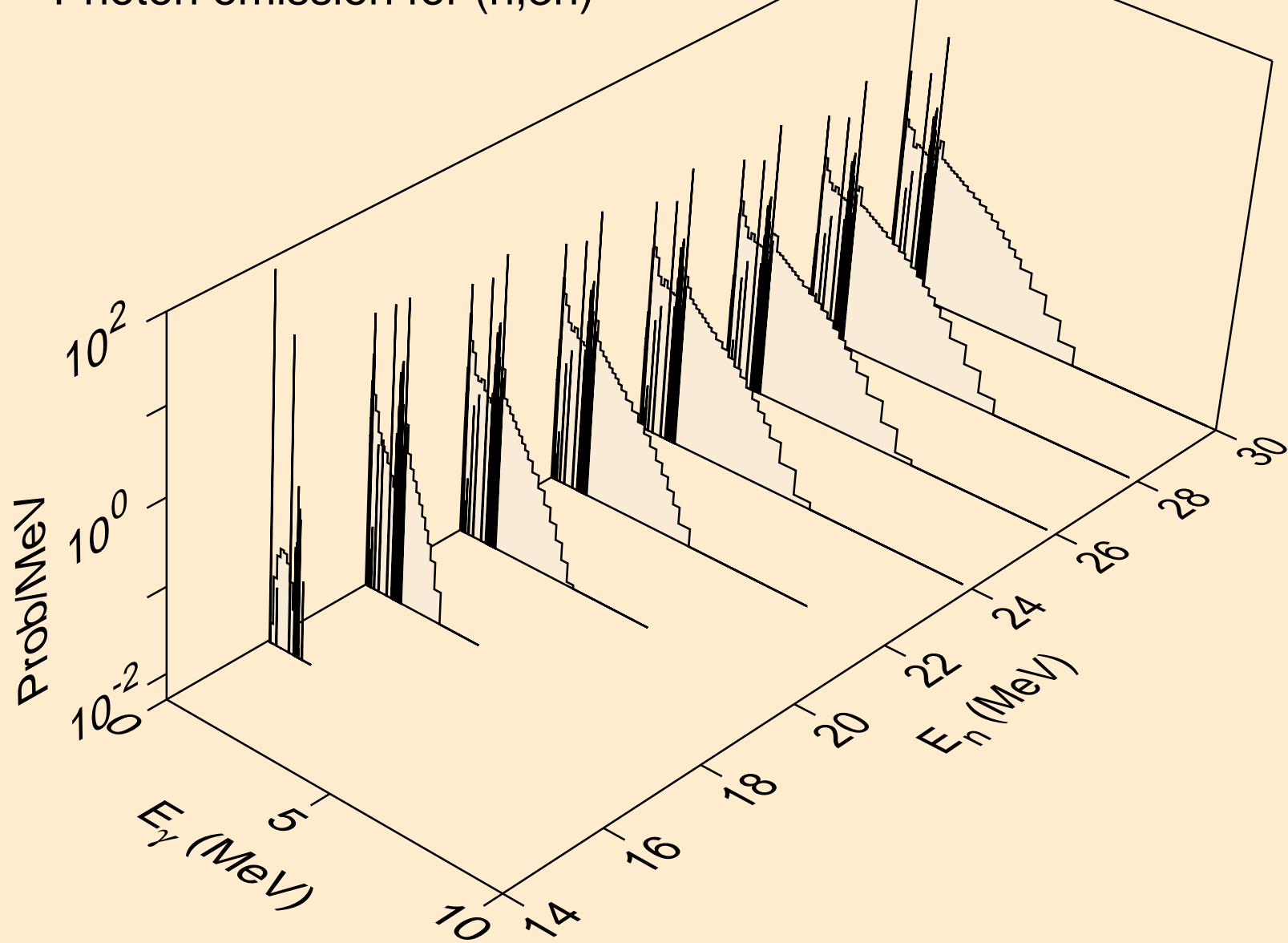

SN123 NEUTRON ACER TENDL-2024 LIBRARY; T=0.K
Photon emission for (n,n*)a

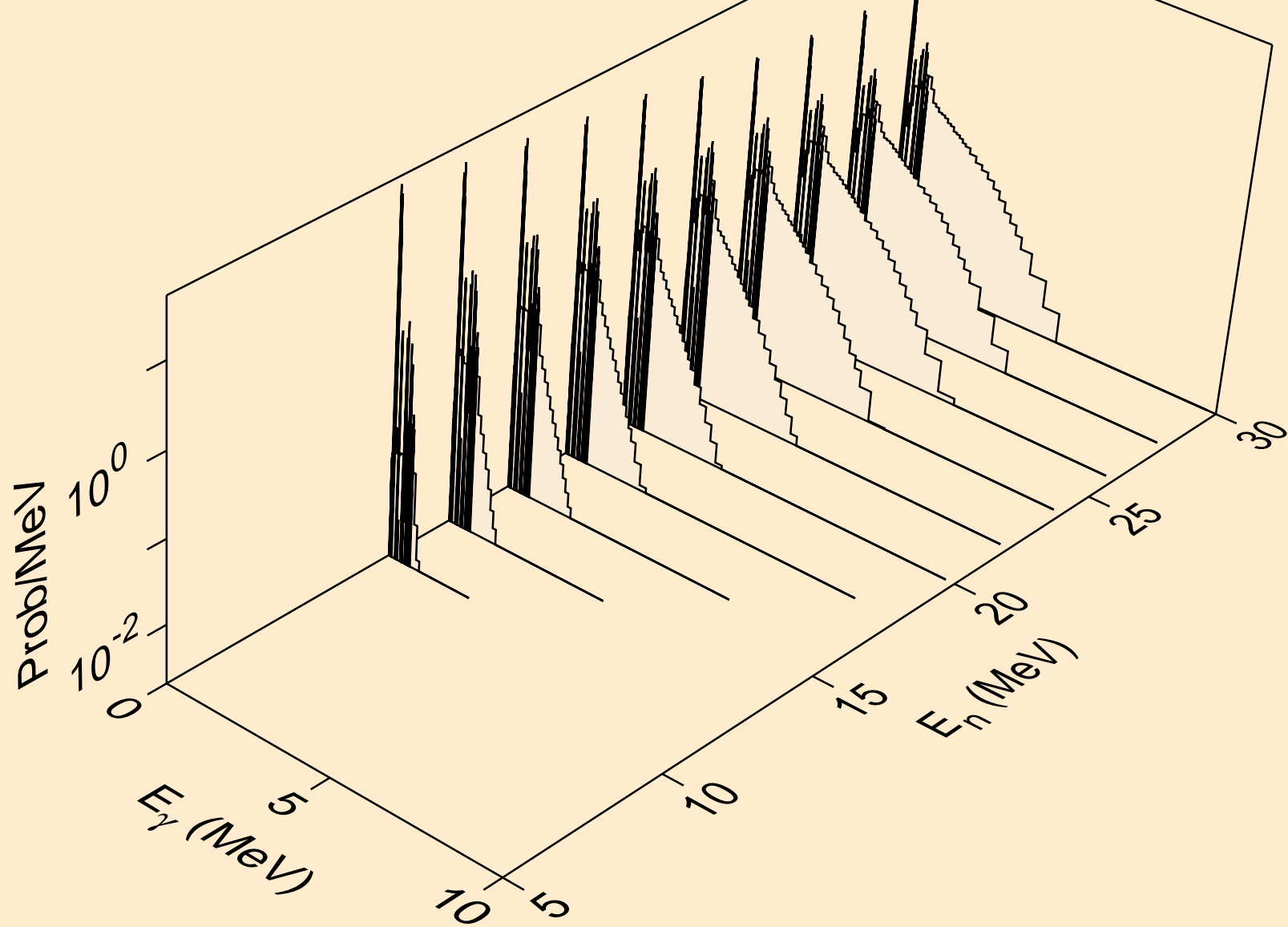

SN123 NEUTRON ACER TENDL-2024 LIBRARY; T=0.K
Photon emission for (n,2n)a

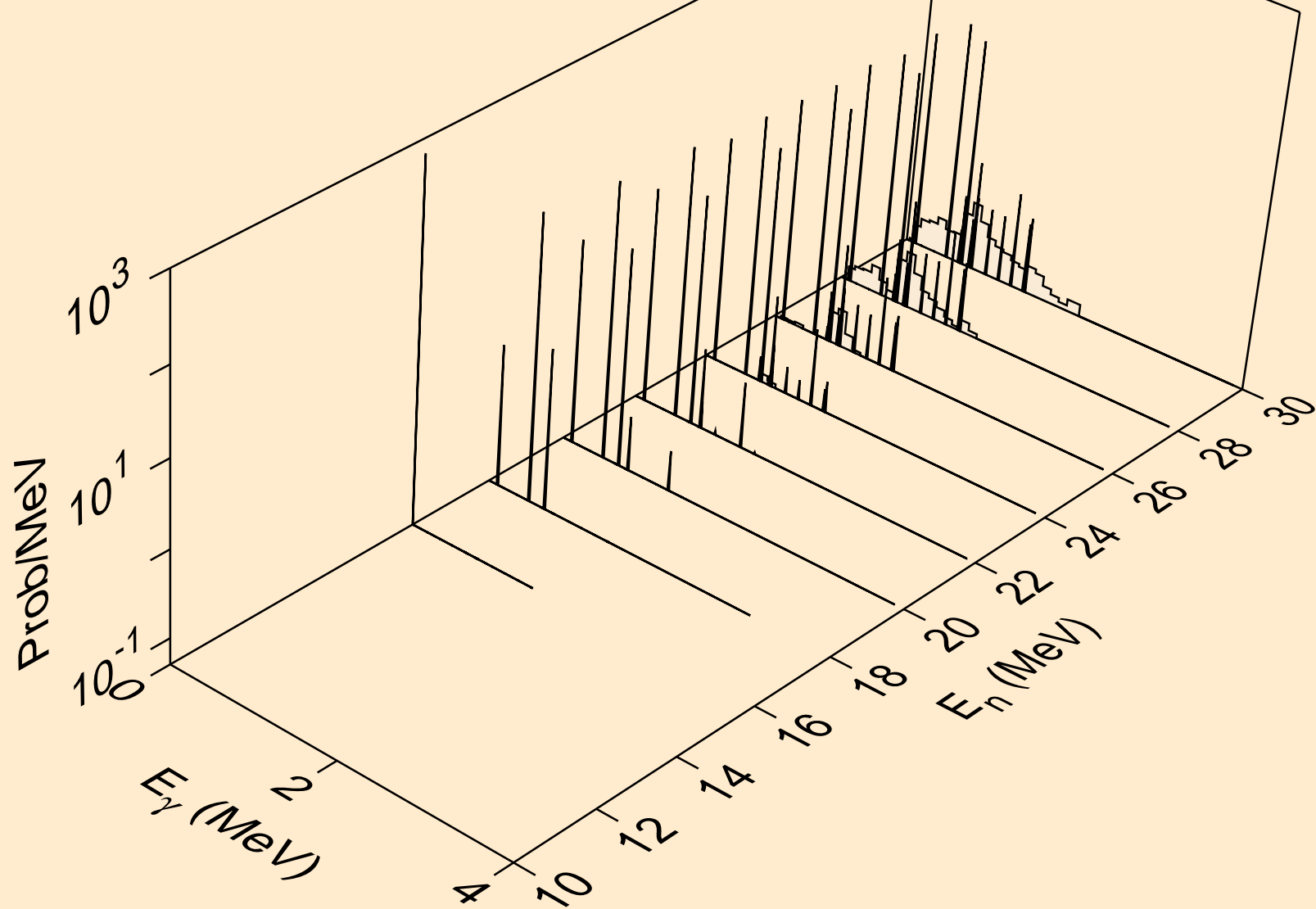

SN123 NEUTRON ACER TENDL-2024 LIBRARY; T=0.K
Photon emission for (n,3n)a

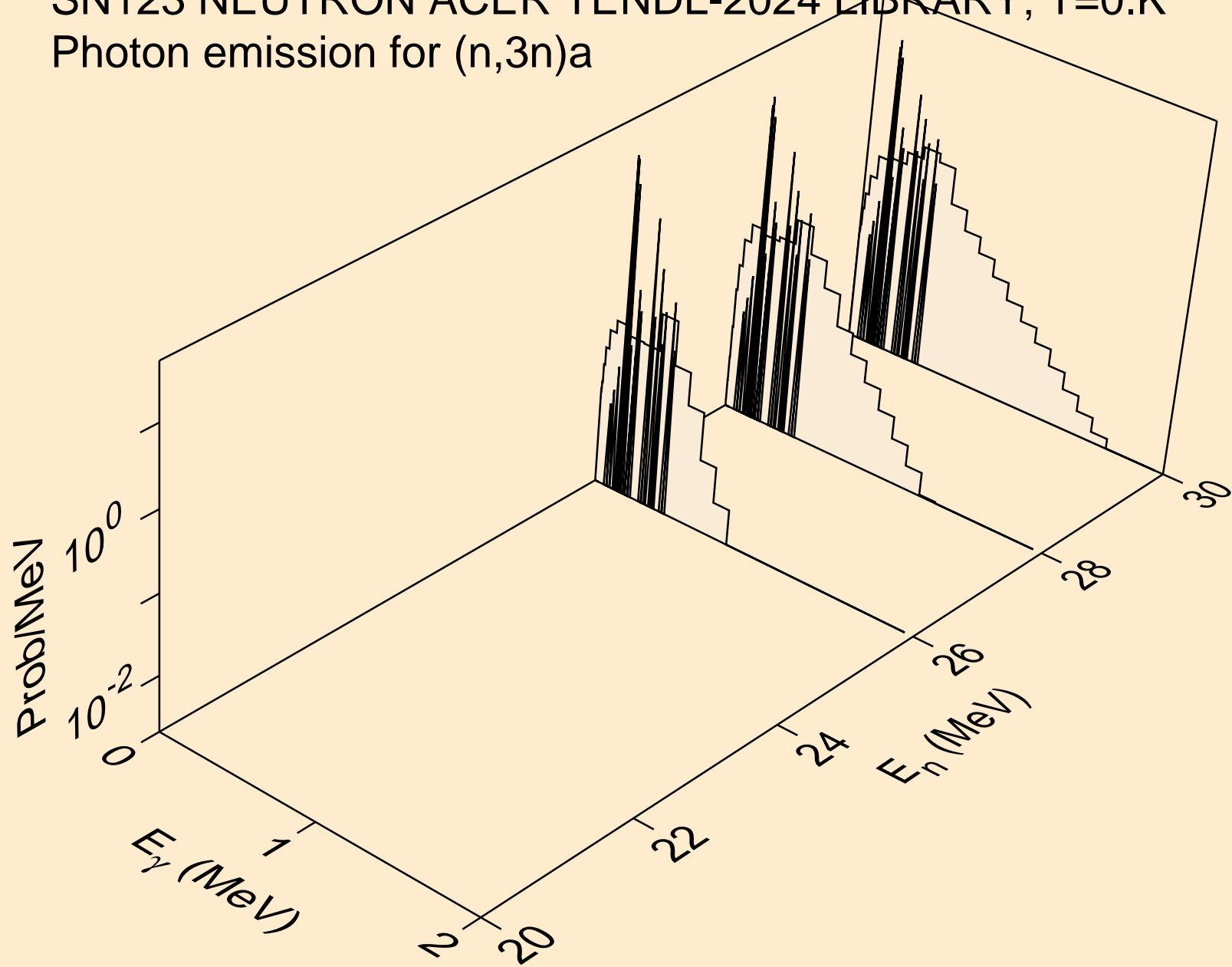

SN123 NEUTRON ACER TENDL-2024 LIBRARY; T=0.K
Photon emission for (n,n*)p

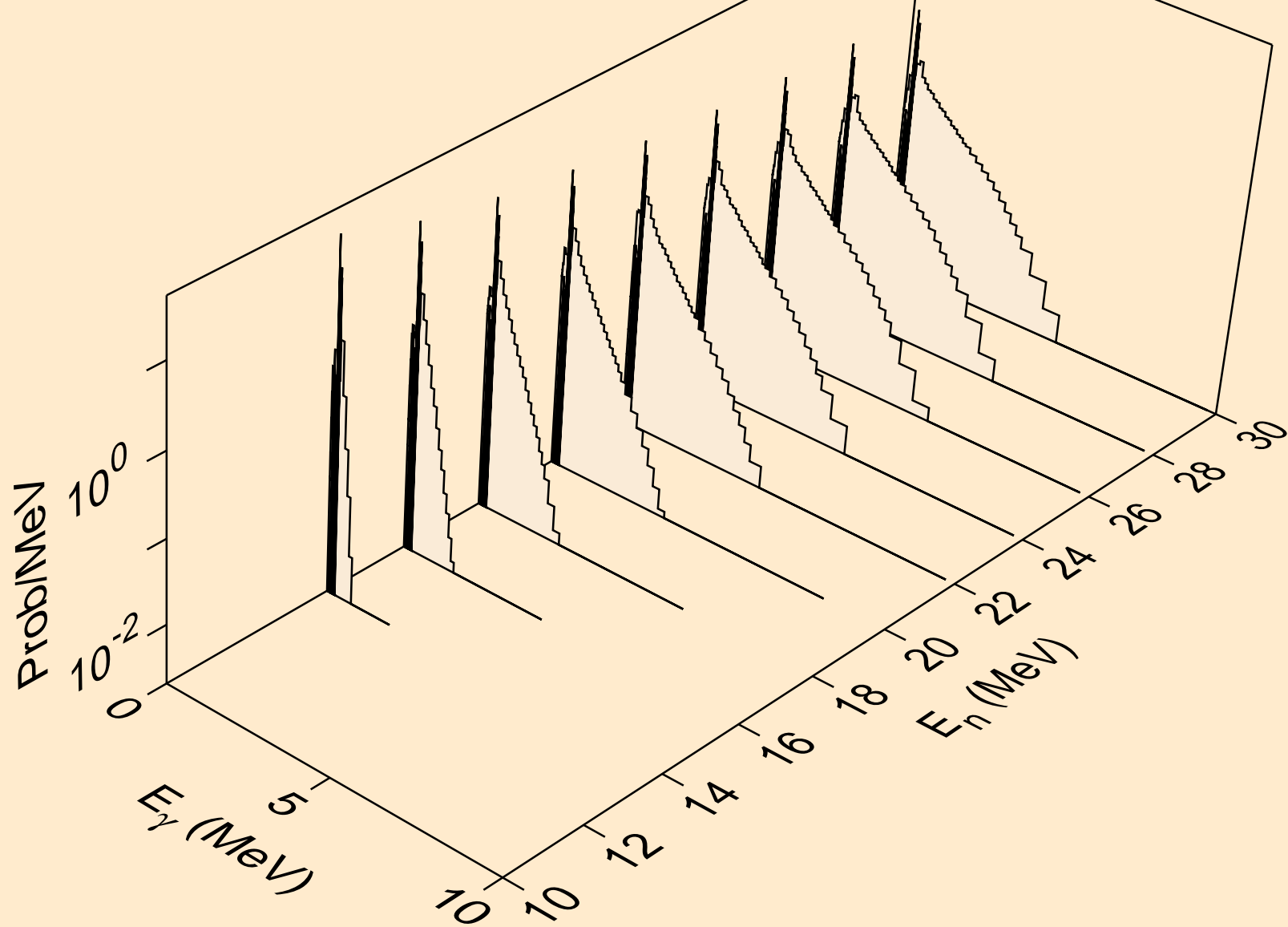

SN123 NEUTRON ACER TENDL-2024 LIBRARY; T=0.K
Photon emission for (n,n*)d

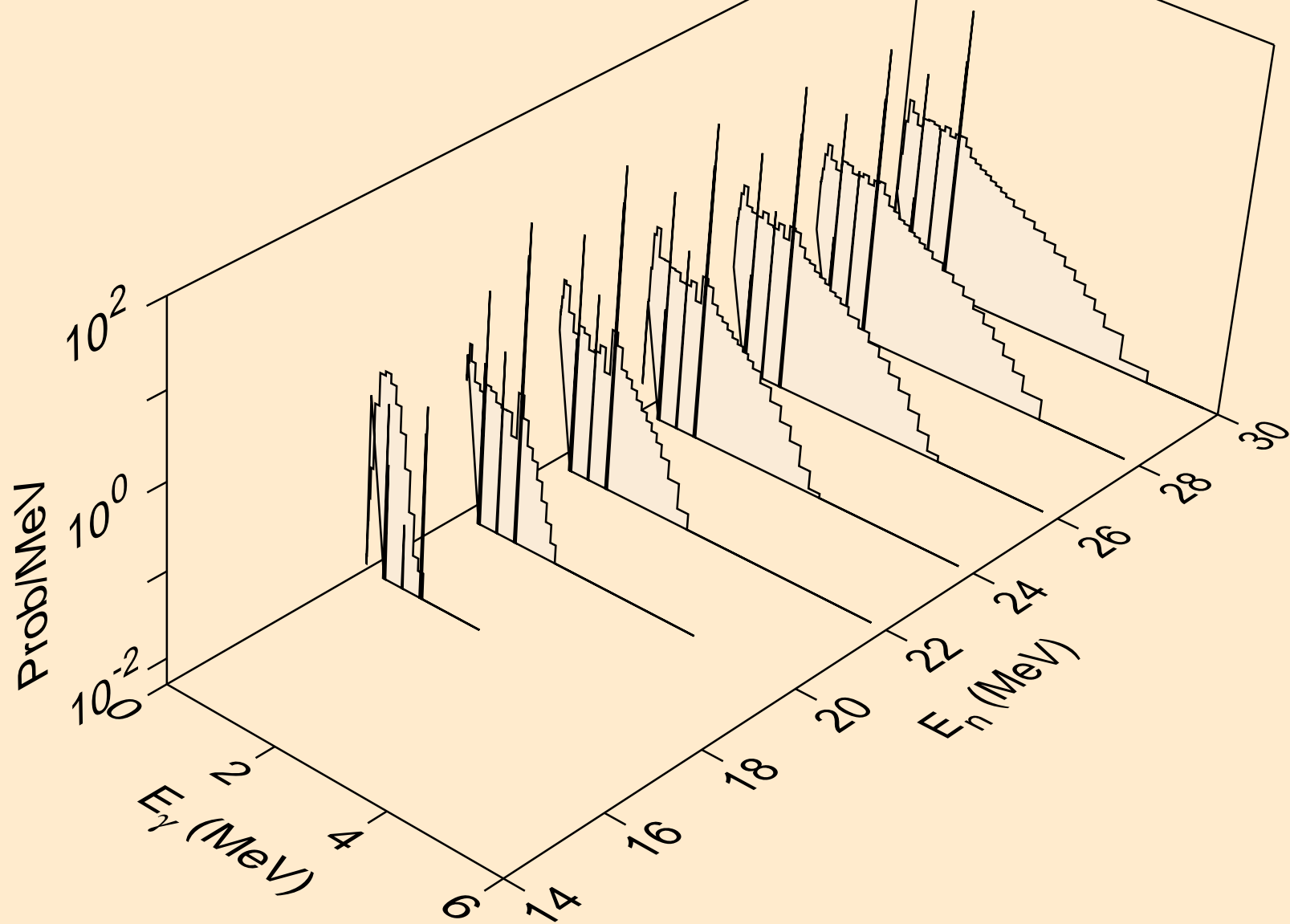

SN123 NEUTRON ACER TENDL-2024 LIBRARY; T=0.K
Photon emission for (n,n*)t

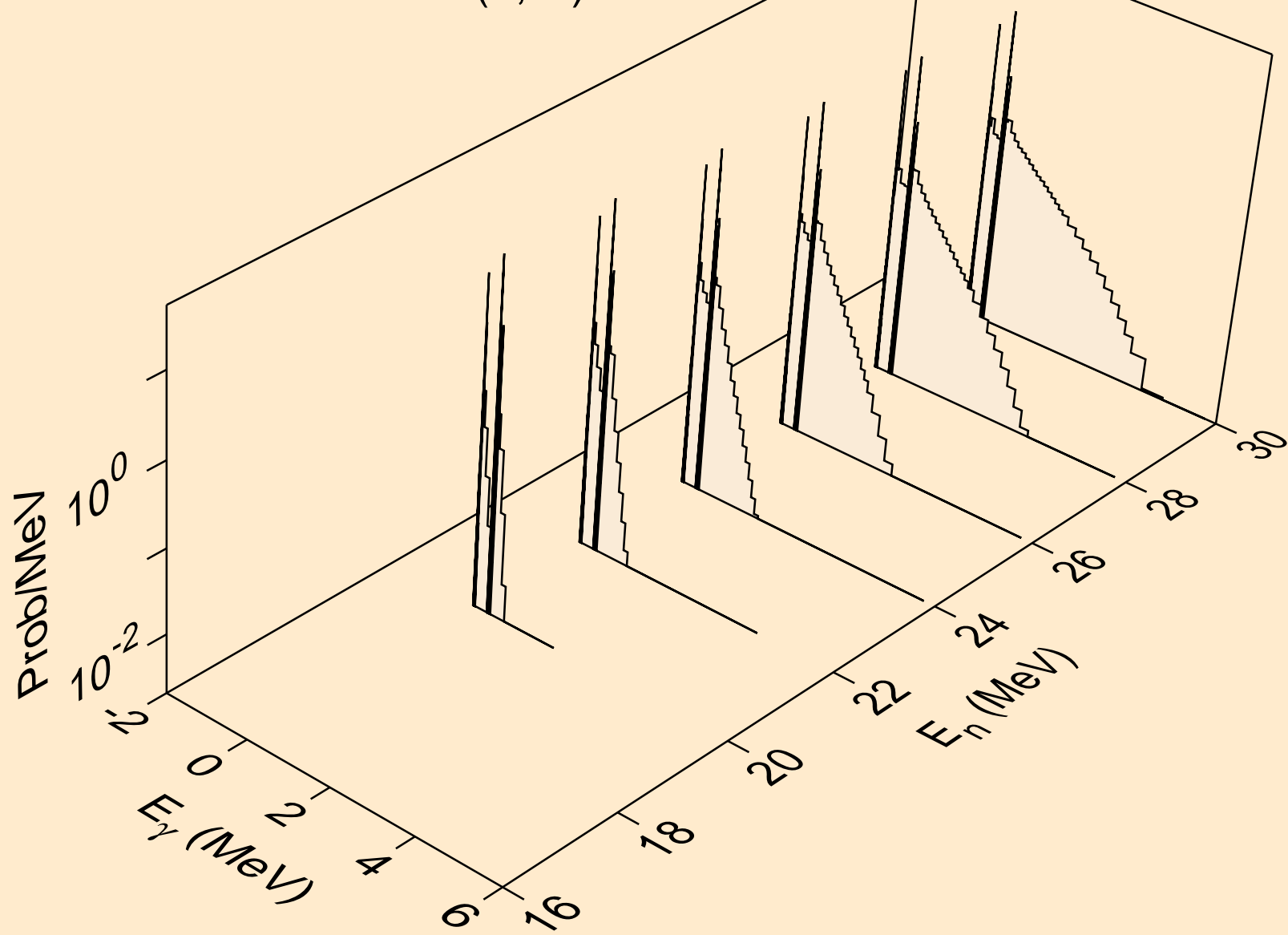

SN123 NEUTRON ACER TENDL-2024 LIBRARY; T=0.K
Photon emission for (n,n*)he3

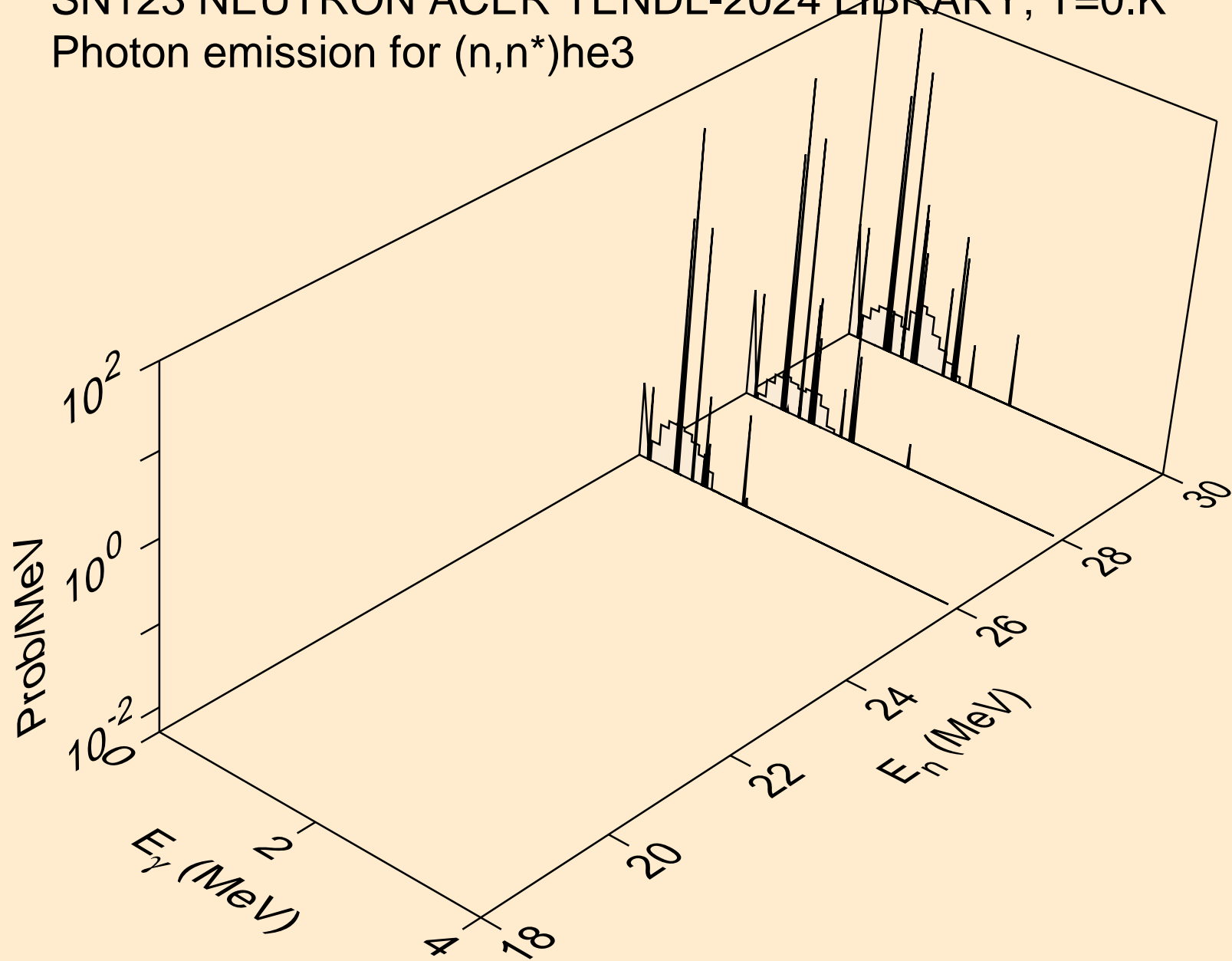

SN123 NEUTRON ACER TENDL-2024 LIBRARY; T=0.K
Photon emission for (n,4n)

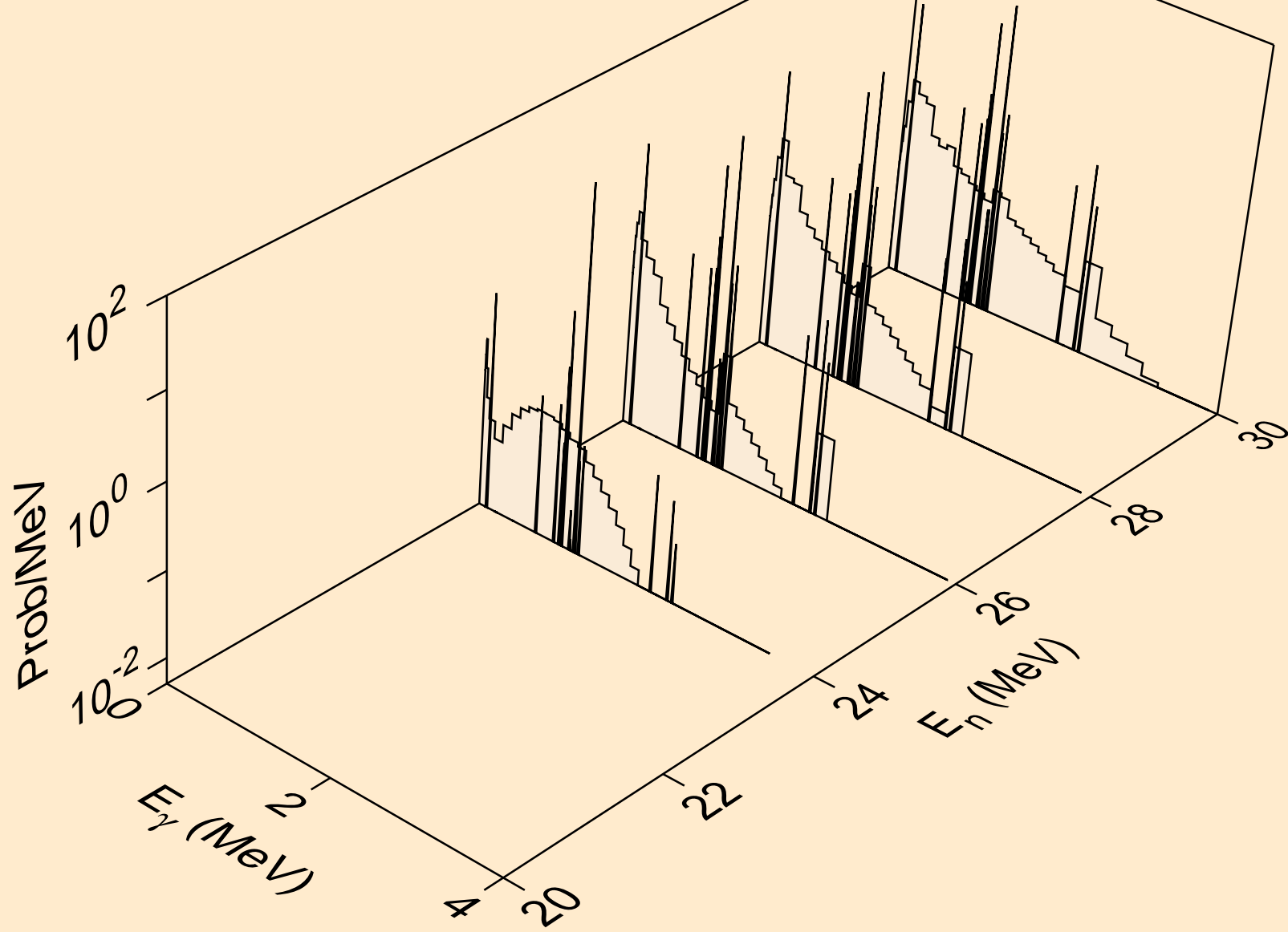

SN123 NEUTRON ACER TENDL-2024 LIBRARY; T=0.K
Photon emission for (n,2np)

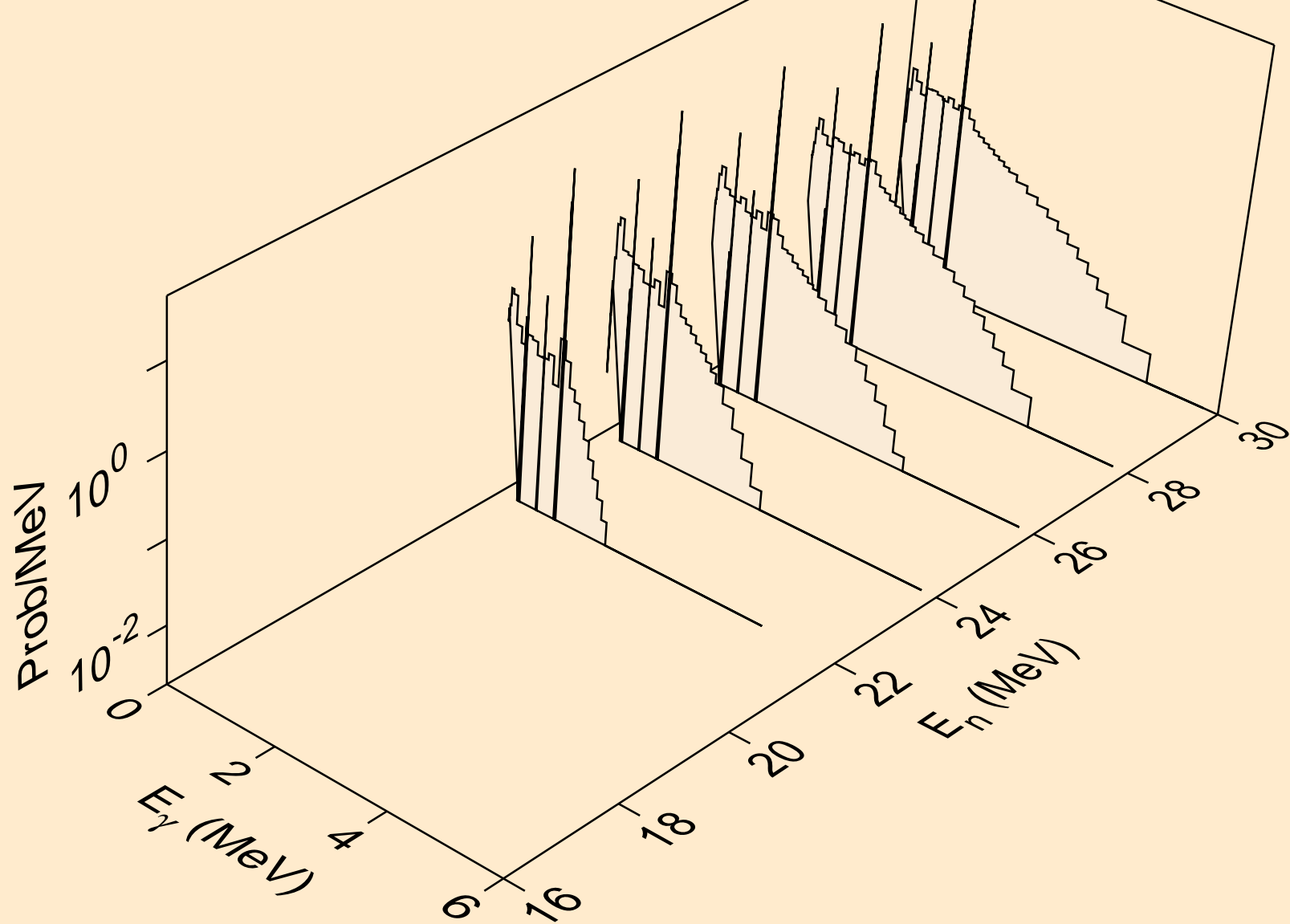

SN123 NEUTRON ACER TENDL-2024 LIBRARY; T=0.K
Photon emission for (n,3np)

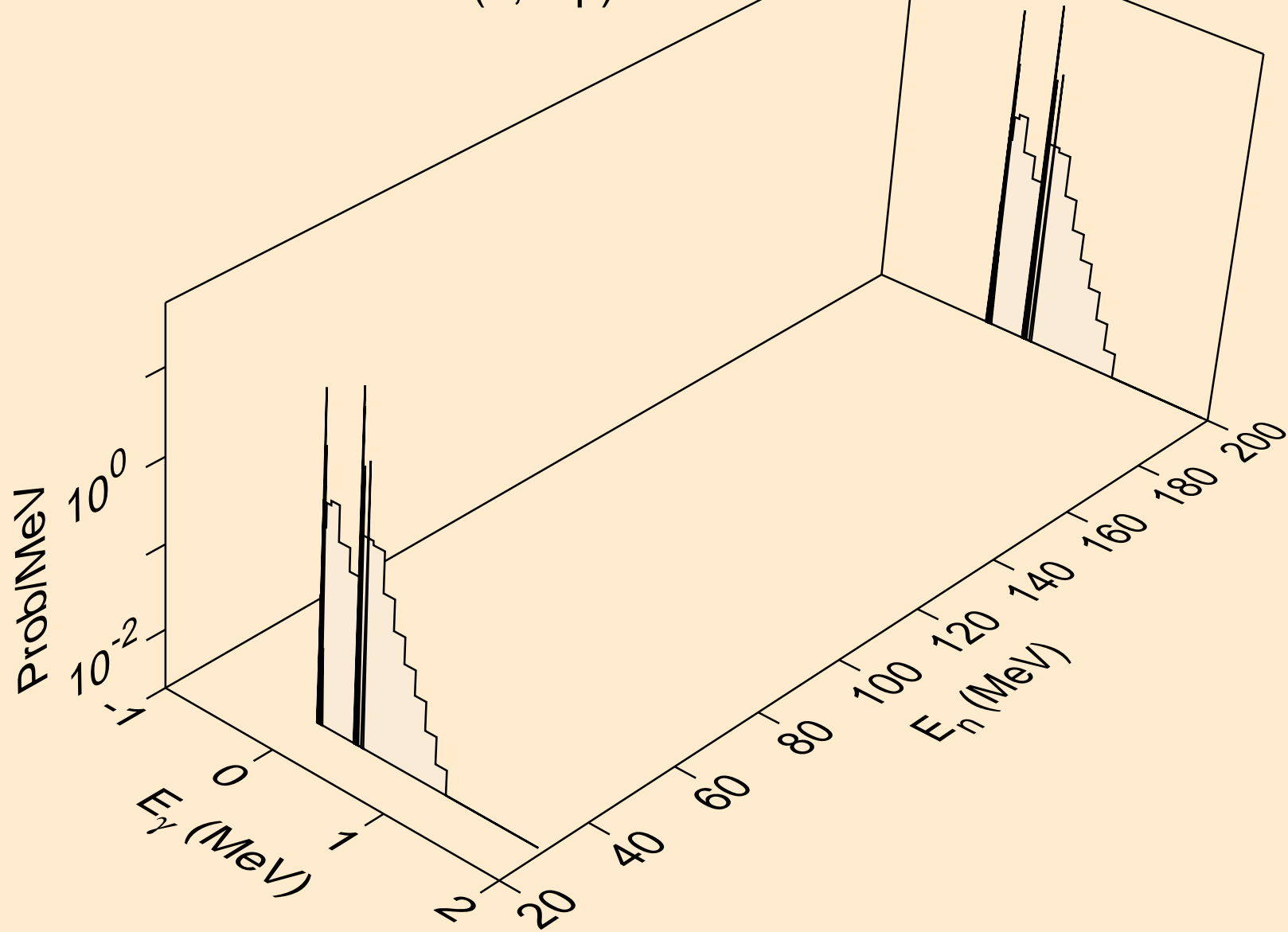

SN123 NEUTRON ACER TENDL-2024 LIBRARY; T=0.K
Photon emission for (n,n*c)

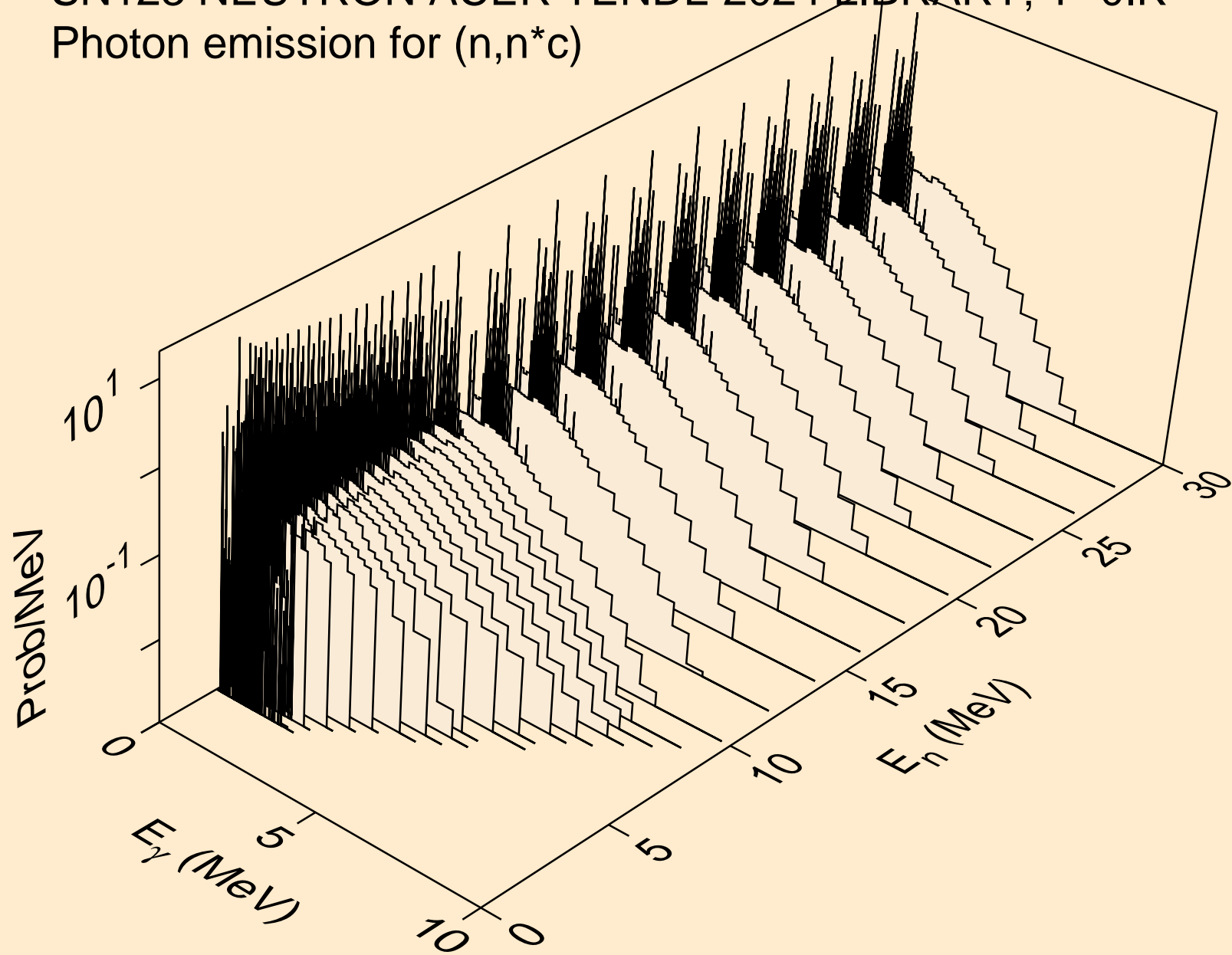

SN123 NEUTRON ACER TENDL-2024 LIBRARY; T=0.K
Photon emission for (n,gma)

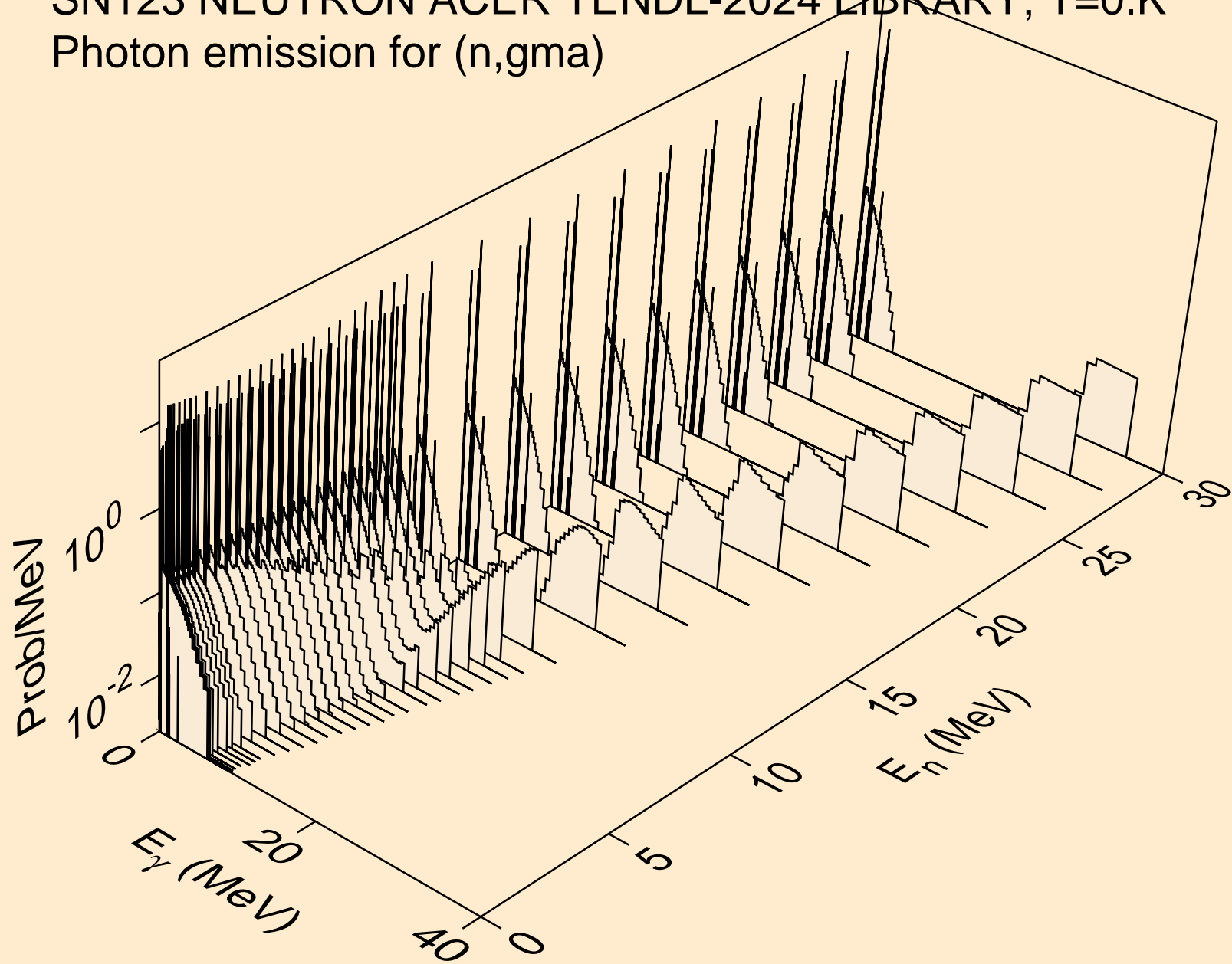

SN123 NEUTRON ACER TENDL-2024 LIBRARY; T=0.K
Photon emission for (n,p)

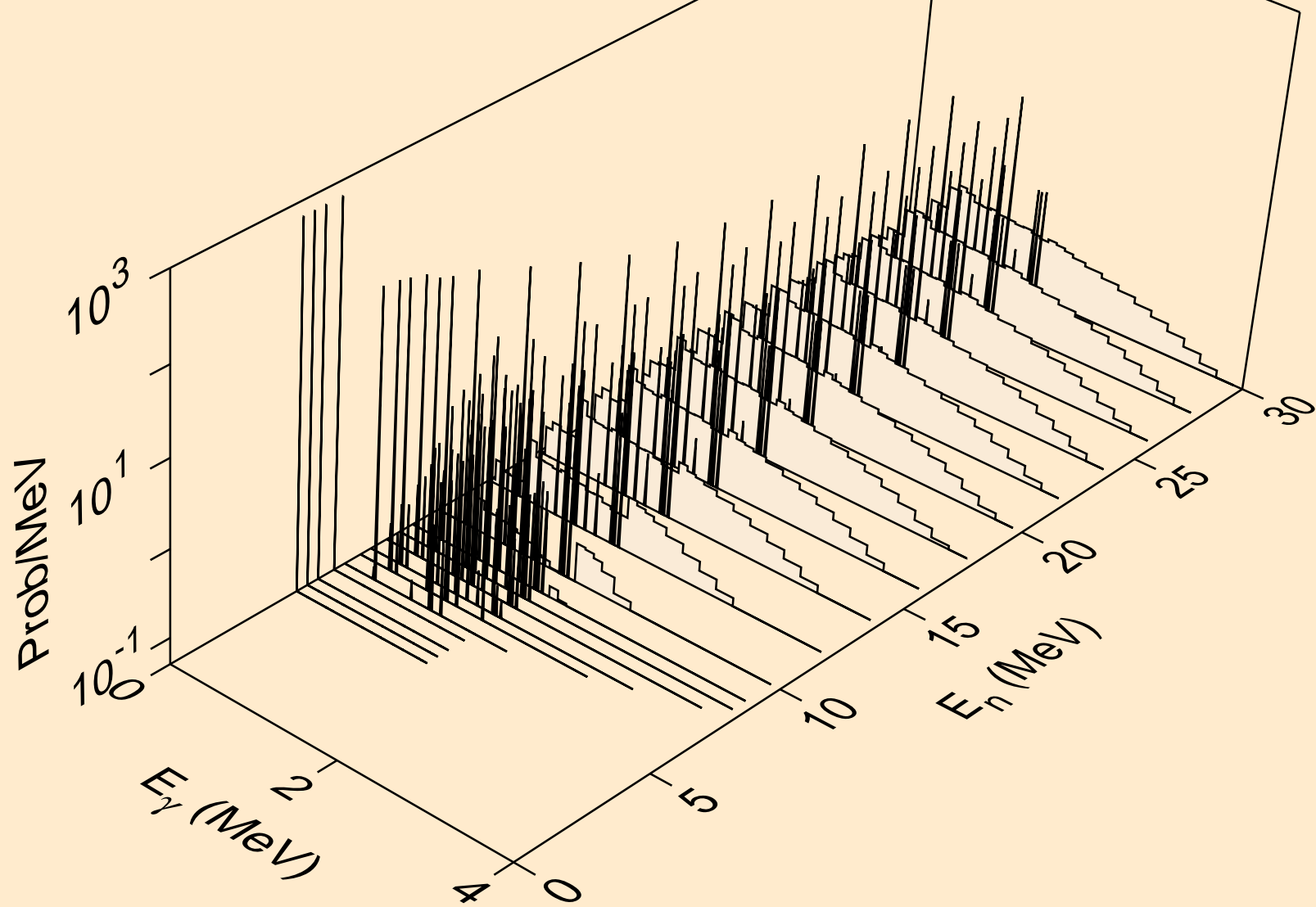

SN123 NEUTRON ACER TENDL-2024 LIBRARY; T=0.K
Photon emission for (n,d)

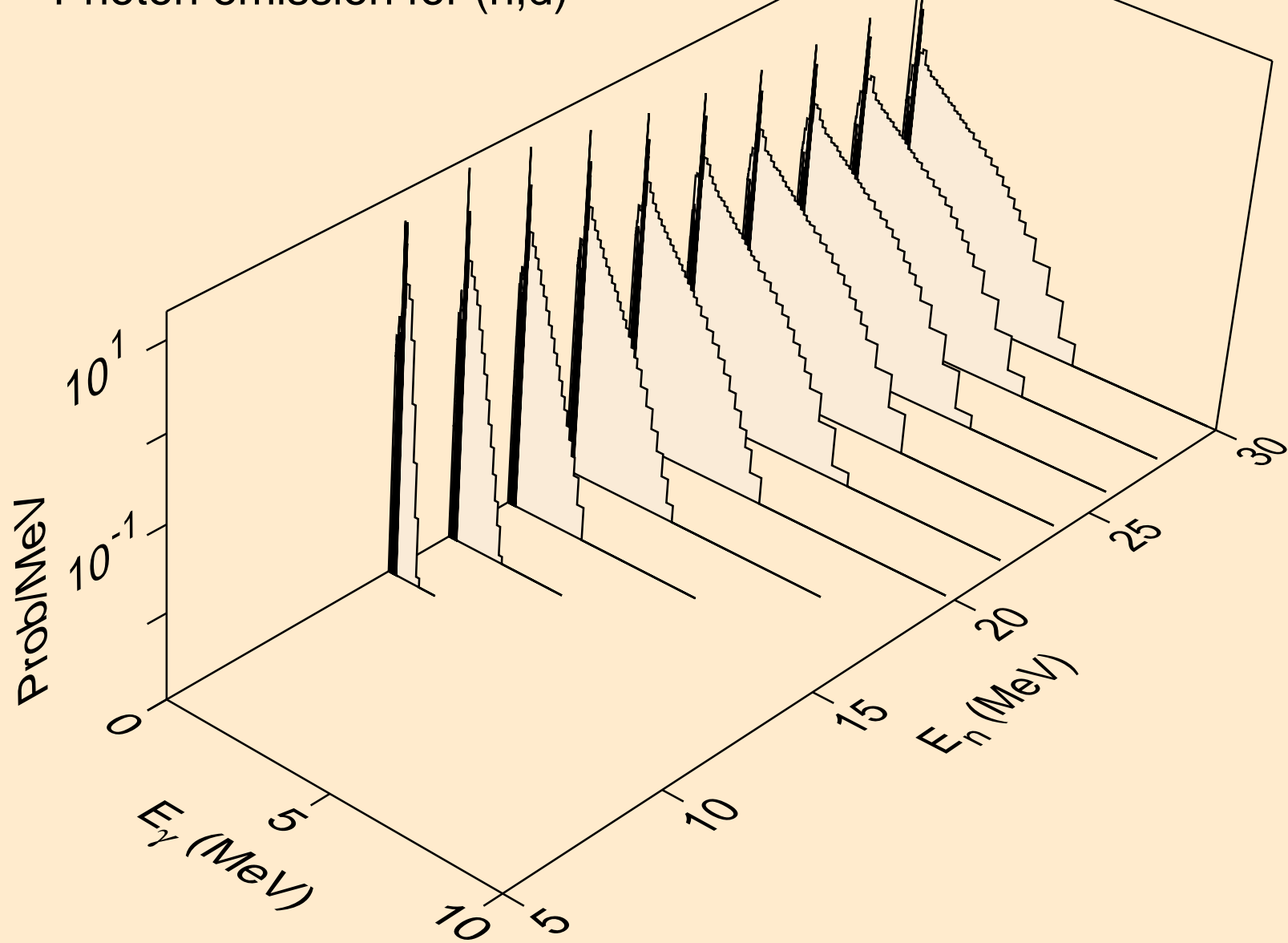

SN123 NEUTRON ACER TENDL-2024 LIBRARY; T=0.K
Photon emission for (n,t)

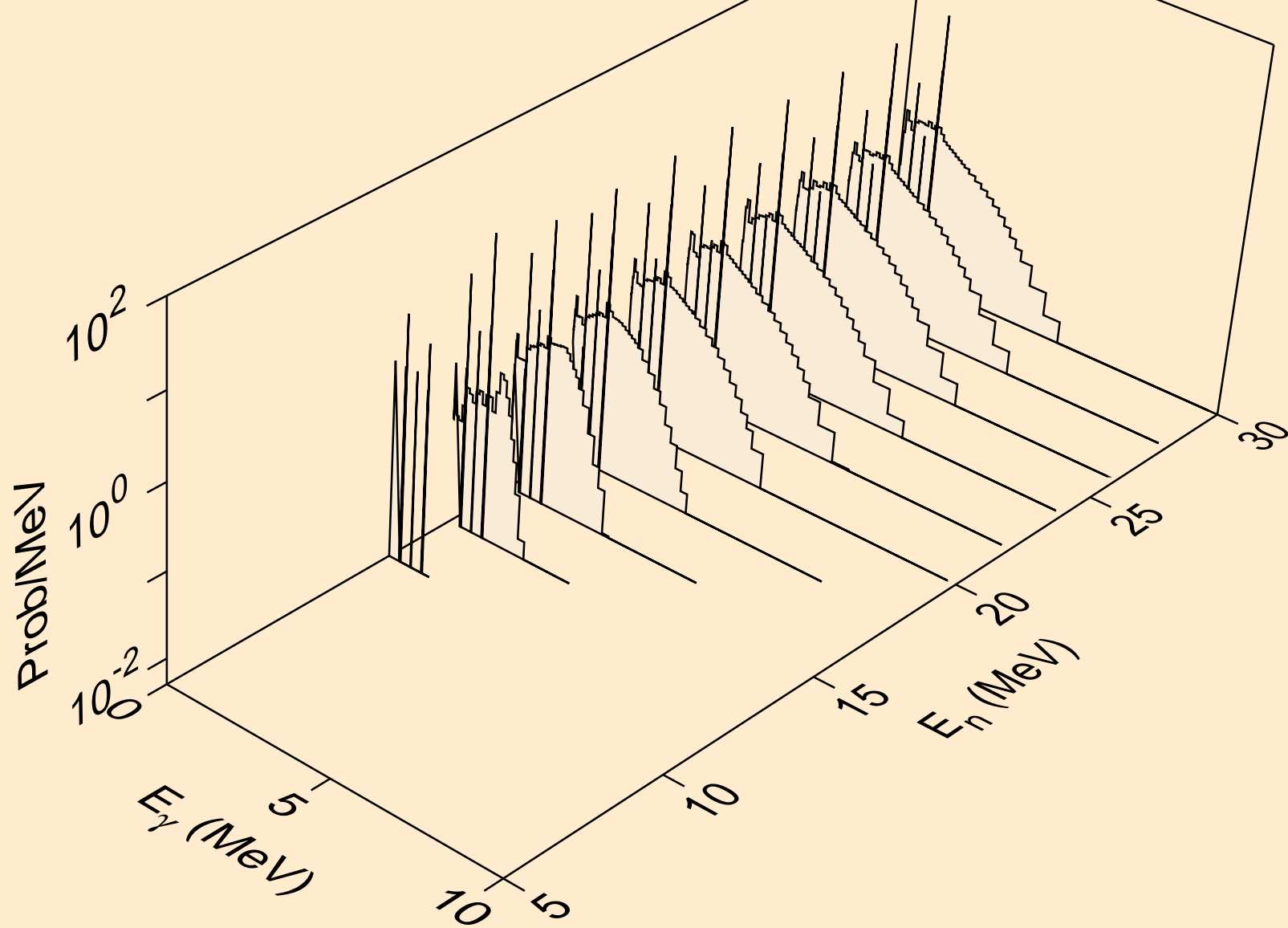

SN123 NEUTRON ACER TENDL-2024 LIBRARY; T=0.K
Photon emission for (n,he3)

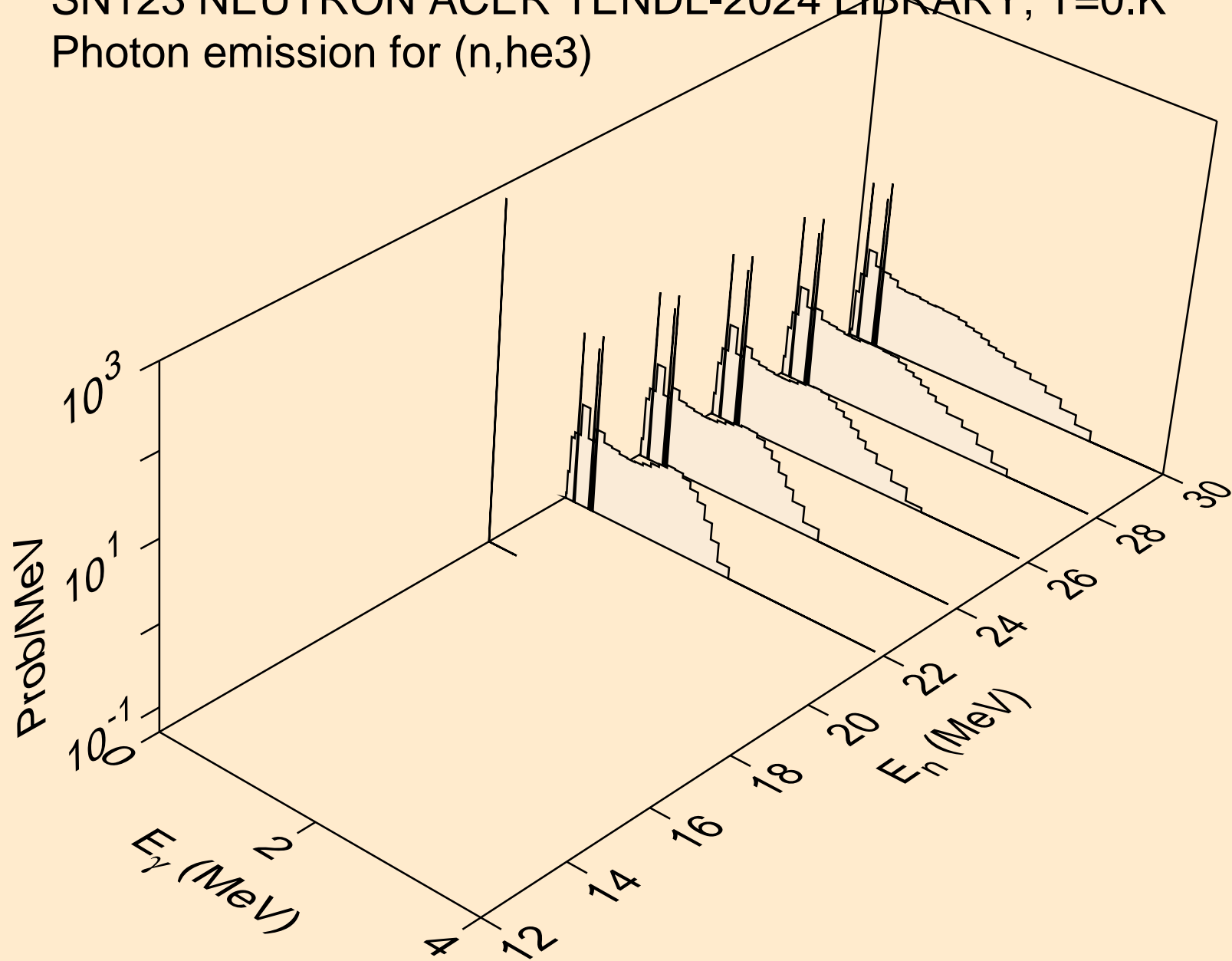

SN123 NEUTRON ACER TENDL-2024 LIBRARY; T=0.K
Photon emission for (n,a)

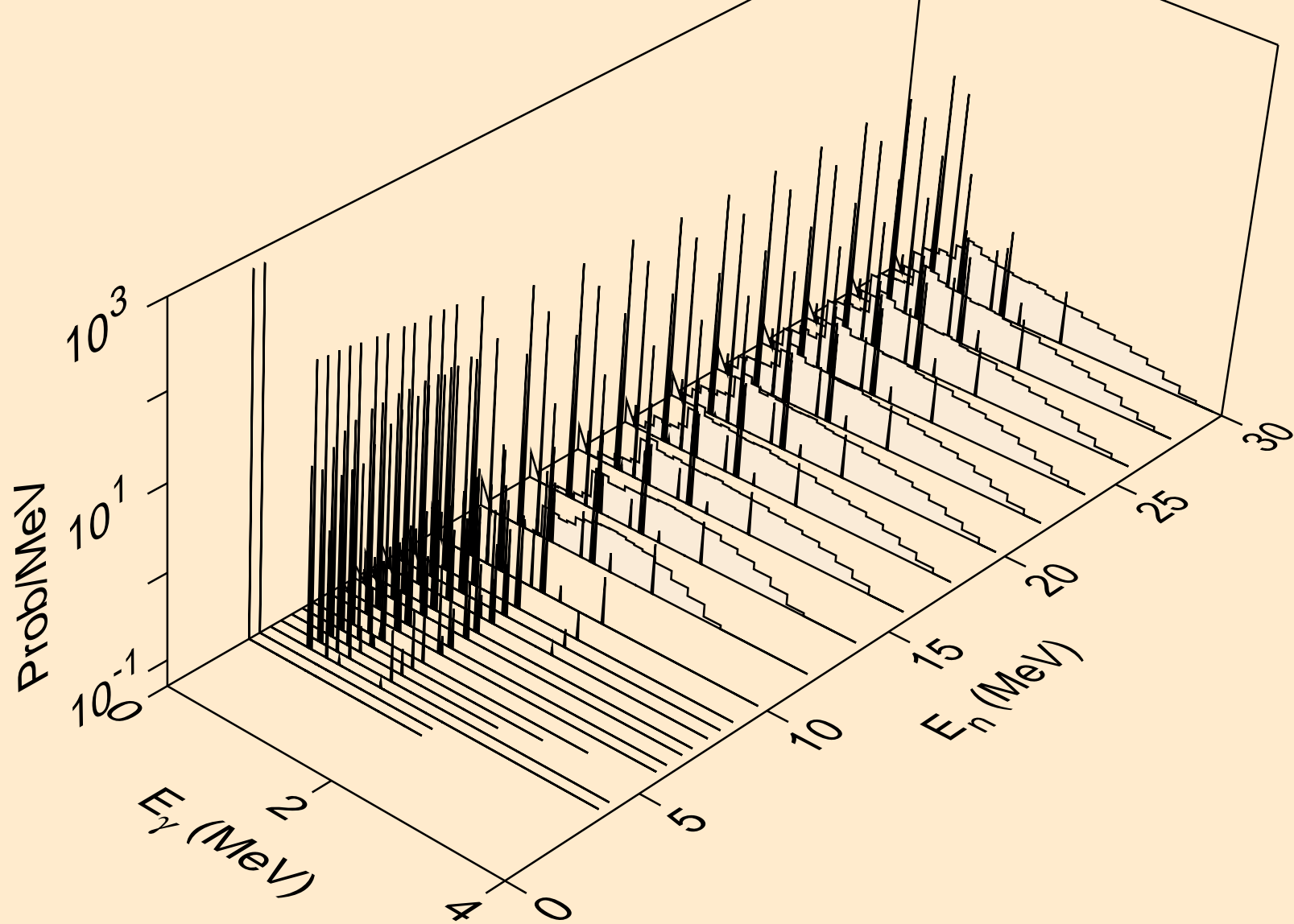

SN123 NEUTRON ACER TENDL-2024 LIBRARY; T=0.K
Photon emission for (n,2p)

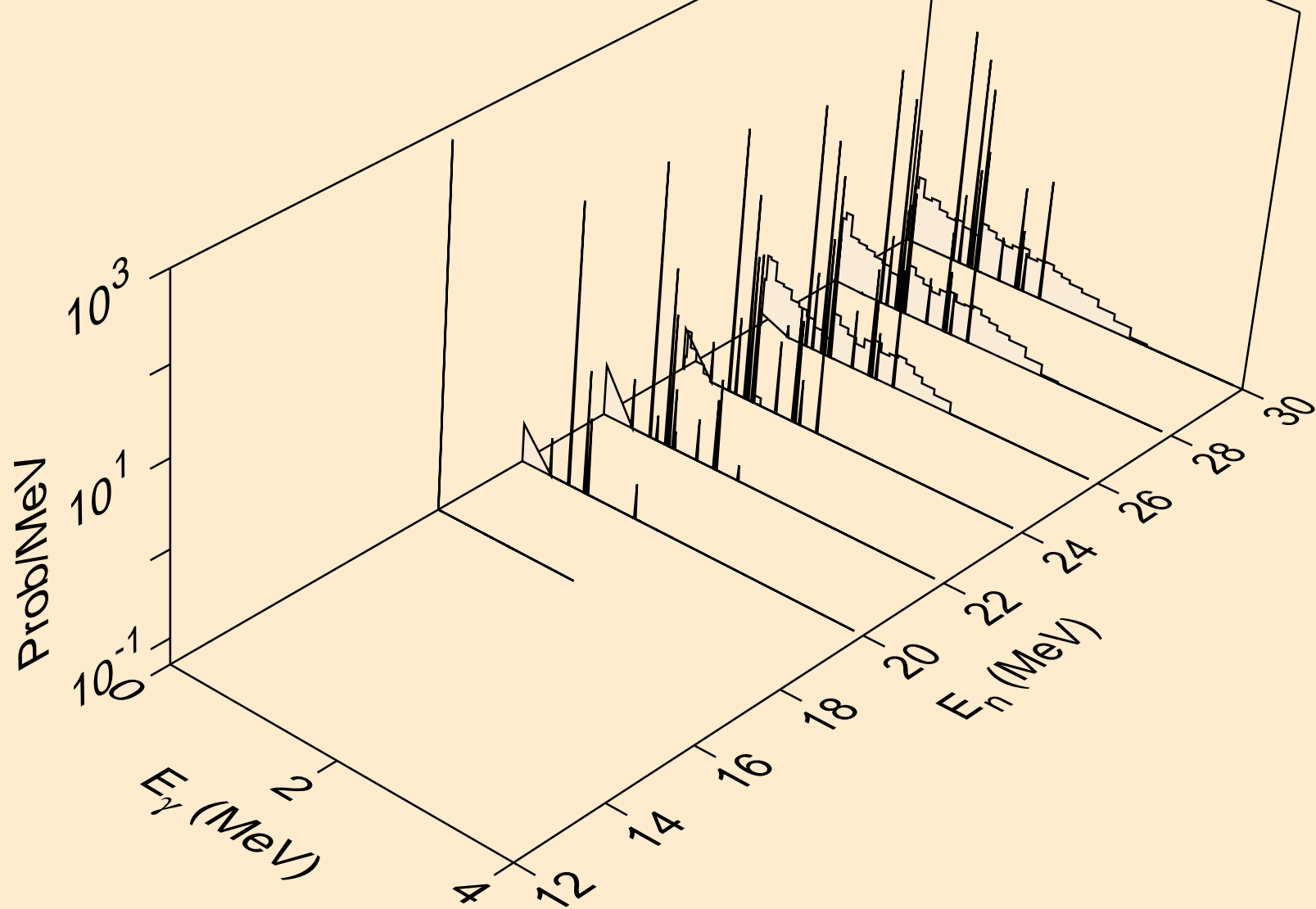

SN123 NEUTRON ACER TENDL-2024 LIBRARY; T=0.K
thermal capture photon spectrum

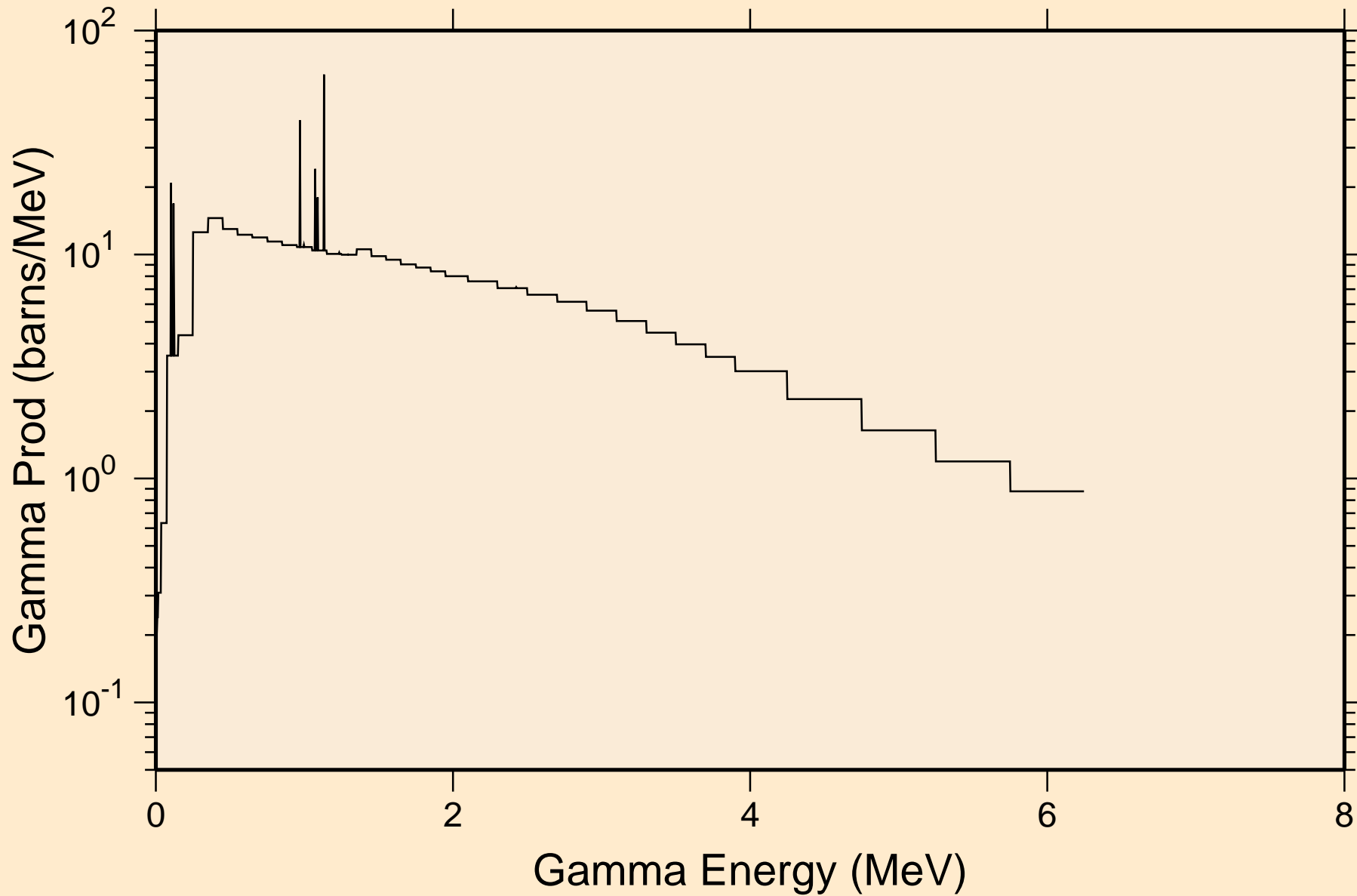

SN123 NEUTRON ACER TENDL-2024 LIBRARY; T=0.K
14 MeV photon spectrum

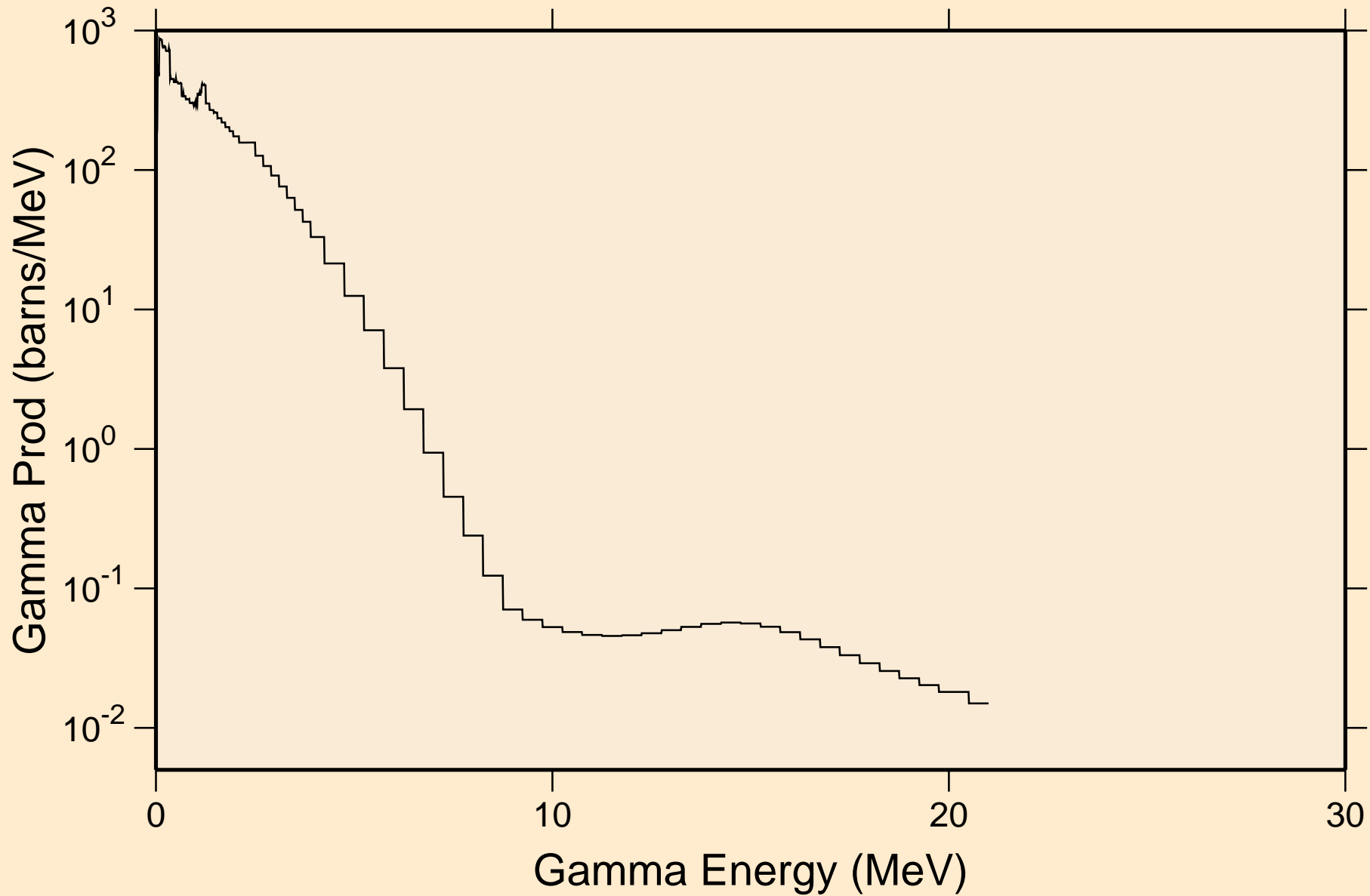

SN123 NEUTRON ACER TENDL-2024 LIBRARY; T=0.K

Particle heating contributions

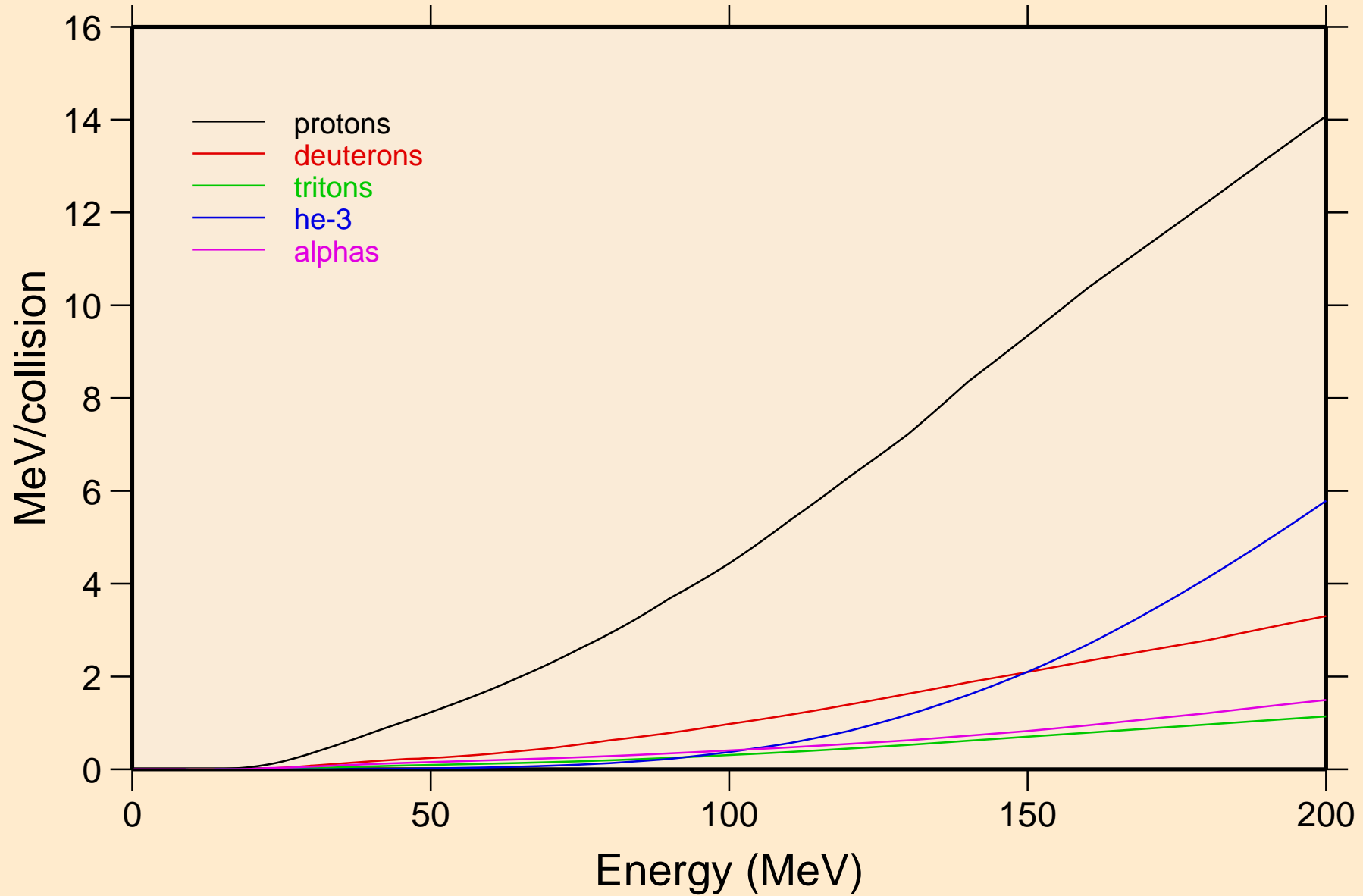

SN123 NEUTRON ACER TENDL-2024 LIBRARY; T=0.K

Recoil Heating

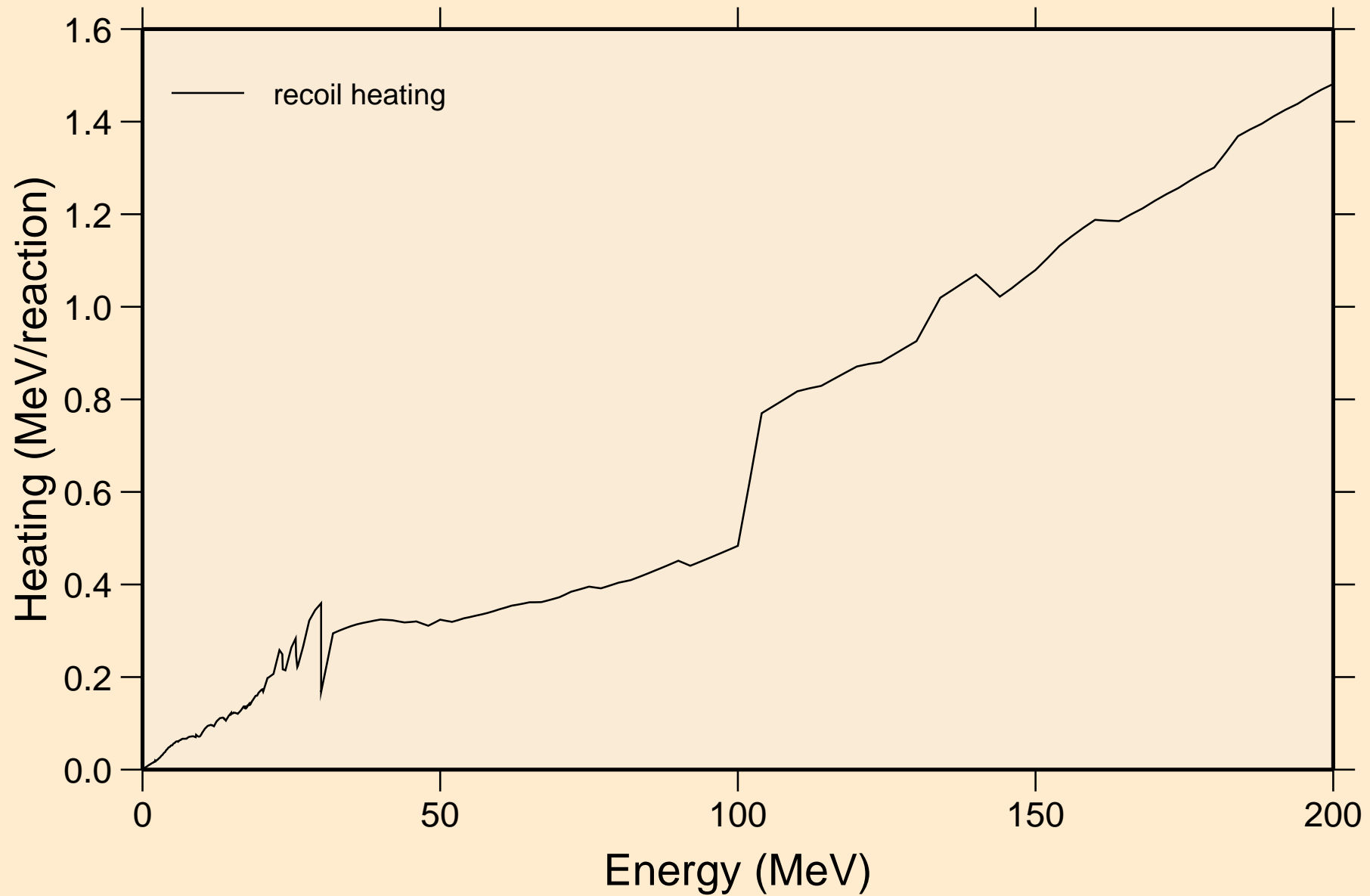

SN123 NEUTRON ACER TENDL-2024 LIBRARY; T=0.K

Particle production cross sections

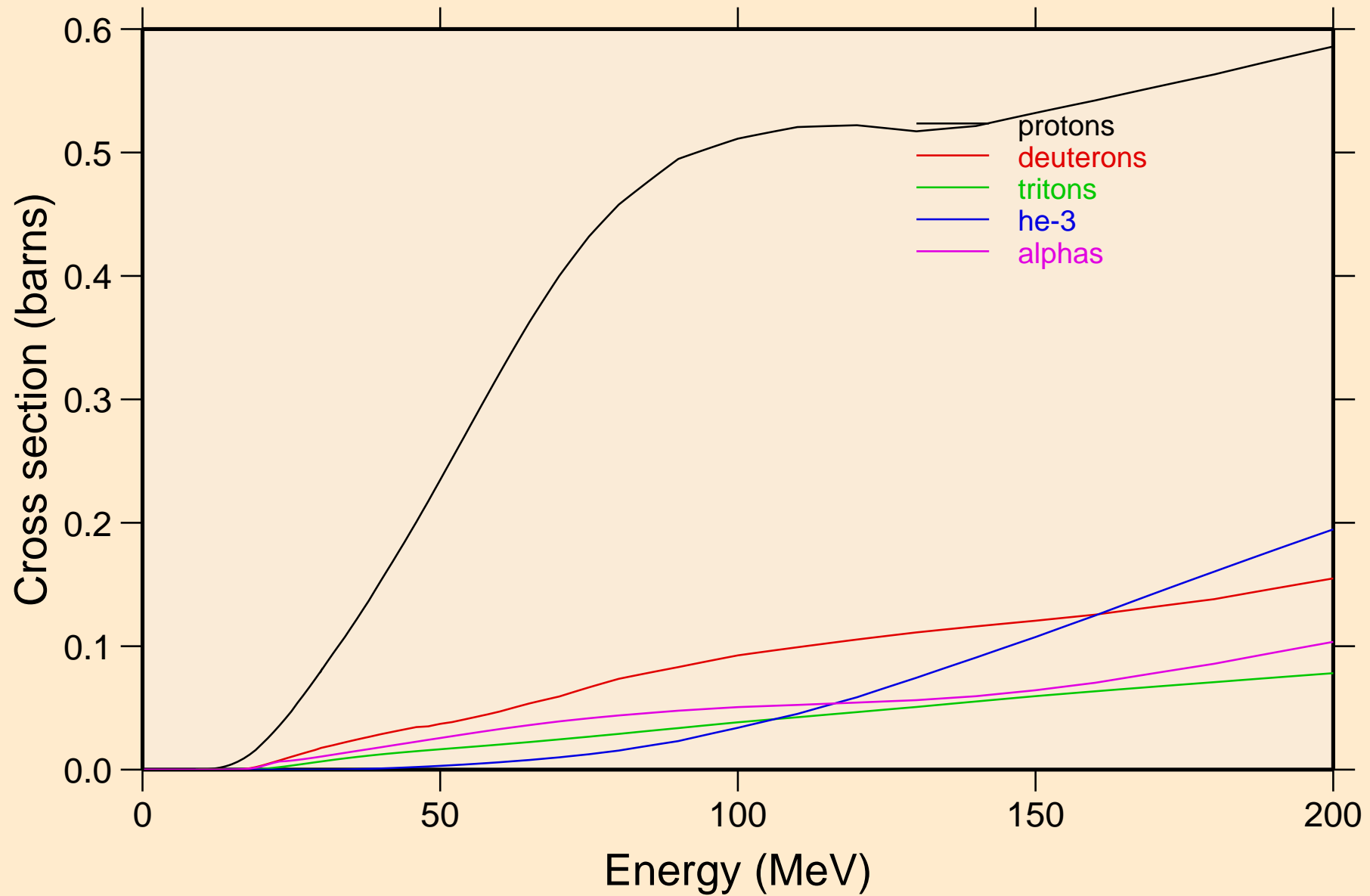

SN123 NEUTRON ACER TENDL-2024 LIBRARY; T=0.K
protons from (n,x)

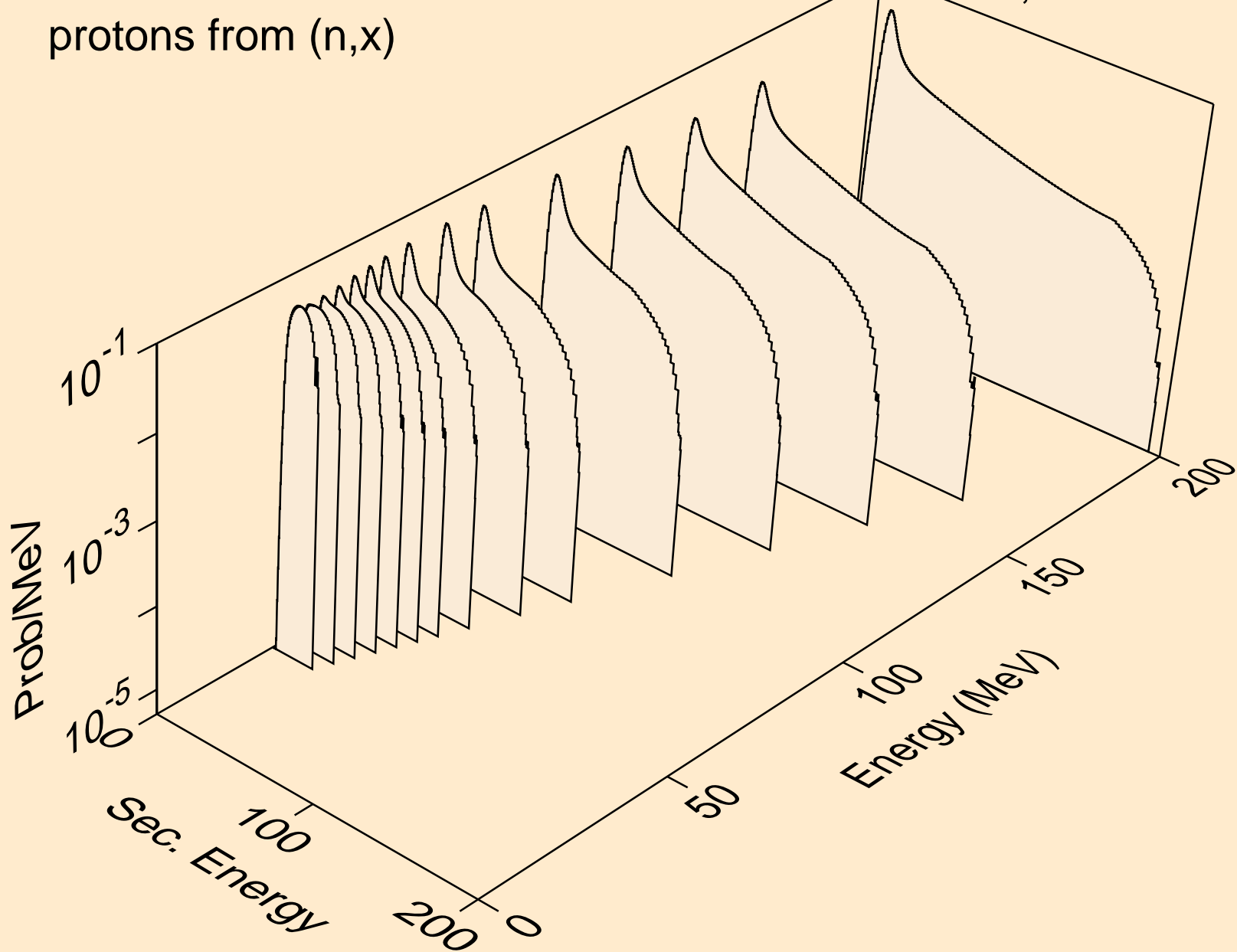

SN123 NEUTRON ACER TENDL-2024 LIBRARY; T=0.K
protons from (n,n*)p

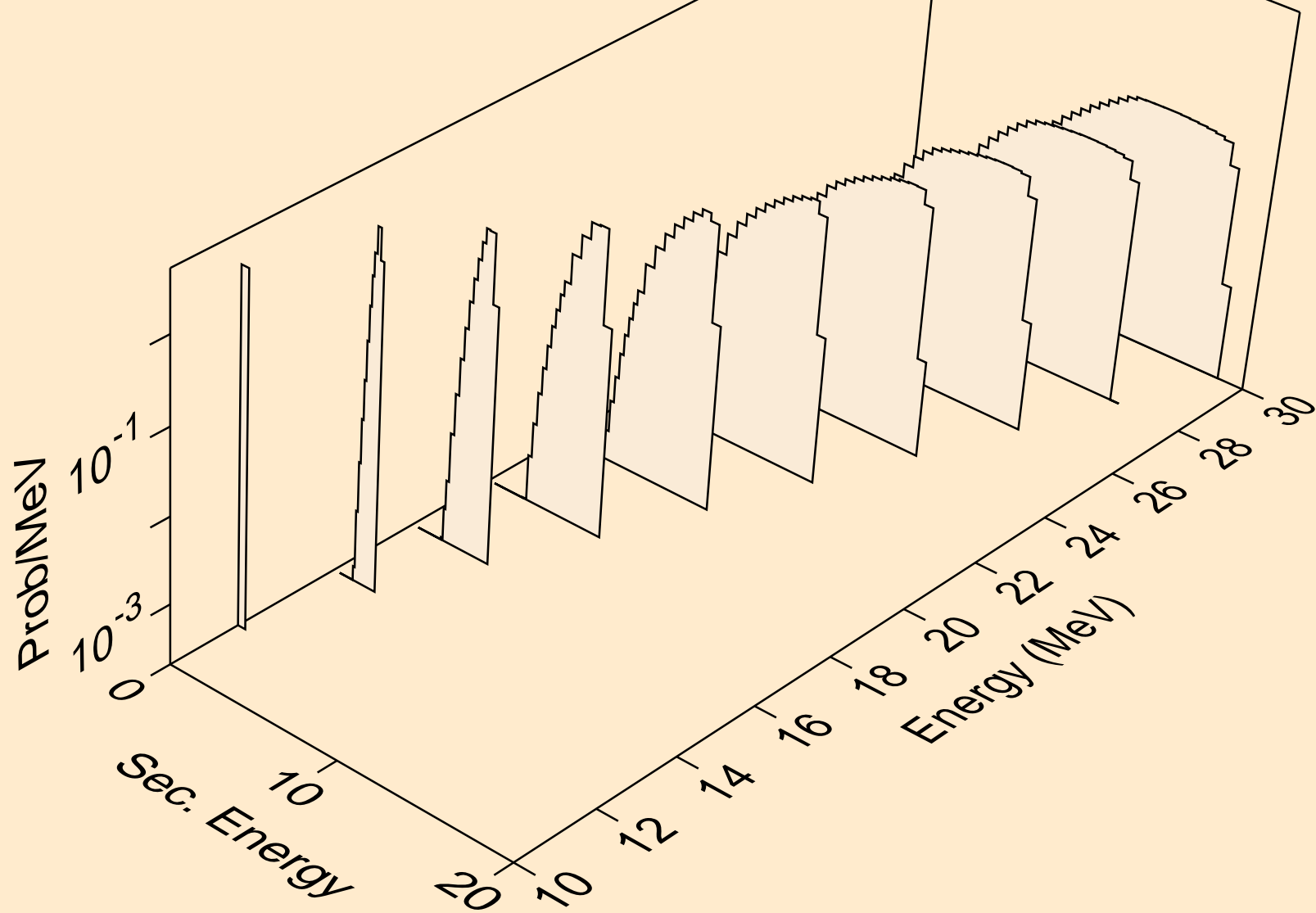

SN123 NEUTRON ACER TENDL-2024 LIBRARY; T=0.K
protons from (n,2np)

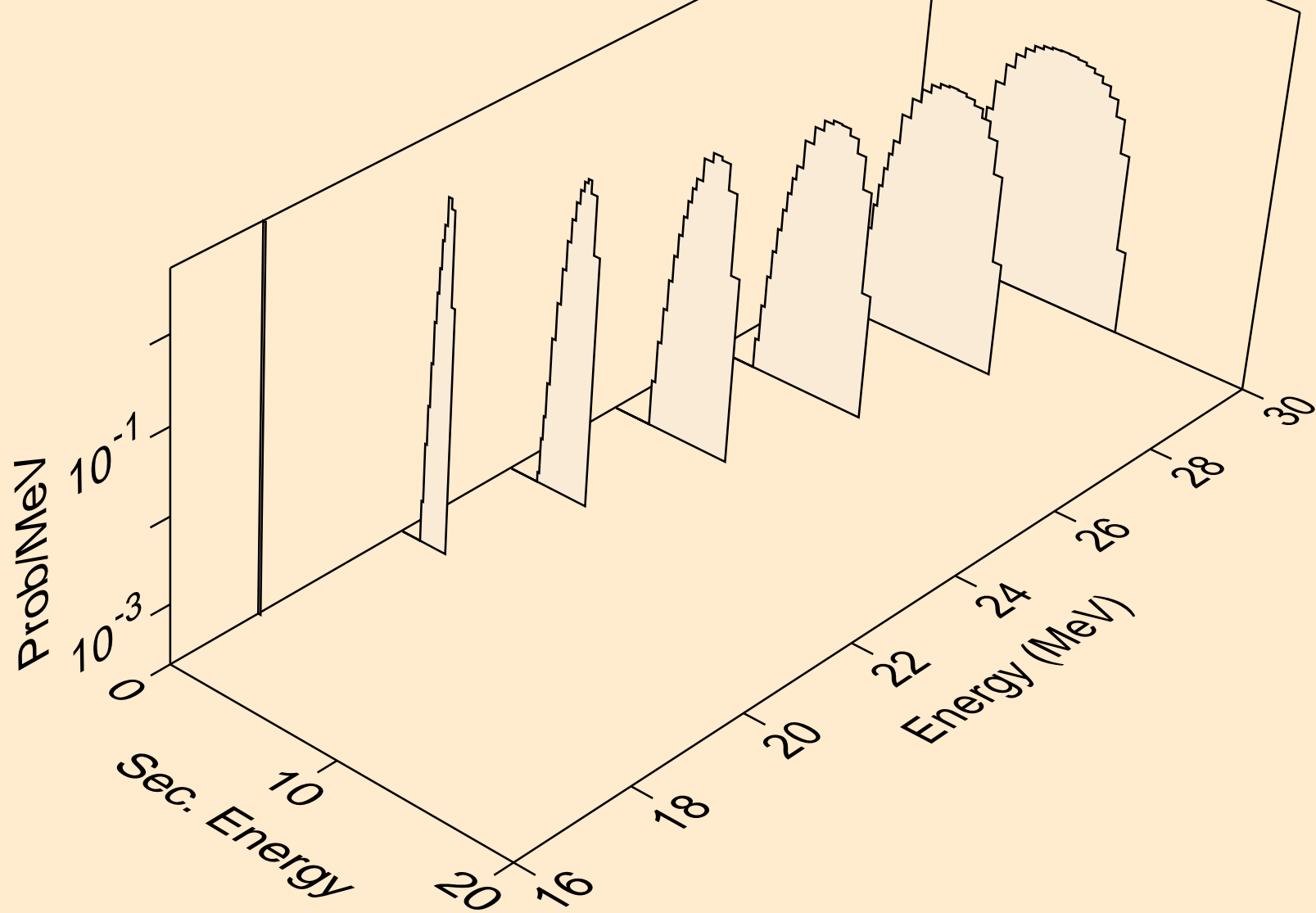

SN123 NEUTRON ACER TENDL-2024 LIBRARY; T=0.K
protons from (n,3np)

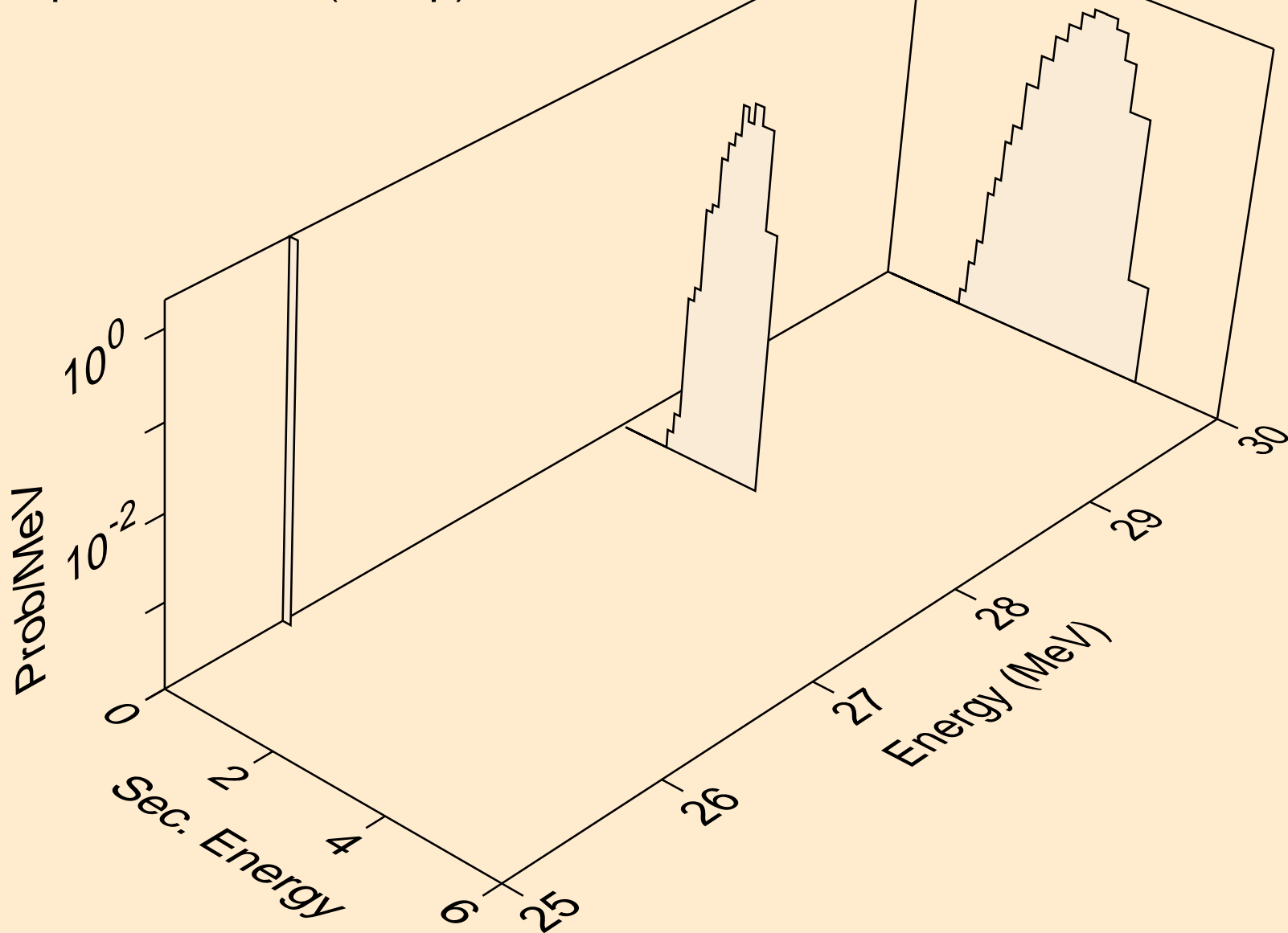

SN123 NEUTRON ACER TENDL-2024 LIBRARY; T=0.K
protons from (n,p)

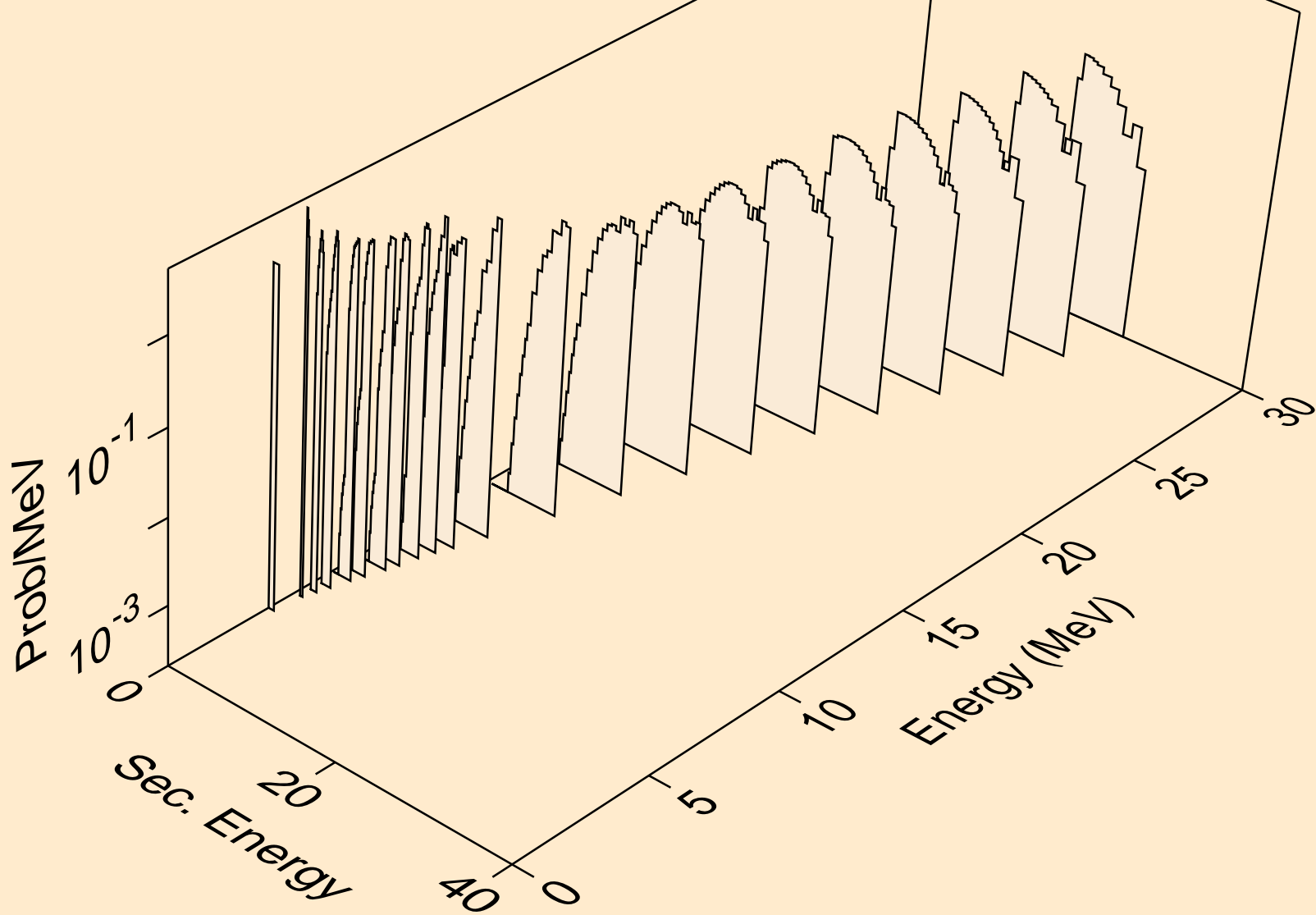

SN123 NEUTRON ACER TENDL-2024 LIBRARY; T=0.K
protons from (n,2p)

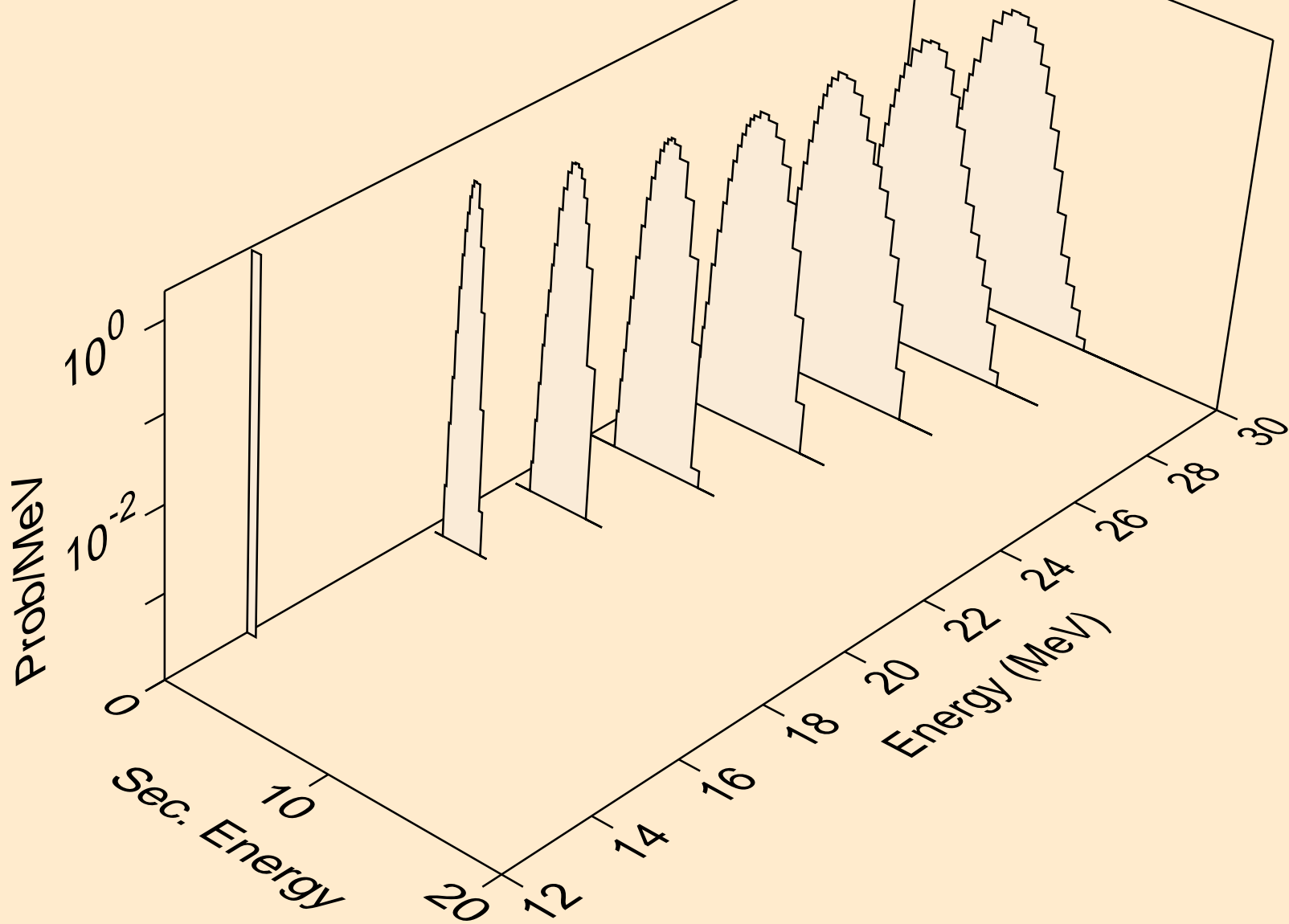

SN123 NEUTRON ACER TENDL-2024 LIBRARY; T=0.K
deuterons from (n,x)

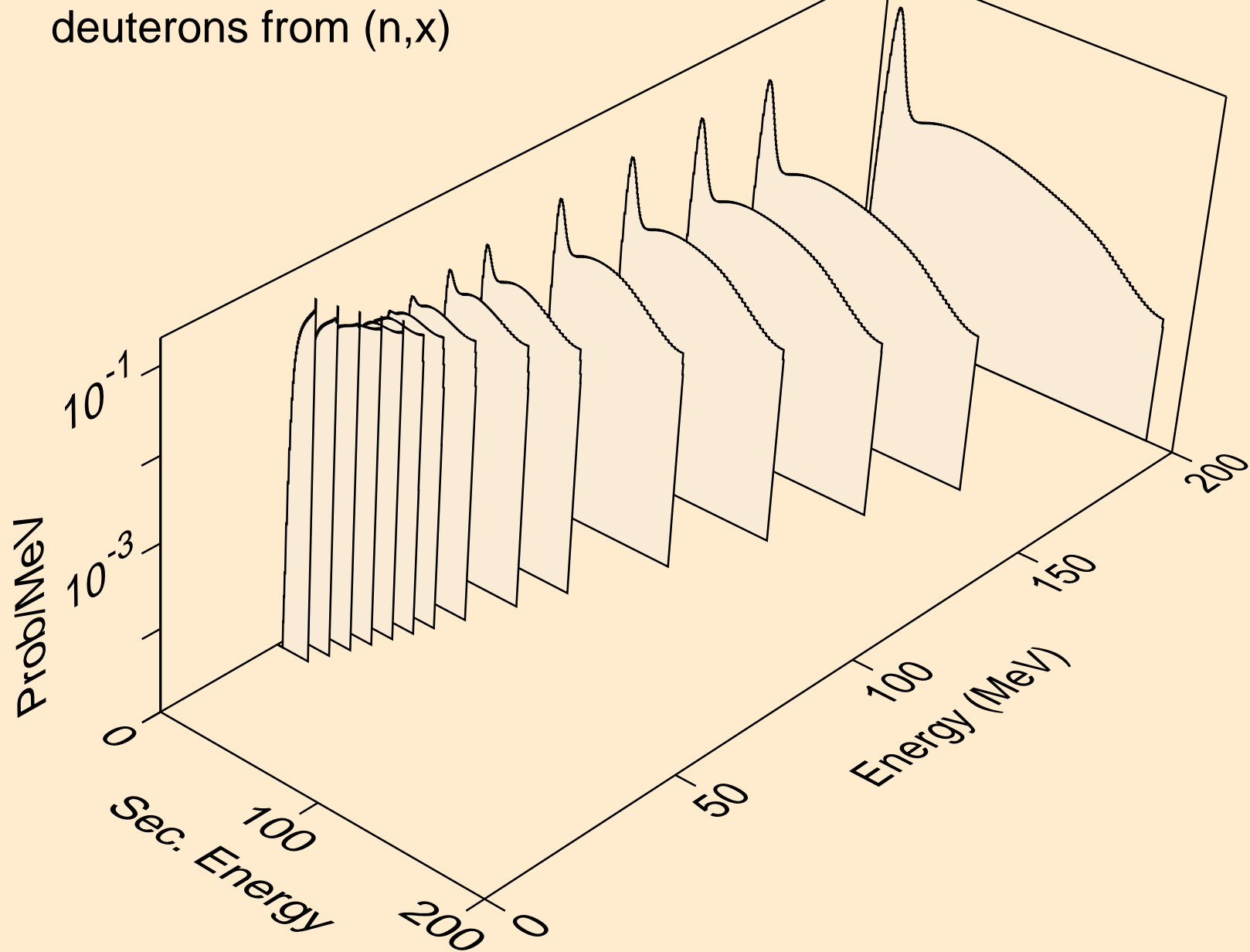

SN123 NEUTRON ACER TENDL-2024 LIBRARY; T=0.K
deuterons from (n,2nd)

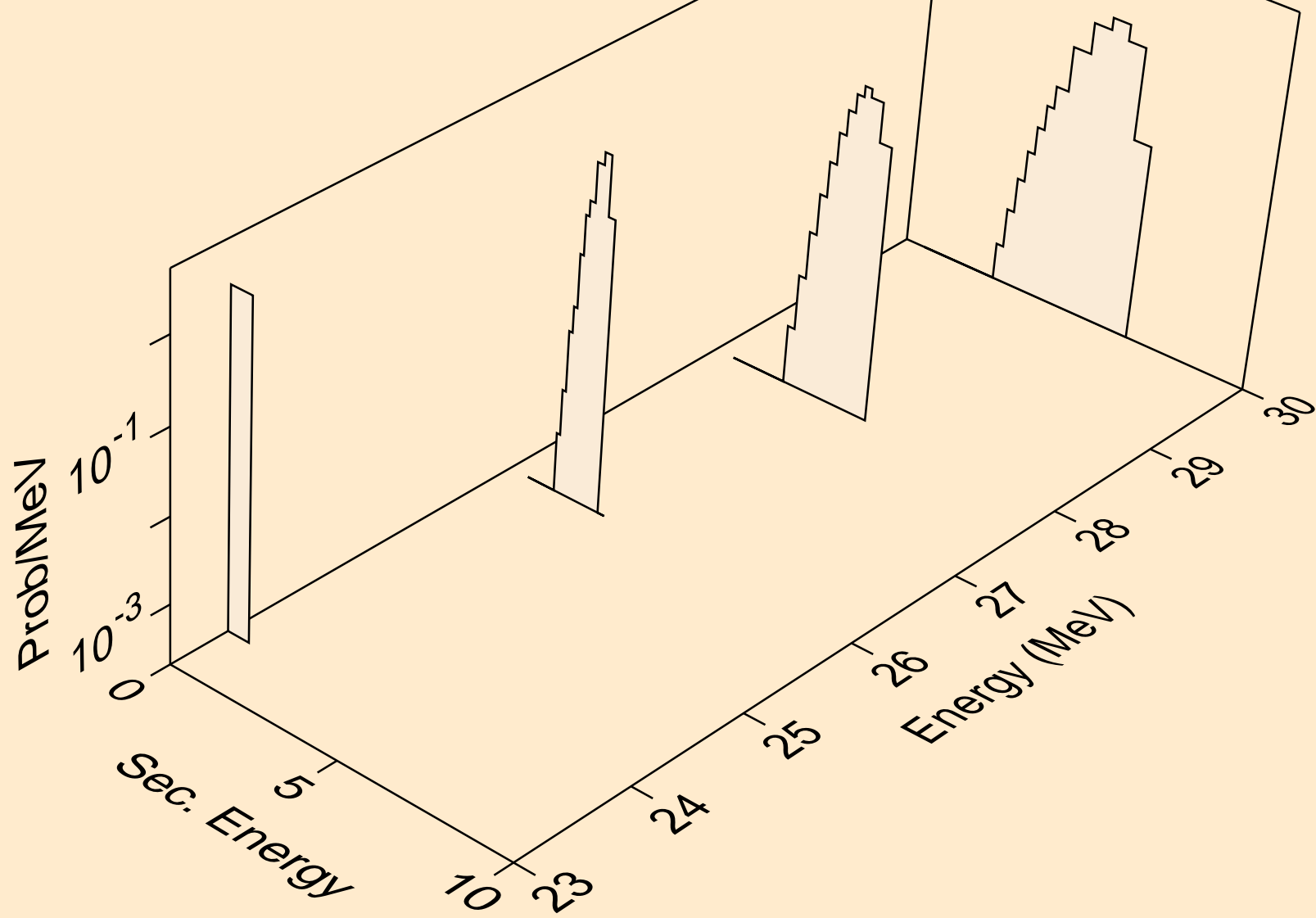

SN123 NEUTRON ACER TENDL-2024 LIBRARY; T=0.K
deuterons from (n,n*)d

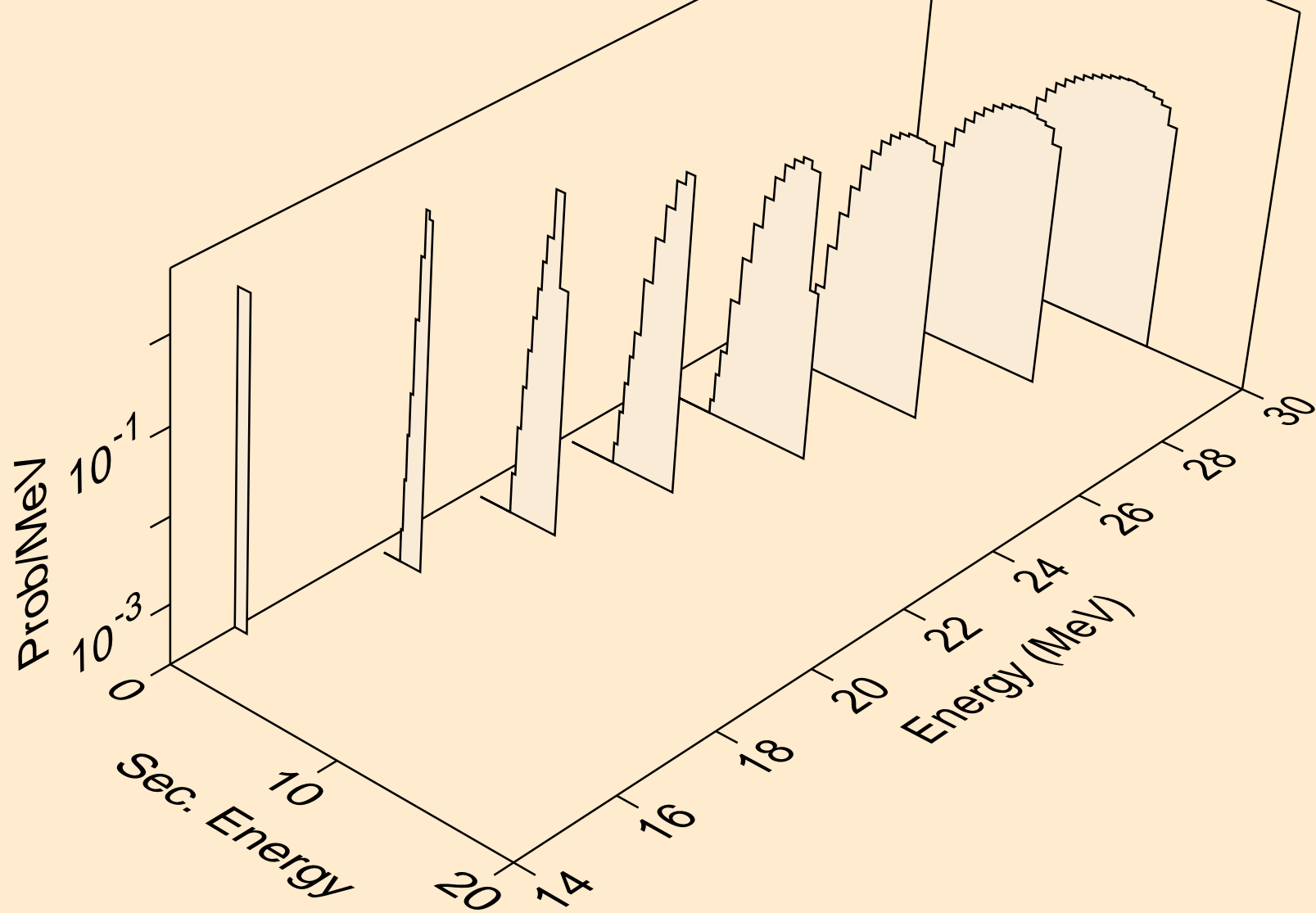

SN123 NEUTRON ACER TENDL-2024 LIBRARY; T=0.K
deuterons from (n,d)

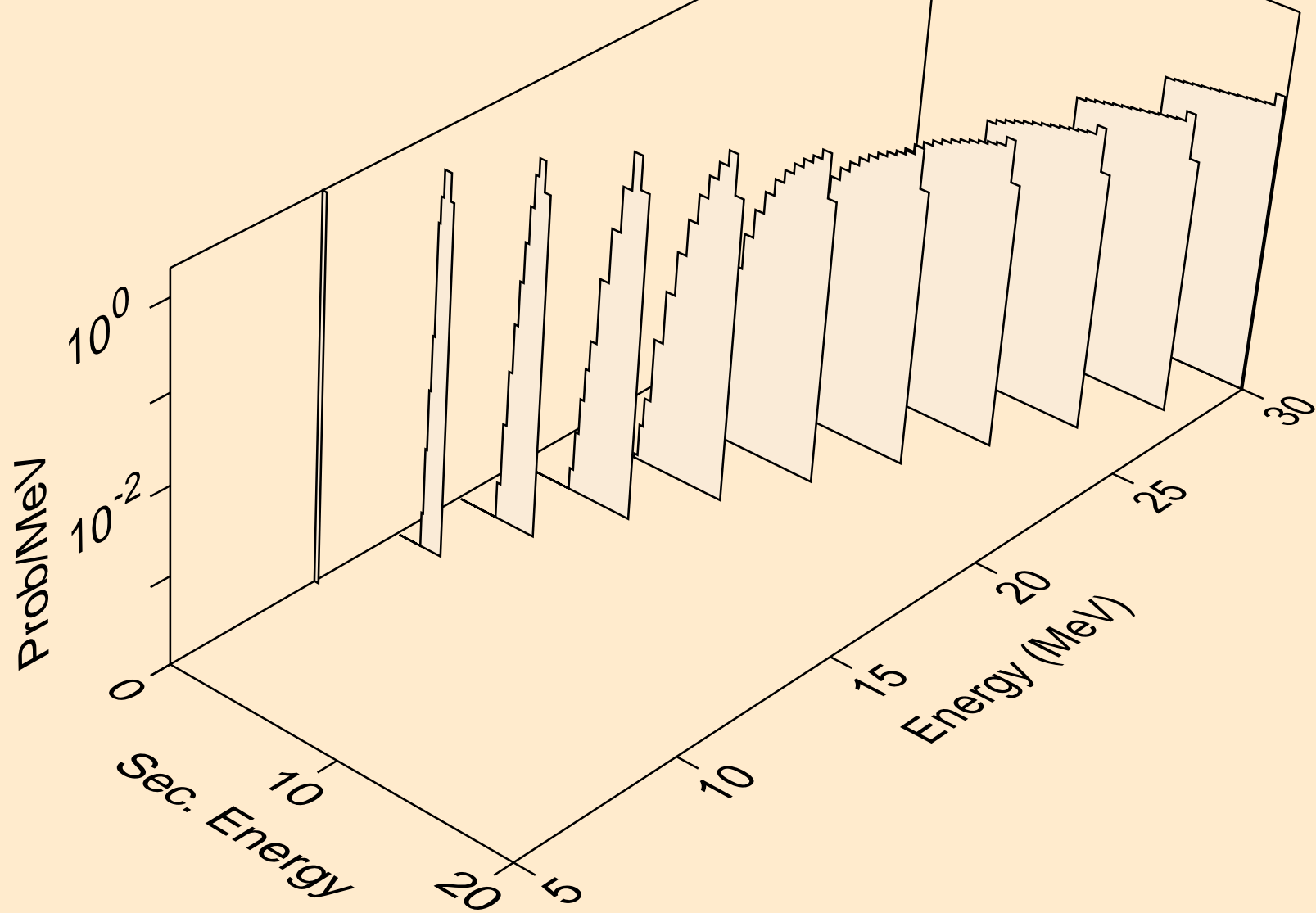

SN123 NEUTRON ACER TENDL-2024 LIBRARY; T=0.K
tritons from (n,x)

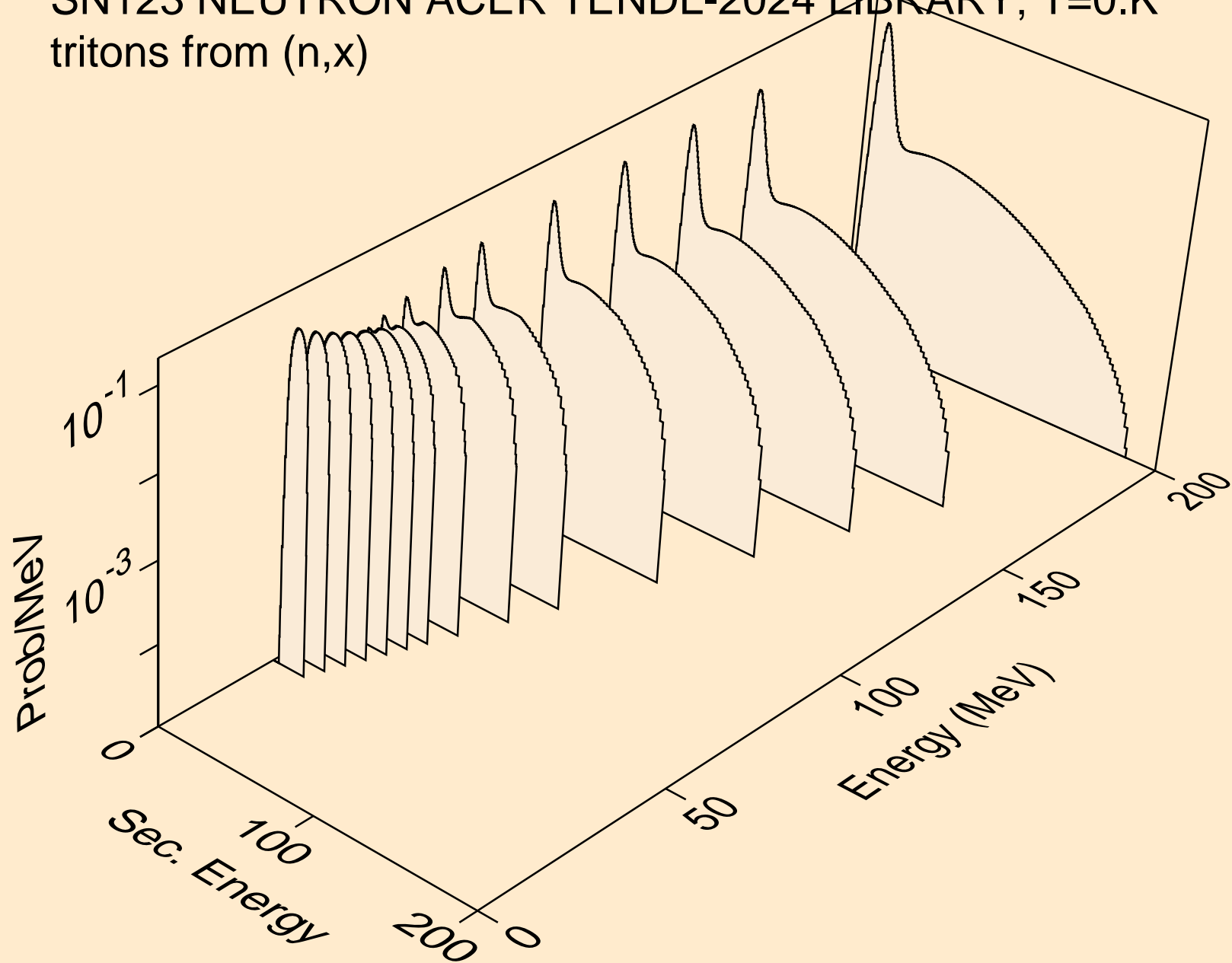

SN123 NEUTRON ACER TENDL-2024 LIBRARY; T=0.K
tritons from (n,n*)t

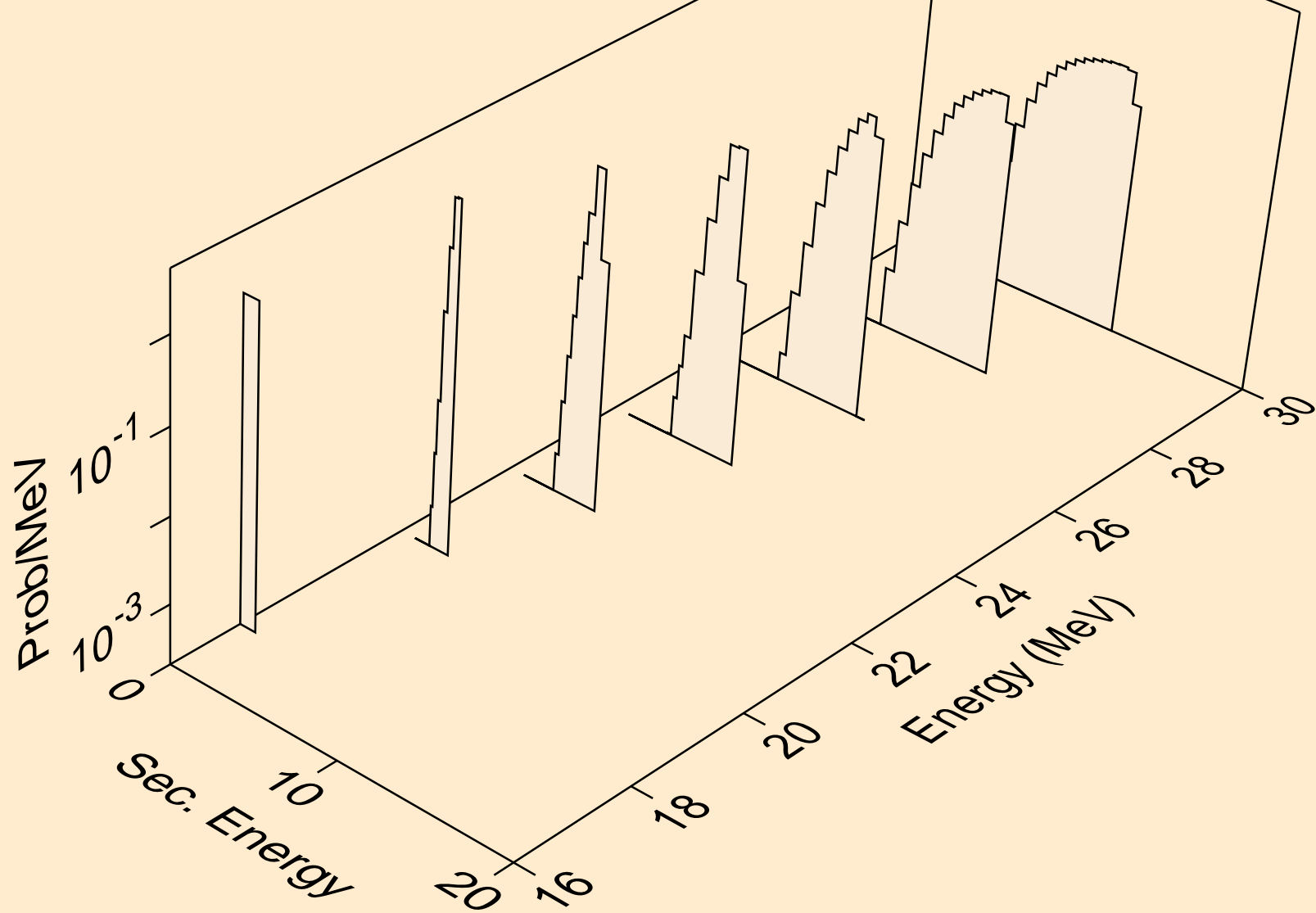

SN123 NEUTRON ACER TENDL-2024 LIBRARY; T=0.K
tritons from (n,t)

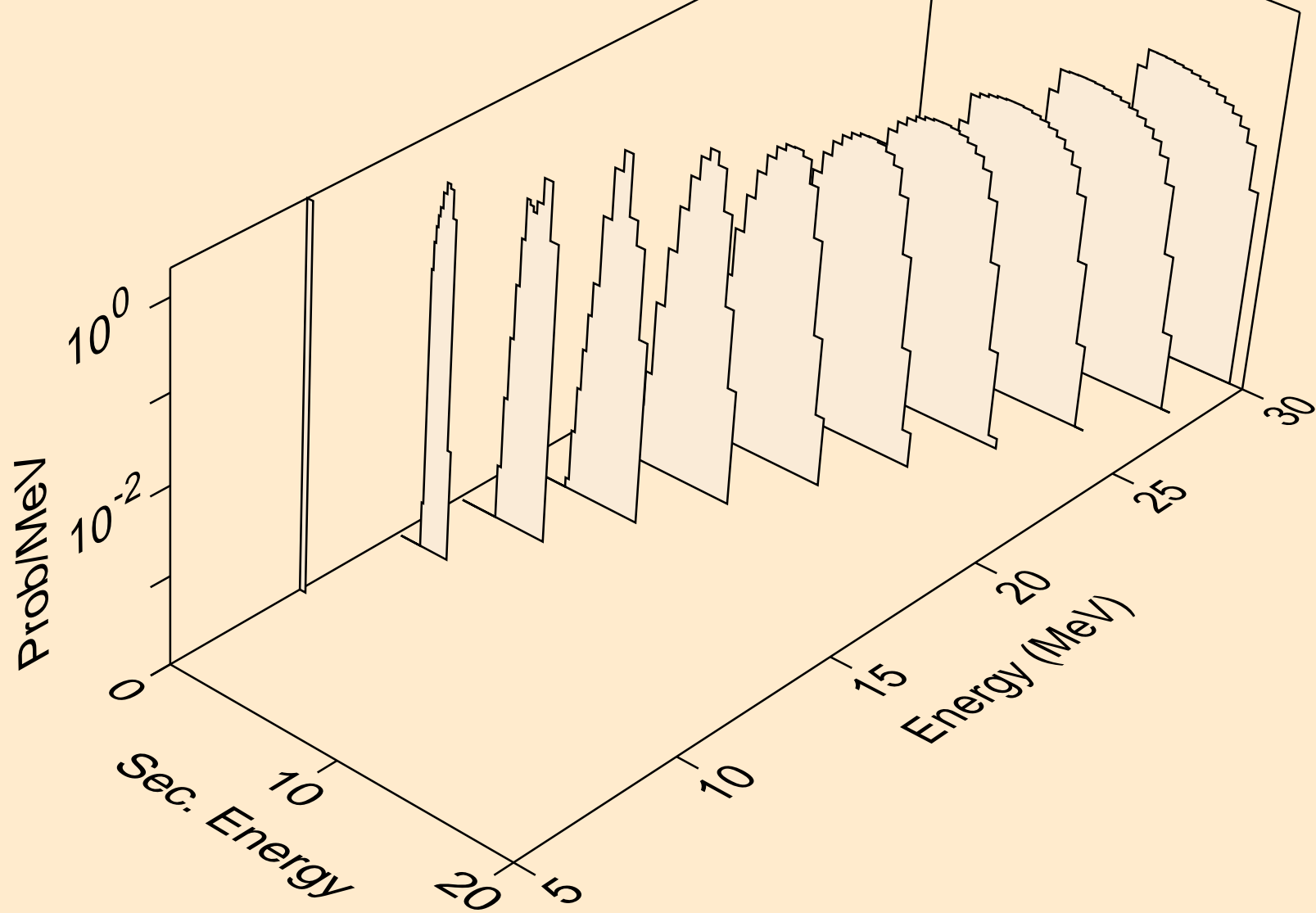

SN123 NEUTRON ACER TENDL-2024 LIBRARY; T=0.K
he3s from (n,x)

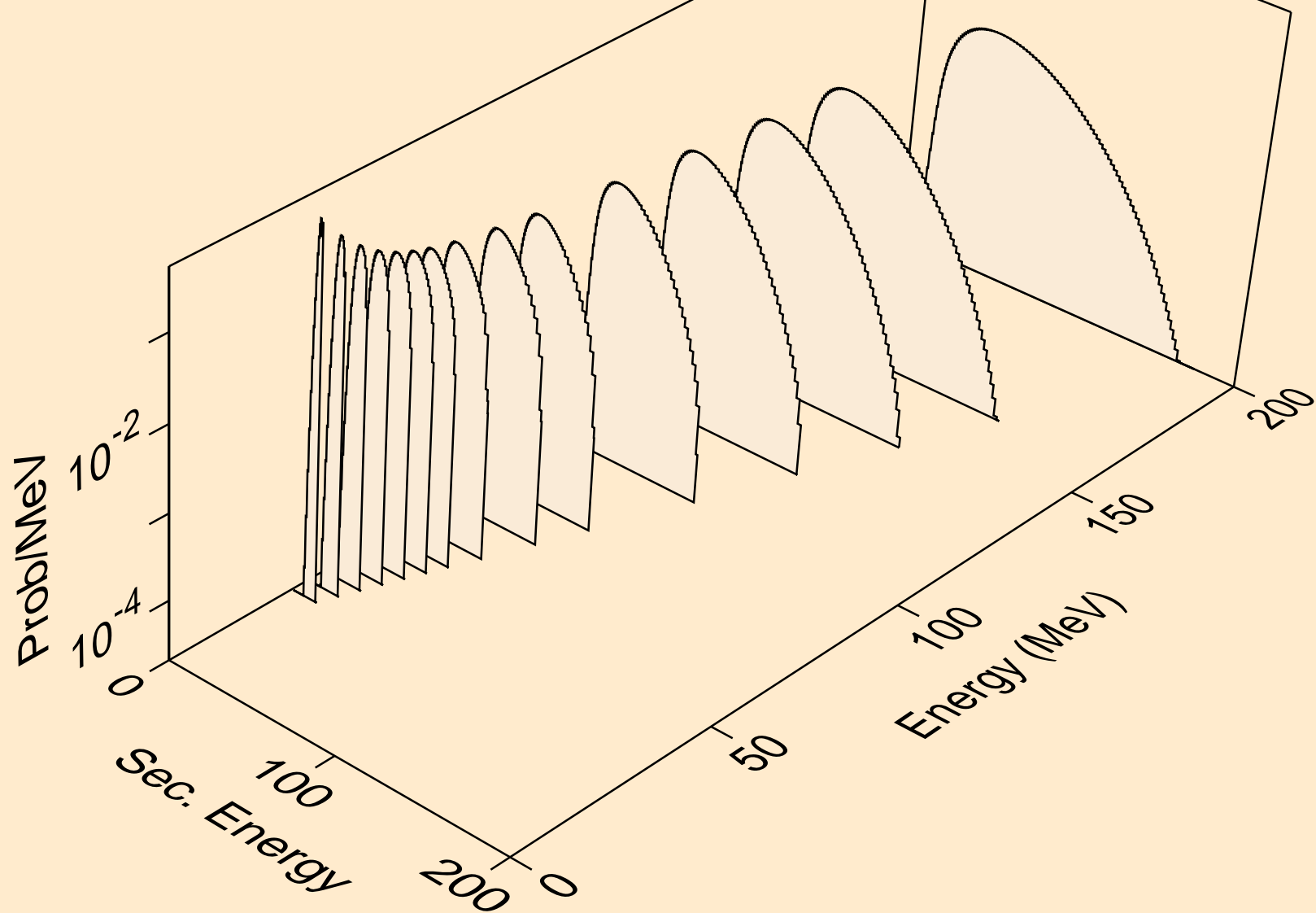

SN123 NEUTRON ACER TENDL-2024 LIBRARY; T=0.K
he3s from (n,n*)he3

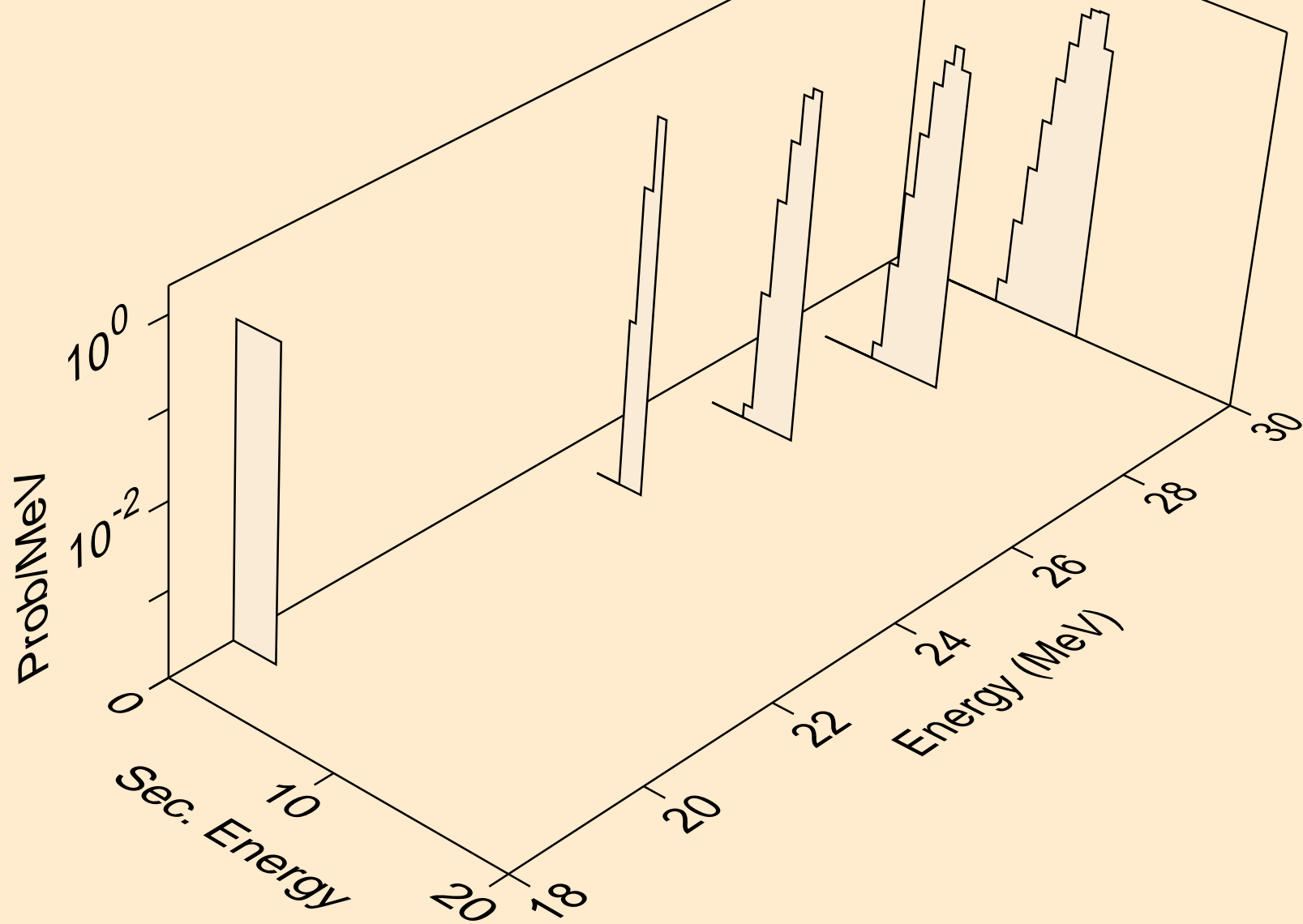

SN123 NEUTRON ACER TENDL-2024 LIBRARY; T=0.K
he3s from (n,he3)

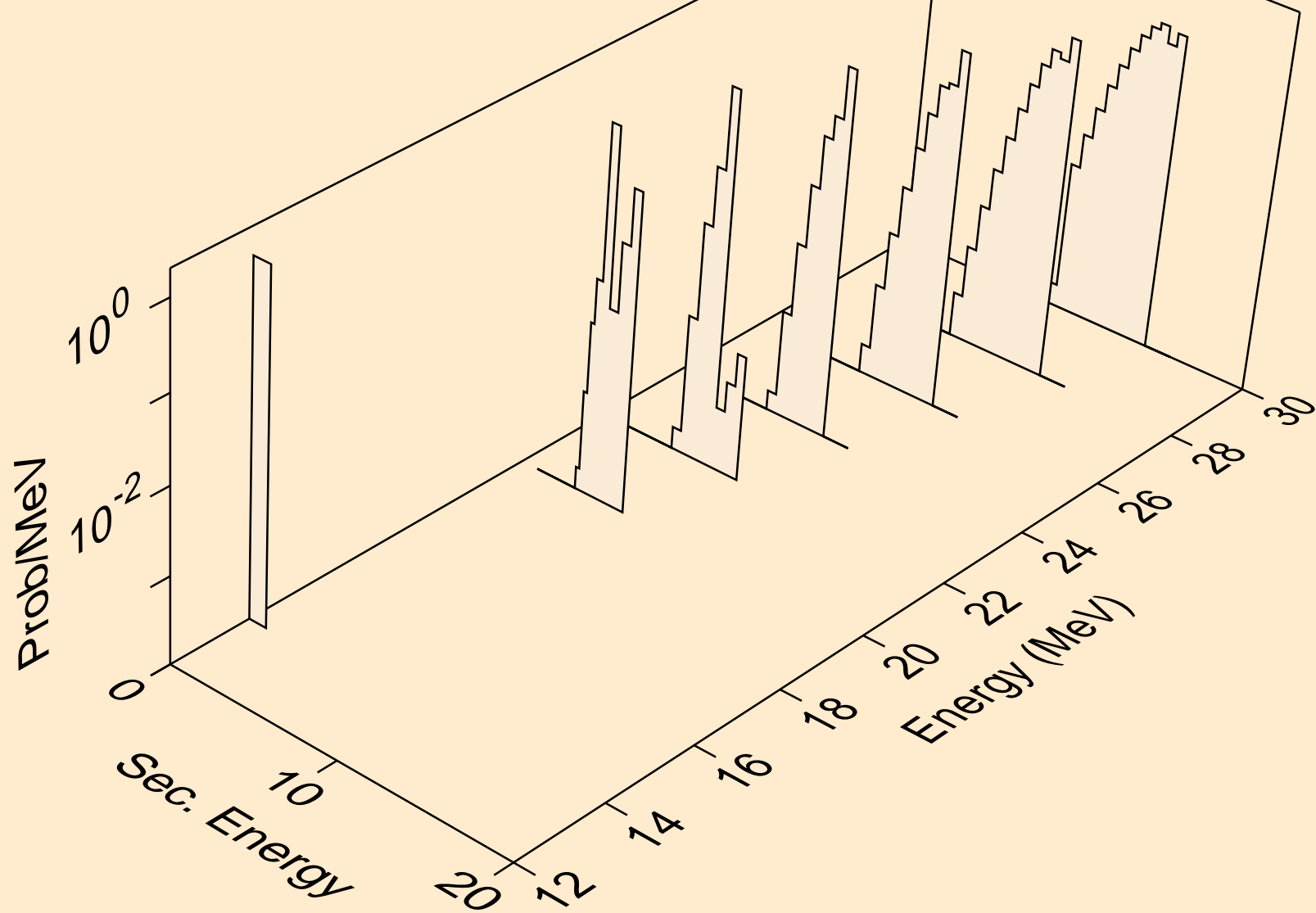

SN123 NEUTRON ACER TENDL-2024 LIBRARY; T=0.K
alphas from (n,x)

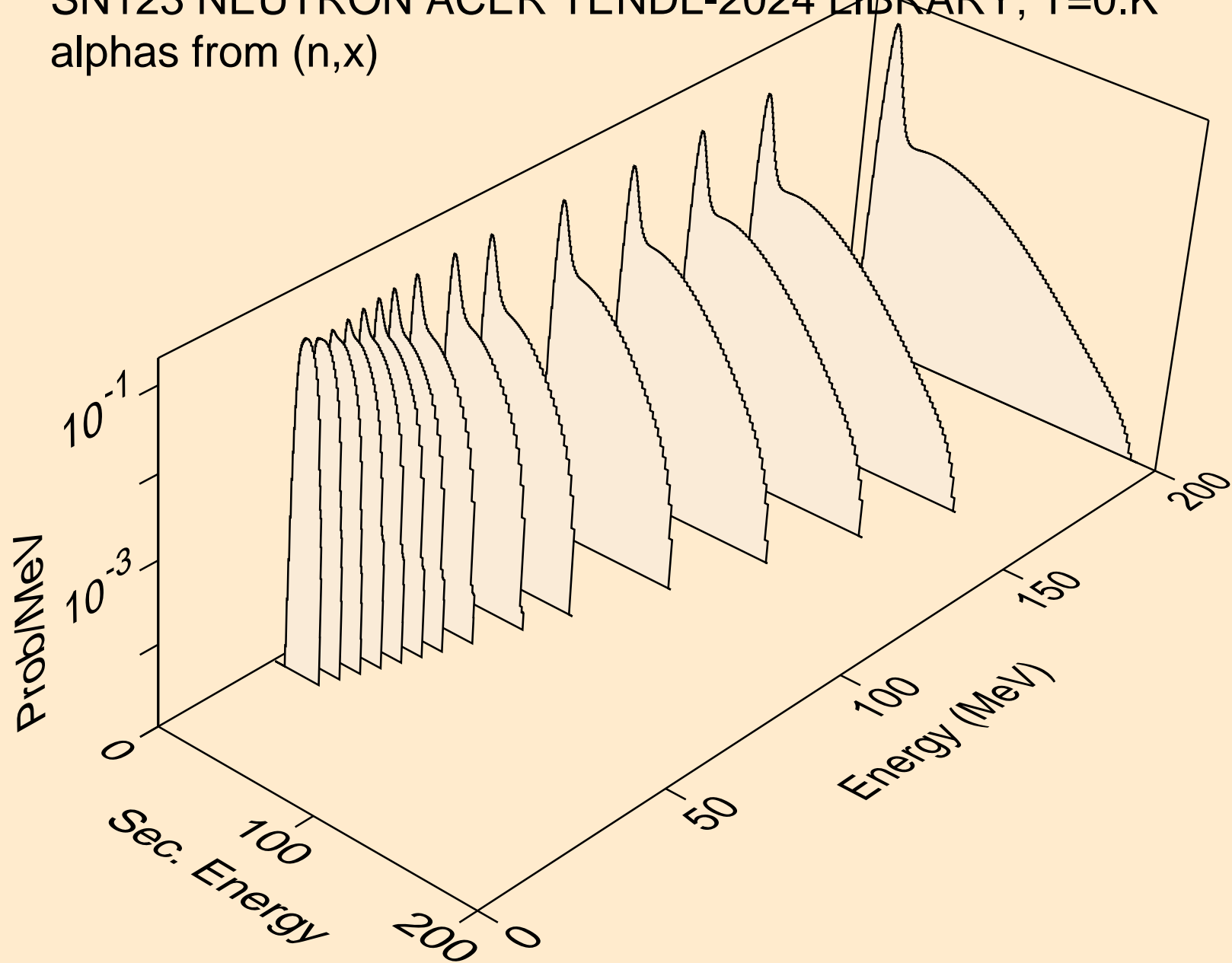

SN123 NEUTRON ACER TENDL-2024 LIBRARY; T=0.K
alphas from (n,n*)a

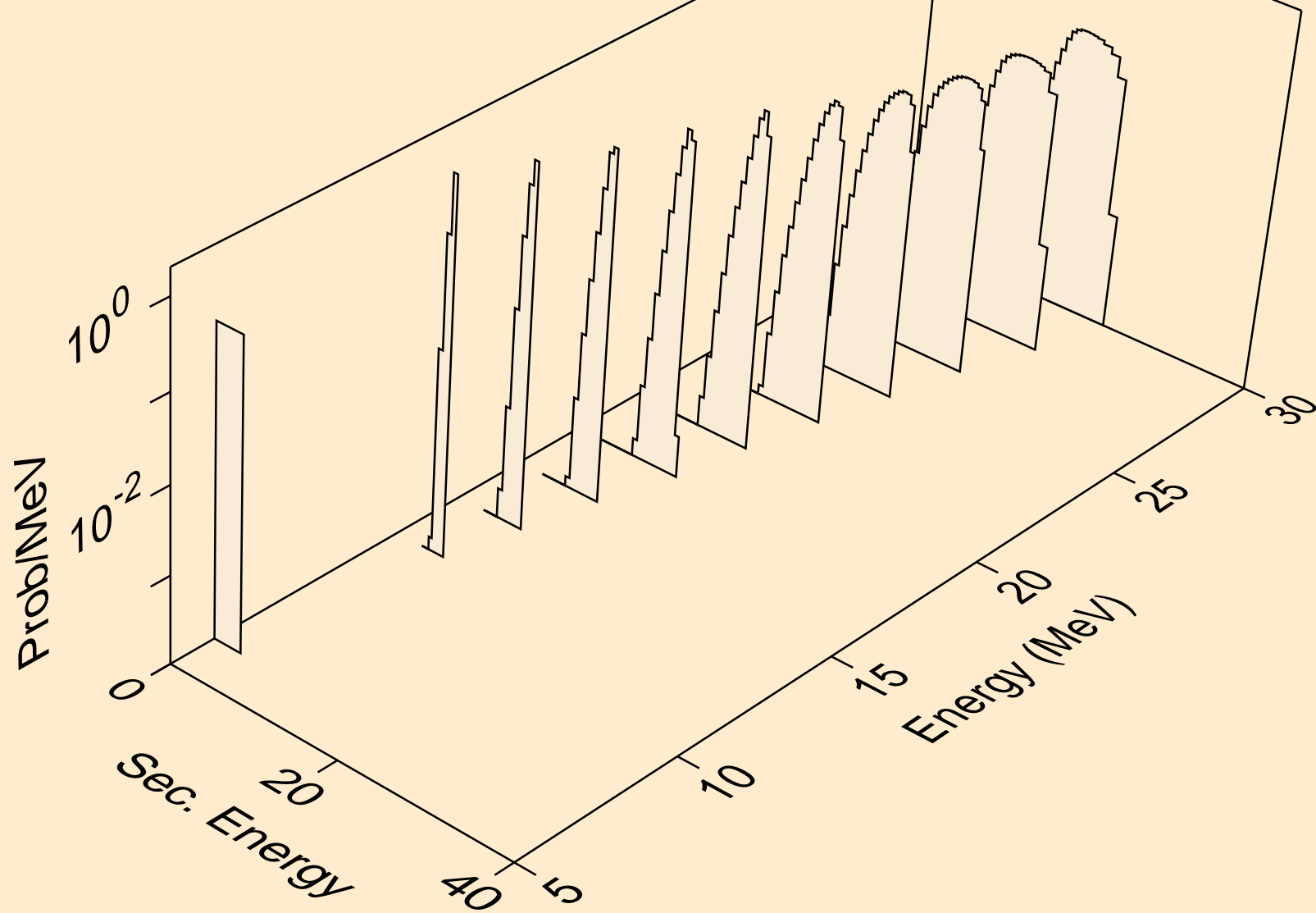

SN123 NEUTRON ACER TENDL-2024 LIBRARY; T=0.K
alphas from (n,2n)a

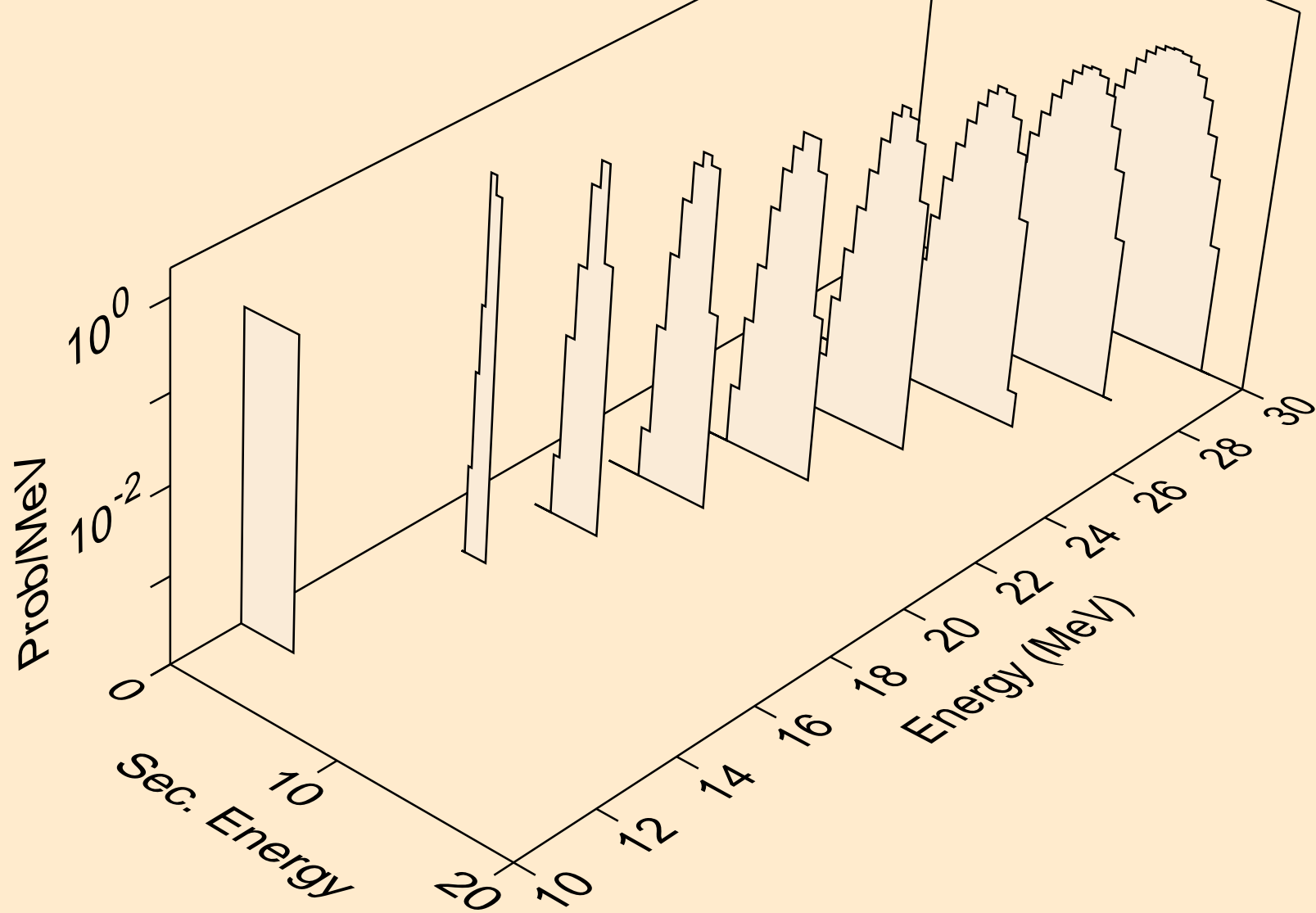

SN123 NEUTRON ACER TENDL-2024 LIBRARY; T=0.K
alphas from (n,3n)a

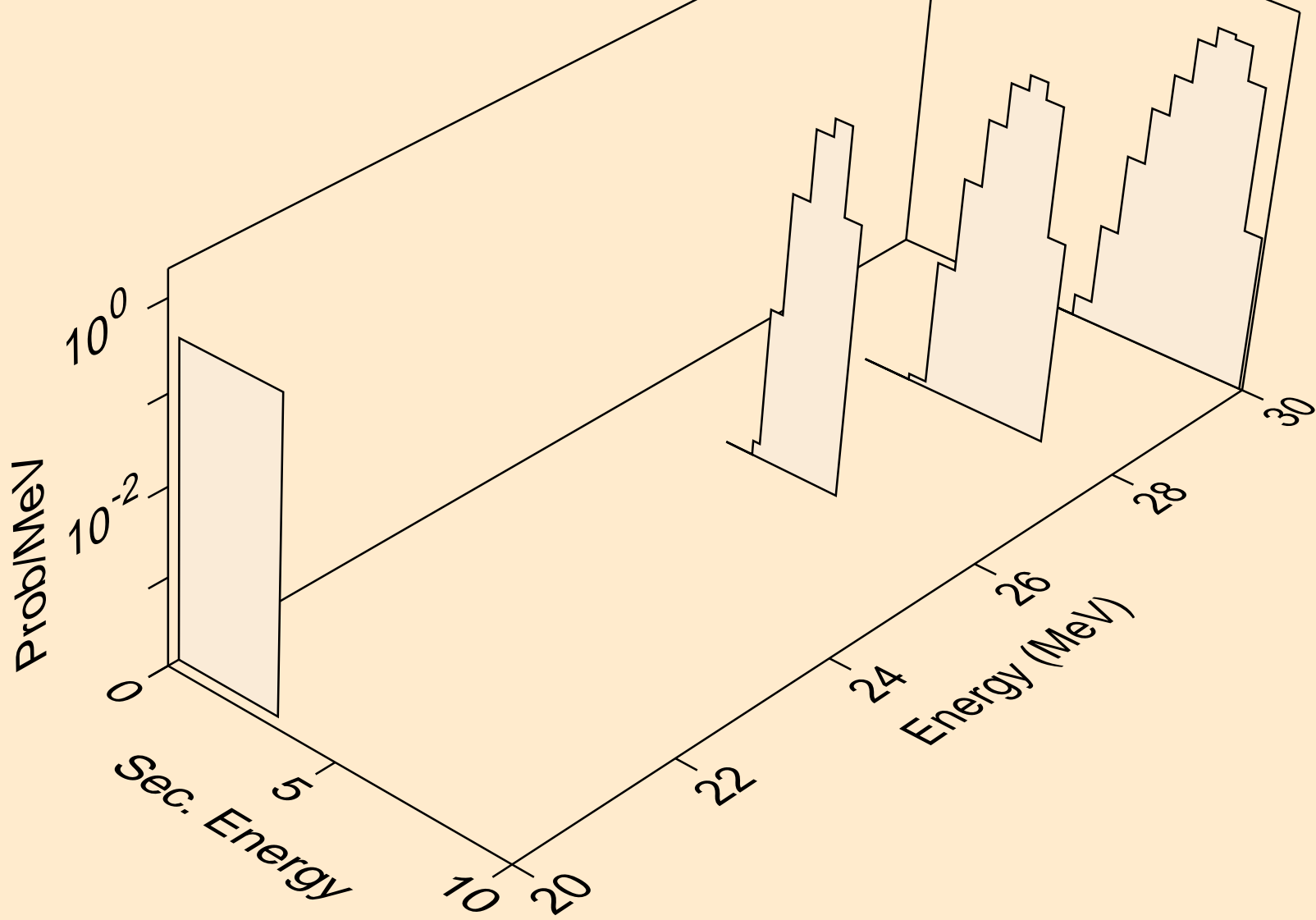

SN123 NEUTRON ACER TENDL-2024 LIBRARY; T=0.K
alphas from (n,a)

