

SR095 NEUTRON ACER TENDL-2024 LIBRARY; T=0.K

Principal cross sections

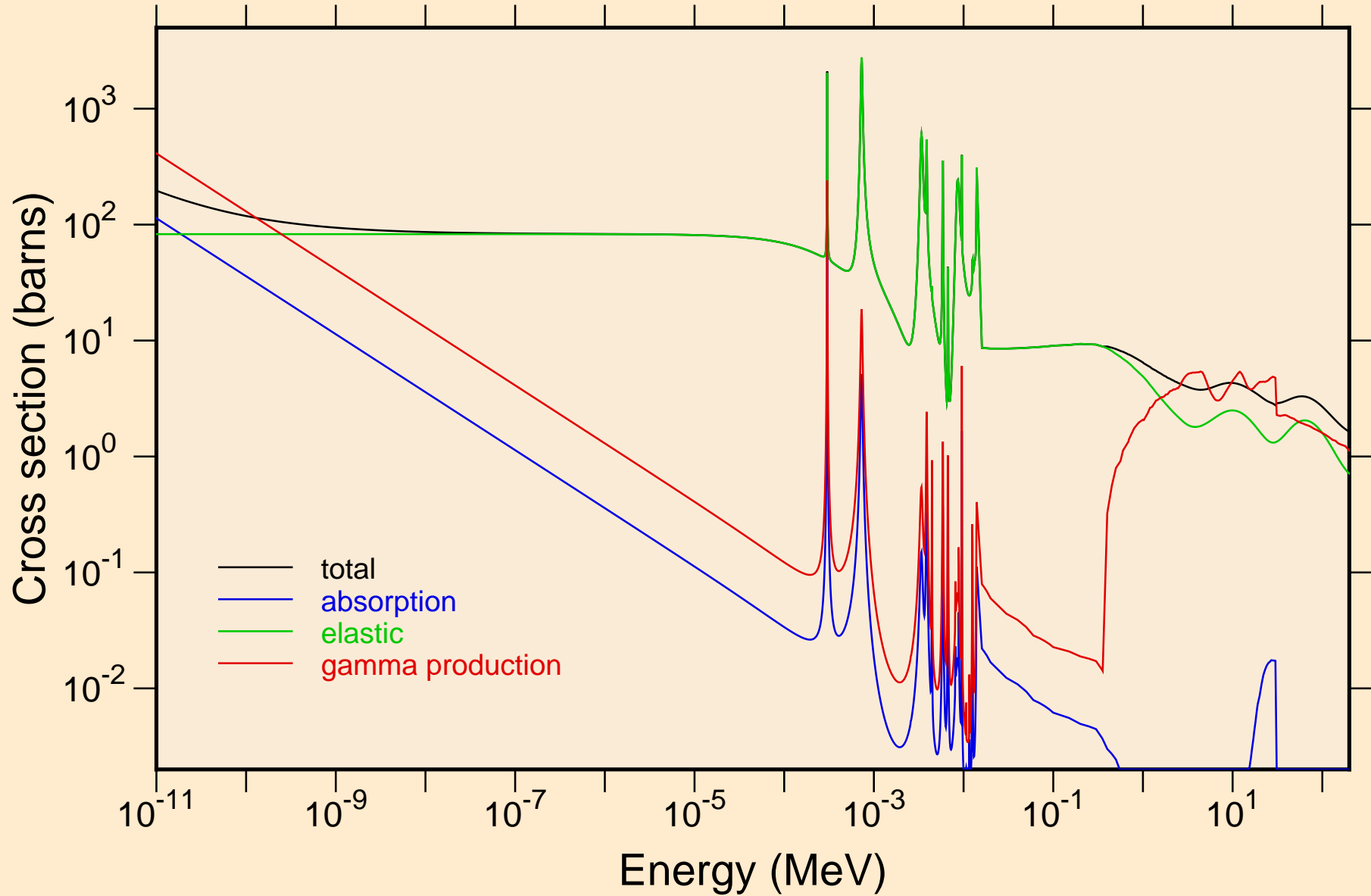

SR095 NEUTRON ACER TENDL-2024 LIBRARY; T=0.K
resonance total cross section

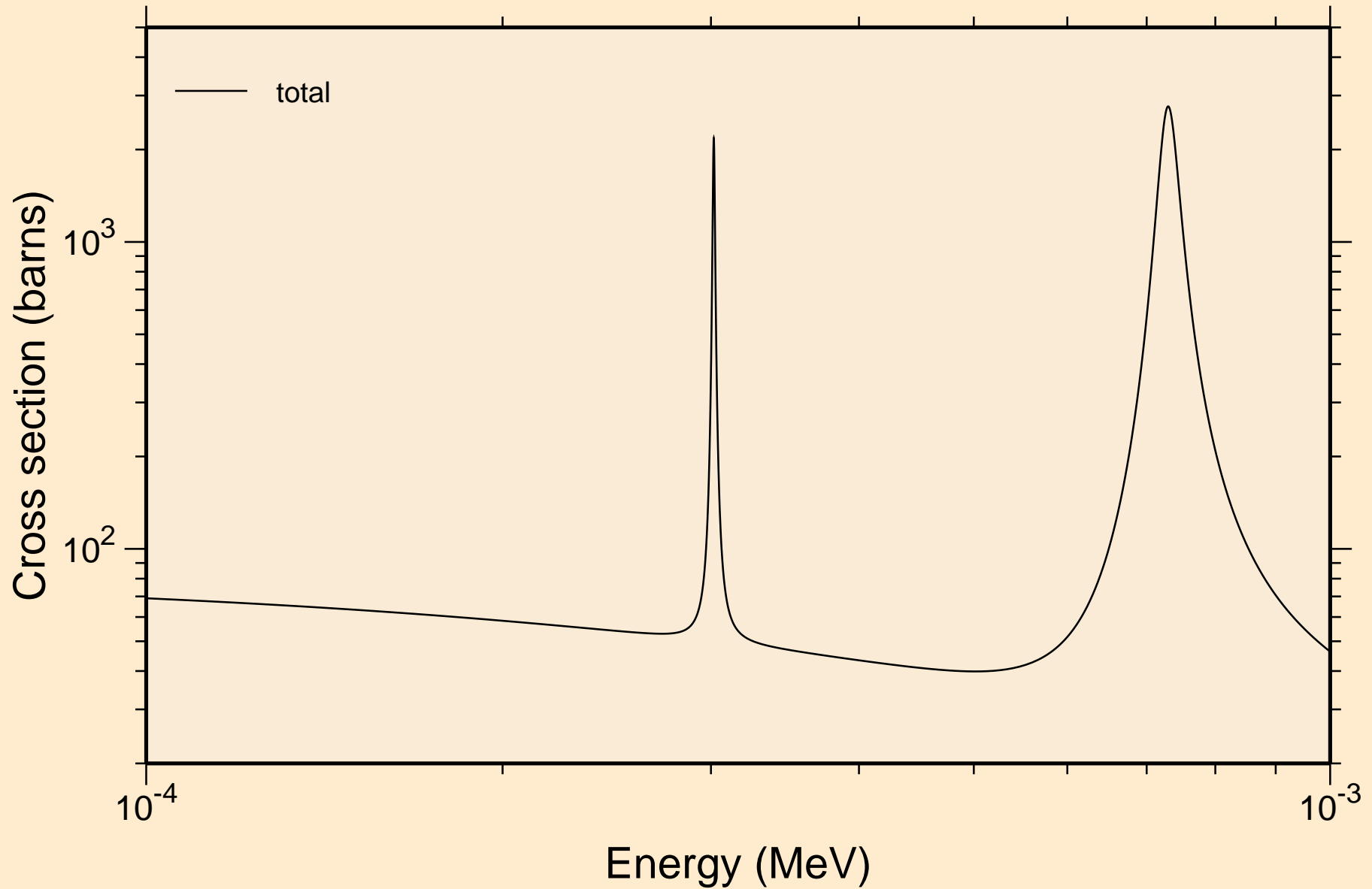

SR095 NEUTRON ACER TENDL-2024 LIBRARY; T=0.K
resonance total cross section

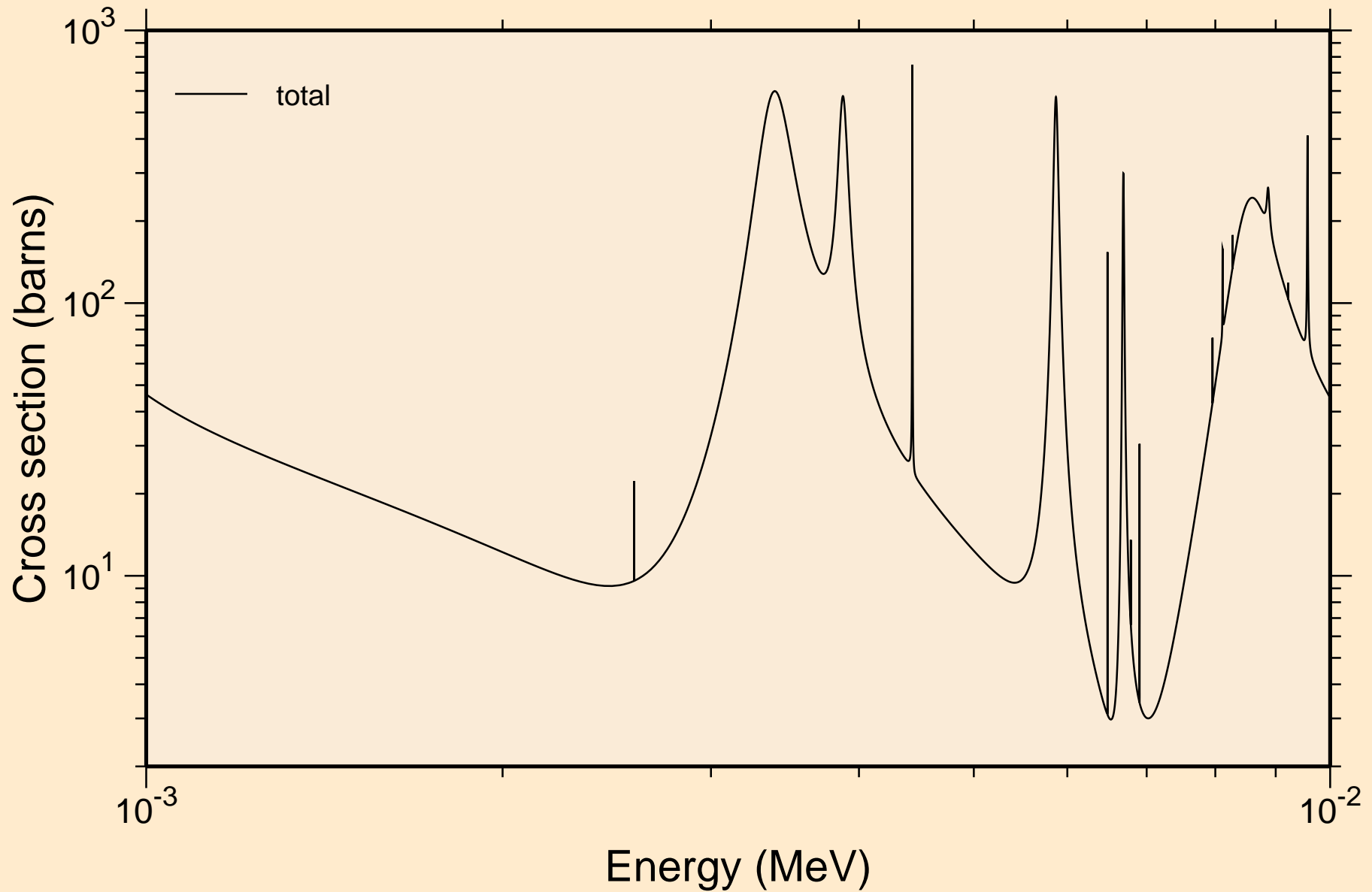

SR095 NEUTRON ACER TENDL-2024 LIBRARY; T=0.K
resonance total cross section

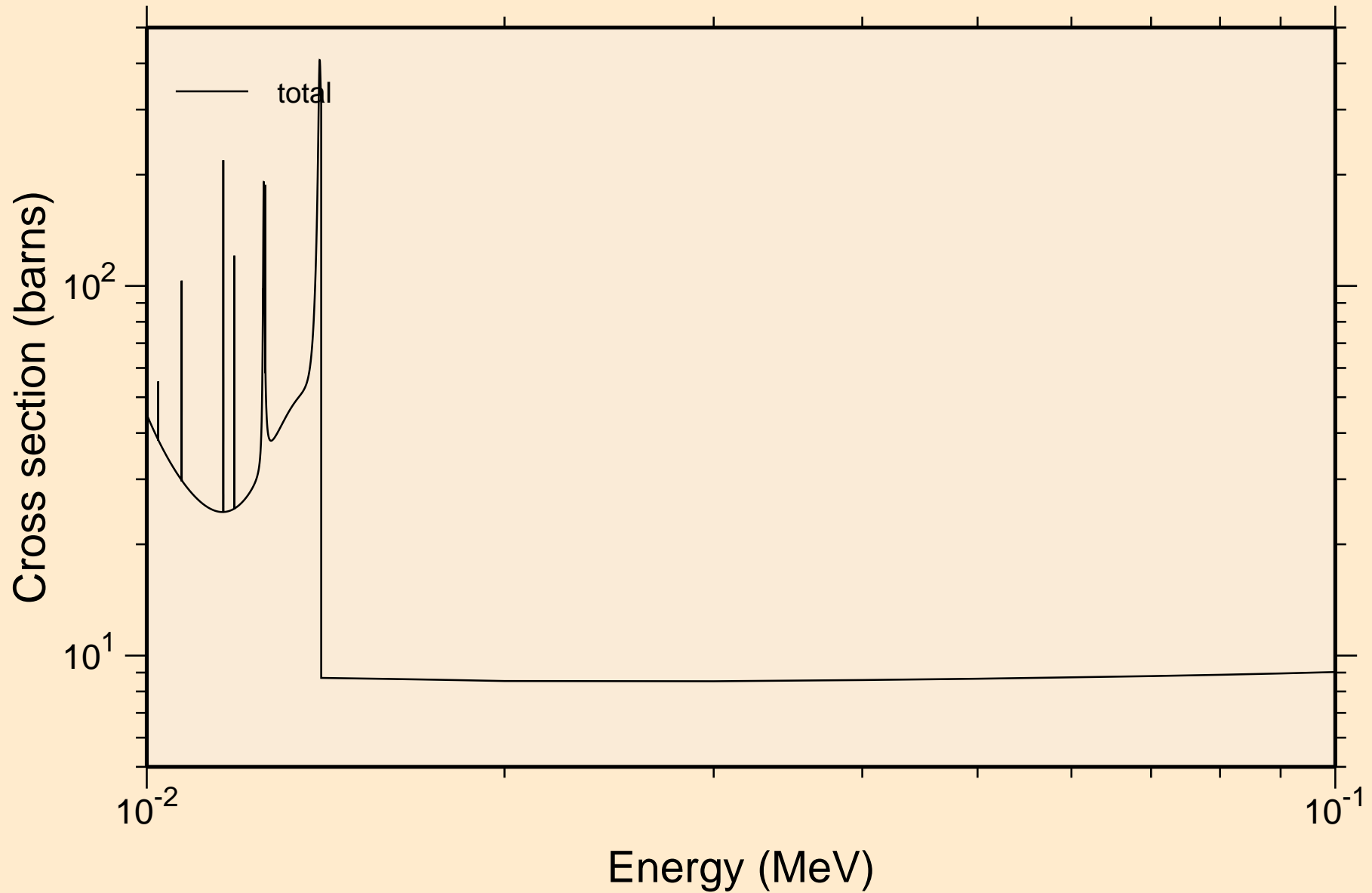

SR095 NEUTRON ACER TENDL-2024 LIBRARY; T=0.K
resonance total cross section

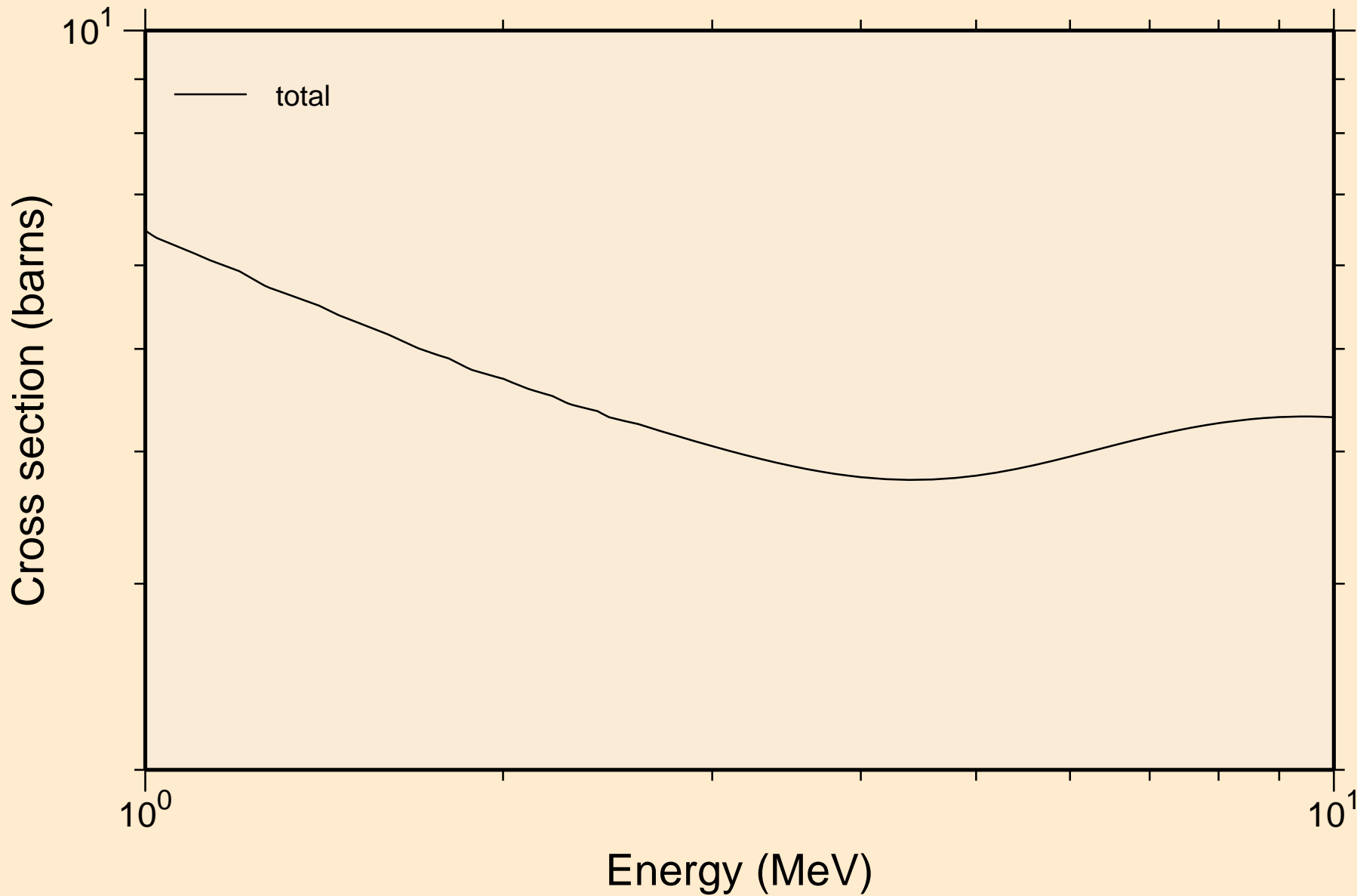

SR095 NEUTRON ACER TENDL-2024 LIBRARY; T=0.K
resonance absorption cross sections

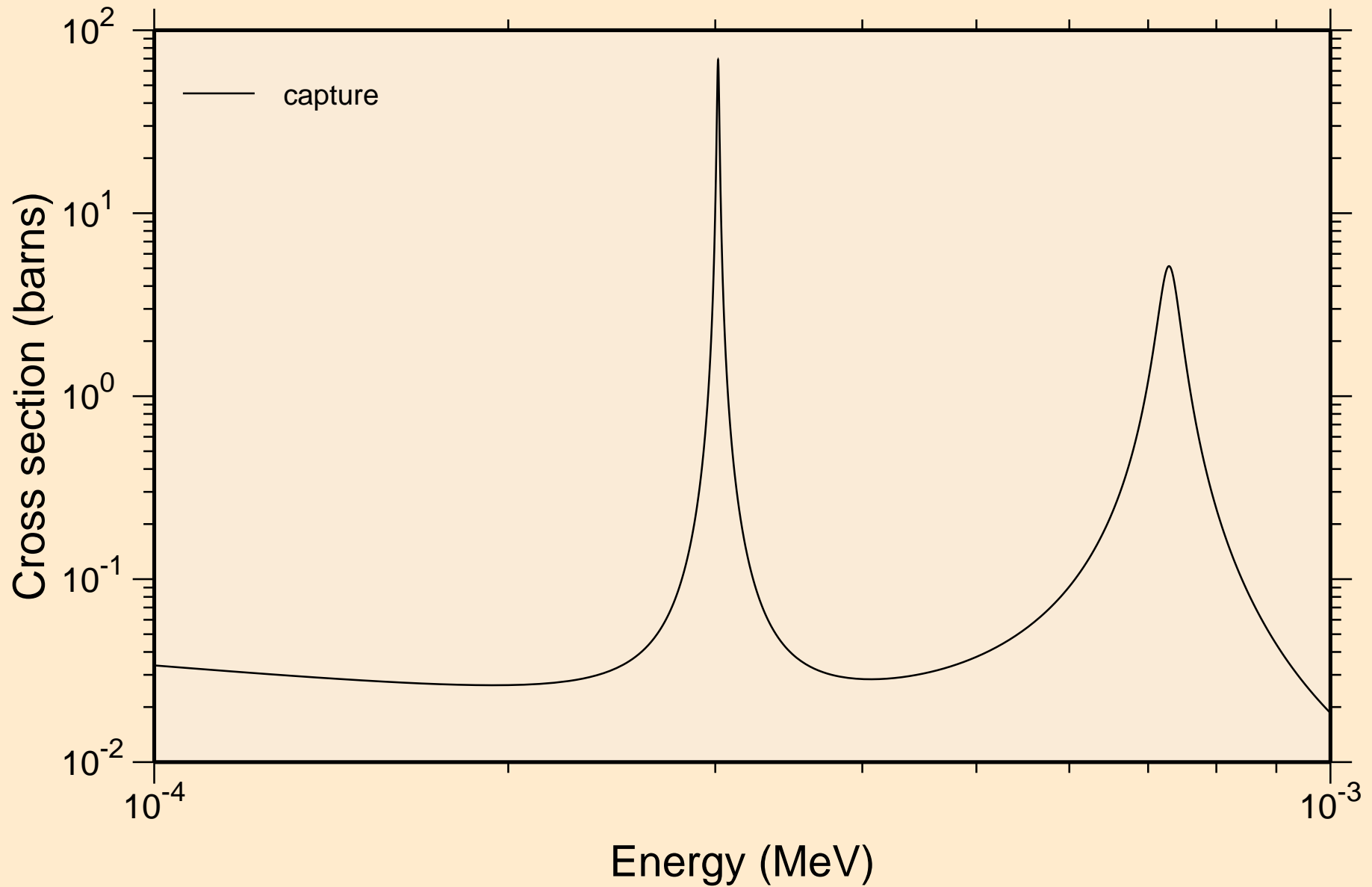

SR095 NEUTRON ACER TENDL-2024 LIBRARY; T=0.K
resonance absorption cross sections

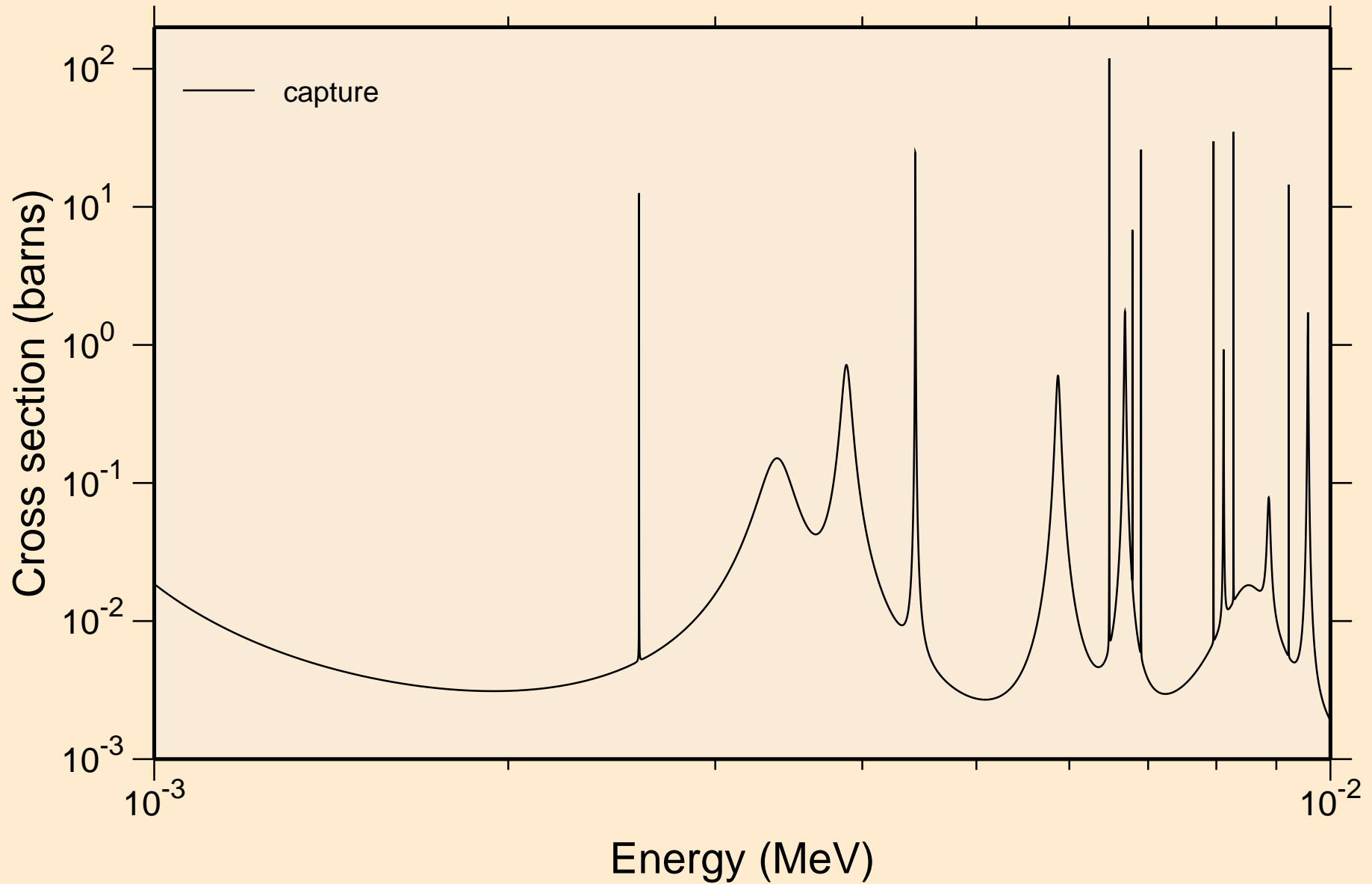

SR095 NEUTRON ACER TENDL-2024 LIBRARY; T=0.K
resonance absorption cross sections

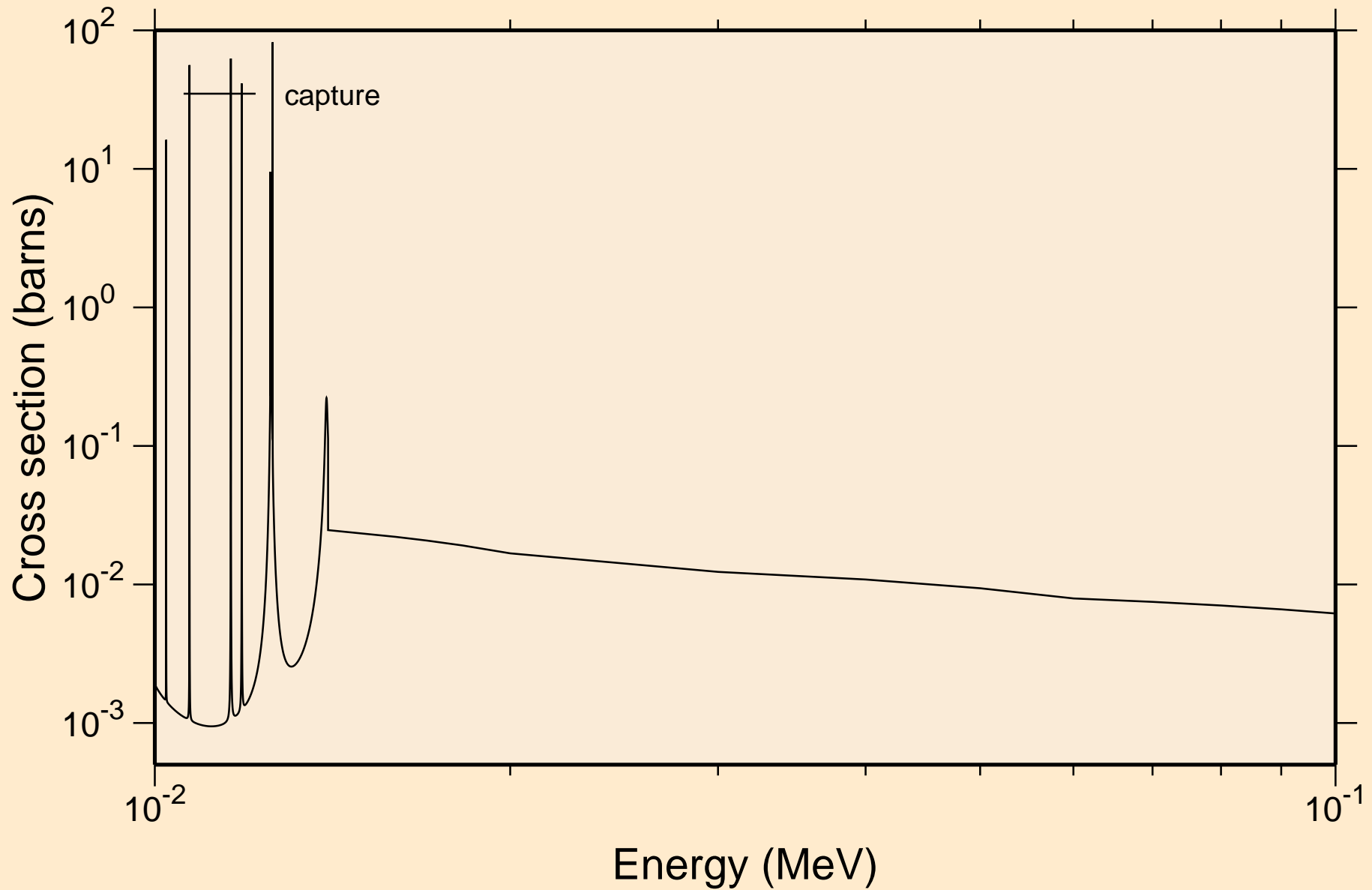

SR095 NEUTRON ACER TENDL-2024 LIBRARY; T=0.K
resonance absorption cross sections

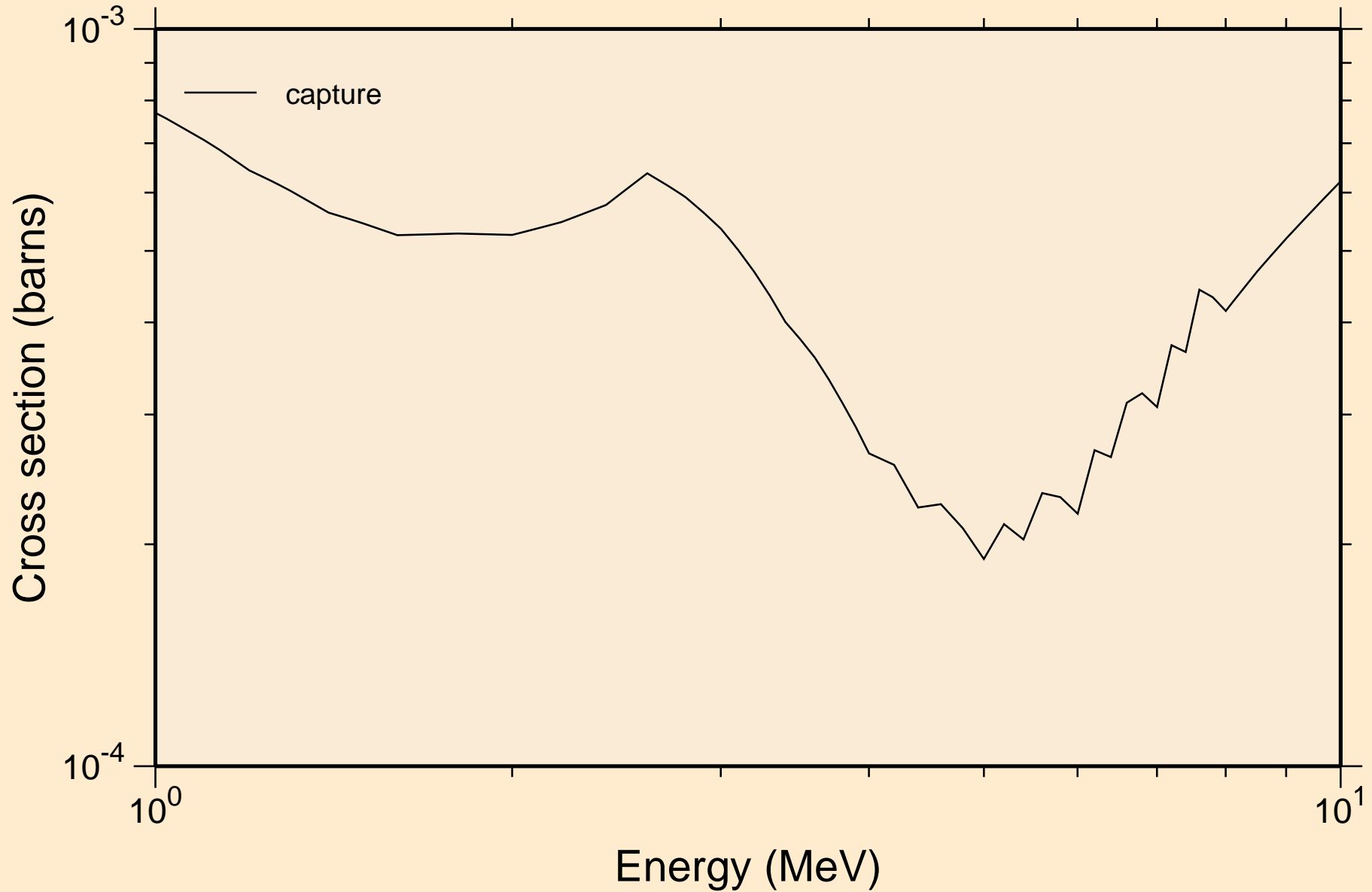

SR095 NEUTRON ACER TENDL-2024 LIBRARY; T=0.K

Heating

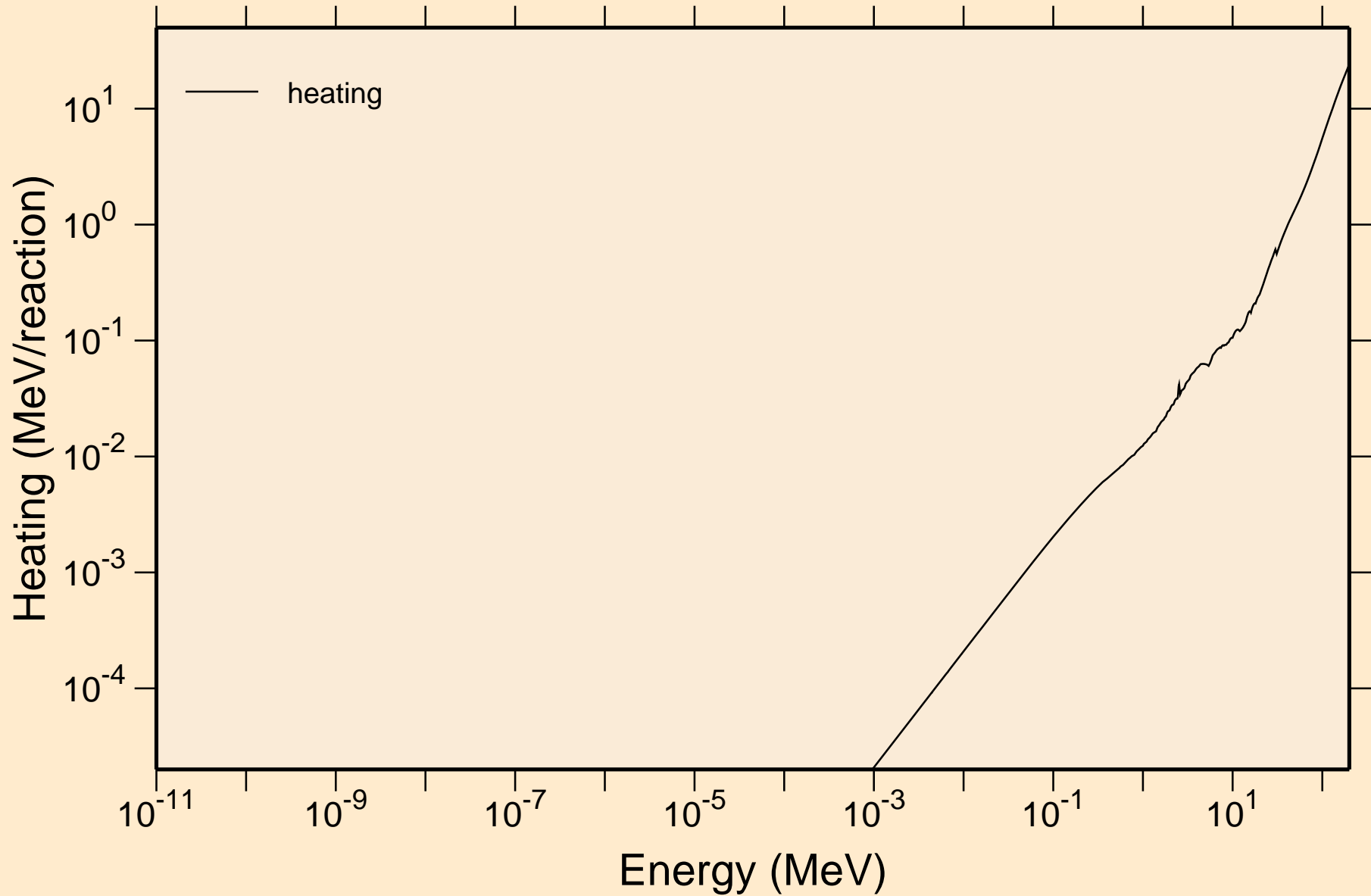

SR095 NEUTRON ACER TENDL-2024 LIBRARY; T=0.K

Damage

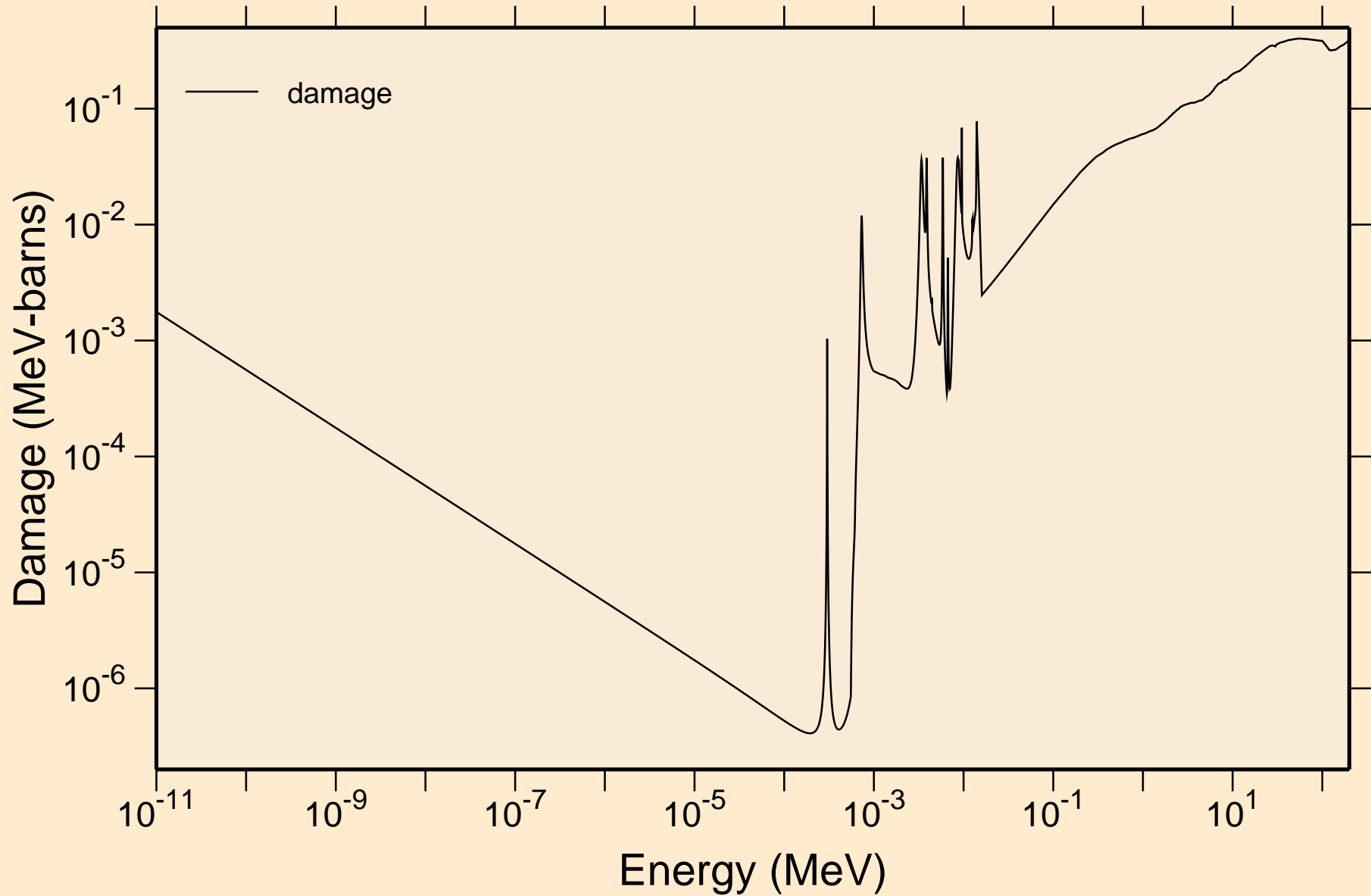

SR095 NEUTRON ACER TENDL-2024 LIBRARY; T=0.K
Non-threshold reactions

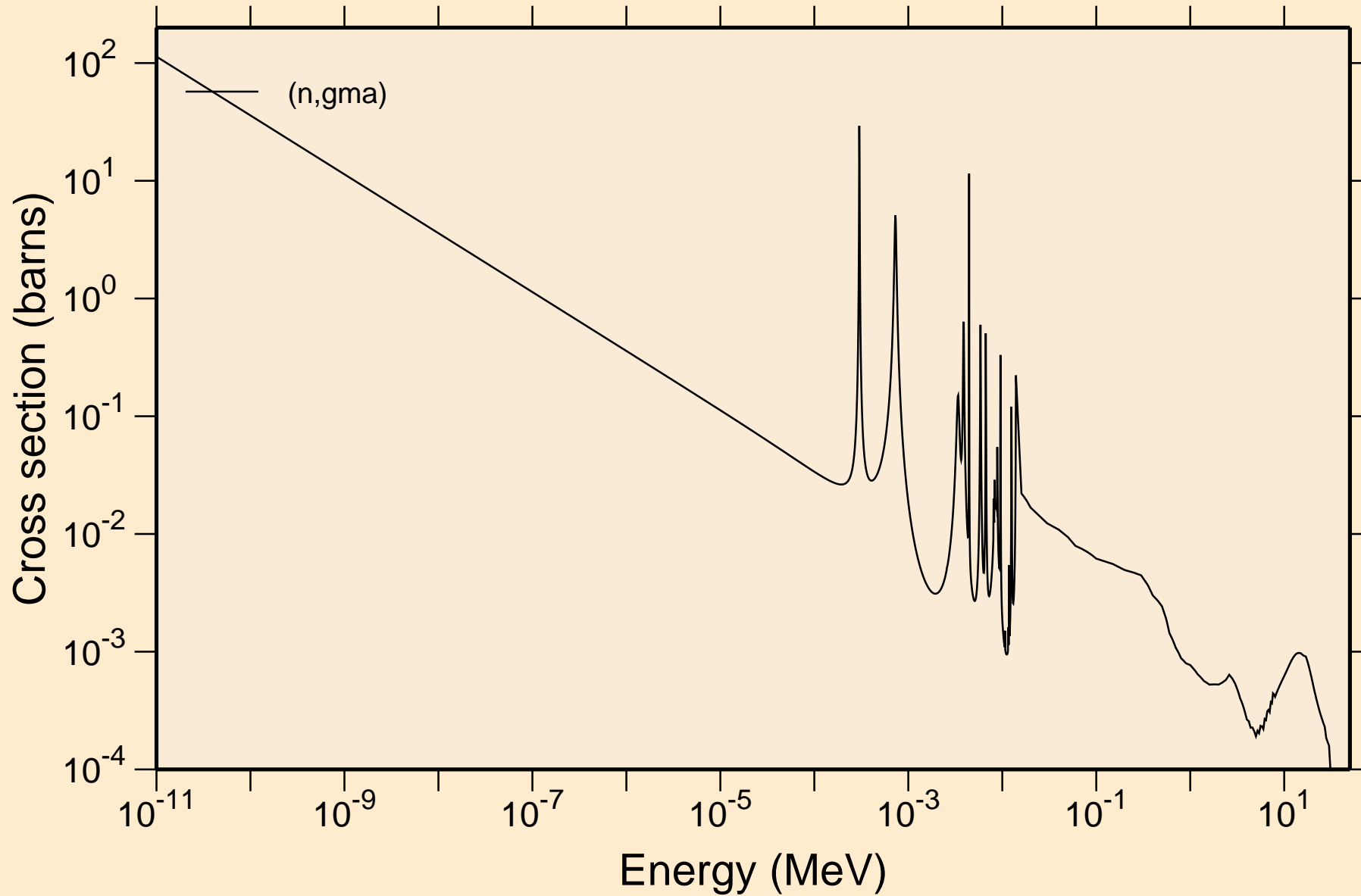

SR095 NEUTRON ACER TENDL-2024 LIBRARY; T=0.K

Principal cross sections

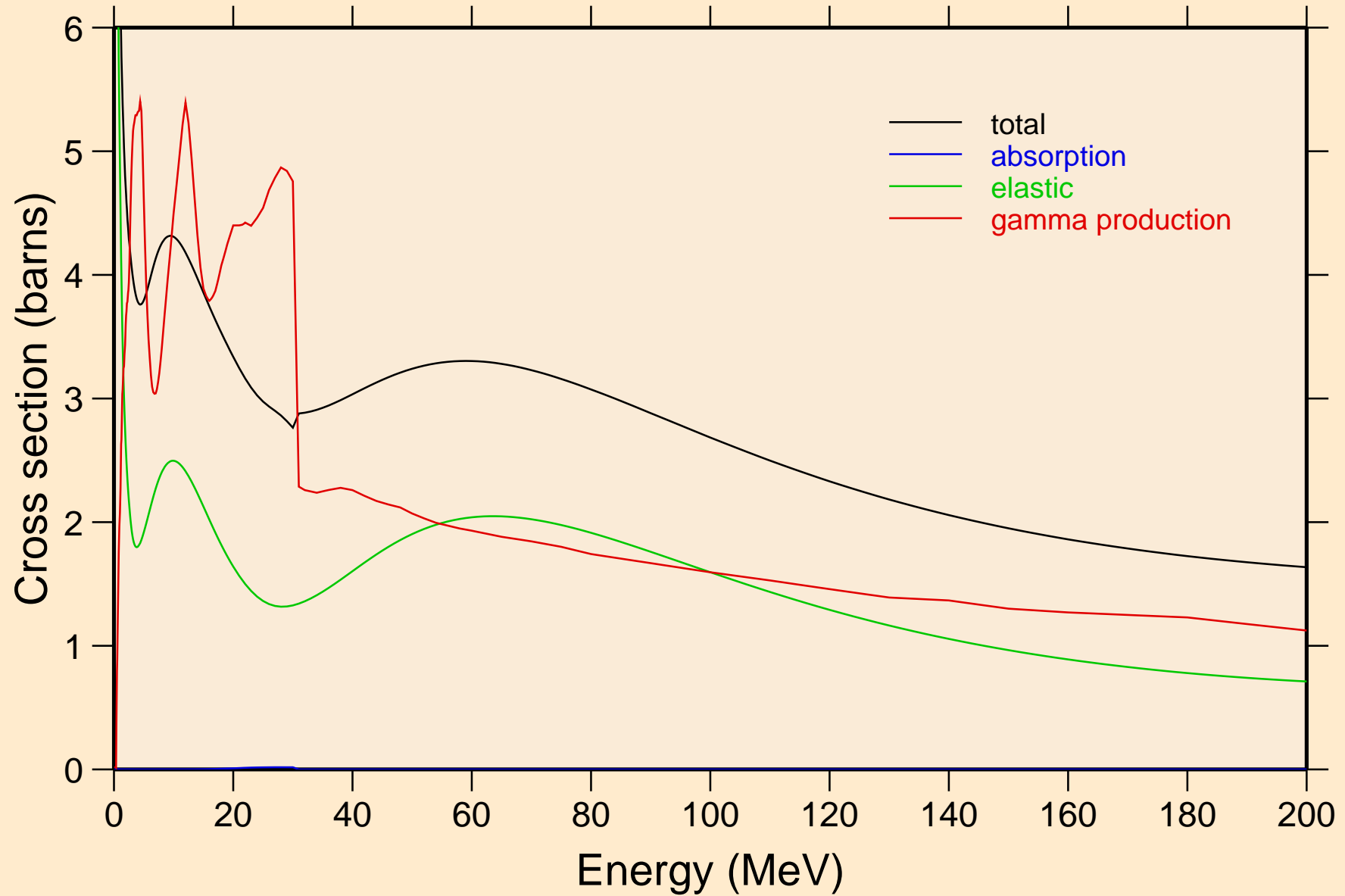

SR095 NEUTRON ACER TENDL-2024 LIBRARY; T=0.K

Heating

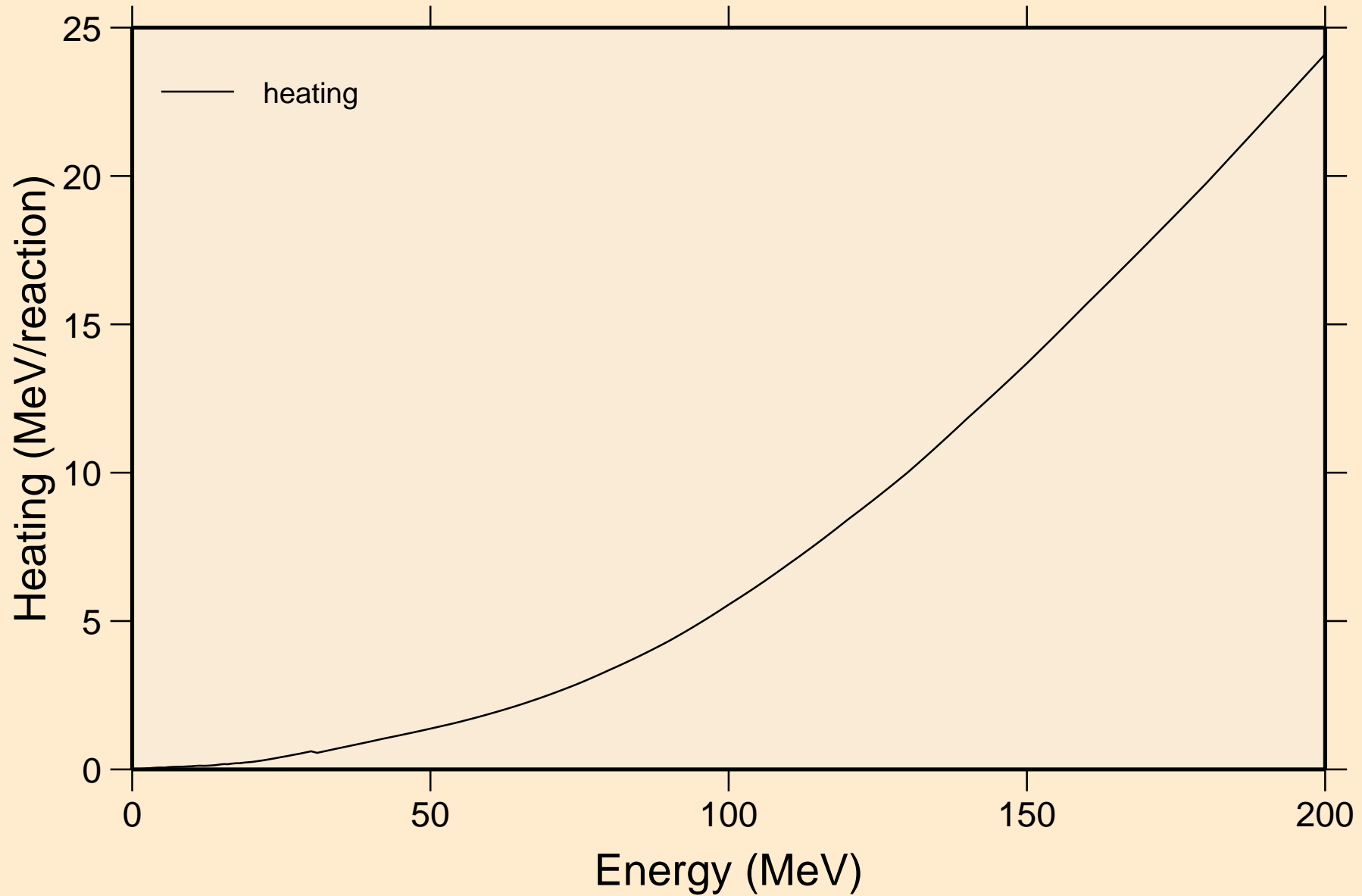

SR095 NEUTRON ACER TENDL-2024 LIBRARY; T=0.K

Damage

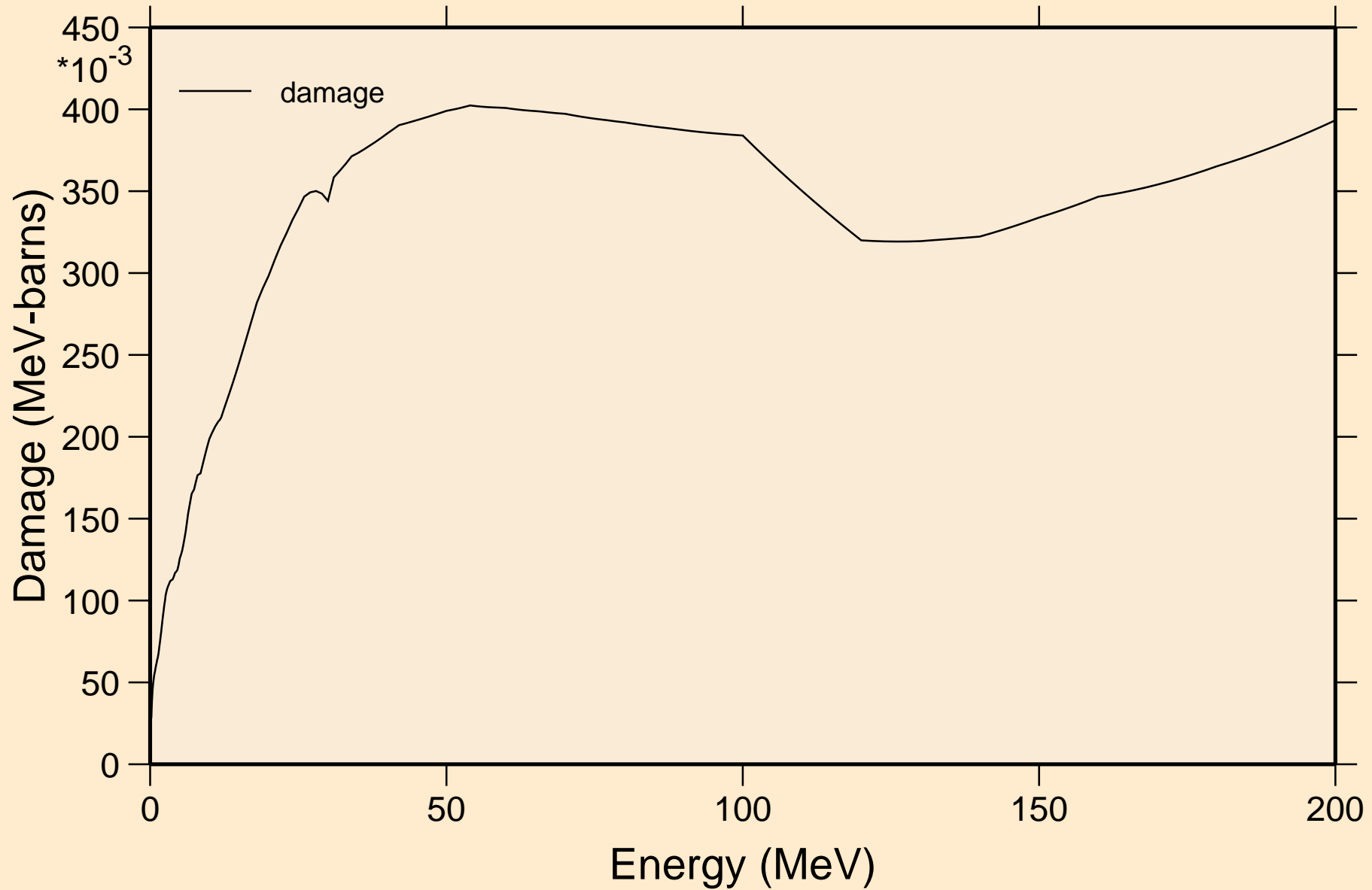

SR095 NEUTRON ACER TENDL-2024 LIBRARY; T=0.K
Non-threshold reactions

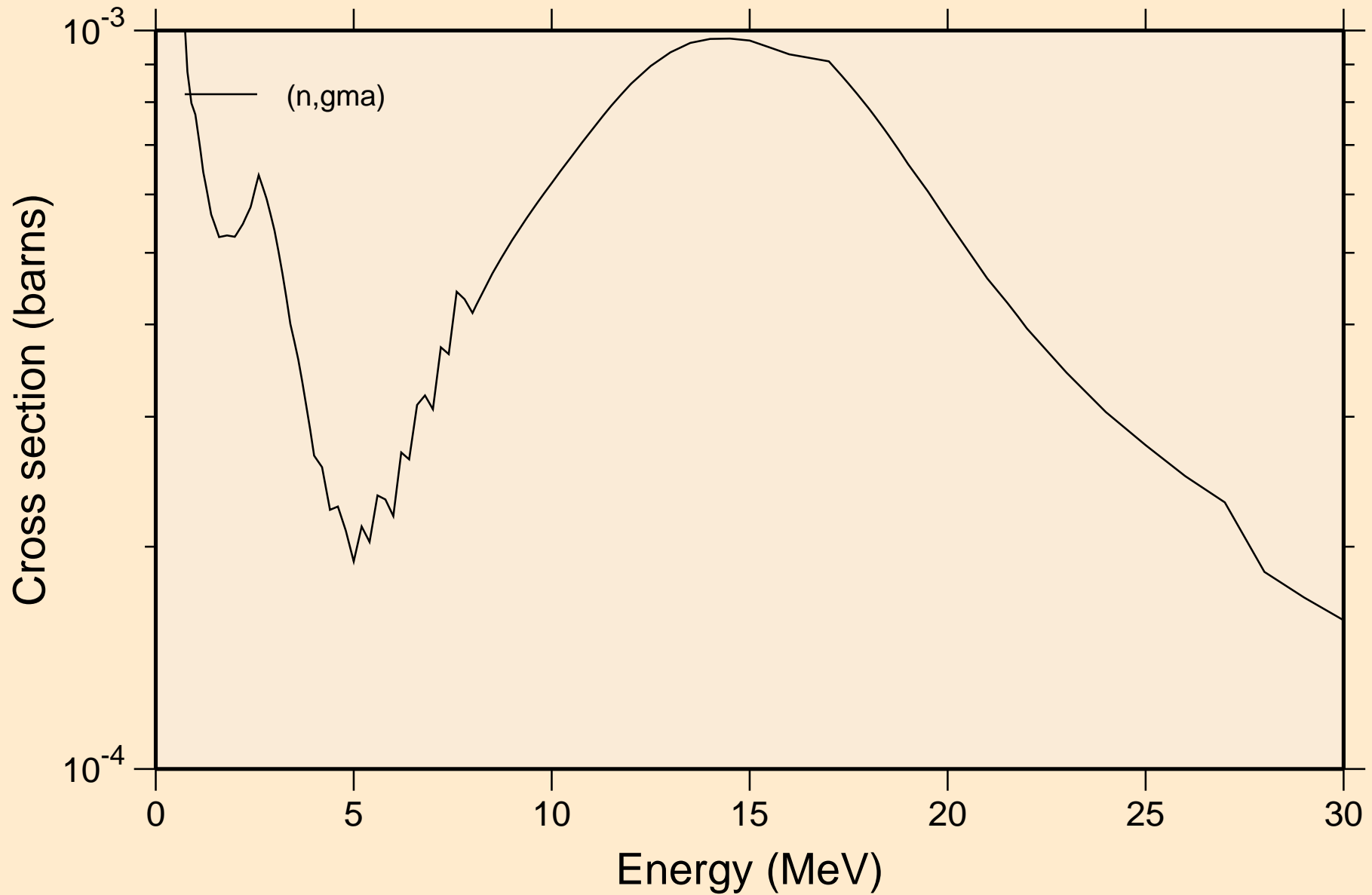

SR095 NEUTRON ACER TENDL-2024 LIBRARY; T=0.K
Inelastic levels

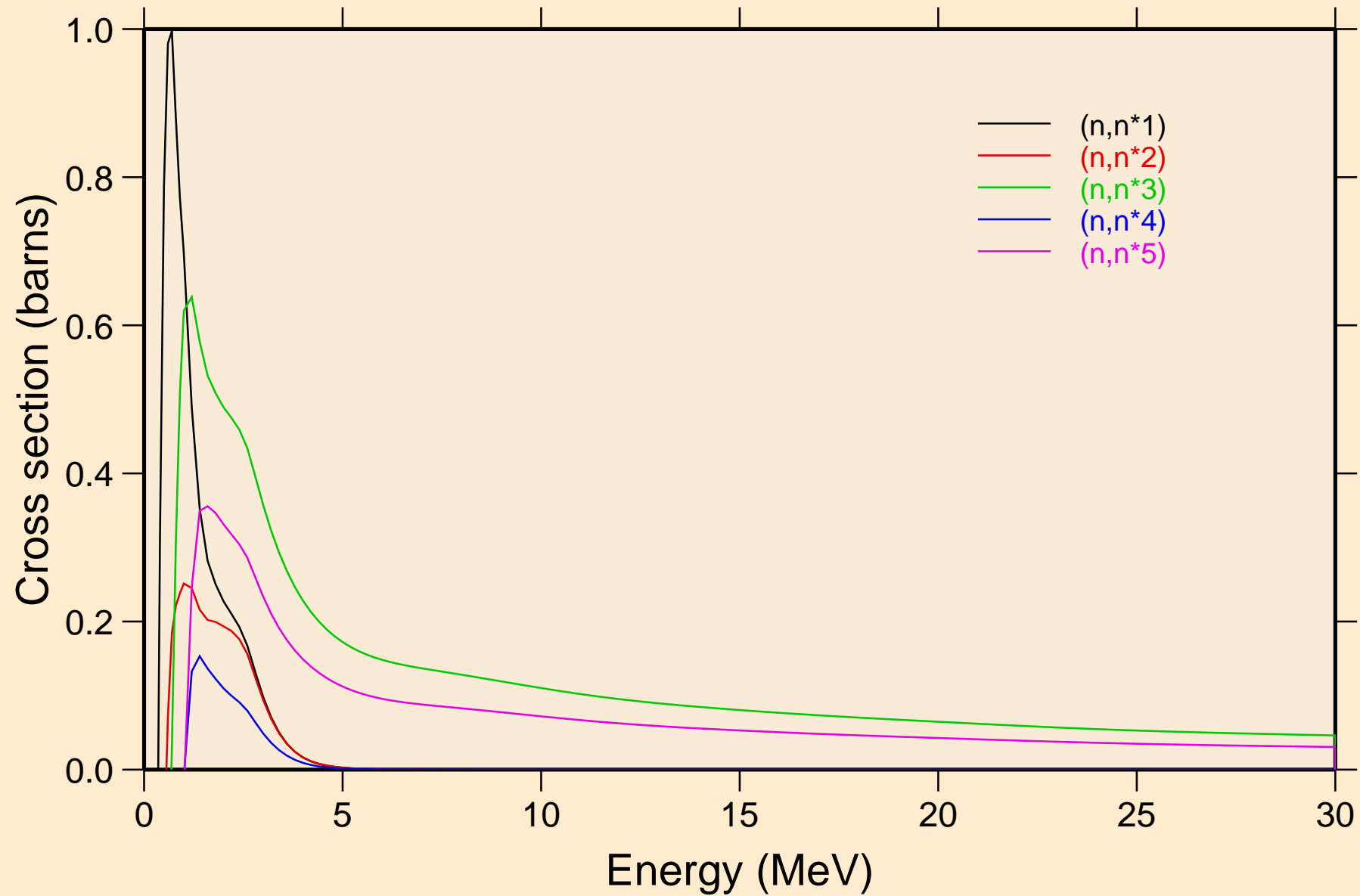

SR095 NEUTRON ACER TENDL-2024 LIBRARY; T=0.K
Inelastic levels

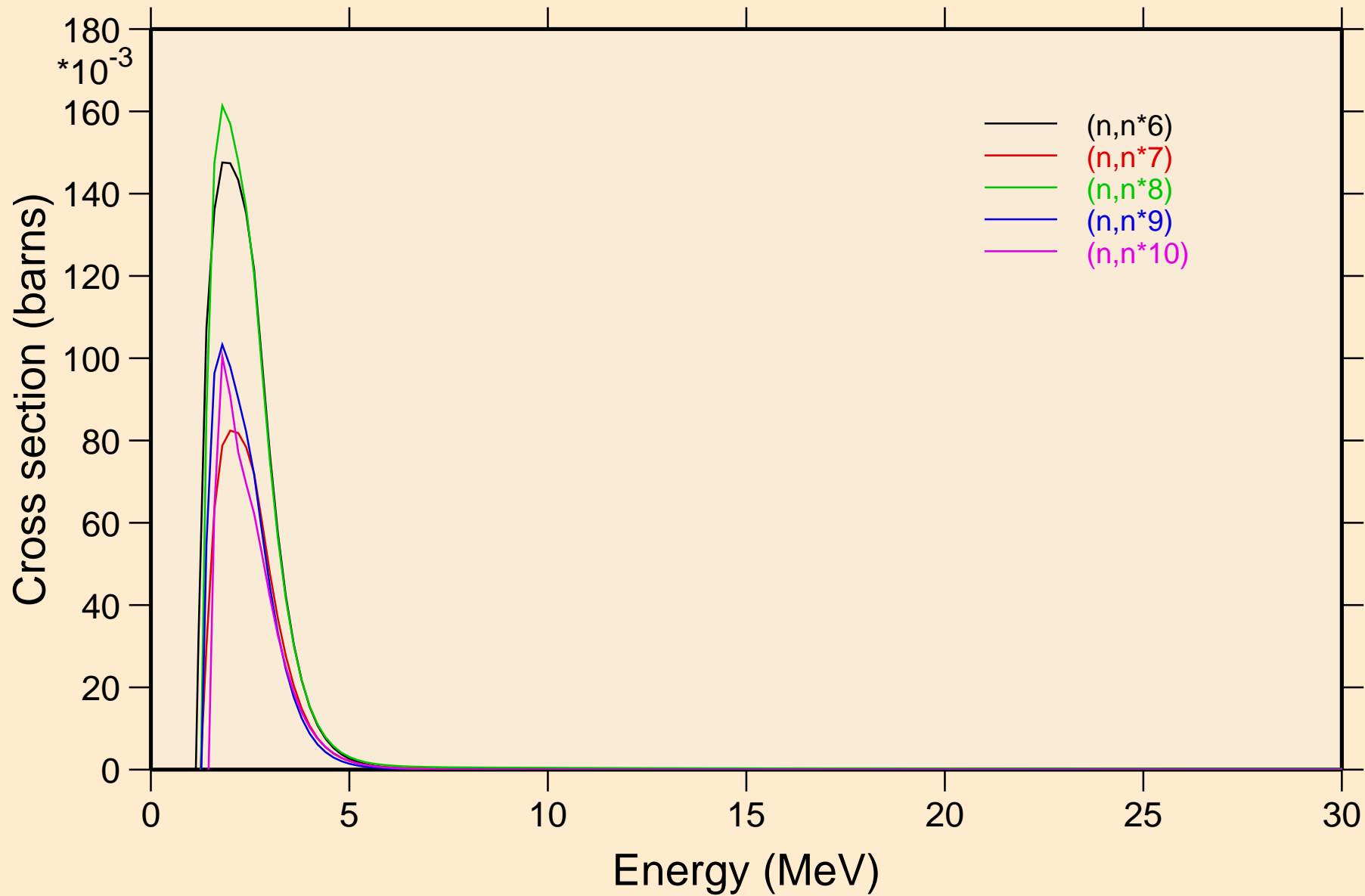

SR095 NEUTRON ACER TENDL-2024 LIBRARY; T=0.K
Inelastic levels

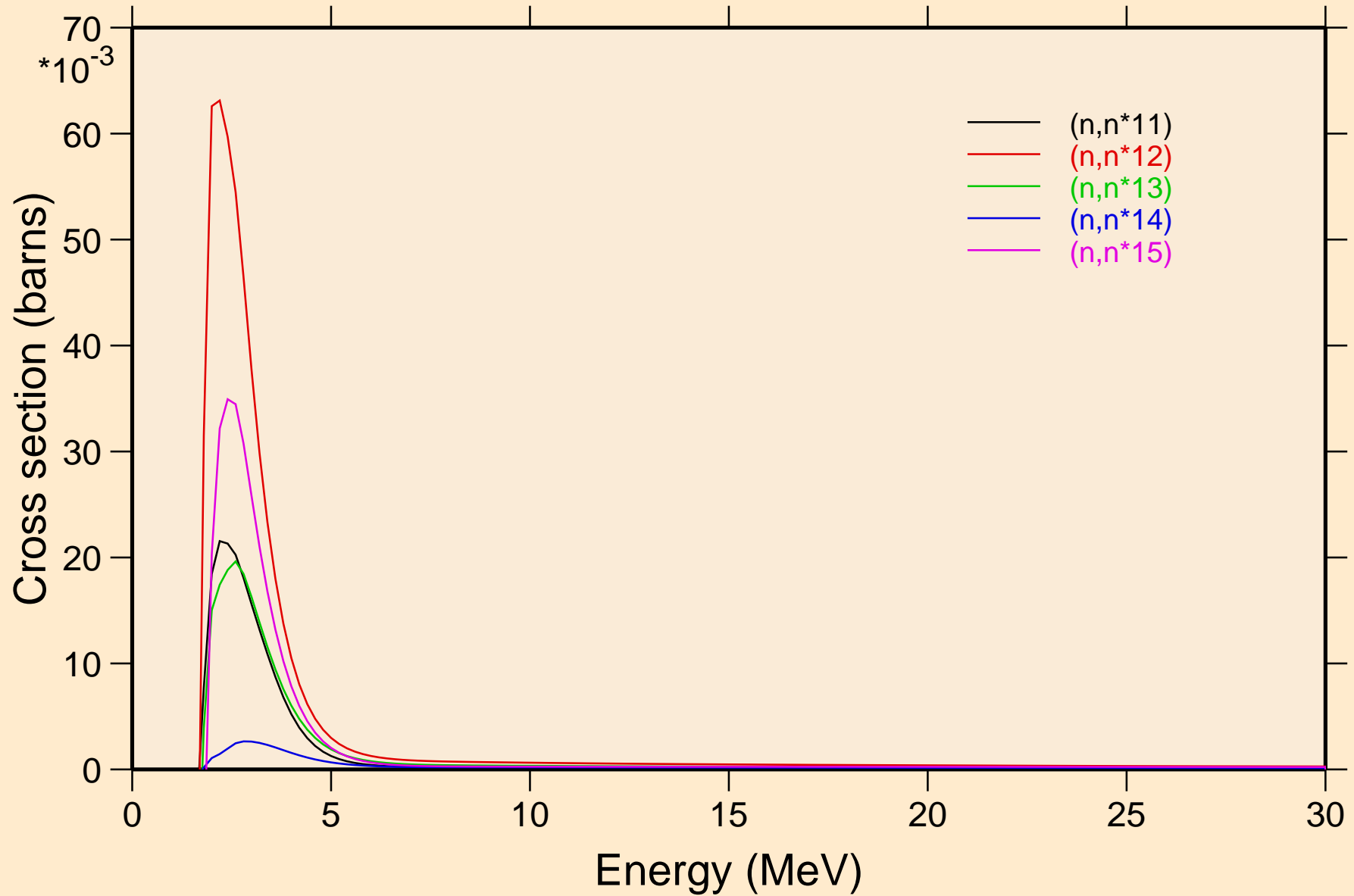

SR095 NEUTRON ACER TENDL-2024 LIBRARY; T=0.K
Inelastic levels

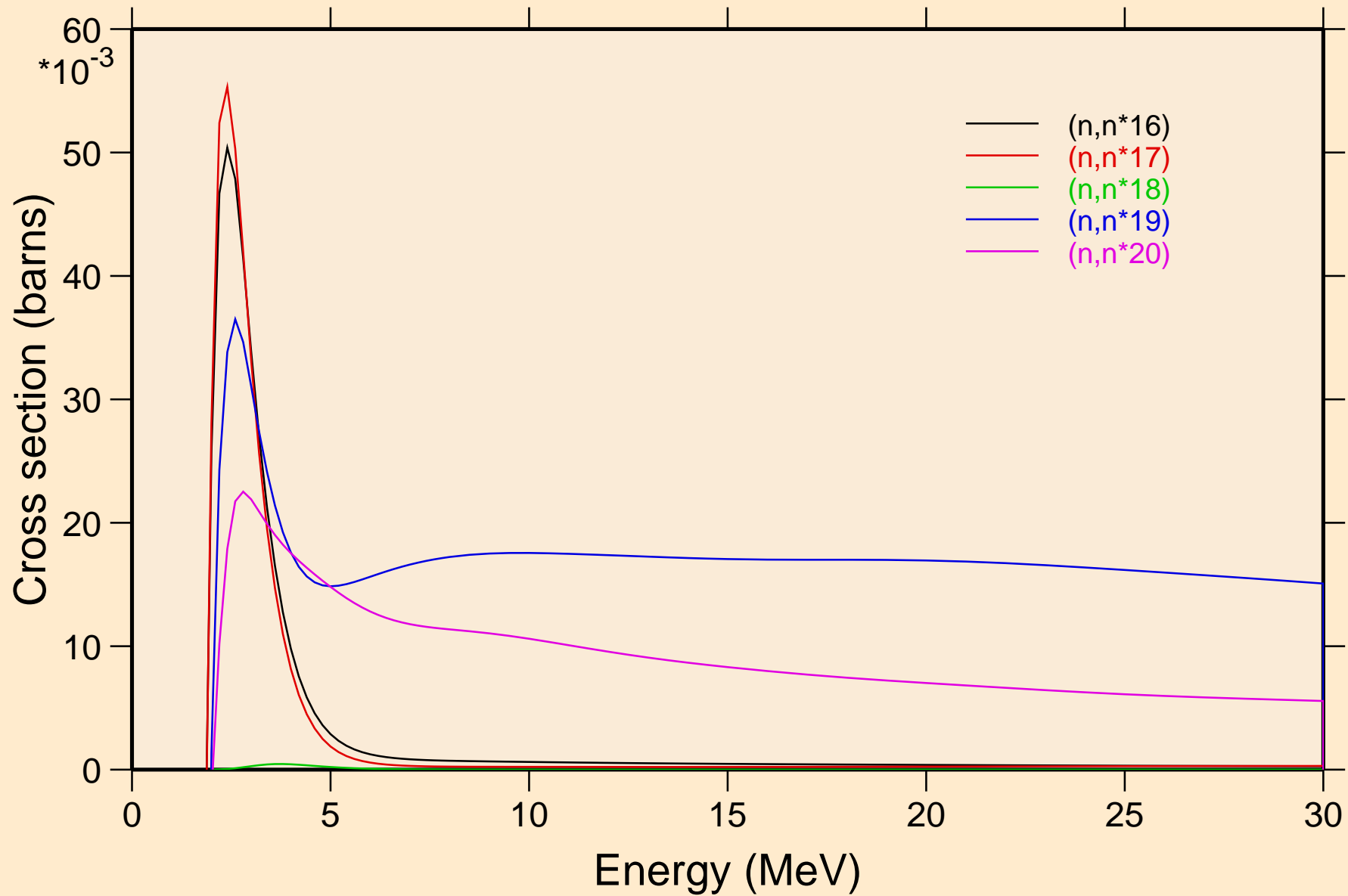

SR095 NEUTRON ACER TENDL-2024 LIBRARY; T=0.K
Inelastic levels

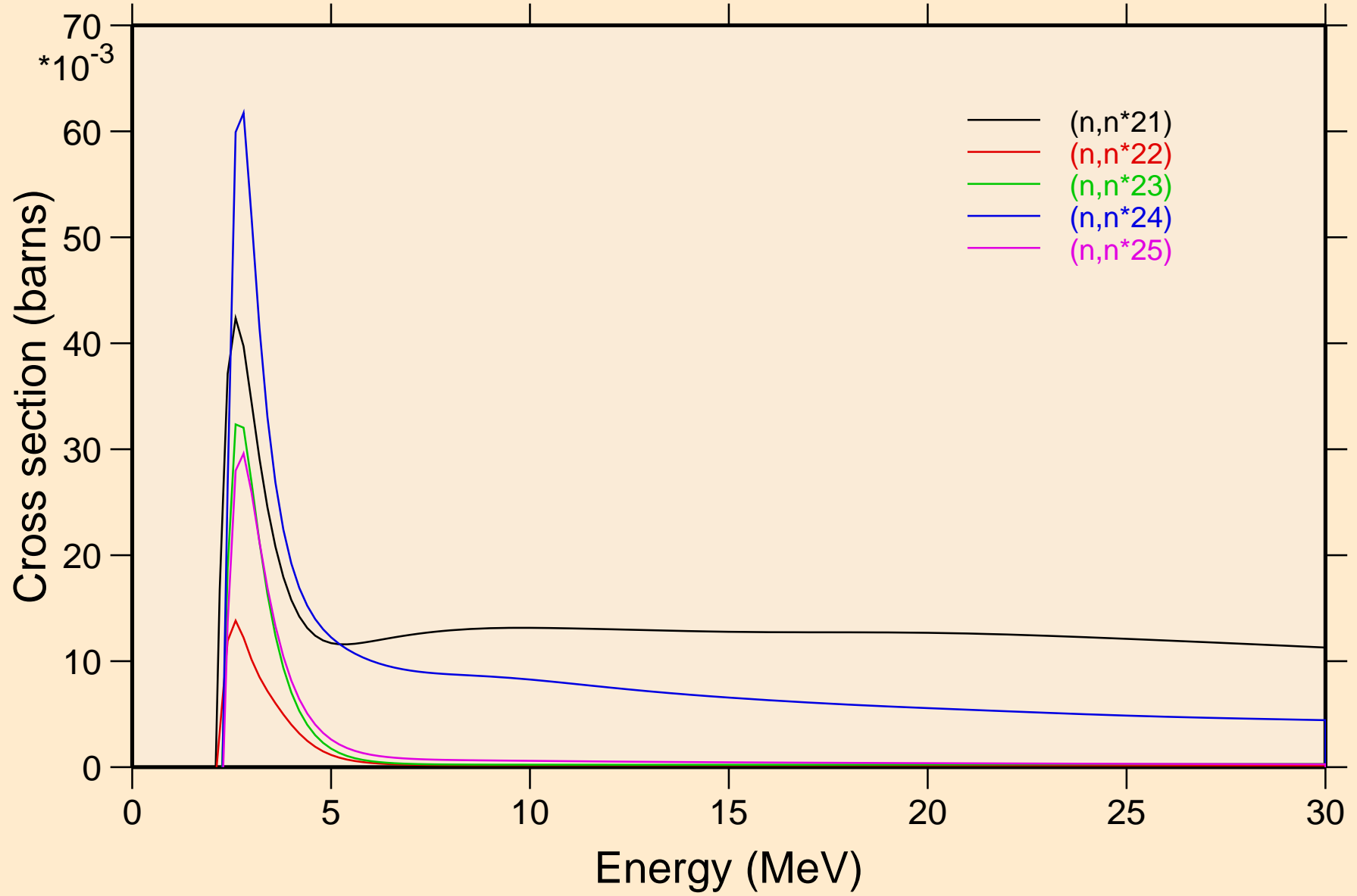

SR095 NEUTRON ACER TENDL-2024 LIBRARY; T=0.K
Inelastic levels

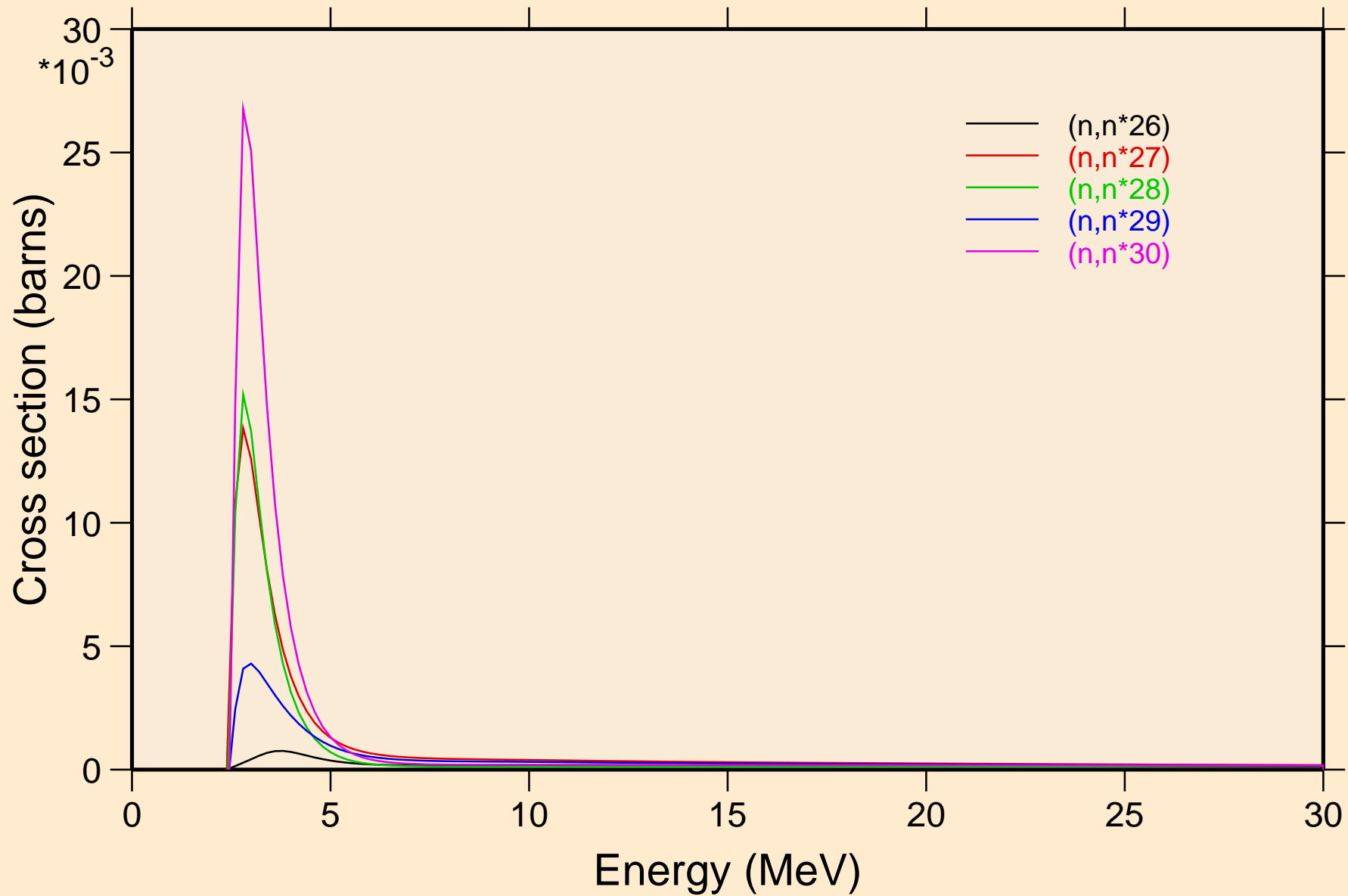

SR095 NEUTRON ACER TENDL-2024 LIBRARY; T=0.K

Threshold reactions

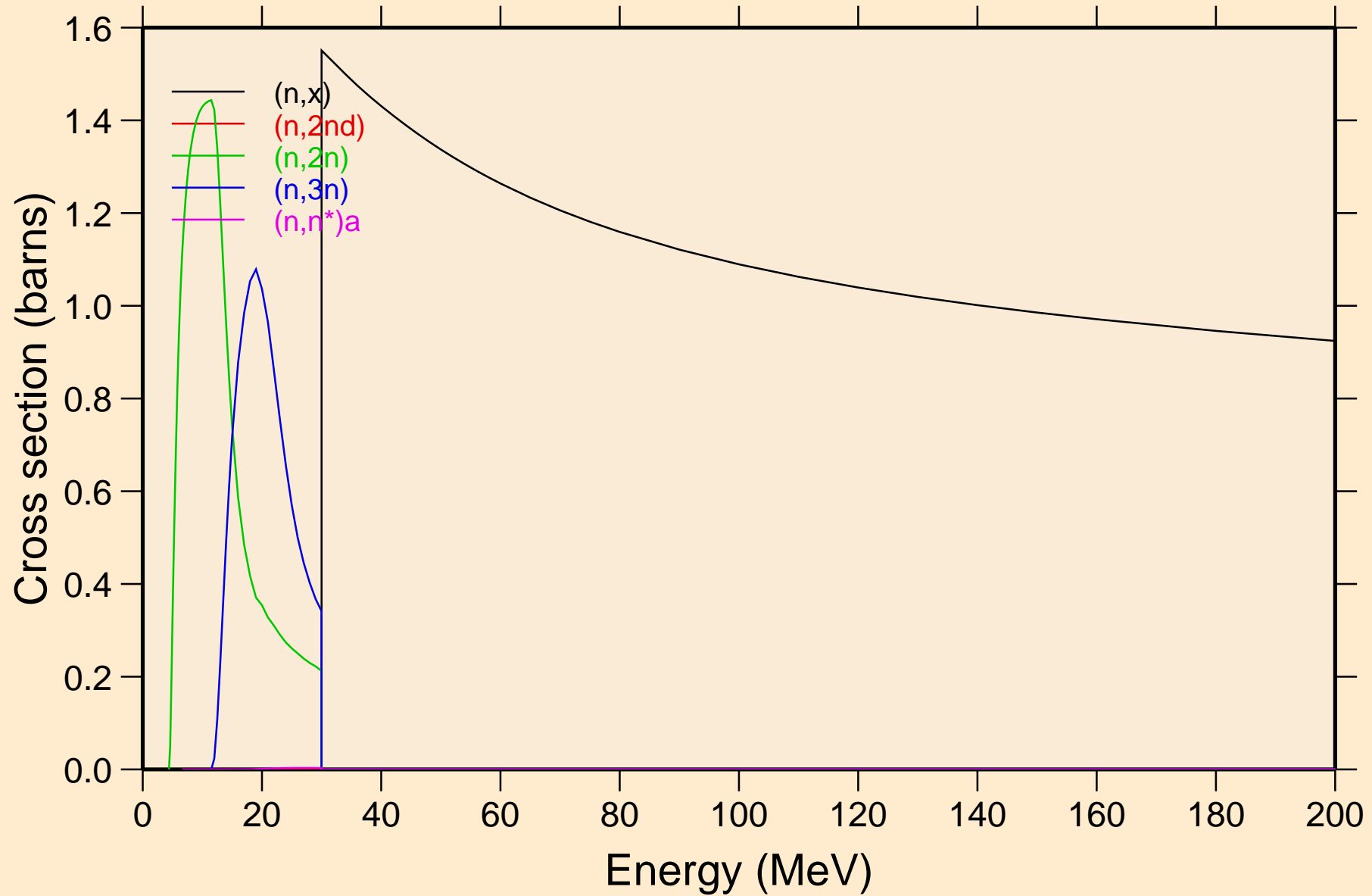

SR095 NEUTRON ACER TENDL-2024 LIBRARY; T=0.K

Threshold reactions

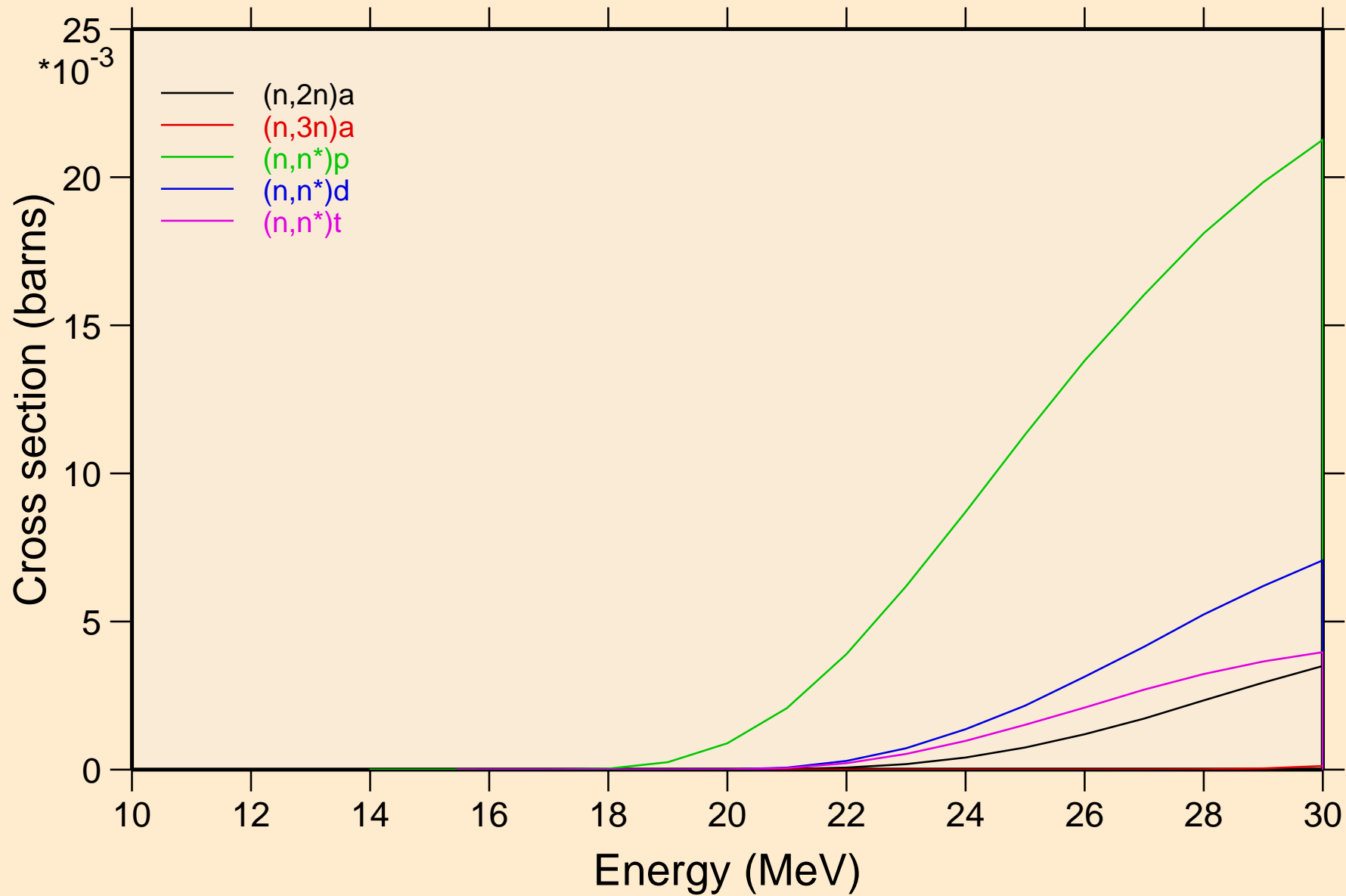

SR095 NEUTRON ACER TENDL-2024 LIBRARY; T=0.K
Threshold reactions

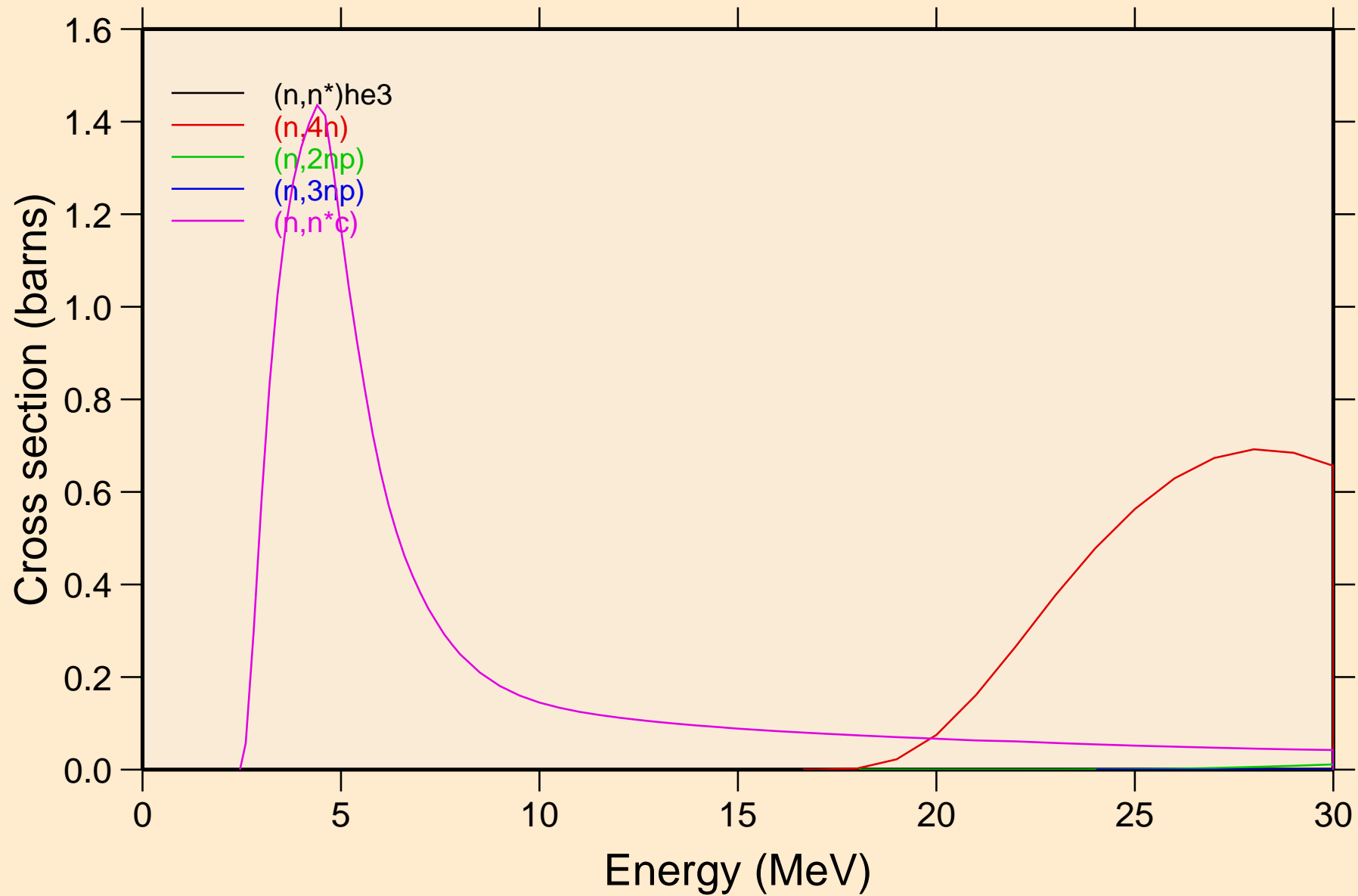

SR095 NEUTRON ACER TENDL-2024 LIBRARY; T=0.K

Threshold reactions

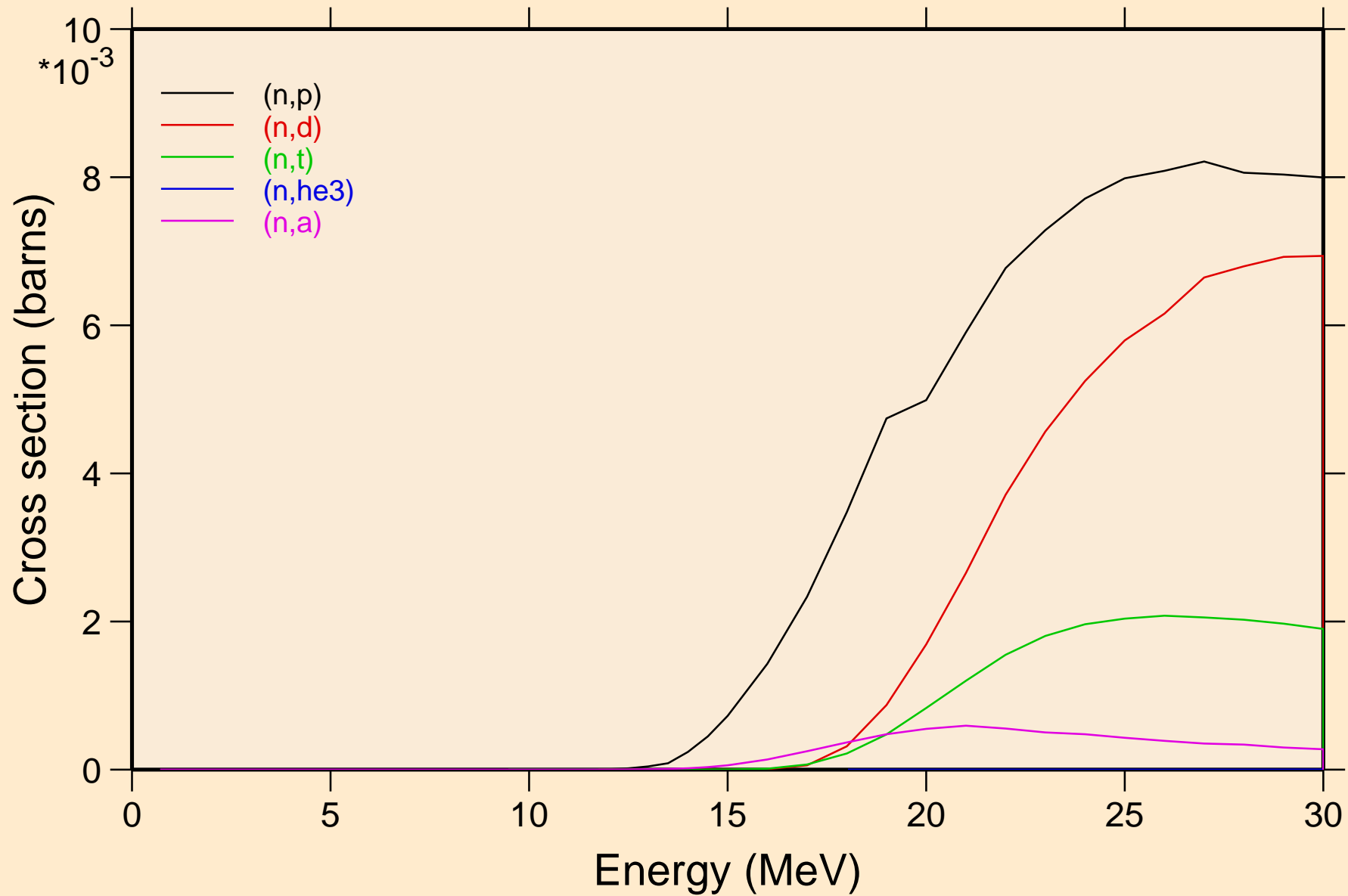

SR095 NEUTRON ACER TENDL-2024 LIBRARY; T=0.K
Threshold reactions

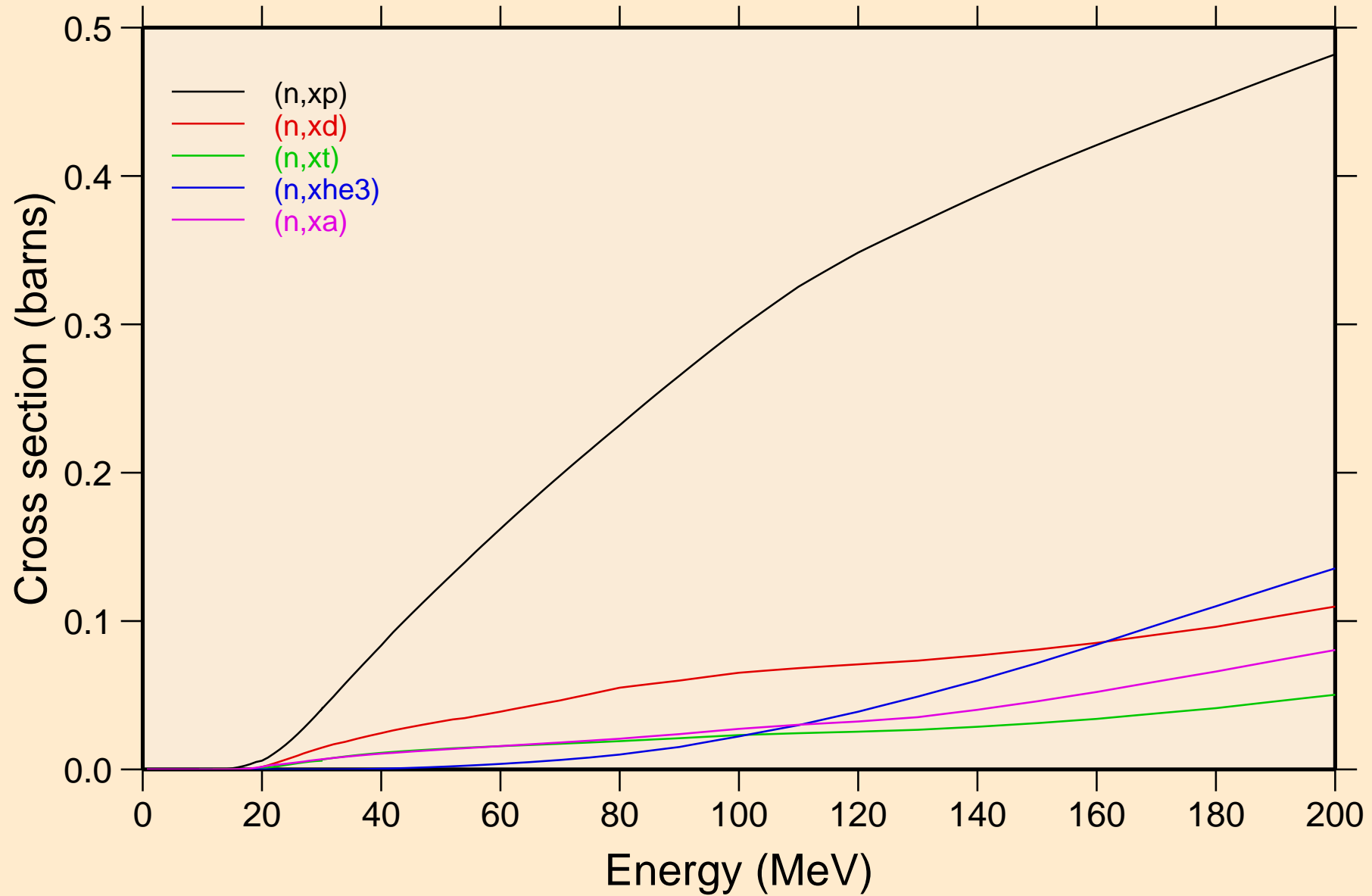

SR095 NEUTRON ACER TENDL-2024 LIBRARY; T=0.K
angular distribution for elastic

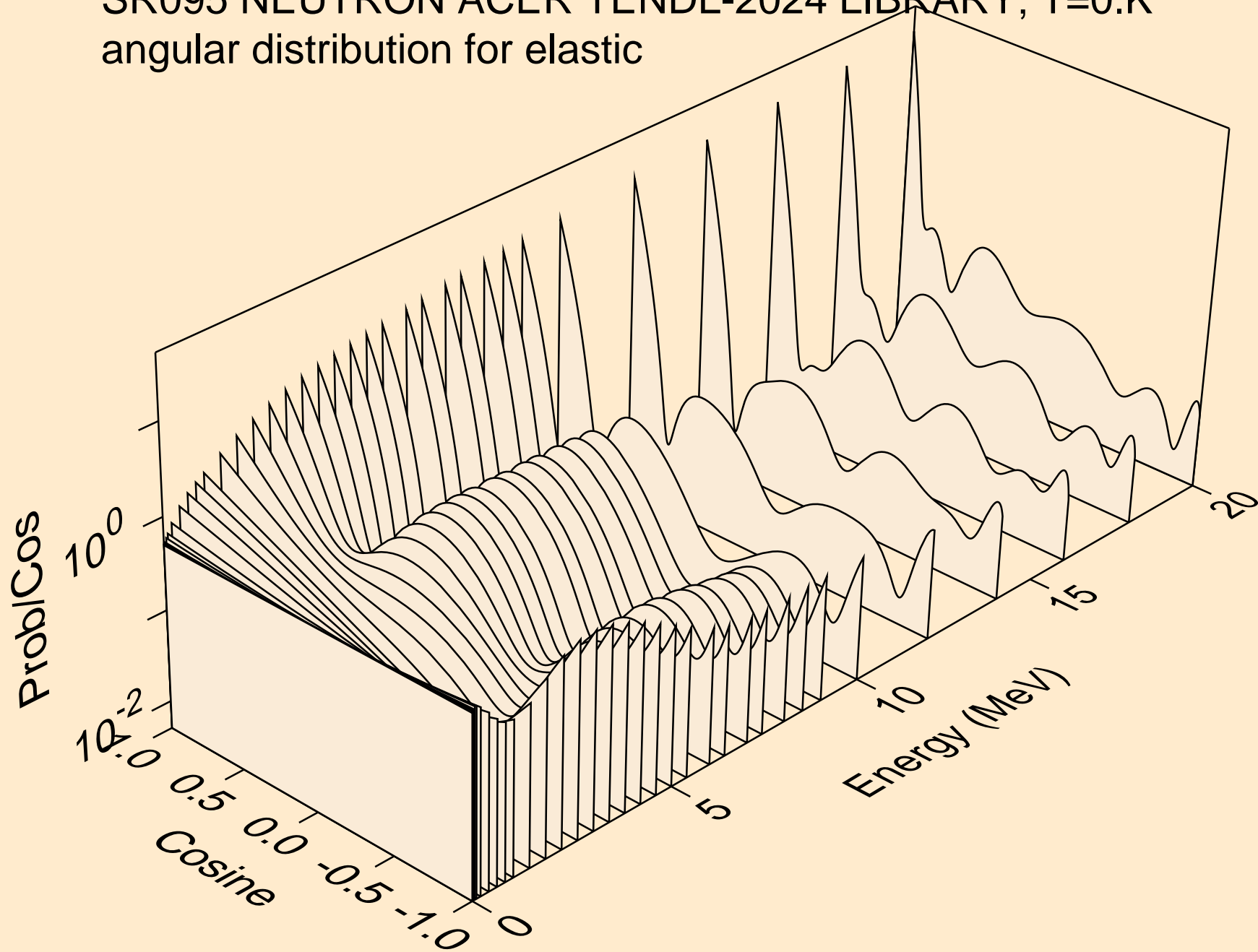

SR095 NEUTRON ACER TENDL-2024 LIBRARY; T=0.K
angular distribution for elastic

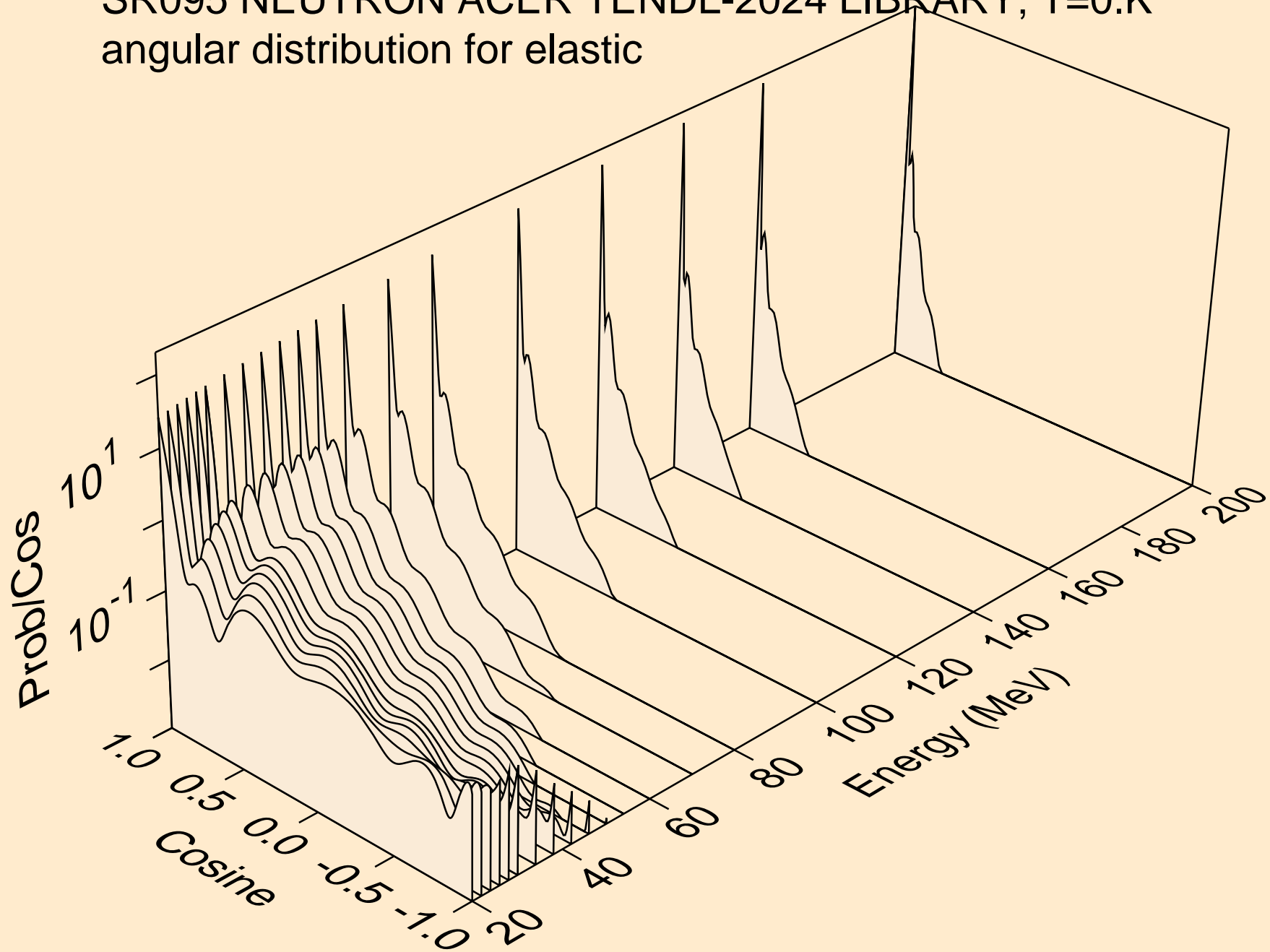

SR095 NEUTRON ACER TENDL-2024 LIBRARY; T=0.K
angular distribution for (n,n*1)

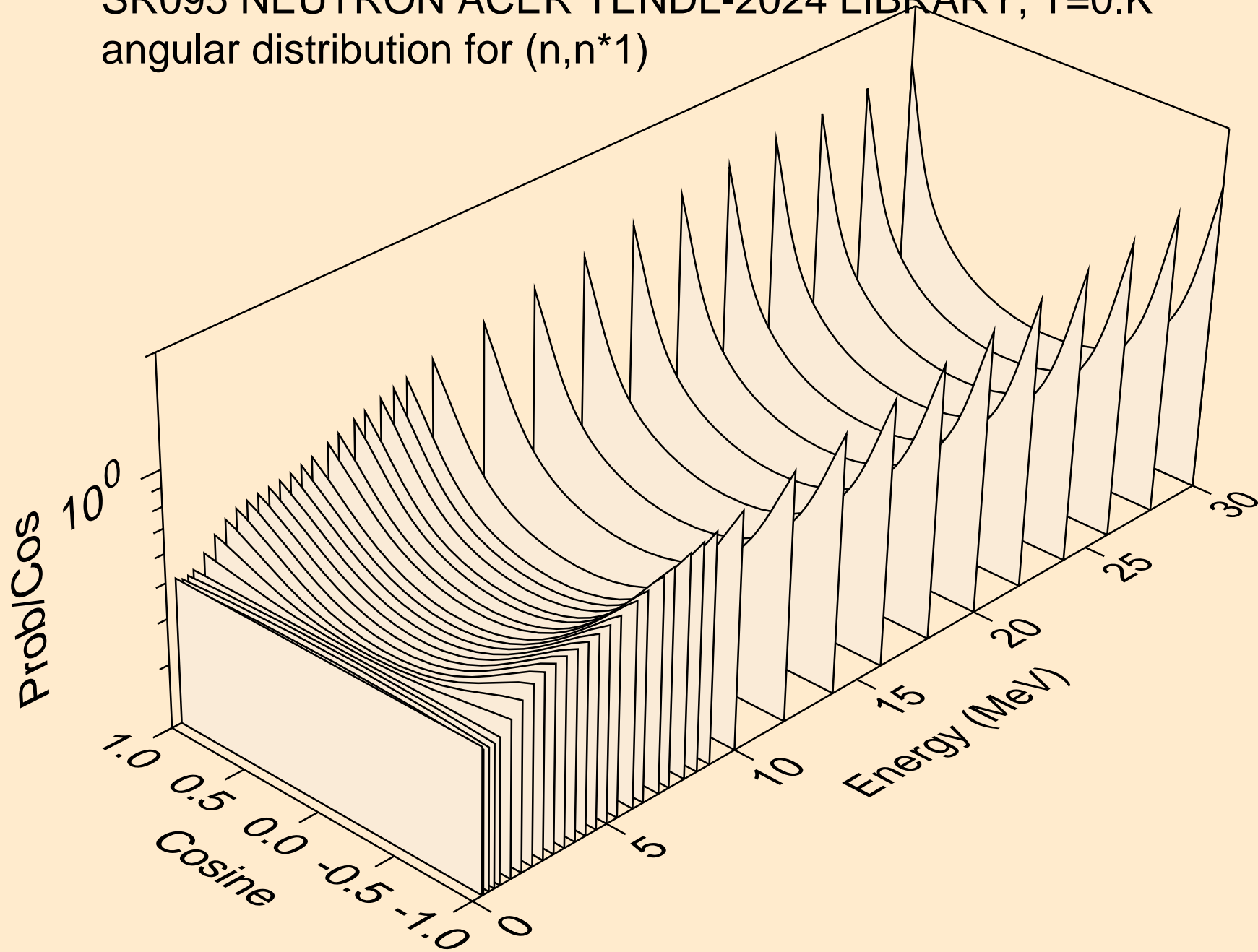

SR095 NEUTRON ACER TENDL-2024 LIBRARY; T=0.K
angular distribution for (n,n*2)

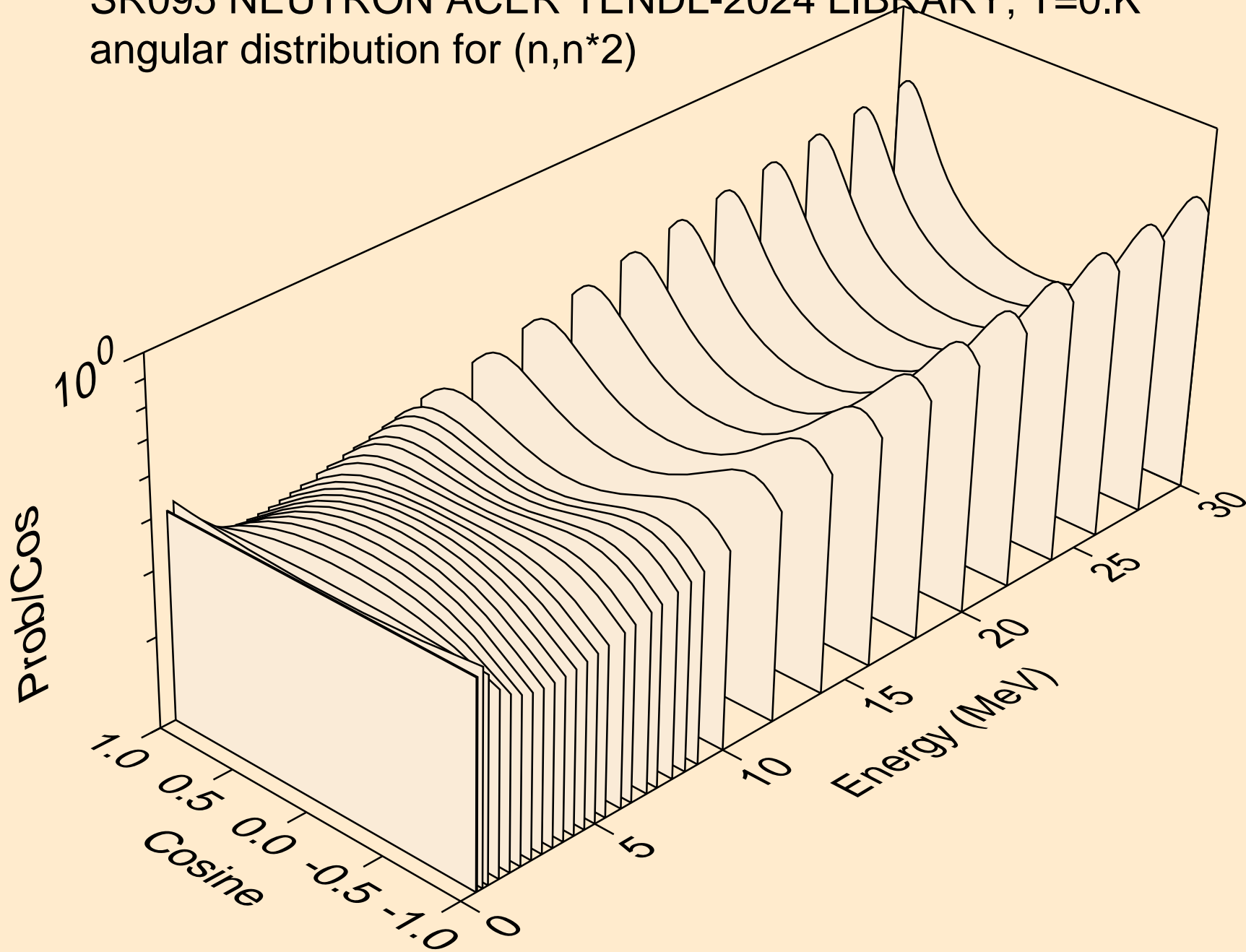

SR095 NEUTRON ACER TENDL-2024 LIBRARY; T=0.K
angular distribution for (n,n*3)

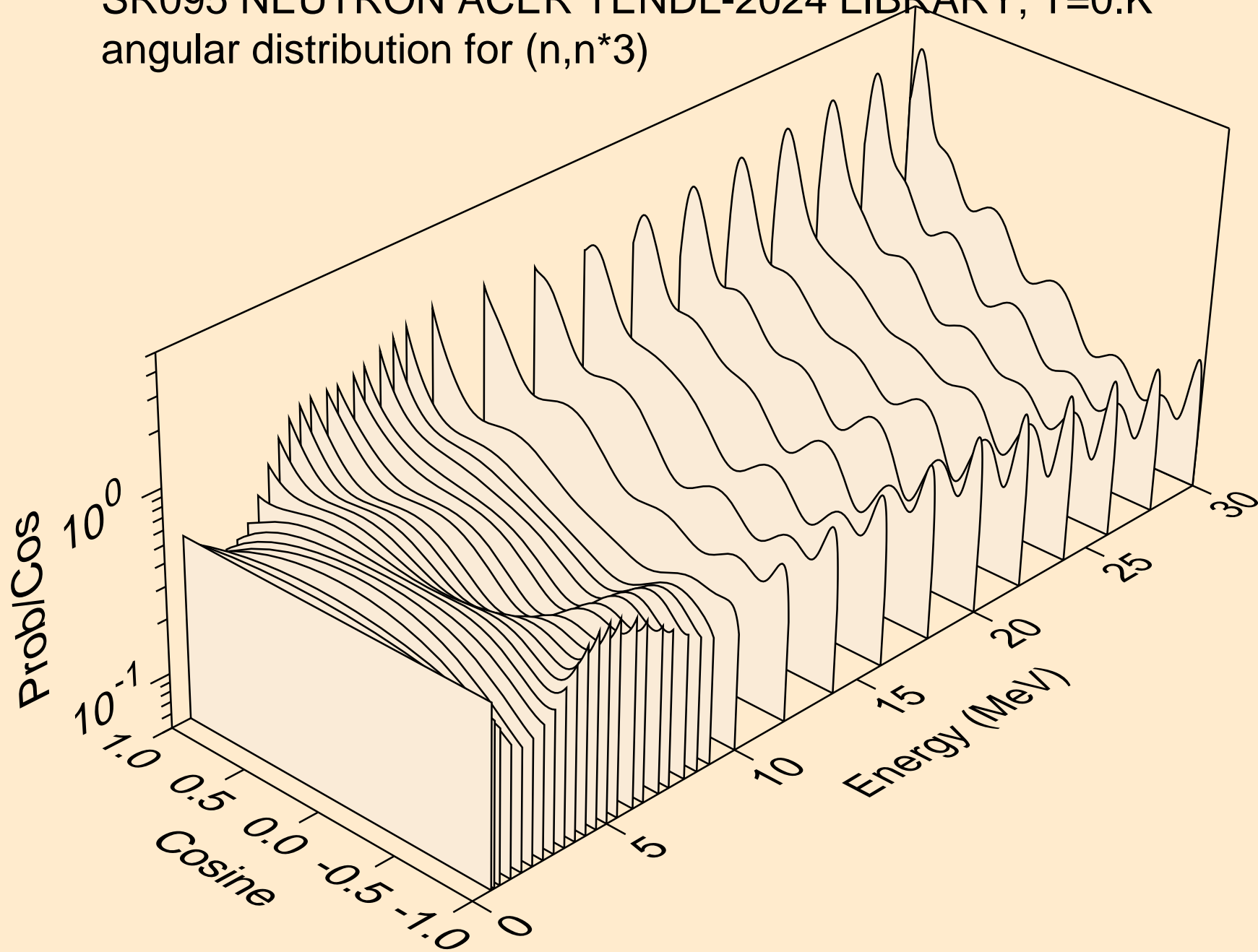

SR095 NEUTRON ACER TENDL-2024 LIBRARY; T=0.K
angular distribution for (n,n*4)

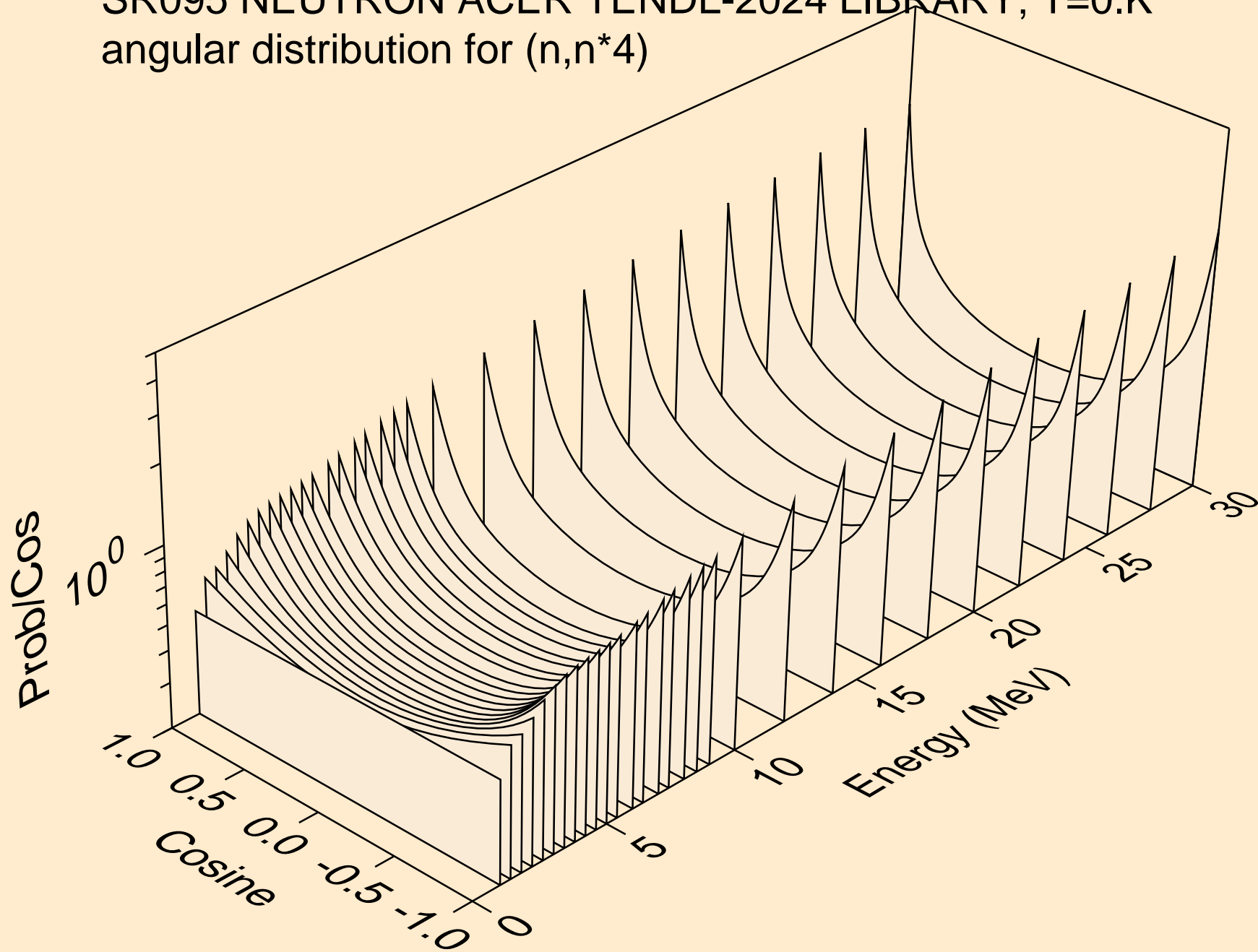

SR095 NEUTRON ACER TENDL-2024 LIBRARY; T=0.K
angular distribution for (n,n*5)

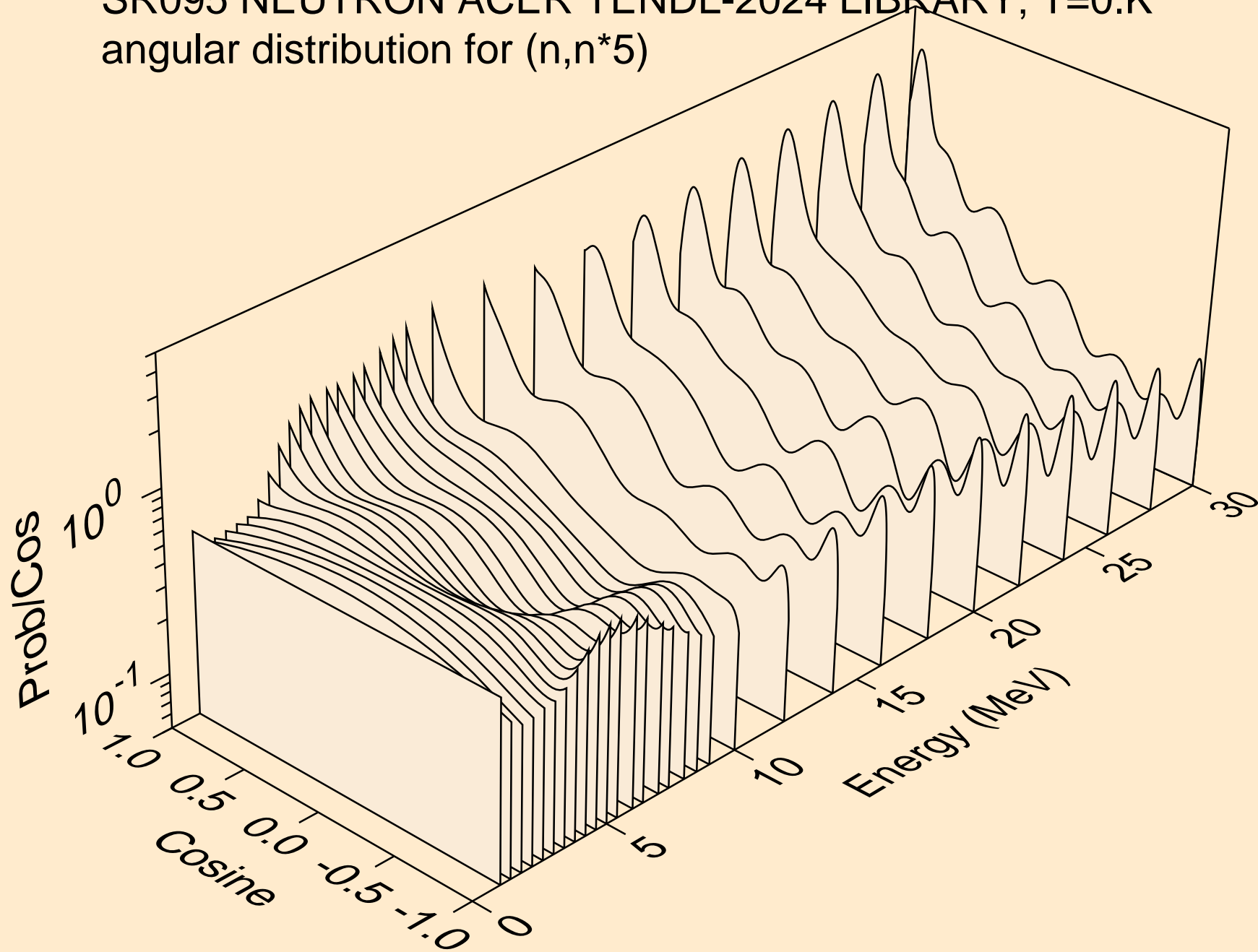

SR095 NEUTRON ACER TENDL-2024 LIBRARY; T=0.K
angular distribution for (n,n*6)

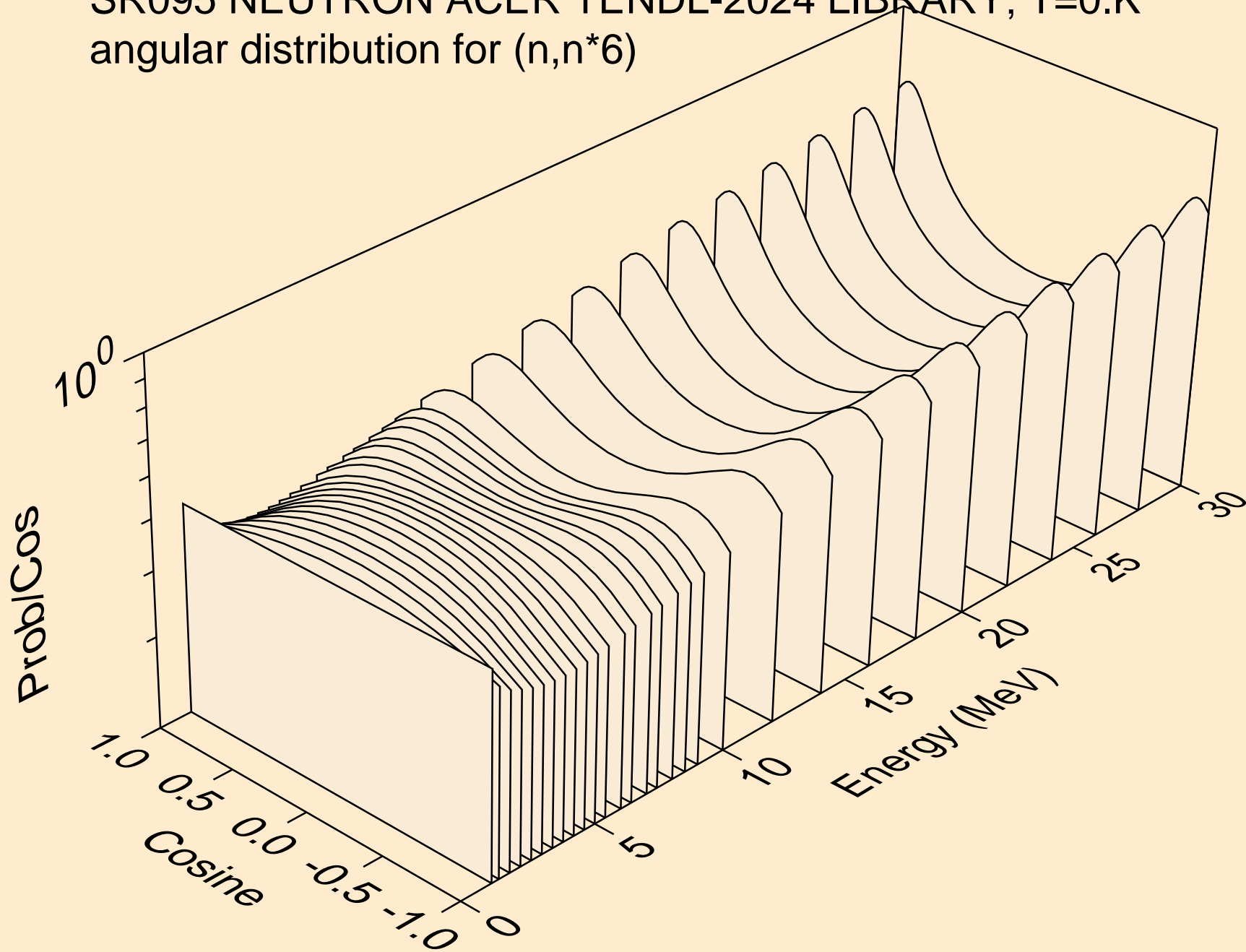

SR095 NEUTRON ACER TENDL-2024 LIBRARY; T=0.K
angular distribution for (n,n*7)

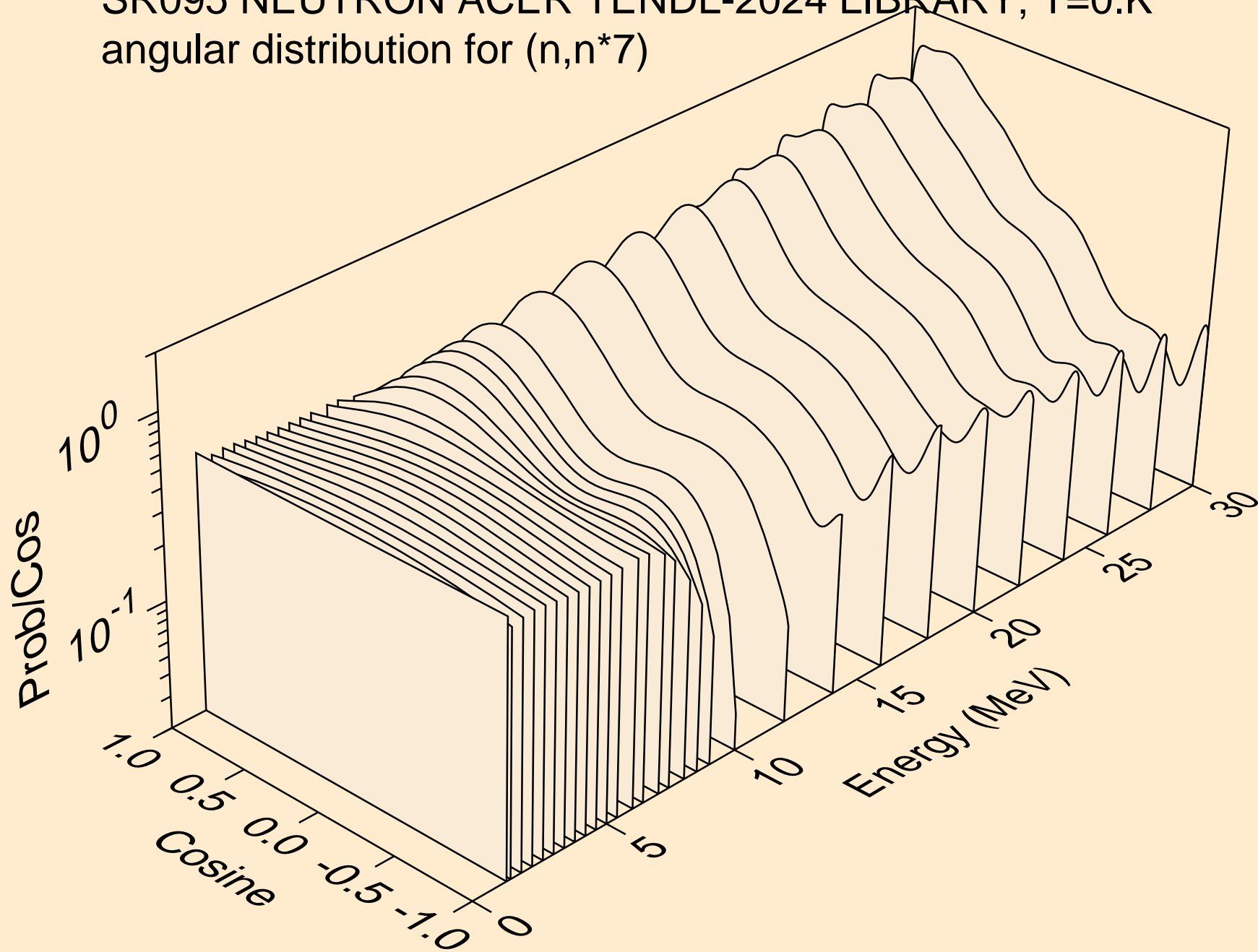

SR095 NEUTRON ACER TENDL-2024 LIBRARY; T=0.K
angular distribution for (n,n*8)

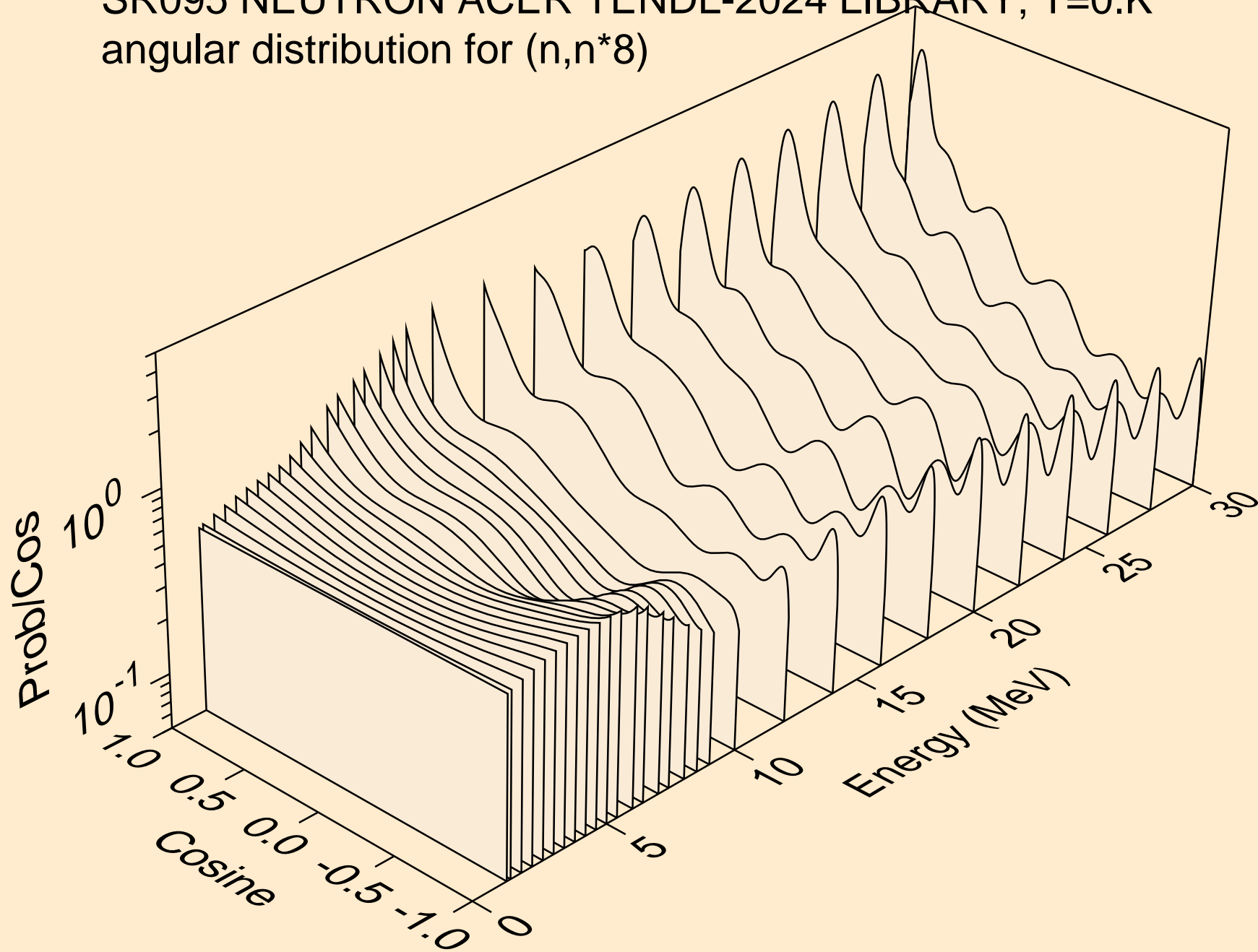

SR095 NEUTRON ACER TENDL-2024 LIBRARY; T=0.K
angular distribution for (n,n*9)

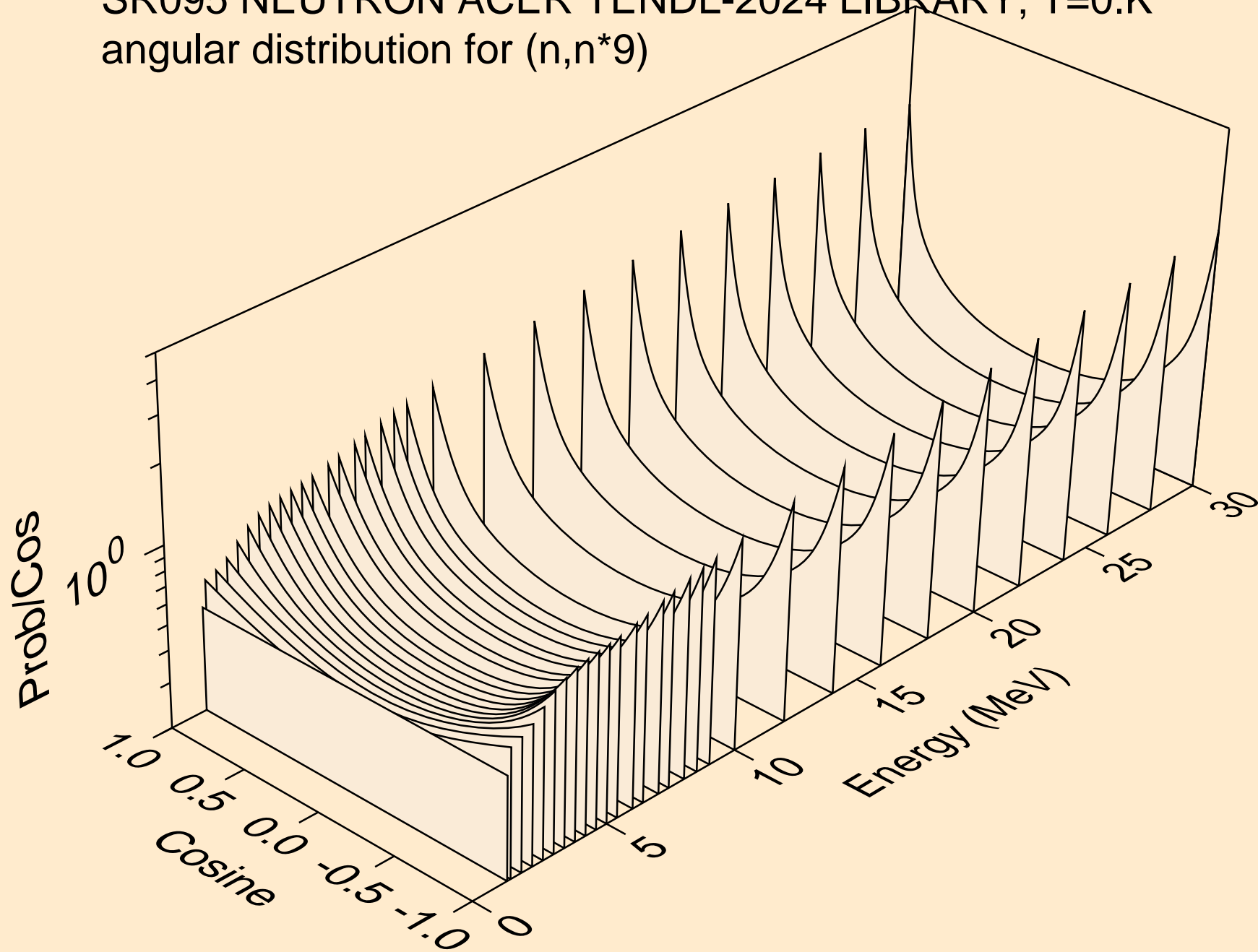

SR095 NEUTRON ACER TENDL-2024 LIBRARY; T=0.K
angular distribution for (n,n*10)

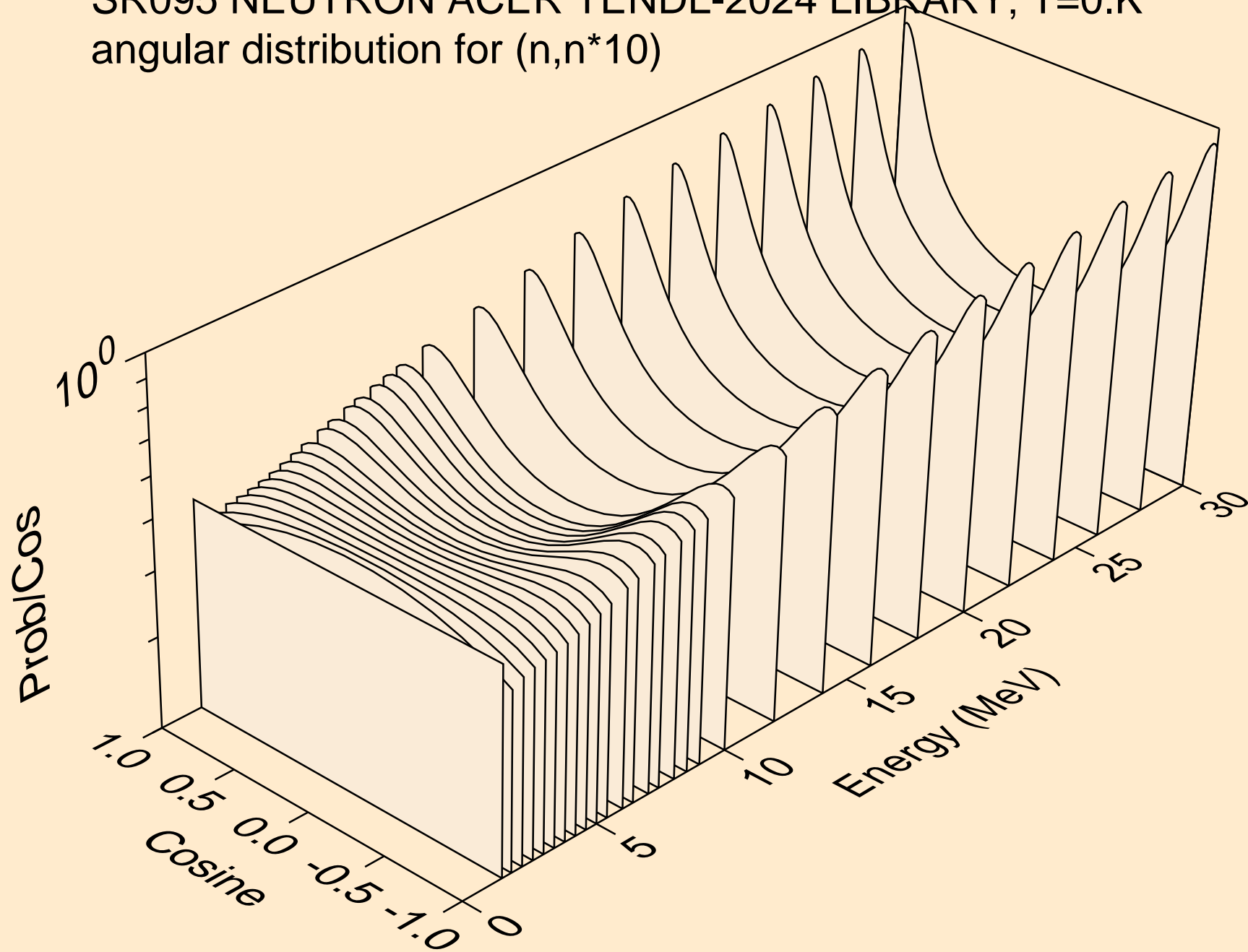

SR095 NEUTRON ACER TENDL-2024 LIBRARY; T=0.K
angular distribution for (n,n*11)

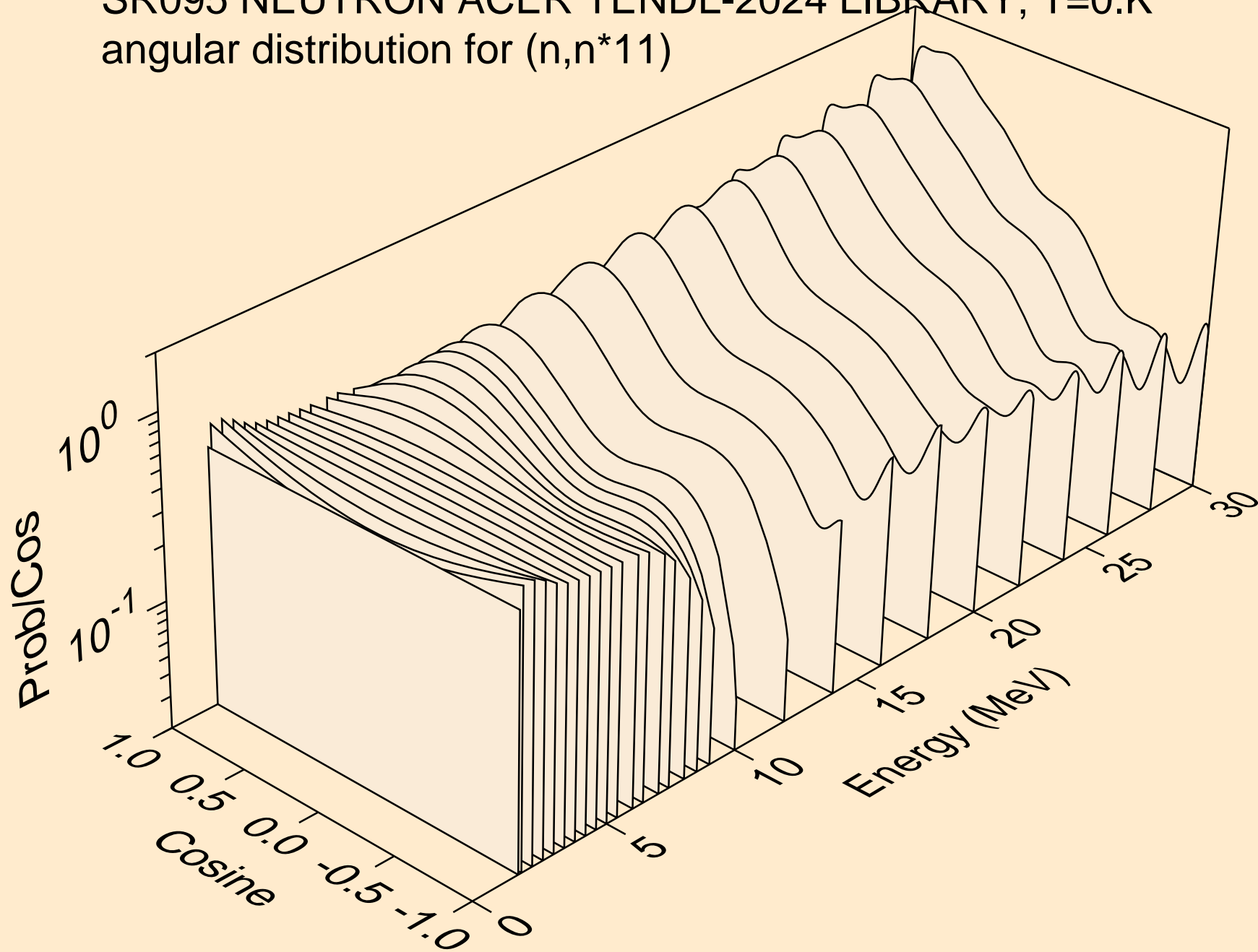

SR095 NEUTRON ACER TENDL-2024 LIBRARY; T=0.K
angular distribution for (n,n*12)

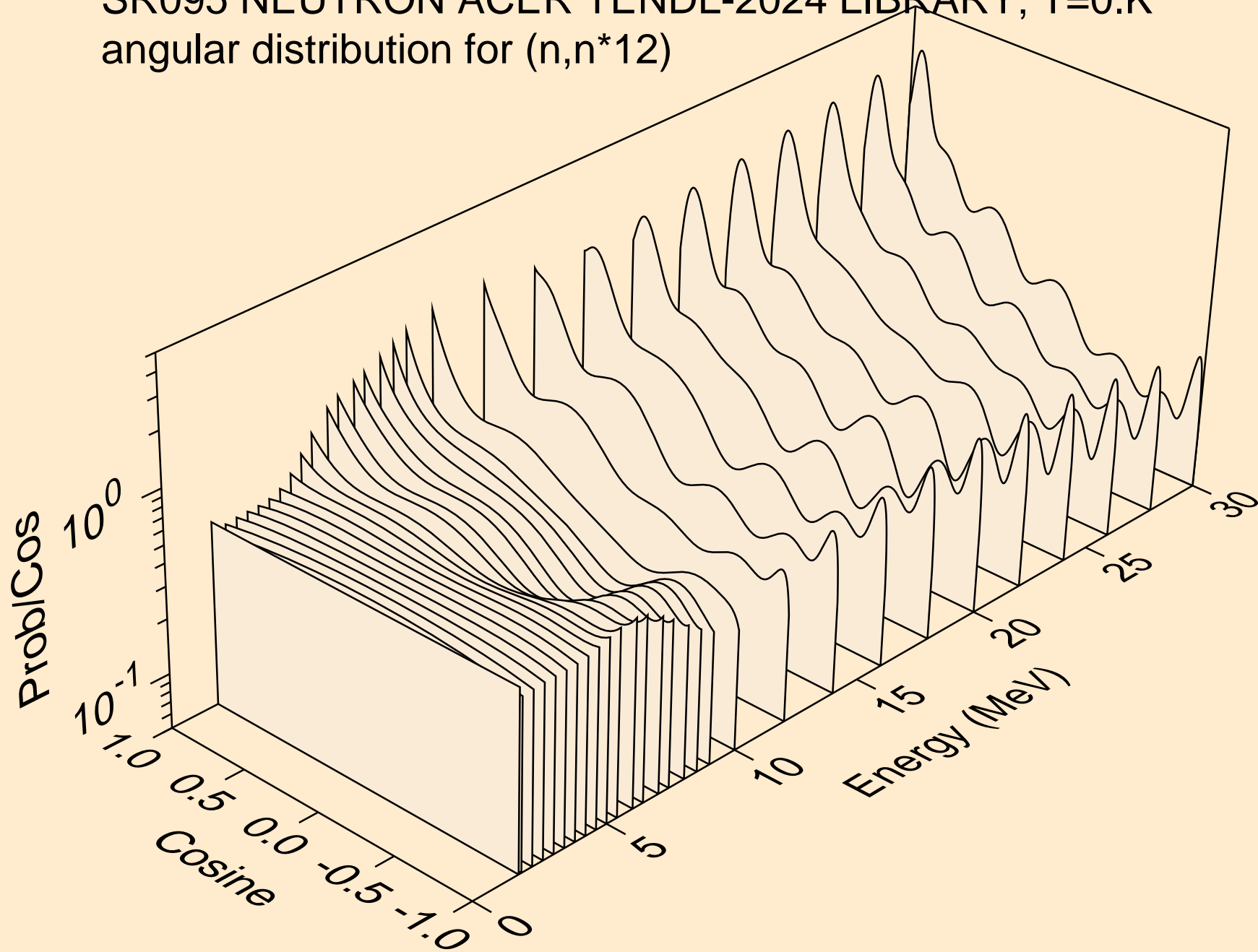

SR095 NEUTRON ACER TENDL-2024 LIBRARY; T=0.K
angular distribution for (n,n*13)

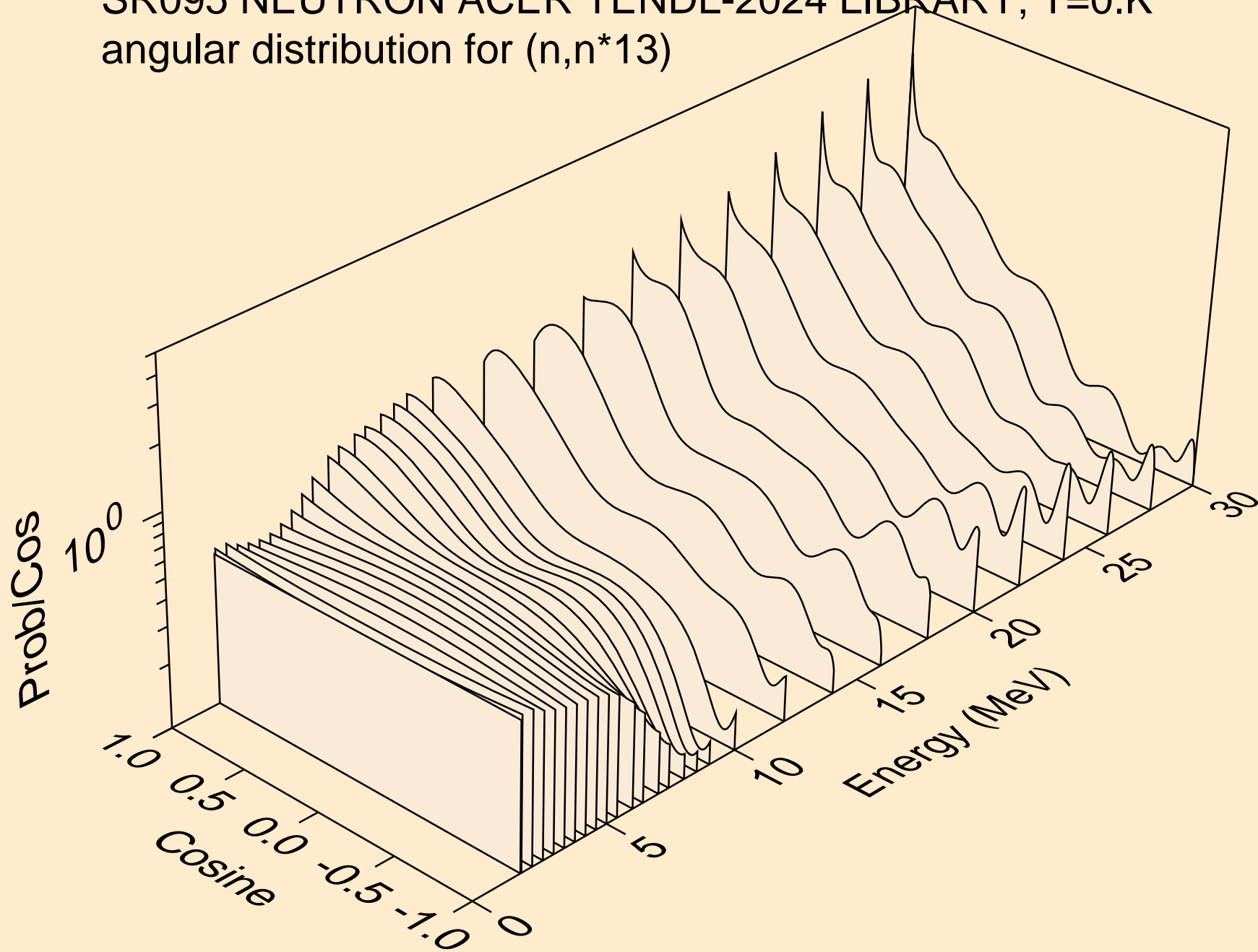

SR095 NEUTRON ACER TENDL-2024 LIBRARY; T=0.K
angular distribution for (n,n*14)

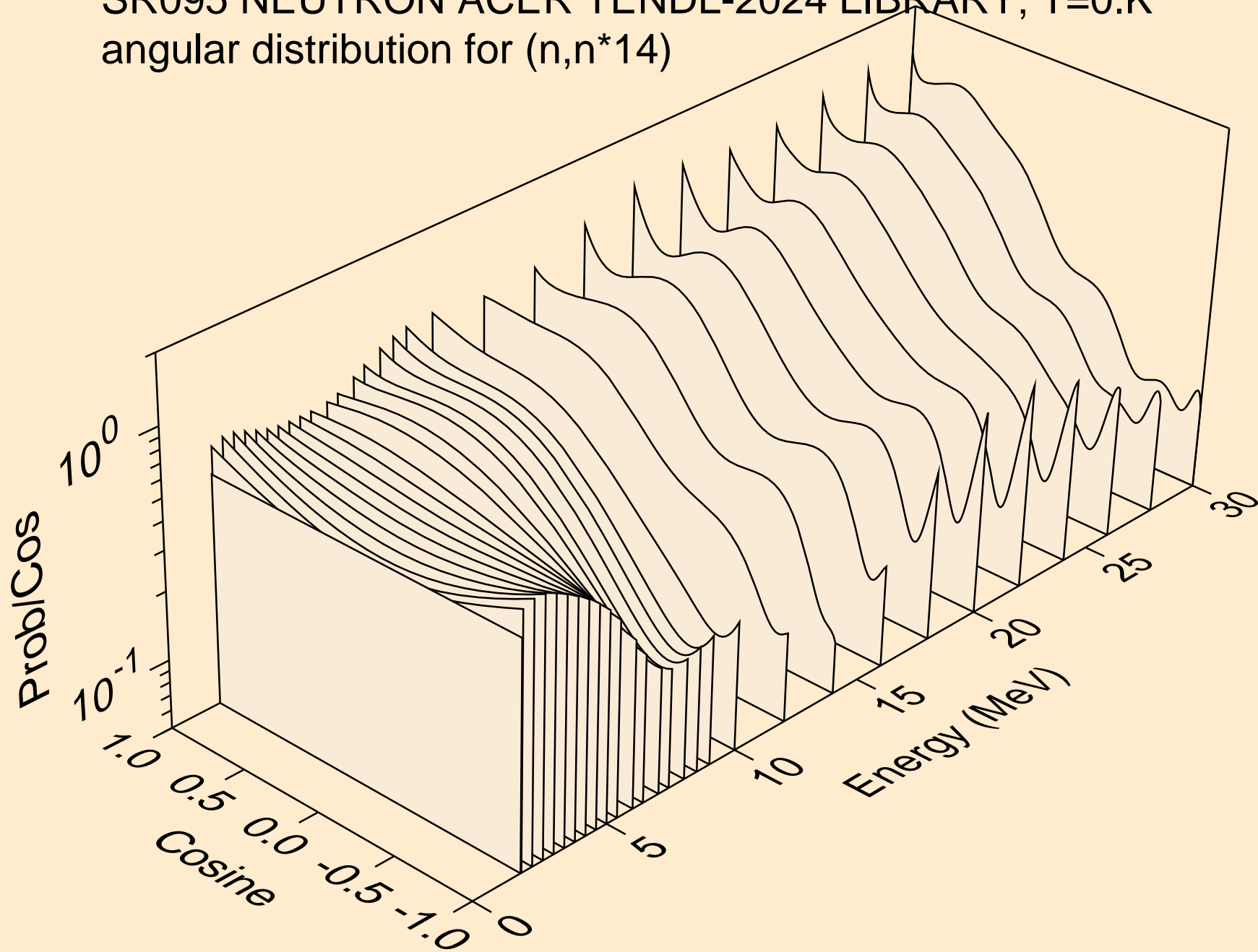

SR095 NEUTRON ACER TENDL-2024 LIBRARY; T=0.K
angular distribution for (n,n*15)

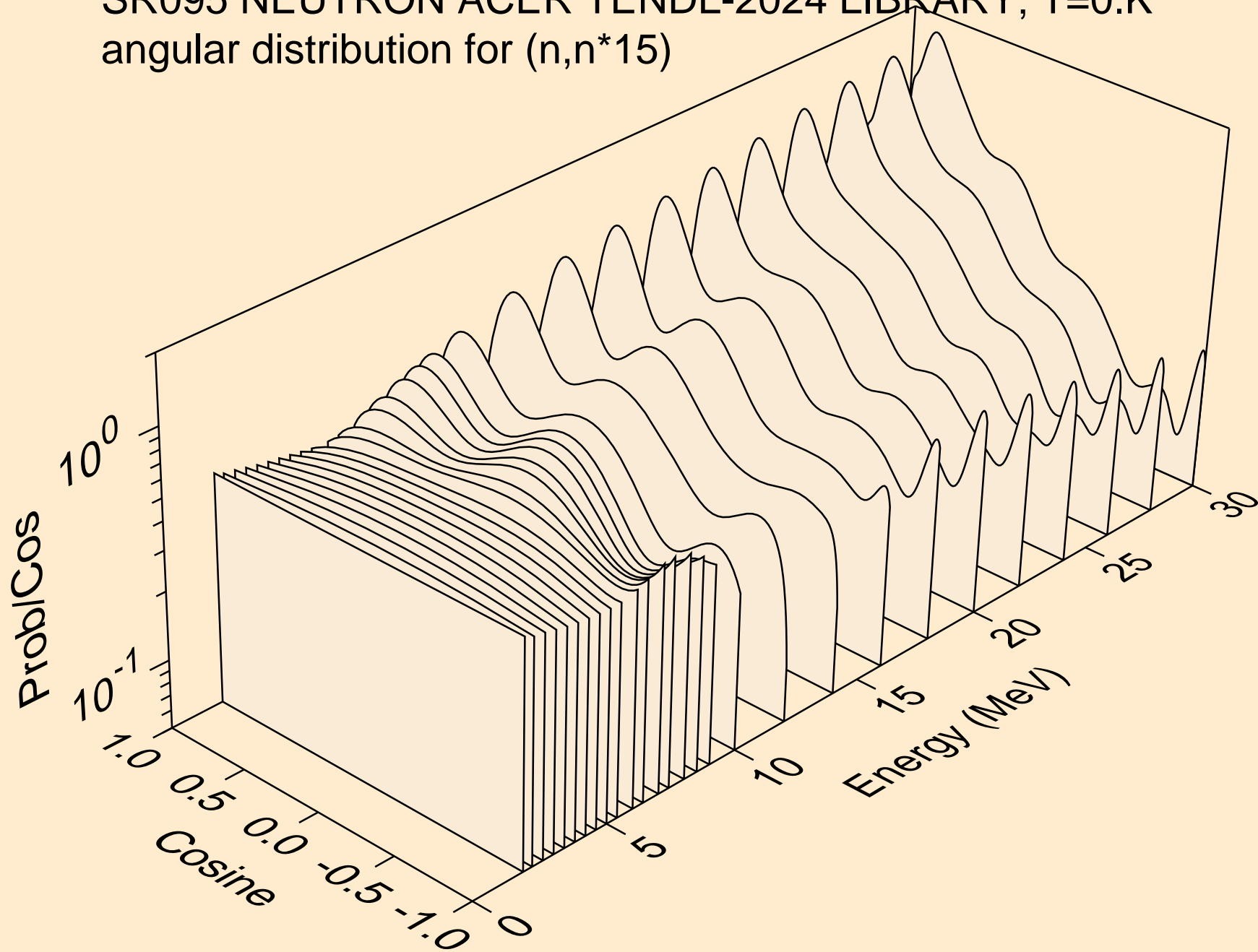

SR095 NEUTRON ACER TENDL-2024 LIBRARY; T=0.K
angular distribution for (n,n*16)

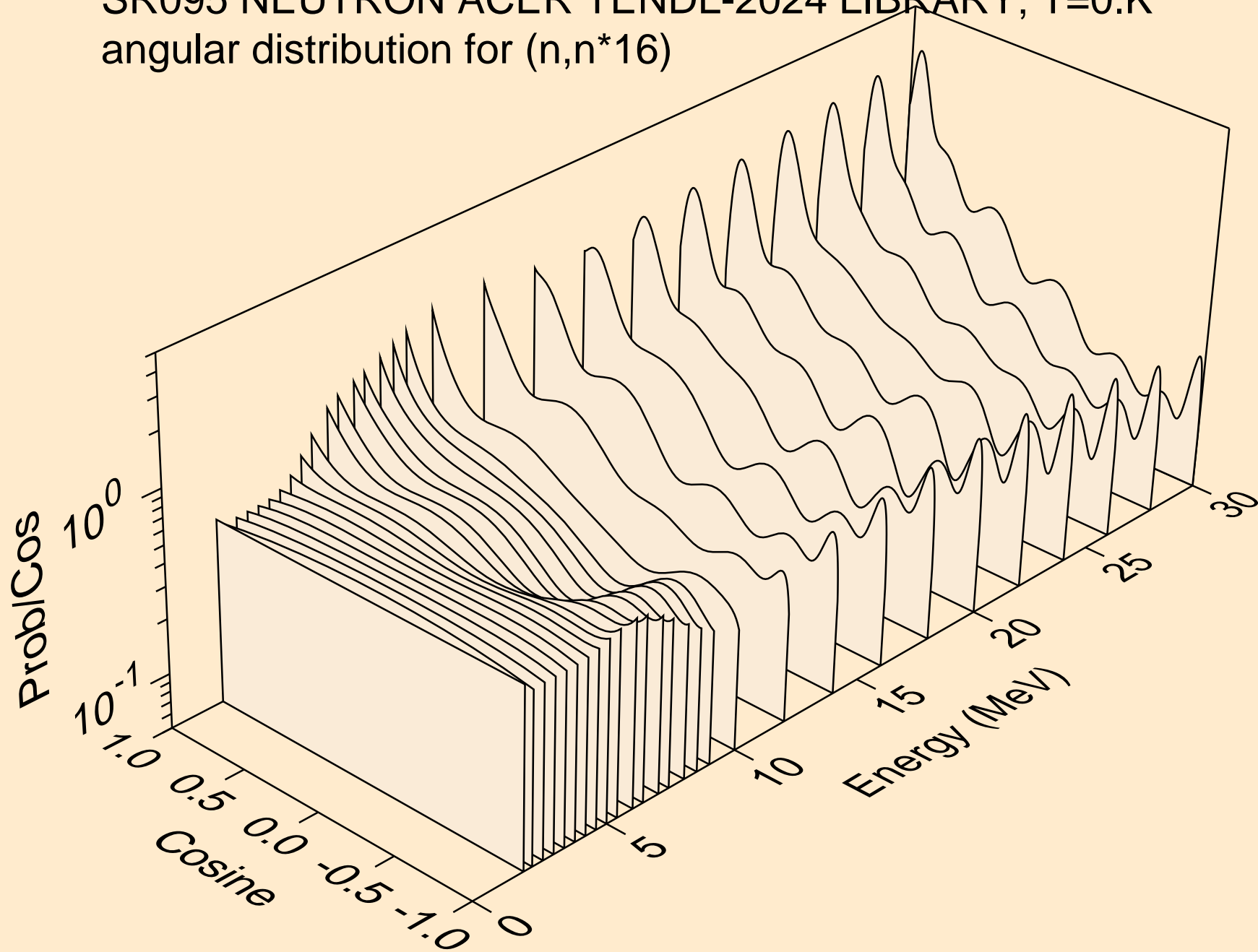

SR095 NEUTRON ACER TENDL-2024 LIBRARY; T=0.K
angular distribution for (n,n*17)

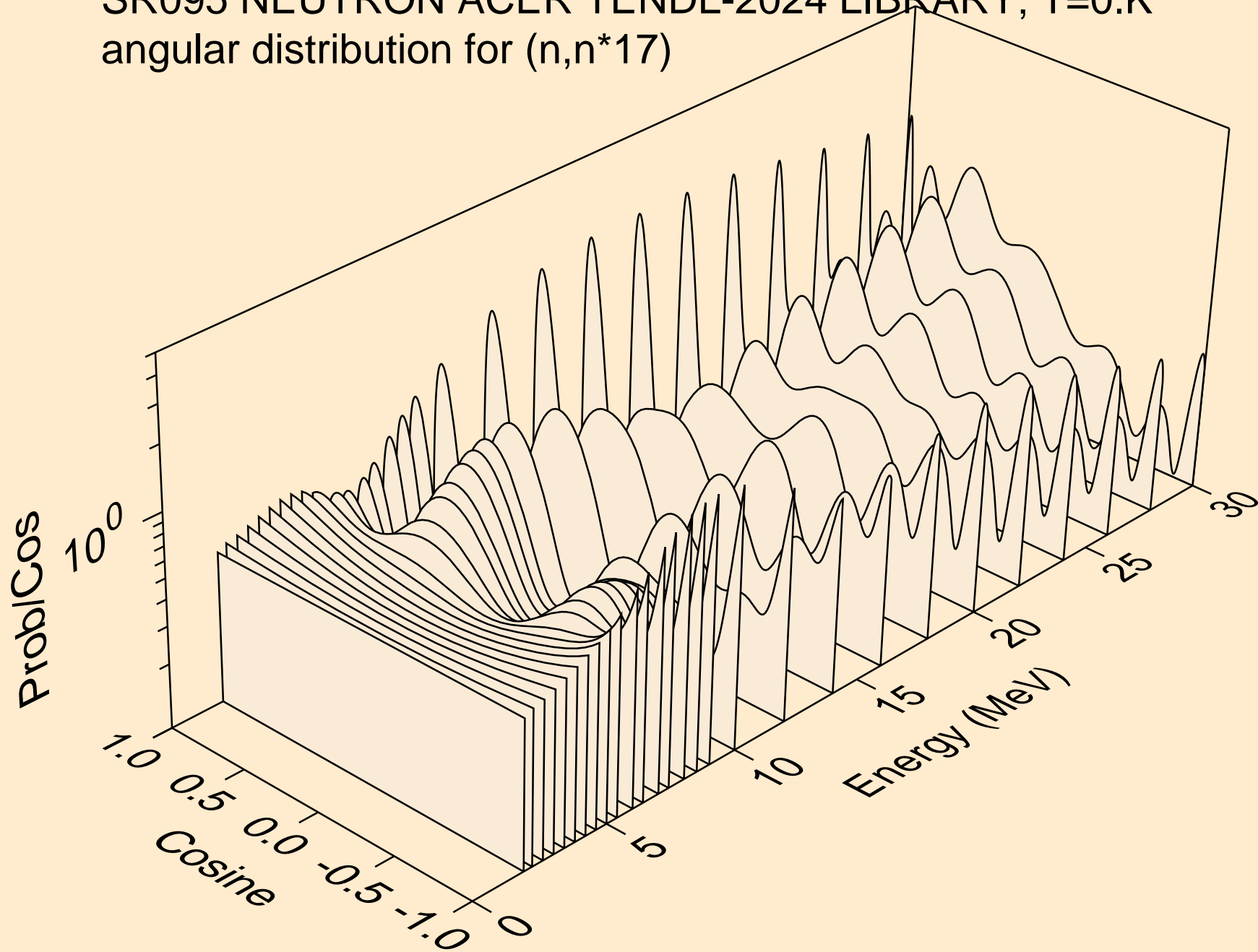

SR095 NEUTRON ACER TENDL-2024 LIBRARY; T=0.K
angular distribution for (n,n*18)

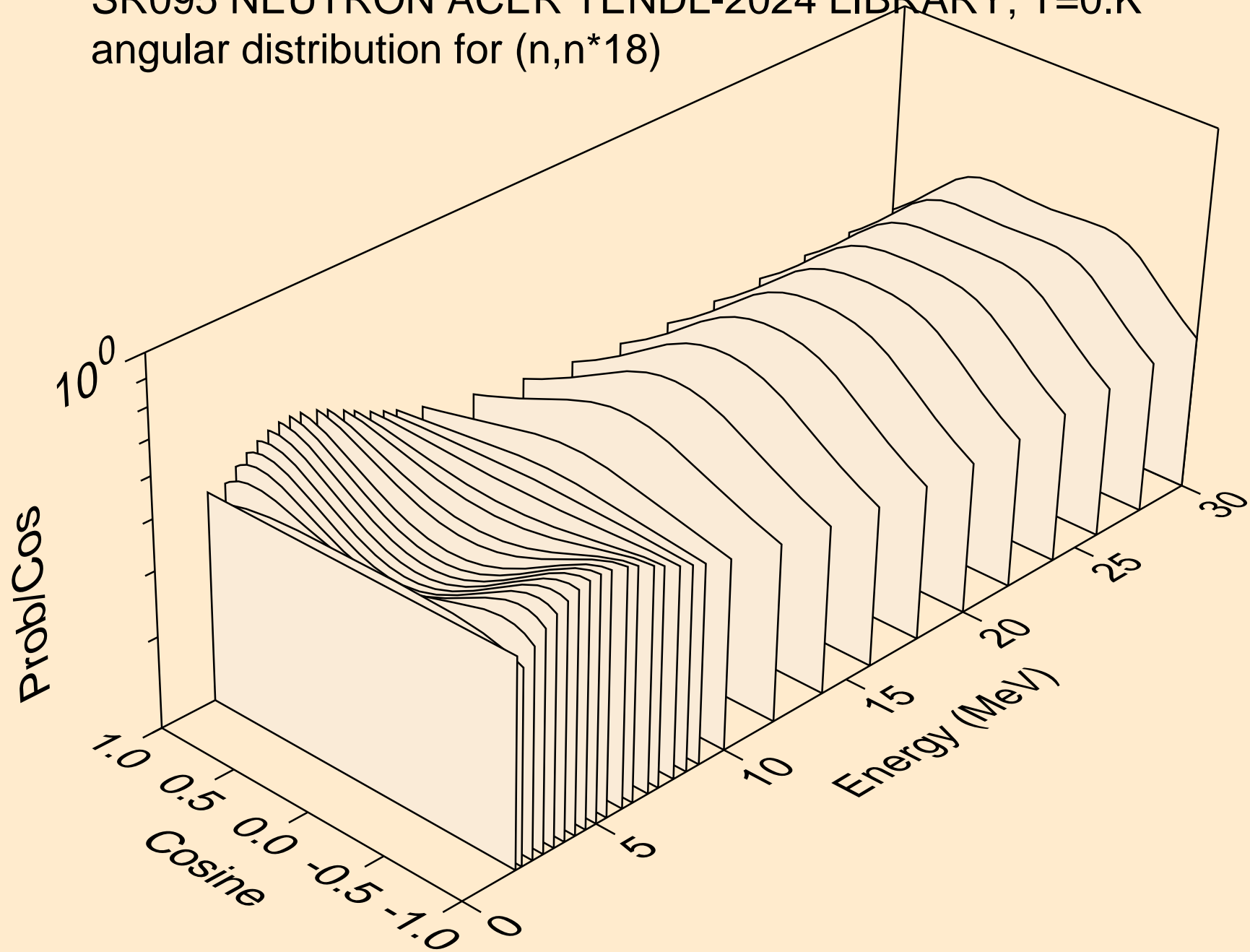

SR095 NEUTRON ACER TENDL-2024 LIBRARY; T=0.K
angular distribution for (n,n*19)

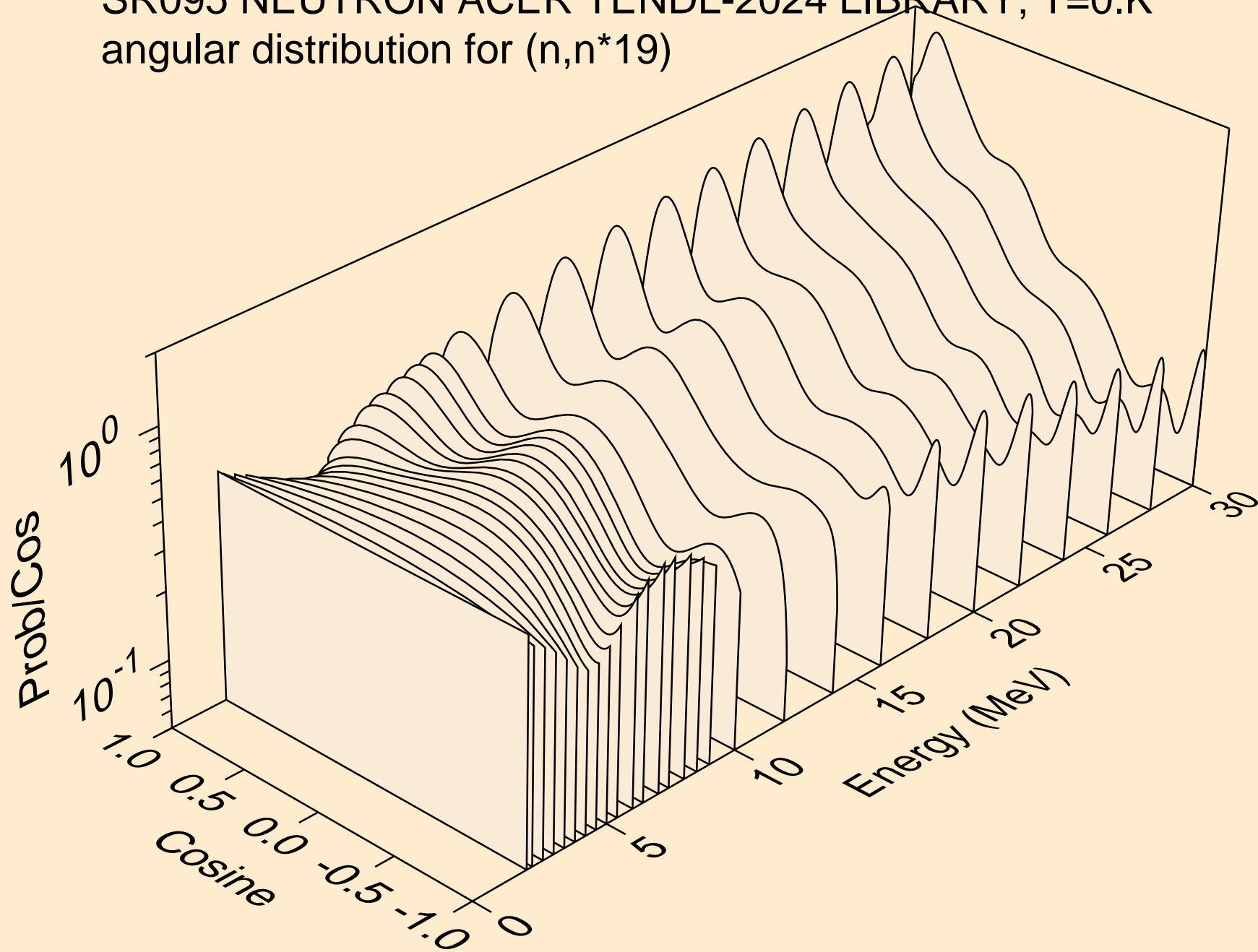

SR095 NEUTRON ACER TENDL-2024 LIBRARY; T=0.K
angular distribution for (n,n*20)

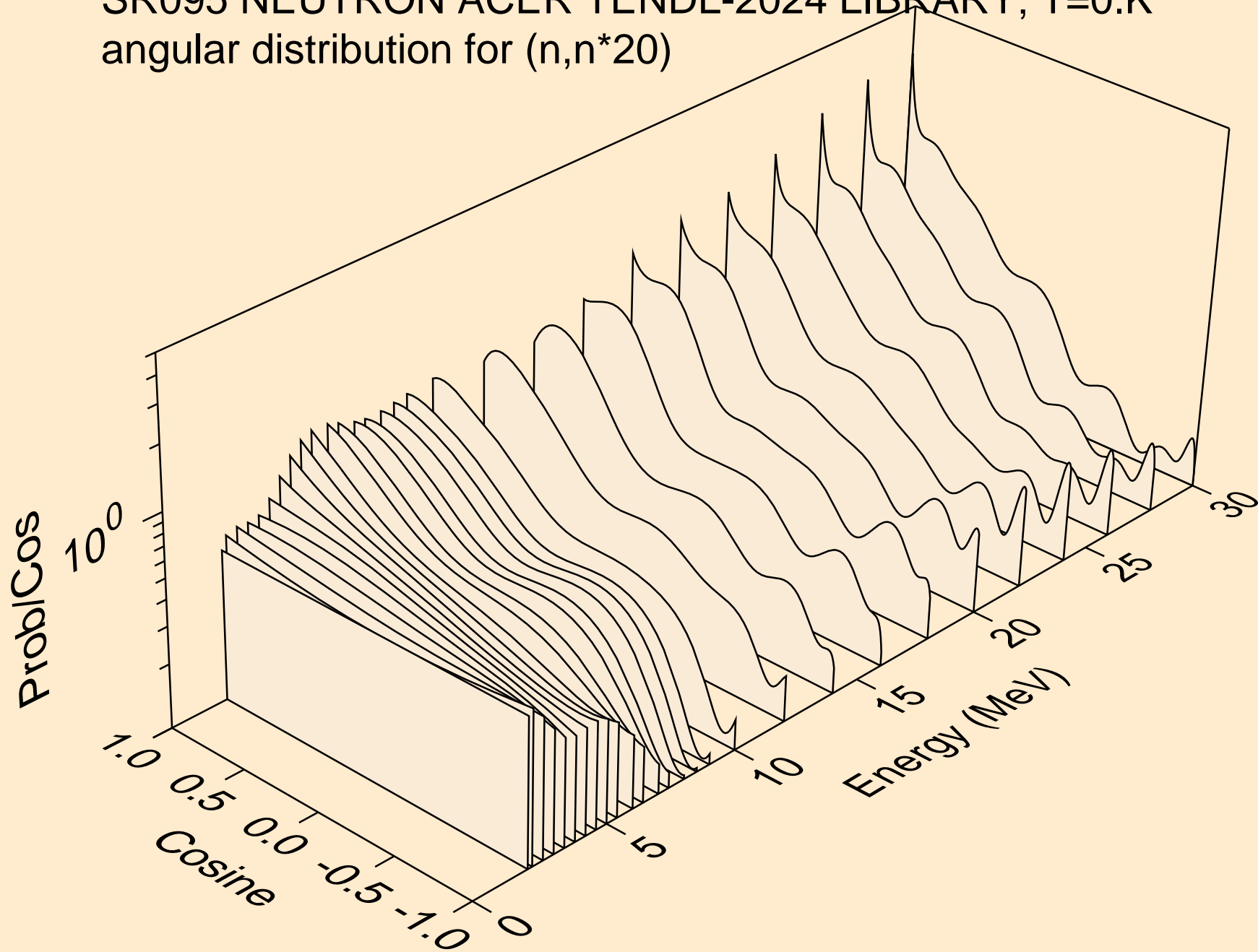

SR095 NEUTRON ACER TENDL-2024 LIBRARY; T=0.K
angular distribution for (n,n*21)

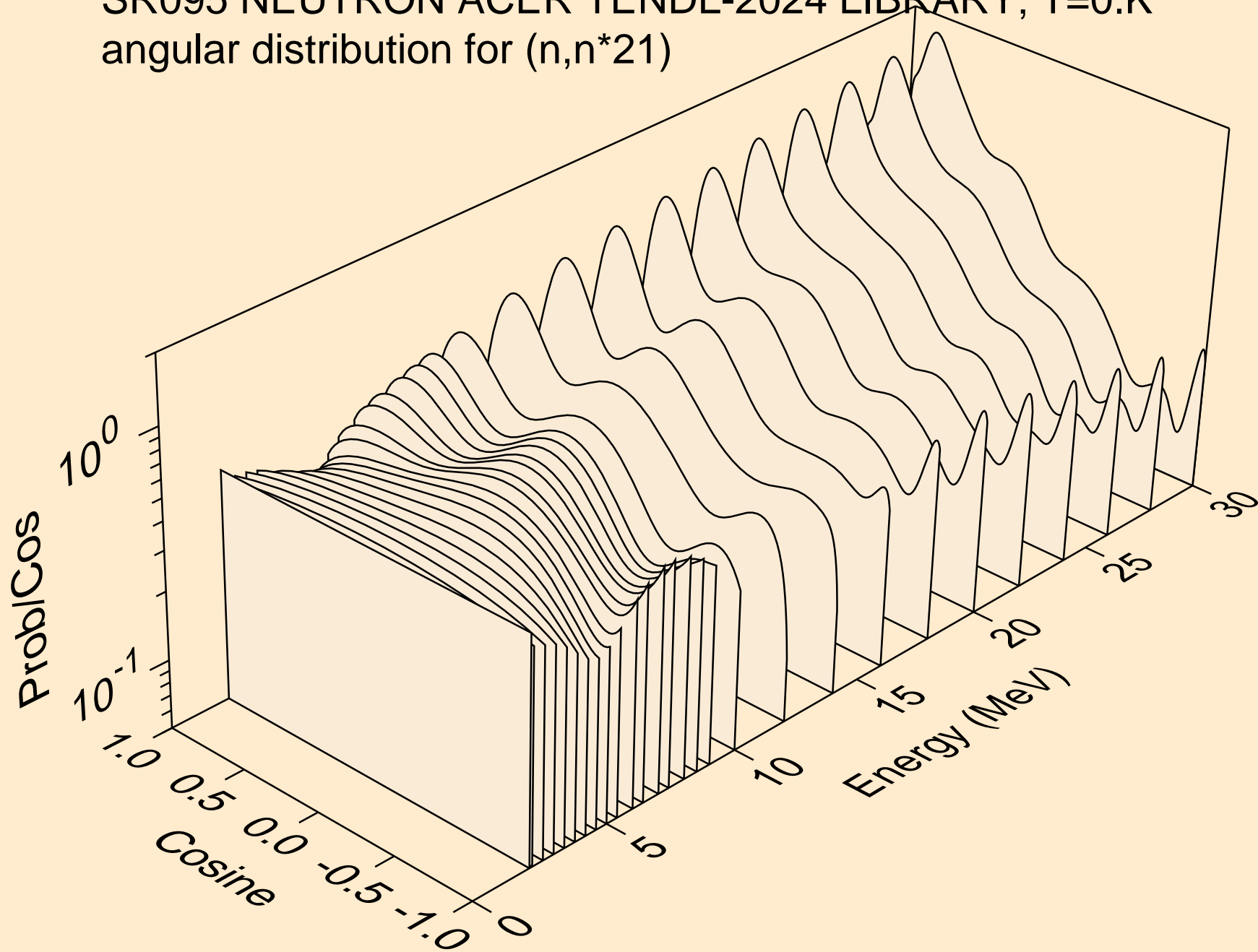

SR095 NEUTRON ACER TENDL-2024 LIBRARY; T=0.K
angular distribution for (n,n*22)

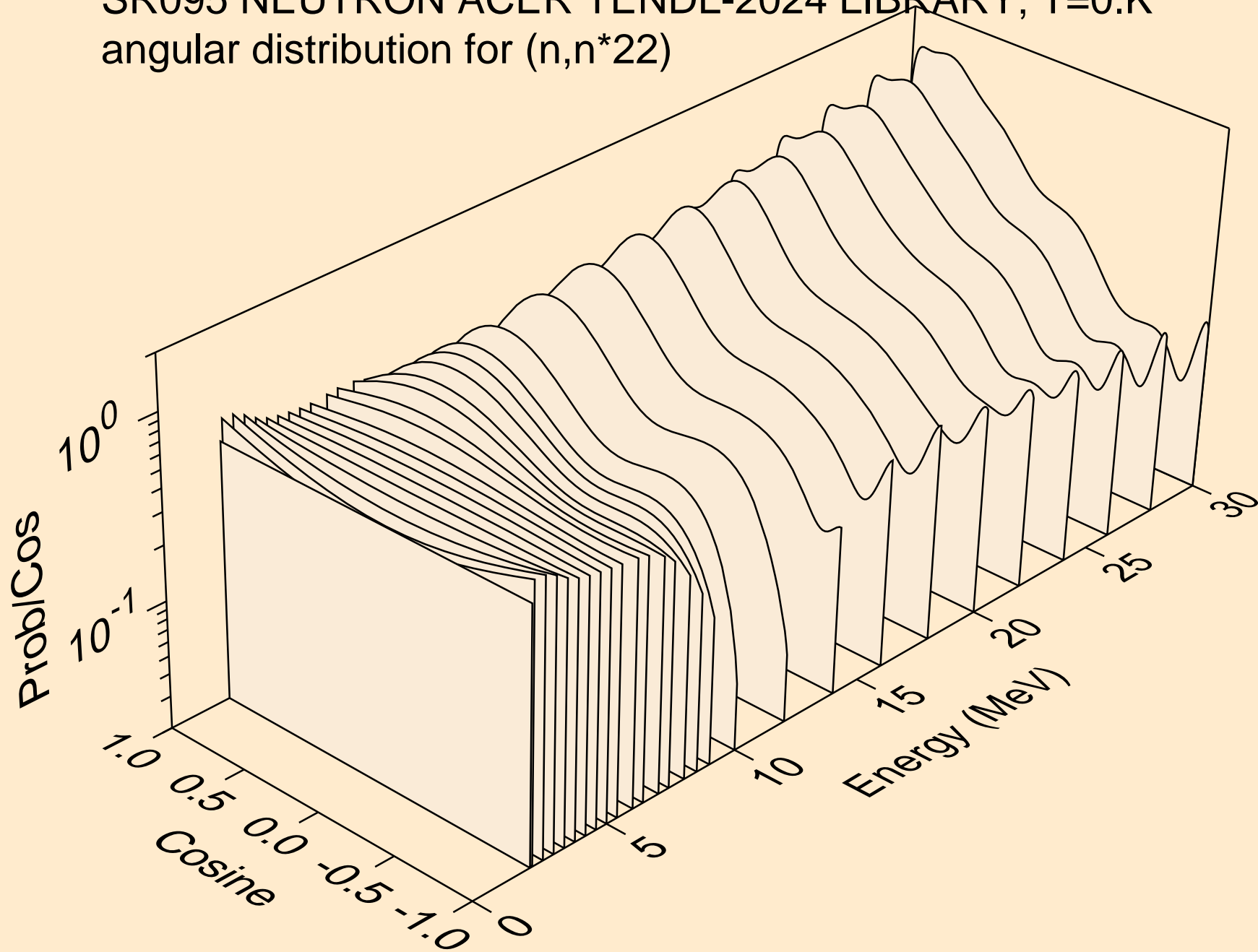

SR095 NEUTRON ACER TENDL-2024 LIBRARY; T=0.K
angular distribution for (n,n*23)

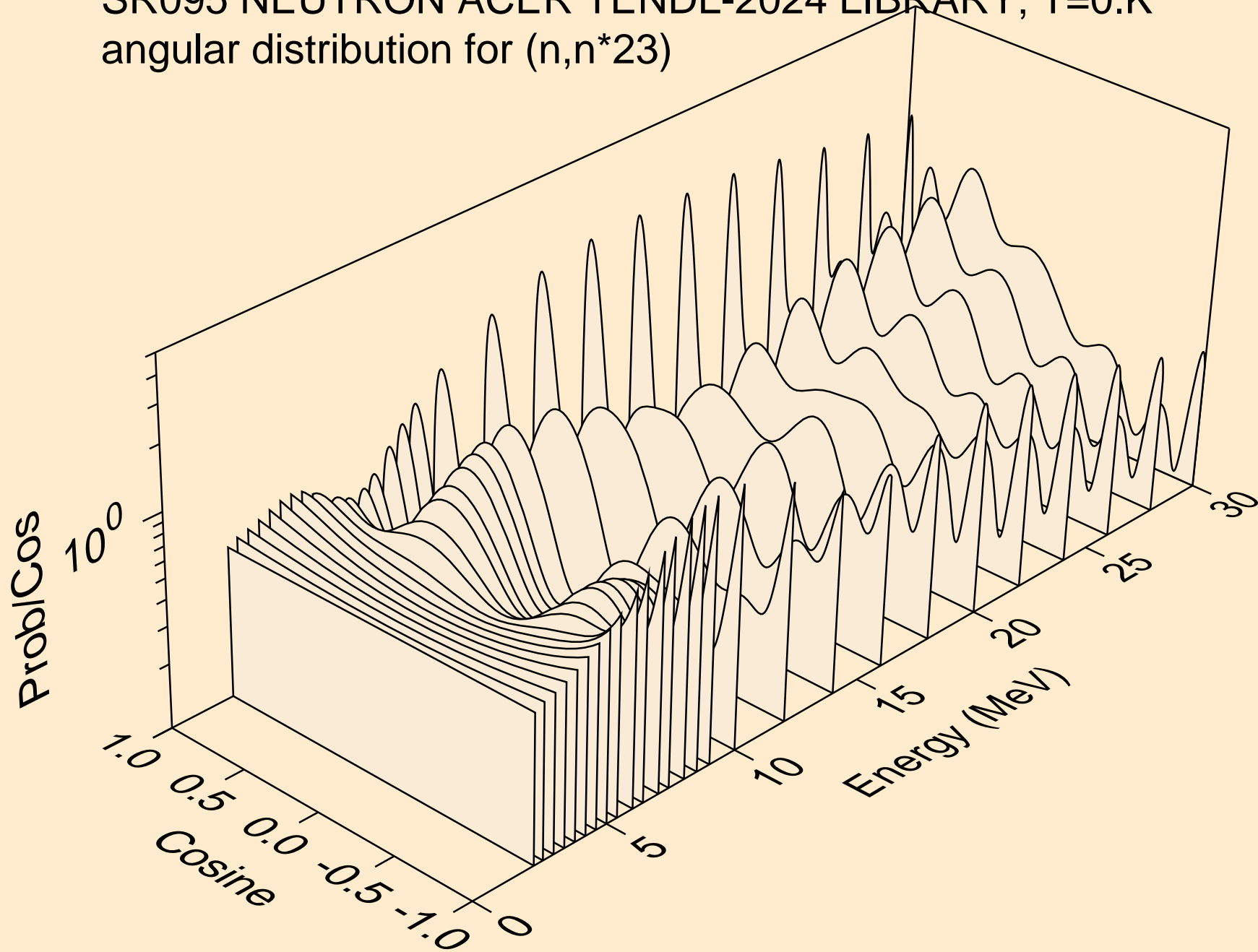

SR095 NEUTRON ACER TENDL-2024 LIBRARY; T=0.K
angular distribution for (n,n*24)

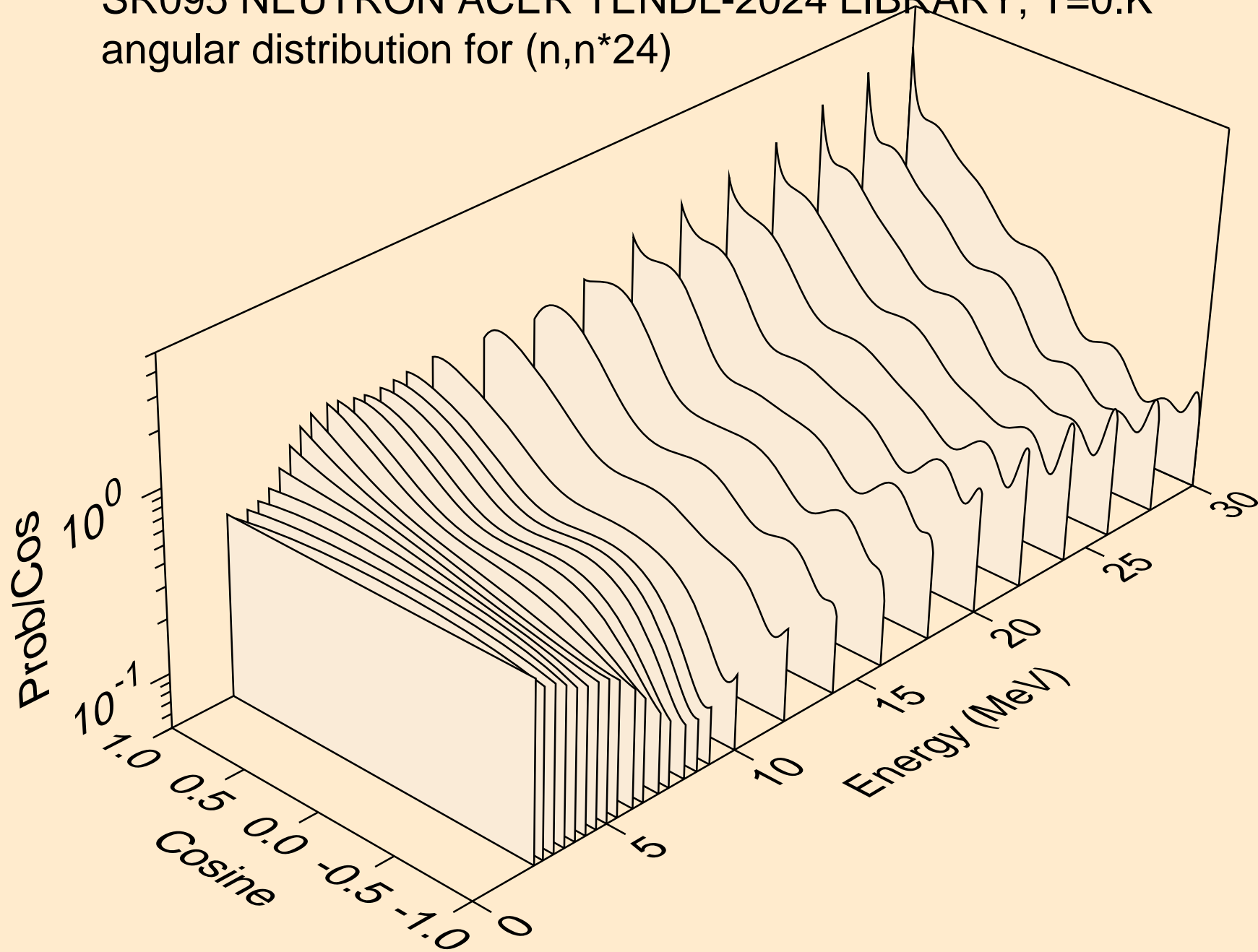

SR095 NEUTRON ACER TENDL-2024 LIBRARY; T=0.K
angular distribution for (n,n*25)

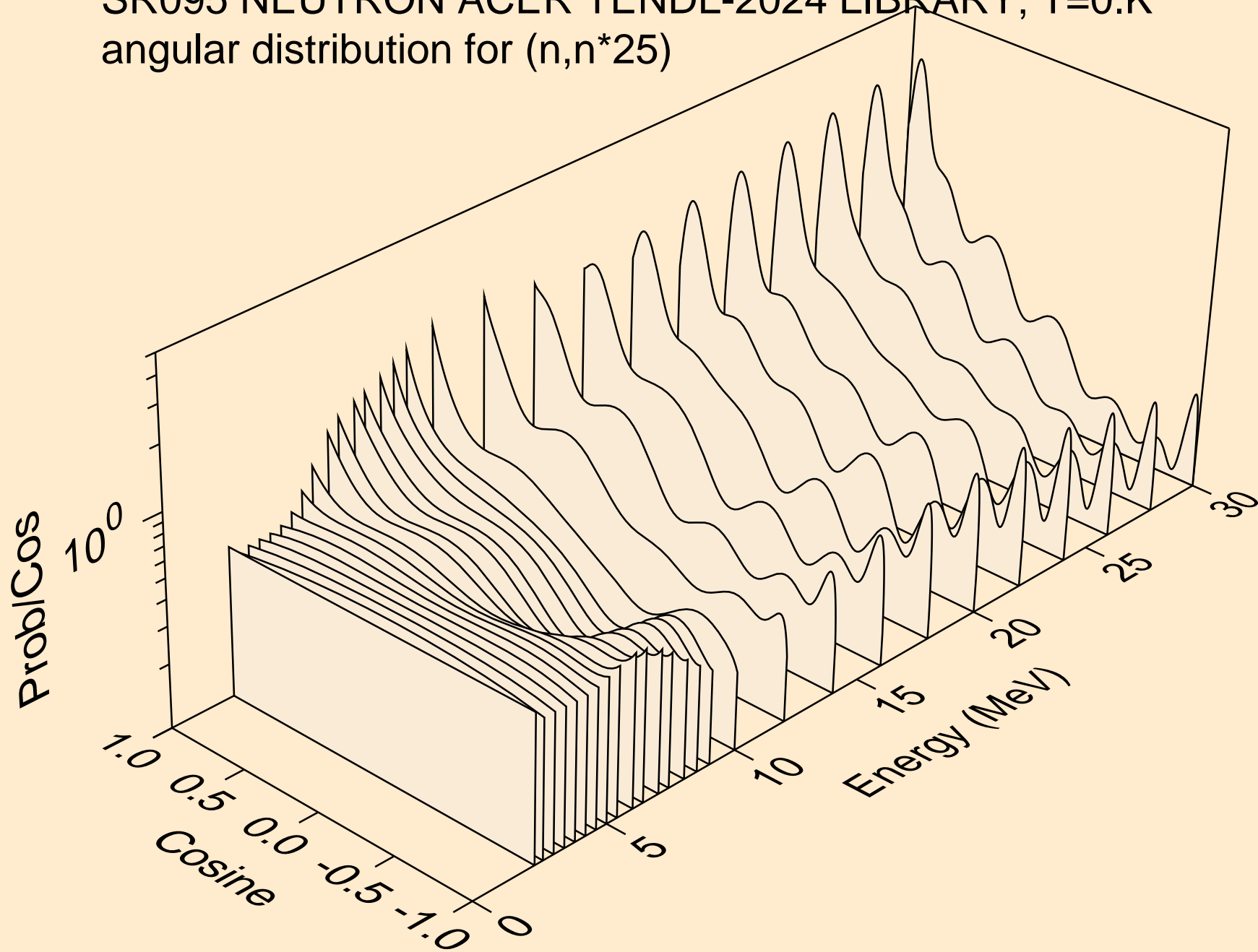

SR095 NEUTRON ACER TENDL-2024 LIBRARY; T=0.K
angular distribution for (n,n*26)

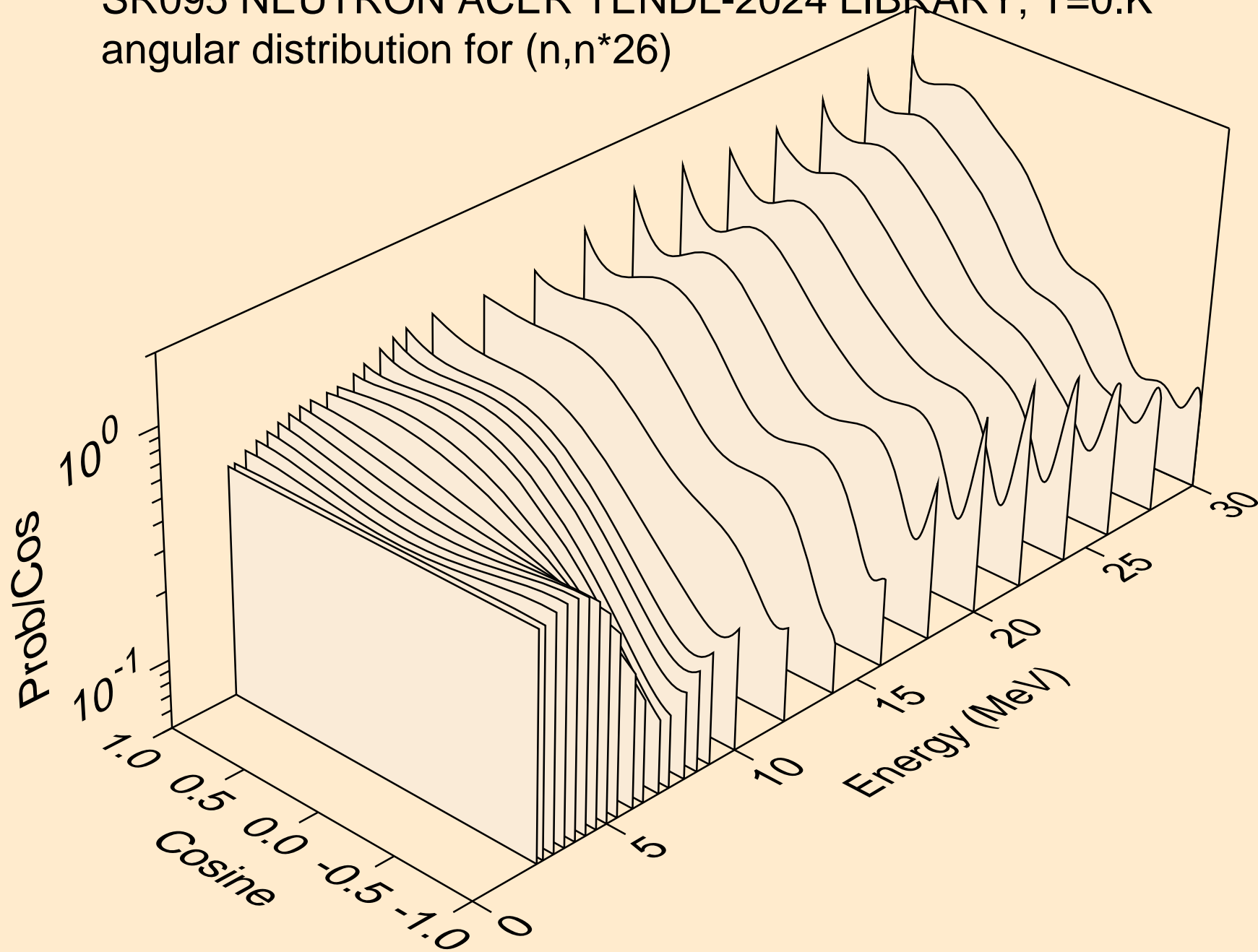

SR095 NEUTRON ACER TENDL-2024 LIBRARY; T=0.K
angular distribution for (n,n*27)

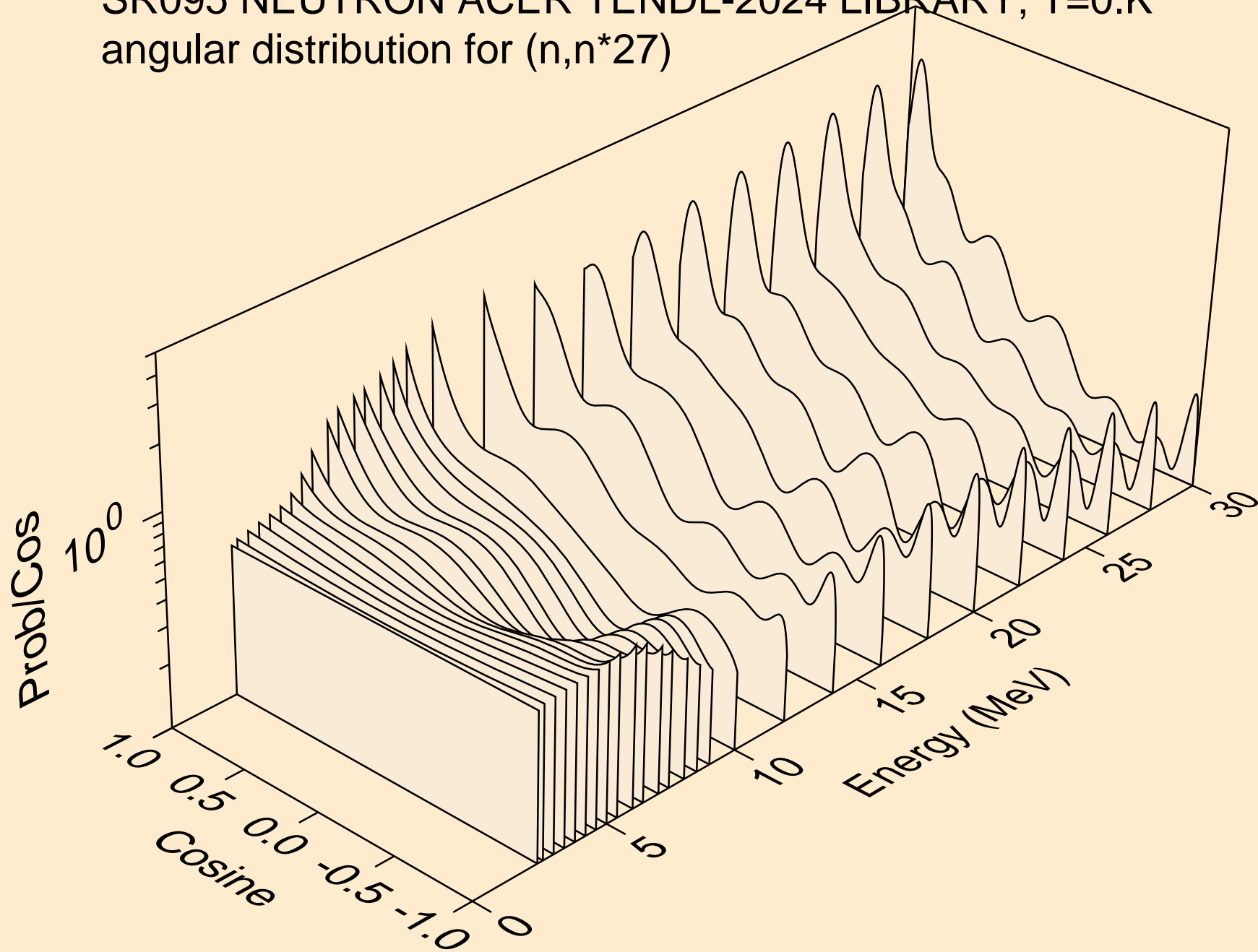

SR095 NEUTRON ACER TENDL-2024 LIBRARY; T=0.K
angular distribution for (n,n*28)

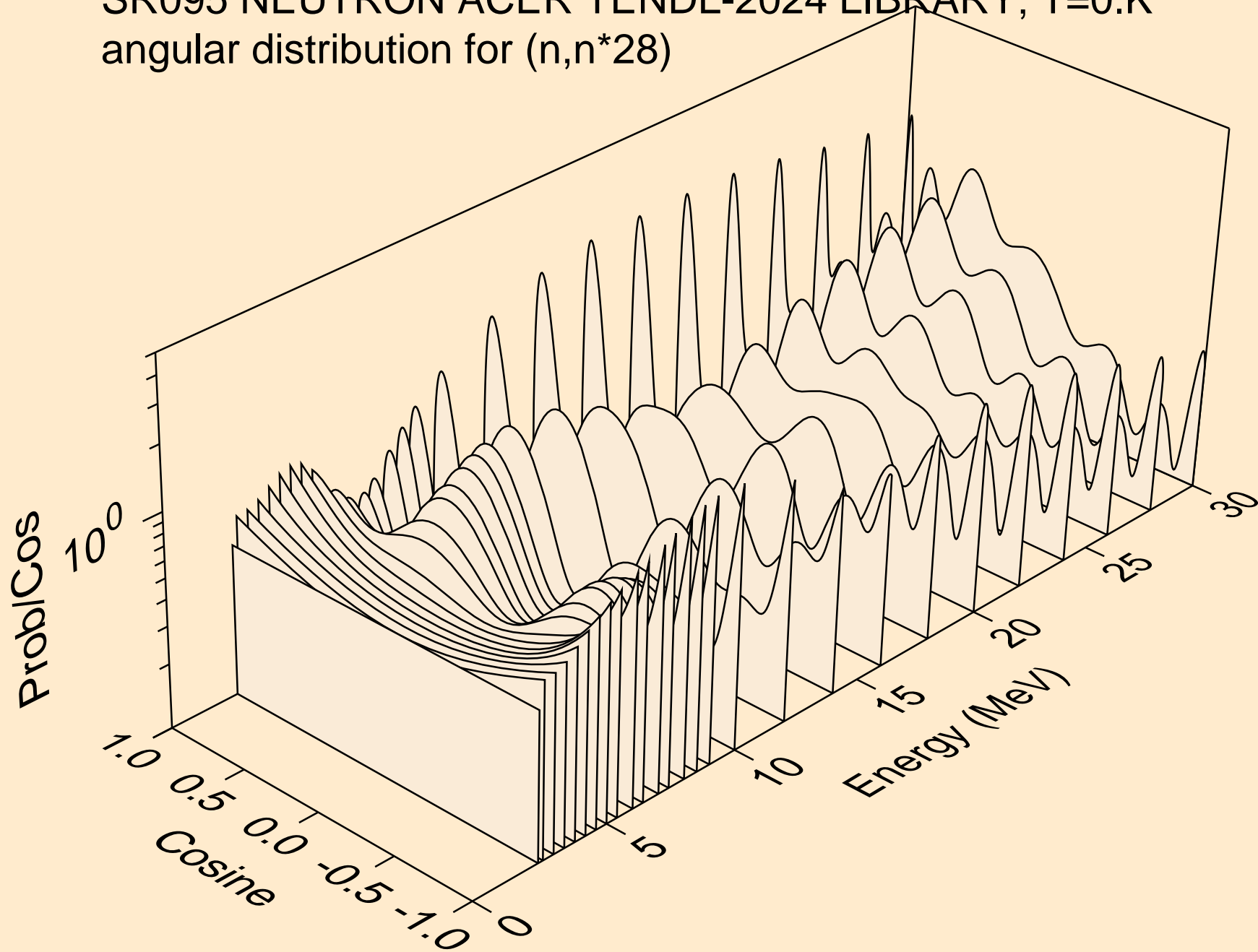

SR095 NEUTRON ACER TENDL-2024 LIBRARY; T=0.K
angular distribution for (n,n*29)

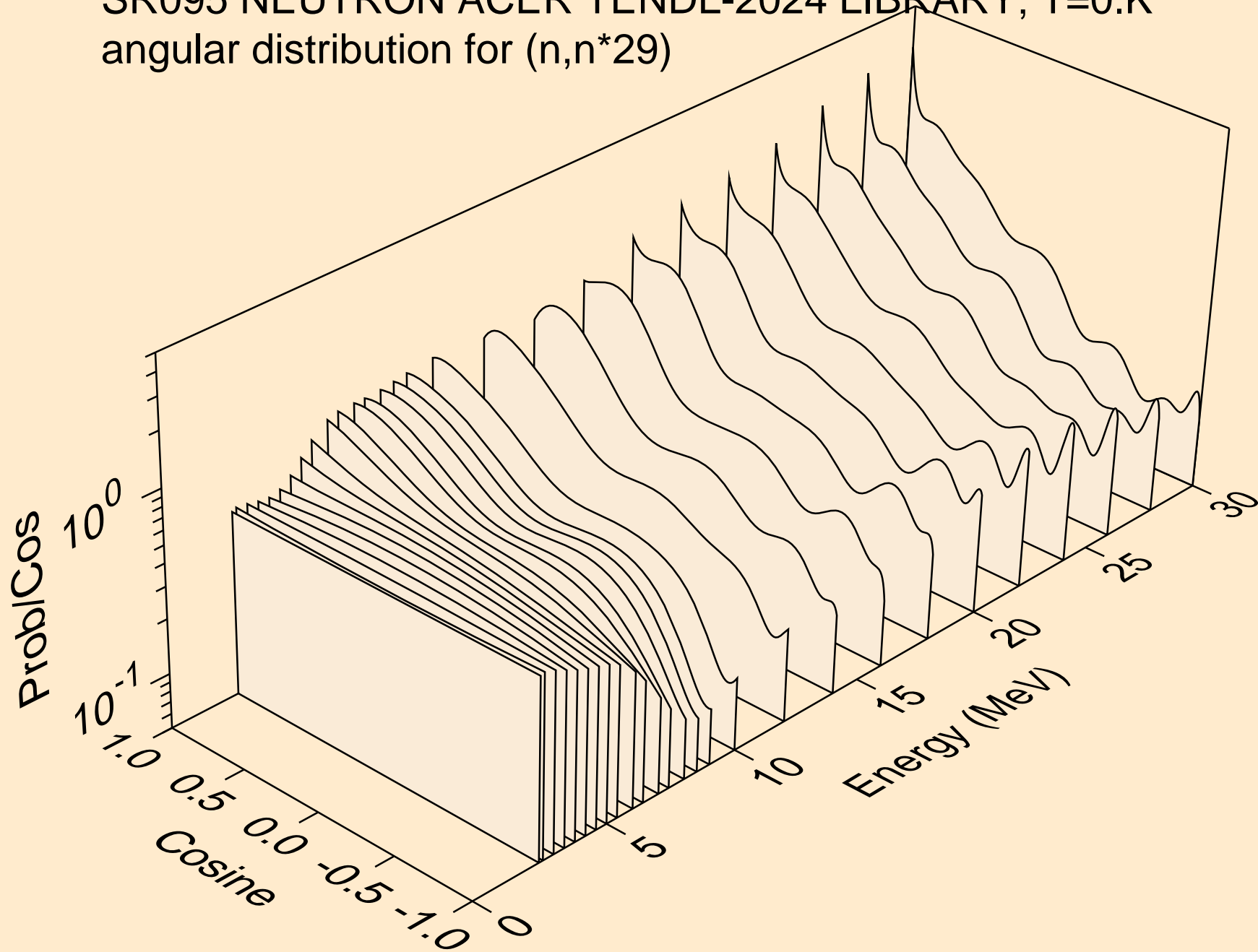

SR095 NEUTRON ACER TENDL-2024 LIBRARY; T=0.K
angular distribution for (n,n*30)

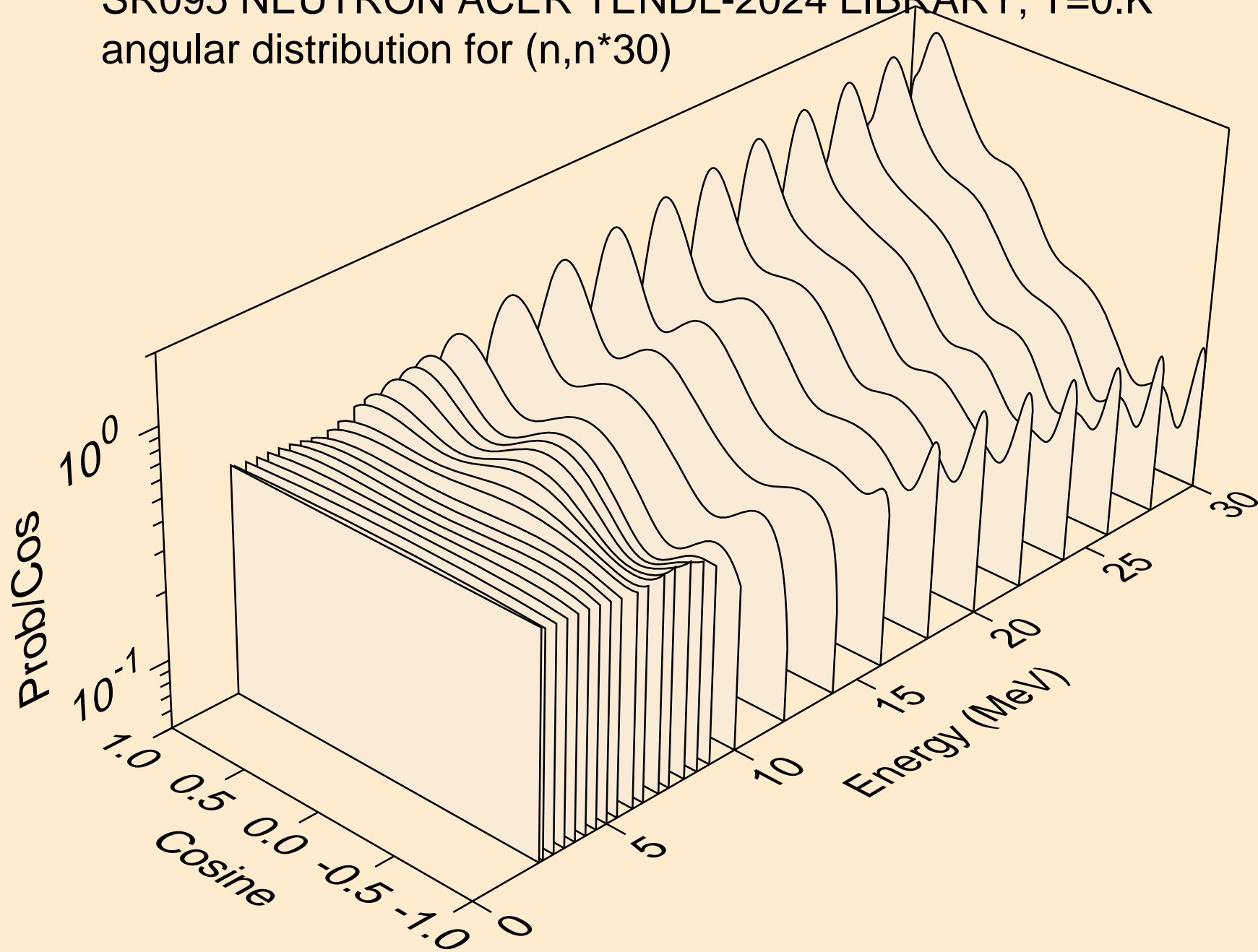

SR095 NEUTRON ACER TENDL-2024 LIBRARY; T=0.K
Neutron emission for (n,x)

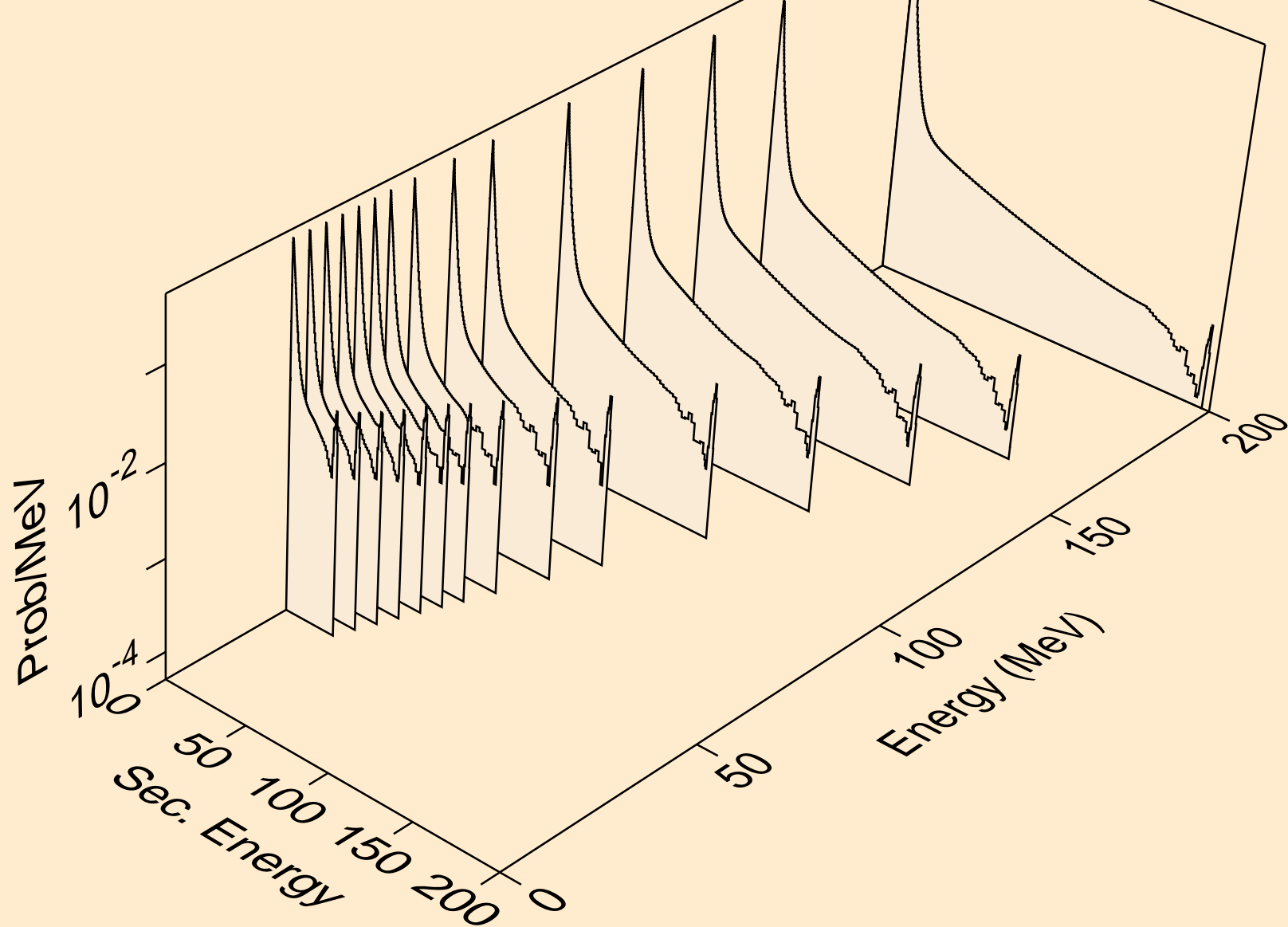

SR095 NEUTRON ACER TENDL-2024 LIBRARY; T=0.K
Neutron emission for (n,2nd)

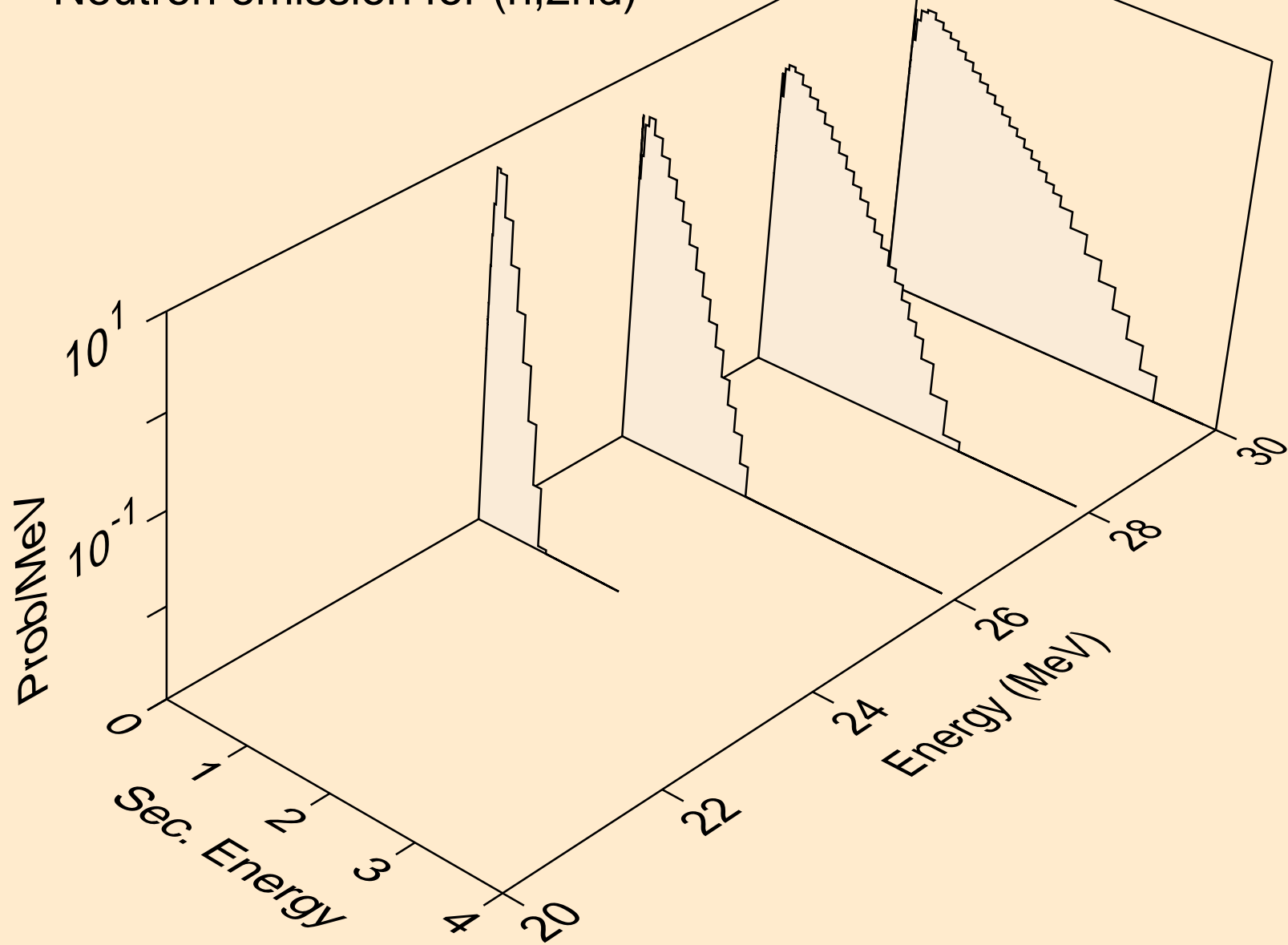

SR095 NEUTRON ACER TENDL-2024 LIBRARY; T=0.K
Neutron emission for (n,2n)

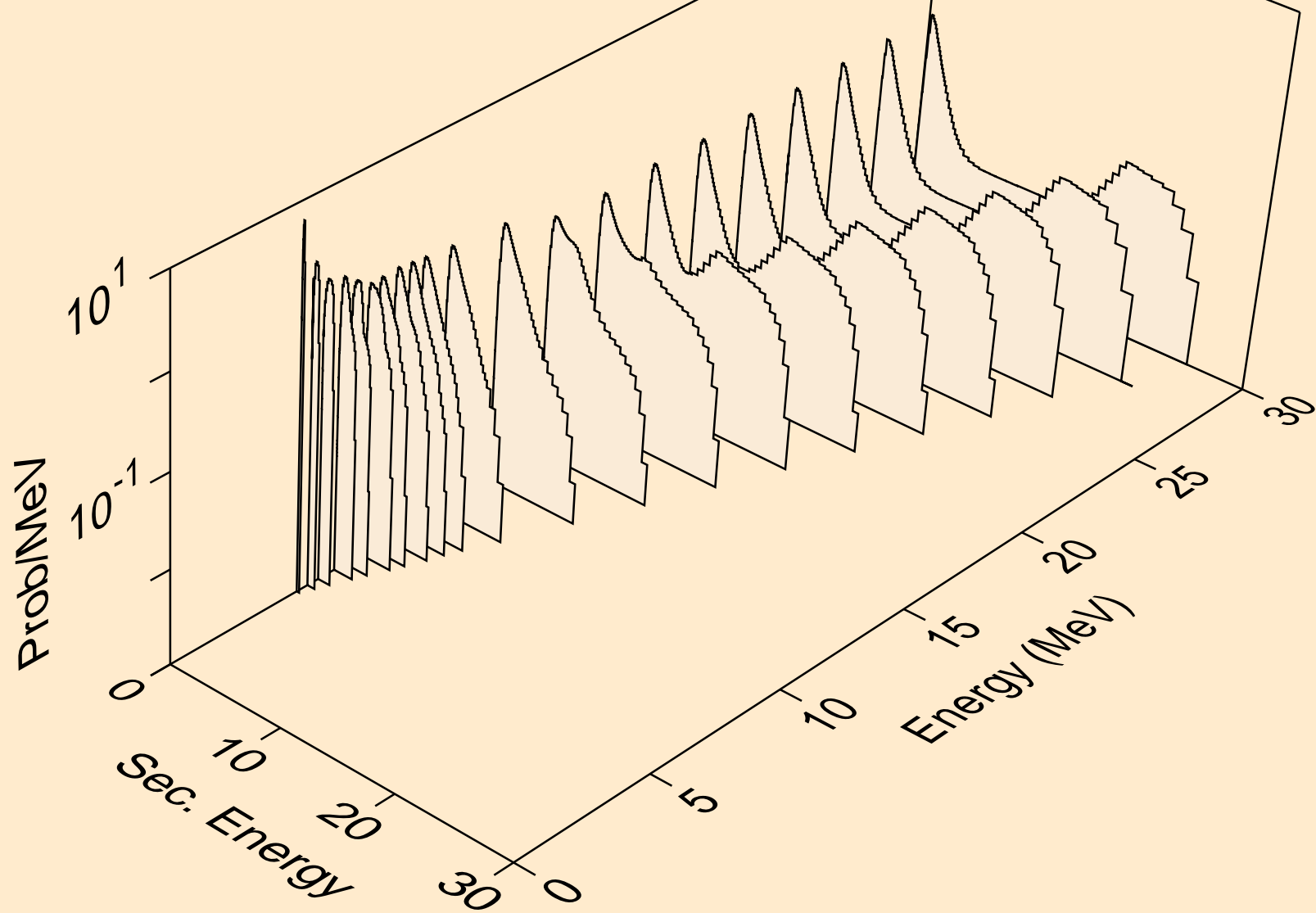

SR095 NEUTRON ACER TENDL-2024 LIBRARY; T=0.K
Neutron emission for (n,3n)

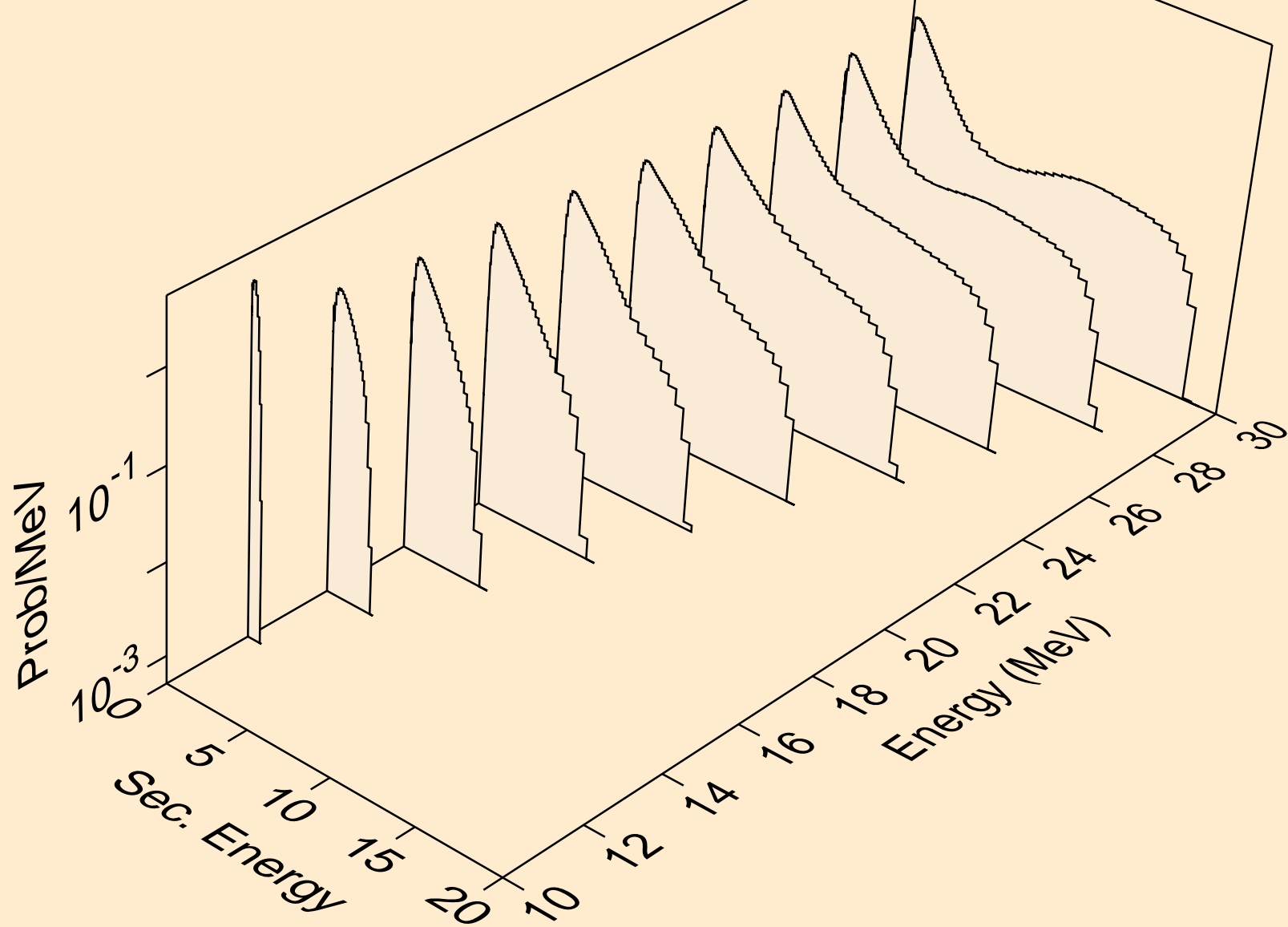

SR095 NEUTRON ACER TENDL-2024 LIBRARY; T=0.K
Neutron emission for (n,n*)a

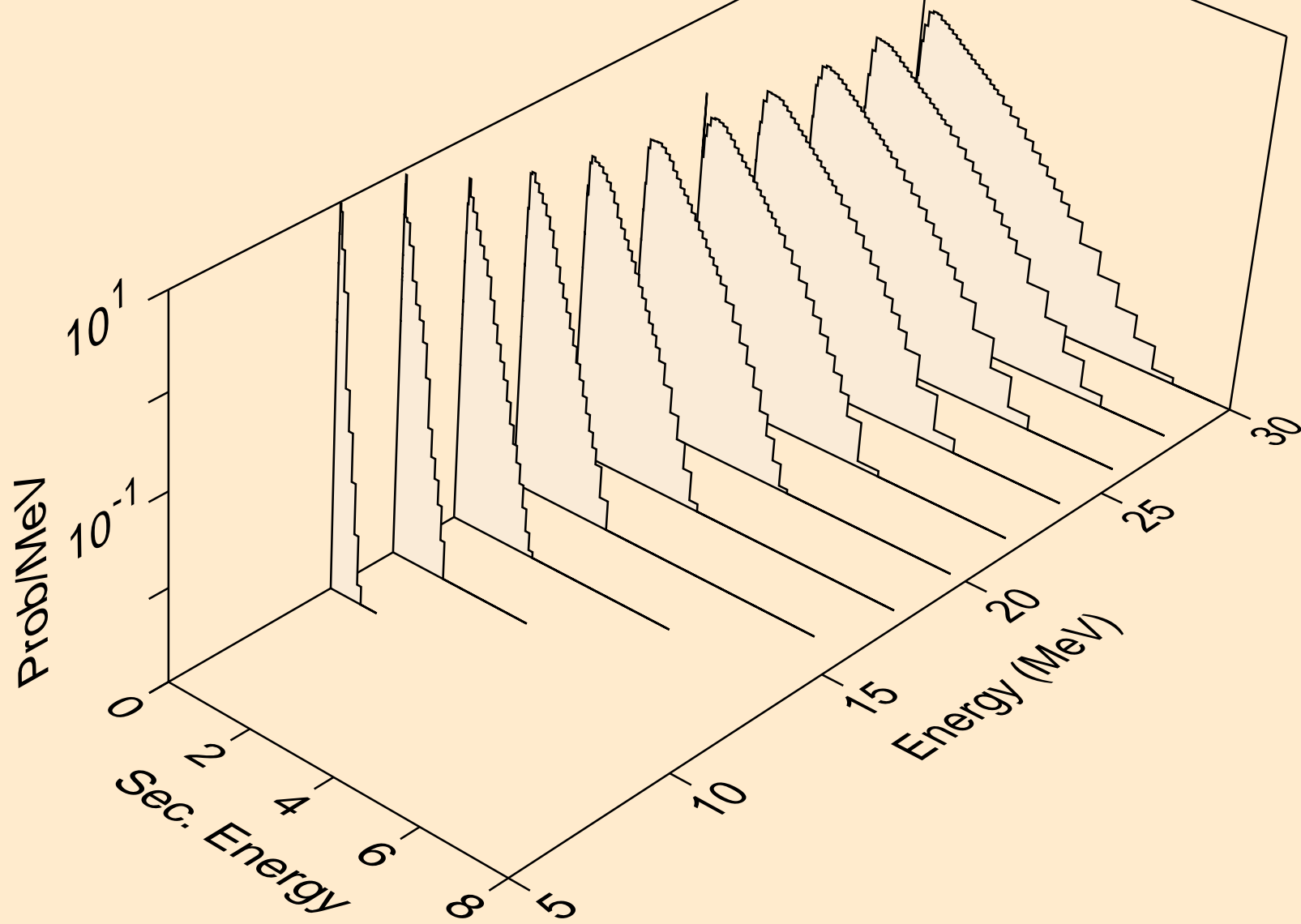

SR095 NEUTRON ACER TENDL-2024 LIBRARY; T=0.K
Neutron emission for (n,2n)a

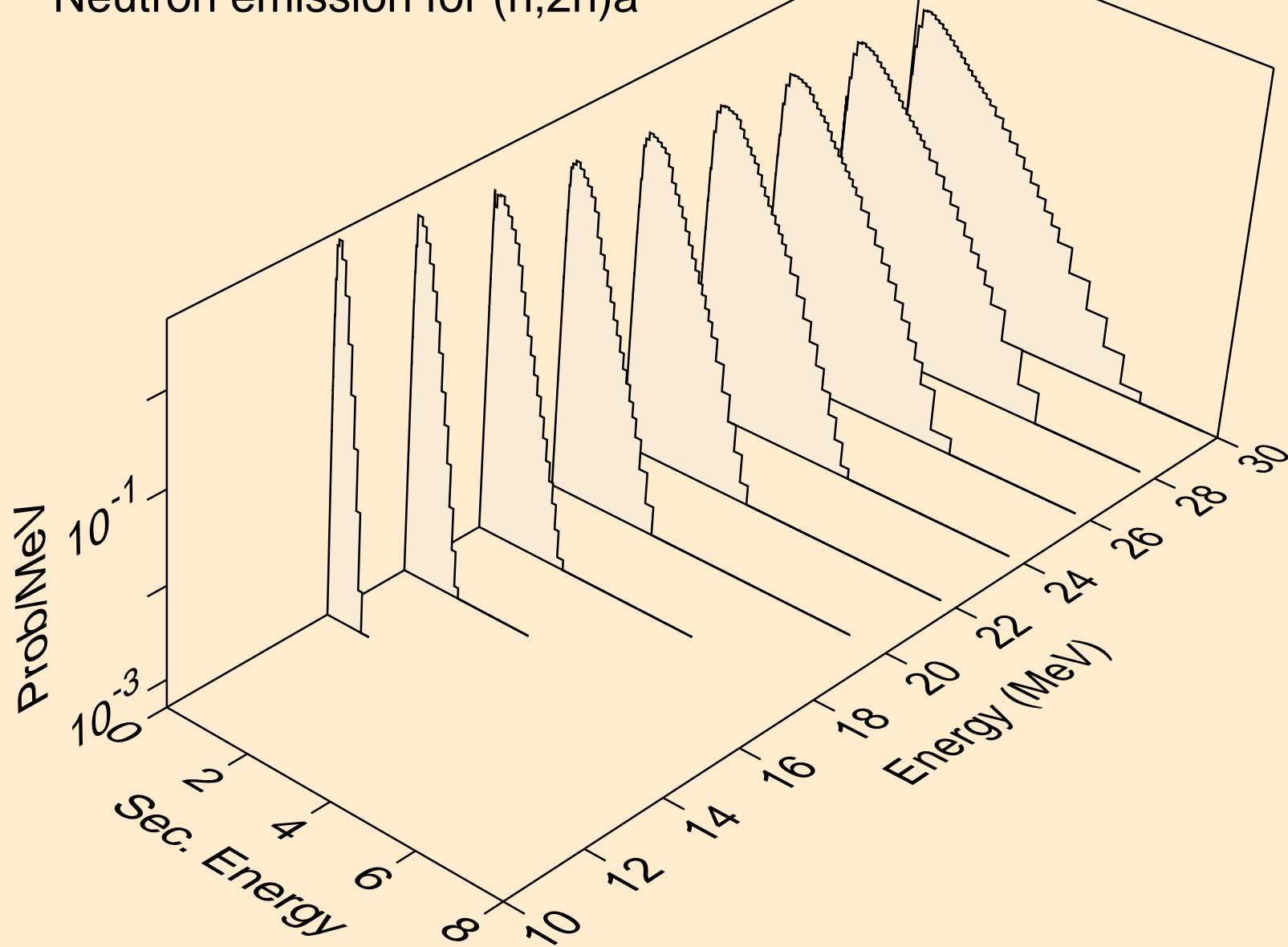

SR095 NEUTRON ACER TENDL-2024 LIBRARY; T=0.K
Neutron emission for (n,3n)a

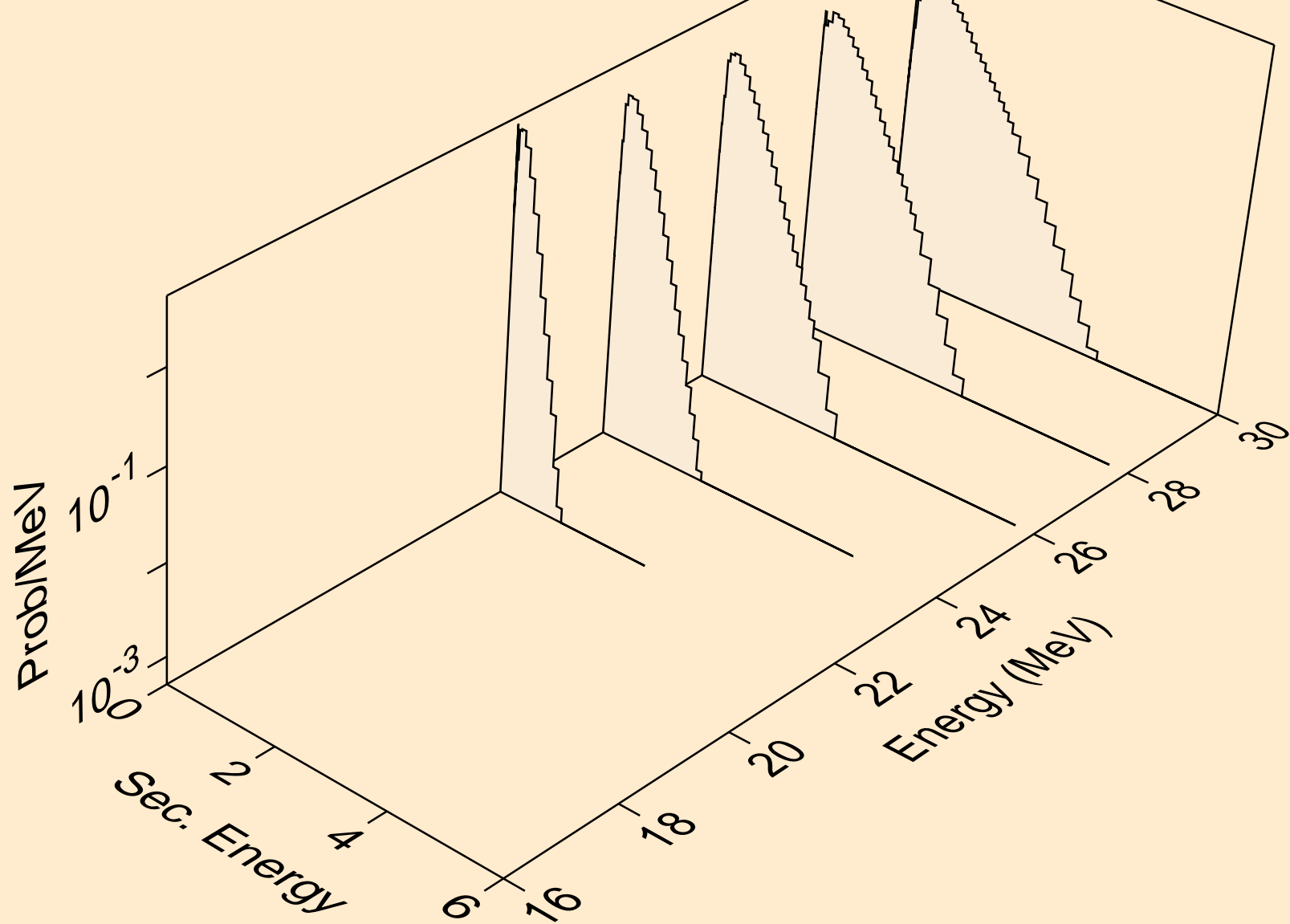

SR095 NEUTRON ACER TENDL-2024 LIBRARY; T=0.K
Neutron emission for (n,n*)p

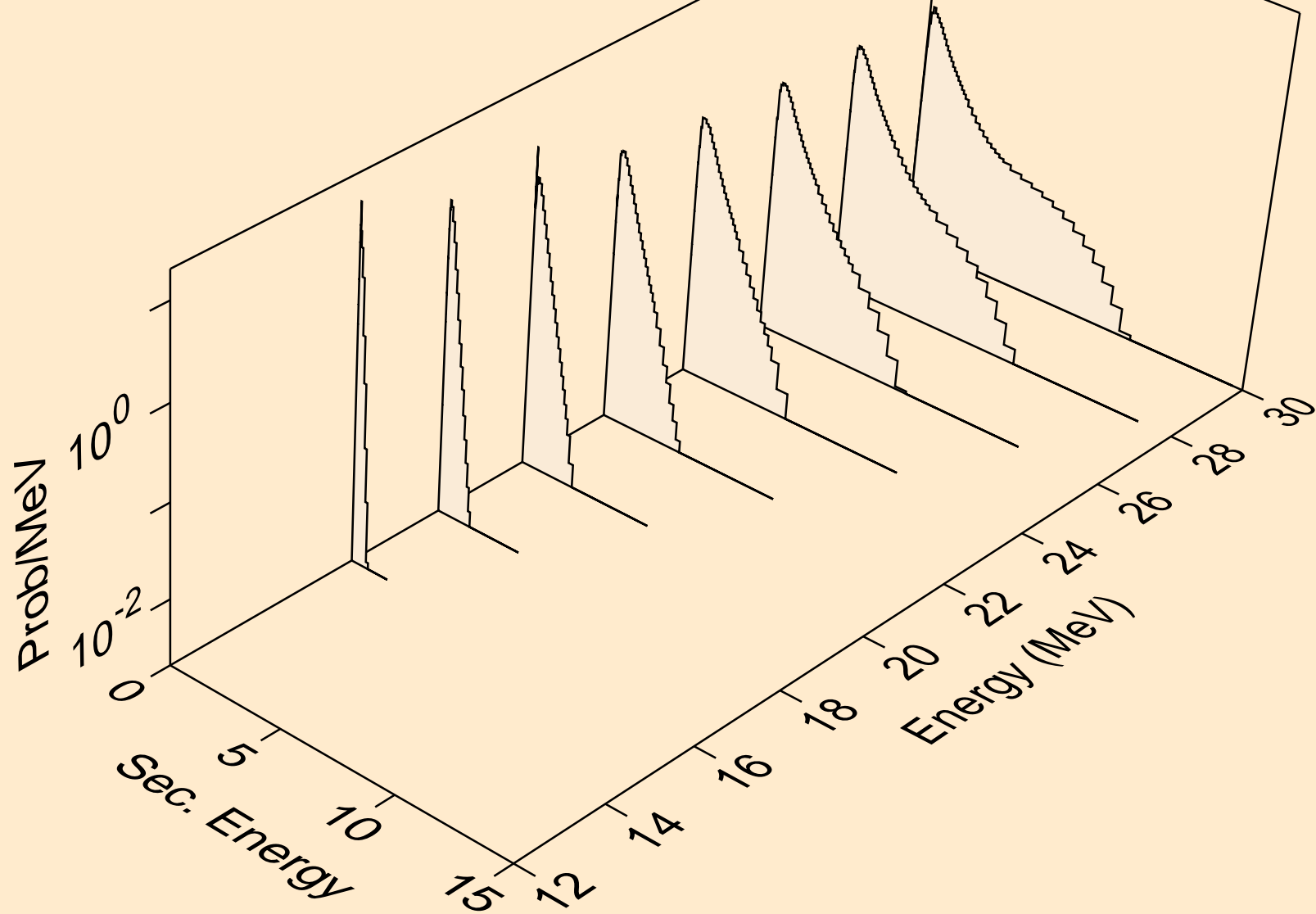

SR095 NEUTRON ACER TENDL-2024 LIBRARY; T=0.K
Neutron emission for (n,n*)d

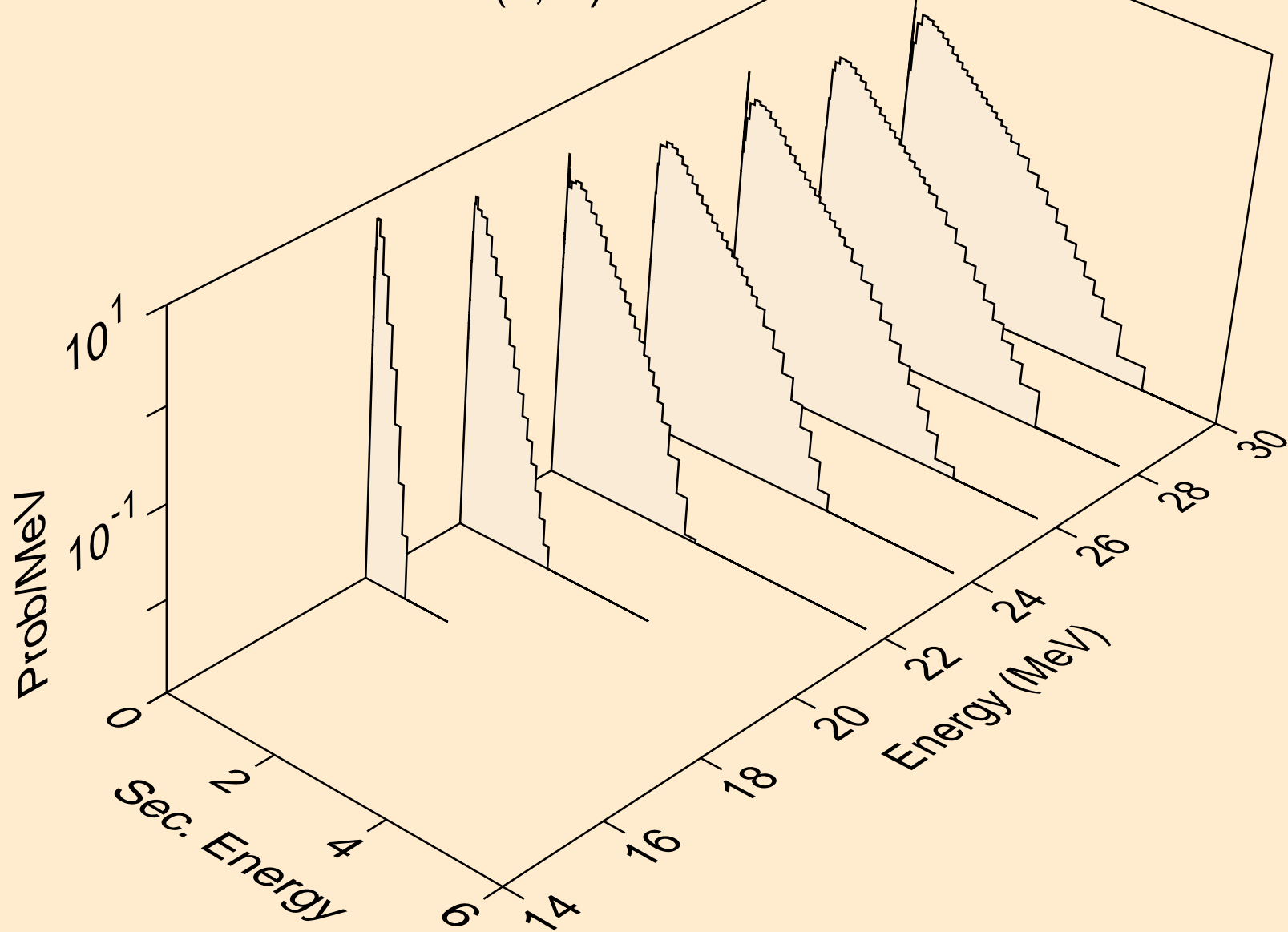

SR095 NEUTRON ACER TENDL-2024 LIBRARY; T=0.K
Neutron emission for (n,n*)t

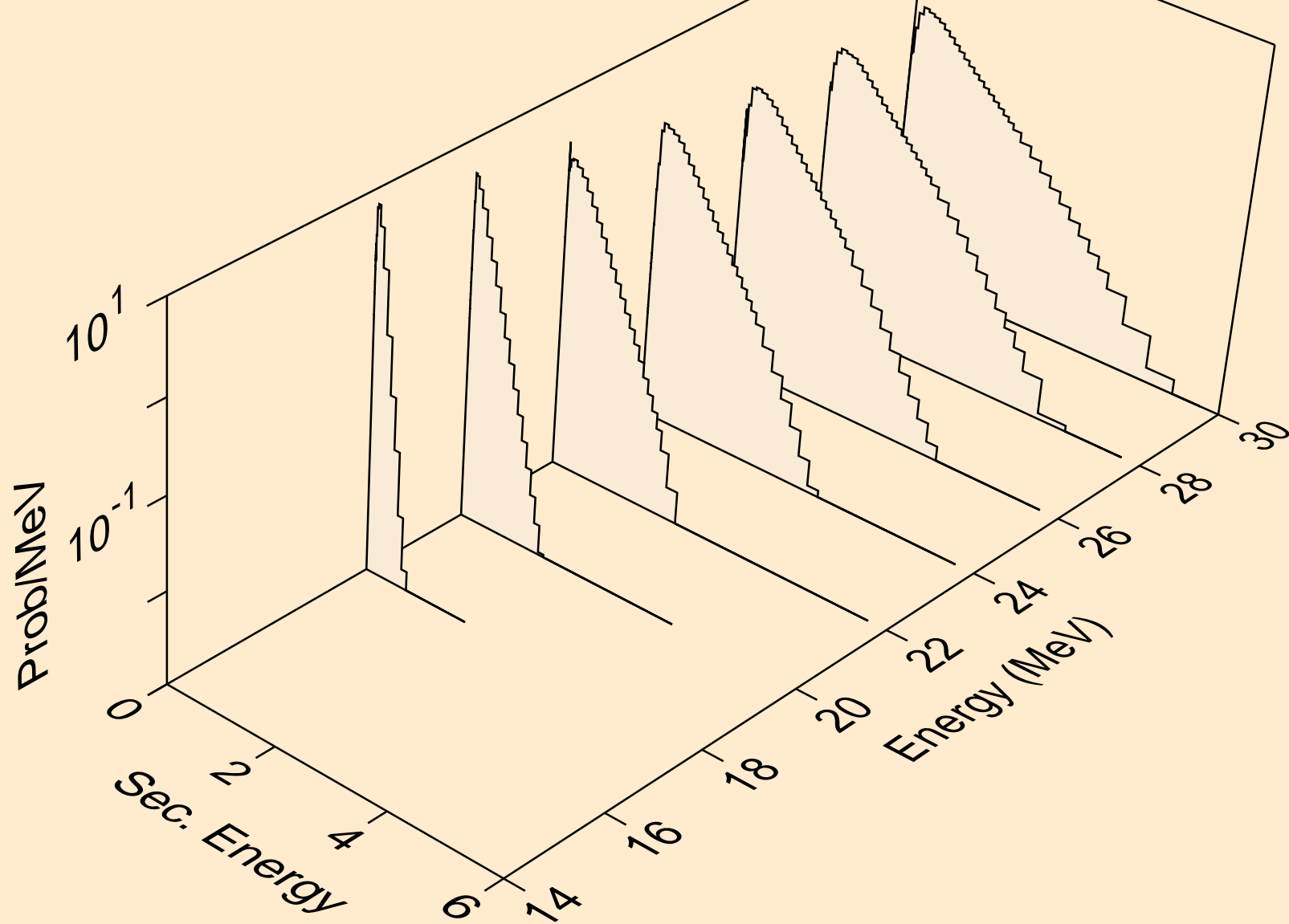

SR095 NEUTRON ACER TENDL-2024 LIBRARY; T=0.K
Neutron emission for (n,n*)he3

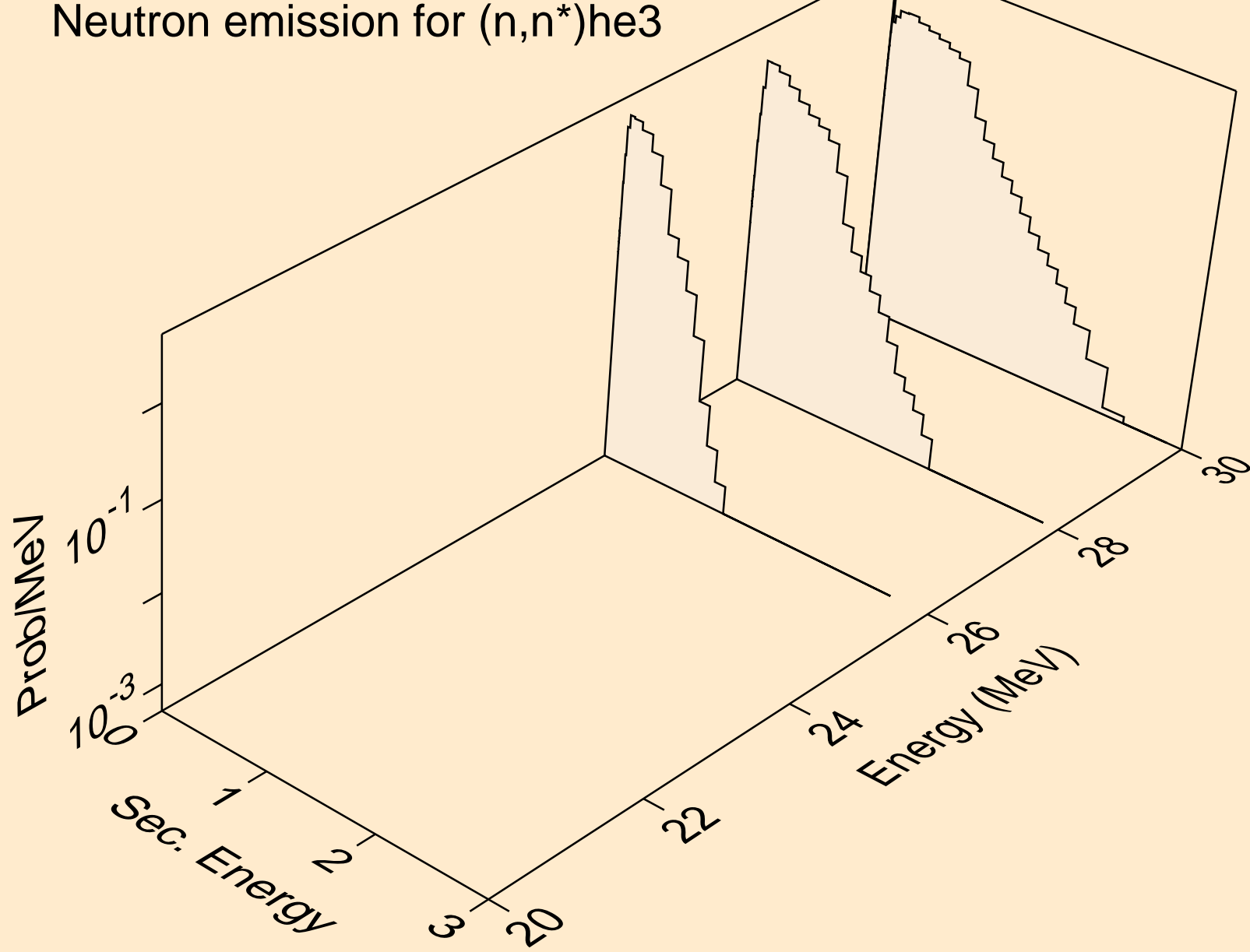

SR095 NEUTRON ACER TENDL-2024 LIBRARY; T=0.K
Neutron emission for (n,4n)

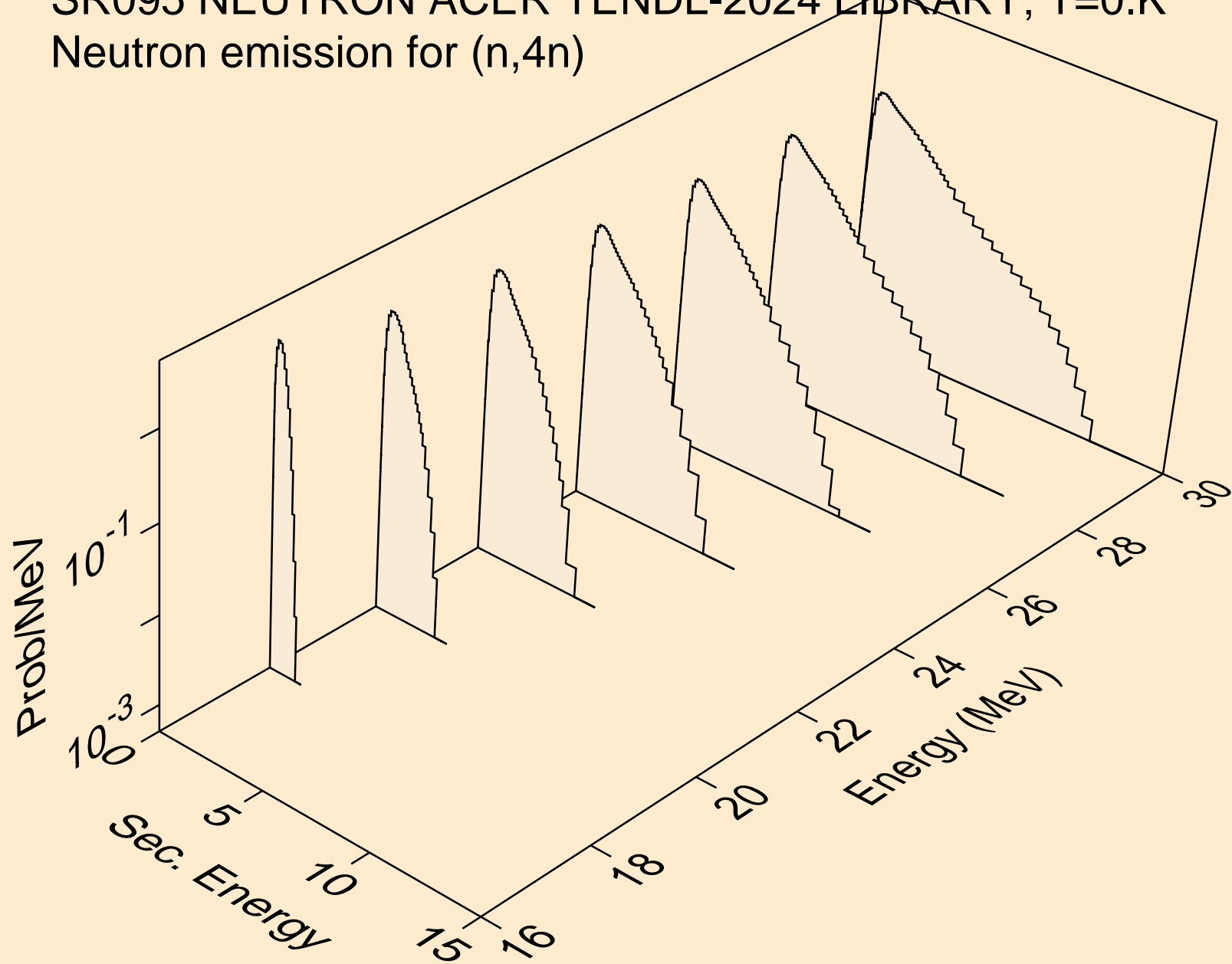

SR095 NEUTRON ACER TENDL-2024 LIBRARY; T=0.K
Neutron emission for (n,2np)

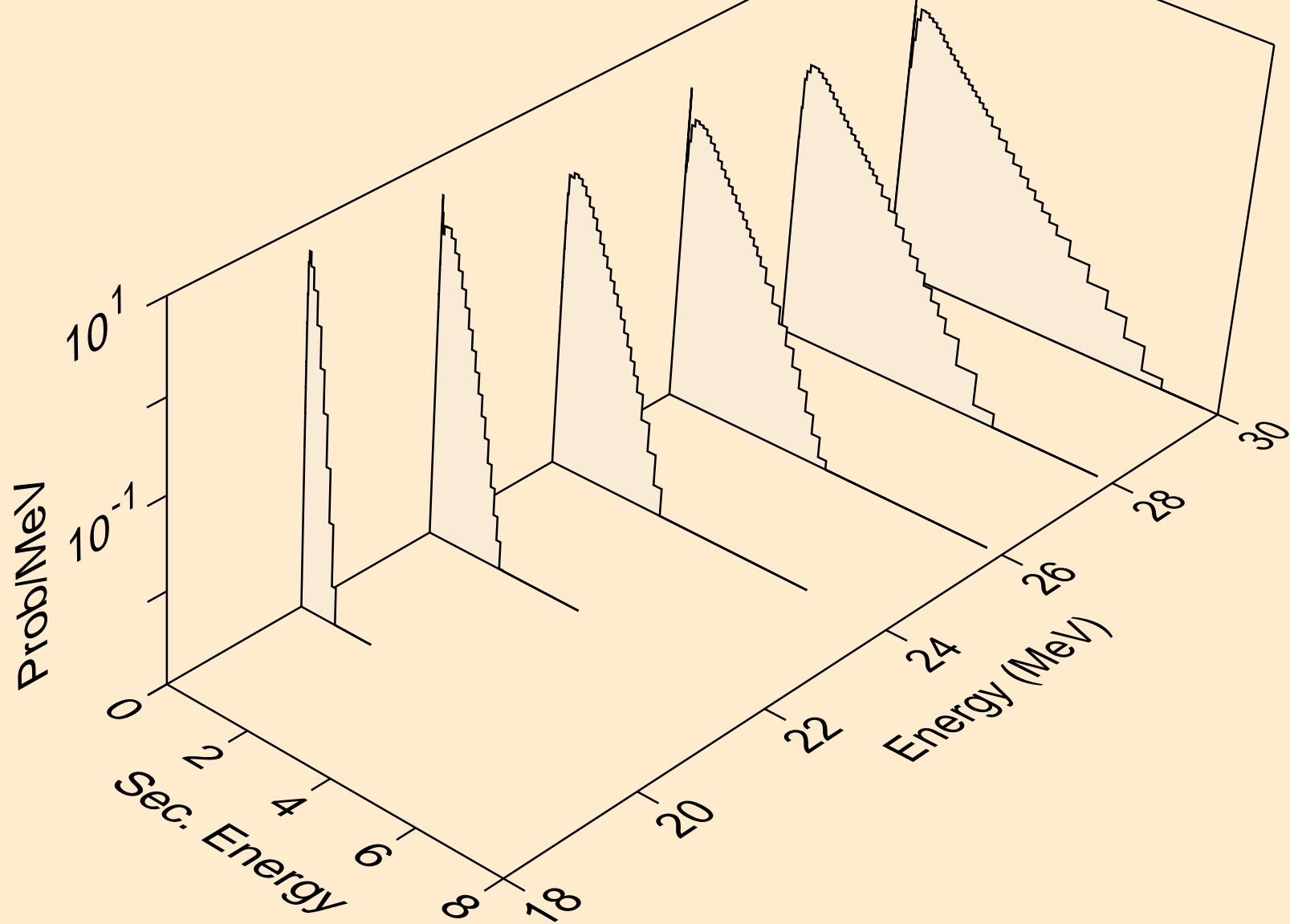

SR095 NEUTRON ACER TENDL-2024 LIBRARY; T=0.K
Neutron emission for (n,3np)

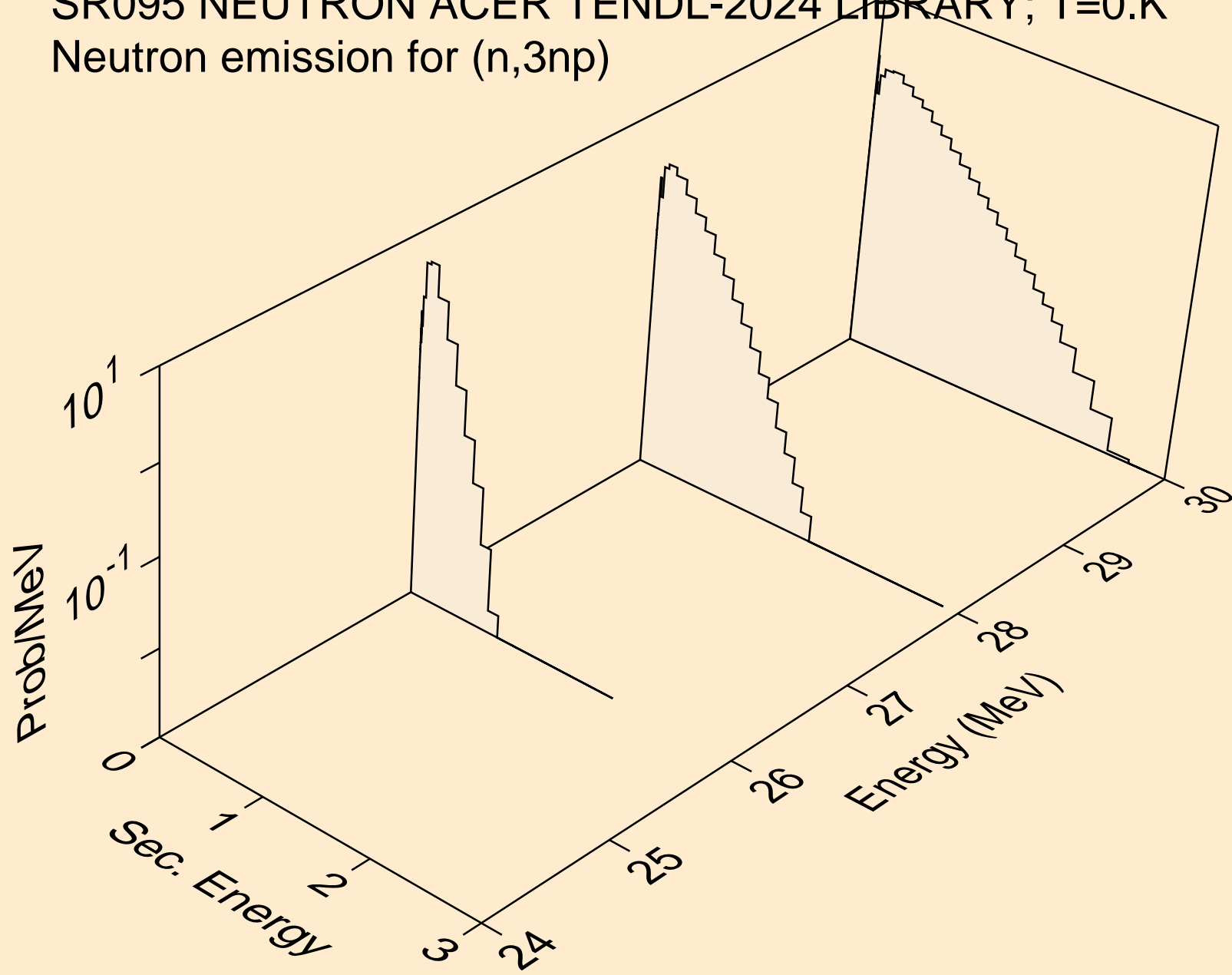

SR095 NEUTRON ACER TENDL-2024 LIBRARY; T=0.K
Neutron emission for (n,n*c)

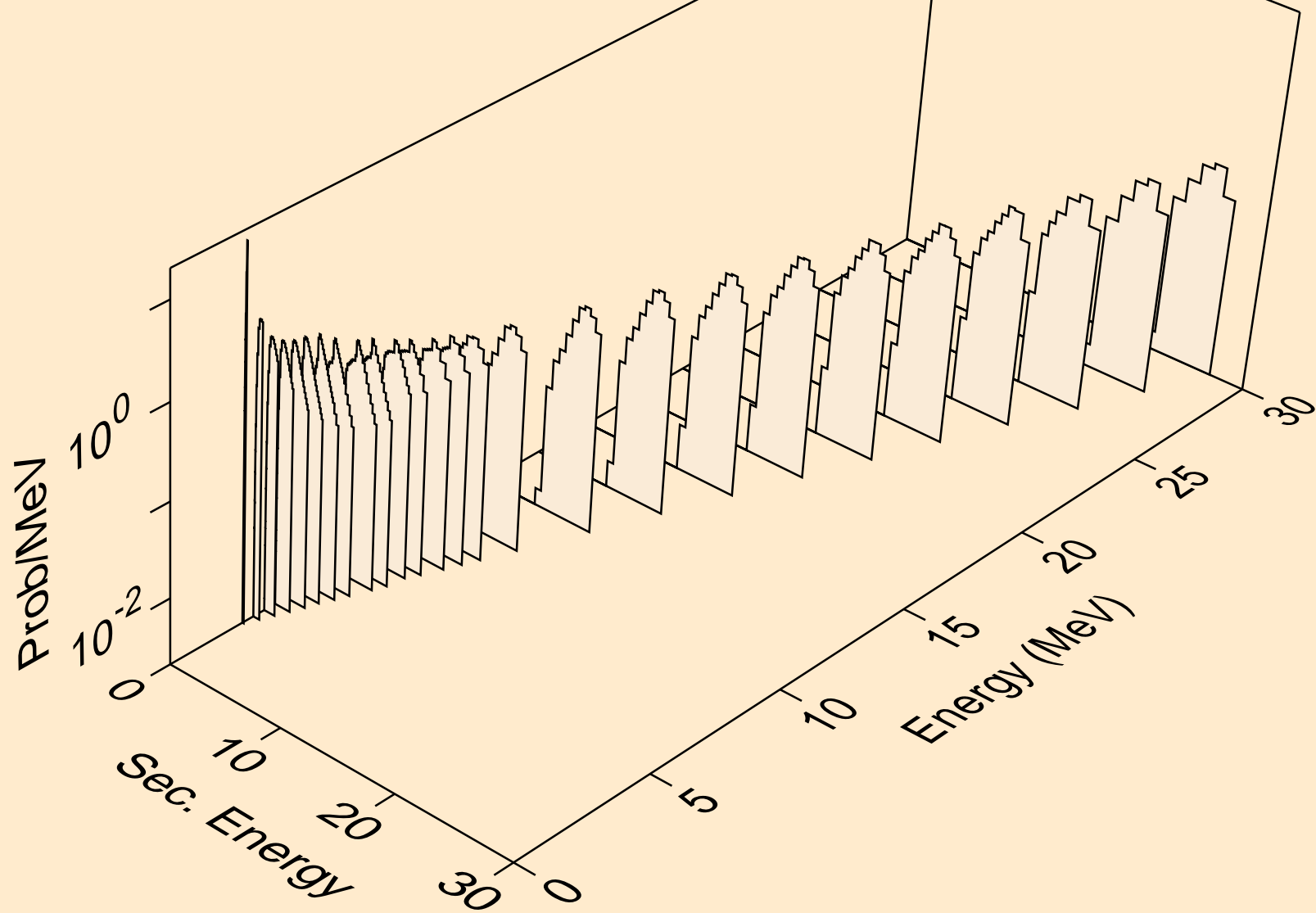

SR095 NEUTRON ACER TENDL-2024 LIBRARY; T=0.K
Photon emission for (n,x)

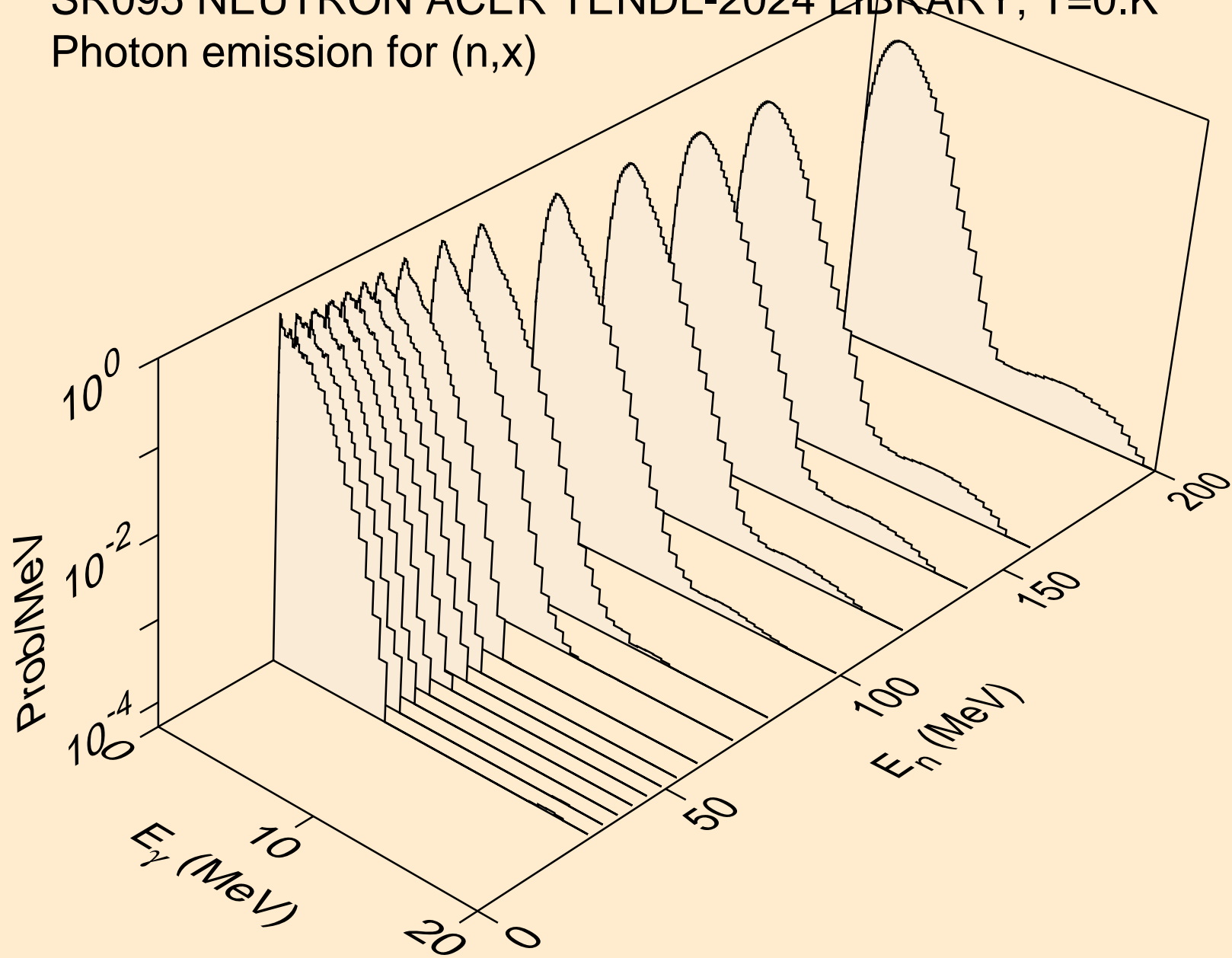

SR095 NEUTRON ACER TENDL-2024 LIBRARY; T=0.K
Photon emission for (n,2nd)

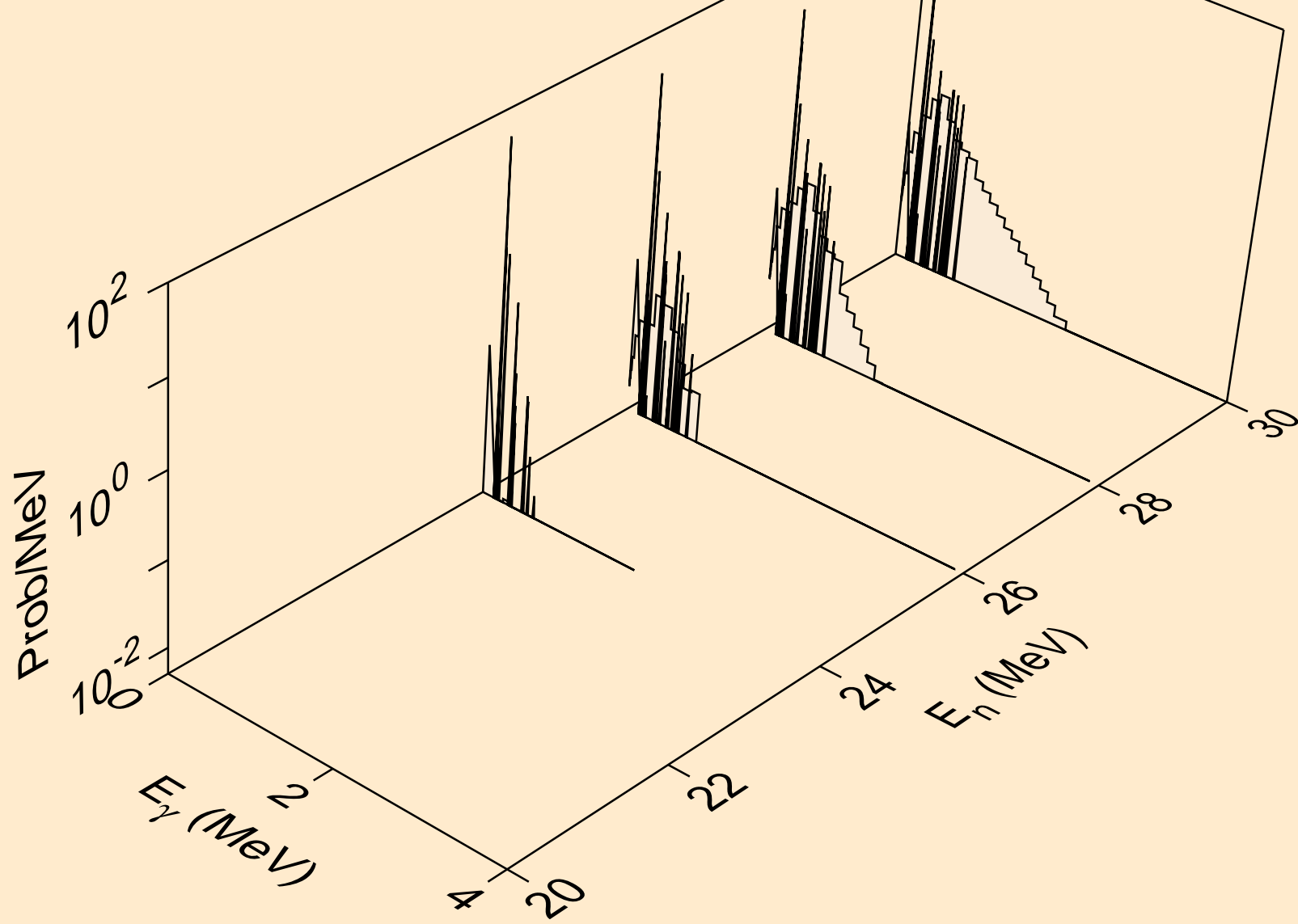

SR095 NEUTRON ACER TENDL-2024 LIBRARY; T=0.K
Photon emission for (n,2n)

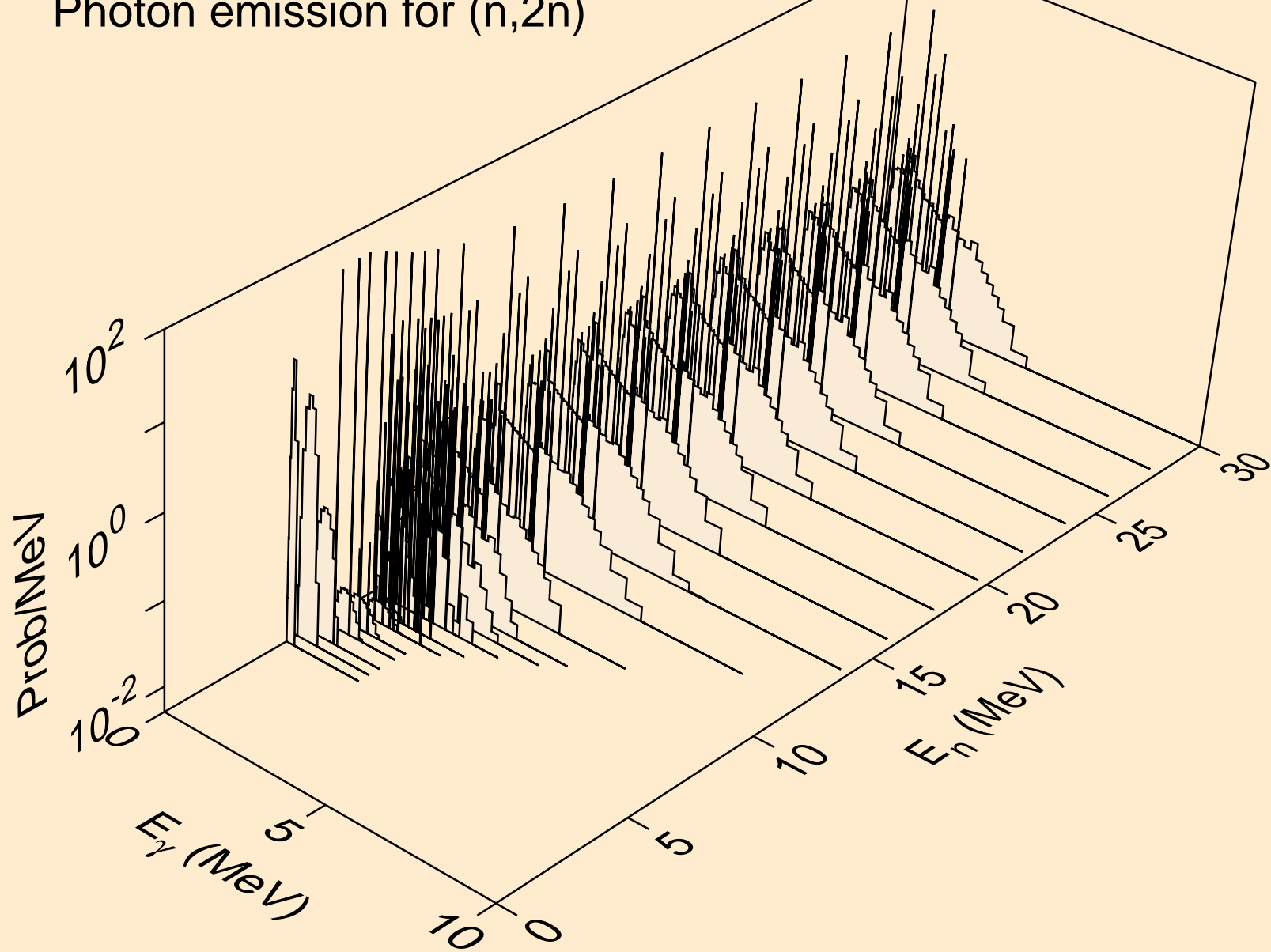

SR095 NEUTRON ACER TENDL-2024 LIBRARY; T=0.K
Photon emission for (n,3n)

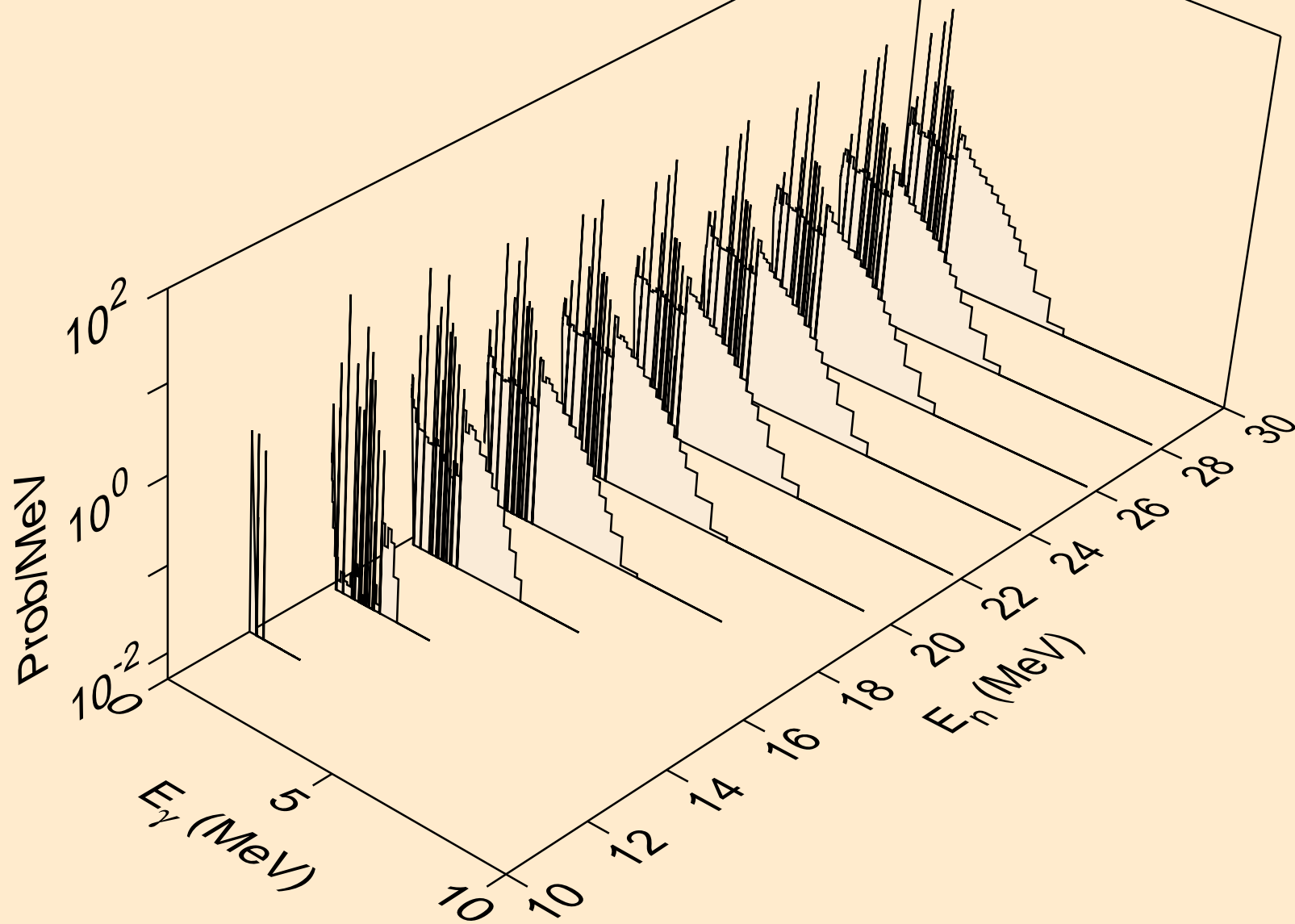

SR095 NEUTRON ACER TENDL-2024 LIBRARY; T=0.K
Photon emission for (n,n*)a

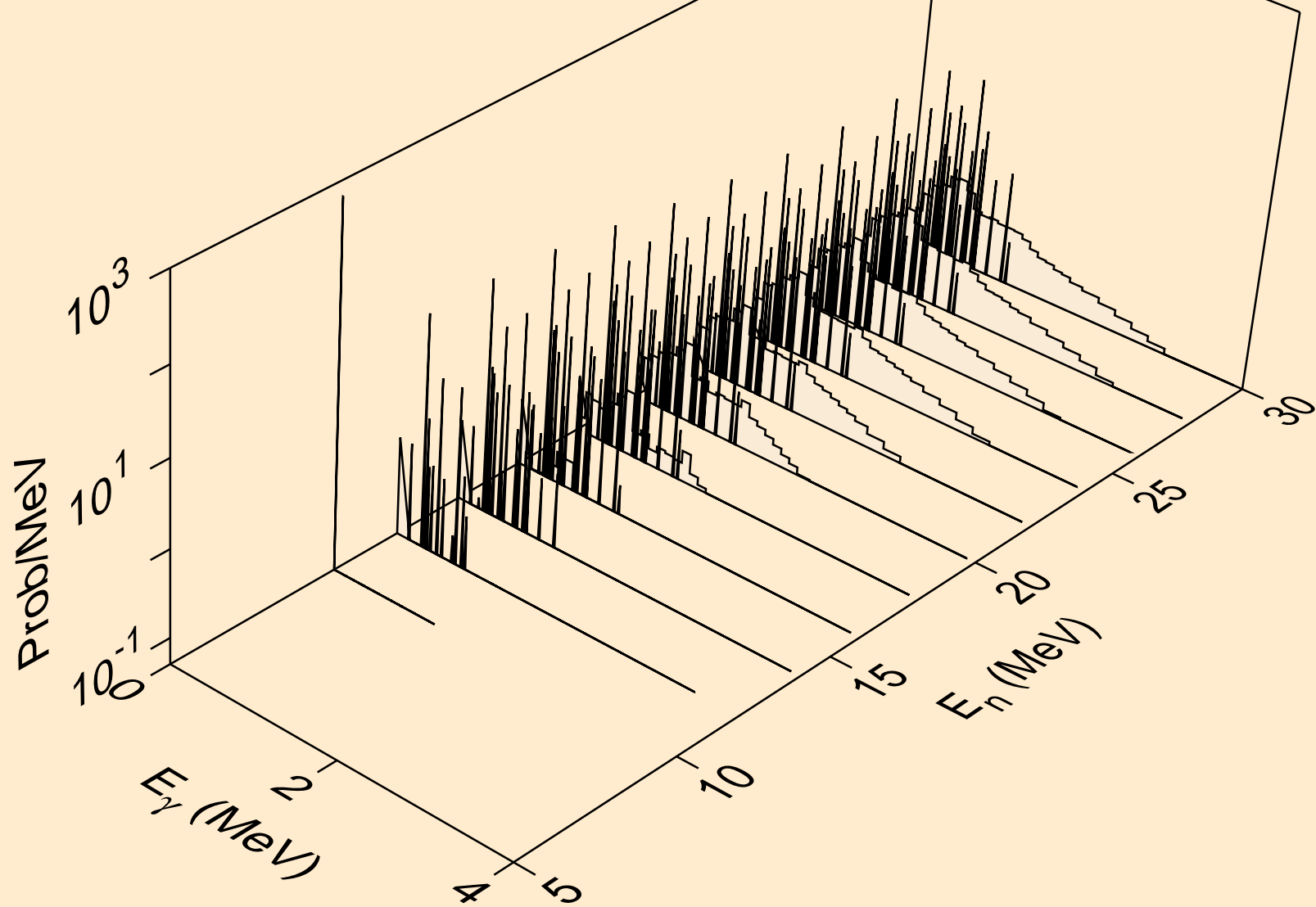

SR095 NEUTRON ACER TENDL-2024 LIBRARY; T=0.K
Photon emission for (n,2n)a

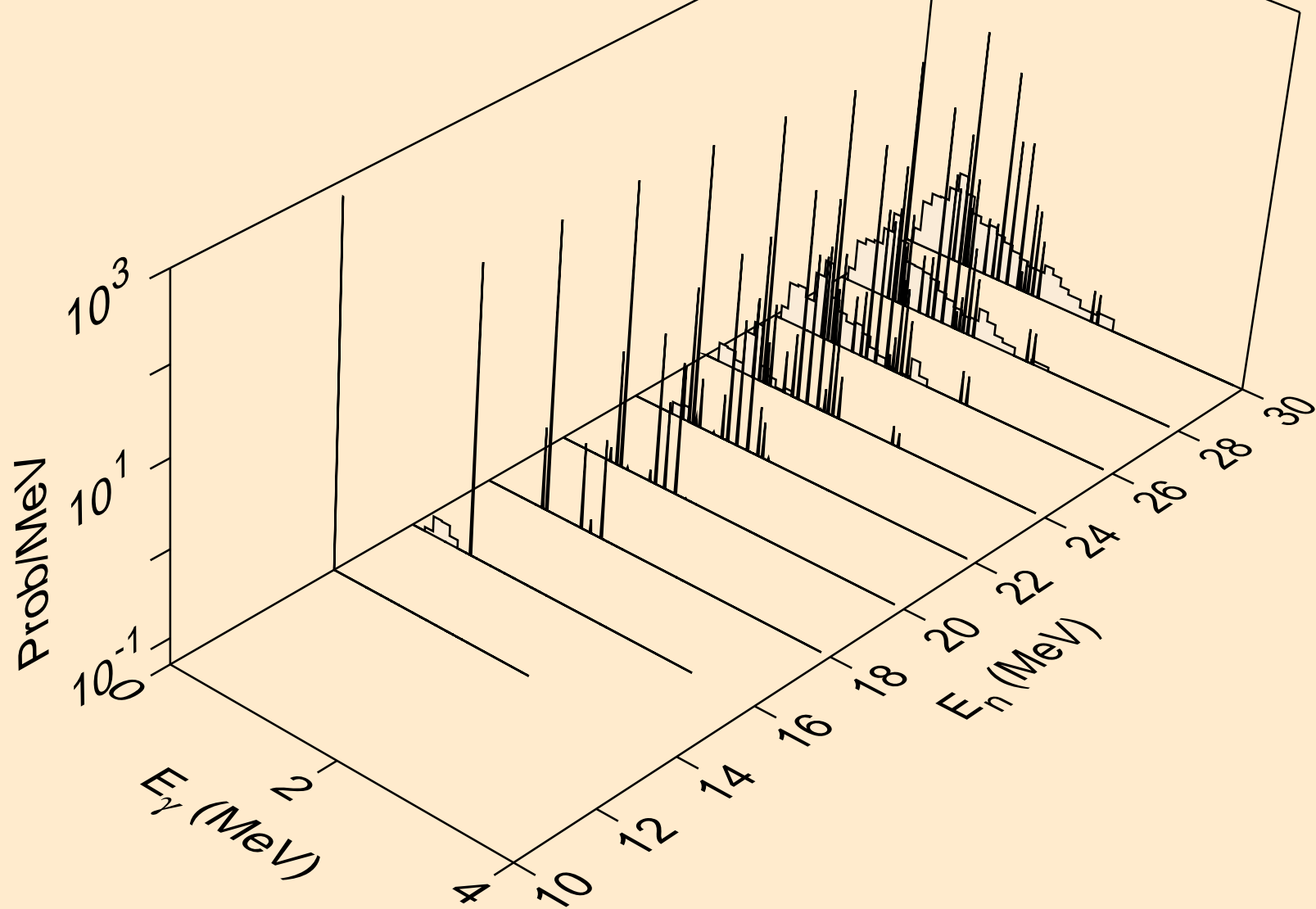

SR095 NEUTRON ACER TENDL-2024 LIBRARY; T=0.K
Photon emission for (n,3n)a

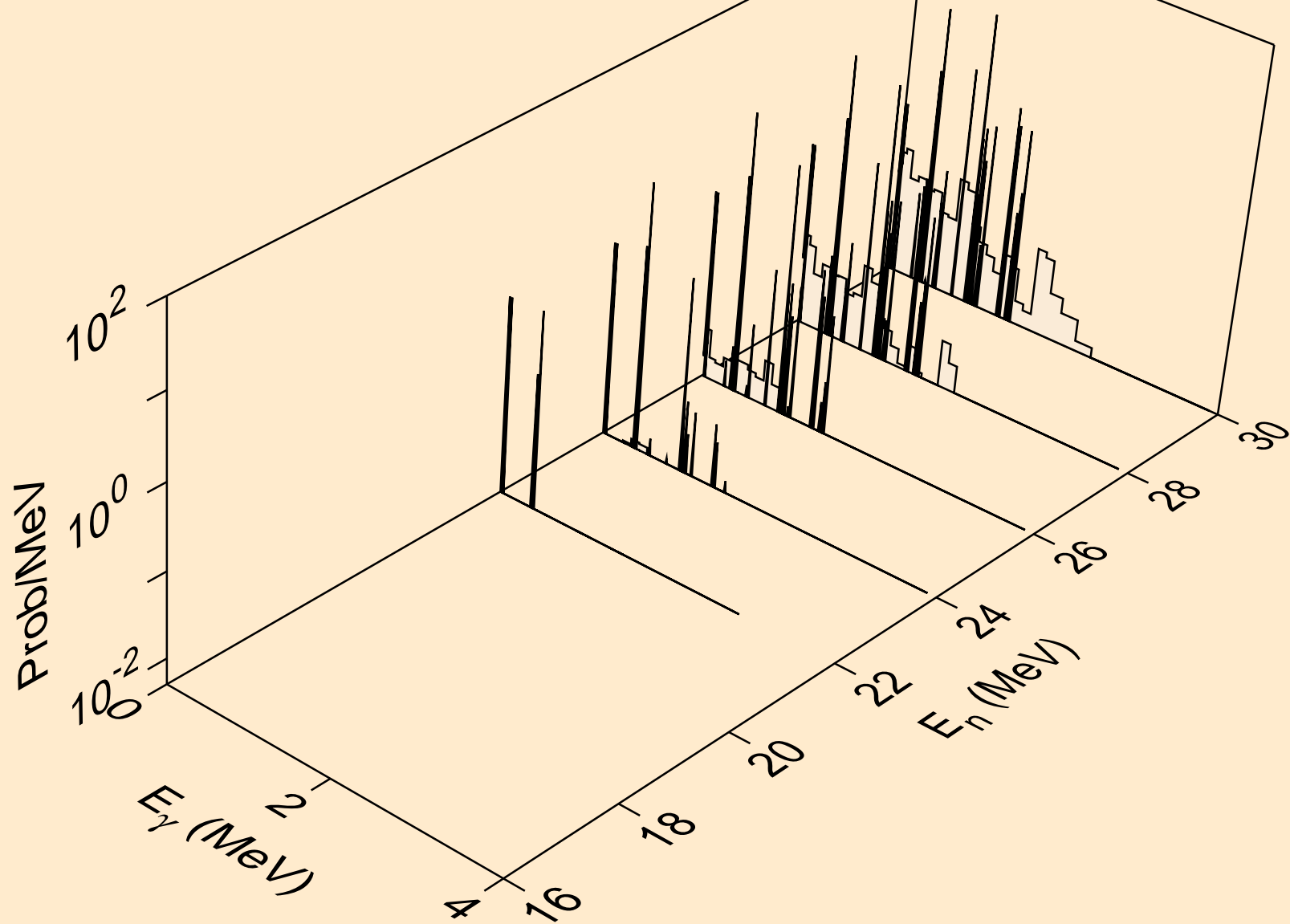

SR095 NEUTRON ACER TENDL-2024 LIBRARY; T=0.K
Photon emission for (n,n*)p

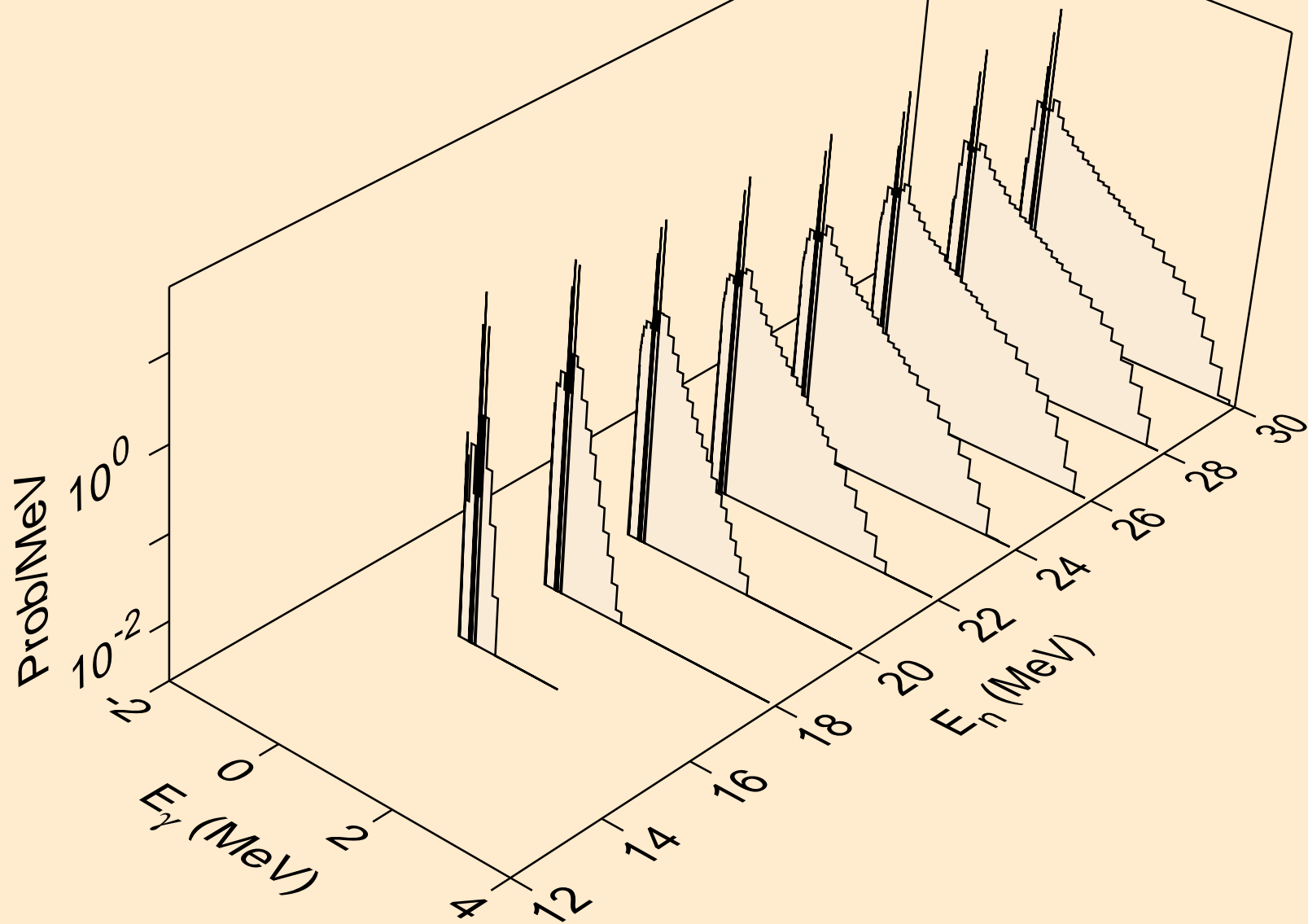

SR095 NEUTRON ACER TENDL-2024 LIBRARY; T=0.K
Photon emission for (n,n*)d

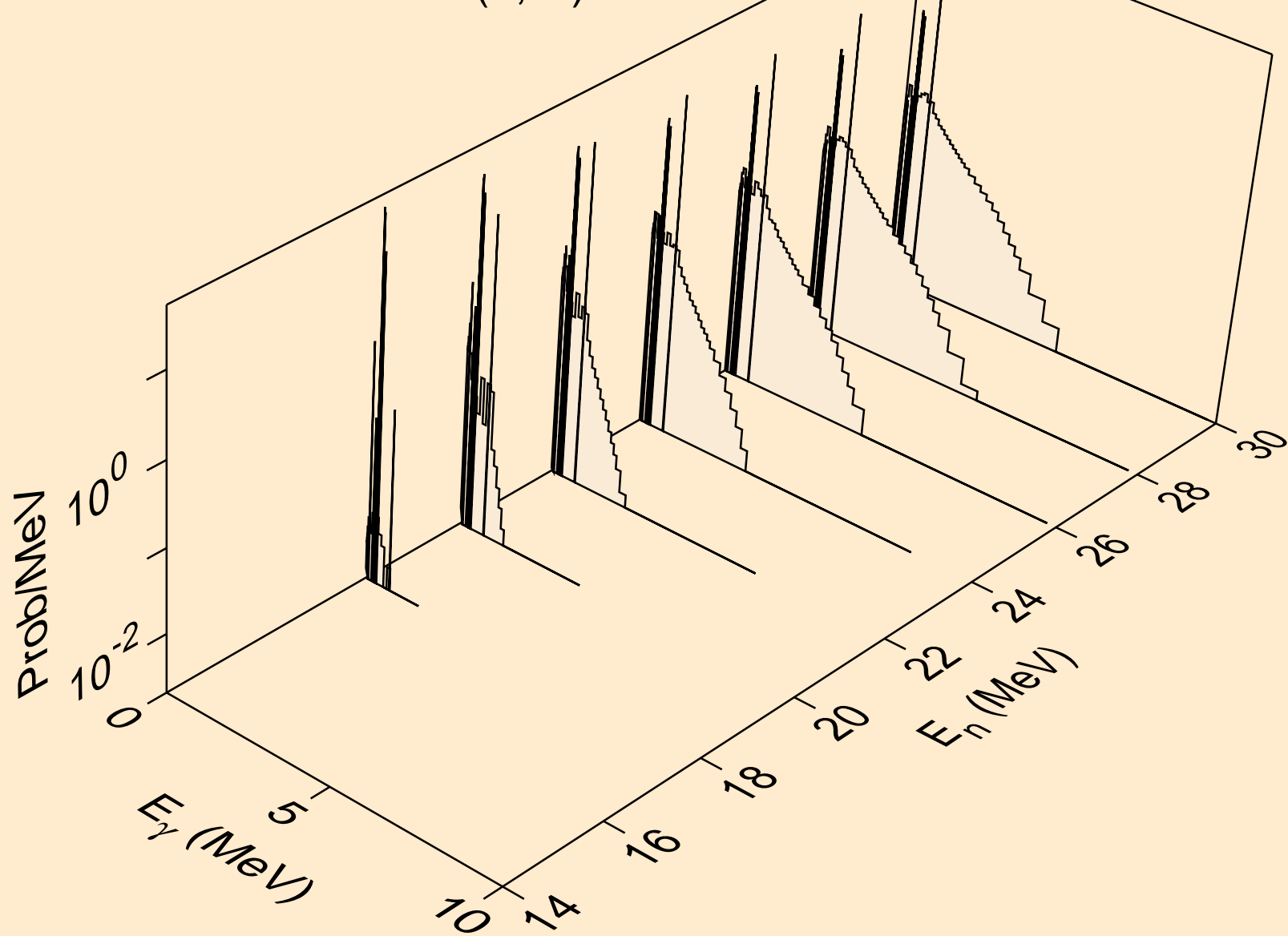

SR095 NEUTRON ACER TENDL-2024 LIBRARY; T=0.K
Photon emission for (n,n*)t

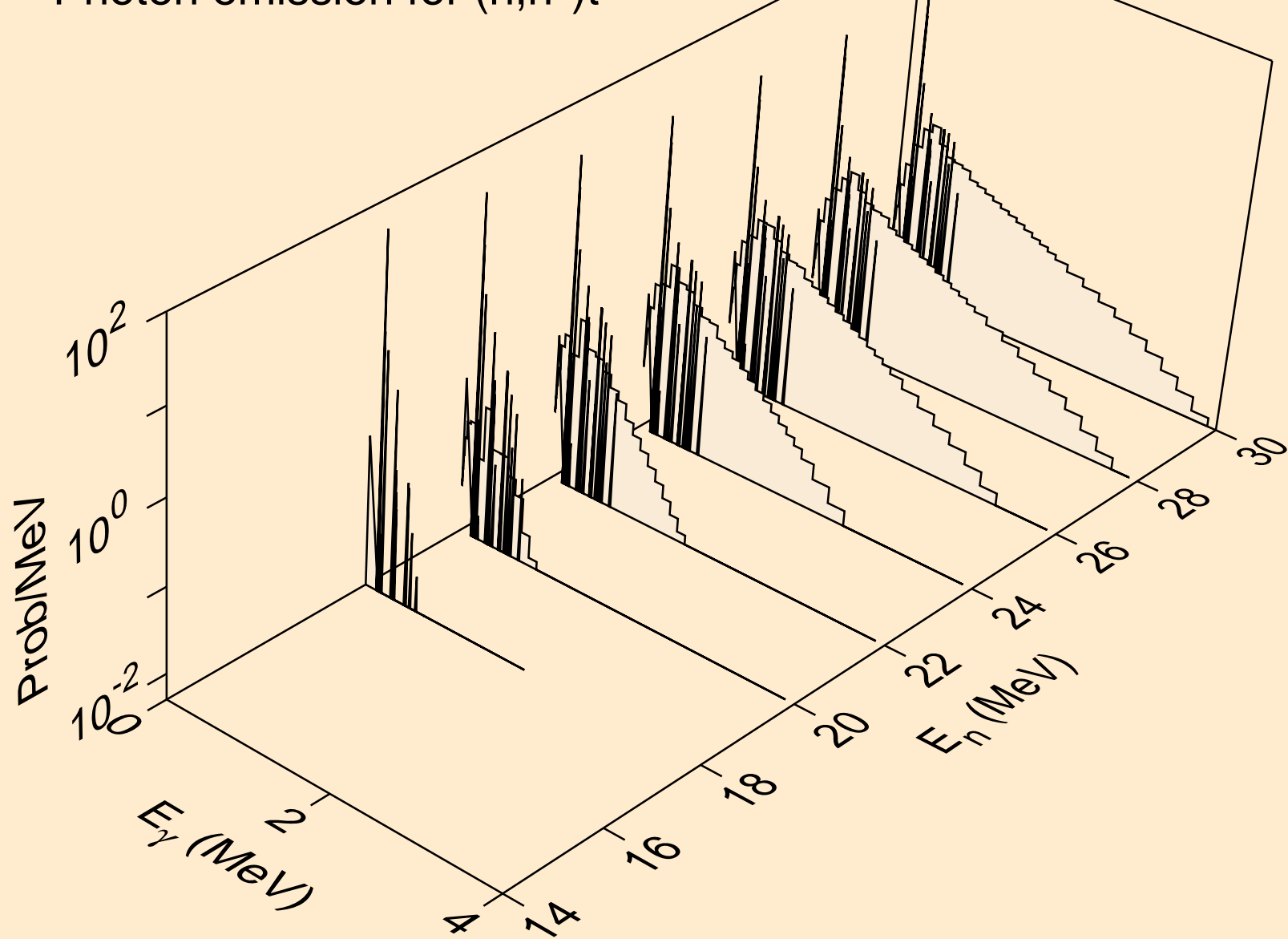

SR095 NEUTRON ACER TENDL-2024 LIBRARY; T=0.K
Photon emission for (n,n*)he3

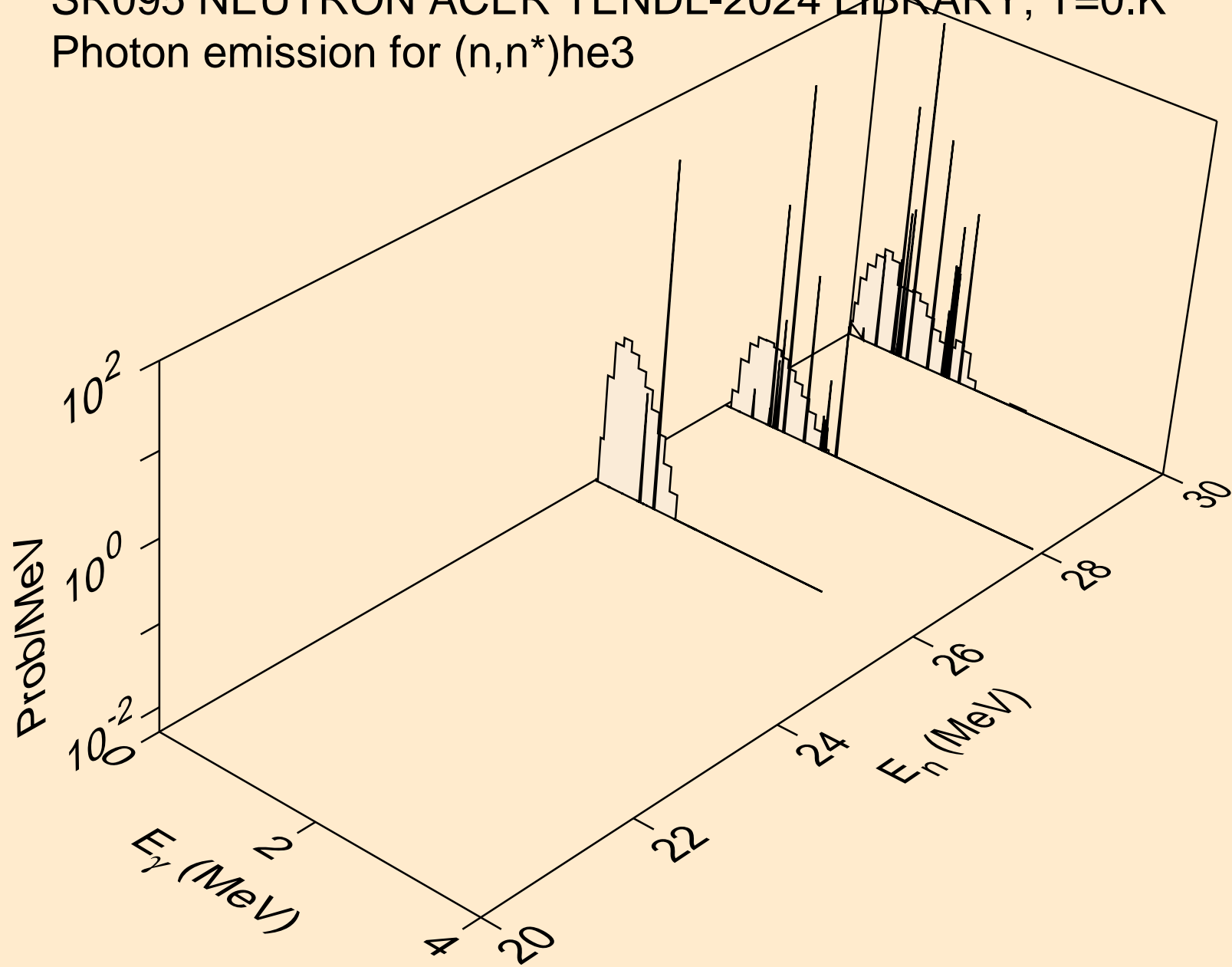

SR095 NEUTRON ACER TENDL-2024 LIBRARY; T=0.K
Photon emission for (n,4n)

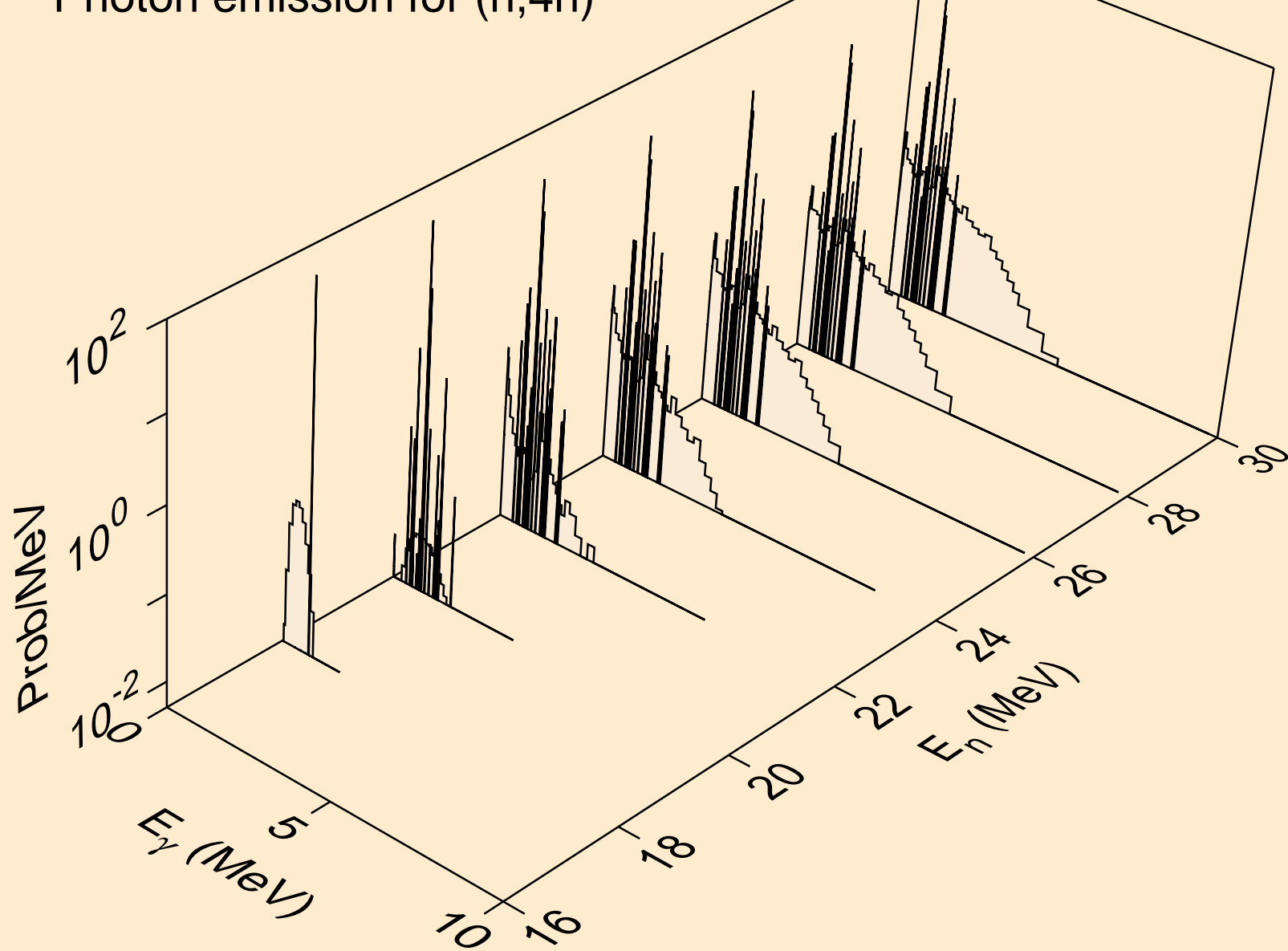

SR095 NEUTRON ACER TENDL-2024 LIBRARY; T=0.K
Photon emission for (n,2np)

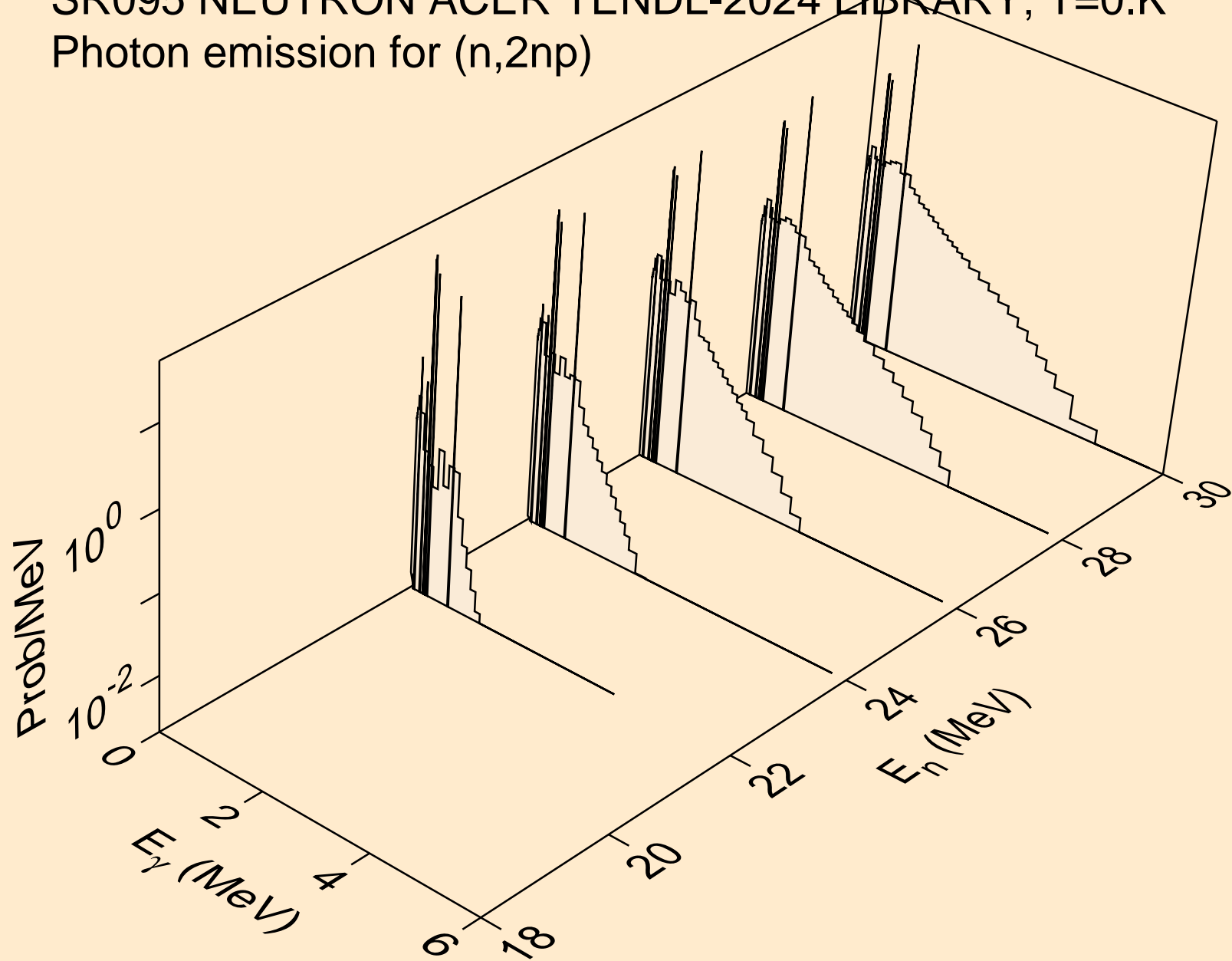

SR095 NEUTRON ACER TENDL-2024 LIBRARY; T=0.K
Photon emission for (n,3np)

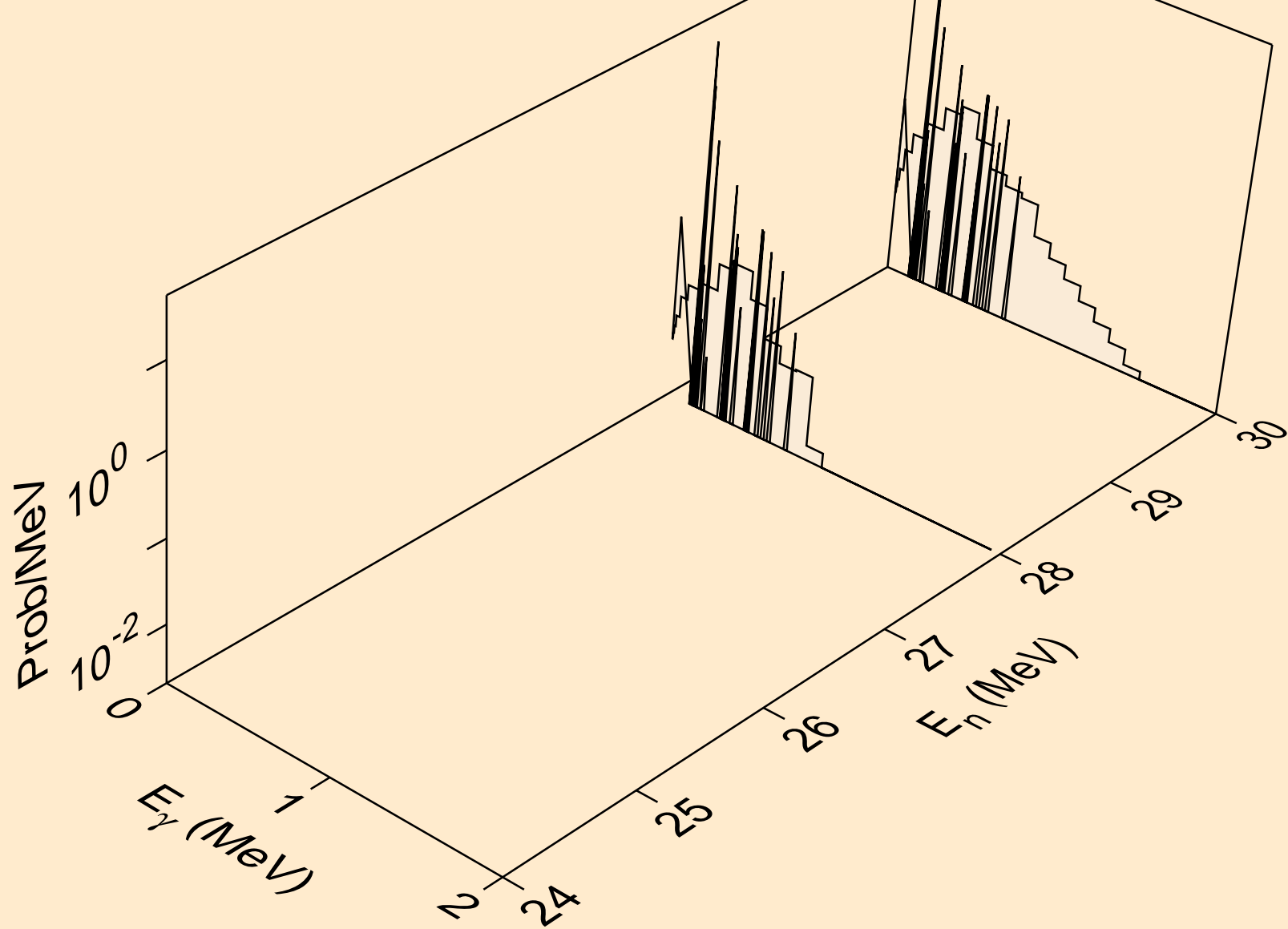

SR095 NEUTRON ACER TENDL-2024 LIBRARY; T=0.K
Photon emission for (n,n*c)

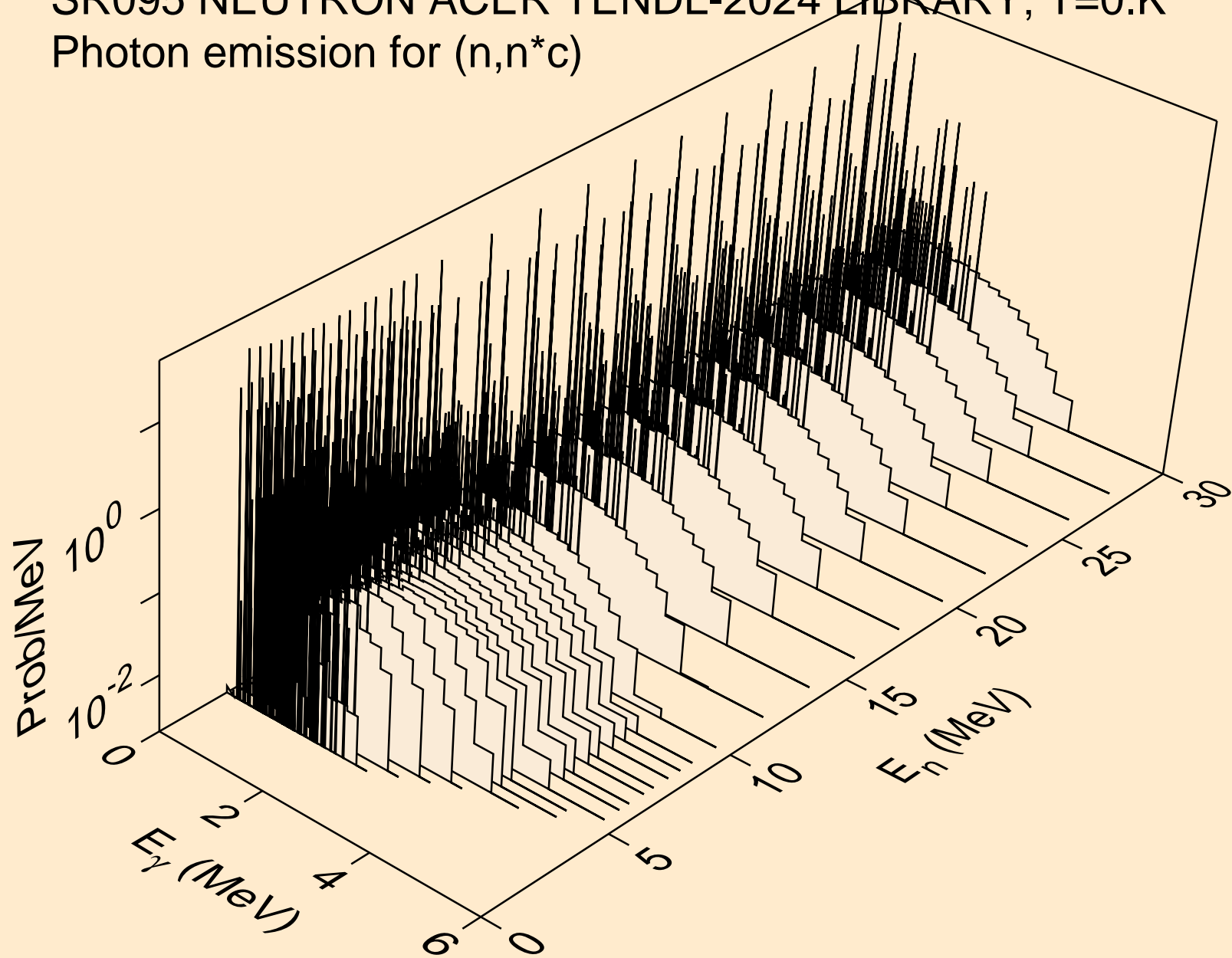

SR095 NEUTRON ACER TENDL-2024 LIBRARY; T=0.K
Photon emission for (n,gma)

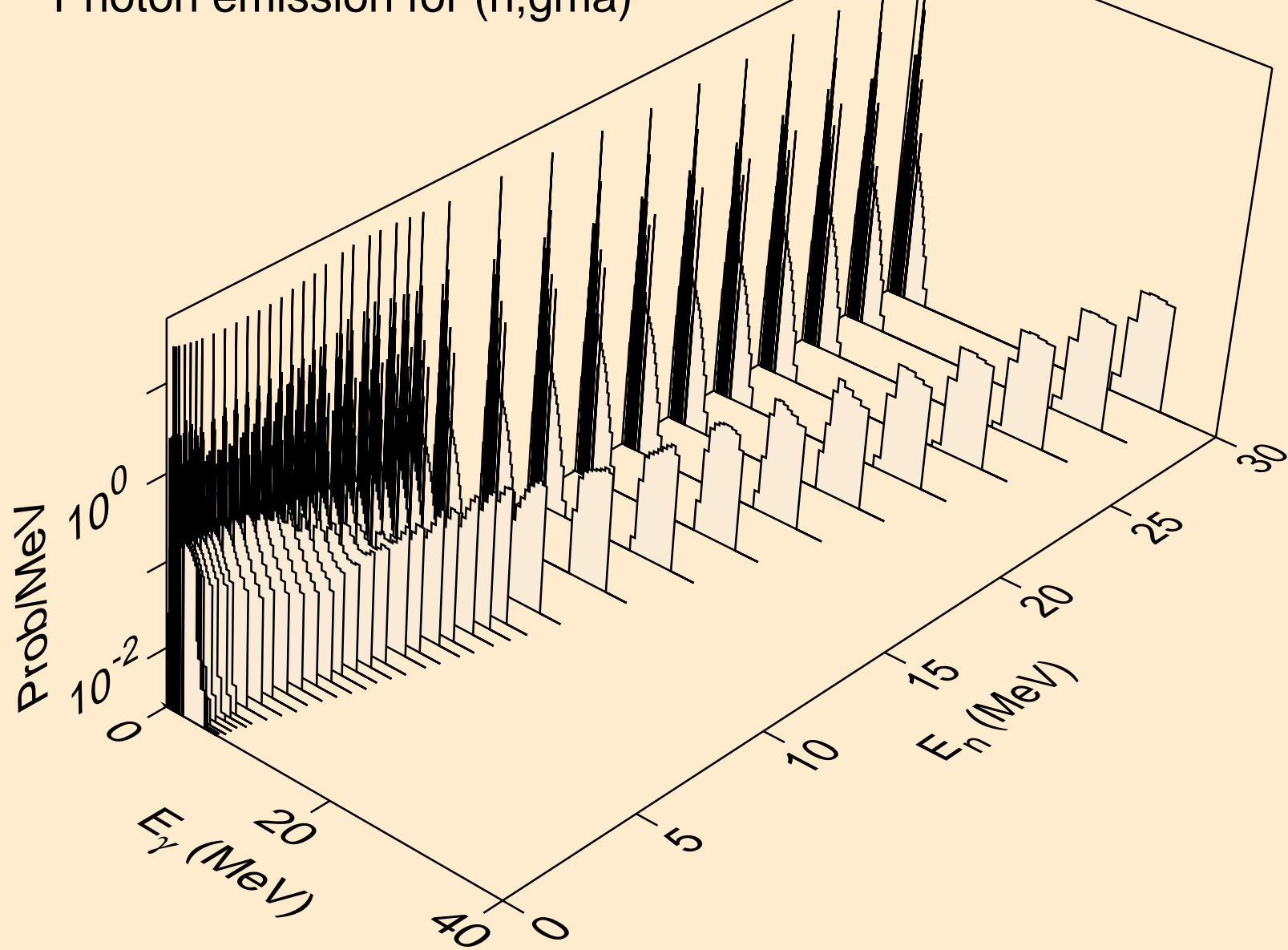

SR095 NEUTRON ACER TENDL-2024 LIBRARY; T=0.K
Photon emission for (n,p)

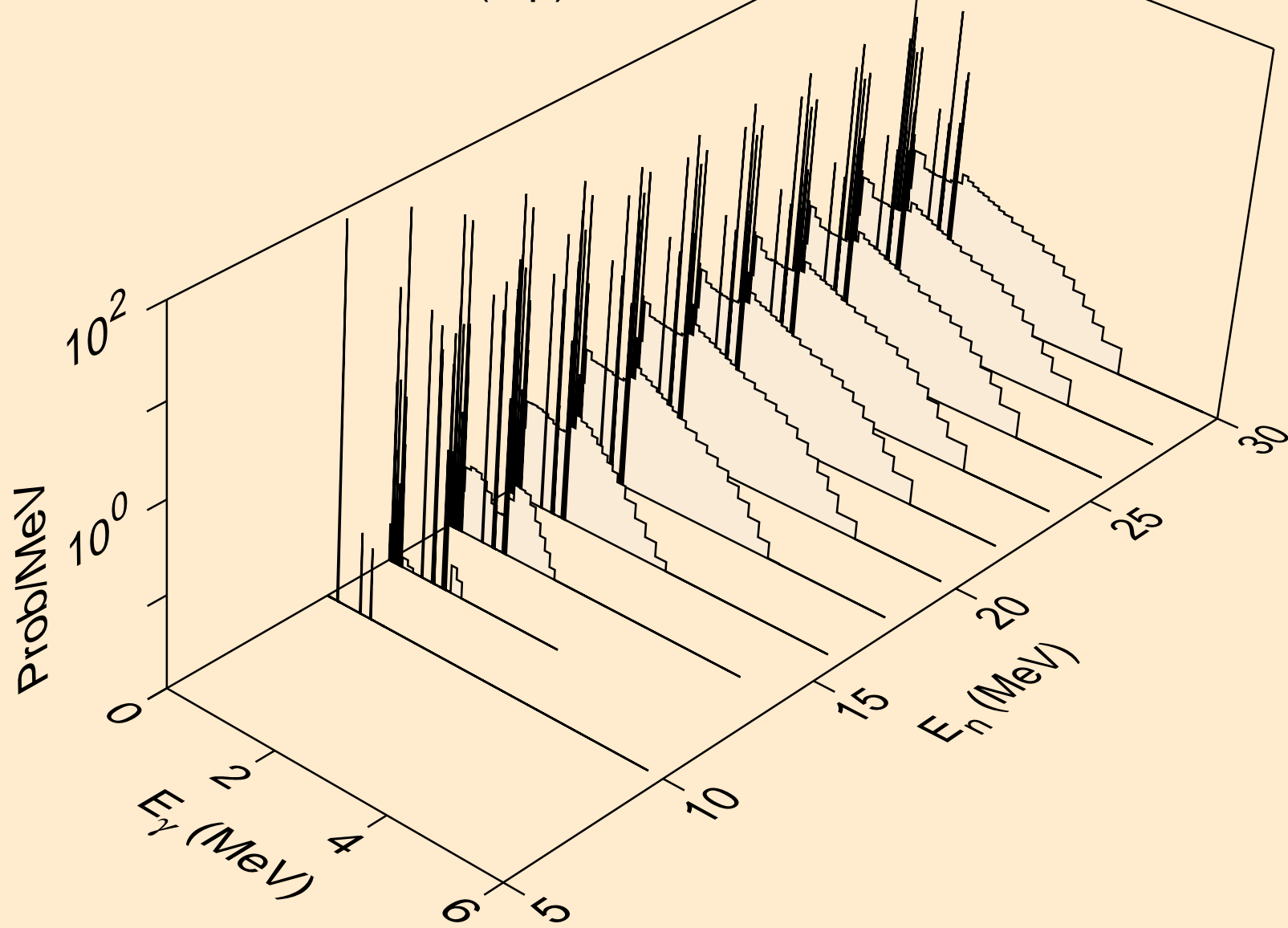

SR095 NEUTRON ACER TENDL-2024 LIBRARY; T=0.K
Photon emission for (n,d)

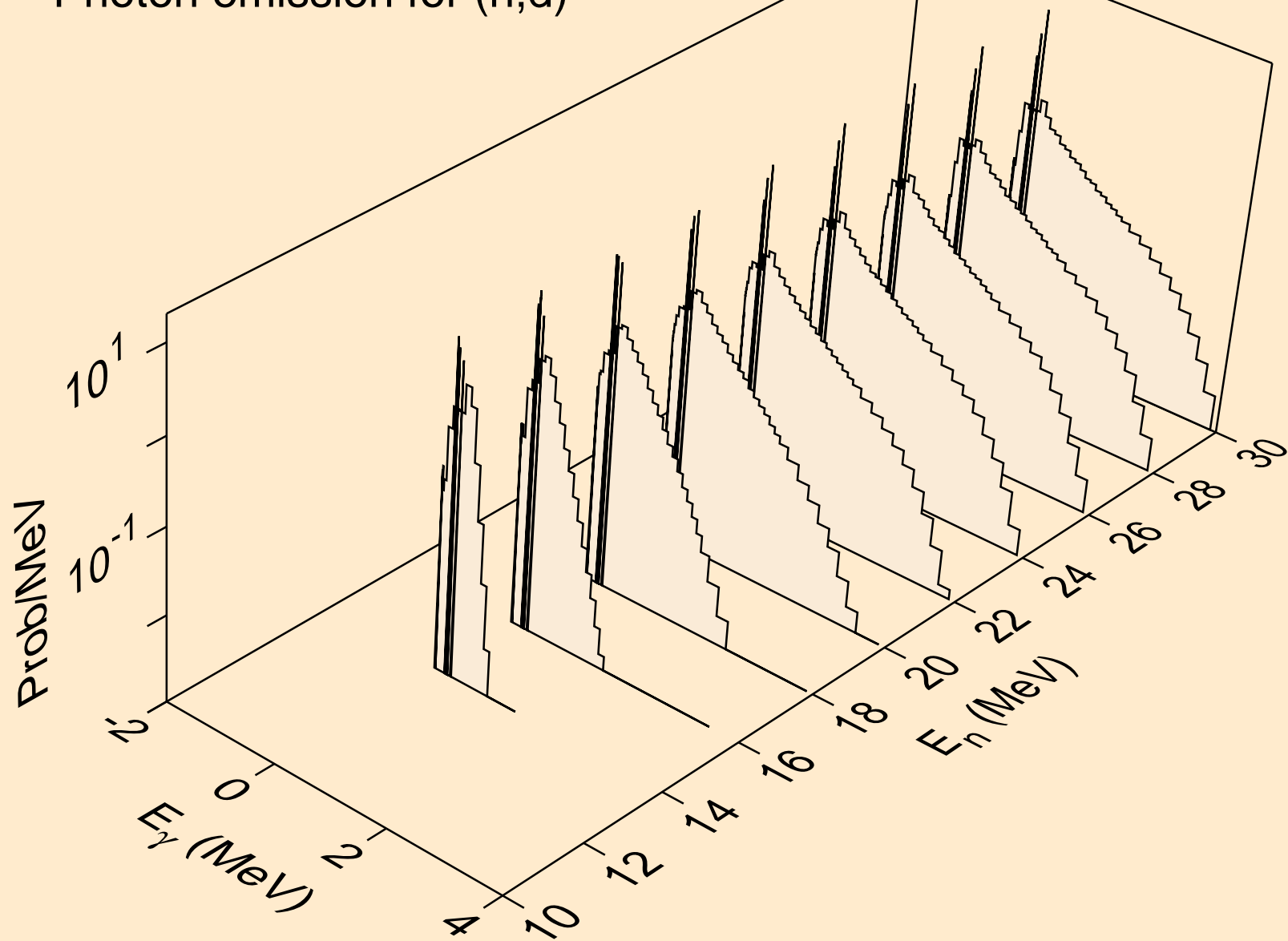

SR095 NEUTRON ACER TENDL-2024 LIBRARY; T=0.K
Photon emission for (n,t)

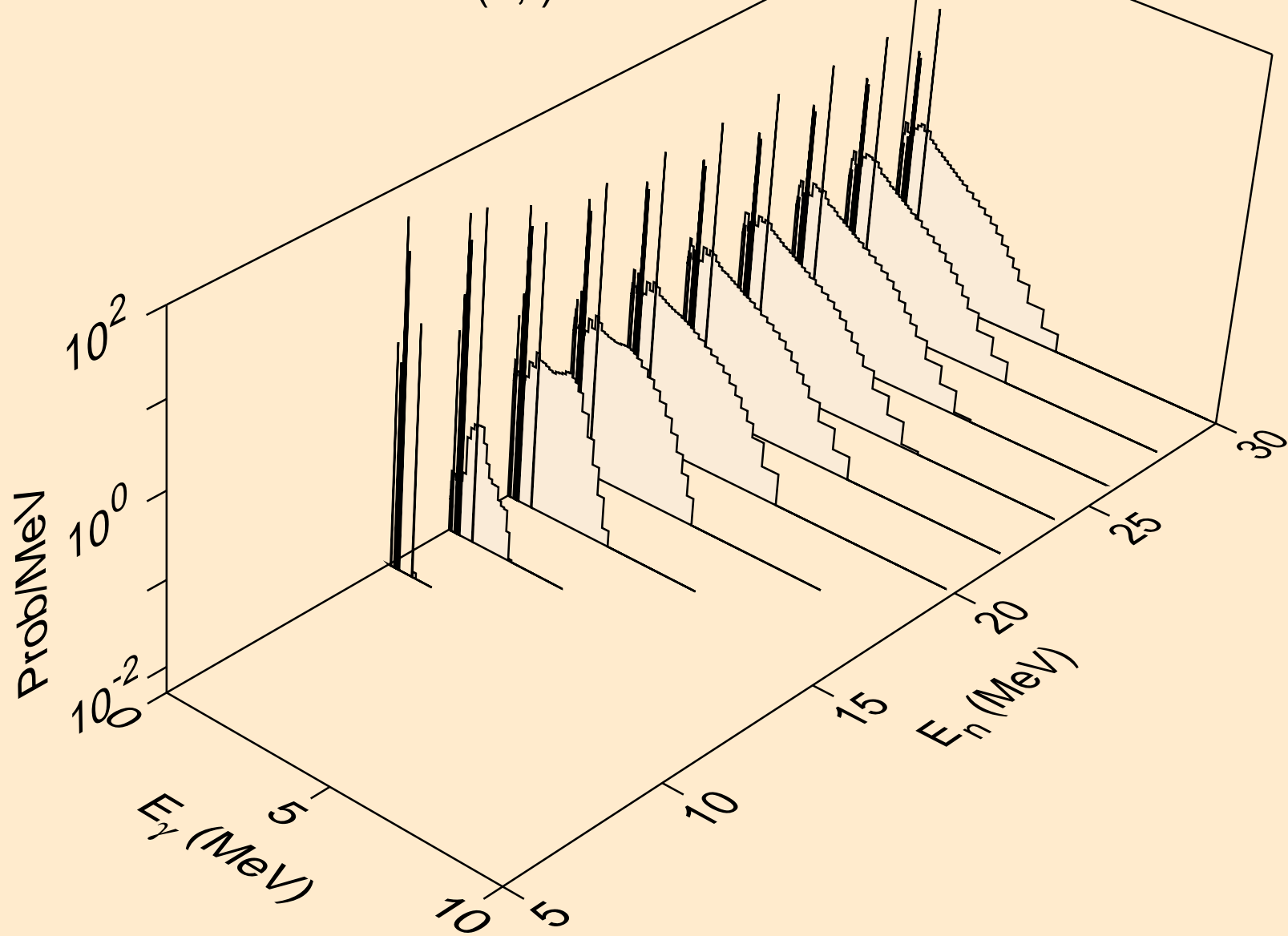

SR095 NEUTRON ACER TENDL-2024 LIBRARY; T=0.K
Photon emission for (n,he3)

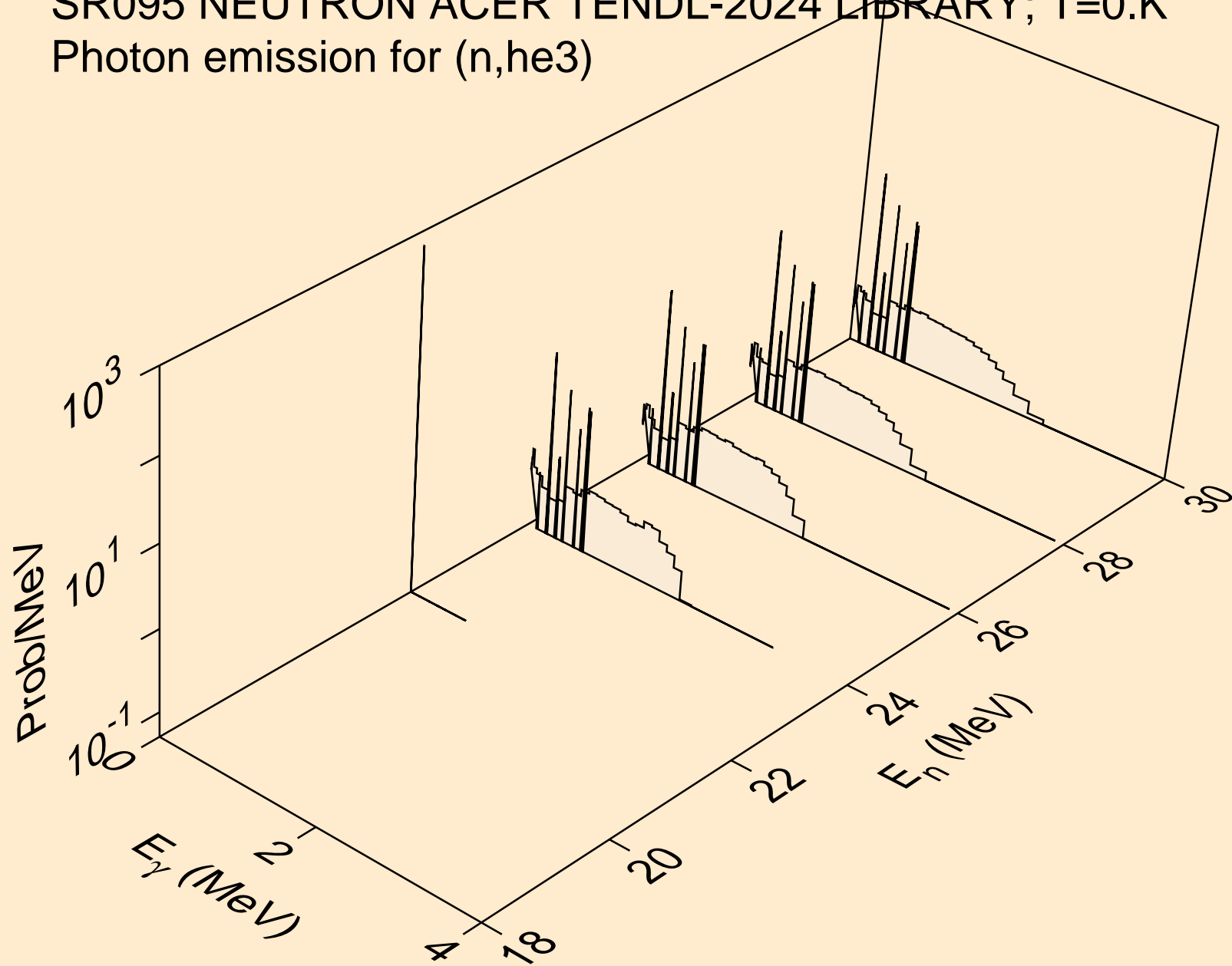

SR095 NEUTRON ACER TENDL-2024 LIBRARY; T=0.K
Photon emission for (n,a)

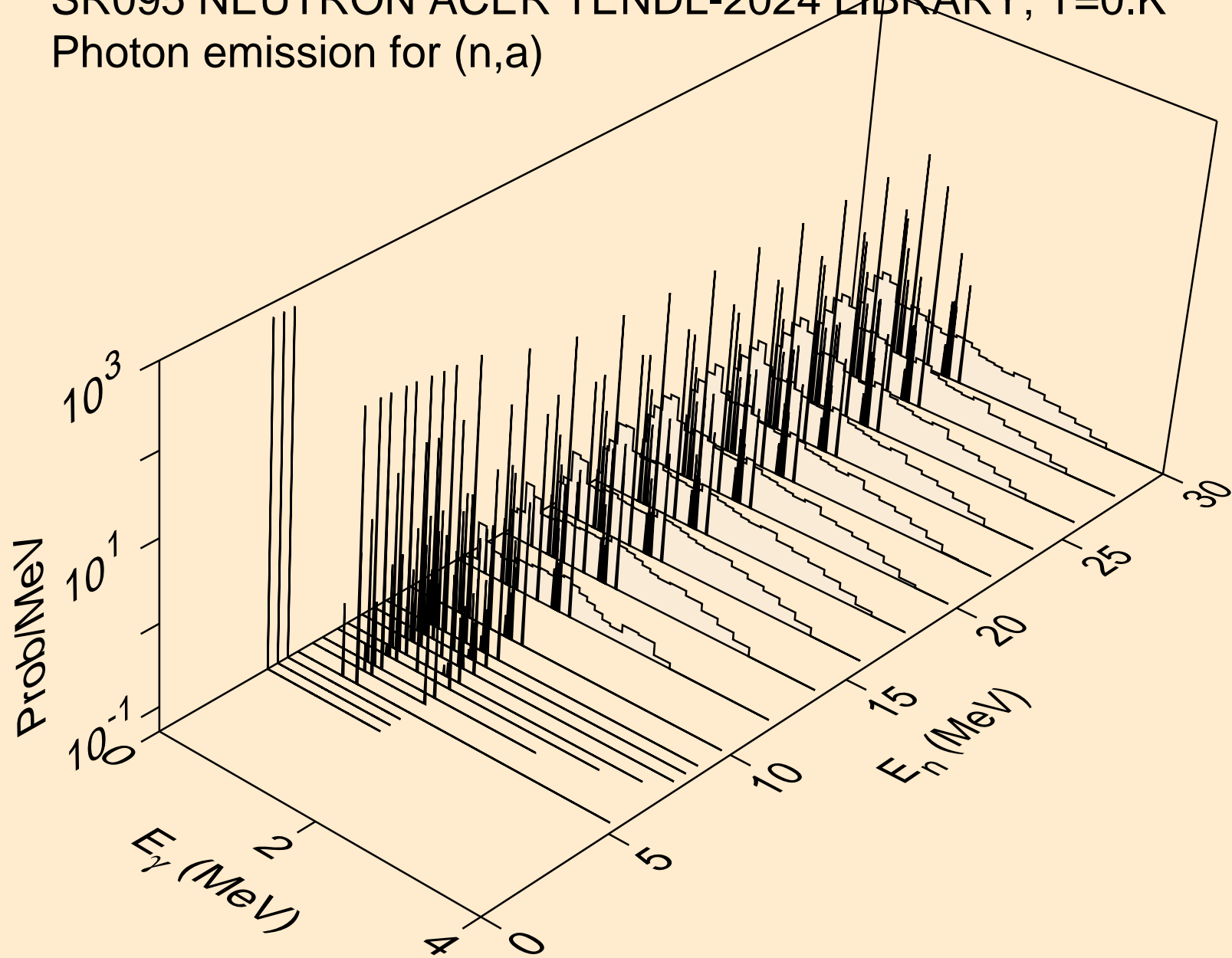

SR095 NEUTRON ACER TENDL-2024 LIBRARY; T=0.K
thermal capture photon spectrum

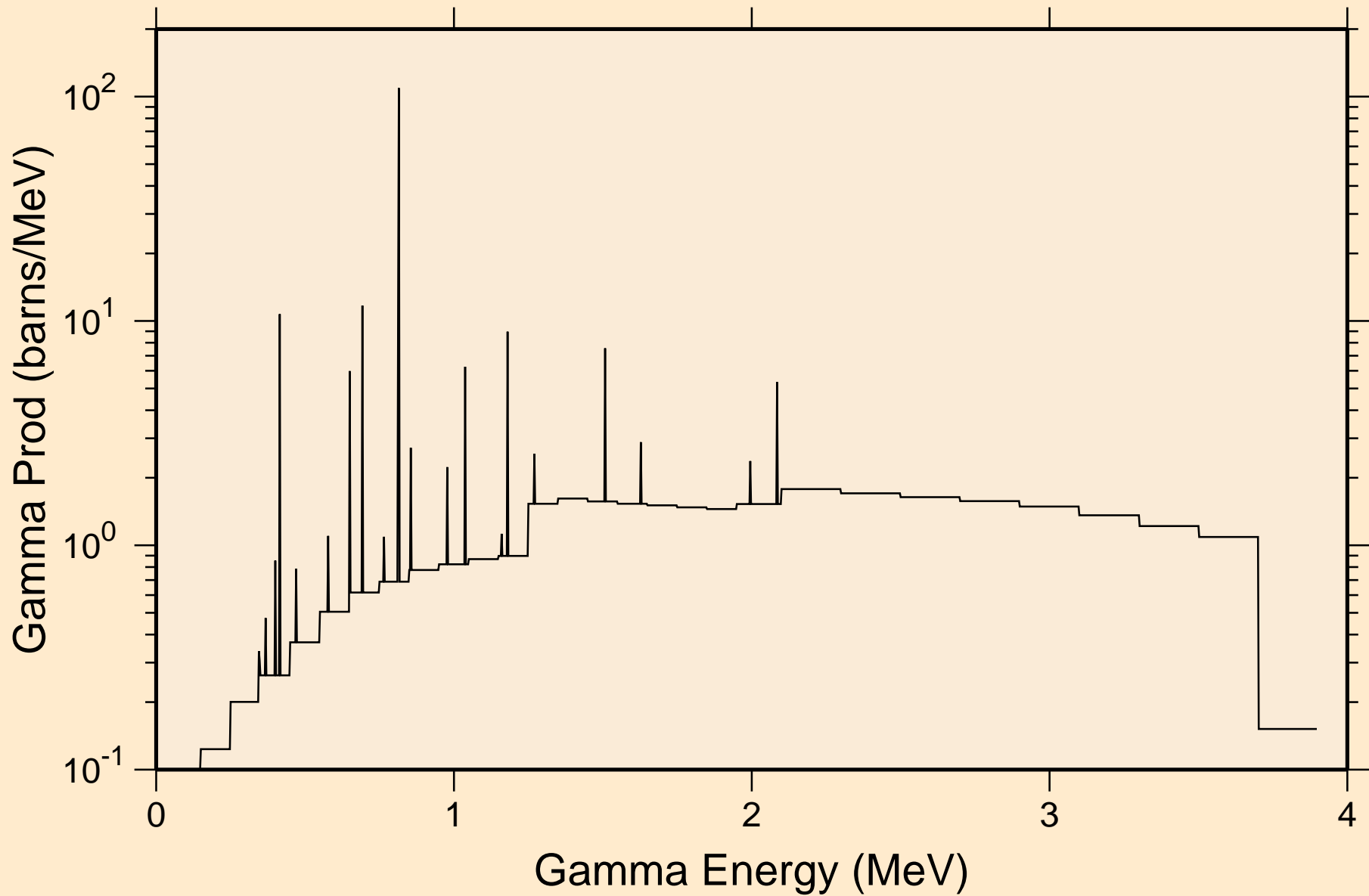

SR095 NEUTRON ACER TENDL-2024 LIBRARY; T=0.K
14 MeV photon spectrum

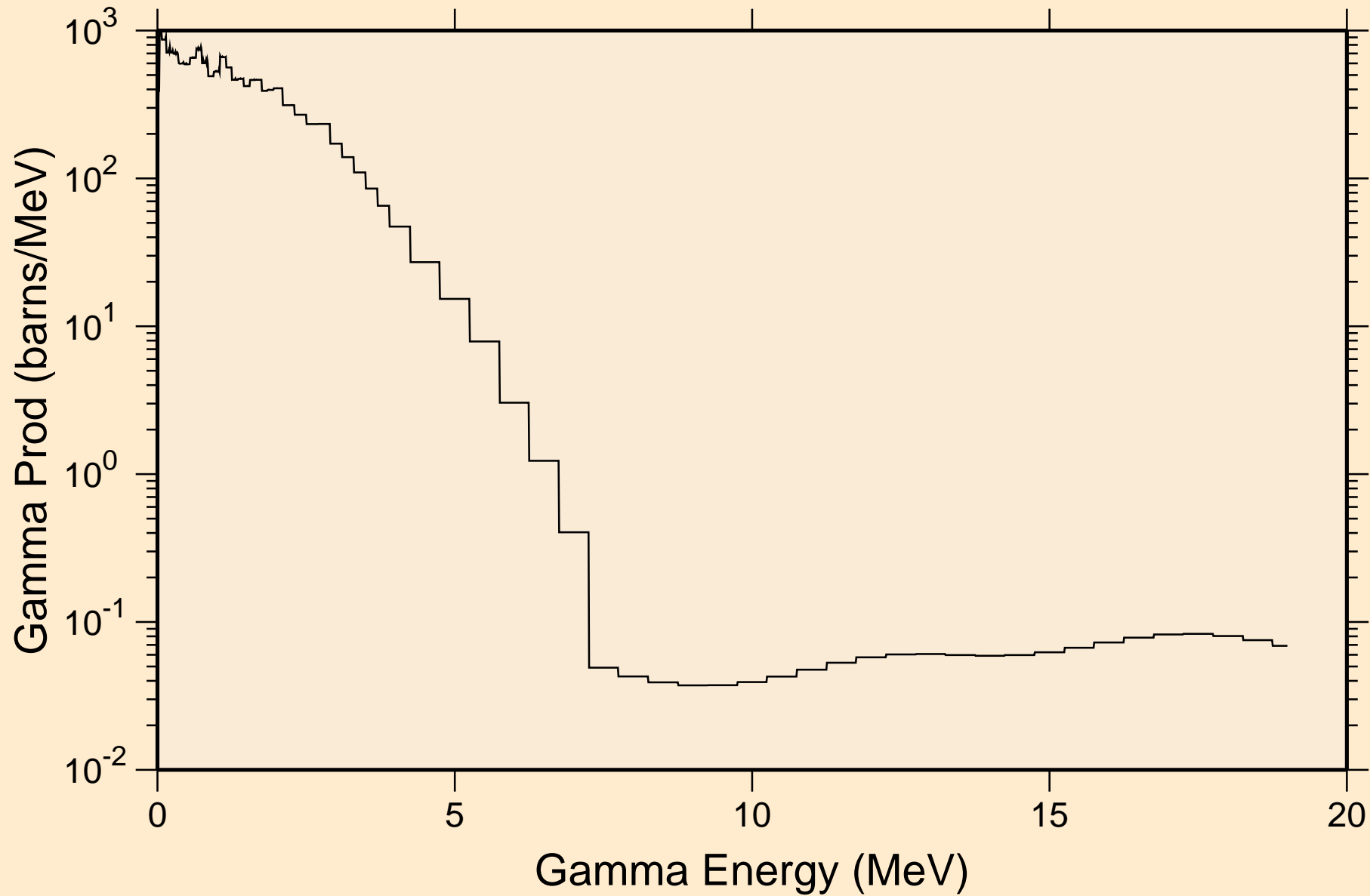

SR095 NEUTRON ACER TENDL-2024 LIBRARY; T=0.K
Particle heating contributions

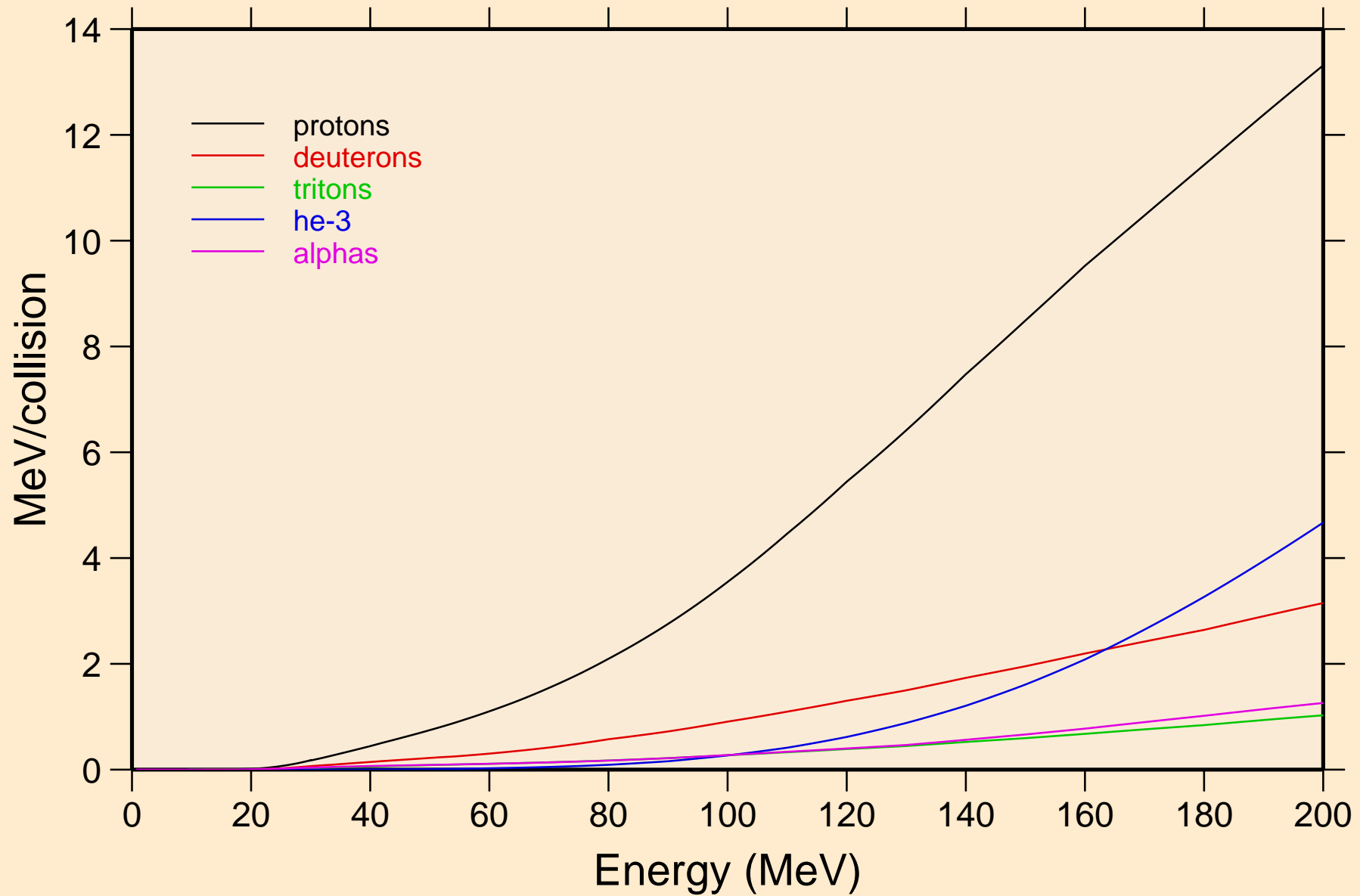

SR095 NEUTRON ACER TENDL-2024 LIBRARY; T=0.K
Recoil Heating

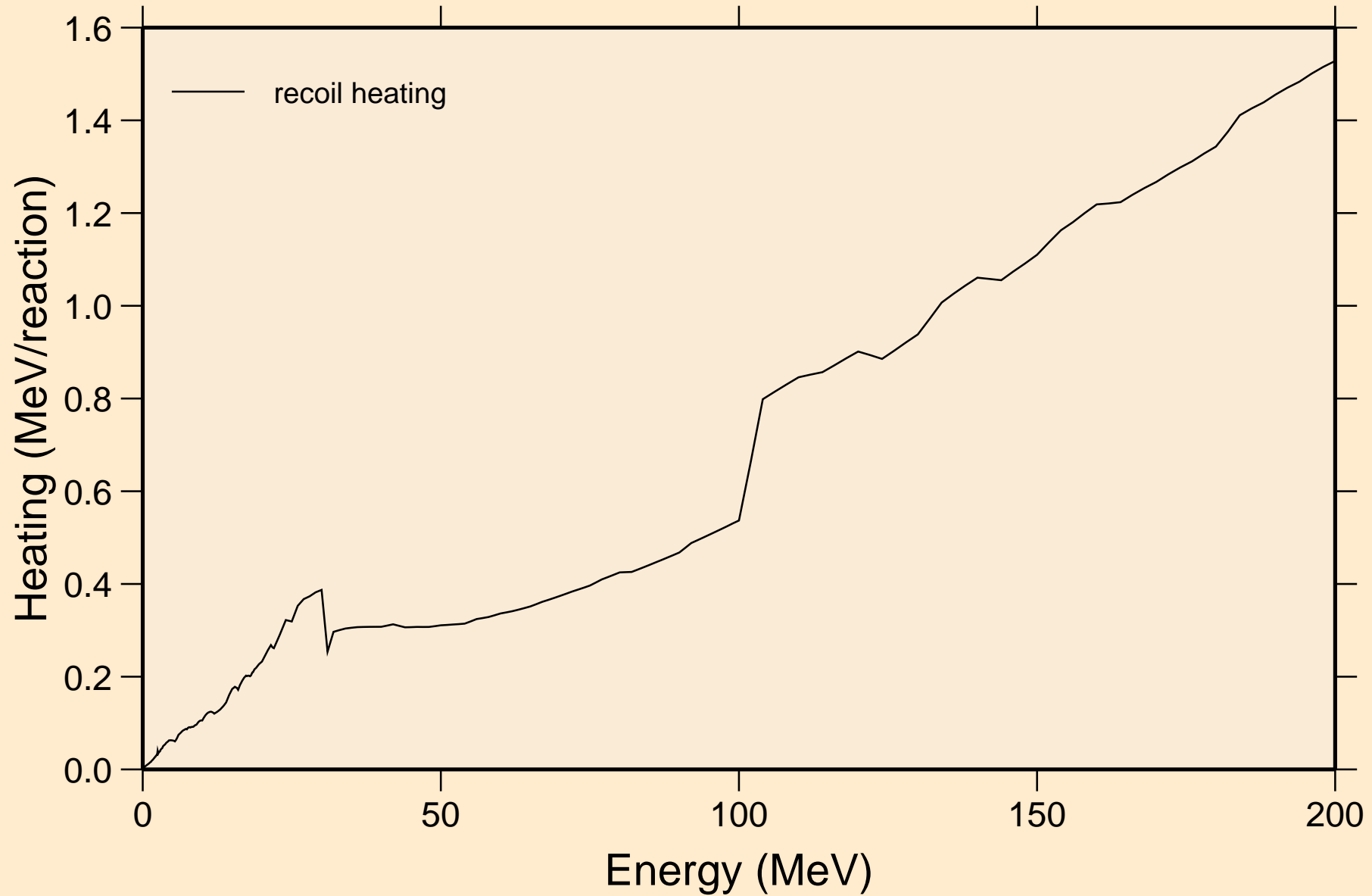

SR095 NEUTRON ACER TENDL-2024 LIBRARY; T=0.K
Particle production cross sections

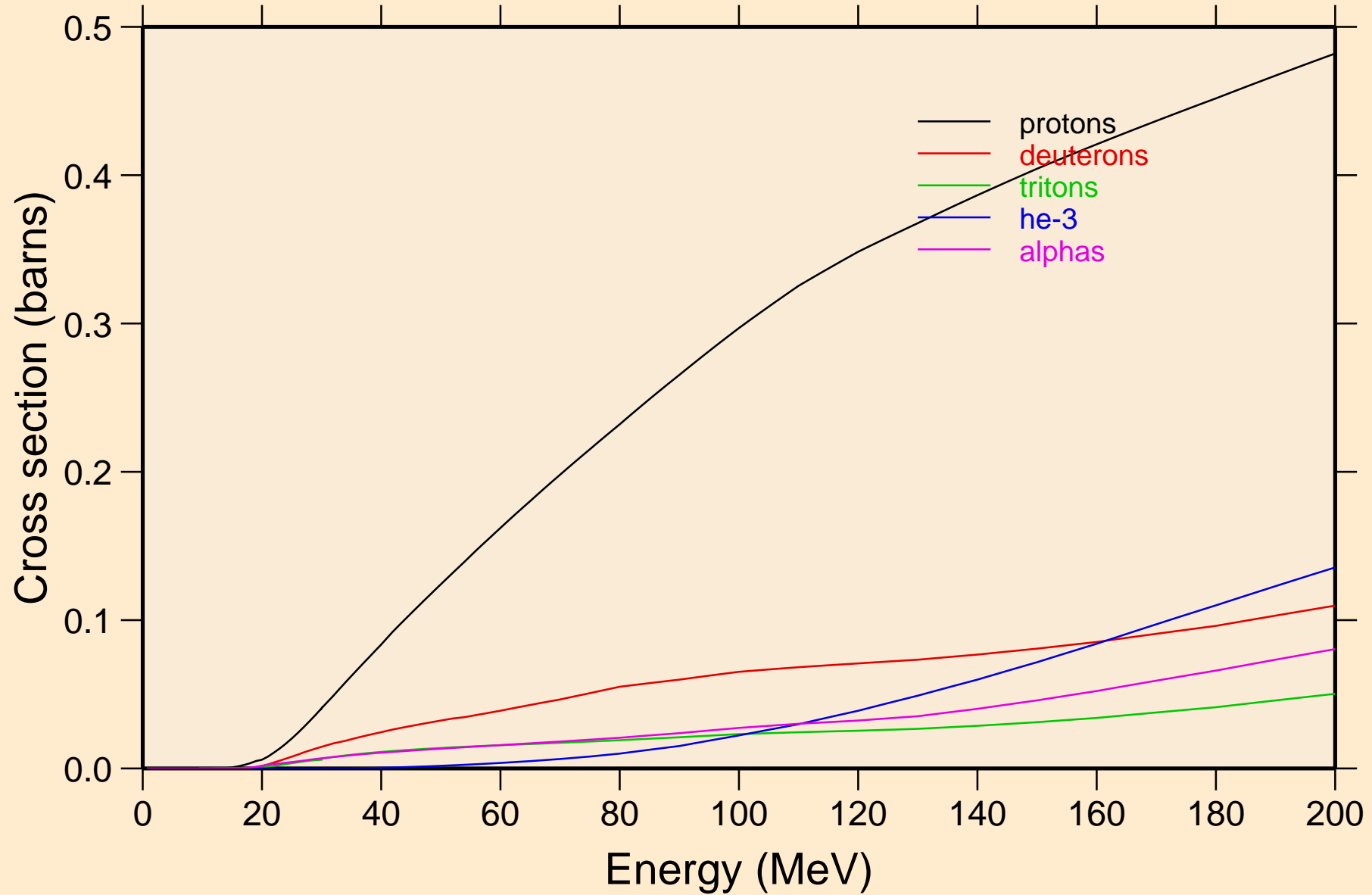

SR095 NEUTRON ACER TENDL-2024 LIBRARY; T=0.K
protons from (n,x)

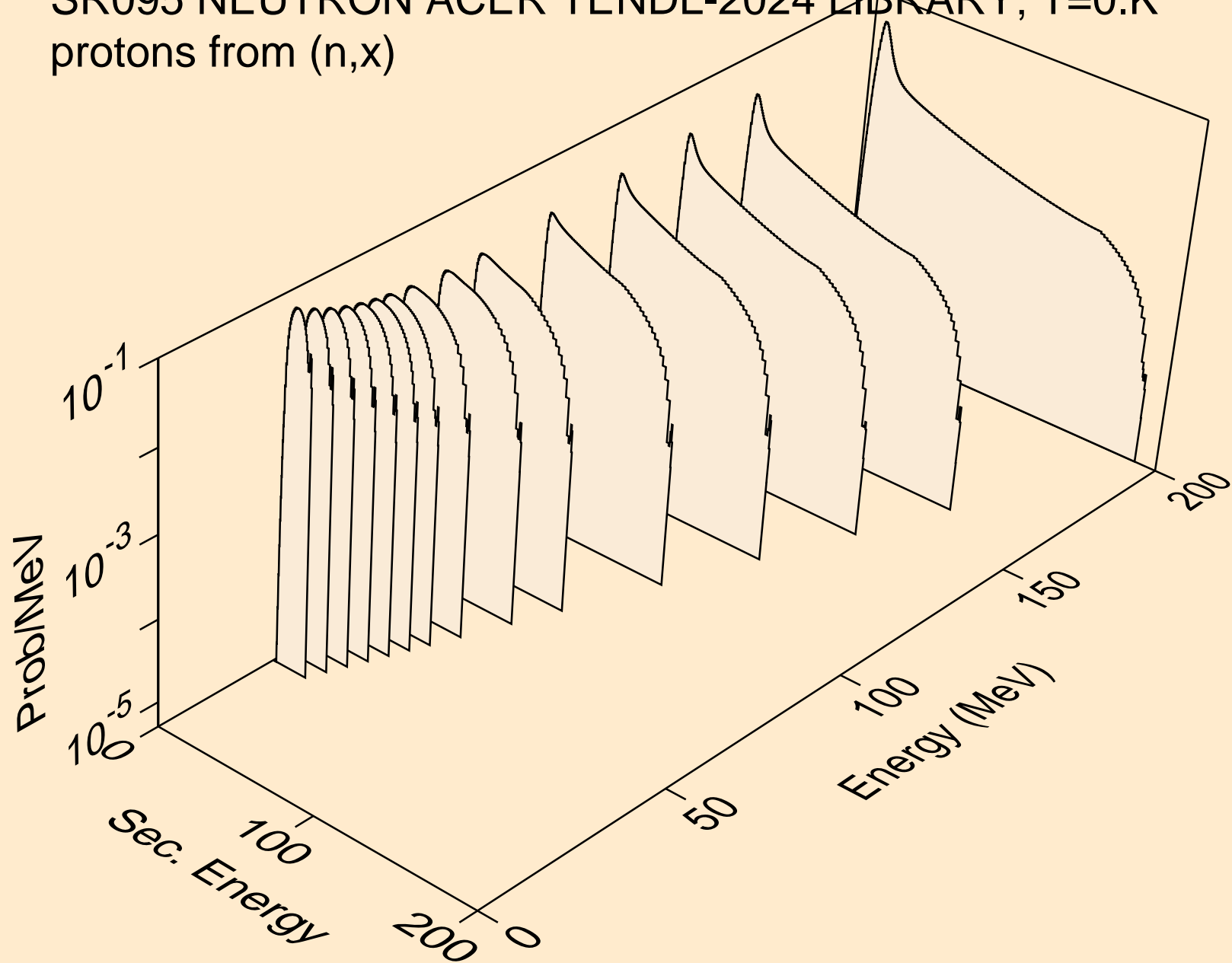

SR095 NEUTRON ACER TENDL-2024 LIBRARY; T=0.K
protons from (n,n*)p

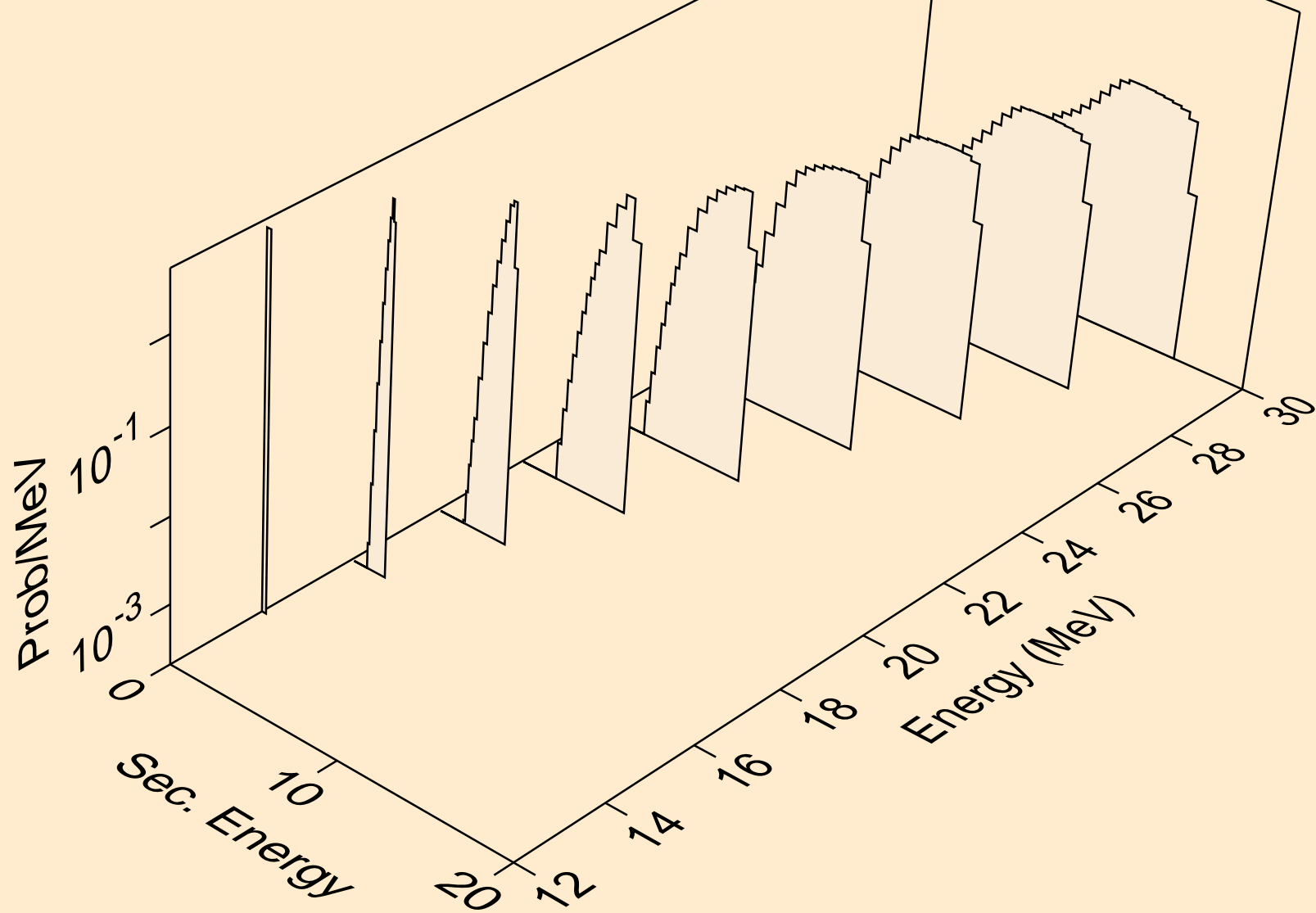

SR095 NEUTRON ACER TENDL-2024 LIBRARY; T=0.K
protons from (n,2np)

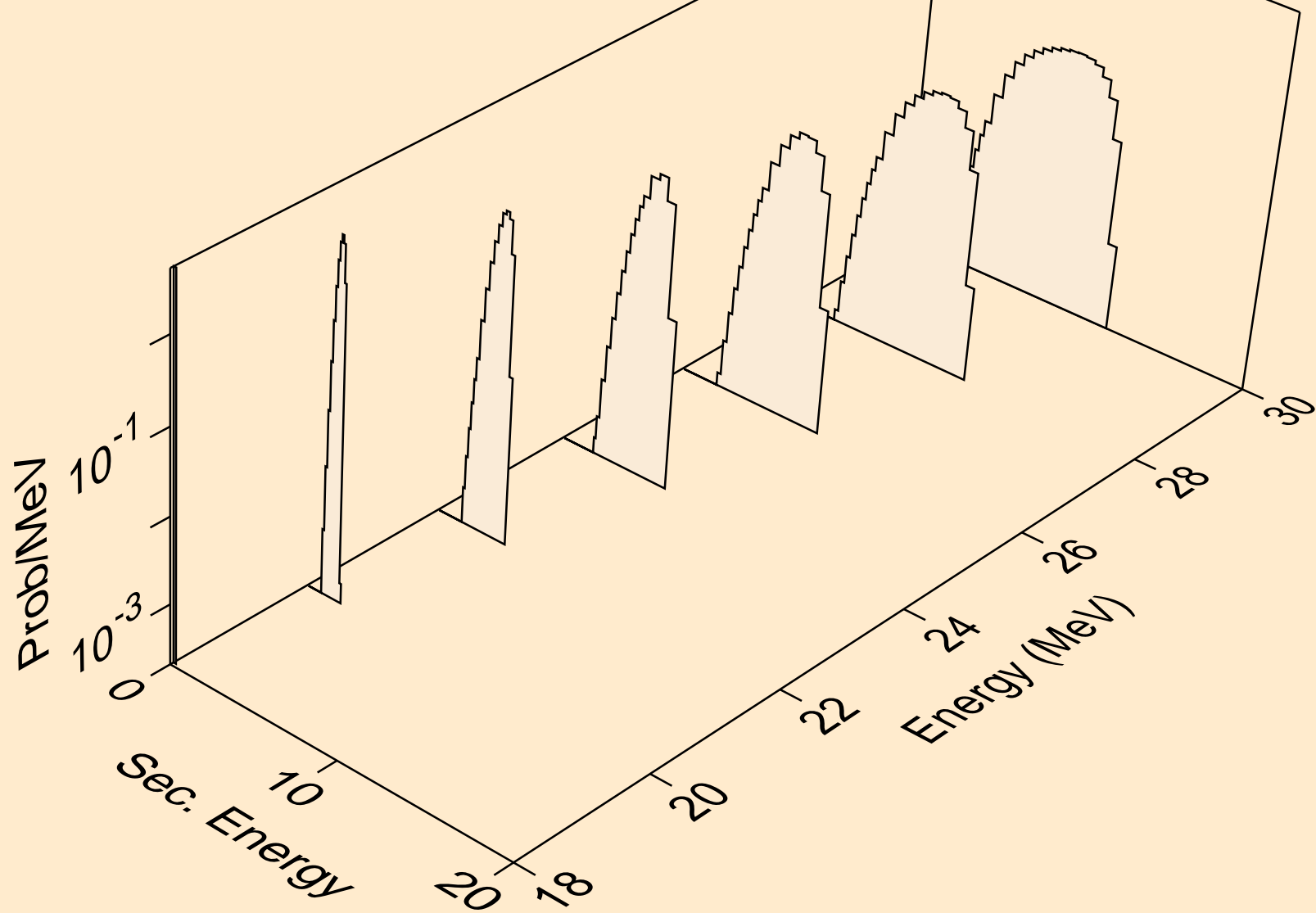

SR095 NEUTRON ACER TENDL-2024 LIBRARY; T=0.K
protons from (n,3np)

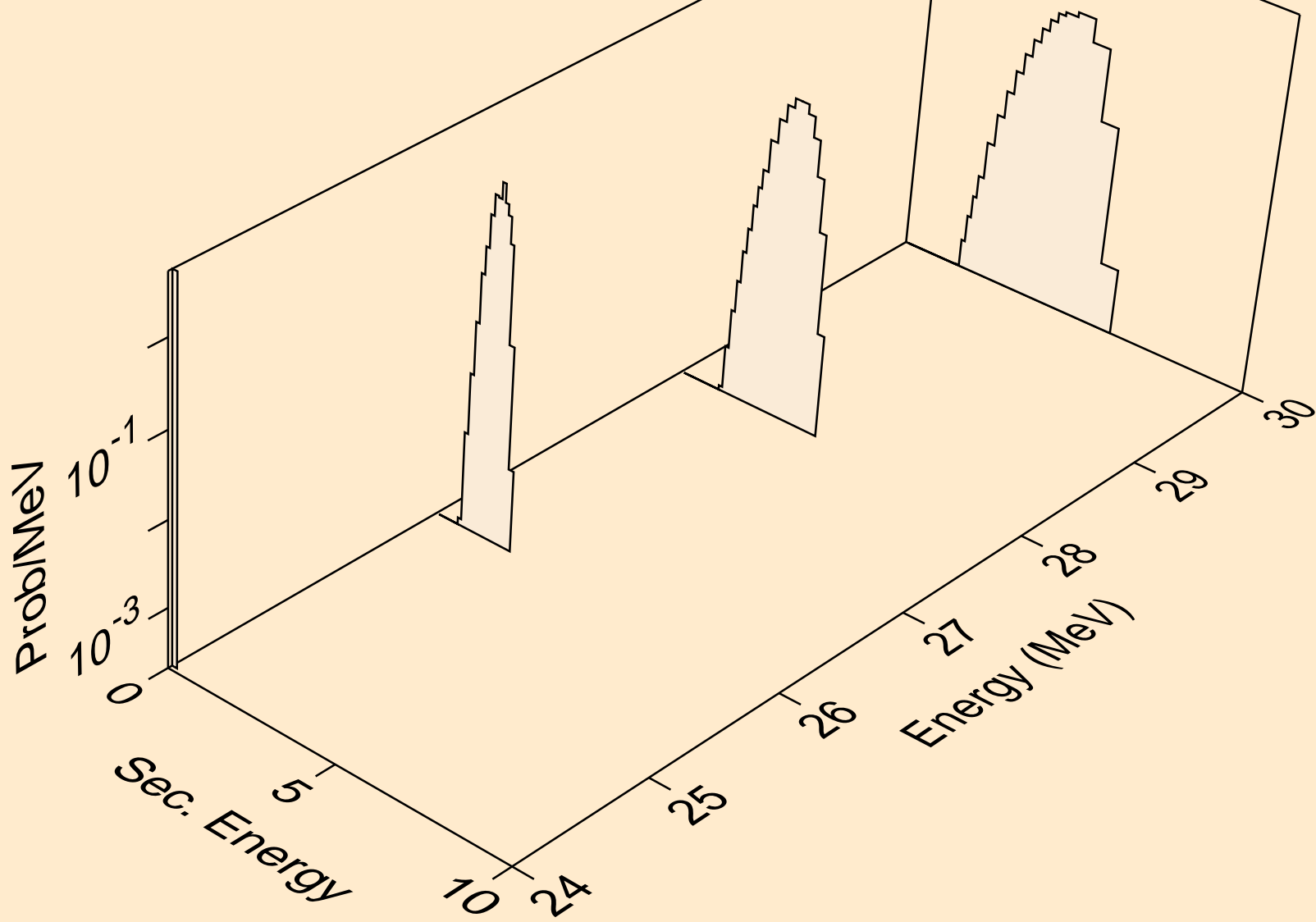

SR095 NEUTRON ACER TENDL-2024 LIBRARY; T=0.K
protons from (n,p)

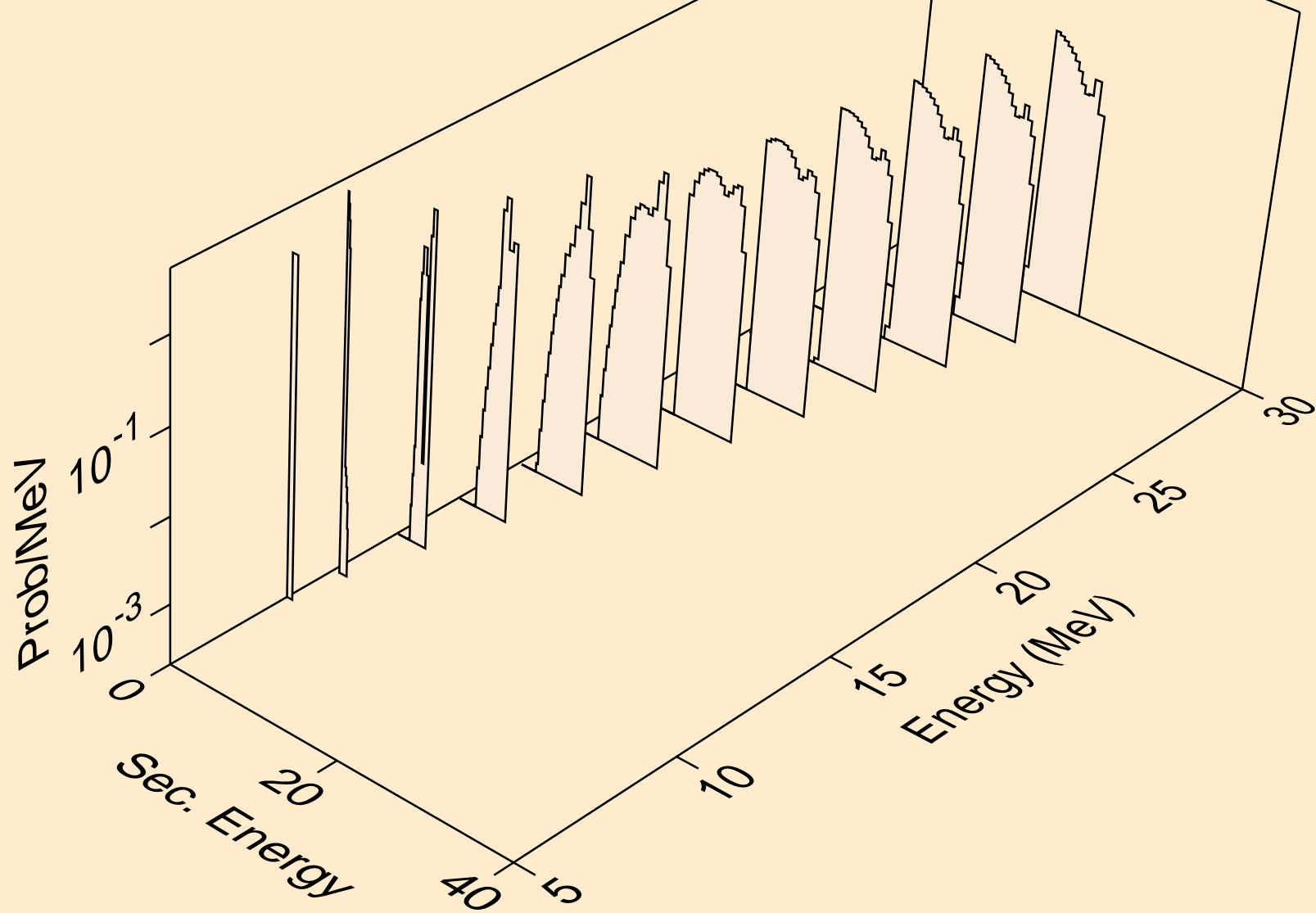

SR095 NEUTRON ACER TENDL-2024 LIBRARY; T=0.K
deuterons from (n,x)

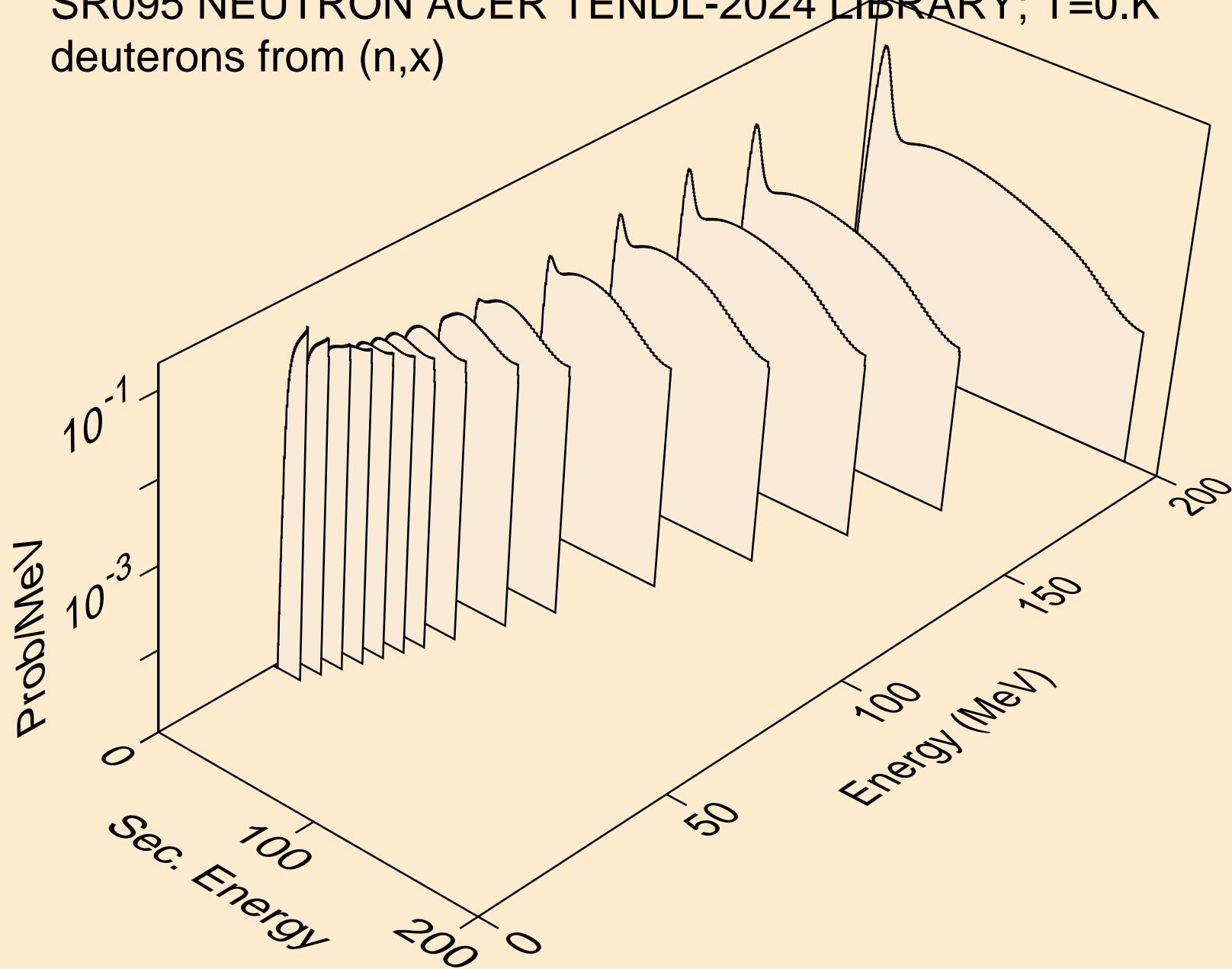

SR095 NEUTRON ACER TENDL-2024 LIBRARY; T=0.K
deuterons from (n,2nd)

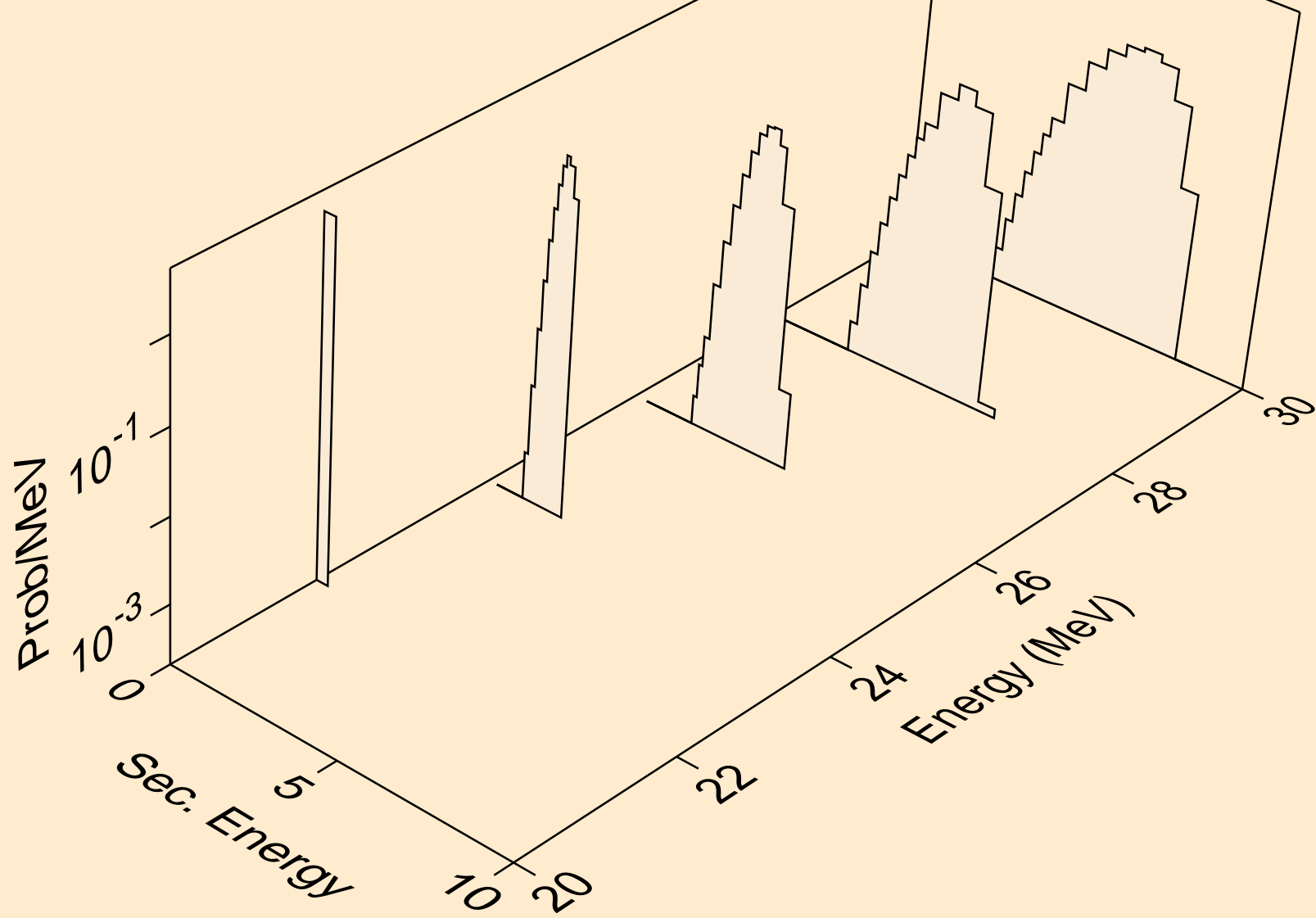

SR095 NEUTRON ACER TENDL-2024 LIBRARY; T=0.K
deuterons from (n,n*)d

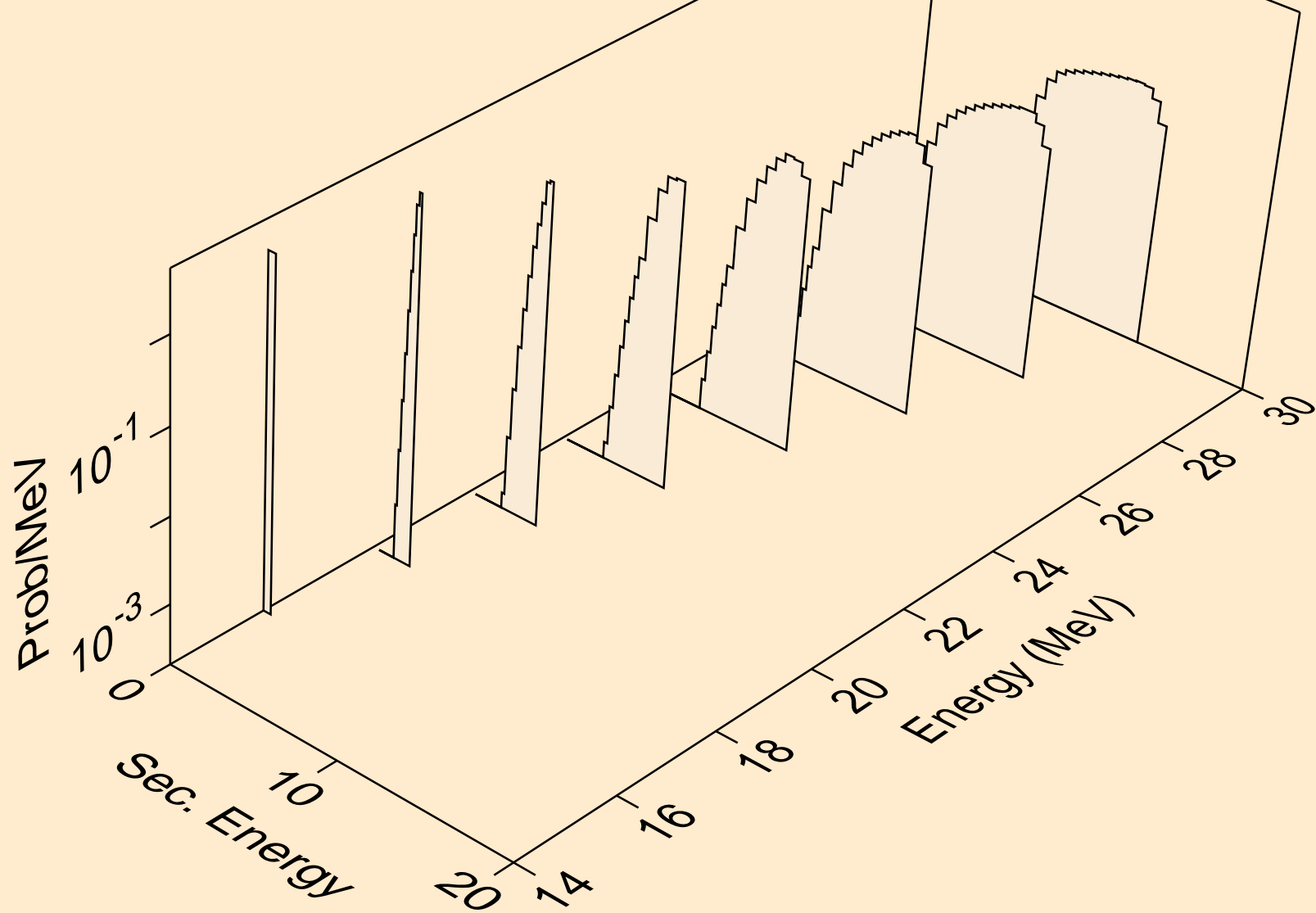

SR095 NEUTRON ACER TENDL-2024 LIBRARY; T=0.K
deuterons from (n,d)

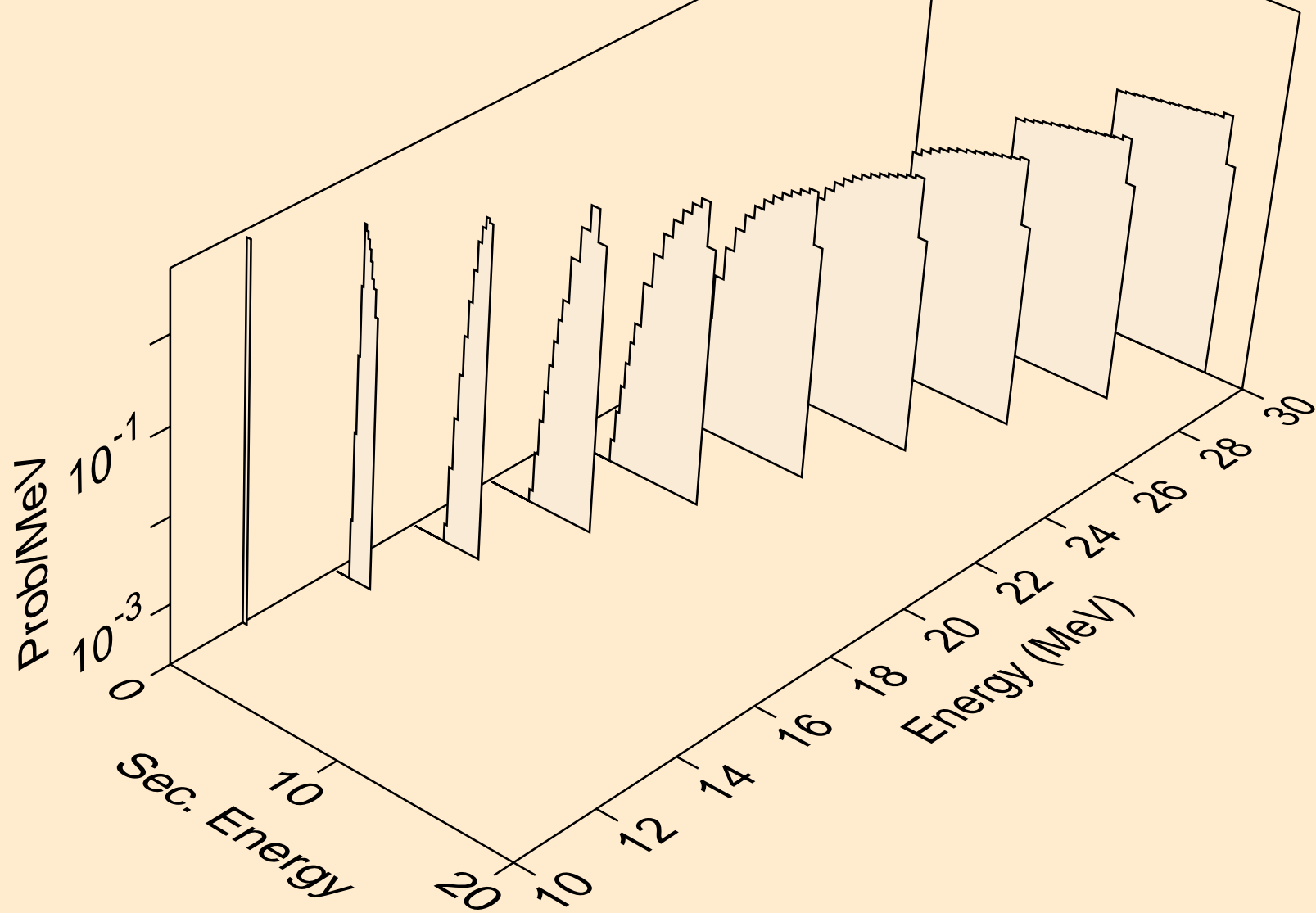

SR095 NEUTRON ACER TENDL-2024 LIBRARY; T=0.K
tritons from (n,x)

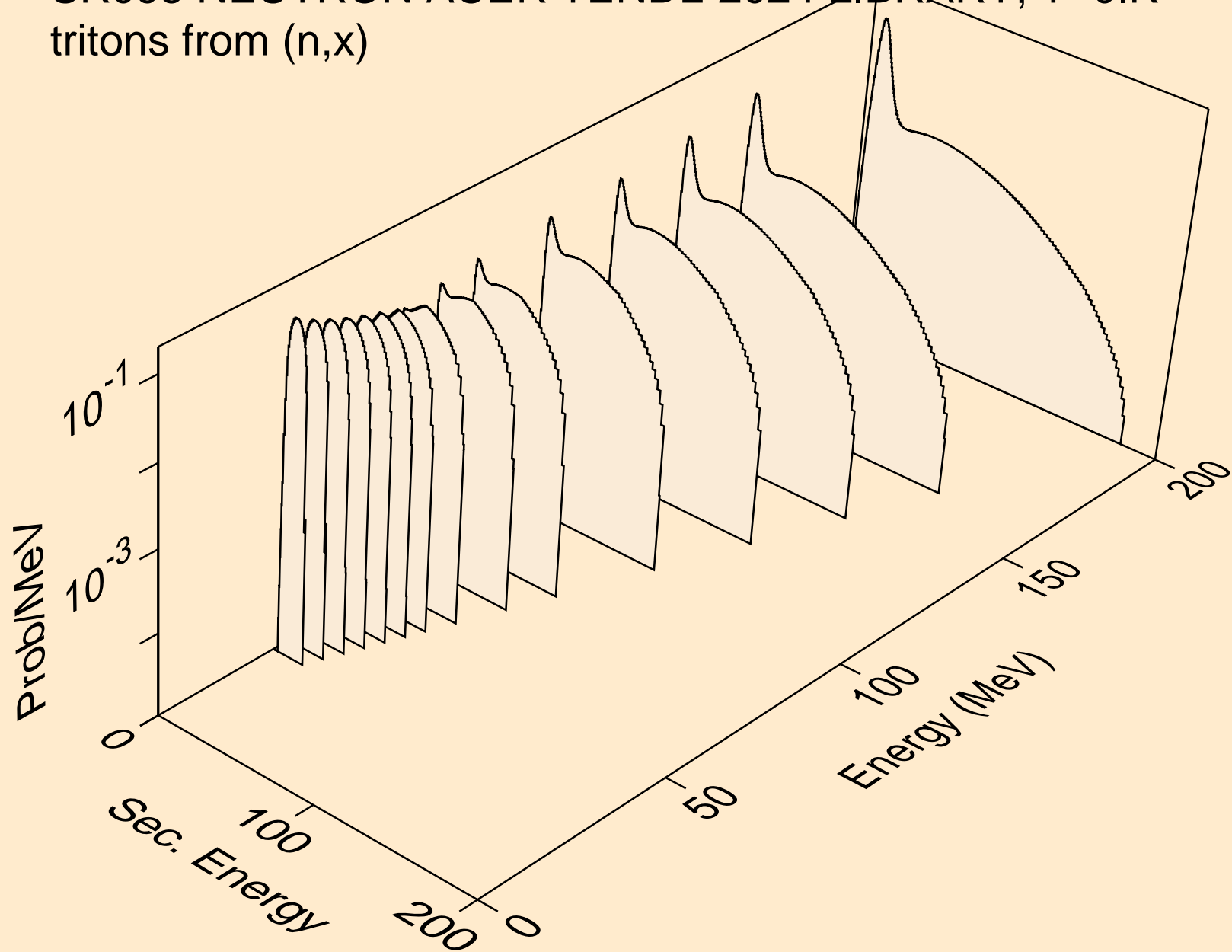

SR095 NEUTRON ACER TENDL-2024 LIBRARY; T=0.K
tritons from (n,n*)t

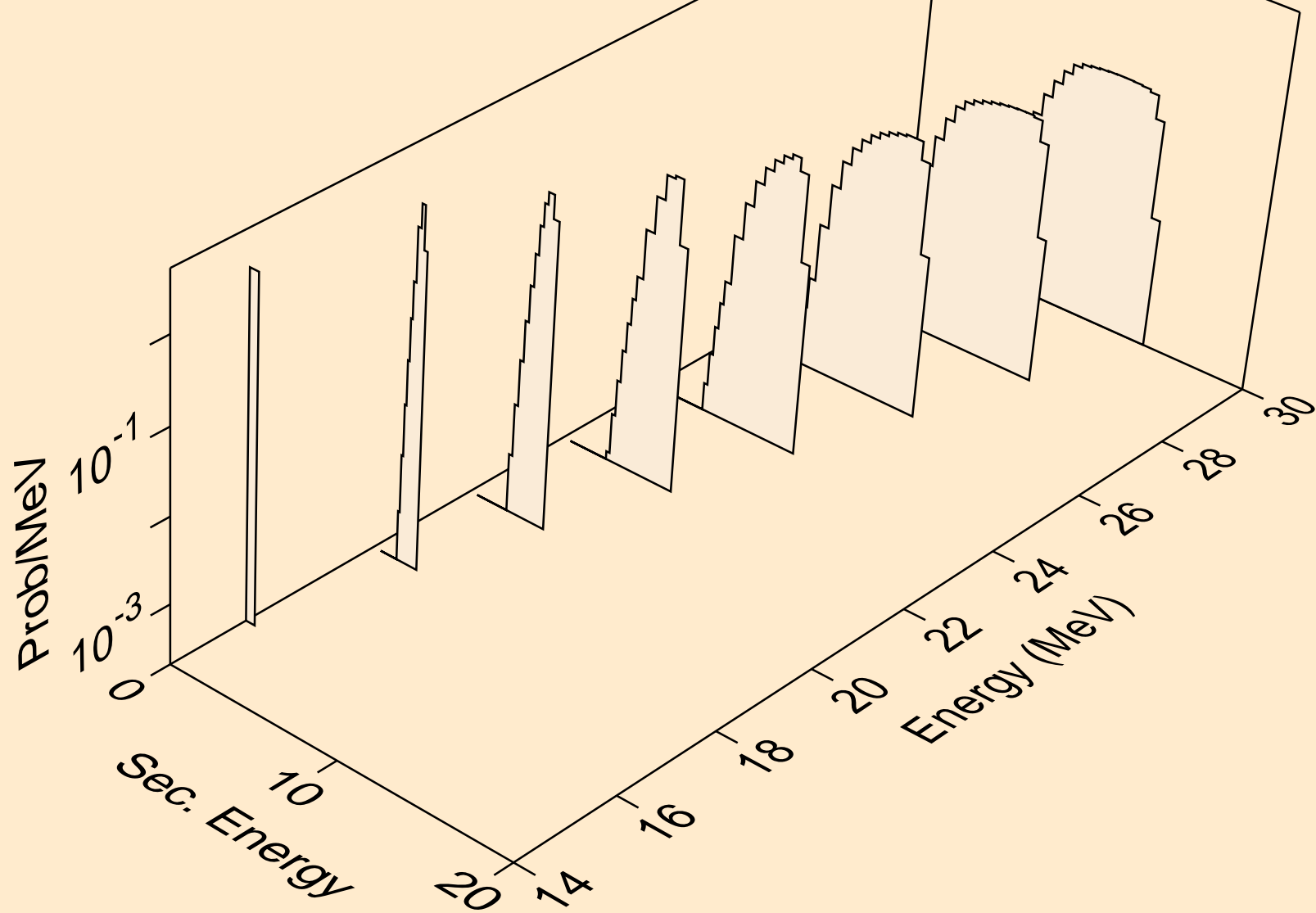

SR095 NEUTRON ACER TENDL-2024 LIBRARY; T=0.K
tritons from (n,t)

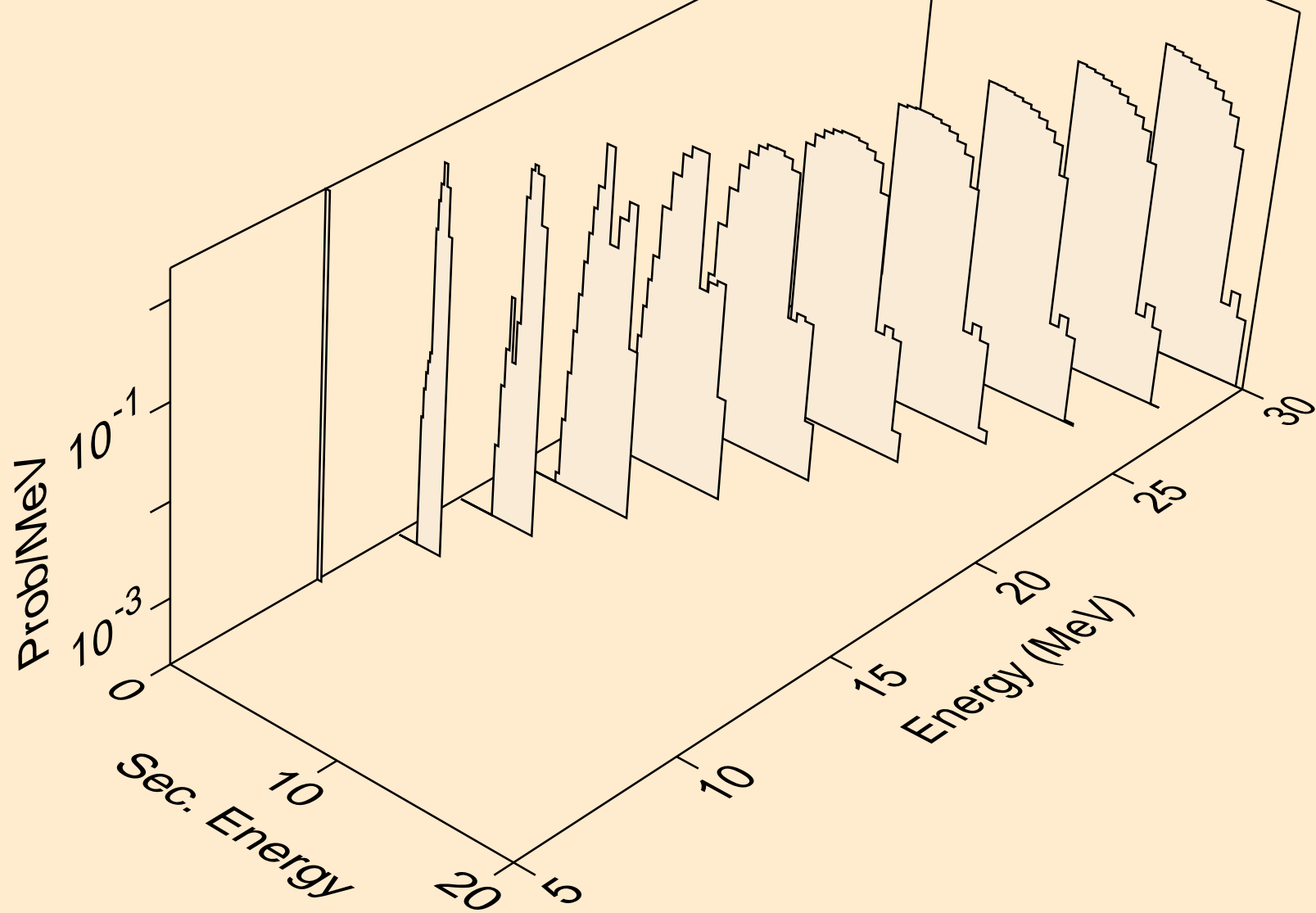

SR095 NEUTRON ACER TENDL-2024 LIBRARY; T=0.K
he3s from (n,x)

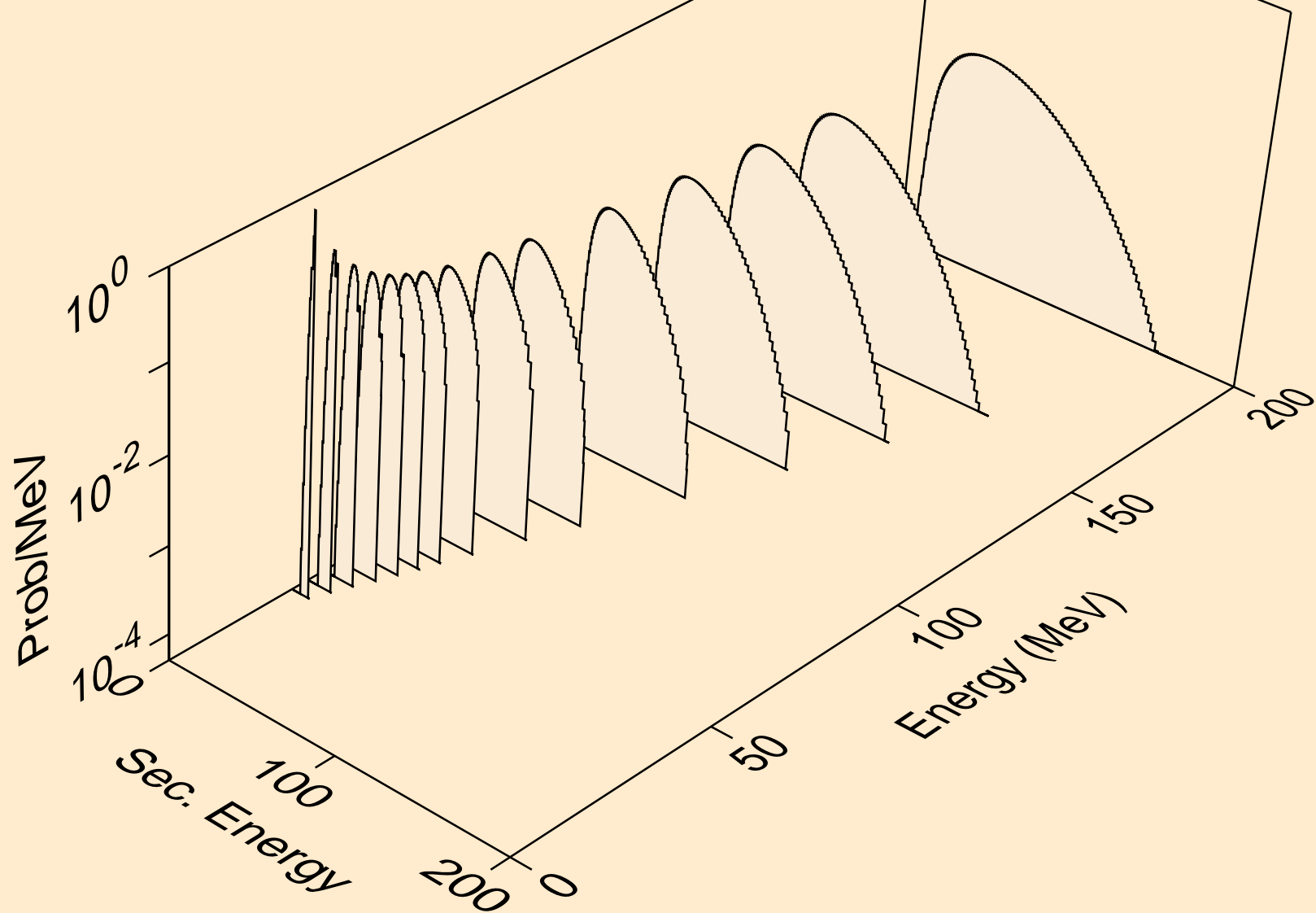

SR095 NEUTRON ACER TENDL-2024 LIBRARY; T=0.K
he3s from (n,n*)he3

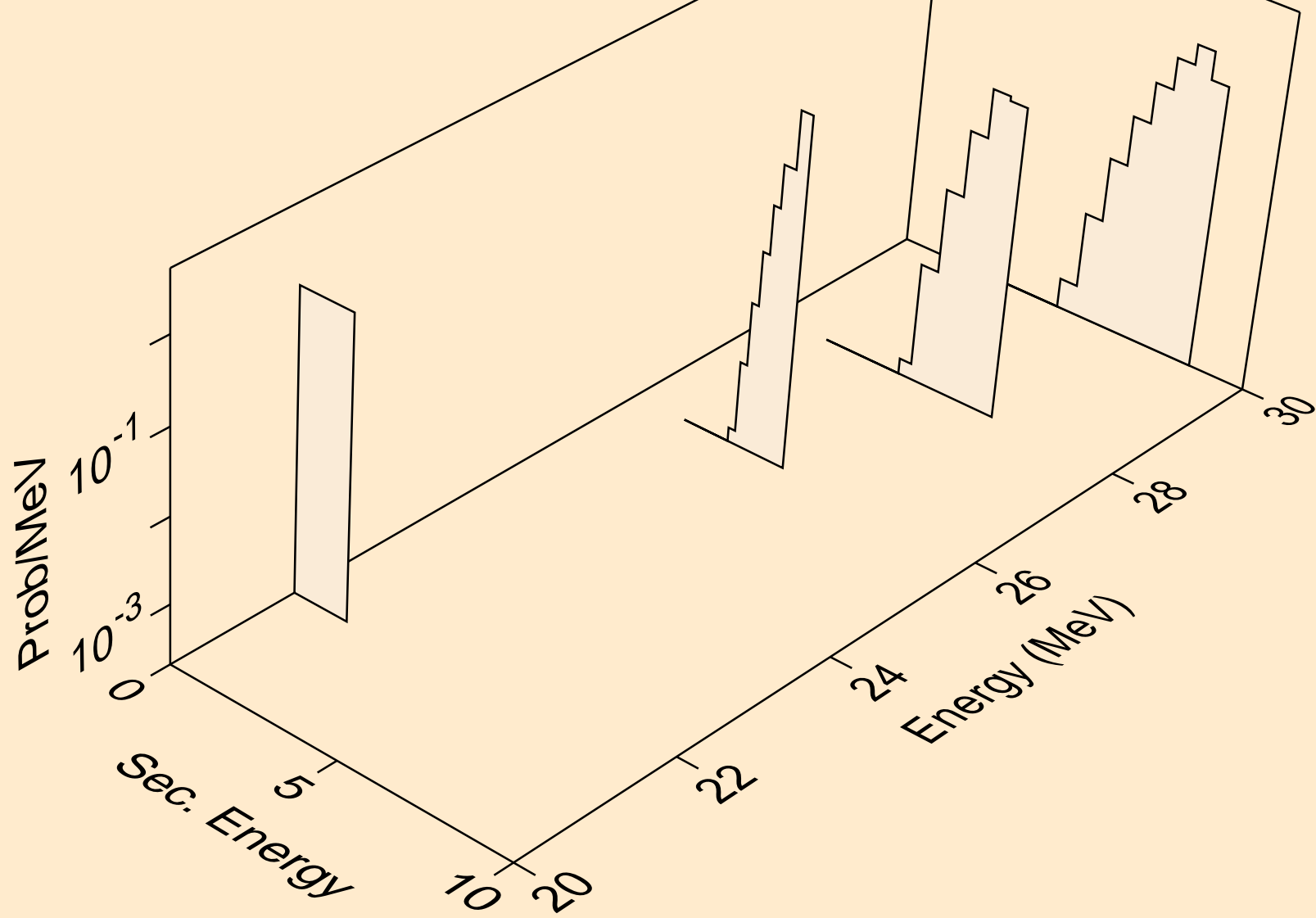

SR095 NEUTRON ACER TENDL-2024 LIBRARY; T=0.K
he3s from (n,he3)

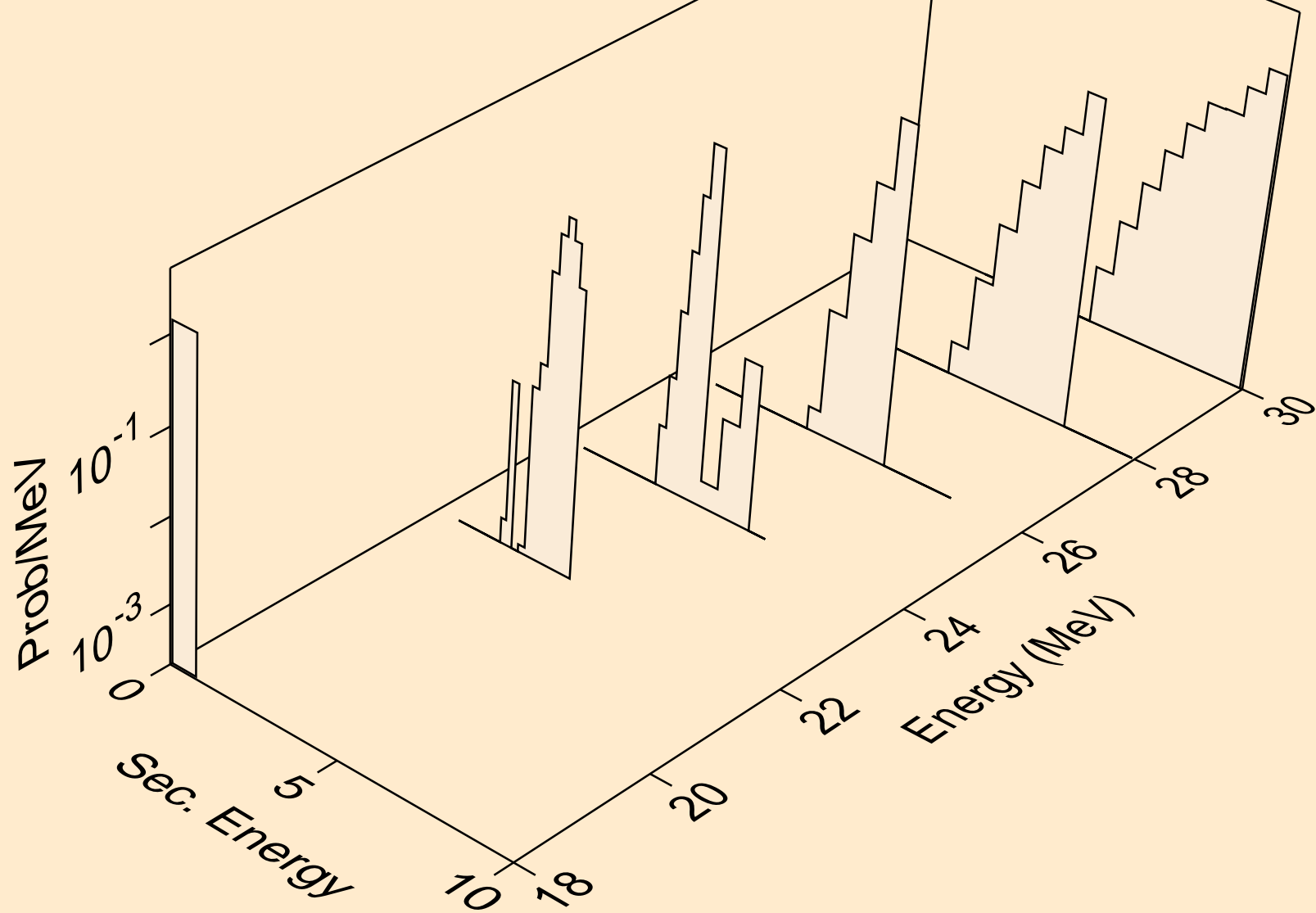

SR095 NEUTRON ACER TENDL-2024 LIBRARY; T=0.K
alphas from (n,x)

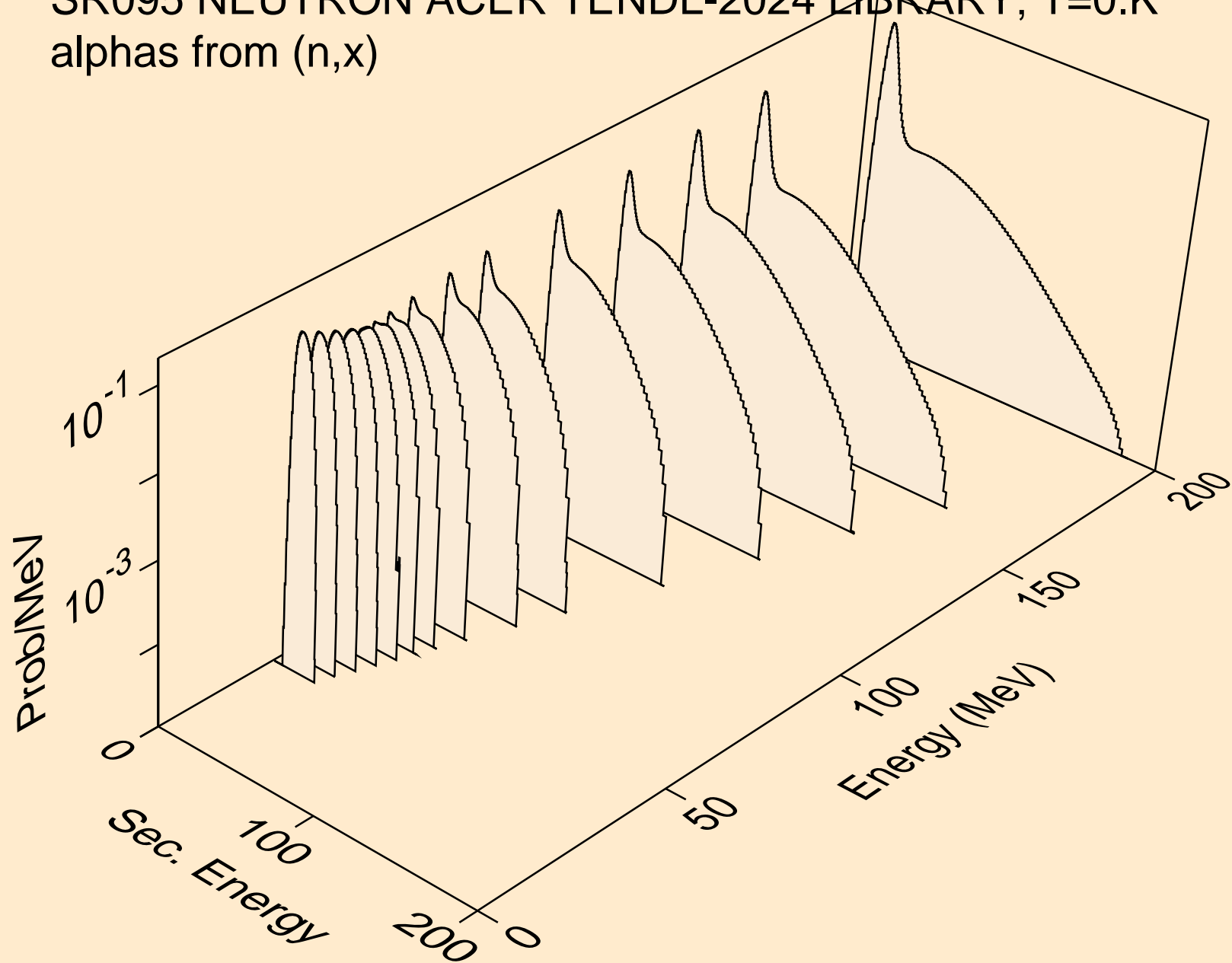

SR095 NEUTRON ACER TENDL-2024 LIBRARY; T=0.K
alphas from (n,n*)a

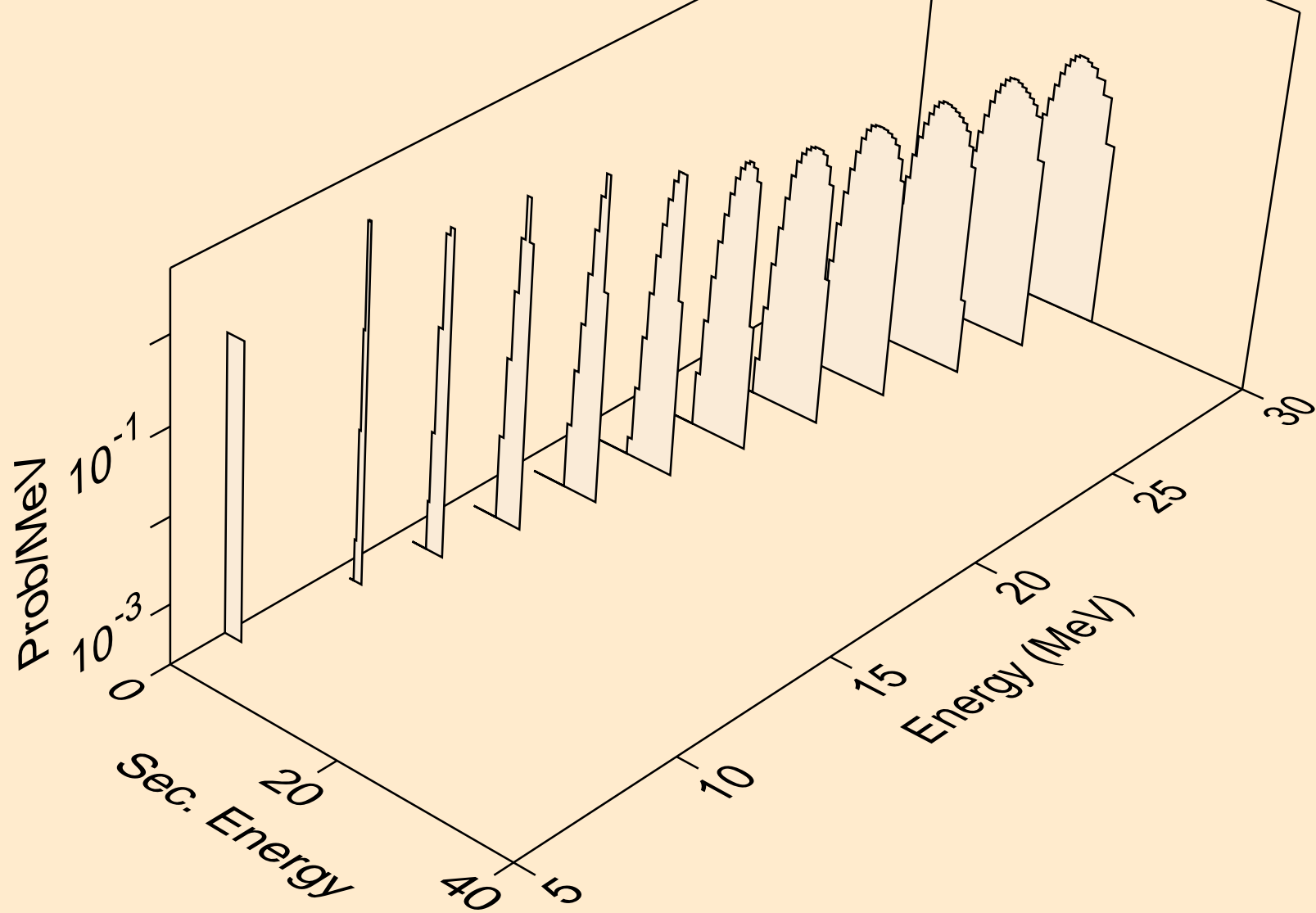

SR095 NEUTRON ACER TENDL-2024 LIBRARY; T=0.K
alphas from (n,2n)a

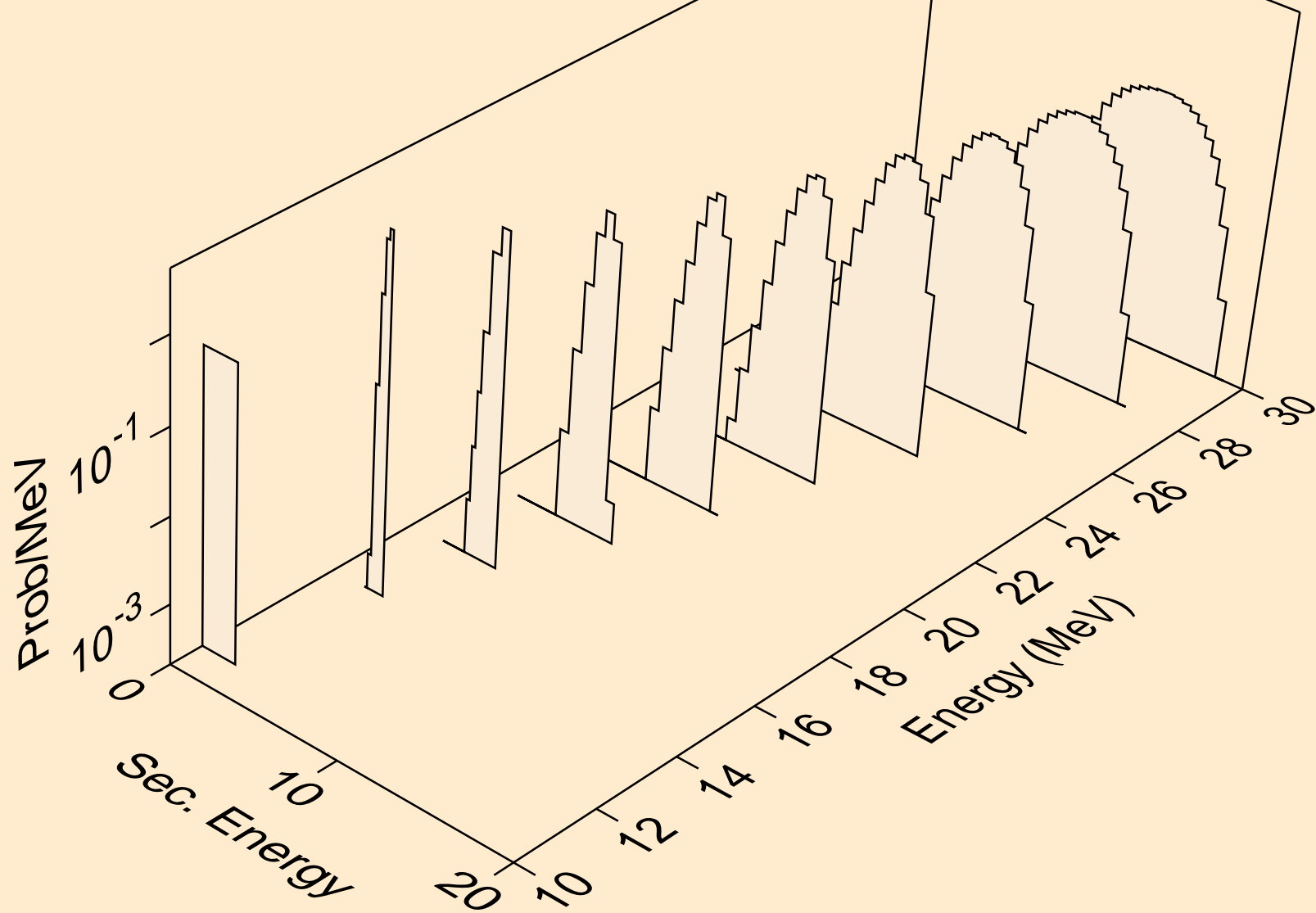

SR095 NEUTRON ACER TENDL-2024 LIBRARY; T=0.K
alphas from (n,3n)a

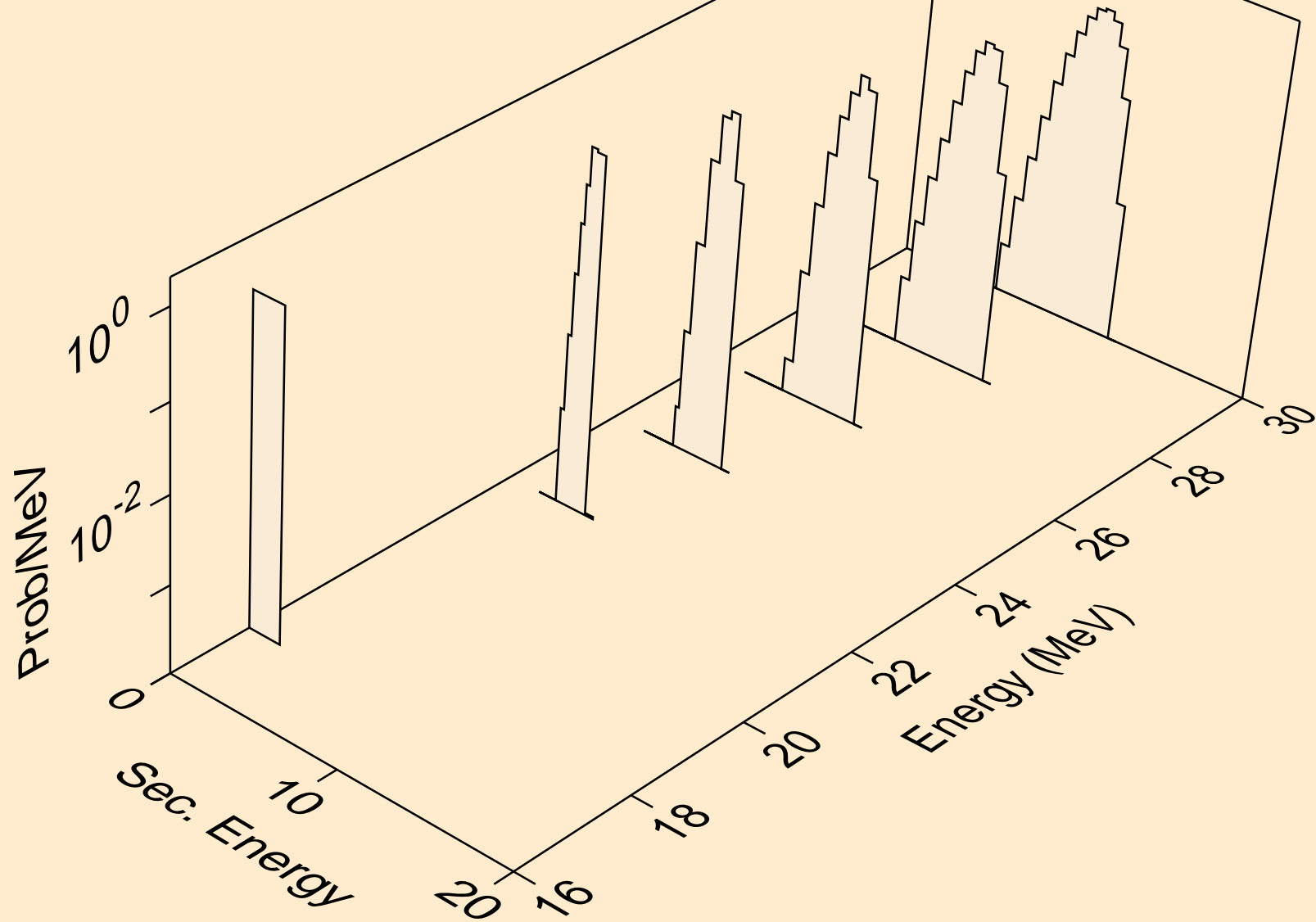

SR095 NEUTRON ACER TENDL-2024 LIBRARY; T=0.K
alphas from (n,a)

