

TA169 NEUTRON ACER TENDL-2024 LIBRARY; T=0.K

Principal cross sections

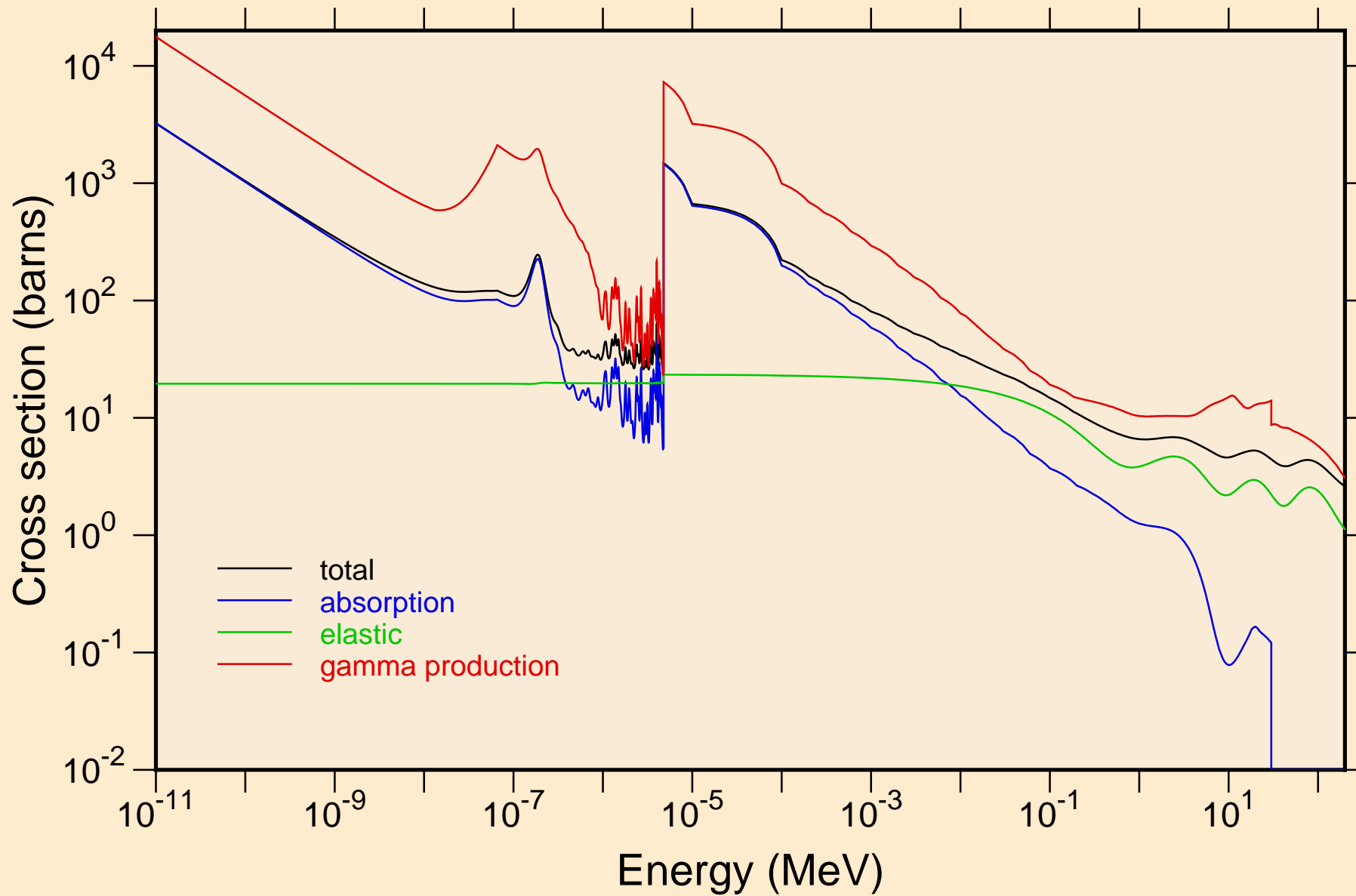

TA169 NEUTRON ACER TENDL-2024 LIBRARY; T=0.K
resonance total cross section

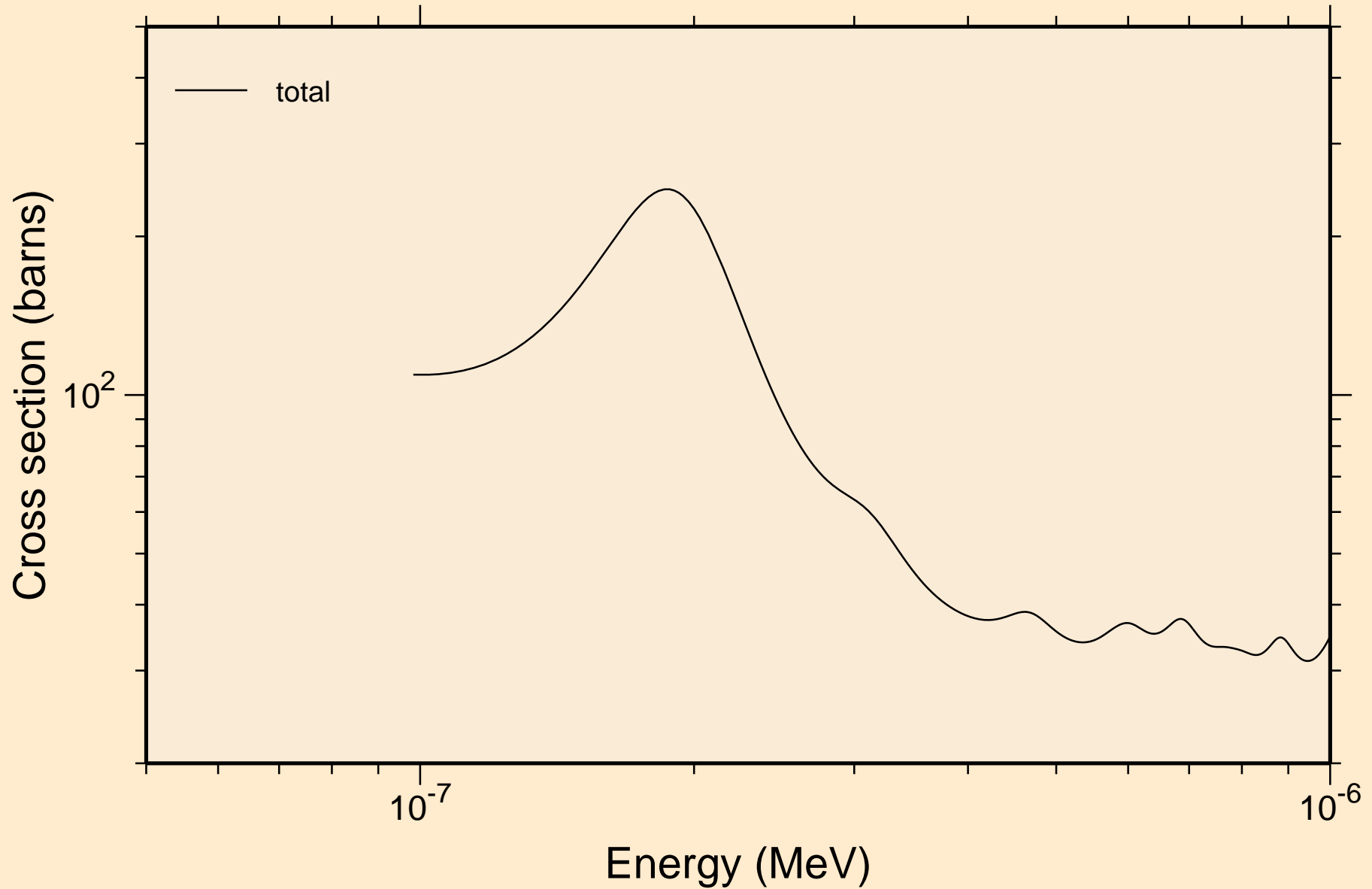

TA169 NEUTRON ACER TENDL-2024 LIBRARY; T=0.K
resonance total cross section

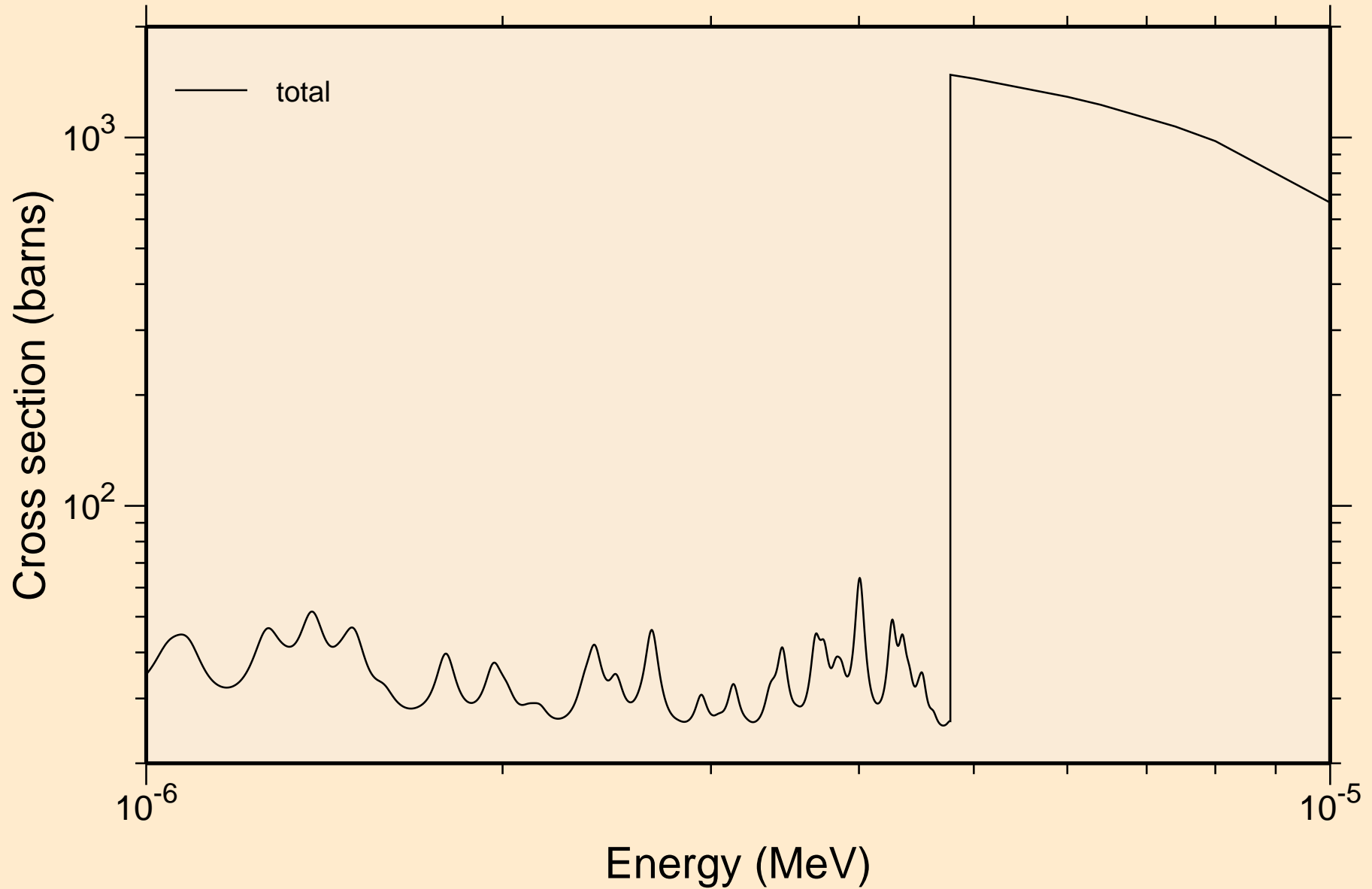

TA169 NEUTRON ACER TENDL-2024 LIBRARY; T=0.K
resonance total cross section

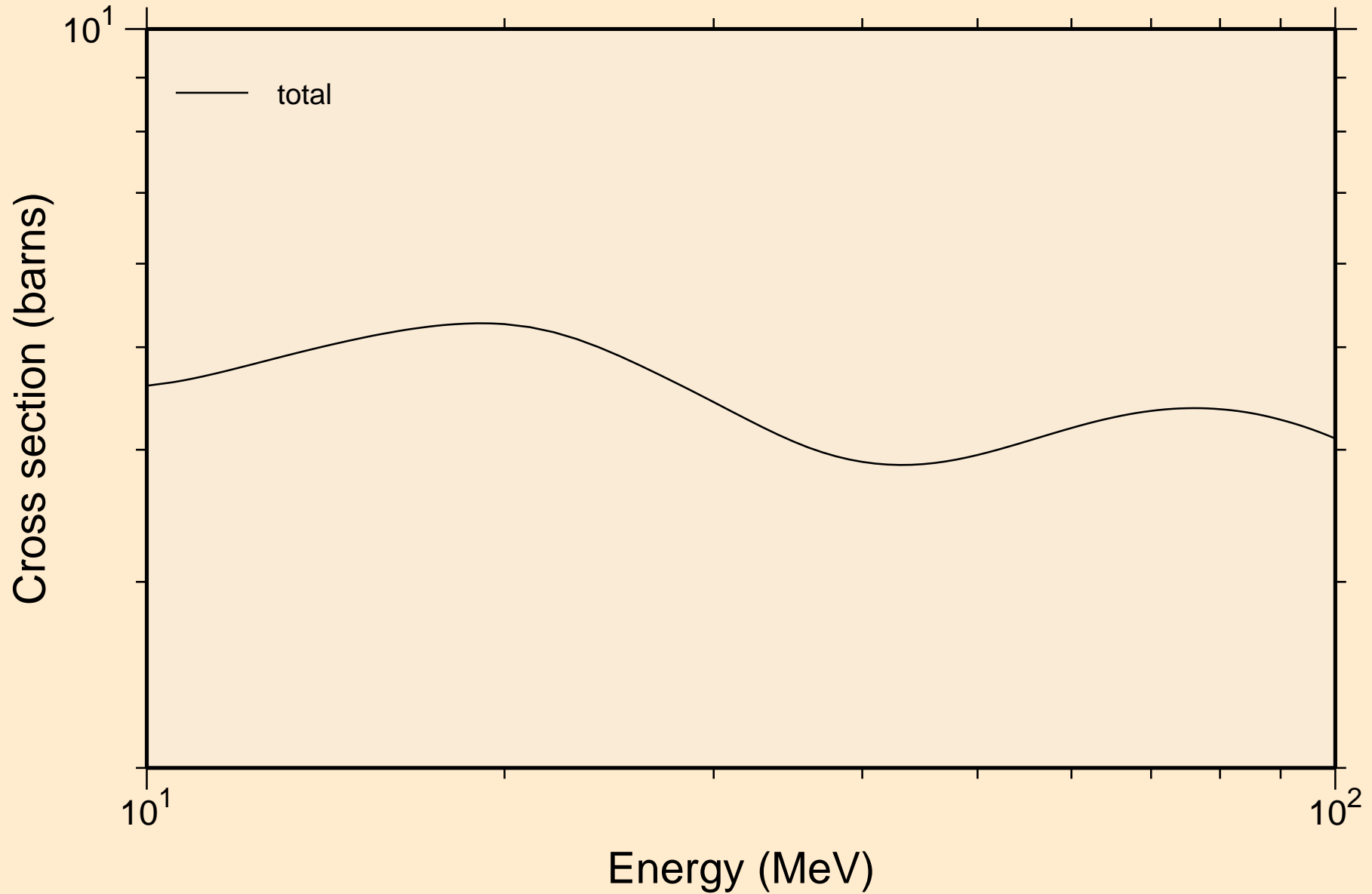

TA169 NEUTRON ACER TENDL-2024 LIBRARY; T=0.K
resonance absorption cross sections

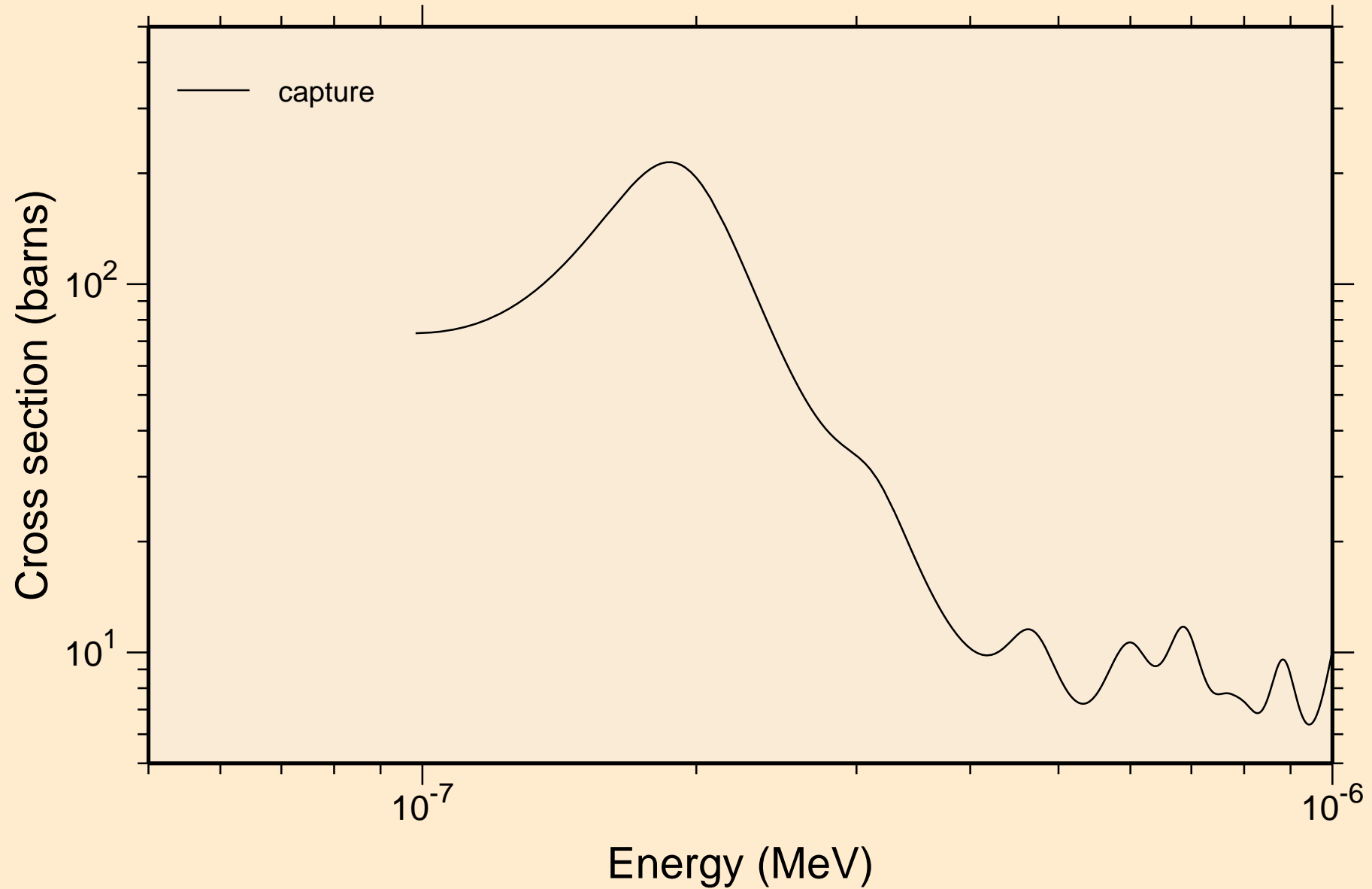

TA169 NEUTRON ACER TENDL-2024 LIBRARY; T=0.K
resonance absorption cross sections

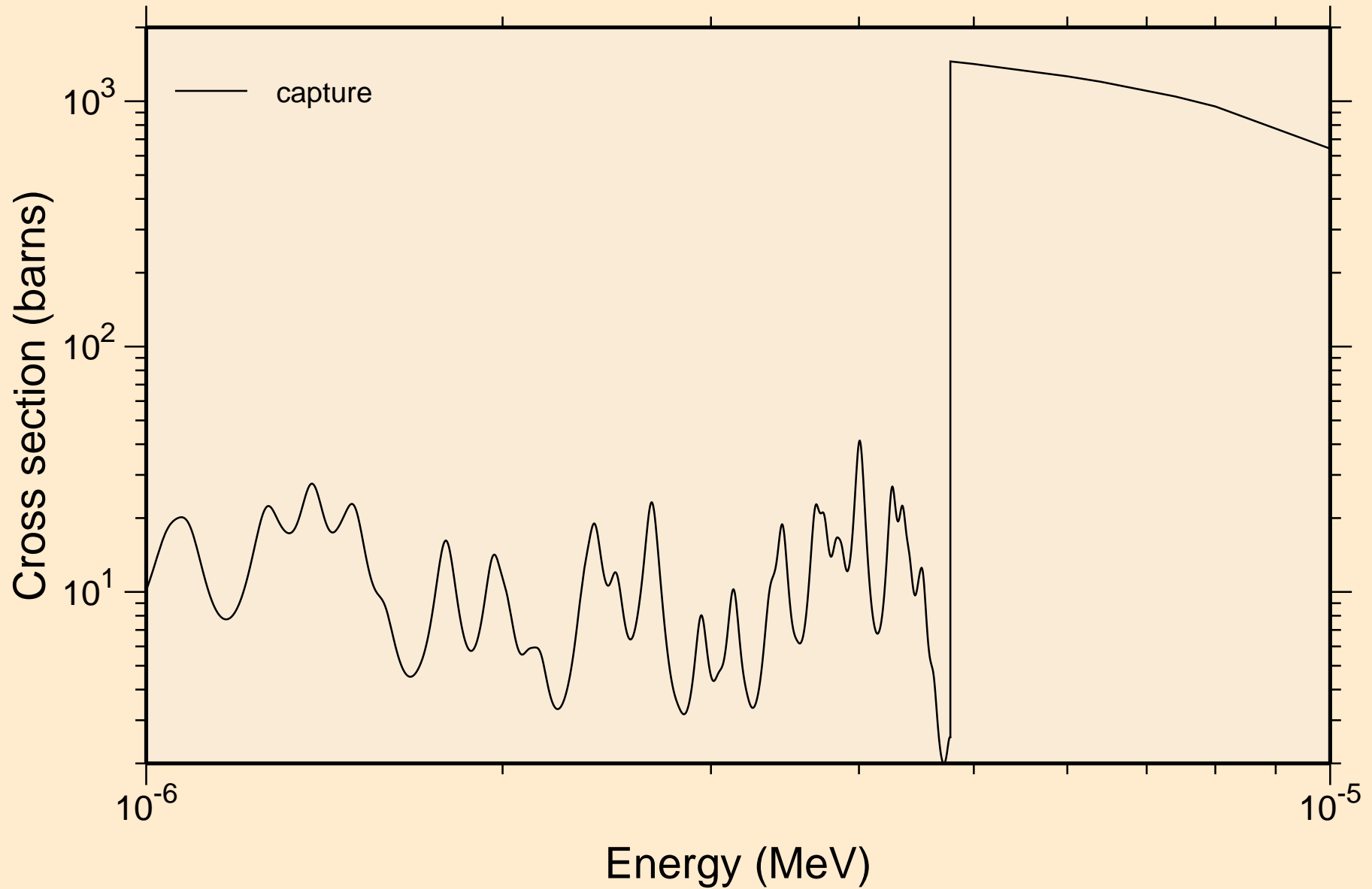

TA169 NEUTRON ACER TENDL-2024 LIBRARY; T=0.K
resonance absorption cross sections

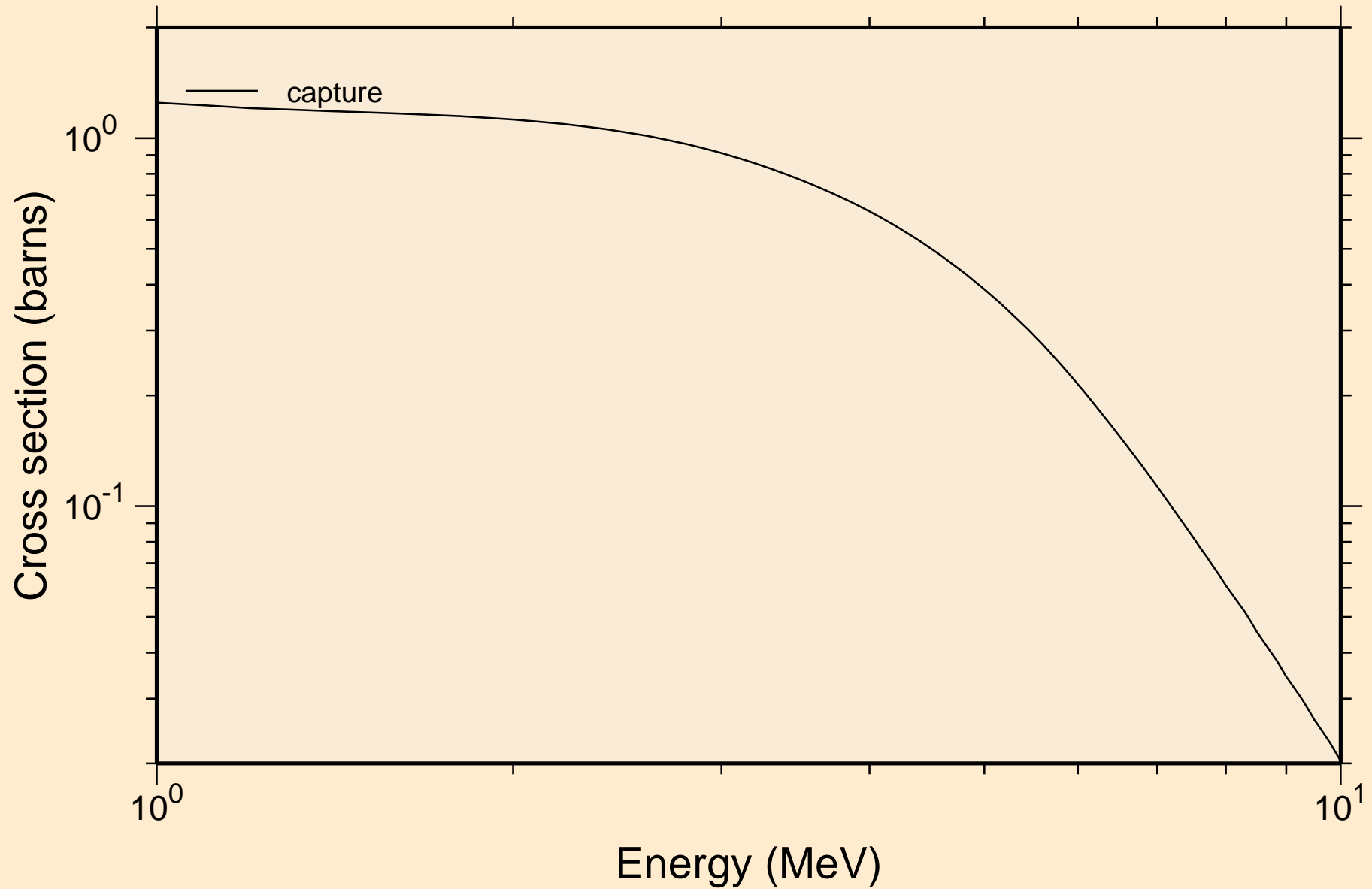

TA169 NEUTRON ACER TENDL-2024 LIBRARY; T=0.K
Heating

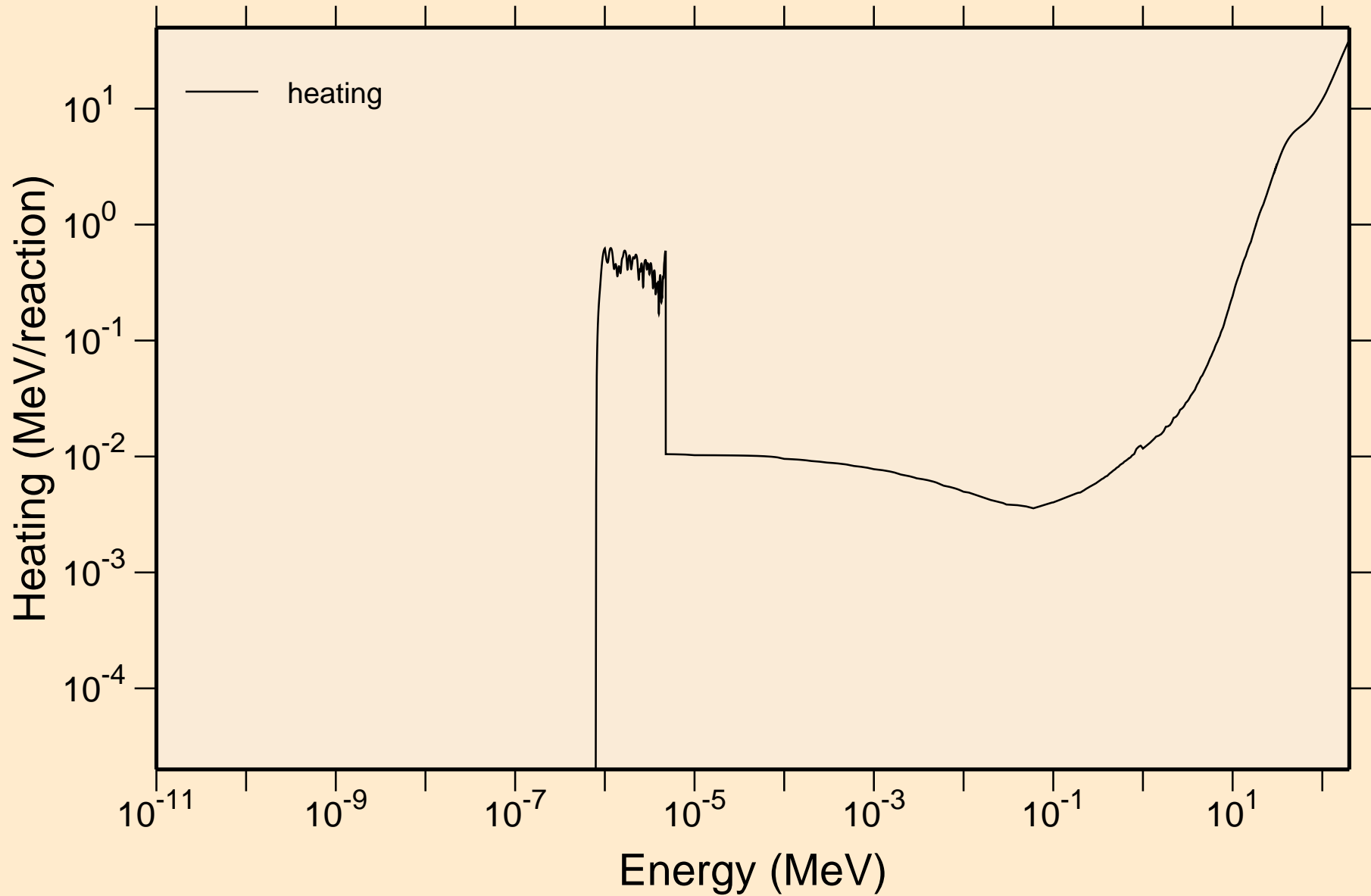

TA169 NEUTRON ACER TENDL-2024 LIBRARY; T=0.K
Damage

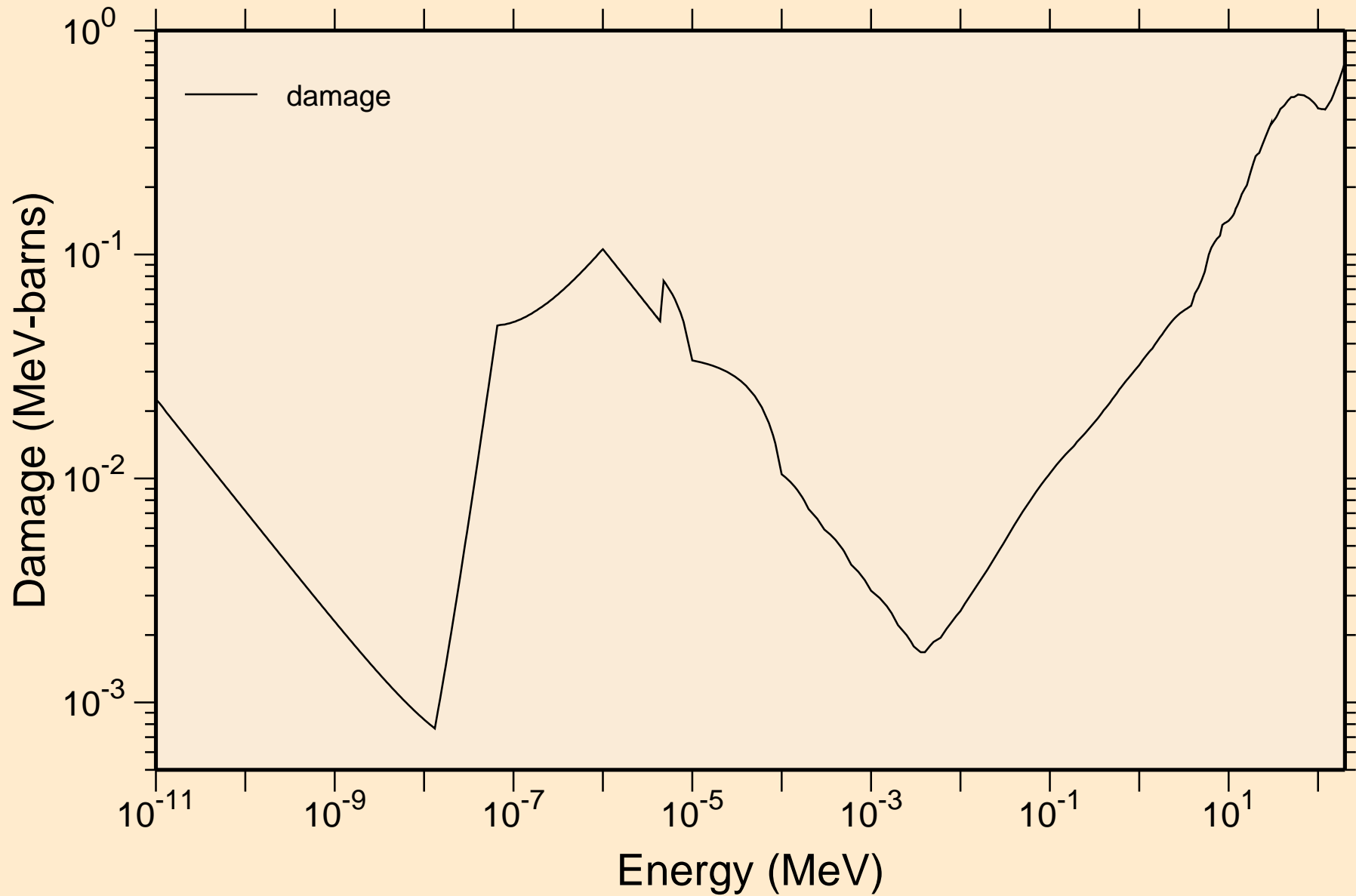

TA169 NEUTRON ACER TENDL-2024 LIBRARY; T=0.K
Non-threshold reactions

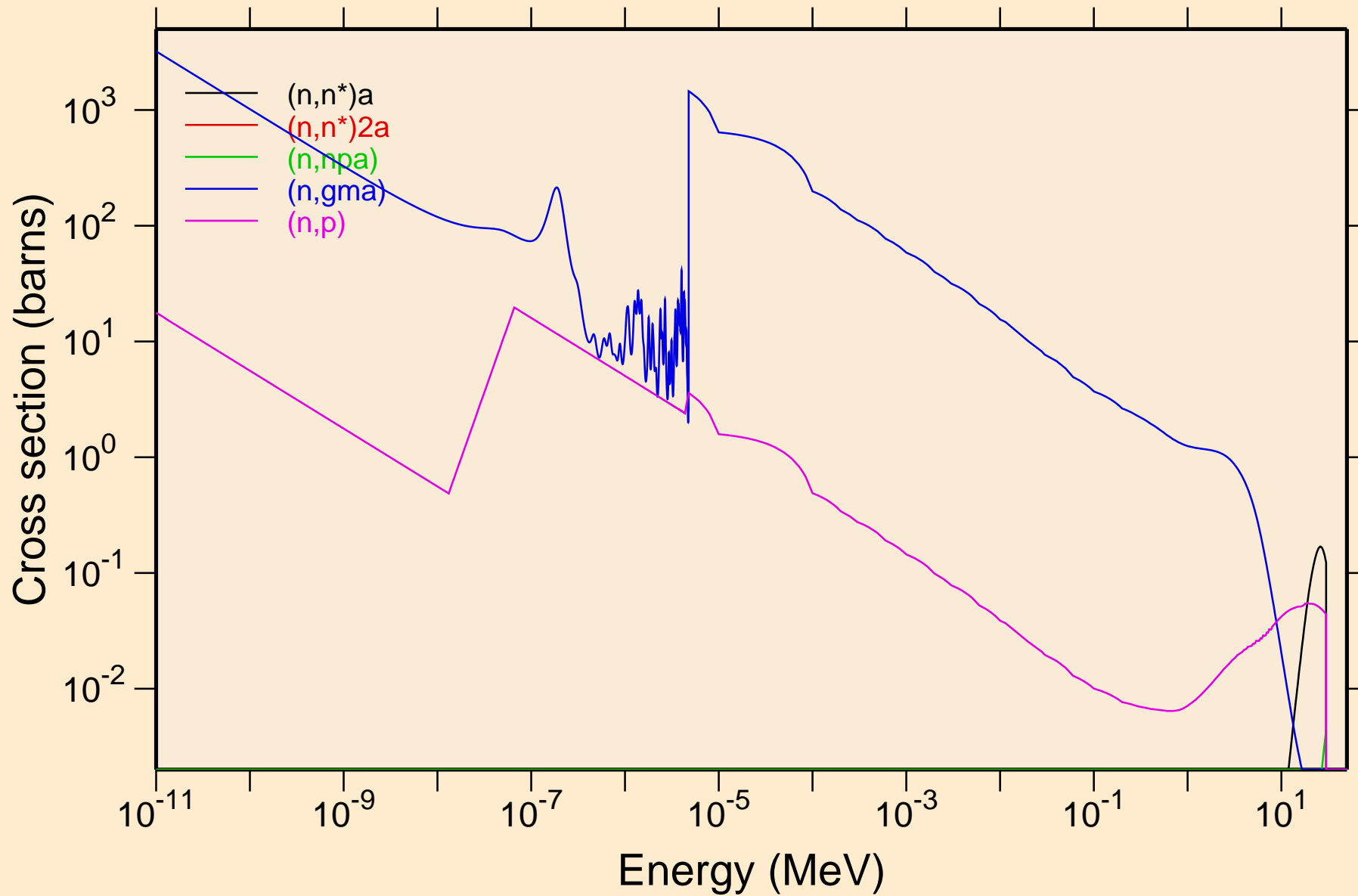

TA169 NEUTRON ACER TENDL-2024 LIBRARY; T=0.K
Non-threshold reactions

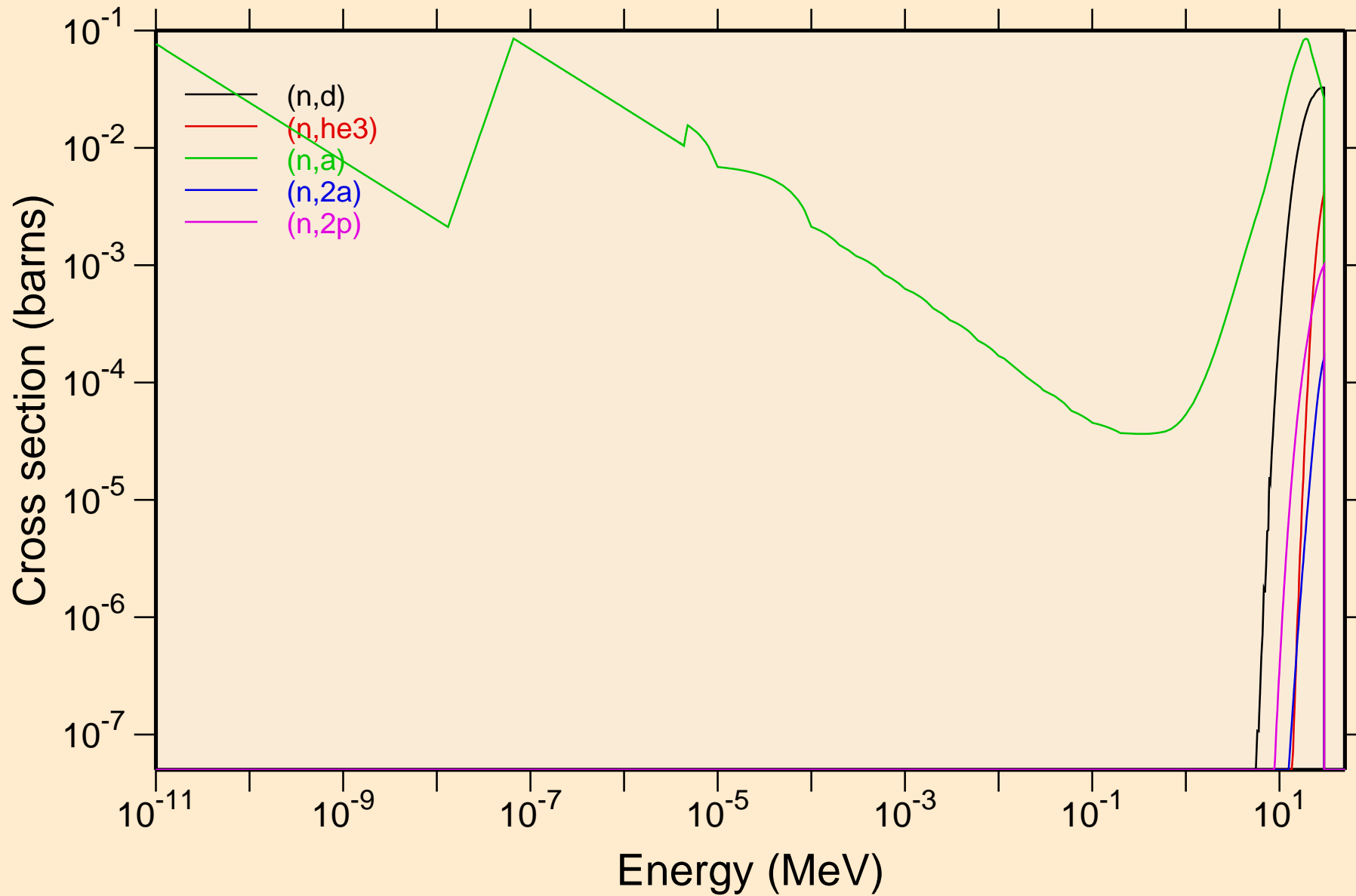

TA169 NEUTRON ACER TENDL-2024 LIBRARY; T=0.K
Non-threshold reactions

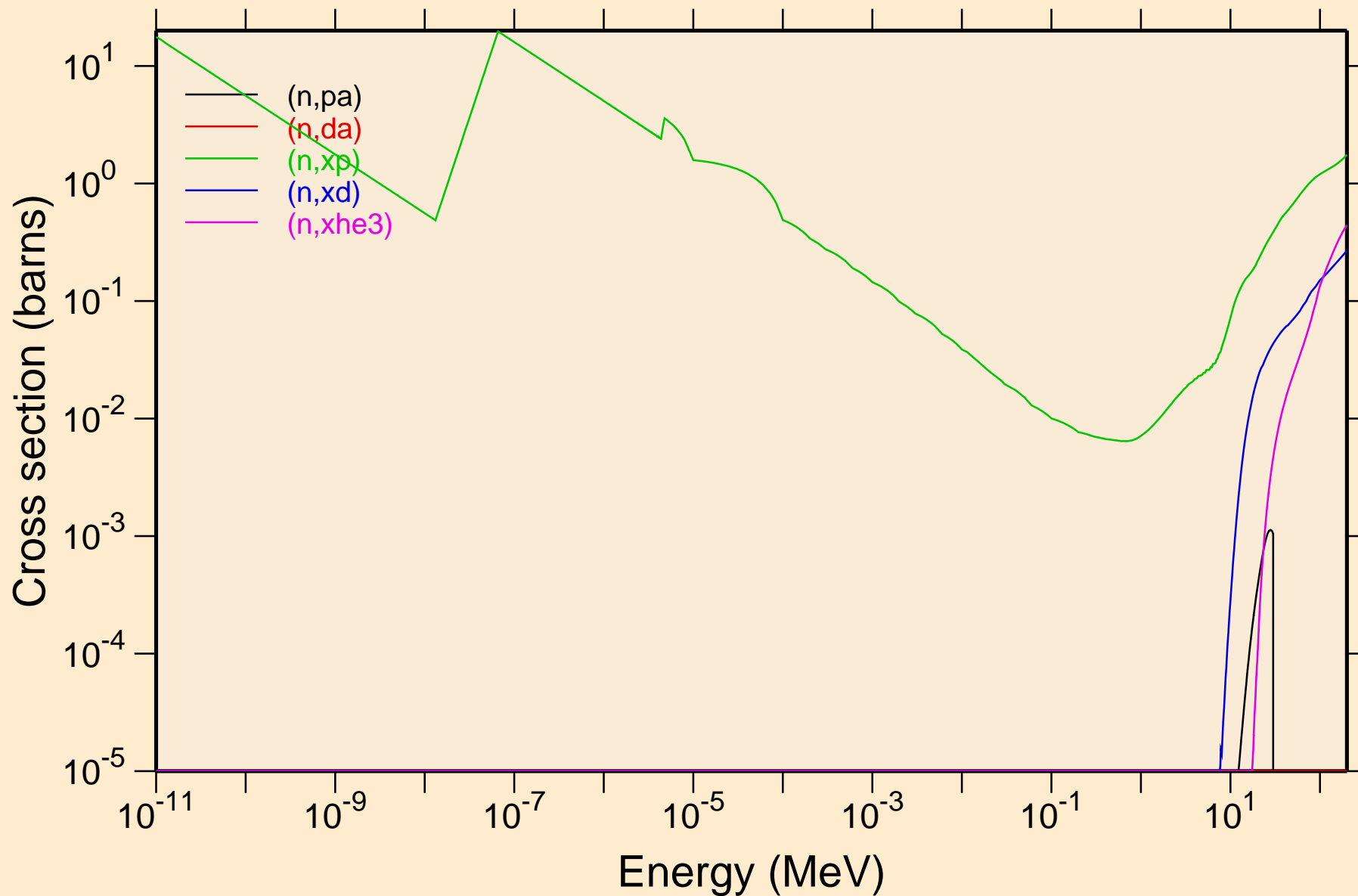

TA169 NEUTRON ACER TENDL-2024 LIBRARY; T=0.K
Non-threshold reactions

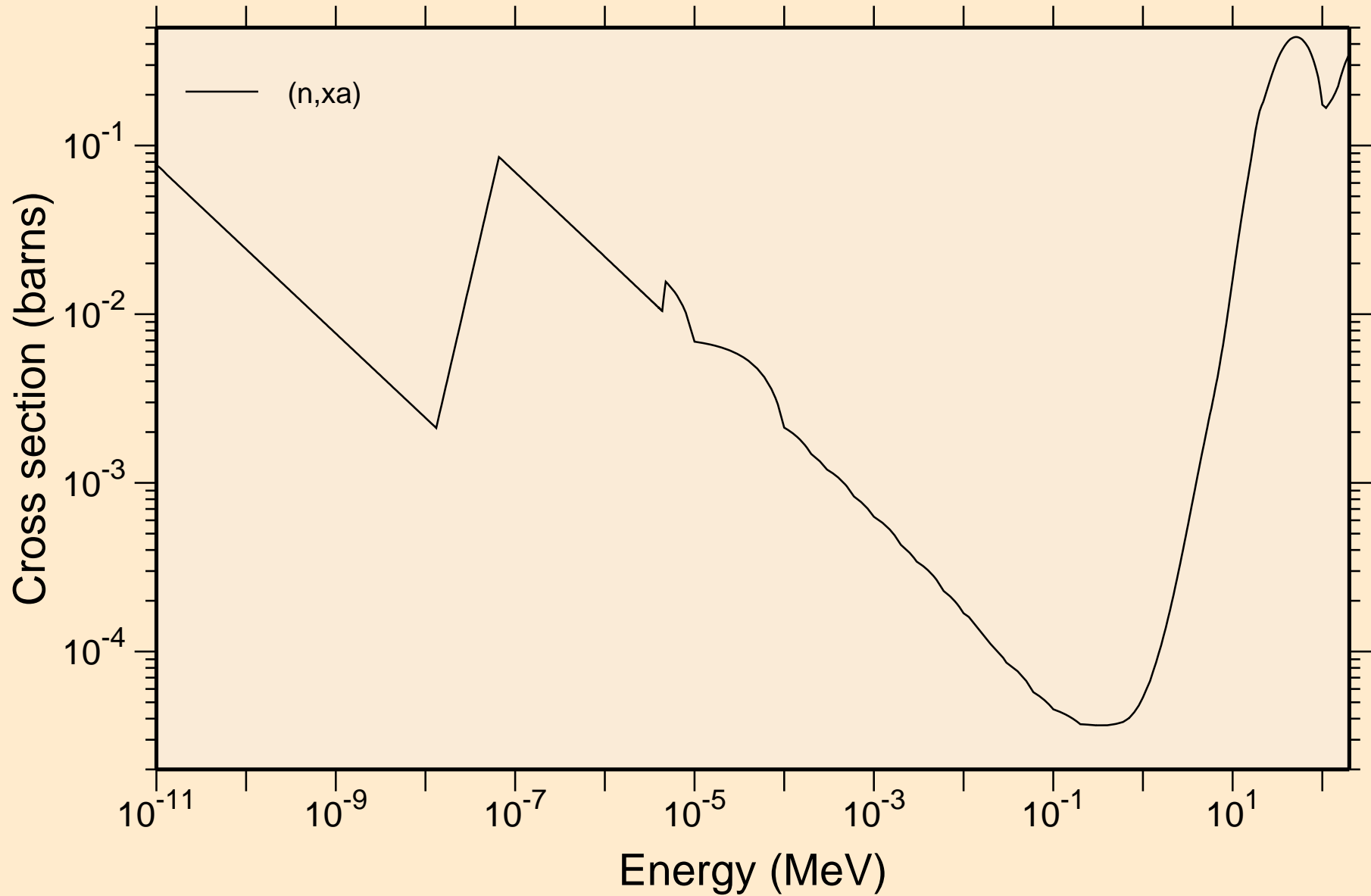

TA169 NEUTRON ACER TENDL-2024 LIBRARY; T=0.K

Principal cross sections

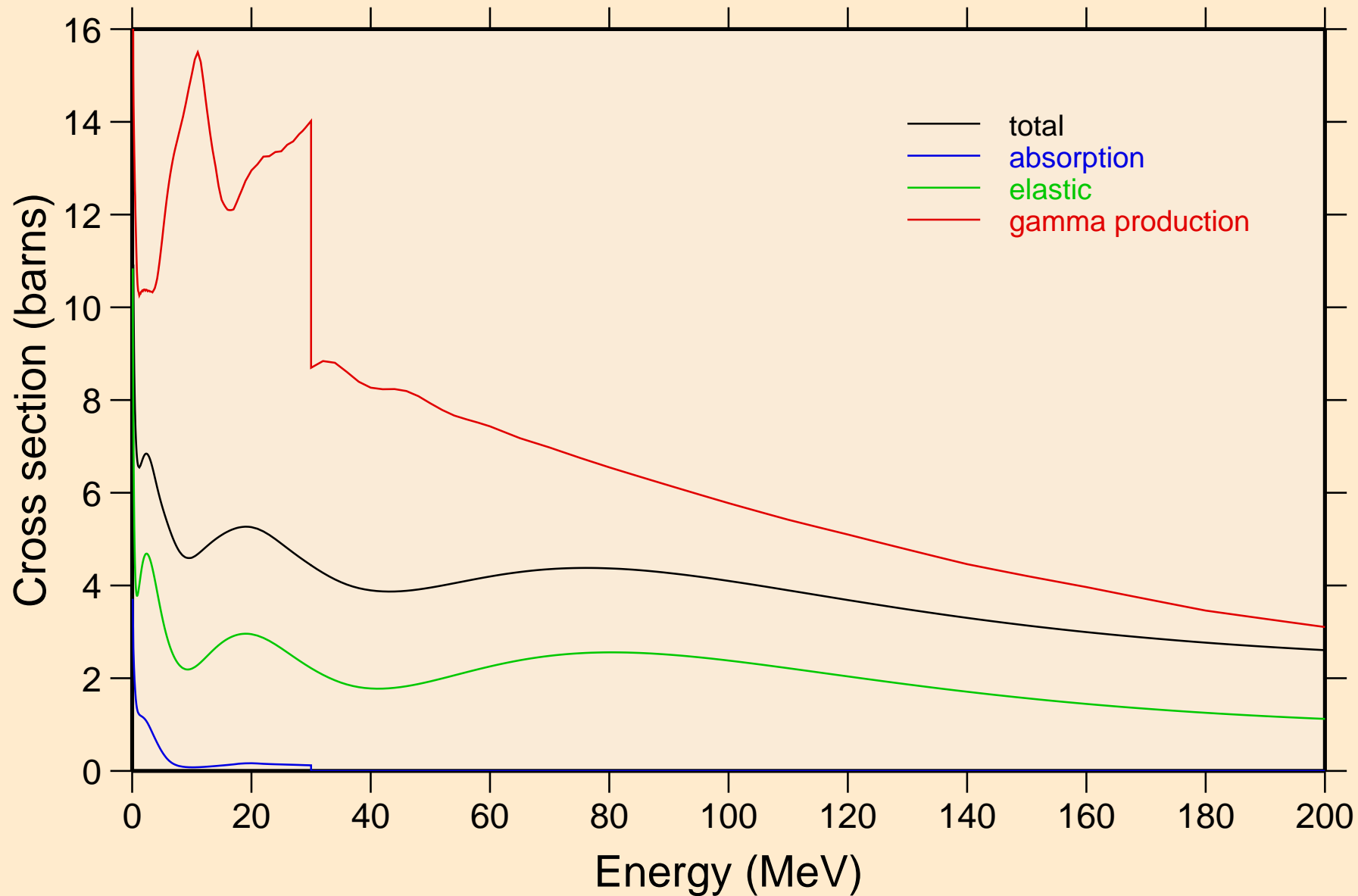

TA169 NEUTRON ACER TENDL-2024 LIBRARY; T=0.K

Heating

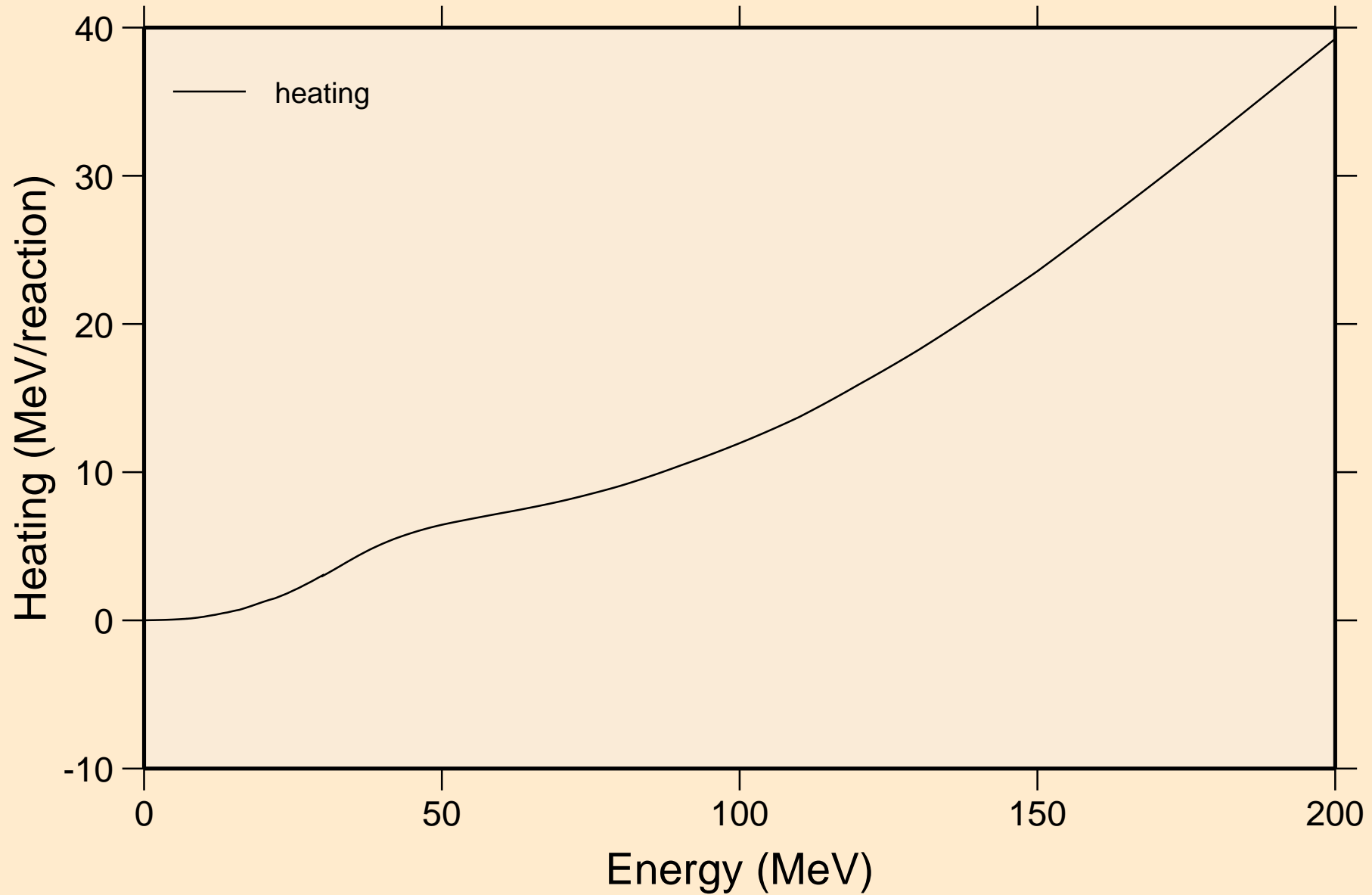

TA169 NEUTRON ACER TENDL-2024 LIBRARY; T=0.K
Damage

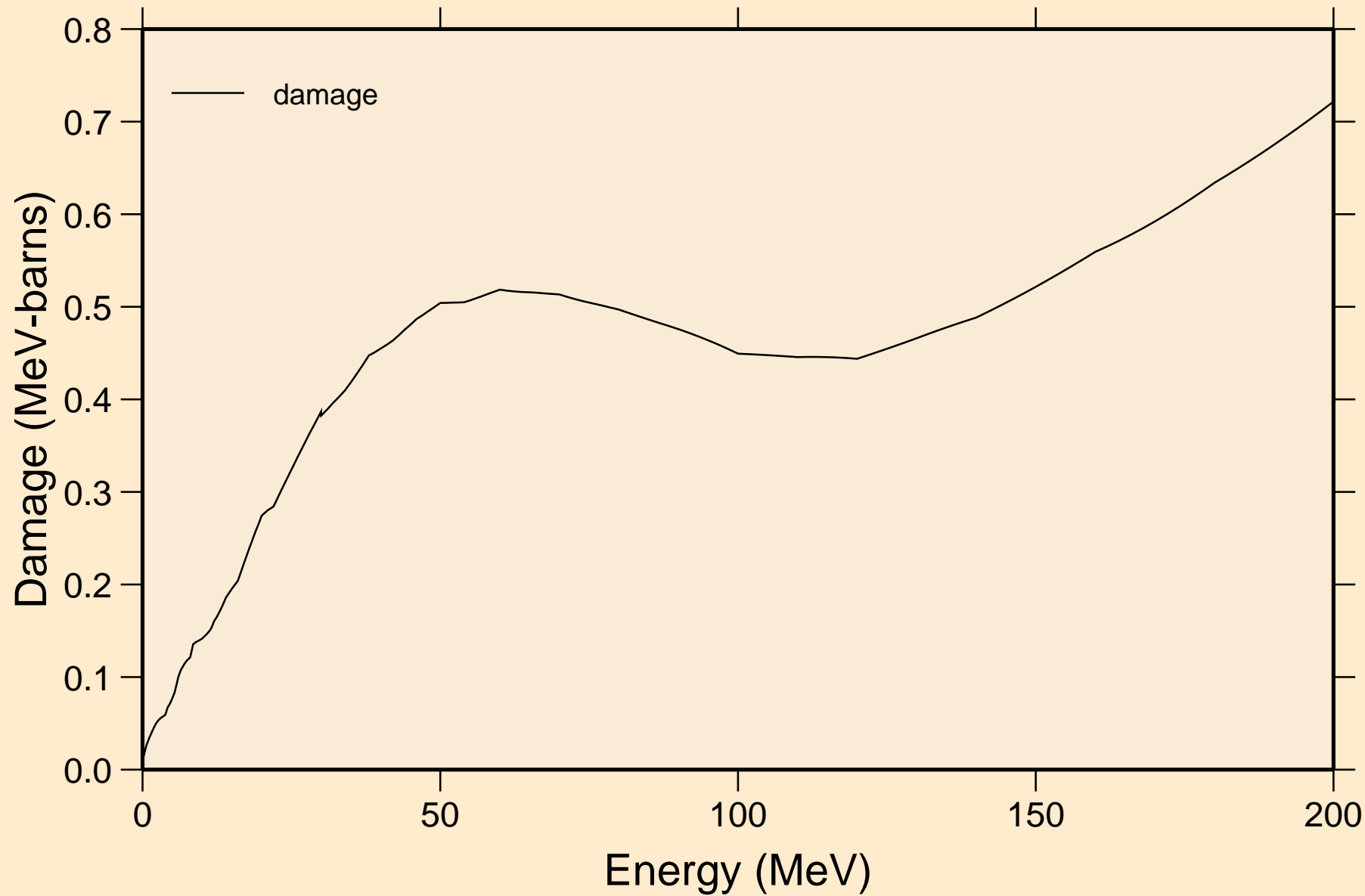

TA169 NEUTRON ACER TENDL-2024 LIBRARY; T=0.K
Non-threshold reactions

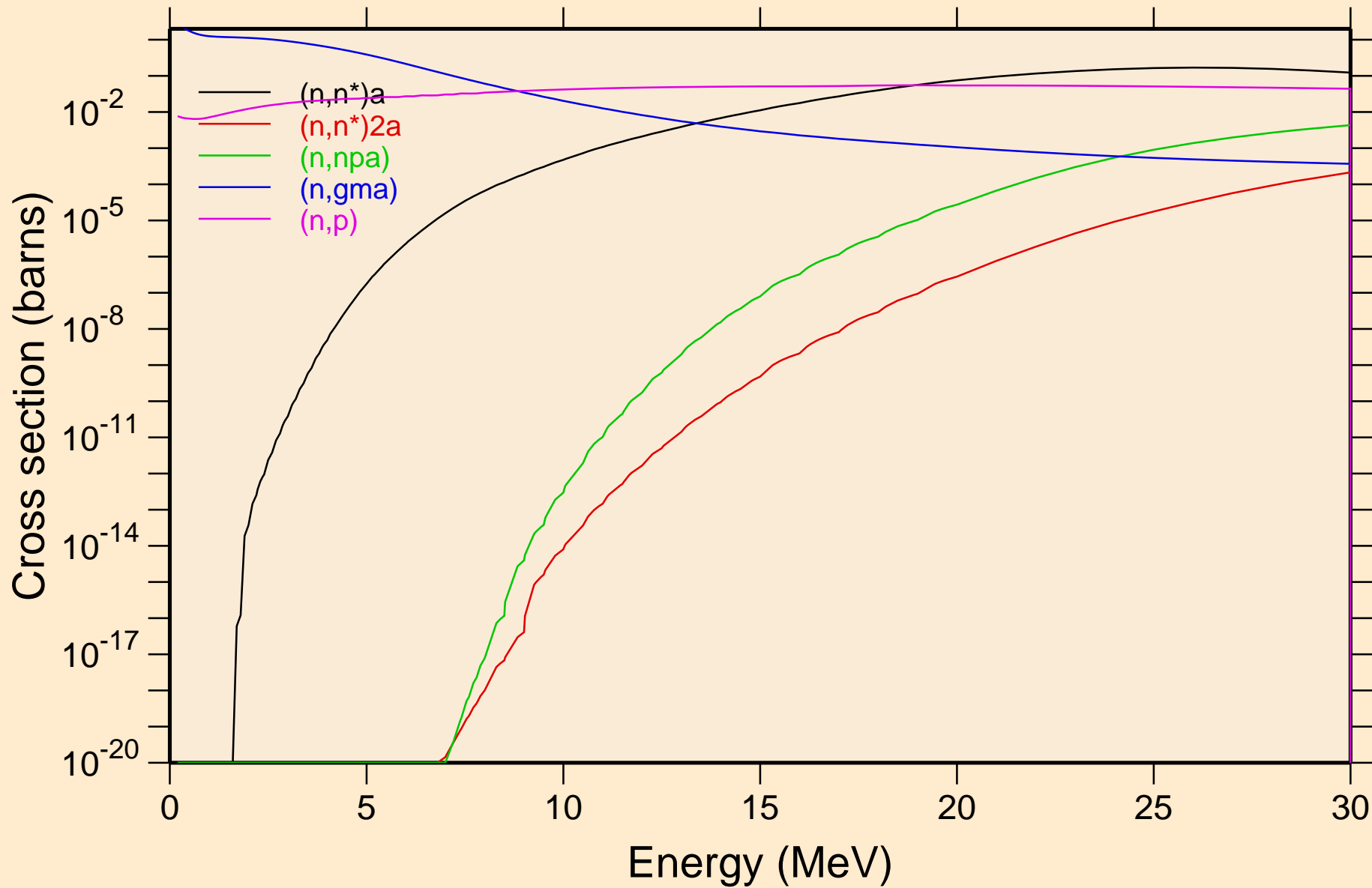

TA169 NEUTRON ACER TENDL-2024 LIBRARY; T=0.K
Non-threshold reactions

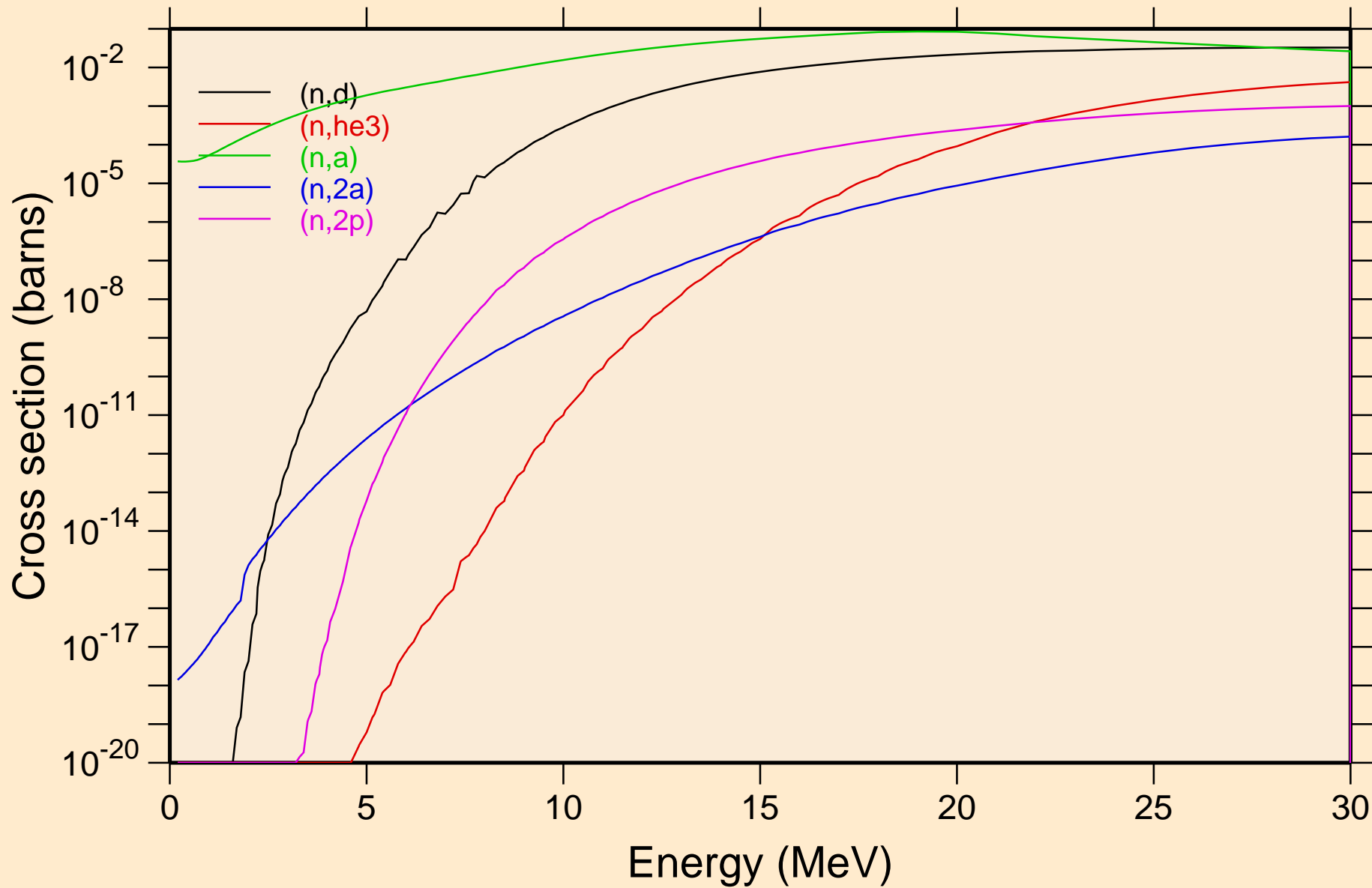

TA169 NEUTRON ACER TENDL-2024 LIBRARY; T=0.K
Non-threshold reactions

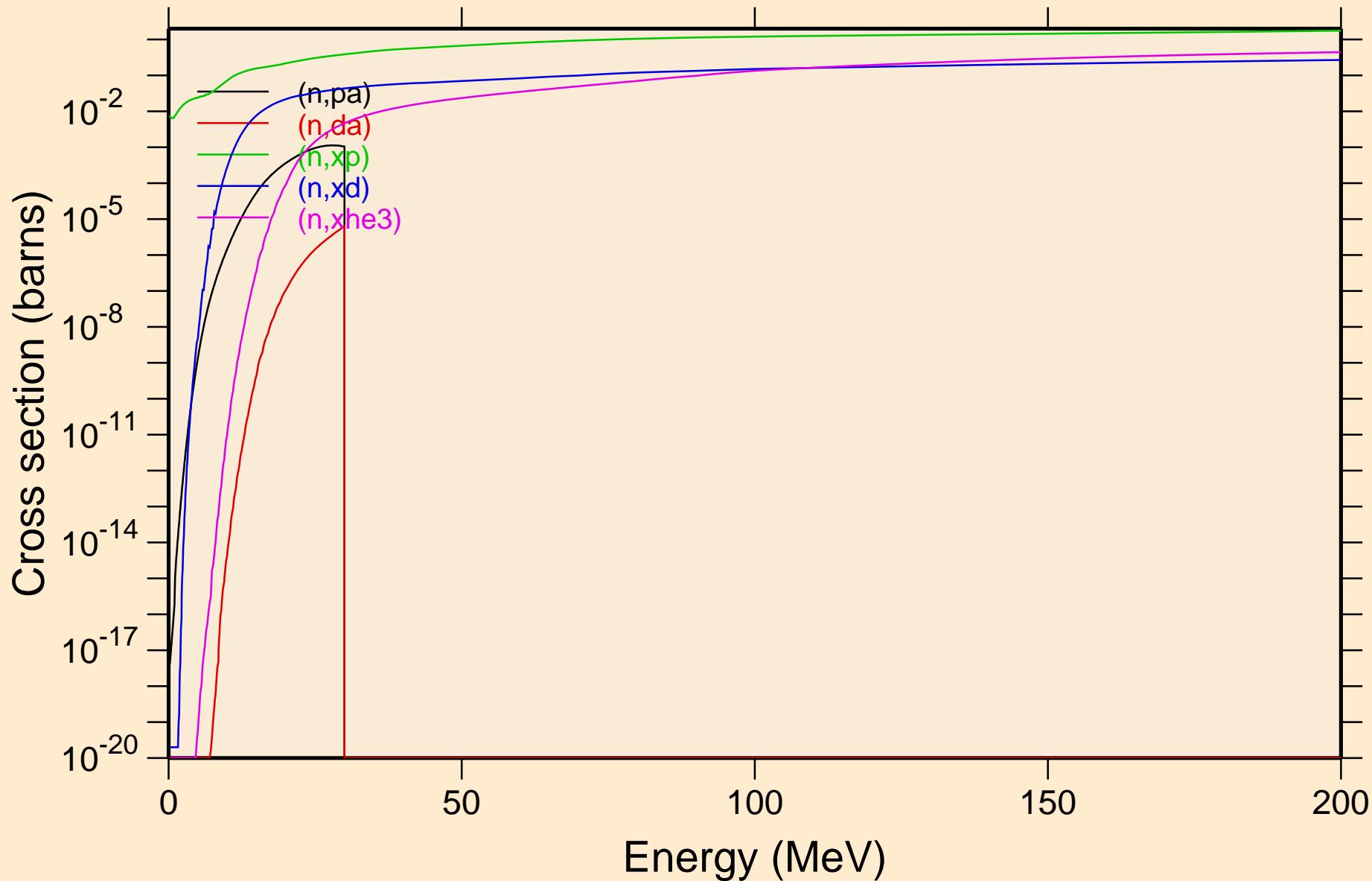

TA169 NEUTRON ACER TENDL-2024 LIBRARY; T=0.K
Non-threshold reactions

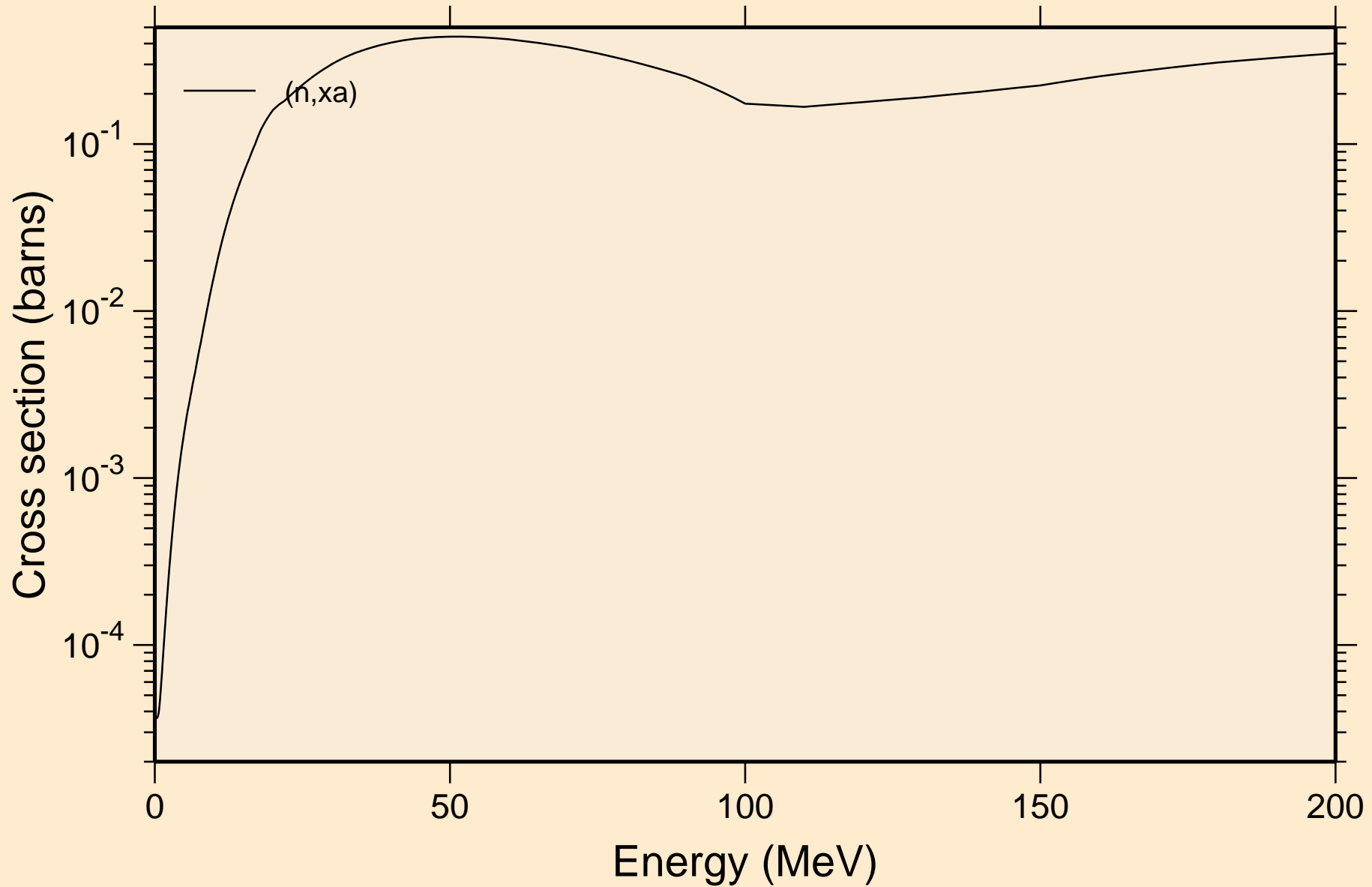

TA169 NEUTRON ACER TENDL-2024 LIBRARY; T=0.K
Inelastic levels

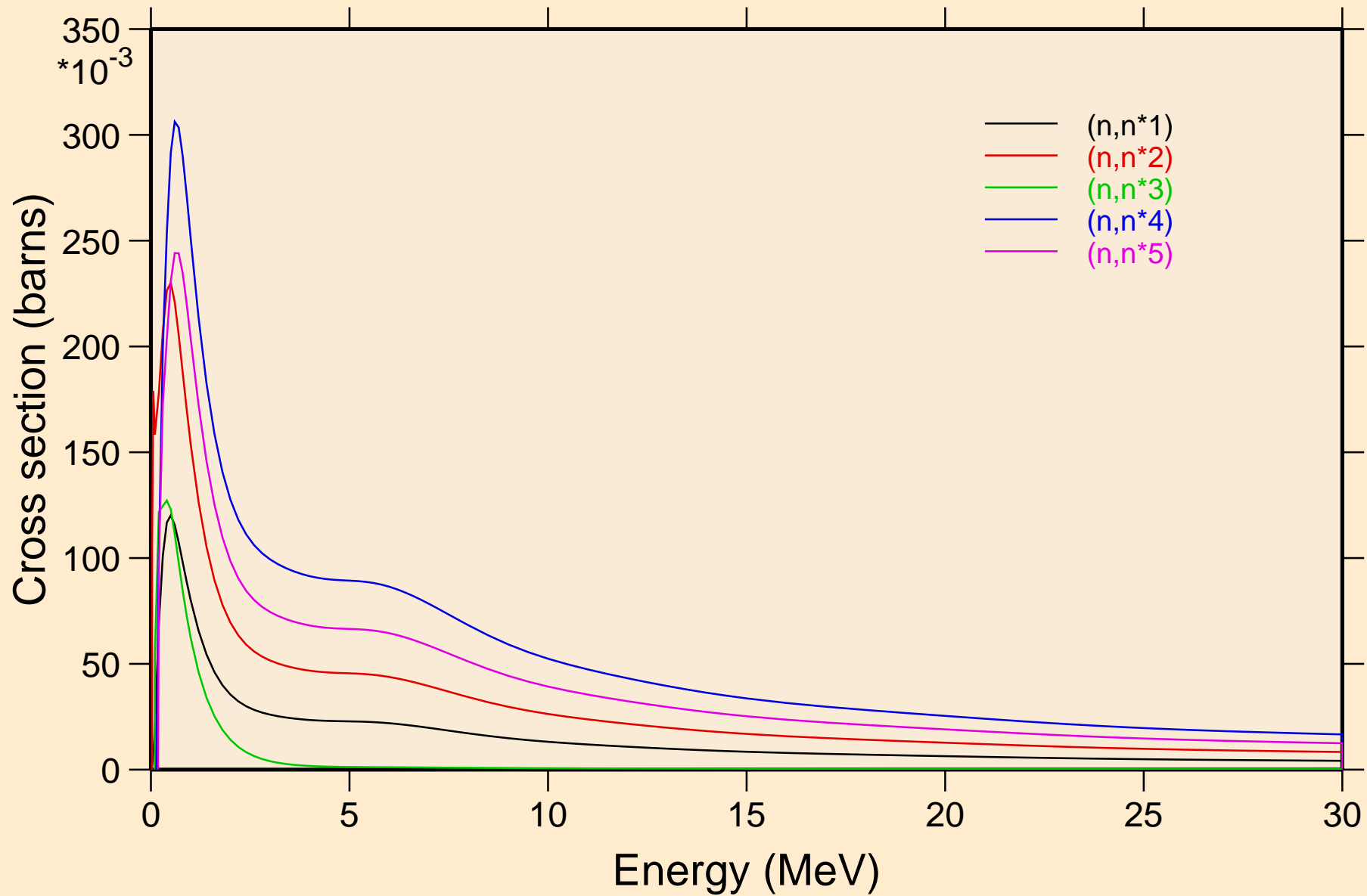

TA169 NEUTRON ACER TENDL-2024 LIBRARY; T=0.K
Inelastic levels

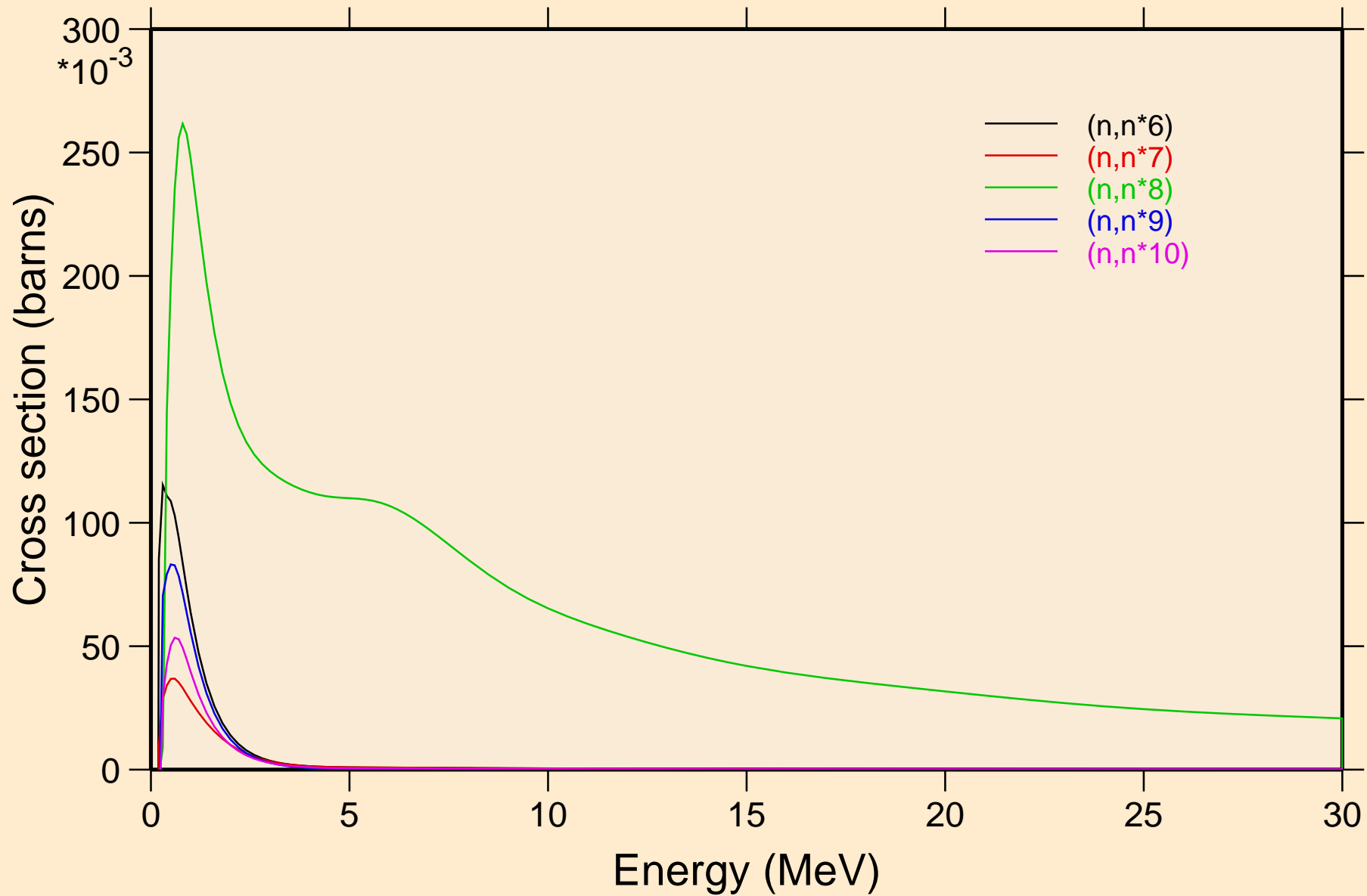

TA169 NEUTRON ACER TENDL-2024 LIBRARY; T=0.K
Inelastic levels

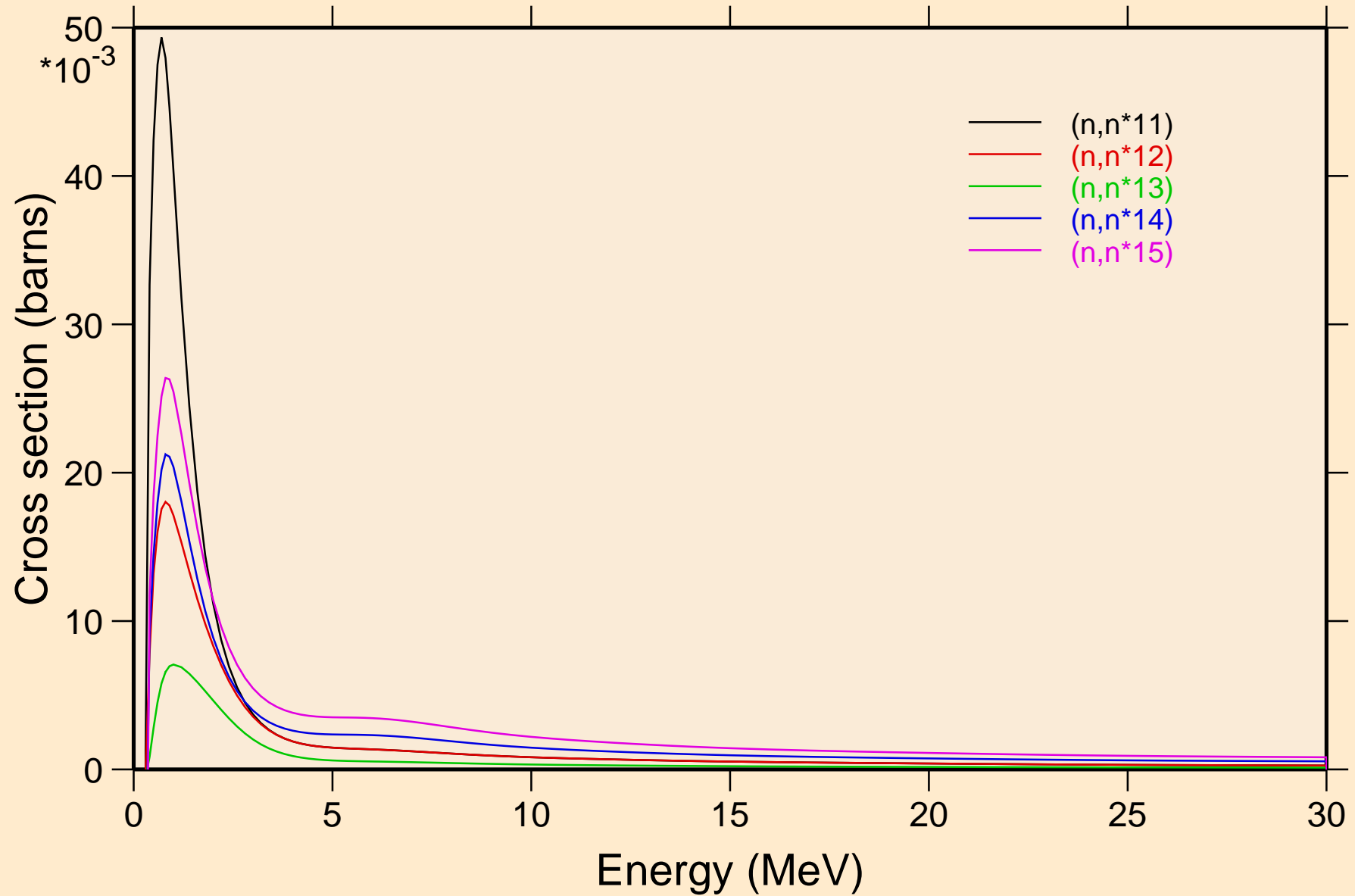

TA169 NEUTRON ACER TENDL-2024 LIBRARY; T=0.K
Inelastic levels

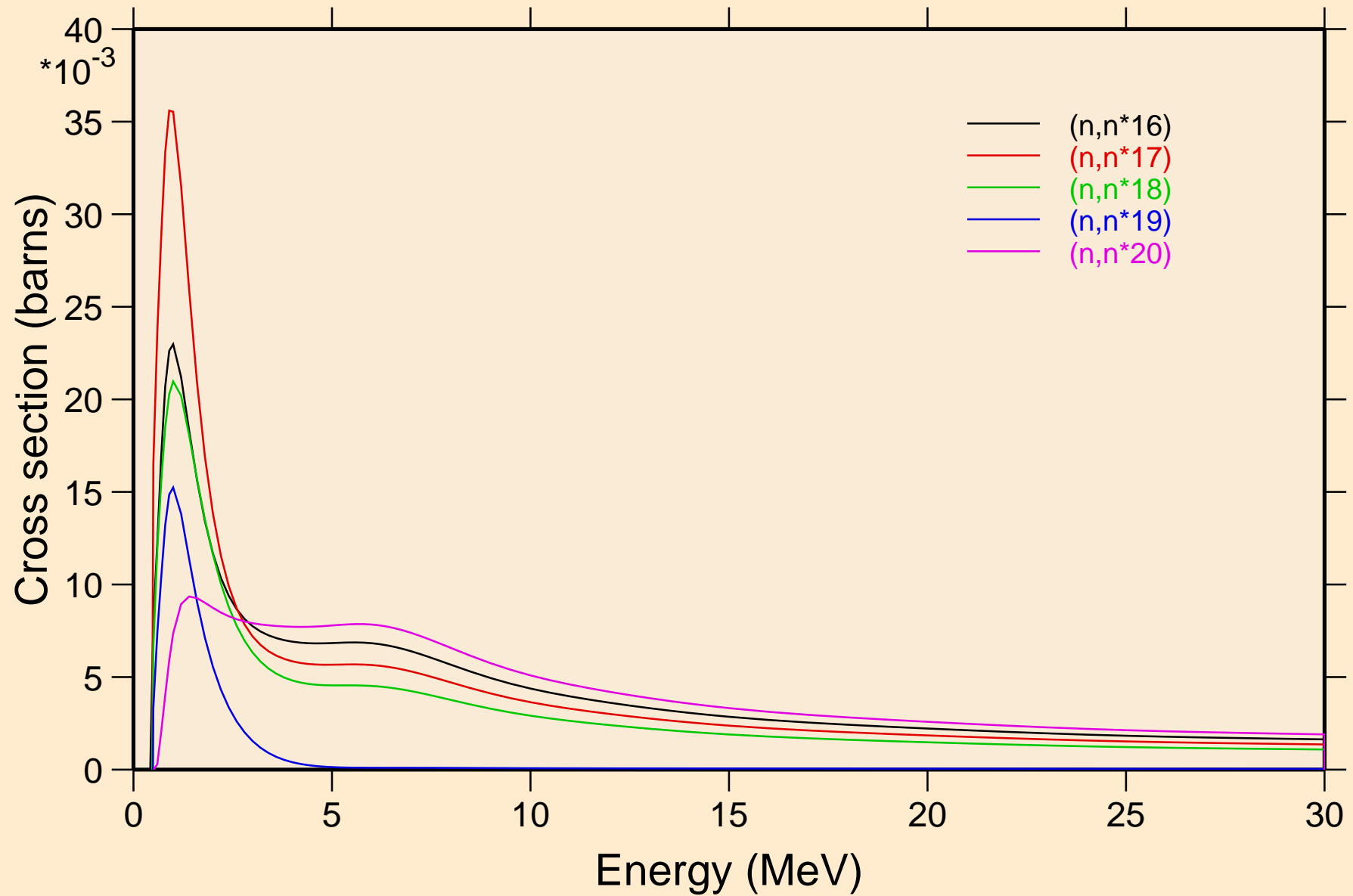

TA169 NEUTRON ACER TENDL-2024 LIBRARY; T=0.K
Inelastic levels

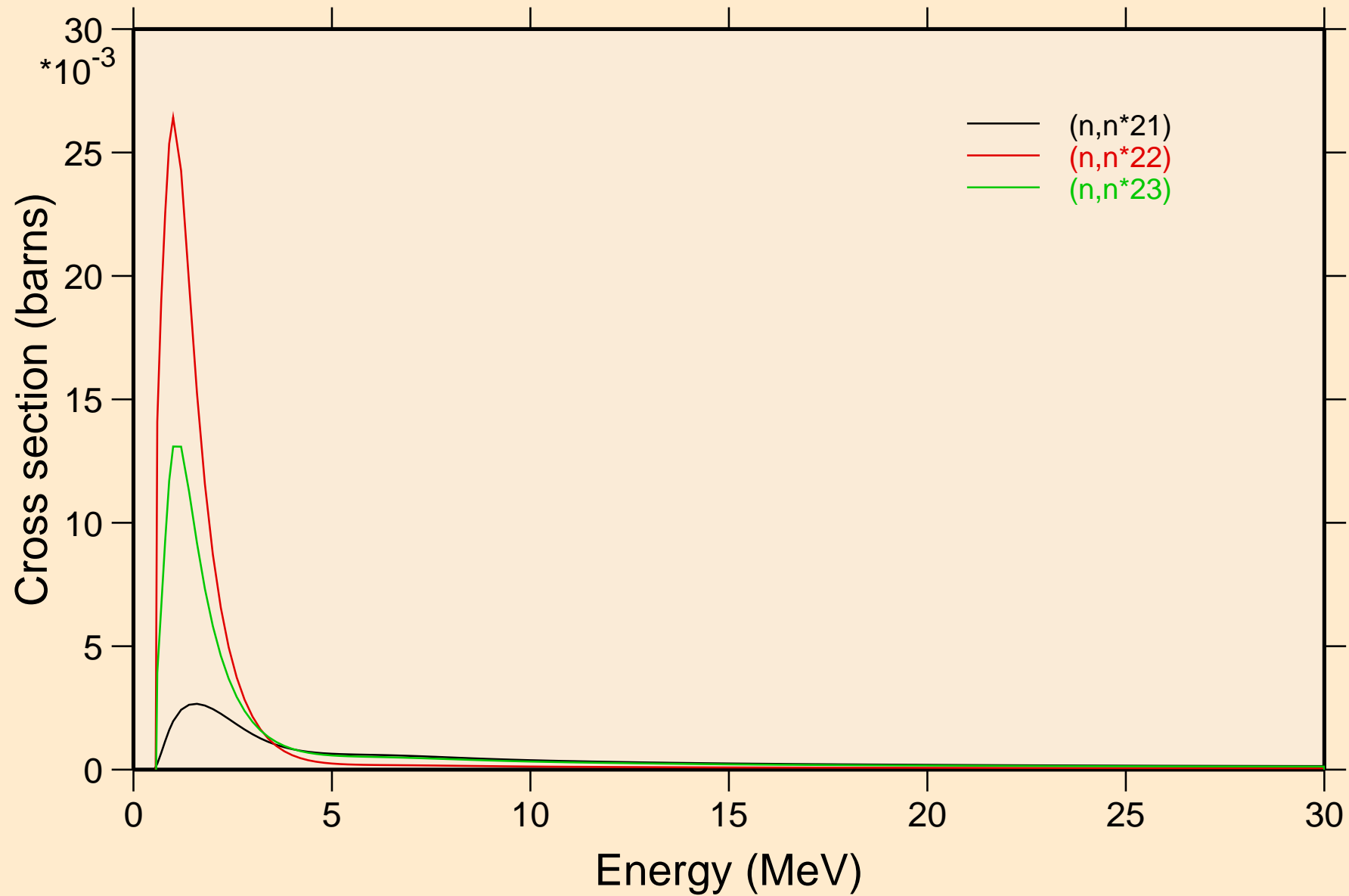

TA169 NEUTRON ACER TENDL-2024 LIBRARY; T=0.K
Threshold reactions

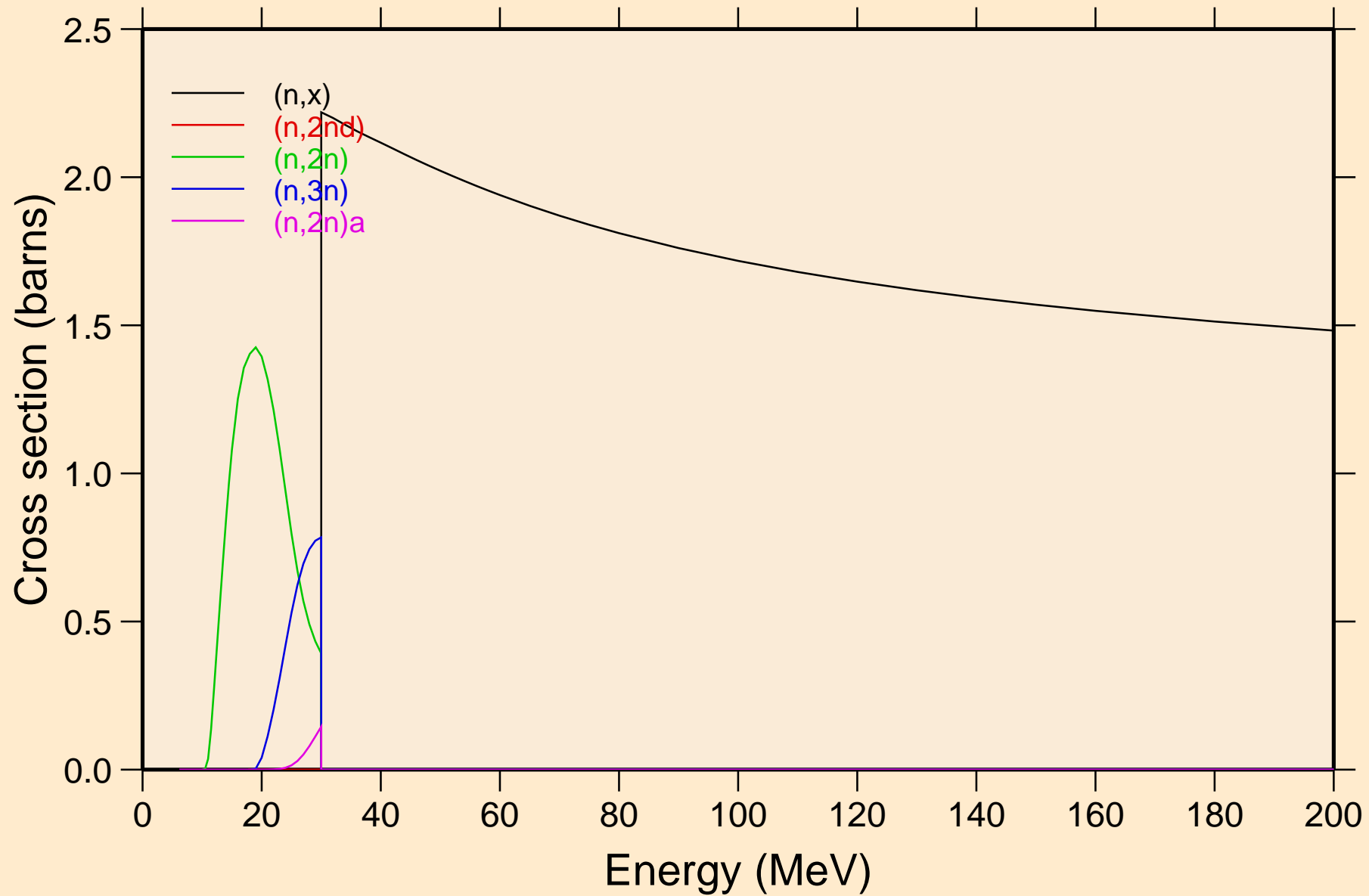

TA169 NEUTRON ACER TENDL-2024 LIBRARY; T=0.K
Threshold reactions

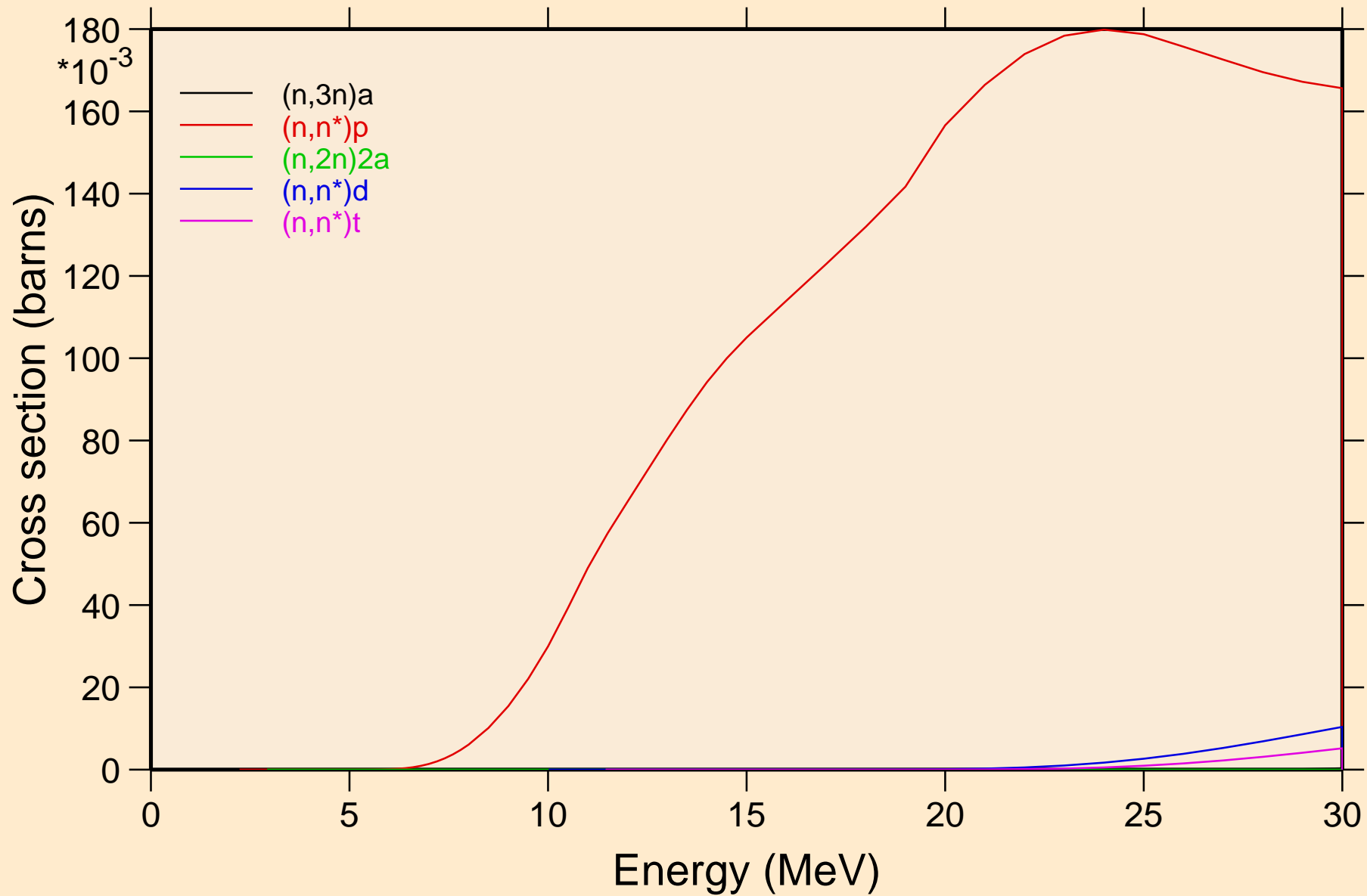

TA169 NEUTRON ACER TENDL-2024 LIBRARY; T=0.K
Threshold reactions

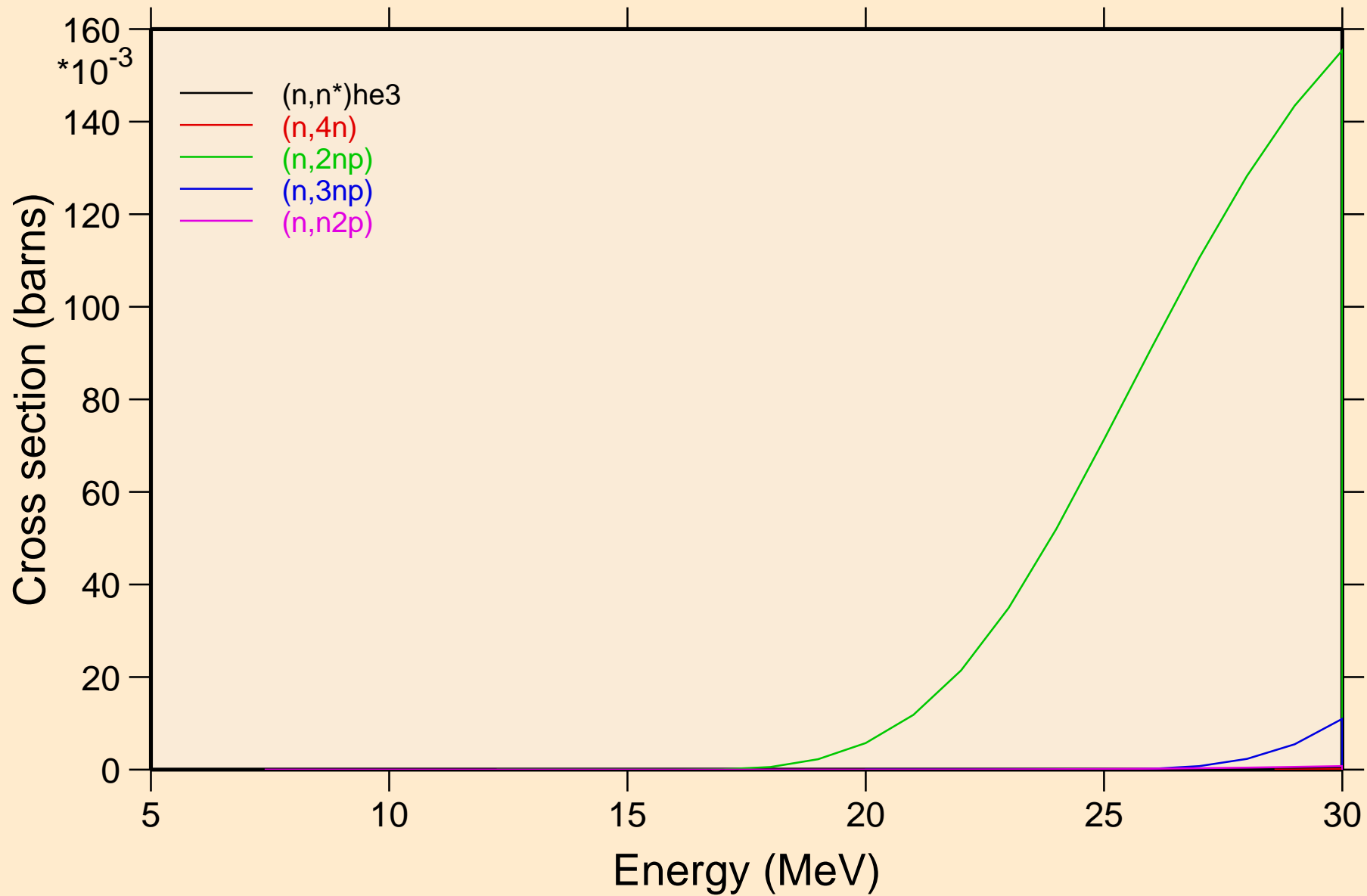

TA169 NEUTRON ACER TENDL-2024 LIBRARY; T=0.K
Threshold reactions

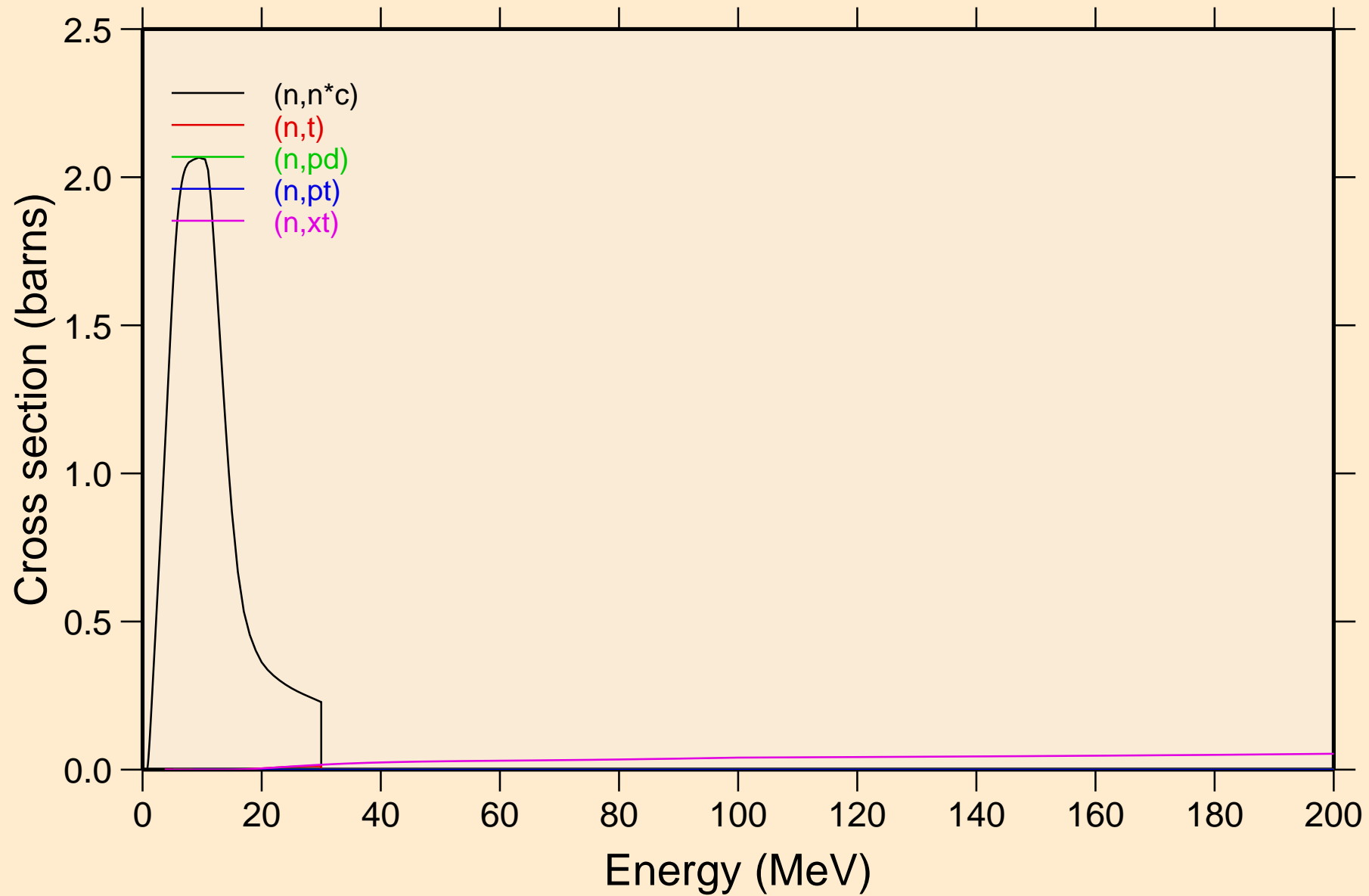

TA169 NEUTRON ACER TENDL-2024 LIBRARY; T=0.K
angular distribution for elastic

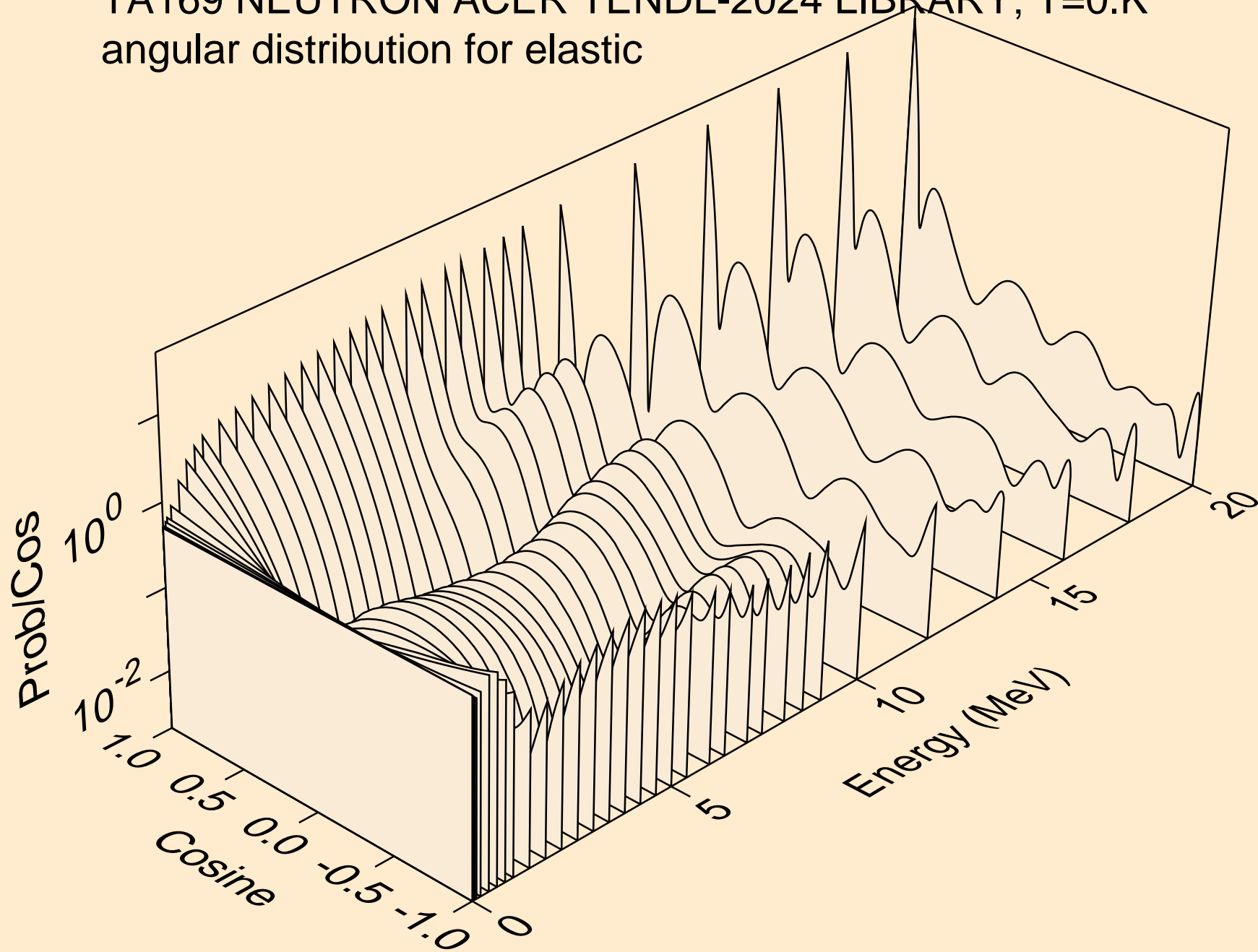

TA169 NEUTRON ACER TENDL-2024 LIBRARY; T=0.K
angular distribution for elastic

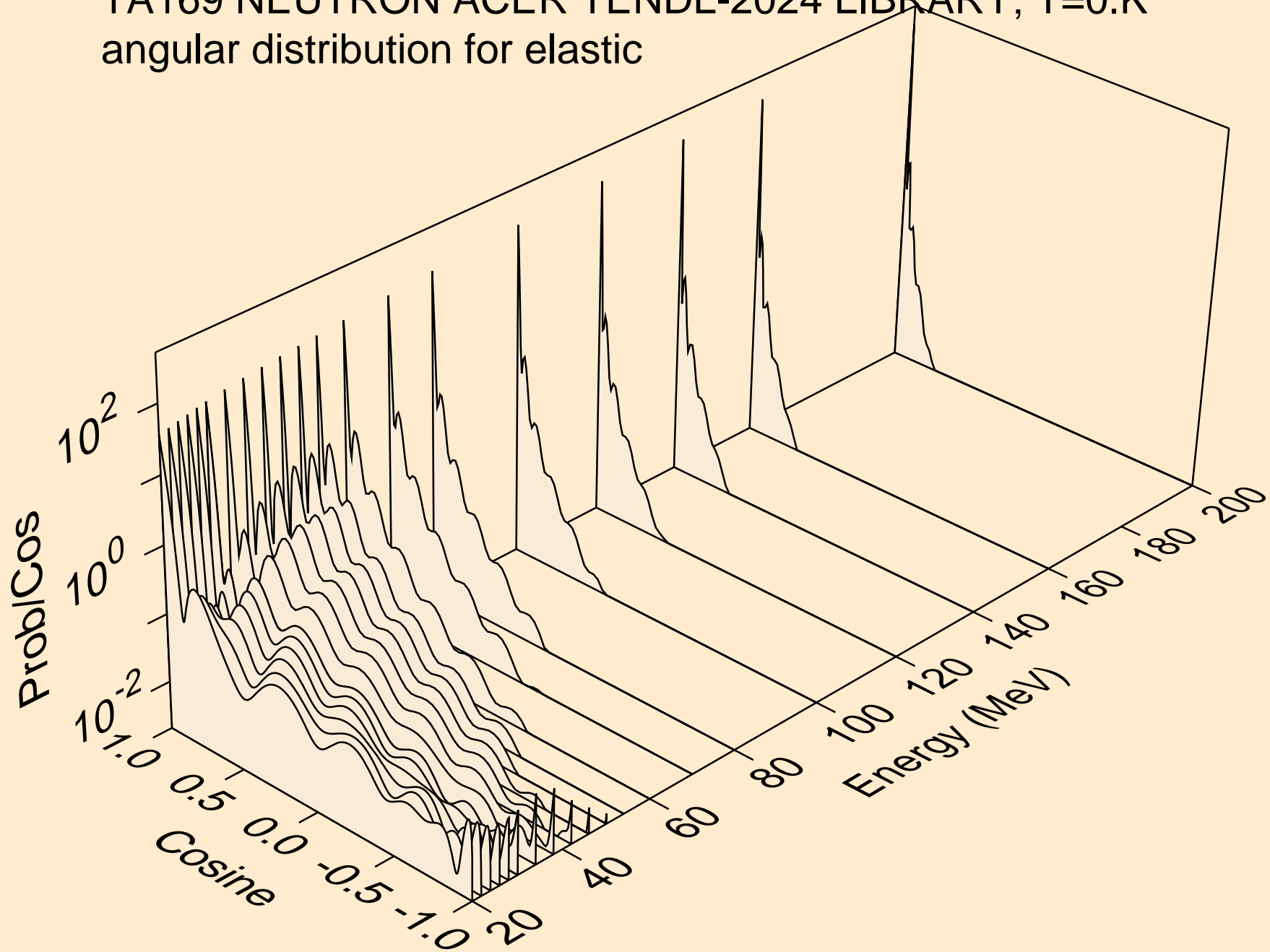

TA169 NEUTRON ACER TENDL-2024 LIBRARY; T=0.K
angular distribution for (n,n*1)

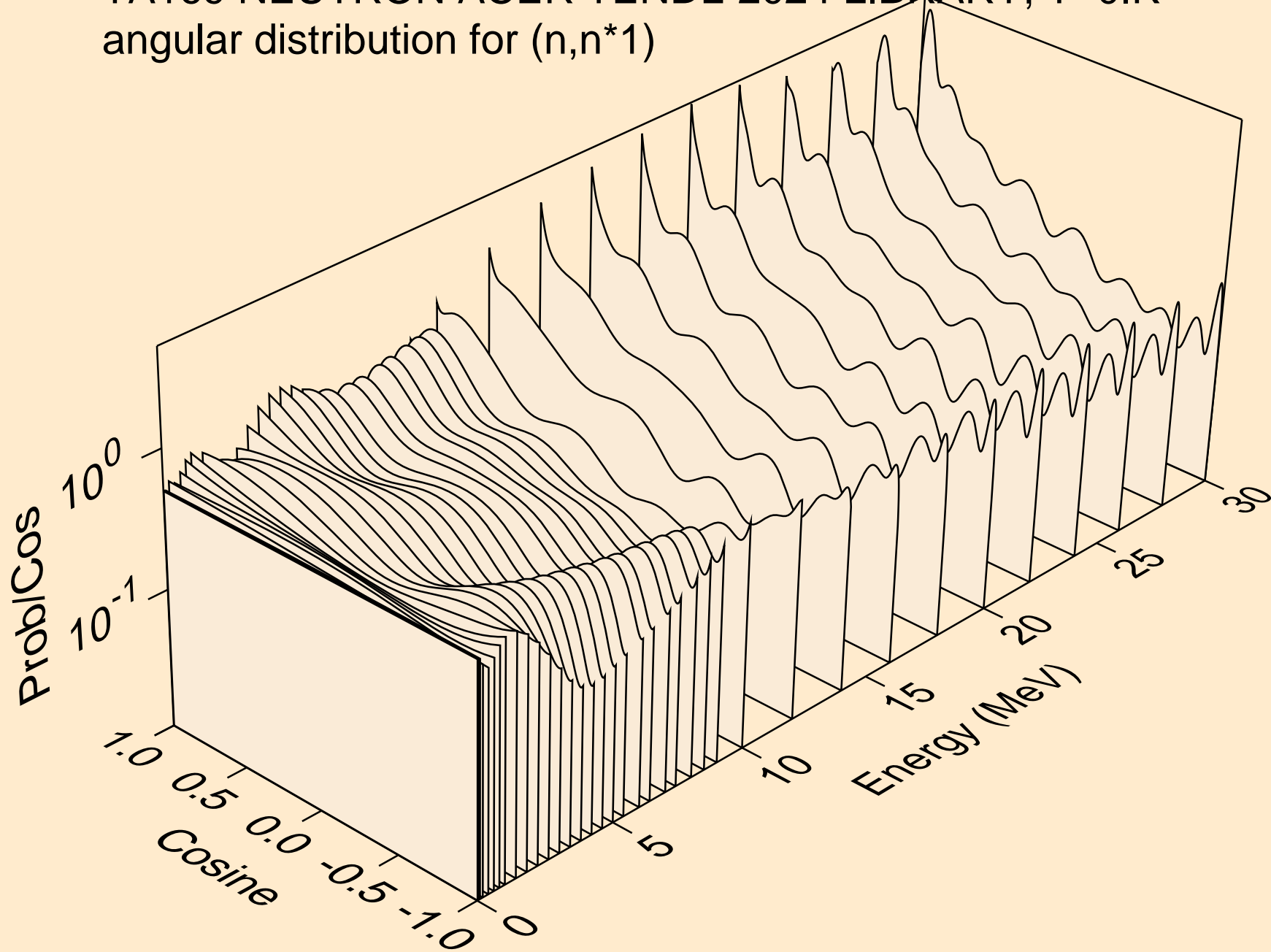

TA169 NEUTRON ACER TENDL-2024 LIBRARY; T=0.K
angular distribution for (n,n*2)

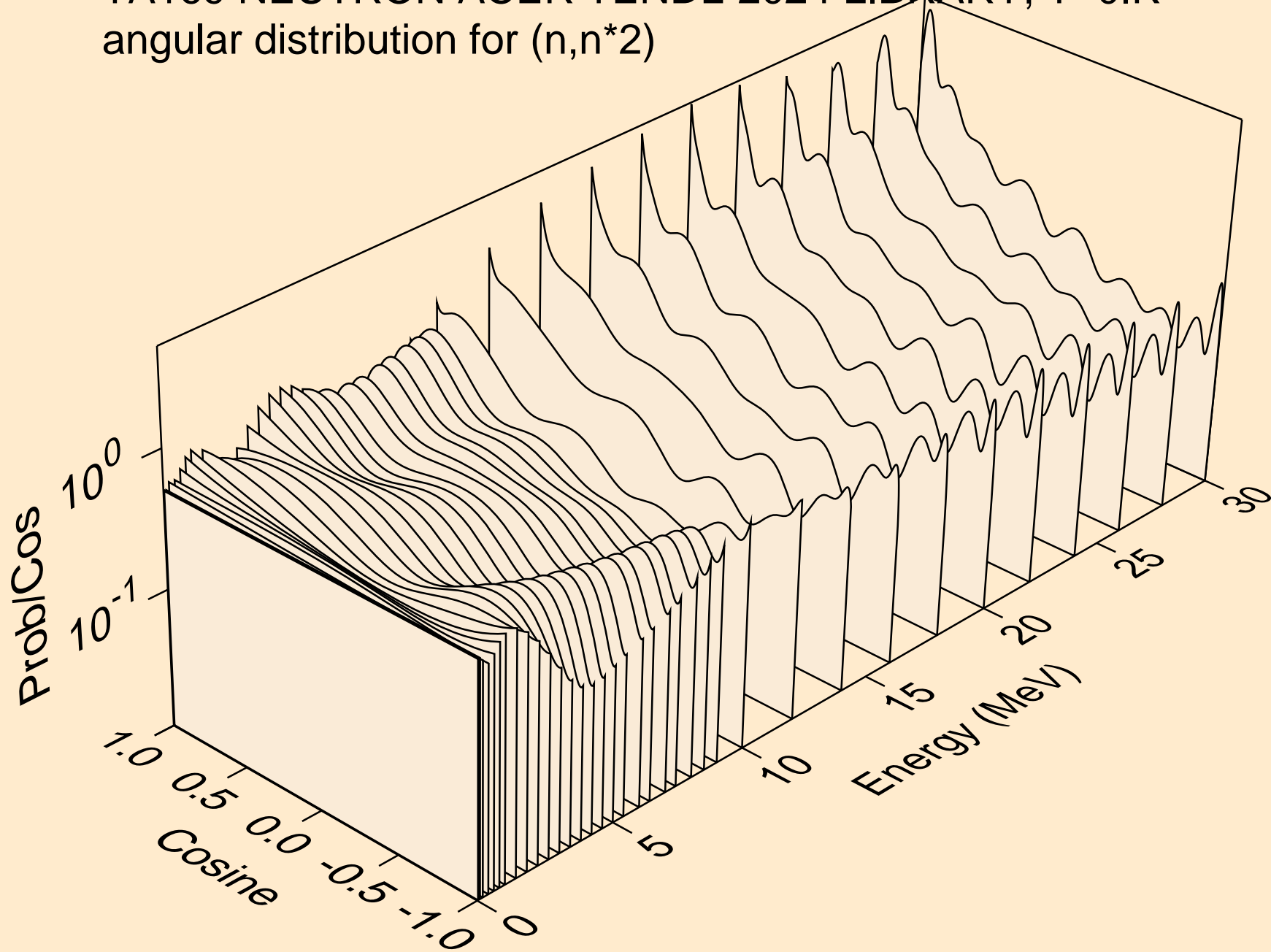

TA169 NEUTRON ACER TENDL-2024 LIBRARY; T=0.K
angular distribution for (n,n*3)

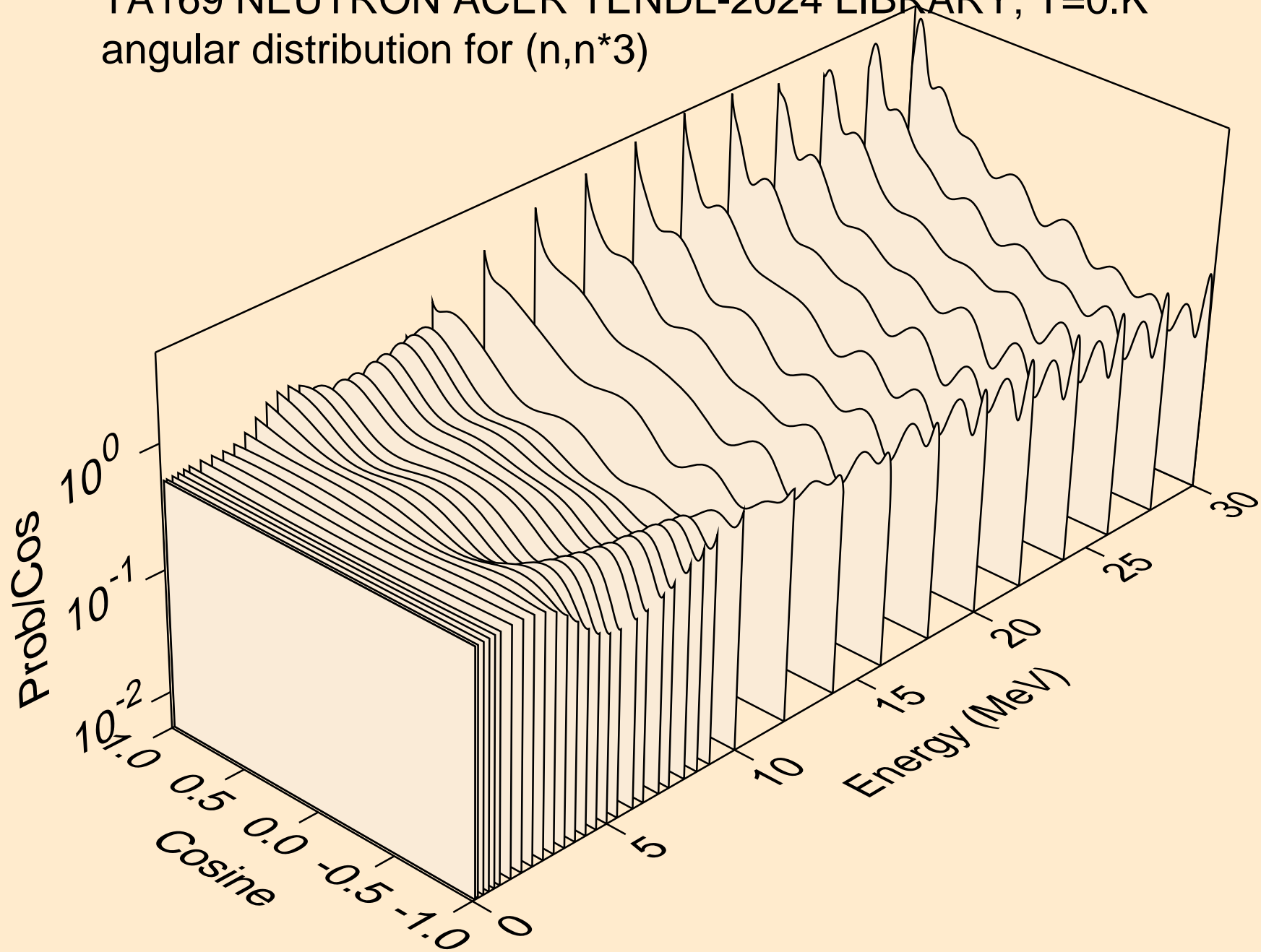

TA169 NEUTRON ACER TENDL-2024 LIBRARY; T=0.K
angular distribution for (n,n*4)

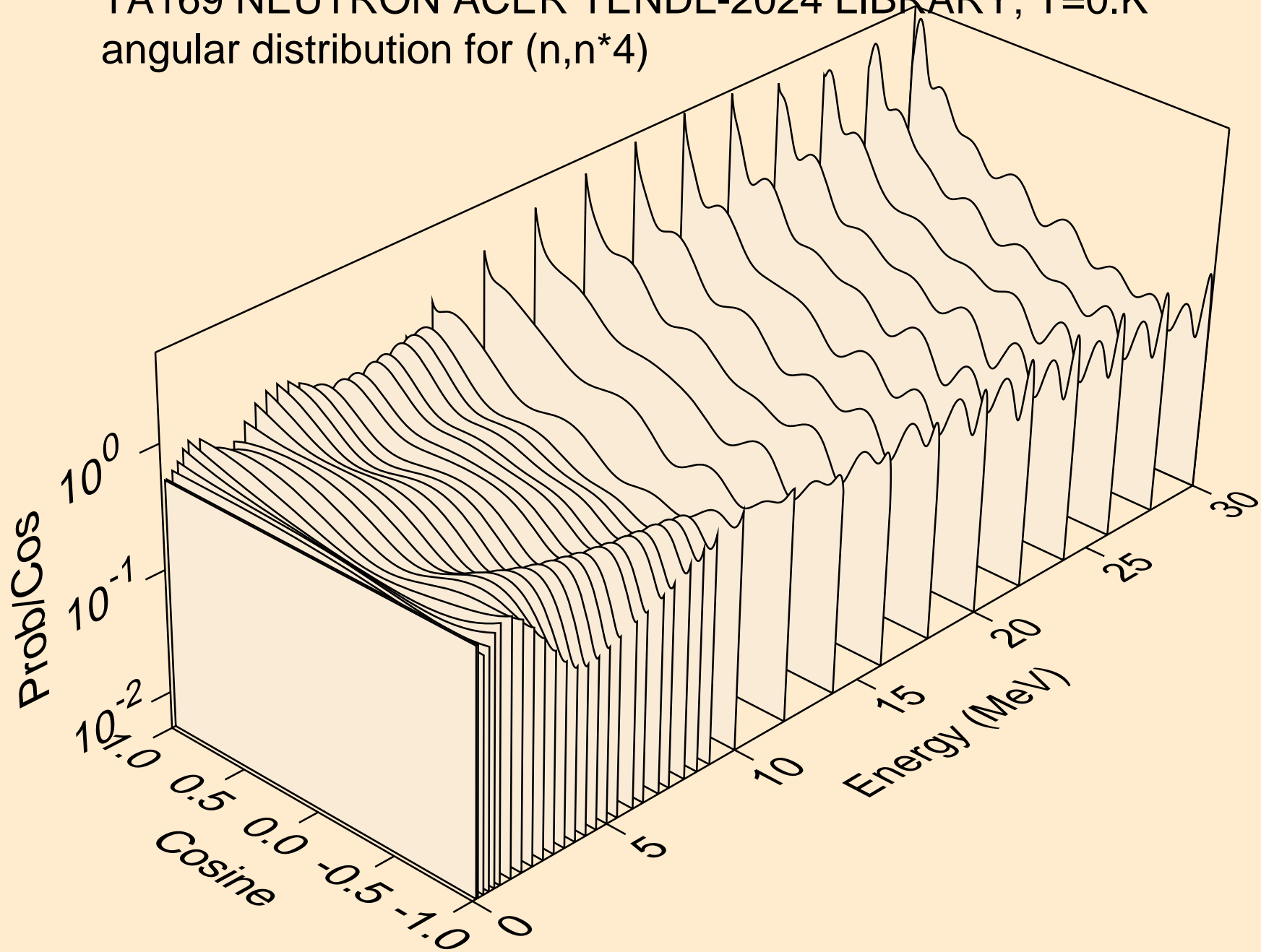

TA169 NEUTRON ACER TENDL-2024 LIBRARY; T=0.K
angular distribution for (n,n*5)

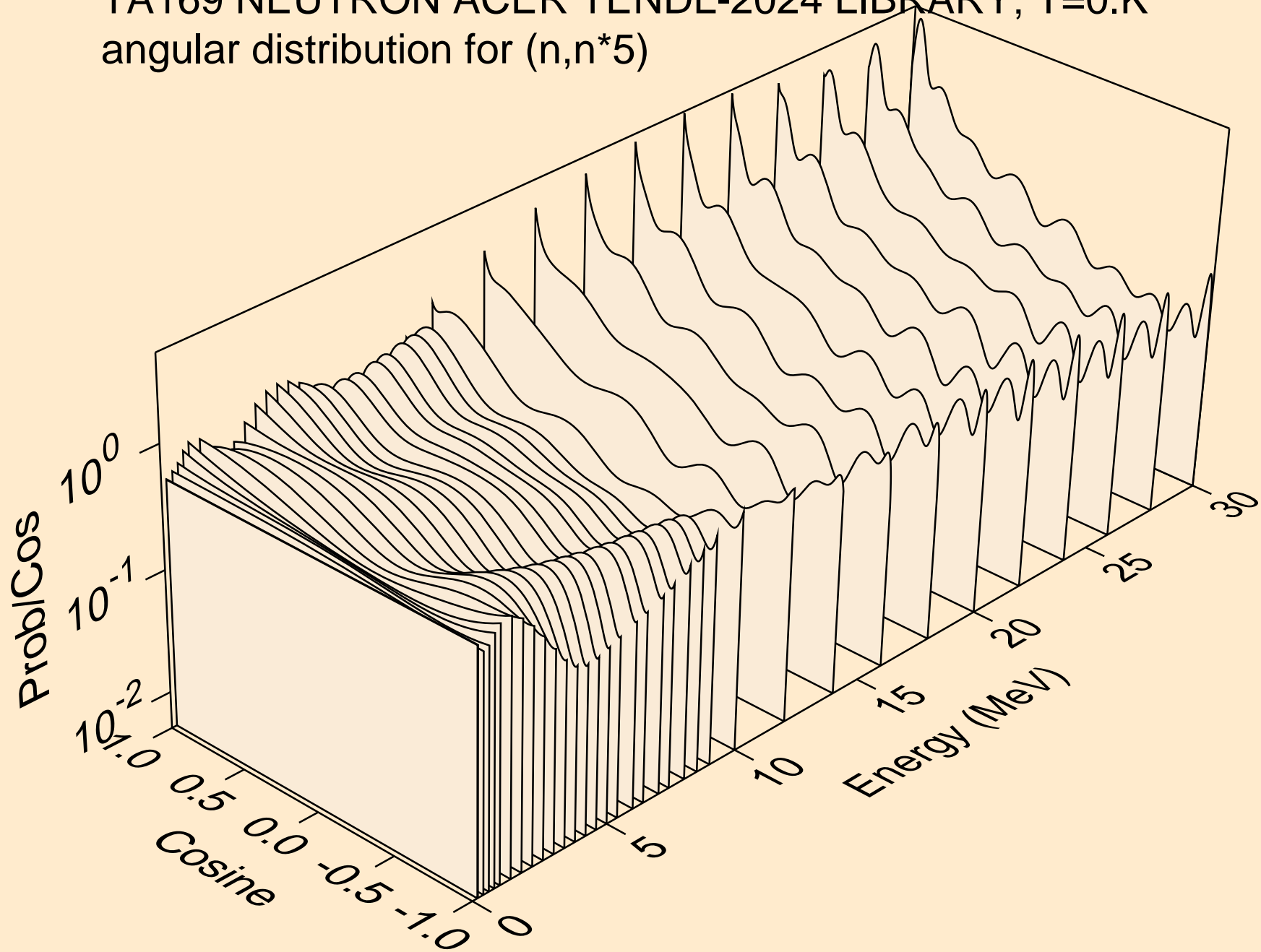

TA169 NEUTRON ACER TENDL-2024 LIBRARY; T=0.K
angular distribution for (n,n*6)

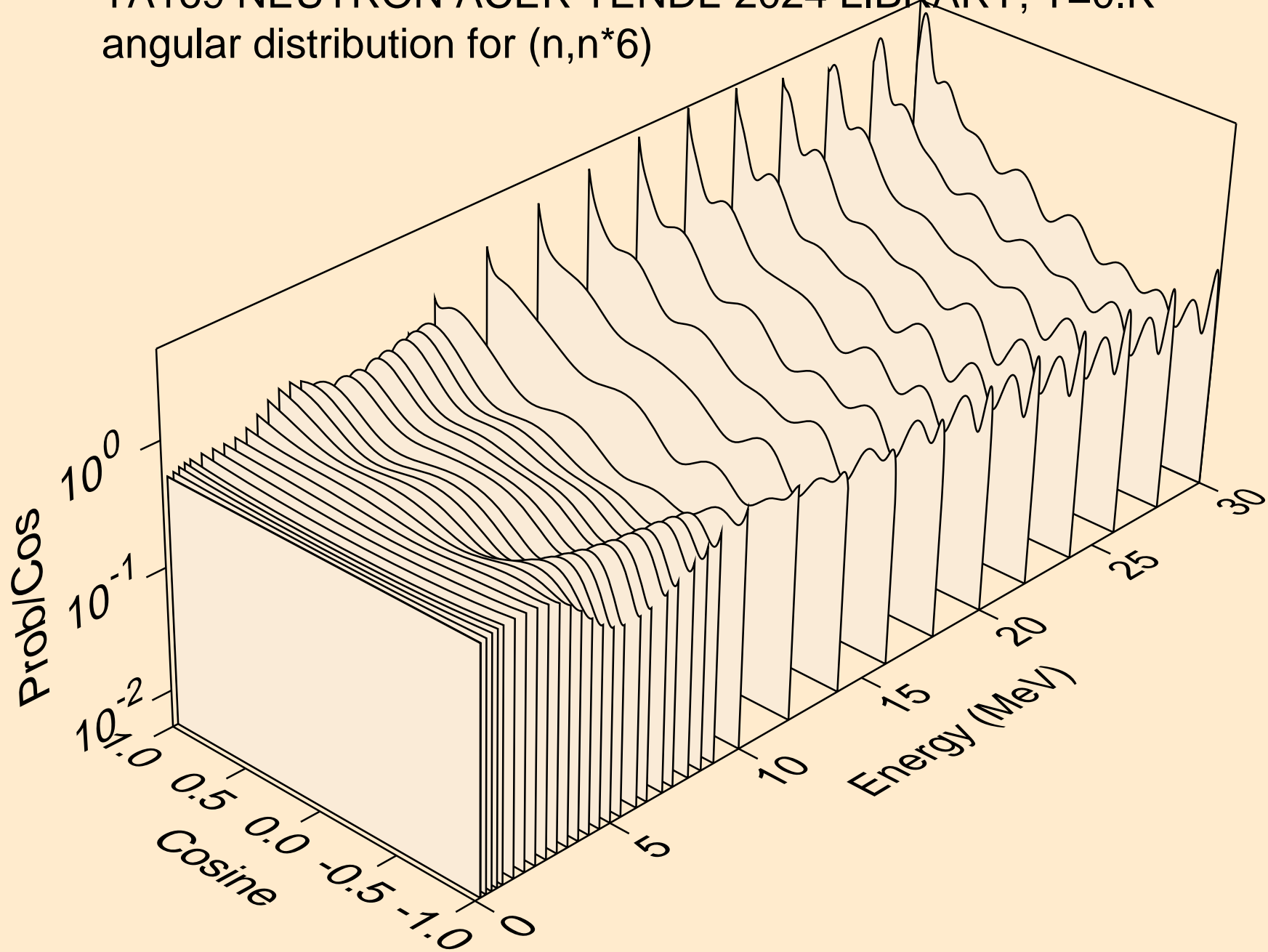

TA169 NEUTRON ACER TENDL-2024 LIBRARY; T=0.K
angular distribution for (n,n*7)

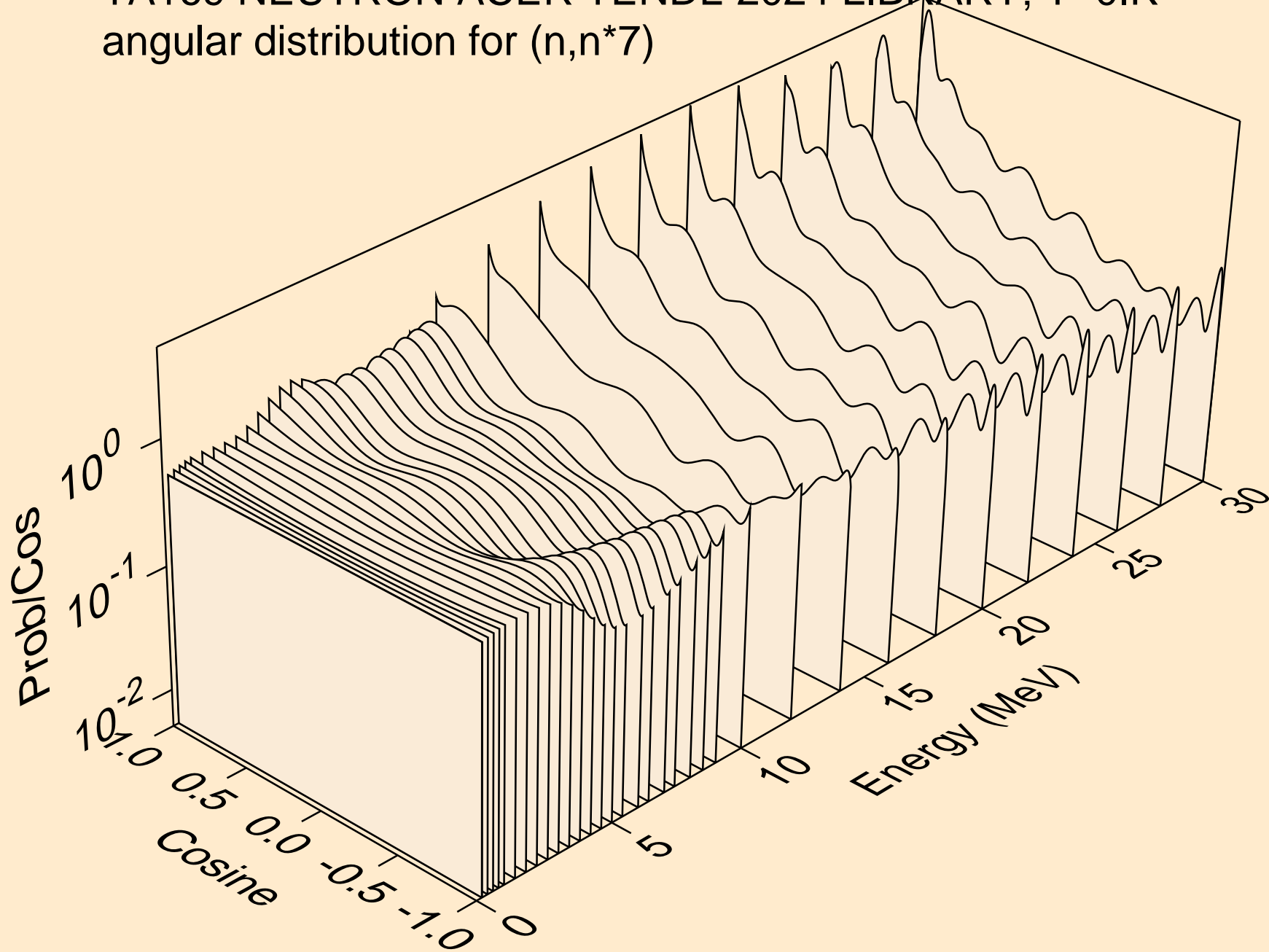

TA169 NEUTRON ACER TENDL-2024 LIBRARY; T=0.K
angular distribution for (n,n*8)

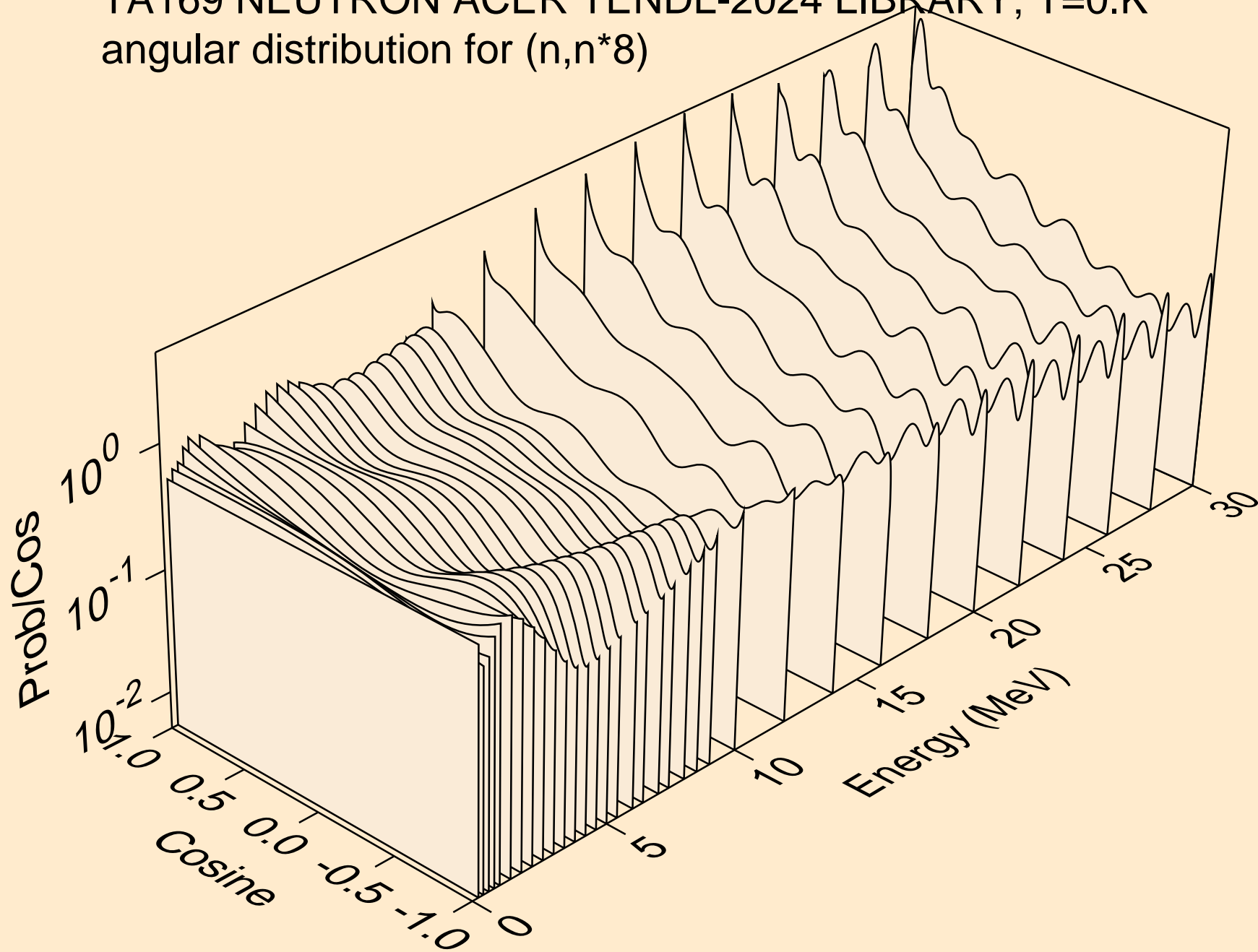

TA169 NEUTRON ACER TENDL-2024 LIBRARY; T=0.K
angular distribution for (n,n*9)

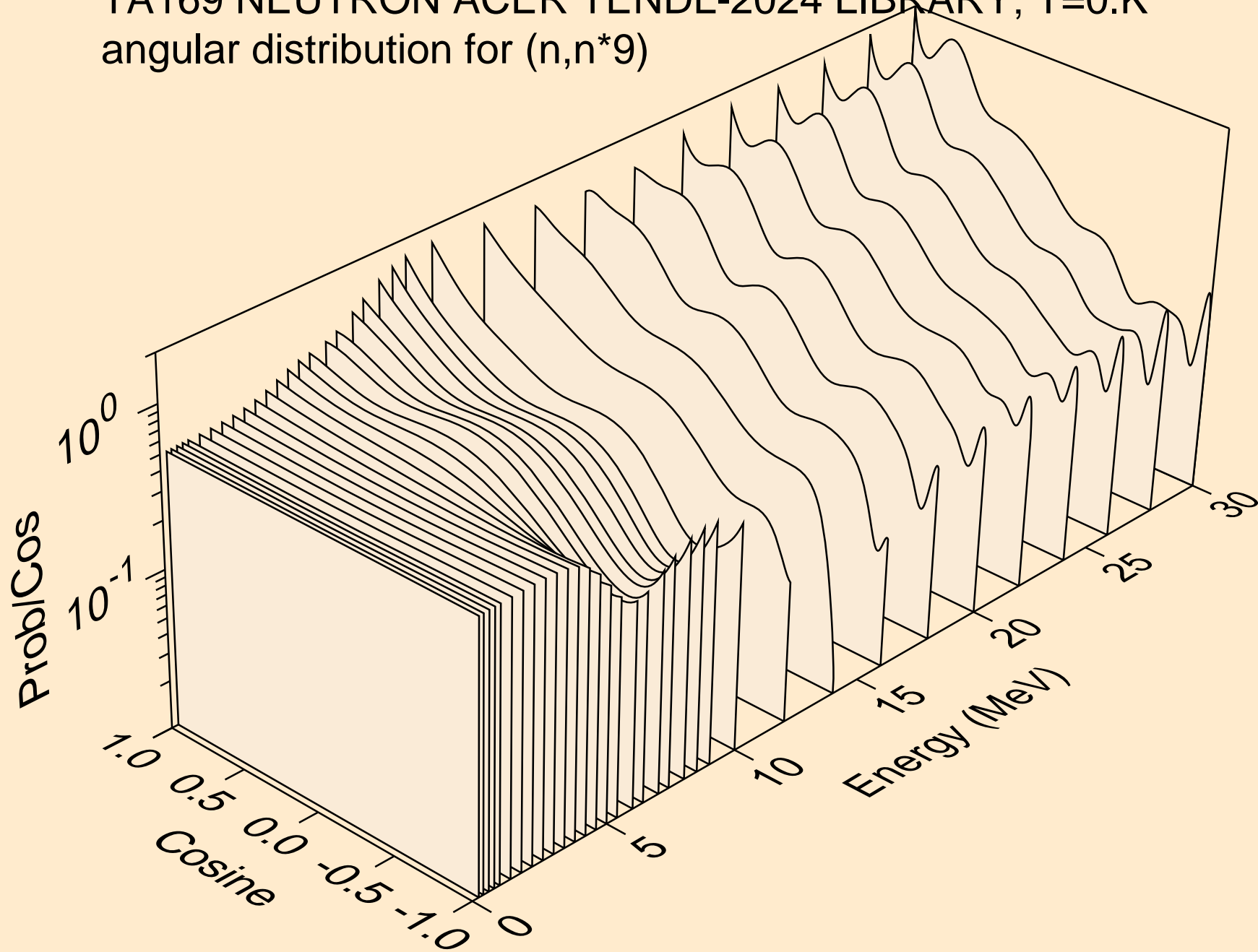

TA169 NEUTRON ACER TENDL-2024 LIBRARY; T=0.K
angular distribution for (n,n*10)

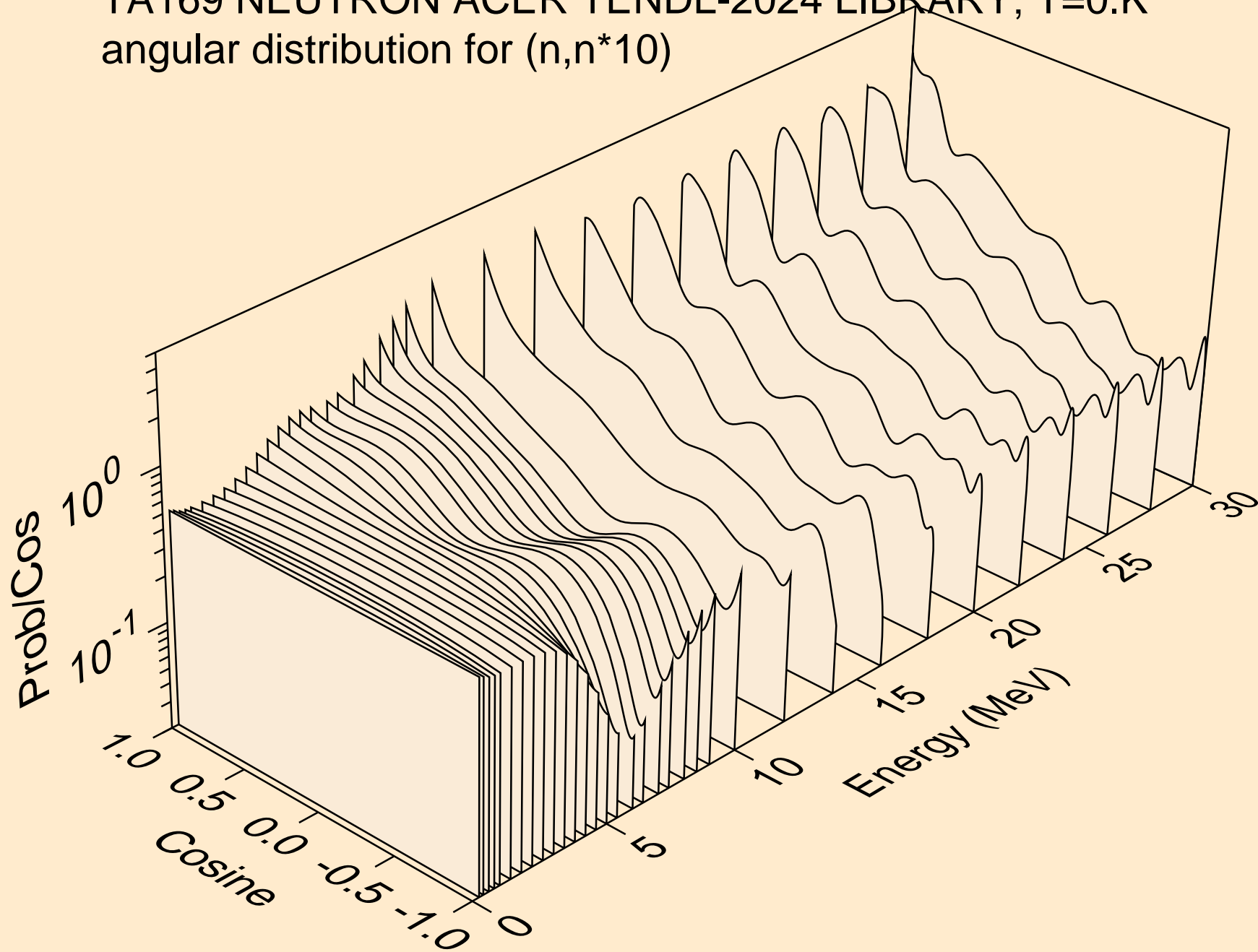

TA169 NEUTRON ACER TENDL-2024 LIBRARY; T=0.K
angular distribution for (n,n*11)

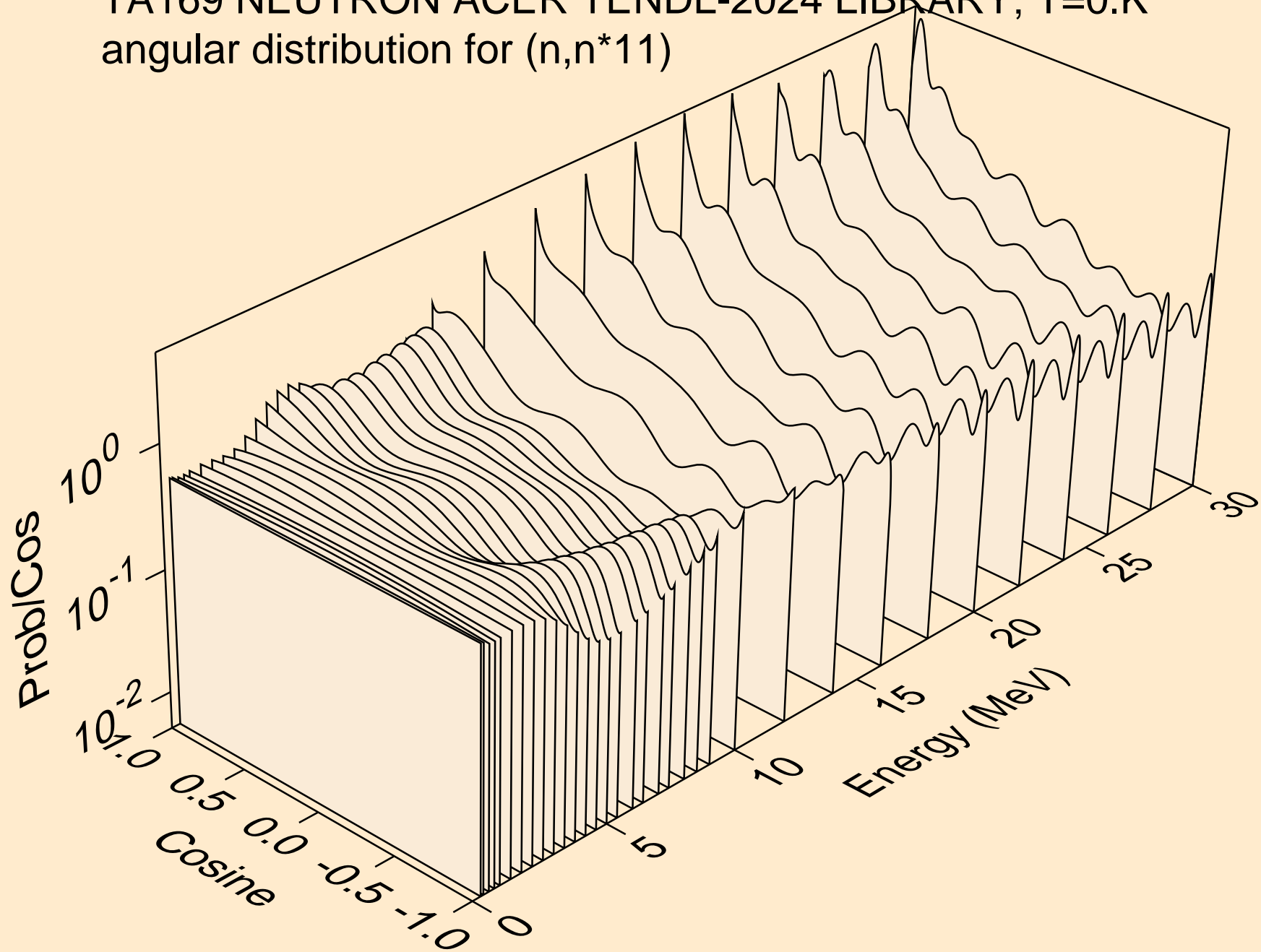

TA169 NEUTRON ACER TENDL-2024 LIBRARY; T=0.K
angular distribution for (n,n*12)

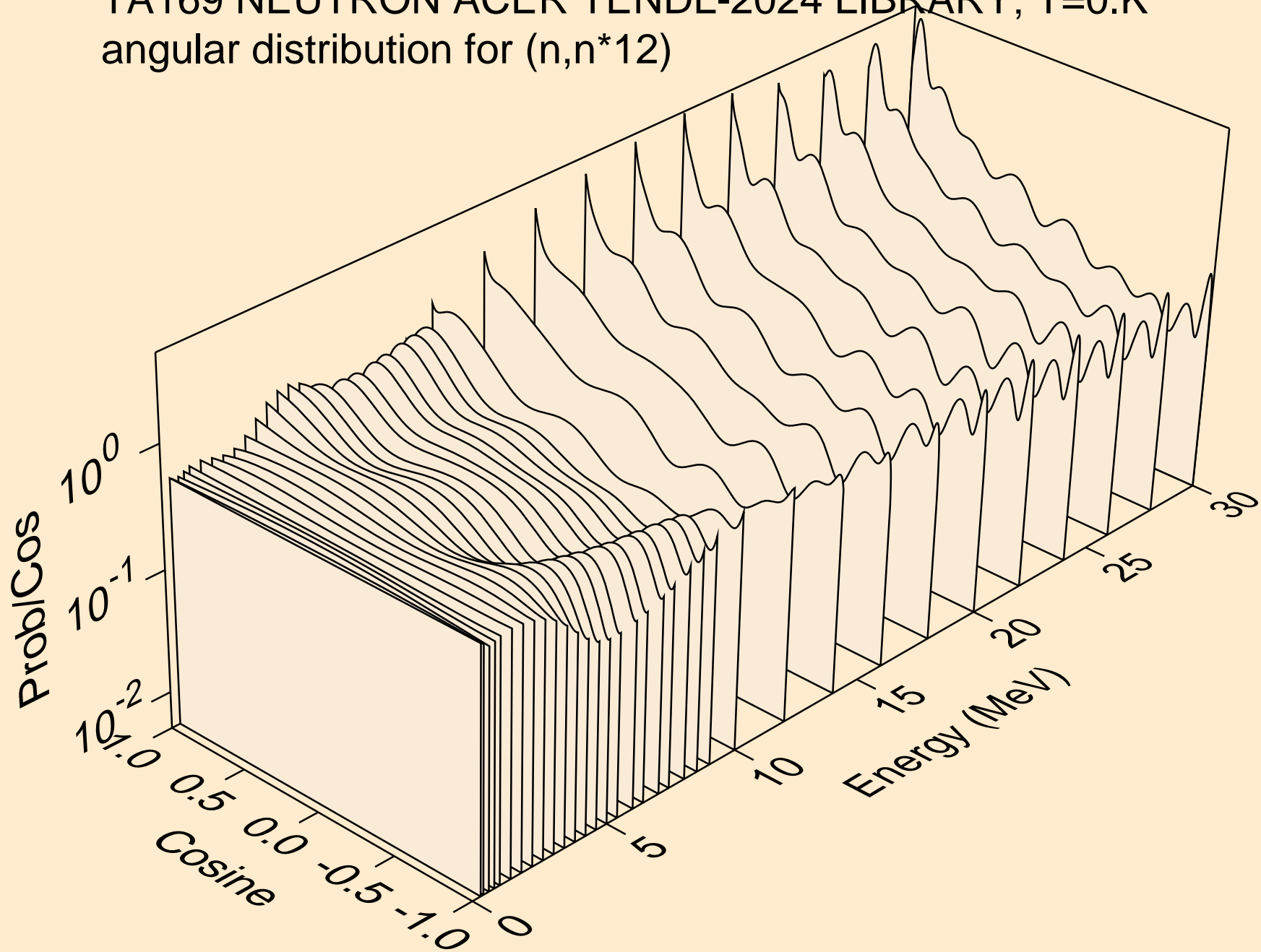

TA169 NEUTRON ACER TENDL-2024 LIBRARY; T=0.K
angular distribution for (n,n*13)

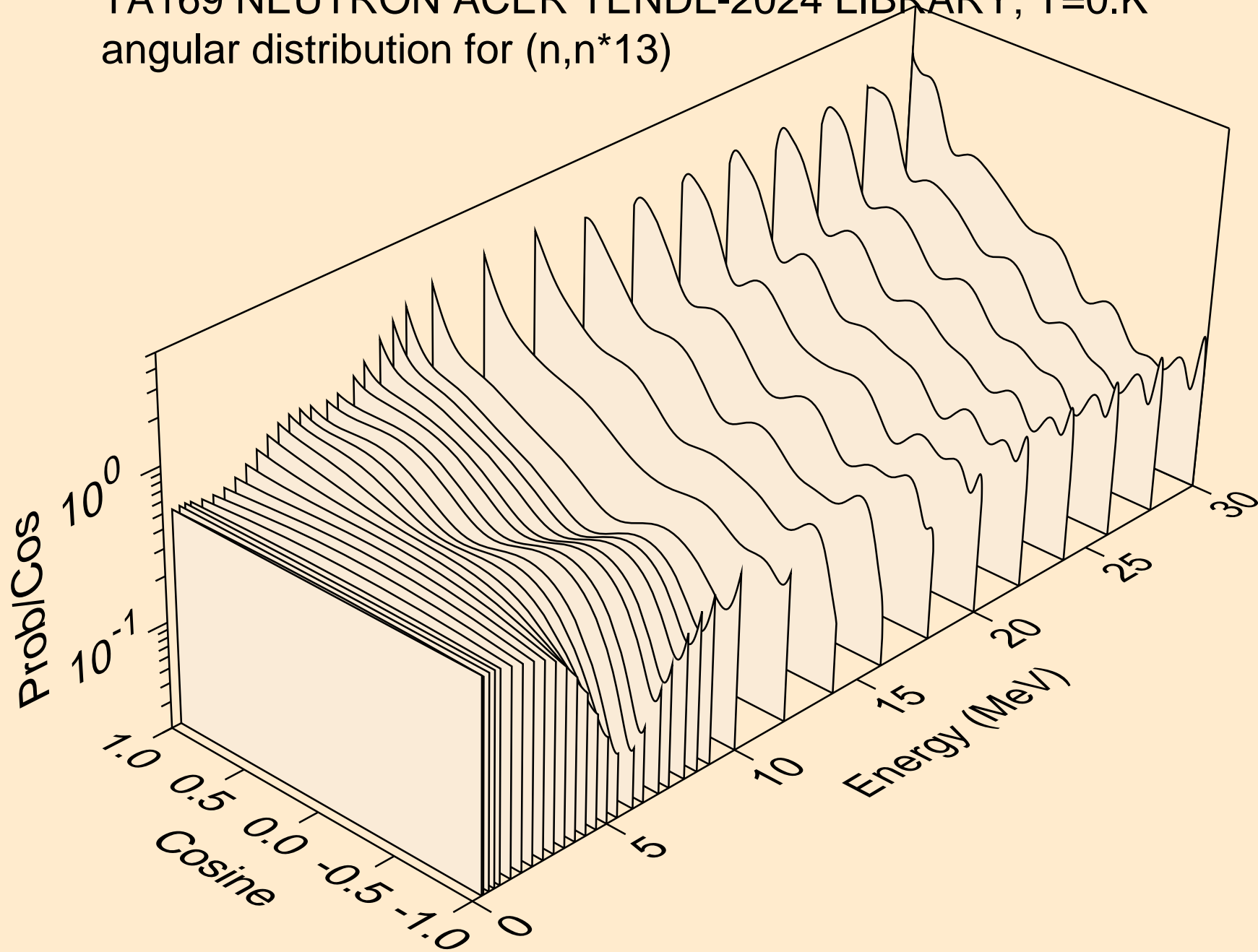

TA169 NEUTRON ACER TENDL-2024 LIBRARY; T=0.K
angular distribution for (n,n*14)

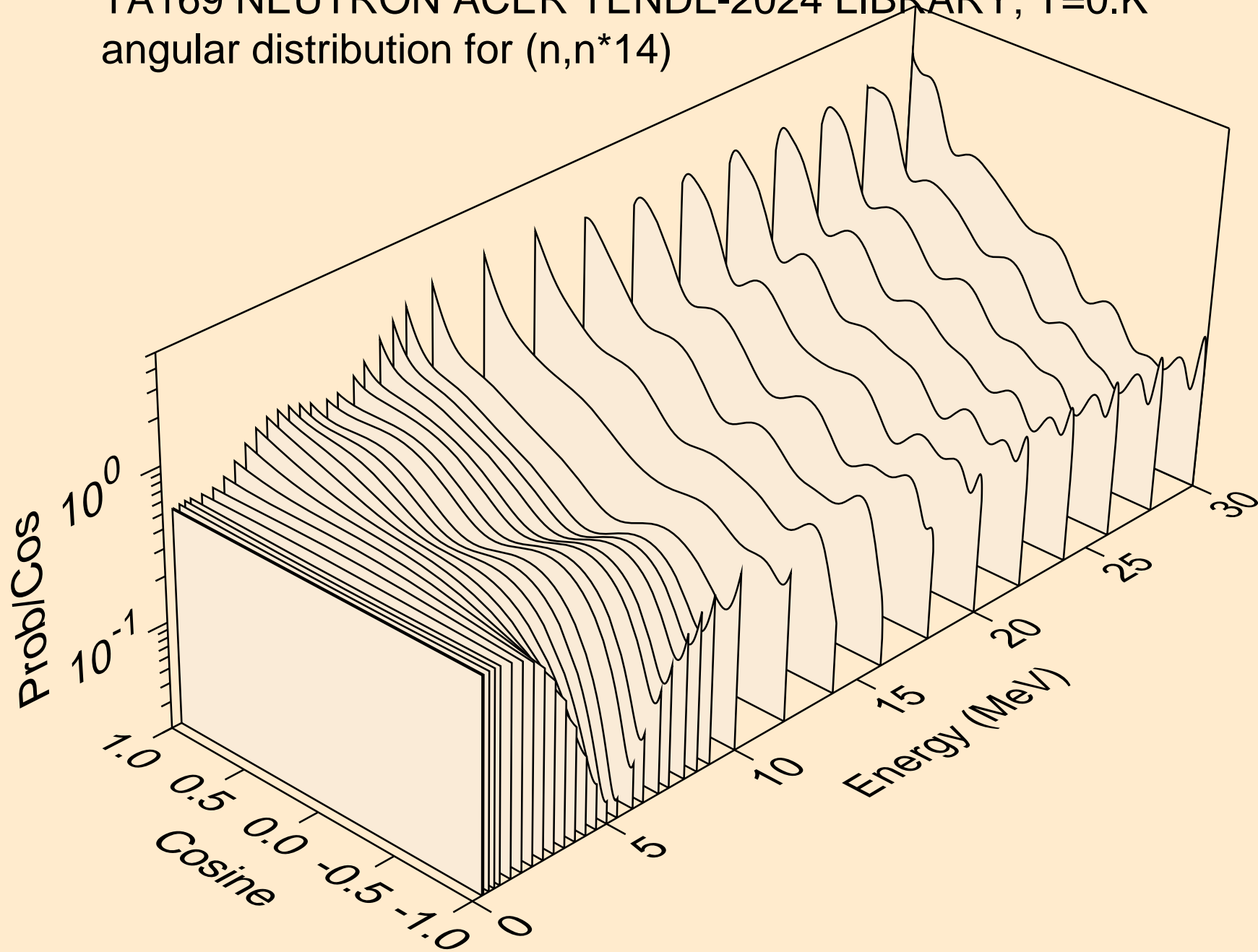

TA169 NEUTRON ACER TENDL-2024 LIBRARY; T=0.K
angular distribution for (n,n*15)

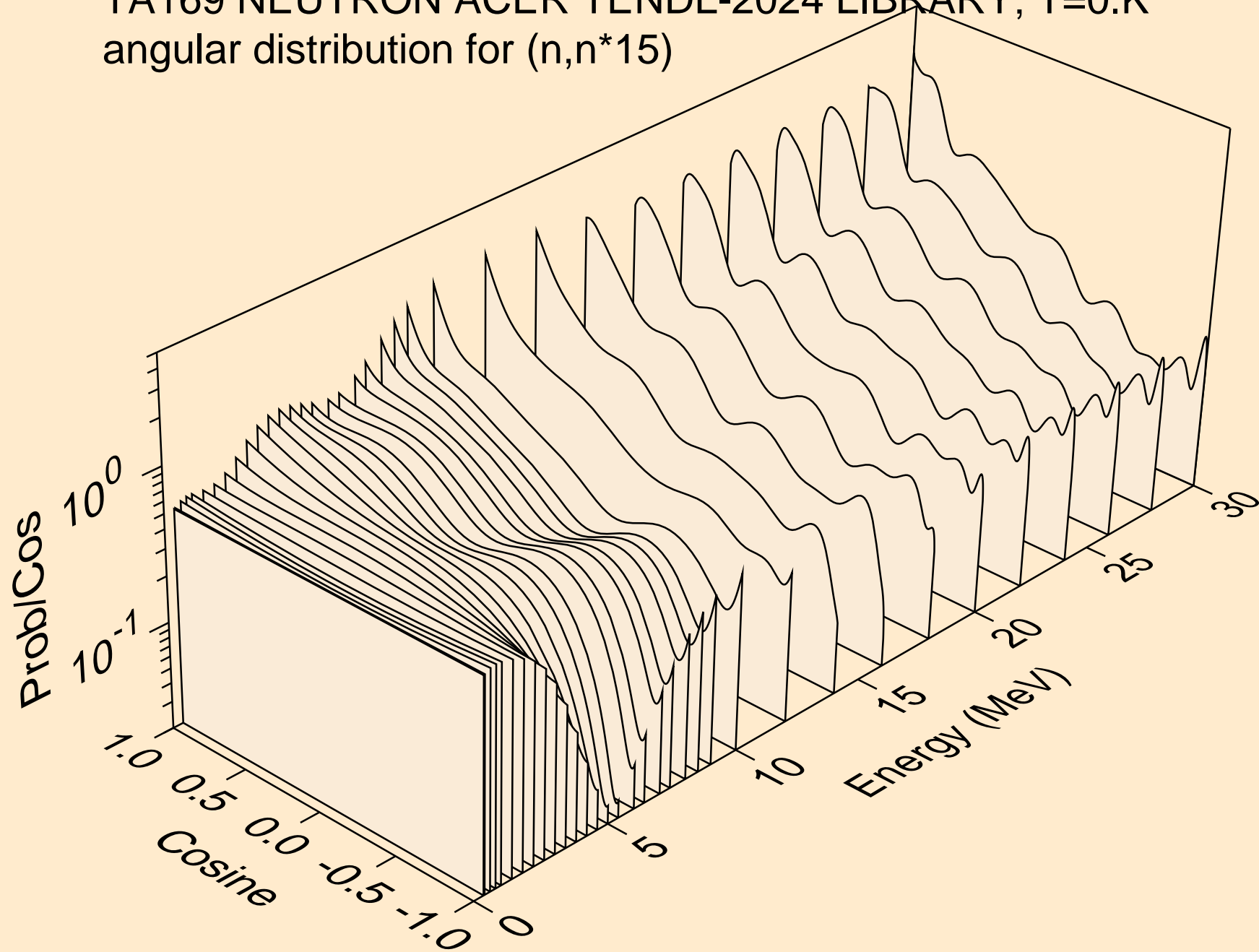

TA169 NEUTRON ACER TENDL-2024 LIBRARY; T=0.K
angular distribution for (n,n*16)

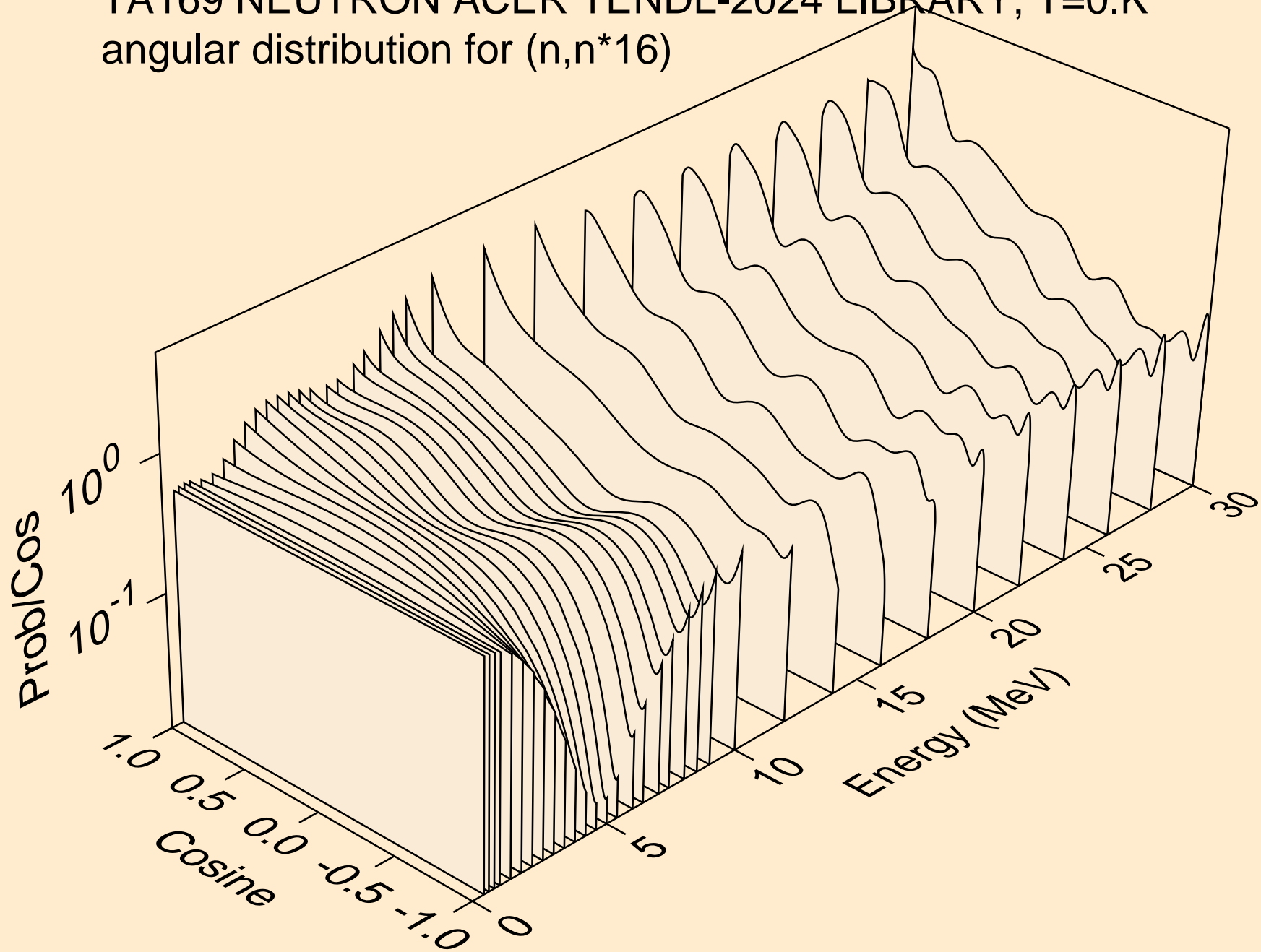

TA169 NEUTRON ACER TENDL-2024 LIBRARY; T=0.K
angular distribution for (n,n*17)

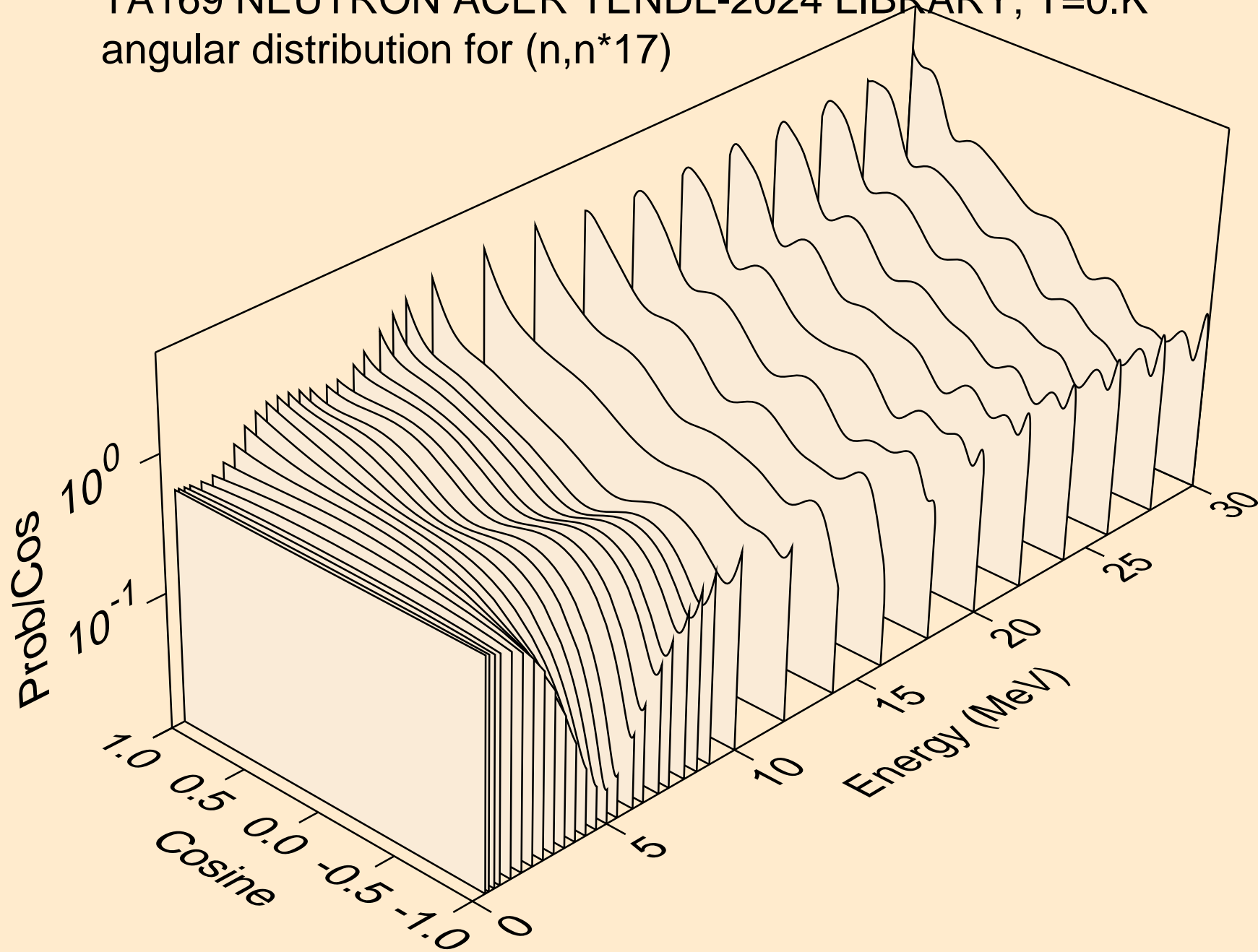

TA169 NEUTRON ACER TENDL-2024 LIBRARY; T=0.K
angular distribution for (n,n*18)

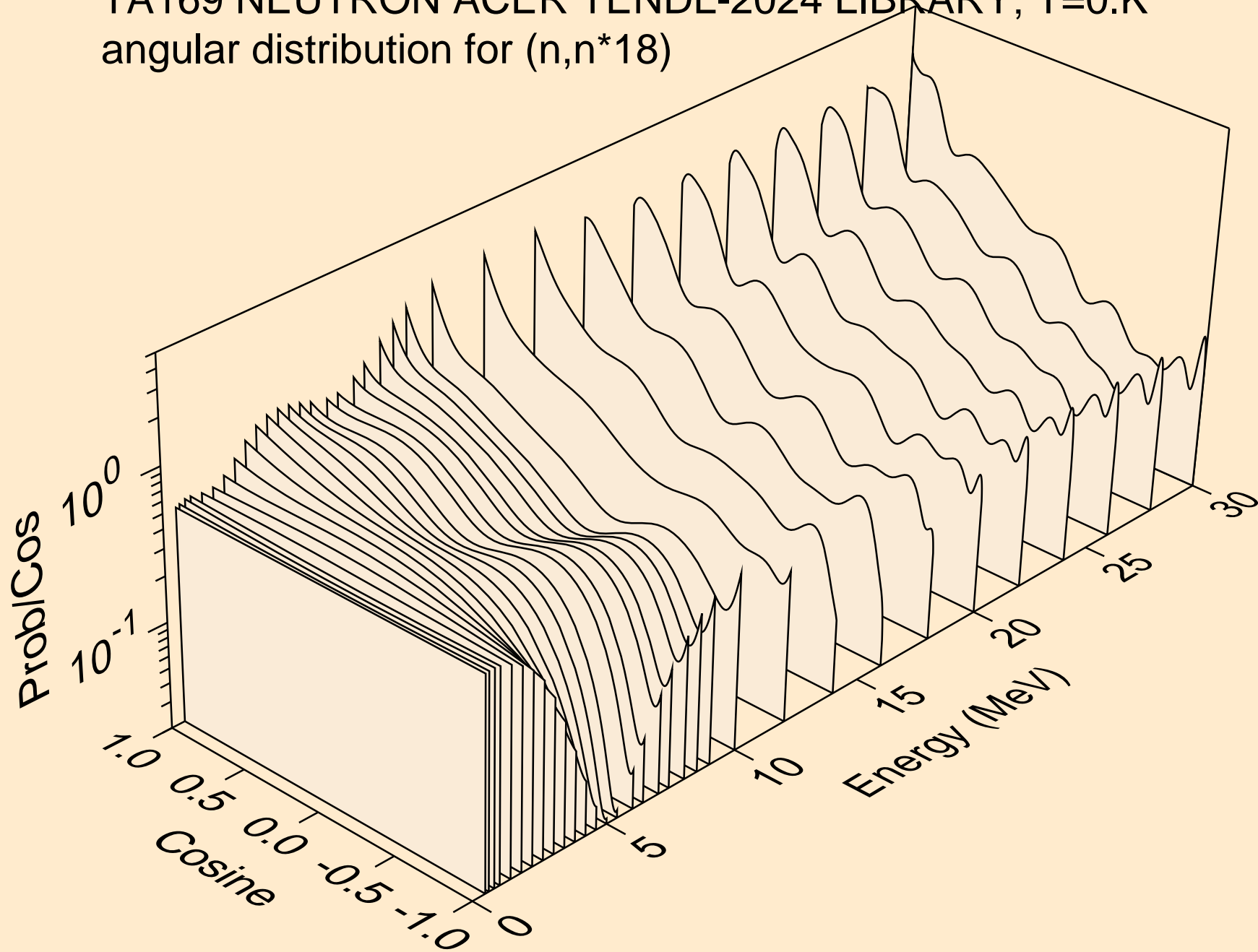

TA169 NEUTRON ACER TENDL-2024 LIBRARY; T=0.K
angular distribution for (n,n*19)

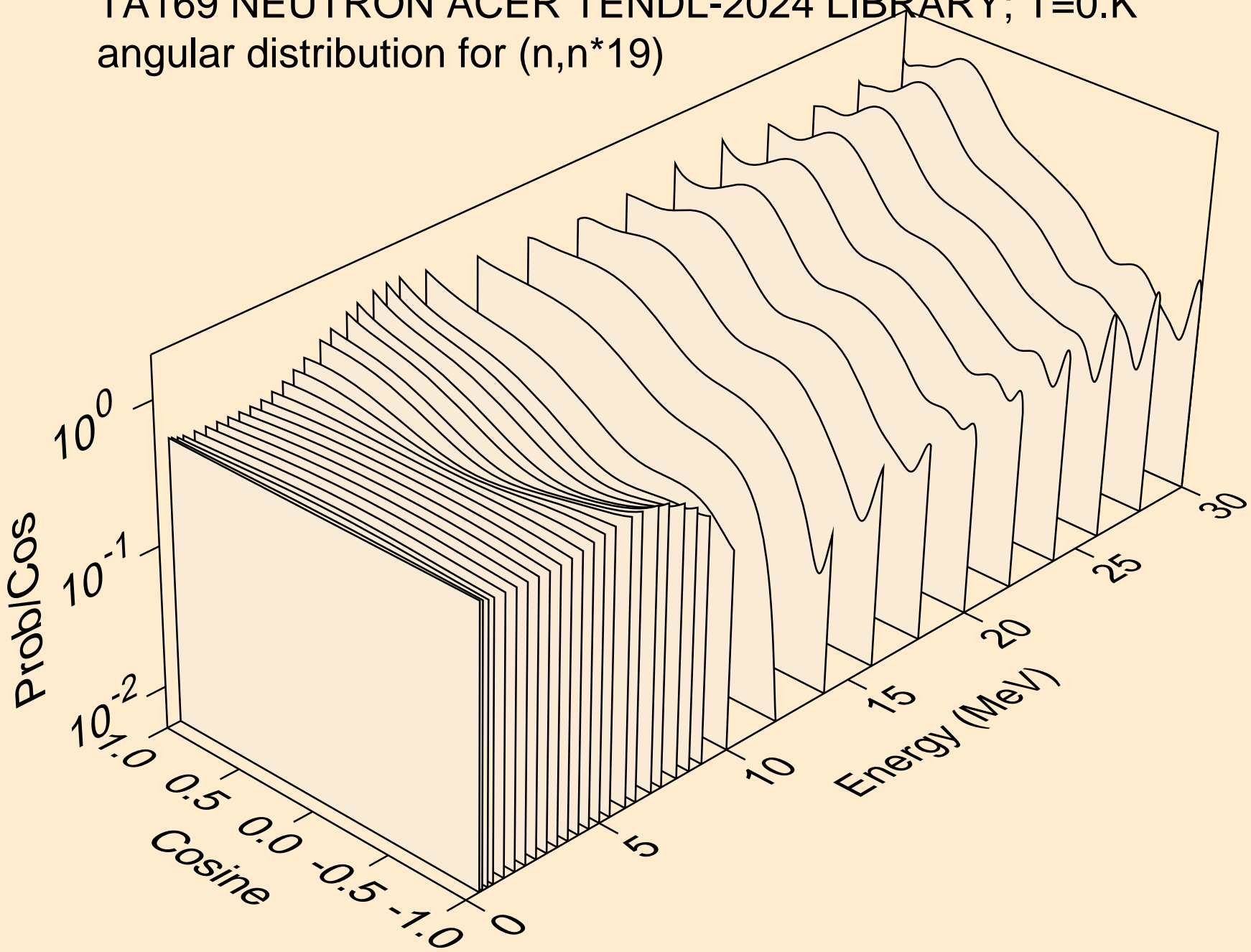

TA169 NEUTRON ACER TENDL-2024 LIBRARY; T=0.K
angular distribution for (n,n*20)

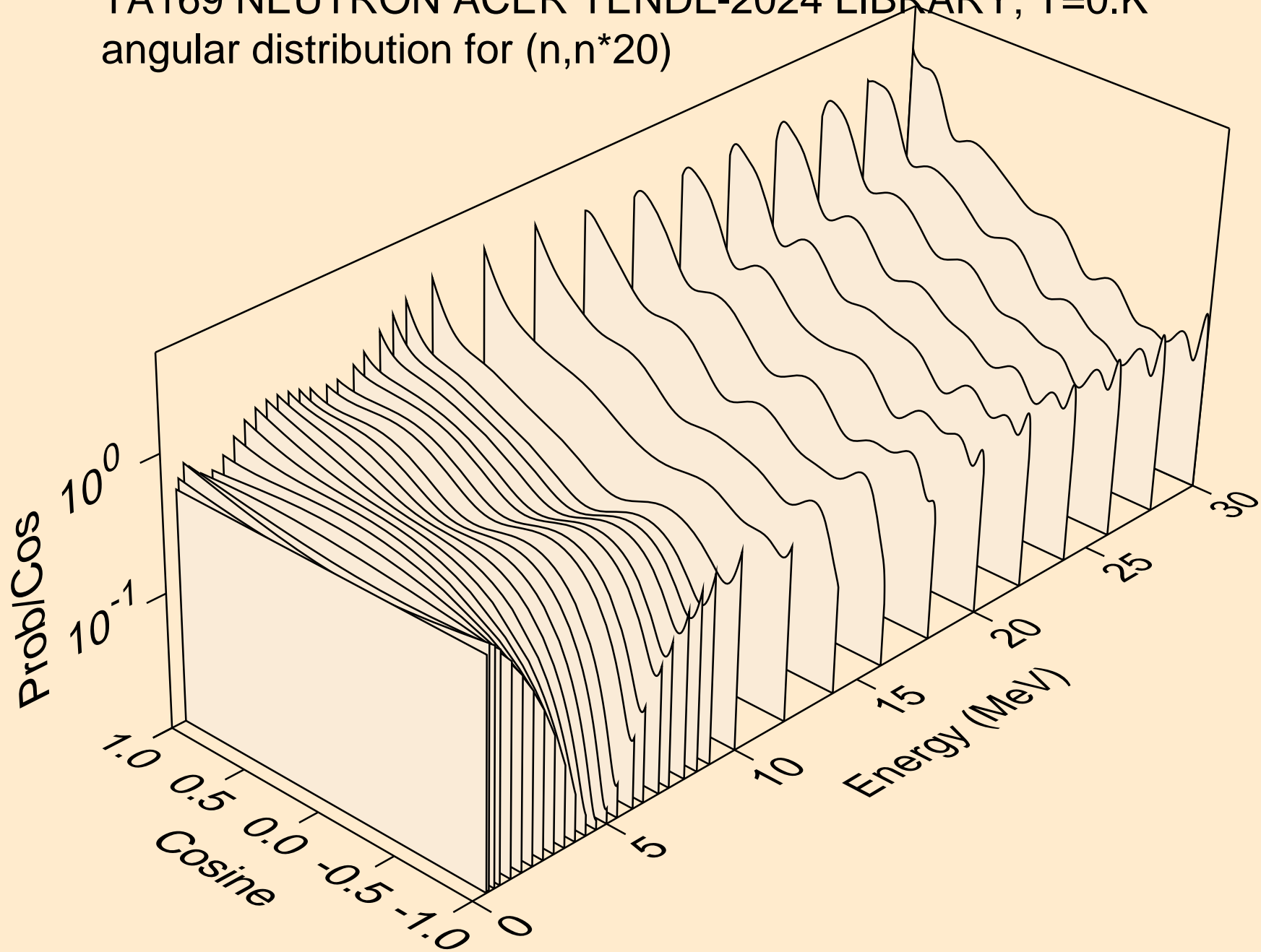

TA169 NEUTRON ACER TENDL-2024 LIBRARY; T=0.K
angular distribution for (n,n*21)

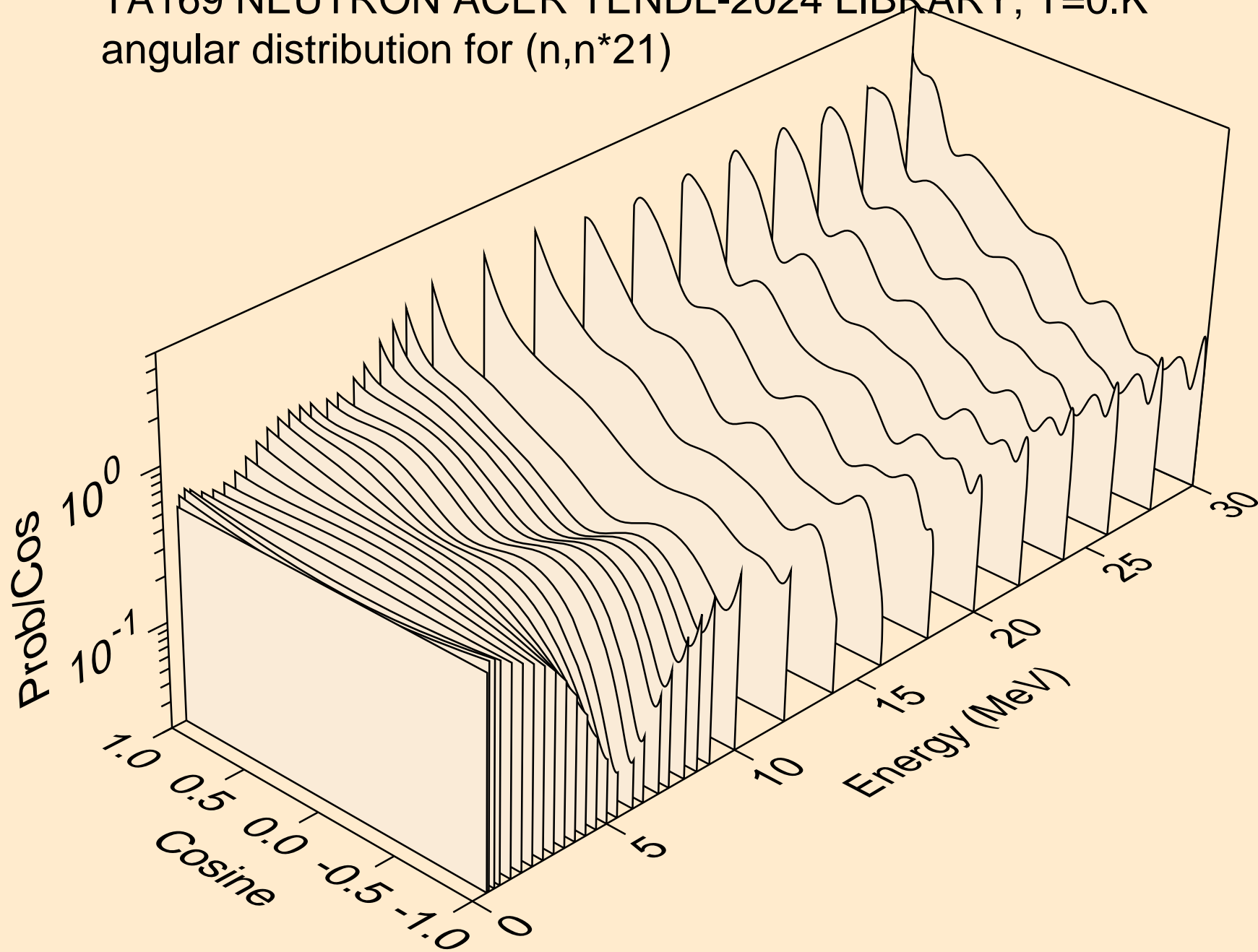

TA169 NEUTRON ACER TENDL-2024 LIBRARY; T=0.K
angular distribution for (n,n*22)

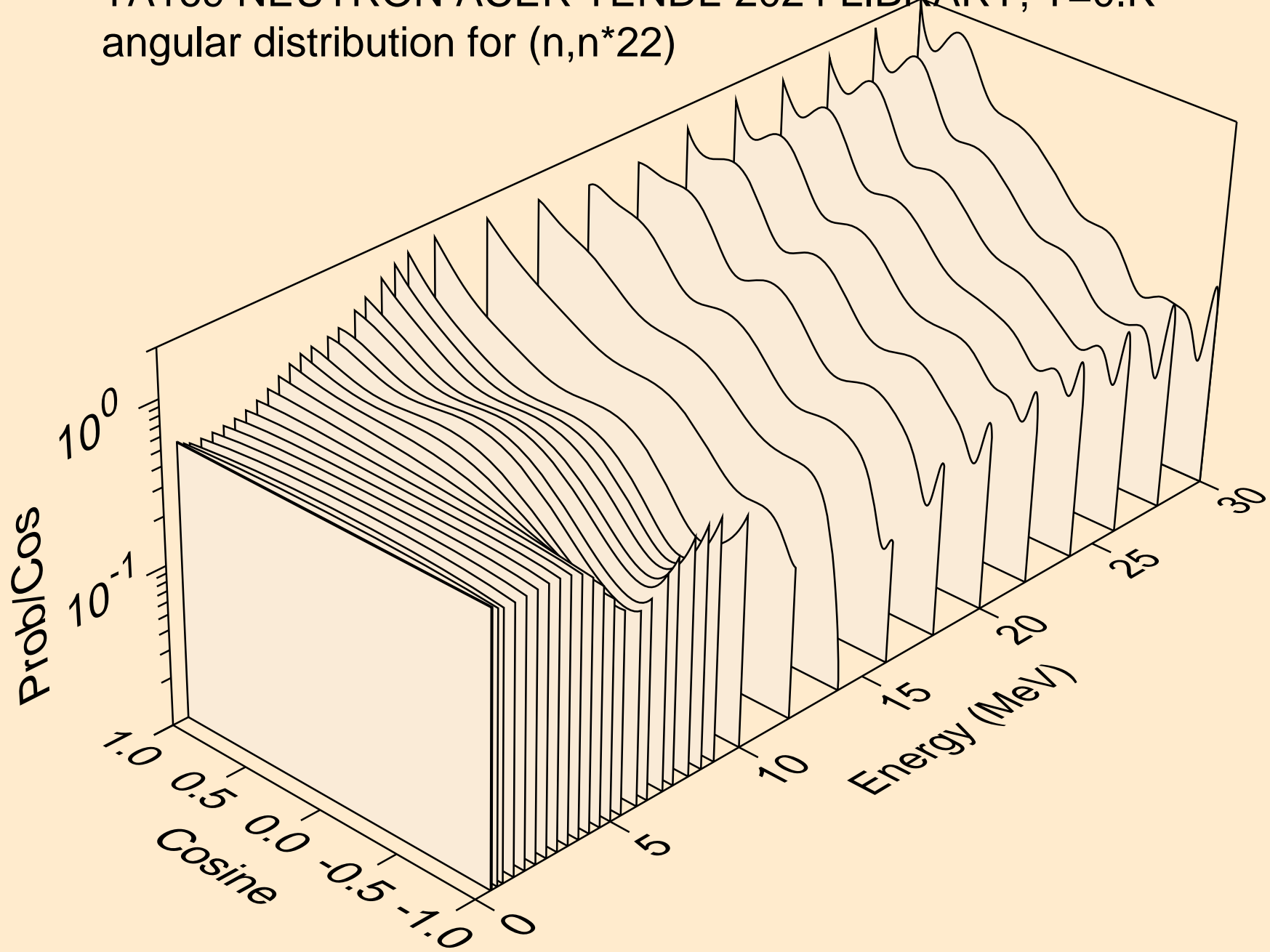

TA169 NEUTRON ACER TENDL-2024 LIBRARY; T=0.K
angular distribution for (n,n*23)

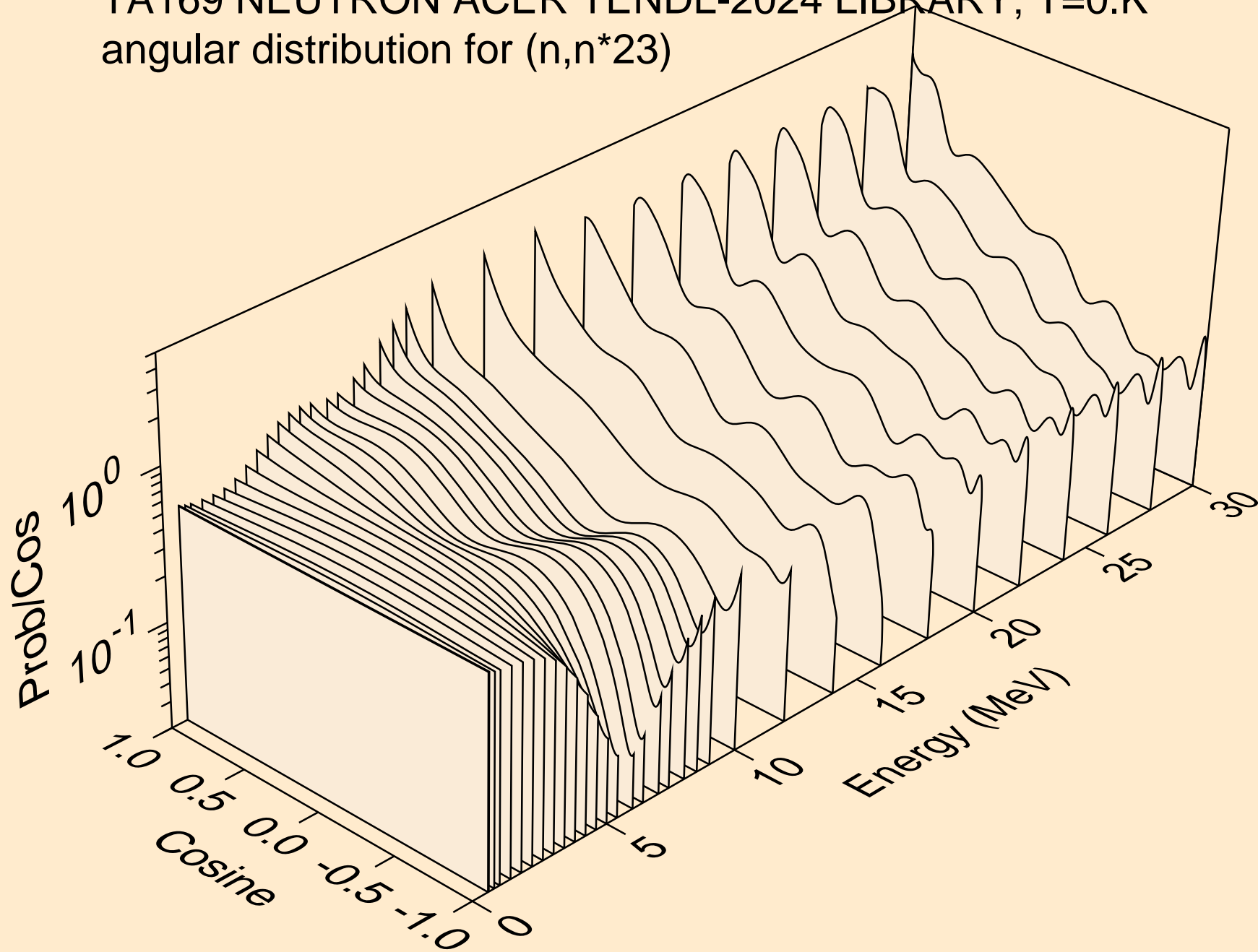

TA169 NEUTRON ACER TENDL-2024 LIBRARY; T=0.K
Neutron emission for (n,x)

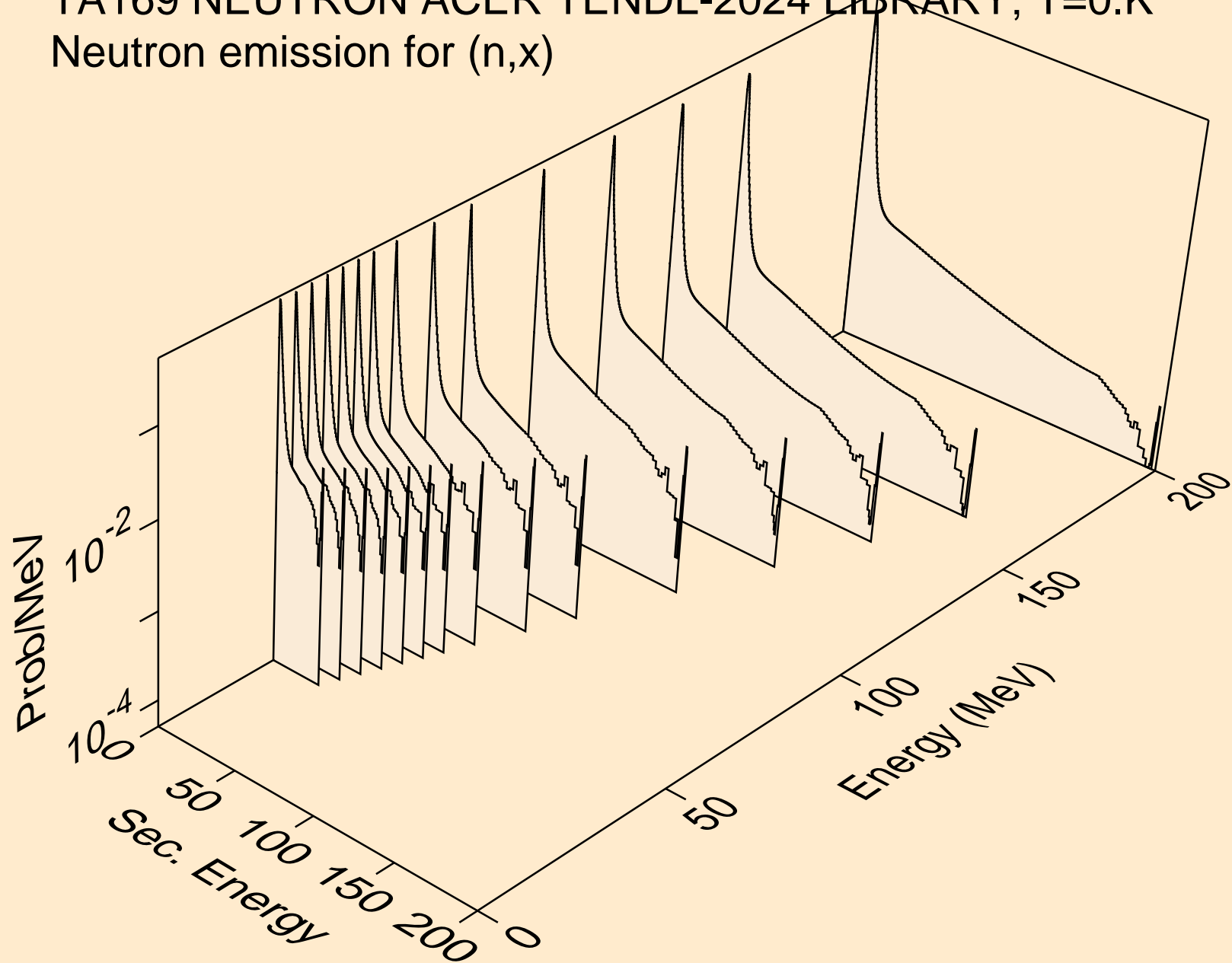

TA169 NEUTRON ACER TENDL-2024 LIBRARY; T=0.K
Neutron emission for (n,2nd)

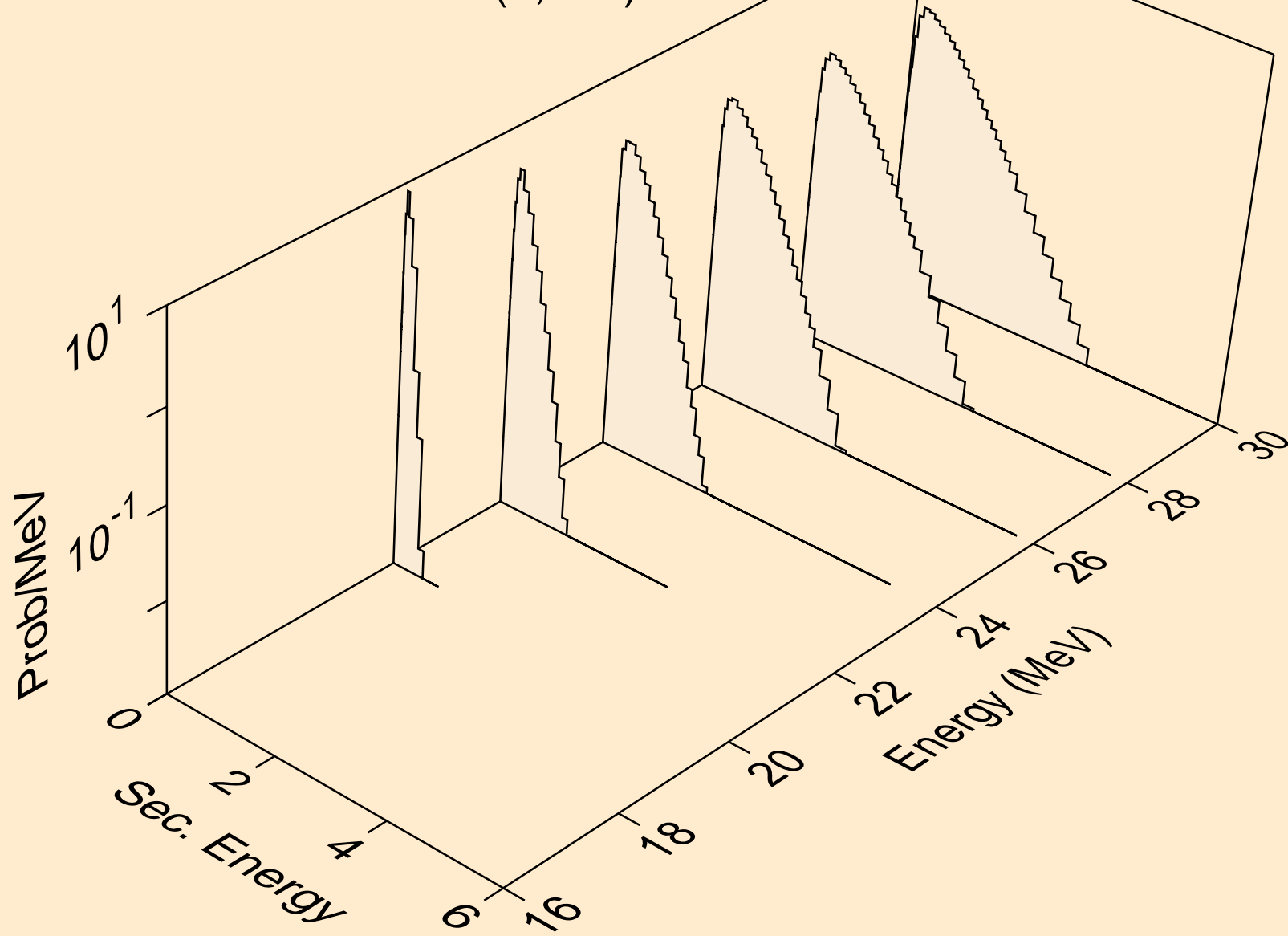

TA169 NEUTRON ACER TENDL-2024 LIBRARY; T=0.K
Neutron emission for (n,2n)

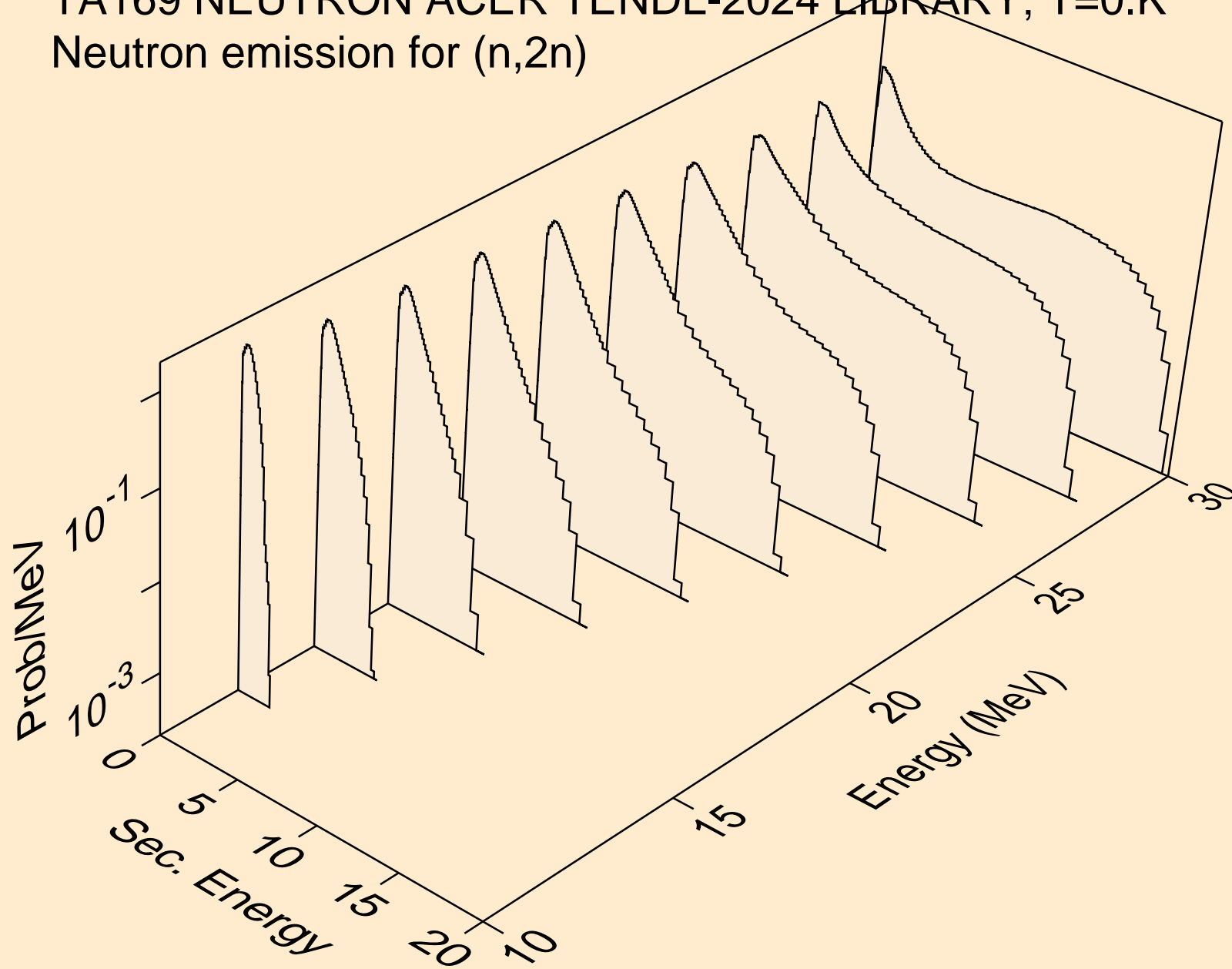

TA169 NEUTRON ACER TENDL-2024 LIBRARY; T=0.K
Neutron emission for (n,3n)

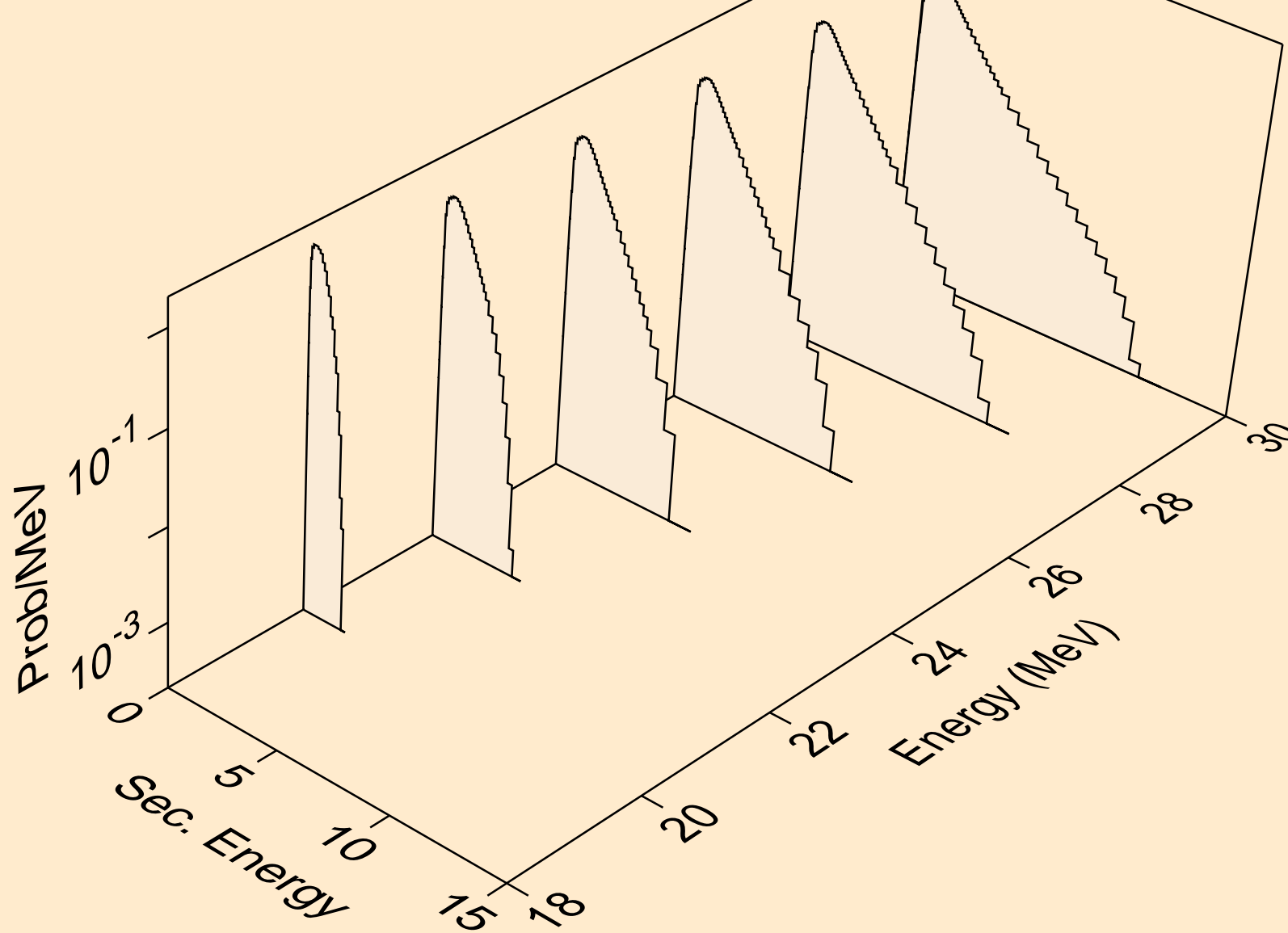

TA169 NEUTRON ACER TENDL-2024 LIBRARY; T=0.K
Neutron emission for (n,n*)a

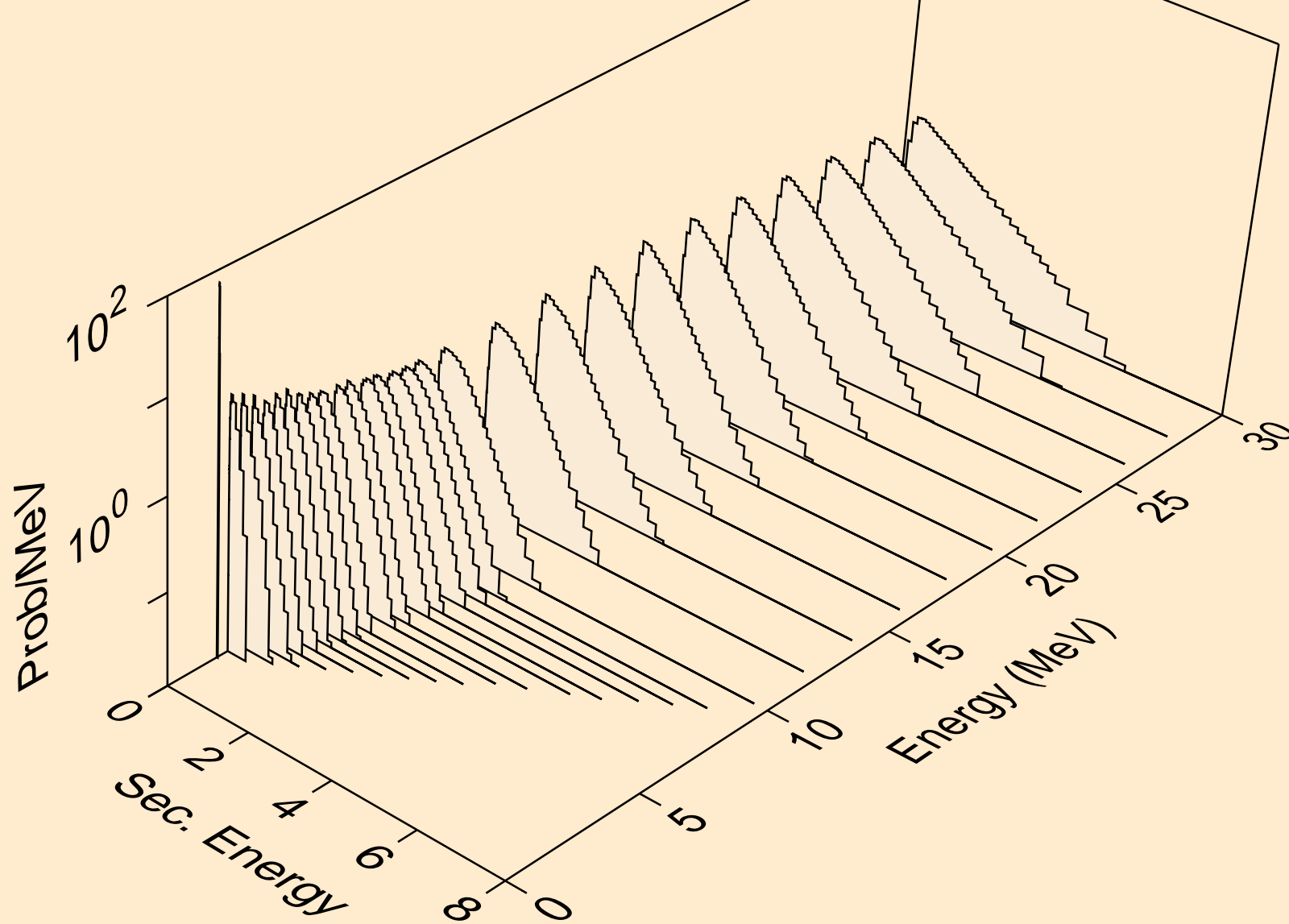

TA169 NEUTRON ACER TENDL-2024 LIBRARY; T=0.K
Neutron emission for (n,2n)a

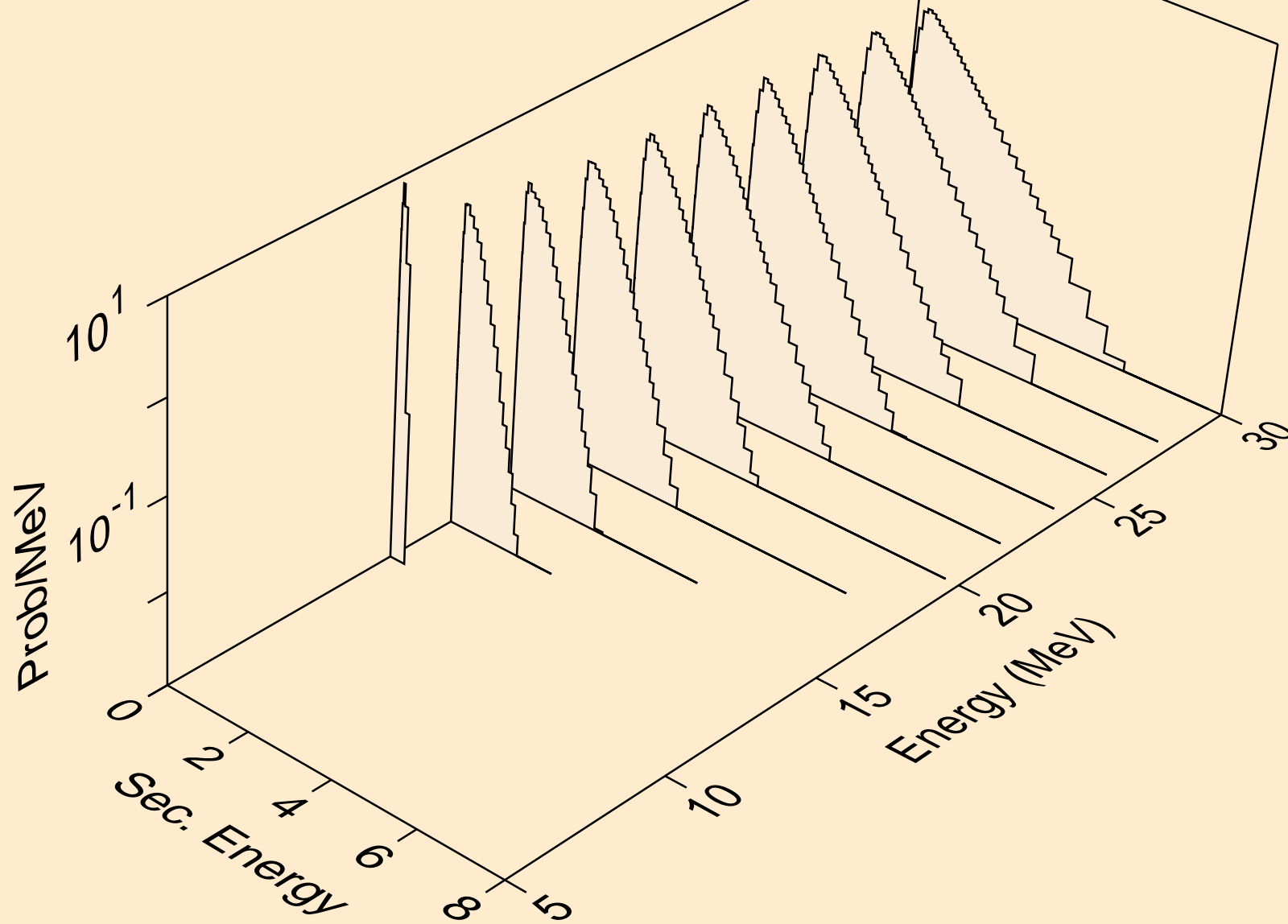

TA169 NEUTRON ACER TENDL-2024 LIBRARY; T=0.K
Neutron emission for (n,3n)a

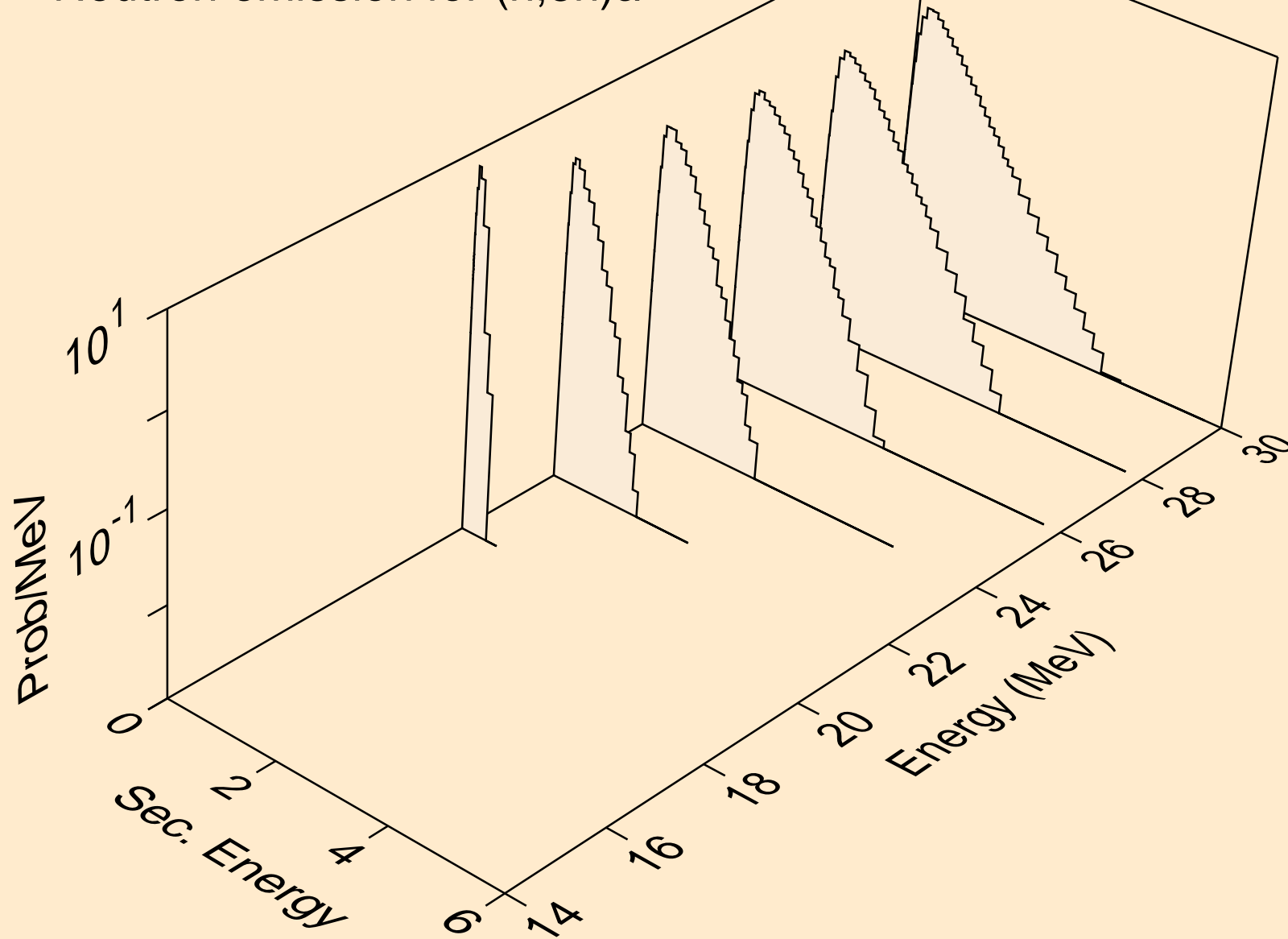

TA169 NEUTRON ACER TENDL-2024 LIBRARY; T=0.K
Neutron emission for (n,n*)p

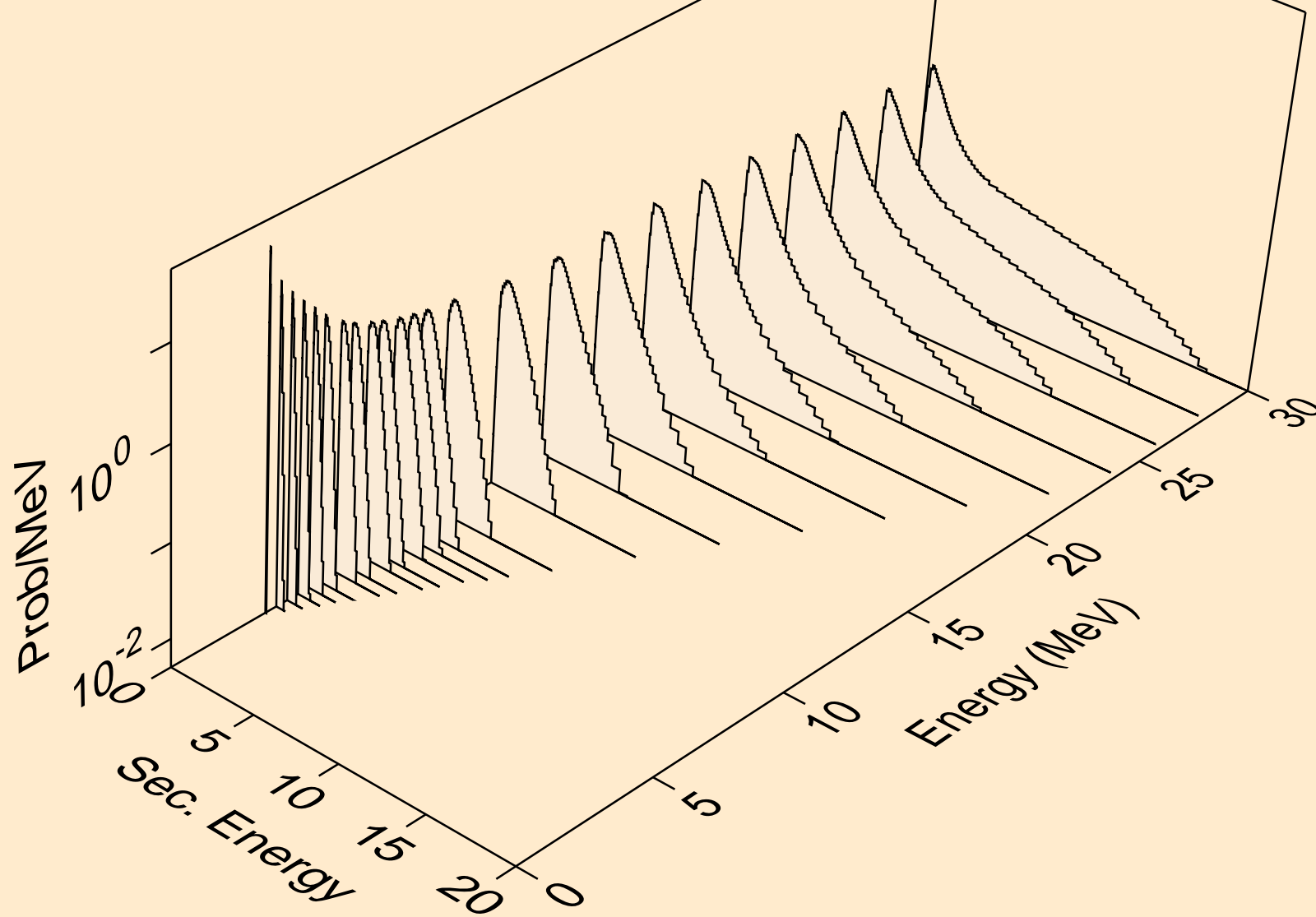

TA169 NEUTRON ACER TENDL-2024 LIBRARY; T=0.K
Neutron emission for (n,n*)2a

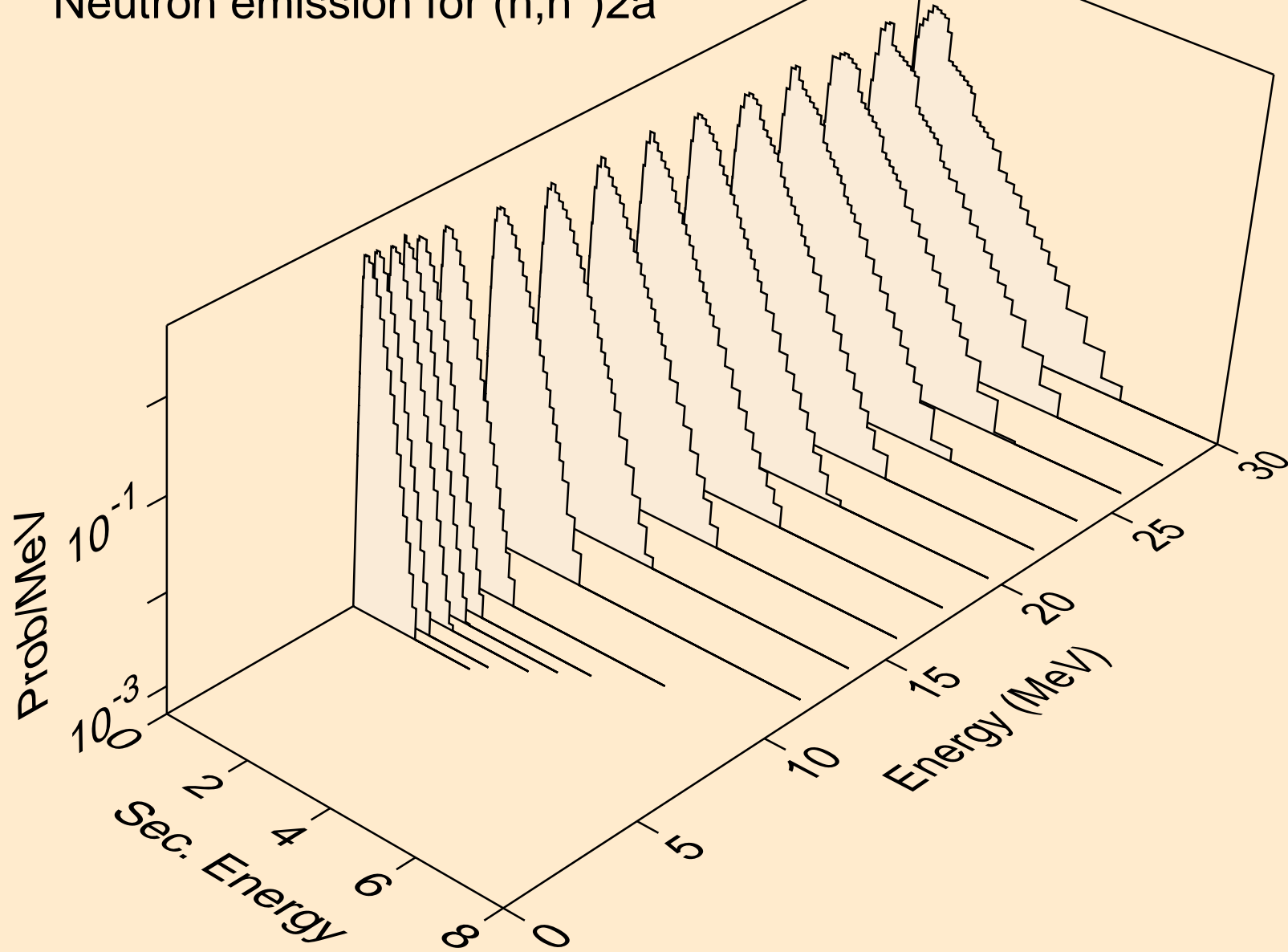

TA169 NEUTRON ACER TENDL-2024 LIBRARY; T=0.K
Neutron emission for (n,2n)2a

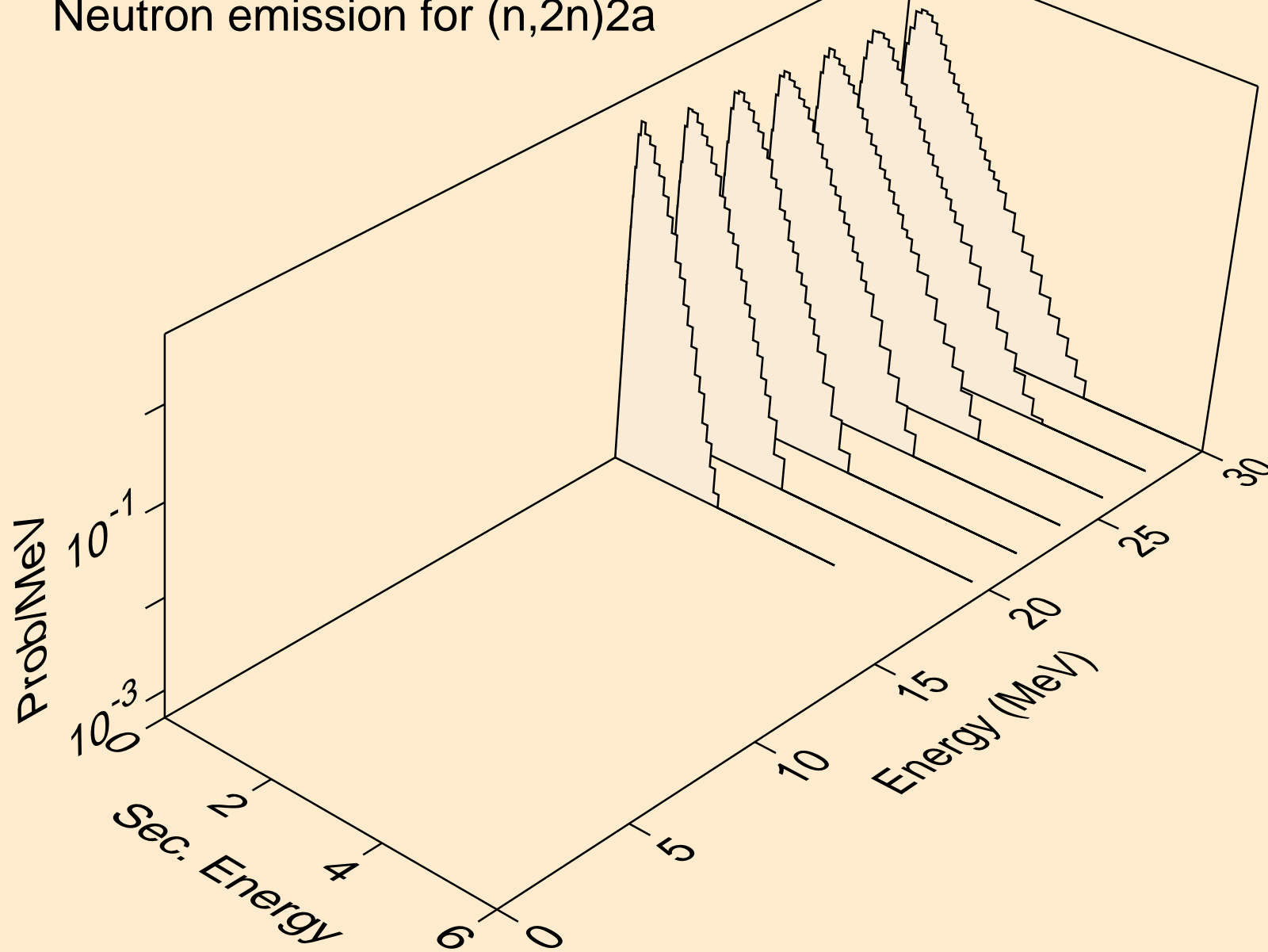

TA169 NEUTRON ACER TENDL-2024 LIBRARY; T=0.K
Neutron emission for (n,n*)d

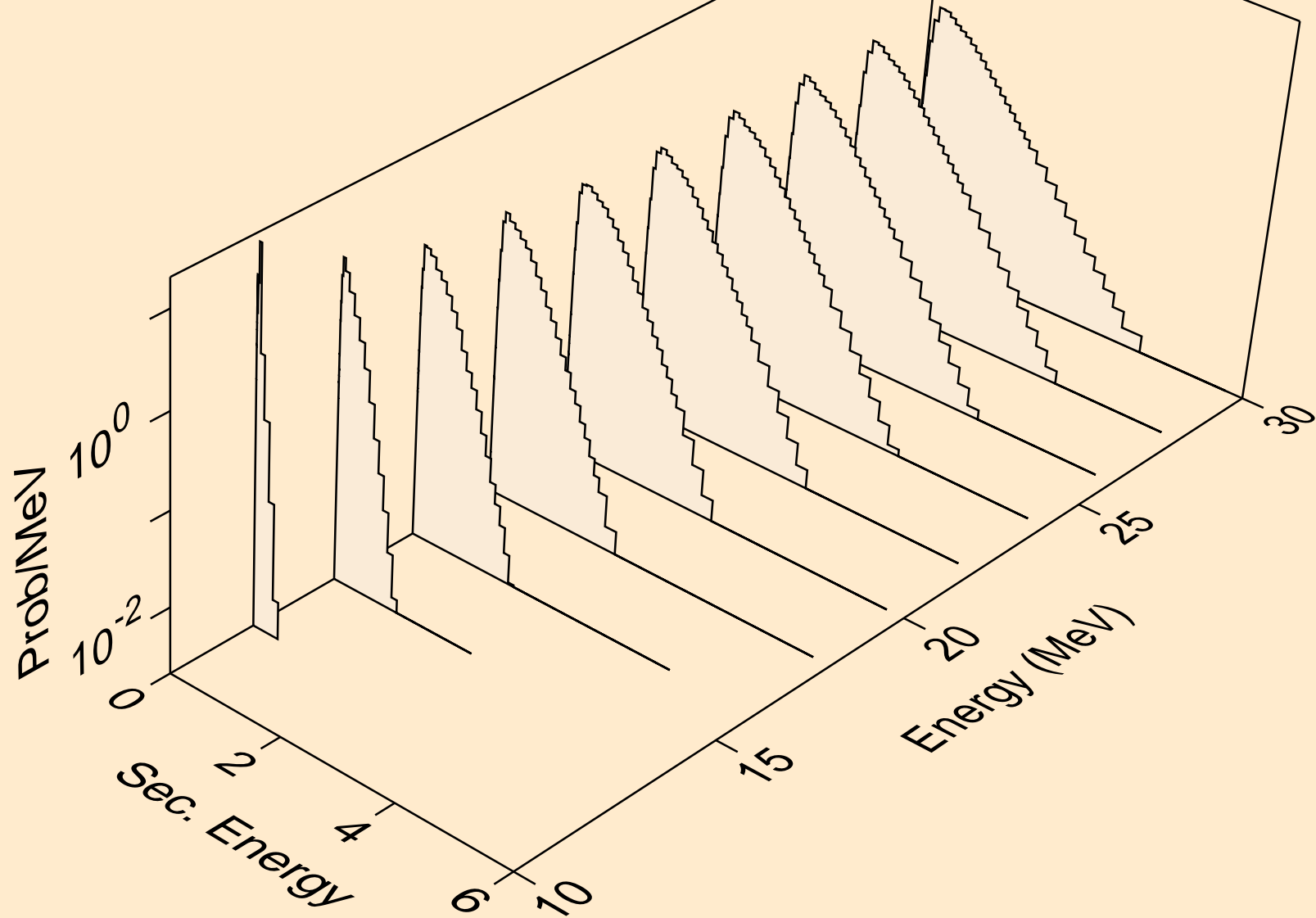

TA169 NEUTRON ACER TENDL-2024 LIBRARY; T=0.K
Neutron emission for (n,n*)t

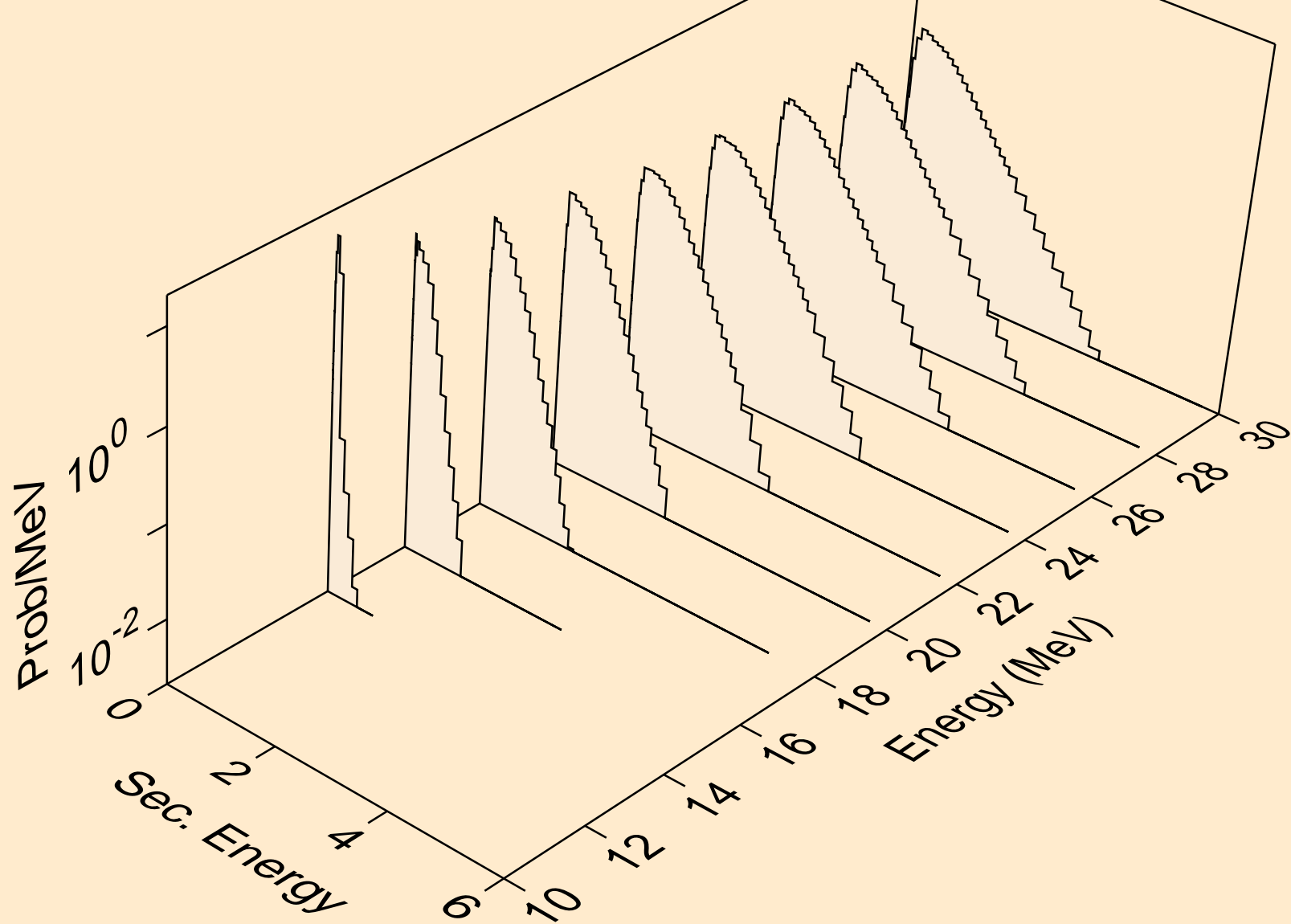

TA169 NEUTRON ACER TENDL-2024 LIBRARY; T=0.K
Neutron emission for (n,n*)he3

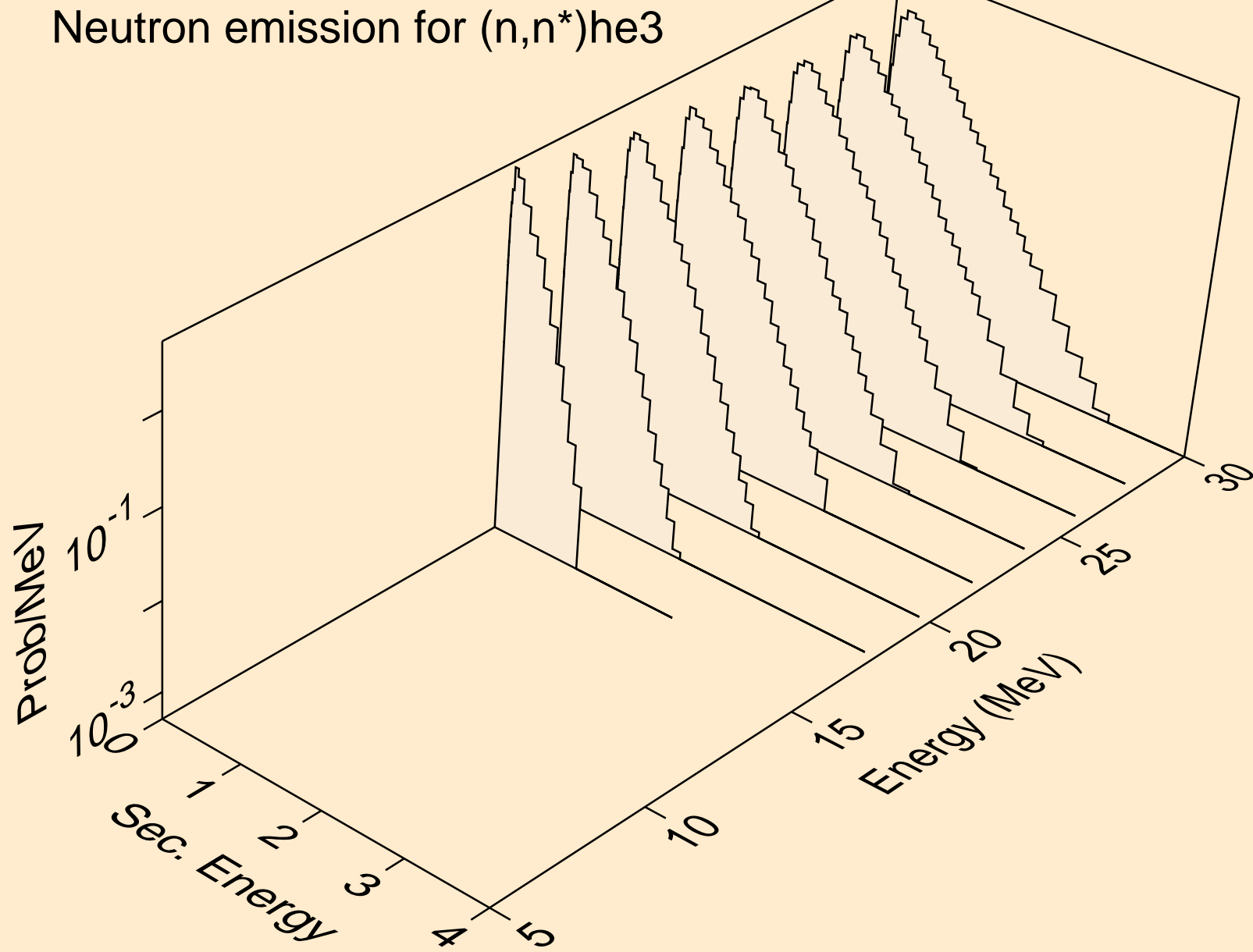

TA169 NEUTRON ACER TENDL-2024 LIBRARY; T=0.K
Neutron emission for (n,4n)

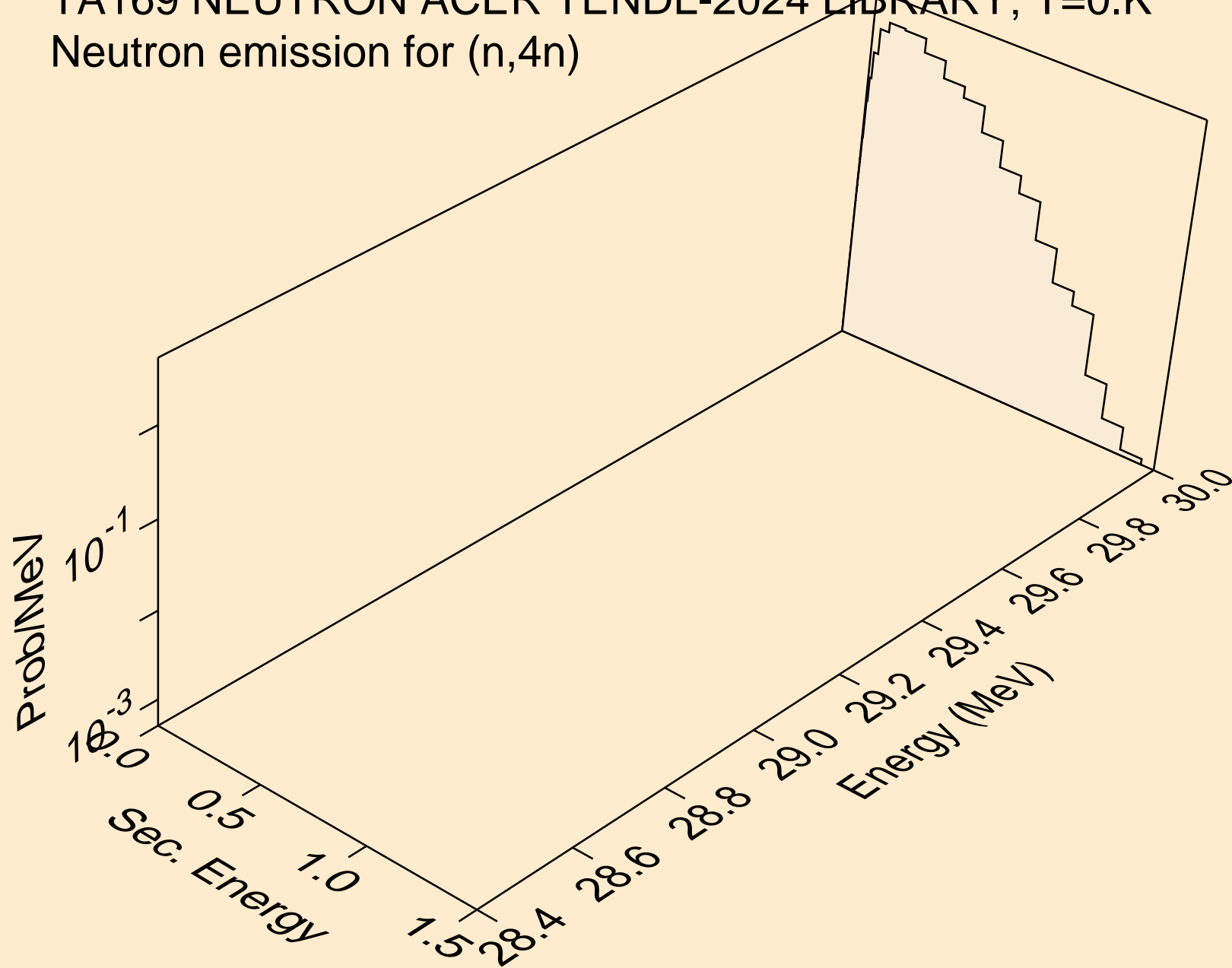

TA169 NEUTRON ACER TENDL-2024 LIBRARY; T=0.K
Neutron emission for (n,2np)

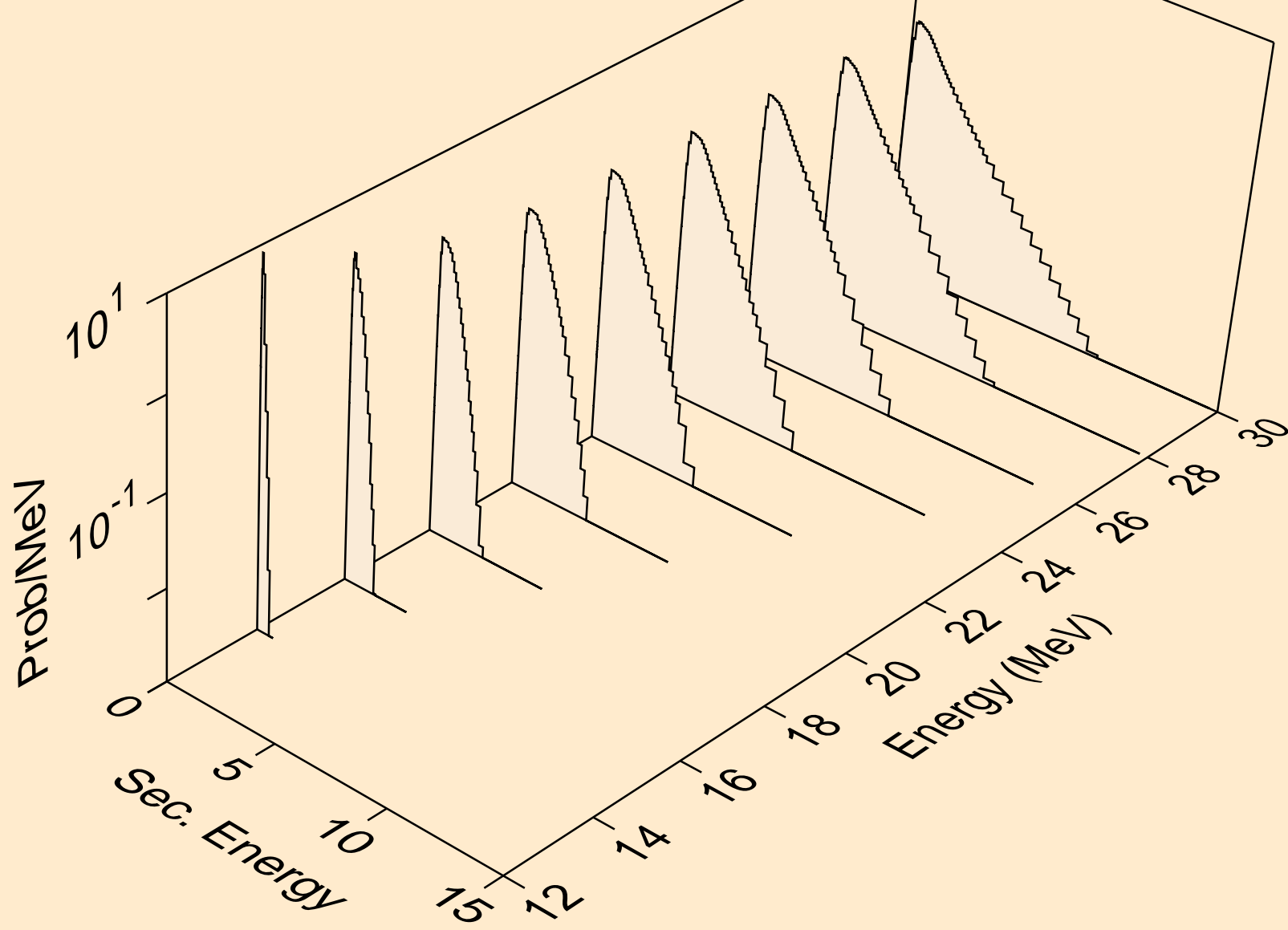

TA169 NEUTRON ACER TENDL-2024 LIBRARY; T=0.K
Neutron emission for (n,3np)

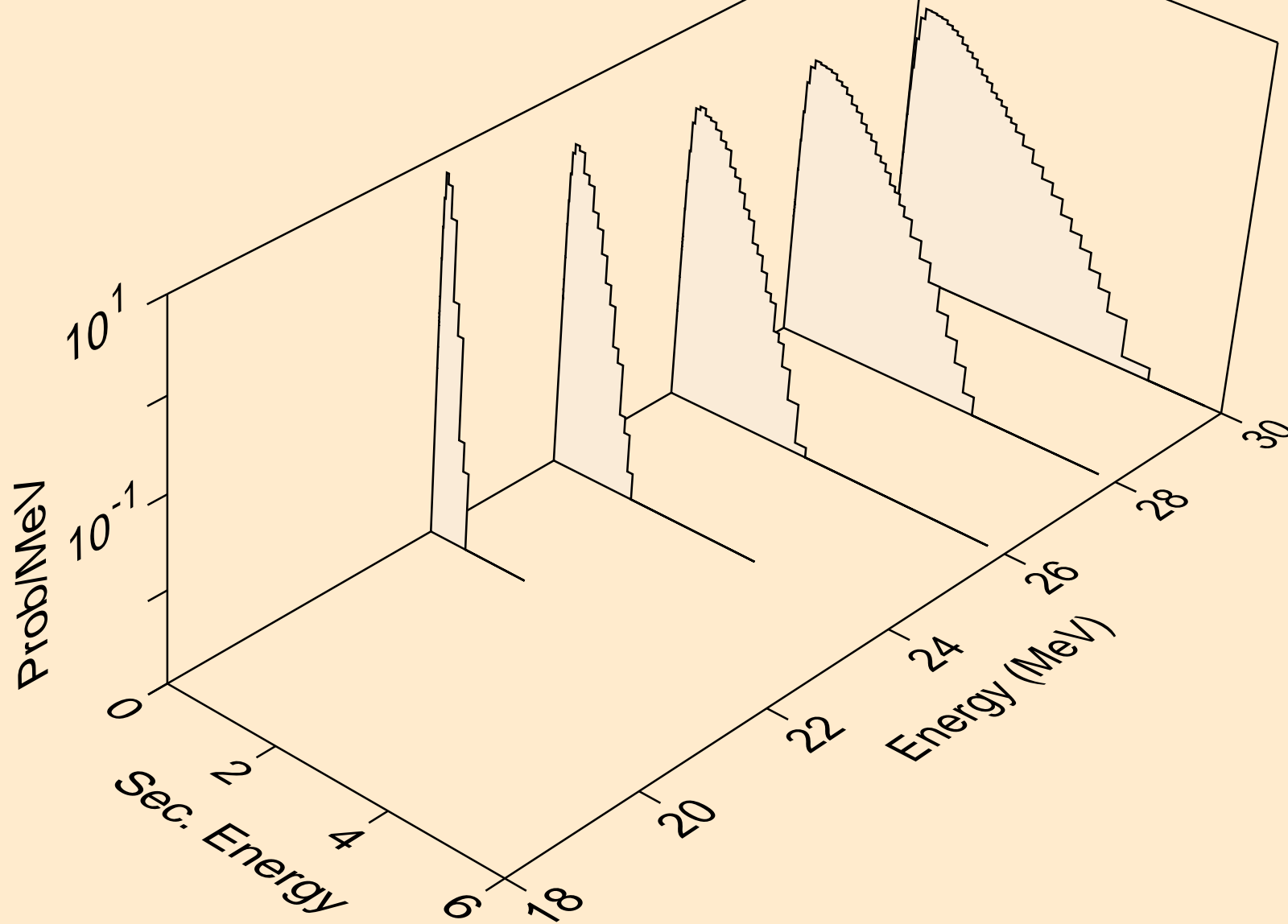

TA169 NEUTRON ACER TENDL-2024 LIBRARY; T=0.K
Neutron emission for (n,n2p)

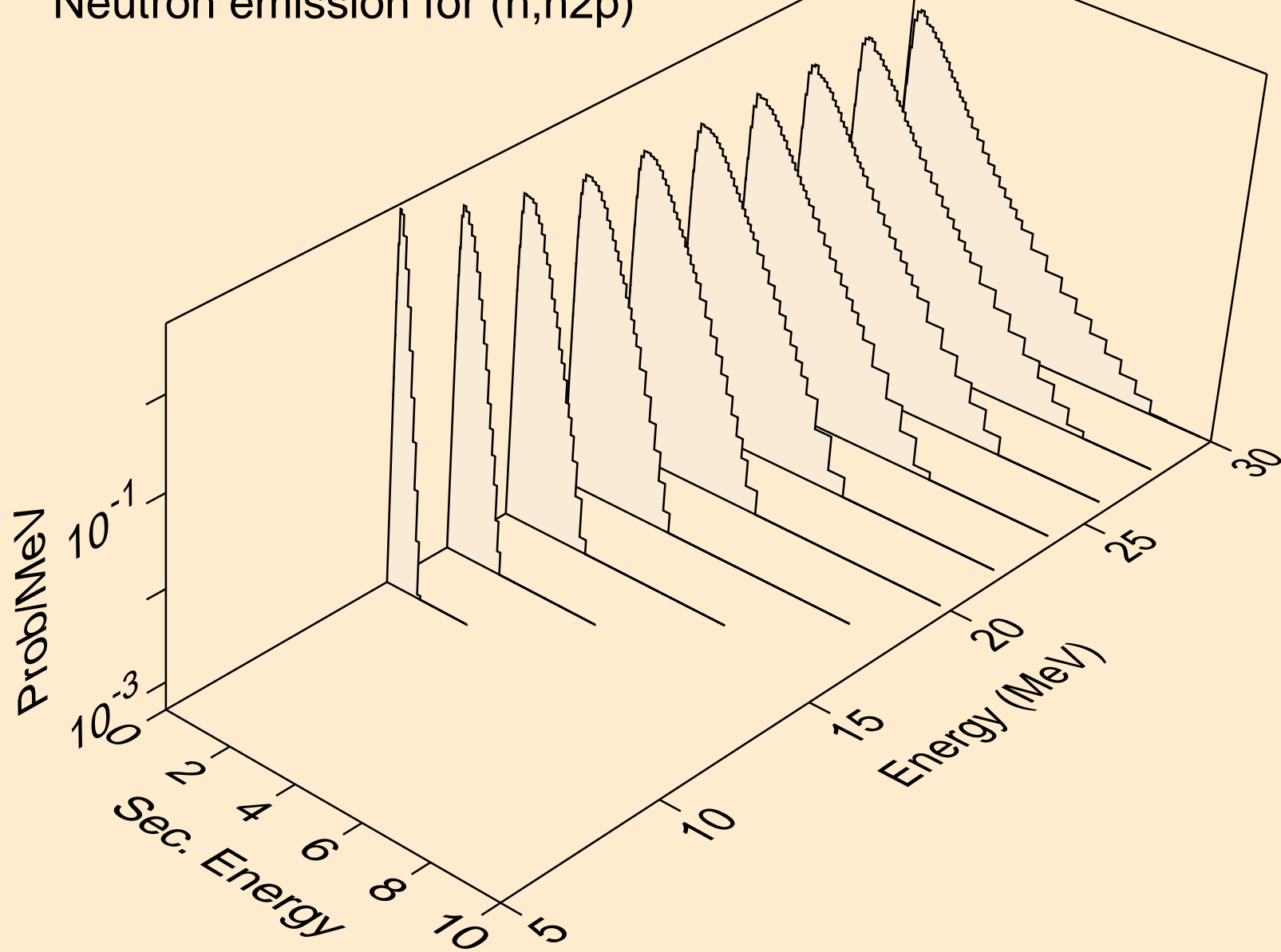

TA169 NEUTRON ACER TENDL-2024 LIBRARY; T=0.K
Neutron emission for (n,npa)

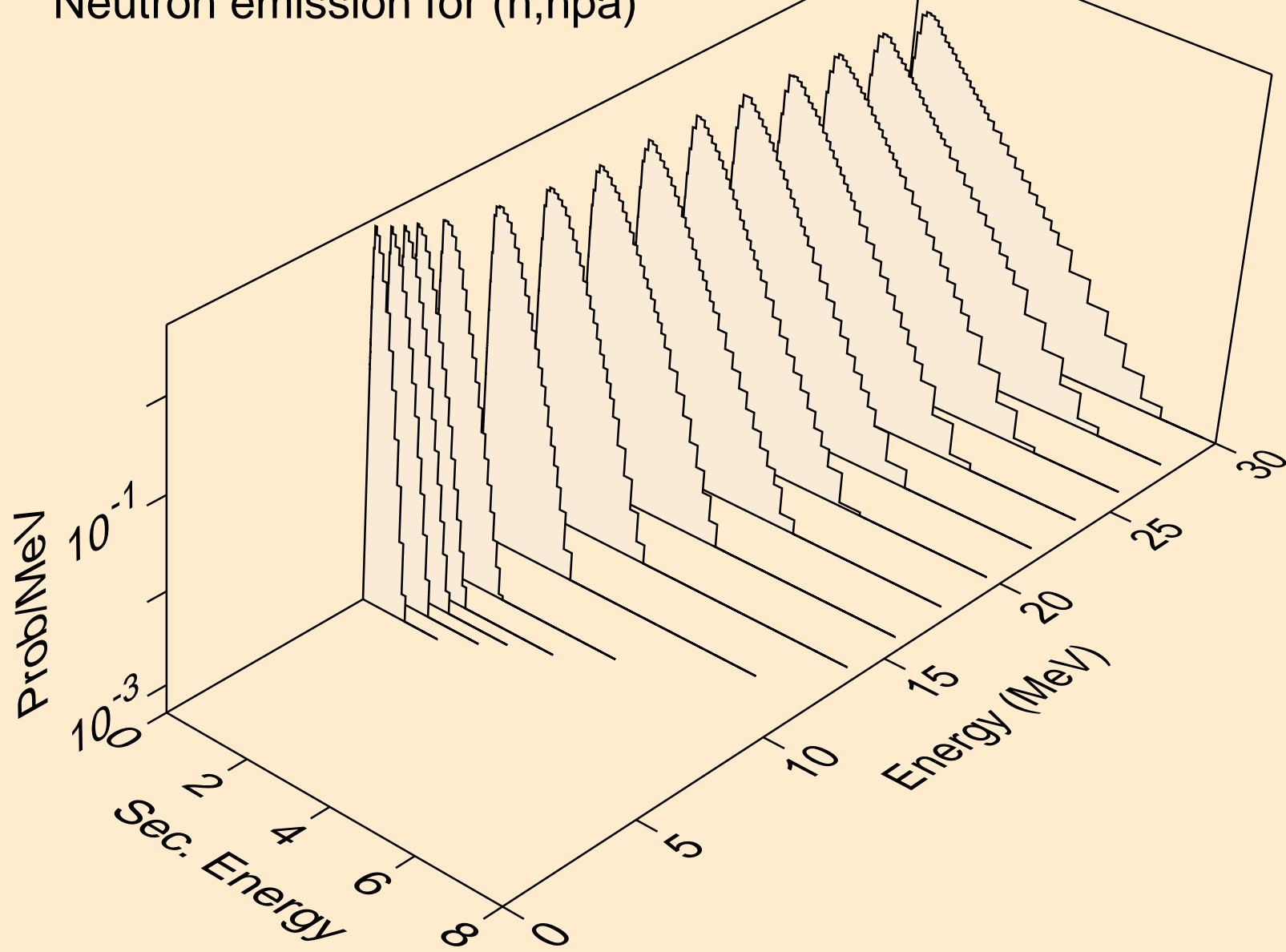

TA169 NEUTRON ACER TENDL-2024 LIBRARY; T=0.K
Neutron emission for (n,n*c)

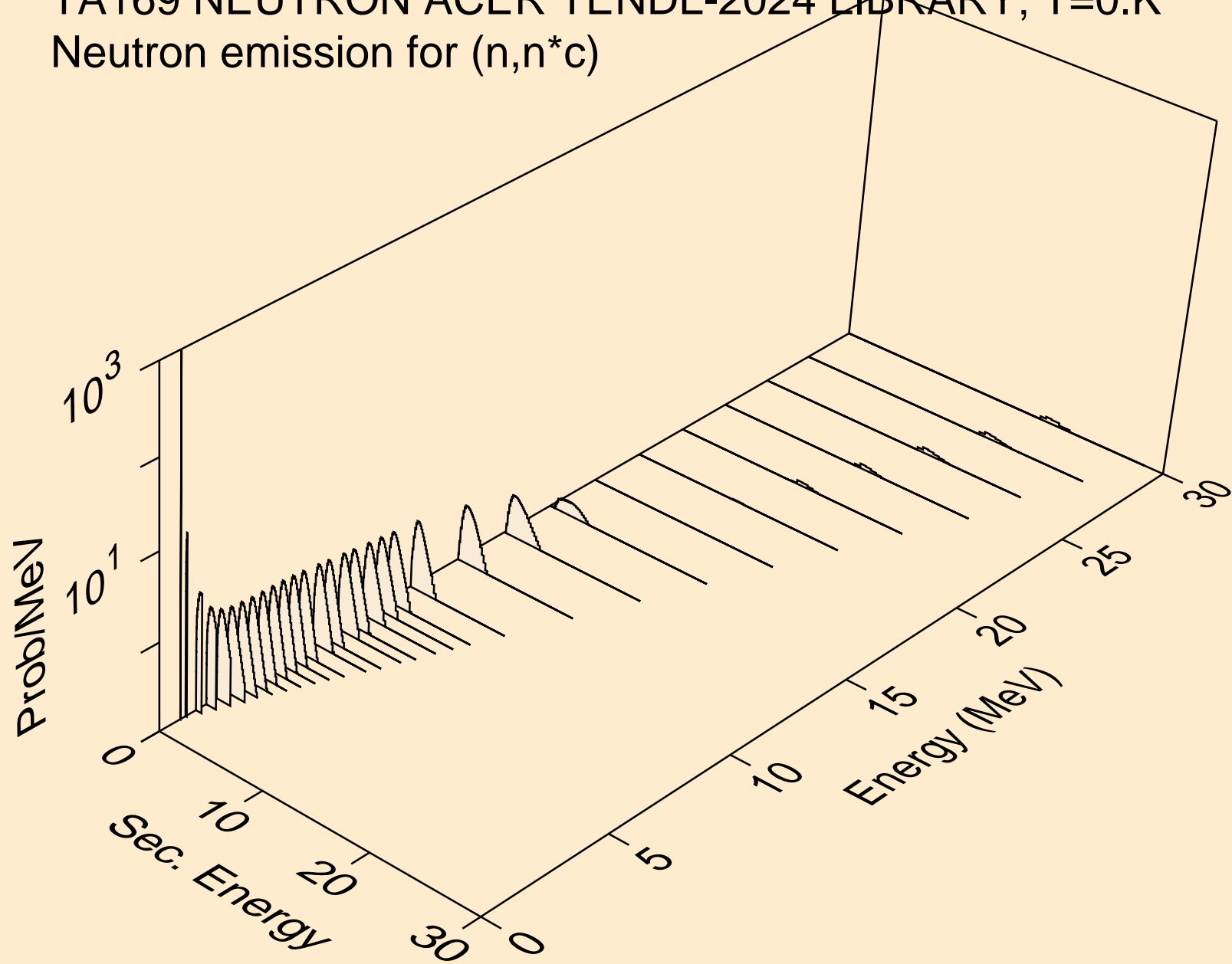

TA169 NEUTRON ACER TENDL-2024 LIBRARY; T=0.K
Photon emission for (n,x)

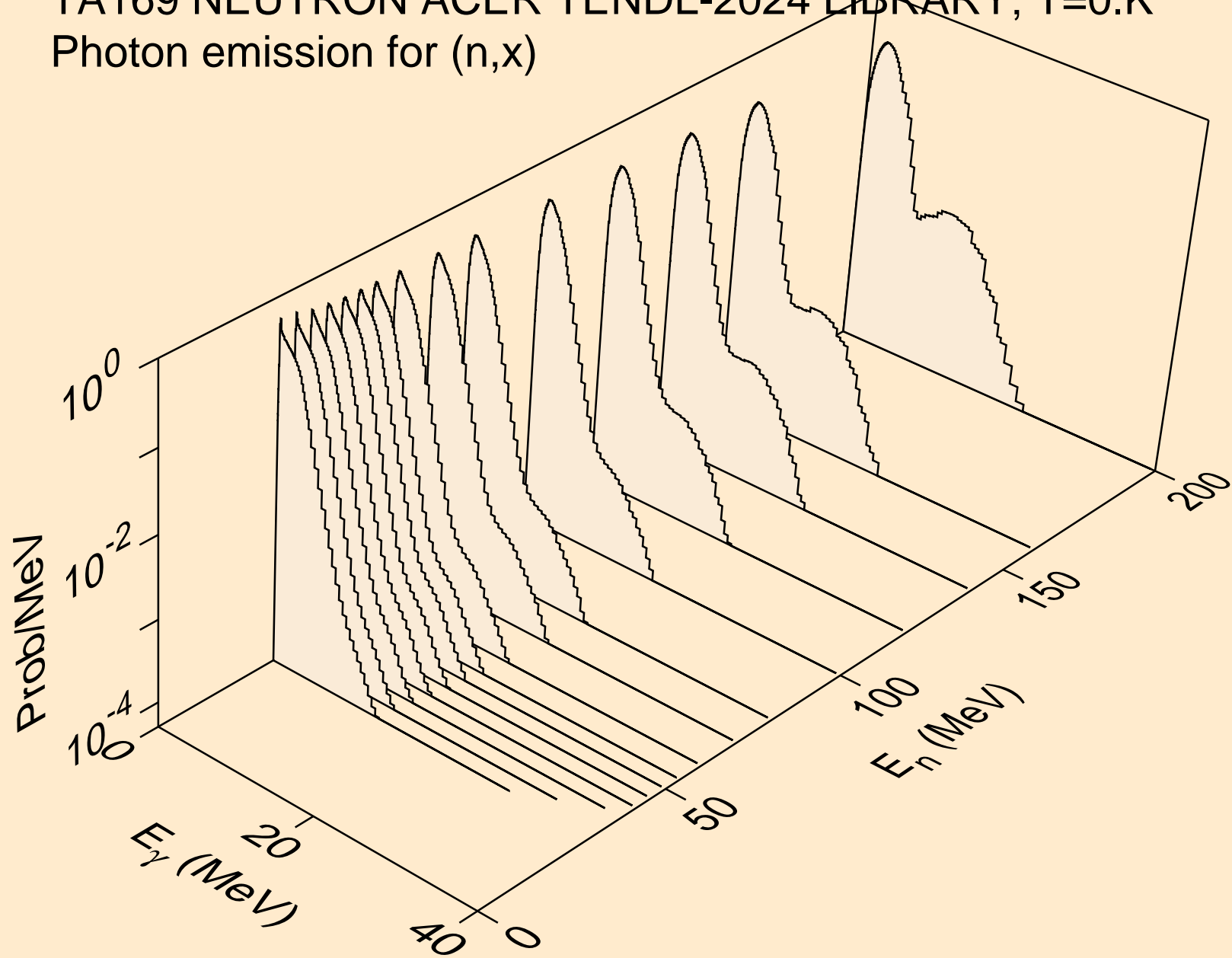

TA169 NEUTRON ACER TENDL-2024 LIBRARY; T=0.K
Photon emission for (n,2nd)

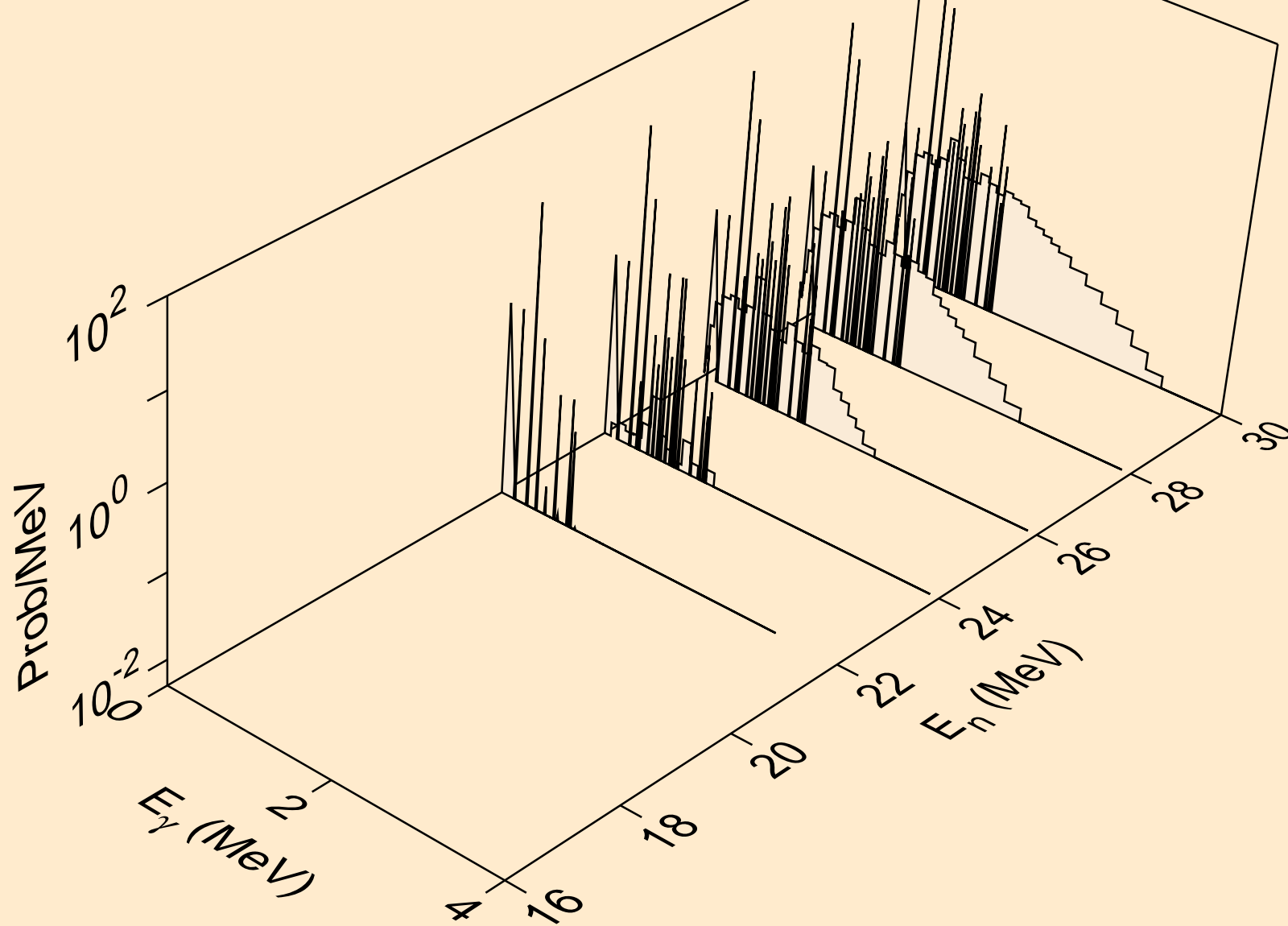

TA169 NEUTRON ACER TENDL-2024 LIBRARY; T=0.K
Photon emission for (n,2n)

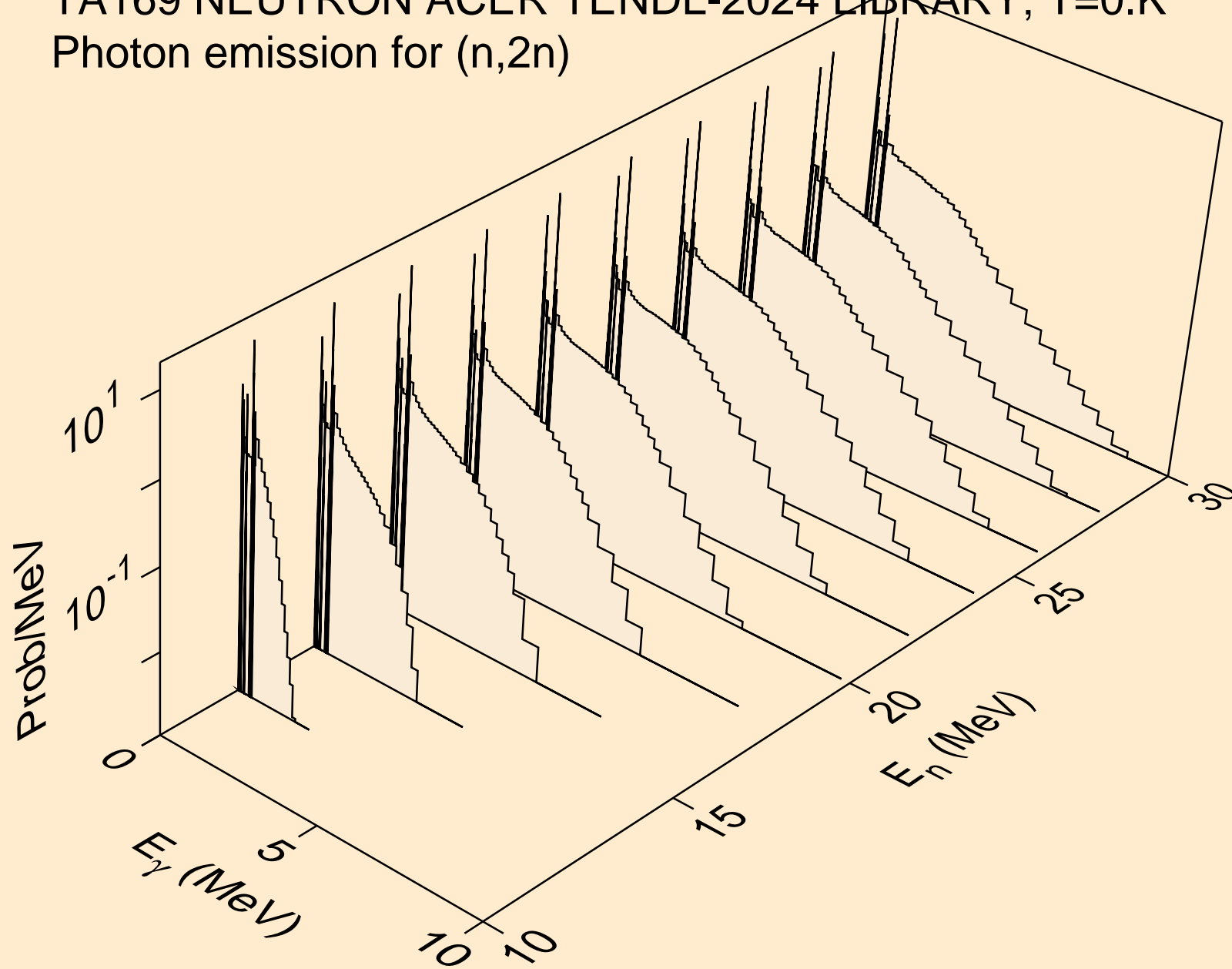

TA169 NEUTRON ACER TENDL-2024 LIBRARY; T=0.K
Photon emission for (n,3n)

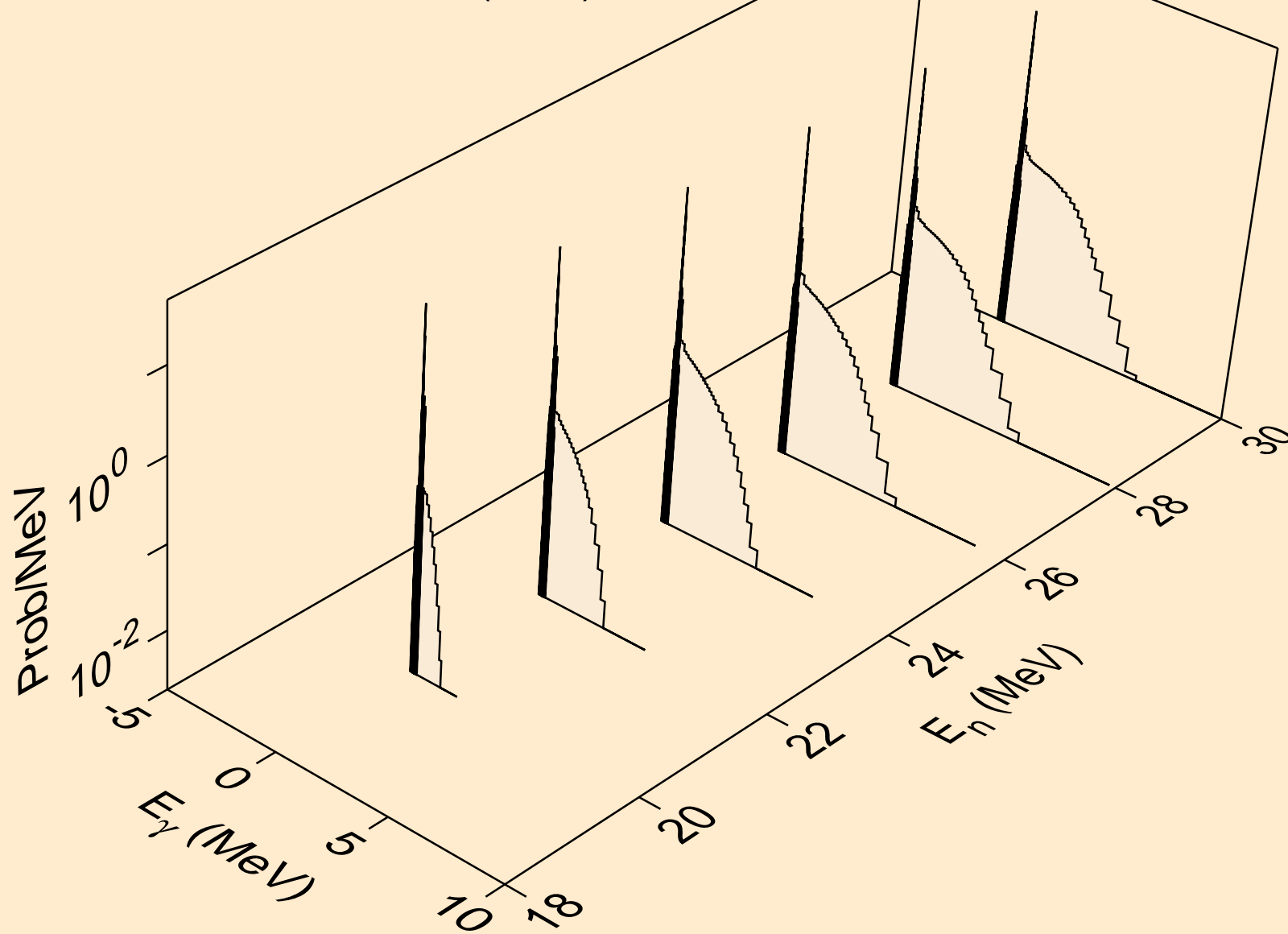

TA169 NEUTRON ACER TENDL-2024 LIBRARY; T=0.K
Photon emission for (n,n*)a

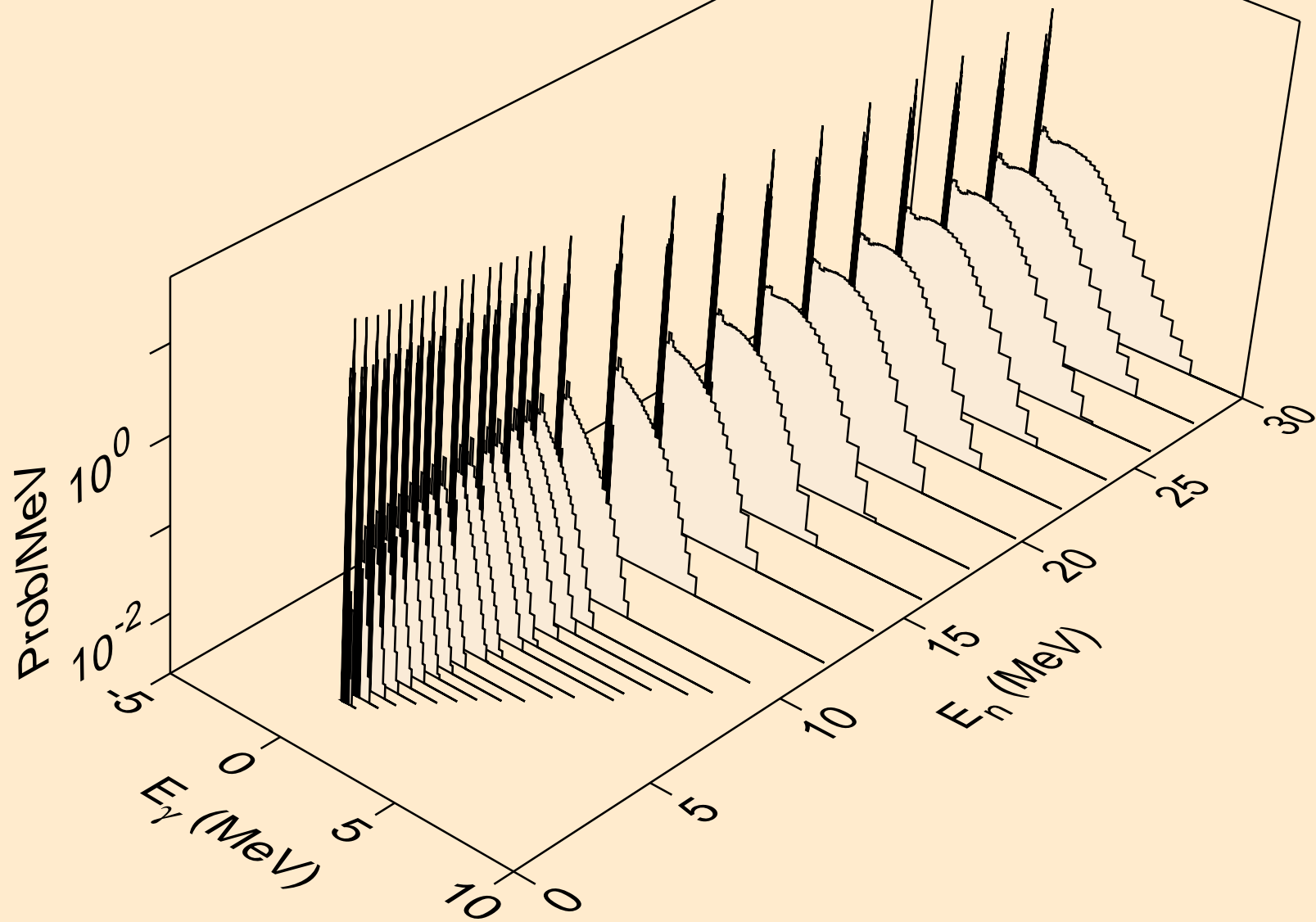

TA169 NEUTRON ACER TENDL-2024 LIBRARY; T=0.K
Photon emission for (n,2n)a

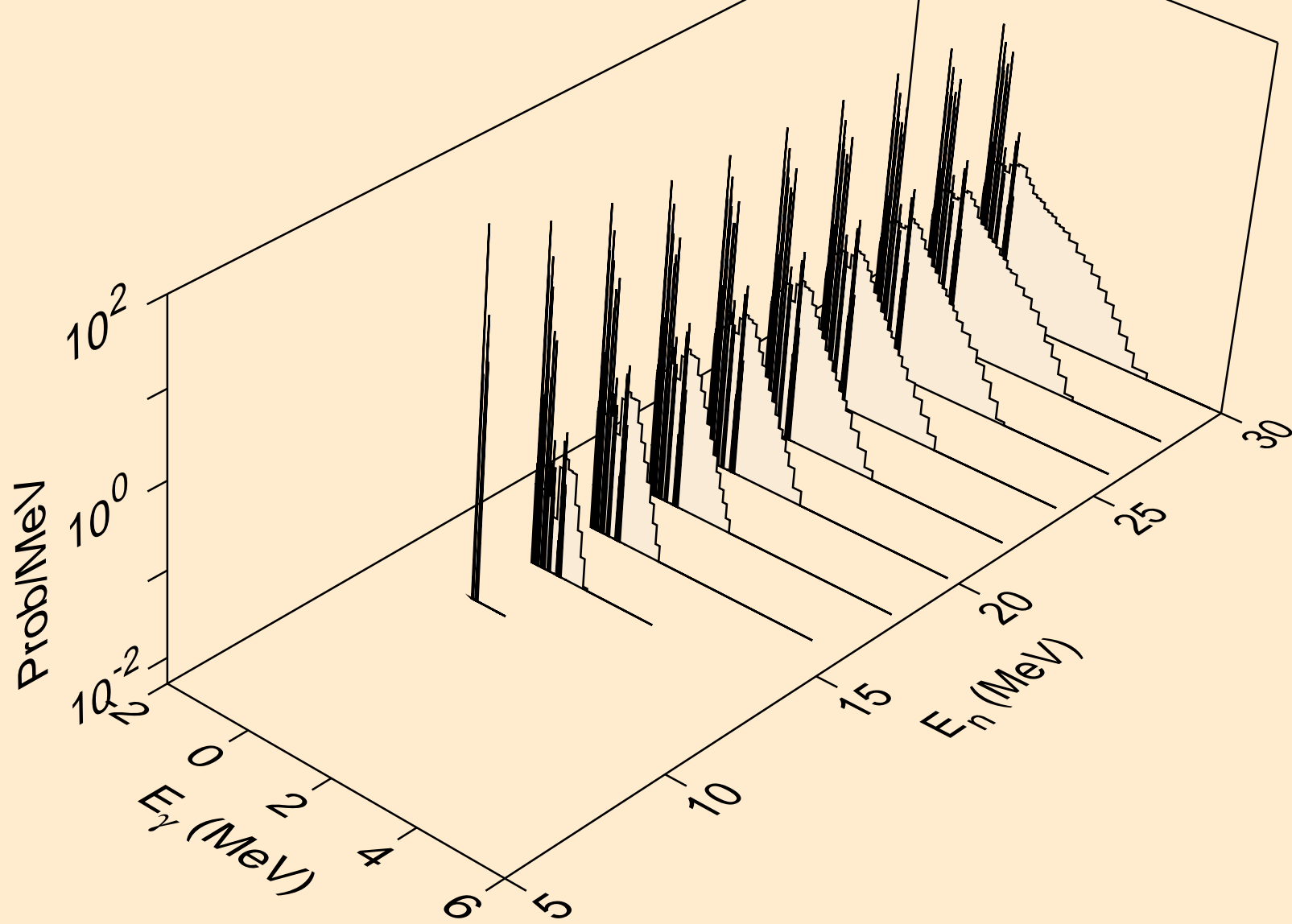

TA169 NEUTRON ACER TENDL-2024 LIBRARY; T=0.K
Photon emission for (n,3n)a

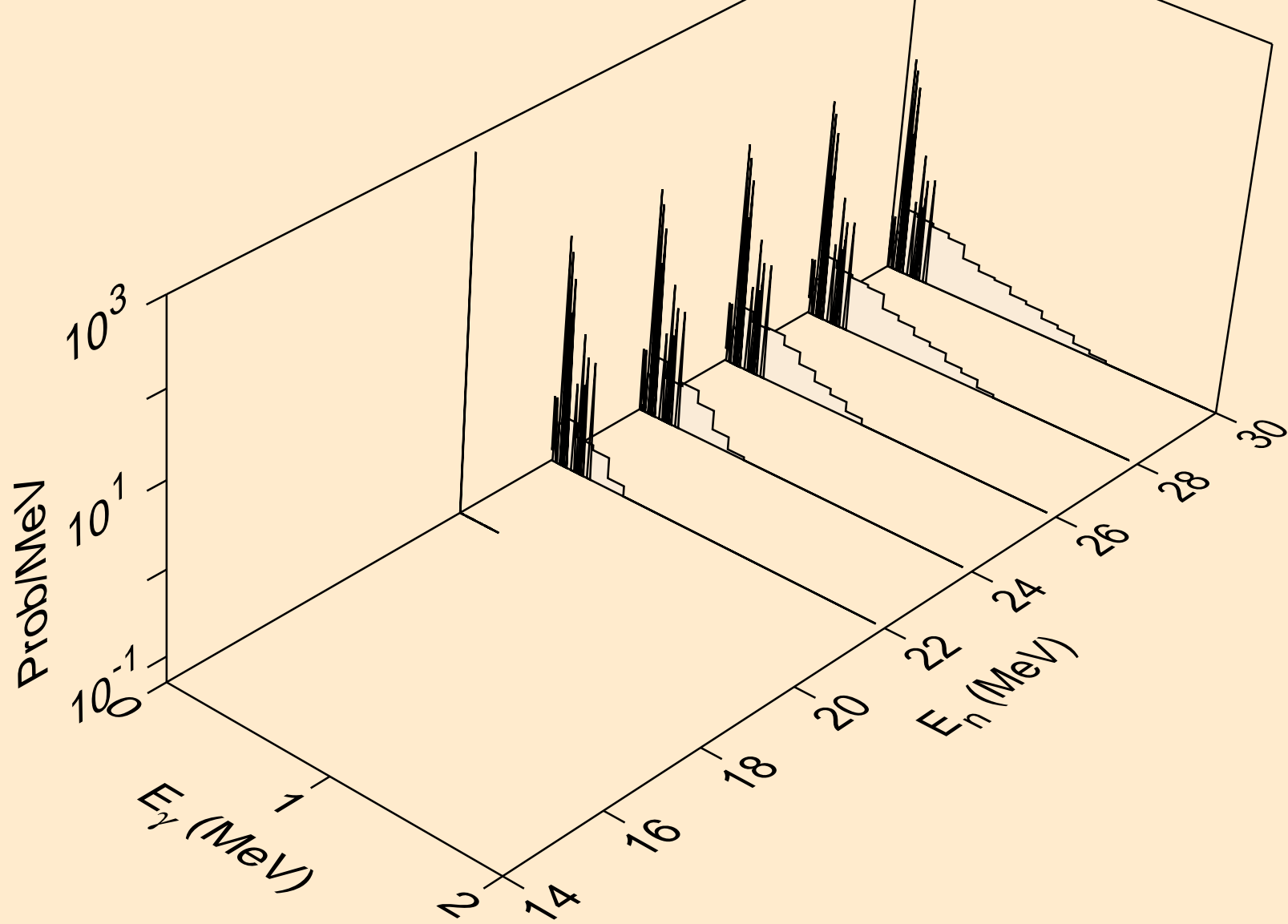

TA169 NEUTRON ACER TENDL-2024 LIBRARY; T=0.K
Photon emission for (n,n*)p

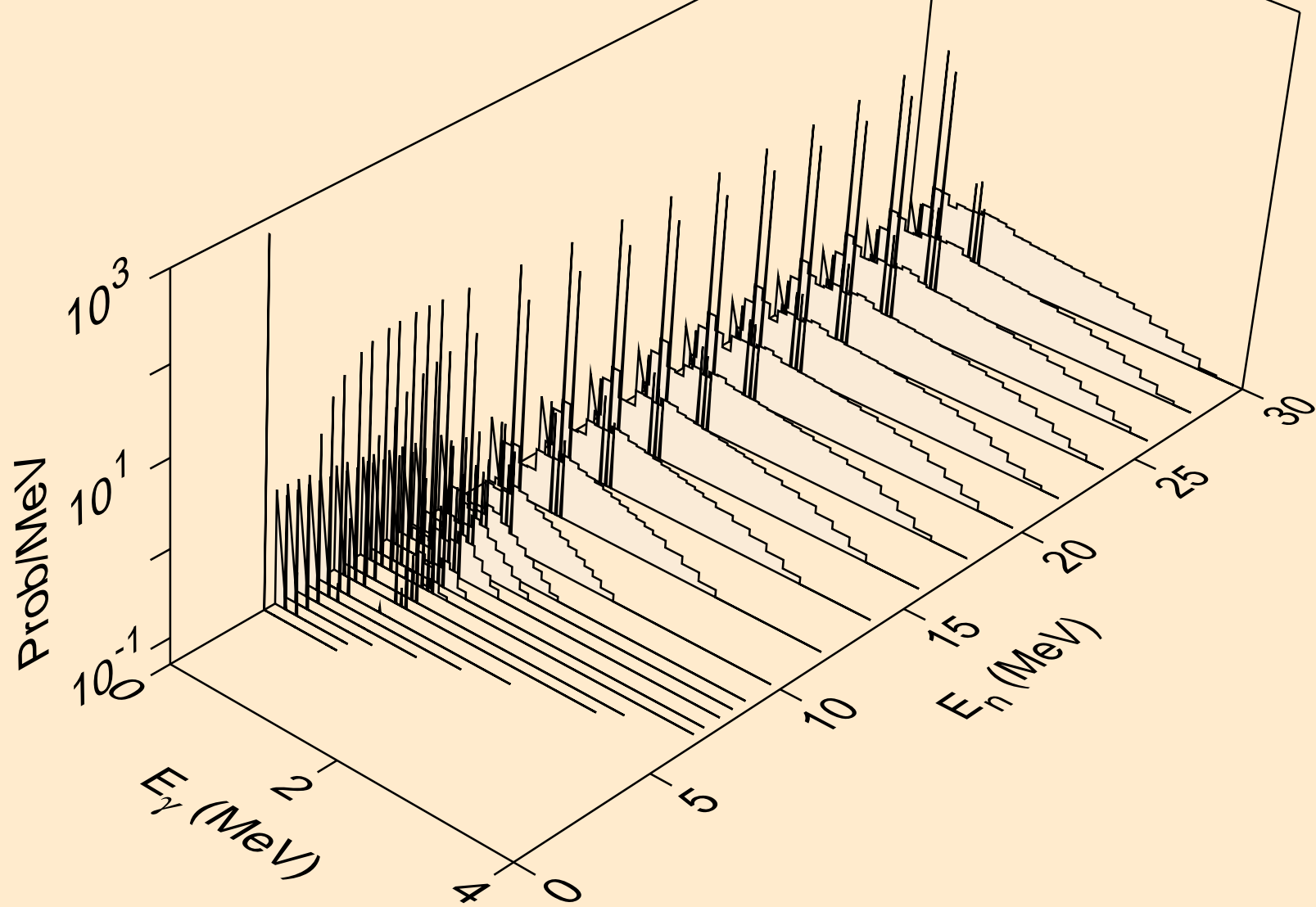

TA169 NEUTRON ACER TENDL-2024 LIBRARY; T=0.K
Photon emission for (n,n*)2a

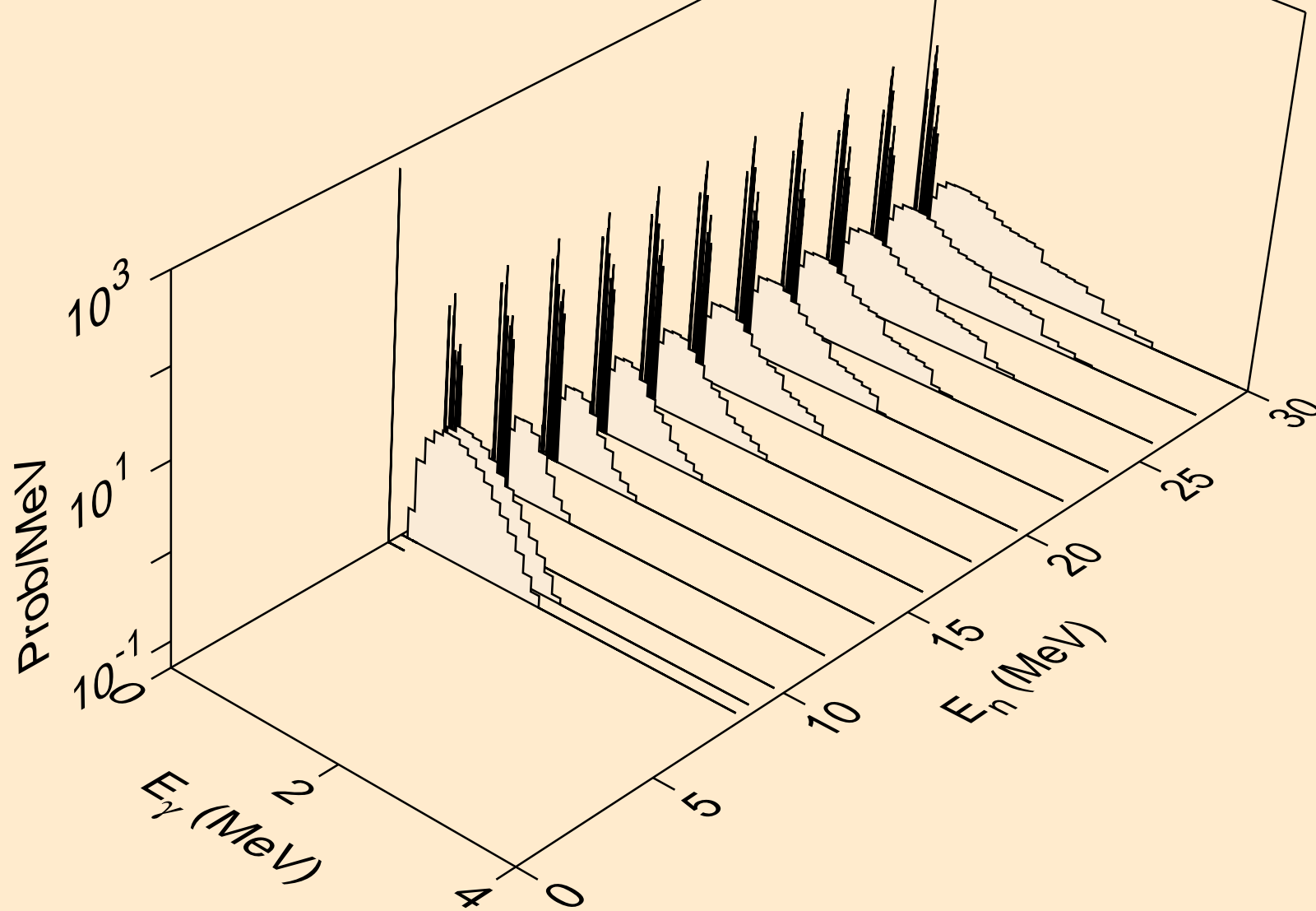

TA169 NEUTRON ACER TENDL-2024 LIBRARY; T=0.K
Photon emission for (n,2n)2a

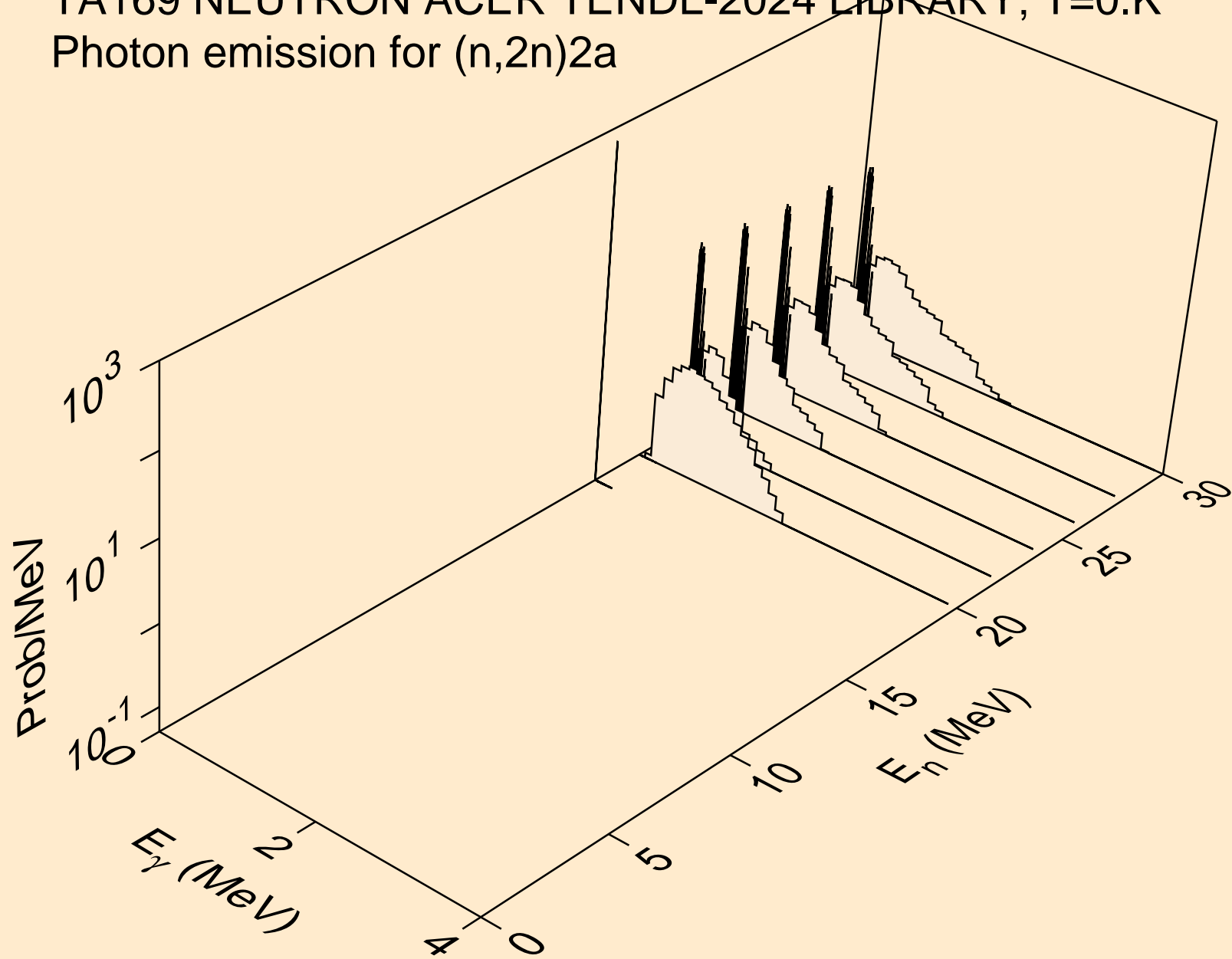

TA169 NEUTRON ACER TENDL-2024 LIBRARY; T=0.K

Photon emission for (n,n*)d

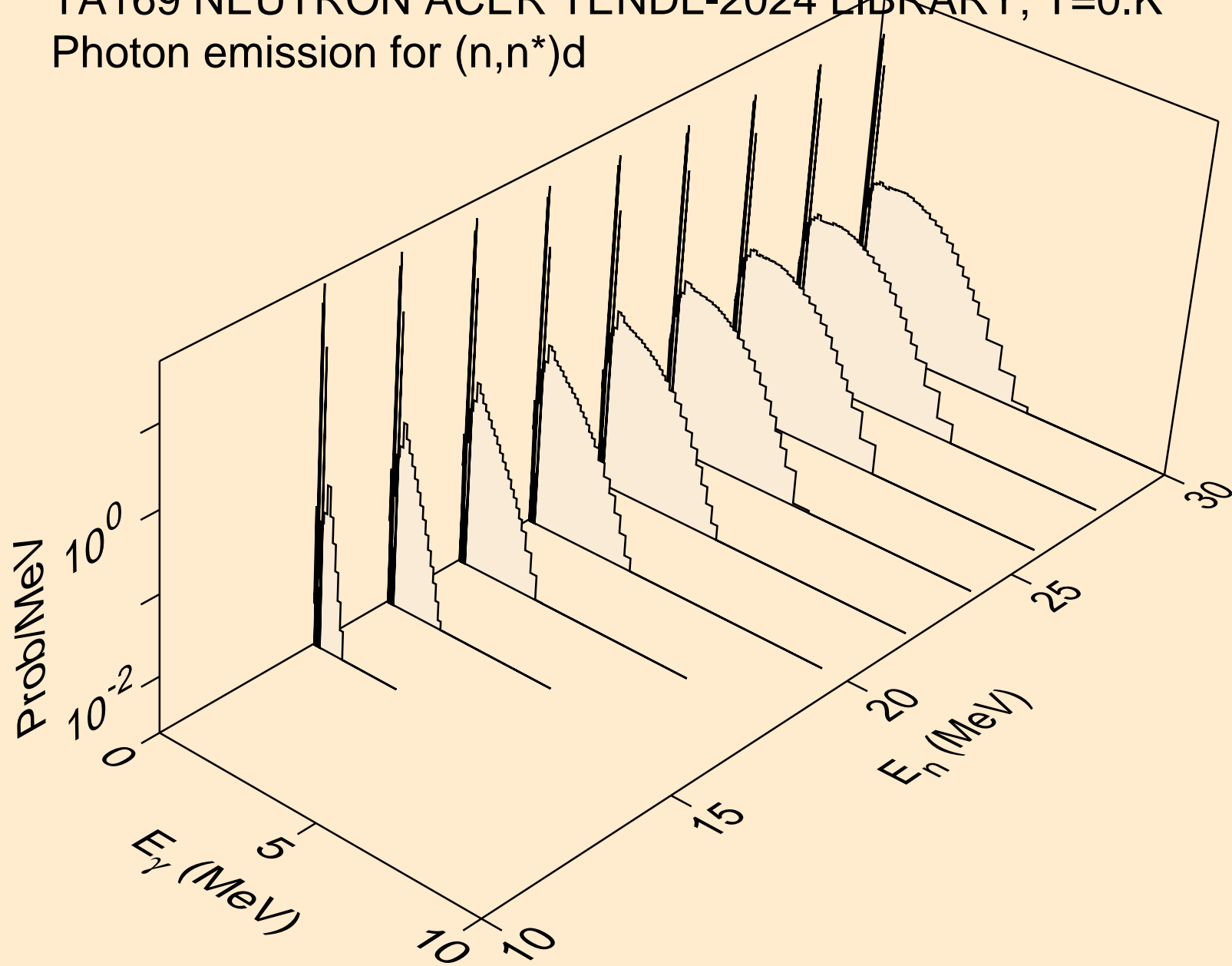

TA169 NEUTRON ACER TENDL-2024 LIBRARY; T=0.K
Photon emission for (n,n*)t

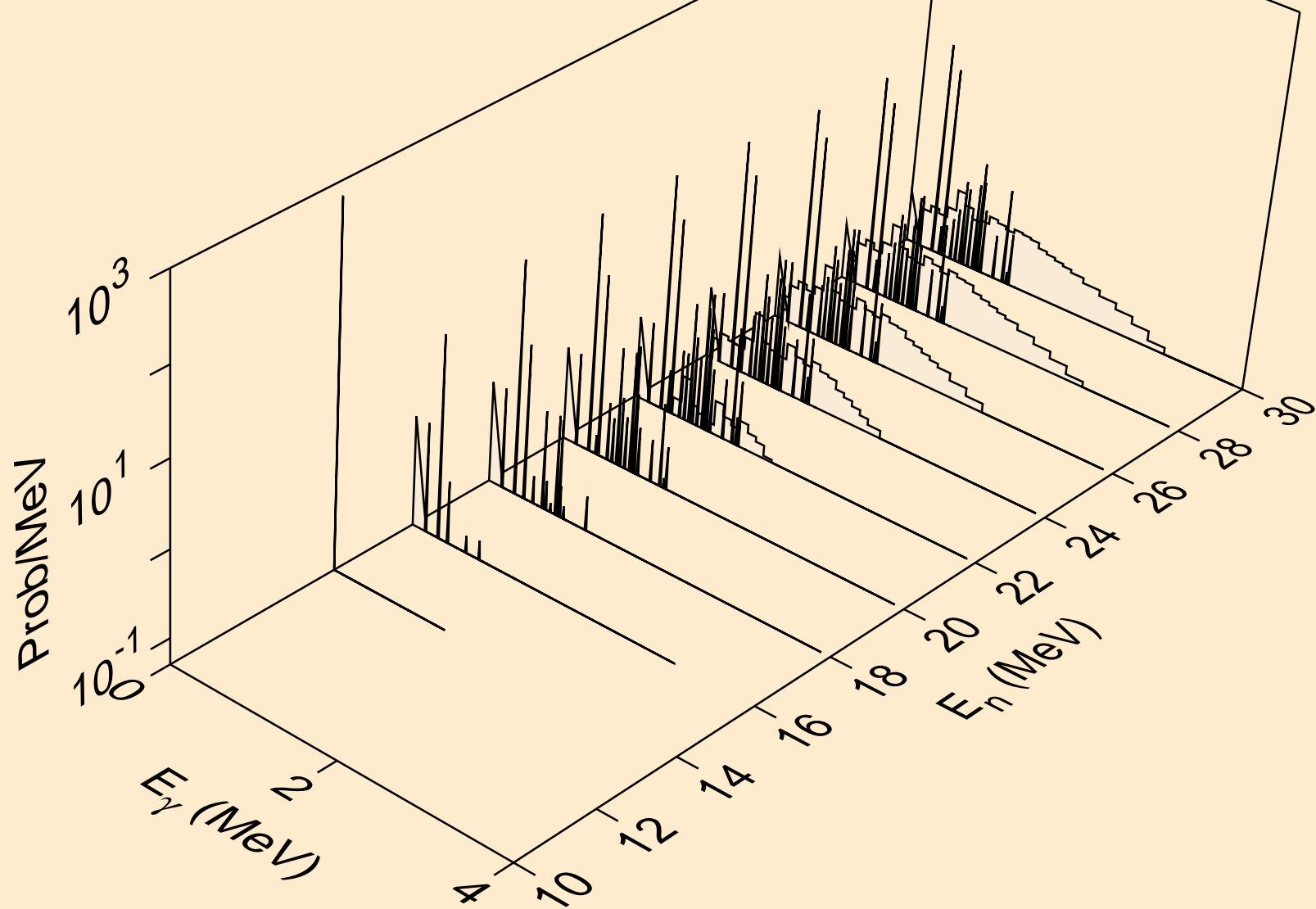

TA169 NEUTRON ACER TENDL-2024 LIBRARY; T=0.K
Photon emission for (n,n*)he3

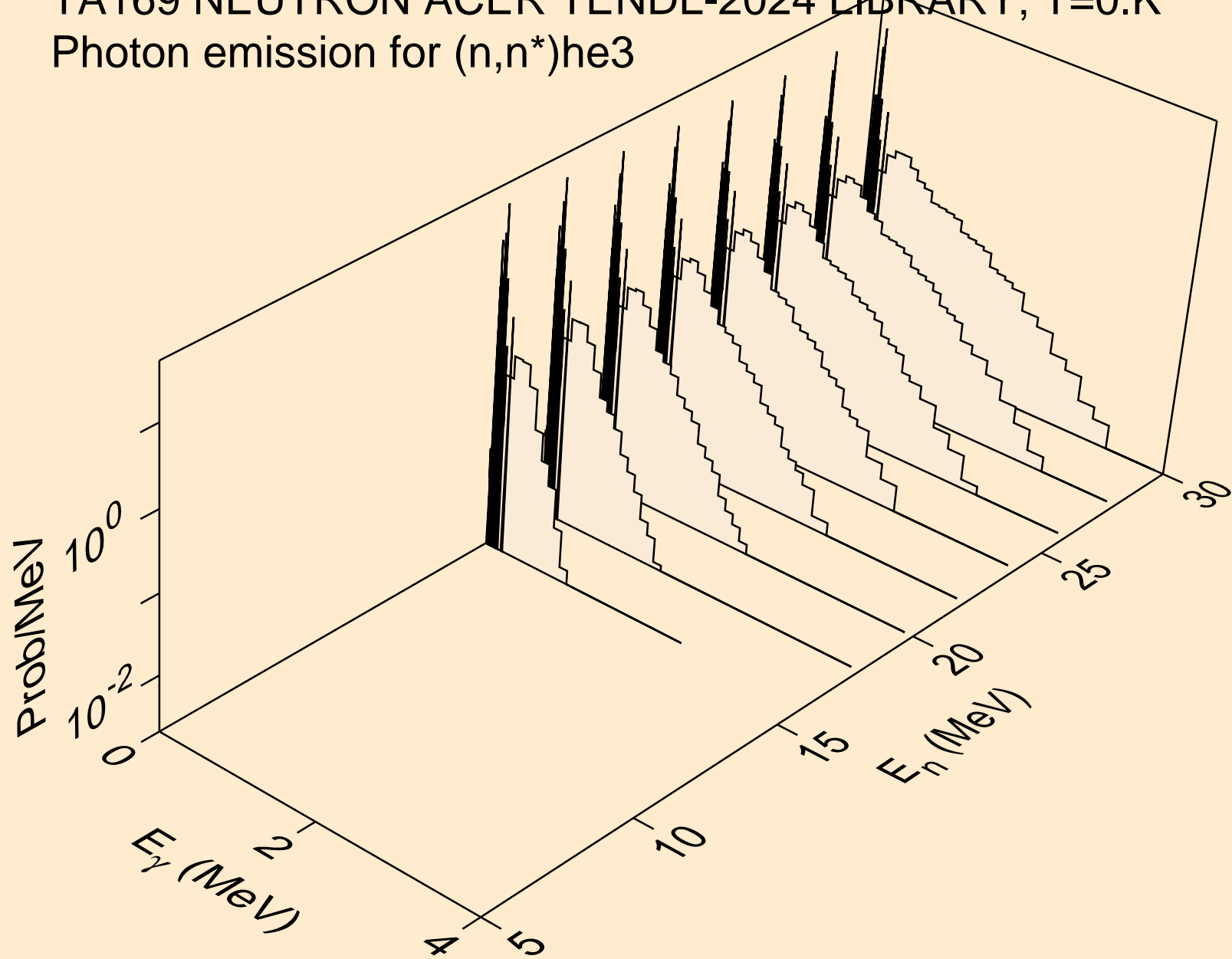

TA169 NEUTRON ACER TENDL-2024 LIBRARY; T=0.K
Photon emission for (n,4n)

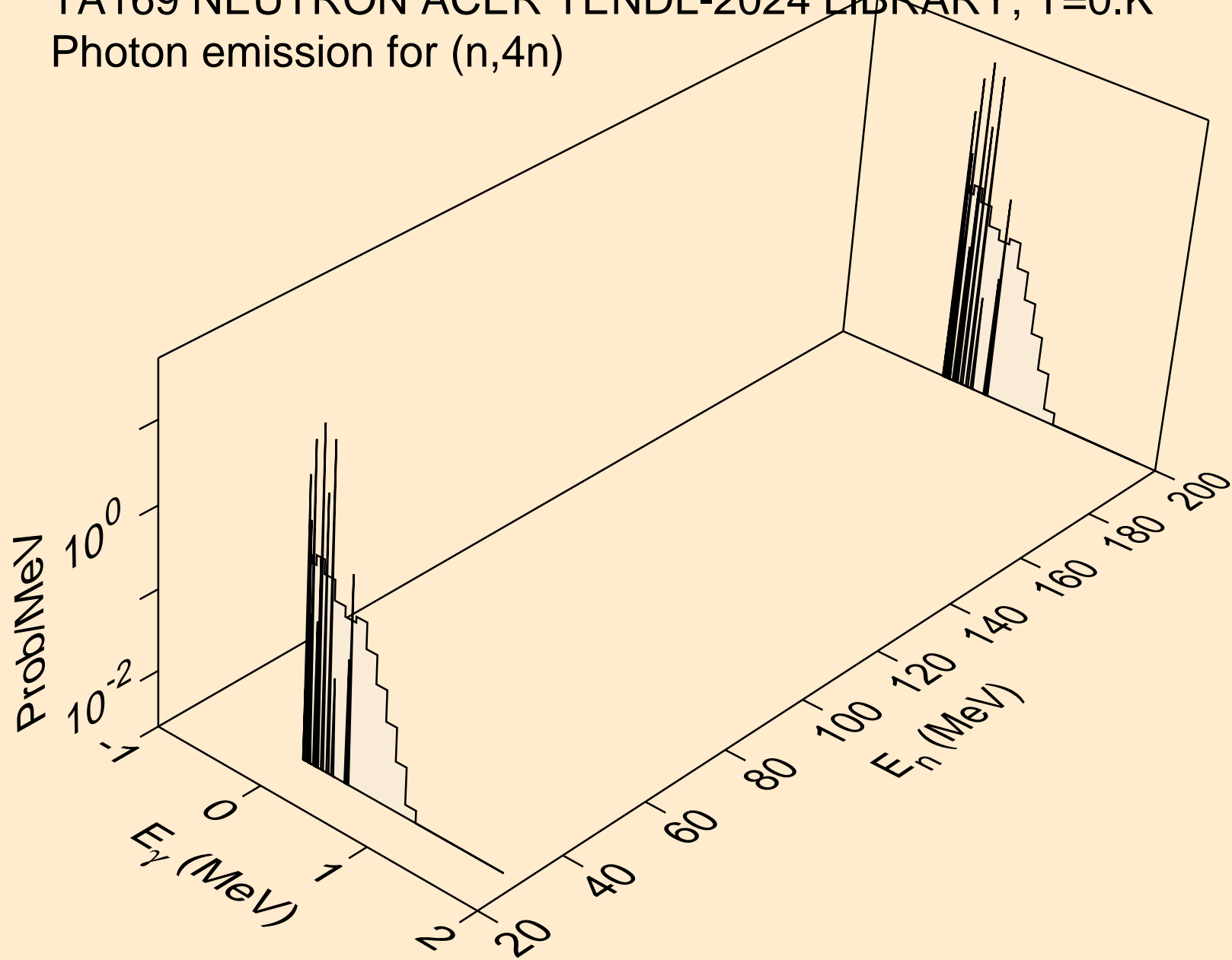

TA169 NEUTRON ACER TENDL-2024 LIBRARY; T=0.K
Photon emission for (n,2np)

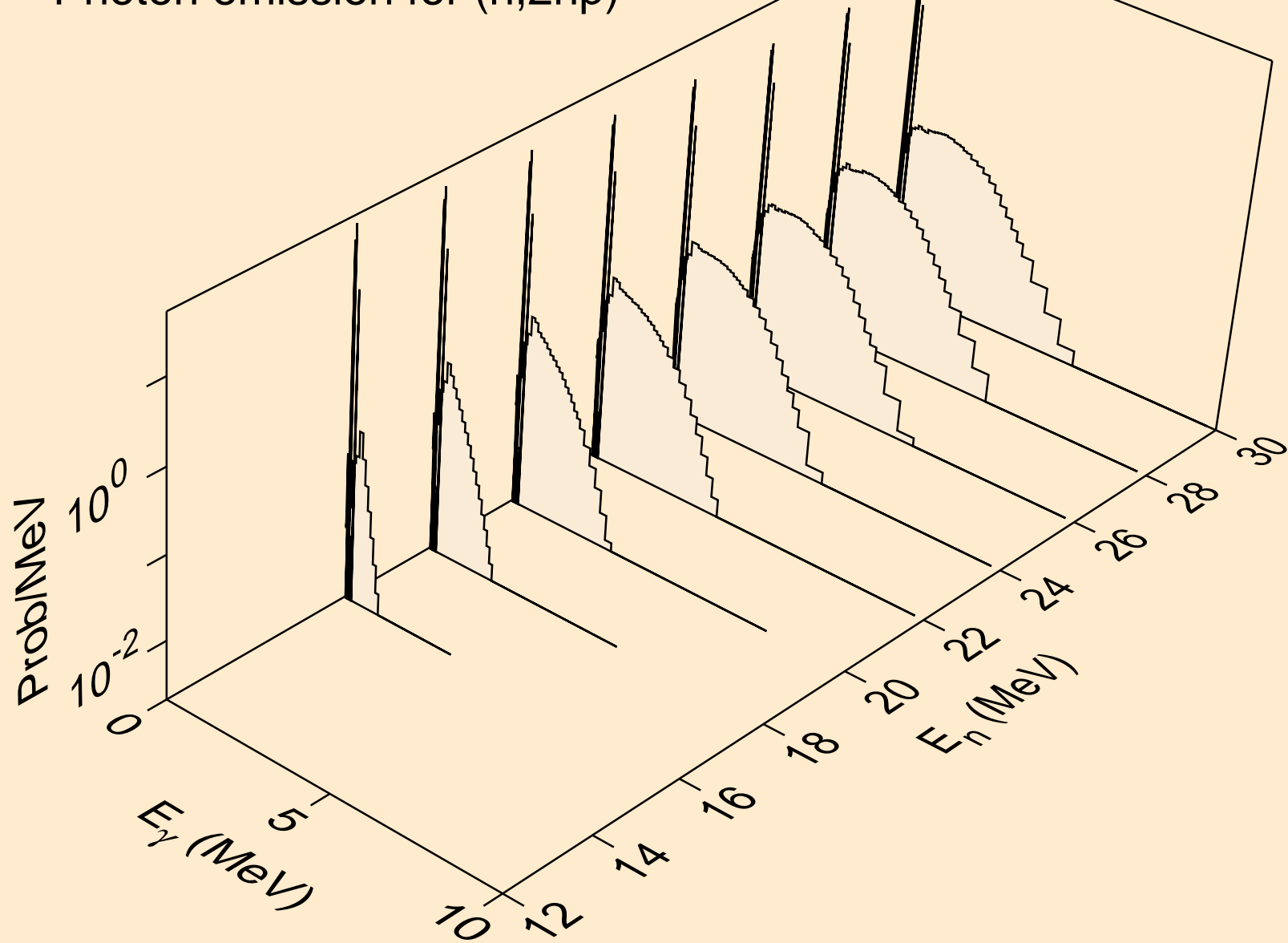

TA169 NEUTRON ACER TENDL-2024 LIBRARY; T=0.K
Photon emission for (n,3np)

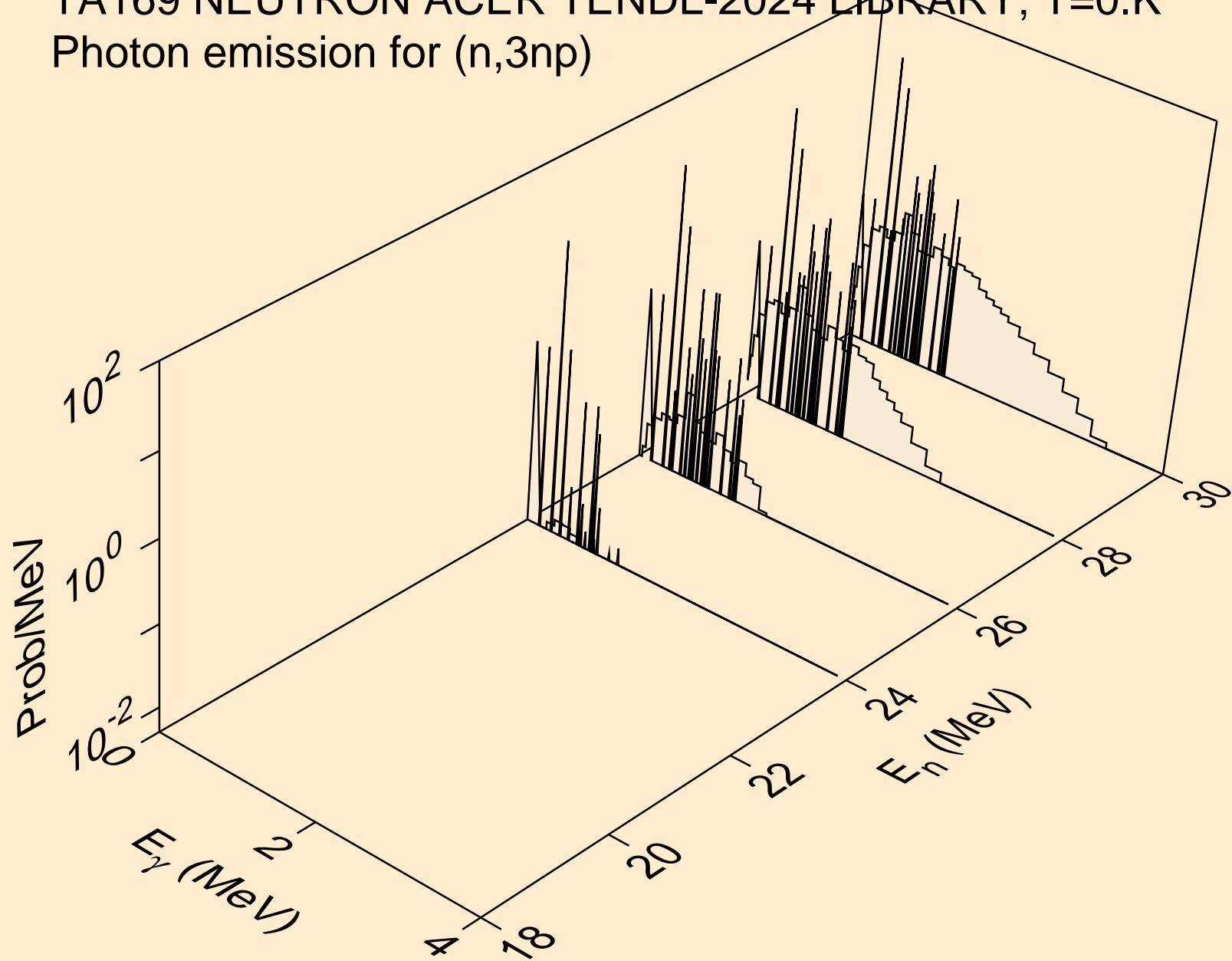

TA169 NEUTRON ACER TENDL-2024 LIBRARY; T=0.K
Photon emission for (n,n2p)

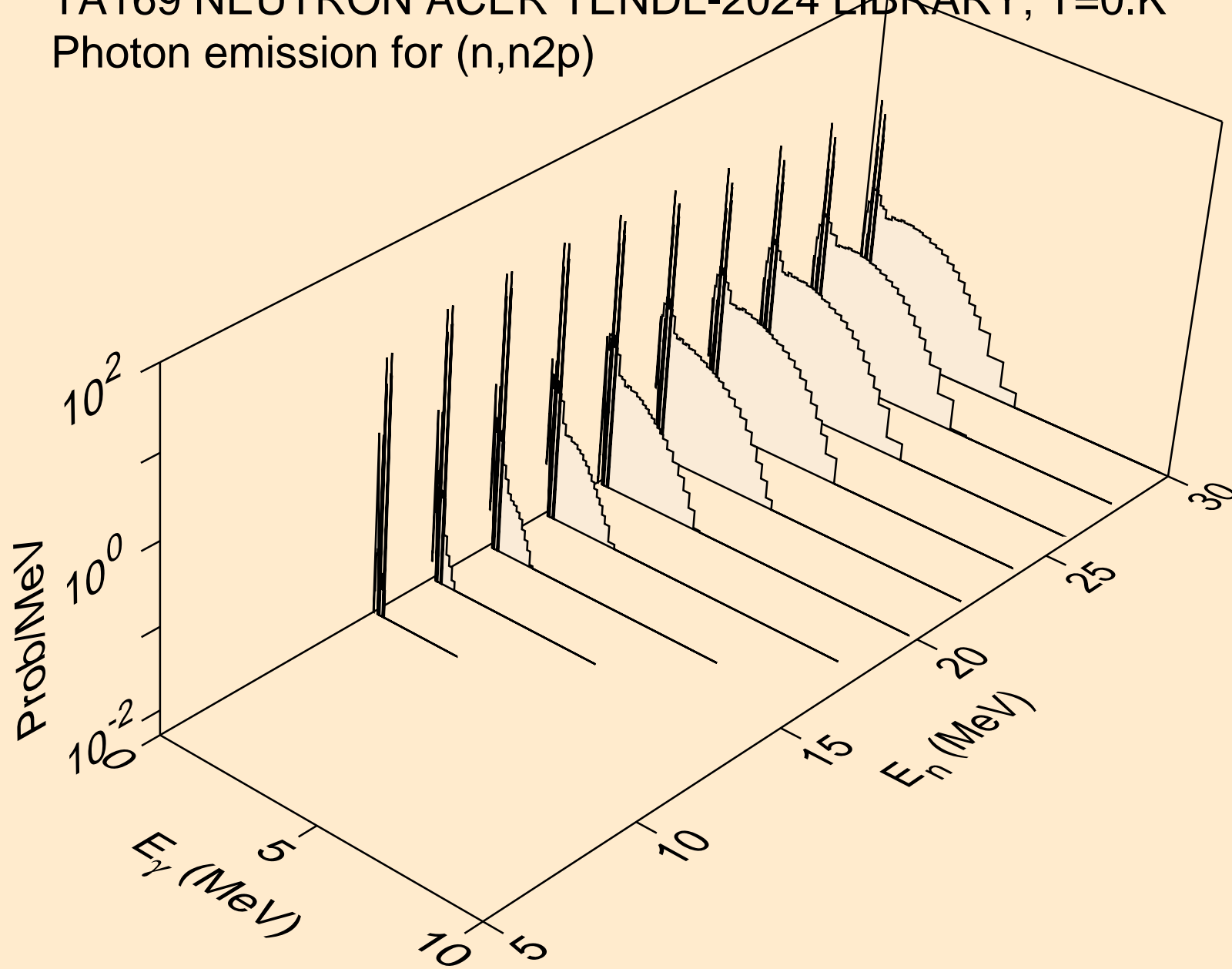

TA169 NEUTRON ACER TENDL-2024 LIBRARY; T=0.K
Photon emission for (n,npa)

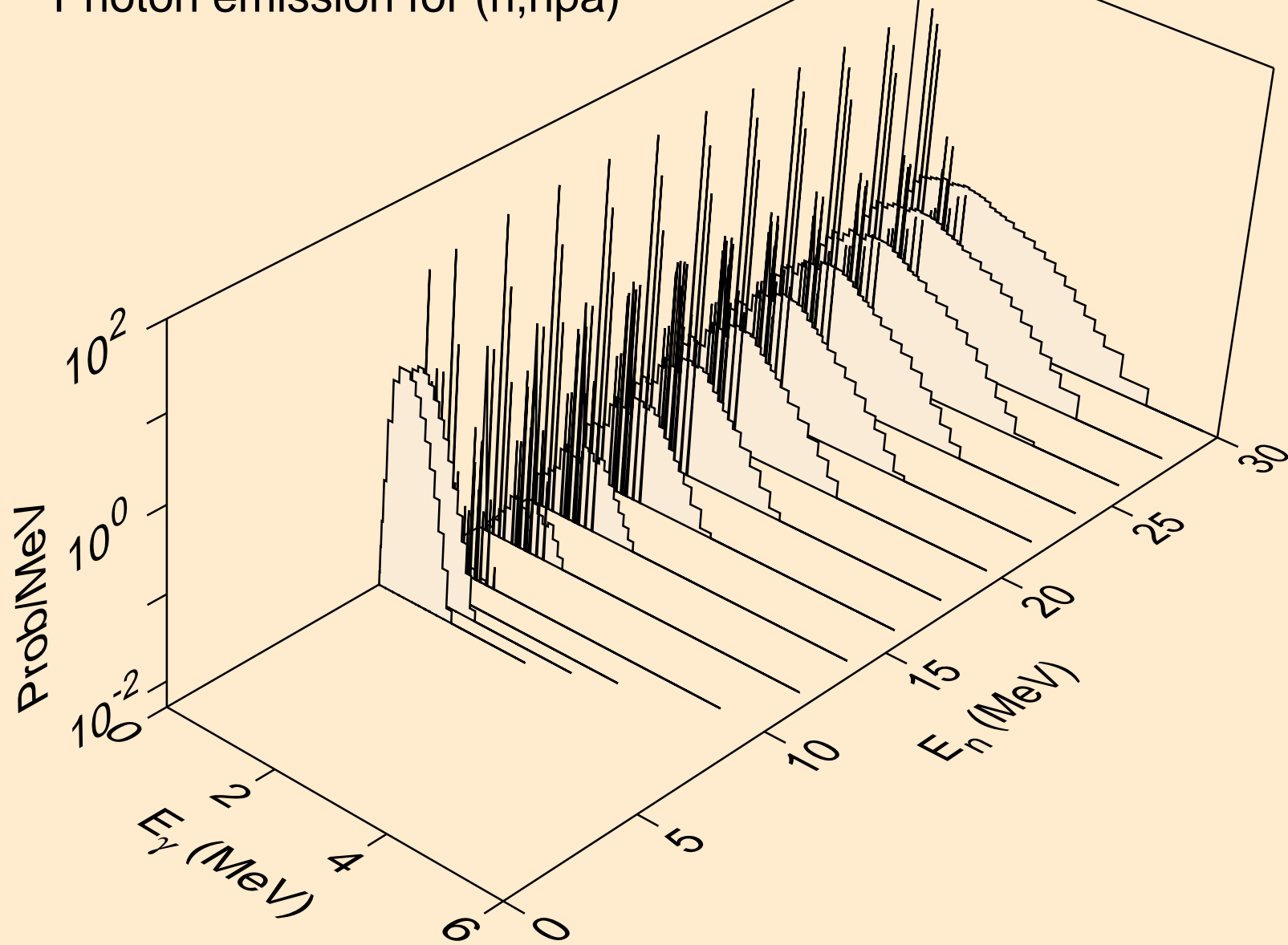

TA169 NEUTRON ACER TENDL-2024 LIBRARY; T=0.K
Photon emission for (n,n*c)

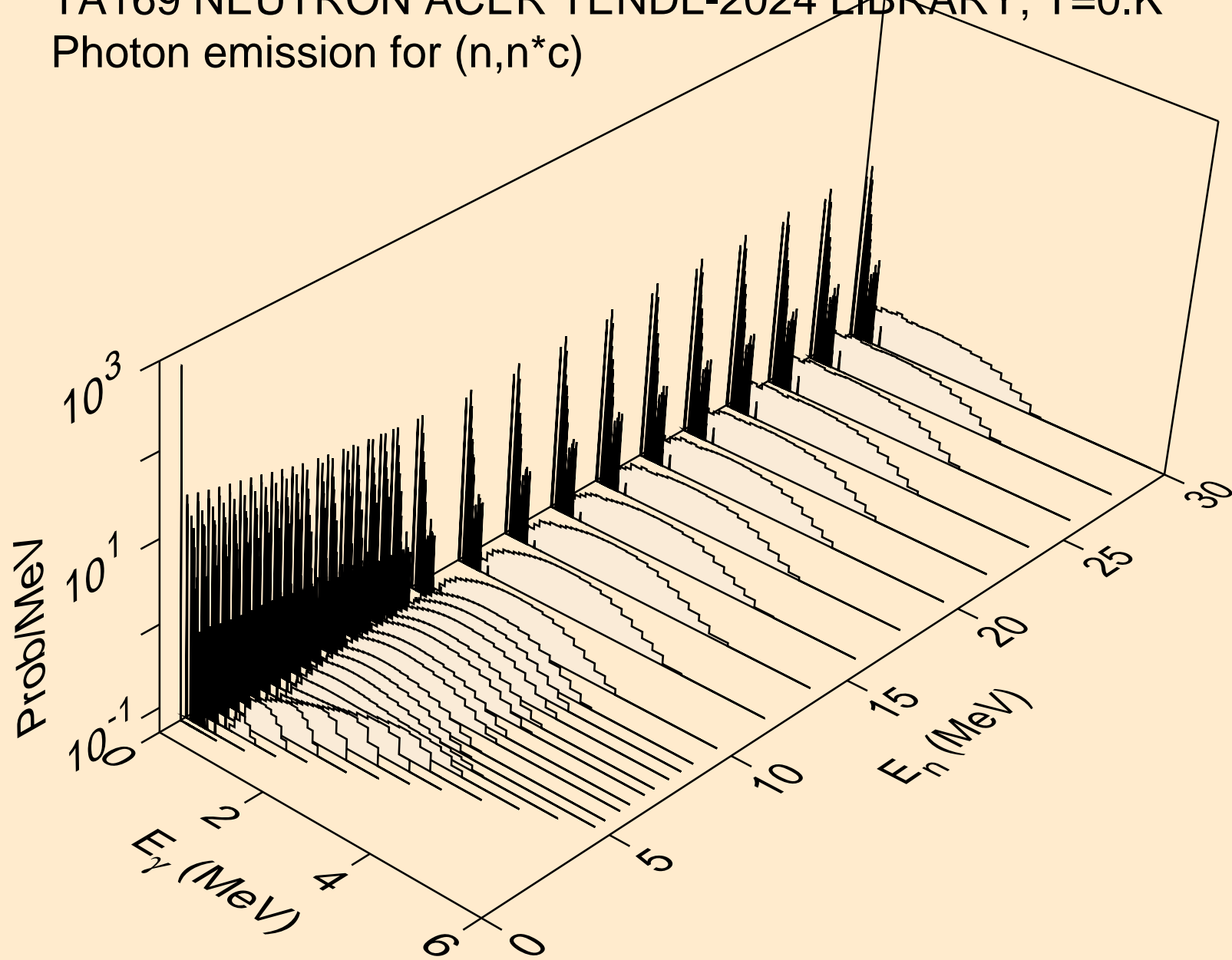

TA169 NEUTRON ACER TENDL-2024 LIBRARY; T=0.K
Photon emission for (n,gma)

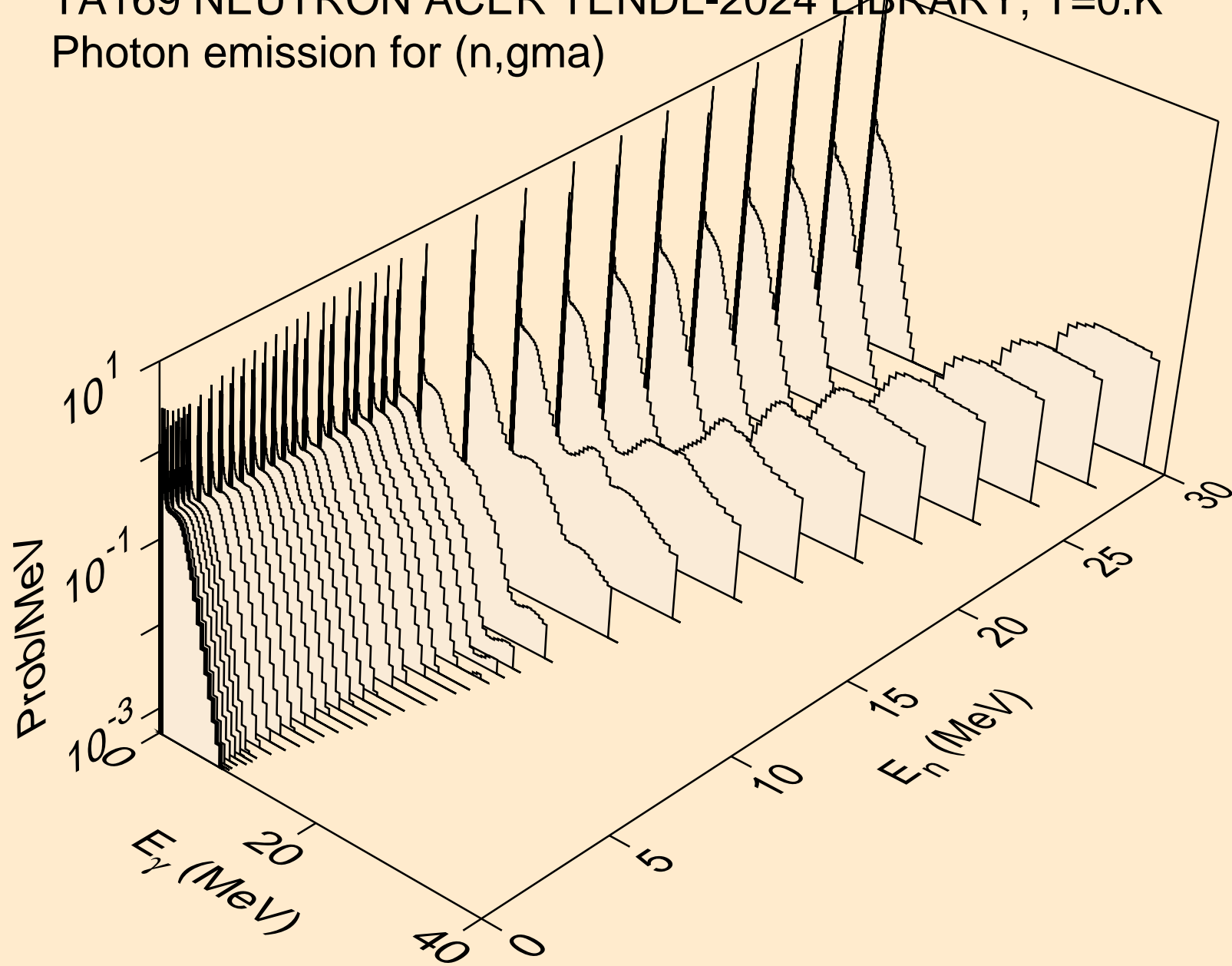

TA169 NEUTRON ACER TENDL-2024 LIBRARY; T=0.K
Photon emission for (n,p)

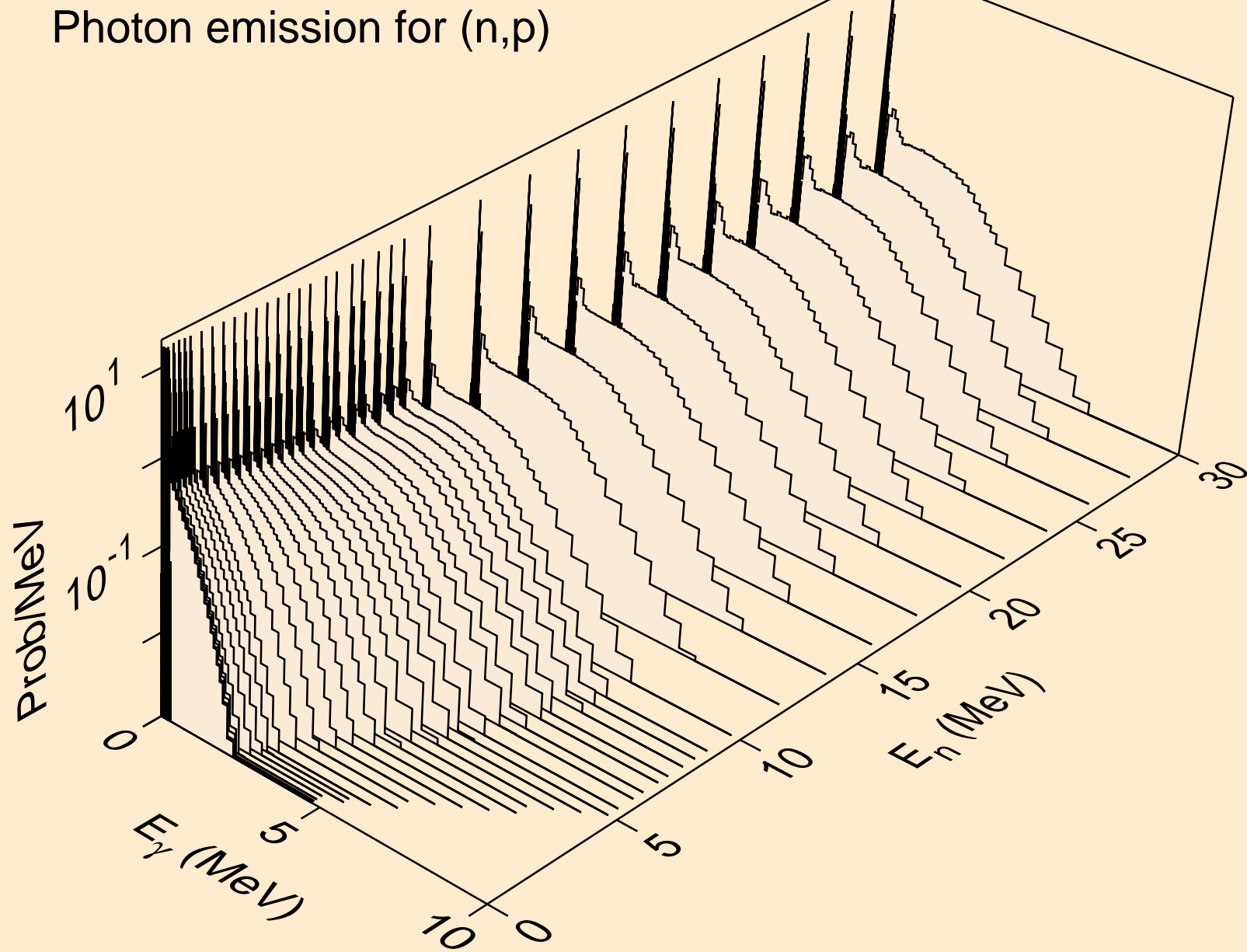

TA169 NEUTRON ACER TENDL-2024 LIBRARY; T=0.K
Photon emission for (n,d)

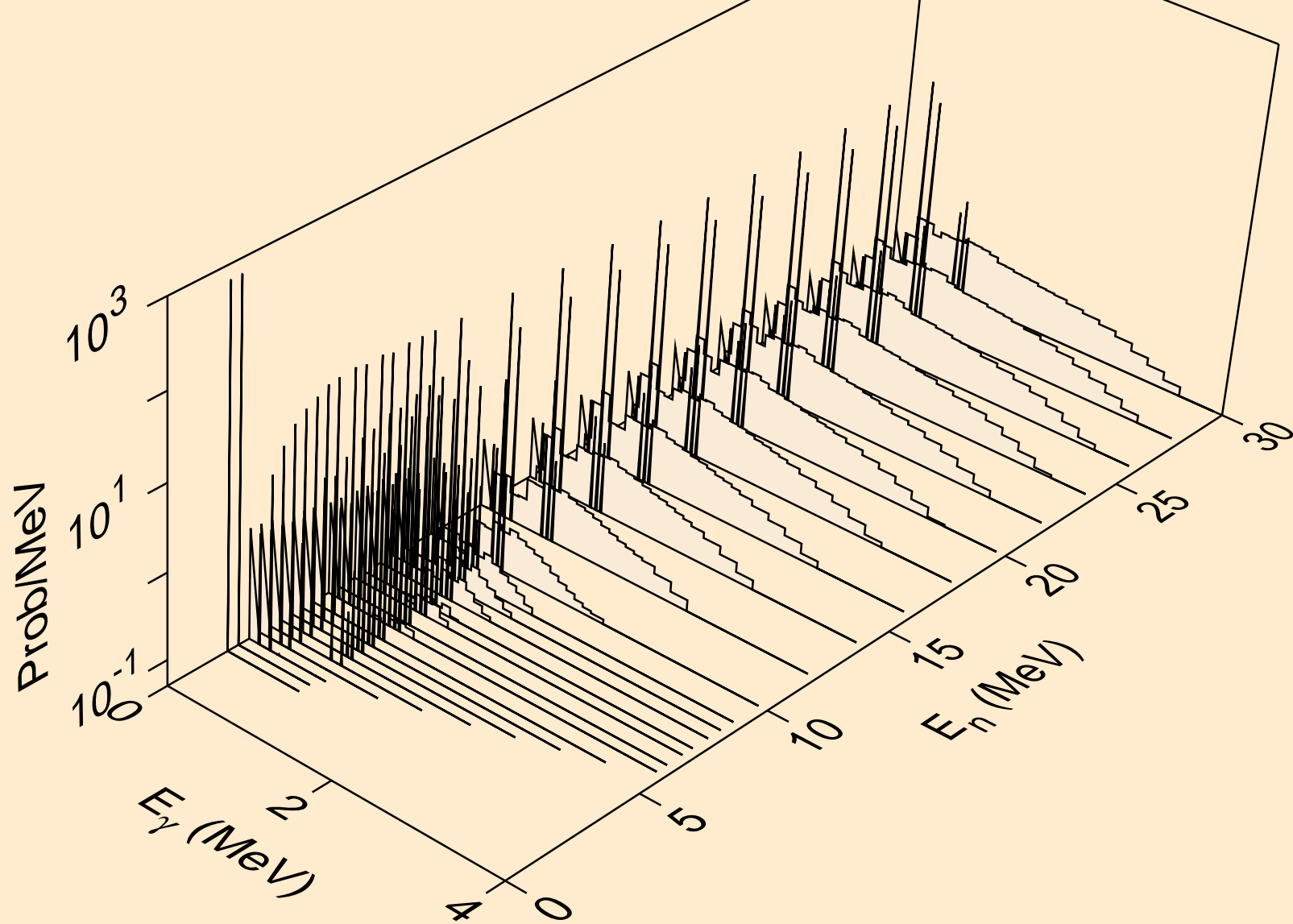

TA169 NEUTRON ACER TENDL-2024 LIBRARY; T=0.K
Photon emission for (n,t)

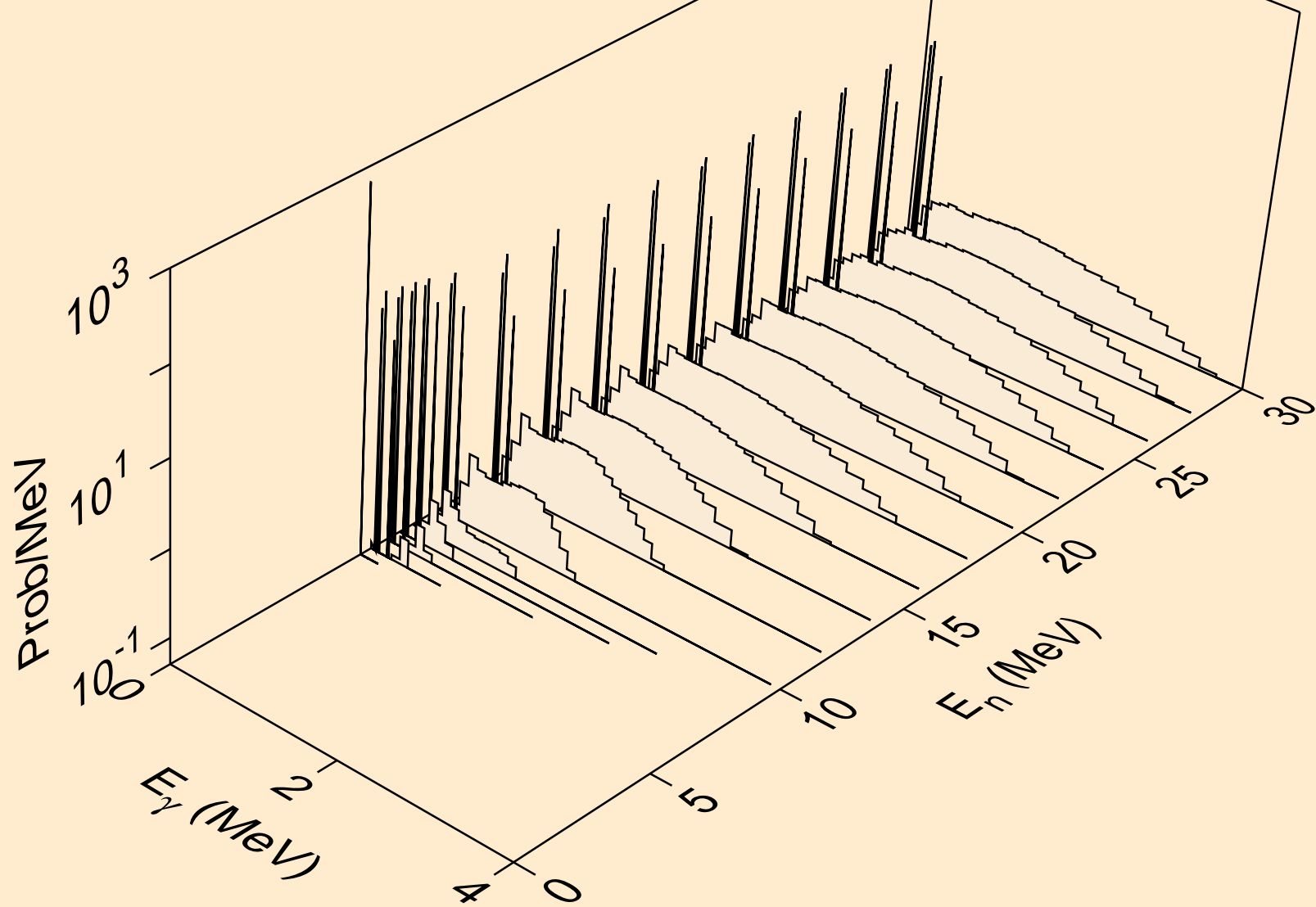

TA169 NEUTRON ACER TENDL-2024 LIBRARY; T=0.K
Photon emission for (n,he3)

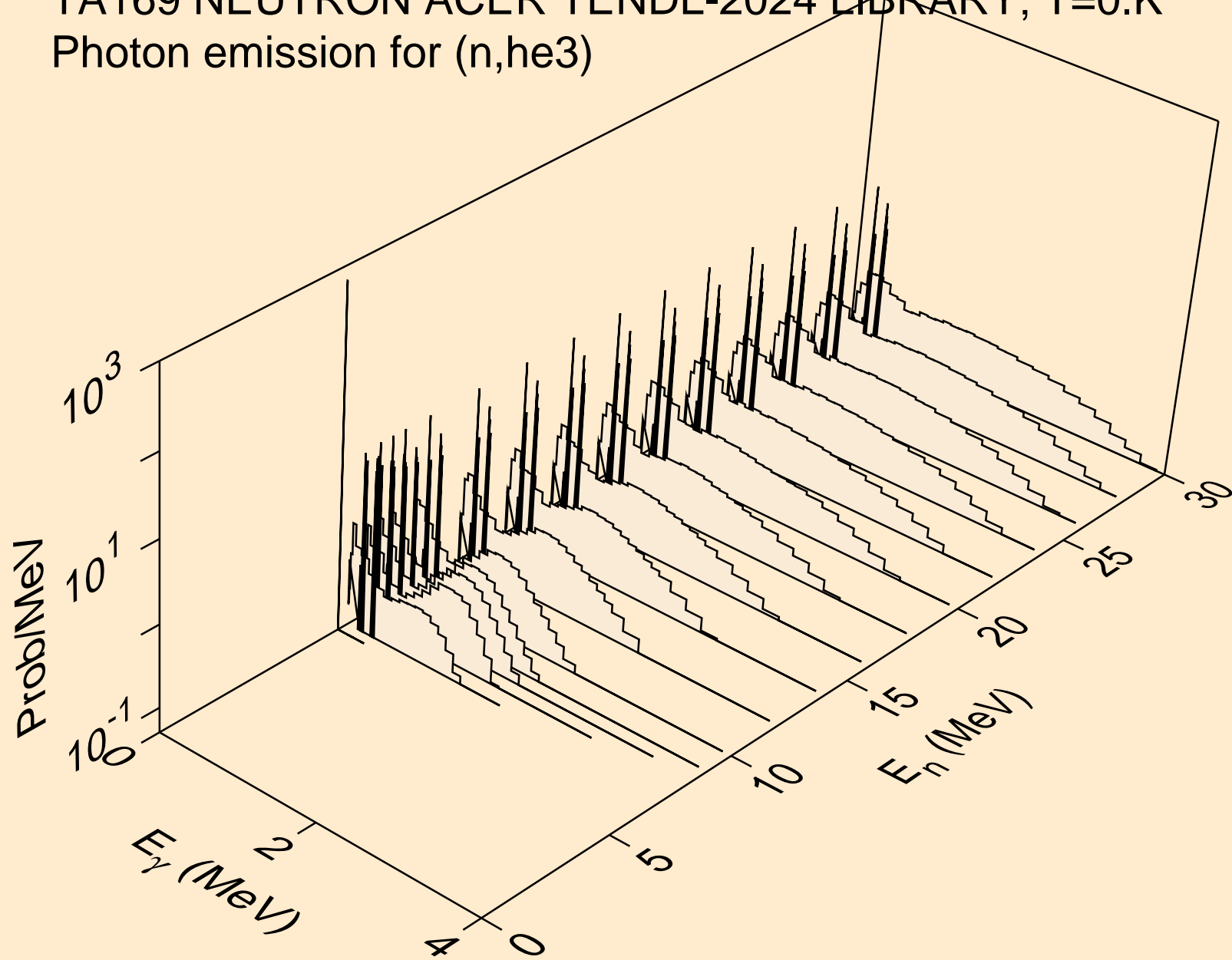

TA169 NEUTRON ACER TENDL-2024 LIBRARY; T=0.K
Photon emission for (n,a)

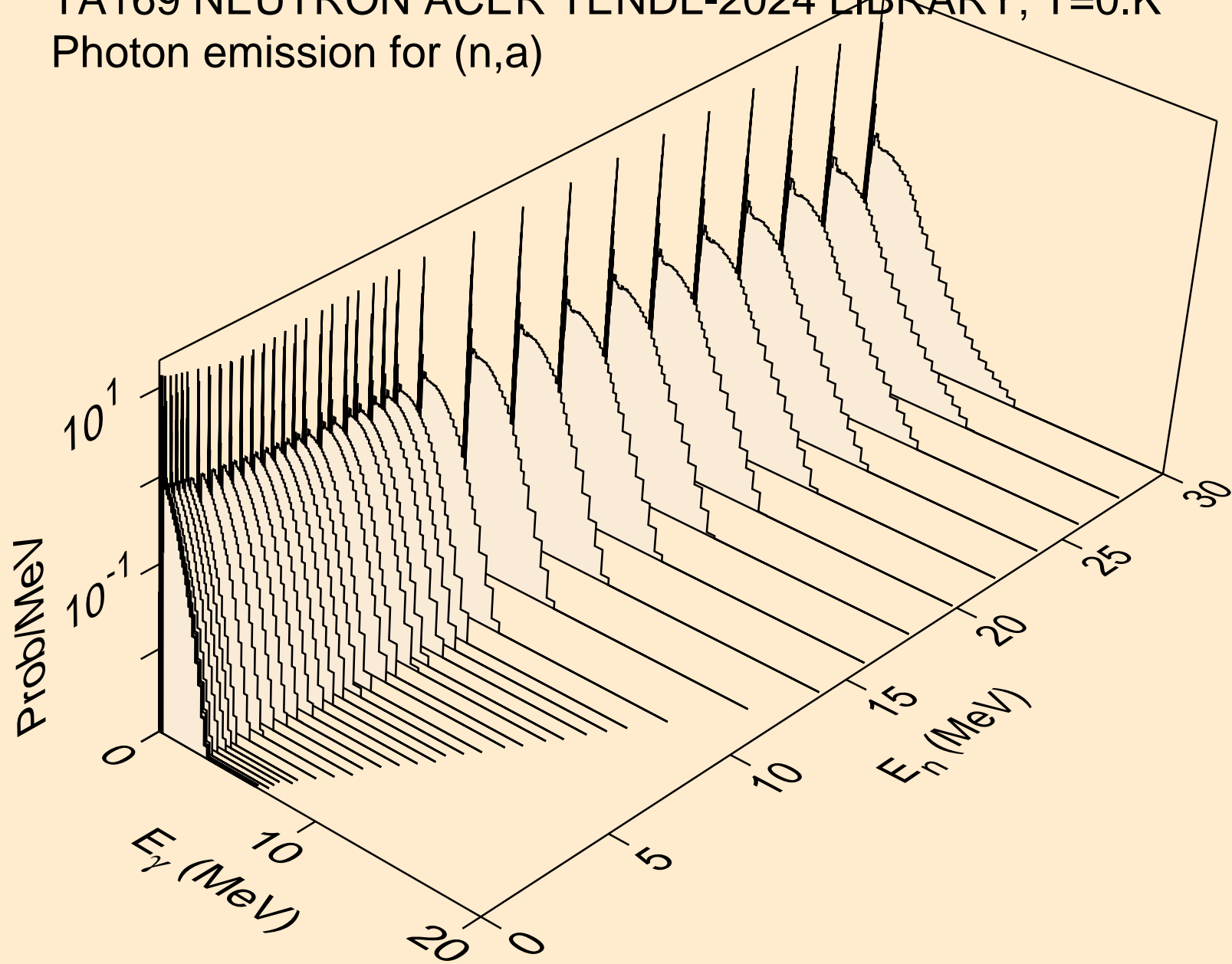

TA169 NEUTRON ACER TENDL-2024 LIBRARY; T=0.K
Photon emission for (n,2a)

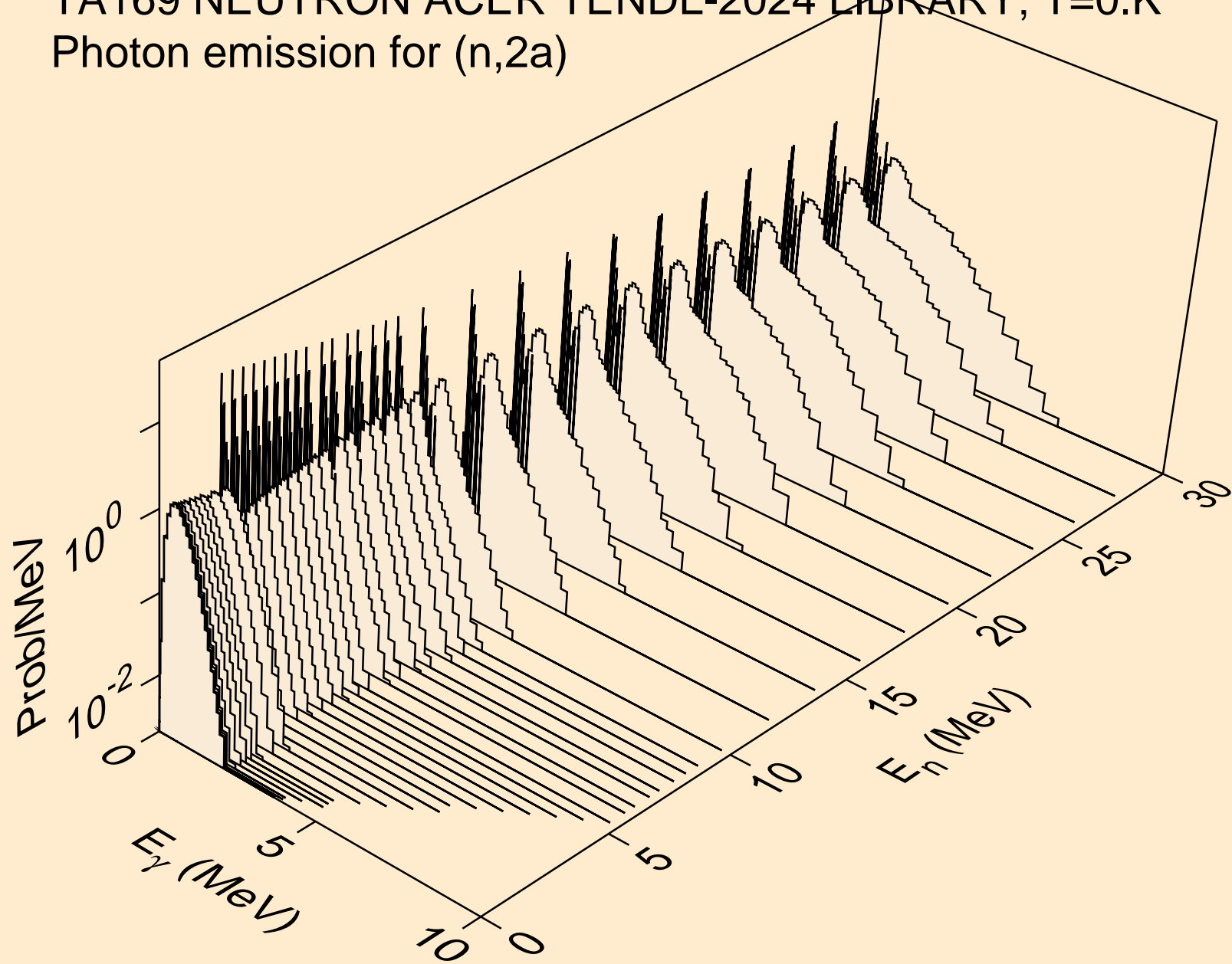

TA169 NEUTRON ACER TENDL-2024 LIBRARY; T=0.K
Photon emission for (n,2p)

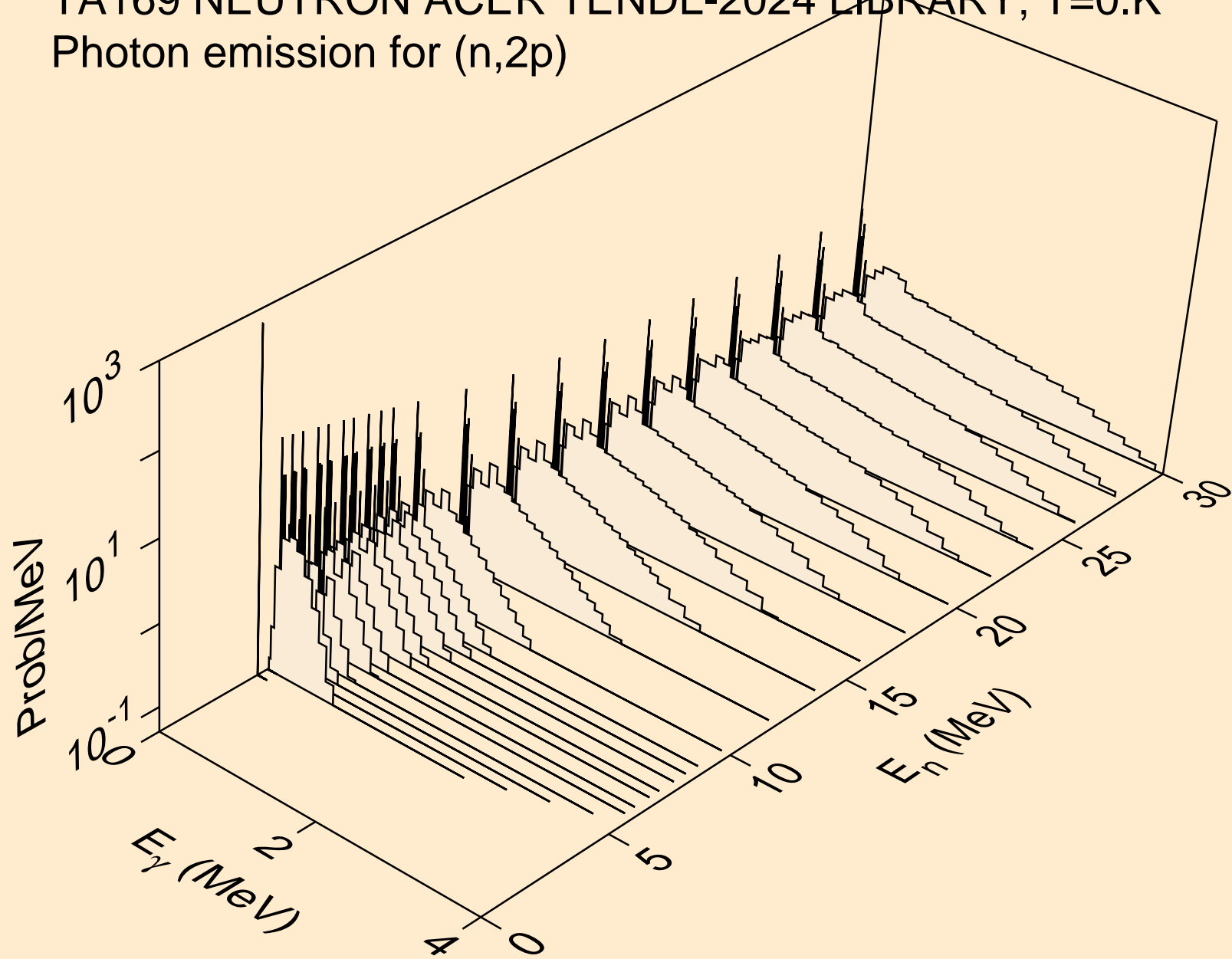

TA169 NEUTRON ACER TENDL-2024 LIBRARY; T=0.K
Photon emission for (n,p α)

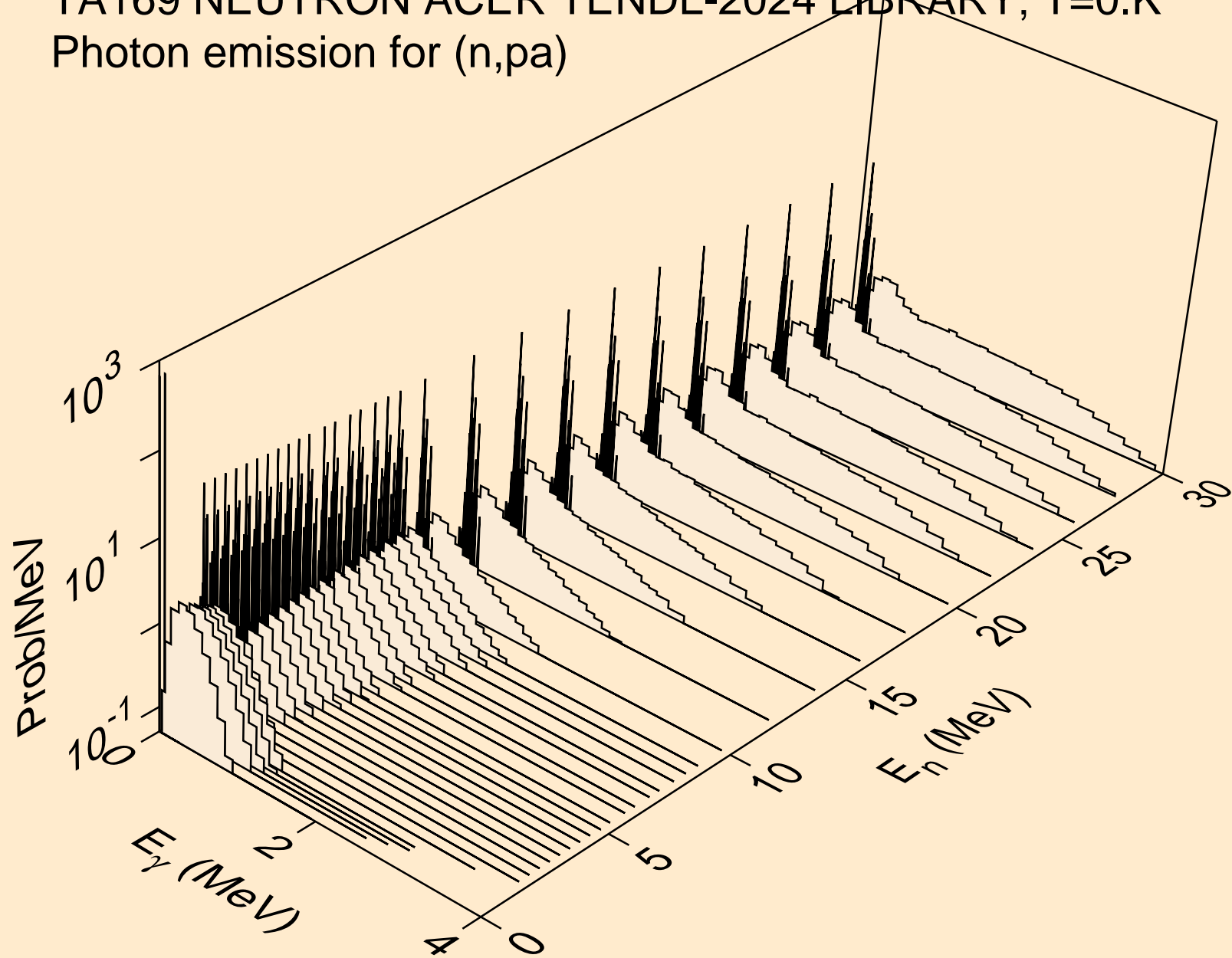

TA169 NEUTRON ACER TENDL-2024 LIBRARY; T=0.K
Photon emission for (n,pd)

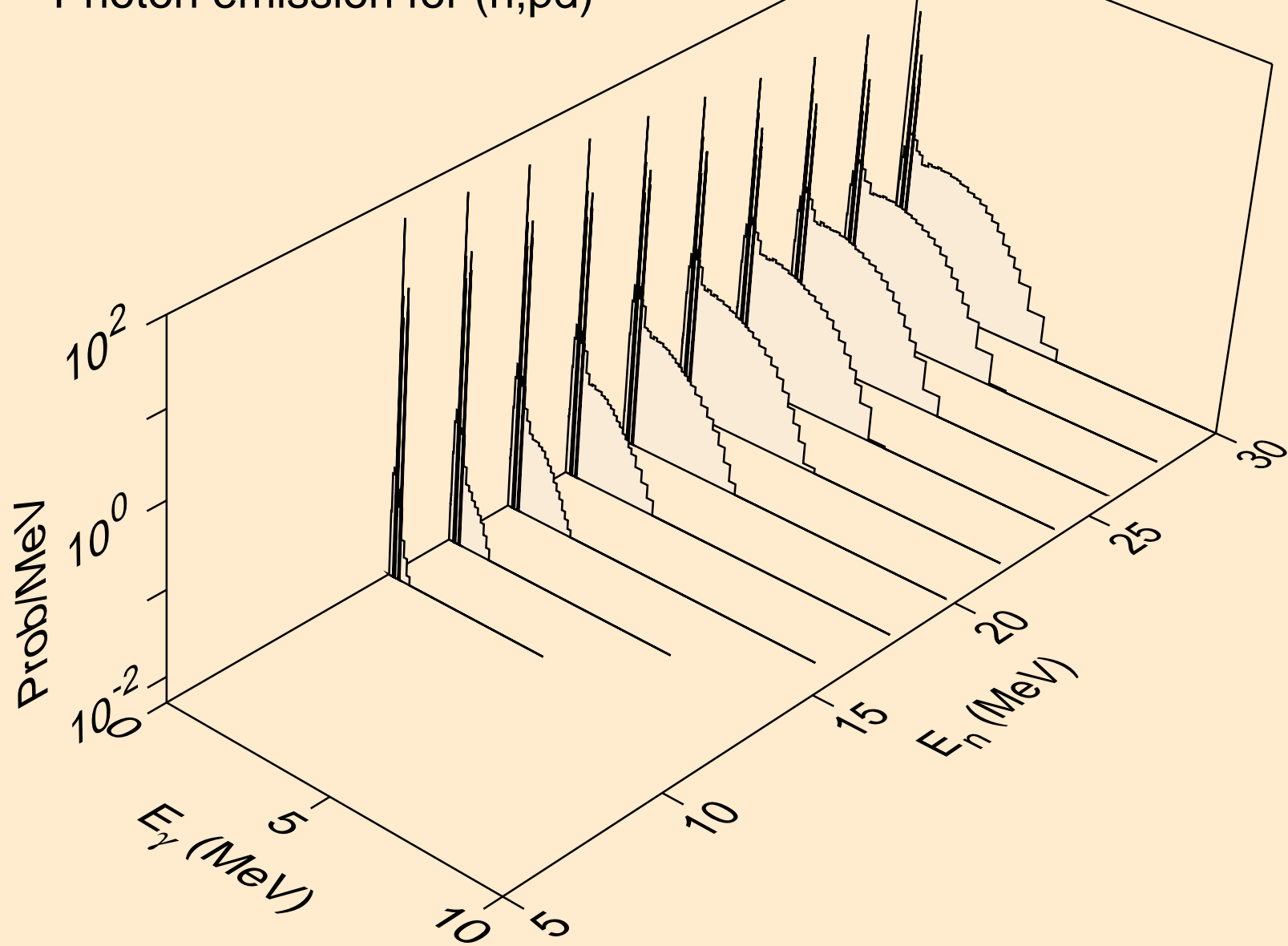

TA169 NEUTRON ACER TENDL-2024 LIBRARY; T=0.K
Photon emission for (n,pt)

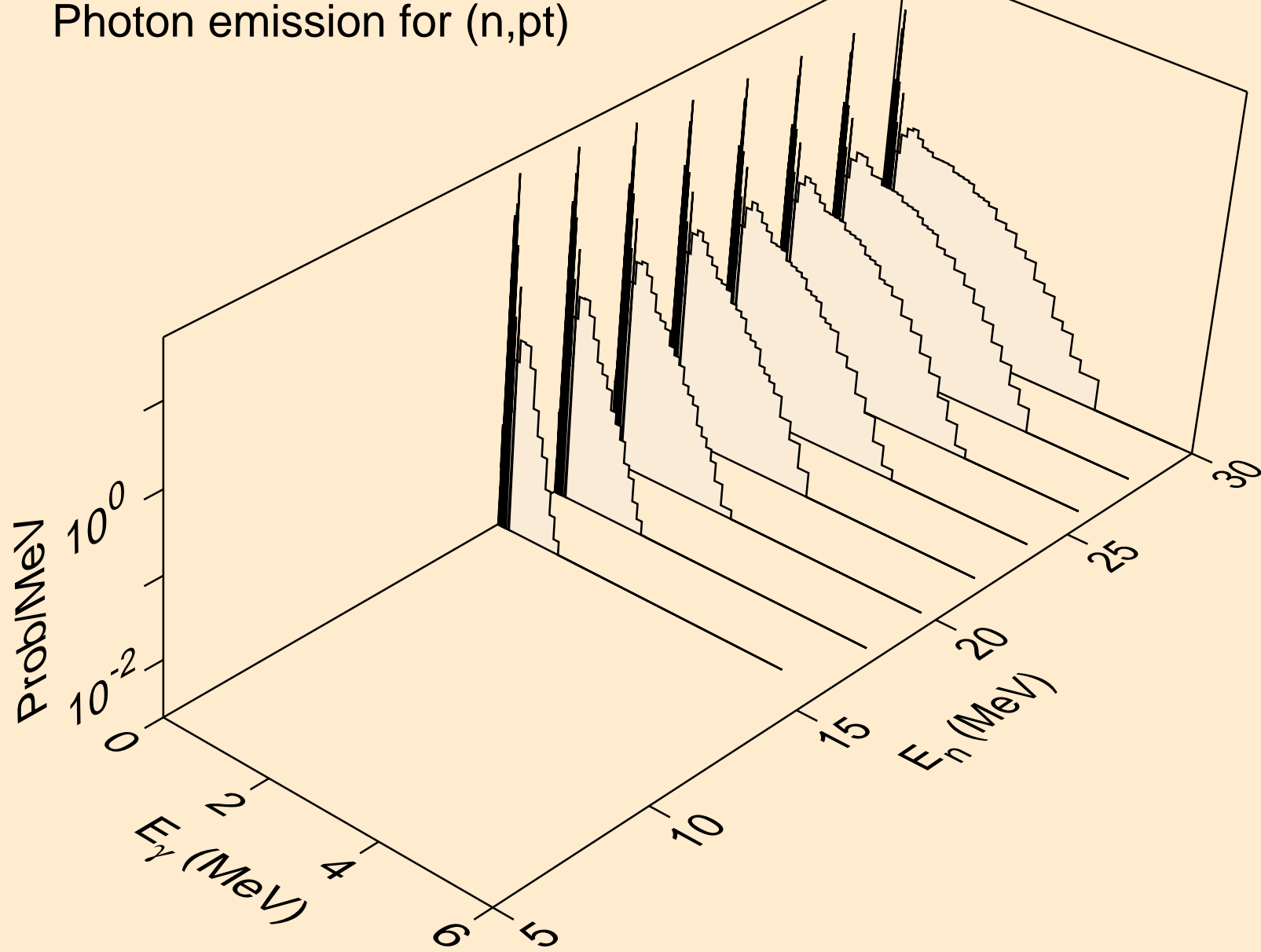

TA169 NEUTRON ACER TENDL-2024 LIBRARY; T=0.K
Photon emission for (n,da)

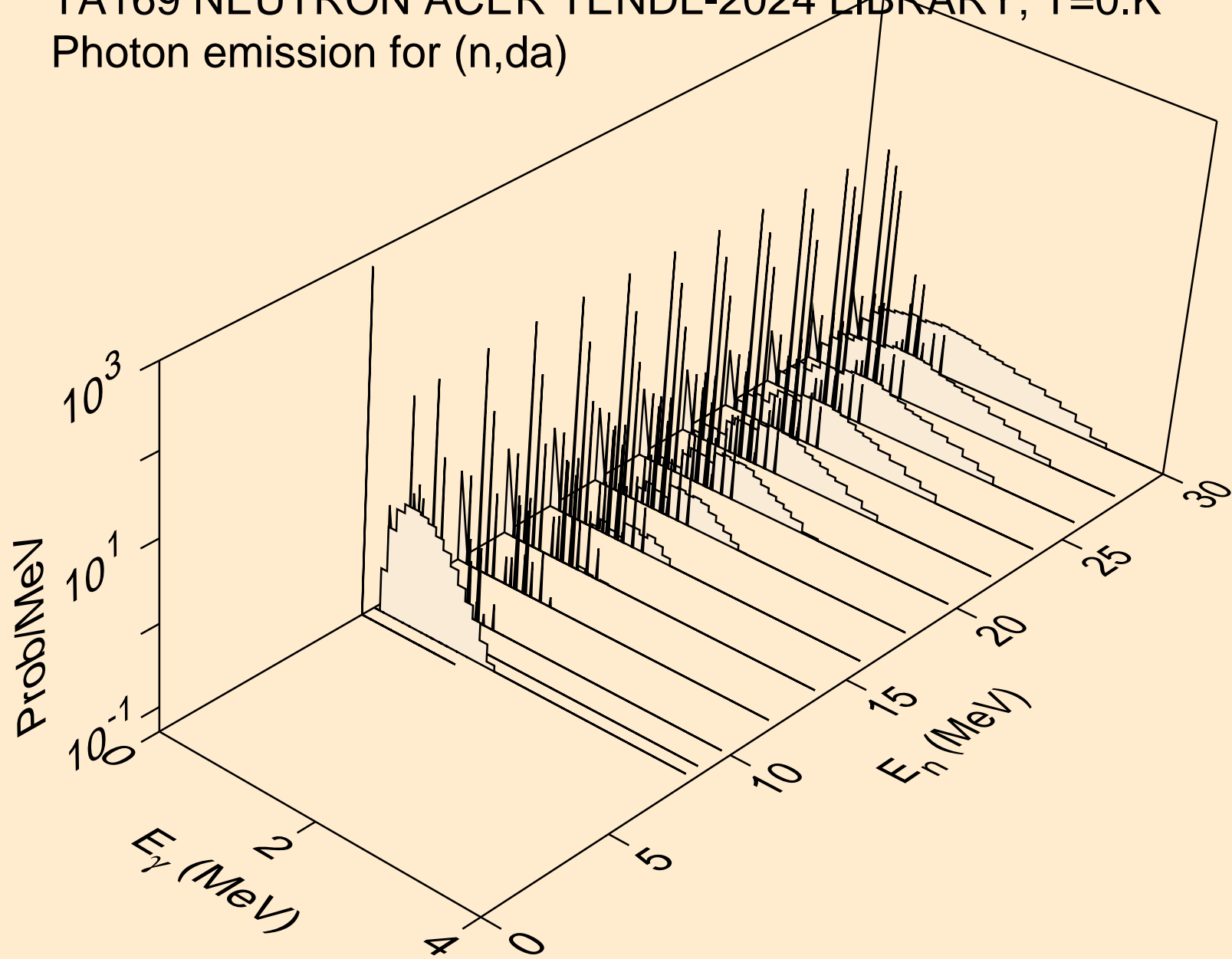

TA169 NEUTRON ACER TENDL-2024 LIBRARY; T=0.K
thermal capture photon spectrum

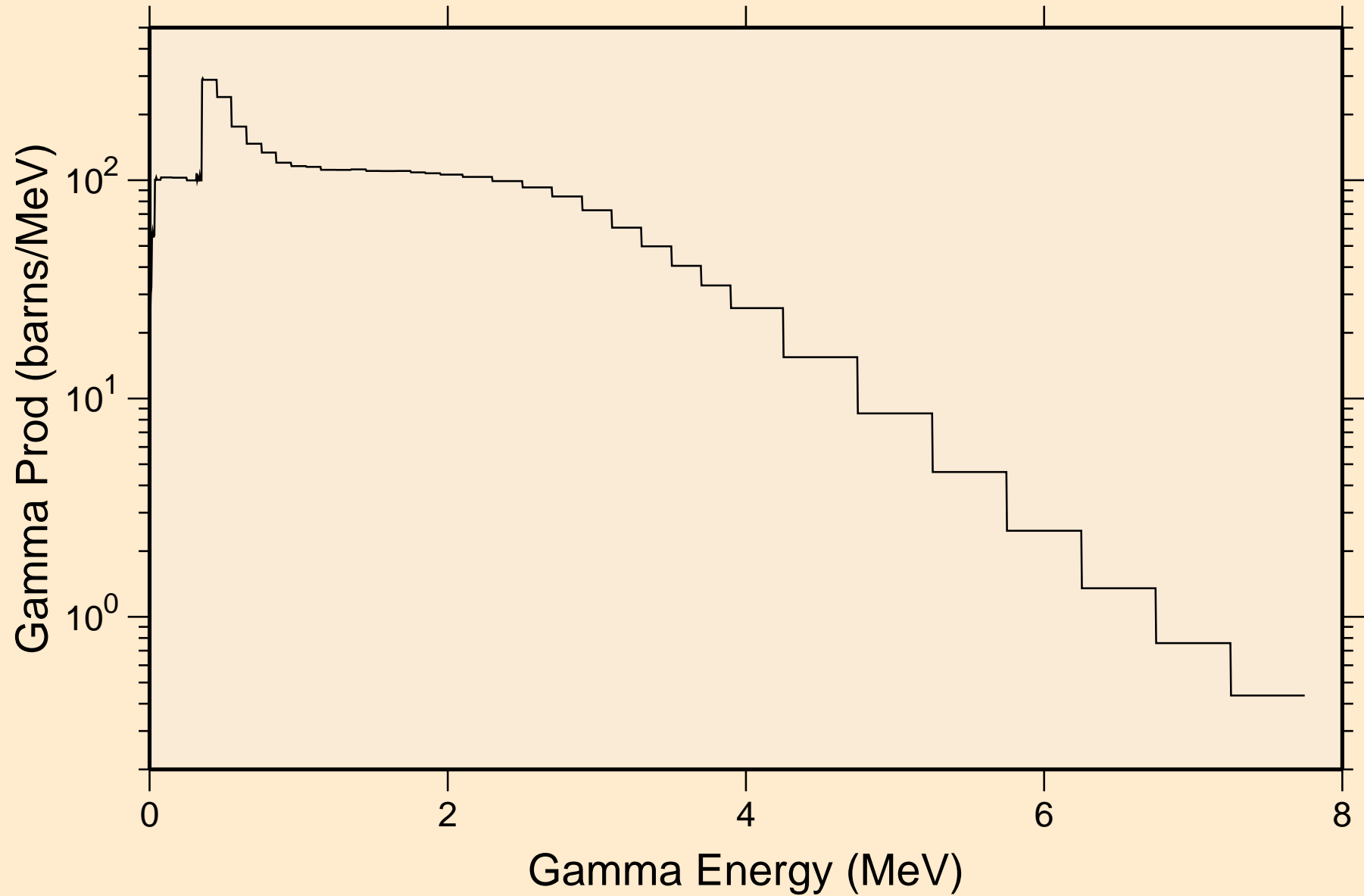

TA169 NEUTRON ACER TENDL-2024 LIBRARY; T=0.K
14 MeV photon spectrum

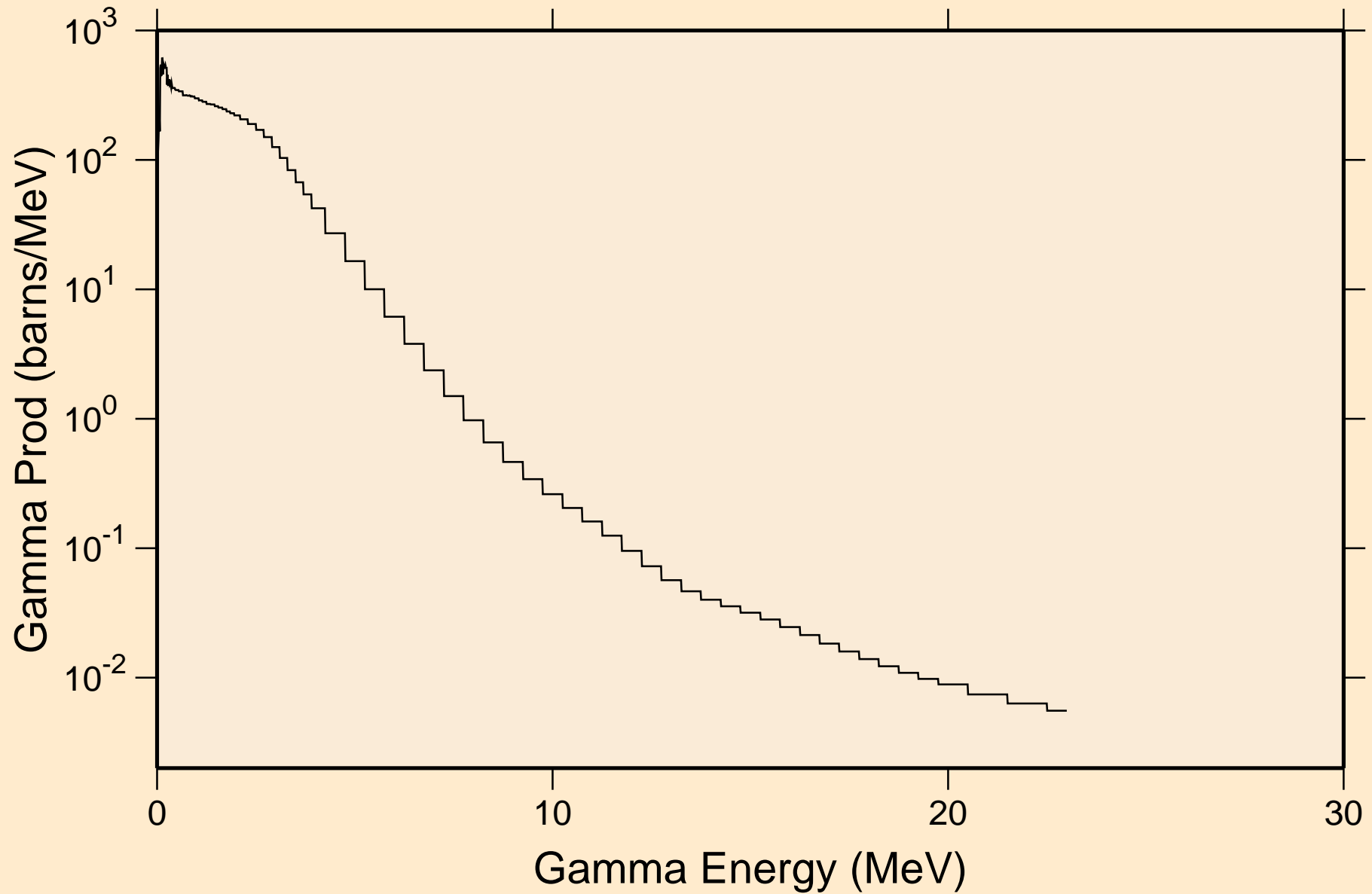

TA169 NEUTRON ACER TENDL-2024 LIBRARY; T=0.K

Particle heating contributions

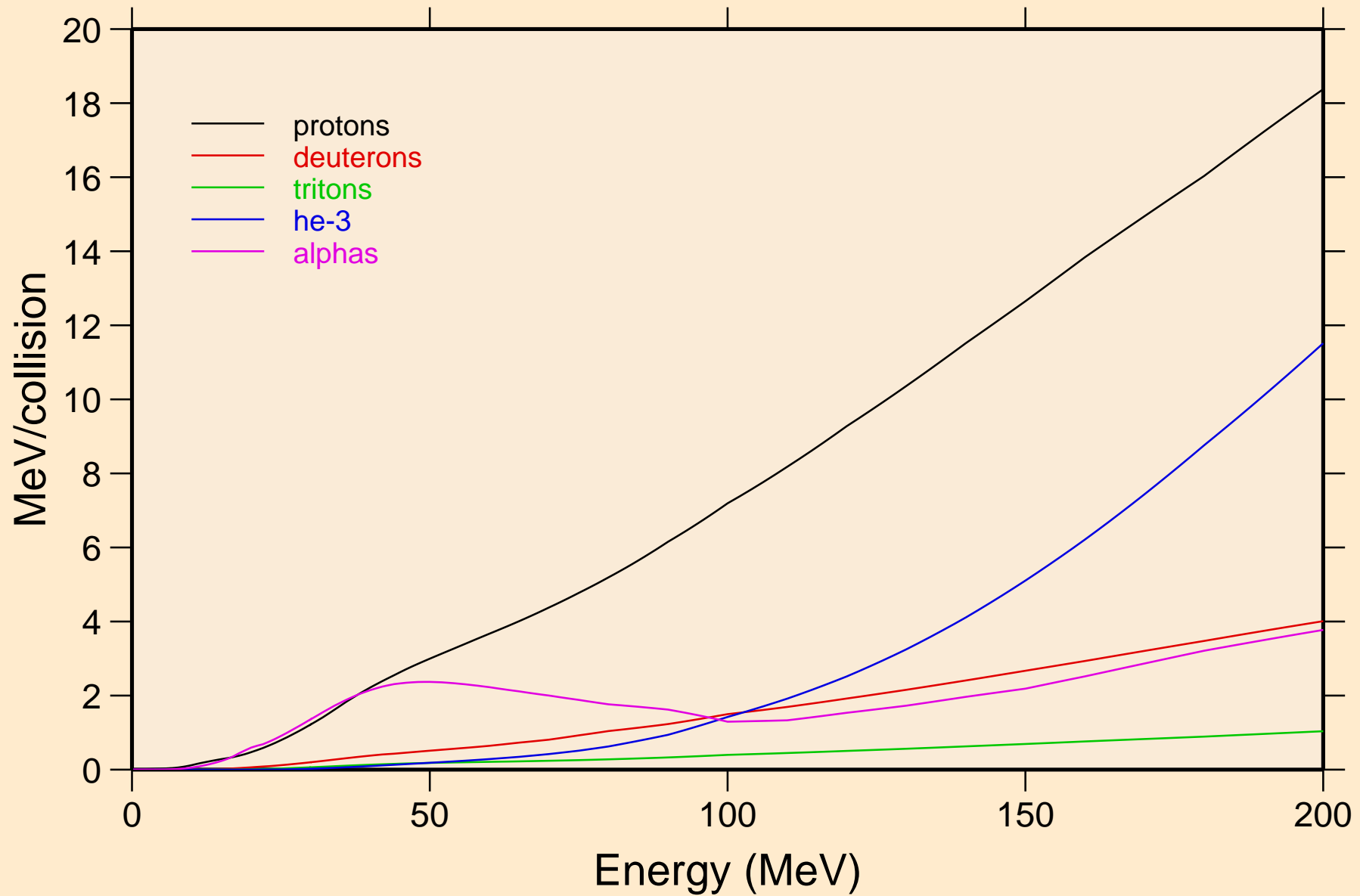

TA169 NEUTRON ACER TENDL-2024 LIBRARY; T=0.K
Recoil Heating

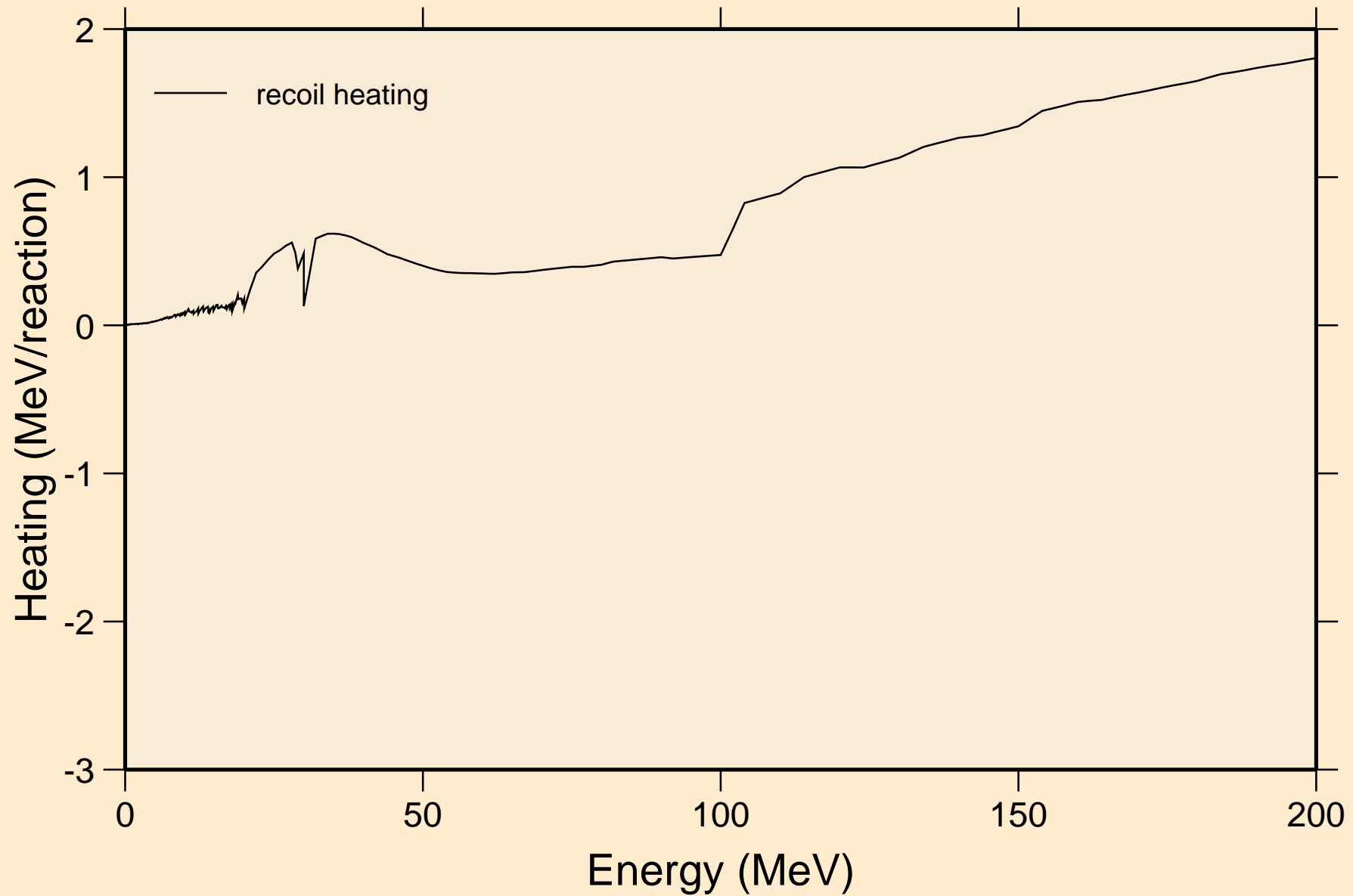

TA169 NEUTRON ACER TENDL-2024 LIBRARY; T=0.K
Particle production cross sections

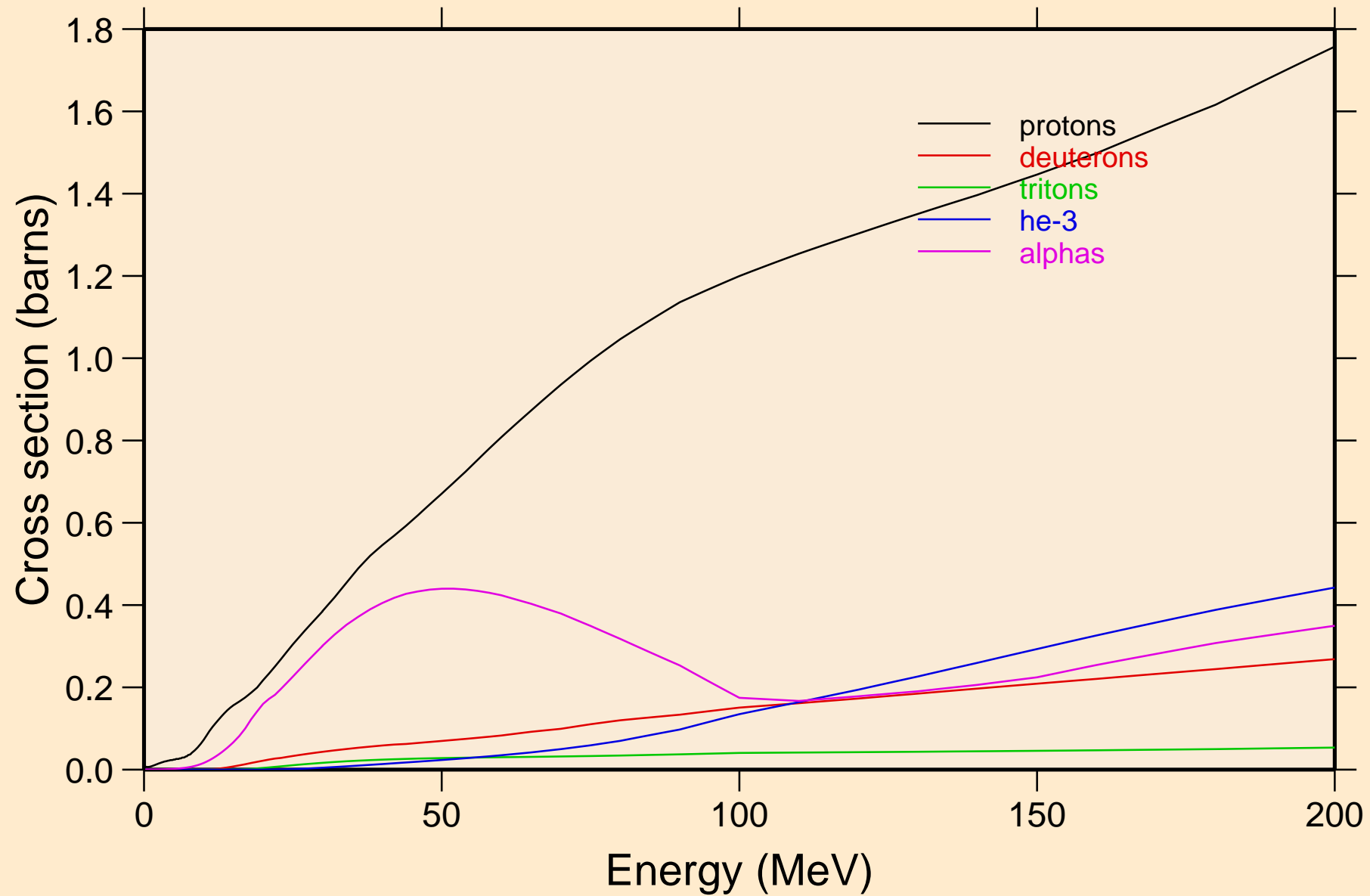

TA169 NEUTRON ACER TENDL-2024 LIBRARY; T=0.K
protons from (n,x)

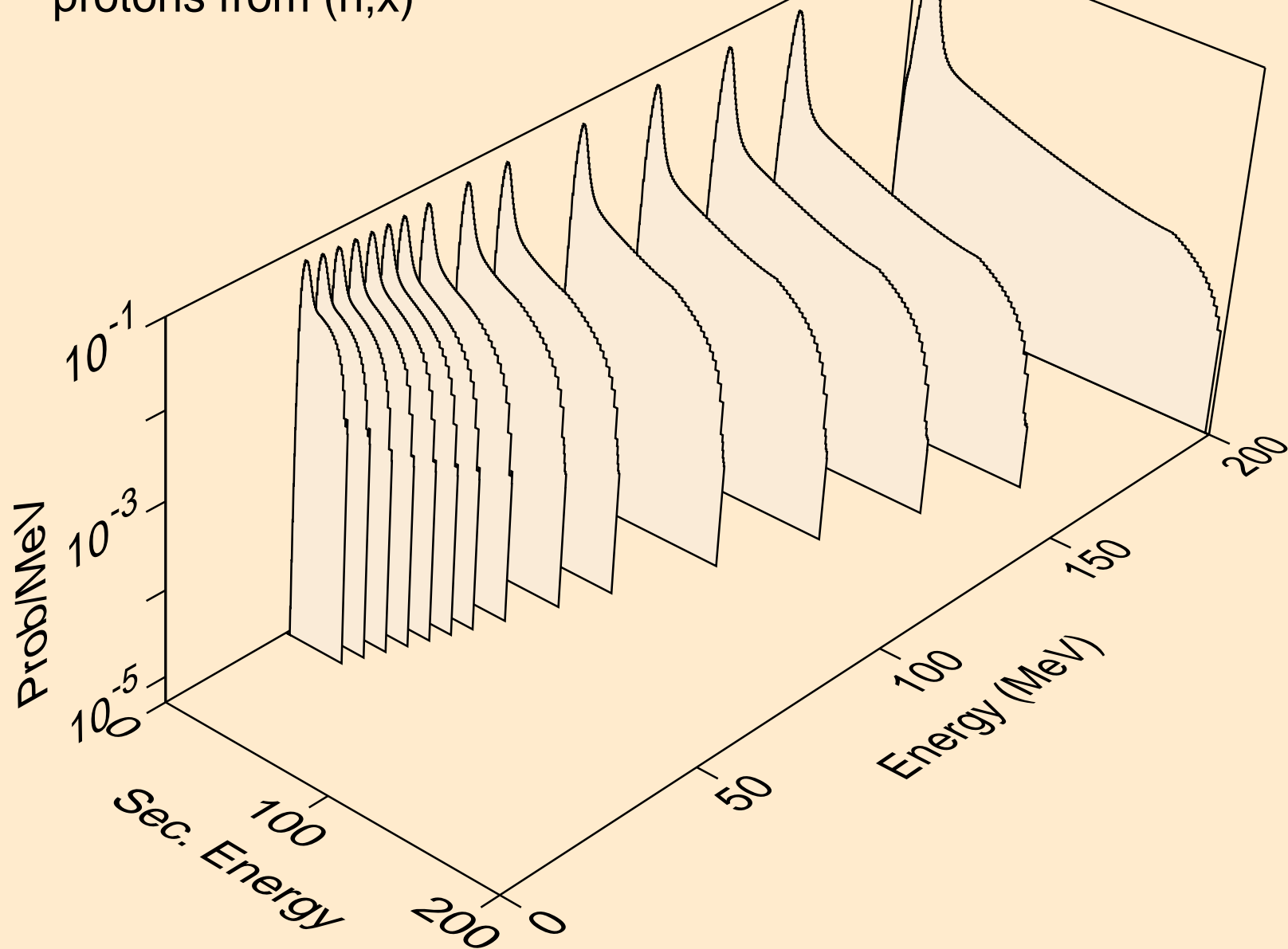

TA169 NEUTRON ACER TENDL-2024 LIBRARY; T=0.K
protons from (n,n*)p

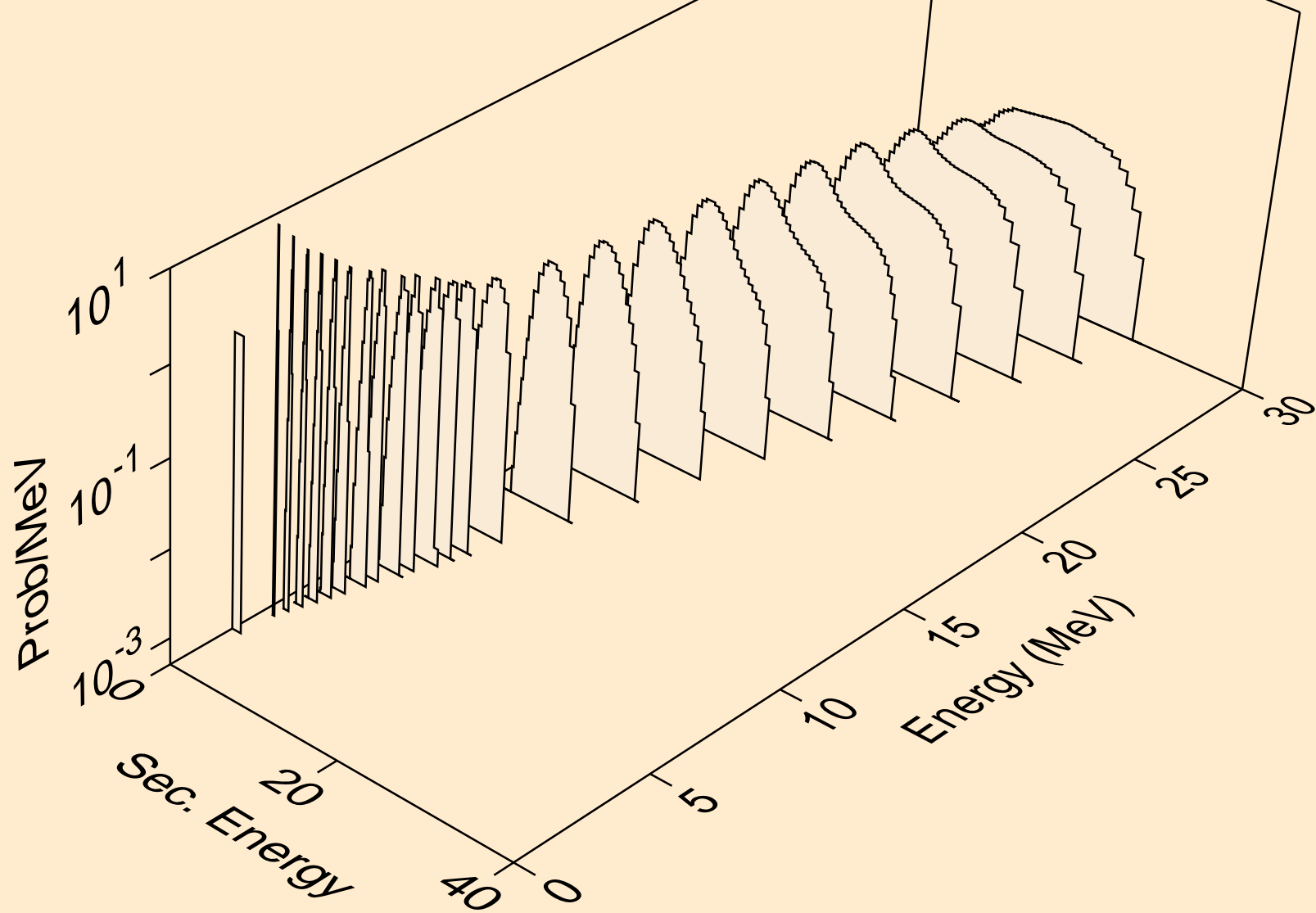

TA169 NEUTRON ACER TENDL-2024 LIBRARY; T=0.K
protons from (n,2np)

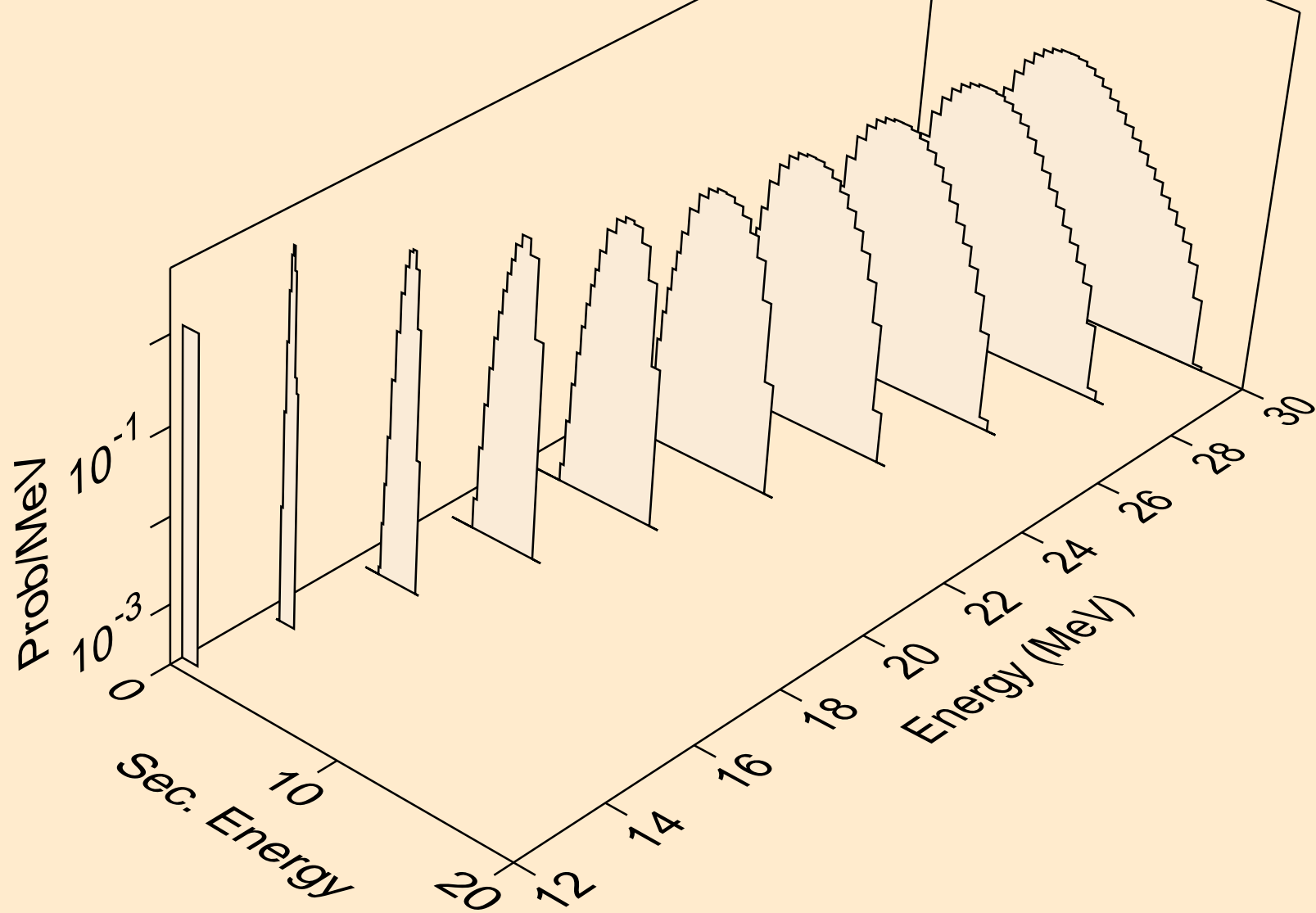

TA169 NEUTRON ACER TENDL-2024 LIBRARY; T=0.K
protons from (n,3np)

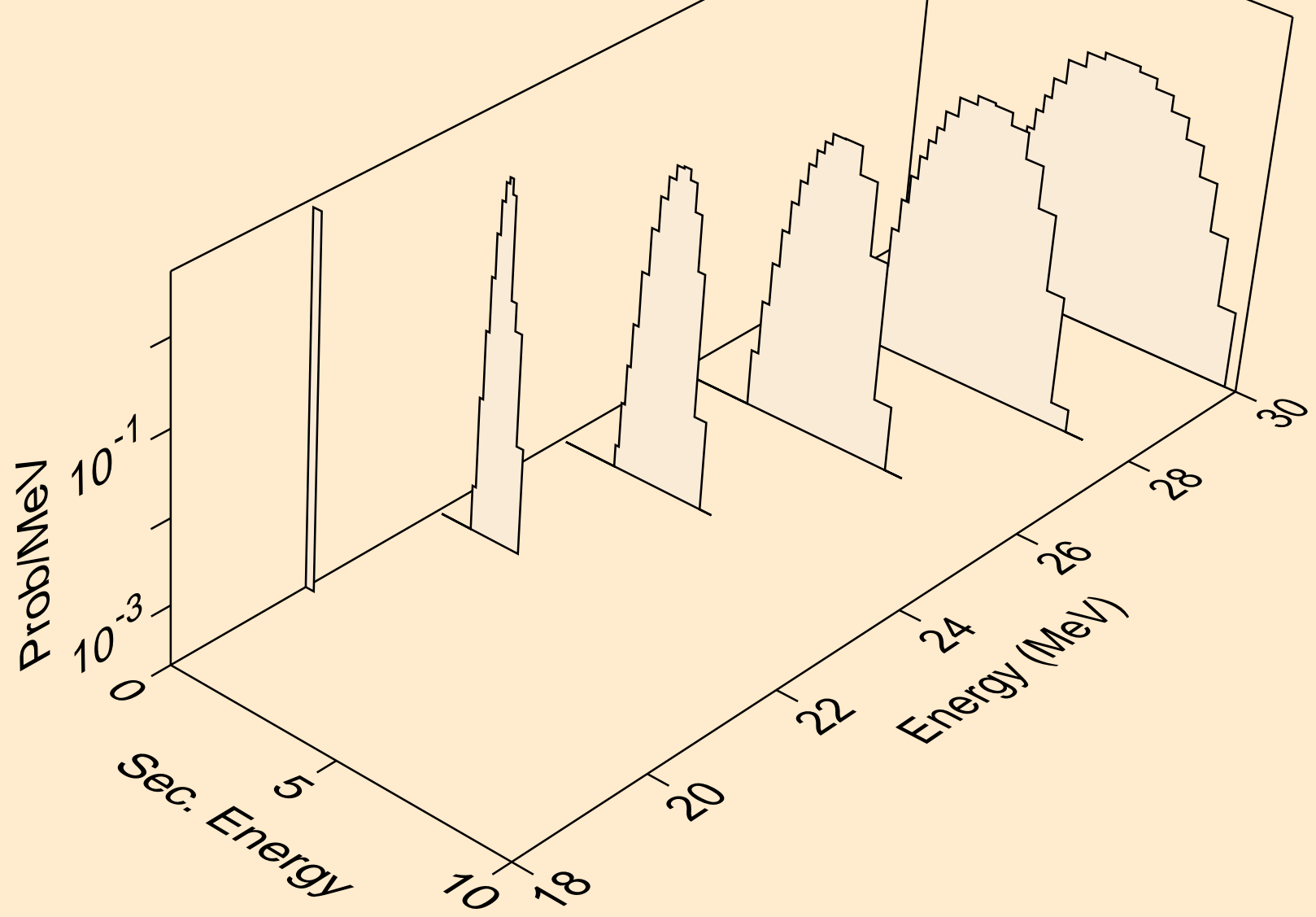

TA169 NEUTRON ACER TENDL-2024 LIBRARY; T=0.K
protons from (n,n2p)

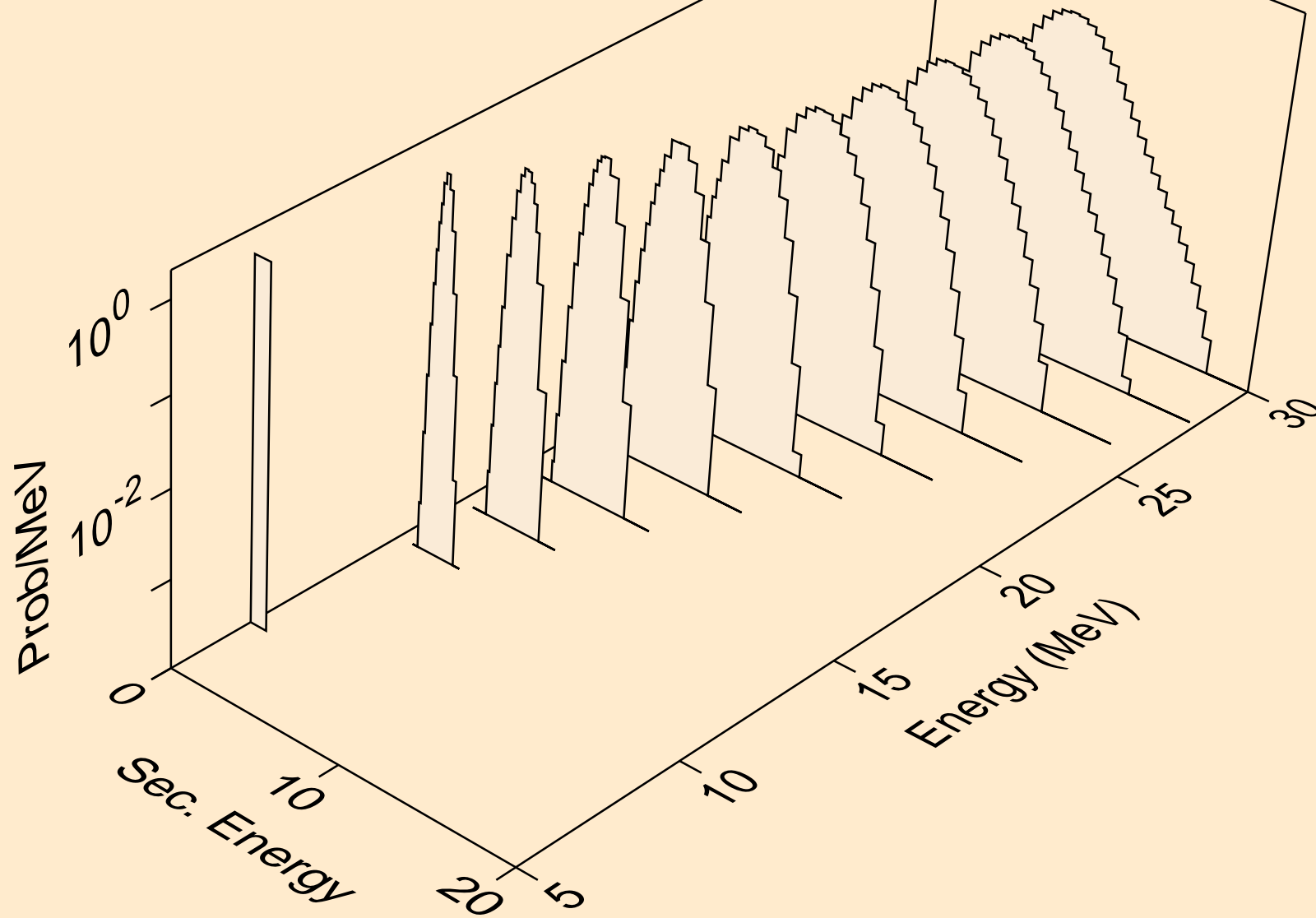

TA169 NEUTRON ACER TENDL-2024 LIBRARY; T=0.K
protons from (n,npa)

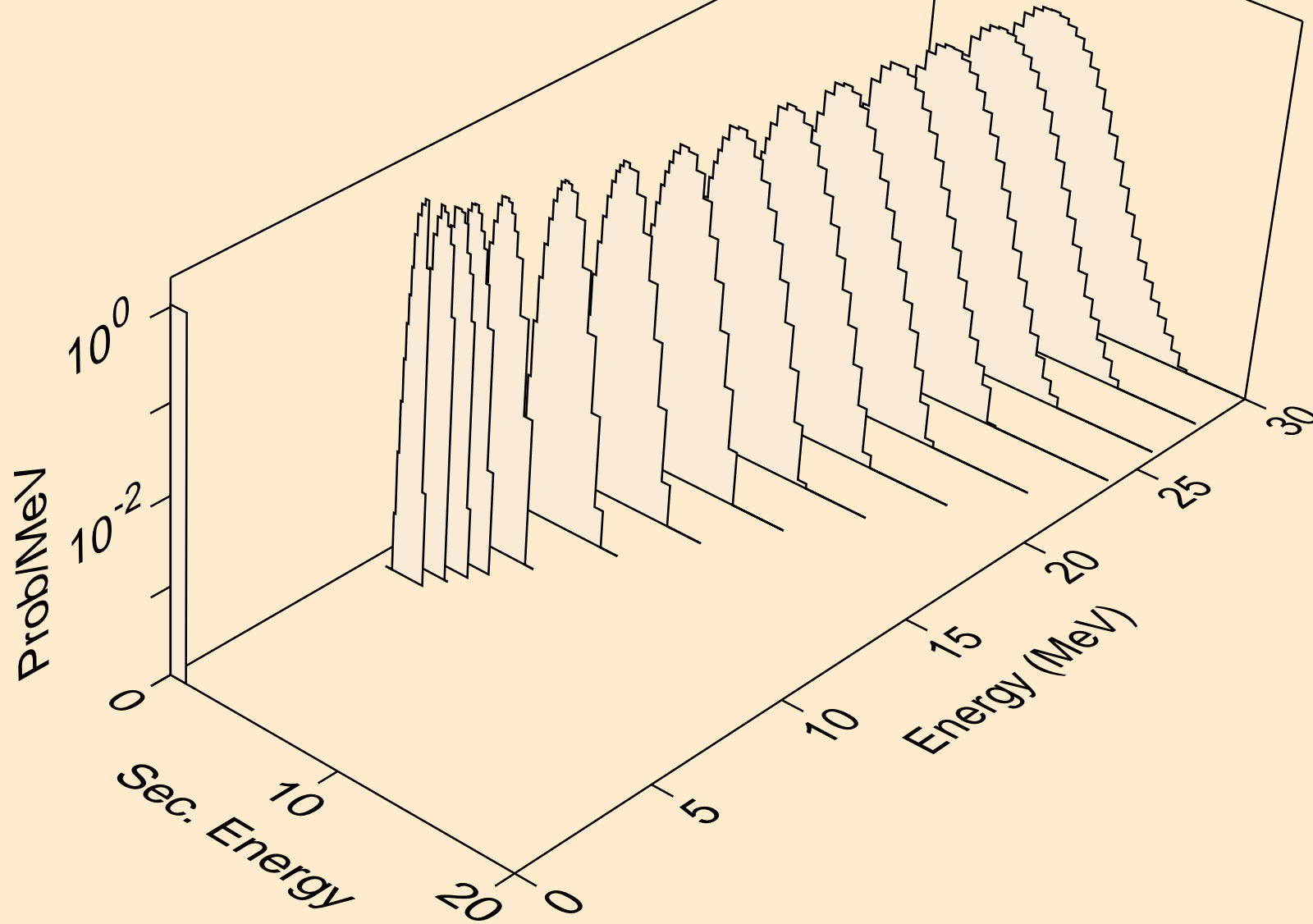

TA169 NEUTRON ACER TENDL-2024 LIBRARY; T=0.K
protons from (n,p)

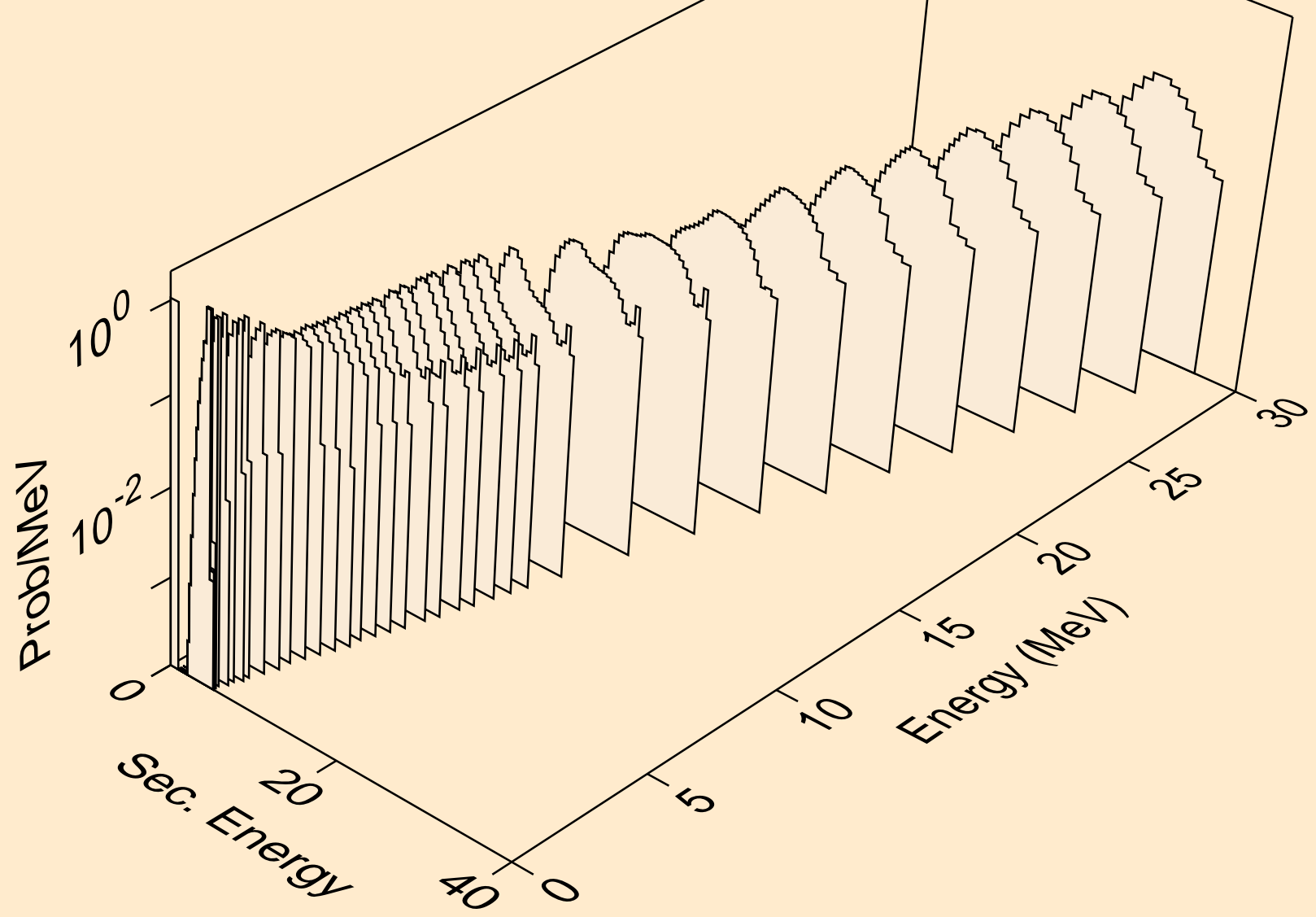

TA169 NEUTRON ACER TENDL-2024 LIBRARY; T=0.K
protons from (n,2p)

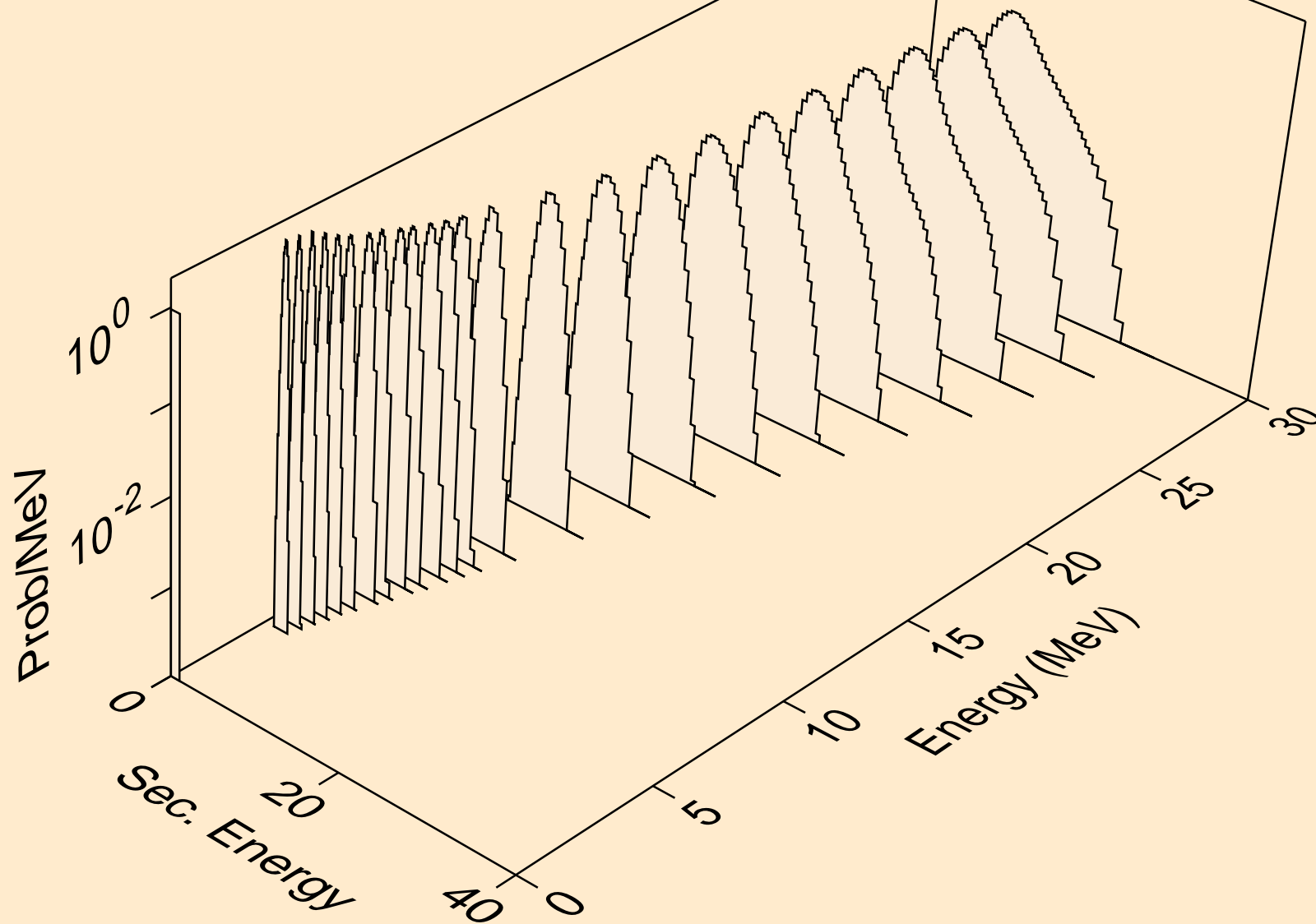

TA169 NEUTRON ACER TENDL-2024 LIBRARY; T=0.K
protons from (n,p)

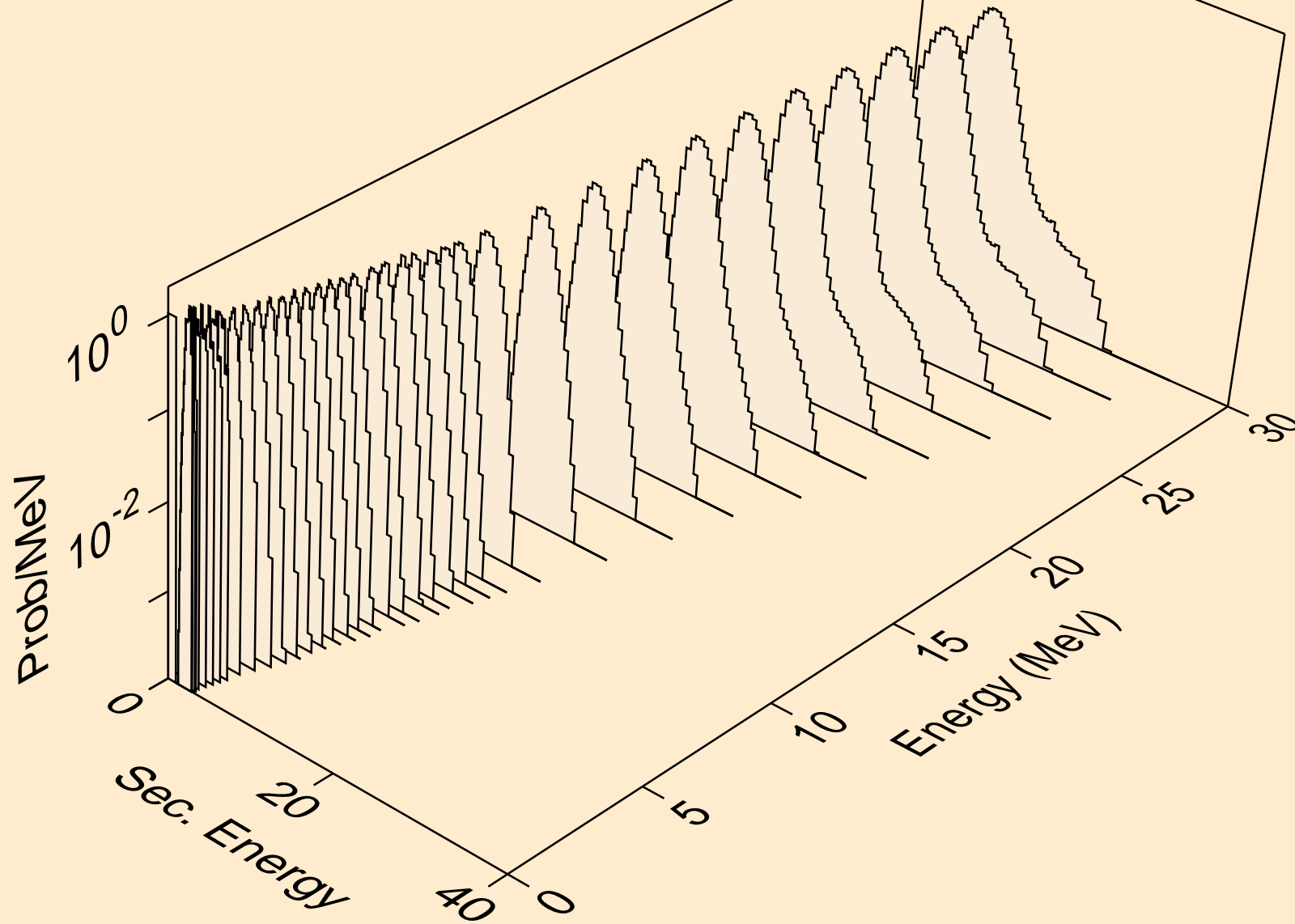

TA169 NEUTRON ACER TENDL-2024 LIBRARY; T=0.K
protons from (n,pd)

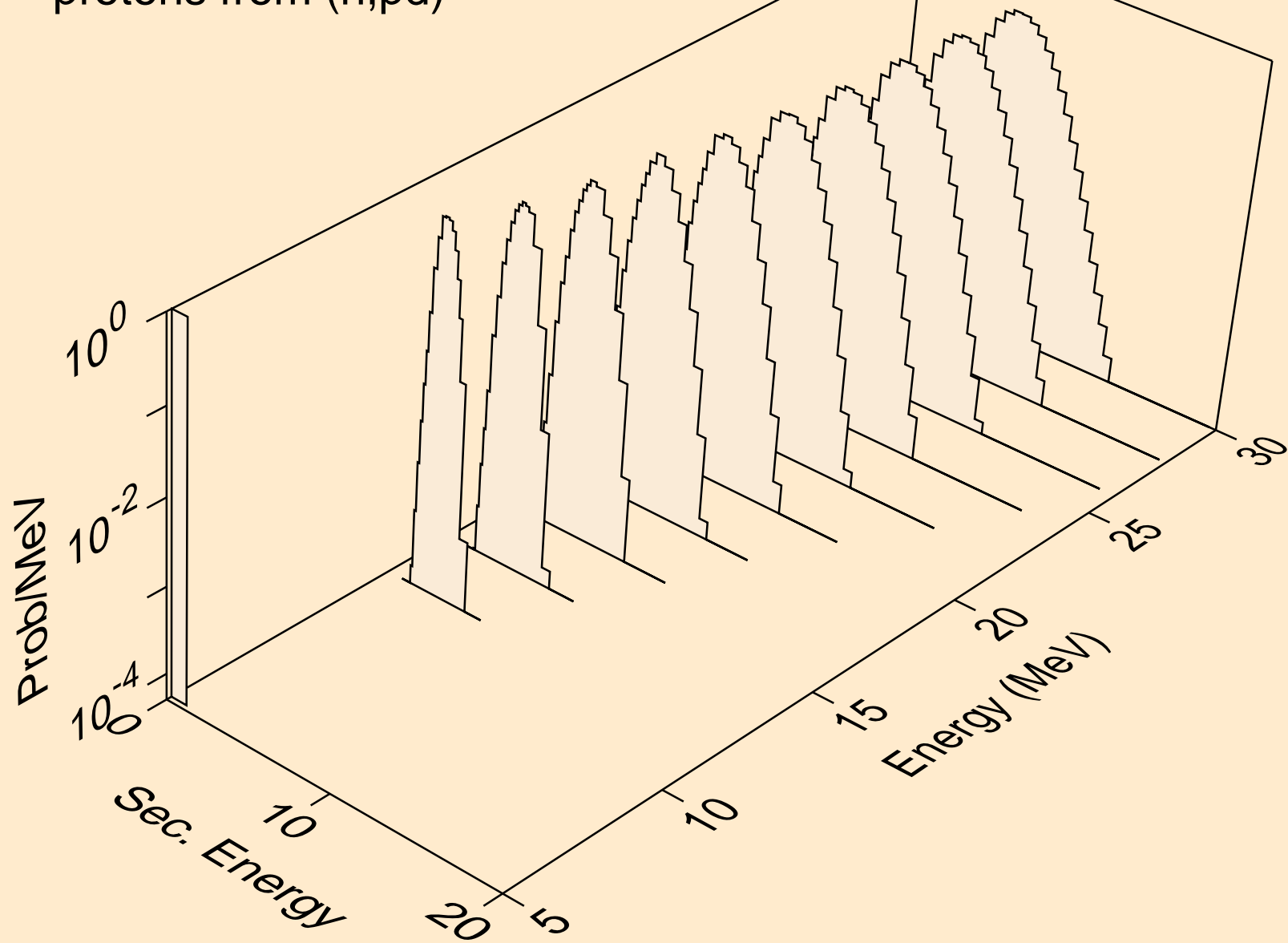

TA169 NEUTRON ACER TENDL-2024 LIBRARY; T=0.K
protons from (n,pt)

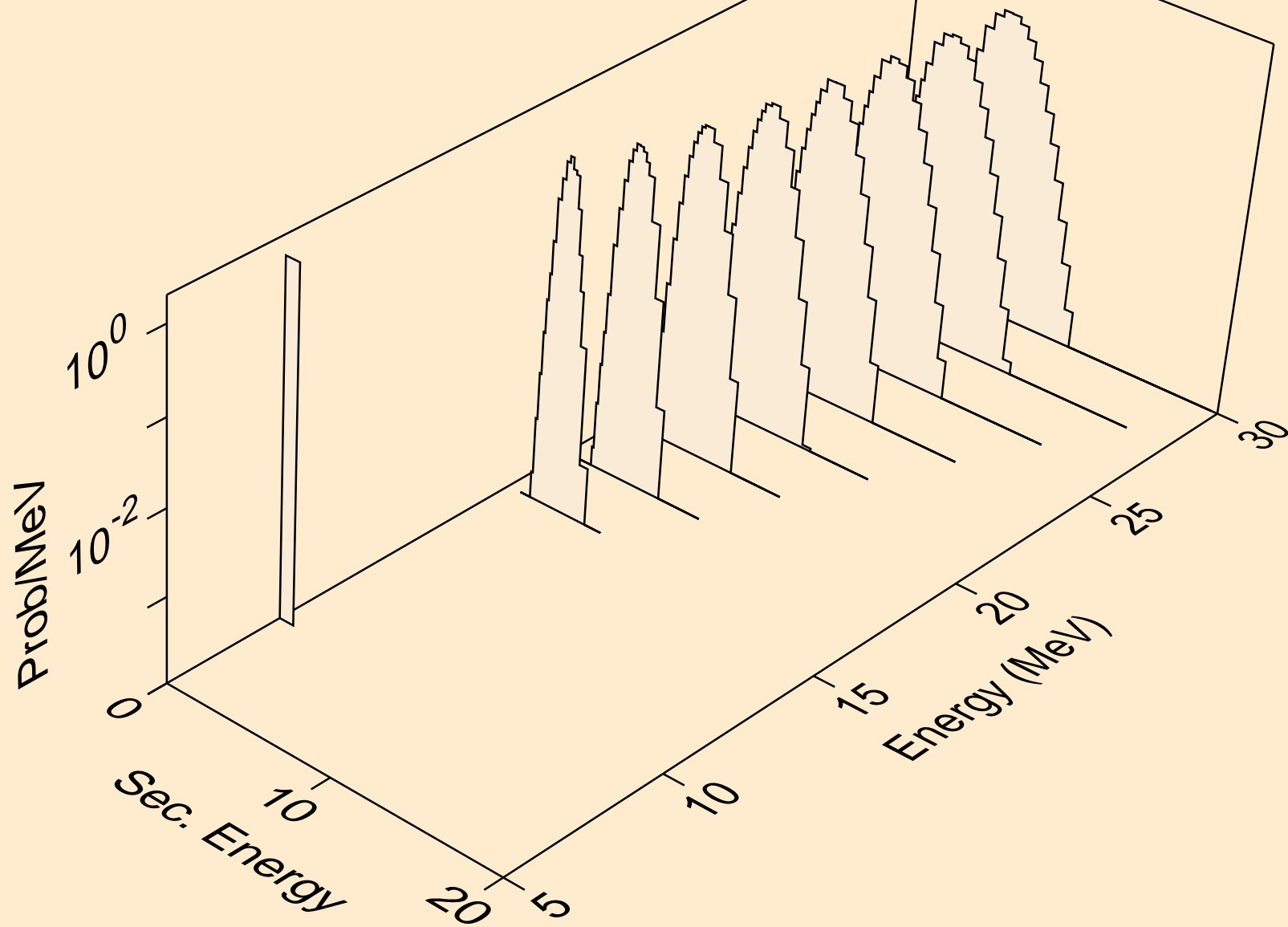

TA169 NEUTRON ACER TENDL-2024 LIBRARY; T=0.K
deuterons from (n,x)

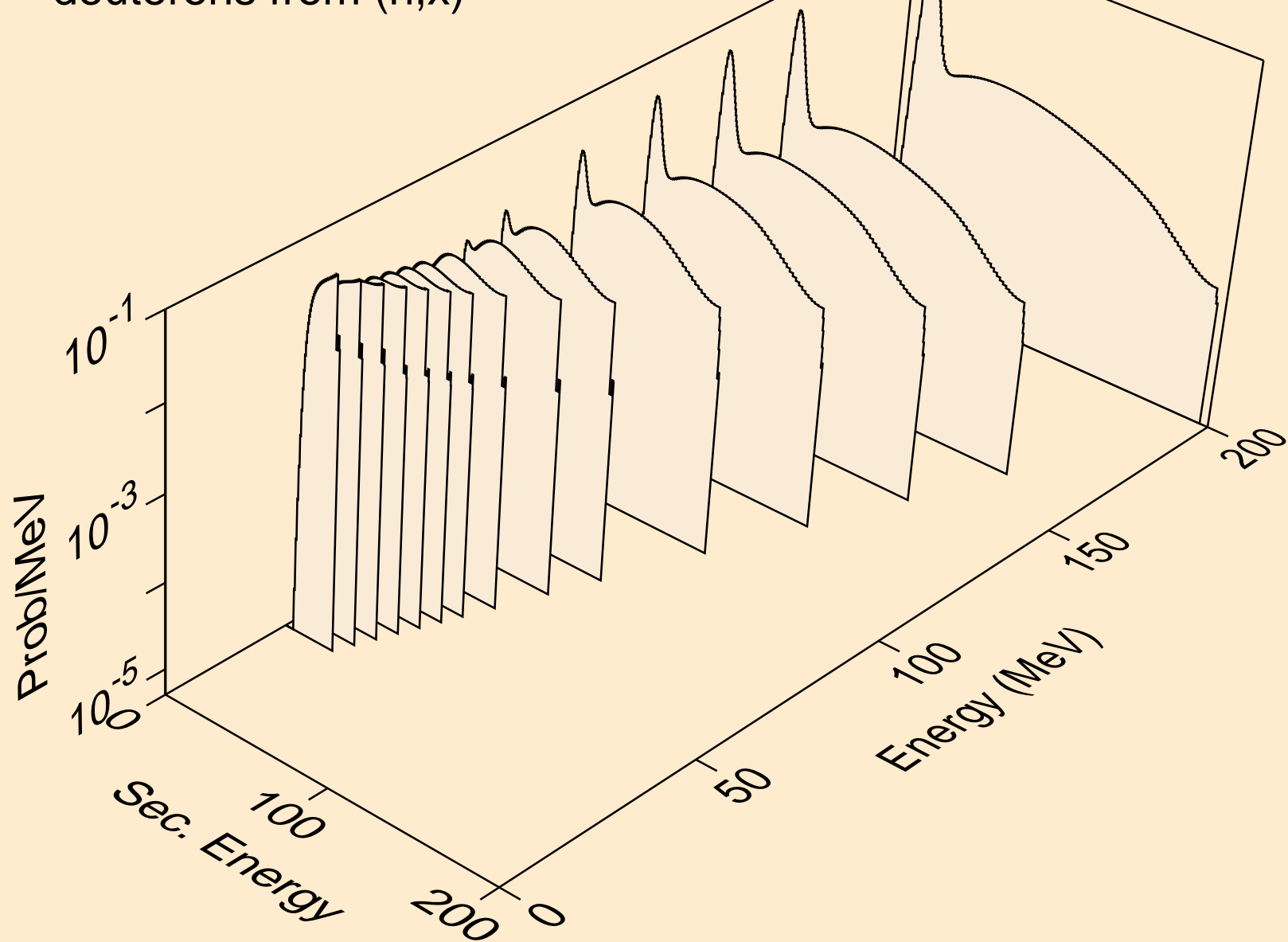

TA169 NEUTRON ACER TENDL-2024 LIBRARY; T=0.K
deuterons from (n,2nd)

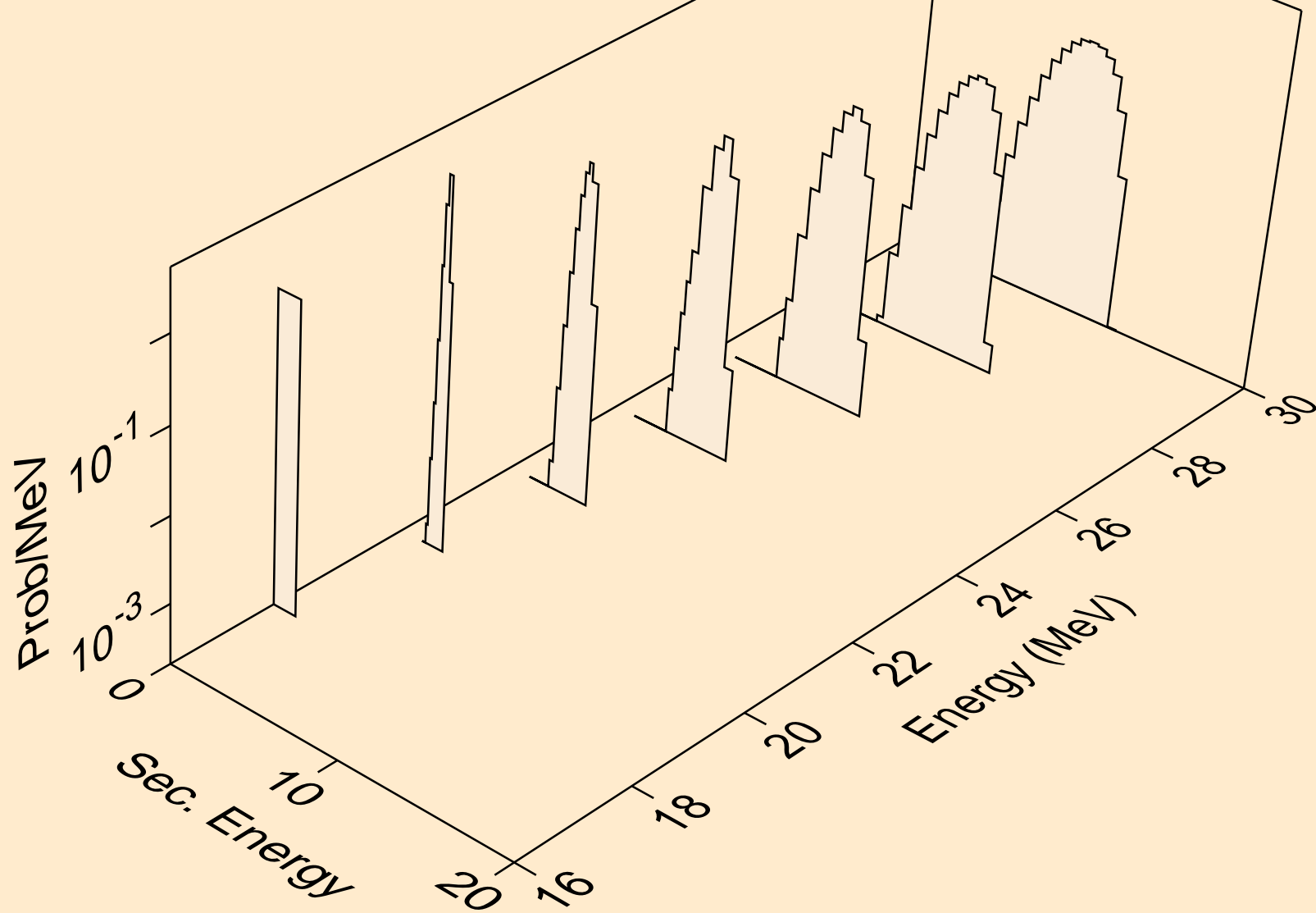

TA169 NEUTRON ACER TENDL-2024 LIBRARY; T=0.K
deuterons from (n,n*)d

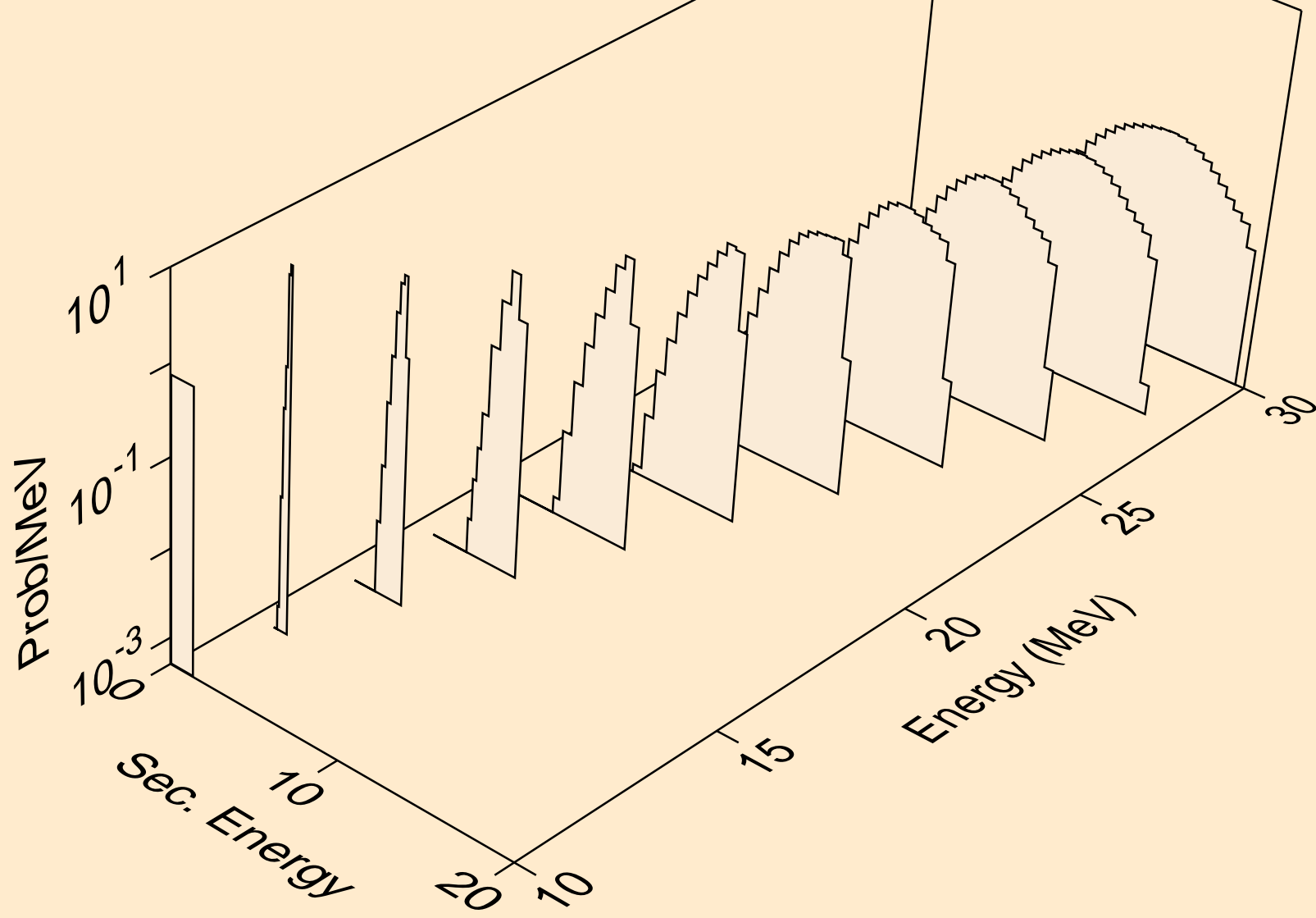

TA169 NEUTRON ACER TENDL-2024 LIBRARY; T=0.K
deuterons from (n,d)

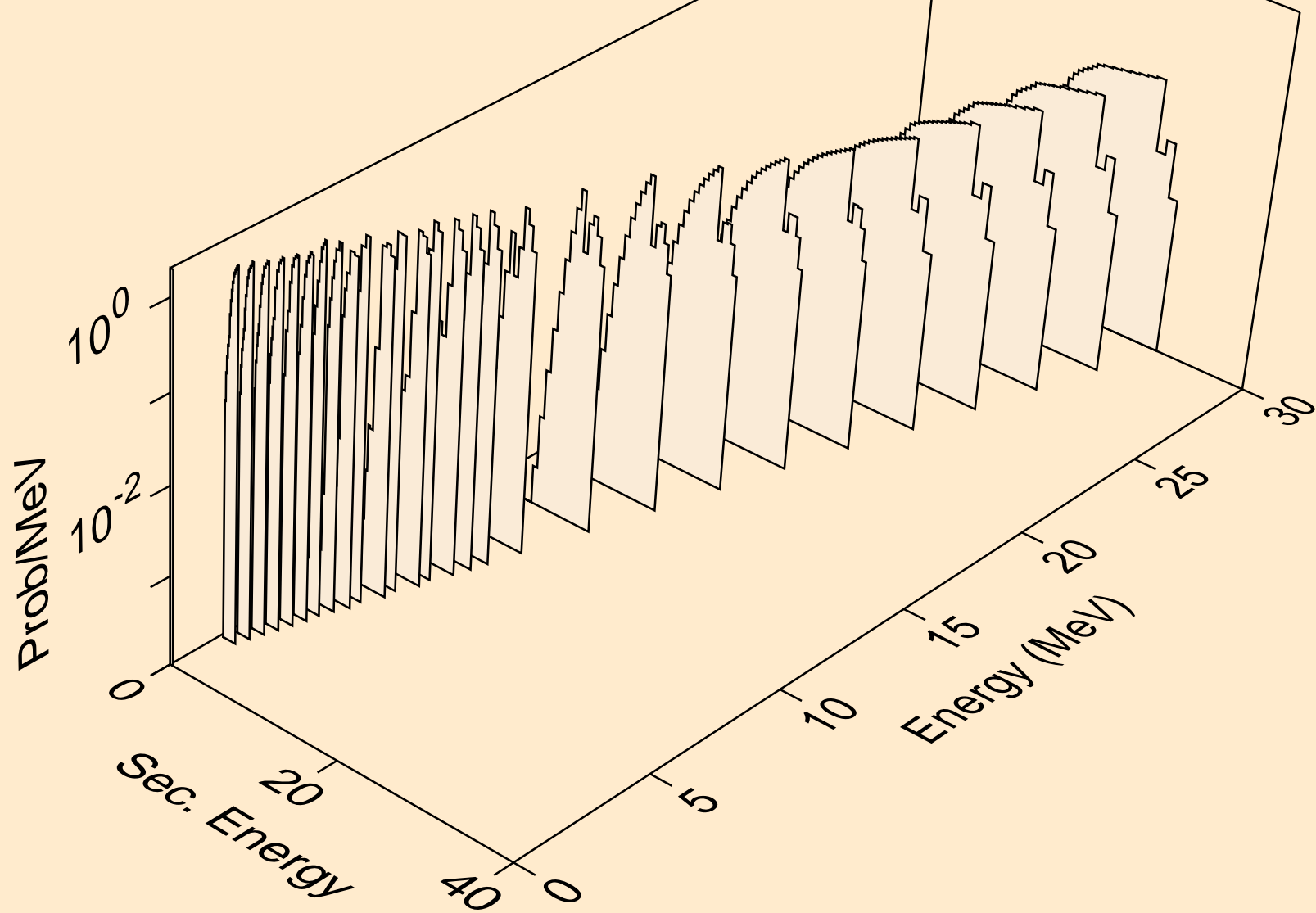

TA169 NEUTRON ACER TENDL-2024 LIBRARY; T=0.K
deuterons from (n,pd)

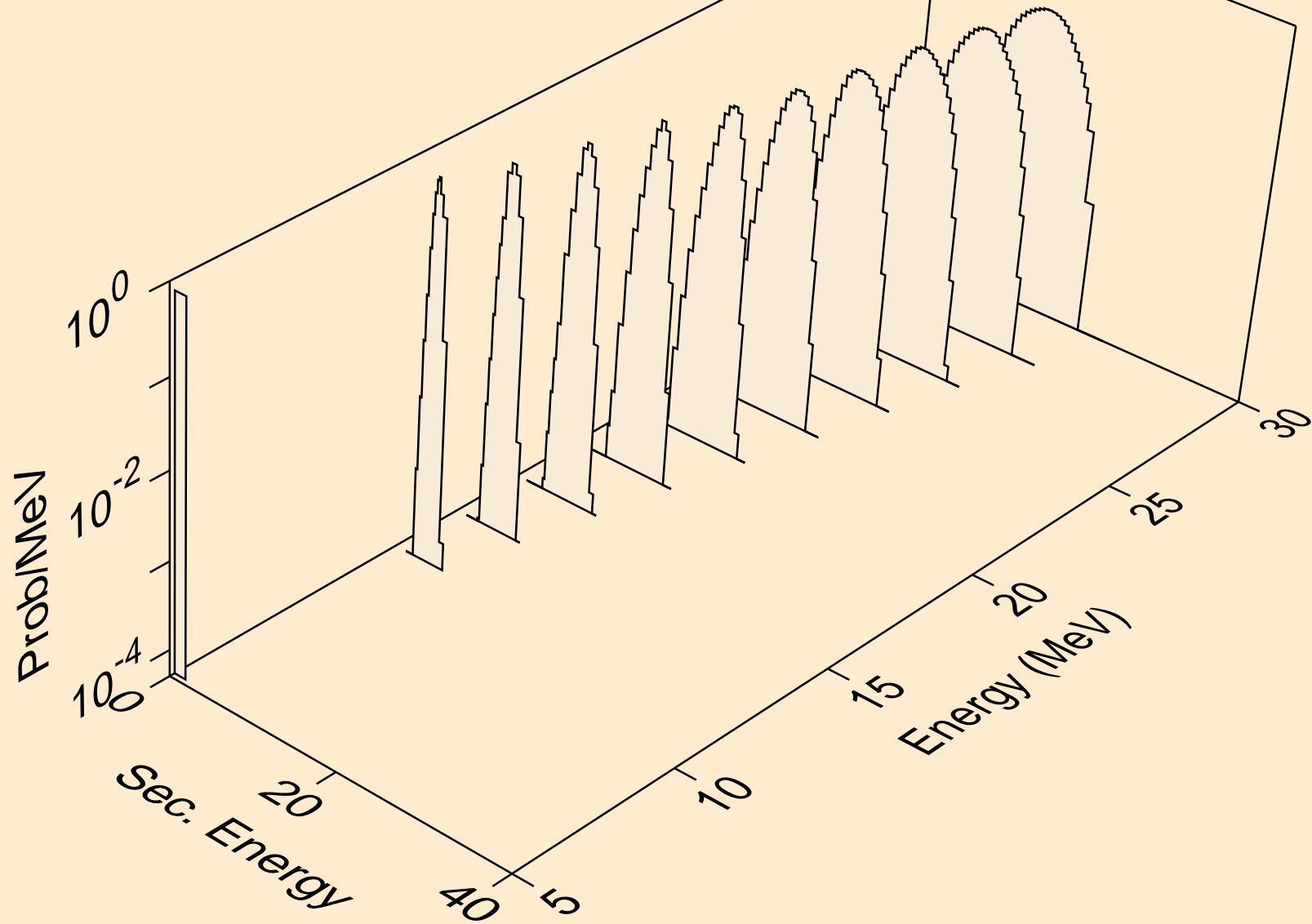

TA169 NEUTRON ACER TENDL-2024 LIBRARY; T=0.K
deuterons from (n,da)

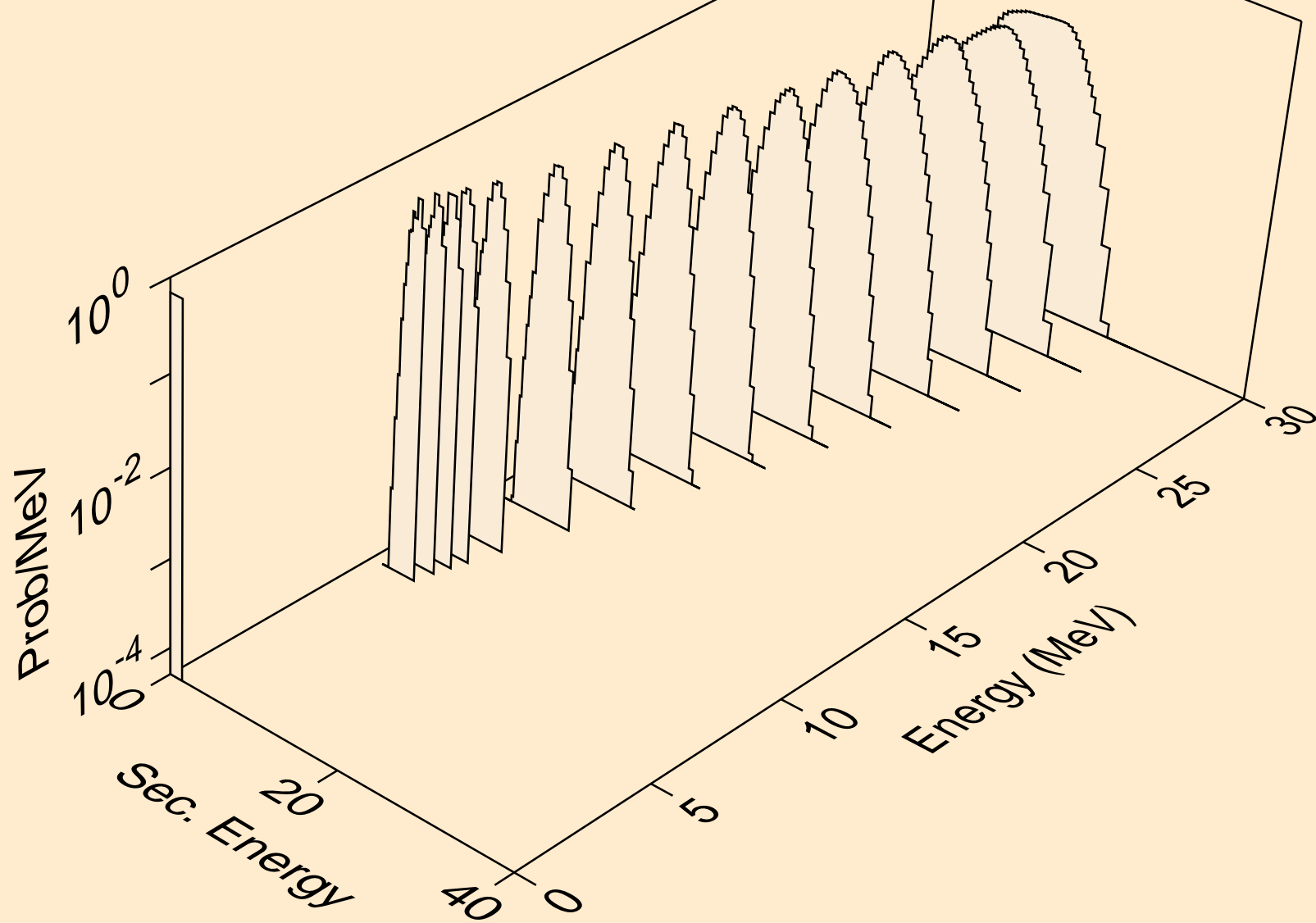

TA169 NEUTRON ACER TENDL-2024 LIBRARY; T=0.K
tritons from (n,x)

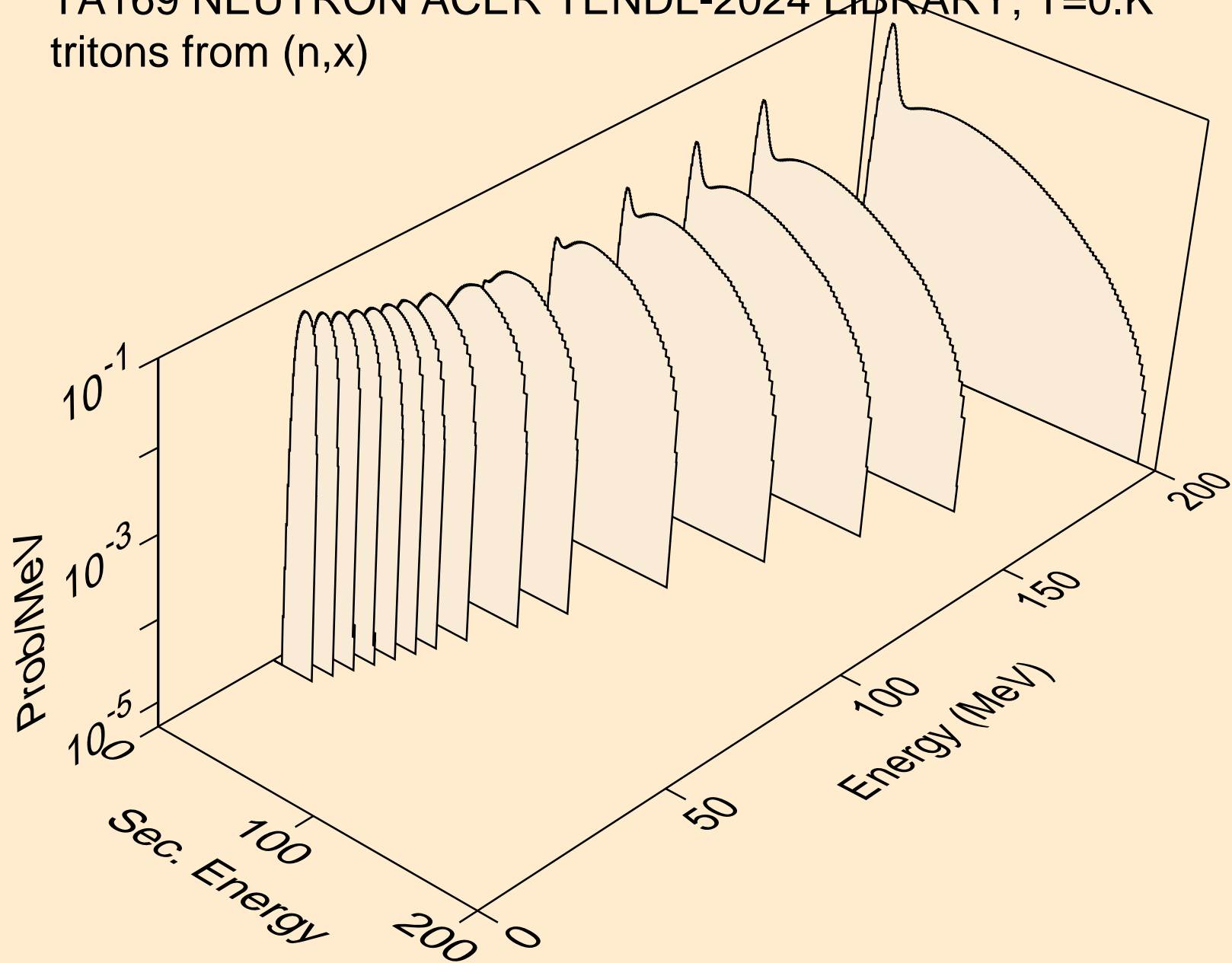

TA169 NEUTRON ACER TENDL-2024 LIBRARY; T=0.K
tritons from (n,n*)t

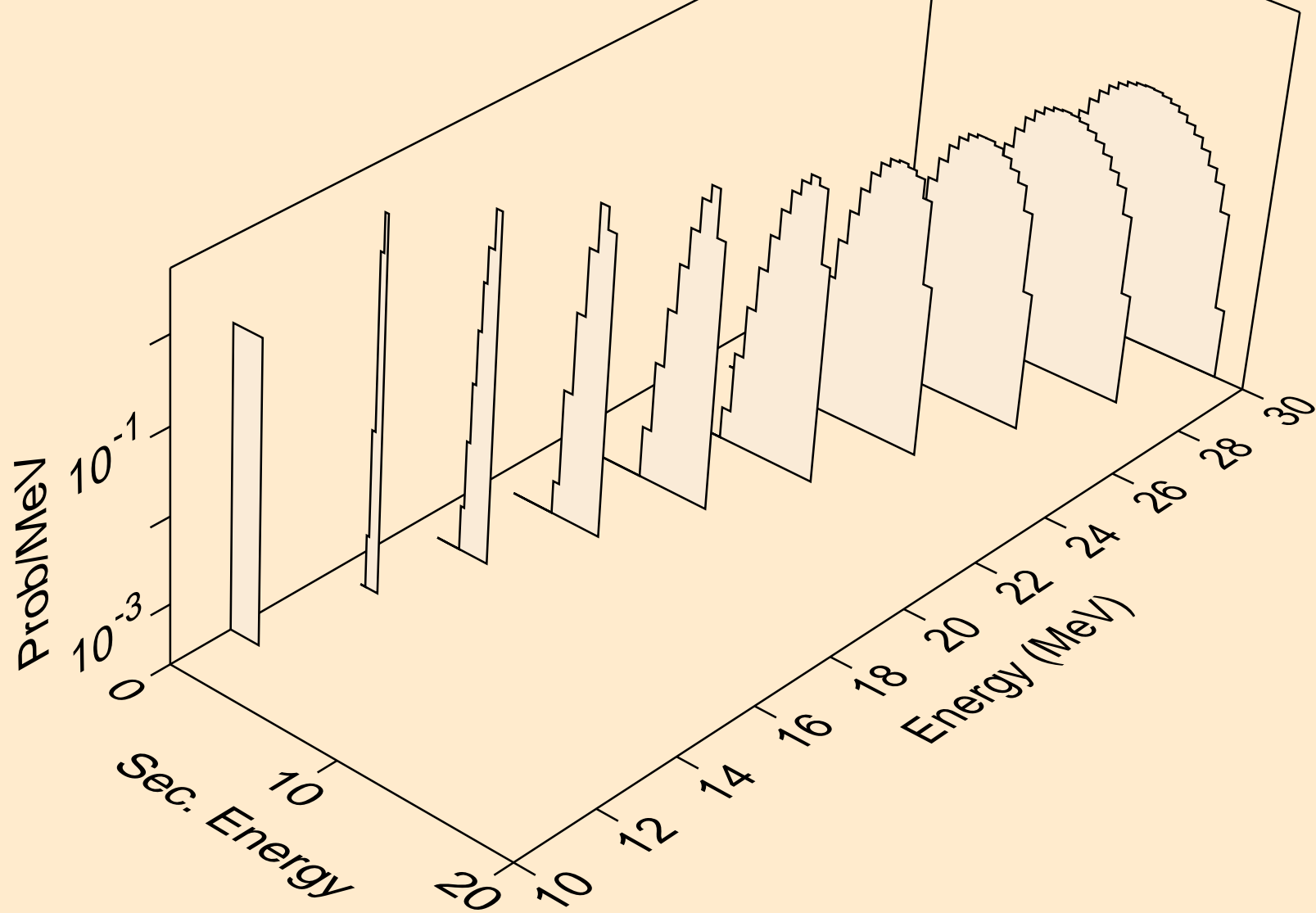

TA169 NEUTRON ACER TENDL-2024 LIBRARY; T=0.K
tritons from (n,t)

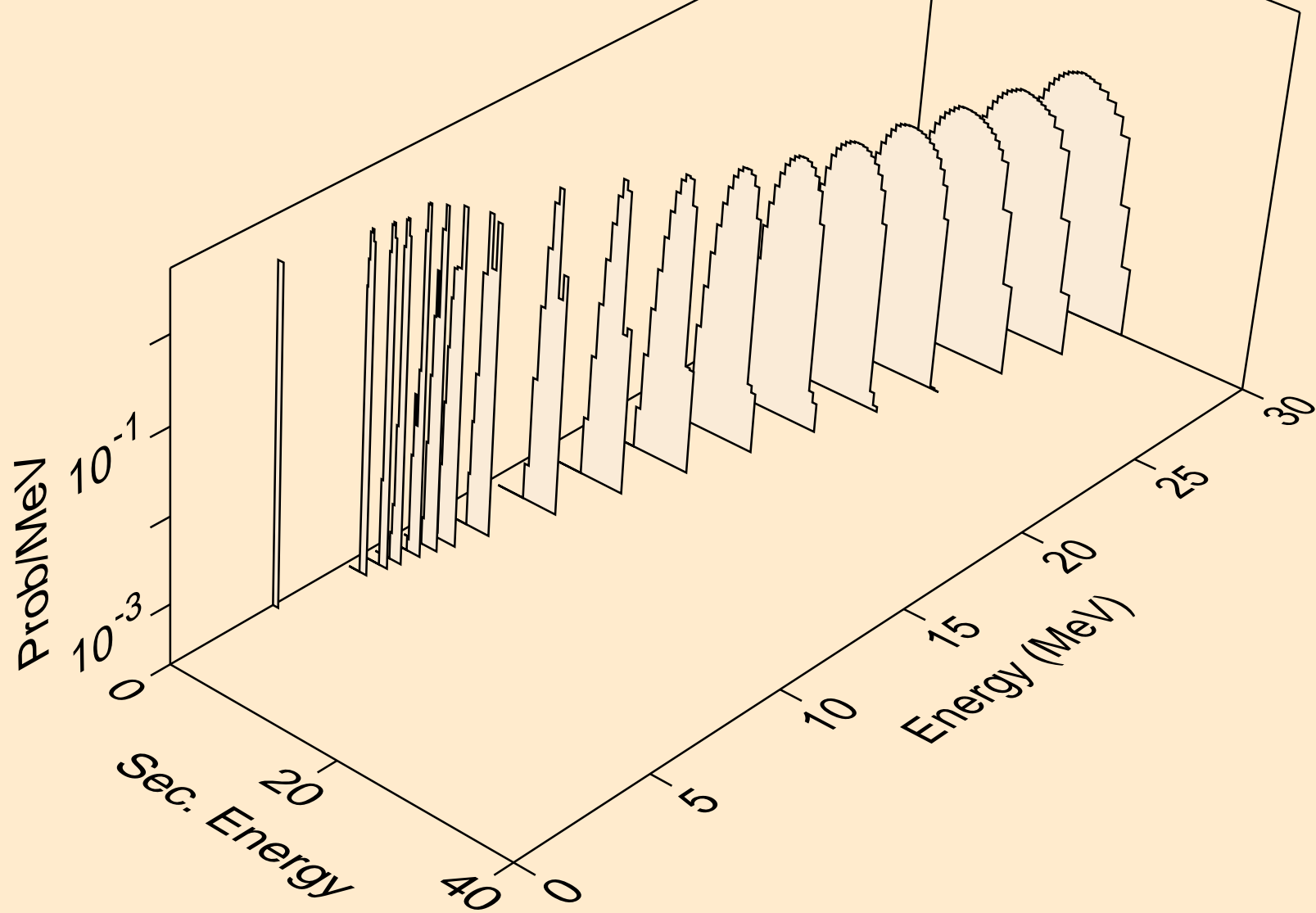

TA169 NEUTRON ACER TENDL-2024 LIBRARY; T=0.K
tritons from (n,pt)

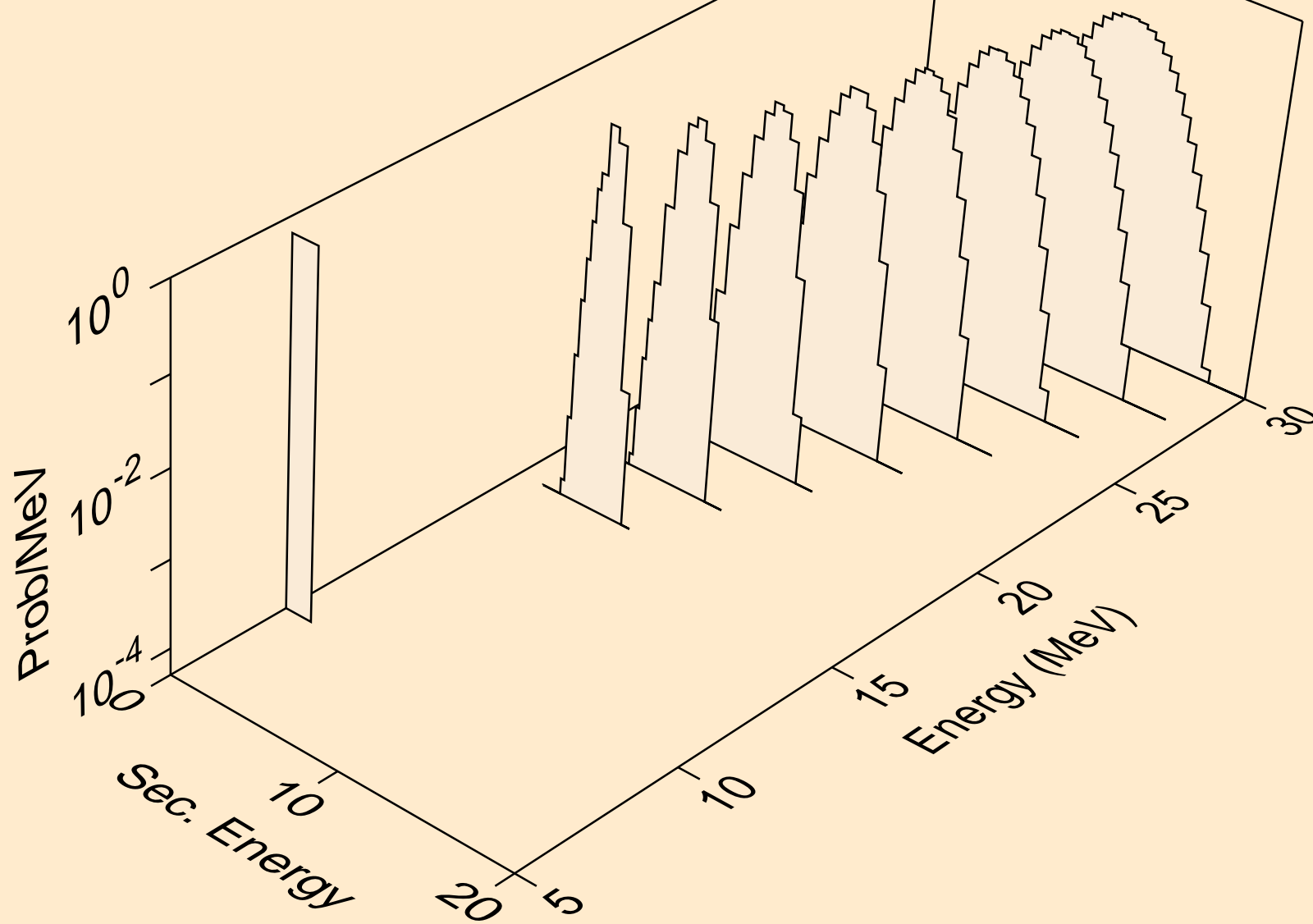

TA169 NEUTRON ACER TENDL-2024 LIBRARY; T=0.K
he3s from (n,x)

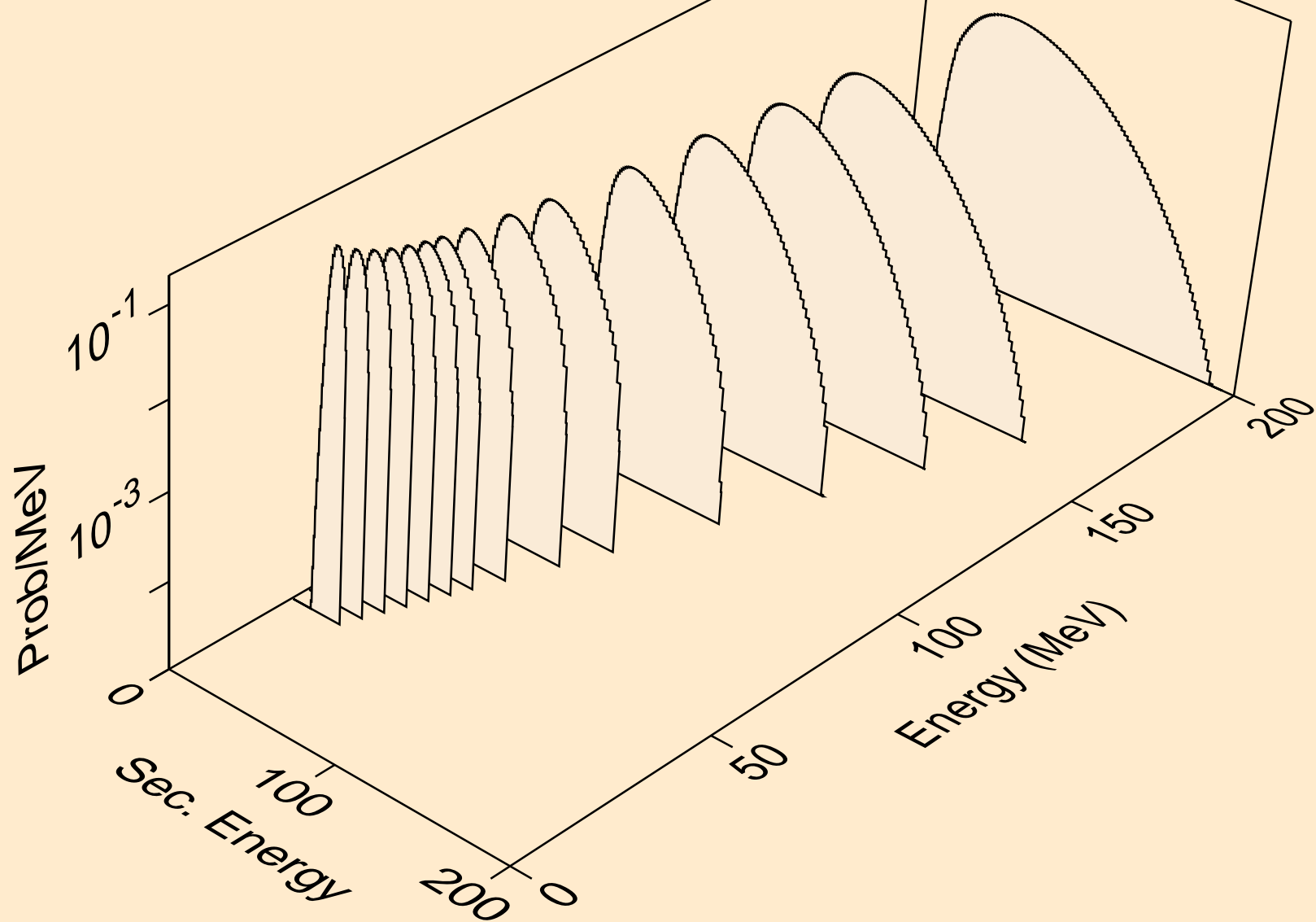

TA169 NEUTRON ACER TENDL-2024 LIBRARY; T=0.K
he3s from (n,n*)he3

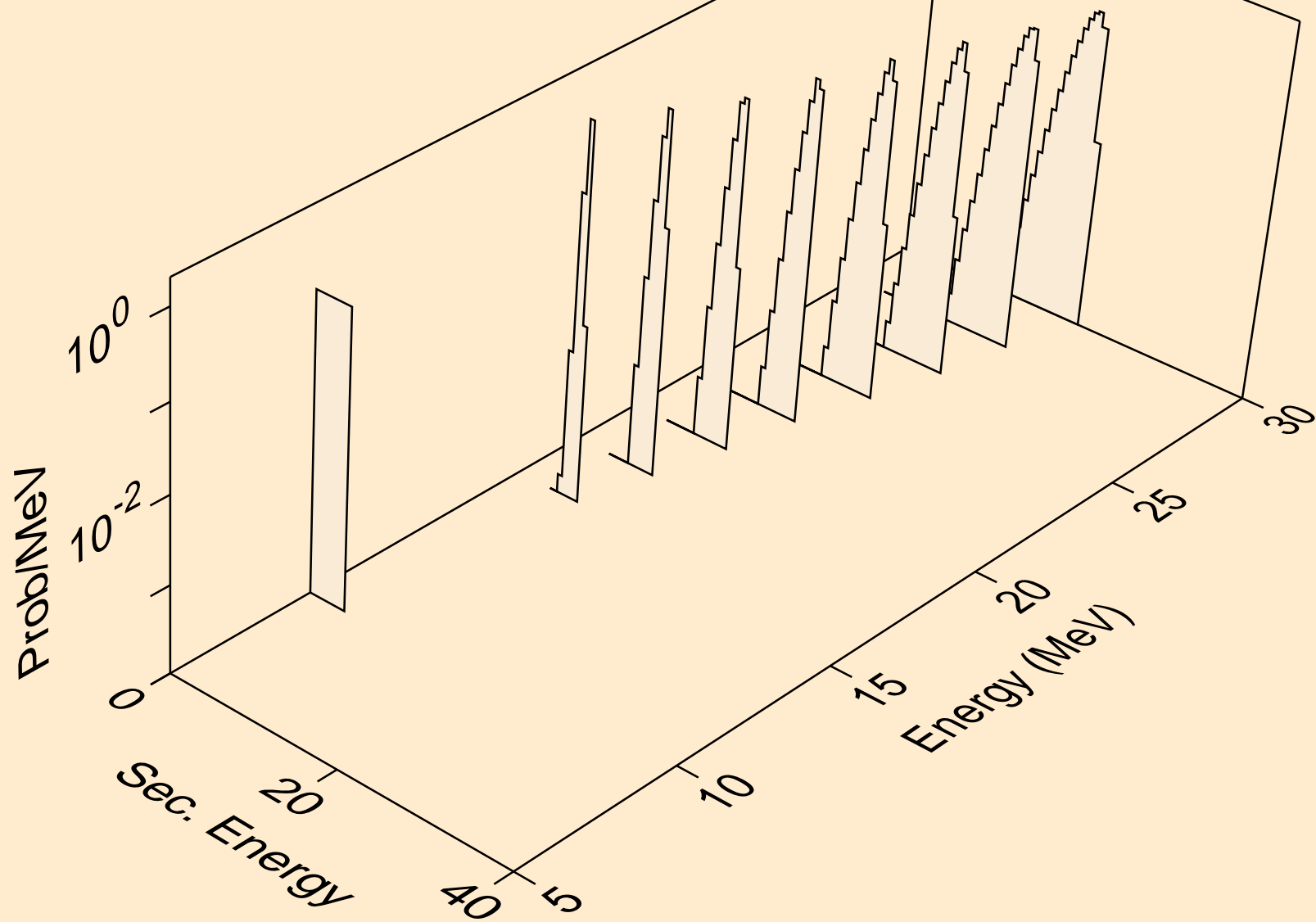

TA169 NEUTRON ACER TENDL-2024 LIBRARY; T=0.K
he3s from (n,he3)

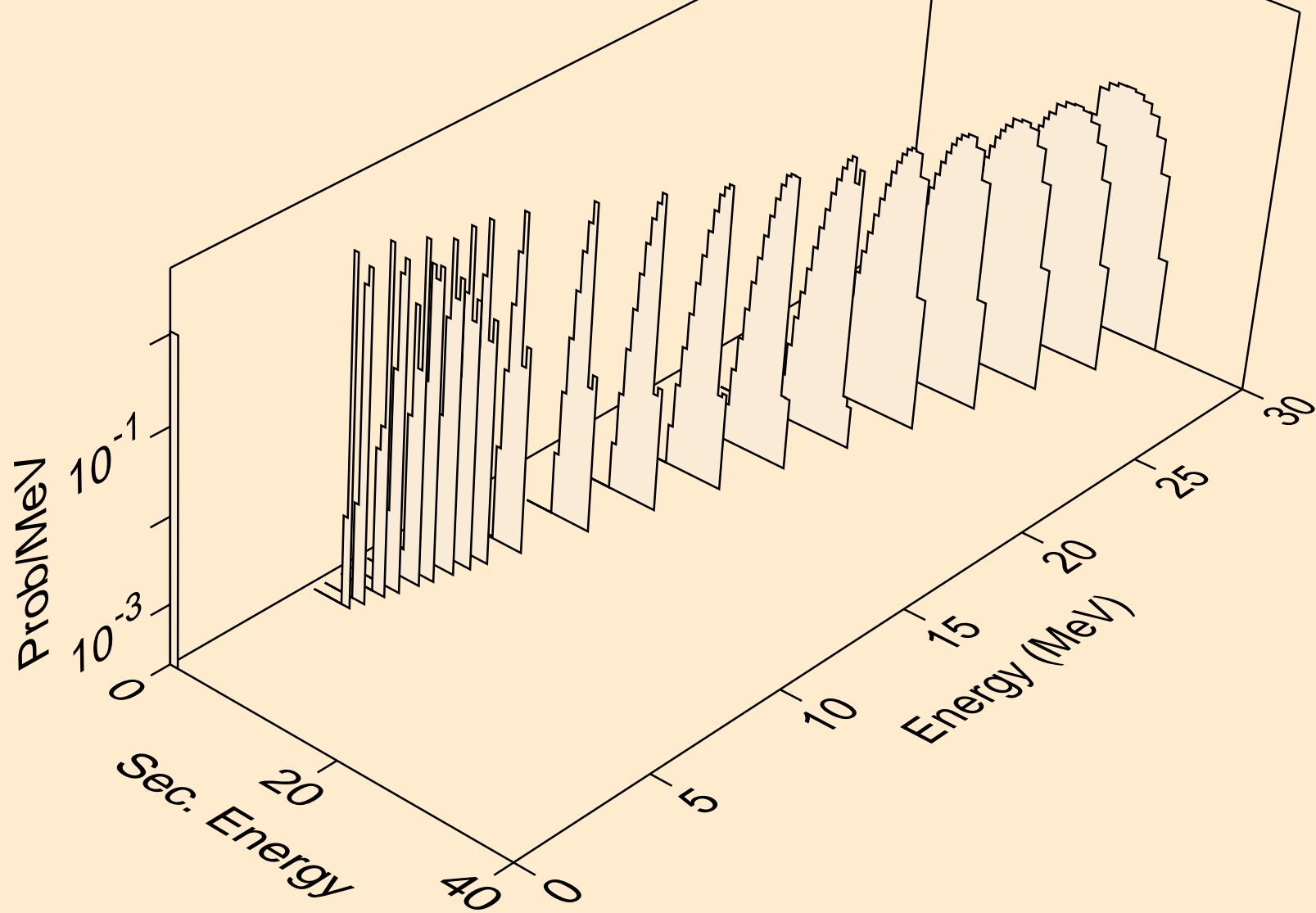

TA169 NEUTRON ACER TENDL-2024 LIBRARY; T=0.K
alphas from (n,x)

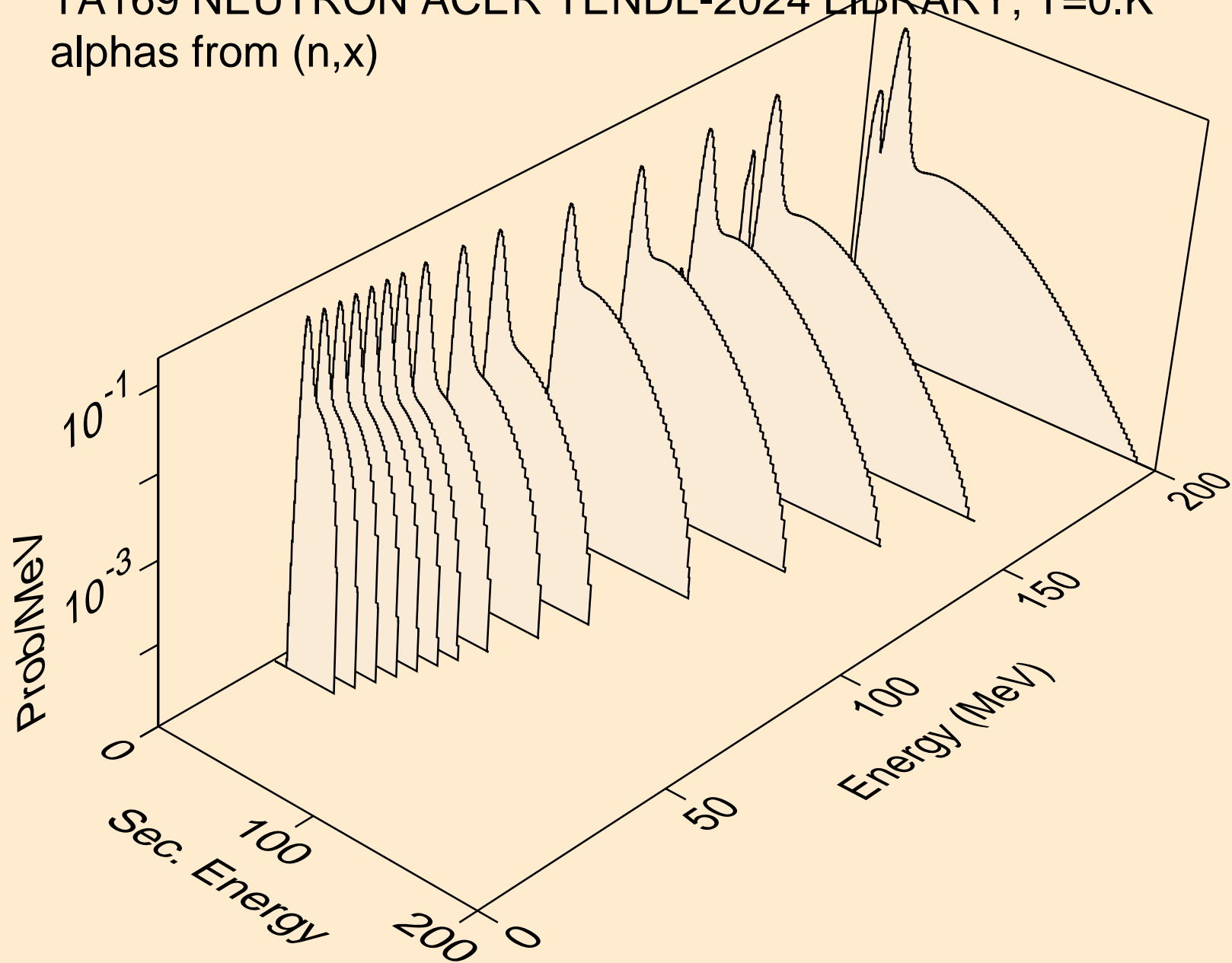

TA169 NEUTRON ACER TENDL-2024 LIBRARY; T=0.K
alphas from (n,n*)a

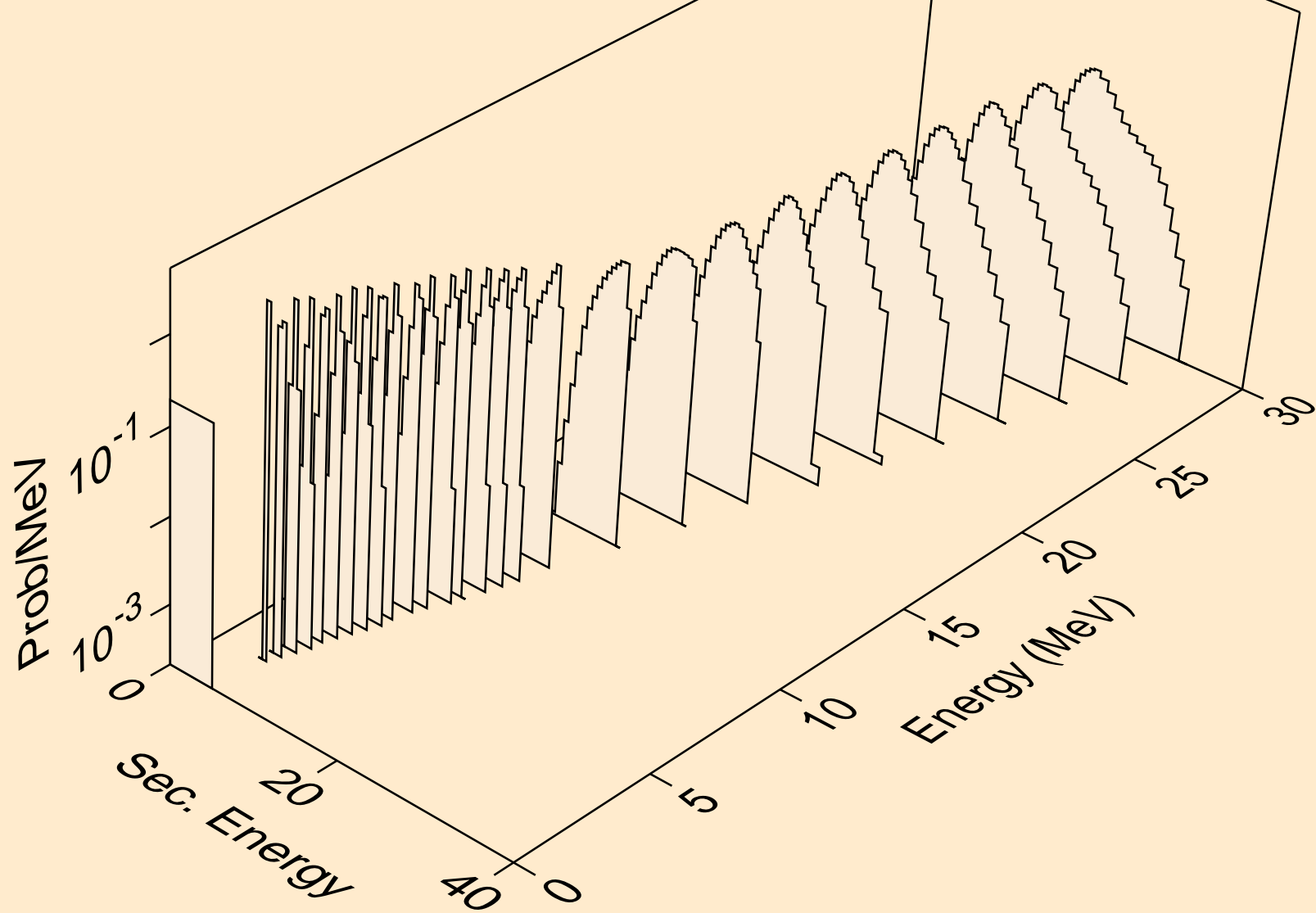

TA169 NEUTRON ACER TENDL-2024 LIBRARY; T=0.K
alphas from (n,2n)a

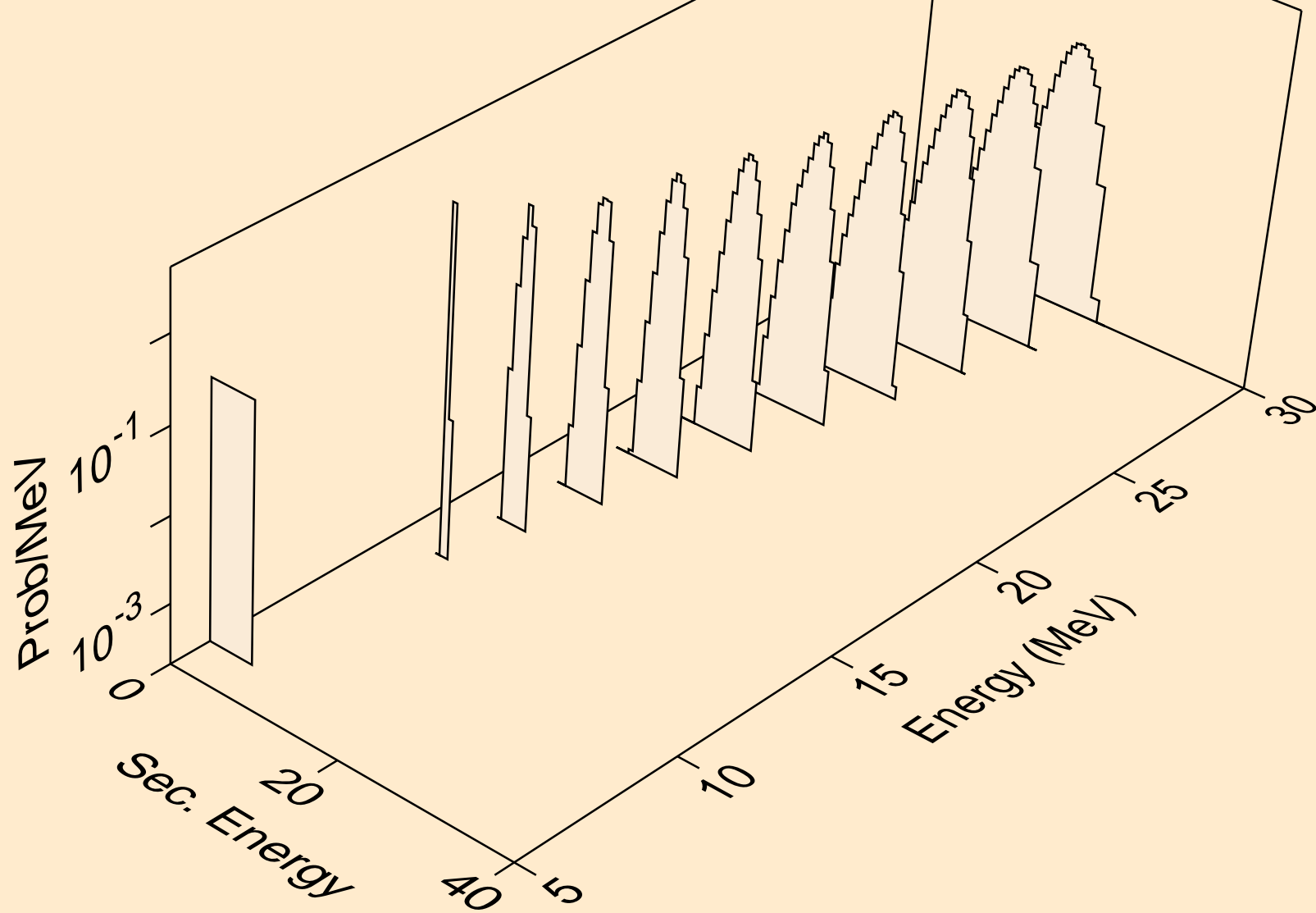

TA169 NEUTRON ACER TENDL-2024 LIBRARY; T=0.K
alphas from (n,3n)a

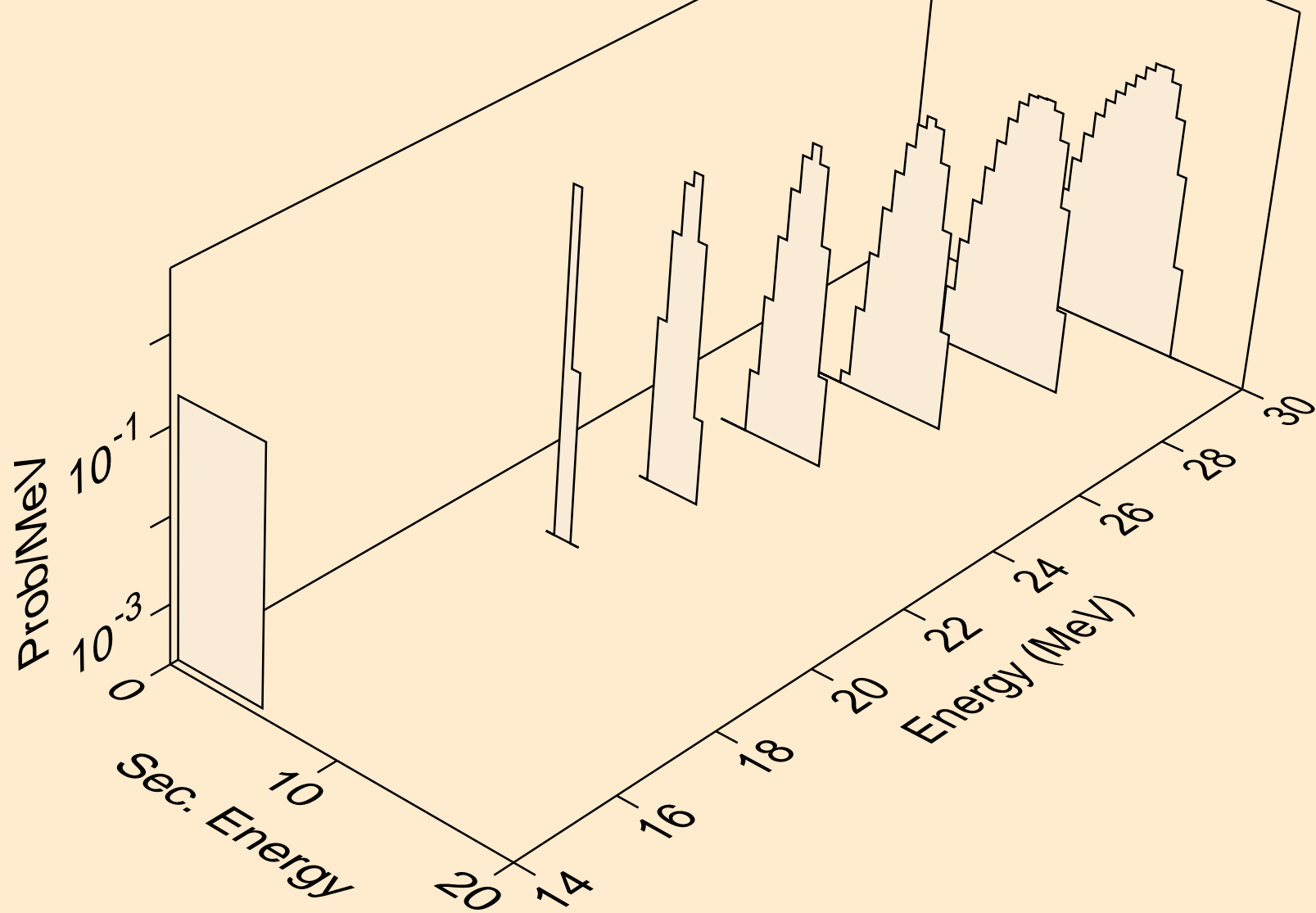

TA169 NEUTRON ACER TENDL-2024 LIBRARY; T=0.K
alphas from (n,n*)2a

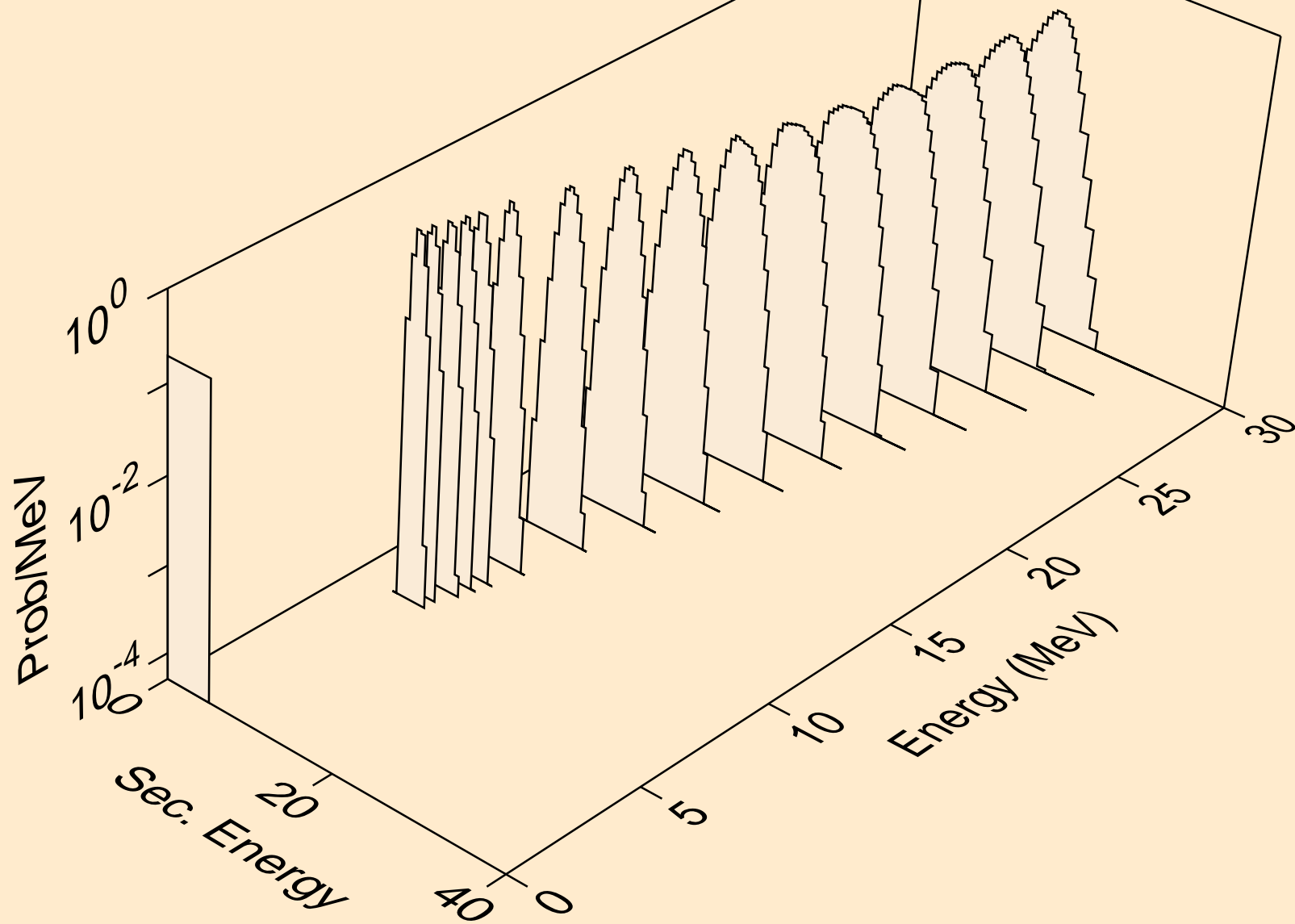

TA169 NEUTRON ACER TENDL-2024 LIBRARY; T=0.K
alphas from (n,2n)2a

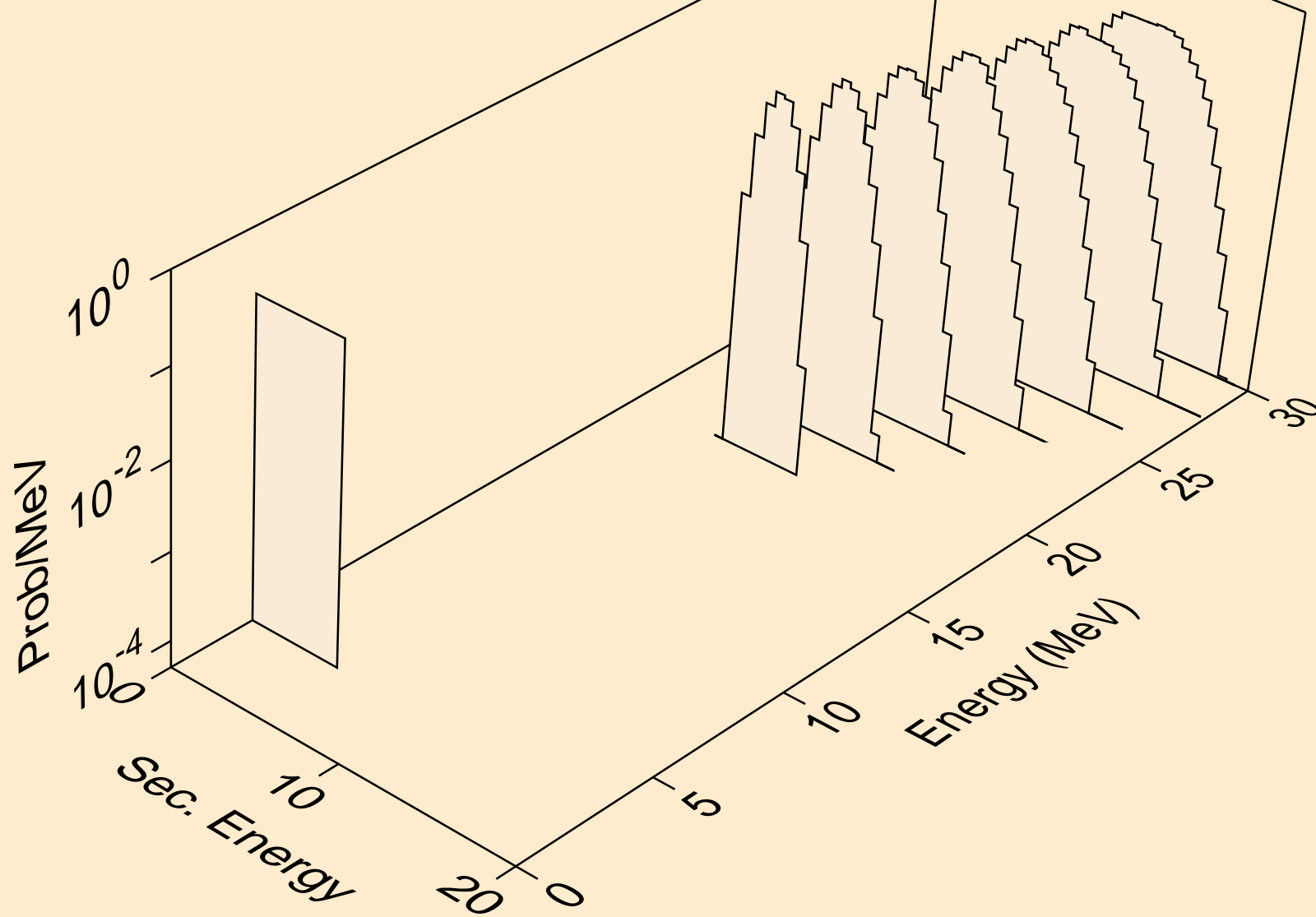

TA169 NEUTRON ACER TENDL-2024 LIBRARY; T=0.K
alphas from (n,npa)

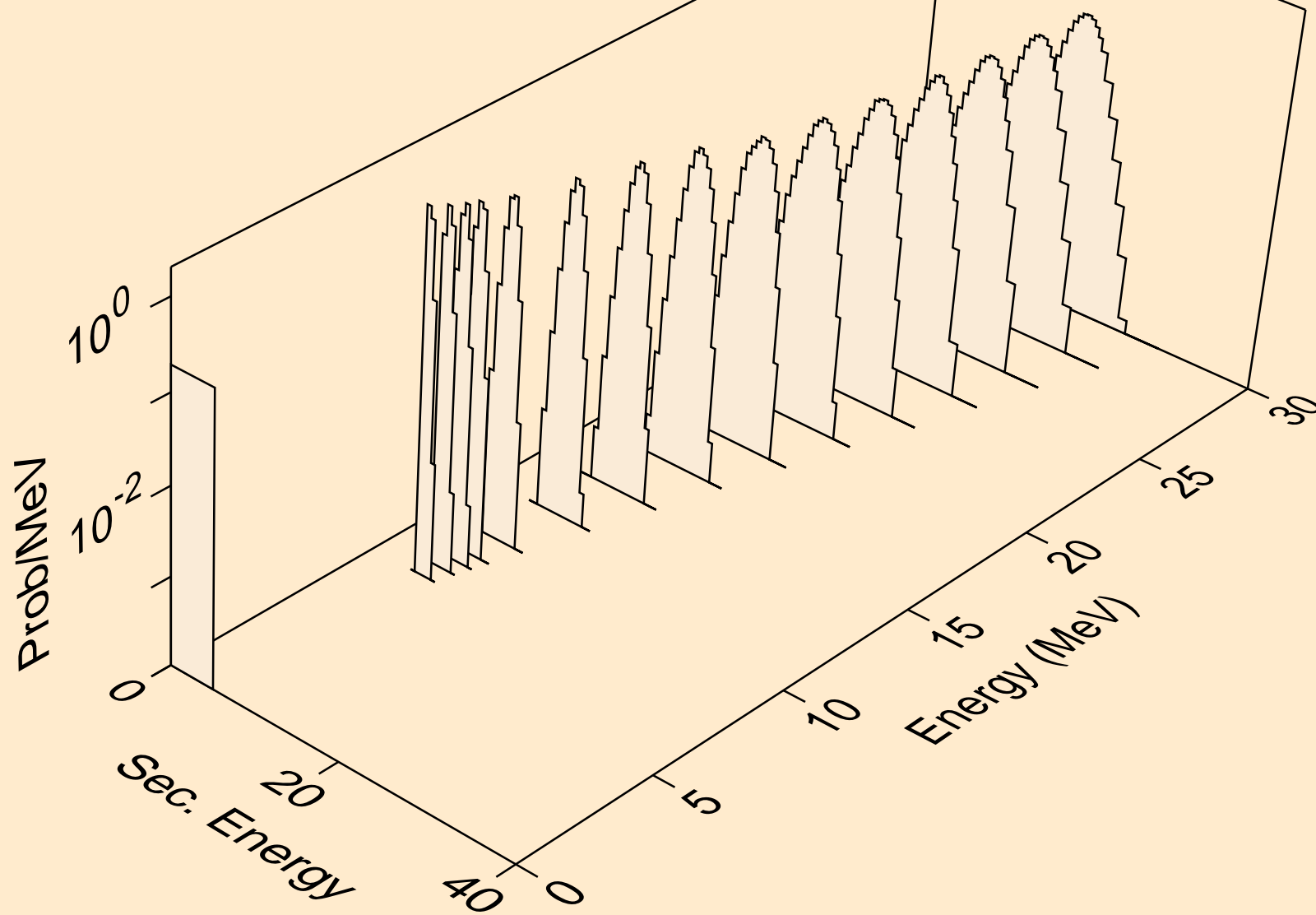

TA169 NEUTRON ACER TENDL-2024 LIBRARY; T=0.K
alphas from (n,a)

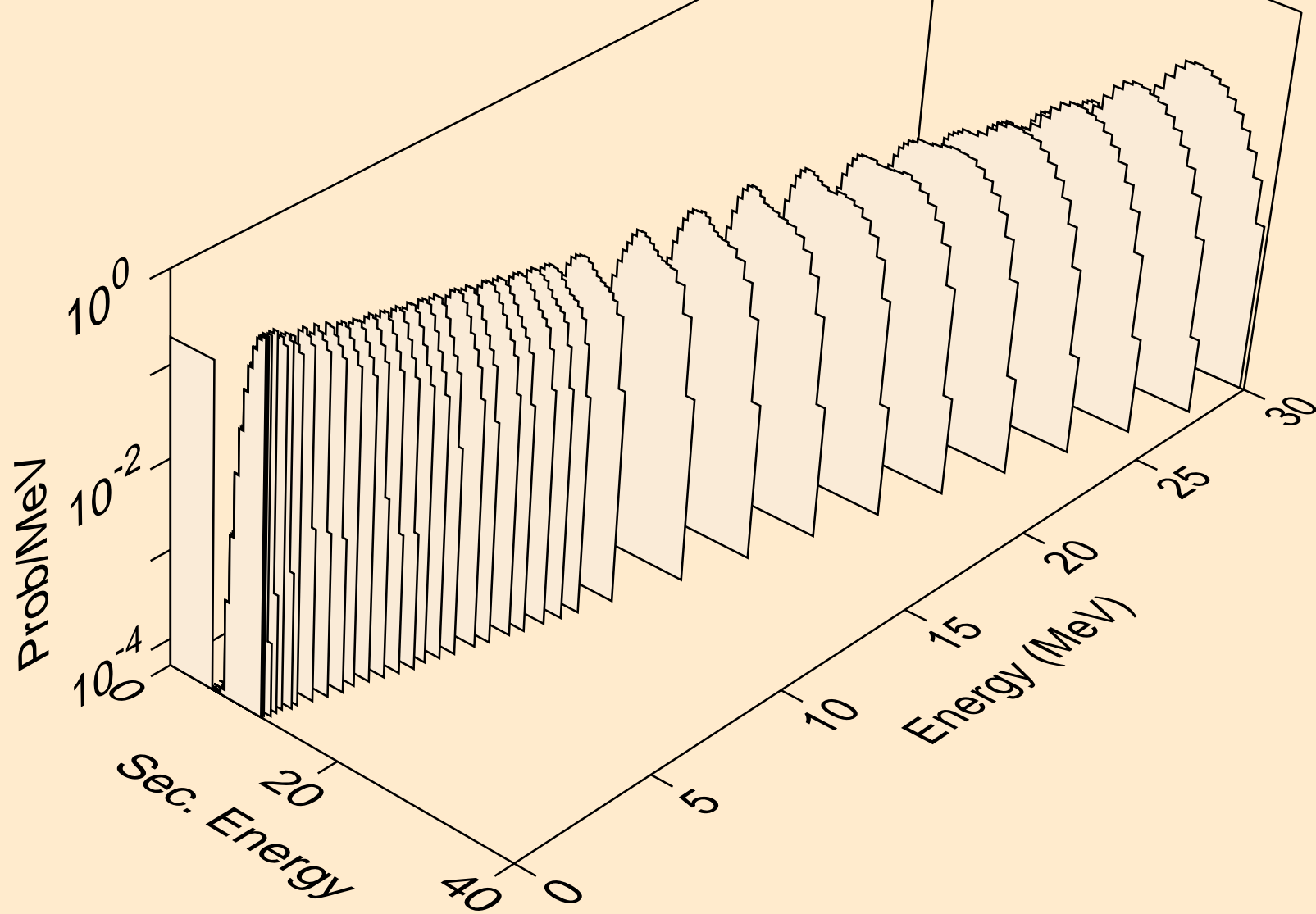

TA169 NEUTRON ACER TENDL-2024 LIBRARY; T=0.K
alphas from (n,2a)

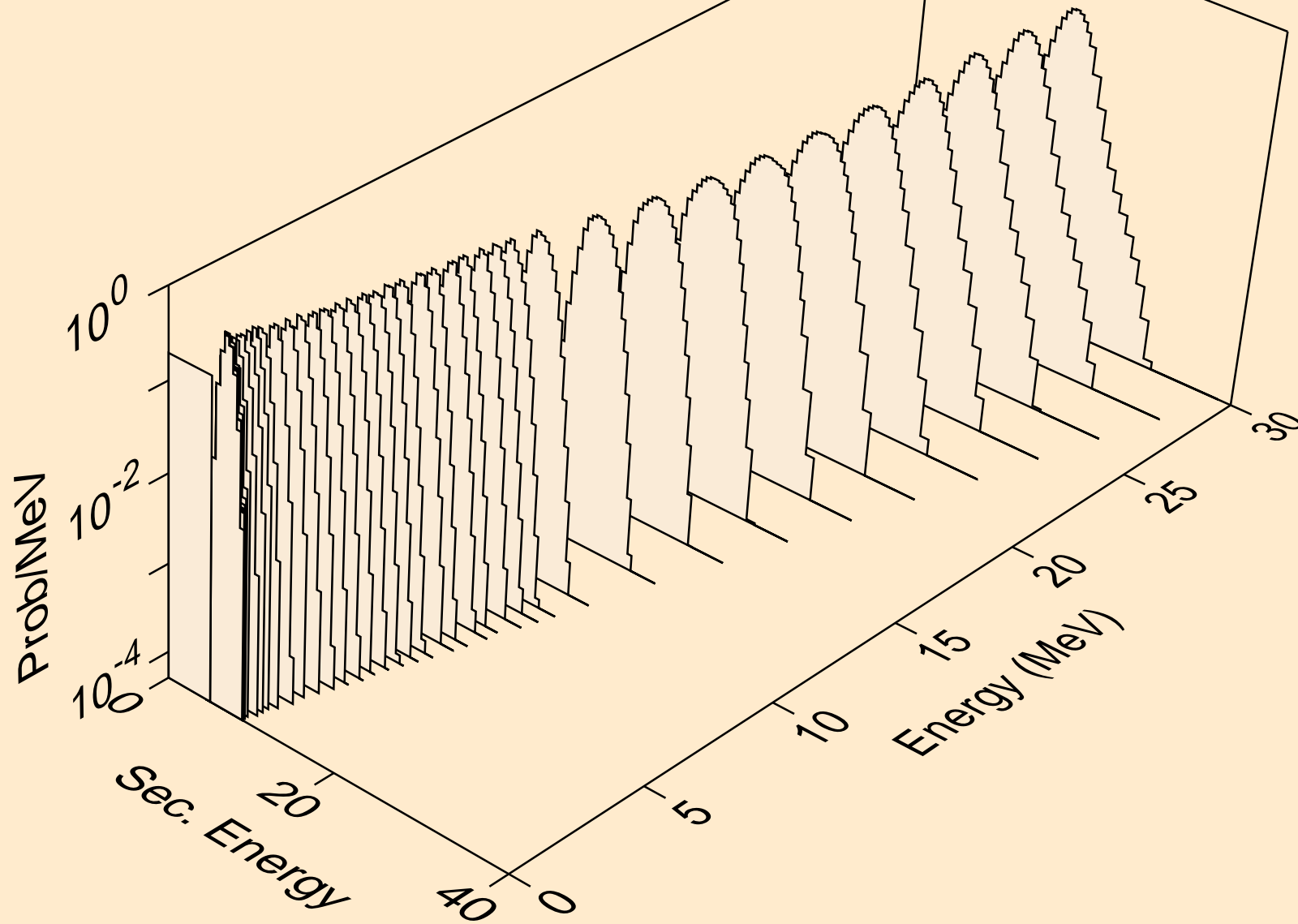

TA169 NEUTRON ACER TENDL-2024 LIBRARY; T=0.K
alphas from (n,pa)

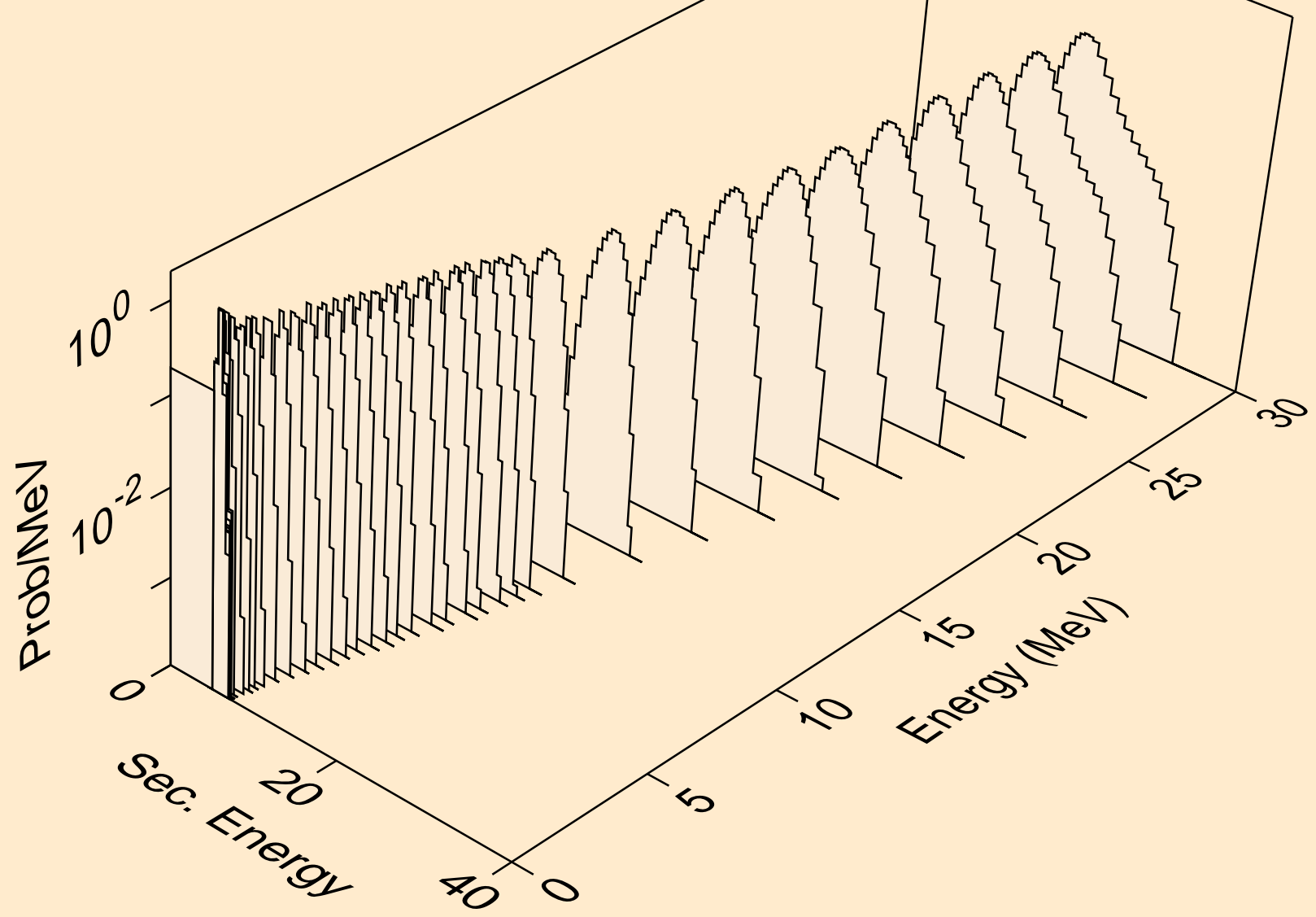

TA169 NEUTRON ACER TENDL-2024 LIBRARY; T=0.K
alphas from (n,da)

