

TC089 NEUTRON ACER TENDL-2024 LIBRARY; T=0.K
Principal cross sections

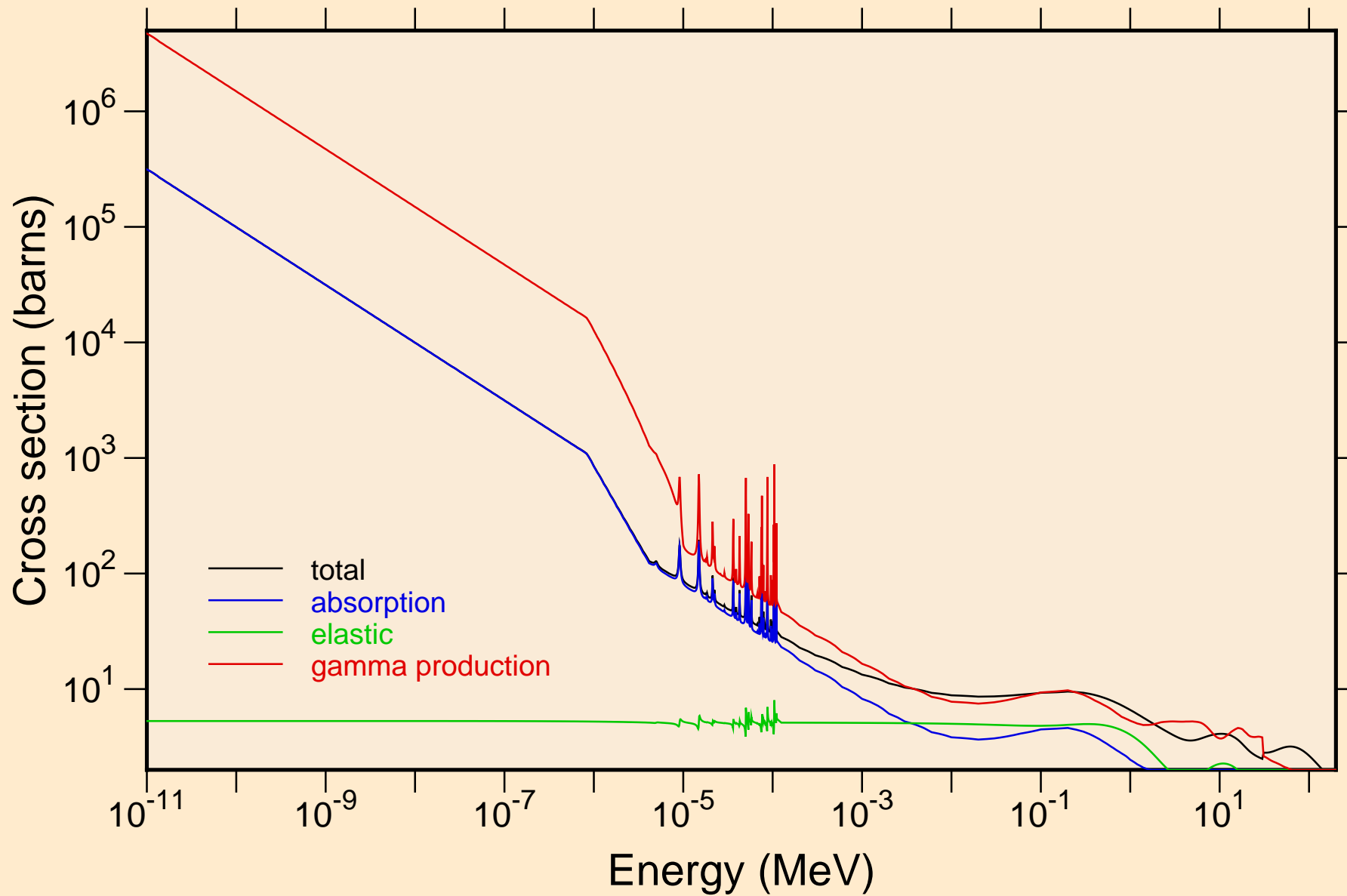

TC089 NEUTRON ACER TENDL-2024 LIBRARY; T=0.K
resonance total cross section

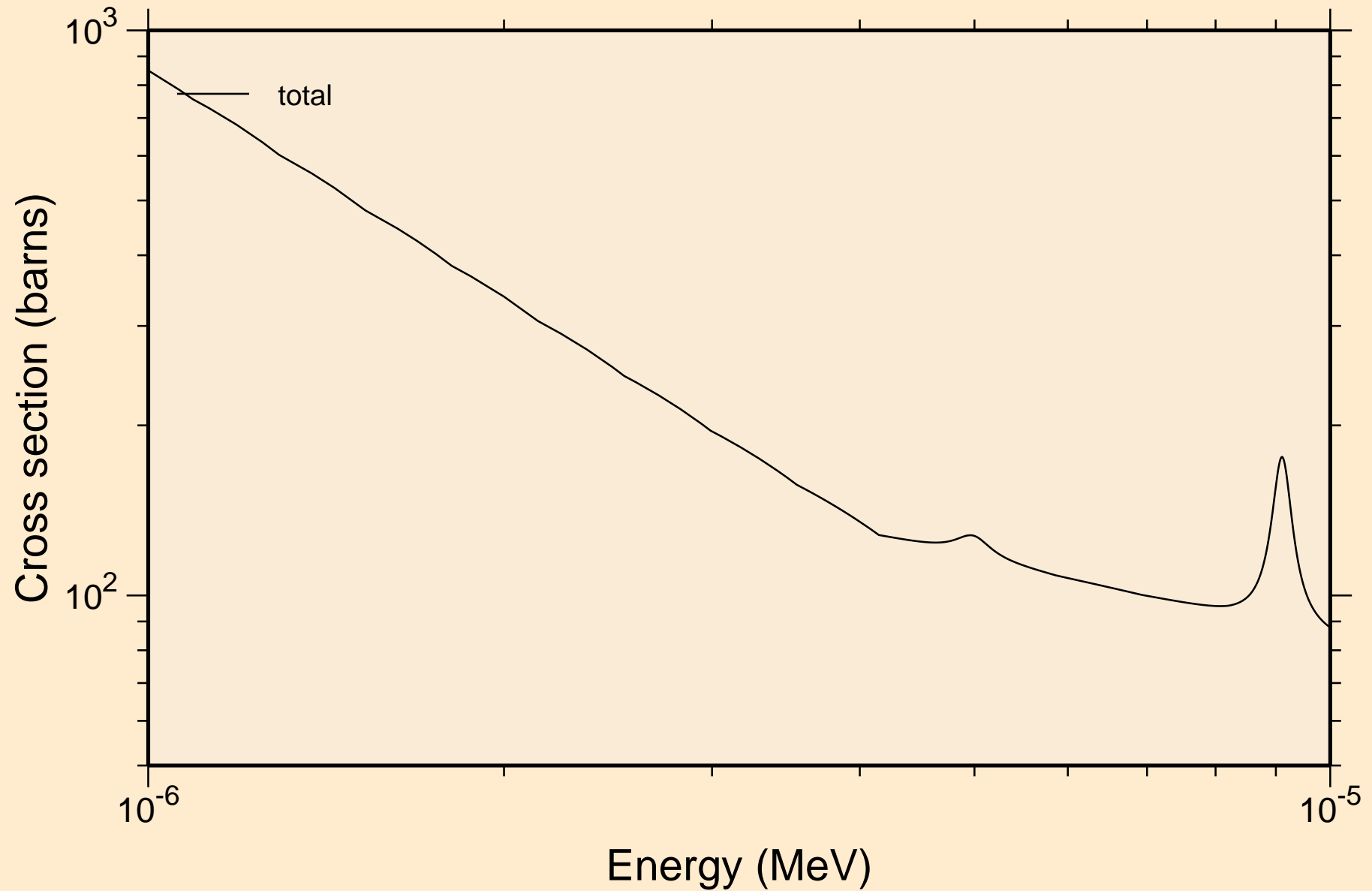

TC089 NEUTRON ACER TENDL-2024 LIBRARY; T=0.K
resonance total cross section

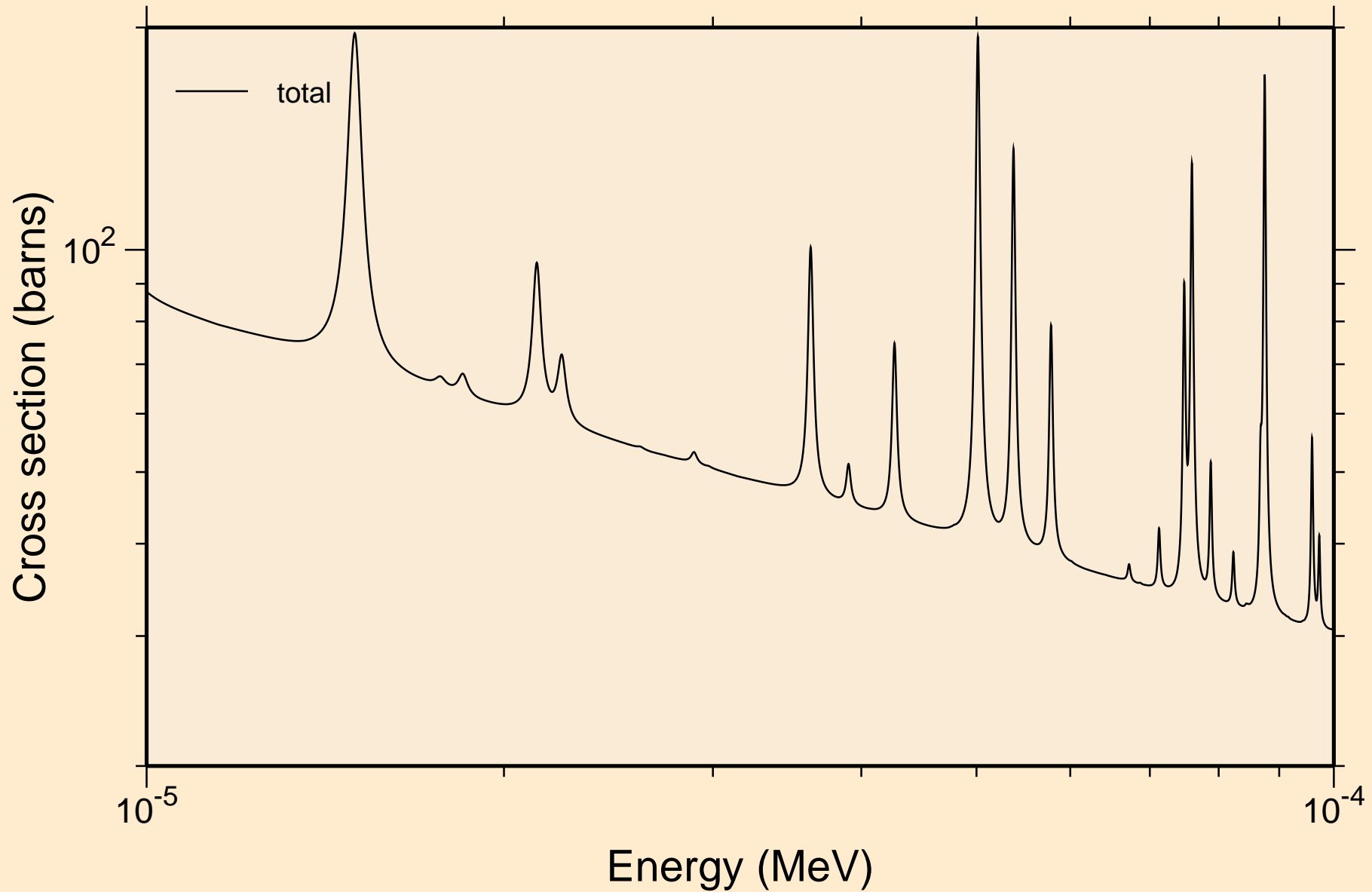

TC089 NEUTRON ACER TENDL-2024 LIBRARY; T=0.K
resonance total cross section

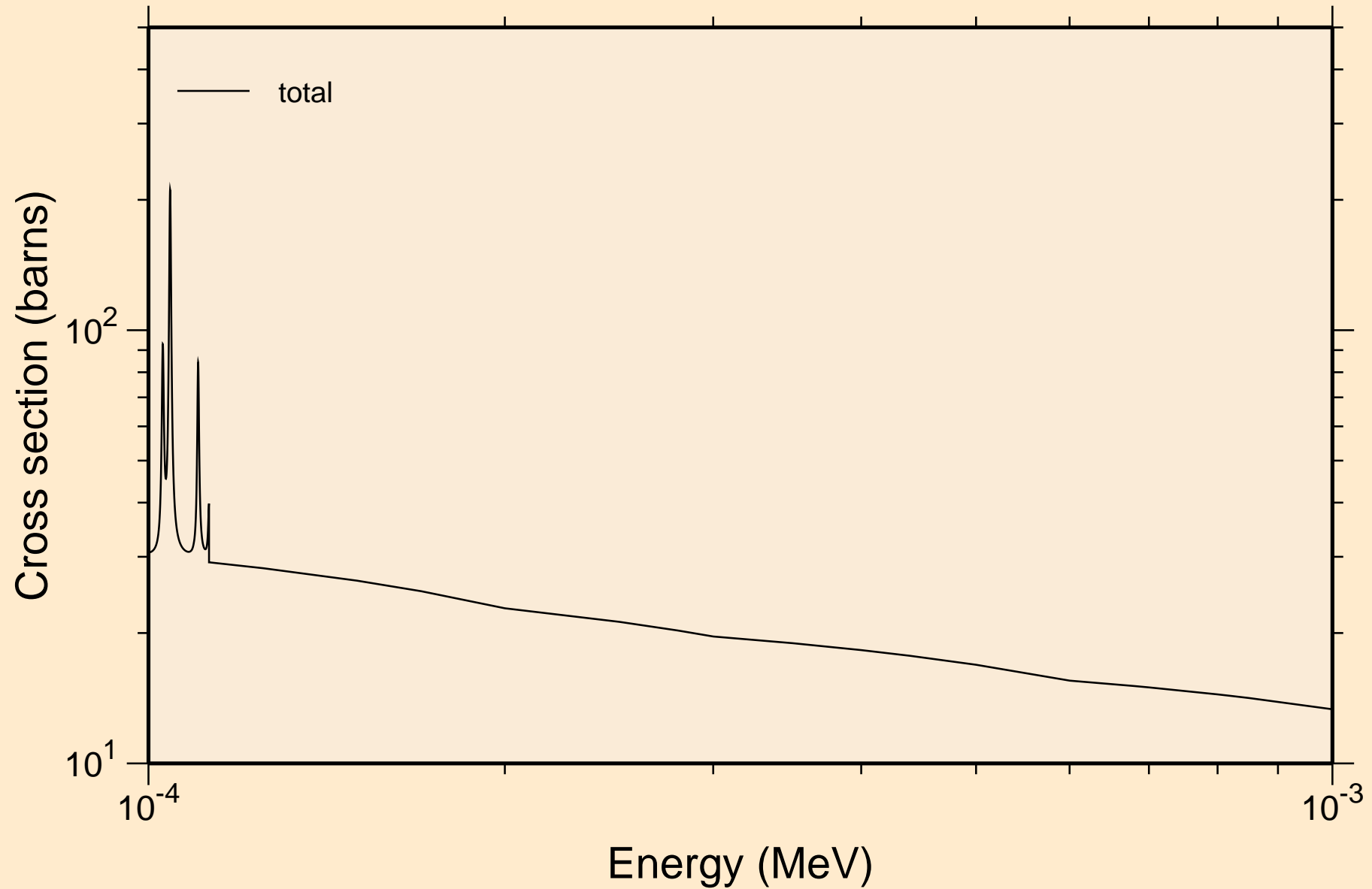

TC089 NEUTRON ACER TENDL-2024 LIBRARY; T=0.K
resonance total cross section

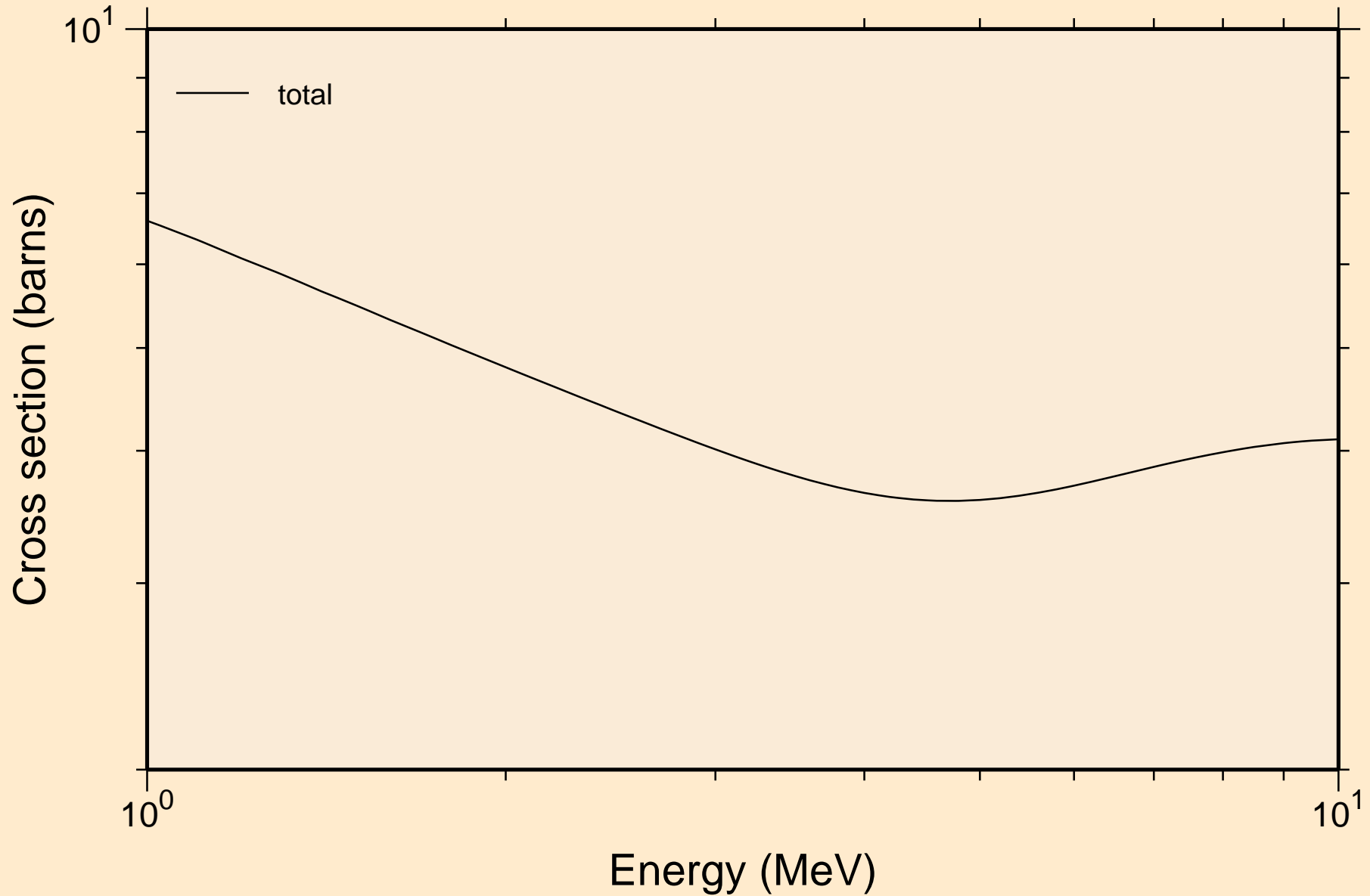

TC089 NEUTRON ACER TENDL-2024 LIBRARY; T=0.K
resonance absorption cross sections

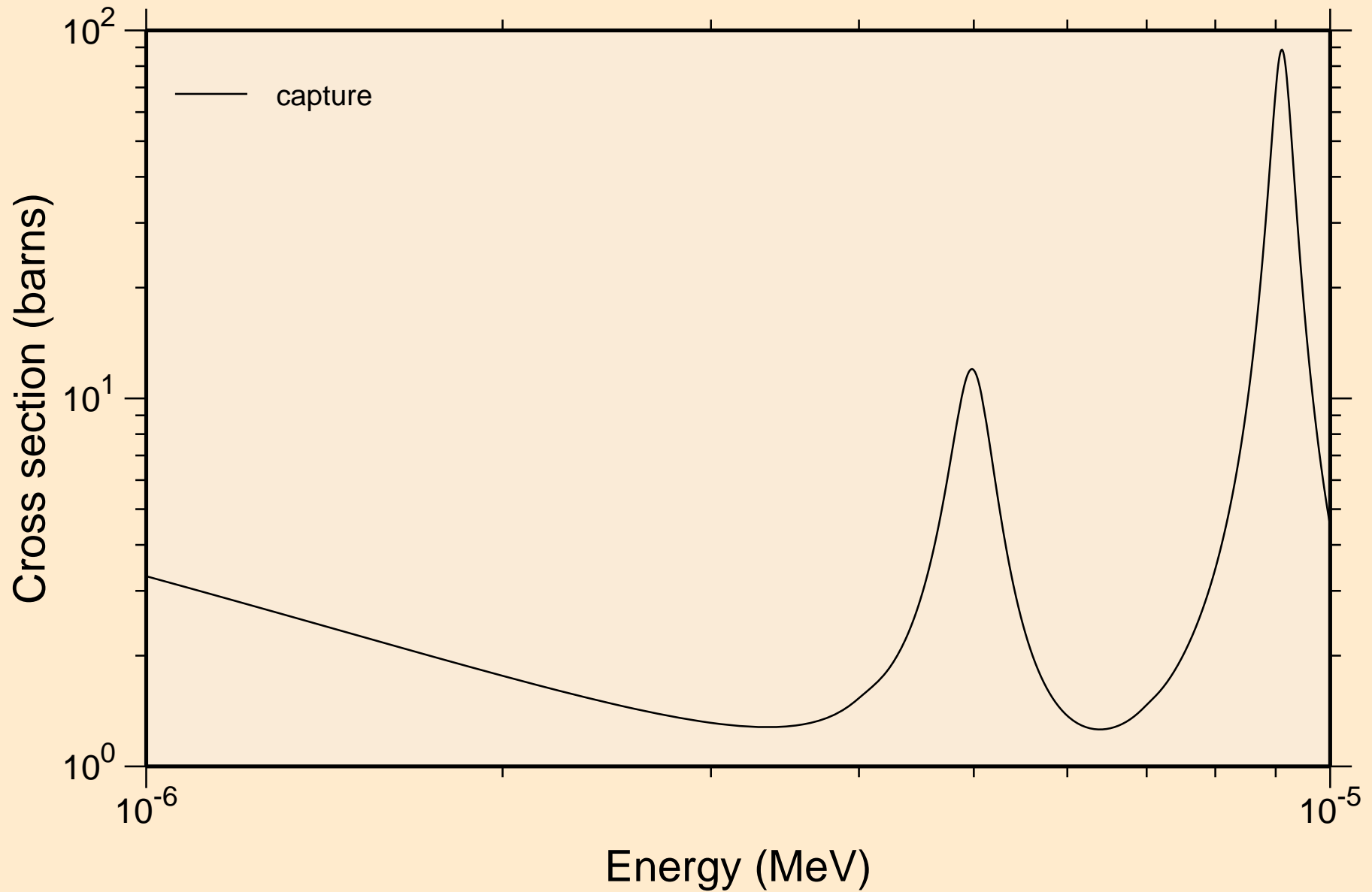

TC089 NEUTRON ACER TENDL-2024 LIBRARY; T=0.K
resonance absorption cross sections

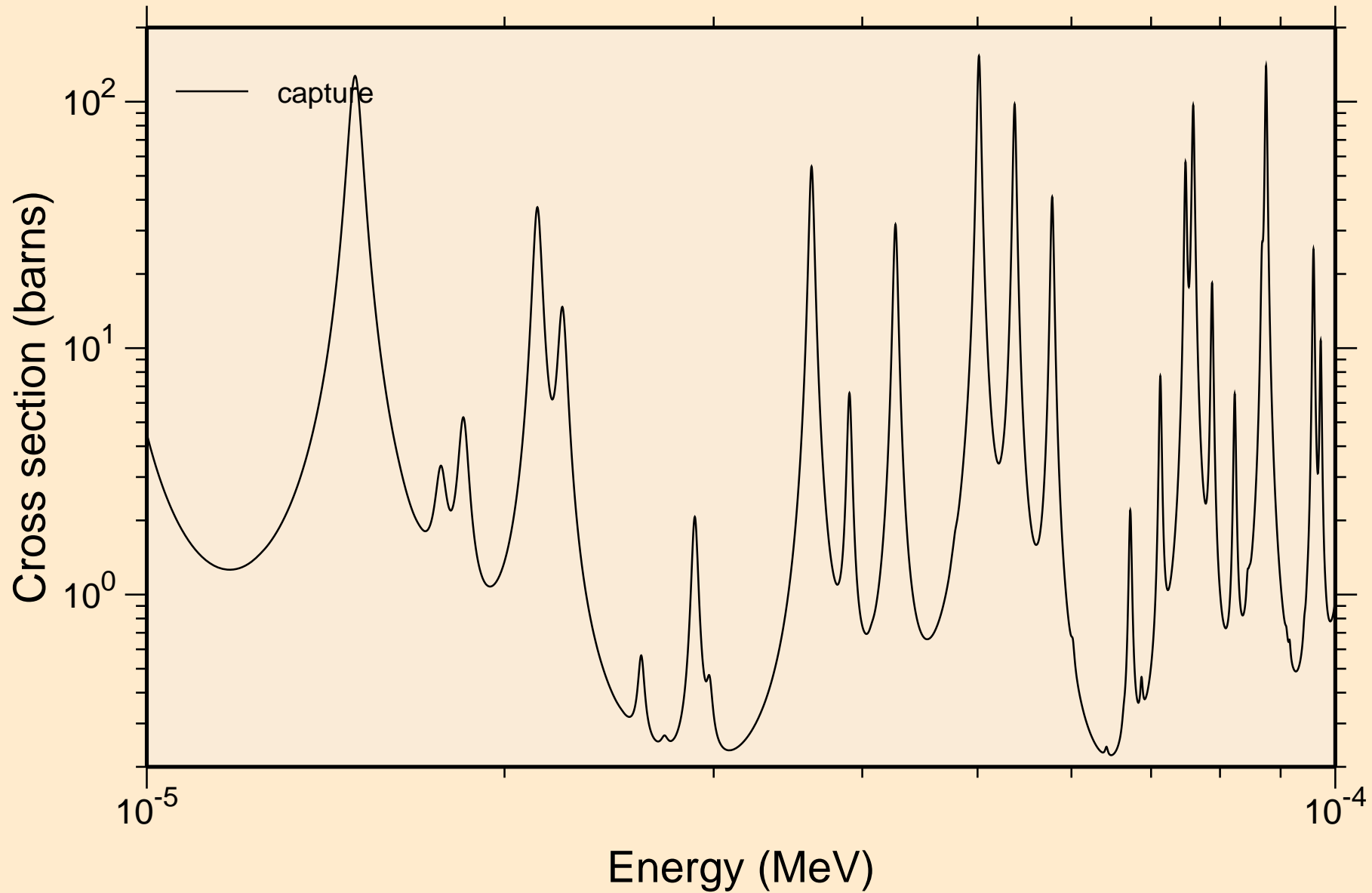

TC089 NEUTRON ACER TENDL-2024 LIBRARY; T=0.K
resonance absorption cross sections

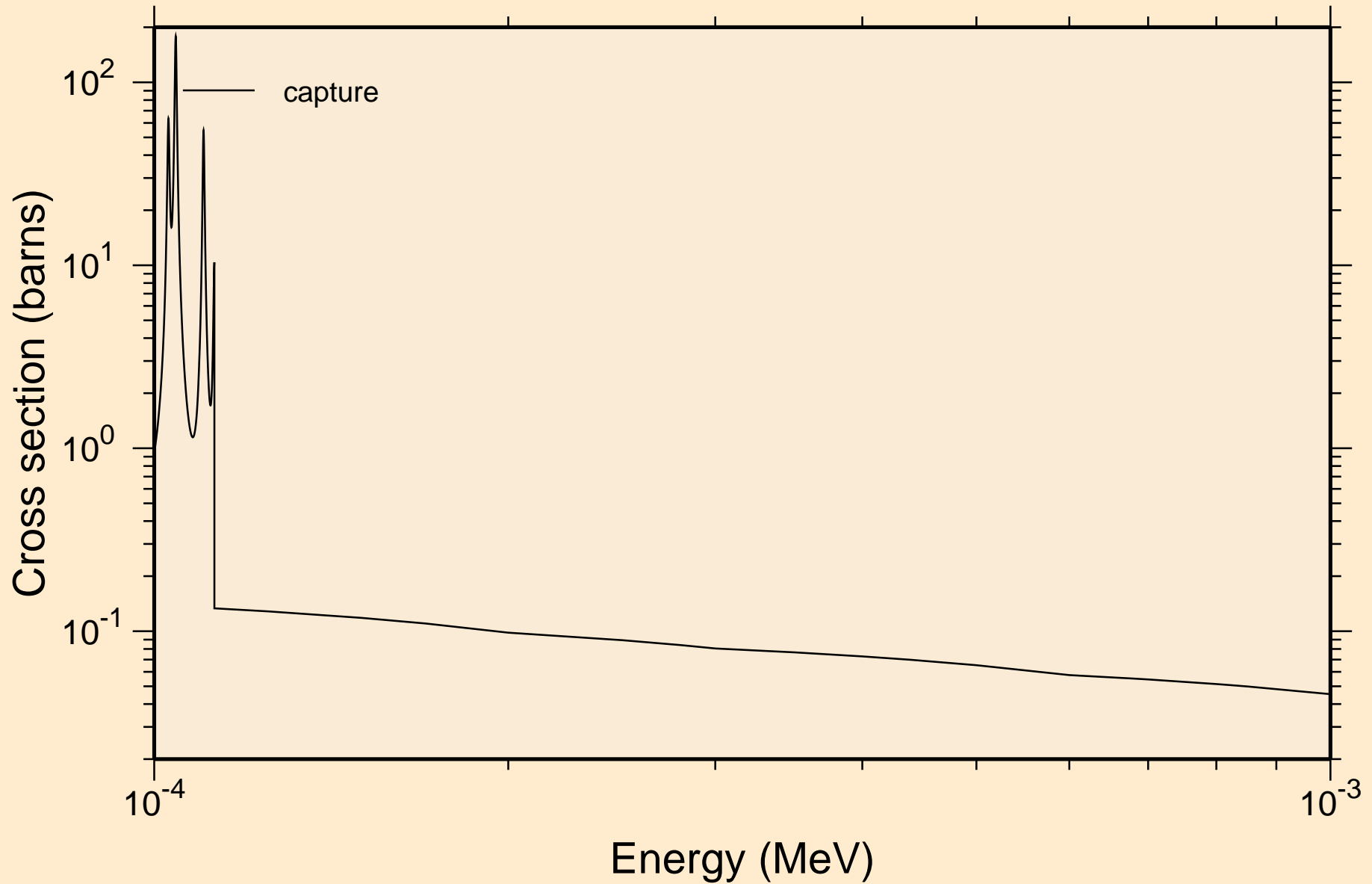

TC089 NEUTRON ACER TENDL-2024 LIBRARY; T=0.K
resonance absorption cross sections

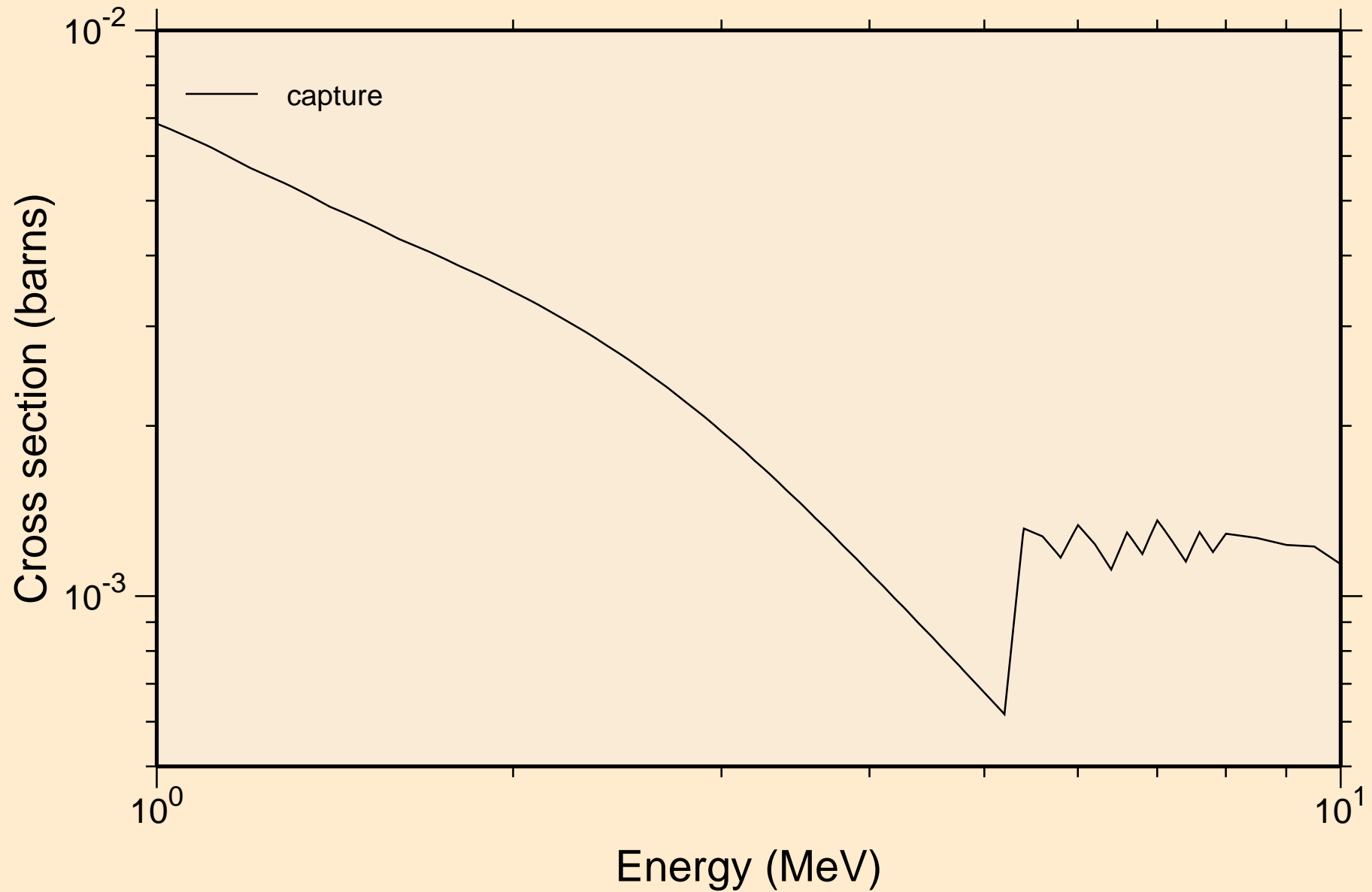

TC089 NEUTRON ACER TENDL-2024 LIBRARY; T=0.K

Heating

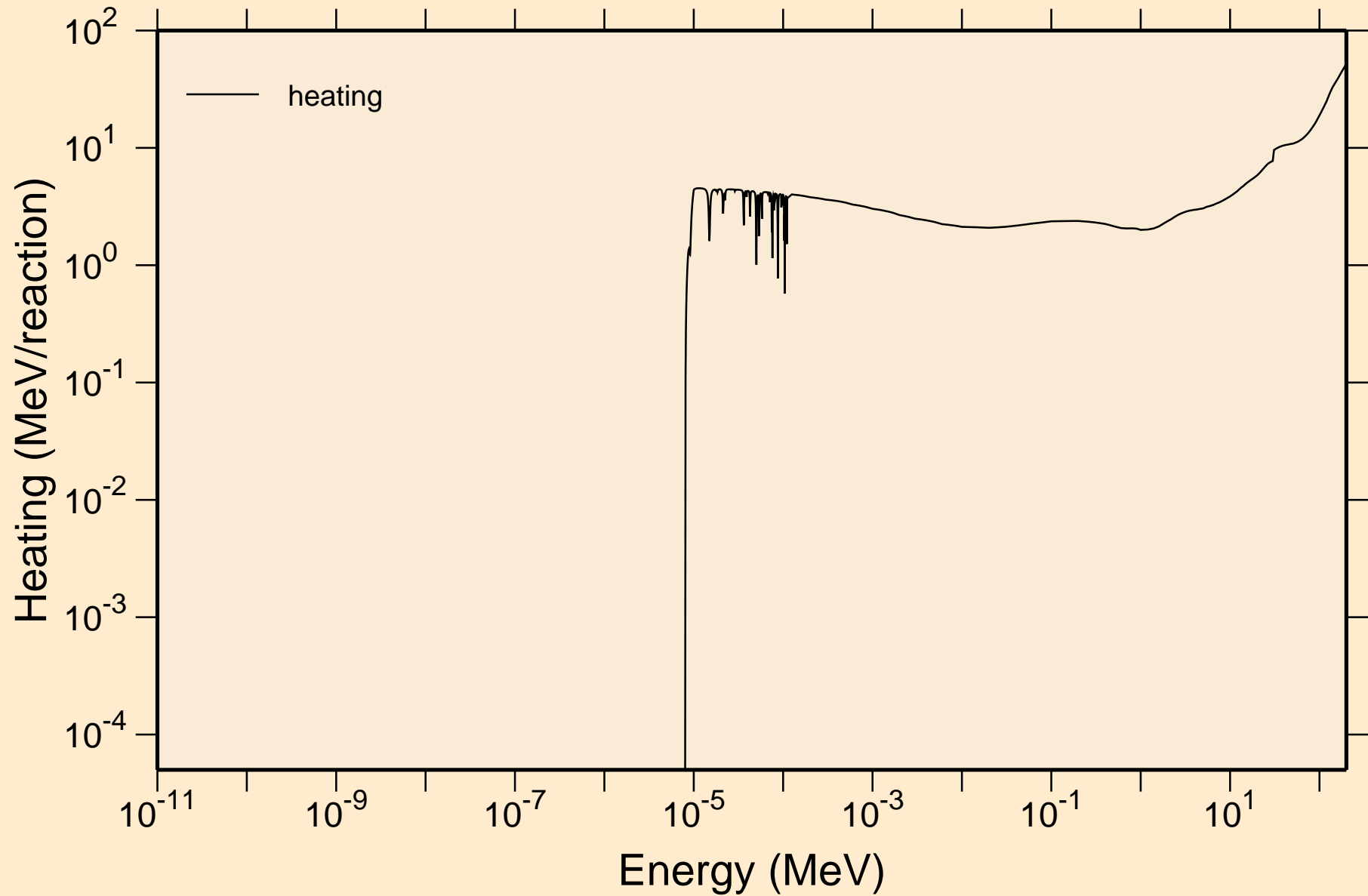

TC089 NEUTRON ACER TENDL-2024 LIBRARY; T=0.K
Damage

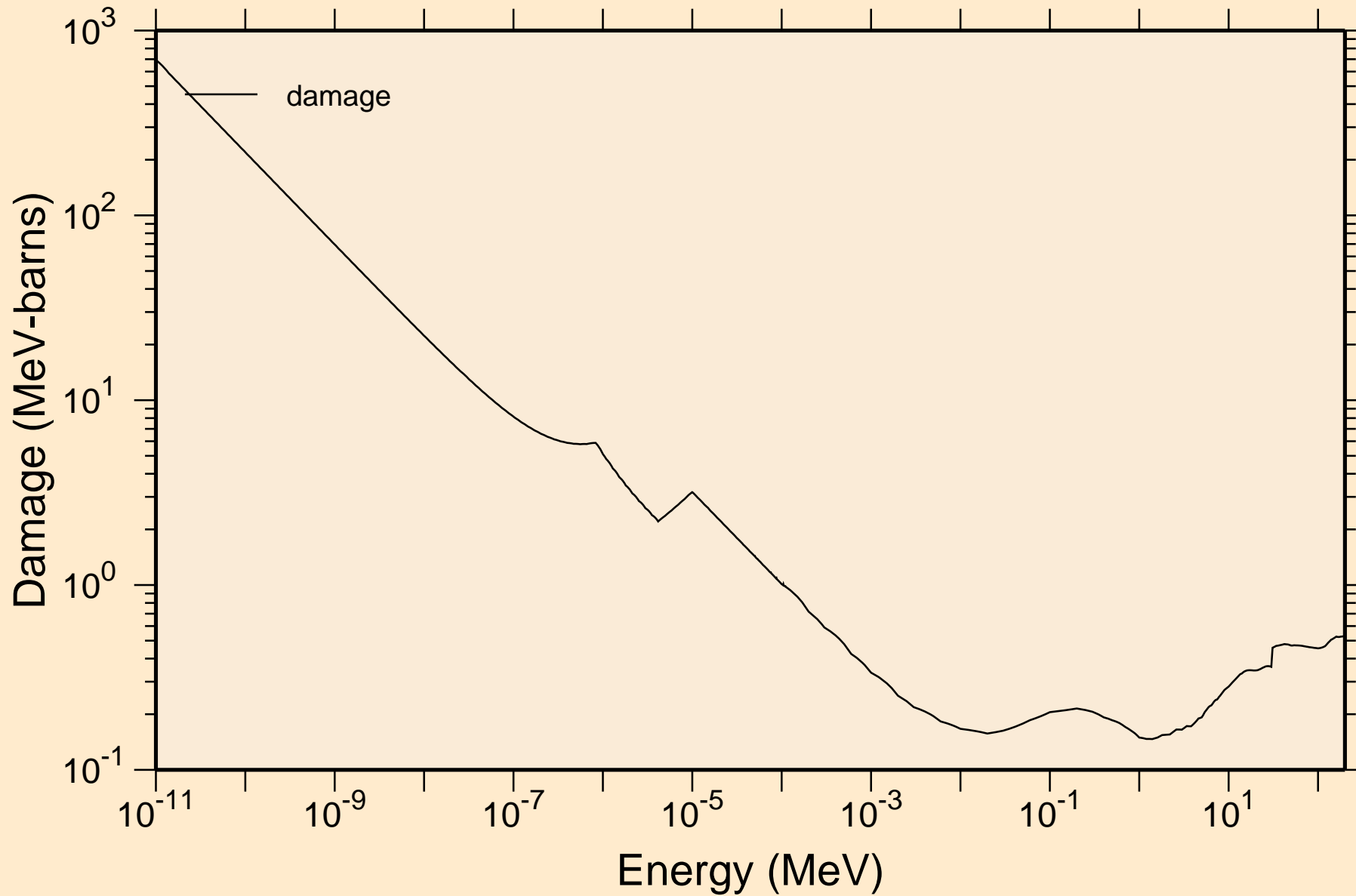

TC089 NEUTRON ACER TENDL-2024 LIBRARY; T=0.K
Non-threshold reactions

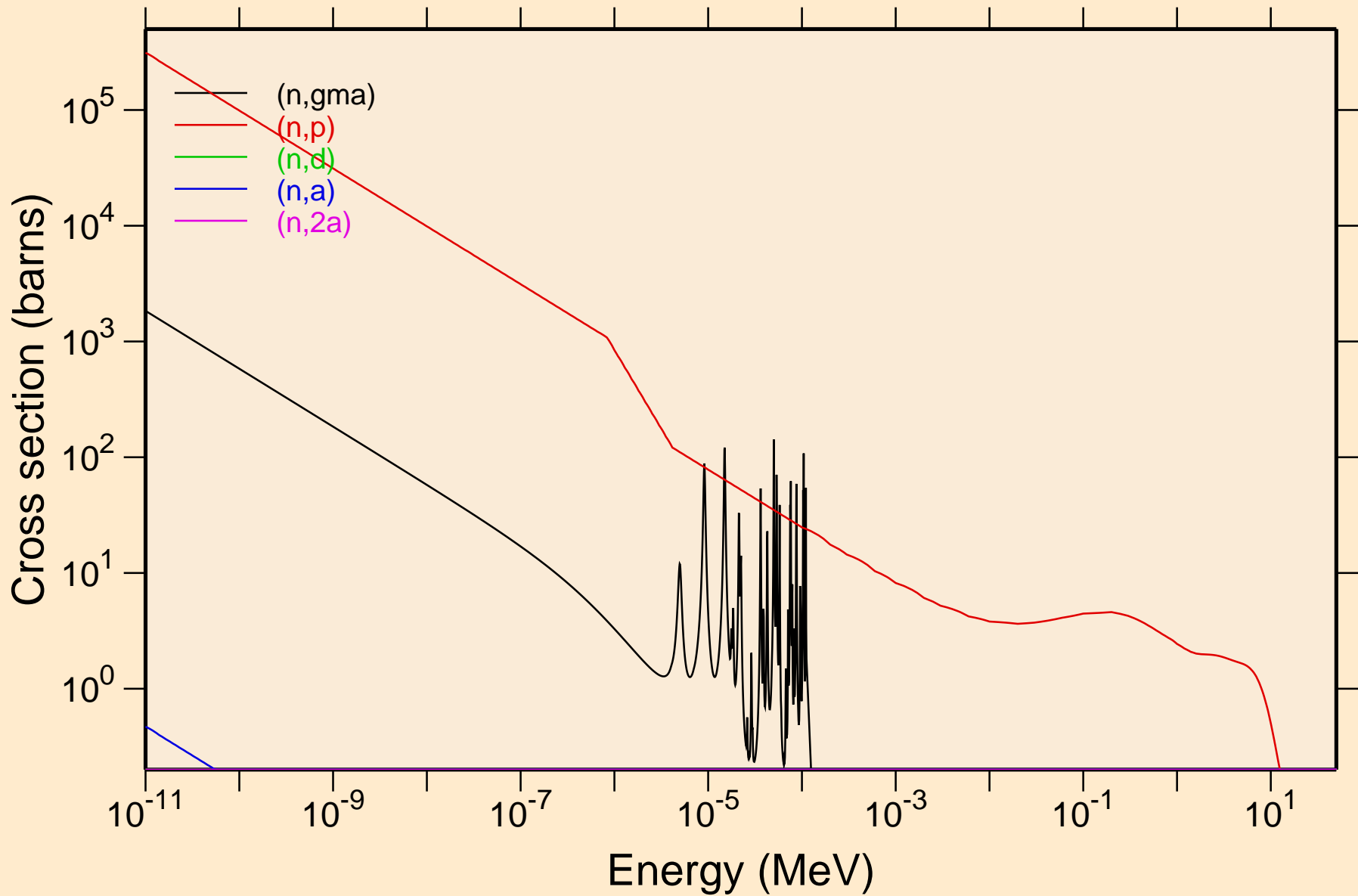

TC089 NEUTRON ACER TENDL-2024 LIBRARY; T=0.K
Non-threshold reactions

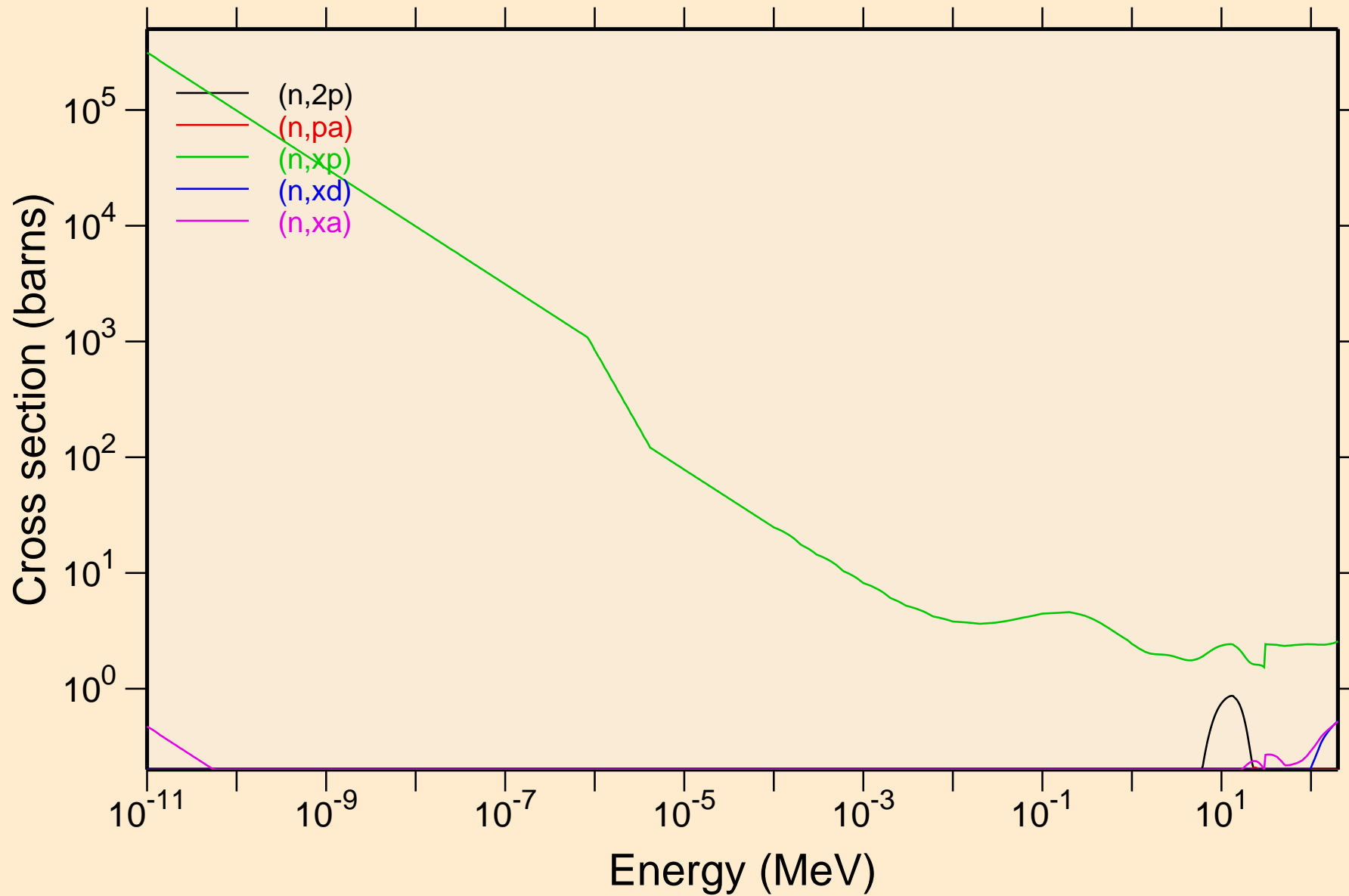

TC089 NEUTRON ACER TENDL-2024 LIBRARY; T=0.K

Principal cross sections

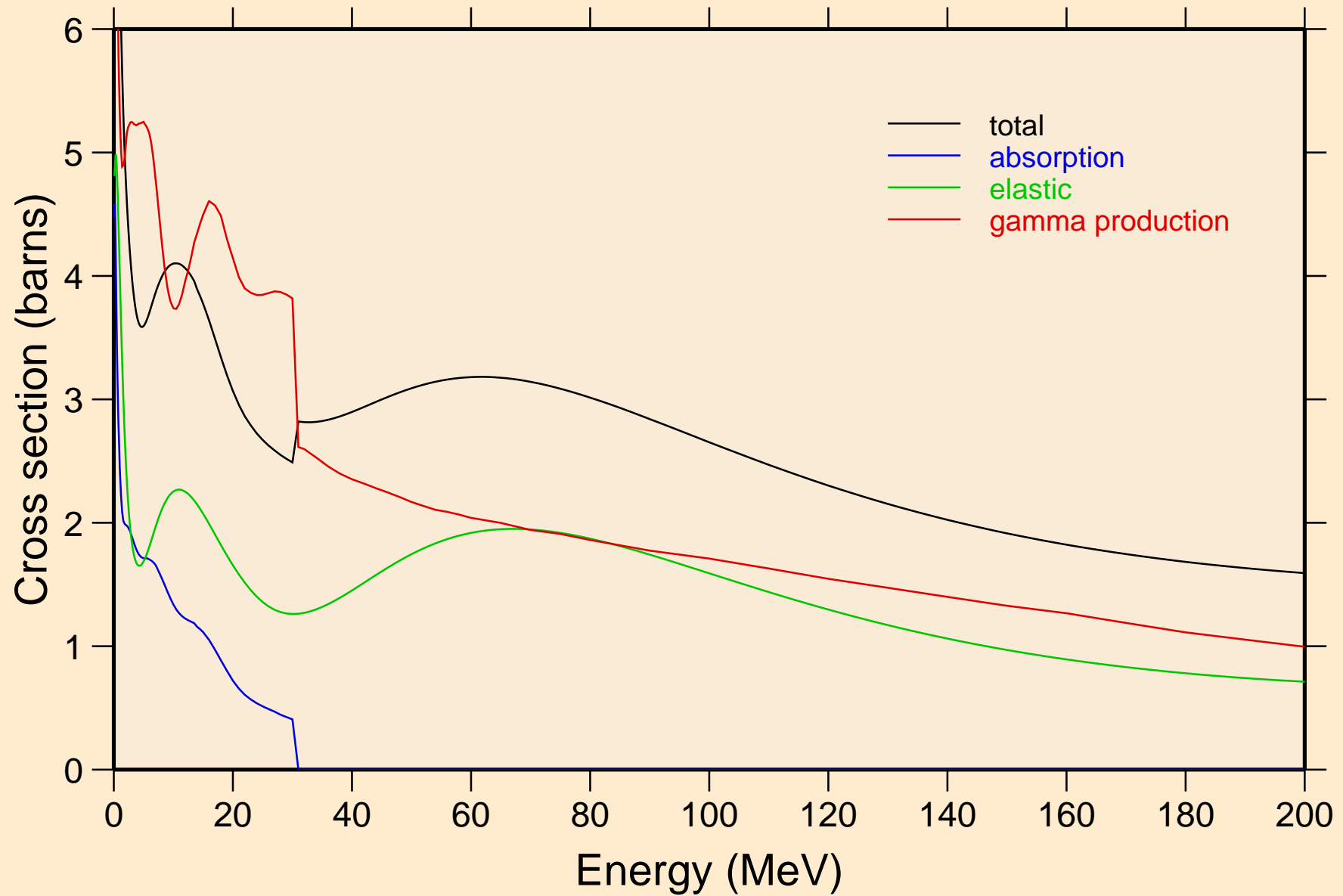

TC089 NEUTRON ACER TENDL-2024 LIBRARY; T=0.K

Heating

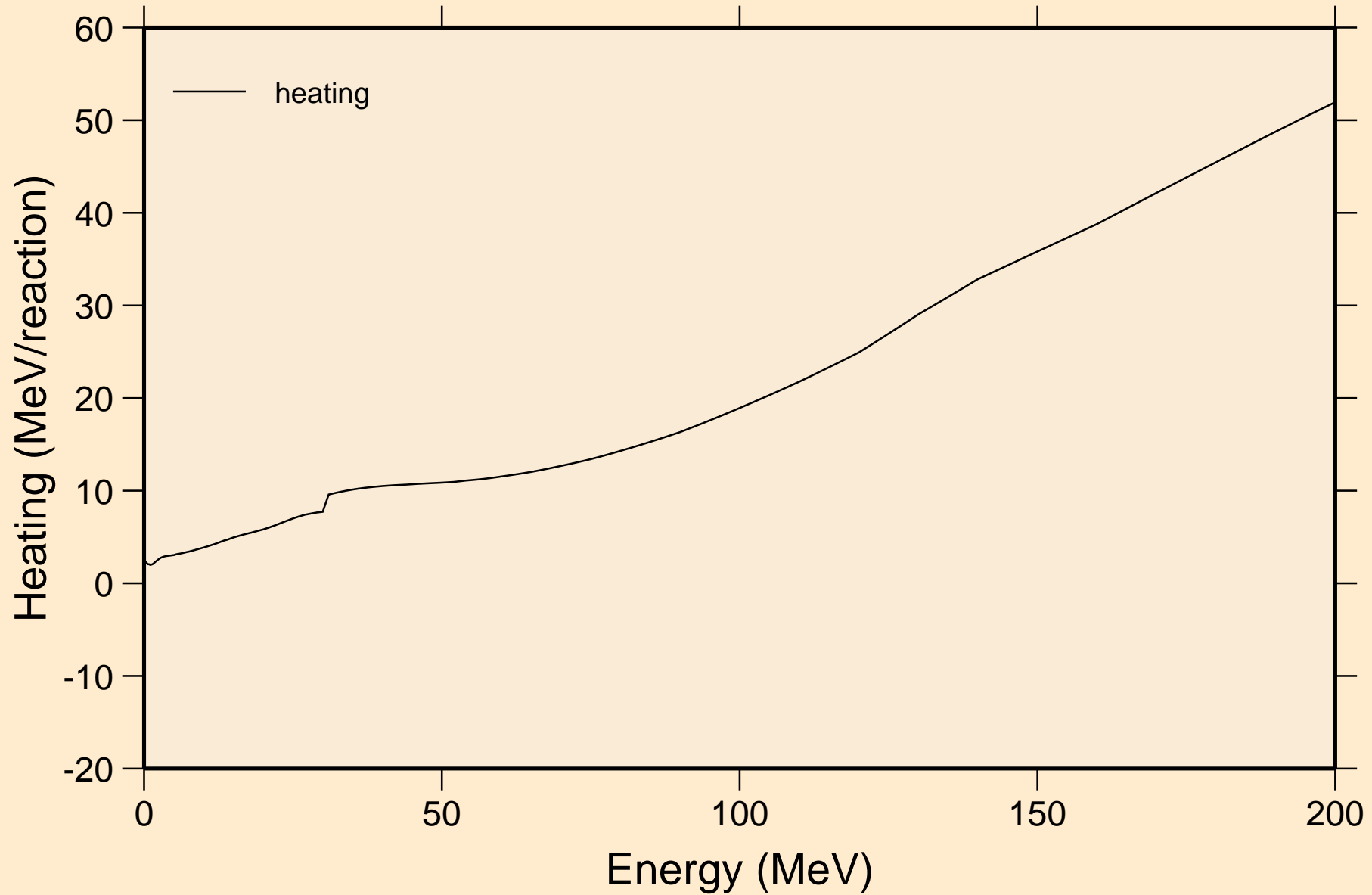

TC089 NEUTRON ACER TENDL-2024 LIBRARY; T=0.K

Damage

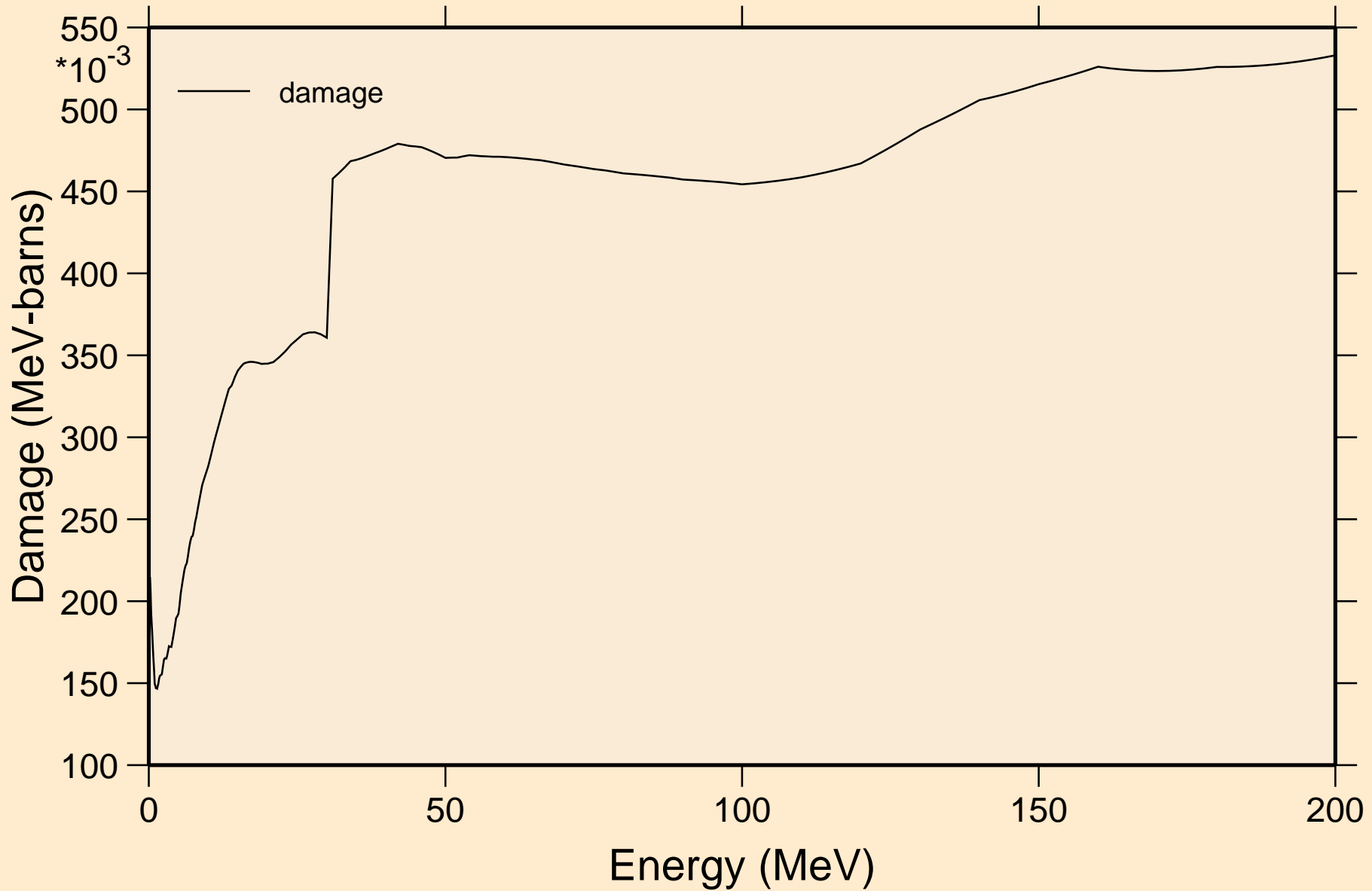

TC089 NEUTRON ACER TENDL-2024 LIBRARY; T=0.K
Non-threshold reactions

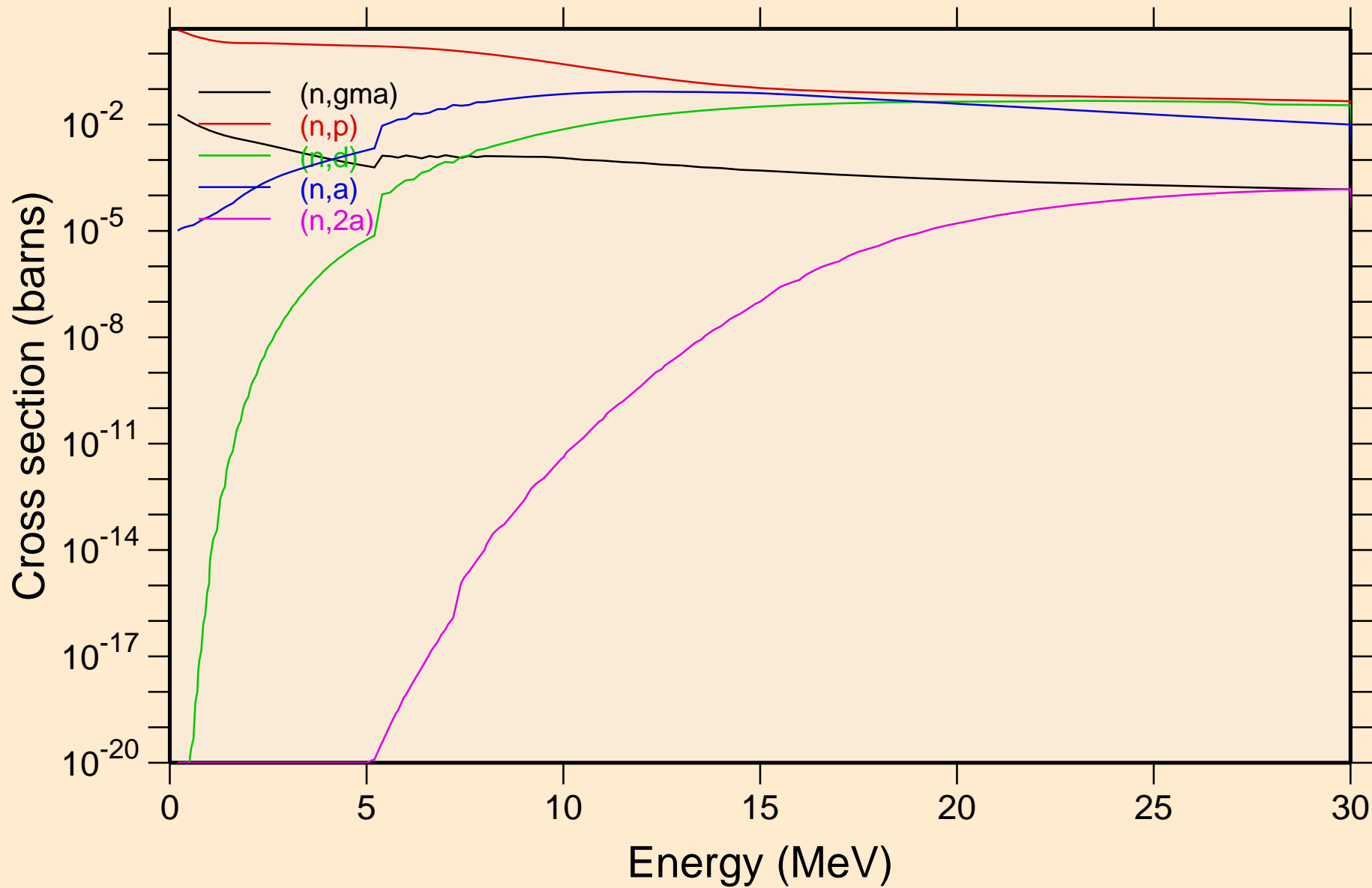

TC089 NEUTRON ACER TENDL-2024 LIBRARY; T=0.K
Non-threshold reactions

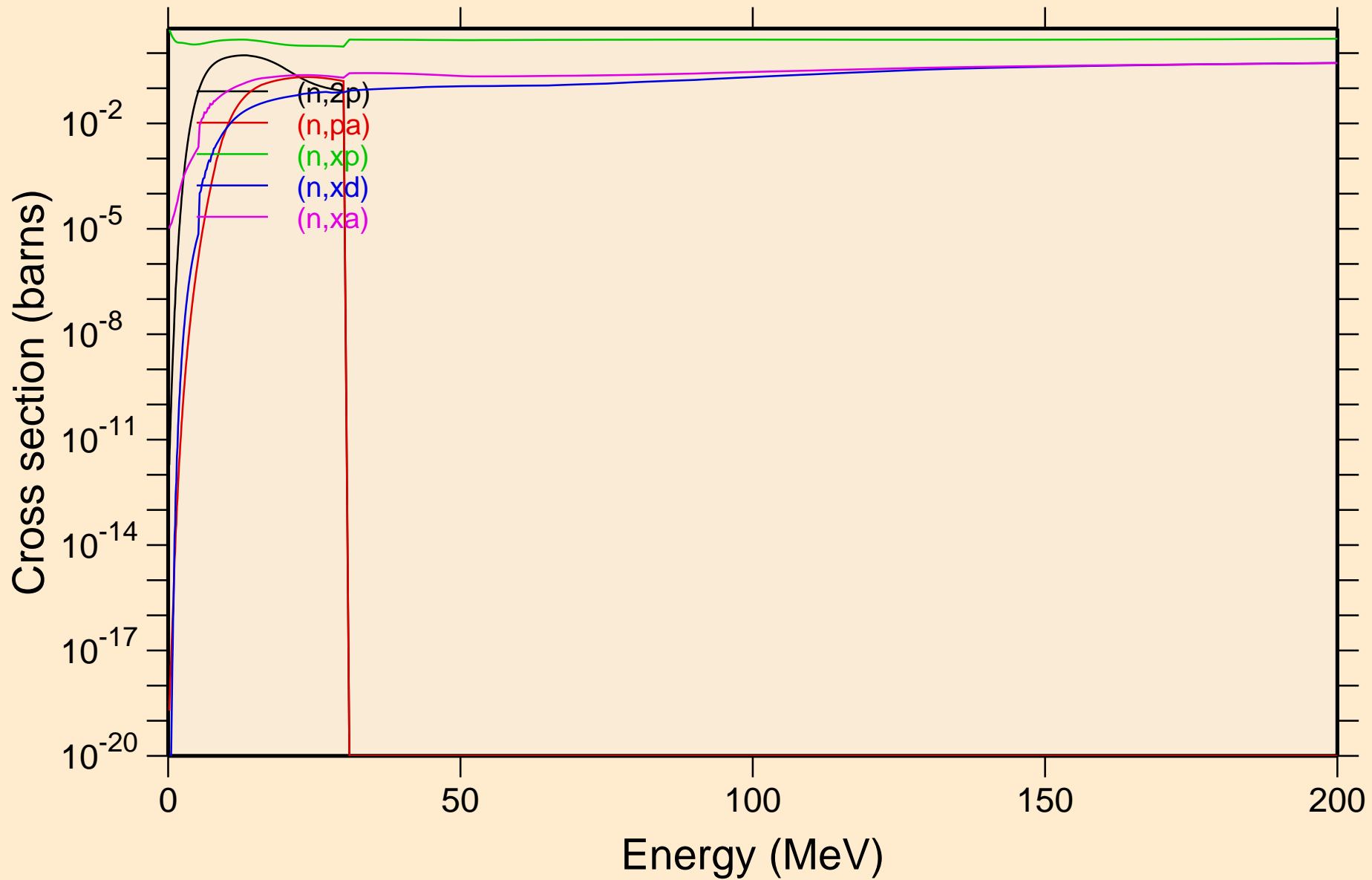

TC089 NEUTRON ACER TENDL-2024 LIBRARY; T=0.K
Inelastic levels

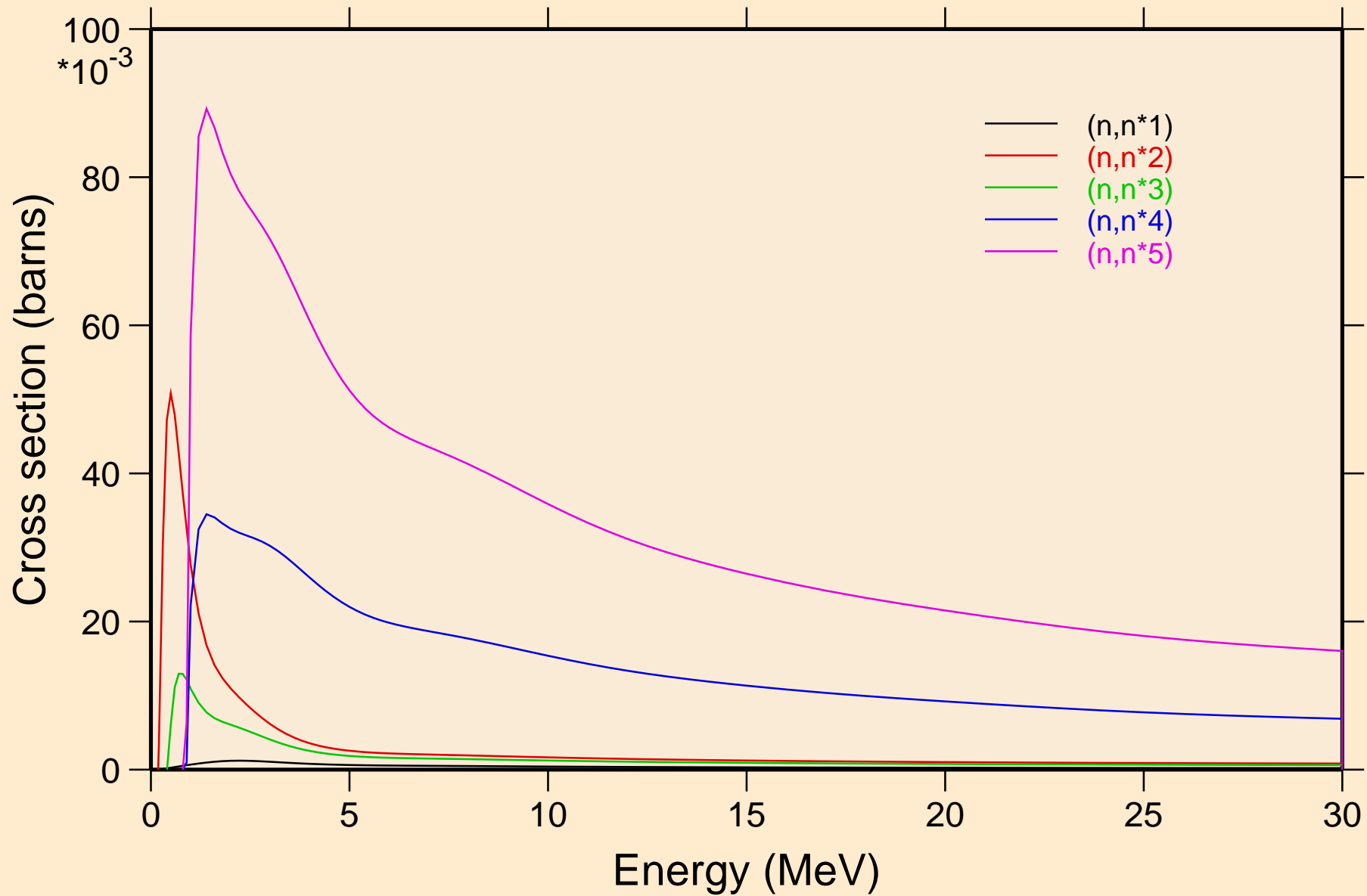

TC089 NEUTRON ACER TENDL-2024 LIBRARY; T=0.K
Inelastic levels

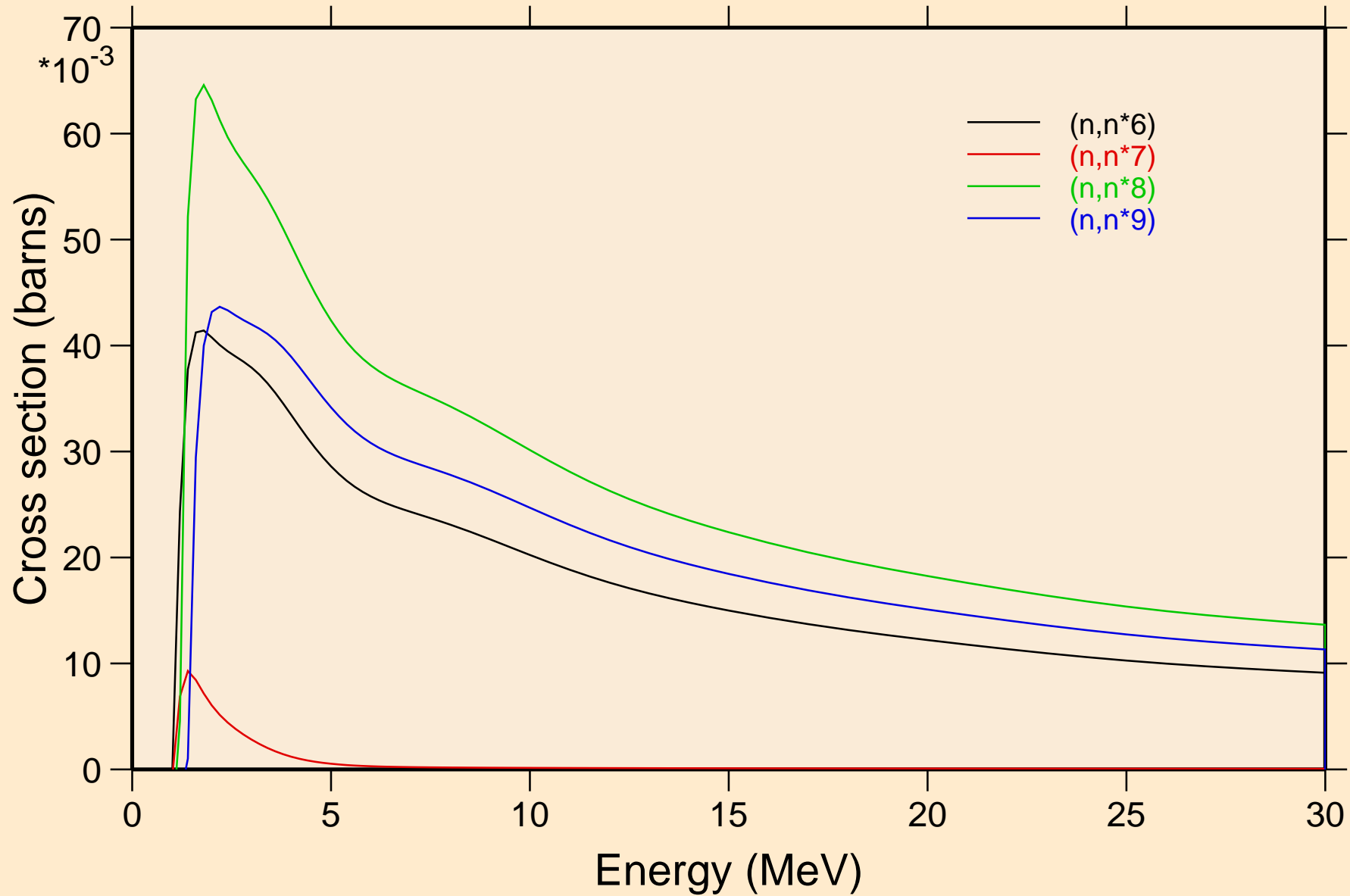

TC089 NEUTRON ACER TENDL-2024 LIBRARY; T=0.K
Threshold reactions

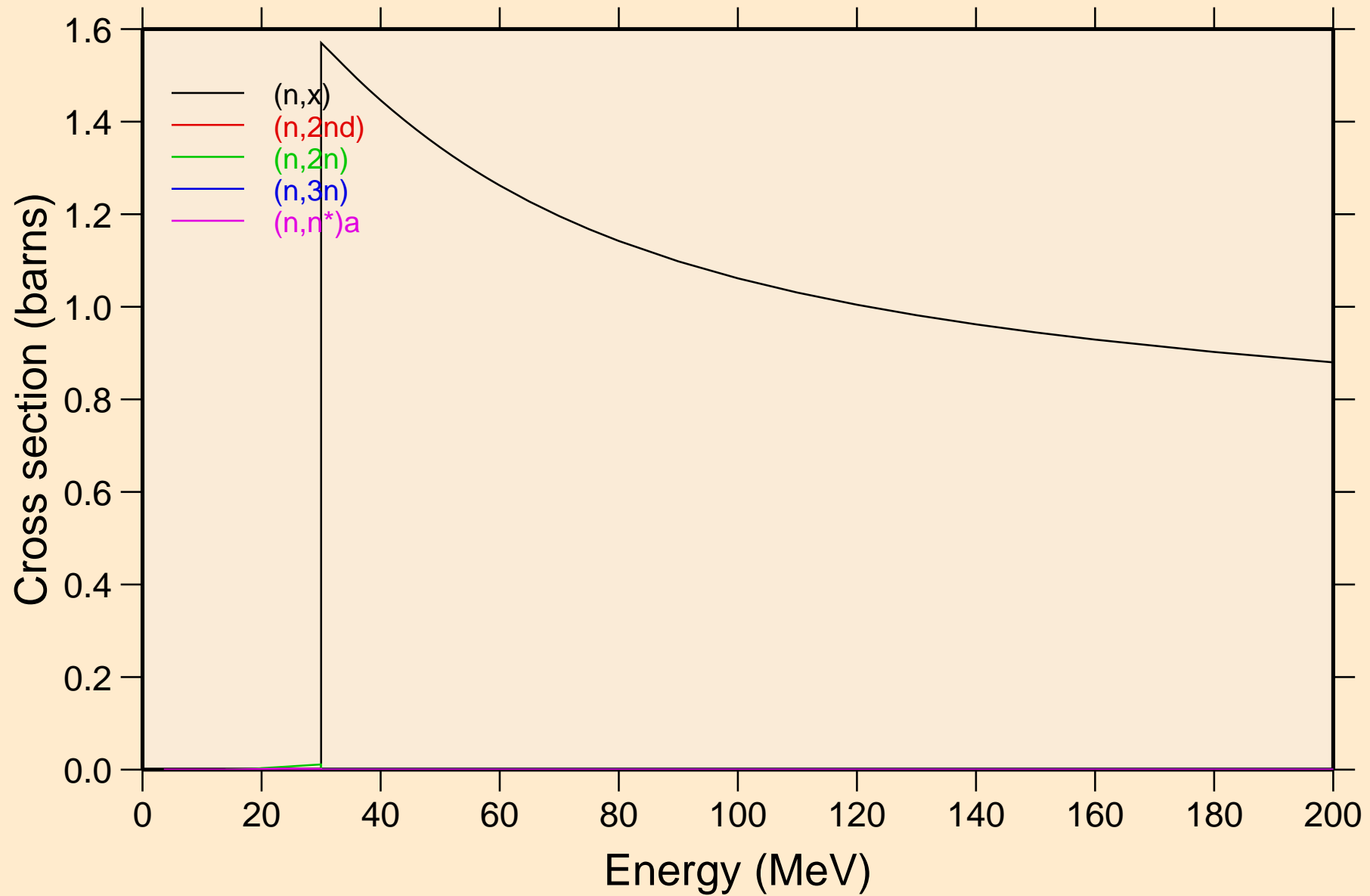

TC089 NEUTRON ACER TENDL-2024 LIBRARY; T=0.K
Threshold reactions

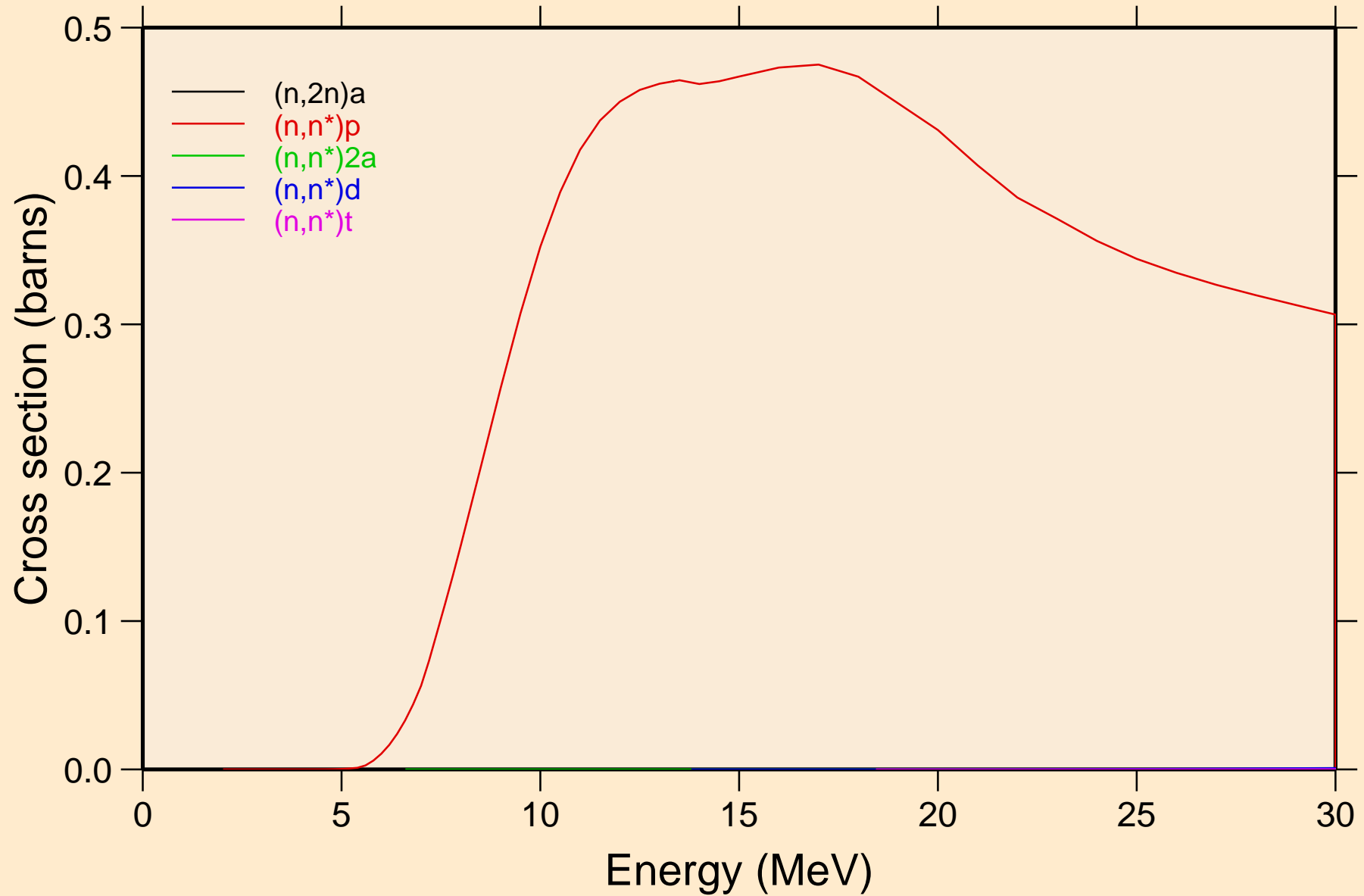

TC089 NEUTRON ACER TENDL-2024 LIBRARY; T=0.K
Threshold reactions

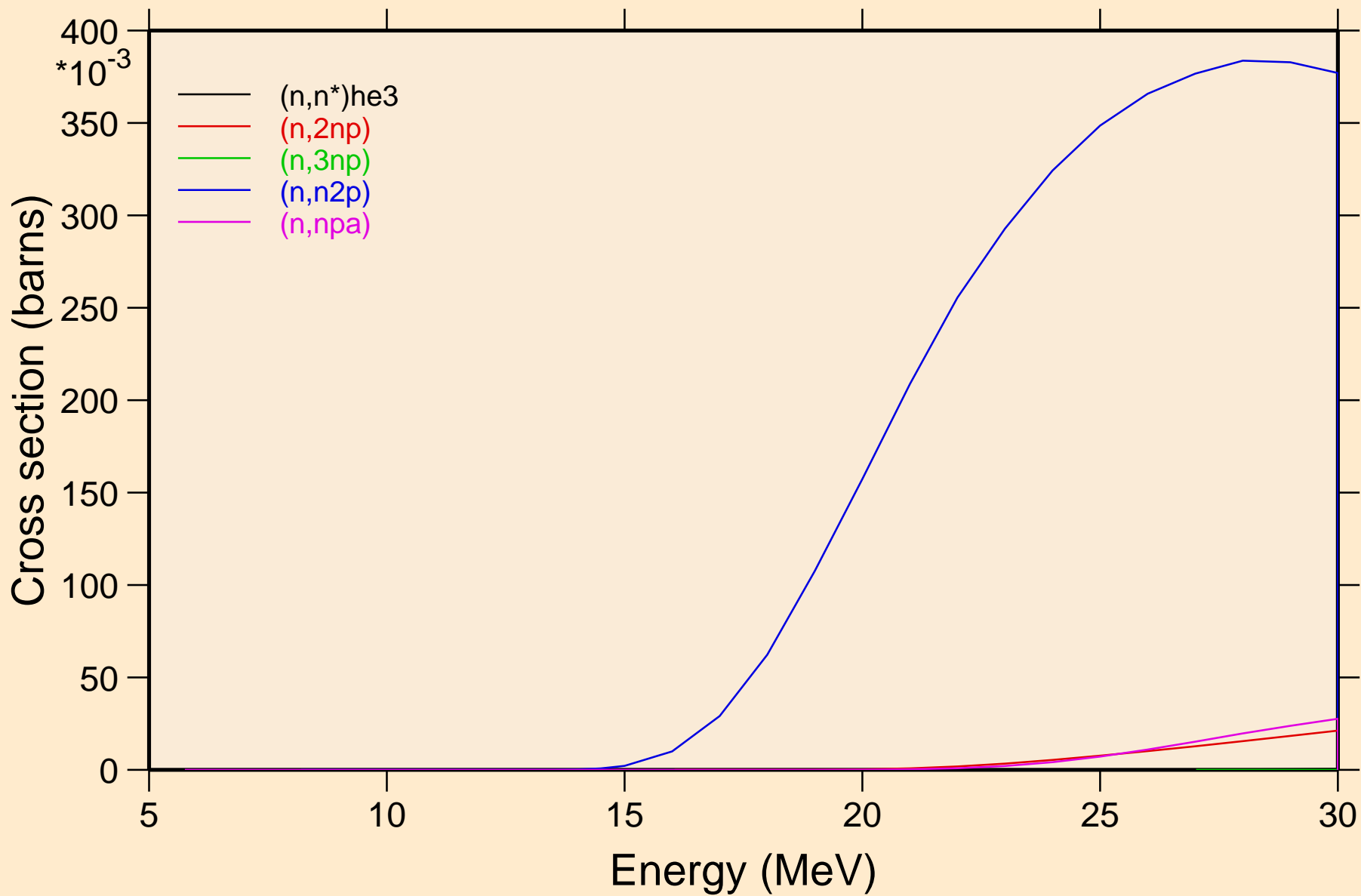

TC089 NEUTRON ACER TENDL-2024 LIBRARY; T=0.K
Threshold reactions

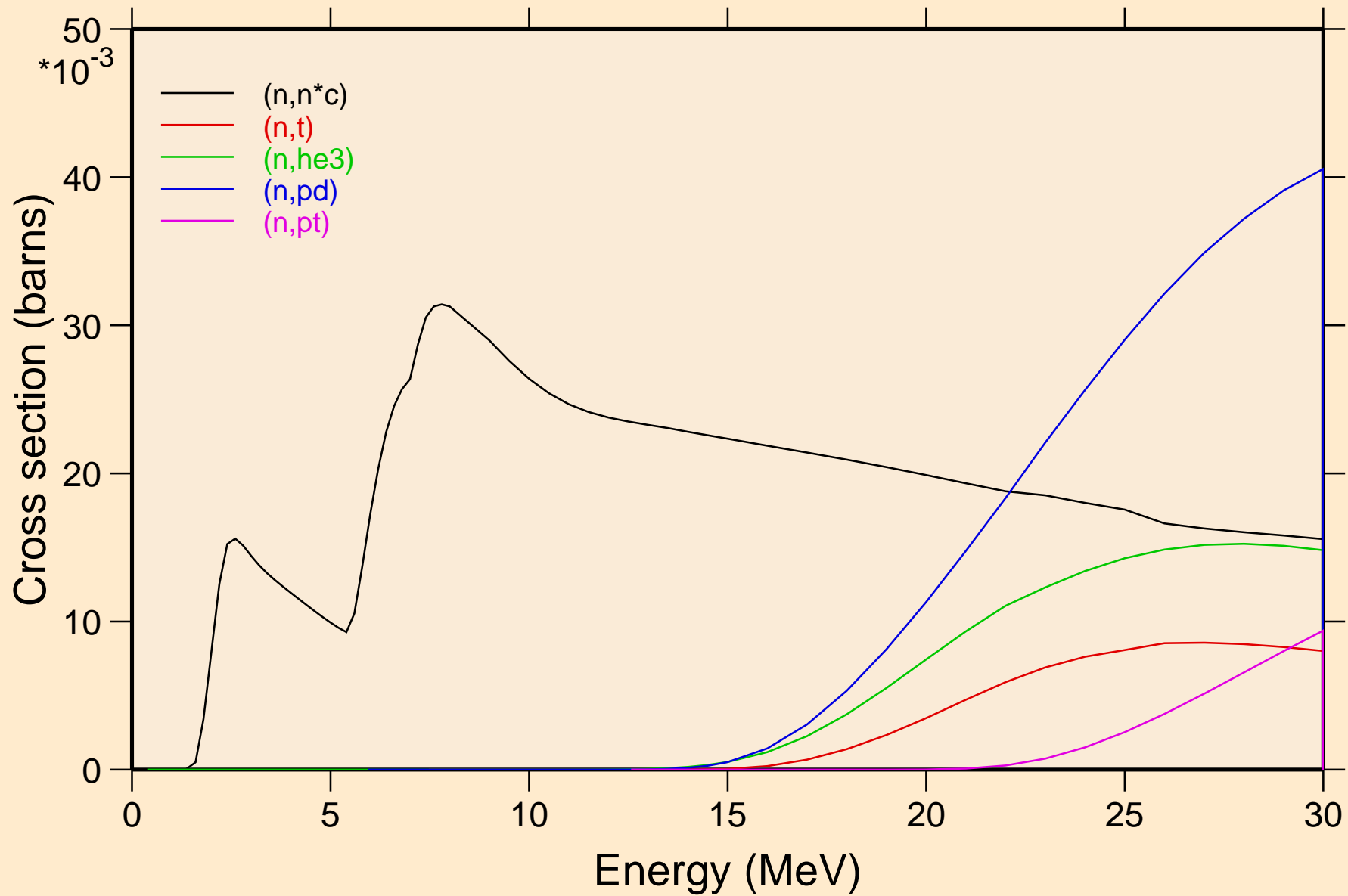

TC089 NEUTRON ACER TENDL-2024 LIBRARY; T=0.K
Threshold reactions

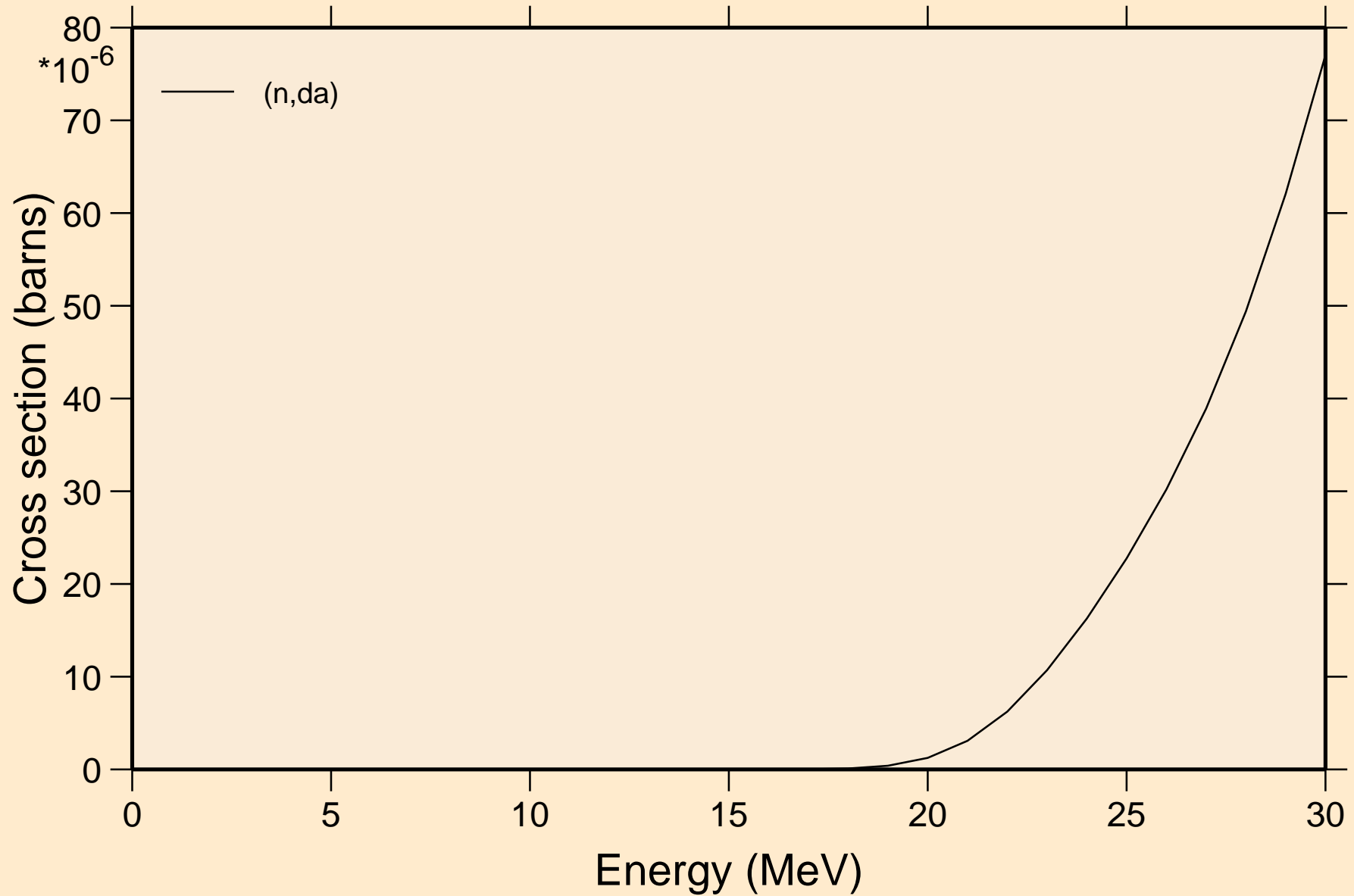

TC089 NEUTRON ACER TENDL-2024 LIBRARY; T=0.K
Threshold reactions

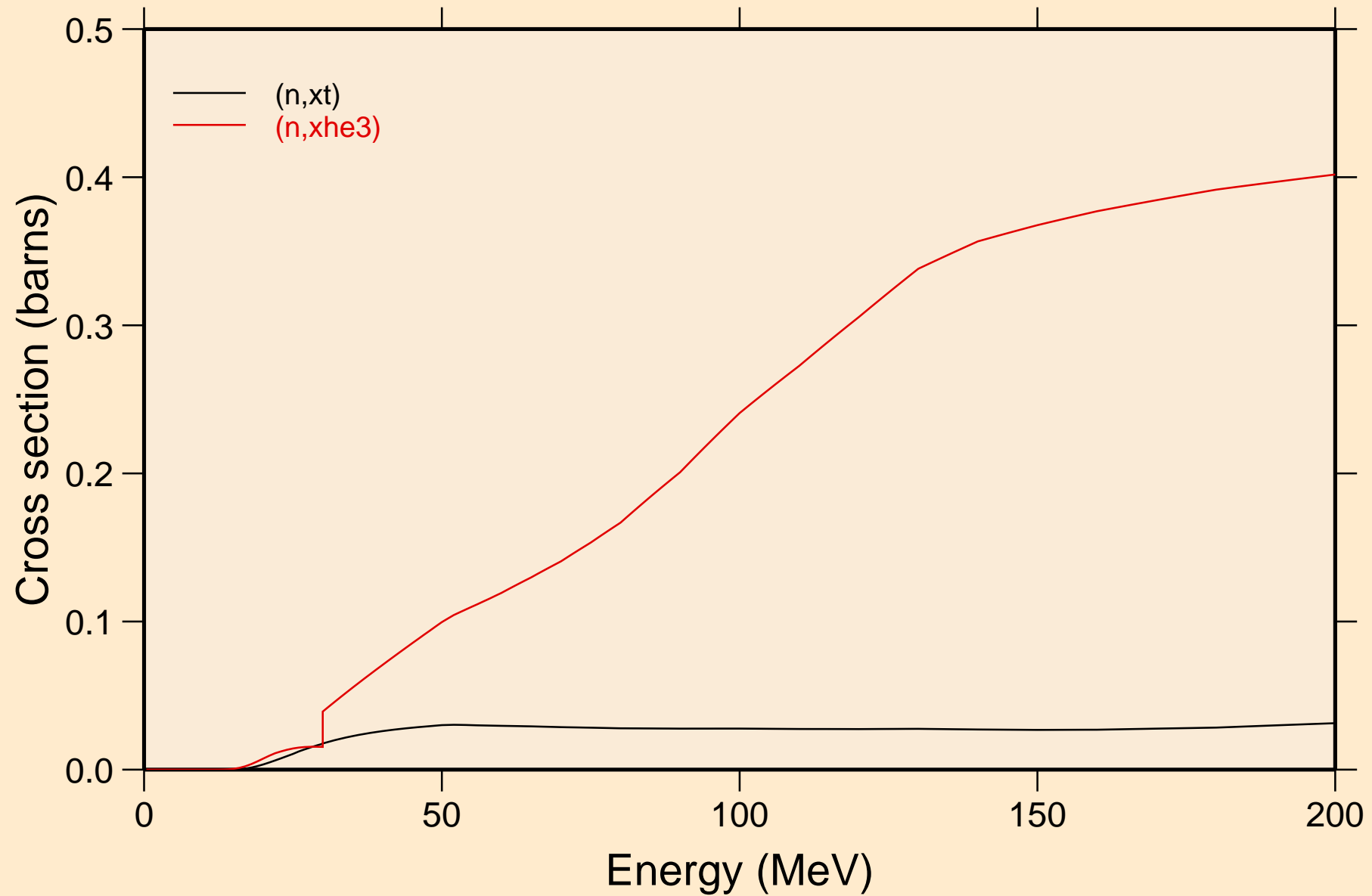

TC089 NEUTRON ACER TENDL-2024 LIBRARY; T=0.K
angular distribution for elastic

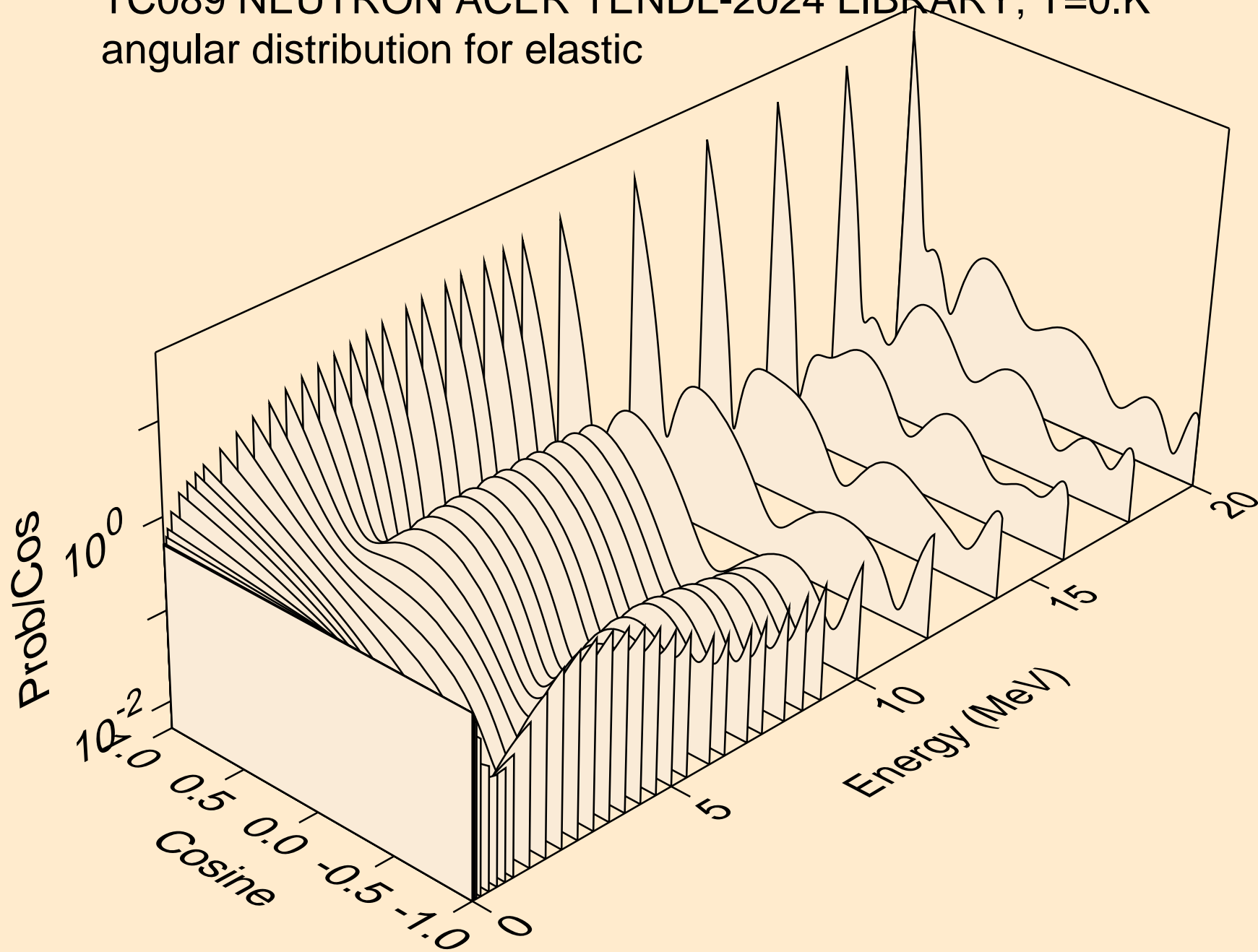

TC089 NEUTRON ACER TENDL-2024 LIBRARY; T=0.K
angular distribution for elastic

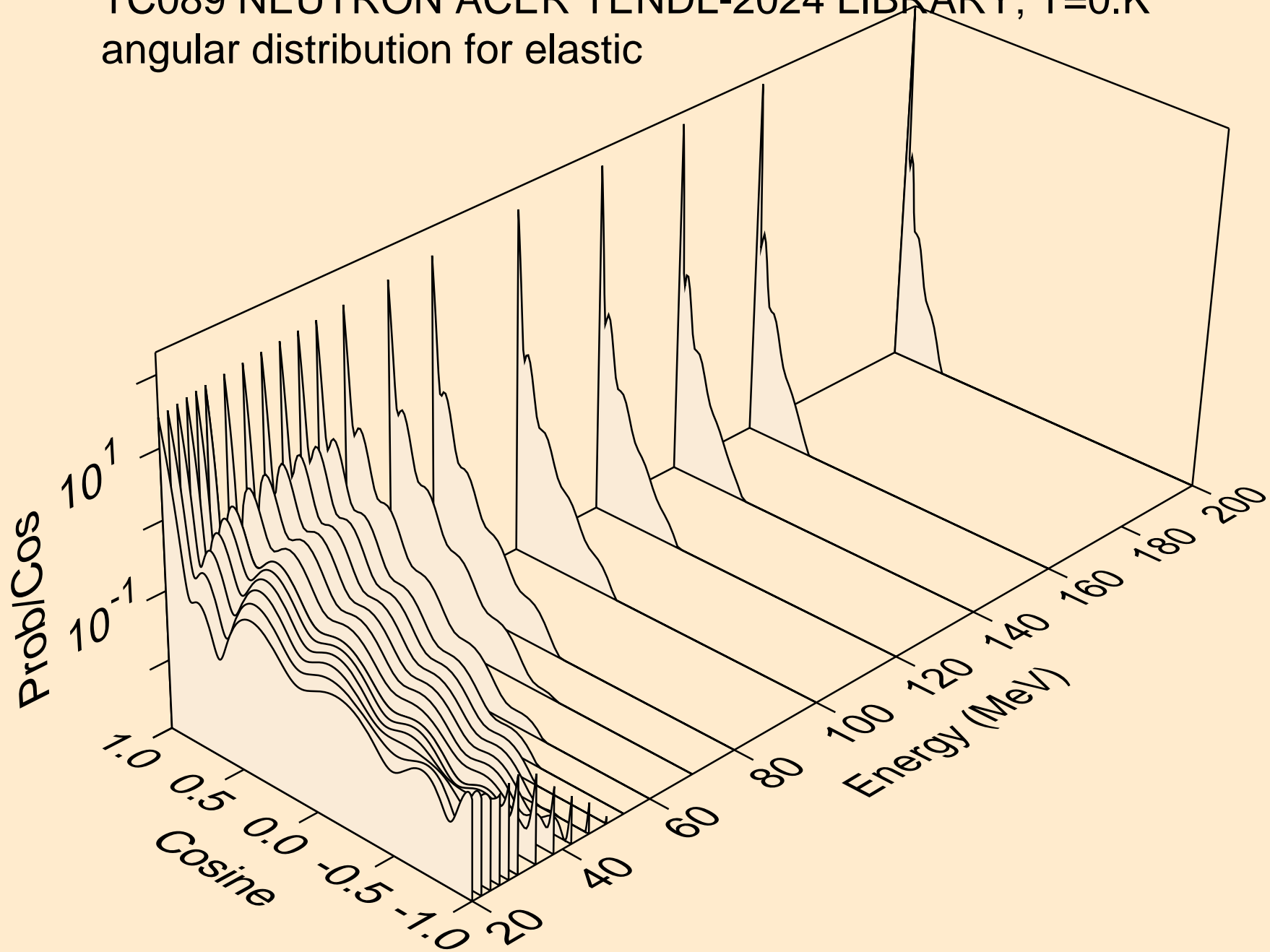

TC089 NEUTRON ACER TENDL-2024 LIBRARY; T=0.K
angular distribution for (n,n*1)

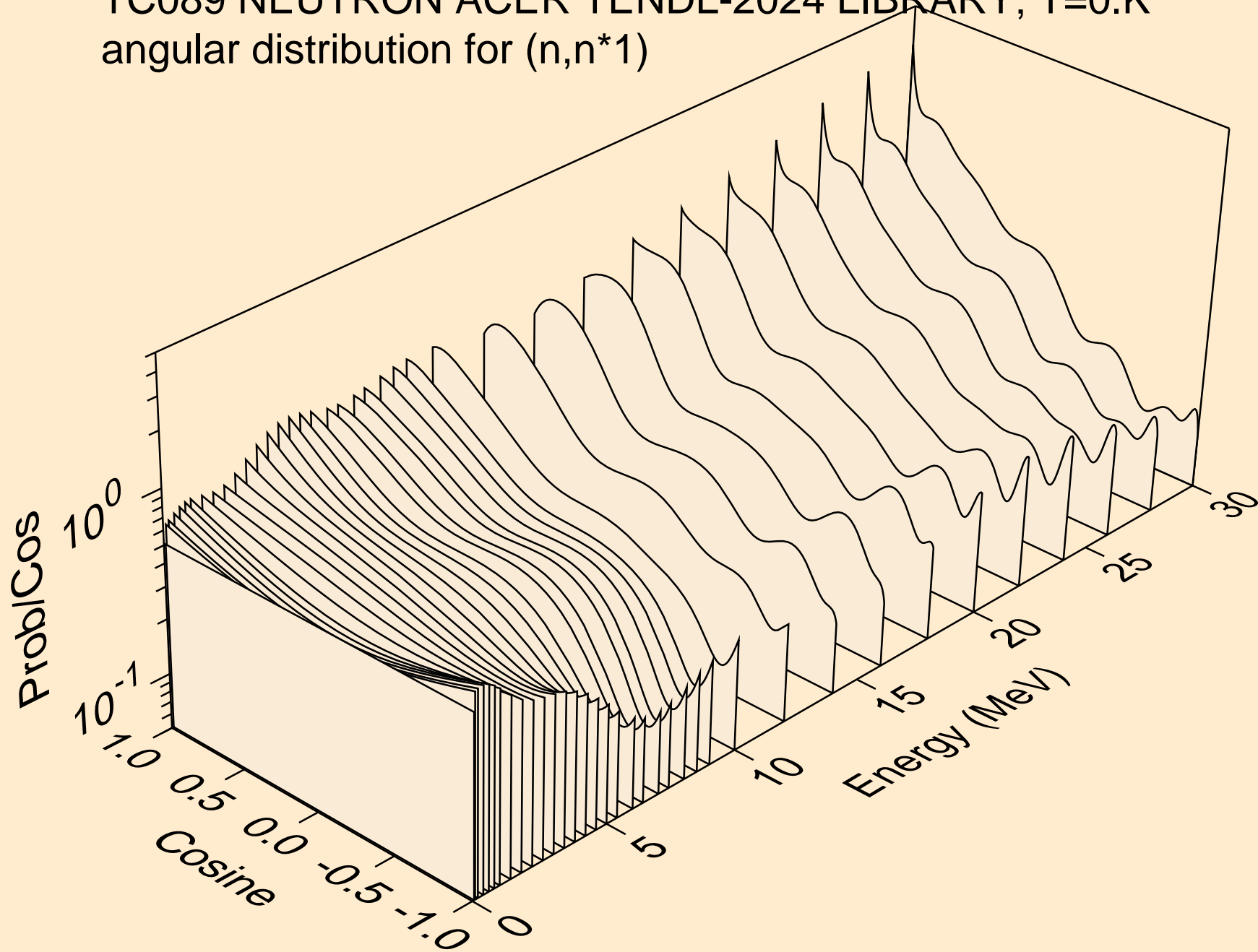

TC089 NEUTRON ACER TENDL-2024 LIBRARY; T=0.K
angular distribution for (n,n*2)

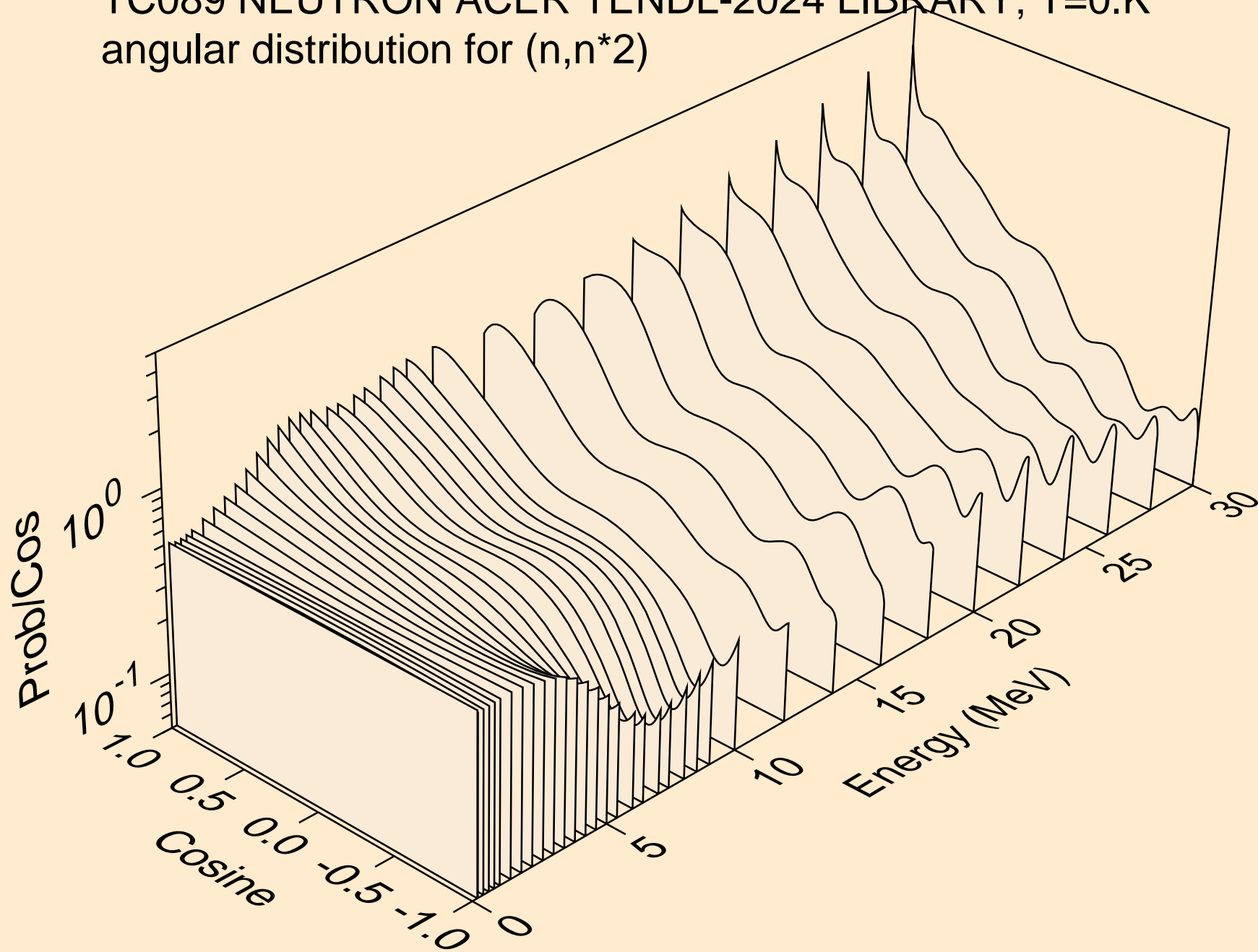

TC089 NEUTRON ACER TENDL-2024 LIBRARY; T=0.K
angular distribution for (n,n*3)

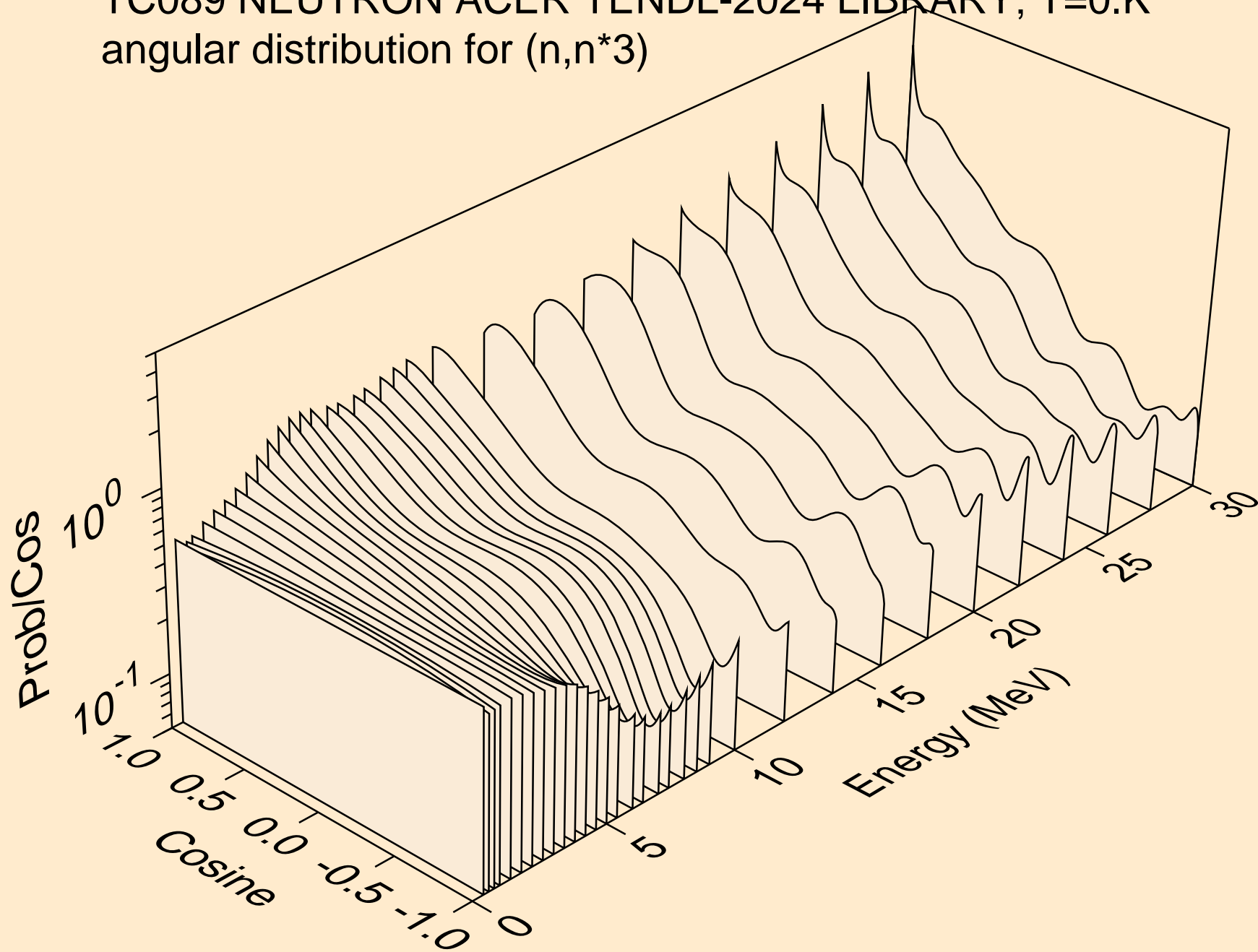

TC089 NEUTRON ACER TENDL-2024 LIBRARY; T=0.K
angular distribution for (n,n*4)

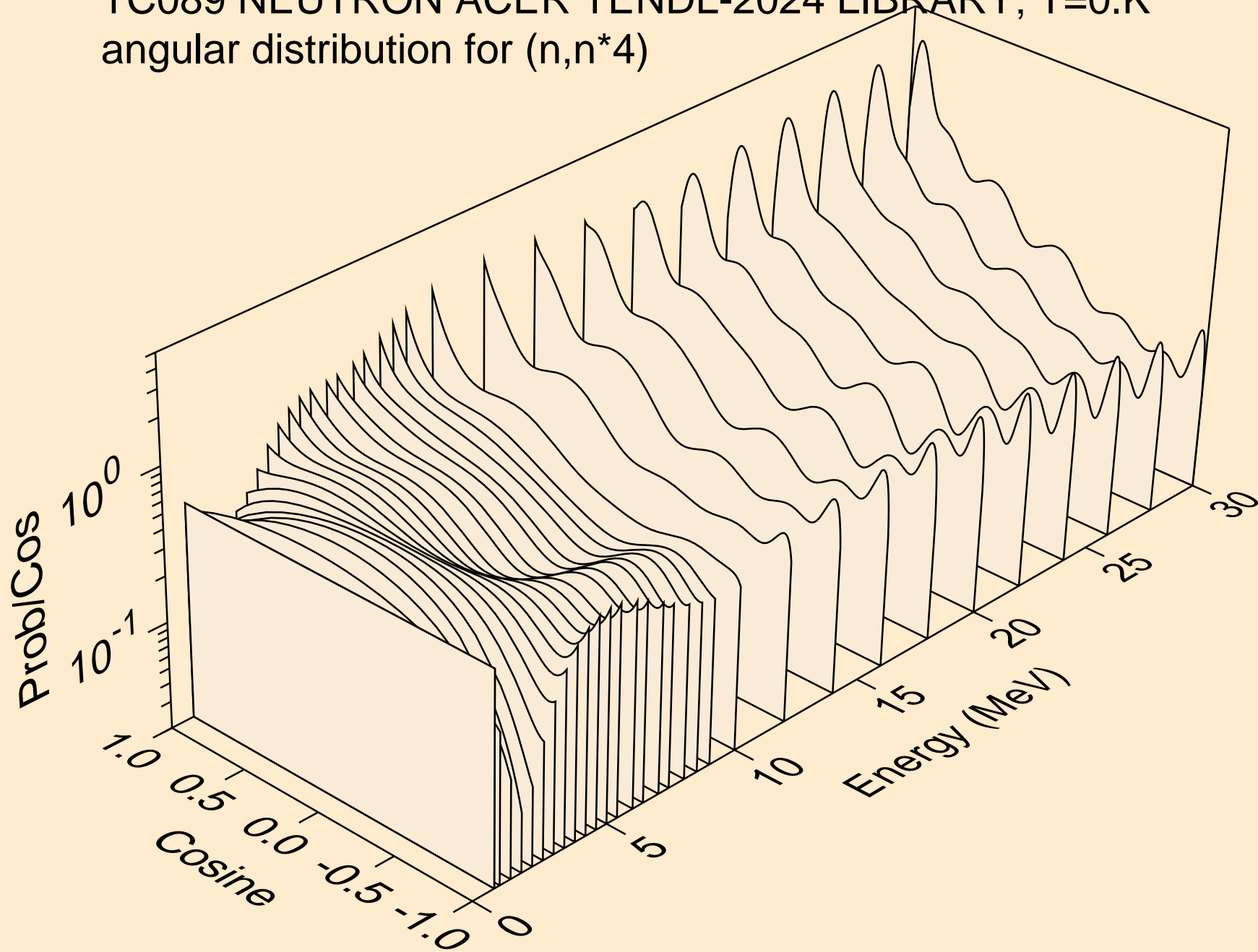

TC089 NEUTRON ACER TENDL-2024 LIBRARY; T=0.K
angular distribution for (n,n*5)

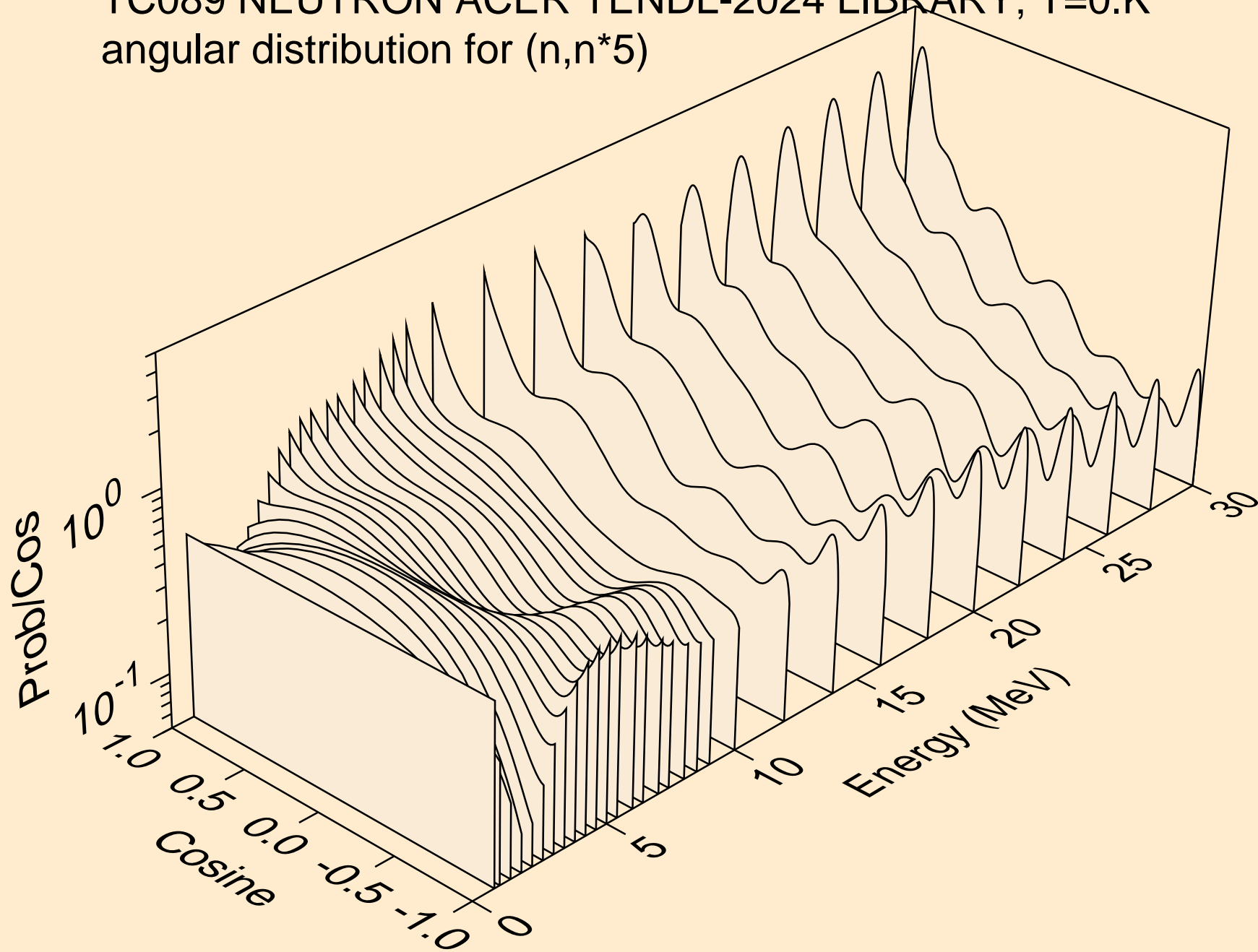

TC089 NEUTRON ACER TENDL-2024 LIBRARY; T=0.K
angular distribution for (n,n*6)

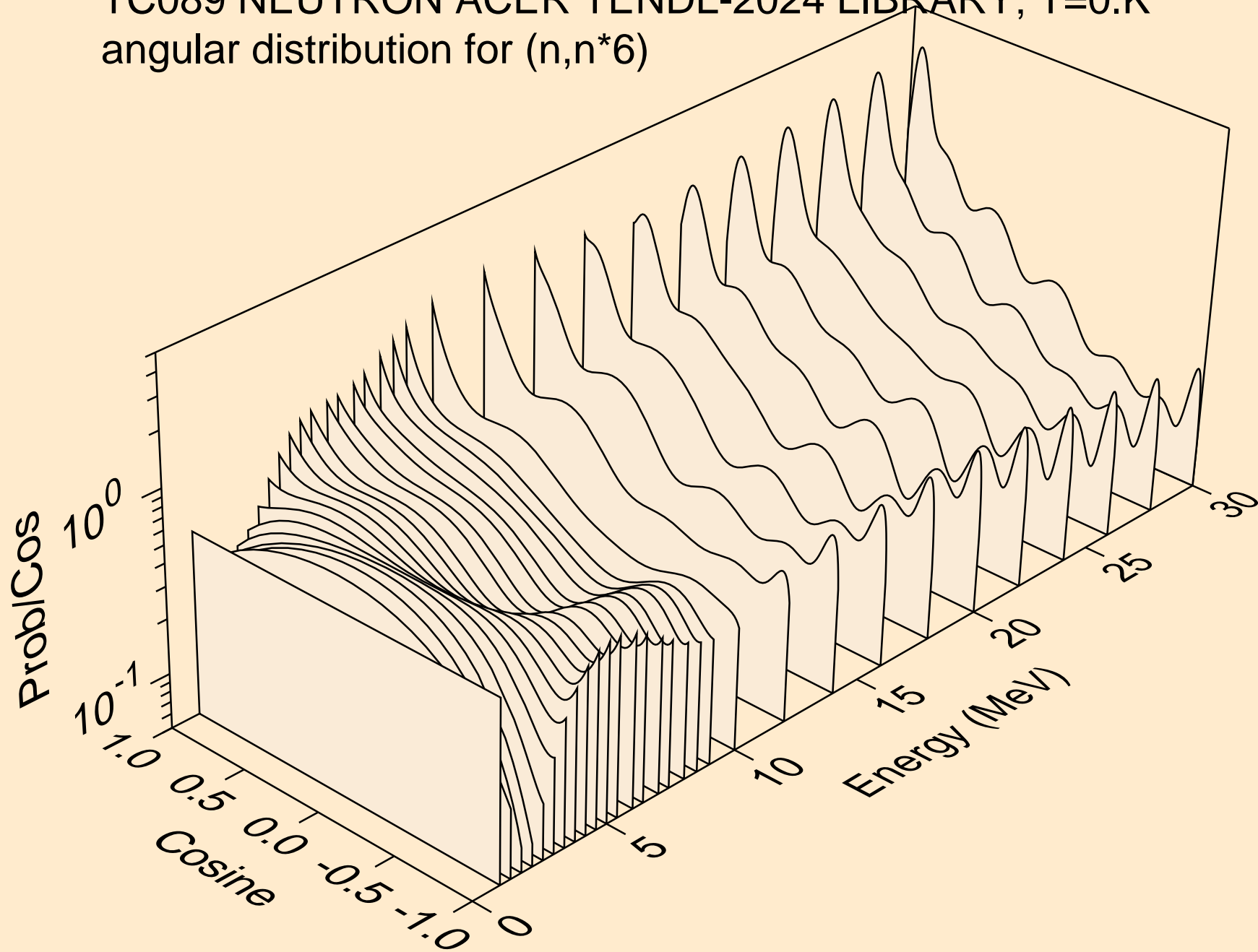

TC089 NEUTRON ACER TENDL-2024 LIBRARY; T=0.K
angular distribution for (n,n*7)

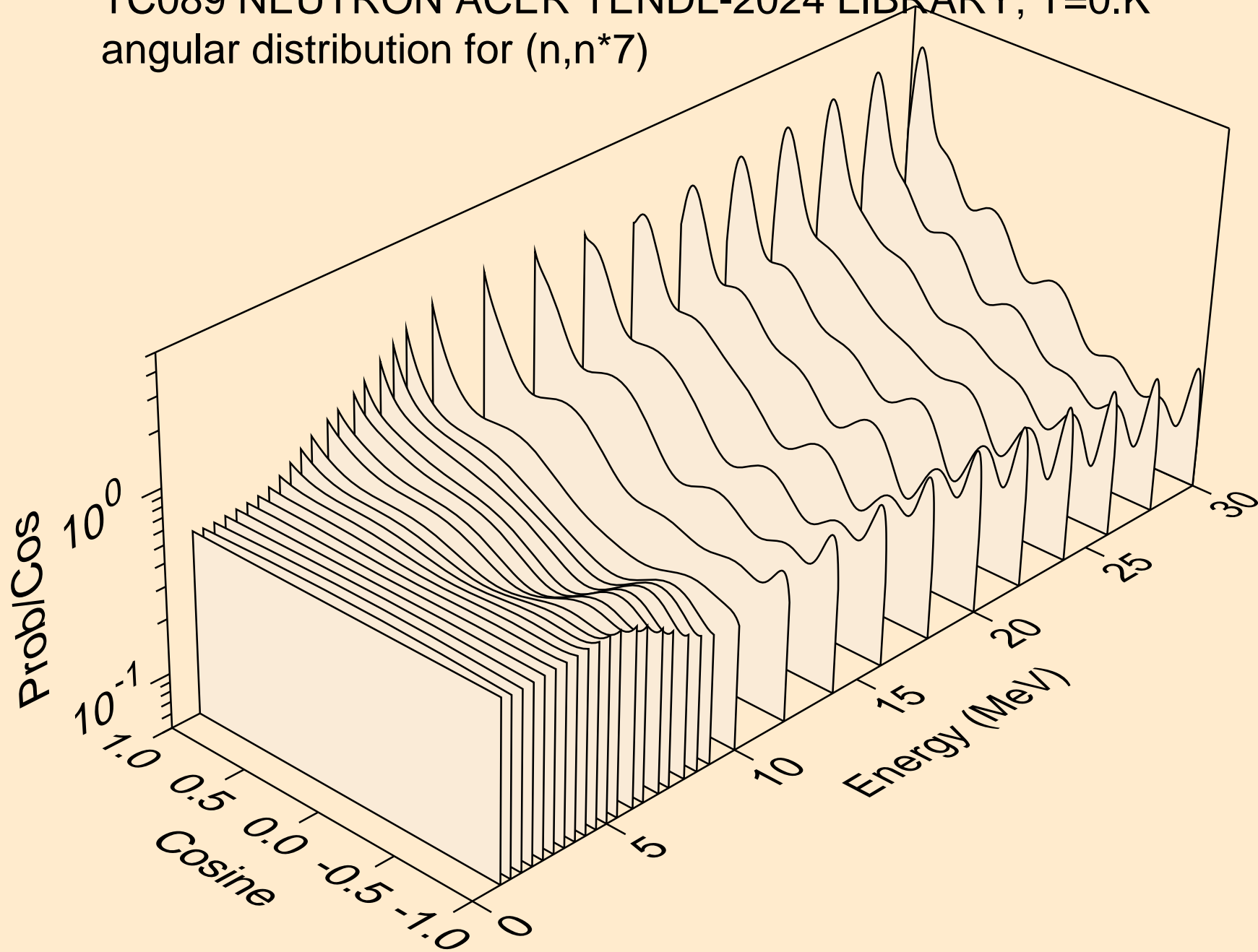

TC089 NEUTRON ACER TENDL-2024 LIBRARY; T=0.K
angular distribution for (n,n*8)

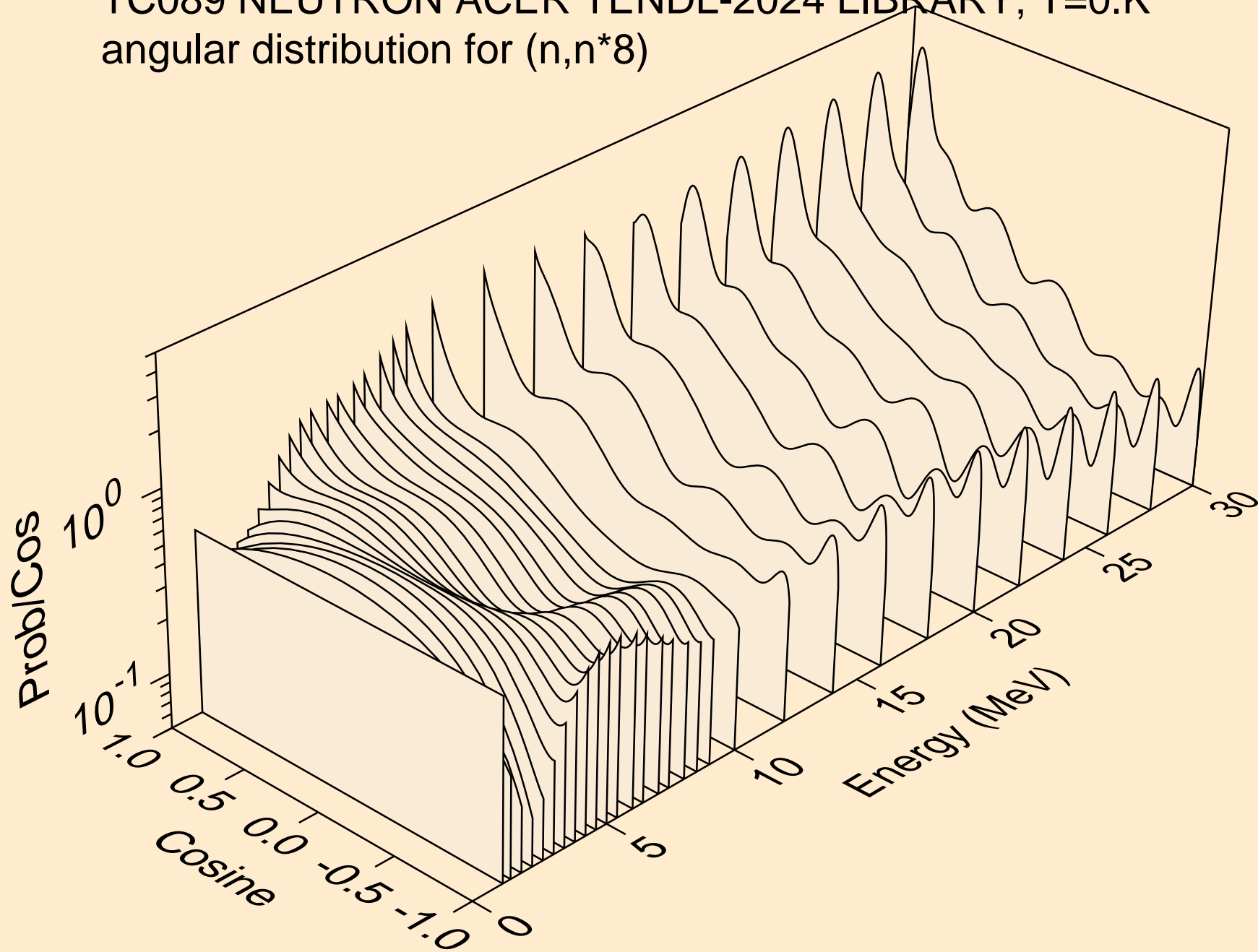

TC089 NEUTRON ACER TENDL-2024 LIBRARY; T=0.K
angular distribution for (n,n*9)

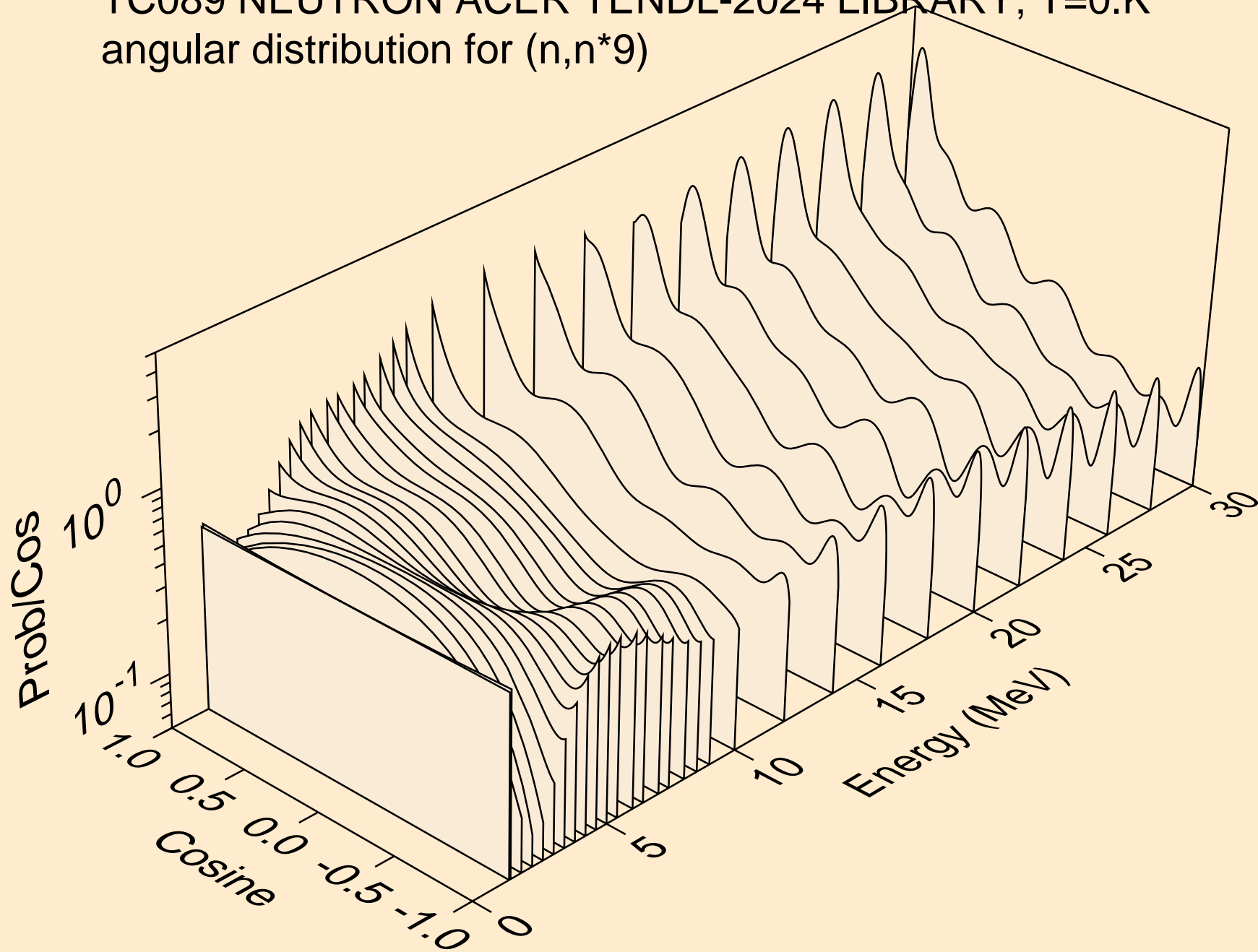

TC089 NEUTRON ACER TENDL-2024 LIBRARY; T=0.K
Neutron emission for (n,x)

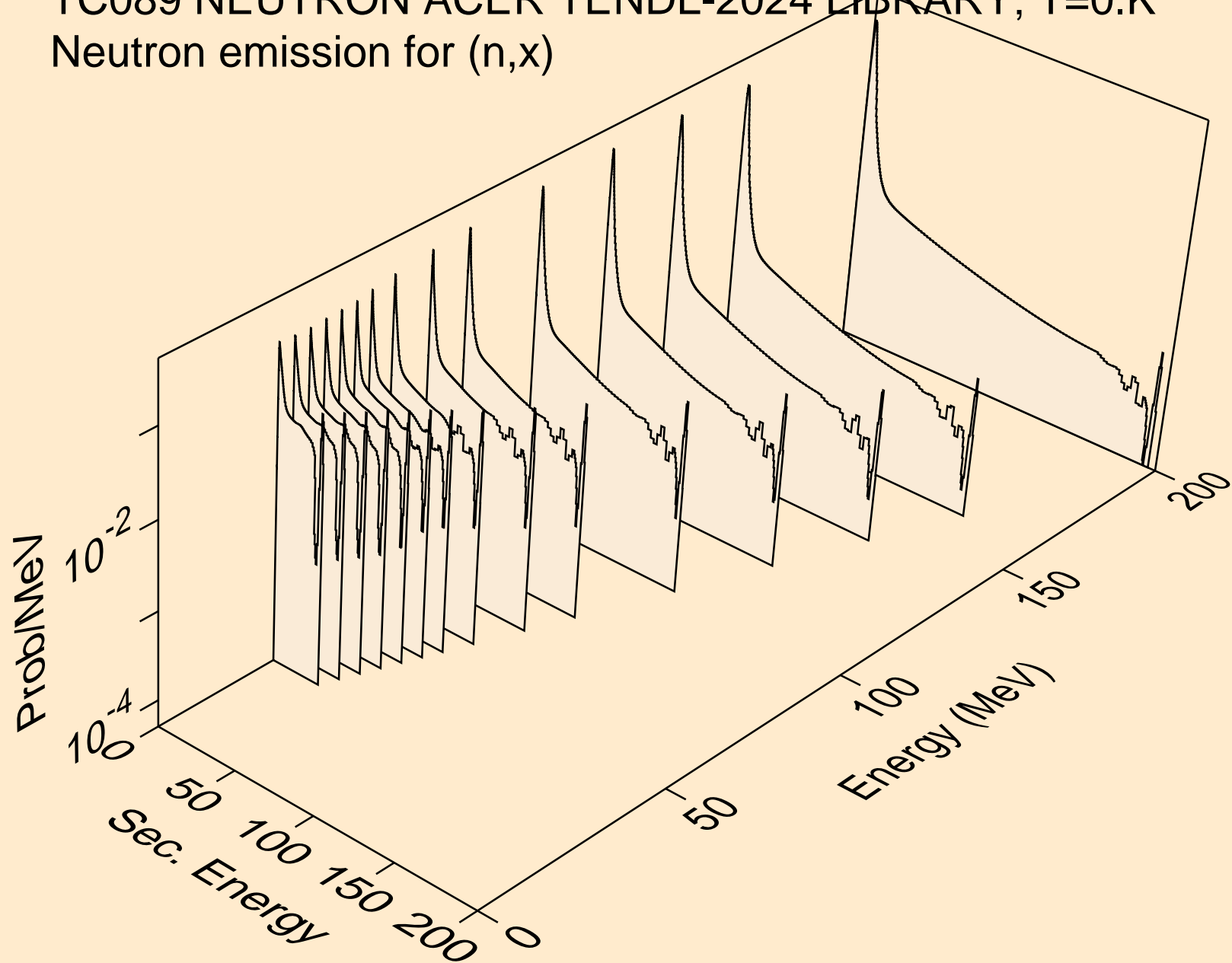

TC089 NEUTRON ACER TENDL-2024 LIBRARY; T=0.K
Neutron emission for (n,2nd)

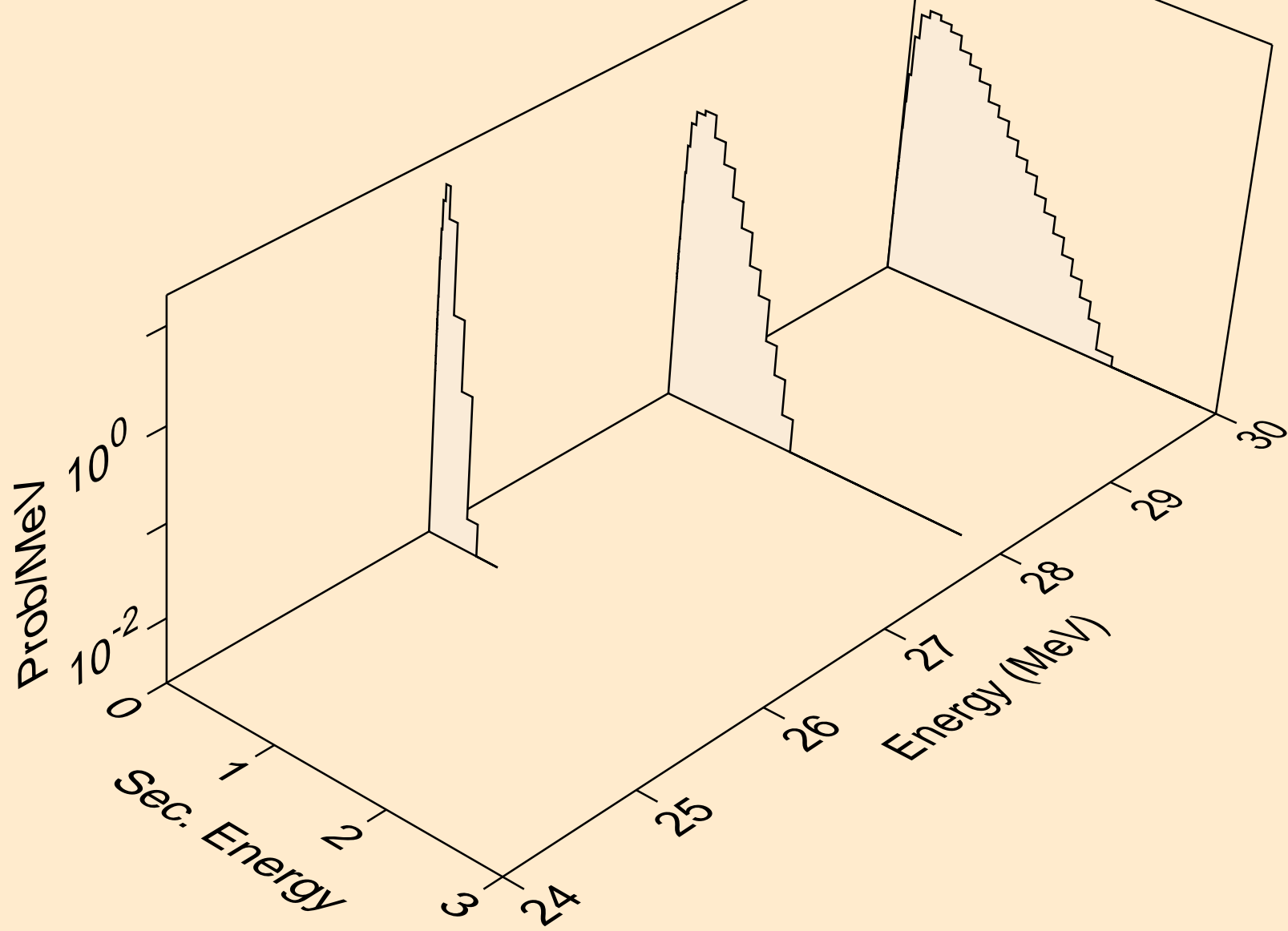

TC089 NEUTRON ACER TENDL-2024 LIBRARY; T=0.K
Neutron emission for (n,2n)

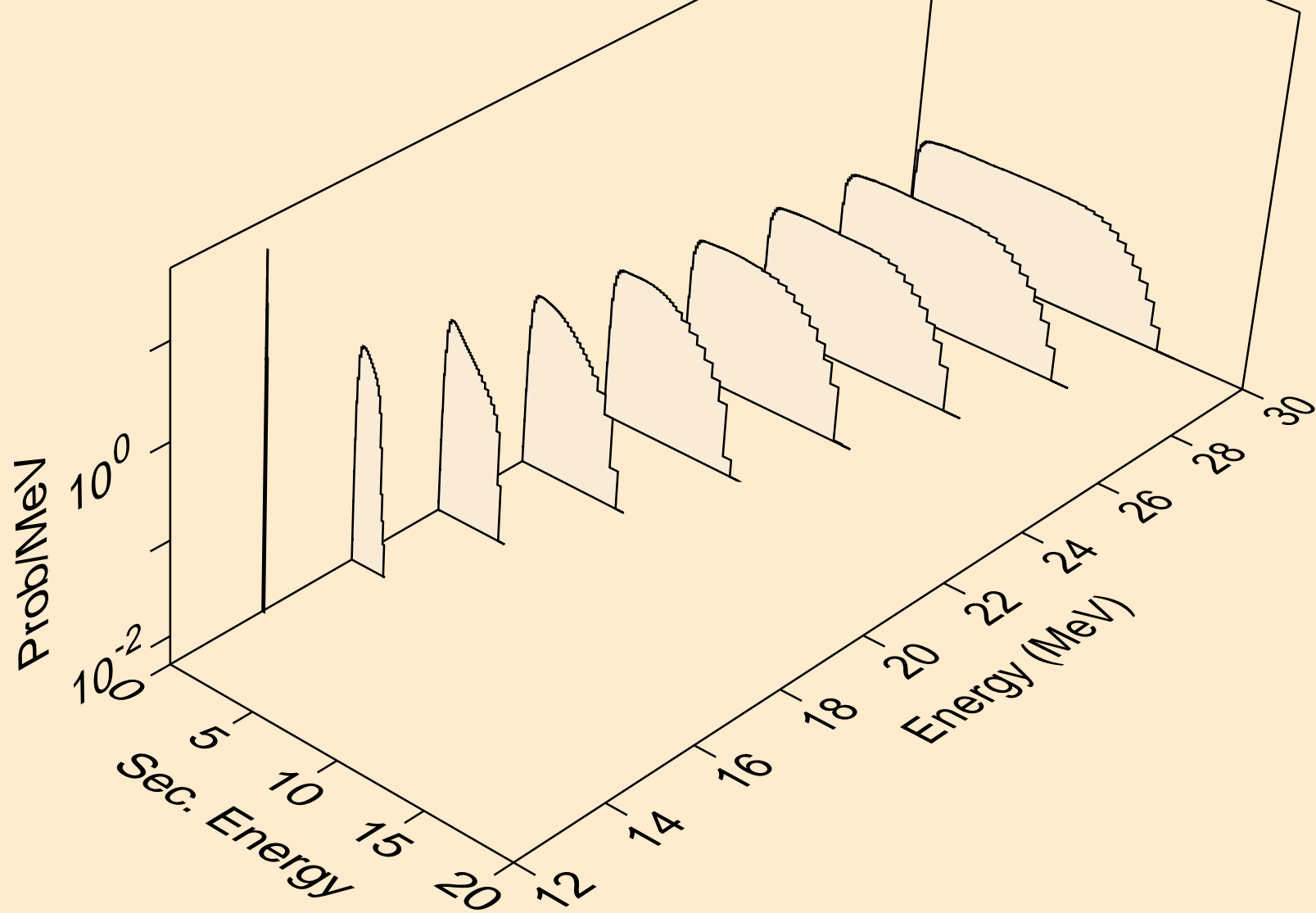

TC089 NEUTRON ACER TENDL-2024 LIBRARY; T=0.K
Neutron emission for (n,3n)

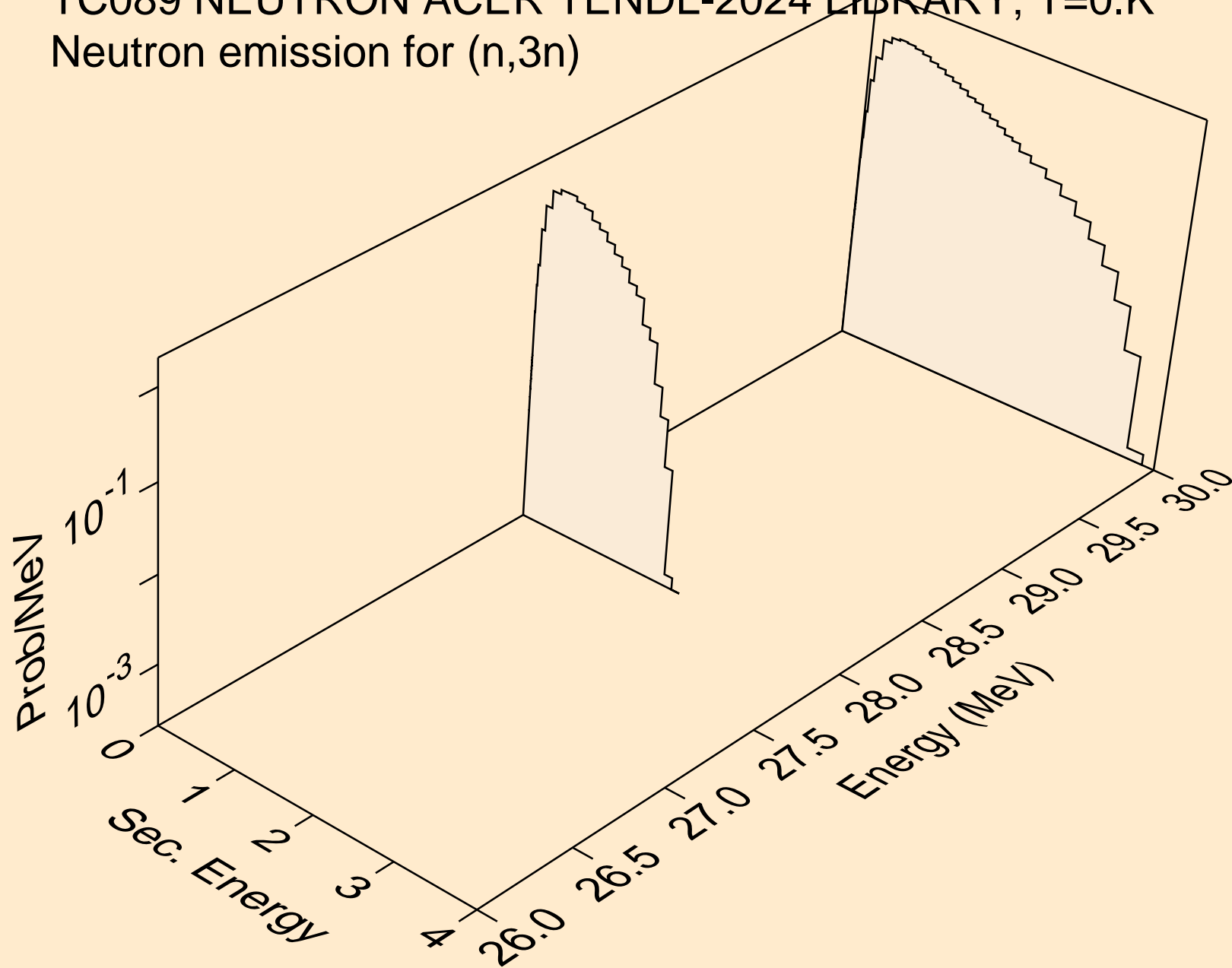

TC089 NEUTRON ACER TENDL-2024 LIBRARY; T=0.K
Neutron emission for (n,n*)a

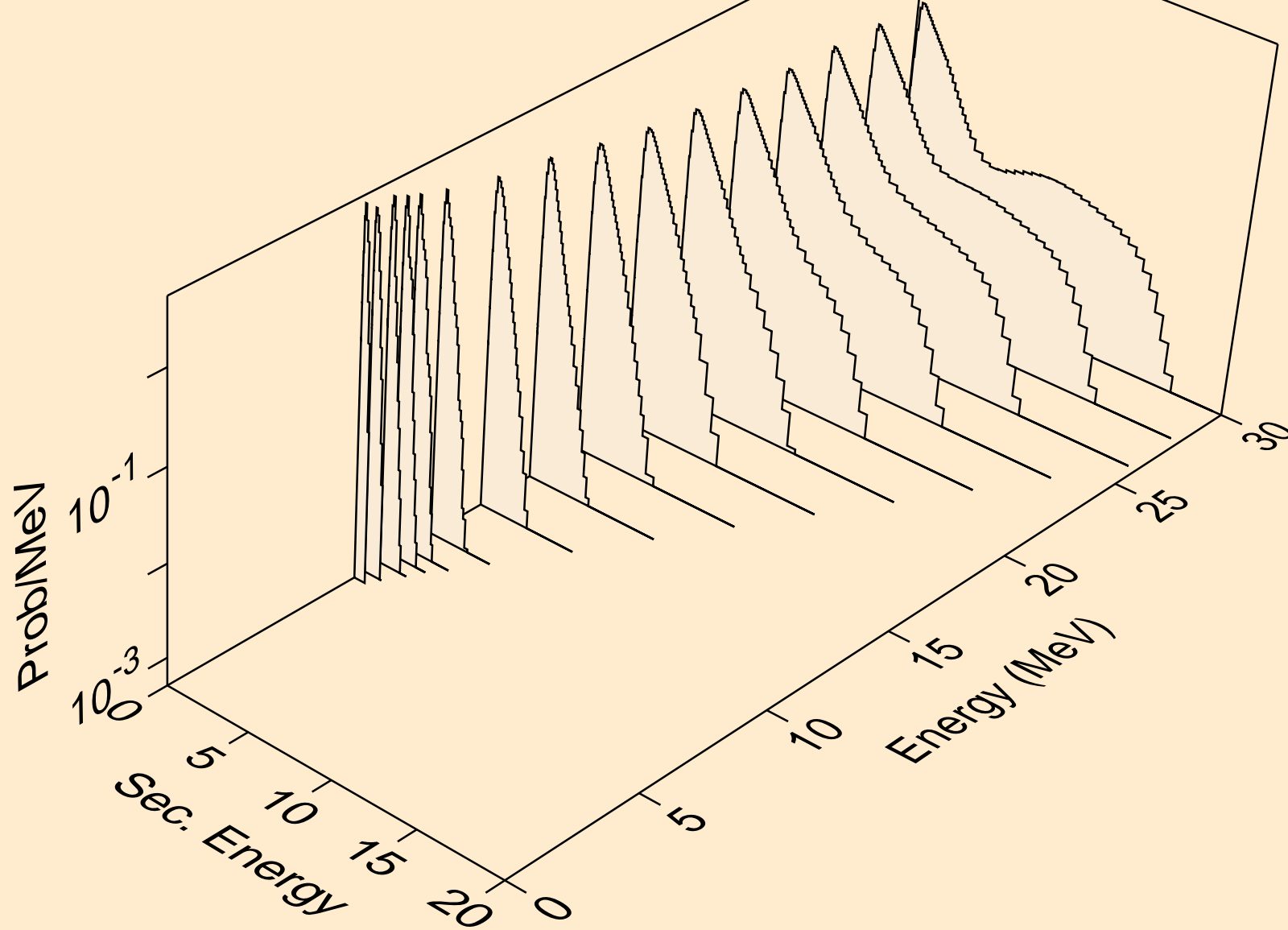

TC089 NEUTRON ACER TENDL-2024 LIBRARY; T=0.K
Neutron emission for (n,2n)a

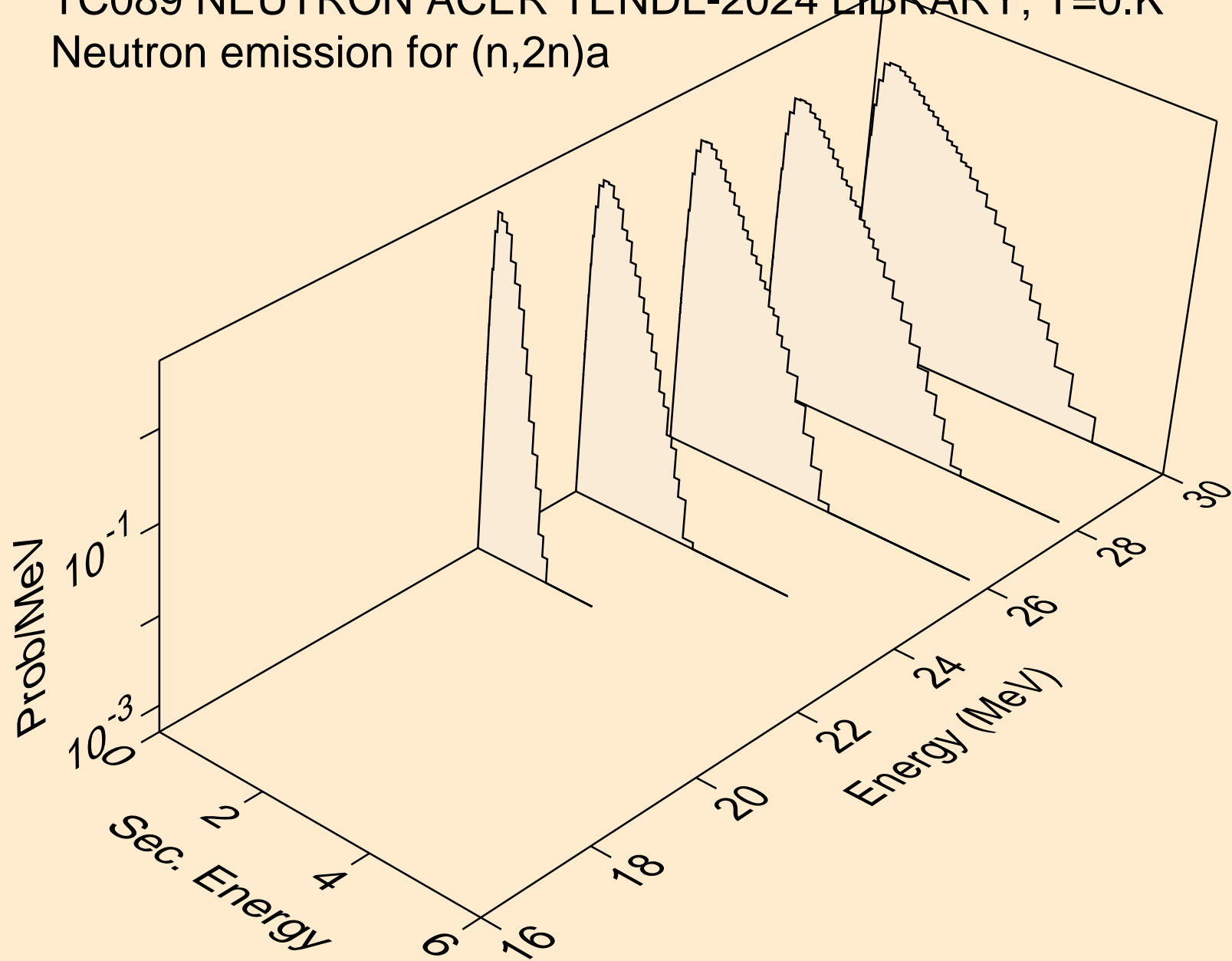

TC089 NEUTRON ACER TENDL-2024 LIBRARY; T=0.K
Neutron emission for (n,n*)p

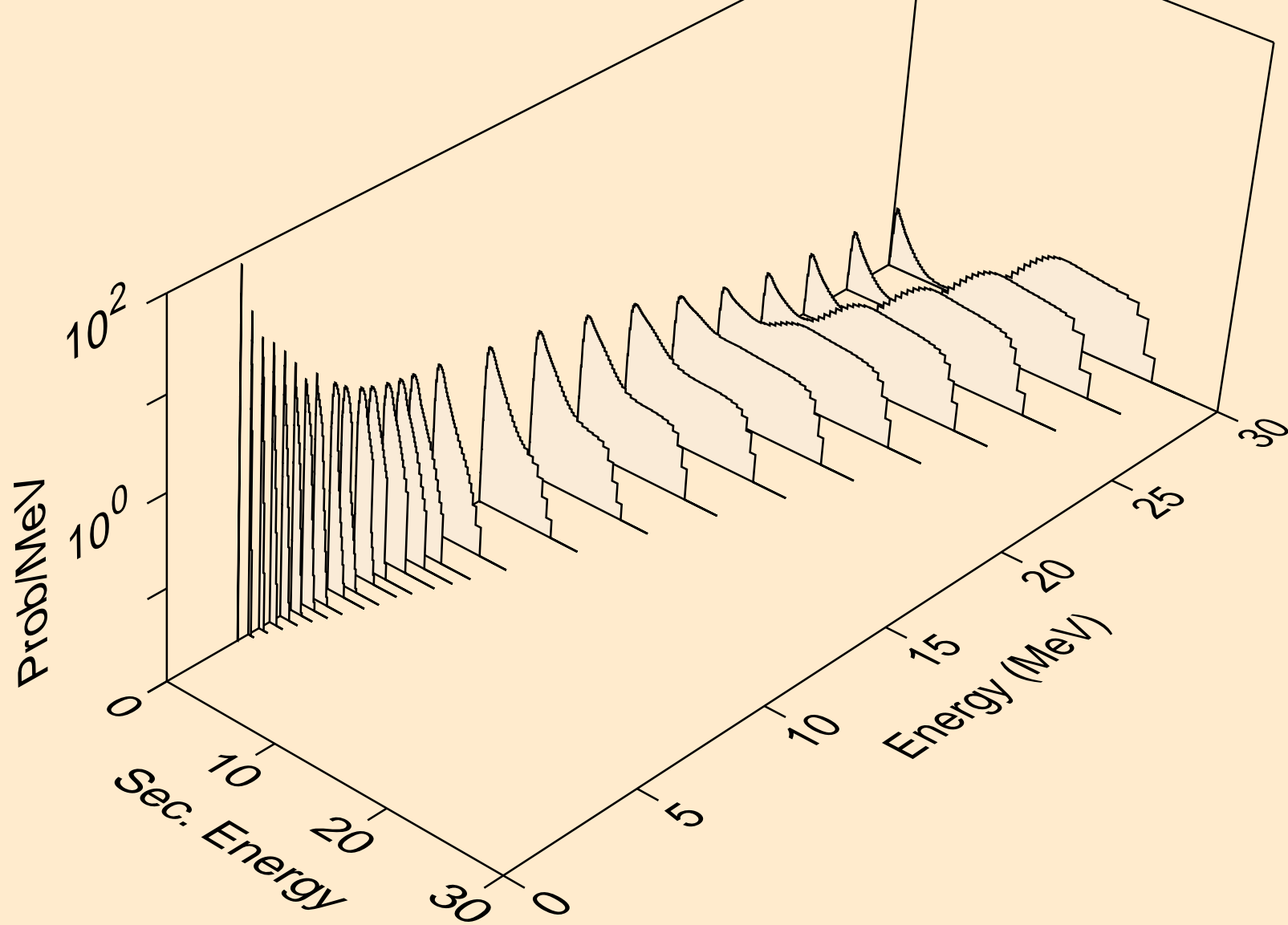

TC089 NEUTRON ACER TENDL-2024 LIBRARY; T=0.K
Neutron emission for (n,n*)2a

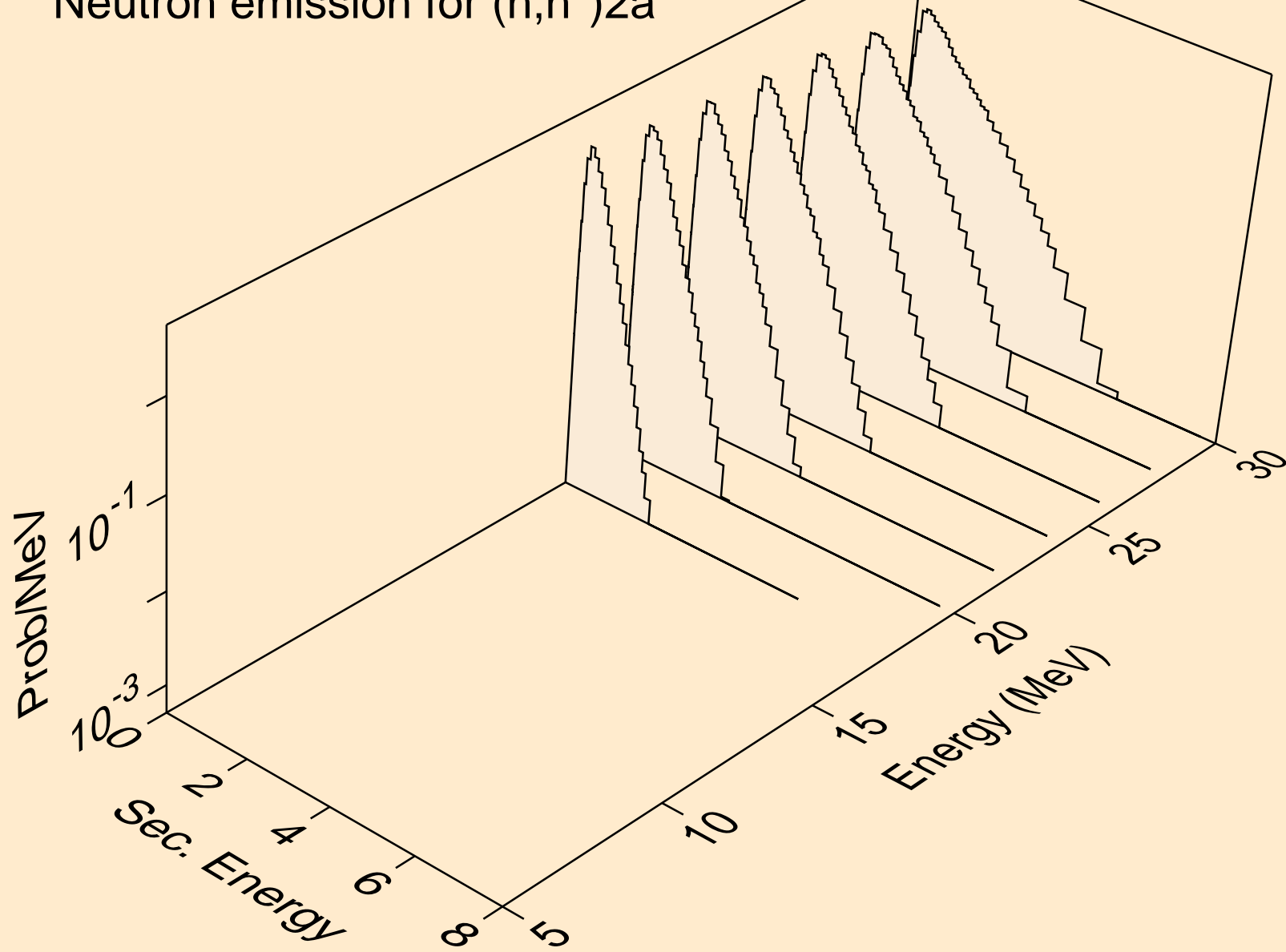

TC089 NEUTRON ACER TENDL-2024 LIBRARY; T=0.K
Neutron emission for (n,n*)d

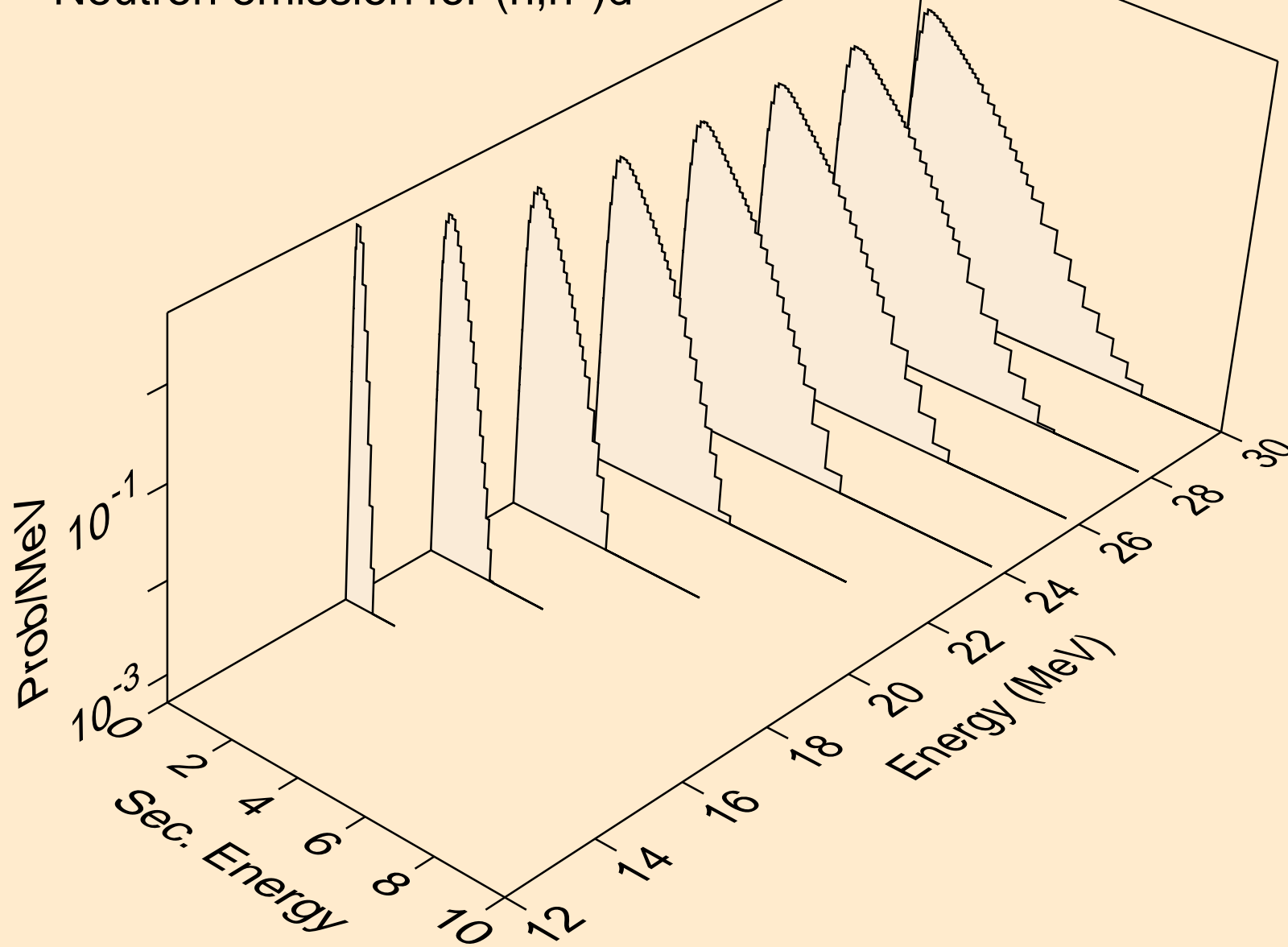

TC089 NEUTRON ACER TENDL-2024 LIBRARY; T=0.K
Neutron emission for (n,n*)t

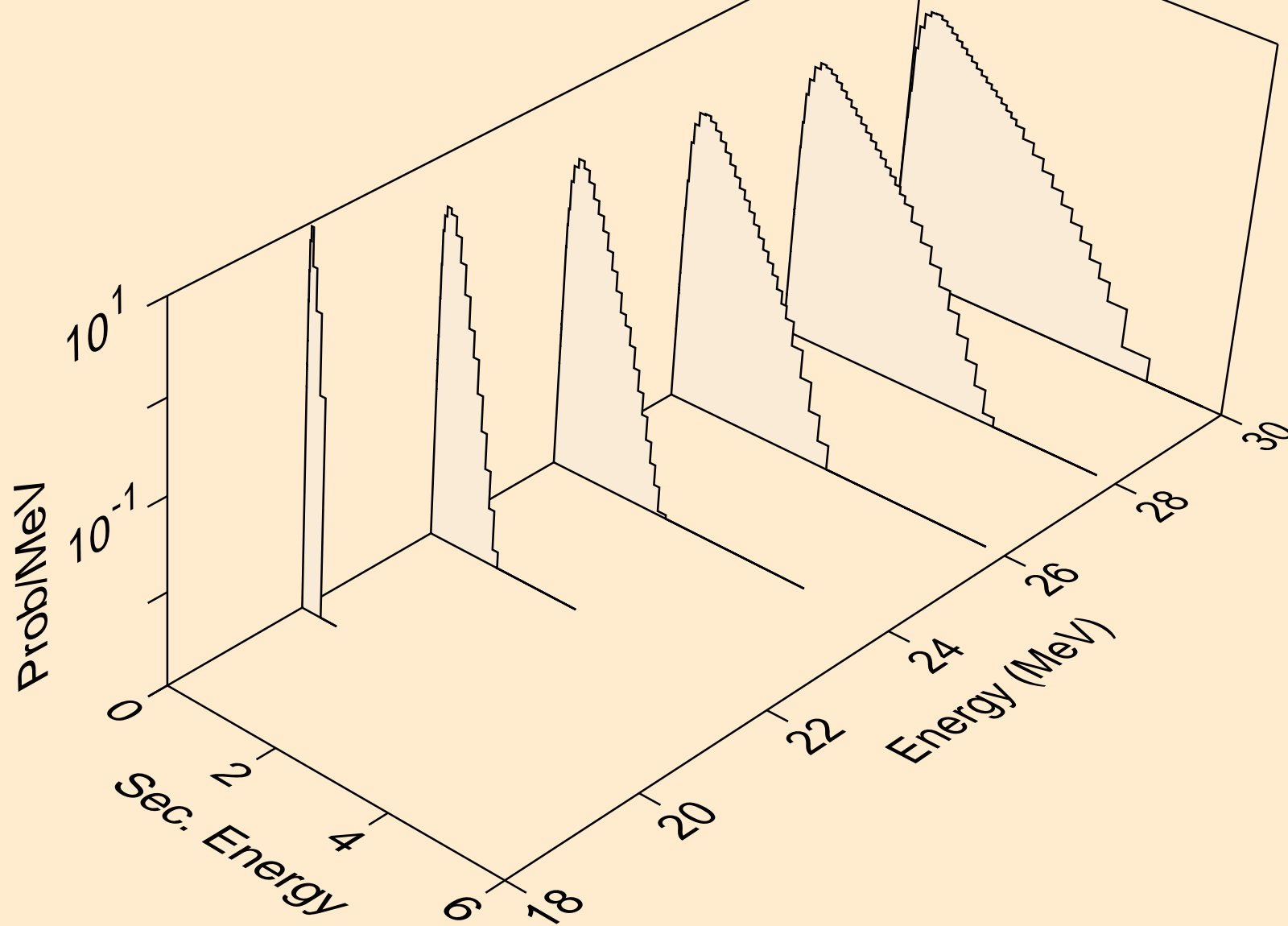

TC089 NEUTRON ACER TENDL-2024 LIBRARY; T=0.K
Neutron emission for (n,n*)he3

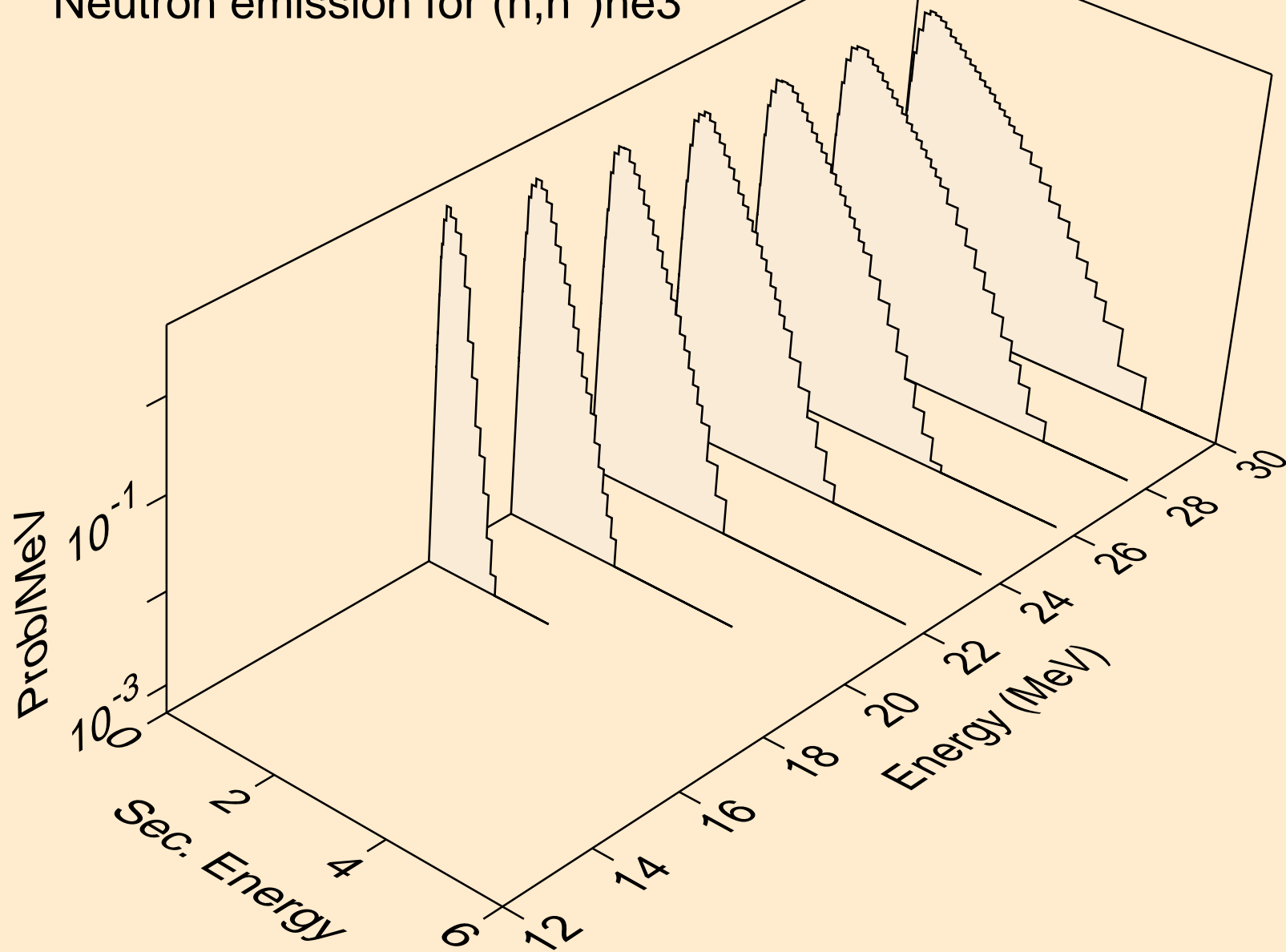

TC089 NEUTRON ACER TENDL-2024 LIBRARY; T=0.K
Neutron emission for (n,2np)

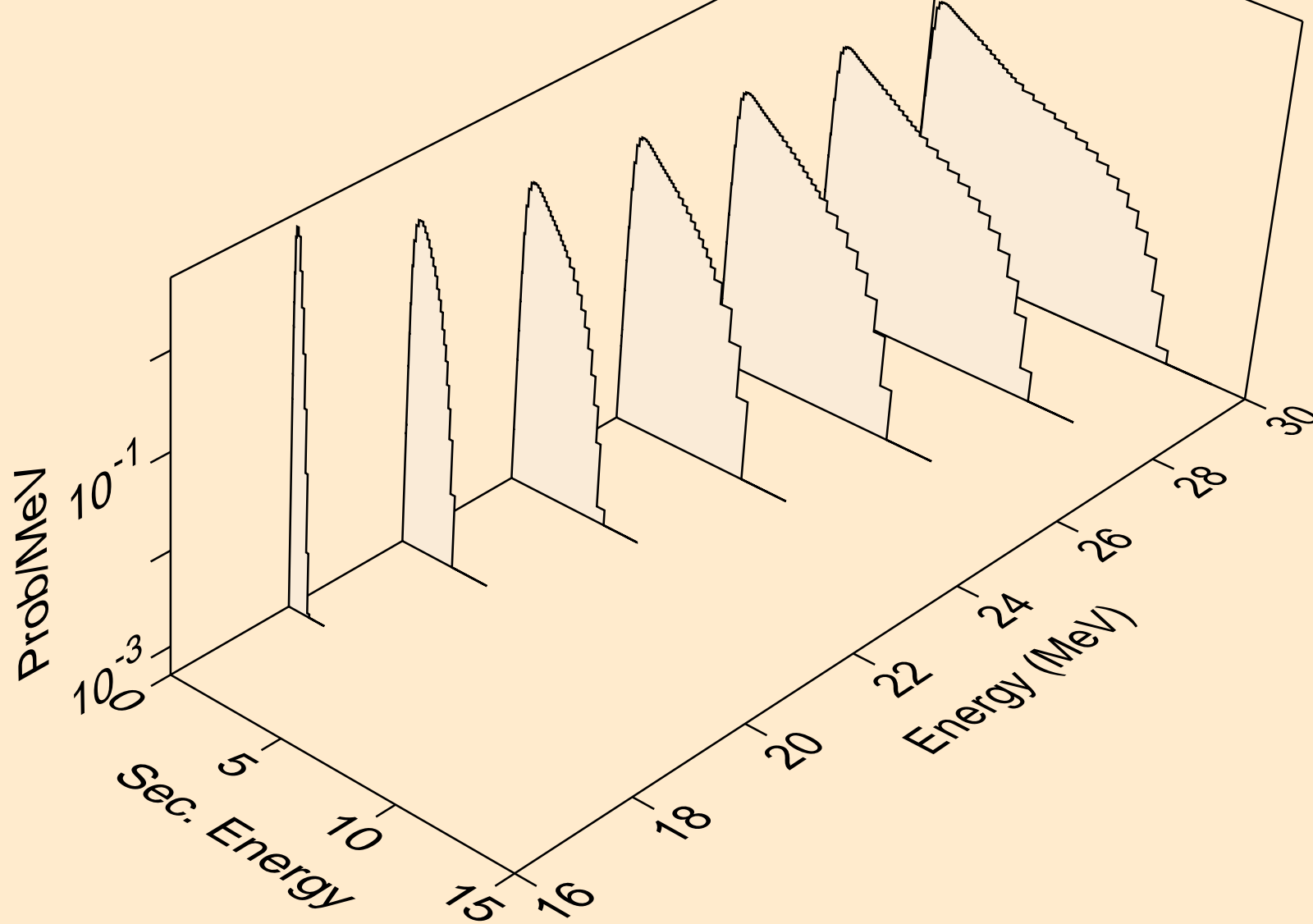

TC089 NEUTRON ACER TENDL-2024 LIBRARY; T=0.K
Neutron emission for (n,3np)

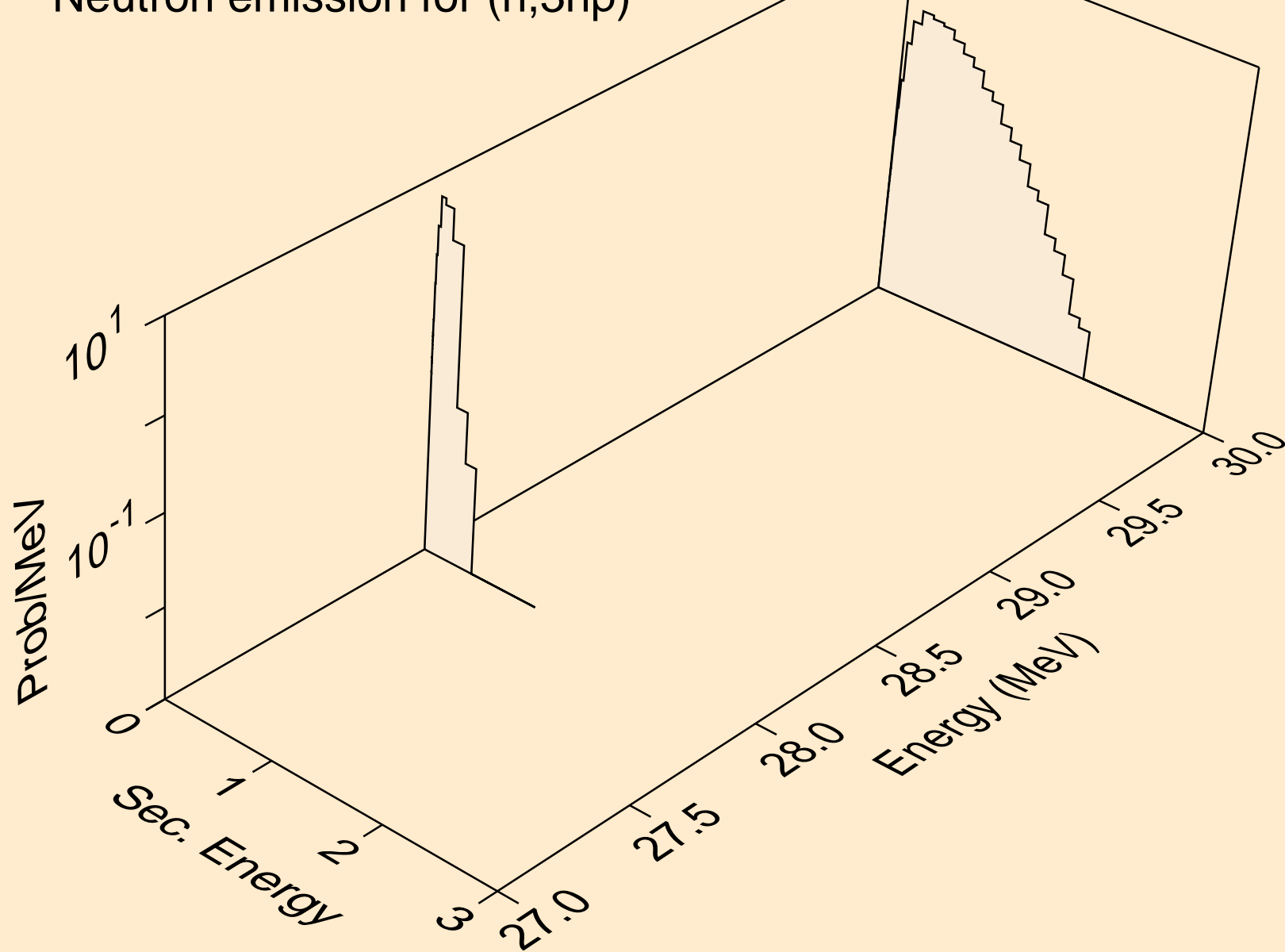

TC089 NEUTRON ACER TENDL-2024 LIBRARY; T=0.K
Neutron emission for (n,n2p)

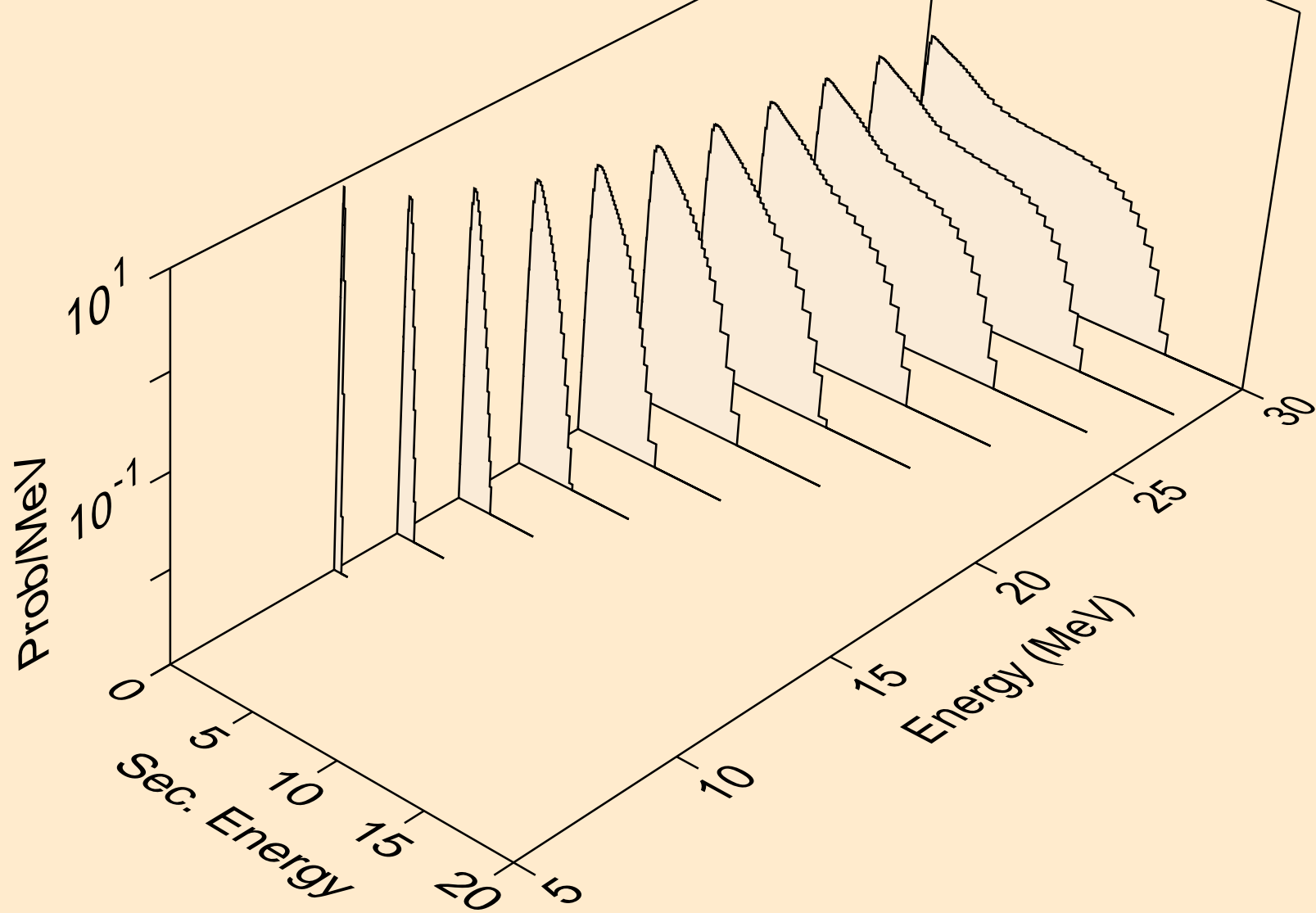

TC089 NEUTRON ACER TENDL-2024 LIBRARY; T=0.K
Neutron emission for (n,npa)

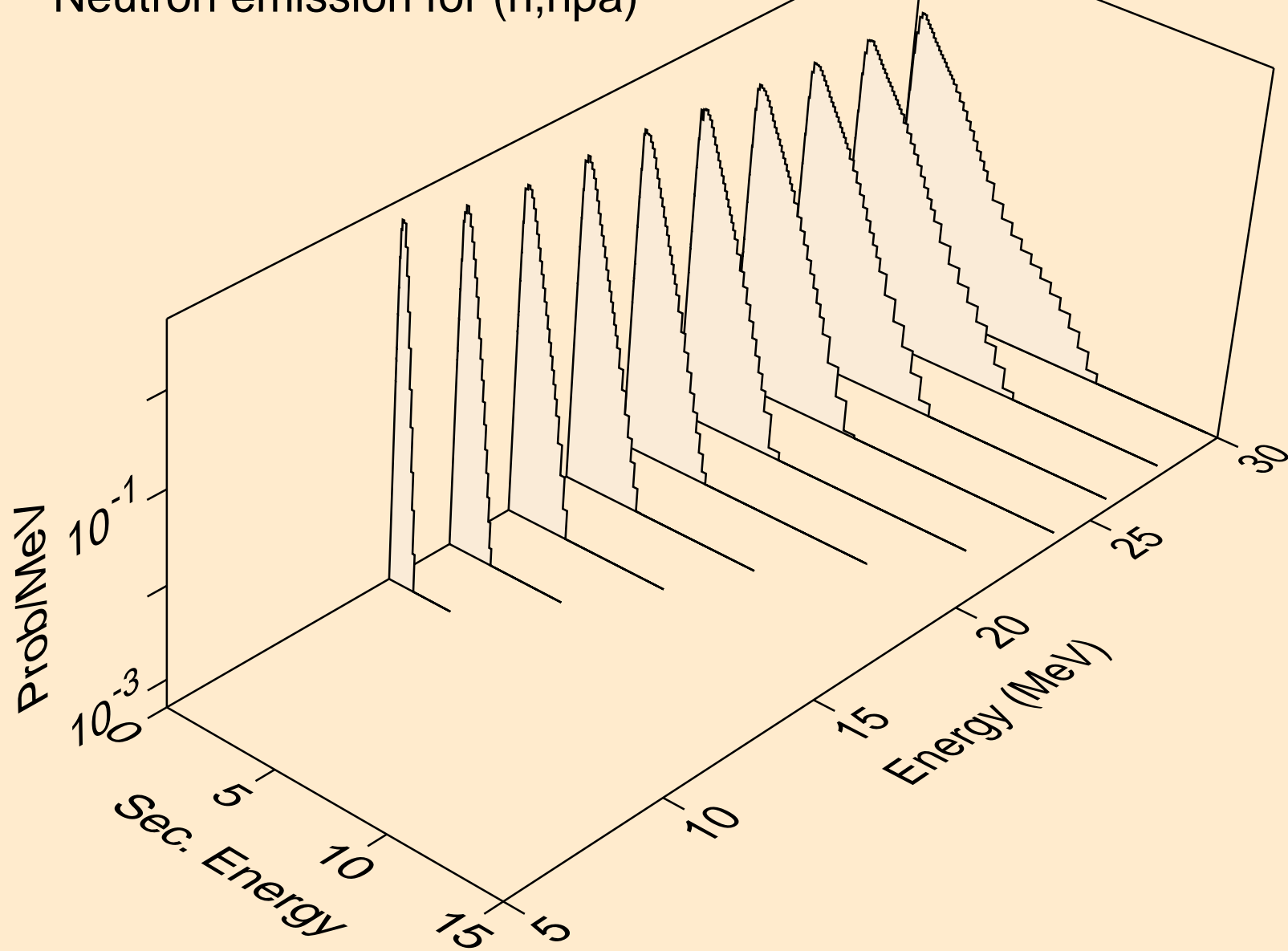

TC089 NEUTRON ACER TENDL-2024 LIBRARY; T=0.K
Neutron emission for (n,n*c)

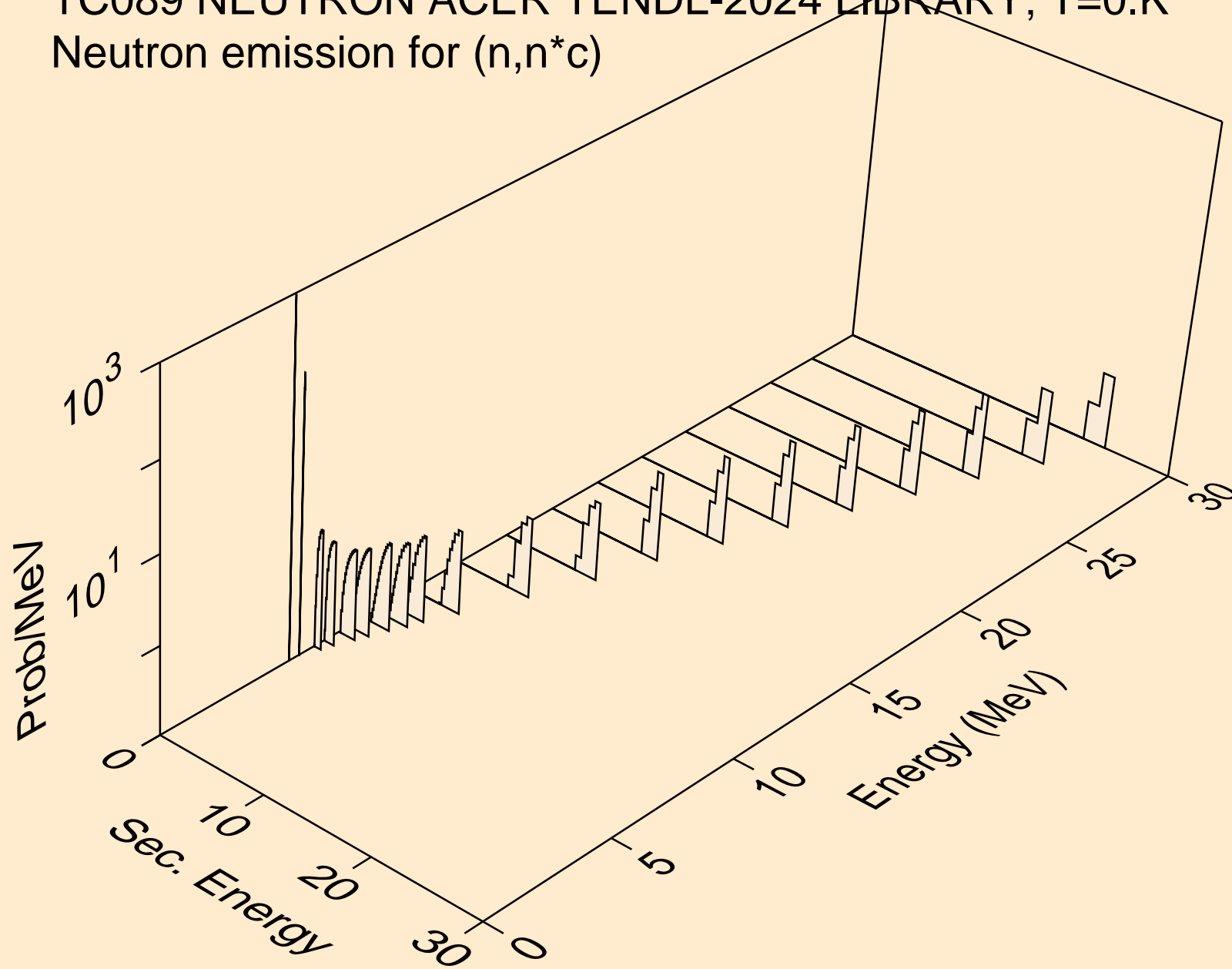

TC089 NEUTRON ACER TENDL-2024 LIBRARY; T=0.K
Photon emission for (n,x)

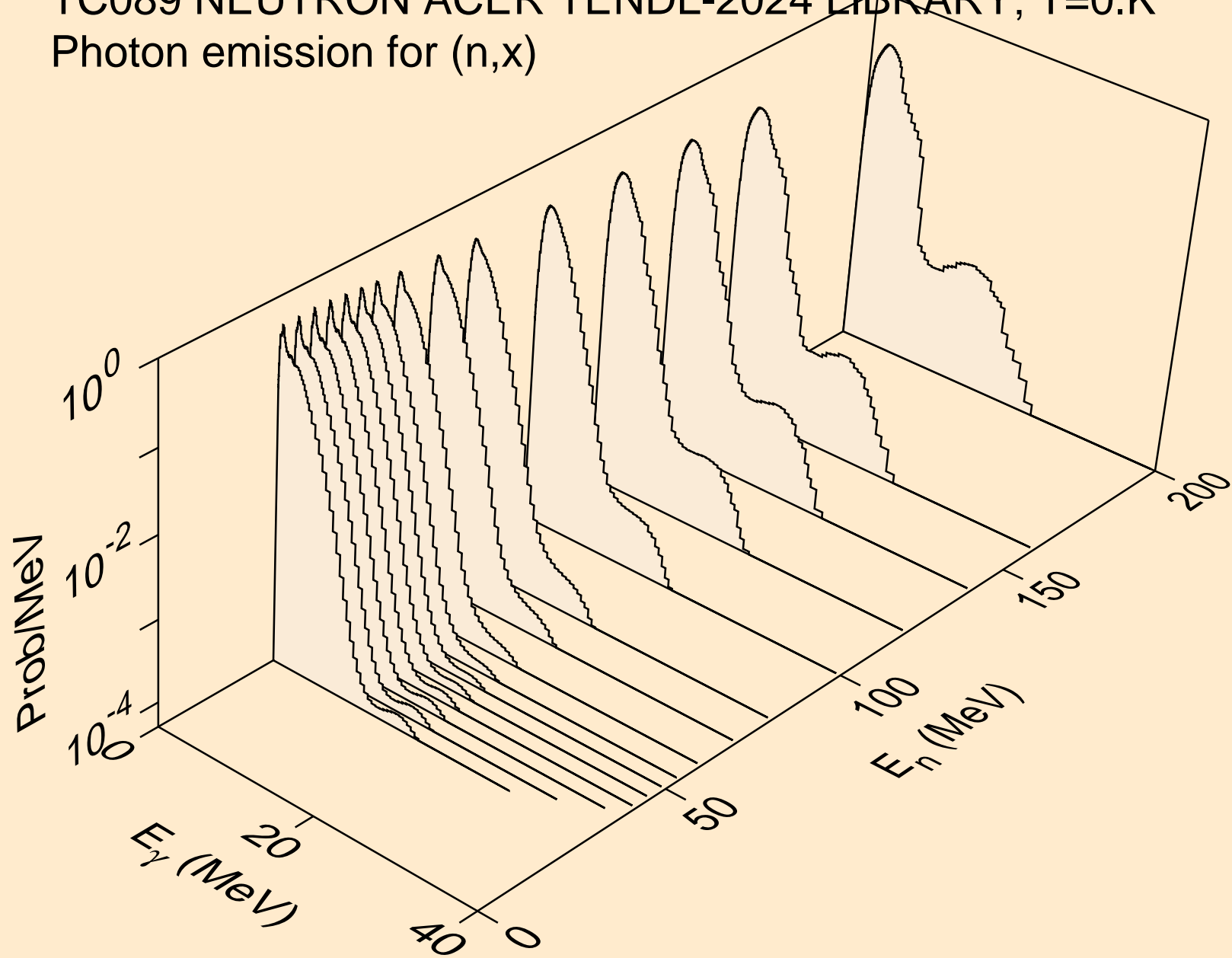

TC089 NEUTRON ACER TENDL-2024 LIBRARY; T=0.K
Photon emission for (n,2nd)

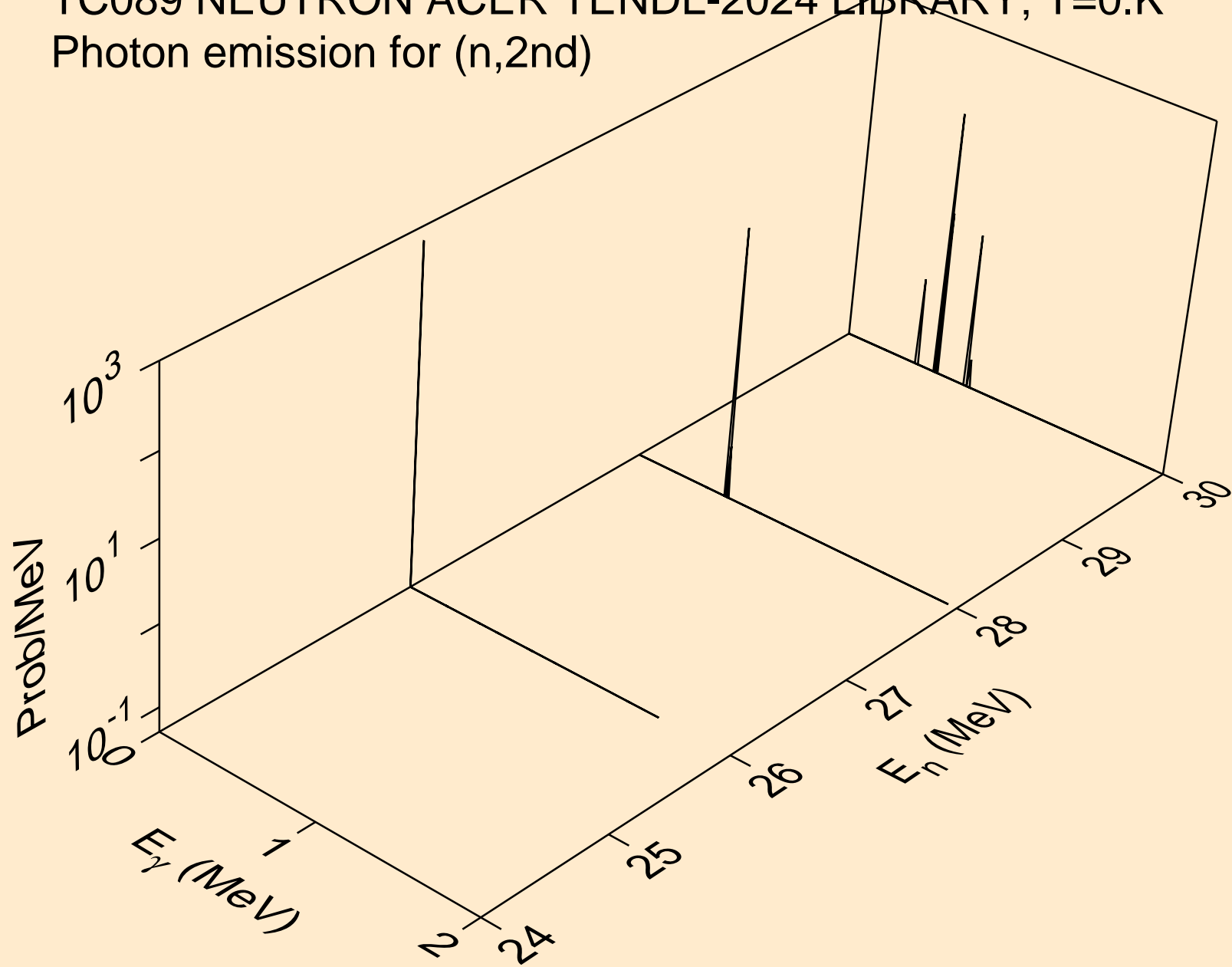

TC089 NEUTRON ACER TENDL-2024 LIBRARY; T=0.K
Photon emission for (n,2n)

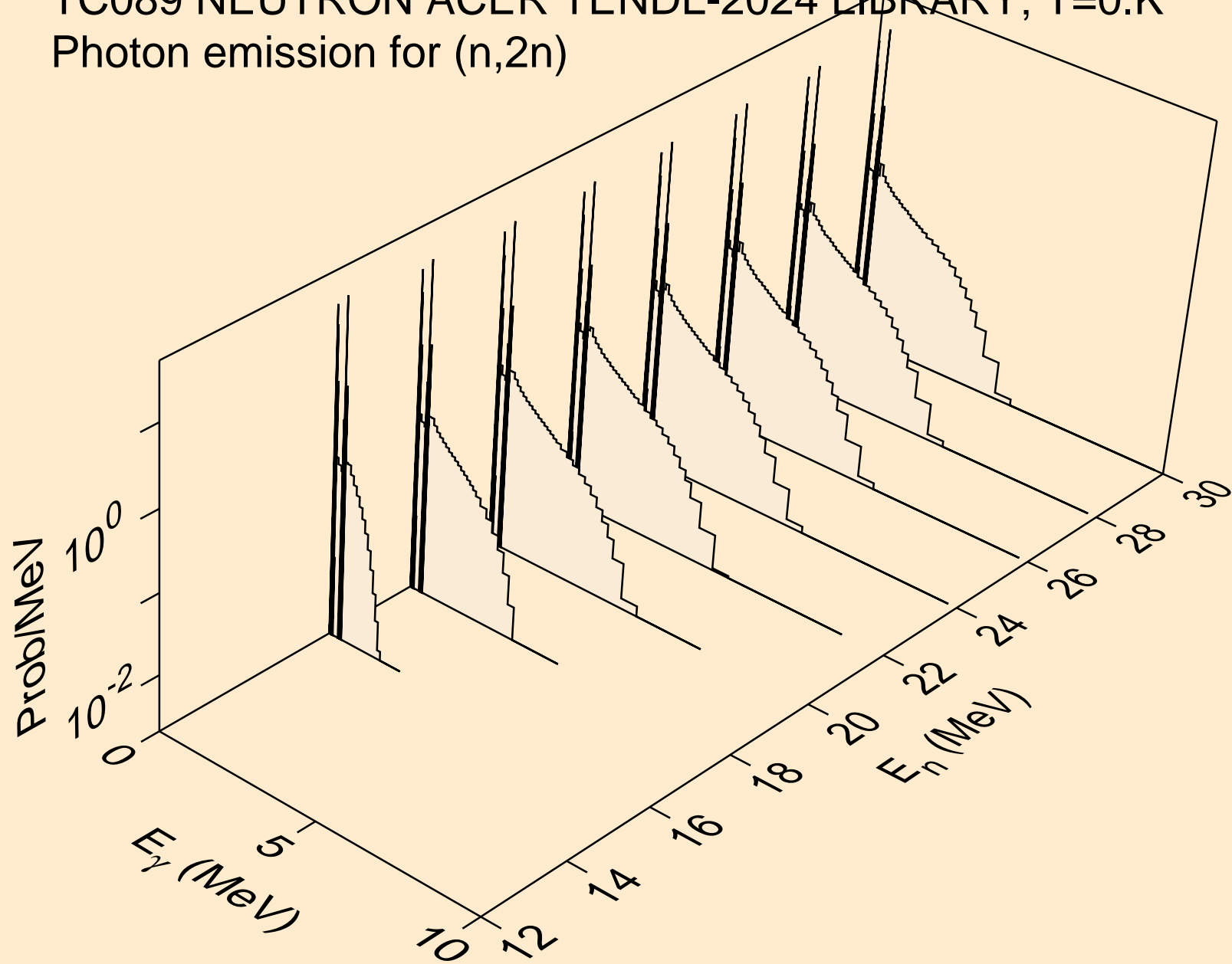

TC089 NEUTRON ACER TENDL-2024 LIBRARY; T=0.K
Photon emission for (n,3n)

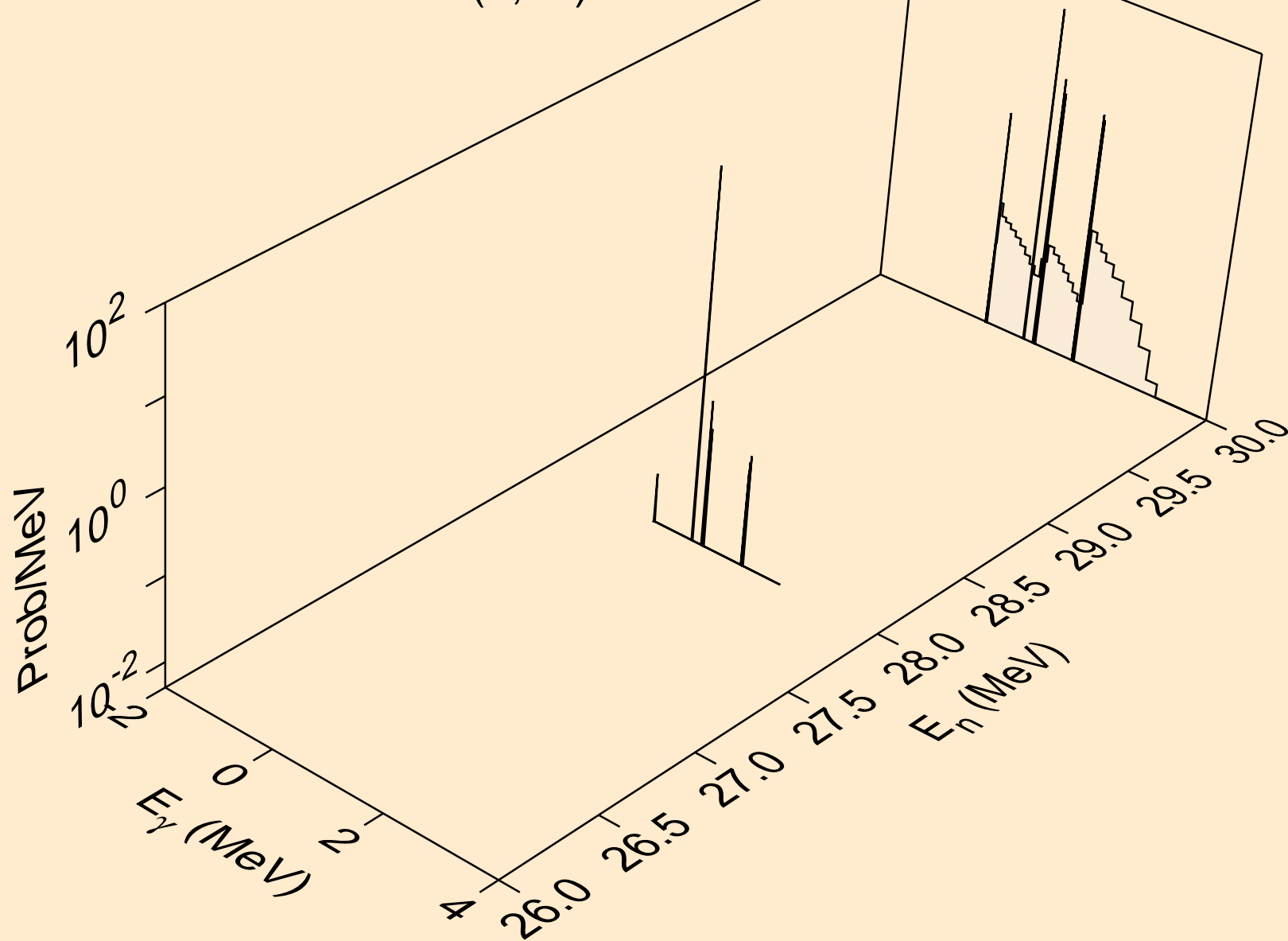

TC089 NEUTRON ACER TENDL-2024 LIBRARY; T=0.K
Photon emission for (n,n*)a

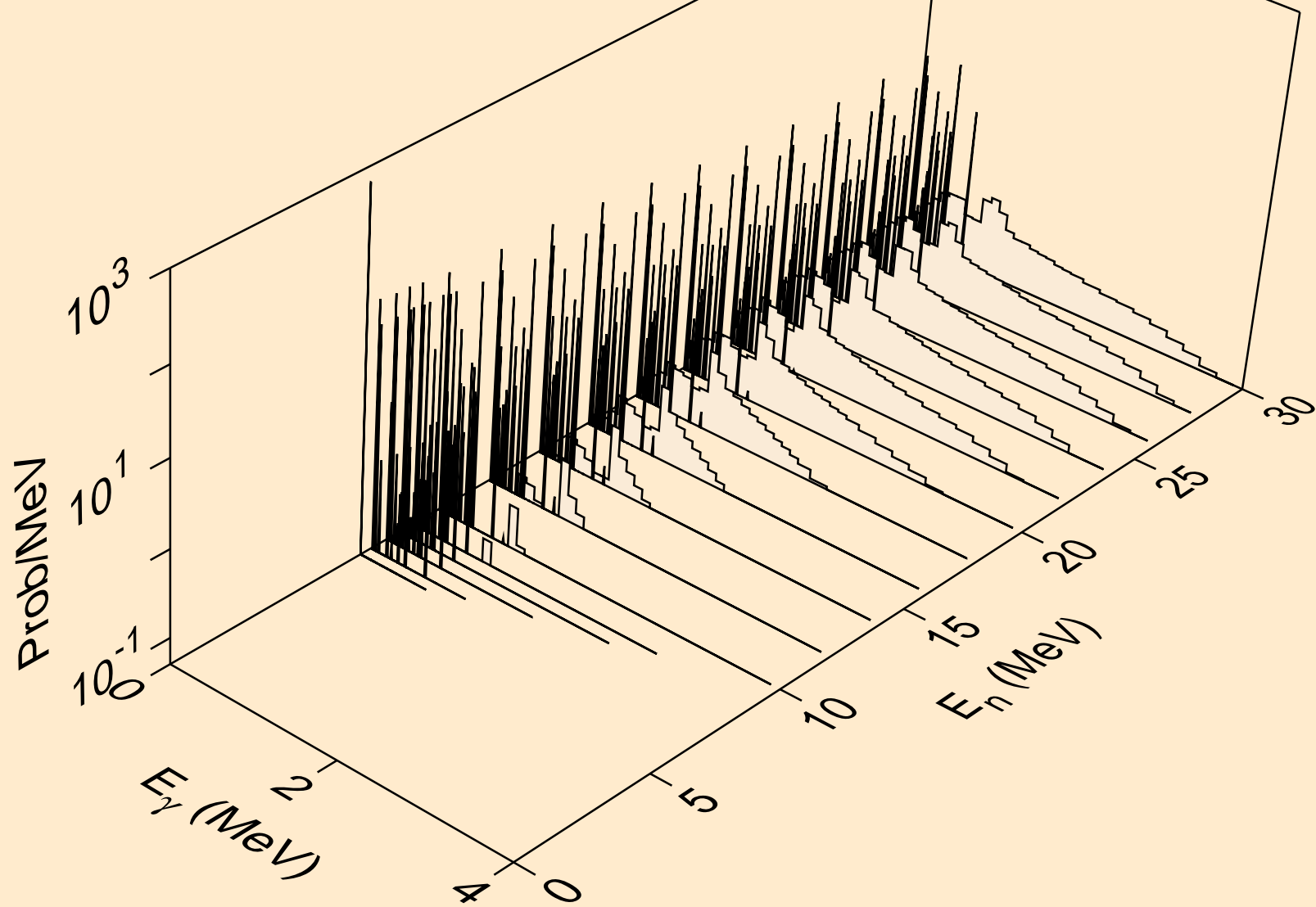

TC089 NEUTRON ACER TENDL-2024 LIBRARY; T=0.K
Photon emission for (n,2n)a

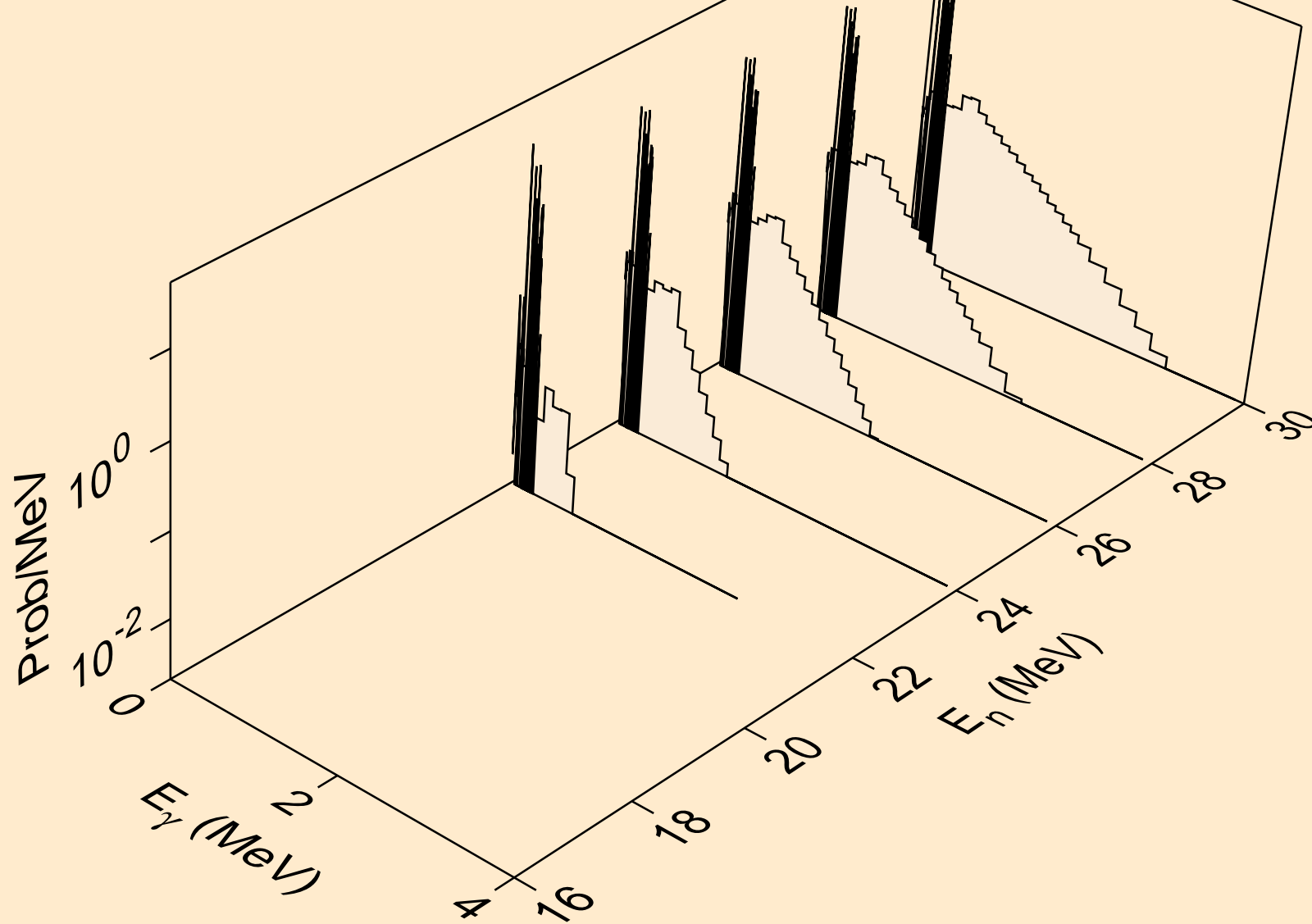

TC089 NEUTRON ACER TENDL-2024 LIBRARY; T=0.K
Photon emission for (n,n*)p

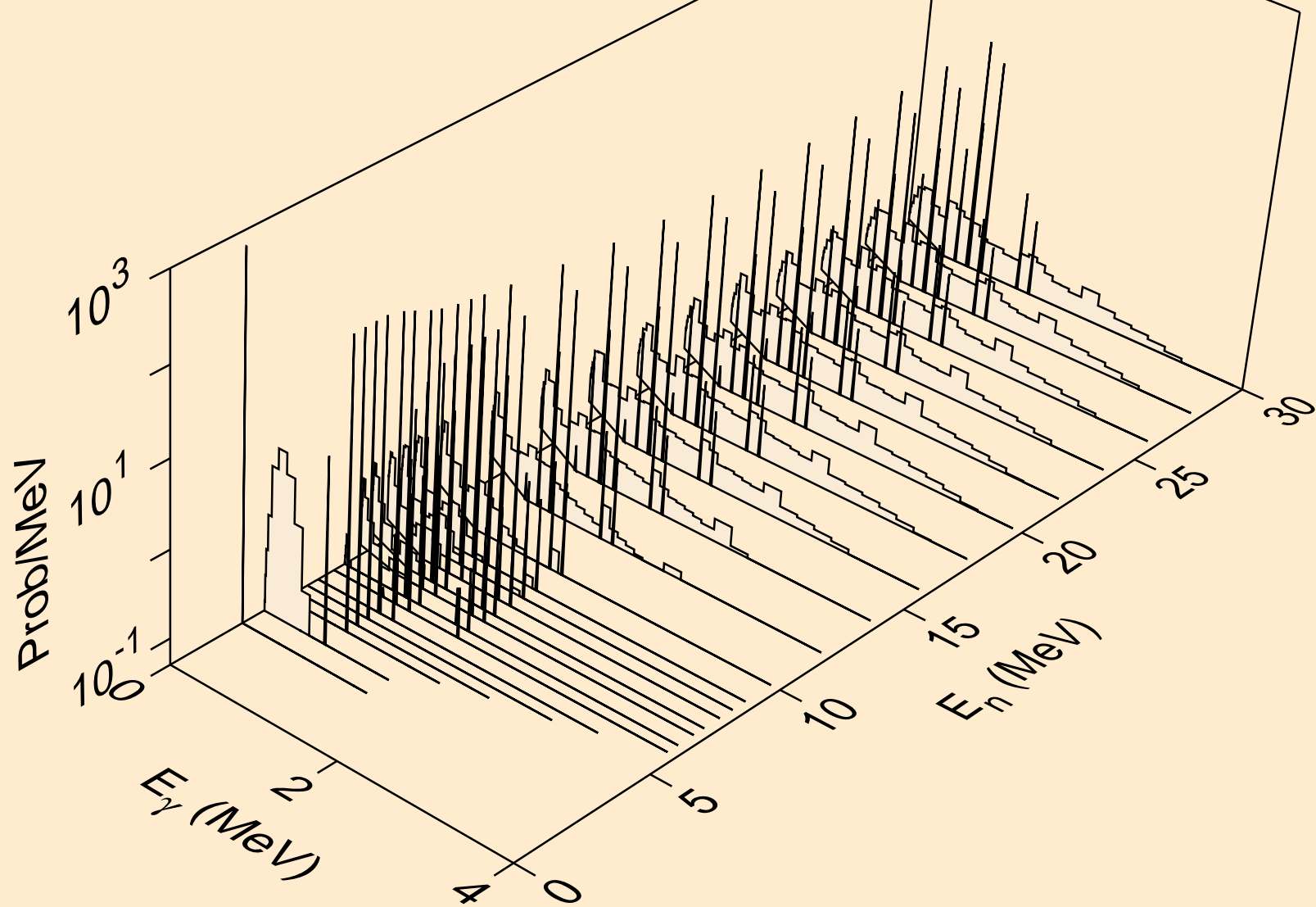

TC089 NEUTRON ACER TENDL-2024 LIBRARY; T=0.K
Photon emission for (n,n*)2a

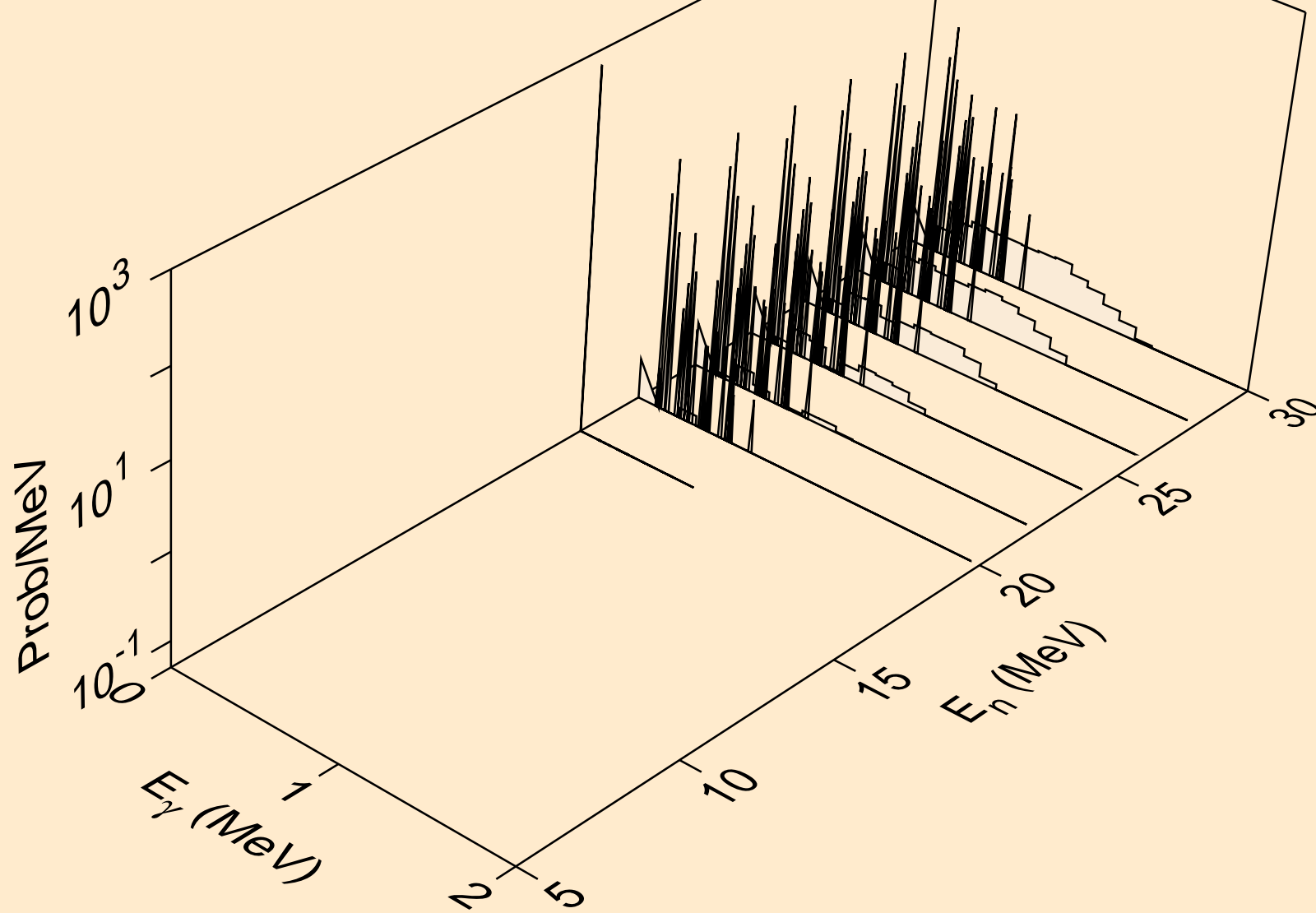

TC089 NEUTRON ACER TENDL-2024 LIBRARY; T=0.K
Photon emission for (n,n*)d

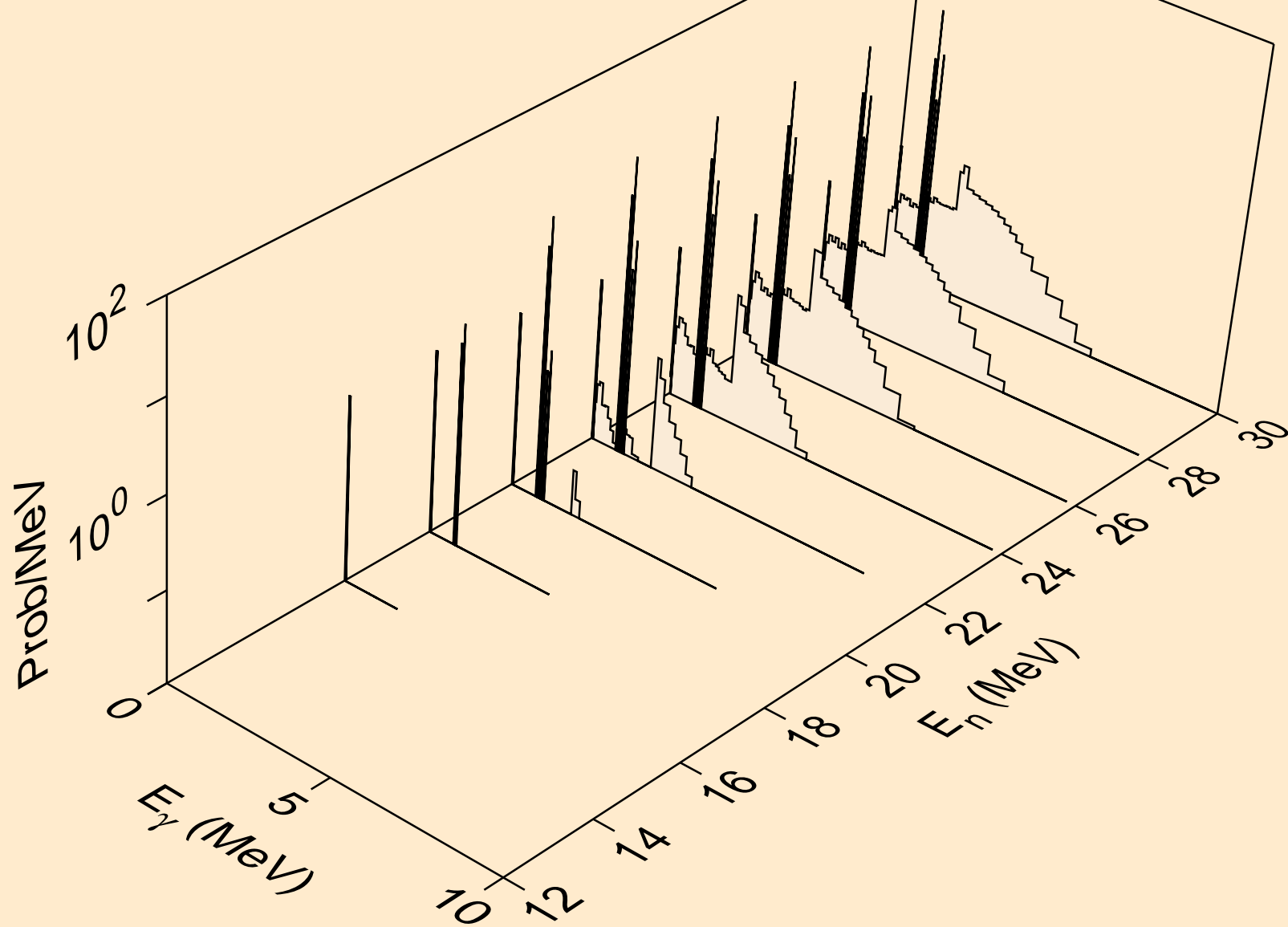

TC089 NEUTRON ACER TENDL-2024 LIBRARY; T=0.K
Photon emission for (n,n*)t

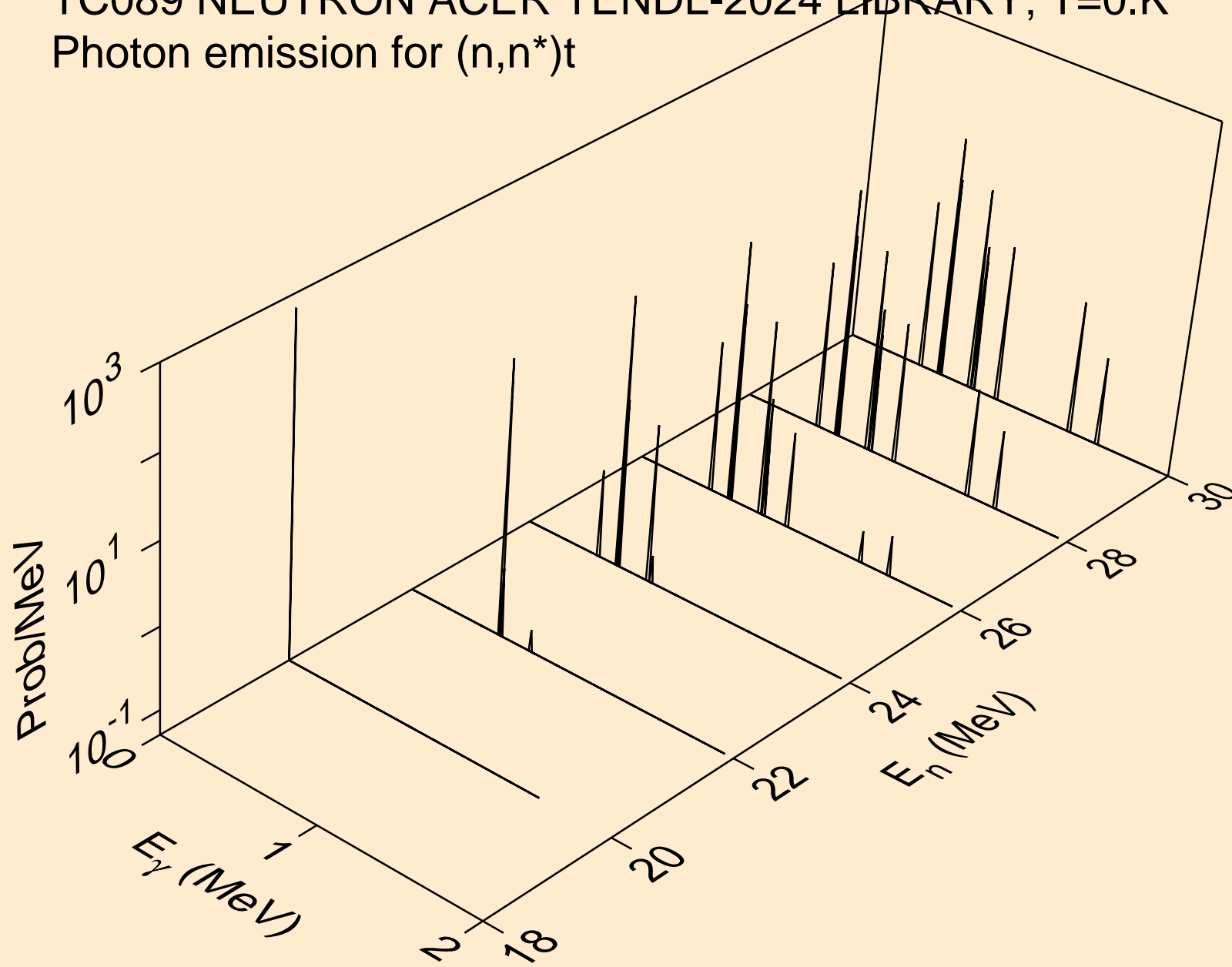

TC089 NEUTRON ACER TENDL-2024 LIBRARY; T=0.K
Photon emission for (n,n*)he3

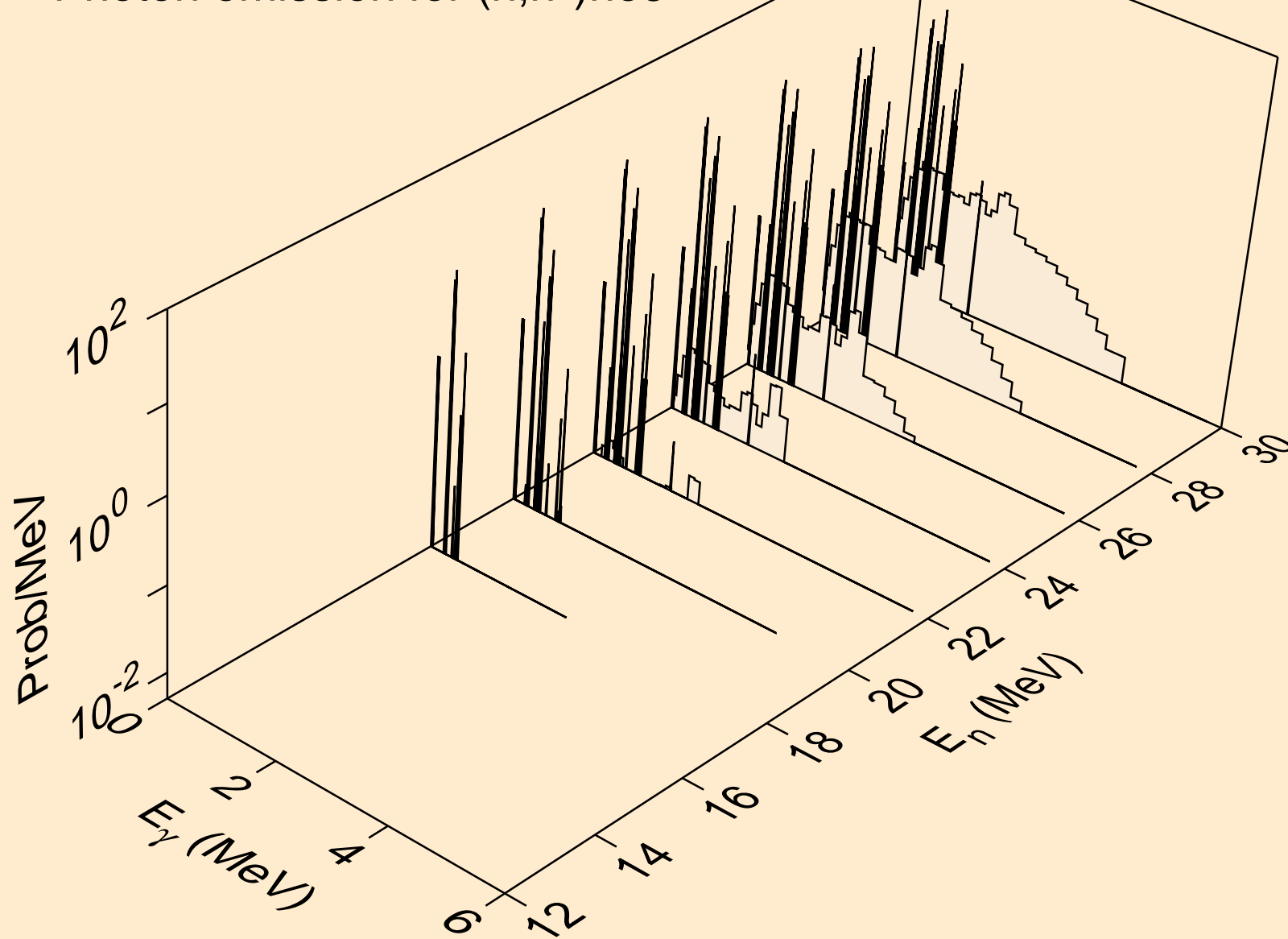

TC089 NEUTRON ACER TENDL-2024 LIBRARY; T=0.K
Photon emission for (n,2np)

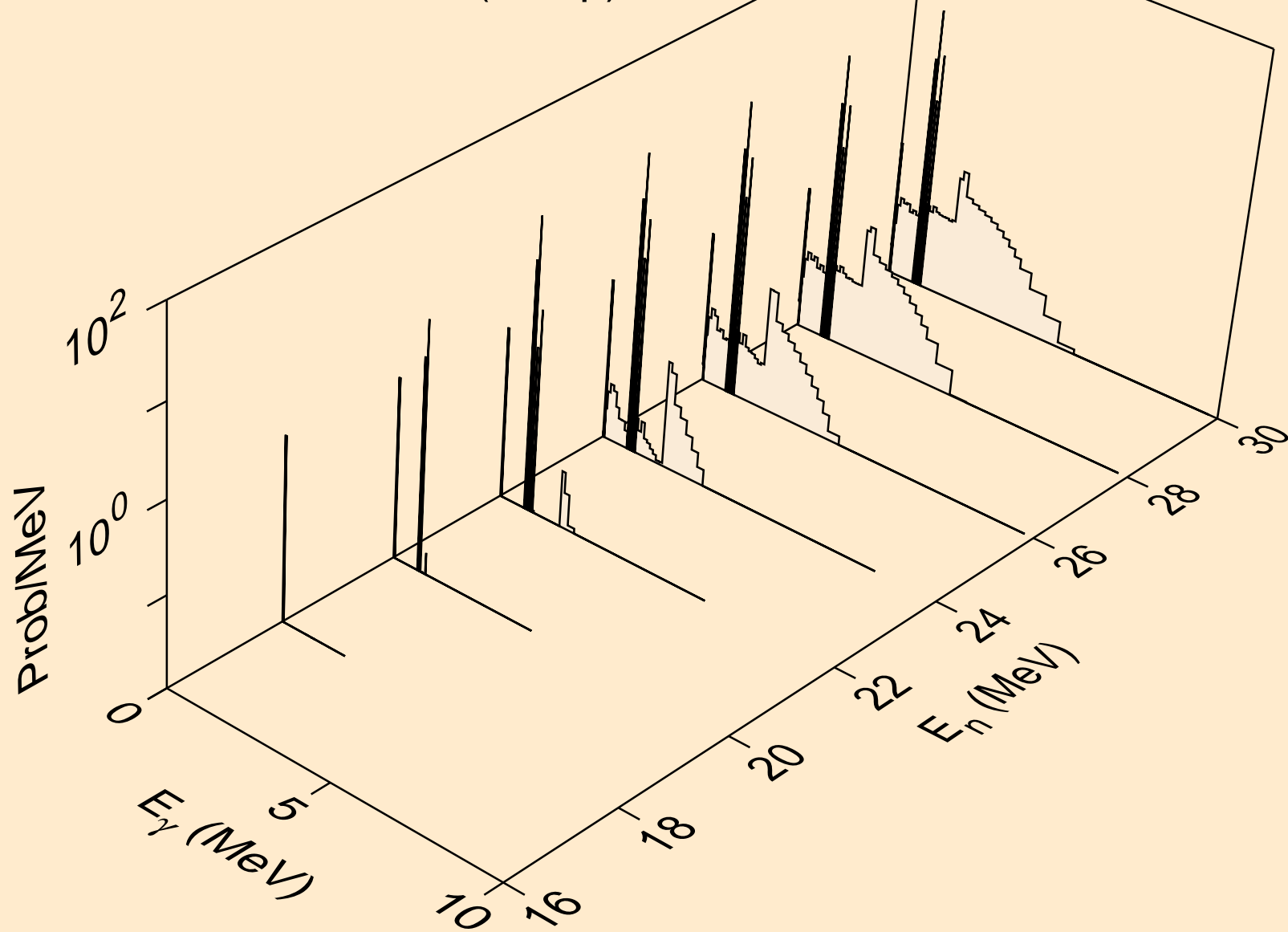

TC089 NEUTRON ACER TENDL-2024 LIBRARY; T=0.K
Photon emission for (n,3np)

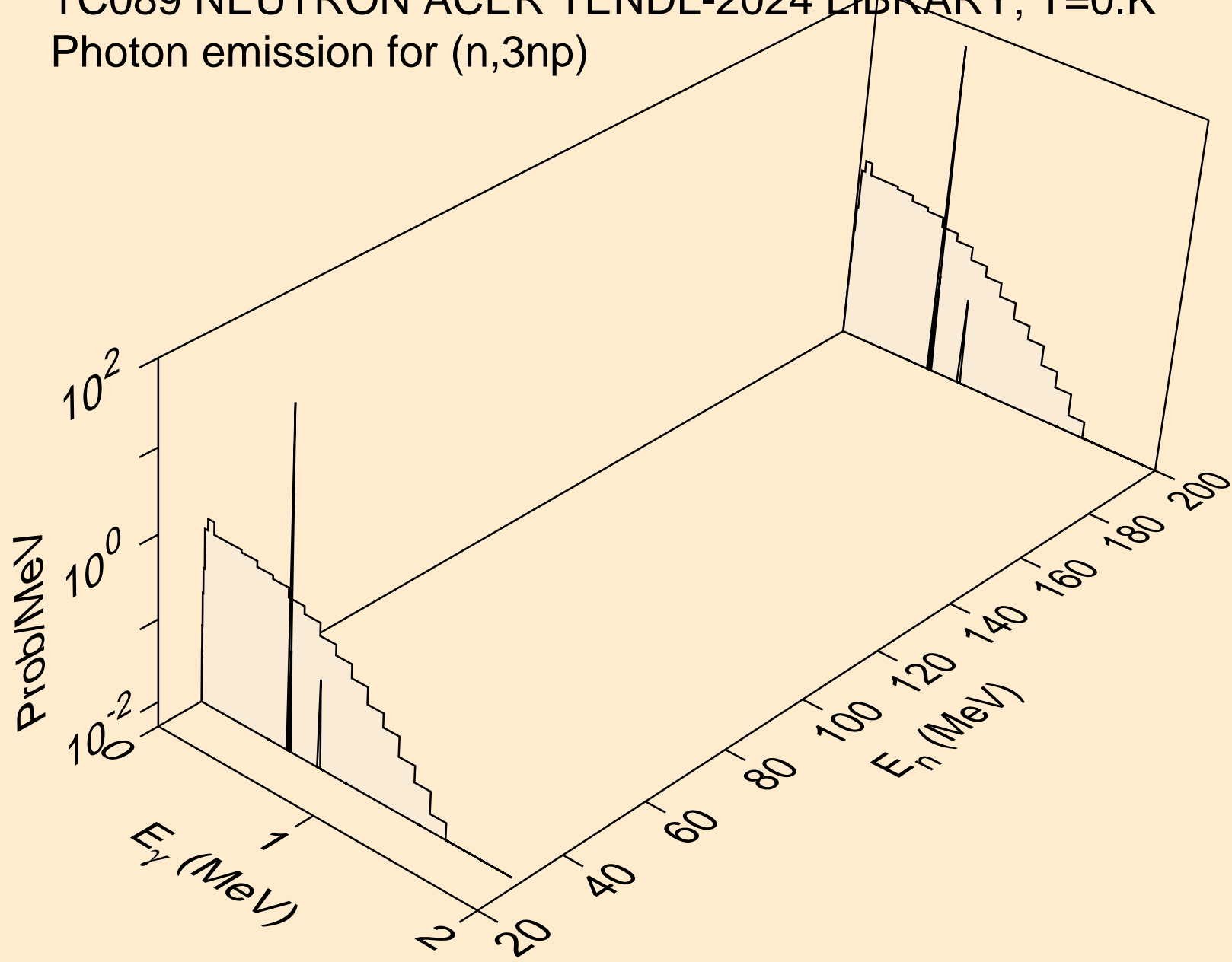

TC089 NEUTRON ACER TENDL-2024 LIBRARY; T=0.K
Photon emission for (n,n2p)

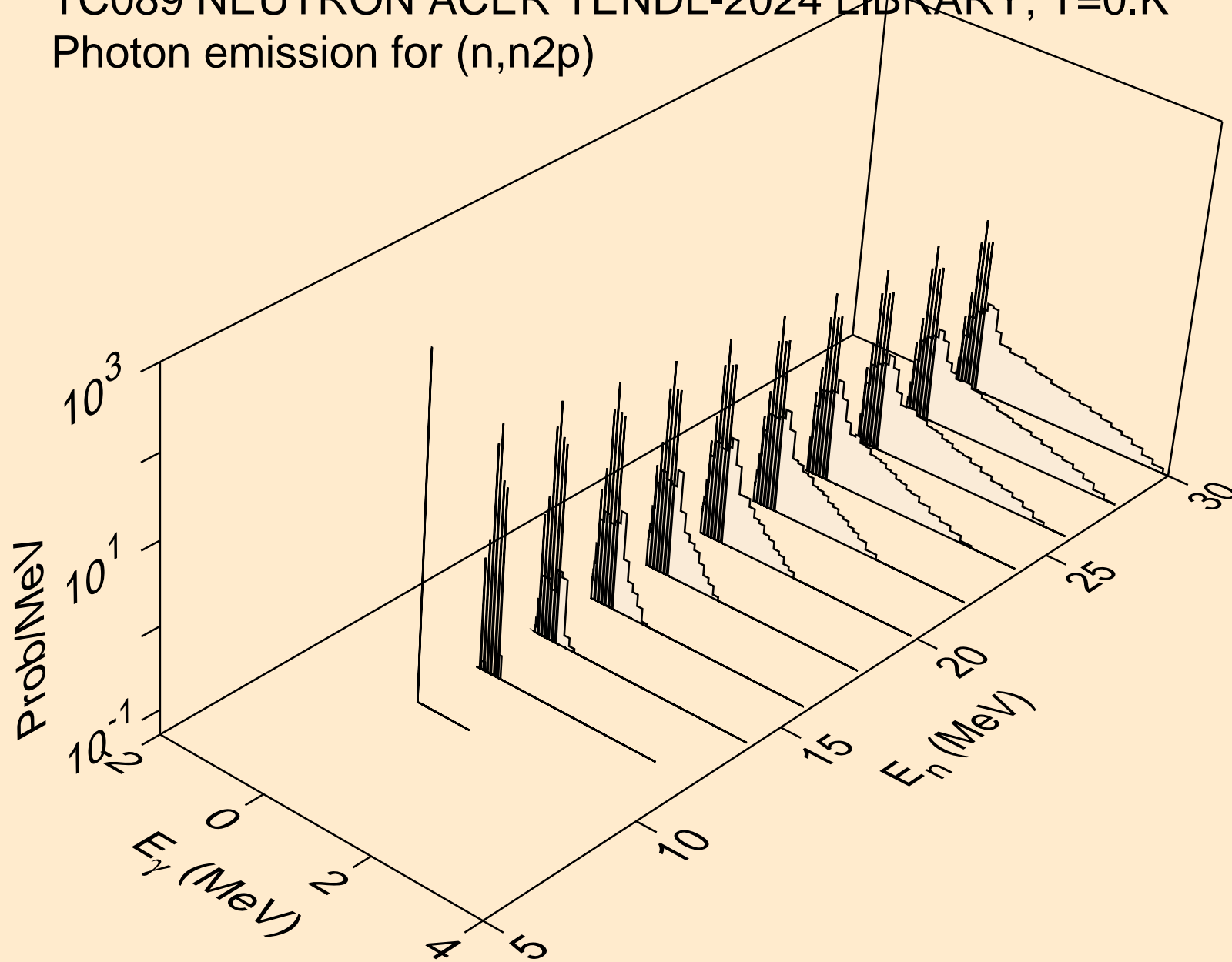

TC089 NEUTRON ACER TENDL-2024 LIBRARY; T=0.K
Photon emission for (n,npa)

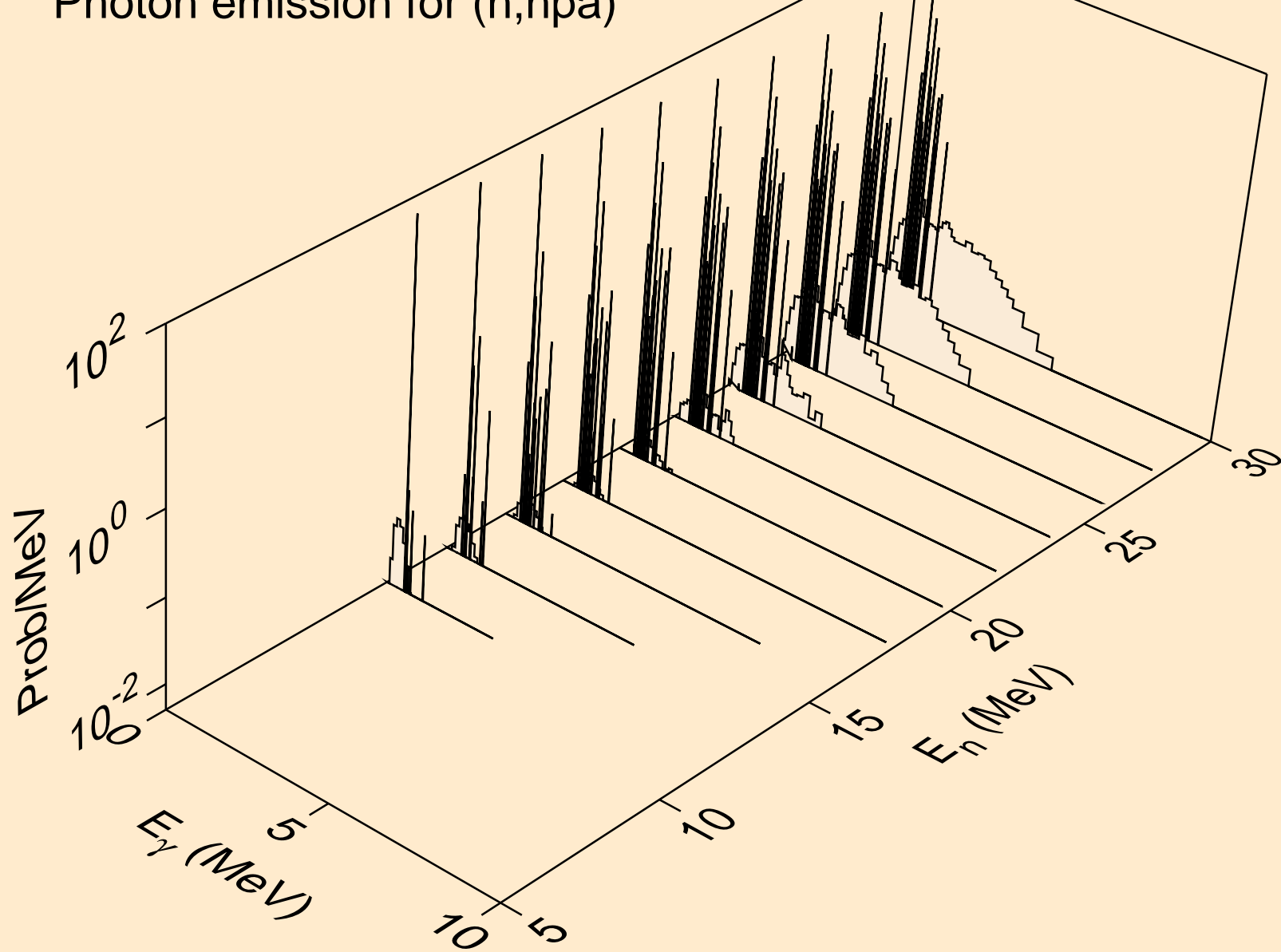

TC089 NEUTRON ACER TENDL-2024 LIBRARY; T=0.K
Photon emission for (n,n*c)

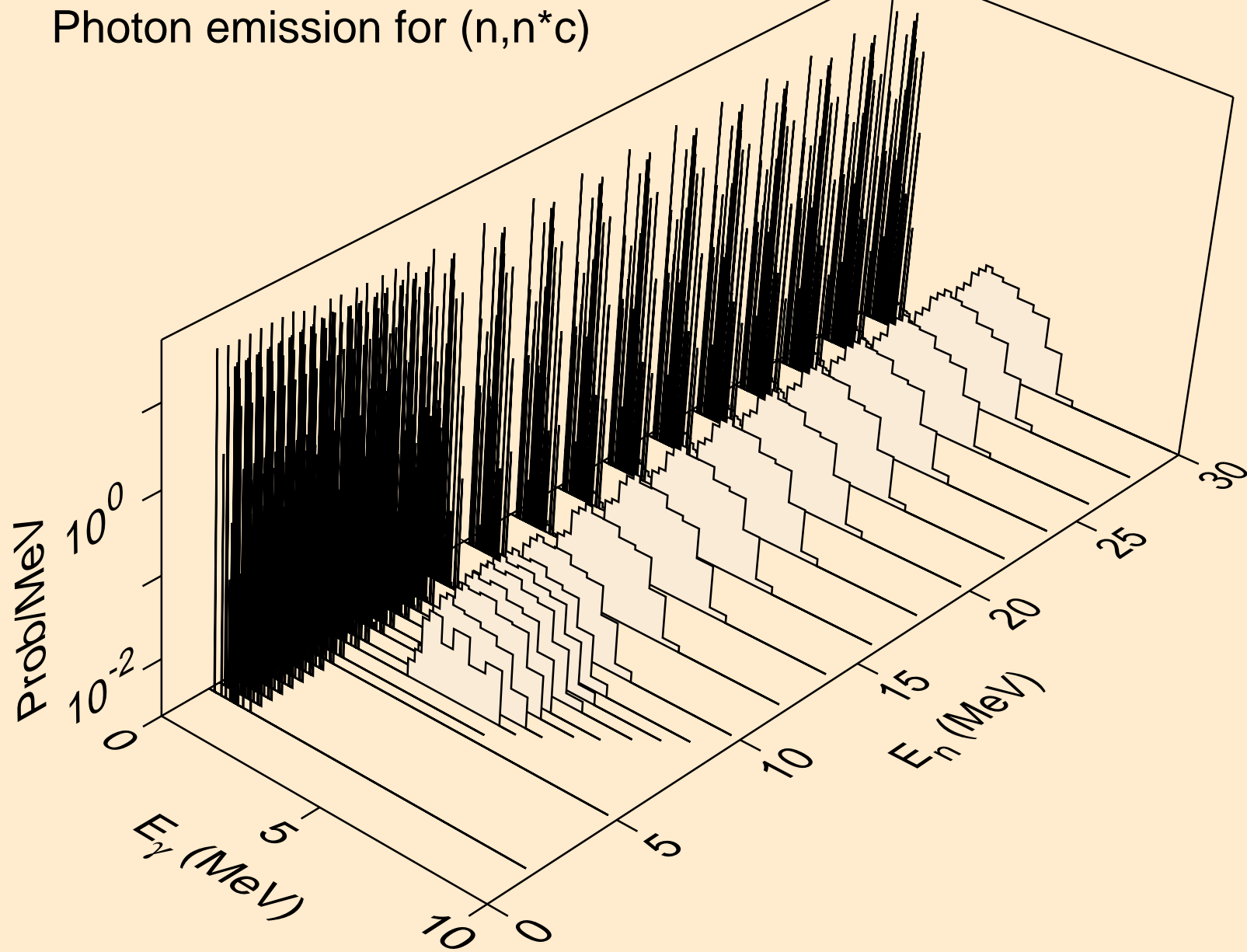

TC089 NEUTRON ACER TENDL-2024 LIBRARY; T=0.K
Photon emission for (n,gma)

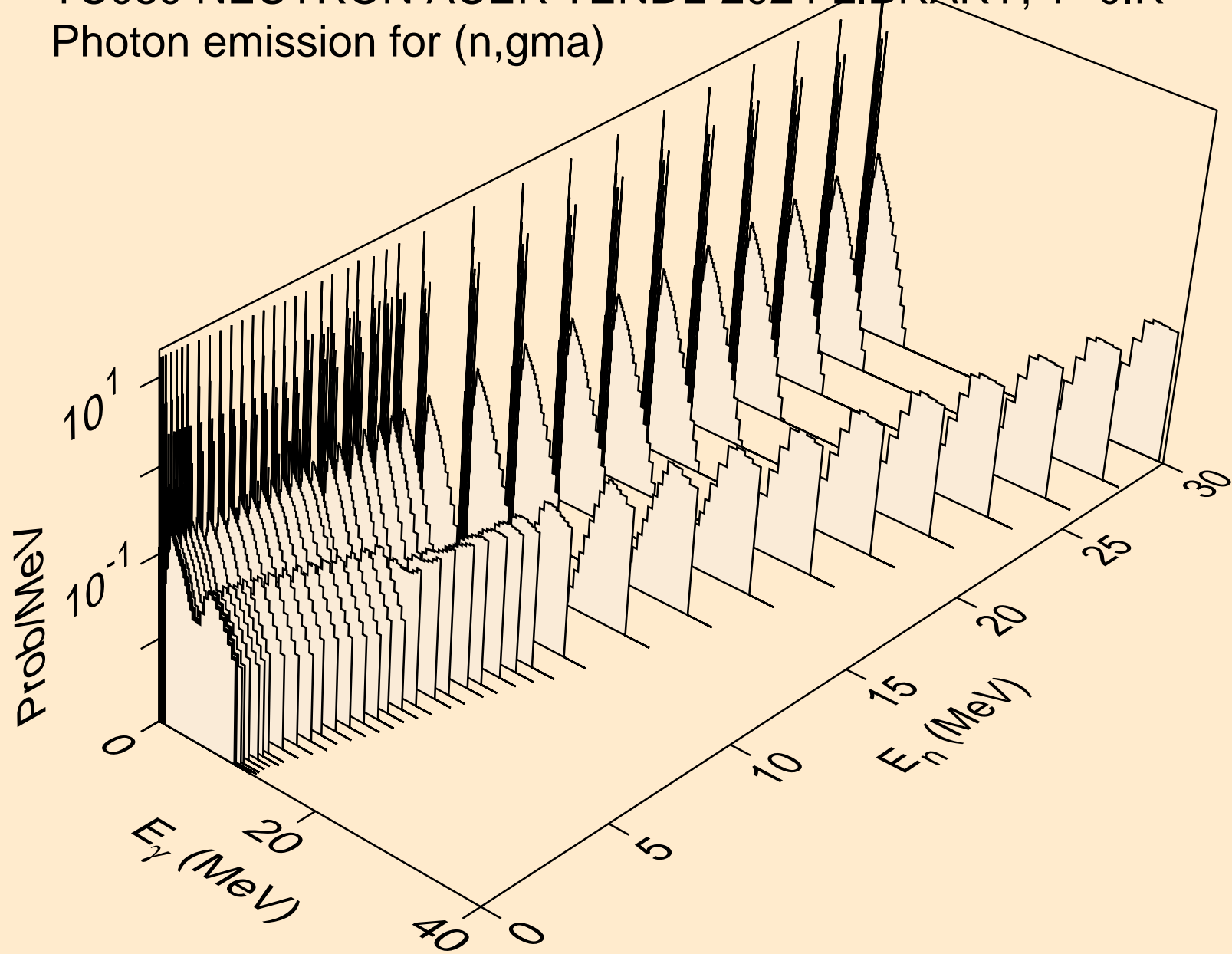

TC089 NEUTRON ACER TENDL-2024 LIBRARY; T=0.K
Photon emission for (n,p)

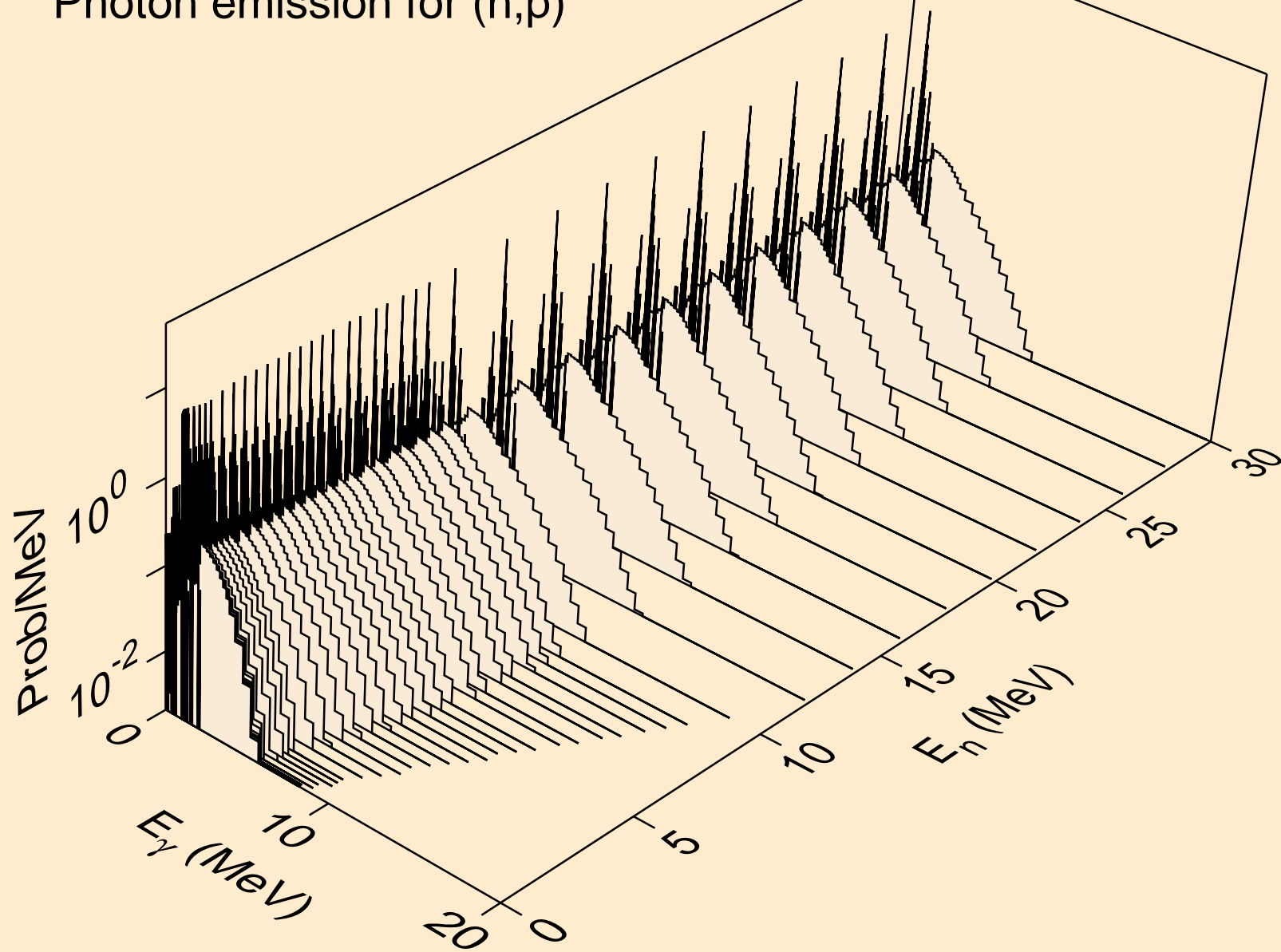

TC089 NEUTRON ACER TENDL-2024 LIBRARY; T=0.K
Photon emission for (n,d)

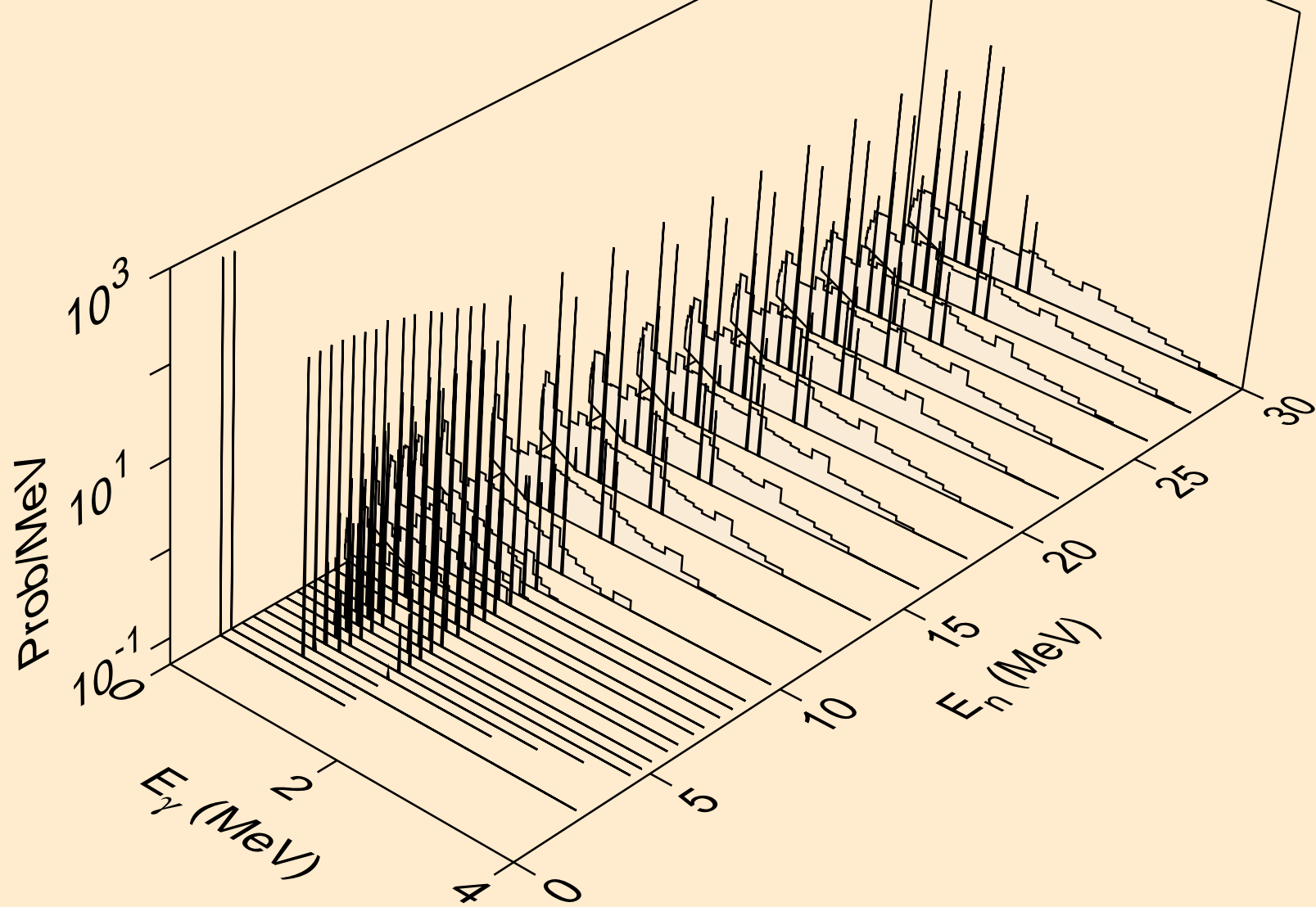

TC089 NEUTRON ACER TENDL-2024 LIBRARY; T=0.K
Photon emission for (n,t)

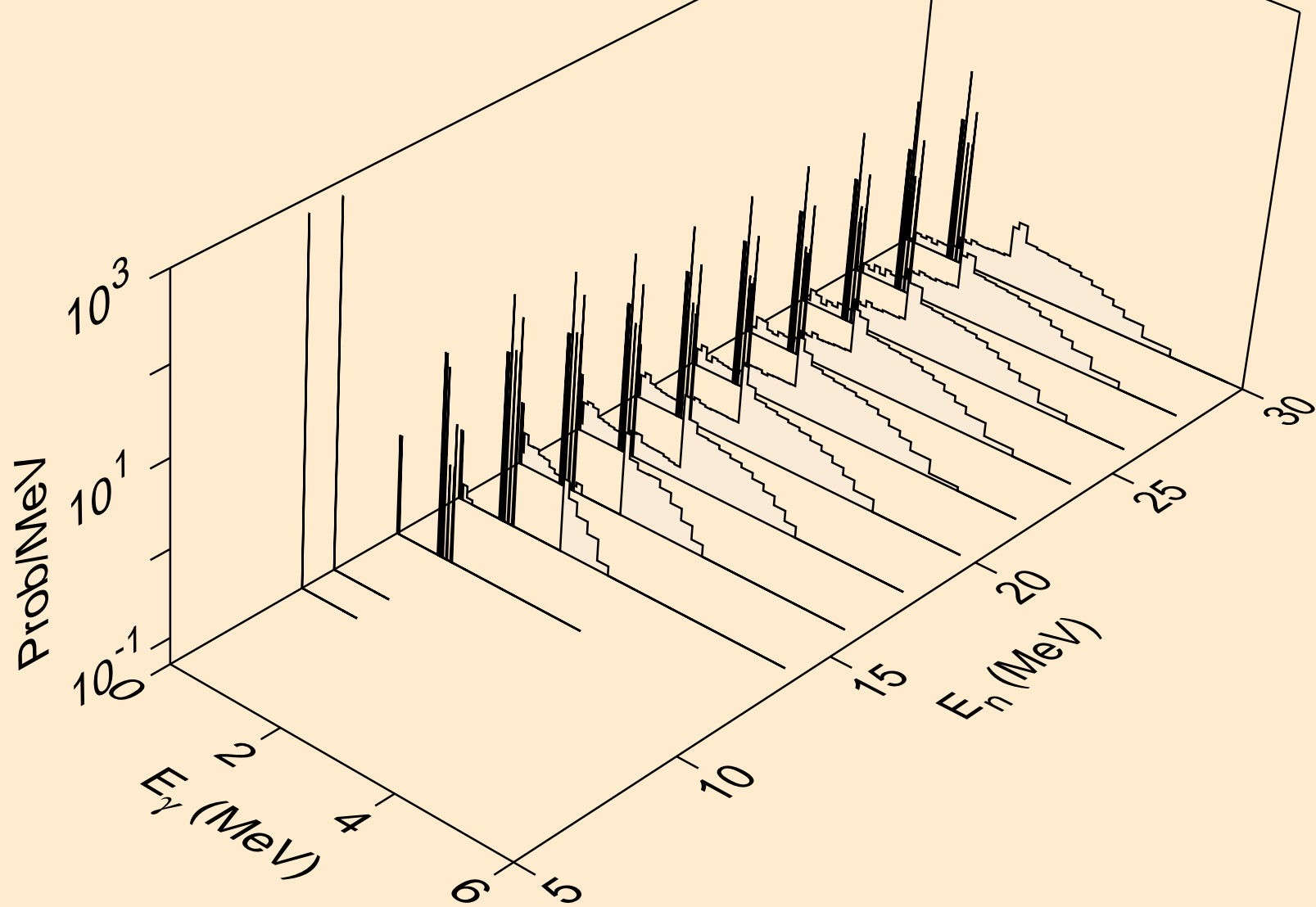

TC089 NEUTRON ACER TENDL-2024 LIBRARY; T=0.K
Photon emission for (n,he3)

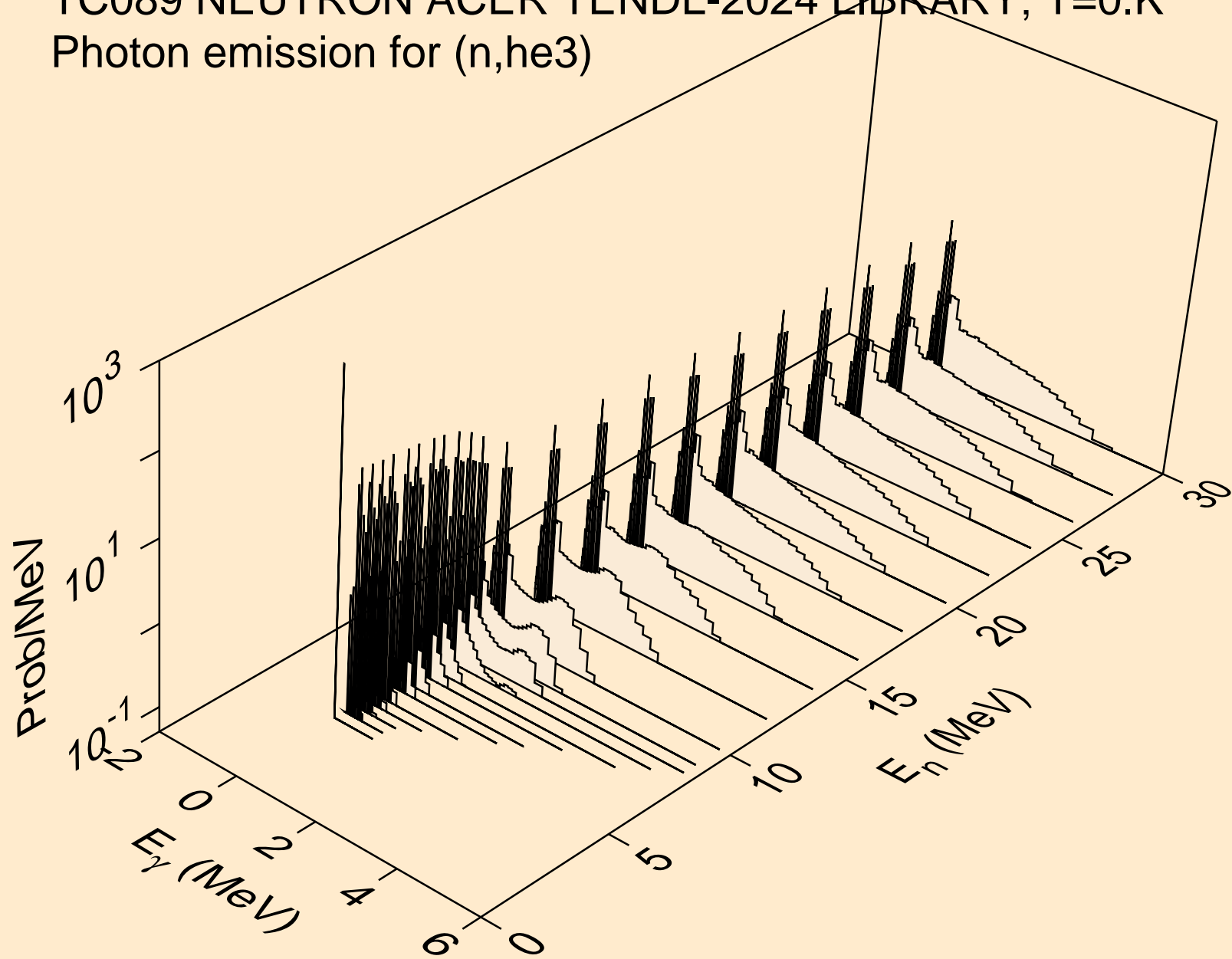

TC089 NEUTRON ACER TENDL-2024 LIBRARY; T=0.K
Photon emission for (n,a)

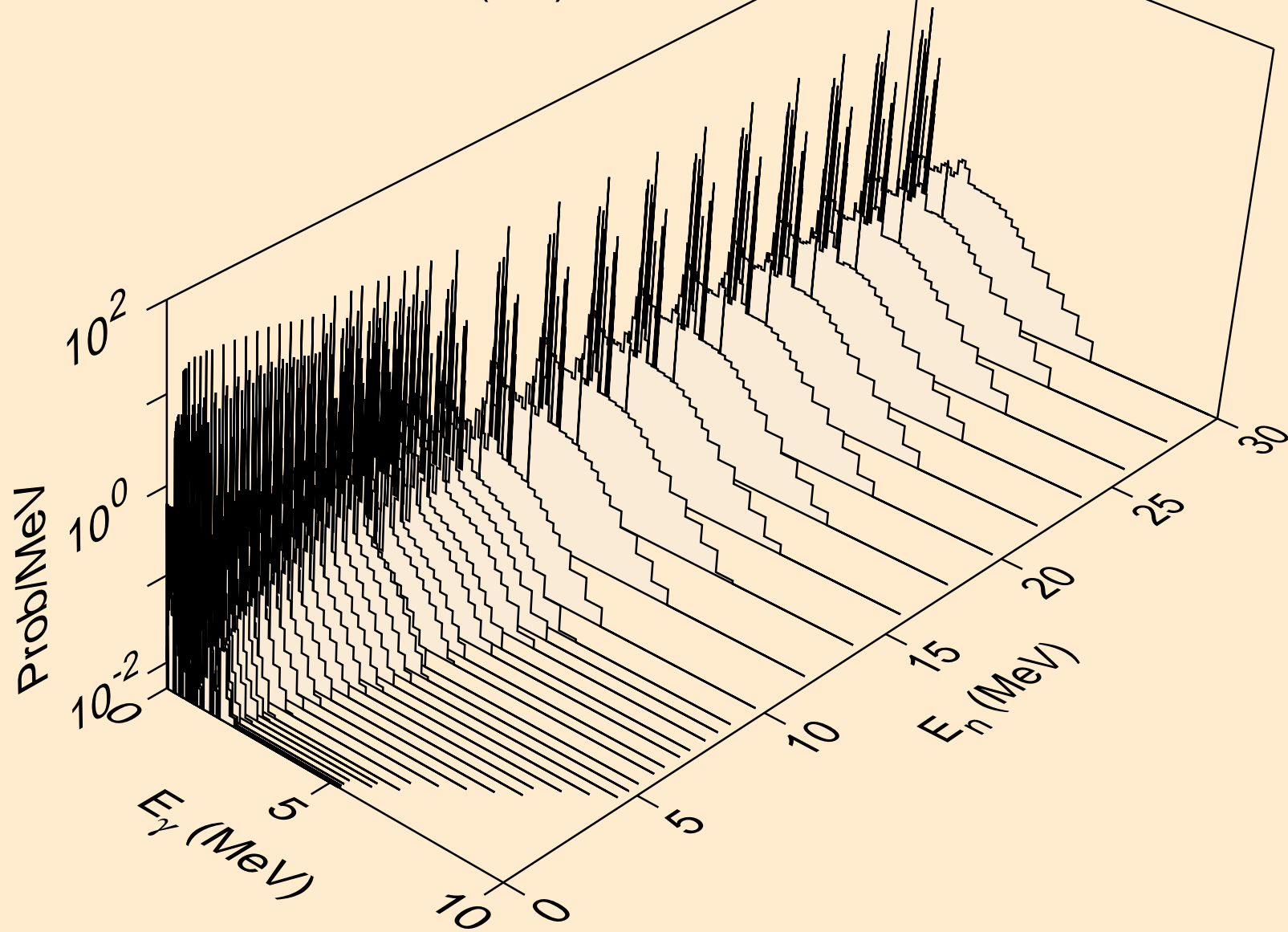

TC089 NEUTRON ACER TENDL-2024 LIBRARY; T=0.K
Photon emission for (n,2a)

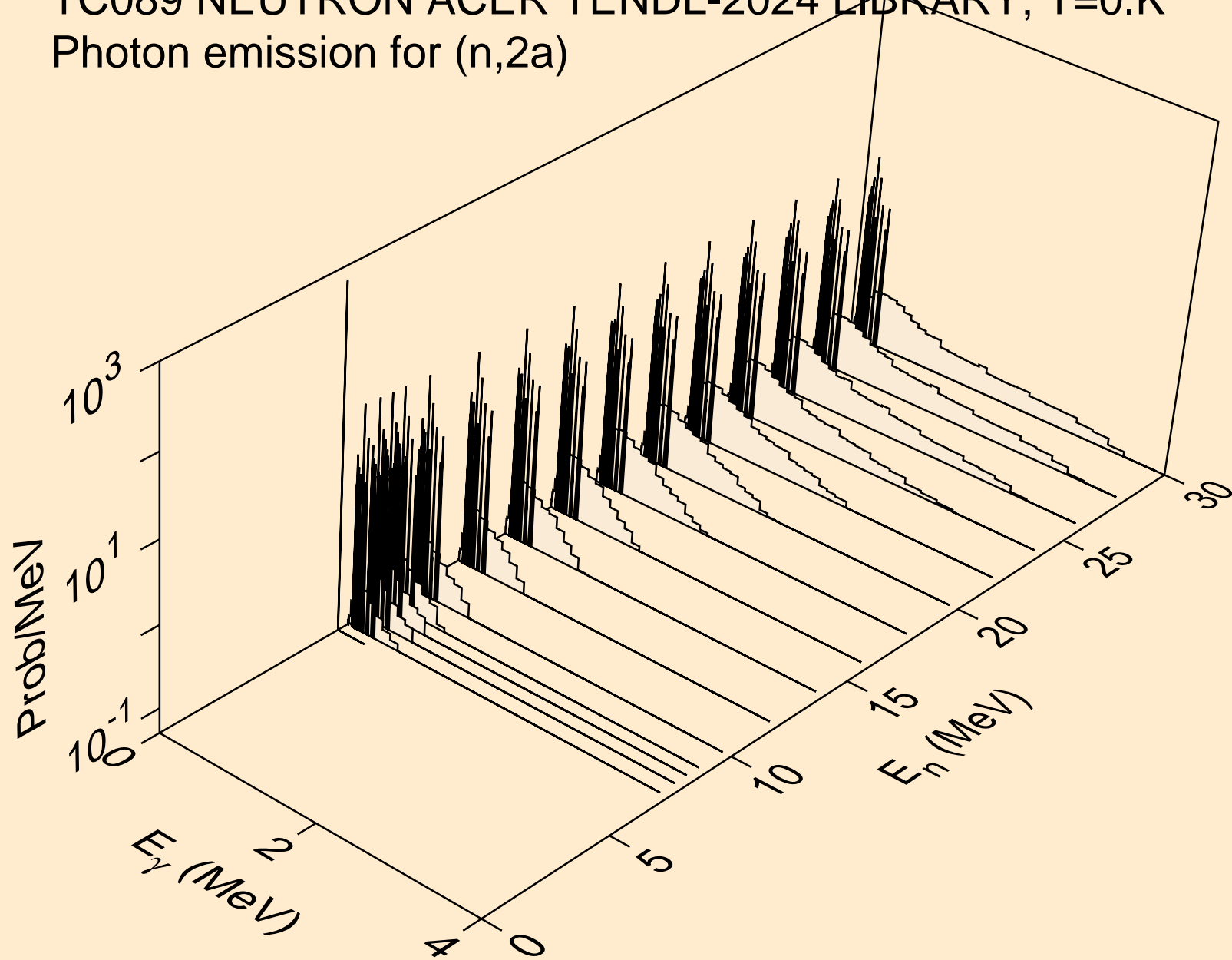

TC089 NEUTRON ACER TENDL-2024 LIBRARY; T=0.K
Photon emission for (n,2p)

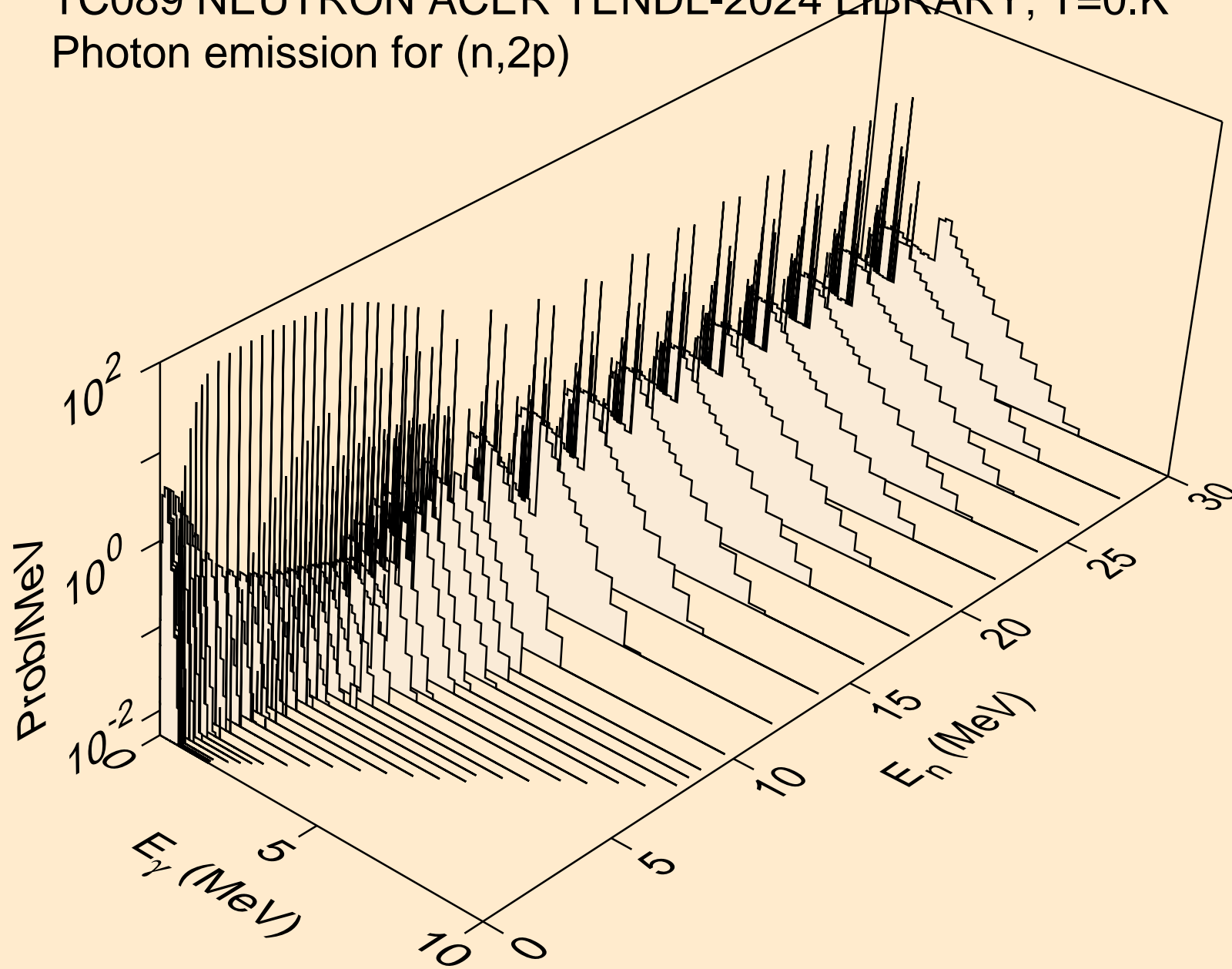

TC089 NEUTRON ACER TENDL-2024 LIBRARY; T=0.K
Photon emission for (n,p α)

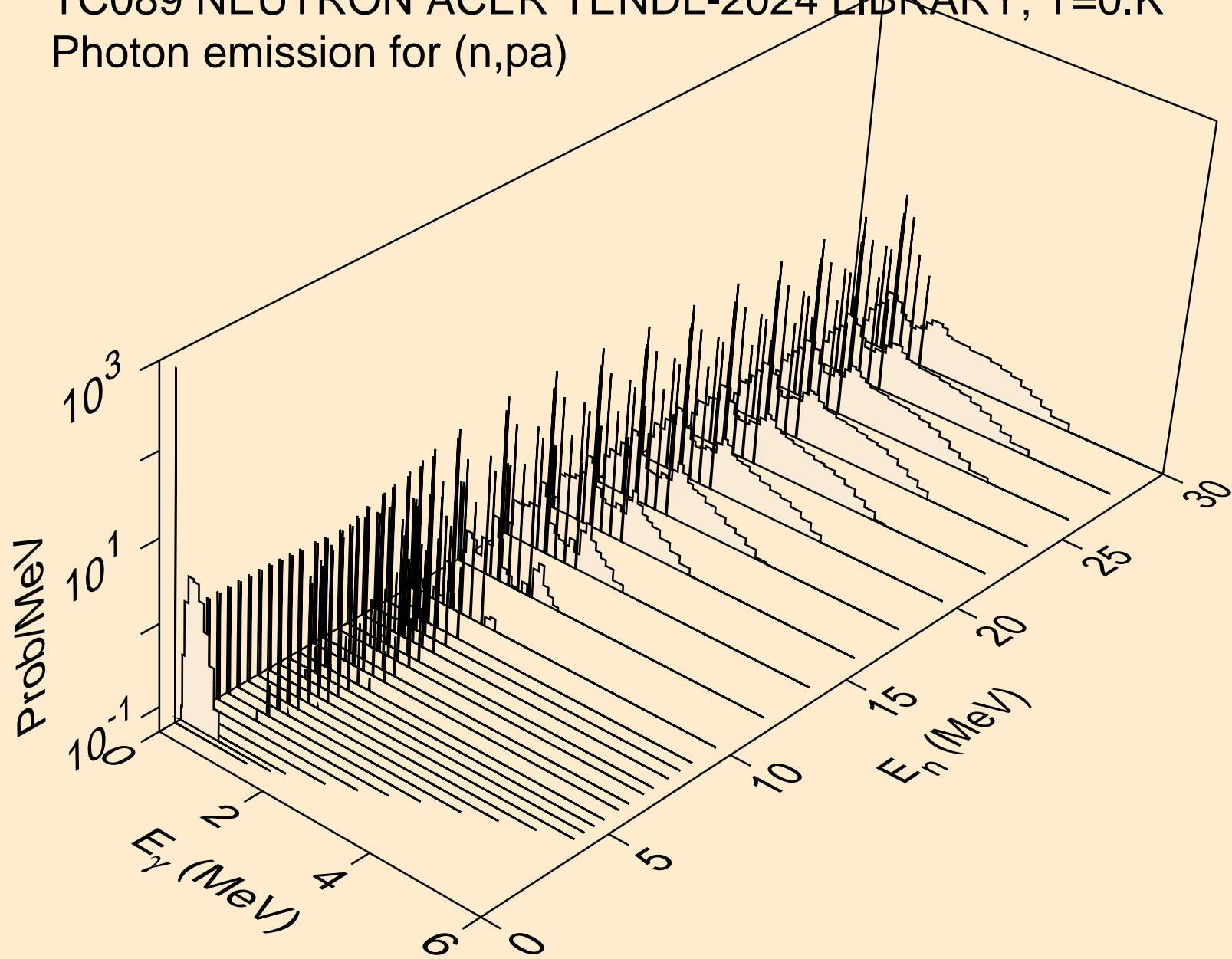

TC089 NEUTRON ACER TENDL-2024 LIBRARY; T=0.K
Photon emission for (n,pd)

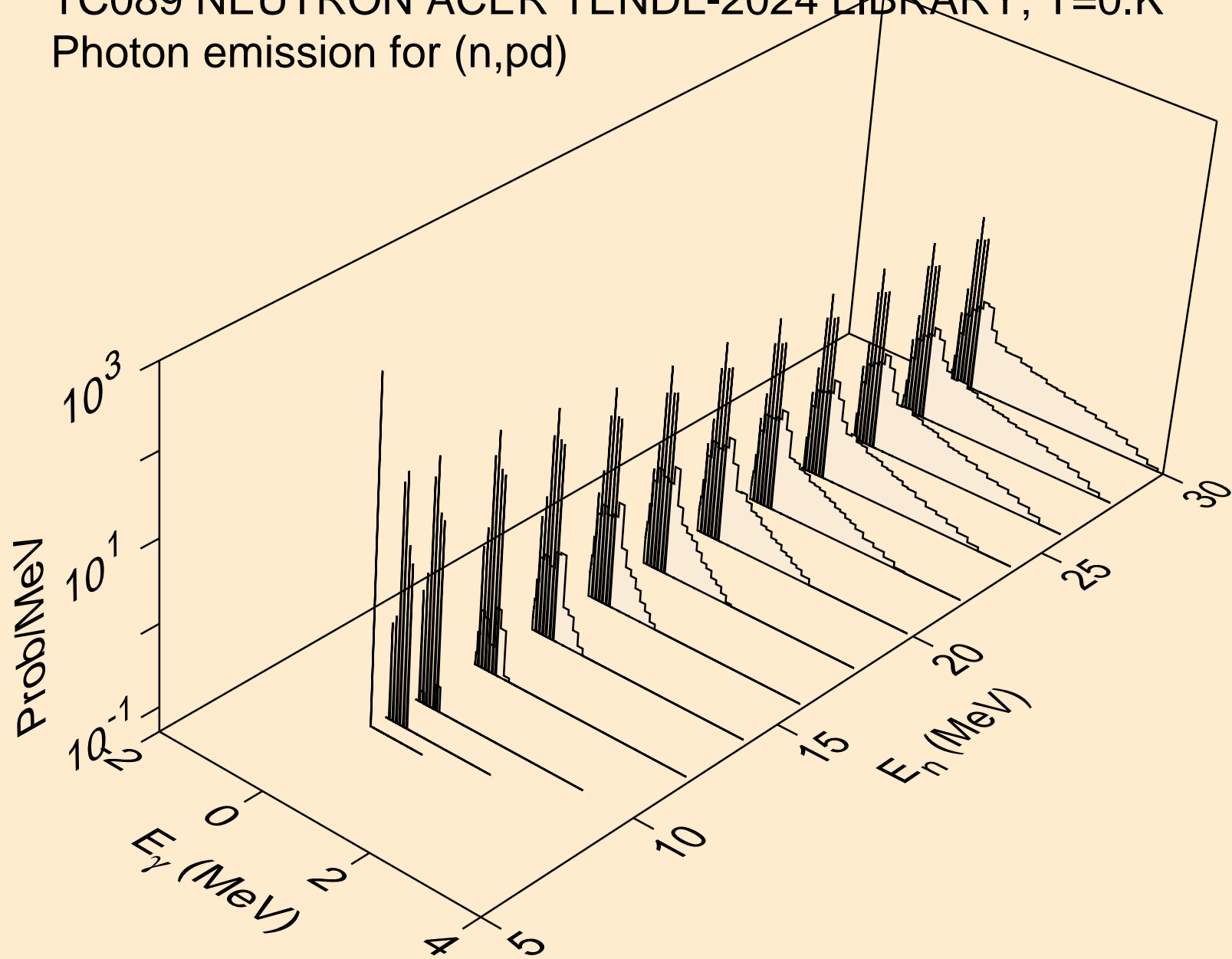

TC089 NEUTRON ACER TENDL-2024 LIBRARY; T=0.K
Photon emission for (n,pt)

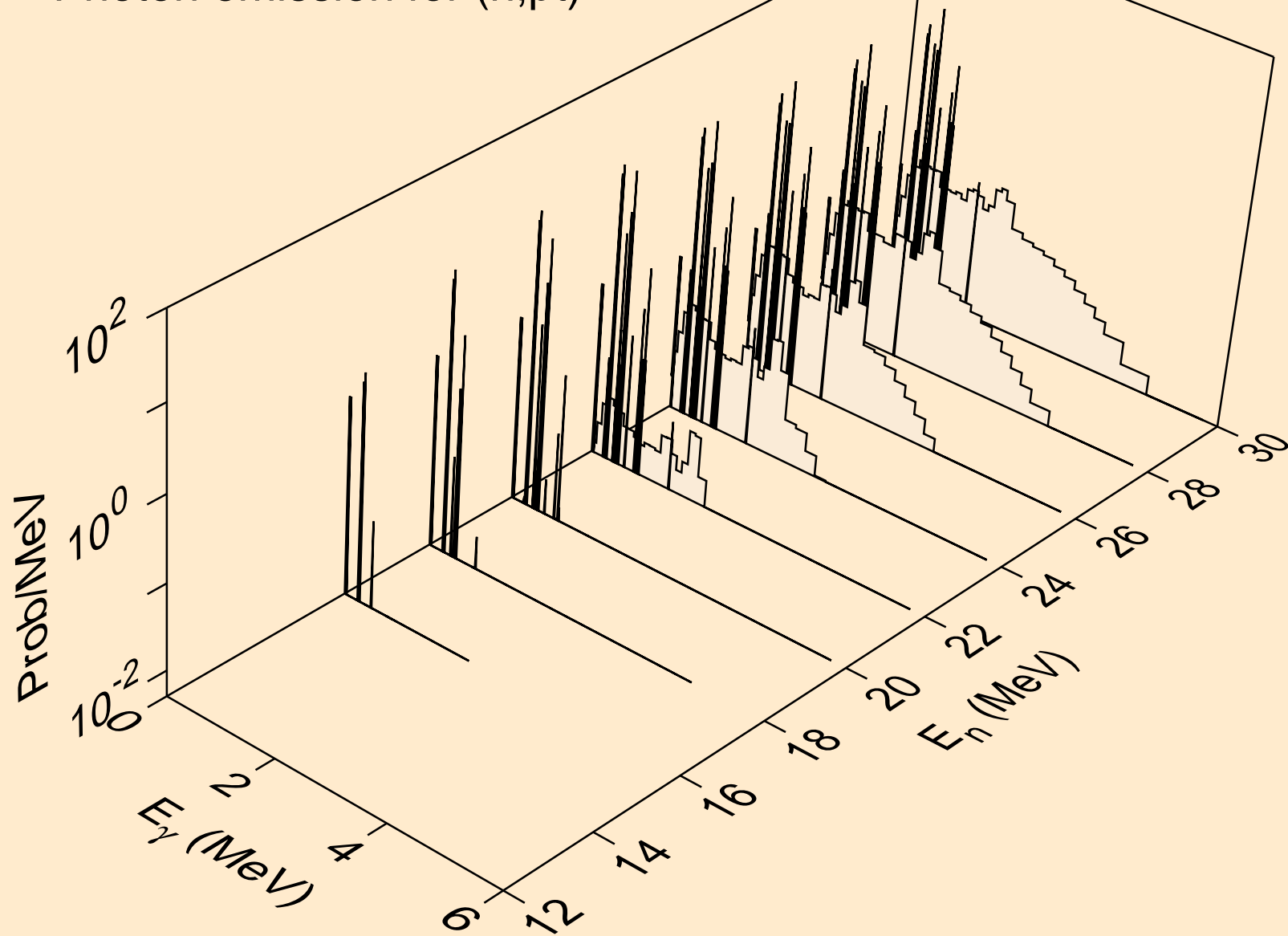

TC089 NEUTRON ACER TENDL-2024 LIBRARY; T=0.K
Photon emission for (n,da)

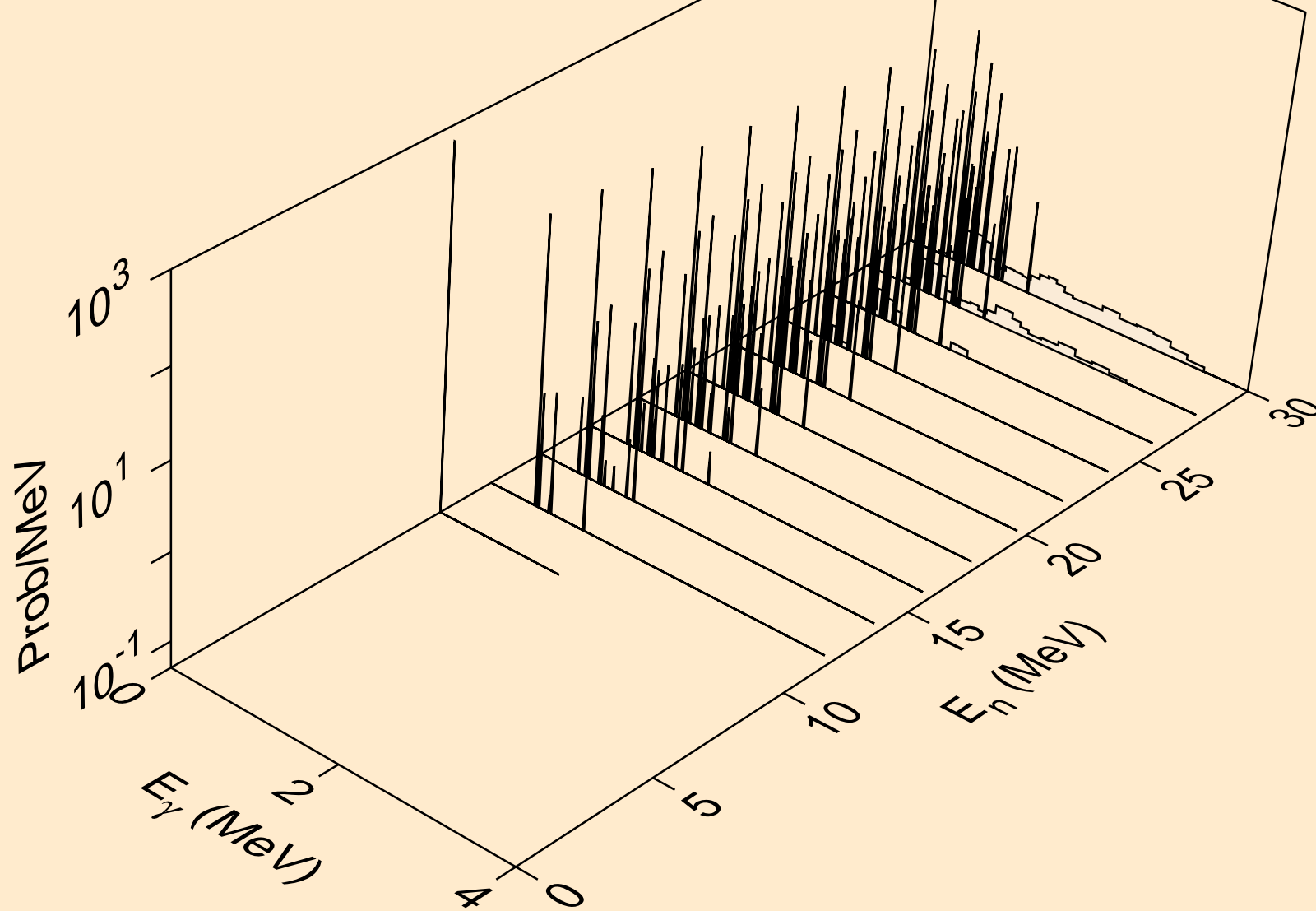

TC089 NEUTRON ACER TENDL-2024 LIBRARY; T=0.K
thermal capture photon spectrum

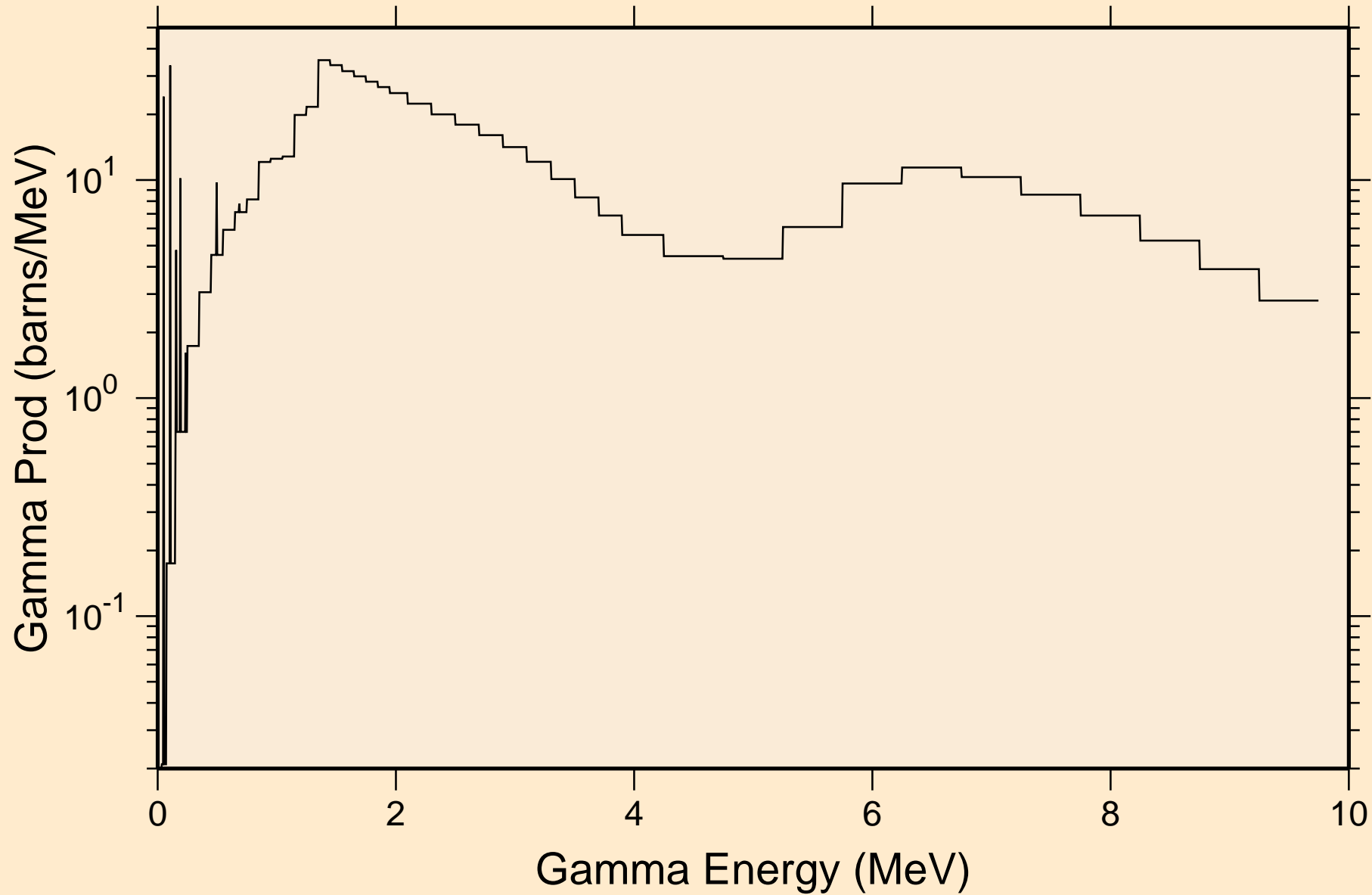

TC089 NEUTRON ACER TENDL-2024 LIBRARY; T=0.K
14 MeV photon spectrum

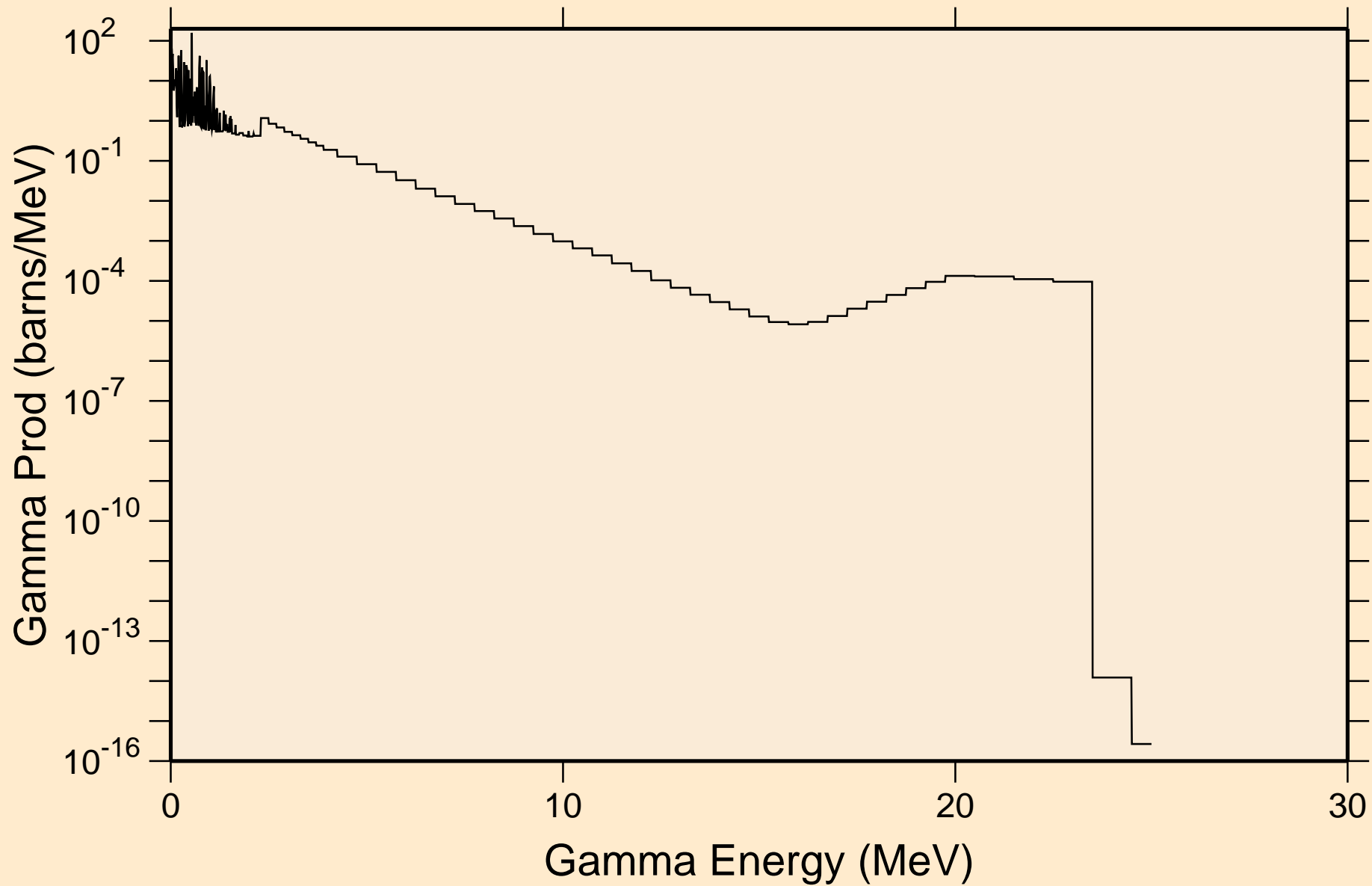

TC089 NEUTRON ACER TENDL-2024 LIBRARY; T=0.K

Particle heating contributions

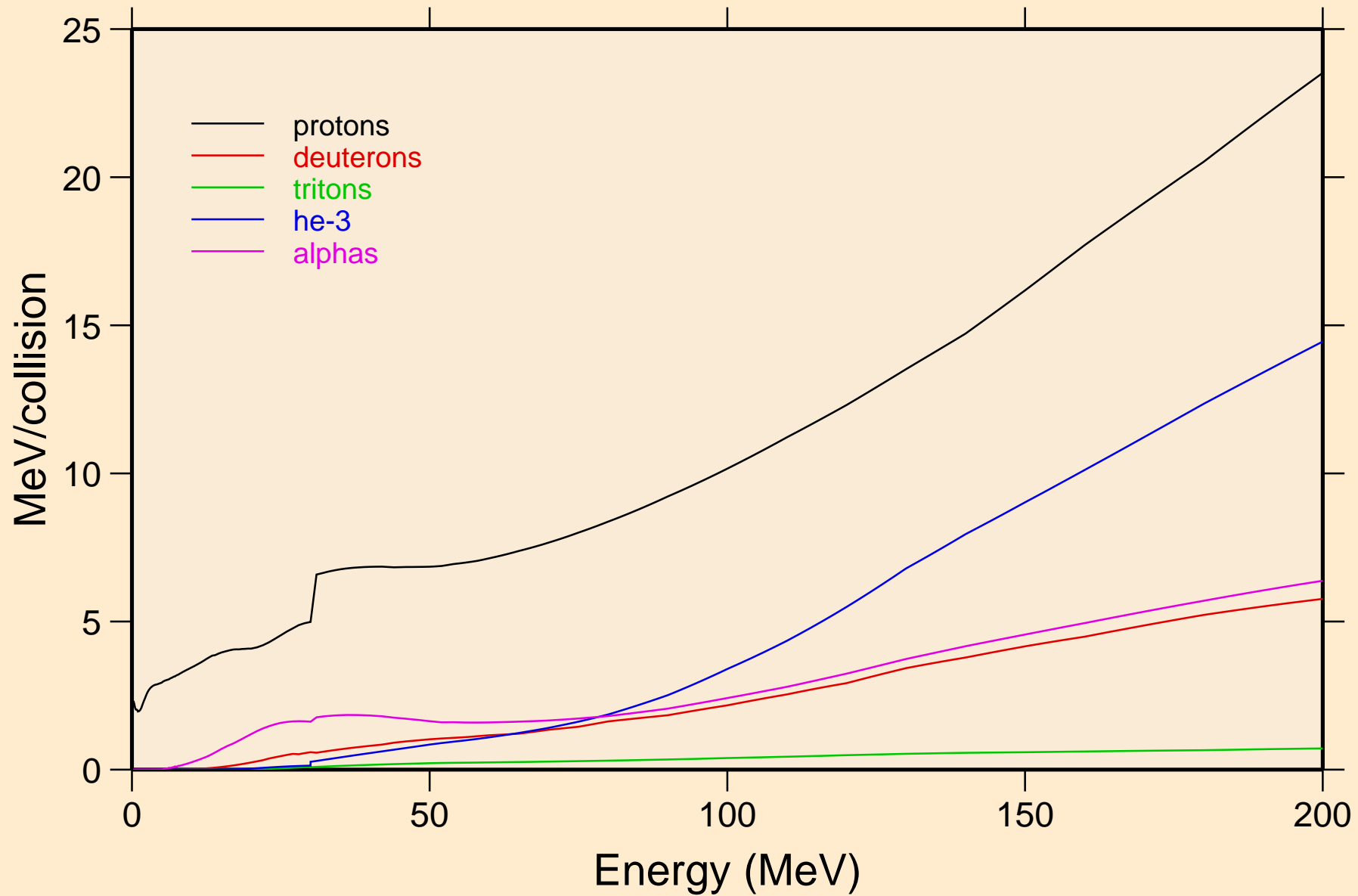

TC089 NEUTRON ACER TENDL-2024 LIBRARY; T=0.K
Recoil Heating

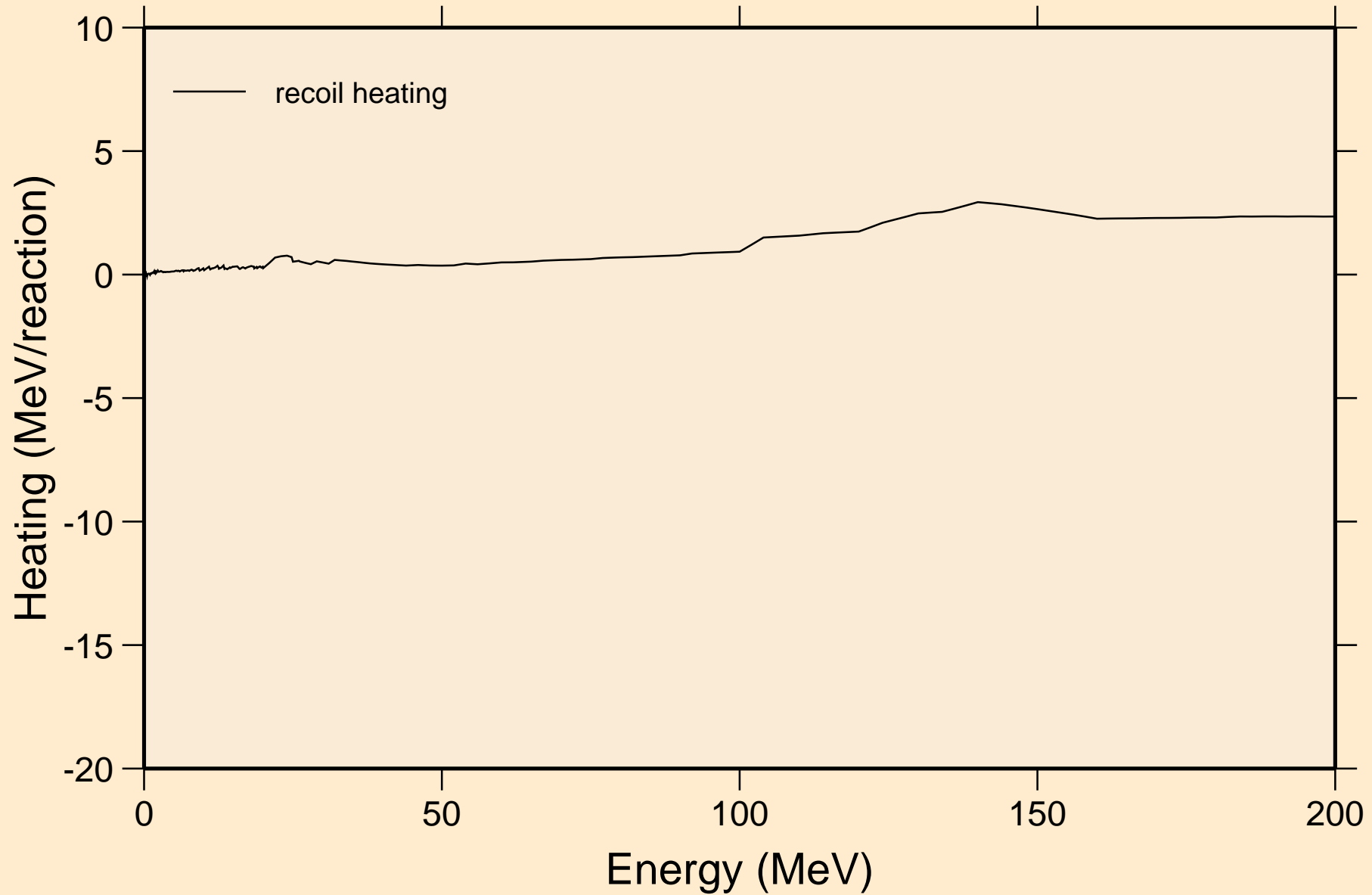

TC089 NEUTRON ACER TENDL-2024 LIBRARY; T=0.K
Particle production cross sections

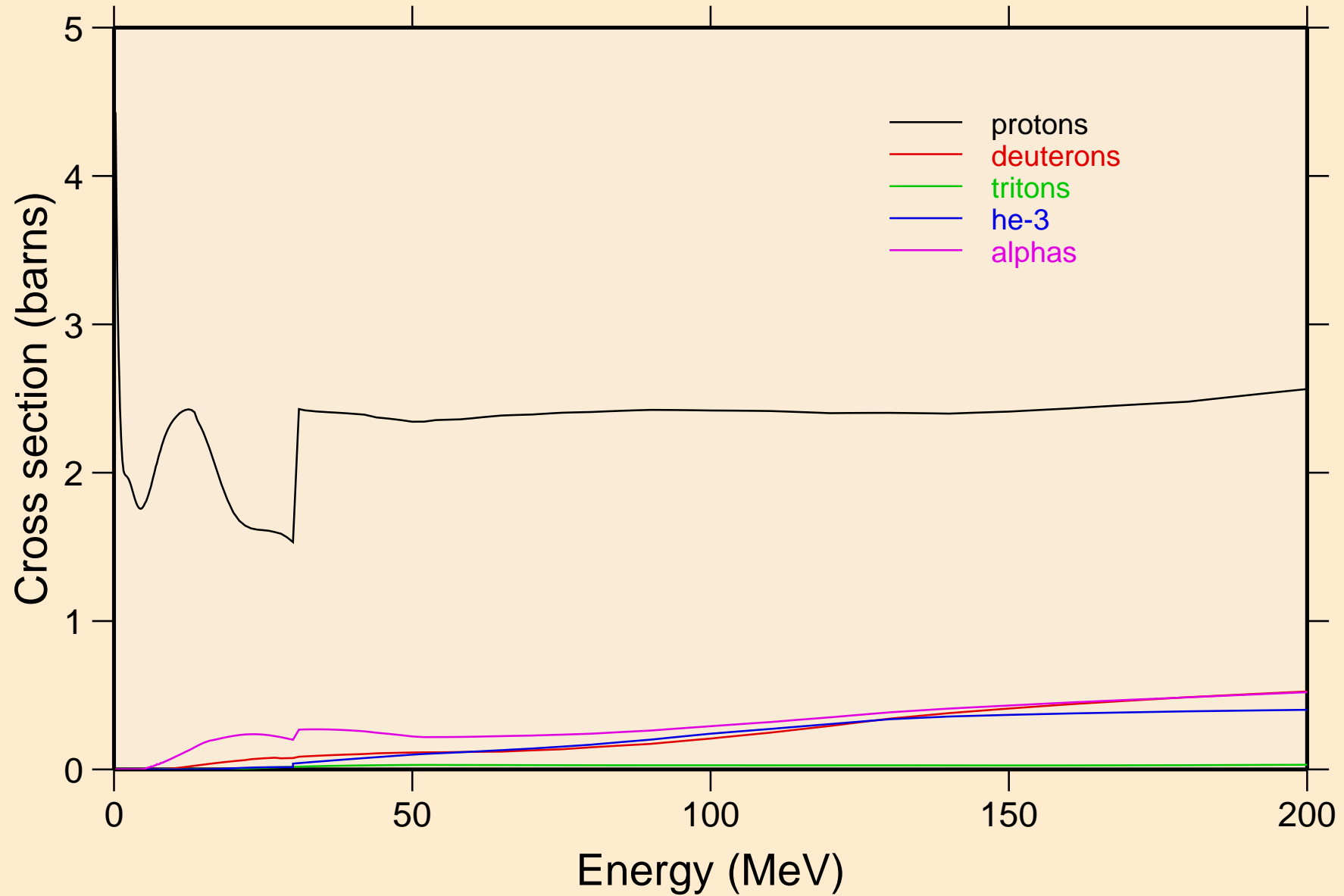

TC089 NEUTRON ACER TENDL-2024 LIBRARY; T=0.K
protons from (n,x)

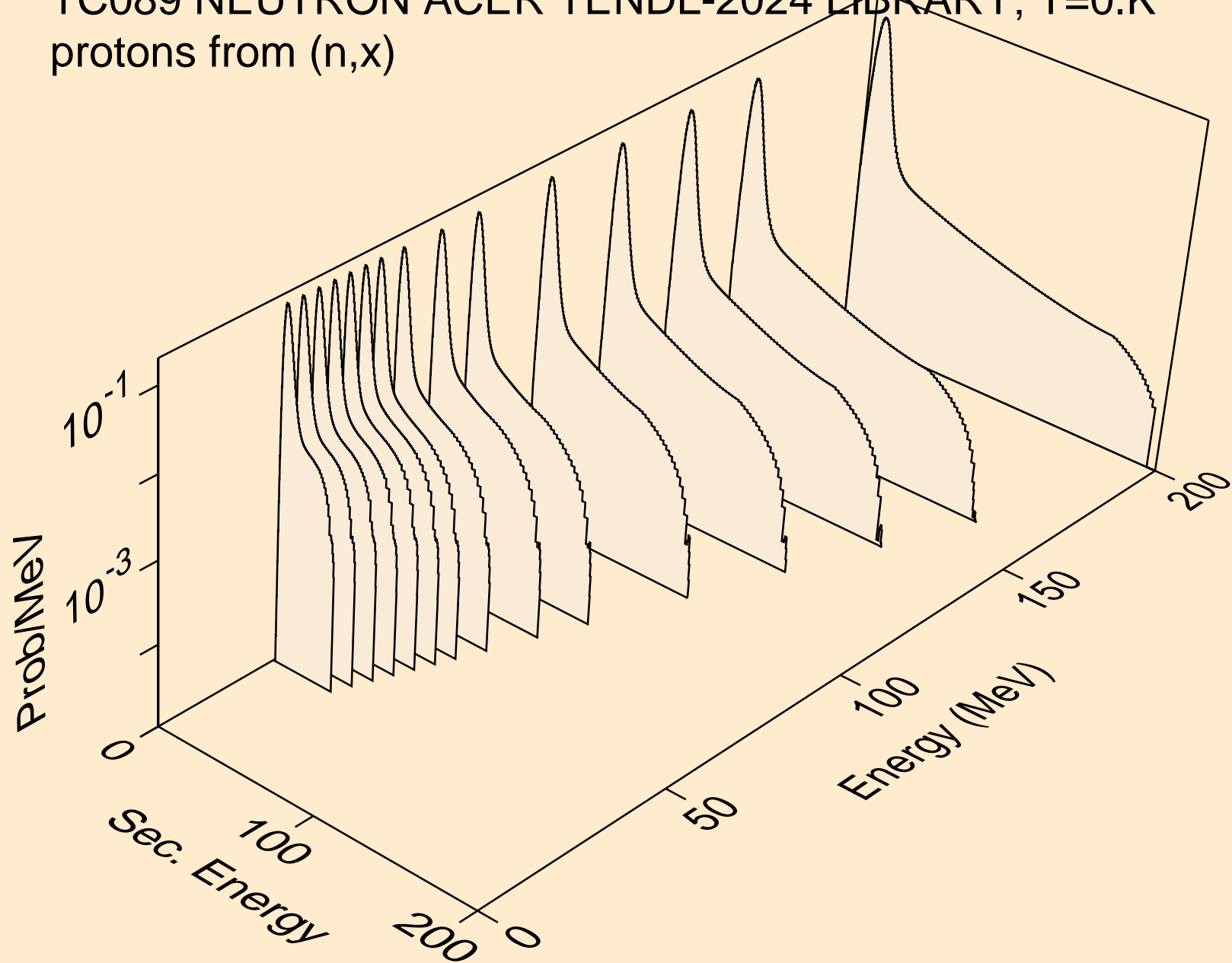

TC089 NEUTRON ACER TENDL-2024 LIBRARY; T=0.K
protons from (n,n*)p

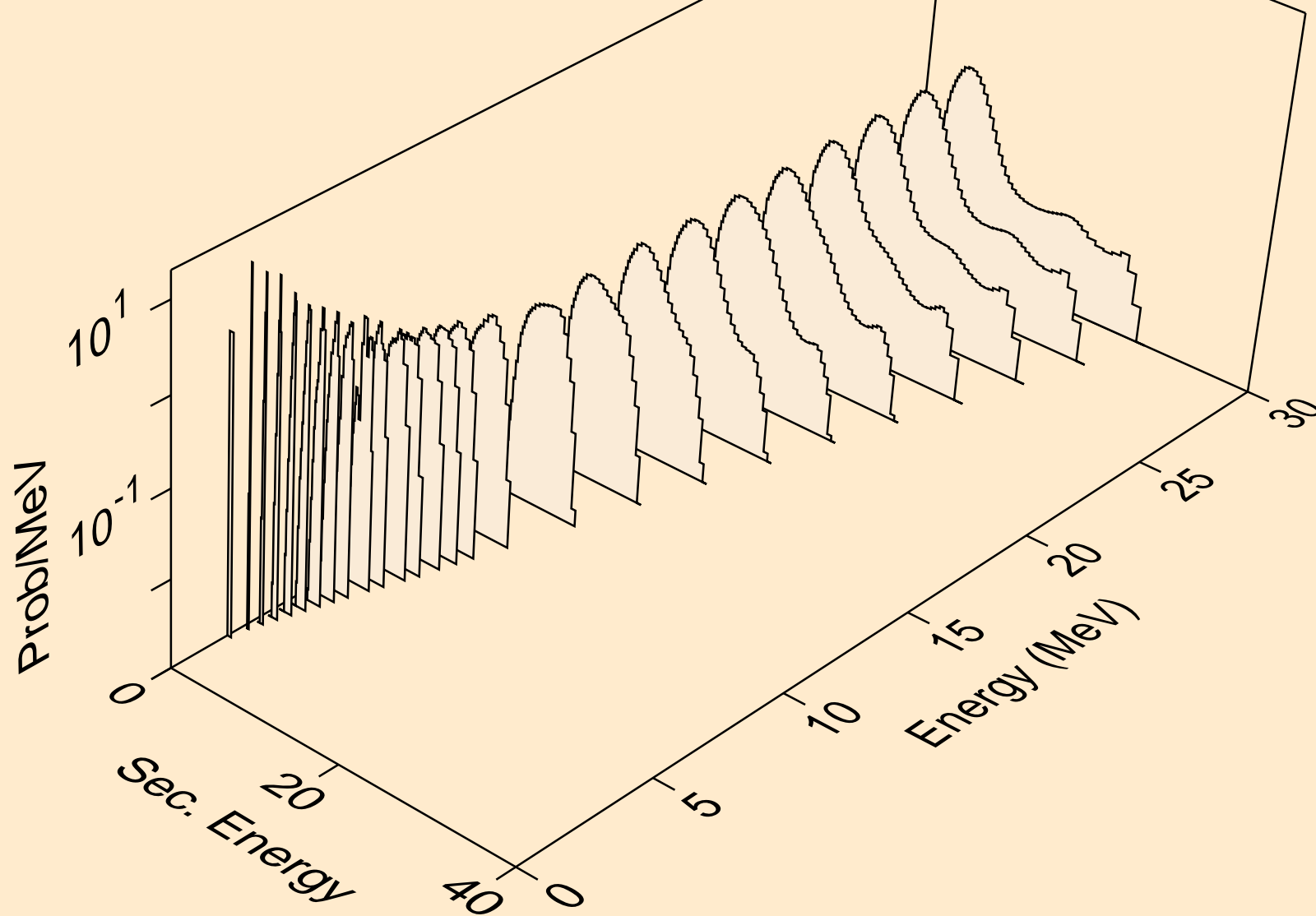

TC089 NEUTRON ACER TENDL-2024 LIBRARY; T=0.K
protons from (n,2np)

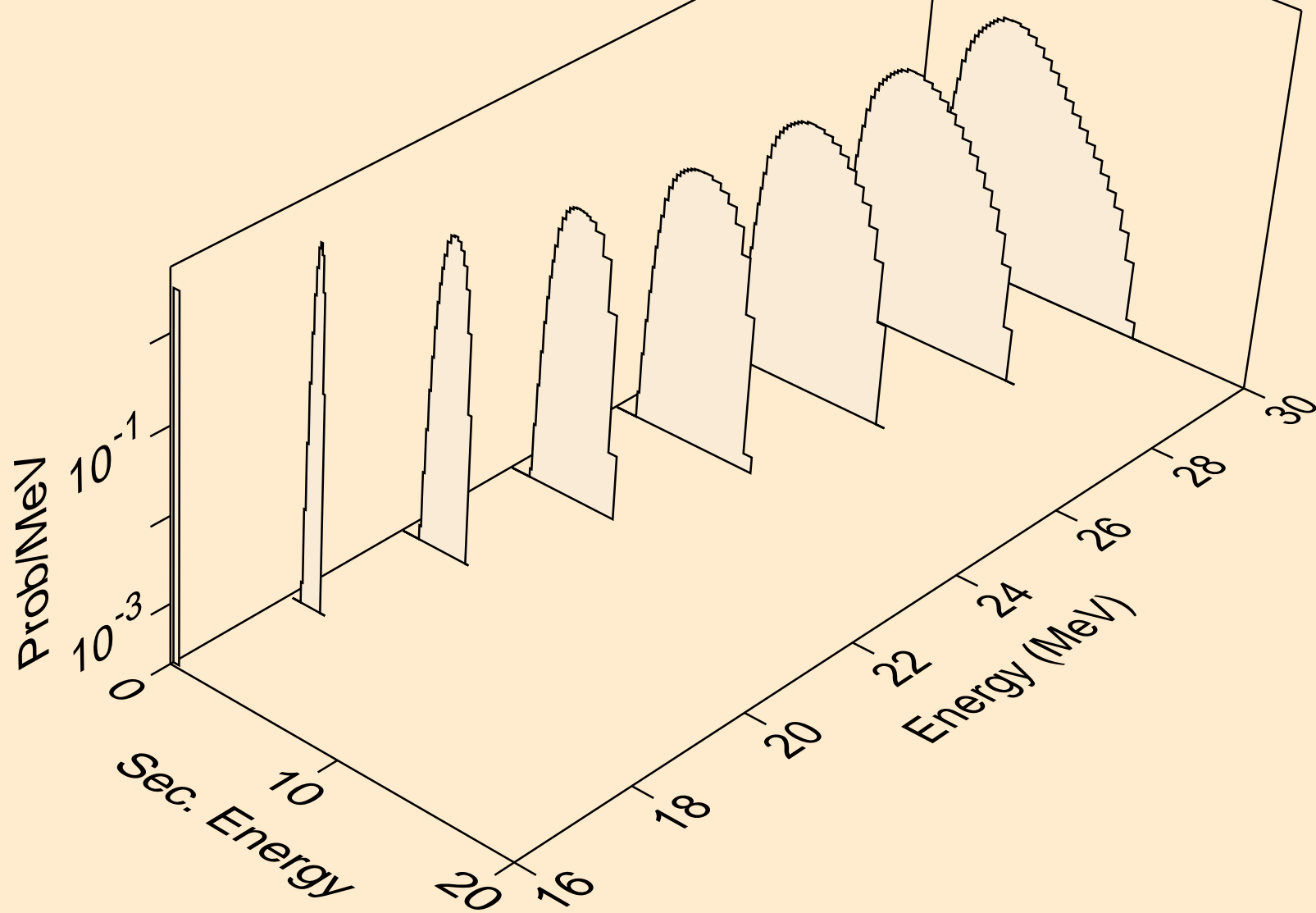

TC089 NEUTRON ACER TENDL-2024 LIBRARY; T=0.K
protons from (n,3np)

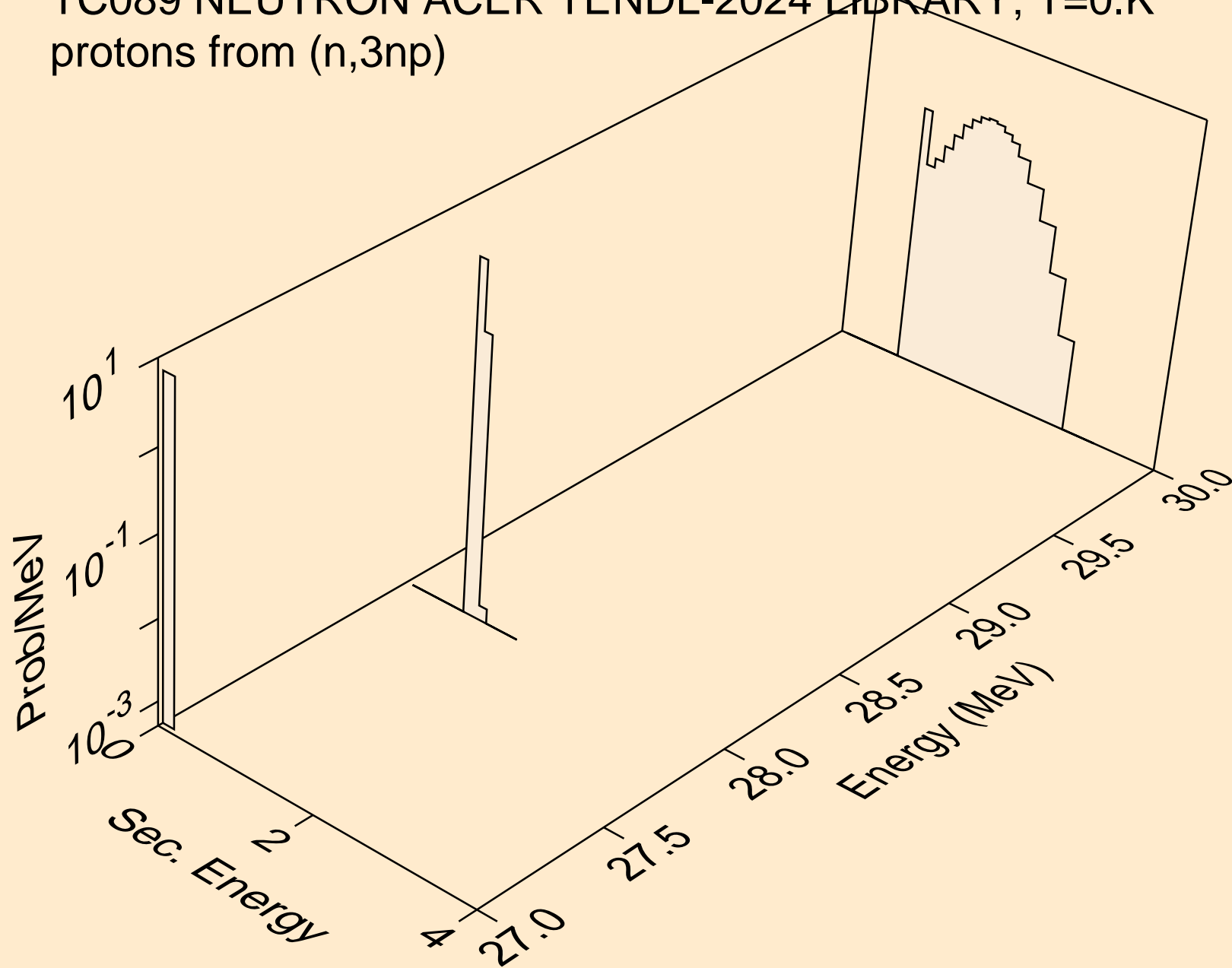

TC089 NEUTRON ACER TENDL-2024 LIBRARY; T=0.K
protons from (n,n2p)

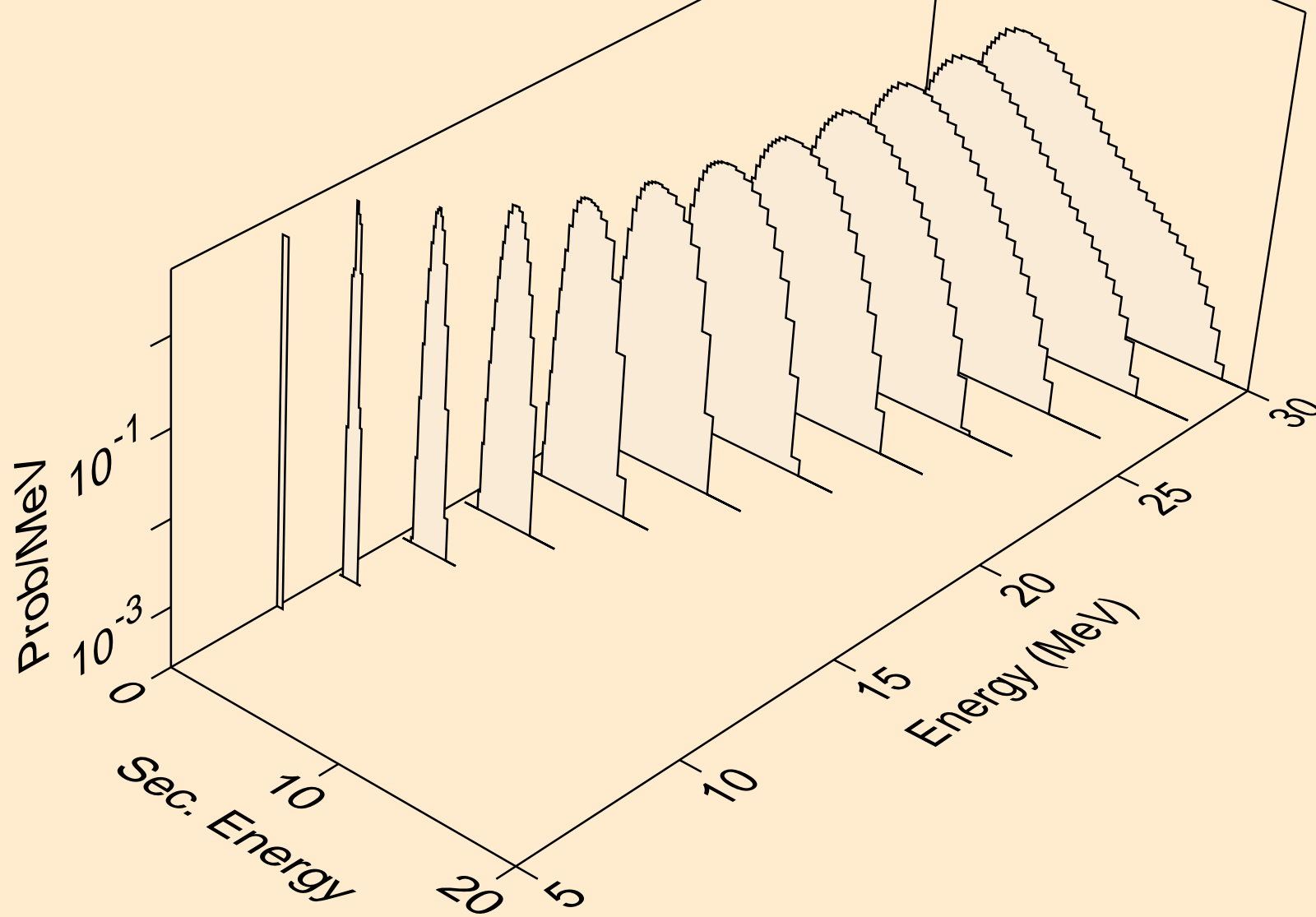

TC089 NEUTRON ACER TENDL-2024 LIBRARY; T=0.K
protons from (n,npa)

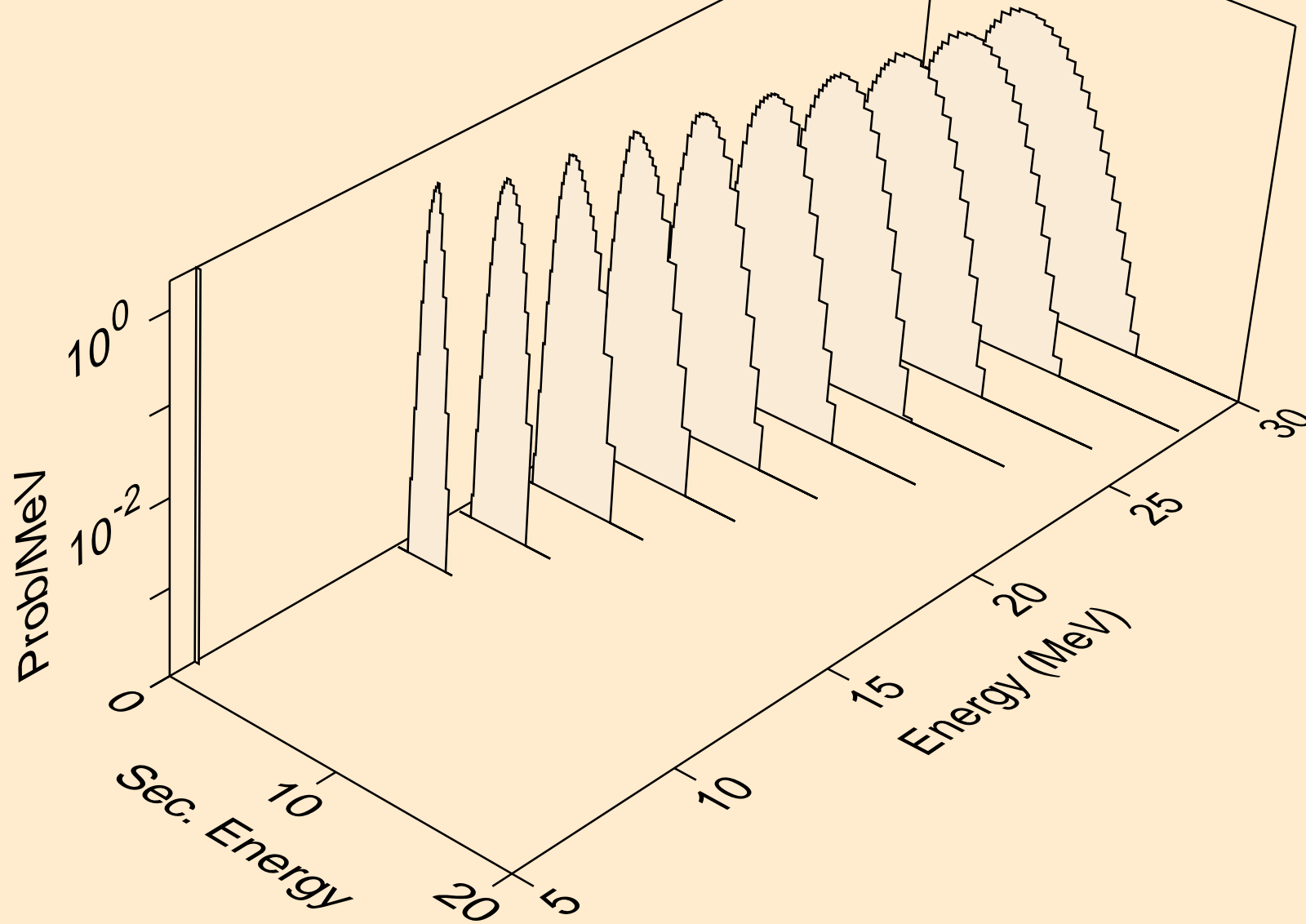

TC089 NEUTRON ACER TENDL-2024 LIBRARY; T=0.K
protons from (n,p)

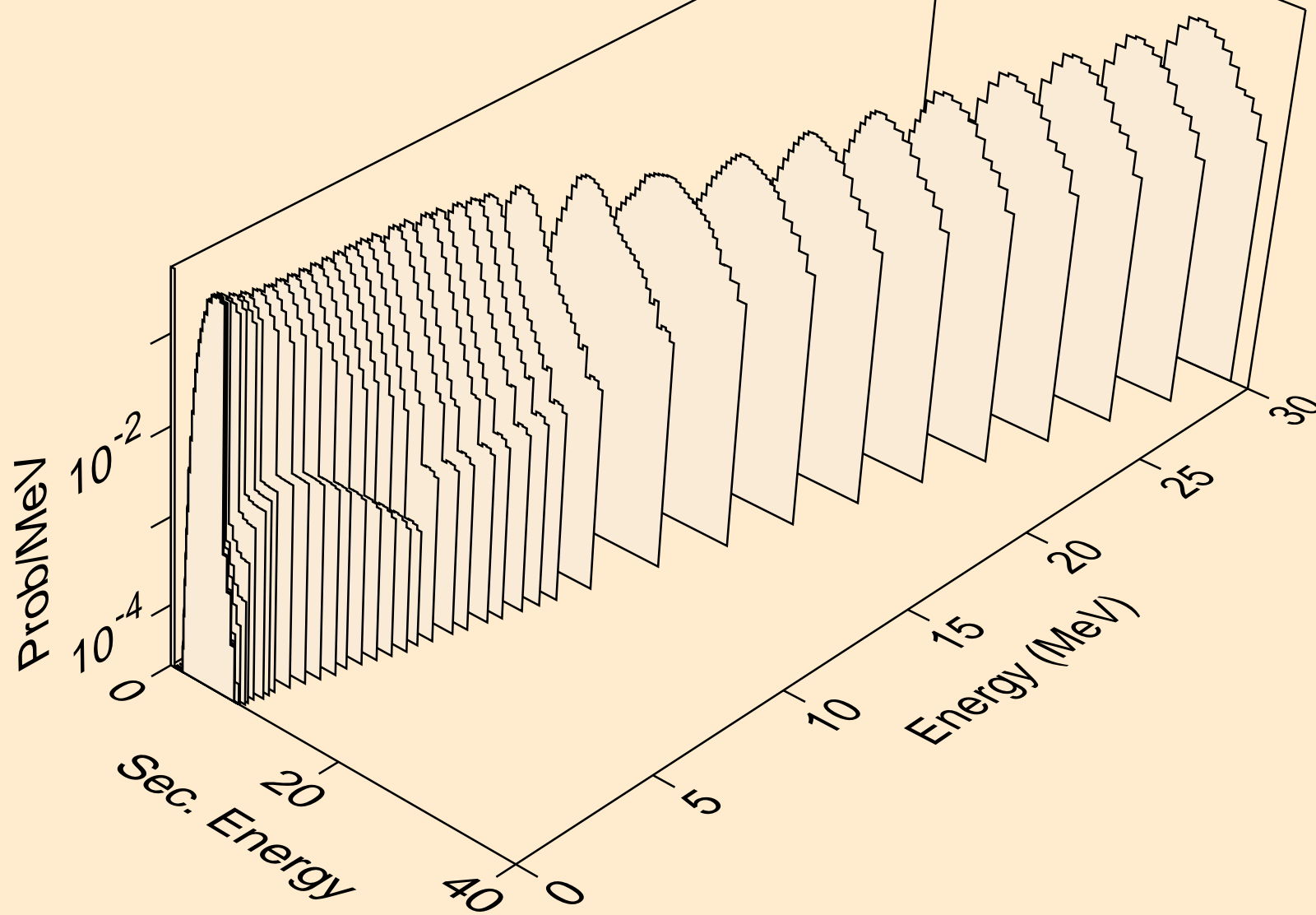

TC089 NEUTRON ACER TENDL-2024 LIBRARY; T=0.K
protons from (n,2p)

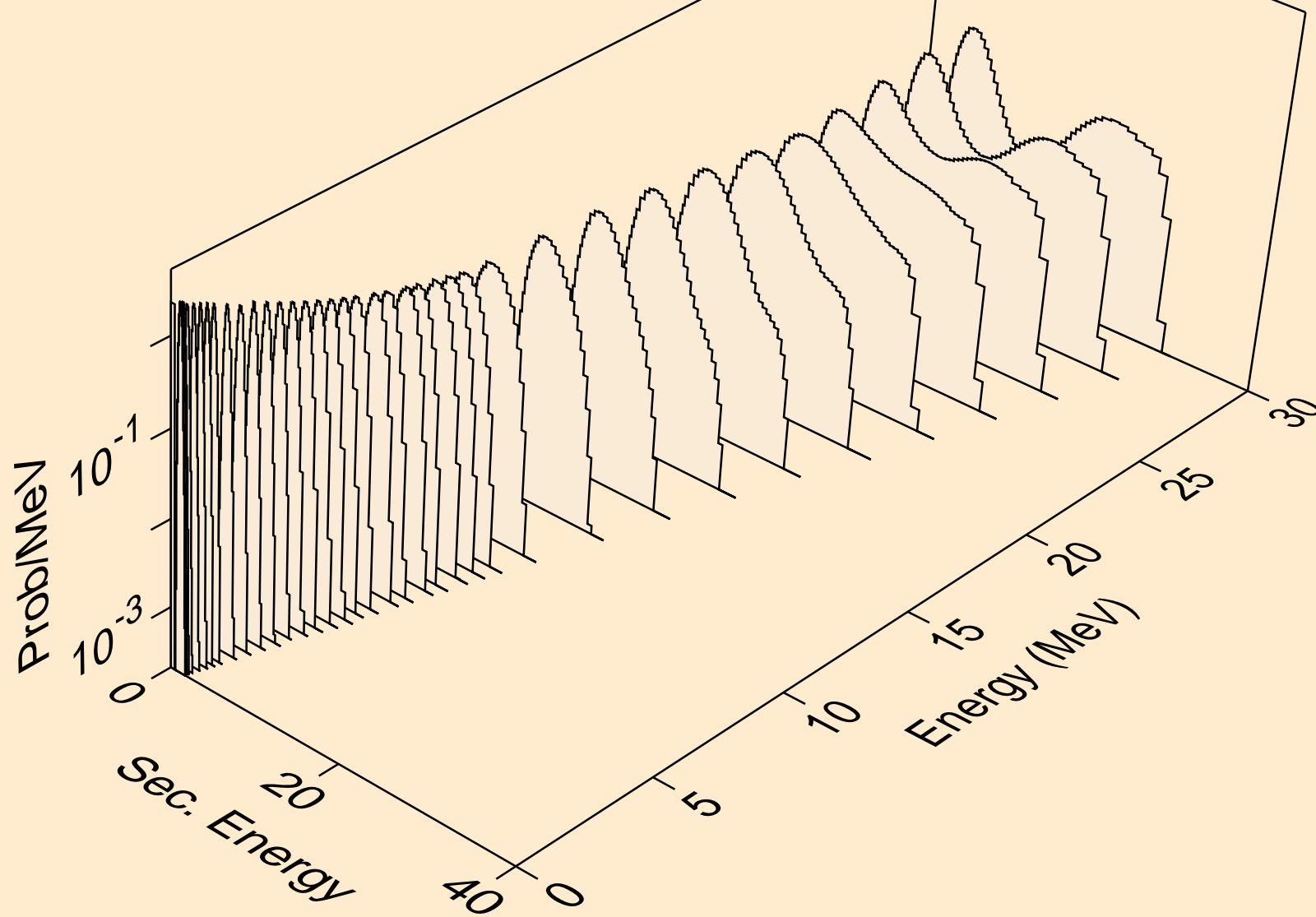

TC089 NEUTRON ACER TENDL-2024 LIBRARY; T=0.K
protons from (n,p)

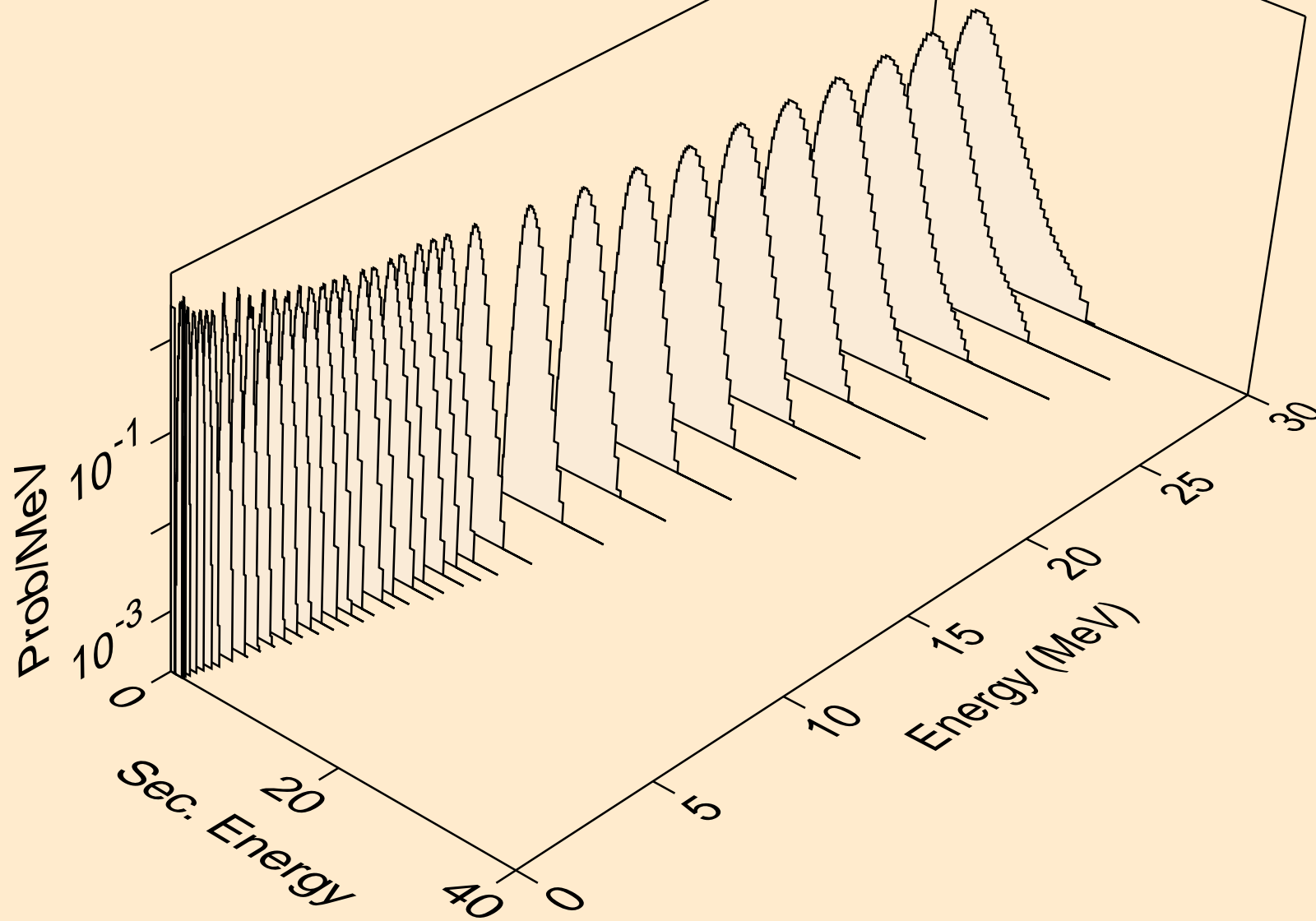

TC089 NEUTRON ACER TENDL-2024 LIBRARY; T=0.K
protons from (n,pd)

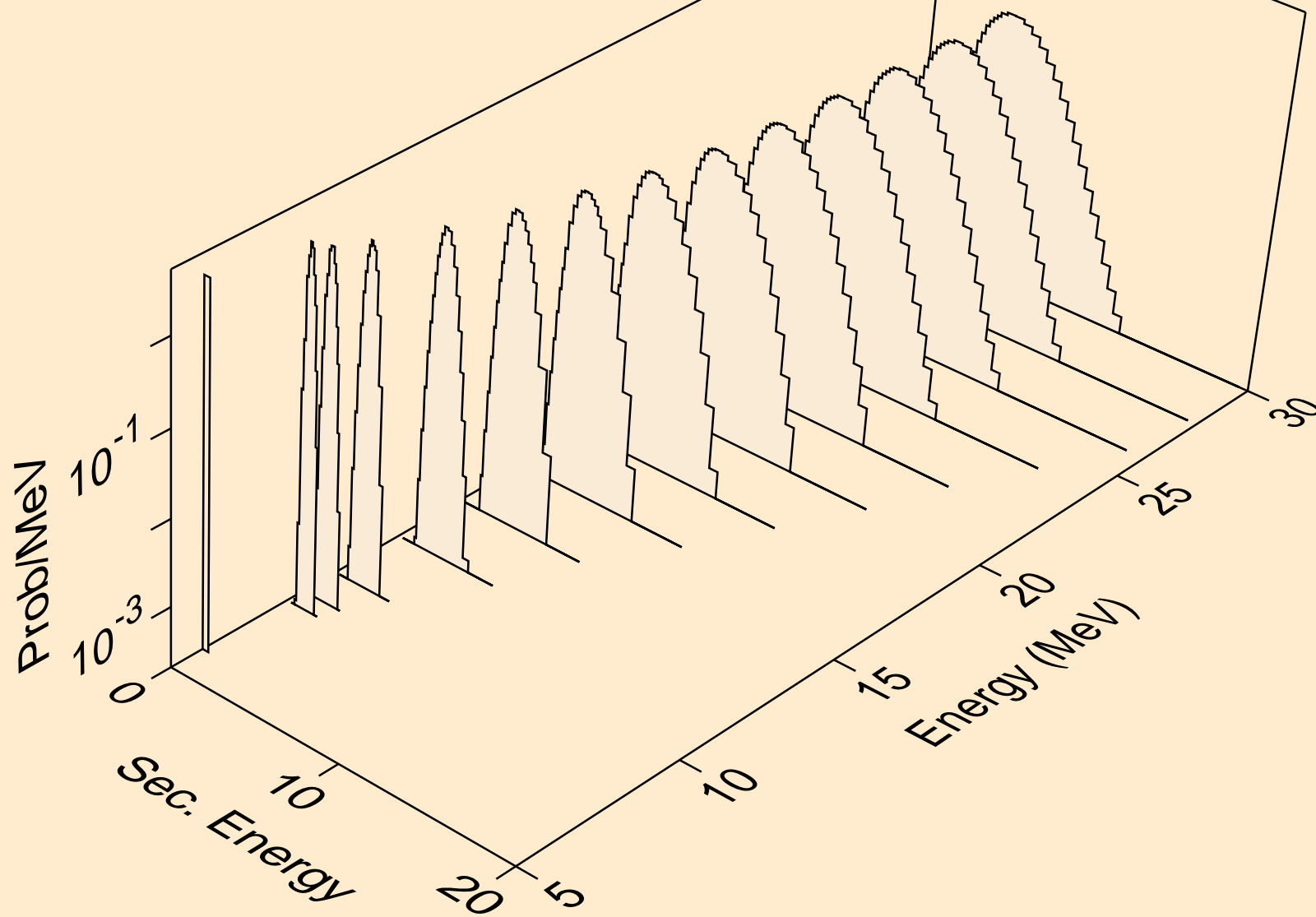

TC089 NEUTRON ACER TENDL-2024 LIBRARY; T=0.K
protons from (n,pt)

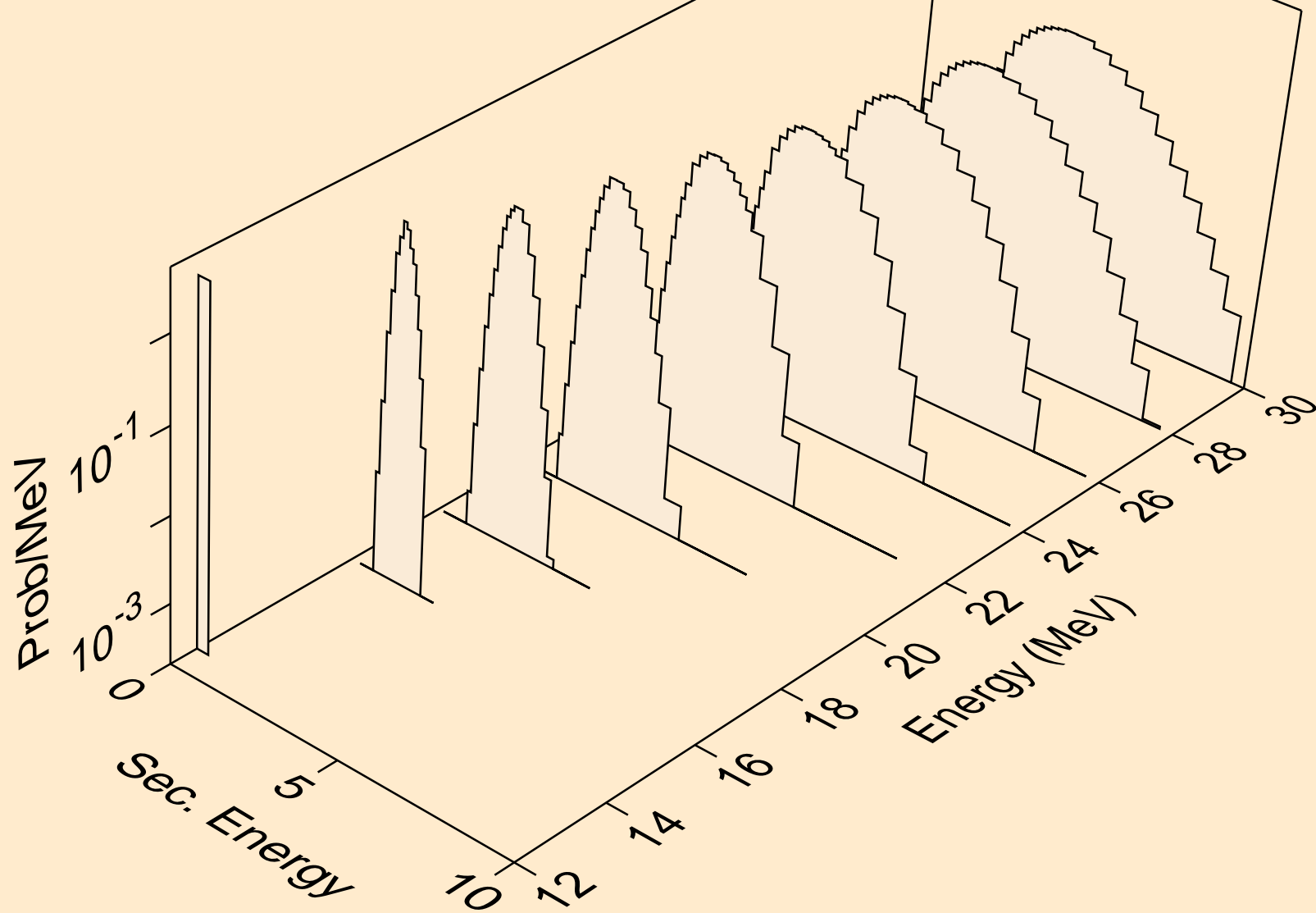

TC089 NEUTRON ACER TENDL-2024 LIBRARY; T=0.K
deuterons from (n,x)

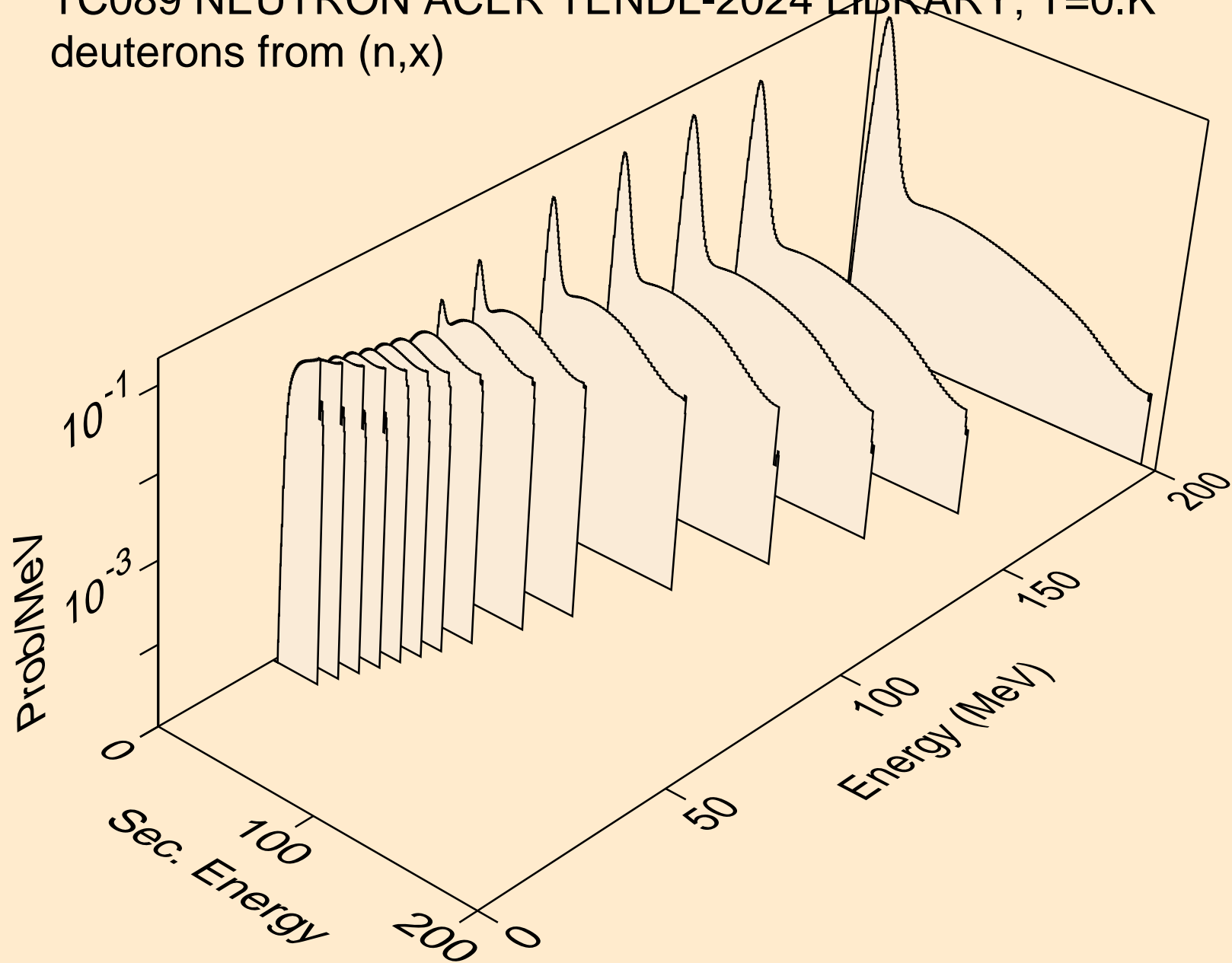

TC089 NEUTRON ACER TENDL-2024 LIBRARY; T=0.K
deuterons from (n,2nd)

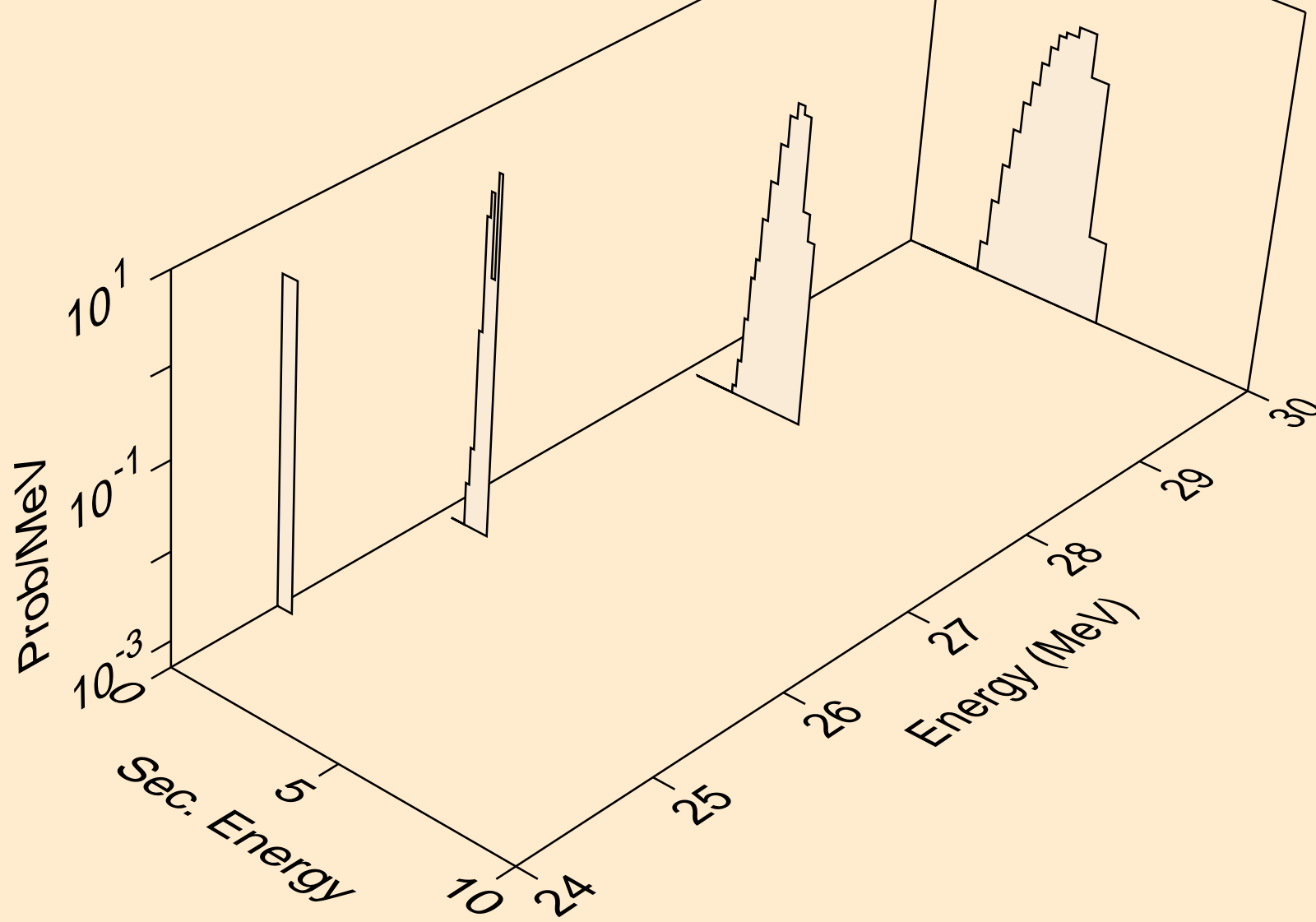

TC089 NEUTRON ACER TENDL-2024 LIBRARY; T=0.K
deuterons from (n,n*)d

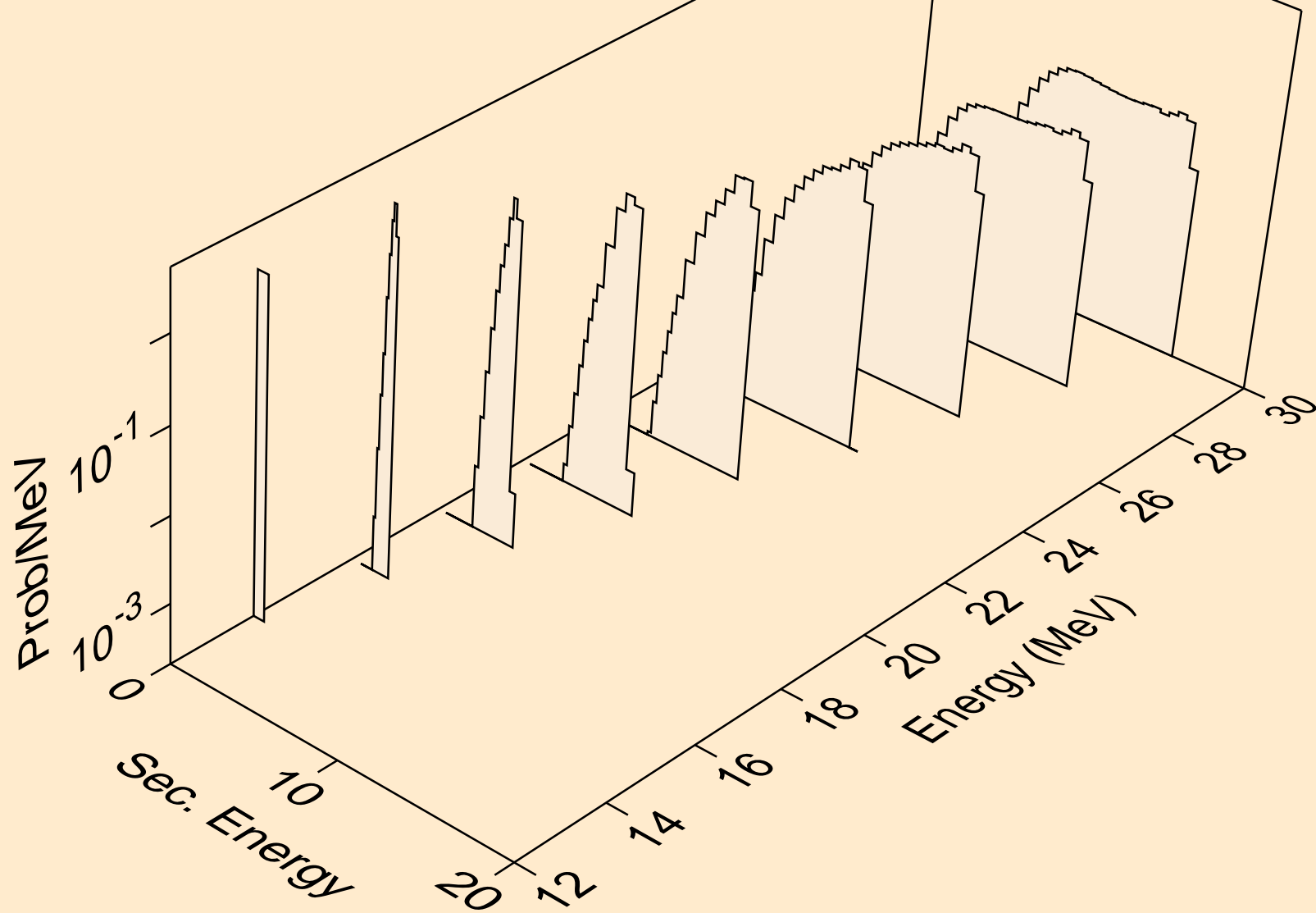

TC089 NEUTRON ACER TENDL-2024 LIBRARY; T=0.K
deuterons from (n,d)

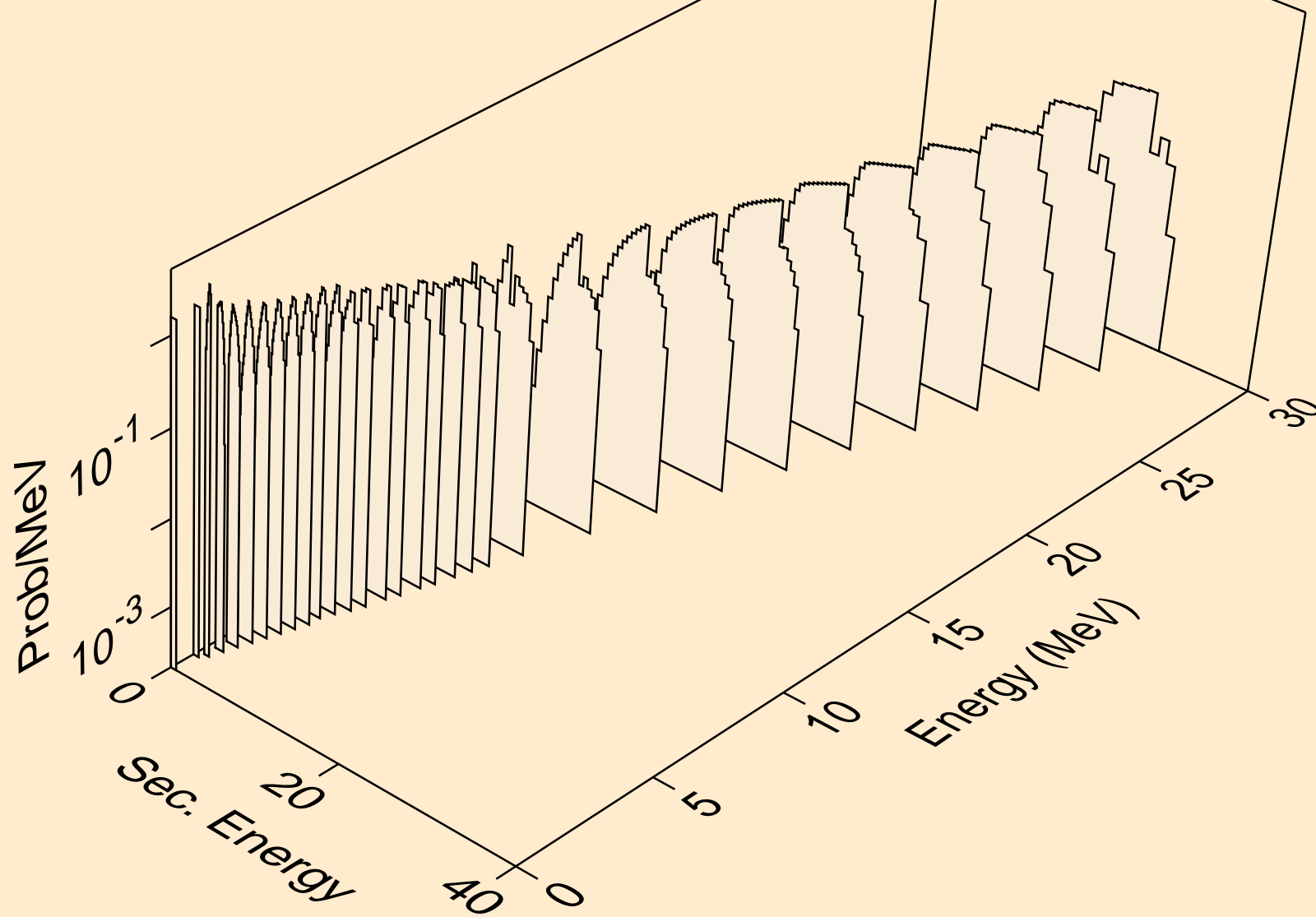

TC089 NEUTRON ACER TENDL-2024 LIBRARY; T=0.K
deuterons from (n,pd)

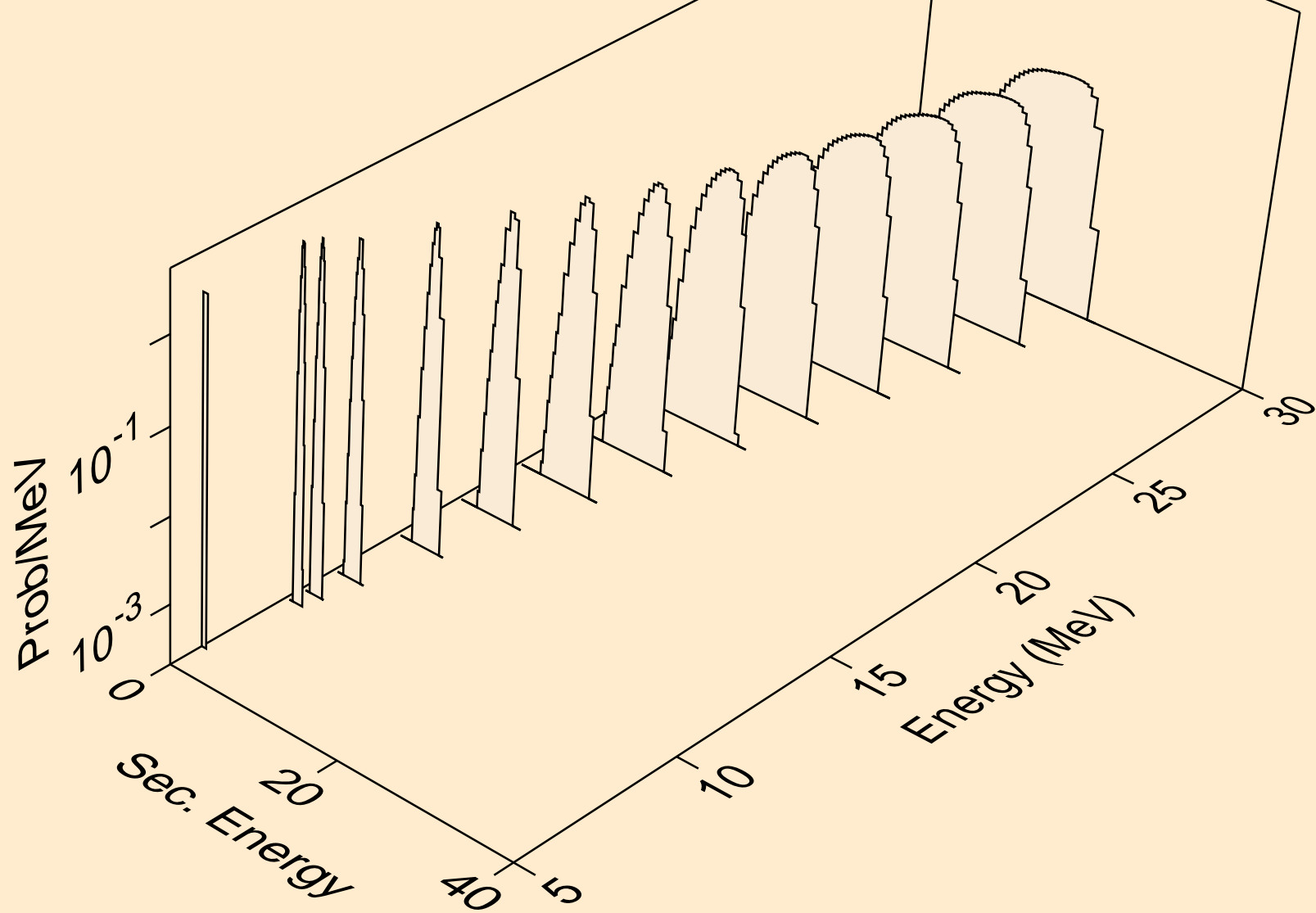

TC089 NEUTRON ACER TENDL-2024 LIBRARY; T=0.K
deuterons from (n,da)

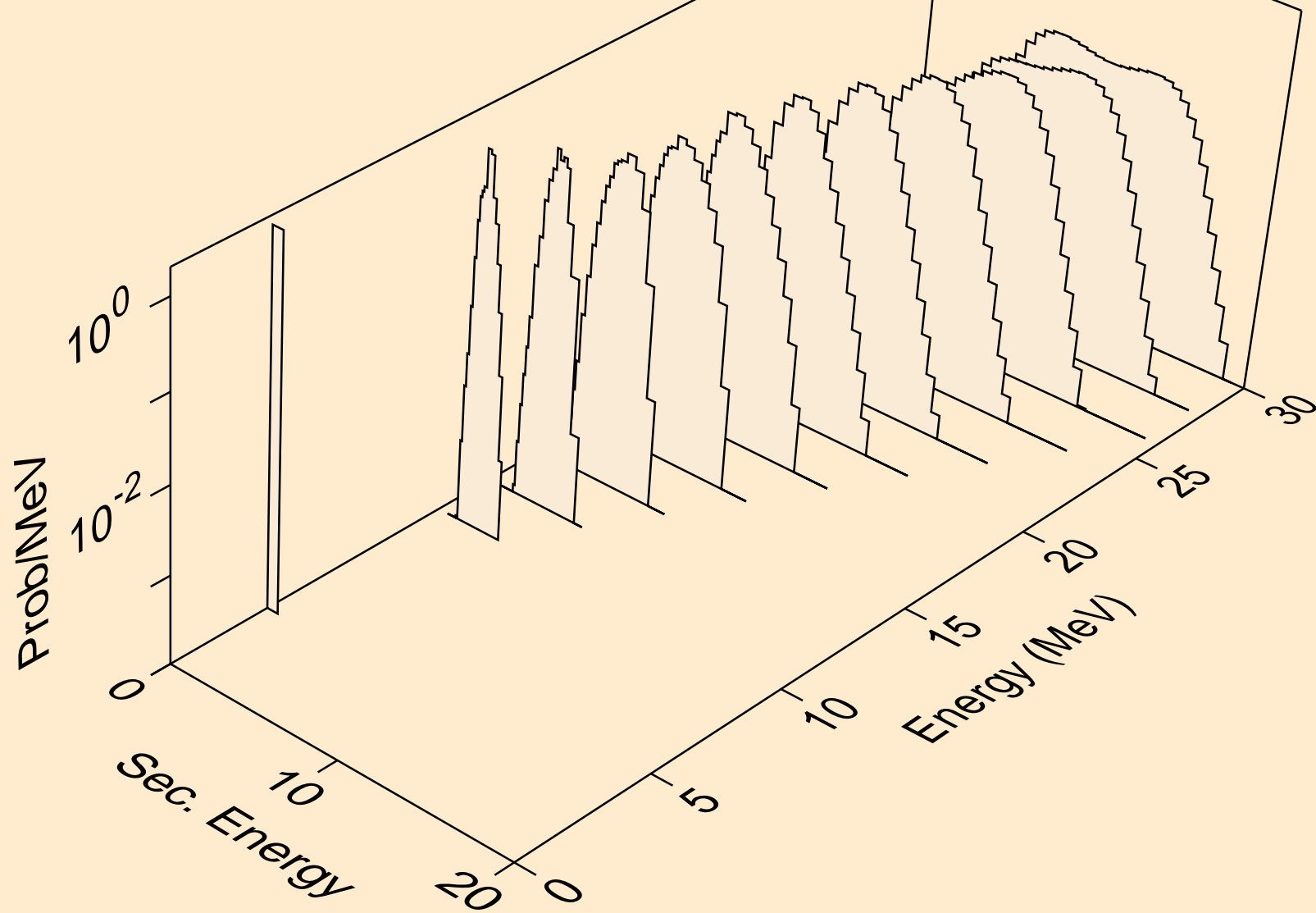

TC089 NEUTRON ACER TENDL-2024 LIBRARY; T=0.K
tritons from (n,x)

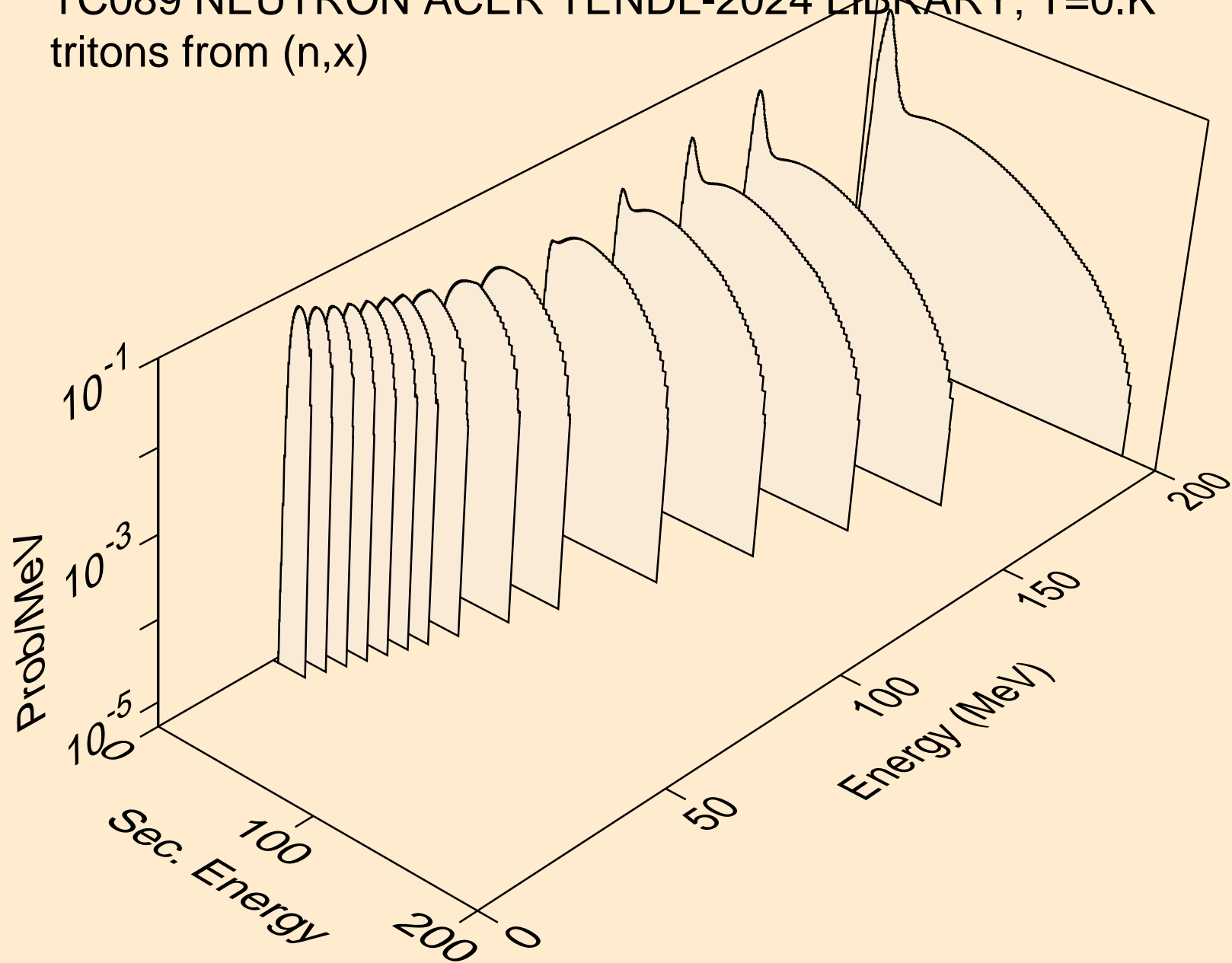

TC089 NEUTRON ACER TENDL-2024 LIBRARY; T=0.K
tritons from (n,n*)t

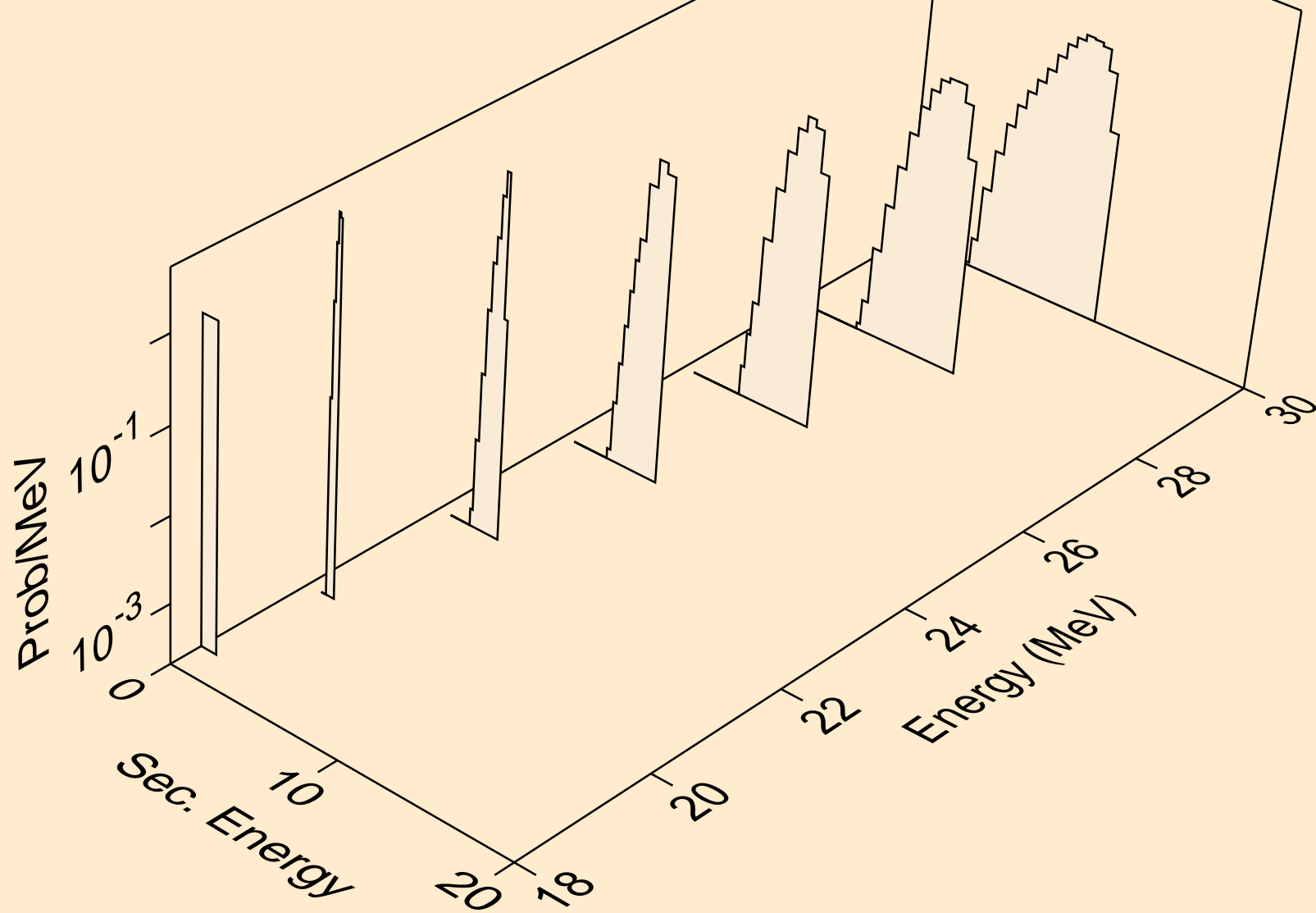

TC089 NEUTRON ACER TENDL-2024 LIBRARY; T=0.K
tritons from (n,t)

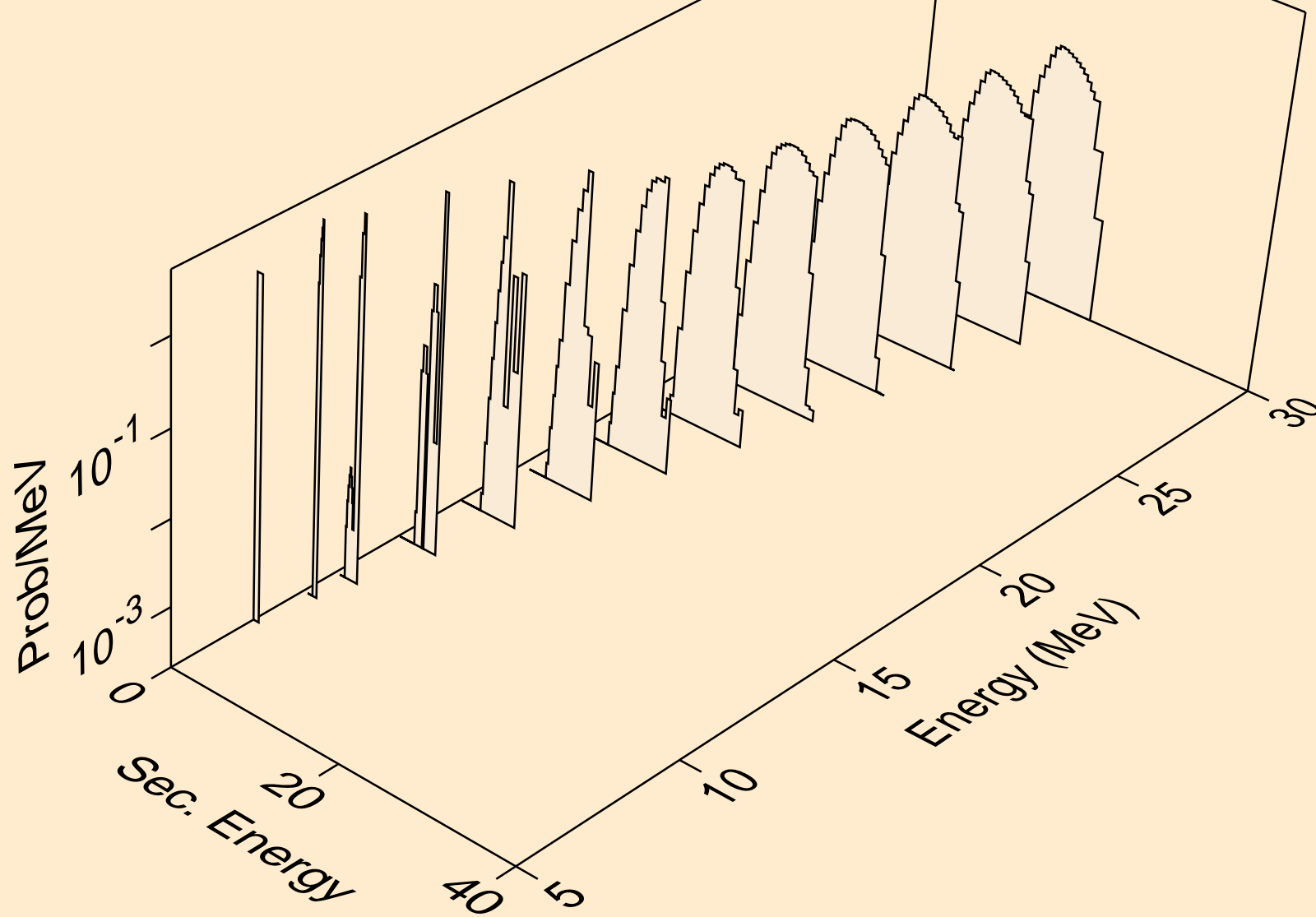

TC089 NEUTRON ACER TENDL-2024 LIBRARY; T=0.K
tritons from (n,pt)

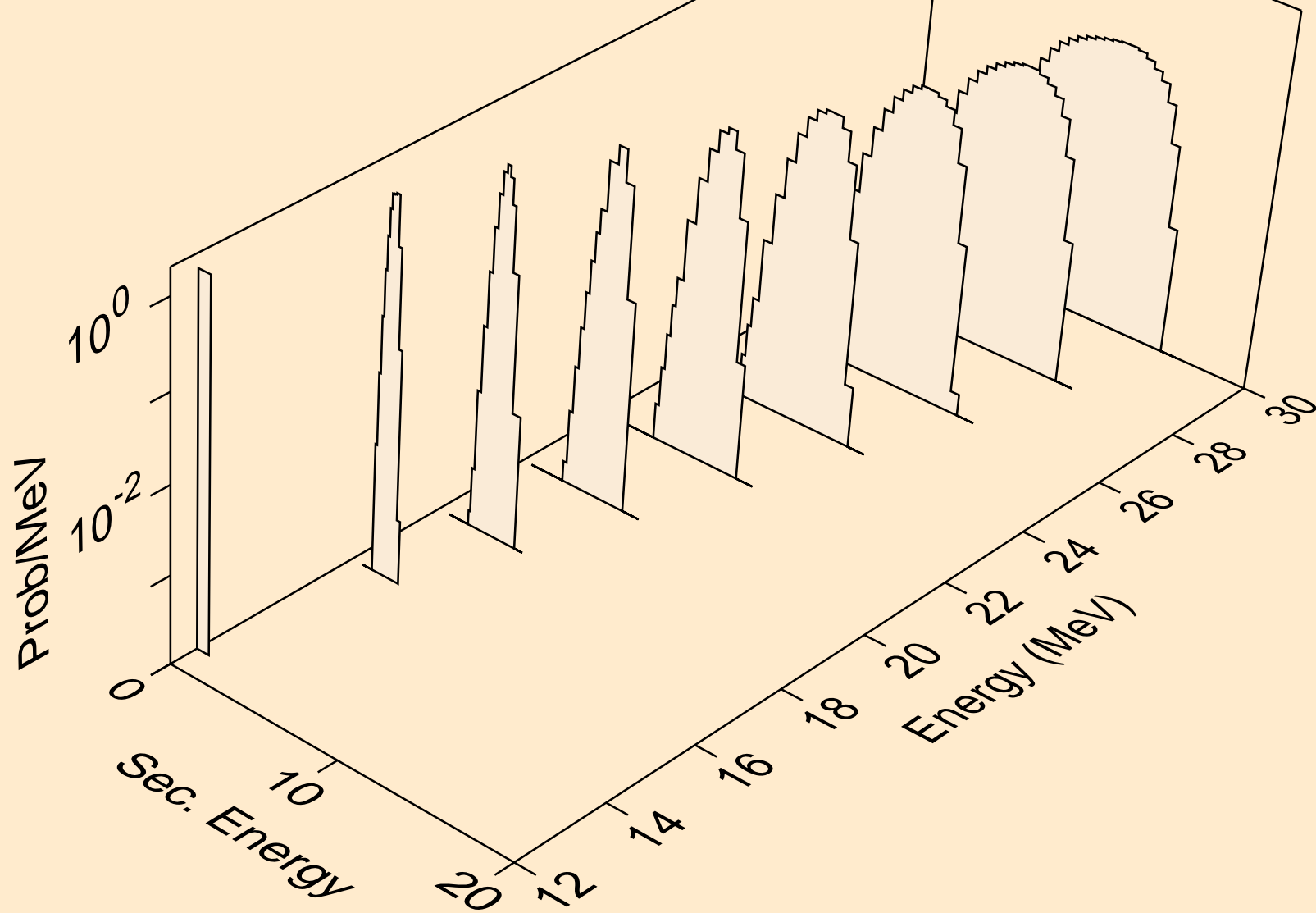

TC089 NEUTRON ACER TENDL-2024 LIBRARY; T=0.K
he3s from (n,x)

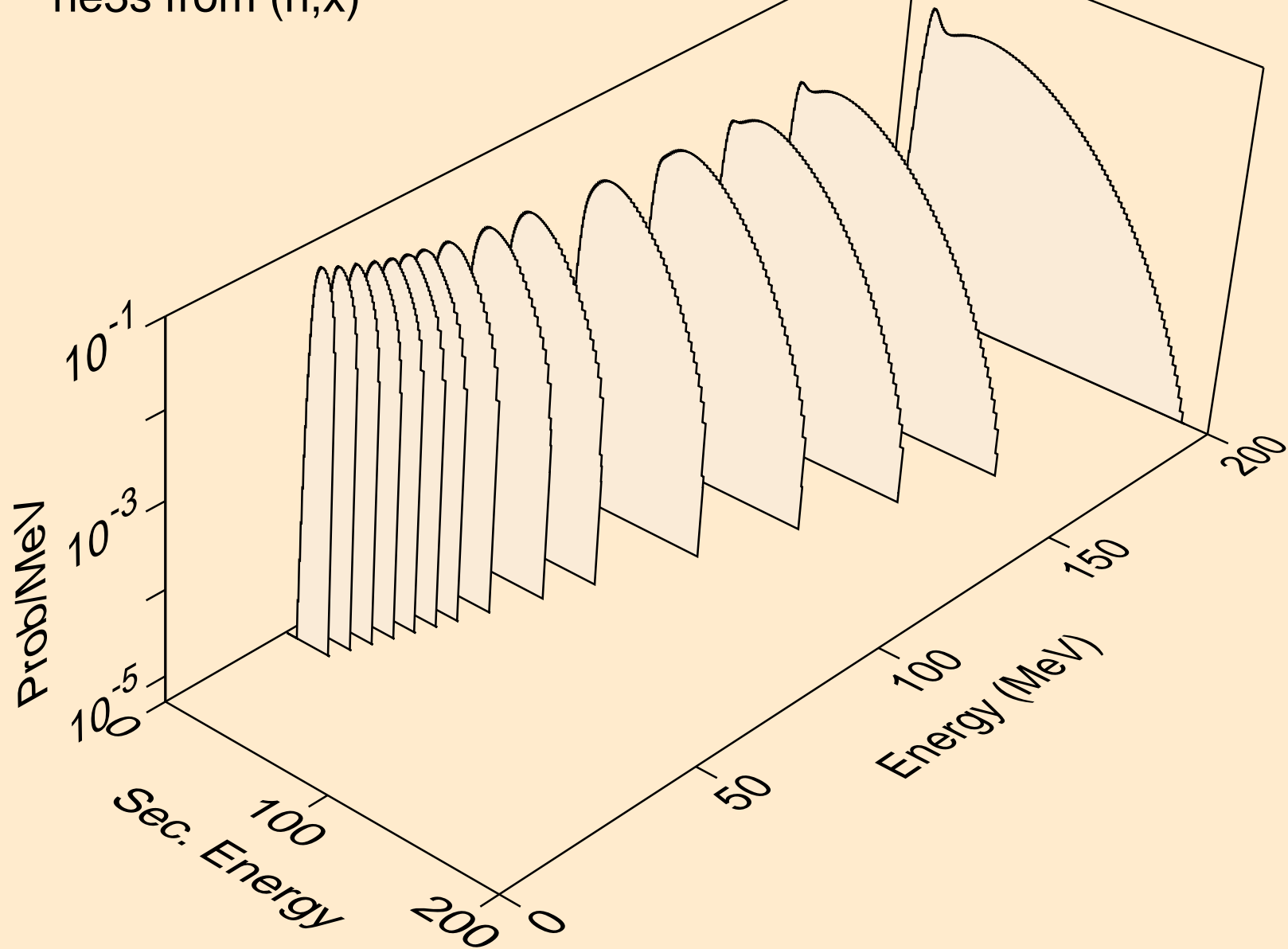

TC089 NEUTRON ACER TENDL-2024 LIBRARY; T=0.K
he3s from (n,n*)he3

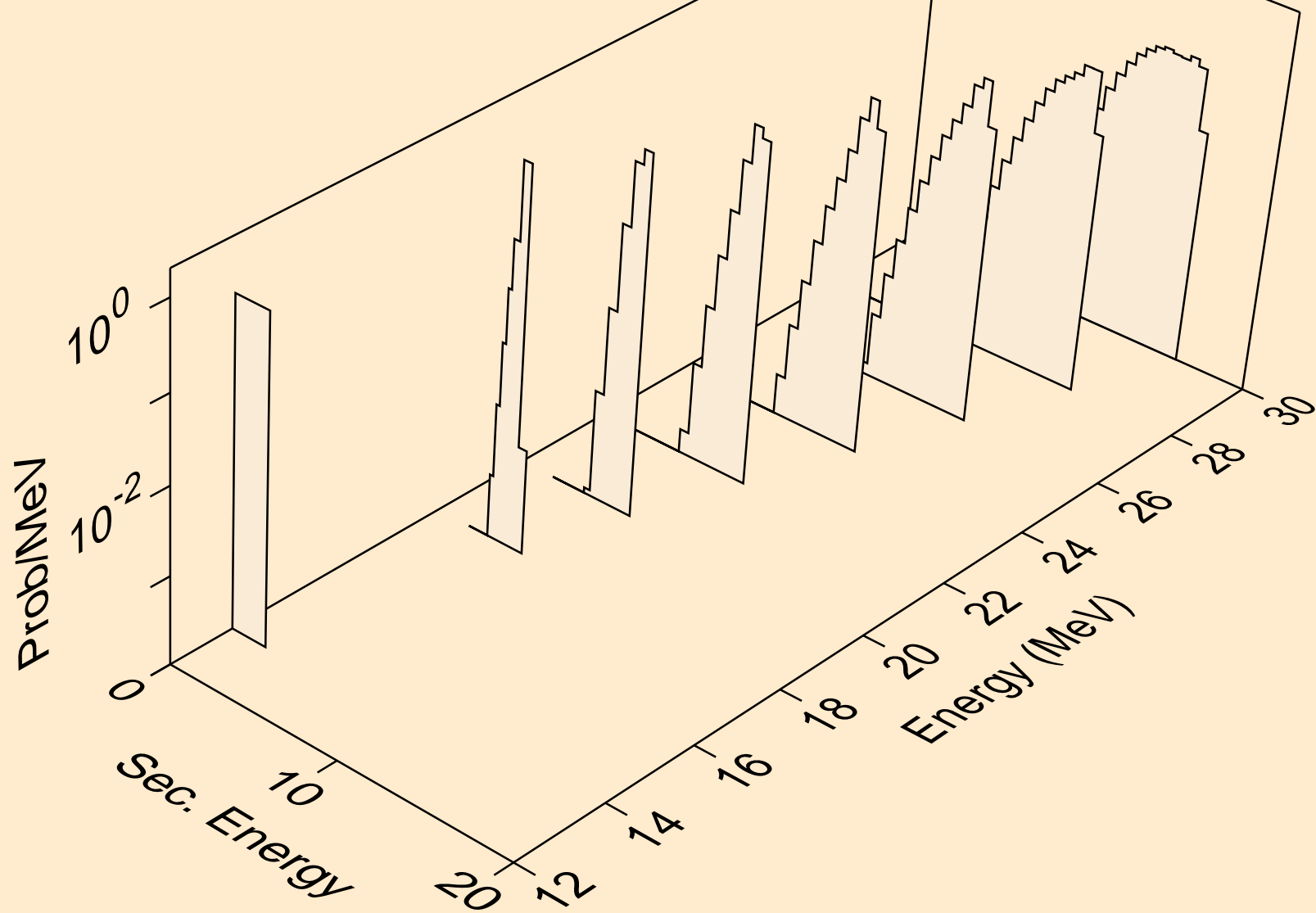

TC089 NEUTRON ACER TENDL-2024 LIBRARY; T=0.K
he3s from (n,he3)

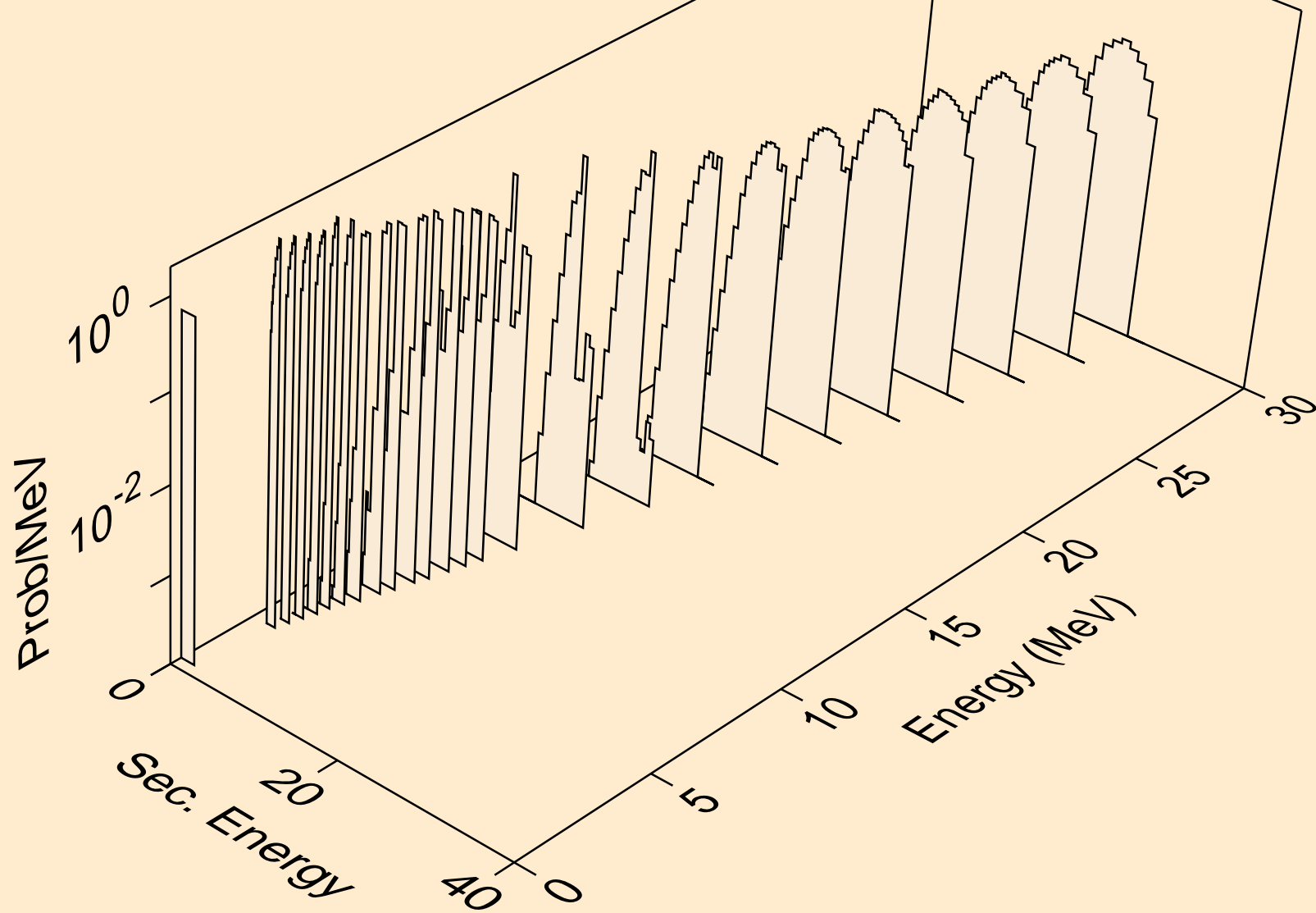

TC089 NEUTRON ACER TENDL-2024 LIBRARY; T=0.K
alphas from (n,x)

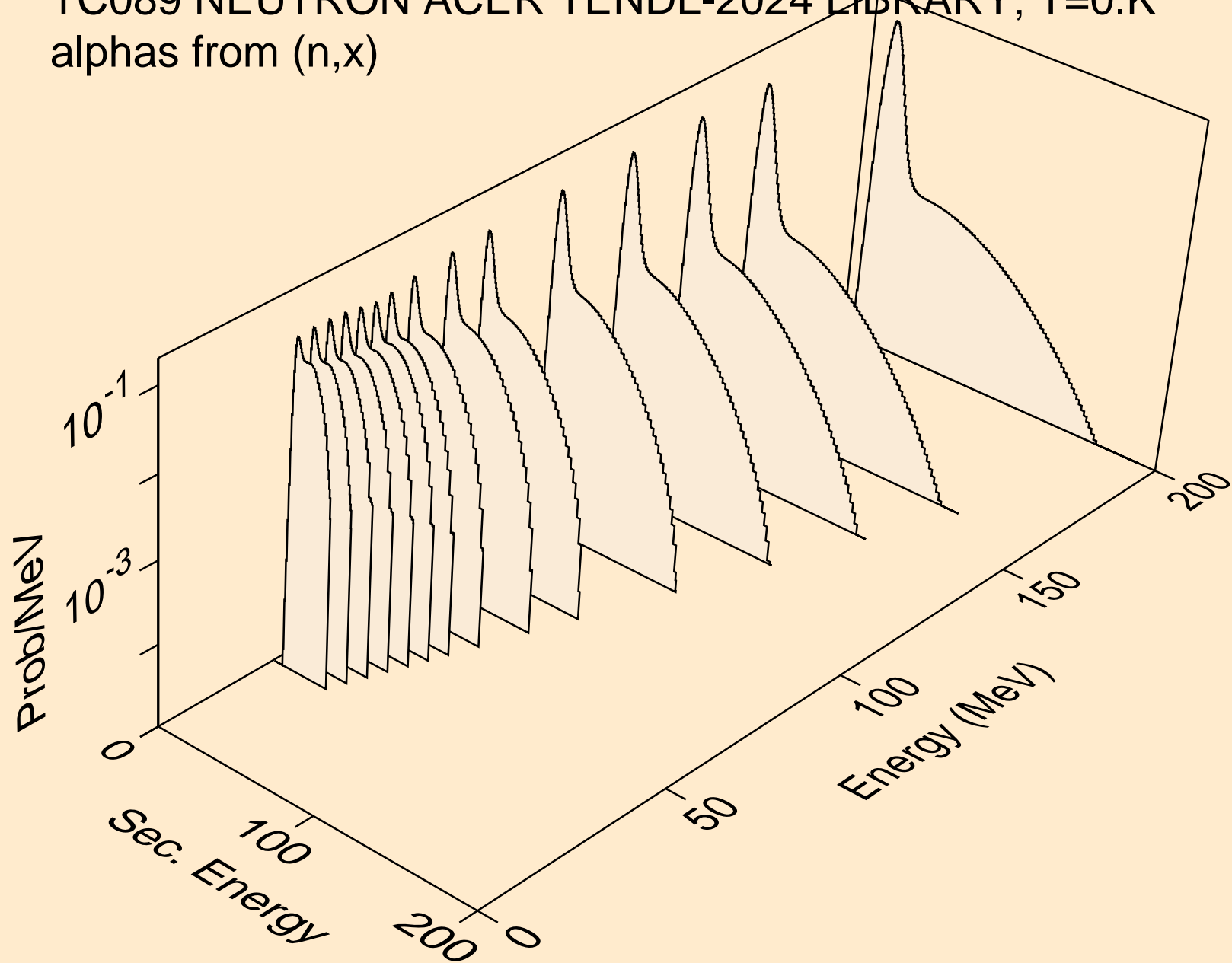

TC089 NEUTRON ACER TENDL-2024 LIBRARY; T=0.K
alphas from (n,n*)a

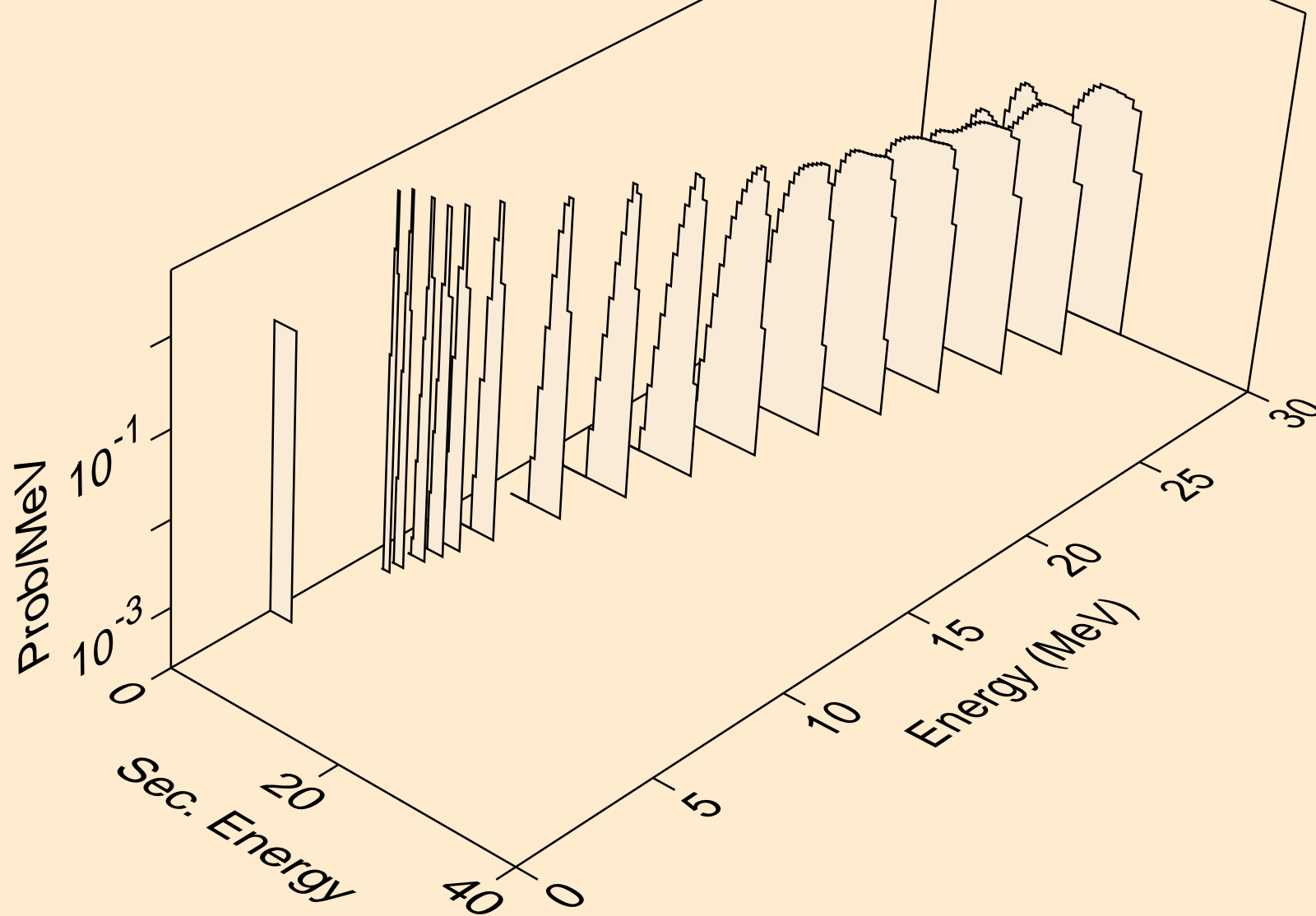

TC089 NEUTRON ACER TENDL-2024 LIBRARY; T=0.K
alphas from (n,2n)a

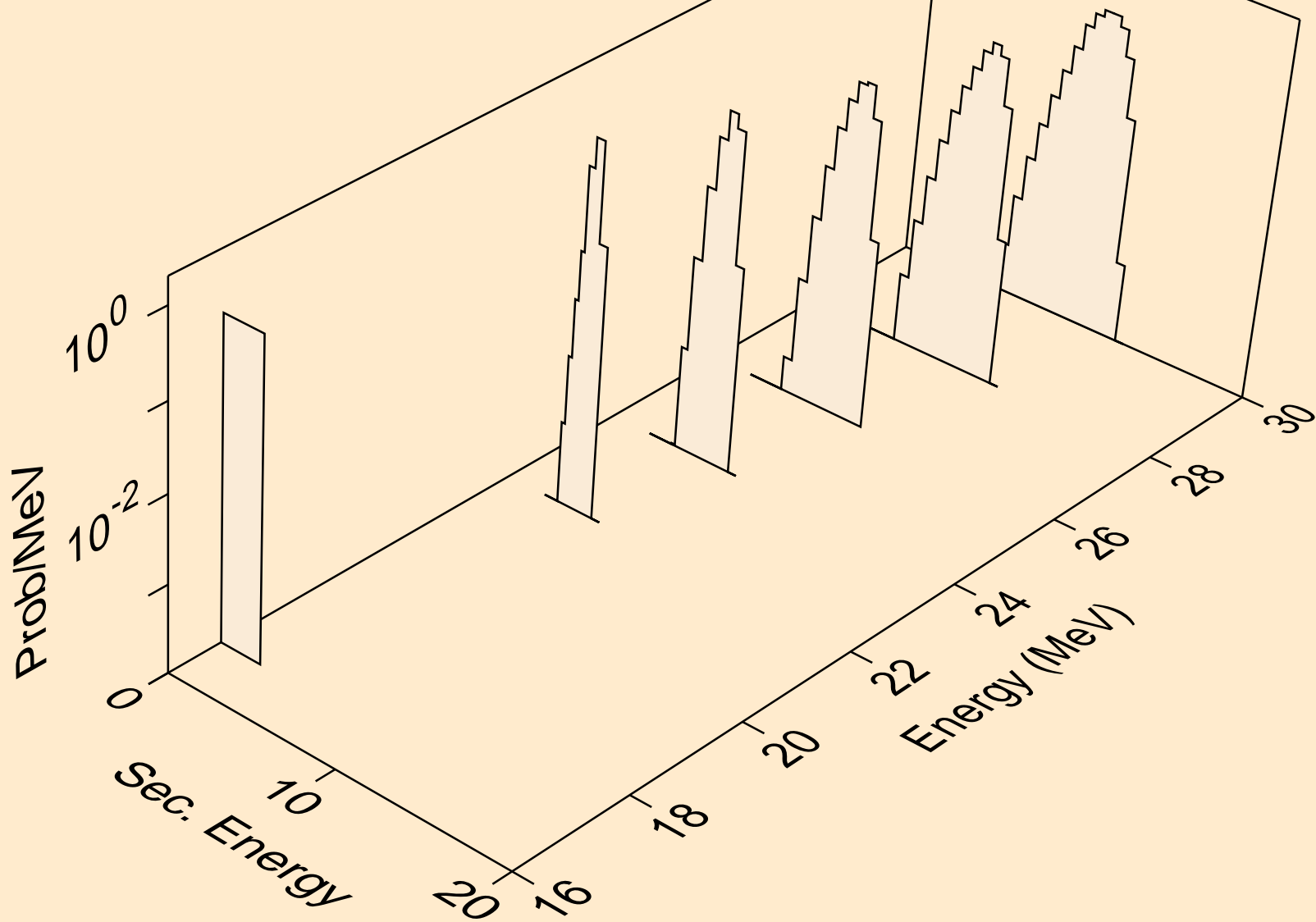

TC089 NEUTRON ACER TENDL-2024 LIBRARY; T=0.K
alphas from (n,n*)2a

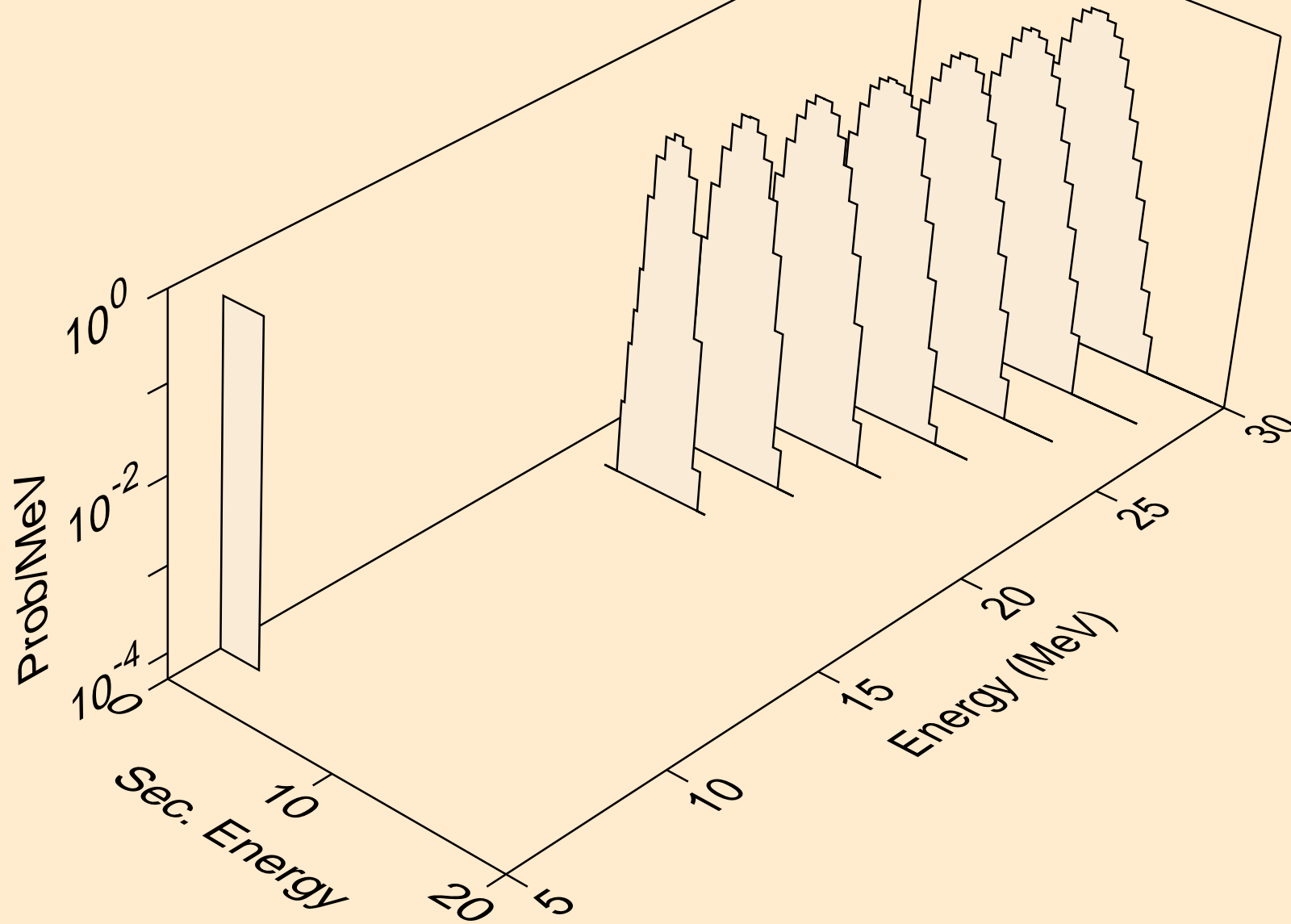

TC089 NEUTRON ACER TENDL-2024 LIBRARY; T=0.K
alphas from (n,npa)

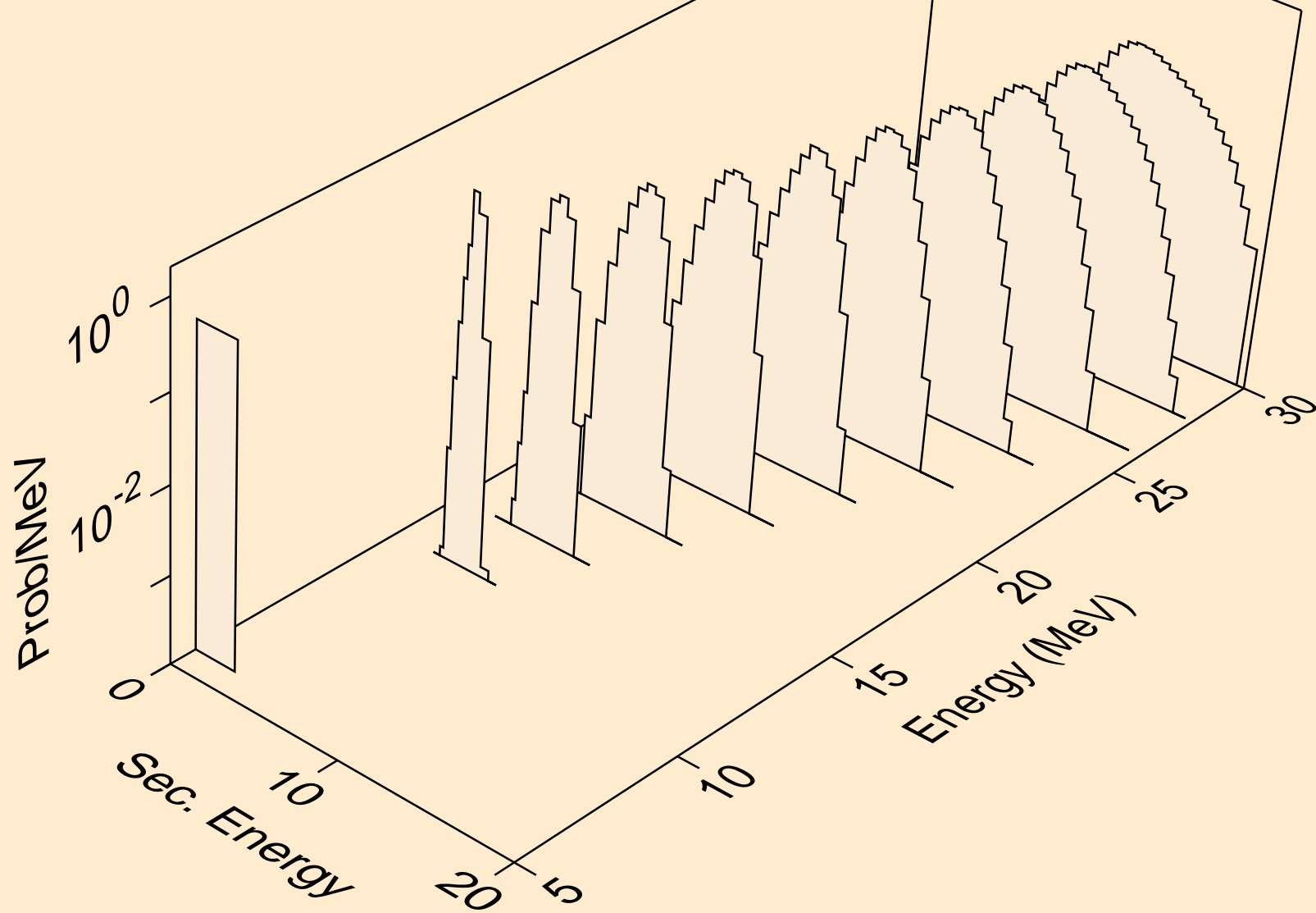

TC089 NEUTRON ACER TENDL-2024 LIBRARY; T=0.K
alphas from (n,a)

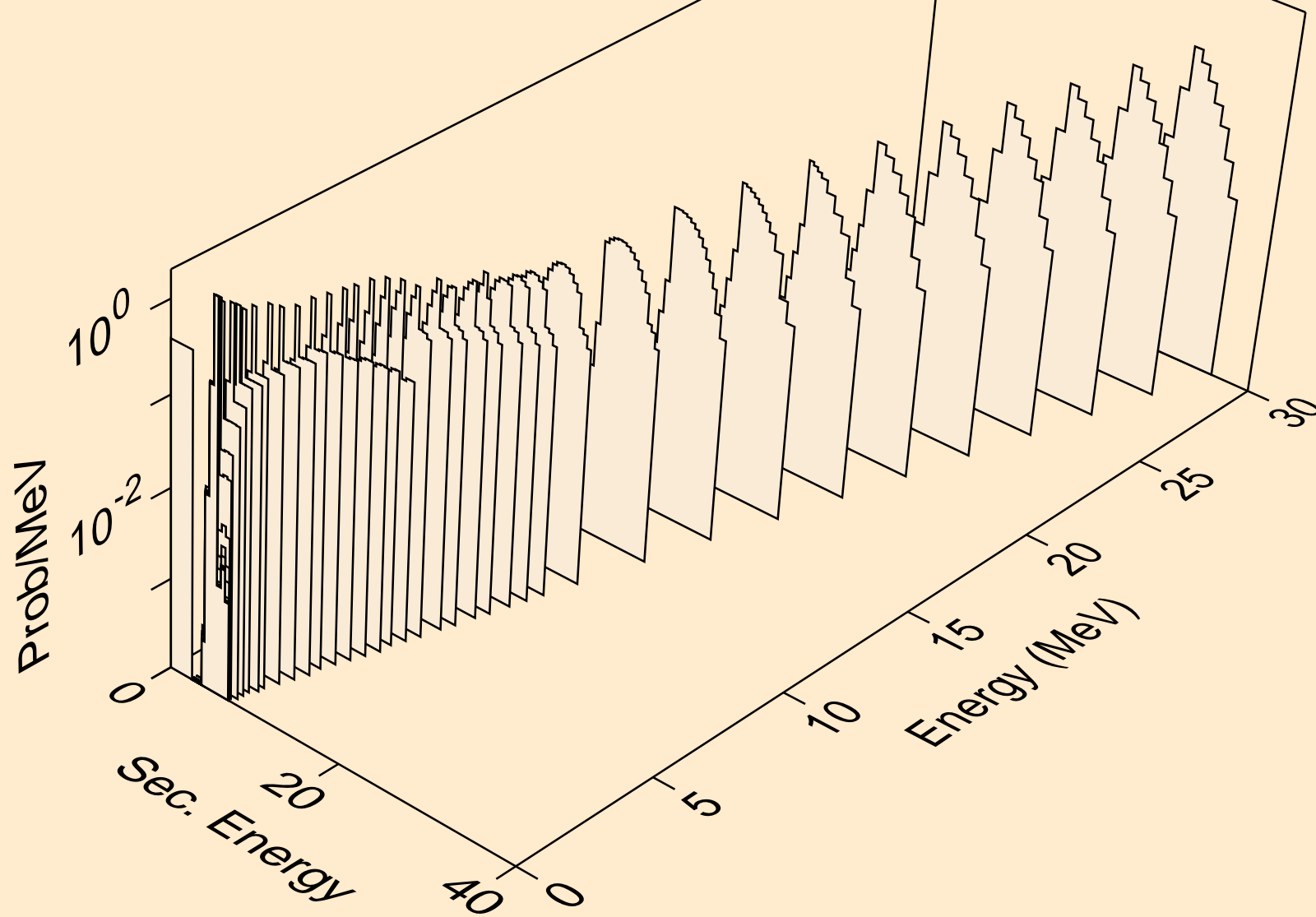

TC089 NEUTRON ACER TENDL-2024 LIBRARY; T=0.K
alphas from (n,2a)

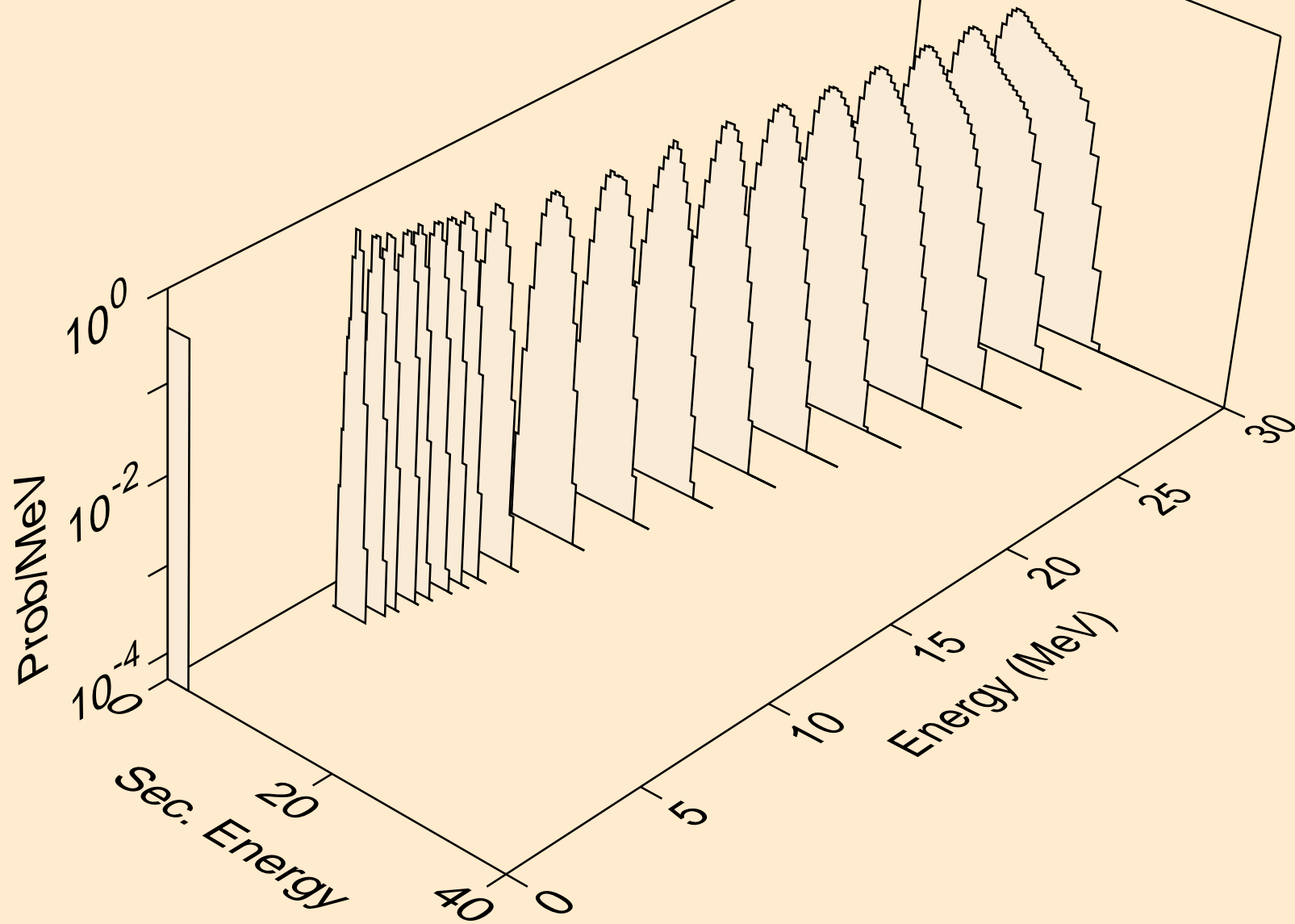

TC089 NEUTRON ACER TENDL-2024 LIBRARY; T=0.K
alphas from (n,pa)

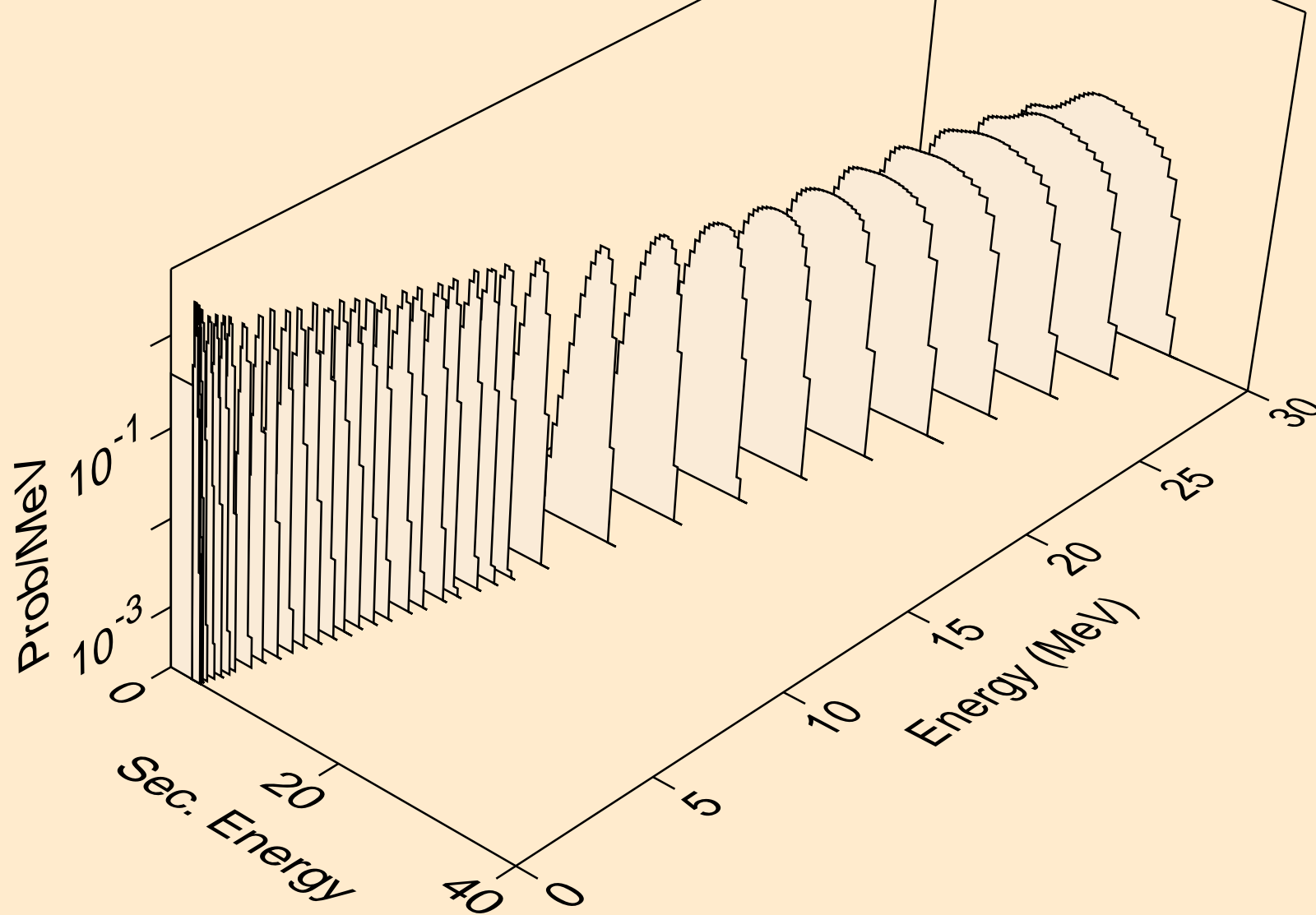

TC089 NEUTRON ACER TENDL-2024 LIBRARY; T=0.K
alphas from (n,da)

