

# TC107 NEUTRON ACER TENDL-2024 LIBRARY; T=0.K

## Principal cross sections

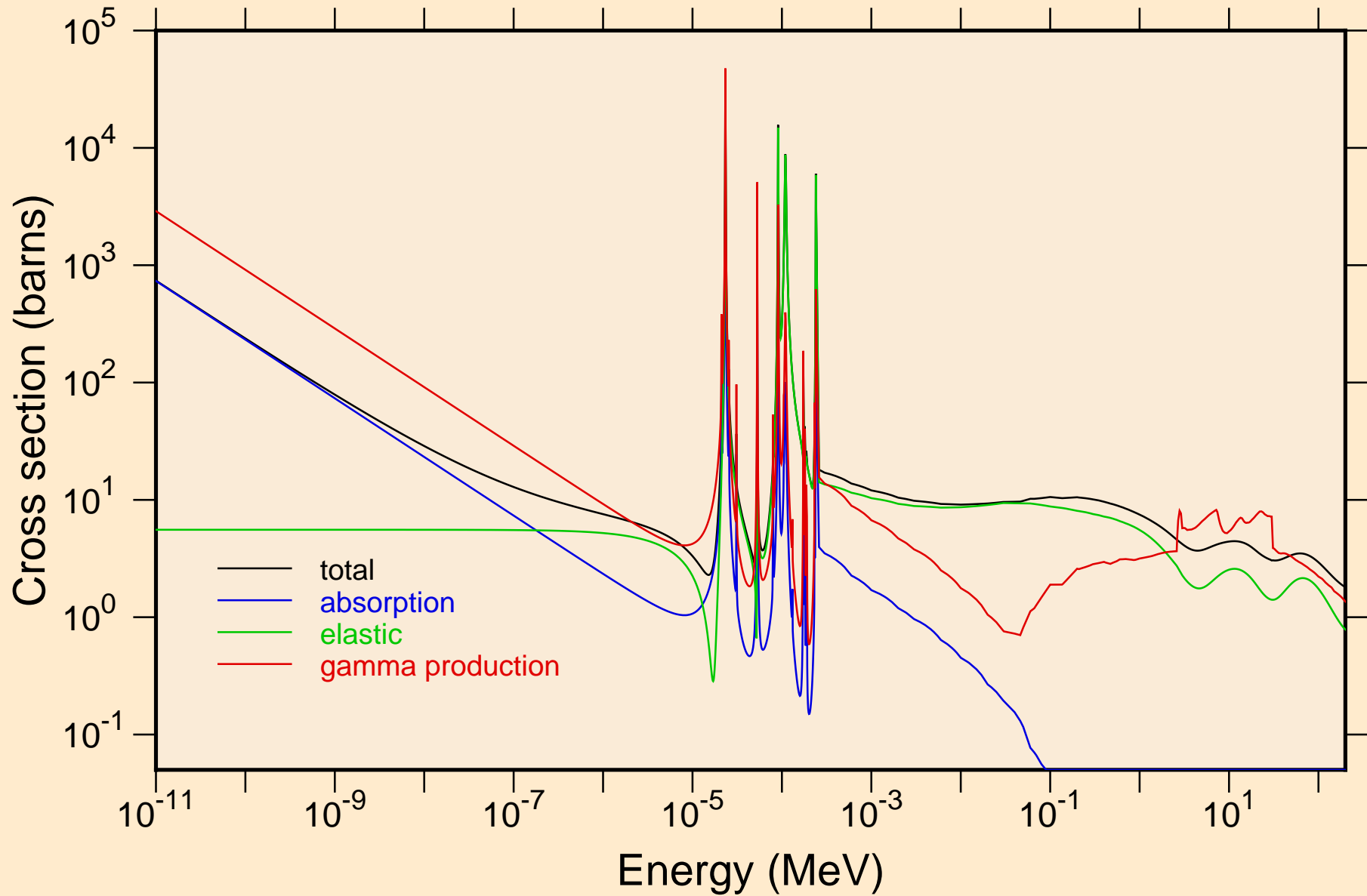

TC107 NEUTRON ACER TENDL-2024 LIBRARY; T=0.K  
resonance total cross section

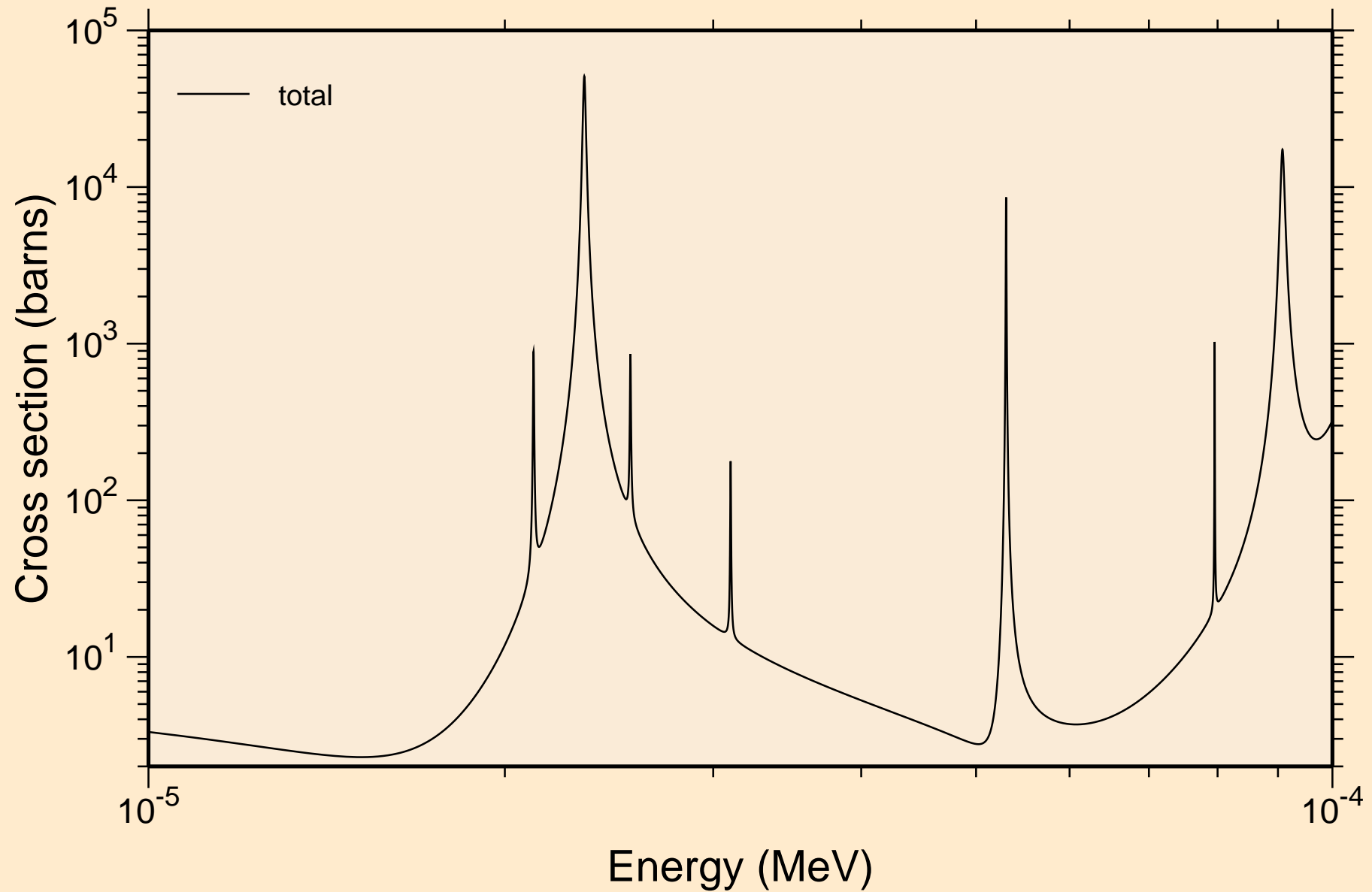

TC107 NEUTRON ACER TENDL-2024 LIBRARY; T=0.K  
resonance total cross section

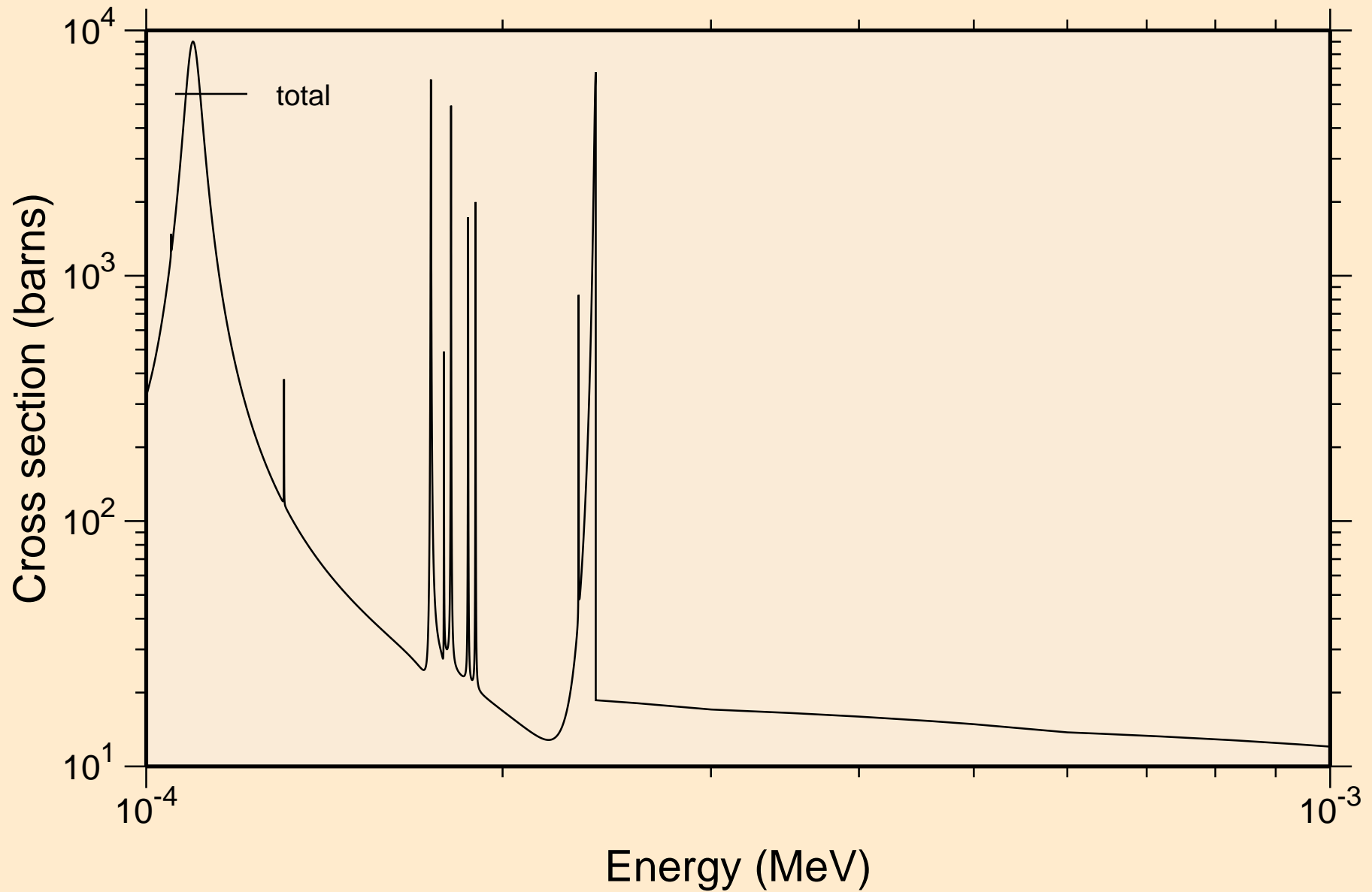

Tc107 NEUTRON ACER TENDL-2024 LIBRARY; T=0.K  
resonance total cross section

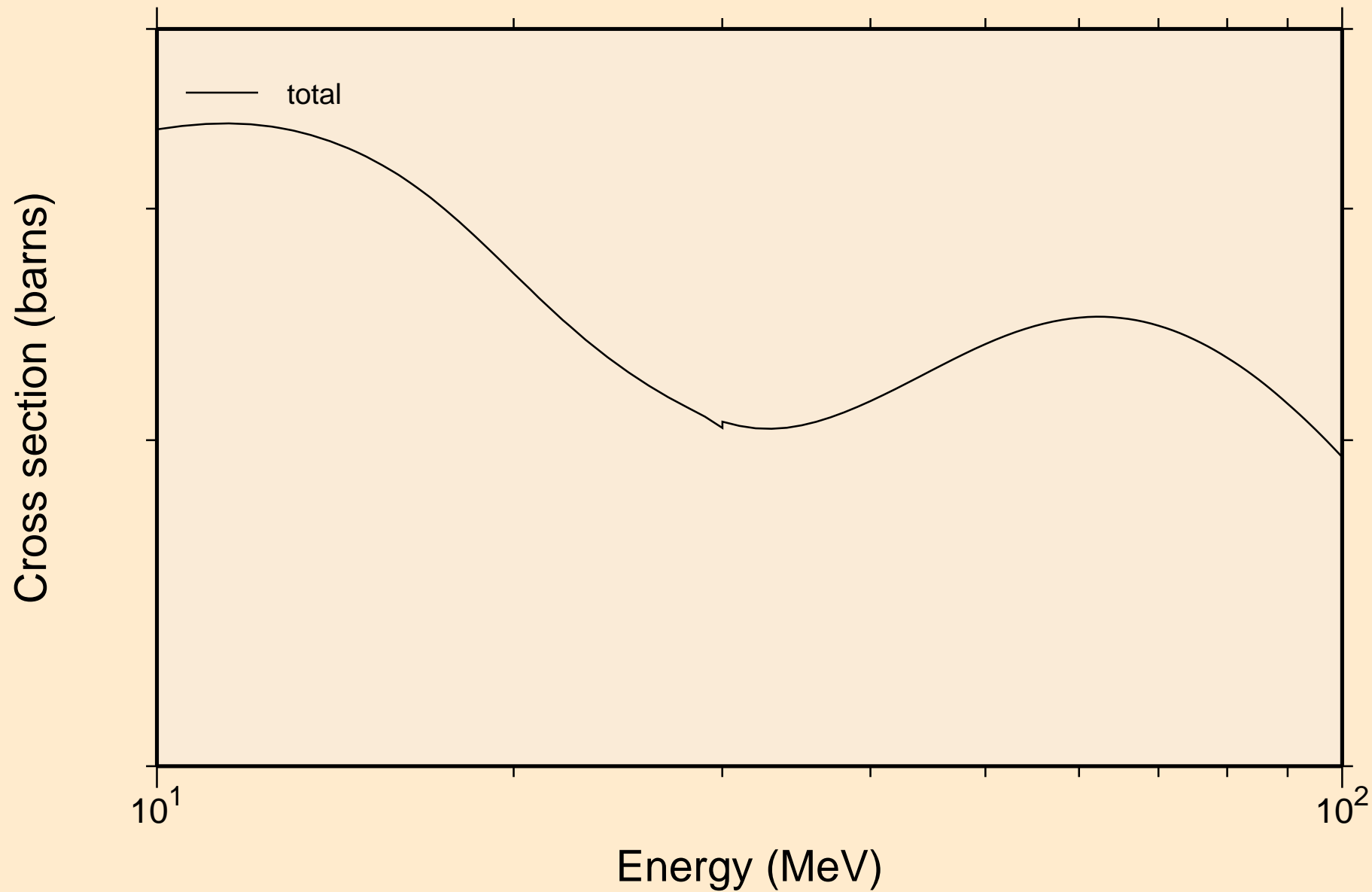

TC107 NEUTRON ACER TENDL-2024 LIBRARY; T=0.K  
resonance absorption cross sections

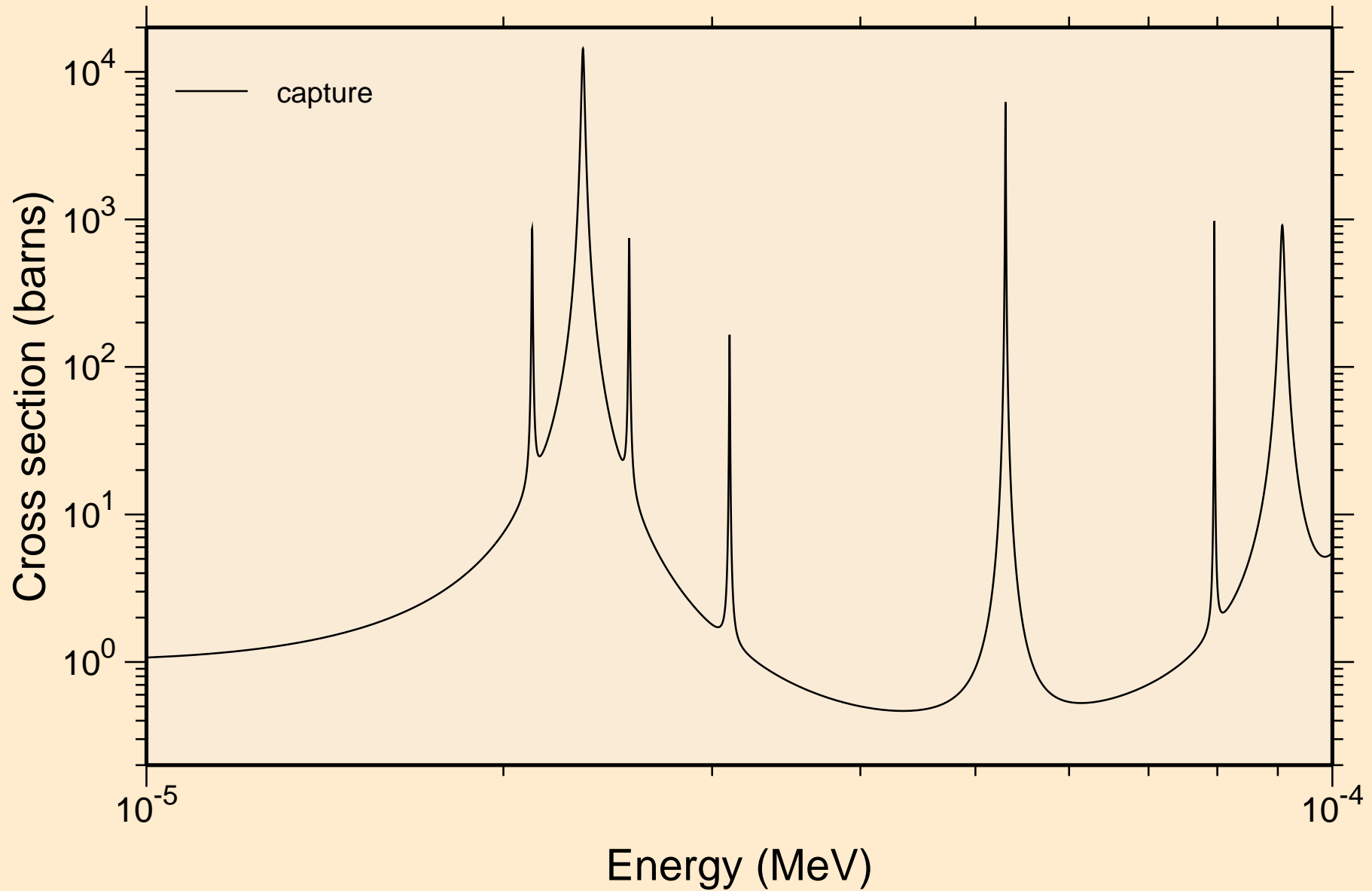

TC107 NEUTRON ACER TENDL-2024 LIBRARY; T=0.K  
resonance absorption cross sections

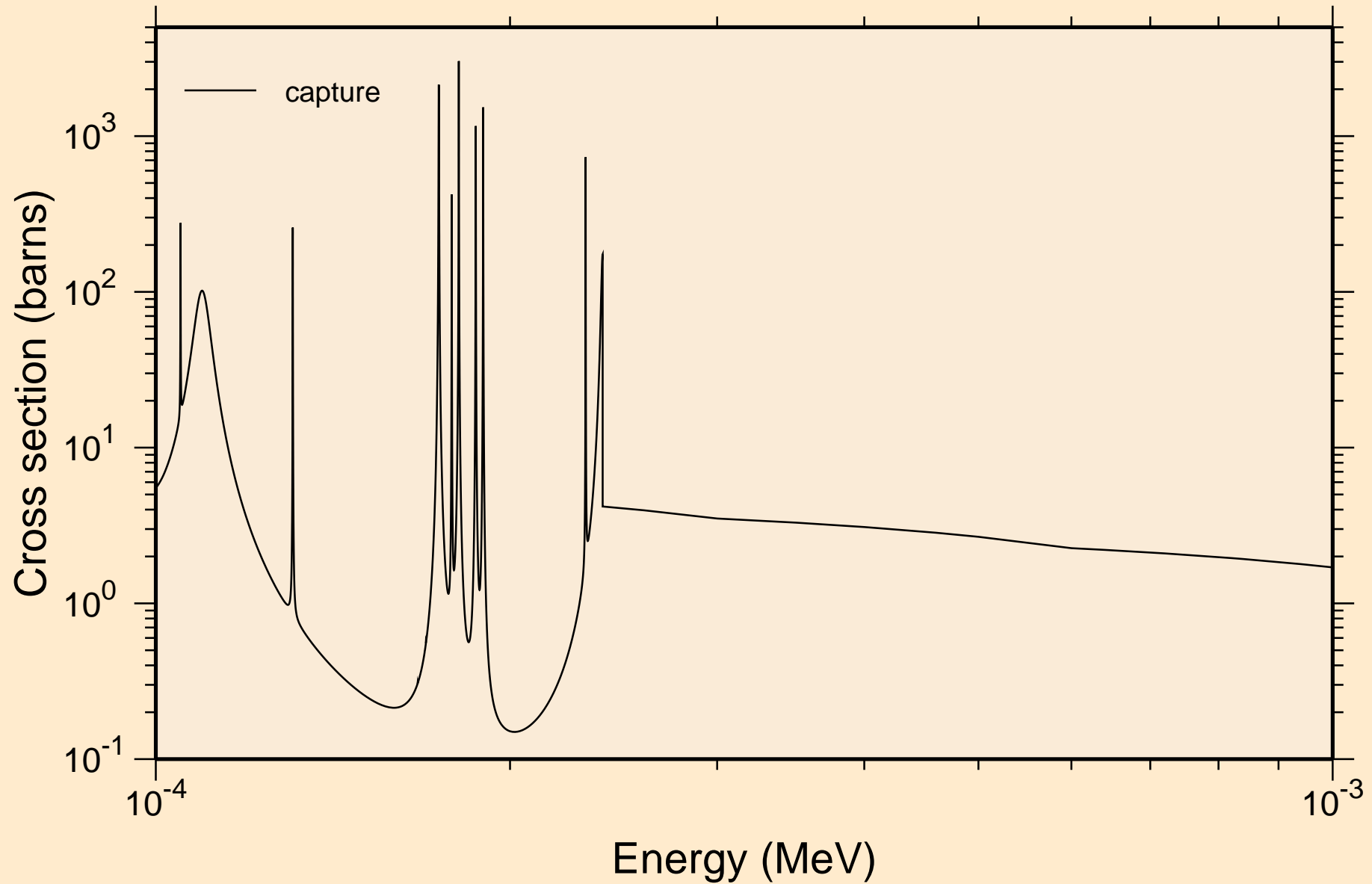

TC107 NEUTRON ACER TENDL-2024 LIBRARY; T=0.K  
resonance absorption cross sections

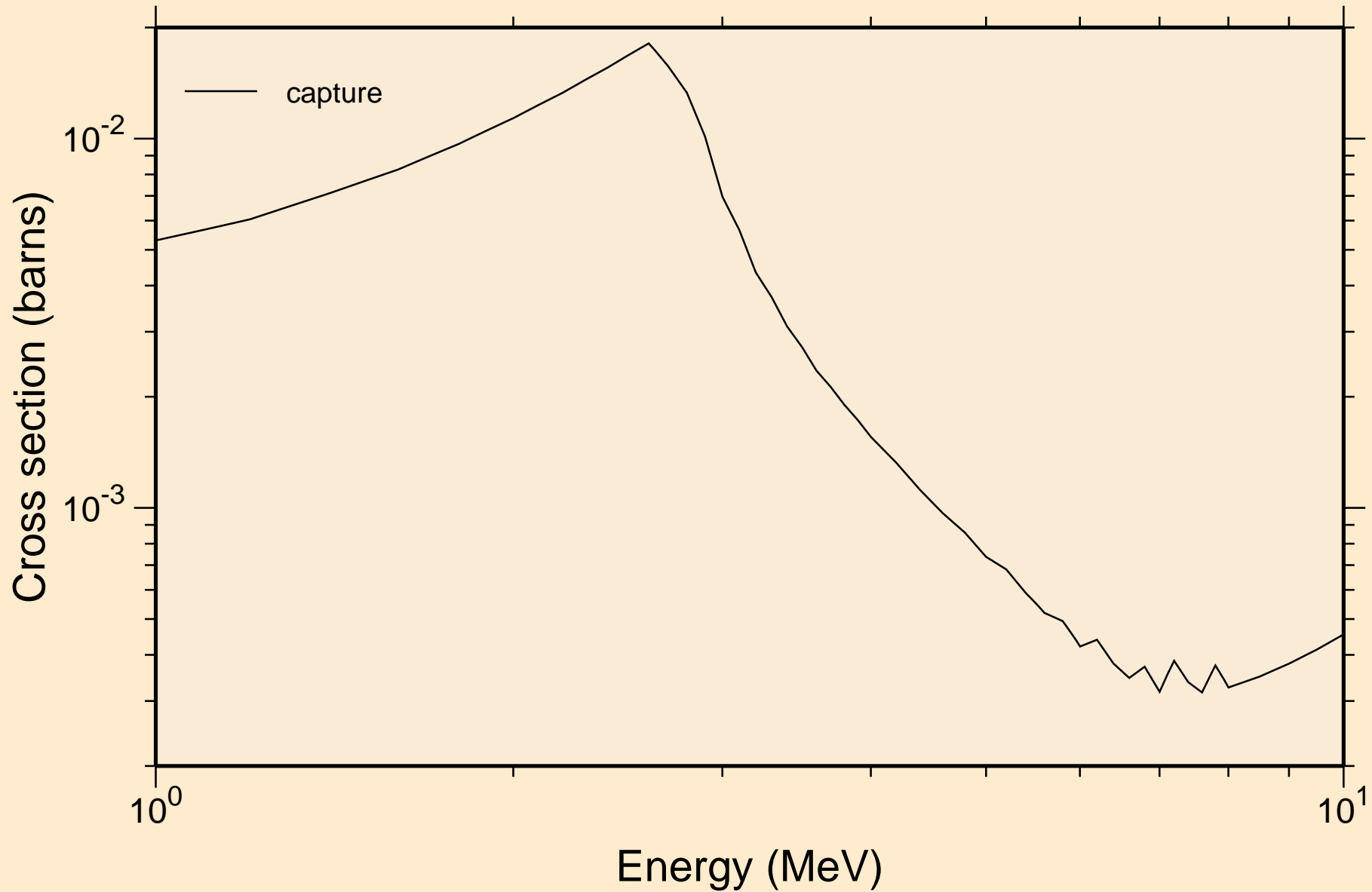

TC107 NEUTRON ACER TENDL-2024 LIBRARY; T=0.K  
Heating

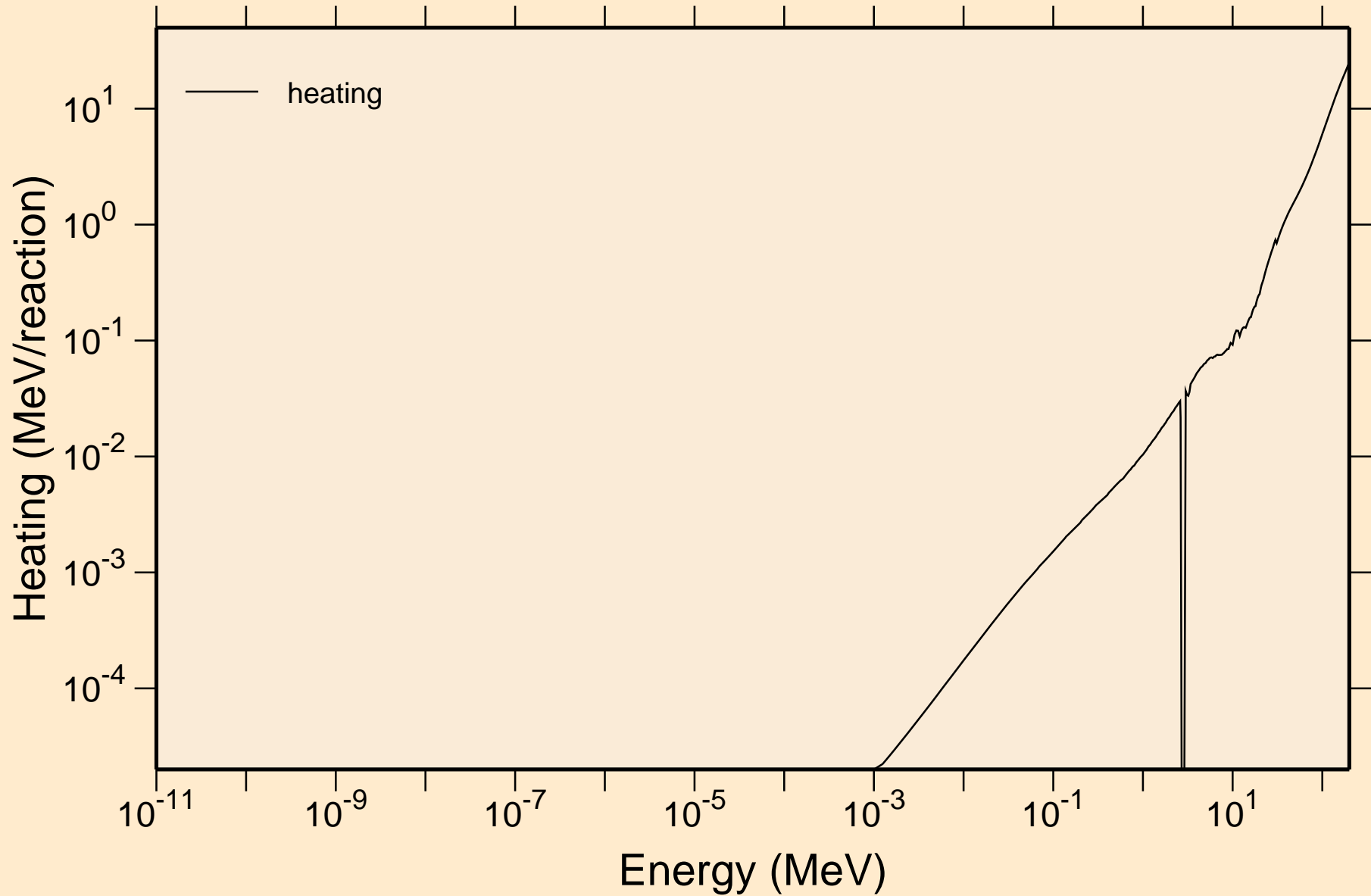



# TC107 NEUTRON ACER TENDL-2024 LIBRARY; T=0.K

## Damage

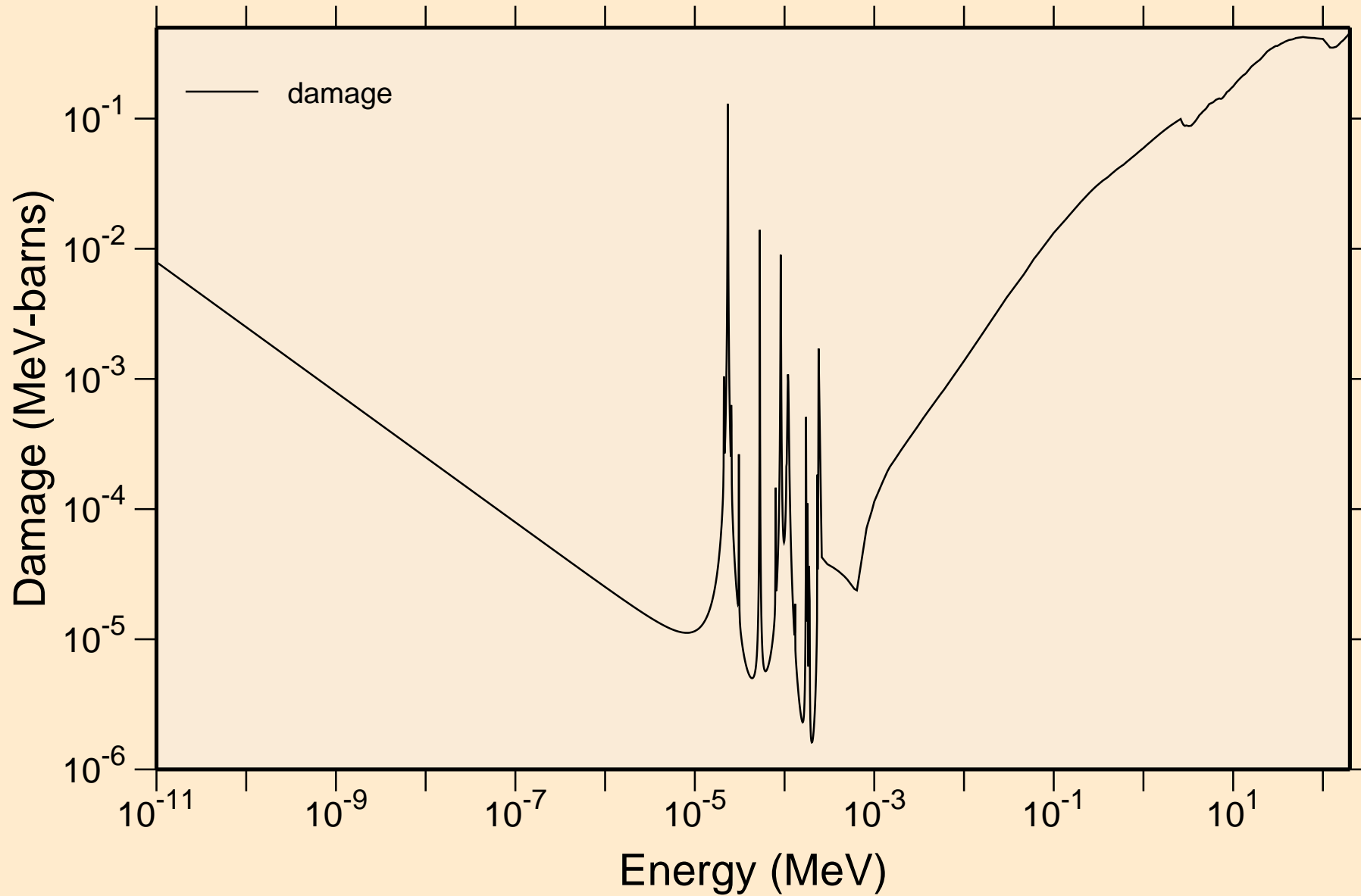

TC107 NEUTRON ACER TENDL-2024 LIBRARY; T=0.K  
Non-threshold reactions

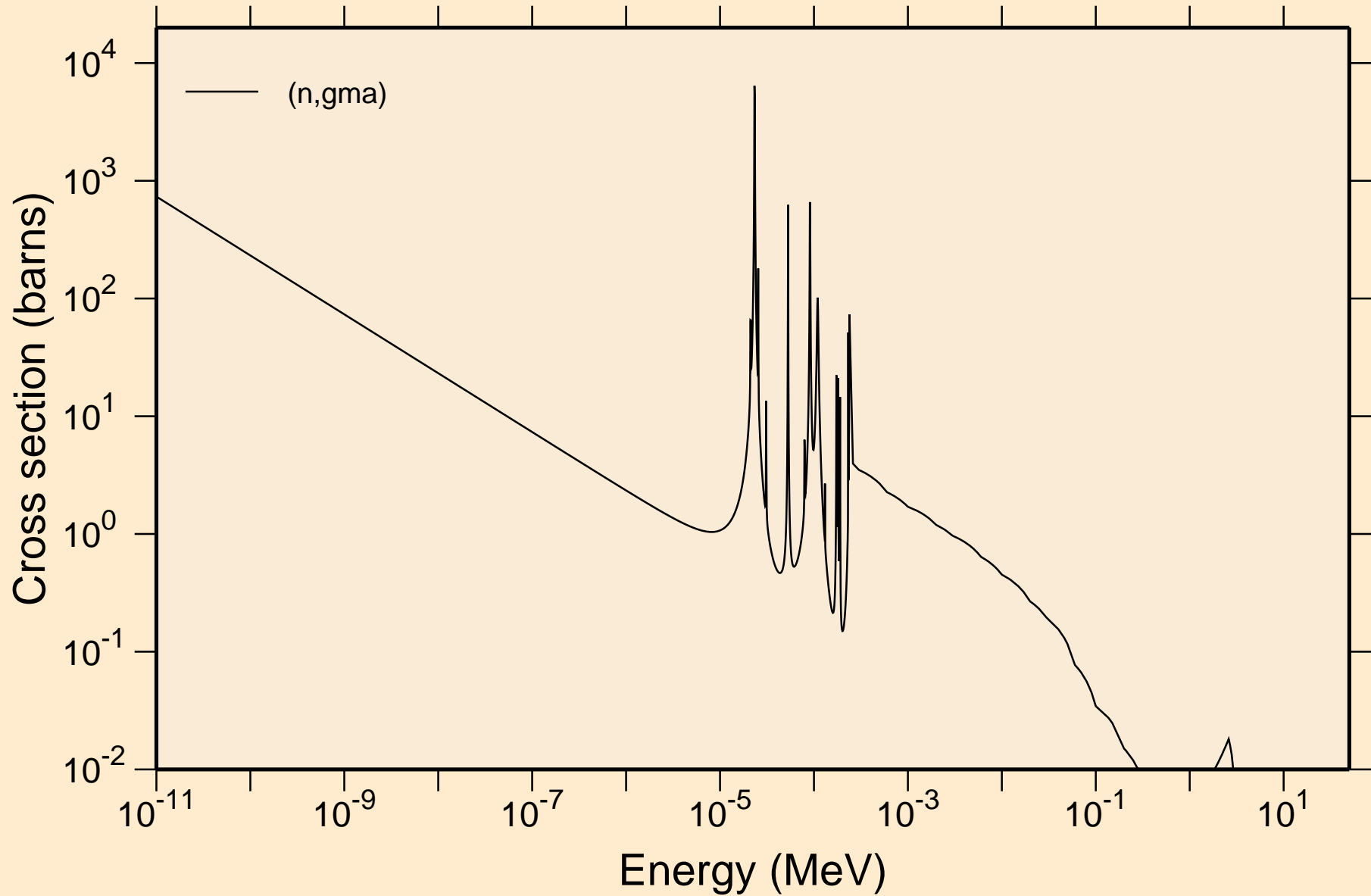

TC107 NEUTRON ACER TENDL-2024 LIBRARY; T=0.K  
Principal cross sections

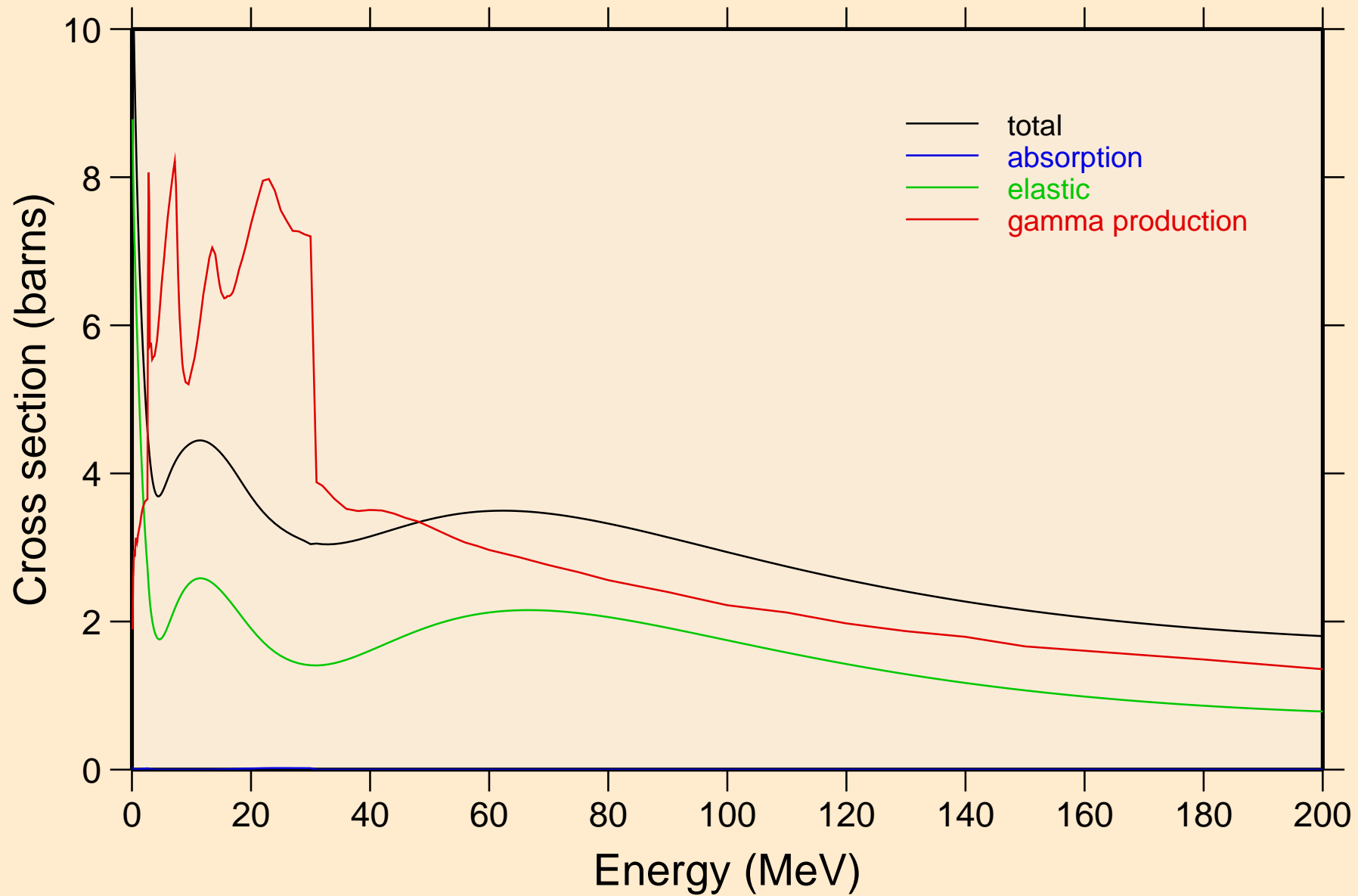

# TC107 NEUTRON ACER TENDL-2024 LIBRARY; T=0.K

## Heating

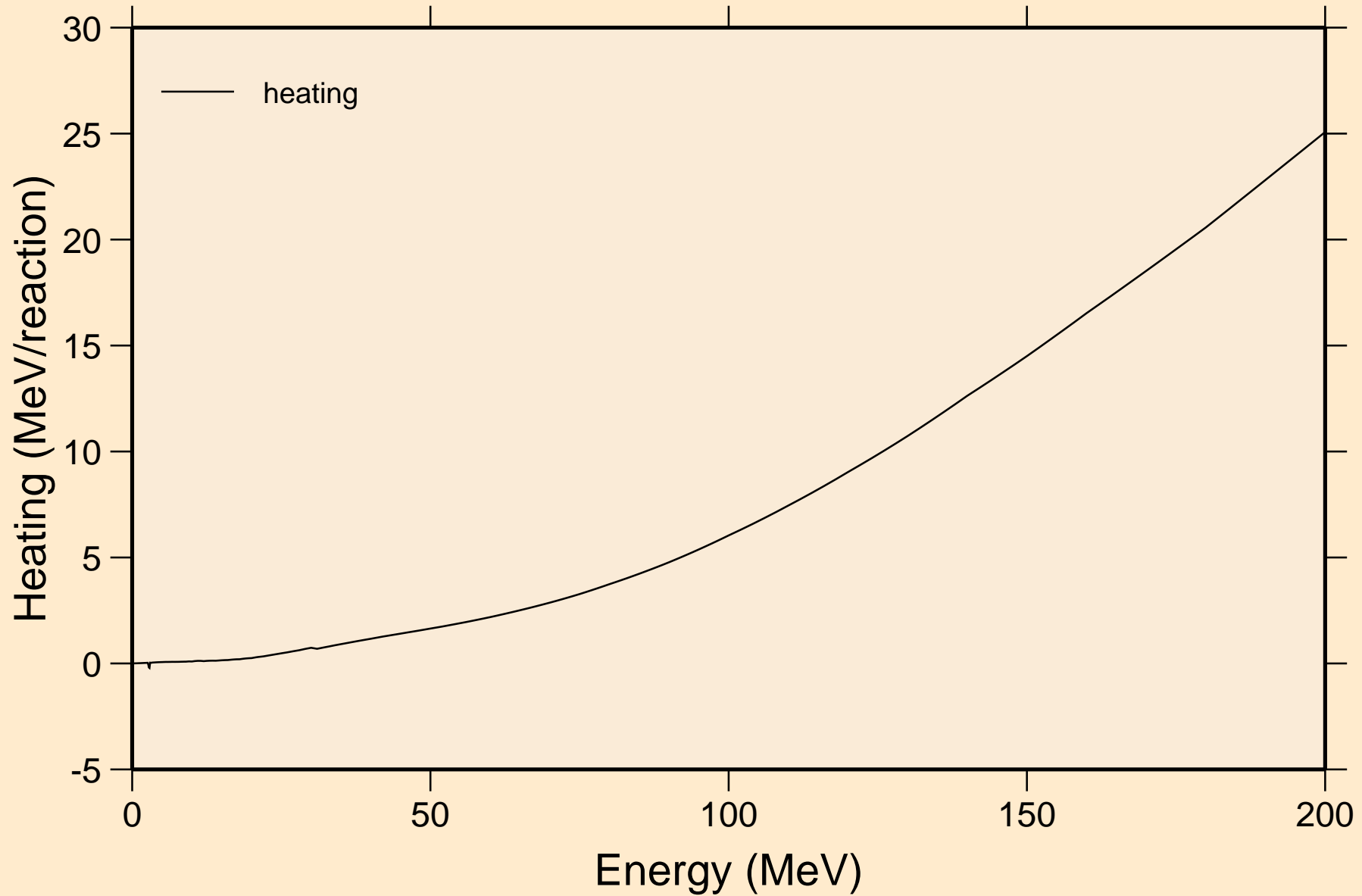

TC107 NEUTRON ACER TENDL-2024 LIBRARY; T=0.K  
Damage

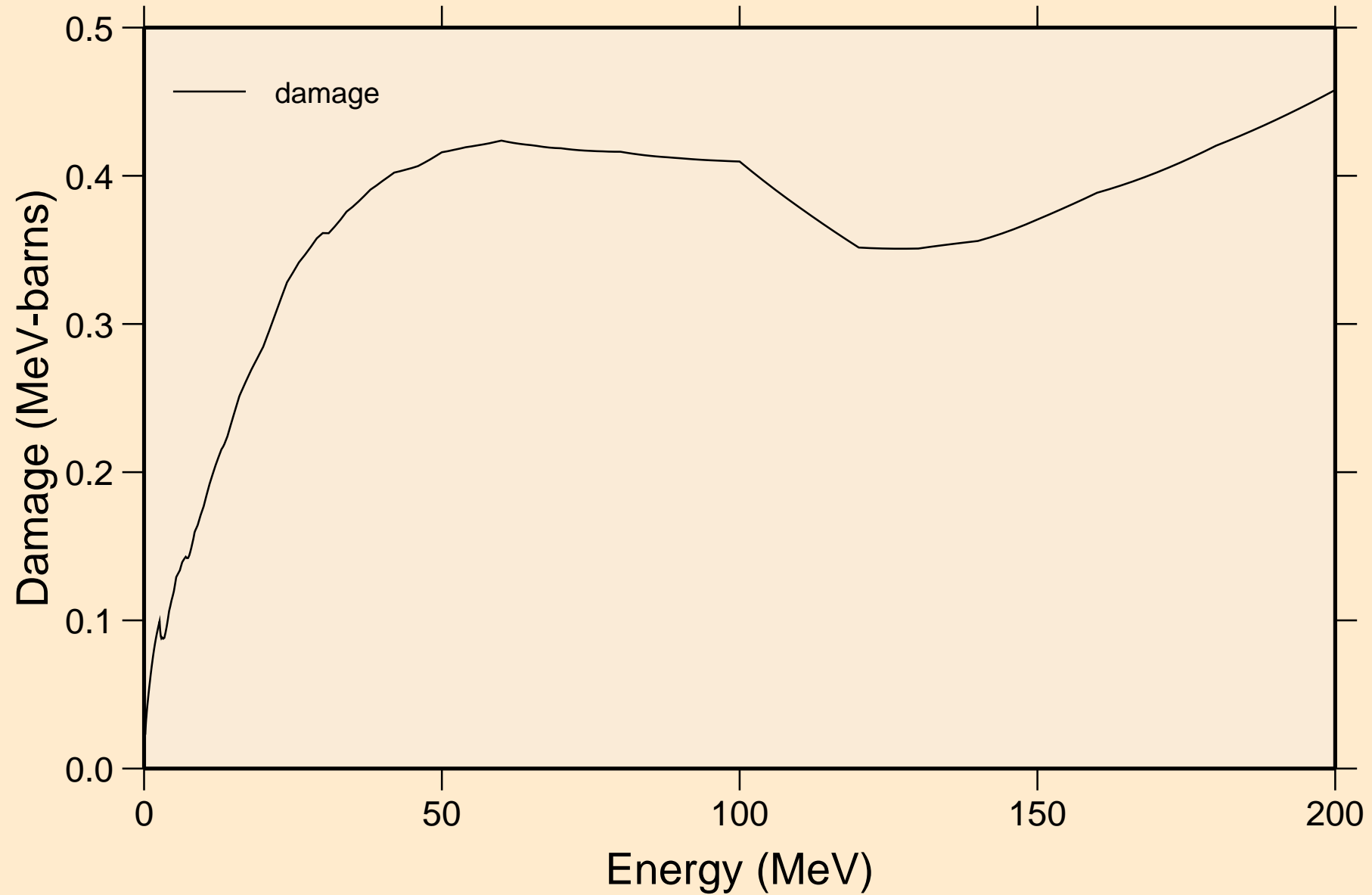

TC107 NEUTRON ACER TENDL-2024 LIBRARY; T=0.K  
Non-threshold reactions

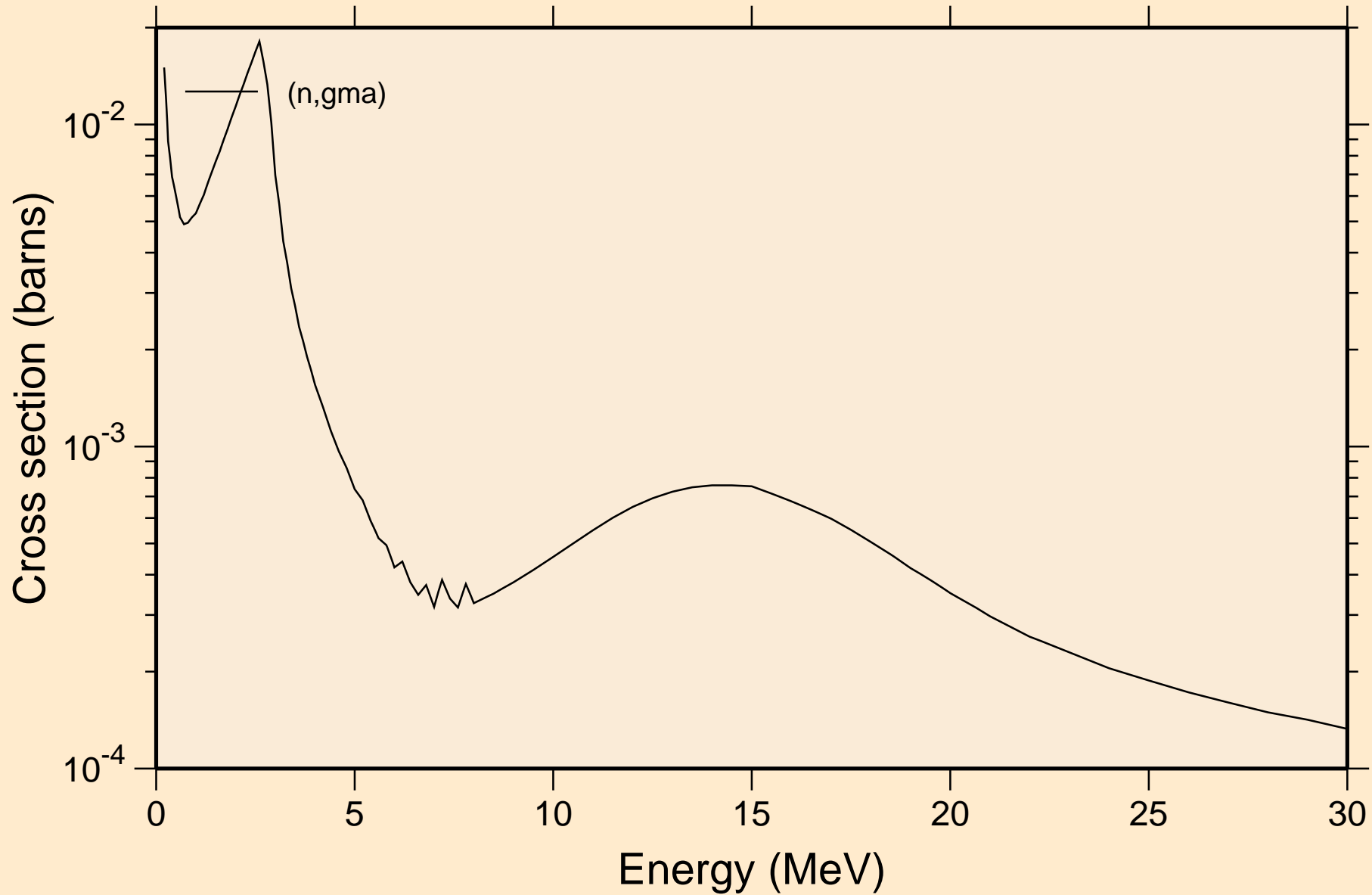

TC107 NEUTRON ACER TENDL-2024 LIBRARY; T=0.K  
Inelastic levels

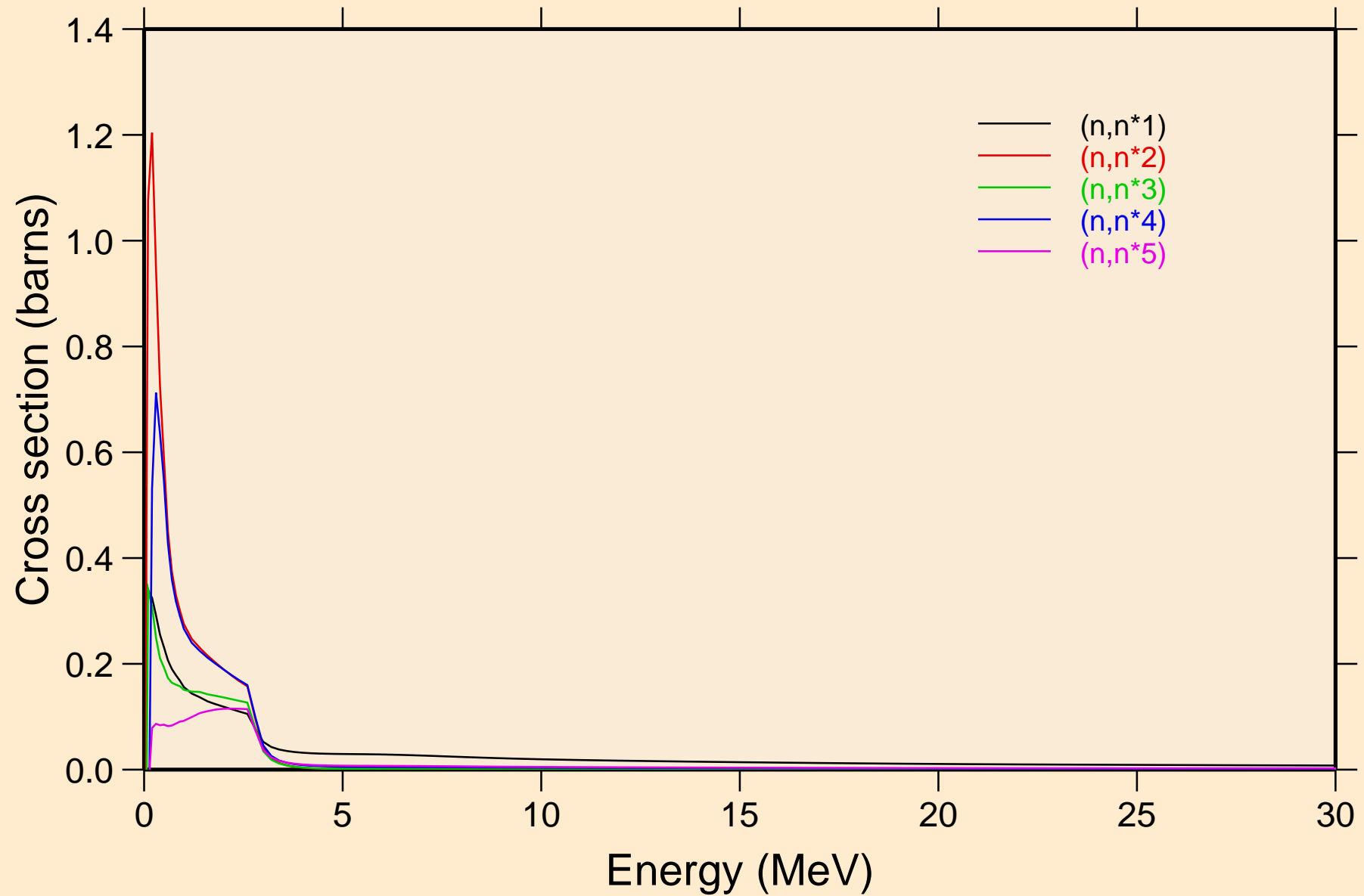

TC107 NEUTRON ACER TENDL-2024 LIBRARY; T=0.K  
Inelastic levels

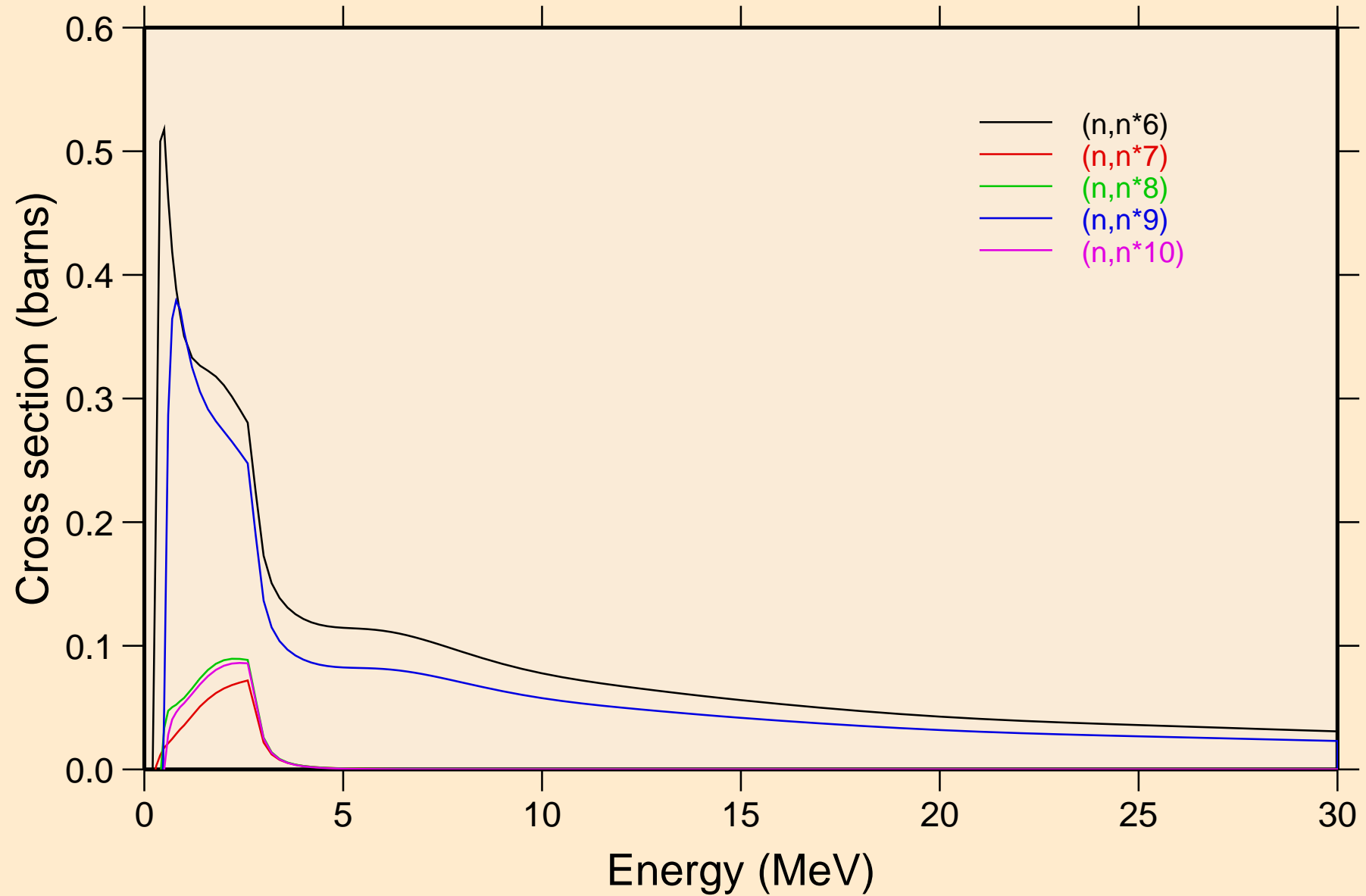



TC107 NEUTRON ACER TENDL-2024 LIBRARY; T=0.K  
Inelastic levels

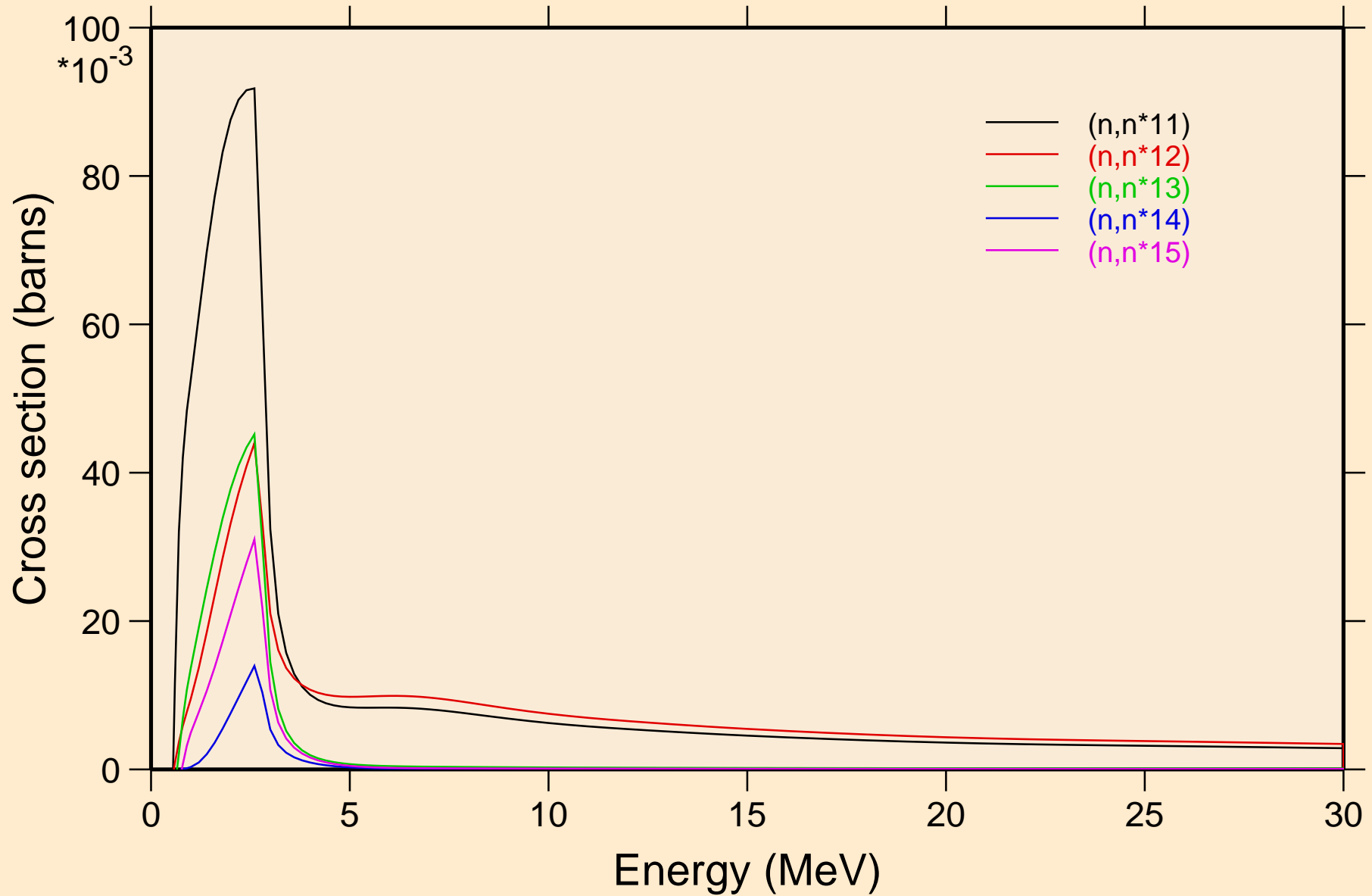

TC107 NEUTRON ACER TENDL-2024 LIBRARY; T=0.K  
Inelastic levels

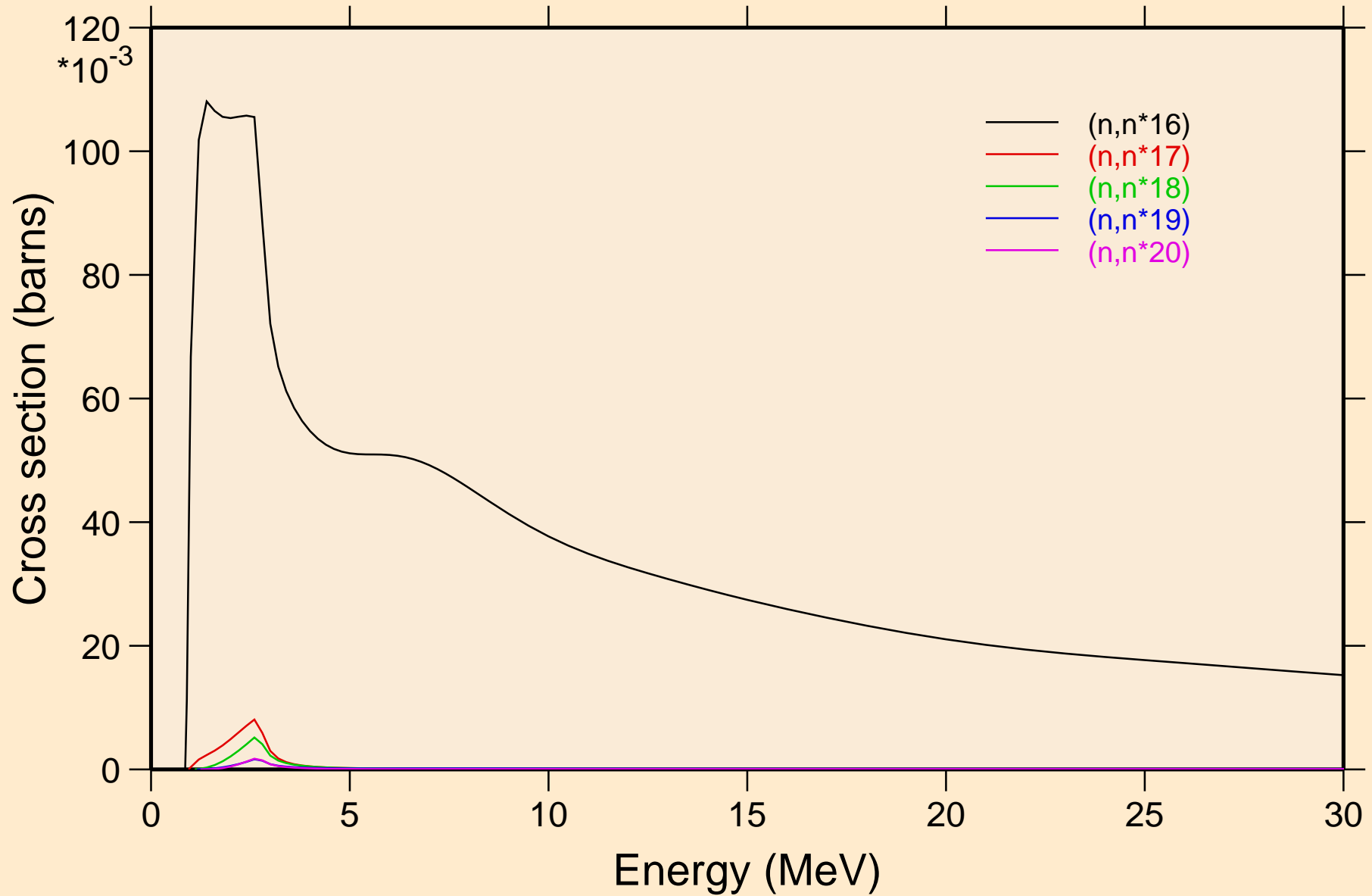

TC107 NEUTRON ACER TENDL-2024 LIBRARY; T=0.K  
Inelastic levels

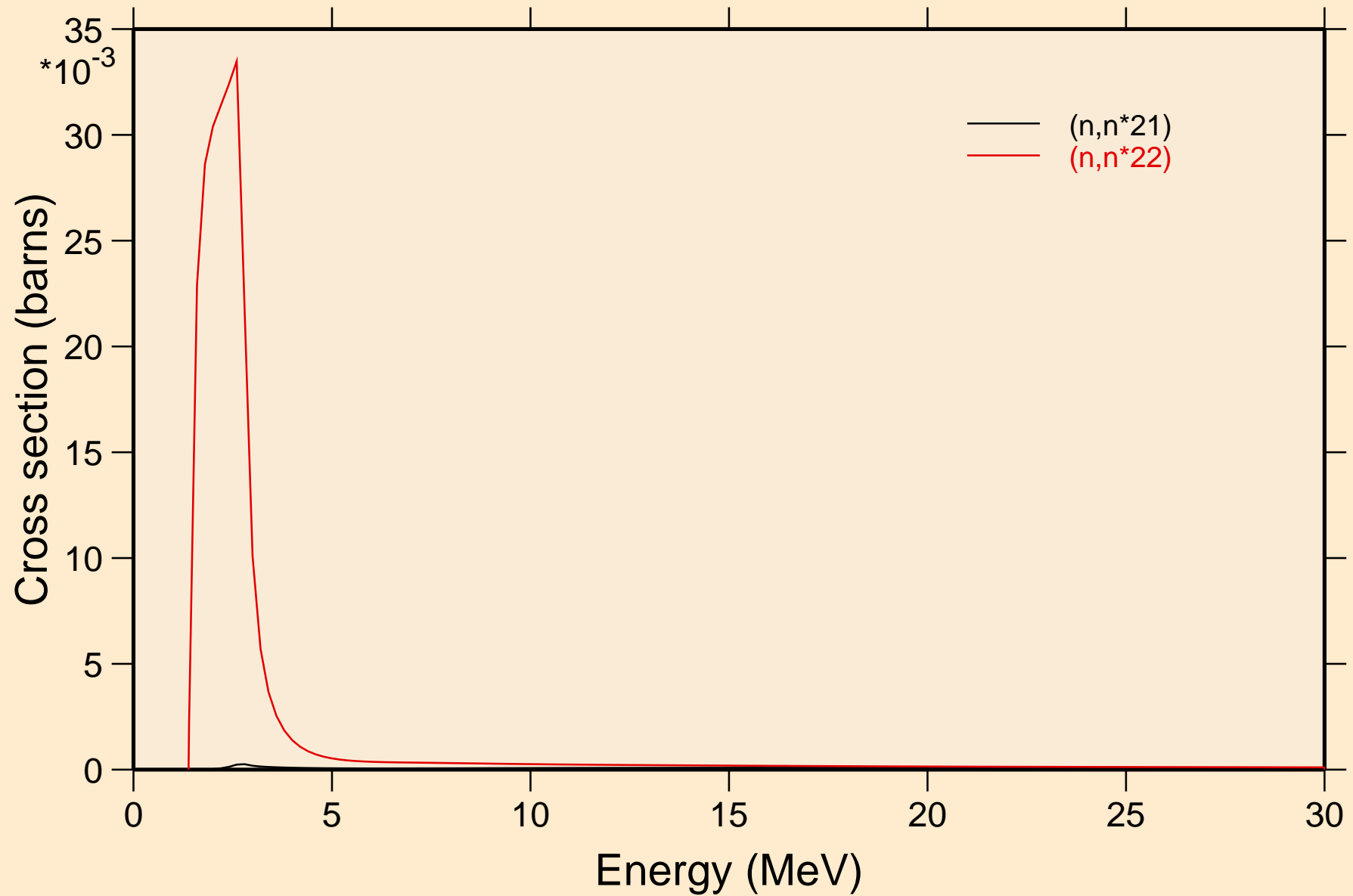

TC107 NEUTRON ACER TENDL-2024 LIBRARY; T=0.K  
Threshold reactions

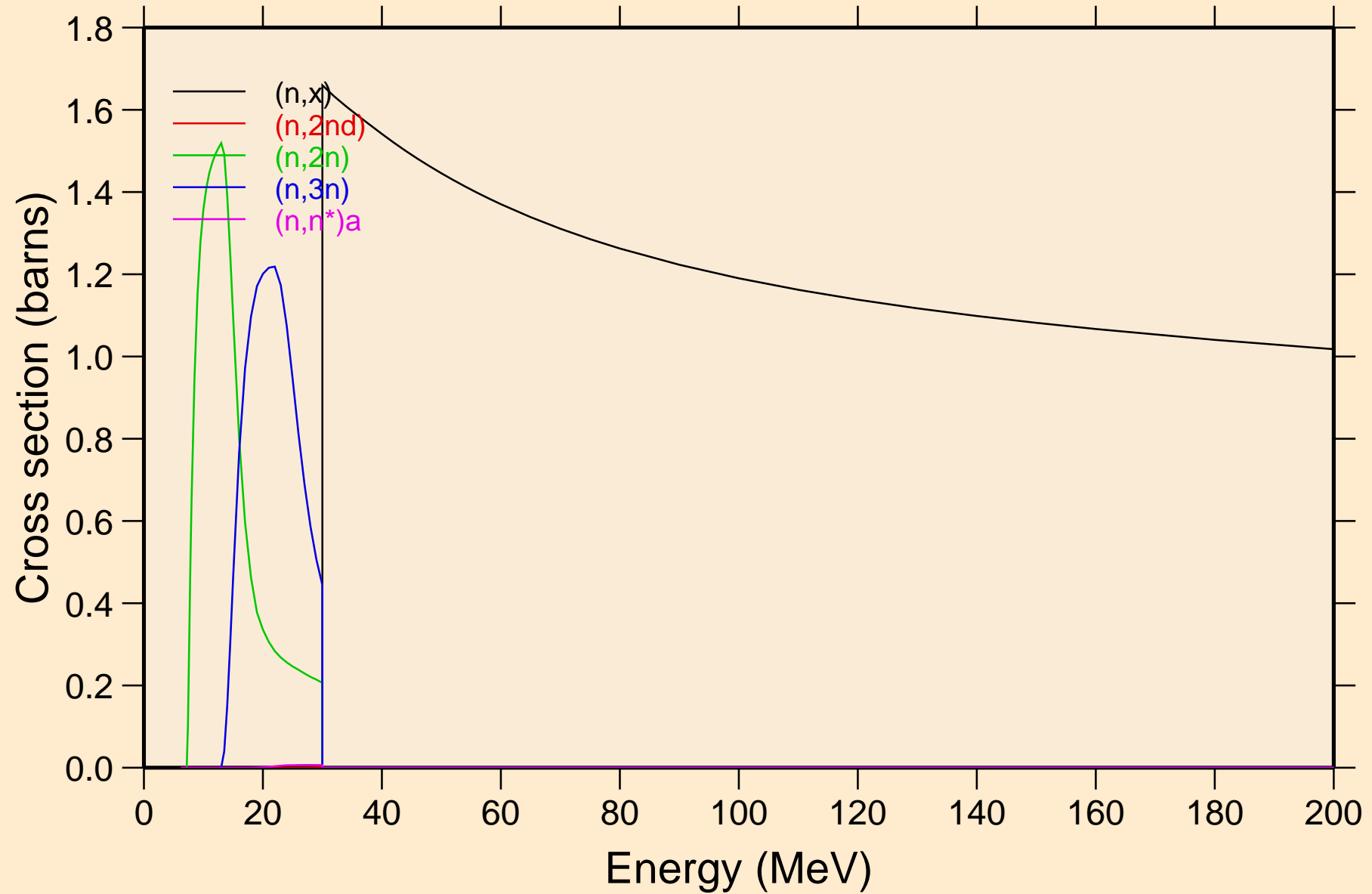

TC107 NEUTRON ACER TENDL-2024 LIBRARY; T=0.K  
Threshold reactions

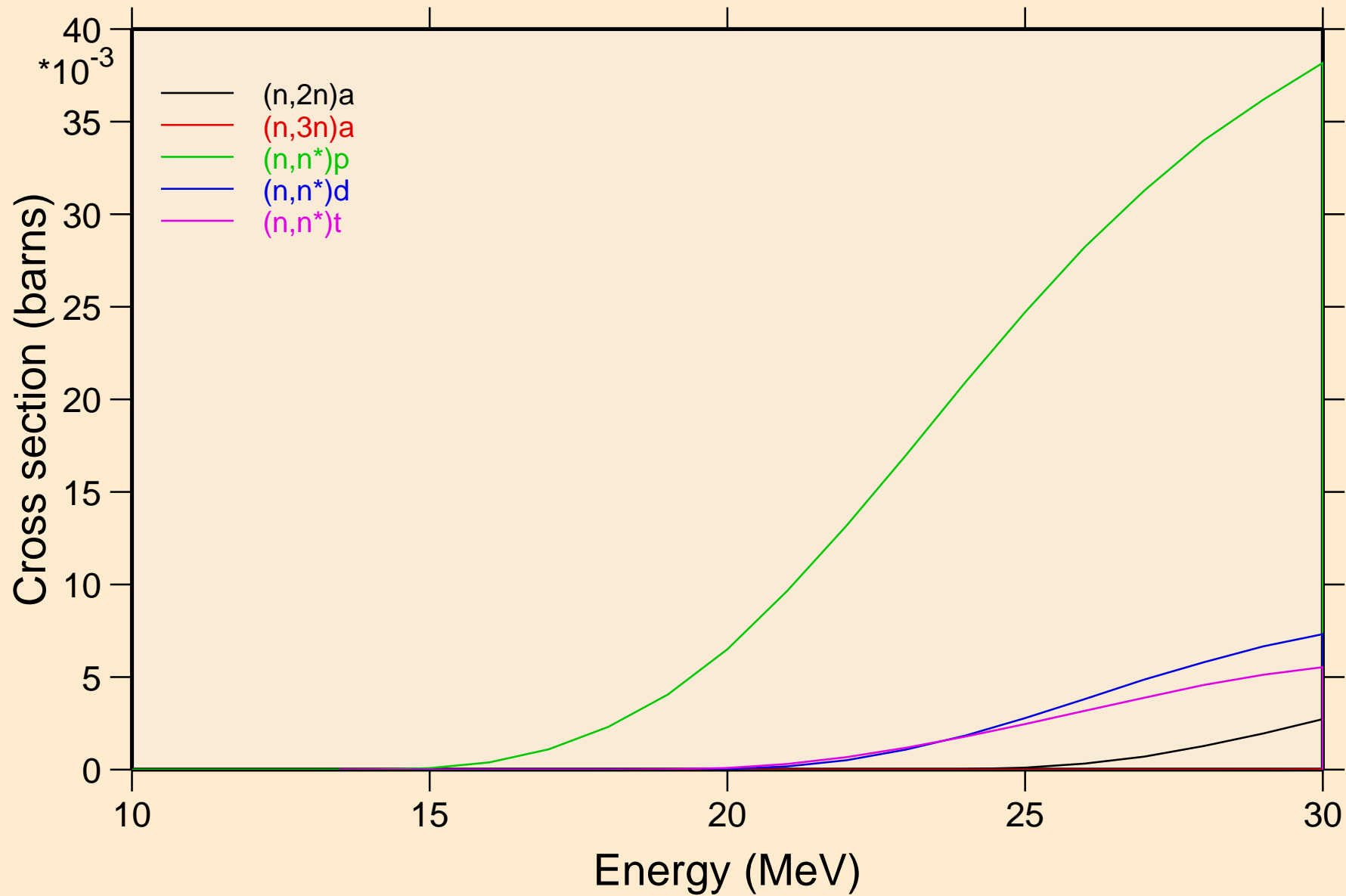

TC107 NEUTRON ACER TENDL-2024 LIBRARY; T=0.K  
Threshold reactions

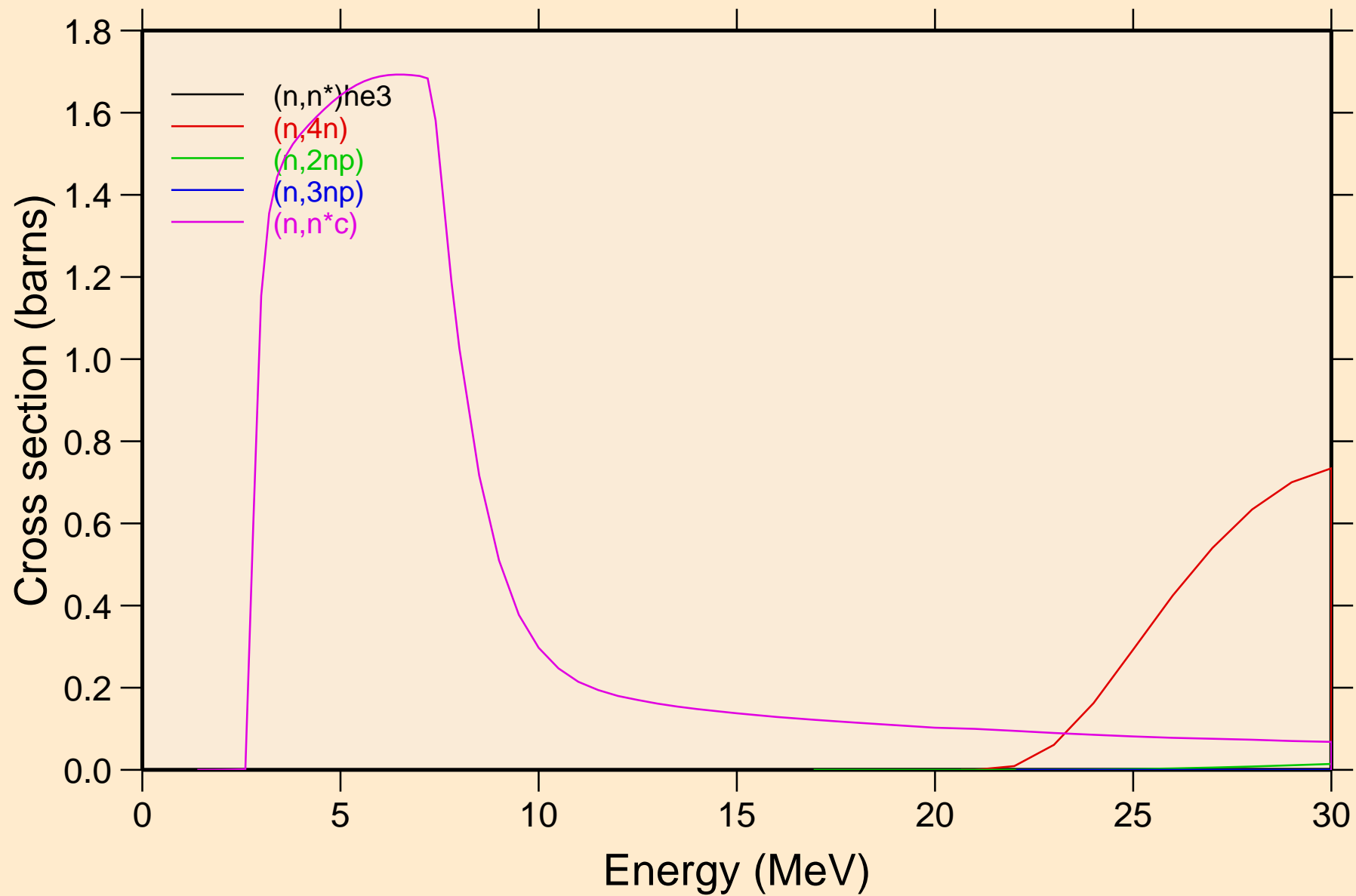

TC107 NEUTRON ACER TENDL-2024 LIBRARY; T=0.K  
Threshold reactions

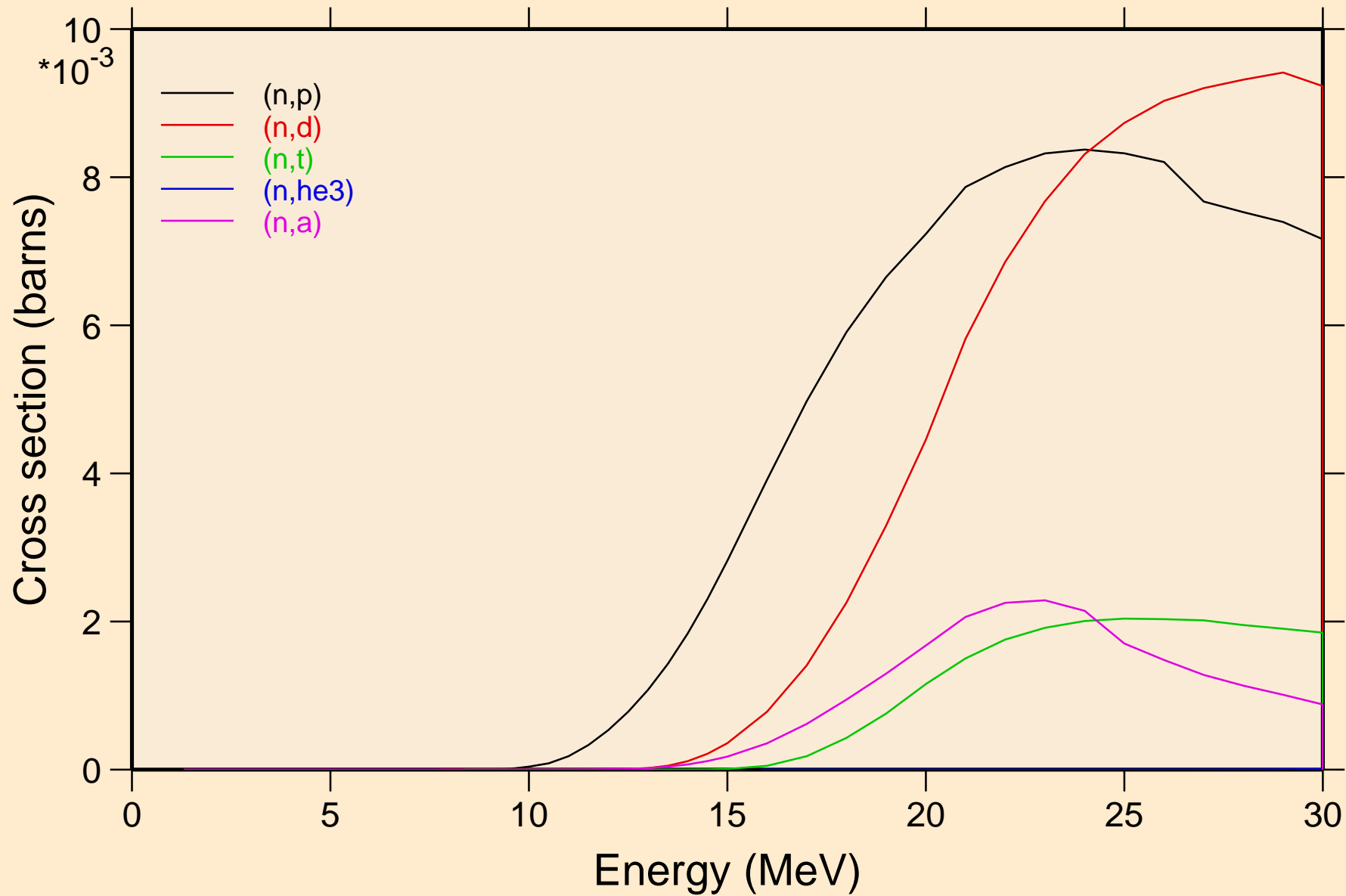

TC107 NEUTRON ACER TENDL-2024 LIBRARY; T=0.K  
Threshold reactions

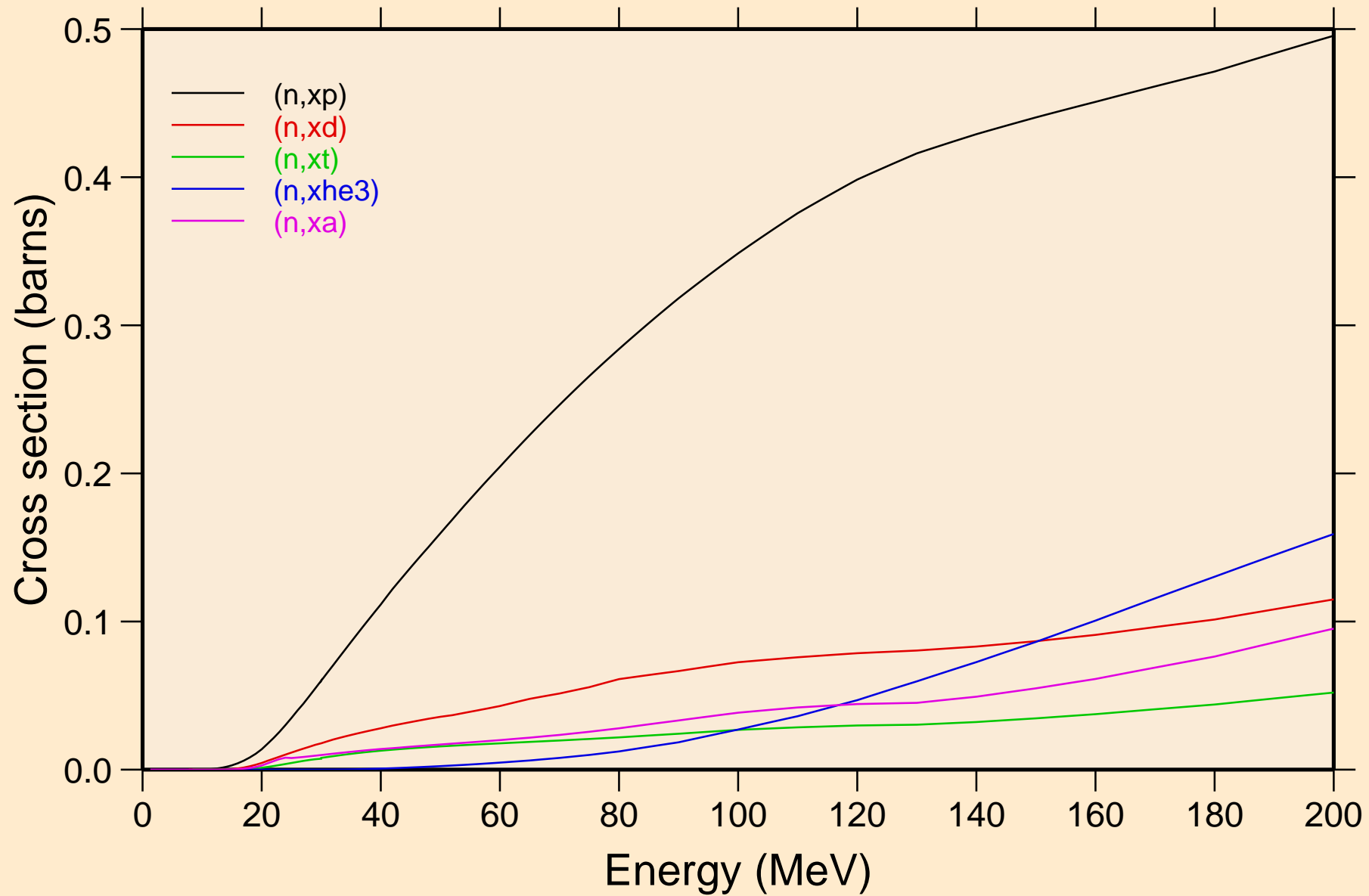



TC107 NEUTRON ACER TENDL-2024 LIBRARY; T=0.K  
angular distribution for elastic

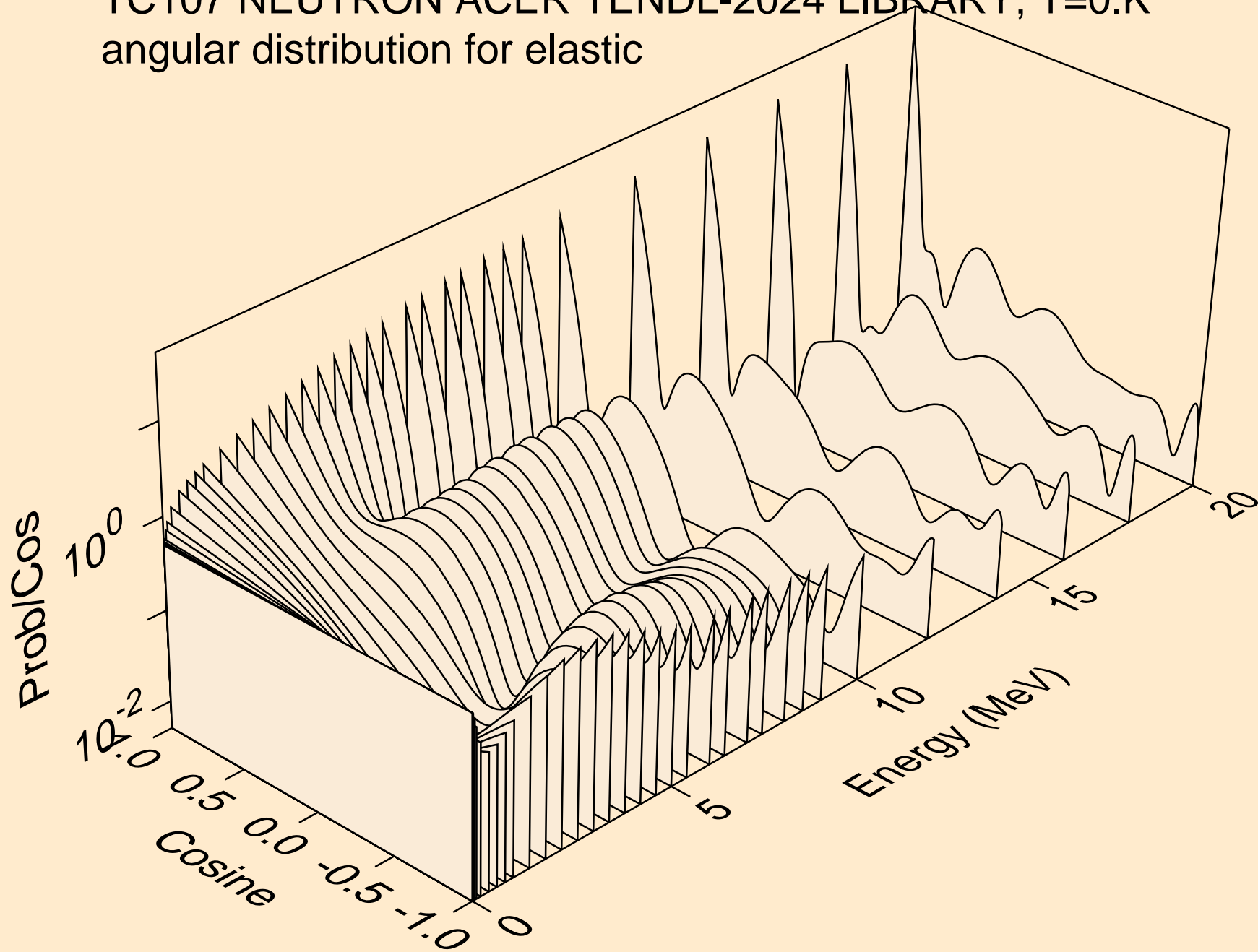

TC107 NEUTRON ACER TENDL-2024 LIBRARY; T=0.K  
angular distribution for elastic

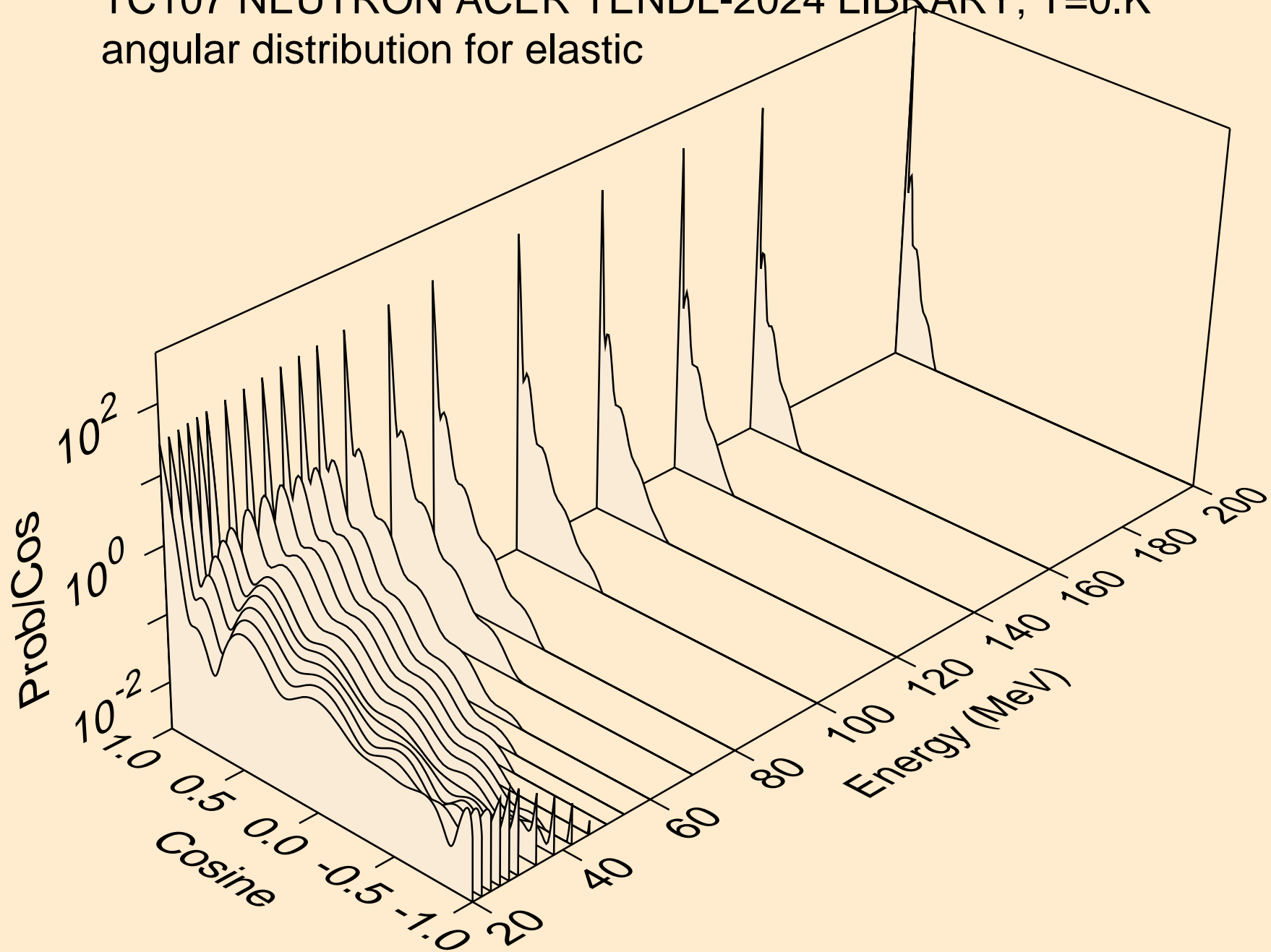

TC107 NEUTRON ACER TENDL-2024 LIBRARY; T=0.K  
angular distribution for (n,n\*1)

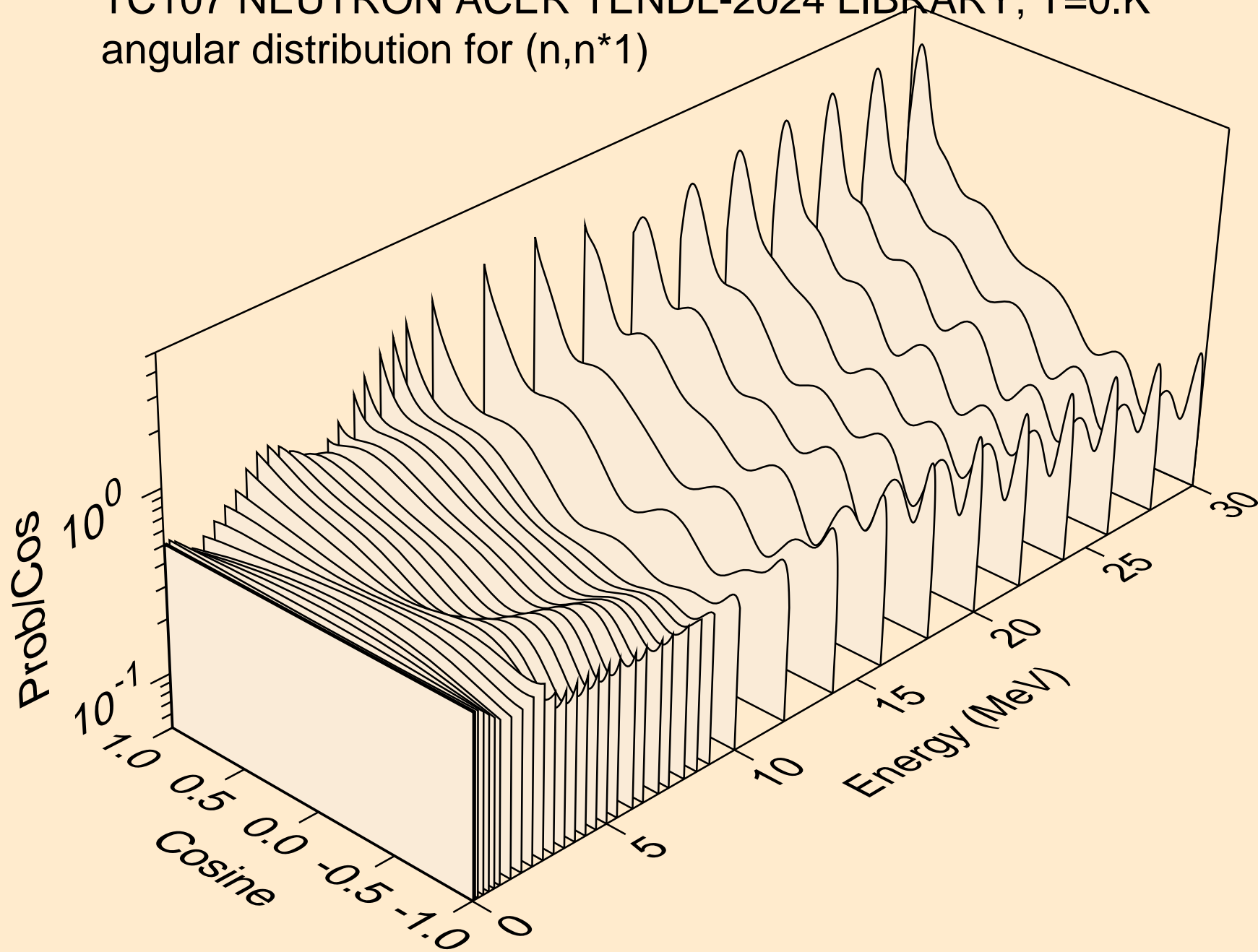

TC107 NEUTRON ACER TENDL-2024 LIBRARY; T=0.K  
angular distribution for (n,n\*2)

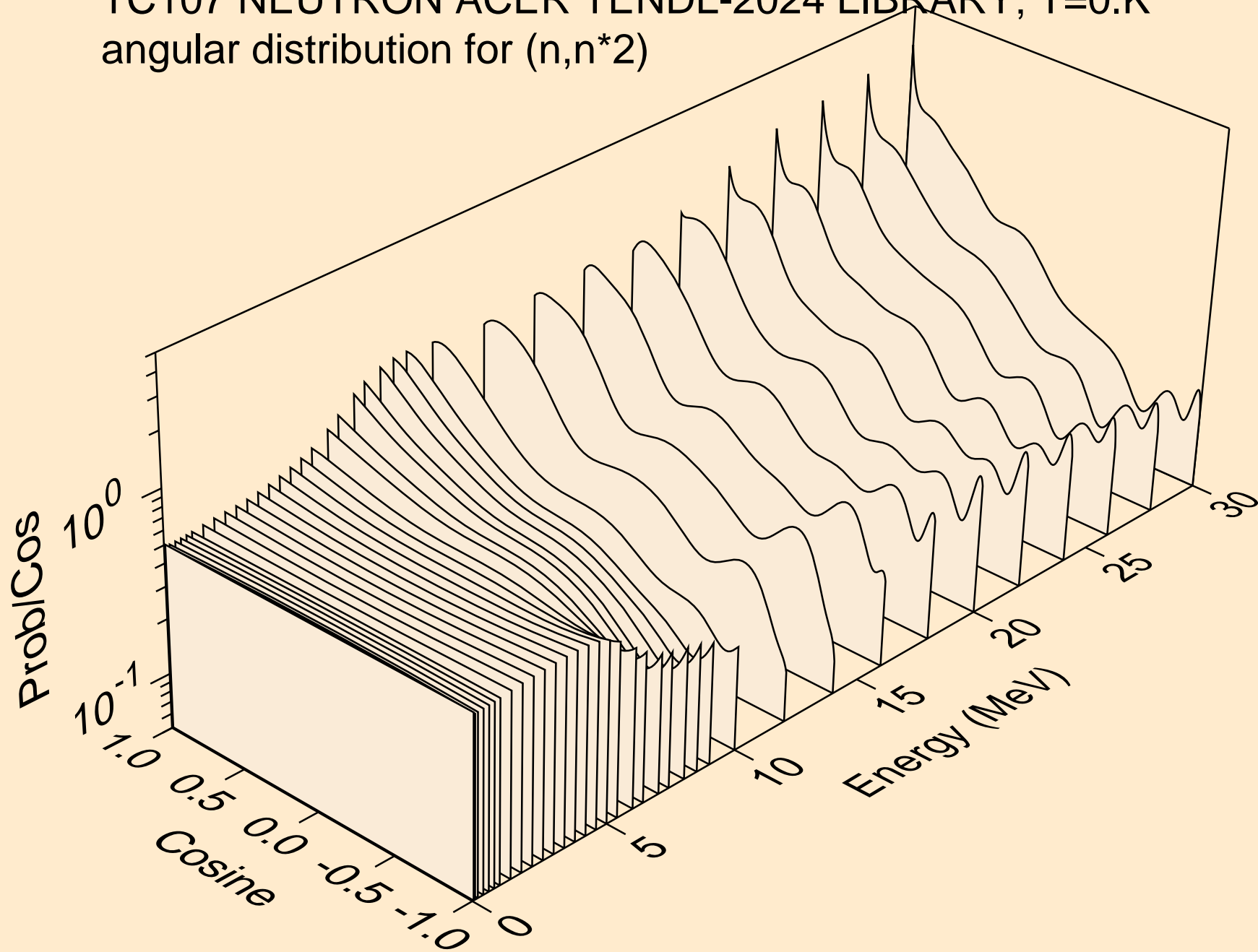

TC107 NEUTRON ACER TENDL-2024 LIBRARY; T=0.K  
angular distribution for (n,n\*3)

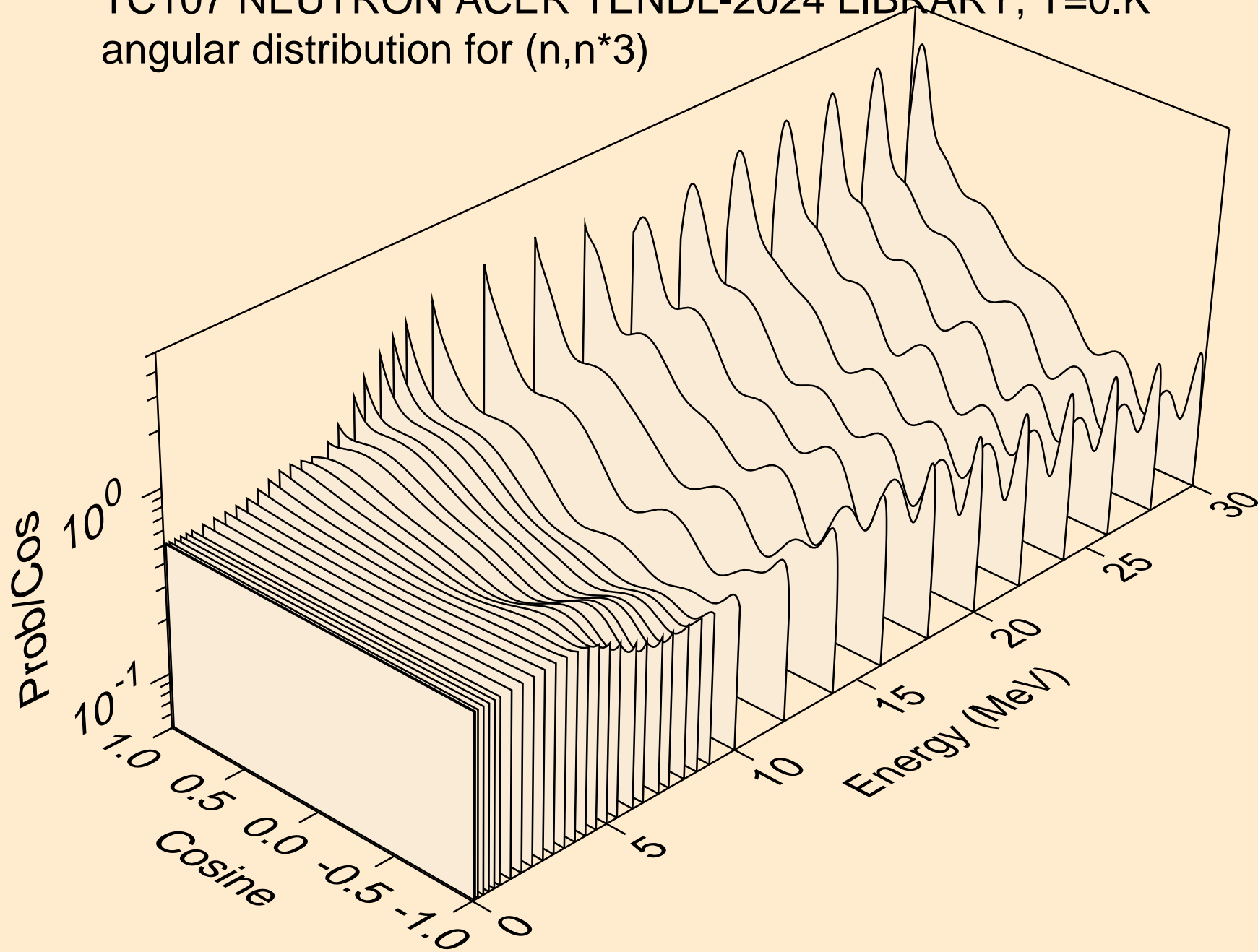

TC107 NEUTRON ACER TENDL-2024 LIBRARY; T=0.K  
angular distribution for (n,n\*4)

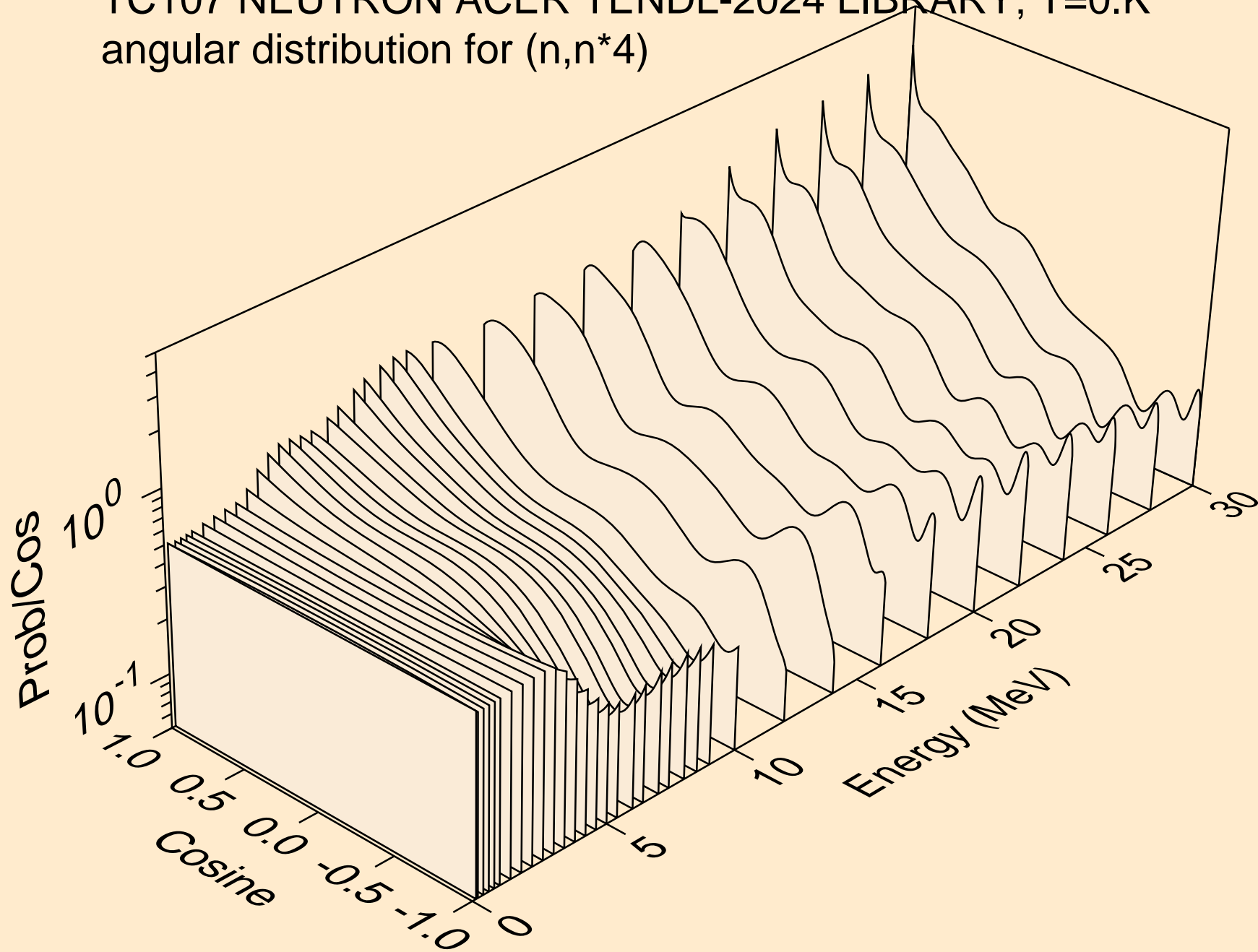

TC107 NEUTRON ACER TENDL-2024 LIBRARY; T=0.K  
angular distribution for (n,n\*5)

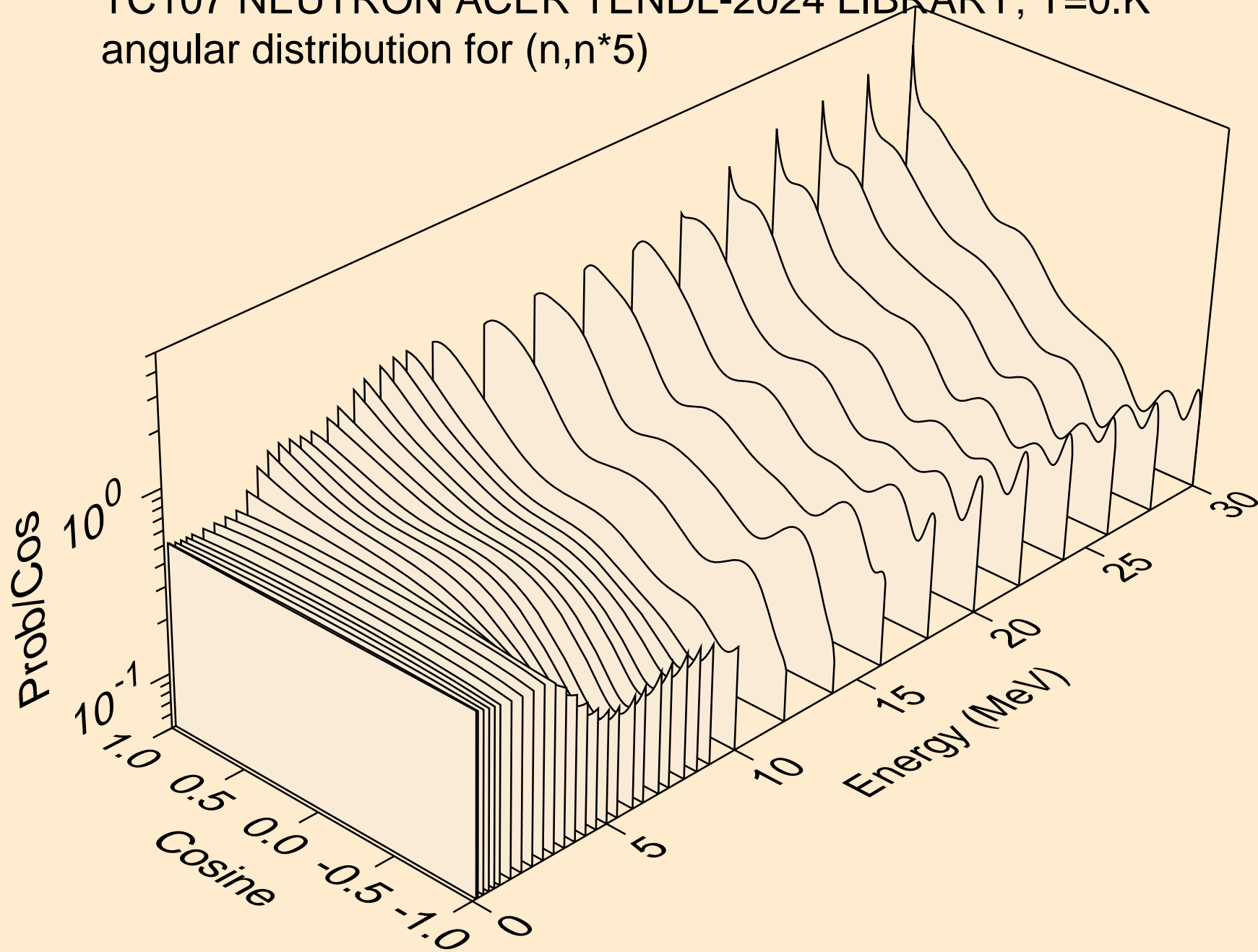

TC107 NEUTRON ACER TENDL-2024 LIBRARY; T=0.K  
angular distribution for (n,n\*6)

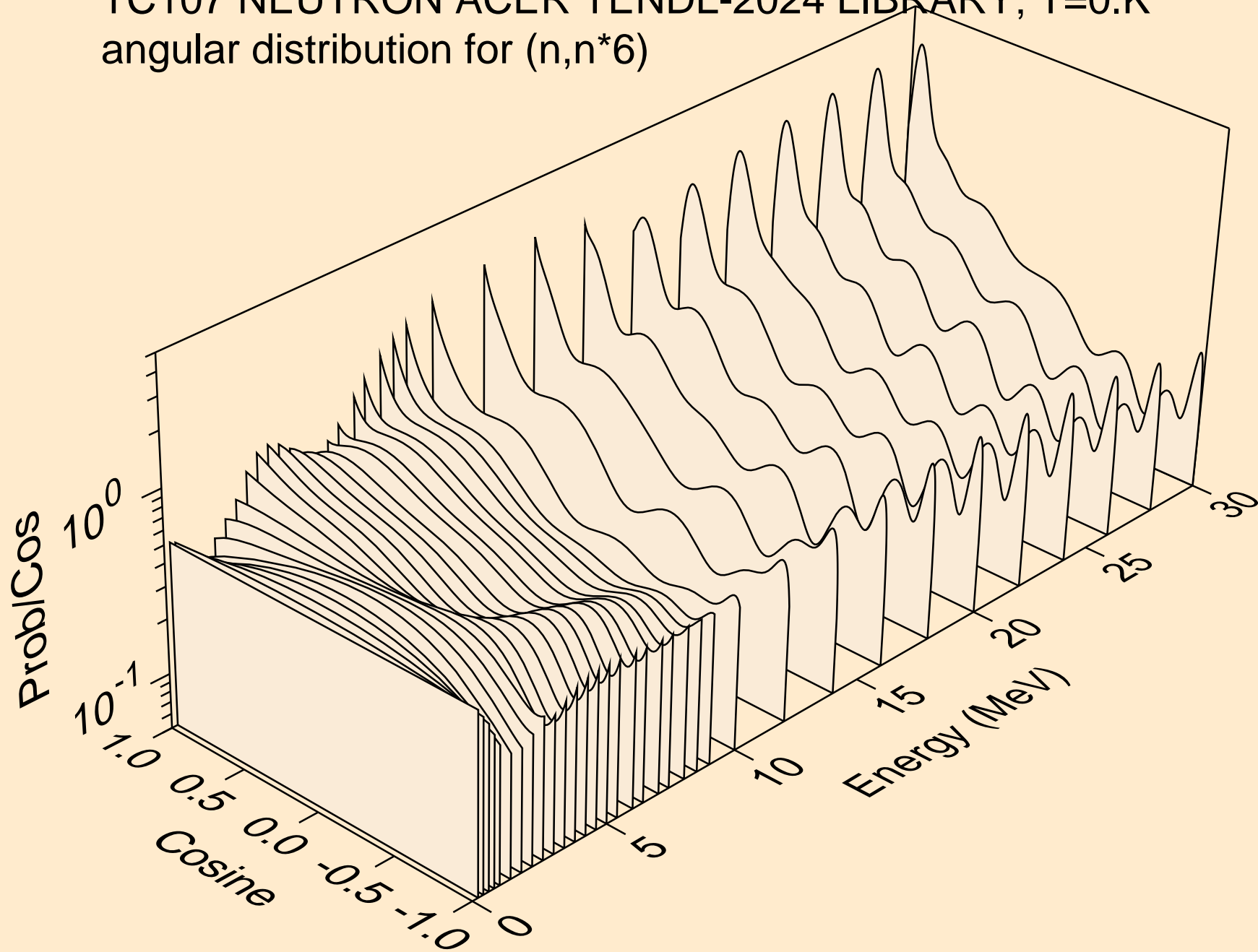



TC107 NEUTRON ACER TENDL-2024 LIBRARY; T=0.K  
angular distribution for (n,n\*7)

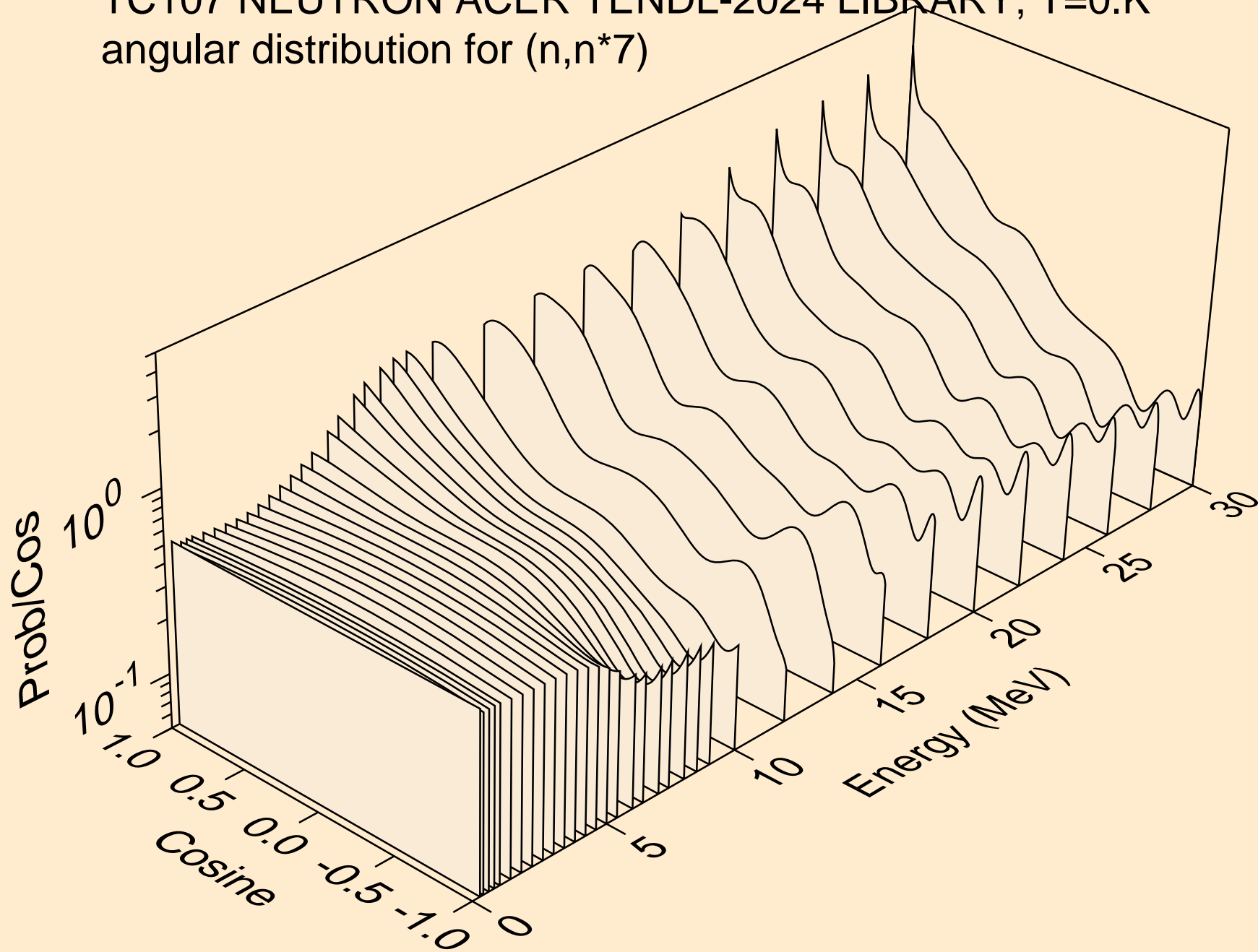

TC107 NEUTRON ACER TENDL-2024 LIBRARY; T=0.K  
angular distribution for (n,n\*8)

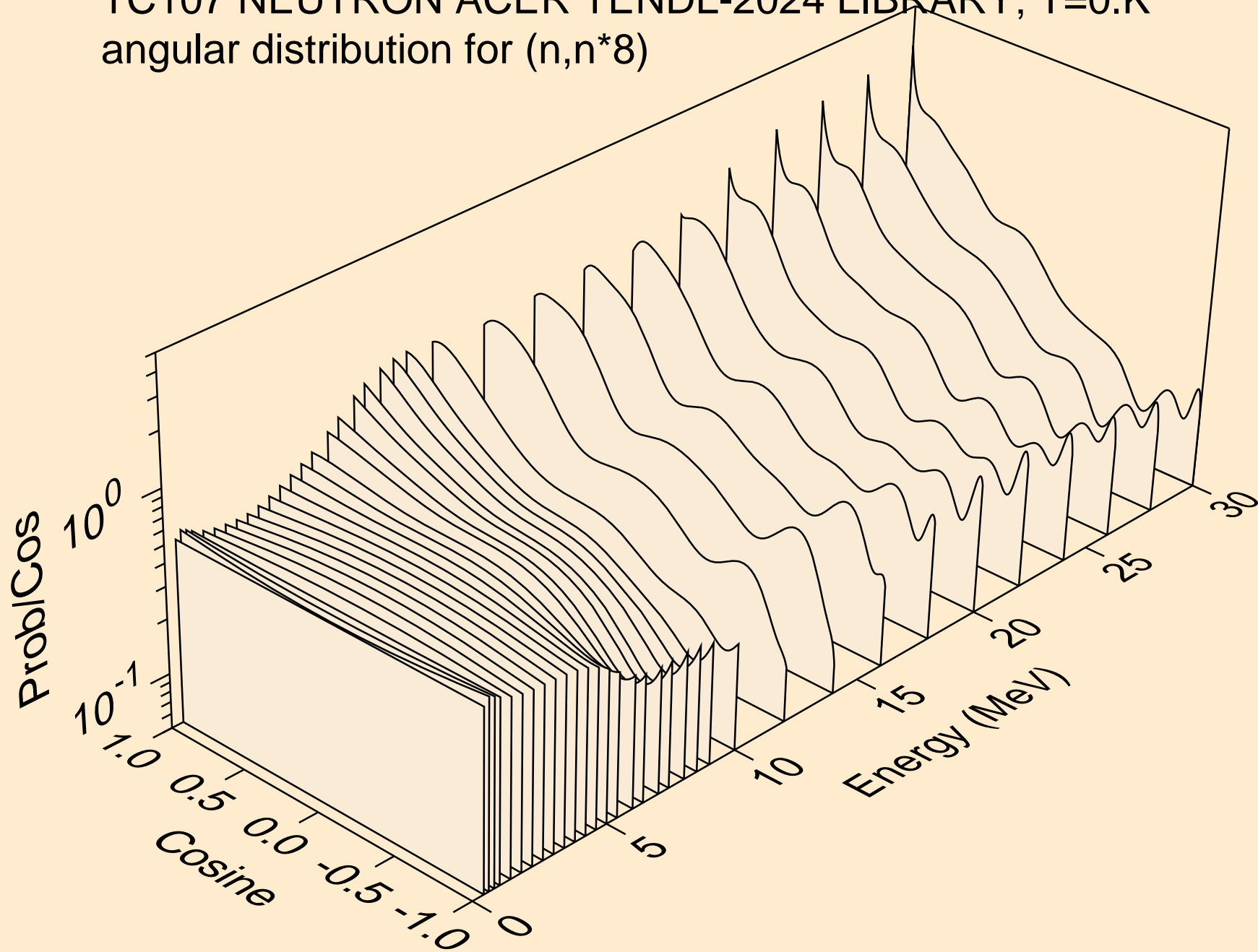

TC107 NEUTRON ACER TENDL-2024 LIBRARY; T=0.K  
angular distribution for (n,n\*9)

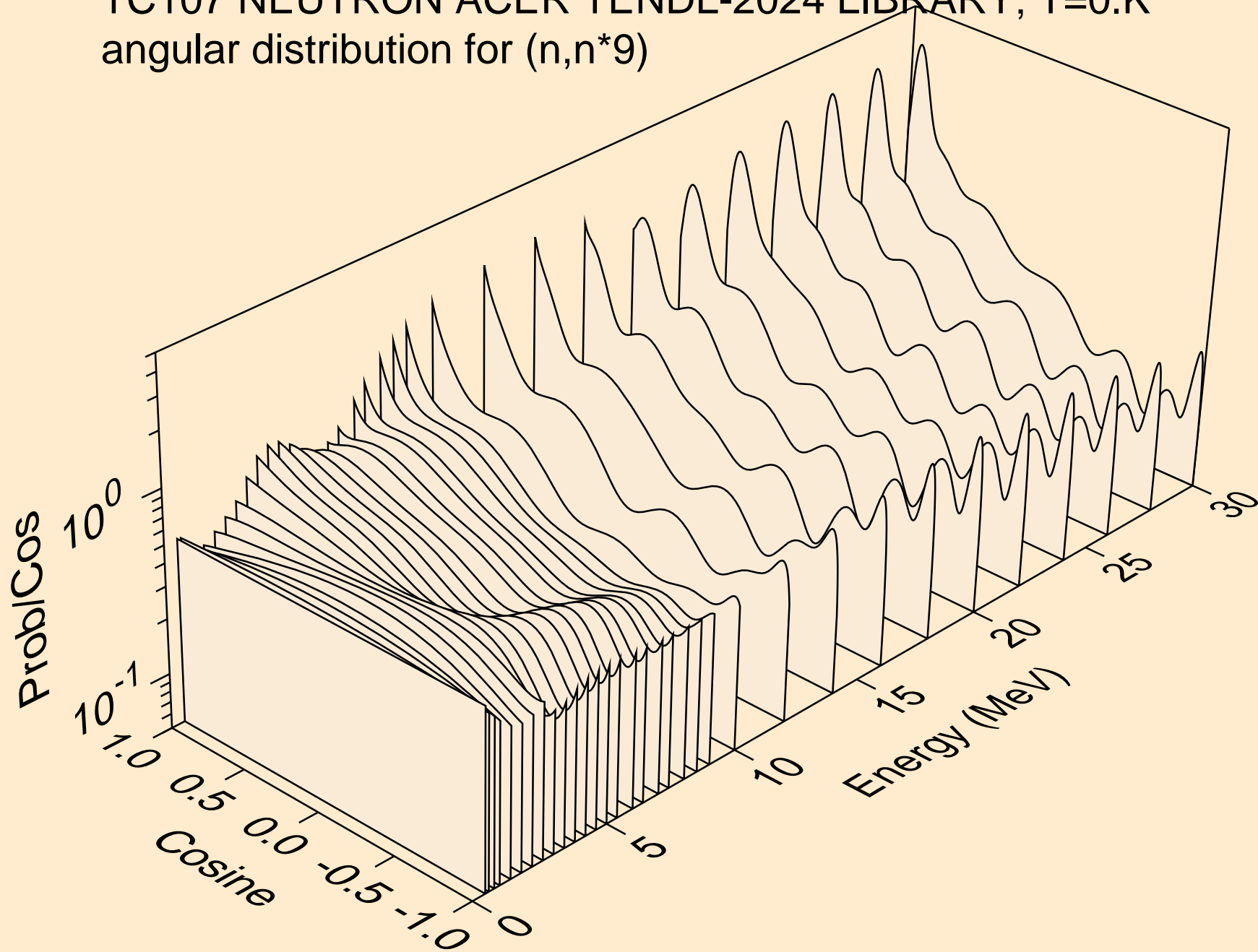

TC107 NEUTRON ACER TENDL-2024 LIBRARY; T=0.K  
angular distribution for (n,n\*10)

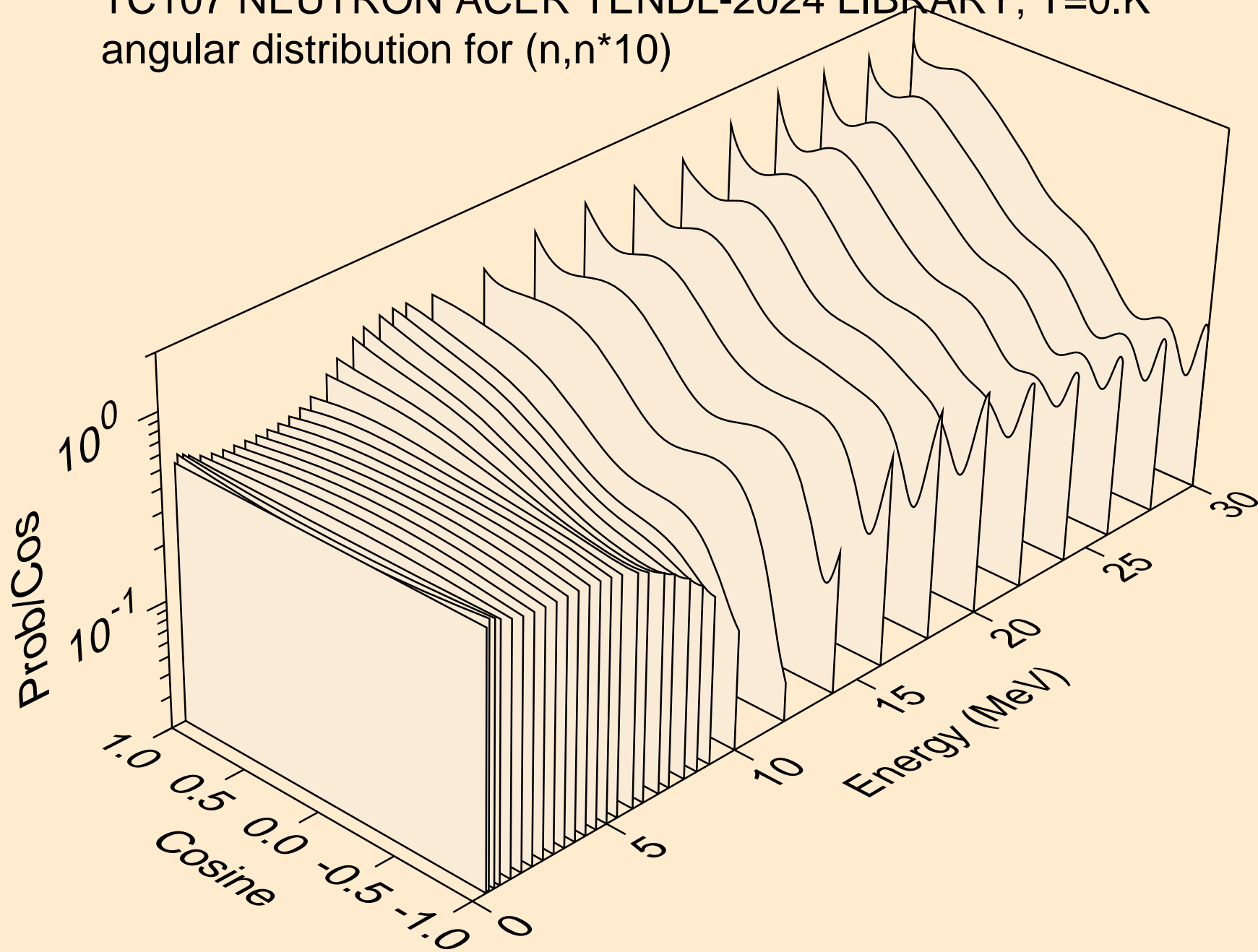

TC107 NEUTRON ACER TENDL-2024 LIBRARY; T=0.K  
angular distribution for (n,n\*11)

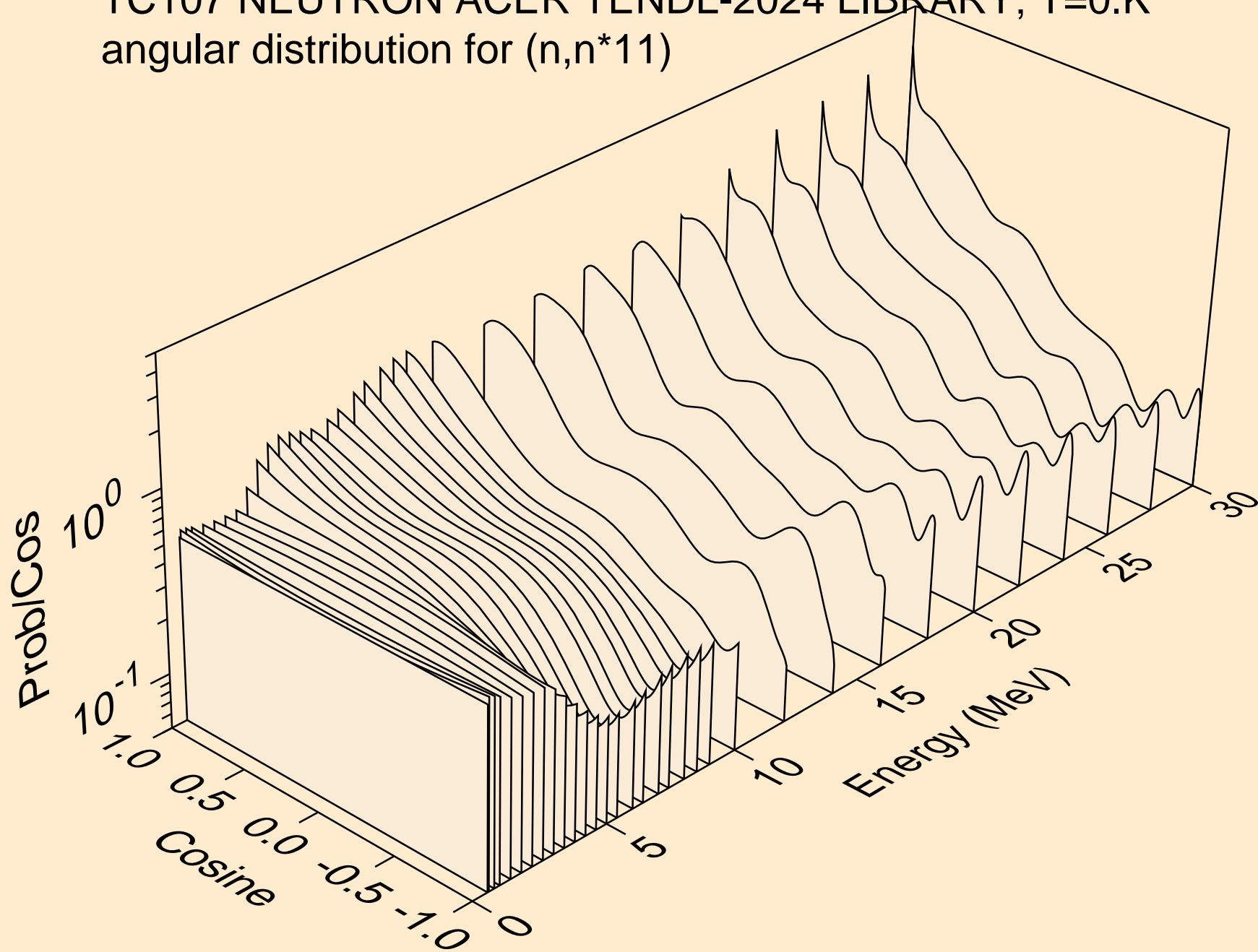

TC107 NEUTRON ACER TENDL-2024 LIBRARY; T=0.K  
angular distribution for (n,n\*12)

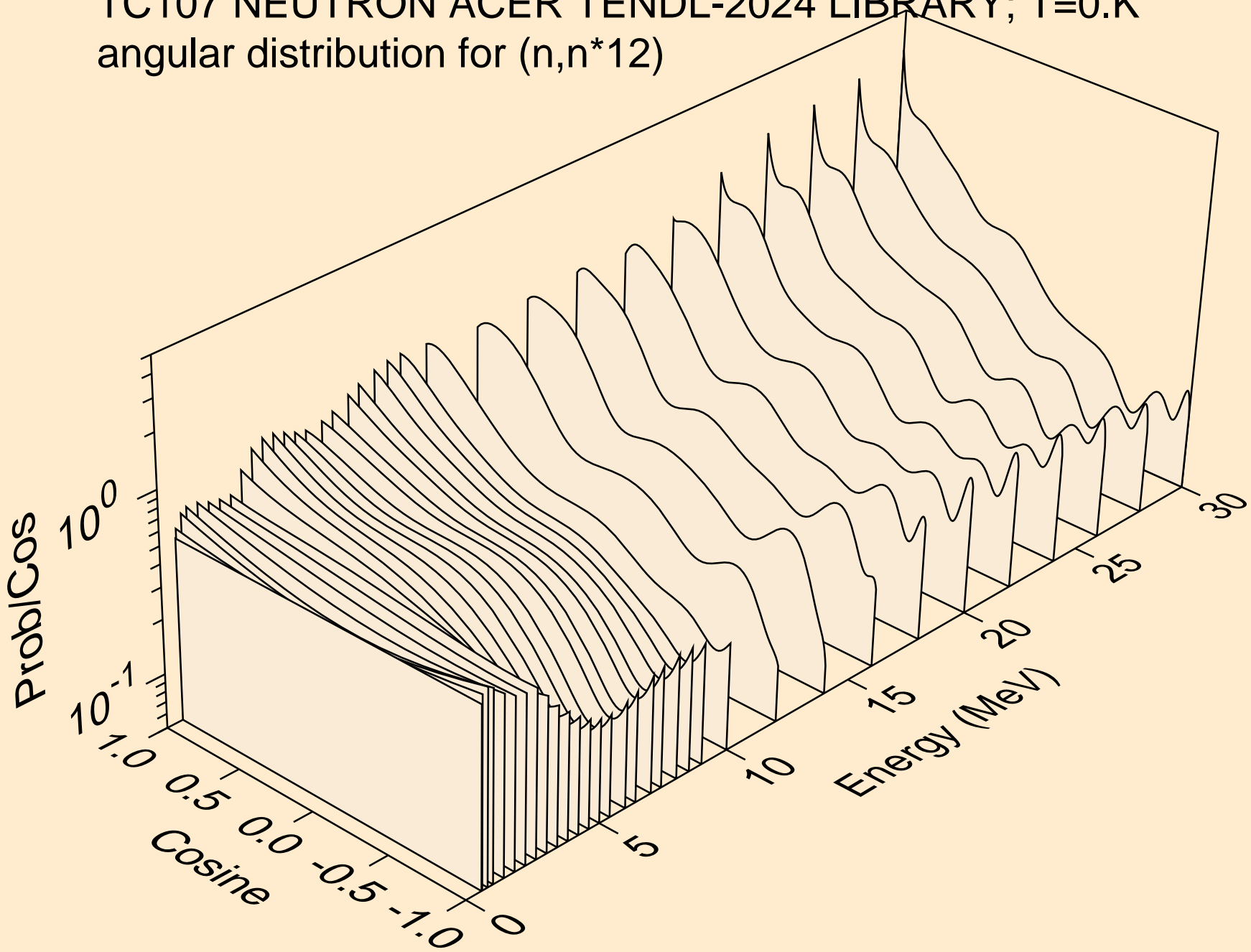

TC107 NEUTRON ACER TENDL-2024 LIBRARY; T=0.K  
angular distribution for (n,n\*13)

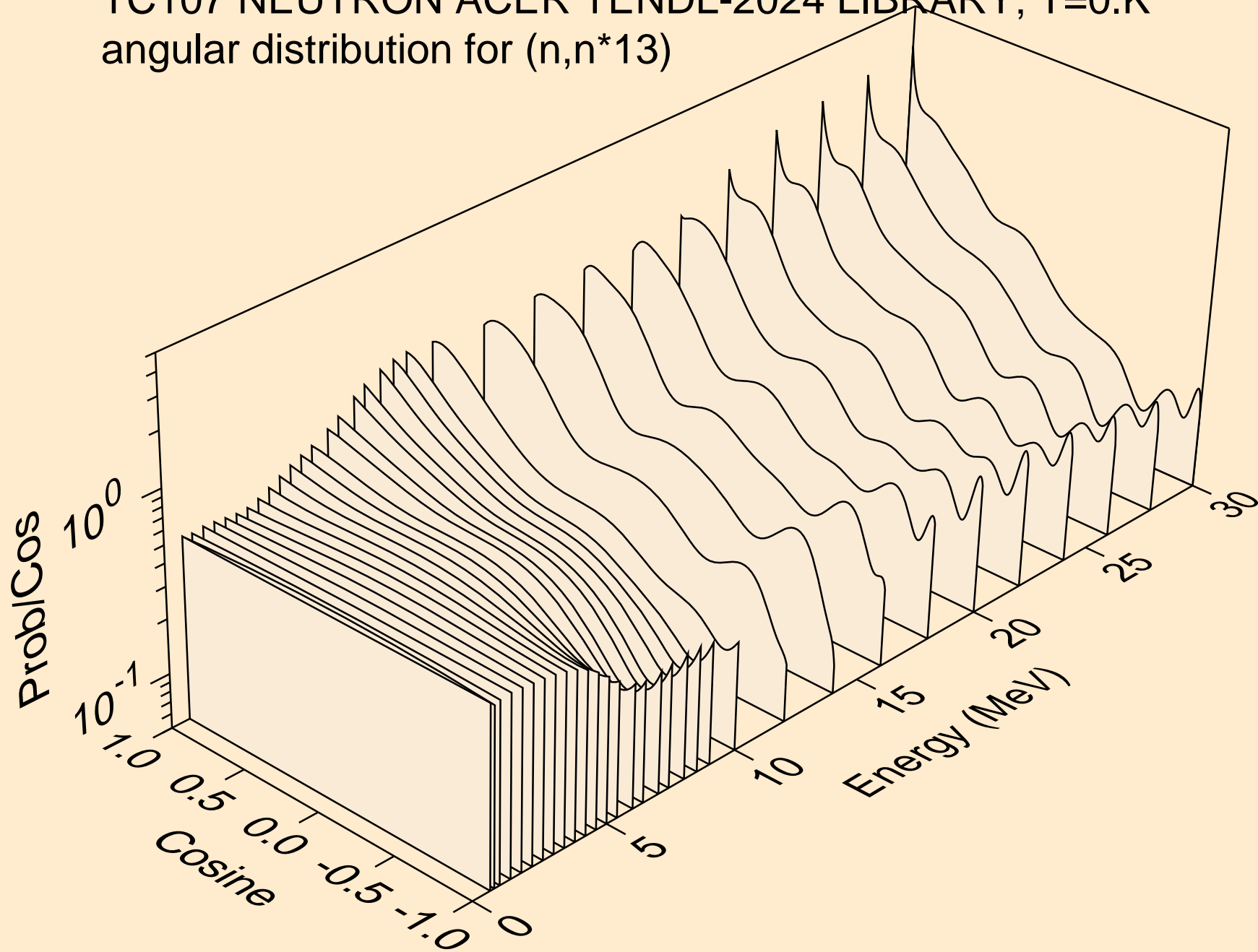

TC107 NEUTRON ACER TENDL-2024 LIBRARY; T=0.K  
angular distribution for (n,n\*14)

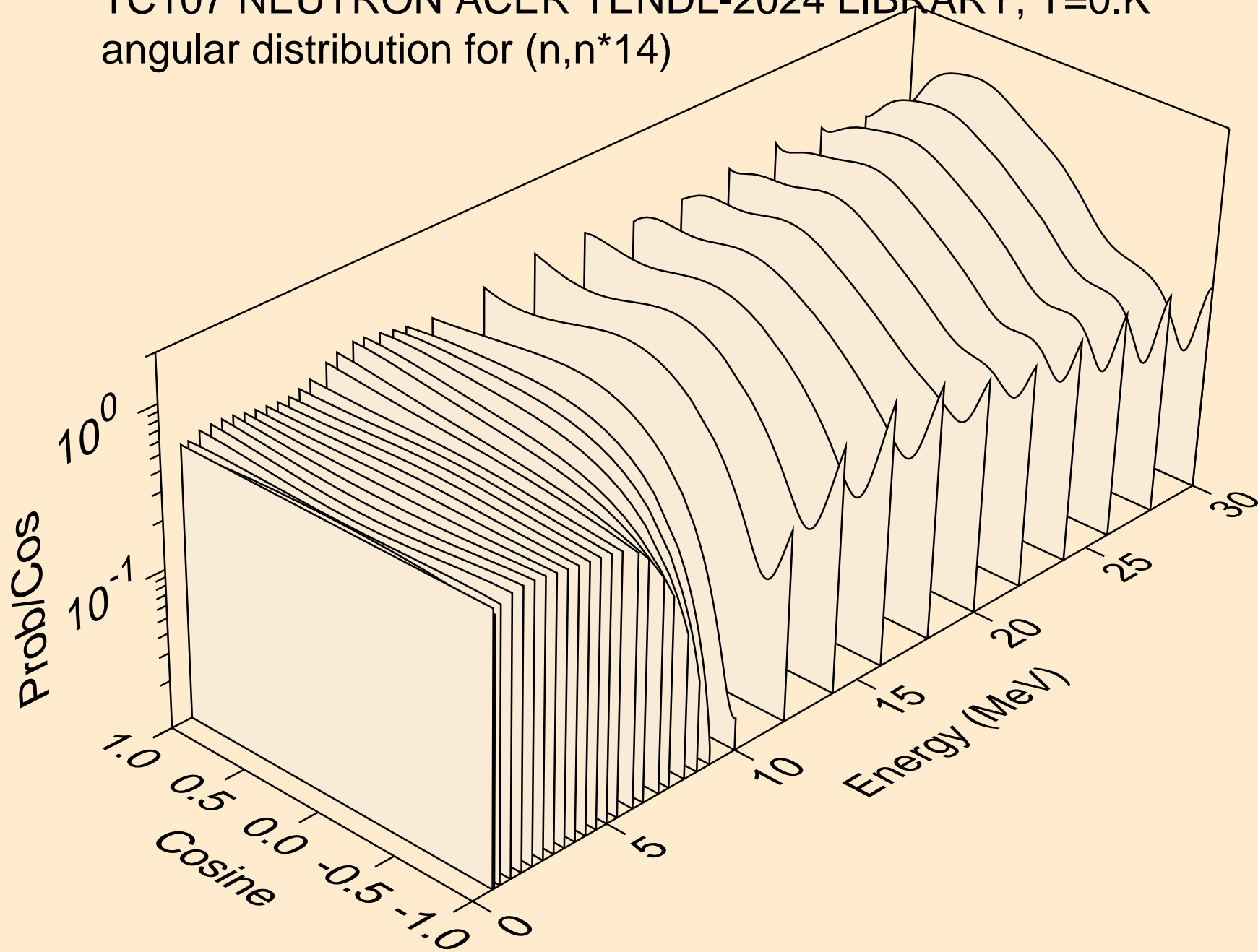



TC107 NEUTRON ACER TENDL-2024 LIBRARY; T=0.K  
angular distribution for (n,n\*15)

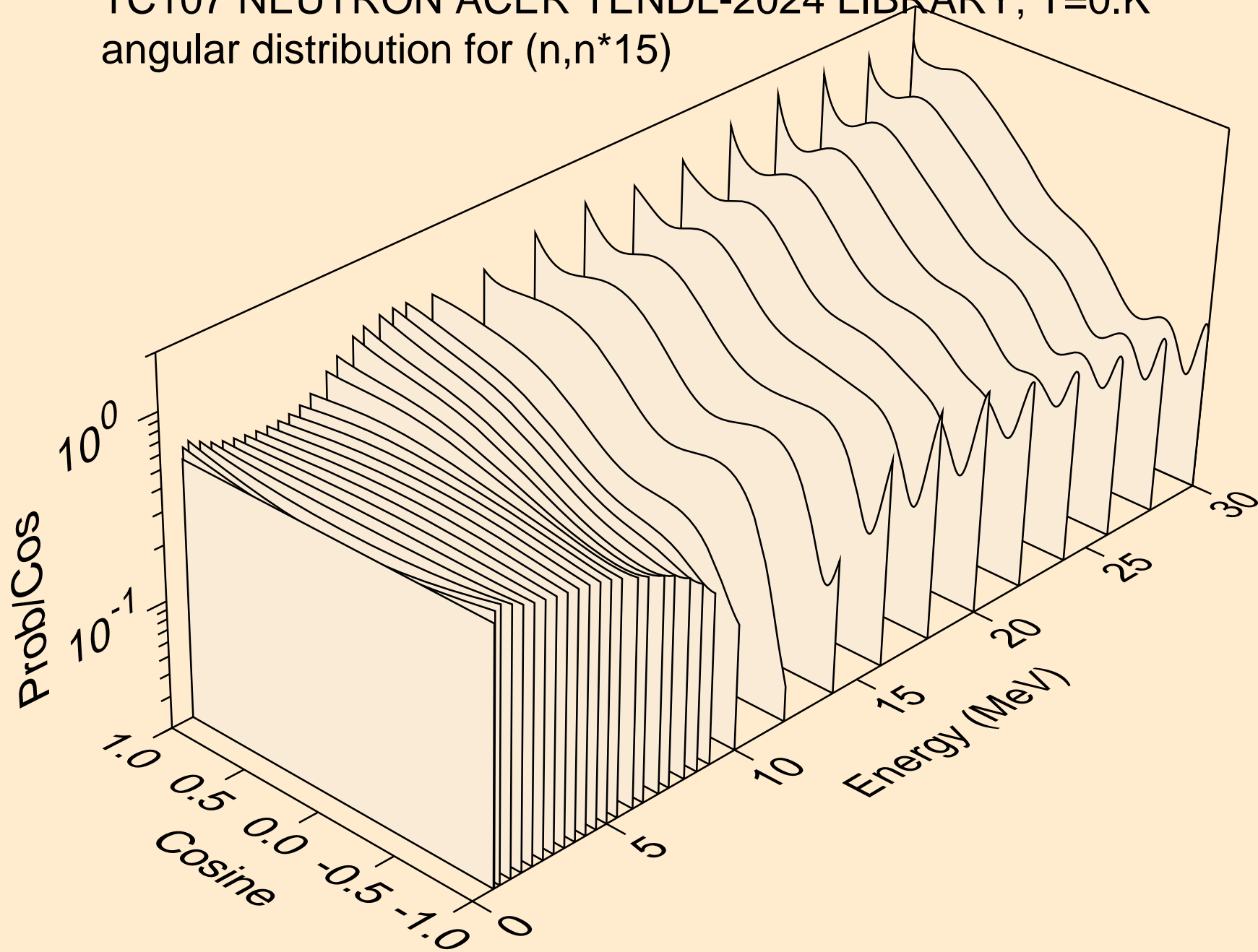

TC107 NEUTRON ACER TENDL-2024 LIBRARY; T=0.K  
angular distribution for (n,n\*16)

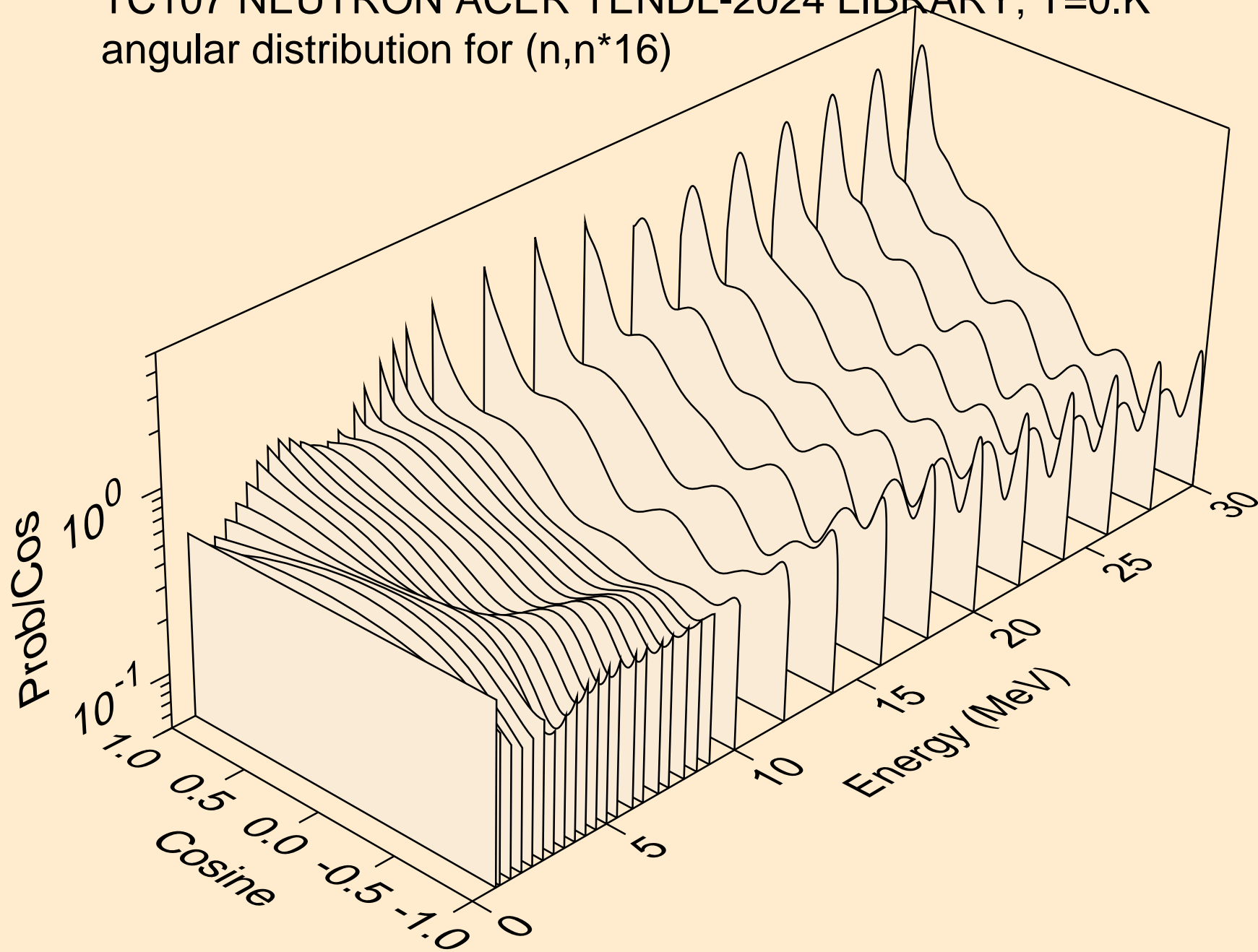

TC107 NEUTRON ACER TENDL-2024 LIBRARY; T=0.K  
angular distribution for (n,n\*17)

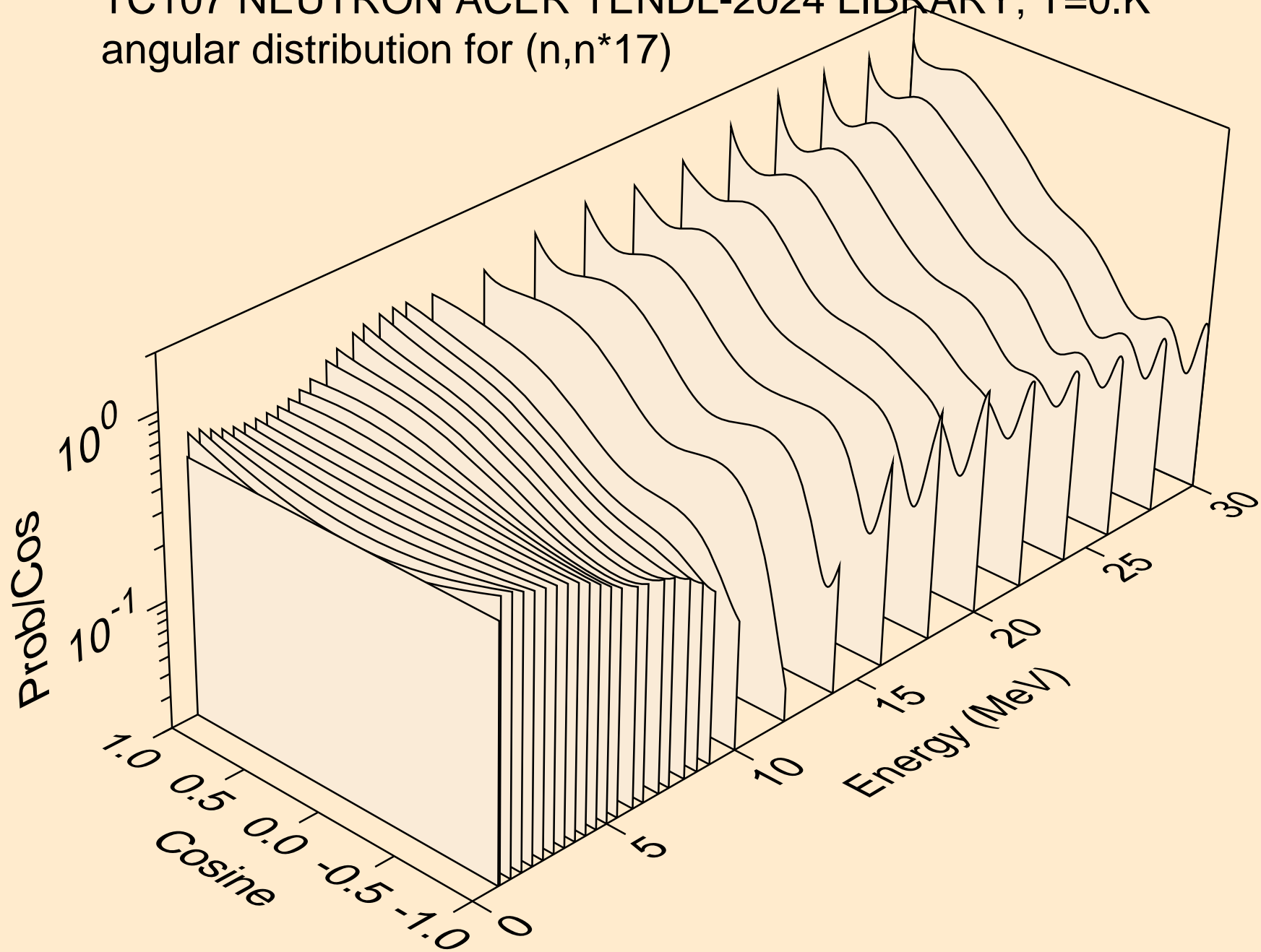

TC107 NEUTRON ACER TENDL-2024 LIBRARY; T=0.K  
angular distribution for (n,n\*18)

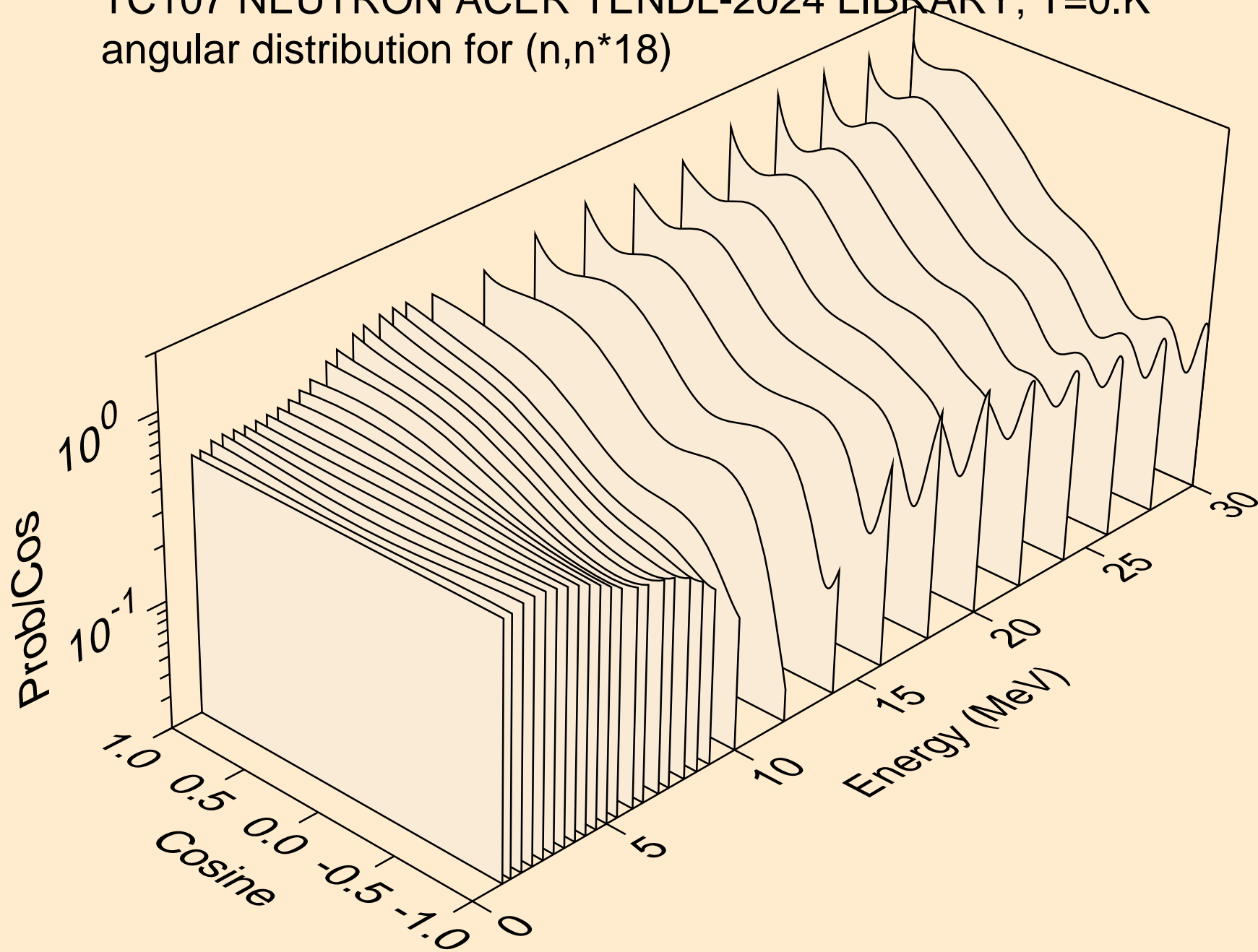

TC107 NEUTRON ACER TENDL-2024 LIBRARY; T=0.K  
angular distribution for (n,n\*19)

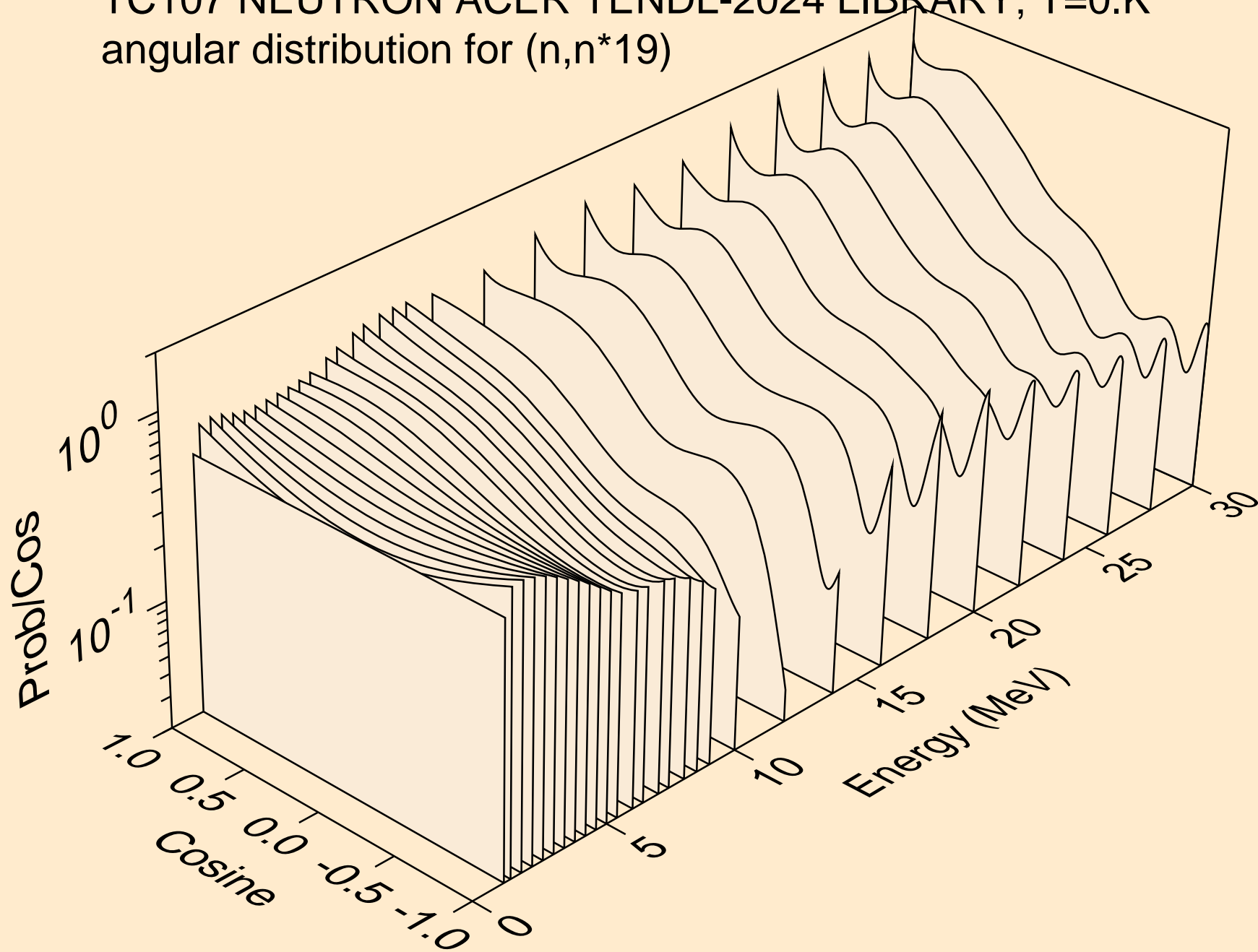

TC107 NEUTRON ACER TENDL-2024 LIBRARY; T=0.K  
angular distribution for (n,n\*20)

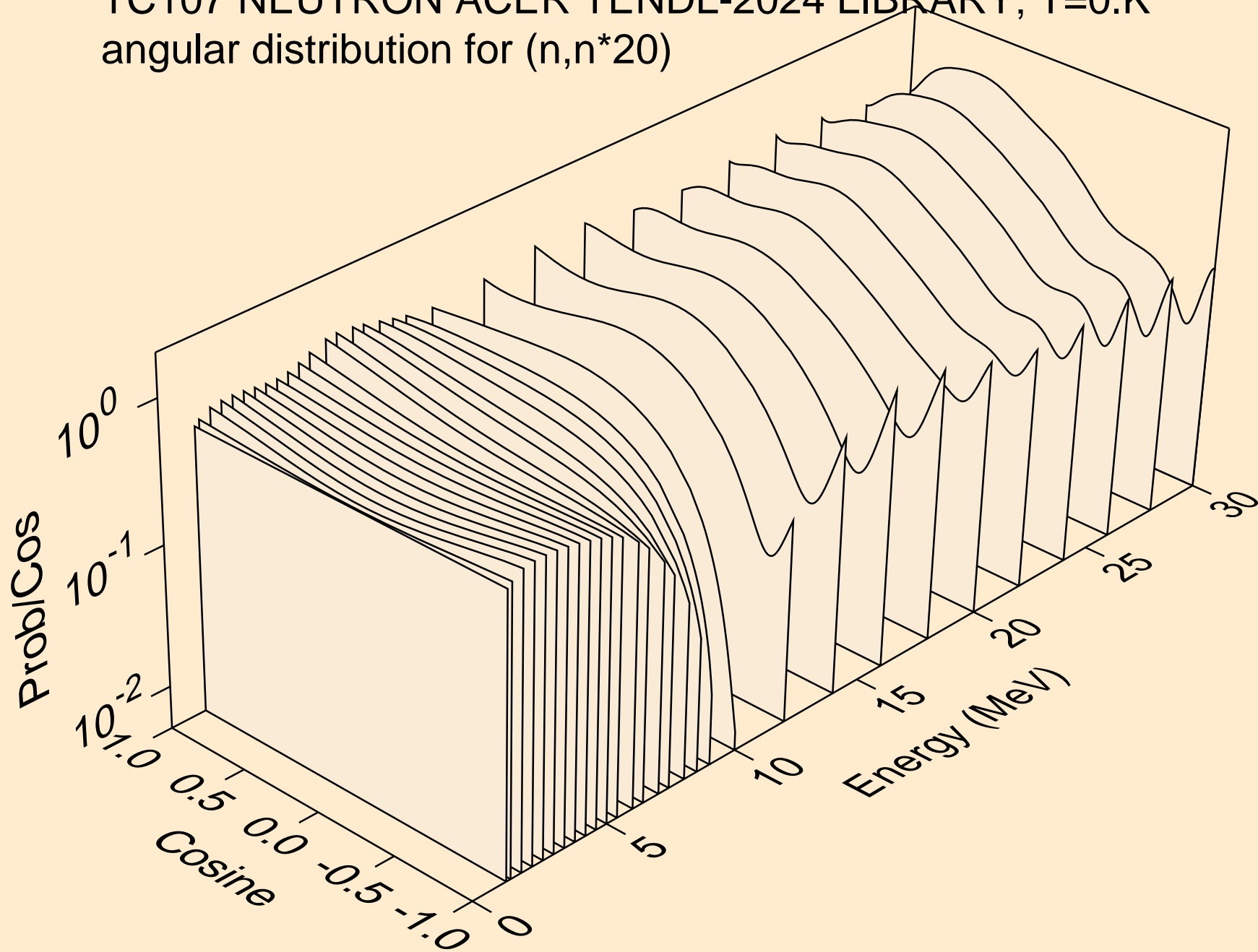

TC107 NEUTRON ACER TENDL-2024 LIBRARY; T=0.K  
angular distribution for (n,n\*21)

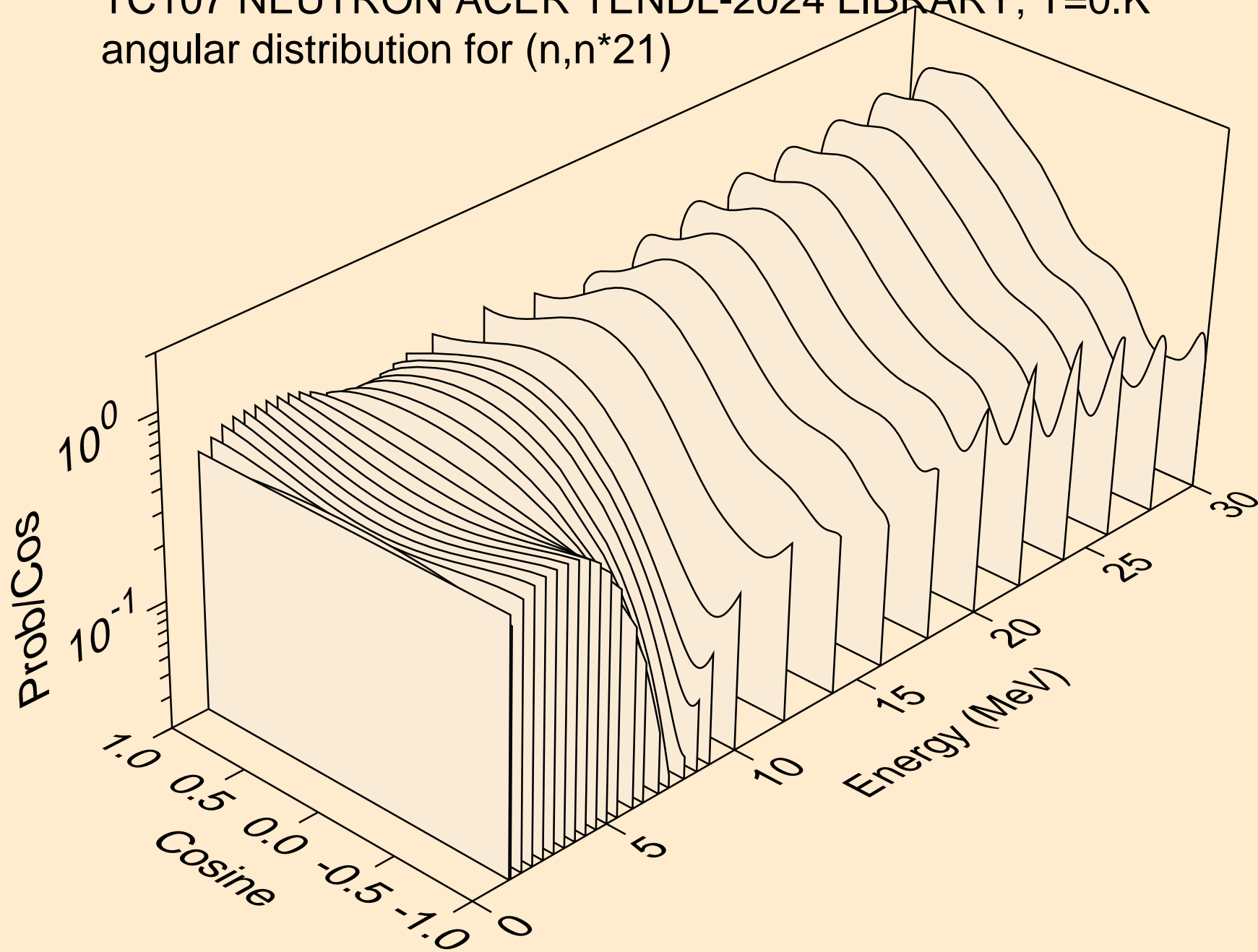

TC107 NEUTRON ACER TENDL-2024 LIBRARY; T=0.K  
angular distribution for (n,n\*22)

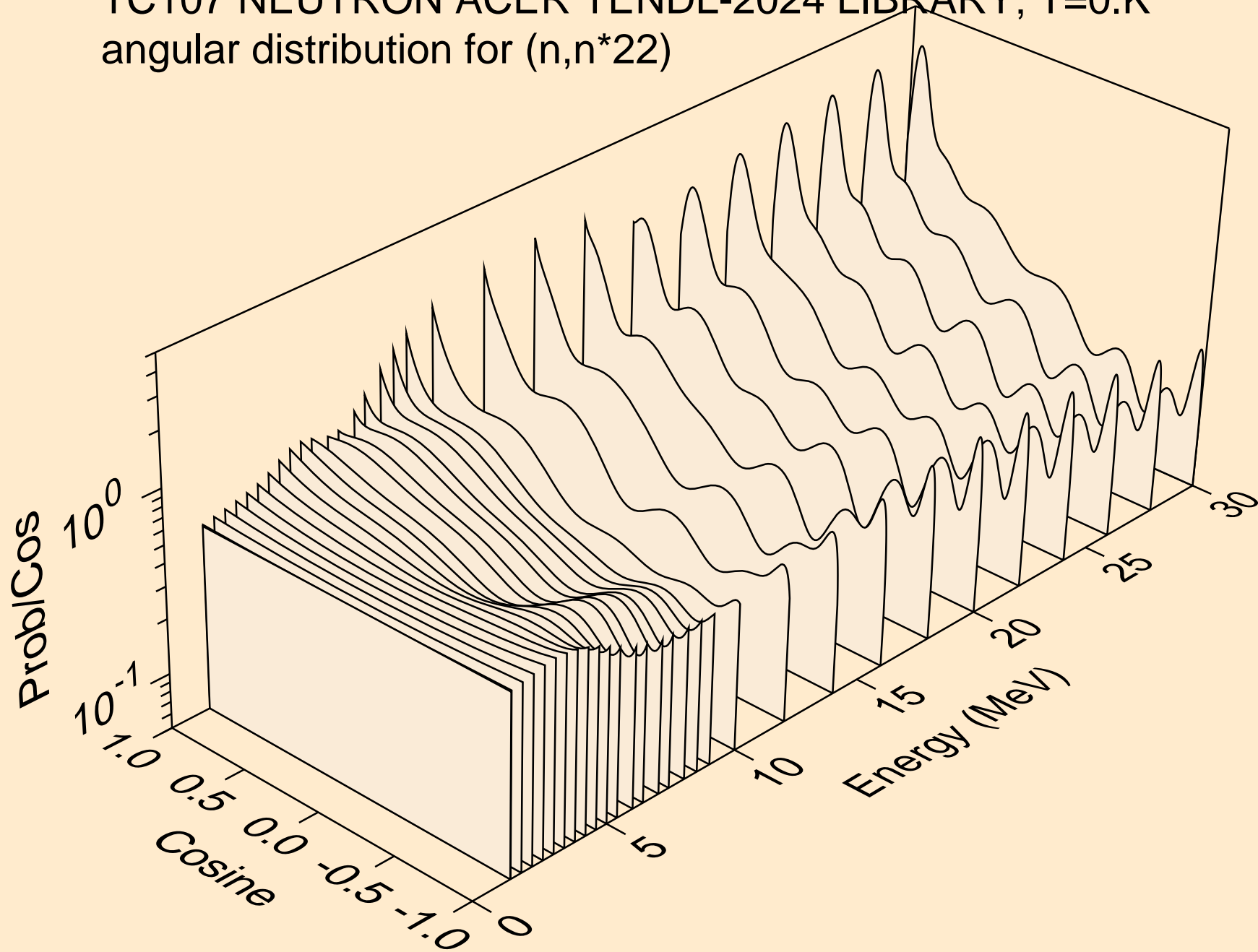



TC107 NEUTRON ACER TENDL-2024 LIBRARY; T=0.K  
Neutron emission for (n,x)

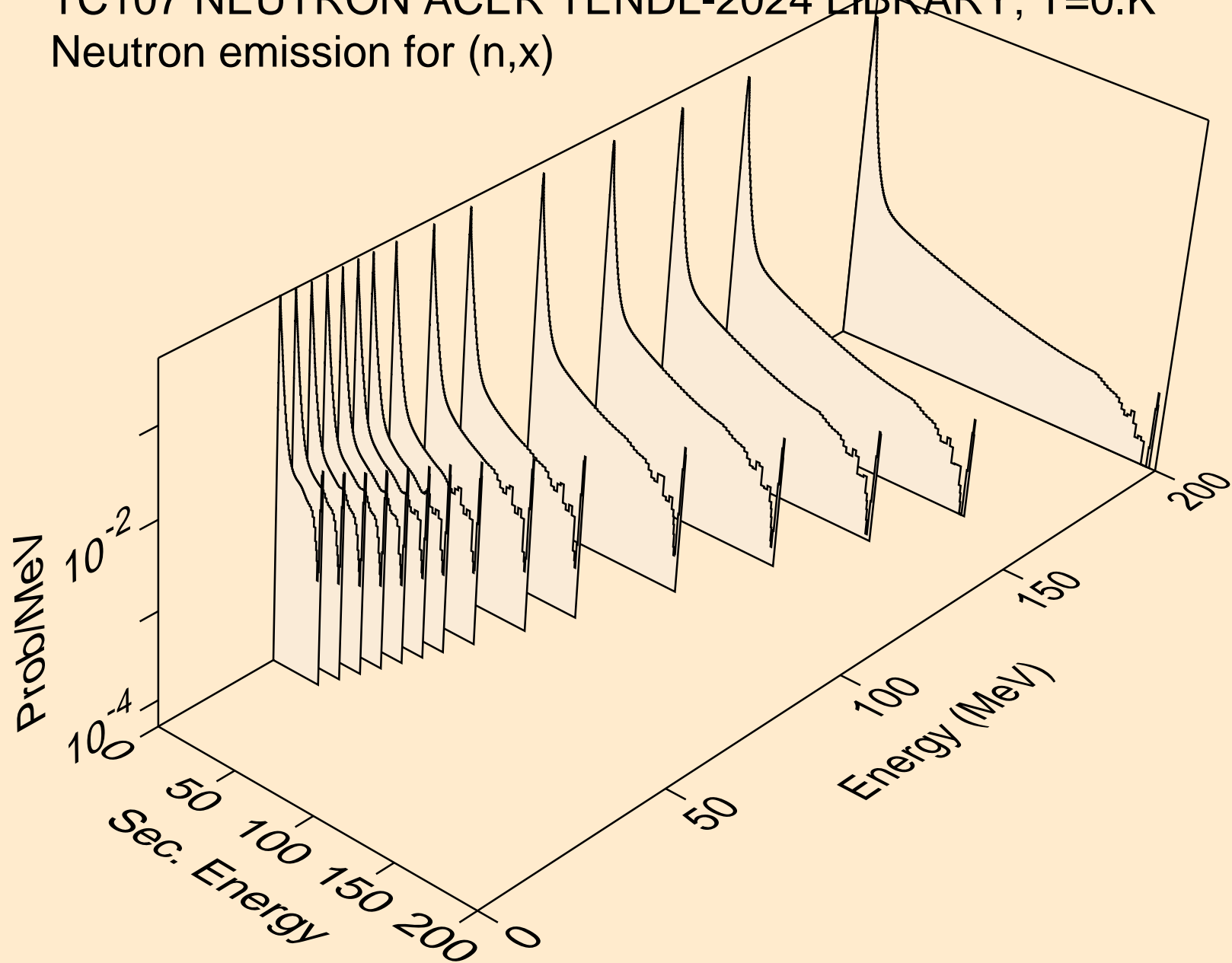

TC107 NEUTRON ACER TENDL-2024 LIBRARY; T=0.K  
Neutron emission for (n,2nd)

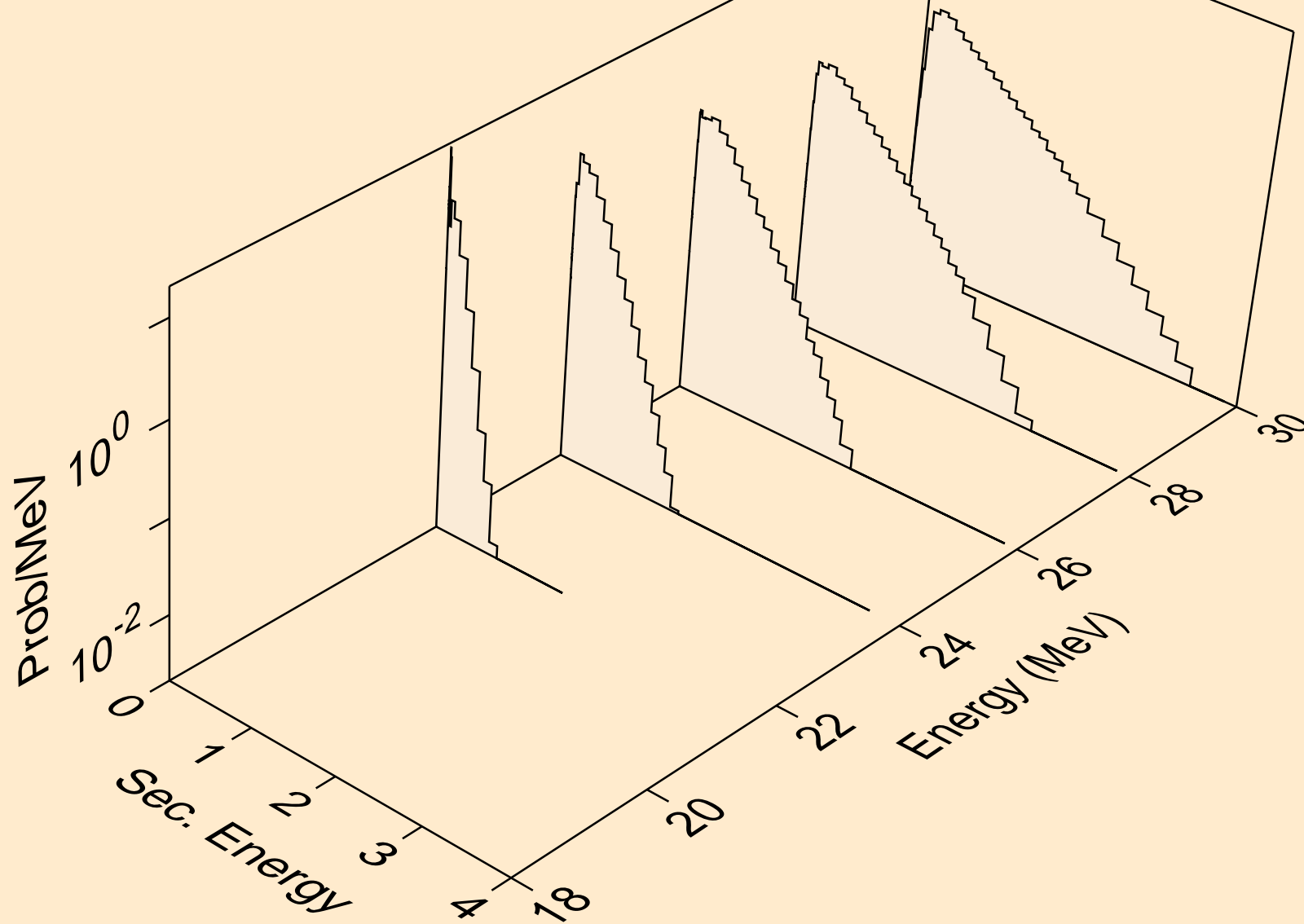

TC107 NEUTRON ACER TENDL-2024 LIBRARY; T=0.K  
Neutron emission for (n,2n)

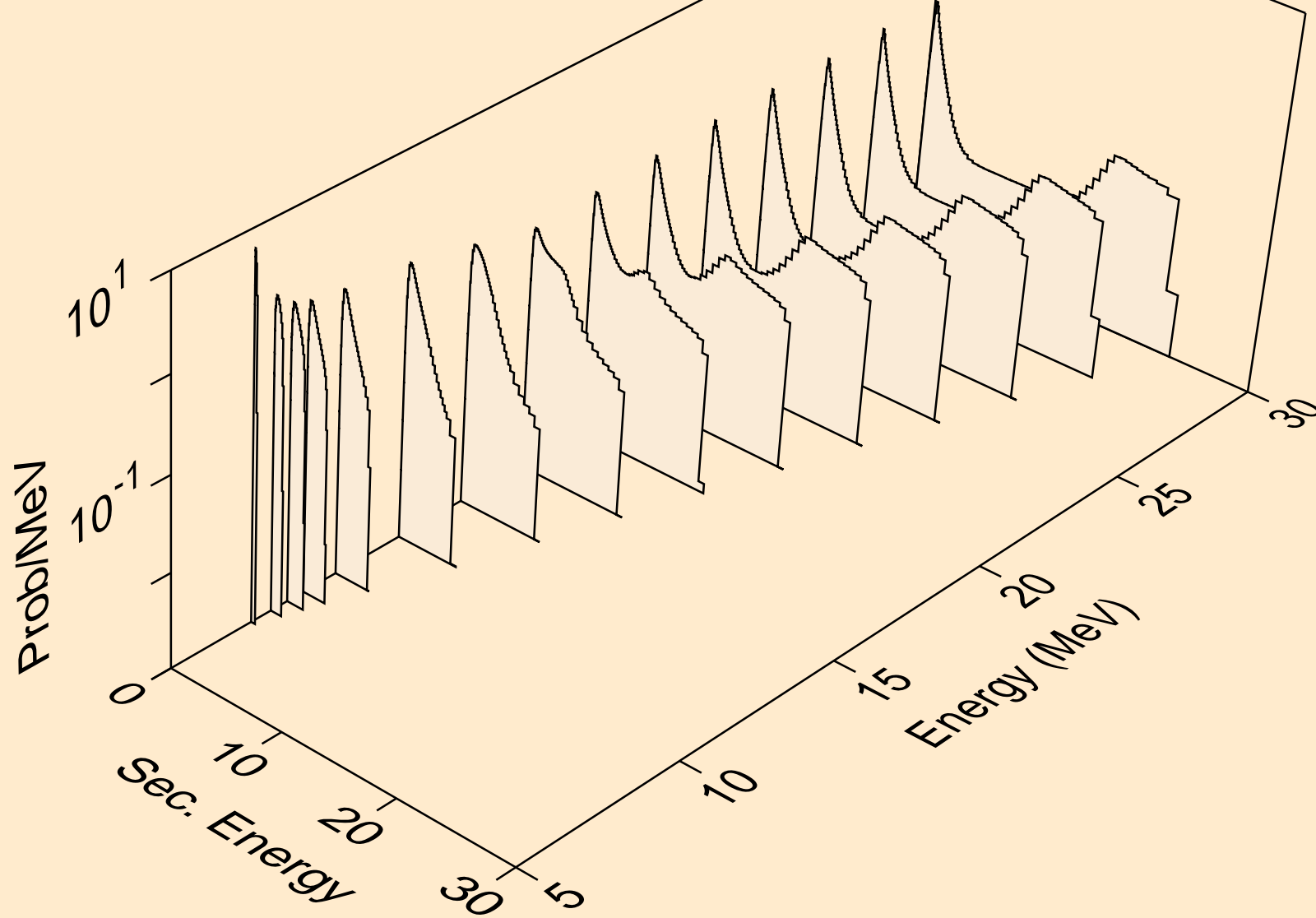

TC107 NEUTRON ACER TENDL-2024 LIBRARY; T=0.K  
Neutron emission for (n,3n)

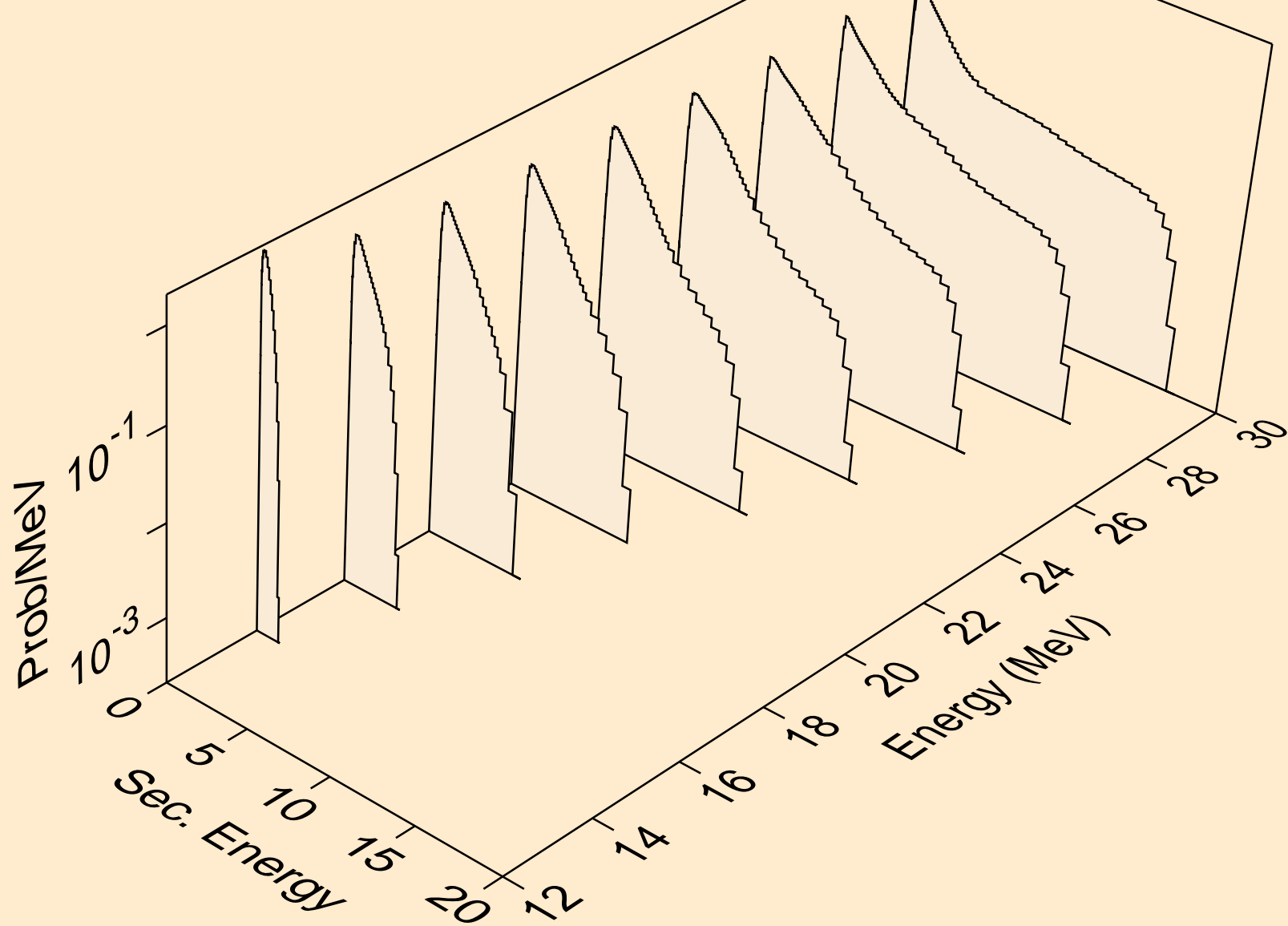

TC107 NEUTRON ACER TENDL-2024 LIBRARY; T=0.K  
Neutron emission for (n,n\*)a

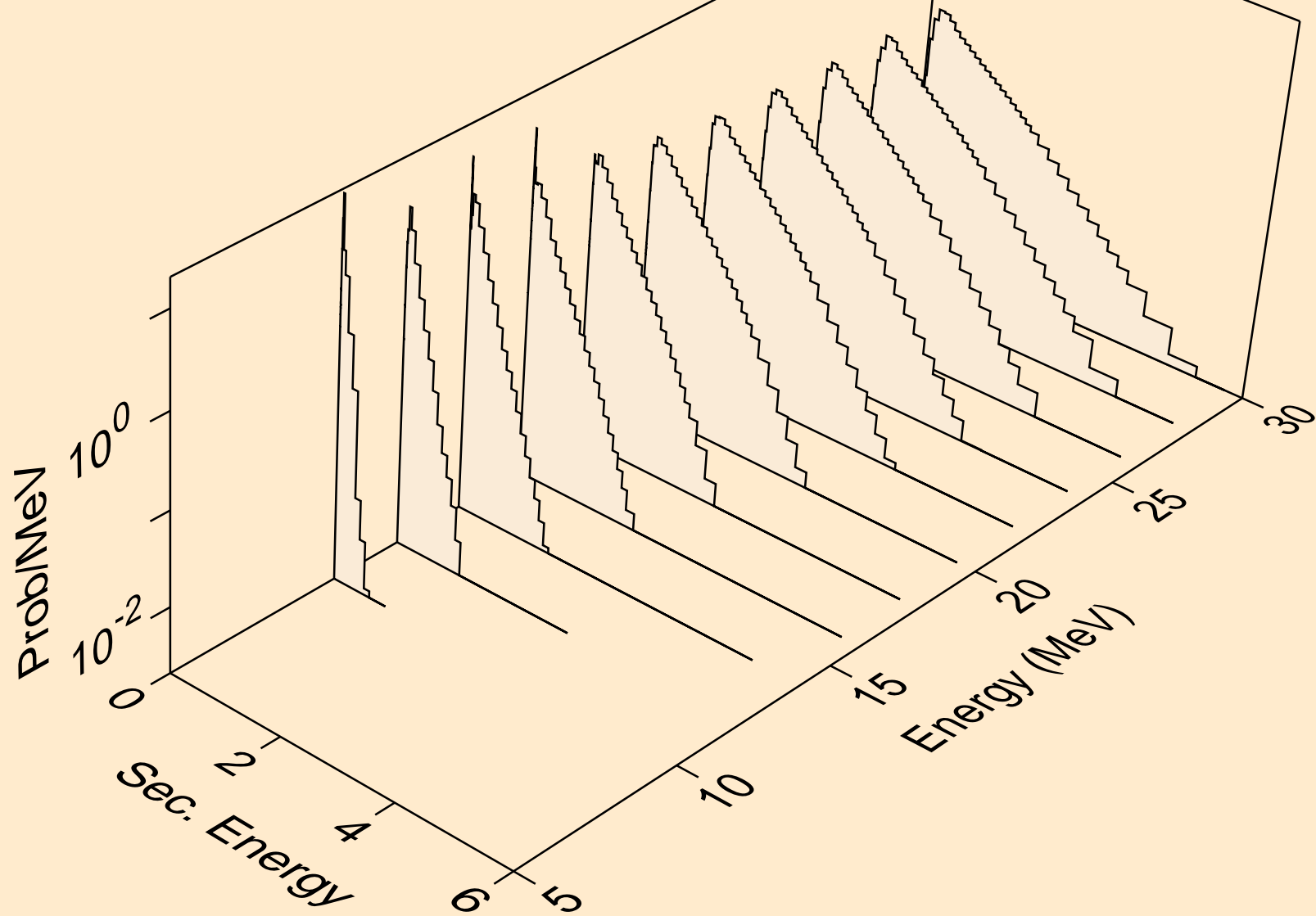

TC107 NEUTRON ACER TENDL-2024 LIBRARY; T=0.K  
Neutron emission for (n,2n)a

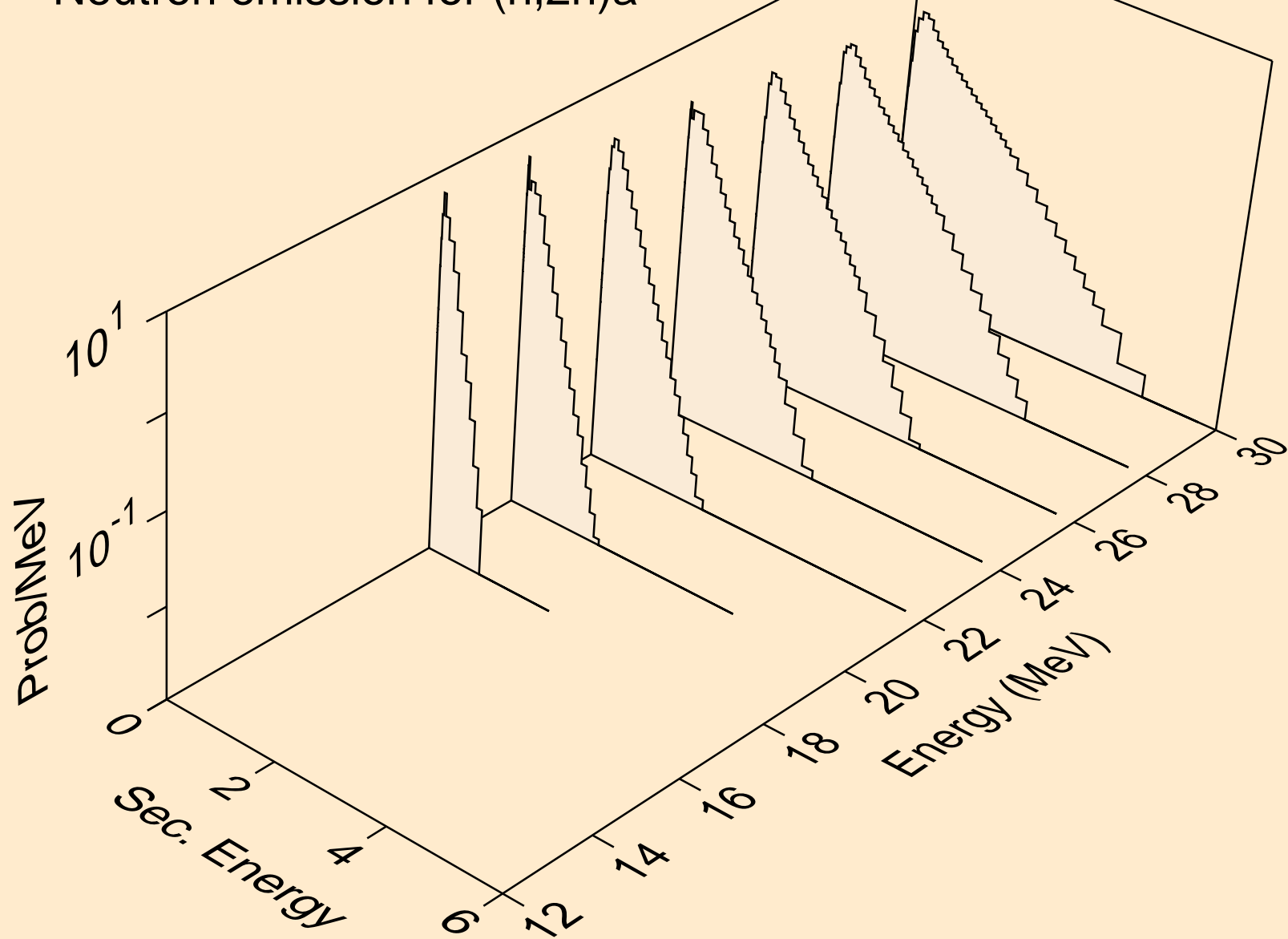

TC107 NEUTRON ACER TENDL-2024 LIBRARY; T=0.K  
Neutron emission for (n,3n)a

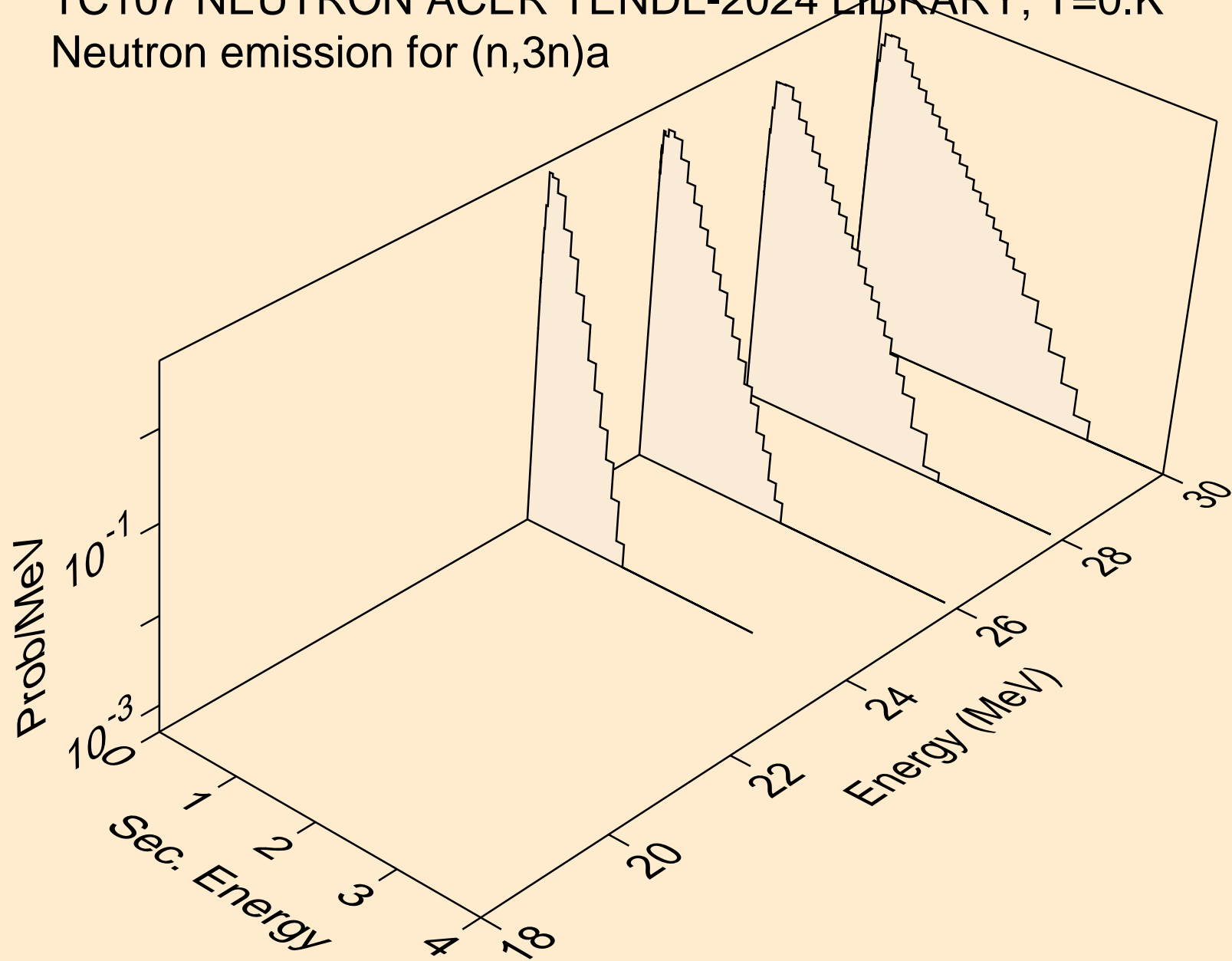

TC107 NEUTRON ACER TENDL-2024 LIBRARY; T=0.K  
Neutron emission for (n,n\*)p

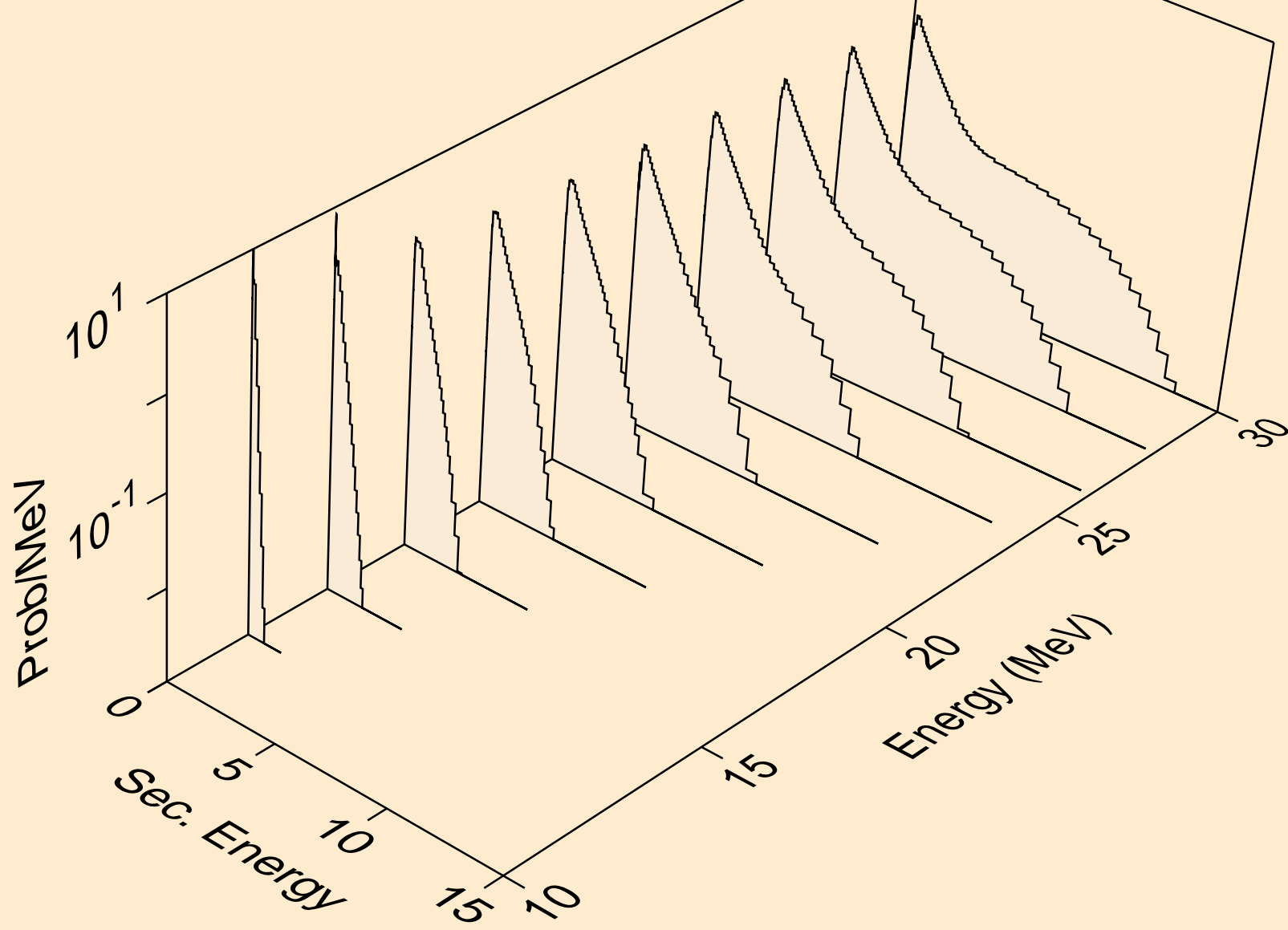



TC107 NEUTRON ACER TENDL-2024 LIBRARY; T=0.K  
Neutron emission for (n,n\*)d

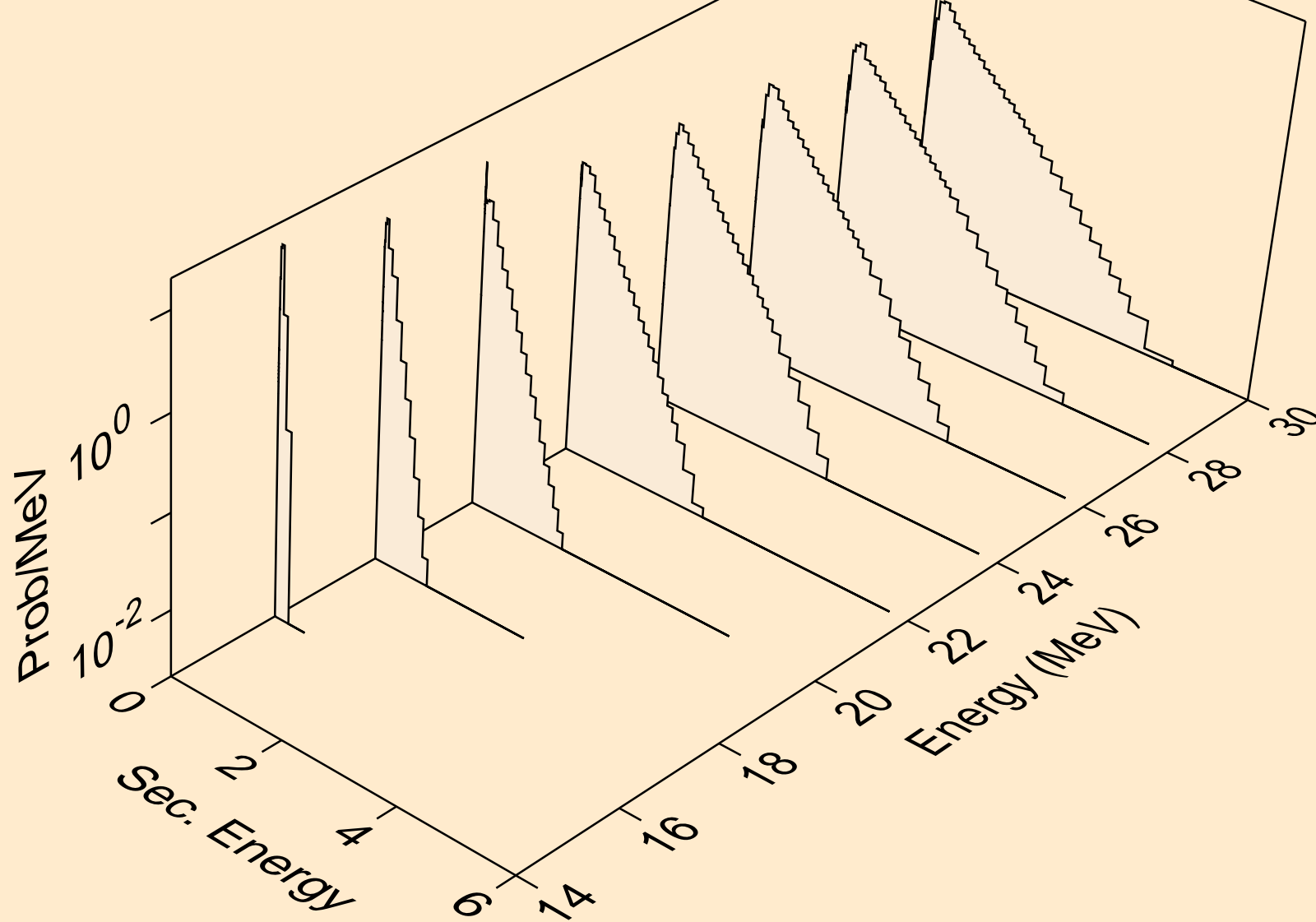

TC107 NEUTRON ACER TENDL-2024 LIBRARY; T=0.K  
Neutron emission for (n,n\*)t

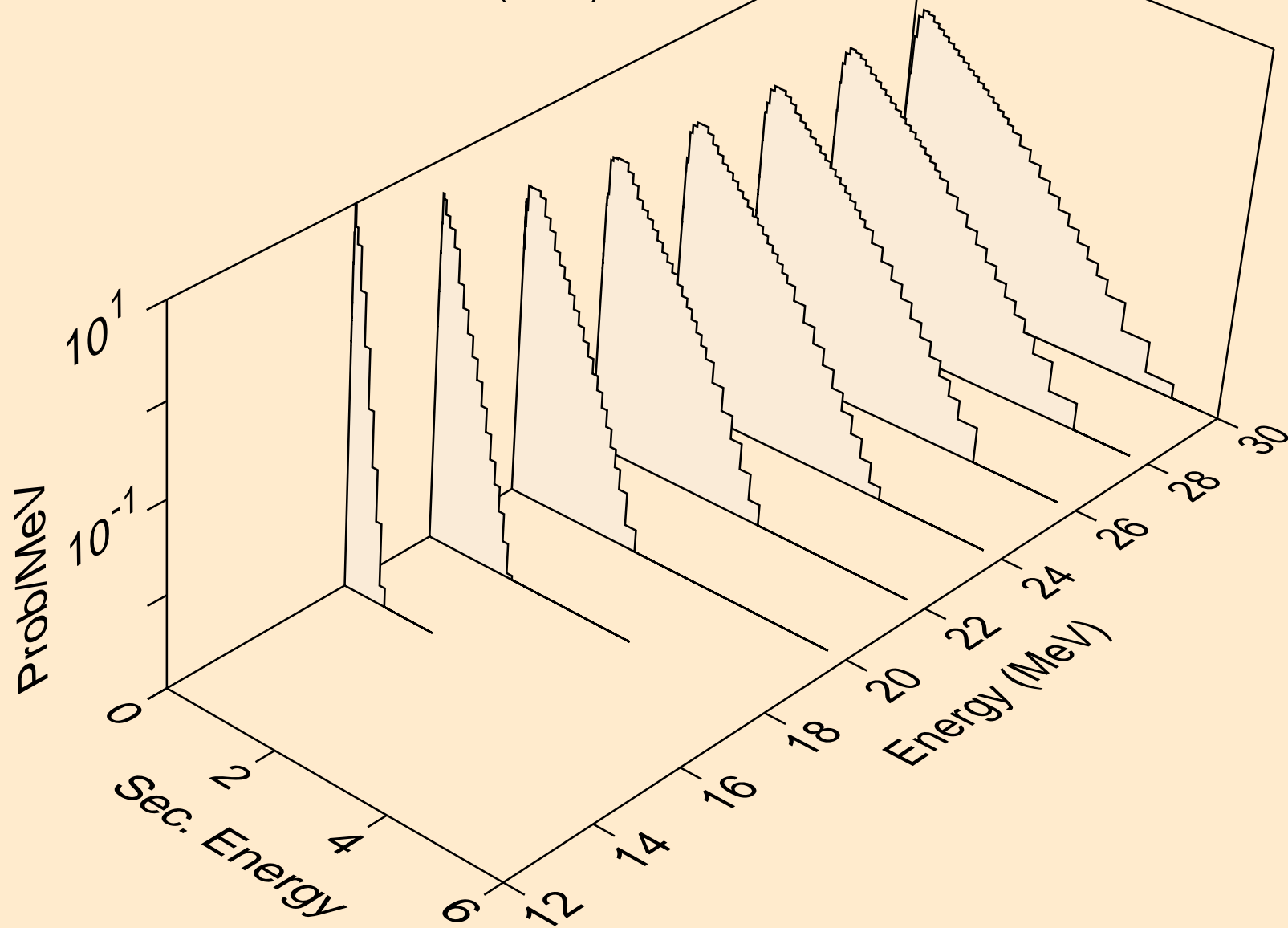

TC107 NEUTRON ACER TENDL-2024 LIBRARY; T=0.K  
Neutron emission for (n,n\*)he3

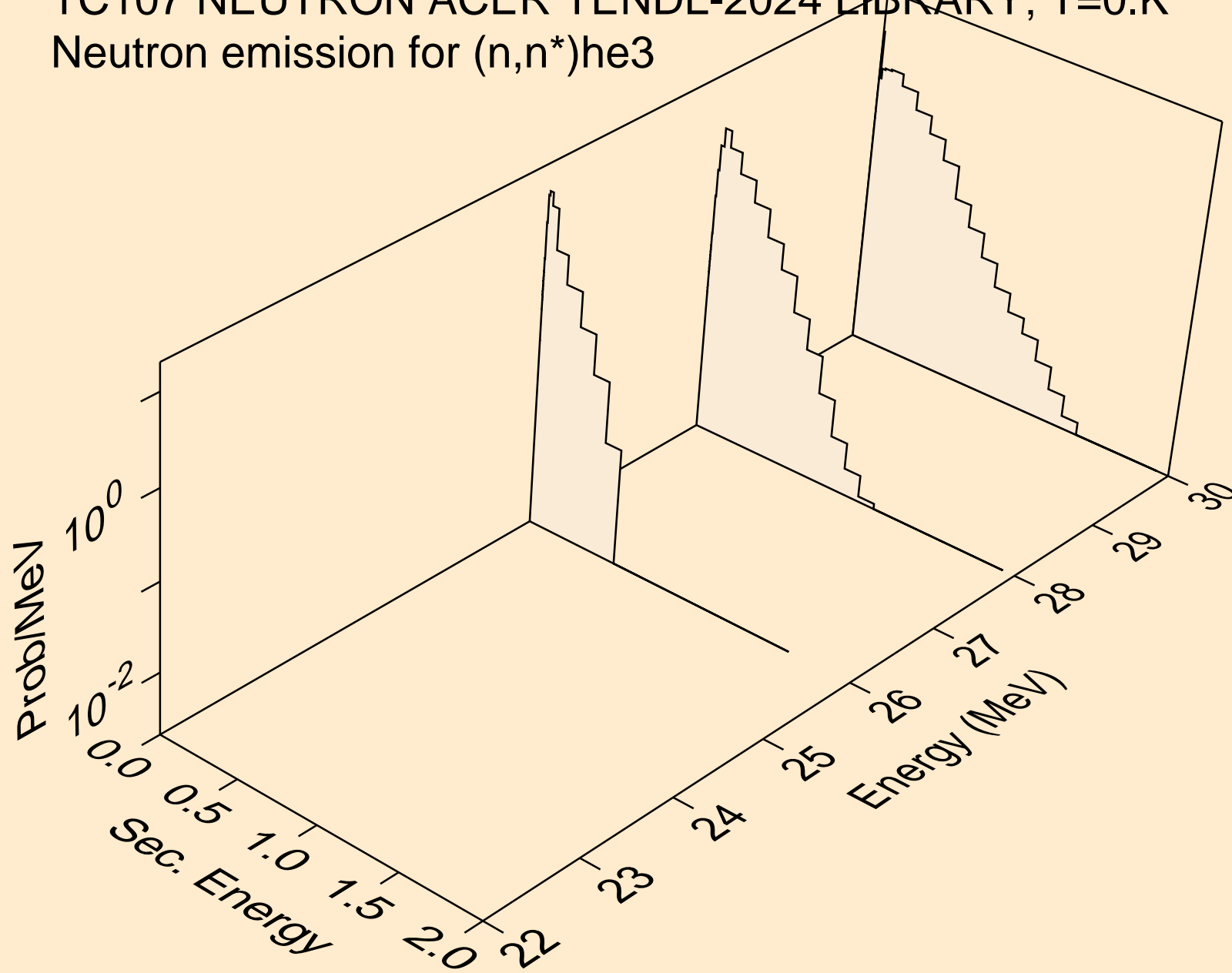

TC107 NEUTRON ACER TENDL-2024 LIBRARY; T=0.K  
Neutron emission for (n,4n)

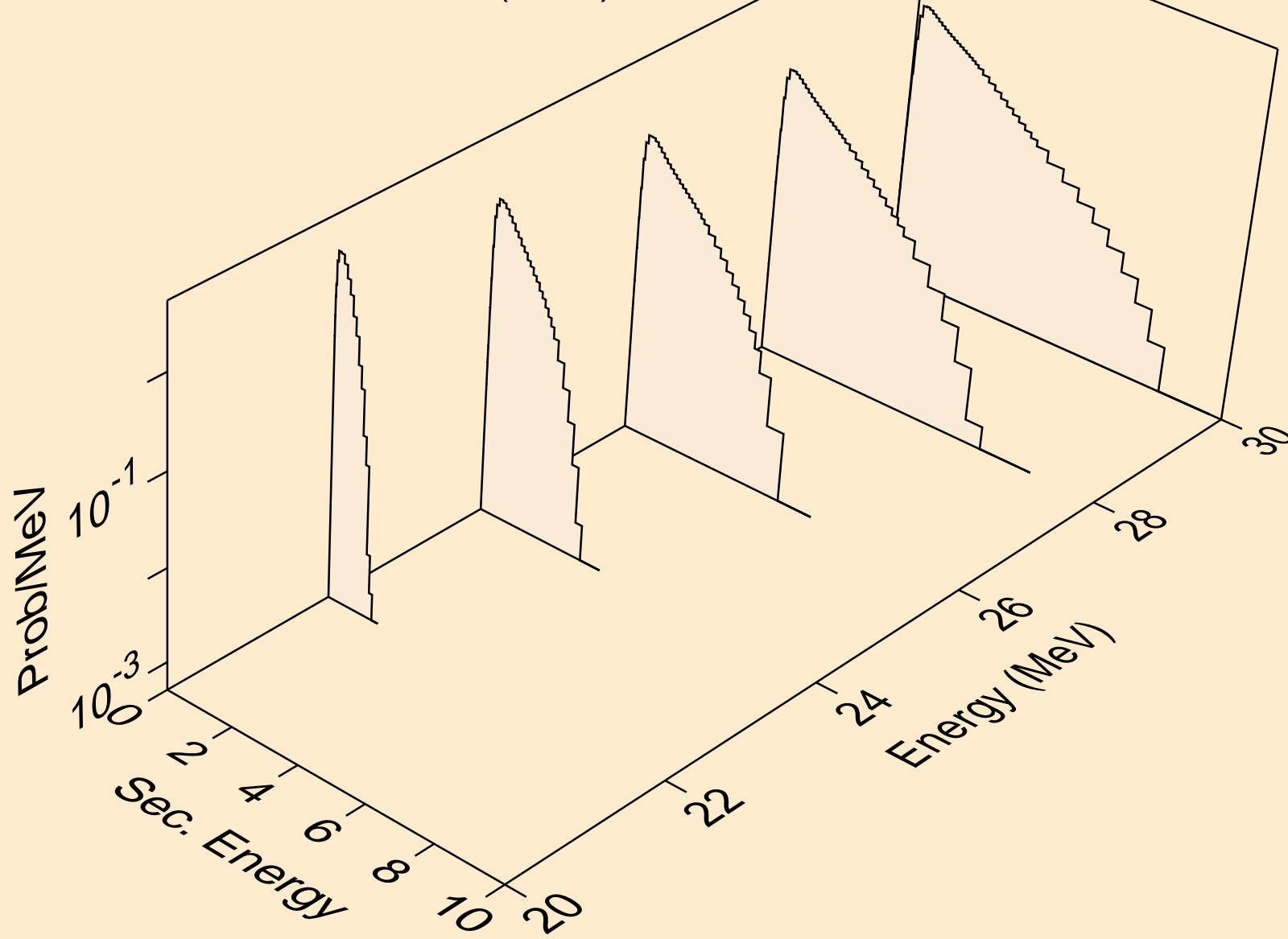

TC107 NEUTRON ACER TENDL-2024 LIBRARY; T=0.K  
Neutron emission for (n,2np)

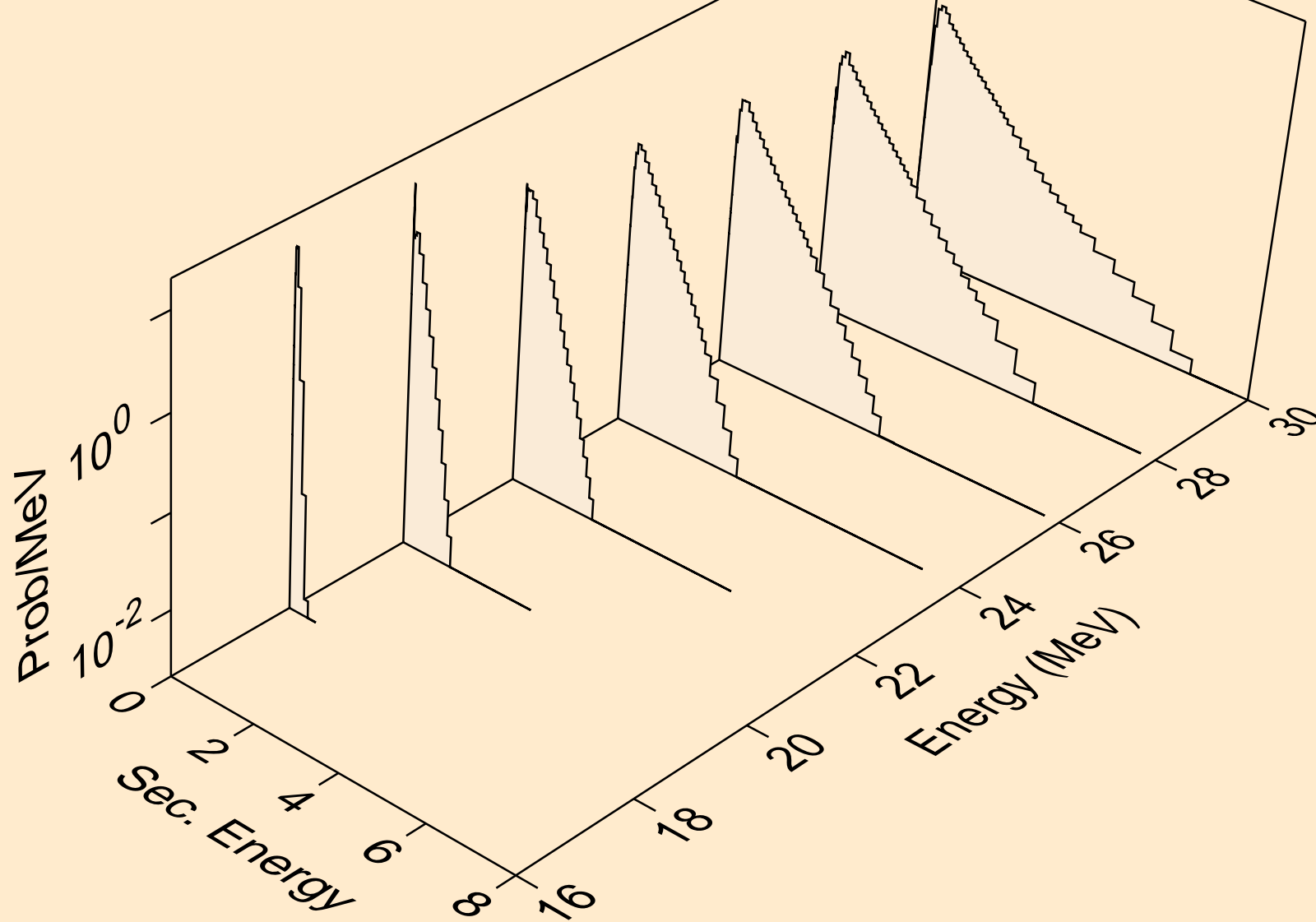

TC107 NEUTRON ACER TENDL-2024 LIBRARY; T=0.K  
Neutron emission for (n,3np)

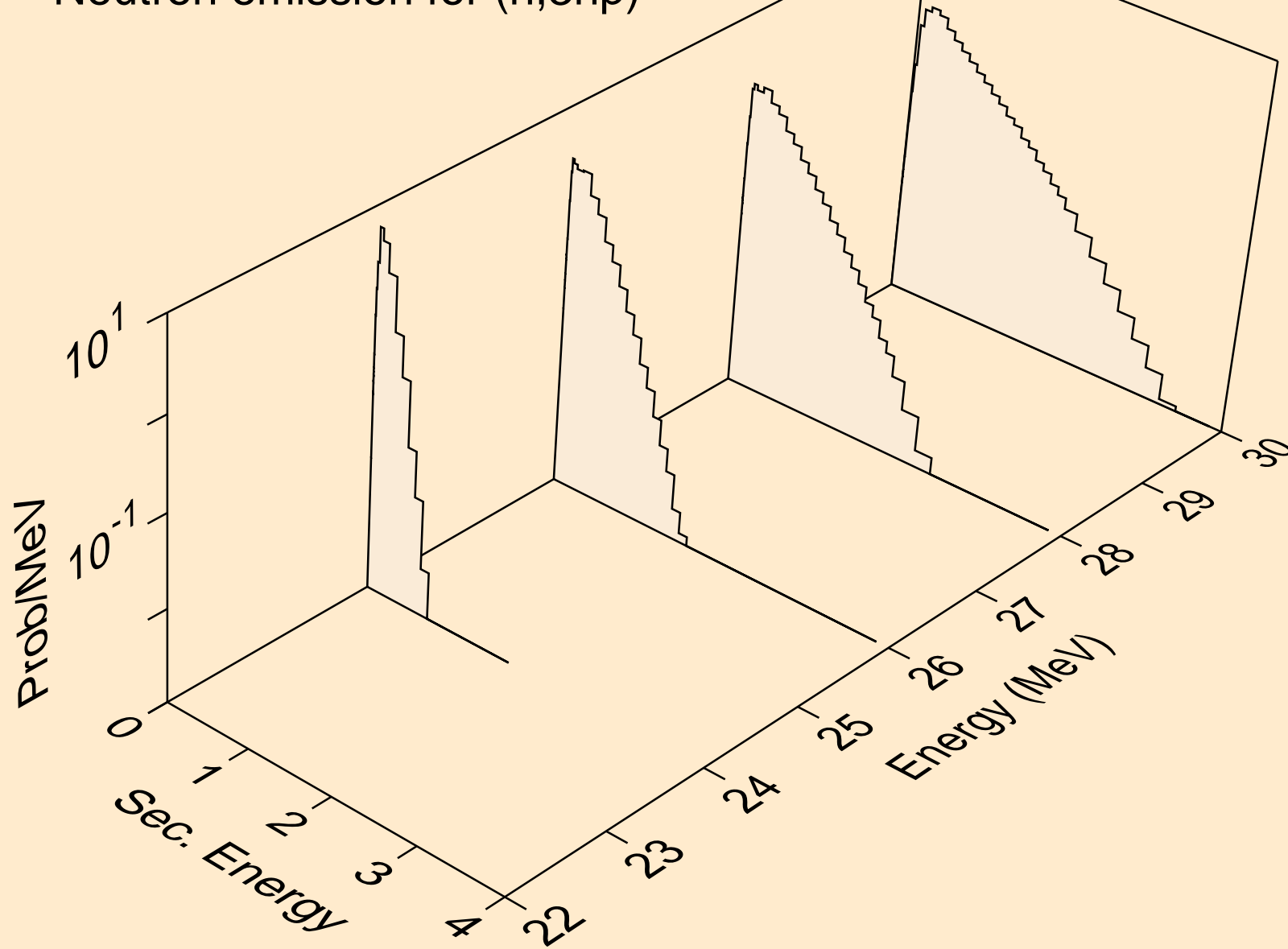

TC107 NEUTRON ACER TENDL-2024 LIBRARY; T=0.K  
Neutron emission for (n,n\*c)

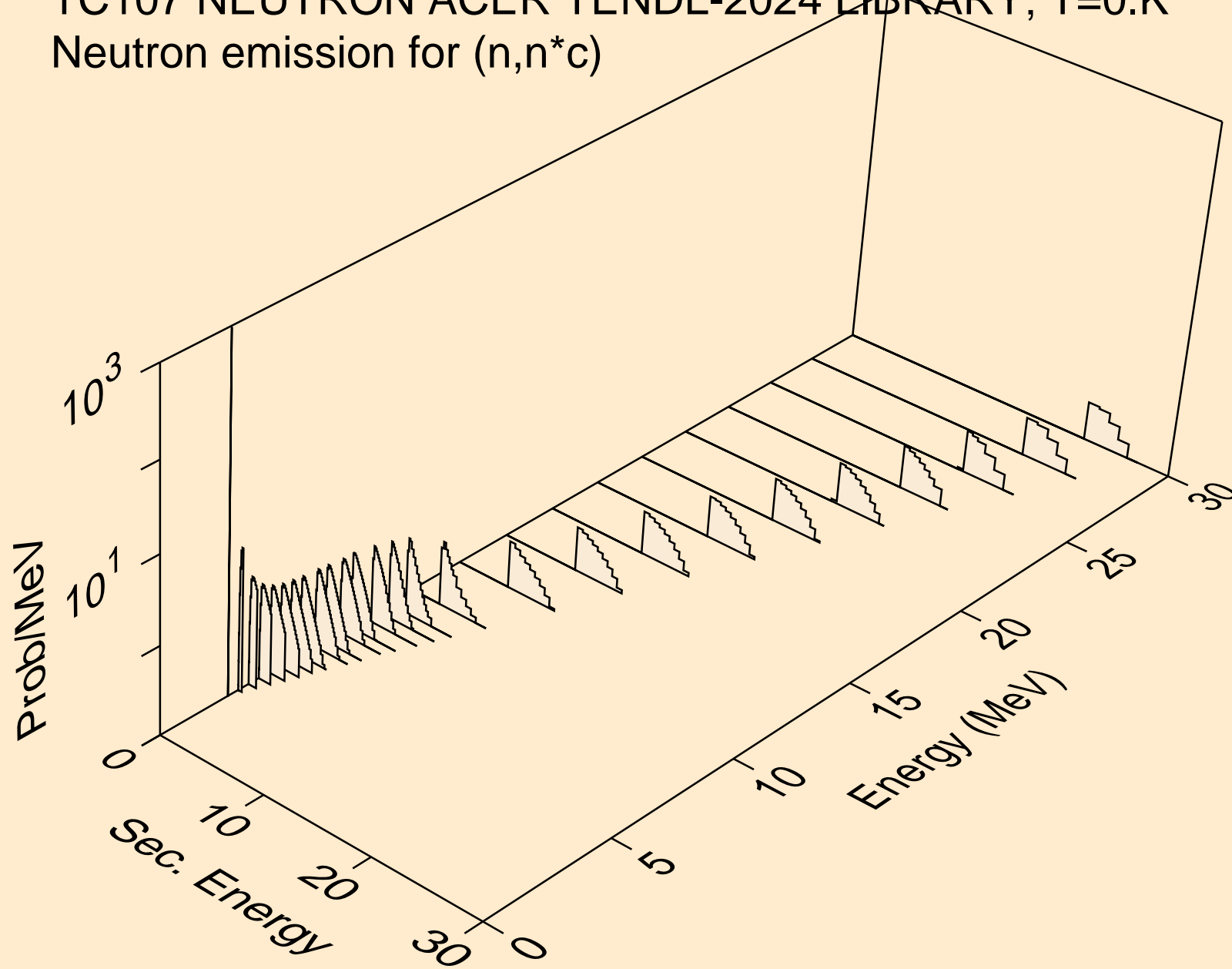

TC107 NEUTRON ACER TENDL-2024 LIBRARY; T=0.K  
Photon emission for (n,x)

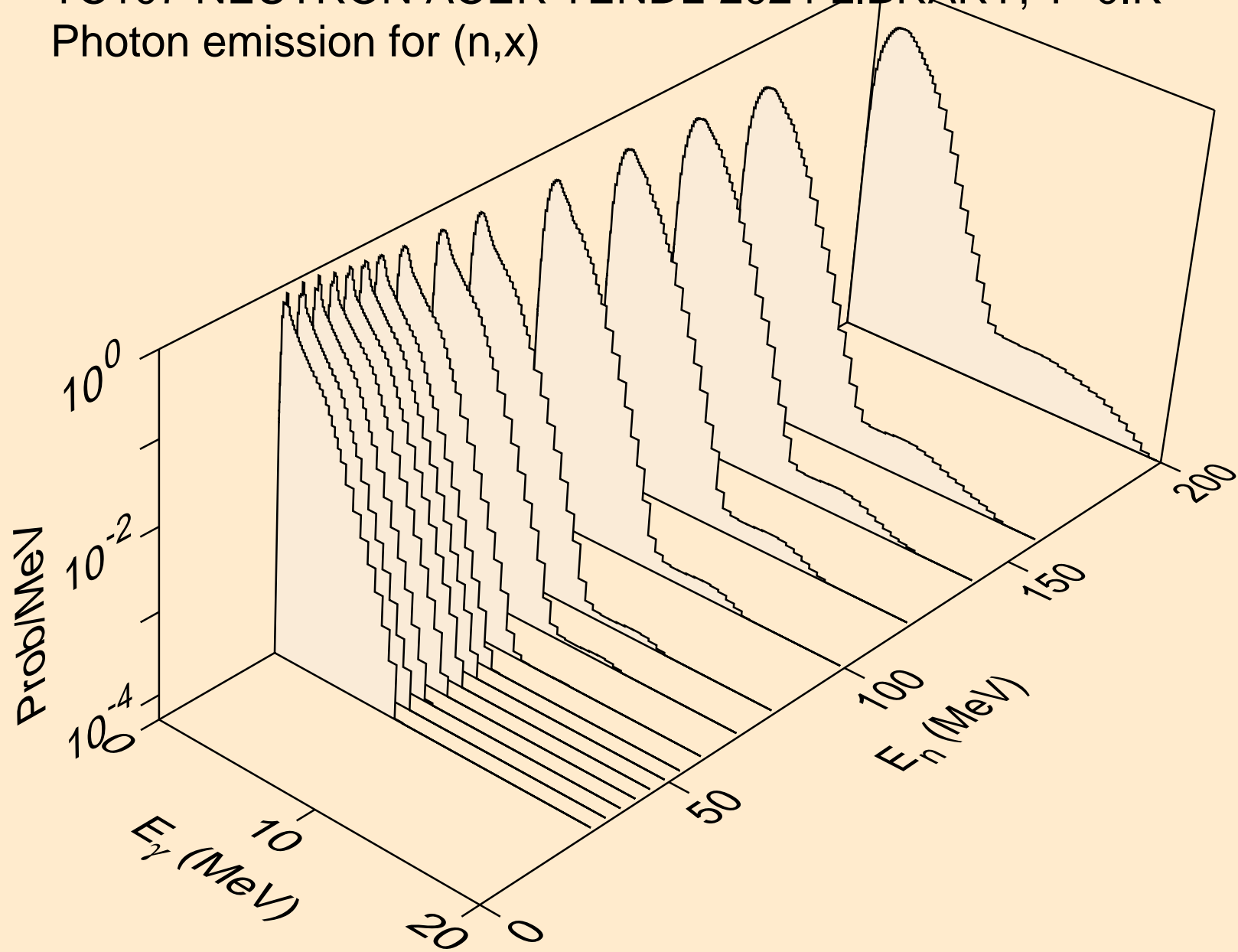



TC107 NEUTRON ACER TENDL-2024 LIBRARY; T=0.K  
Photon emission for (n,2nd)

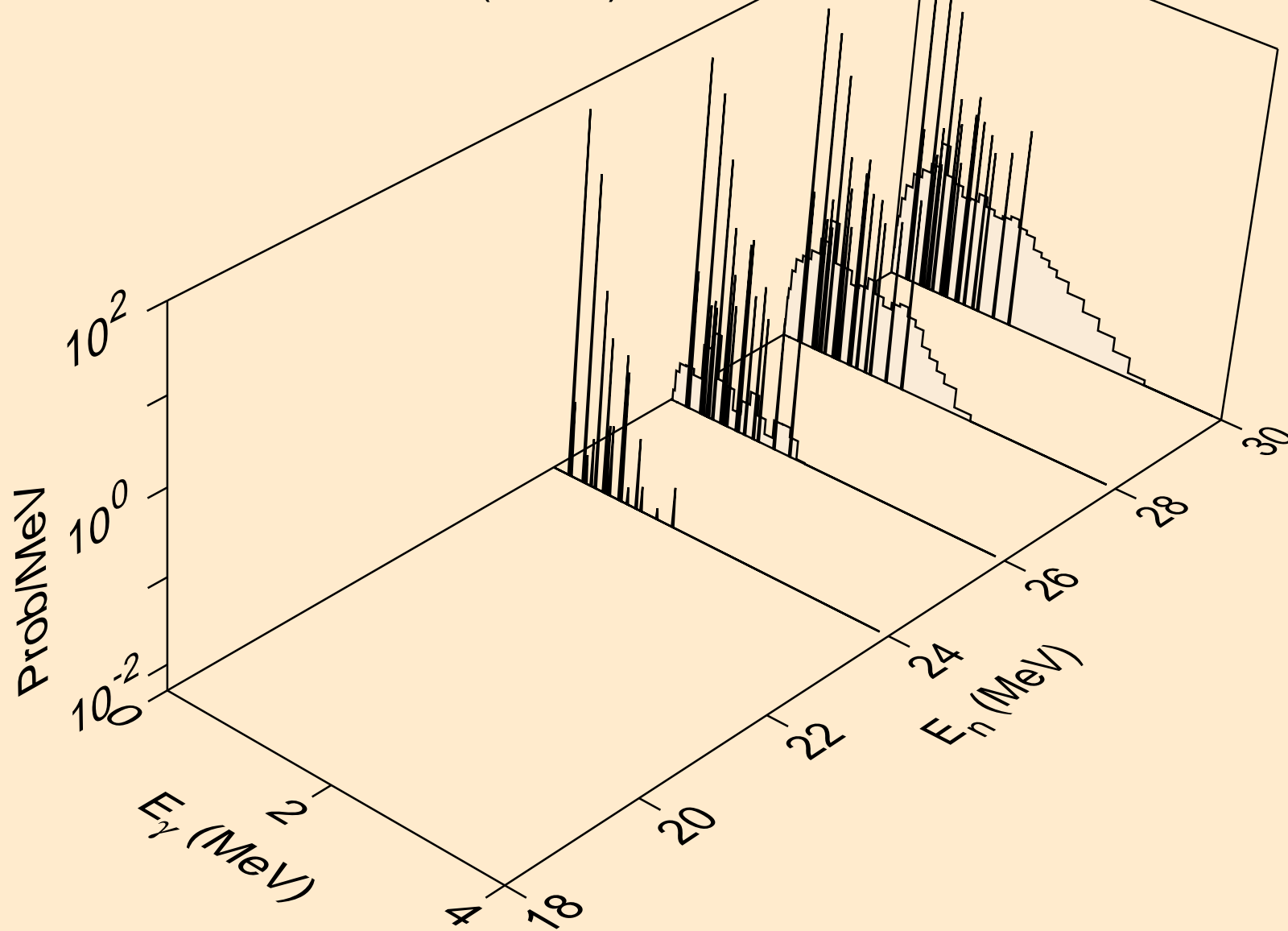

TC107 NEUTRON ACER TENDL-2024 LIBRARY; T=0.K  
Photon emission for (n,2n)

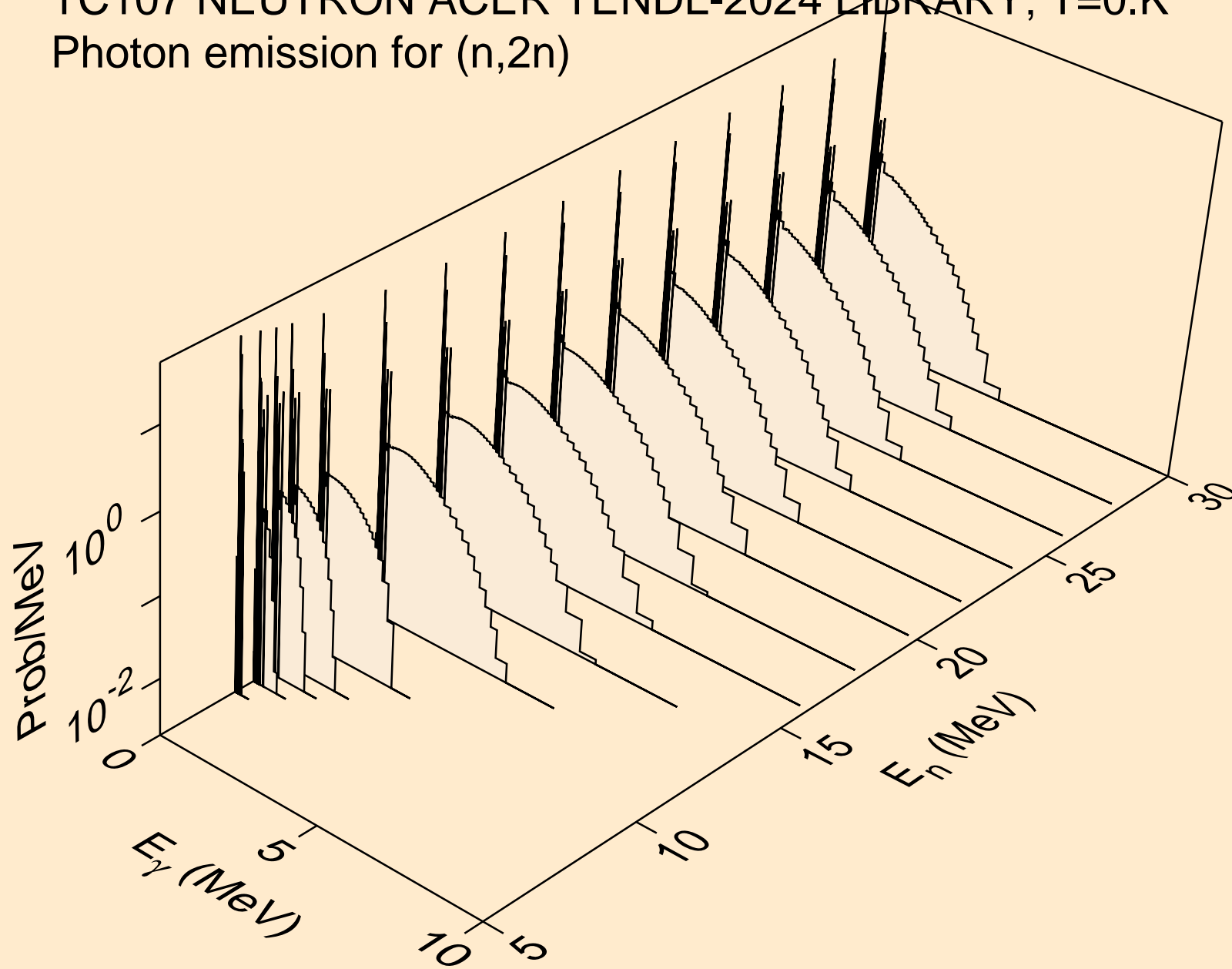

TC107 NEUTRON ACER TENDL-2024 LIBRARY; T=0.K  
Photon emission for (n,3n)

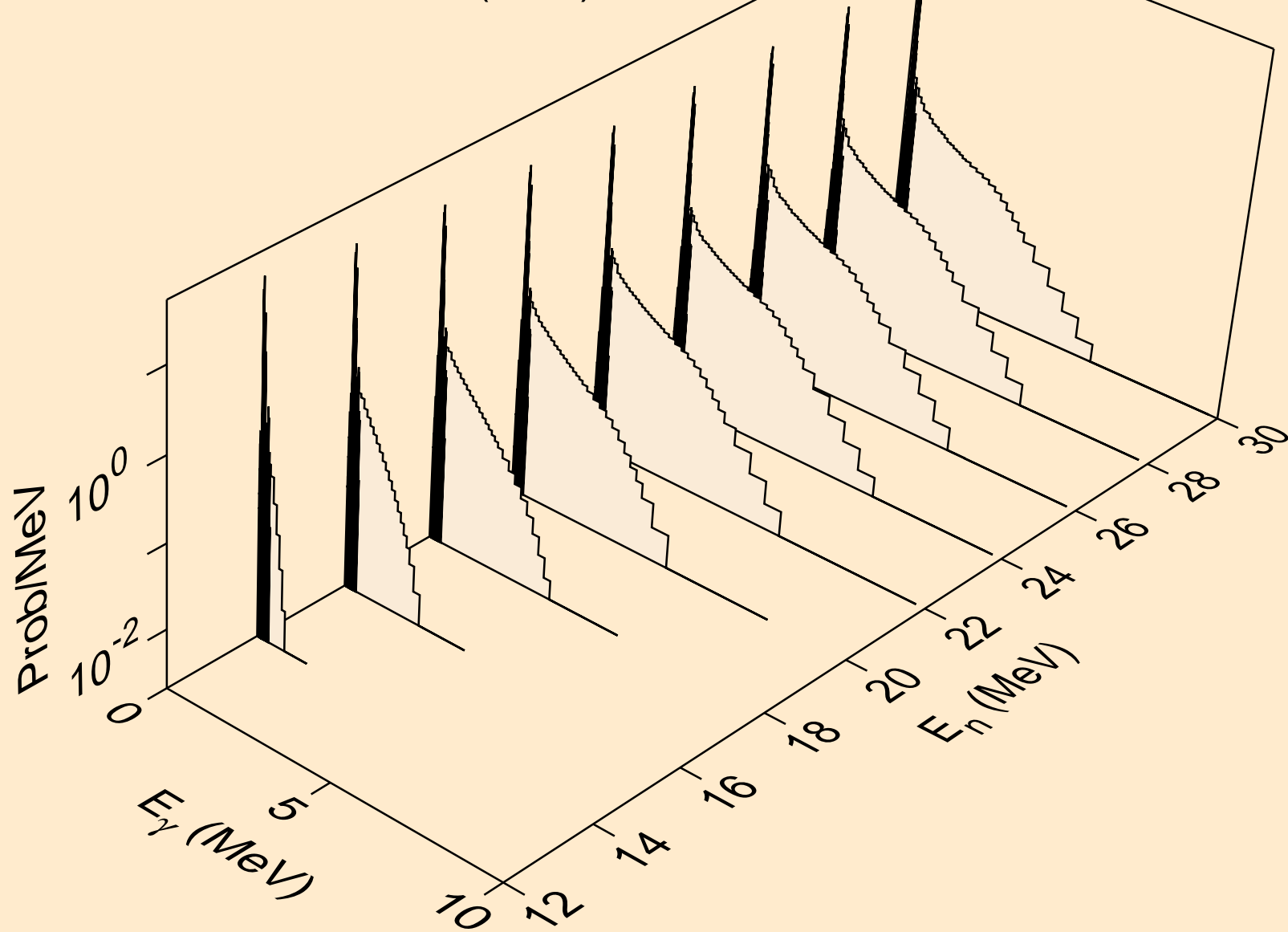

TC107 NEUTRON ACER TENDL-2024 LIBRARY; T=0.K  
Photon emission for (n,n\*)a

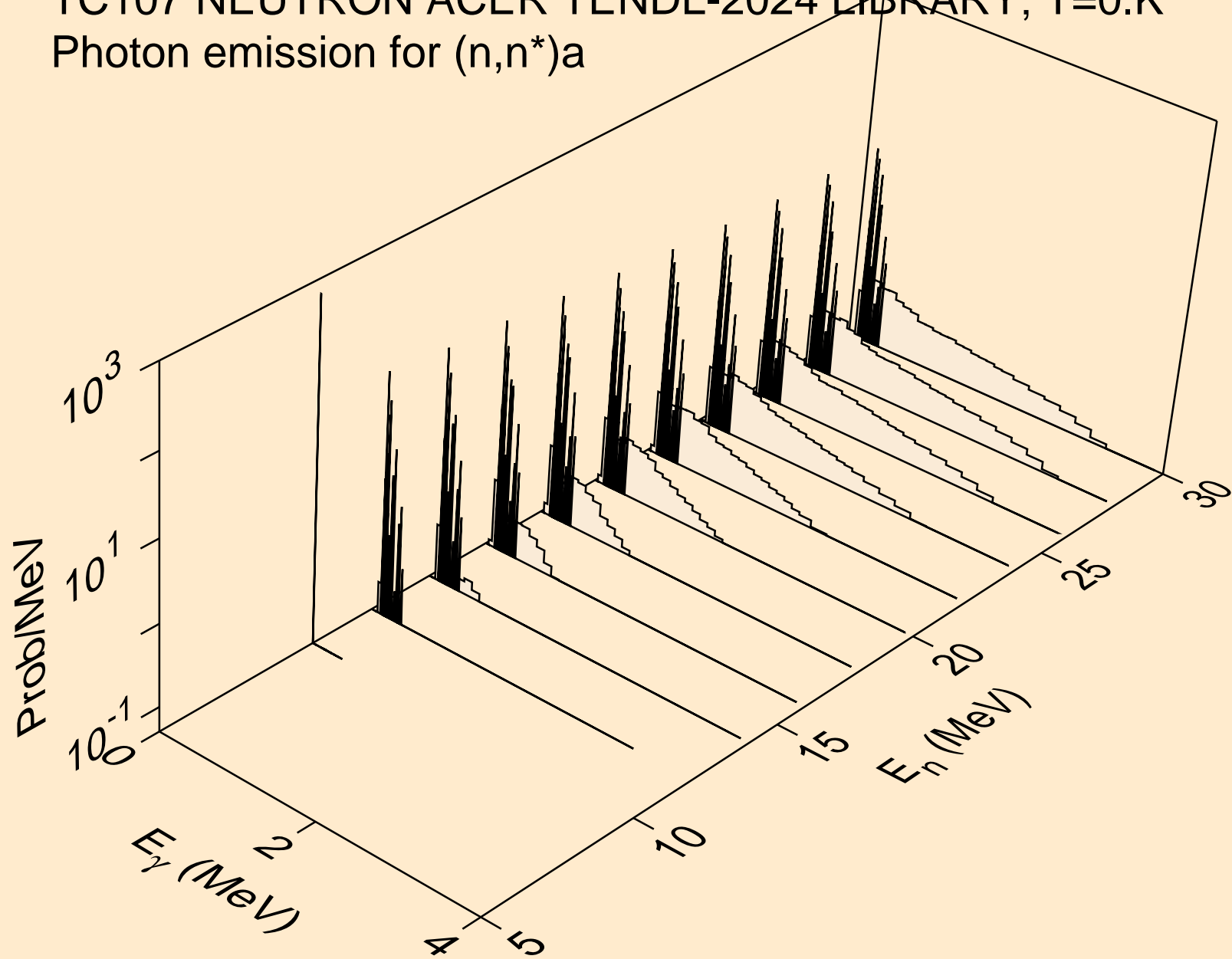

TC107 NEUTRON ACER TENDL-2024 LIBRARY; T=0.K  
Photon emission for (n,2n)a

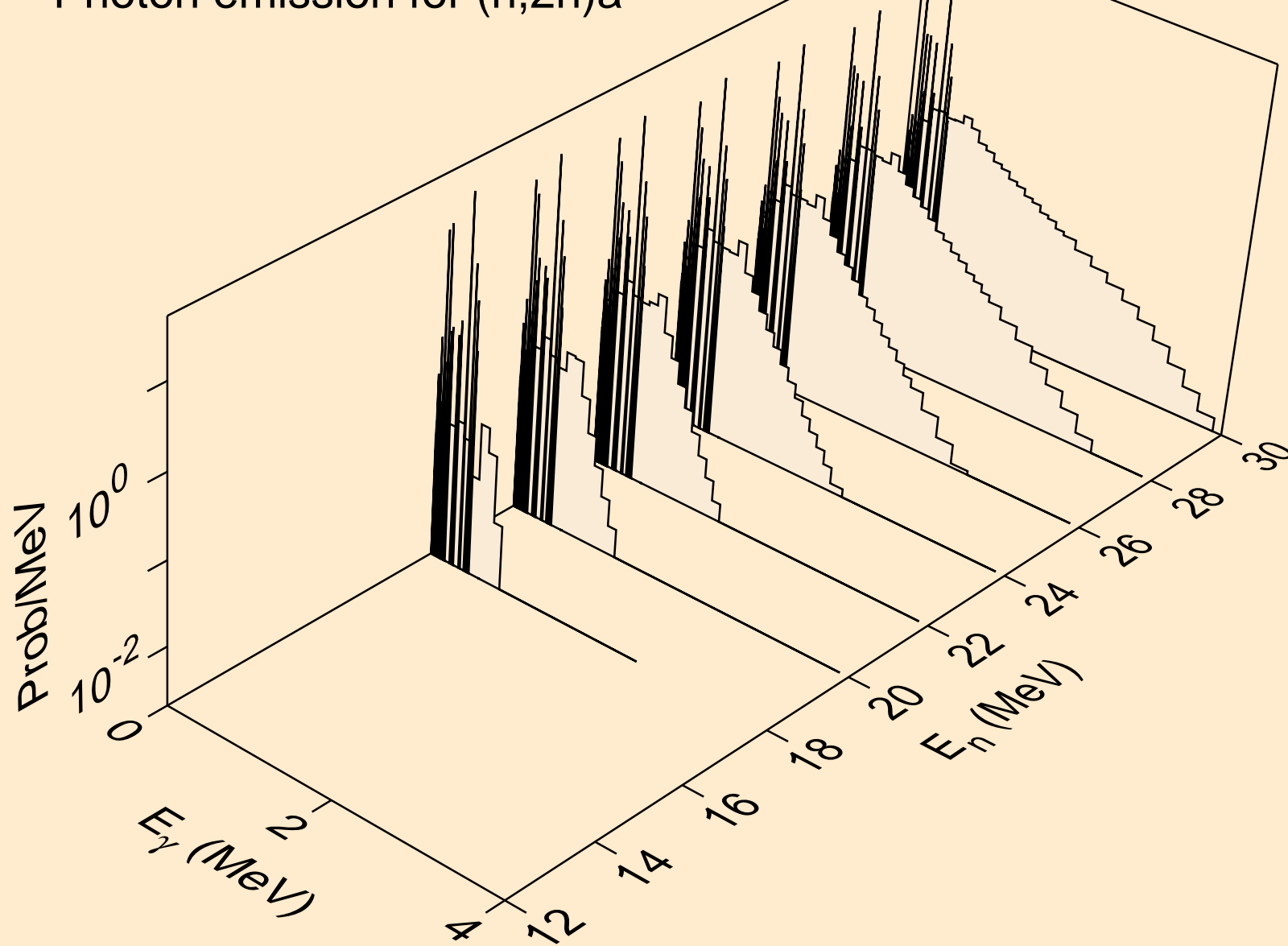

TC107 NEUTRON ACER TENDL-2024 LIBRARY; T=0.K  
Photon emission for (n,3n)a

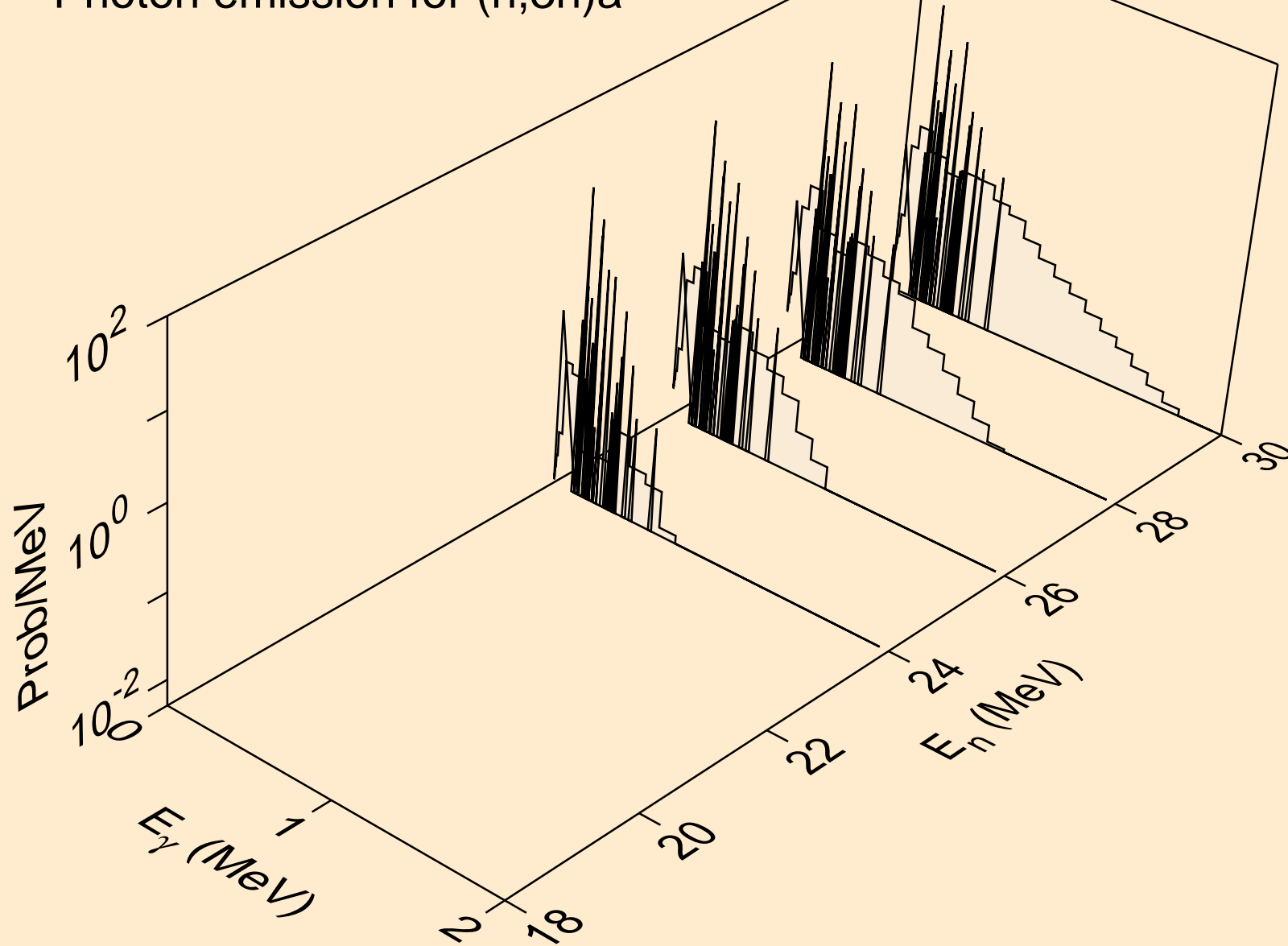

TC107 NEUTRON ACER TENDL-2024 LIBRARY; T=0.K  
Photon emission for (n,n\*)p

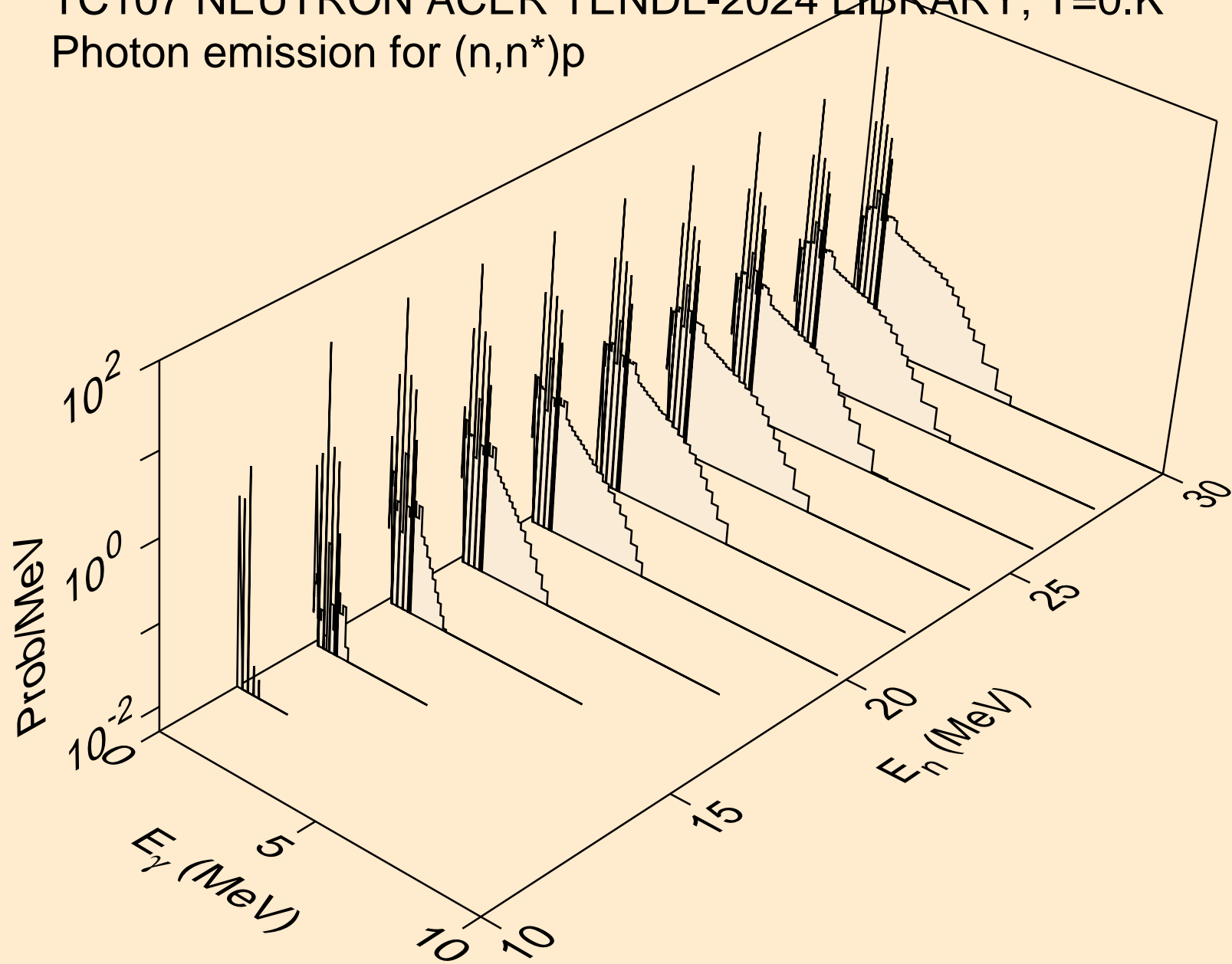

TC107 NEUTRON ACER TENDL-2024 LIBRARY; T=0.K  
Photon emission for (n,n\*)d

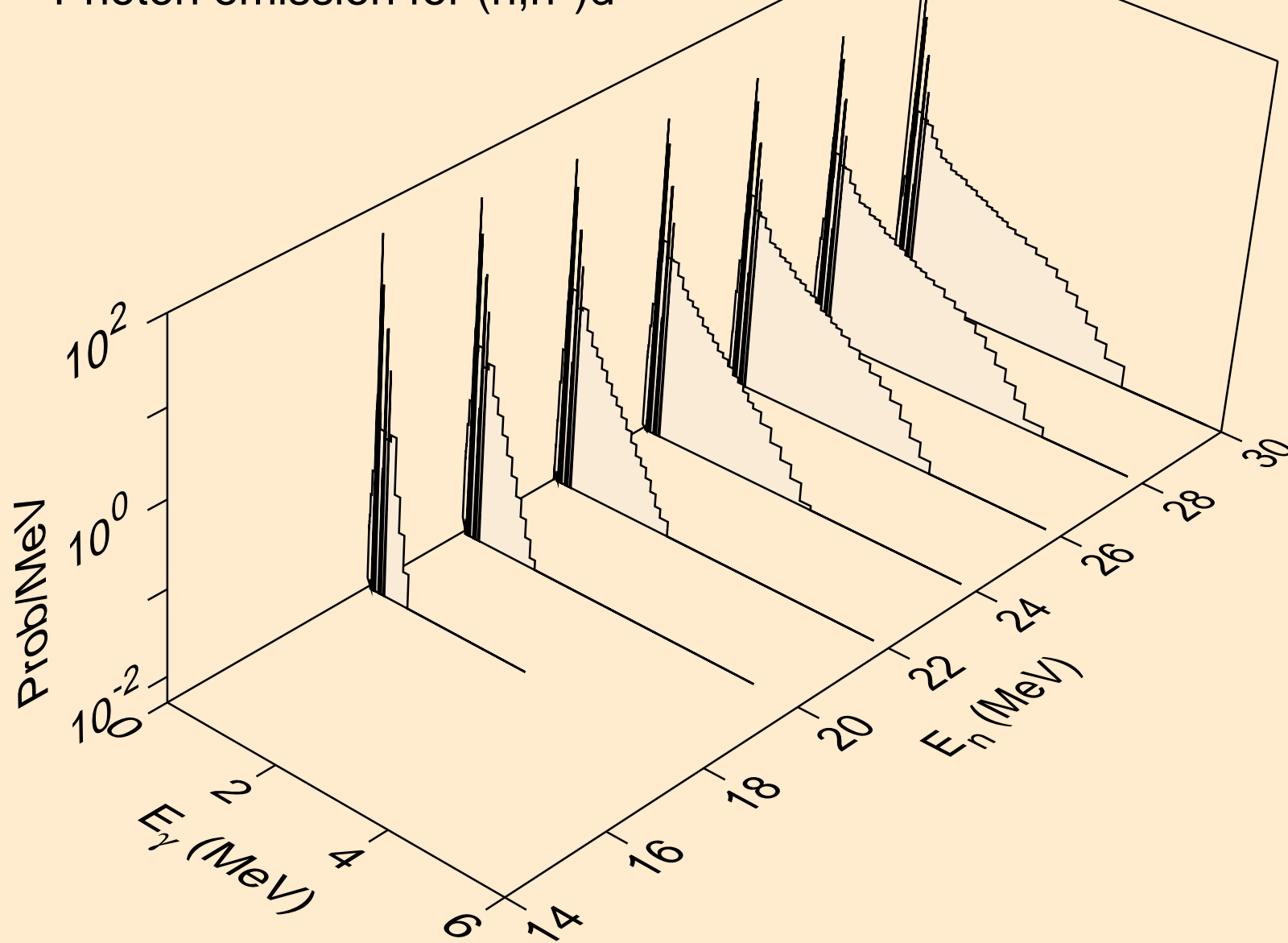



TC107 NEUTRON ACER TENDL-2024 LIBRARY; T=0.K  
Photon emission for (n,n\*)t

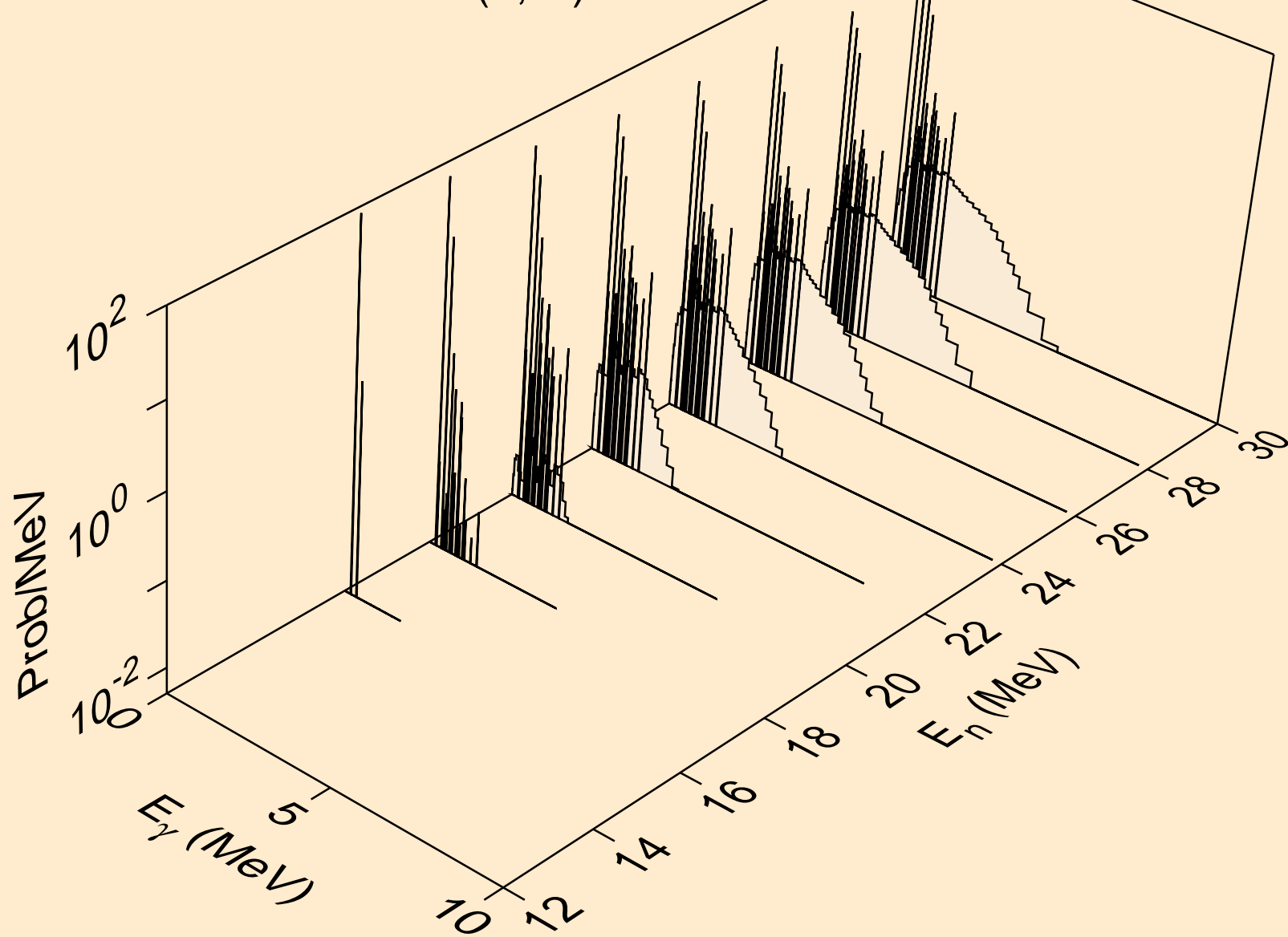

TC107 NEUTRON ACER TENDL-2024 LIBRARY; T=0.K  
Photon emission for (n,n\*)he3

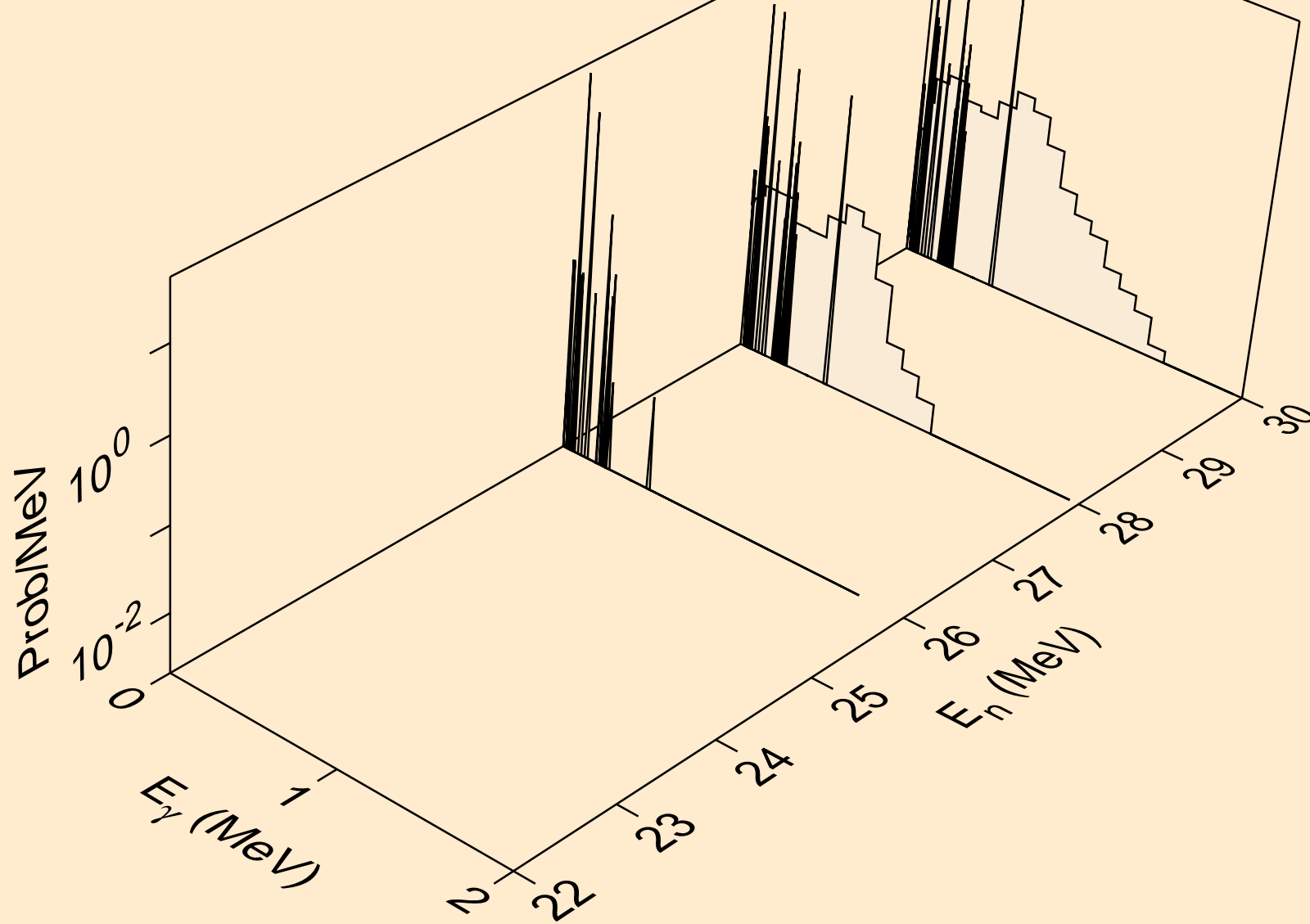

TC107 NEUTRON ACER TENDL-2024 LIBRARY; T=0.K  
Photon emission for (n,4n)

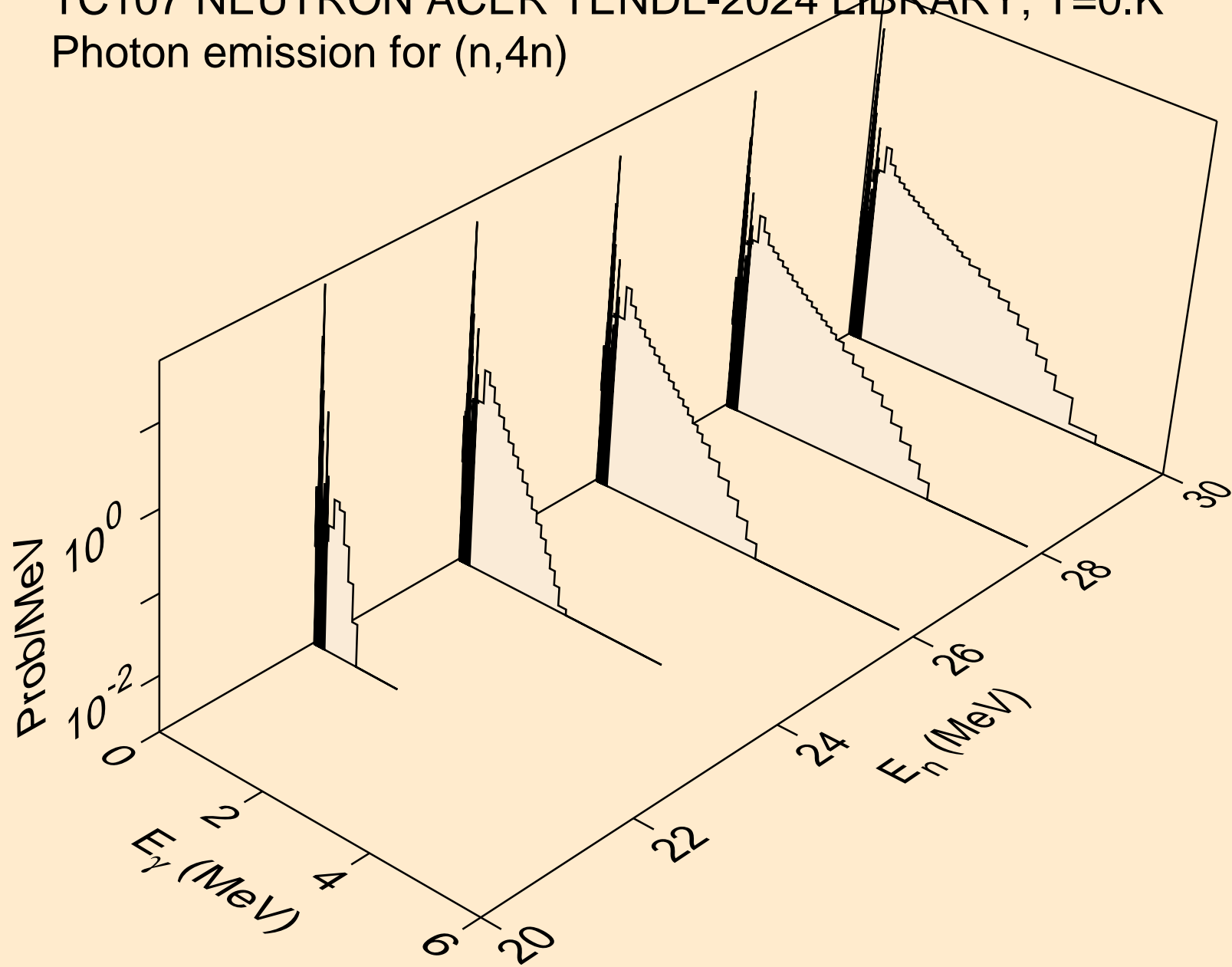

TC107 NEUTRON ACER TENDL-2024 LIBRARY; T=0.K  
Photon emission for (n,2np)

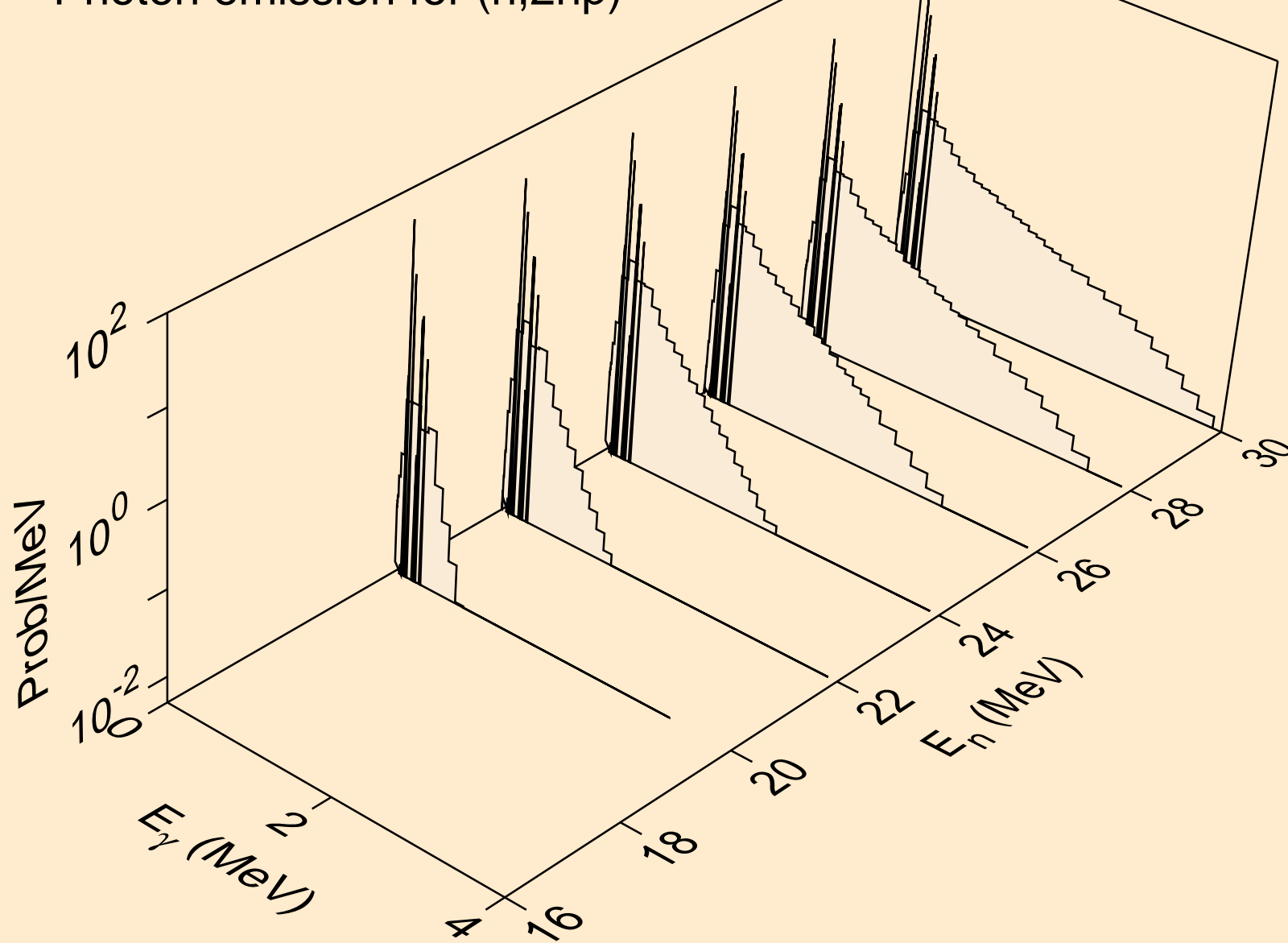

TC107 NEUTRON ACER TENDL-2024 LIBRARY; T=0.K  
Photon emission for (n,3np)

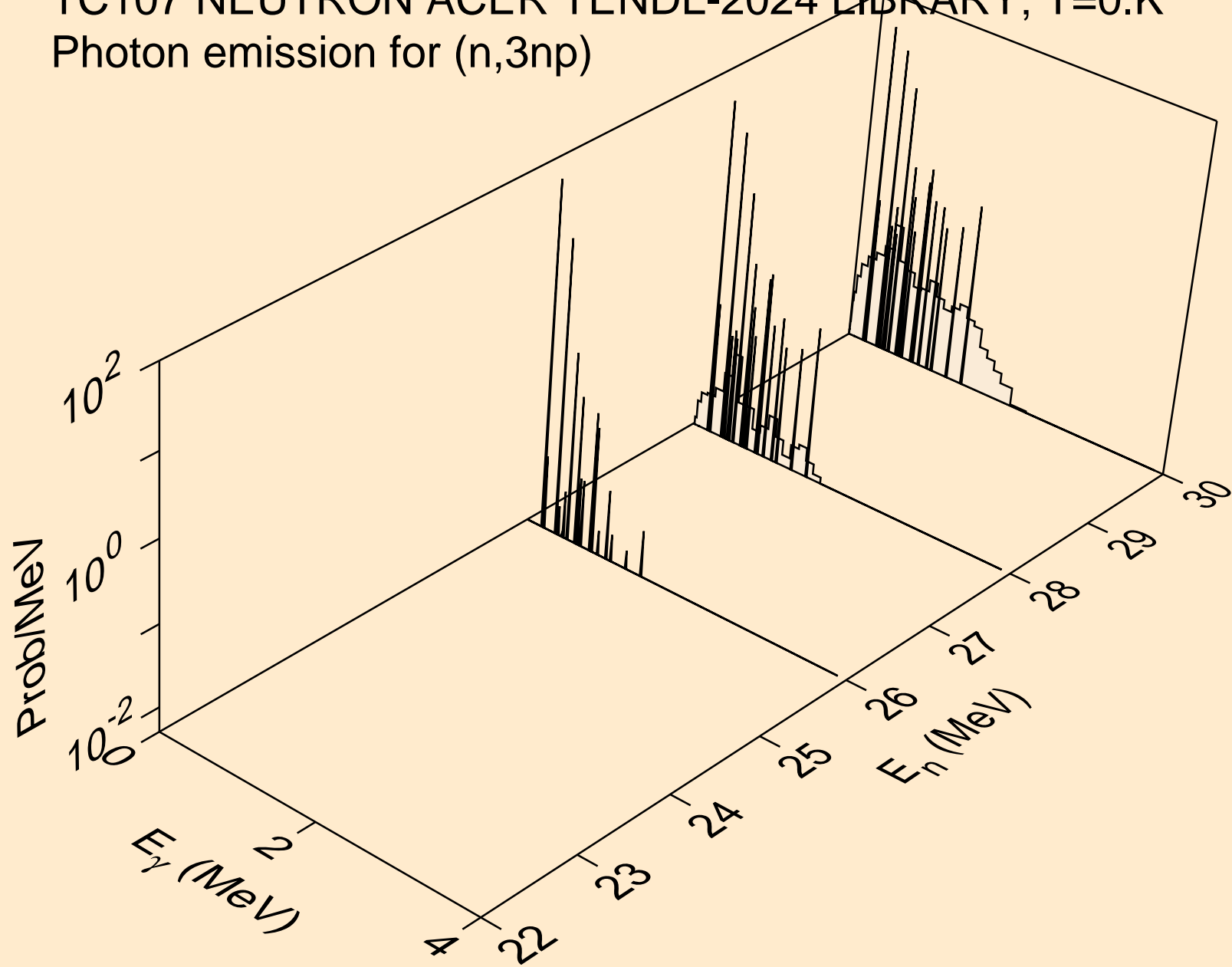

TC107 NEUTRON ACER TENDL-2024 LIBRARY; T=0.K  
Photon emission for (n,n\*c)

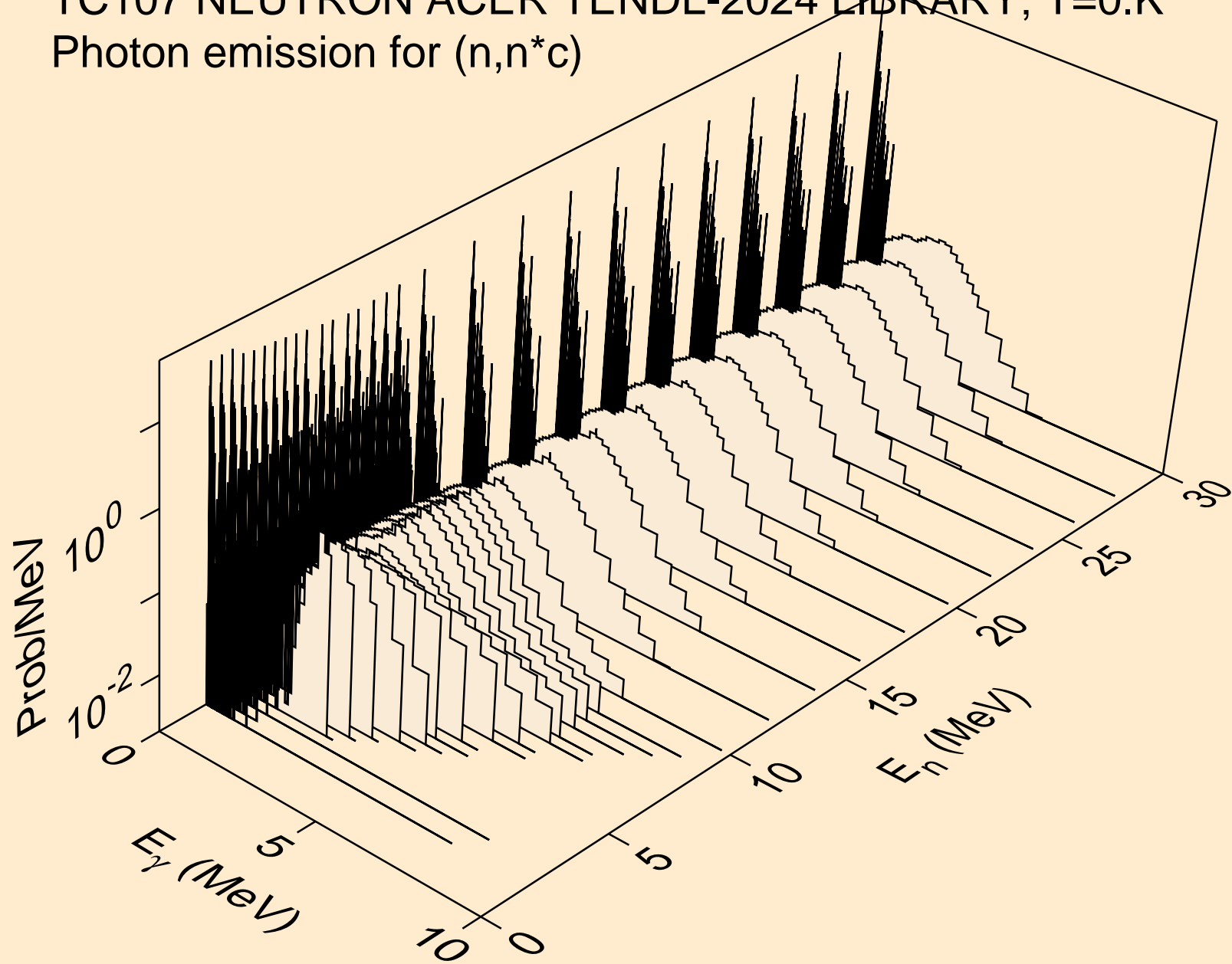

TC107 NEUTRON ACER TENDL-2024 LIBRARY; T=0.K  
Photon emission for (n,gma)

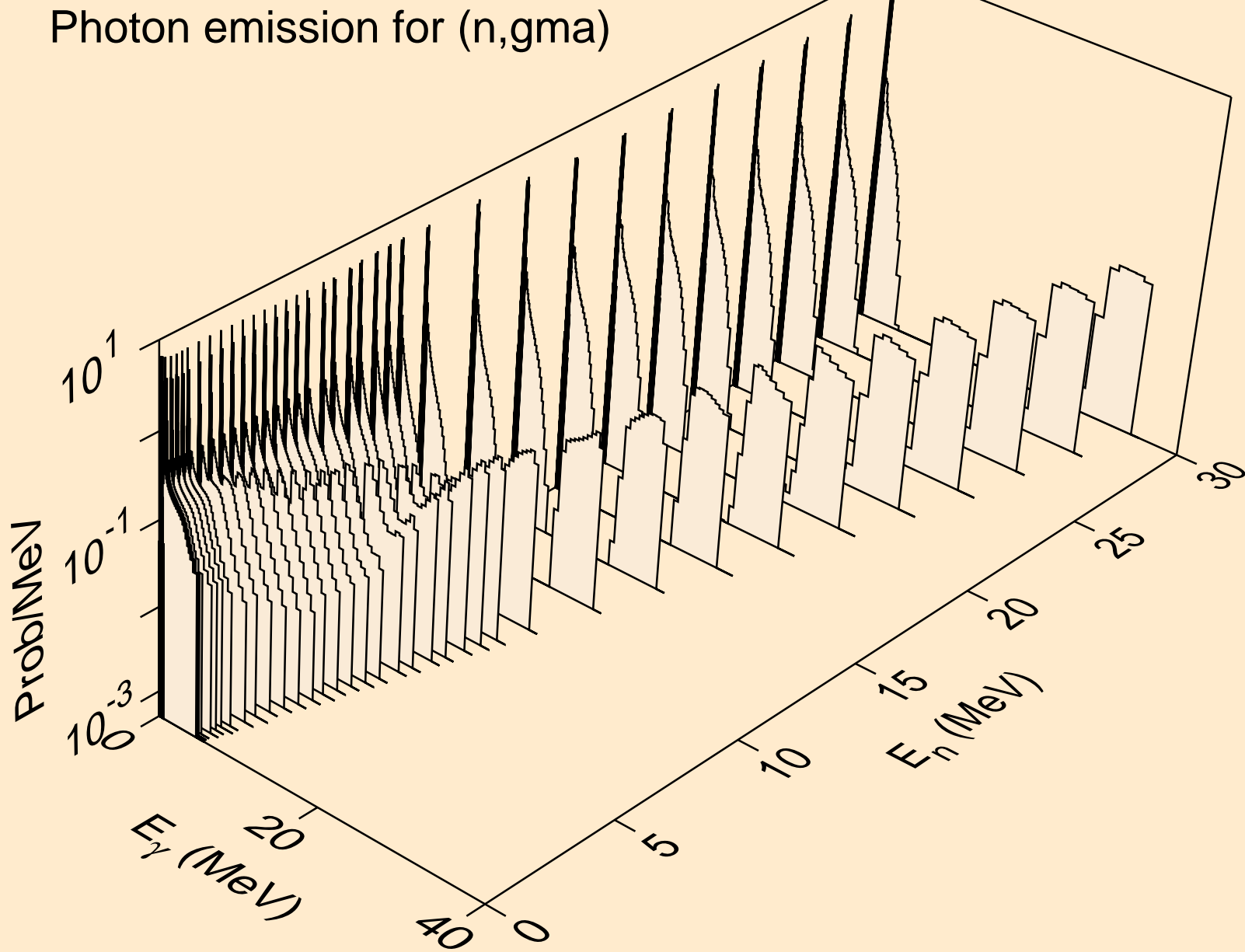

TC107 NEUTRON ACER TENDL-2024 LIBRARY; T=0.K  
Photon emission for (n,p)

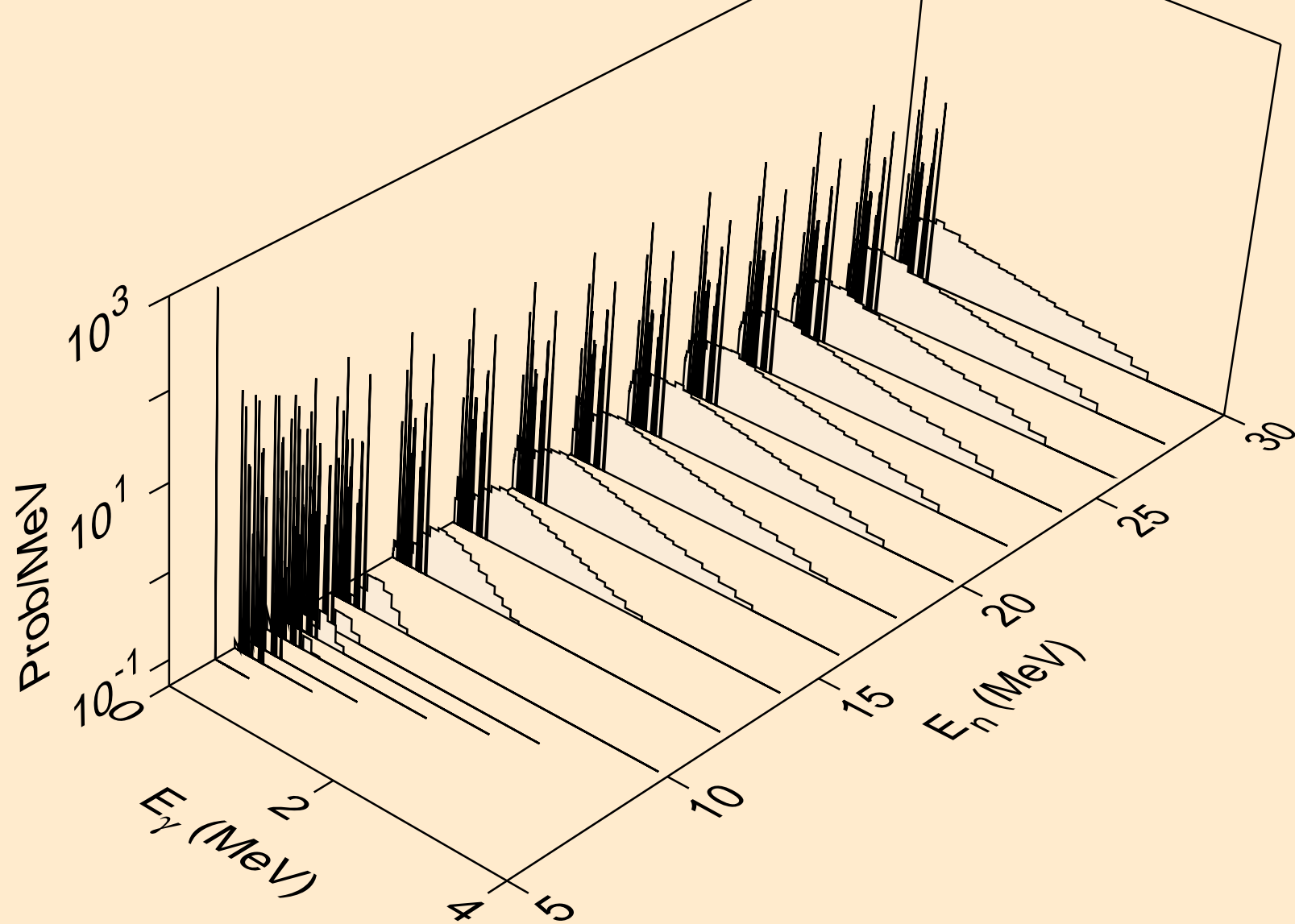



TC107 NEUTRON ACER TENDL-2024 LIBRARY; T=0.K  
Photon emission for (n,d)

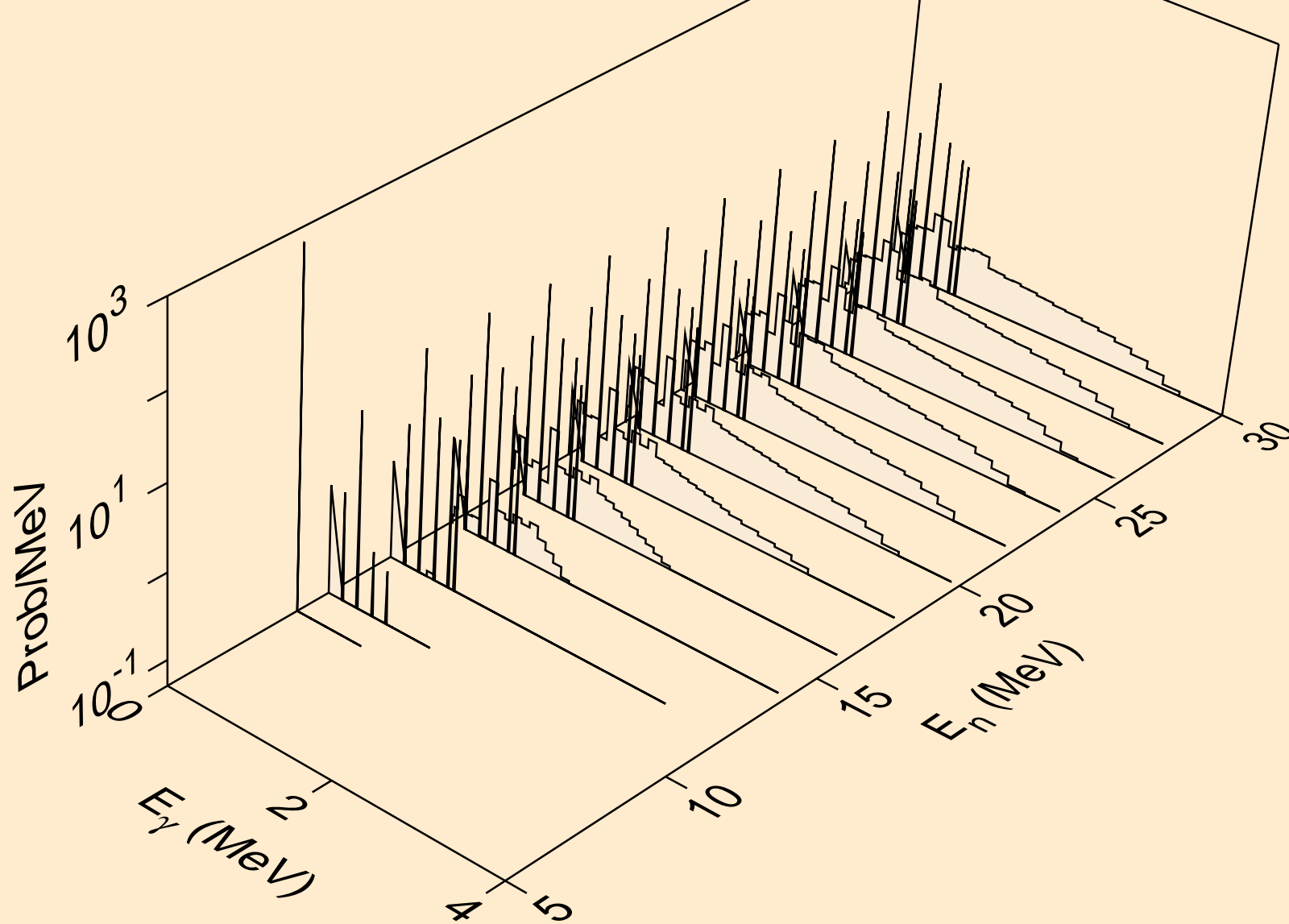

TC107 NEUTRON ACER TENDL-2024 LIBRARY; T=0.K  
Photon emission for (n,t)

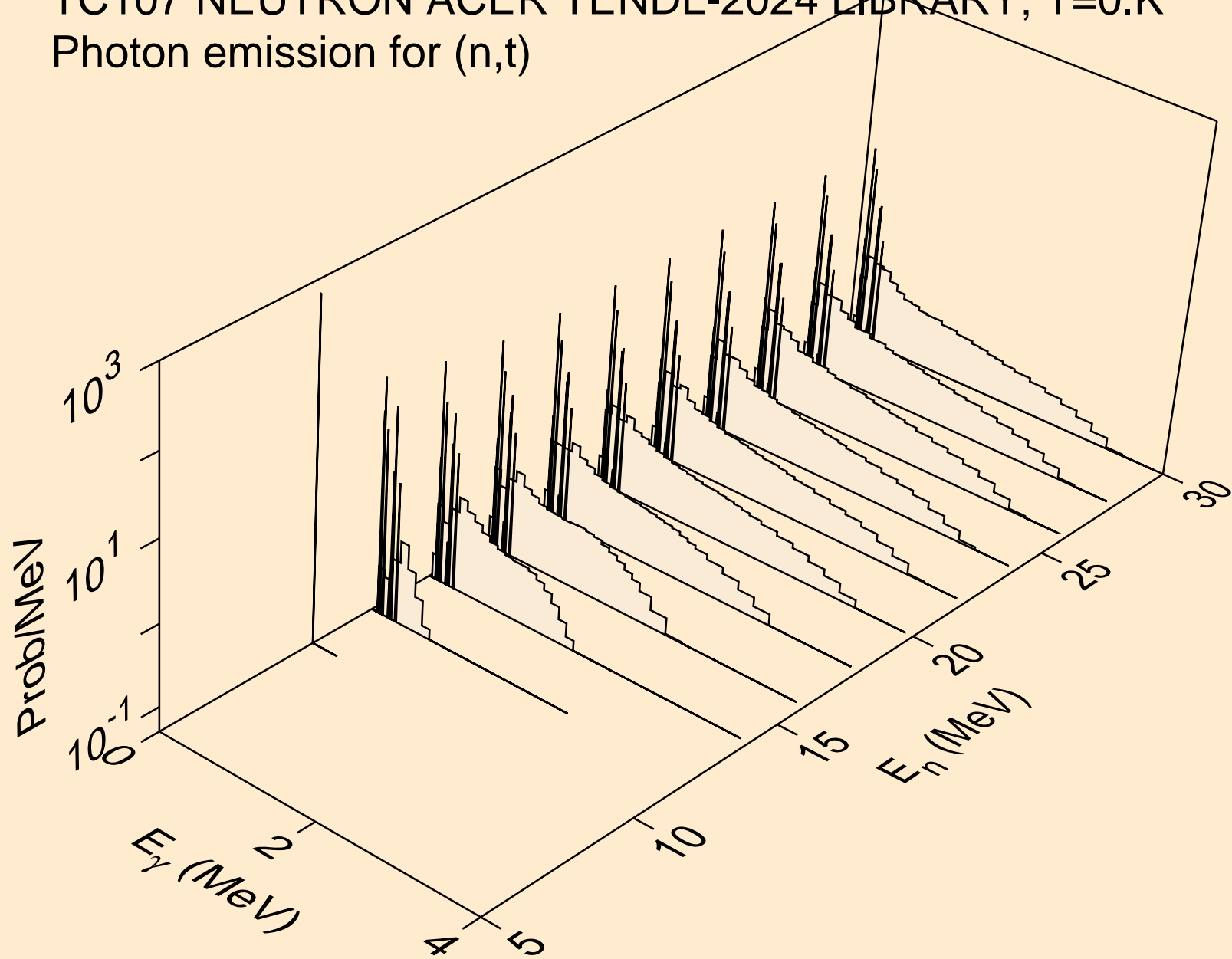

TC107 NEUTRON ACER TENDL-2024 LIBRARY; T=0.K  
Photon emission for (n,he3)

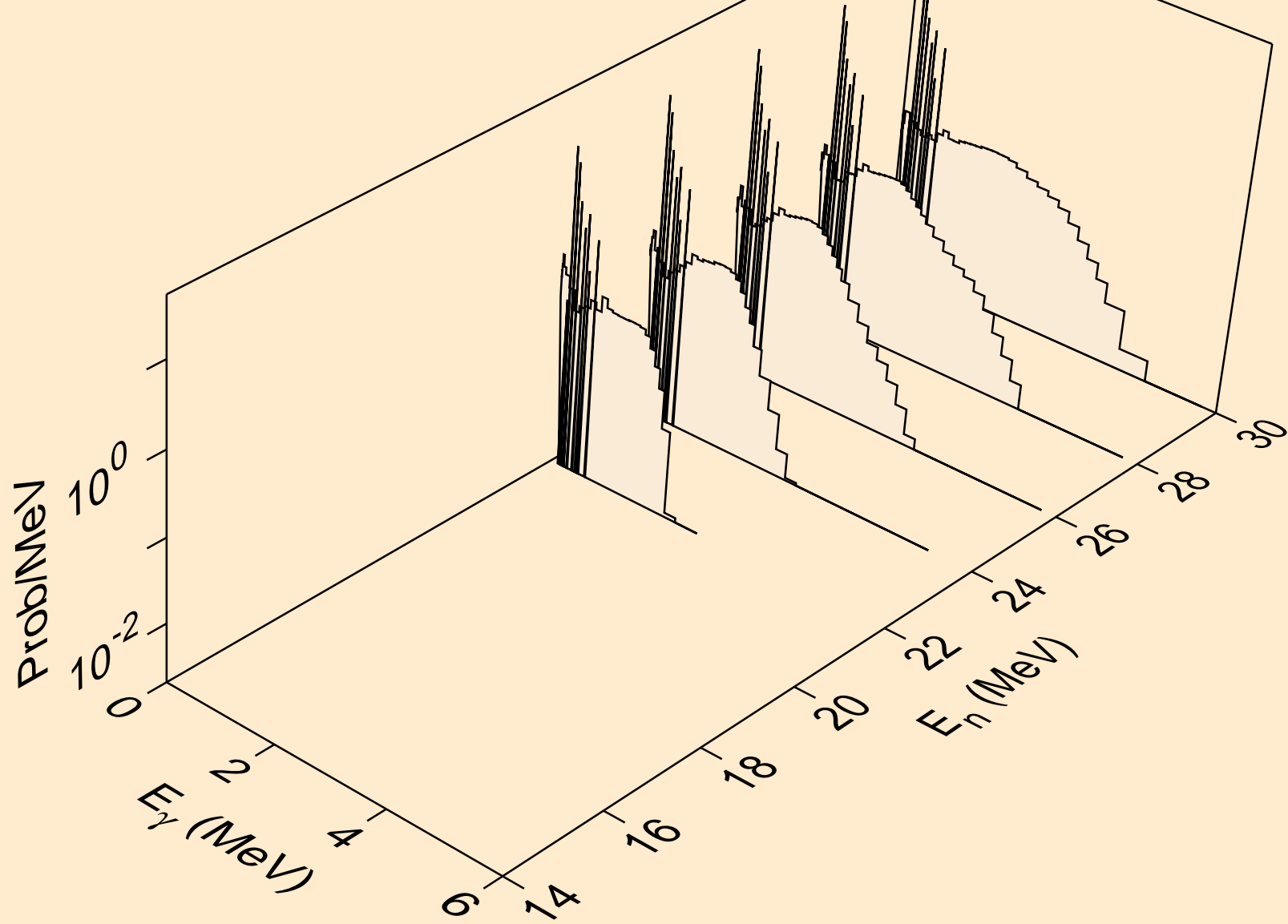

TC107 NEUTRON ACER TENDL-2024 LIBRARY; T=0.K  
Photon emission for (n,a)

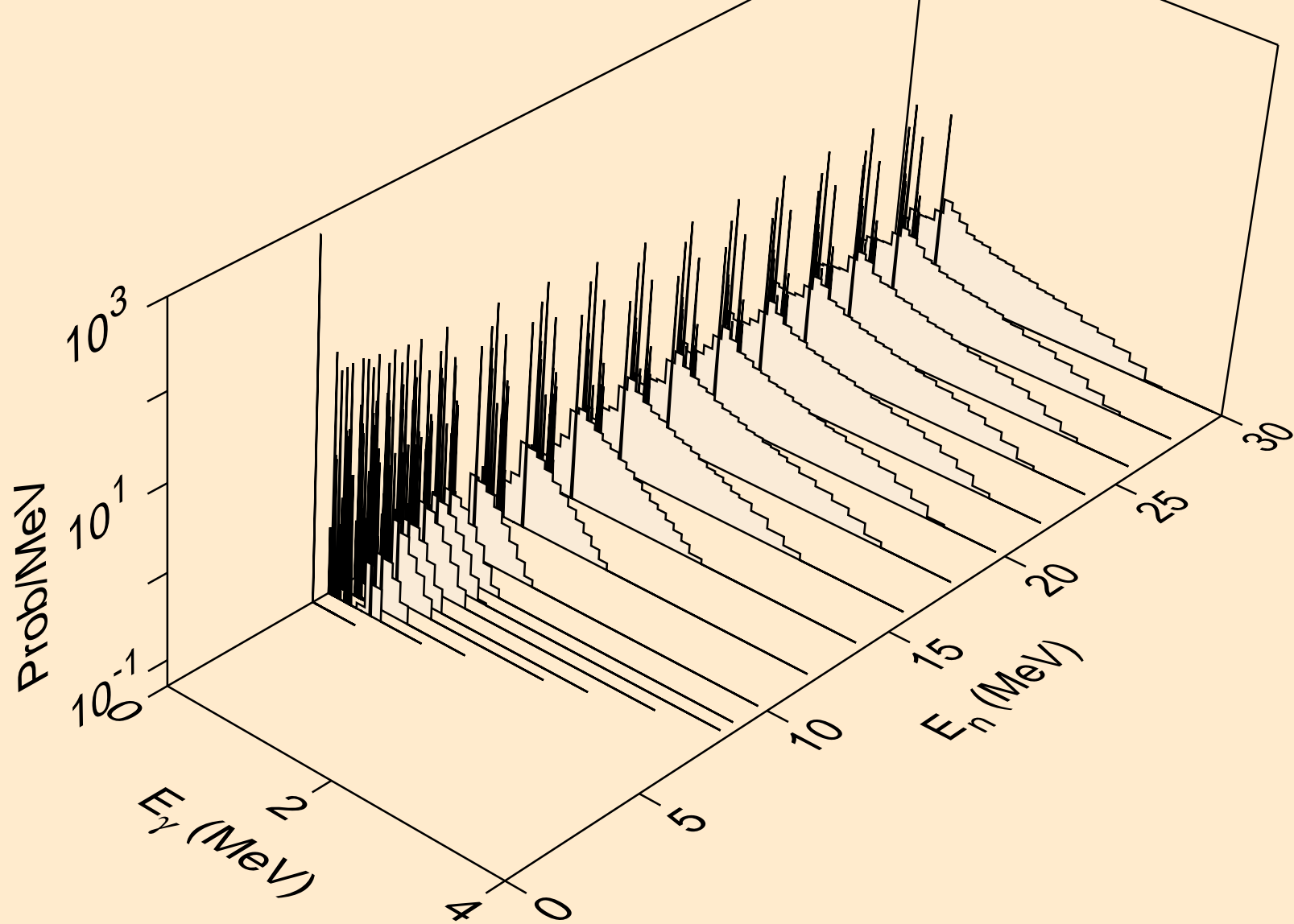

TC107 NEUTRON ACER TENDL-2024 LIBRARY; T=0.K  
thermal capture photon spectrum

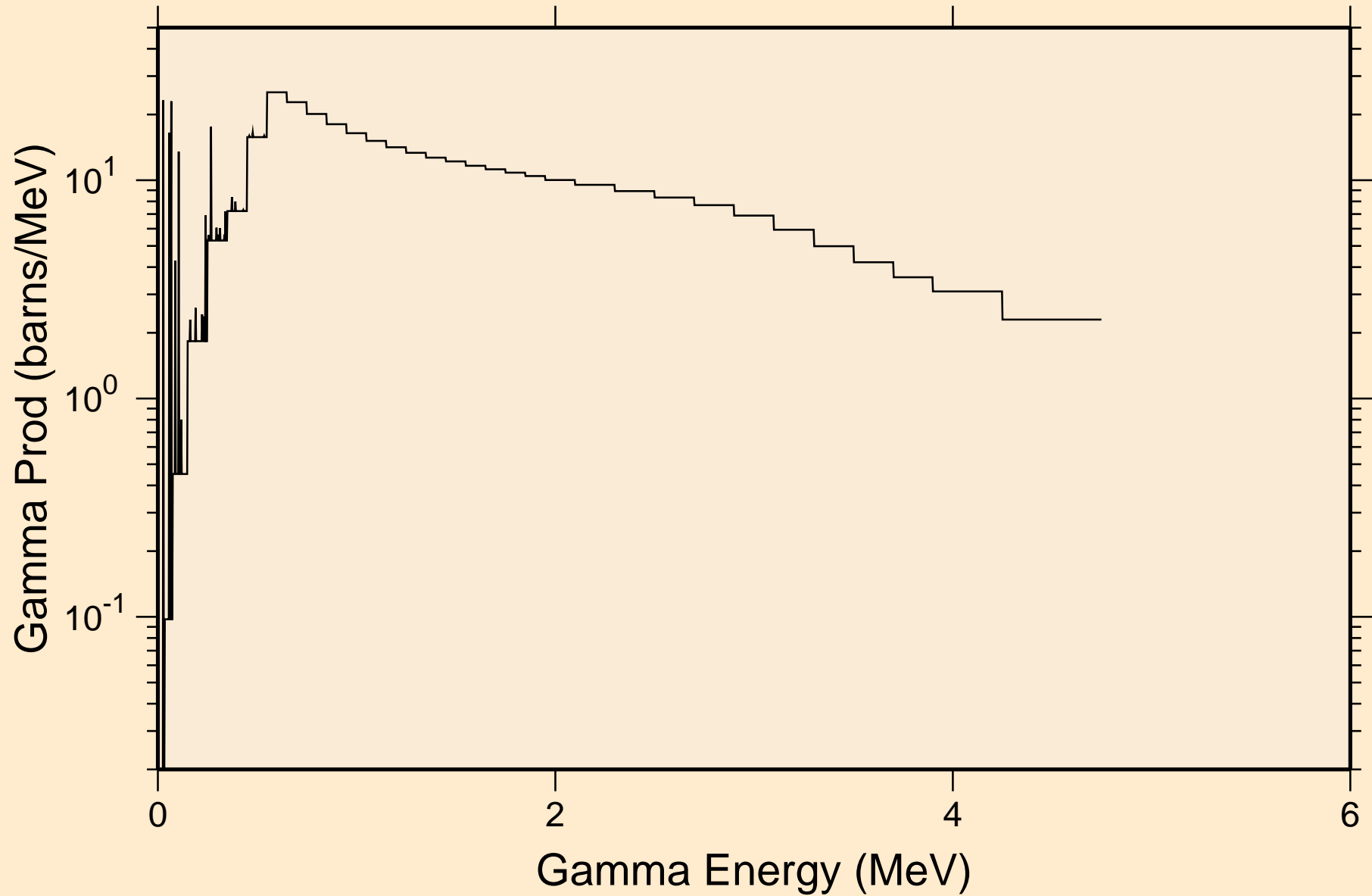

TC107 NEUTRON ACER TENDL-2024 LIBRARY; T=0.K  
14 MeV photon spectrum

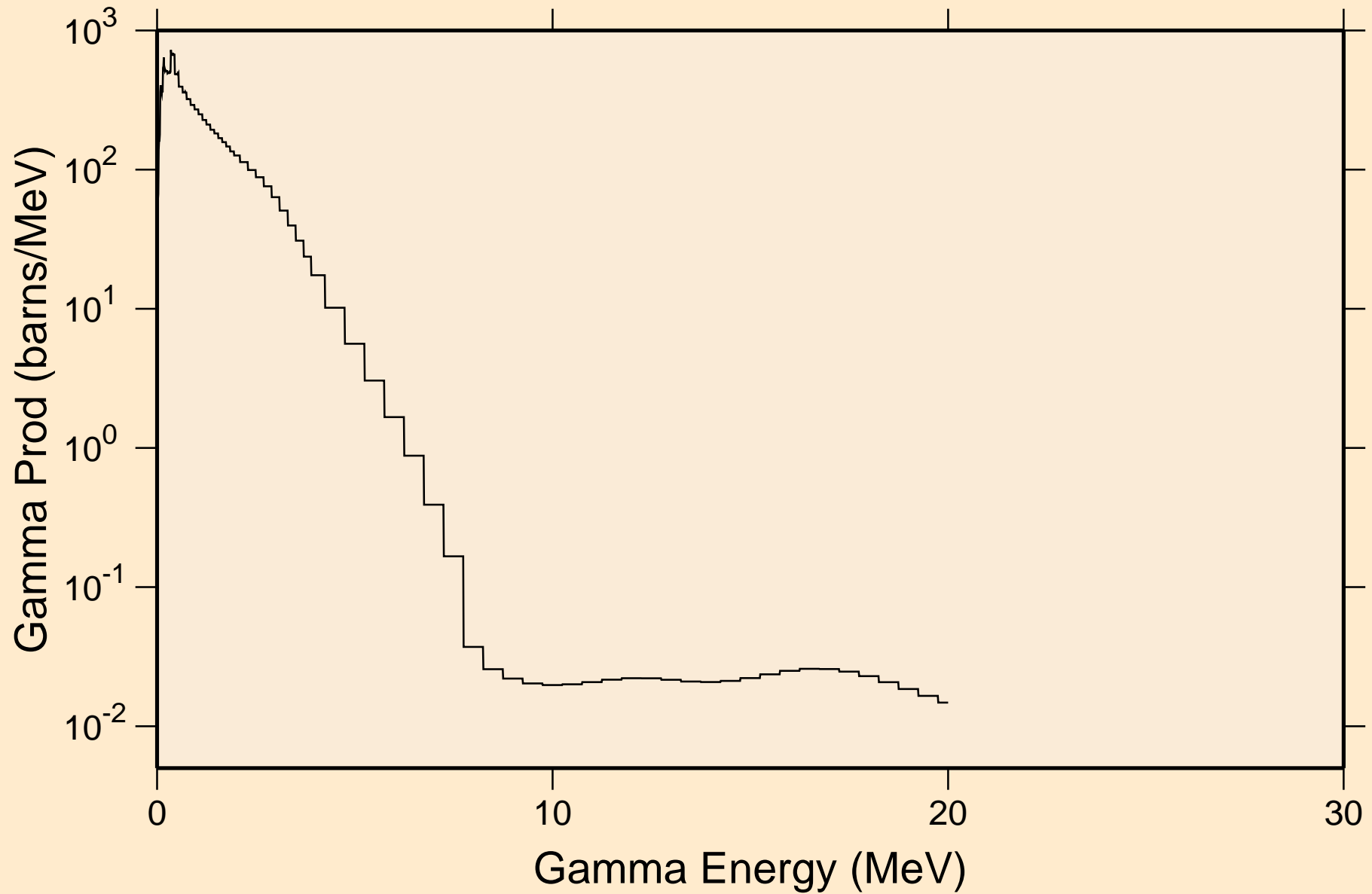

# TC107 NEUTRON ACER TENDL-2024 LIBRARY; T=0.K

## Particle heating contributions

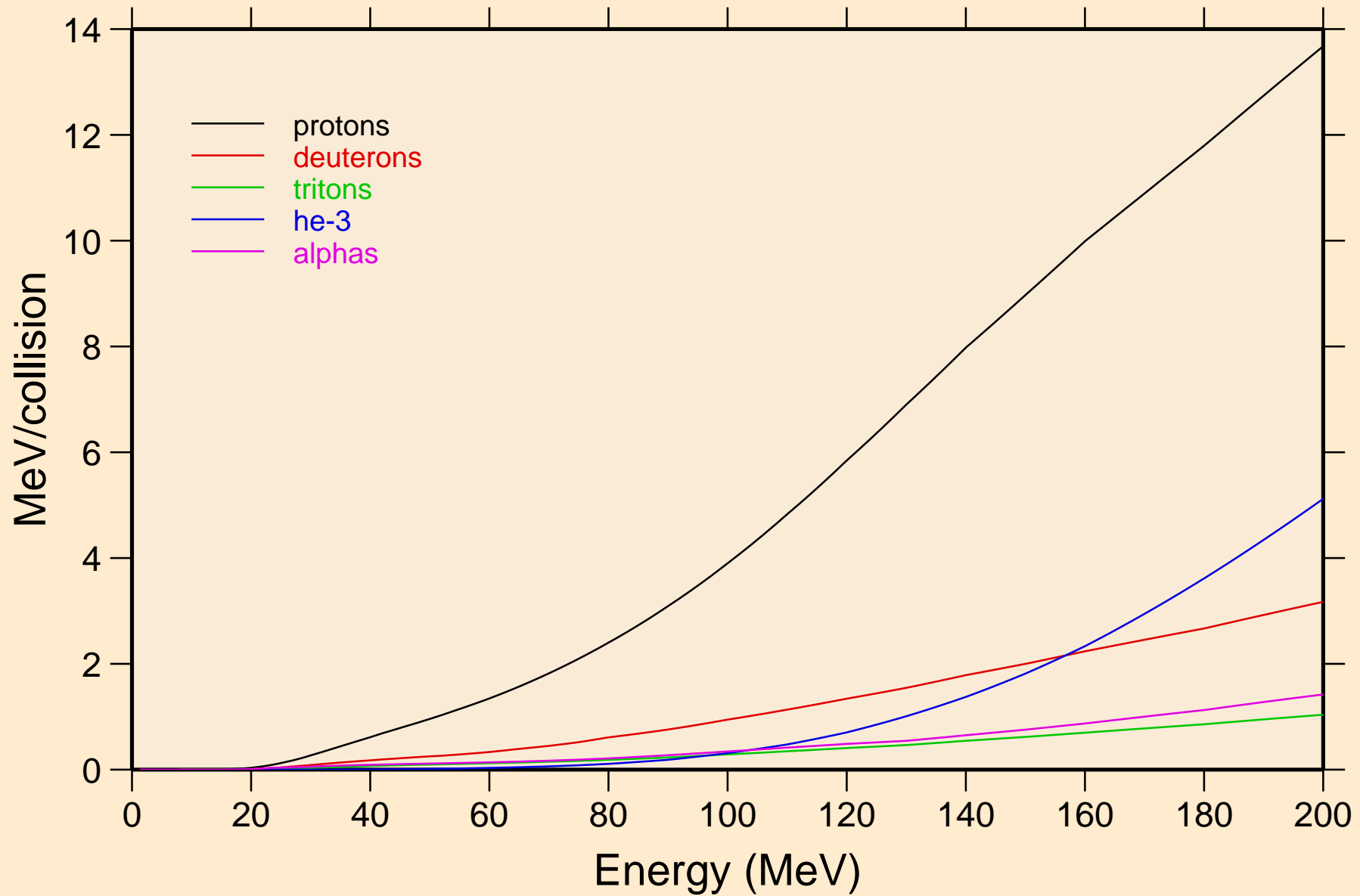

TC107 NEUTRON ACER TENDL-2024 LIBRARY; T=0.K  
Recoil Heating

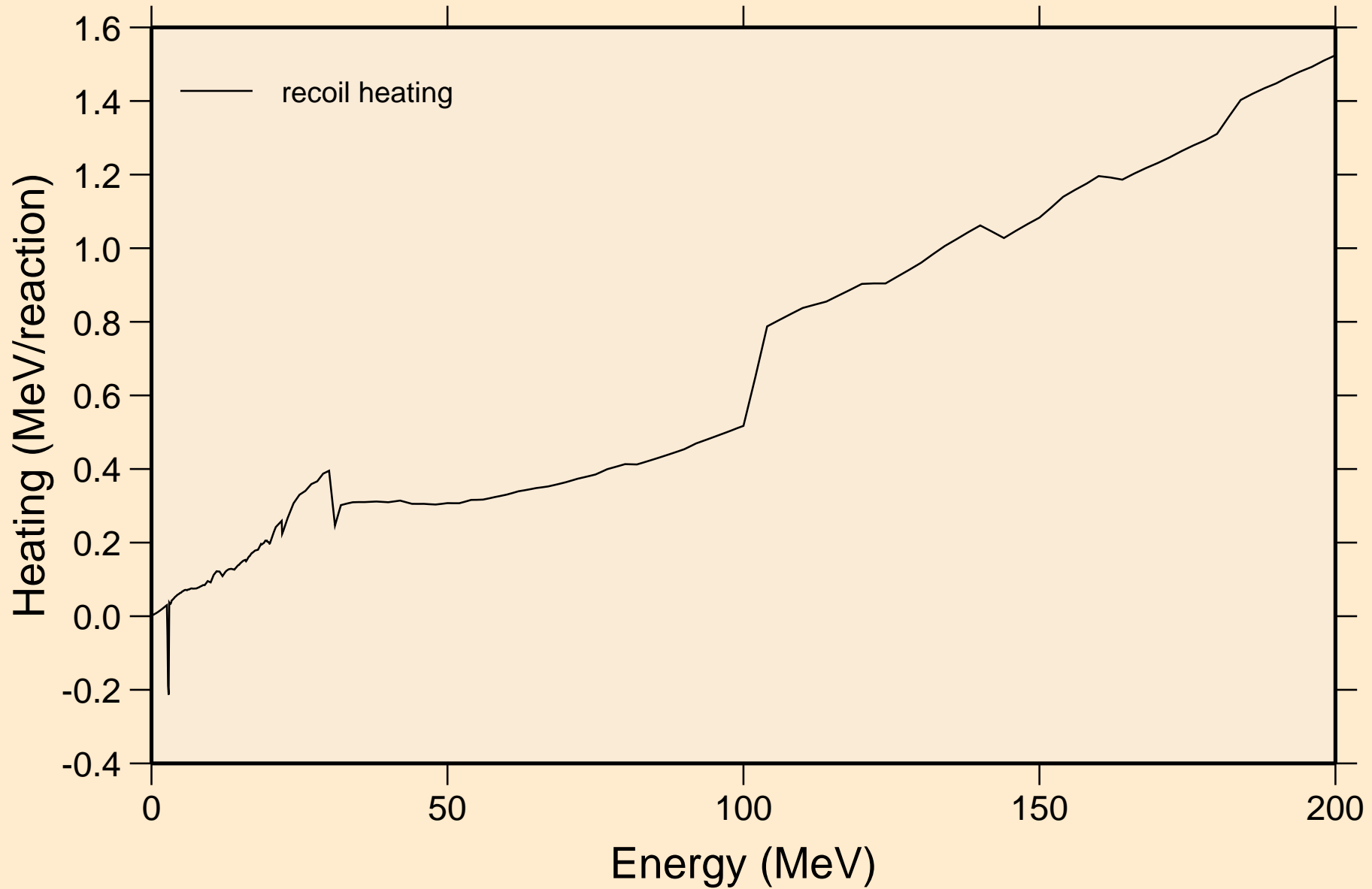



TC107 NEUTRON ACER TENDL-2024 LIBRARY; T=0.K  
Particle production cross sections

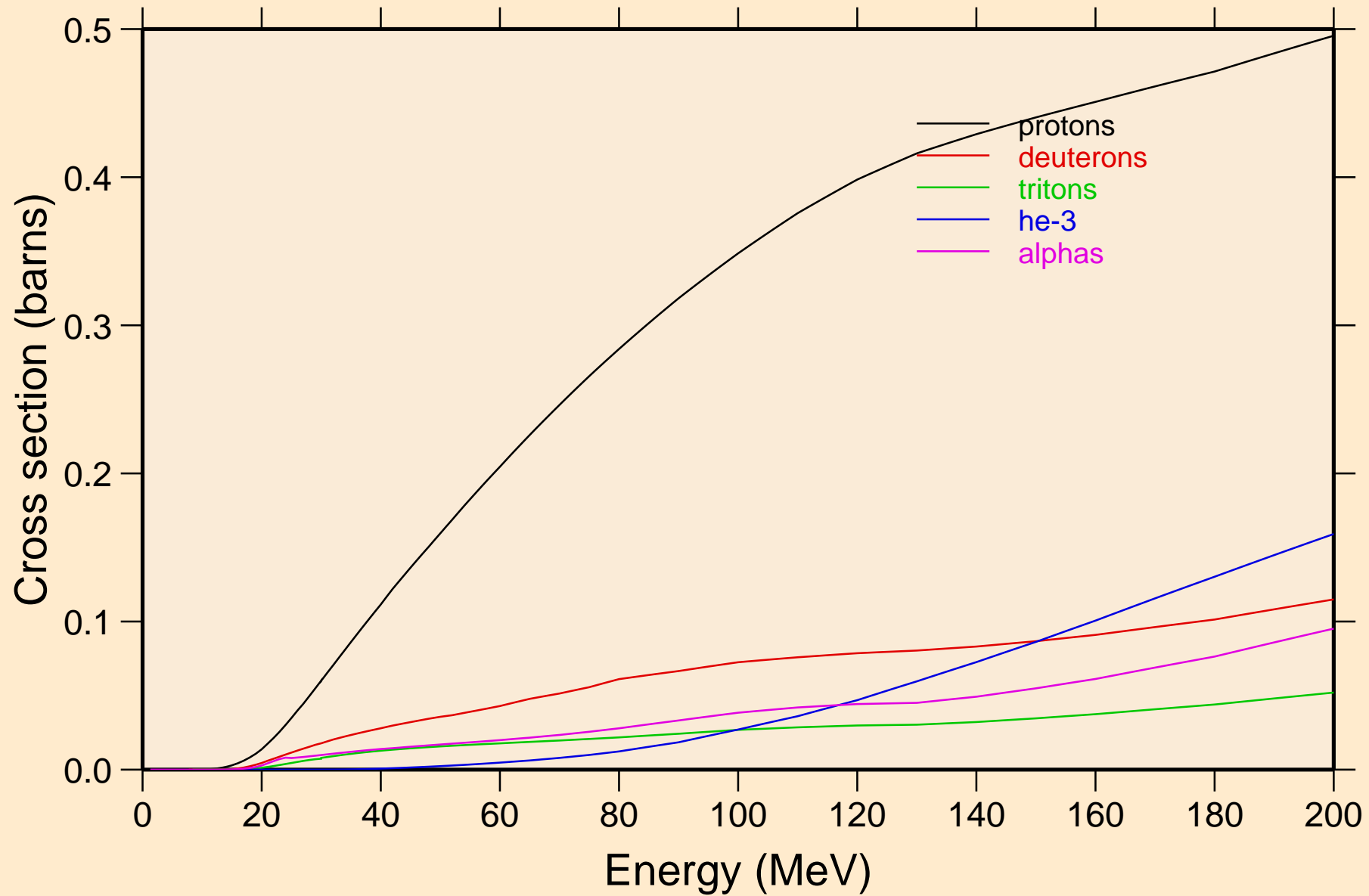

TC107 NEUTRON ACER TENDL-2024 LIBRARY; T=0.K  
protons from (n,x)

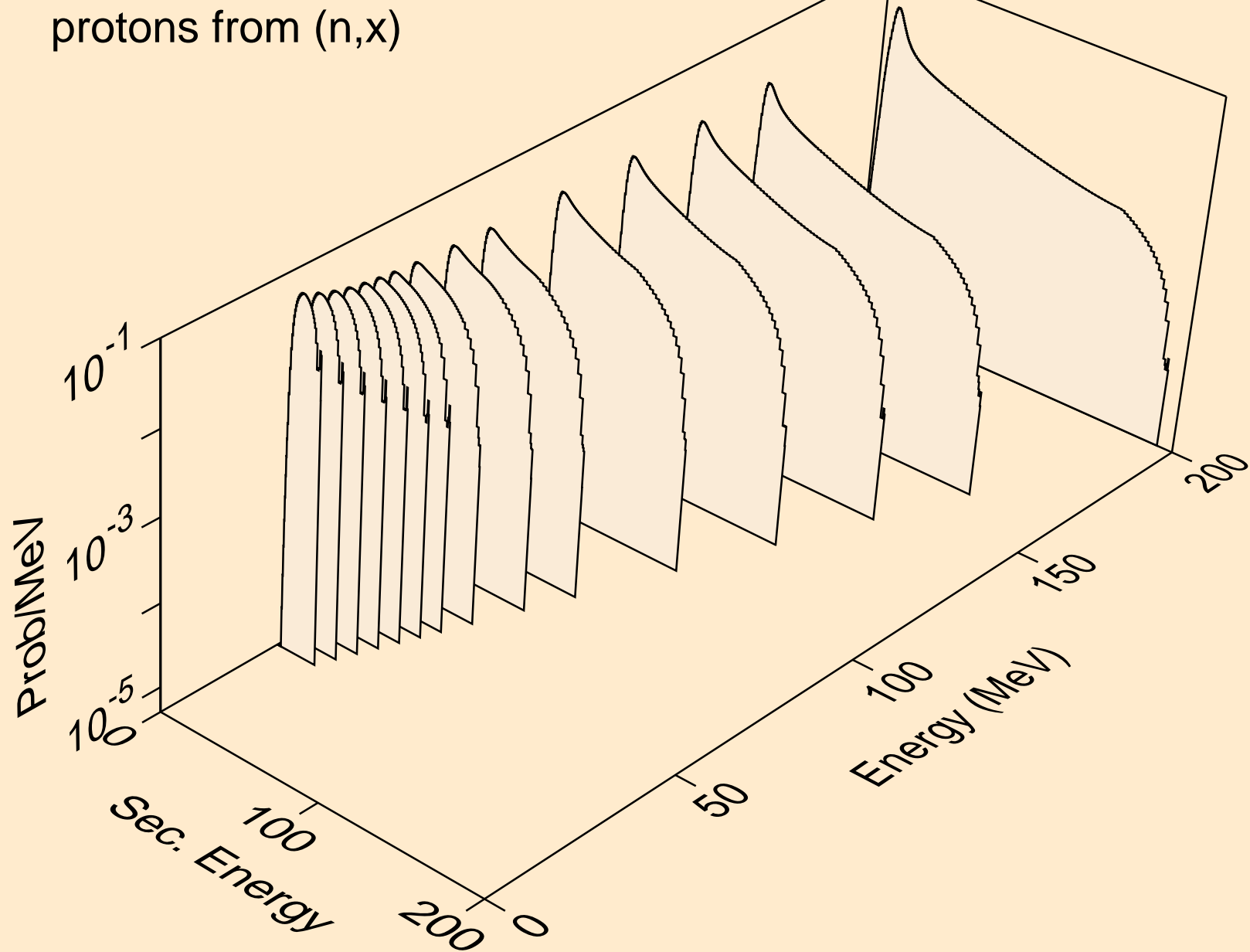

TC107 NEUTRON ACER TENDL-2024 LIBRARY; T=0.K  
protons from (n,n\*)p

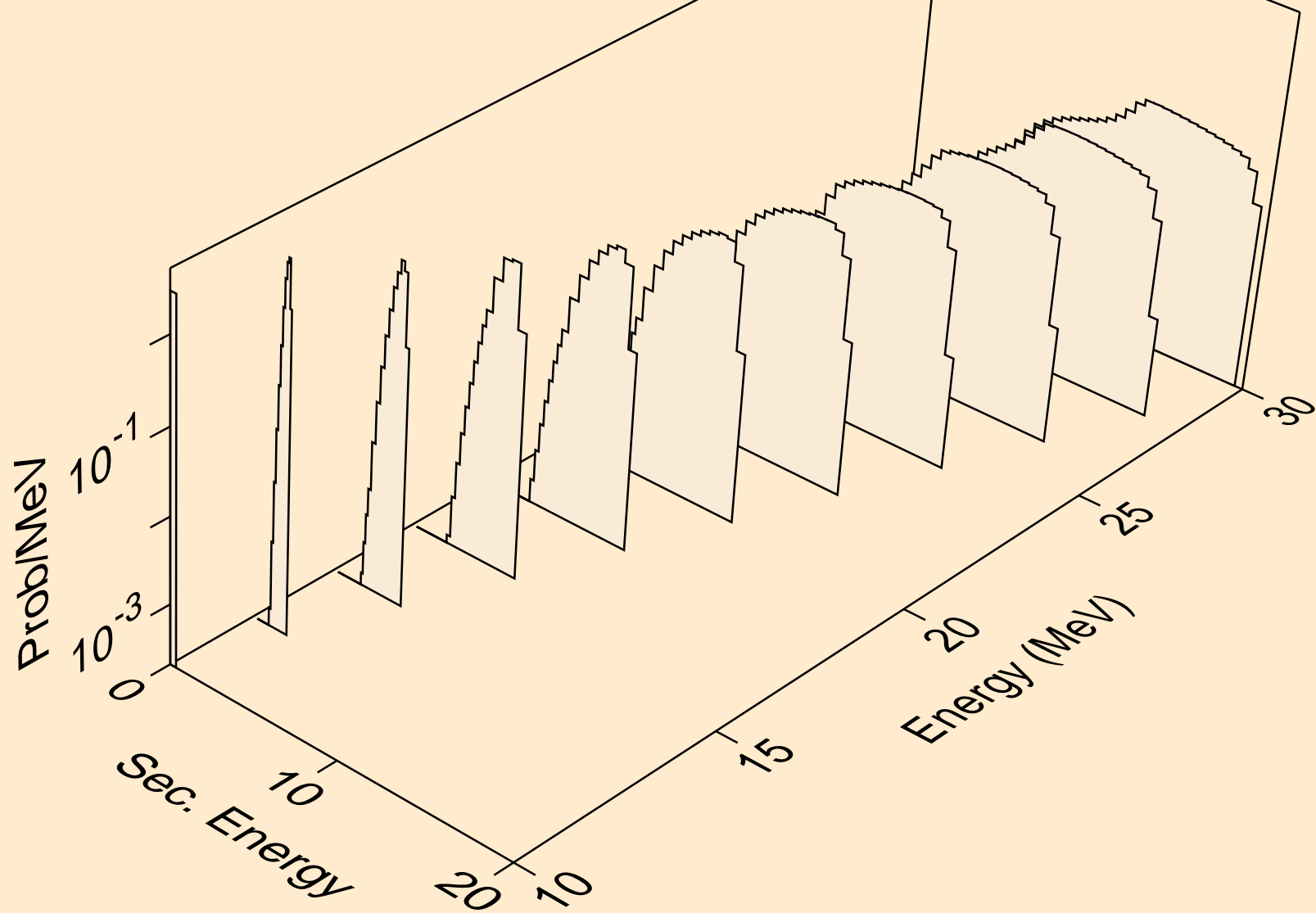

TC107 NEUTRON ACER TENDL-2024 LIBRARY; T=0.K  
protons from (n,2np)

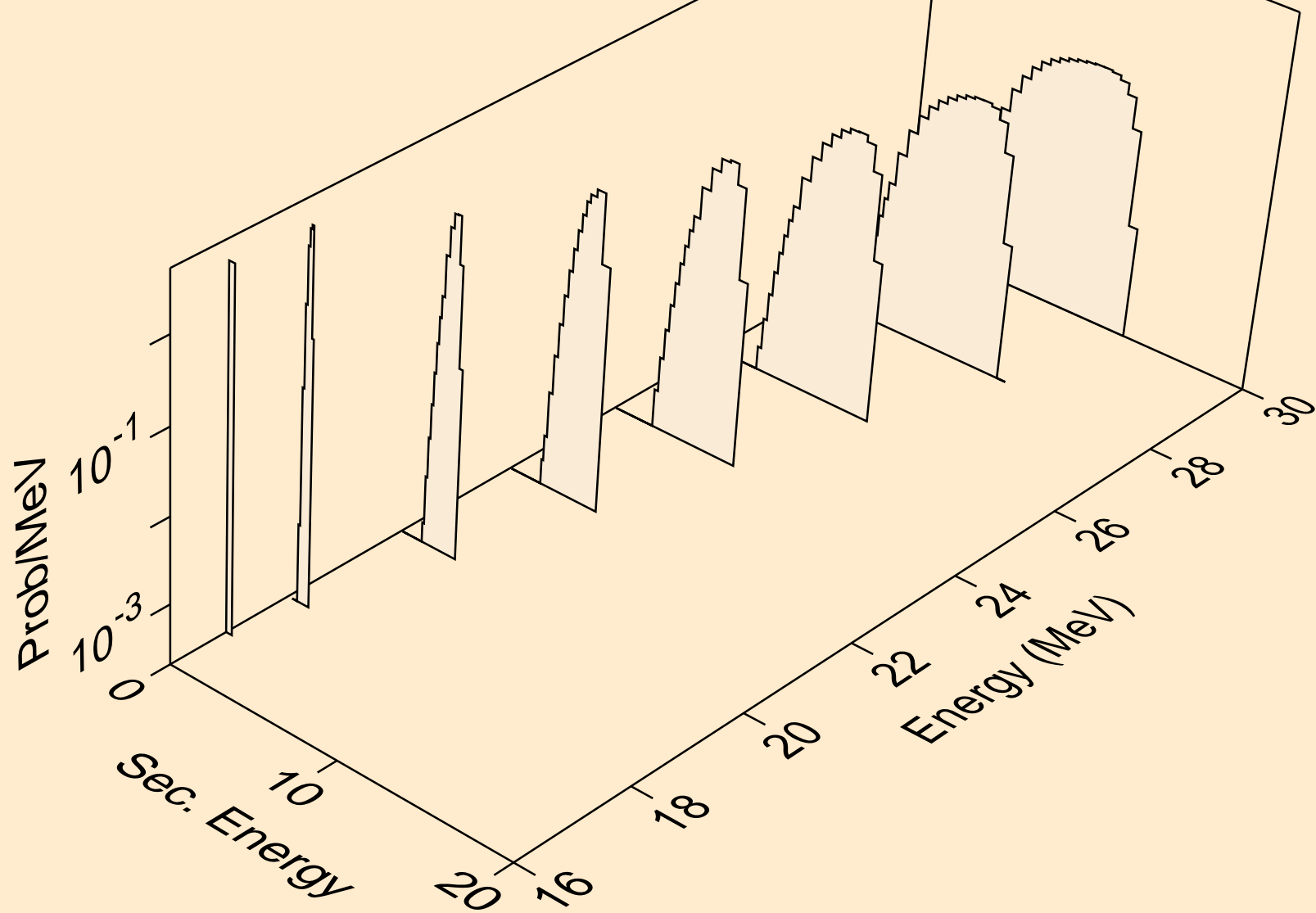

TC107 NEUTRON ACER TENDL-2024 LIBRARY; T=0.K  
protons from (n,3np)

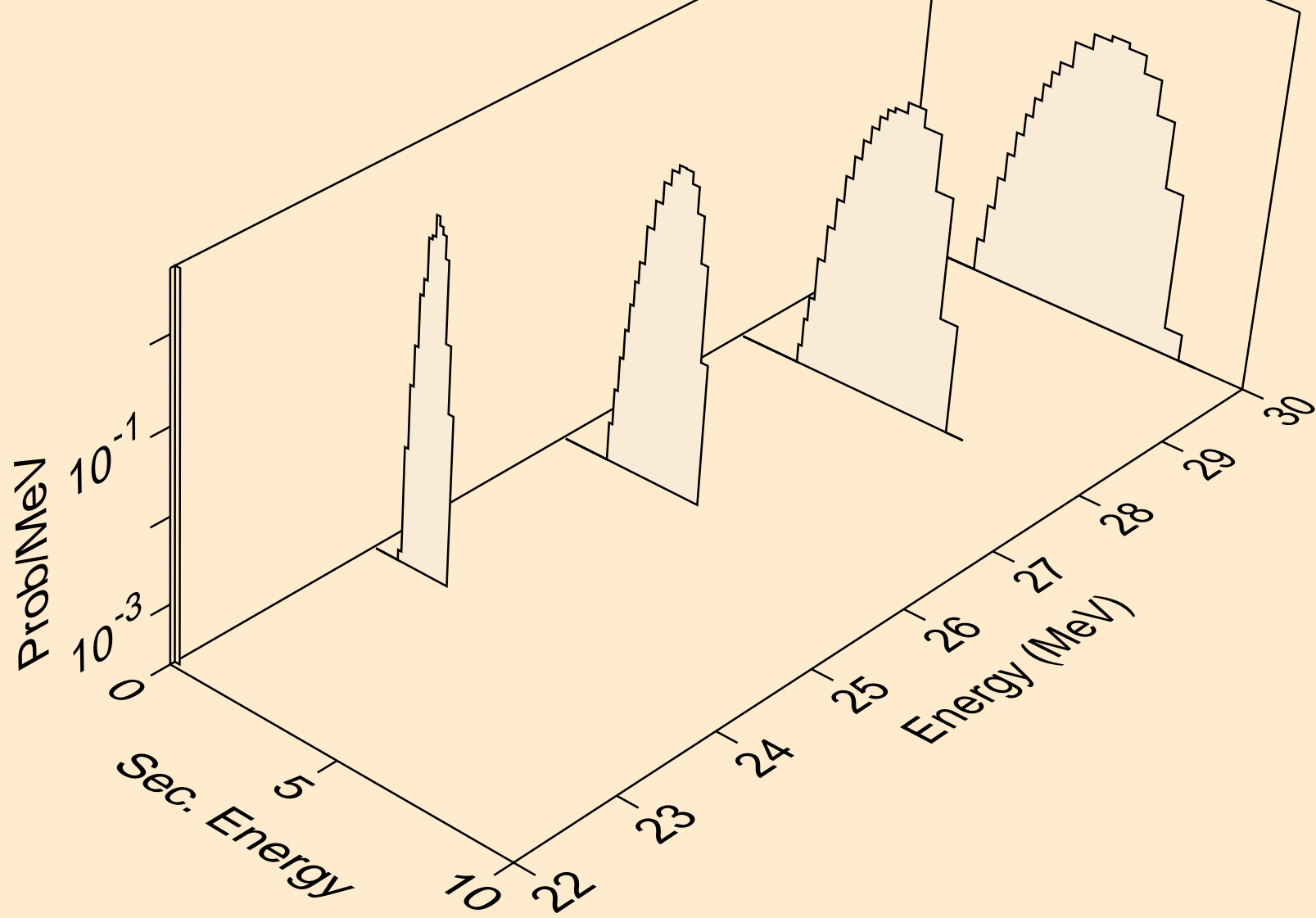

TC107 NEUTRON ACER TENDL-2024 LIBRARY; T=0.K  
protons from (n,p)

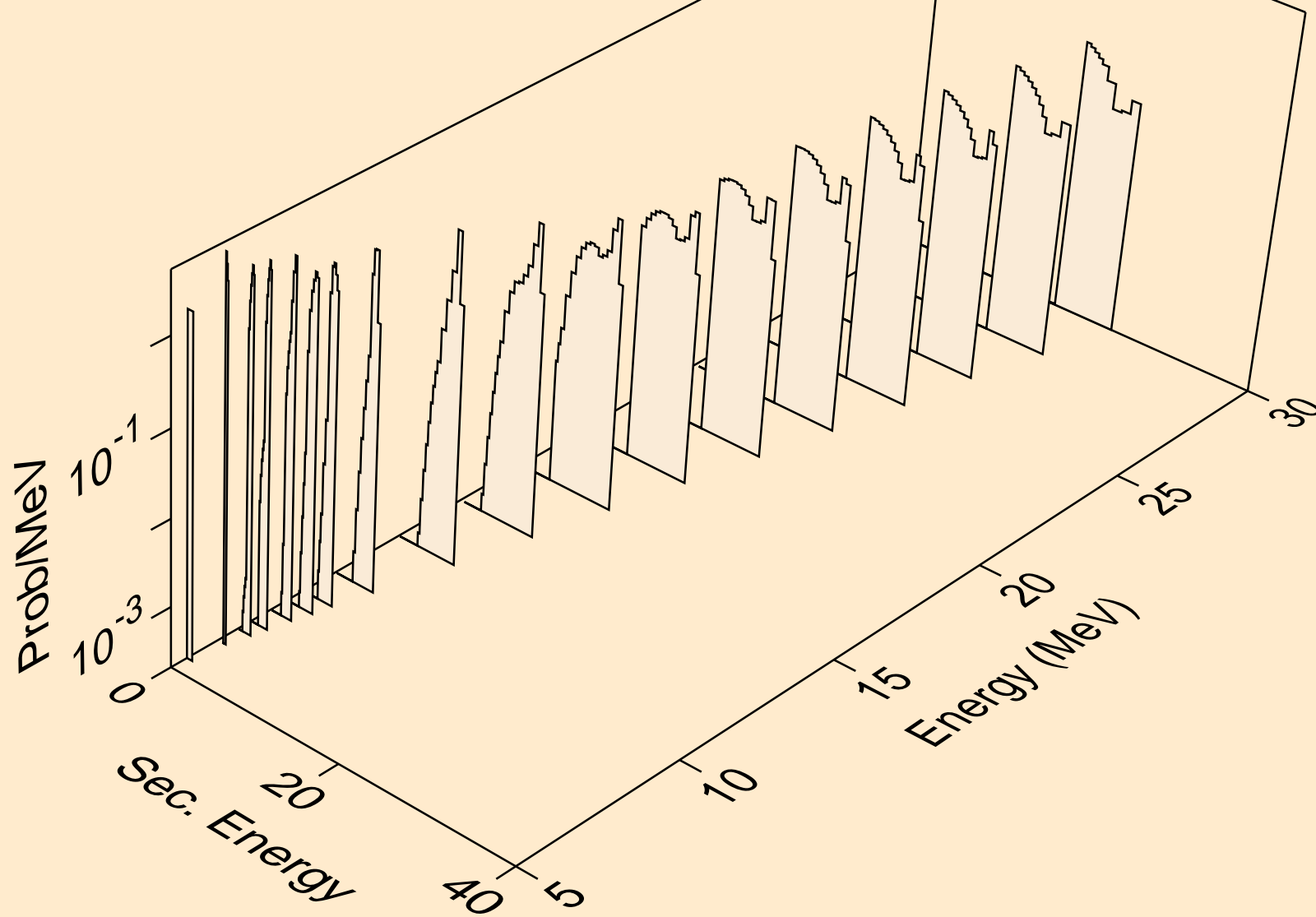

TC107 NEUTRON ACER TENDL-2024 LIBRARY; T=0.K  
deuterons from (n,x)

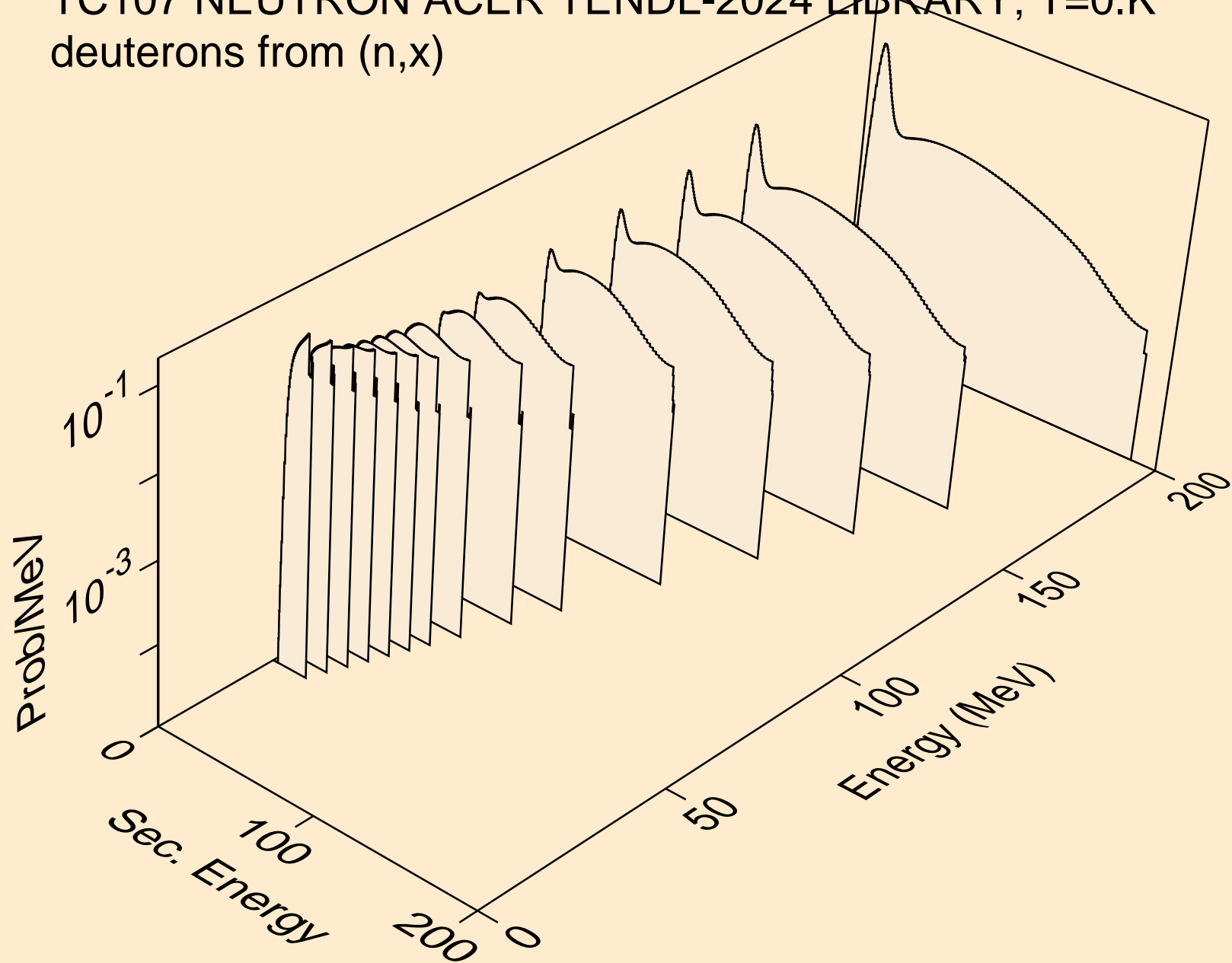

TC107 NEUTRON ACER TENDL-2024 LIBRARY; T=0.K  
deuterons from (n,2nd)

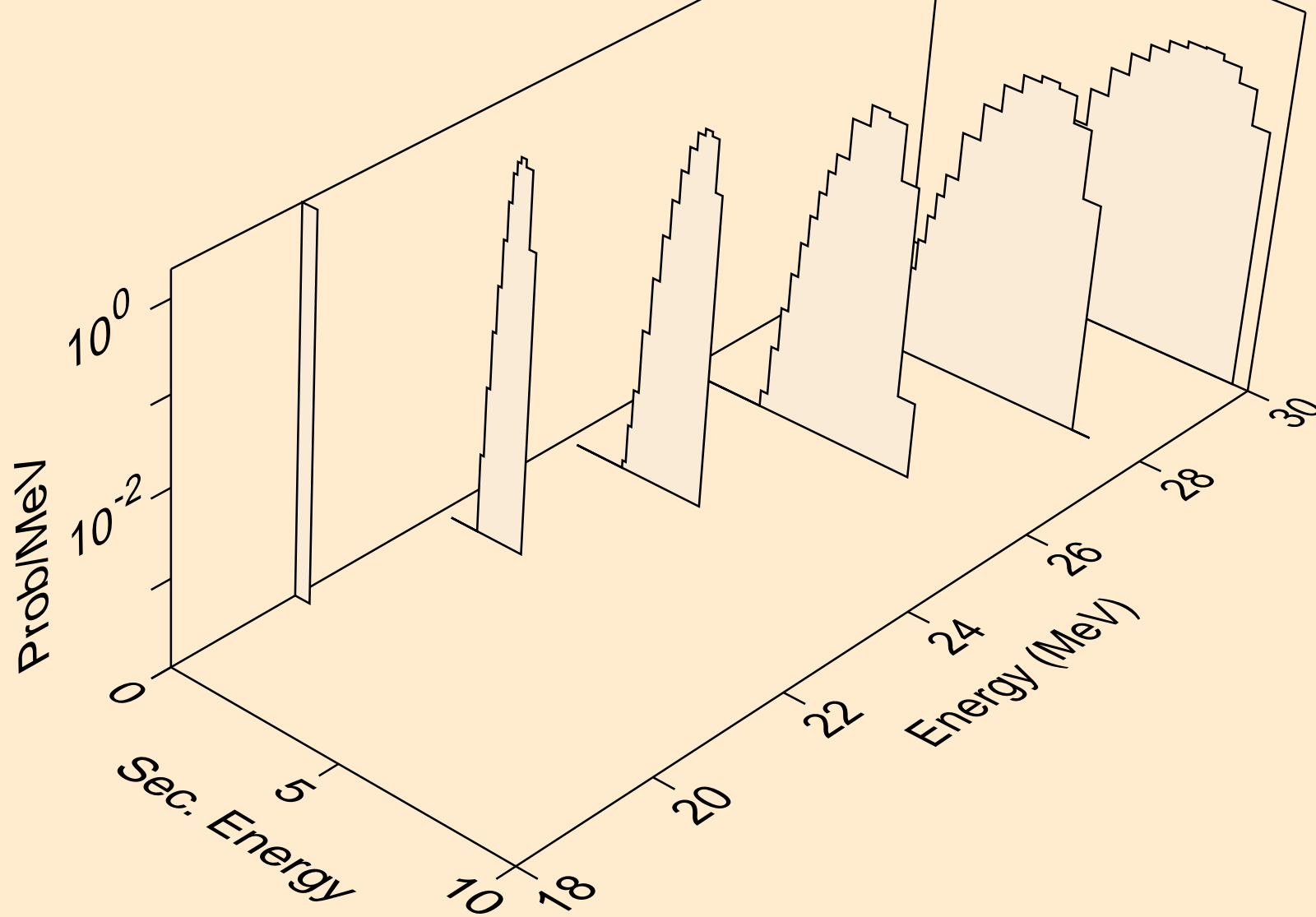



TC107 NEUTRON ACER TENDL-2024 LIBRARY; T=0.K  
deuterons from (n,n\*)d

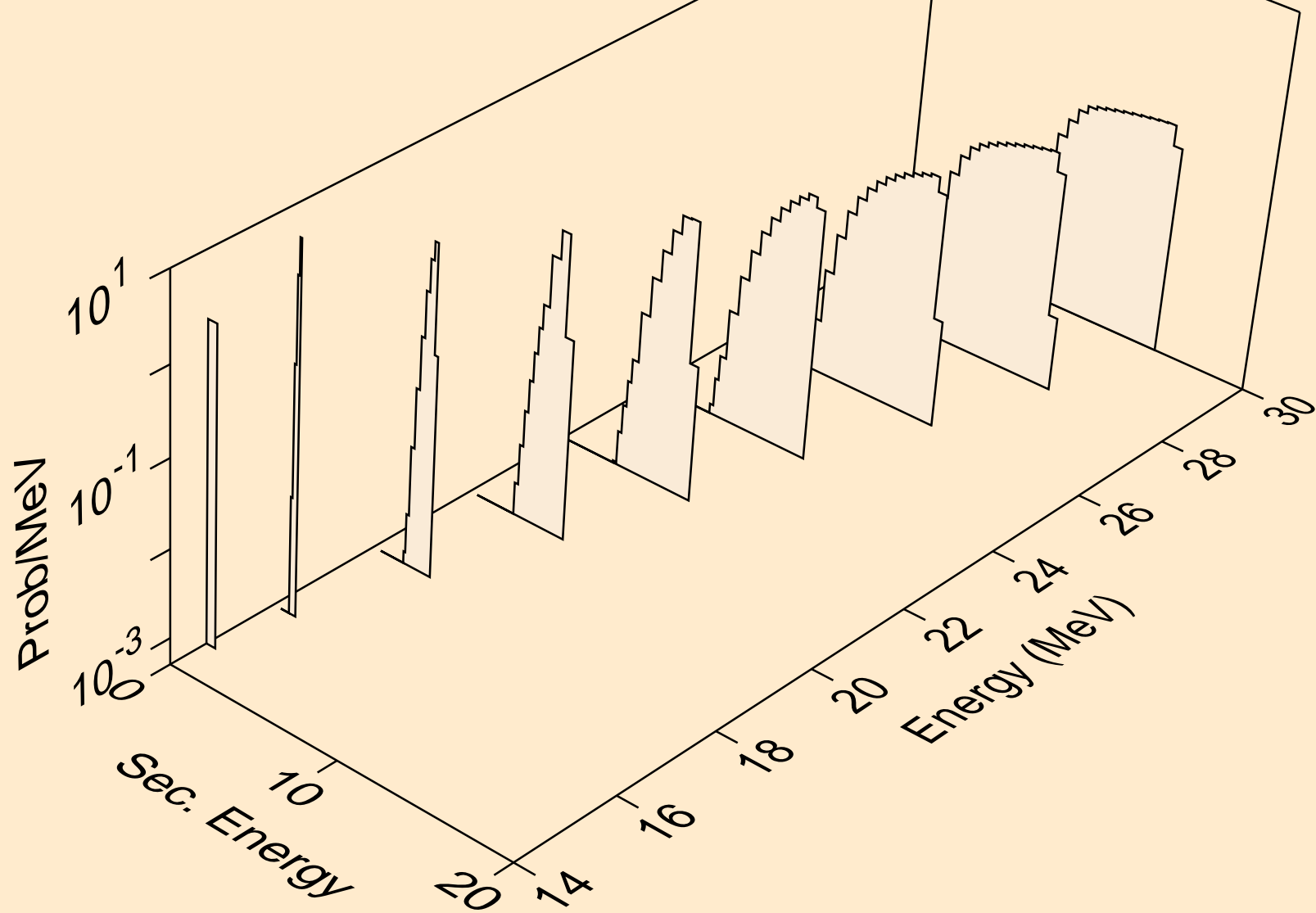

TC107 NEUTRON ACER TENDL-2024 LIBRARY; T=0.K  
deuterons from (n,d)

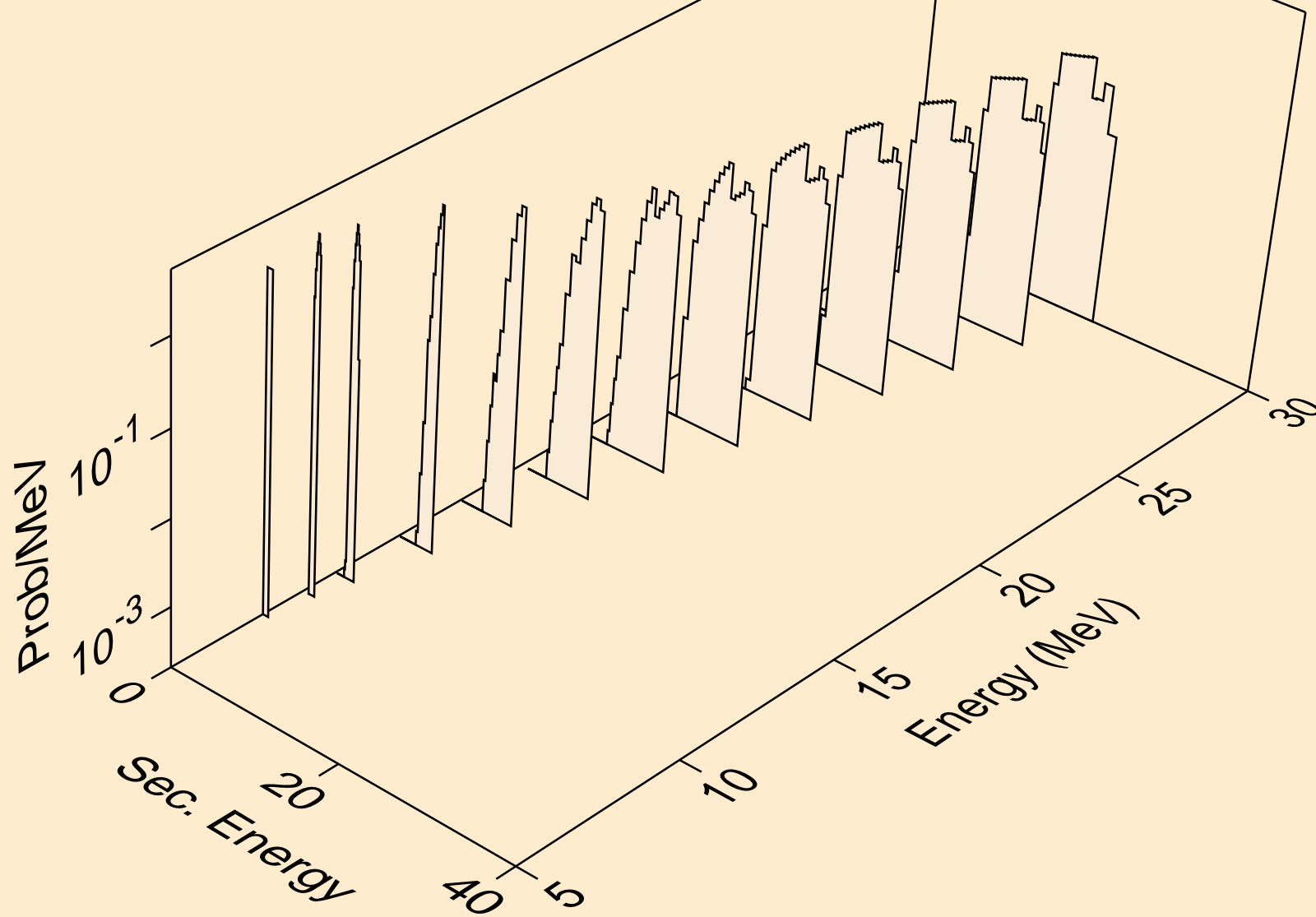

TC107 NEUTRON ACER TENDL-2024 LIBRARY; T=0.K  
tritons from (n,x)

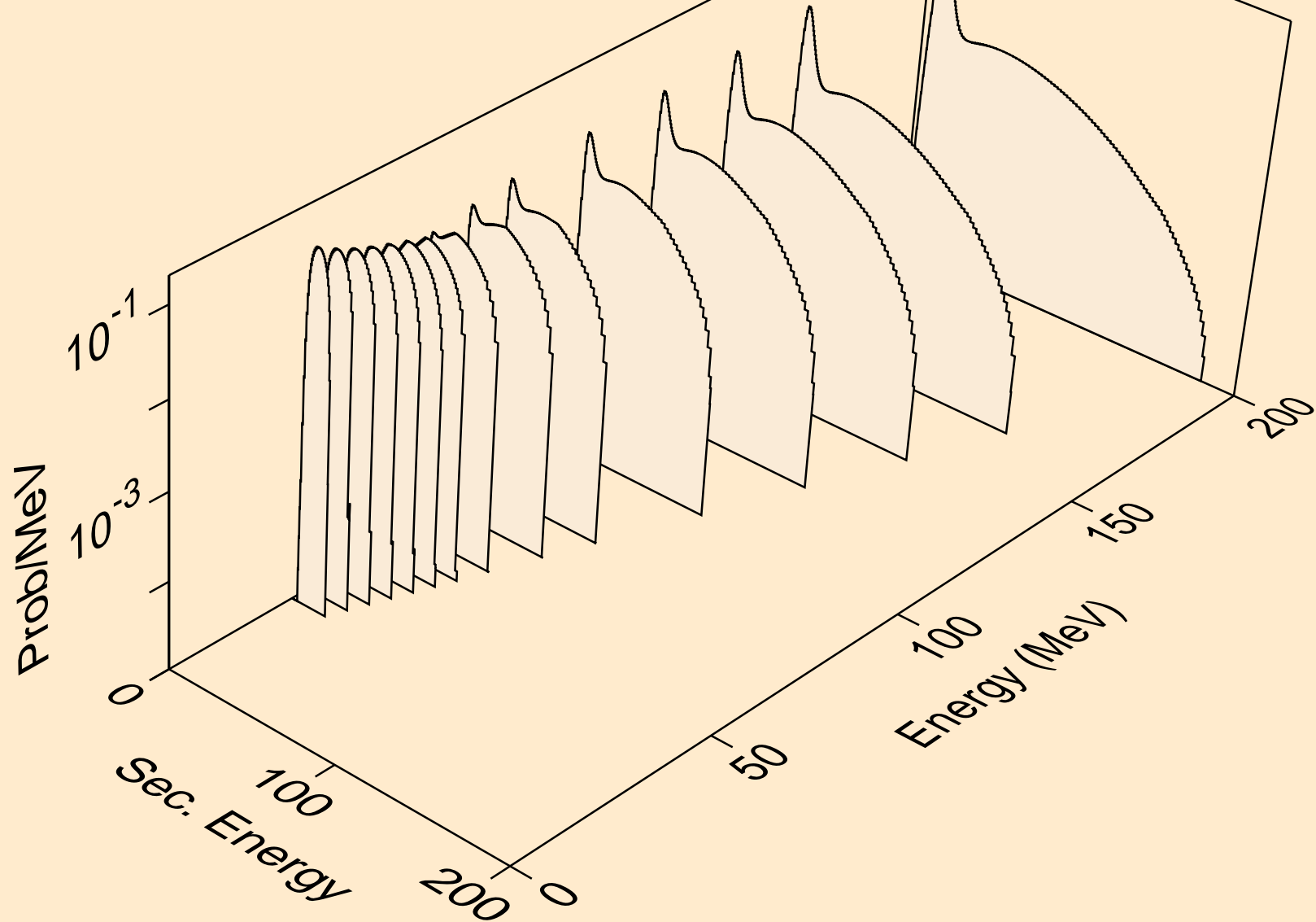

TC107 NEUTRON ACER TENDL-2024 LIBRARY; T=0.K  
tritons from (n,n\*)t

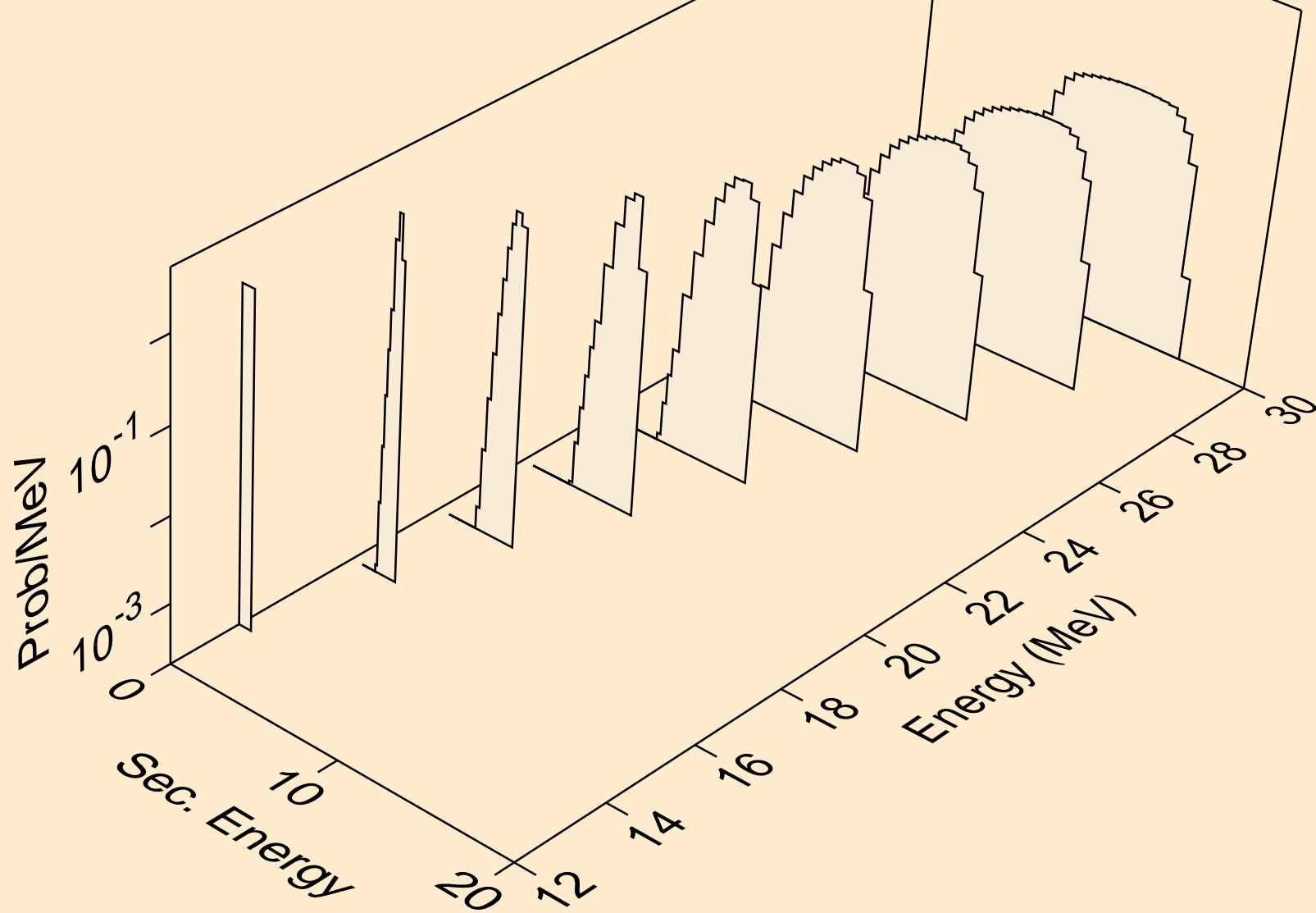

TC107 NEUTRON ACER TENDL-2024 LIBRARY; T=0.K  
tritons from (n,t)

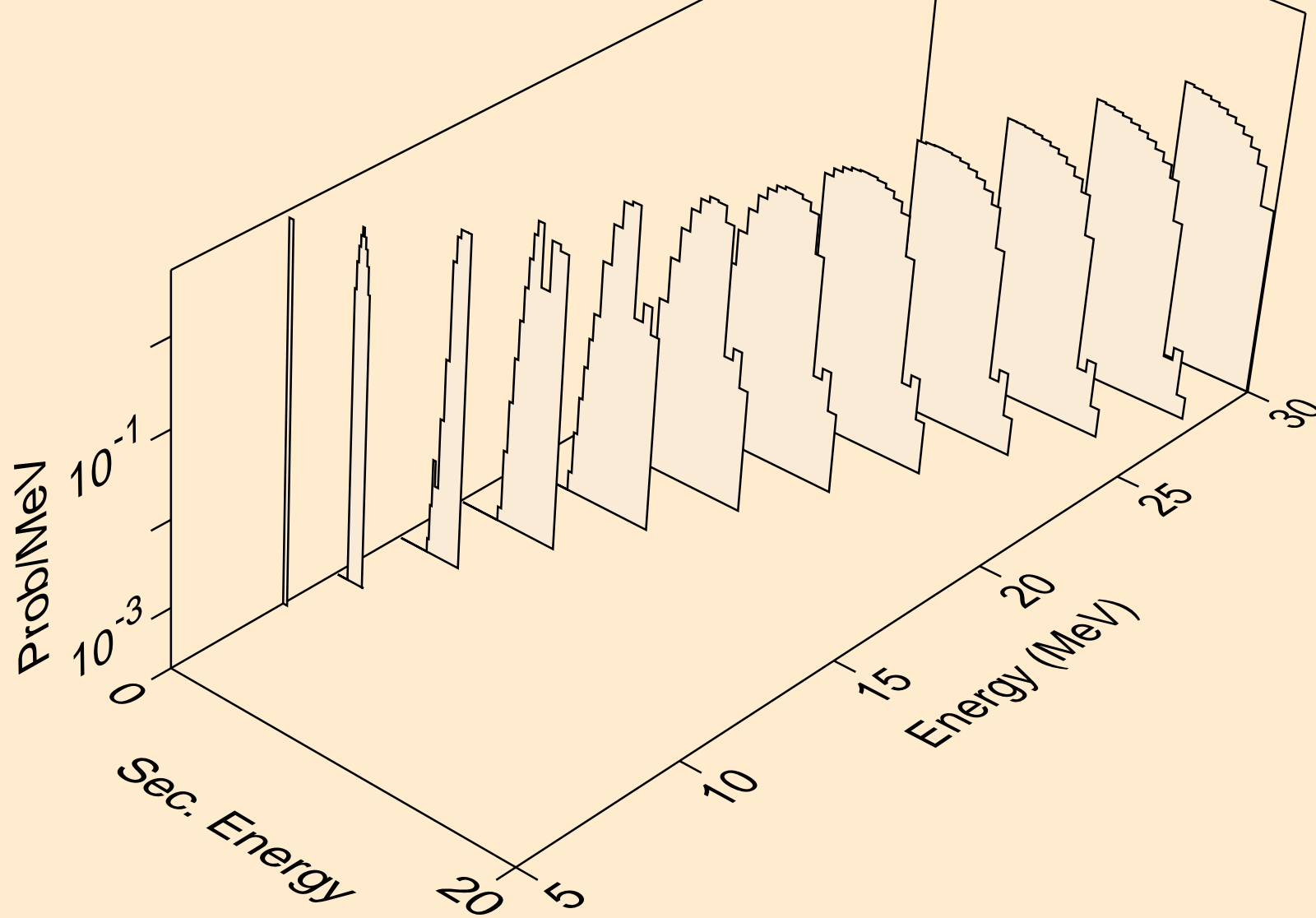

TC107 NEUTRON ACER TENDL-2024 LIBRARY; T=0.K  
he3s from (n,x)

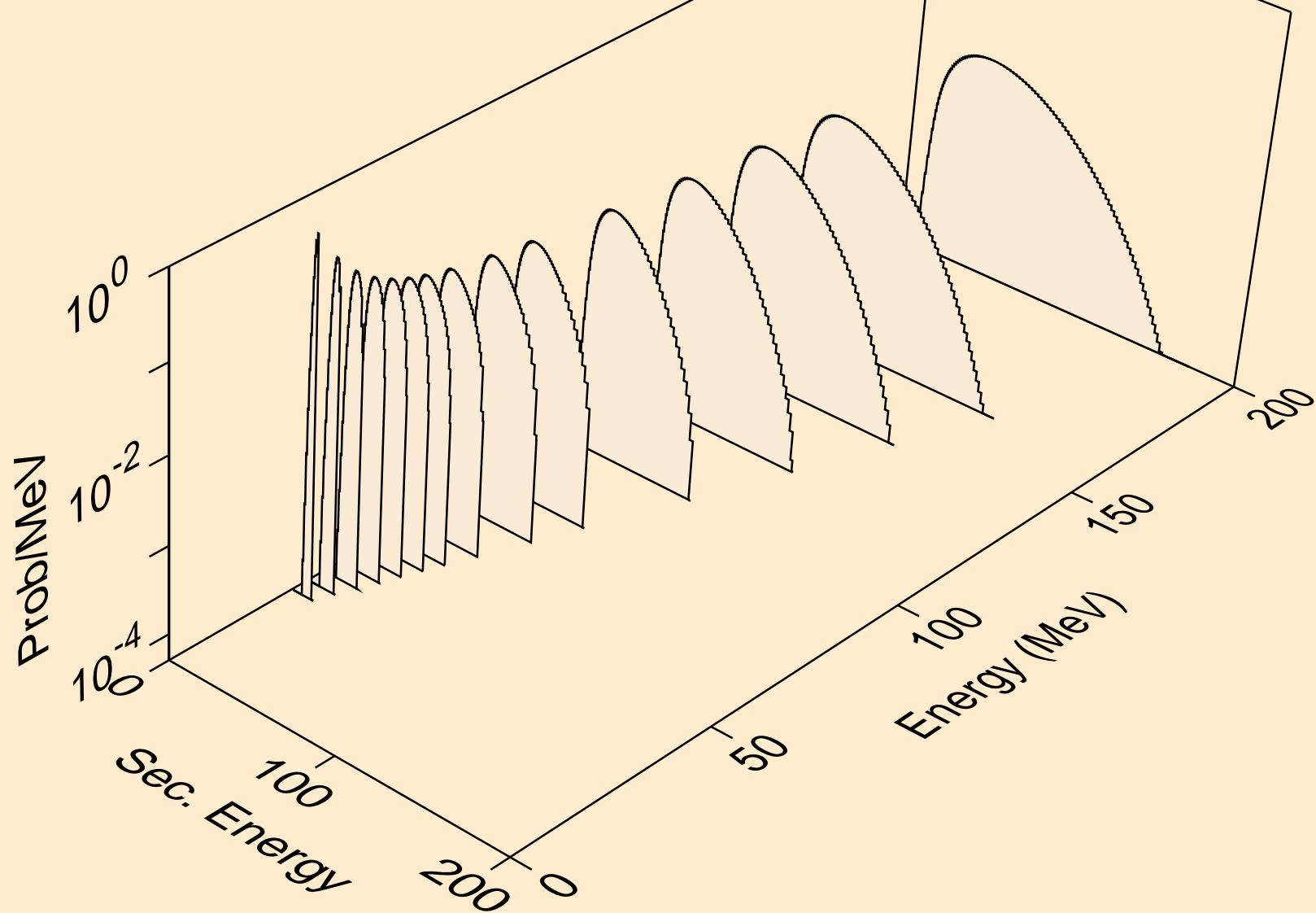

TC107 NEUTRON ACER TENDL-2024 LIBRARY; T=0.K  
he3s from (n,n\*)he3

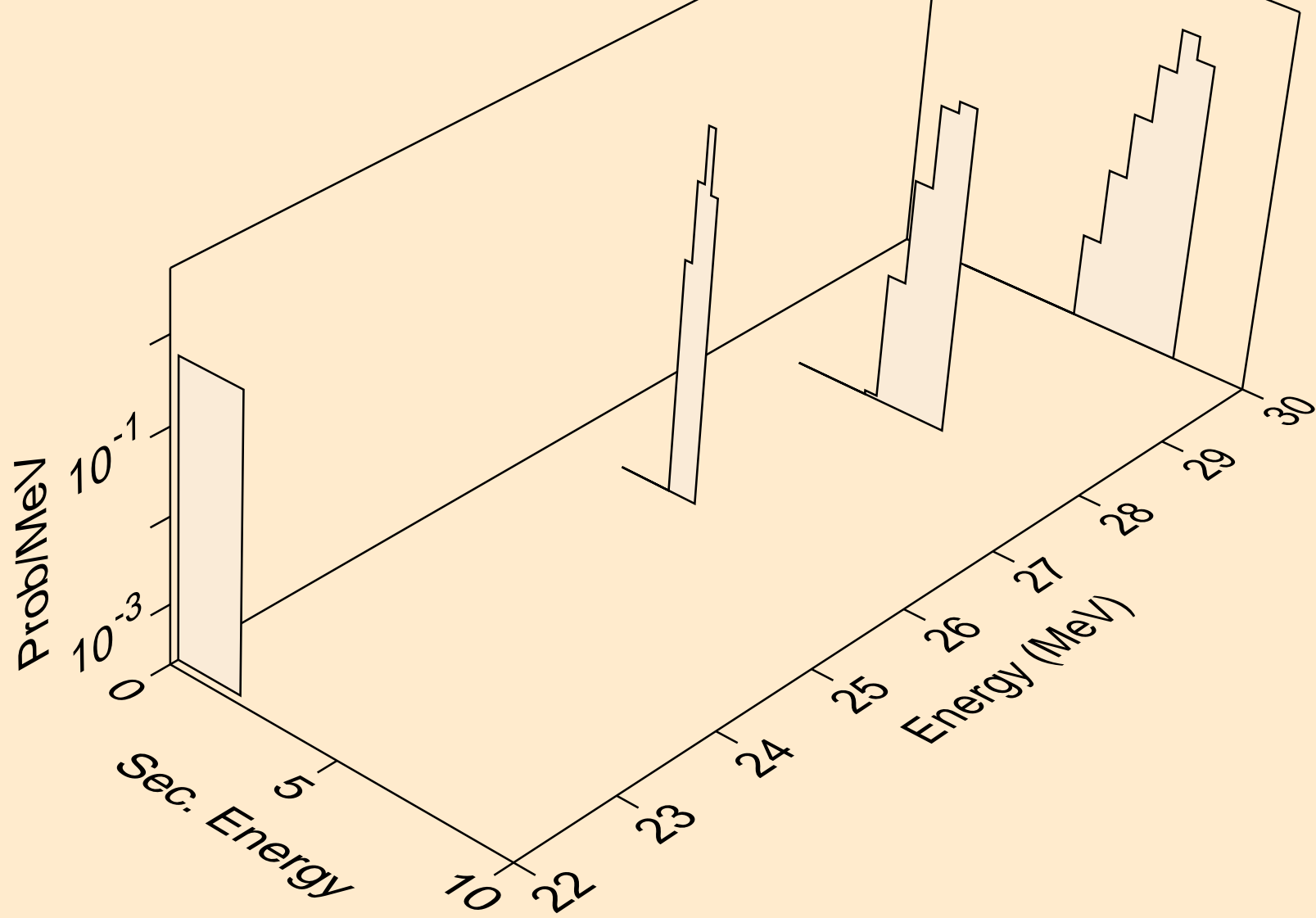

TC107 NEUTRON ACER TENDL-2024 LIBRARY; T=0.K  
he3s from (n,he3)

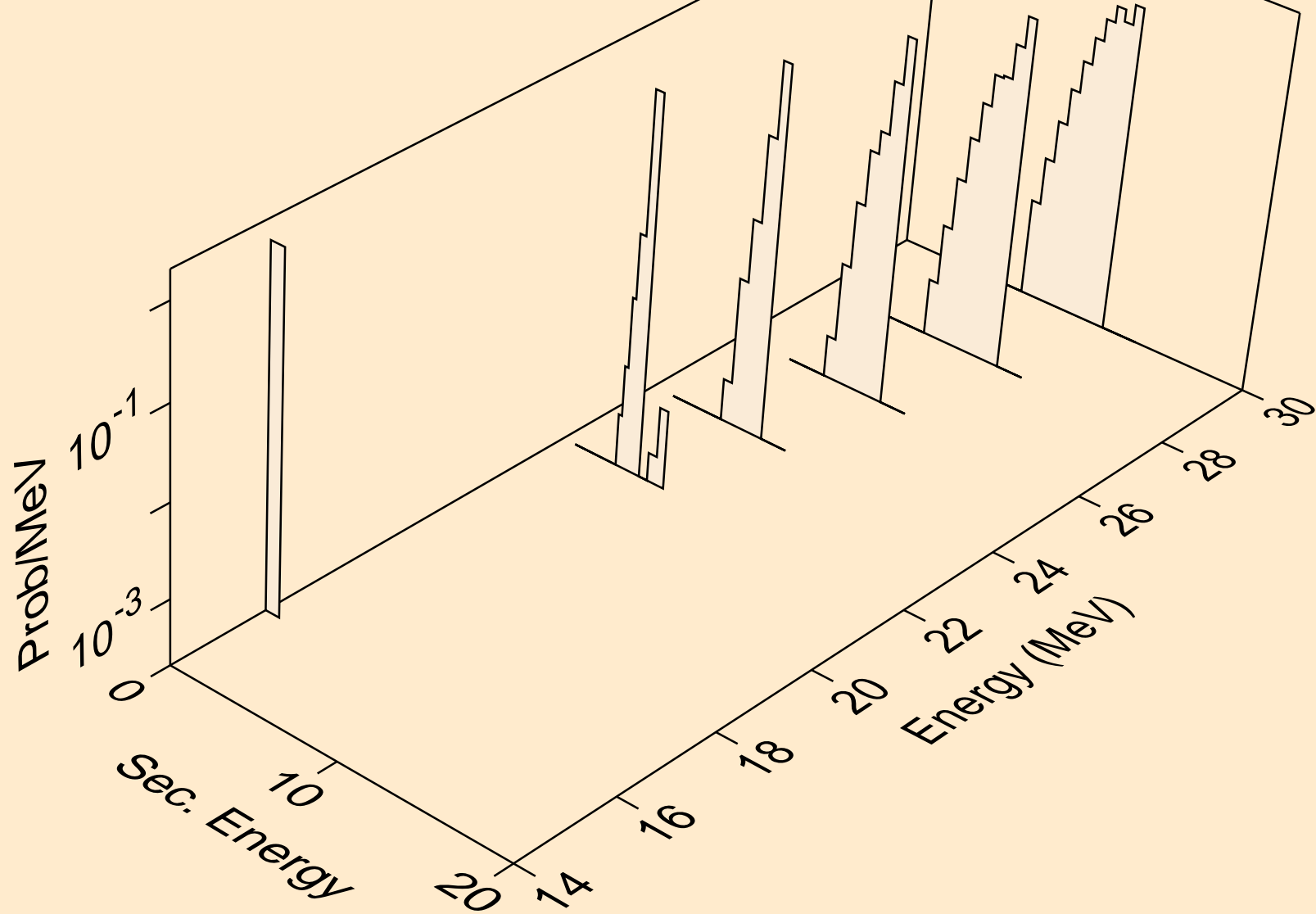



TC107 NEUTRON ACER TENDL-2024 LIBRARY; T=0.K  
alphas from (n,x)

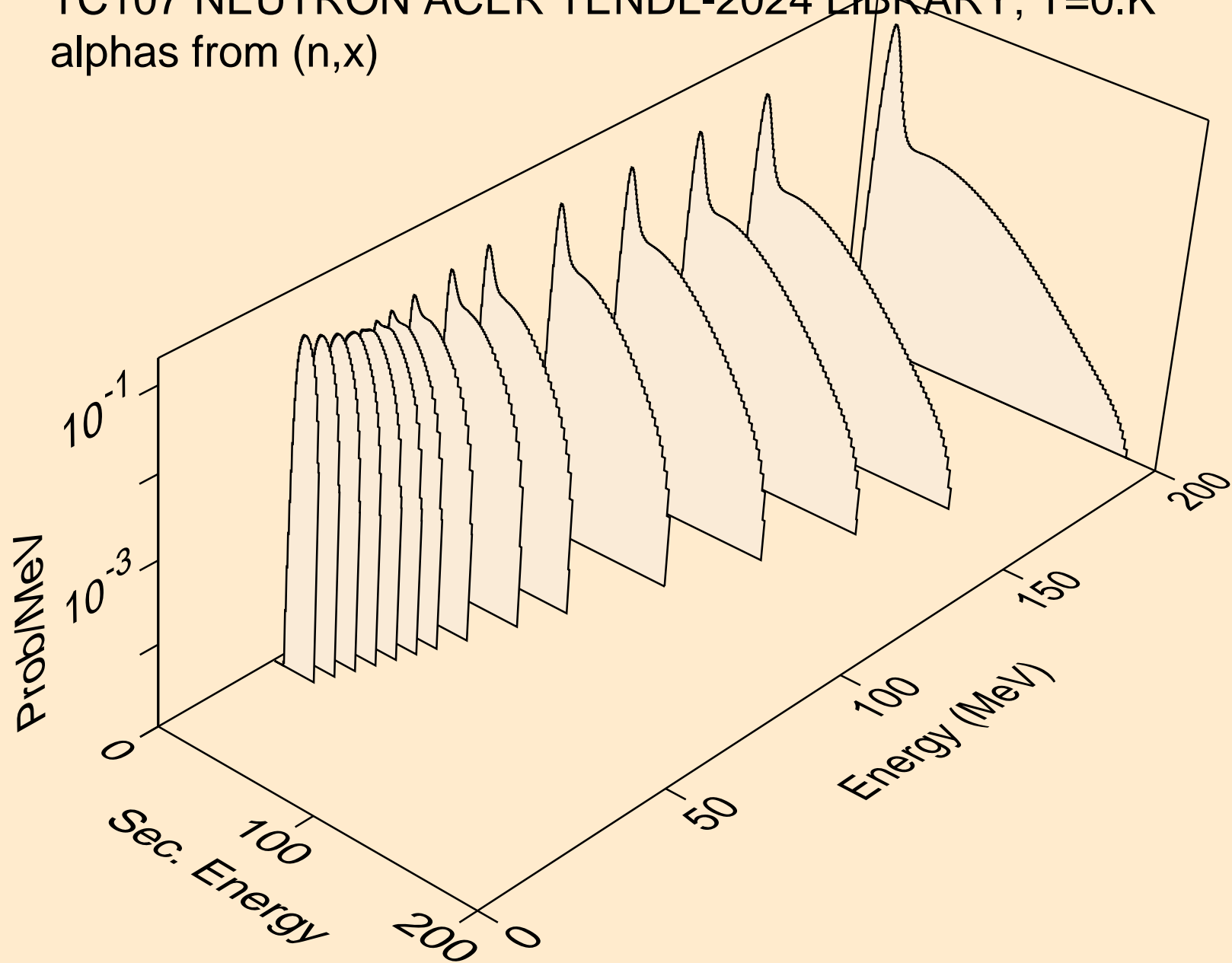

TC107 NEUTRON ACER TENDL-2024 LIBRARY; T=0.K  
alphas from (n,n\*)a

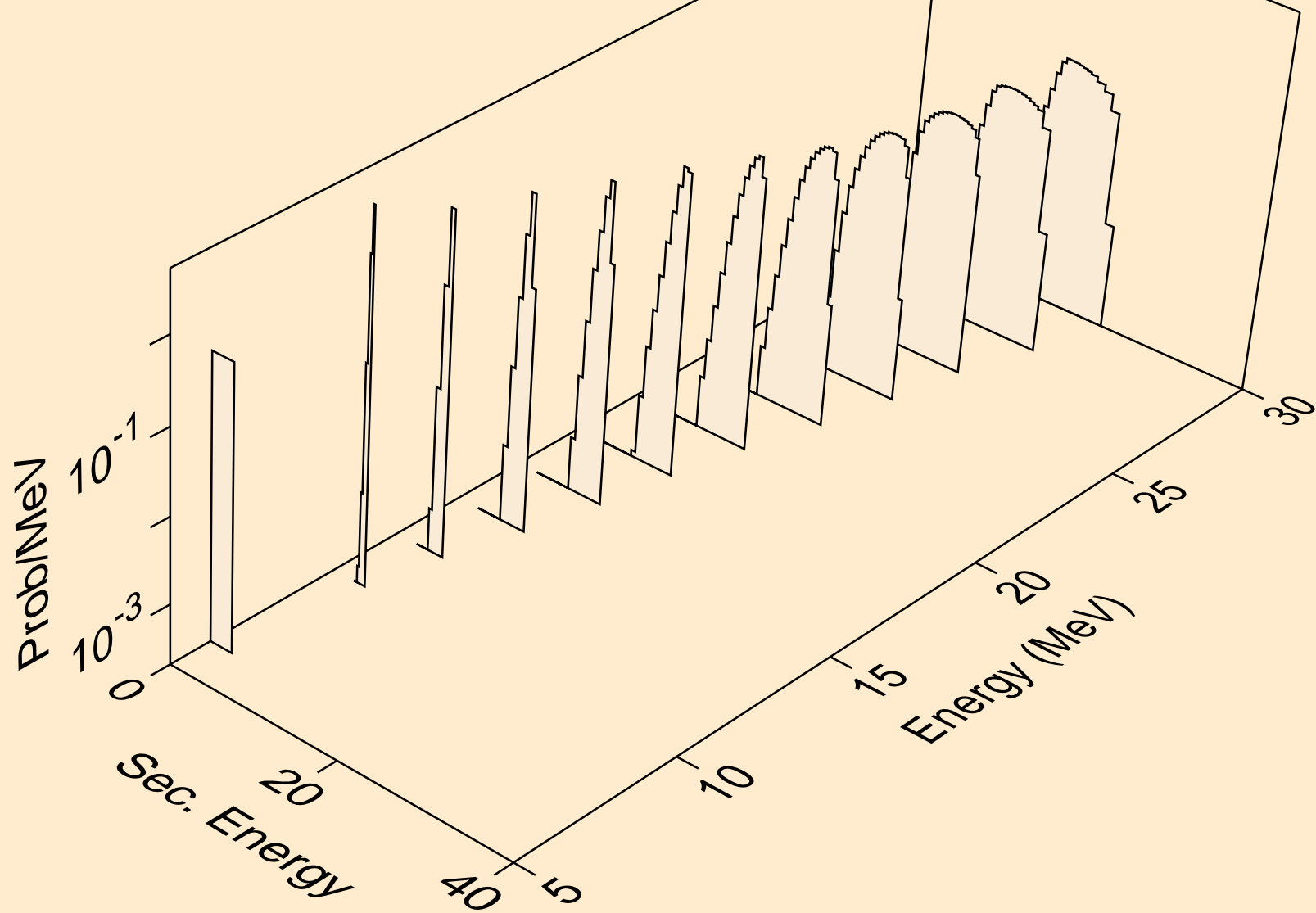

TC107 NEUTRON ACER TENDL-2024 LIBRARY; T=0.K  
alphas from (n,2n)a

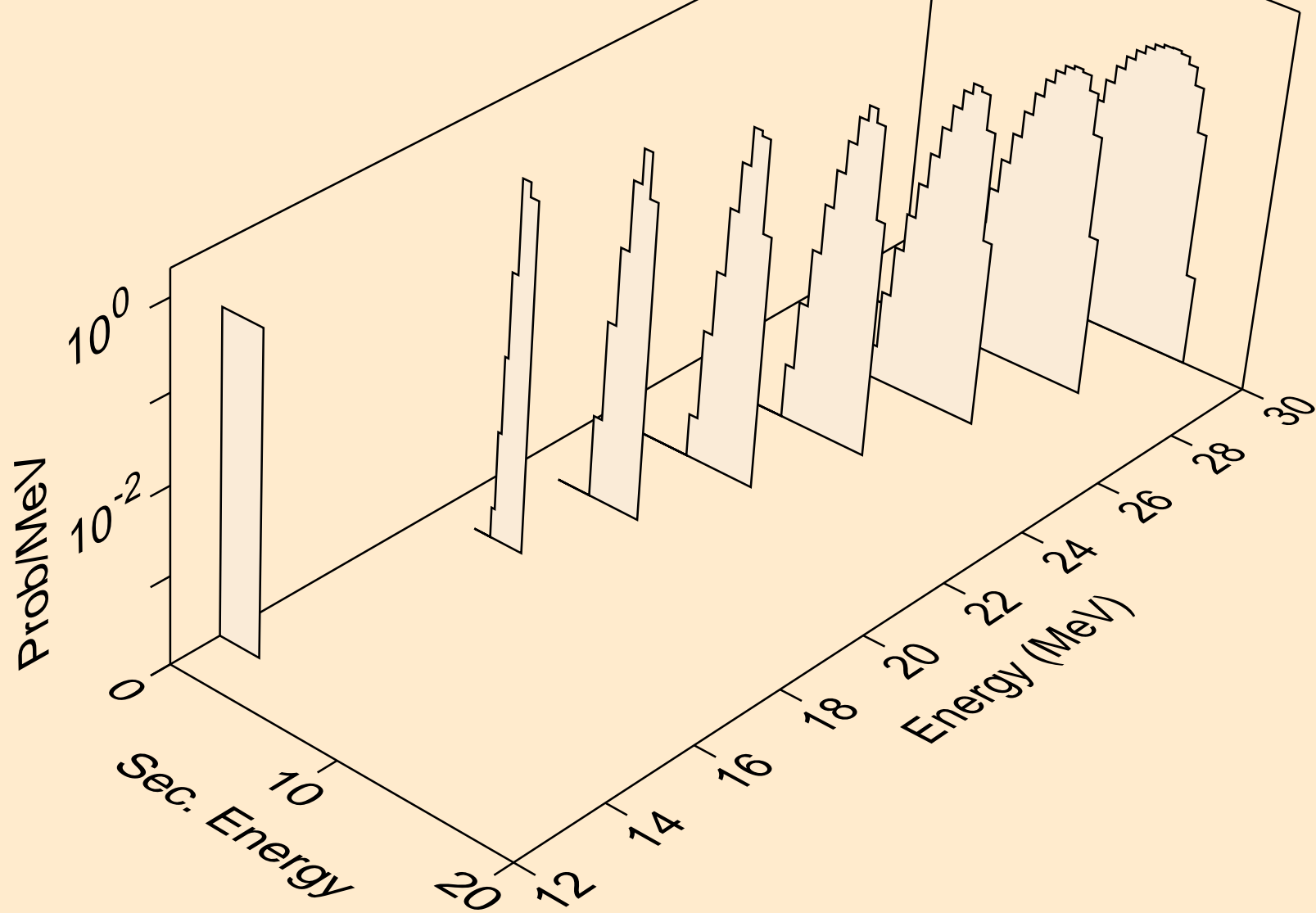

TC107 NEUTRON ACER TENDL-2024 LIBRARY; T=0.K  
alphas from (n,3n)a

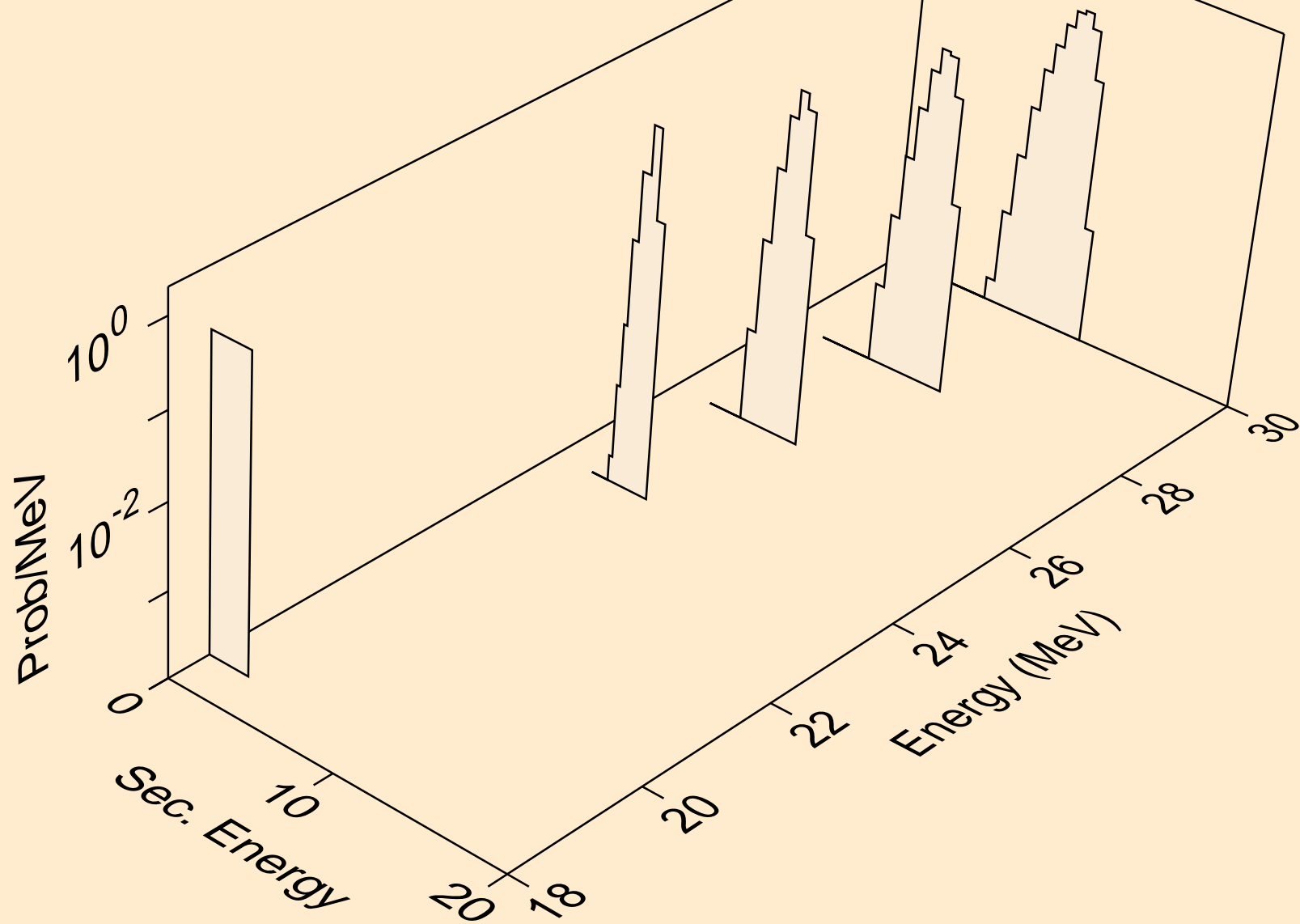

TC107 NEUTRON ACER TENDL-2024 LIBRARY; T=0.K  
alphas from (n,a)

