

# TE120 NEUTRON ACER TENDL-2024 LIBRARY; T=0.K

## Principal cross sections

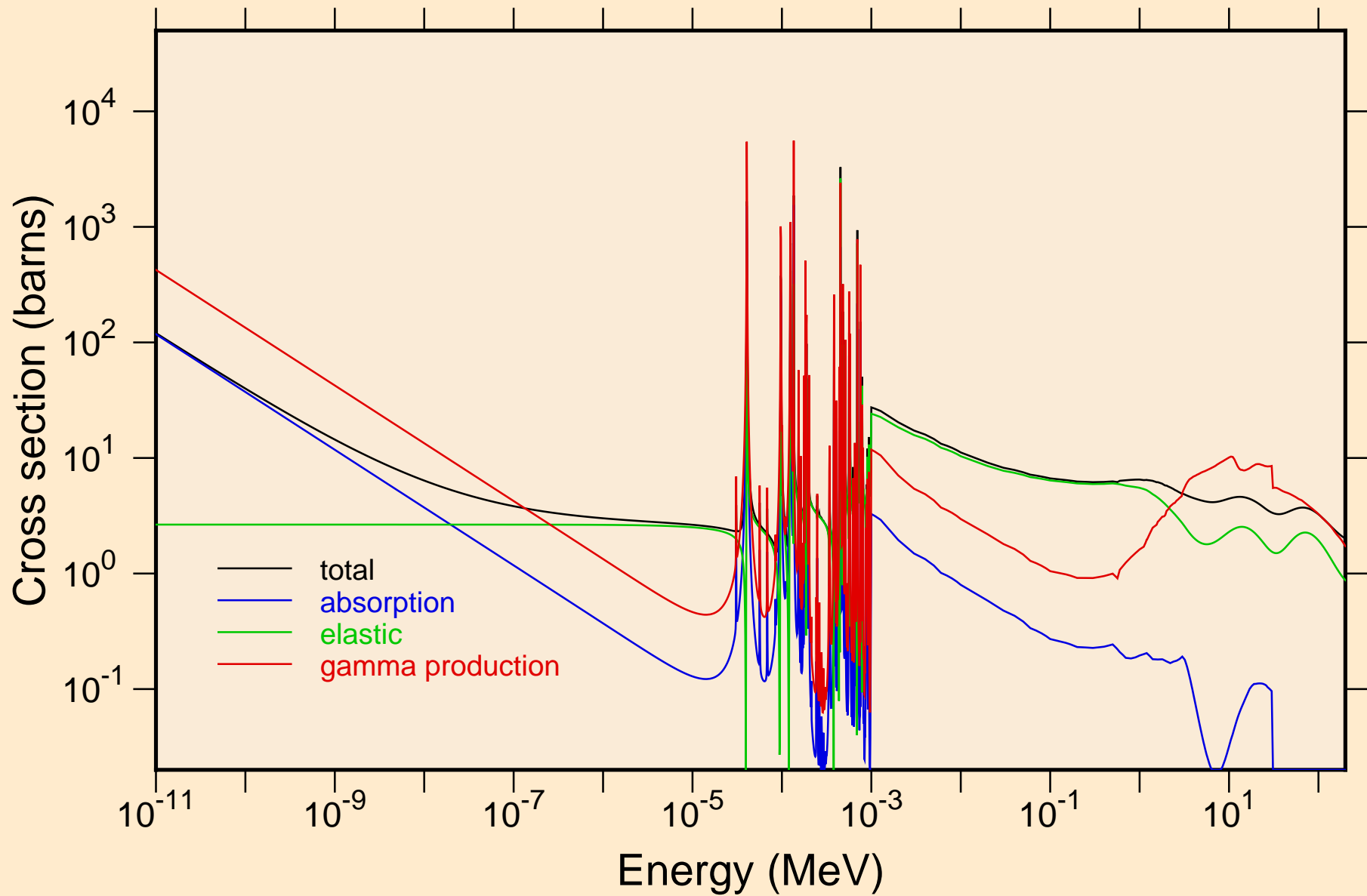

TE120 NEUTRON ACER TENDL-2024 LIBRARY; T=0.K  
resonance total cross section

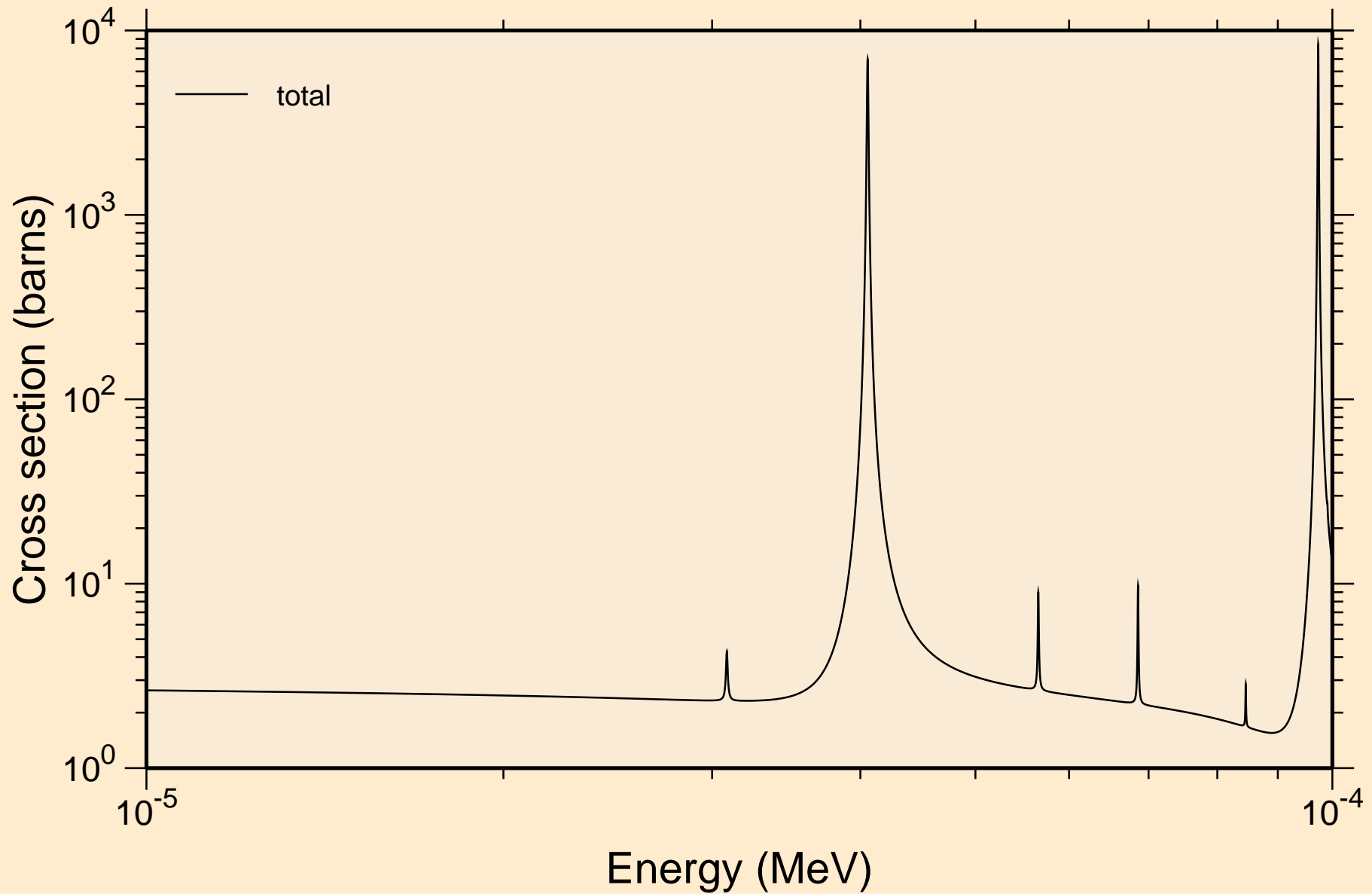

TE120 NEUTRON ACER TENDL-2024 LIBRARY; T=0.K  
resonance total cross section

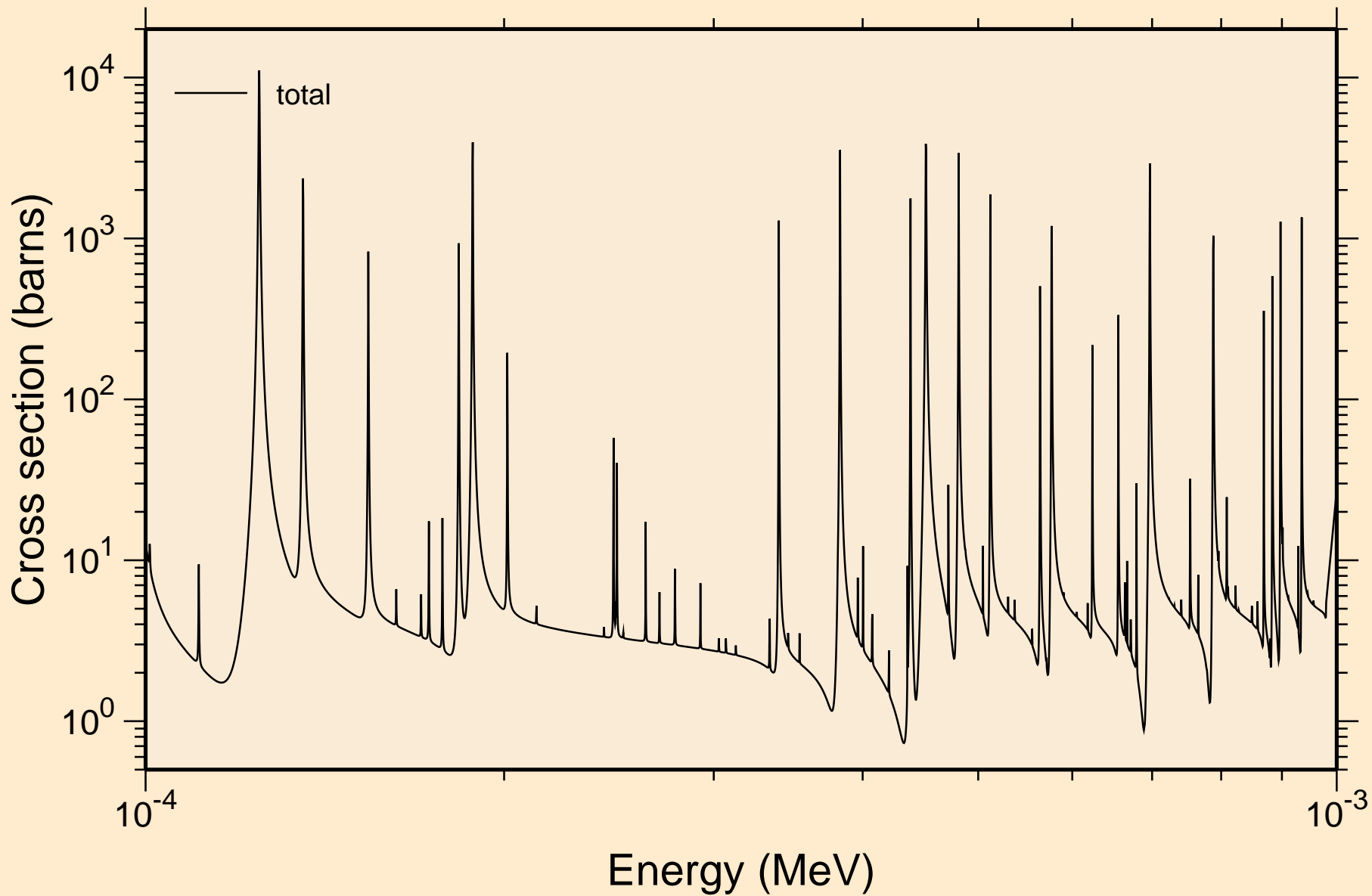

TE120 NEUTRON ACER TENDL-2024 LIBRARY; T=0.K  
resonance total cross section

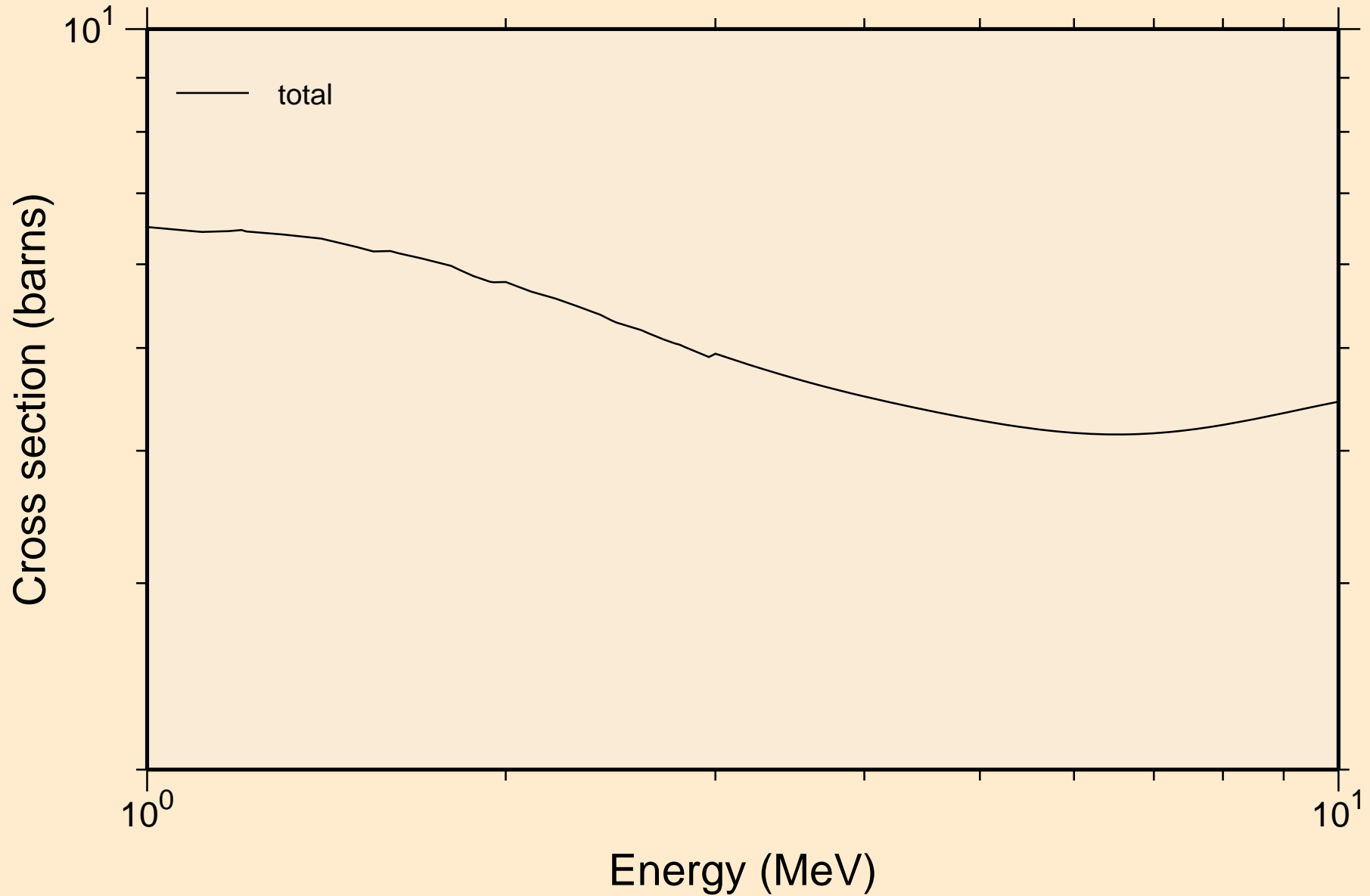

TE120 NEUTRON ACER TENDL-2024 LIBRARY; T=0.K  
resonance absorption cross sections

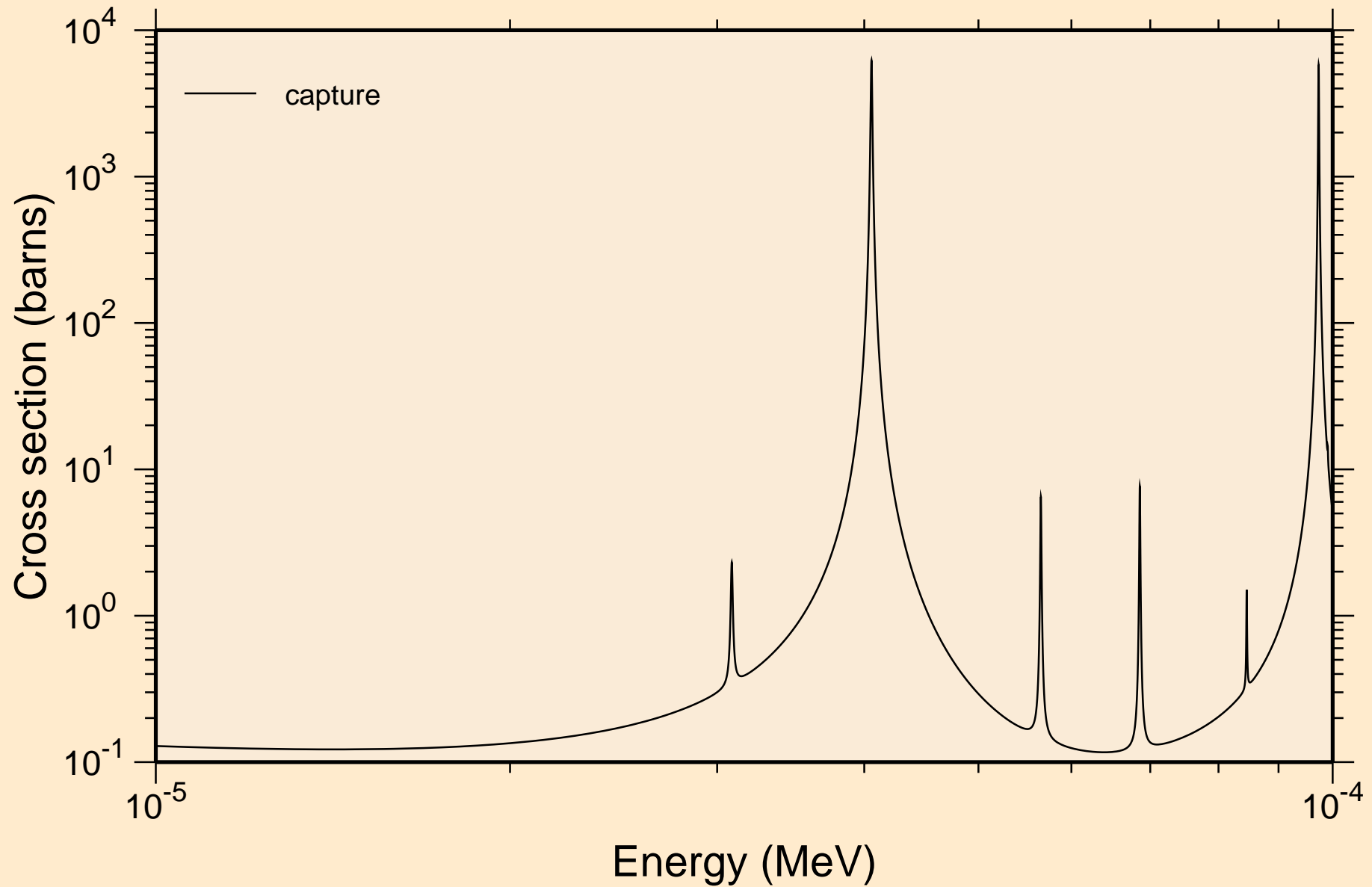

TE120 NEUTRON ACER TENDL-2024 LIBRARY; T=0.K  
resonance absorption cross sections

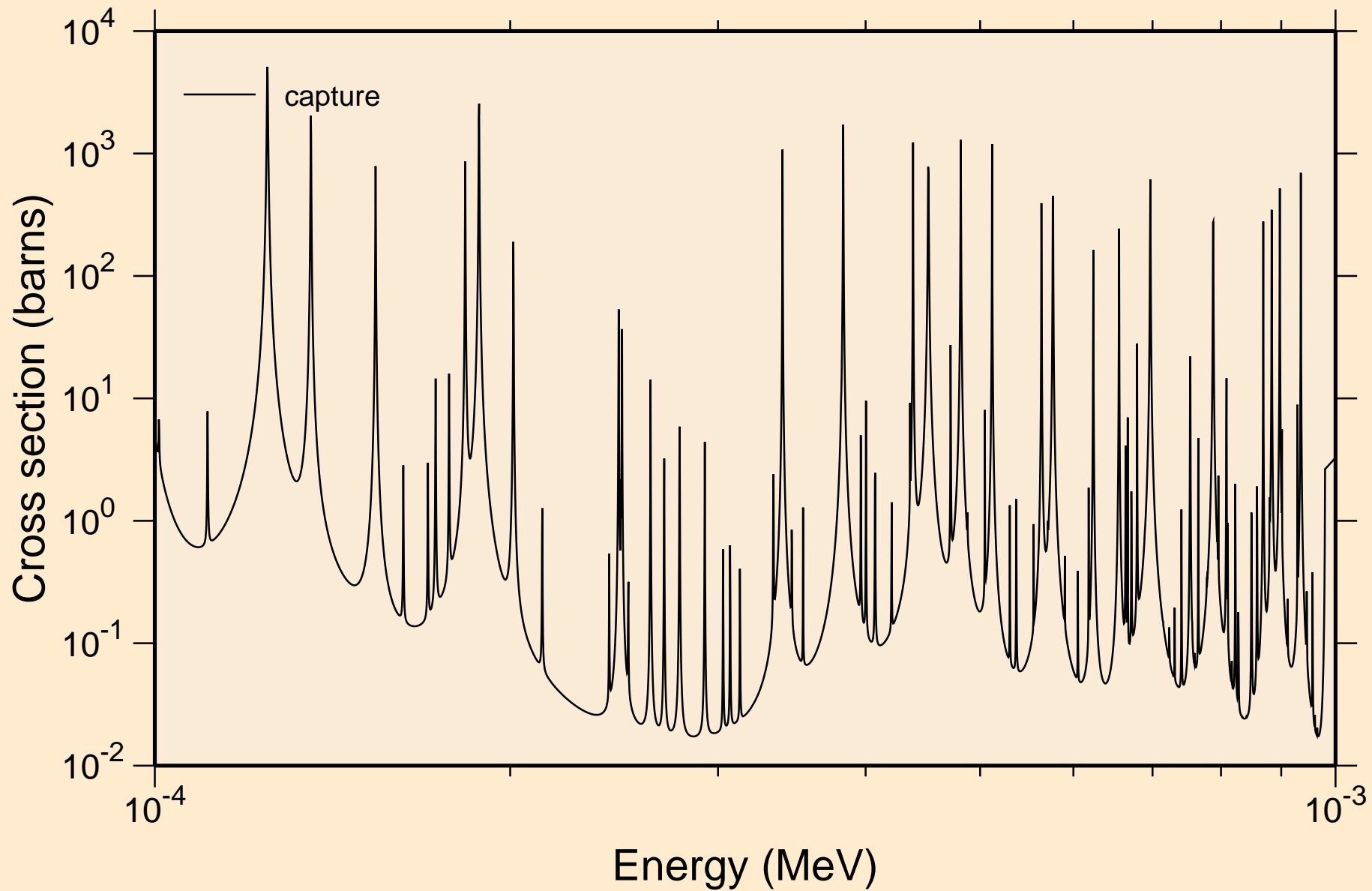

TE120 NEUTRON ACER TENDL-2024 LIBRARY; T=0.K  
resonance absorption cross sections

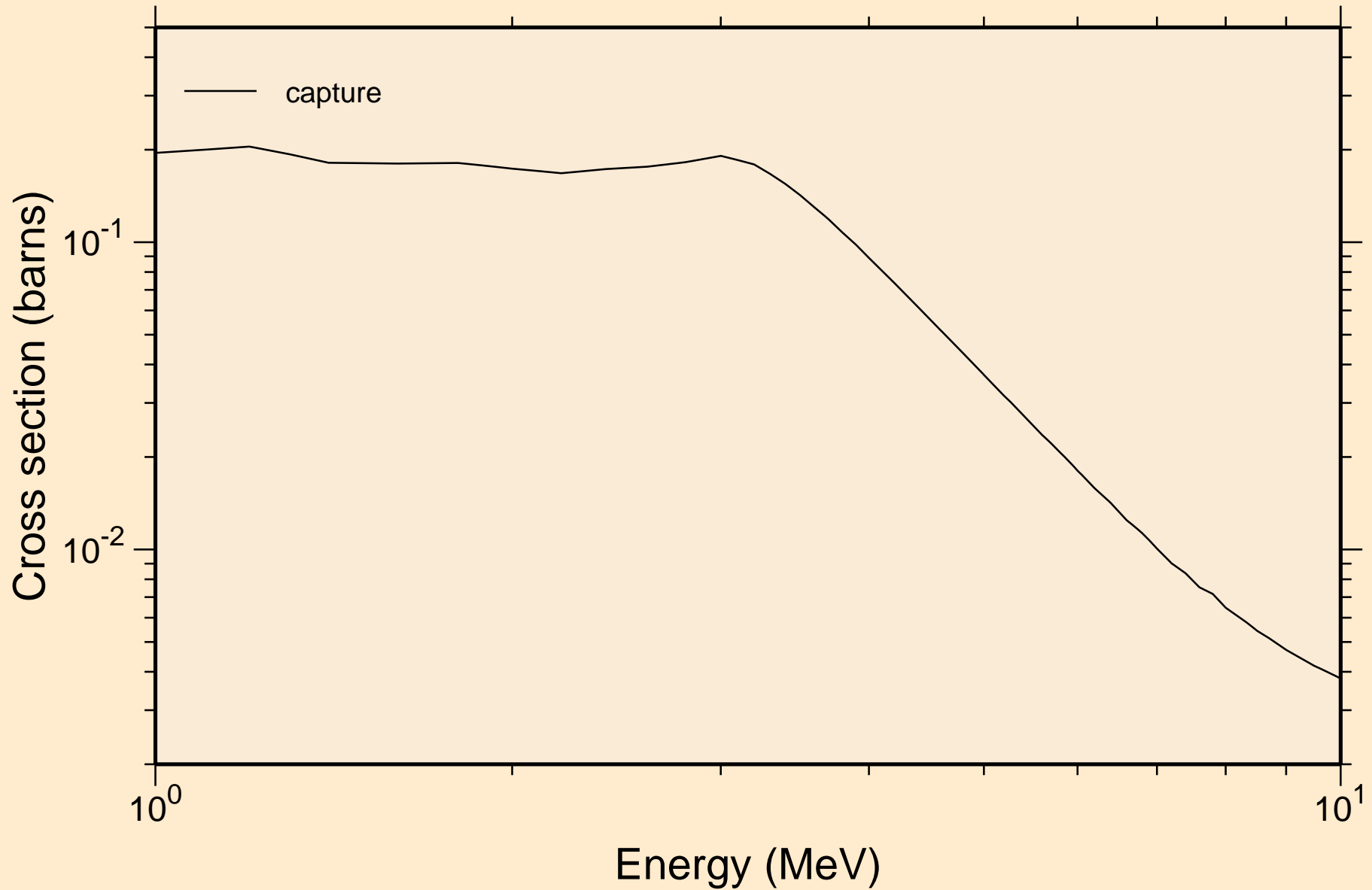

# TE120 NEUTRON ACER TENDL-2024 LIBRARY; T=0.K

## Heating

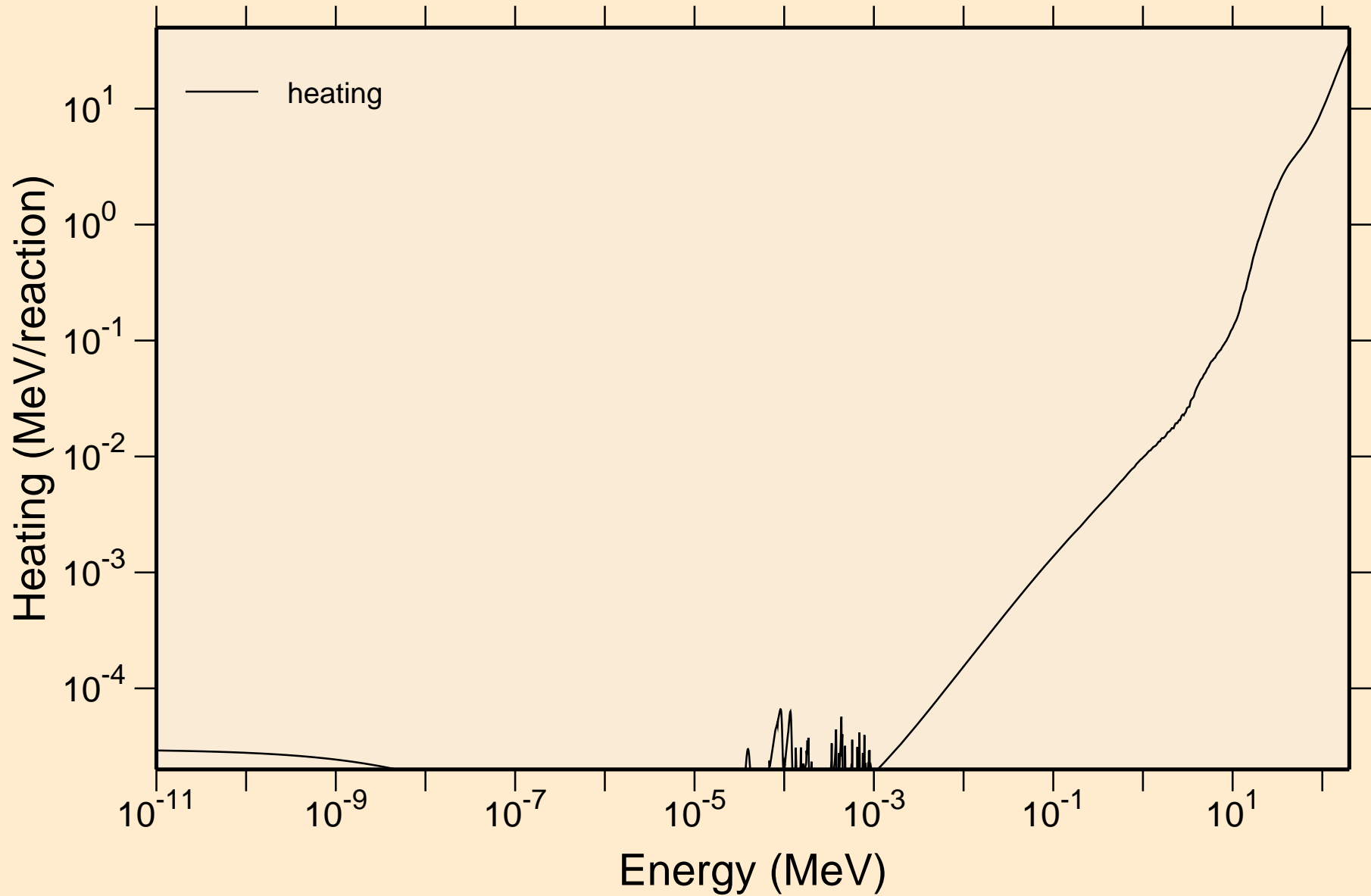



TE120 NEUTRON ACER TENDL-2024 LIBRARY; T=0.K  
Damage

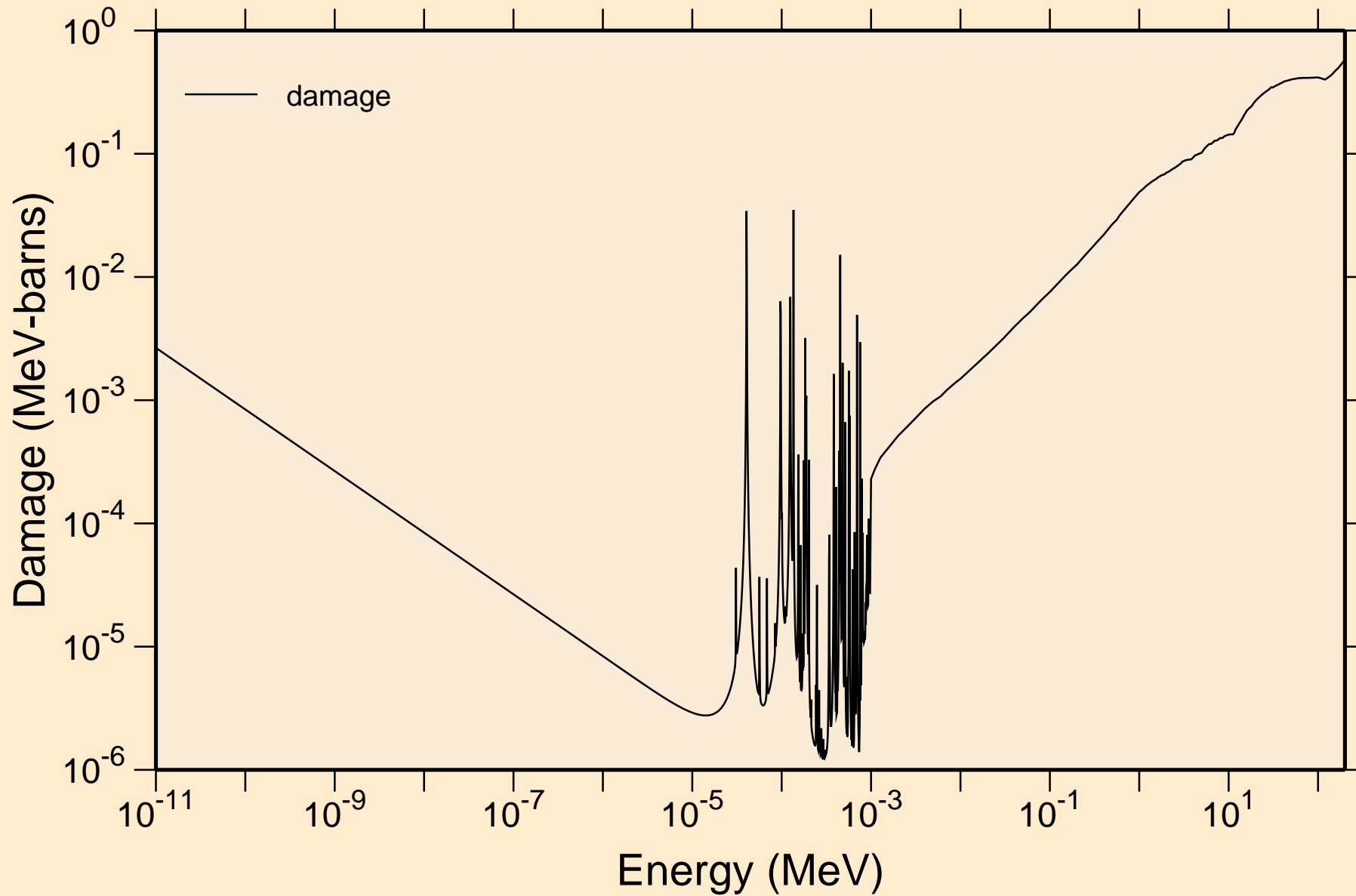

TE120 NEUTRON ACER TENDL-2024 LIBRARY; T=0.K  
Non-threshold reactions

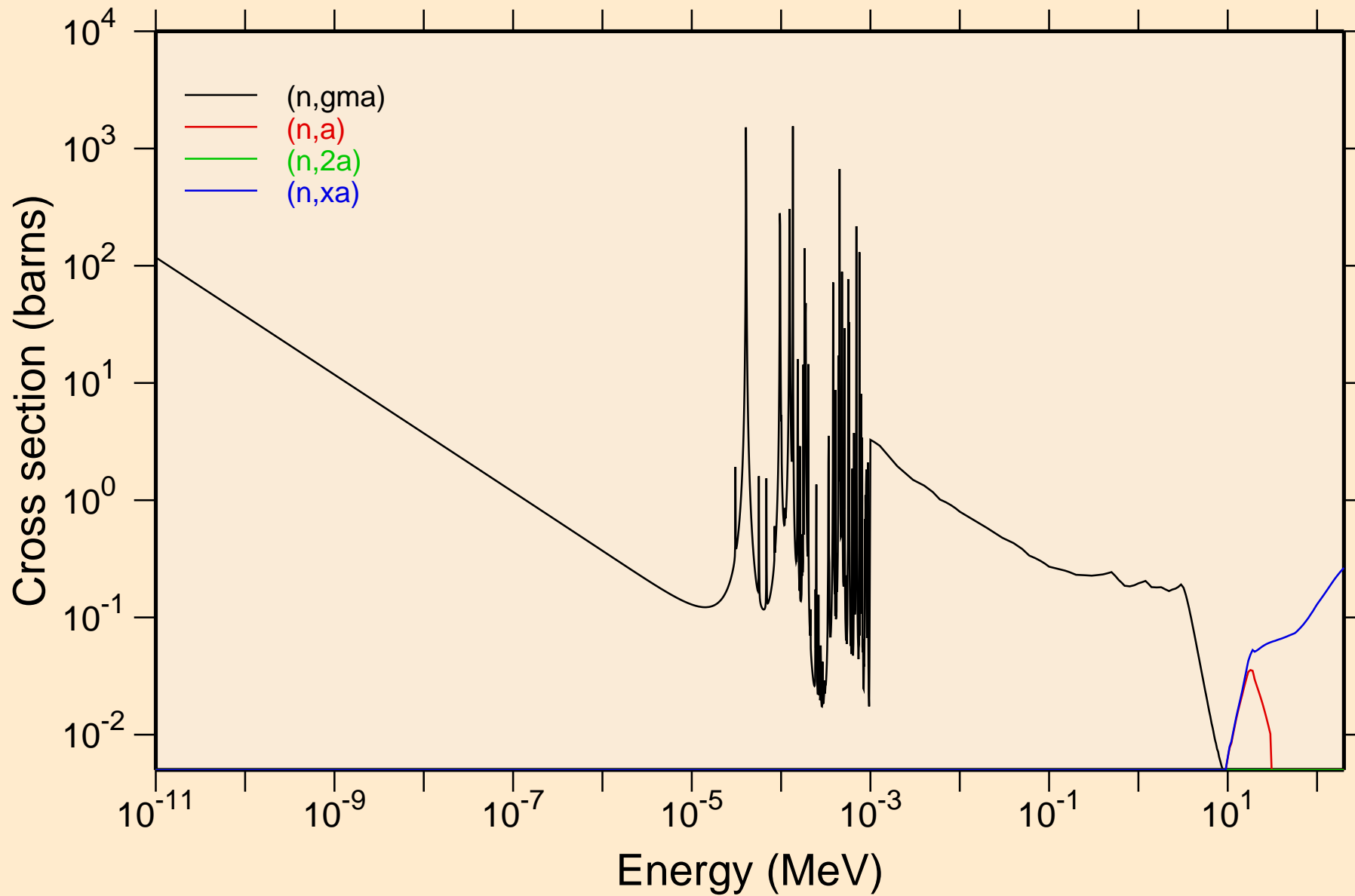

TE120 NEUTRON ACER TENDL-2024 LIBRARY; T=0.K  
Principal cross sections

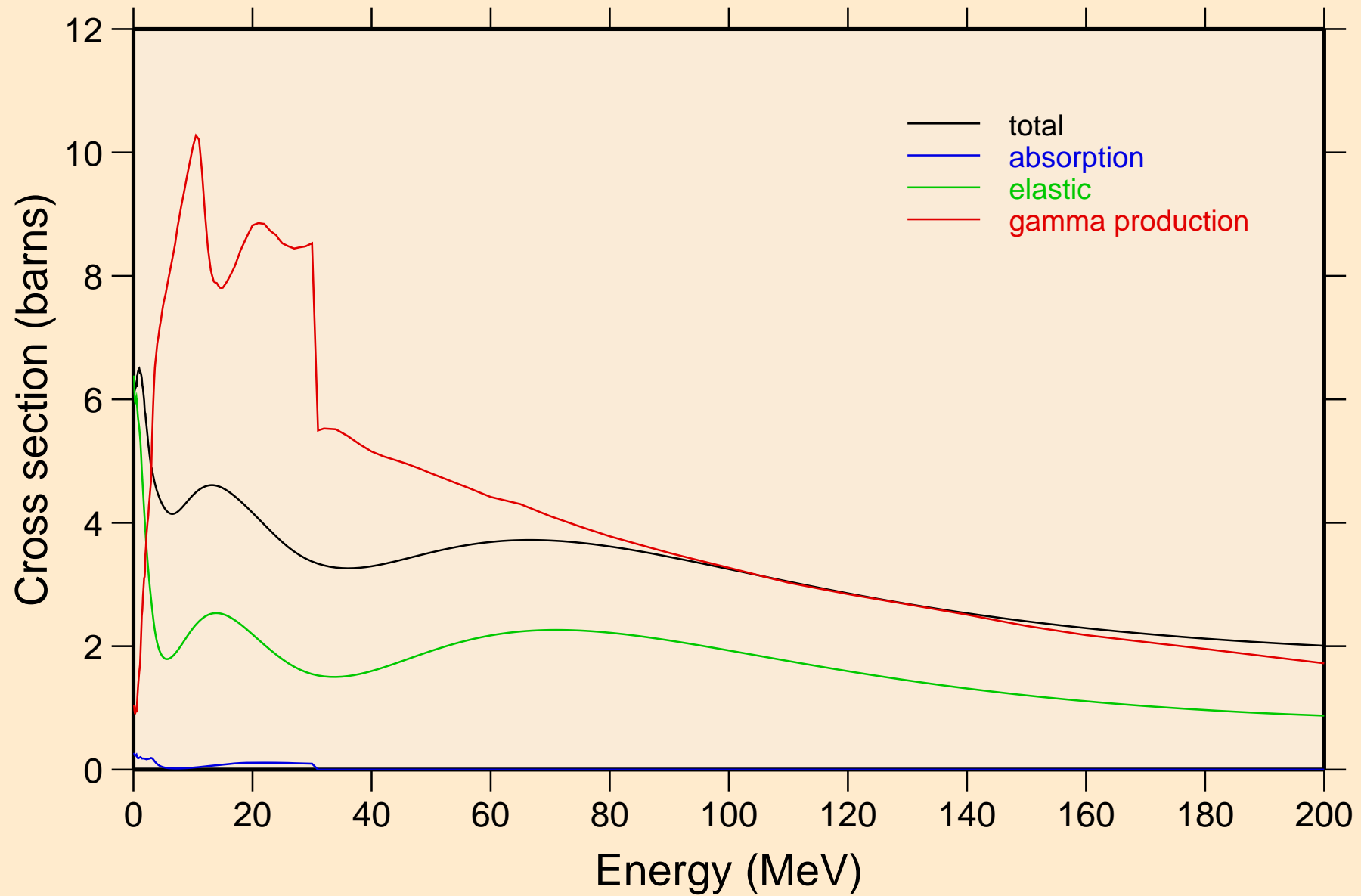

# TE120 NEUTRON ACER TENDL-2024 LIBRARY; T=0.K

## Heating

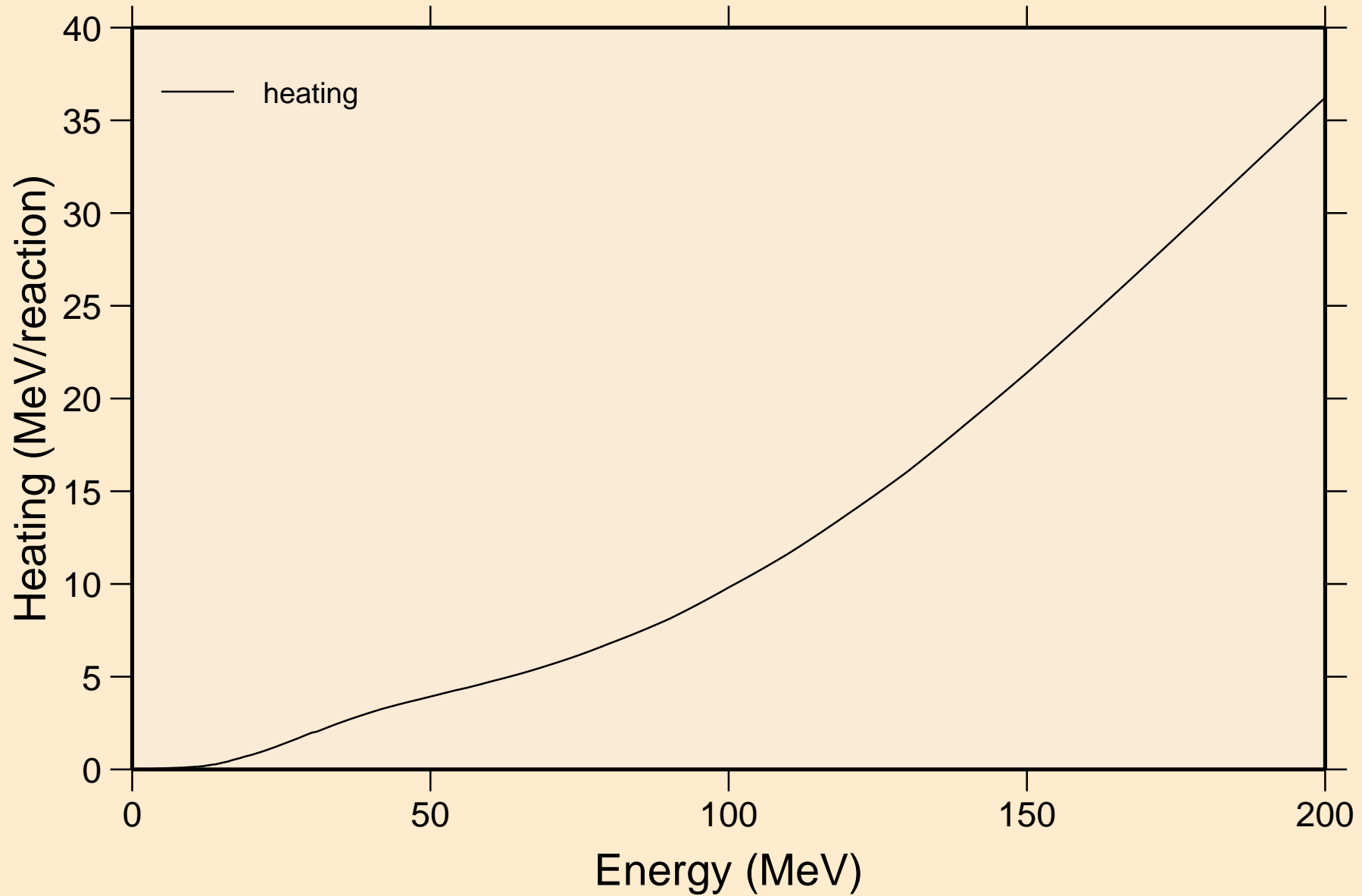

TE120 NEUTRON ACER TENDL-2024 LIBRARY; T=0.K  
Damage

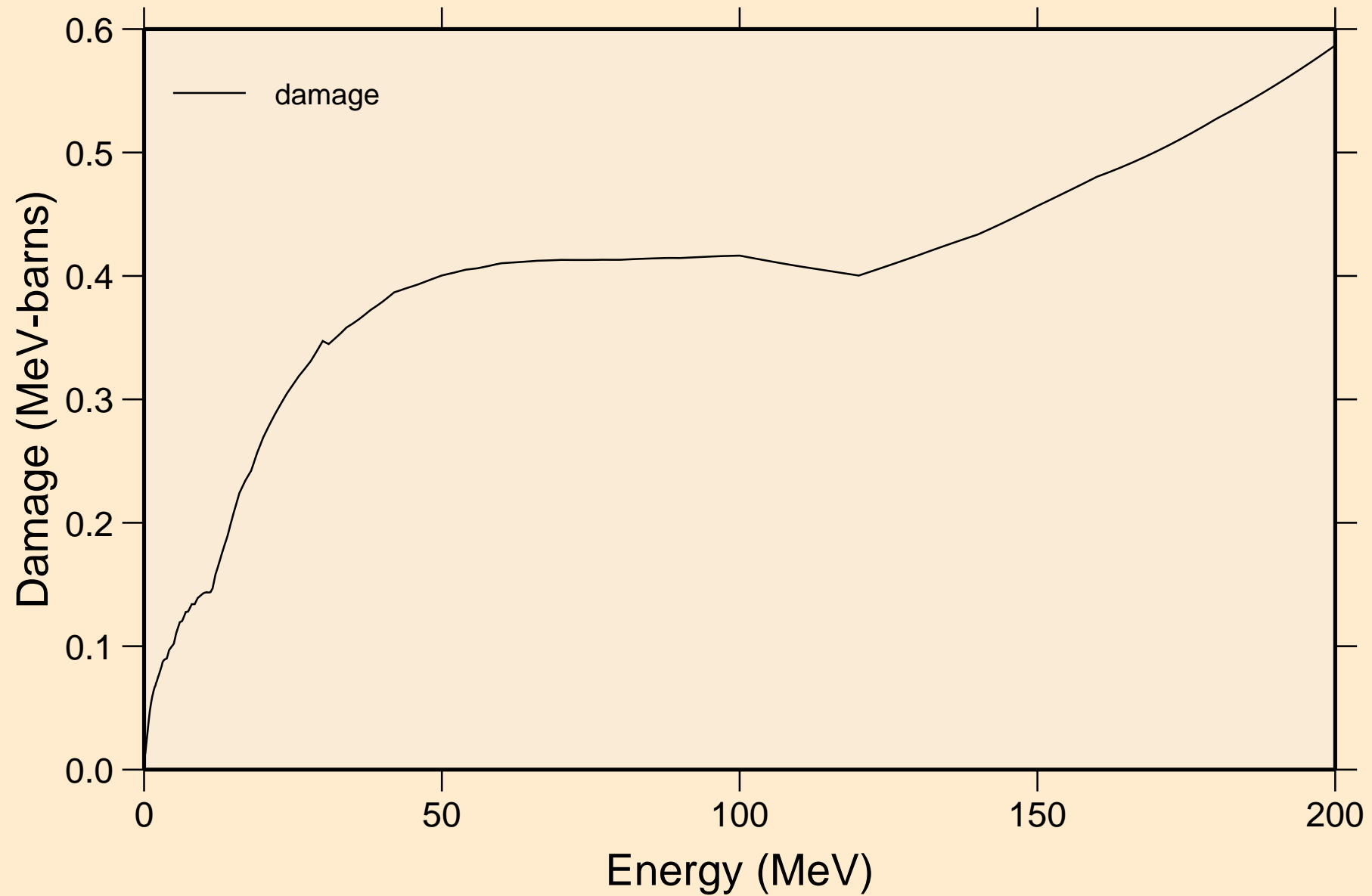

TE120 NEUTRON ACER TENDL-2024 LIBRARY; T=0.K  
Non-threshold reactions

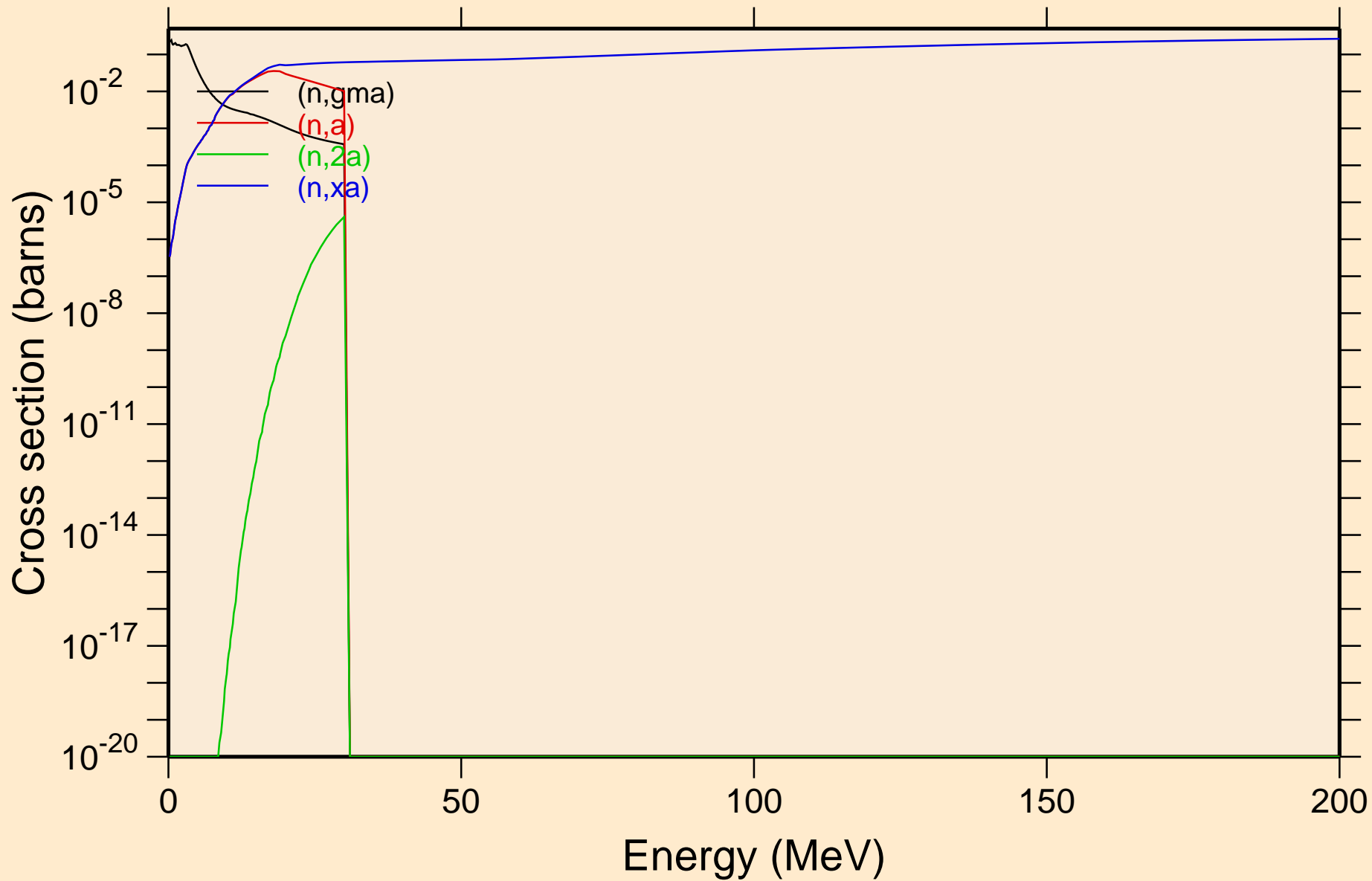

TE120 NEUTRON ACER TENDL-2024 LIBRARY; T=0.K  
Inelastic levels

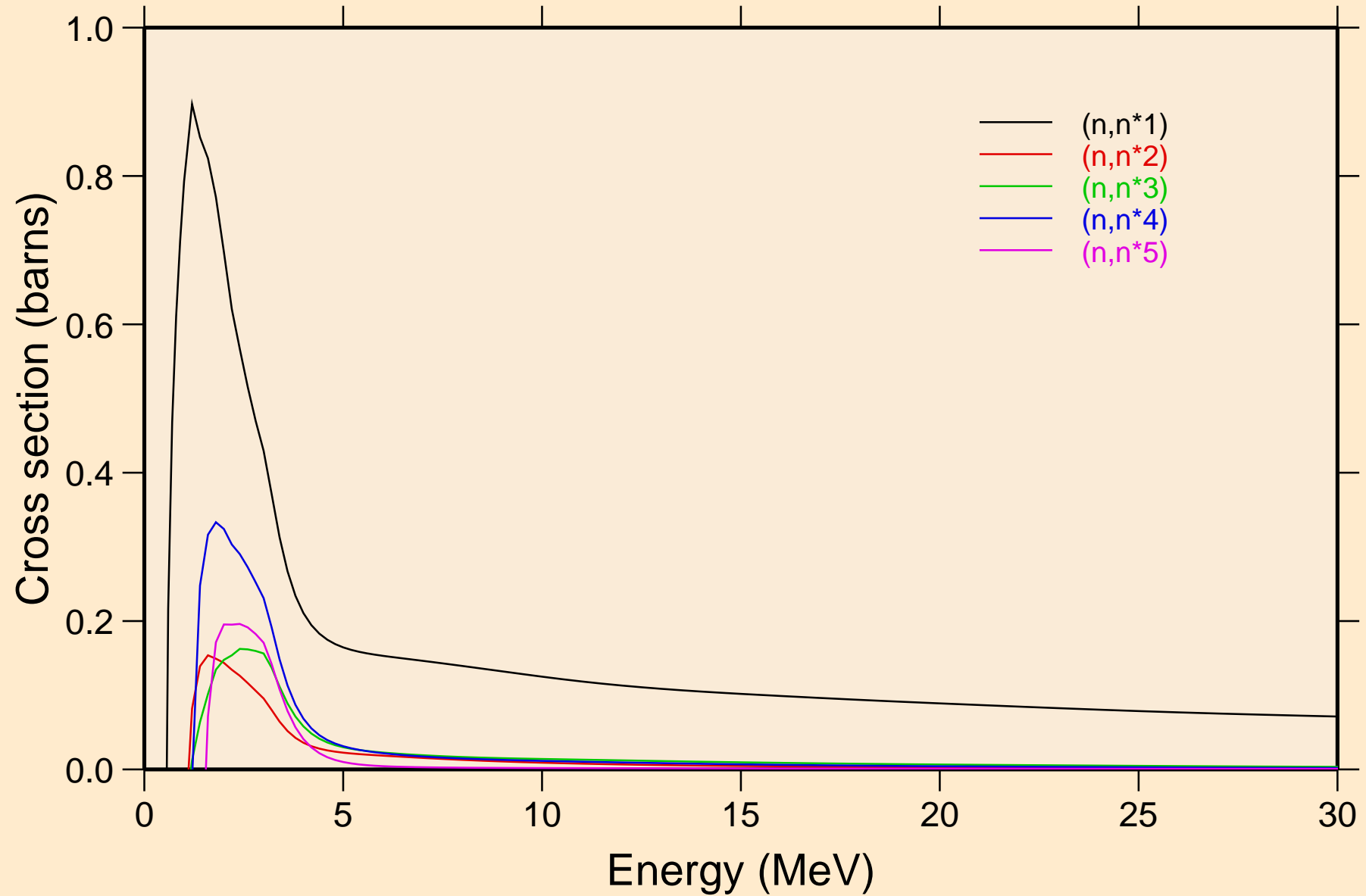

TE120 NEUTRON ACER TENDL-2024 LIBRARY; T=0.K  
Inelastic levels

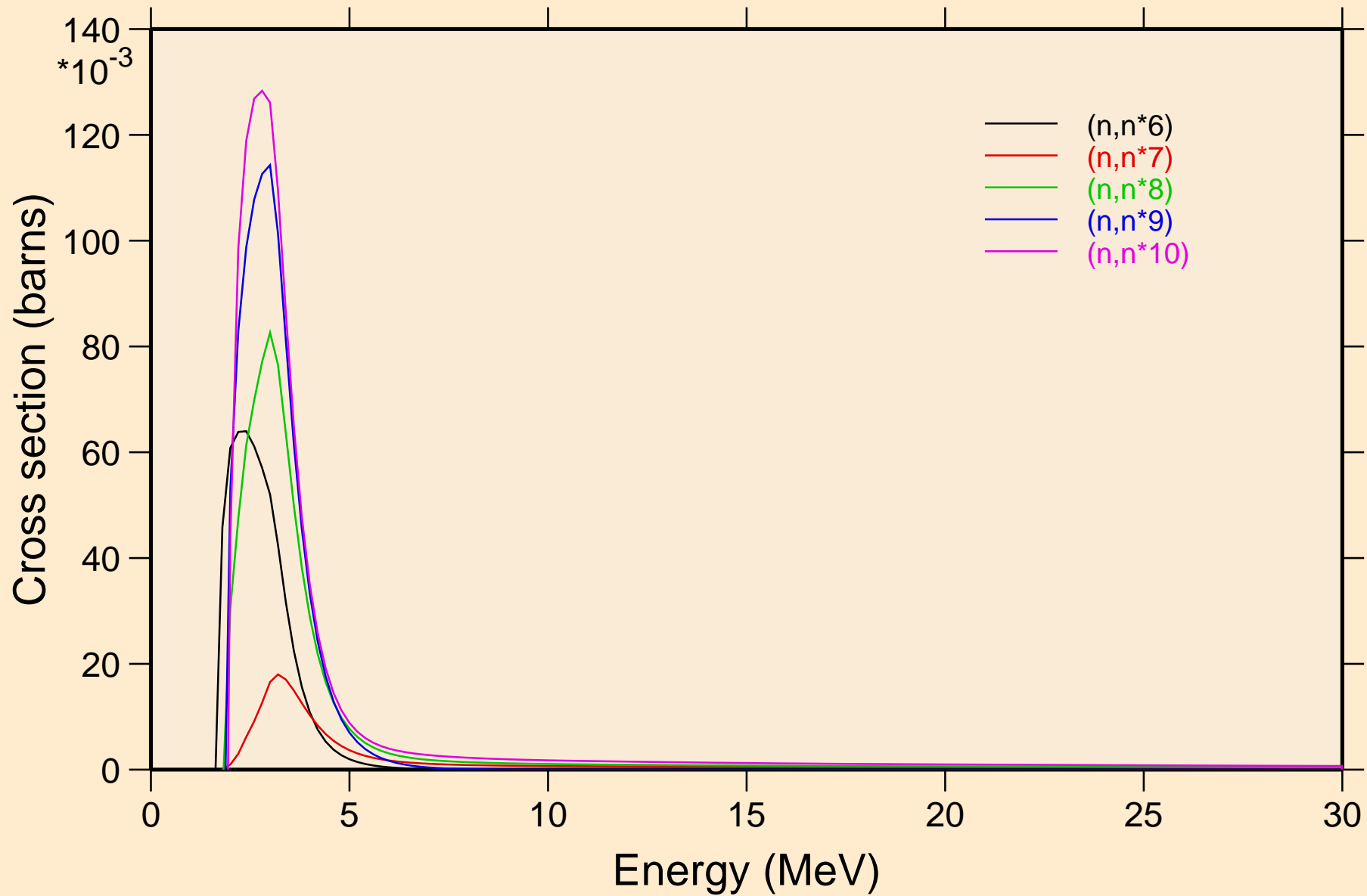



TE120 NEUTRON ACER TENDL-2024 LIBRARY; T=0.K  
Inelastic levels

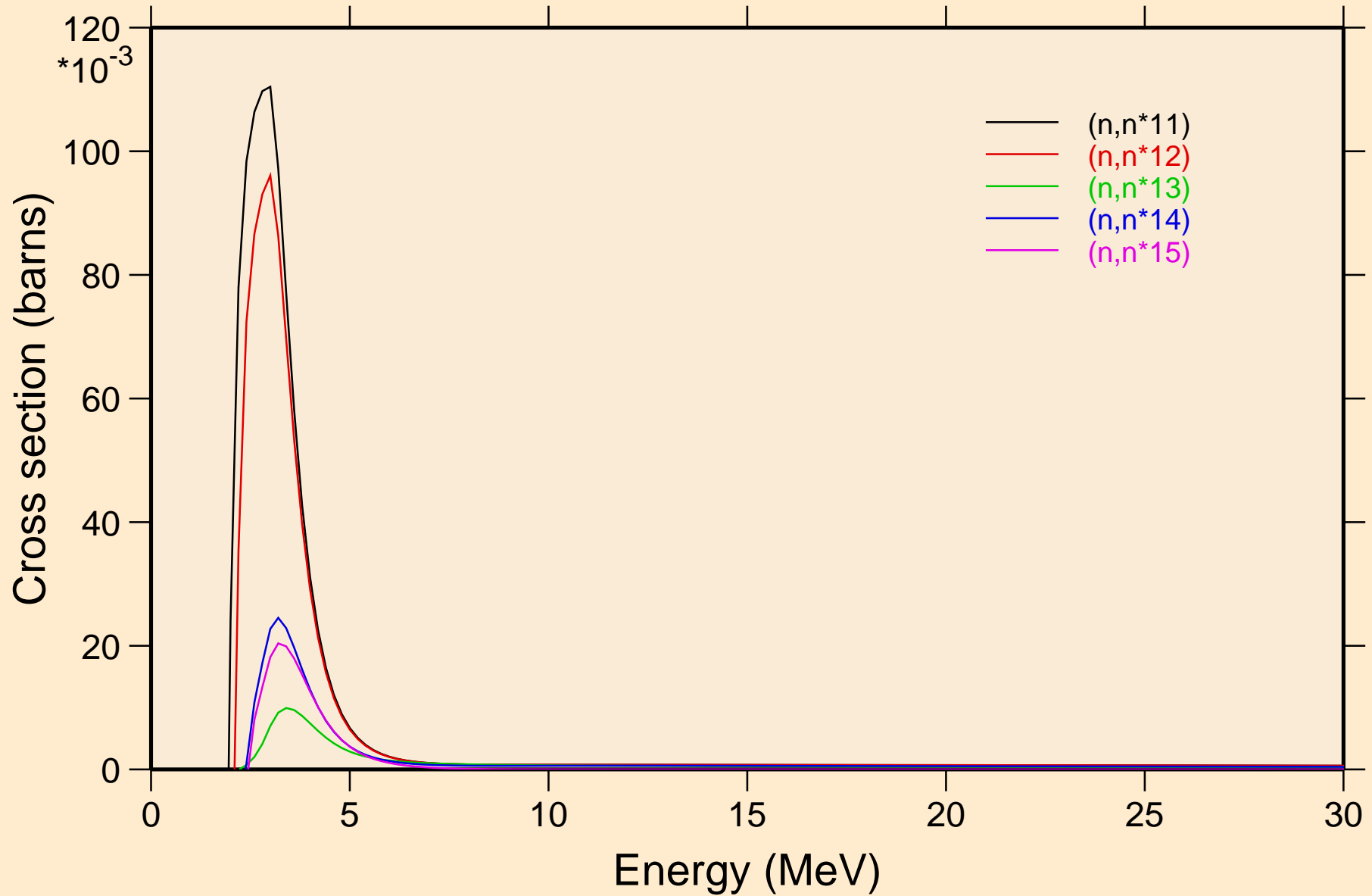

TE120 NEUTRON ACER TENDL-2024 LIBRARY; T=0.K  
Inelastic levels

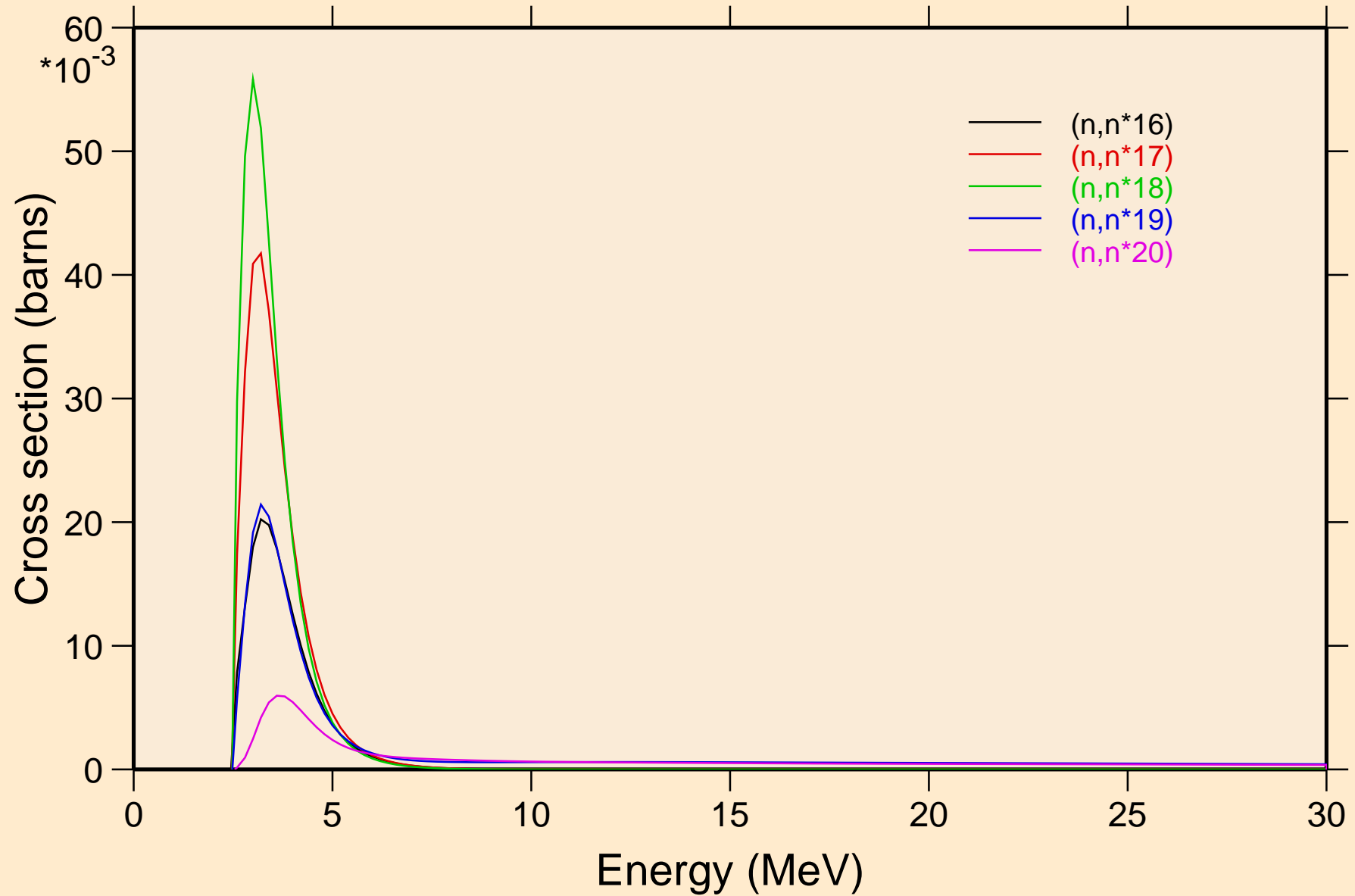

TE120 NEUTRON ACER TENDL-2024 LIBRARY; T=0.K  
Inelastic levels

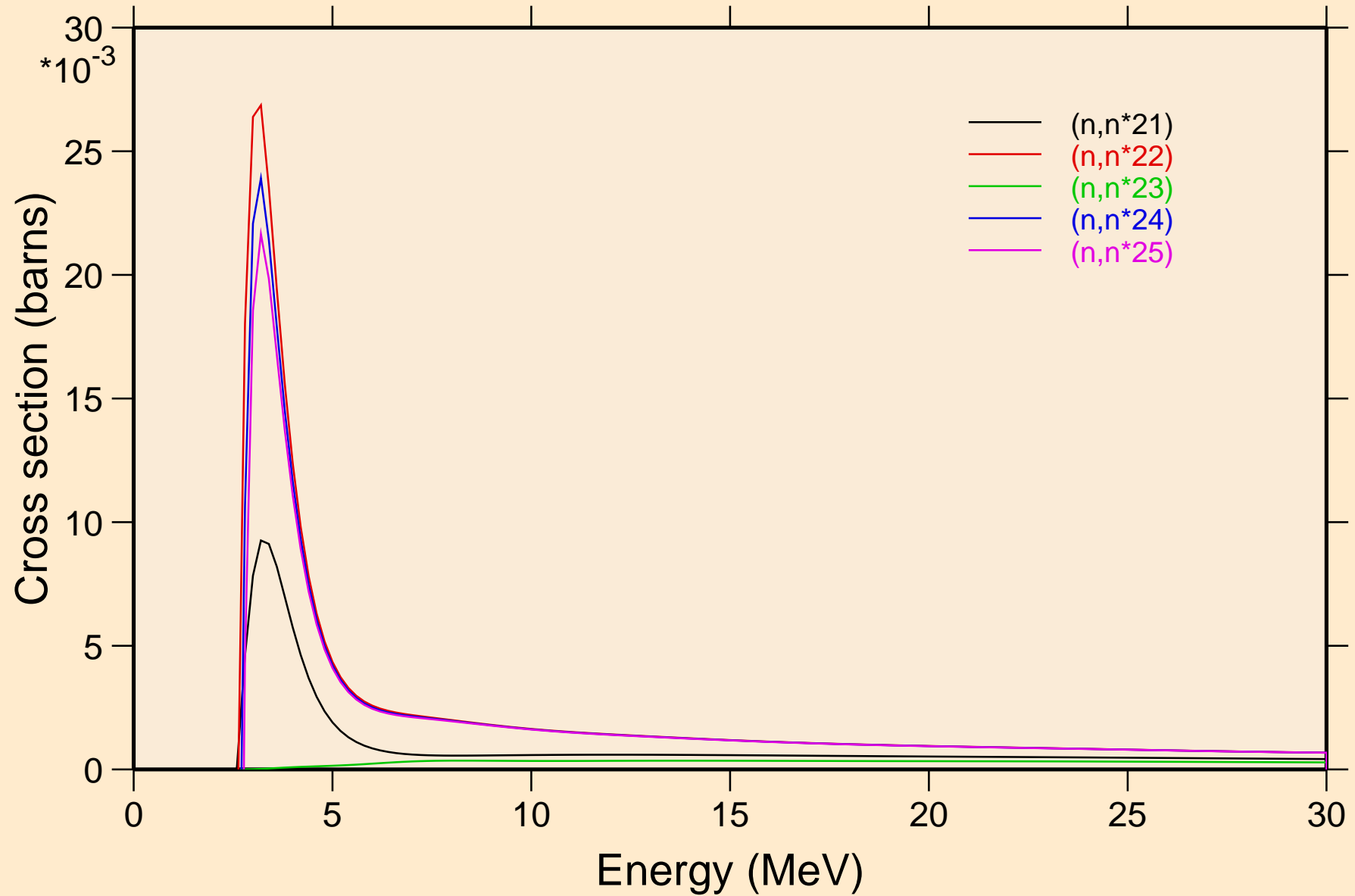

TE120 NEUTRON ACER TENDL-2024 LIBRARY; T=0.K  
Inelastic levels

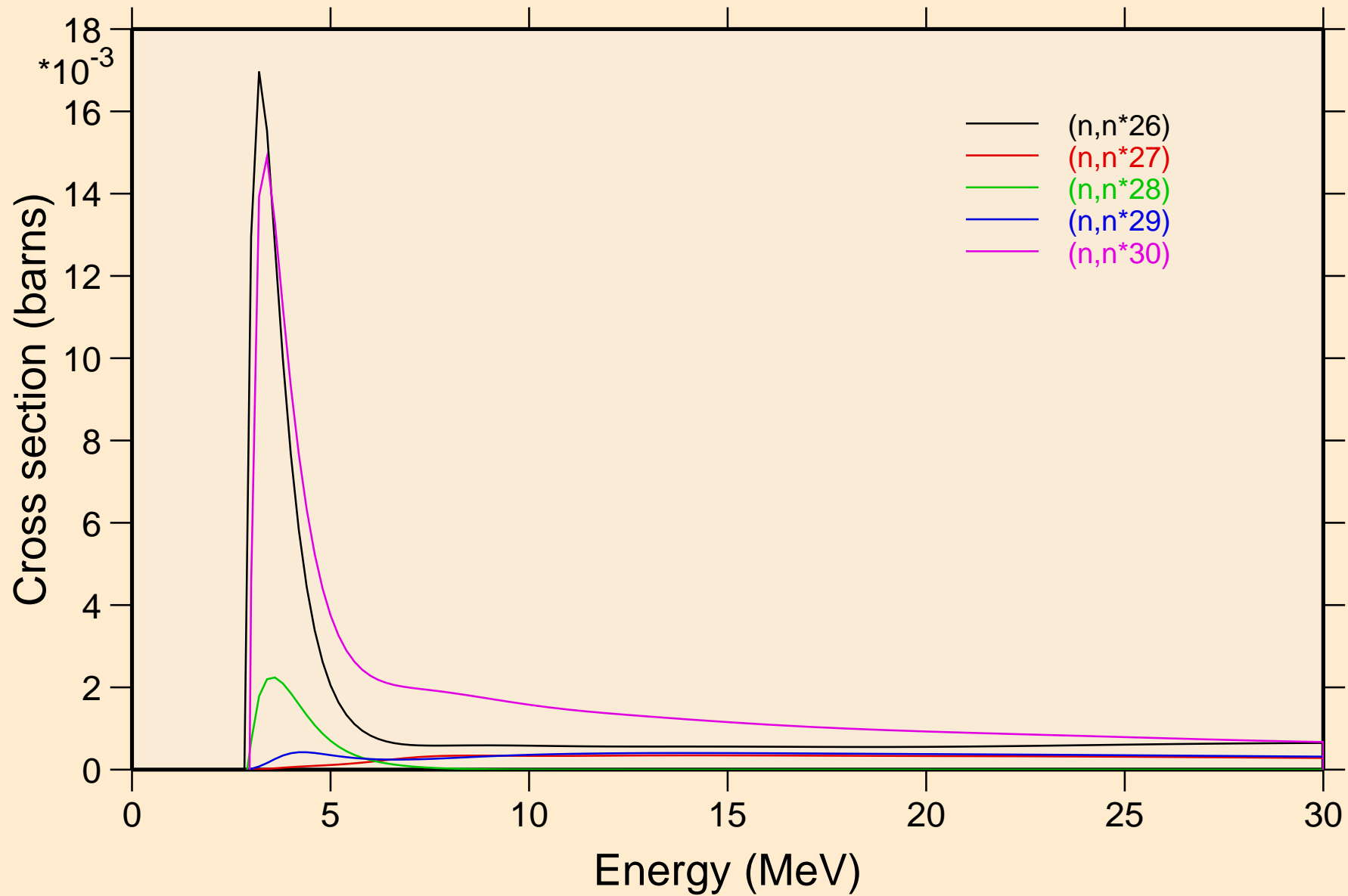

TE120 NEUTRON ACER TENDL-2024 LIBRARY; T=0.K  
Threshold reactions

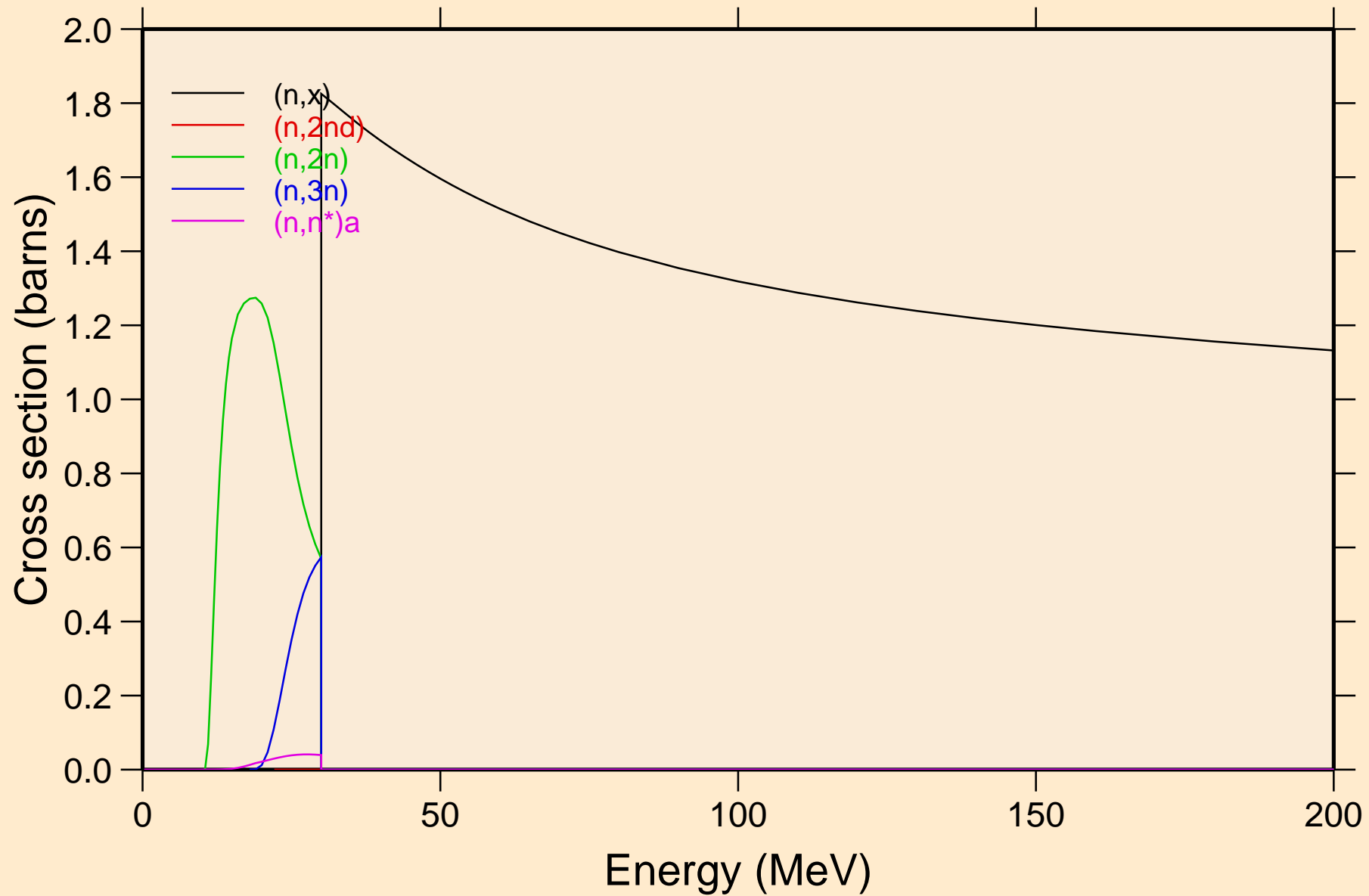

TE120 NEUTRON ACER TENDL-2024 LIBRARY; T=0.K  
Threshold reactions

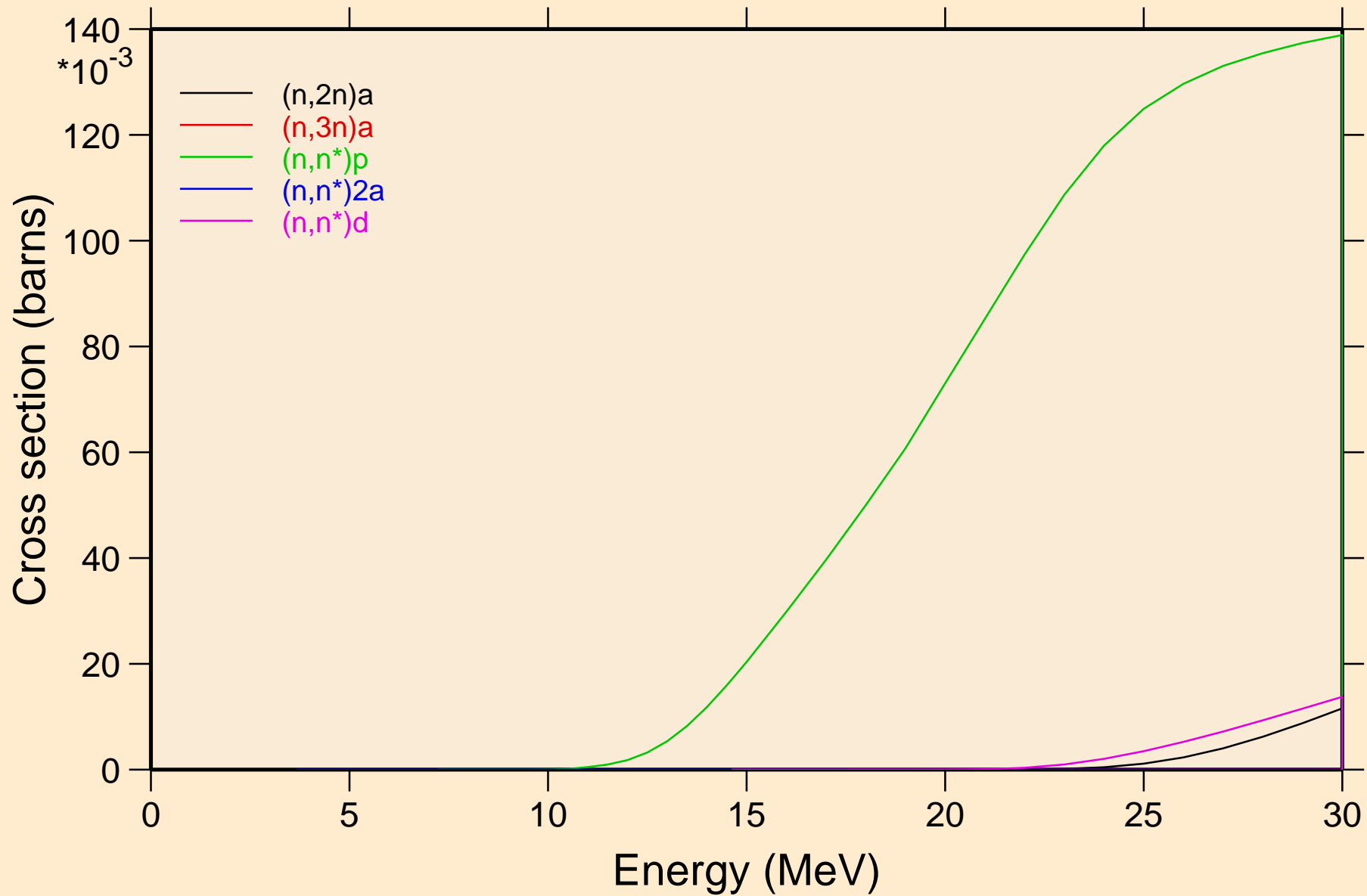

TE120 NEUTRON ACER TENDL-2024 LIBRARY; T=0.K  
Threshold reactions

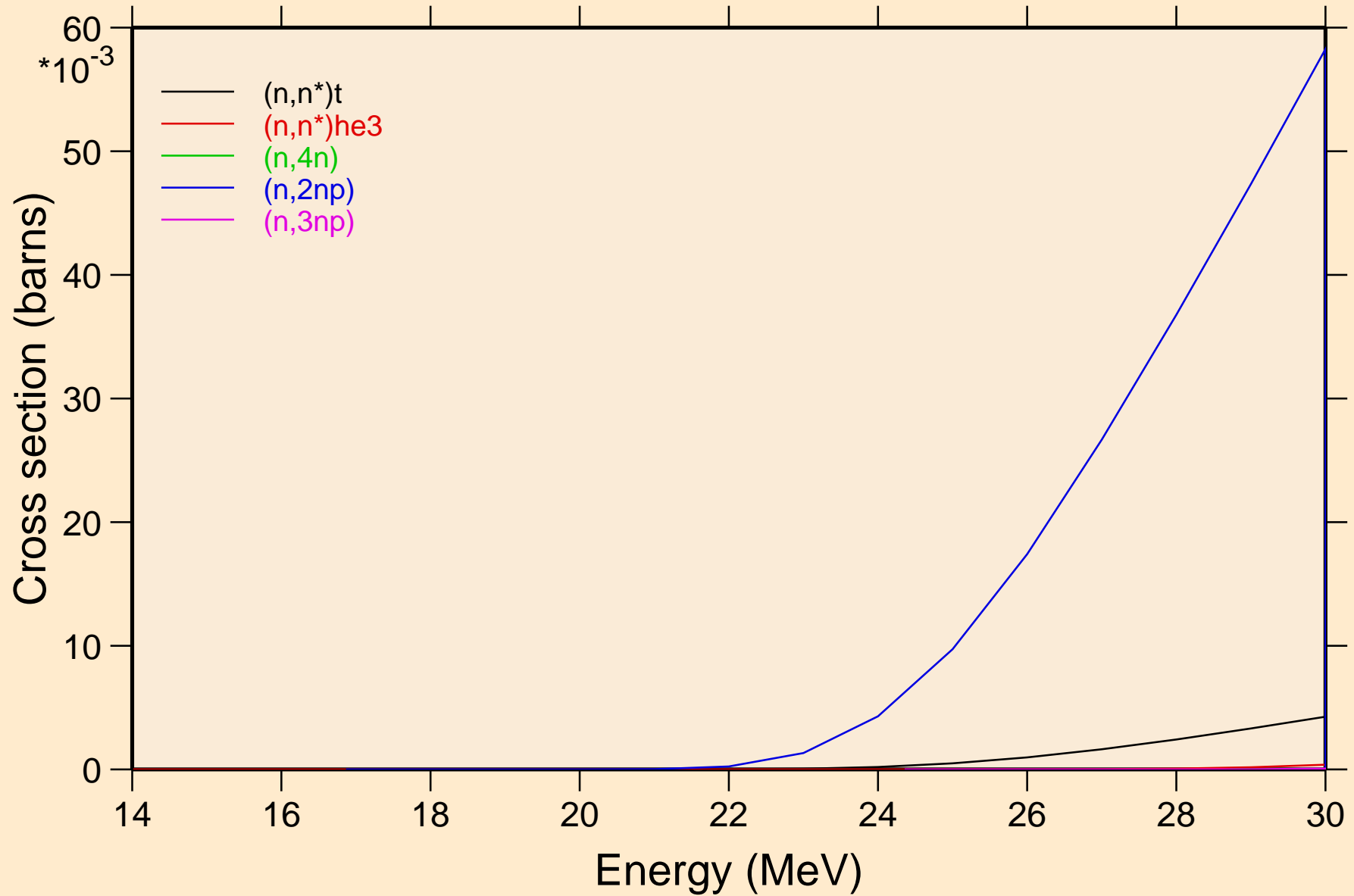

TE120 NEUTRON ACER TENDL-2024 LIBRARY; T=0.K  
Threshold reactions

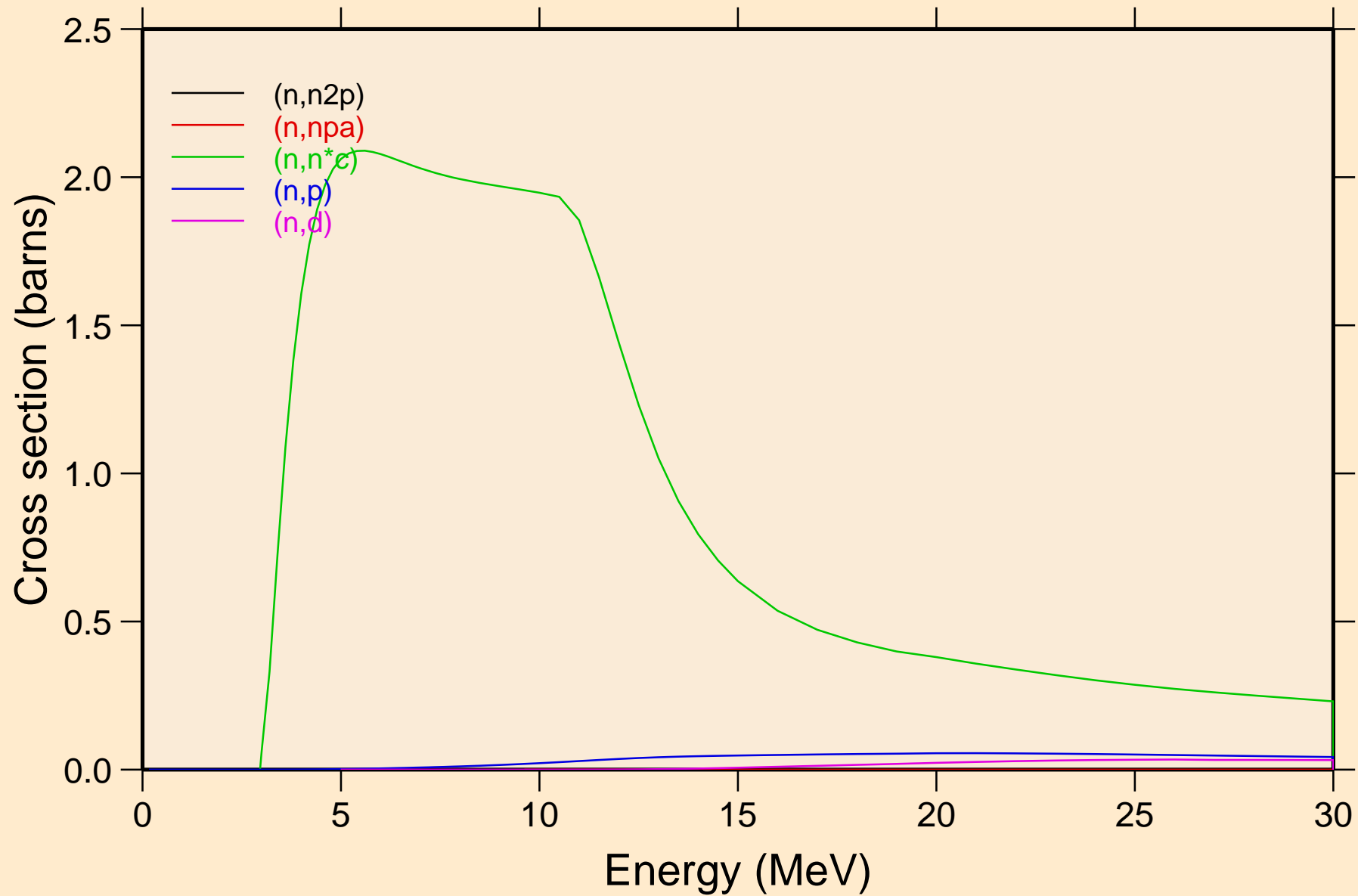



TE120 NEUTRON ACER TENDL-2024 LIBRARY; T=0.K  
Threshold reactions

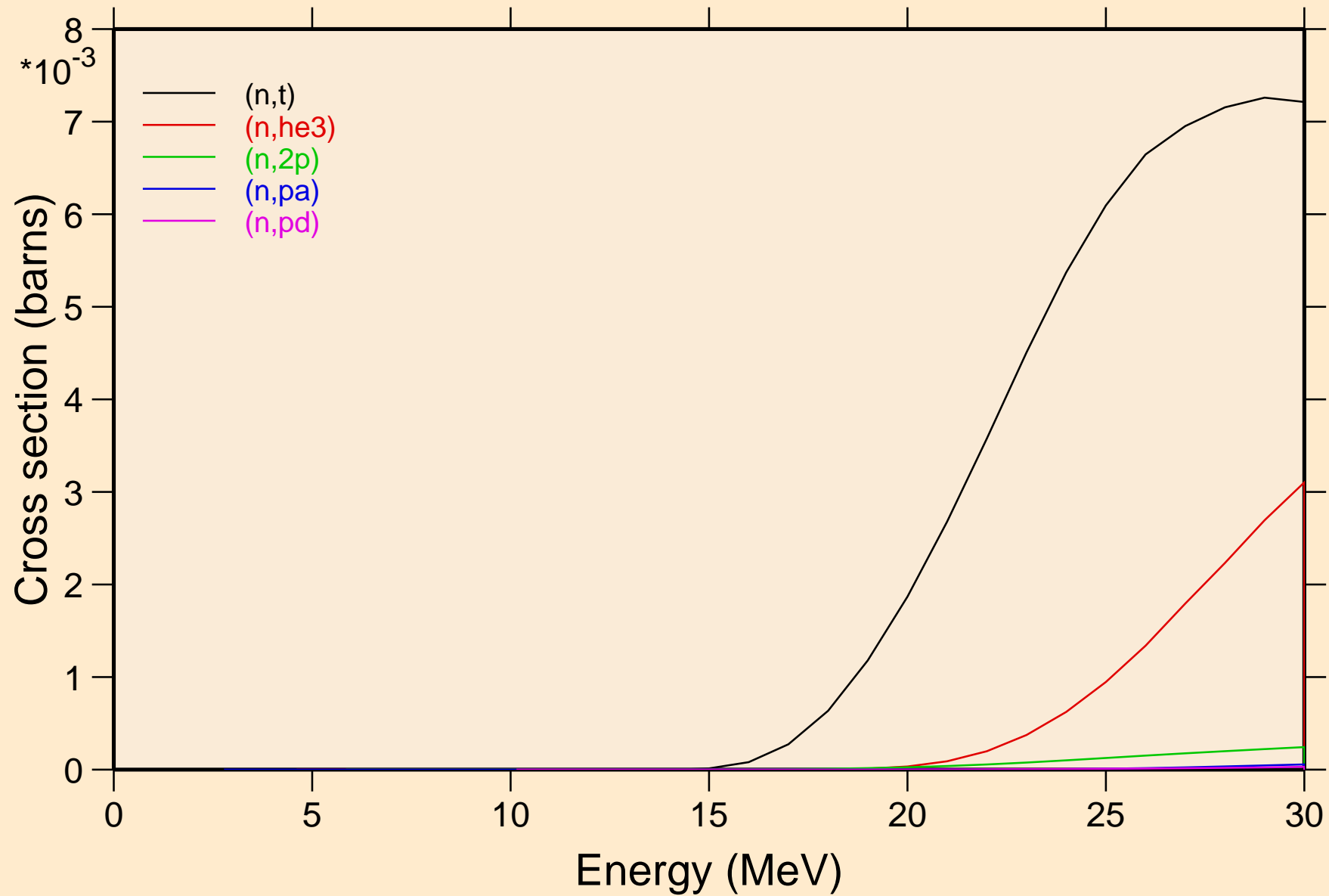

TE120 NEUTRON ACER TENDL-2024 LIBRARY; T=0.K  
Threshold reactions

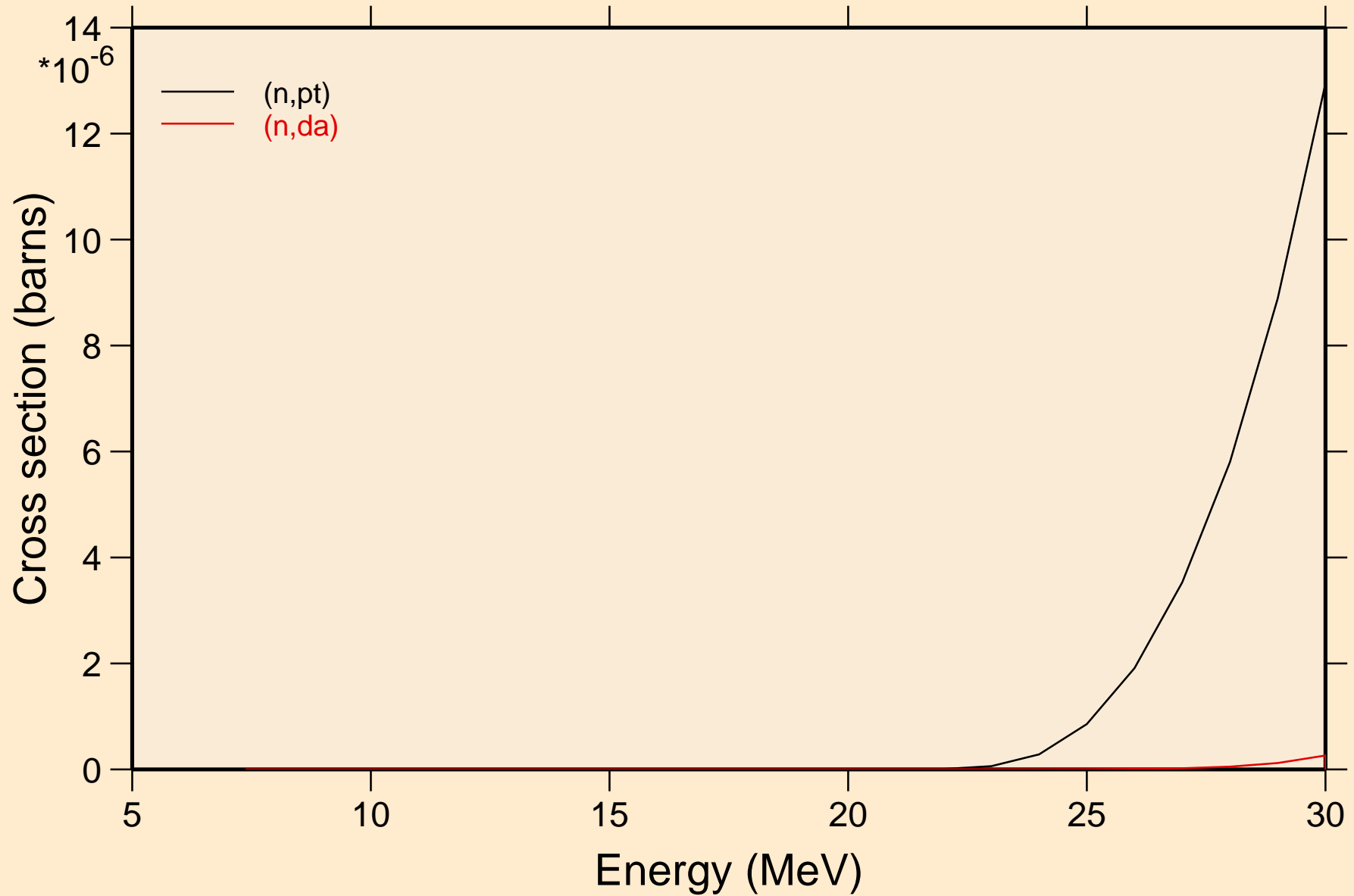

TE120 NEUTRON ACER TENDL-2024 LIBRARY; T=0.K  
Threshold reactions

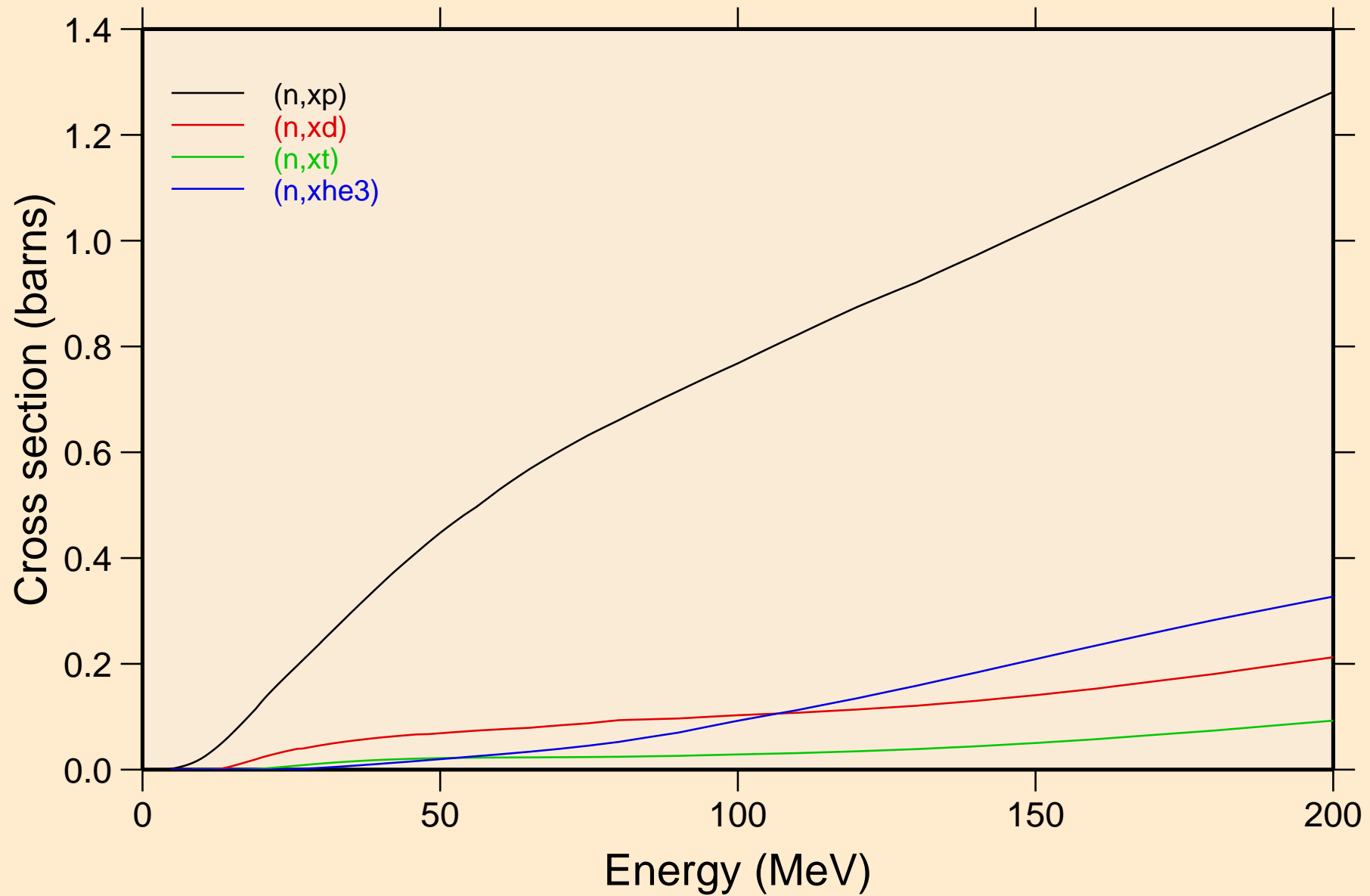

TE120 NEUTRON ACER TENDL-2024 LIBRARY; T=0.K  
angular distribution for elastic

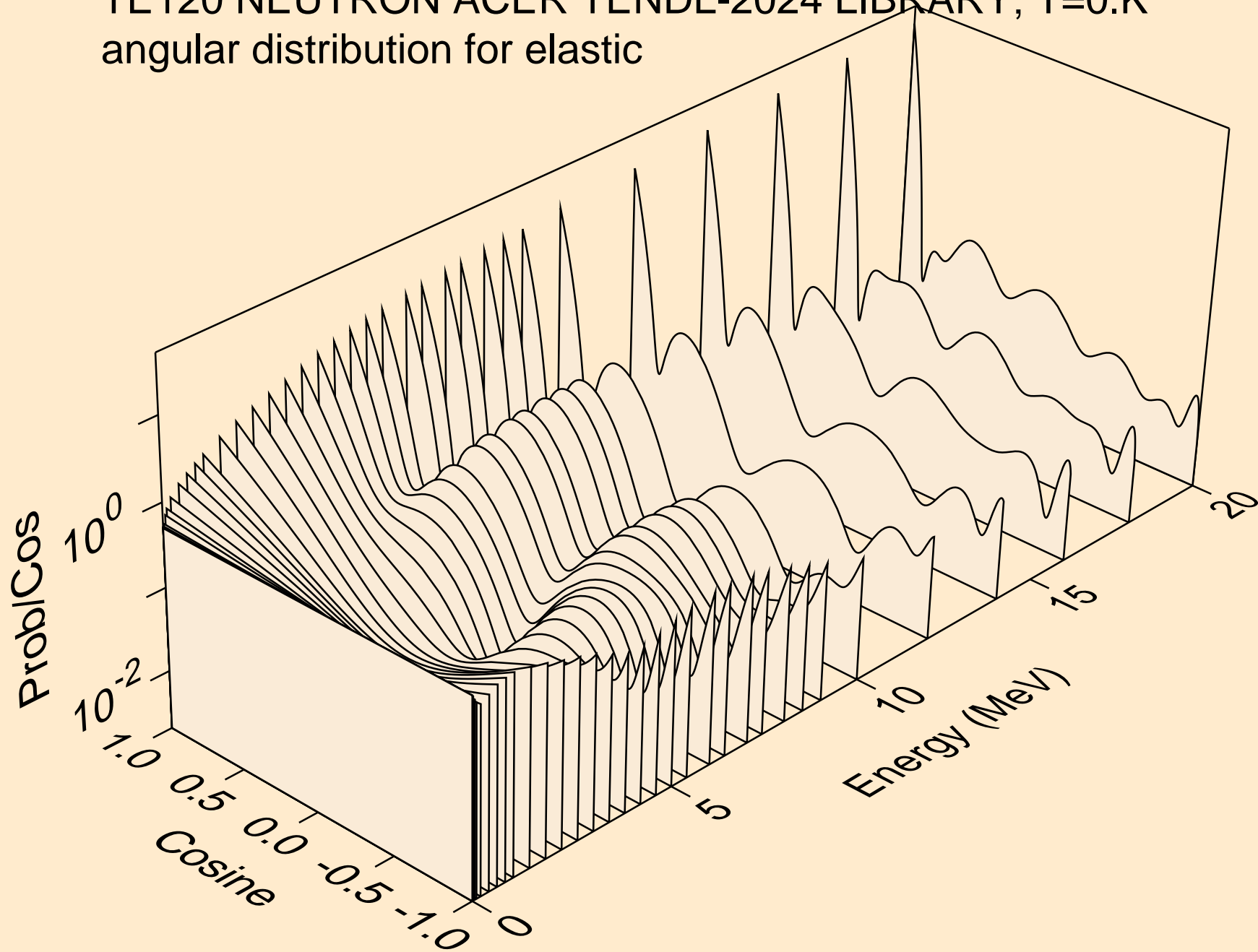

TE120 NEUTRON ACER TENDL-2024 LIBRARY; T=0.K  
angular distribution for elastic

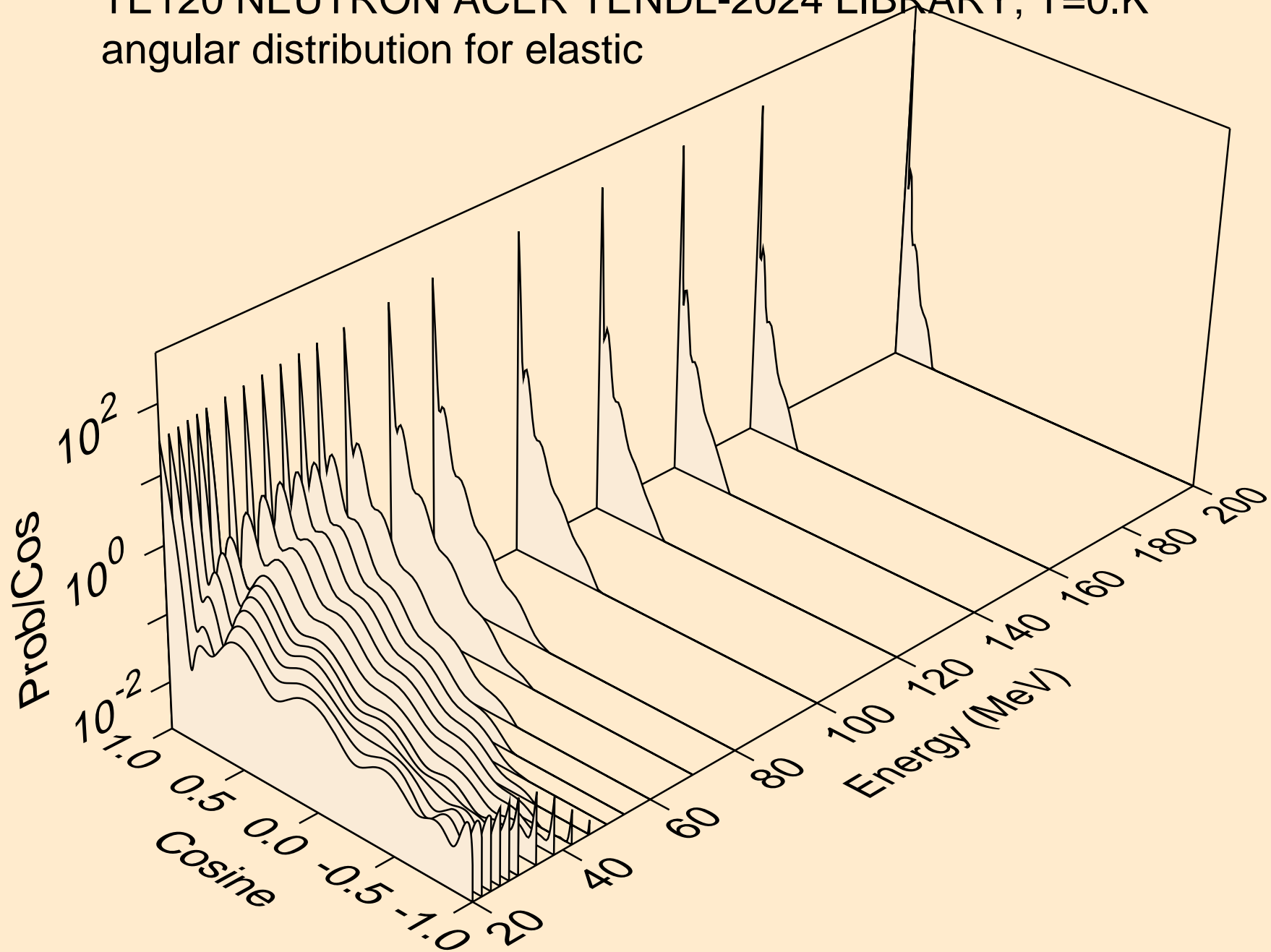

TE120 NEUTRON ACER TENDL-2024 LIBRARY; T=0.K  
angular distribution for (n,n\*1)

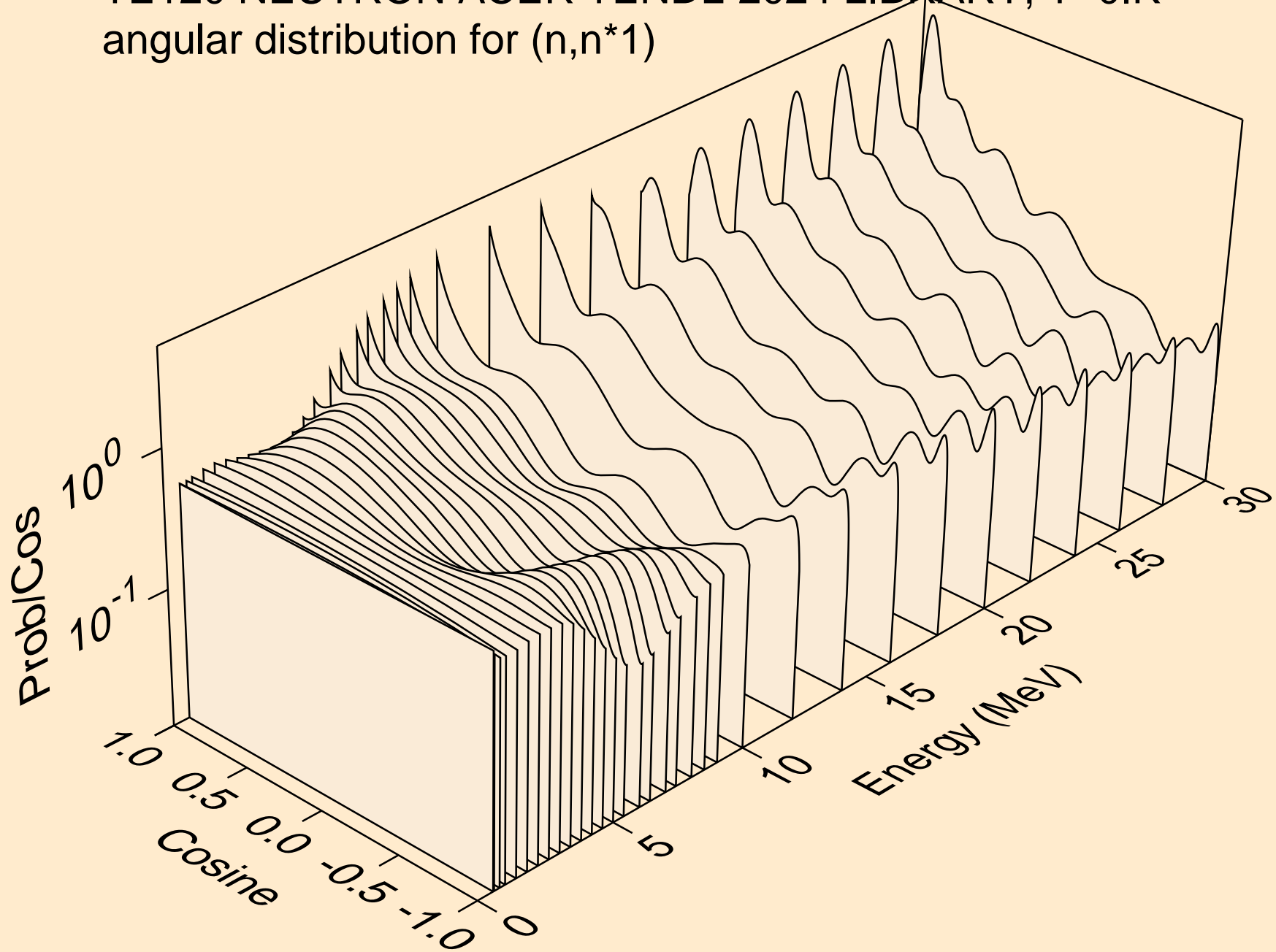

TE120 NEUTRON ACER TENDL-2024 LIBRARY; T=0.K  
angular distribution for (n,n\*2)

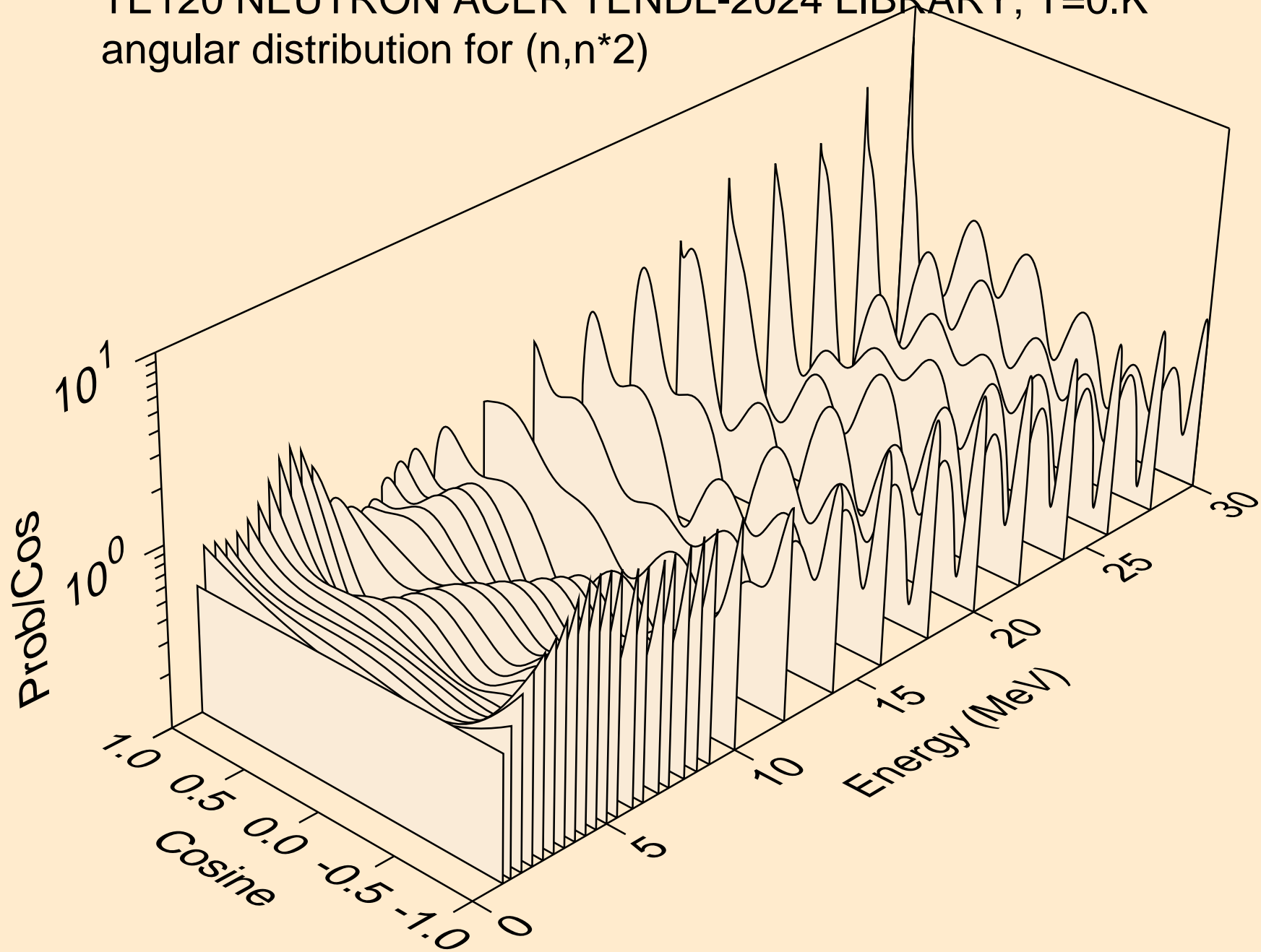

TE120 NEUTRON ACER TENDL-2024 LIBRARY; T=0.K  
angular distribution for (n,n\*3)

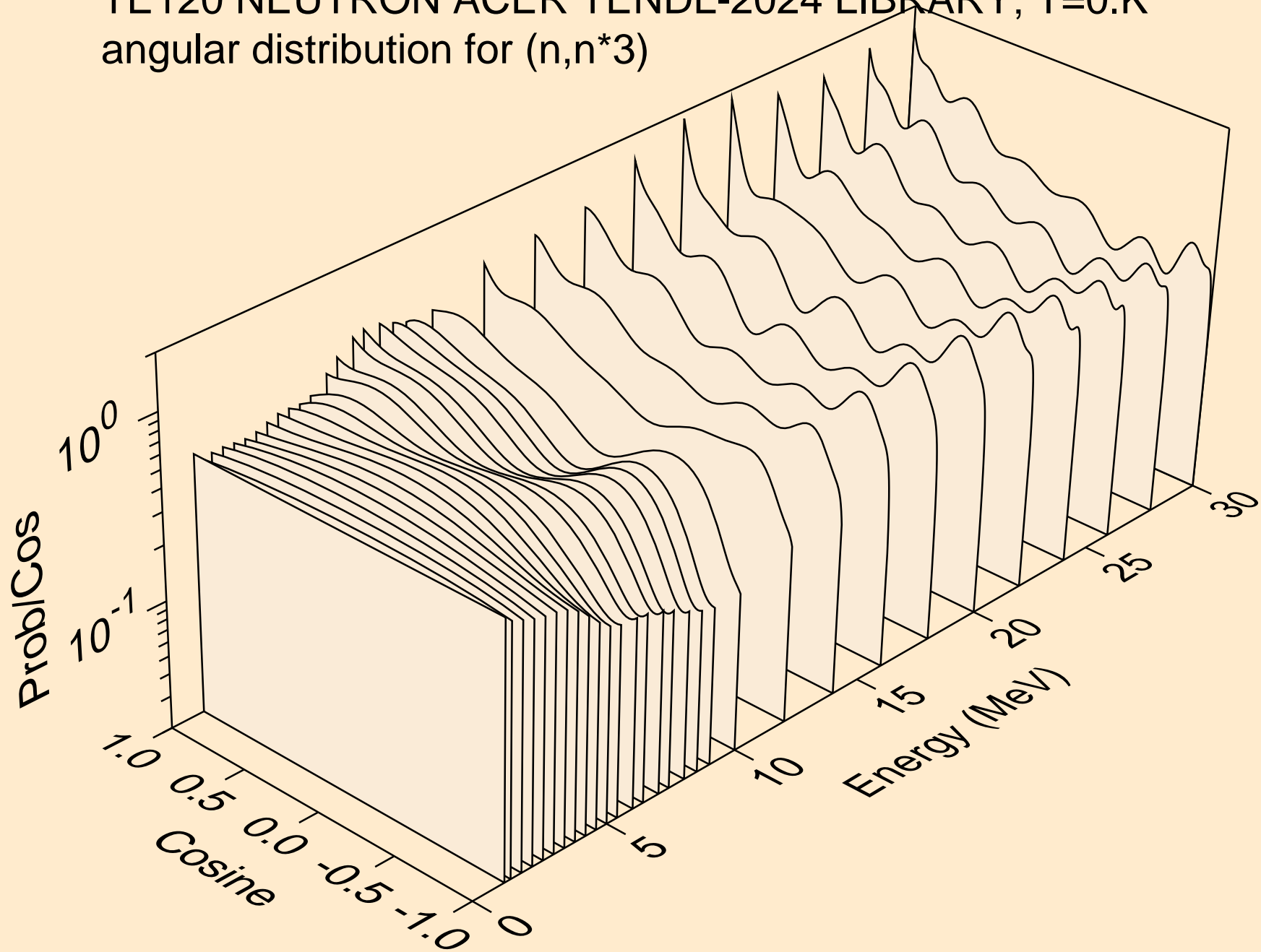



TE120 NEUTRON ACER TENDL-2024 LIBRARY; T=0.K  
angular distribution for (n,n\*4)

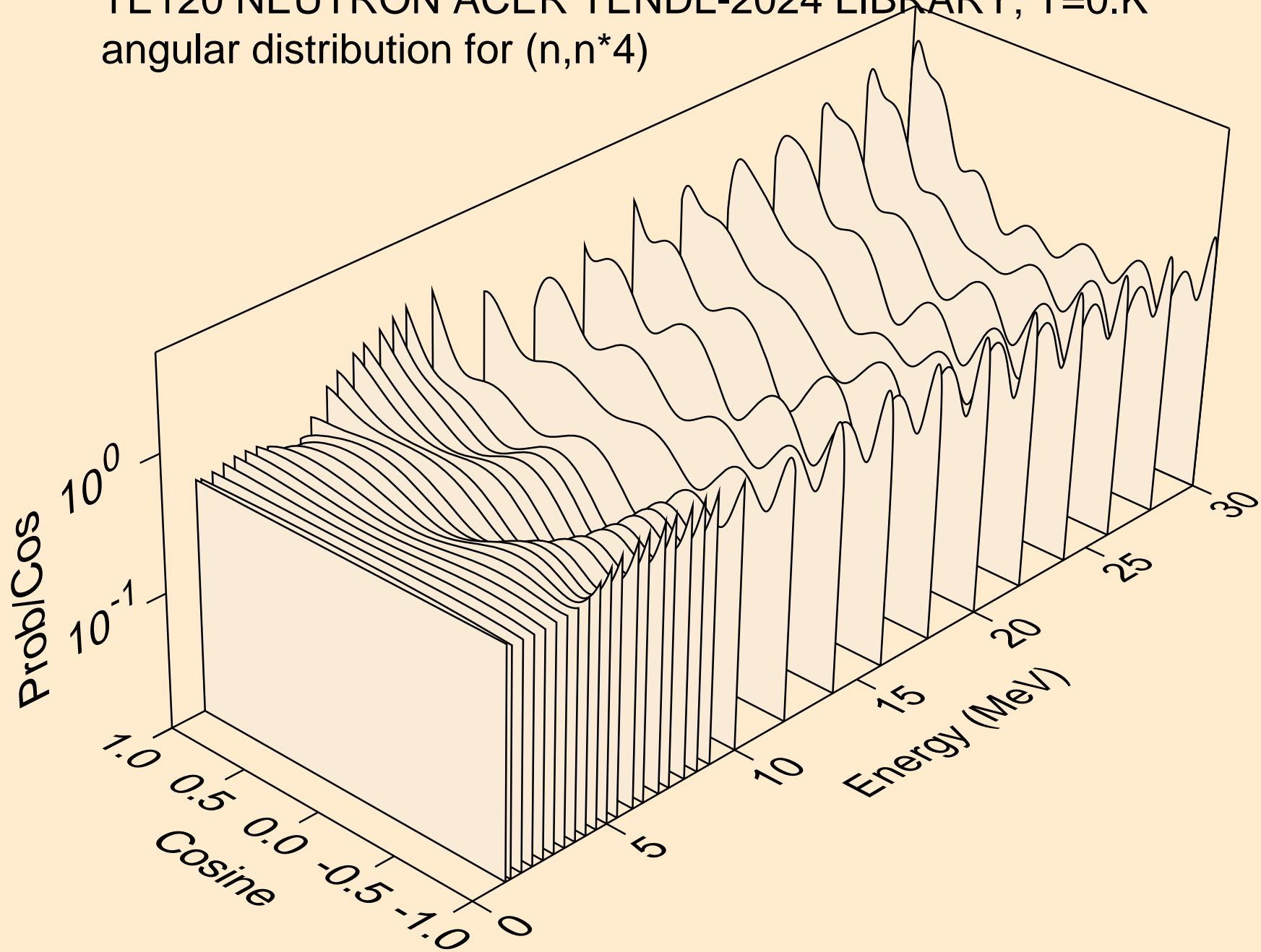

TE120 NEUTRON ACER TENDL-2024 LIBRARY; T=0.K  
angular distribution for (n,n\*5)

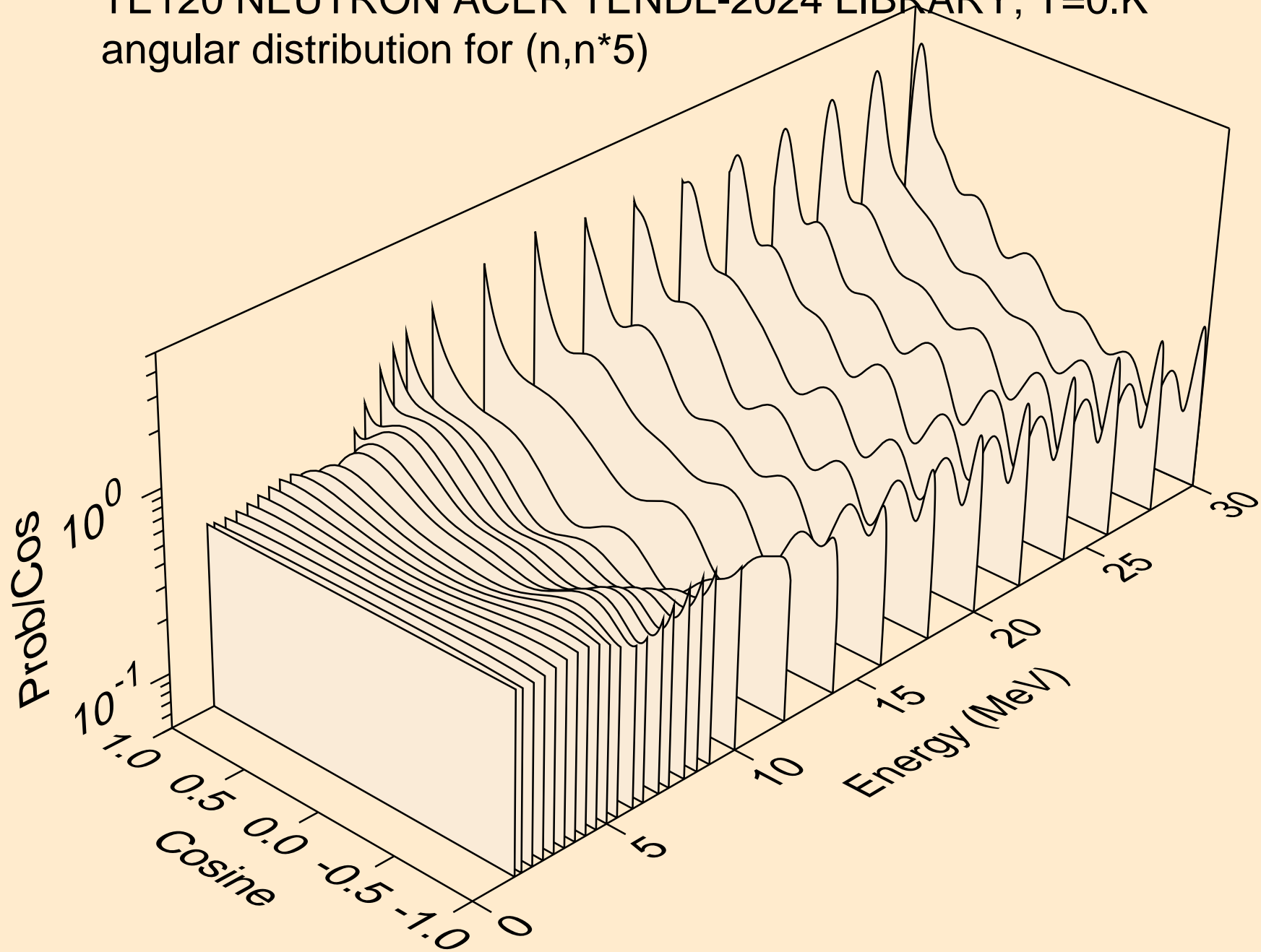

TE120 NEUTRON ACER TENDL-2024 LIBRARY; T=0.K  
angular distribution for (n,n\*6)

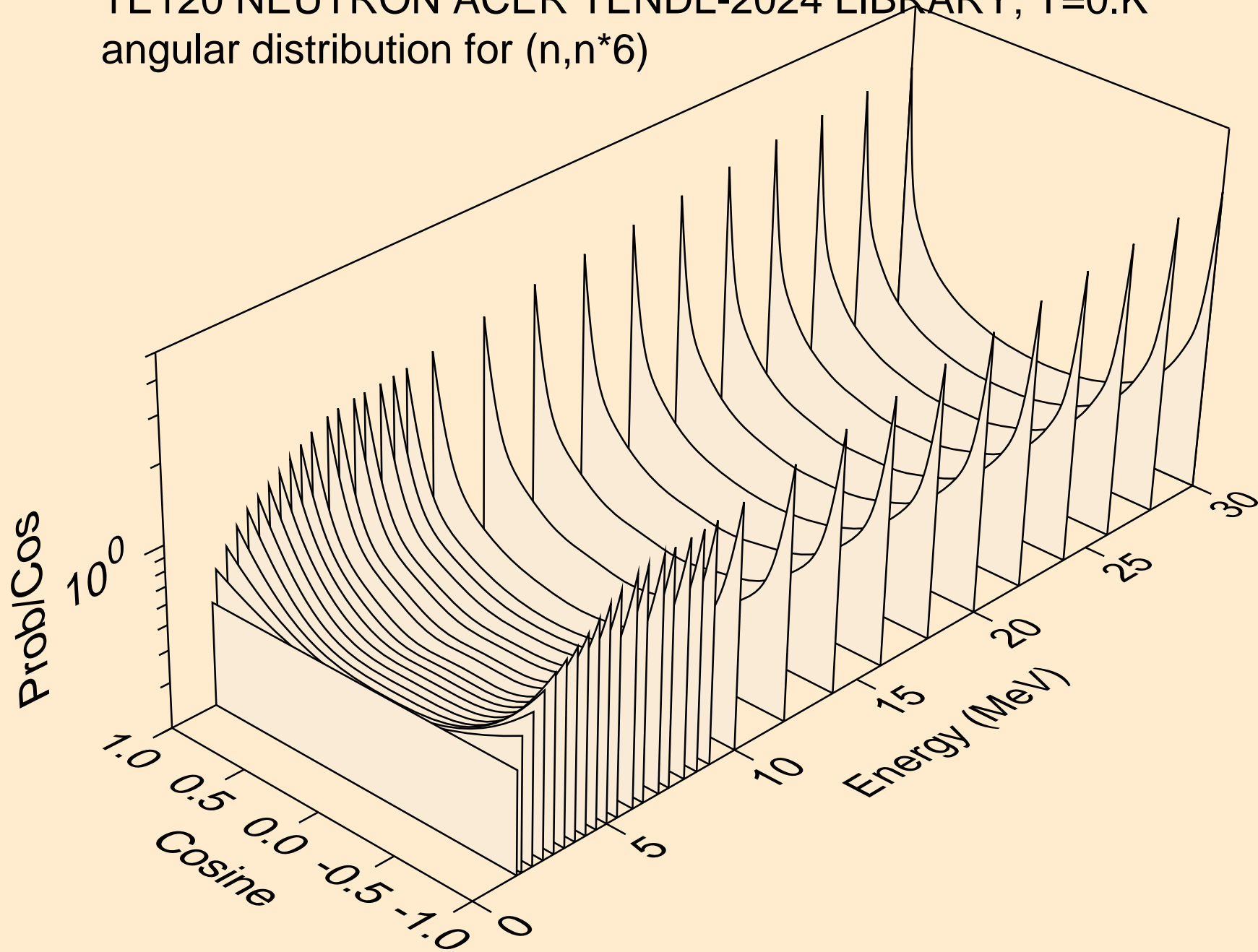

TE120 NEUTRON ACER TENDL-2024 LIBRARY; T=0.K  
angular distribution for (n,n\*7)

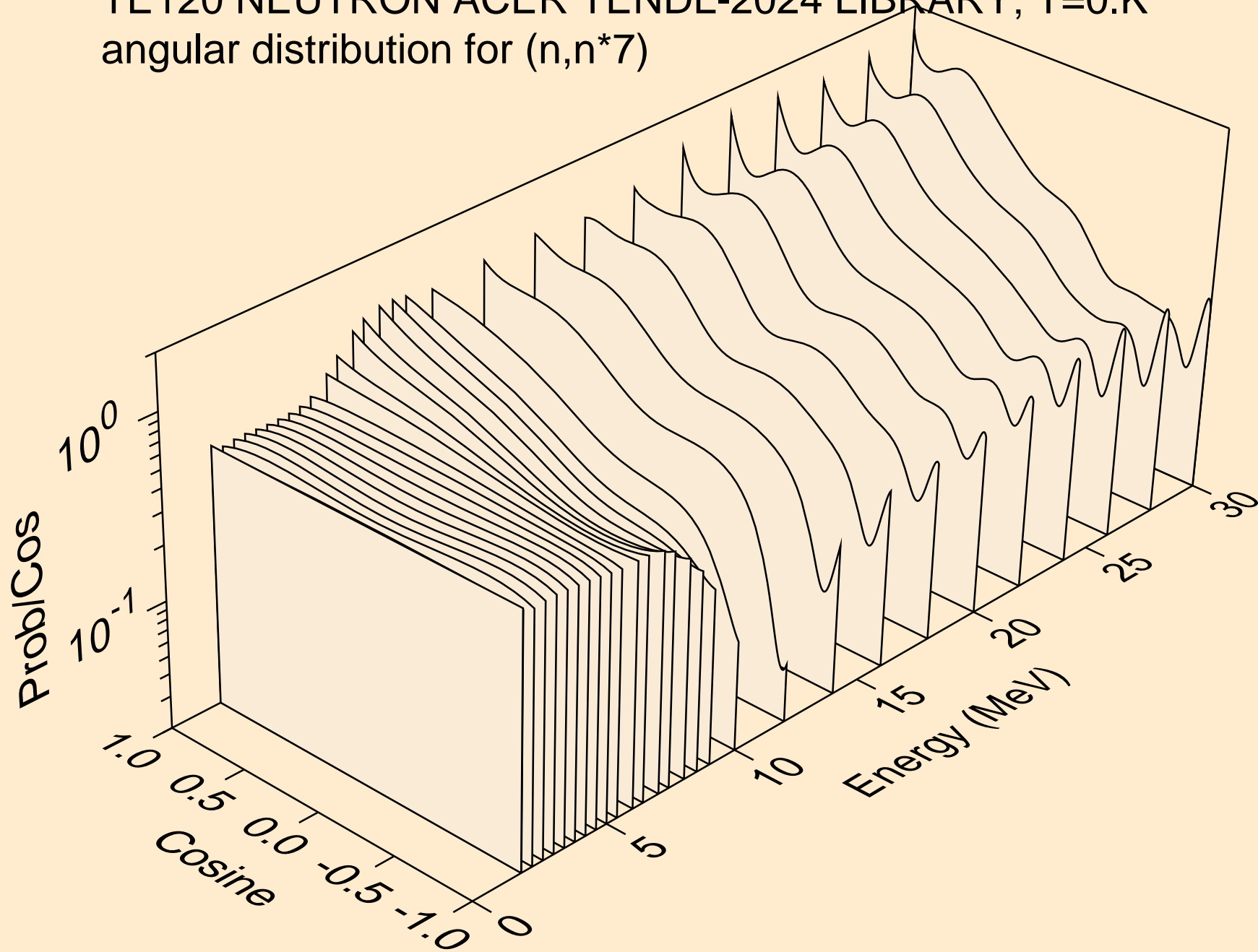

TE120 NEUTRON ACER TENDL-2024 LIBRARY; T=0.K  
angular distribution for (n,n\*8)

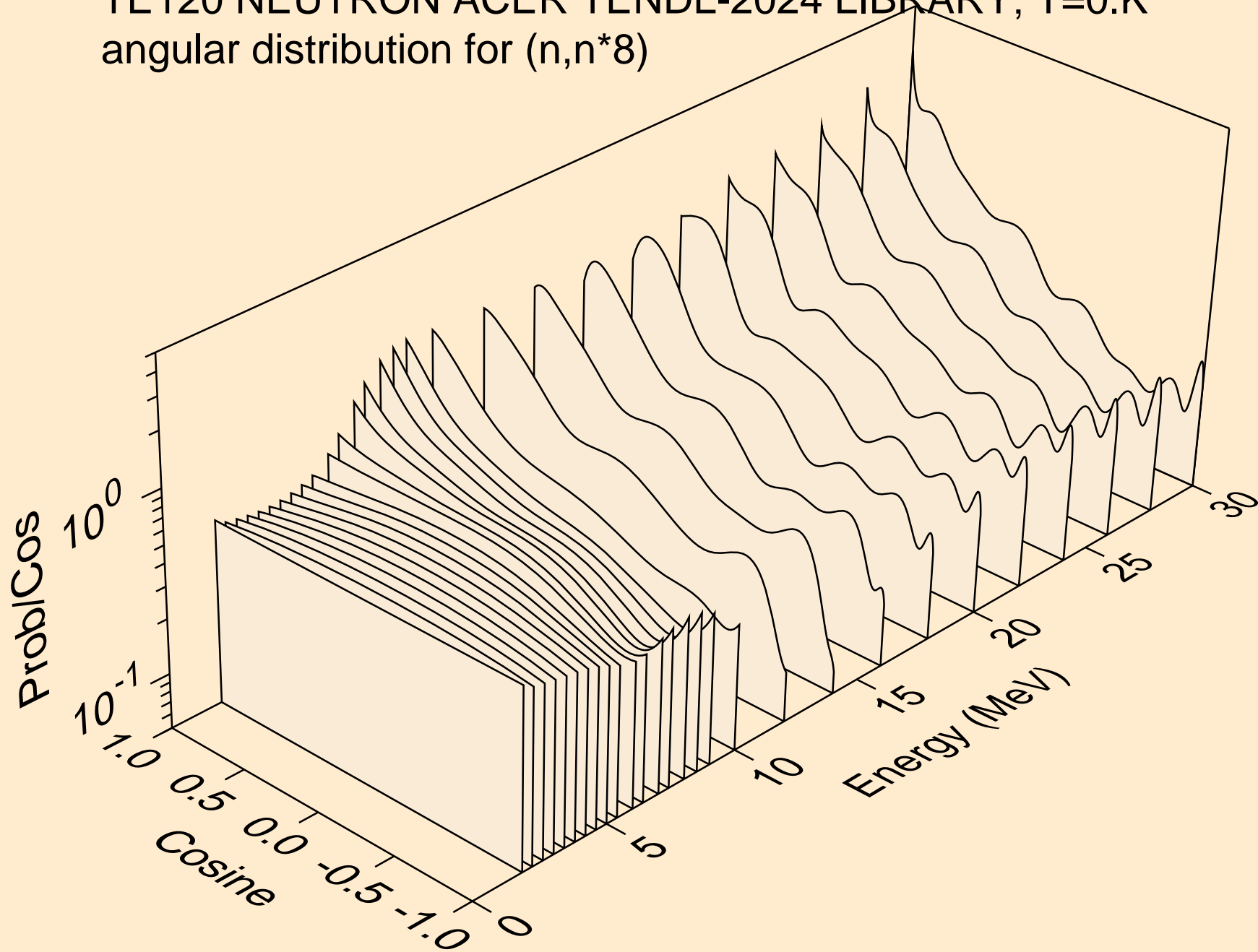

TE120 NEUTRON ACER TENDL-2024 LIBRARY; T=0.K  
angular distribution for (n,n\*9)

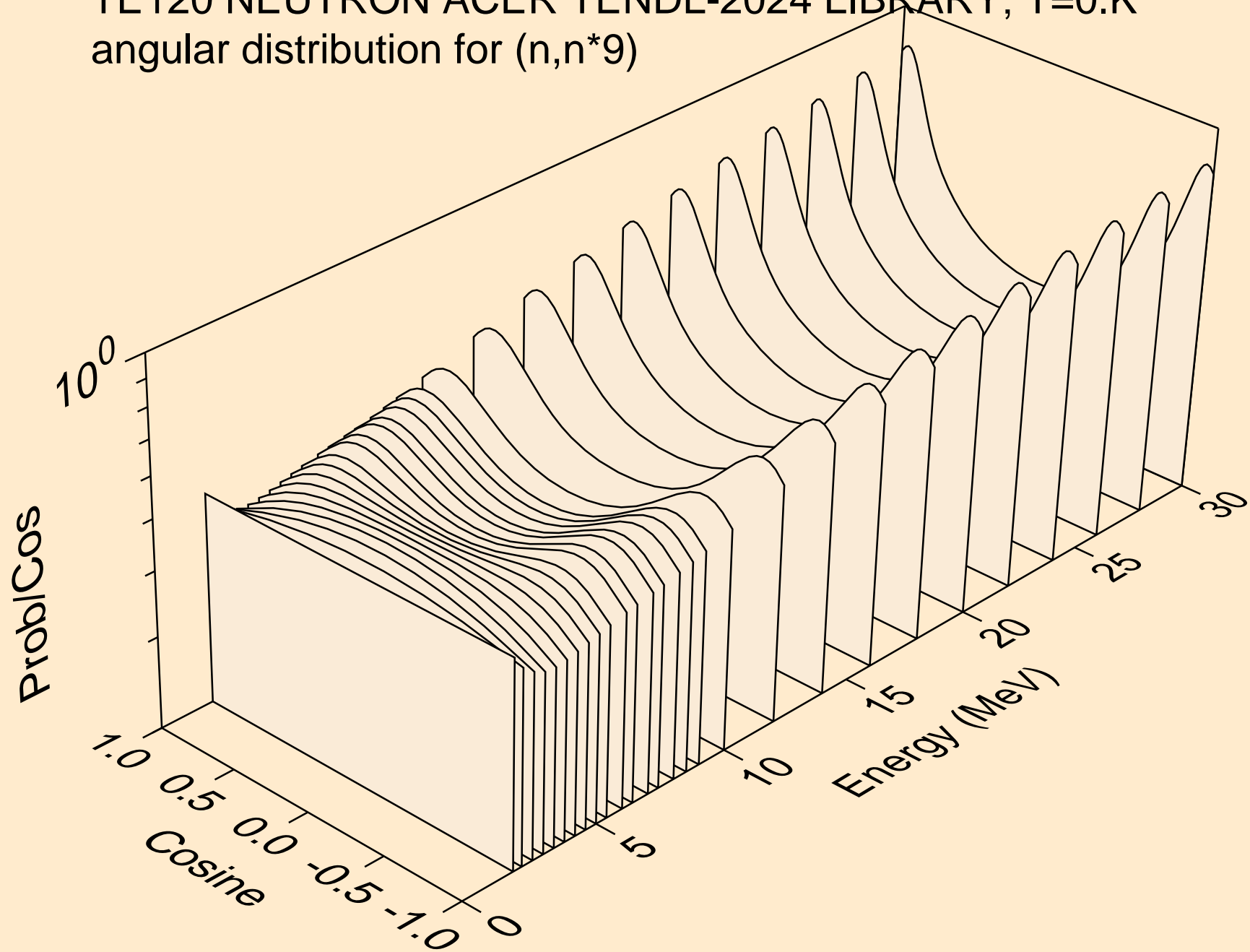

TE120 NEUTRON ACER TENDL-2024 LIBRARY; T=0.K  
angular distribution for (n,n\*10)

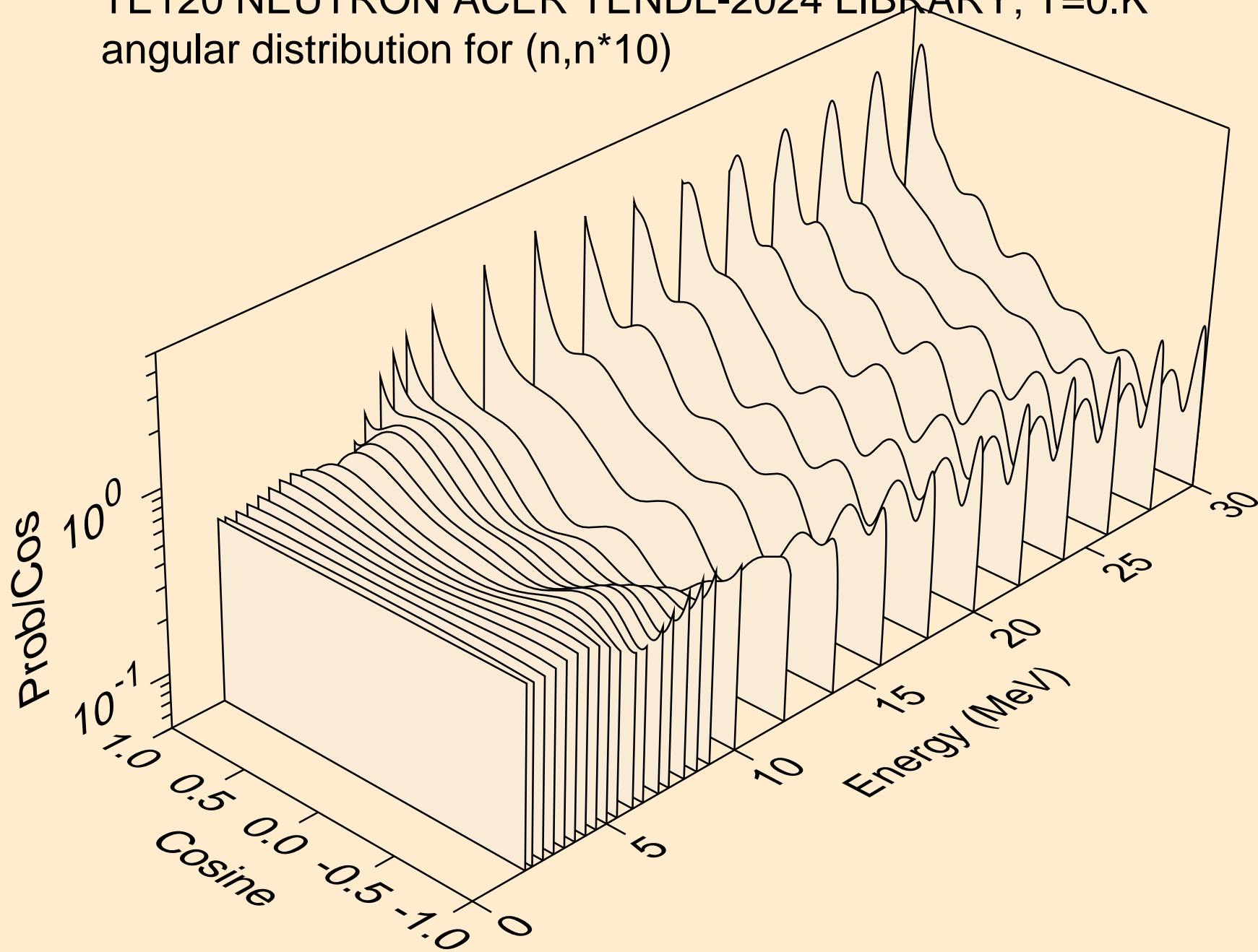

TE120 NEUTRON ACER TENDL-2024 LIBRARY; T=0.K  
angular distribution for (n,n\*11)

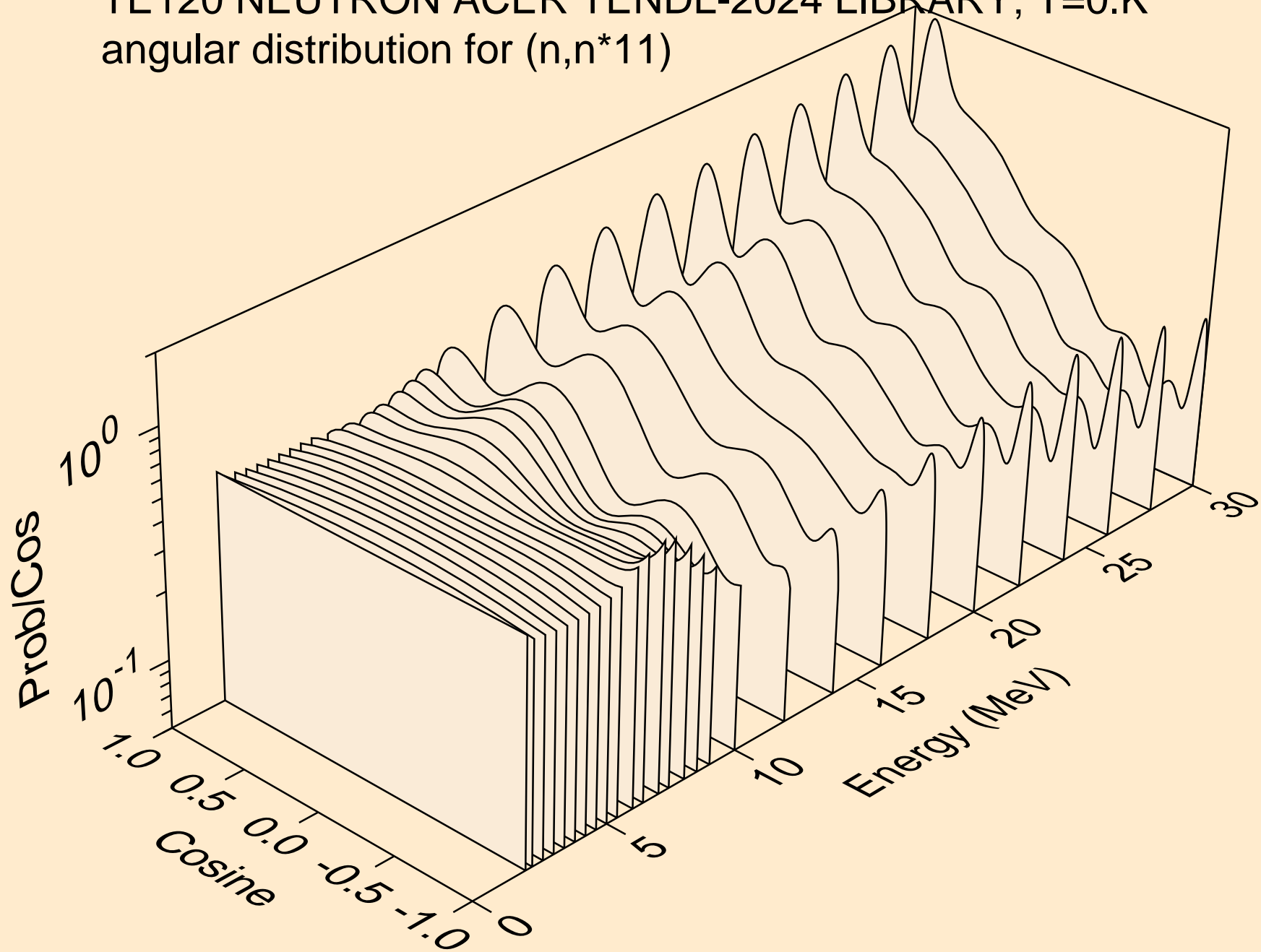



TE120 NEUTRON ACER TENDL-2024 LIBRARY; T=0.K  
angular distribution for (n,n\*12)

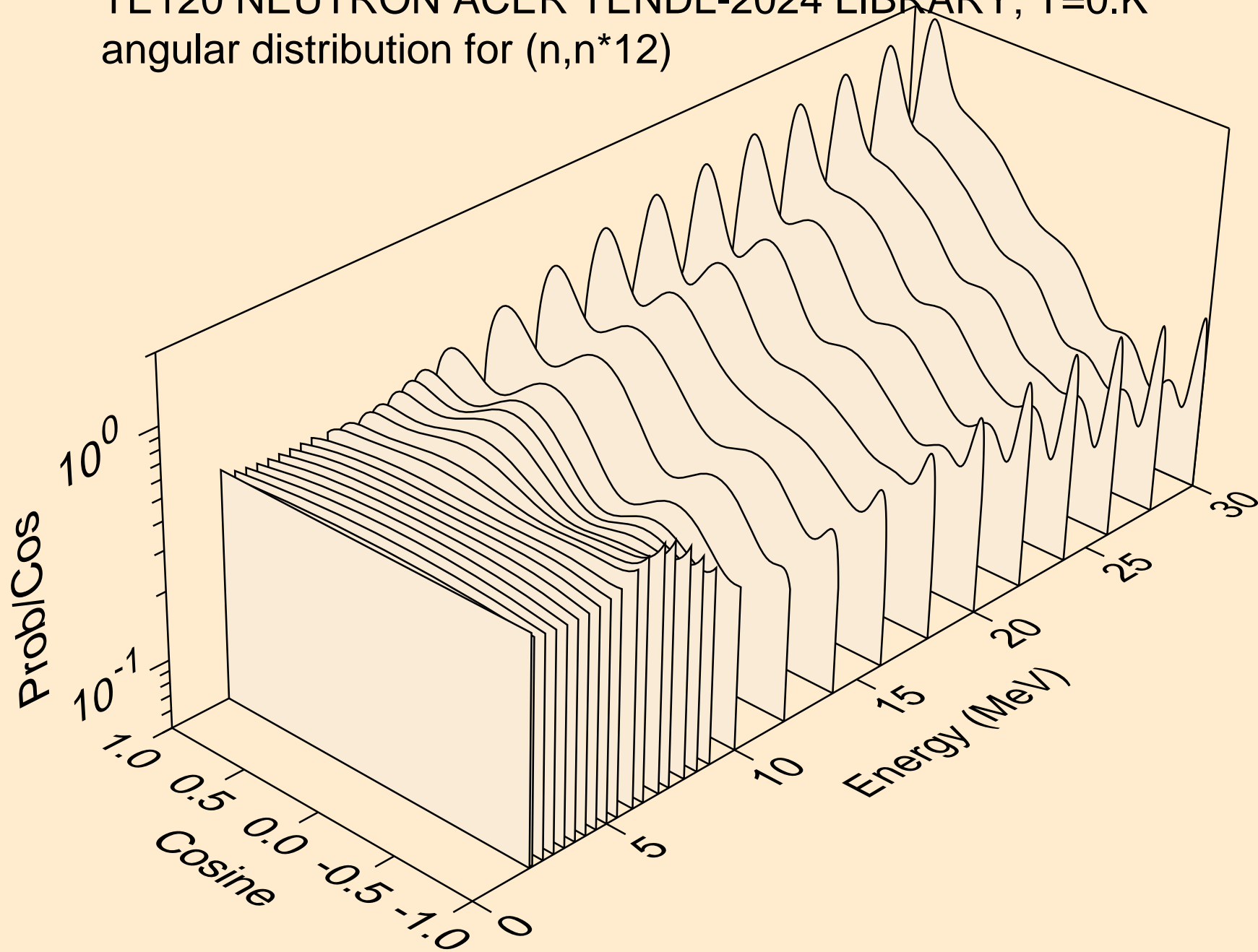

TE120 NEUTRON ACER TENDL-2024 LIBRARY; T=0.K  
angular distribution for (n,n\*13)

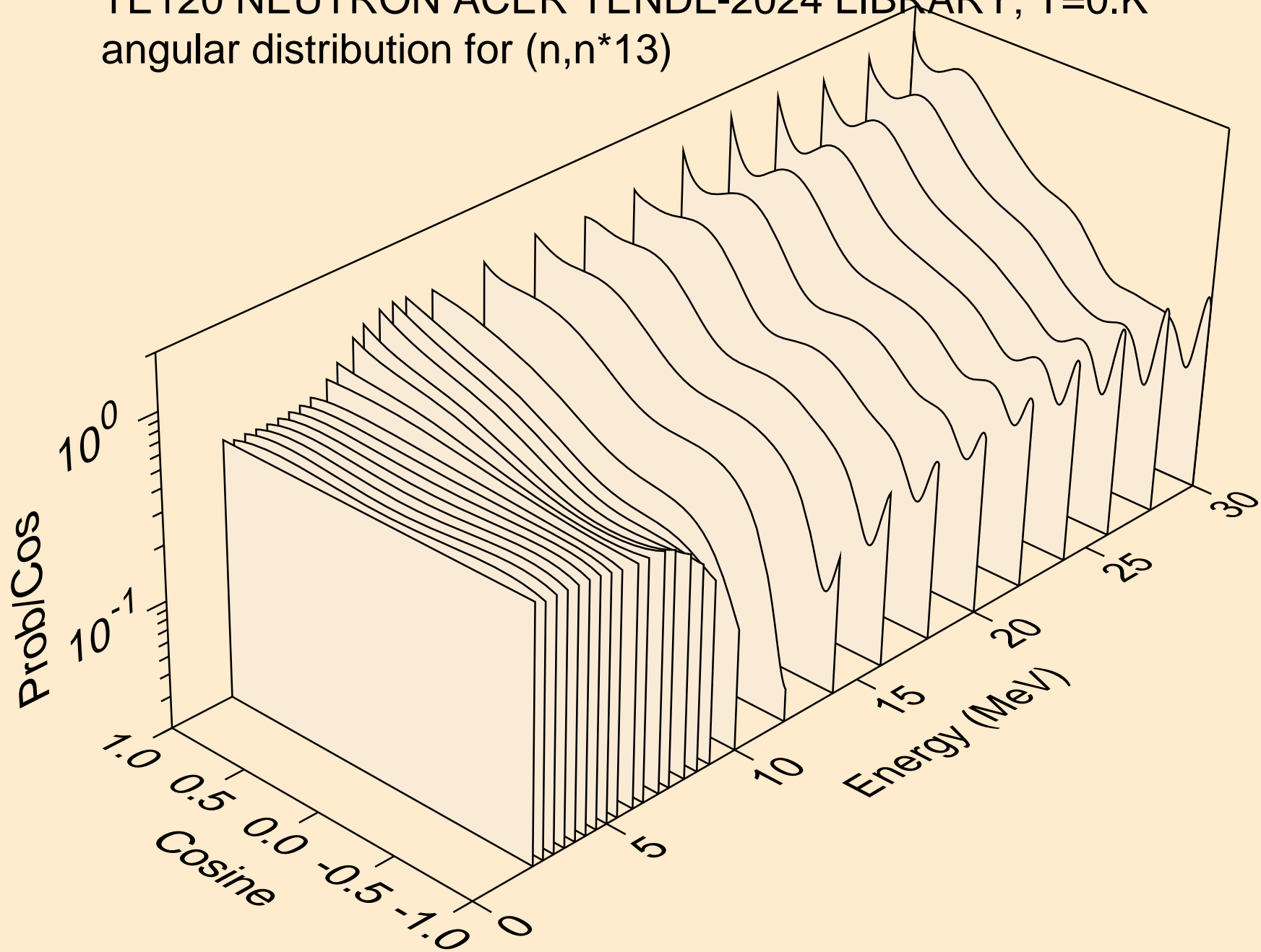

TE120 NEUTRON ACER TENDL-2024 LIBRARY; T=0.K  
angular distribution for (n,n\*14)

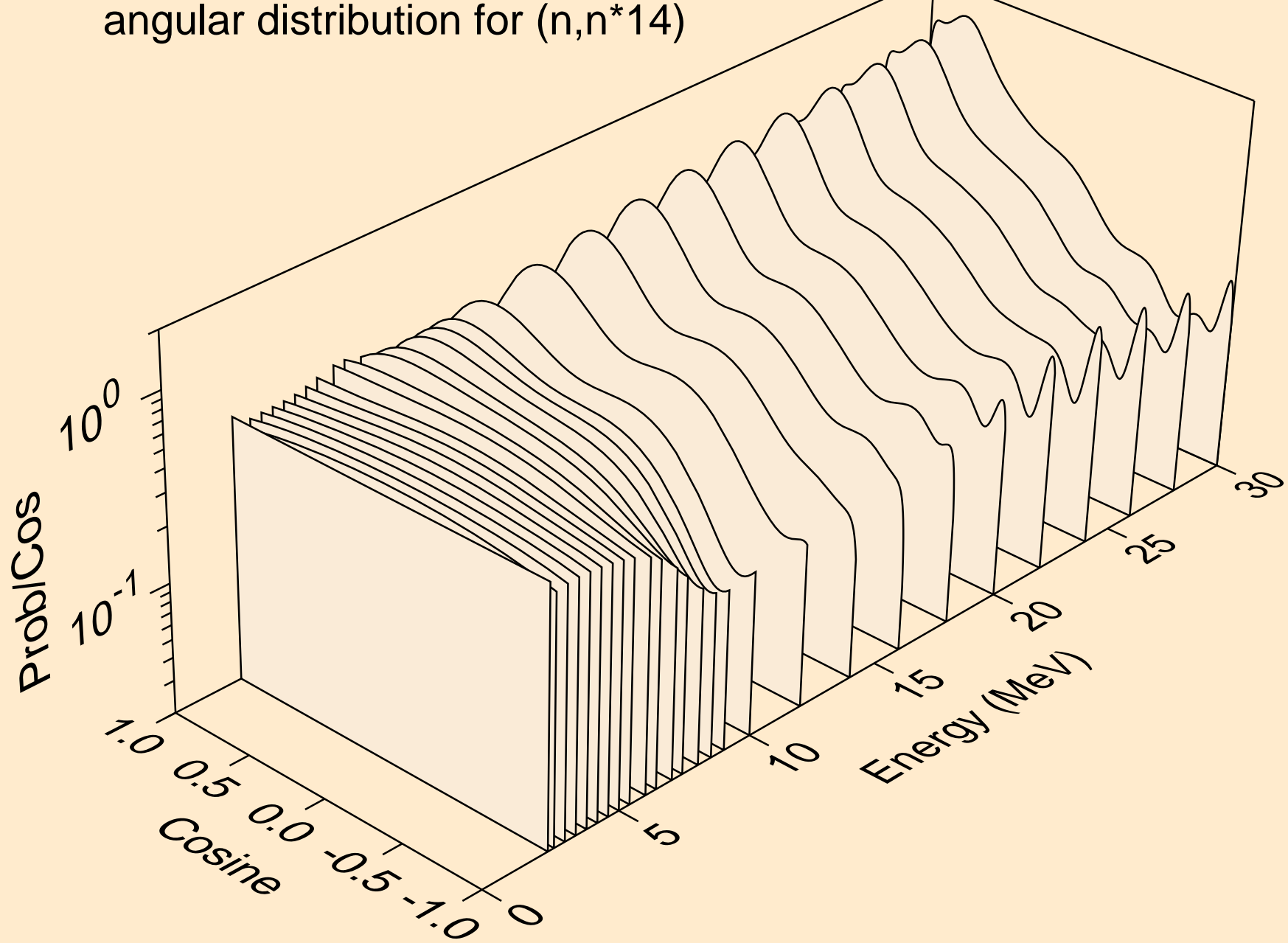

TE120 NEUTRON ACER TENDL-2024 LIBRARY; T=0.K  
angular distribution for (n,n\*15)

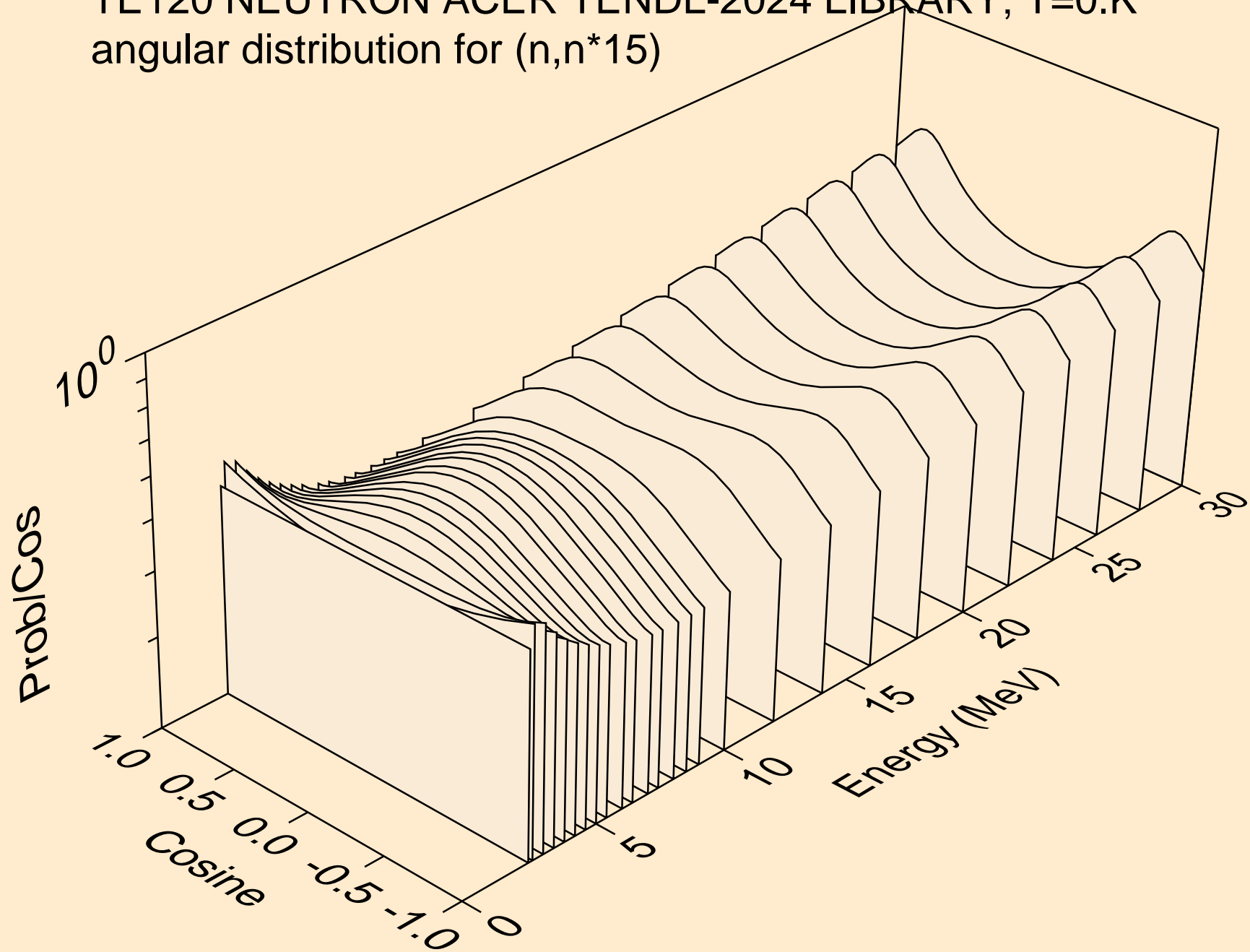

TE120 NEUTRON ACER TENDL-2024 LIBRARY; T=0.K  
angular distribution for (n,n\*16)

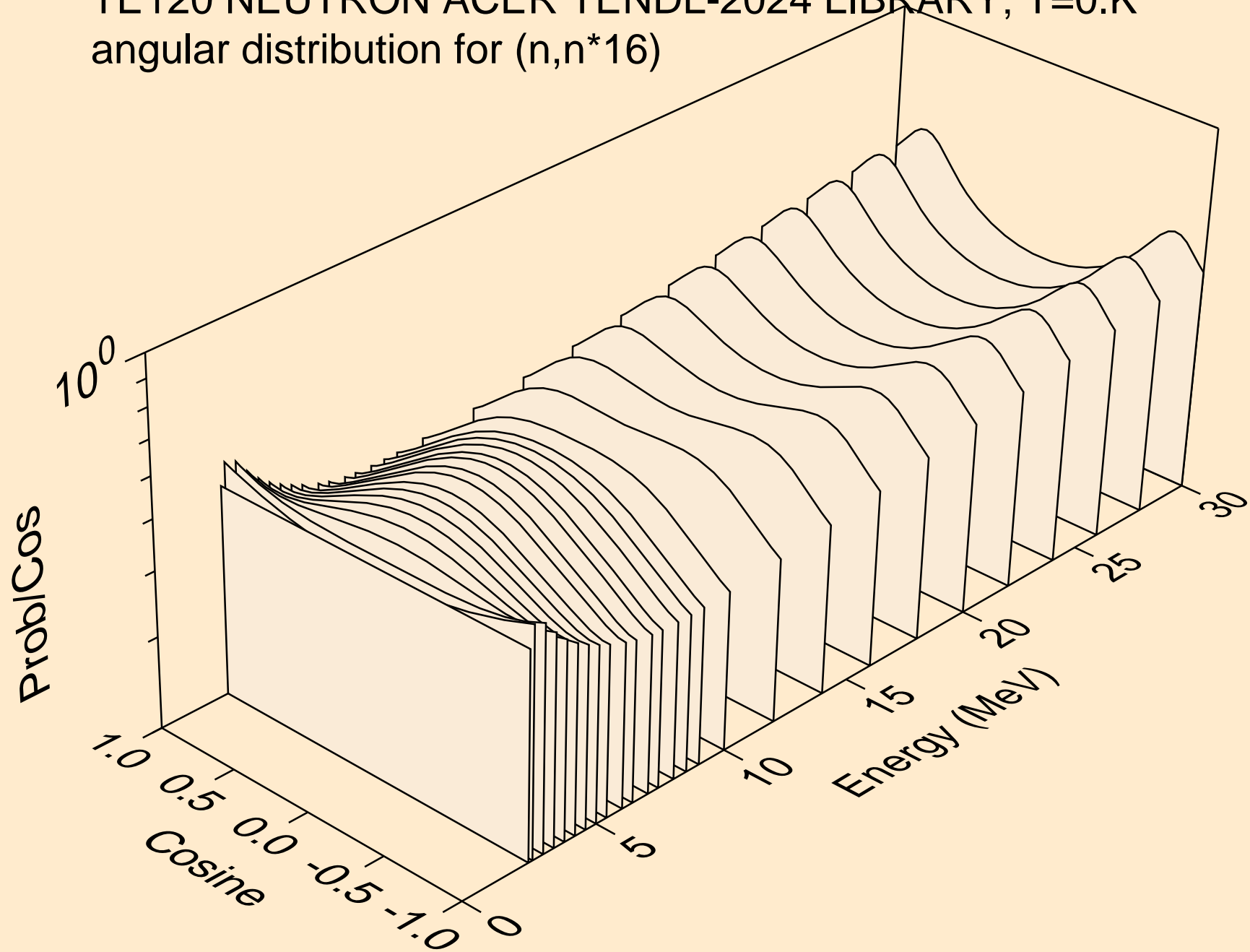

TE120 NEUTRON ACER TENDL-2024 LIBRARY; T=0.K  
angular distribution for (n,n\*17)

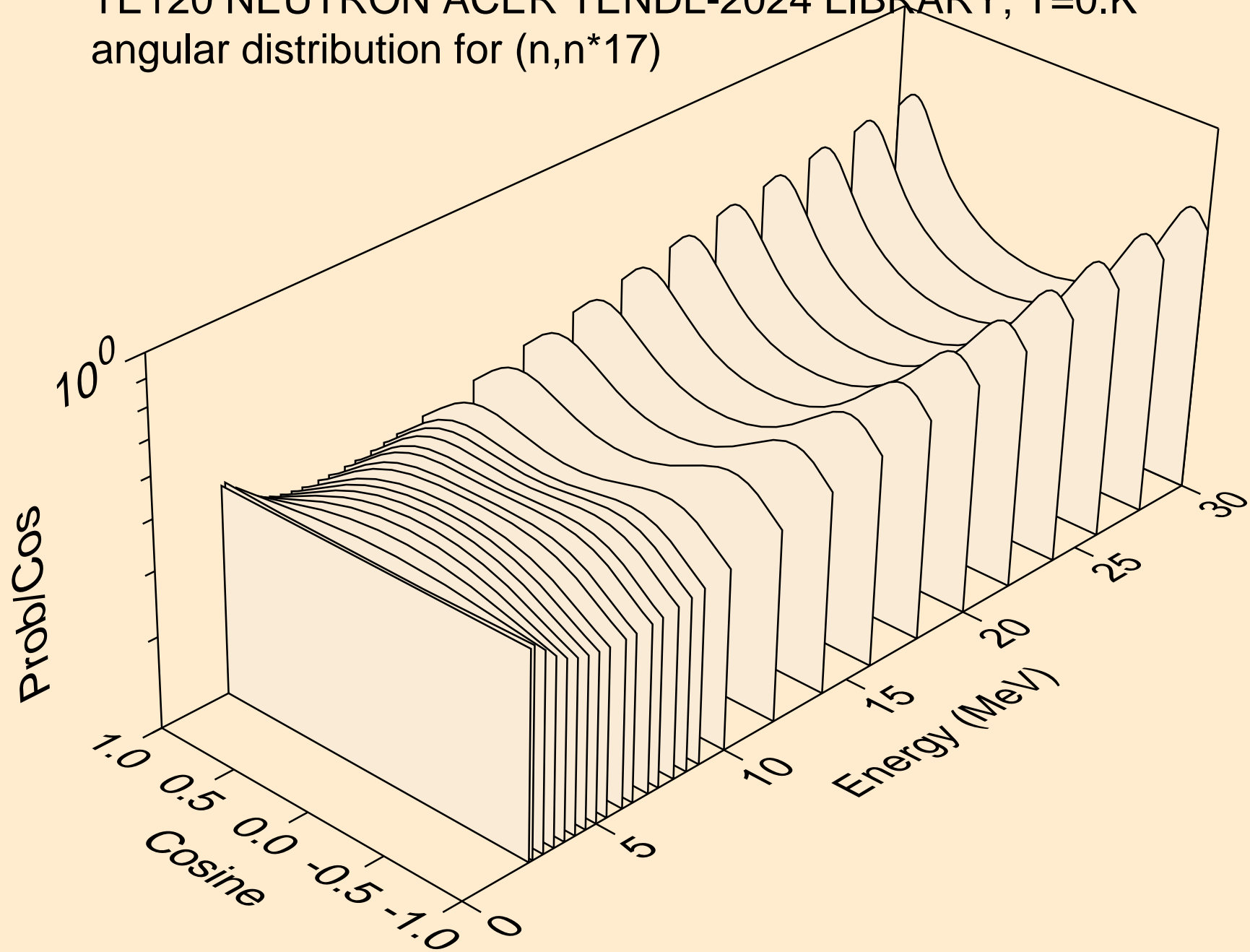

TE120 NEUTRON ACER TENDL-2024 LIBRARY; T=0.K  
angular distribution for (n,n\*18)

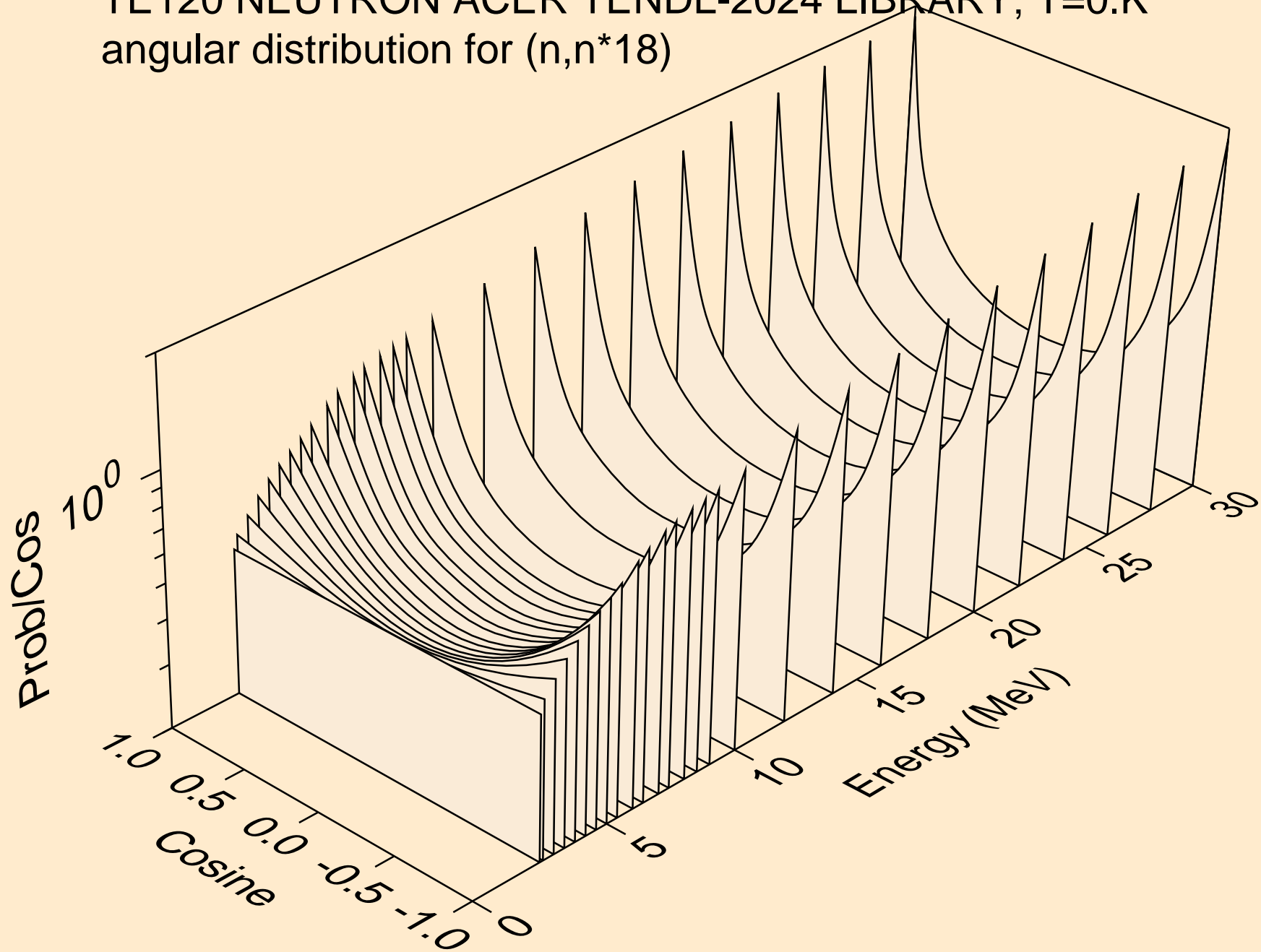

TE120 NEUTRON ACER TENDL-2024 LIBRARY; T=0.K  
angular distribution for (n,n\*19)

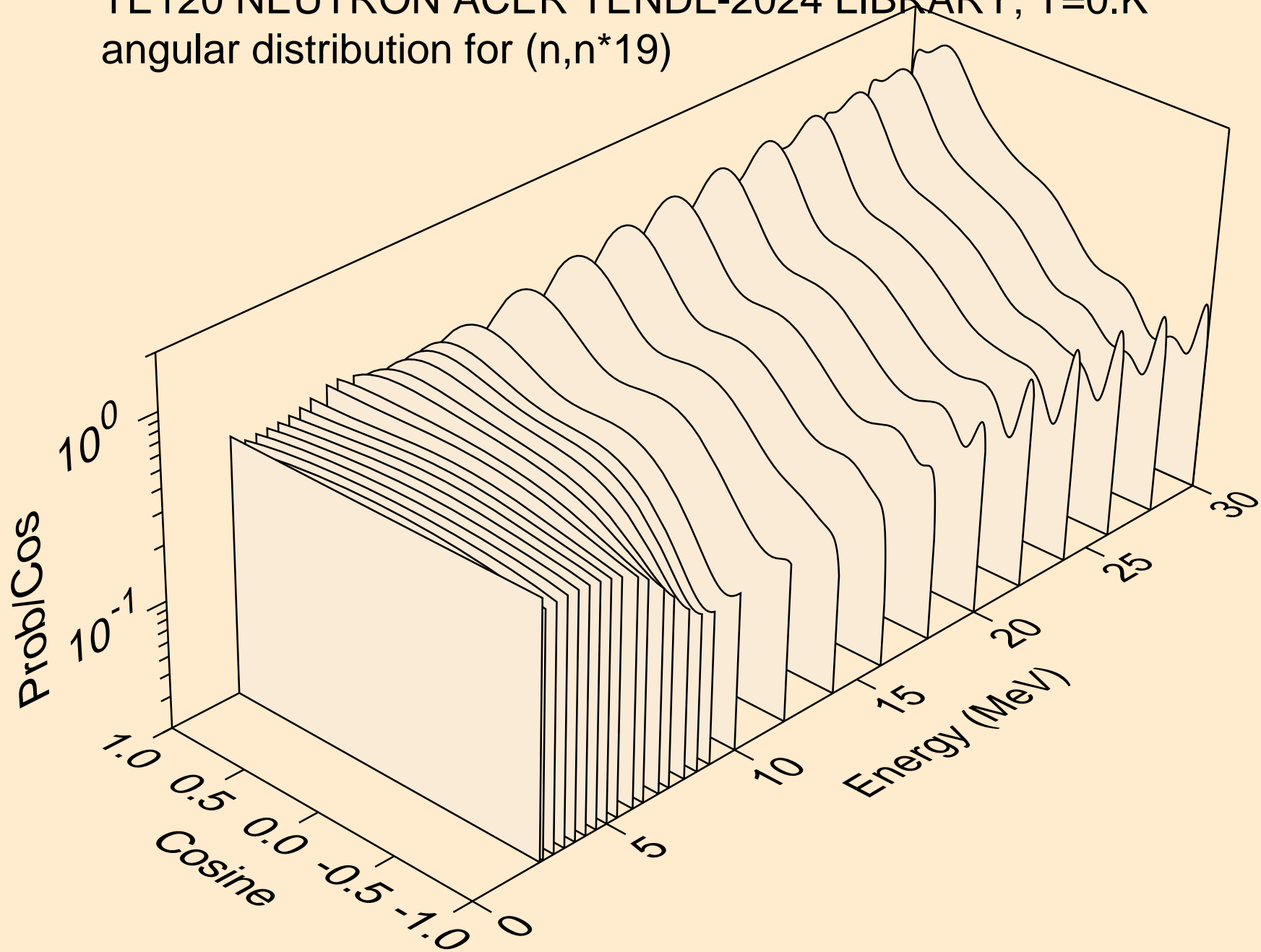



TE120 NEUTRON ACER TENDL-2024 LIBRARY; T=0.K  
angular distribution for (n,n\*20)

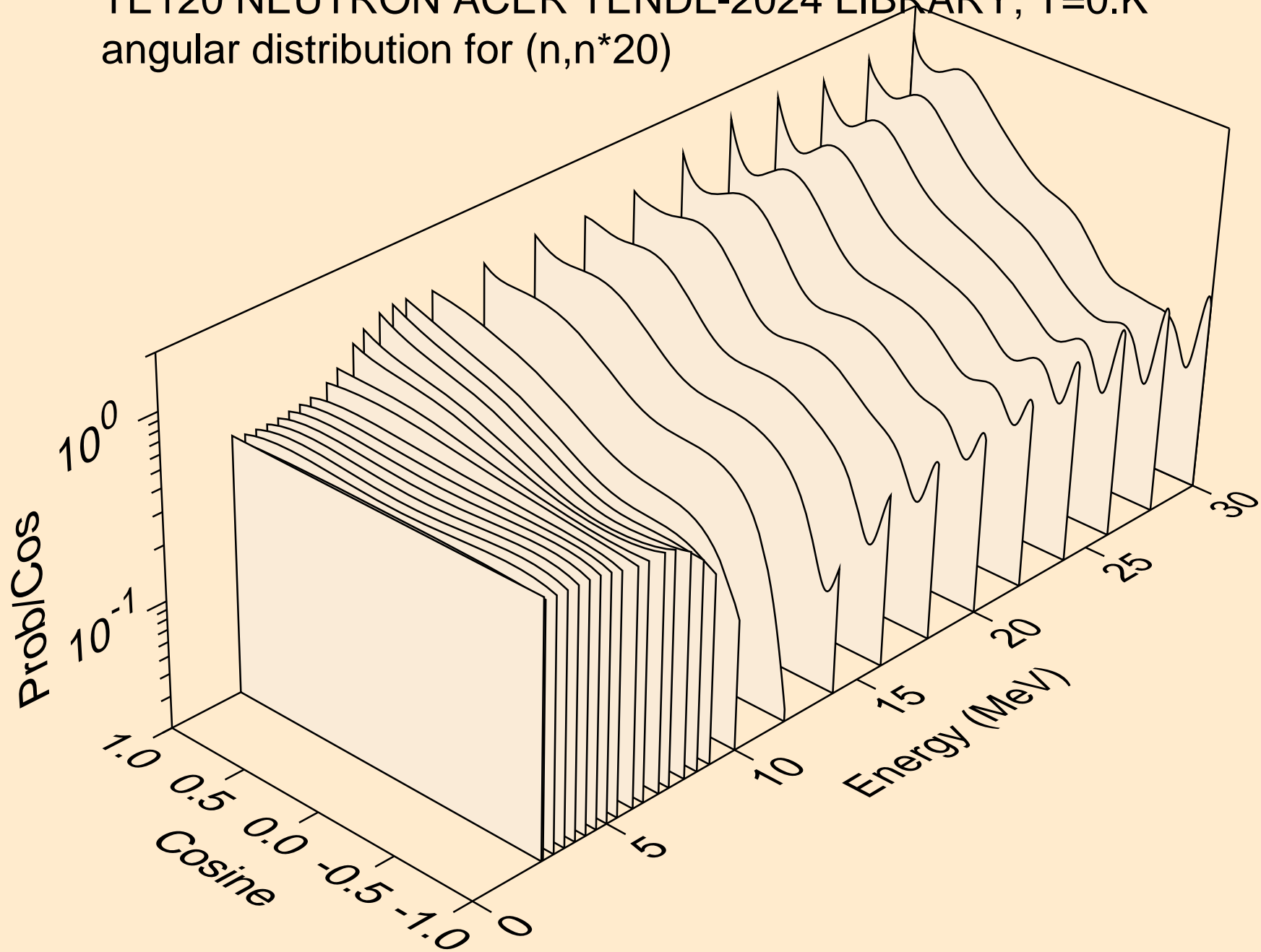

TE120 NEUTRON ACER TENDL-2024 LIBRARY; T=0.K  
angular distribution for (n,n\*21)

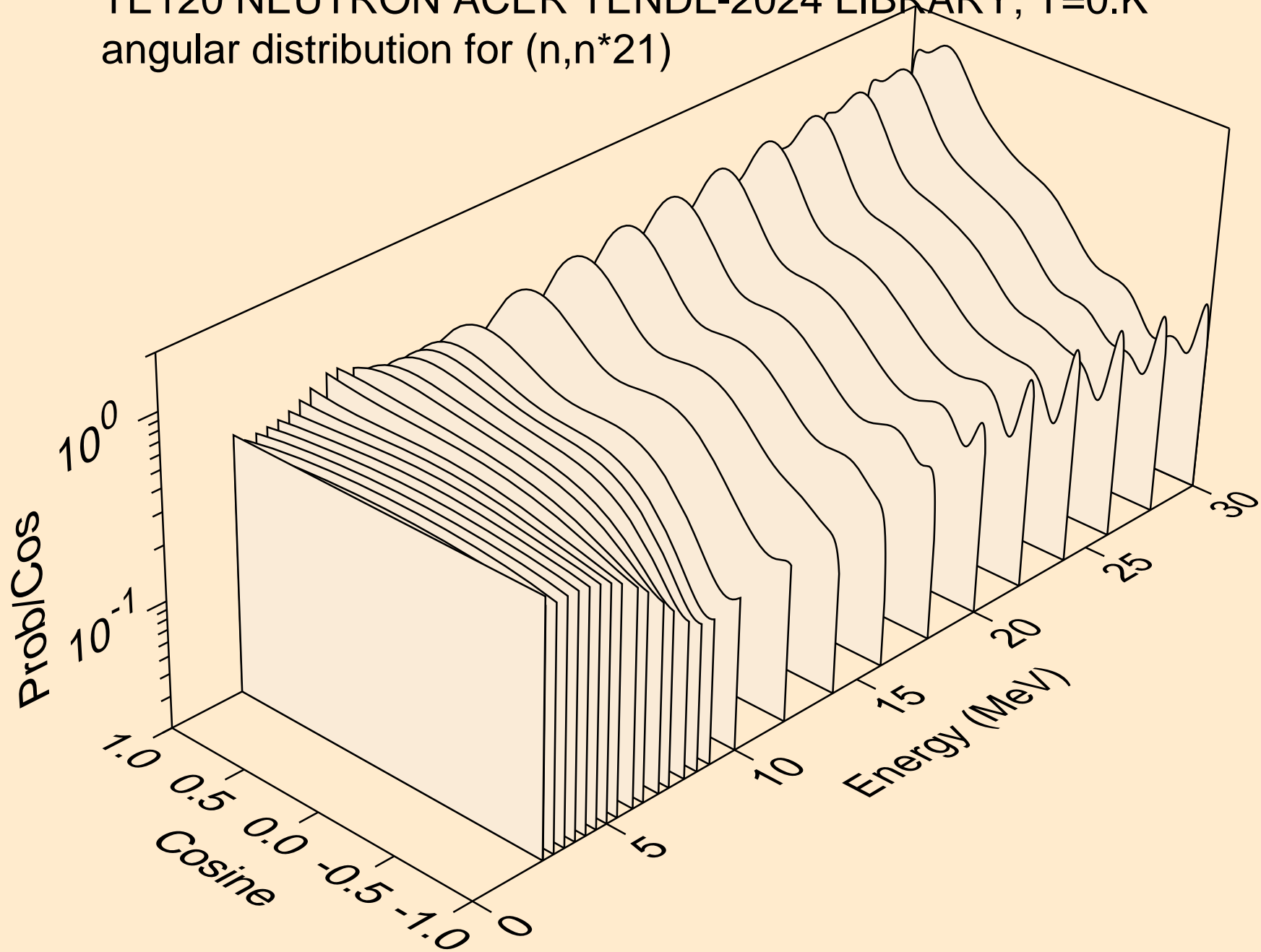

TE120 NEUTRON ACER TENDL-2024 LIBRARY; T=0.K  
angular distribution for (n,n\*22)

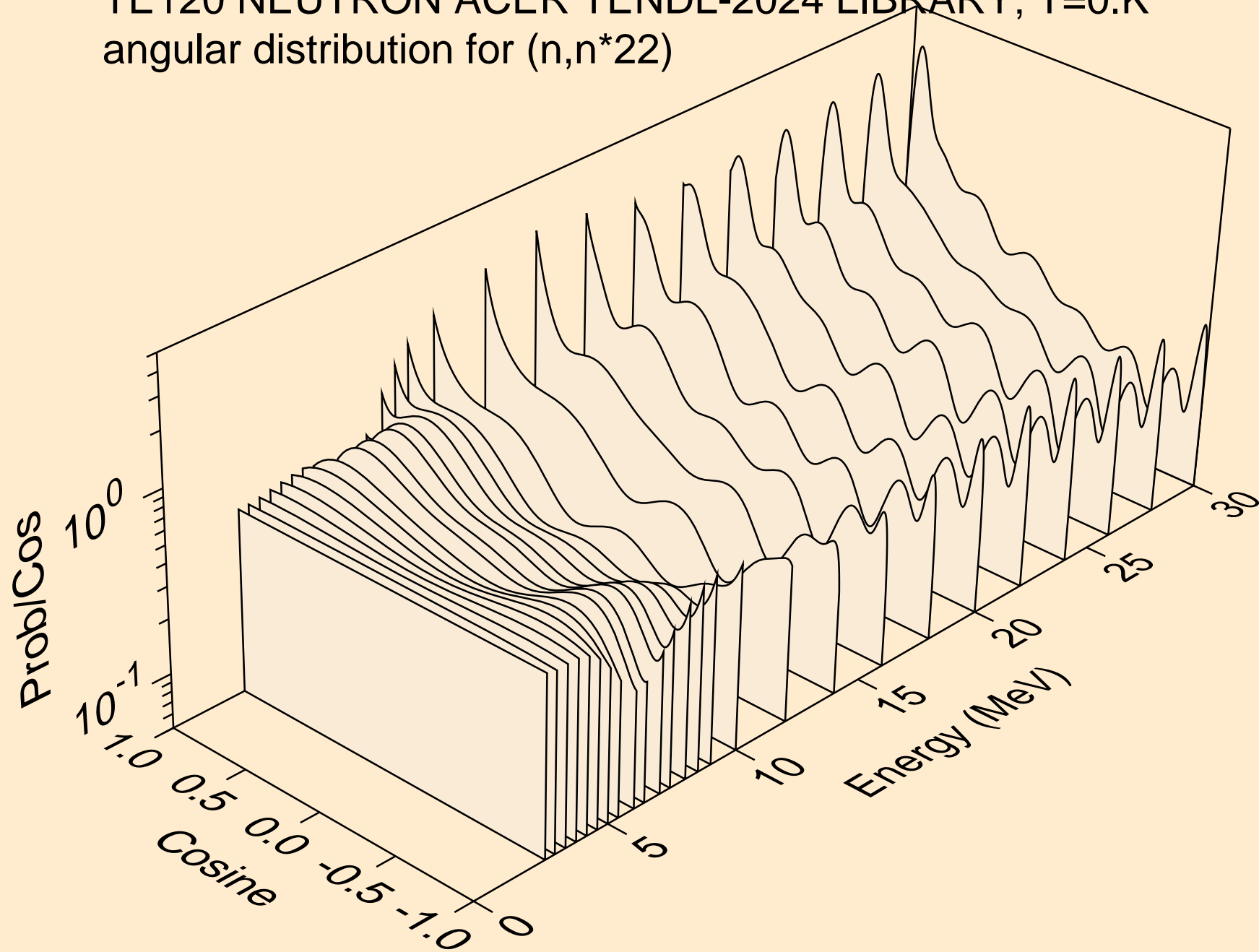

TE120 NEUTRON ACER TENDL-2024 LIBRARY; T=0.K  
angular distribution for (n,n\*23)

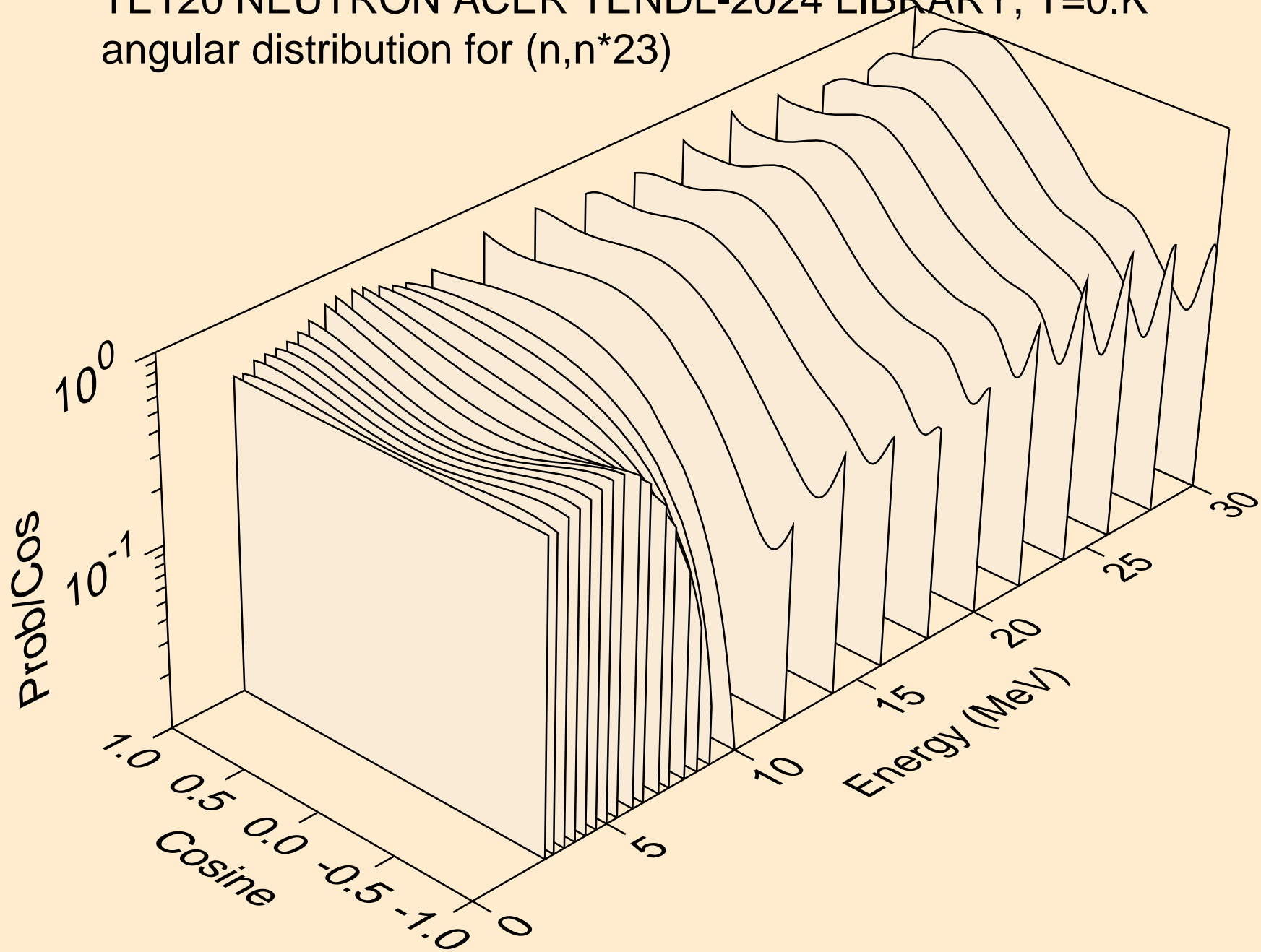

TE120 NEUTRON ACER TENDL-2024 LIBRARY; T=0.K  
angular distribution for (n,n\*24)

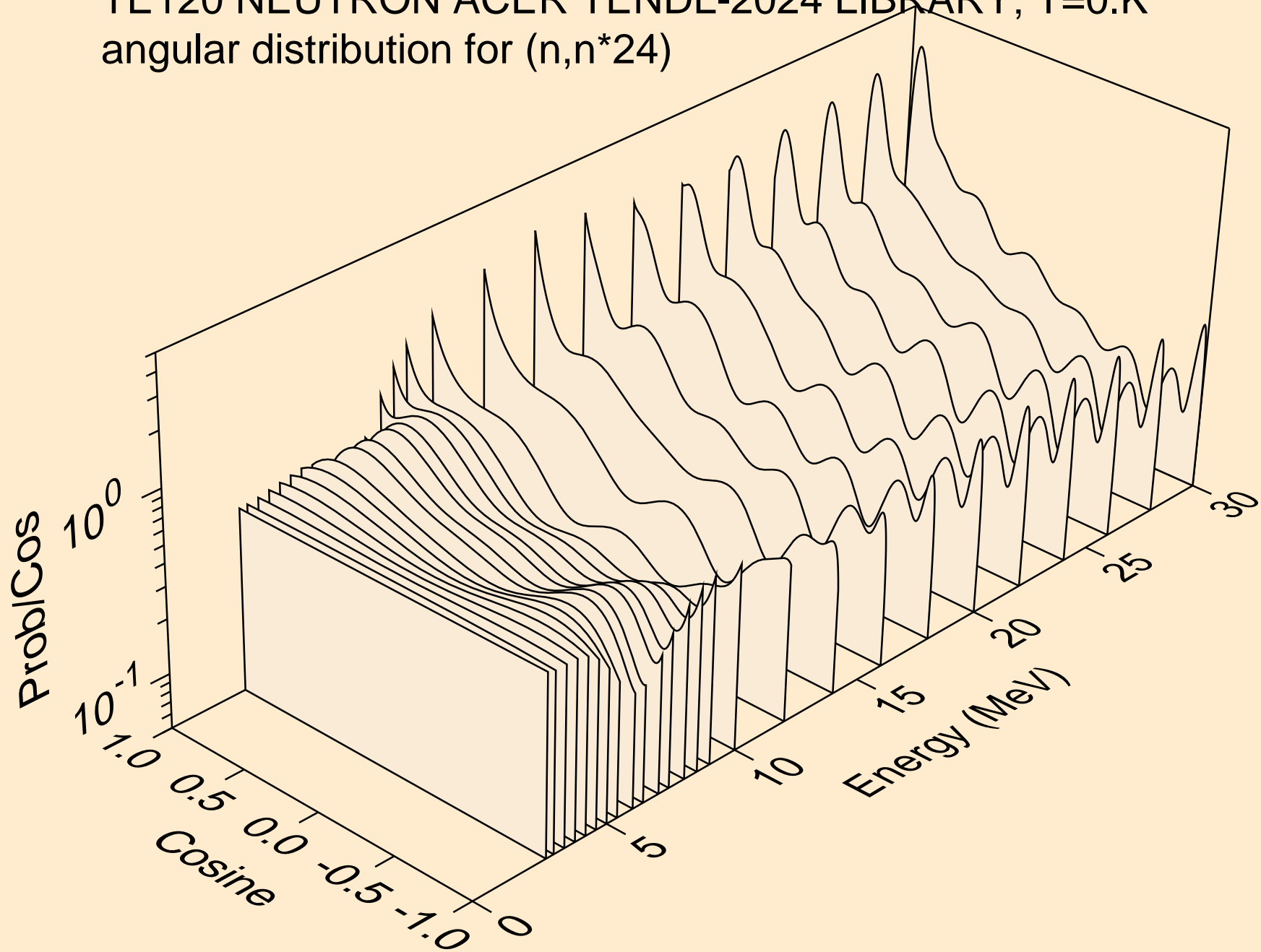

TE120 NEUTRON ACER TENDL-2024 LIBRARY; T=0.K  
angular distribution for (n,n\*25)

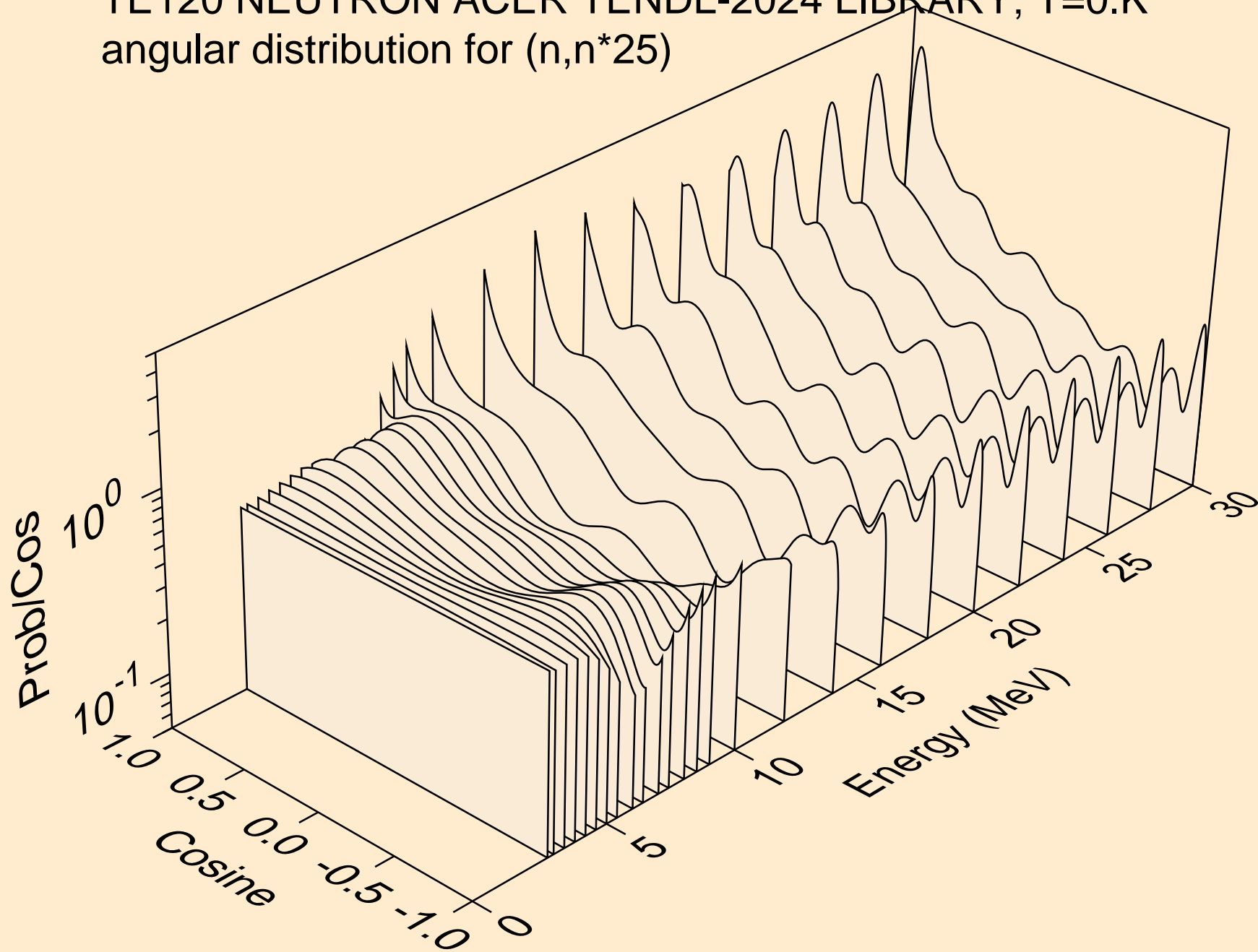

TE120 NEUTRON ACER TENDL-2024 LIBRARY; T=0.K  
angular distribution for (n,n\*26)

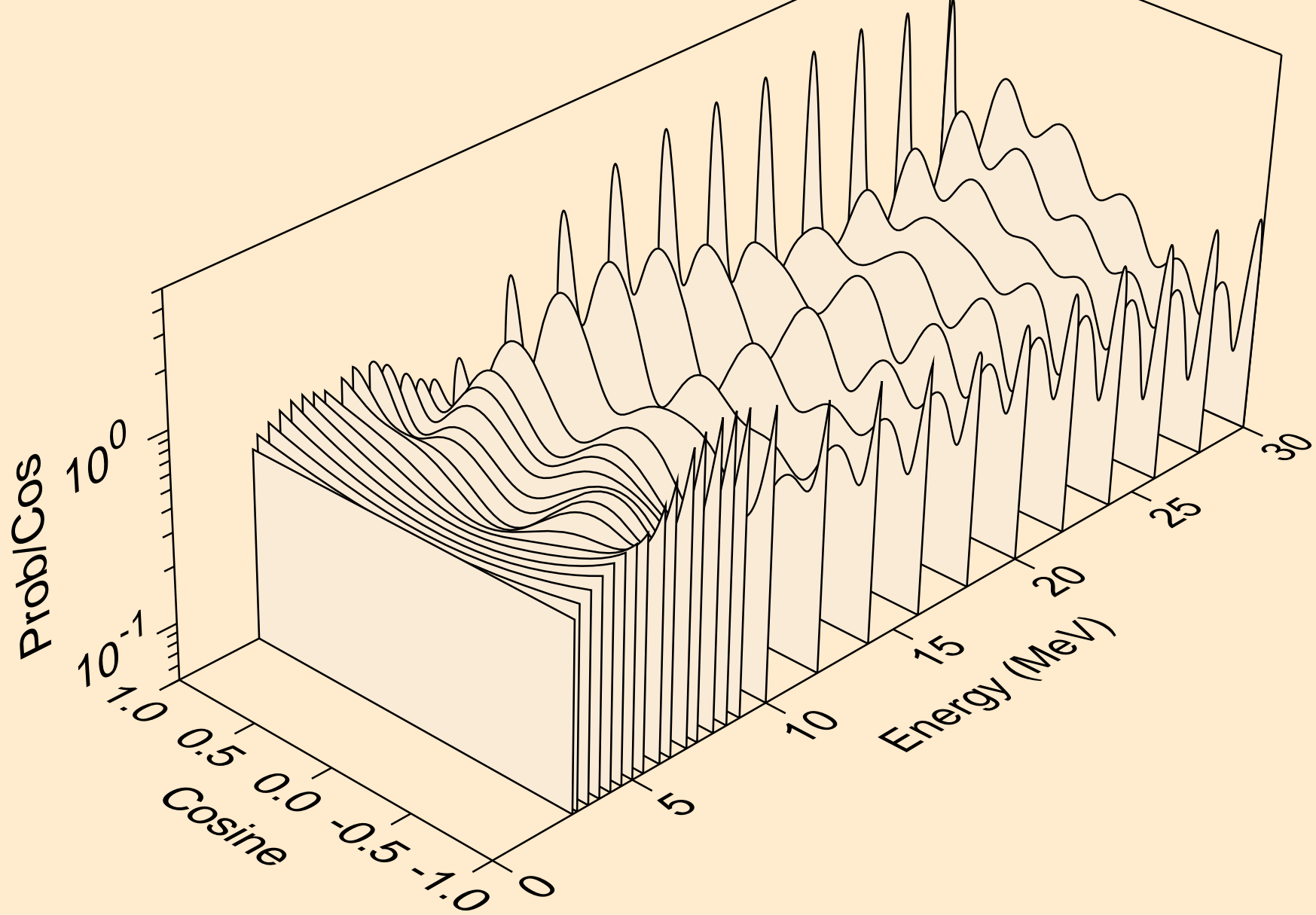

TE120 NEUTRON ACER TENDL-2024 LIBRARY; T=0.K  
angular distribution for (n,n\*27)

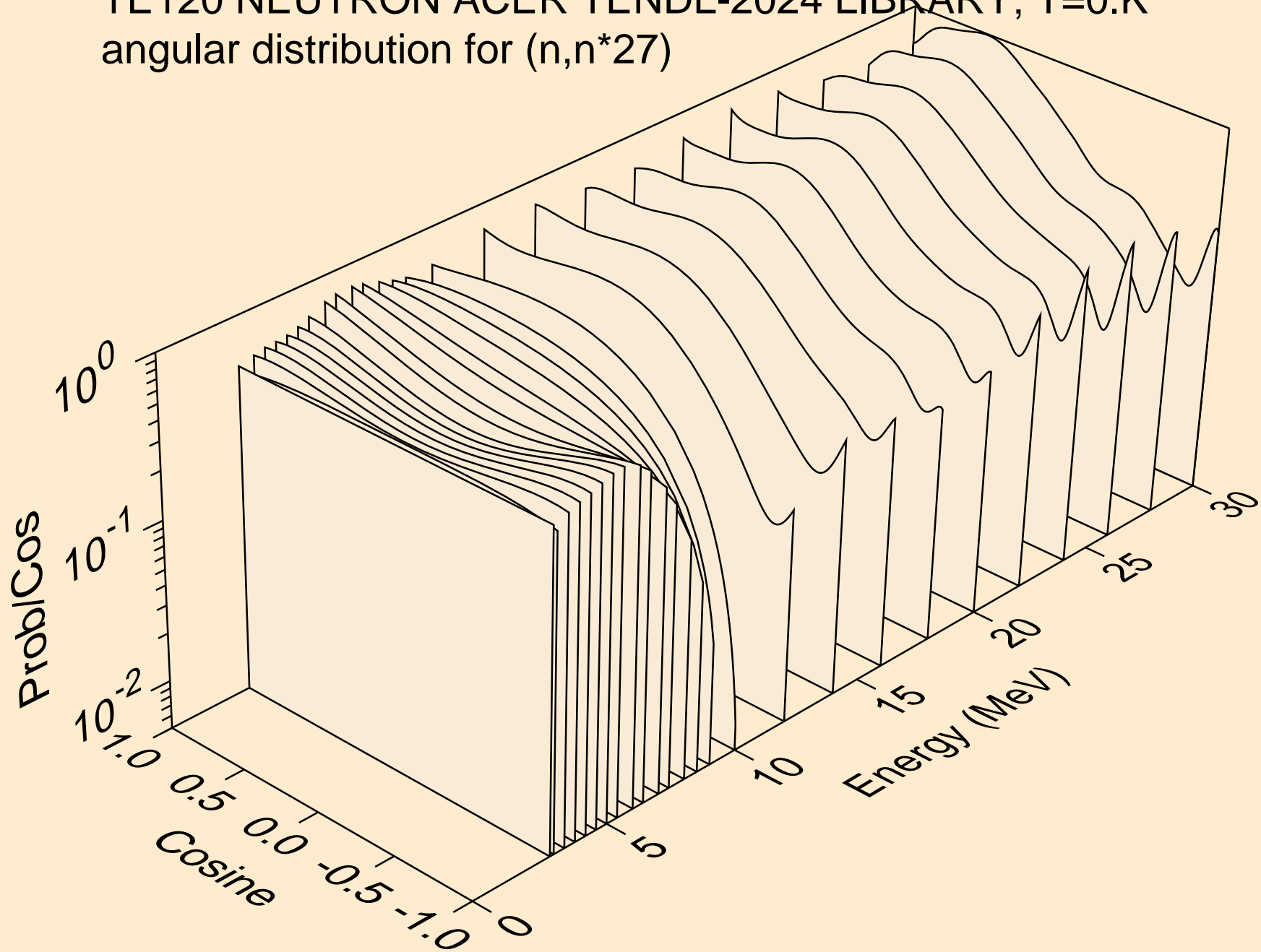



TE120 NEUTRON ACER TENDL-2024 LIBRARY; T=0.K  
angular distribution for (n,n\*28)

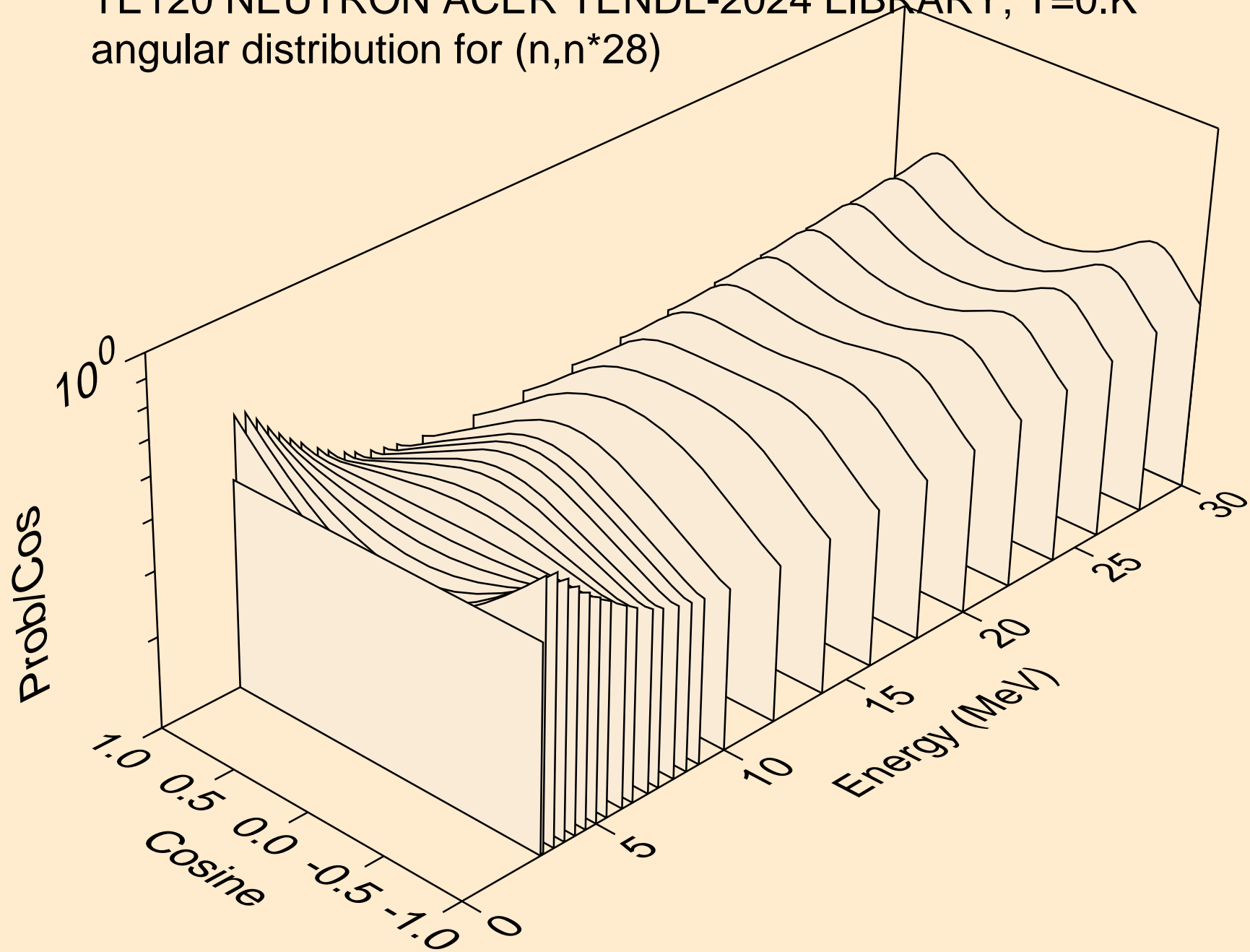

TE120 NEUTRON ACER TENDL-2024 LIBRARY; T=0.K  
angular distribution for (n,n\*29)

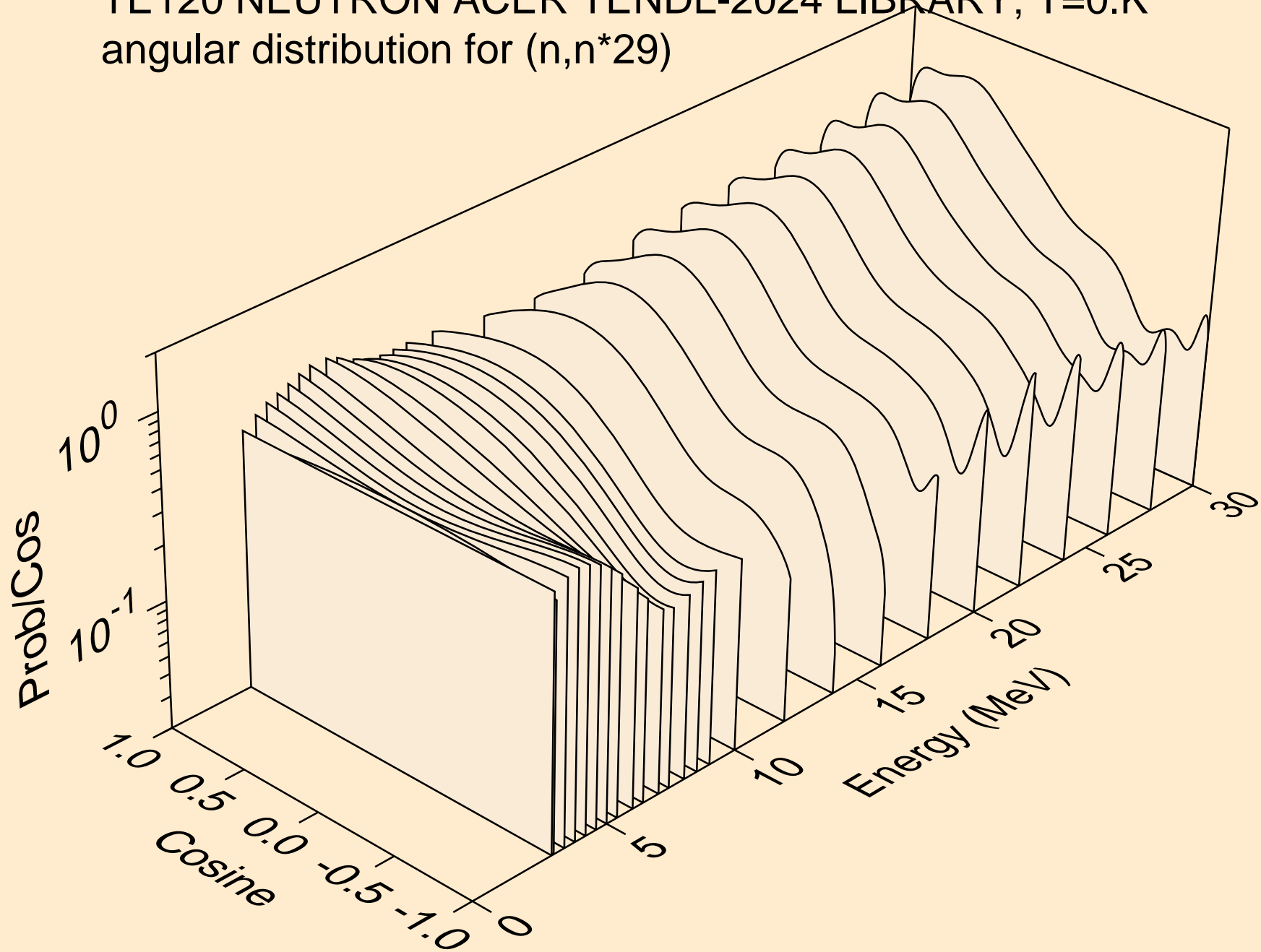

TE120 NEUTRON ACER TENDL-2024 LIBRARY; T=0.K  
angular distribution for (n,n\*30)

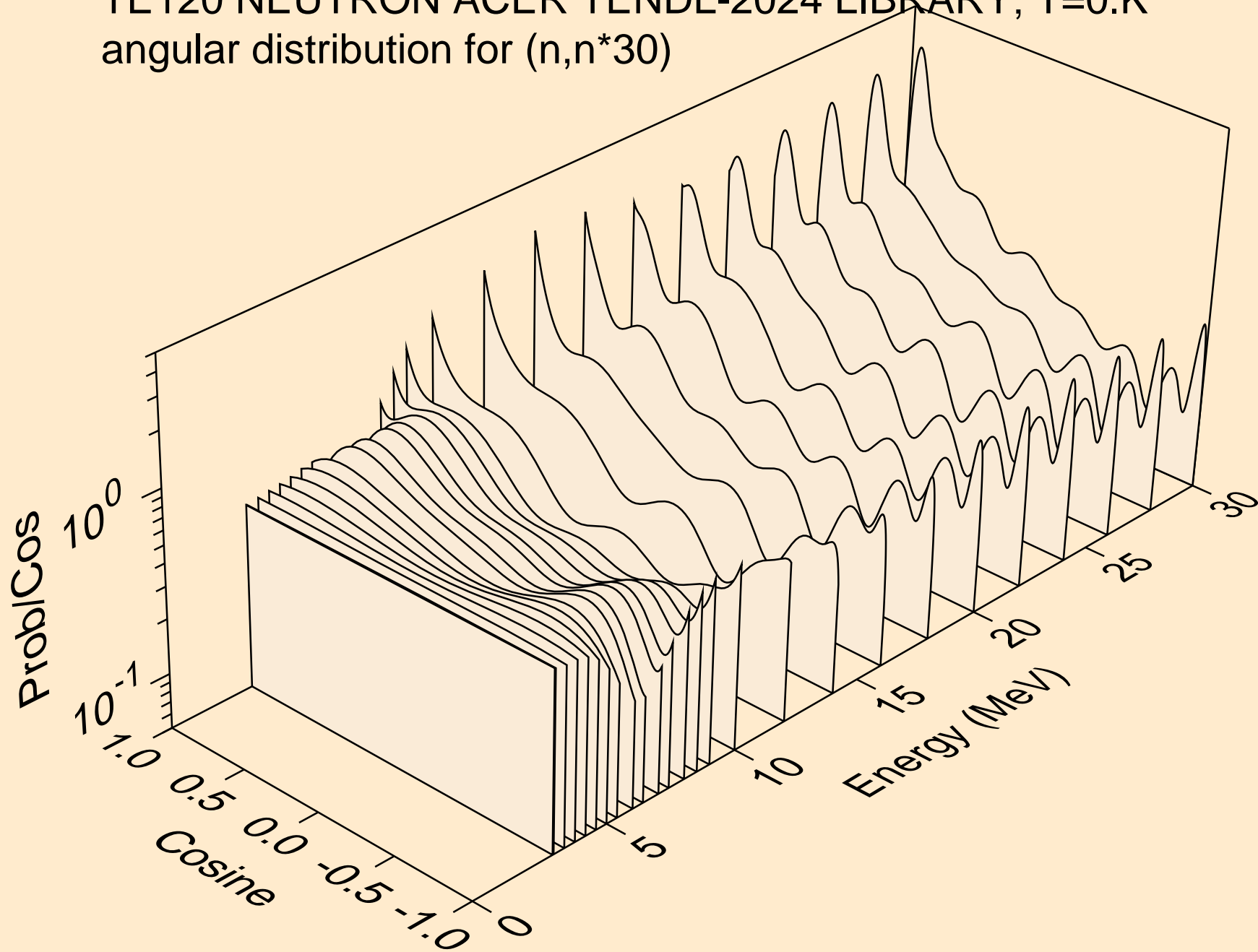

TE120 NEUTRON ACER TENDL-2024 LIBRARY; T=0.K  
Neutron emission for (n,x)

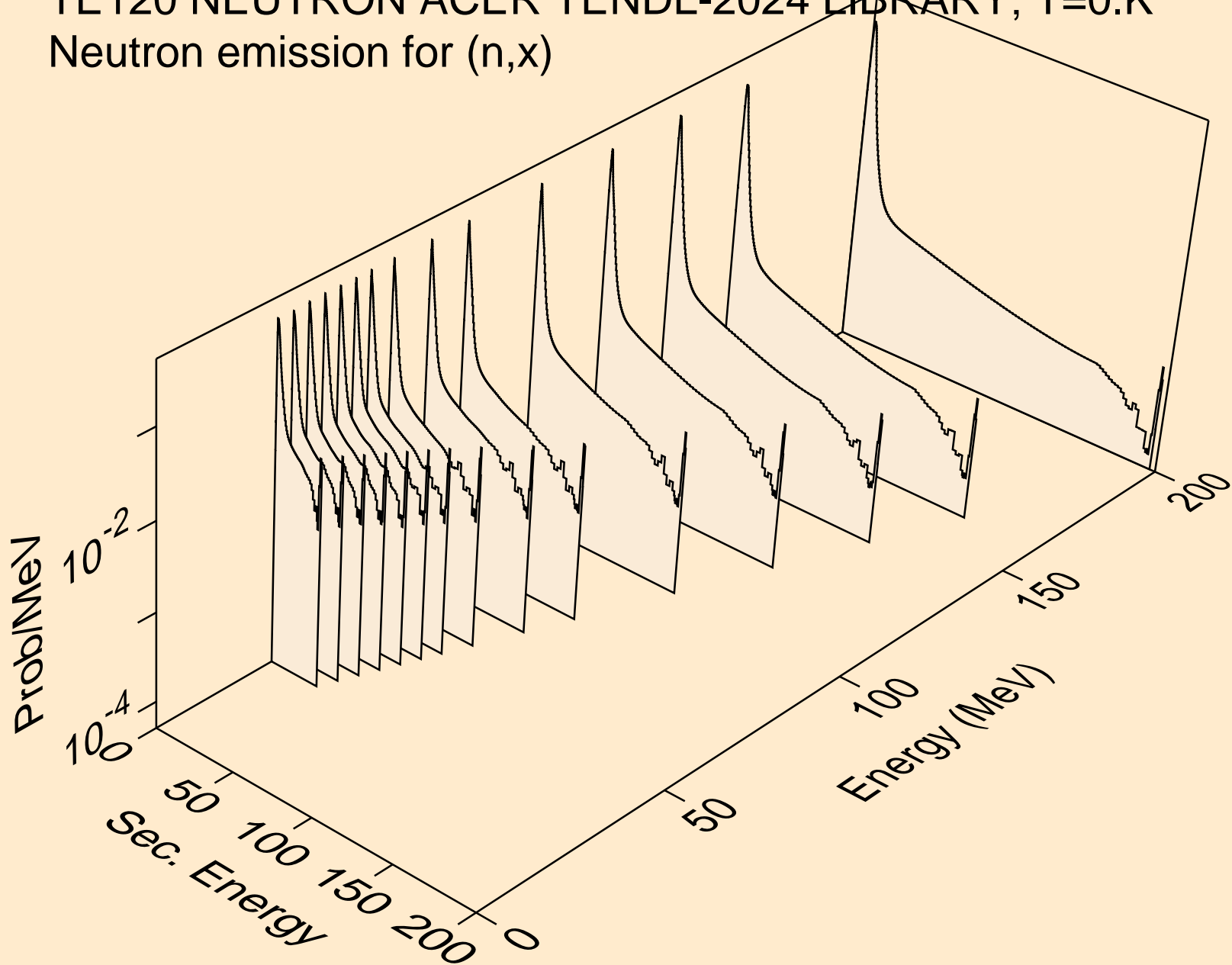

TE120 NEUTRON ACER TENDL-2024 LIBRARY; T=0.K  
Neutron emission for (n,2nd)

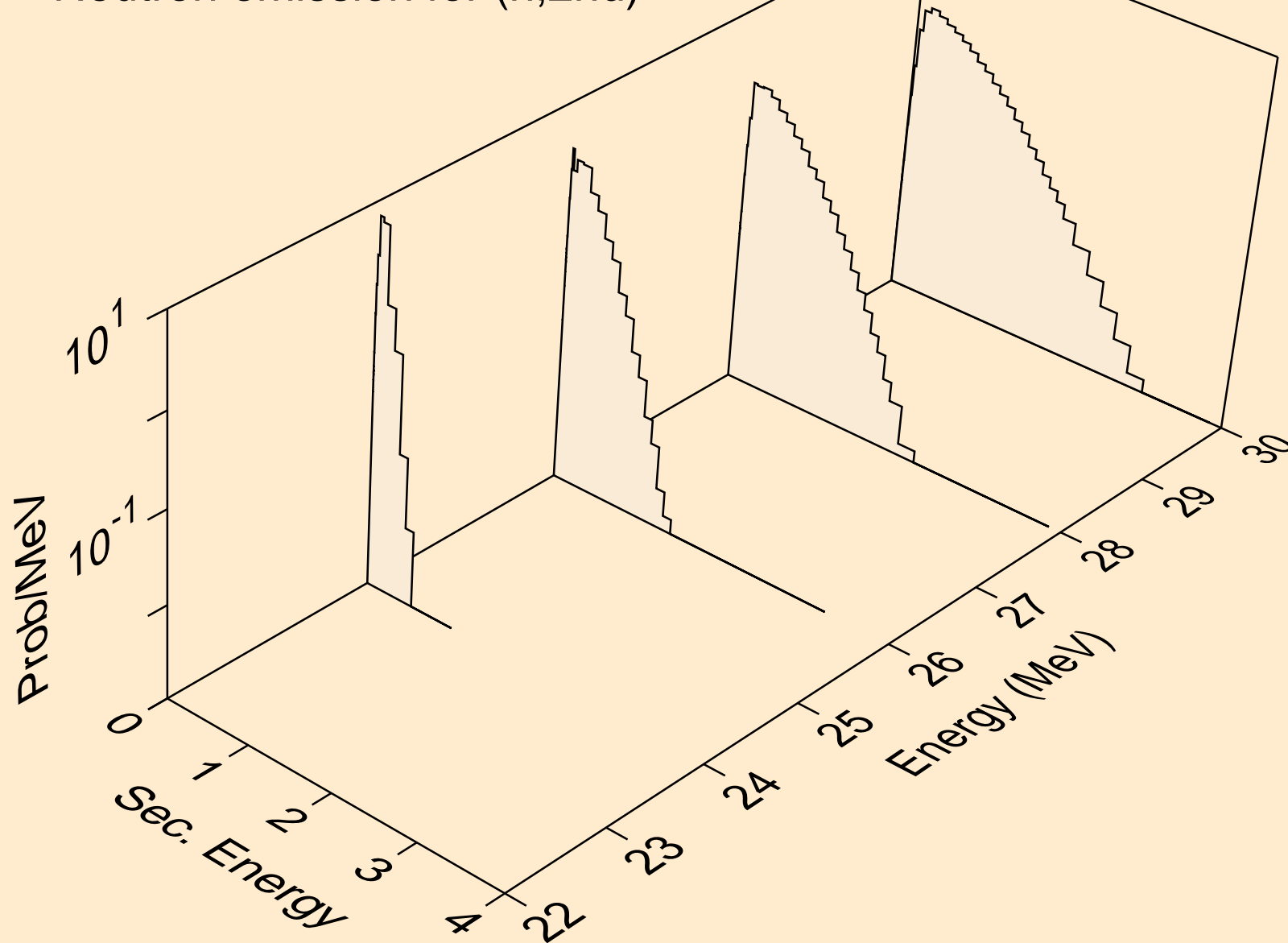

TE120 NEUTRON ACER TENDL-2024 LIBRARY; T=0.K  
Neutron emission for (n,2n)

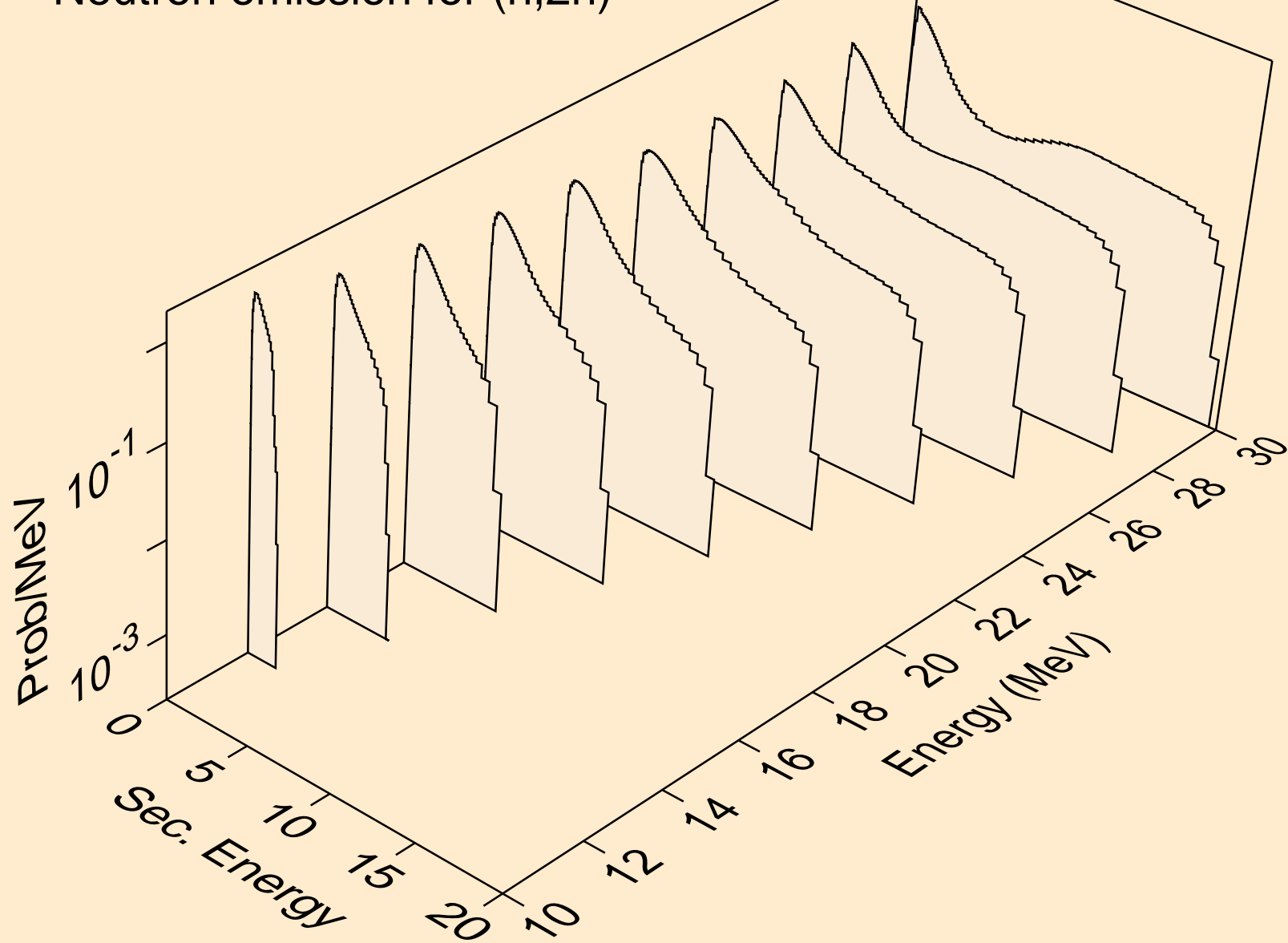

TE120 NEUTRON ACER TENDL-2024 LIBRARY; T=0.K  
Neutron emission for (n,3n)

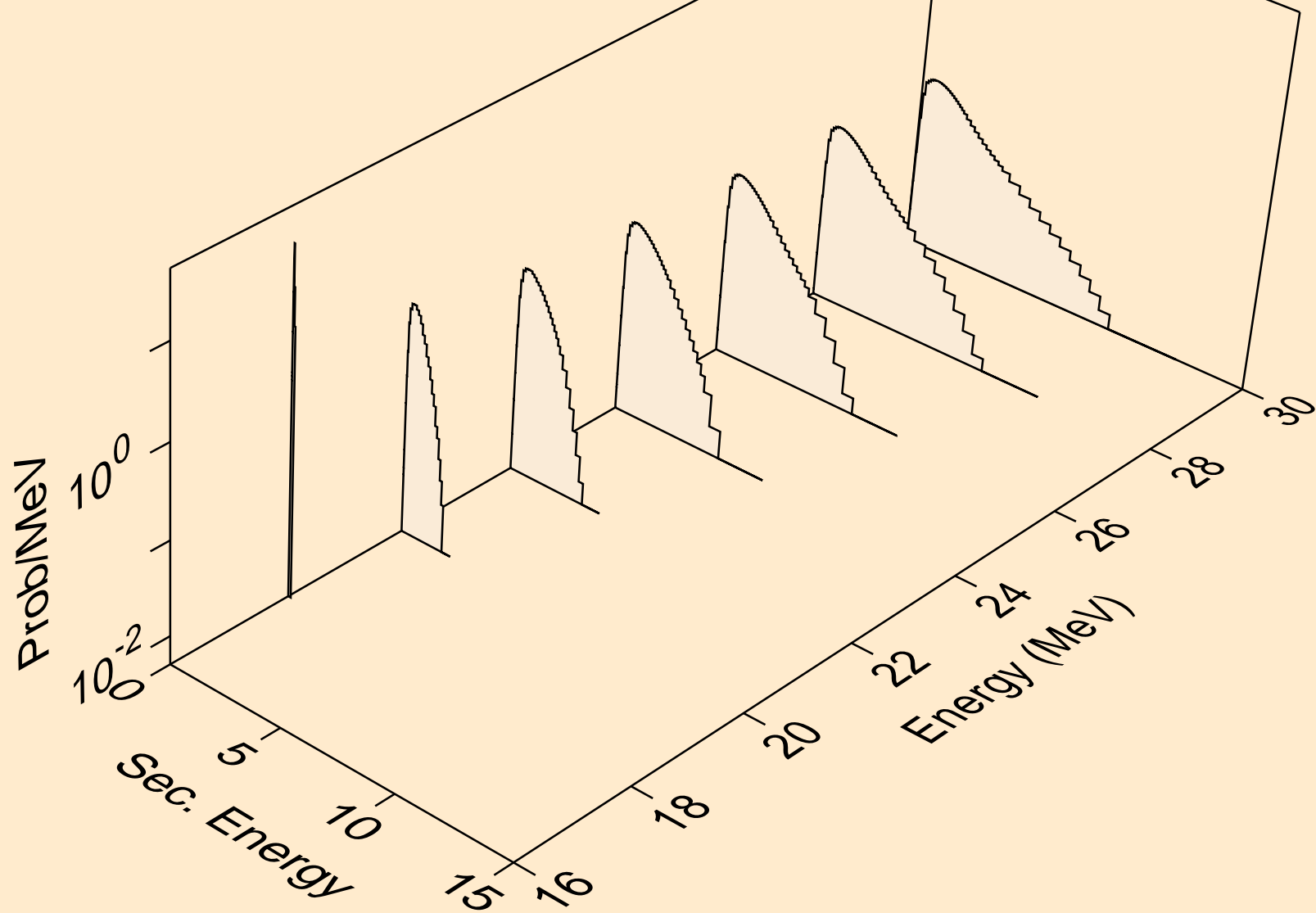

TE120 NEUTRON ACER TENDL-2024 LIBRARY; T=0.K  
Neutron emission for (n,n\*)a

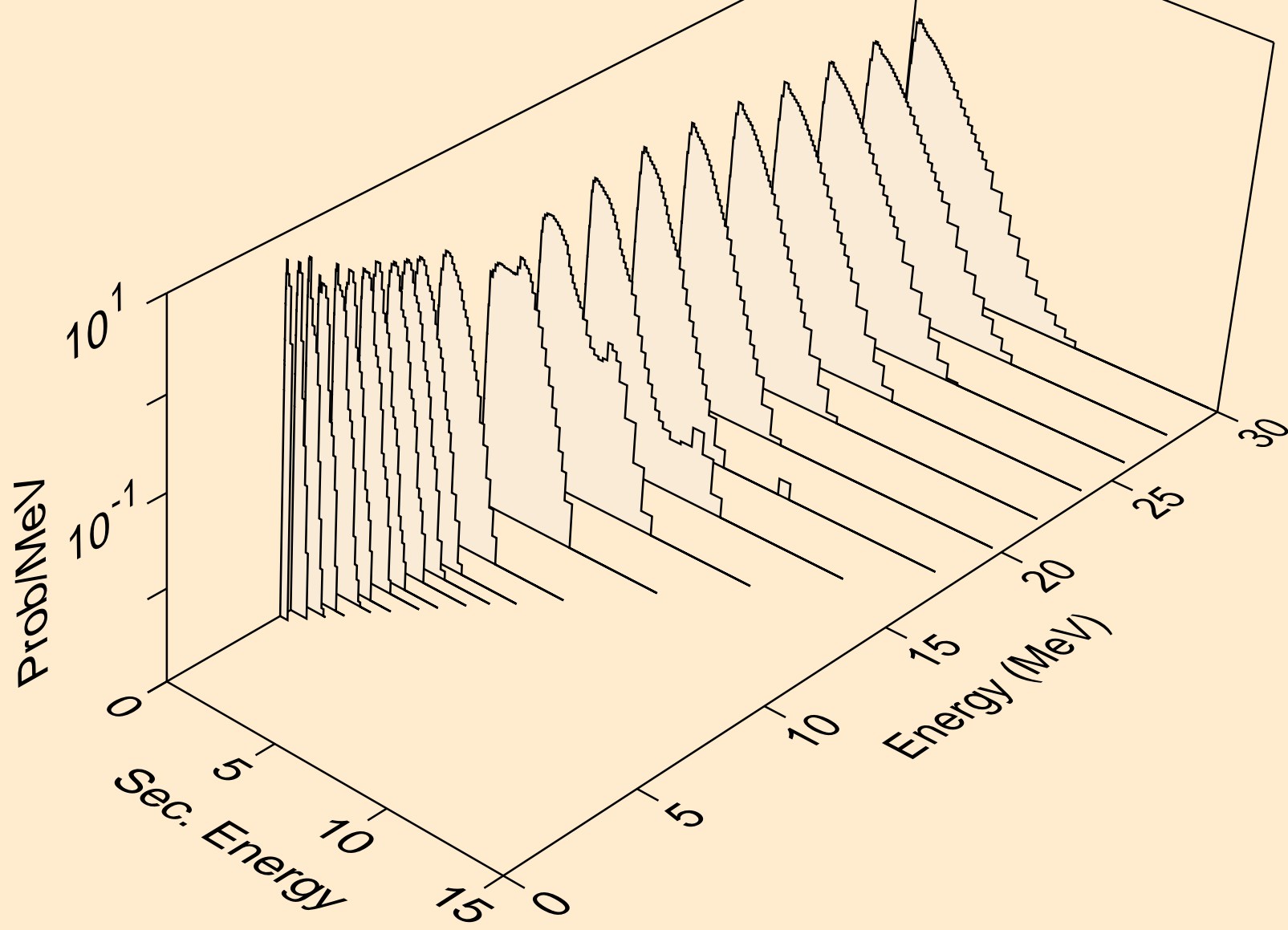



TE120 NEUTRON ACER TENDL-2024 LIBRARY; T=0.K  
Neutron emission for (n,2n)a

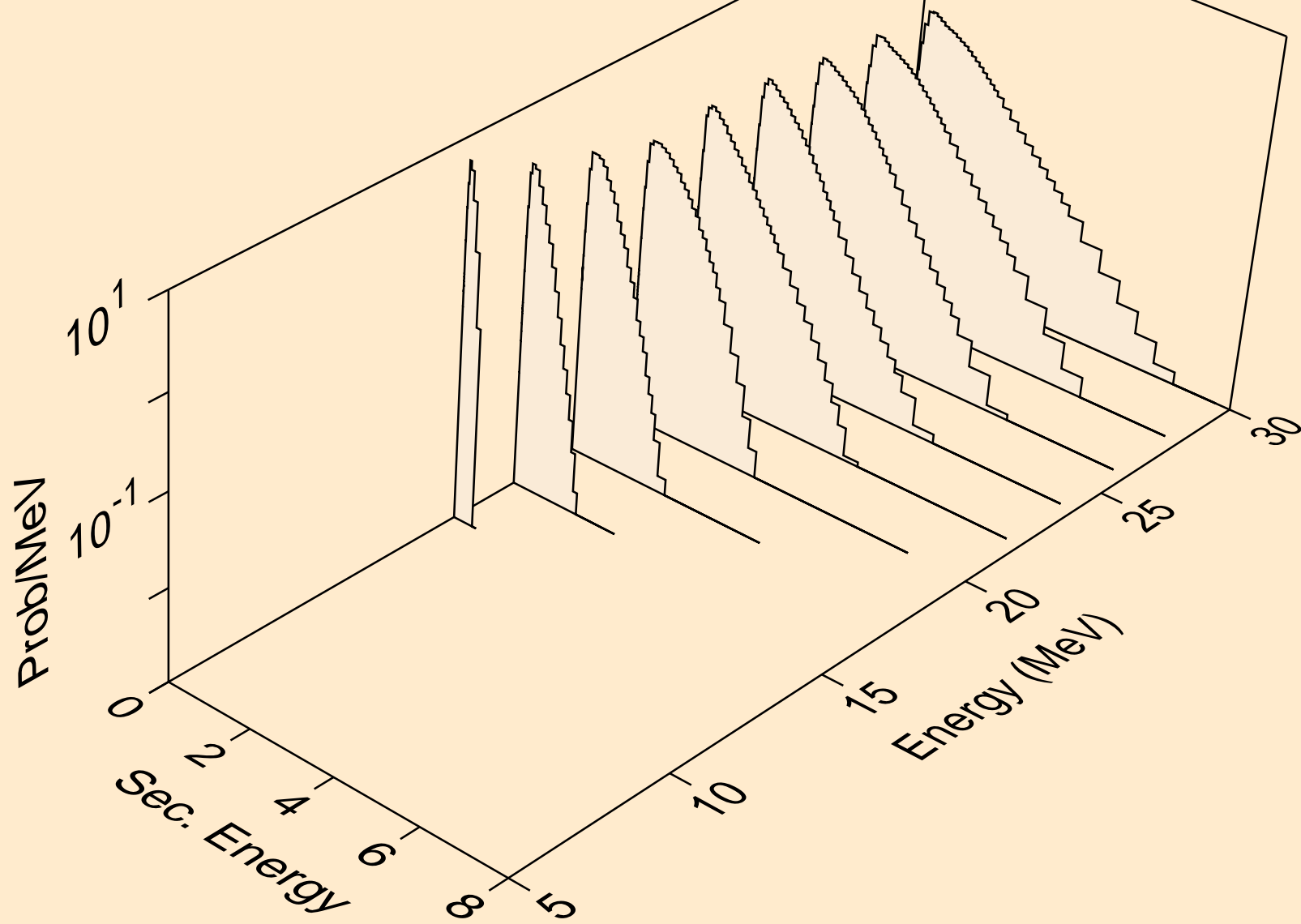

TE120 NEUTRON ACER TENDL-2024 LIBRARY; T=0.K  
Neutron emission for (n,3n)a

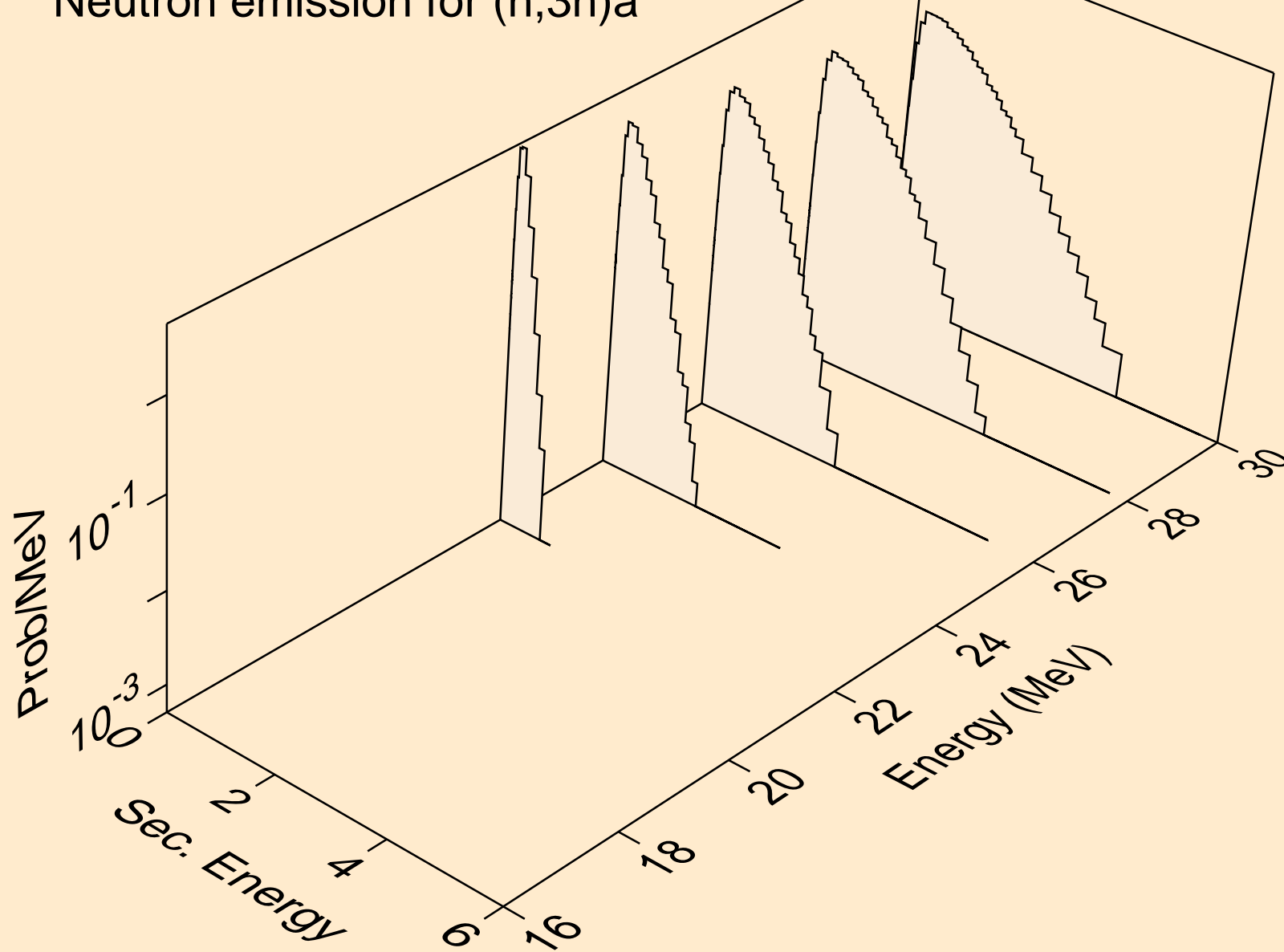

TE120 NEUTRON ACER TENDL-2024 LIBRARY; T=0.K  
Neutron emission for (n,n\*)p

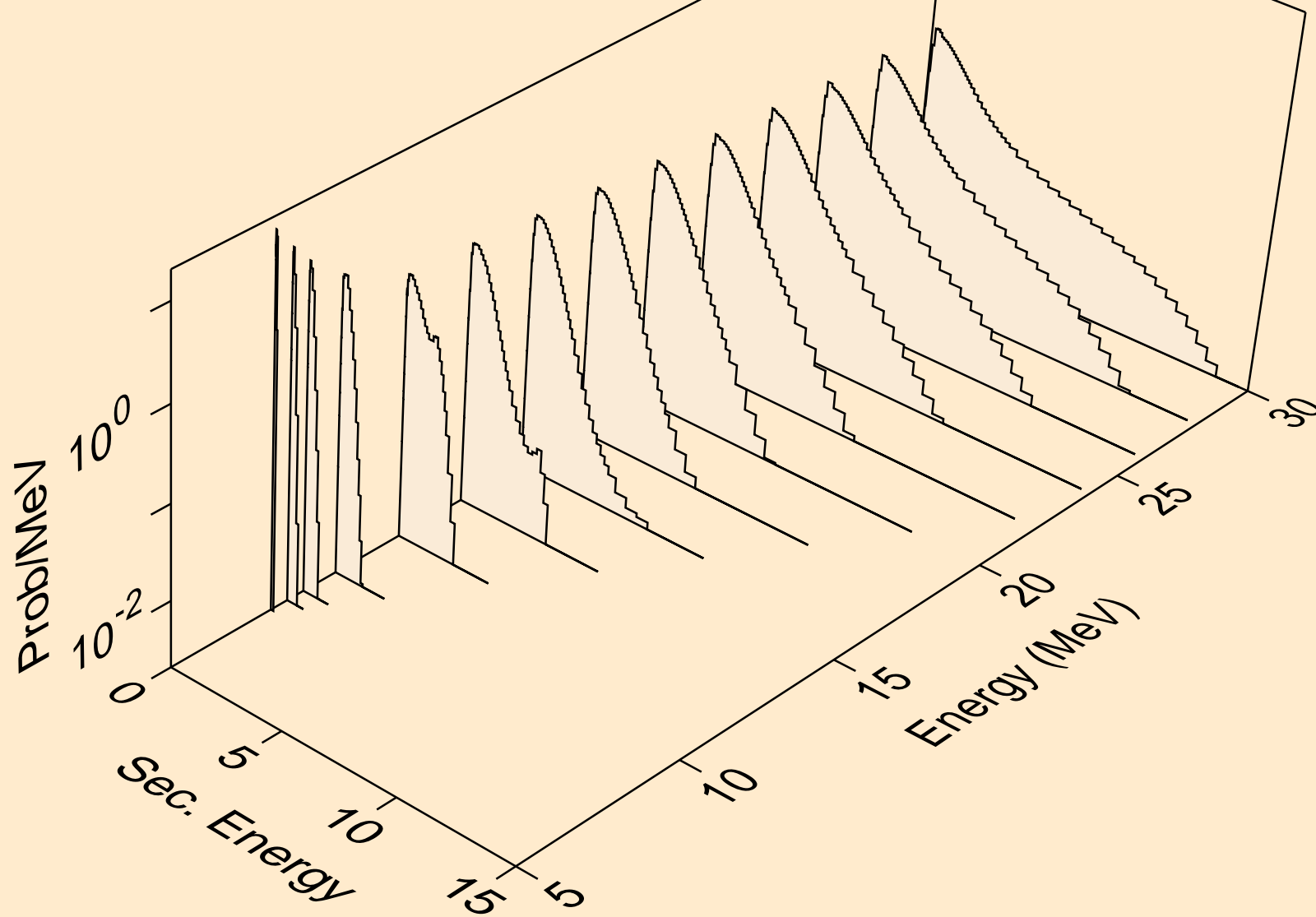

TE120 NEUTRON ACER TENDL-2024 LIBRARY; T=0.K  
Neutron emission for (n,n\*)2a

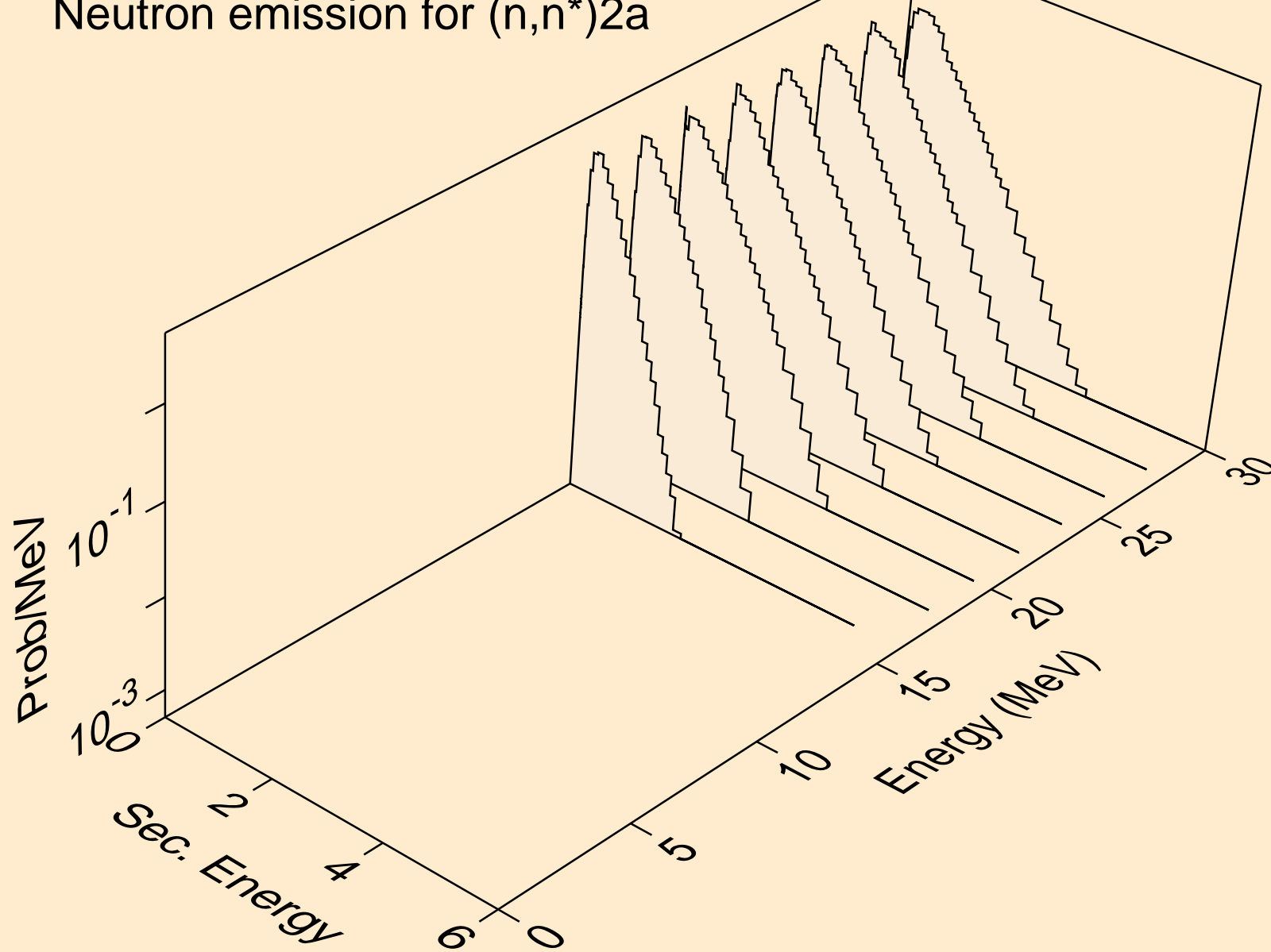

TE120 NEUTRON ACER TENDL-2024 LIBRARY; T=0.K  
Neutron emission for (n,n\*)d

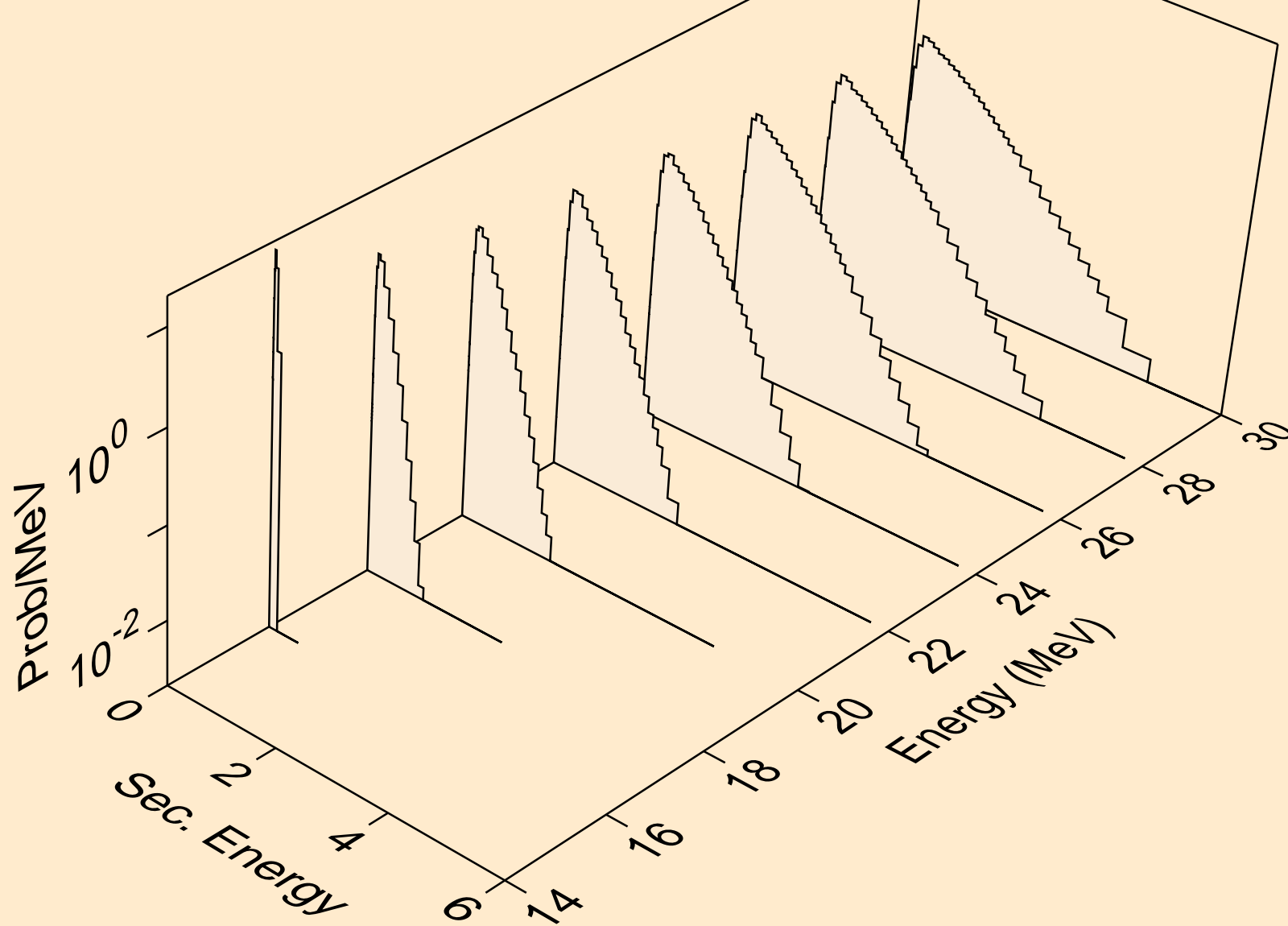

TE120 NEUTRON ACER TENDL-2024 LIBRARY; T=0.K  
Neutron emission for (n,n\*)t

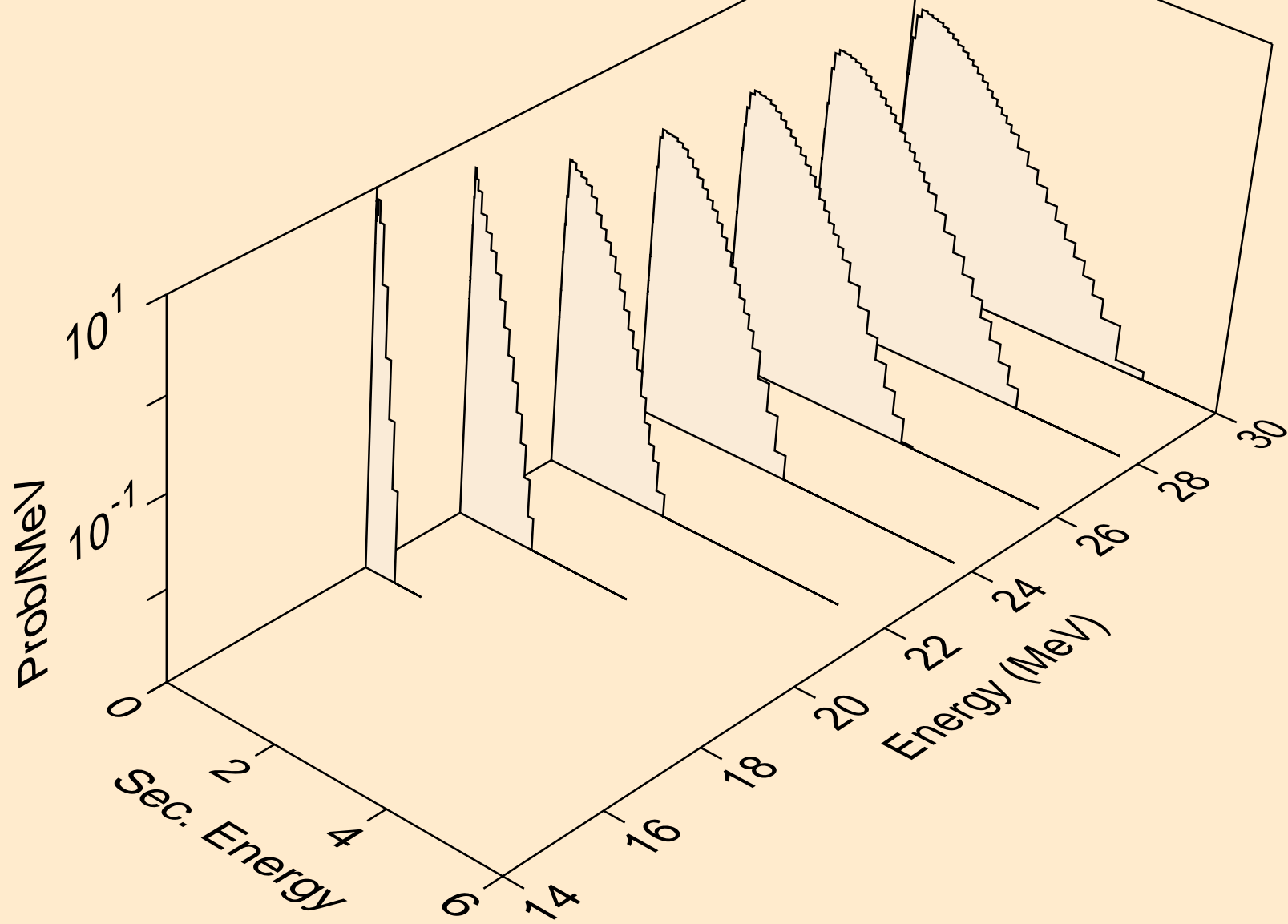

TE120 NEUTRON ACER TENDL-2024 LIBRARY; T=0.K  
Neutron emission for (n,n\*)he3

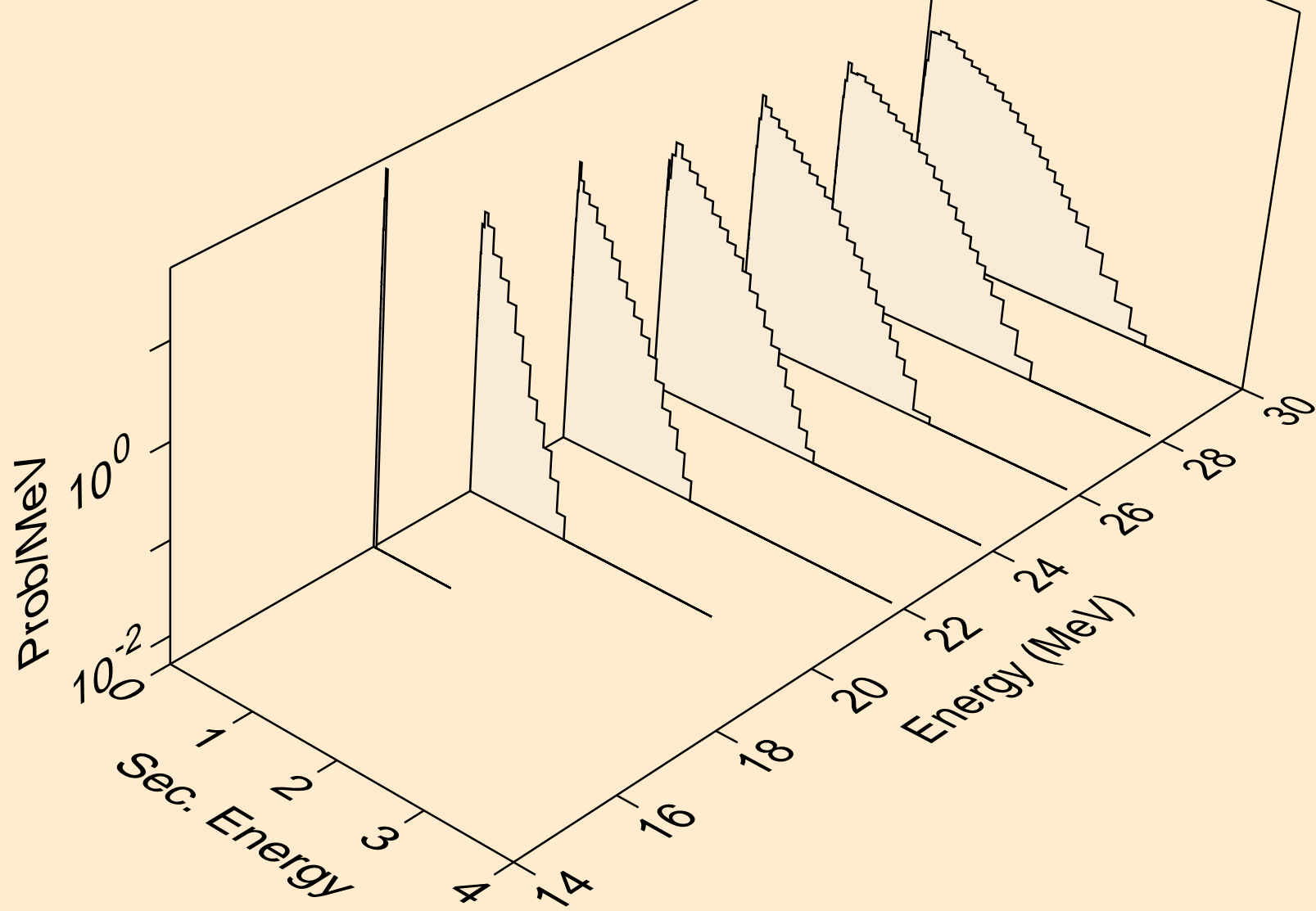

TE120 NEUTRON ACER TENDL-2024 LIBRARY; T=0.K  
Neutron emission for (n,4n)

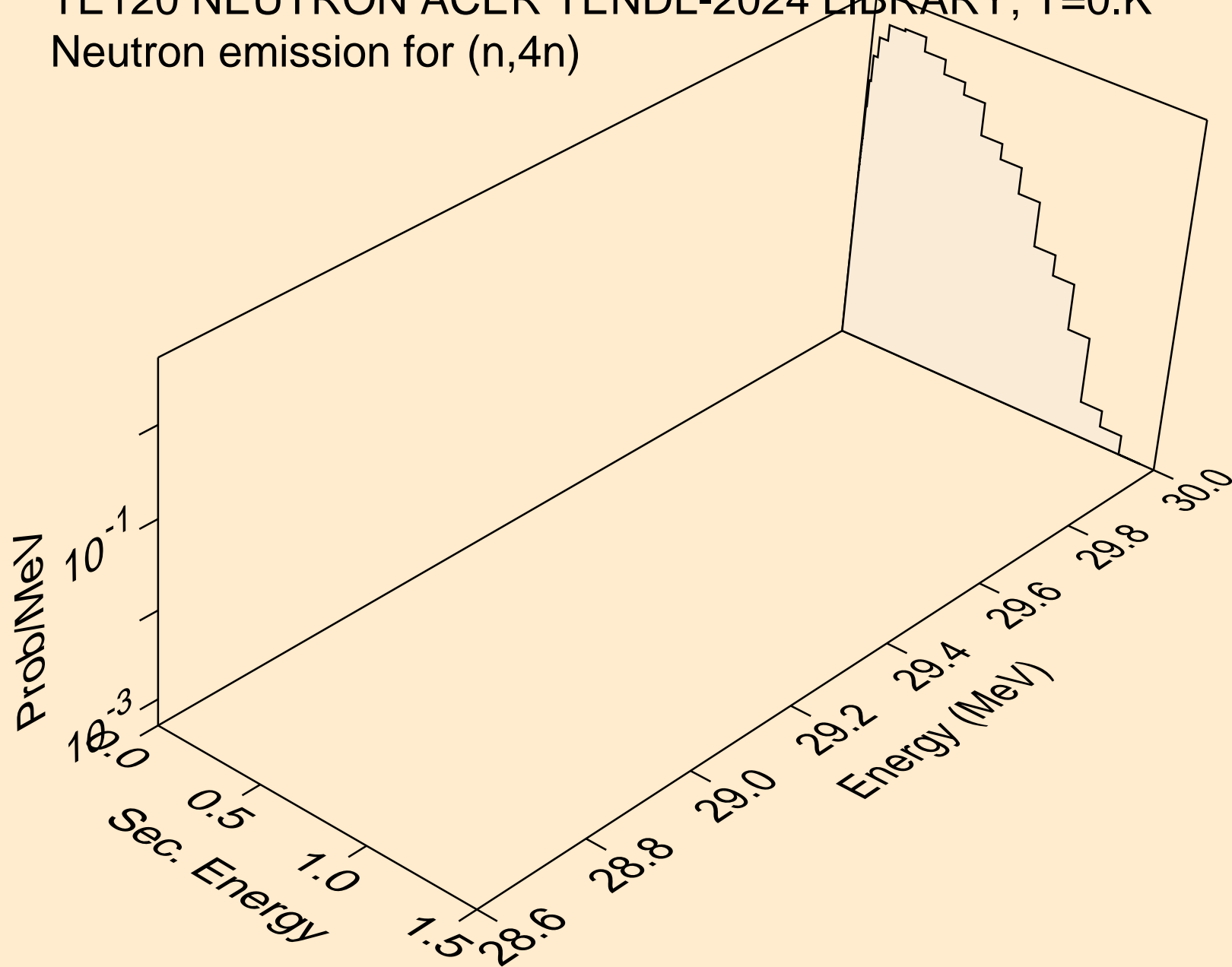



TE120 NEUTRON ACER TENDL-2024 LIBRARY; T=0.K  
Neutron emission for (n,2np)

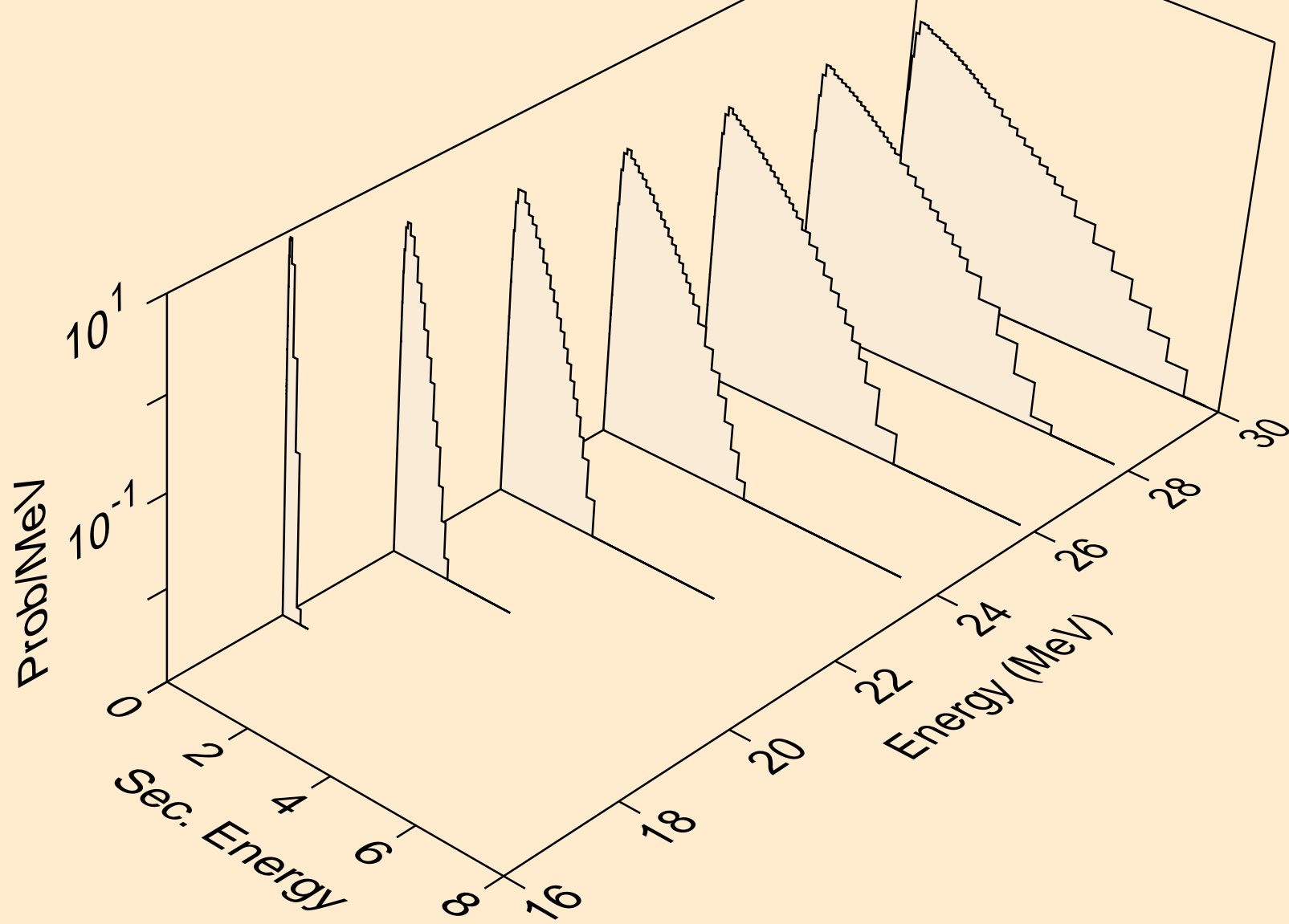

TE120 NEUTRON ACER TENDL-2024 LIBRARY; T=0.K  
Neutron emission for (n,3np)

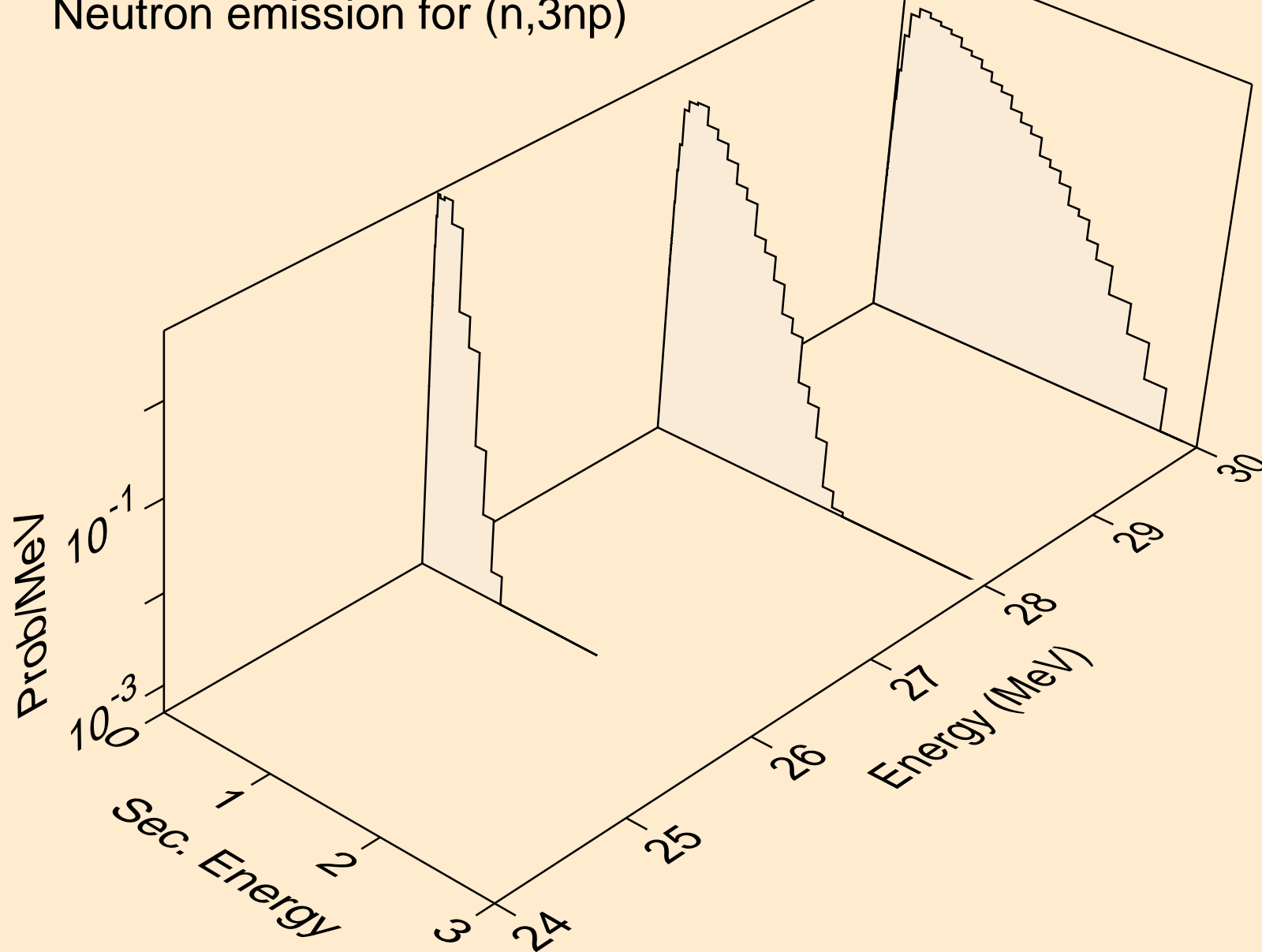

TE120 NEUTRON ACER TENDL-2024 LIBRARY; T=0.K  
Neutron emission for (n,n2p)

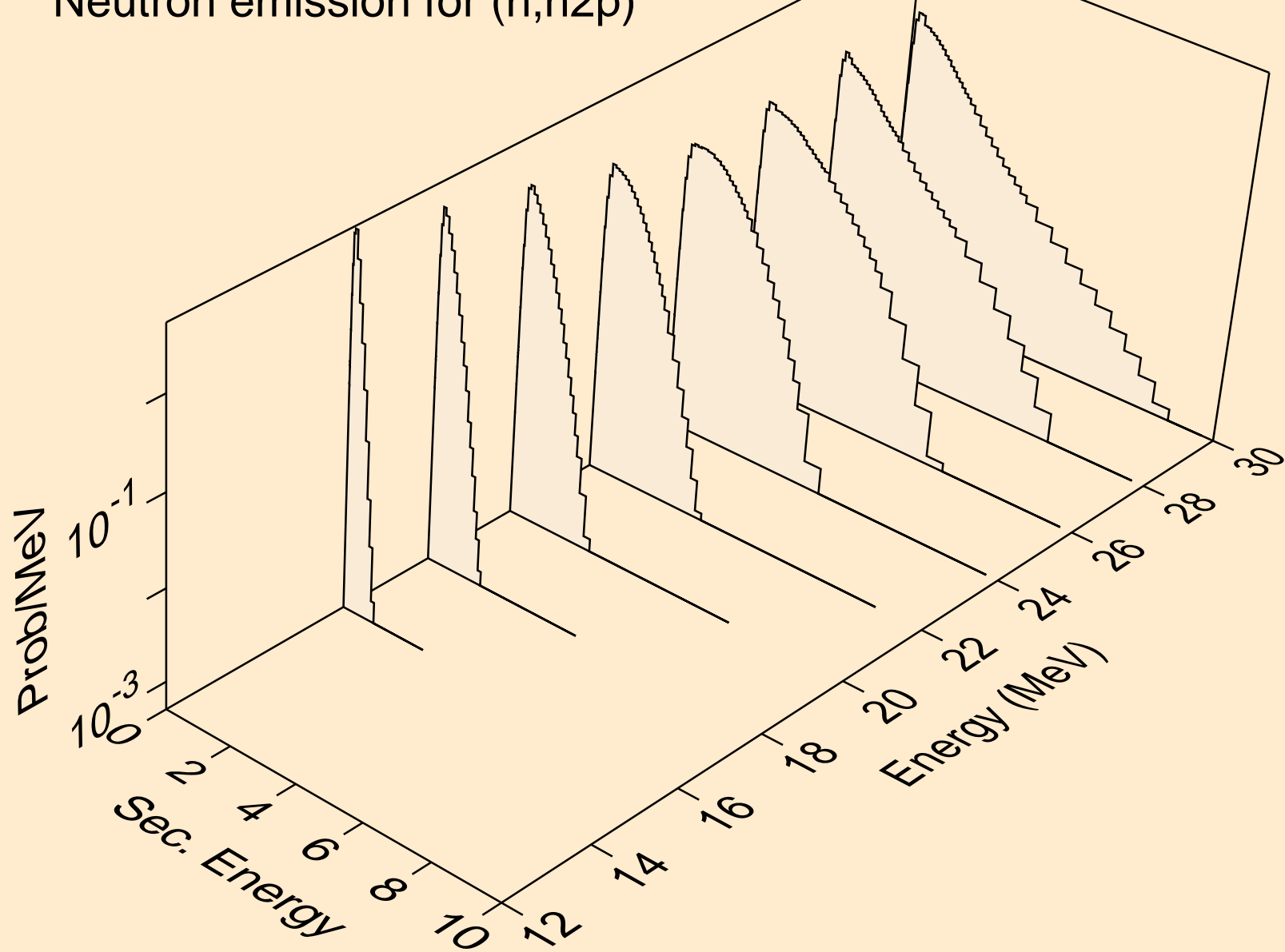

TE120 NEUTRON ACER TENDL-2024 LIBRARY; T=0.K  
Neutron emission for (n,npa)

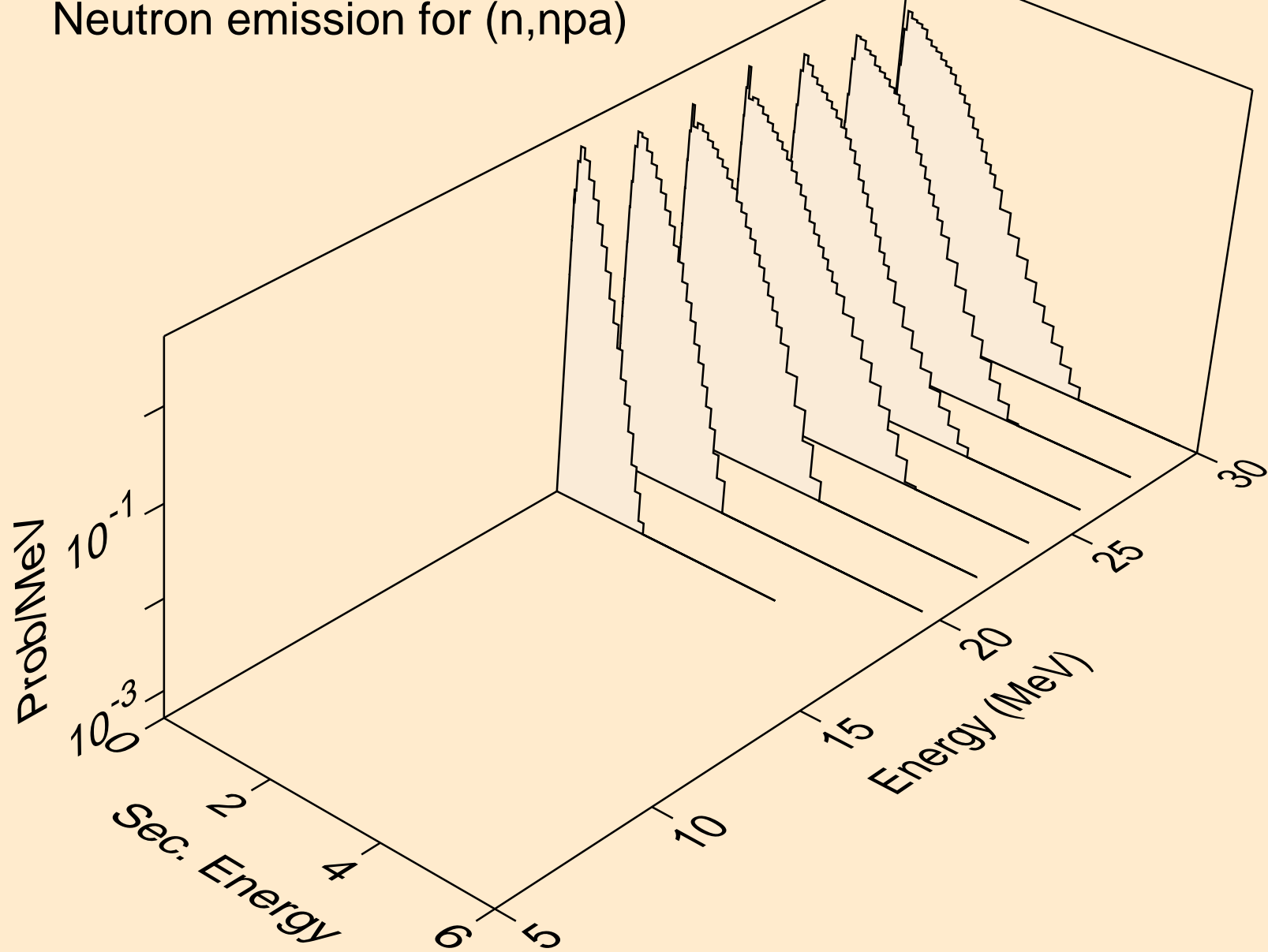

TE120 NEUTRON ACER TENDL-2024 LIBRARY; T=0.K  
Neutron emission for (n,n\*c)

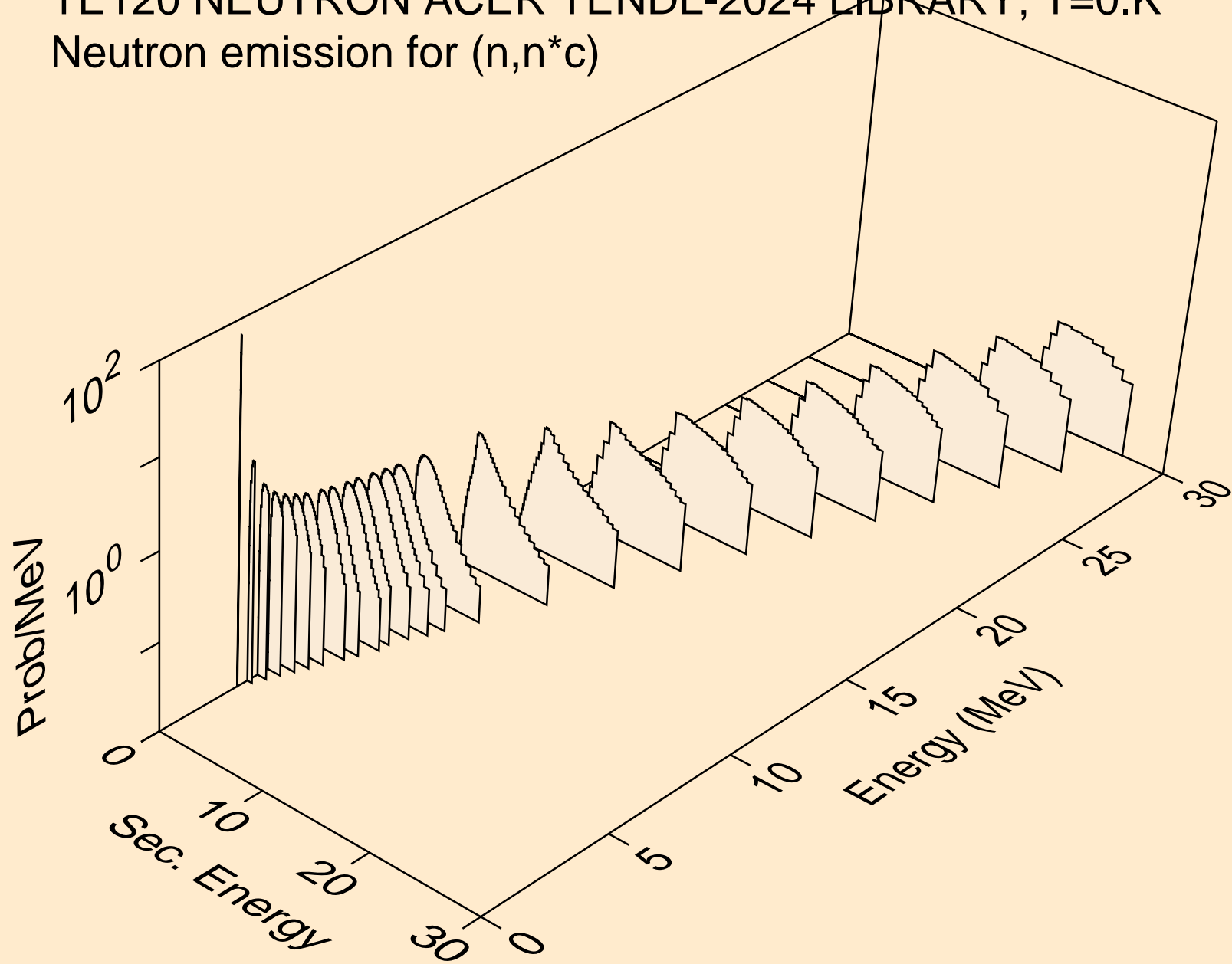

TE120 NEUTRON ACER TENDL-2024 LIBRARY; T=0.K  
Photon emission for (n,x)

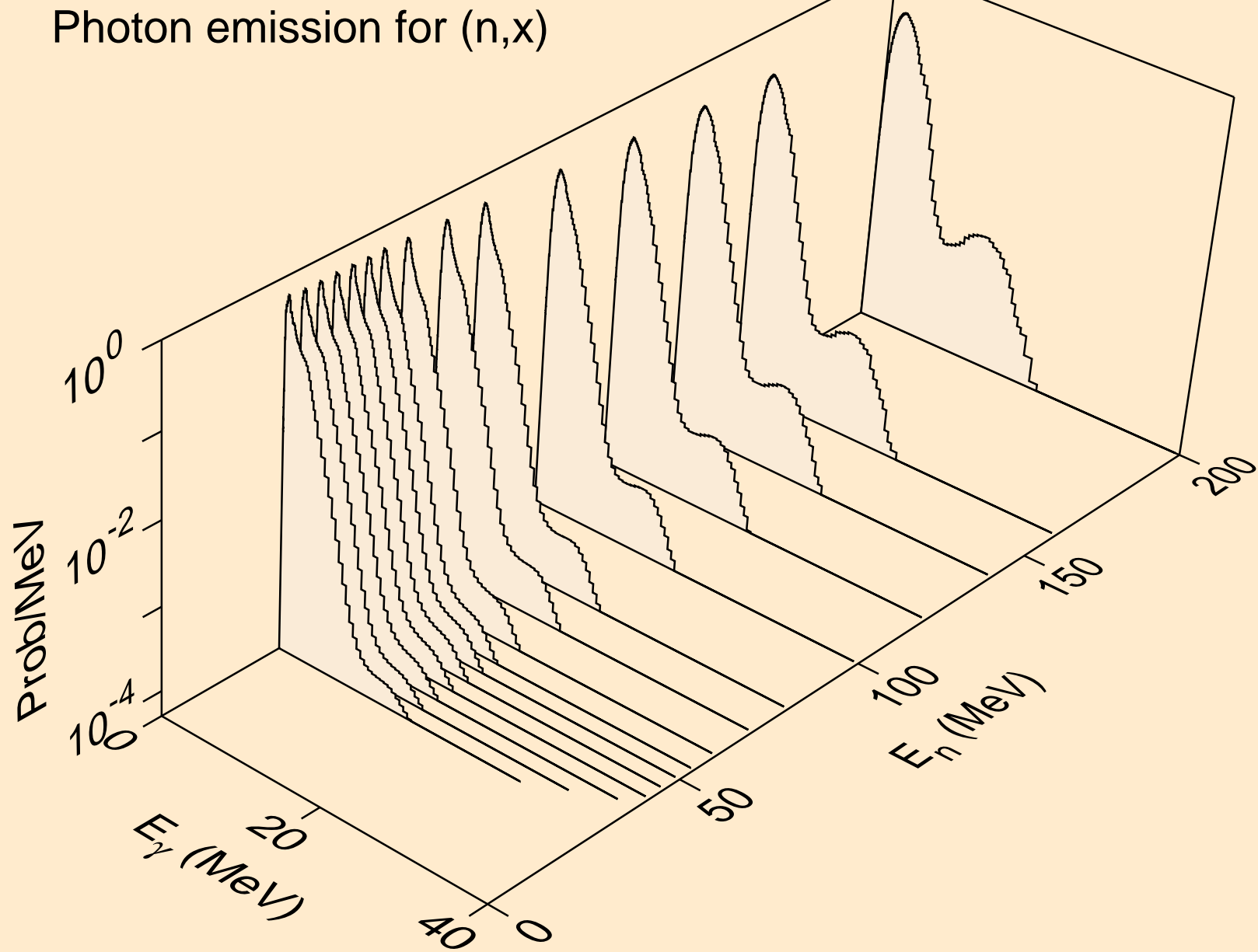

TE120 NEUTRON ACER TENDL-2024 LIBRARY; T=0.K  
Photon emission for (n,2nd)

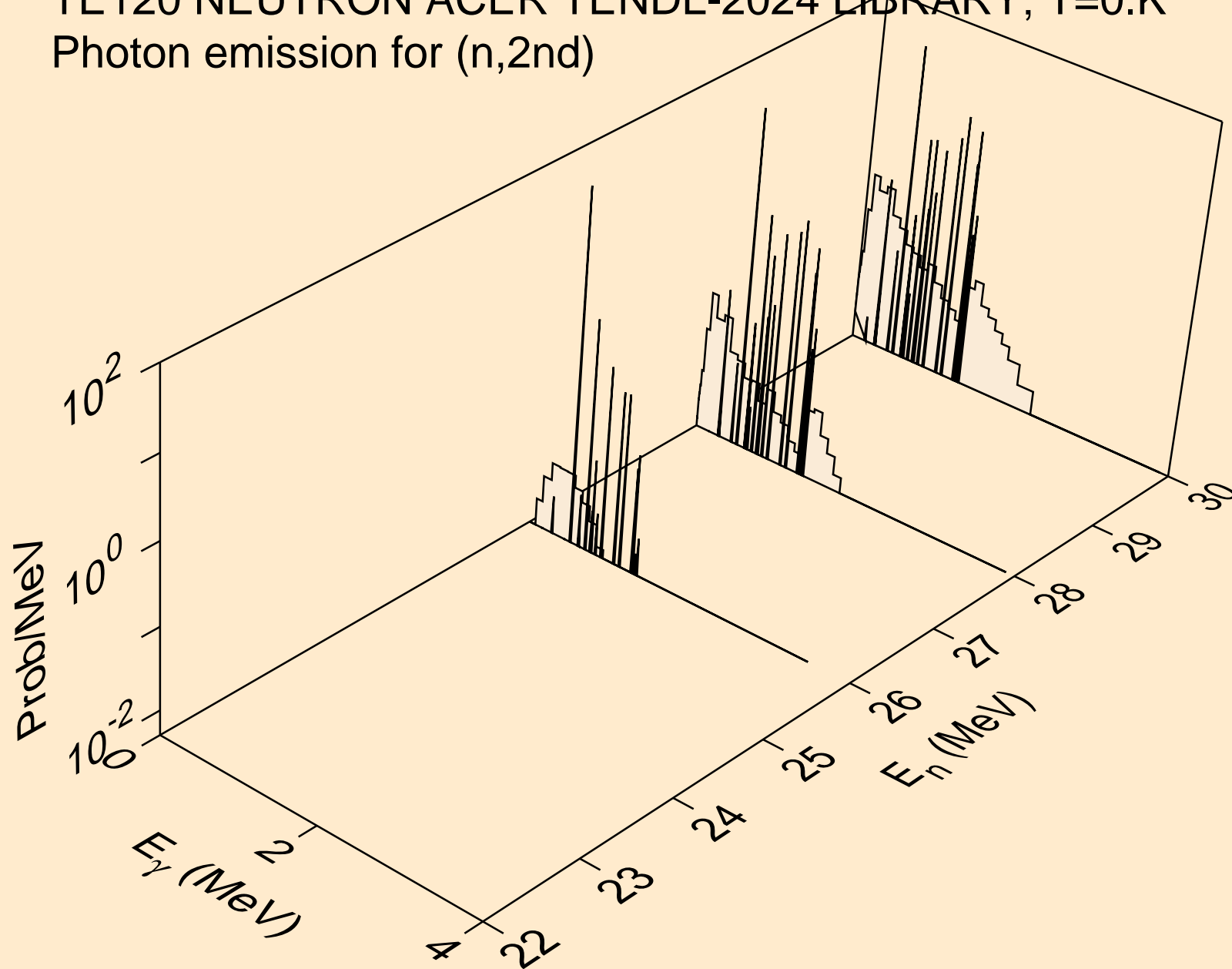

TE120 NEUTRON ACER TENDL-2024 LIBRARY; T=0.K  
Photon emission for (n,2n)

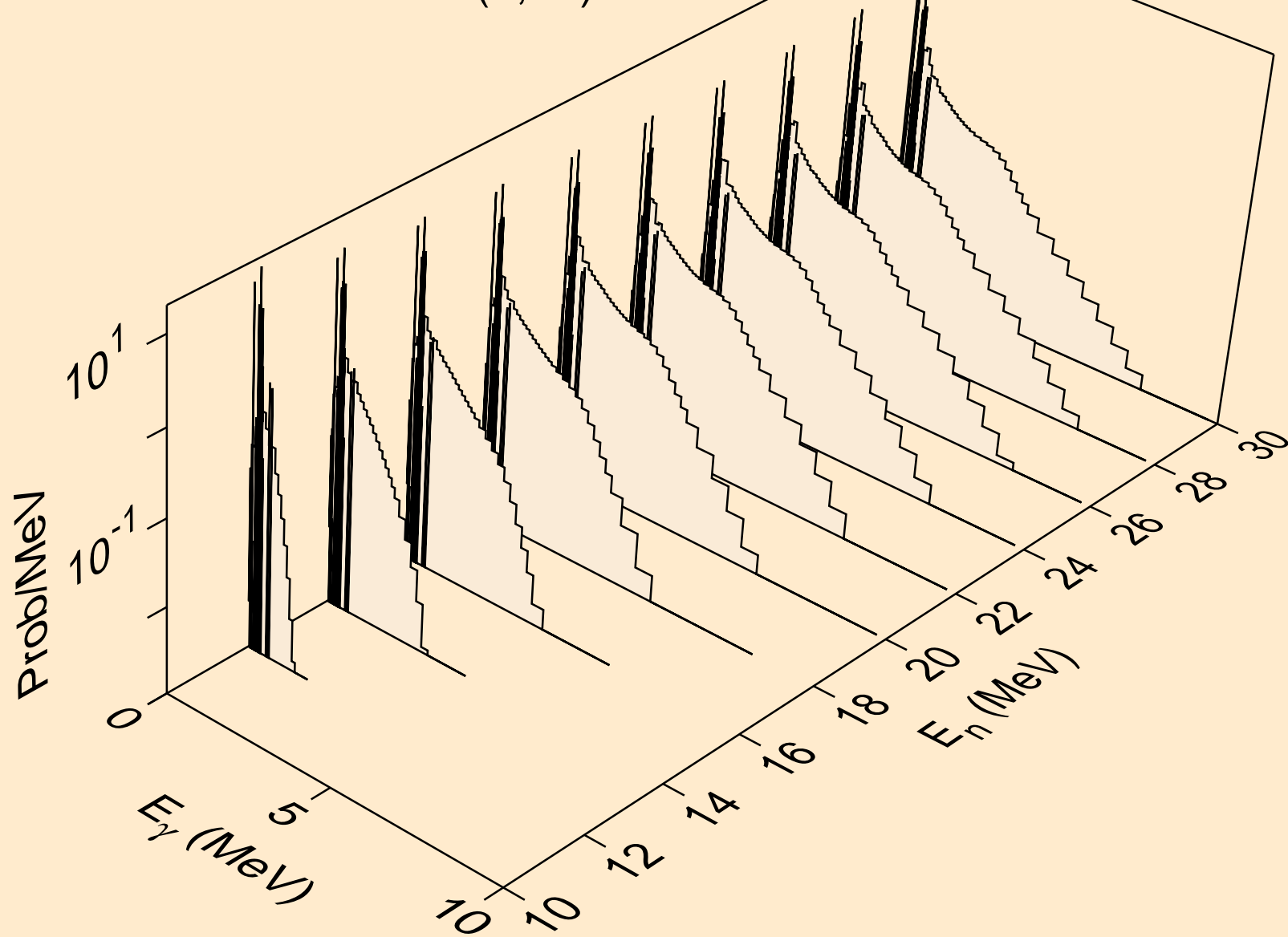



TE120 NEUTRON ACER TENDL-2024 LIBRARY; T=0.K  
Photon emission for (n,3n)

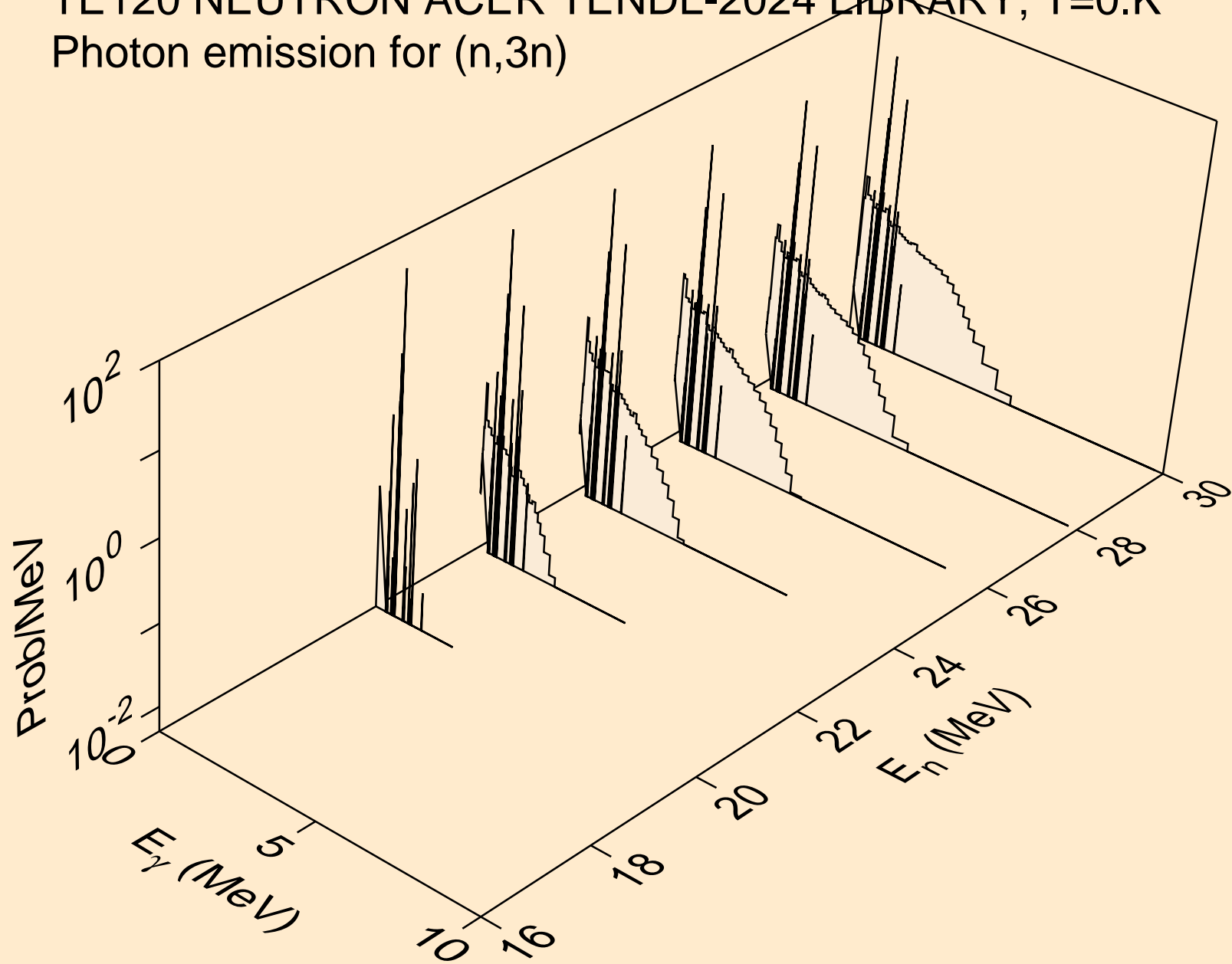

TE120 NEUTRON ACER TENDL-2024 LIBRARY; T=0.K  
Photon emission for (n,n\*)a

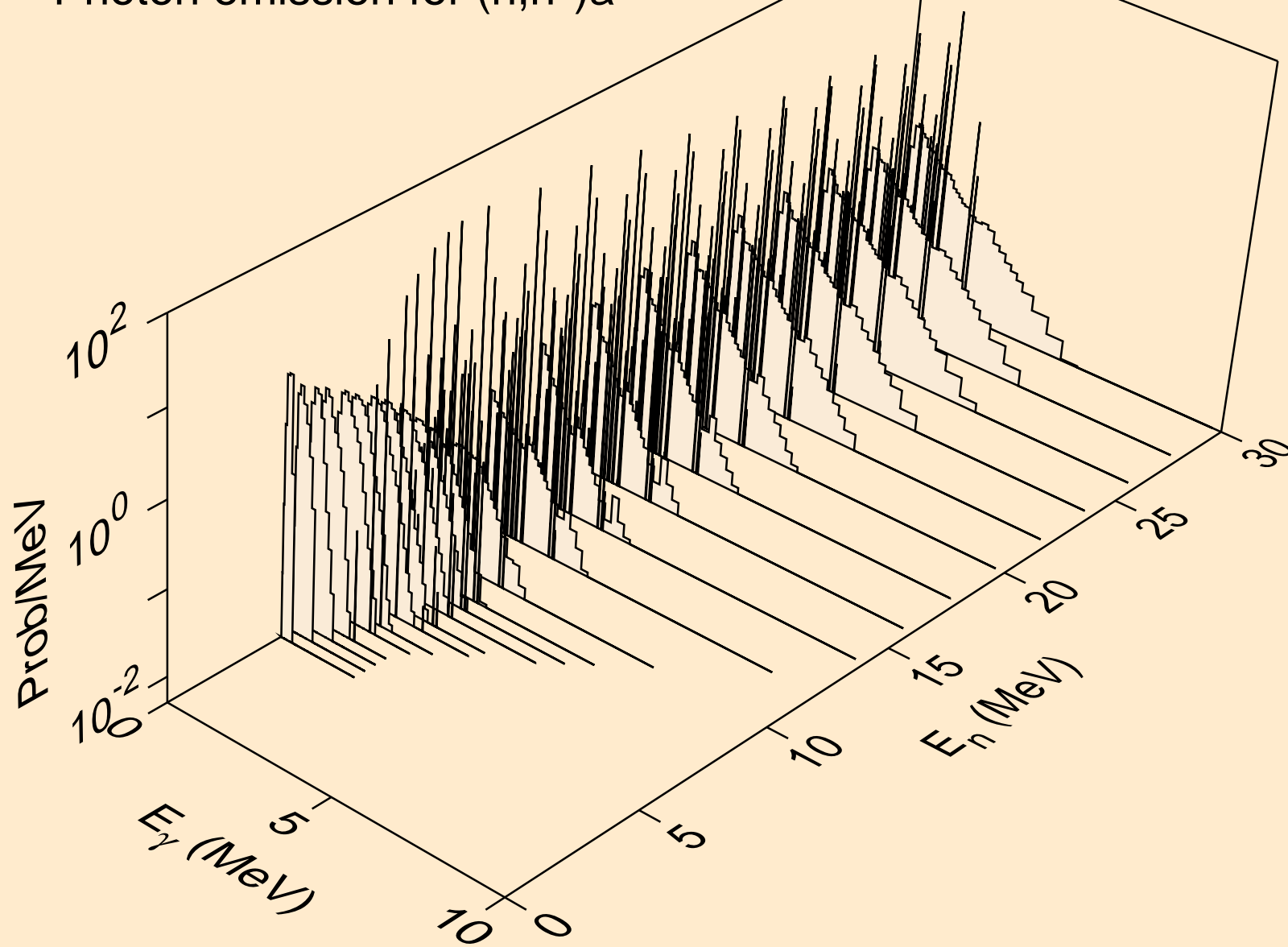

TE120 NEUTRON ACER TENDL-2024 LIBRARY; T=0.K  
Photon emission for (n,2n)a

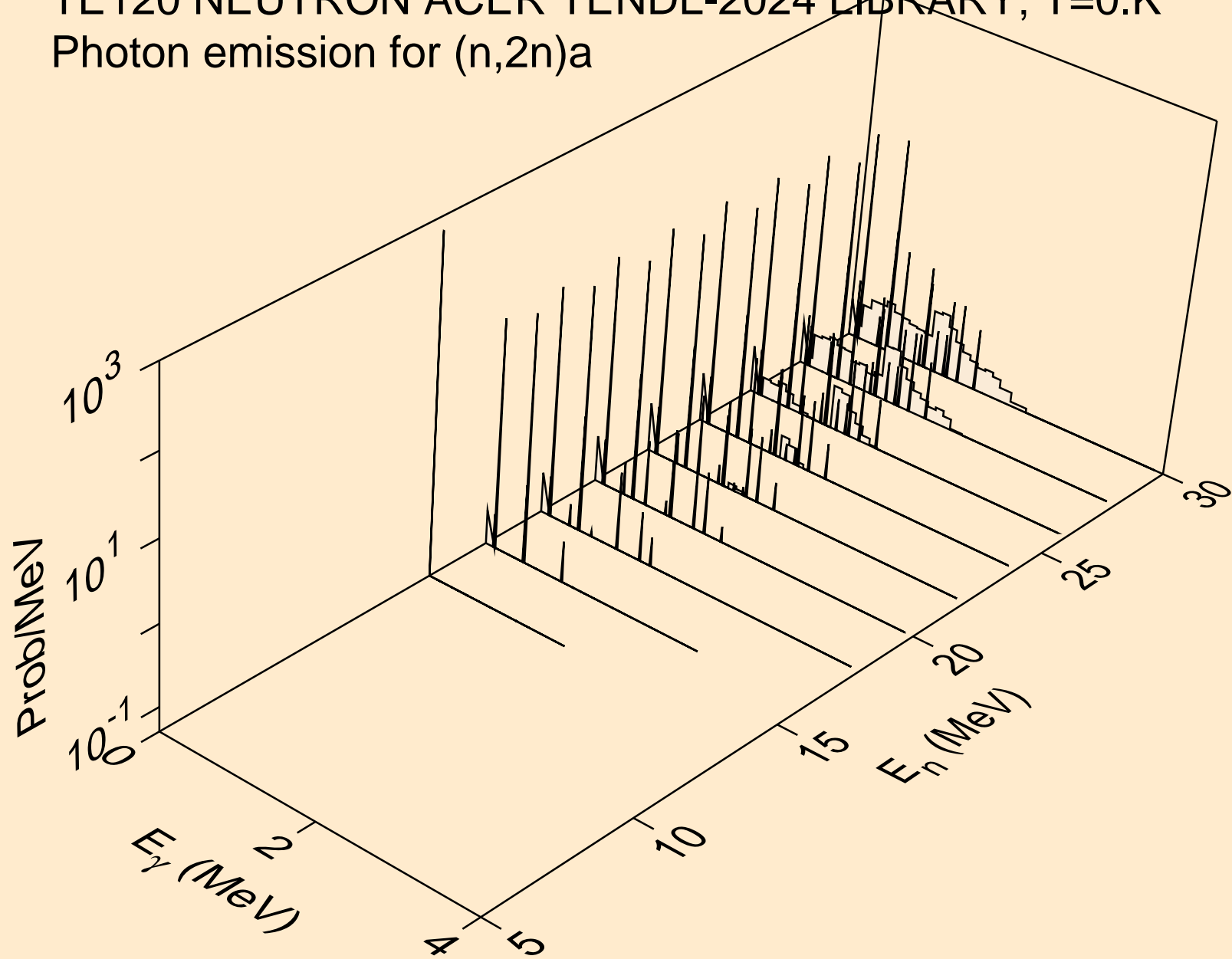

TE120 NEUTRON ACER TENDL-2024 LIBRARY; T=0.K  
Photon emission for (n,3n)a

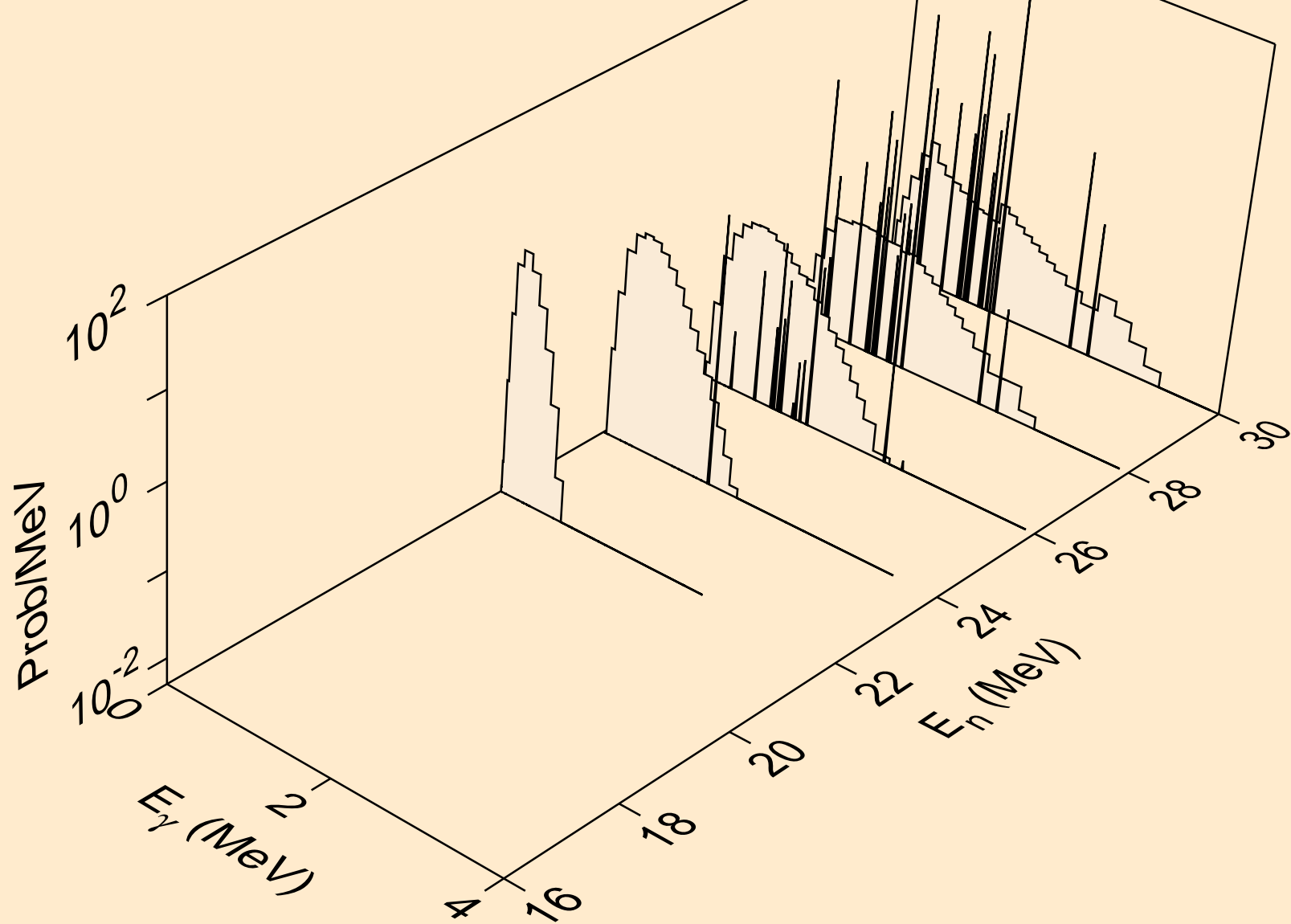

TE120 NEUTRON ACER TENDL-2024 LIBRARY; T=0.K  
Photon emission for (n,n\*)p

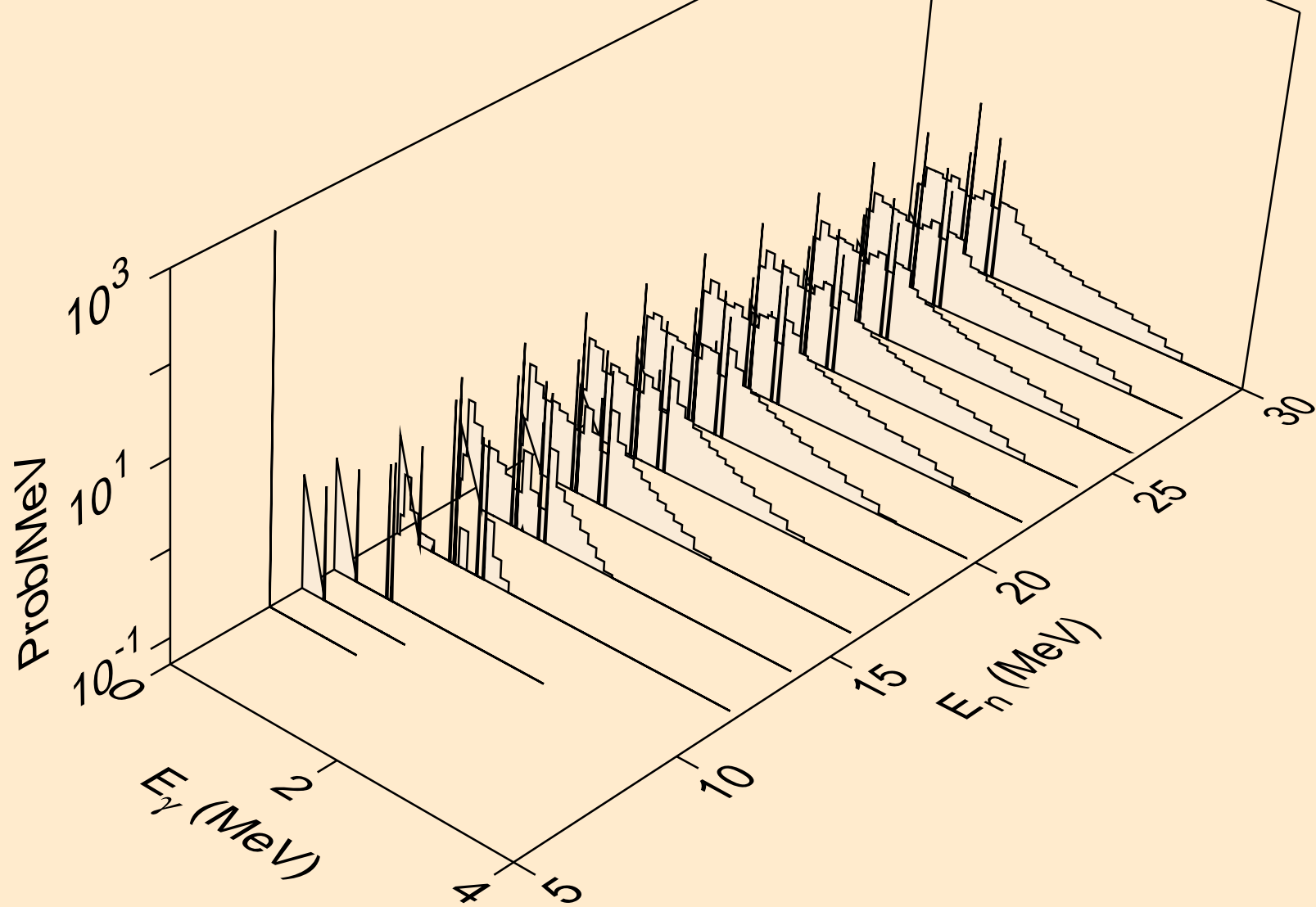

TE120 NEUTRON ACER TENDL-2024 LIBRARY; T=0.K  
Photon emission for (n,n\*)2a

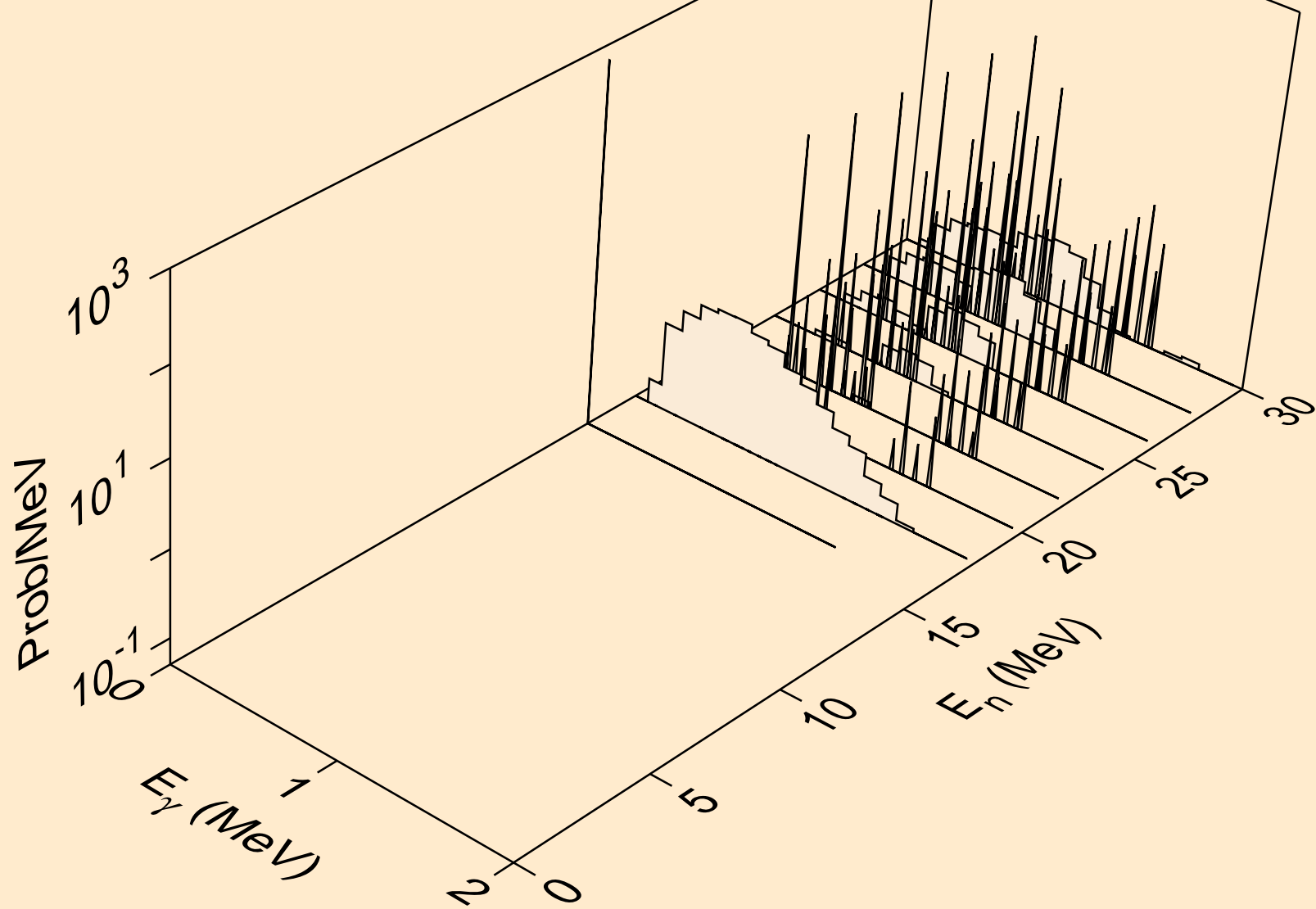

TE120 NEUTRON ACER TENDL-2024 LIBRARY; T=0.K

Photon emission for (n,n\*)d

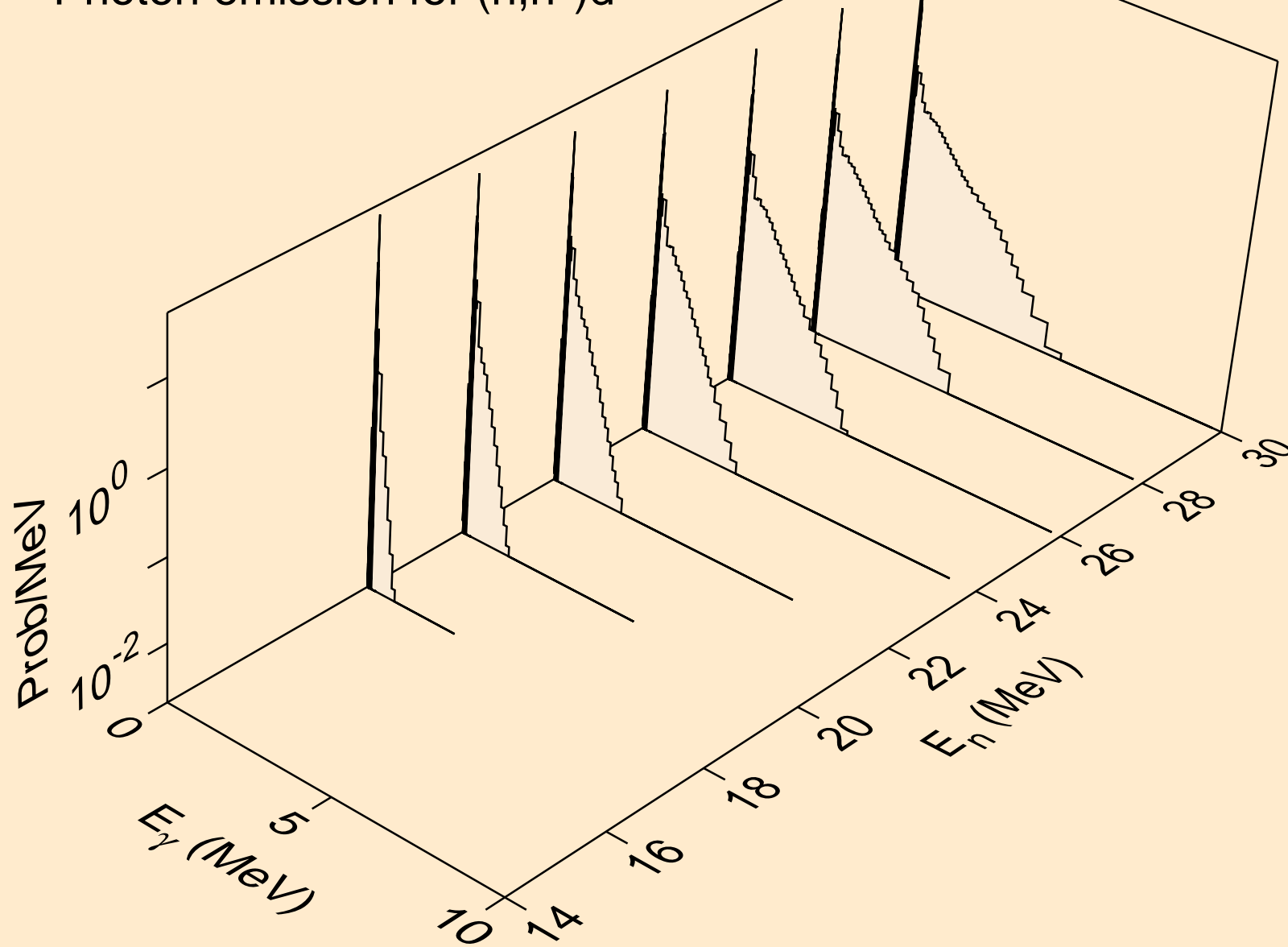

TE120 NEUTRON ACER TENDL-2024 LIBRARY; T=0.K  
Photon emission for (n,n\*)t

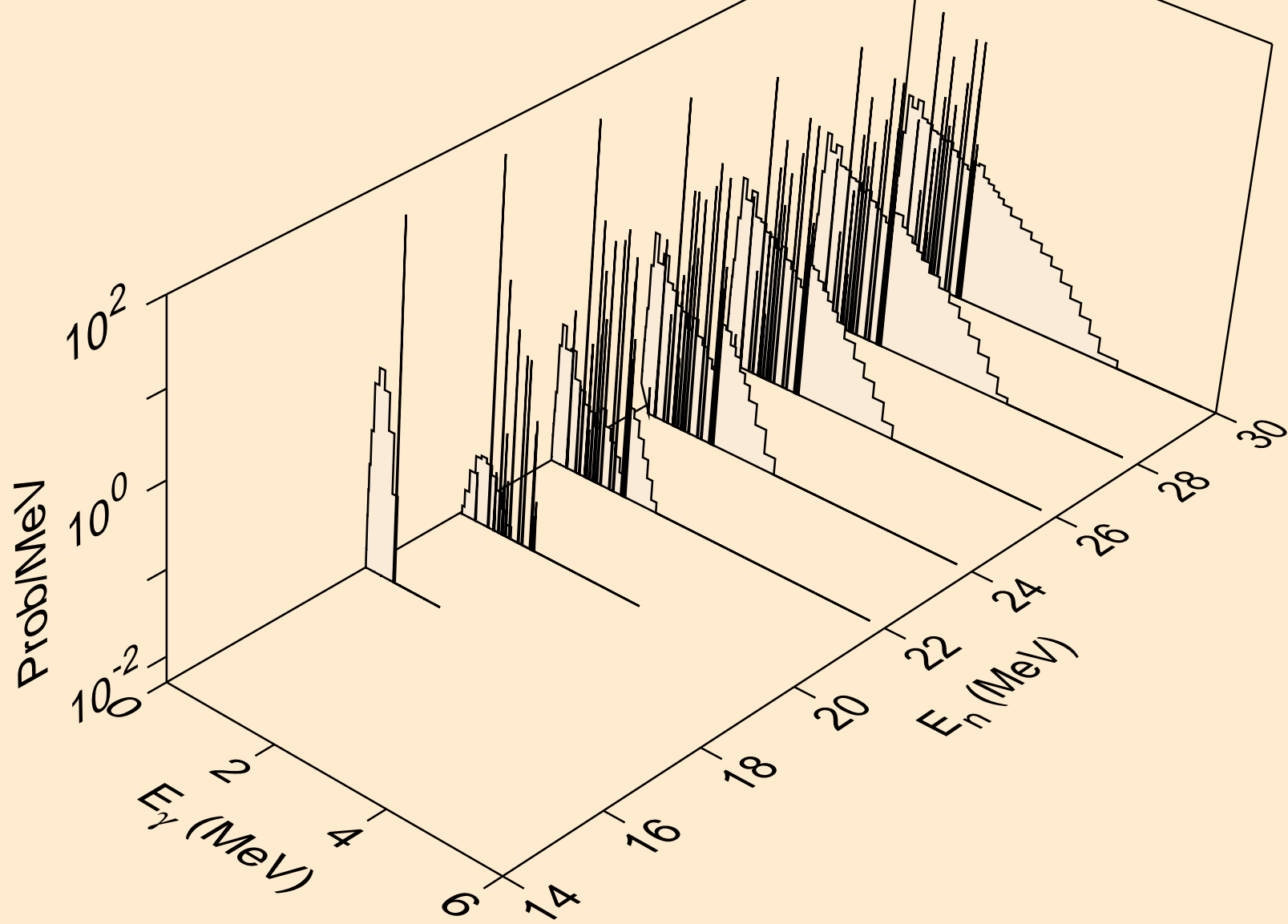



TE120 NEUTRON ACER TENDL-2024 LIBRARY; T=0.K  
Photon emission for (n,n\*)he3

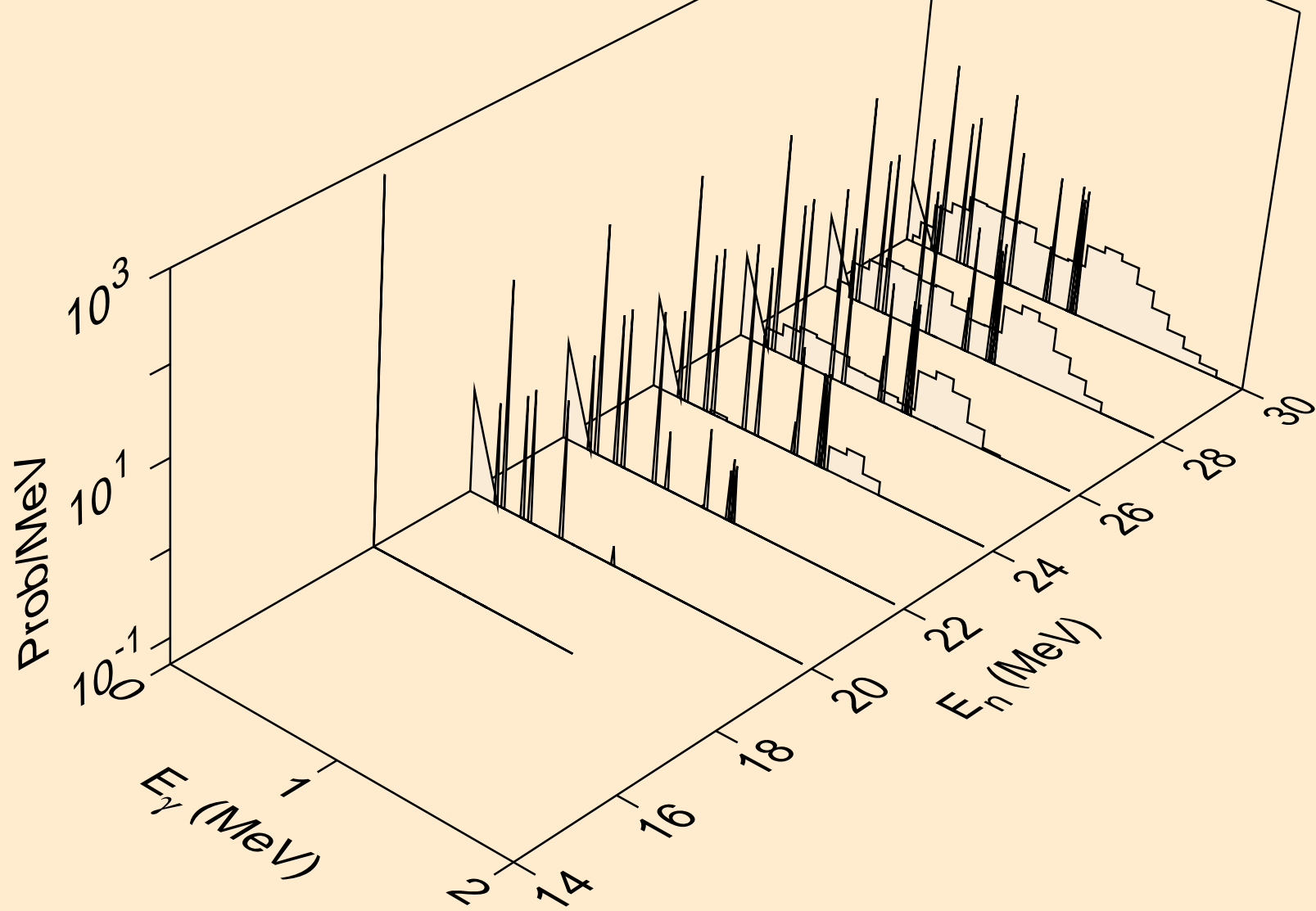

TE120 NEUTRON ACER TENDL-2024 LIBRARY; T=0.K  
Photon emission for (n,4n)

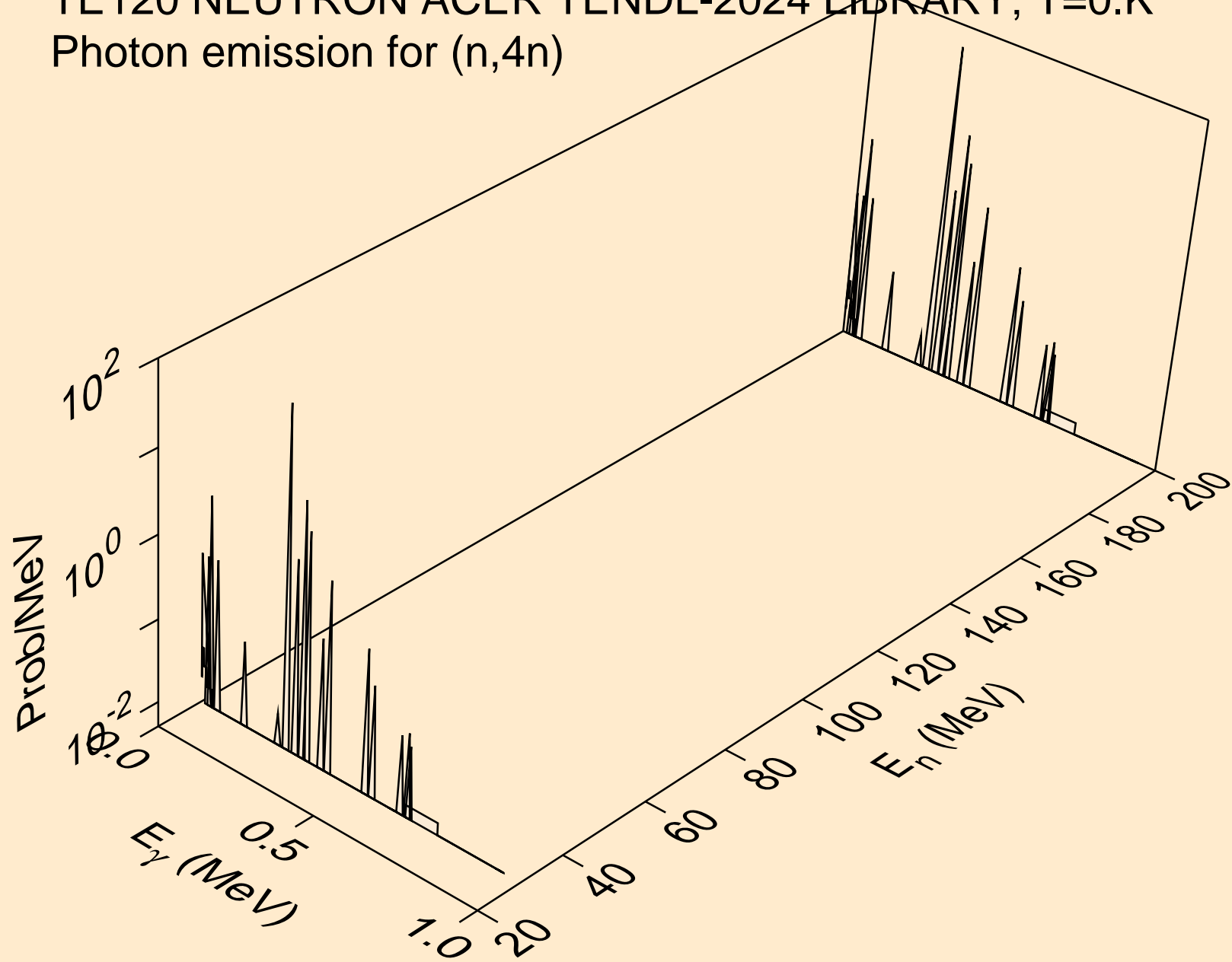

TE120 NEUTRON ACER TENDL-2024 LIBRARY; T=0.K  
Photon emission for (n,2np)

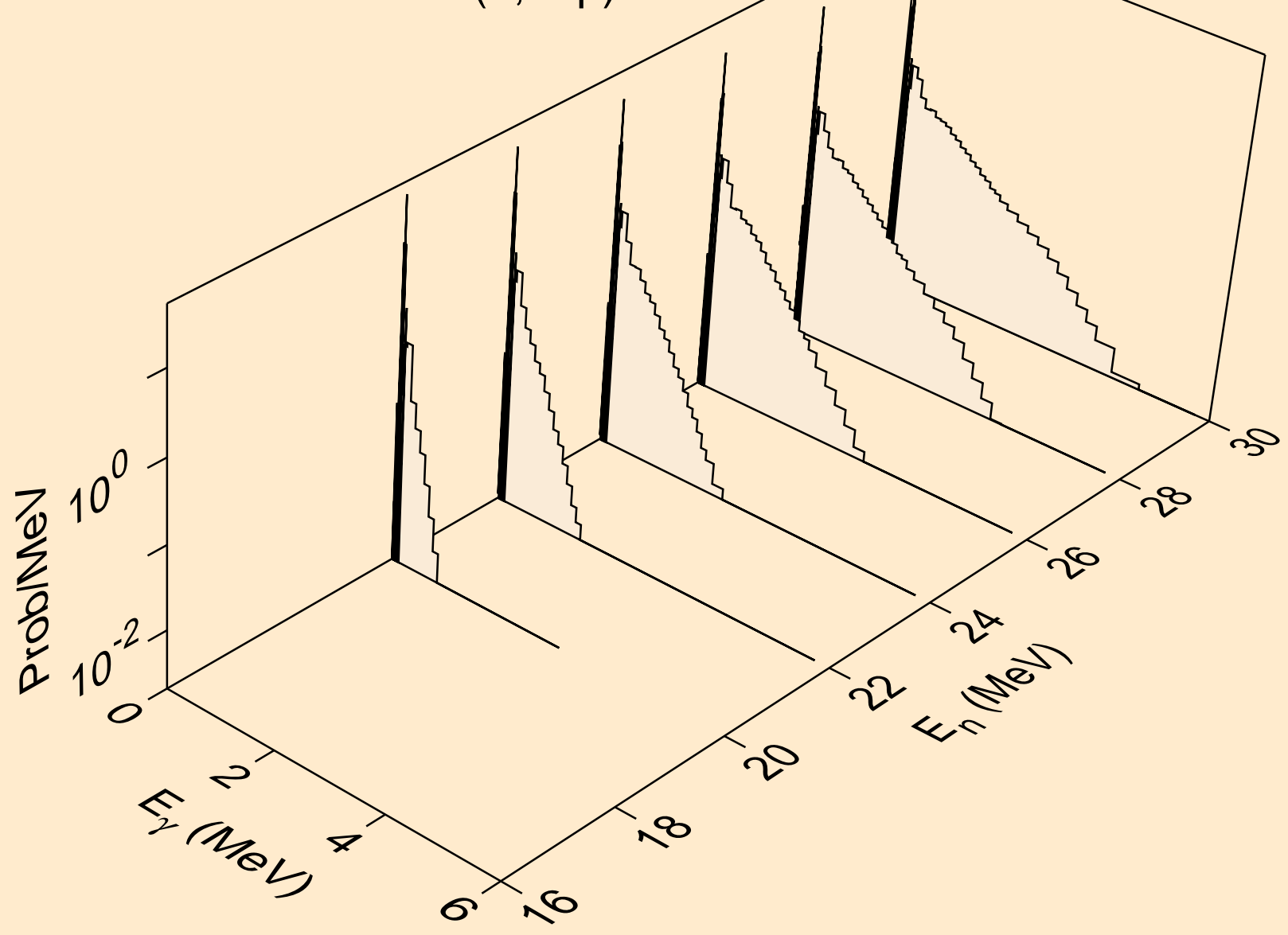

TE120 NEUTRON ACER TENDL-2024 LIBRARY; T=0.K  
Photon emission for (n,3np)

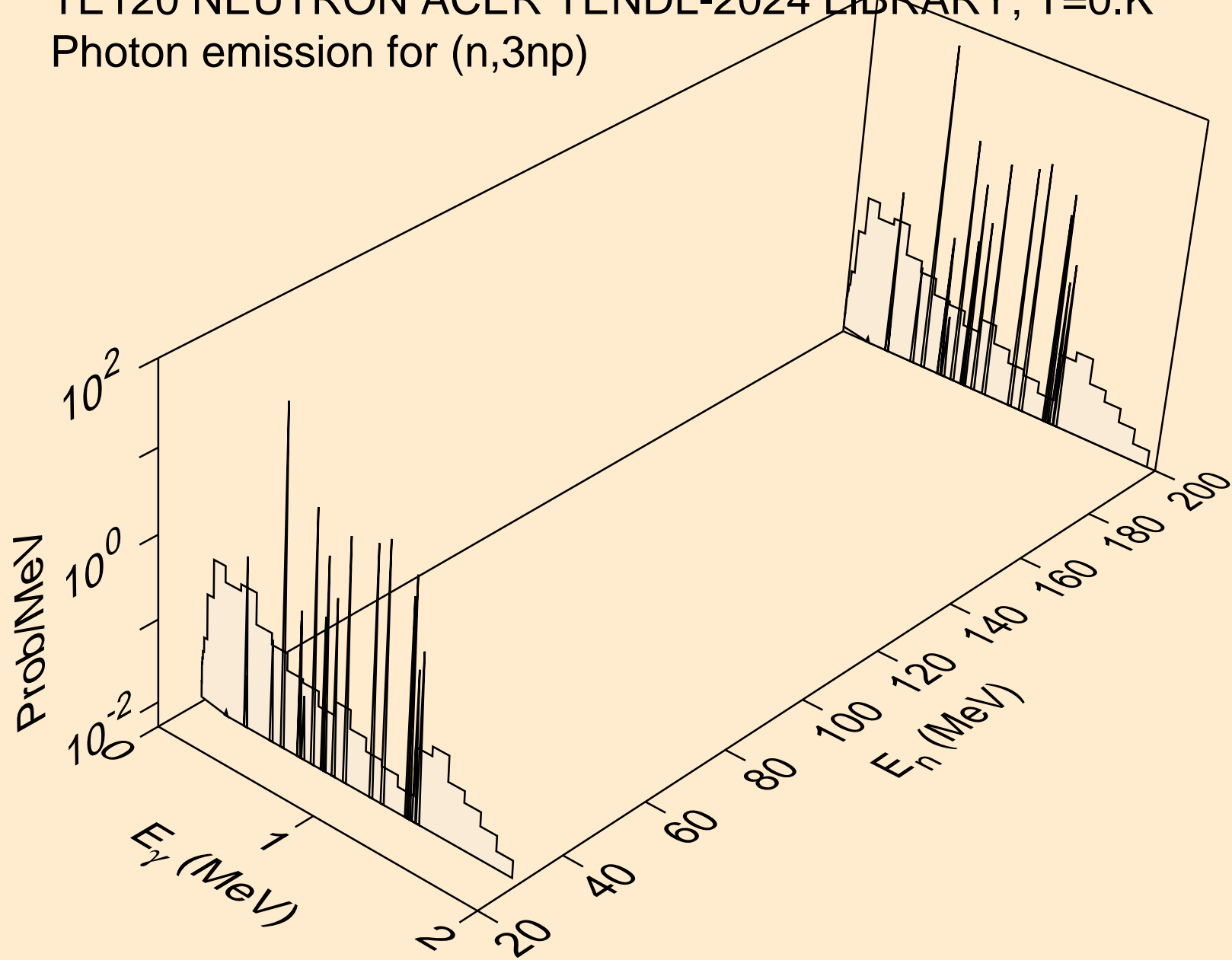

TE120 NEUTRON ACER TENDL-2024 LIBRARY; T=0.K  
Photon emission for (n,n2p)

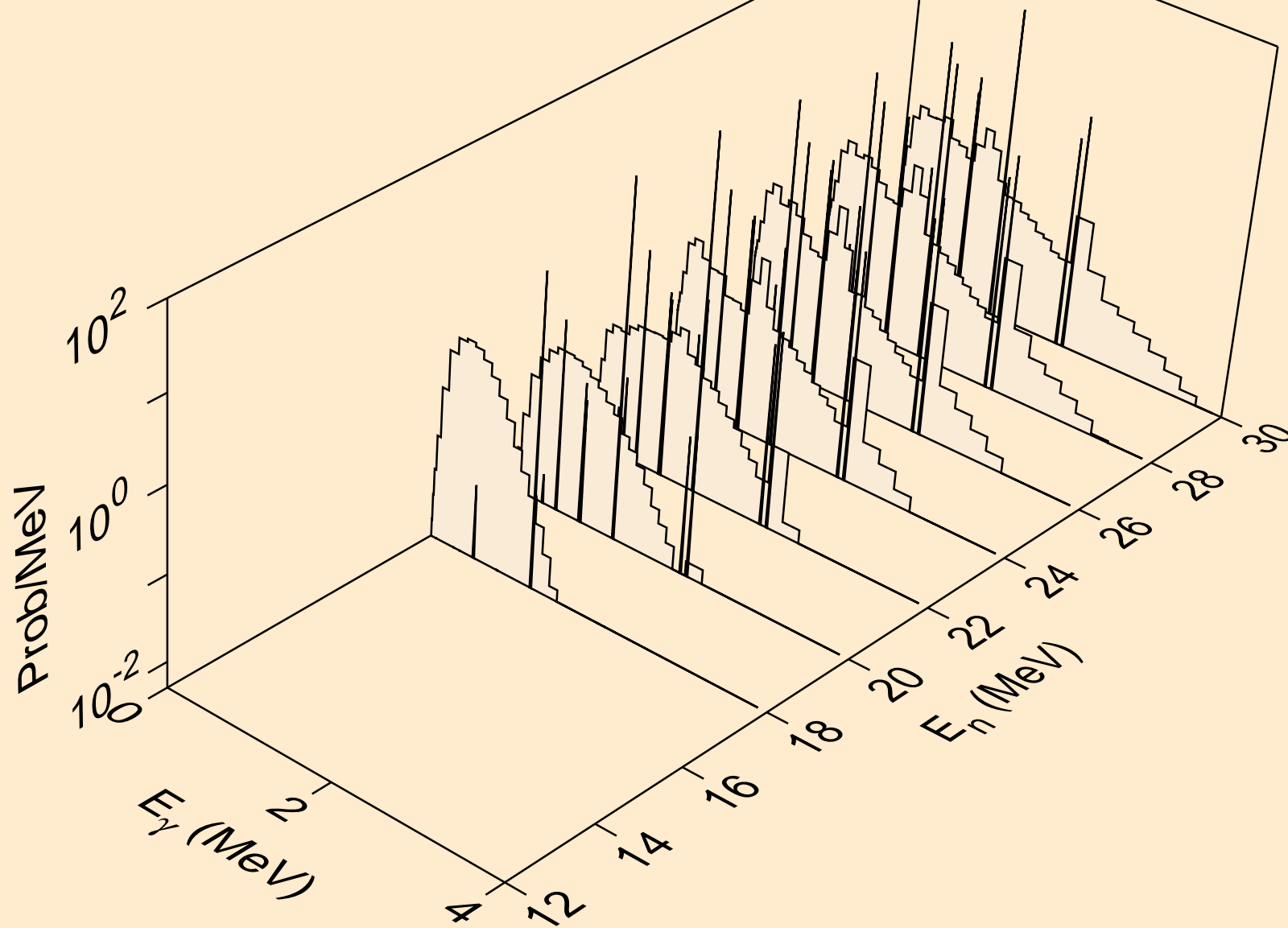

TE120 NEUTRON ACER TENDL-2024 LIBRARY; T=0.K  
Photon emission for (n,npa)

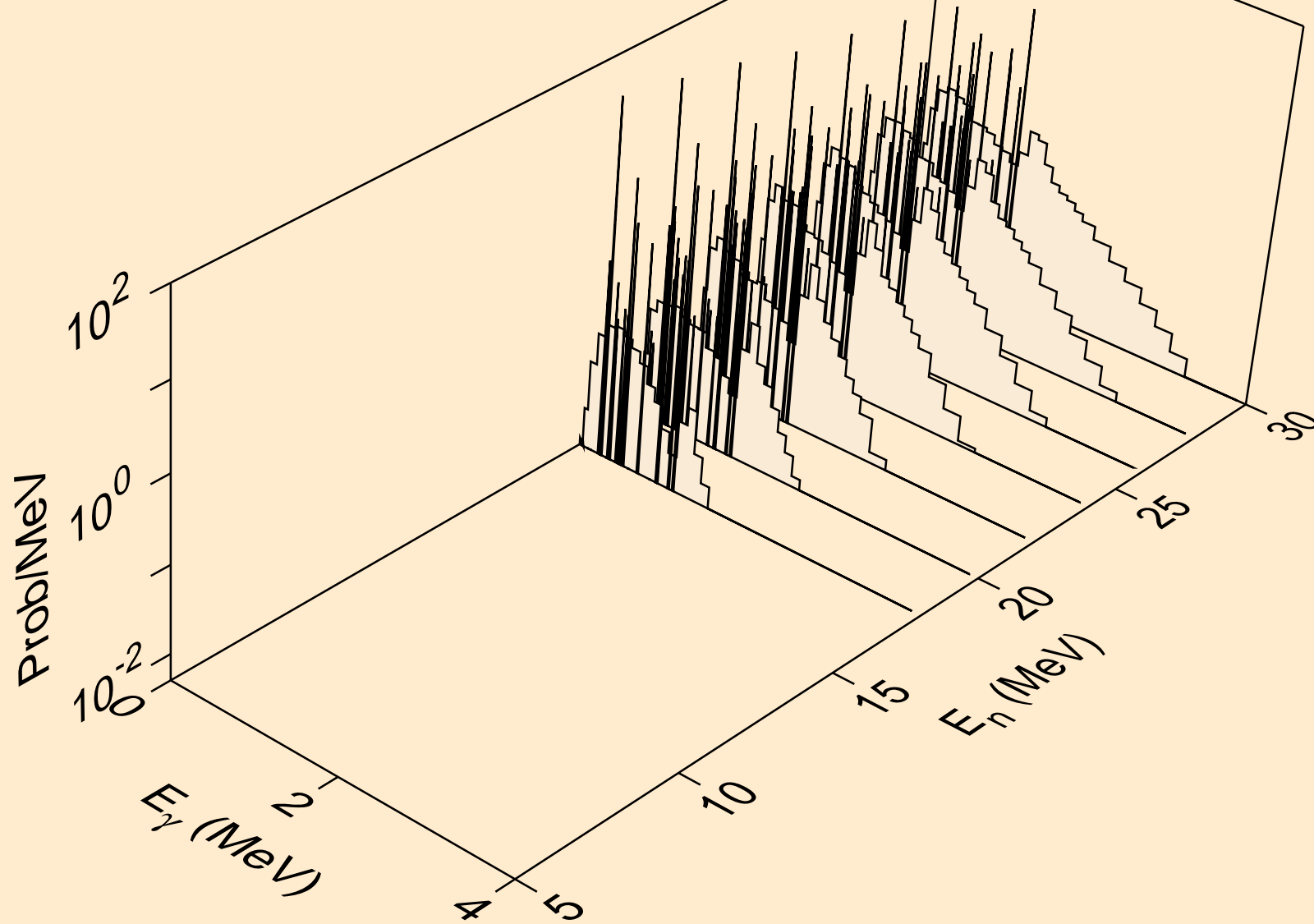

TE120 NEUTRON ACER TENDL-2024 LIBRARY; T=0.K  
Photon emission for (n,n\*c)

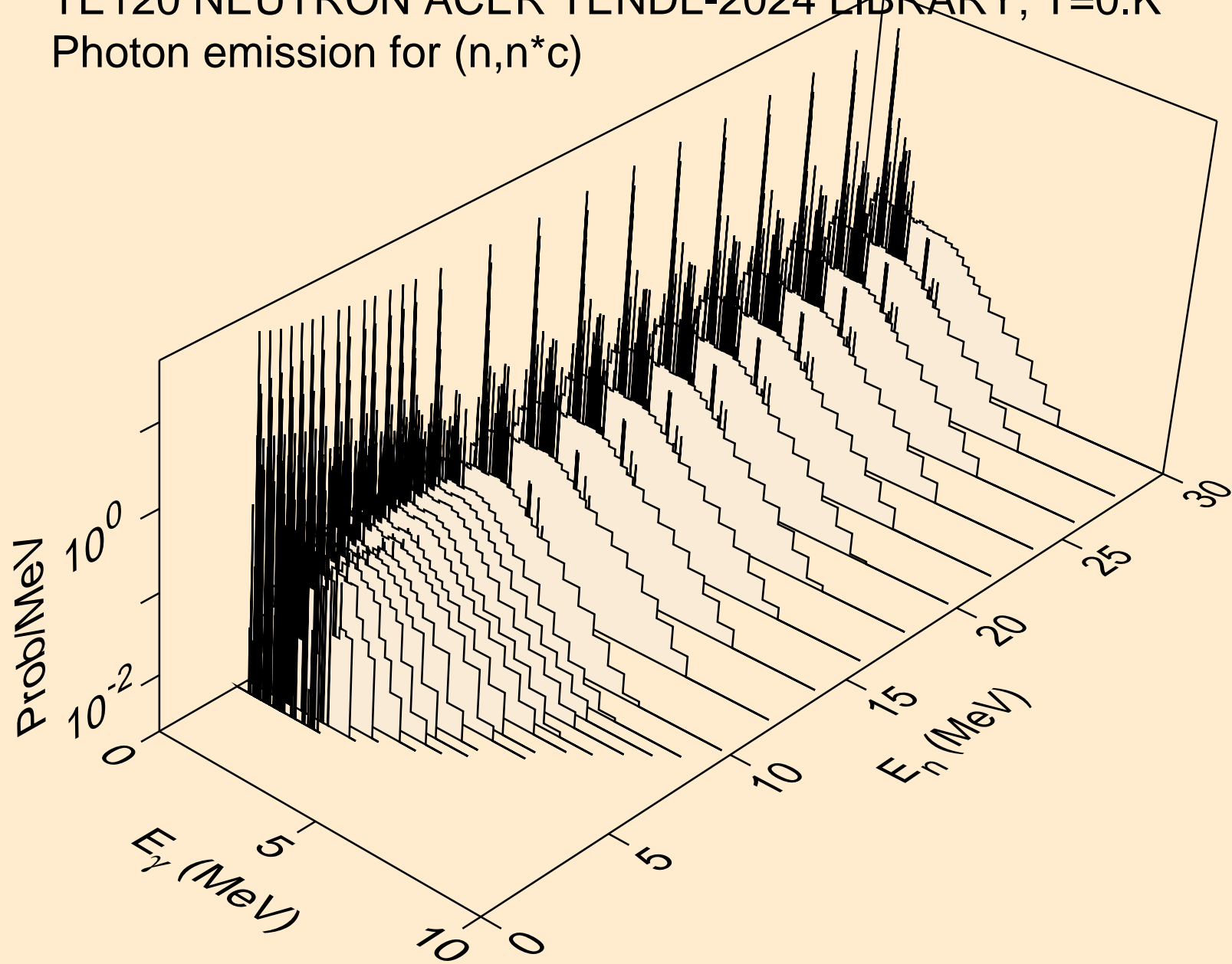

TE120 NEUTRON ACER TENDL-2024 LIBRARY; T=0.K  
Photon emission for (n,gma)

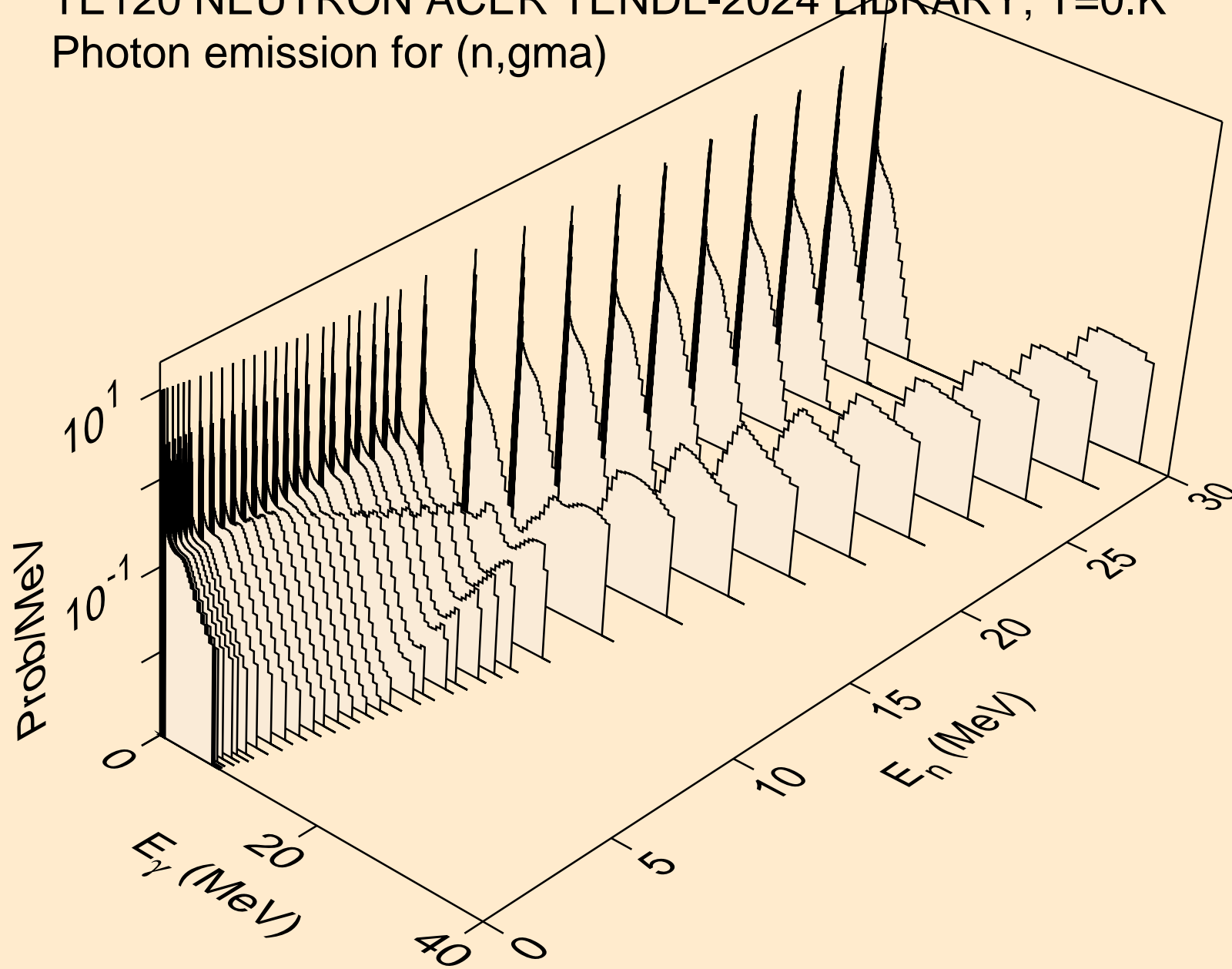



TE120 NEUTRON ACER TENDL-2024 LIBRARY; T=0.K  
Photon emission for (n,p)

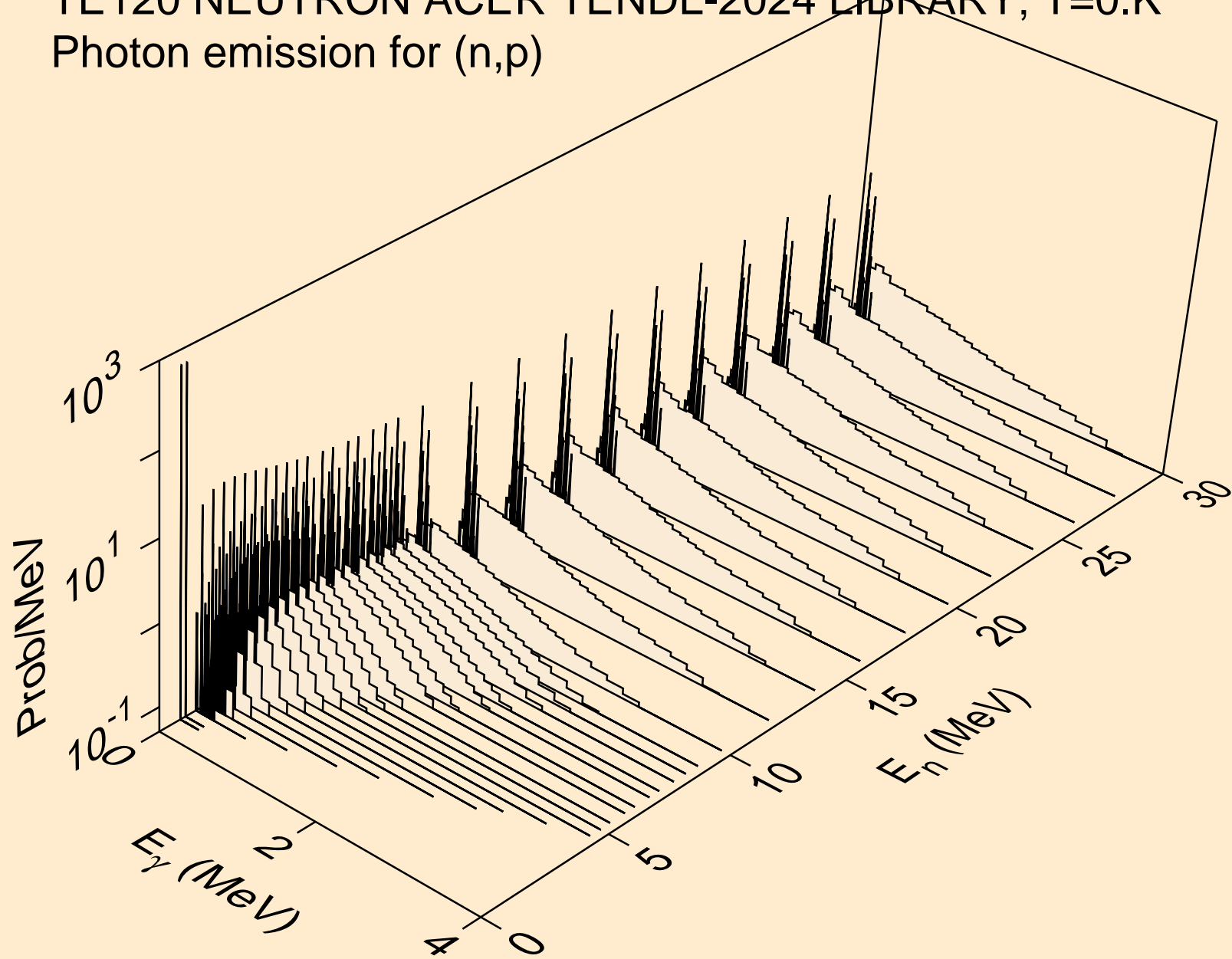

TE120 NEUTRON ACER TENDL-2024 LIBRARY; T=0.K  
Photon emission for (n,d)

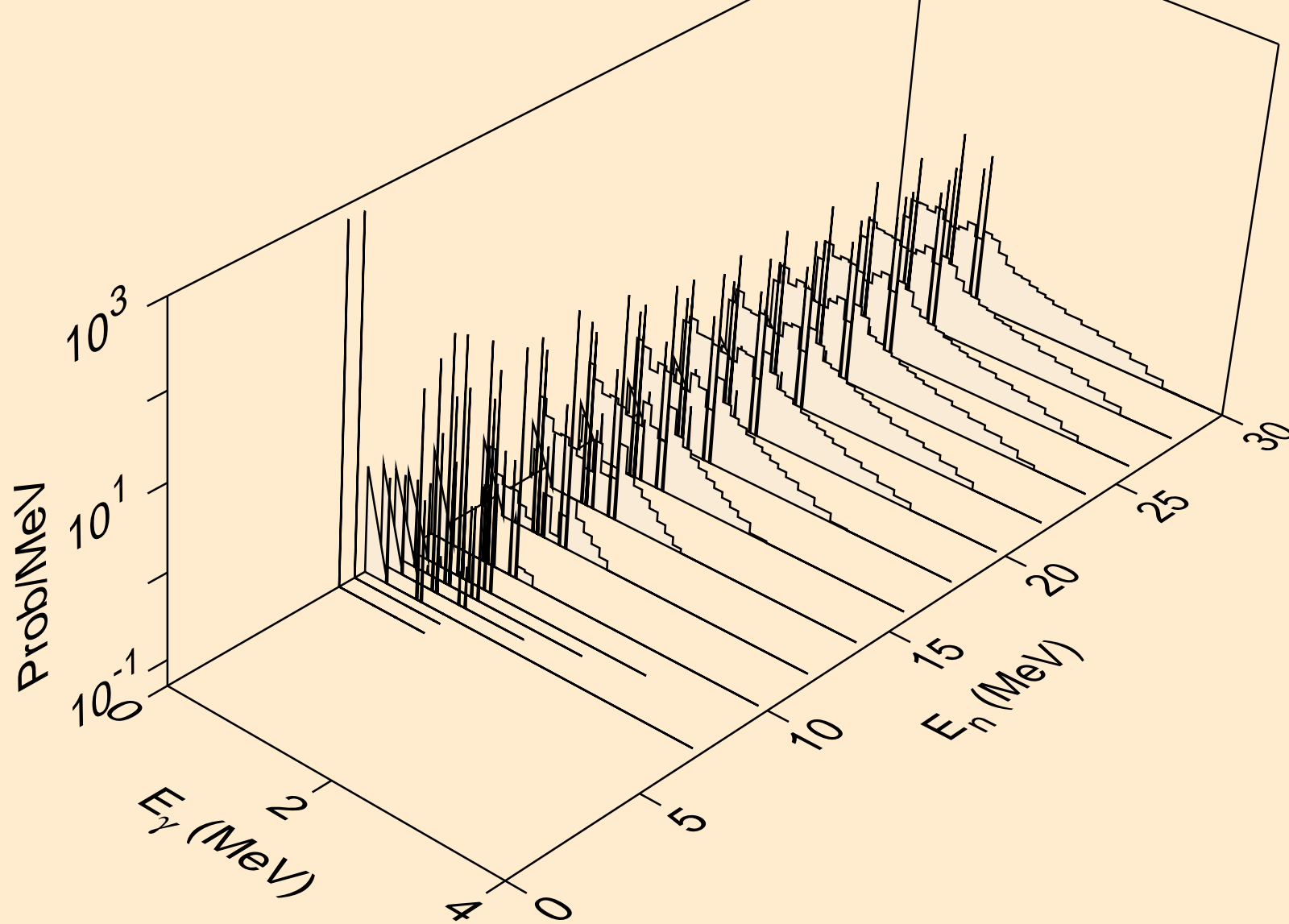

TE120 NEUTRON ACER TENDL-2024 LIBRARY; T=0.K  
Photon emission for (n,t)

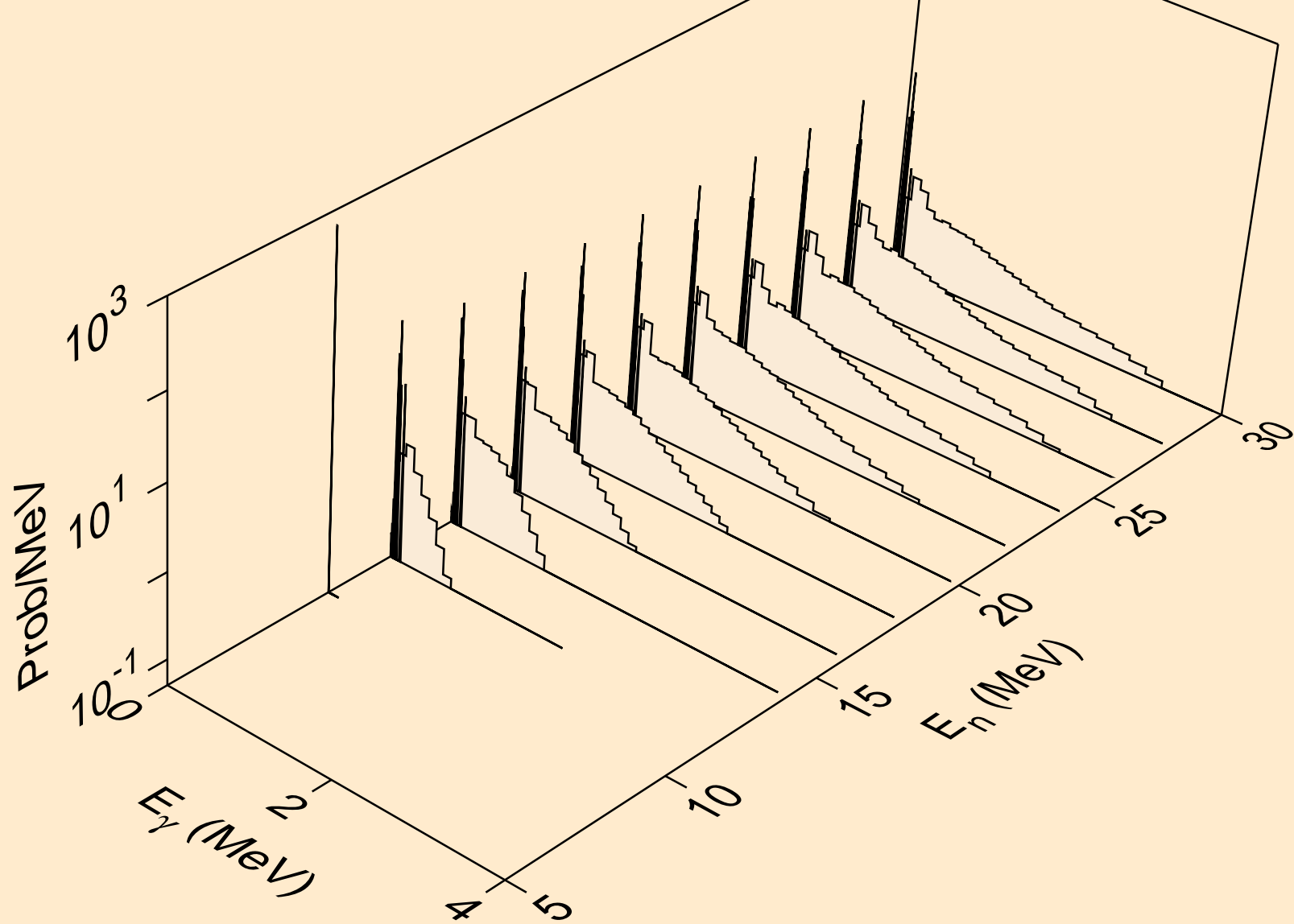

TE120 NEUTRON ACER TENDL-2024 LIBRARY; T=0.K  
Photon emission for (n,he3)

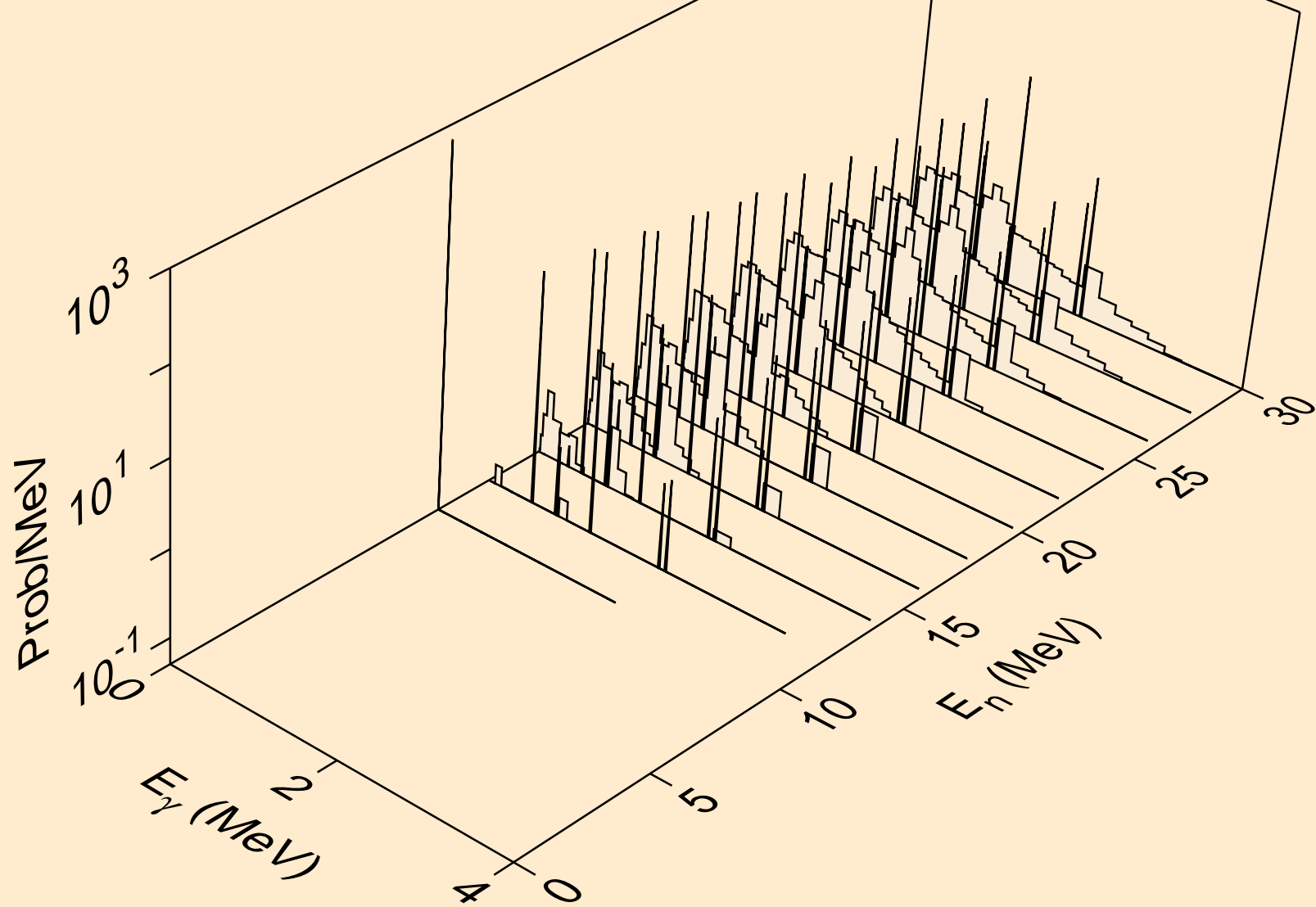

TE120 NEUTRON ACER TENDL-2024 LIBRARY; T=0.K  
Photon emission for (n,a)

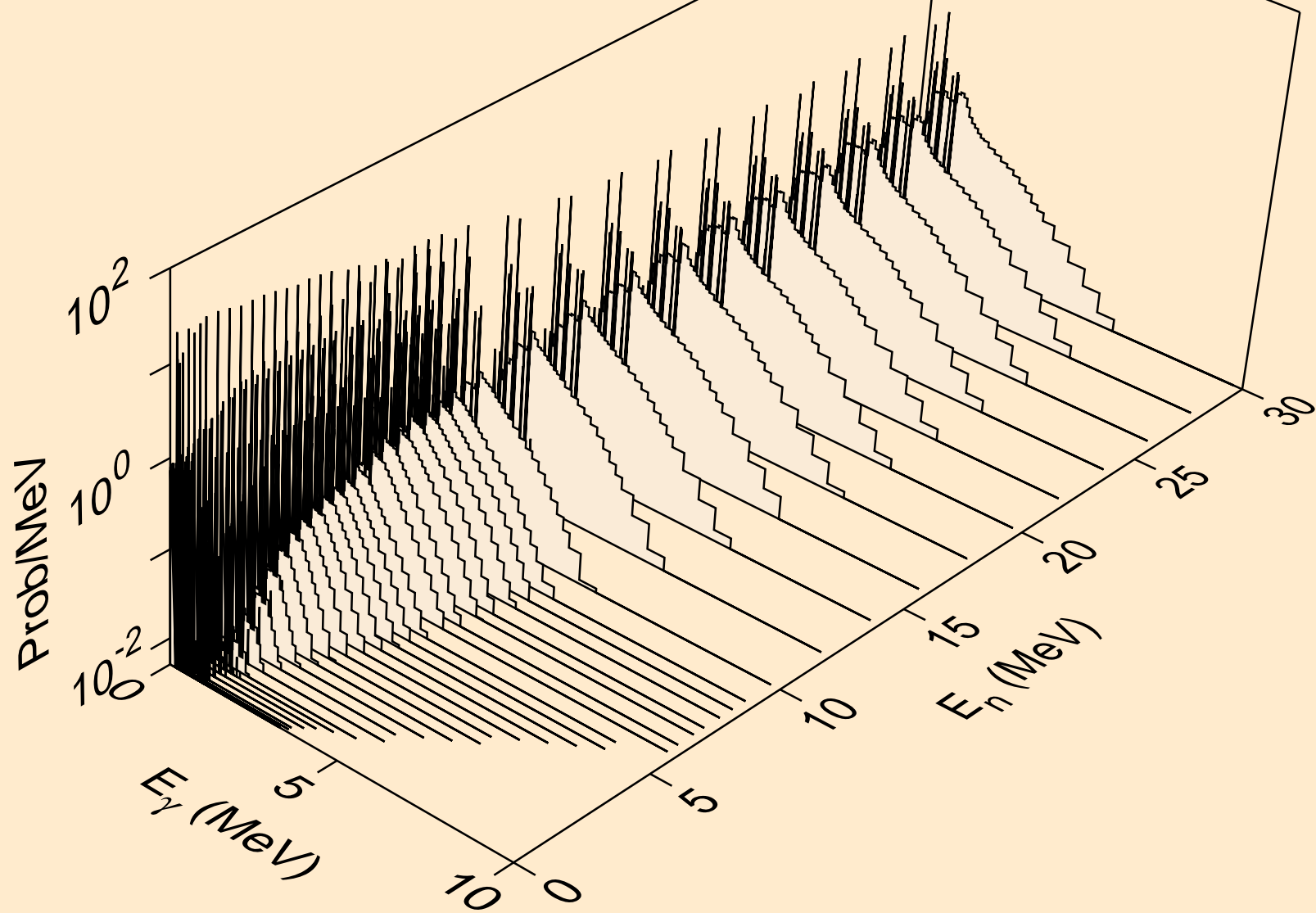

TE120 NEUTRON ACER TENDL-2024 LIBRARY; T=0.K  
Photon emission for (n,2a)

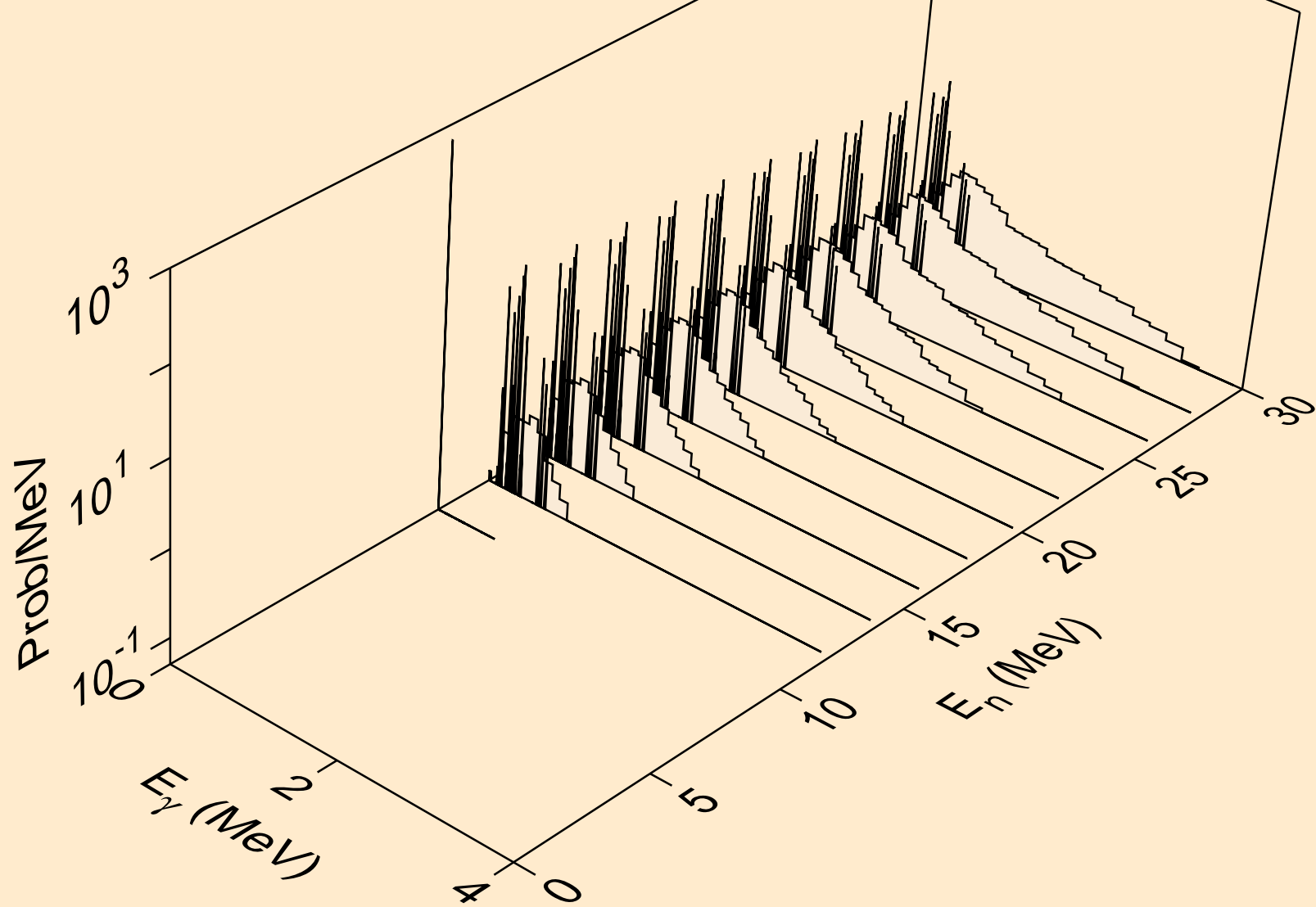

TE120 NEUTRON ACER TENDL-2024 LIBRARY; T=0.K  
Photon emission for (n,2p)

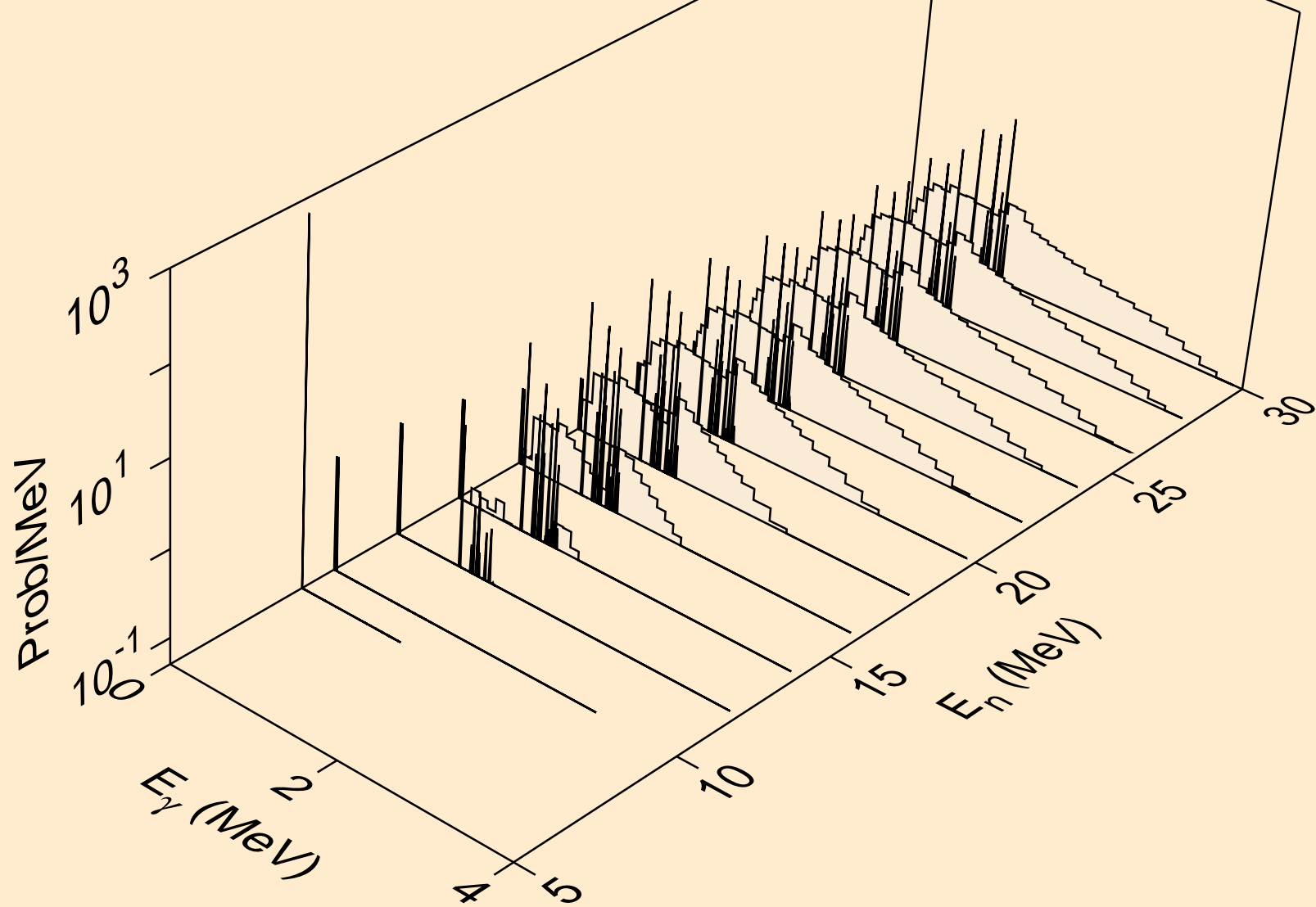

TE120 NEUTRON ACER TENDL-2024 LIBRARY; T=0.K  
Photon emission for (n,p)

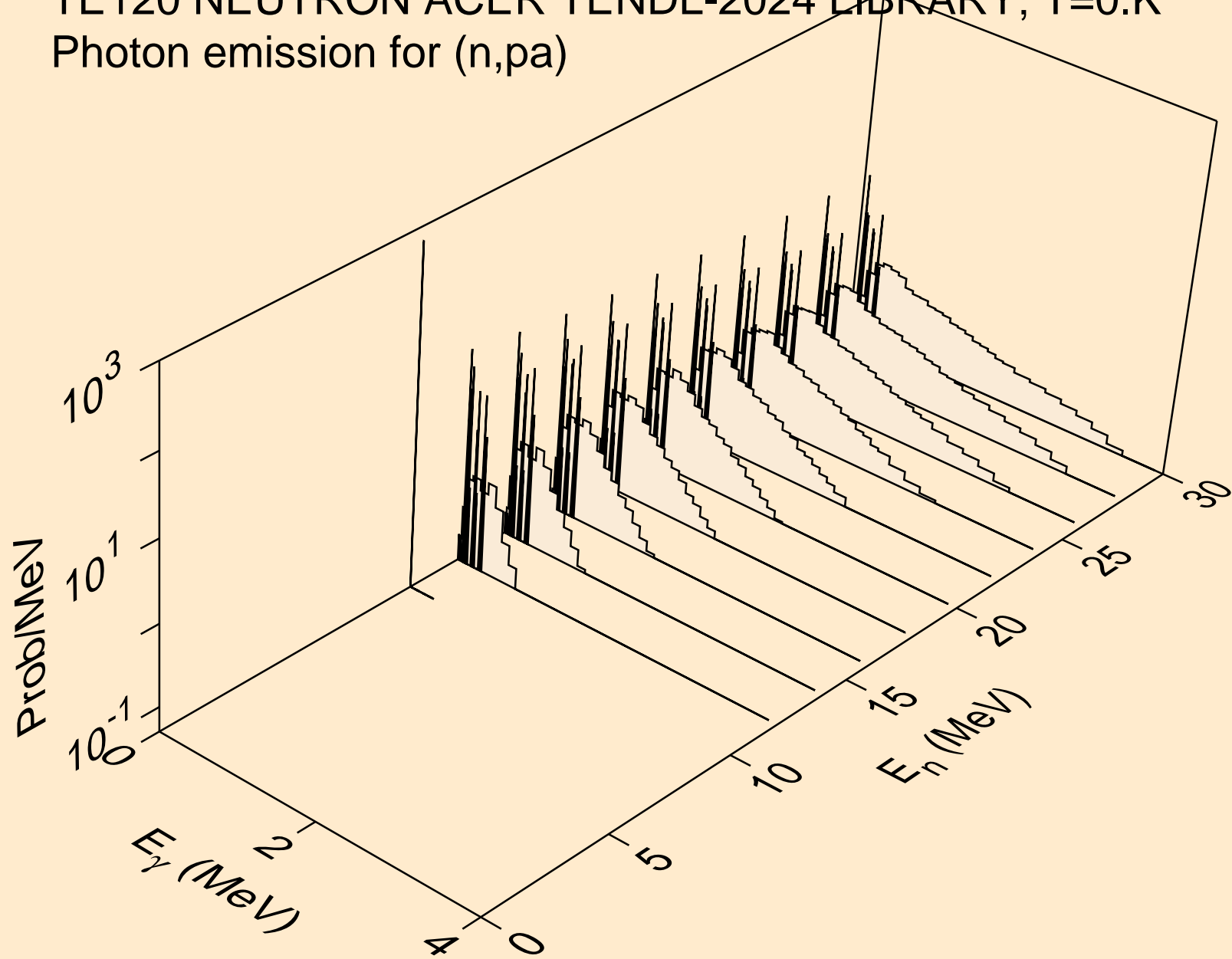



TE120 NEUTRON ACER TENDL-2024 LIBRARY; T=0.K  
Photon emission for (n,pd)

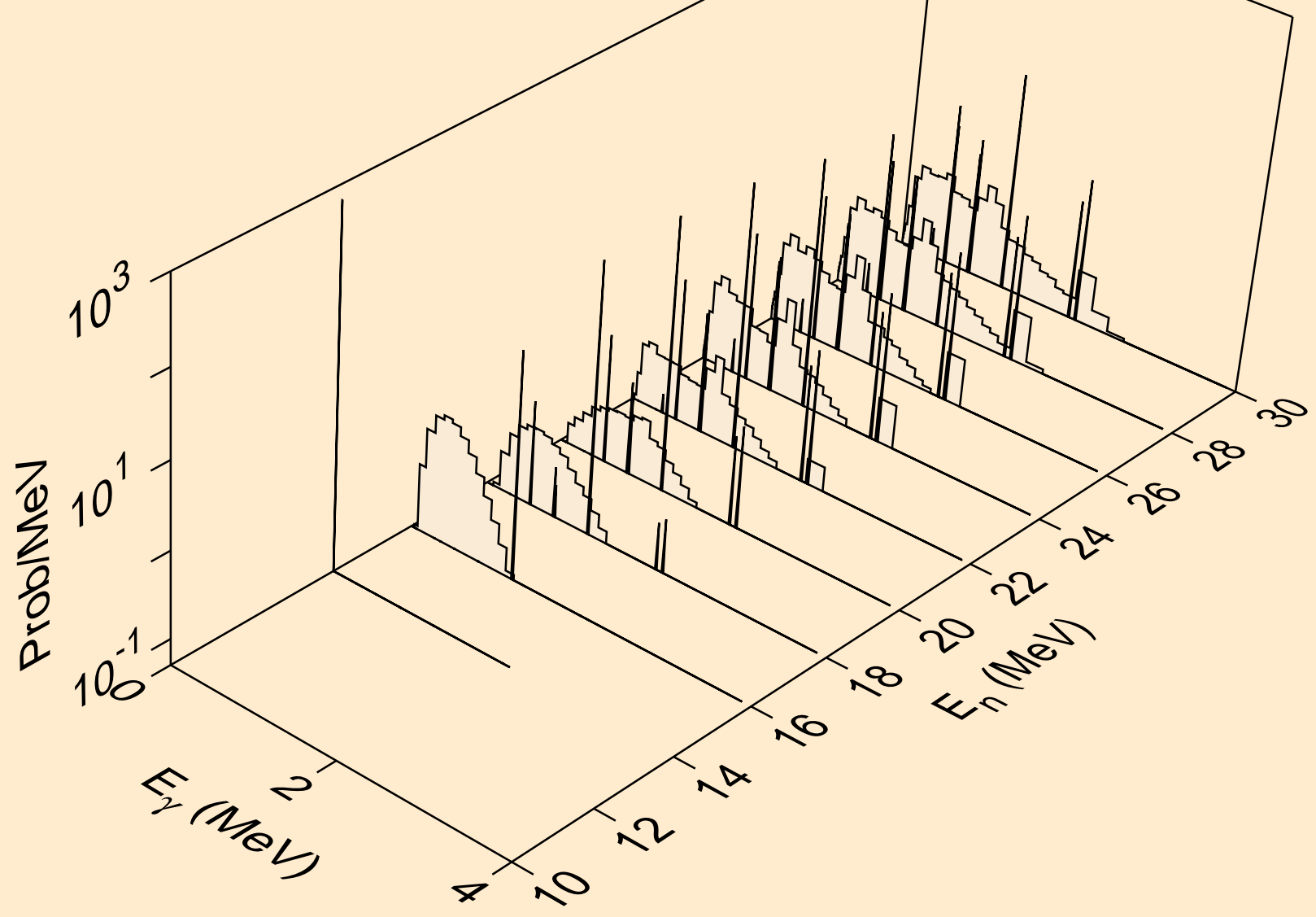

TE120 NEUTRON ACER TENDL-2024 LIBRARY; T=0.K  
Photon emission for (n,pt)

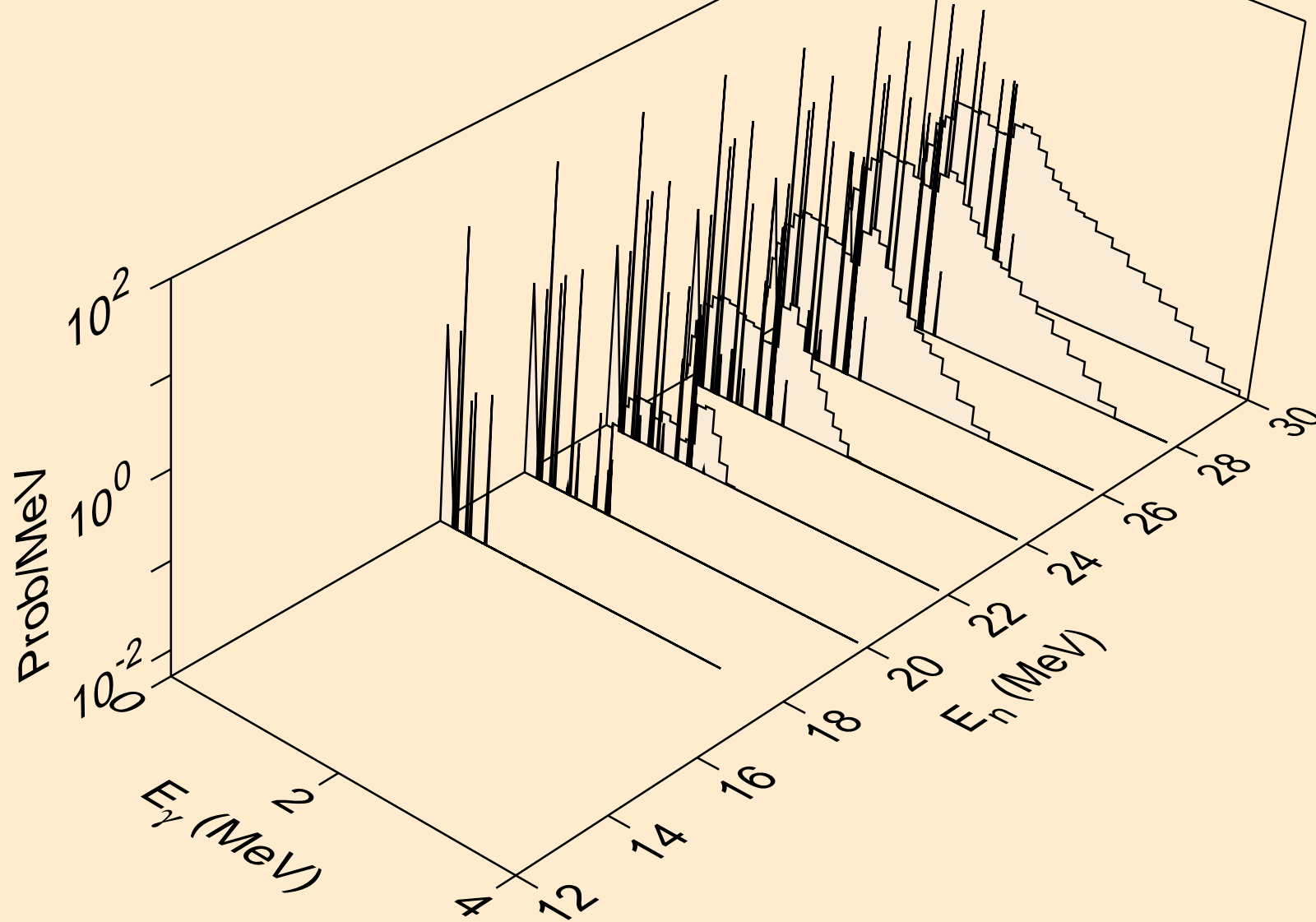

TE120 NEUTRON ACER TENDL-2024 LIBRARY; T=0.K  
Photon emission for (n,da)

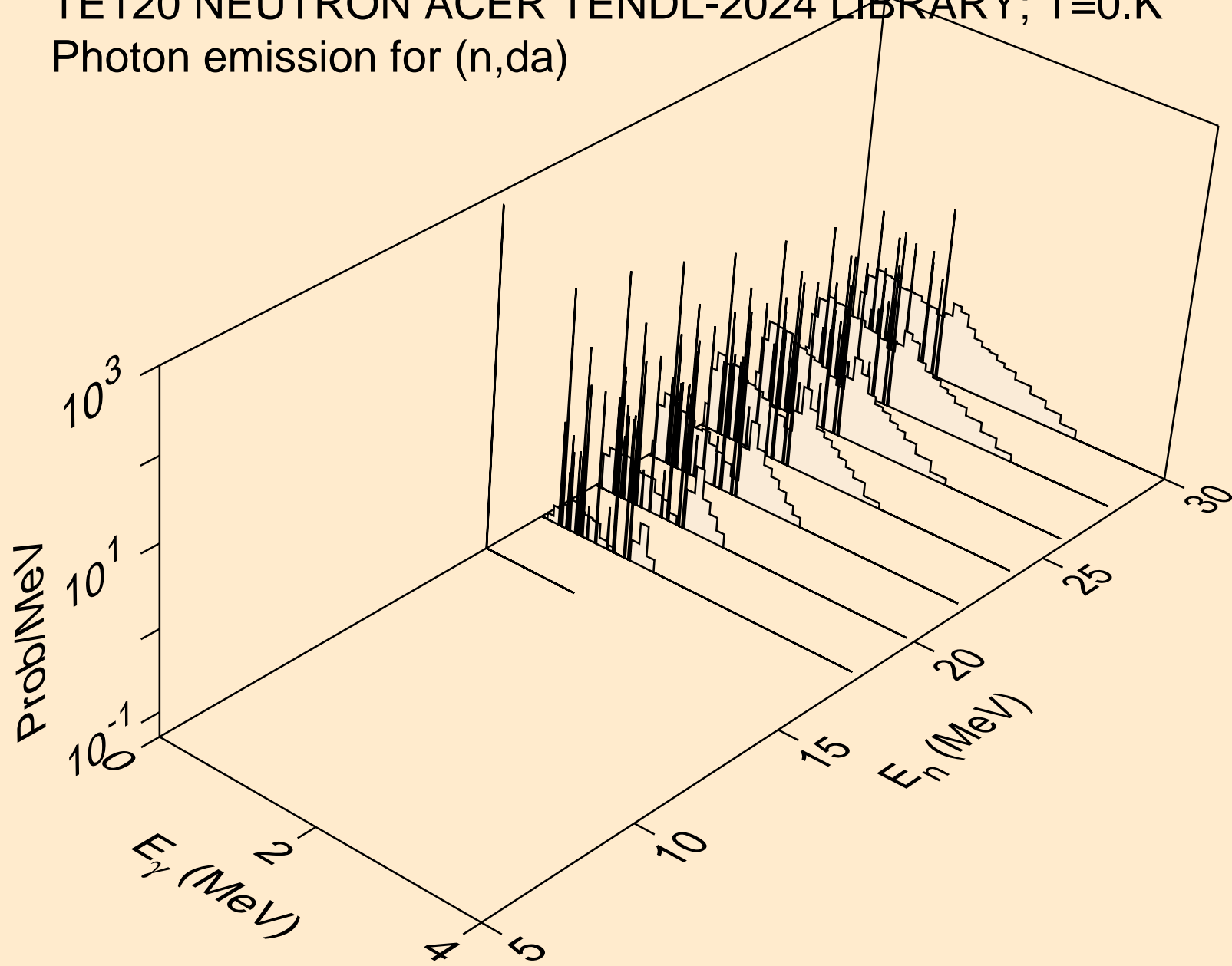

TE120 NEUTRON ACER TENDL-2024 LIBRARY; T=0.K  
thermal capture photon spectrum

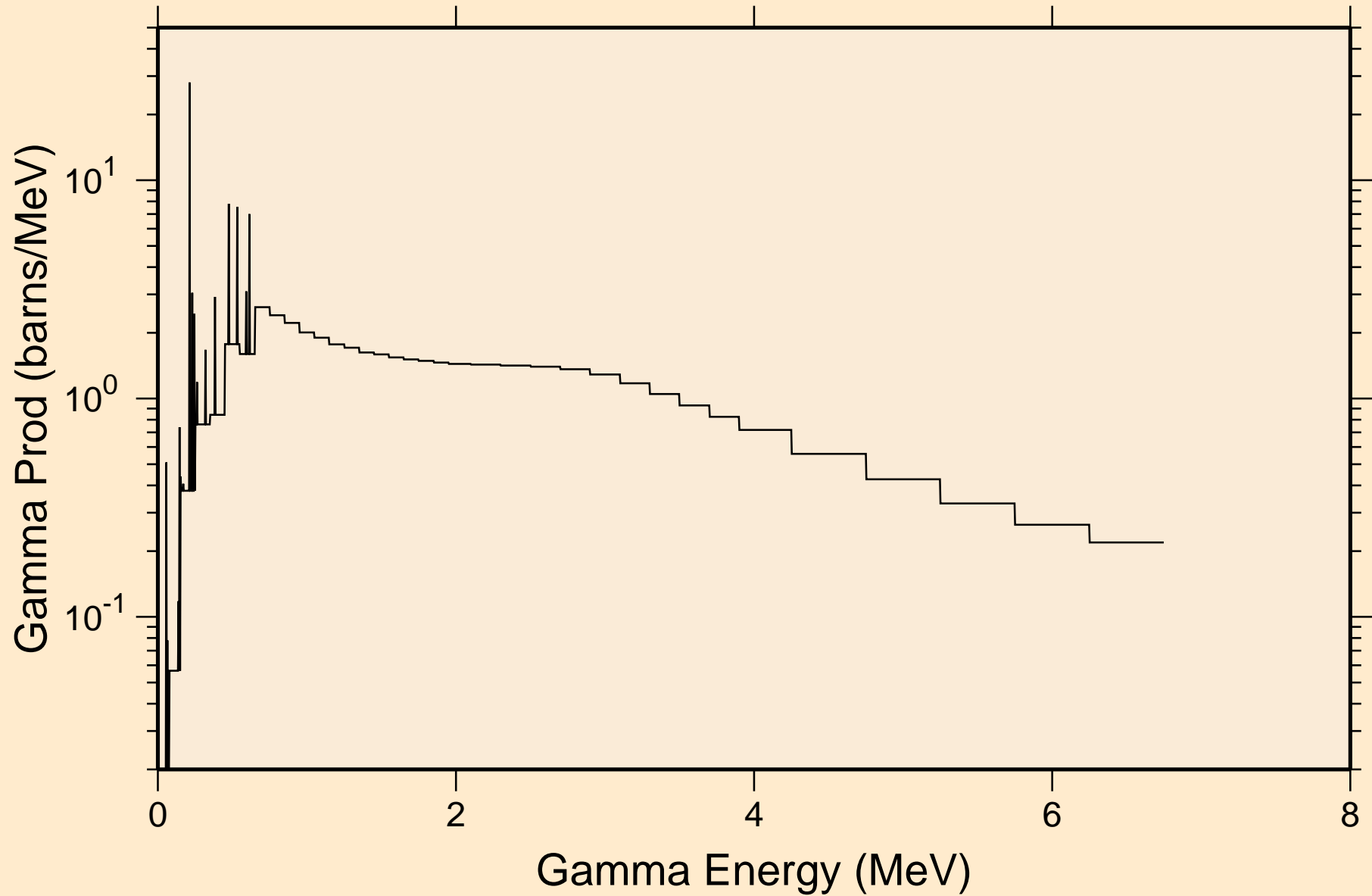

TE120 NEUTRON ACER TENDL-2024 LIBRARY; T=0.K  
14 MeV photon spectrum

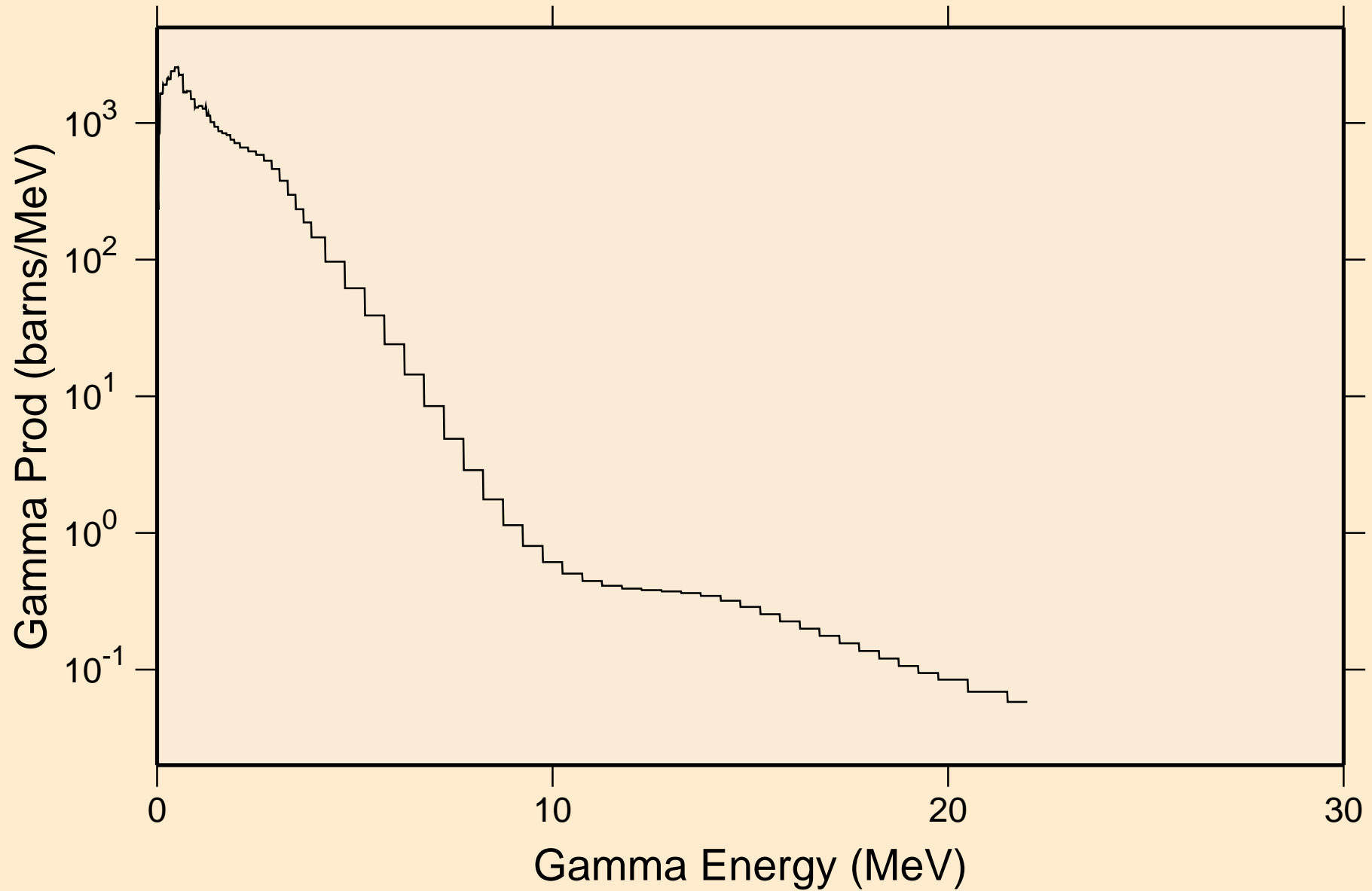

# TE120 NEUTRON ACER TENDL-2024 LIBRARY; T=0.K

## Particle heating contributions

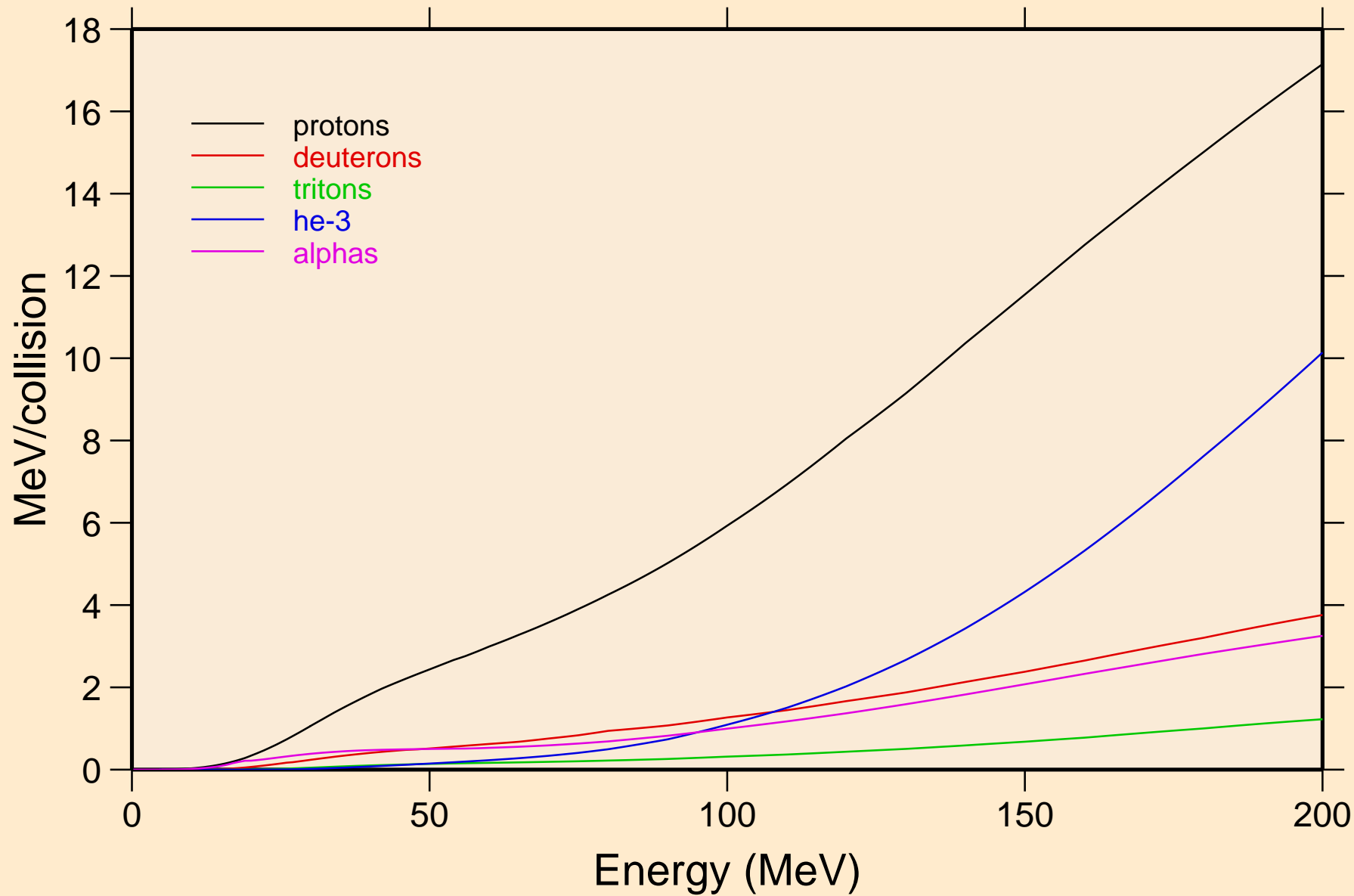

TE120 NEUTRON ACER TENDL-2024 LIBRARY; T=0.K  
Recoil Heating

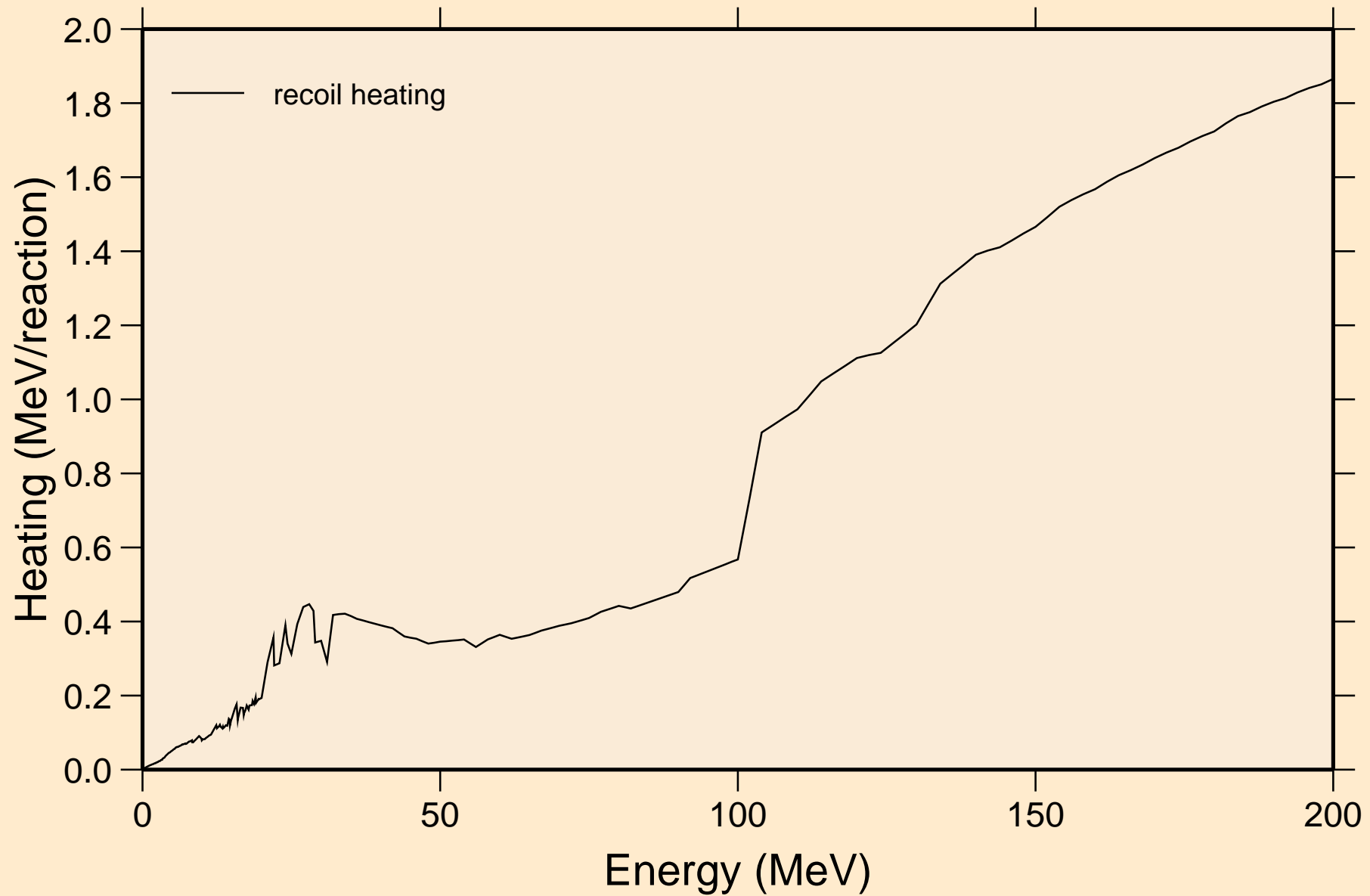

TE120 NEUTRON ACER TENDL-2024 LIBRARY; T=0.K  
Particle production cross sections

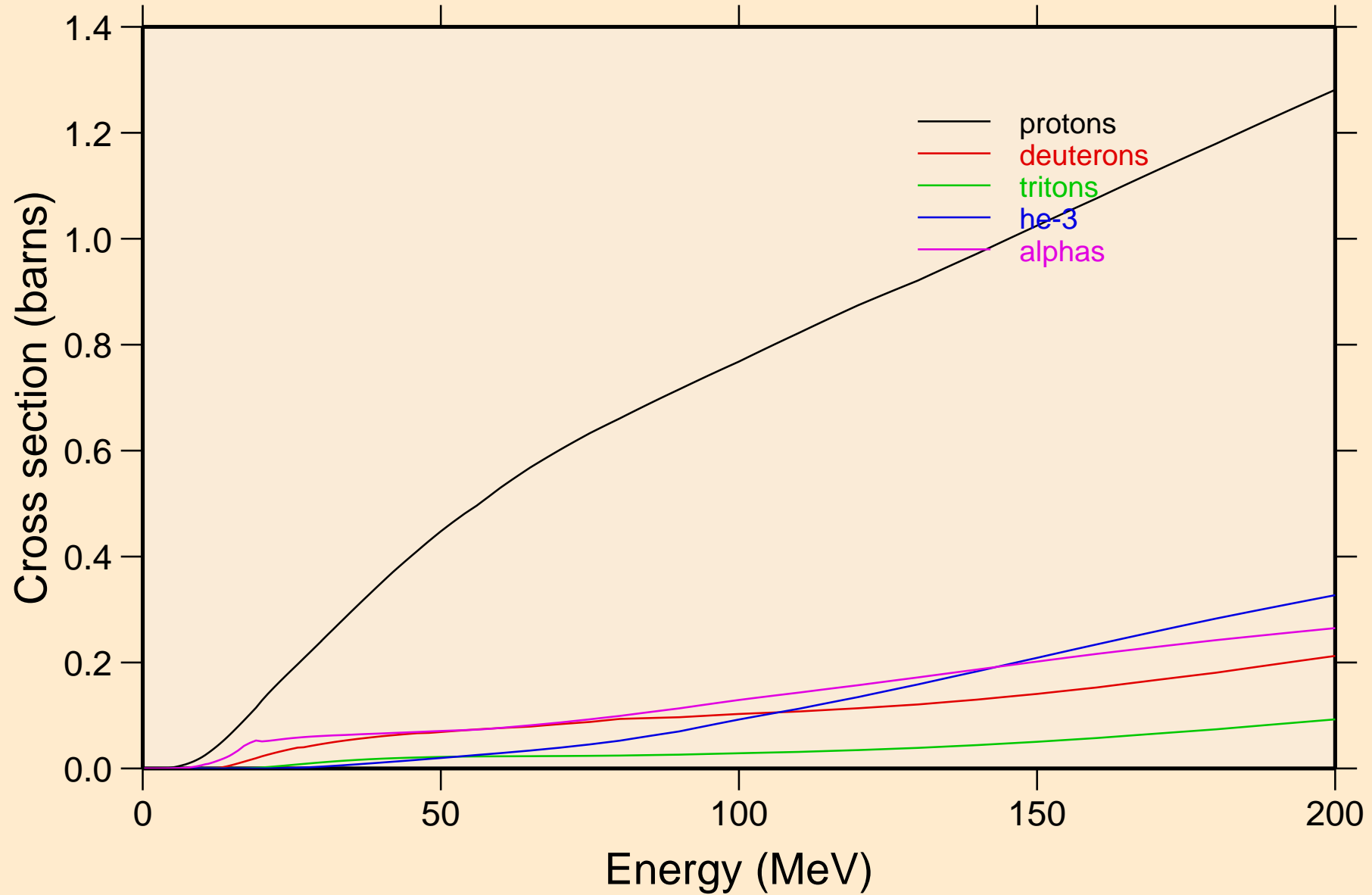



TE120 NEUTRON ACER TENDL-2024 LIBRARY; T=0.K  
protons from (n,x)

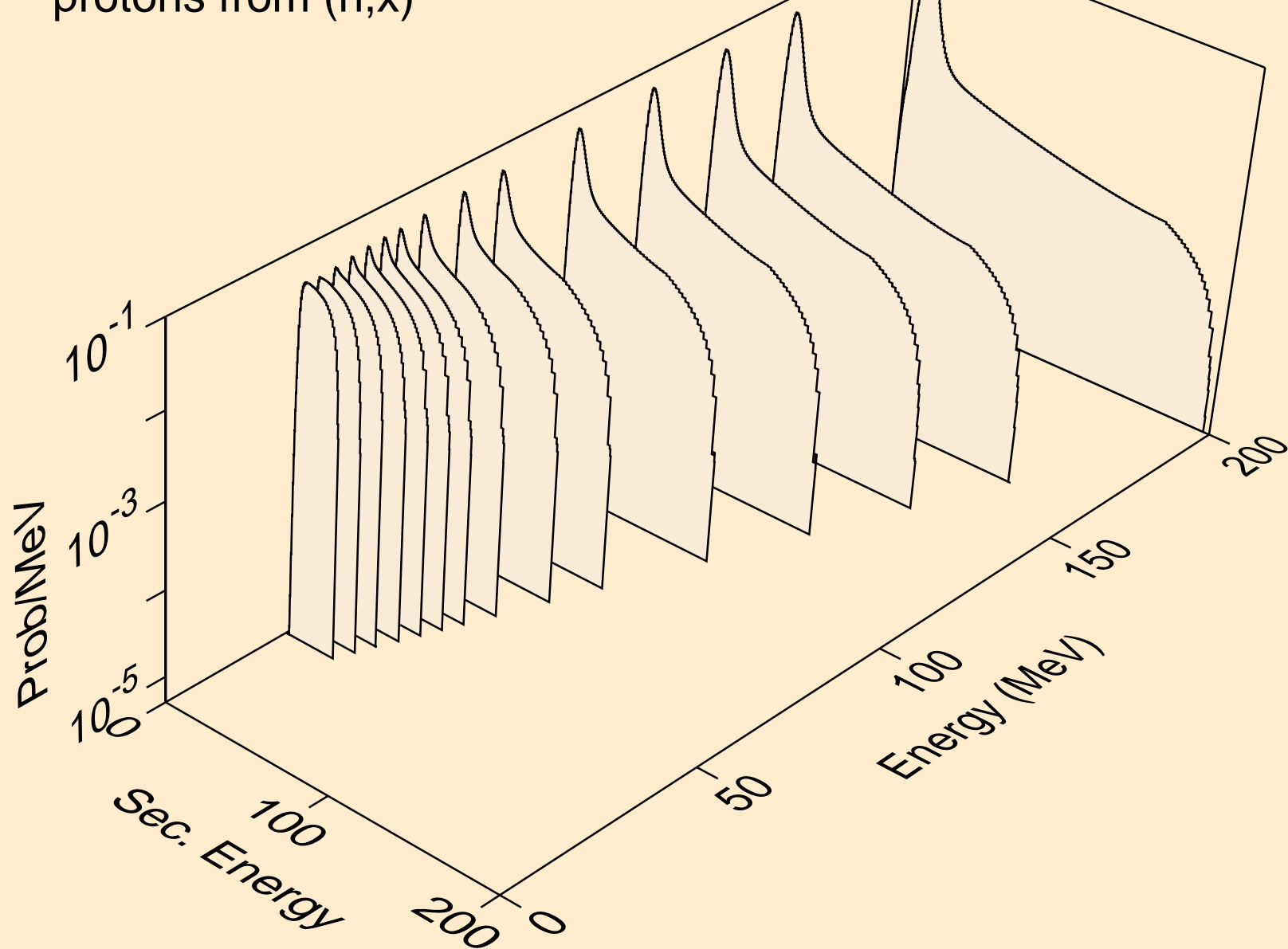

TE120 NEUTRON ACER TENDL-2024 LIBRARY; T=0.K  
protons from (n,n\*)p

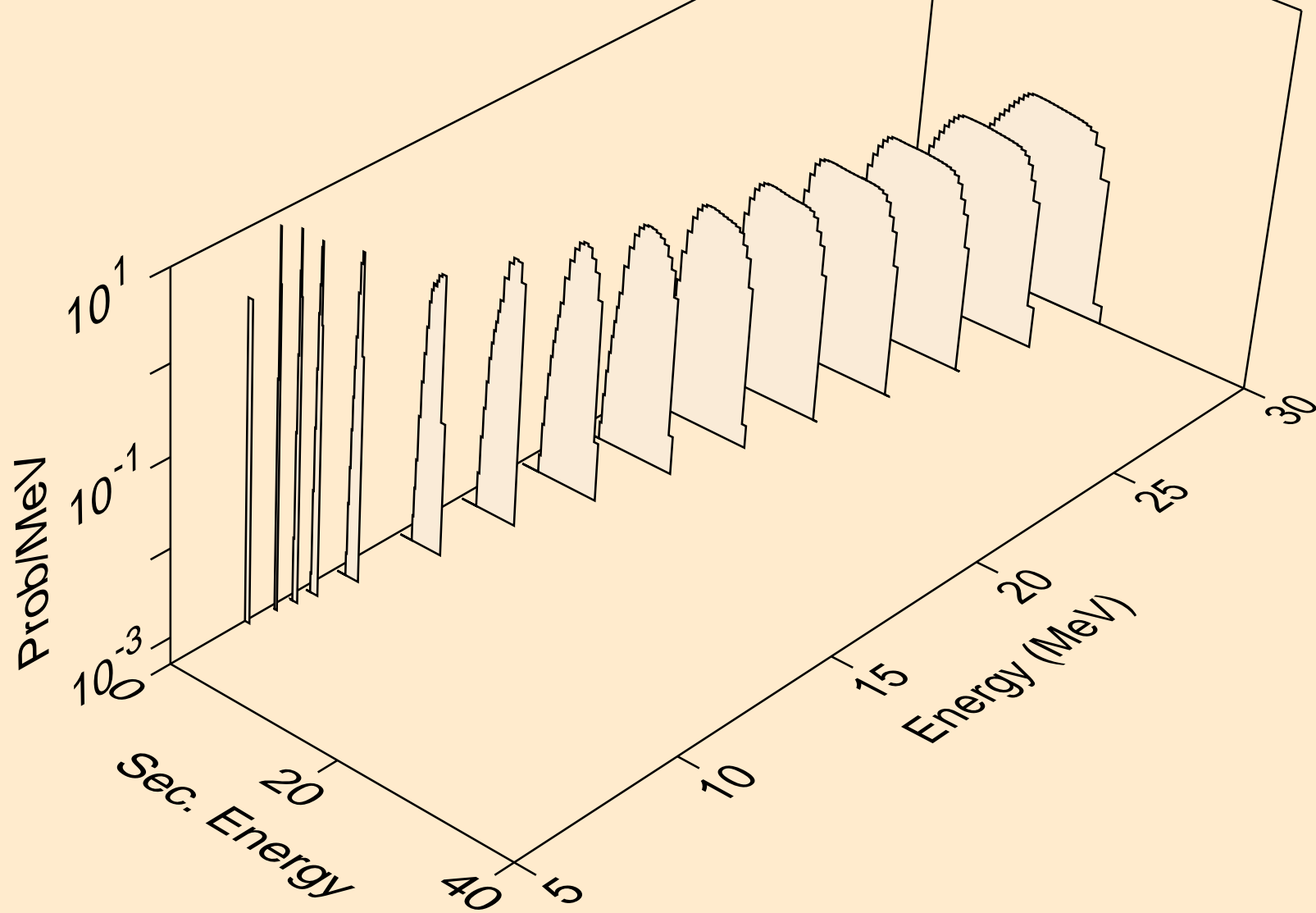

TE120 NEUTRON ACER TENDL-2024 LIBRARY; T=0.K  
protons from (n,2np)

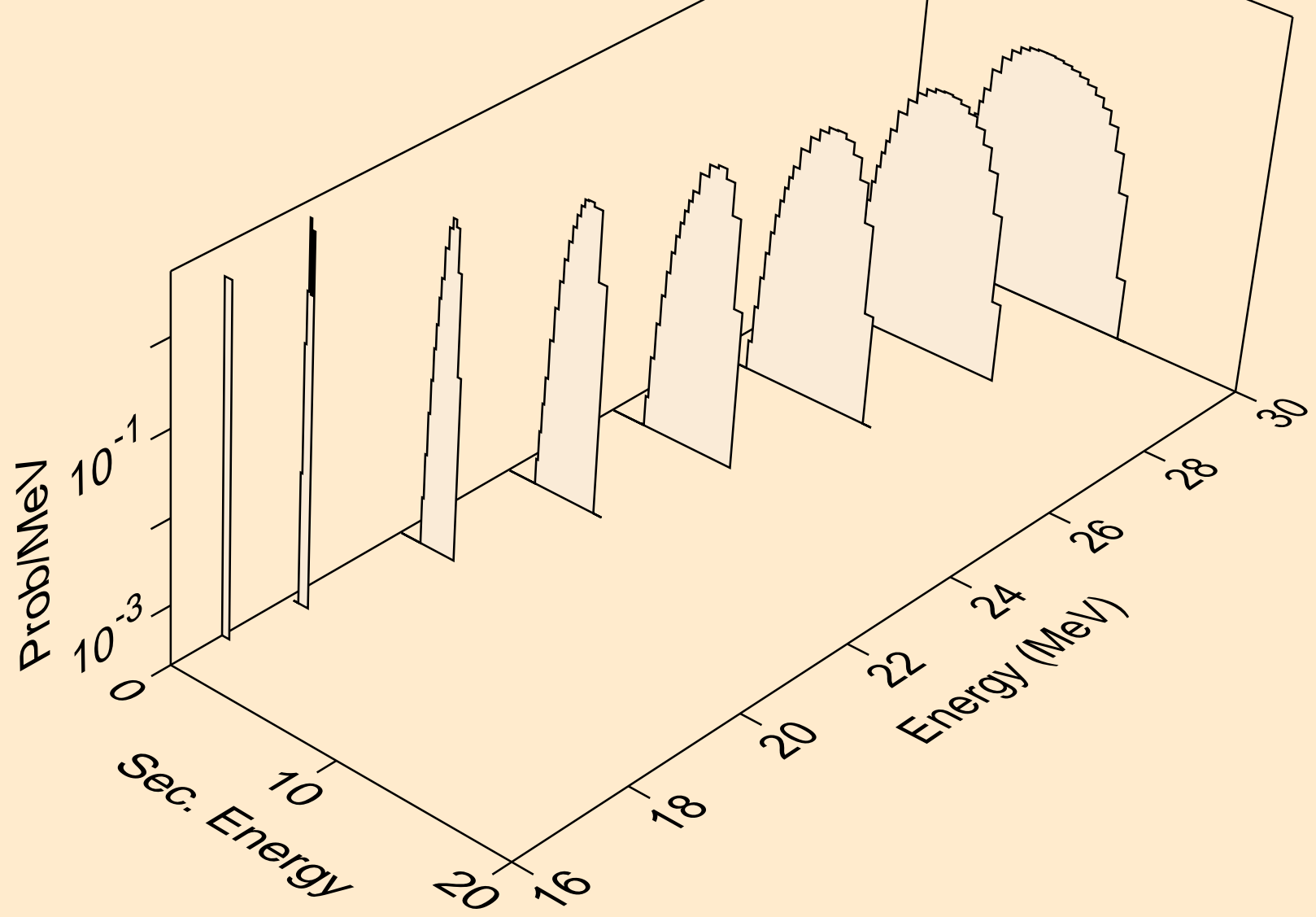

TE120 NEUTRON ACER TENDL-2024 LIBRARY; T=0.K  
protons from (n,3np)

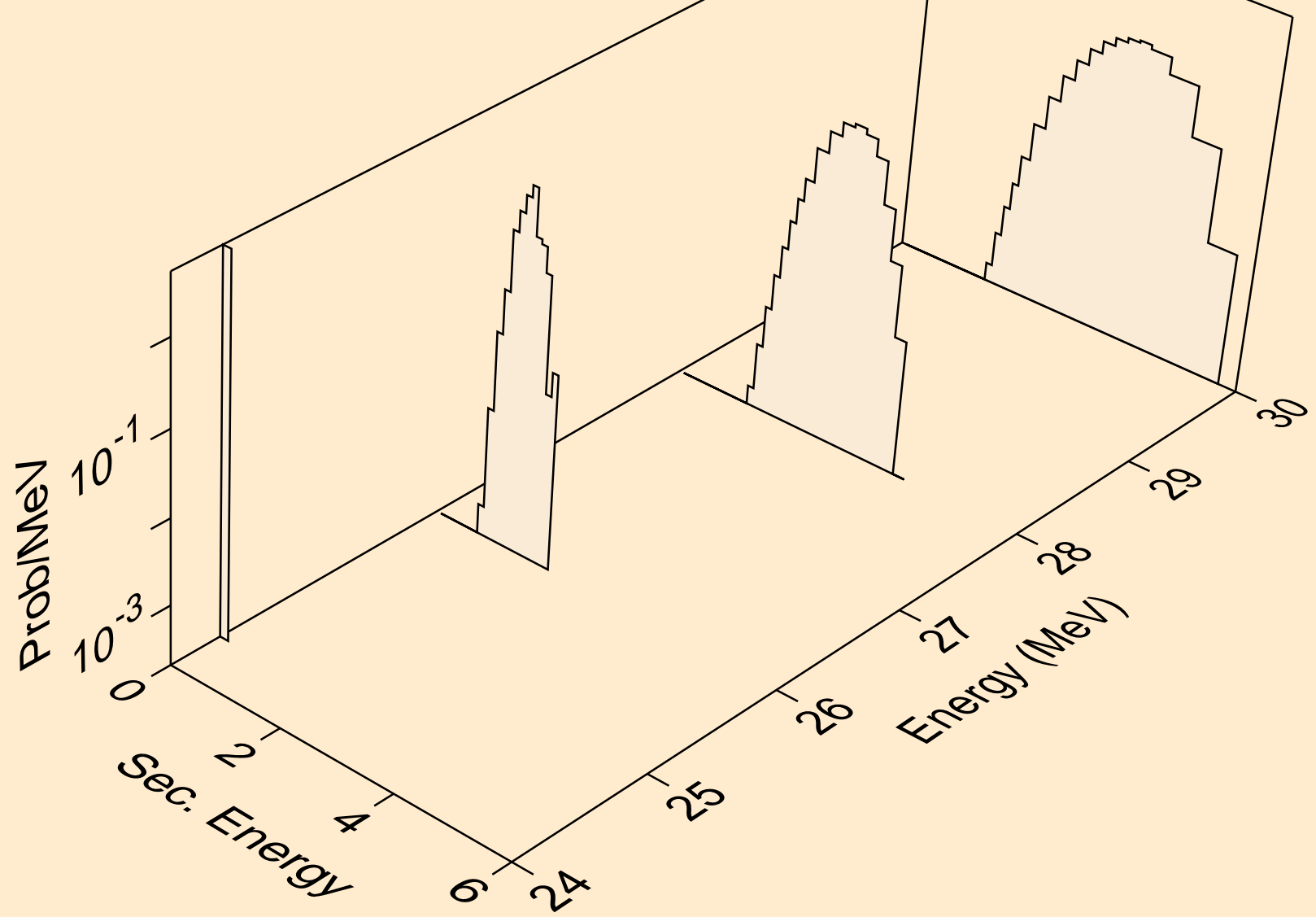

TE120 NEUTRON ACER TENDL-2024 LIBRARY; T=0.K  
protons from (n,n2p)

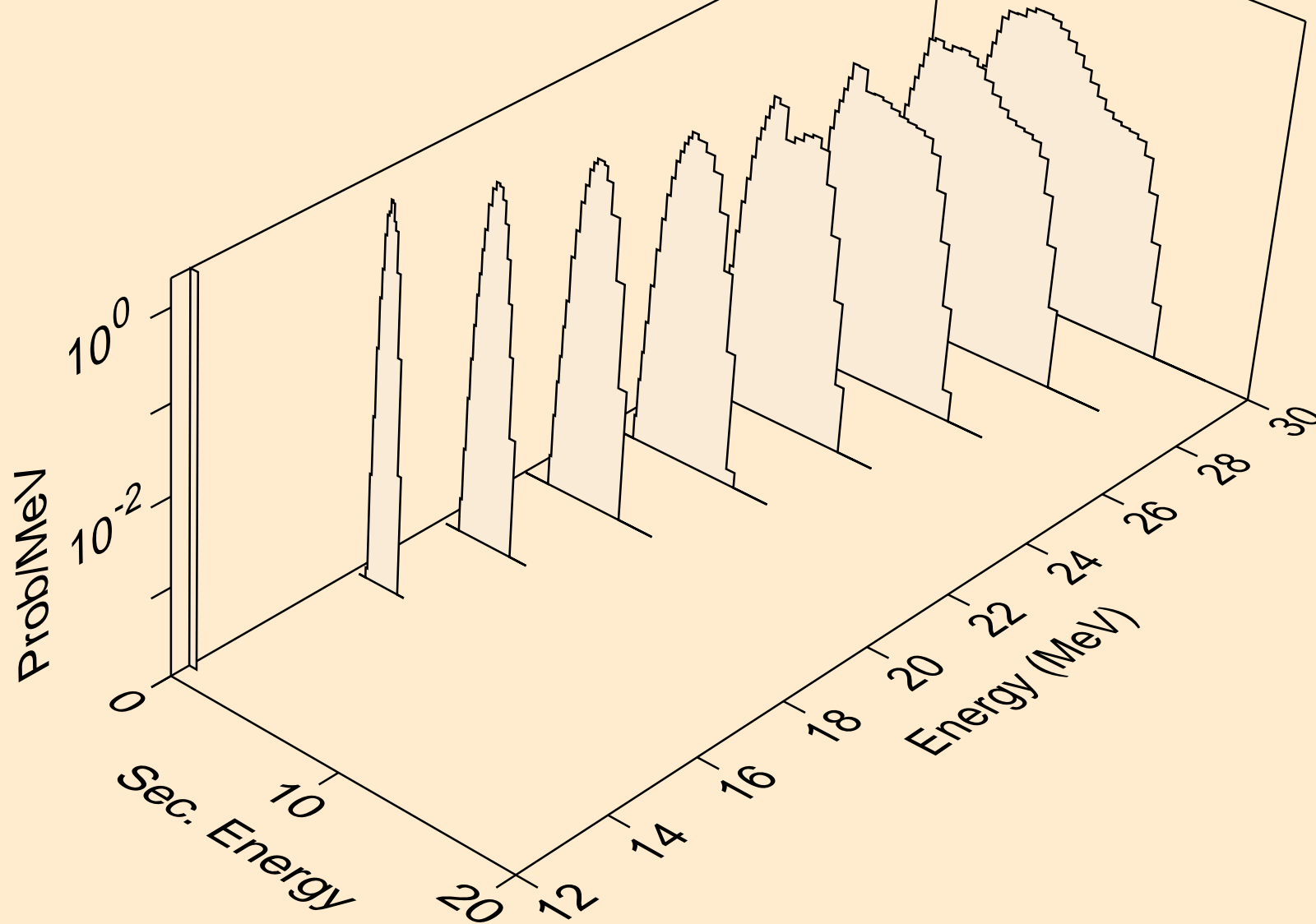

TE120 NEUTRON ACER TENDL-2024 LIBRARY; T=0.K  
protons from (n,npa)

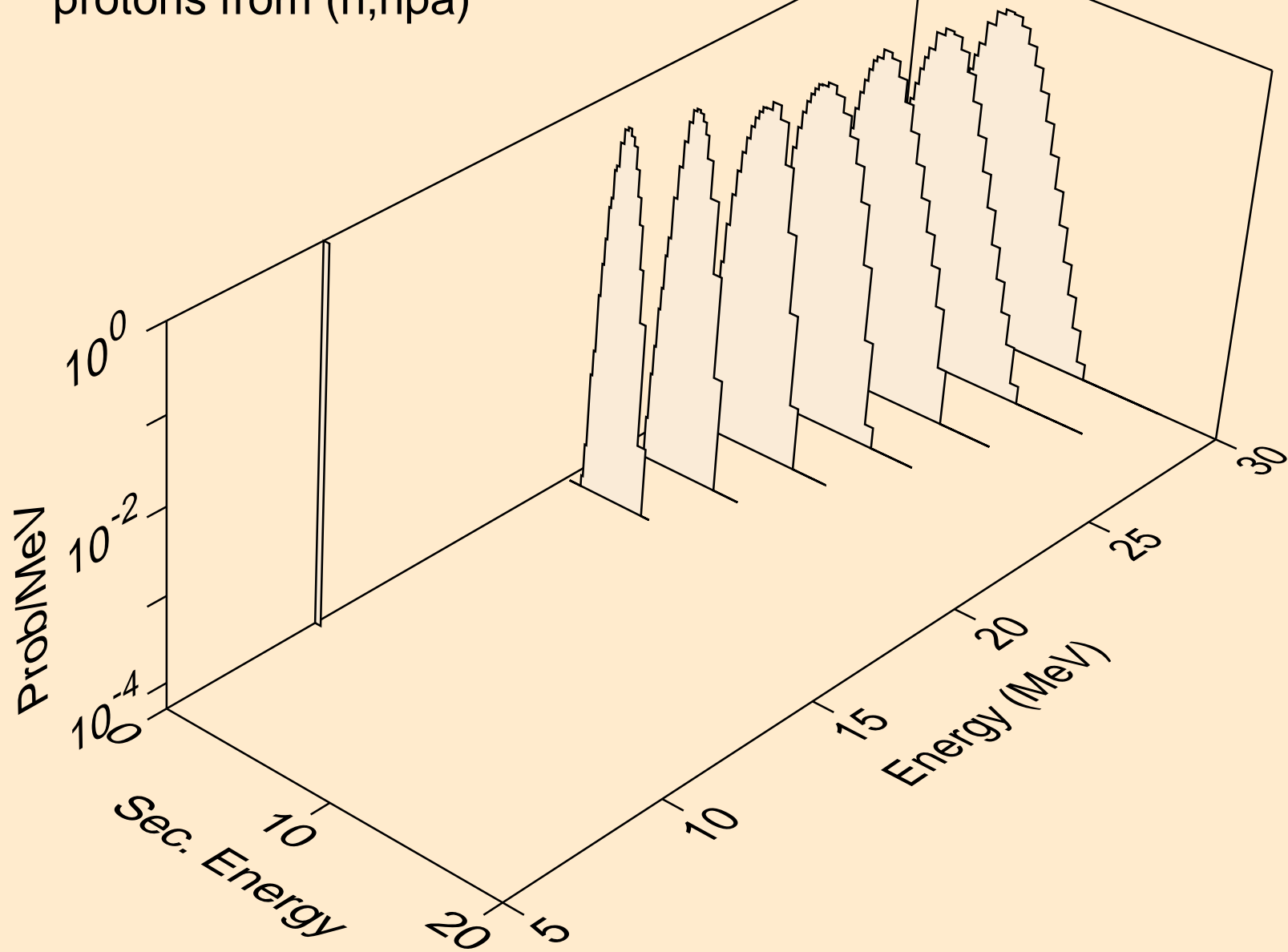

TE120 NEUTRON ACER TENDL-2024 LIBRARY; T=0.K  
protons from (n,p)

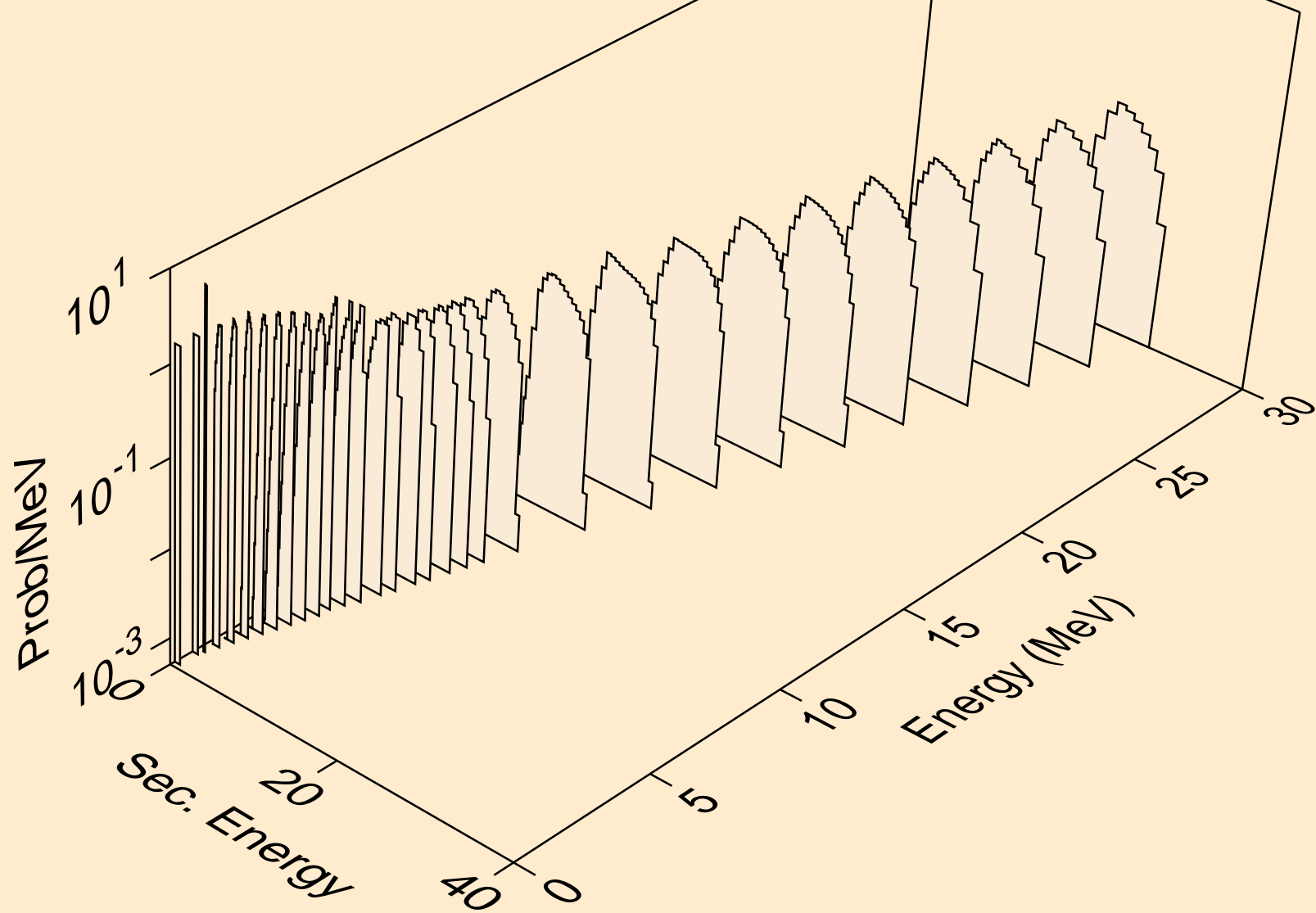

TE120 NEUTRON ACER TENDL-2024 LIBRARY; T=0.K  
protons from (n,2p)

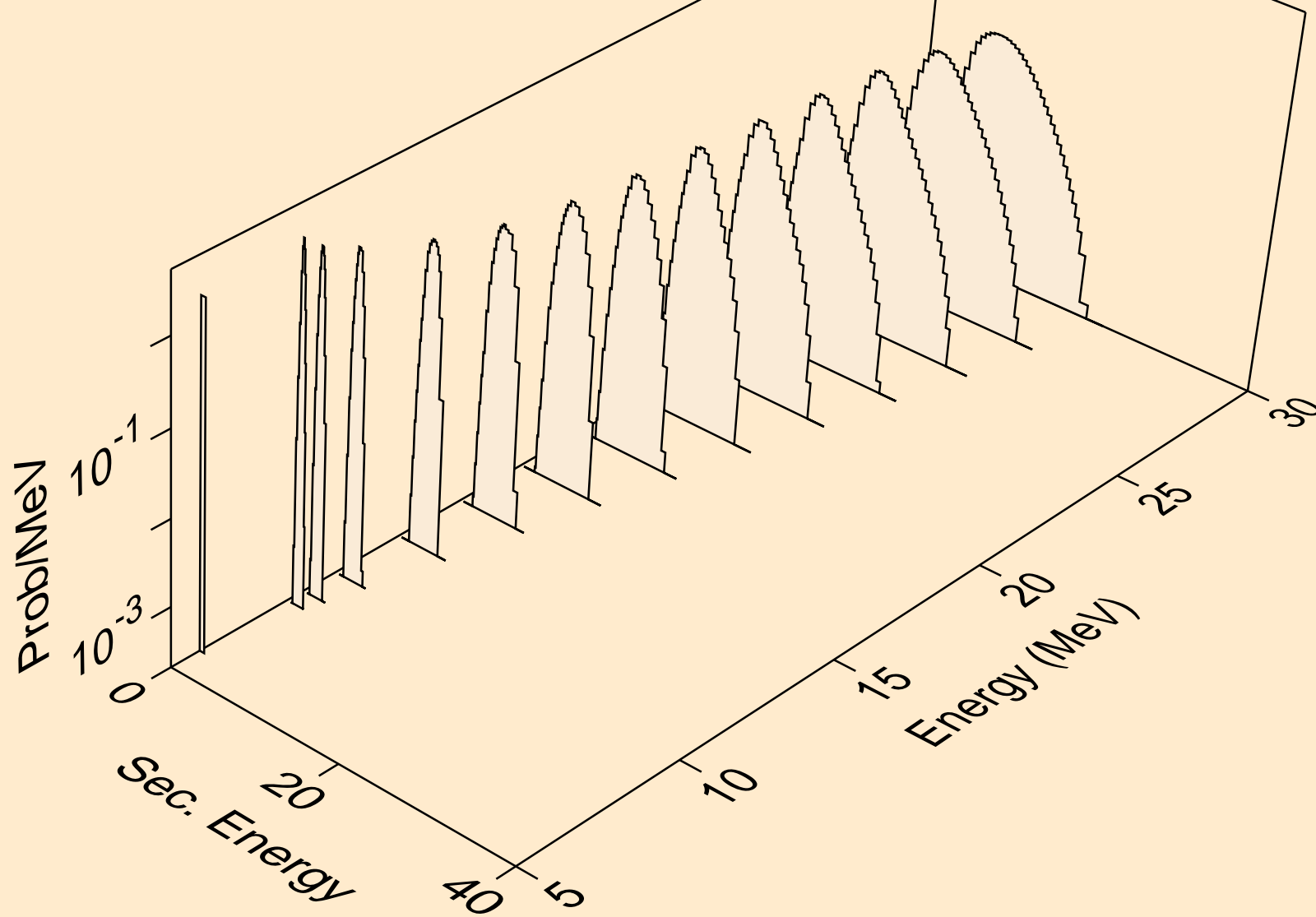



TE120 NEUTRON ACER TENDL-2024 LIBRARY; T=0.K  
protons from (n,p)

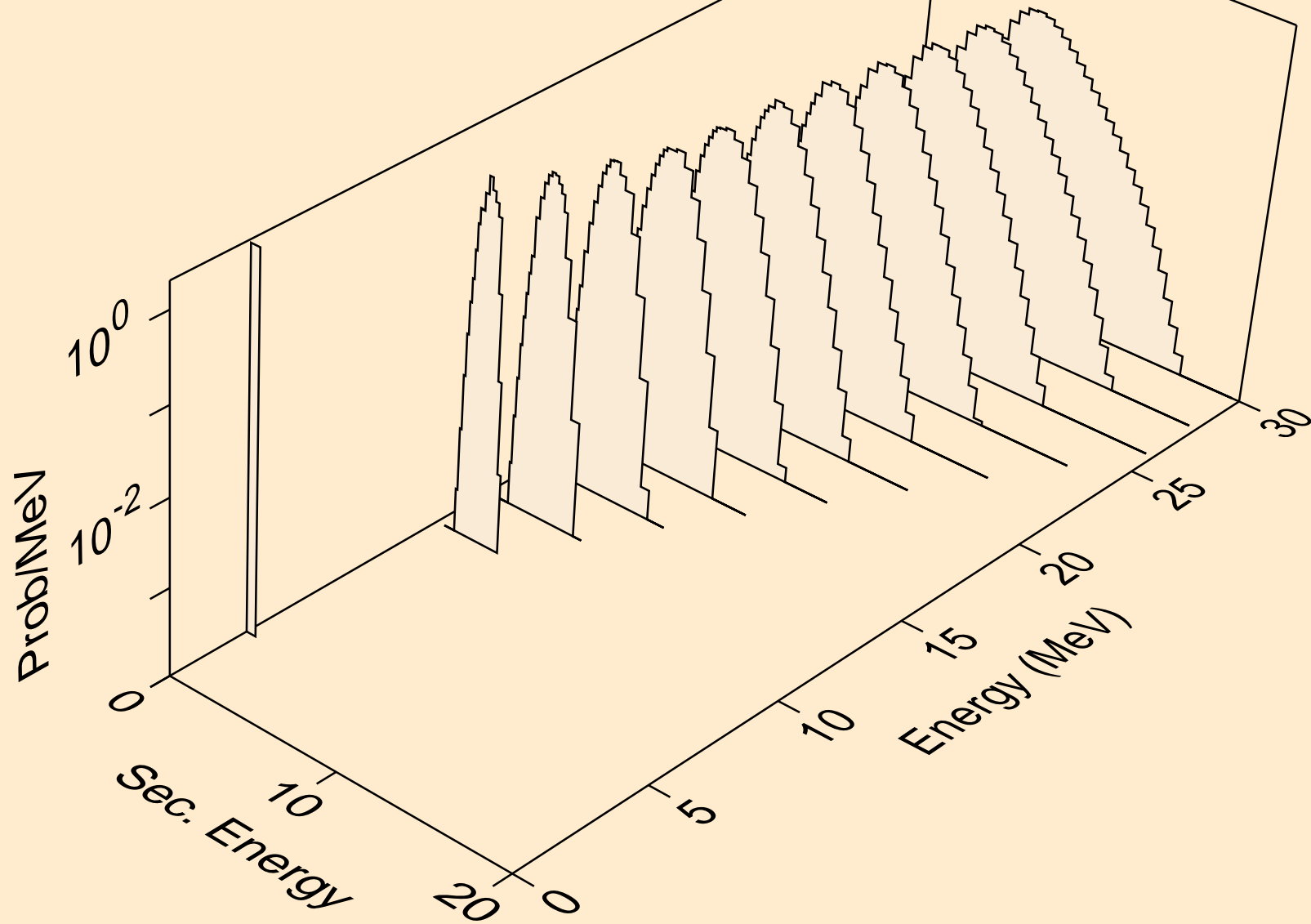

TE120 NEUTRON ACER TENDL-2024 LIBRARY; T=0.K  
protons from (n,pd)

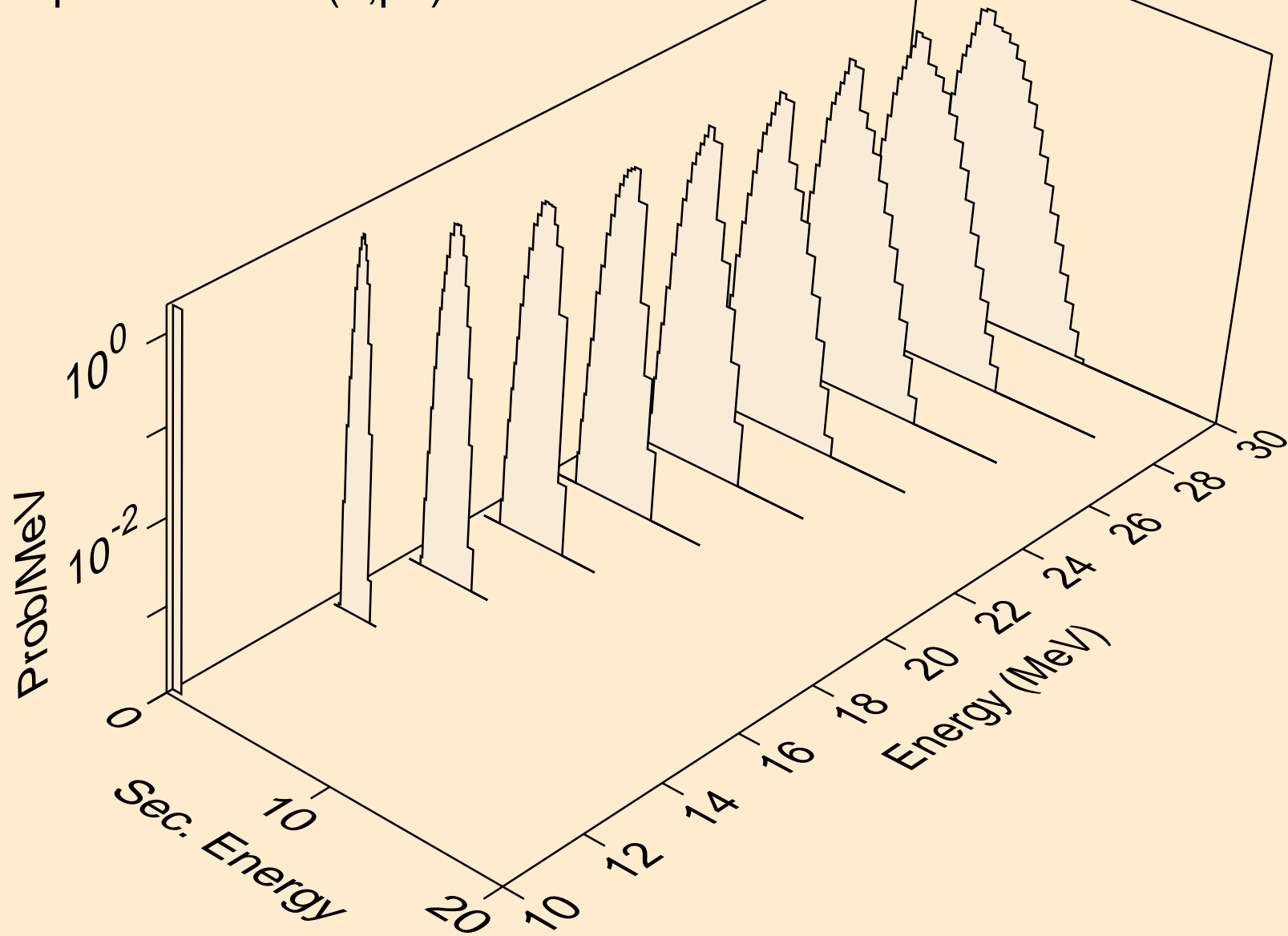

TE120 NEUTRON ACER TENDL-2024 LIBRARY; T=0.K  
protons from (n,pt)

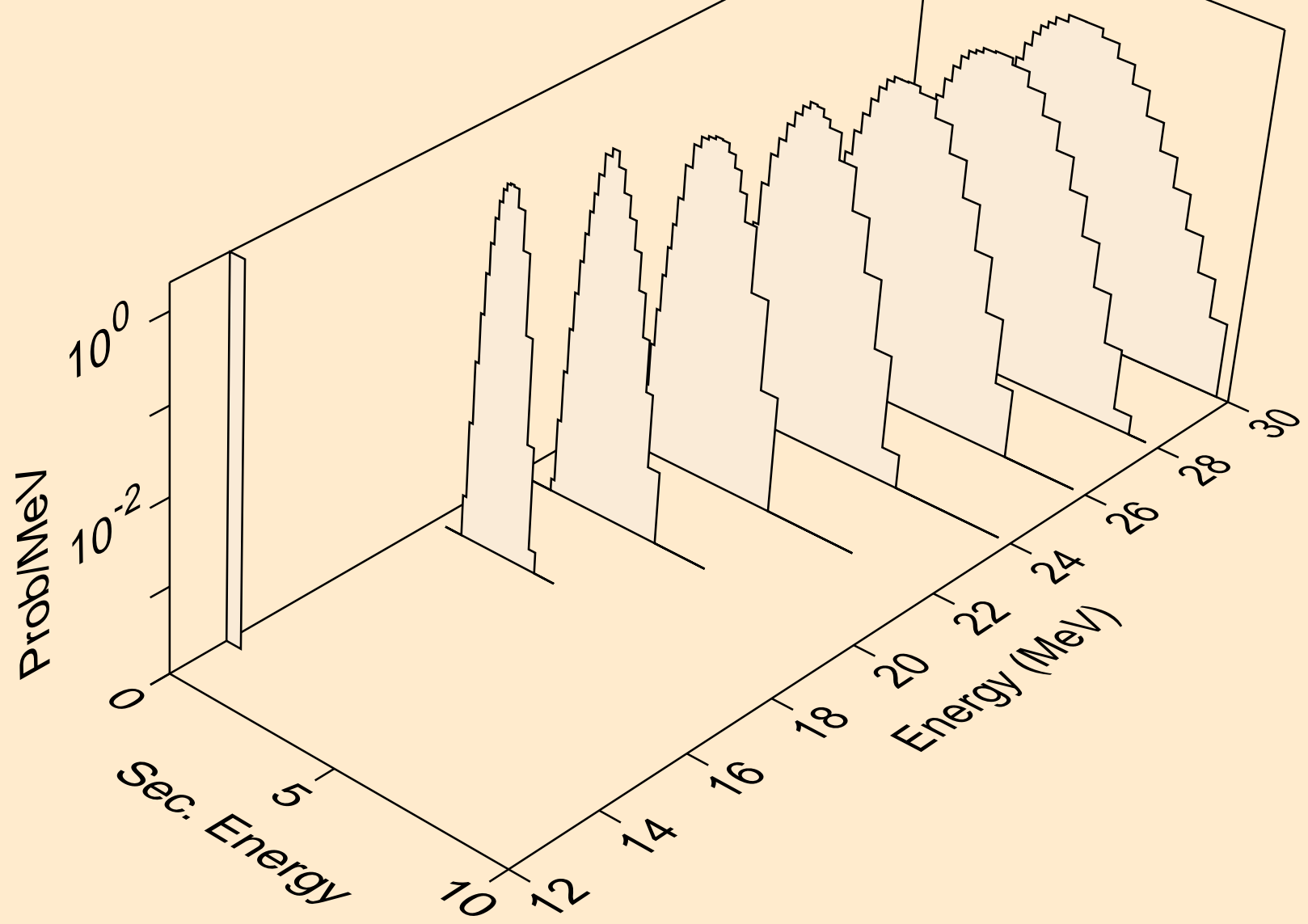

TE120 NEUTRON ACER TENDL-2024 LIBRARY; T=0.K  
deuterons from (n,x)

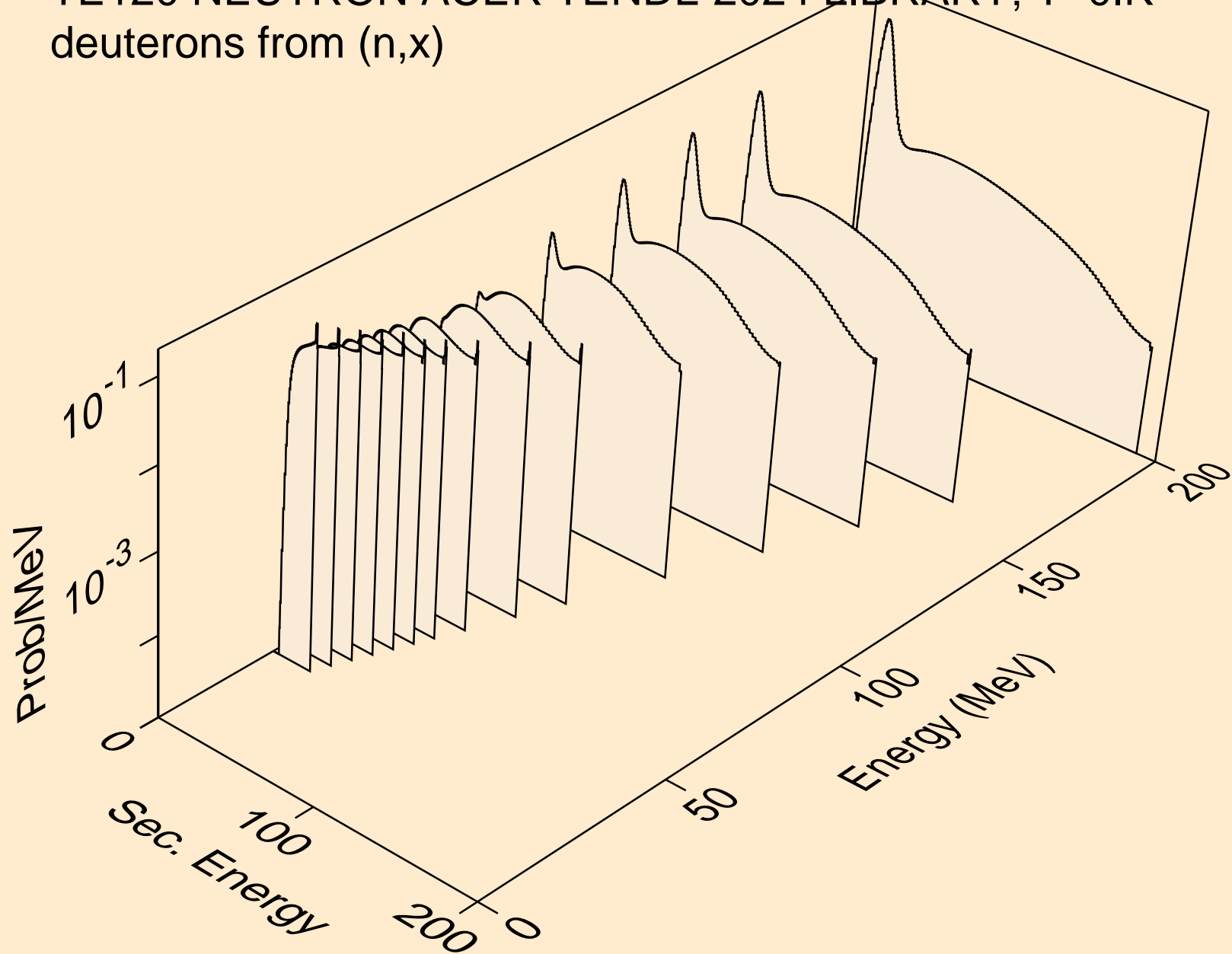

TE120 NEUTRON ACER TENDL-2024 LIBRARY; T=0.K  
deuterons from (n,2nd)

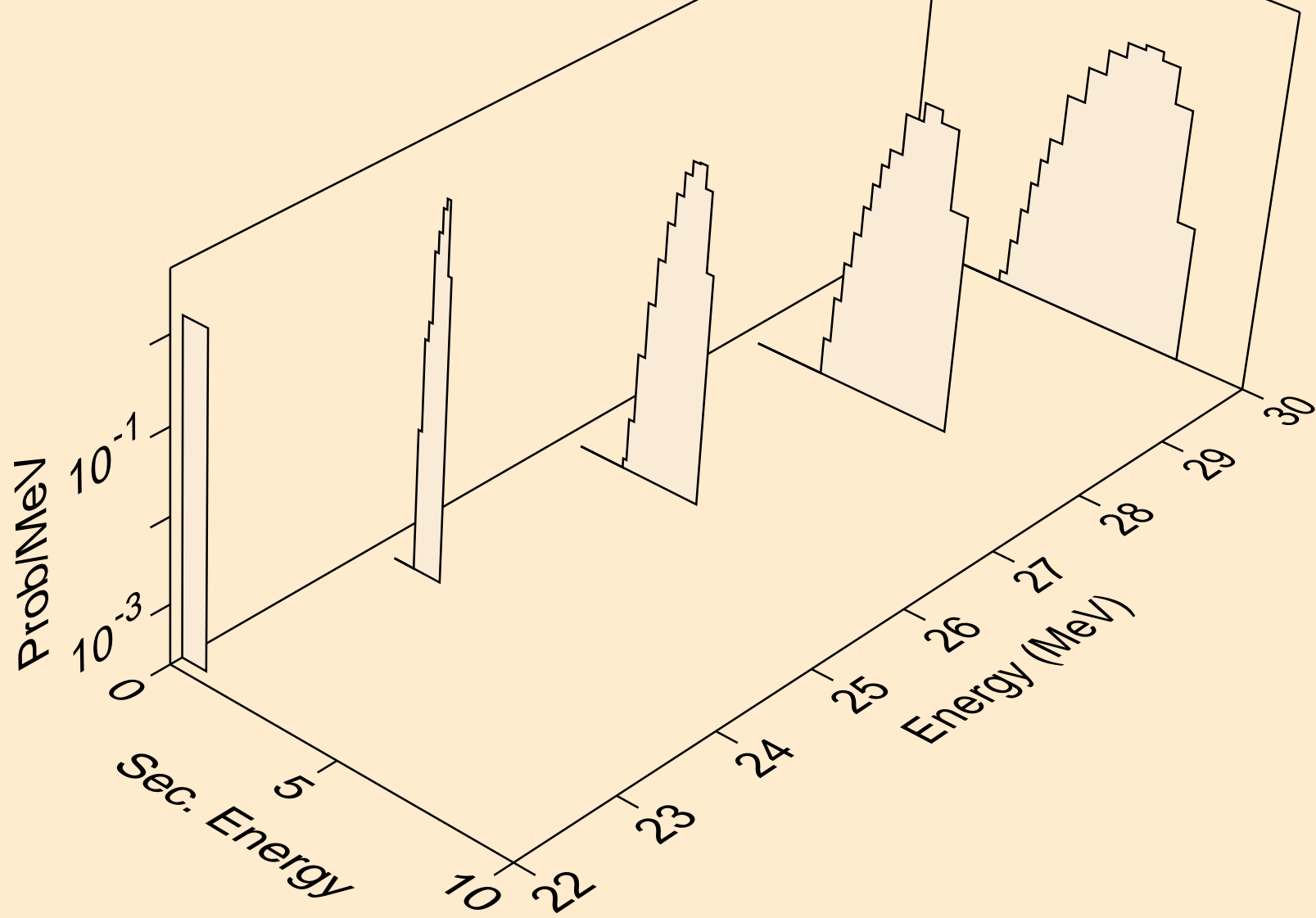

TE120 NEUTRON ACER TENDL-2024 LIBRARY; T=0.K  
deuterons from (n,n\*)d

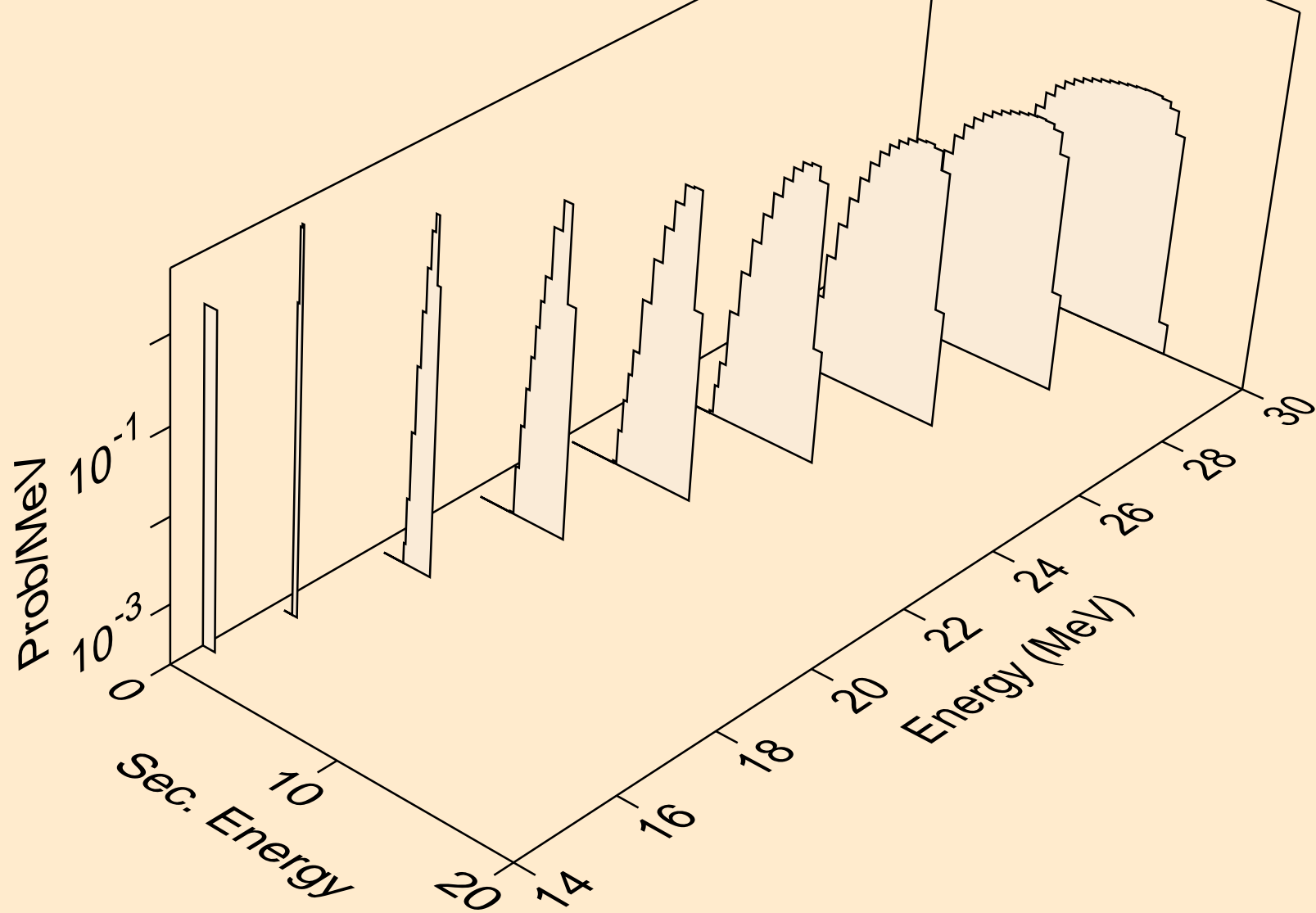

TE120 NEUTRON ACER TENDL-2024 LIBRARY; T=0.K  
deuterons from (n,d)

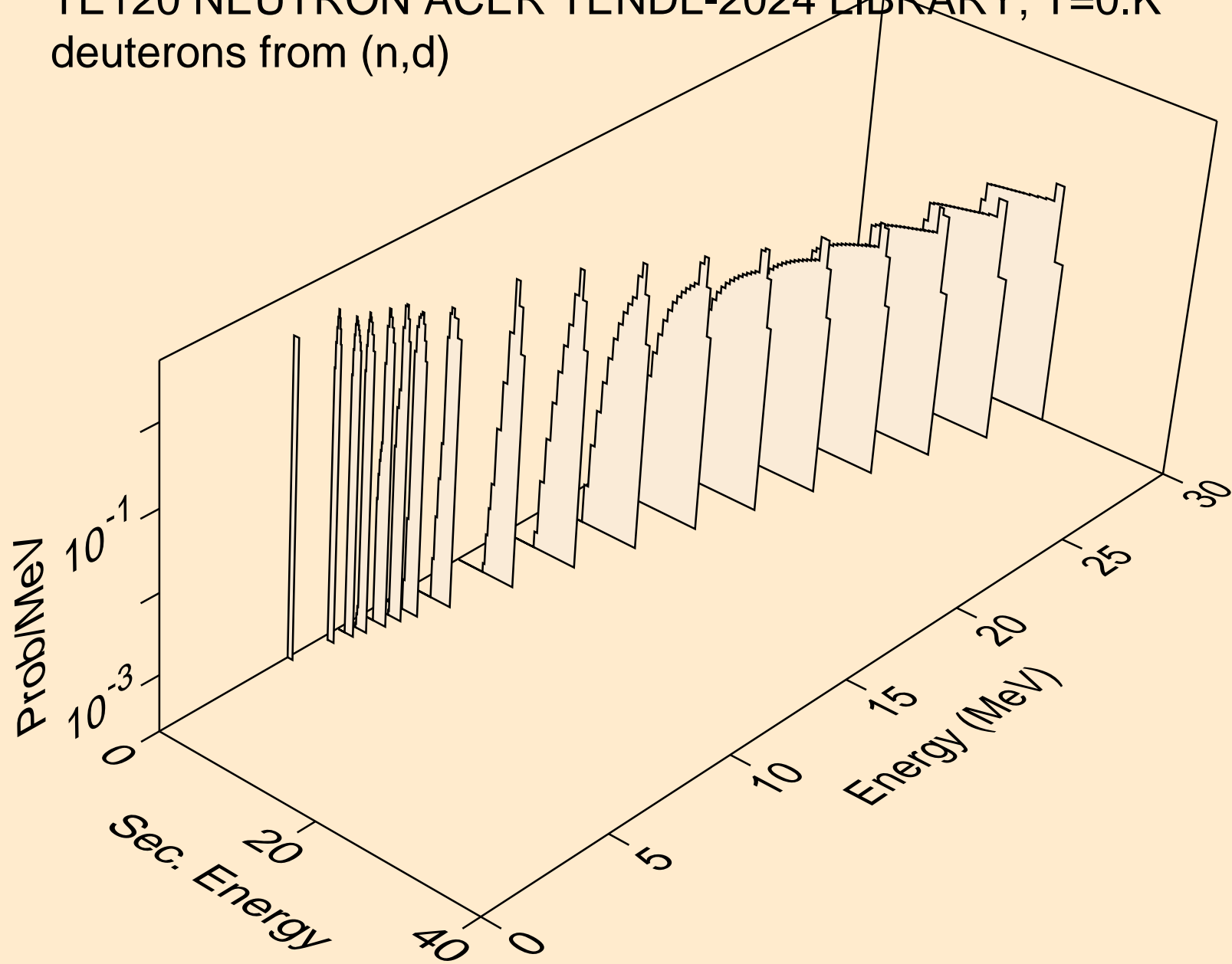

TE120 NEUTRON ACER TENDL-2024 LIBRARY; T=0.K  
deuterons from (n,pd)

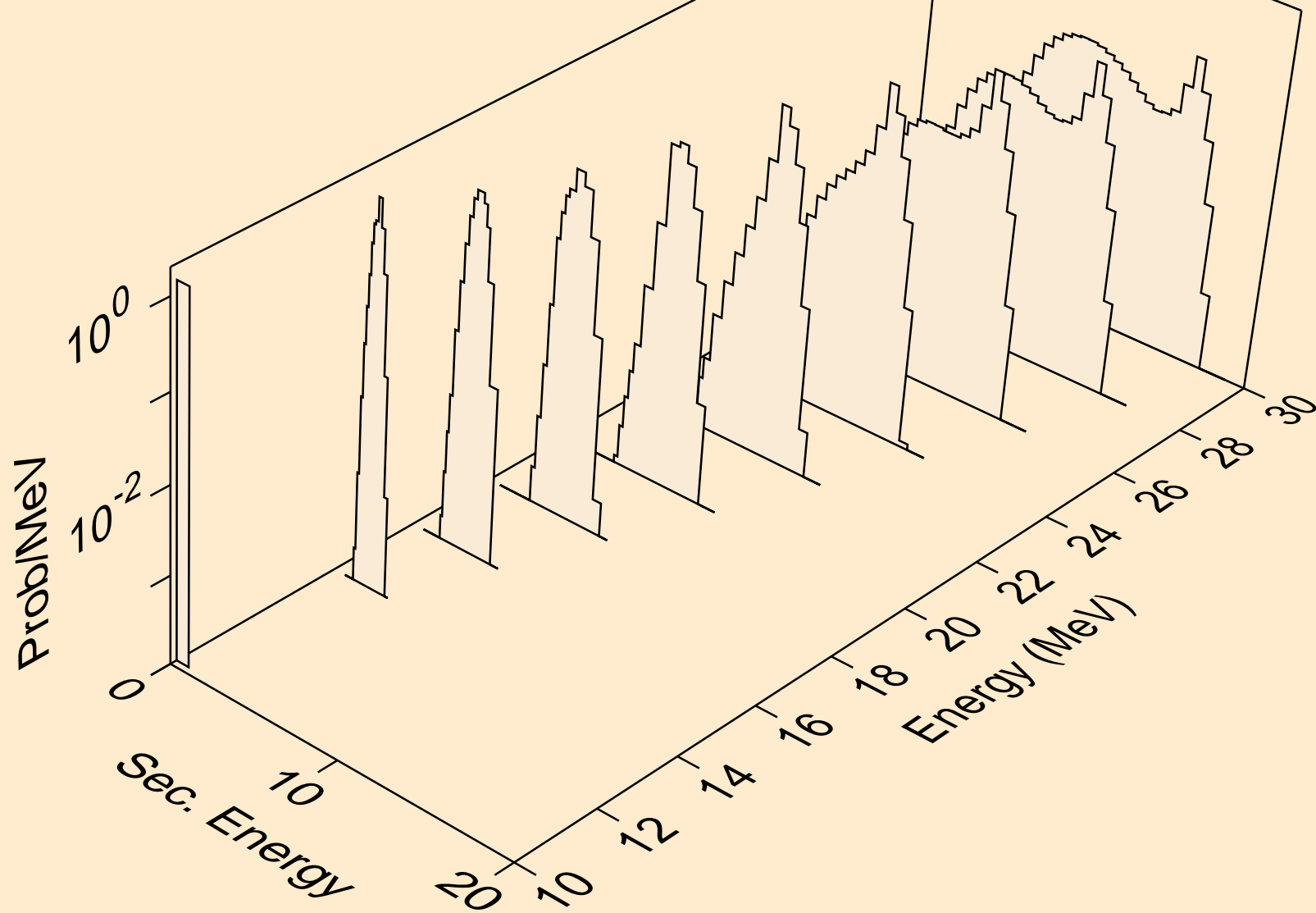



TE120 NEUTRON ACER TENDL-2024 LIBRARY; T=0.K  
deuterons from (n,da)

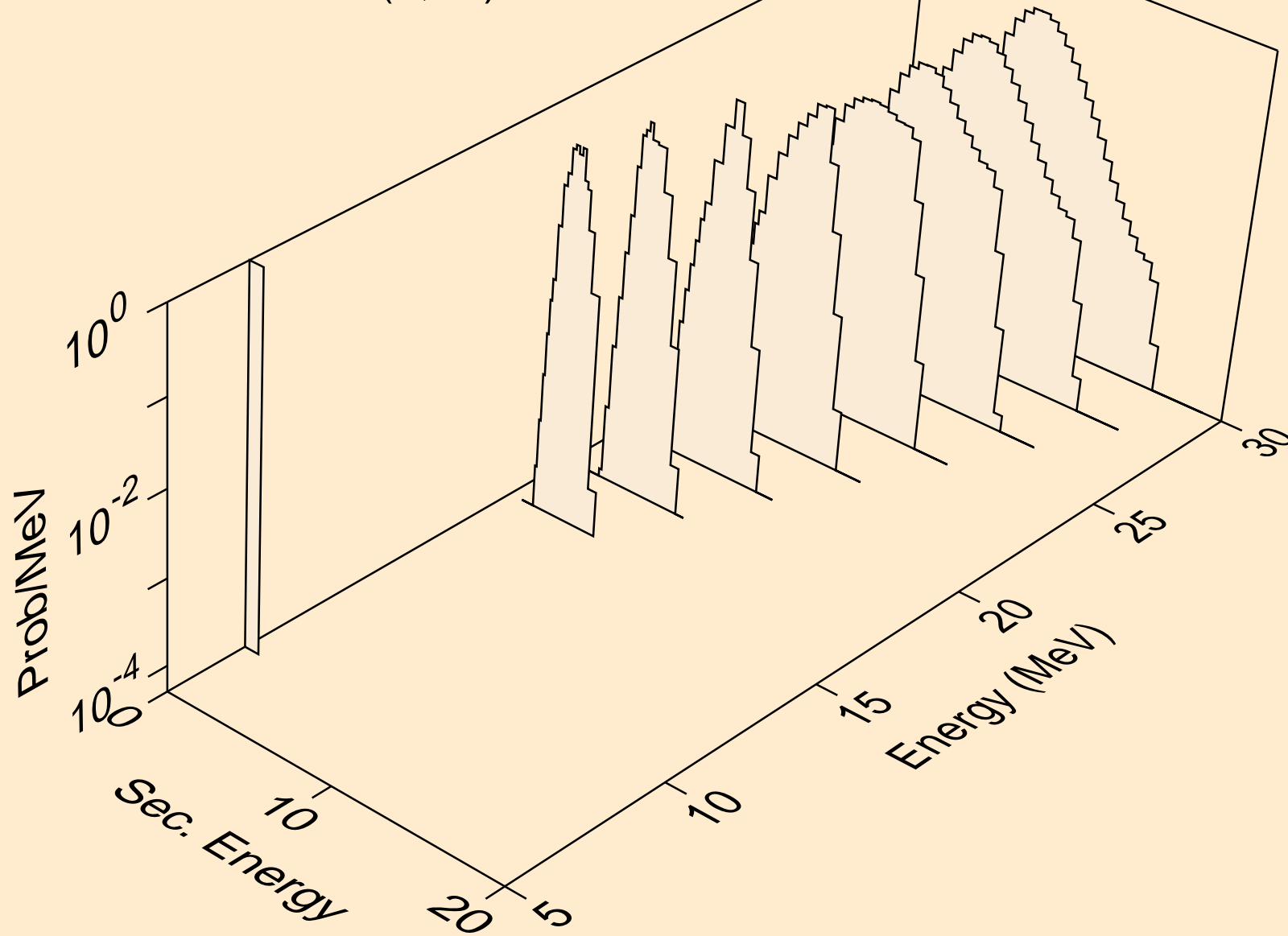

TE120 NEUTRON ACER TENDL-2024 LIBRARY; T=0.K  
tritons from (n,x)

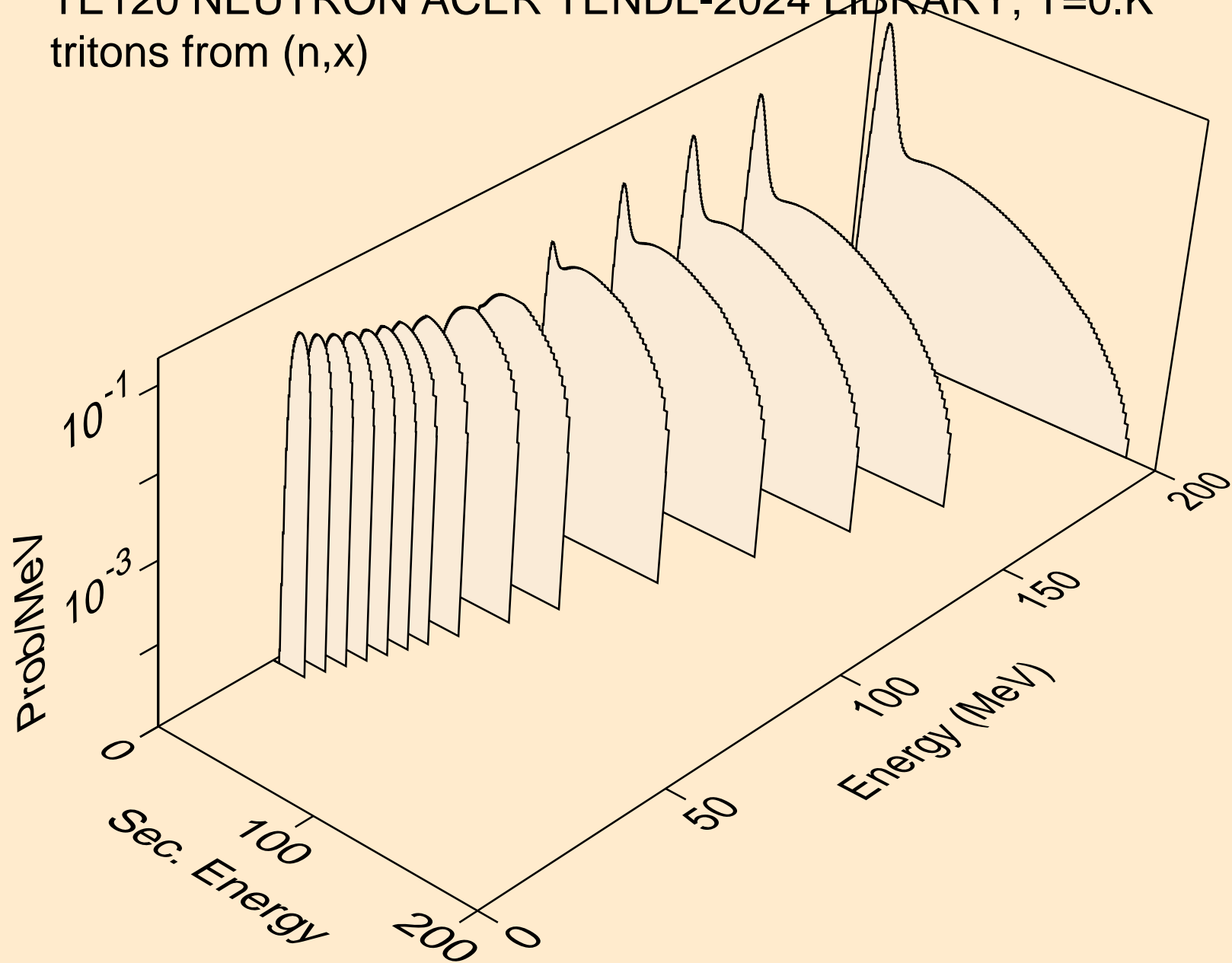

TE120 NEUTRON ACER TENDL-2024 LIBRARY; T=0.K  
tritons from (n,n\*)t

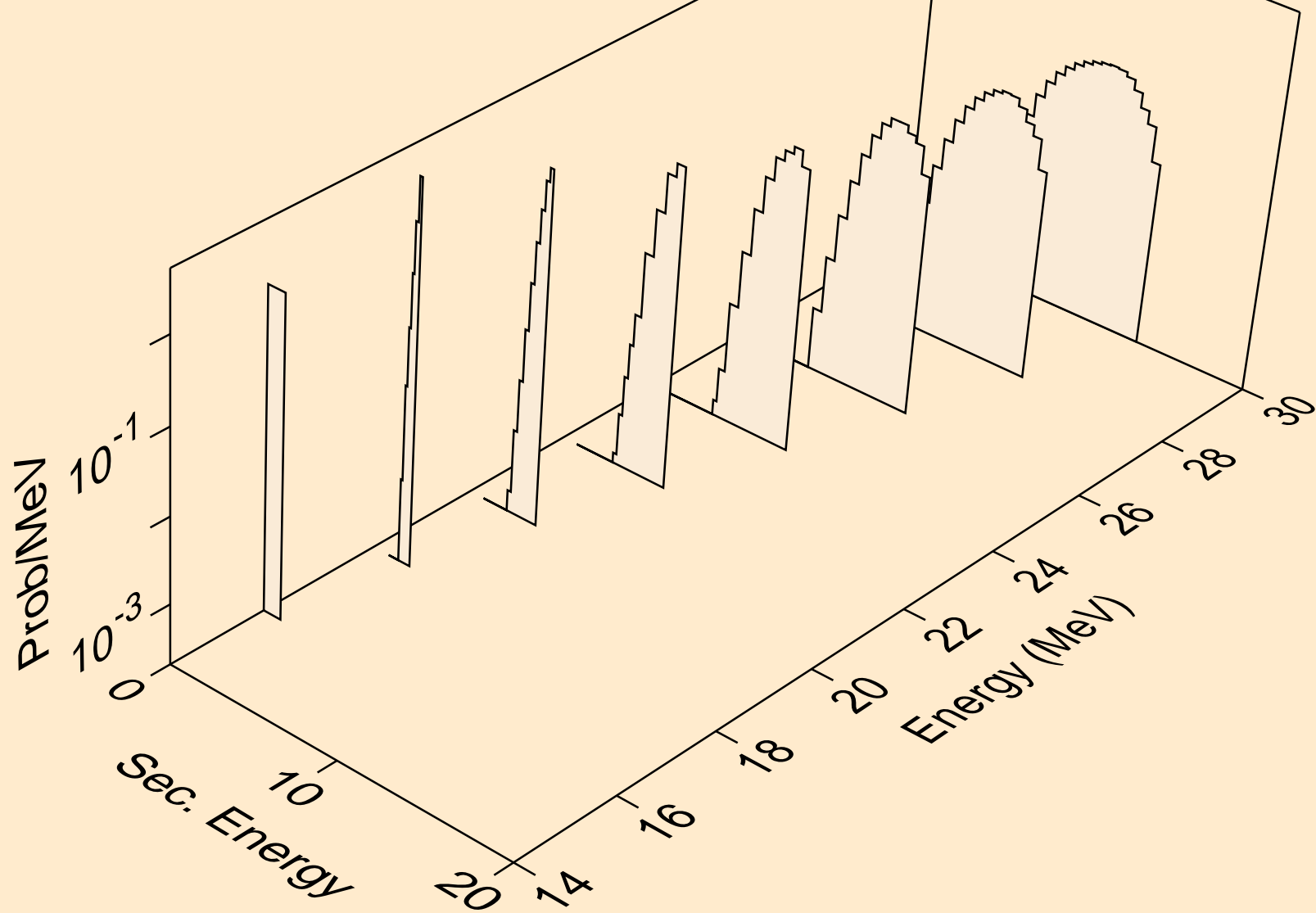

TE120 NEUTRON ACER TENDL-2024 LIBRARY; T=0.K  
tritons from (n,t)

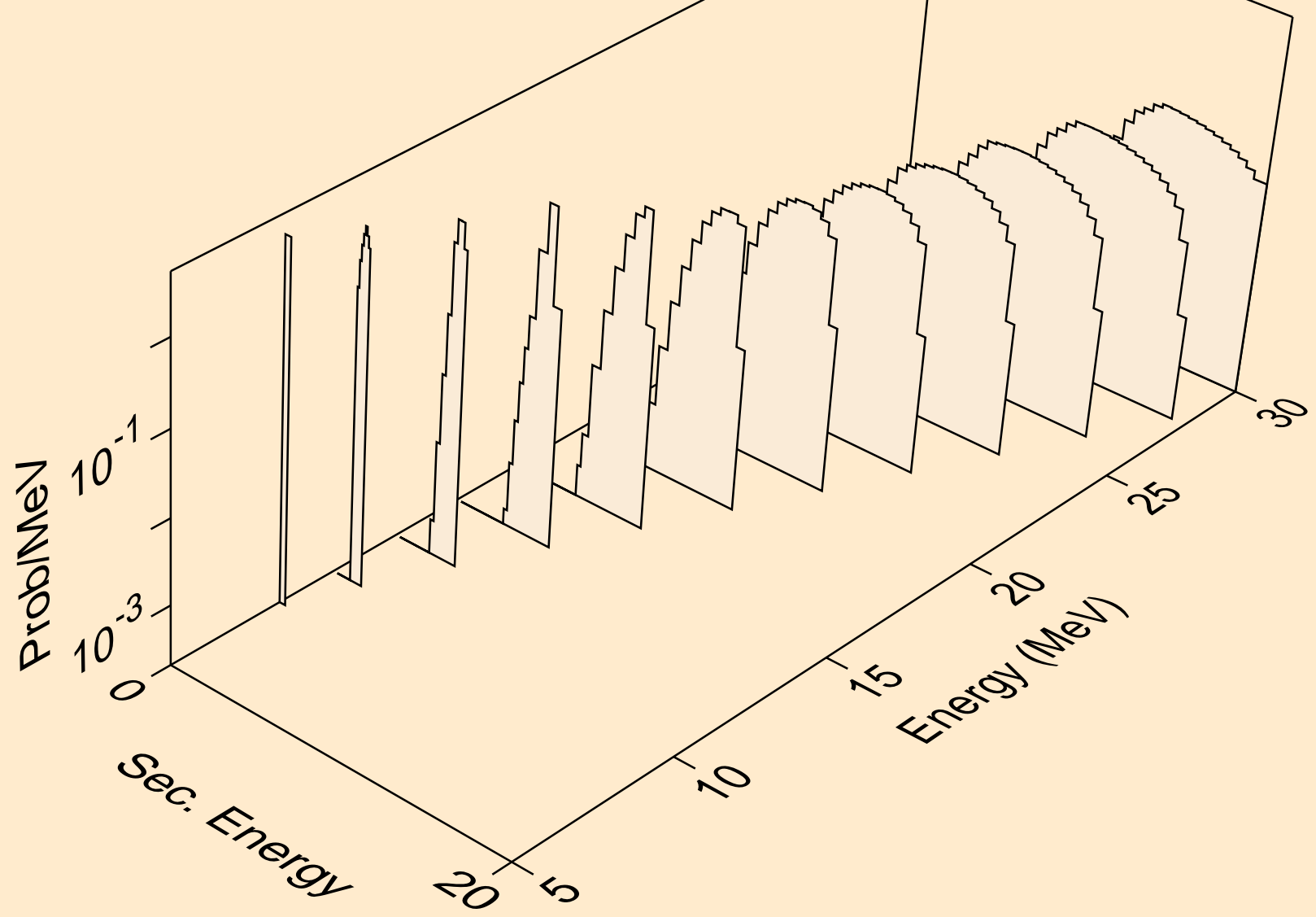

TE120 NEUTRON ACER TENDL-2024 LIBRARY; T=0.K  
tritons from (n,pt)

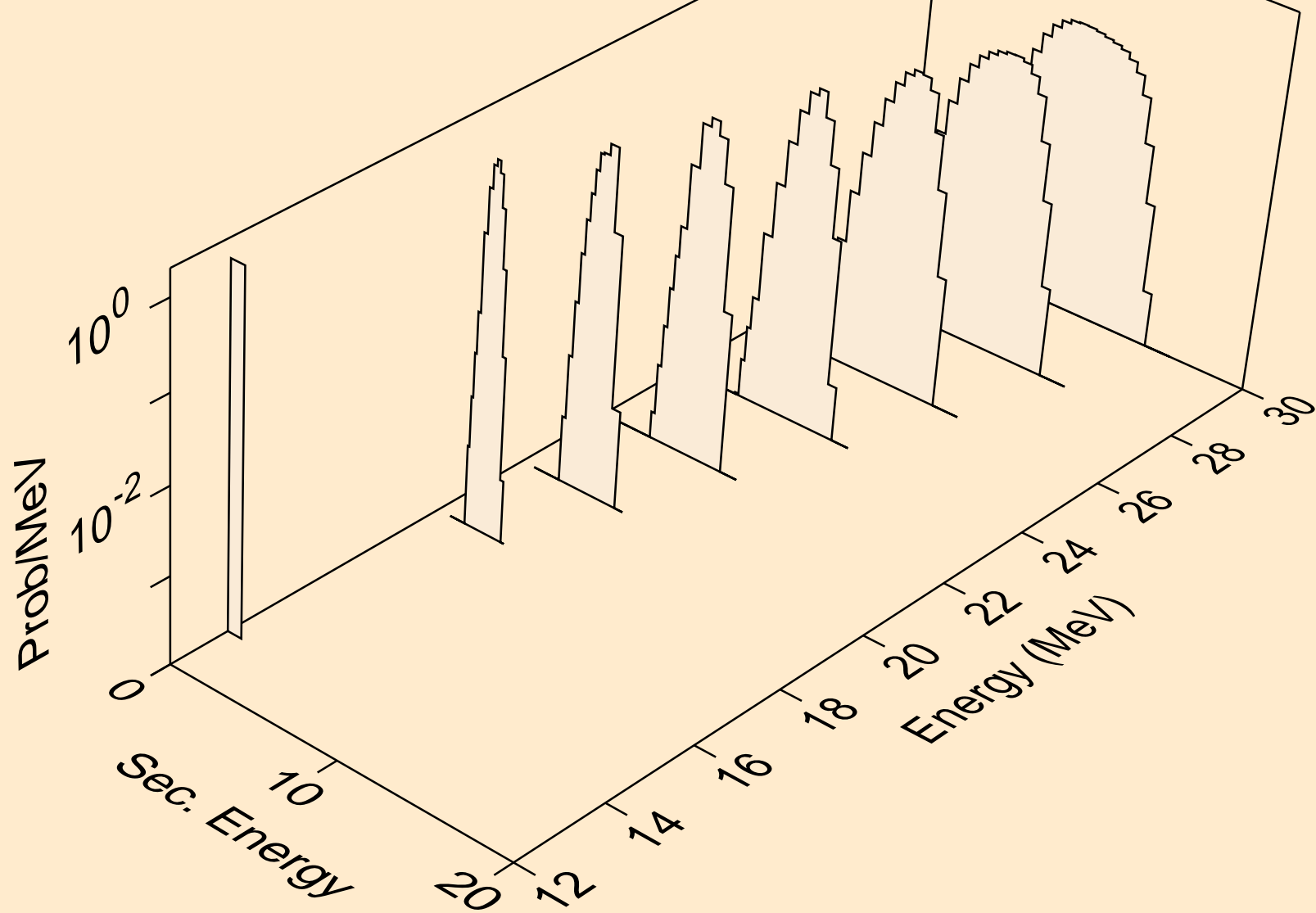

TE120 NEUTRON ACER TENDL-2024 LIBRARY; T=0.K  
he3s from (n,x)

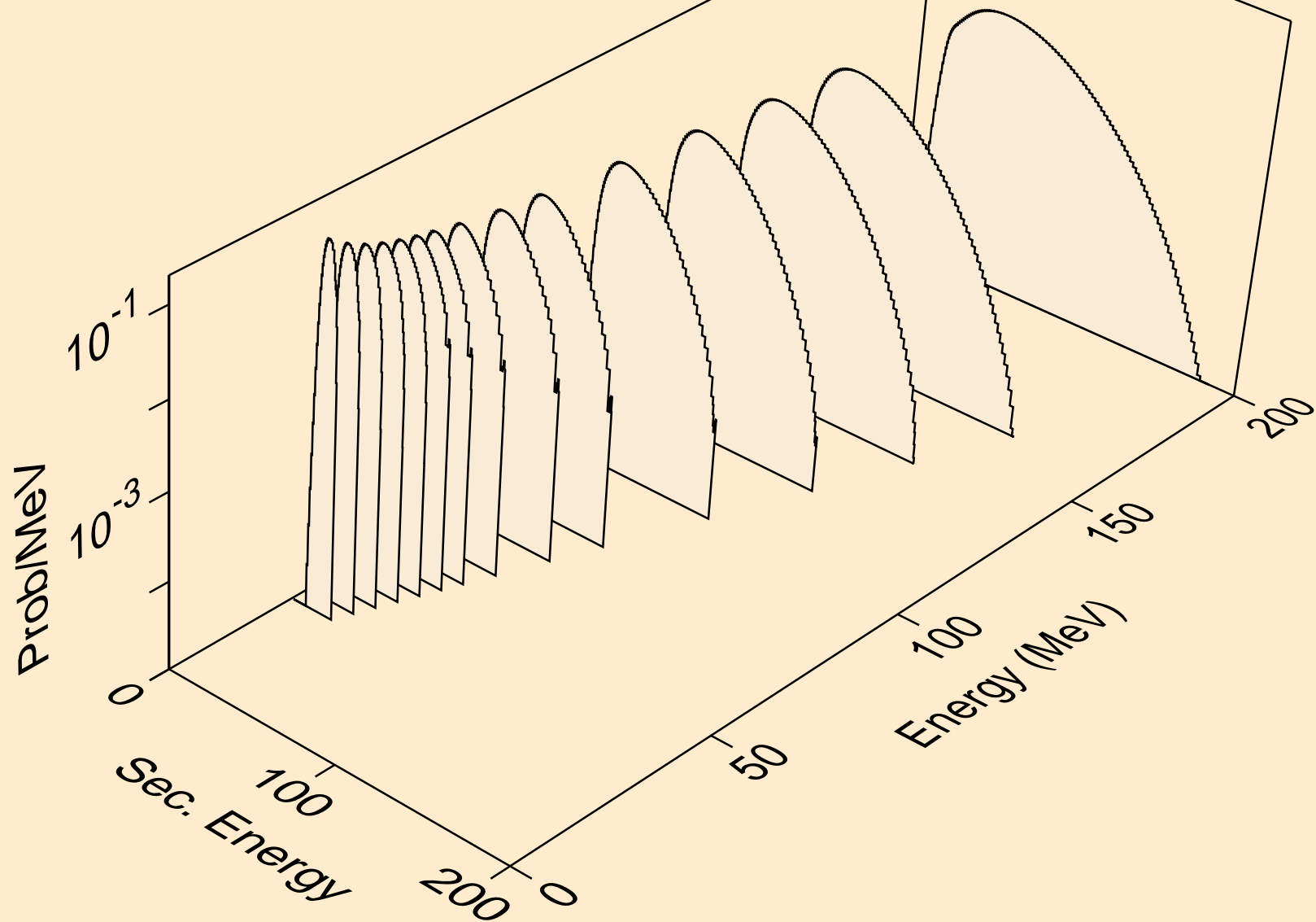

TE120 NEUTRON ACER TENDL-2024 LIBRARY; T=0.K  
he3s from (n,n\*)he3

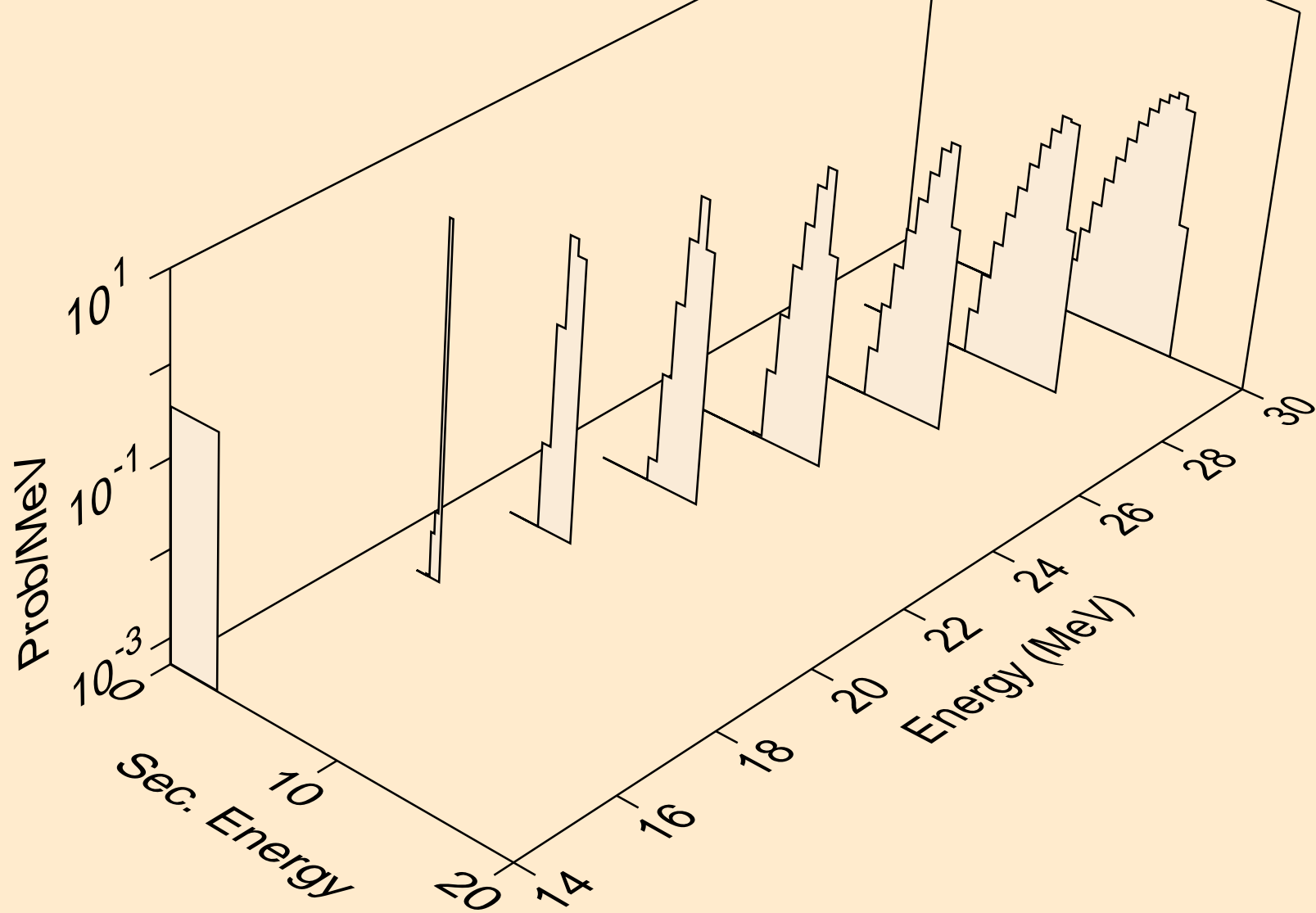

TE120 NEUTRON ACER TENDL-2024 LIBRARY; T=0.K  
he3s from (n,he3)

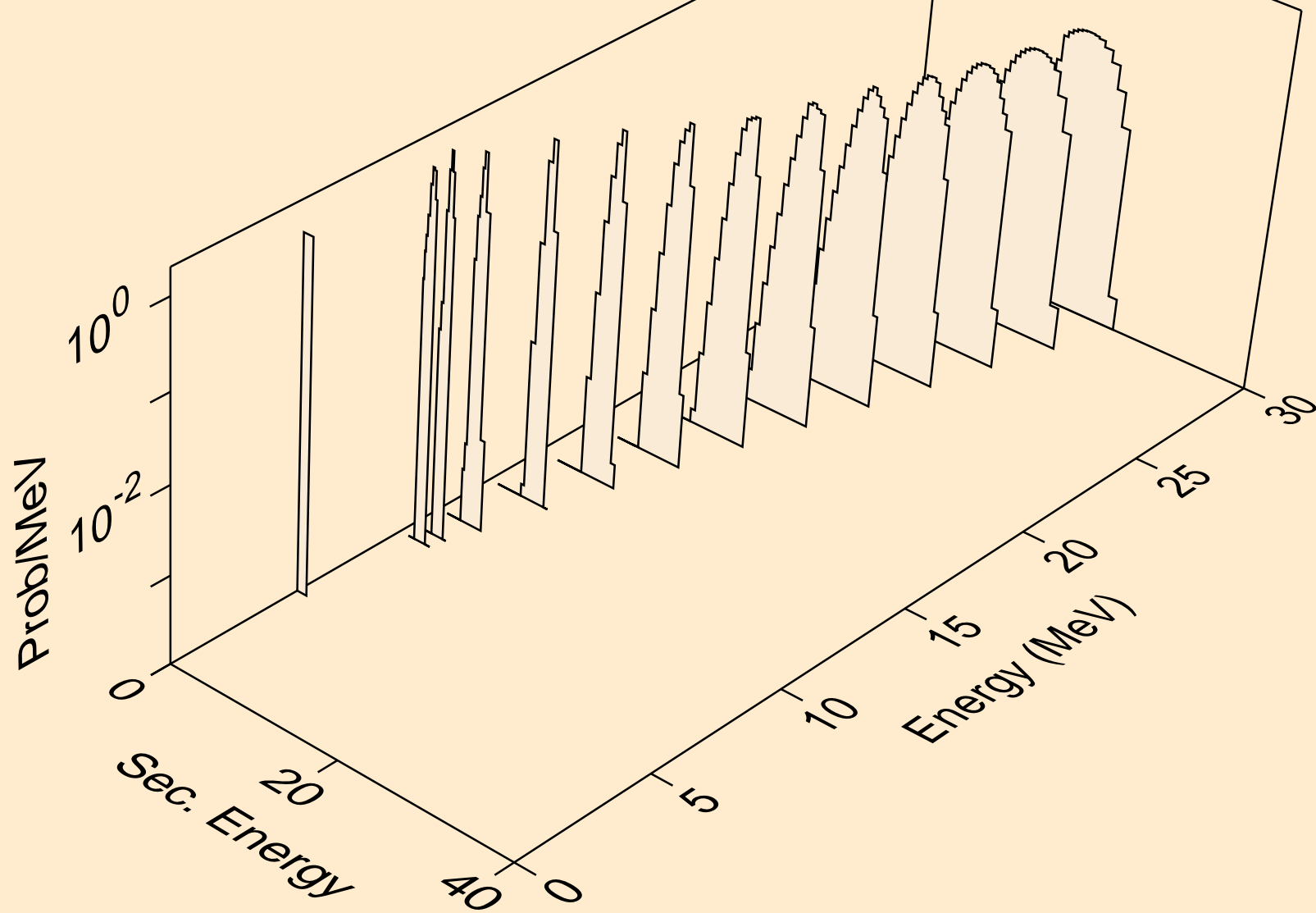



TE120 NEUTRON ACER TENDL-2024 LIBRARY; T=0.K  
alphas from (n,x)

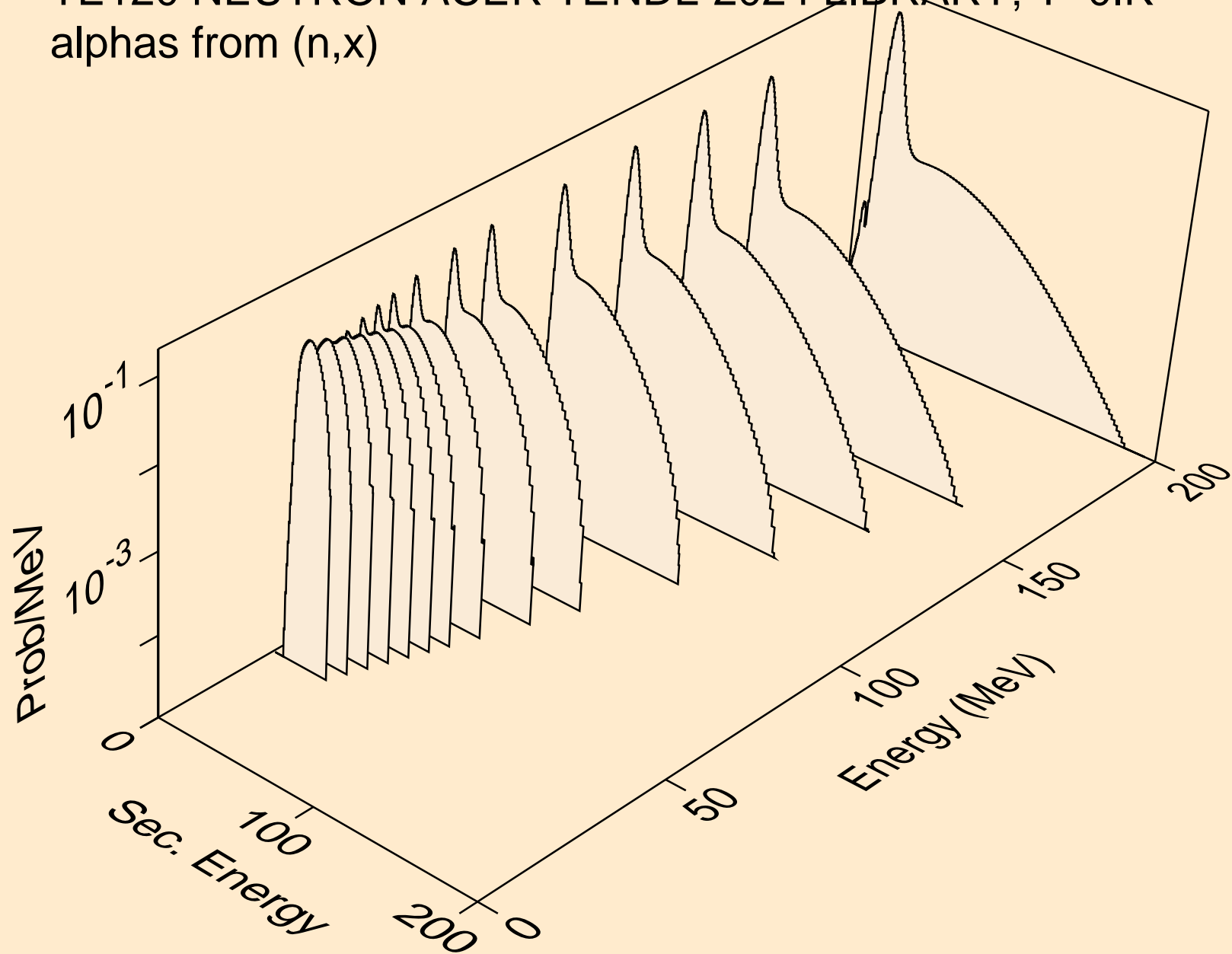

TE120 NEUTRON ACER TENDL-2024 LIBRARY; T=0.K  
alphas from (n,n\*)a

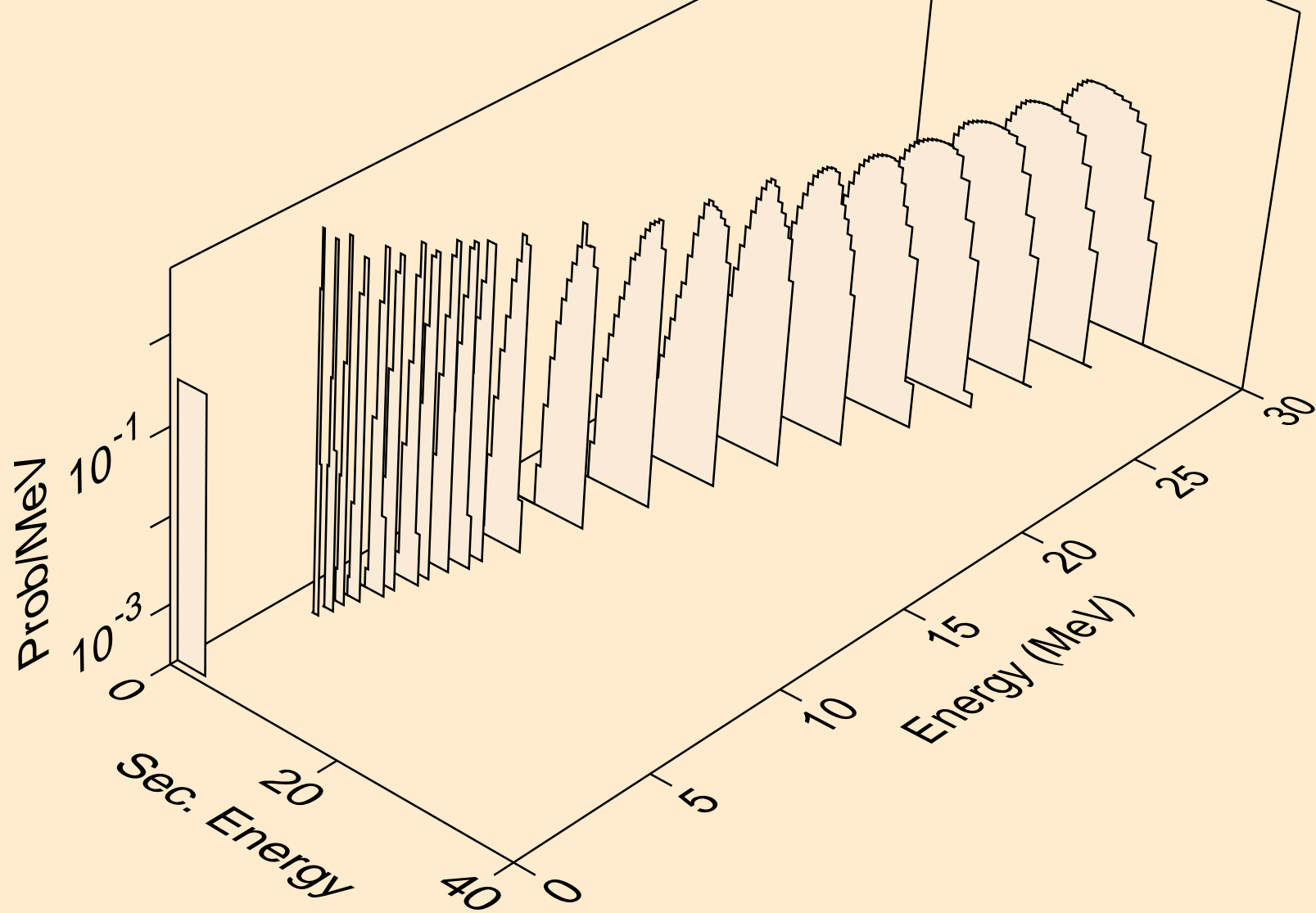

TE120 NEUTRON ACER TENDL-2024 LIBRARY; T=0.K  
alphas from (n,2n)a

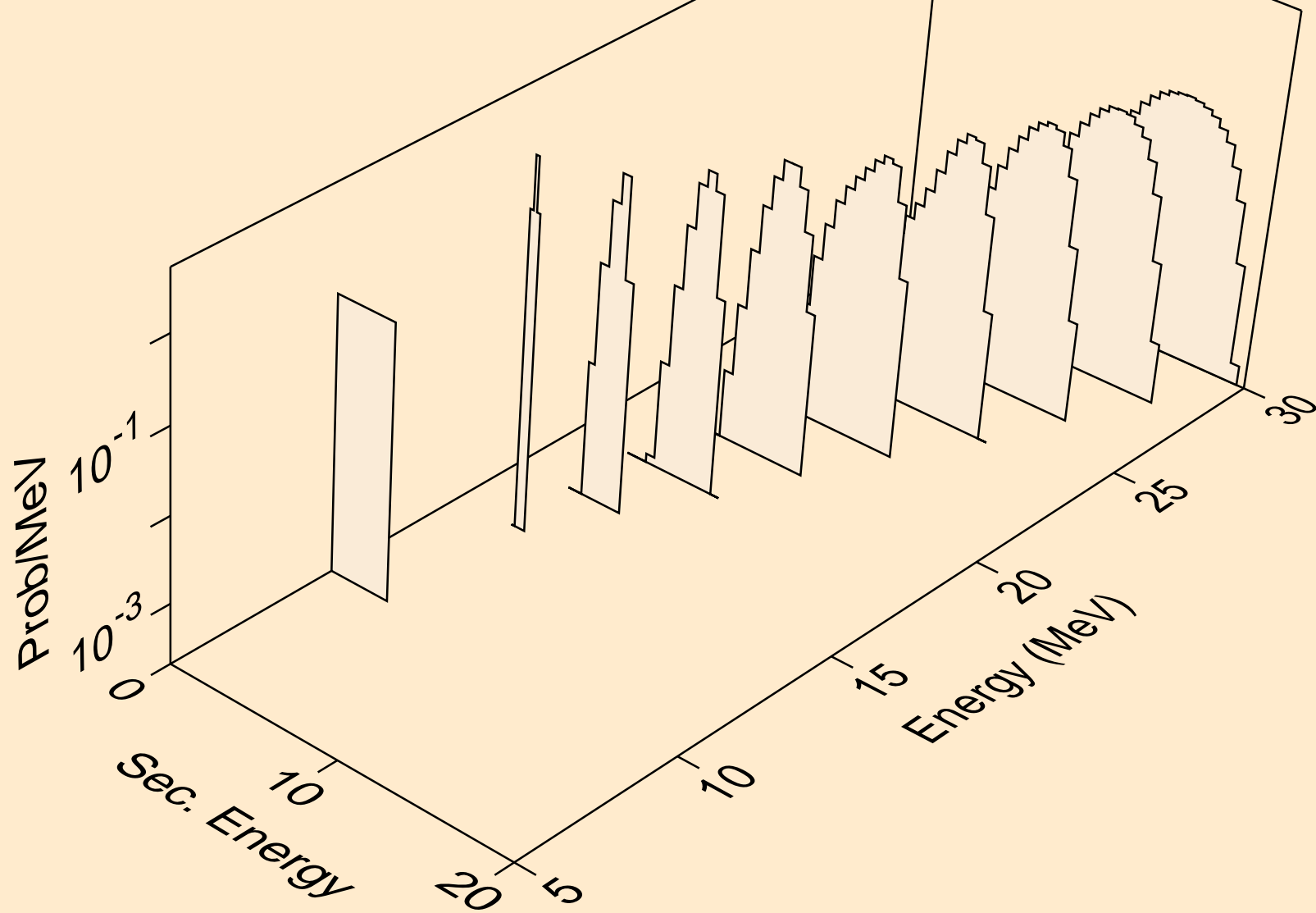

TE120 NEUTRON ACER TENDL-2024 LIBRARY; T=0.K  
alphas from (n,3n)a

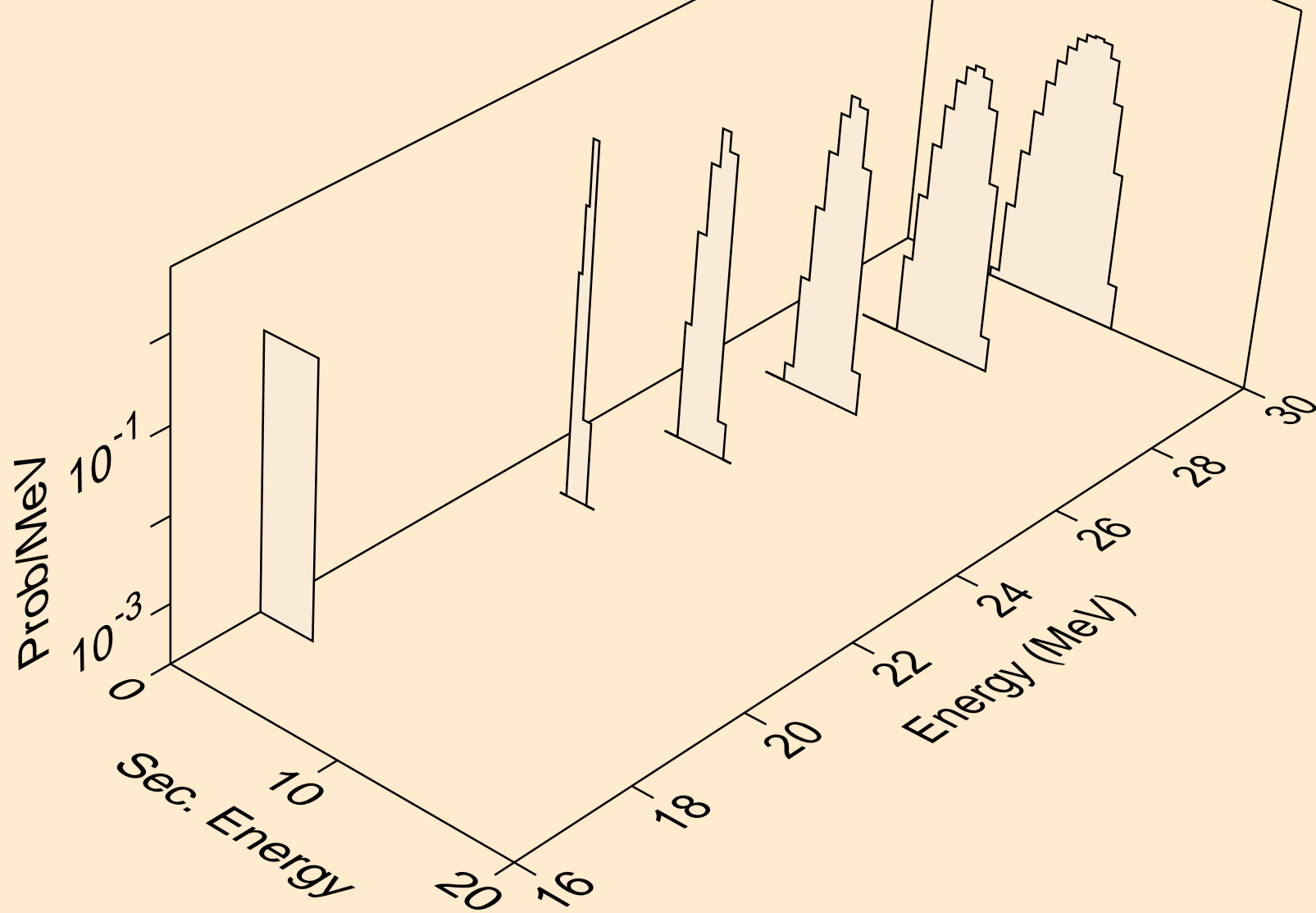

TE120 NEUTRON ACER TENDL-2024 LIBRARY; T=0.K  
alphas from (n,n\*)2a

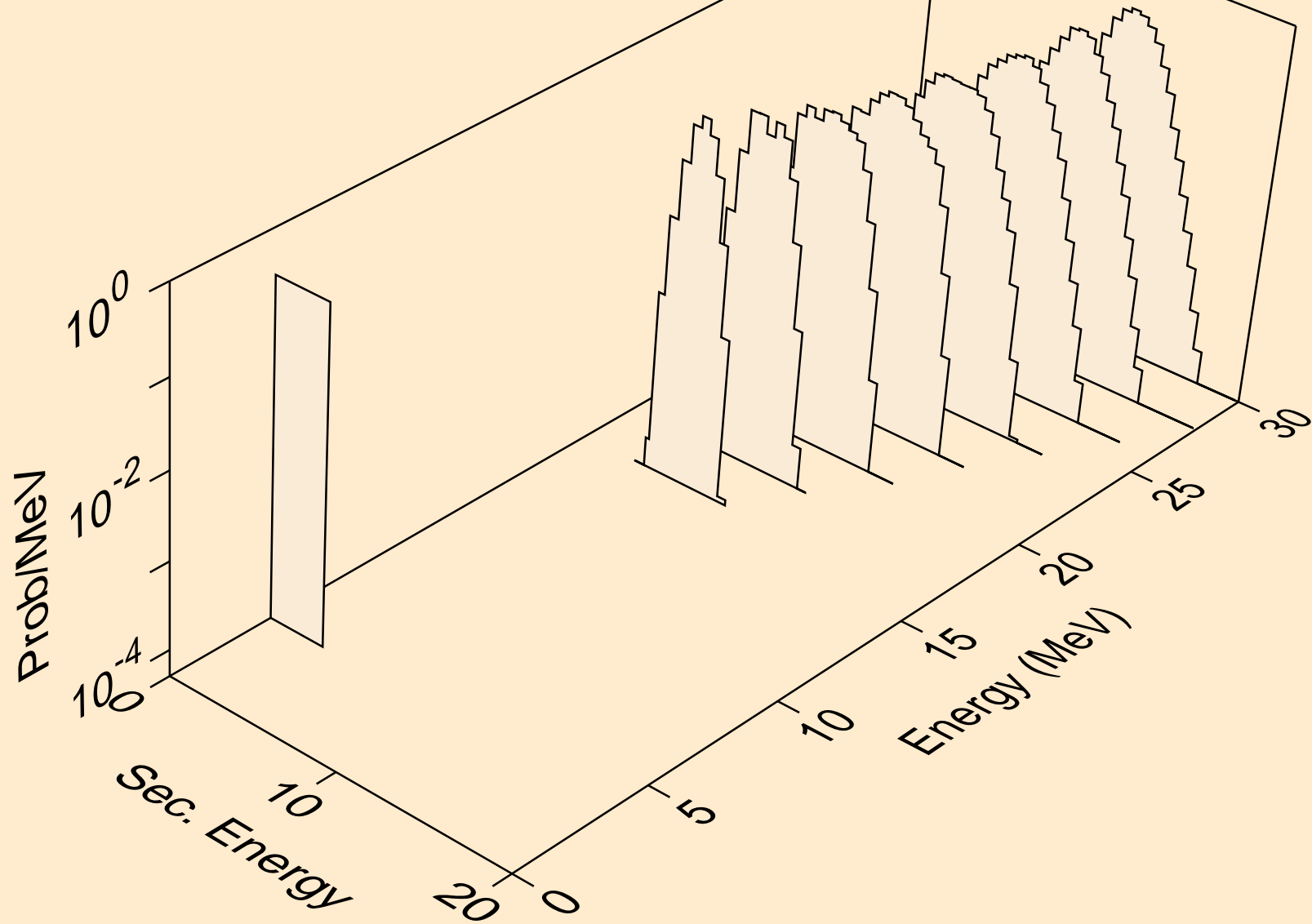

TE120 NEUTRON ACER TENDL-2024 LIBRARY; T=0.K  
alphas from (n,npa)

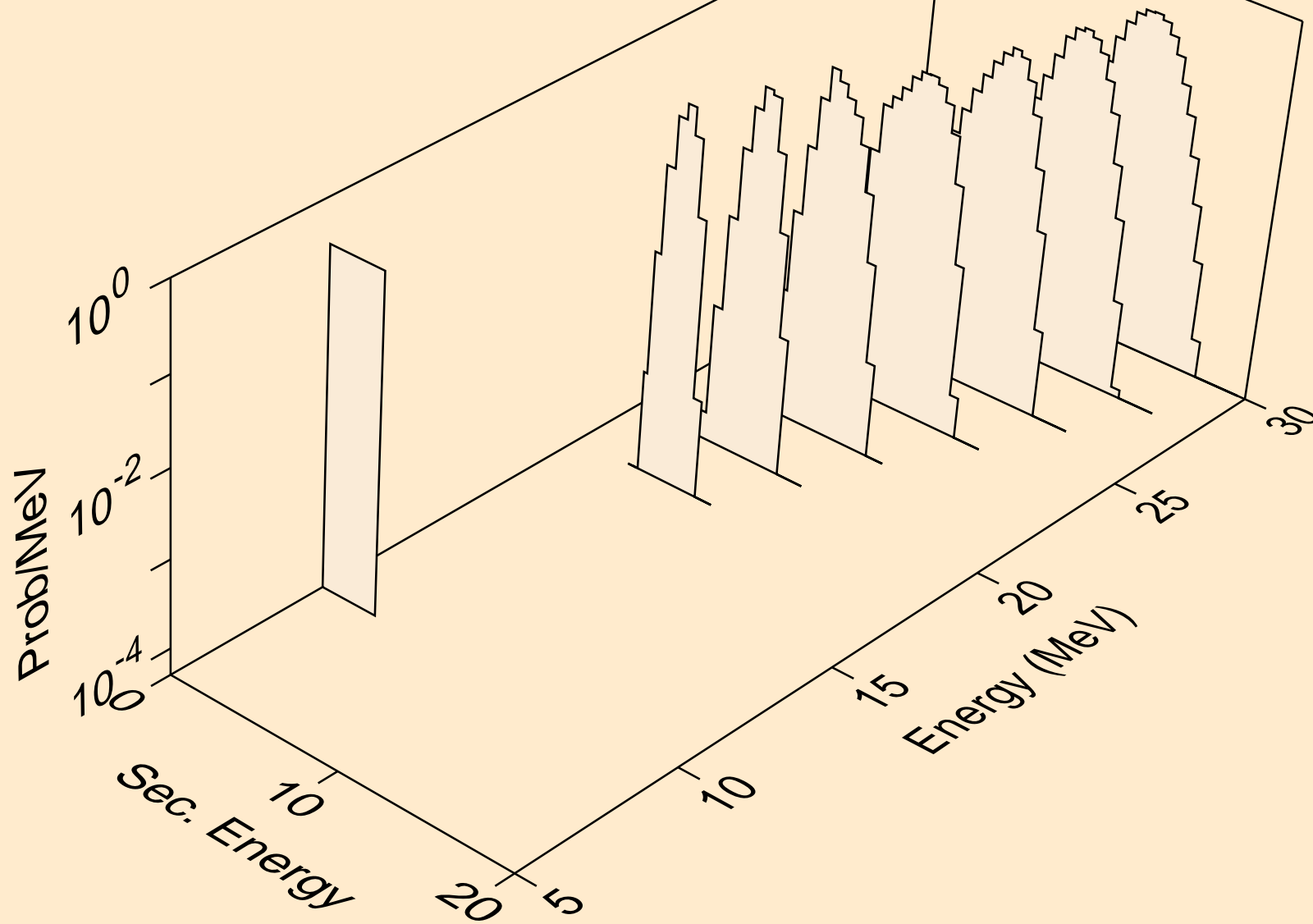

TE120 NEUTRON ACER TENDL-2024 LIBRARY; T=0.K  
alphas from (n,a)

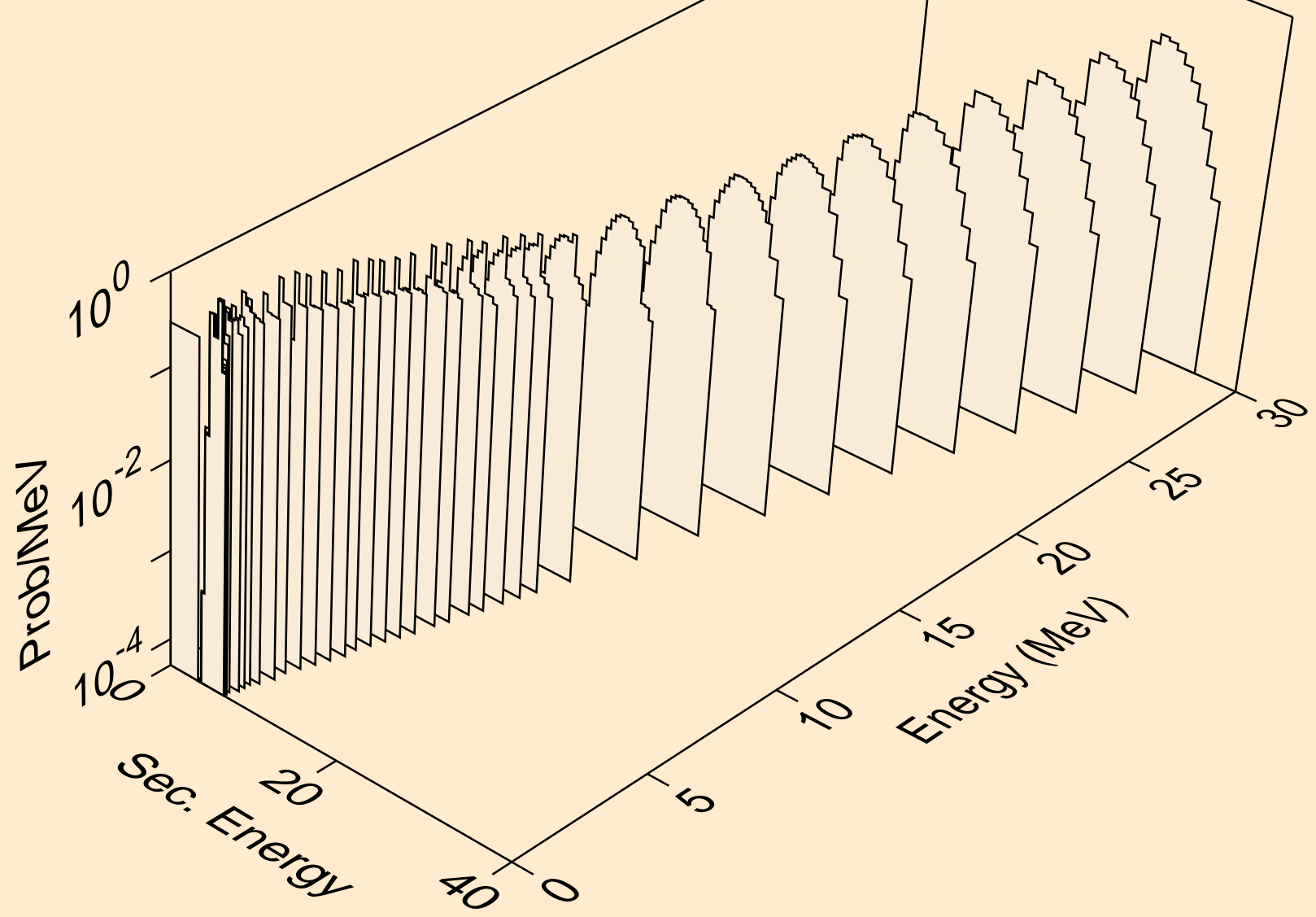

TE120 NEUTRON ACER TENDL-2024 LIBRARY; T=0.K  
alphas from (n,2a)

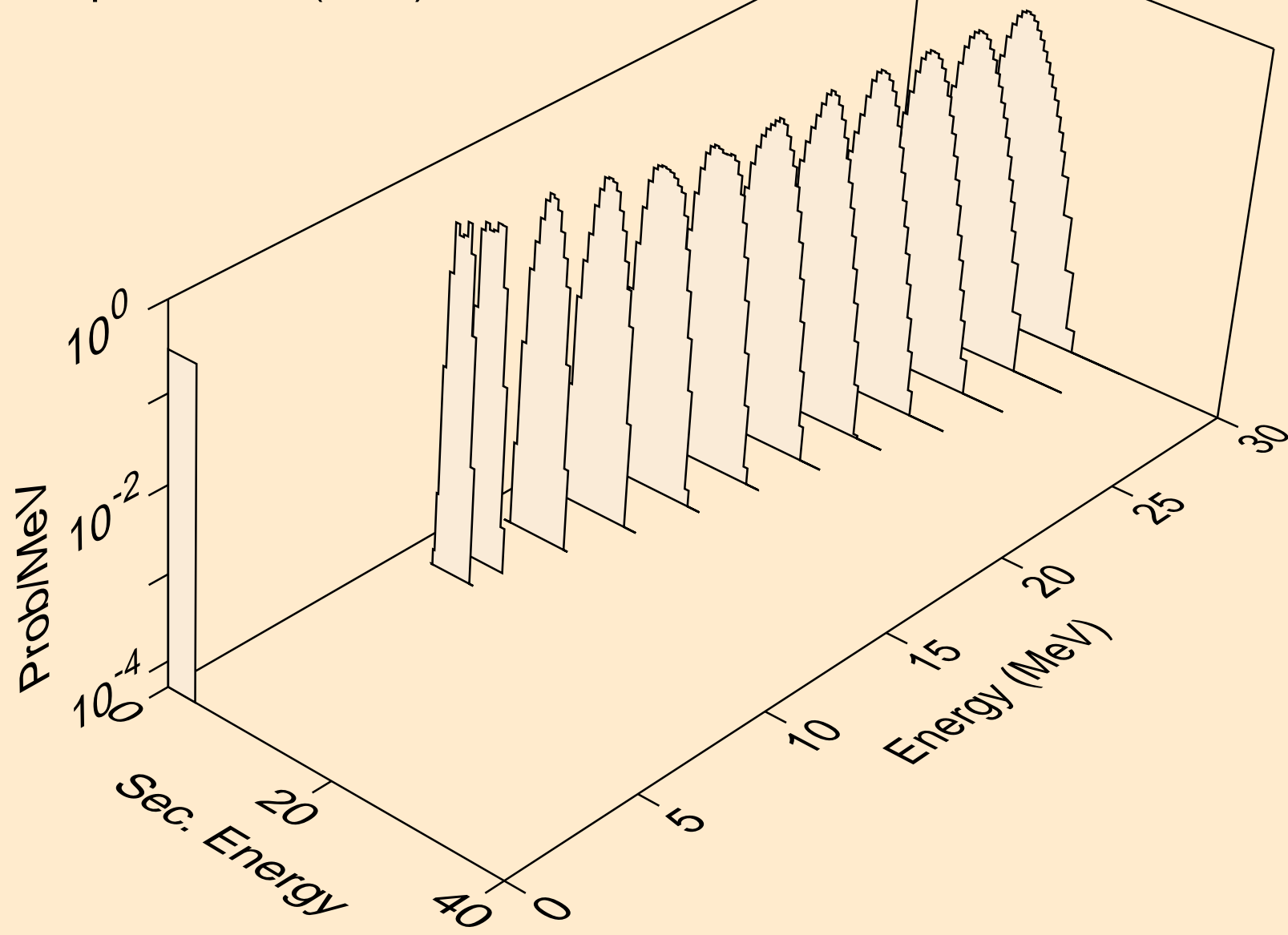



TE120 NEUTRON ACER TENDL-2024 LIBRARY; T=0.K  
alphas from (n,pa)

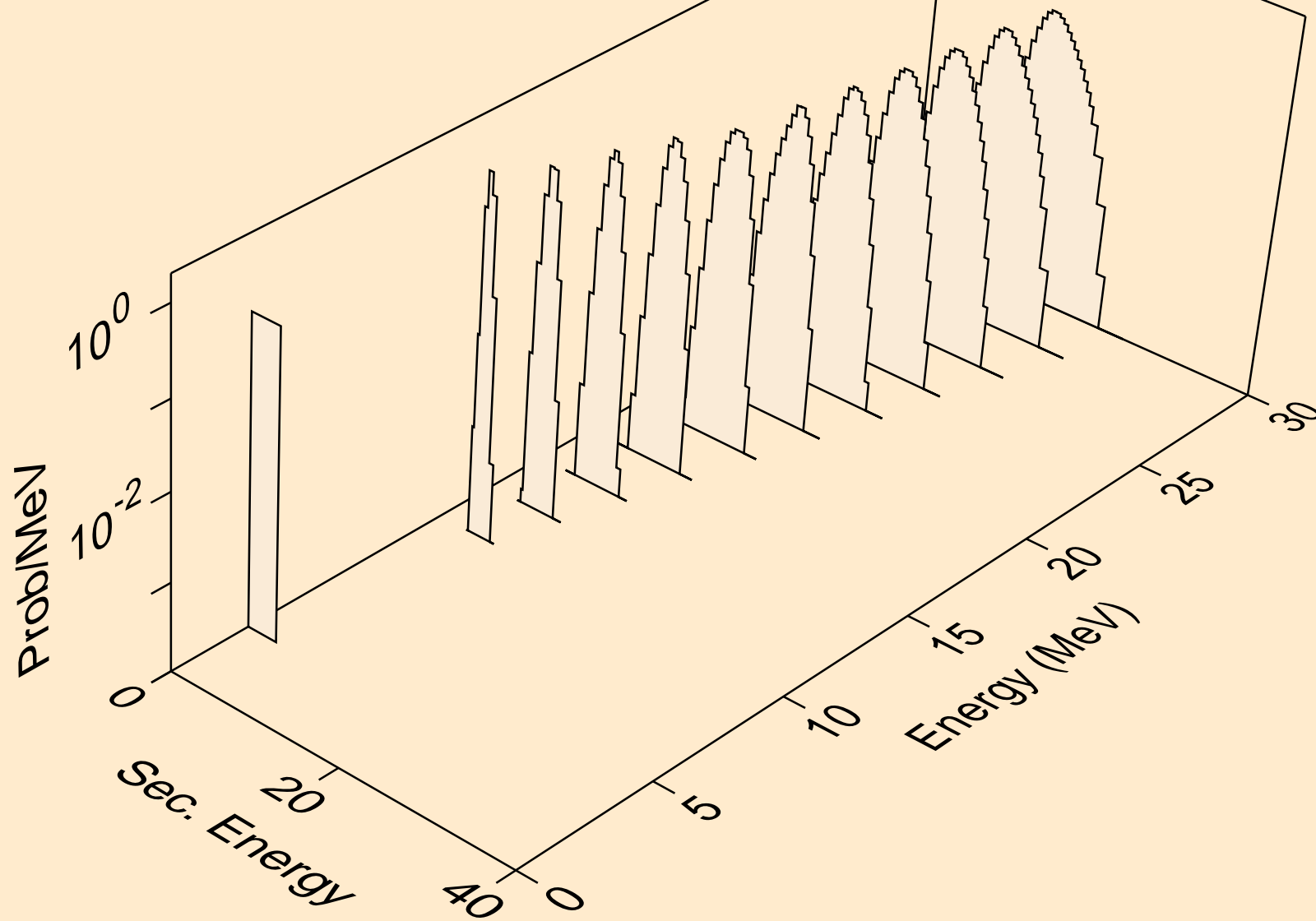

TE120 NEUTRON ACER TENDL-2024 LIBRARY; T=0.K  
alphas from (n,da)

