

# TH238 NEUTRON ACER TENDL-2024 LIBRARY; T=0.K

## Principal cross sections

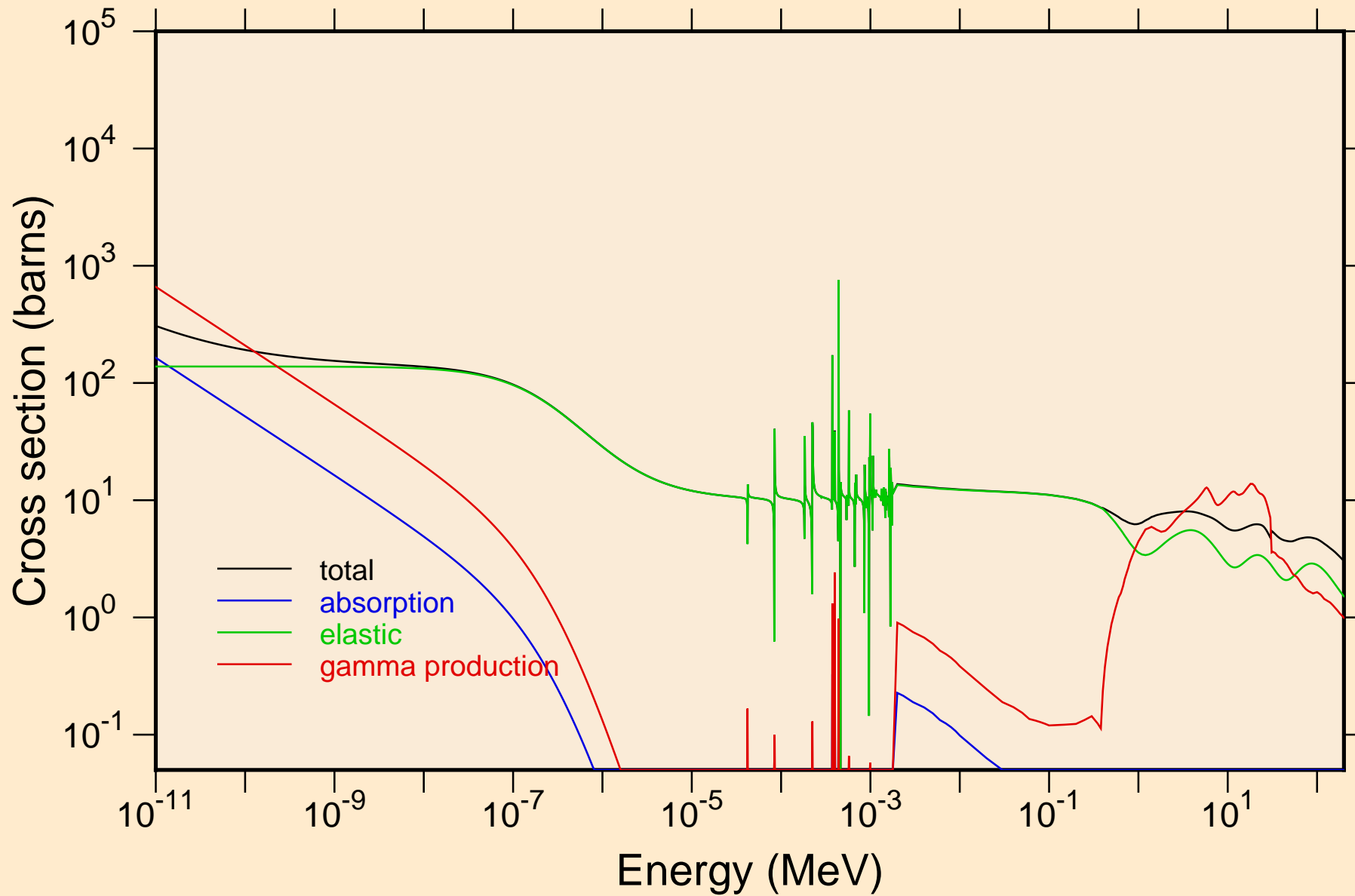

TH238 NEUTRON ACER TENDL-2024 LIBRARY; T=0.K  
resonance total cross section

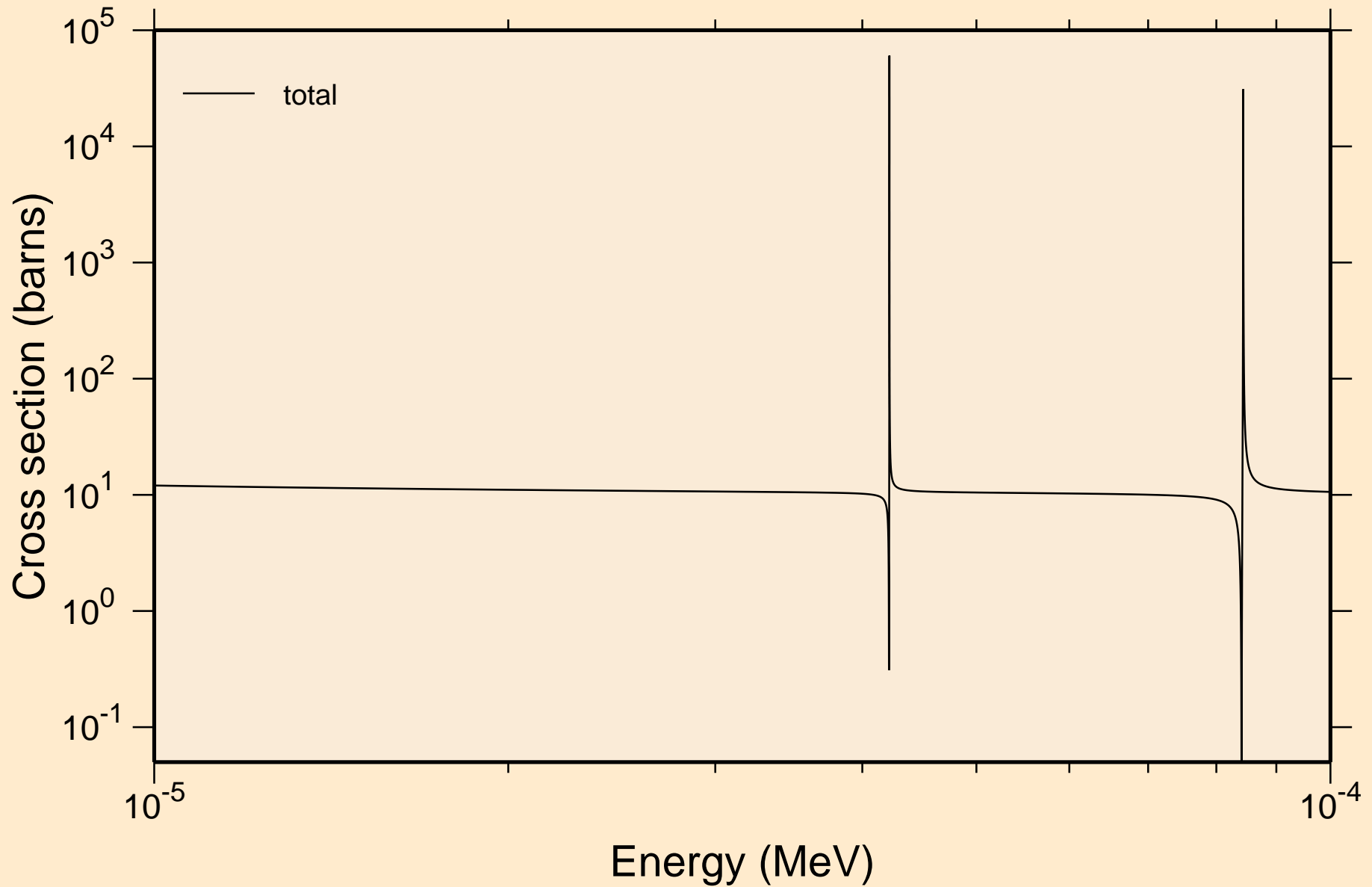

TH238 NEUTRON ACER TENDL-2024 LIBRARY; T=0.K  
resonance total cross section

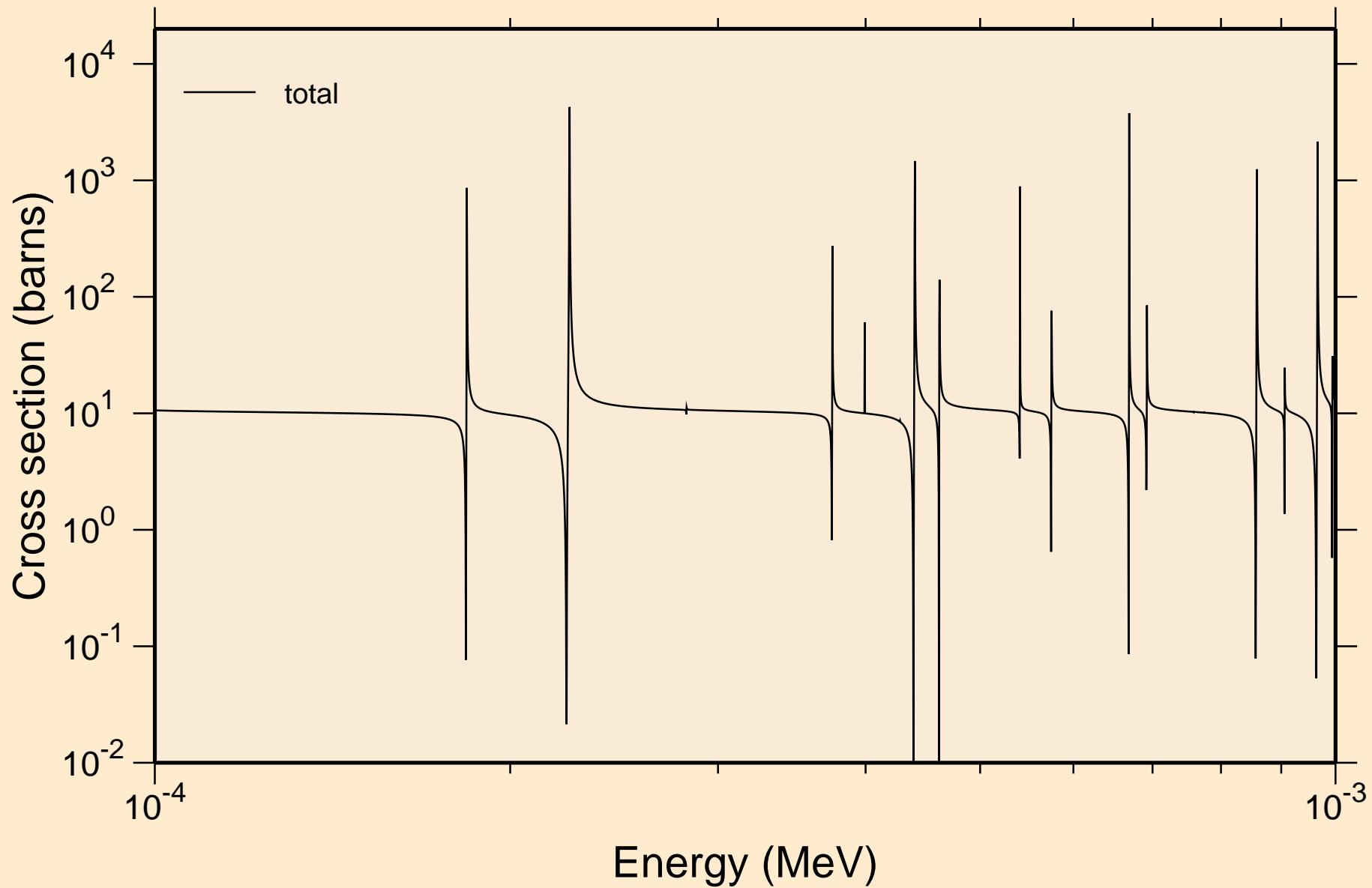

TH238 NEUTRON ACER TENDL-2024 LIBRARY; T=0.K  
resonance total cross section

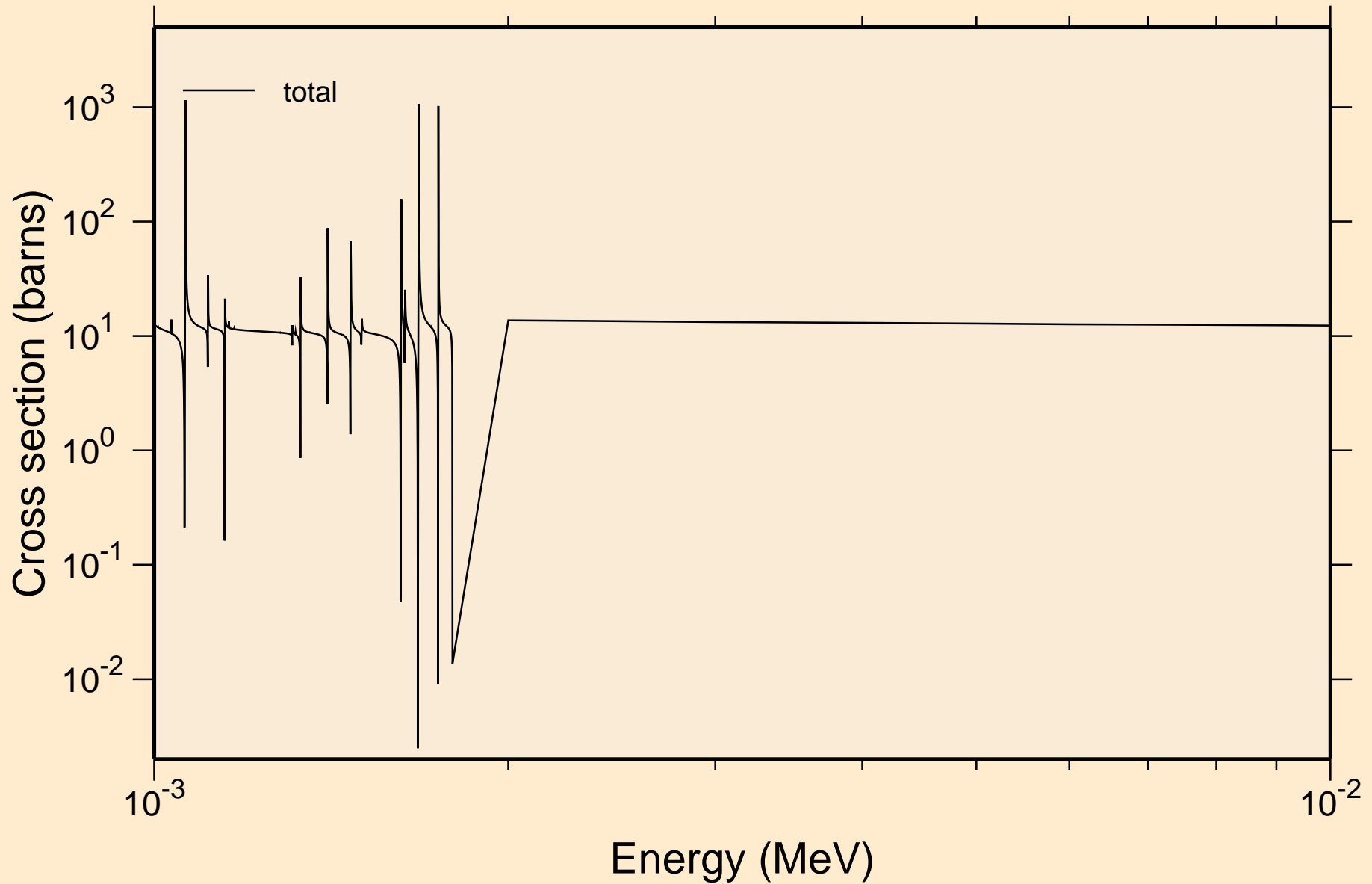

TH238 NEUTRON ACER TENDL-2024 LIBRARY; T=0.K  
resonance total cross section

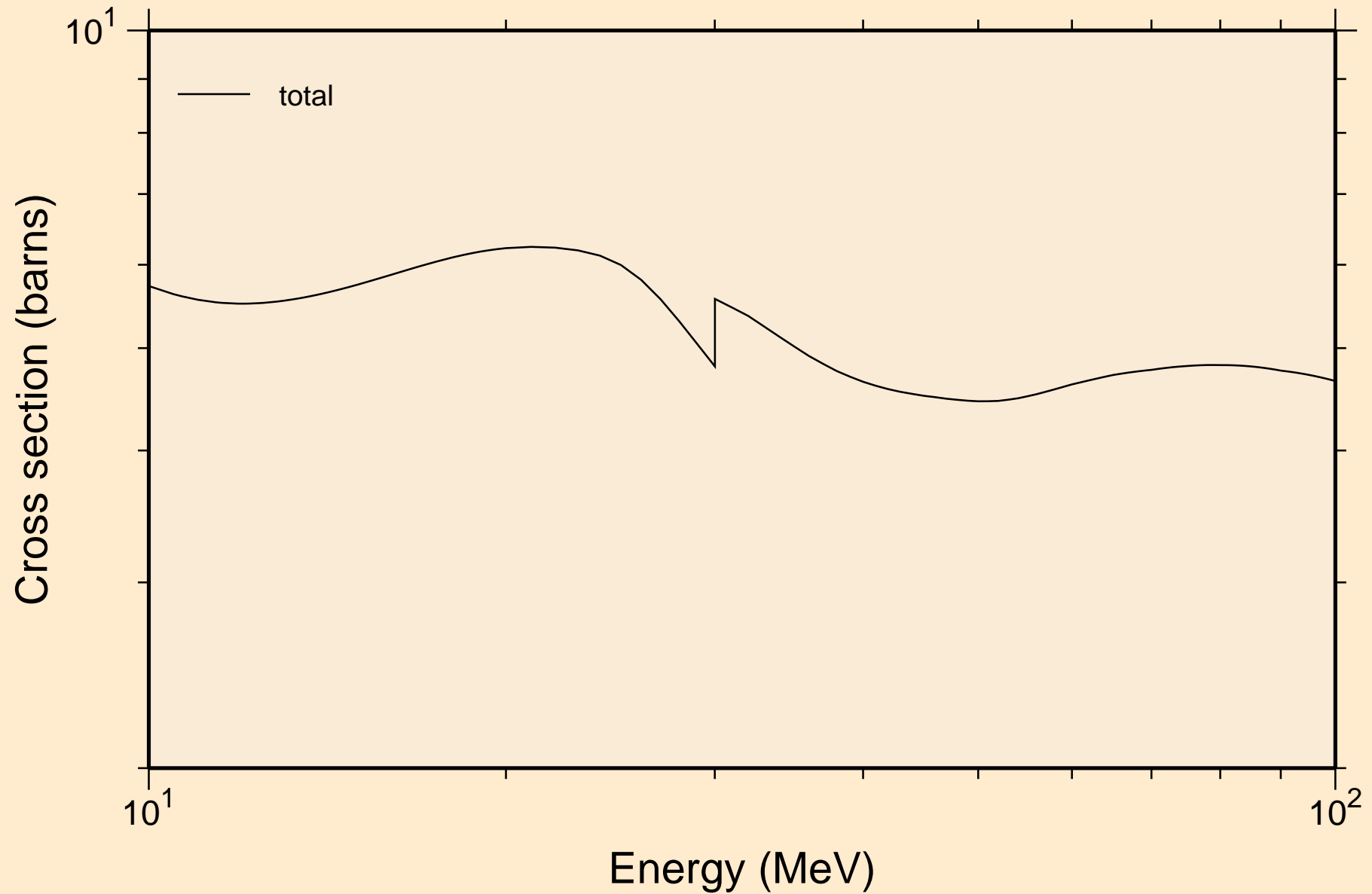

TH238 NEUTRON ACER TENDL-2024 LIBRARY; T=0.K  
resonance absorption cross sections

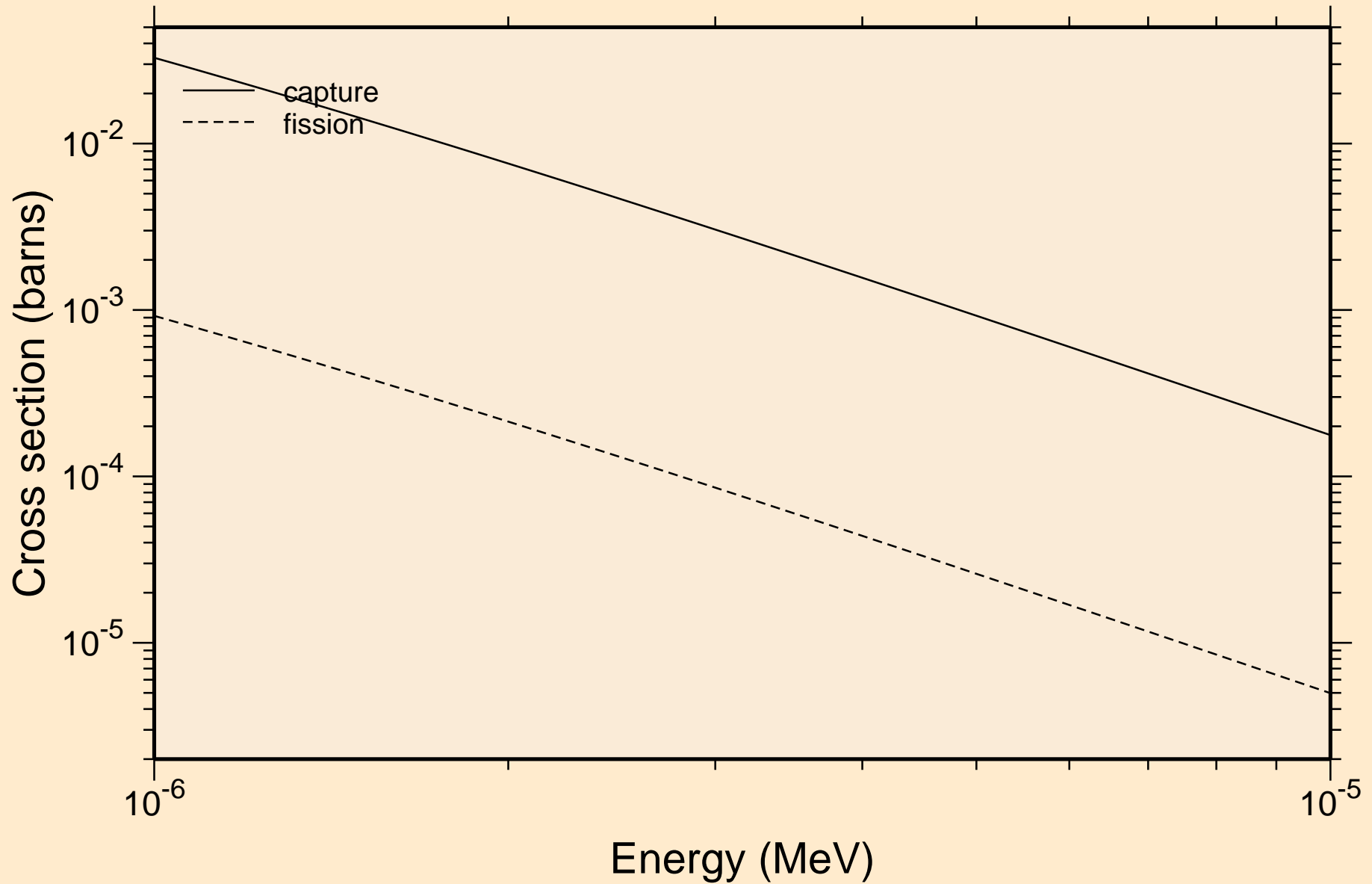

TH238 NEUTRON ACER TENDL-2024 LIBRARY; T=0.K  
resonance absorption cross sections

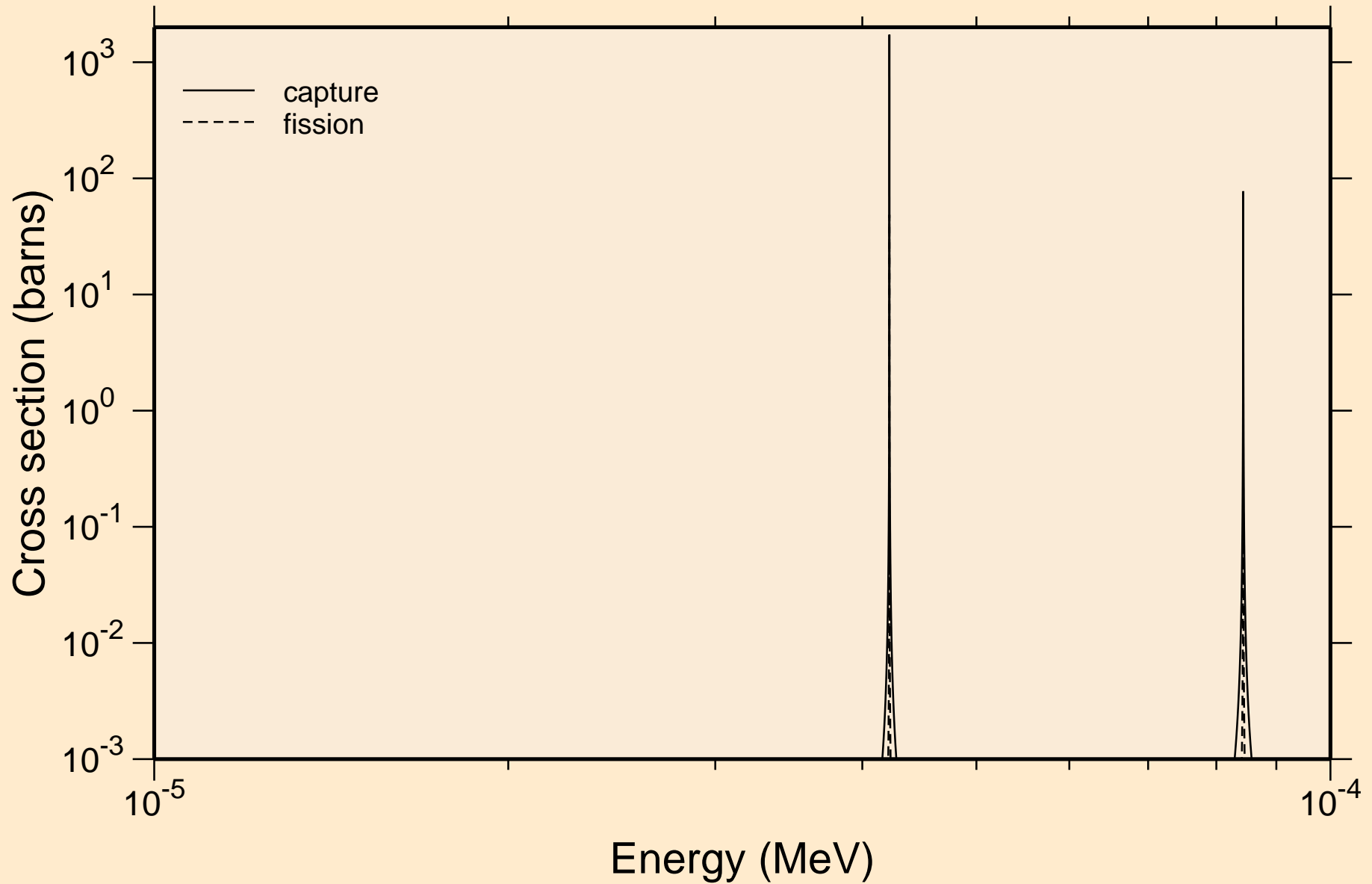

# TH238 NEUTRON ACER TENDL-2024 LIBRARY; T=0.K

## resonance absorption cross sections

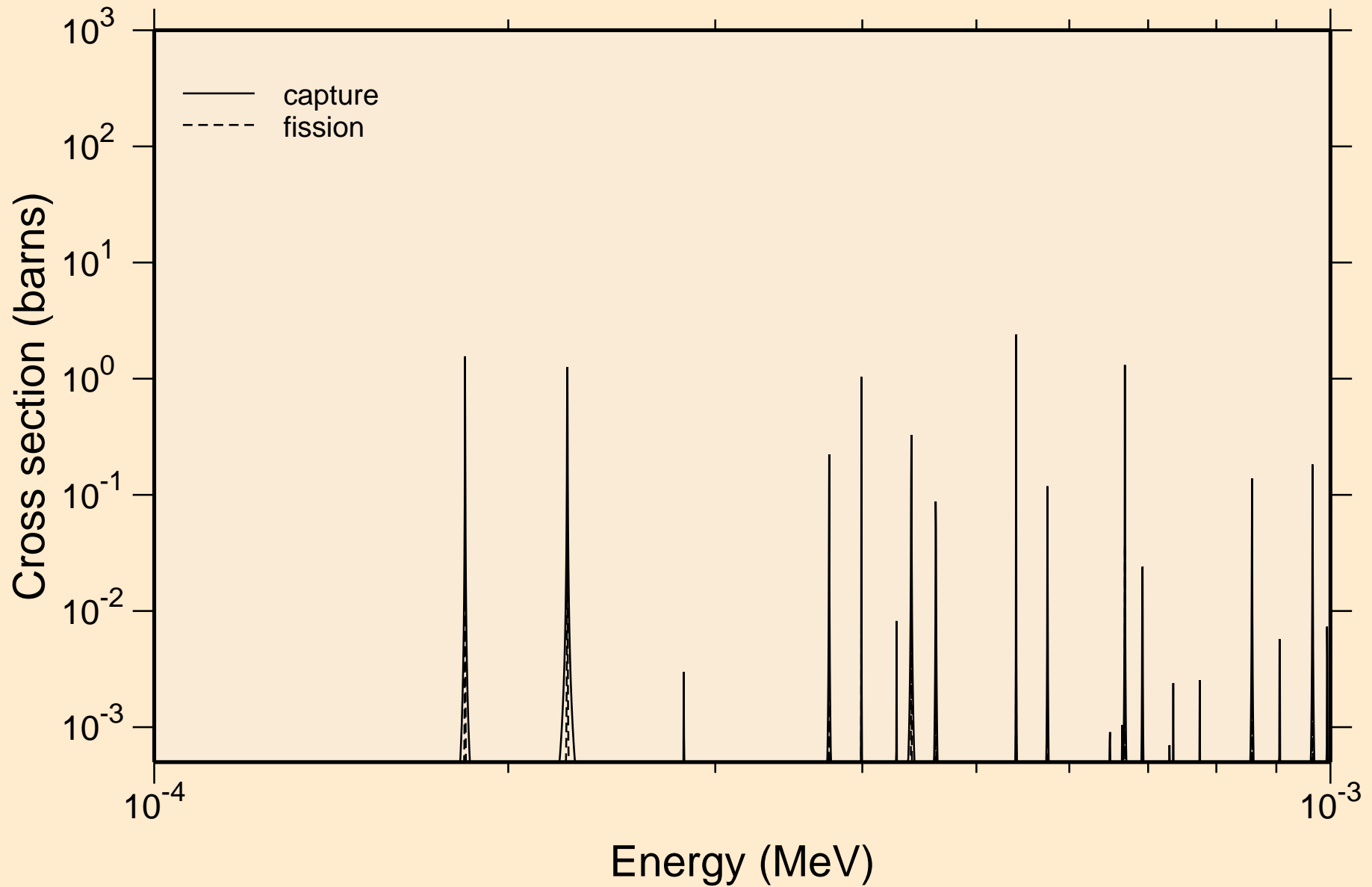



TH238 NEUTRON ACER TENDL-2024 LIBRARY; T=0.K  
resonance absorption cross sections

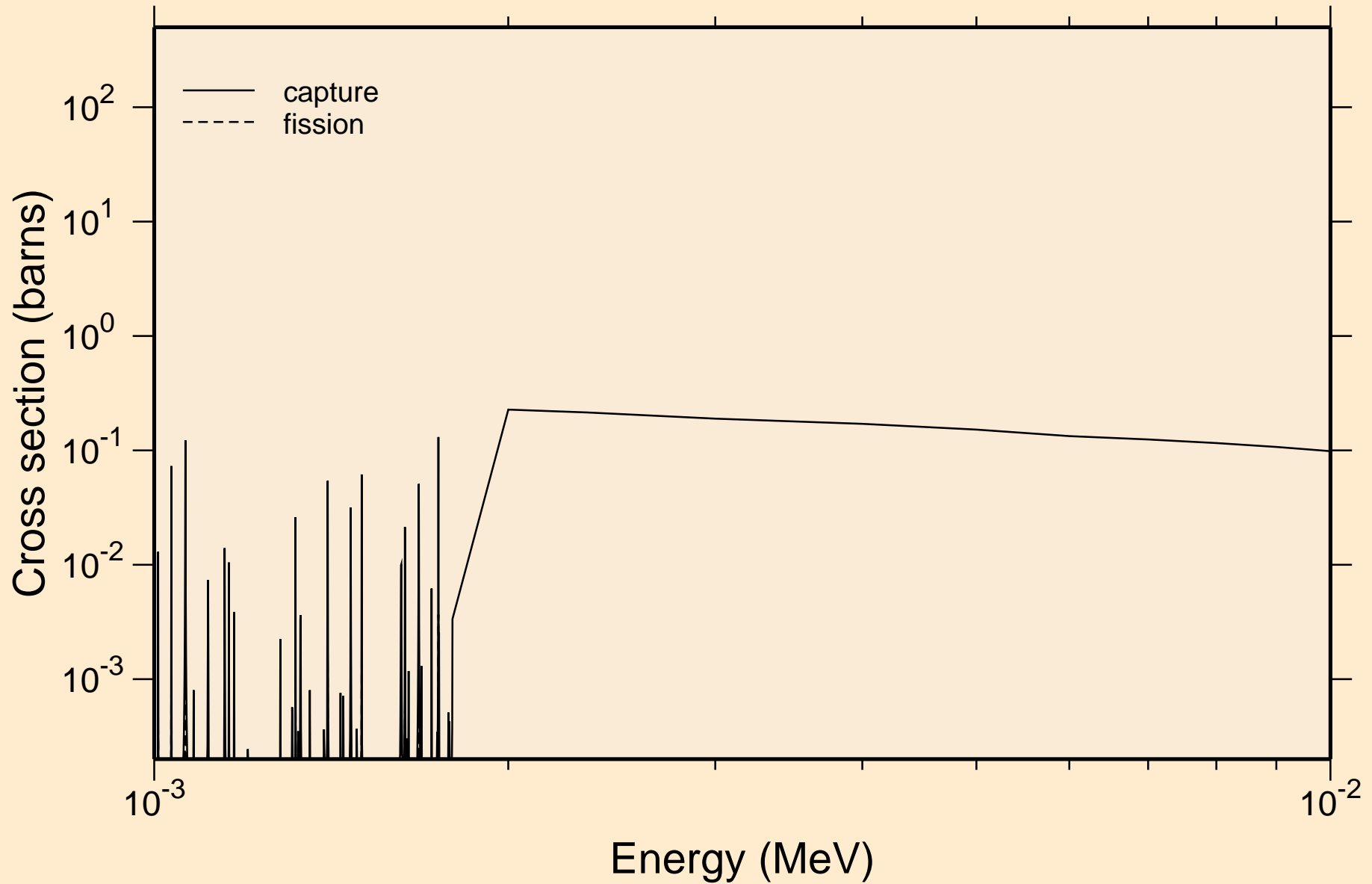

TH238 NEUTRON ACER TENDL-2024 LIBRARY; T=0.K  
resonance absorption cross sections

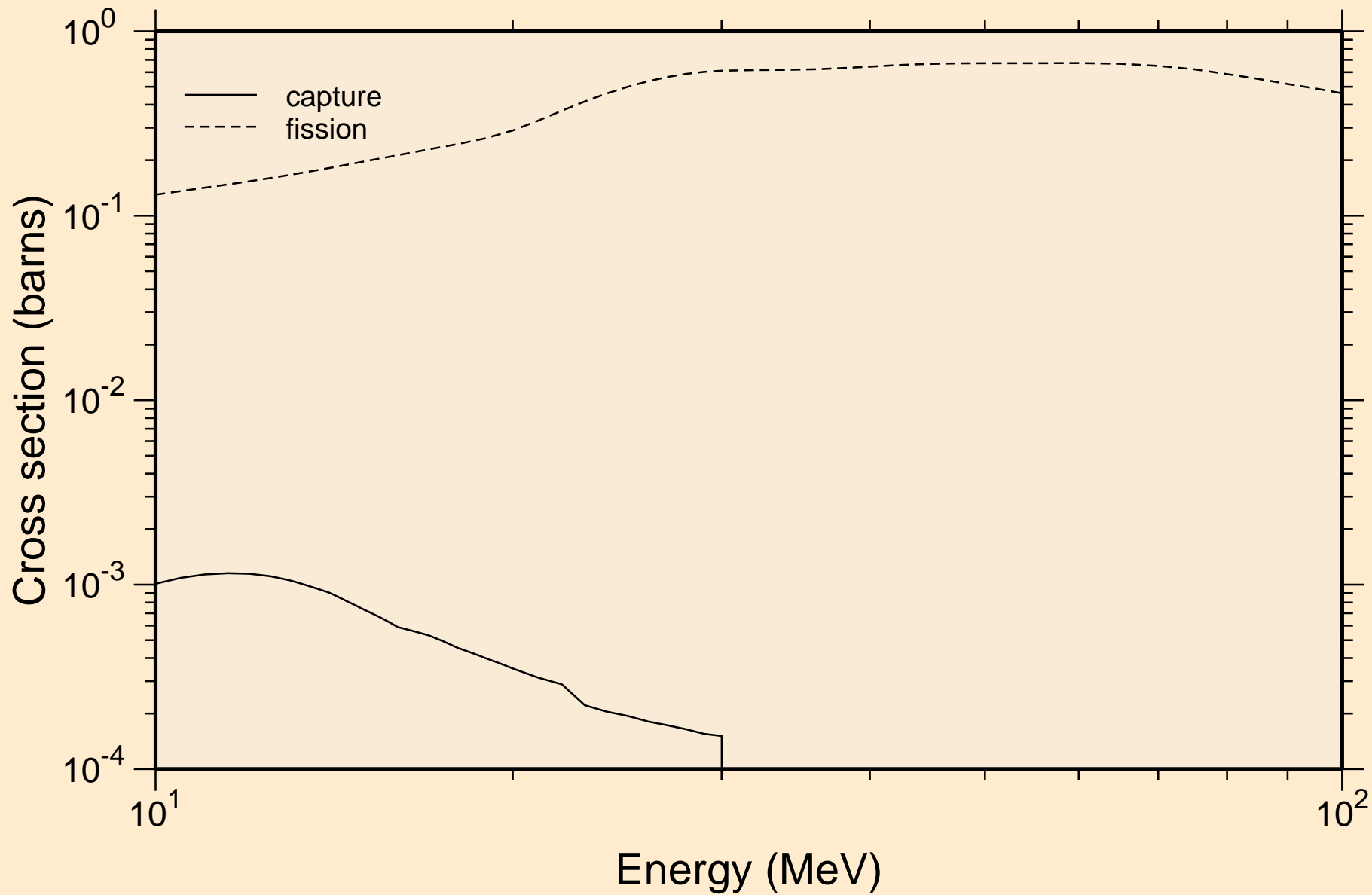

TH238 NEUTRON ACER TENDL-2024 LIBRARY; T=0.K  
Heating

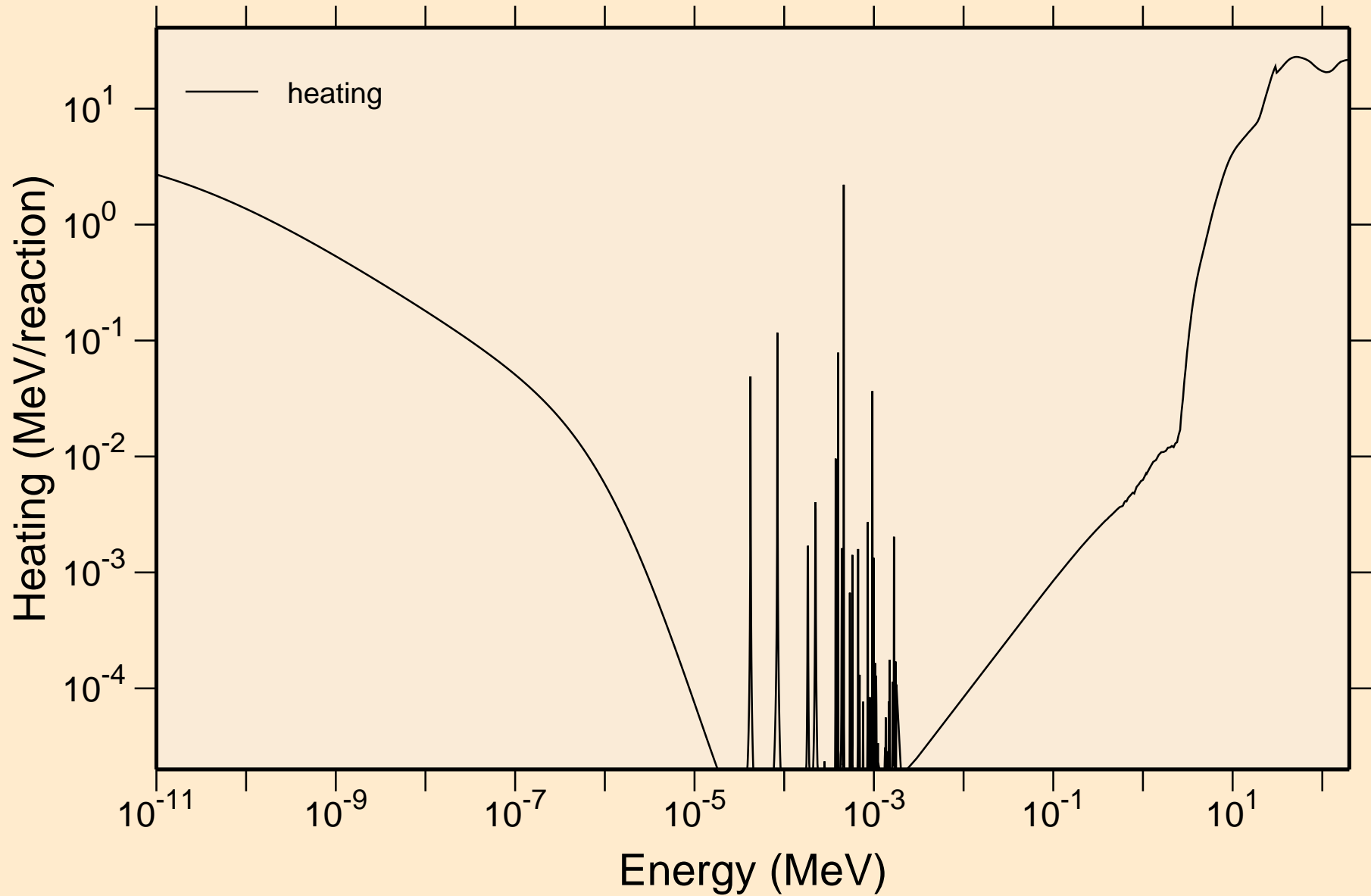

# TH238 NEUTRON ACER TENDL-2024 LIBRARY; T=0.K

## Damage

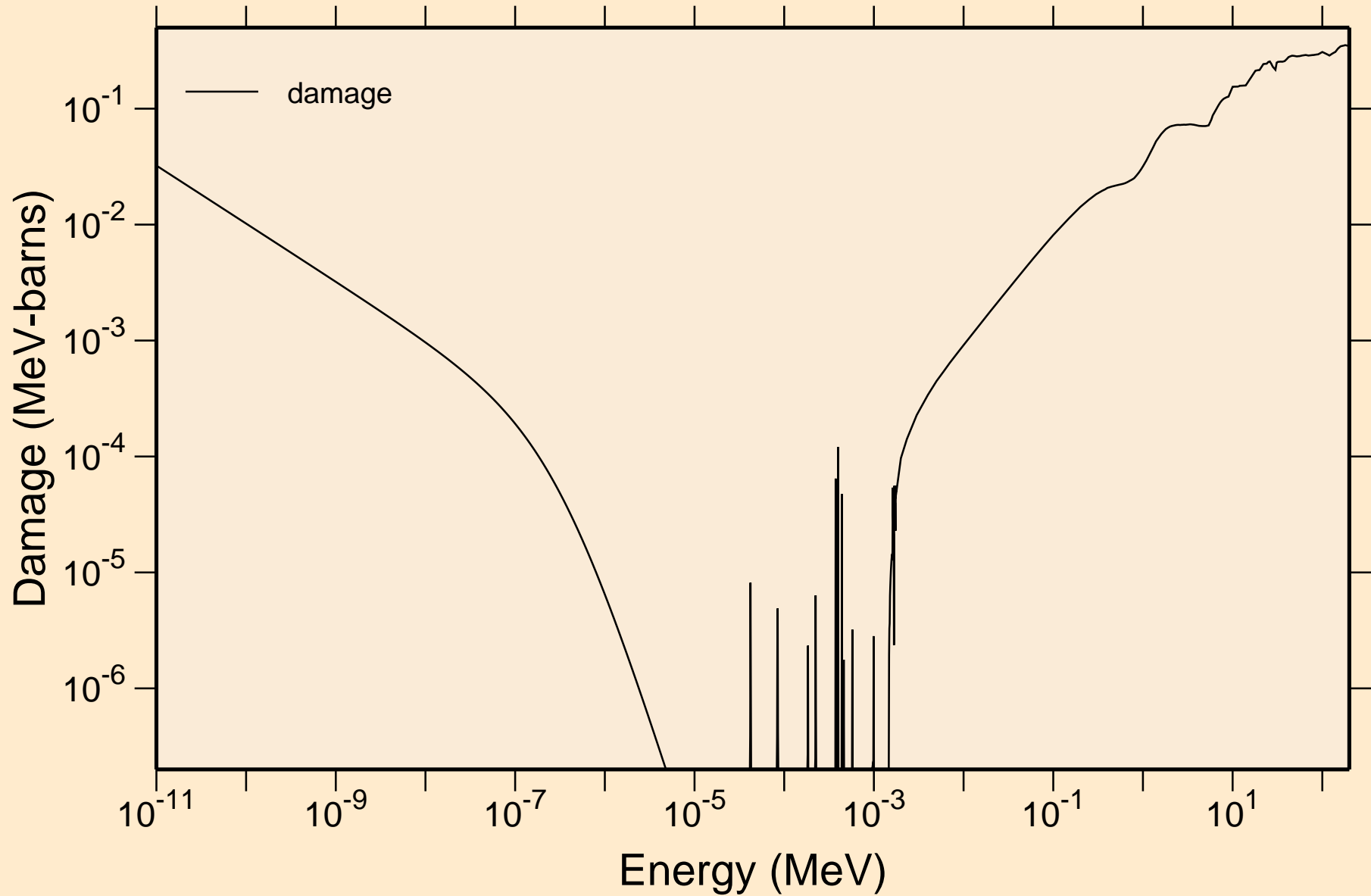

# TH238 NEUTRON ACER TENDL-2024 LIBRARY; T=0.K

## Non-threshold reactions

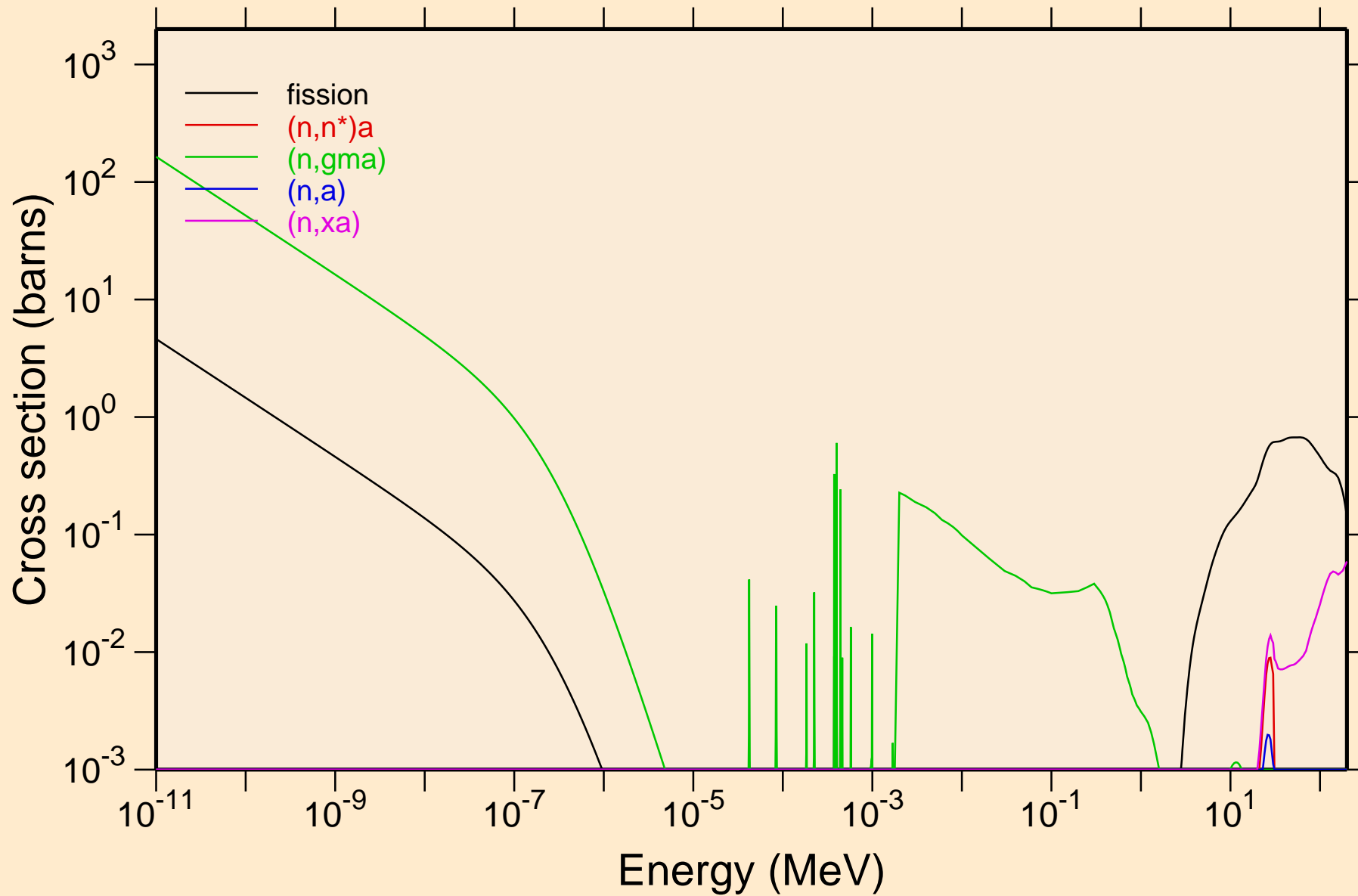

# TH238 NEUTRON ACER TENDL-2024 LIBRARY; T=0.K

## Principal cross sections

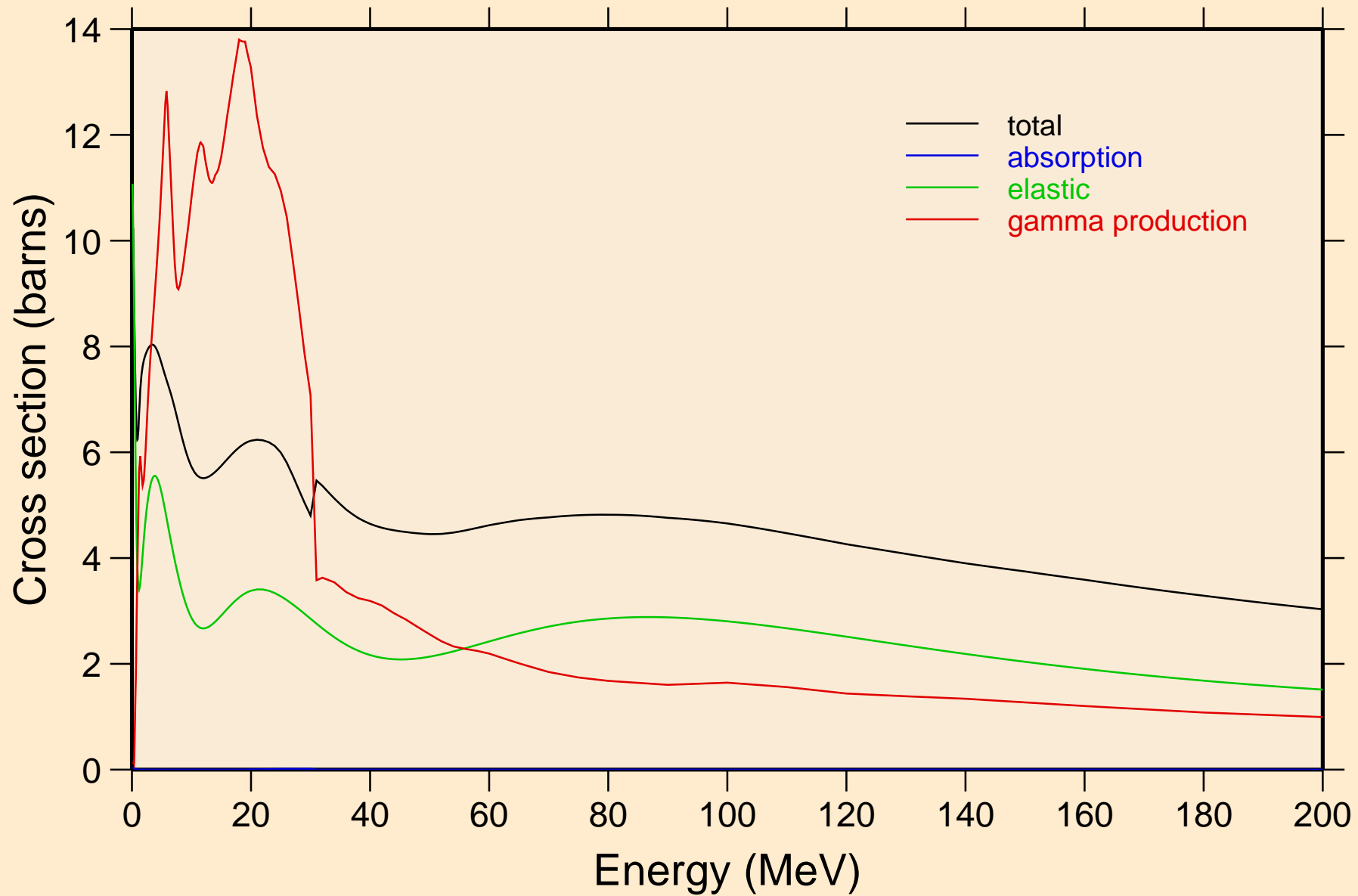

# TH238 NEUTRON ACER TENDL-2024 LIBRARY; T=0.K

## Heating

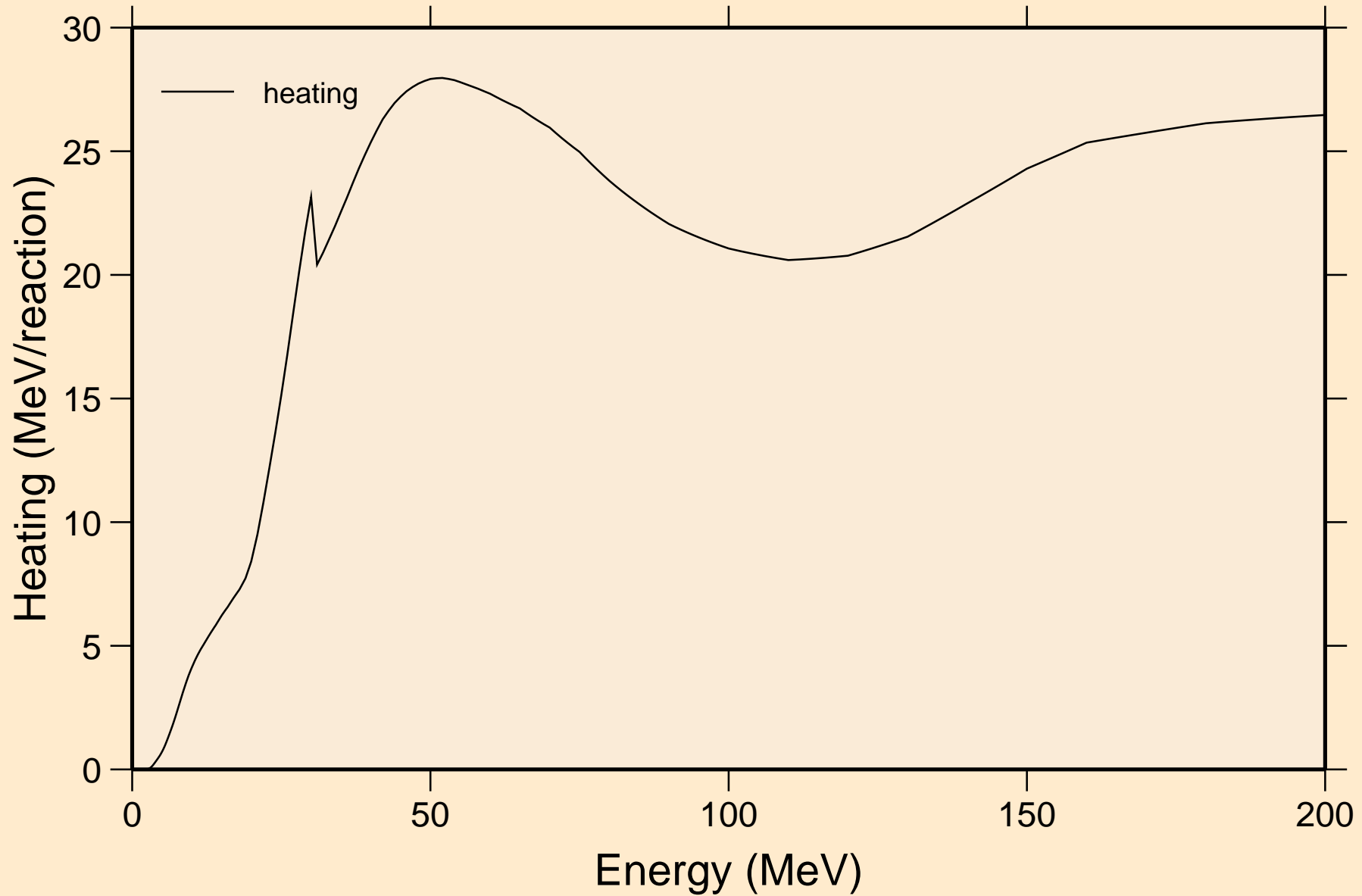

# TH238 NEUTRON ACER TENDL-2024 LIBRARY; T=0.K

## Damage

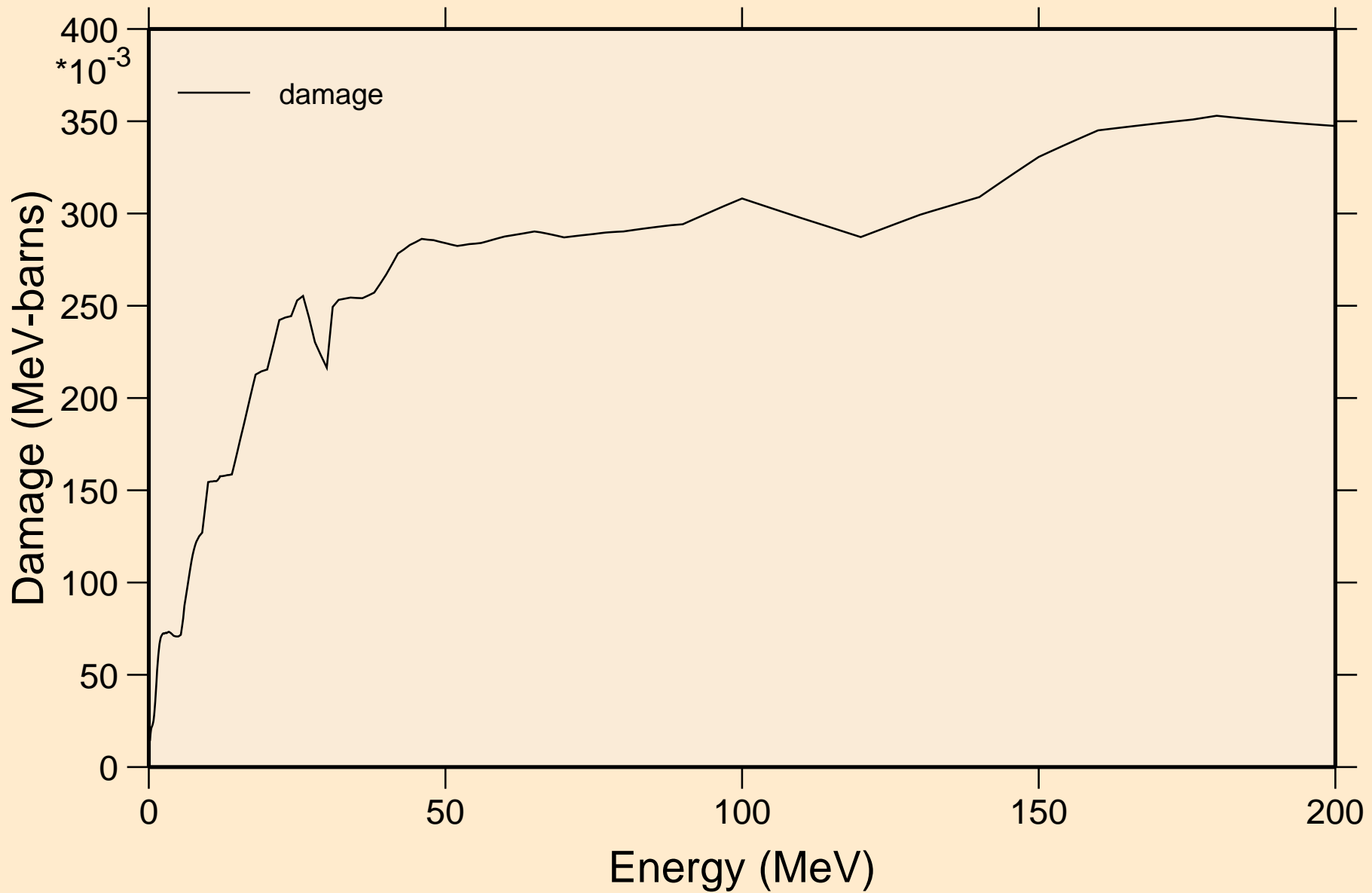



# TH238 NEUTRON ACER TENDL-2024 LIBRARY; T=0.K

## Non-threshold reactions

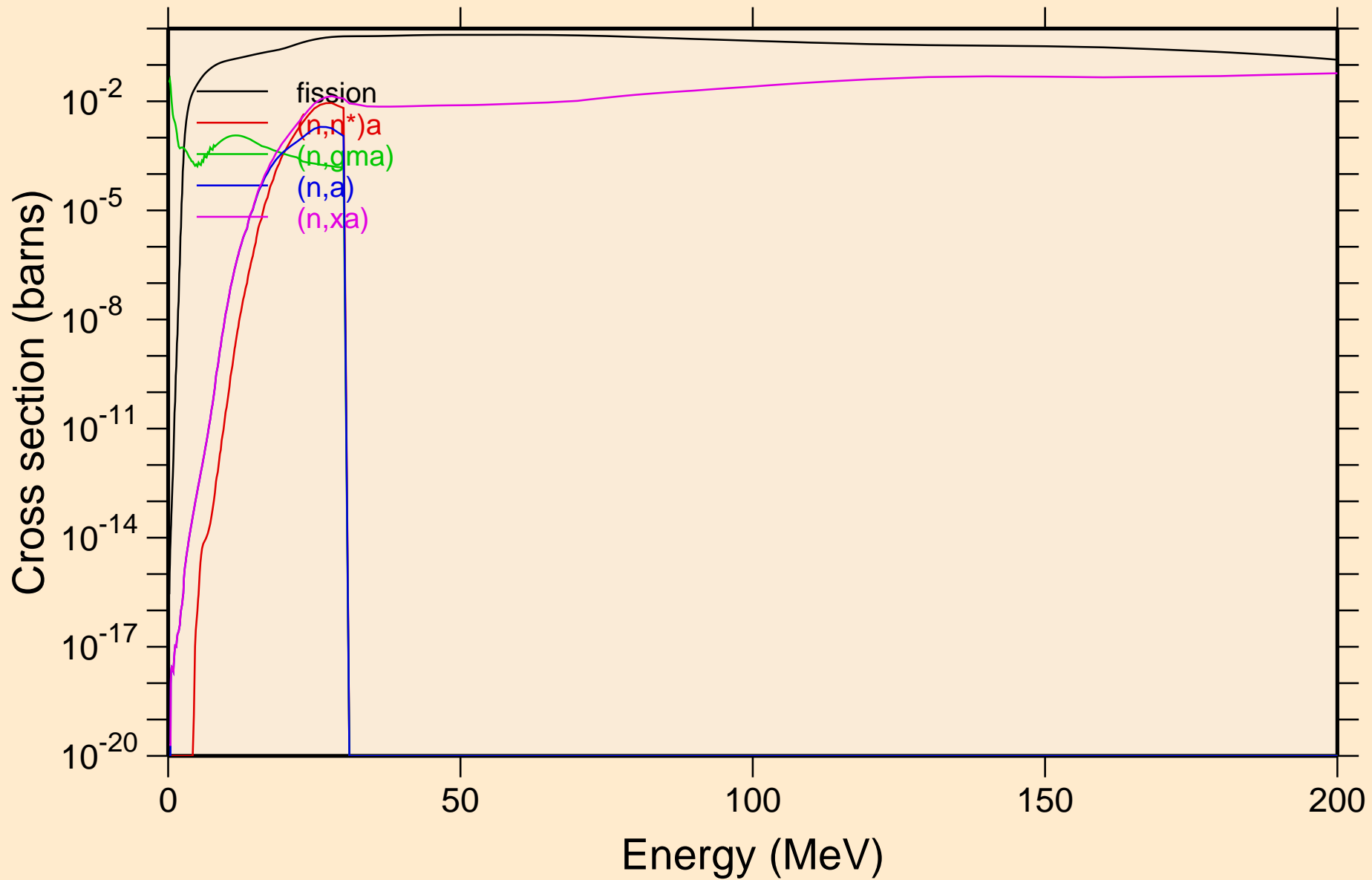

TH238 NEUTRON ACER TENDL-2024 LIBRARY; T=0.K  
Inelastic levels

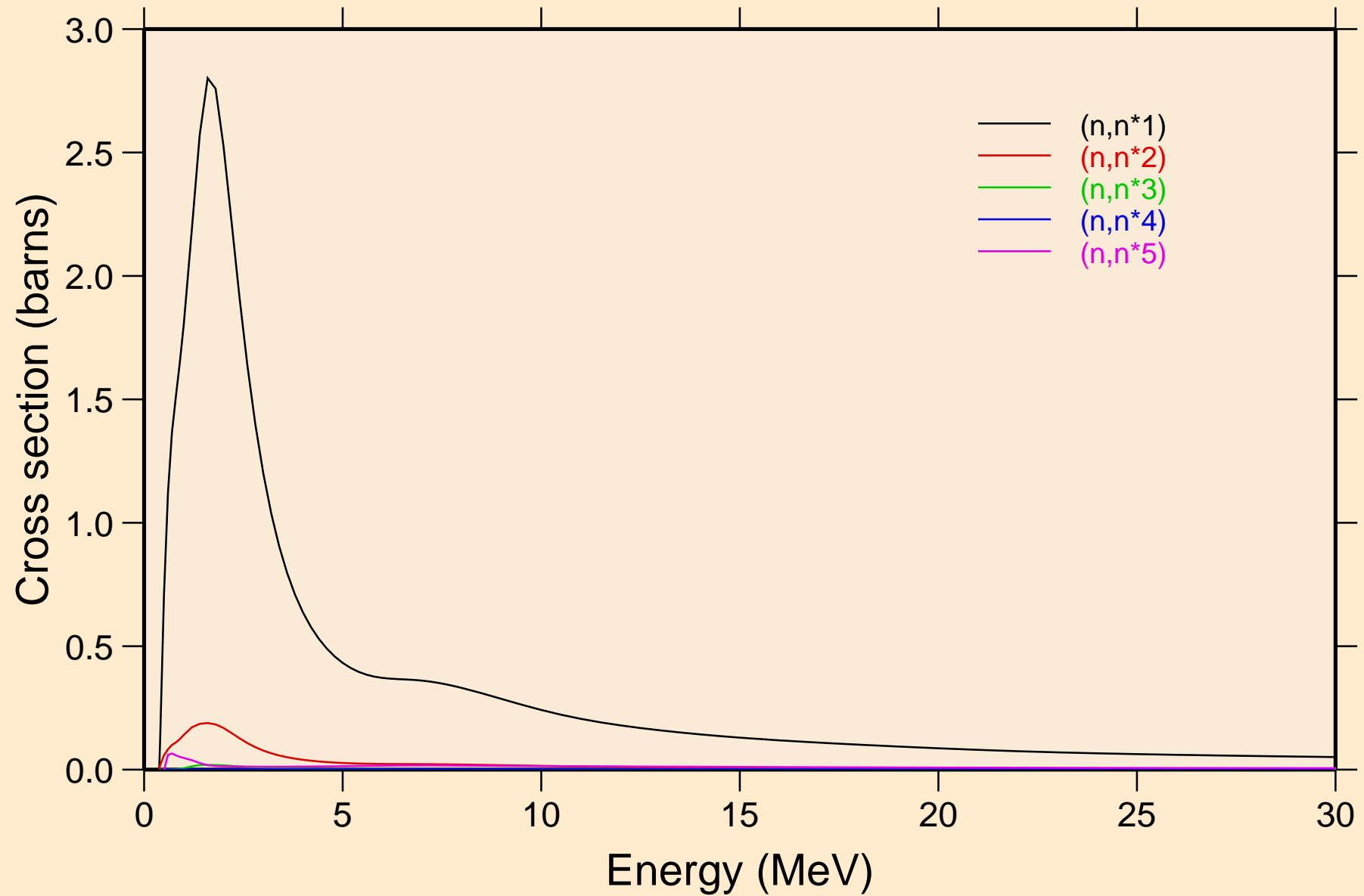

TH238 NEUTRON ACER TENDL-2024 LIBRARY; T=0.K  
Inelastic levels

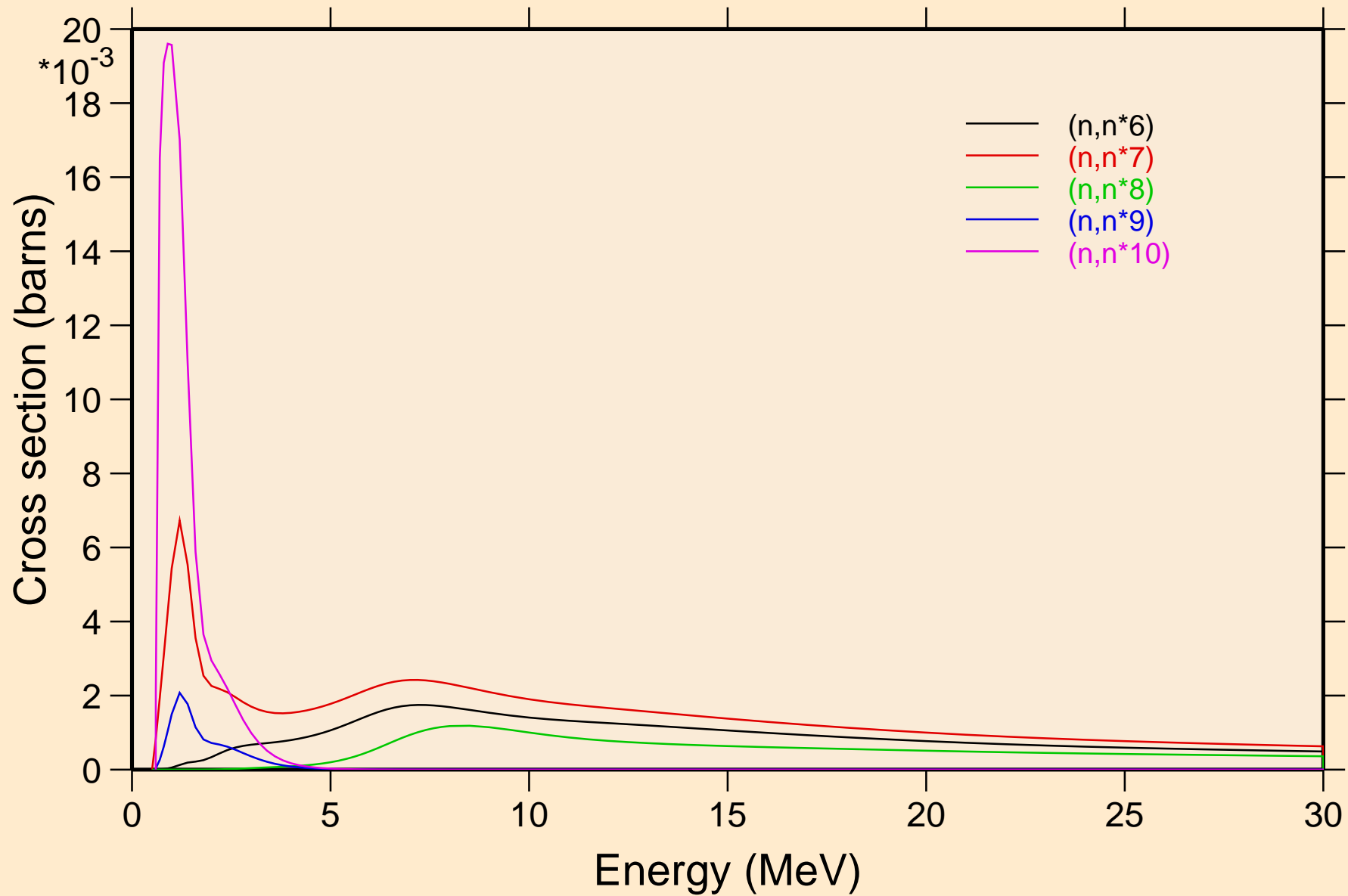

# TH238 NEUTRON ACER TENDL-2024 LIBRARY; T=0.K

## Inelastic levels

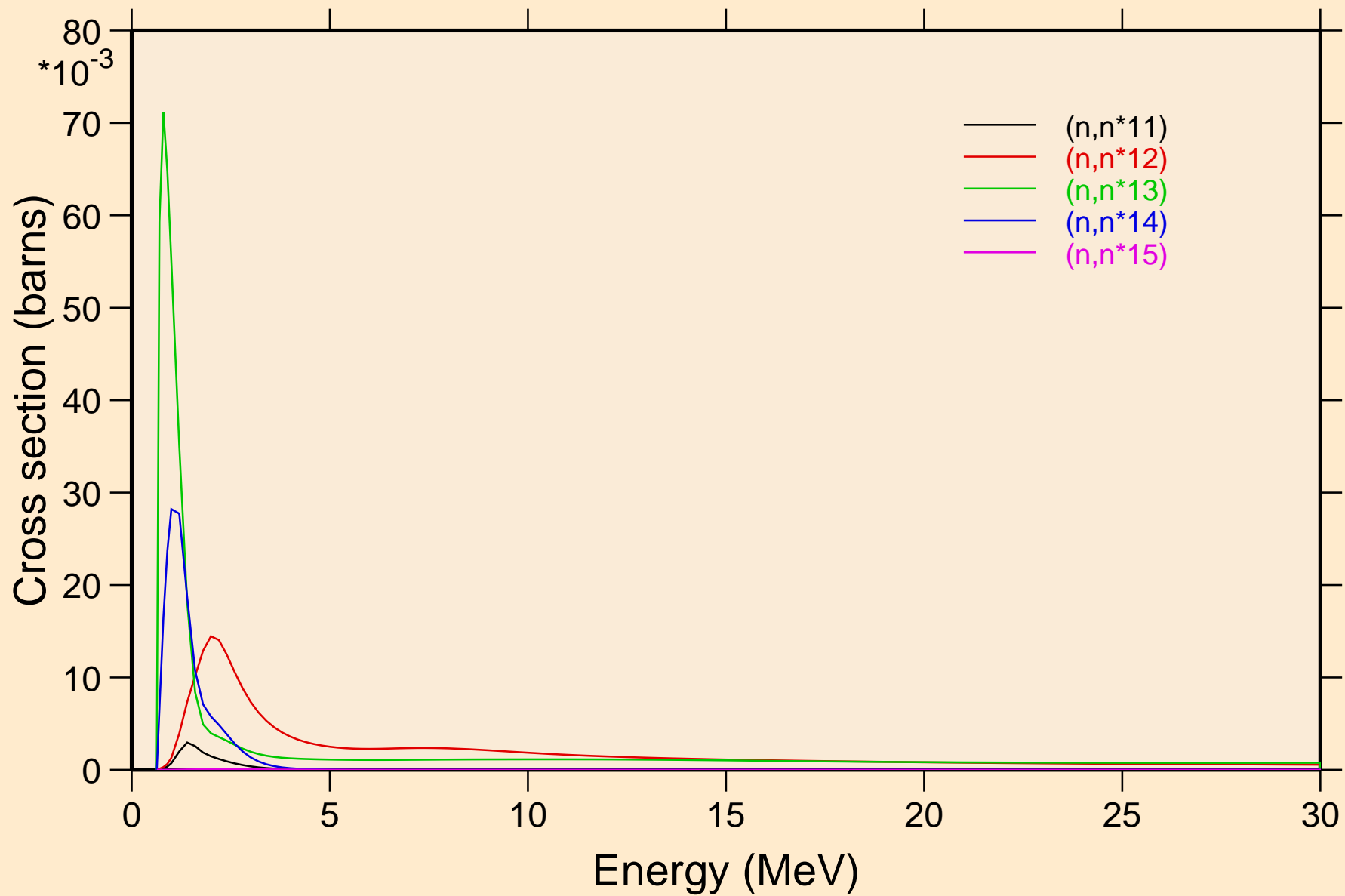

TH238 NEUTRON ACER TENDL-2024 LIBRARY; T=0.K  
Inelastic levels

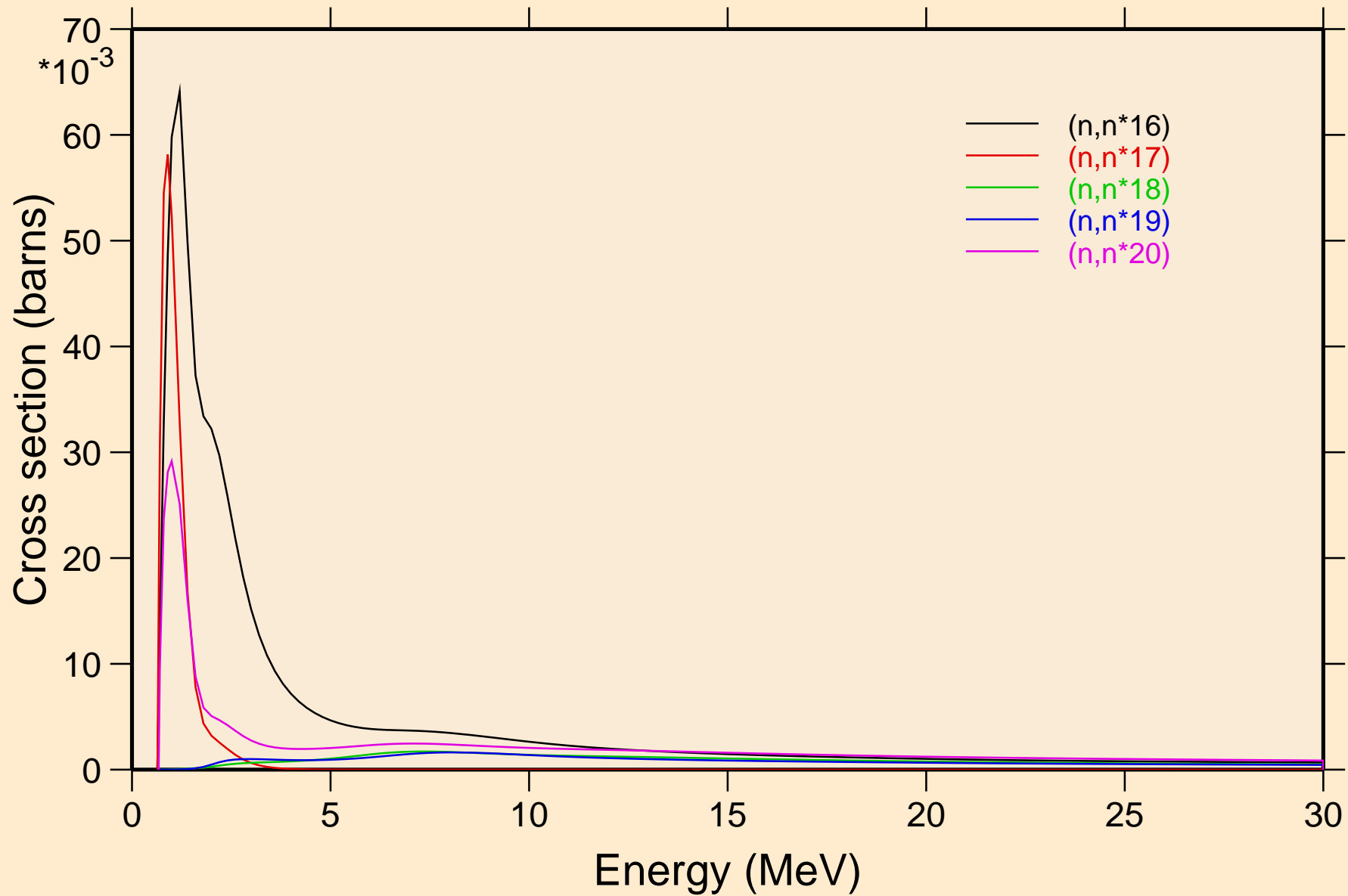

TH238 NEUTRON ACER TENDL-2024 LIBRARY; T=0.K  
Inelastic levels

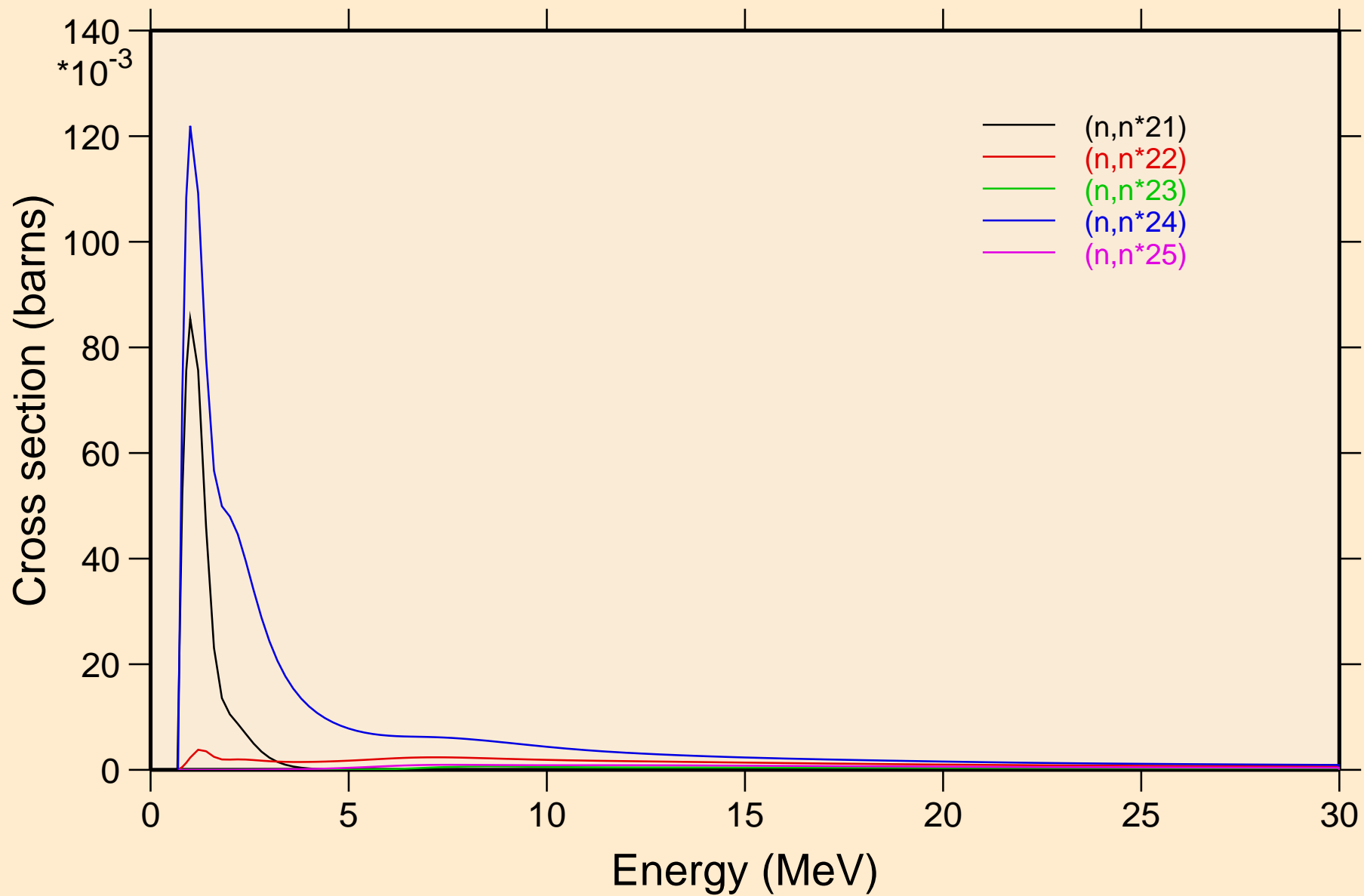

# TH238 NEUTRON ACER TENDL-2024 LIBRARY; T=0.K

## Inelastic levels

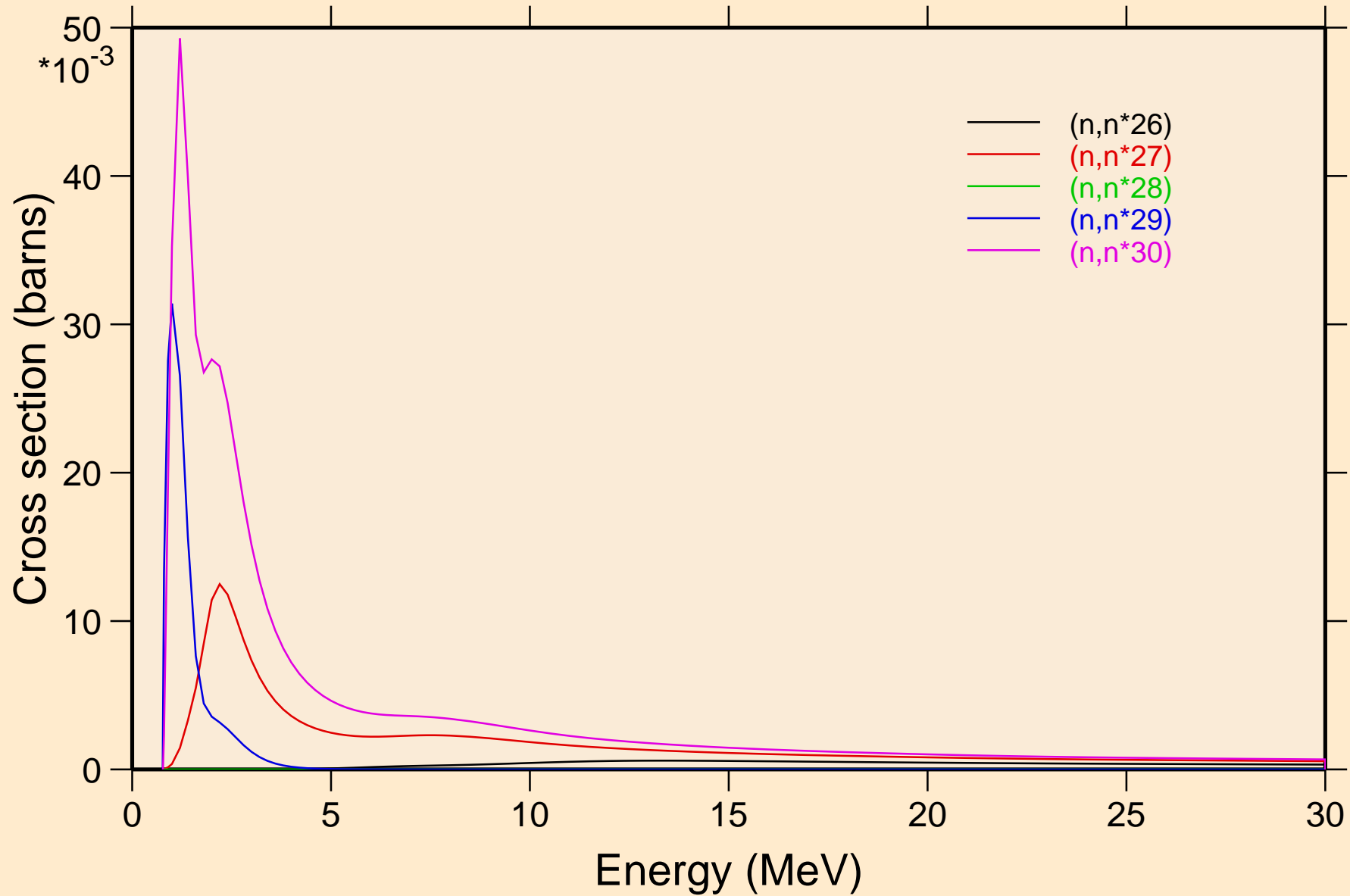

# TH238 NEUTRON ACER TENDL-2024 LIBRARY; T=0.K

## Threshold reactions

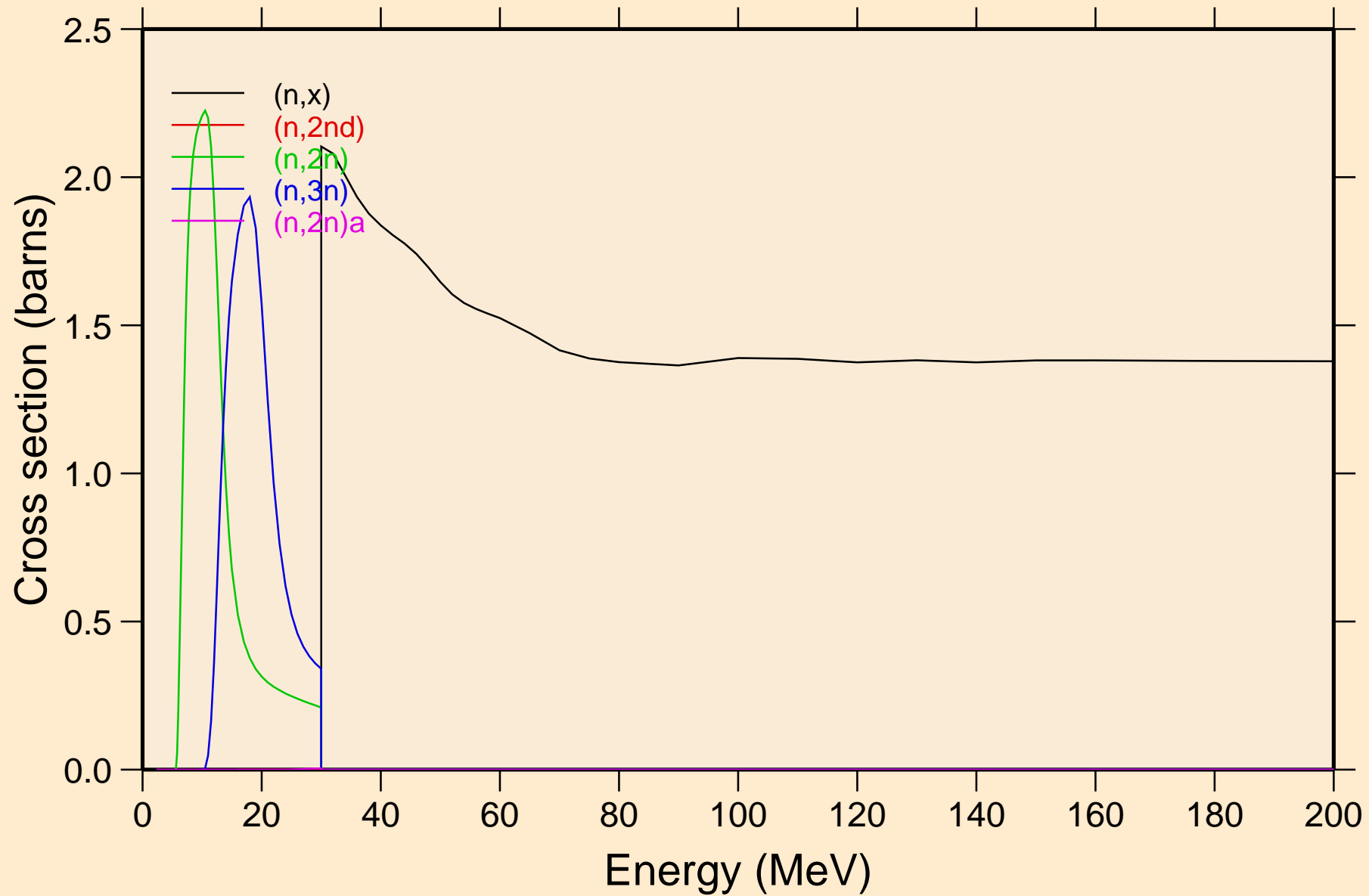



# TH238 NEUTRON ACER TENDL-2024 LIBRARY; T=0.K

## Threshold reactions

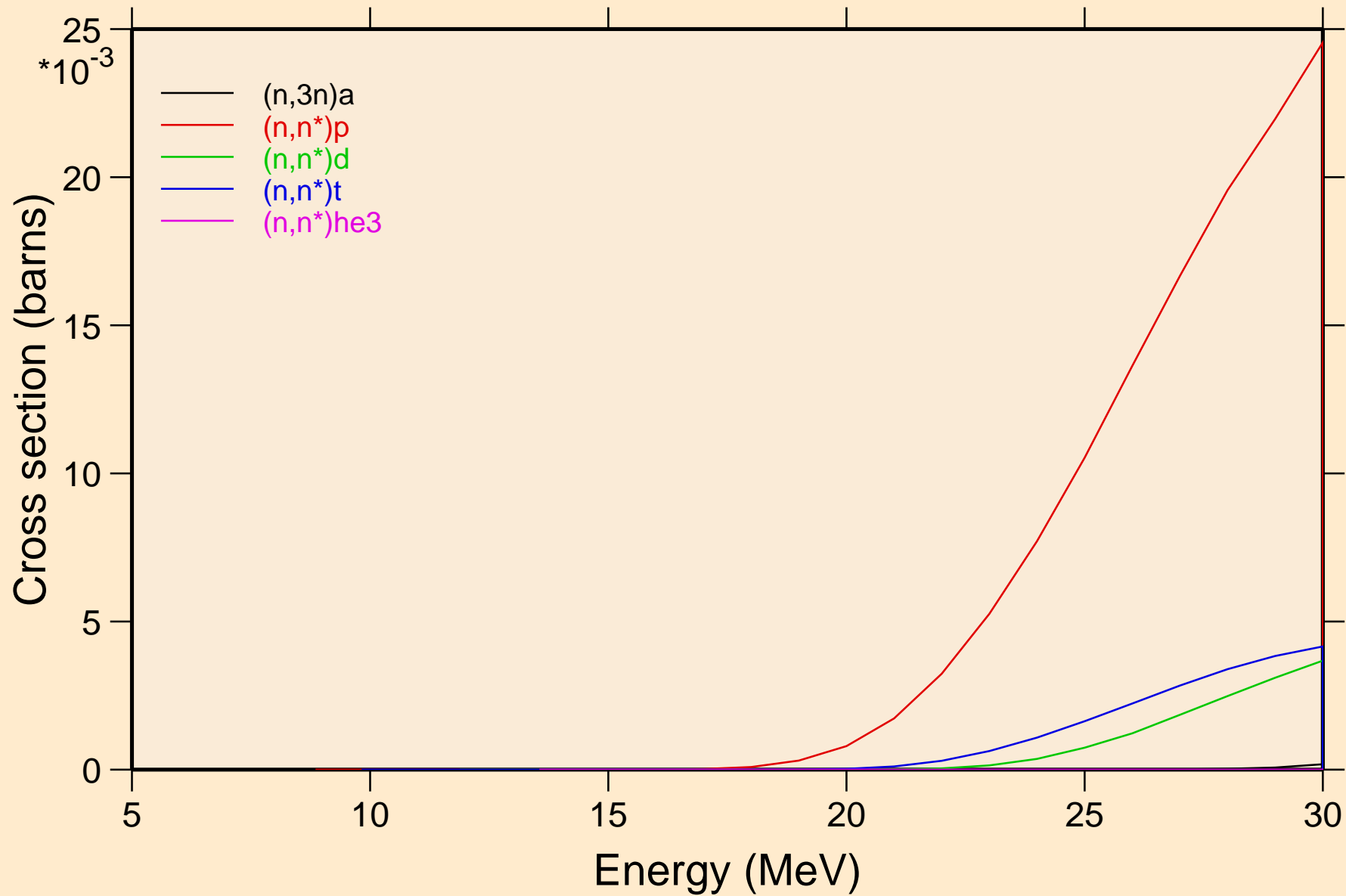

# TH238 NEUTRON ACER TENDL-2024 LIBRARY; T=0.K

## Threshold reactions

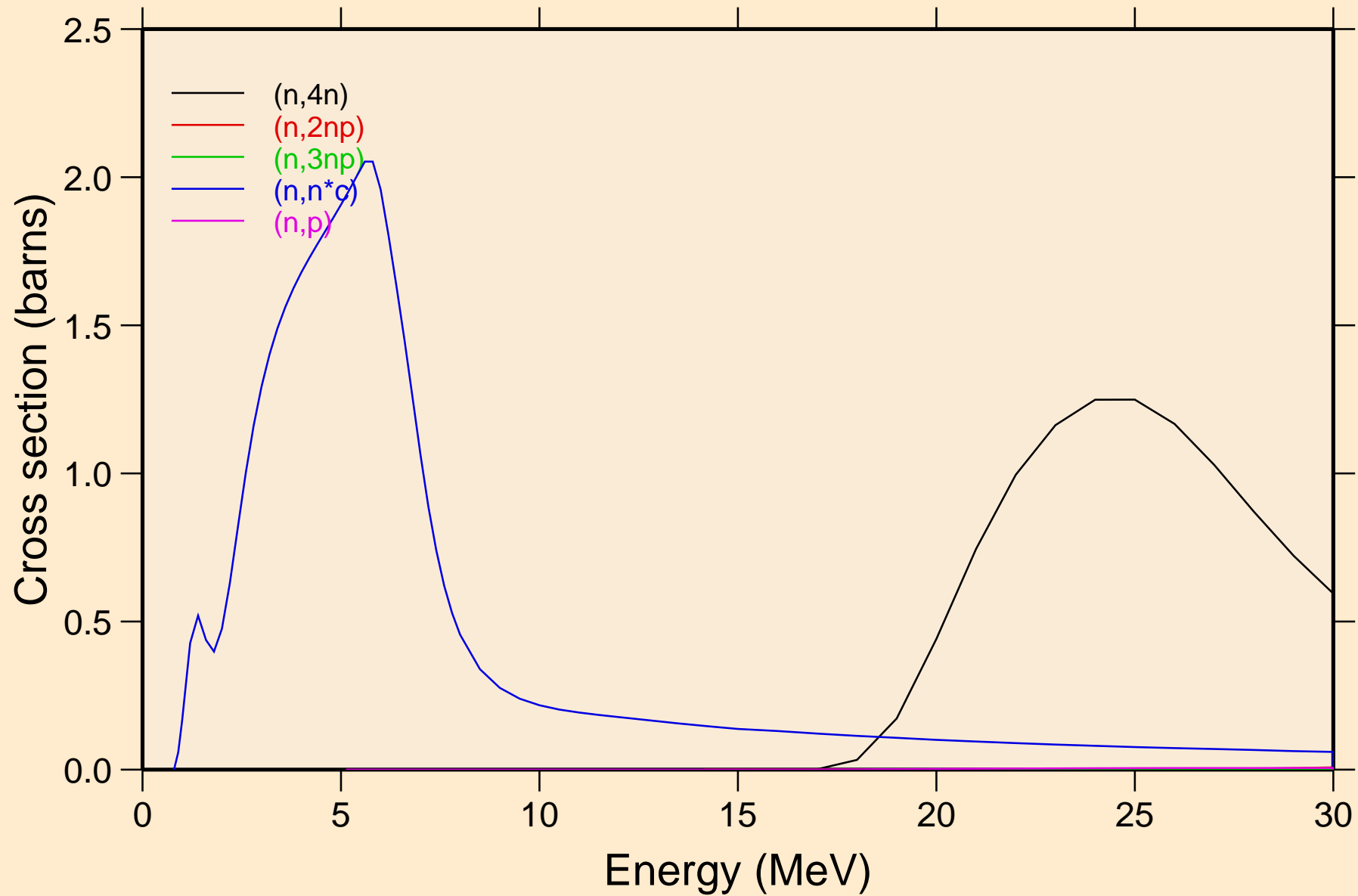

# TH238 NEUTRON ACER TENDL-2024 LIBRARY; T=0.K

## Threshold reactions

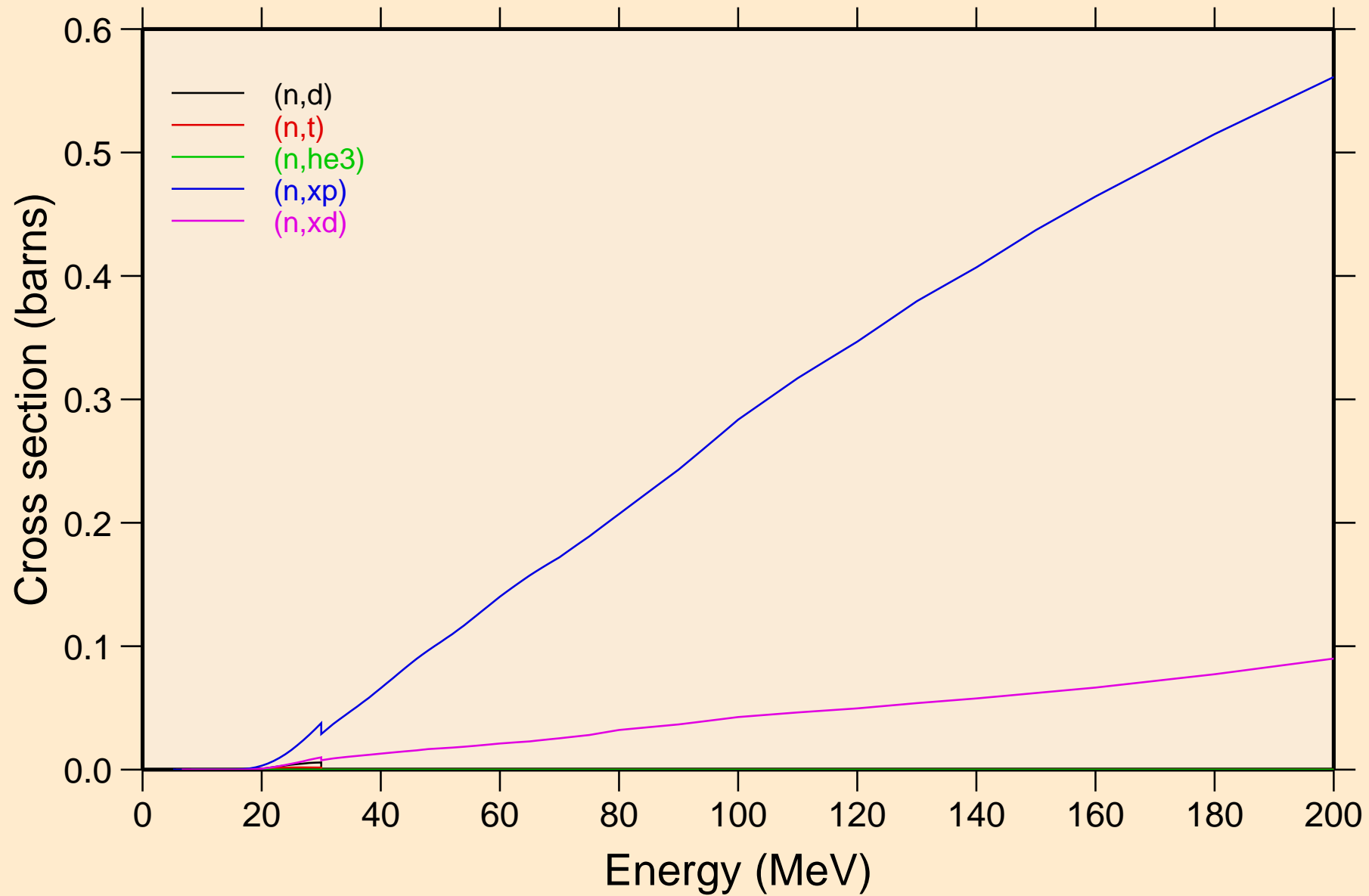

TH238 NEUTRON ACER TENDL-2024 LIBRARY; T=0.K  
Threshold reactions

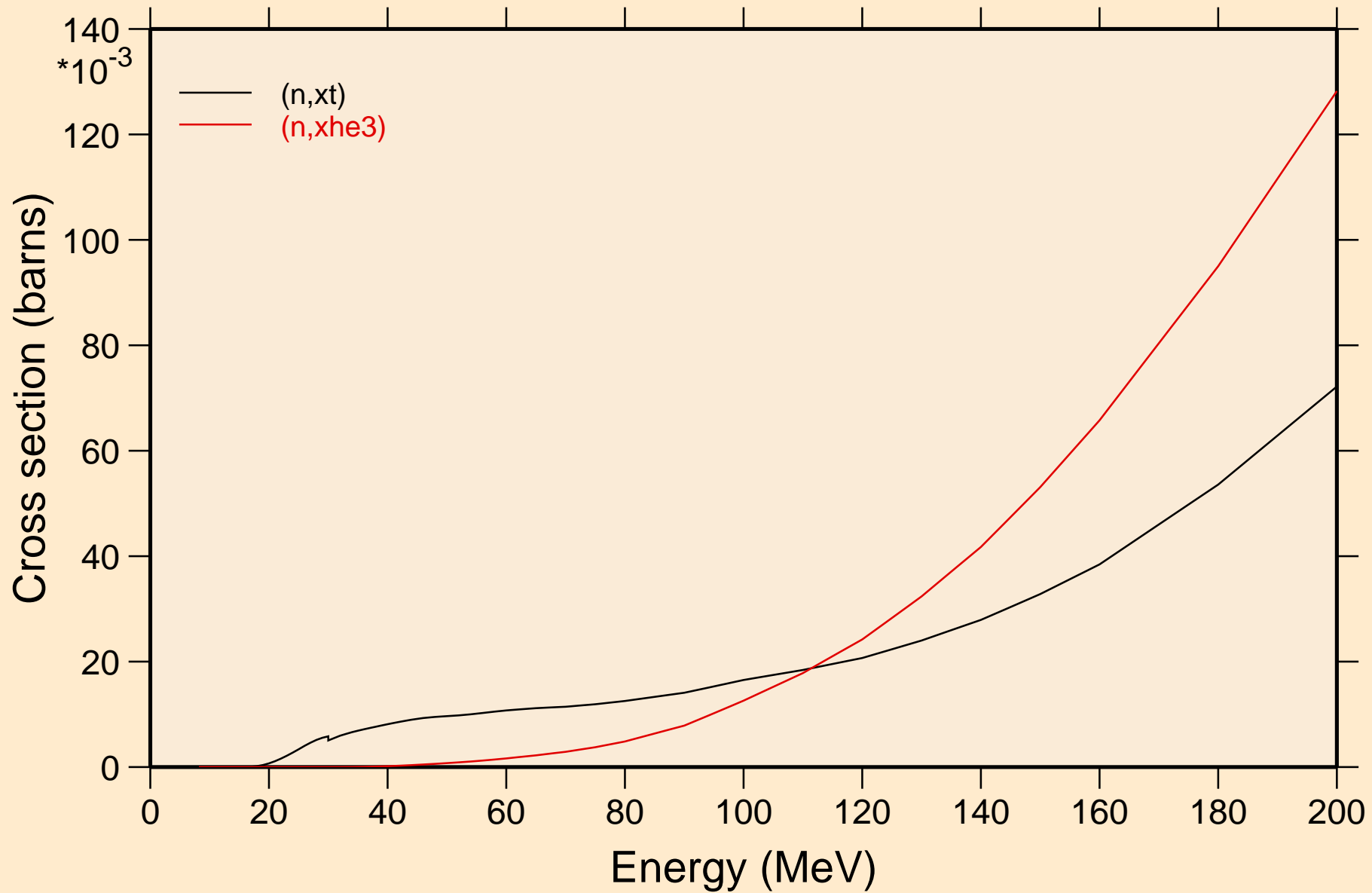

TH238 NEUTRON ACER TENDL-2024 LIBRARY; T=0.K  
angular distribution for elastic

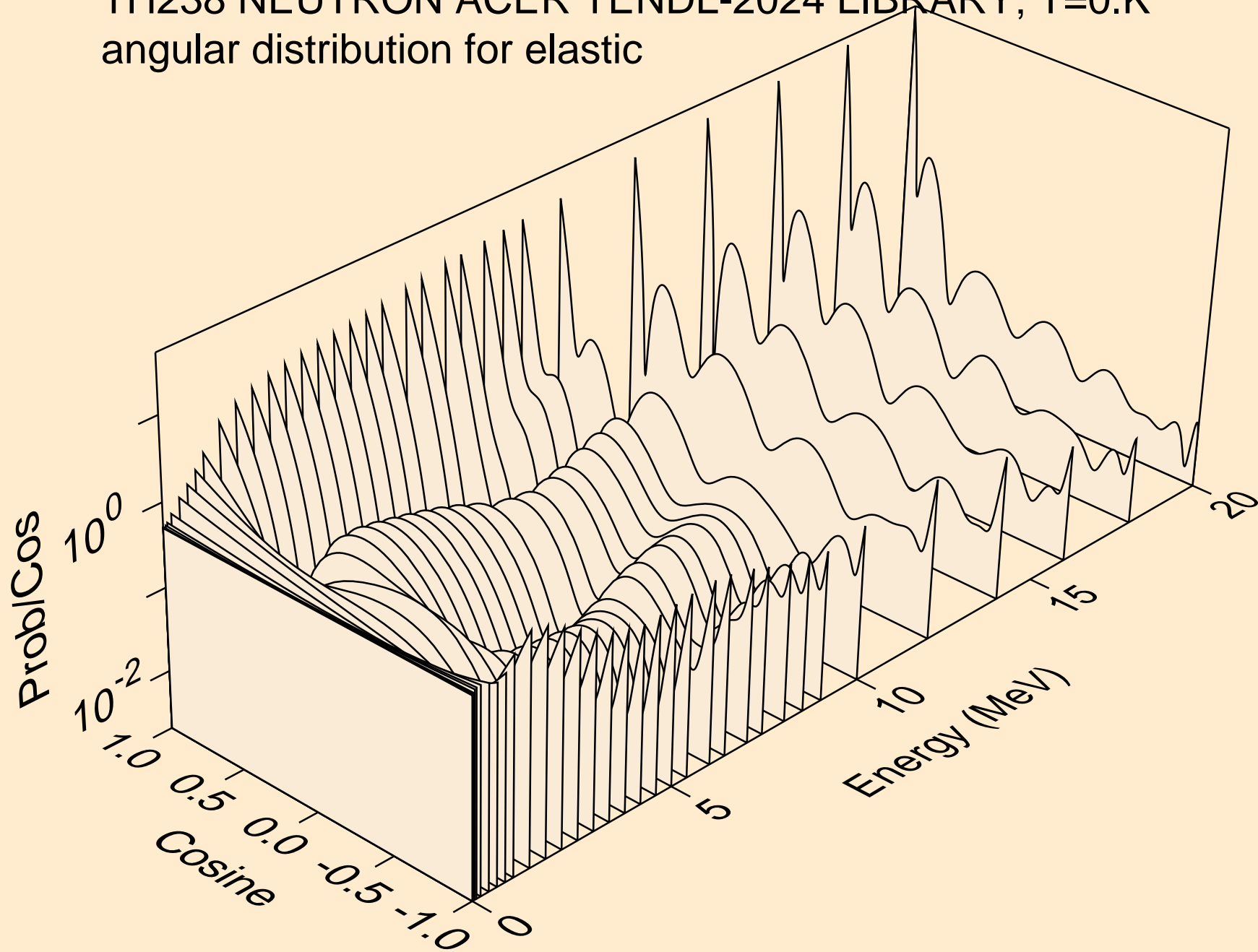

TH238 NEUTRON ACER TENDL-2024 LIBRARY; T=0.K  
angular distribution for elastic

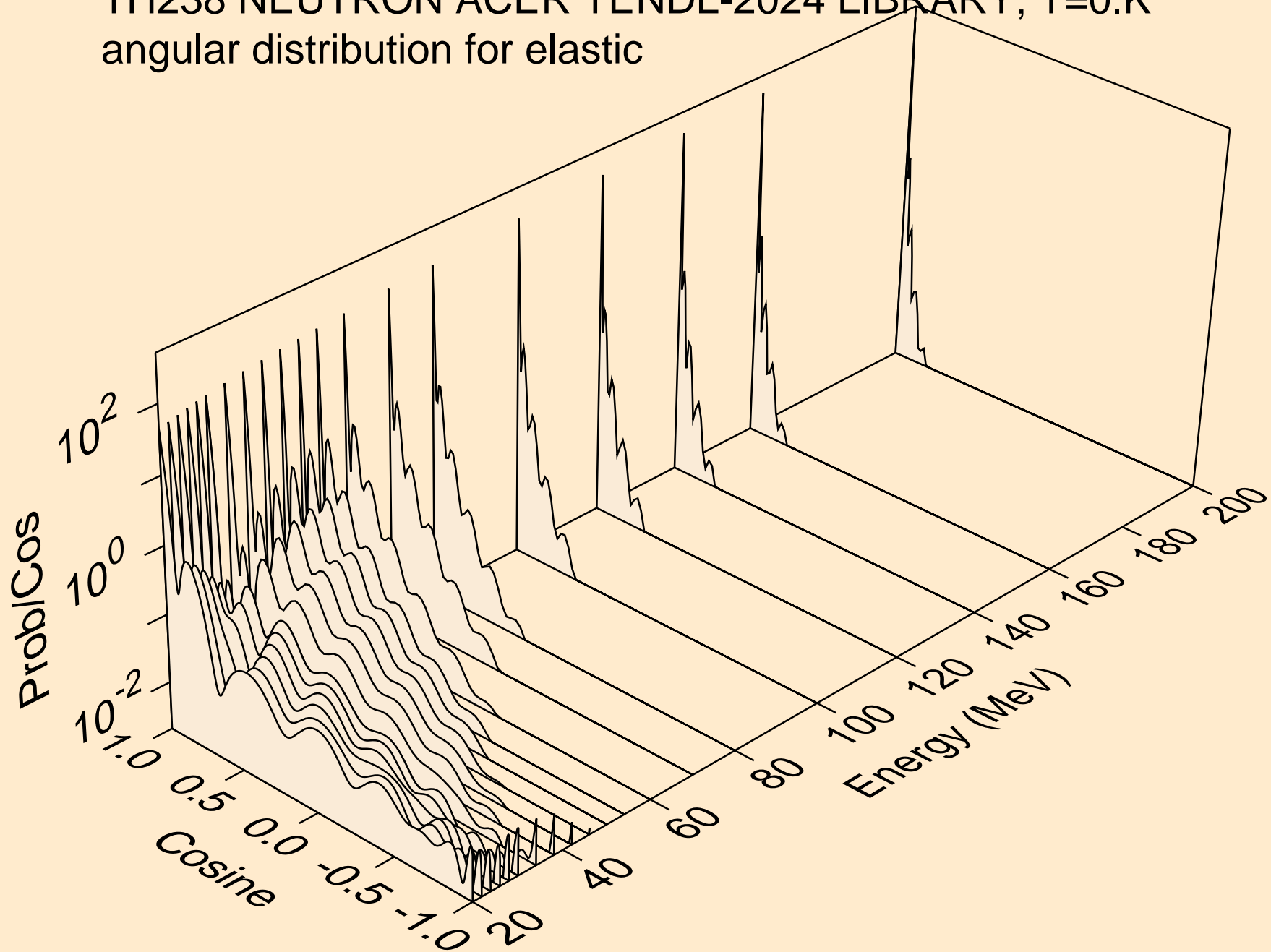

TH238 NEUTRON ACER TENDL-2024 LIBRARY; T=0.K  
angular distribution for (n,n\*1)

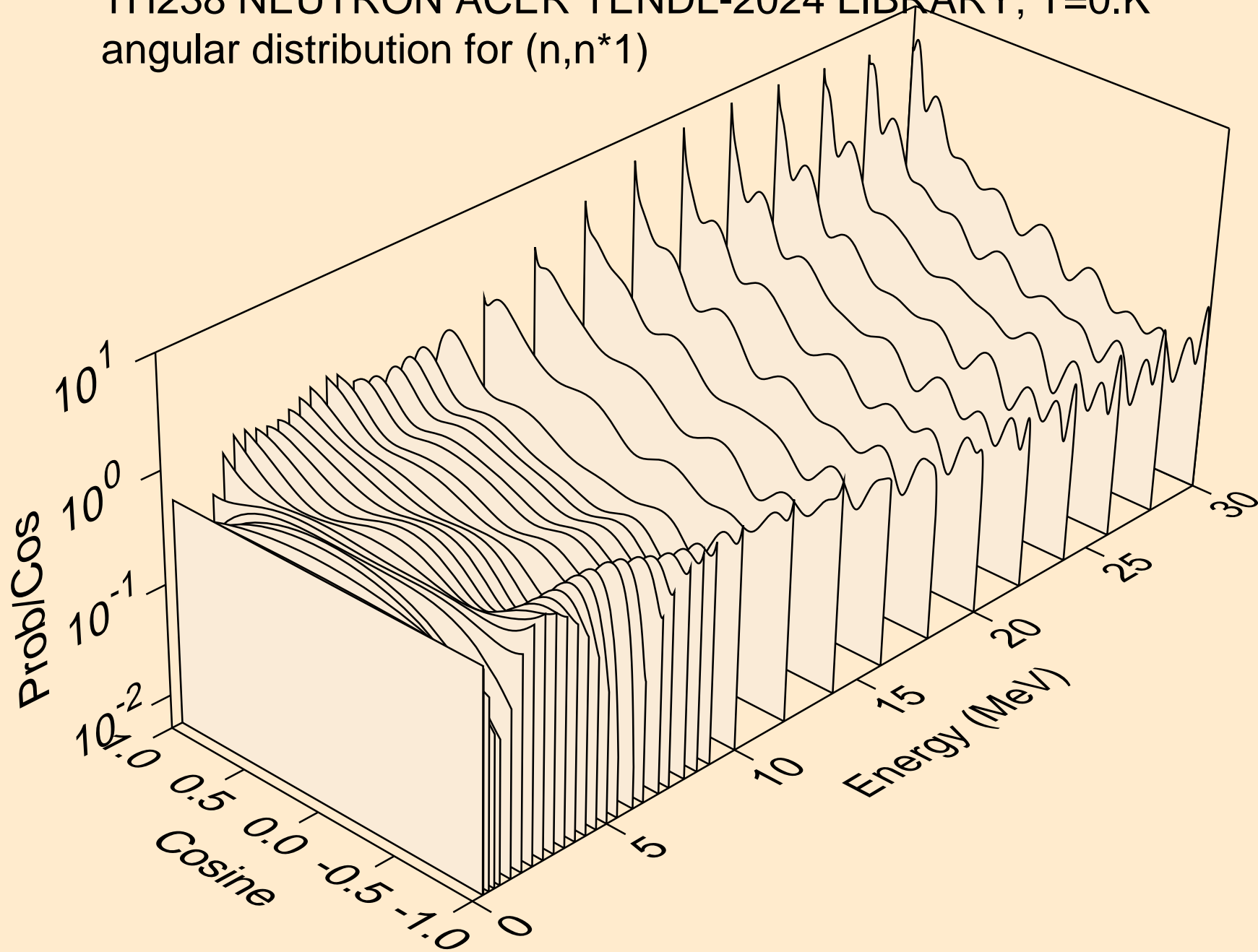

TH238 NEUTRON ACER TENDL-2024 LIBRARY; T=0.K  
angular distribution for (n,n\*2)

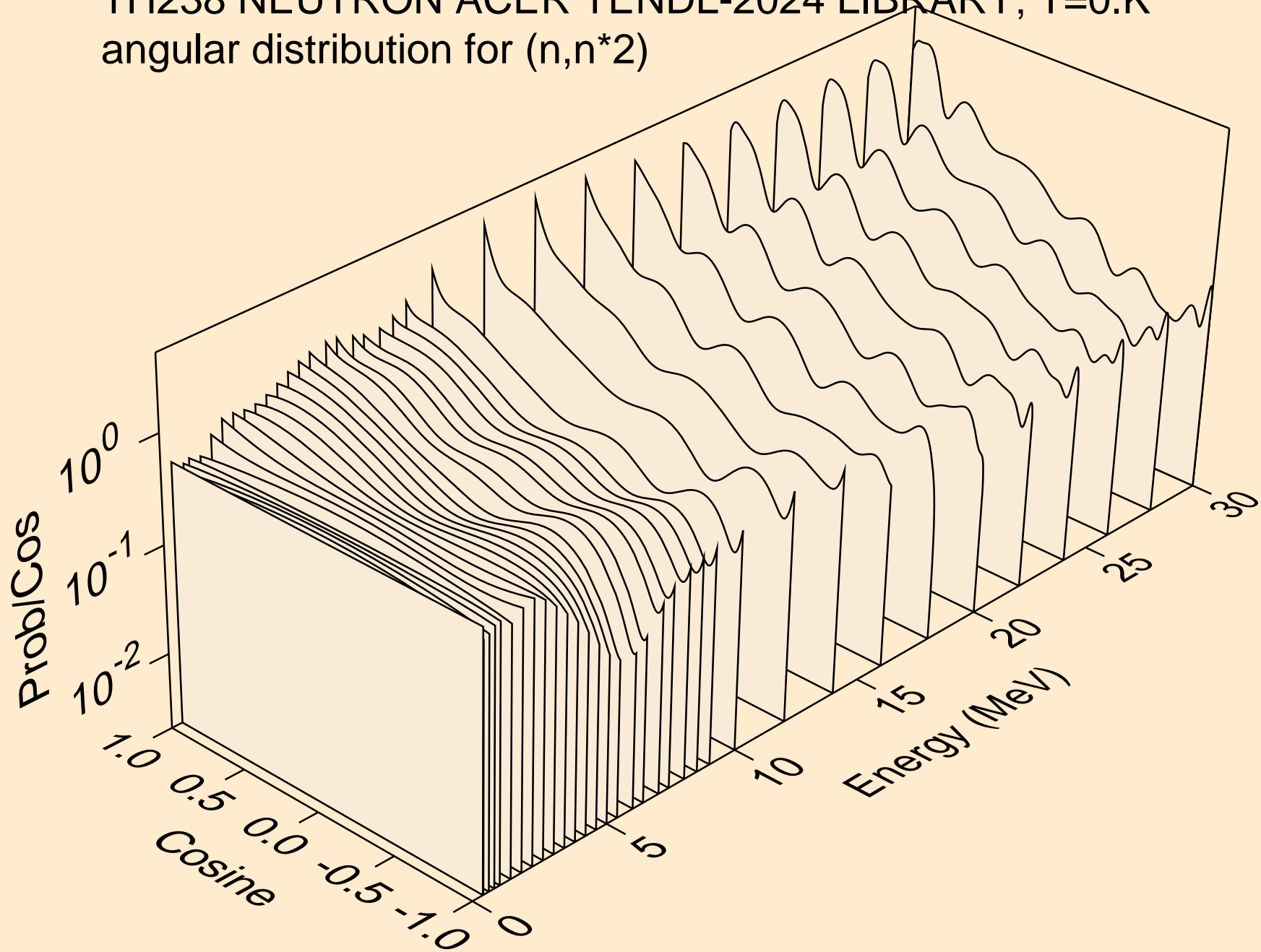



TH238 NEUTRON ACER TENDL-2024 LIBRARY; T=0.K  
angular distribution for (n,n\*3)

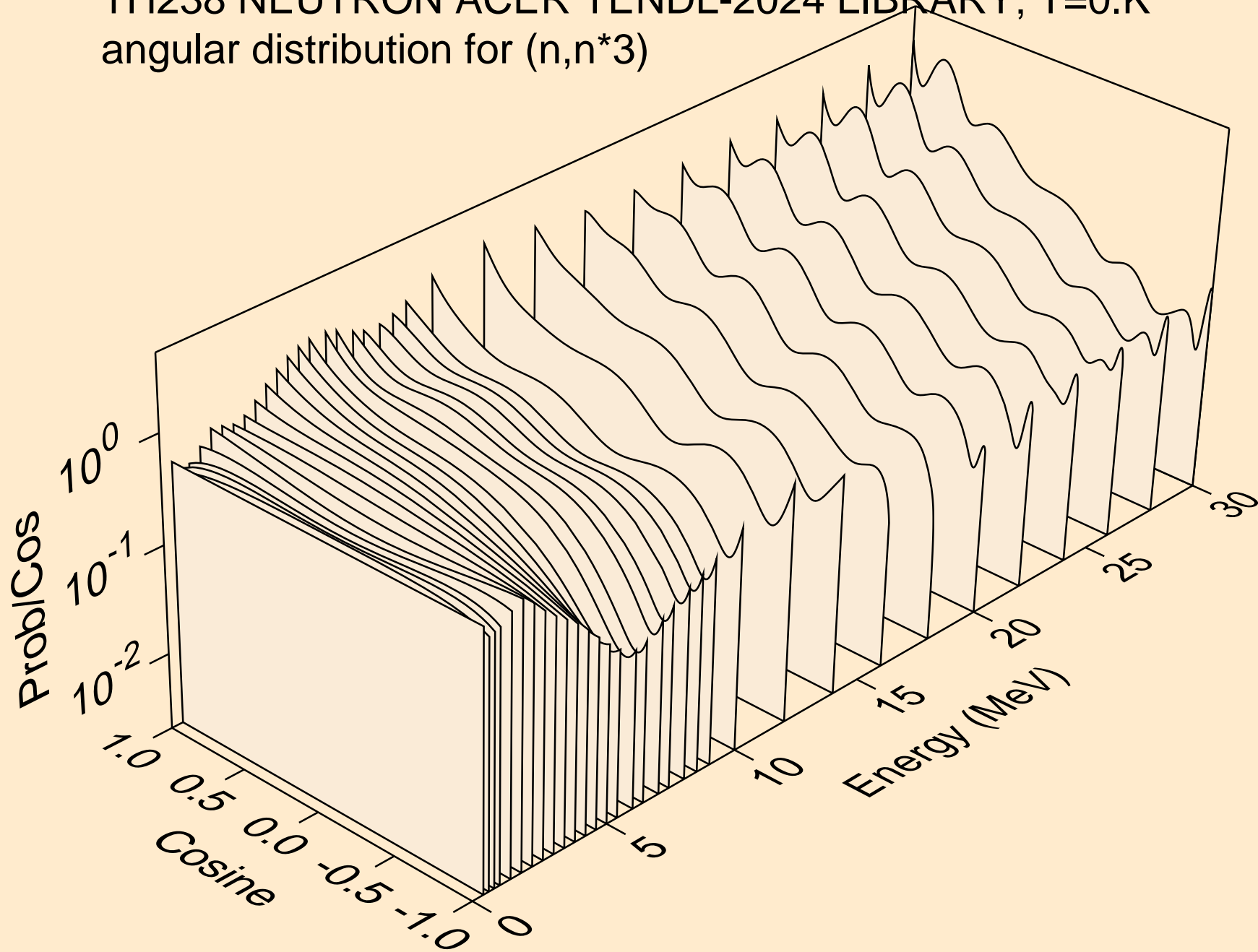

TH238 NEUTRON ACER TENDL-2024 LIBRARY; T=0.K  
angular distribution for (n,n\*4)

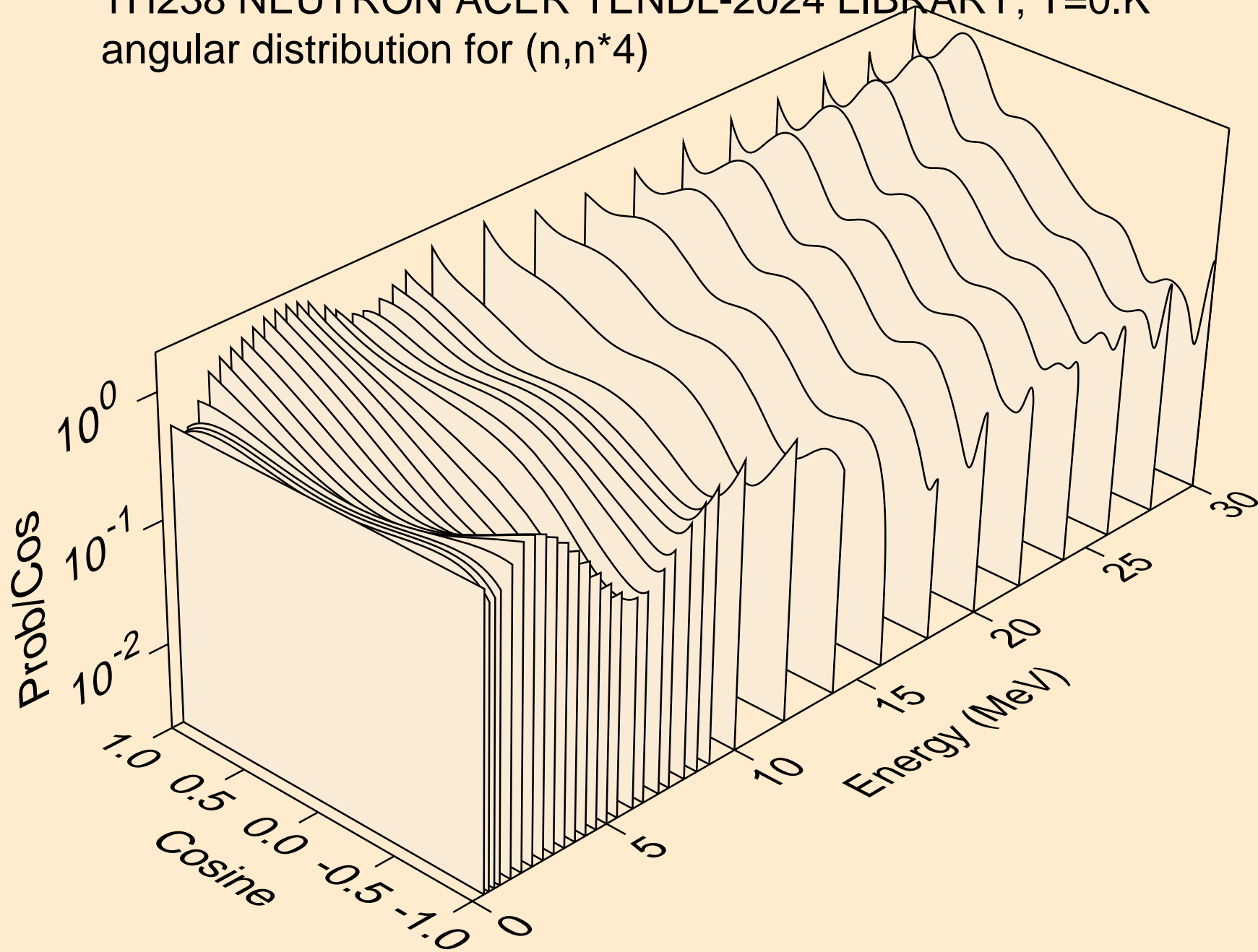

TH238 NEUTRON ACER TENDL-2024 LIBRARY; T=0.K  
angular distribution for (n,n\*5)

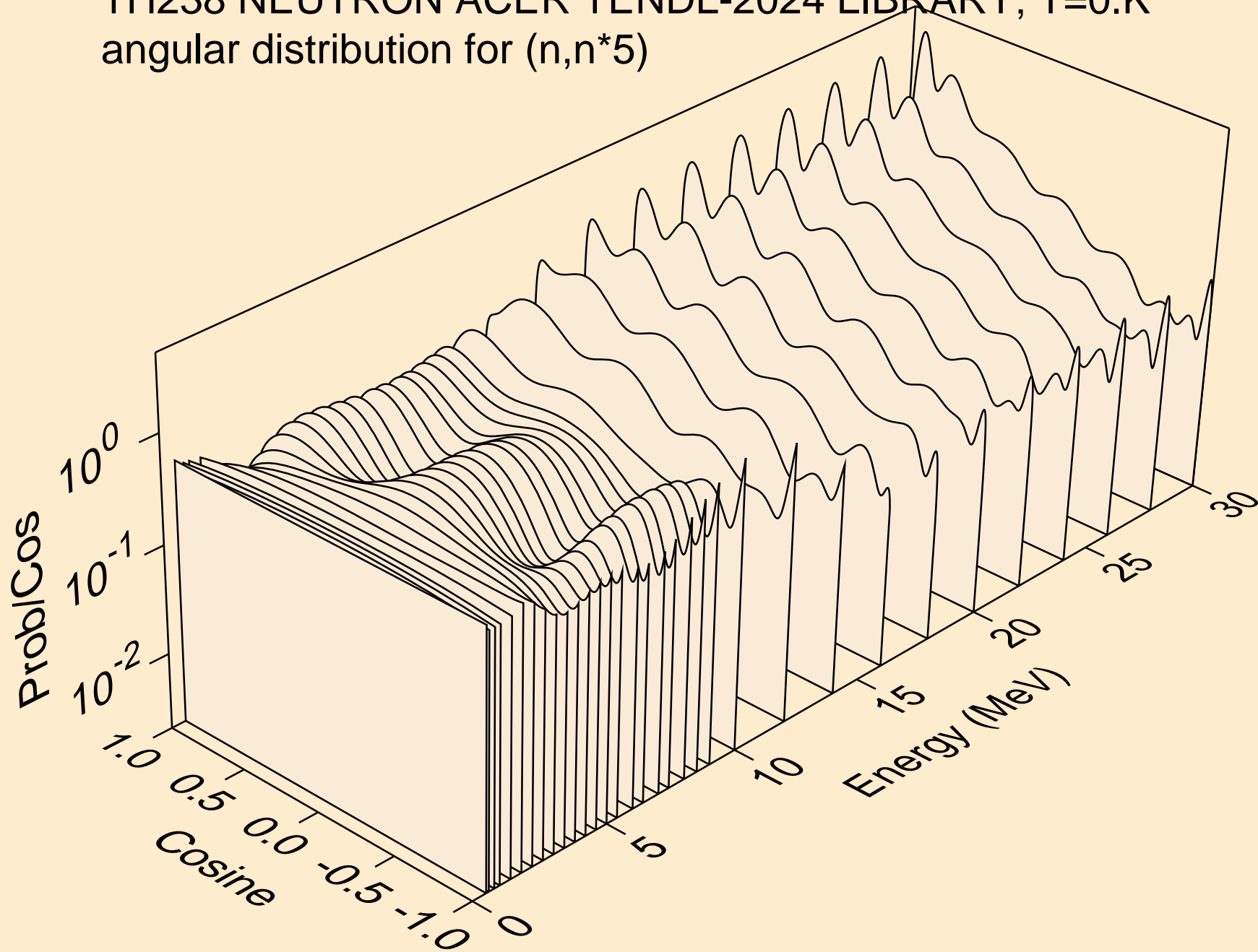

TH238 NEUTRON ACER TENDL-2024 LIBRARY; T=0.K  
angular distribution for (n,n\*6)

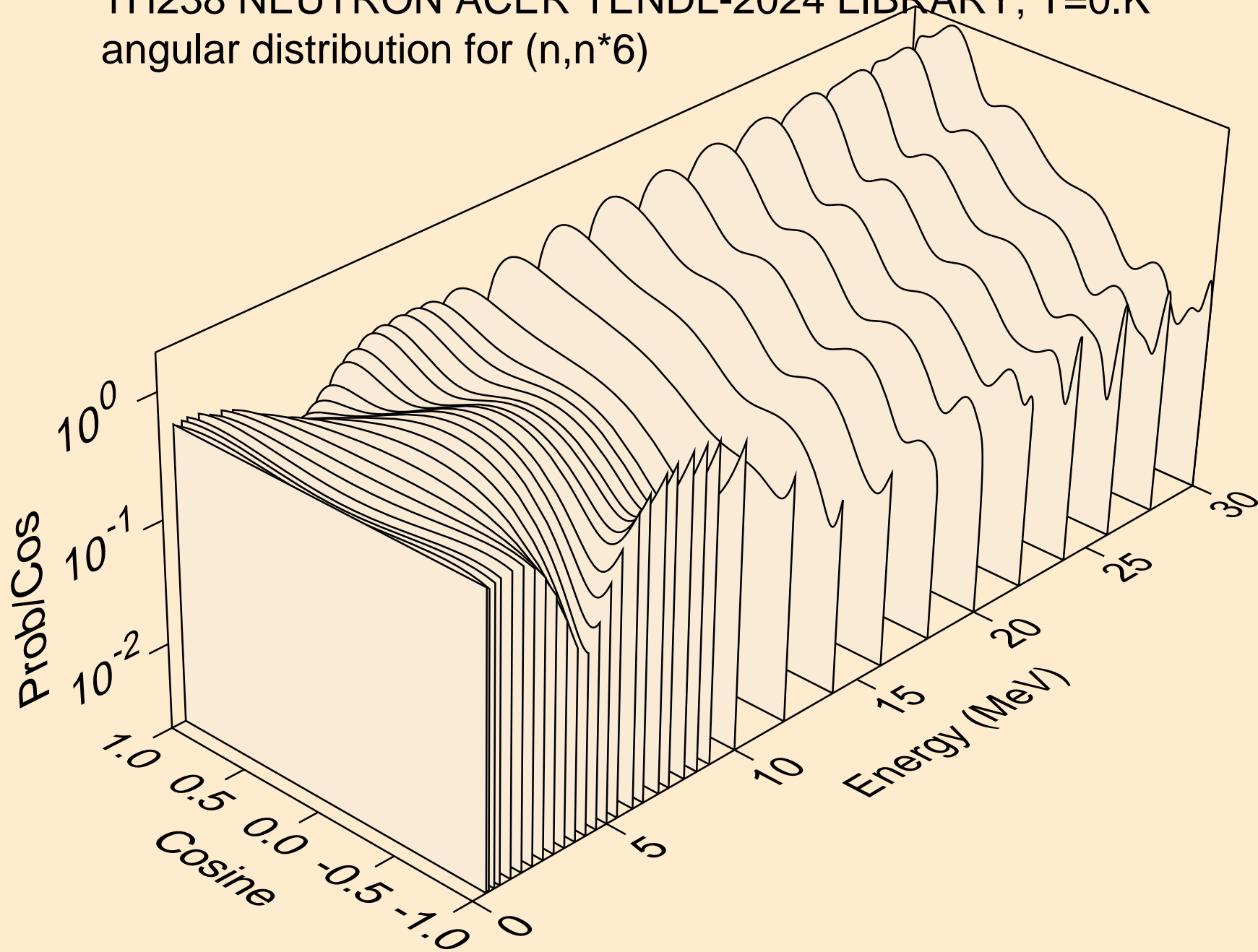

TH238 NEUTRON ACER TENDL-2024 LIBRARY; T=0.K  
angular distribution for (n,n\*7)

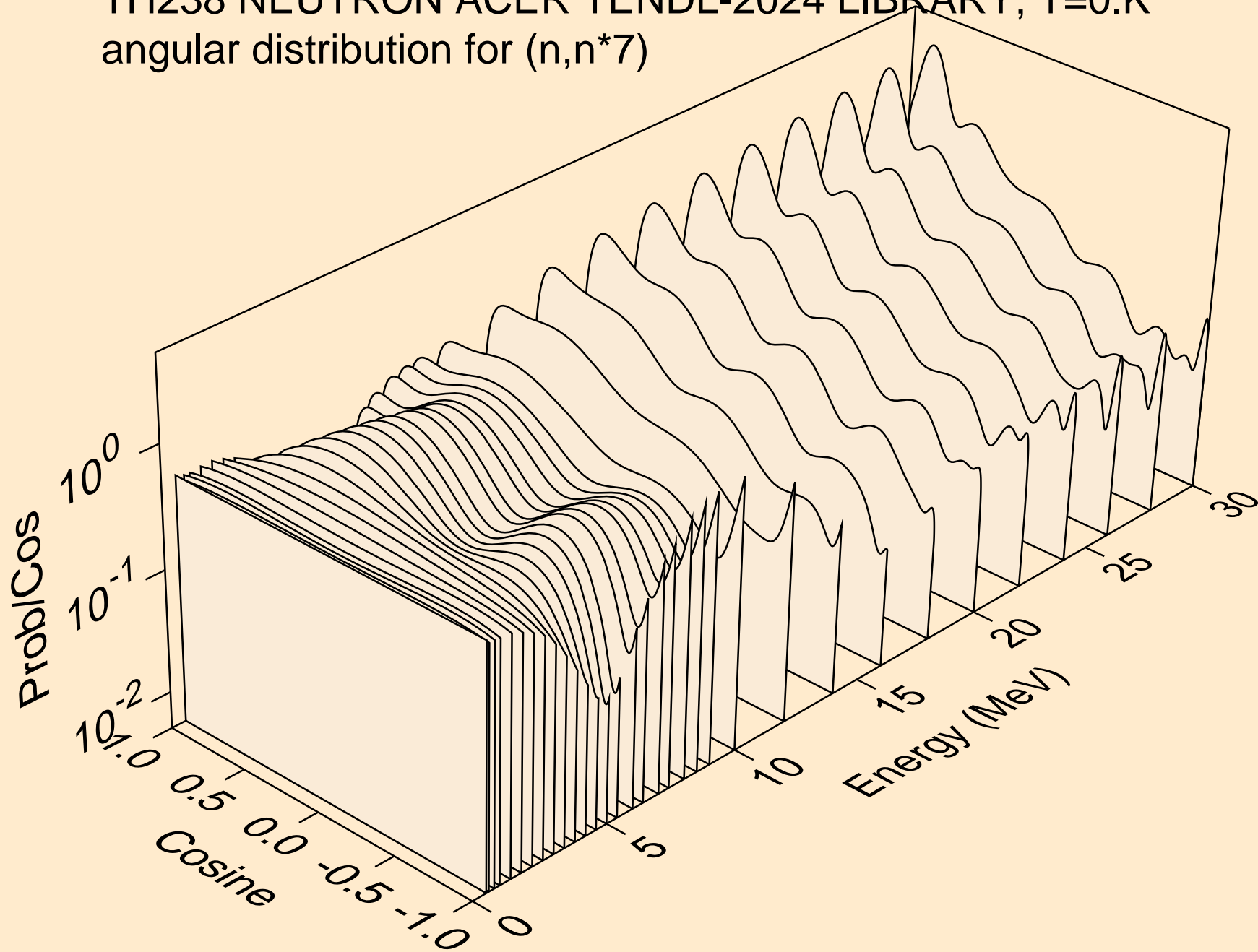

TH238 NEUTRON ACER TENDL-2024 LIBRARY; T=0.K  
angular distribution for (n,n\*8)

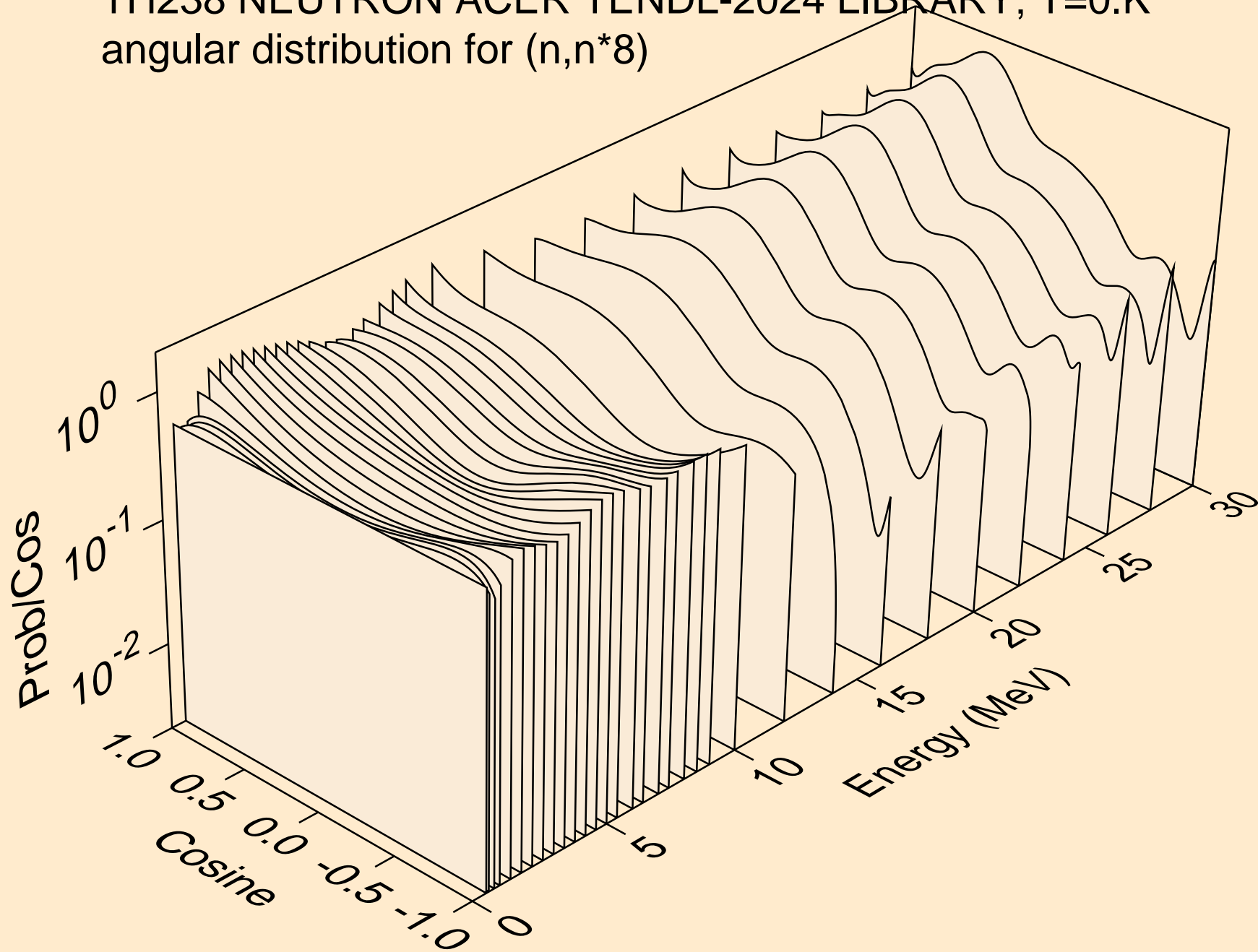

TH238 NEUTRON ACER TENDL-2024 LIBRARY; T=0.K  
angular distribution for (n,n\*9)

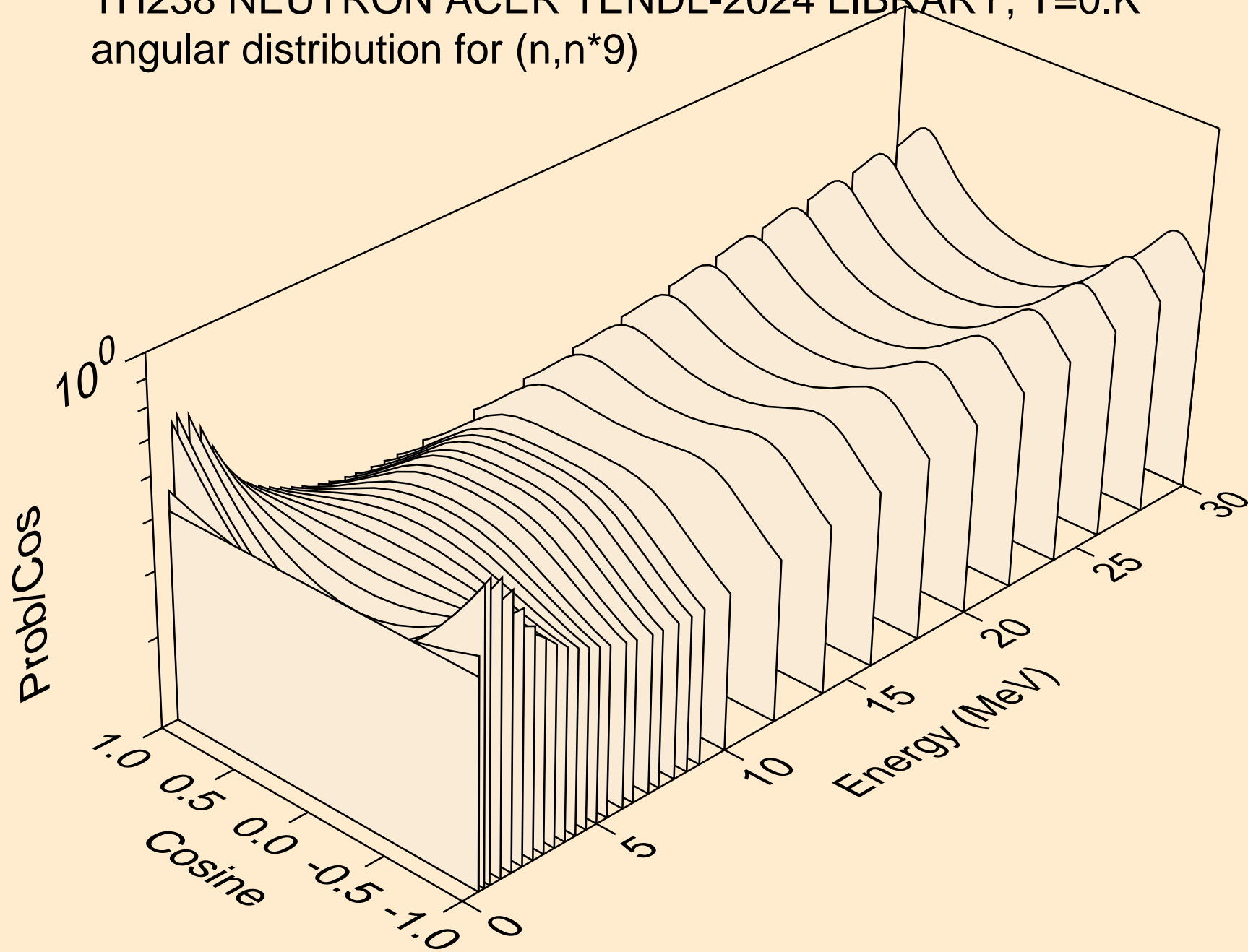

TH238 NEUTRON ACER TENDL-2024 LIBRARY; T=0.K  
angular distribution for (n,n\*10)

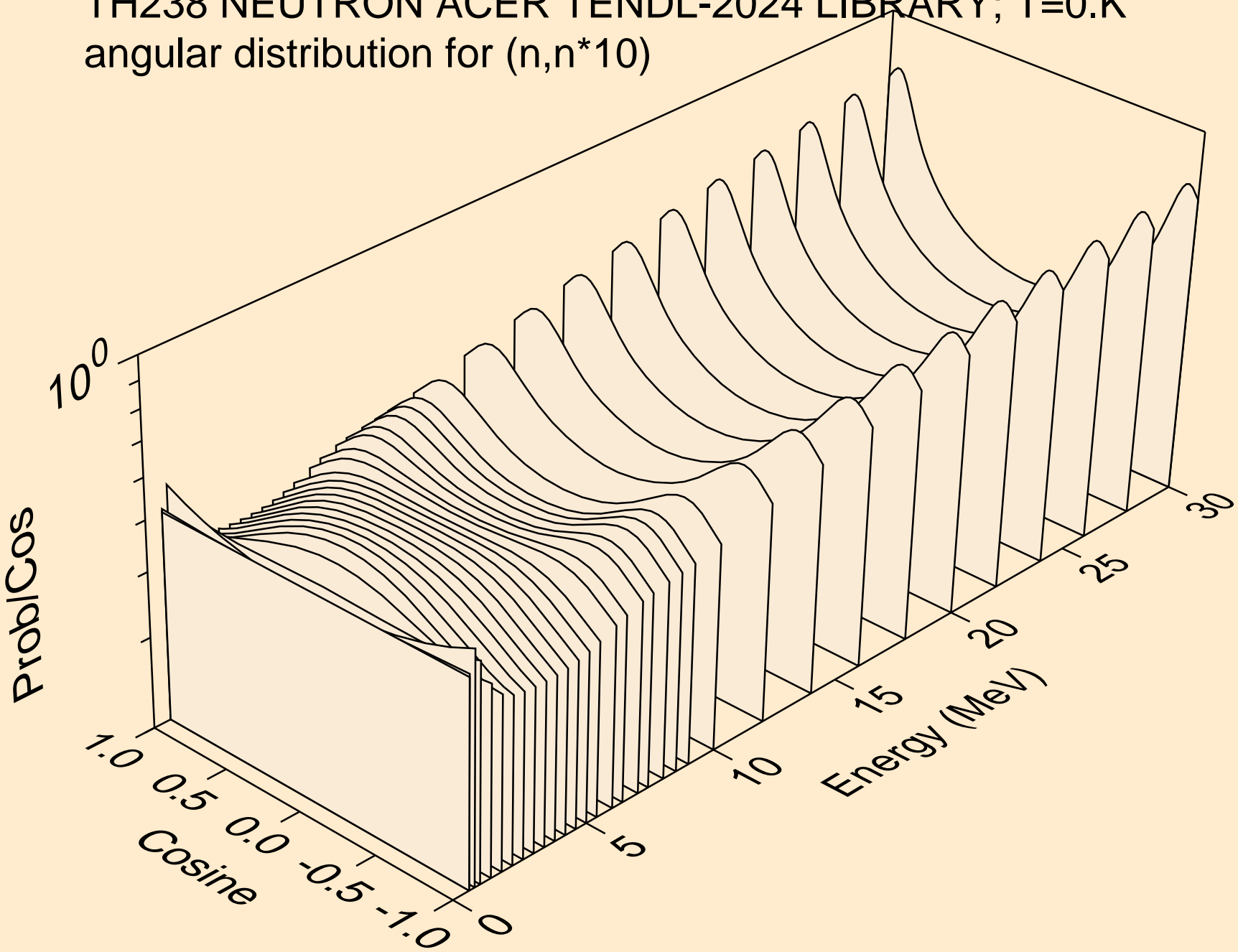



TH238 NEUTRON ACER TENDL-2024 LIBRARY; T=0.K  
angular distribution for (n,n\*11)

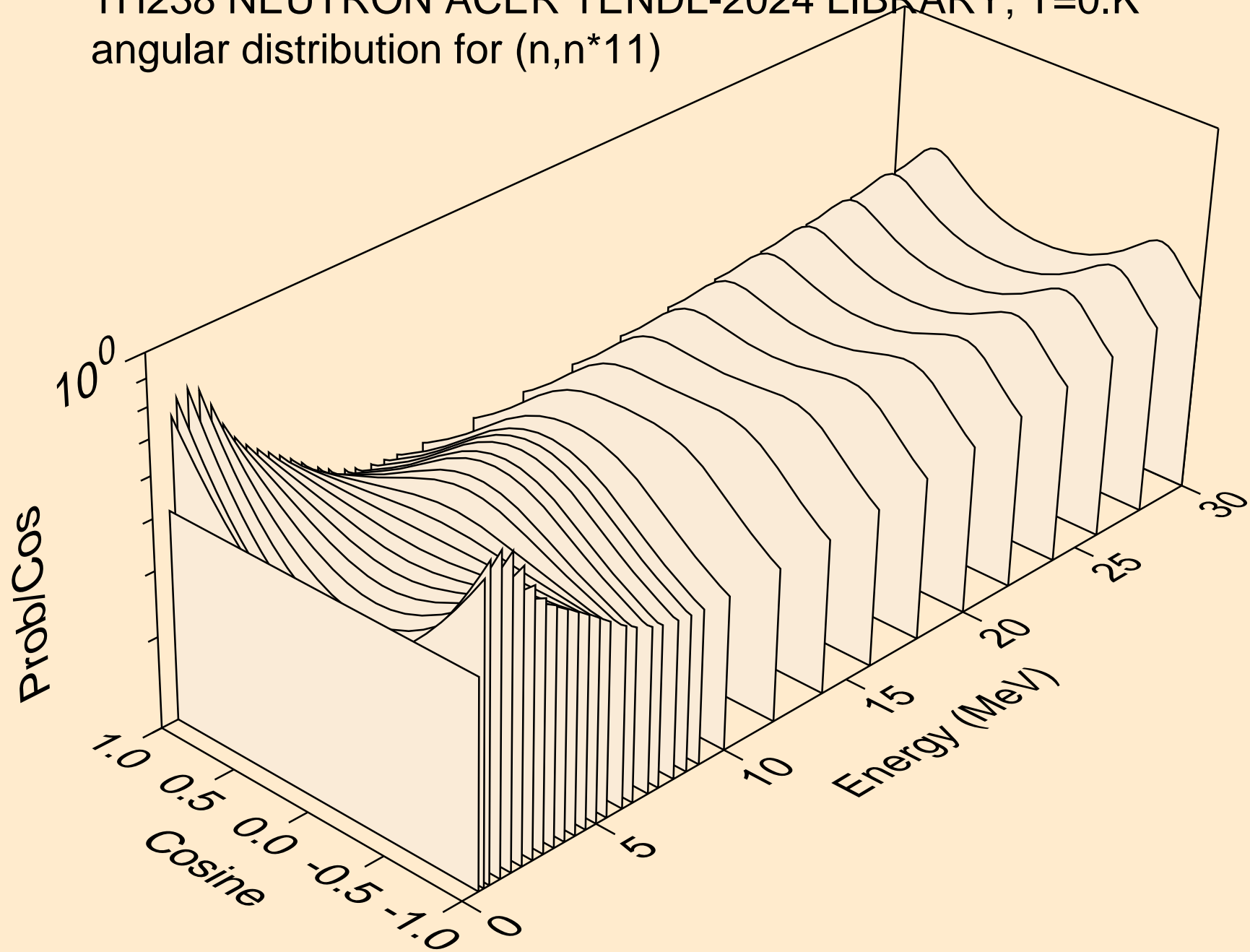

TH238 NEUTRON ACER TENDL-2024 LIBRARY; T=0.K  
angular distribution for (n,n\*12)

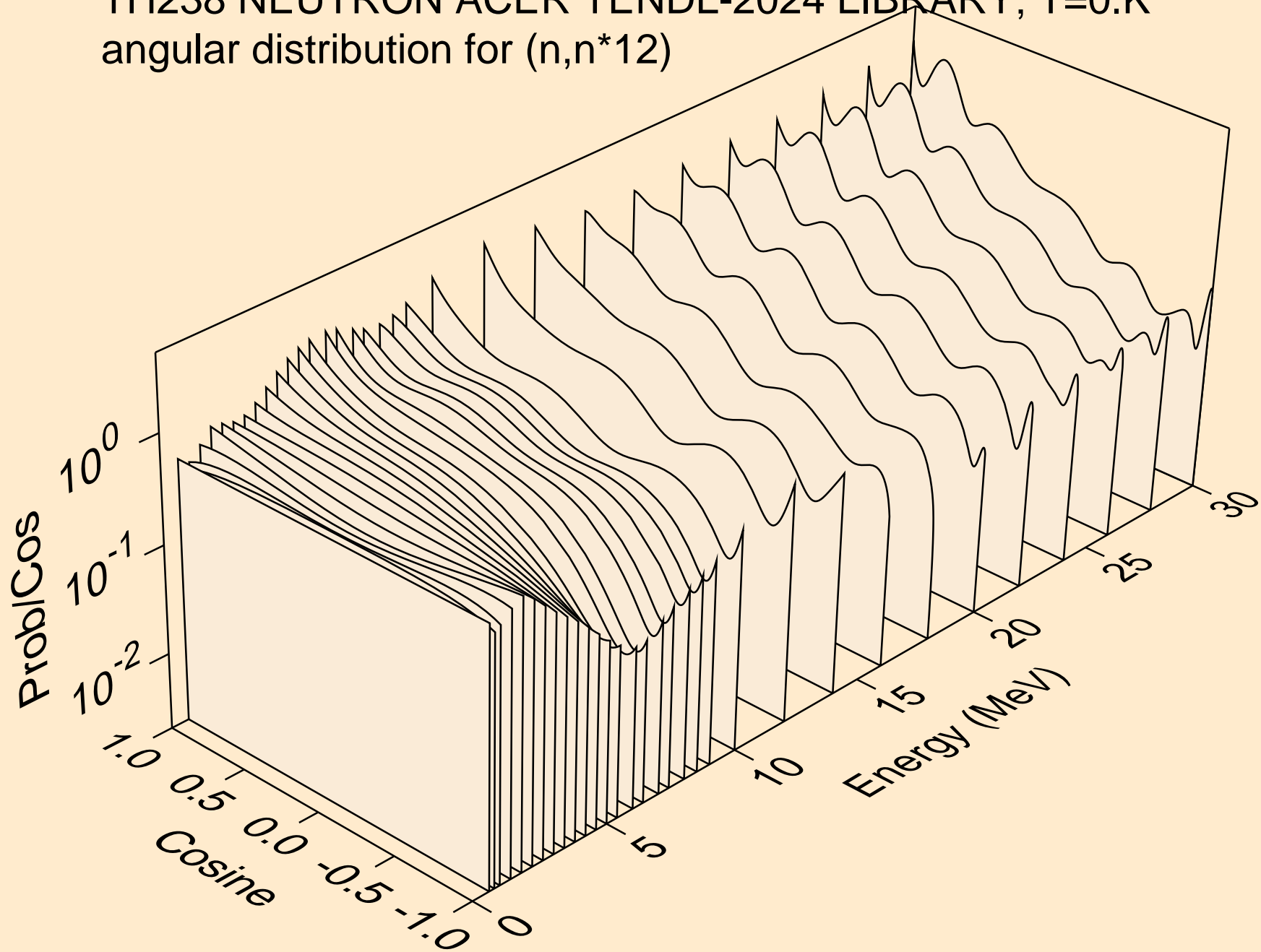

TH238 NEUTRON ACER TENDL-2024 LIBRARY; T=0.K  
angular distribution for (n,n\*13)

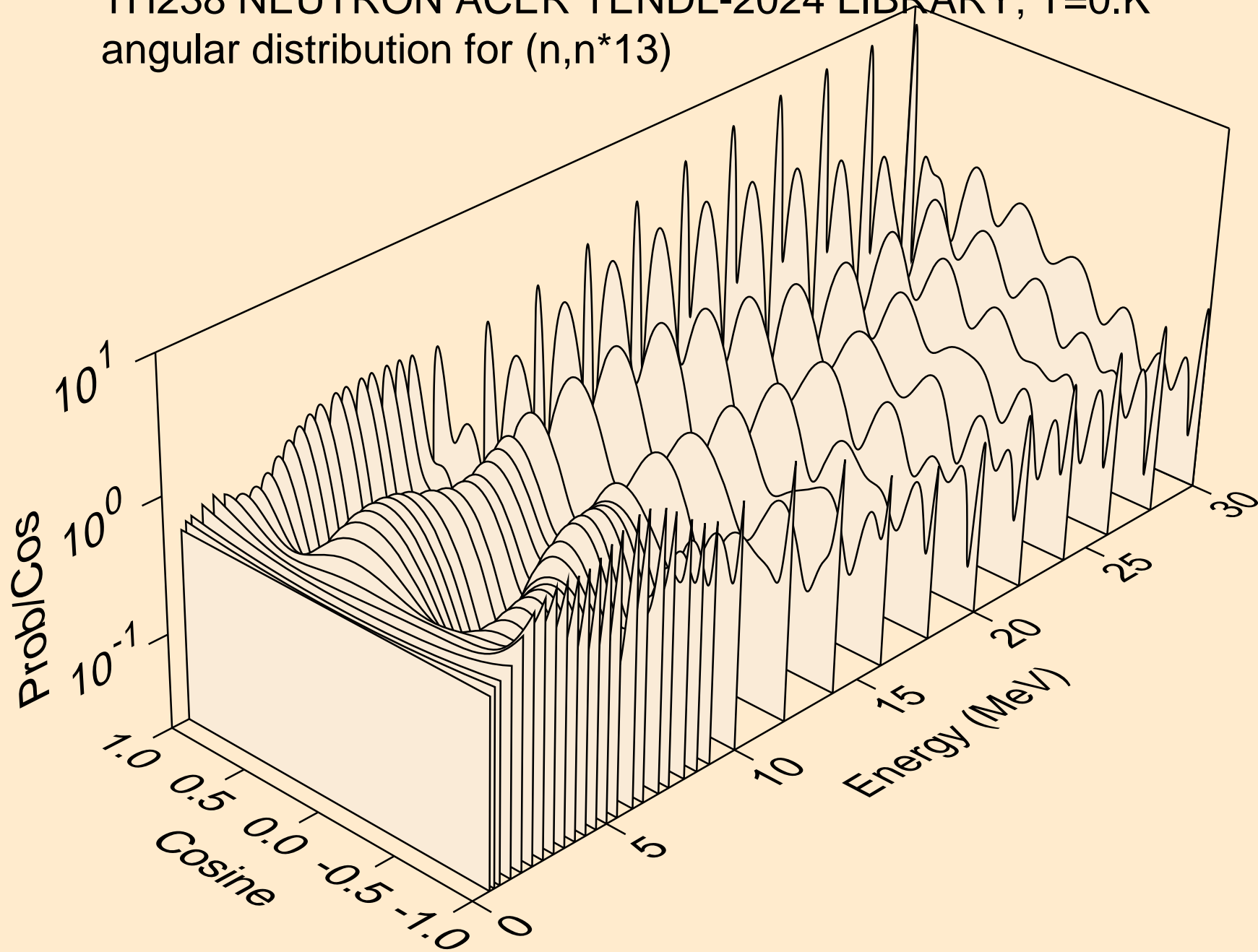

TH238 NEUTRON ACER TENDL-2024 LIBRARY; T=0.K  
angular distribution for (n,n\*14)

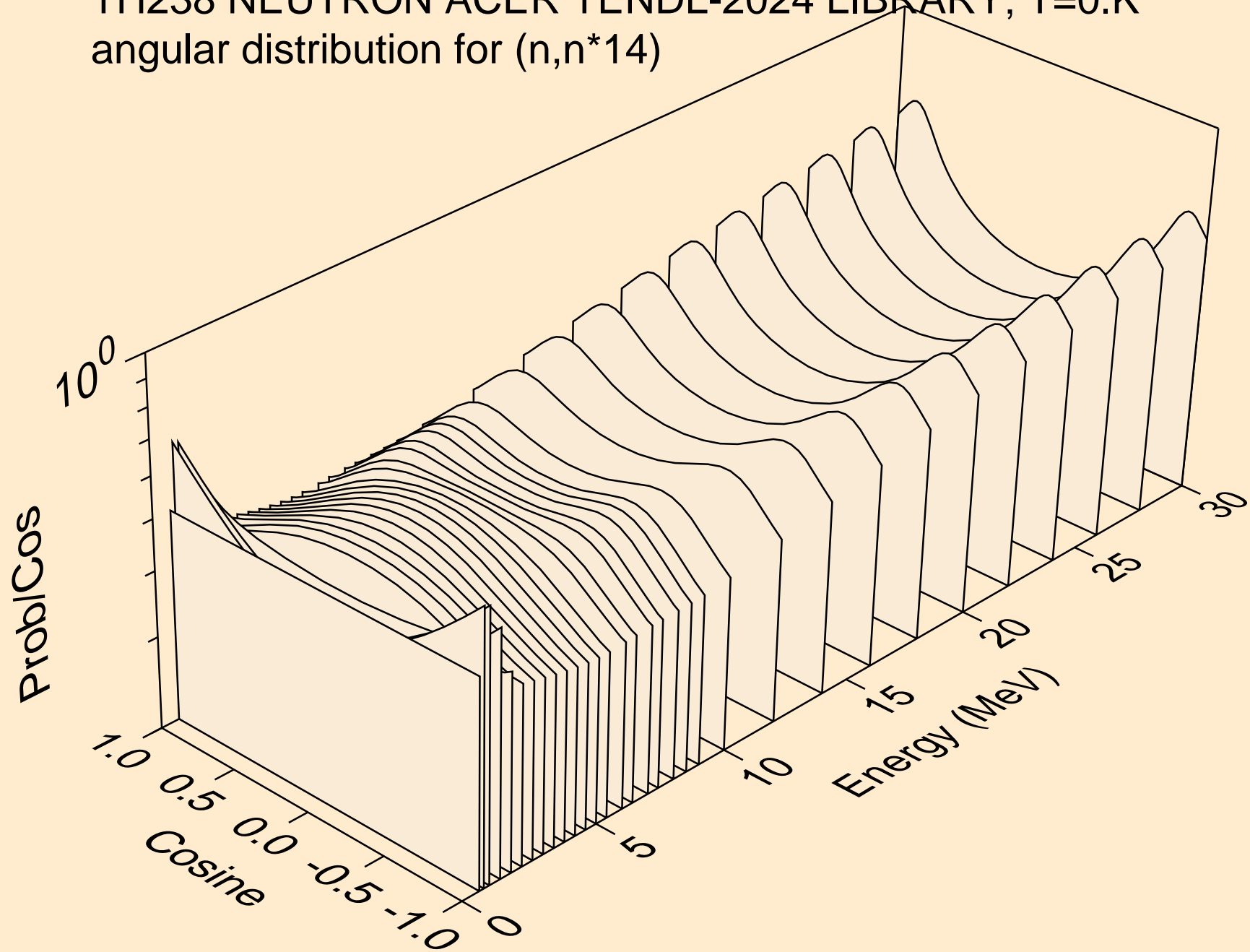

TH238 NEUTRON ACER TENDL-2024 LIBRARY; T=0.K  
angular distribution for (n,n\*15)

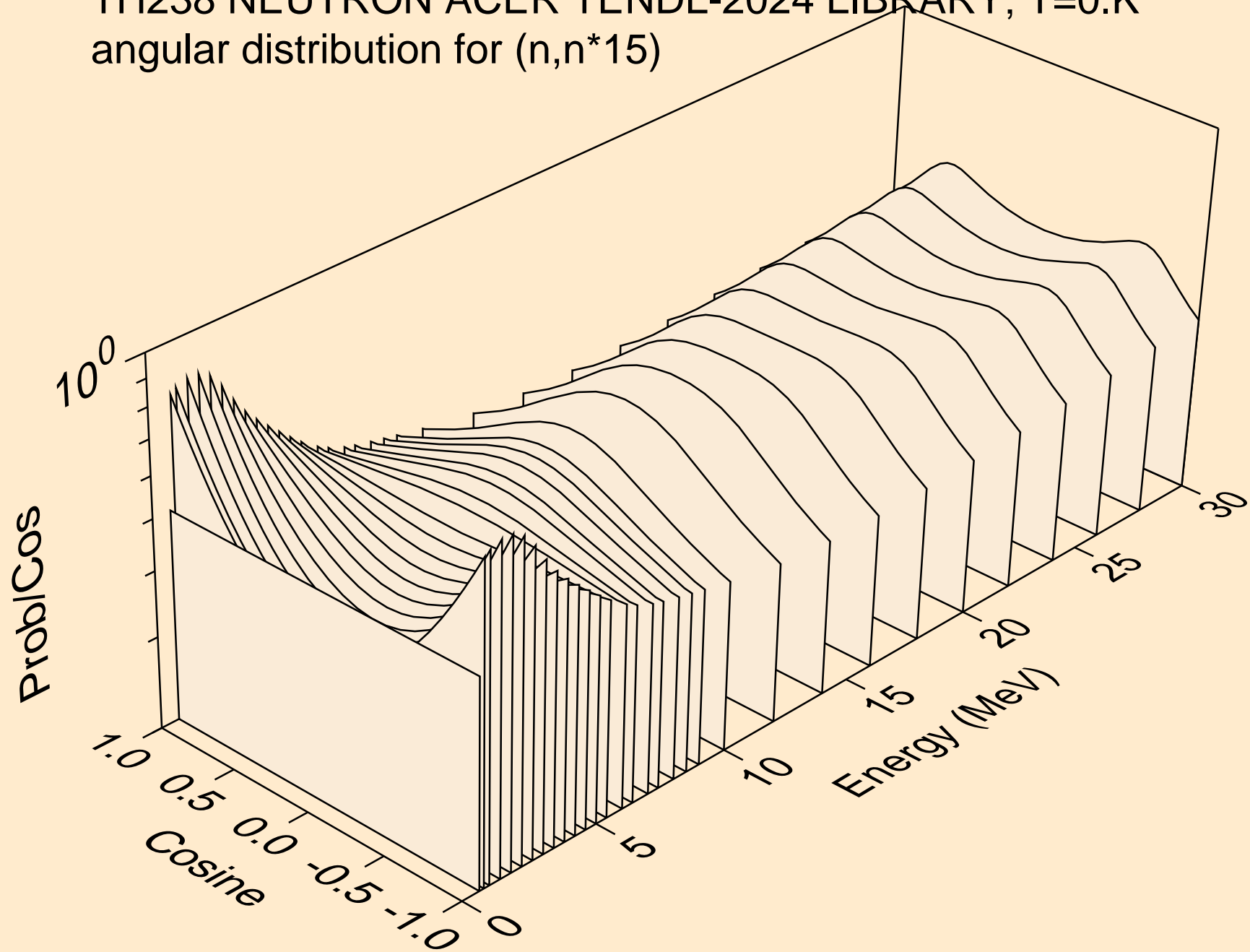

TH238 NEUTRON ACER TENDL-2024 LIBRARY; T=0.K  
angular distribution for (n,n\*16)

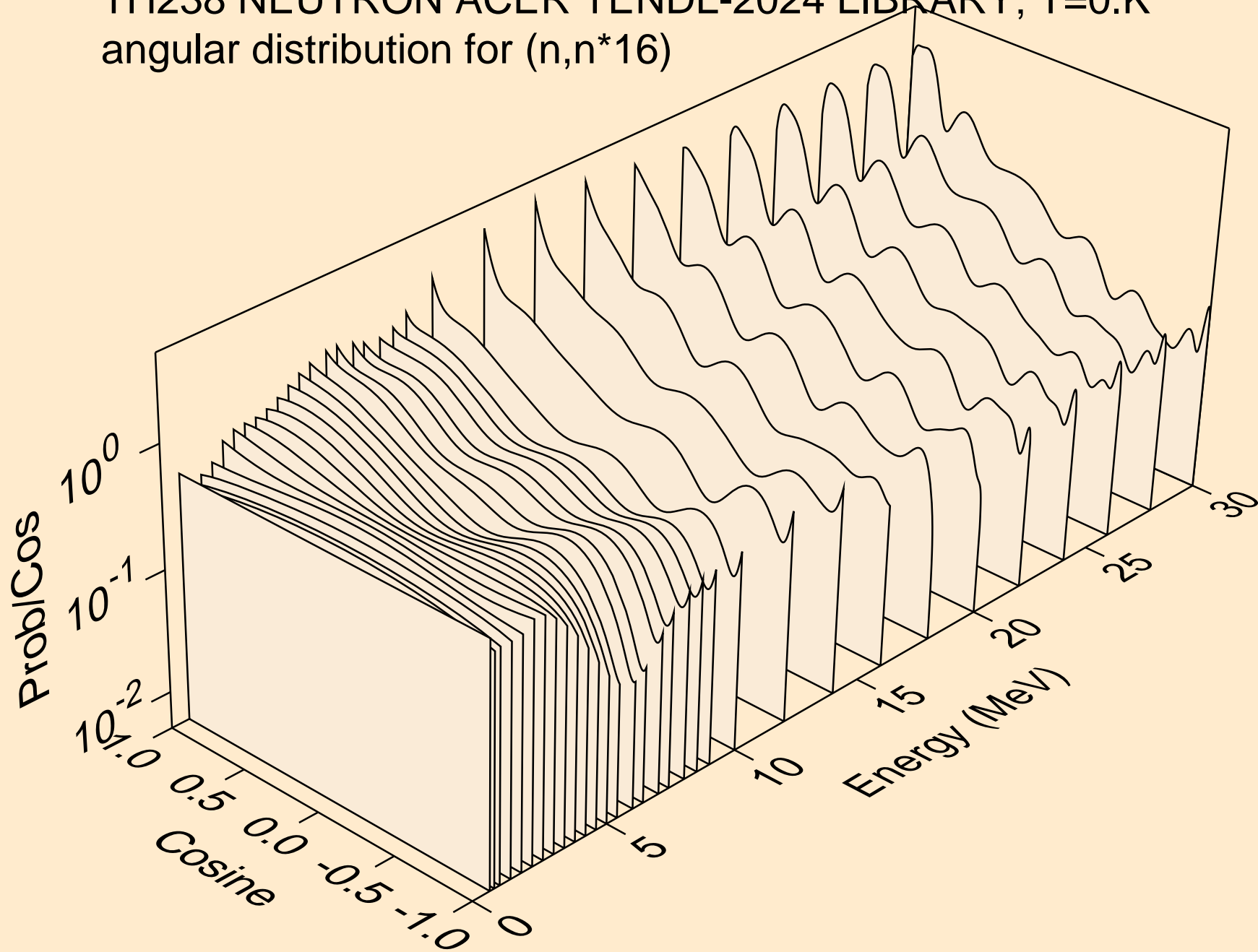

TH238 NEUTRON ACER TENDL-2024 LIBRARY; T=0.K  
angular distribution for (n,n\*17)

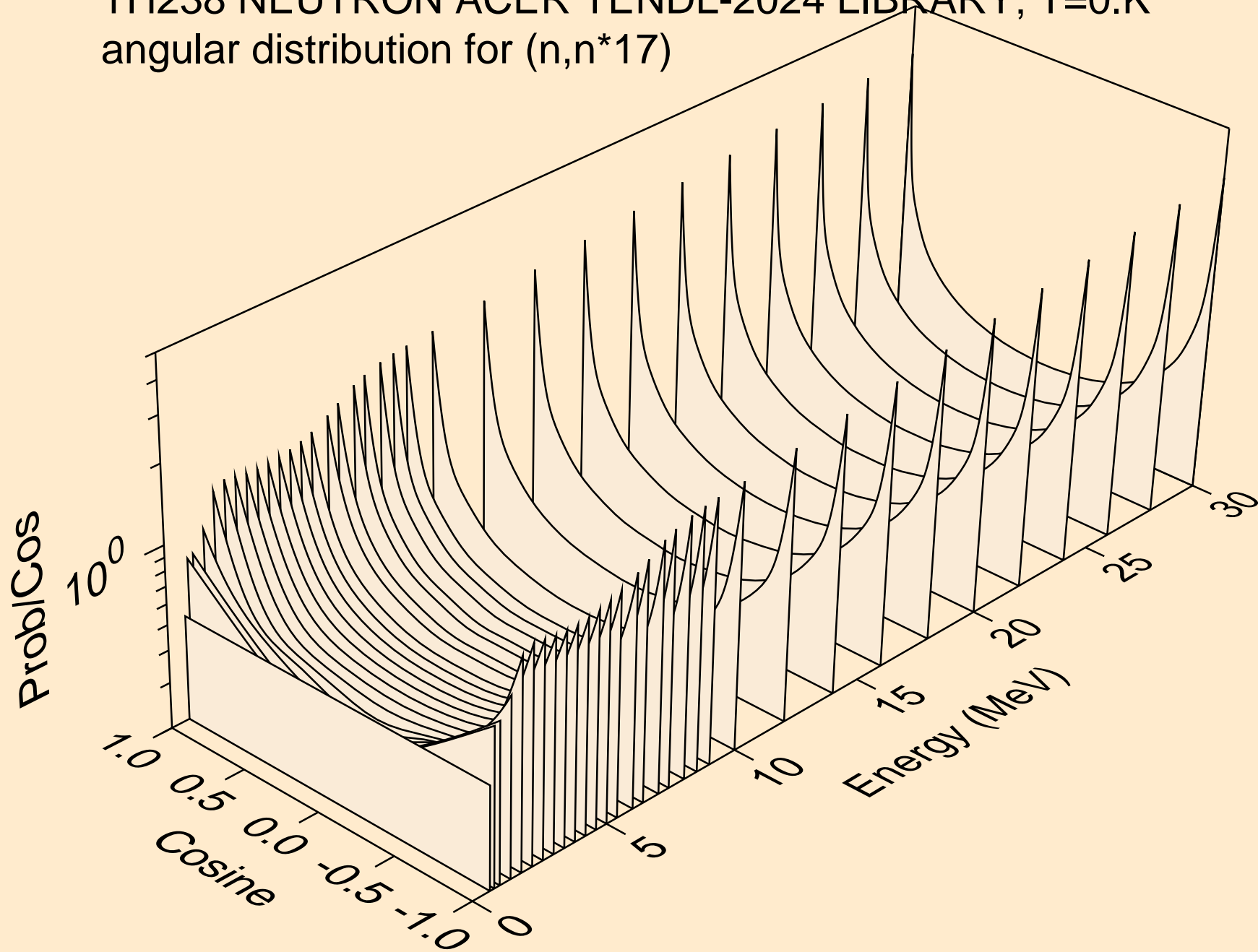

TH238 NEUTRON ACER TENDL-2024 LIBRARY; T=0.K  
angular distribution for (n,n\*18)

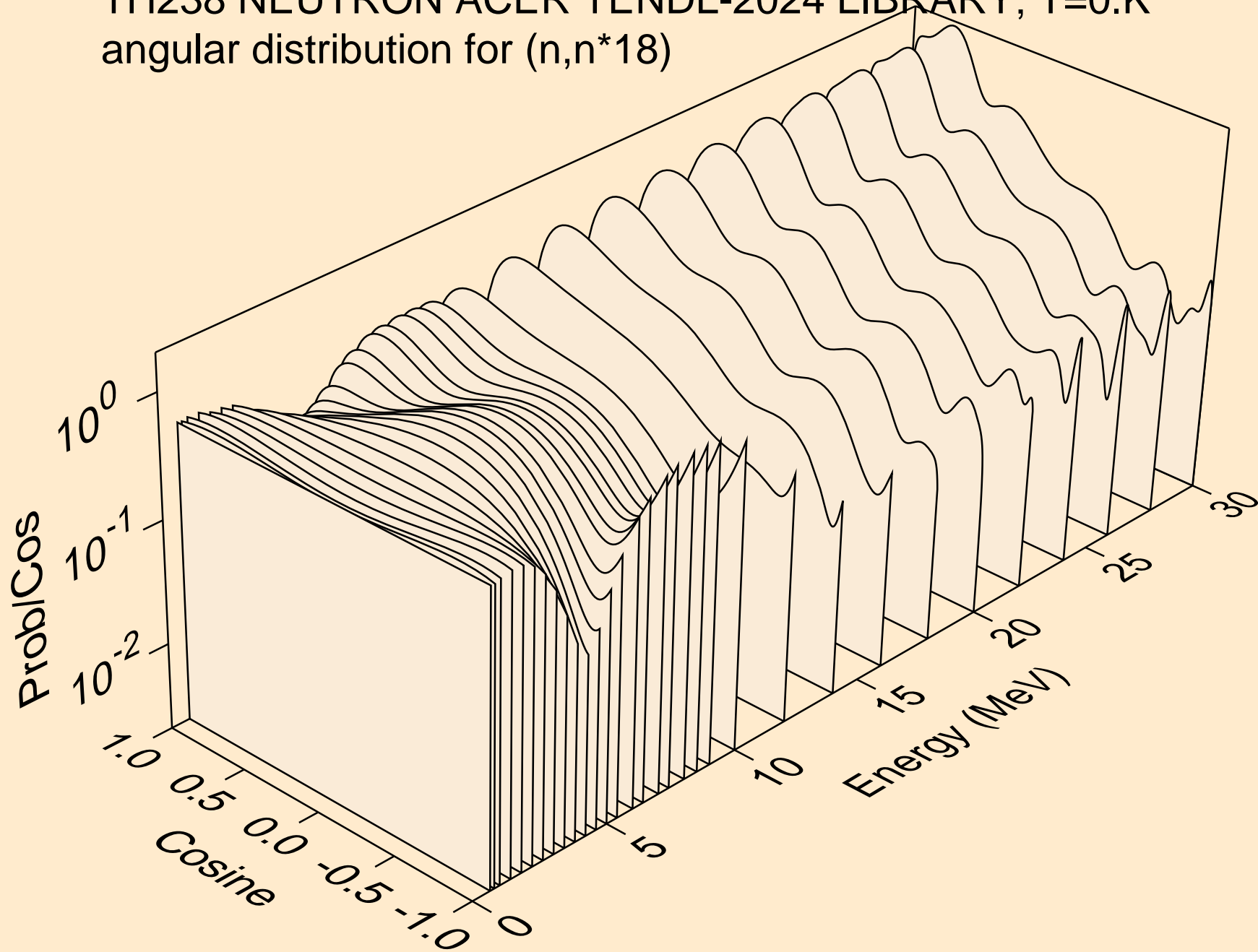



TH238 NEUTRON ACER TENDL-2024 LIBRARY; T=0.K  
angular distribution for (n,n\*19)

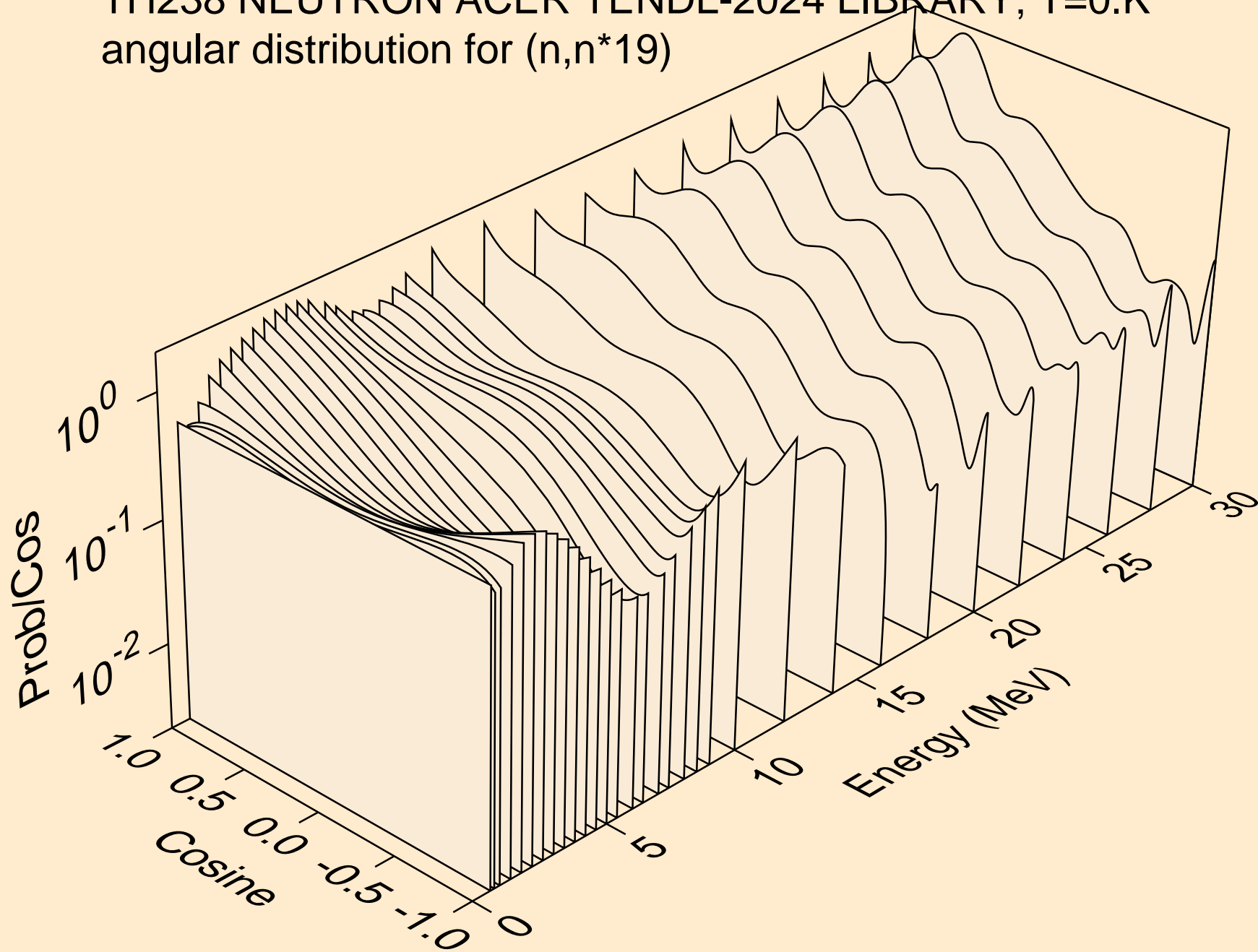

TH238 NEUTRON ACER TENDL-2024 LIBRARY; T=0.K  
angular distribution for (n,n\*20)

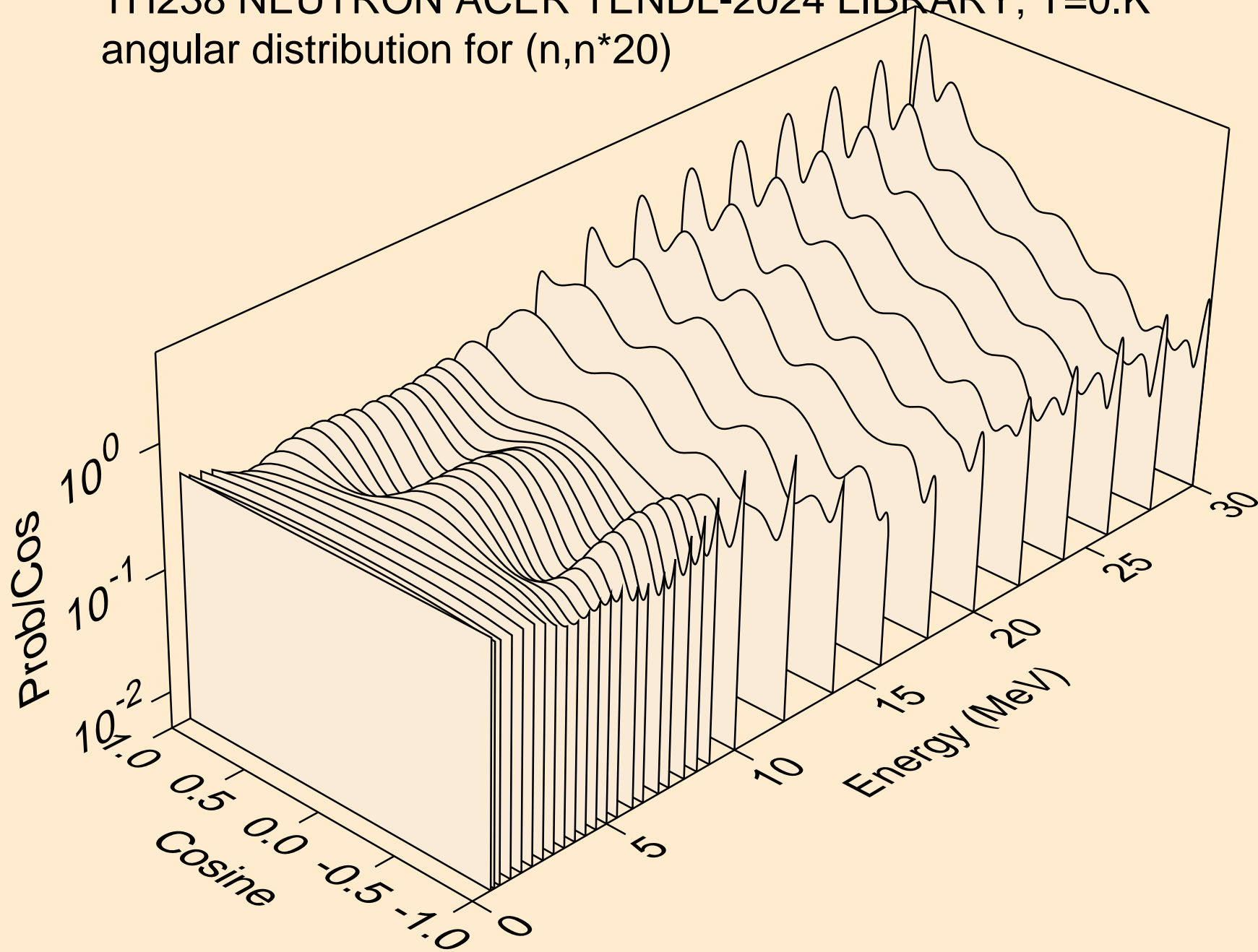

TH238 NEUTRON ACER TENDL-2024 LIBRARY; T=0.K  
angular distribution for (n,n\*21)

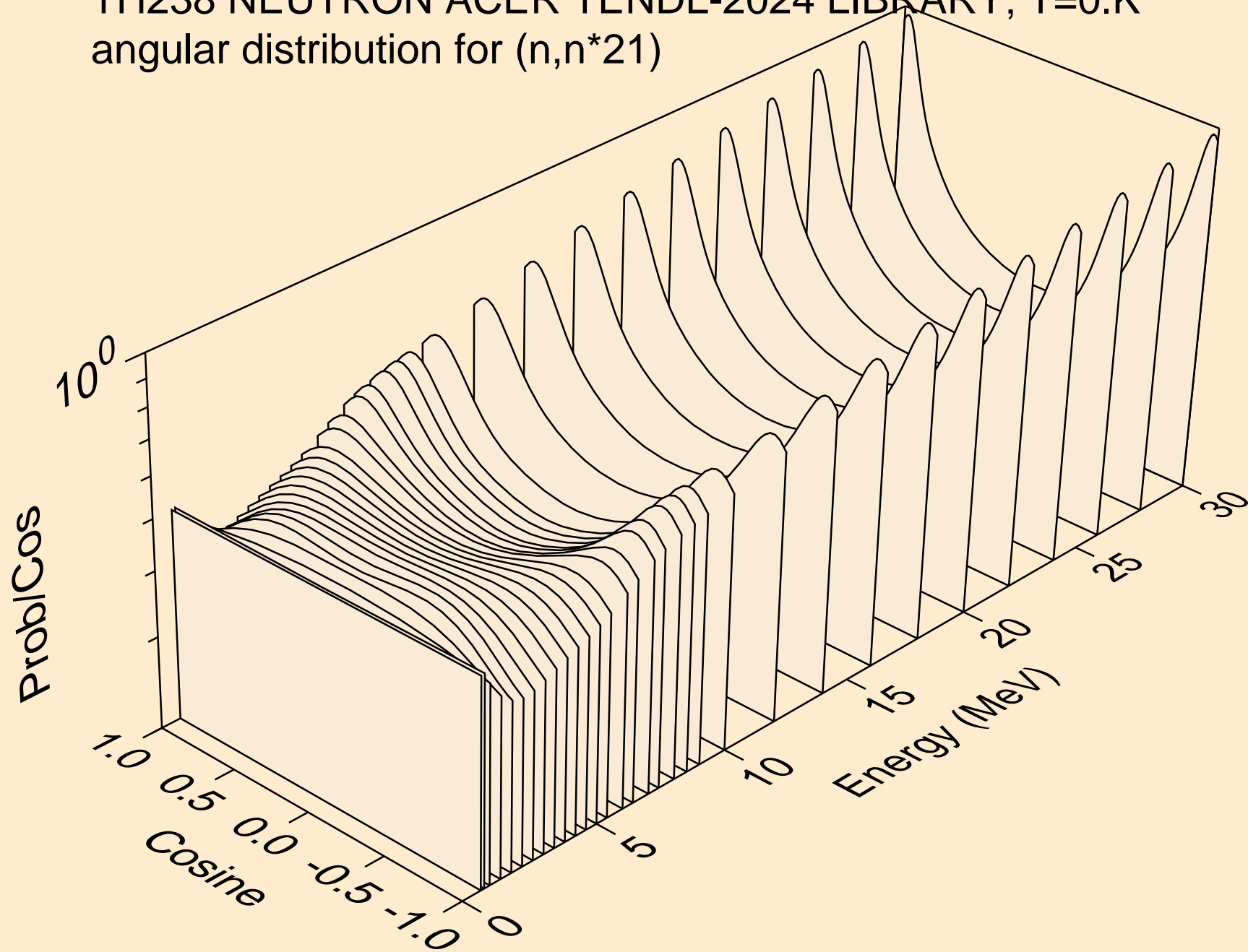

TH238 NEUTRON ACER TENDL-2024 LIBRARY; T=0.K  
angular distribution for (n,n\*22)

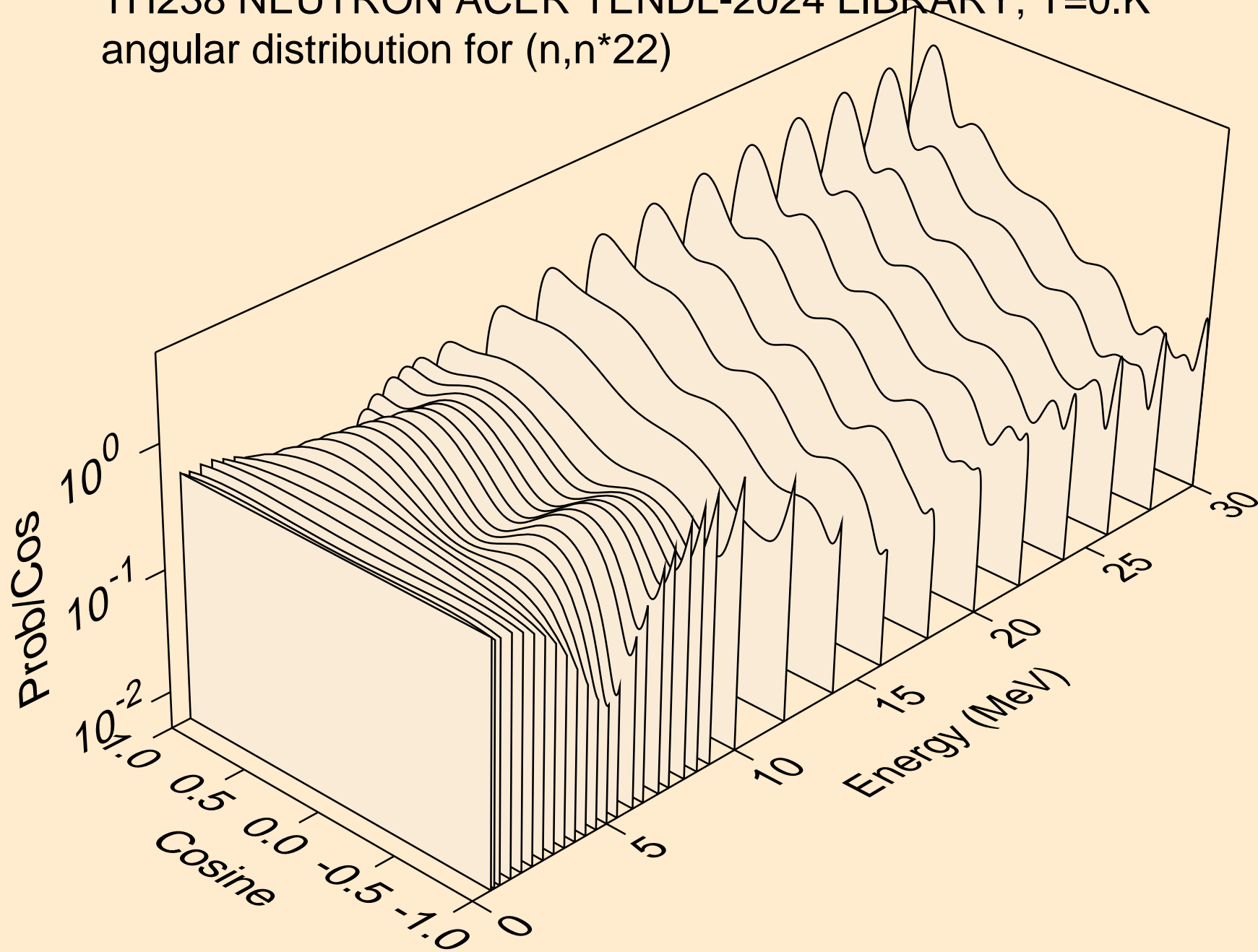

TH238 NEUTRON ACER TENDL-2024 LIBRARY; T=0.K  
angular distribution for (n,n\*23)

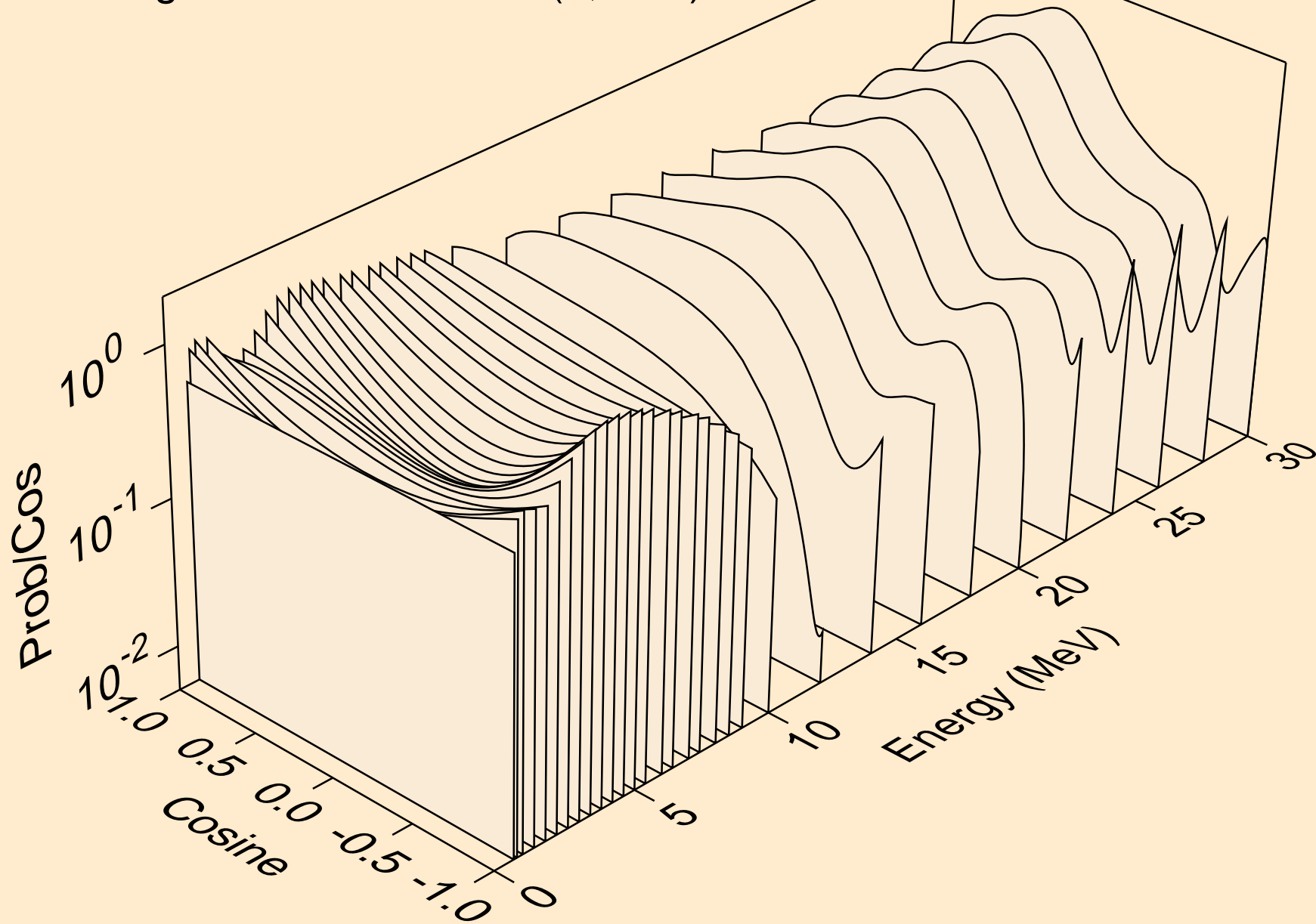

TH238 NEUTRON ACER TENDL-2024 LIBRARY; T=0.K  
angular distribution for (n,n\*24)

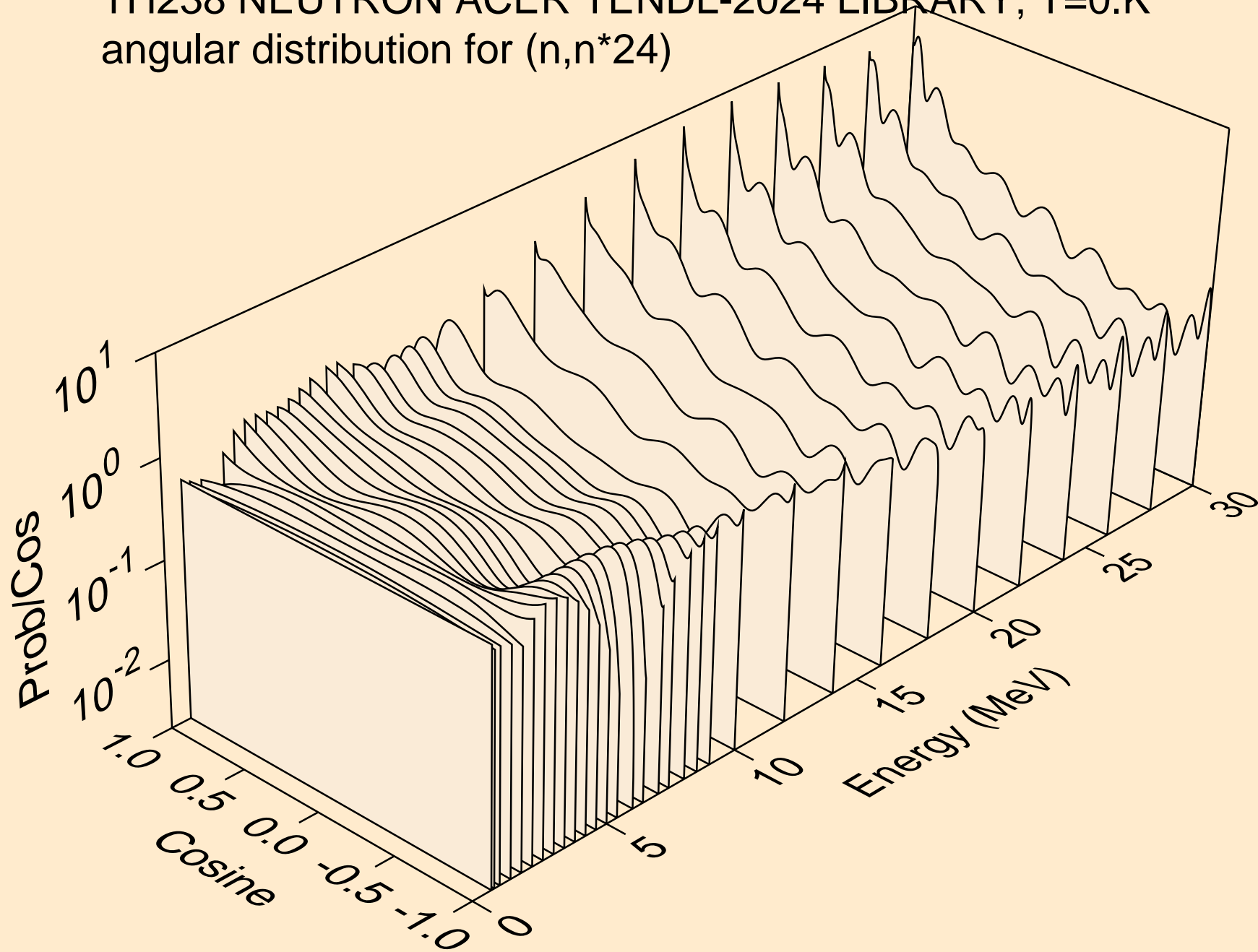

TH238 NEUTRON ACER TENDL-2024 LIBRARY; T=0.K  
angular distribution for (n,n\*25)

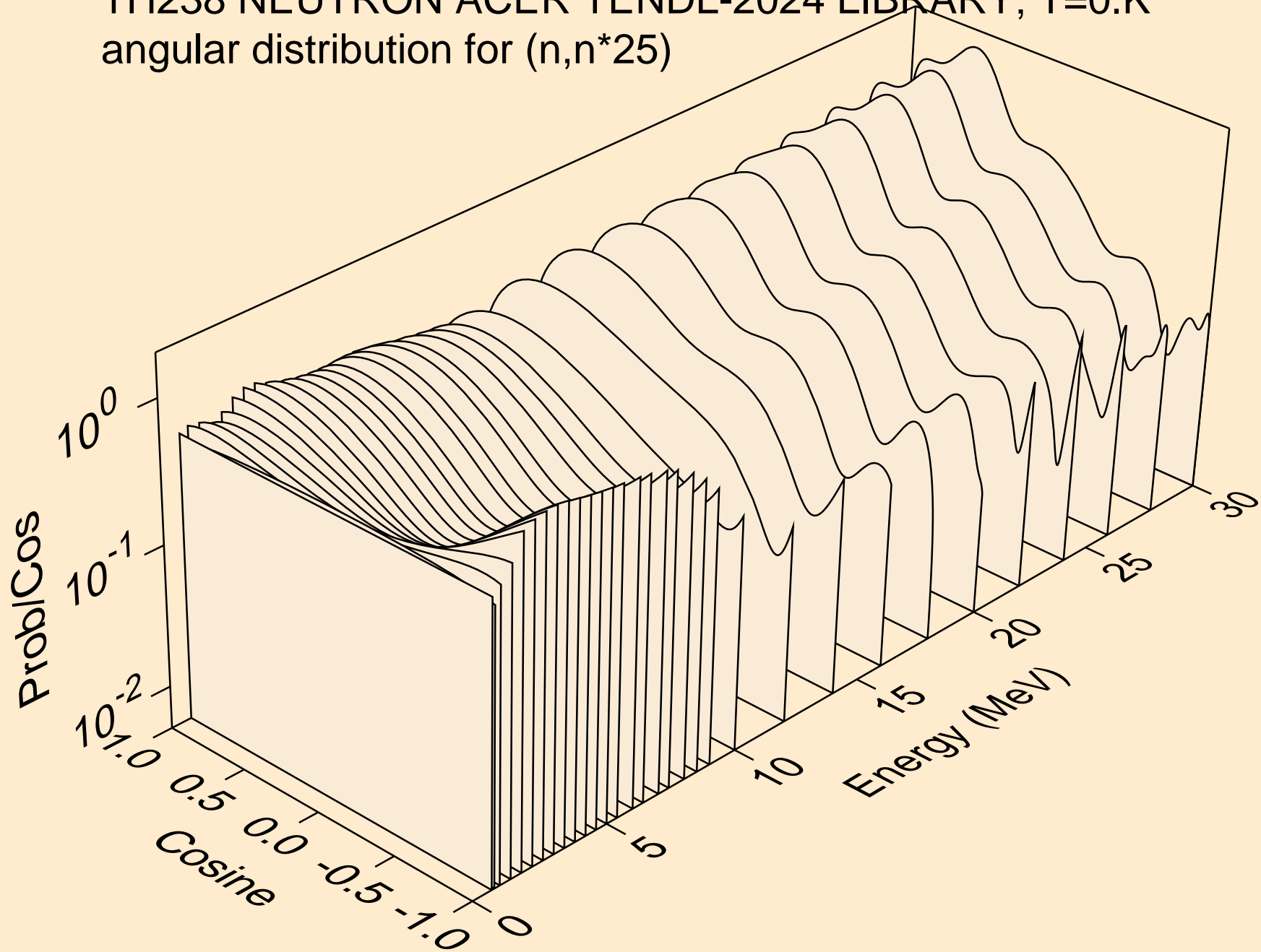

TH238 NEUTRON ACER TENDL-2024 LIBRARY; T=0.K  
angular distribution for (n,n\*26)

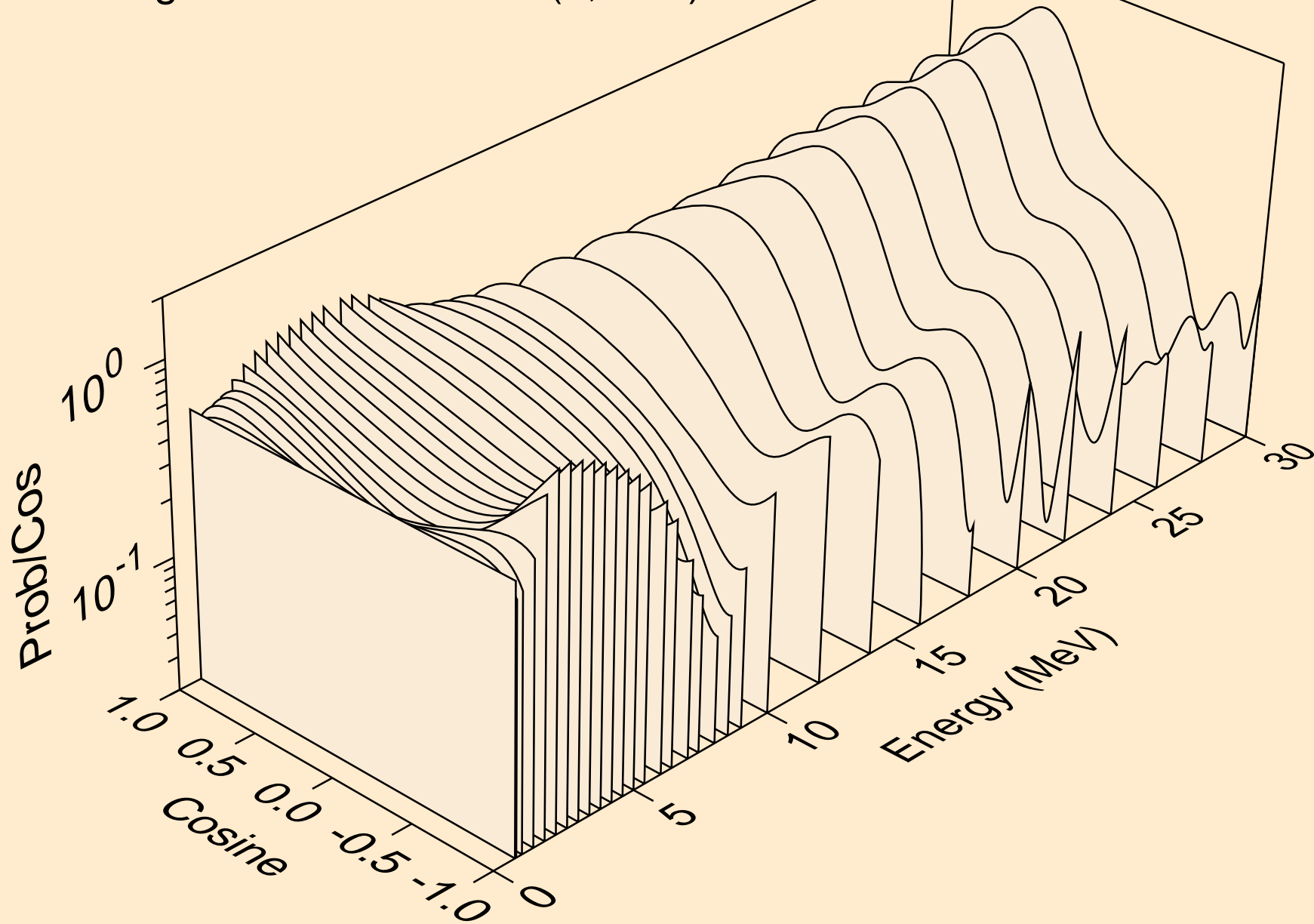



TH238 NEUTRON ACER TENDL-2024 LIBRARY; T=0.K  
angular distribution for (n,n\*27)

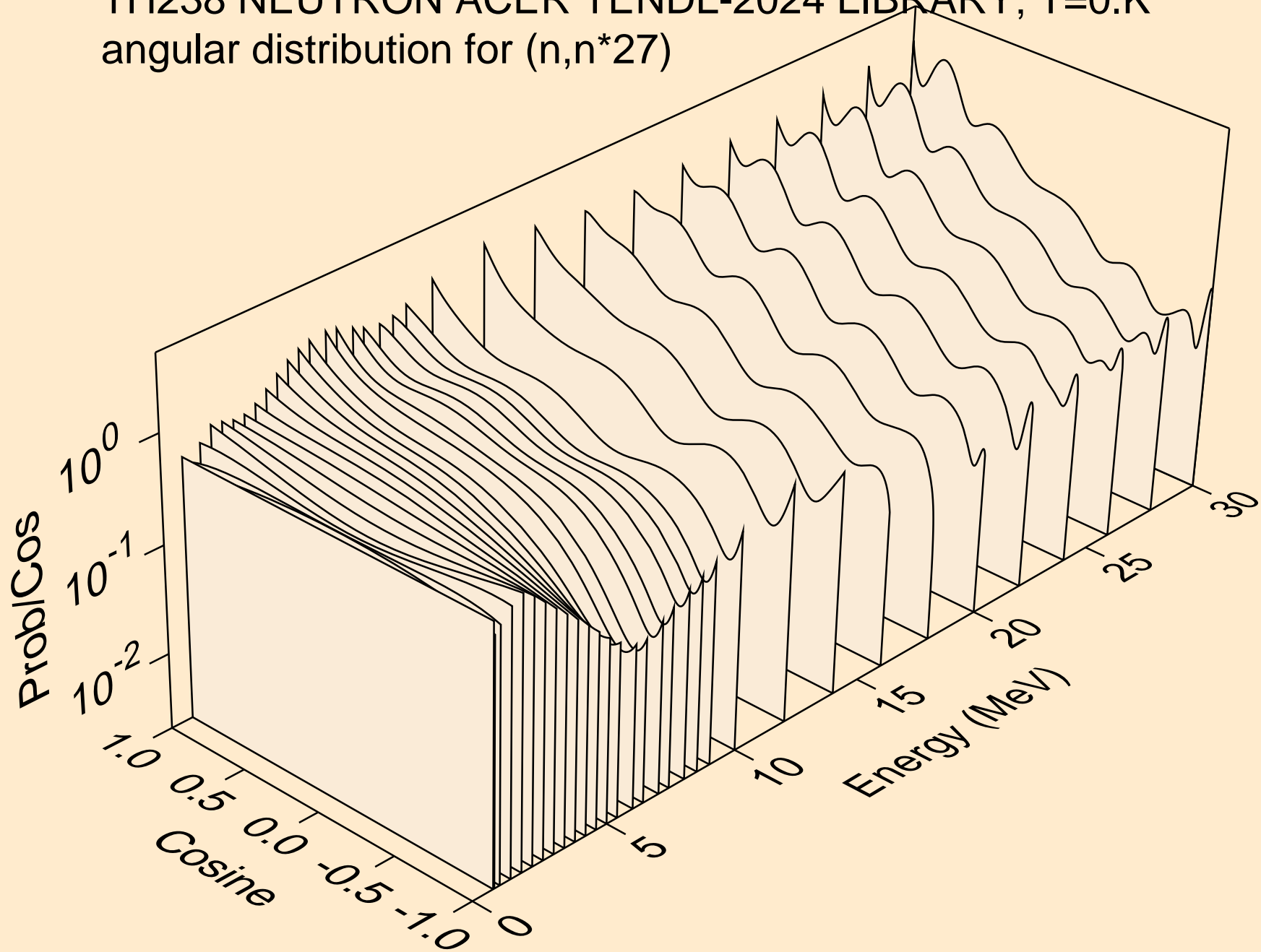

TH238 NEUTRON ACER TENDL-2024 LIBRARY; T=0.K  
angular distribution for (n,n\*28)

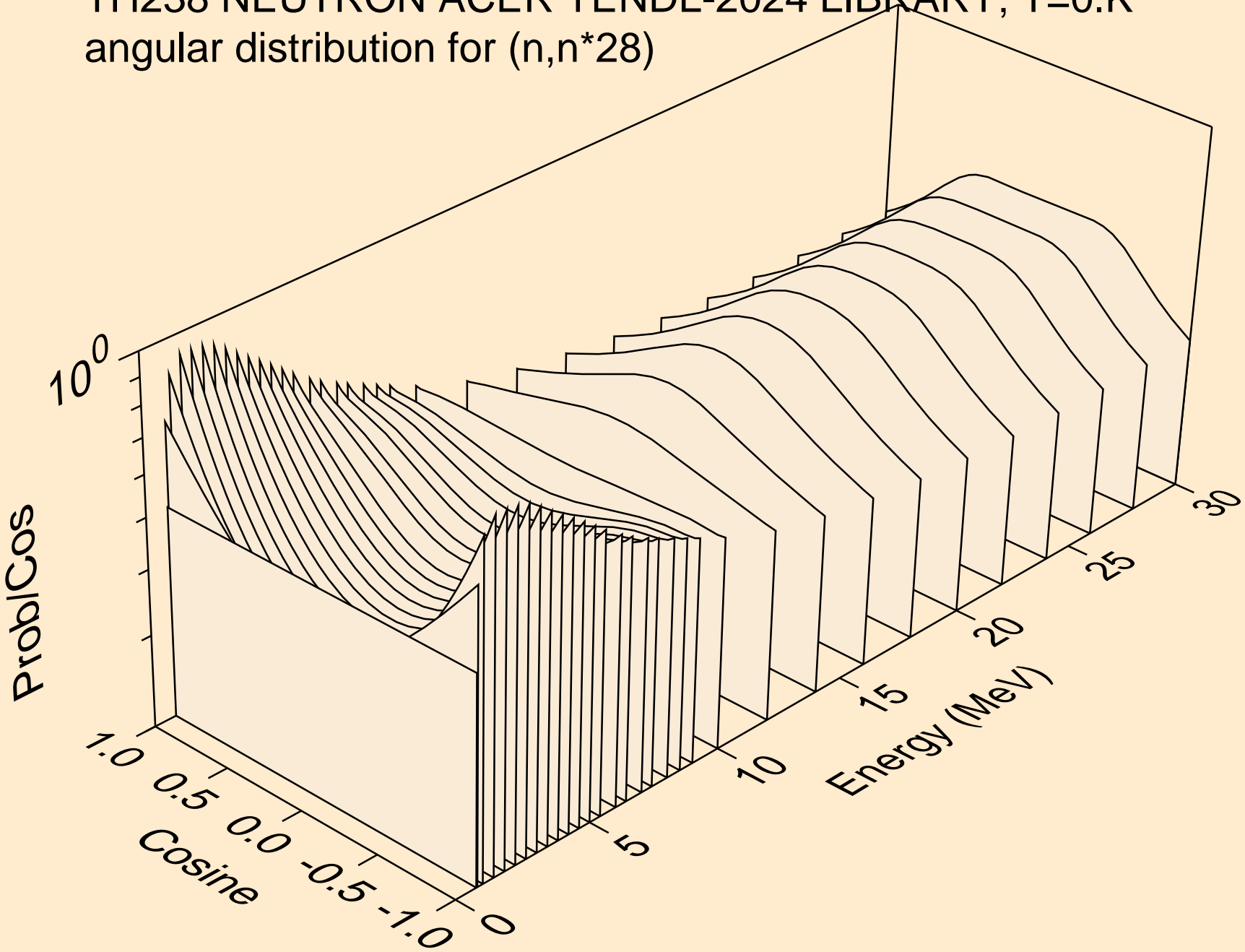

TH238 NEUTRON ACER TENDL-2024 LIBRARY; T=0.K  
angular distribution for (n,n\*29)

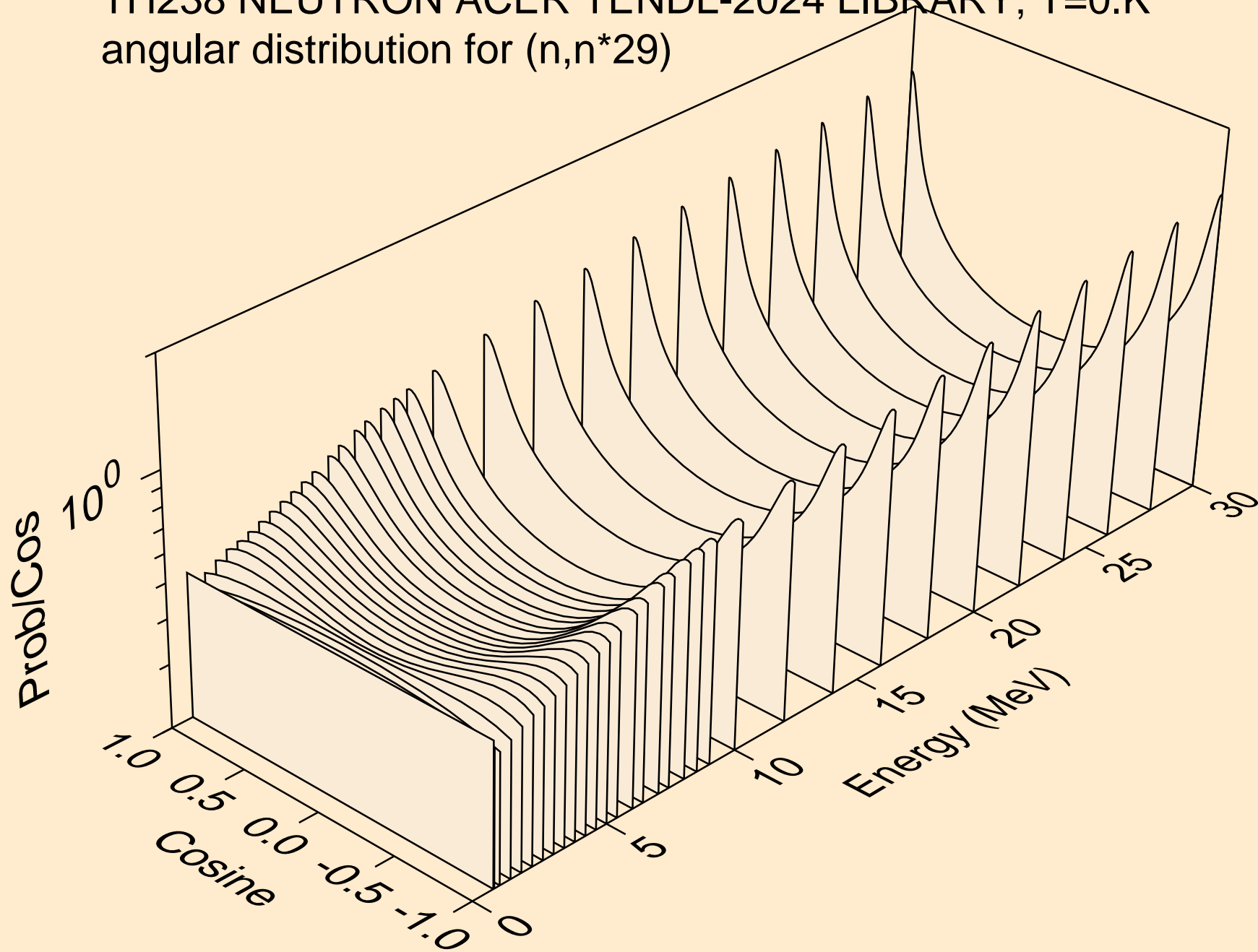

TH238 NEUTRON ACER TENDL-2024 LIBRARY; T=0.K  
angular distribution for (n,n\*30)

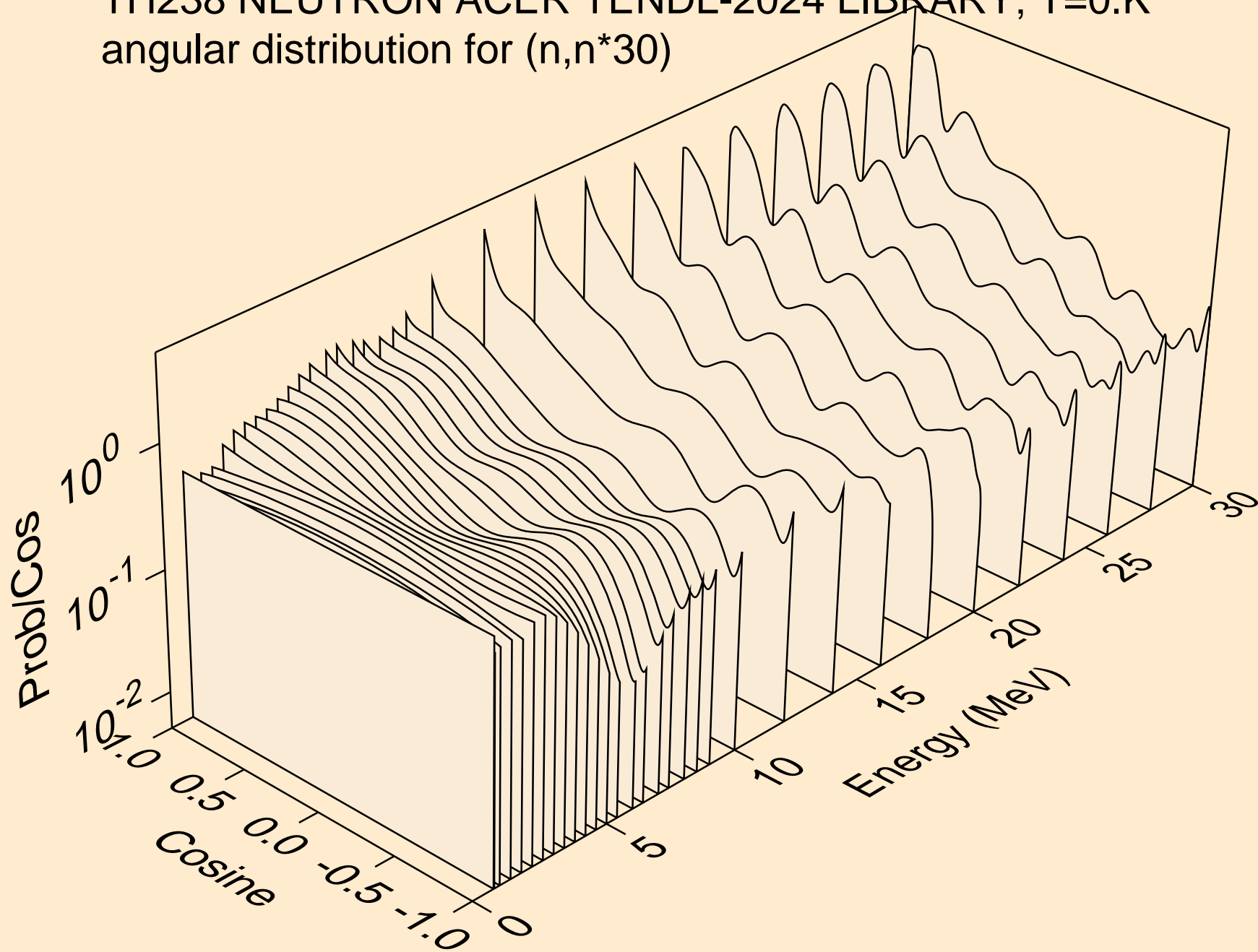

# TH238 NEUTRON ACER TENDL-2024 LIBRARY; T=0.K

Total fission nubar

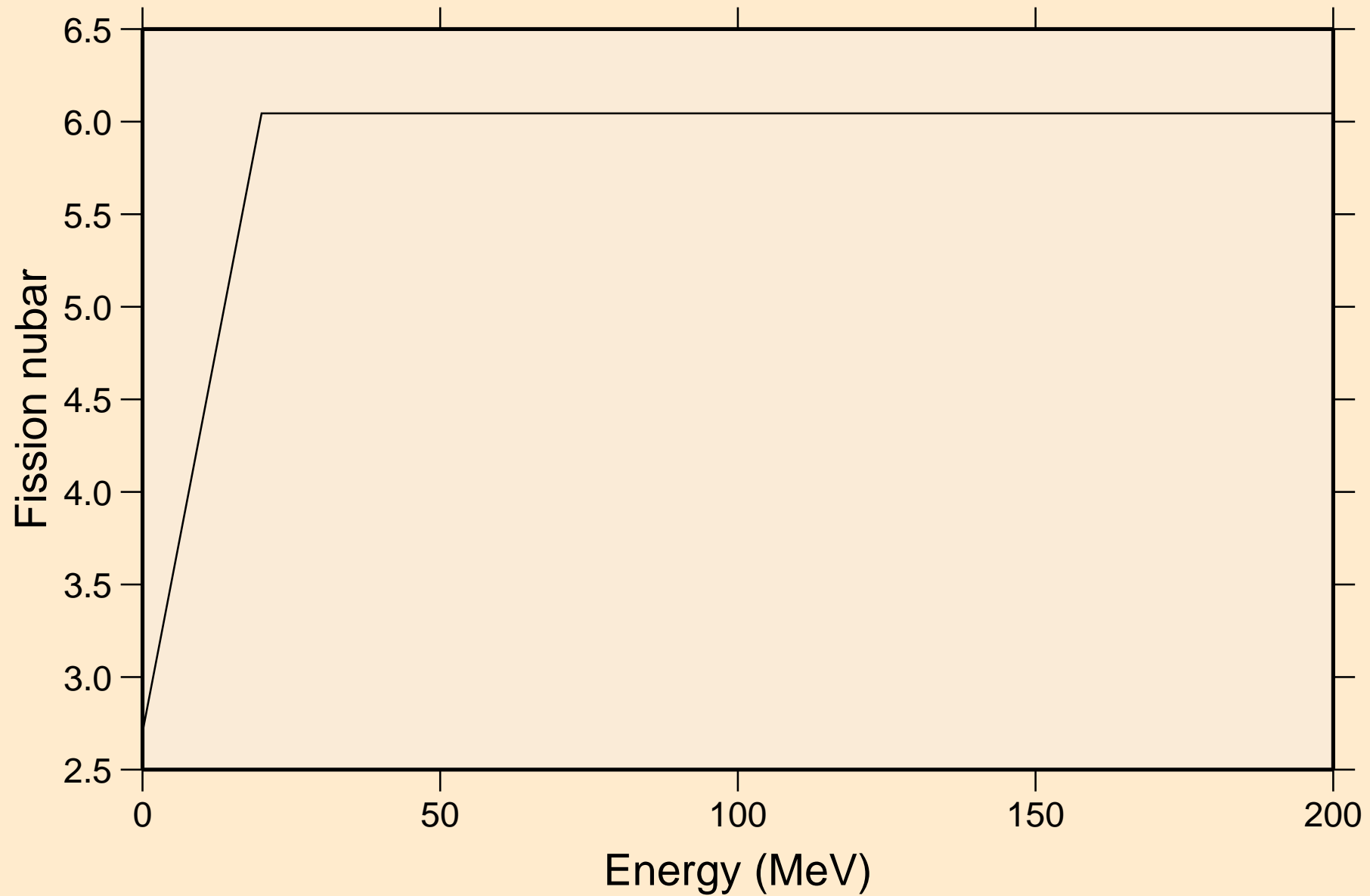

TH238 NEUTRON ACER TENDL-2024 LIBRARY; T=0.K  
Neutron emission for (n,x)

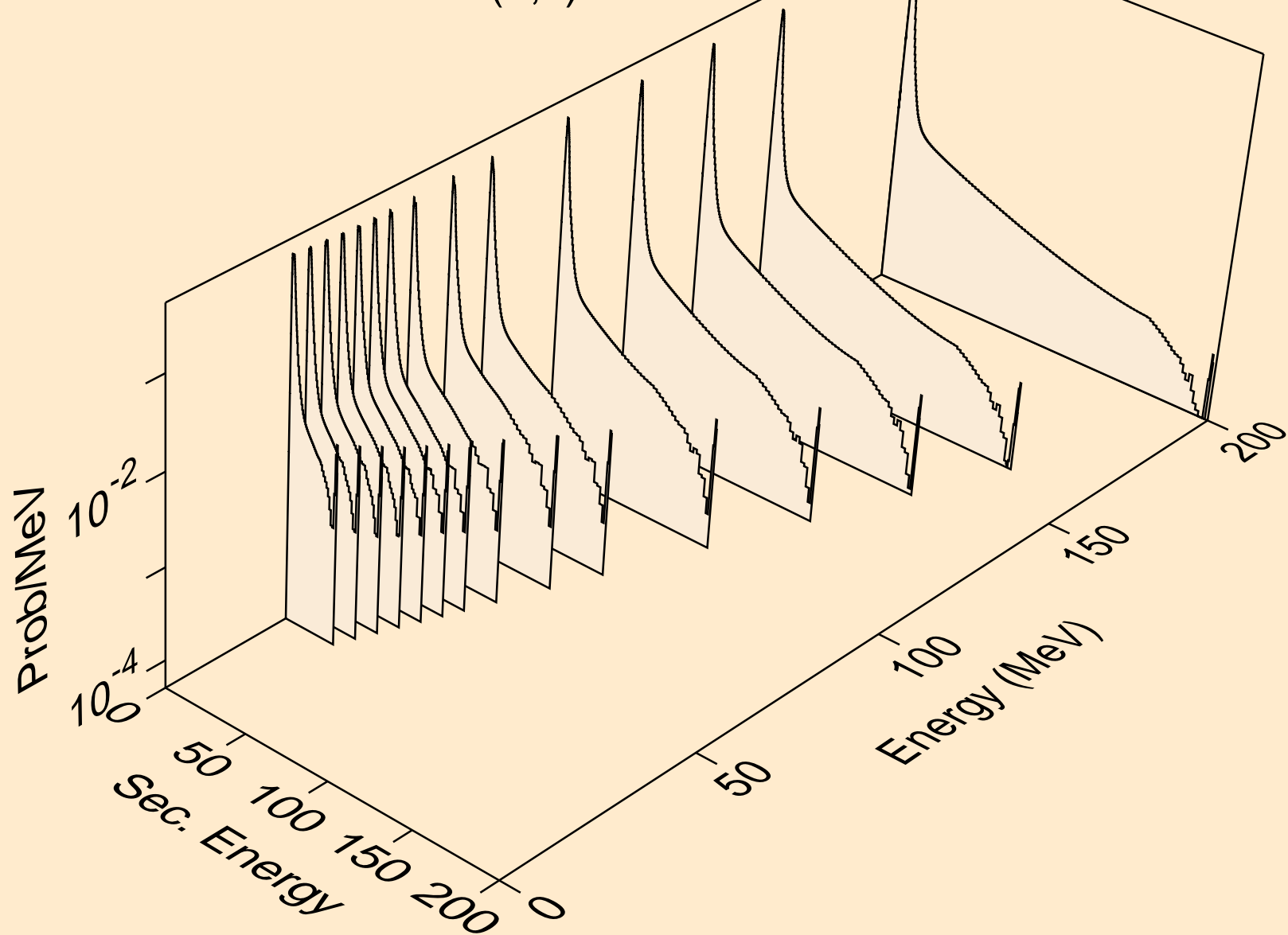

TH238 NEUTRON ACER TENDL-2024 LIBRARY; T=0.K  
Neutron emission for (n,2nd)

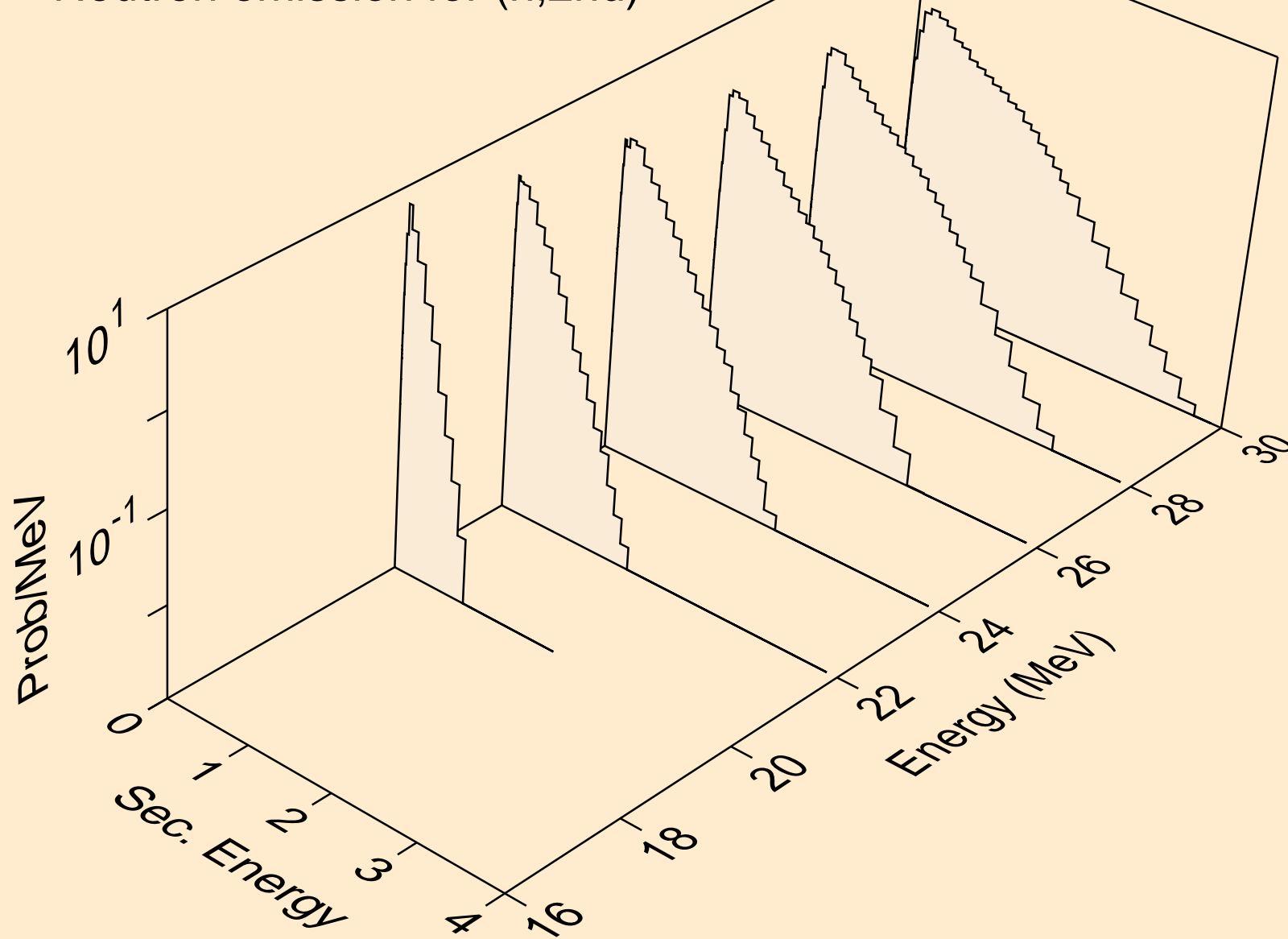

TH238 NEUTRON ACER TENDL-2024 LIBRARY; T=0.K  
Neutron emission for (n,2n)

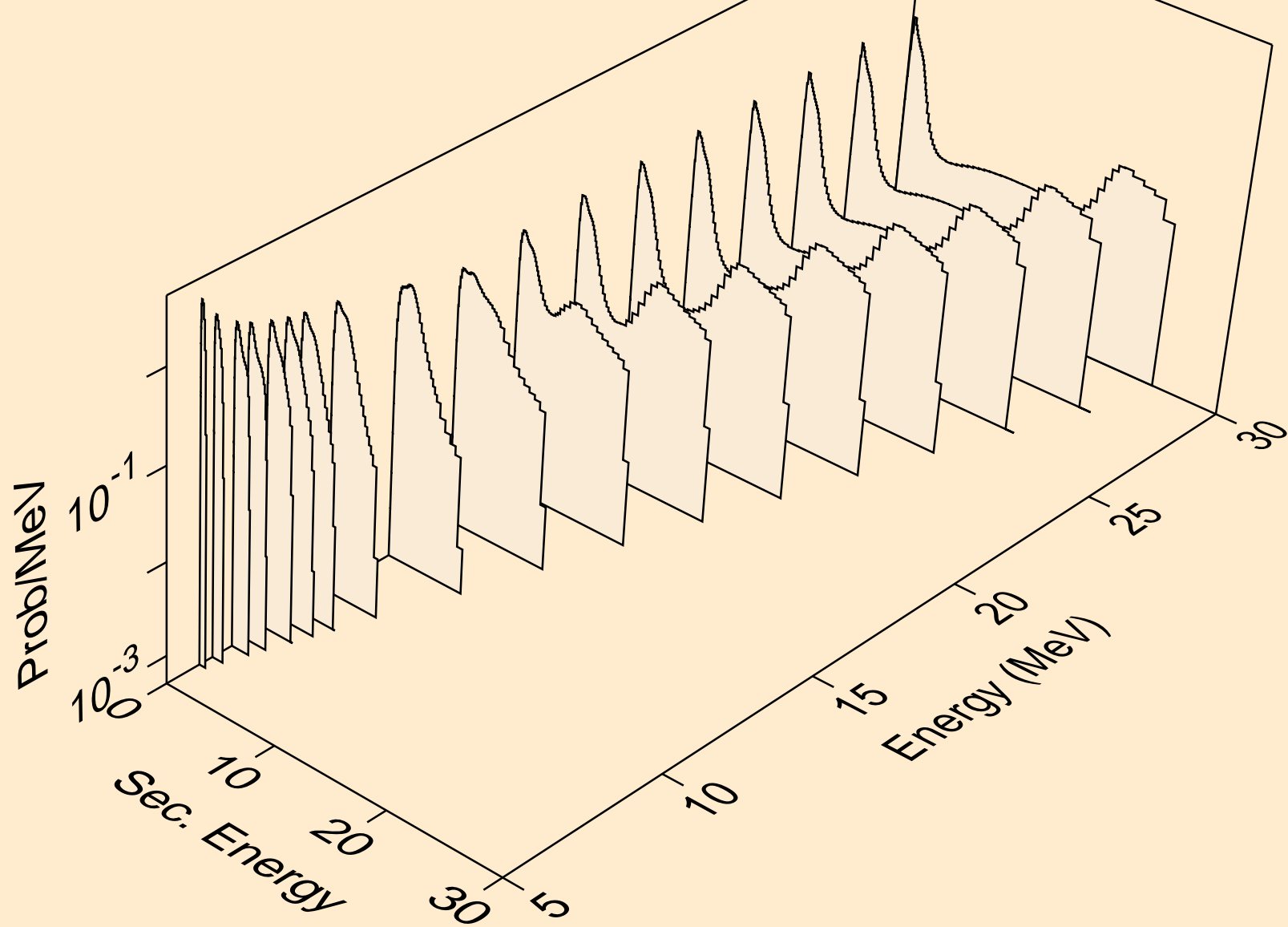



TH238 NEUTRON ACER TENDL-2024 LIBRARY; T=0.K  
Neutron emission for (n,3n)

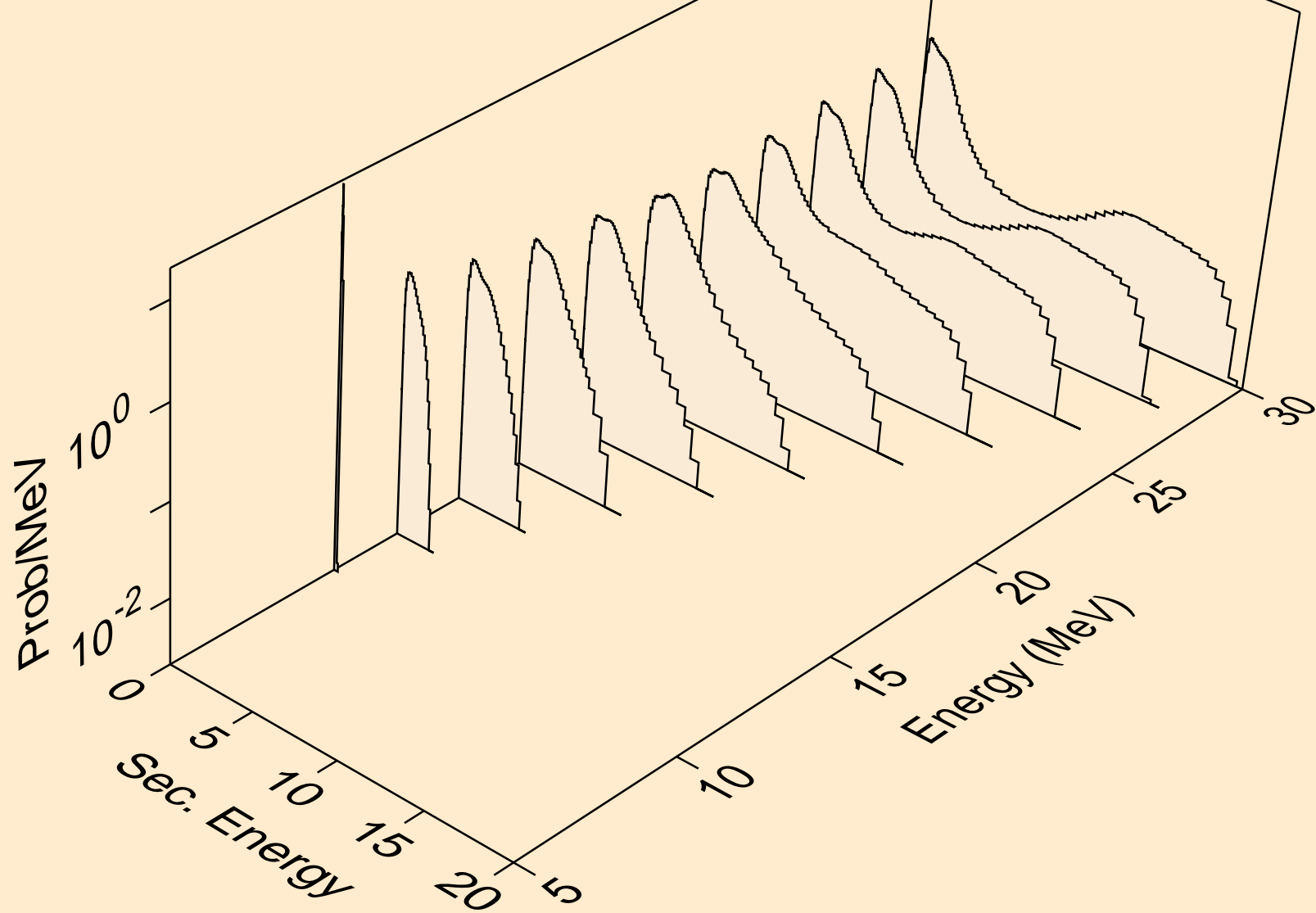

TH238 NEUTRON ACER TENDL-2024 LIBRARY; T=0.K  
Neutron emission for fission

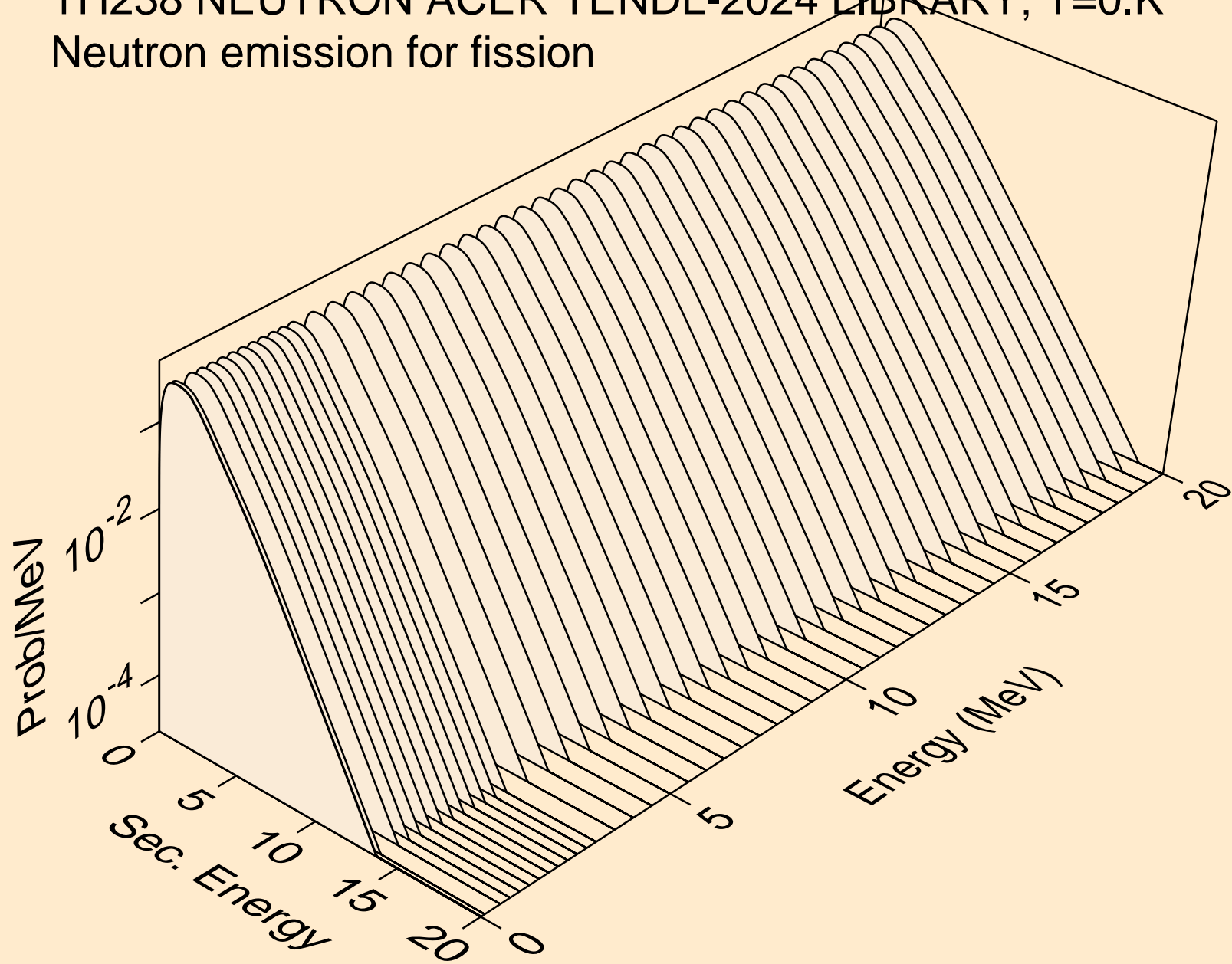

TH238 NEUTRON ACER TENDL-2024 LIBRARY; T=0.K  
Neutron emission for (n,n\*)a

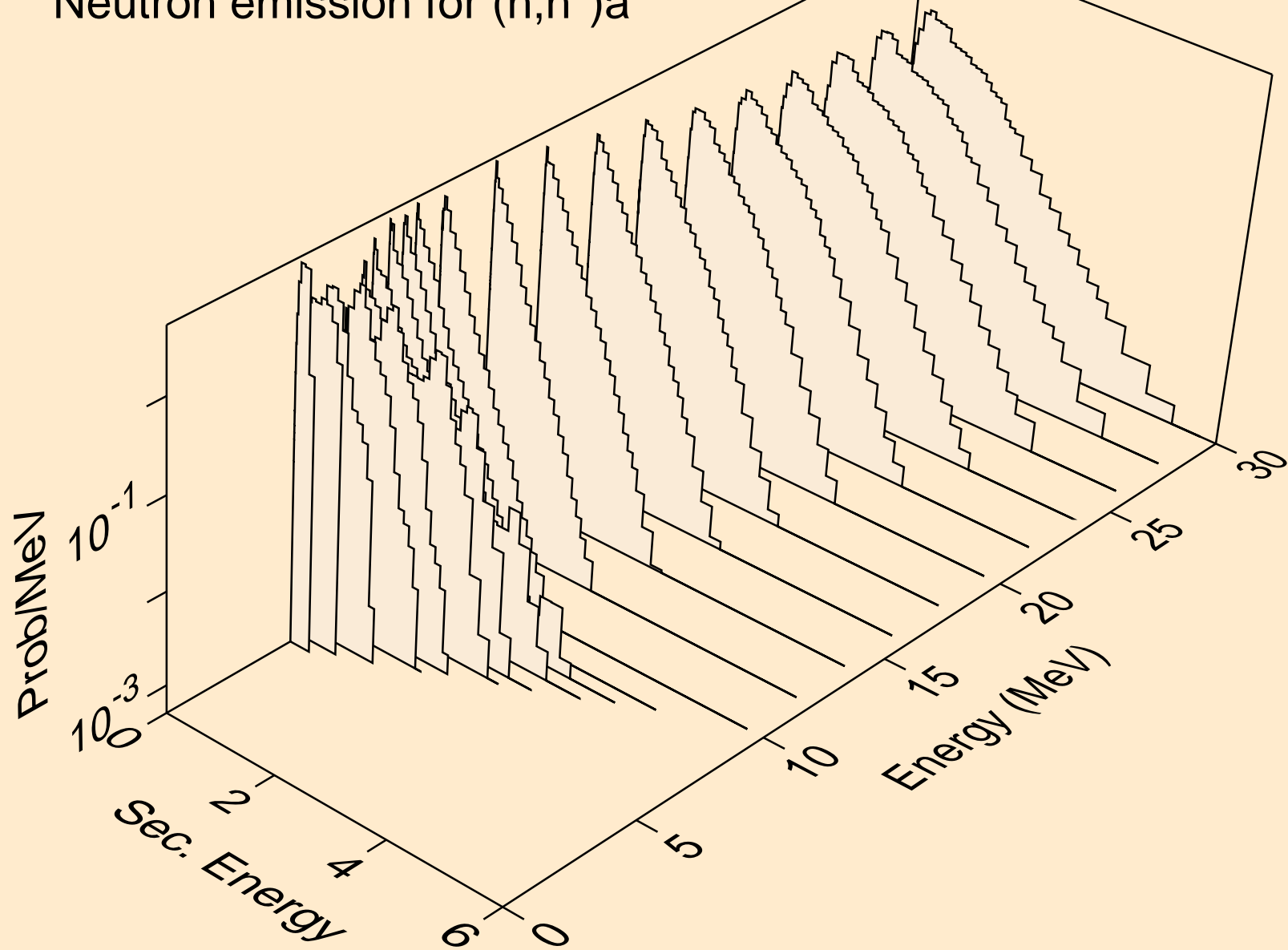

TH238 NEUTRON ACER TENDL-2024 LIBRARY; T=0.K  
Neutron emission for (n,2n)a

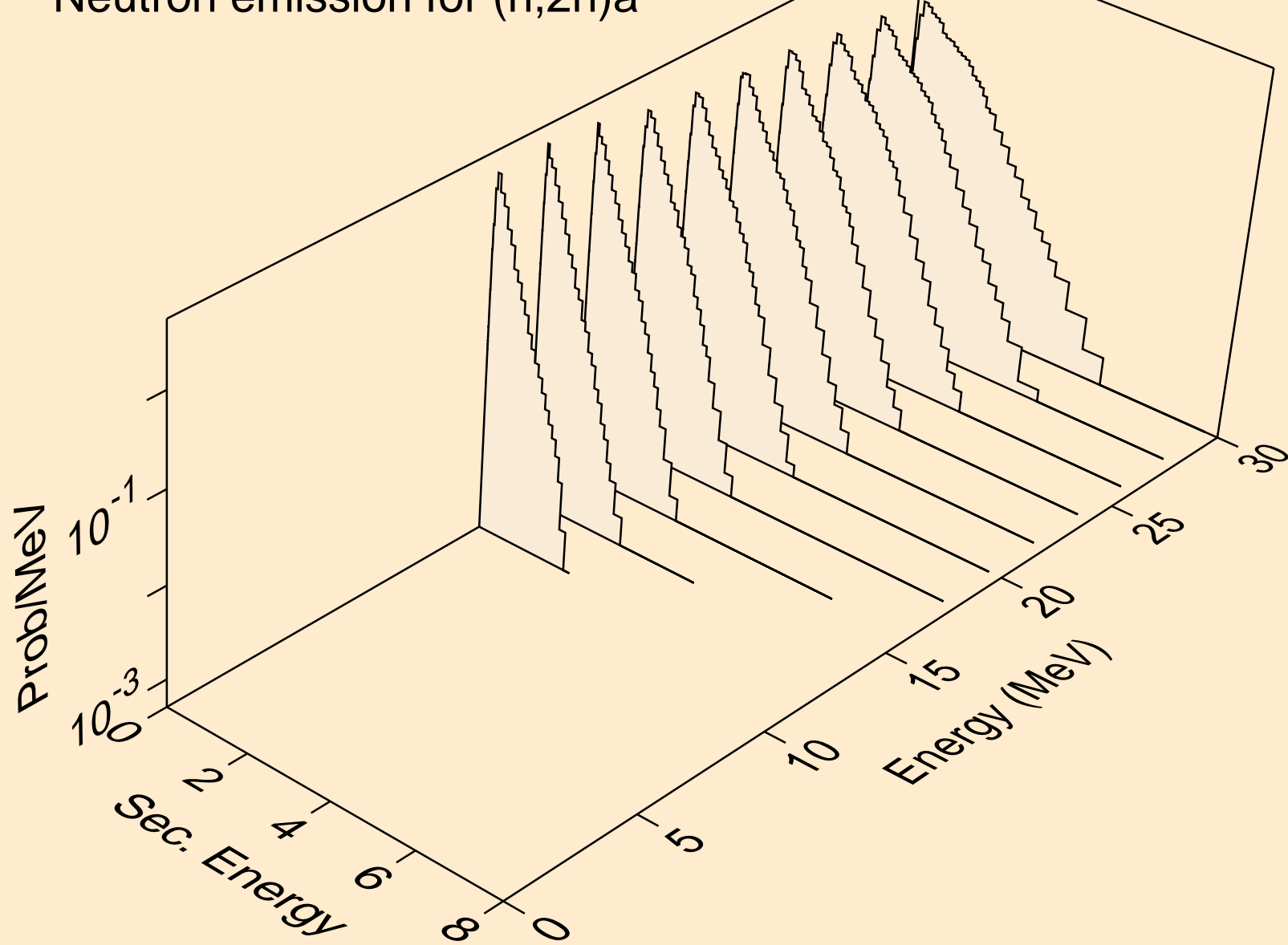

TH238 NEUTRON ACER TENDL-2024 LIBRARY; T=0.K  
Neutron emission for (n,3n)a

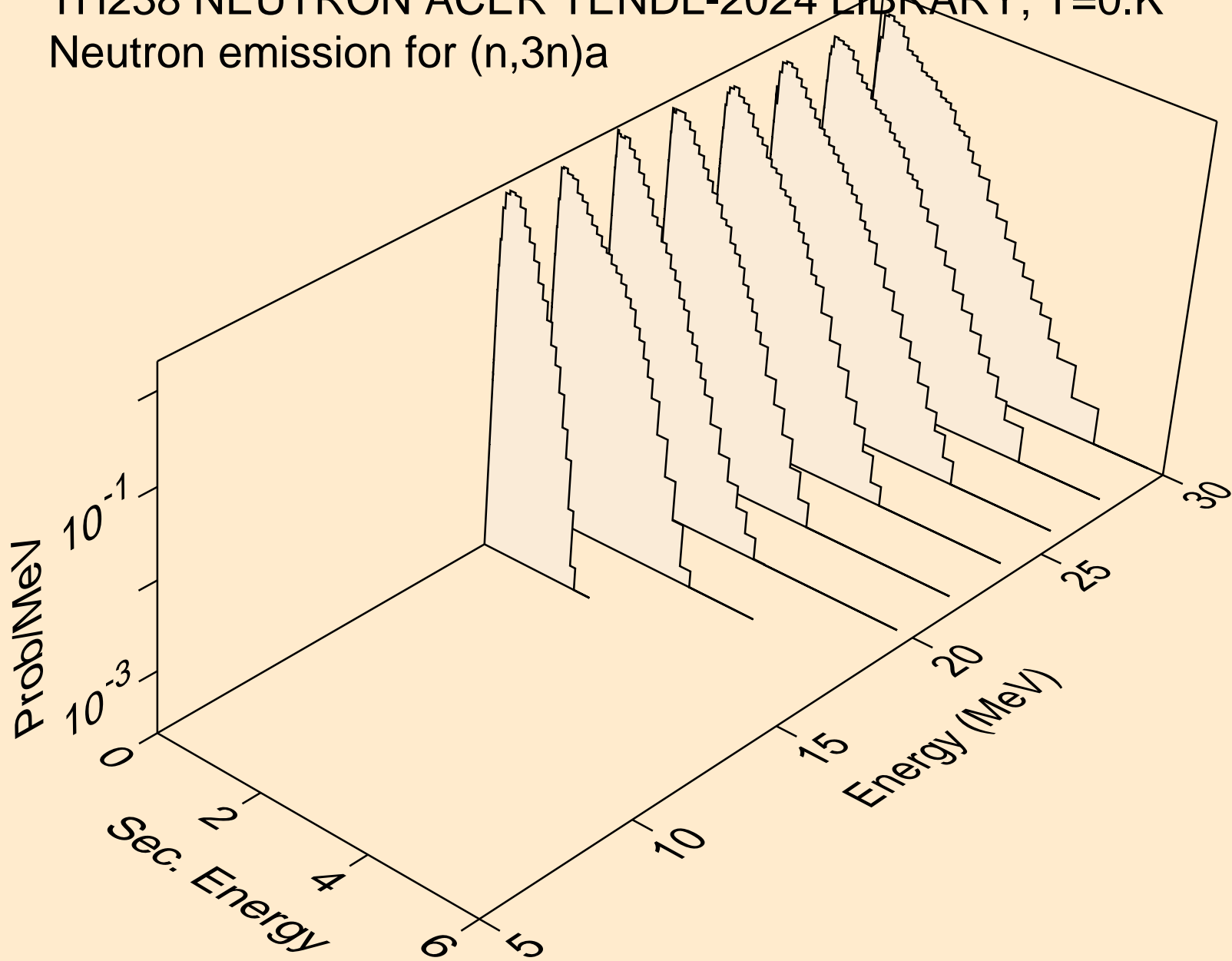

TH238 NEUTRON ACER TENDL-2024 LIBRARY; T=0.K  
Neutron emission for (n,n\*)p

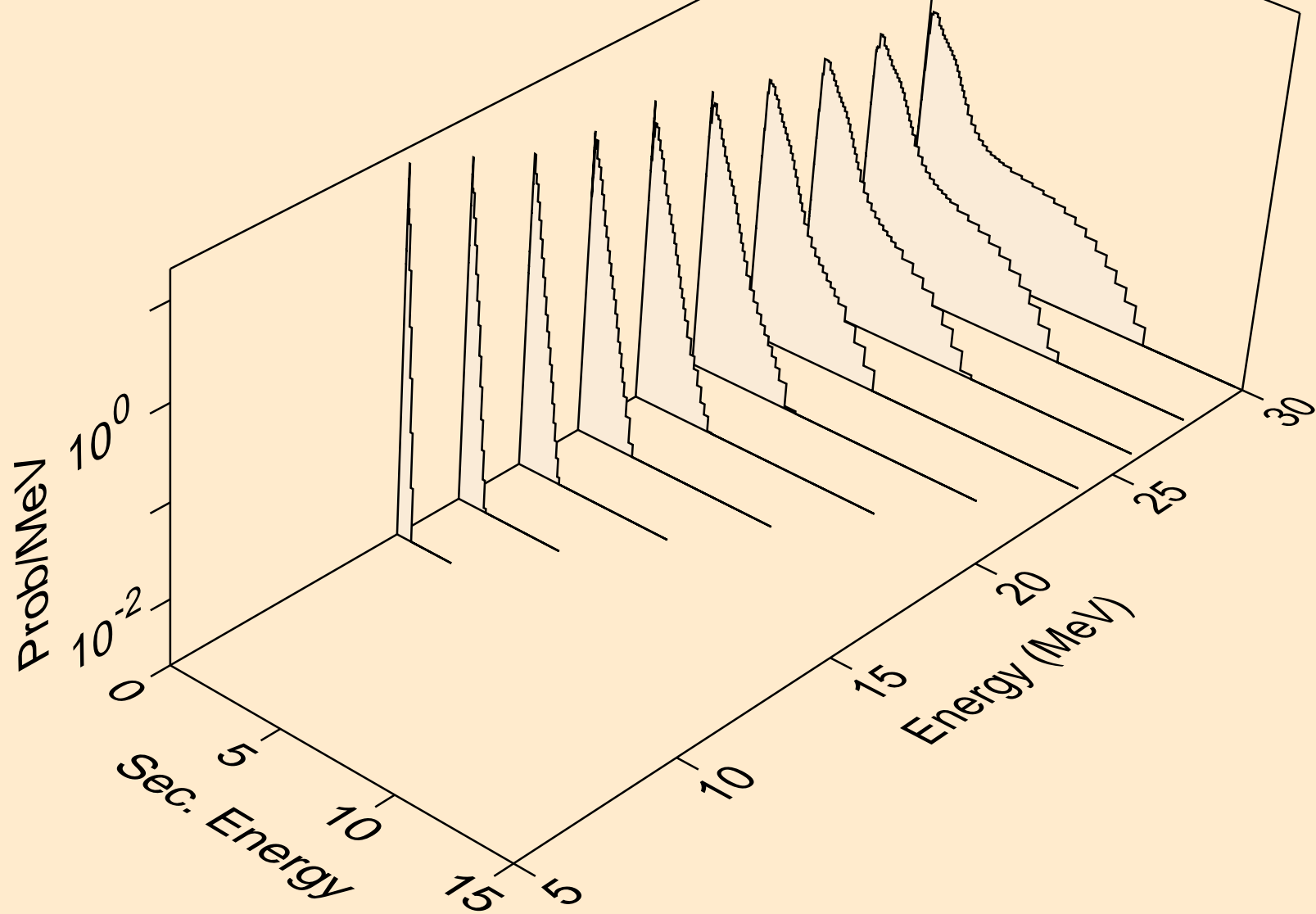

TH238 NEUTRON ACER TENDL-2024 LIBRARY; T=0.K  
Neutron emission for (n,n\*)d

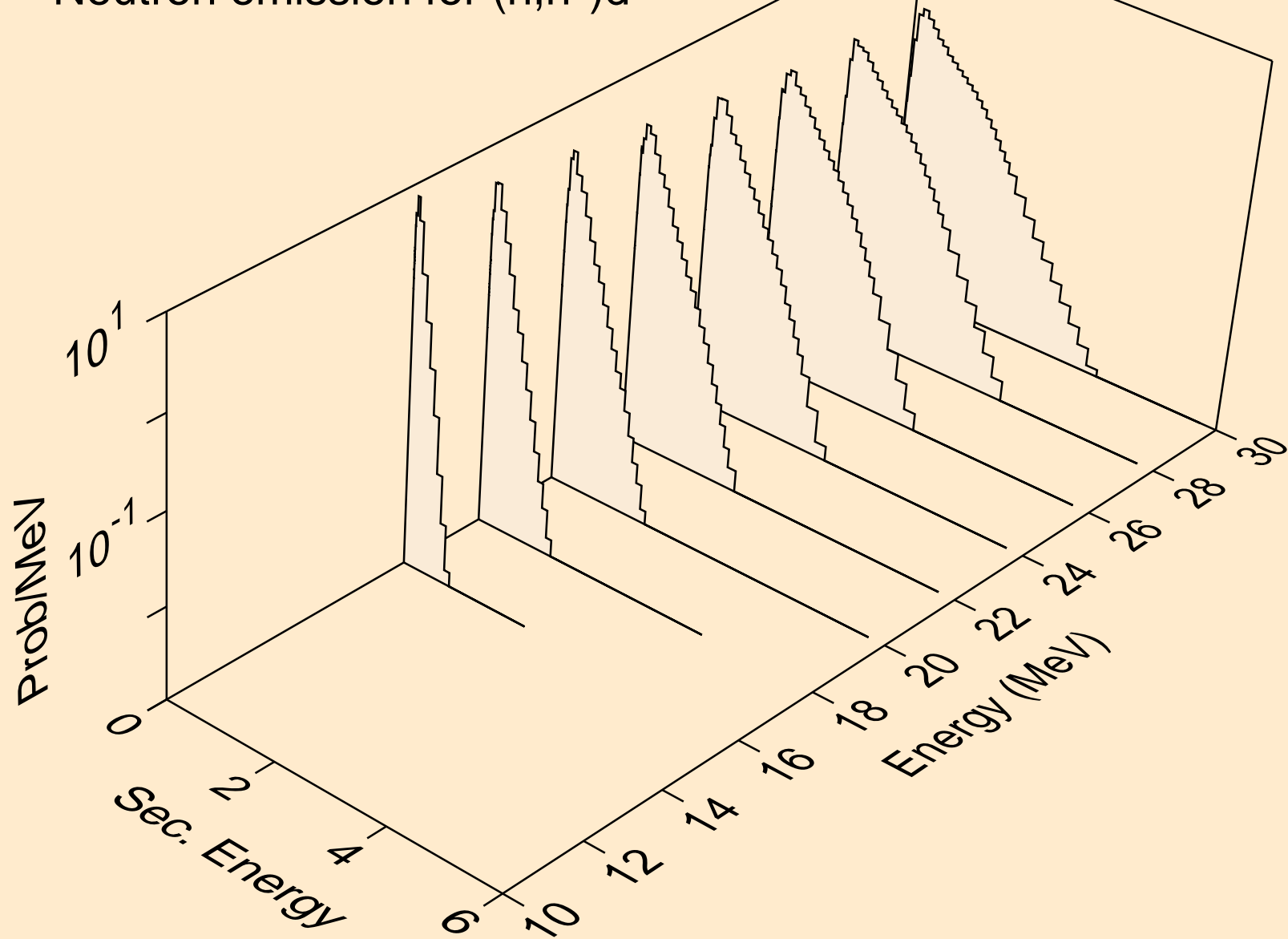

TH238 NEUTRON ACER TENDL-2024 LIBRARY; T=0.K  
Neutron emission for (n,n\*)t

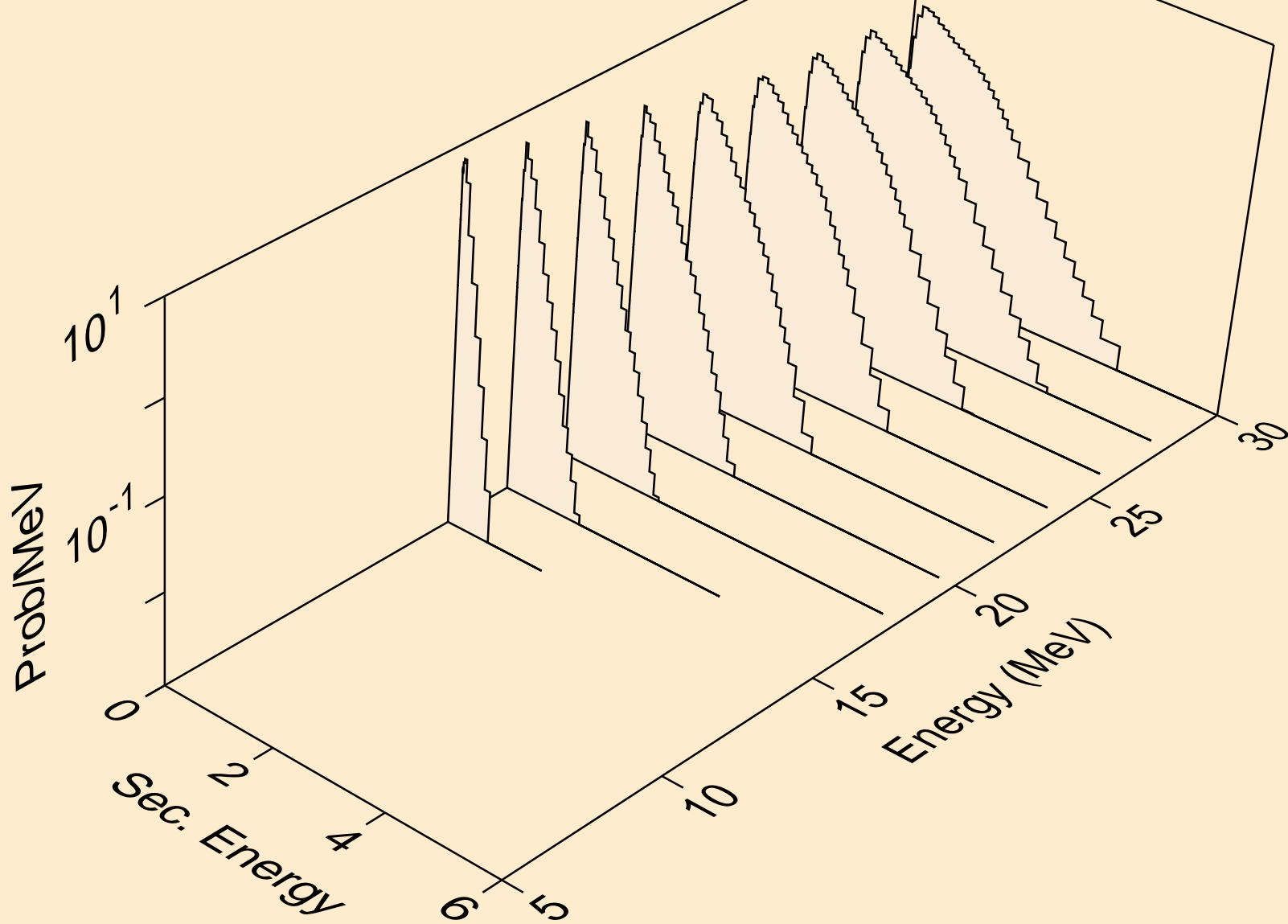



TH238 NEUTRON ACER TENDL-2024 LIBRARY; T=0.K  
Neutron emission for (n,n\*)he3

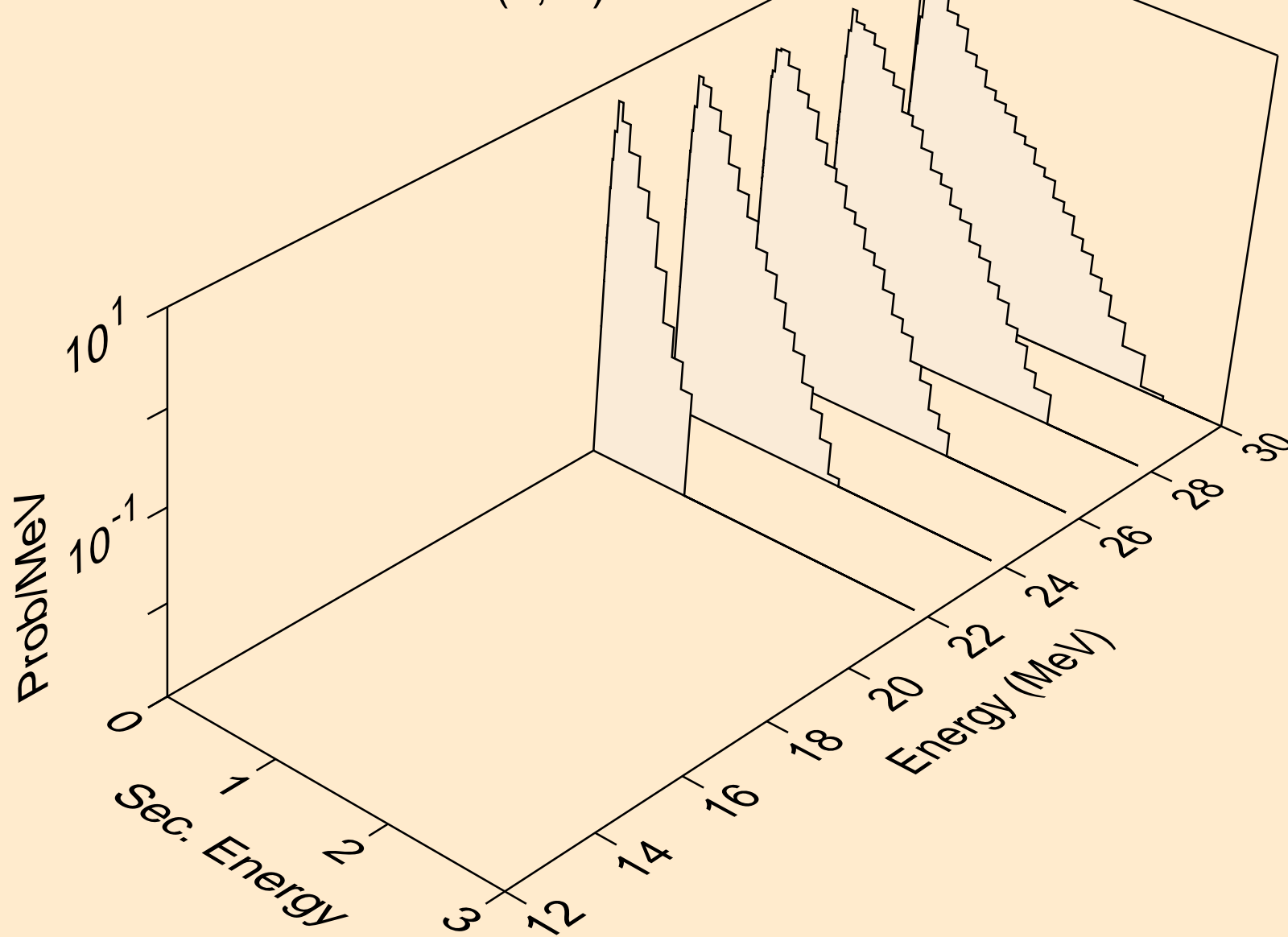

TH238 NEUTRON ACER TENDL-2024 LIBRARY; T=0.K  
Neutron emission for (n,4n)

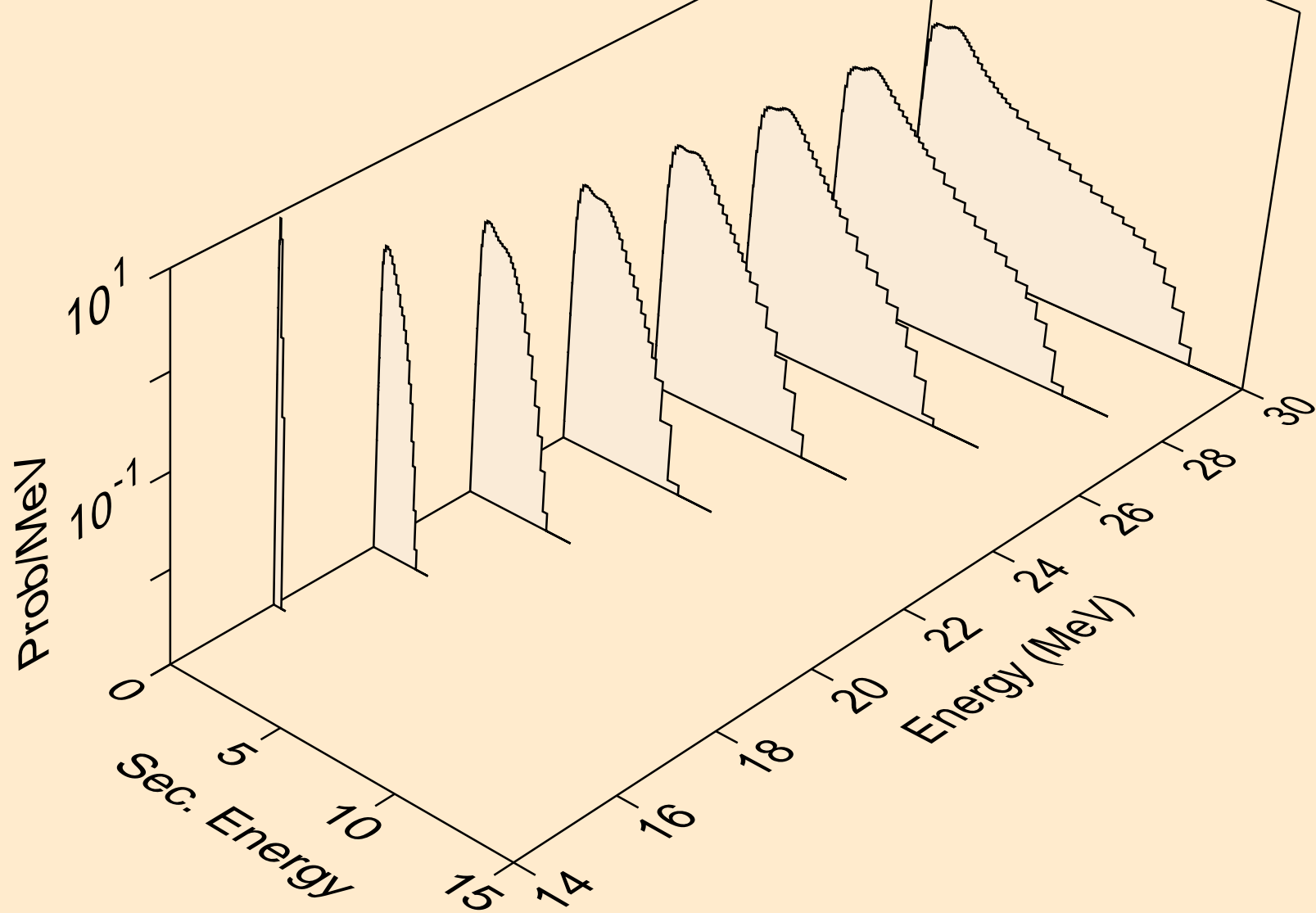

TH238 NEUTRON ACER TENDL-2024 LIBRARY; T=0.K  
Neutron emission for (n,2np)

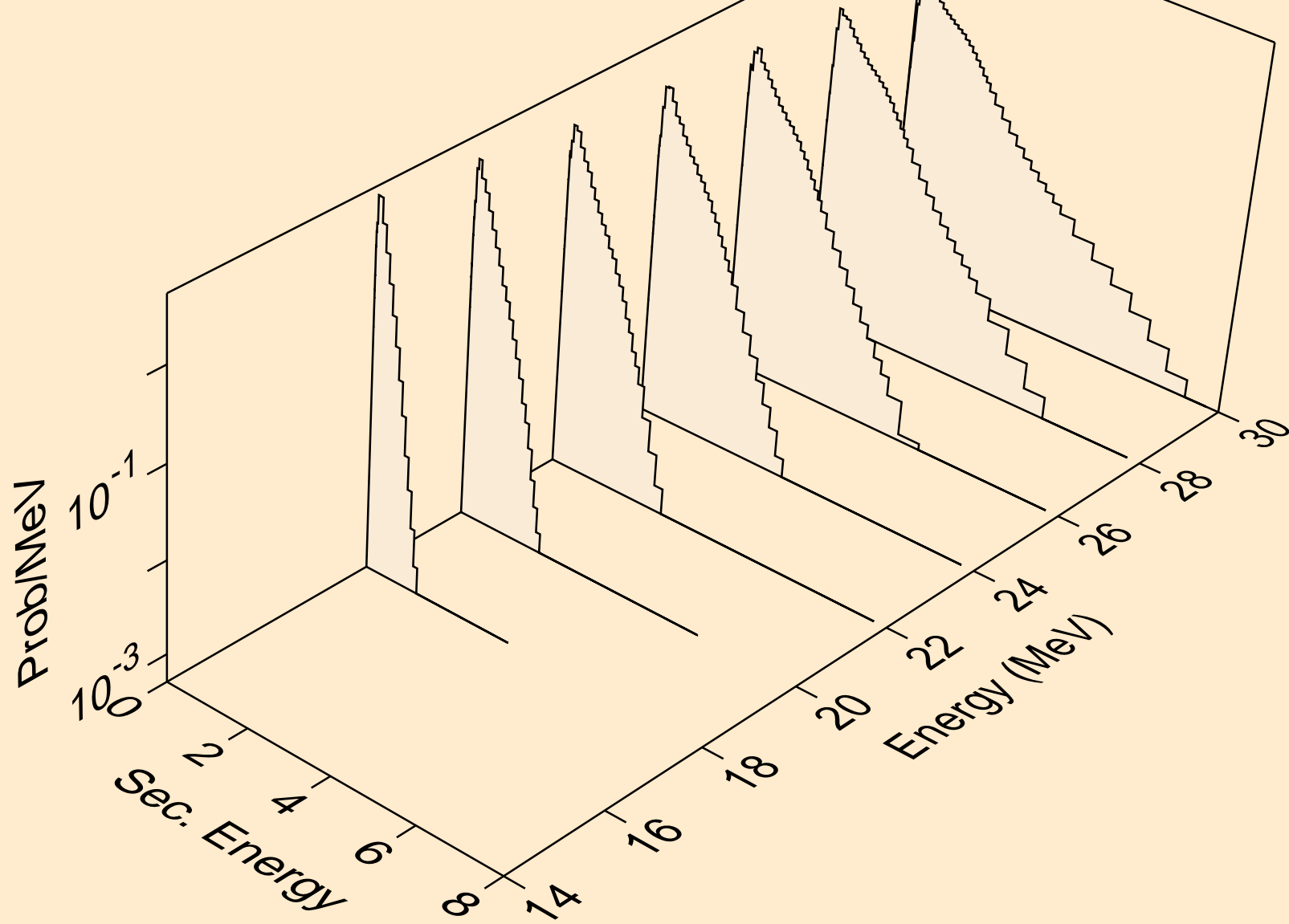

TH238 NEUTRON ACER TENDL-2024 LIBRARY; T=0.K  
Neutron emission for (n,3np)

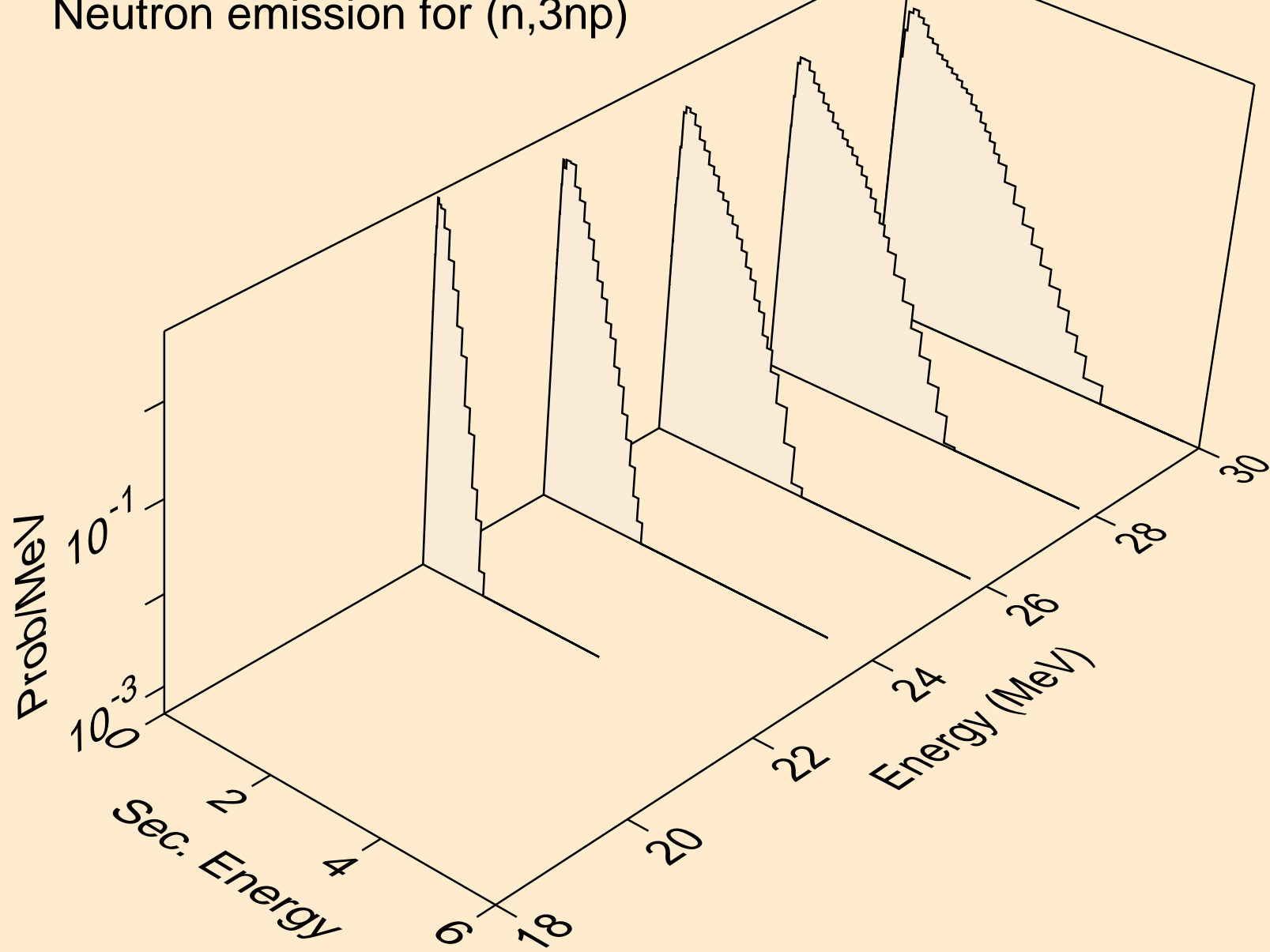

TH238 NEUTRON ACER TENDL-2024 LIBRARY; T=0.K  
Neutron emission for (n,n\*c)

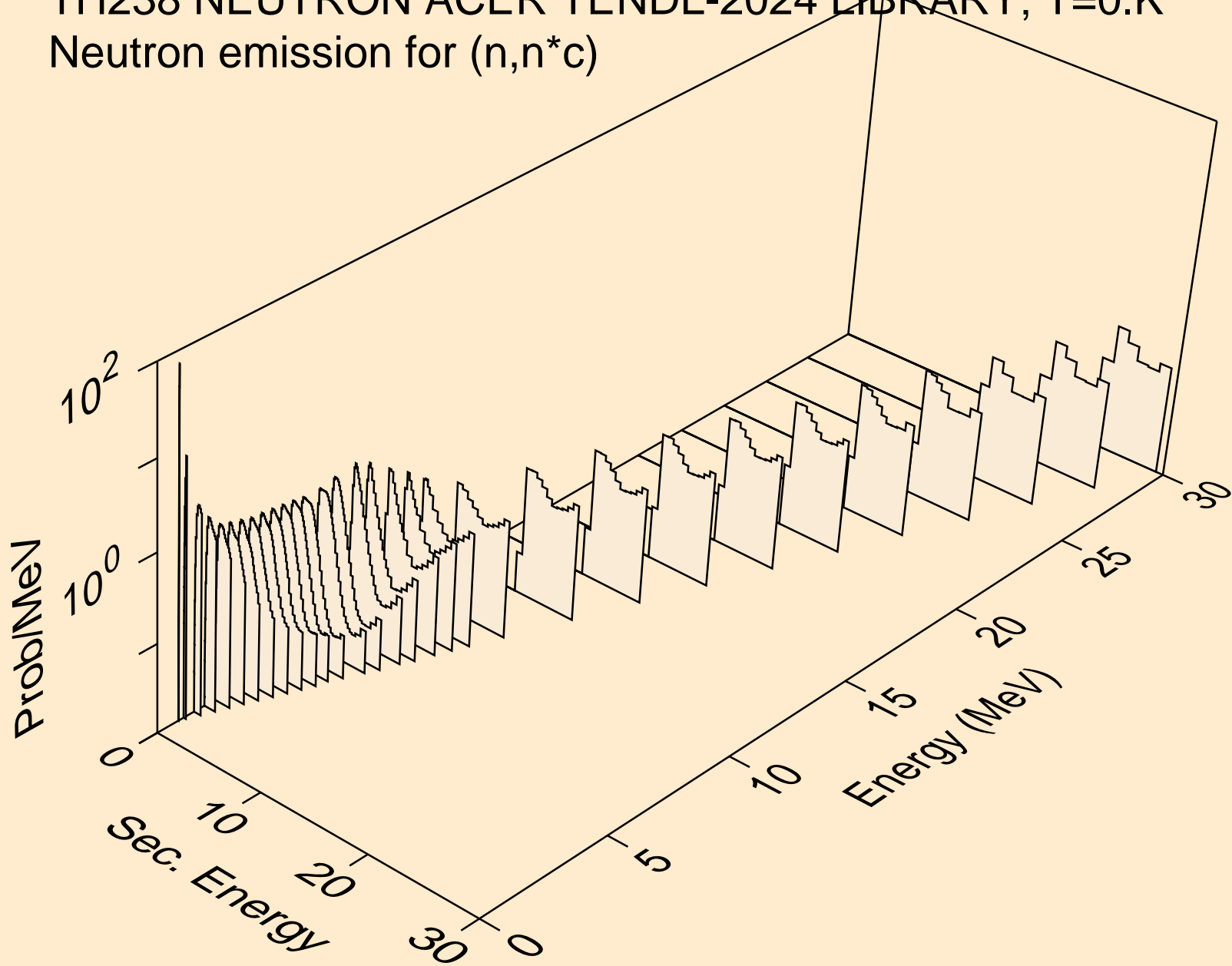

# TH238 NEUTRON ACER TENDL-2024 LIBRARY; T=0.K

Delayed nubar

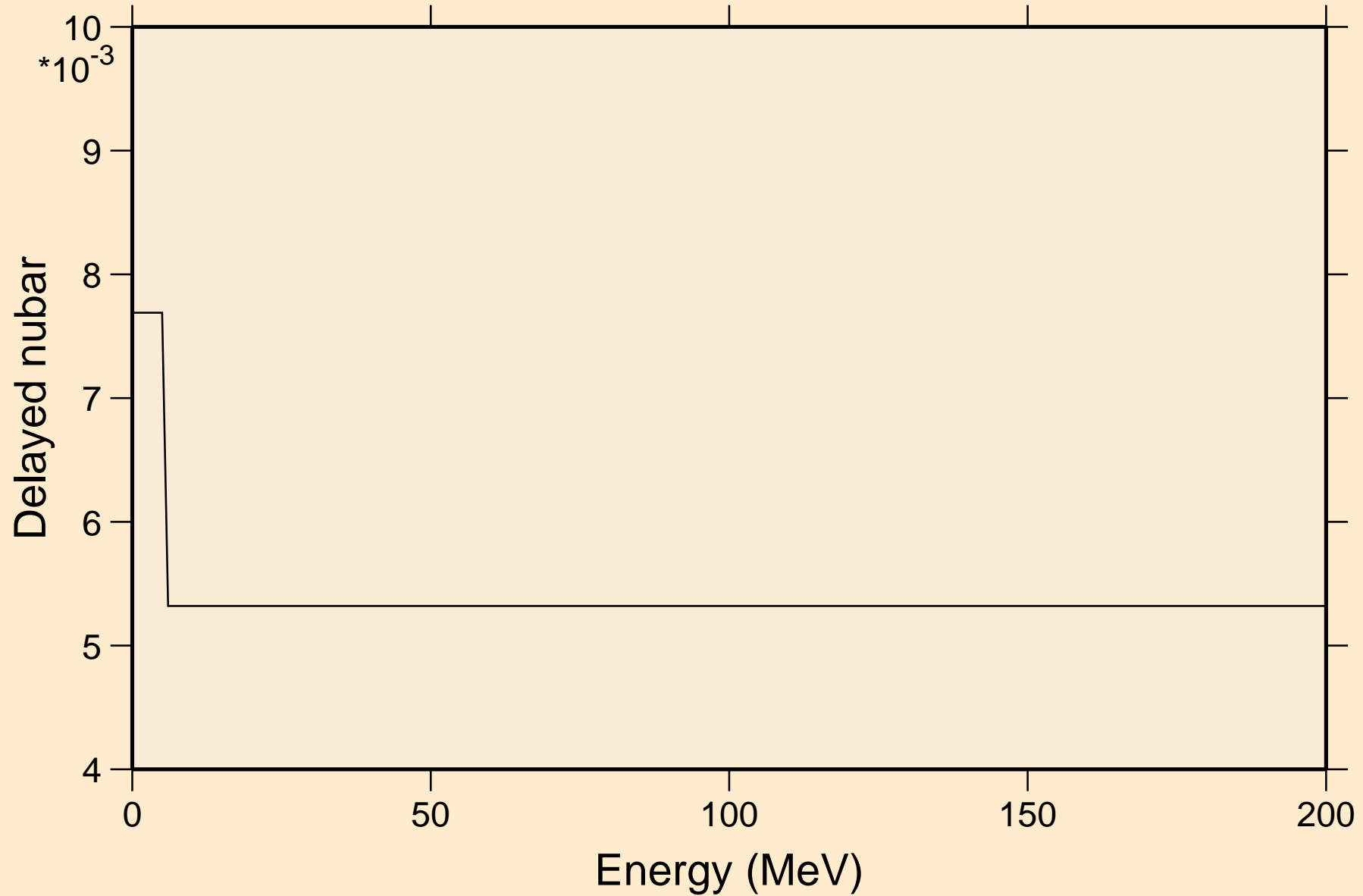

# TH238 NEUTRON ACER TENDL-2024 LIBRARY; T=0.K

## Delayed neutron spectra

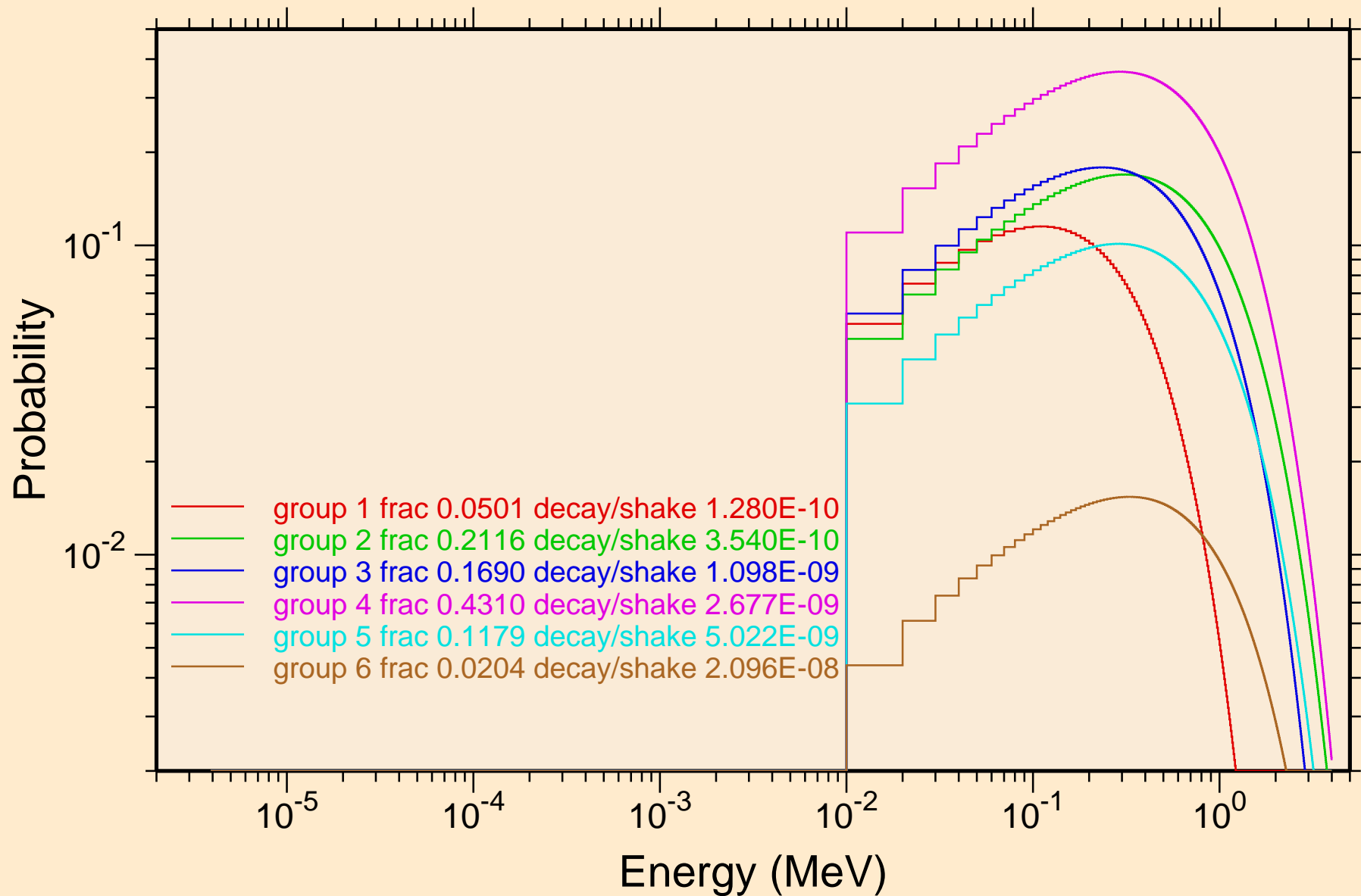

TH238 NEUTRON ACER TENDL-2024 LIBRARY; T=0.K  
Photon emission for (n,x)

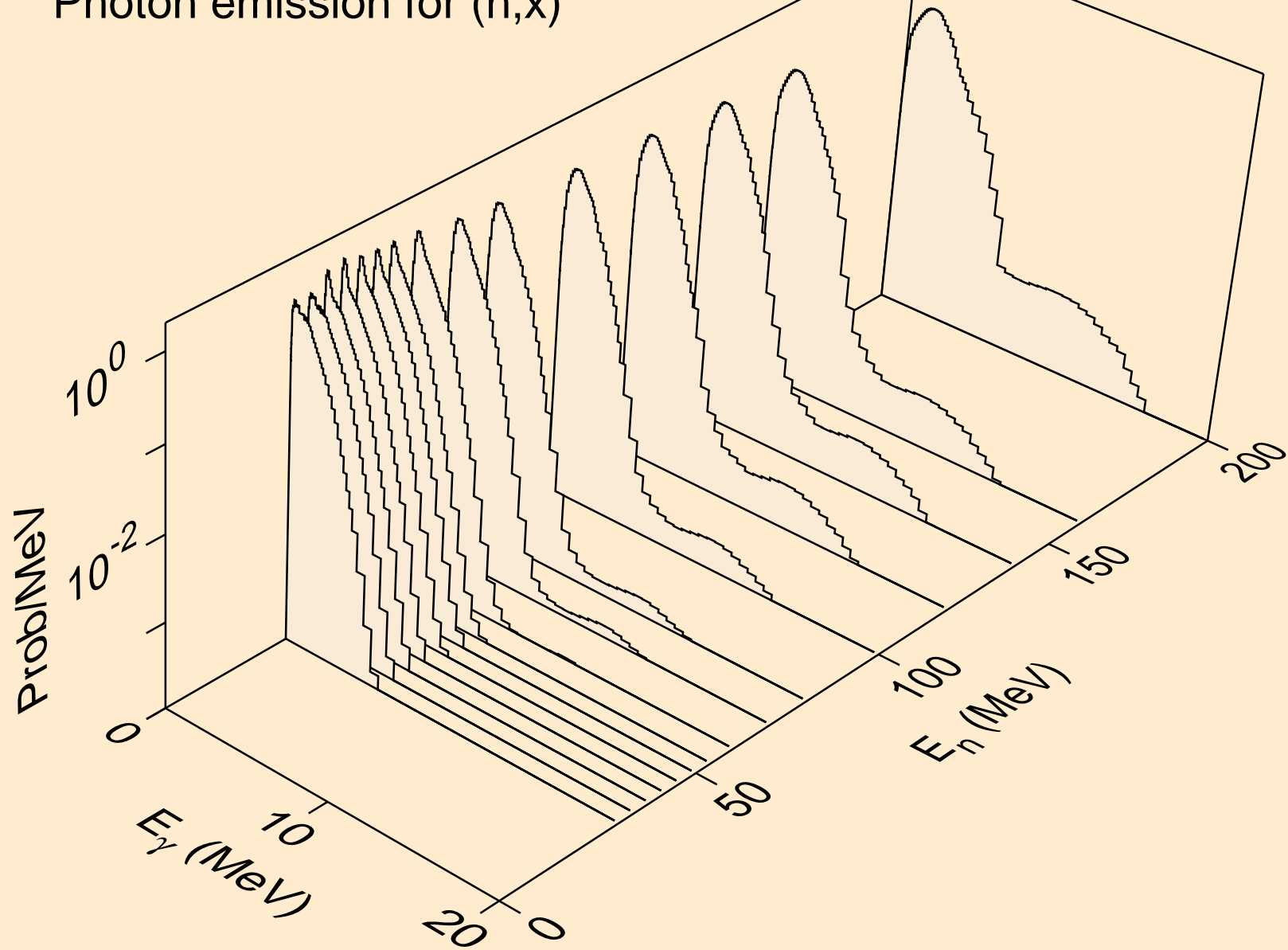



TH238 NEUTRON ACER TENDL-2024 LIBRARY; T=0.K  
Photon emission for (n,2nd)

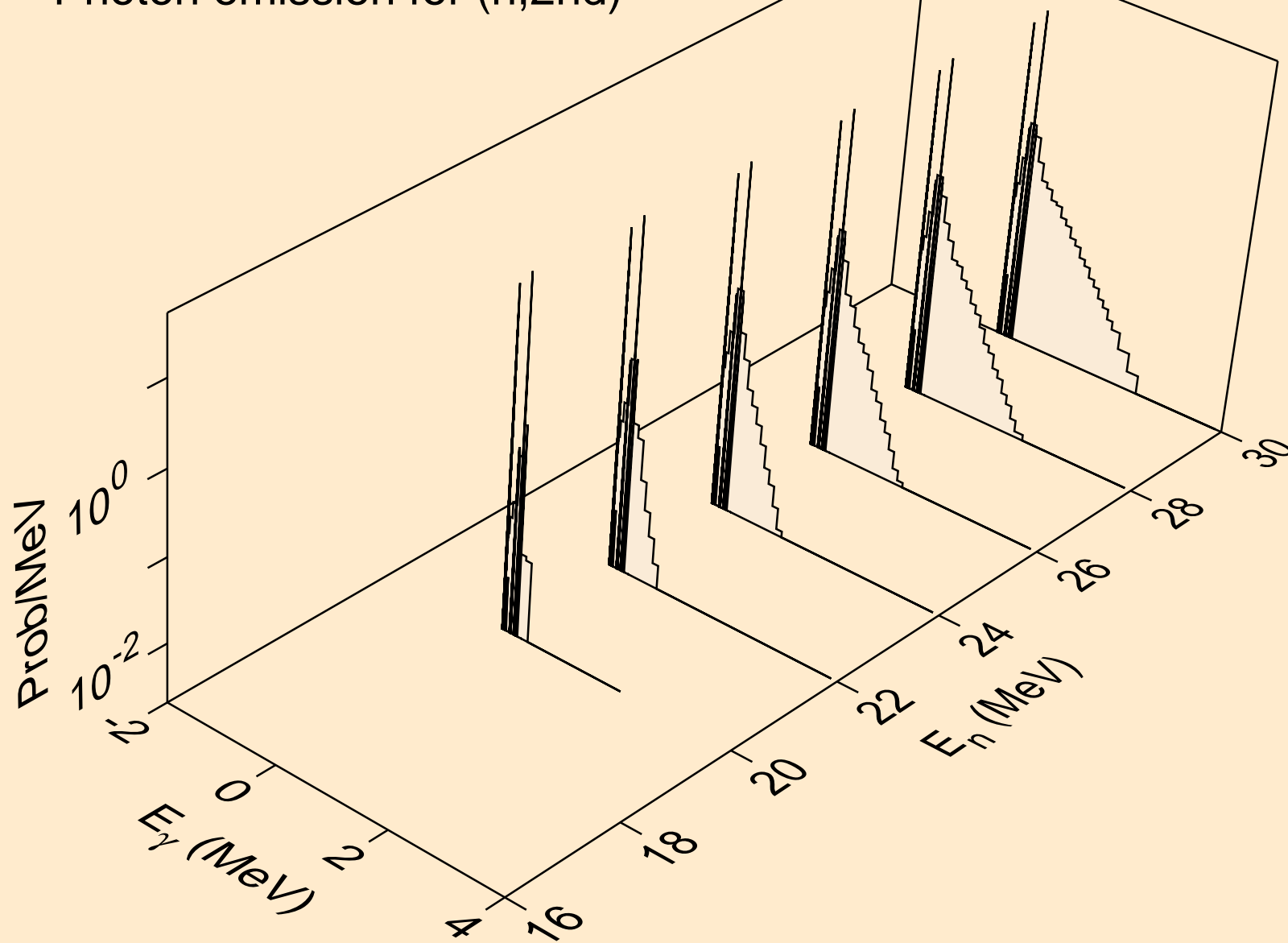

TH238 NEUTRON ACER TENDL-2024 LIBRARY; T=0.K  
Photon emission for (n,2n)

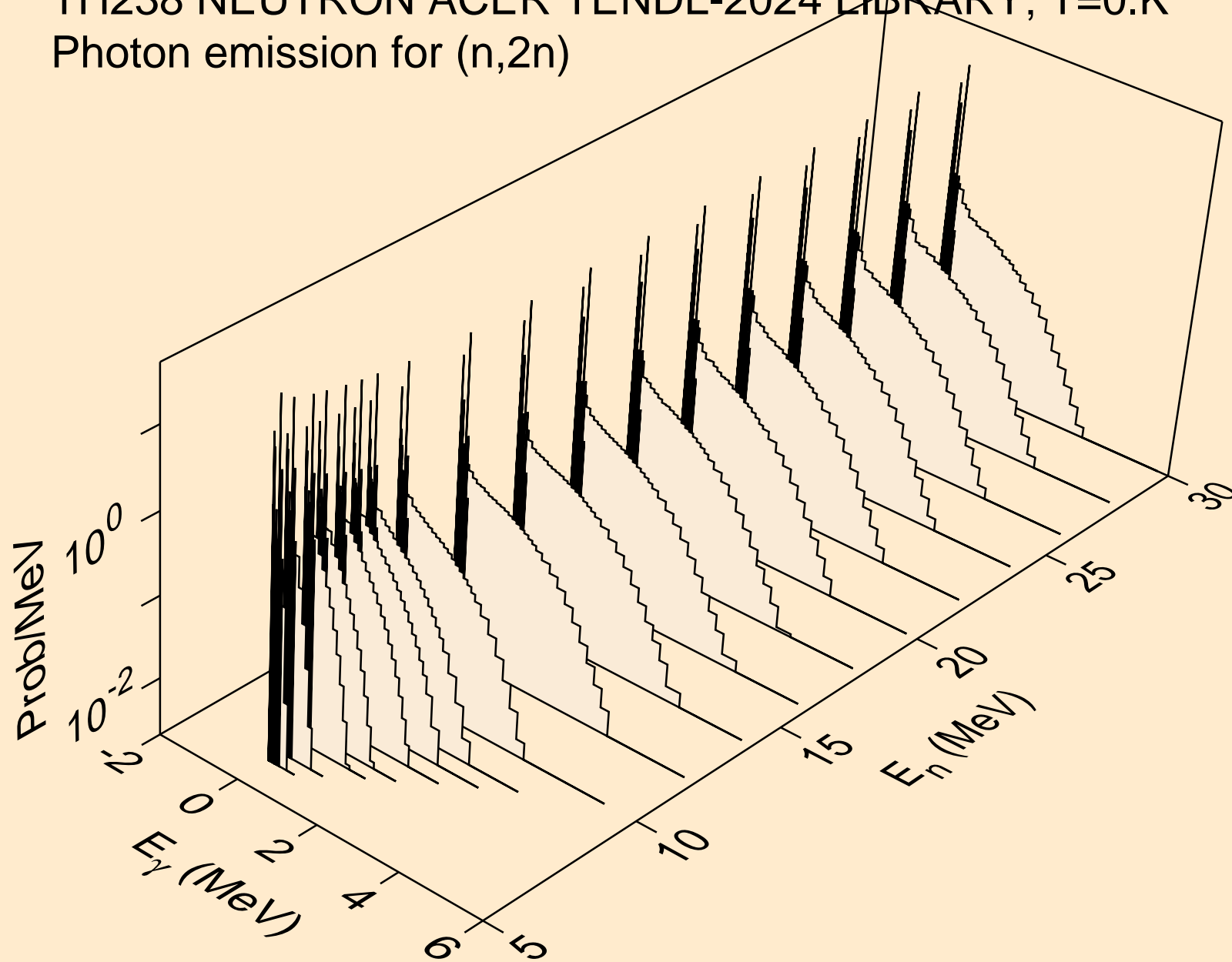

TH238 NEUTRON ACER TENDL-2024 LIBRARY; T=0.K  
Photon emission for (n,3n)

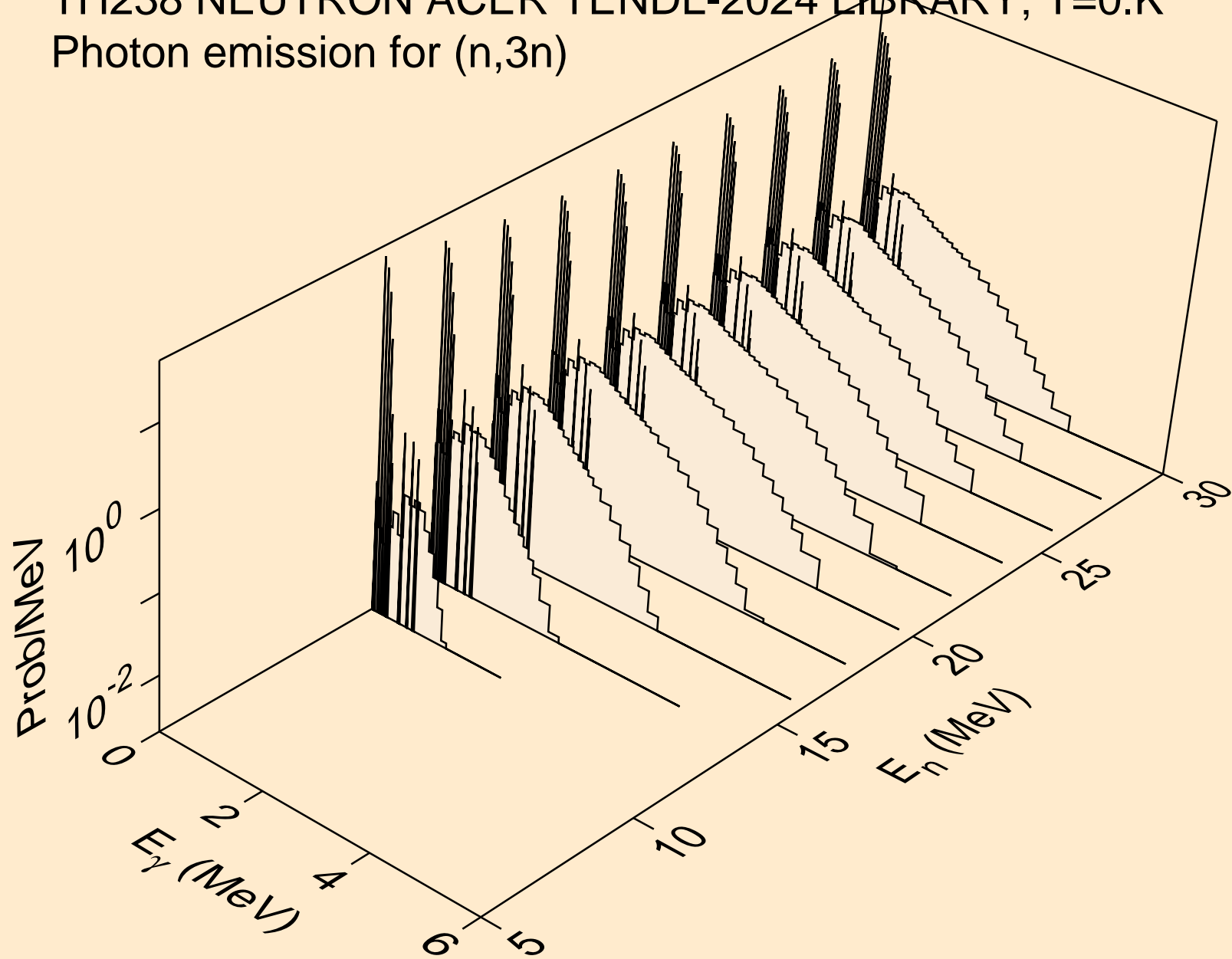

TH238 NEUTRON ACER TENDL-2024 LIBRARY; T=0.K  
Photon emission for (n,n\*)a

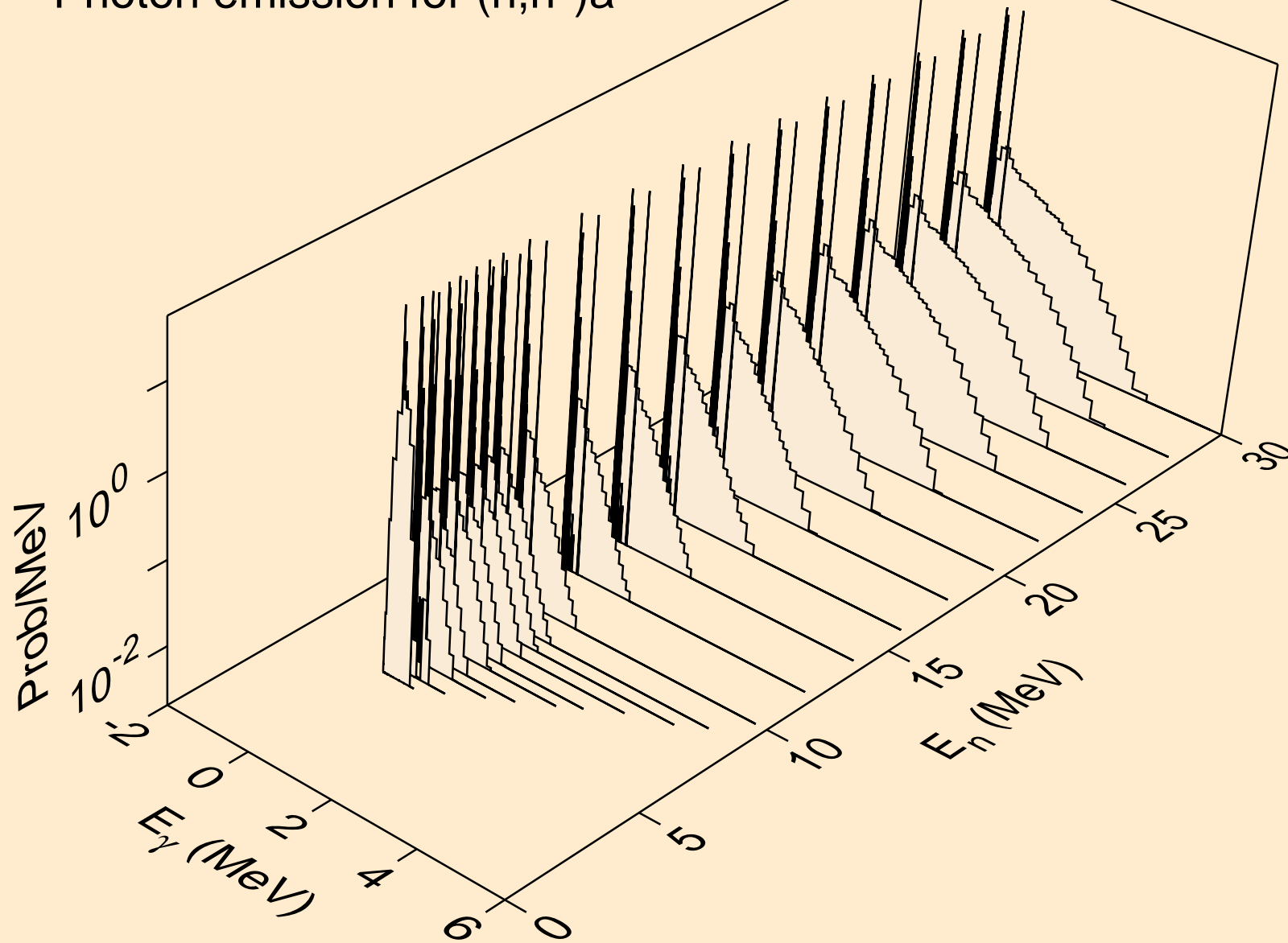

TH238 NEUTRON ACER TENDL-2024 LIBRARY; T=0.K  
Photon emission for (n,2n)a

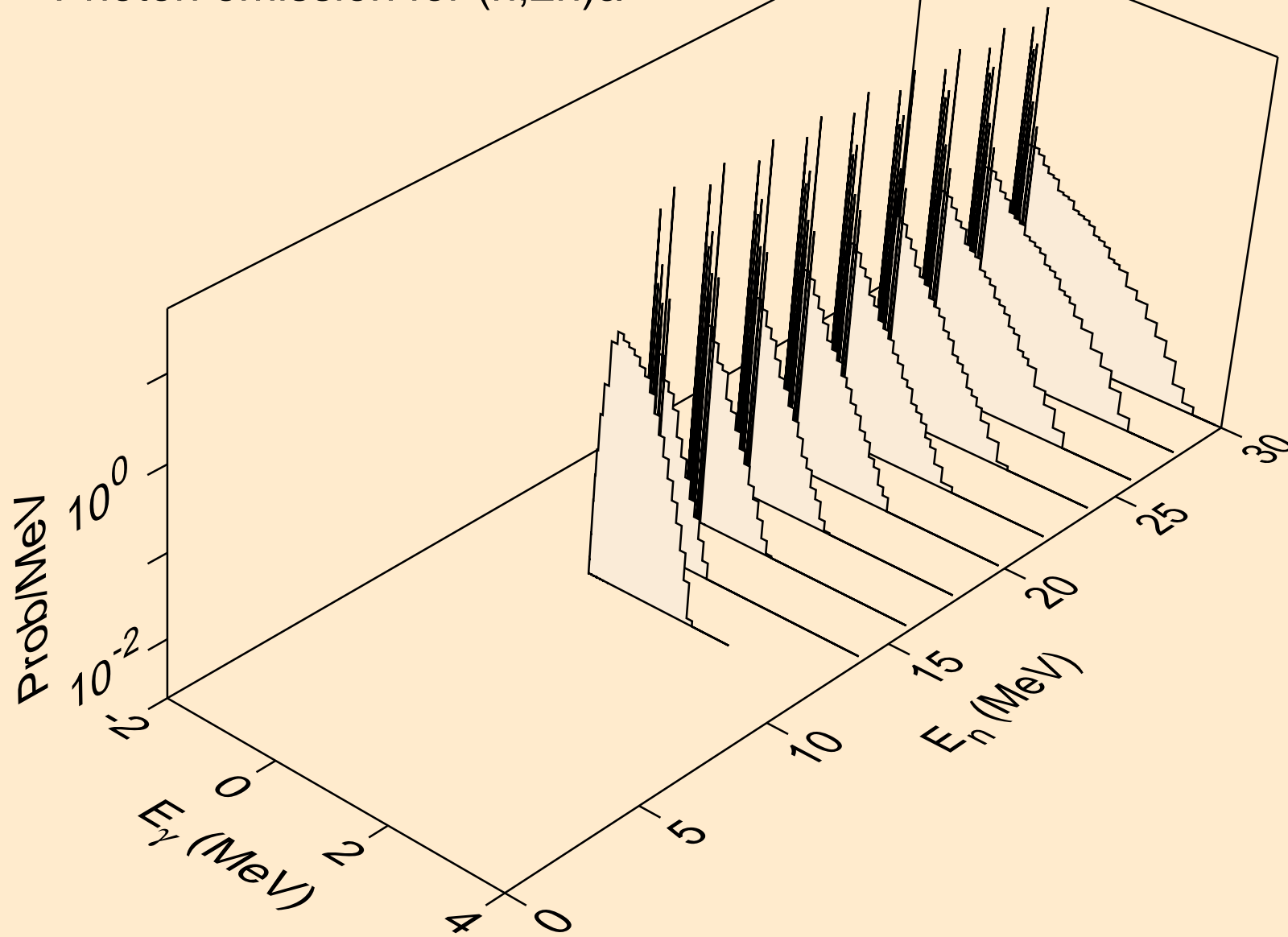

TH238 NEUTRON ACER TENDL-2024 LIBRARY; T=0.K  
Photon emission for (n,3n)a

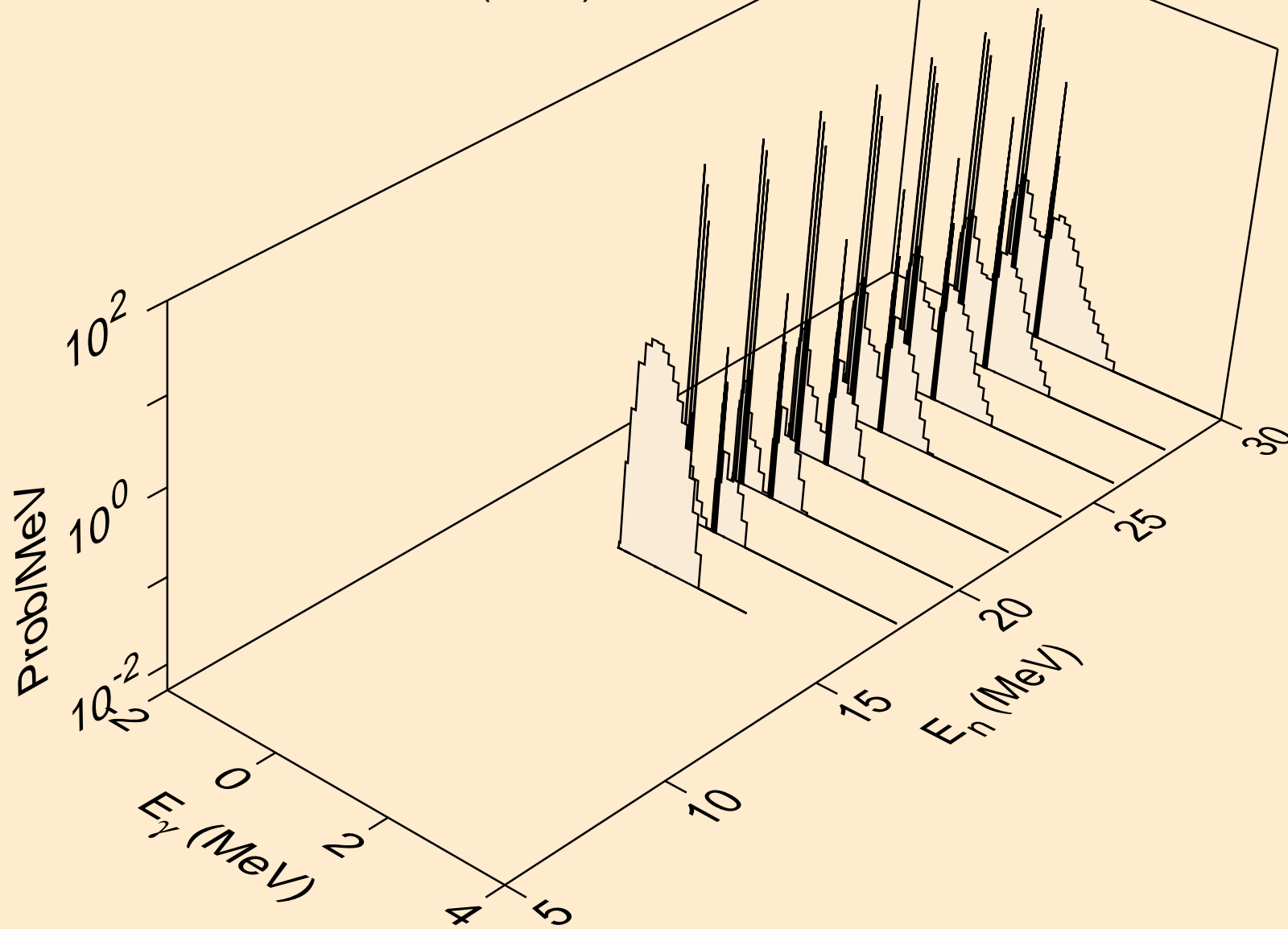

TH238 NEUTRON ACER TENDL-2024 LIBRARY; T=0.K  
Photon emission for (n,n\*)p

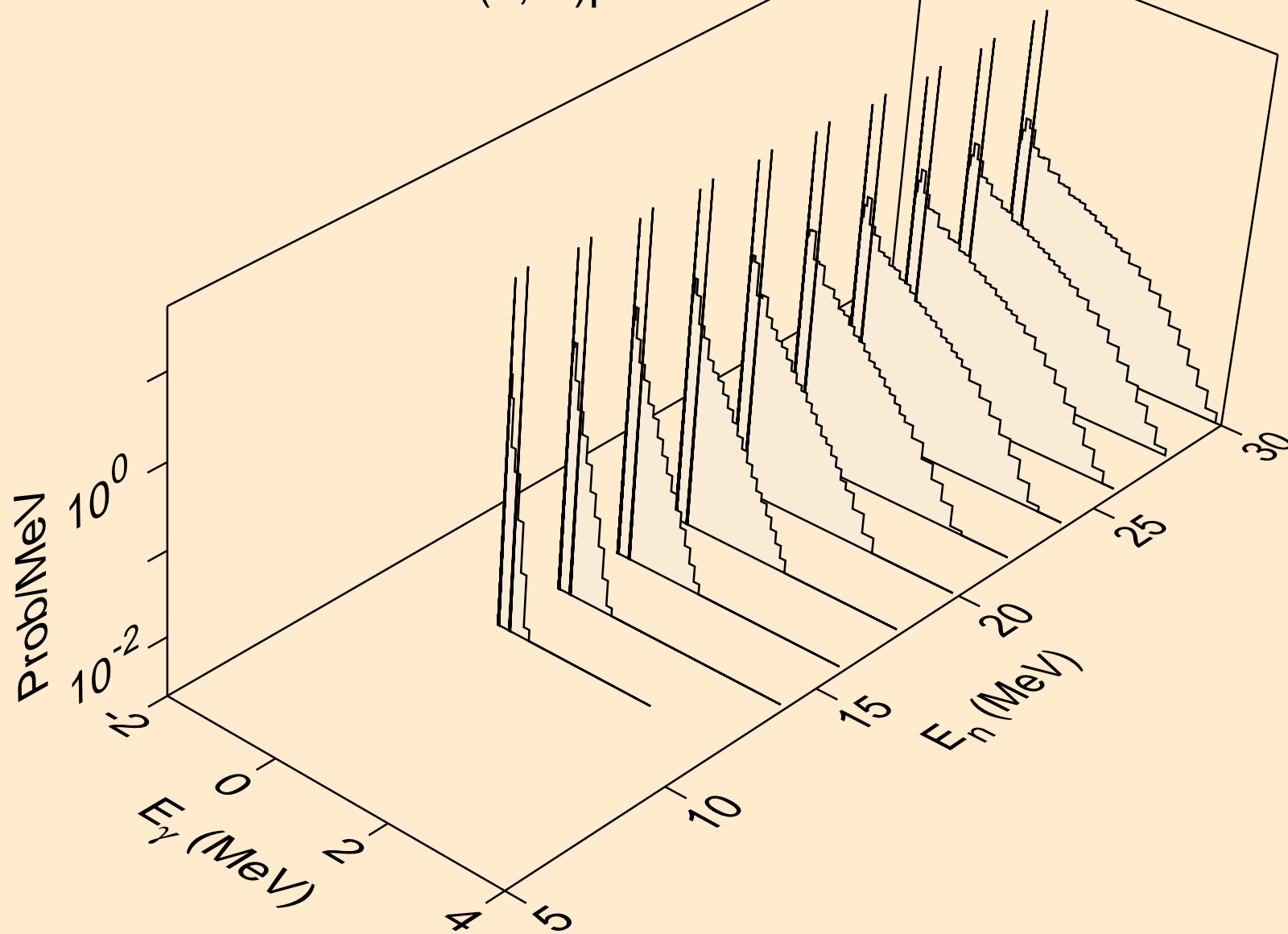

TH238 NEUTRON ACER TENDL-2024 LIBRARY; T=0.K  
Photon emission for (n,n\*)d

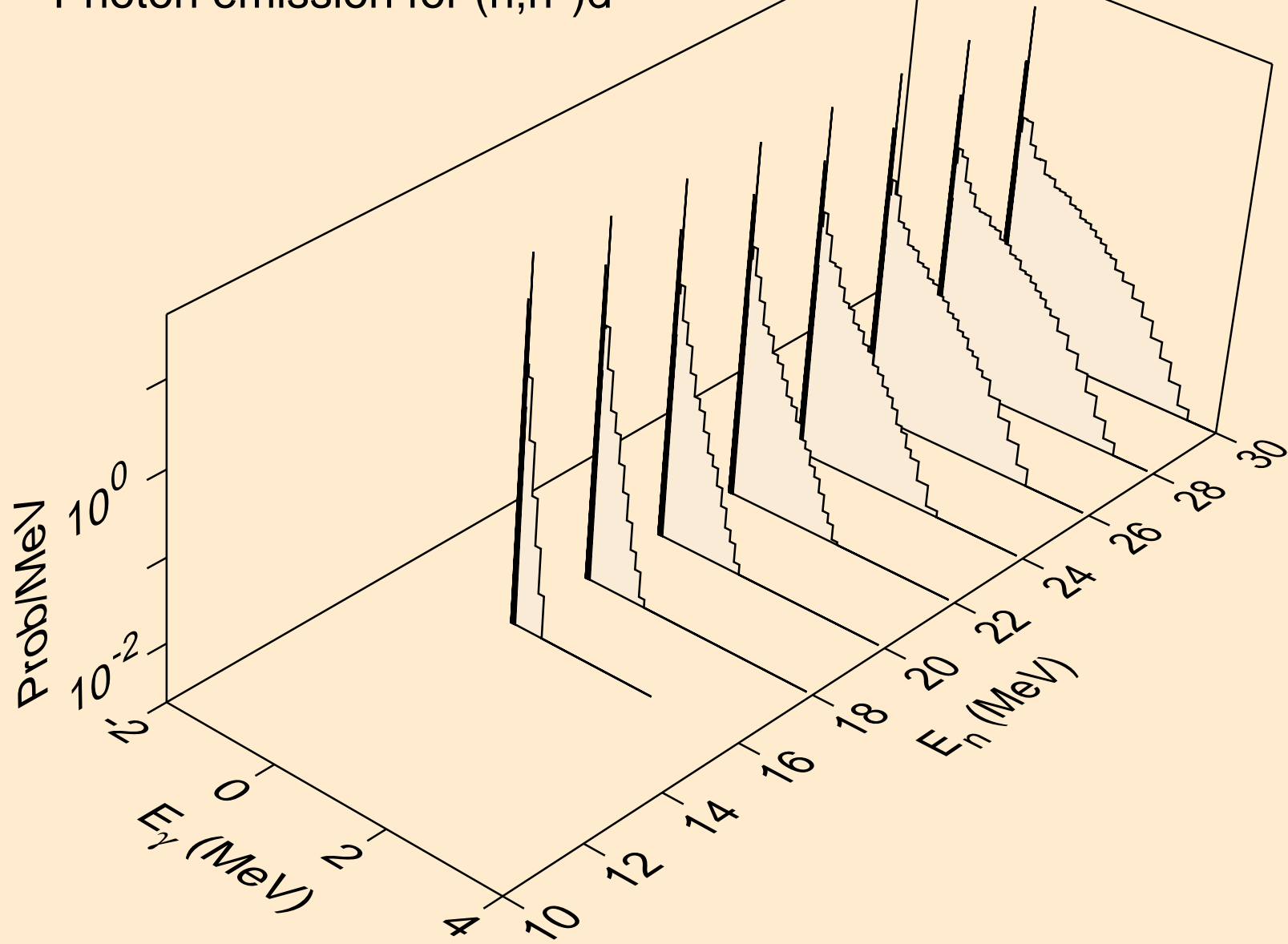



TH238 NEUTRON ACER TENDL-2024 LIBRARY; T=0.K  
Photon emission for (n,n\*)t

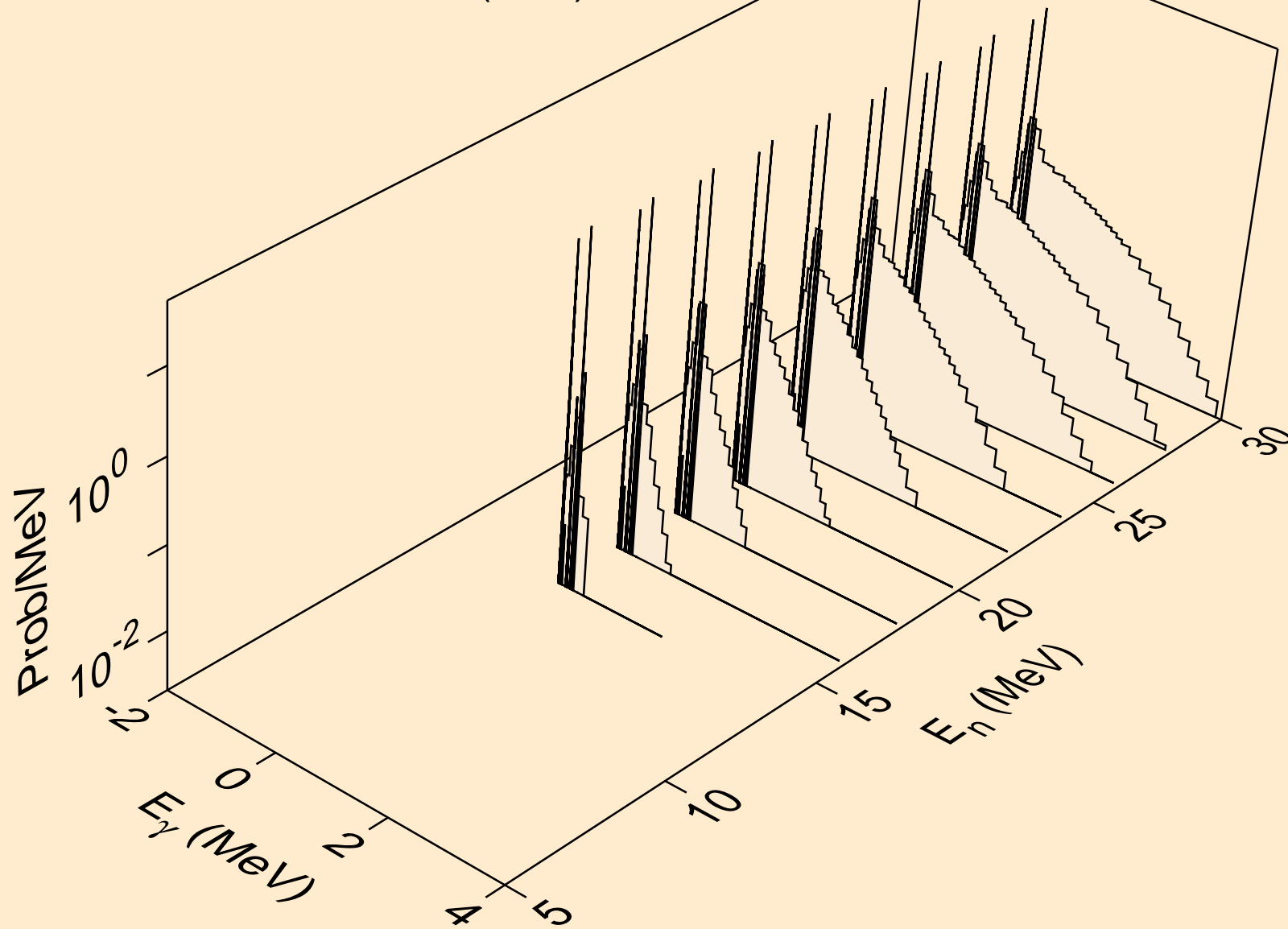

TH238 NEUTRON ACER TENDL-2024 LIBRARY; T=0.K  
Photon emission for (n,n\*)he3

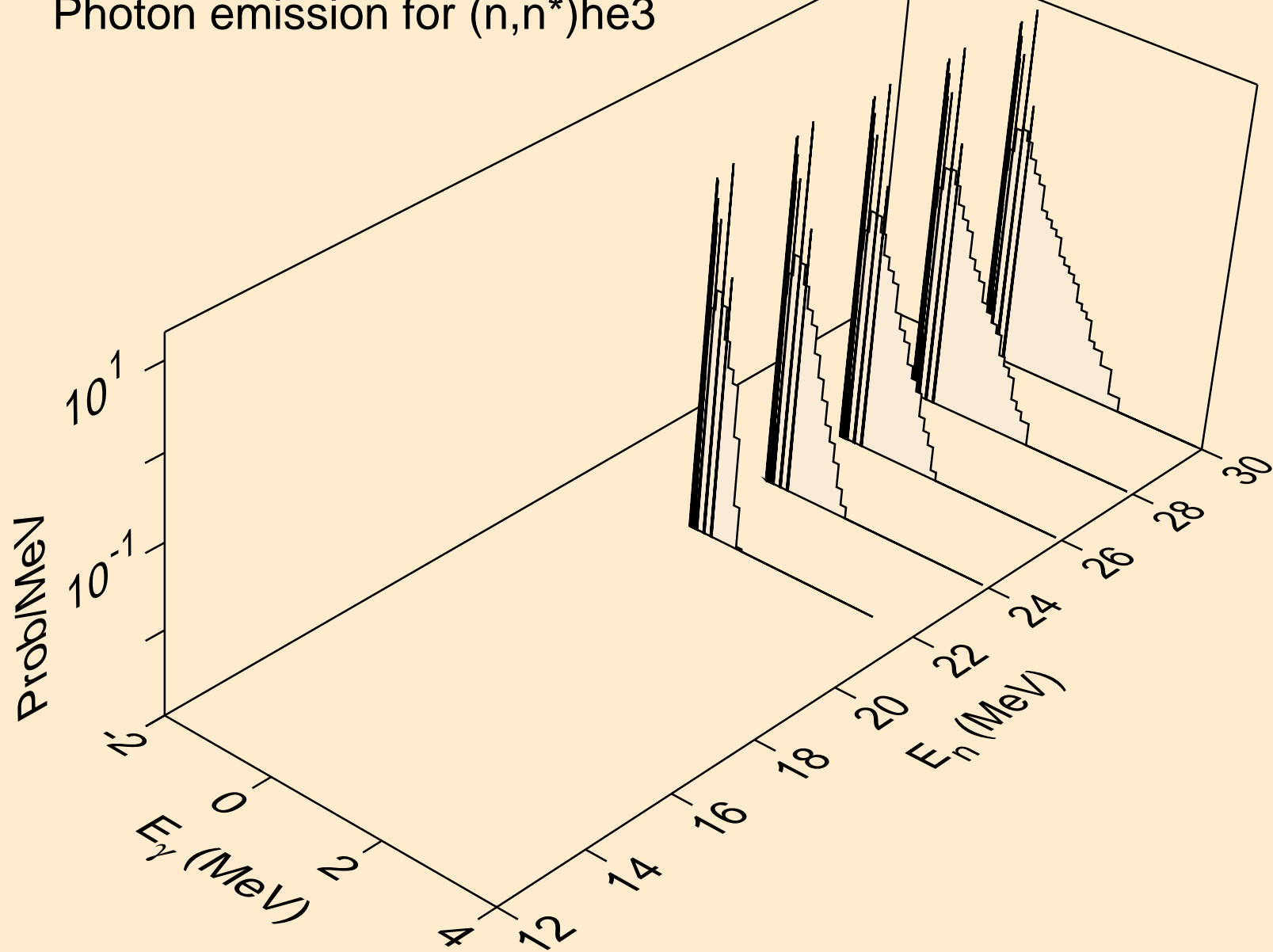

TH238 NEUTRON ACER TENDL-2024 LIBRARY; T=0.K  
Photon emission for (n,4n)

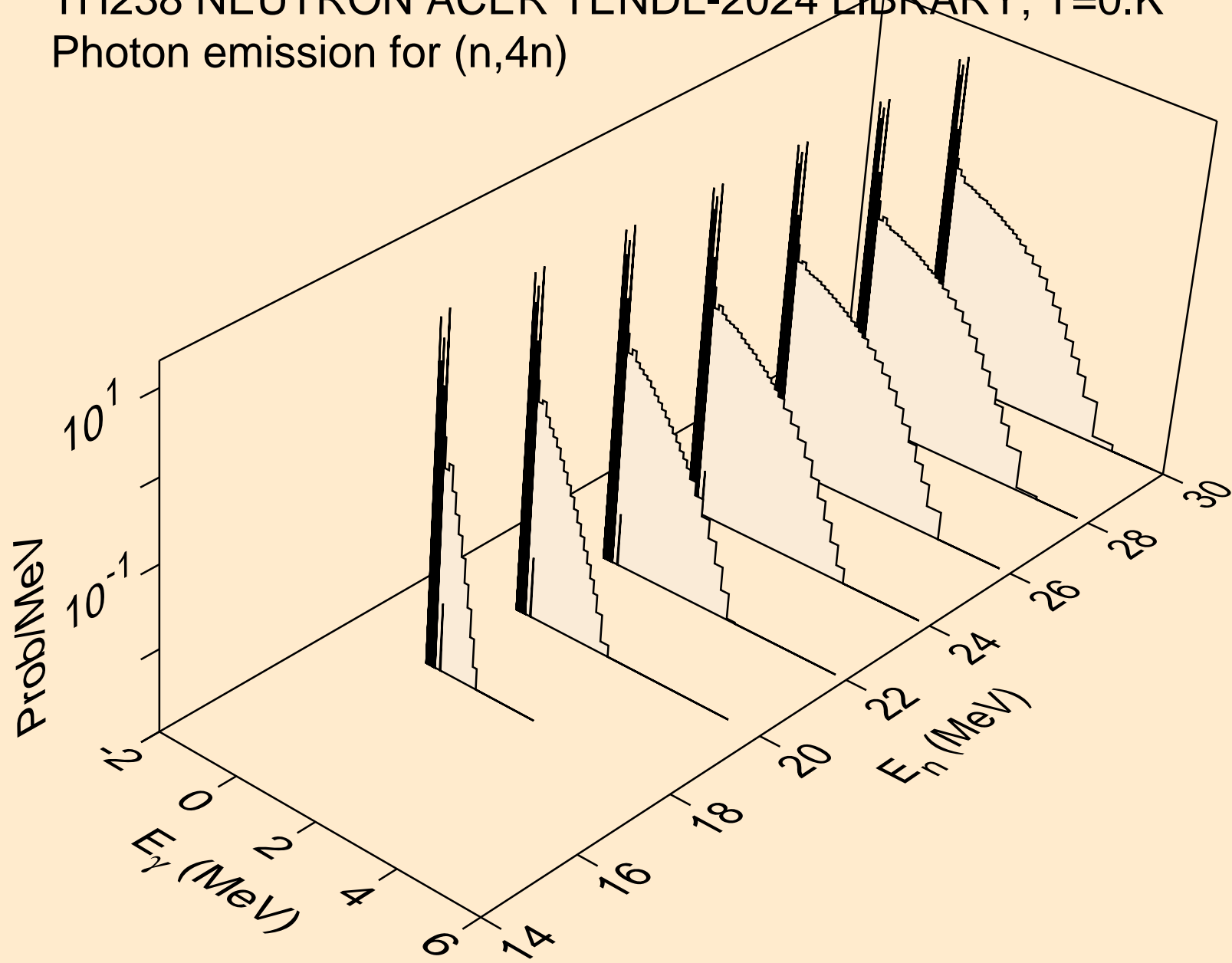

TH238 NEUTRON ACER TENDL-2024 LIBRARY; T=0.K  
Photon emission for (n,2np)

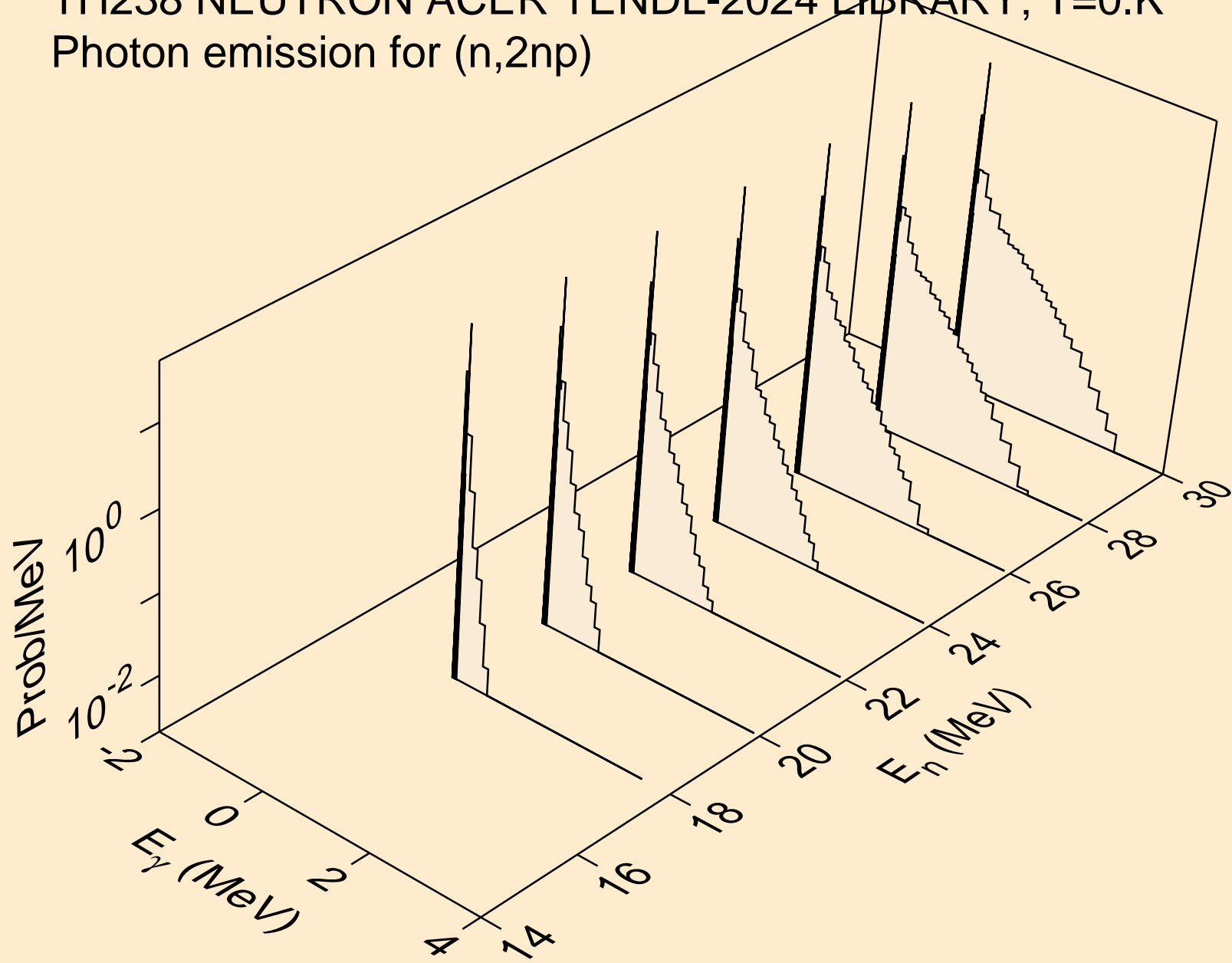

TH238 NEUTRON ACER TENDL-2024 LIBRARY; T=0.K  
Photon emission for (n,3np)

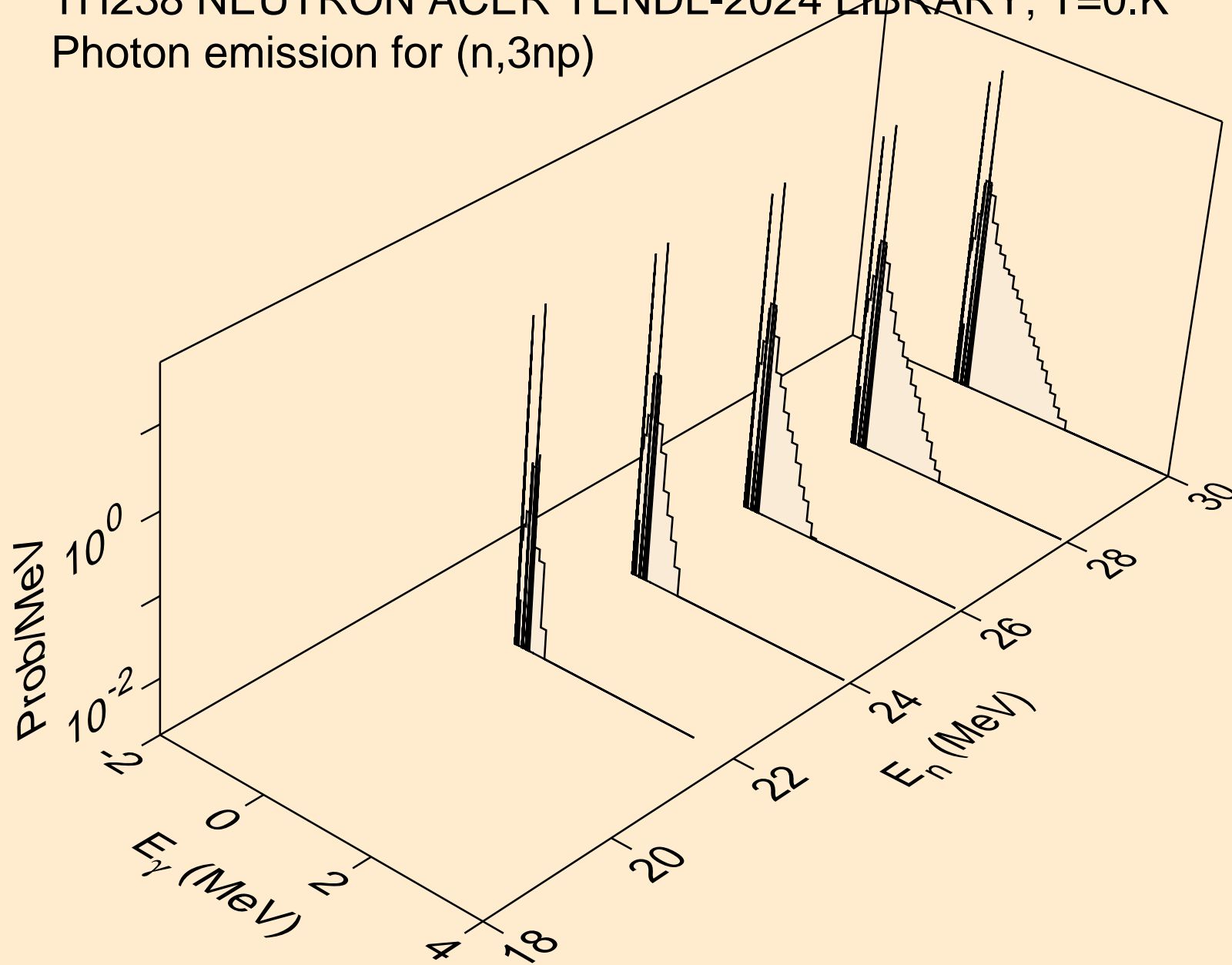

TH238 NEUTRON ACER TENDL-2024 LIBRARY; T=0.K  
Photon emission for (n,n\*c)

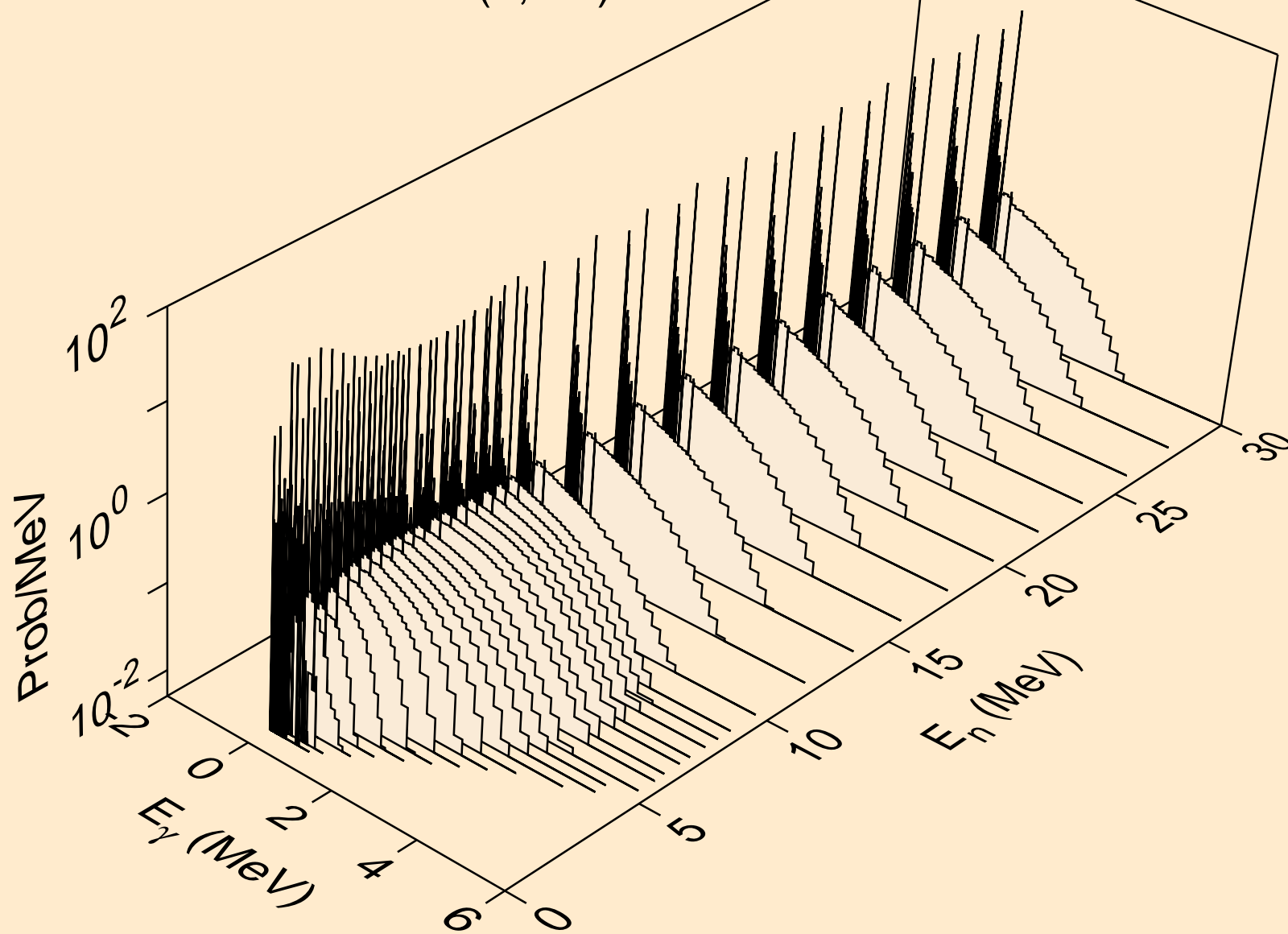

TH238 NEUTRON ACER TENDL-2024 LIBRARY; T=0.K  
Photon emission for (n,gma)

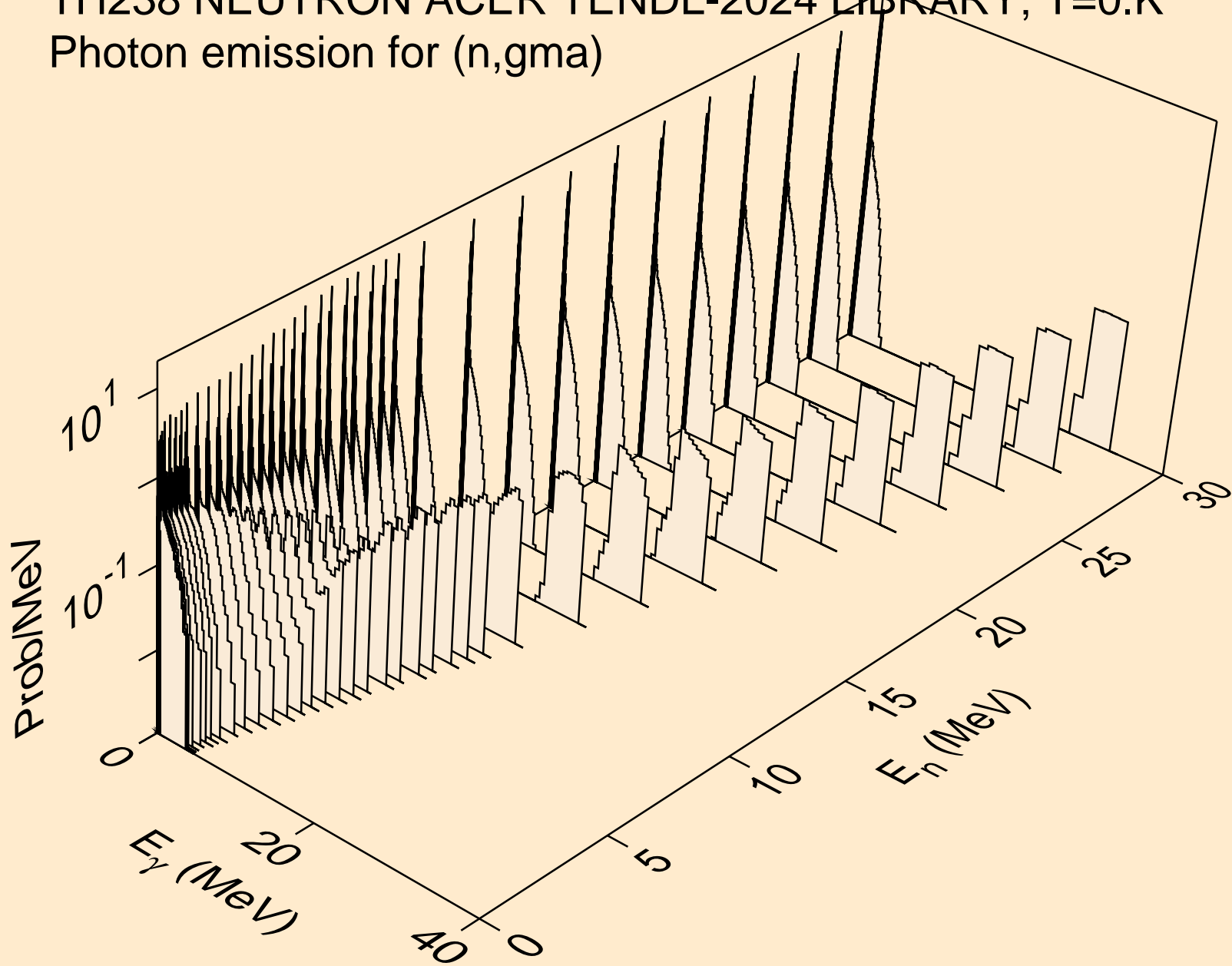

TH238 NEUTRON ACER TENDL-2024 LIBRARY; T=0.K  
Photon emission for (n,p)

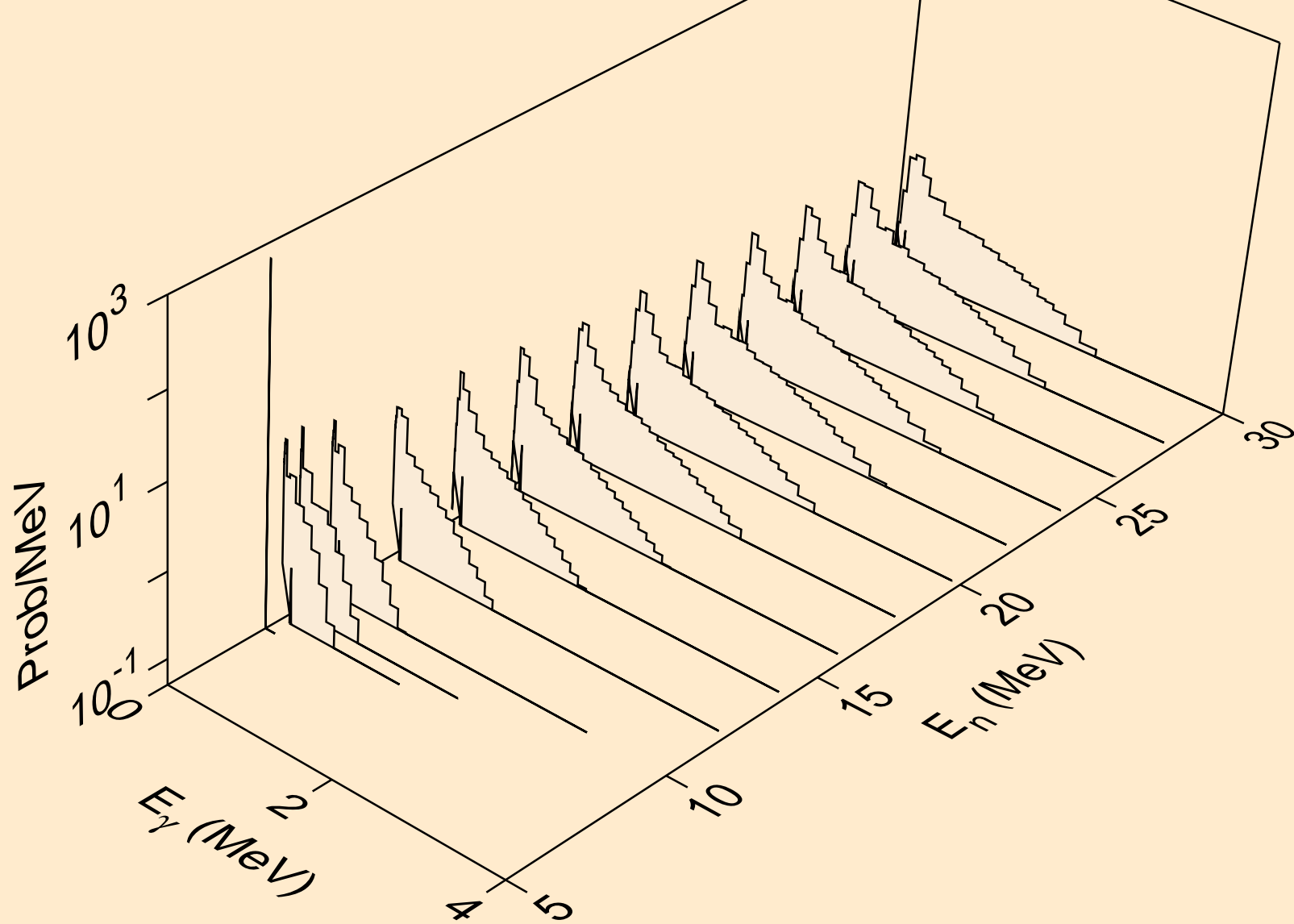



TH238 NEUTRON ACER TENDL-2024 LIBRARY; T=0.K  
Photon emission for (n,d)

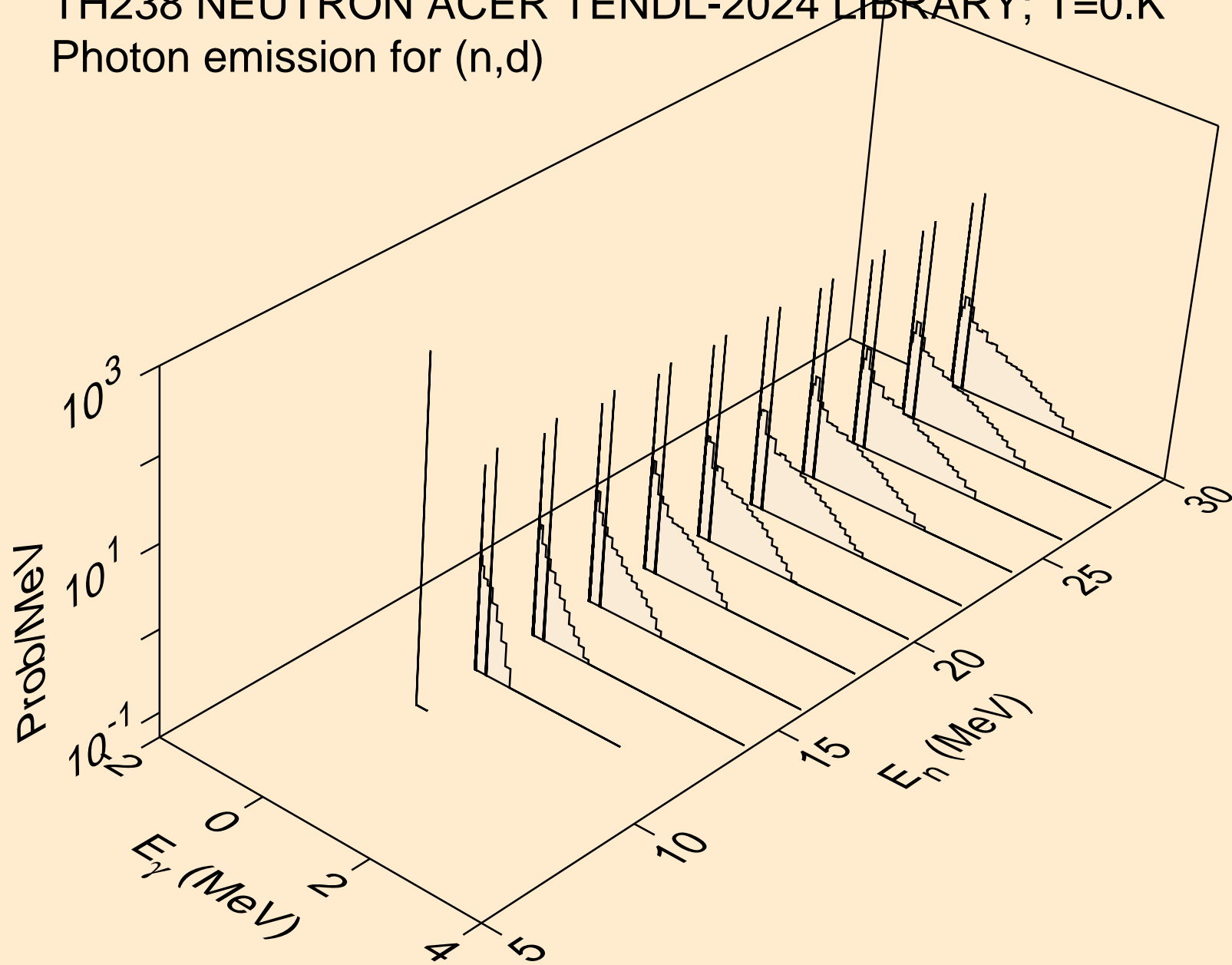

TH238 NEUTRON ACER TENDL-2024 LIBRARY; T=0.K  
Photon emission for (n,t)

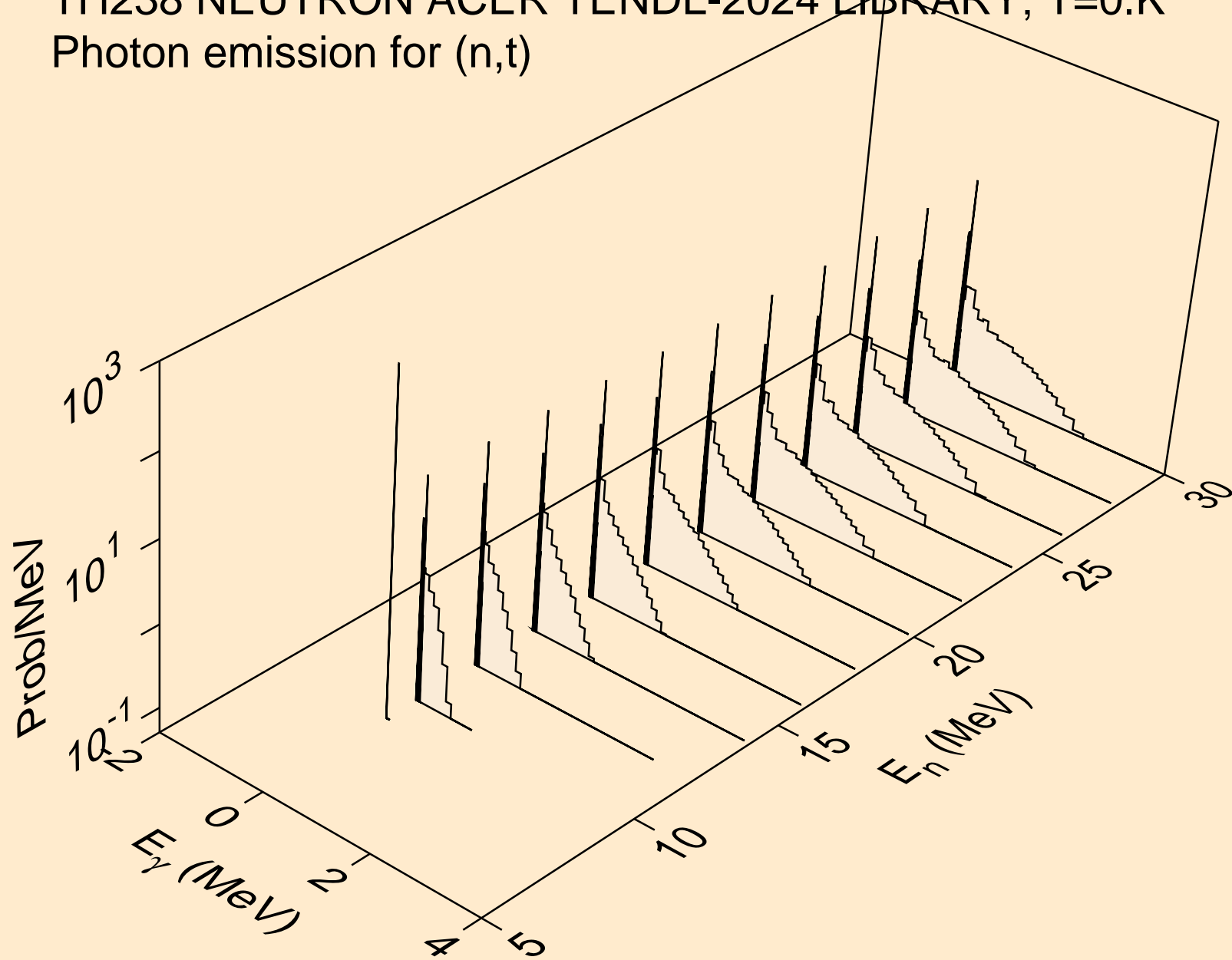

TH238 NEUTRON ACER TENDL-2024 LIBRARY; T=0.K  
Photon emission for (n,he3)

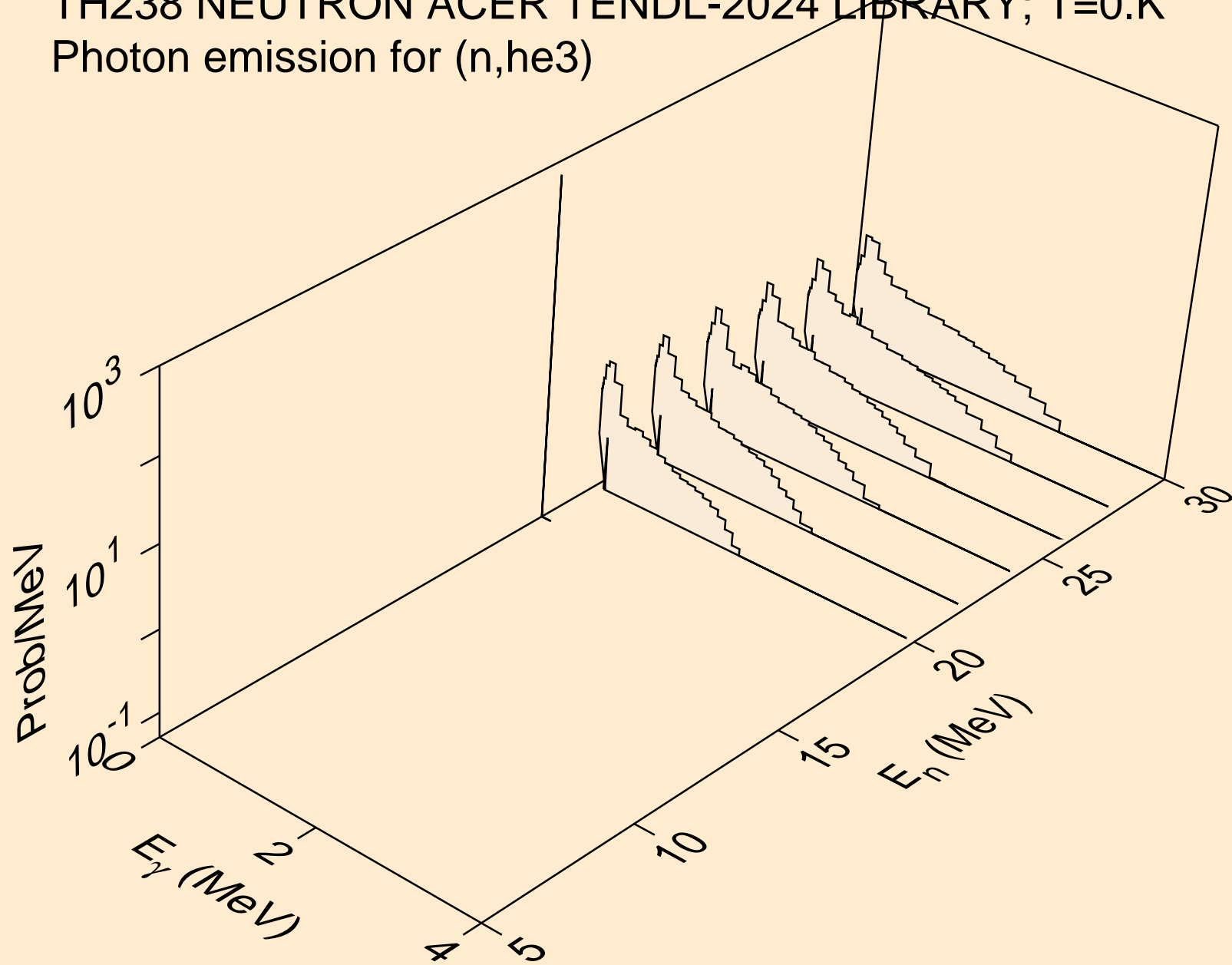

TH238 NEUTRON ACER TENDL-2024 LIBRARY; T=0.K  
Photon emission for (n,a)

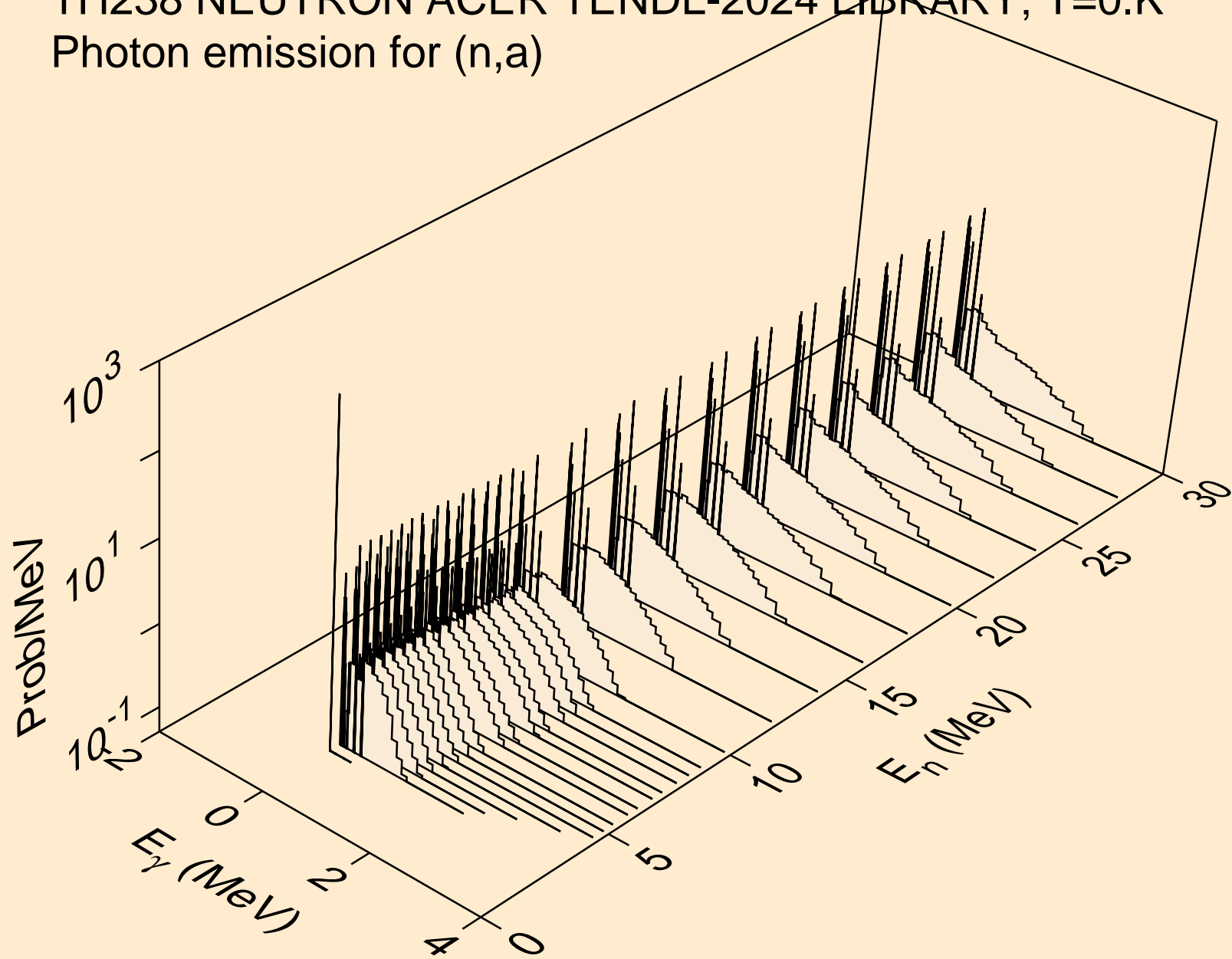

TH238 NEUTRON ACER TENDL-2024 LIBRARY; T=0.K  
thermal capture photon spectrum

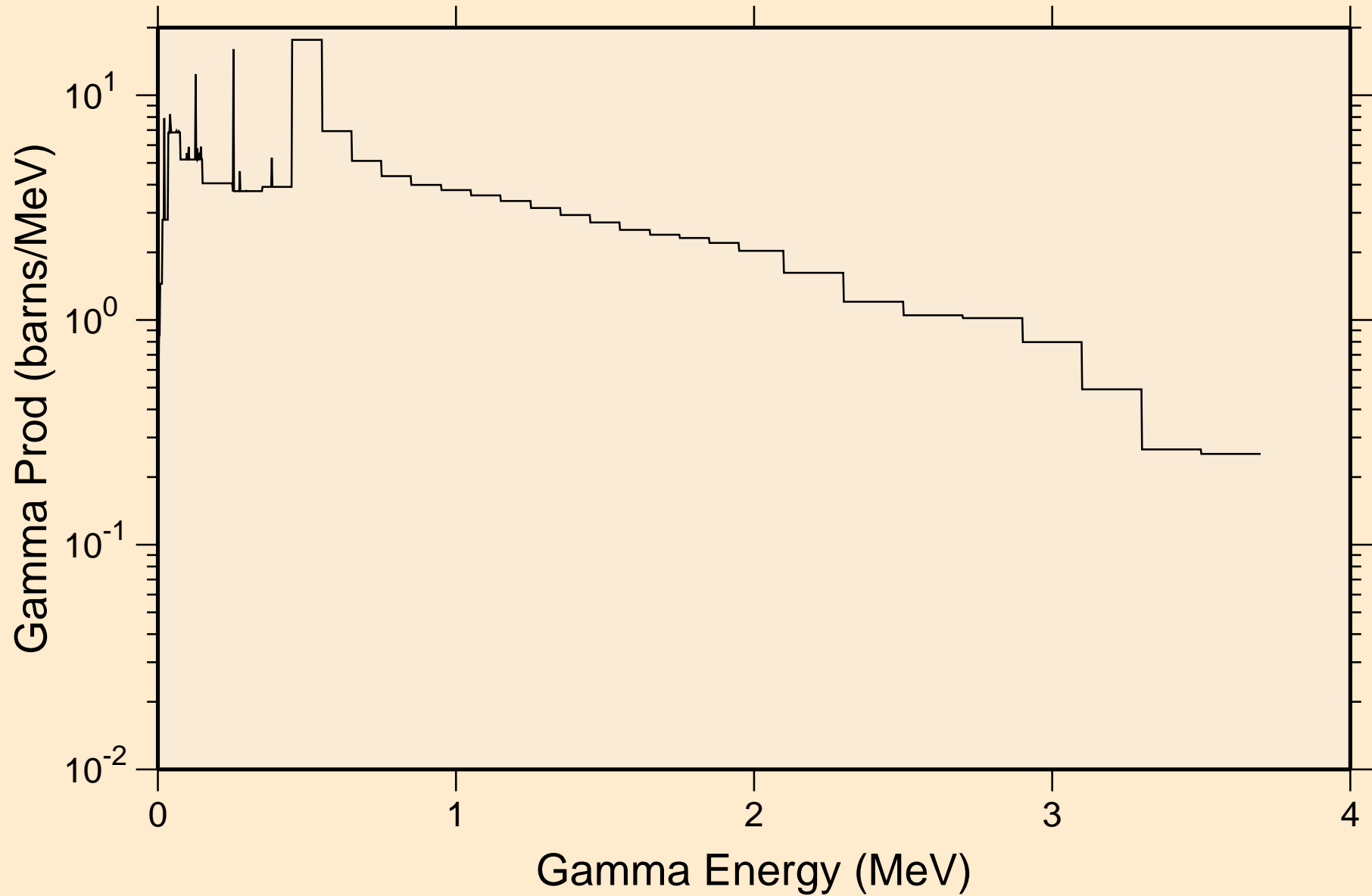

TH238 NEUTRON ACER TENDL-2024 LIBRARY; T=0.K  
14 MeV photon spectrum

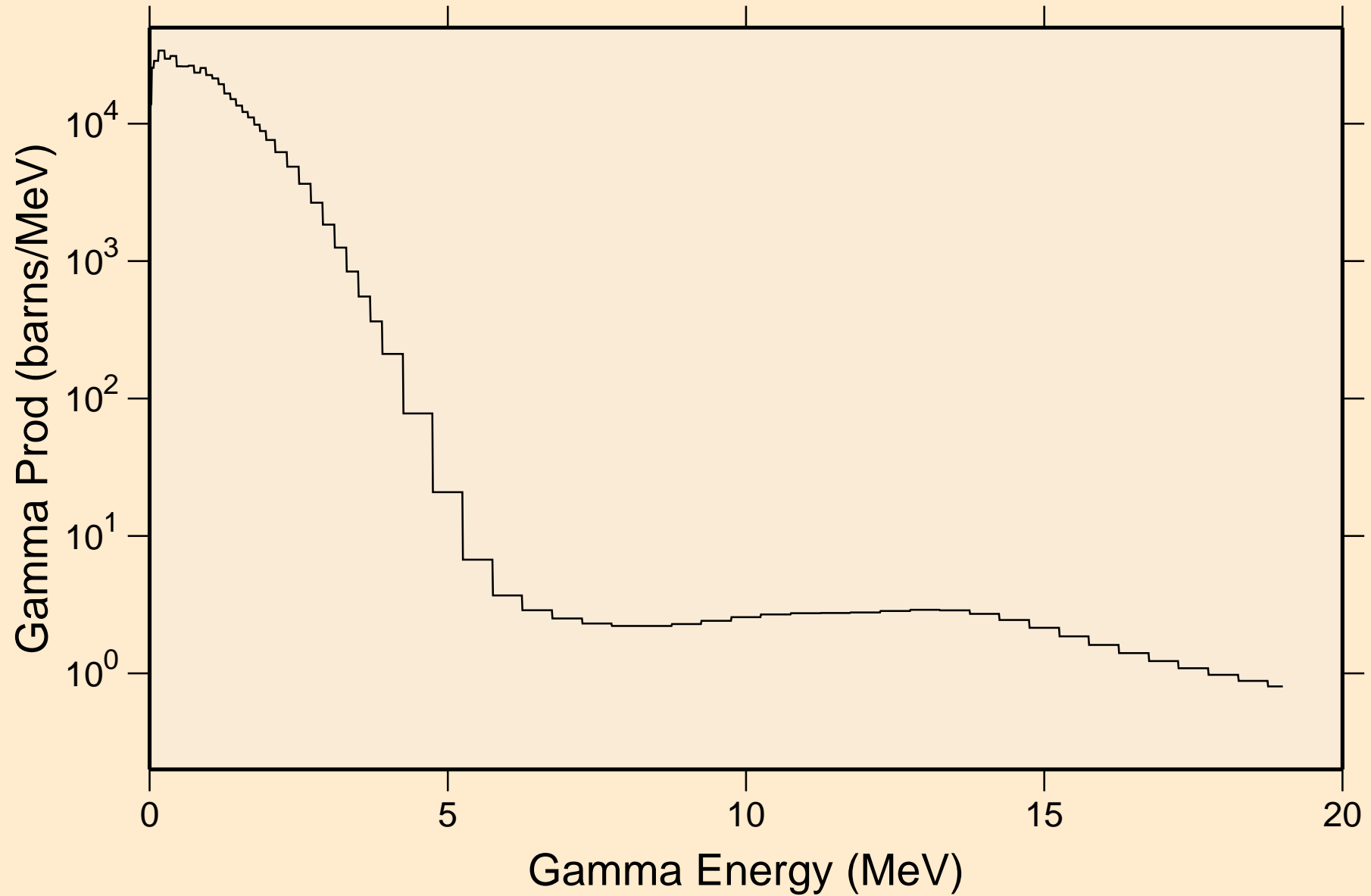

# TH238 NEUTRON ACER TENDL-2024 LIBRARY; T=0.K

## Particle heating contributions

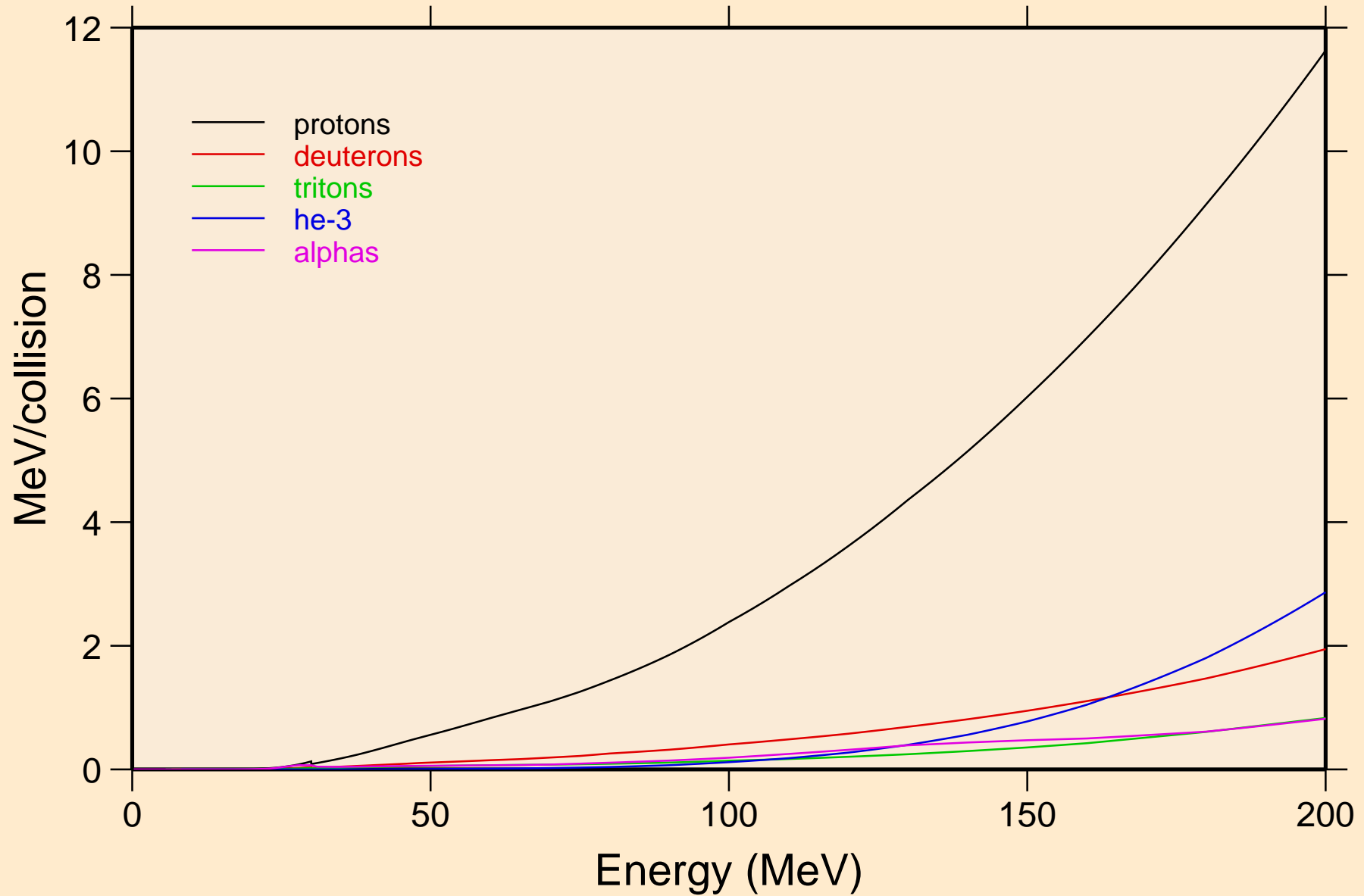

TH238 NEUTRON ACER TENDL-2024 LIBRARY; T=0.K  
Recoil Heating

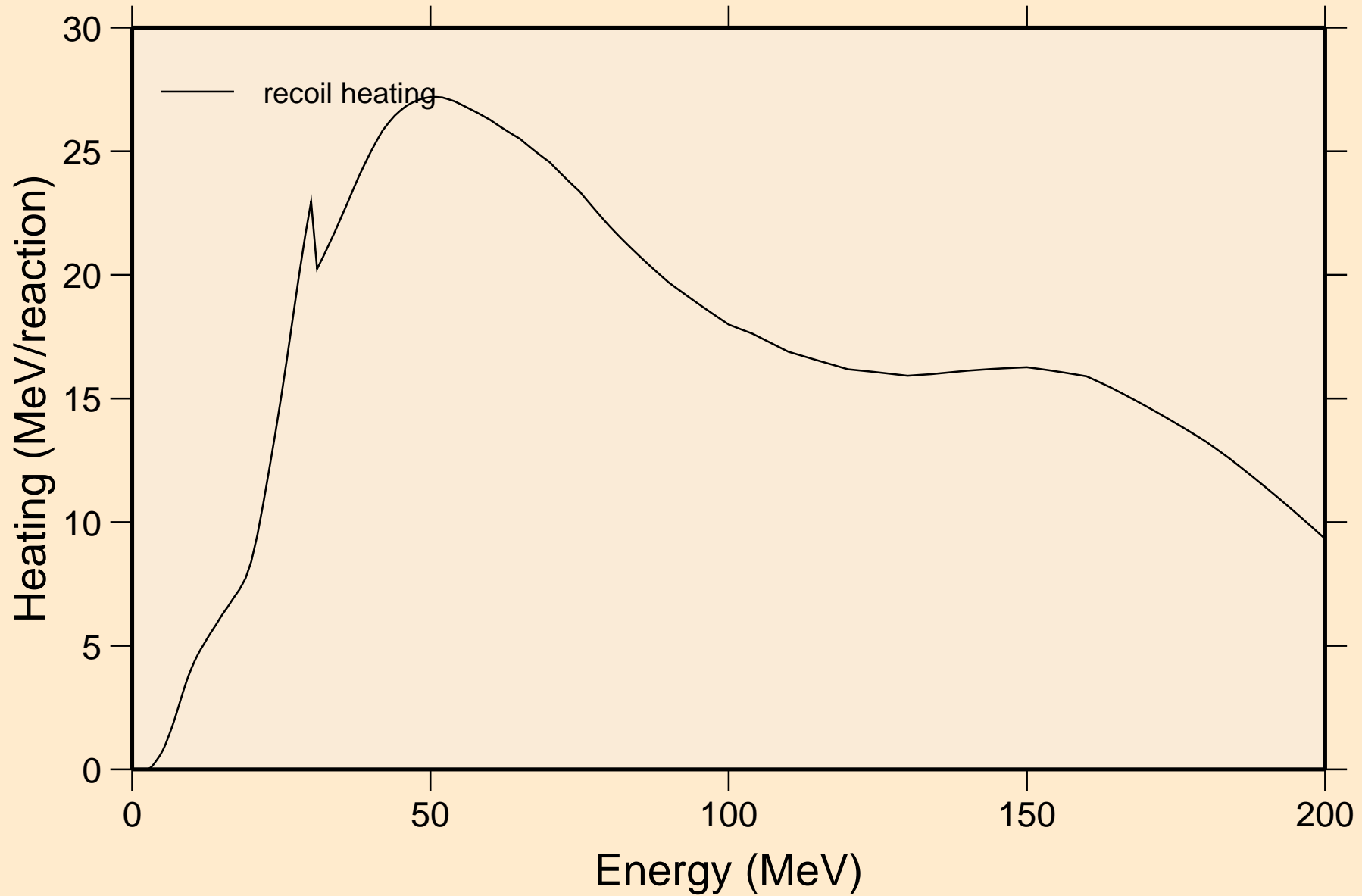



TH238 NEUTRON ACER TENDL-2024 LIBRARY; T=0.K  
Particle production cross sections

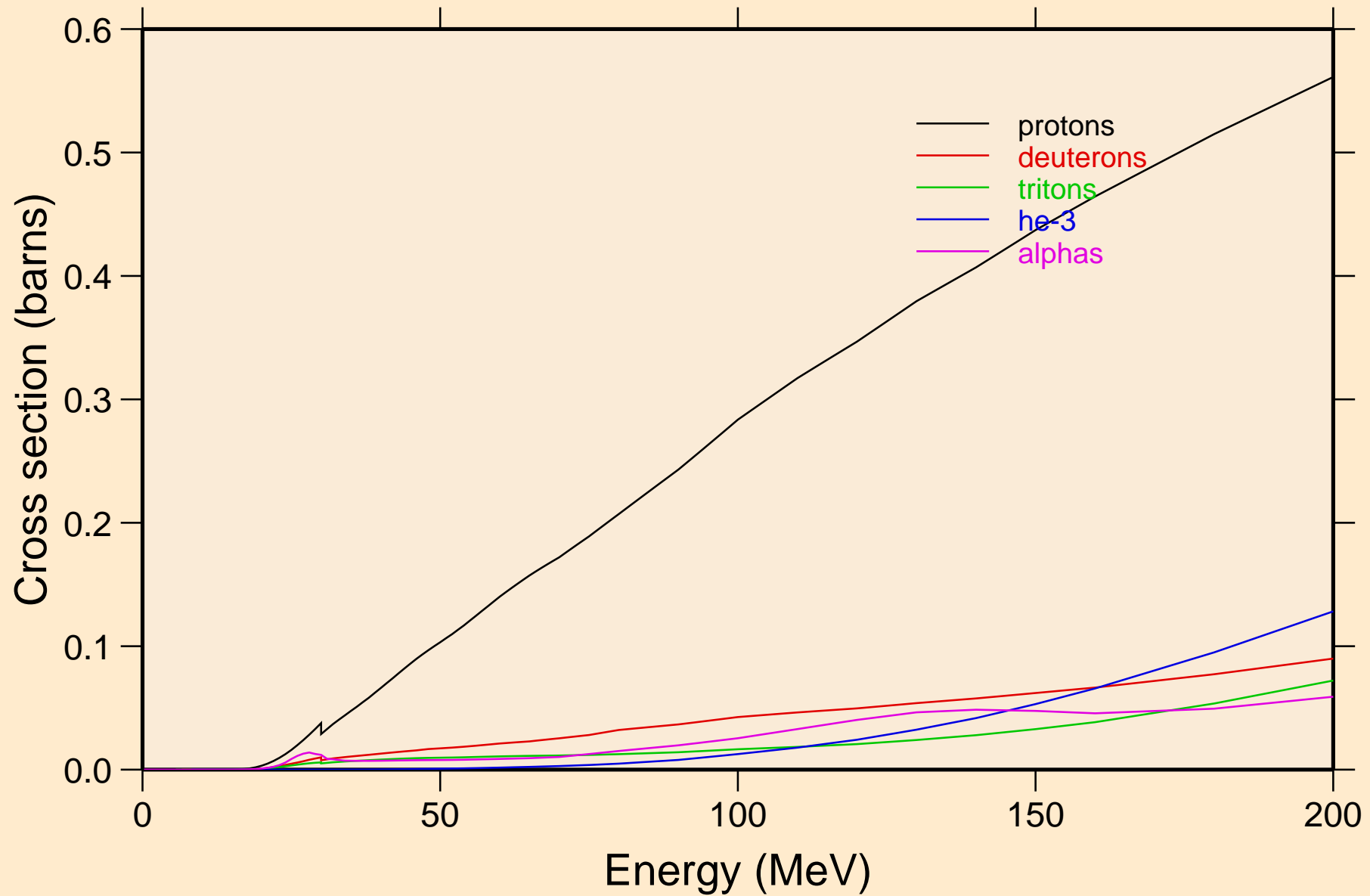

TH238 NEUTRON ACER TENDL-2024 LIBRARY; T=0.K  
protons from (n,x)

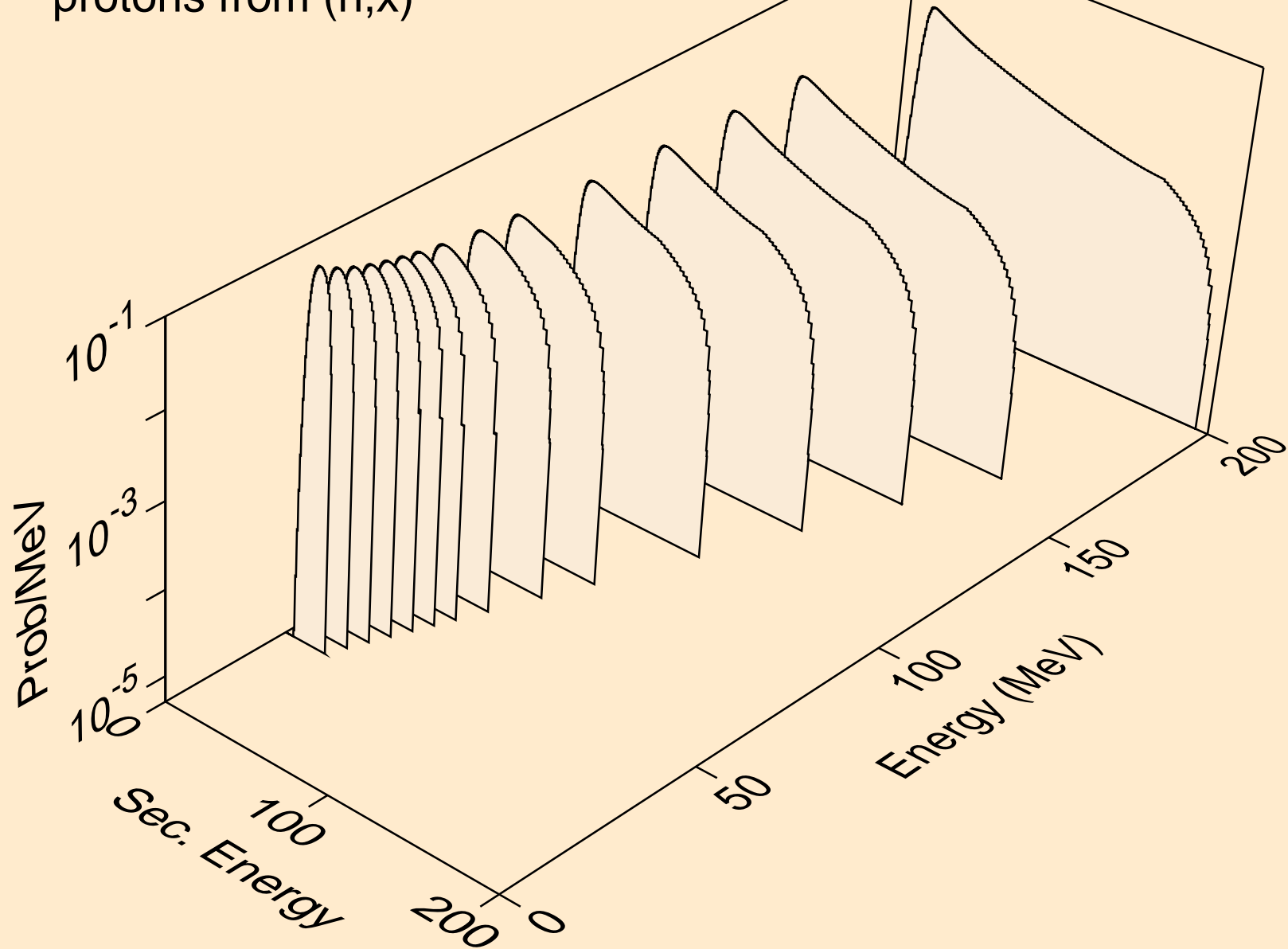

TH238 NEUTRON ACER TENDL-2024 LIBRARY; T=0.K  
protons from (n,n\*)p

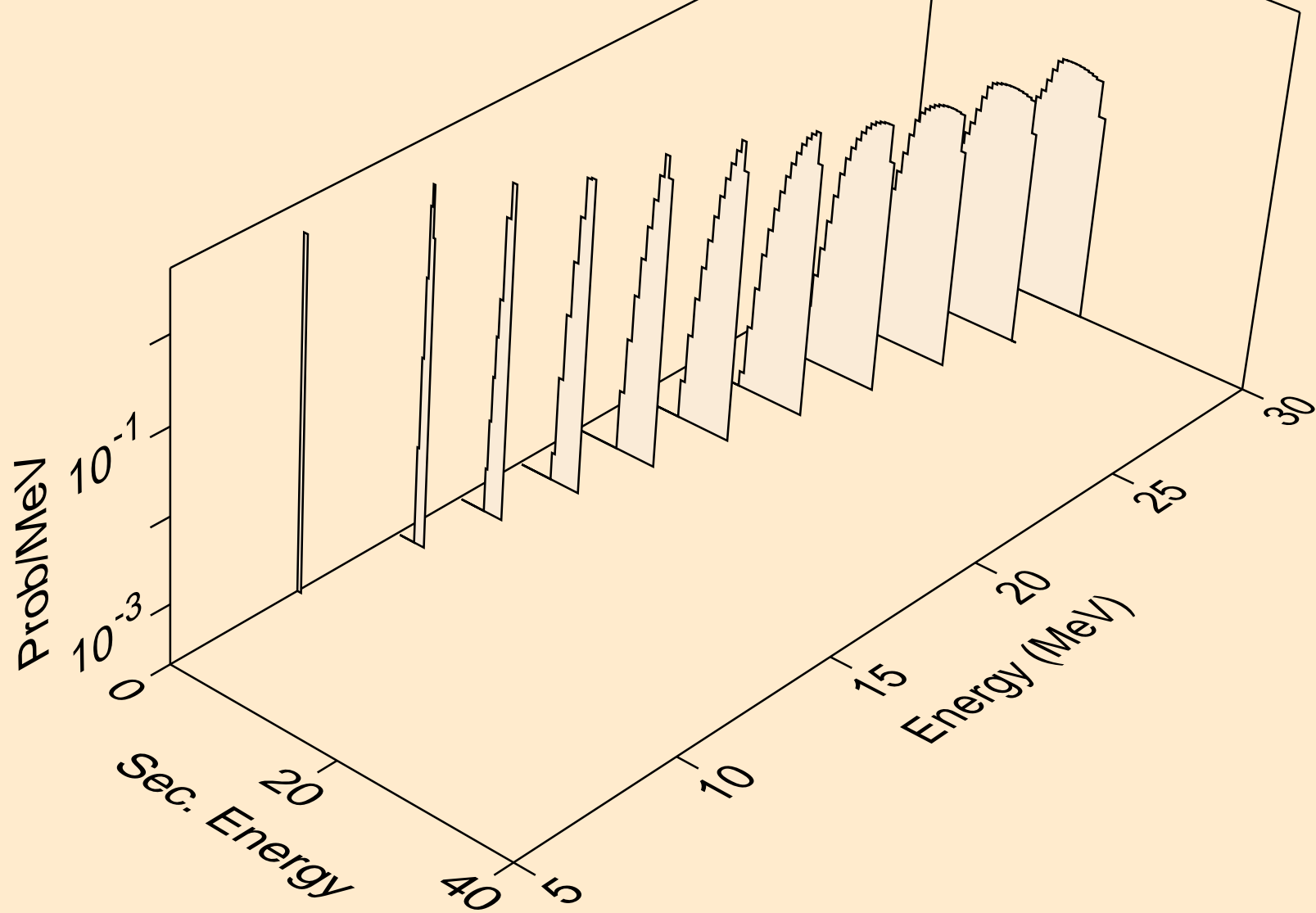

TH238 NEUTRON ACER TENDL-2024 LIBRARY; T=0.K  
protons from (n,2np)

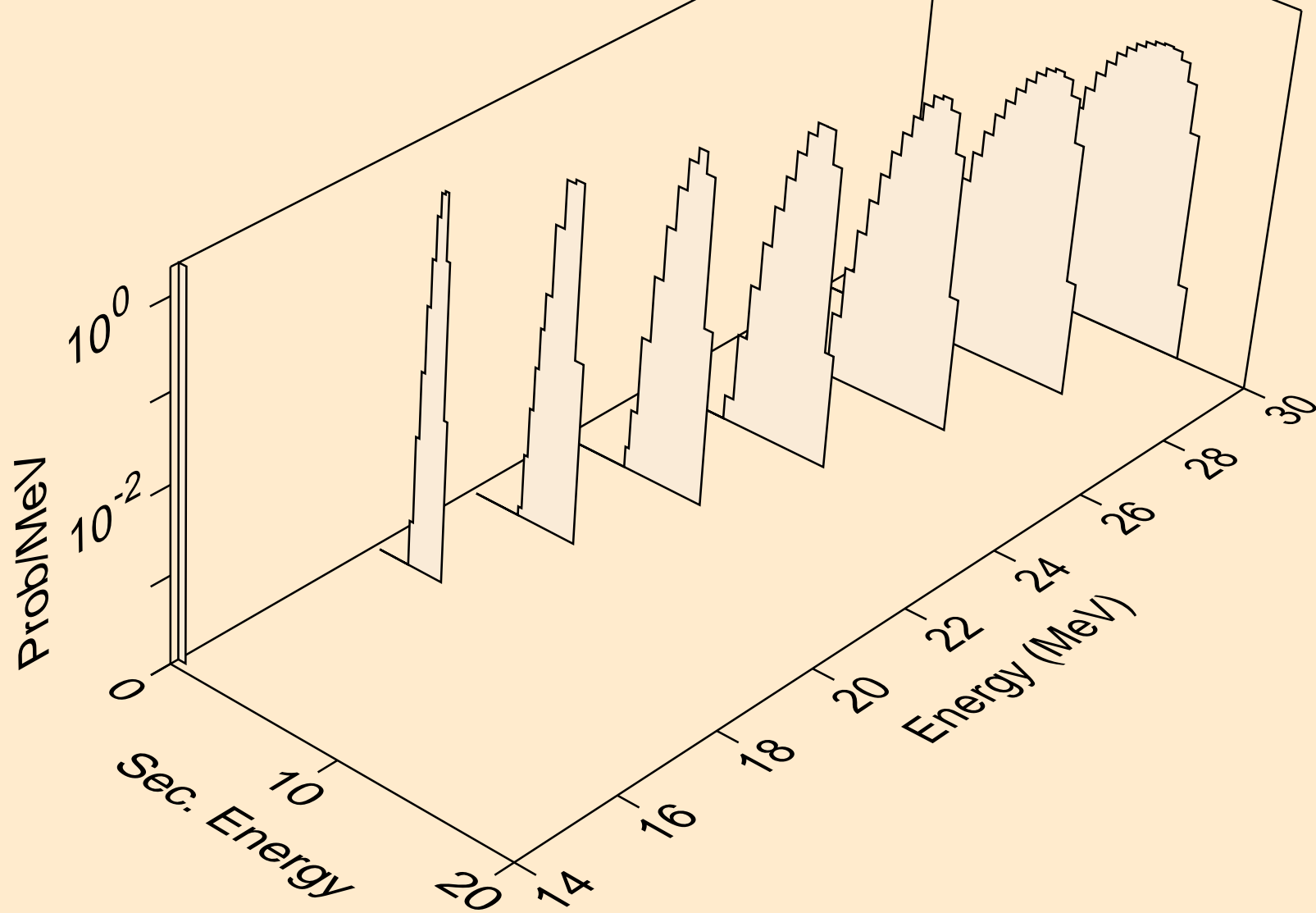

TH238 NEUTRON ACER TENDL-2024 LIBRARY; T=0.K  
protons from (n,3np)

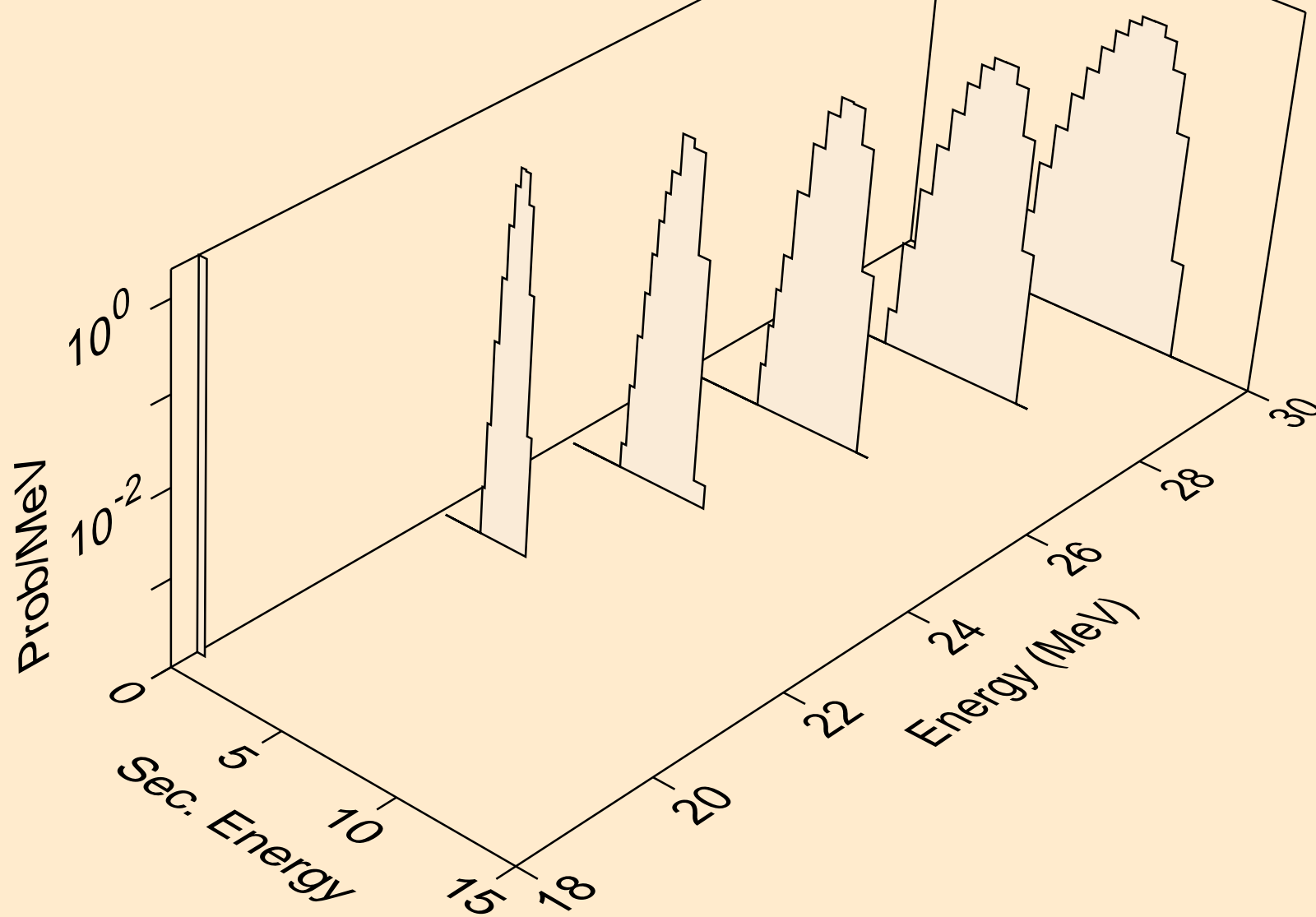

TH238 NEUTRON ACER TENDL-2024 LIBRARY; T=0.K  
protons from (n,p)

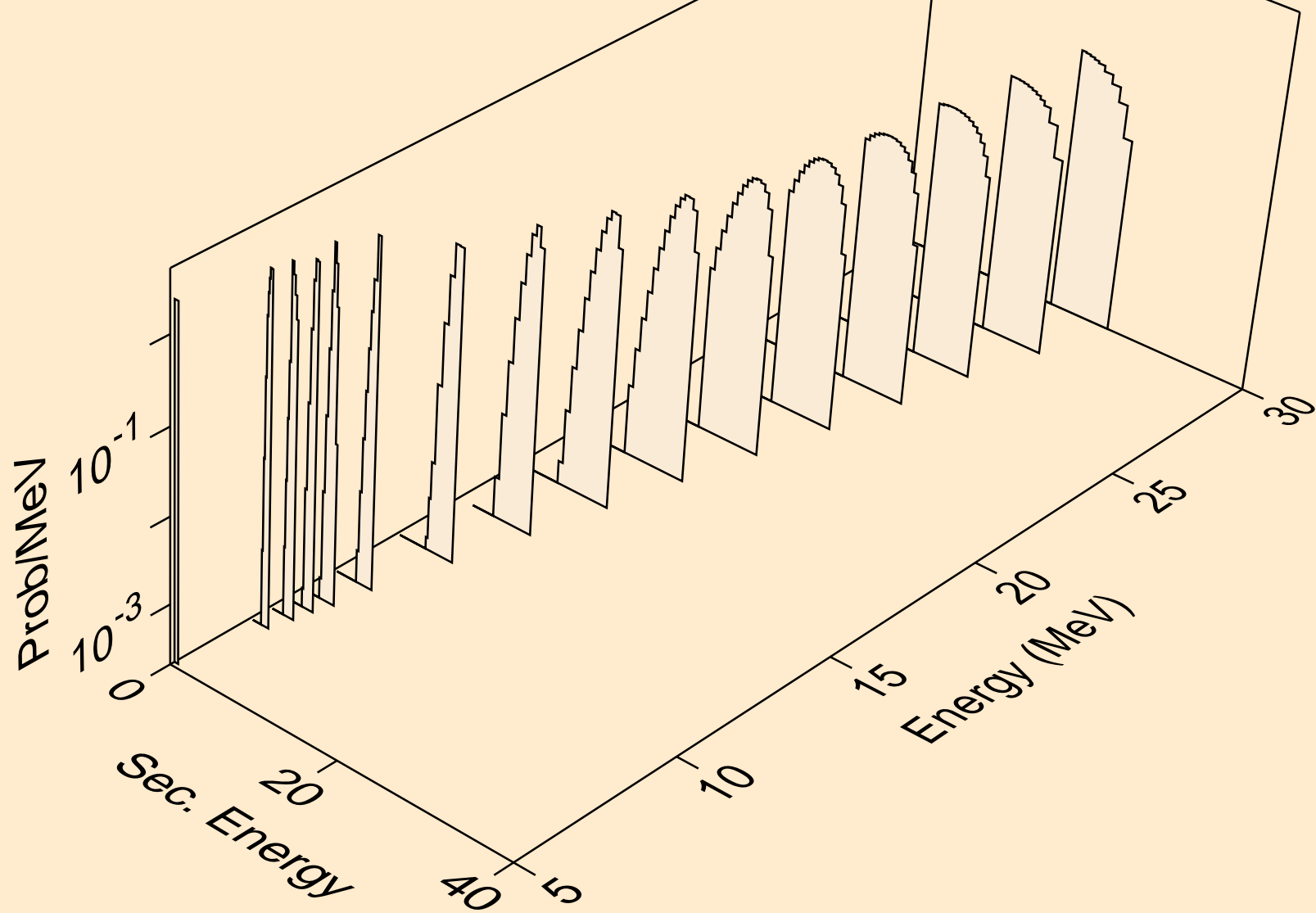

TH238 NEUTRON ACER TENDL-2024 LIBRARY; T=0.K  
deuterons from (n,x)

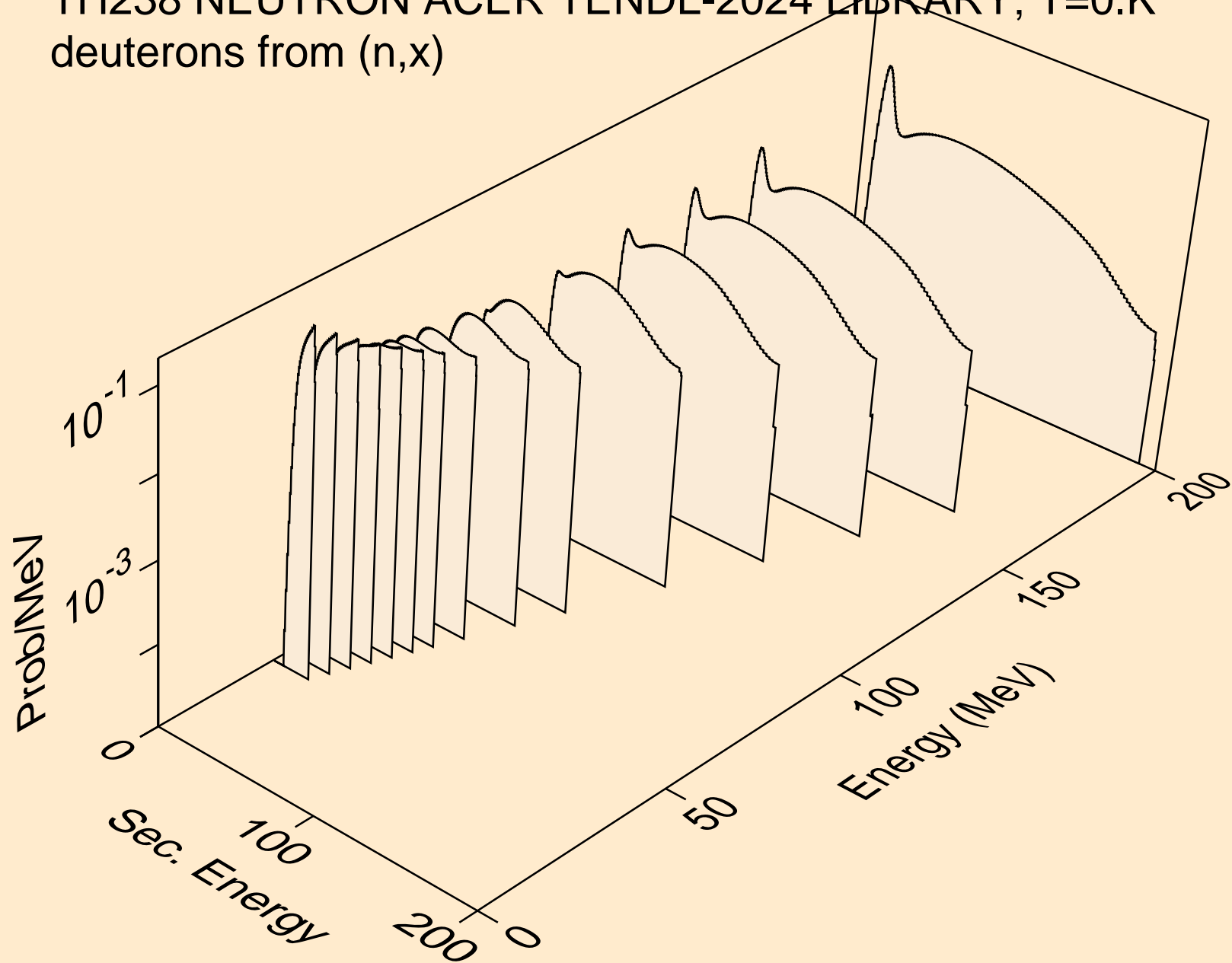

TH238 NEUTRON ACER TENDL-2024 LIBRARY; T=0.K  
deuterons from (n,2nd)

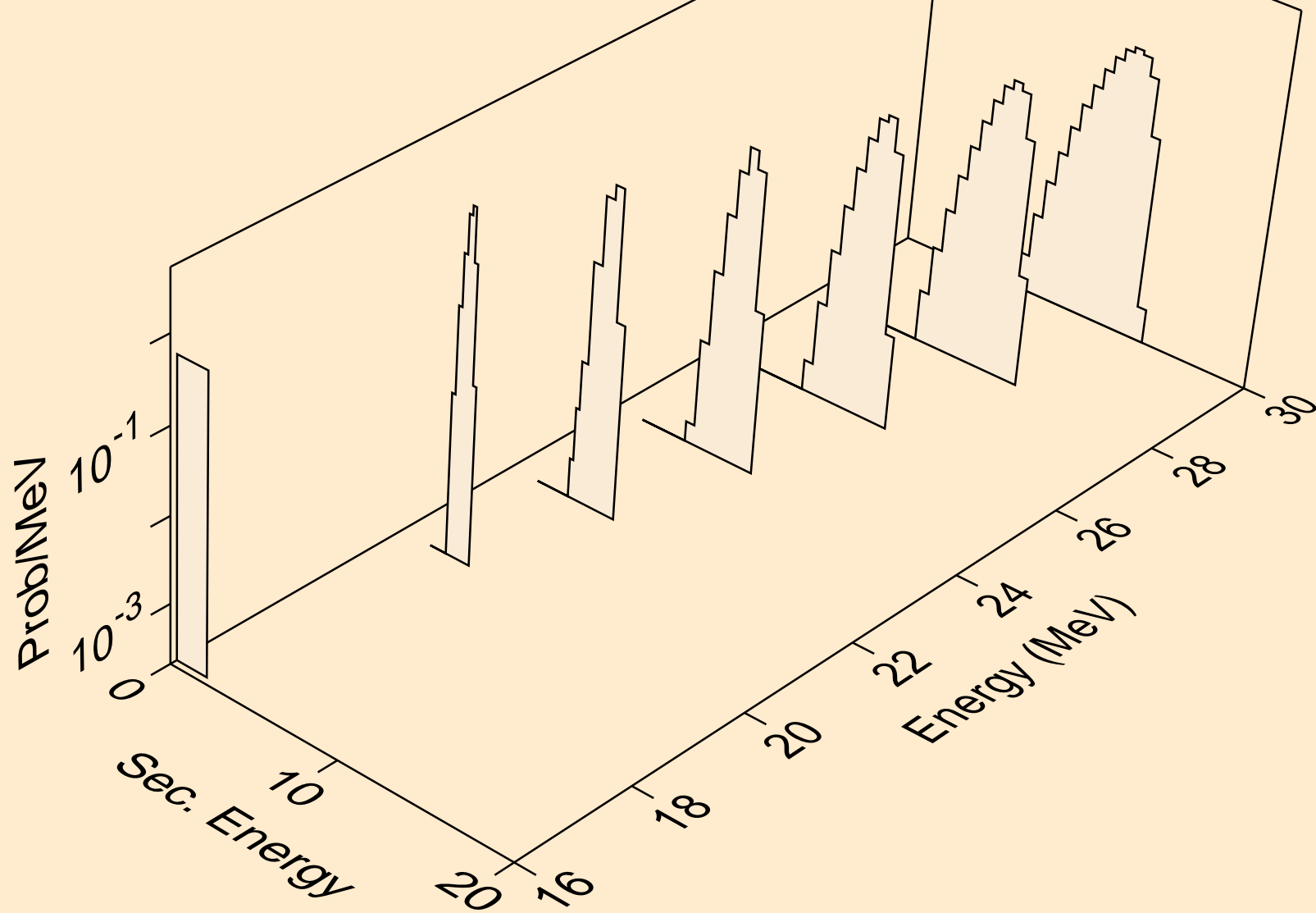



TH238 NEUTRON ACER TENDL-2024 LIBRARY; T=0.K  
deuterons from (n,n\*)d

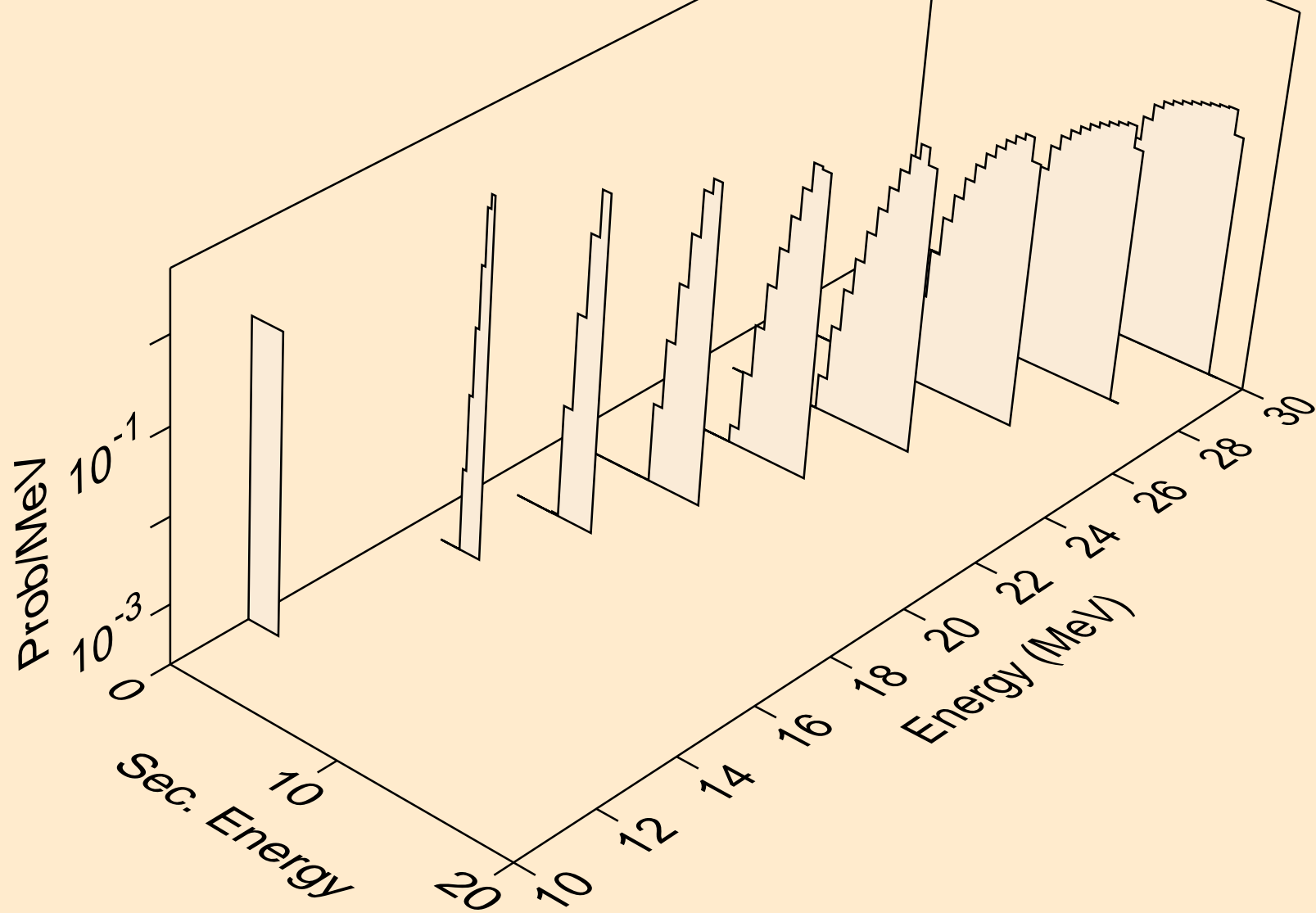

TH238 NEUTRON ACER TENDL-2024 LIBRARY; T=0.K  
deuterons from (n,d)

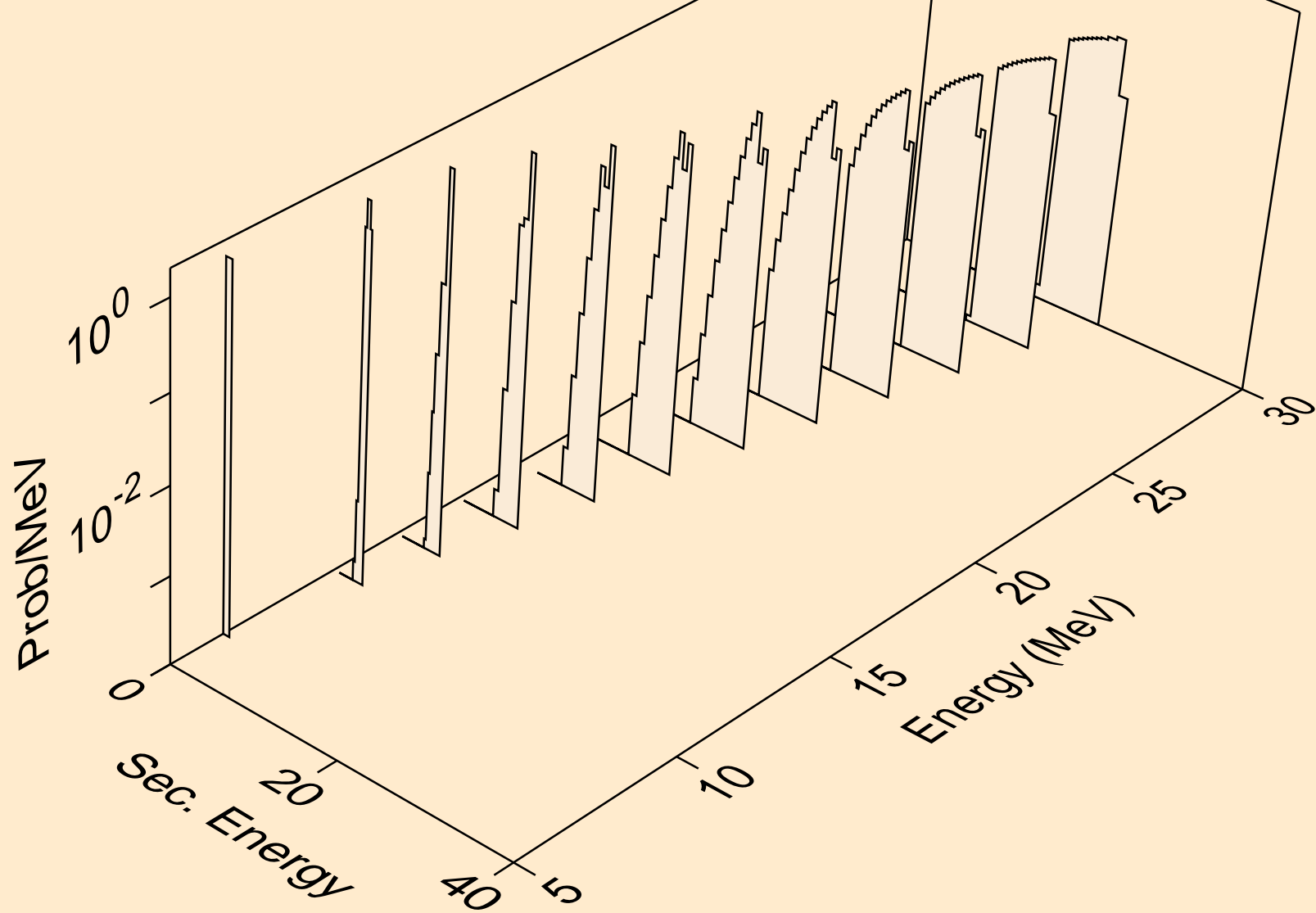

TH238 NEUTRON ACER TENDL-2024 LIBRARY; T=0.K  
tritons from (n,x)

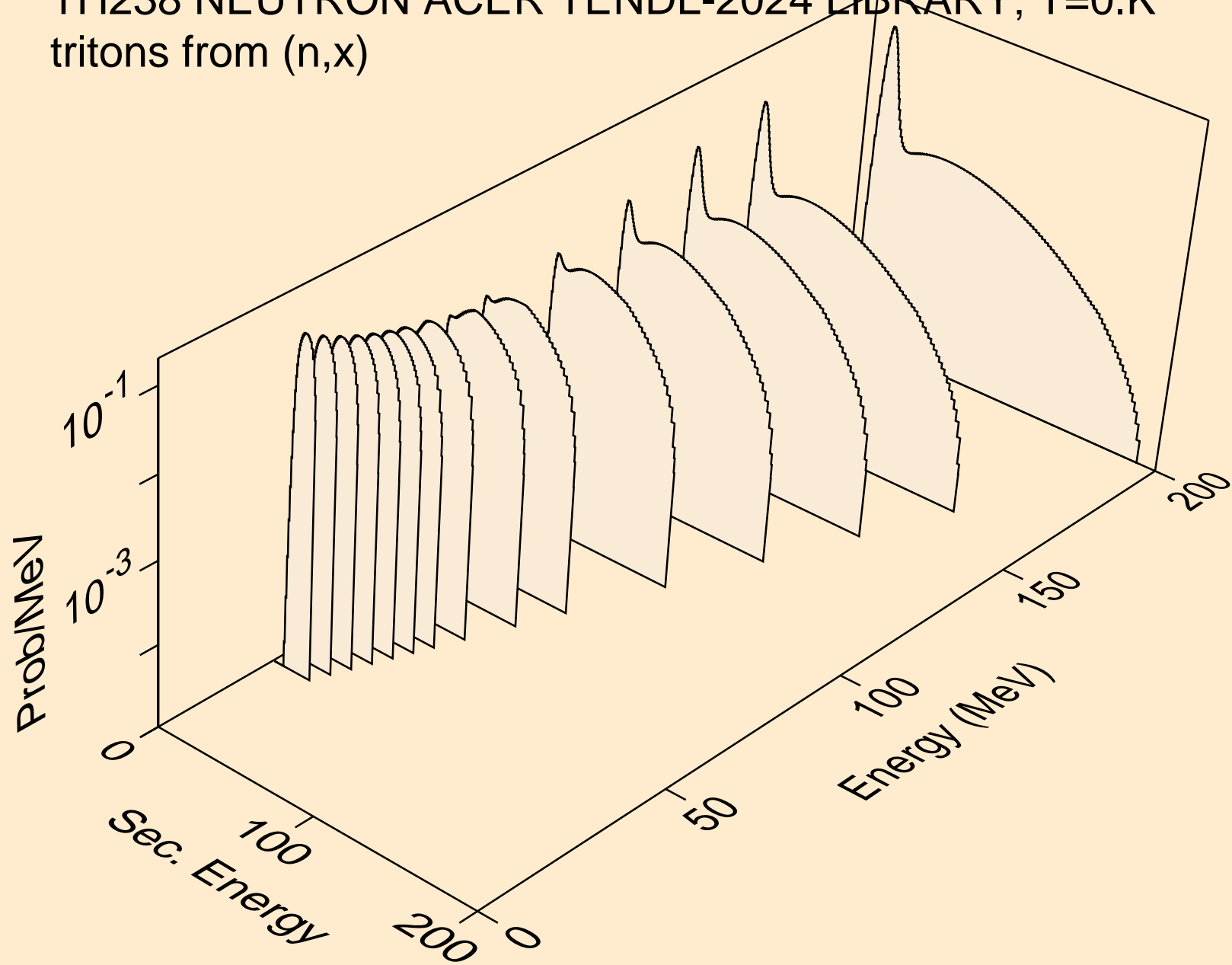

TH238 NEUTRON ACER TENDL-2024 LIBRARY; T=0.K  
tritons from (n,n\*)t

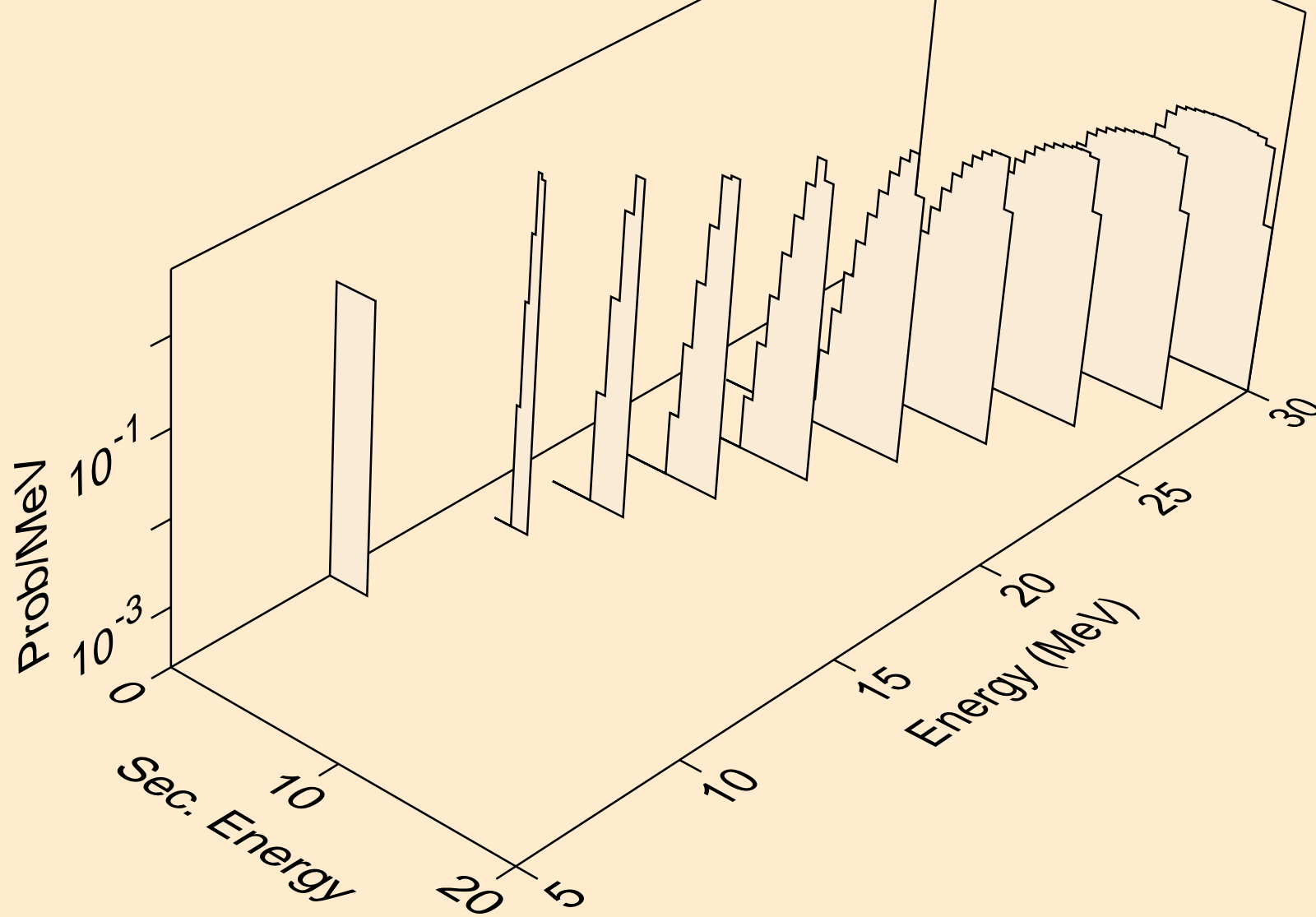

TH238 NEUTRON ACER TENDL-2024 LIBRARY; T=0.K  
tritons from (n,t)

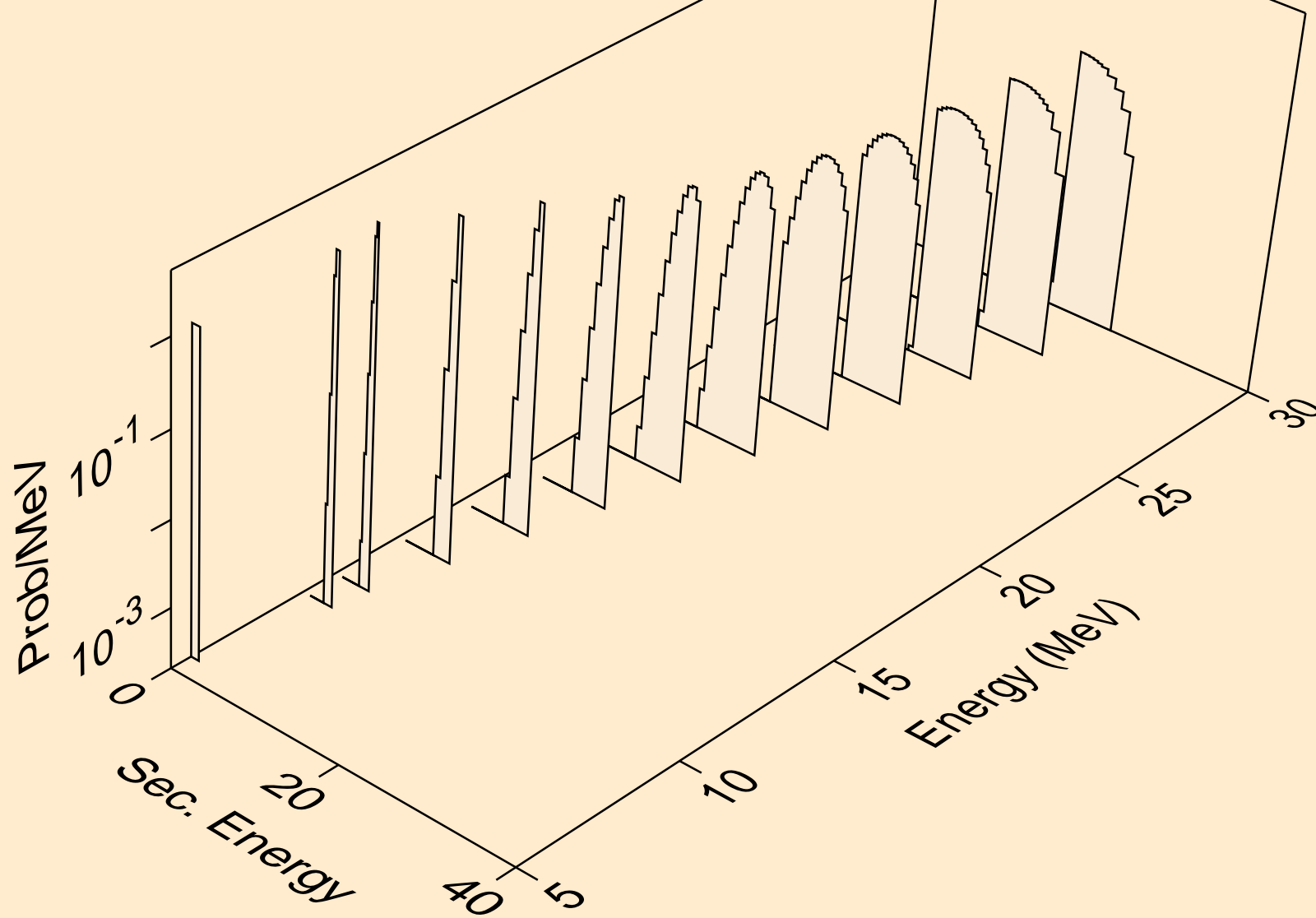

TH238 NEUTRON ACER TENDL-2024 LIBRARY; T=0.K  
he3s from (n,x)

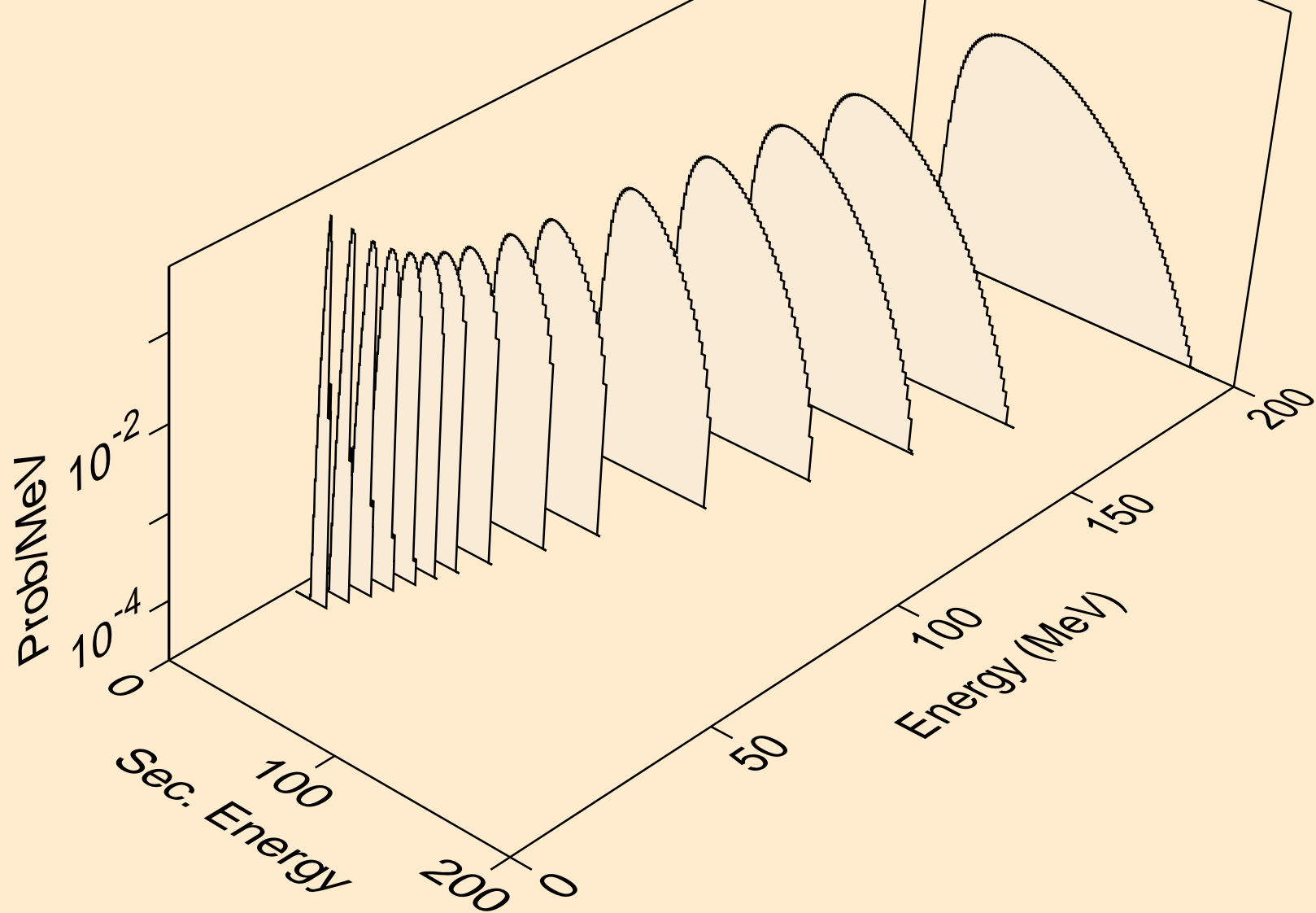

TH238 NEUTRON ACER TENDL-2024 LIBRARY; T=0.K  
he3s from (n,n\*)he3

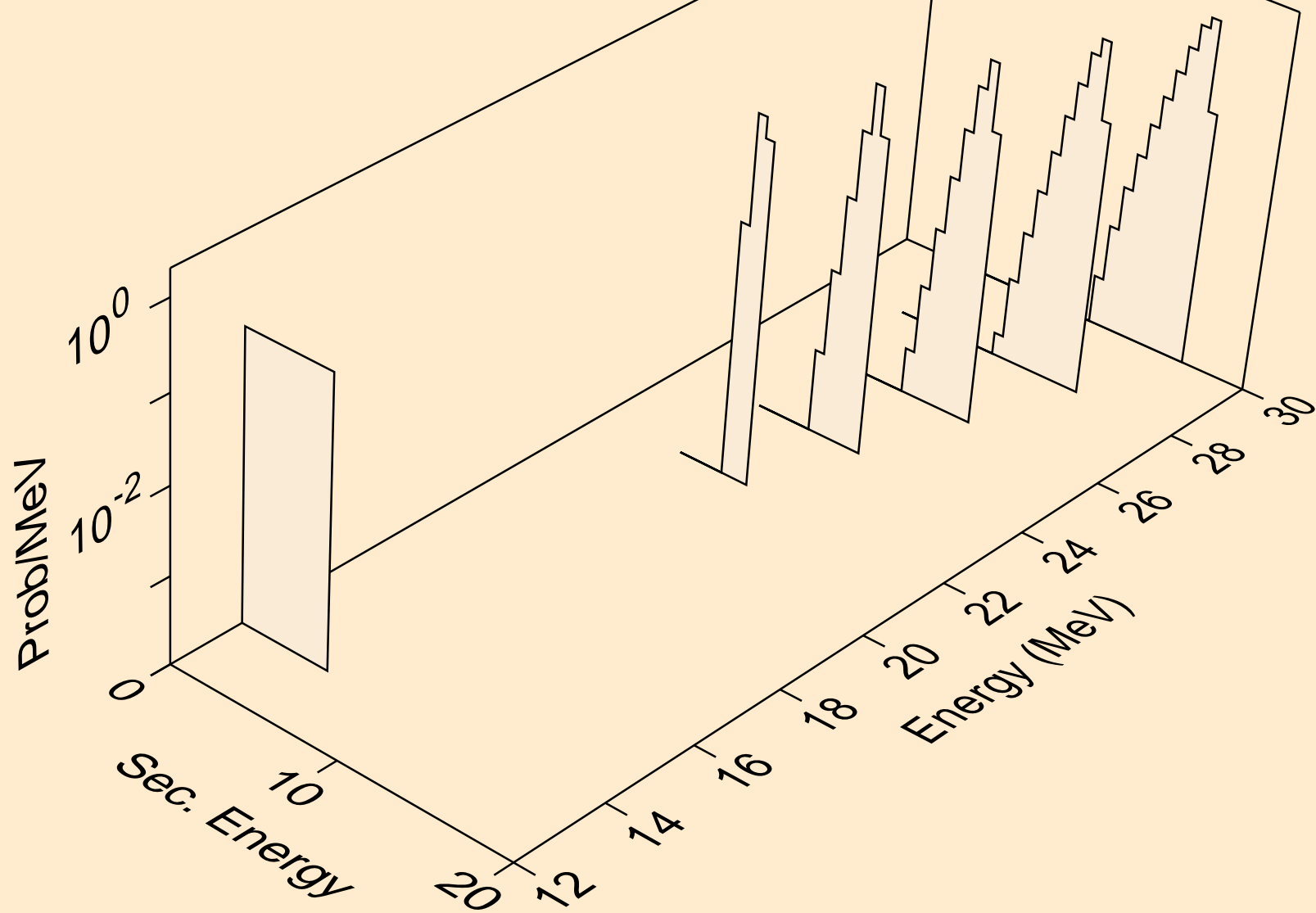

TH238 NEUTRON ACER TENDL-2024 LIBRARY; T=0.K  
he3s from (n,he3)

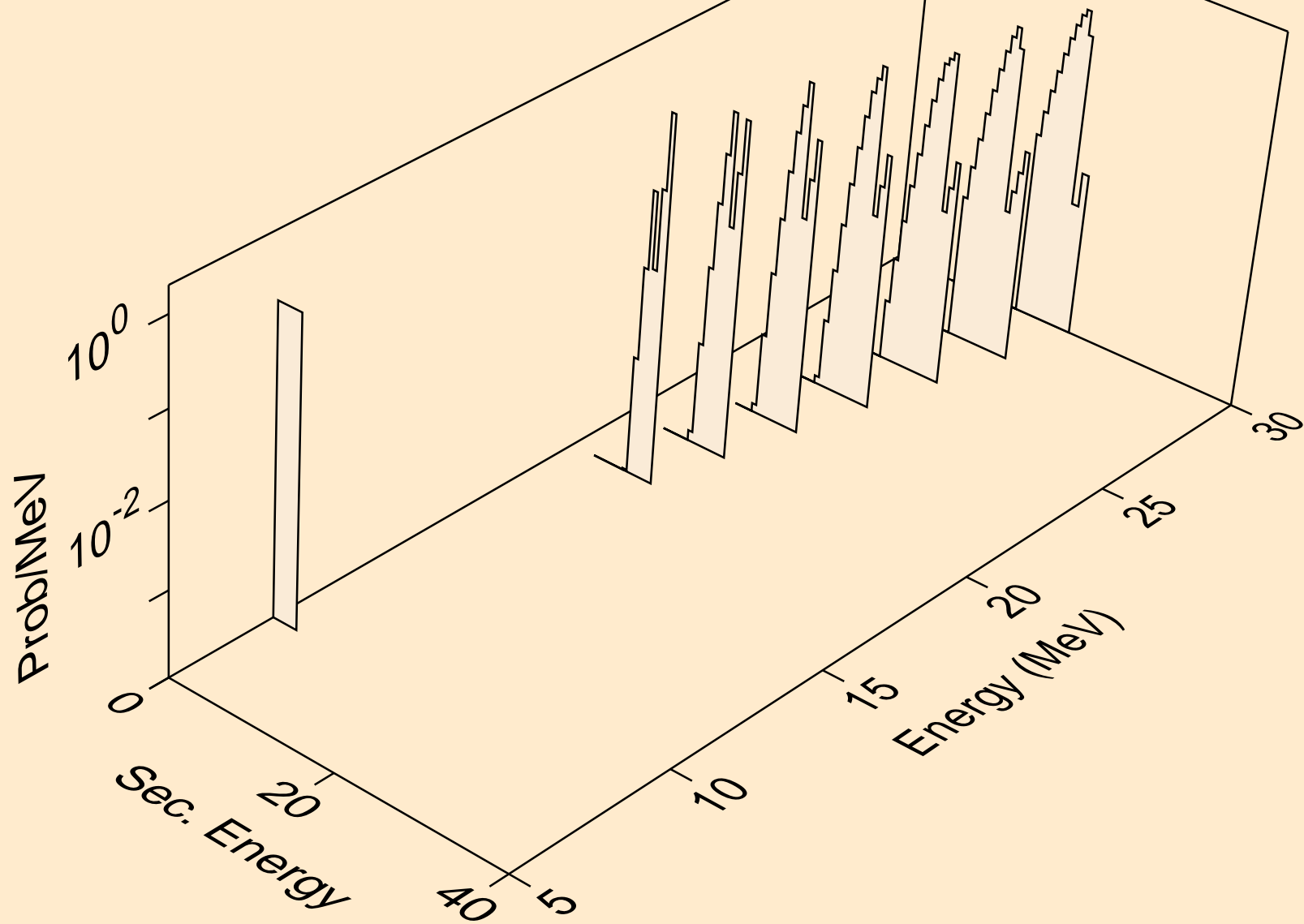



TH238 NEUTRON ACER TENDL-2024 LIBRARY; T=0.K  
alphas from (n,x)

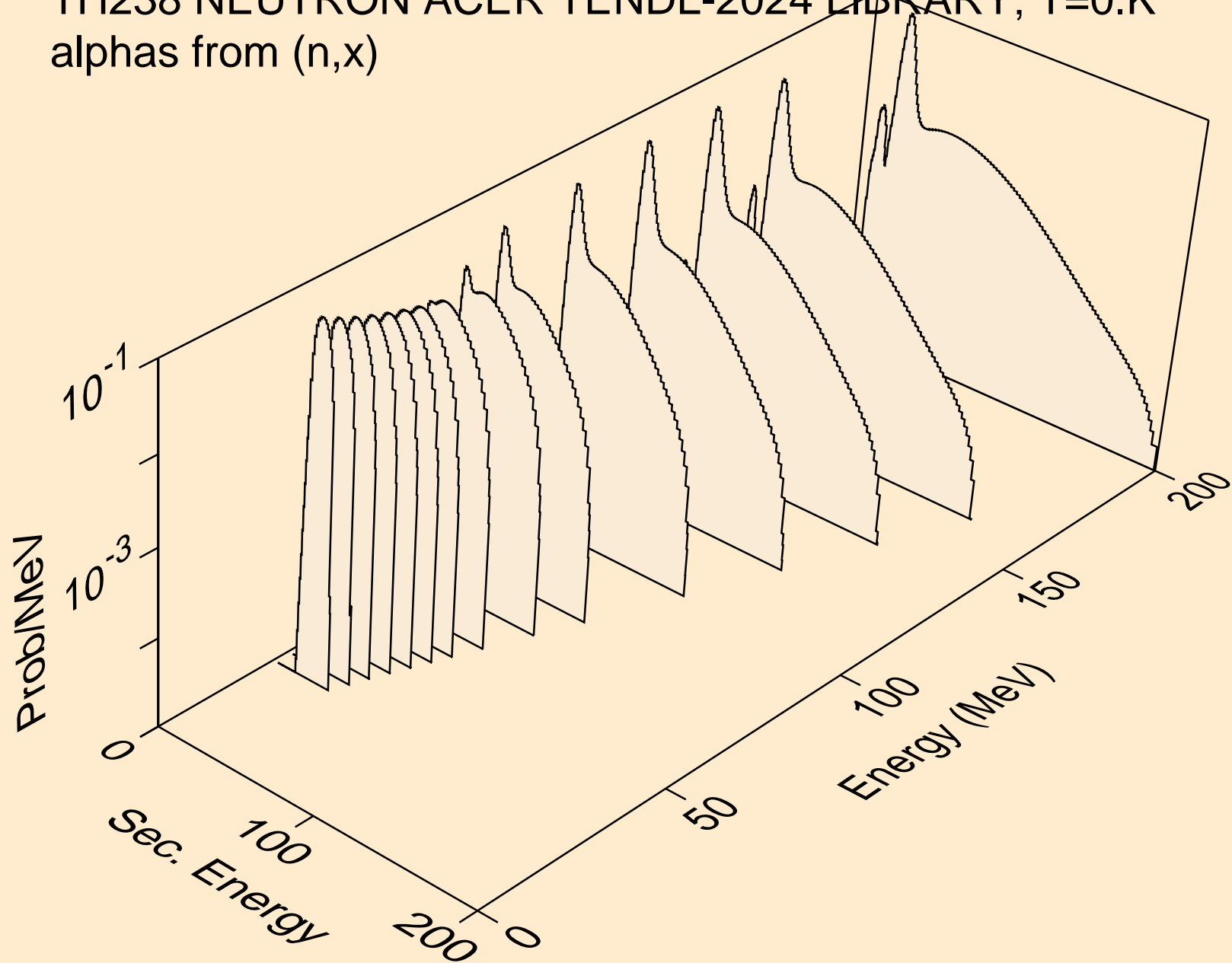

TH238 NEUTRON ACER TENDL-2024 LIBRARY; T=0.K  
alphas from (n,n\*)a

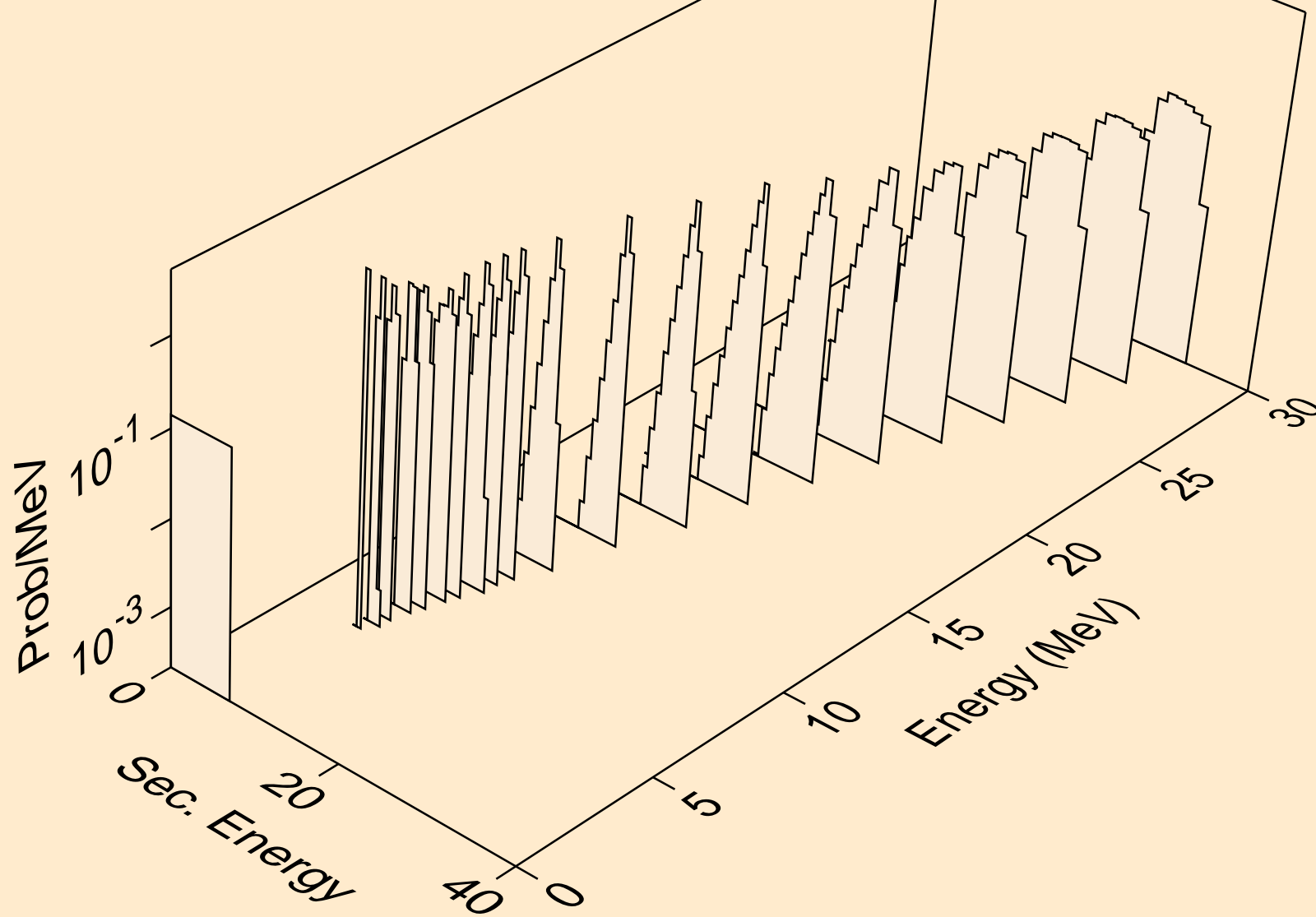

TH238 NEUTRON ACER TENDL-2024 LIBRARY; T=0.K  
alphas from (n,2n)a

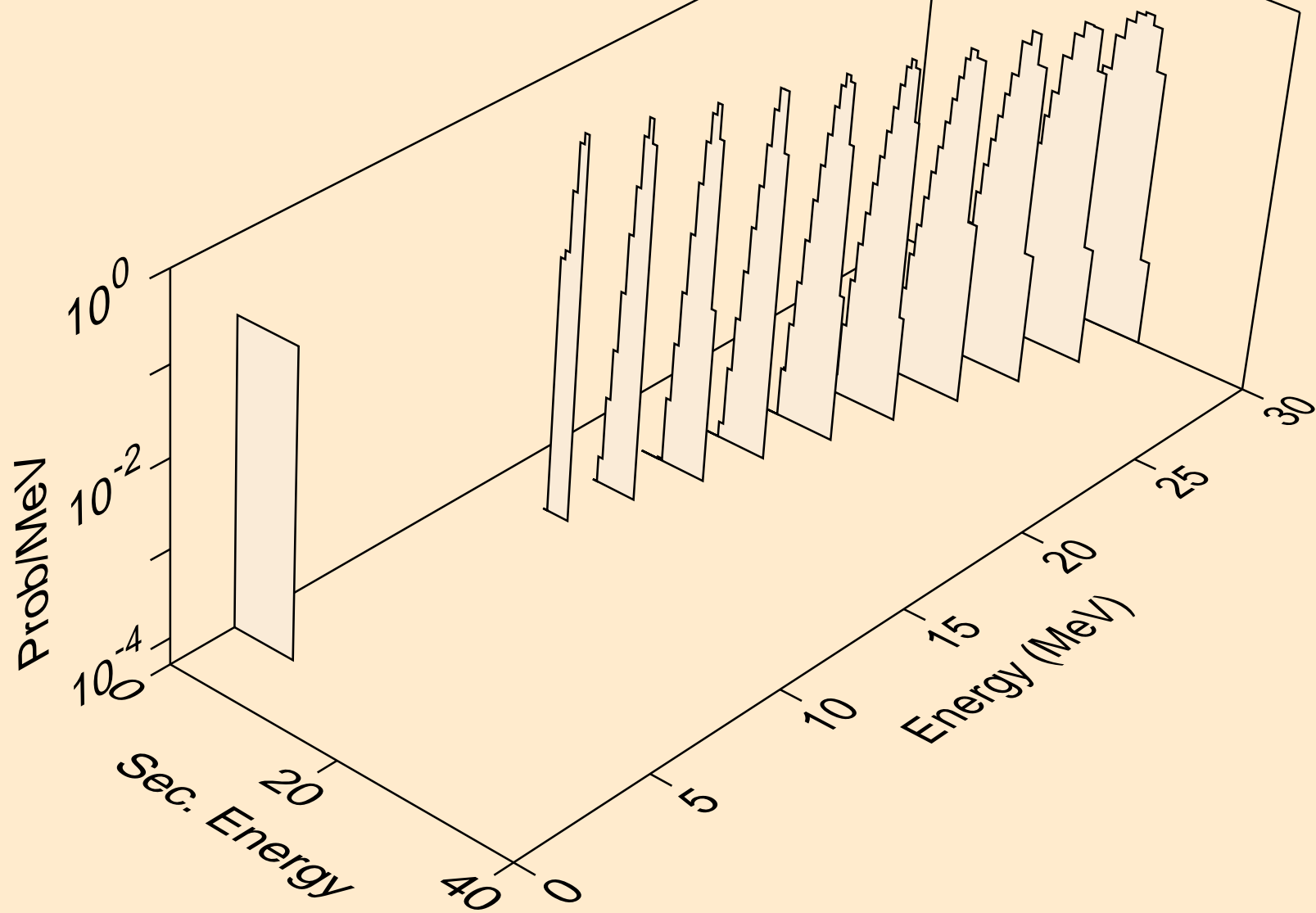

TH238 NEUTRON ACER TENDL-2024 LIBRARY; T=0.K  
alphas from (n,3n)a

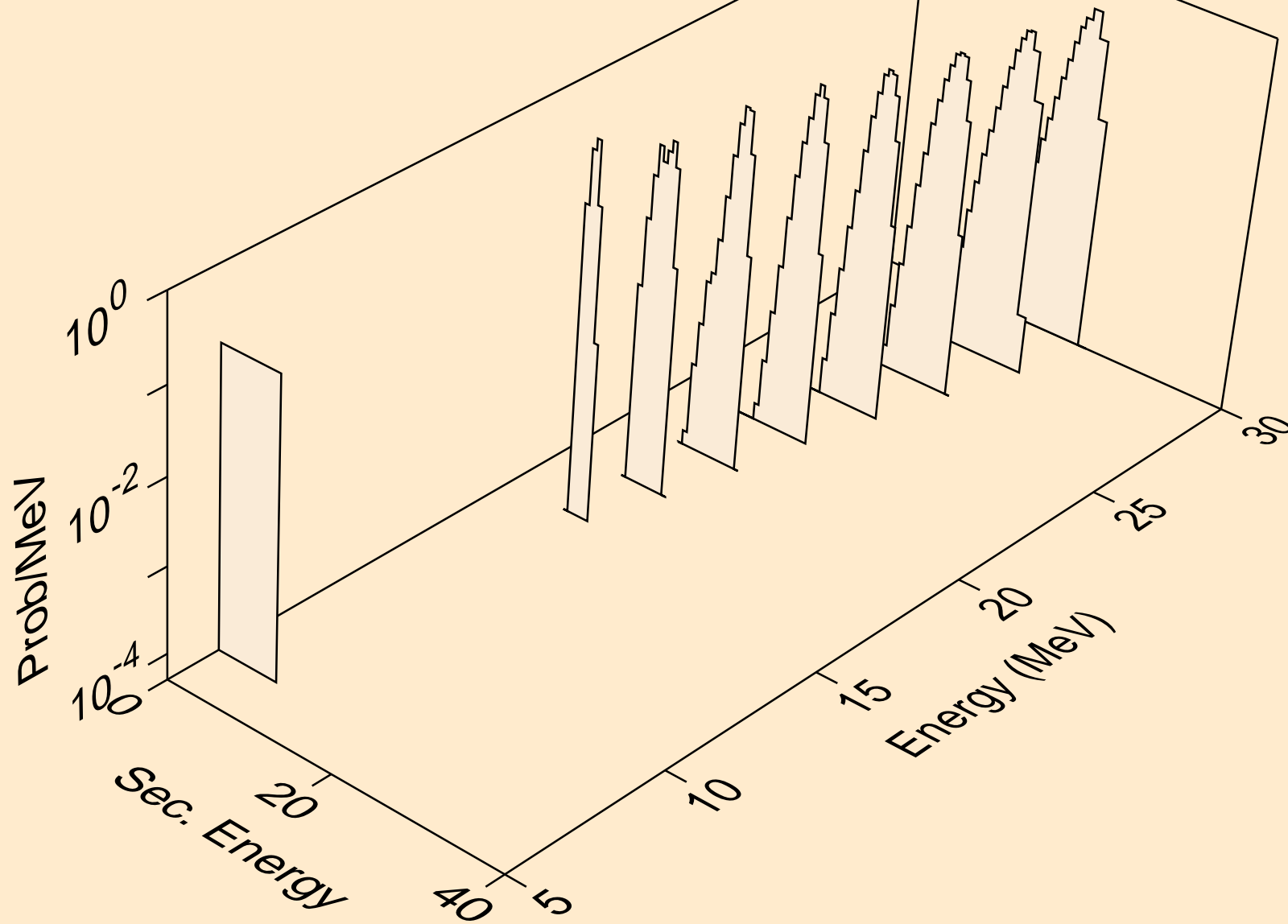

TH238 NEUTRON ACER TENDL-2024 LIBRARY; T=0.K  
alphas from (n,a)

