

TI050 NEUTRON ACER TENDL-2024 LIBRARY; T=0.K
Principal cross sections

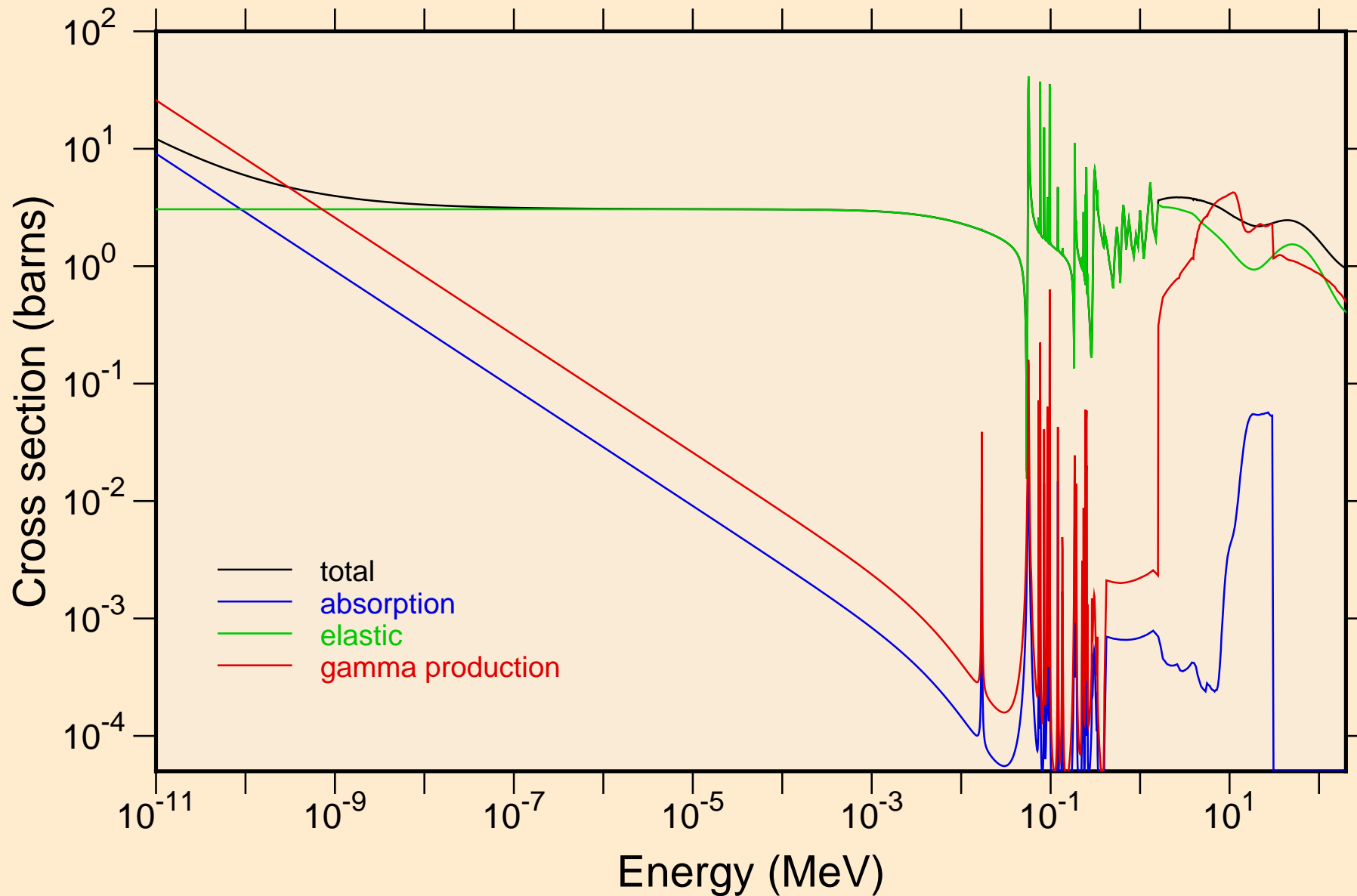

TI050 NEUTRON ACER TENDL-2024 LIBRARY; T=0.K
resonance total cross section

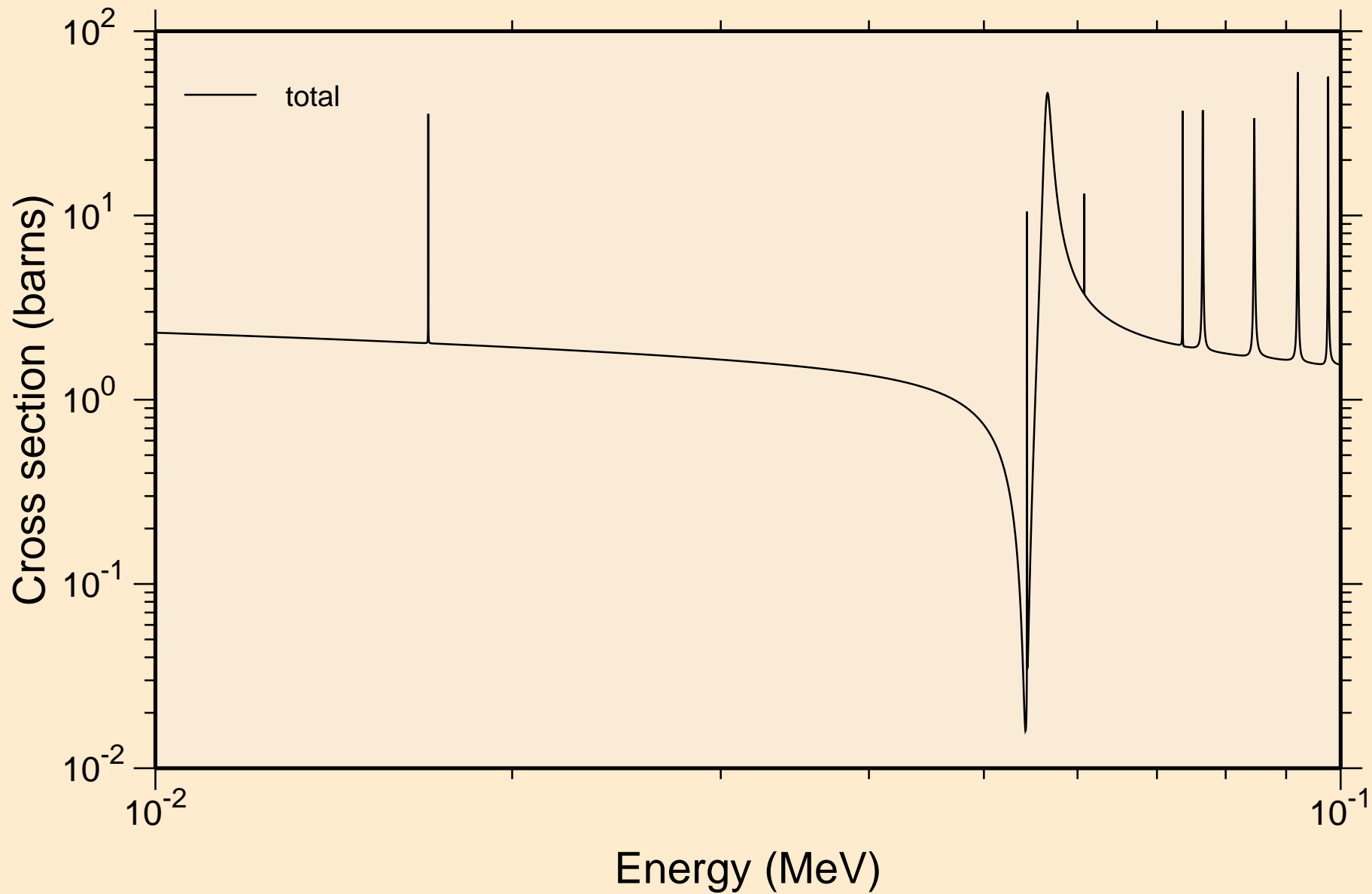

TI050 NEUTRON ACER TENDL-2024 LIBRARY; T=0.K
resonance total cross section

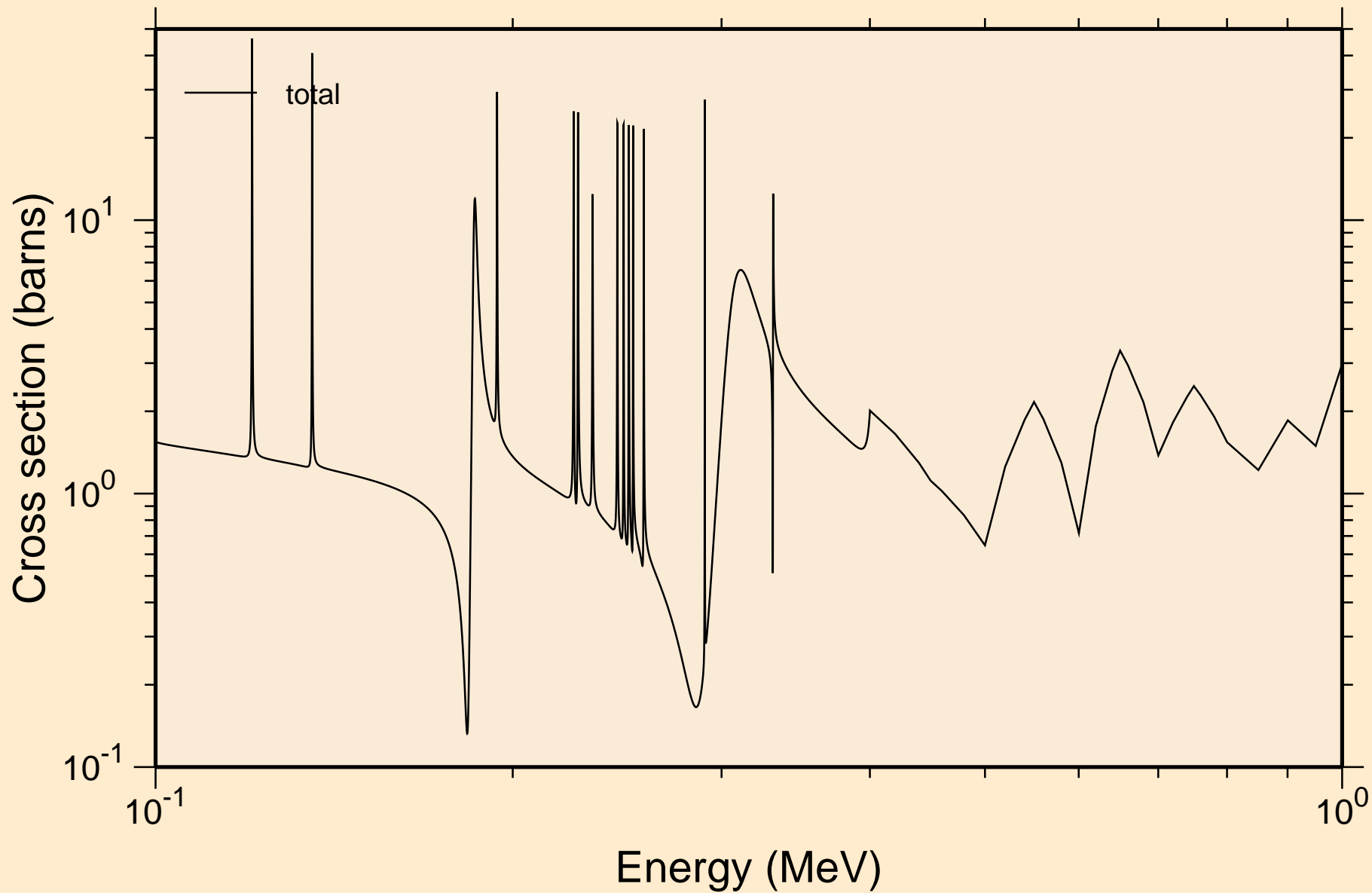

TI050 NEUTRON ACER TENDL-2024 LIBRARY; T=0.K
resonance total cross section

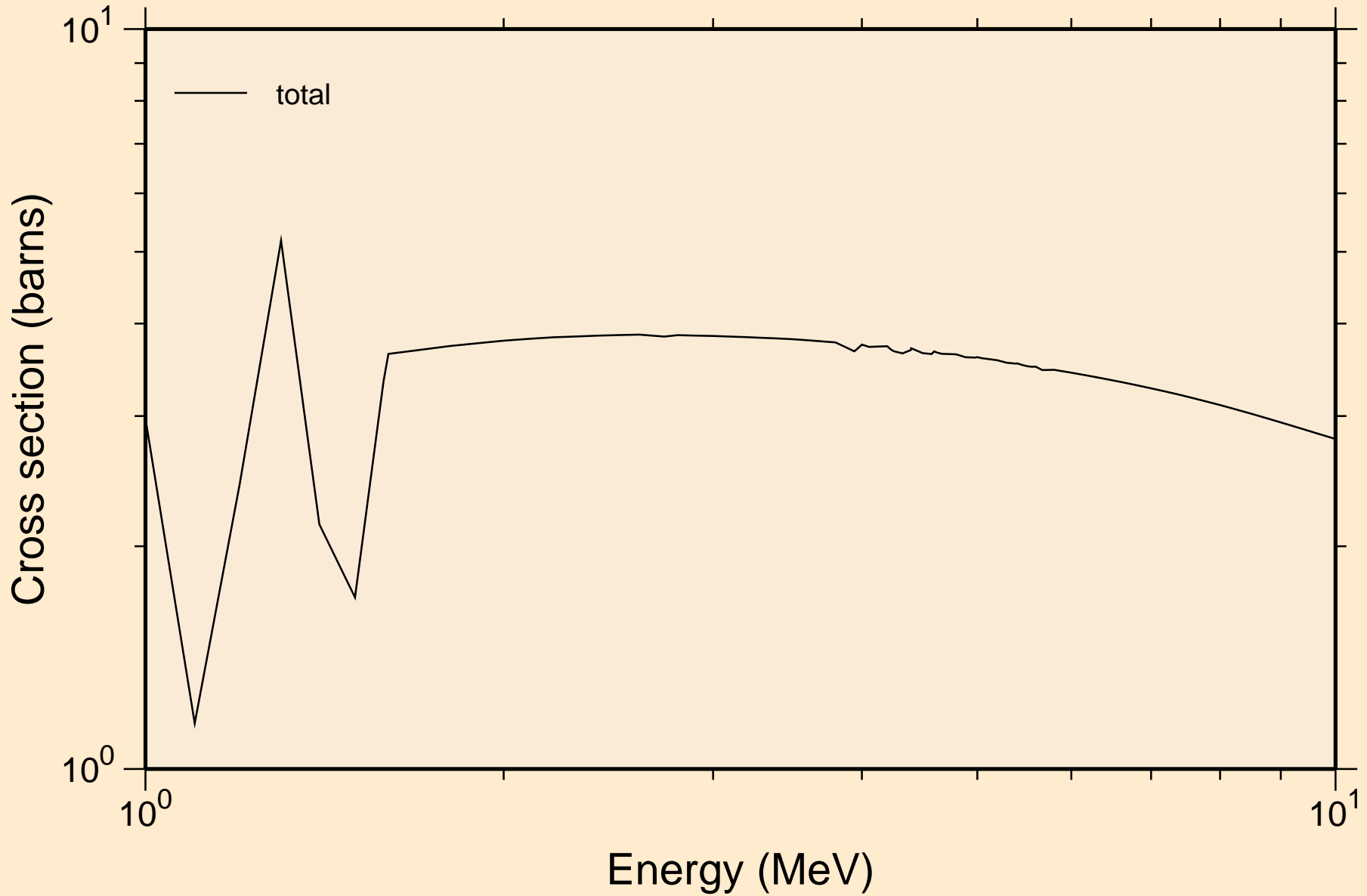

TI050 NEUTRON ACER TENDL-2024 LIBRARY; T=0.K
resonance absorption cross sections

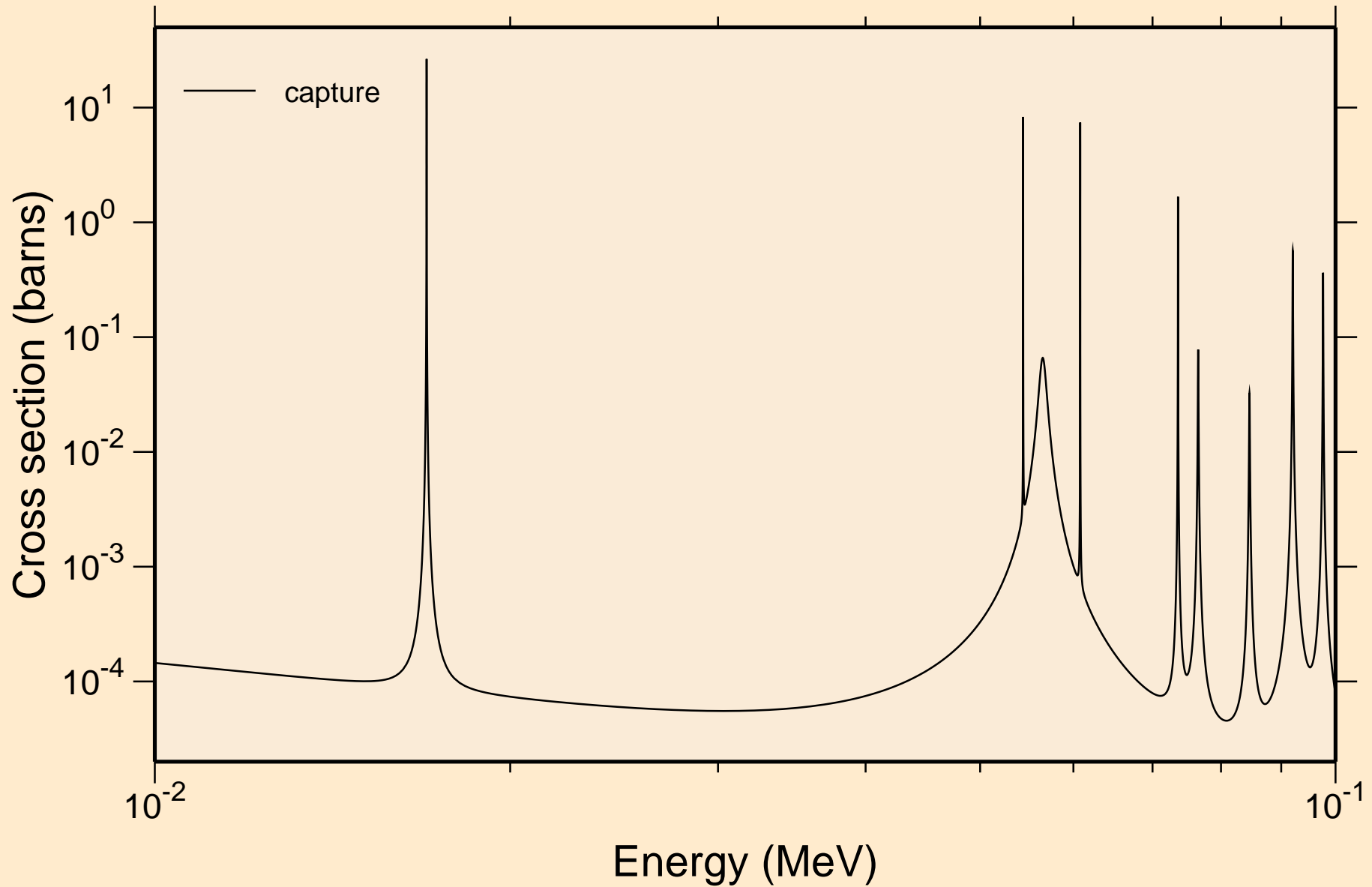

TI050 NEUTRON ACER TENDL-2024 LIBRARY; T=0.K
resonance absorption cross sections

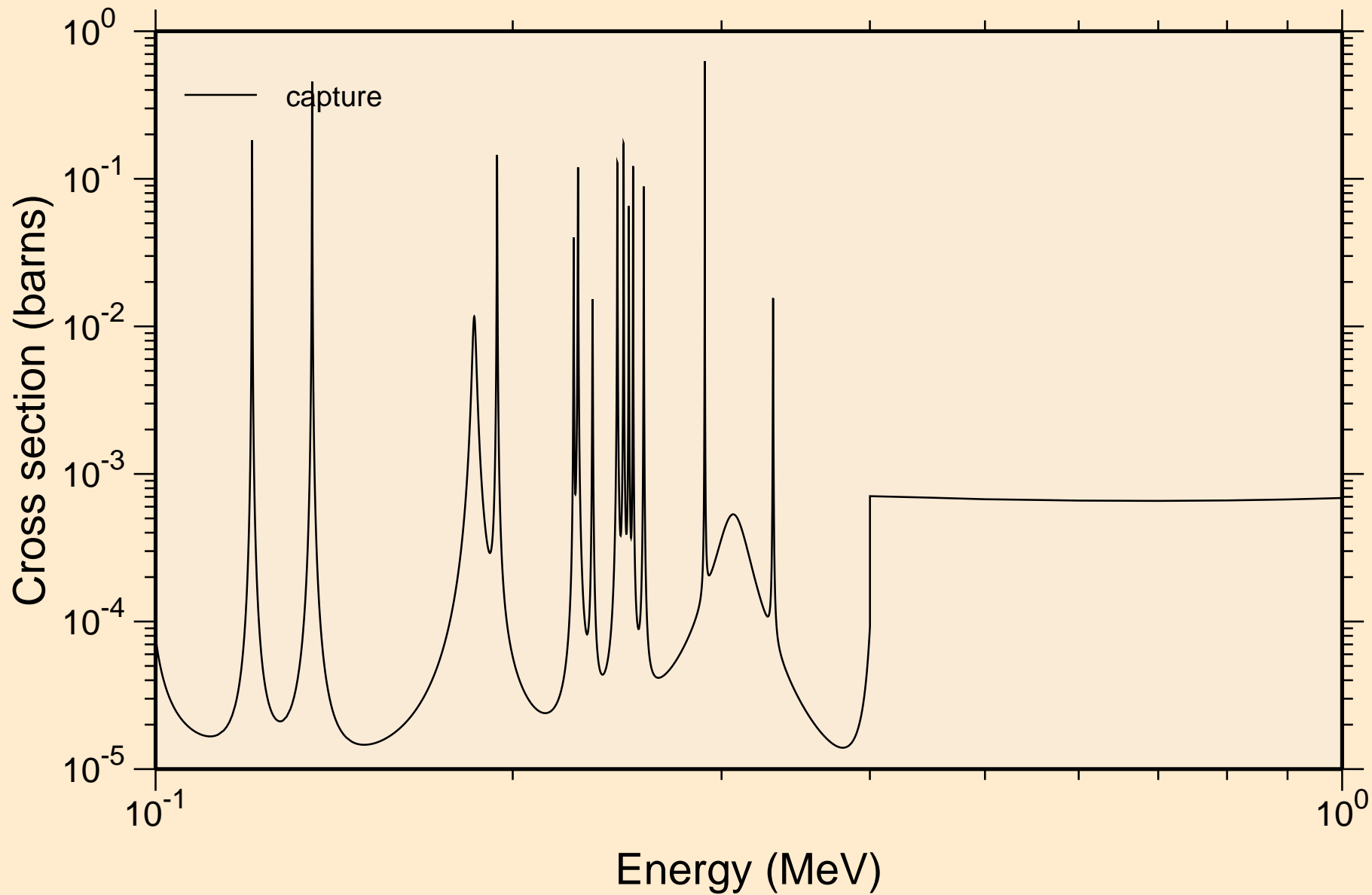

TI050 NEUTRON ACER TENDL-2024 LIBRARY; T=0.K
resonance absorption cross sections

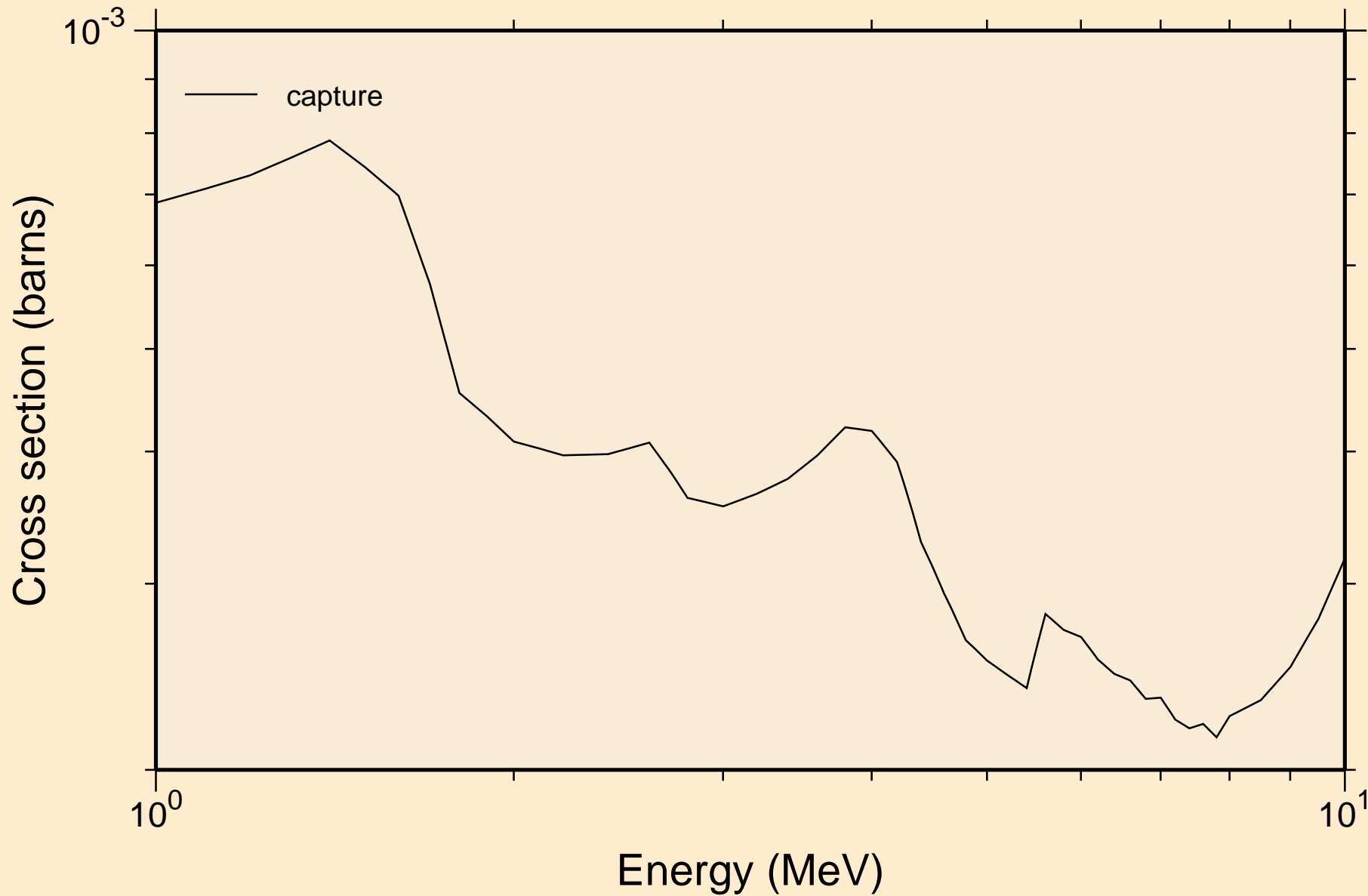

TI050 NEUTRON ACER TENDL-2024 LIBRARY; T=0.K
Heating

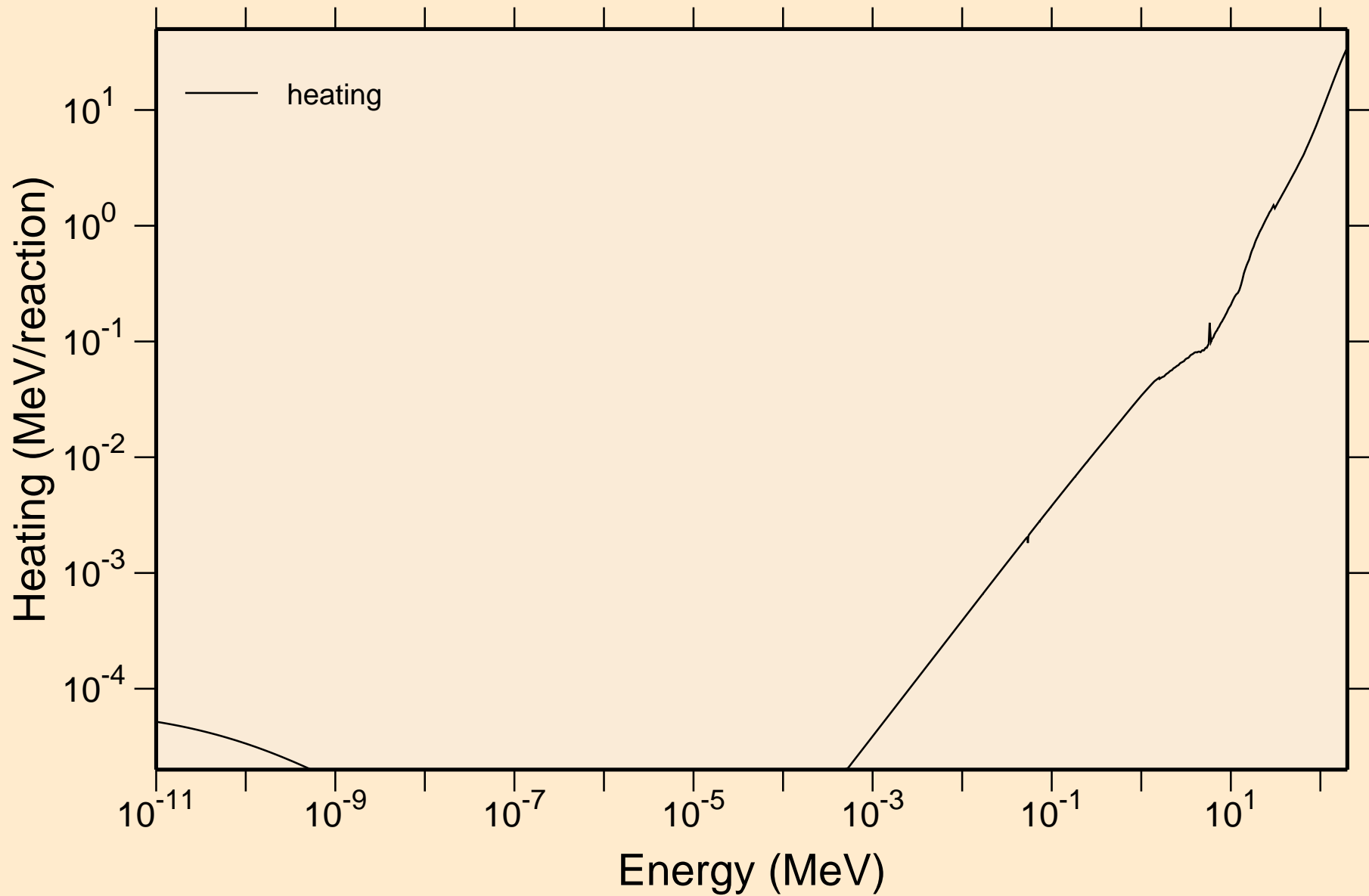

TI050 NEUTRON ACER TENDL-2024 LIBRARY; T=0.K
Damage

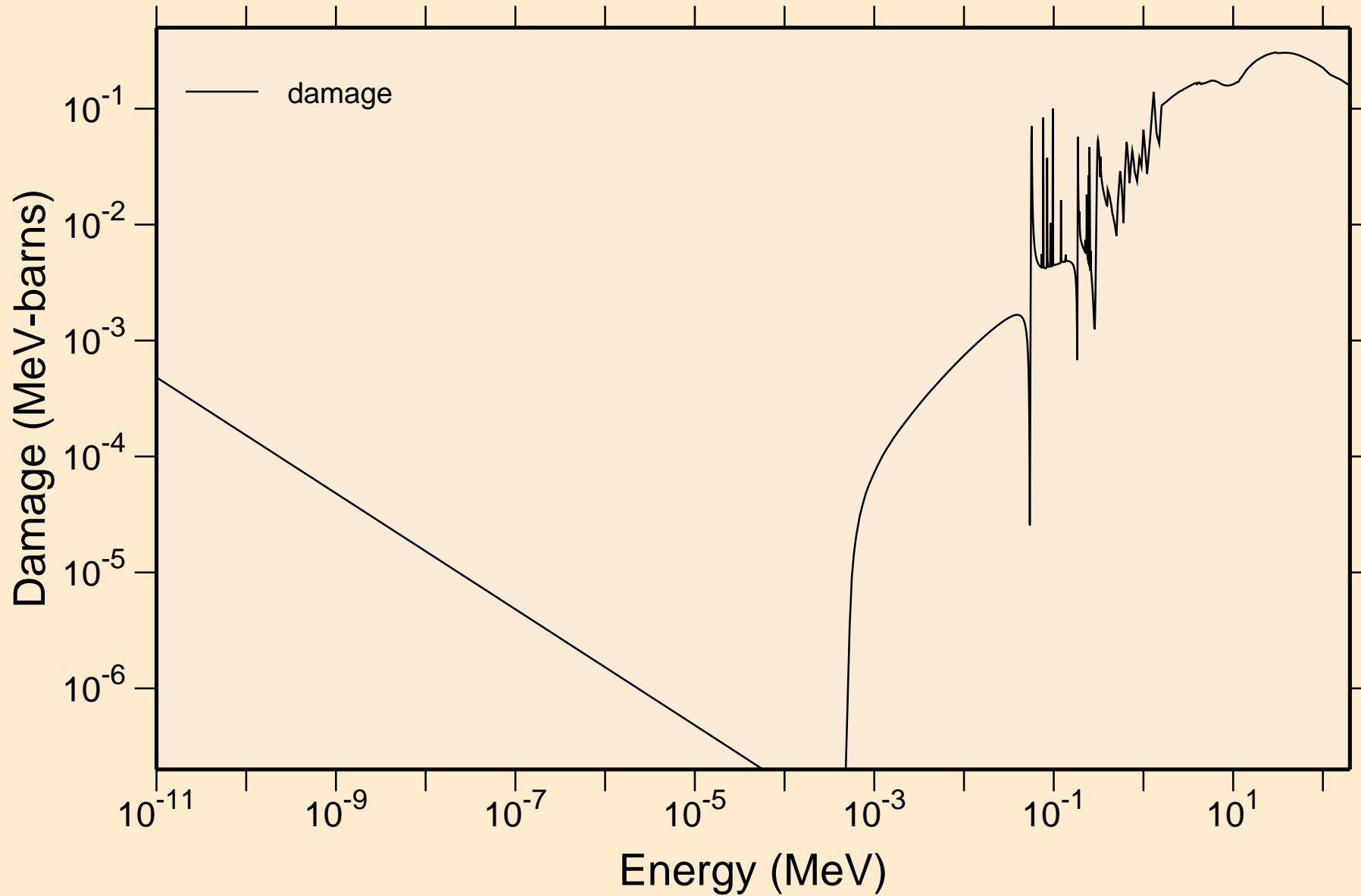

TI050 NEUTRON ACER TENDL-2024 LIBRARY; T=0.K
Non-threshold reactions

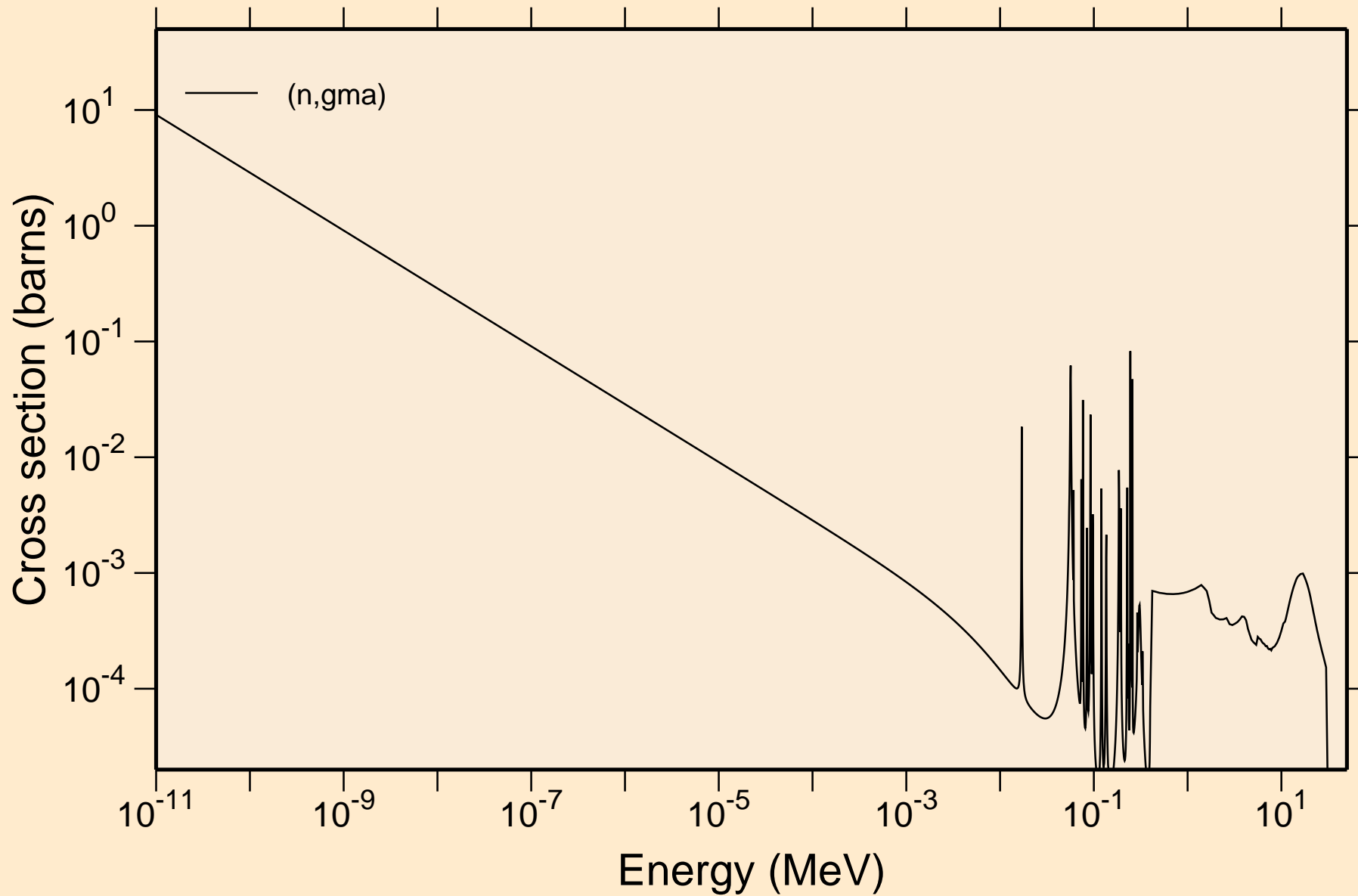

TI050 NEUTRON ACER TENDL-2024 LIBRARY; T=0.K

Principal cross sections

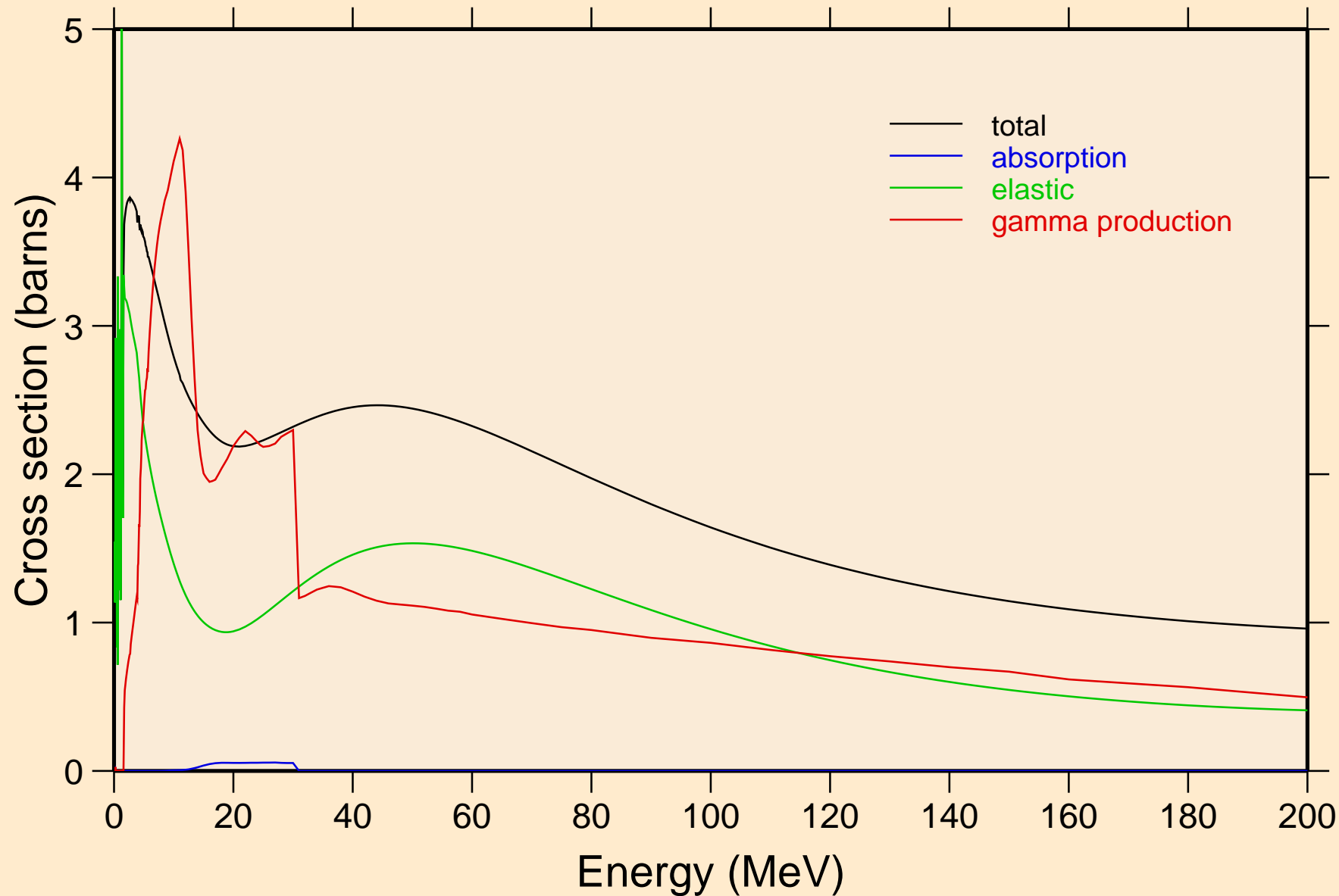

TI050 NEUTRON ACER TENDL-2024 LIBRARY; T=0.K

Heating

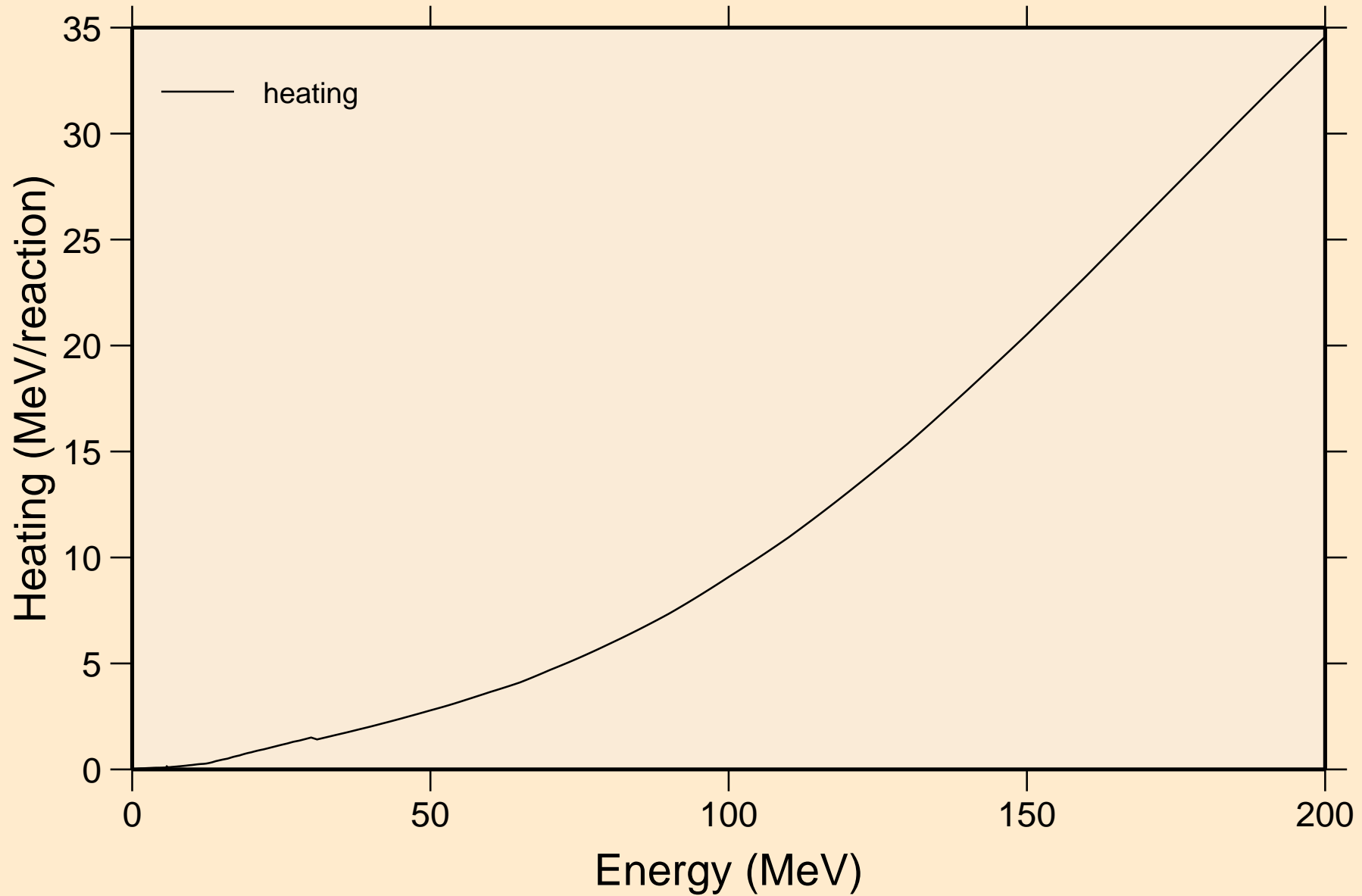

TI050 NEUTRON ACER TENDL-2024 LIBRARY; T=0.K
Damage

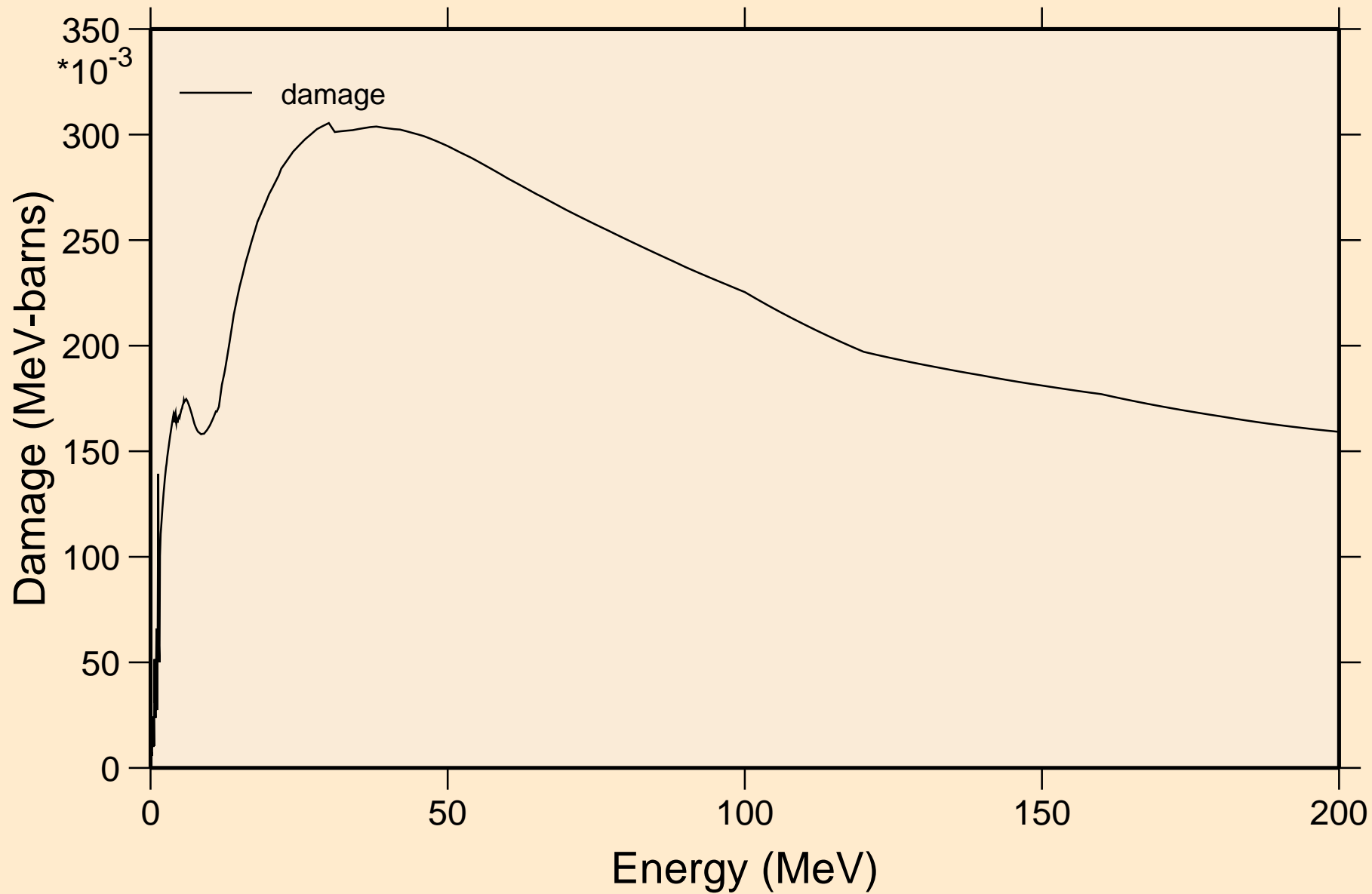

TI050 NEUTRON ACER TENDL-2024 LIBRARY; T=0.K
Non-threshold reactions

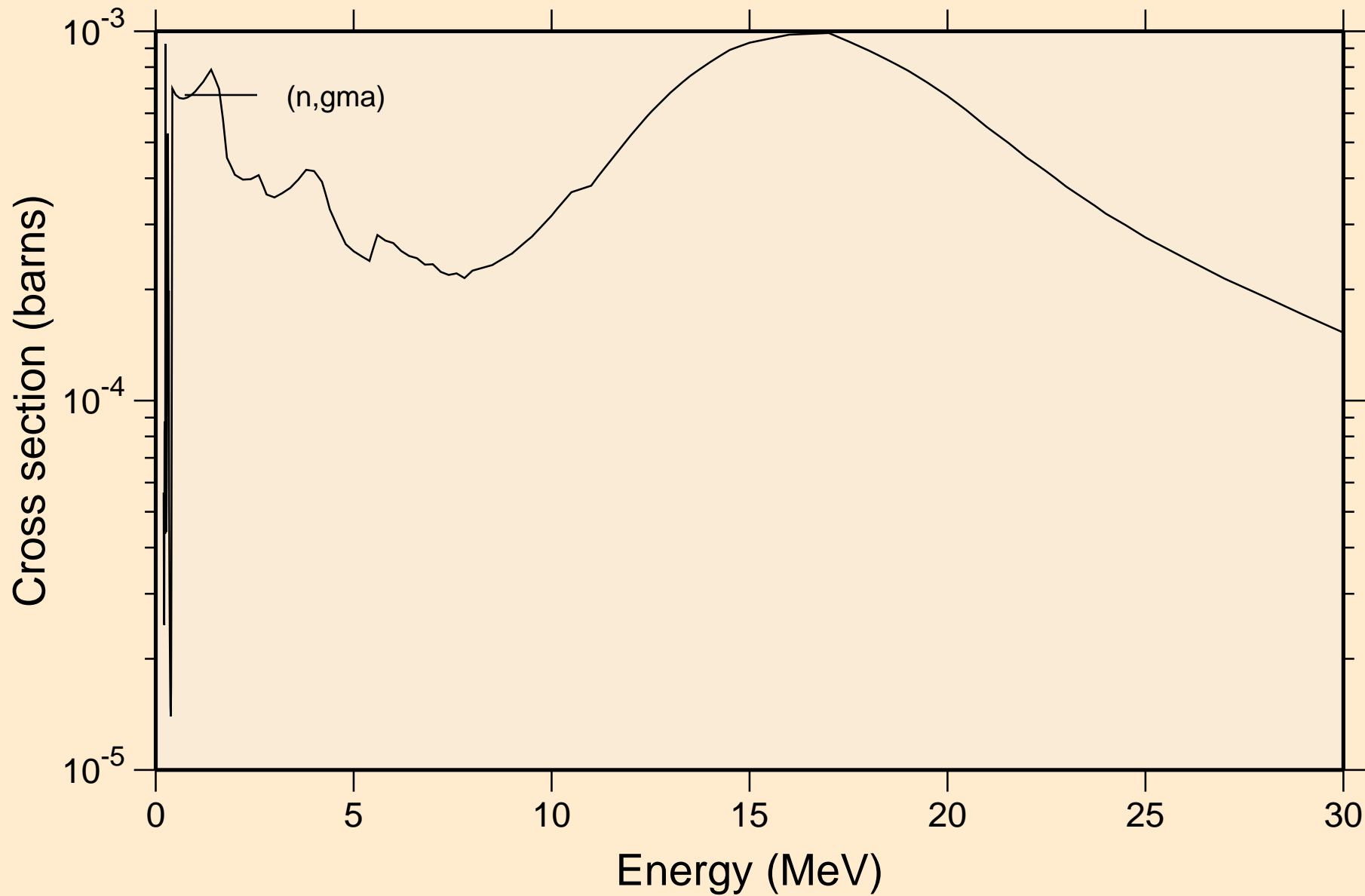

TI050 NEUTRON ACER TENDL-2024 LIBRARY; T=0.K
Inelastic levels

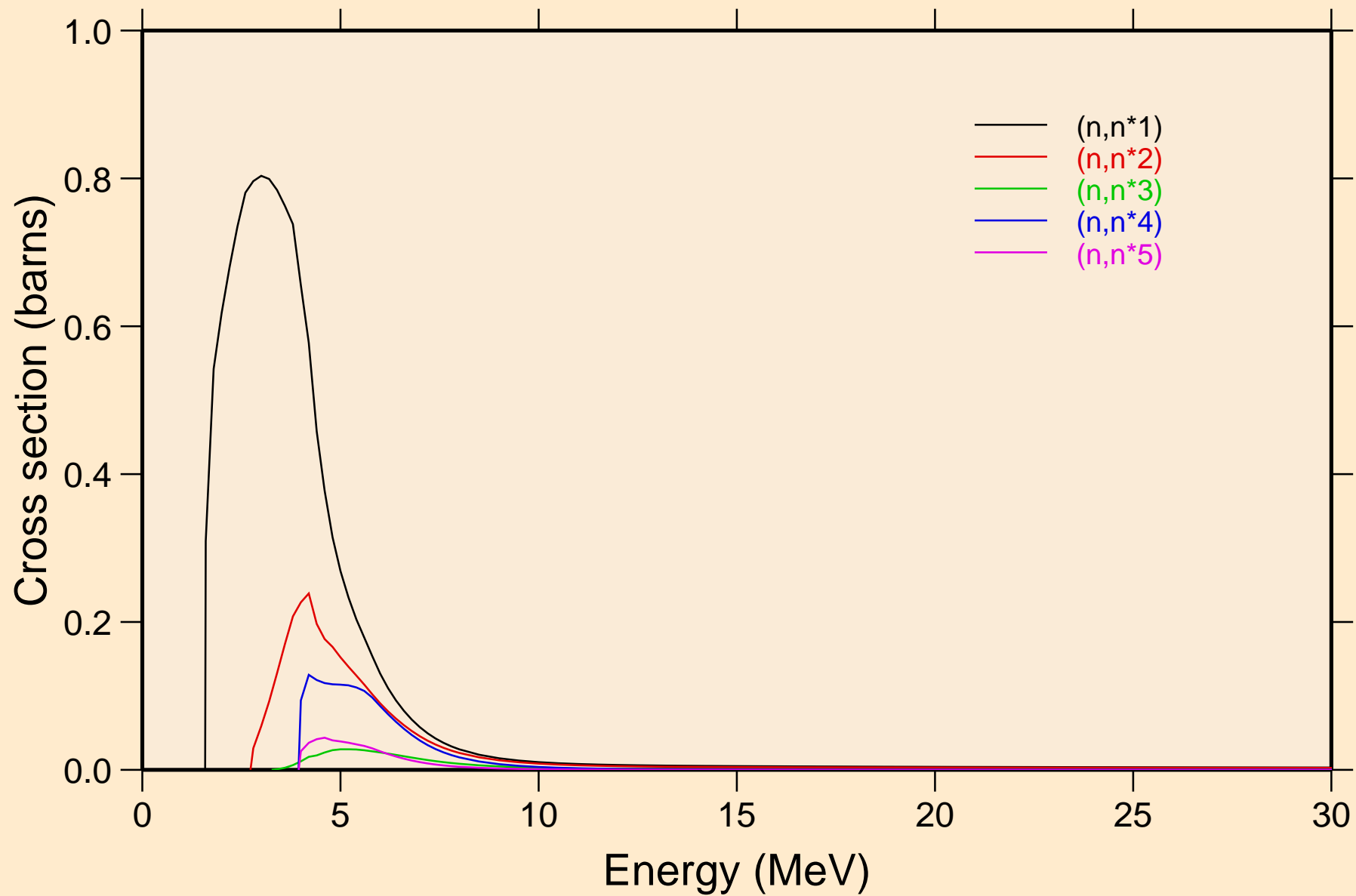

TI050 NEUTRON ACER TENDL-2024 LIBRARY; T=0.K
Inelastic levels

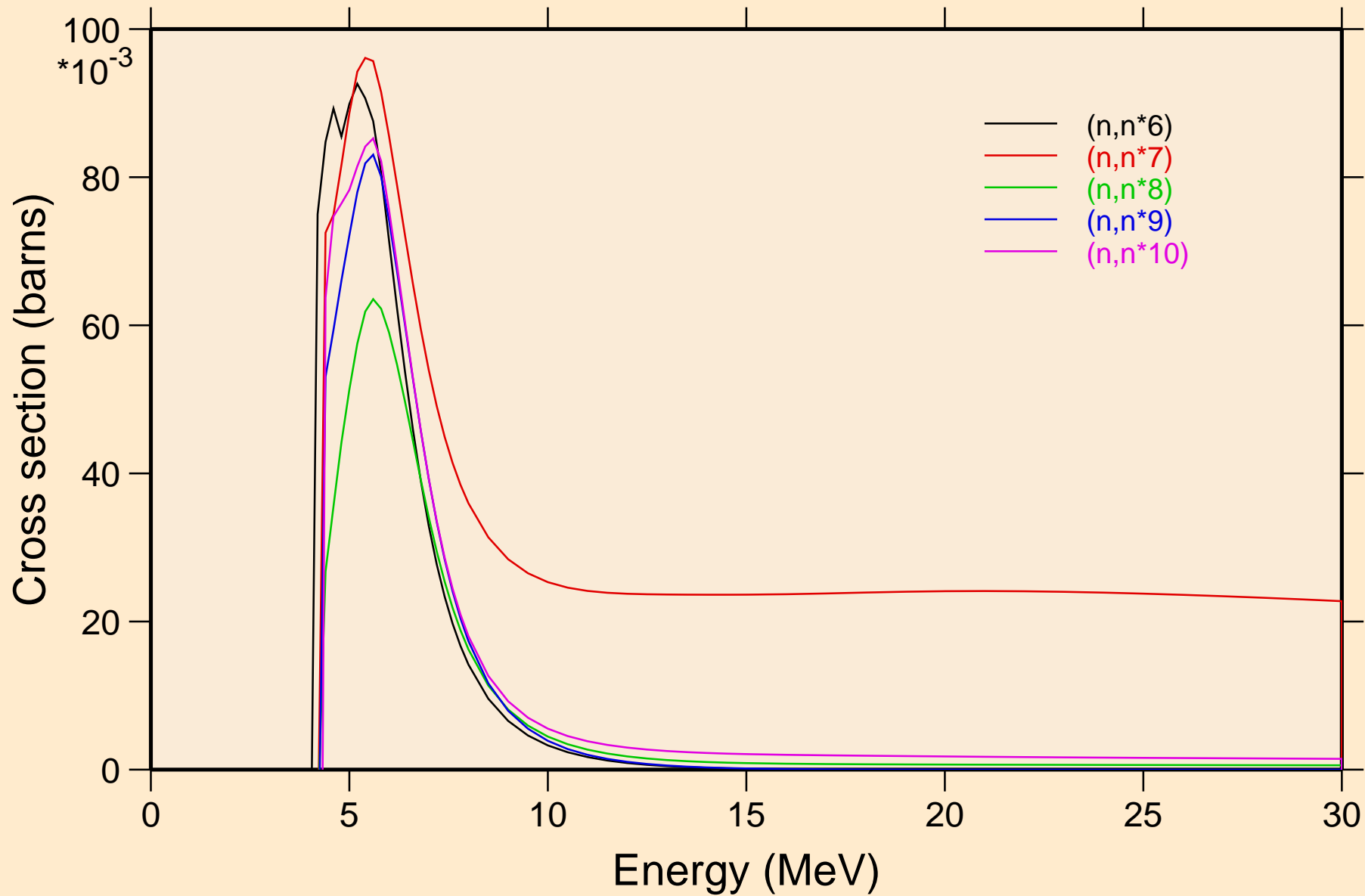

TI050 NEUTRON ACER TENDL-2024 LIBRARY; T=0.K
Inelastic levels

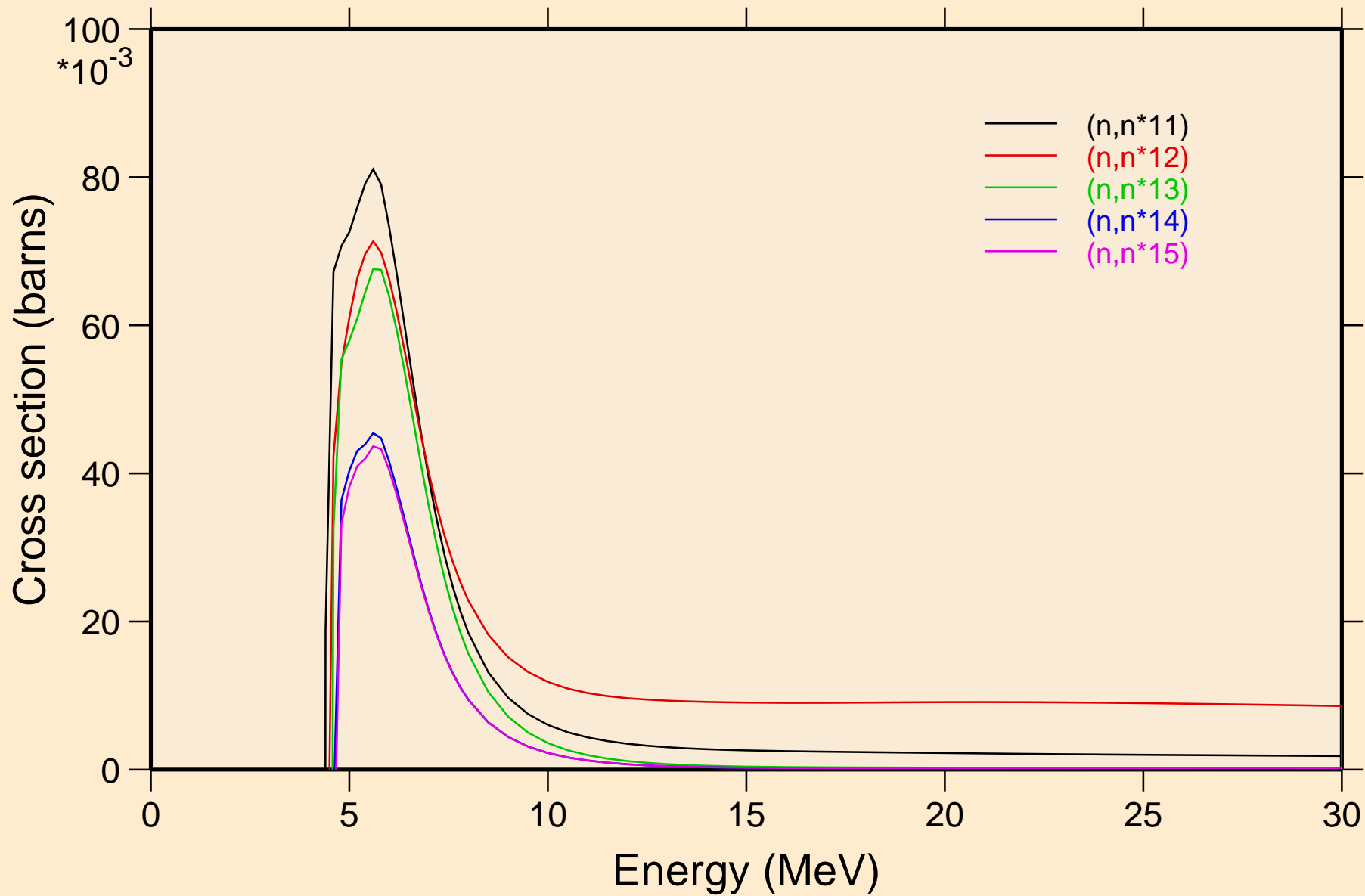

TI050 NEUTRON ACER TENDL-2024 LIBRARY; T=0.K
Inelastic levels

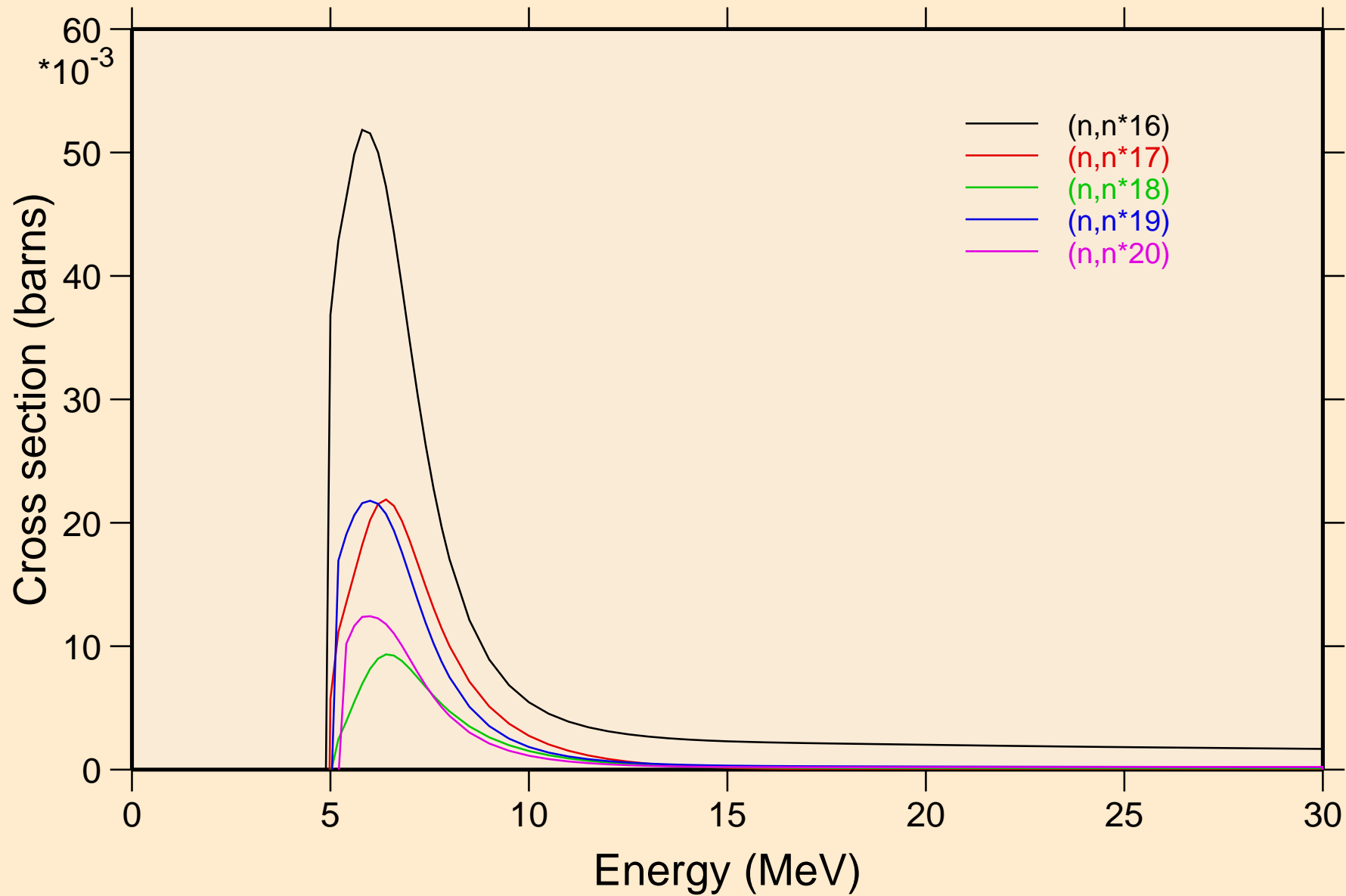

TI050 NEUTRON ACER TENDL-2024 LIBRARY; T=0.K
Inelastic levels

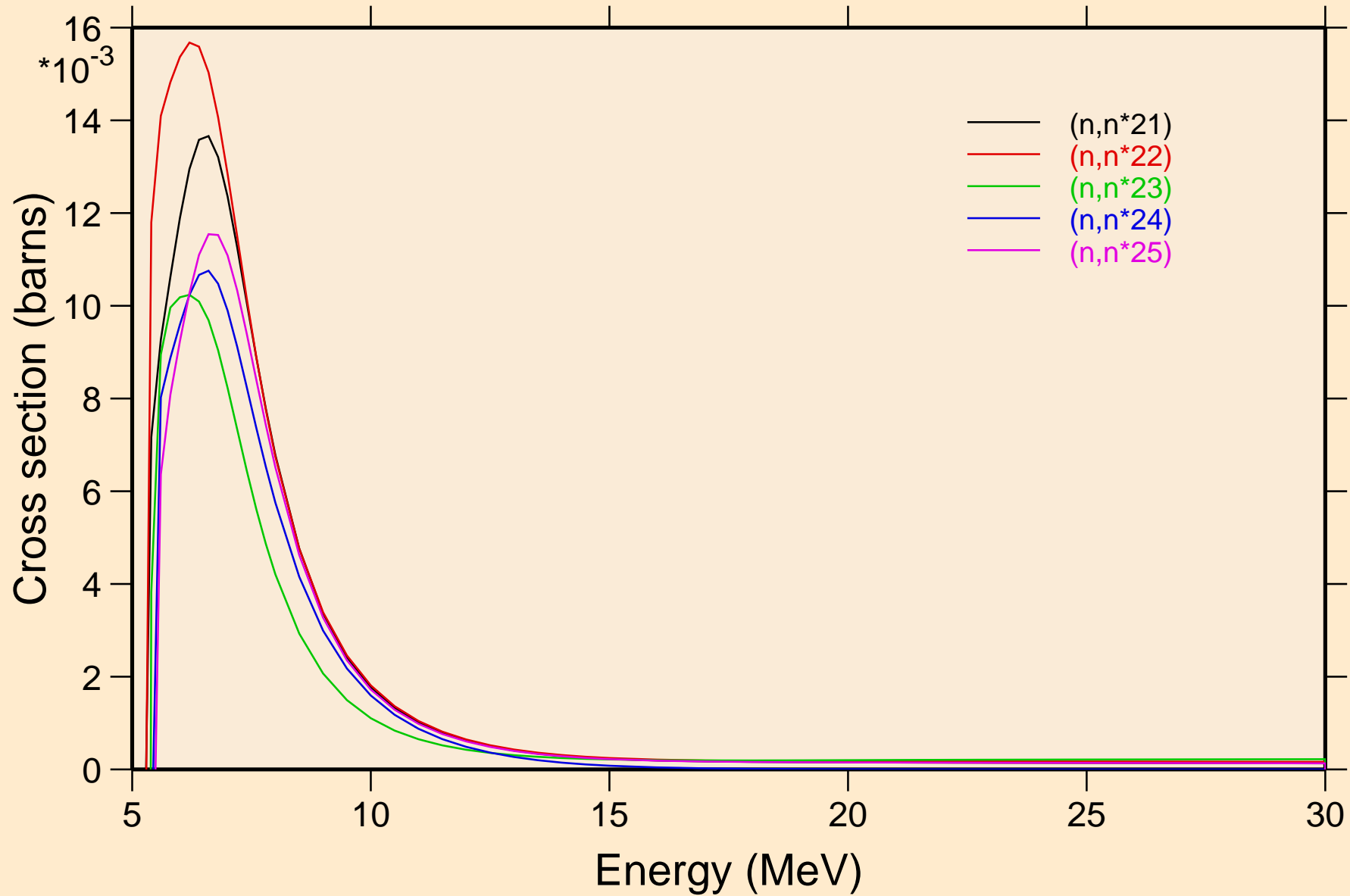

TI050 NEUTRON ACER TENDL-2024 LIBRARY; T=0.K
Inelastic levels

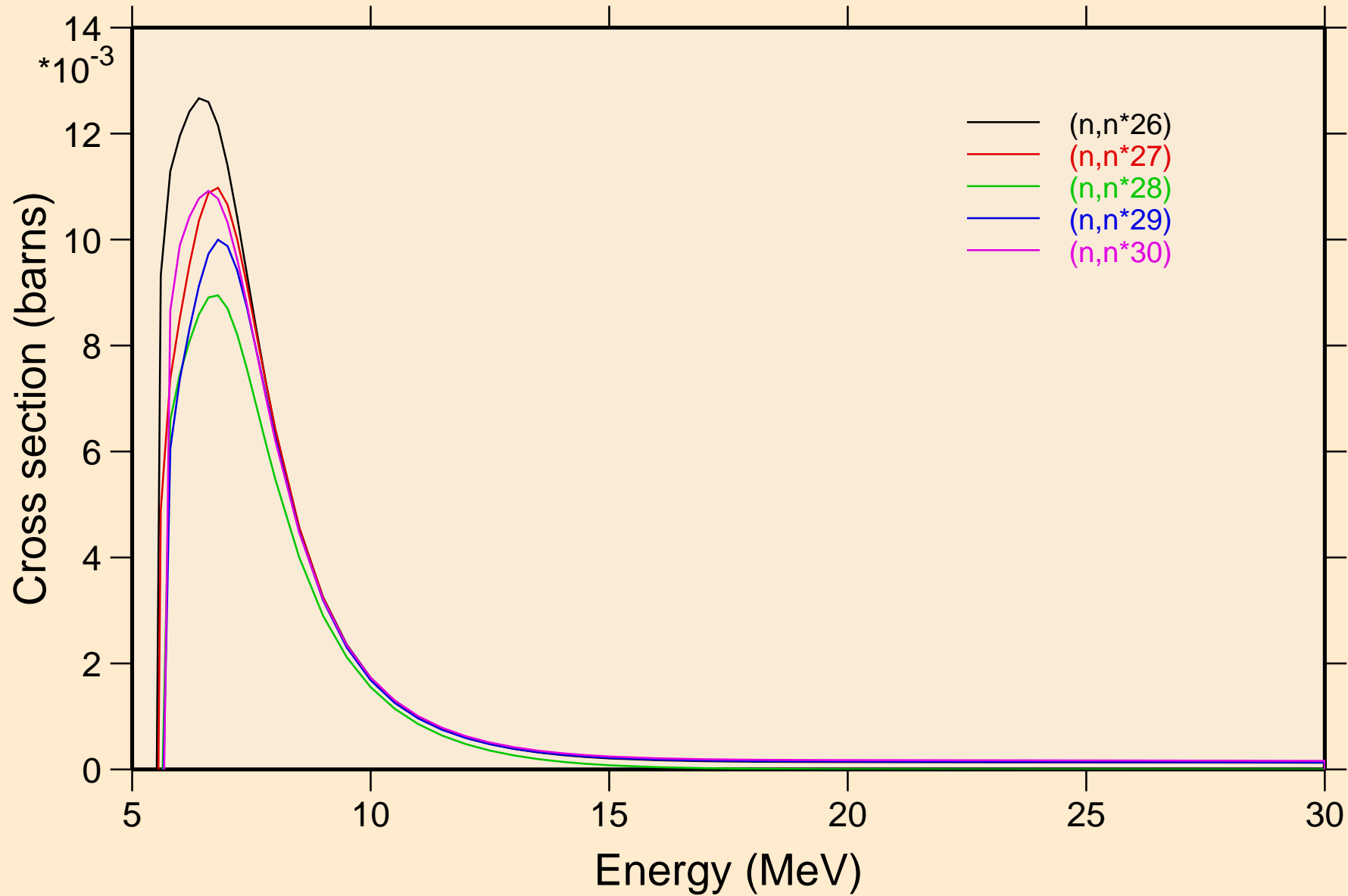

TI050 NEUTRON ACER TENDL-2024 LIBRARY; T=0.K
Threshold reactions

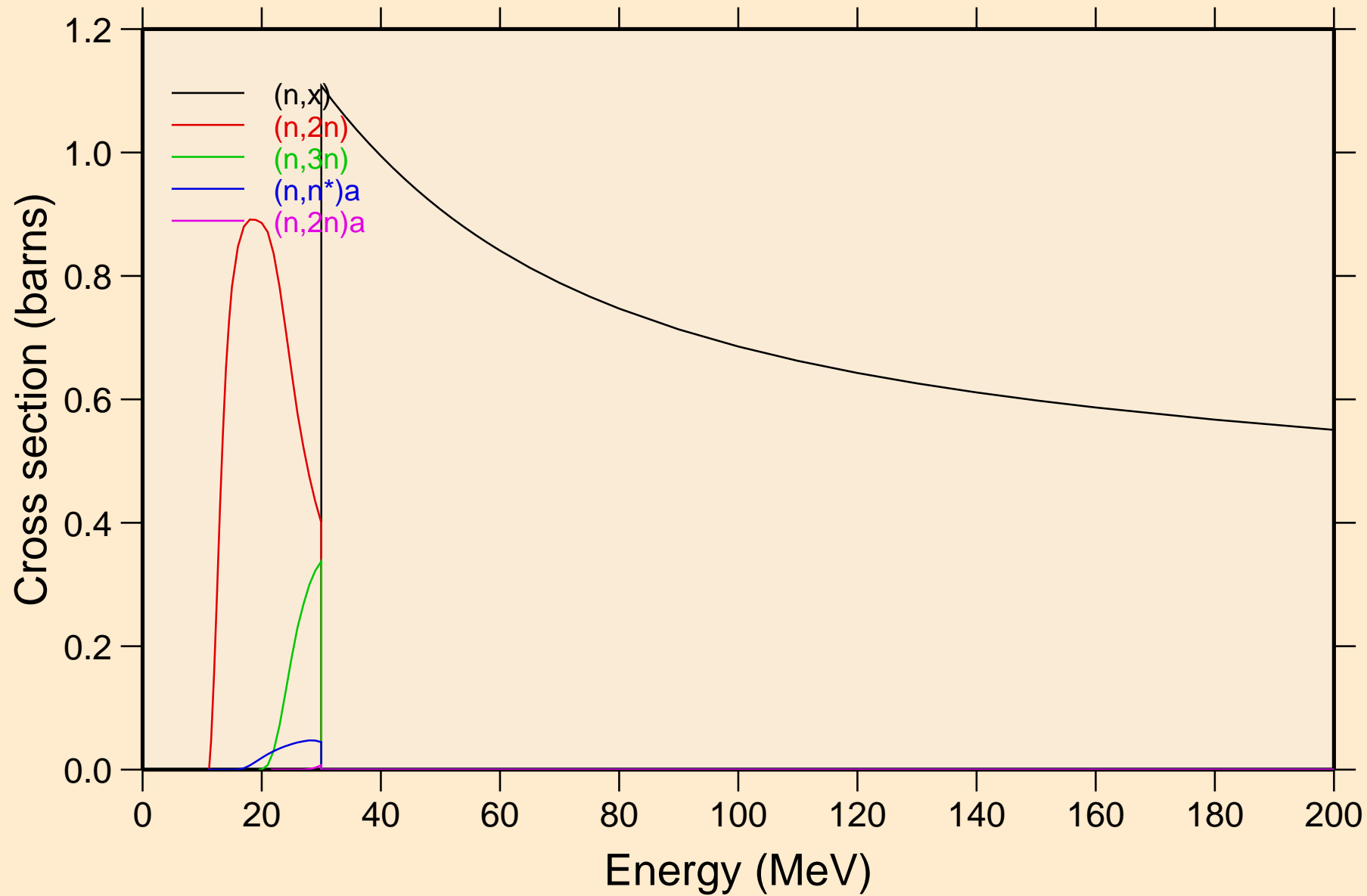

TI050 NEUTRON ACER TENDL-2024 LIBRARY; T=0.K

Threshold reactions

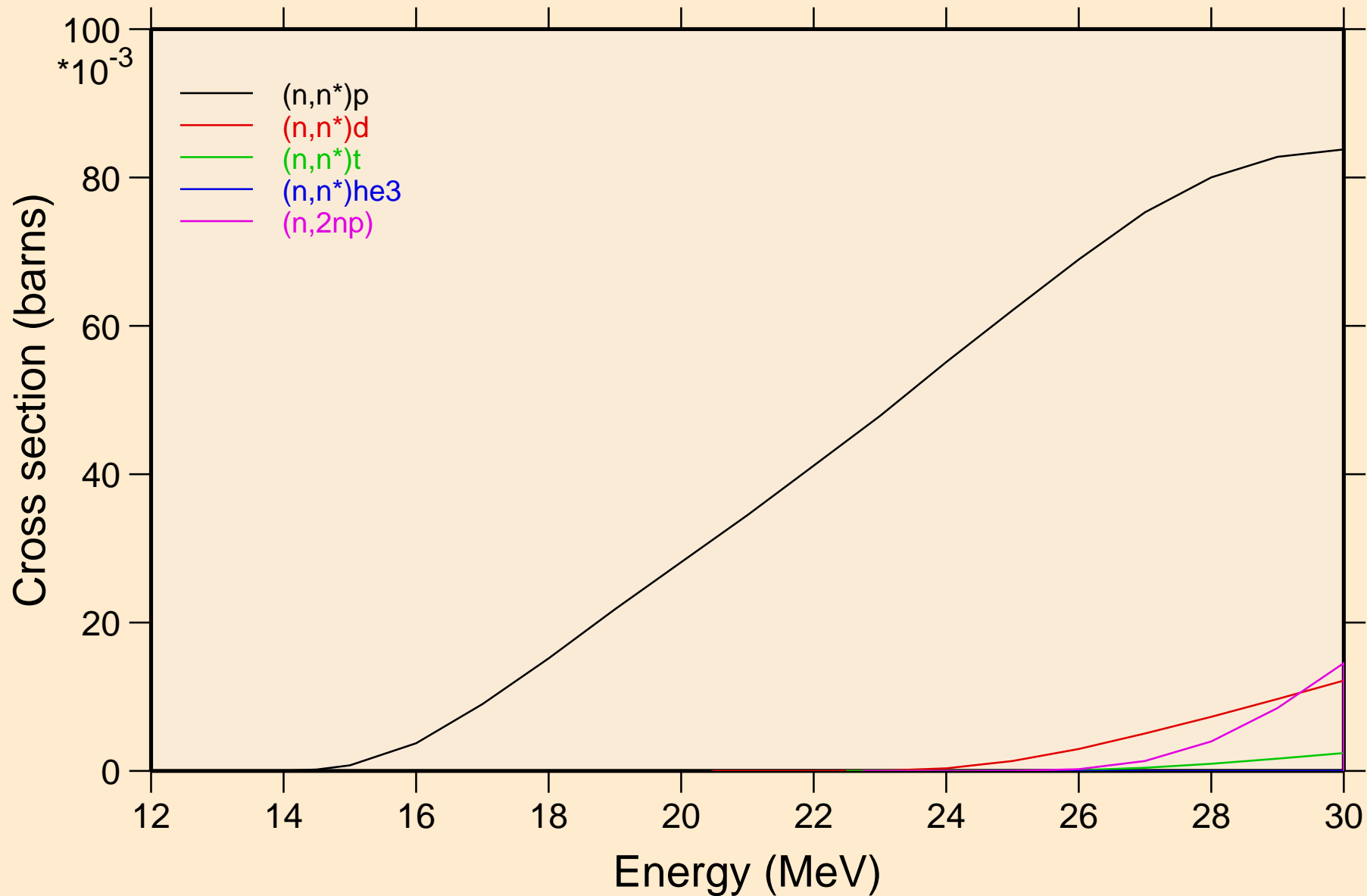

TI050 NEUTRON ACER TENDL-2024 LIBRARY; T=0.K
Threshold reactions

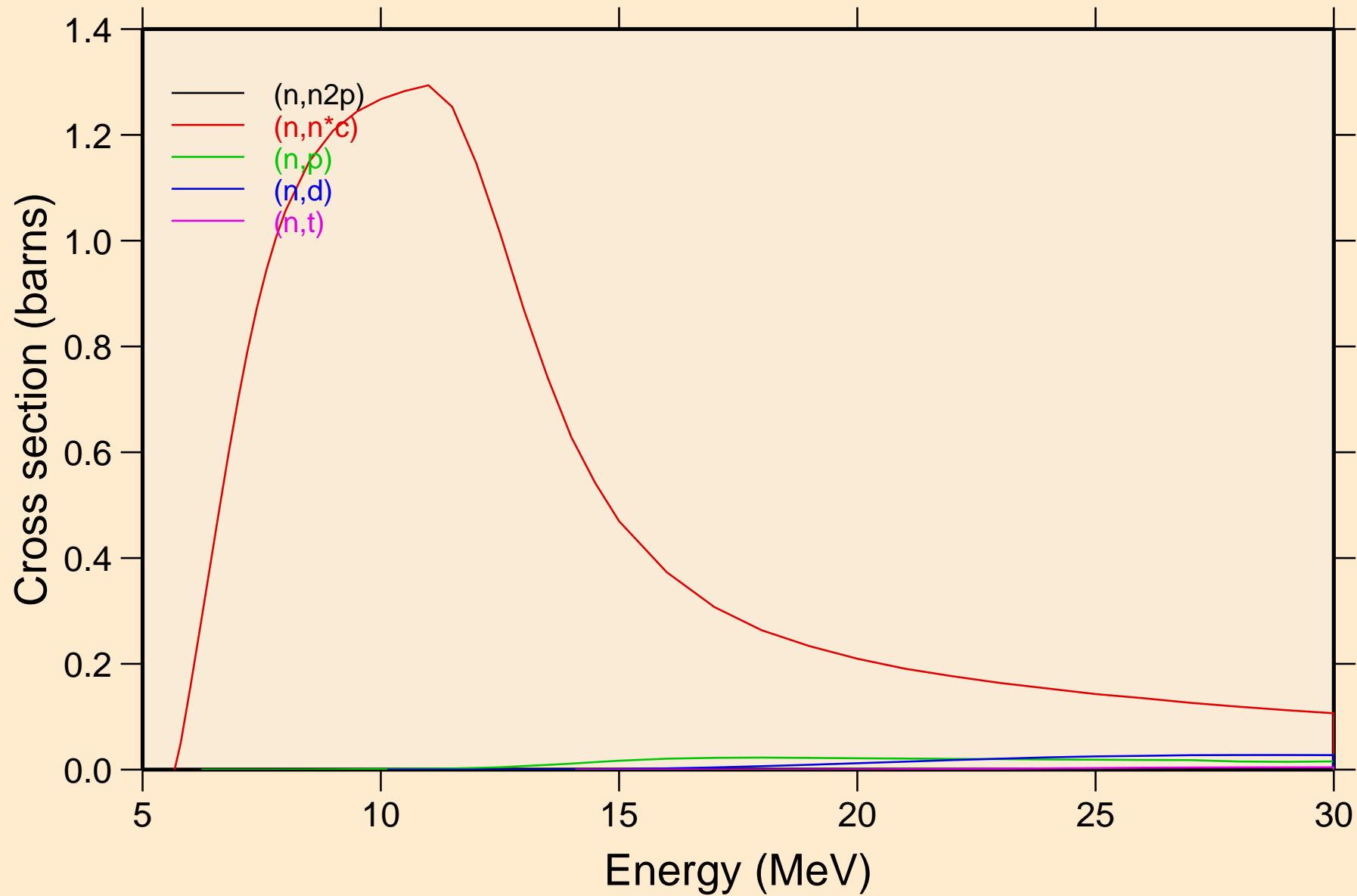

TI050 NEUTRON ACER TENDL-2024 LIBRARY; T=0.K
Threshold reactions

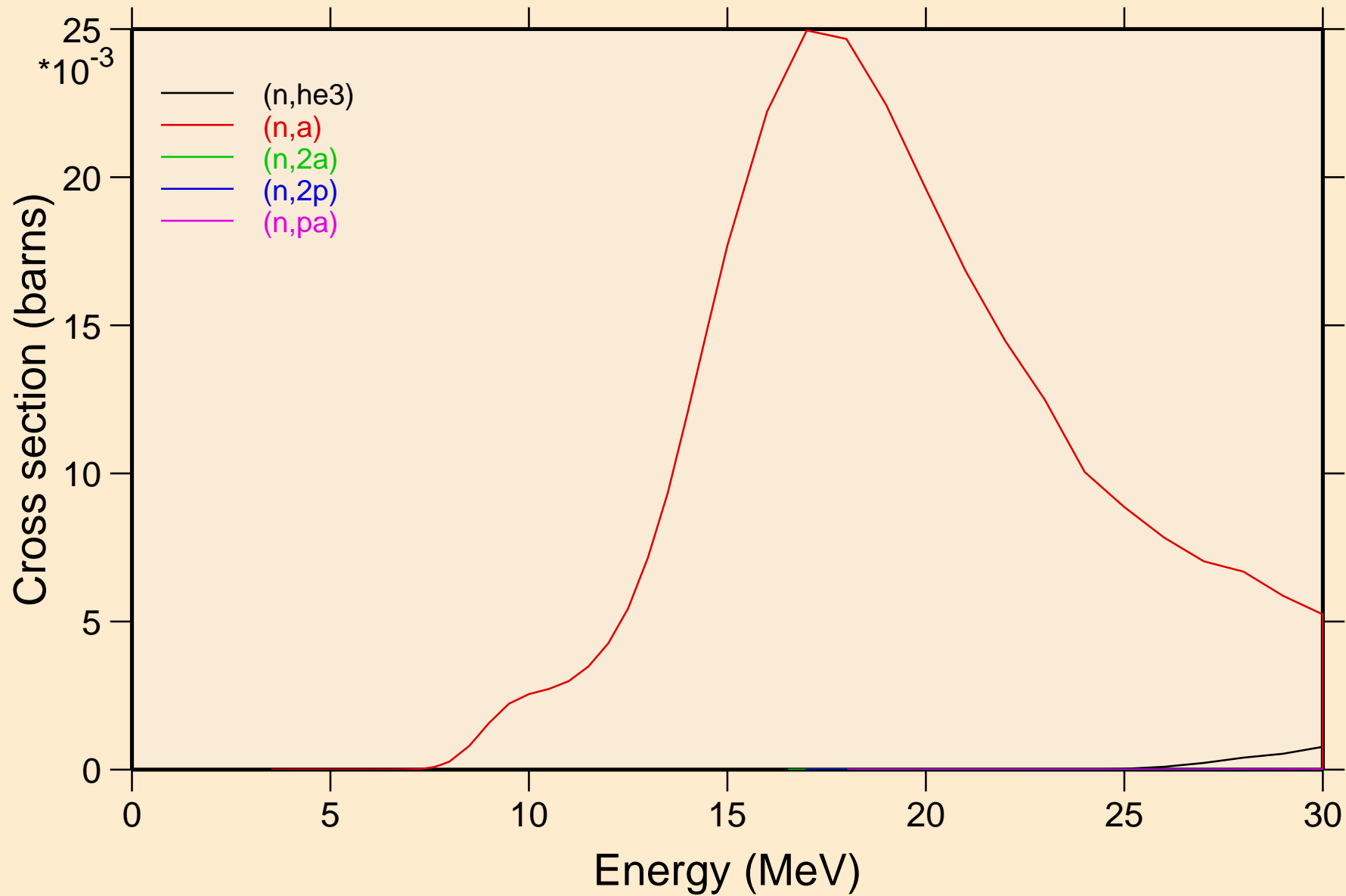

TI050 NEUTRON ACER TENDL-2024 LIBRARY; T=0.K
Threshold reactions

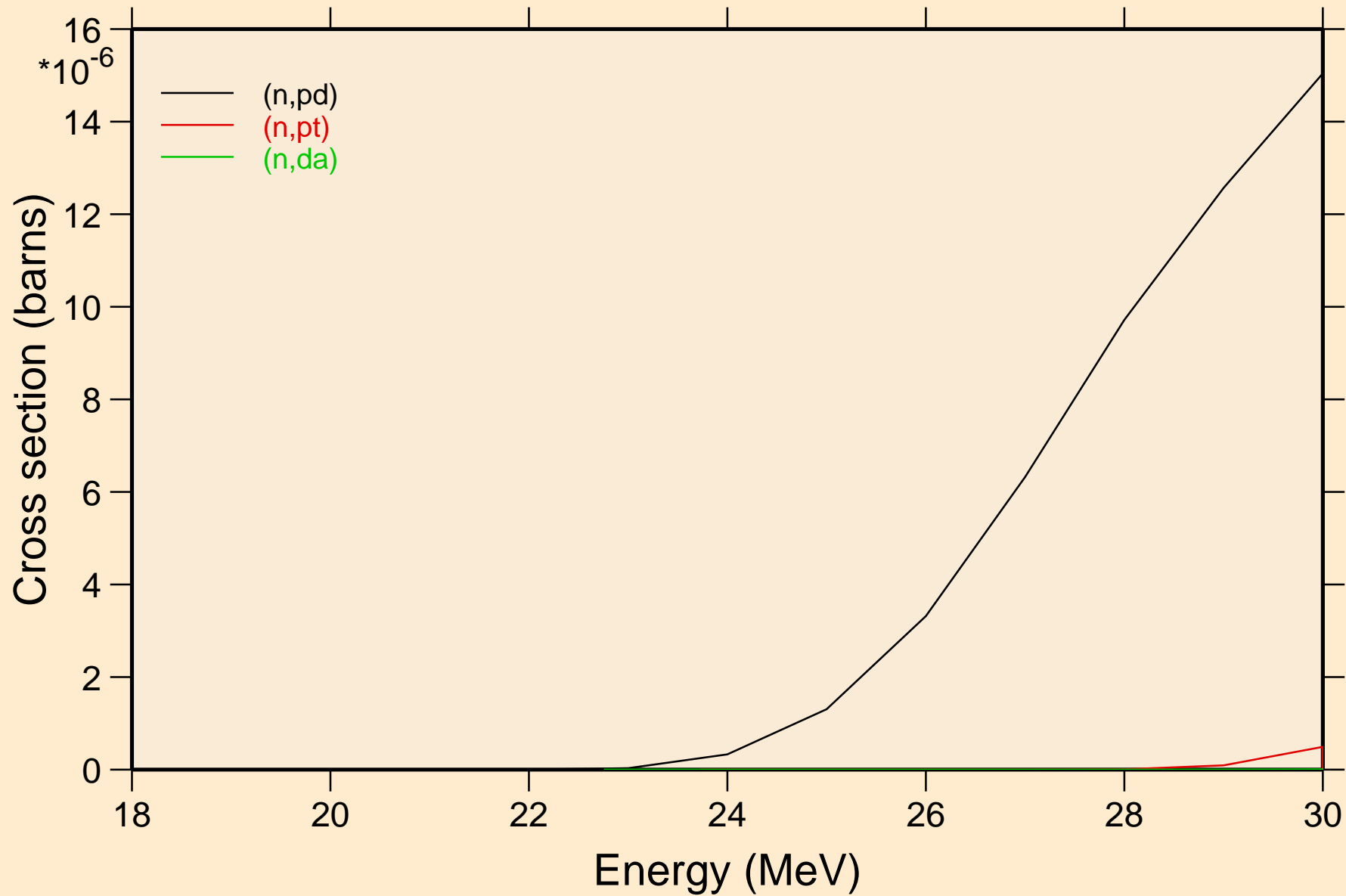

TI050 NEUTRON ACER TENDL-2024 LIBRARY; T=0.K
Threshold reactions

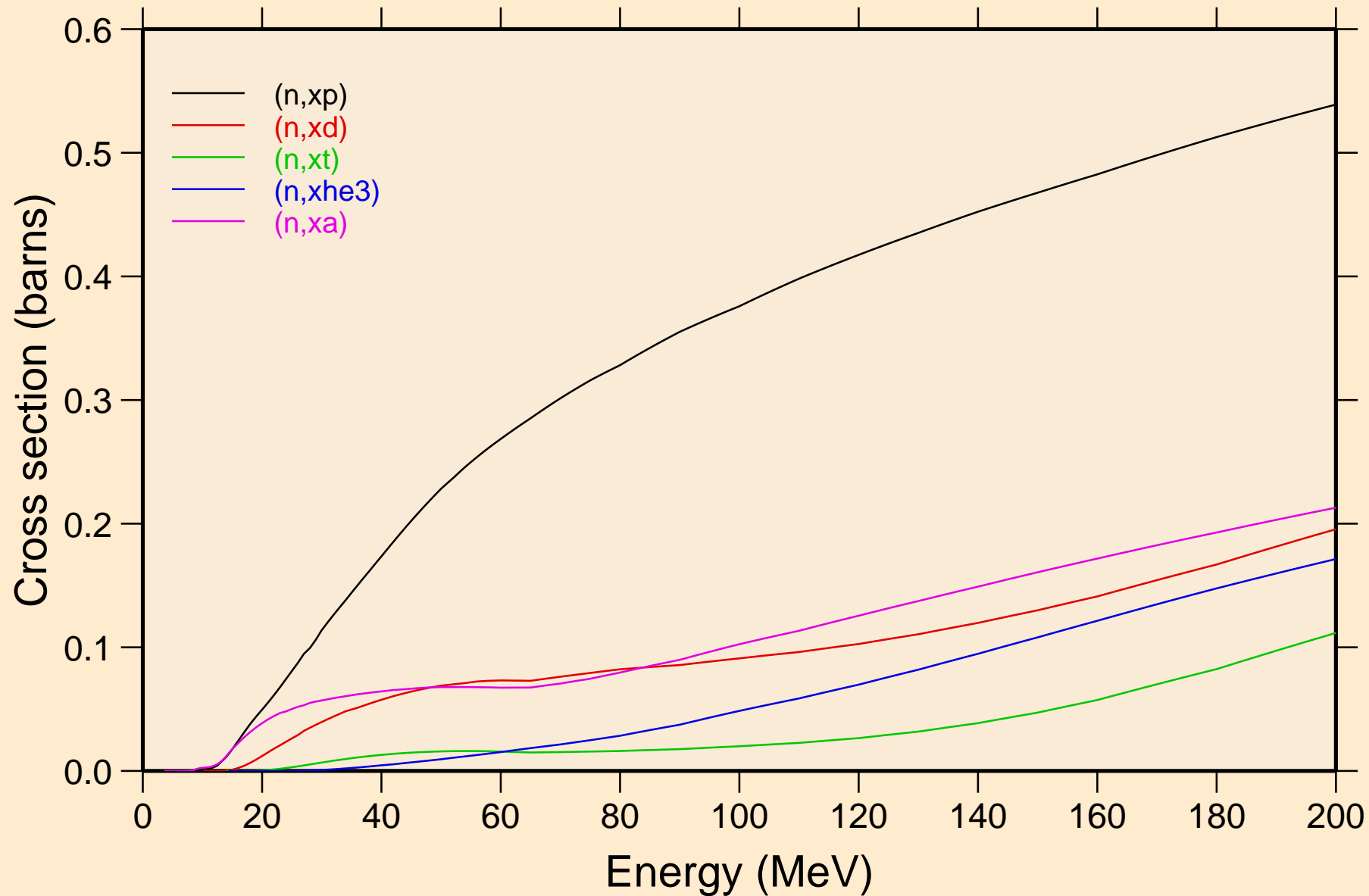

TI050 NEUTRON ACER TENDL-2024 LIBRARY; T=0.K
angular distribution for elastic

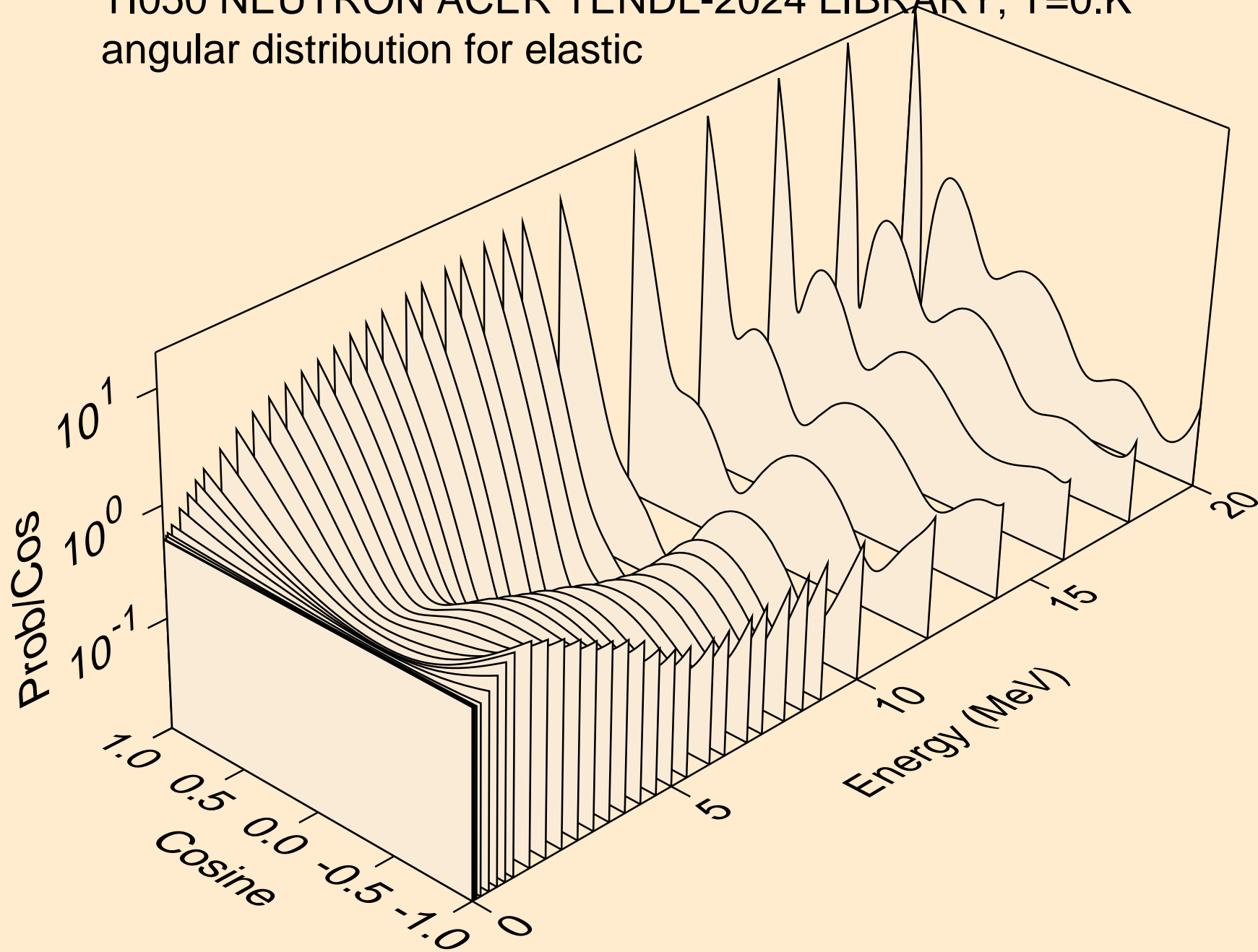

TI050 NEUTRON ACER TENDL-2024 LIBRARY; T=0.K
angular distribution for elastic

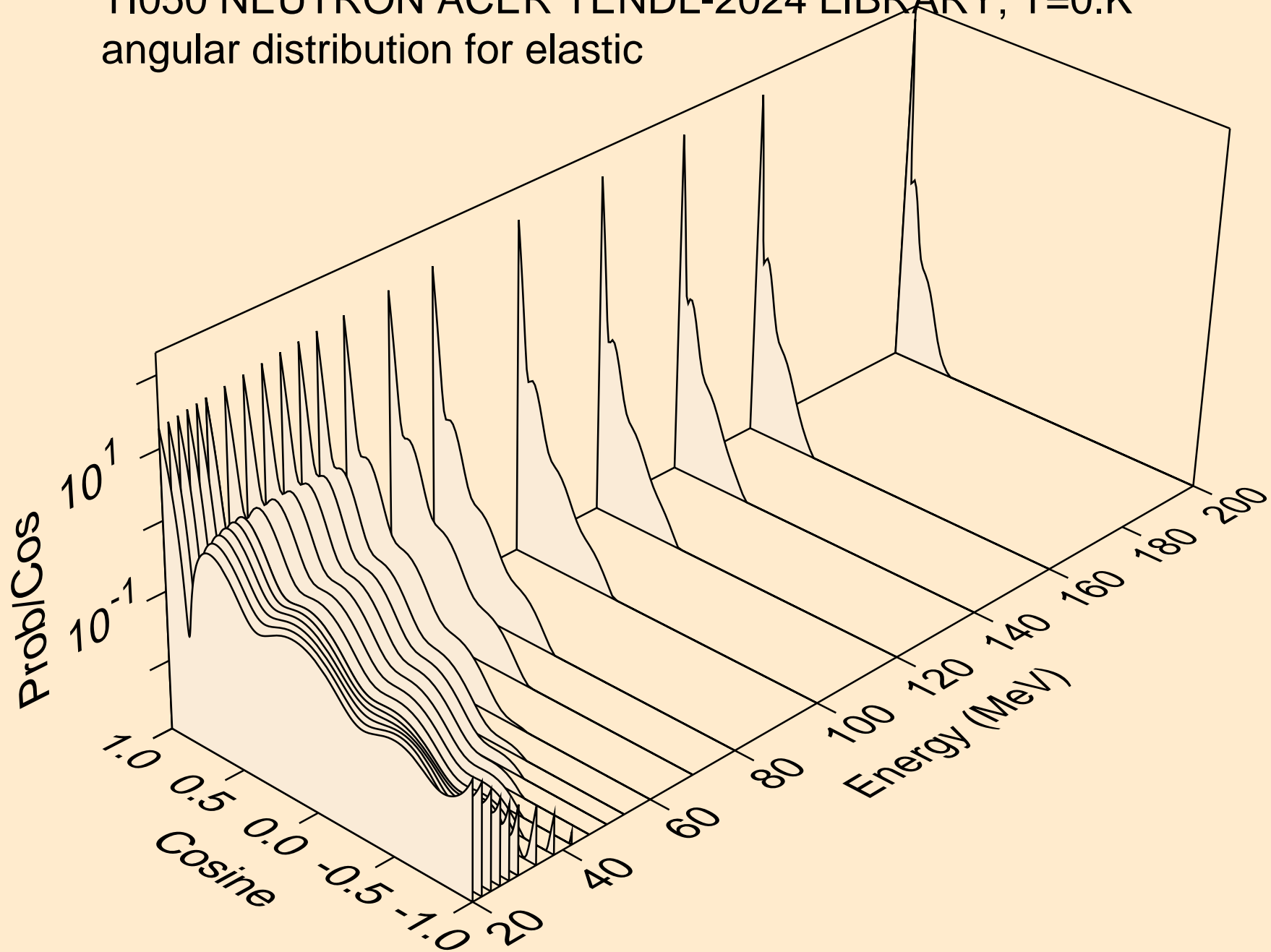

TI050 NEUTRON ACER TENDL-2024 LIBRARY; T=0.K
angular distribution for (n,n*1)

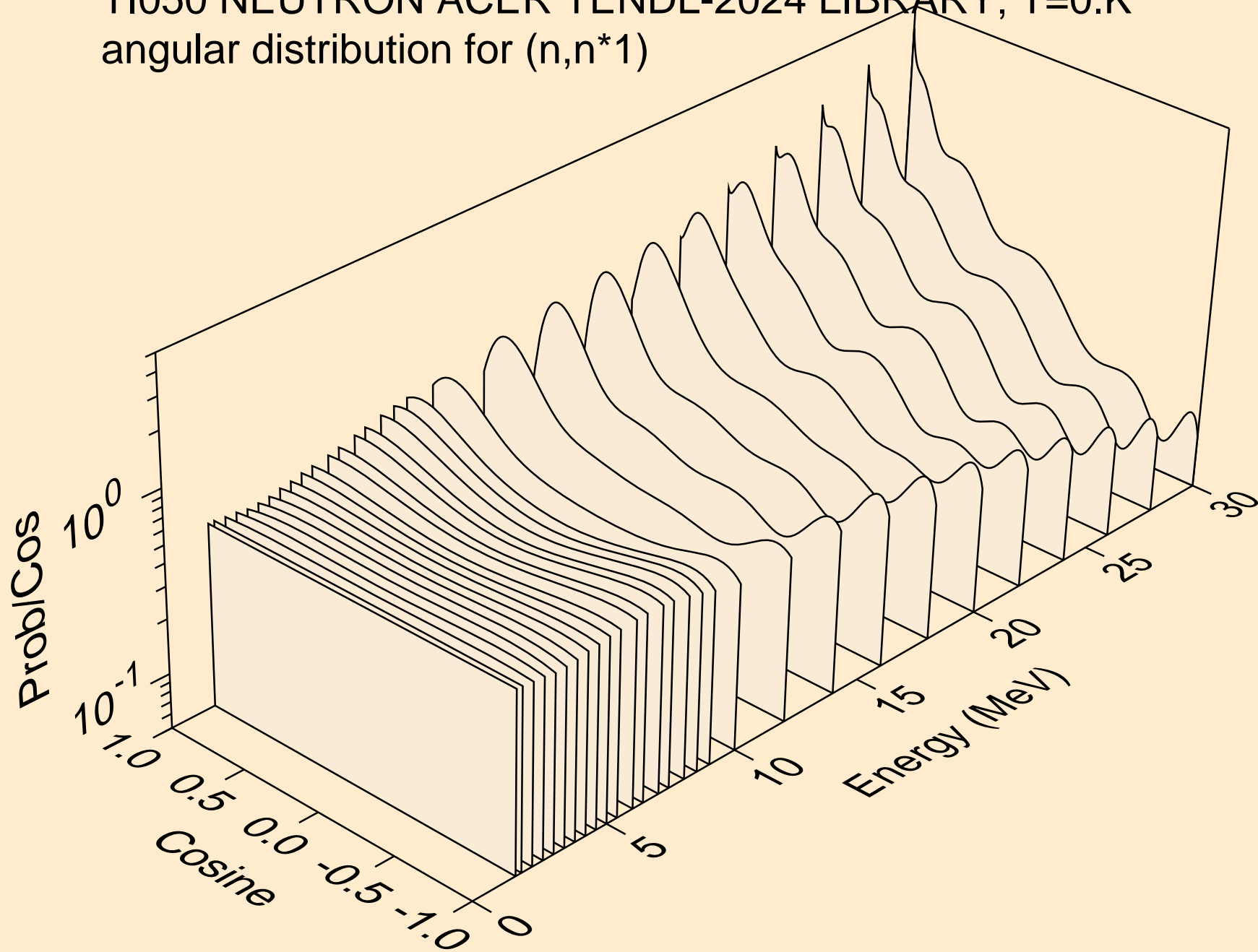

TI050 NEUTRON ACER TENDL-2024 LIBRARY; T=0.K
angular distribution for (n,n*2)

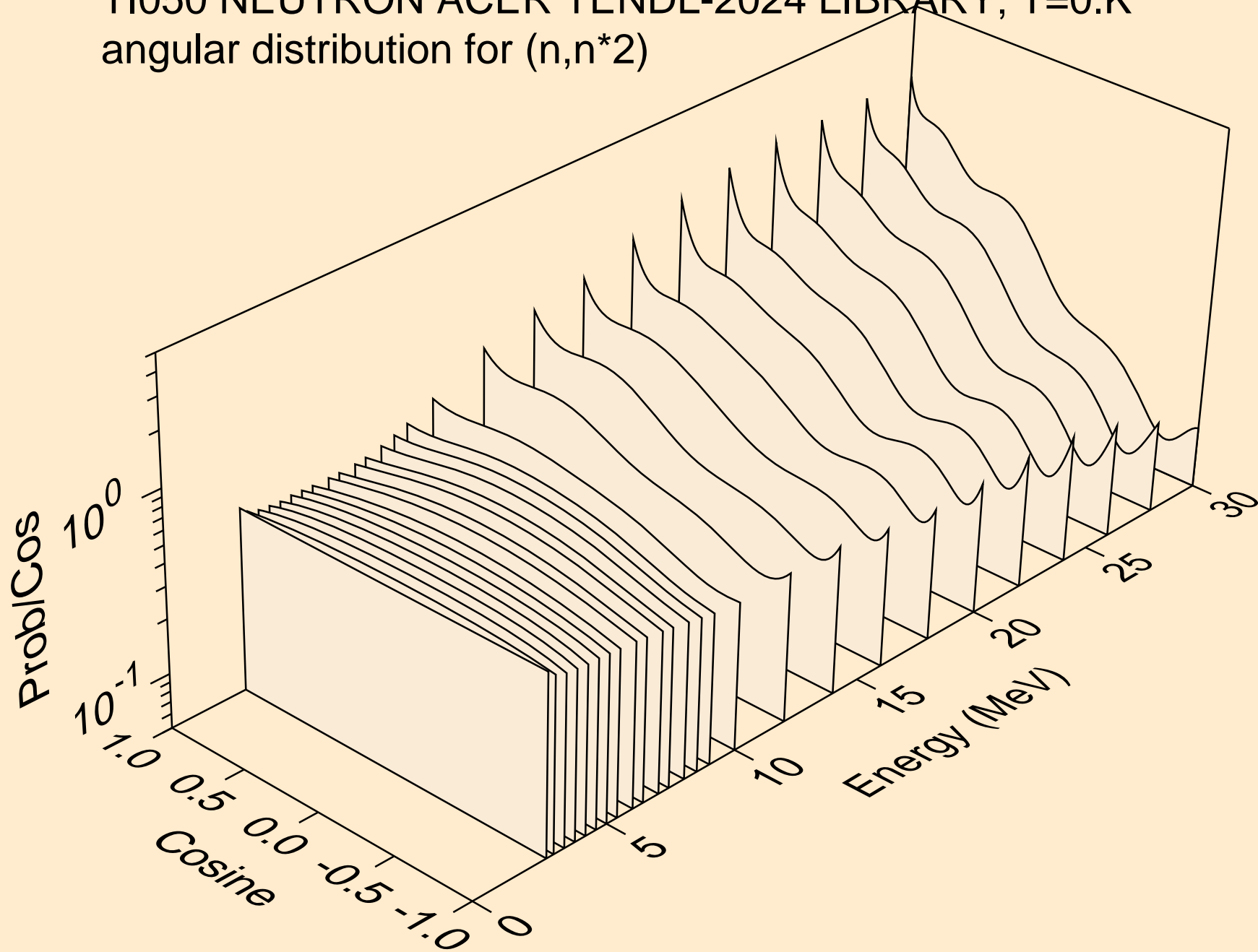

TI050 NEUTRON ACER TENDL-2024 LIBRARY; T=0.K
angular distribution for (n,n*3)

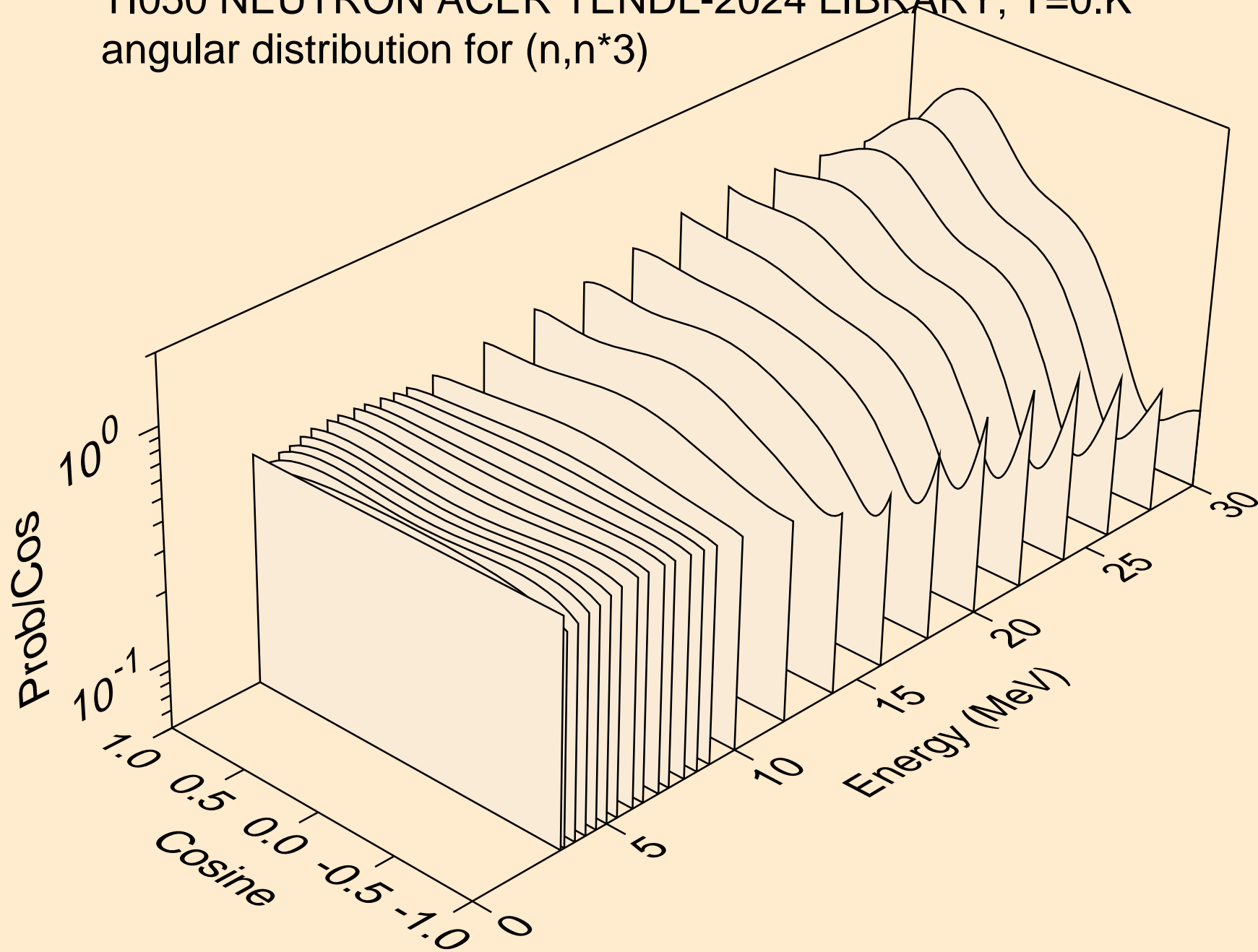

TI050 NEUTRON ACER TENDL-2024 LIBRARY; T=0.K
angular distribution for (n,n*4)

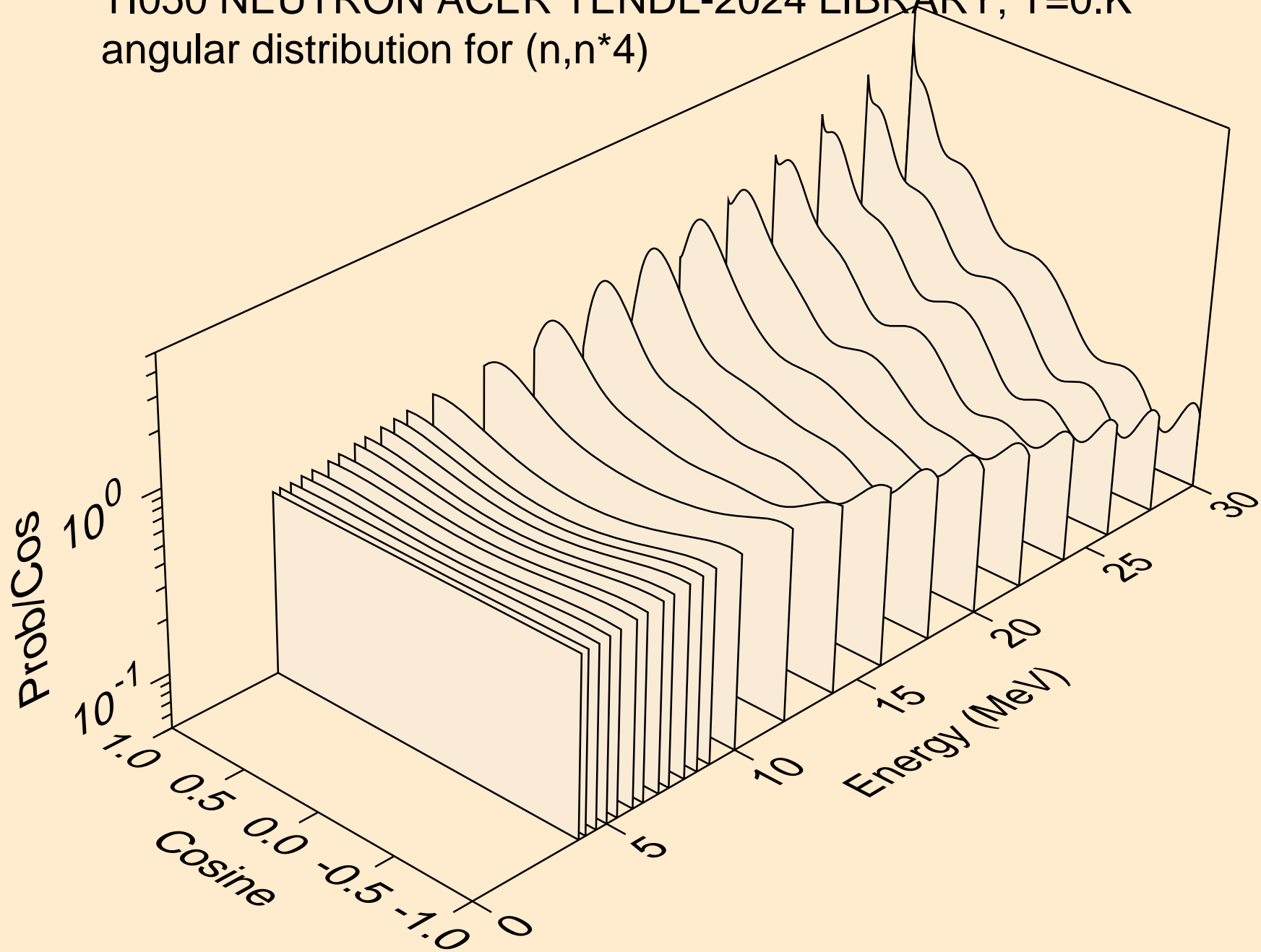

TI050 NEUTRON ACER TENDL-2024 LIBRARY; T=0.K
angular distribution for (n,n*5)

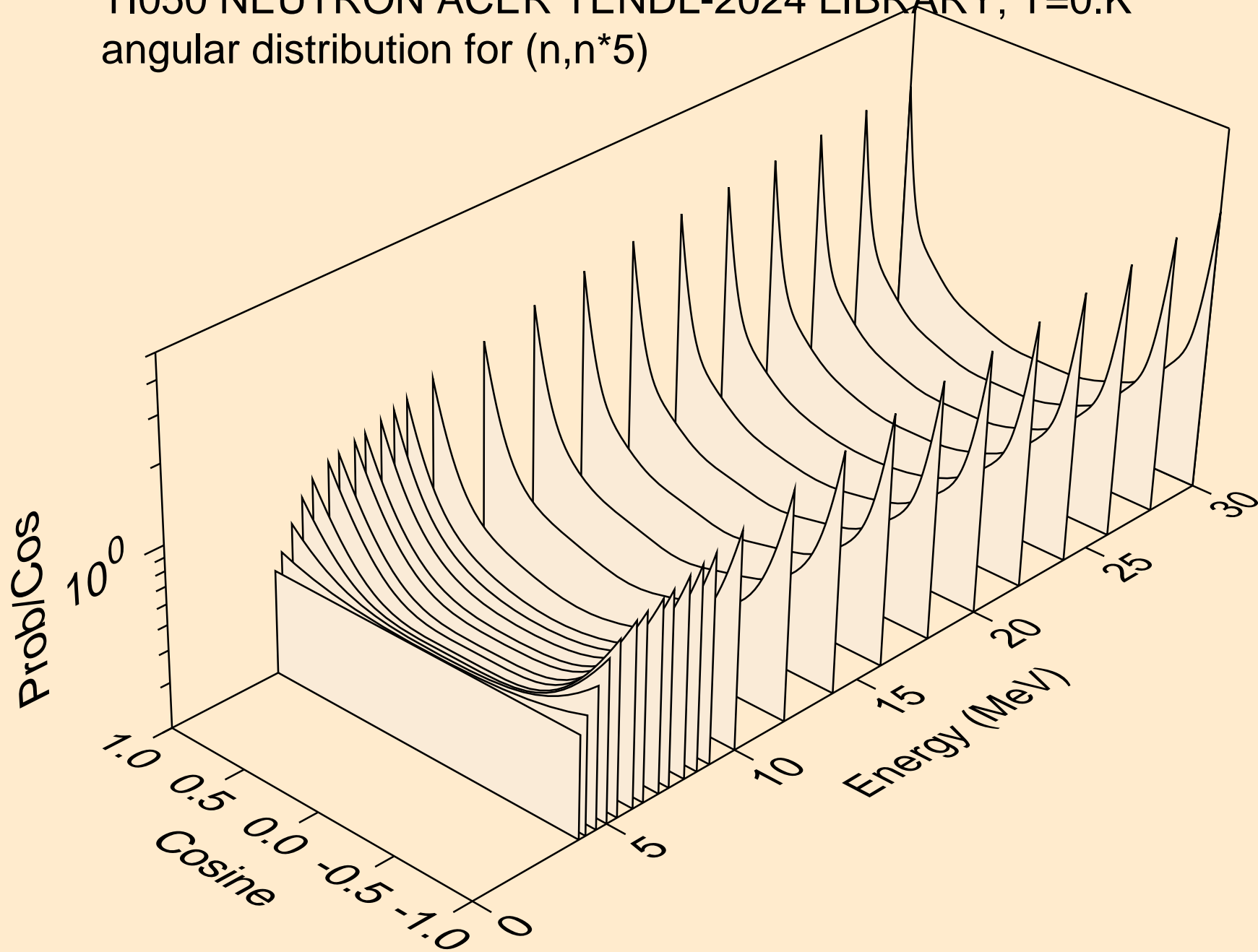

TI050 NEUTRON ACER TENDL-2024 LIBRARY; T=0.K
angular distribution for (n,n*6)

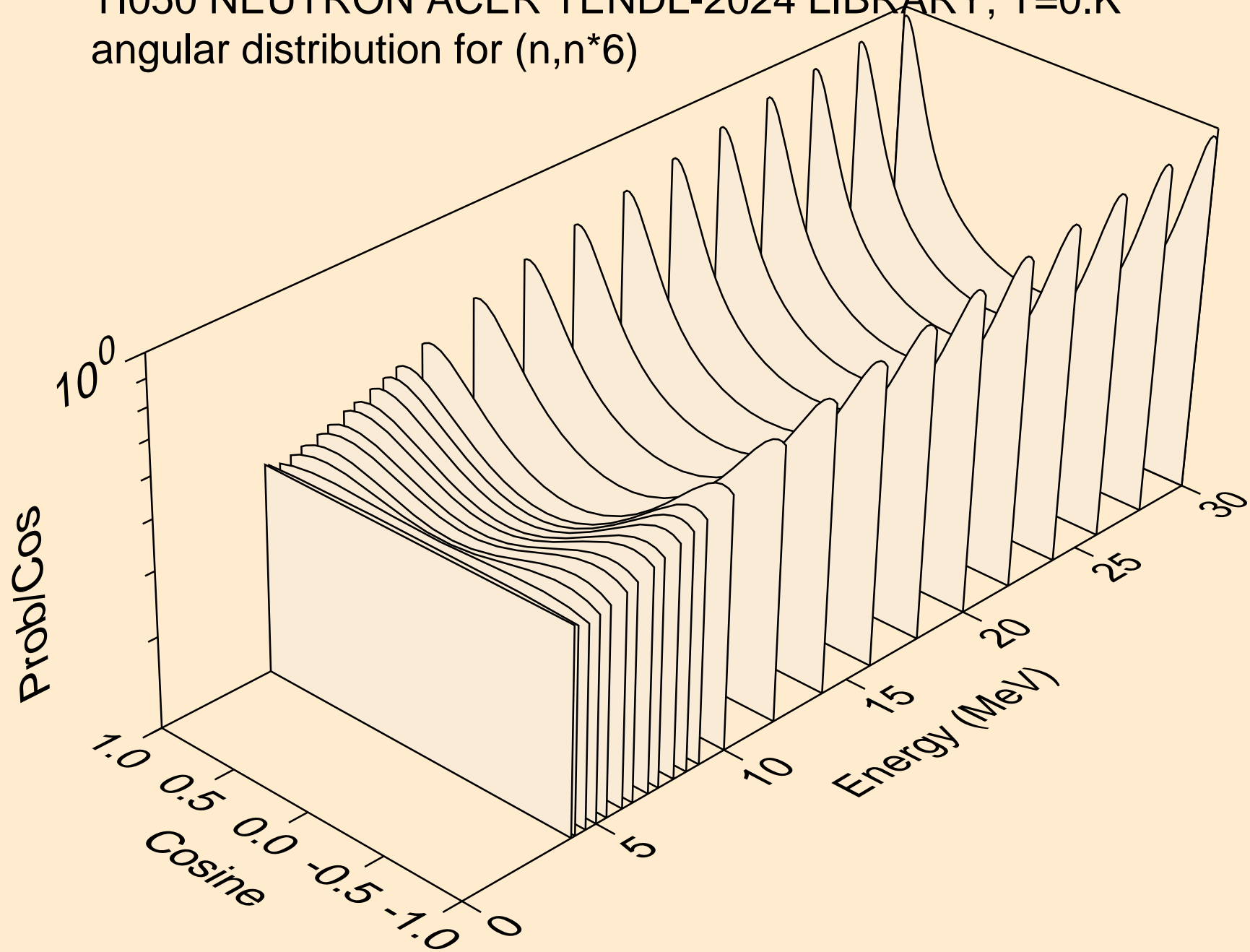

TI050 NEUTRON ACER TENDL-2024 LIBRARY; T=0.K
angular distribution for (n,n*7)

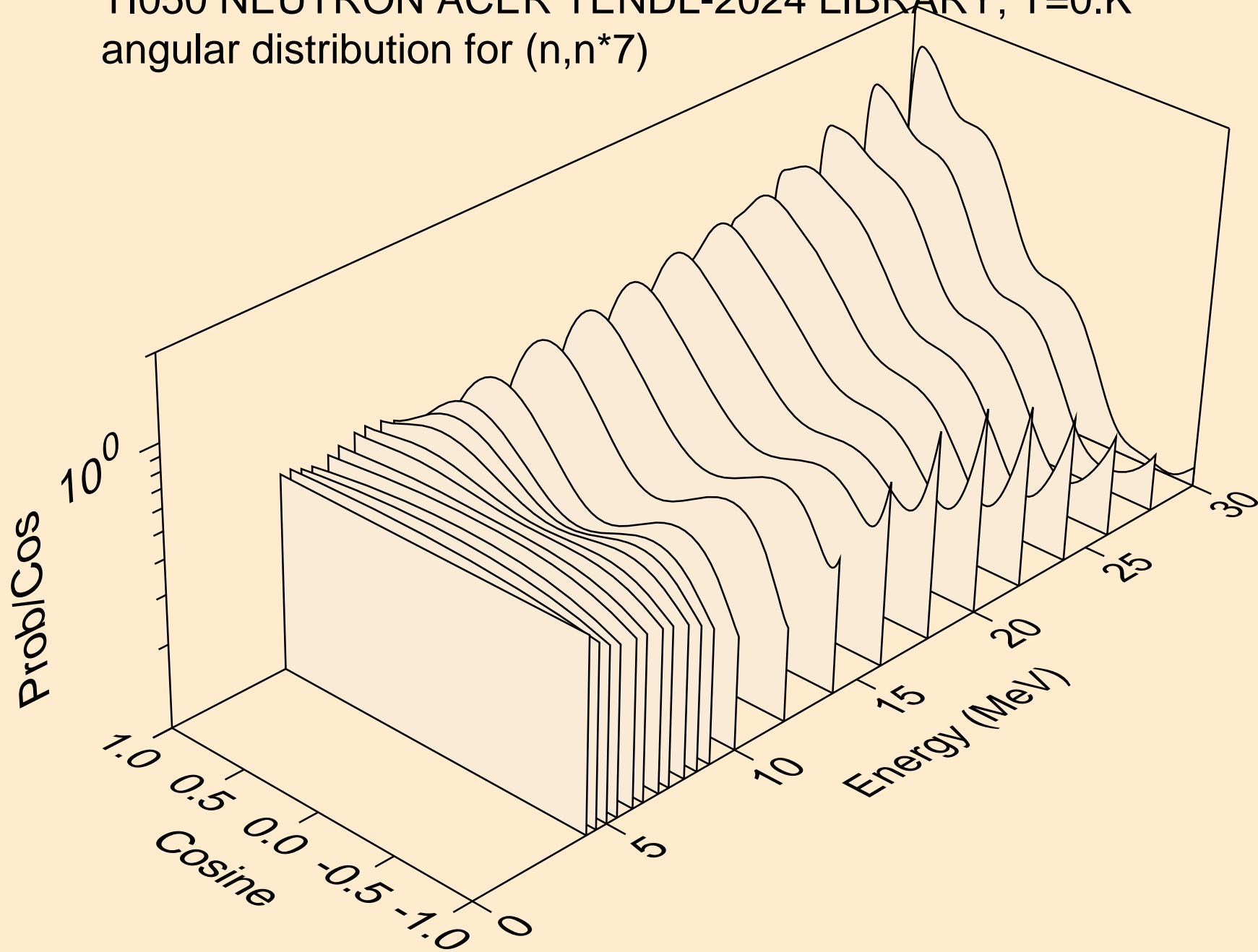

TI050 NEUTRON ACER TENDL-2024 LIBRARY; T=0.K
angular distribution for (n,n*8)

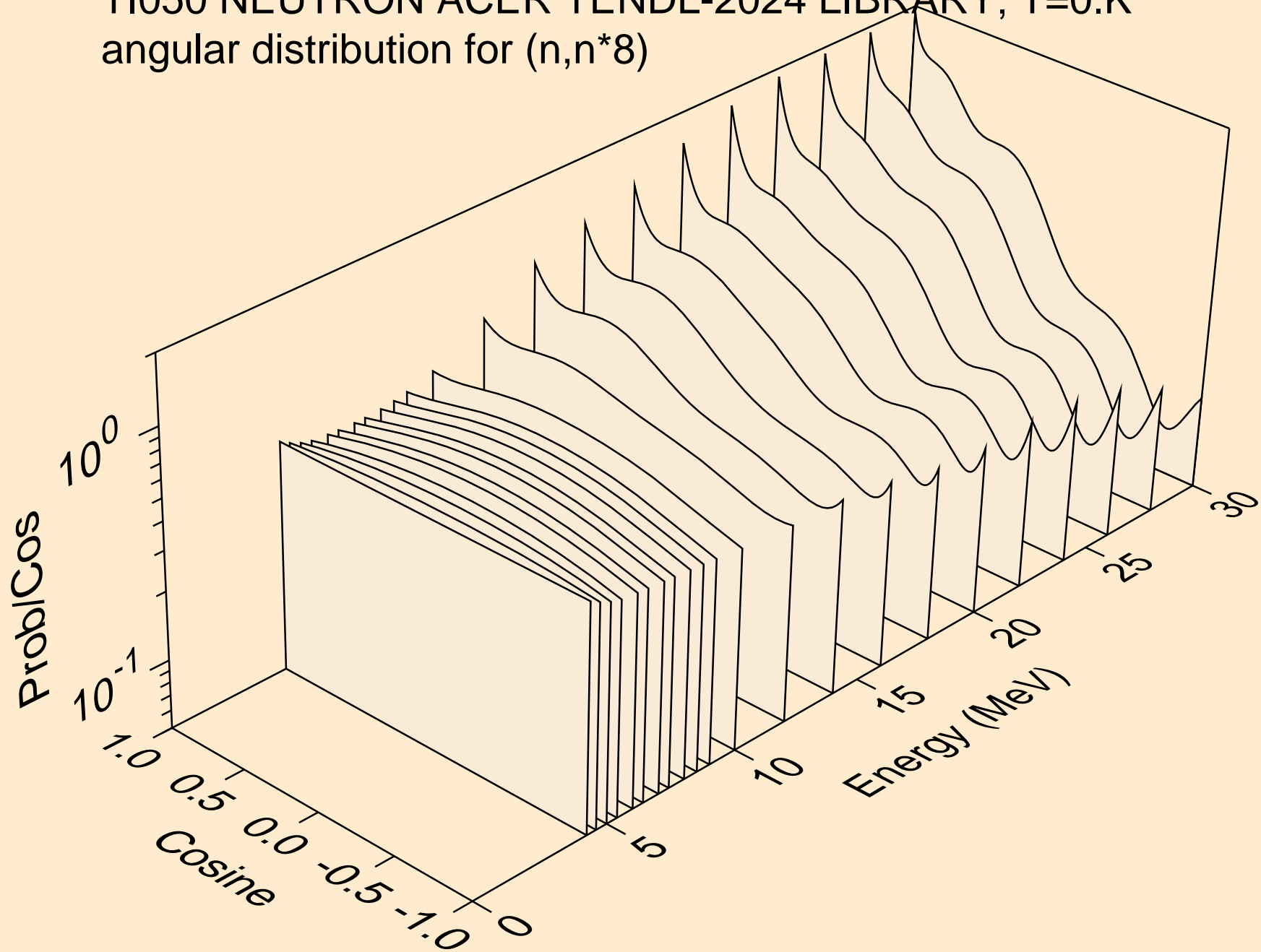

TI050 NEUTRON ACER TENDL-2024 LIBRARY; T=0.K
angular distribution for (n,n*9)

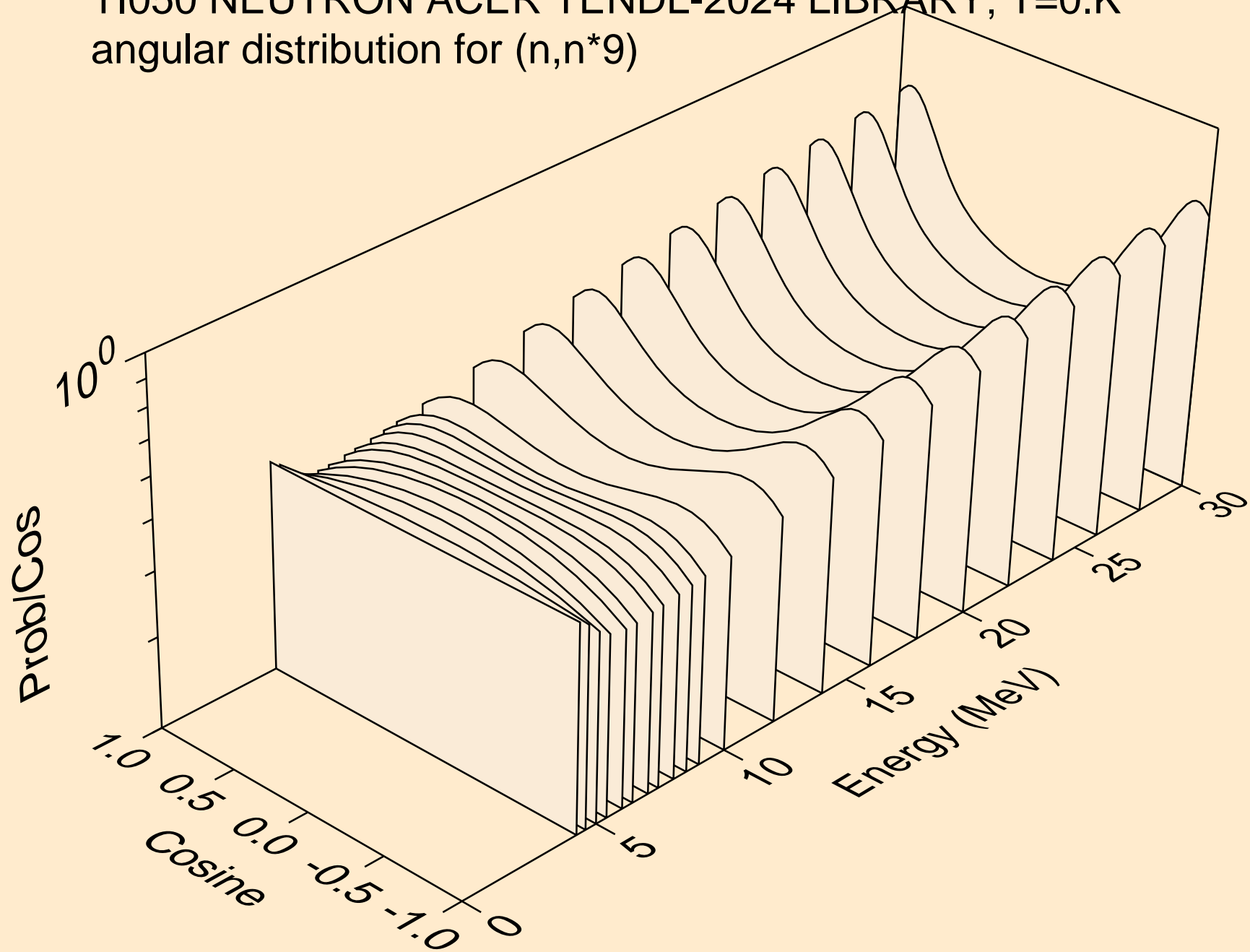

TI050 NEUTRON ACER TENDL-2024 LIBRARY; T=0.K
angular distribution for (n,n*10)

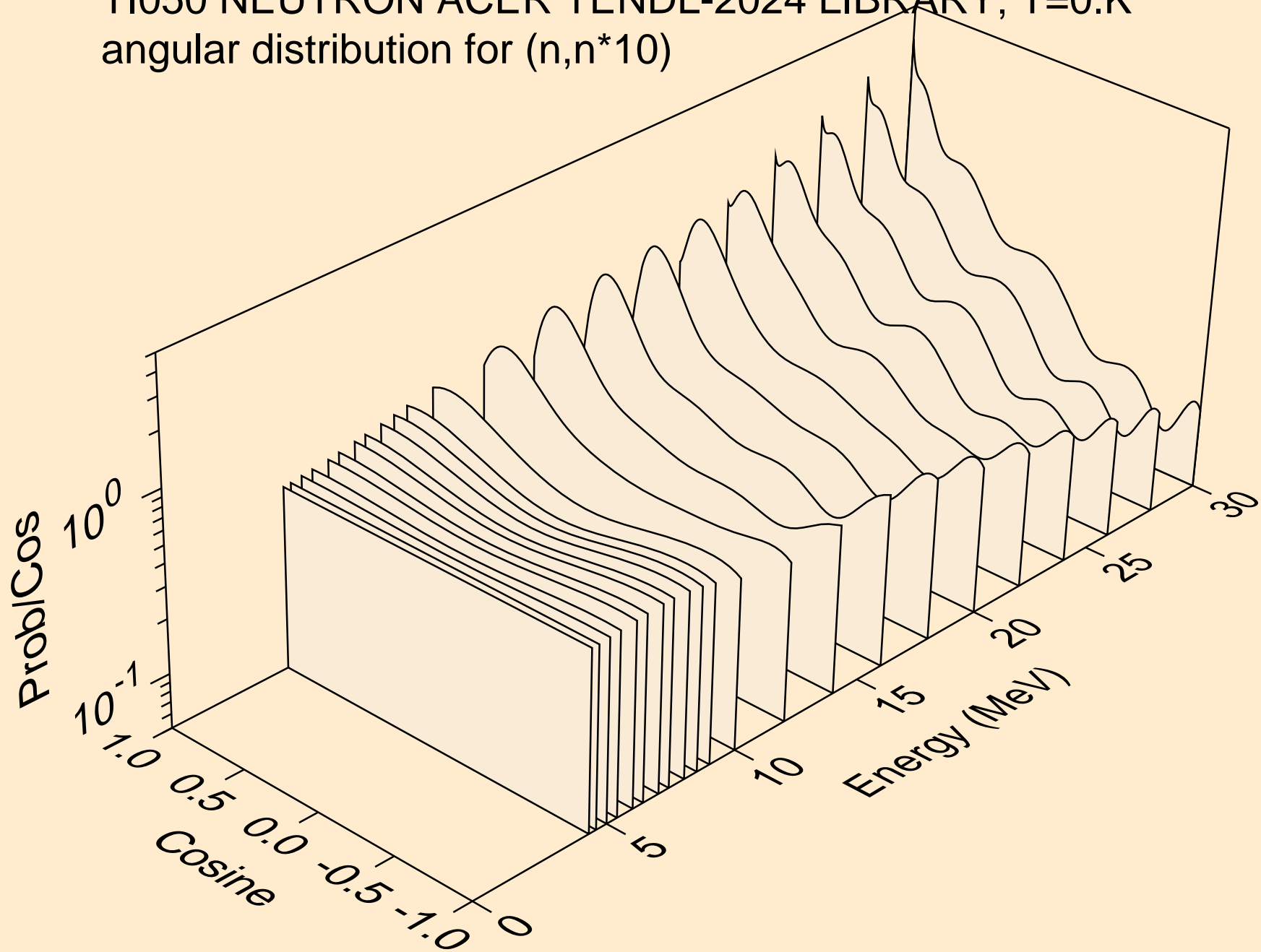

TI050 NEUTRON ACER TENDL-2024 LIBRARY; T=0.K
angular distribution for (n,n*11)

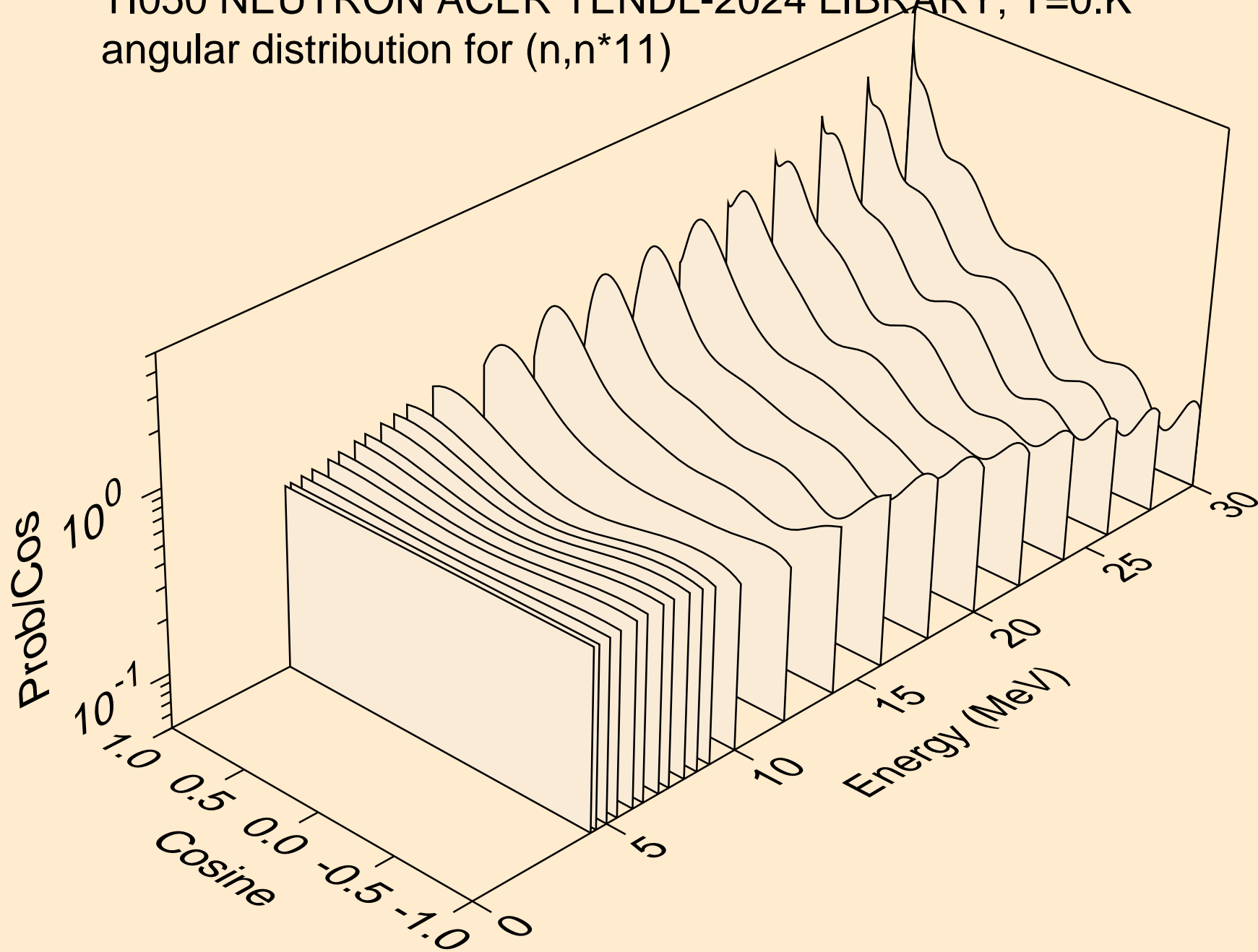

TI050 NEUTRON ACER TENDL-2024 LIBRARY; T=0.K
angular distribution for (n,n*12)

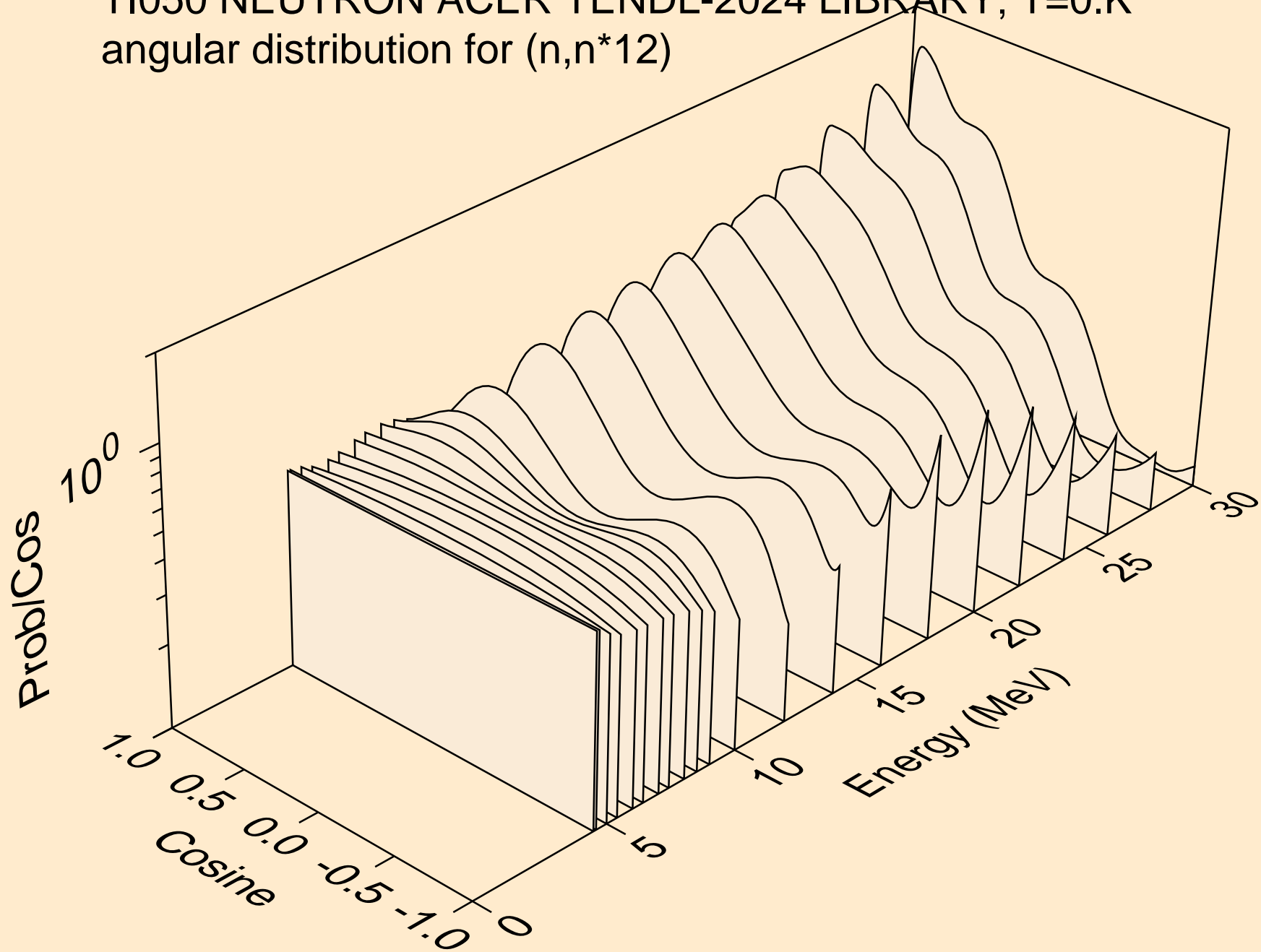

TI050 NEUTRON ACER TENDL-2024 LIBRARY; T=0.K
angular distribution for (n,n*13)

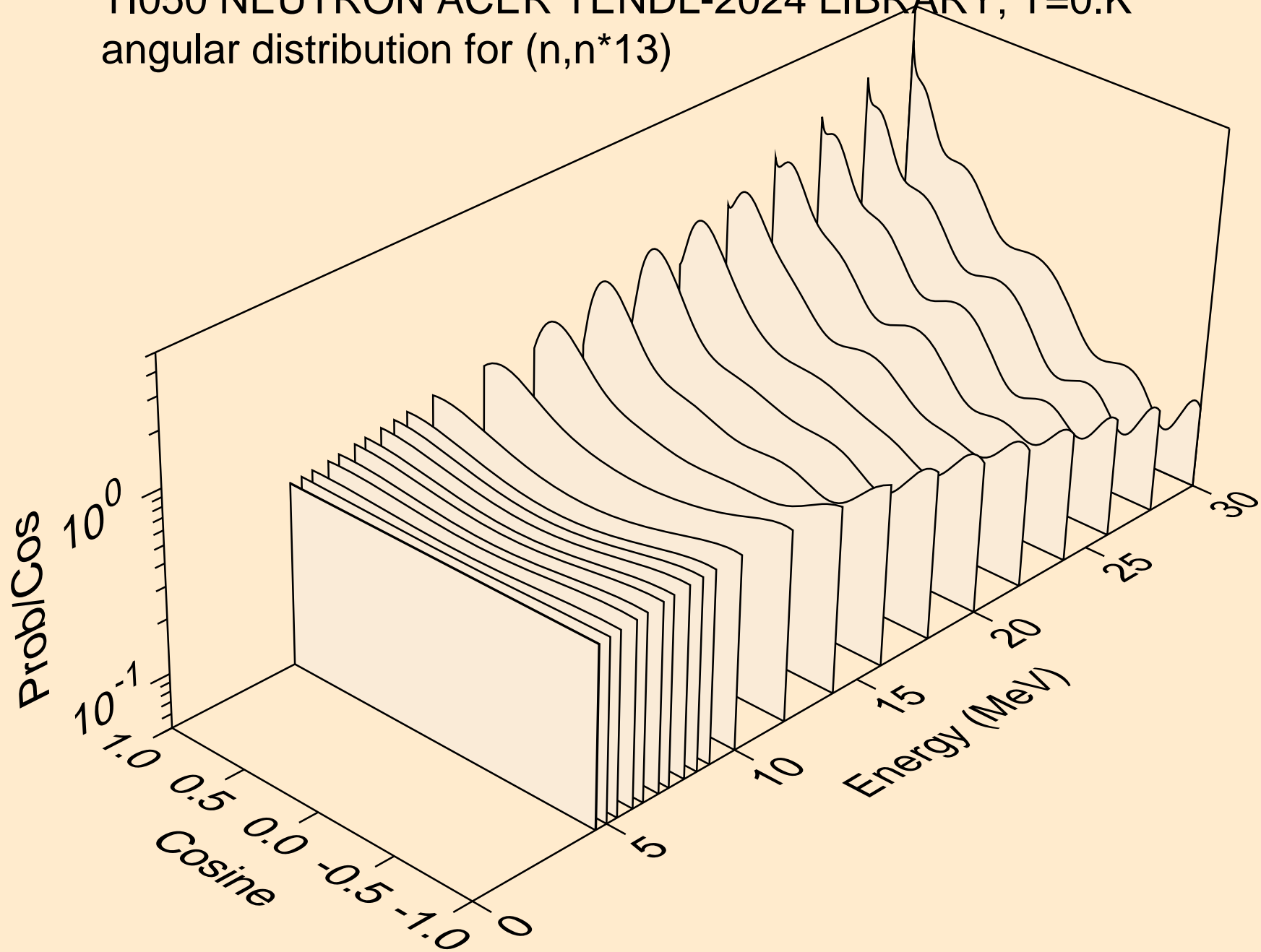

TI050 NEUTRON ACER TENDL-2024 LIBRARY; T=0.K
angular distribution for (n,n*14)

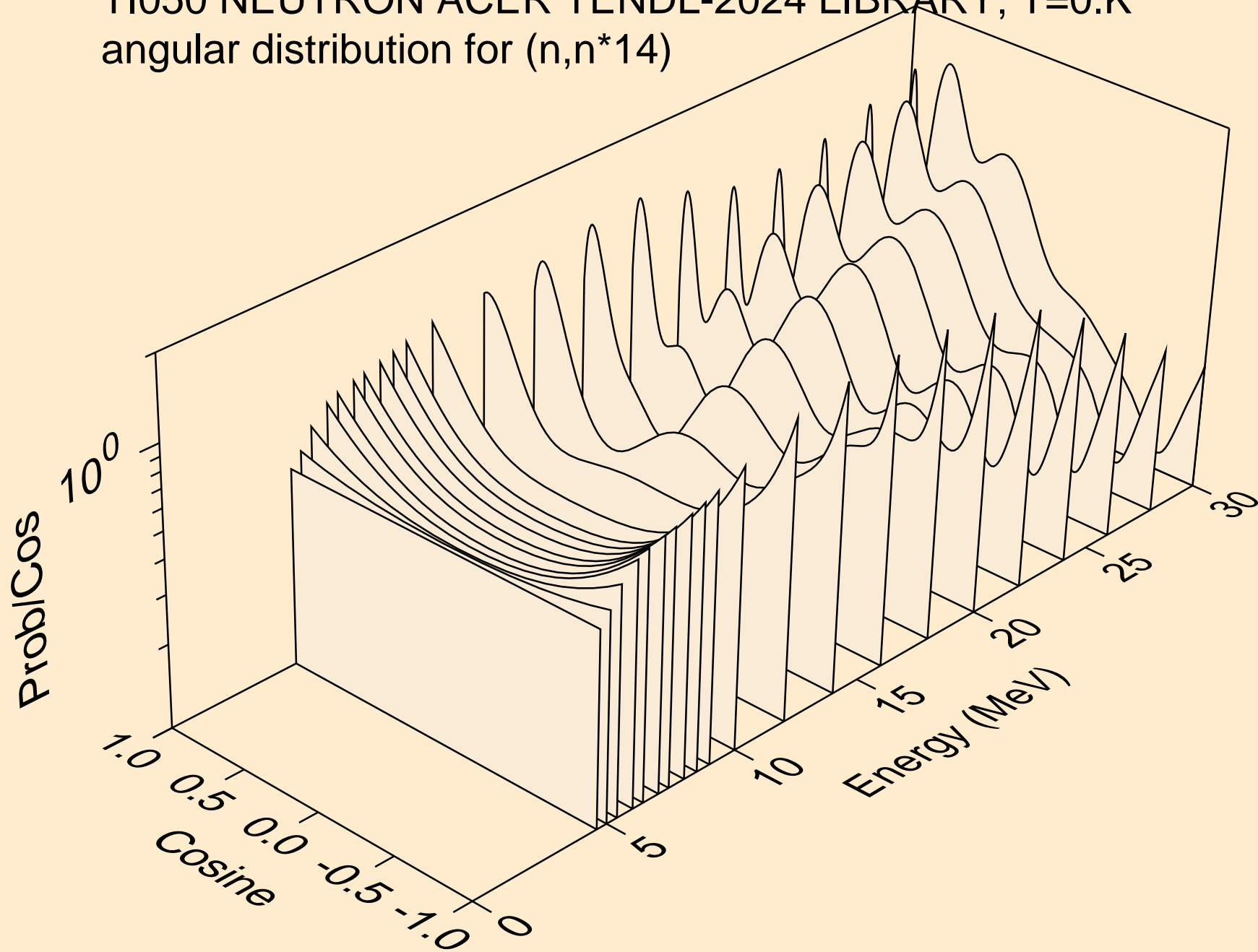

TI050 NEUTRON ACER TENDL-2024 LIBRARY; T=0.K
angular distribution for (n,n*15)

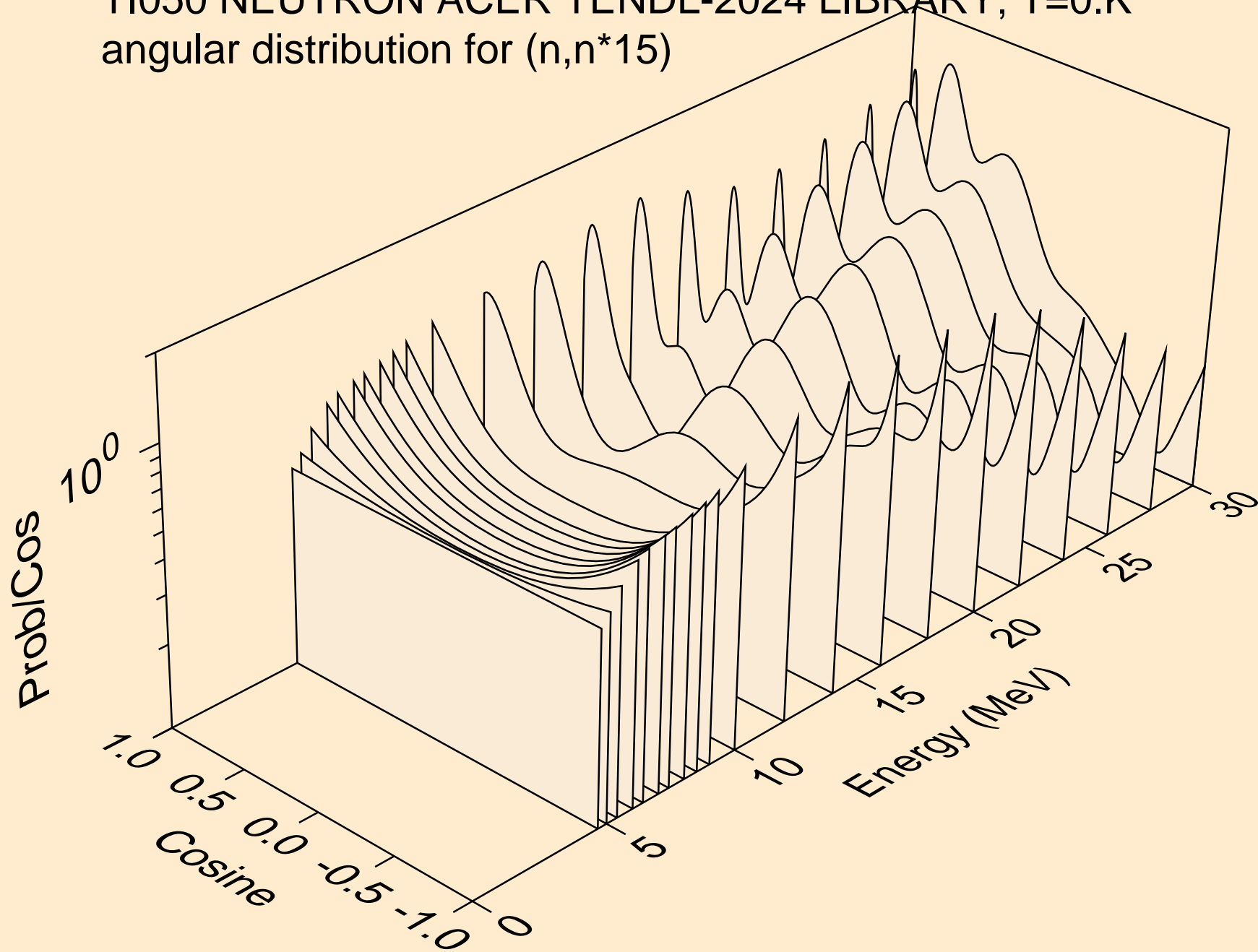

TI050 NEUTRON ACER TENDL-2024 LIBRARY; T=0.K
angular distribution for (n,n*16)

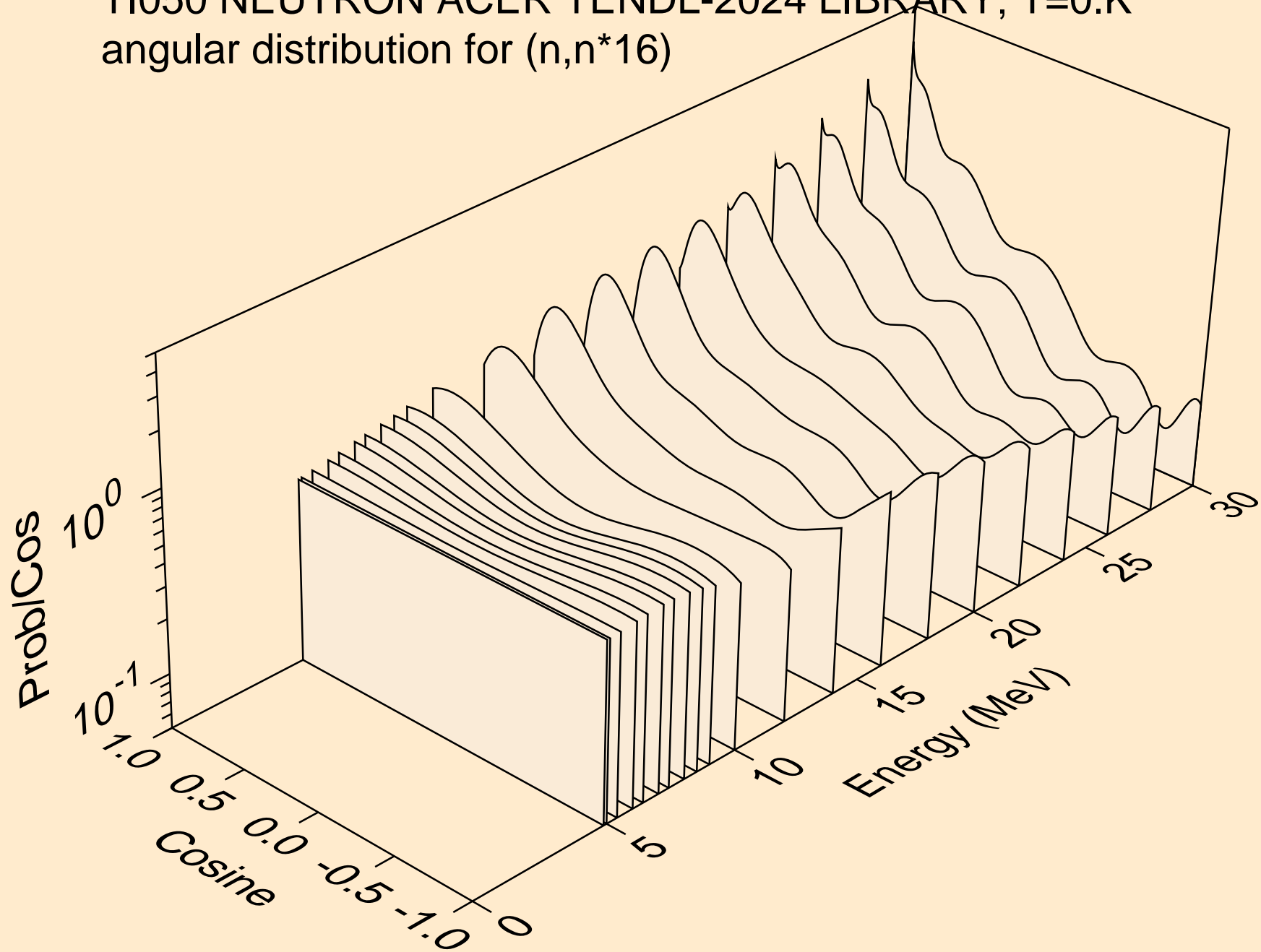

TI050 NEUTRON ACER TENDL-2024 LIBRARY; T=0.K
angular distribution for (n,n*17)

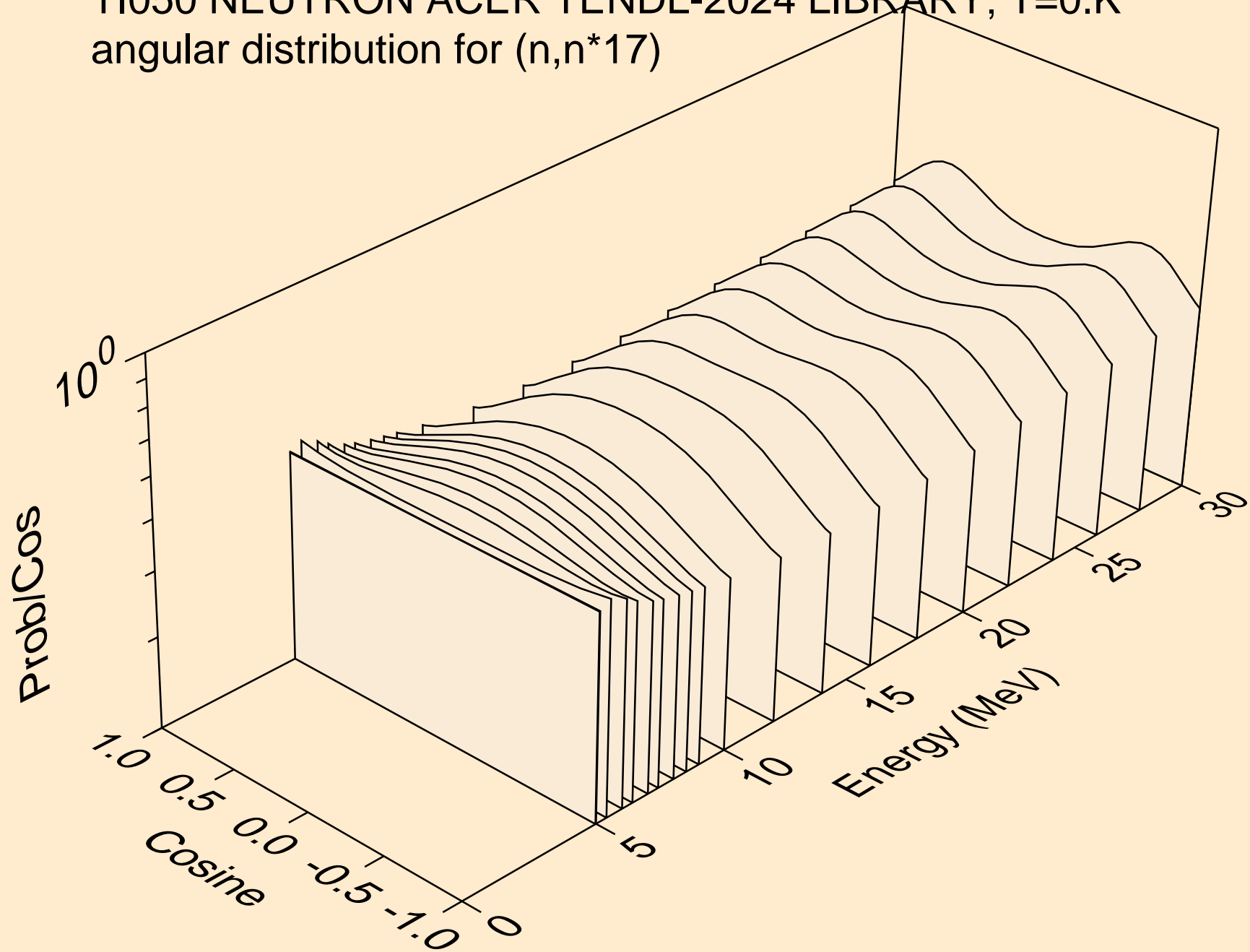

TI050 NEUTRON ACER TENDL-2024 LIBRARY; T=0.K
angular distribution for (n,n*18)

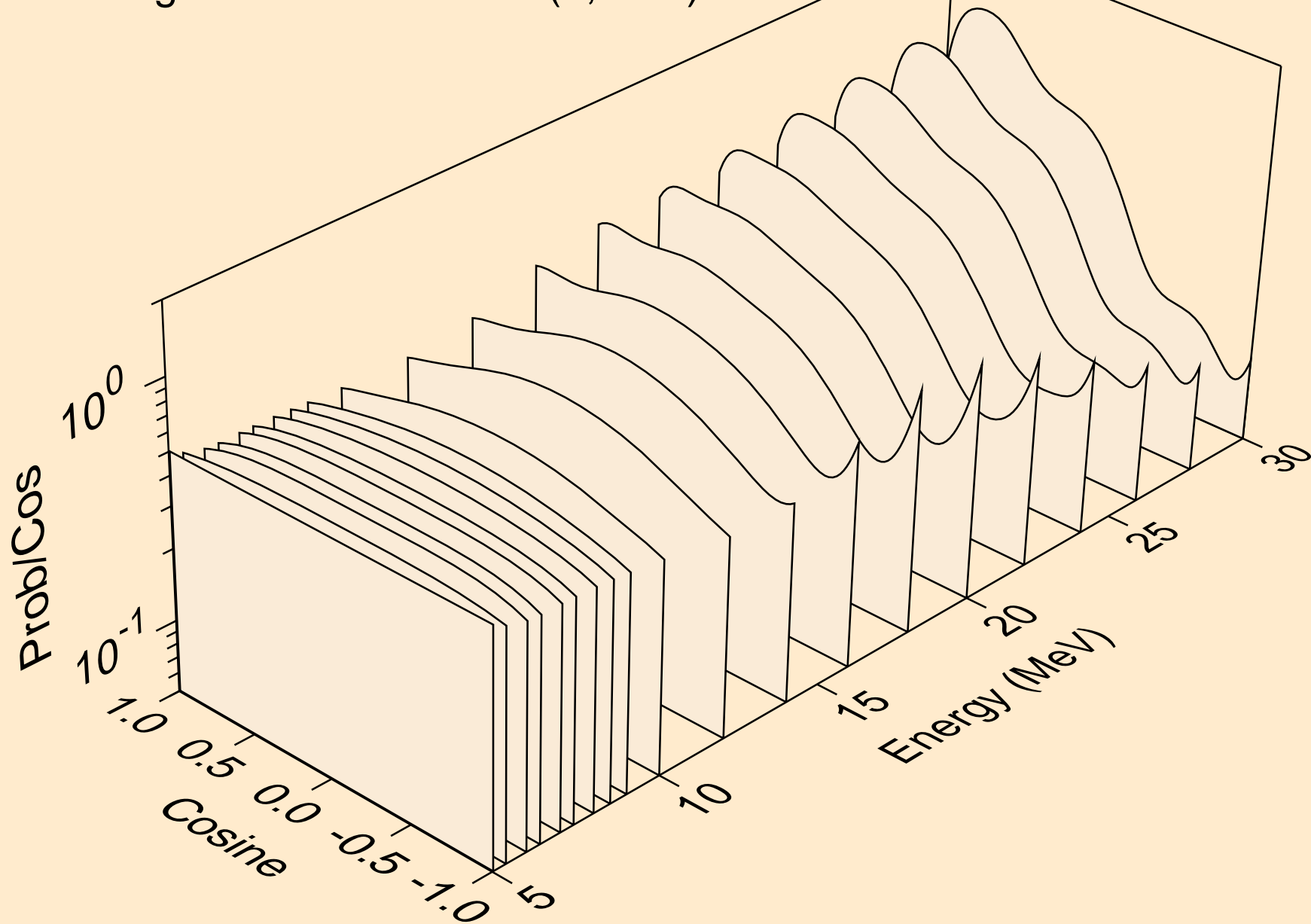

TI050 NEUTRON ACER TENDL-2024 LIBRARY; T=0.K
angular distribution for (n,n*19)

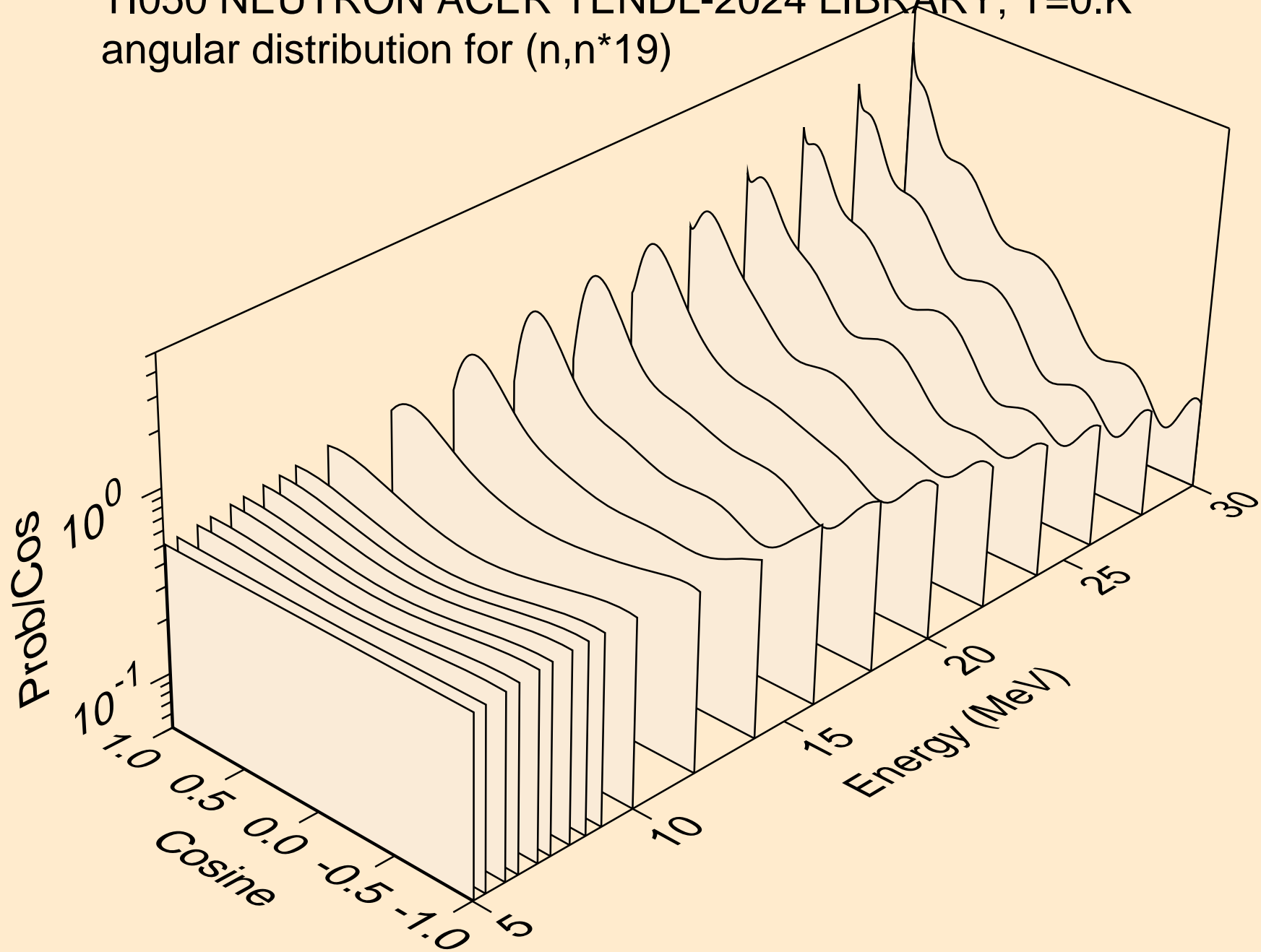

TI050 NEUTRON ACER TENDL-2024 LIBRARY; T=0.K
angular distribution for (n,n*20)

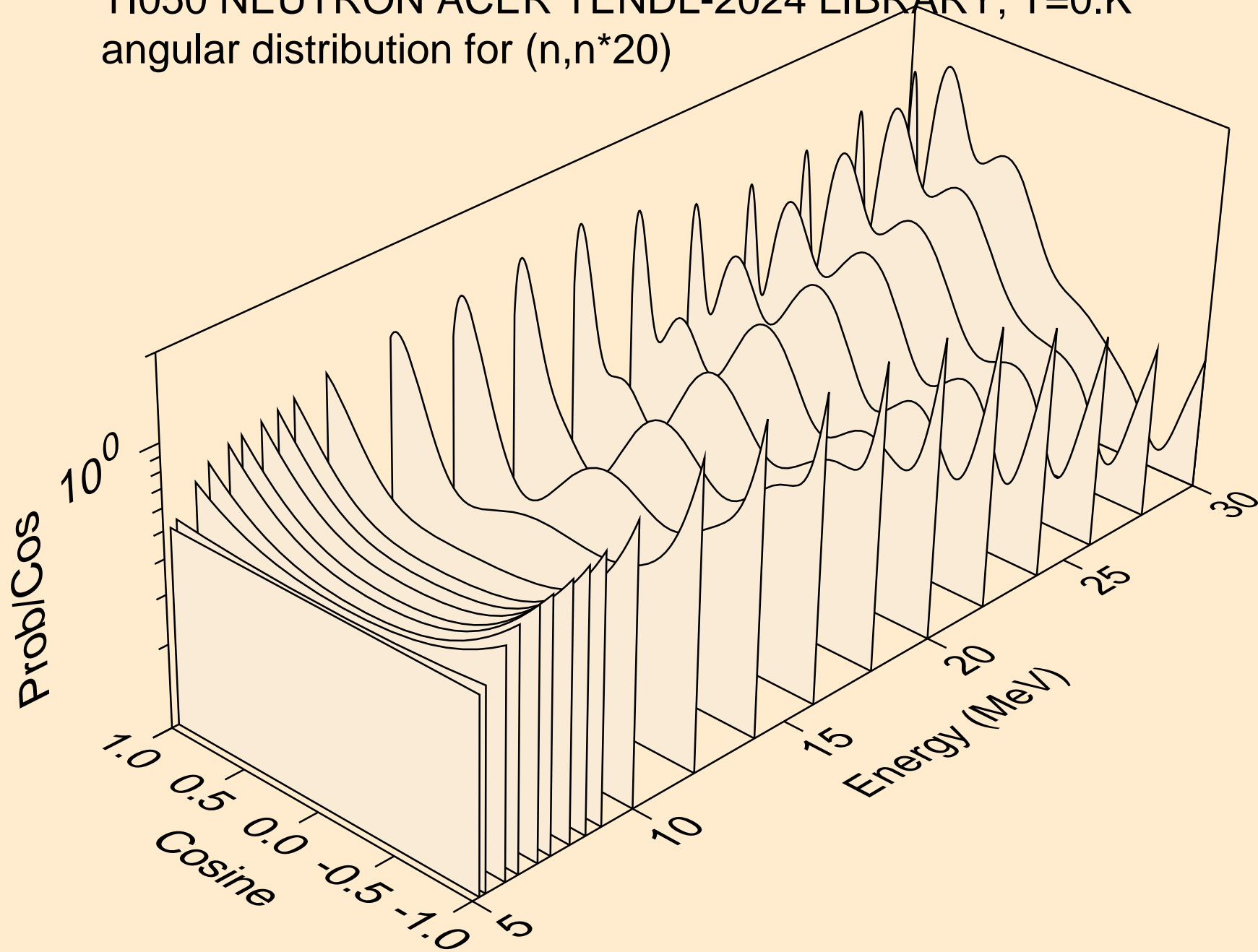

TI050 NEUTRON ACER TENDL-2024 LIBRARY; T=0.K
angular distribution for (n,n*21)

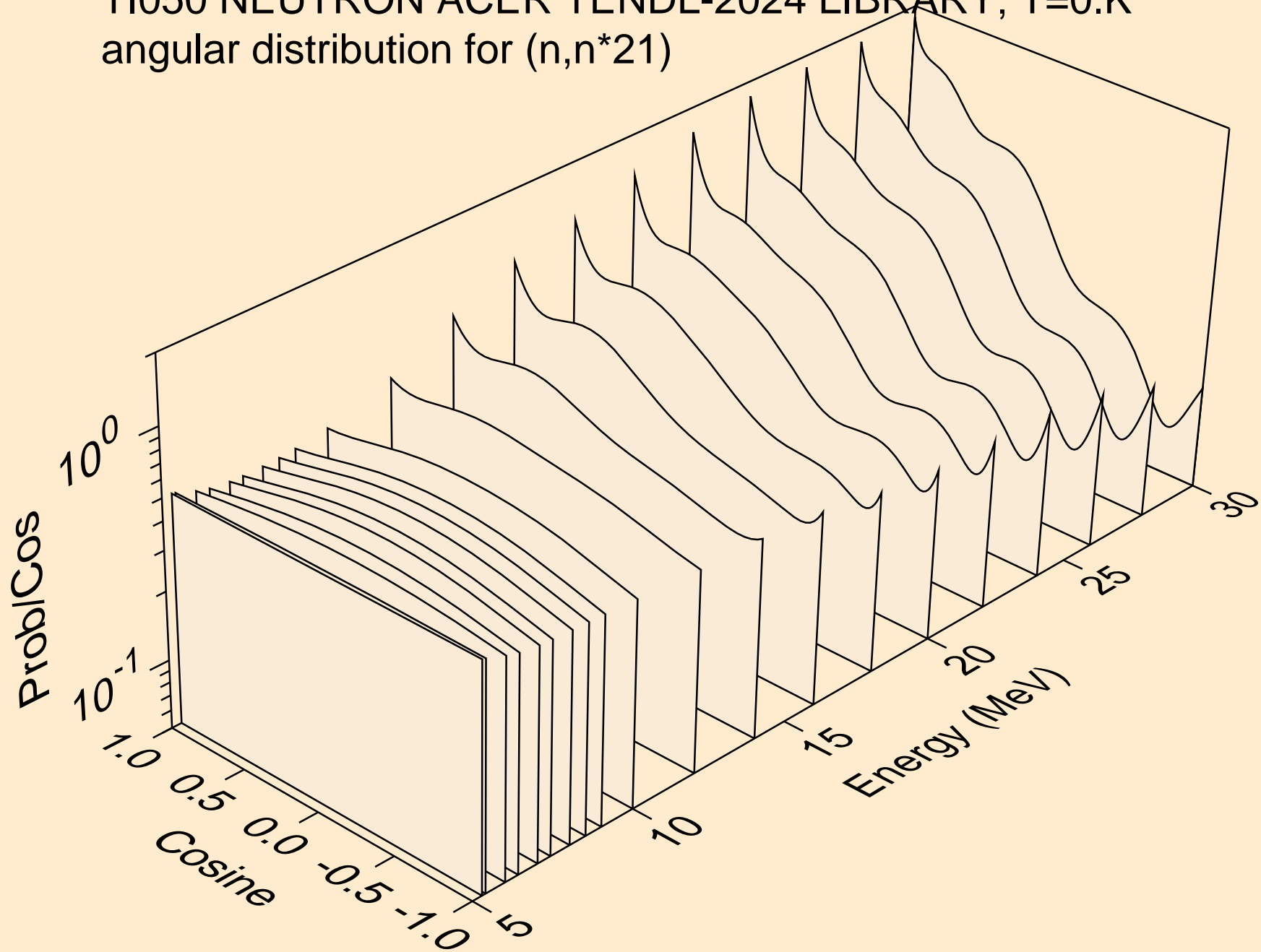

TI050 NEUTRON ACER TENDL-2024 LIBRARY; T=0.K
angular distribution for (n,n*22)

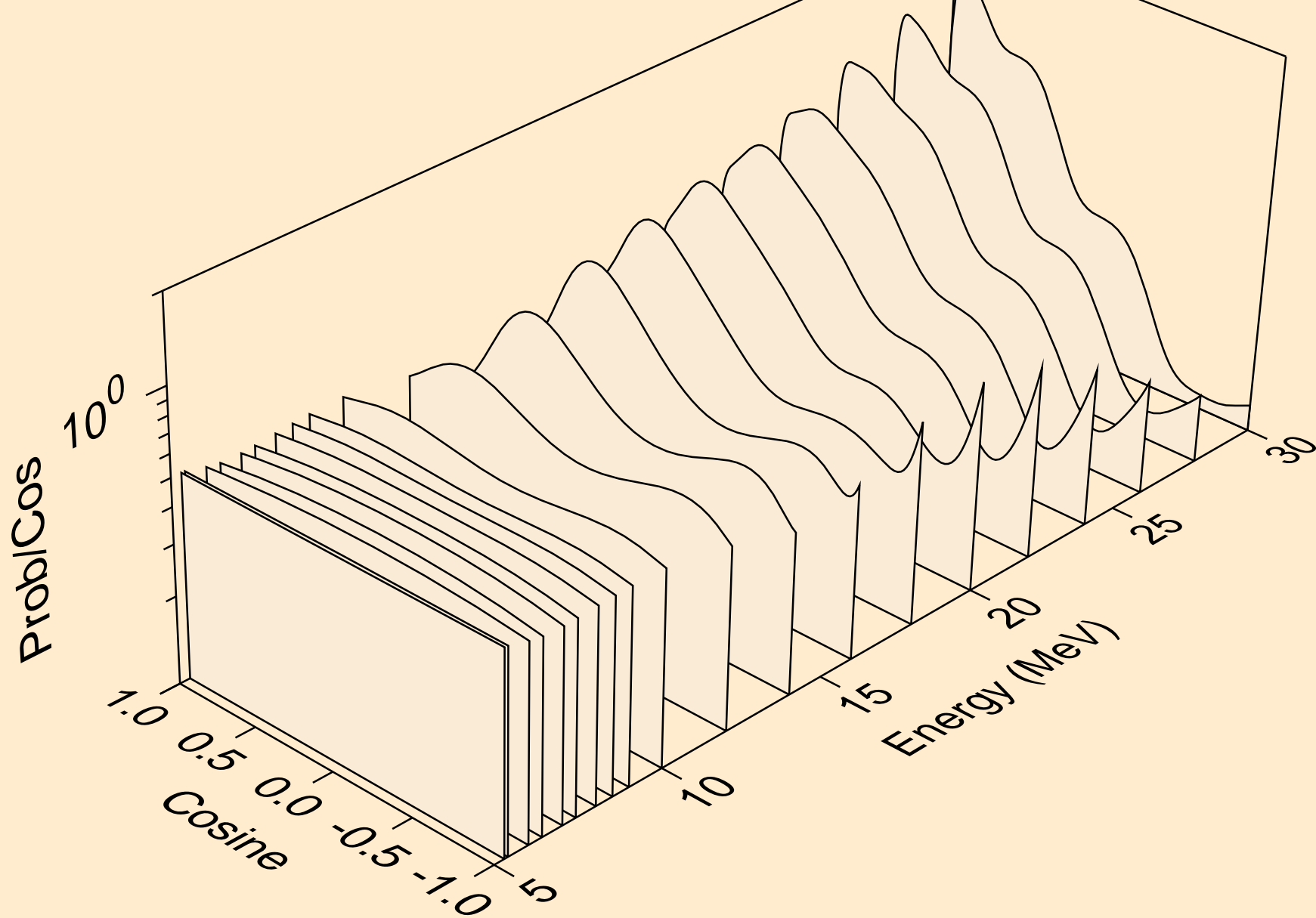

TI050 NEUTRON ACER TENDL-2024 LIBRARY; T=0.K
angular distribution for (n,n*23)

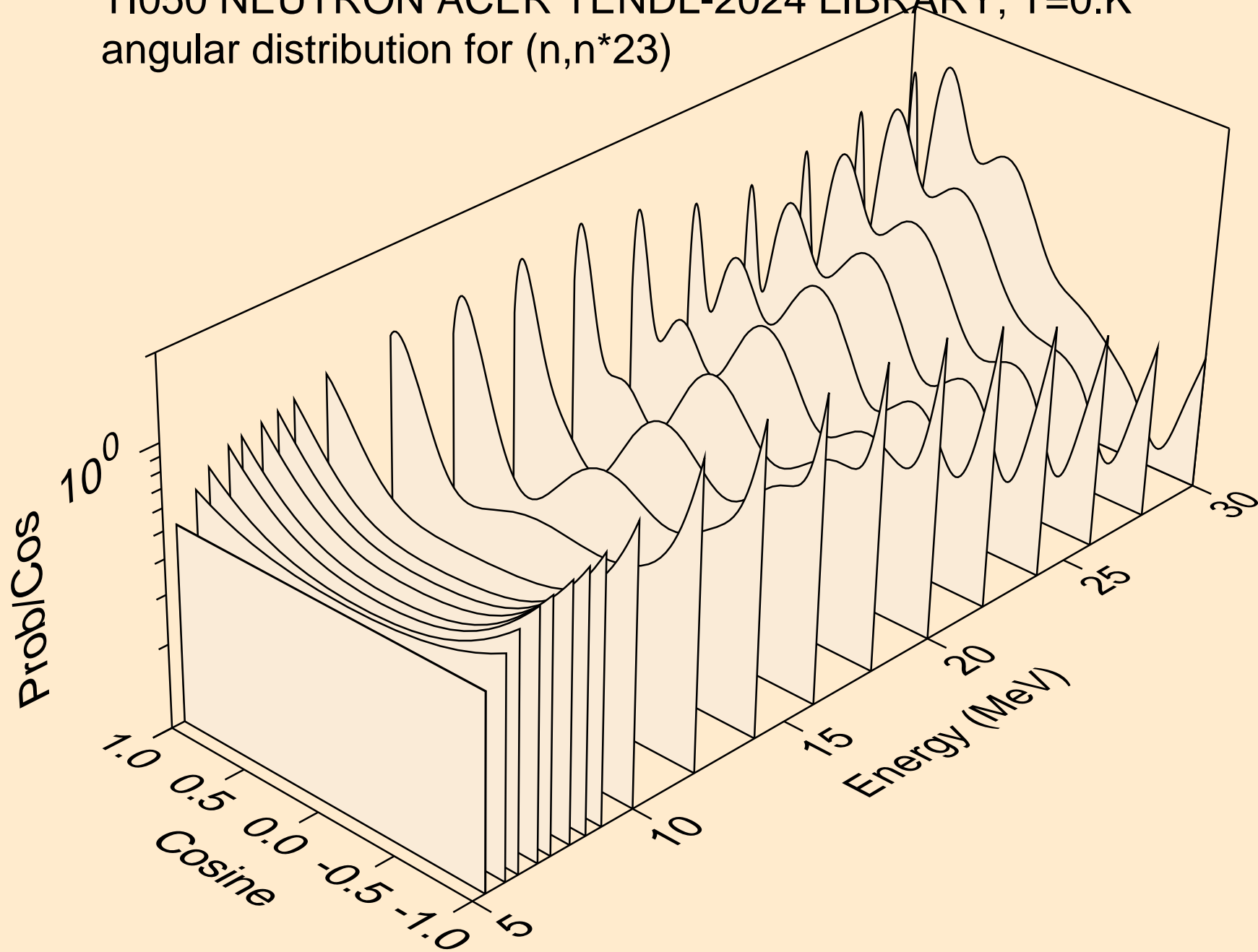

TI050 NEUTRON ACER TENDL-2024 LIBRARY; T=0.K
angular distribution for (n,n*24)

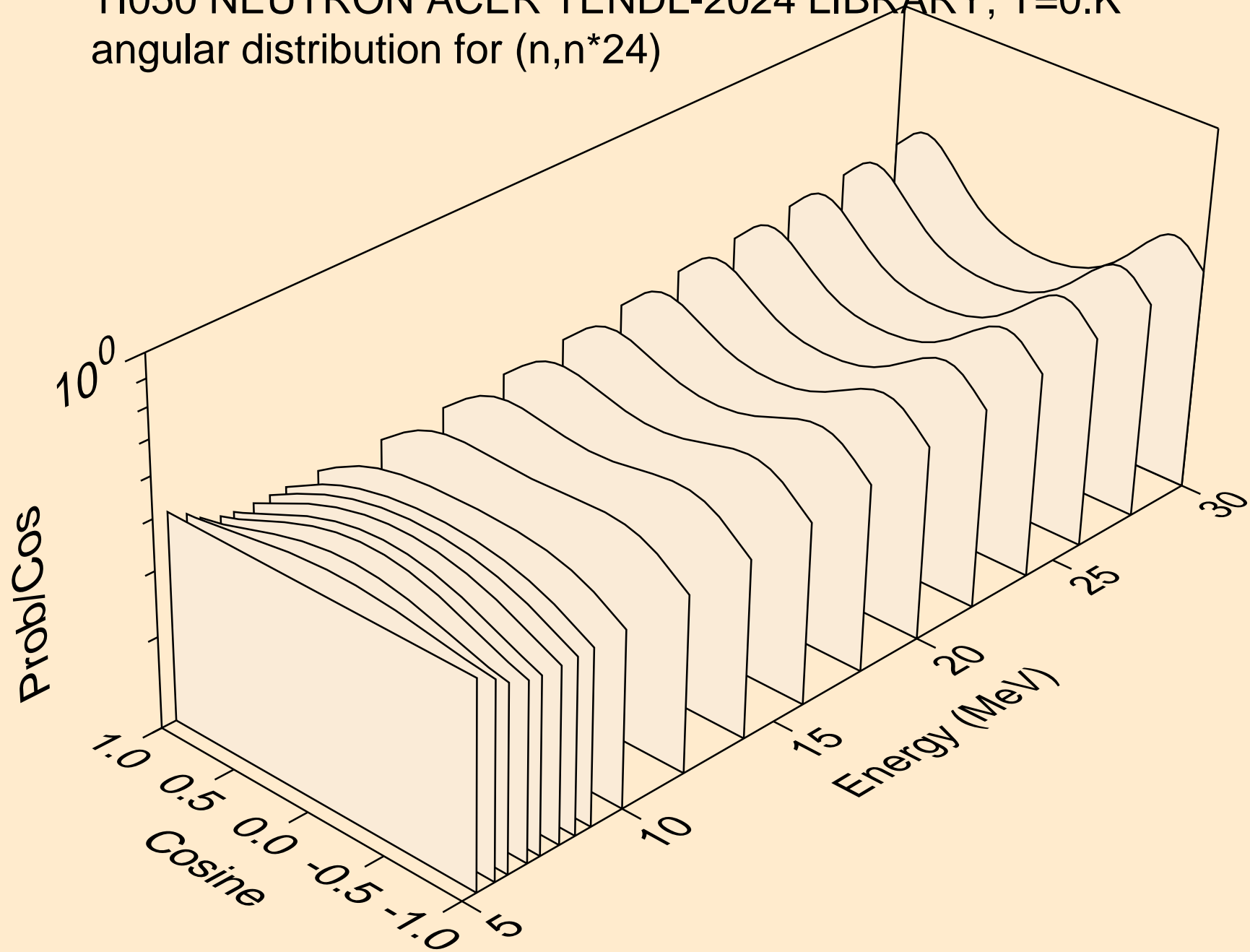

TI050 NEUTRON ACER TENDL-2024 LIBRARY; T=0.K
angular distribution for (n,n*25)

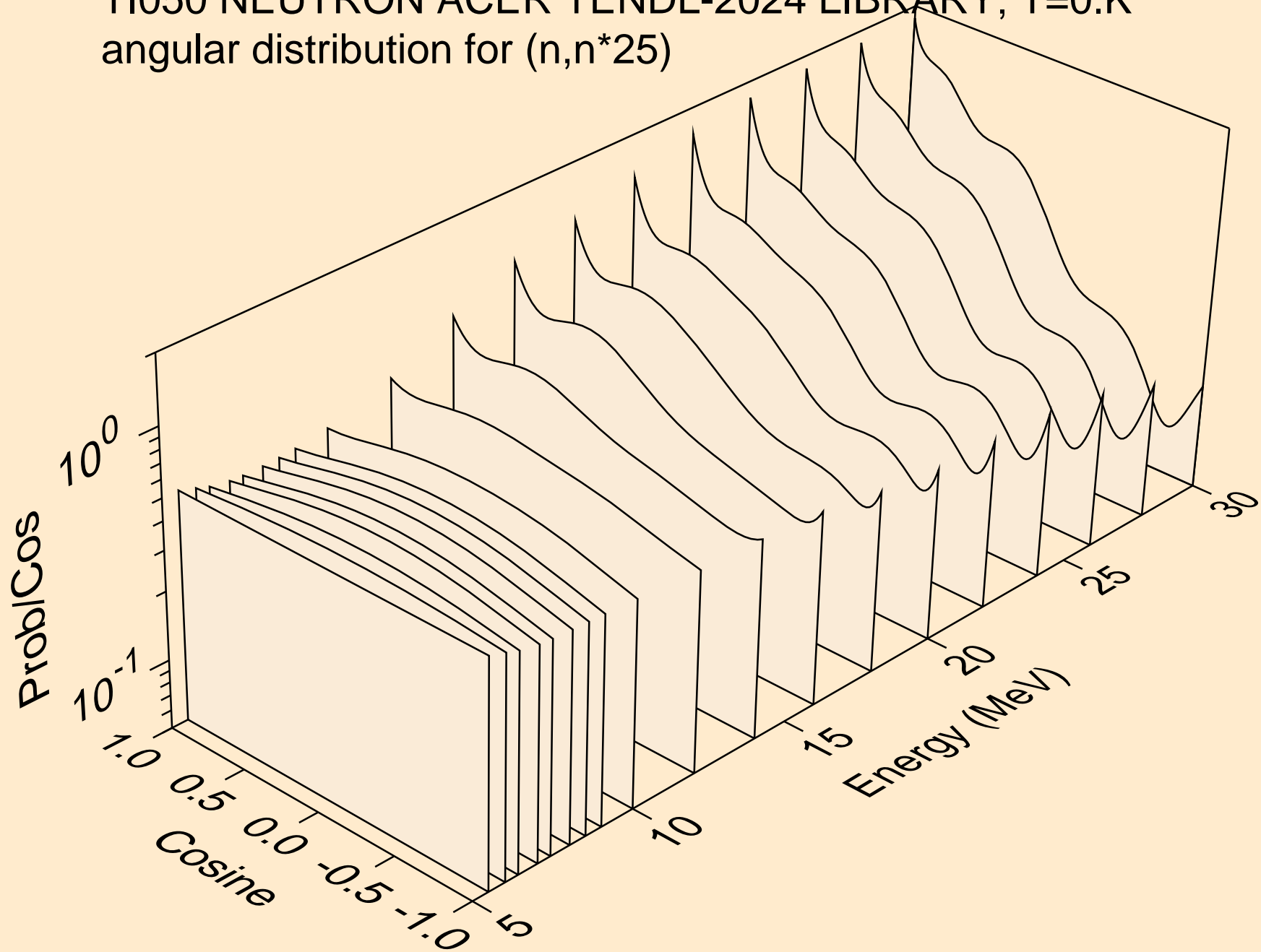

TI050 NEUTRON ACER TENDL-2024 LIBRARY; T=0.K
angular distribution for (n,n*26)

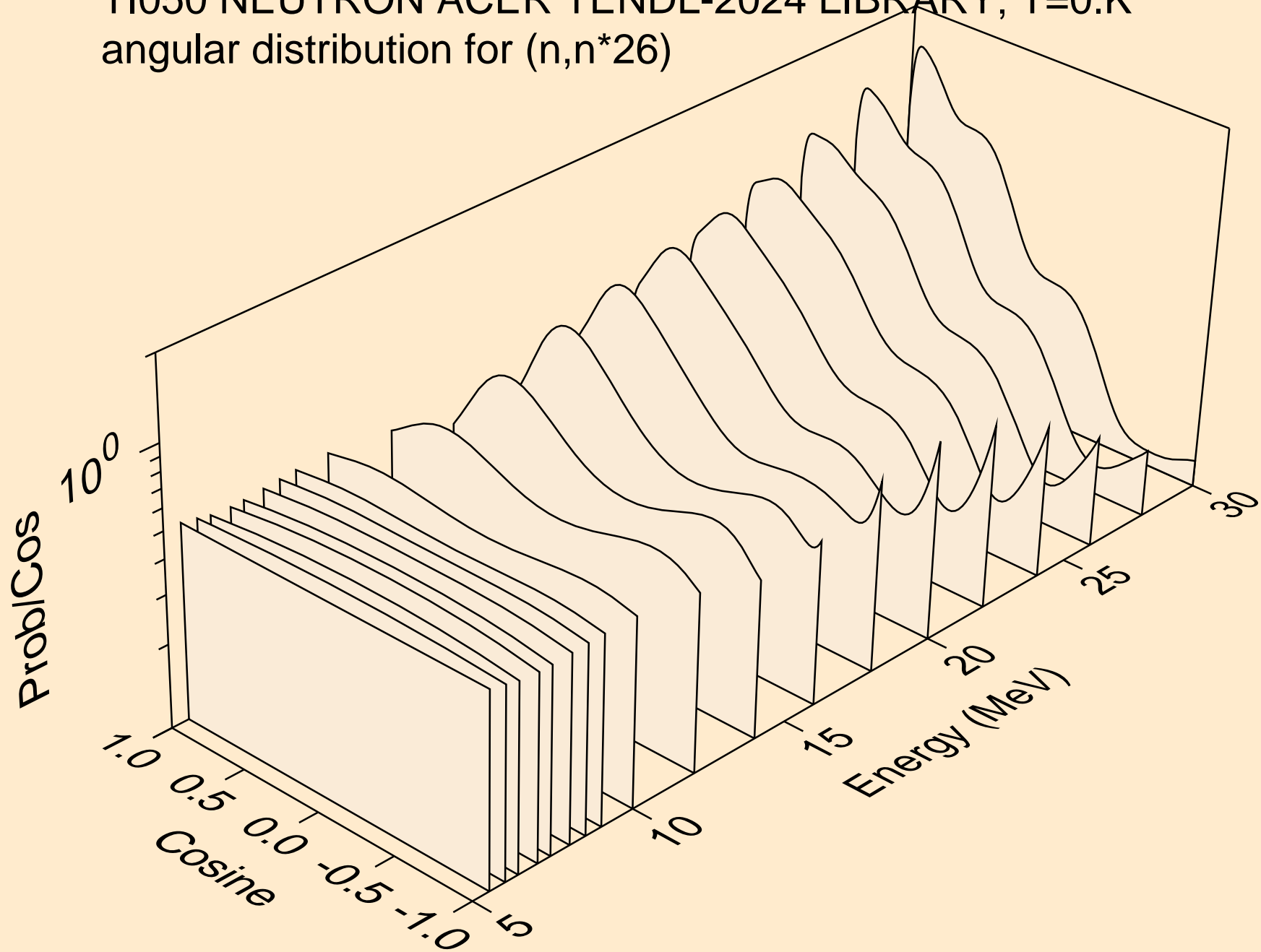

TI050 NEUTRON ACER TENDL-2024 LIBRARY; T=0.K
angular distribution for (n,n*27)

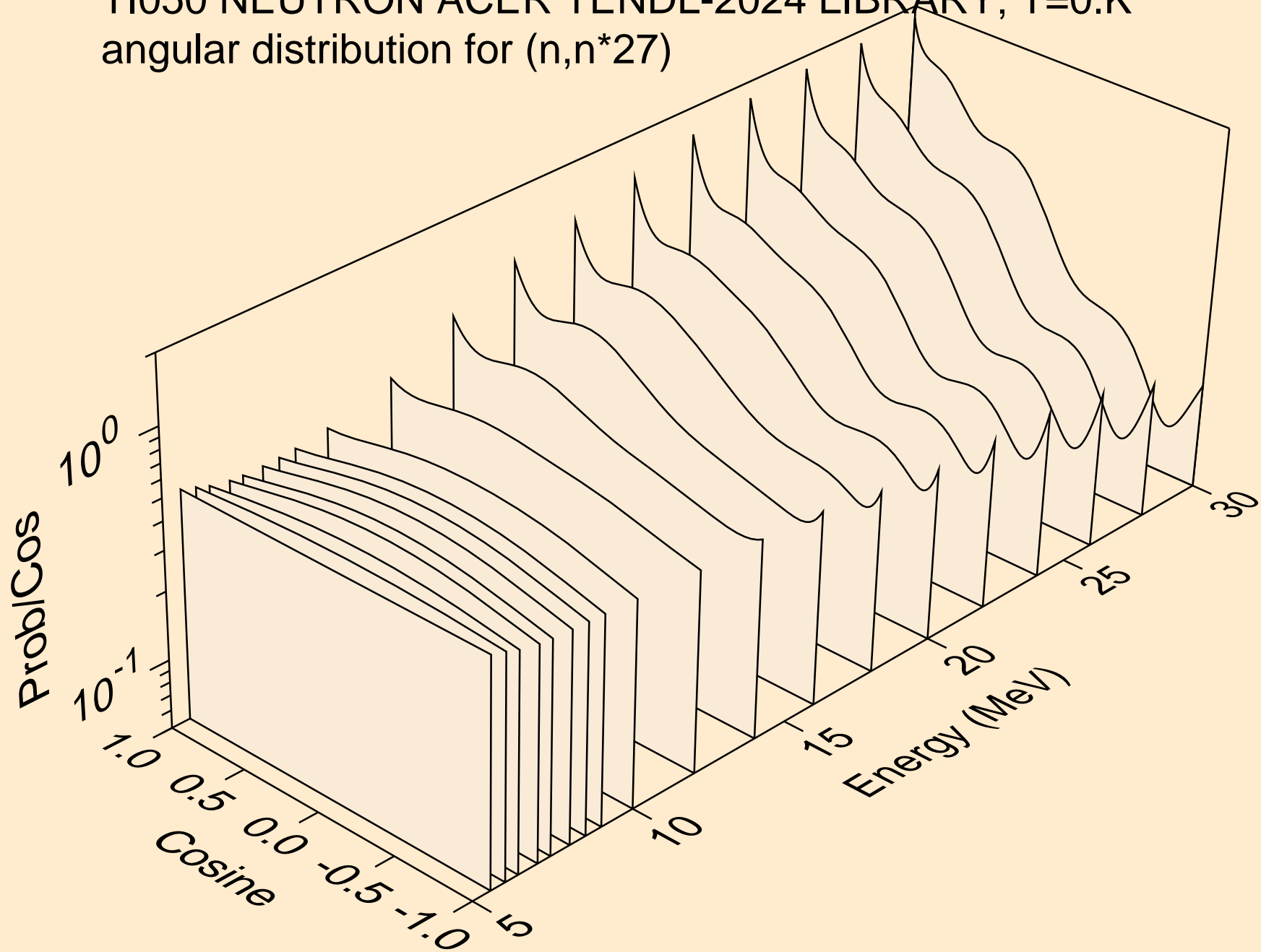

TI050 NEUTRON ACER TENDL-2024 LIBRARY; T=0.K
angular distribution for (n,n*28)

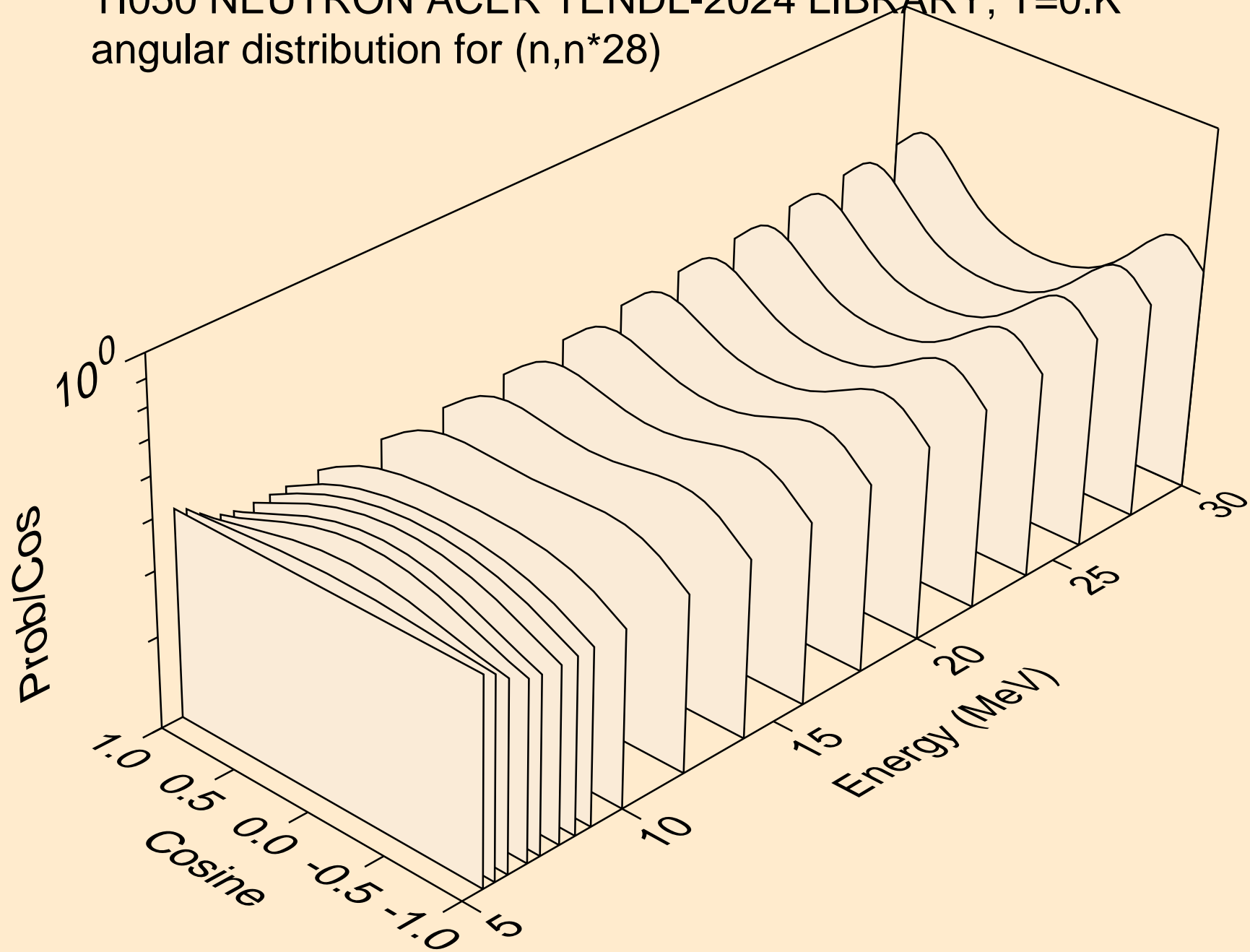

TI050 NEUTRON ACER TENDL-2024 LIBRARY; T=0.K
angular distribution for (n,n*29)

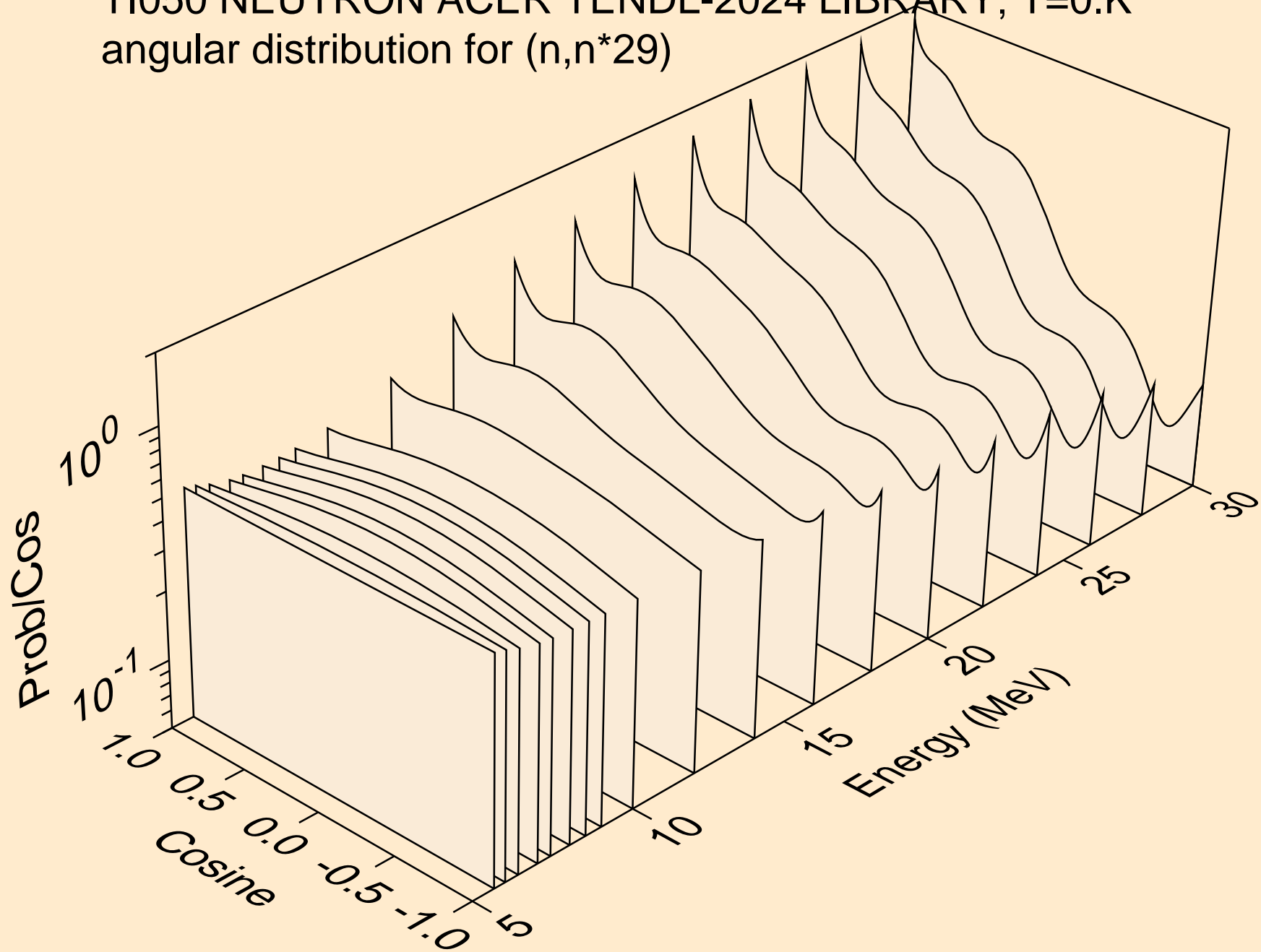

TI050 NEUTRON ACER TENDL-2024 LIBRARY; T=0.K
angular distribution for (n,n*30)

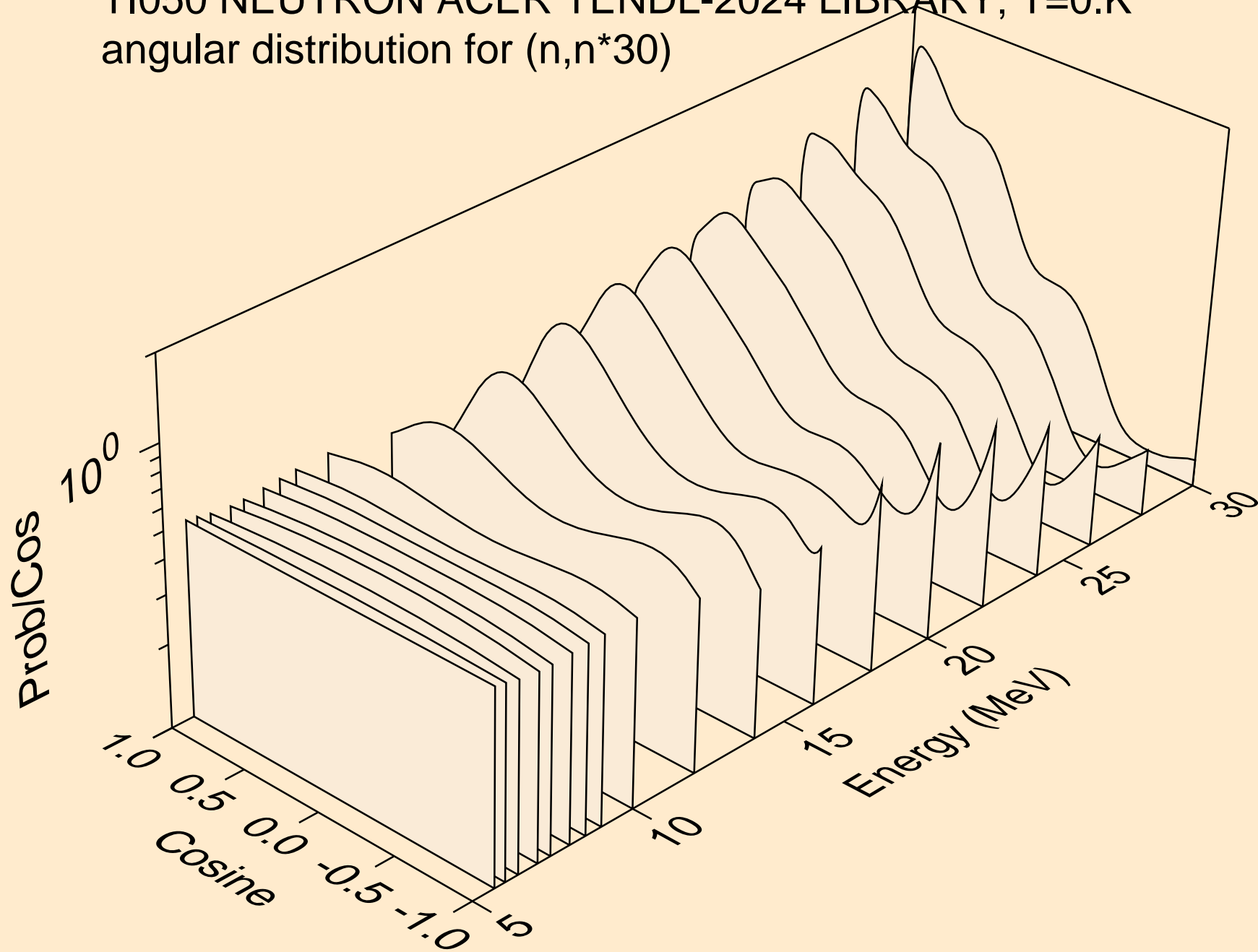

TI050 NEUTRON ACER TENDL-2024 LIBRARY; T=0.K
Neutron emission for (n,x)

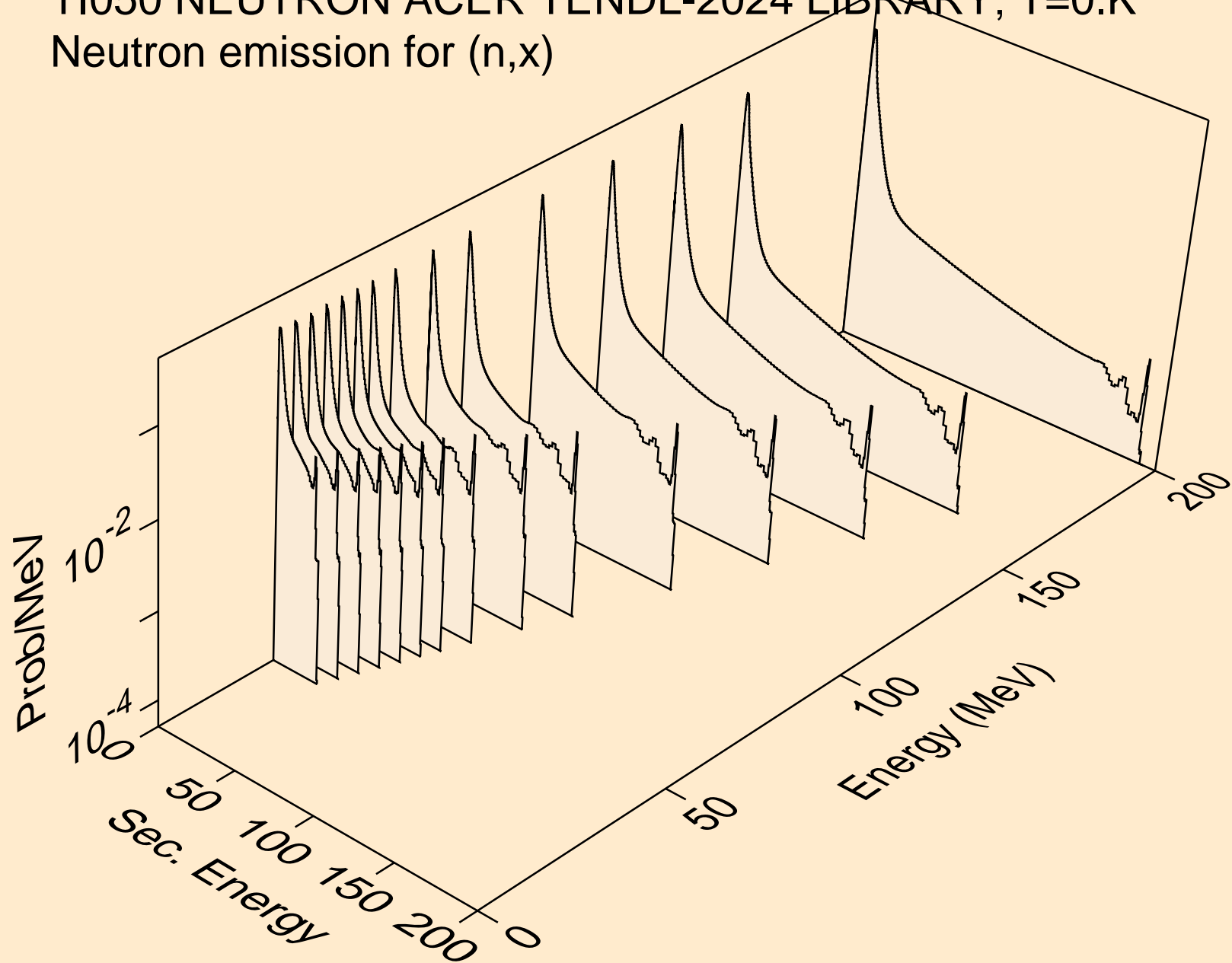

TI050 NEUTRON ACER TENDL-2024 LIBRARY; T=0.K
Neutron emission for (n,2n)

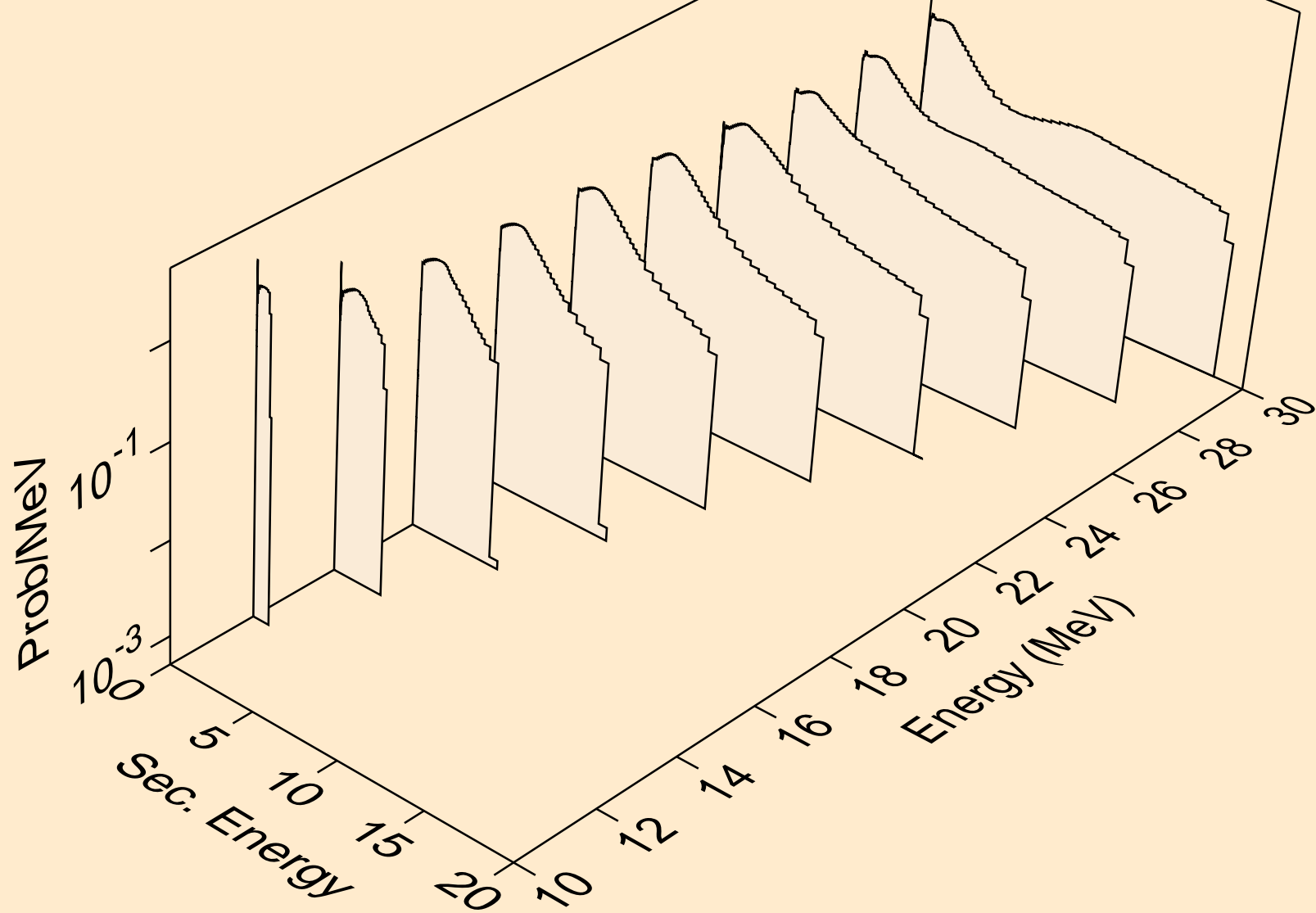

TI050 NEUTRON ACER TENDL-2024 LIBRARY; T=0.K
Neutron emission for (n,3n)

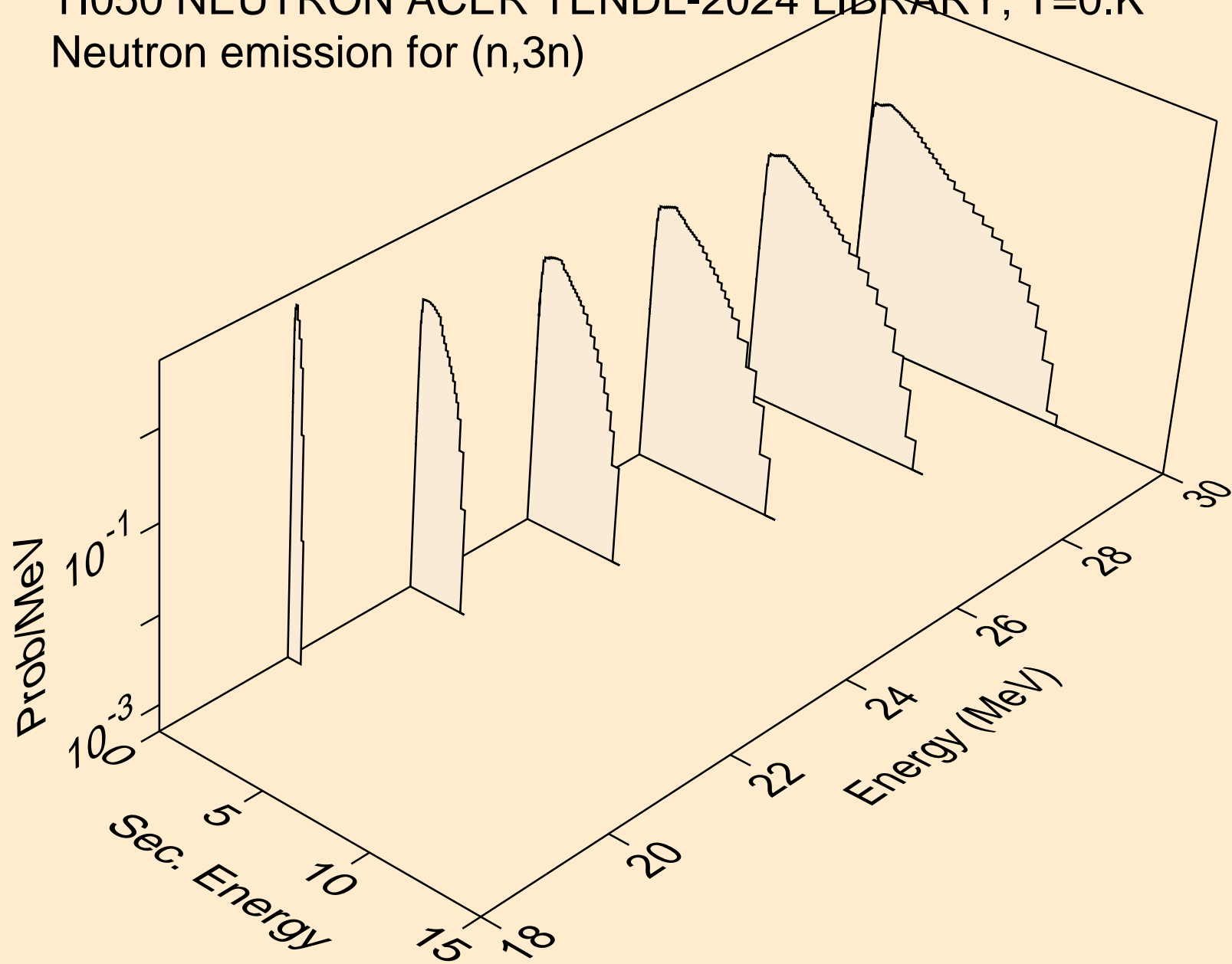

TI050 NEUTRON ACER TENDL-2024 LIBRARY; T=0.K
Neutron emission for (n,n*)a

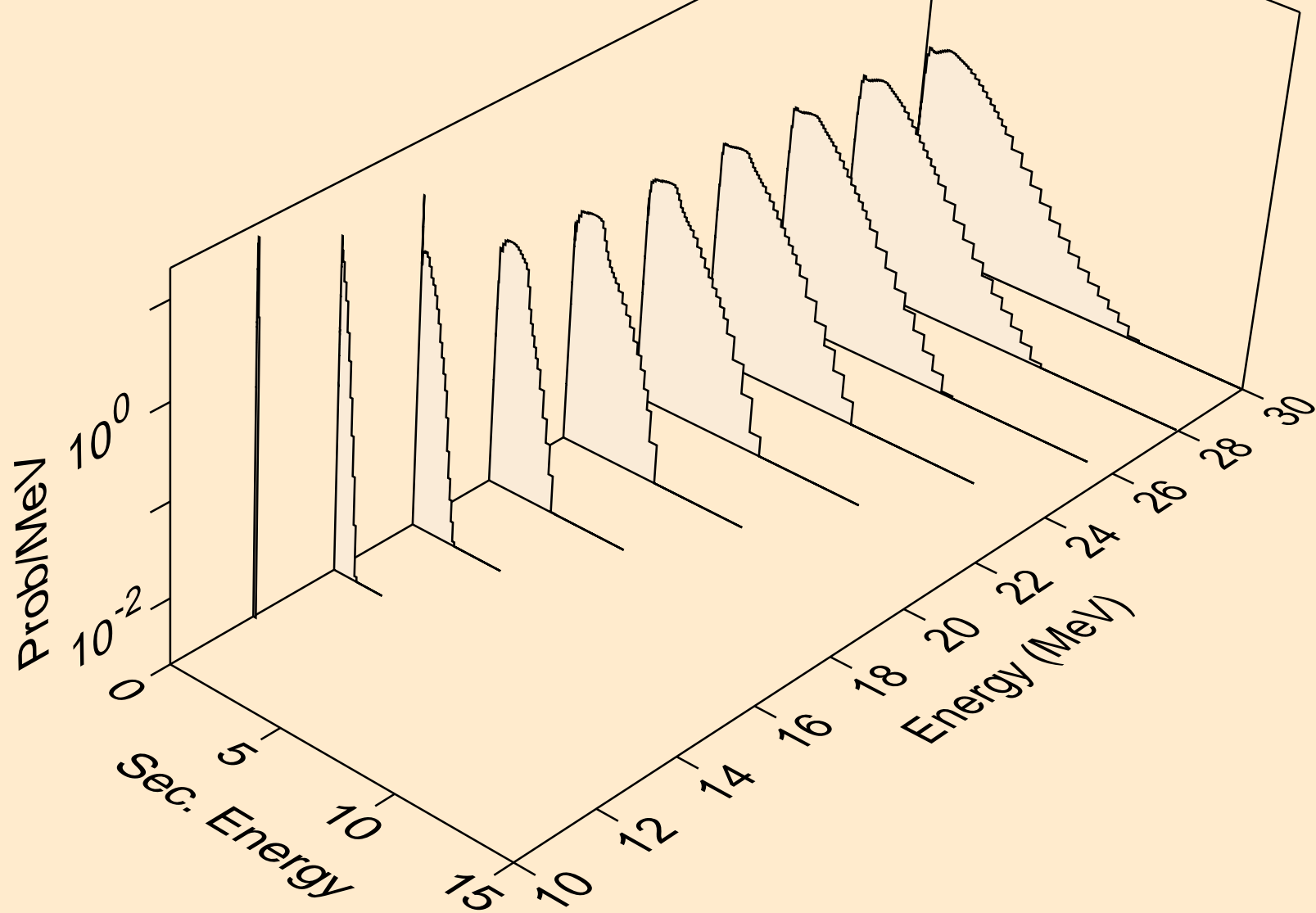

TI050 NEUTRON ACER TENDL-2024 LIBRARY; T=0.K
Neutron emission for (n,2n)a

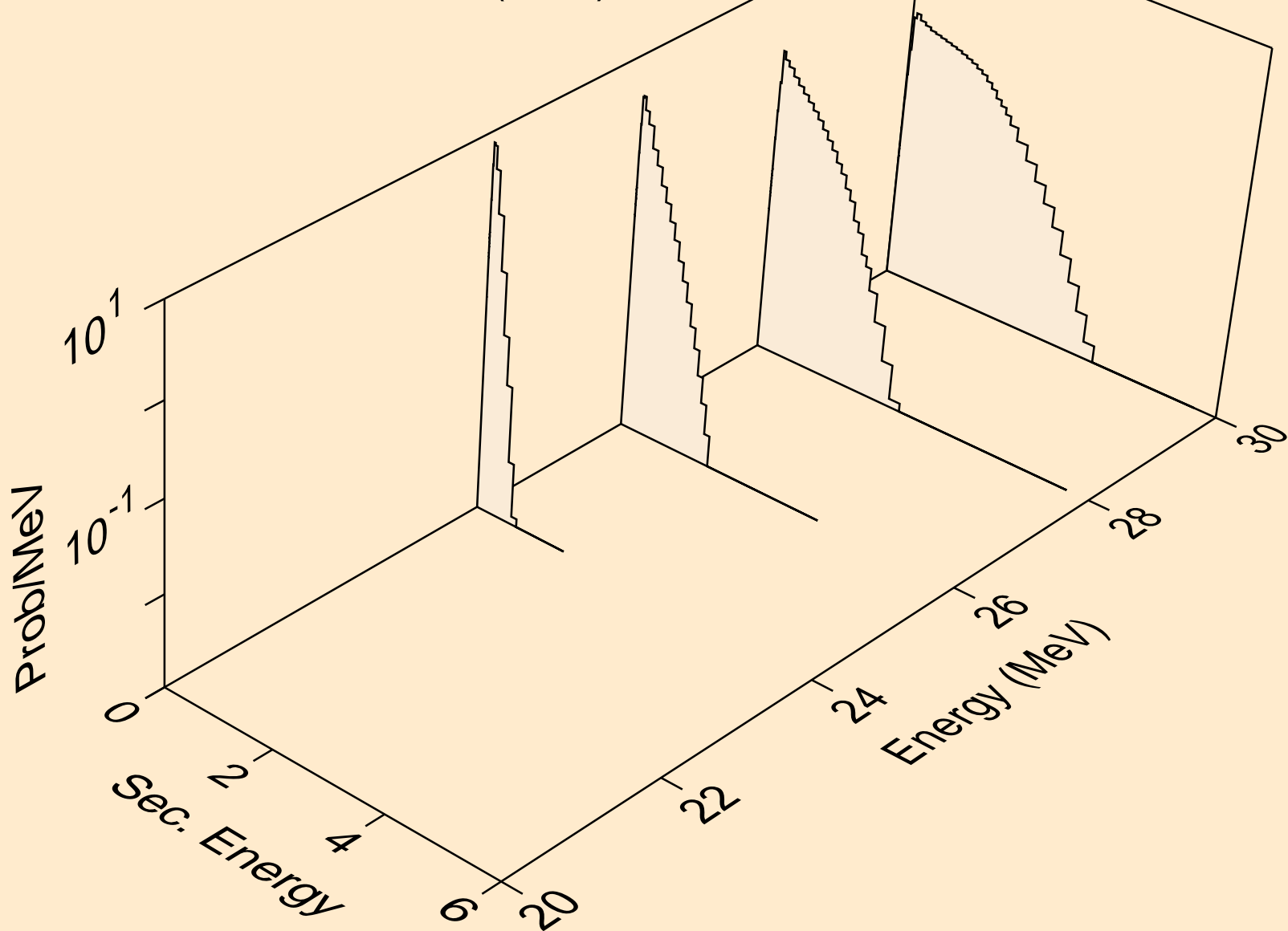

TI050 NEUTRON ACER TENDL-2024 LIBRARY; T=0.K
Neutron emission for (n,n*)p

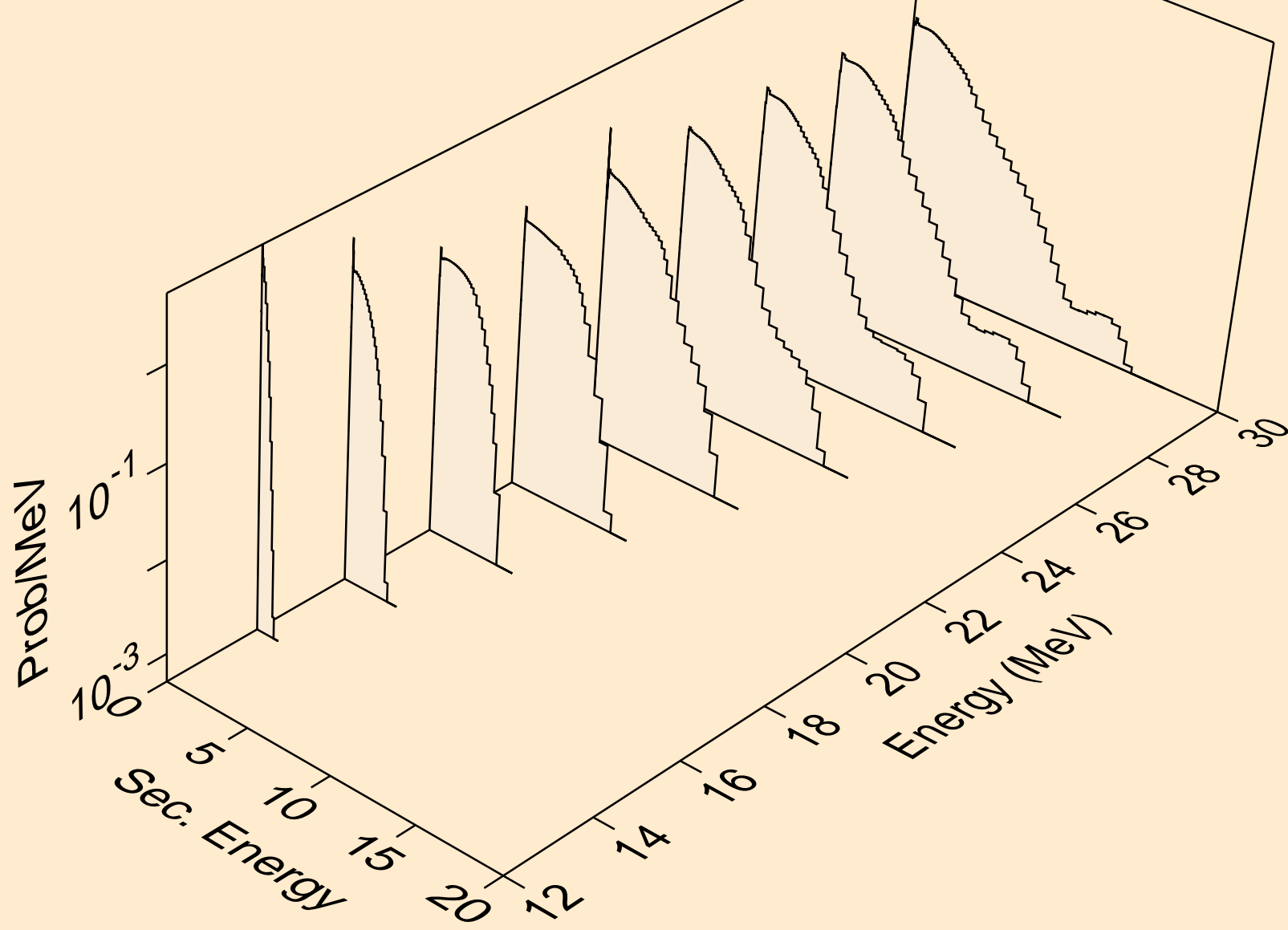

TI050 NEUTRON ACER TENDL-2024 LIBRARY; T=0.K
Neutron emission for (n,n*)d

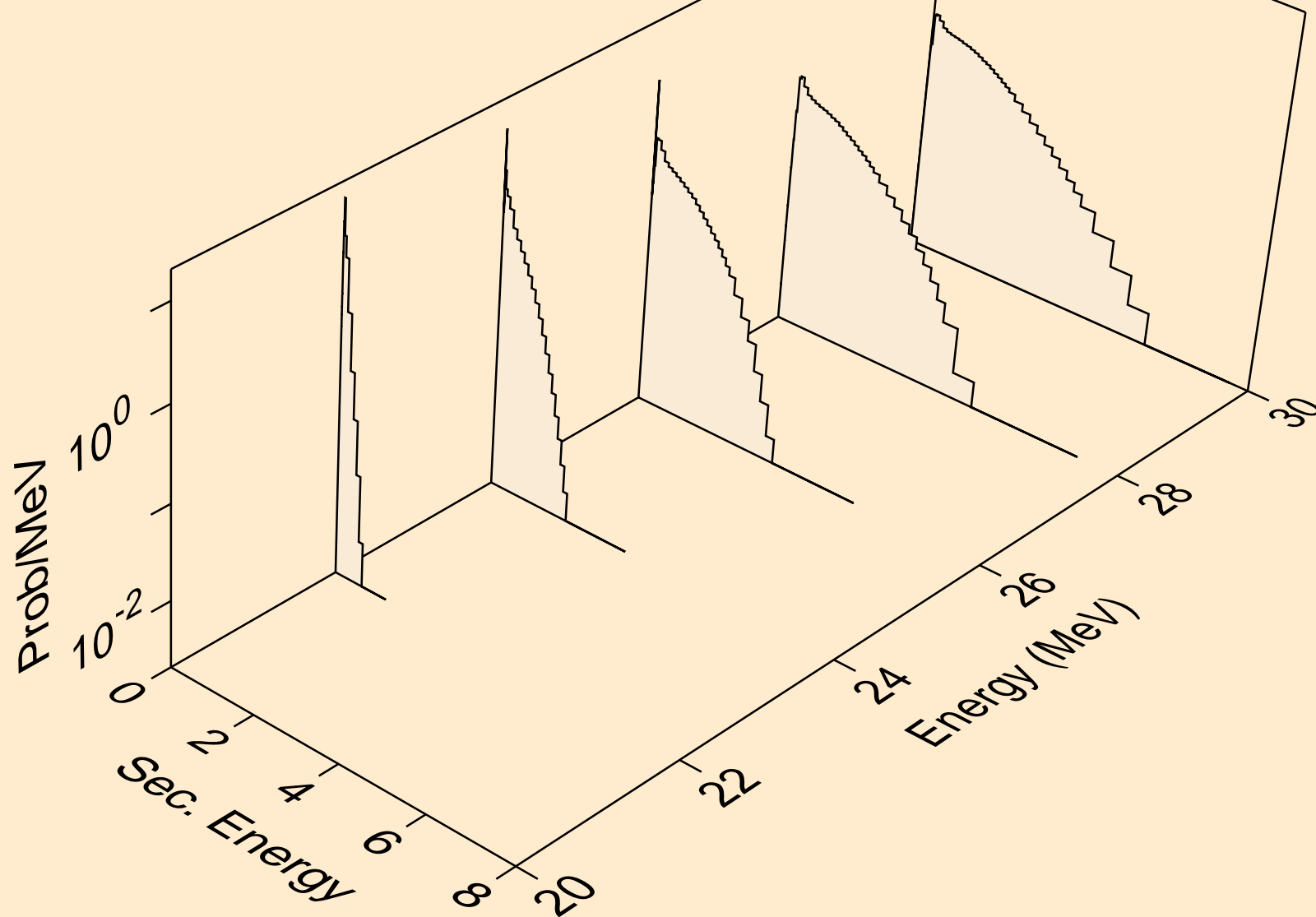

TI050 NEUTRON ACER TENDL-2024 LIBRARY; T=0.K
Neutron emission for (n,n*)t

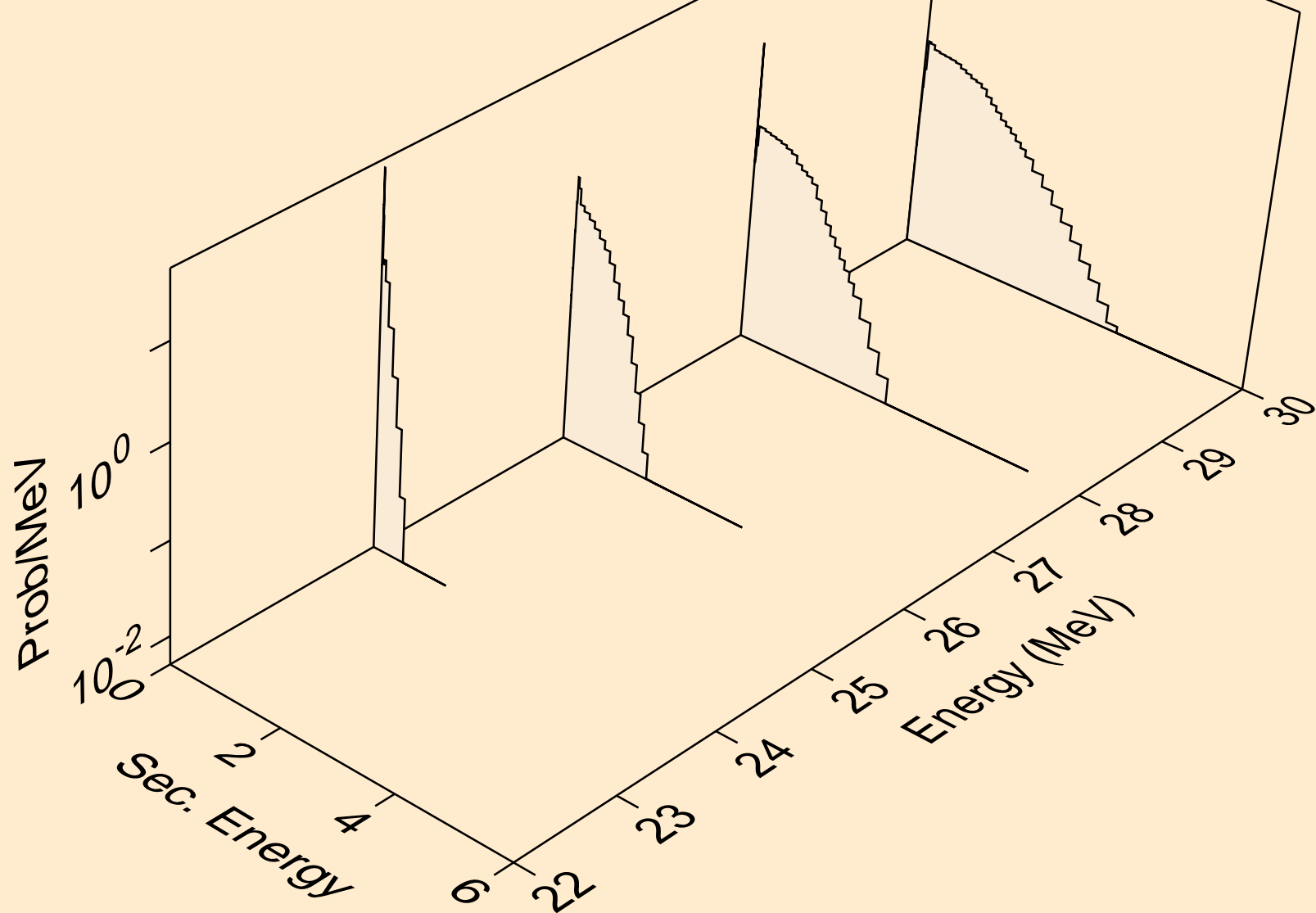

TI050 NEUTRON ACER TENDL-2024 LIBRARY; T=0.K
Neutron emission for (n,n*)he3

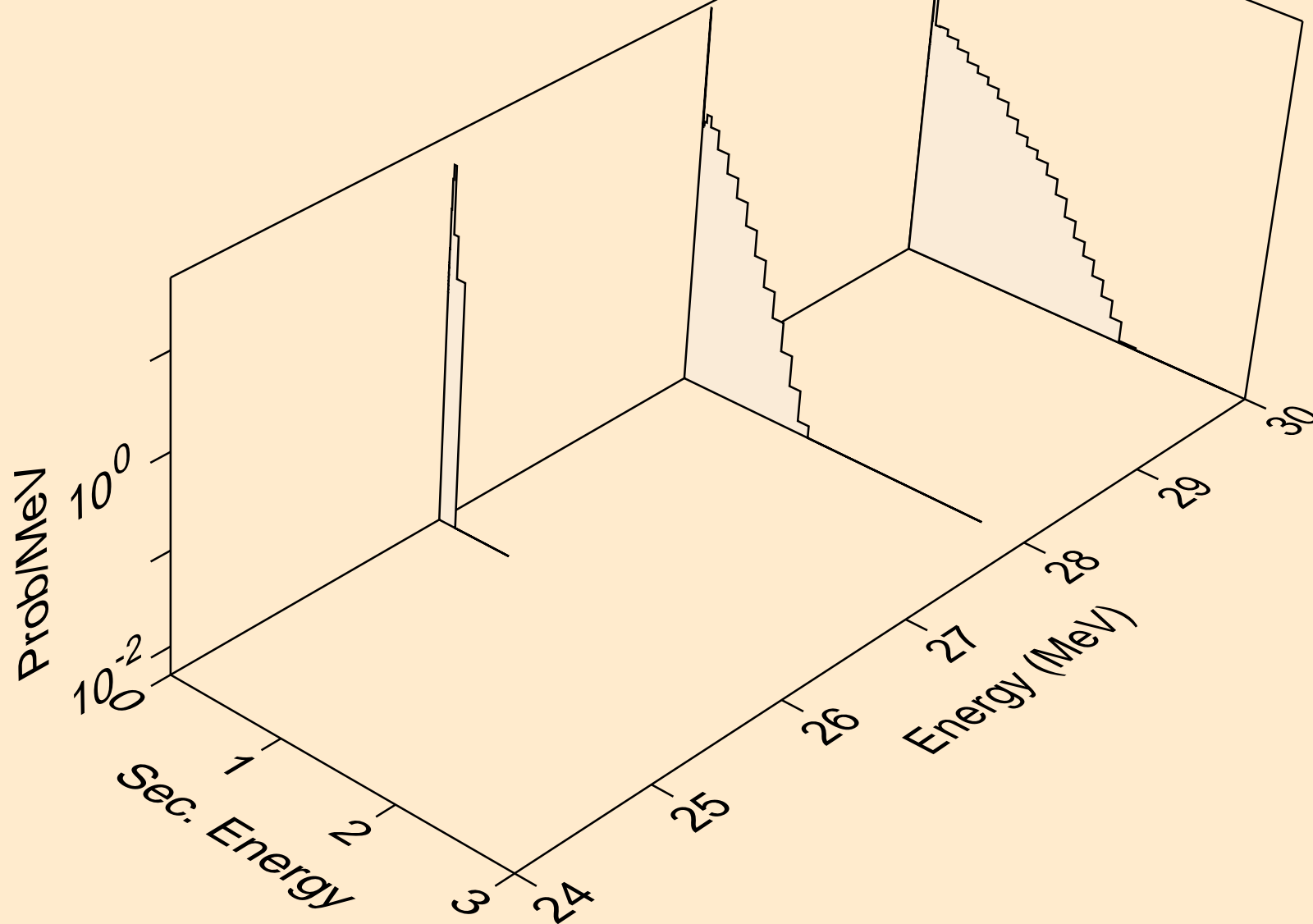

TI050 NEUTRON ACER TENDL-2024 LIBRARY; T=0.K
Neutron emission for (n,2np)

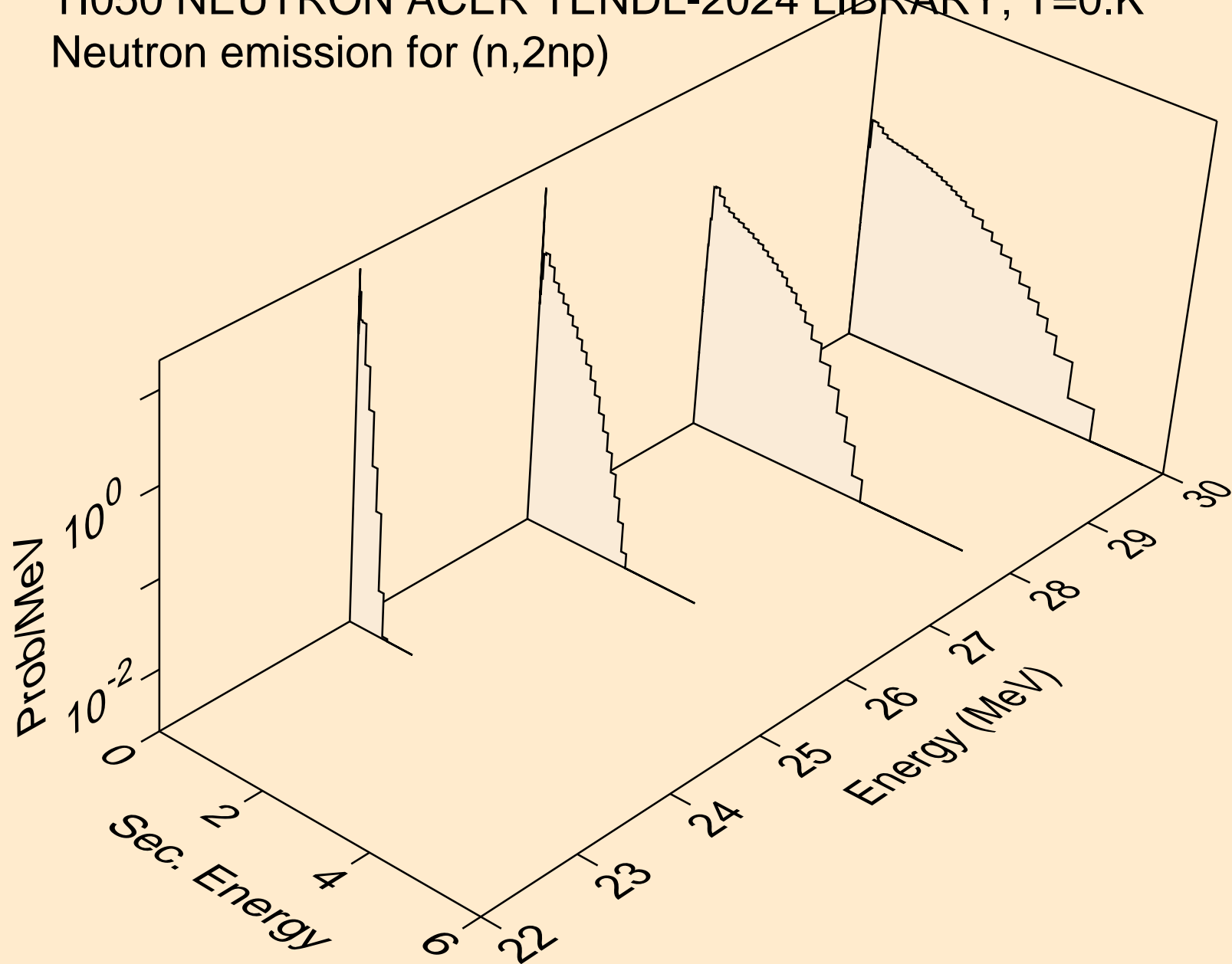

TI050 NEUTRON ACER TENDL-2024 LIBRARY; T=0.K
Neutron emission for (n,n2p)

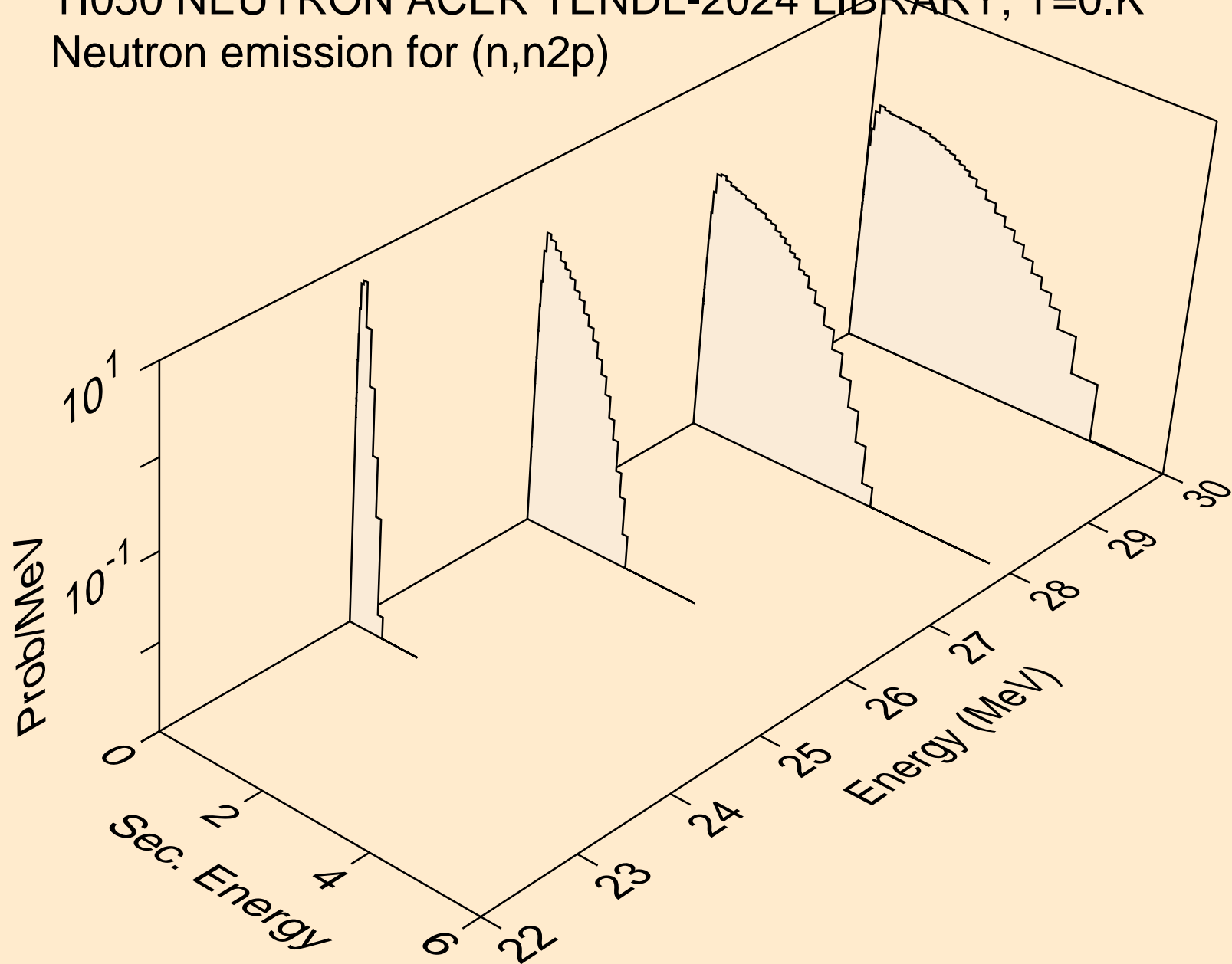

TI050 NEUTRON ACER TENDL-2024 LIBRARY; T=0.K
Neutron emission for (n,n*c)

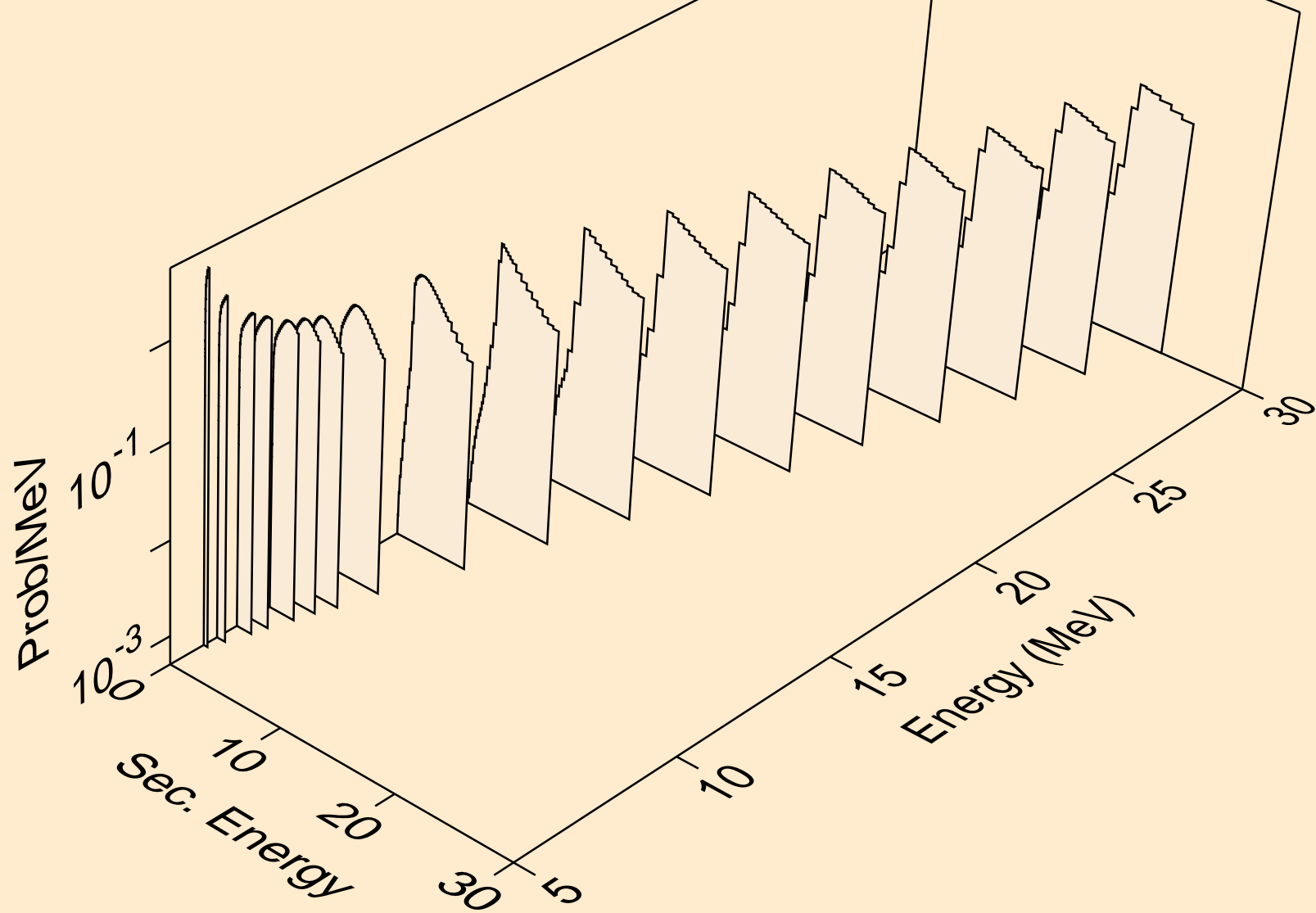

TI050 NEUTRON ACER TENDL-2024 LIBRARY; T=0.K
Photon emission for (n,x)

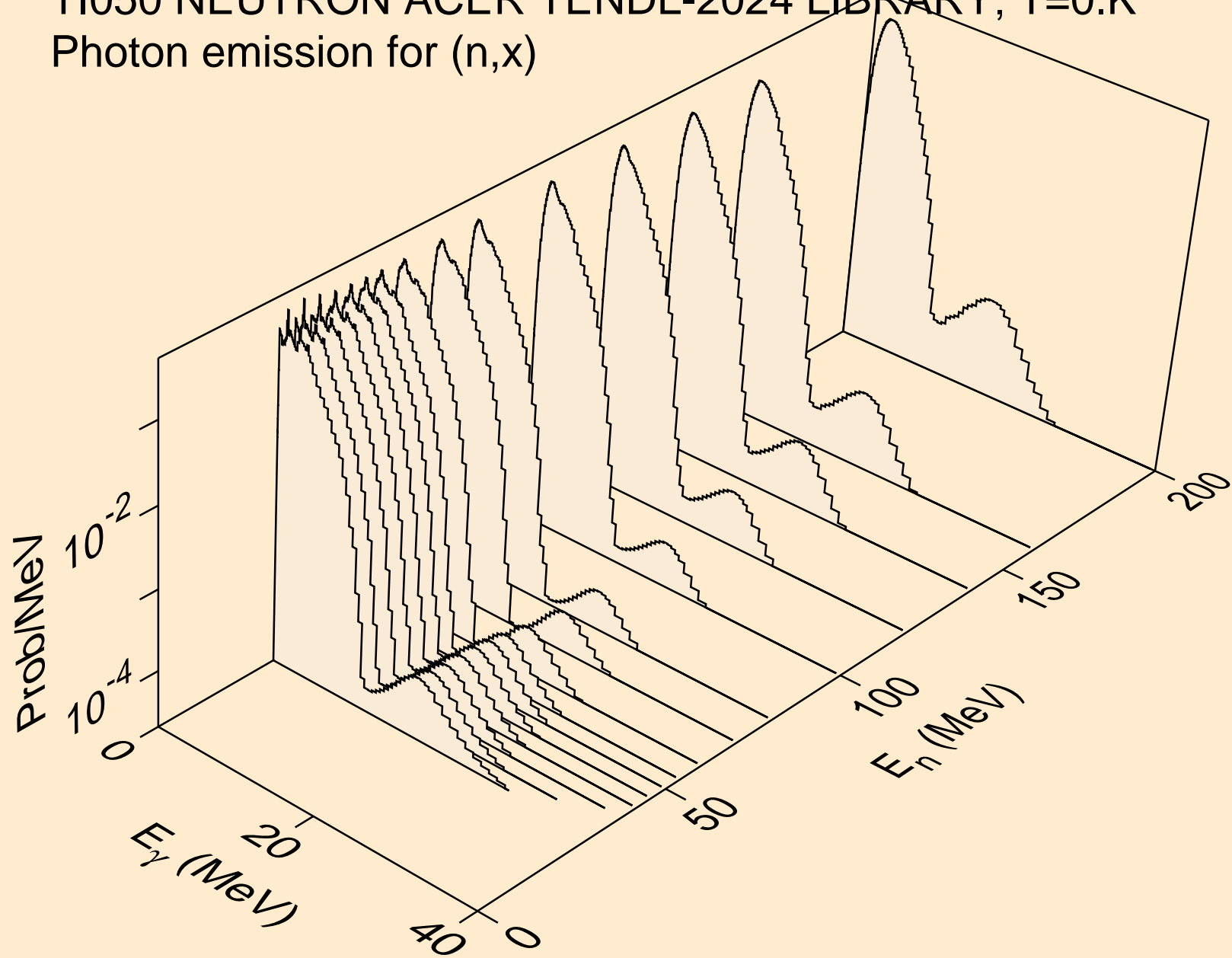

TI050 NEUTRON ACER TENDL-2024 LIBRARY; T=0.K
Photon emission for (n,2n)

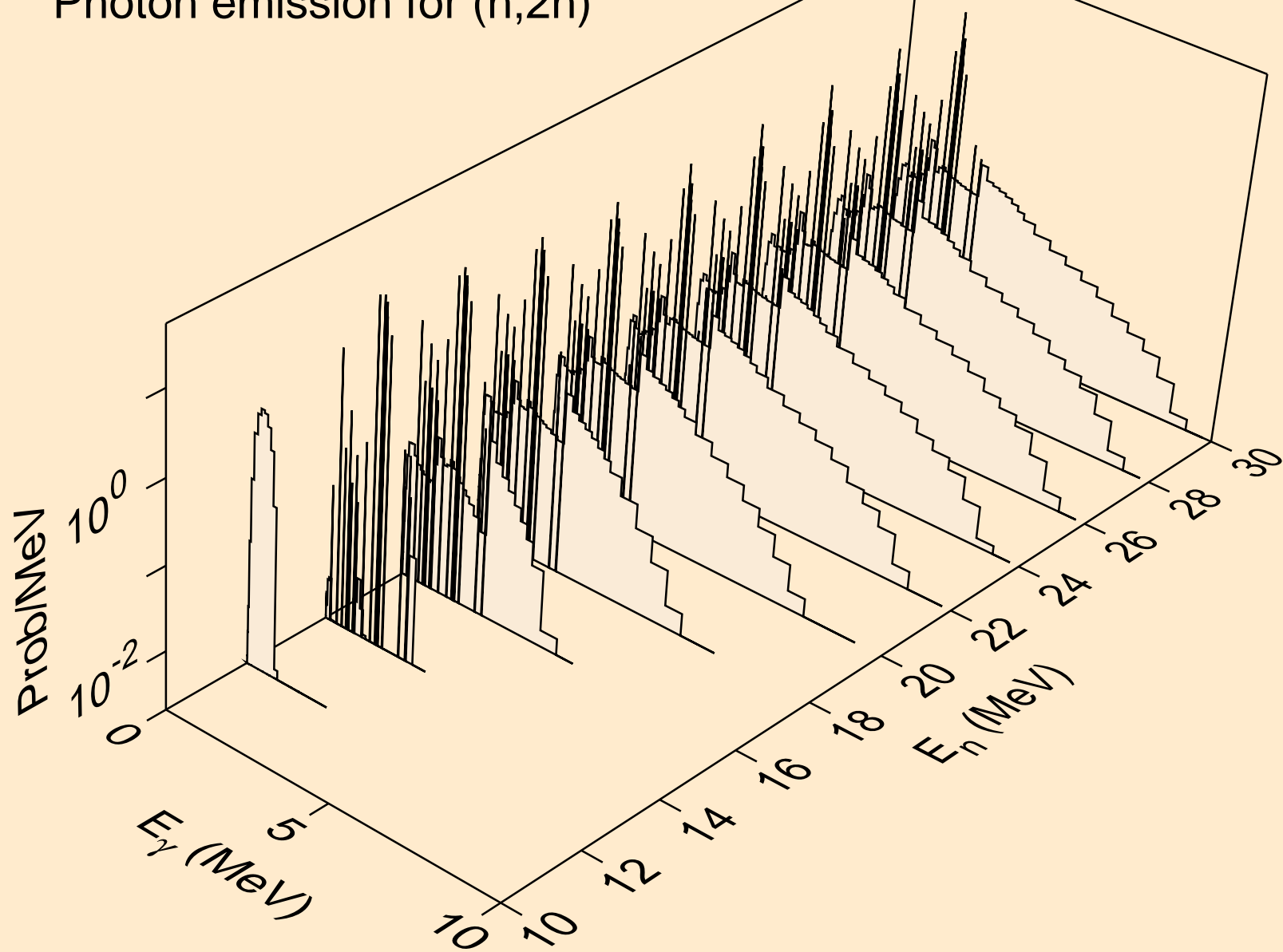

TI050 NEUTRON ACER TENDL-2024 LIBRARY; T=0.K
Photon emission for (n,3n)

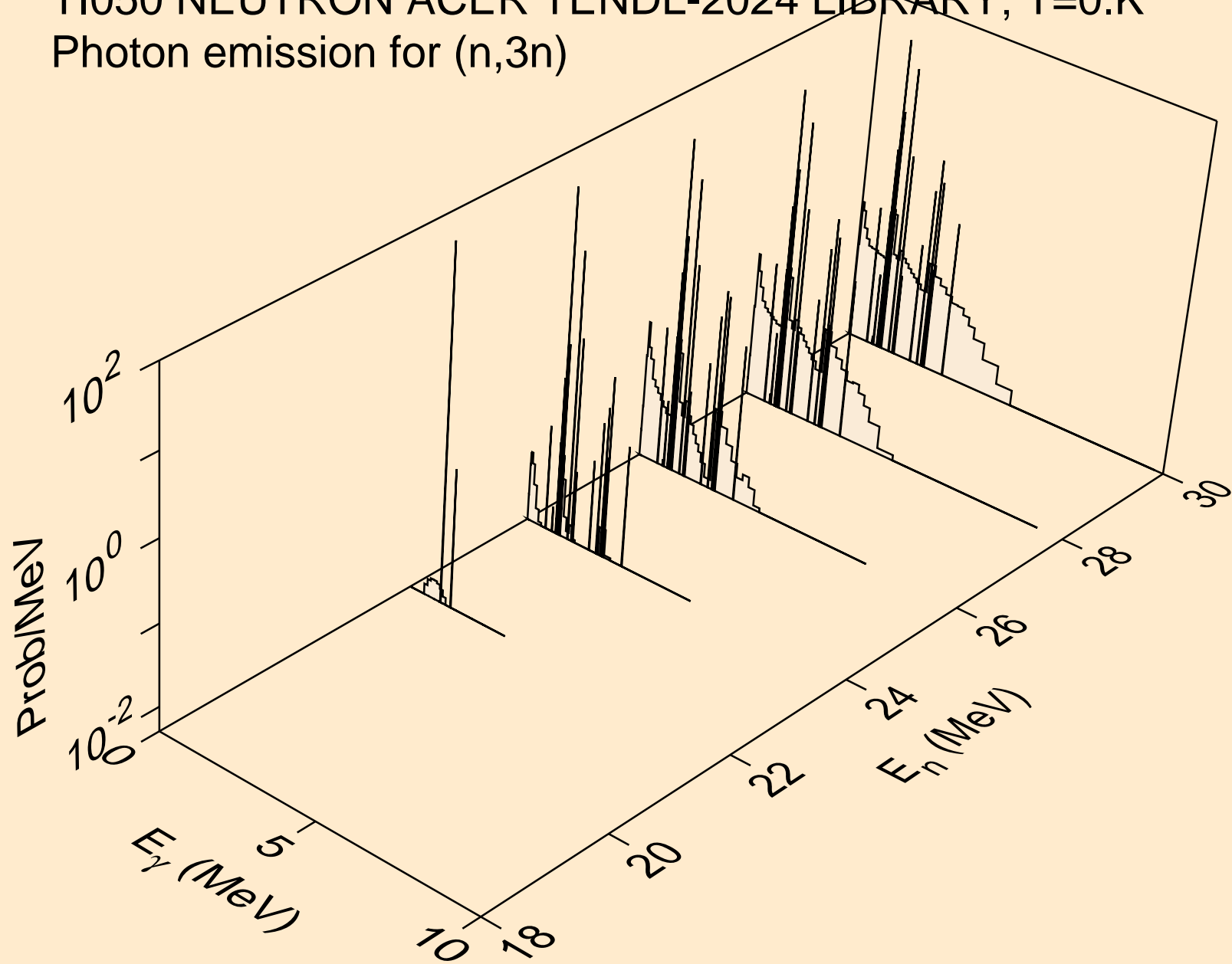

TI050 NEUTRON ACER TENDL-2024 LIBRARY; T=0.K
Photon emission for (n,n*)a

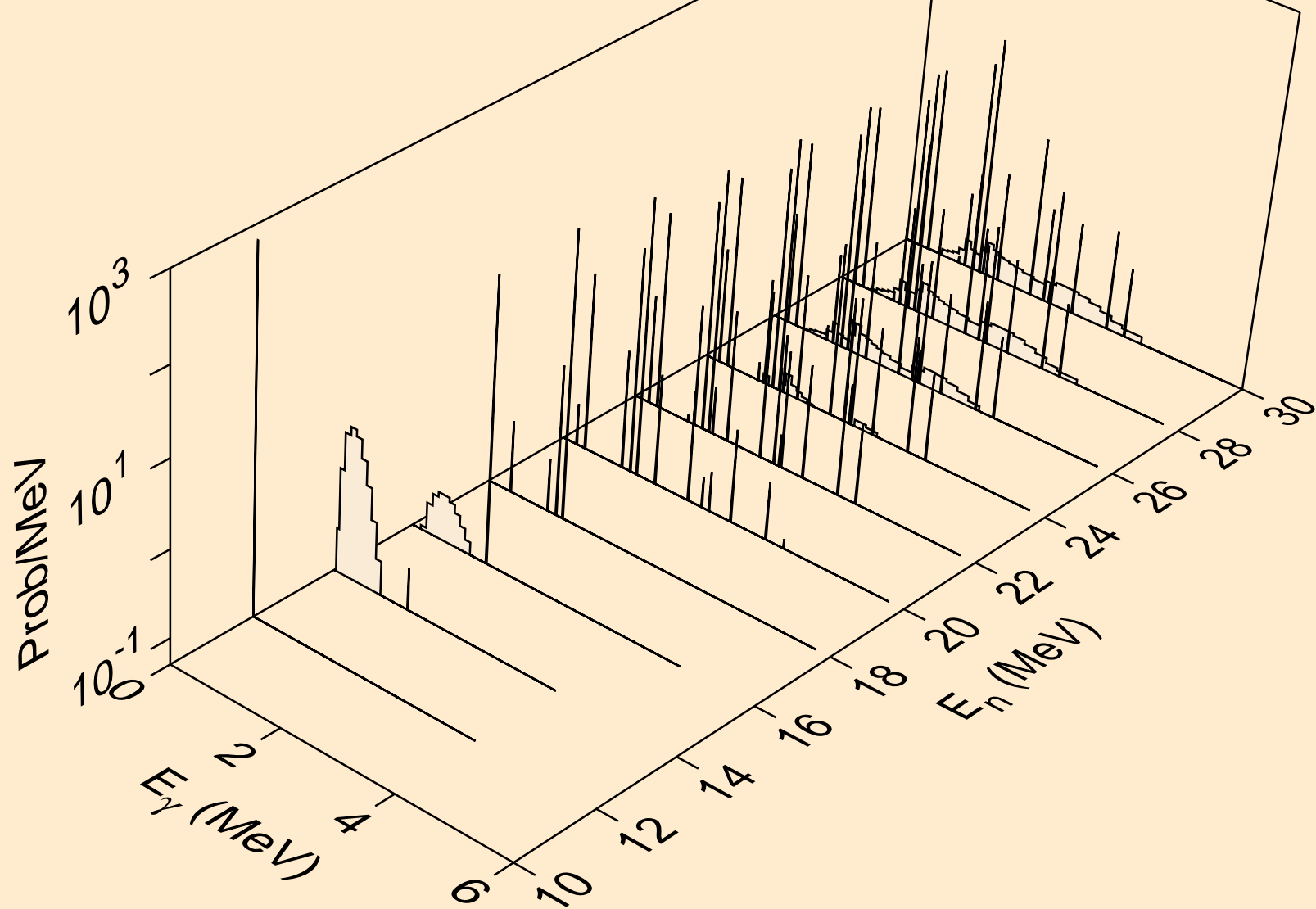

TI050 NEUTRON ACER TENDL-2024 LIBRARY; T=0.K
Photon emission for (n,2n)a

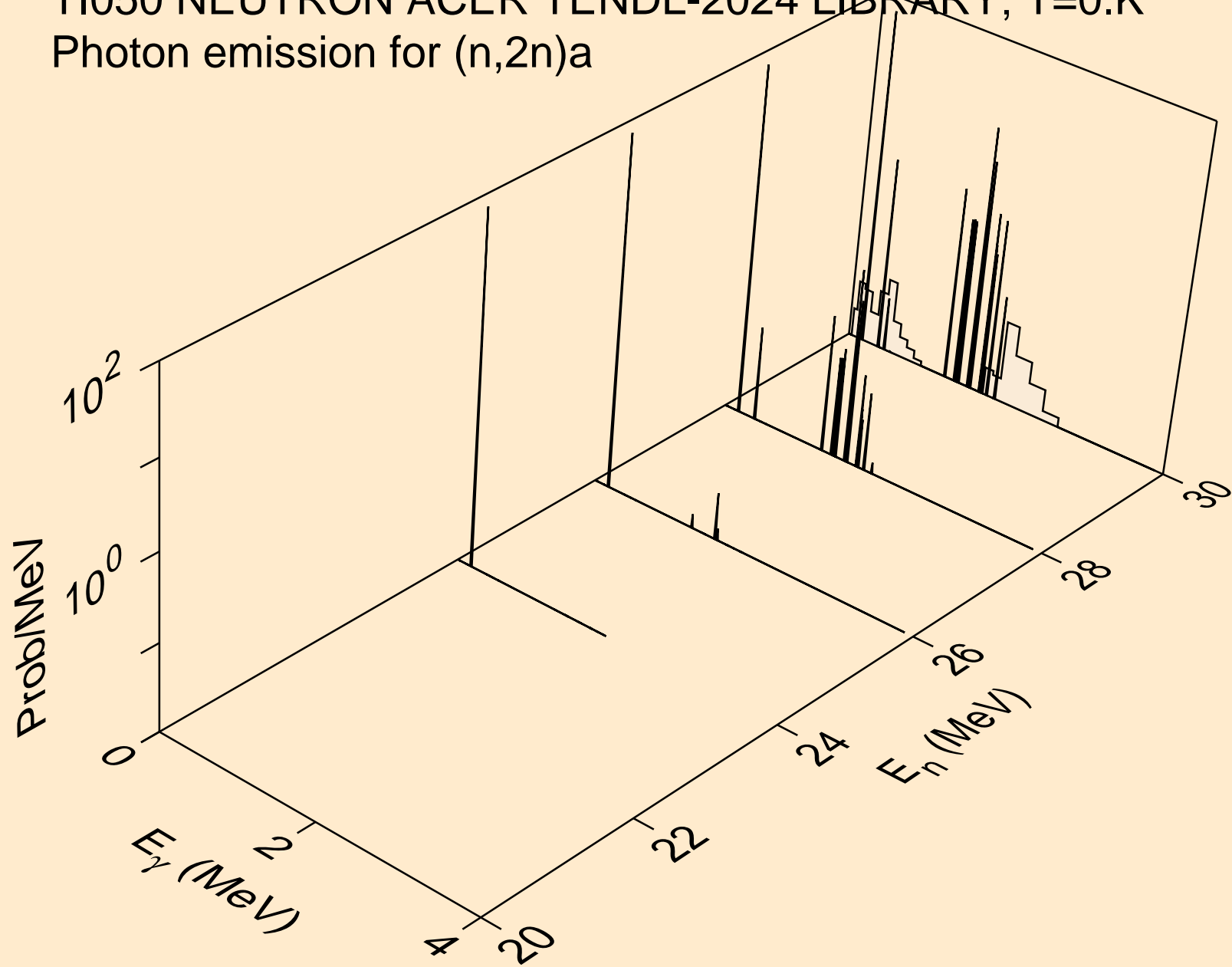

TI050 NEUTRON ACER TENDL-2024 LIBRARY; T=0.K
Photon emission for (n,n*)p

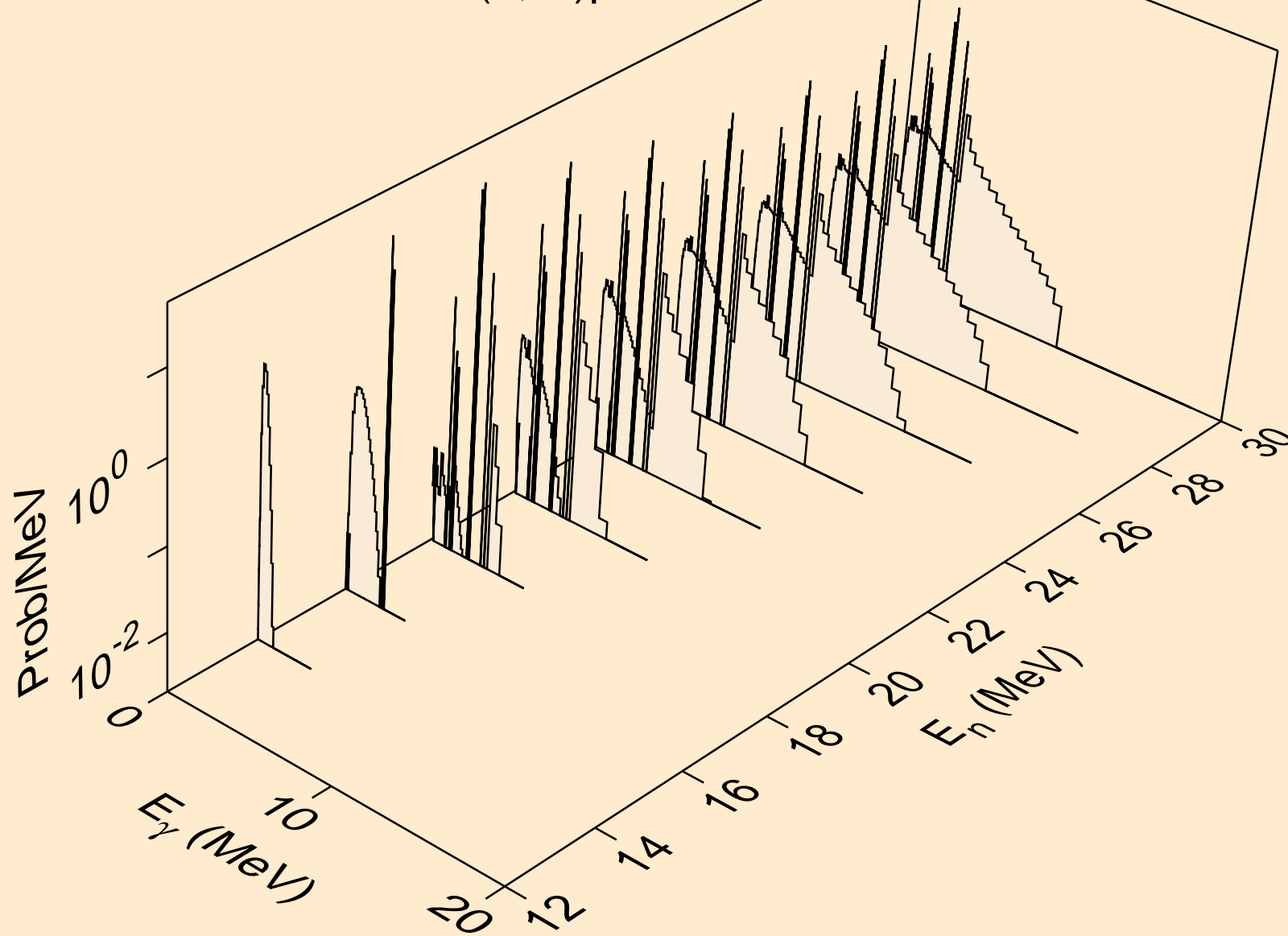

TI050 NEUTRON ACER TENDL-2024 LIBRARY; T=0.K
Photon emission for (n,n*)d

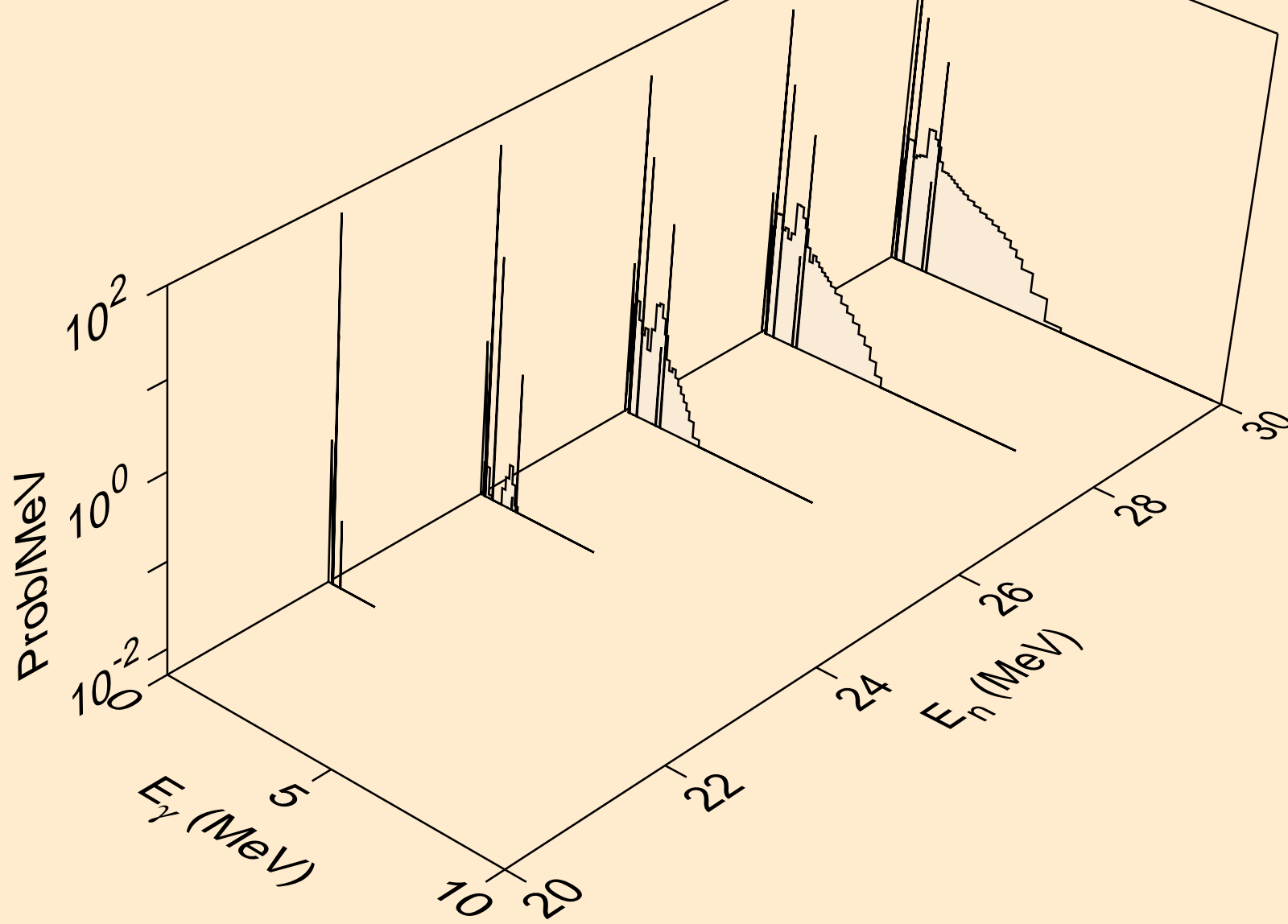

TI050 NEUTRON ACER TENDL-2024 LIBRARY; T=0.K
Photon emission for (n,n*)t

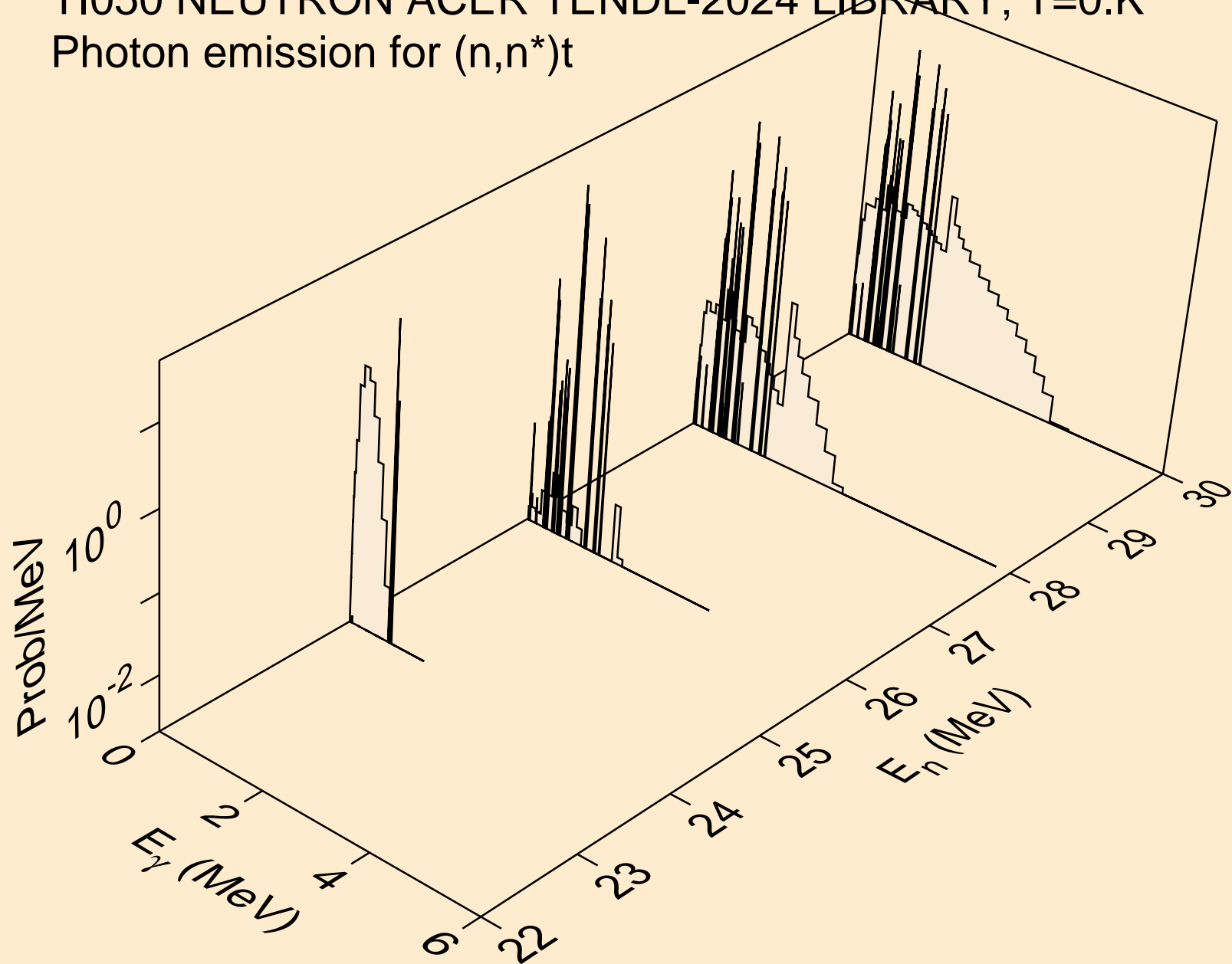

TI050 NEUTRON ACER TENDL-2024 LIBRARY; T=0.K
Photon emission for (n,n*)he3

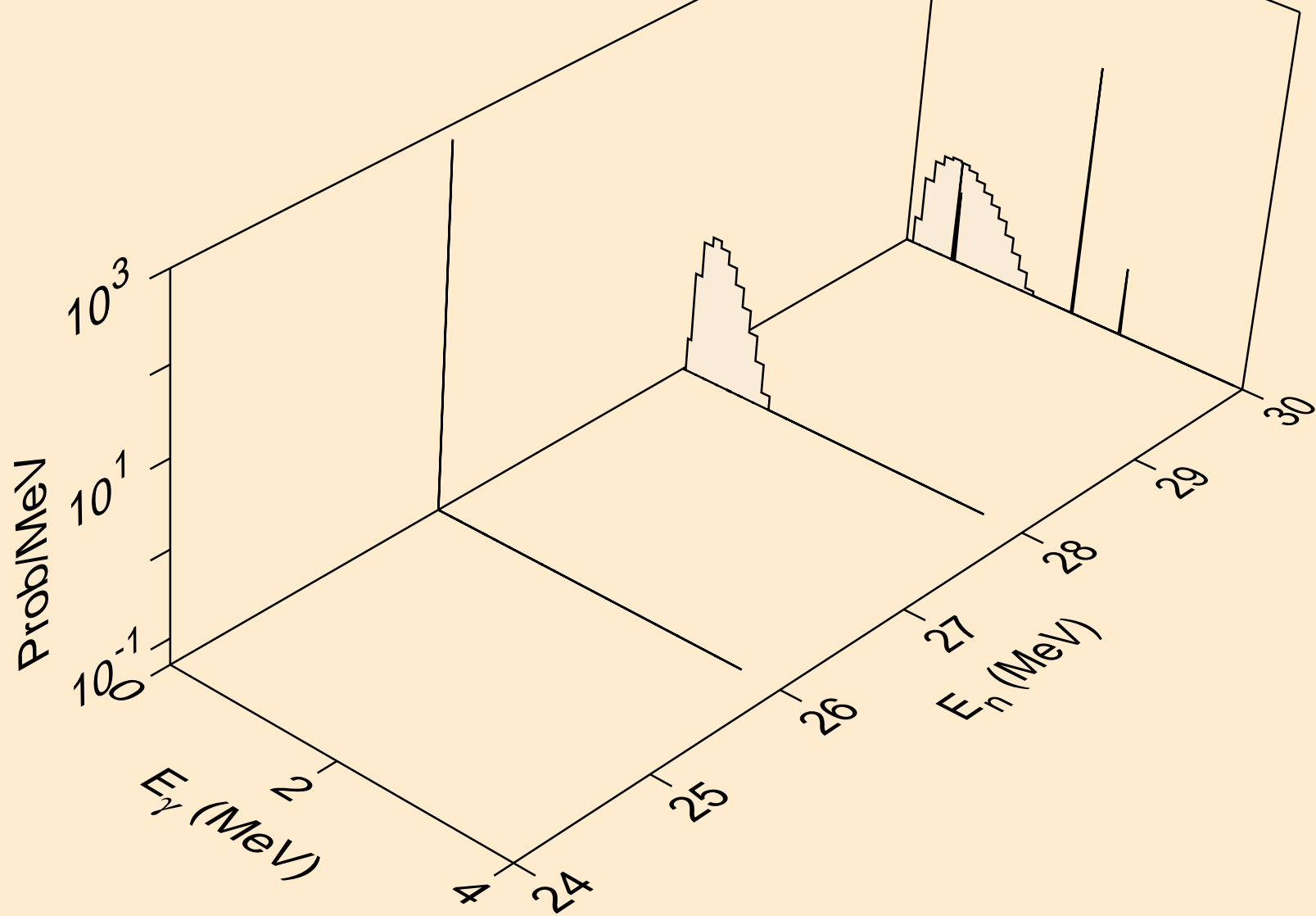

TI050 NEUTRON ACER TENDL-2024 LIBRARY; T=0.K
Photon emission for (n,2np)

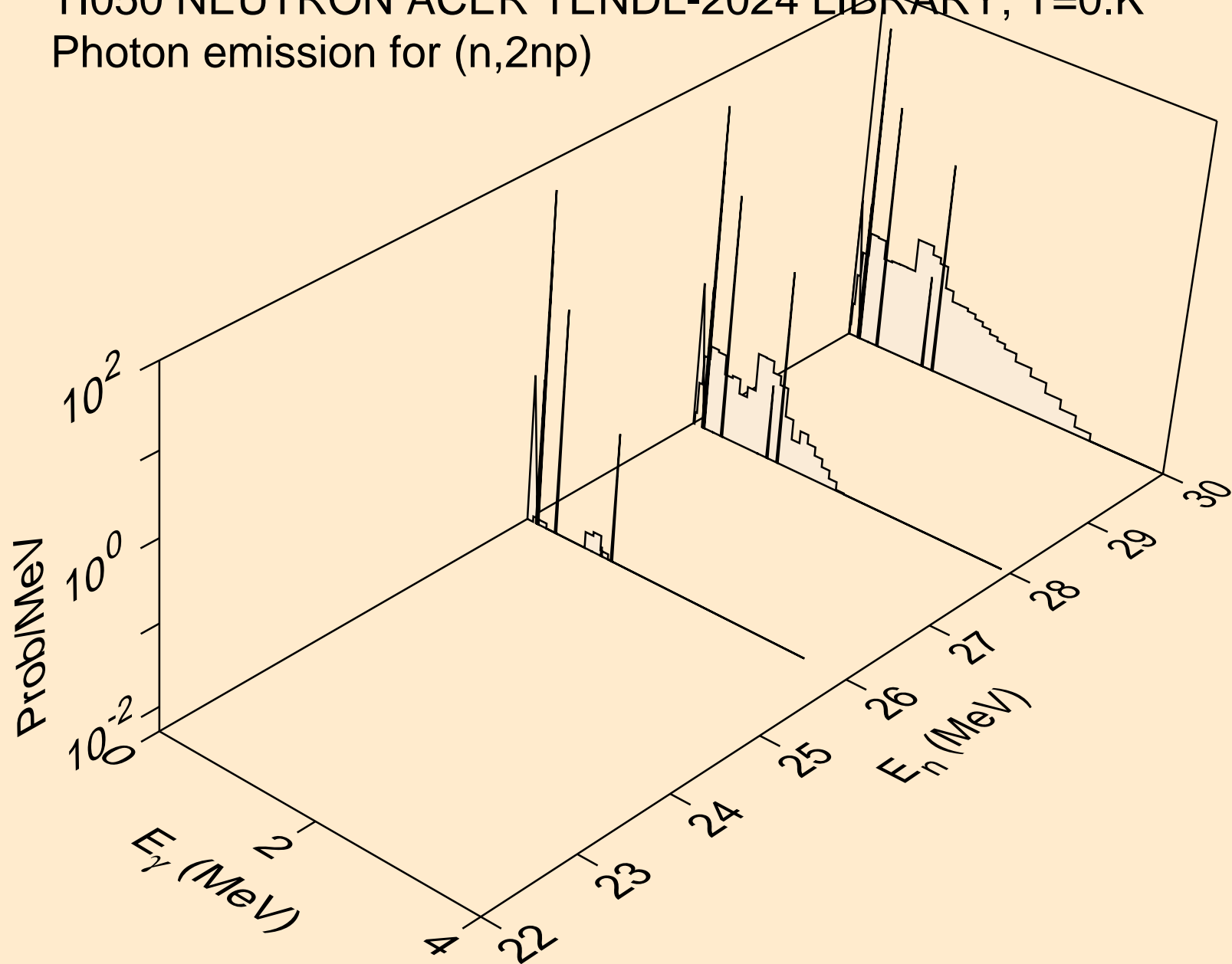

TI050 NEUTRON ACER TENDL-2024 LIBRARY; T=0.K
Photon emission for (n,n2p)

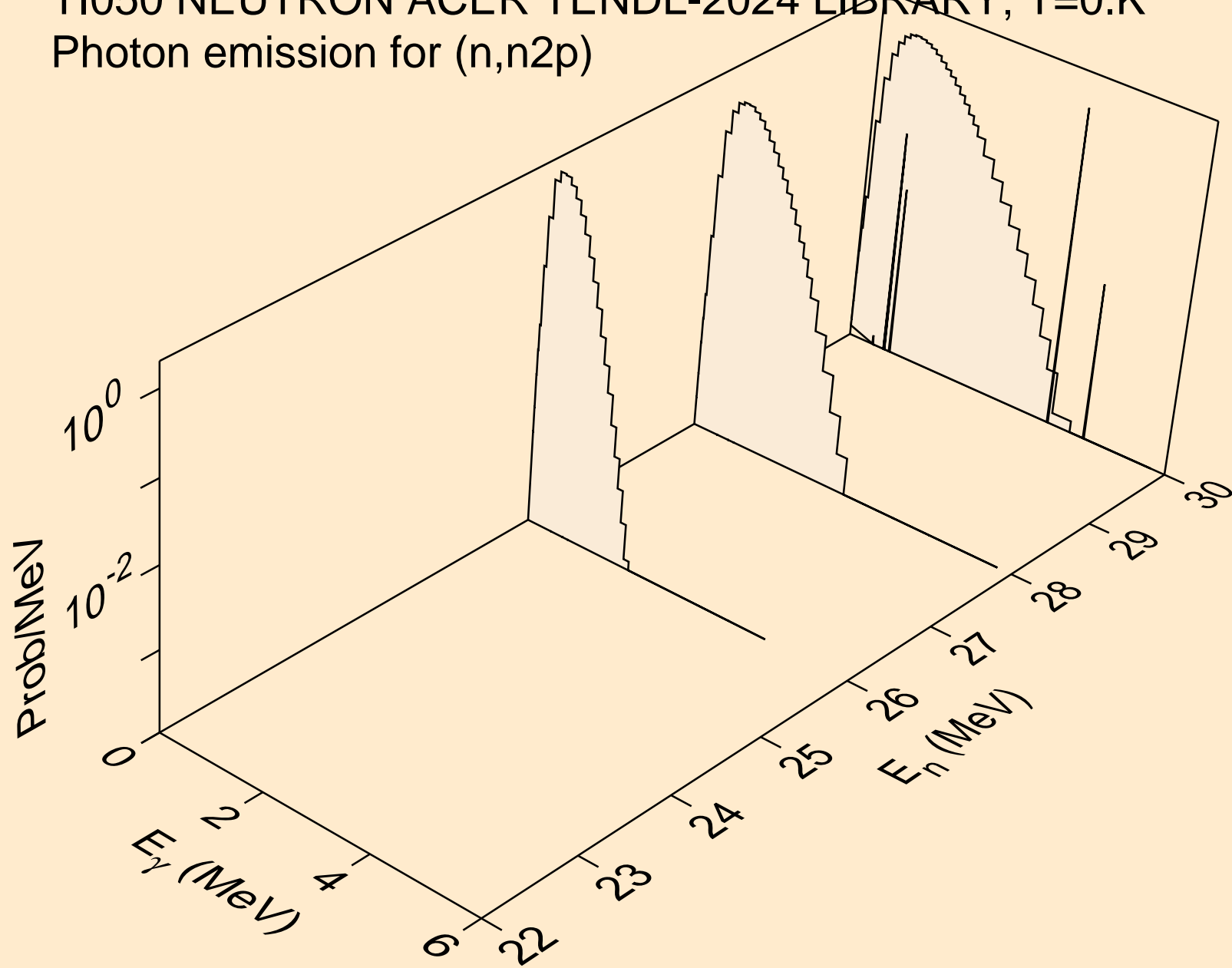

TI050 NEUTRON ACER TENDL-2024 LIBRARY; T=0.K
Photon emission for (n,n*c)

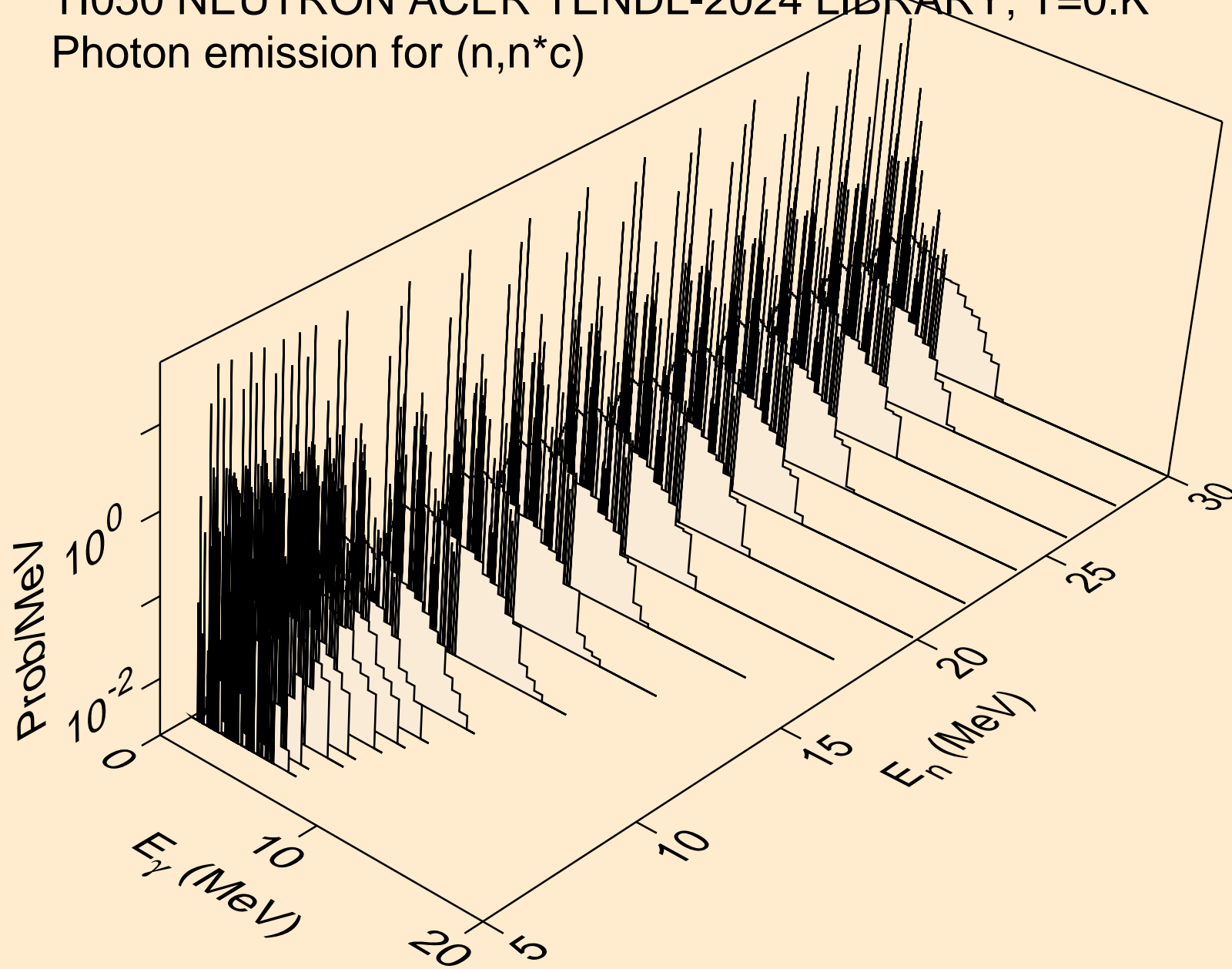

TI050 NEUTRON ACER TENDL-2024 LIBRARY; T=0.K
Photon emission for (n,gma)

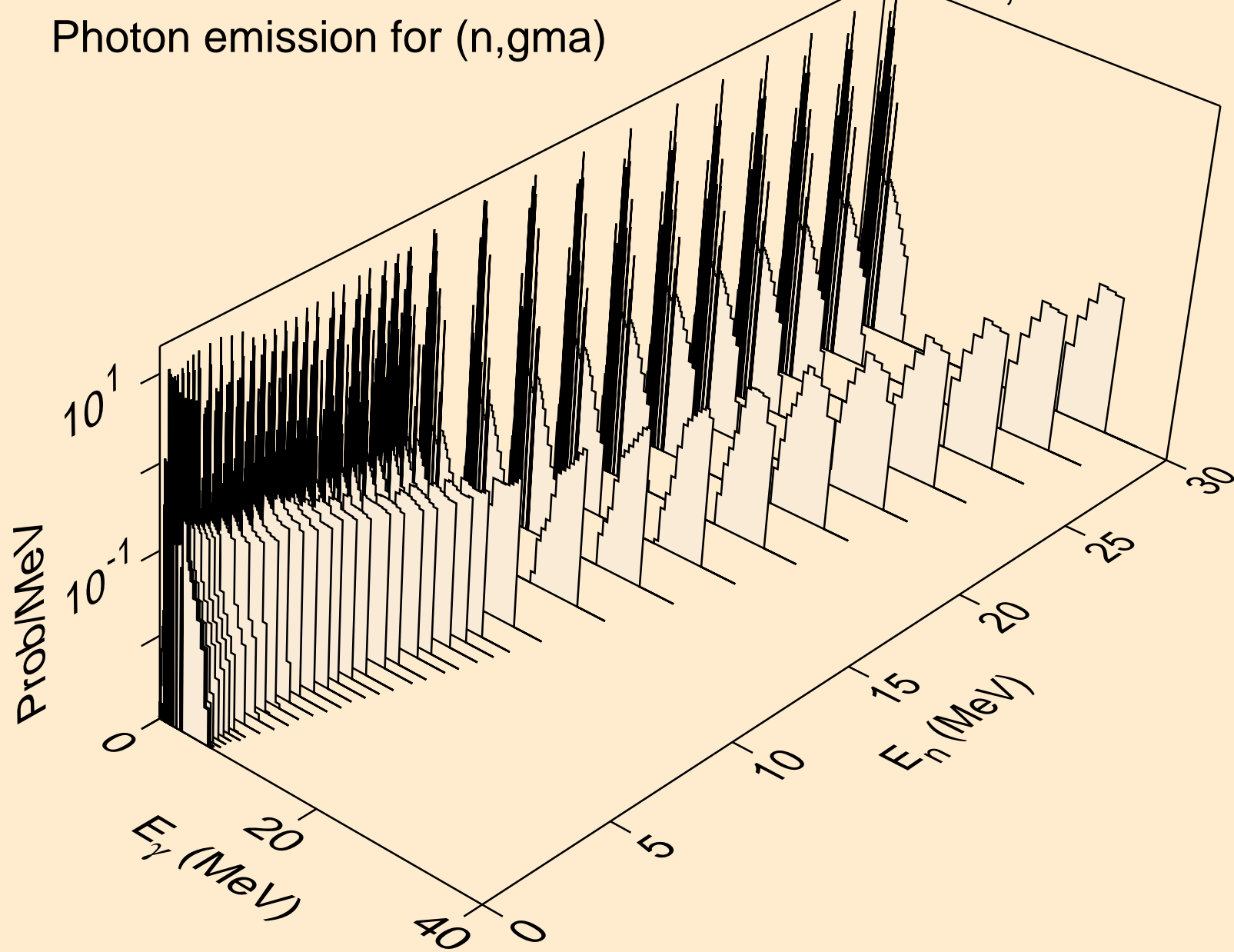

TI050 NEUTRON ACER TENDL-2024 LIBRARY; T=0.K
Photon emission for (n,p)

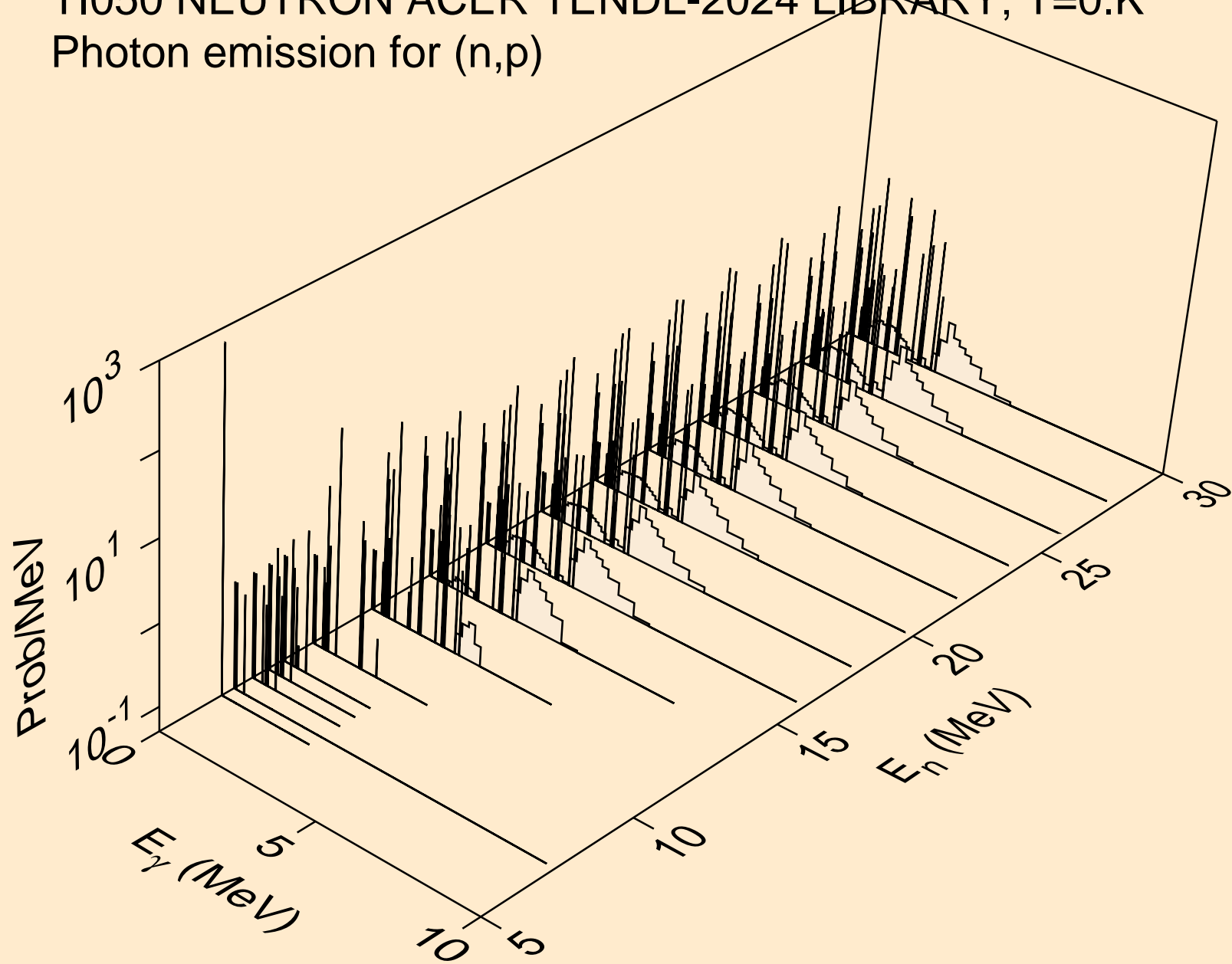

TI050 NEUTRON ACER TENDL-2024 LIBRARY; T=0.K
Photon emission for (n,d)

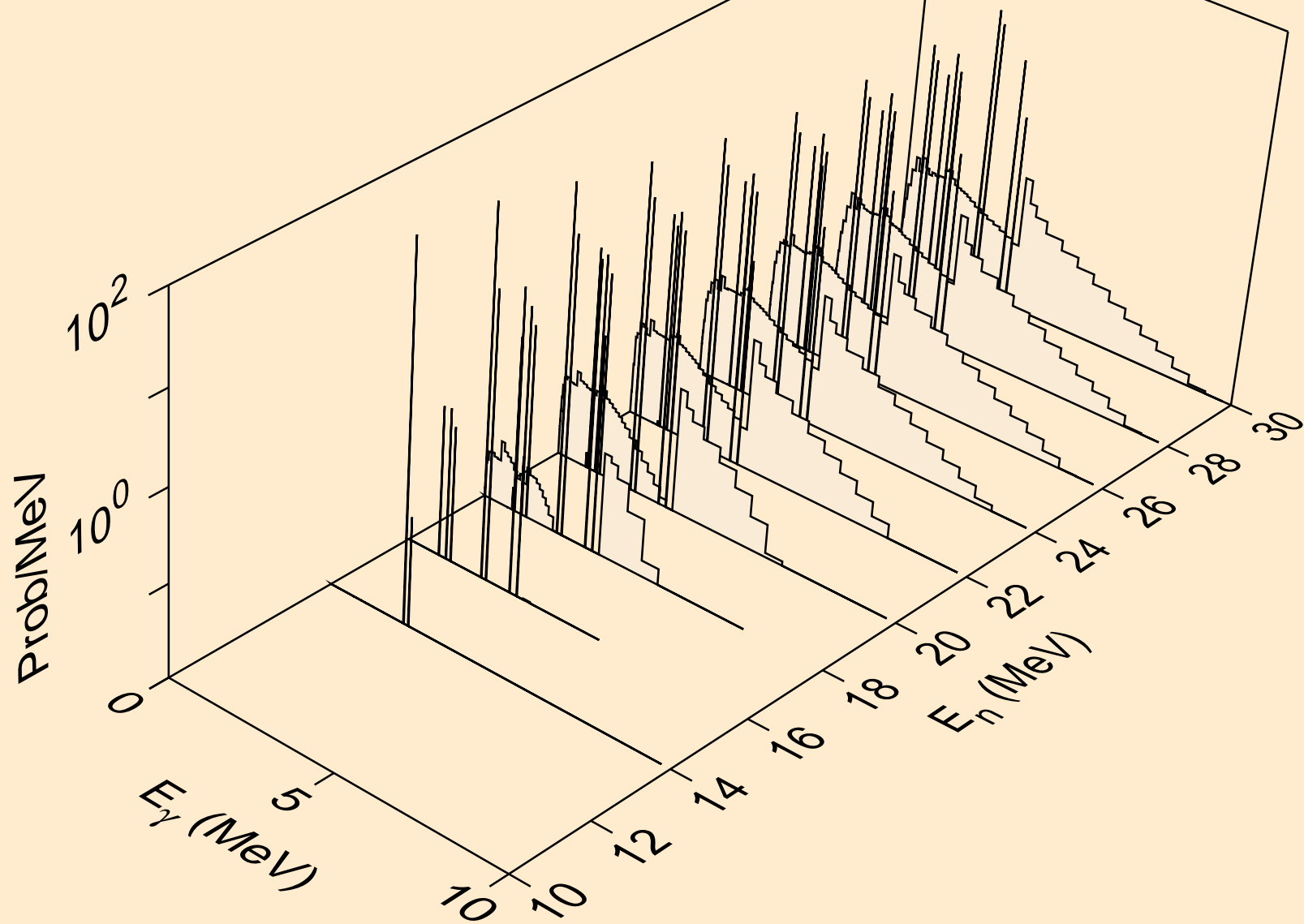

TI050 NEUTRON ACER TENDL-2024 LIBRARY; T=0.K
Photon emission for (n,t)

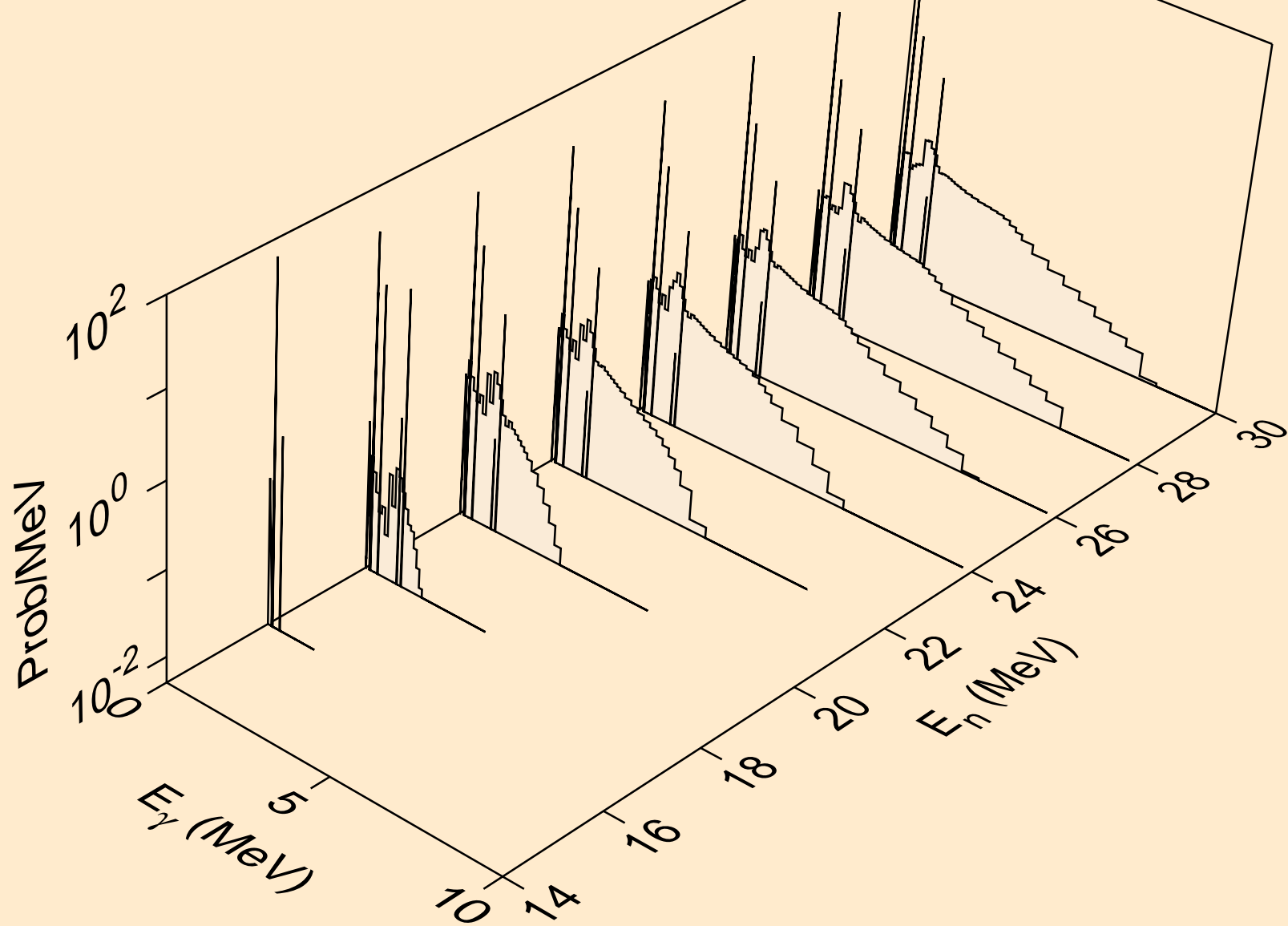

TI050 NEUTRON ACER TENDL-2024 LIBRARY; T=0.K
Photon emission for (n,he3)

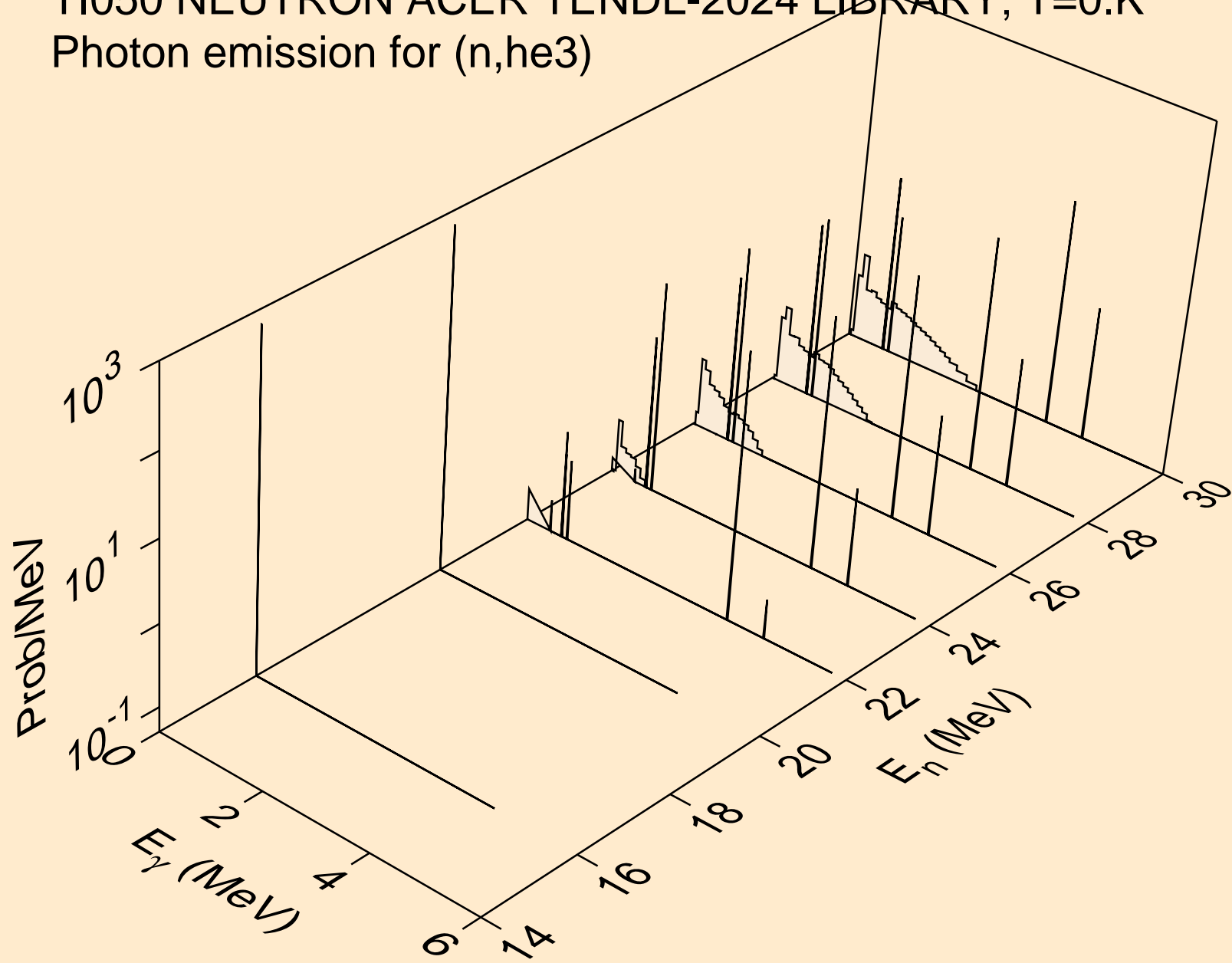

TI050 NEUTRON ACER TENDL-2024 LIBRARY; T=0.K
Photon emission for (n,a)

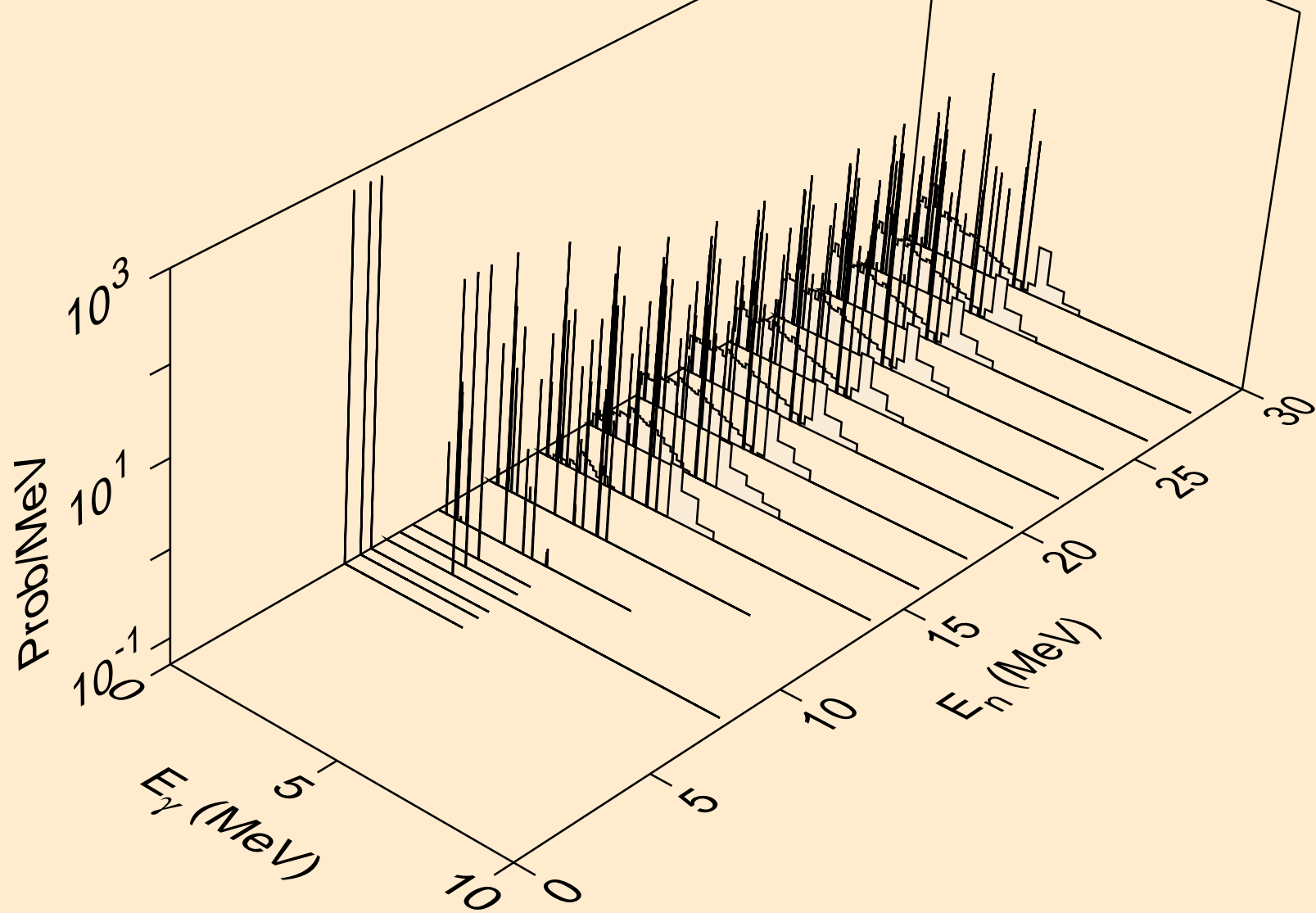

TI050 NEUTRON ACER TENDL-2024 LIBRARY; T=0.K
Photon emission for (n,2a)

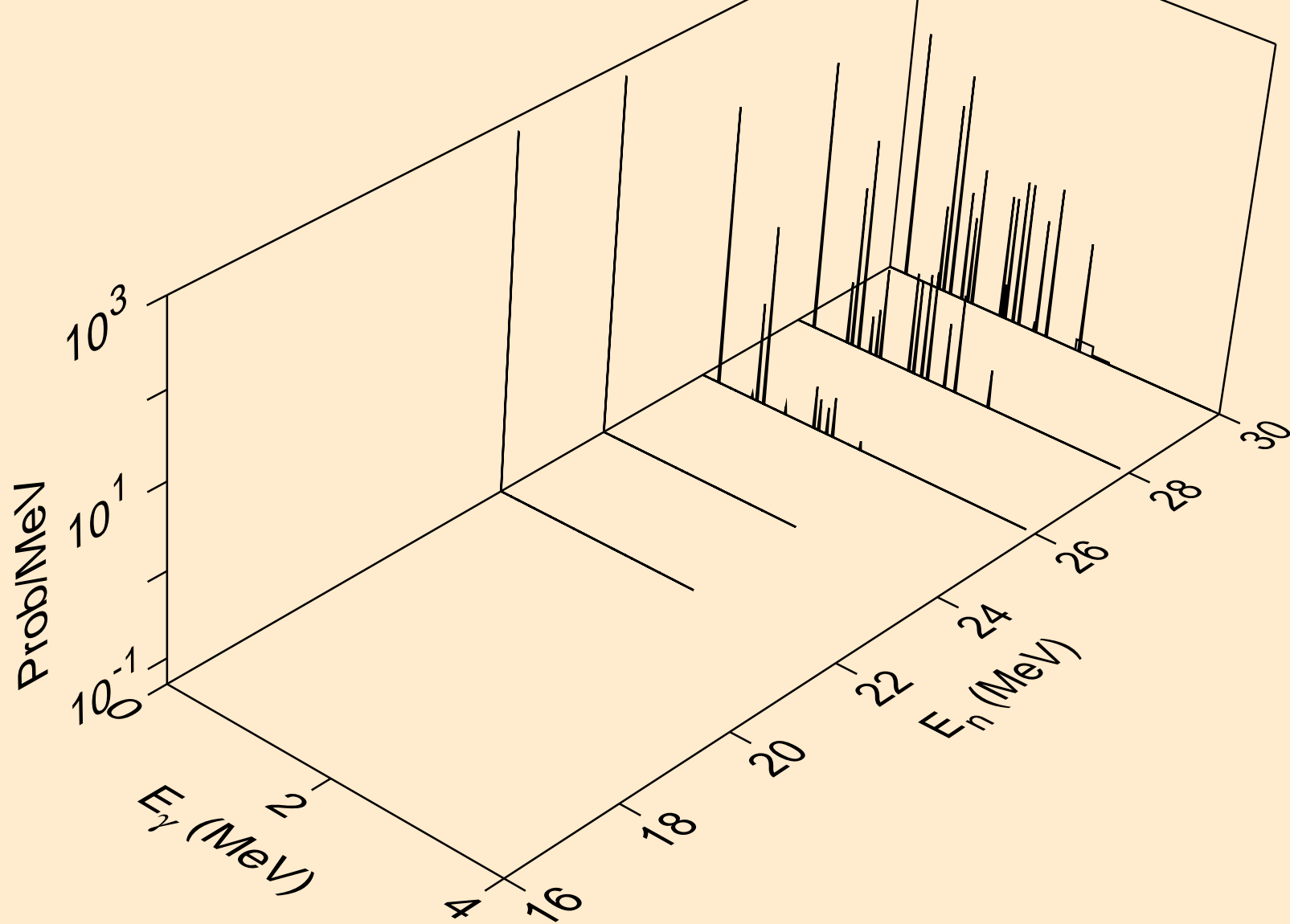

TI050 NEUTRON ACER TENDL-2024 LIBRARY; T=0.K
Photon emission for (n,2p)

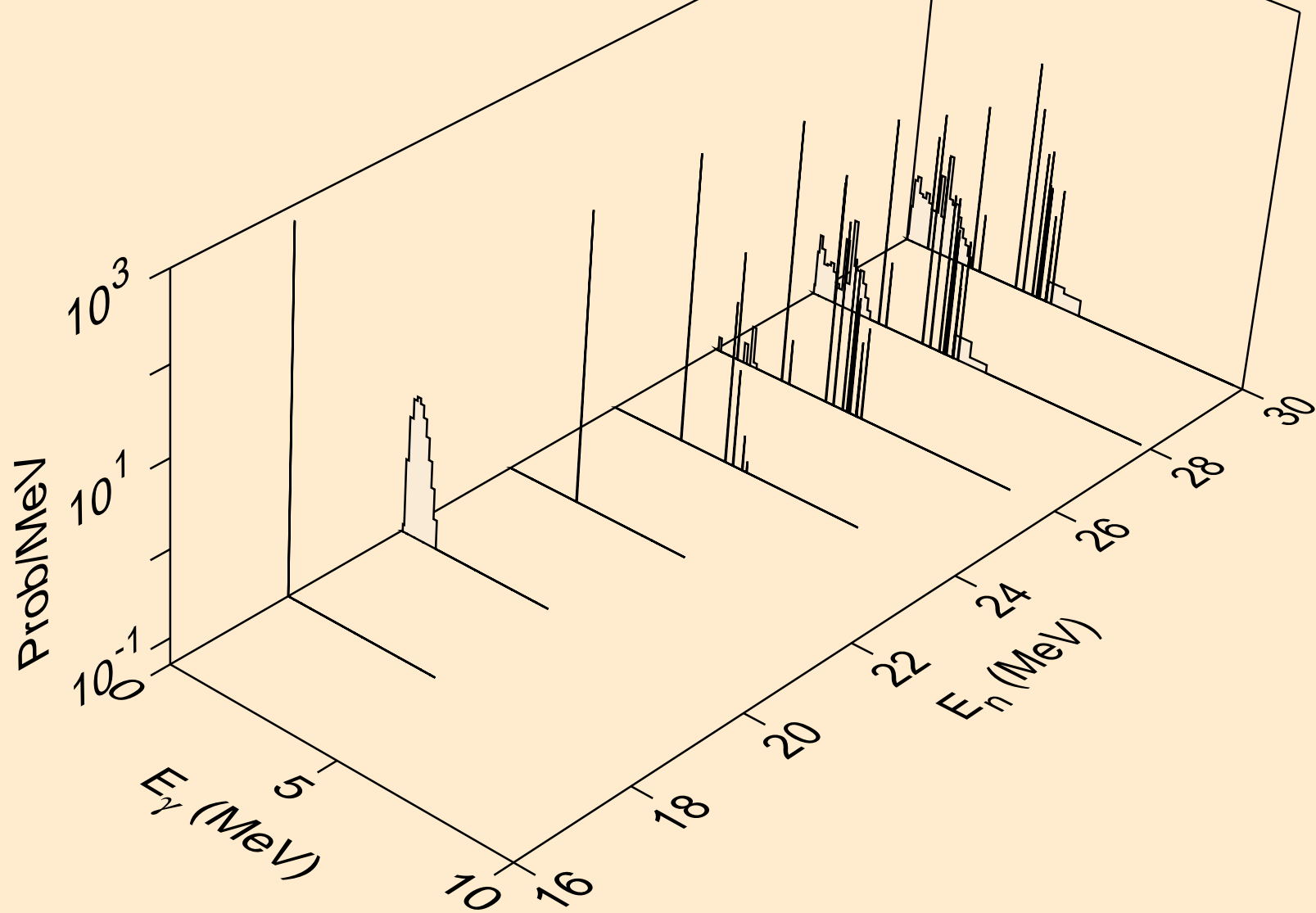

TI050 NEUTRON ACER TENDL-2024 LIBRARY; T=0.K
Photon emission for (n,p α)

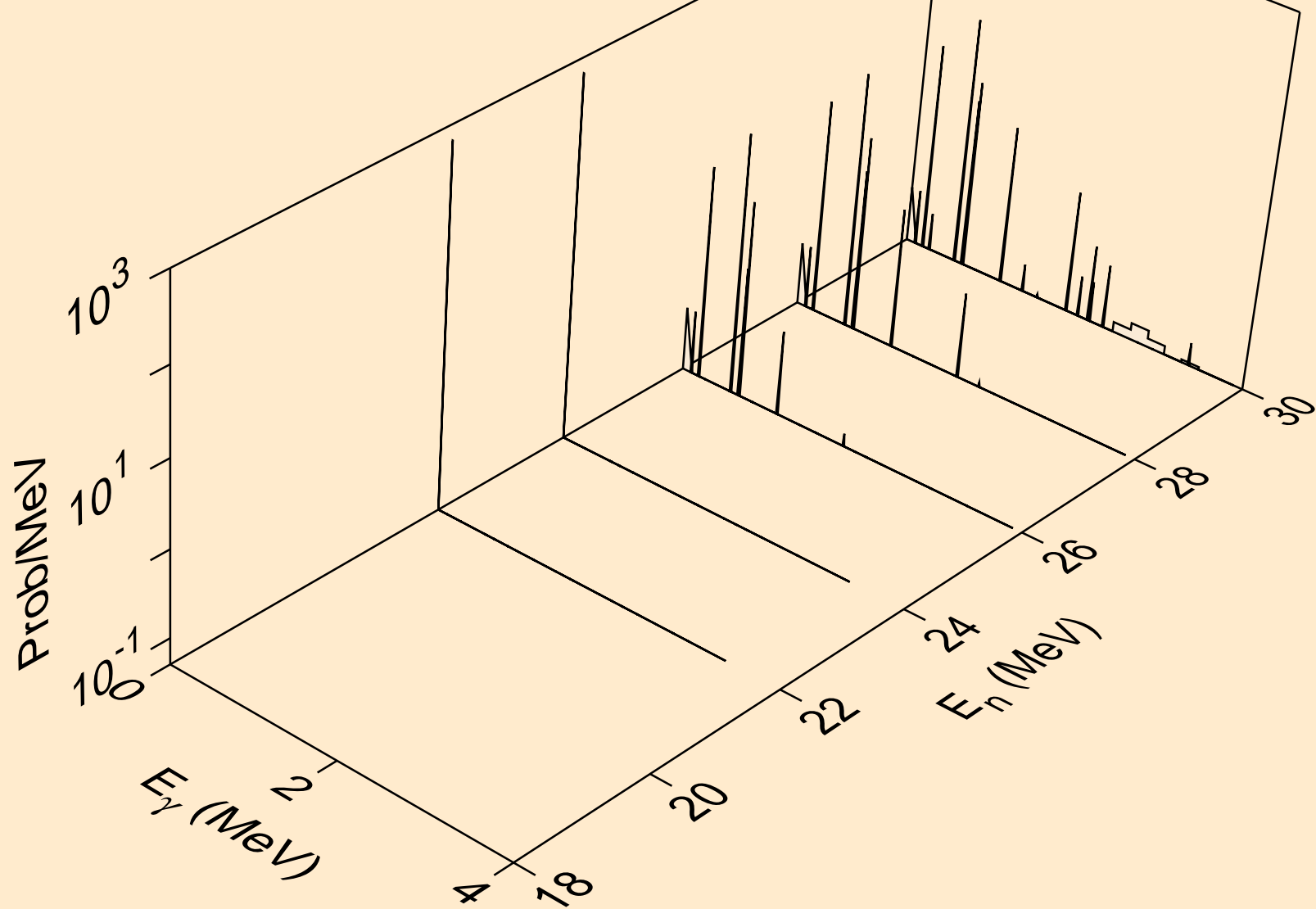

TI050 NEUTRON ACER TENDL-2024 LIBRARY; T=0.K
Photon emission for (n,pd)

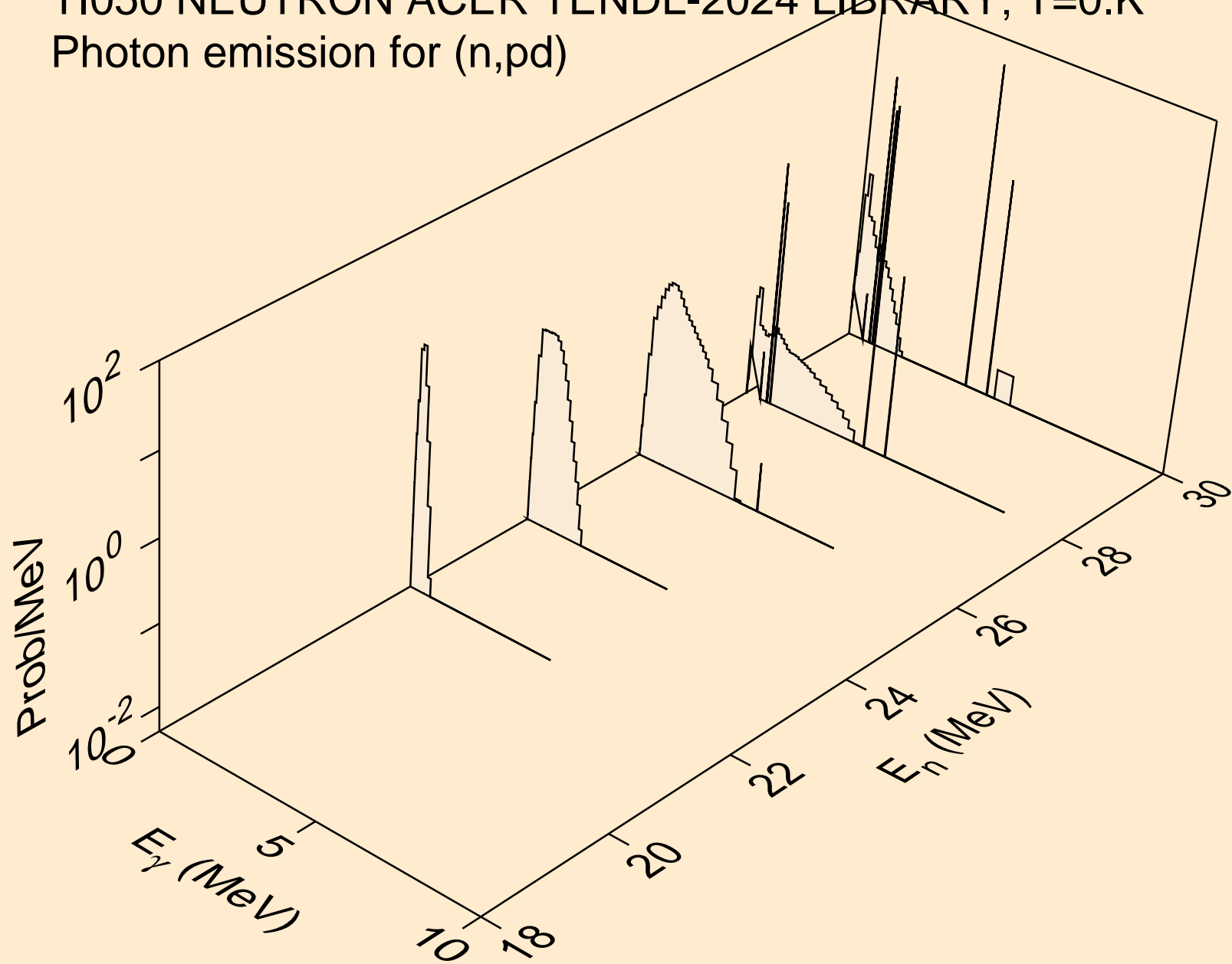

TI050 NEUTRON ACER TENDL-2024 LIBRARY; T=0.K
Photon emission for (n,pt)

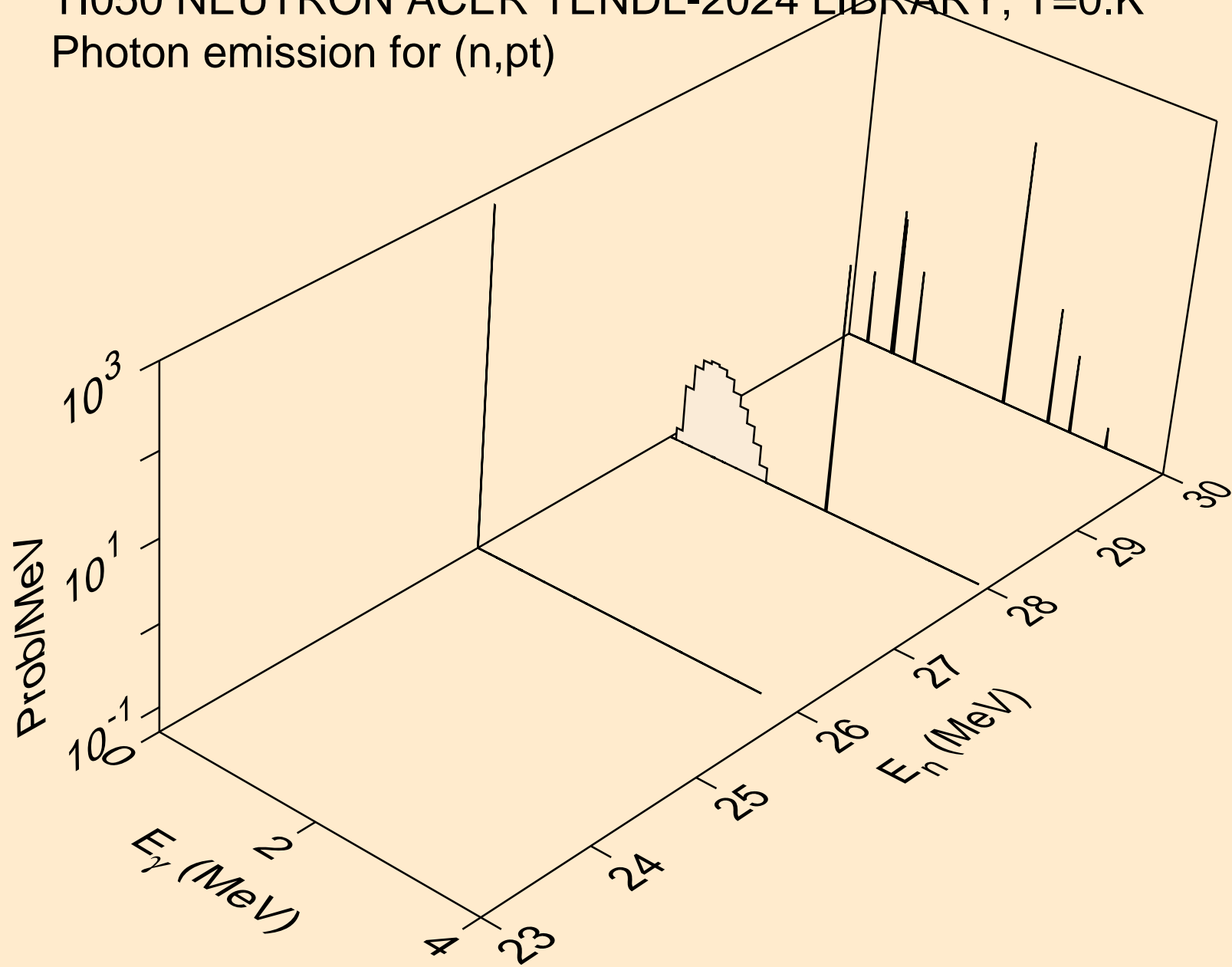

TI050 NEUTRON ACER TENDL-2024 LIBRARY; T=0.K
Photon emission for (n,da)

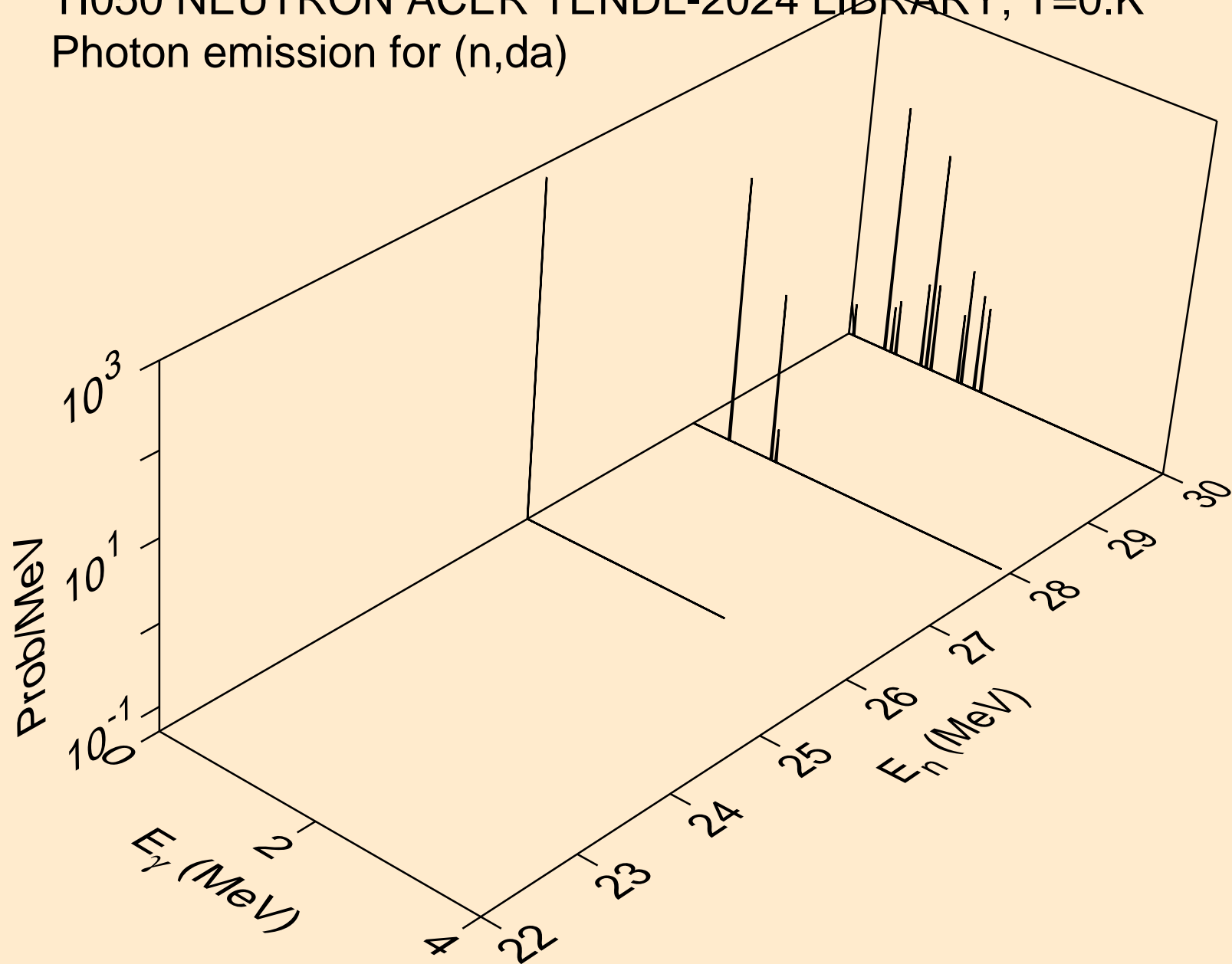

TI050 NEUTRON ACER TENDL-2024 LIBRARY; T=0.K
thermal capture photon spectrum

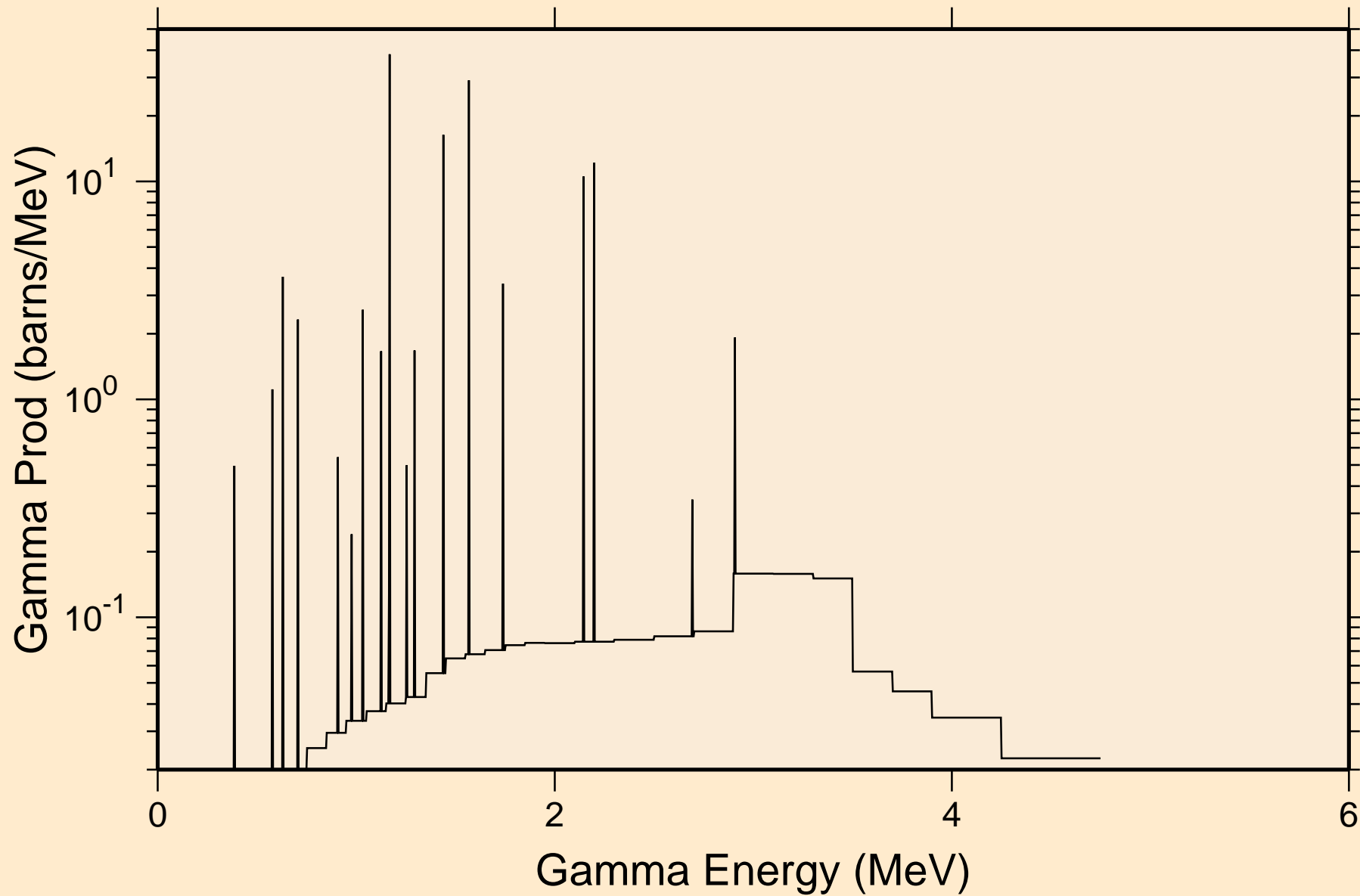

TI050 NEUTRON ACER TENDL-2024 LIBRARY; T=0.K
14 MeV photon spectrum

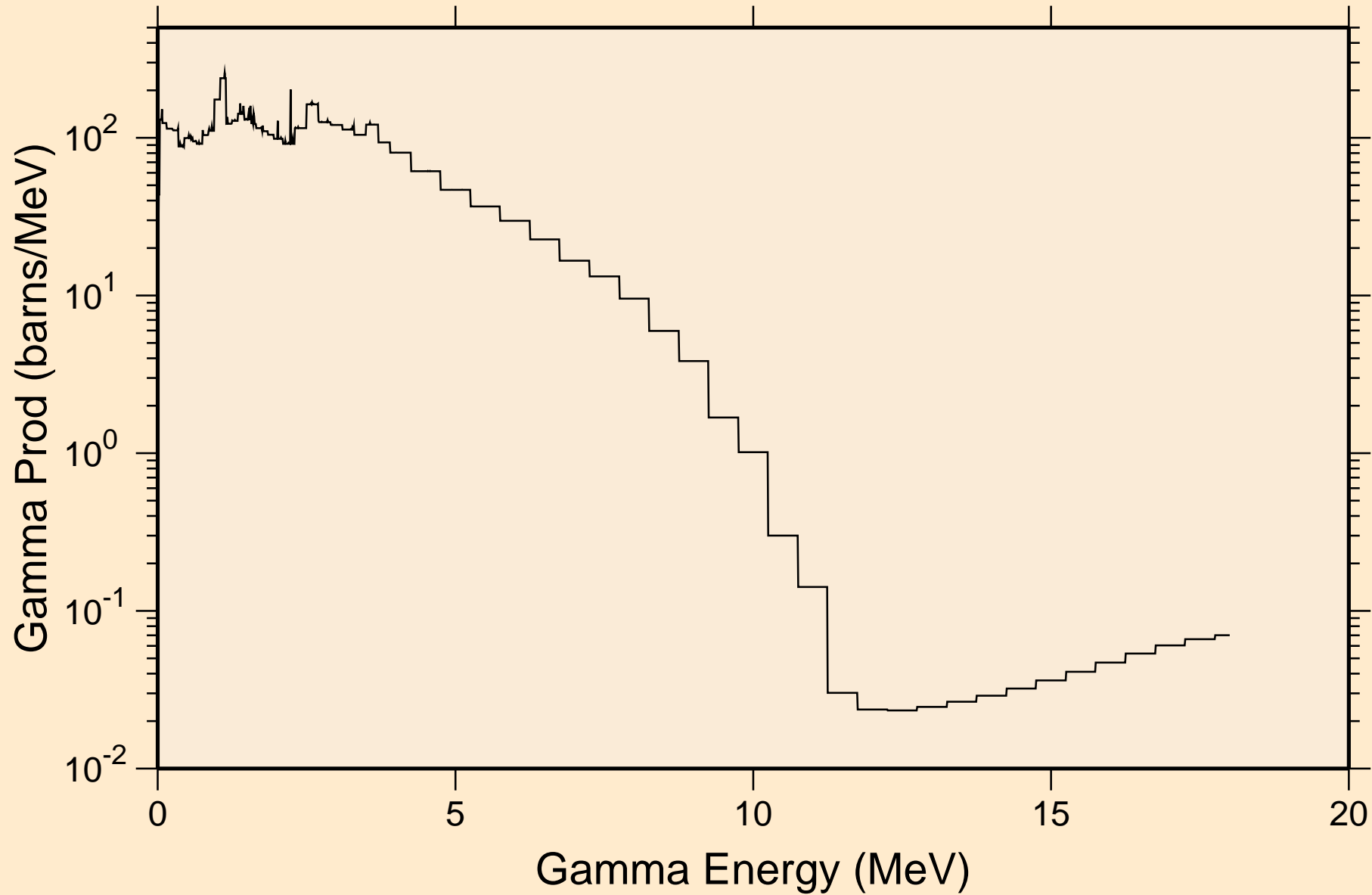

TI050 NEUTRON ACER TENDL-2024 LIBRARY; T=0.K

Particle heating contributions

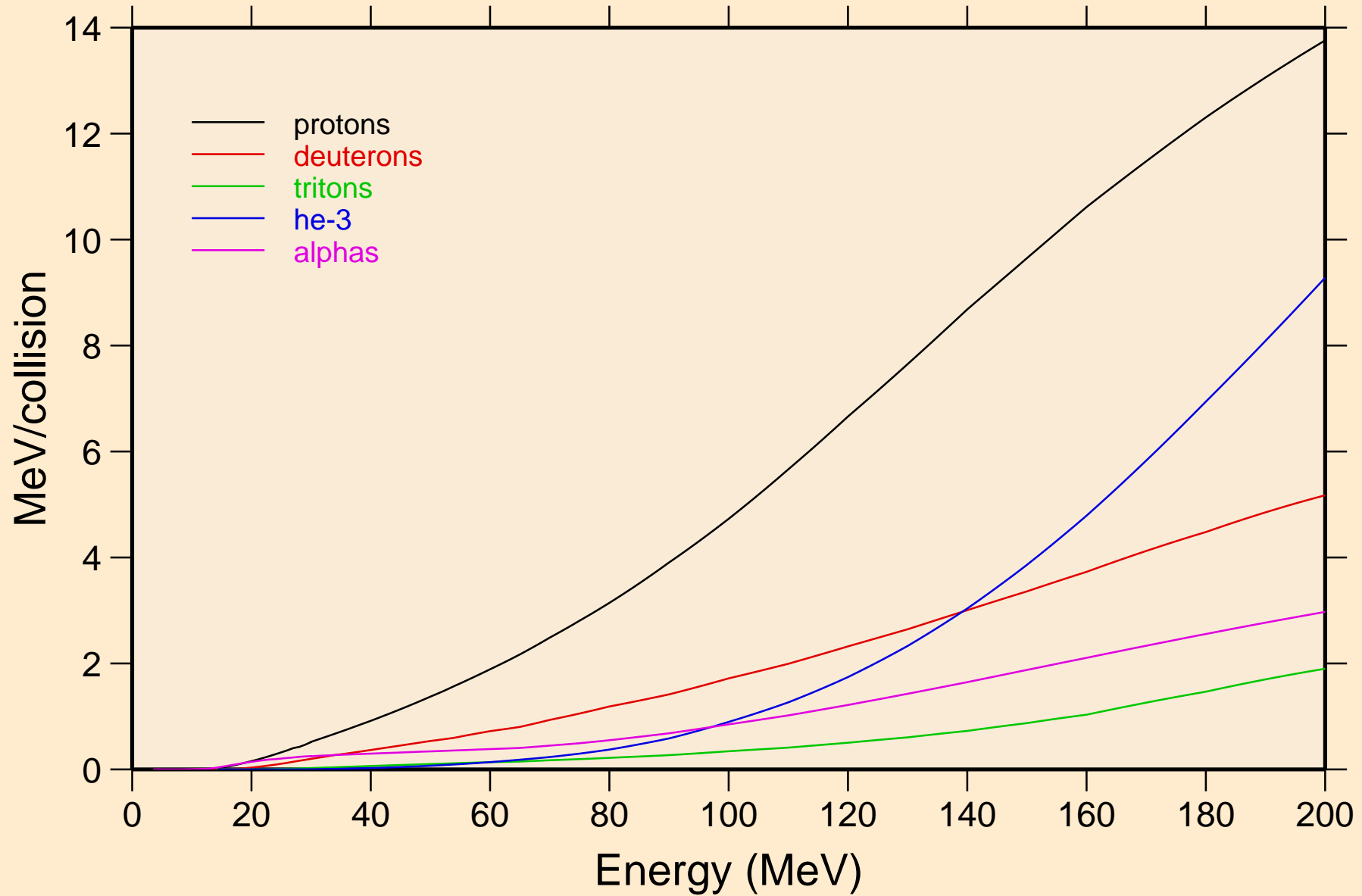

TI050 NEUTRON ACER TENDL-2024 LIBRARY; T=0.K
Recoil Heating

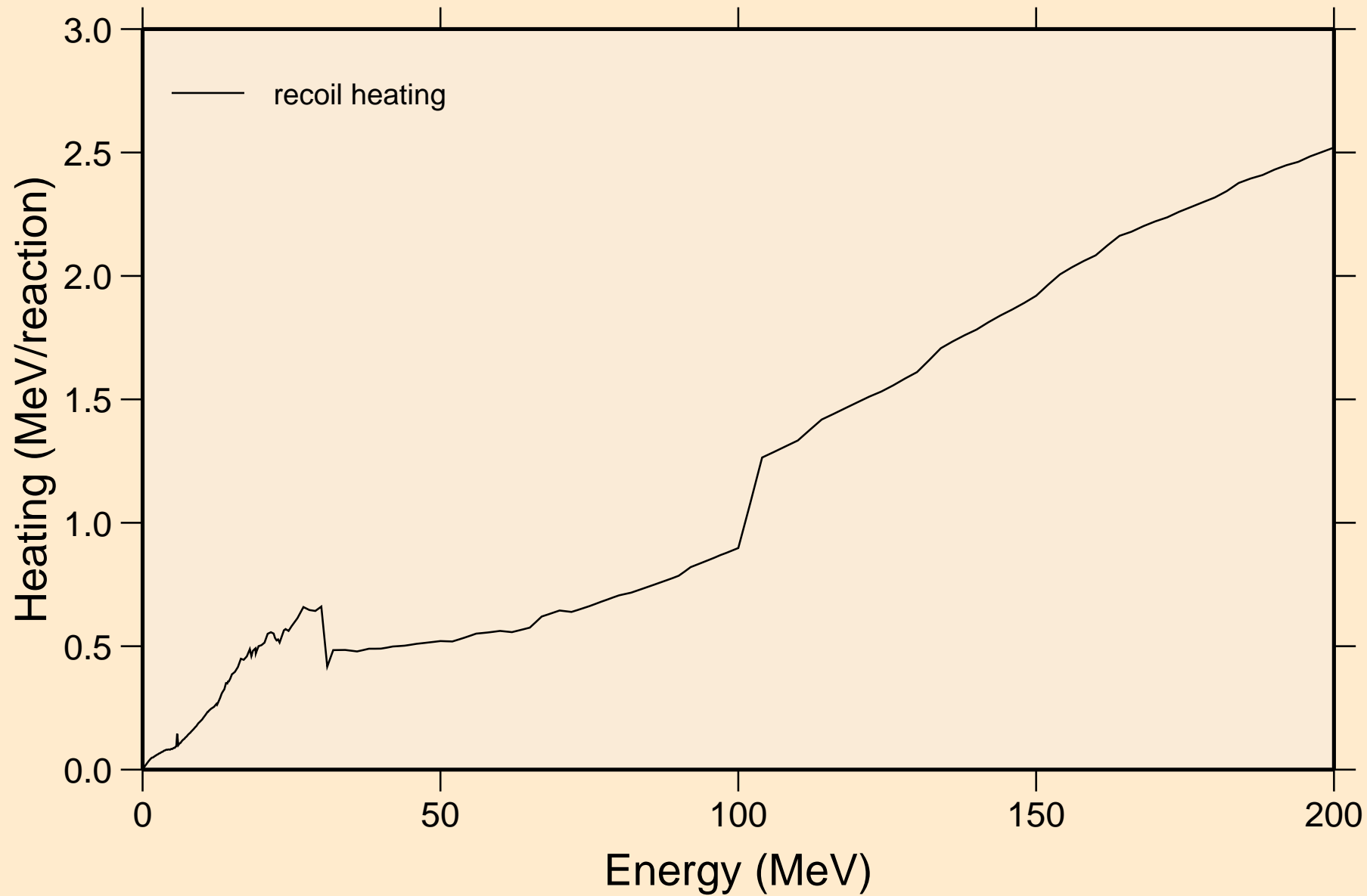

TI050 NEUTRON ACER TENDL-2024 LIBRARY; T=0.K
Particle production cross sections

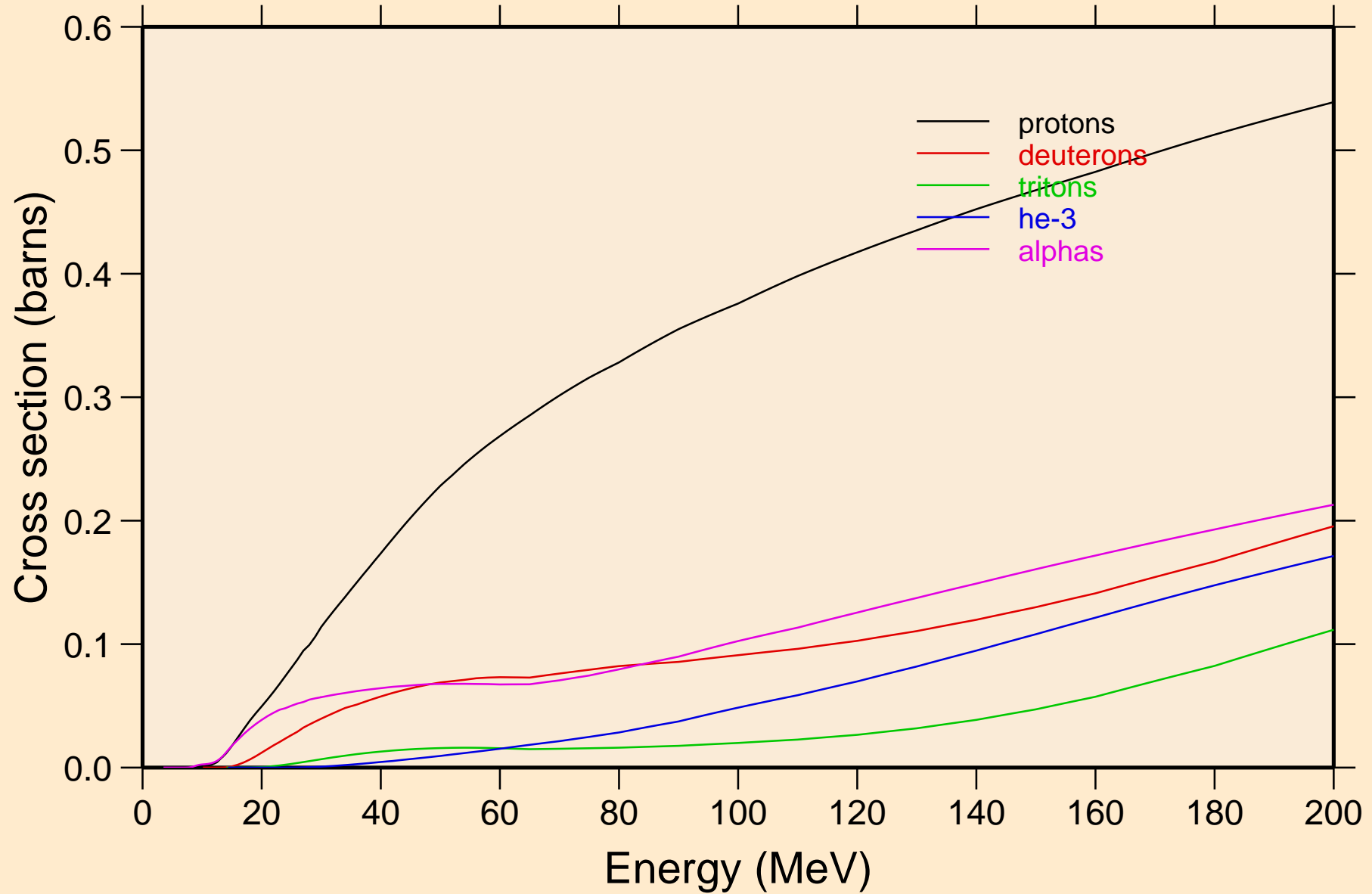

TI050 NEUTRON ACER TENDL-2024 LIBRARY; T=0.K
protons from (n,x)

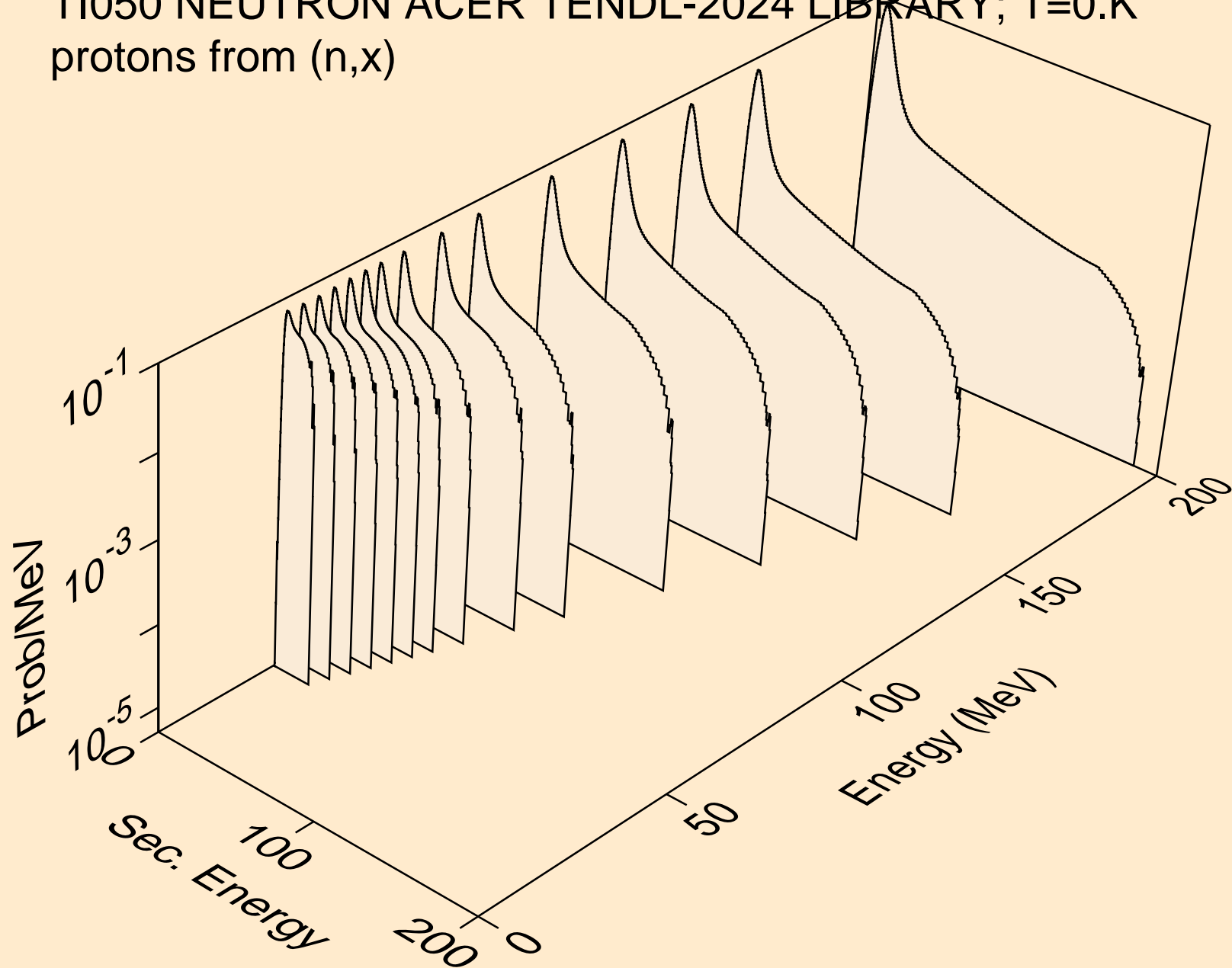

TI050 NEUTRON ACER TENDL-2024 LIBRARY; T=0.K
protons from (n,n*)p

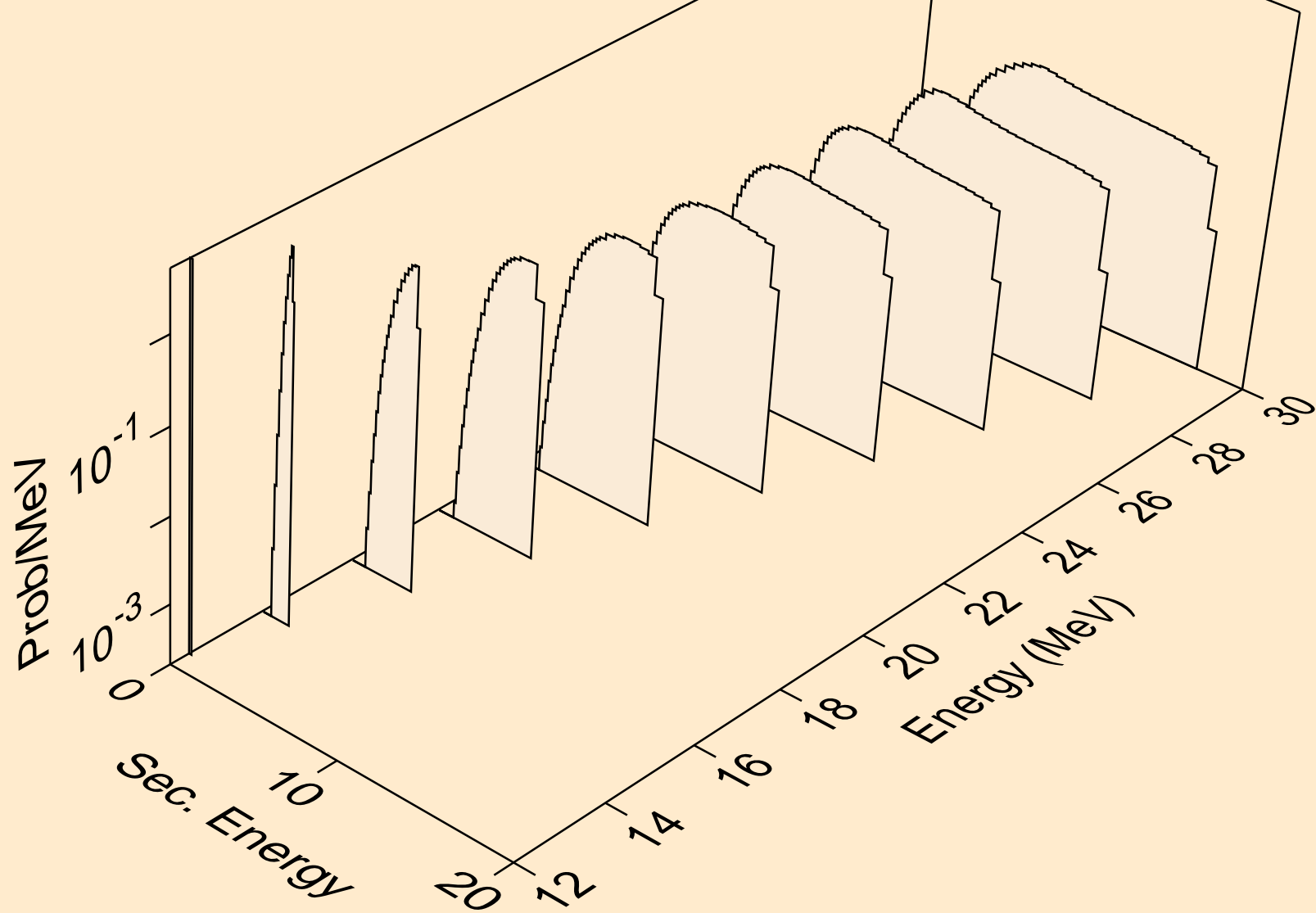

TI050 NEUTRON ACER TENDL-2024 LIBRARY; T=0.K
protons from (n,2np)

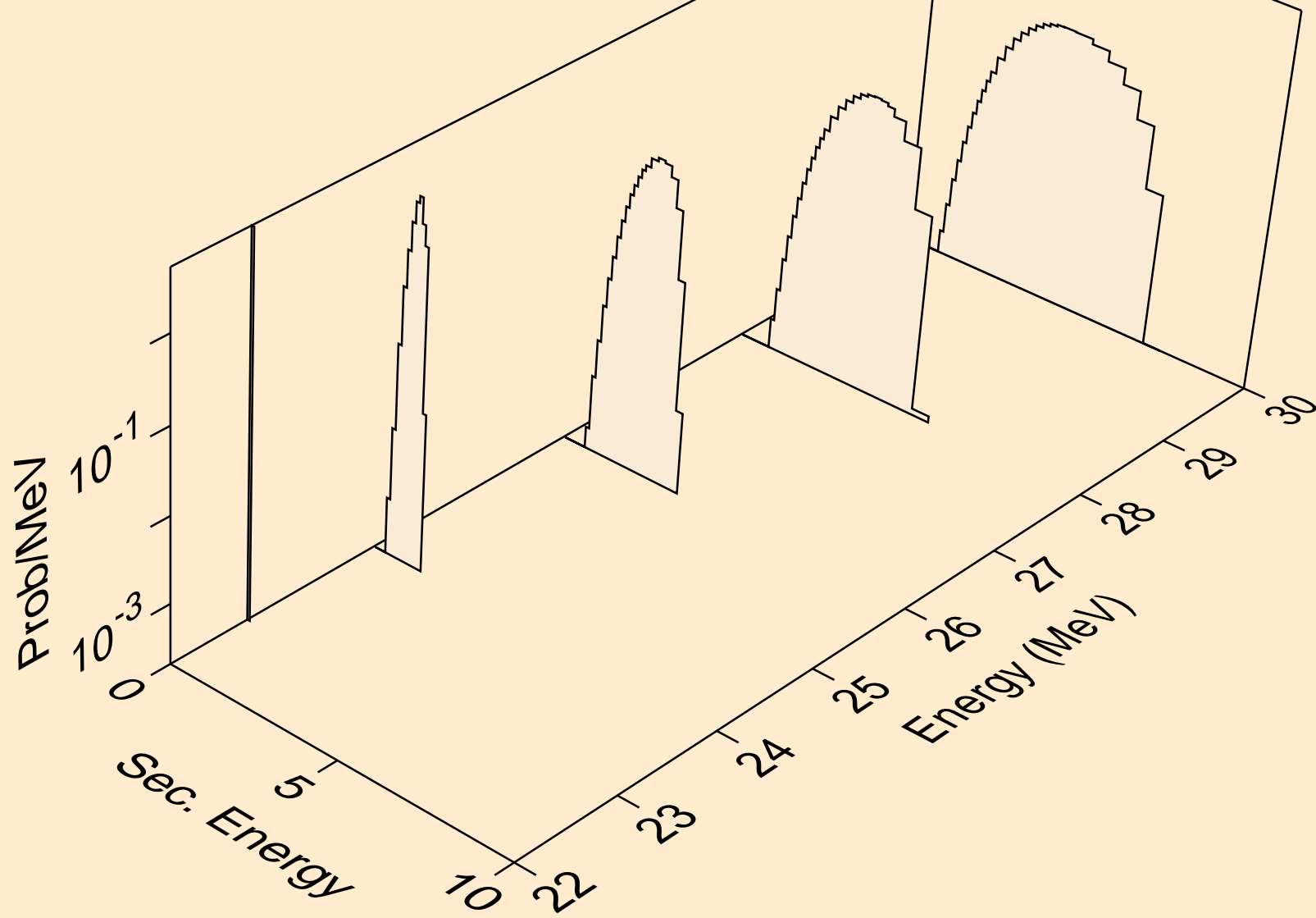

TI050 NEUTRON ACER TENDL-2024 LIBRARY; T=0.K
protons from (n,n2p)

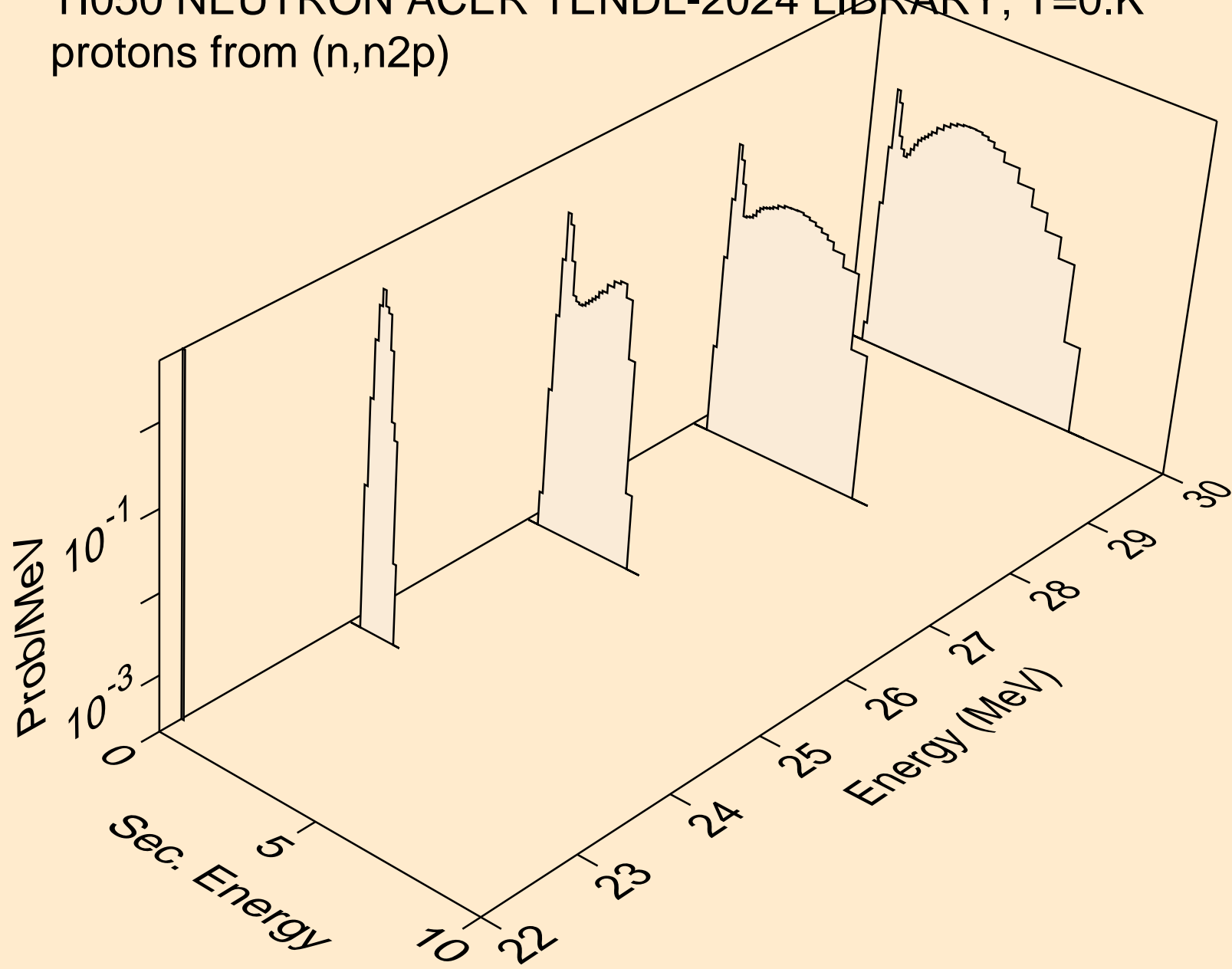

TI050 NEUTRON ACER TENDL-2024 LIBRARY; T=0.K
protons from (n,p)

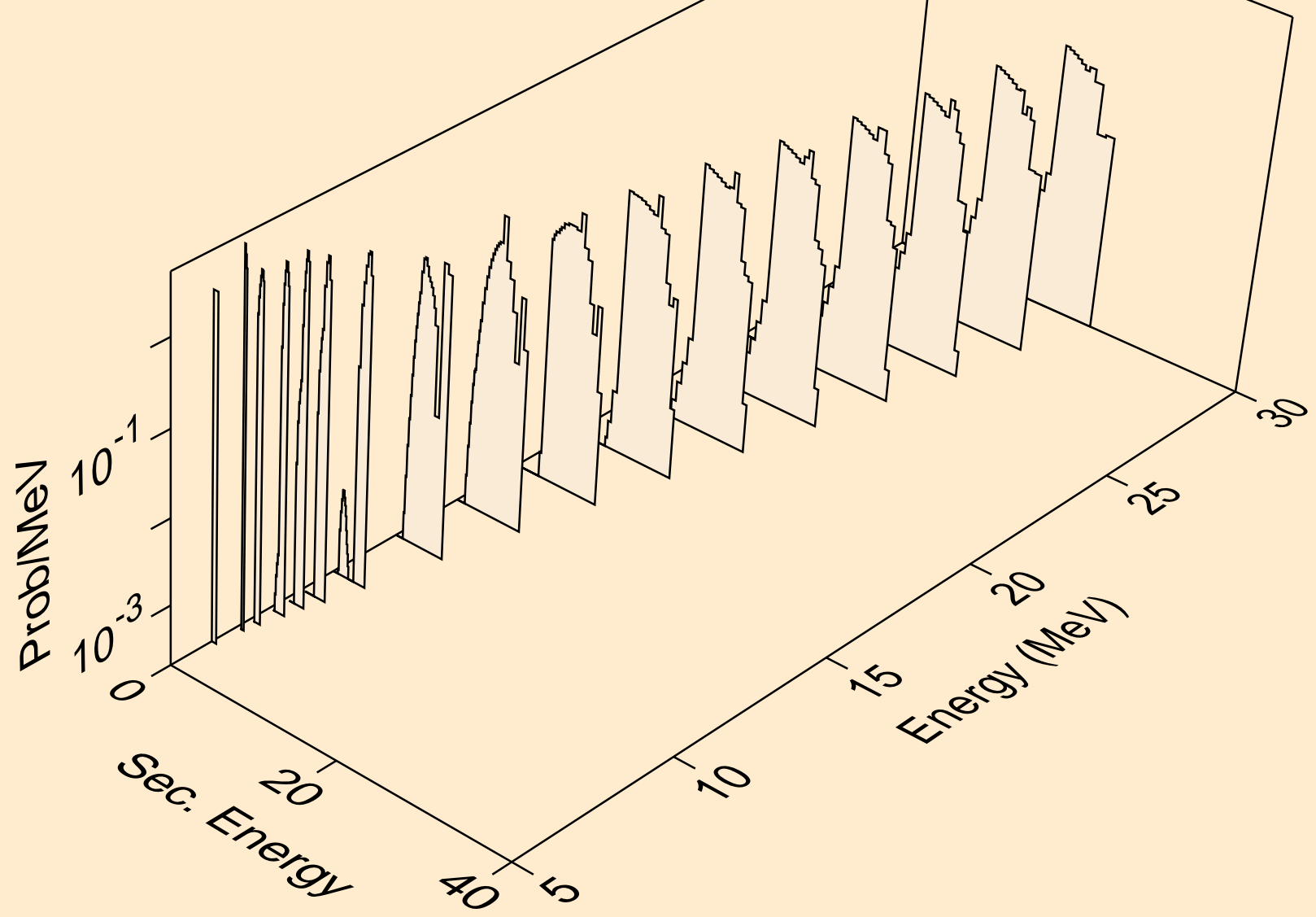

TI050 NEUTRON ACER TENDL-2024 LIBRARY; T=0.K
protons from (n,2p)

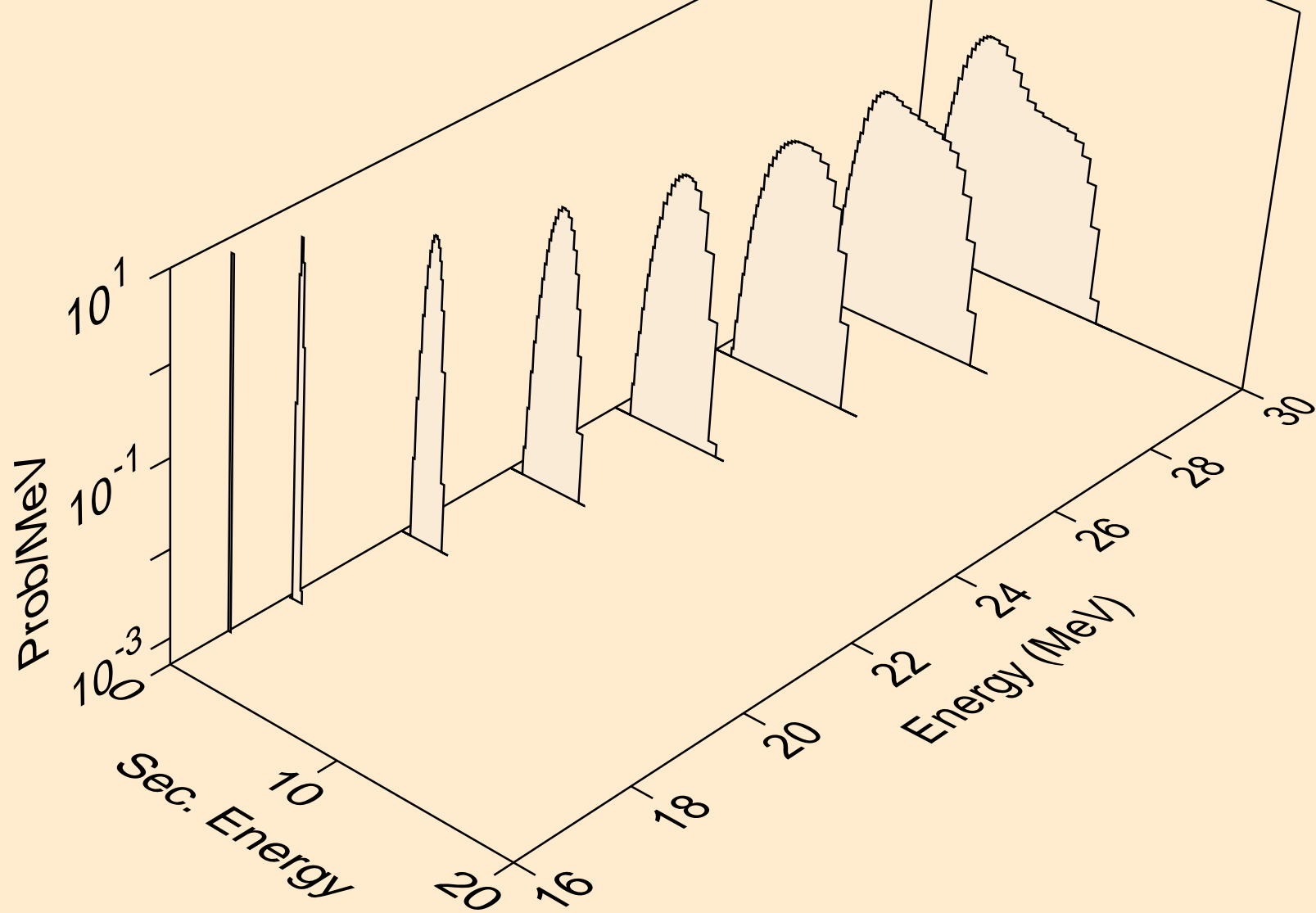

TI050 NEUTRON ACER TENDL-2024 LIBRARY; T=0.K
protons from (n,pa)

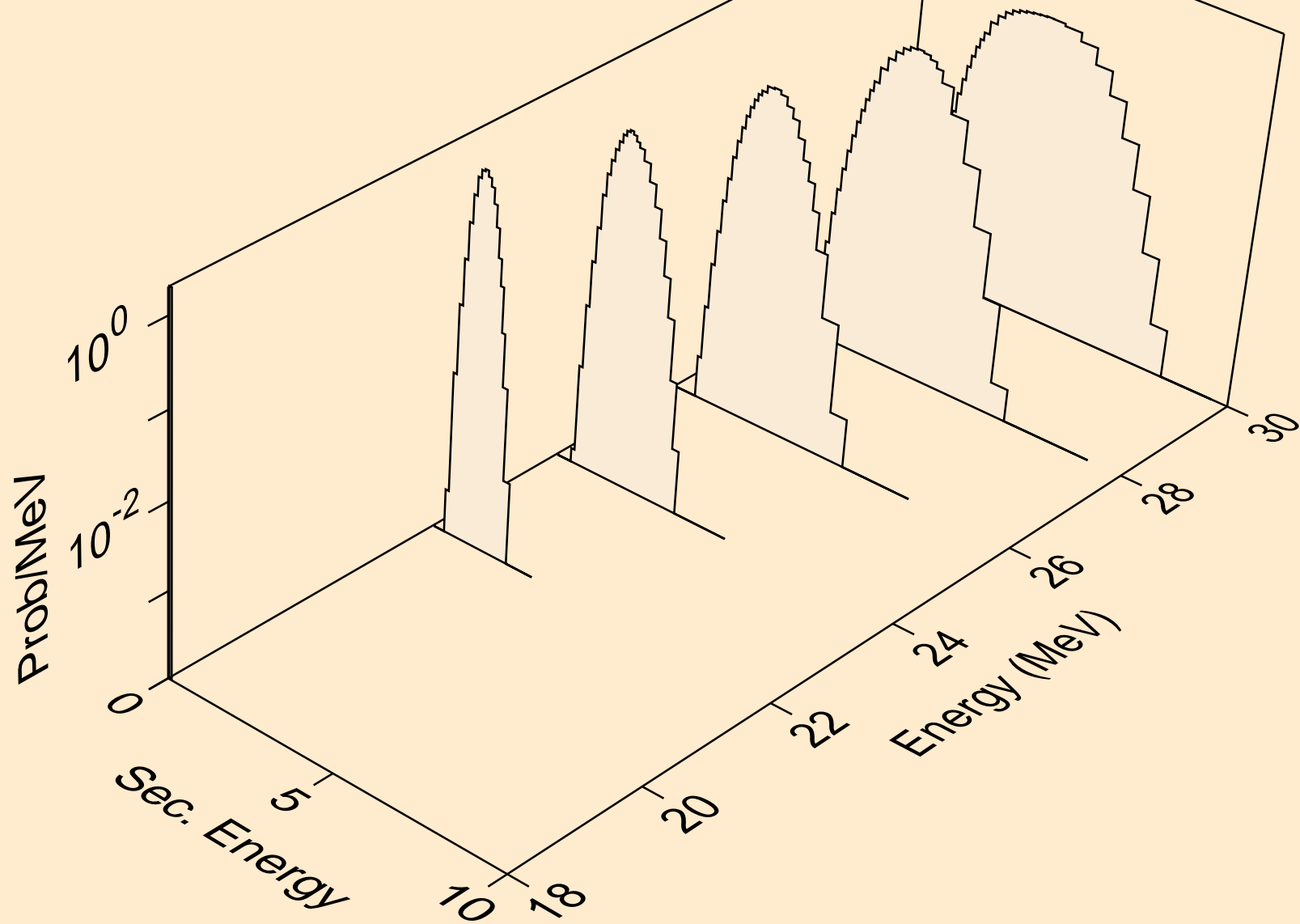

TI050 NEUTRON ACER TENDL-2024 LIBRARY; T=0.K
protons from (n,pd)

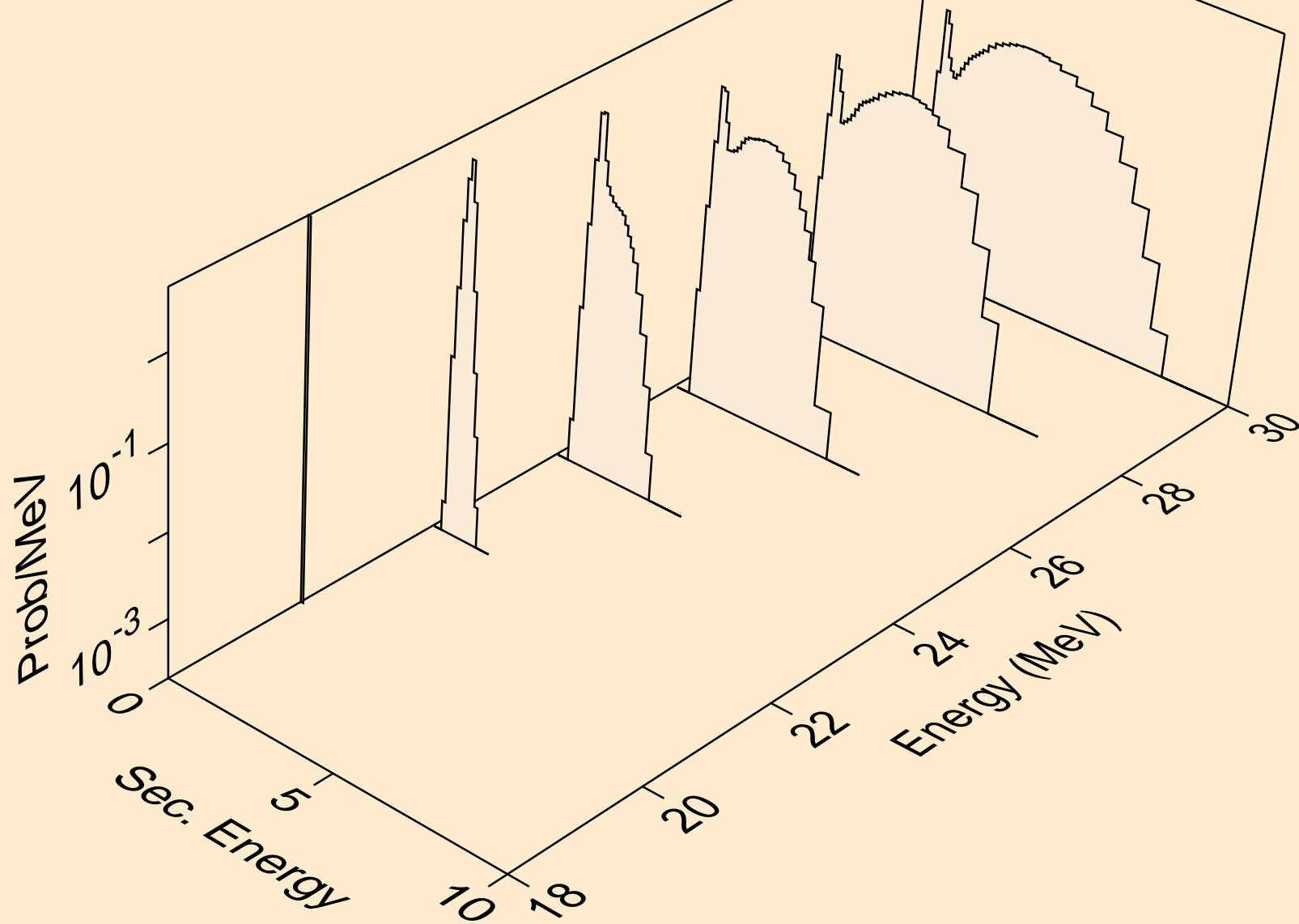

TI050 NEUTRON ACER TENDL-2024 LIBRARY; T=0.K
protons from (n,pt)

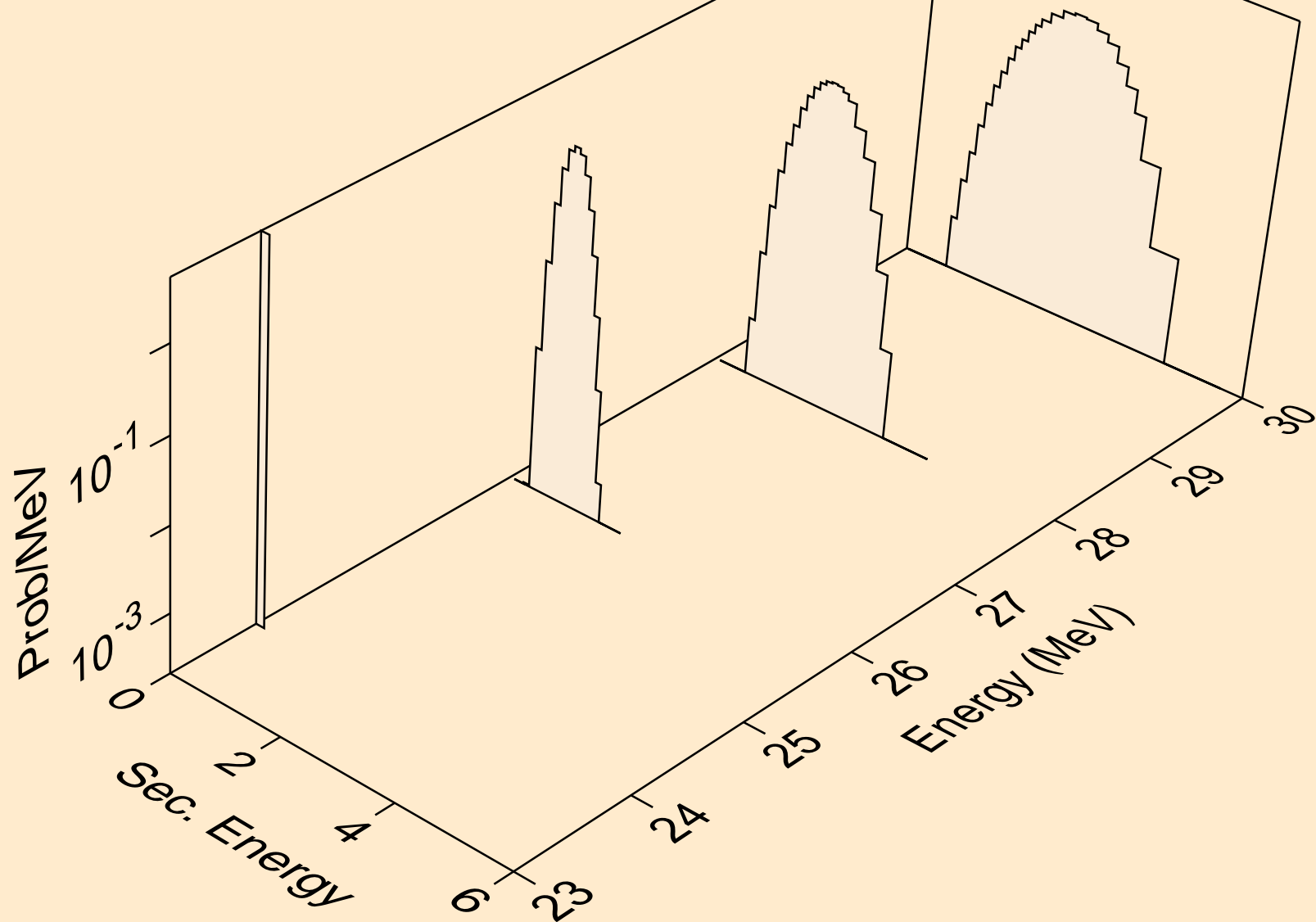

TI050 NEUTRON ACER TENDL-2024 LIBRARY; T=0.K
deuterons from (n,x)

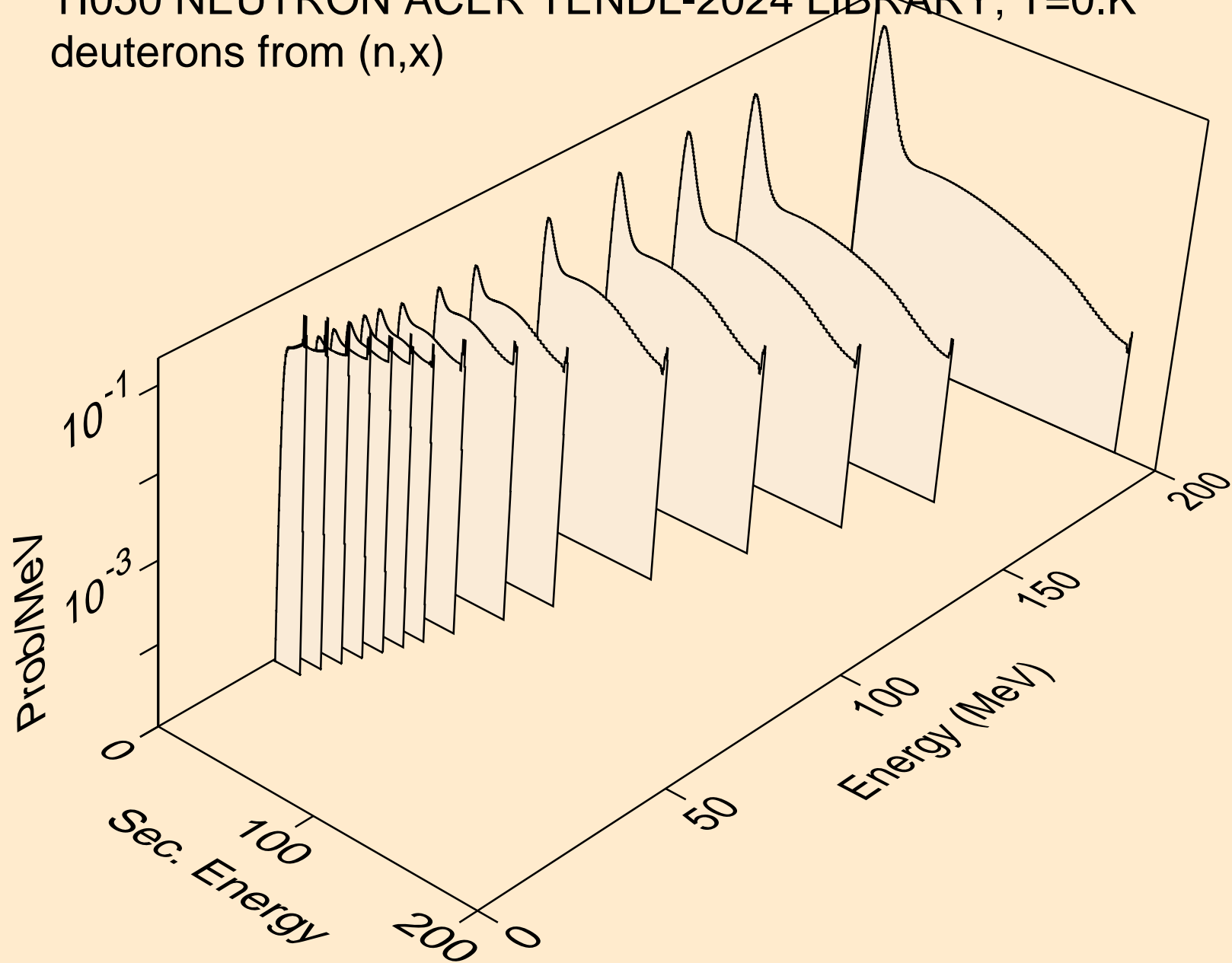

TI050 NEUTRON ACER TENDL-2024 LIBRARY; T=0.K
deuterons from (n,n*)d

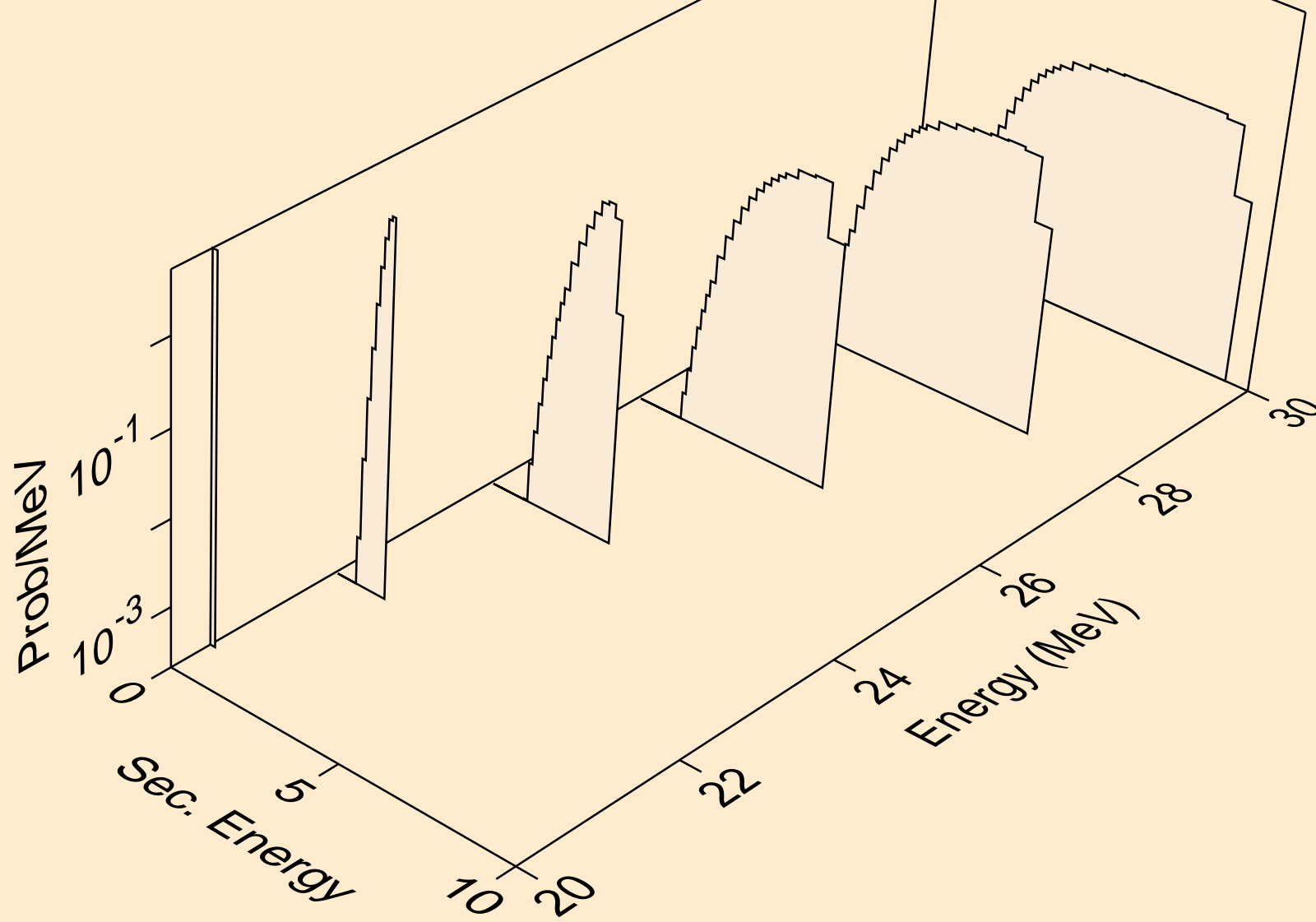

TI050 NEUTRON ACER TENDL-2024 LIBRARY; T=0.K
deuterons from (n,d)

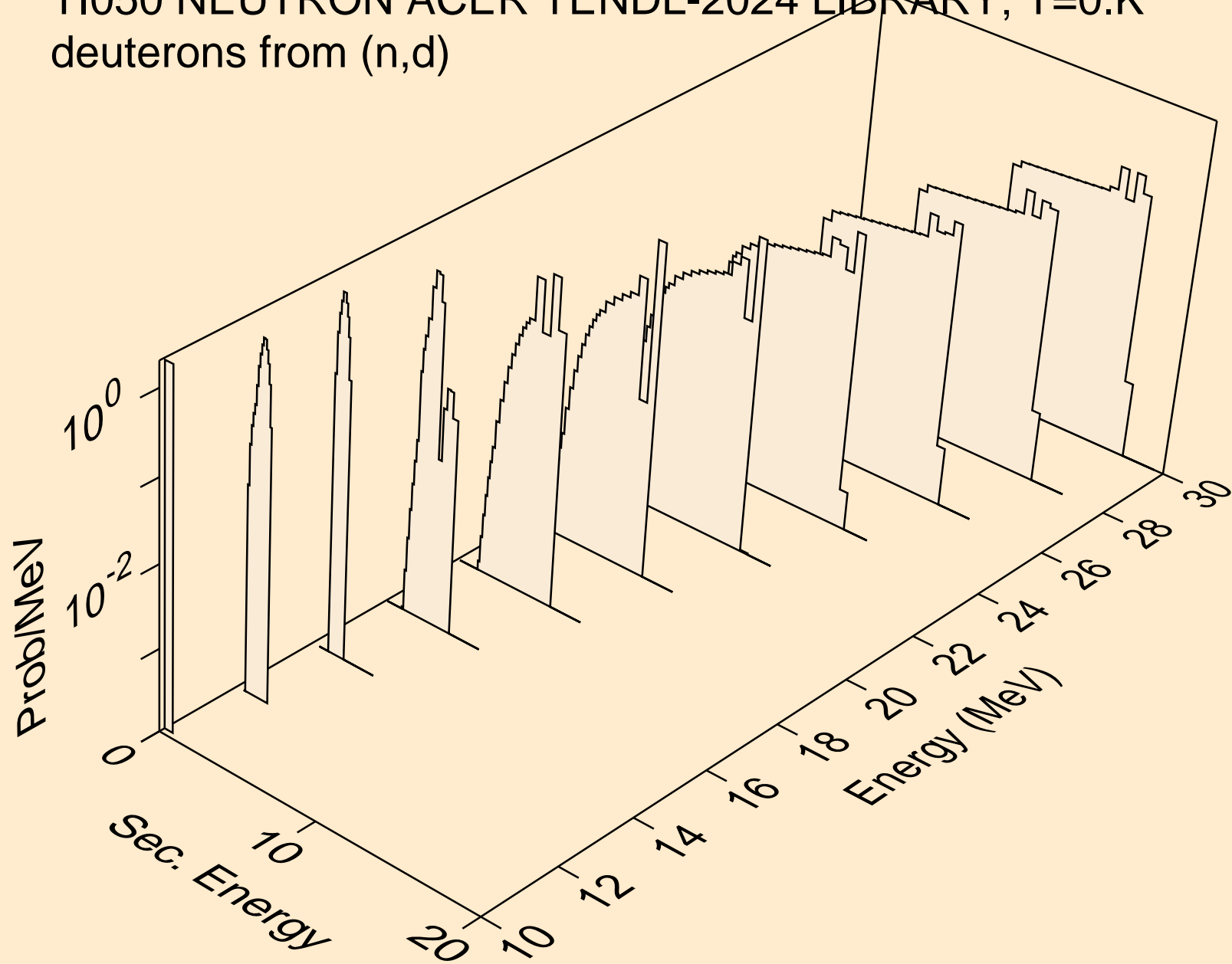

TI050 NEUTRON ACER TENDL-2024 LIBRARY; T=0.K
deuterons from (n,pd)

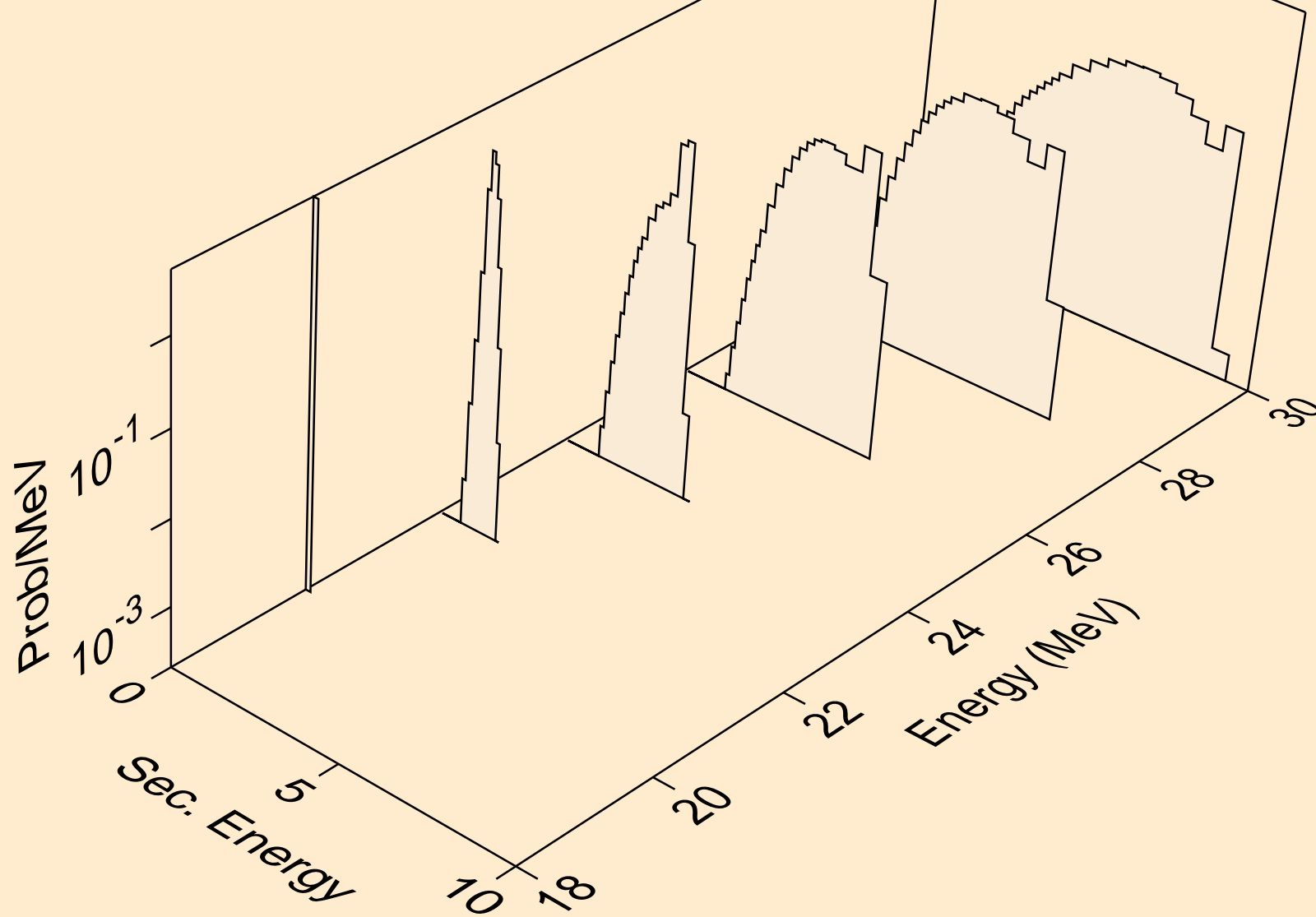

TI050 NEUTRON ACER TENDL-2024 LIBRARY; T=0.K
deuterons from (n,da)

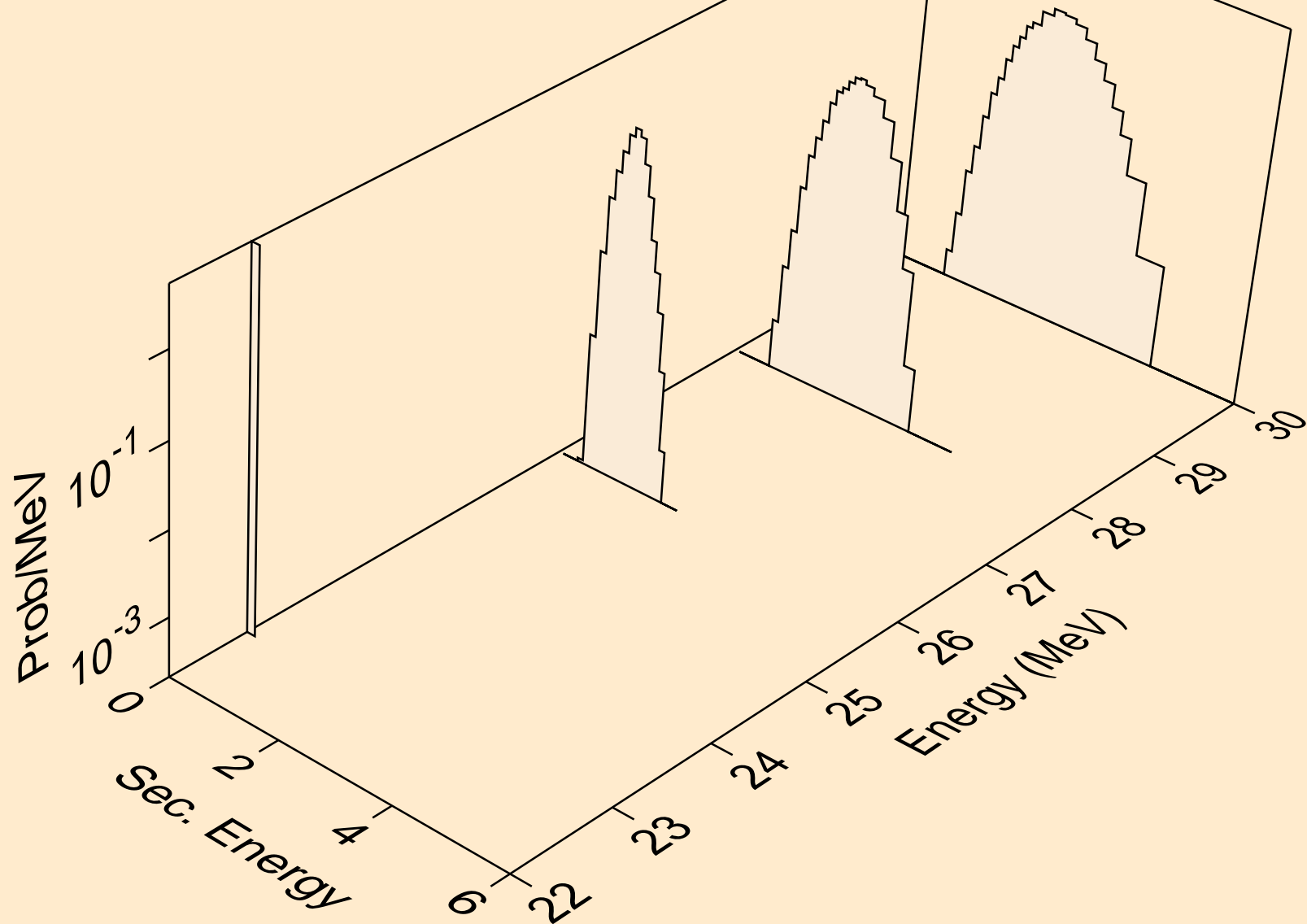

TI050 NEUTRON ACER TENDL-2024 LIBRARY; T=0.K
tritons from (n,x)

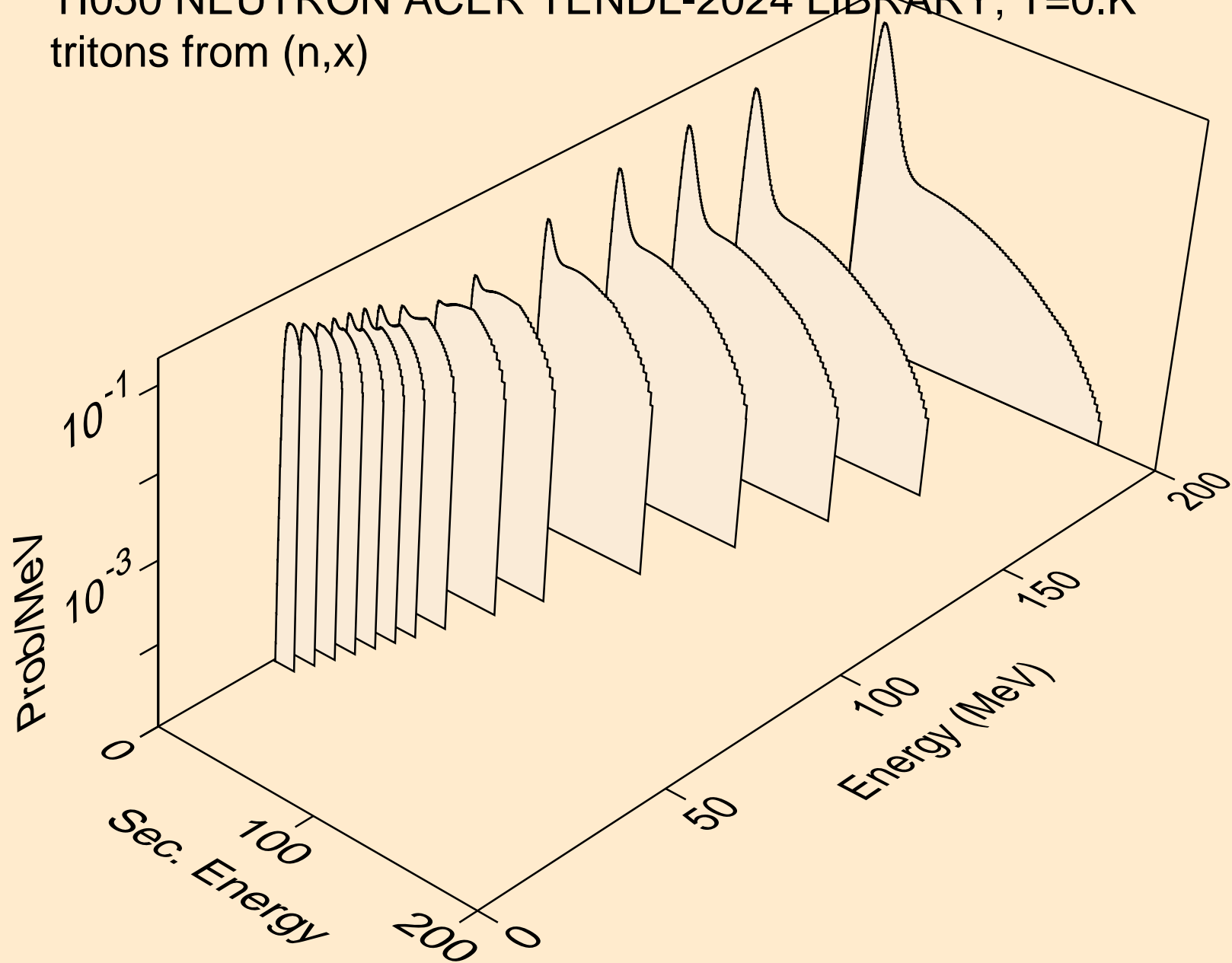

TI050 NEUTRON ACER TENDL-2024 LIBRARY; T=0.K
tritons from (n,n*)t

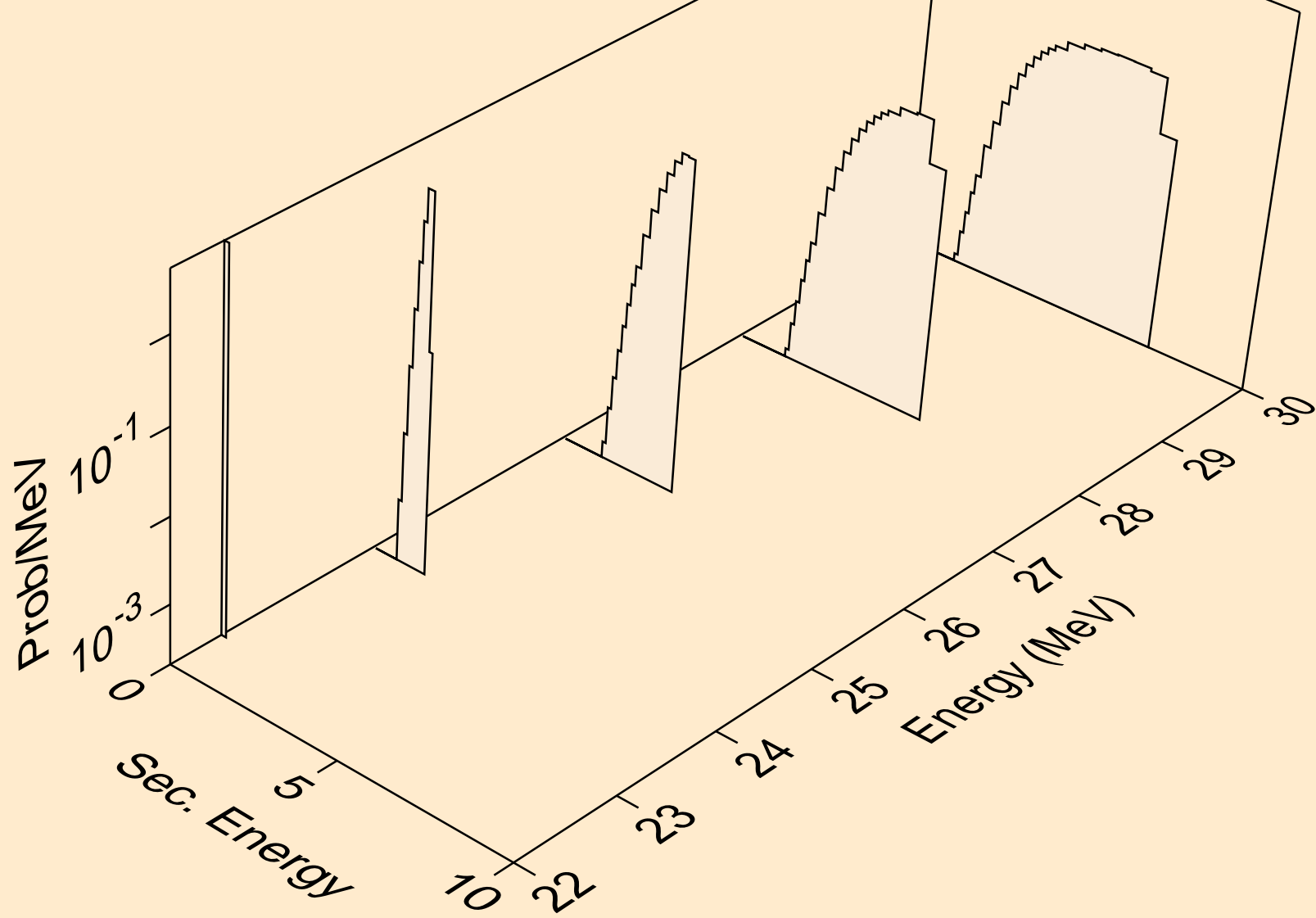

TI050 NEUTRON ACER TENDL-2024 LIBRARY; T=0.K
tritons from (n,t)

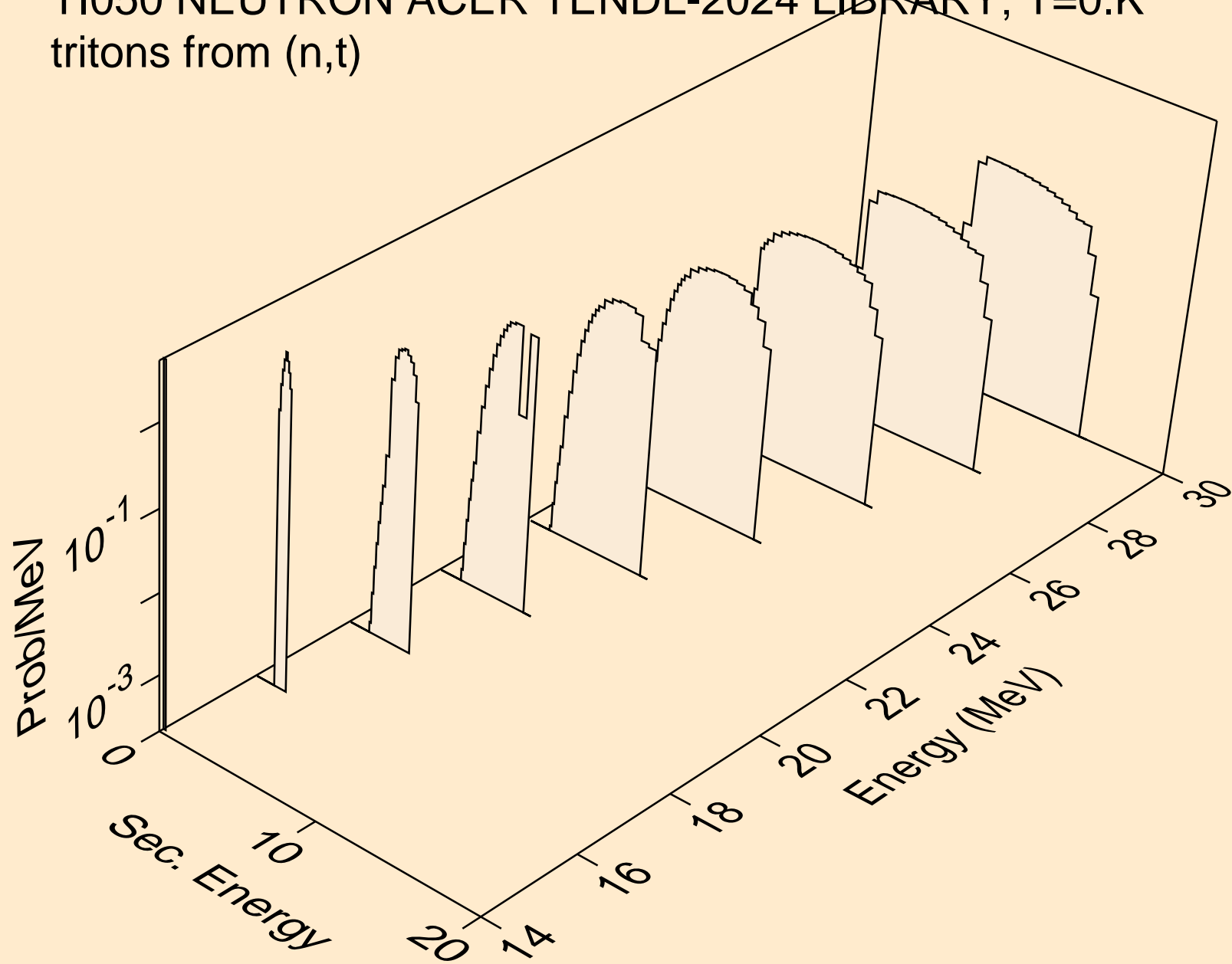

TI050 NEUTRON ACER TENDL-2024 LIBRARY; T=0.K
tritons from (n,pt)

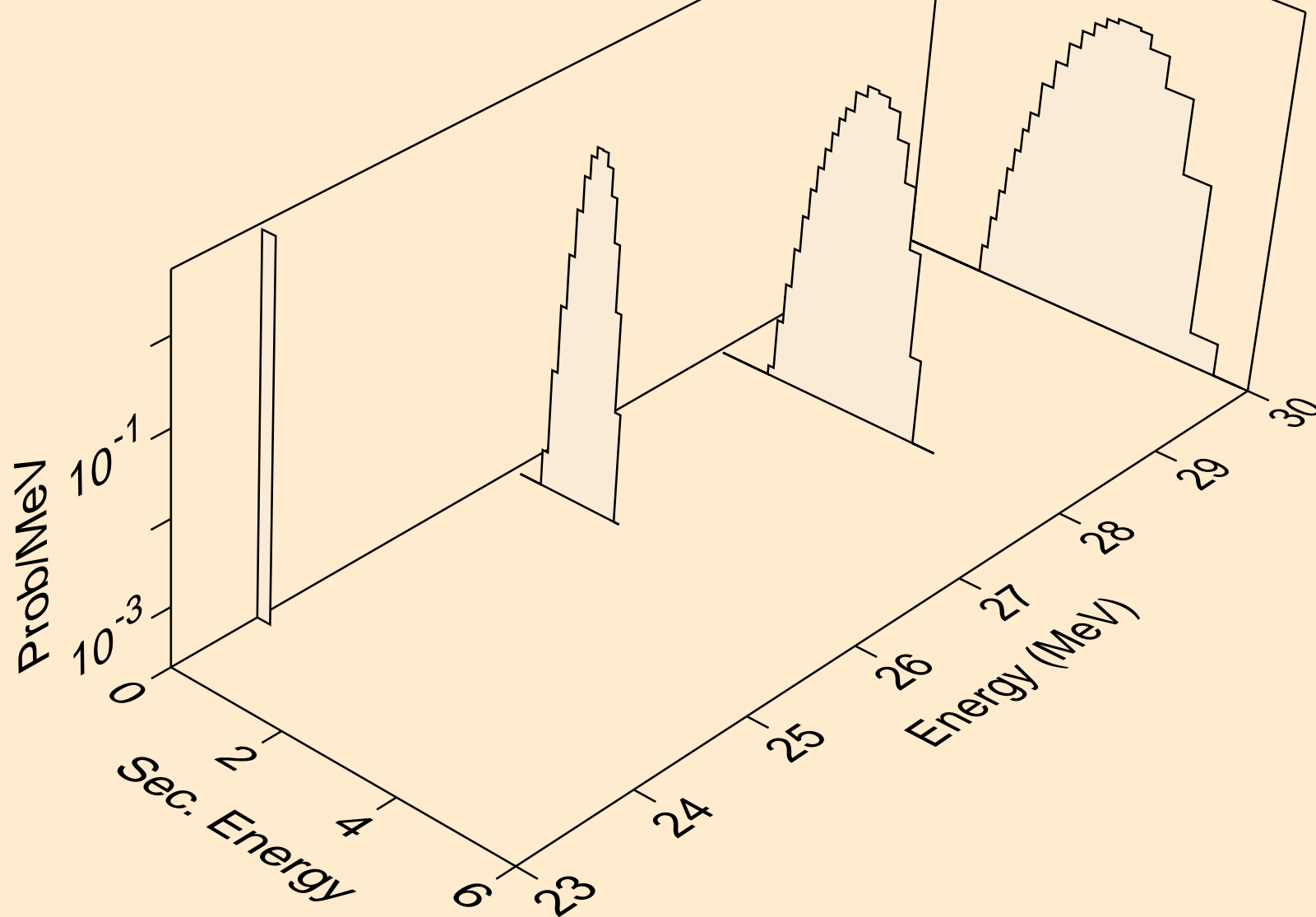

TI050 NEUTRON ACER TENDL-2024 LIBRARY; T=0.K
he3s from (n,x)

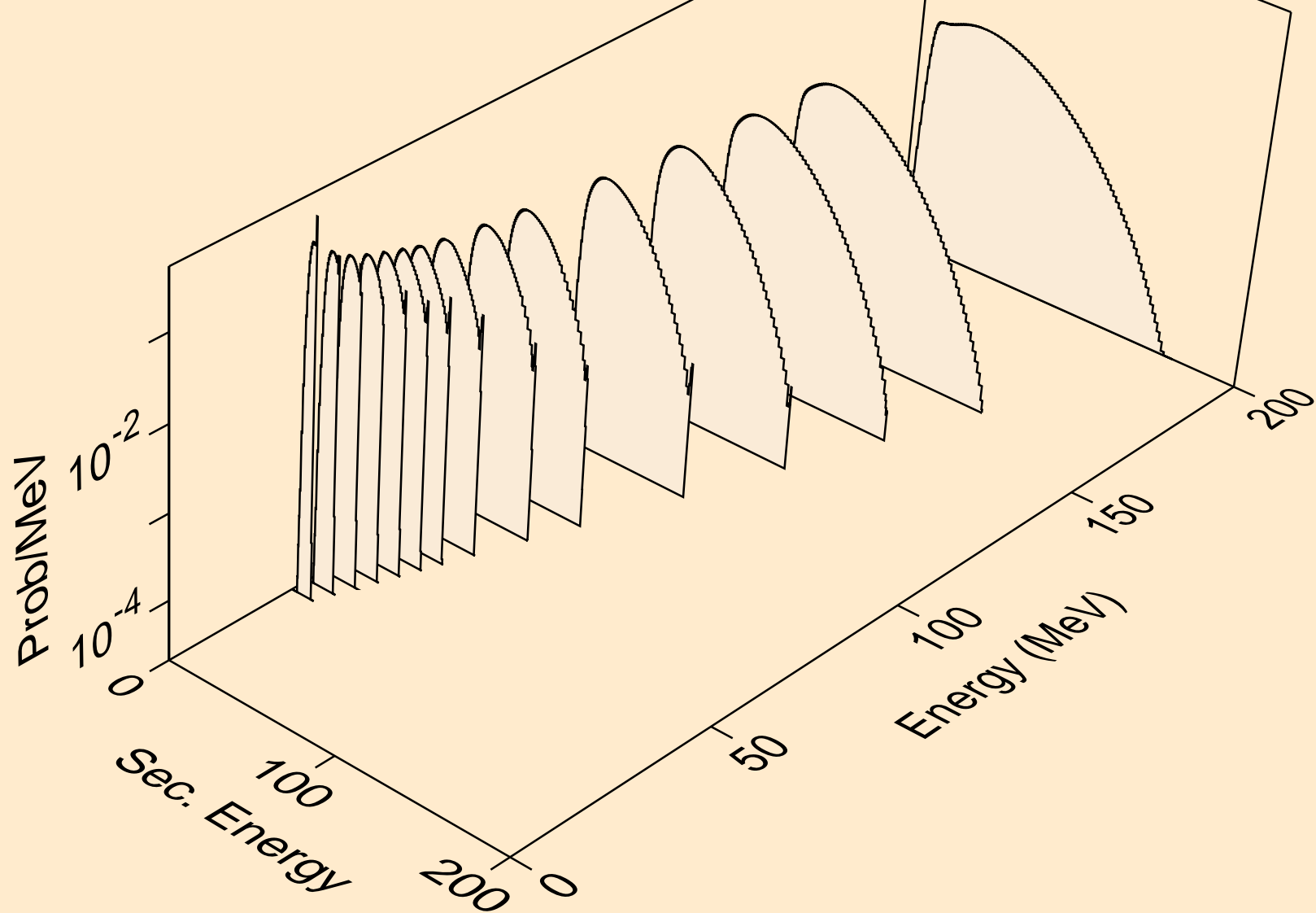

TI050 NEUTRON ACER TENDL-2024 LIBRARY; T=0.K
he3s from (n,n*)he3

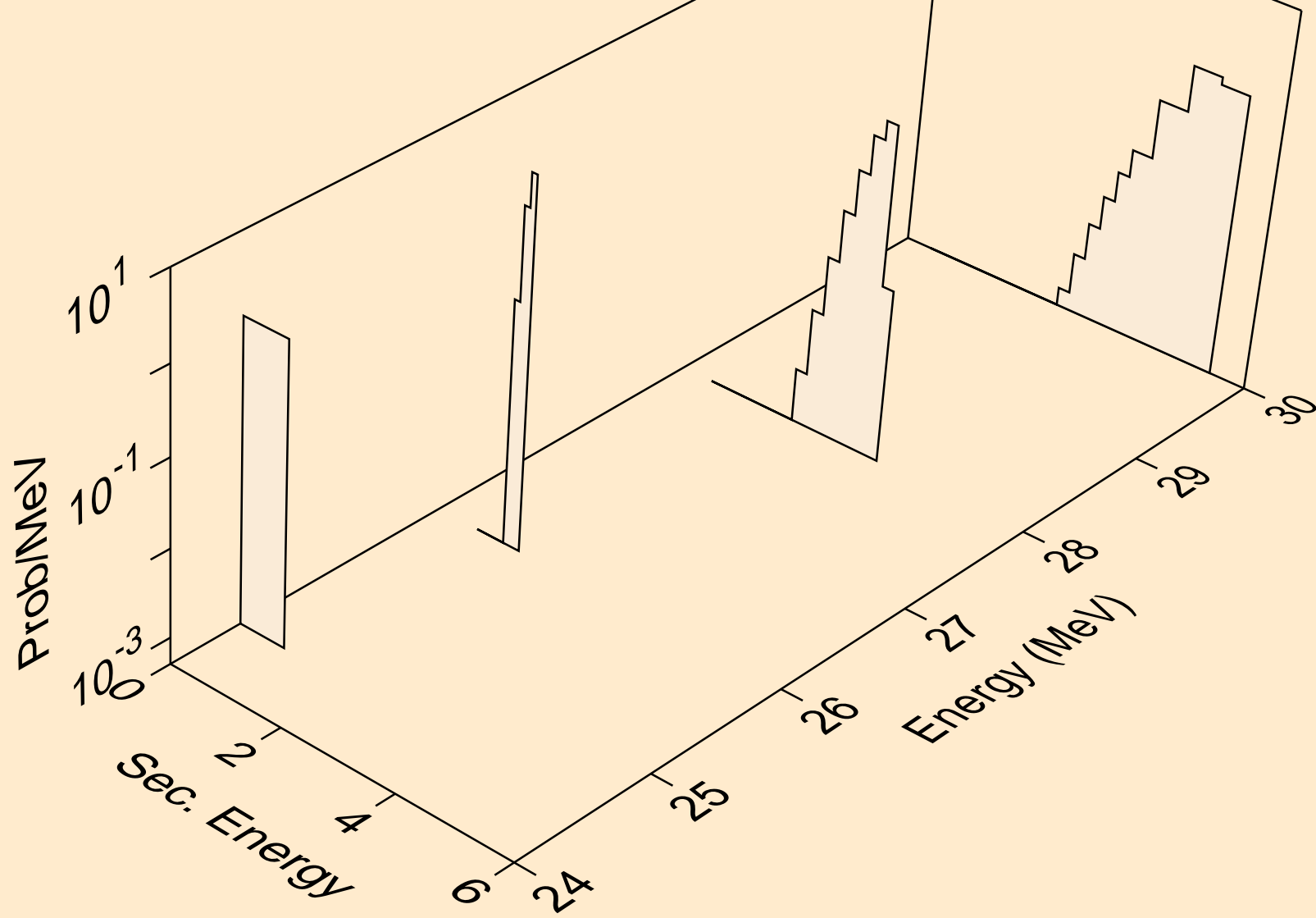

TI050 NEUTRON ACER TENDL-2024 LIBRARY; T=0.K
he3s from (n,he3)

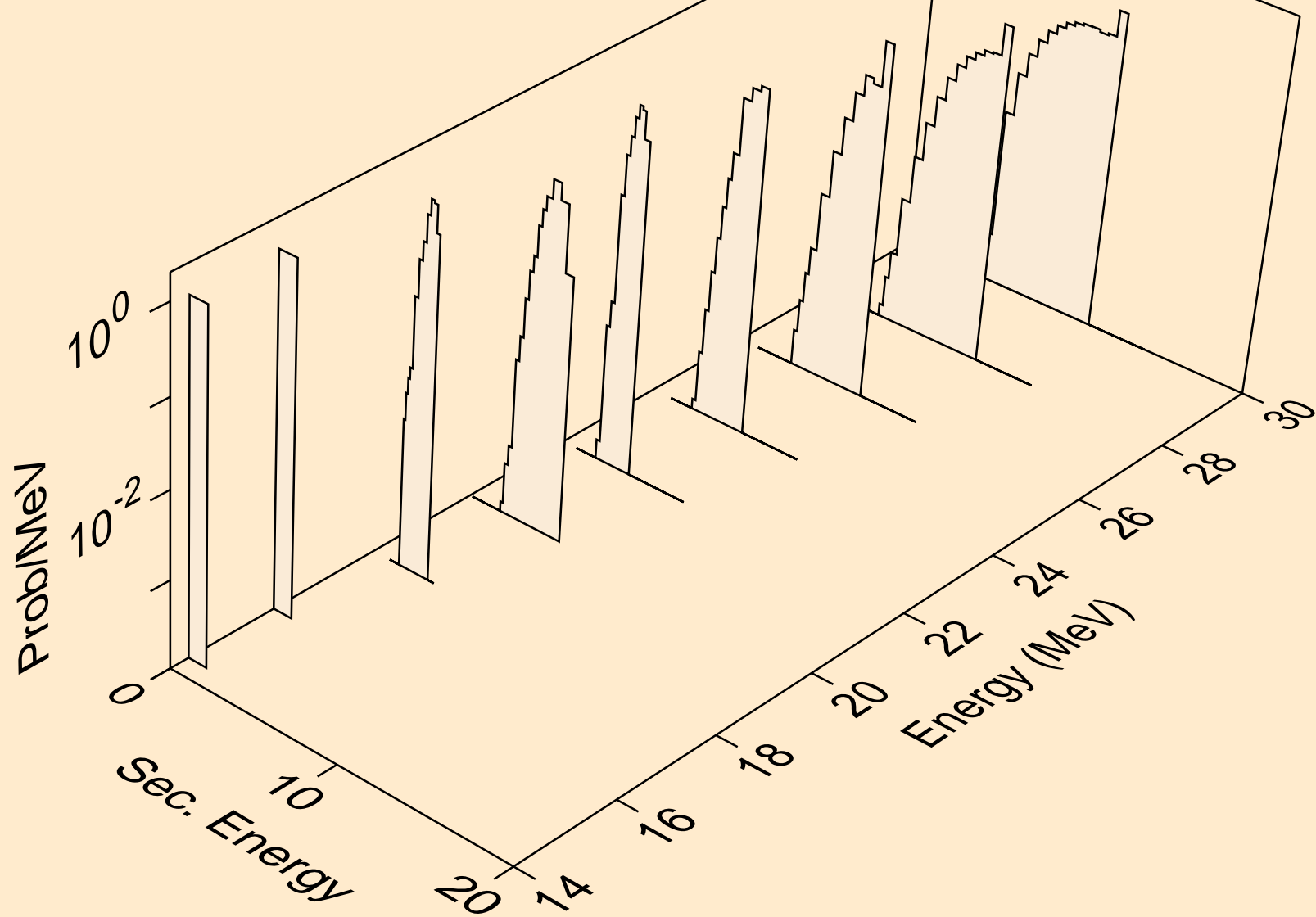

TI050 NEUTRON ACER TENDL-2024 LIBRARY; T=0.K
alphas from (n,x)

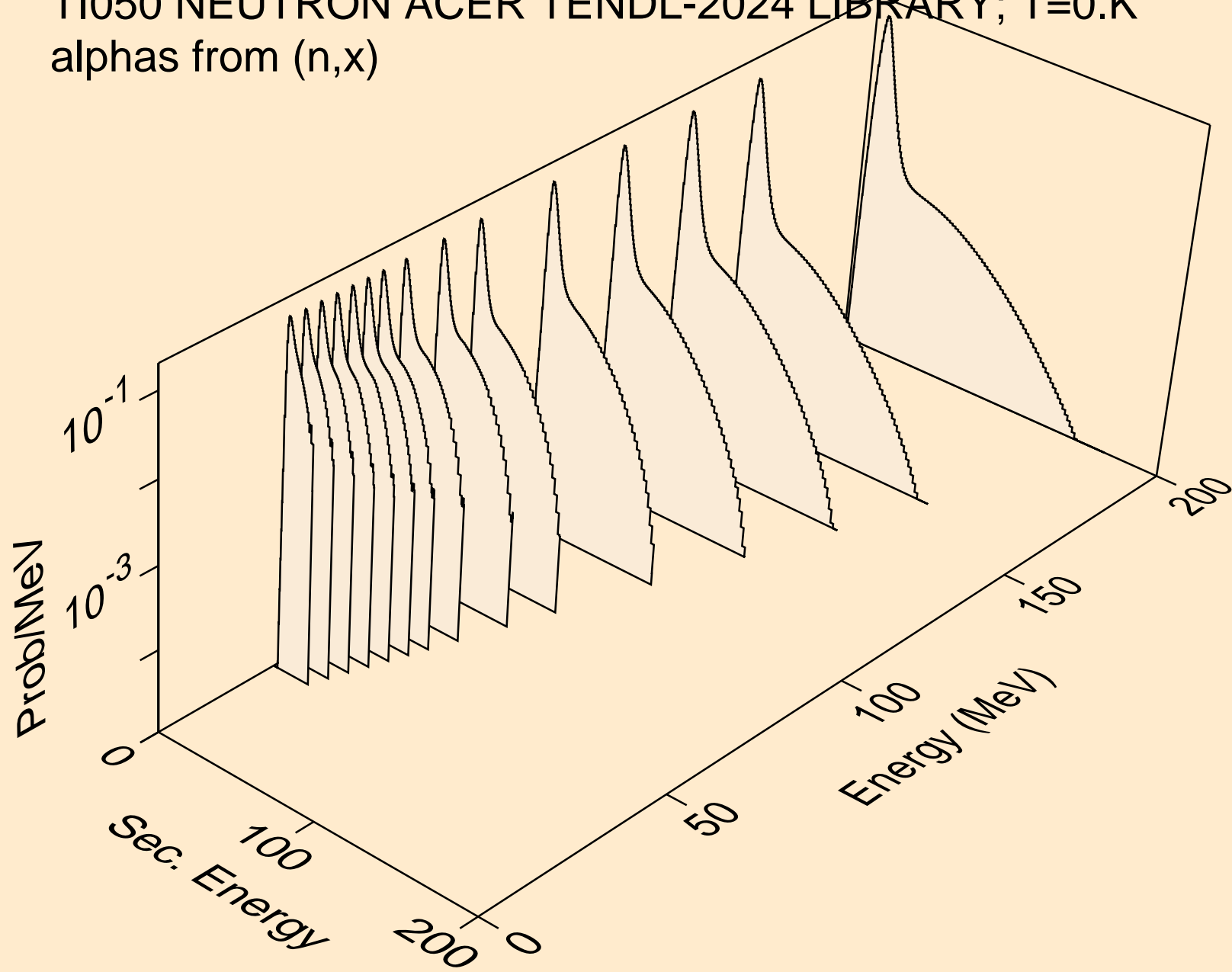

TI050 NEUTRON ACER TENDL-2024 LIBRARY; T=0.K
alphas from (n,n*)a

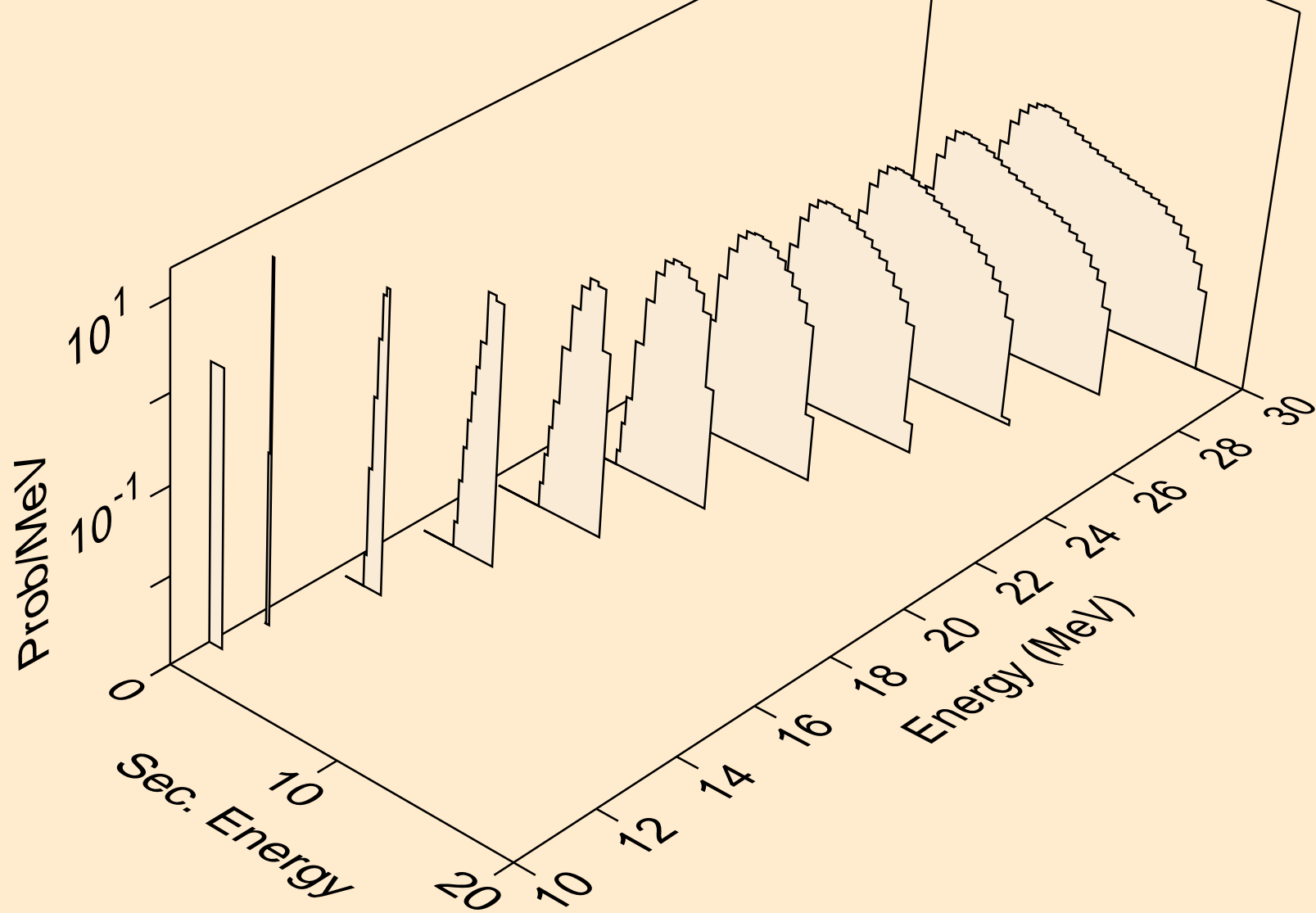

TI050 NEUTRON ACER TENDL-2024 LIBRARY; T=0.K
alphas from (n,2n)a

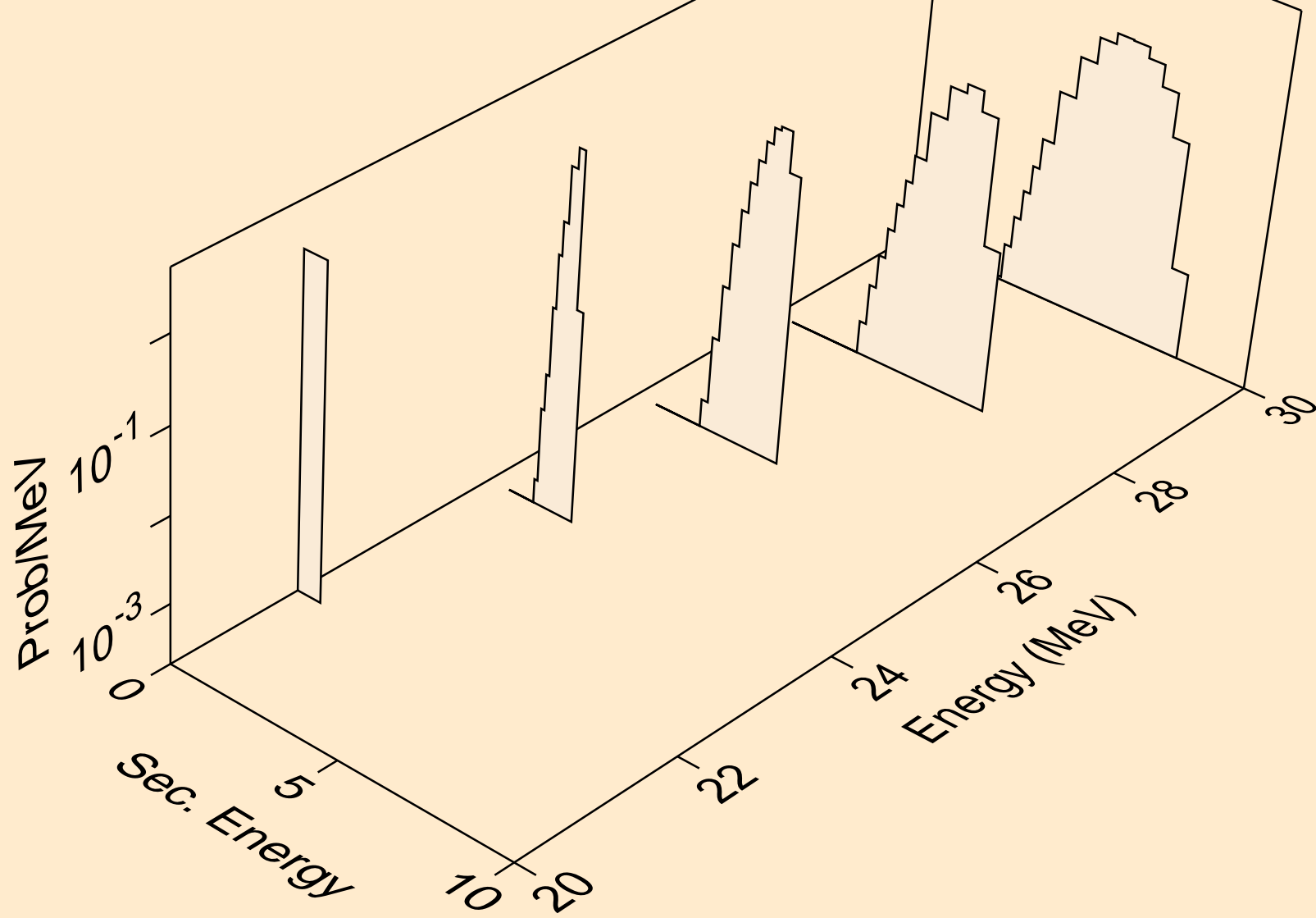

TI050 NEUTRON ACER TENDL-2024 LIBRARY; T=0.K
alphas from (n,a)

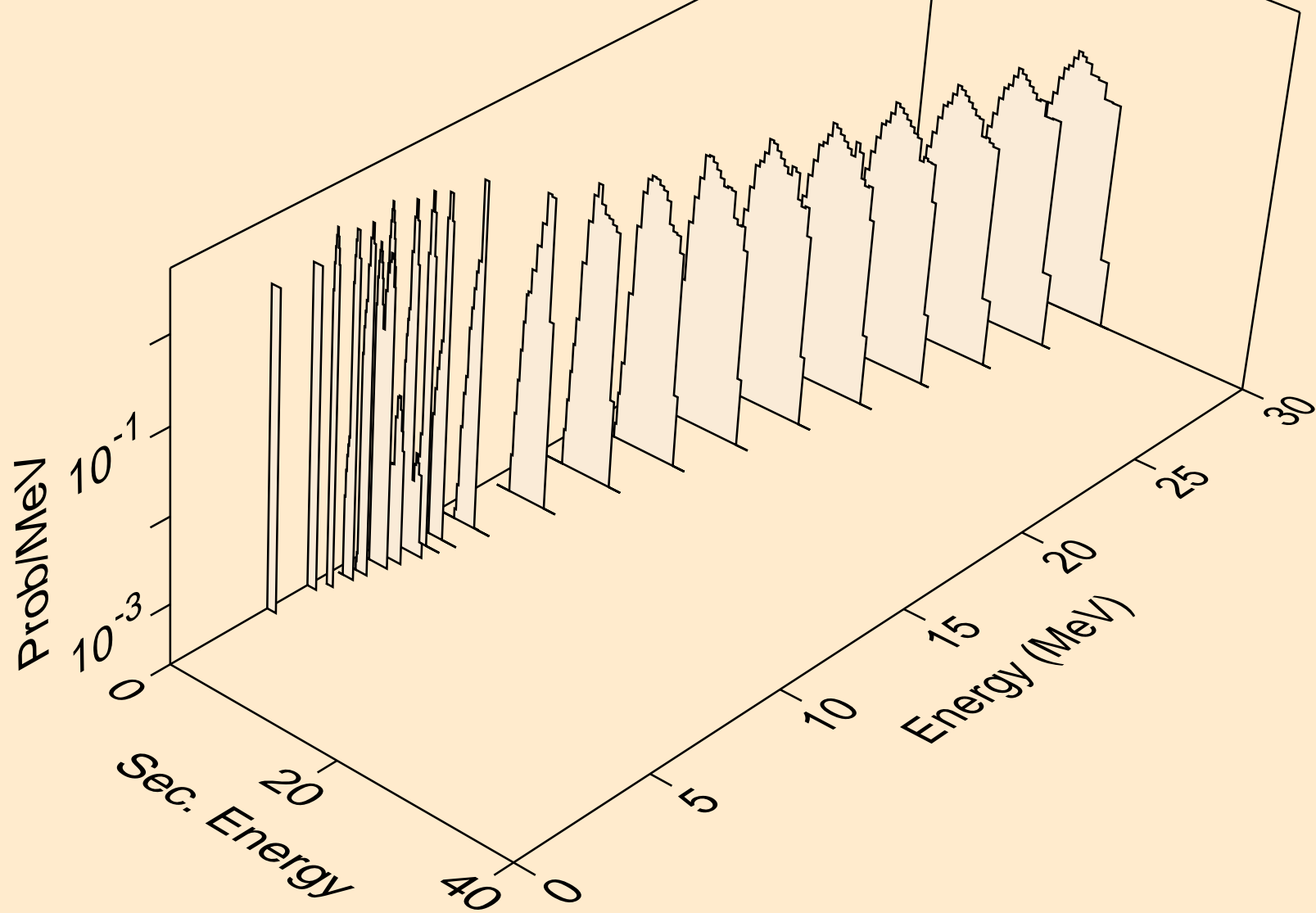

TI050 NEUTRON ACER TENDL-2024 LIBRARY; T=0.K
alphas from (n,2a)

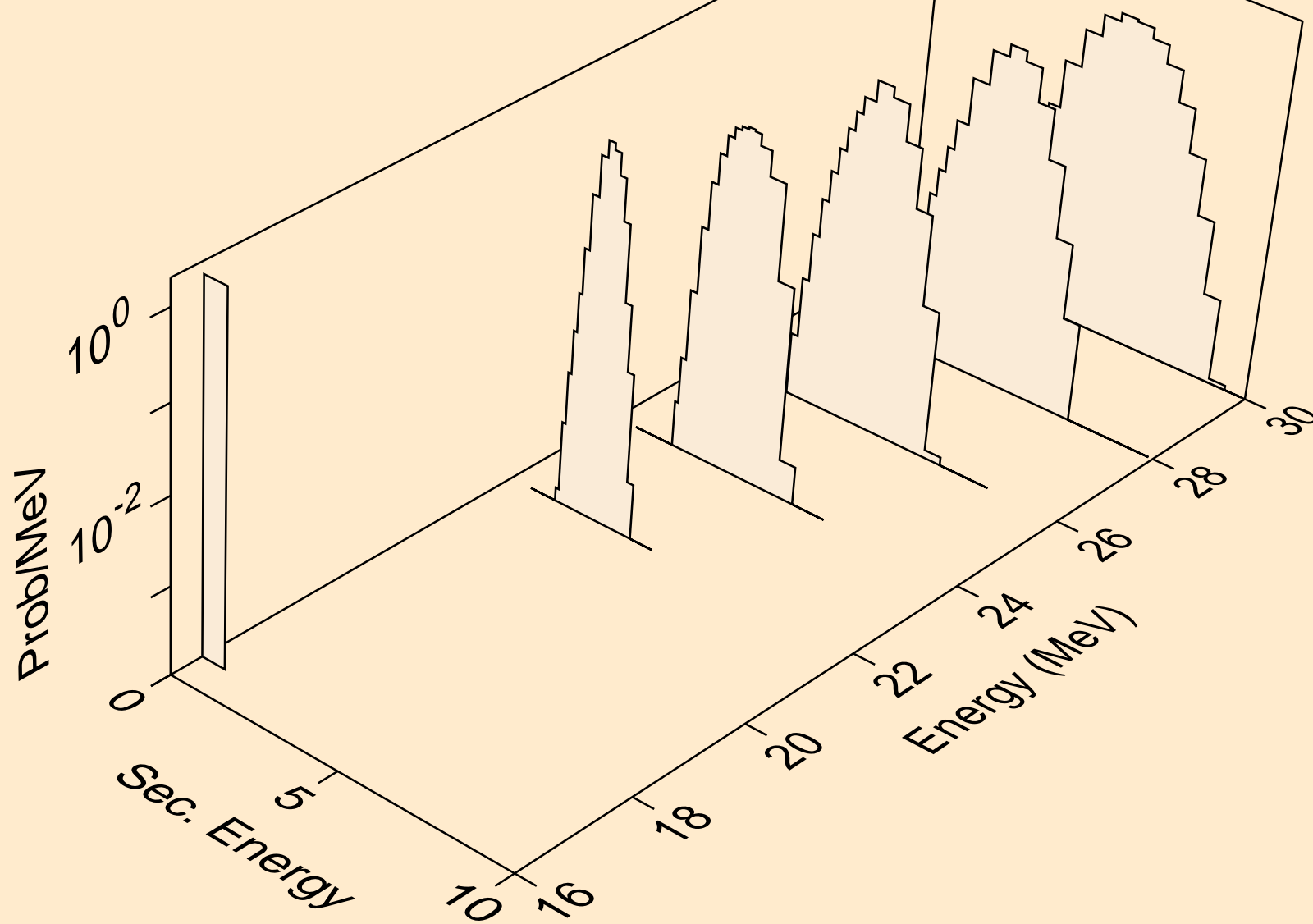

TI050 NEUTRON ACER TENDL-2024 LIBRARY; T=0.K
alphas from (n,pa)

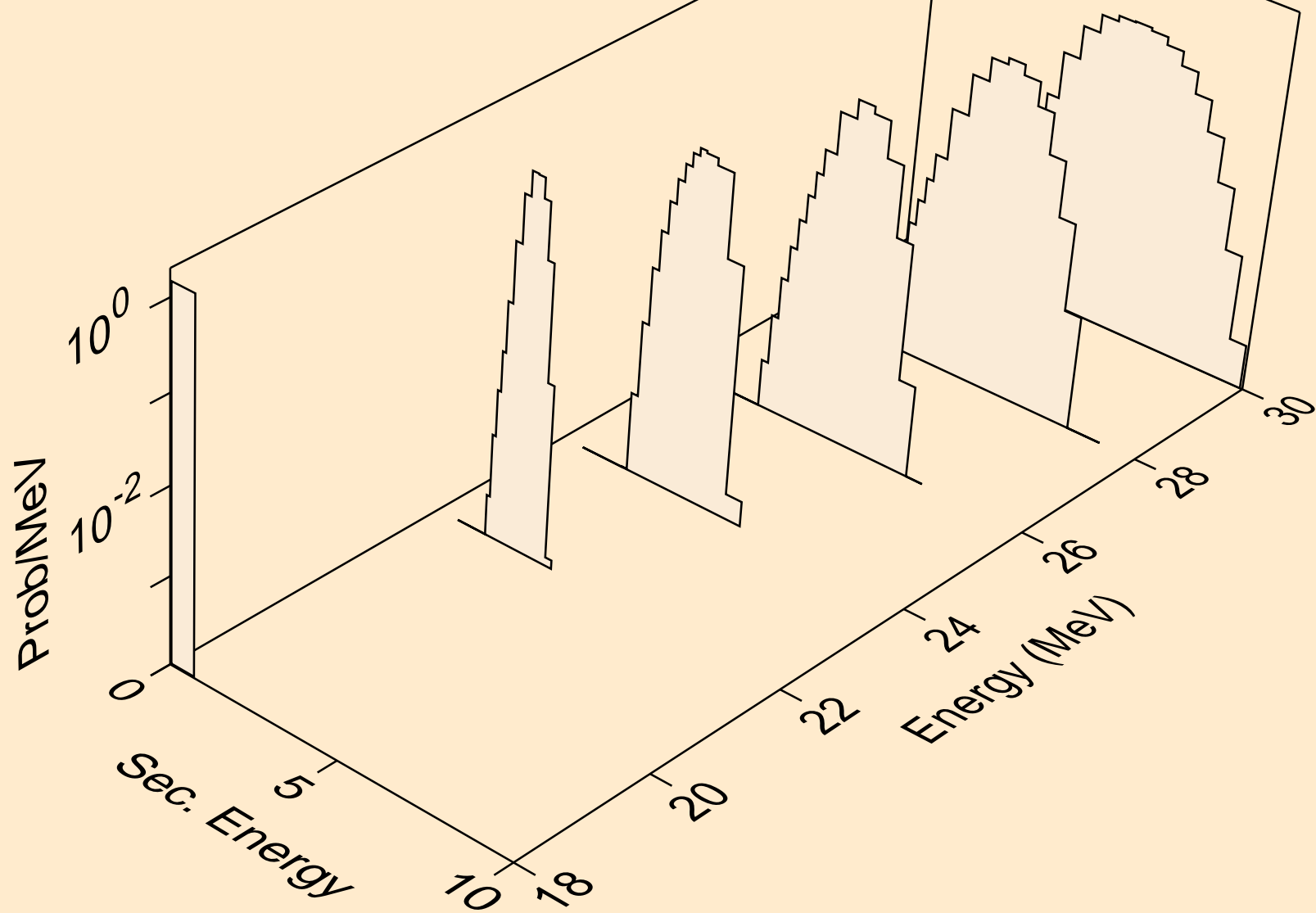

TI050 NEUTRON ACER TENDL-2024 LIBRARY; T=0.K
alphas from (n,da)

