

TL183 NEUTRON ACER TENDL-2024 LIBRARY; T=0.K
Principal cross sections

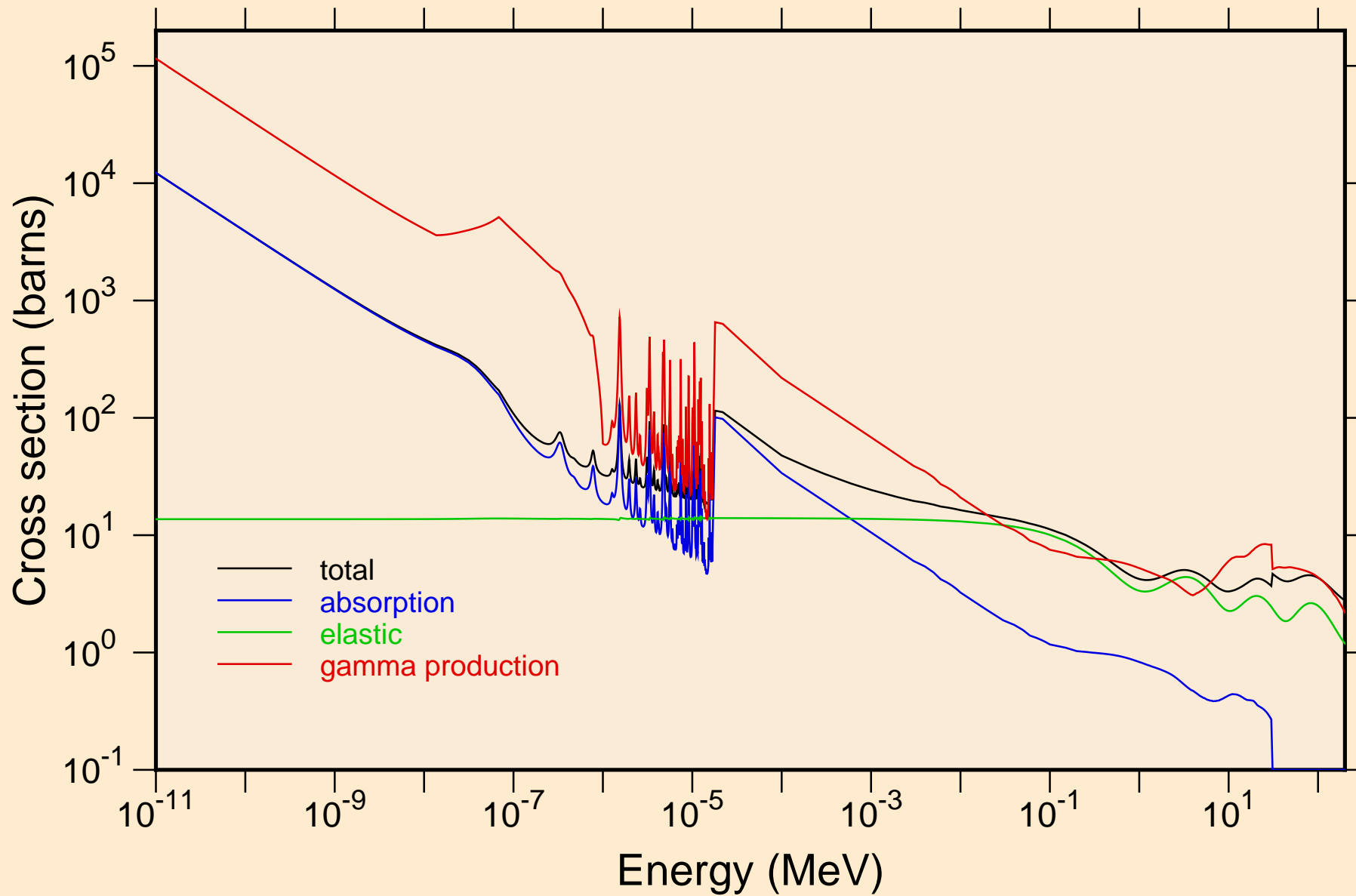

TL183 NEUTRON ACER TENDL-2024 LIBRARY; T=0.K
resonance total cross section

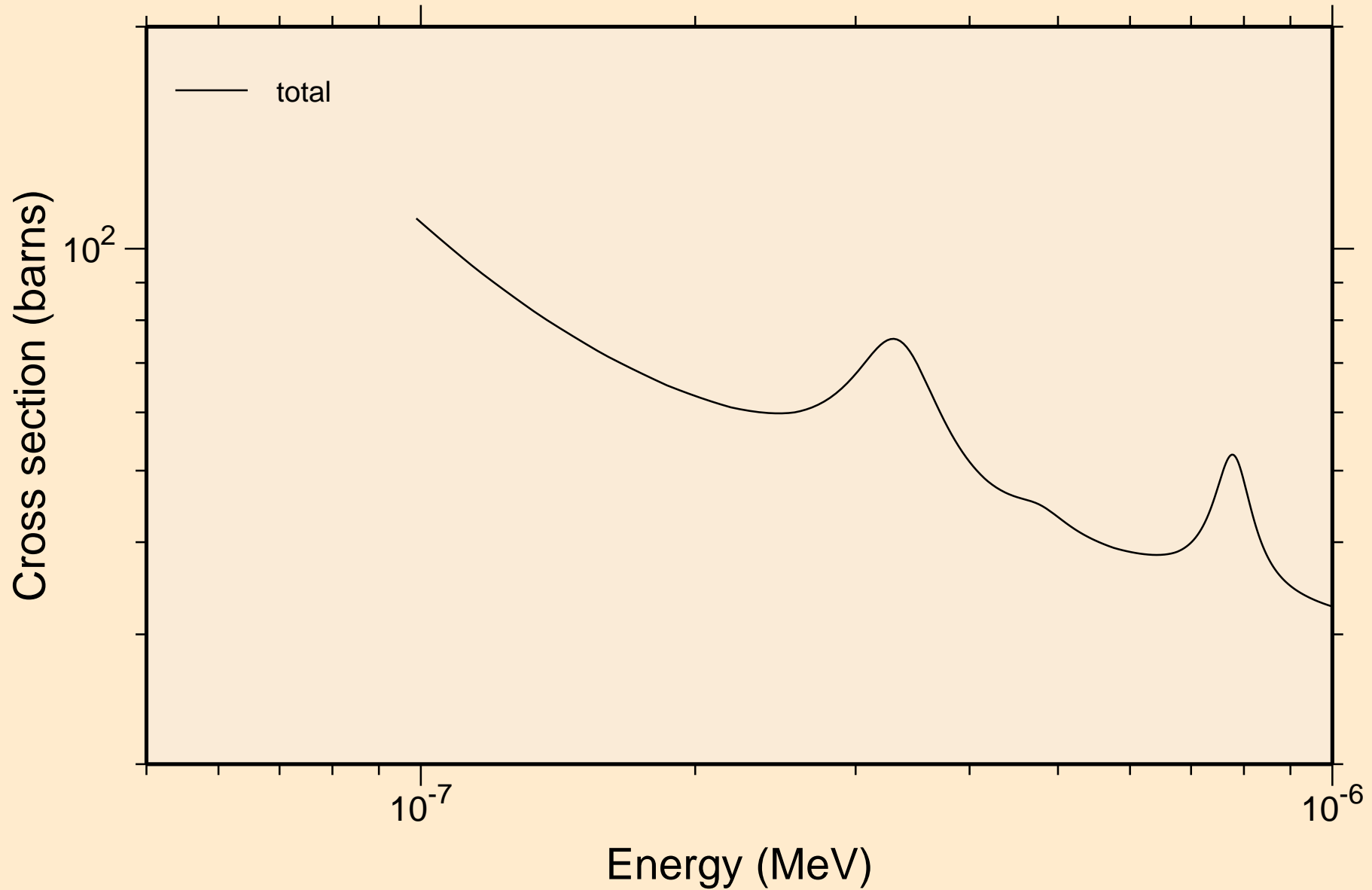

TL183 NEUTRON ACER TENDL-2024 LIBRARY; T=0.K
resonance total cross section

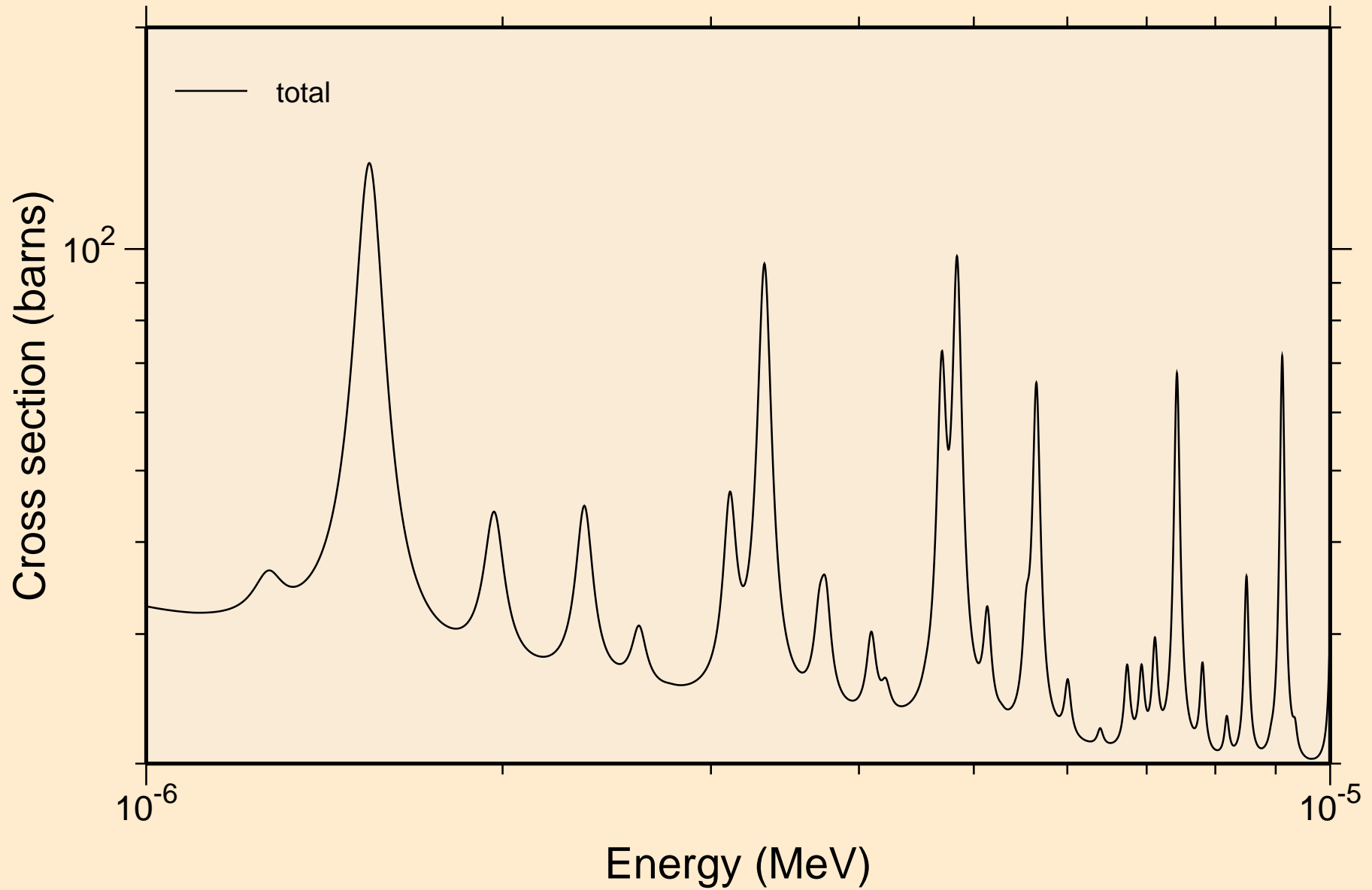

TL183 NEUTRON ACER TENDL-2024 LIBRARY; T=0.K
resonance total cross section

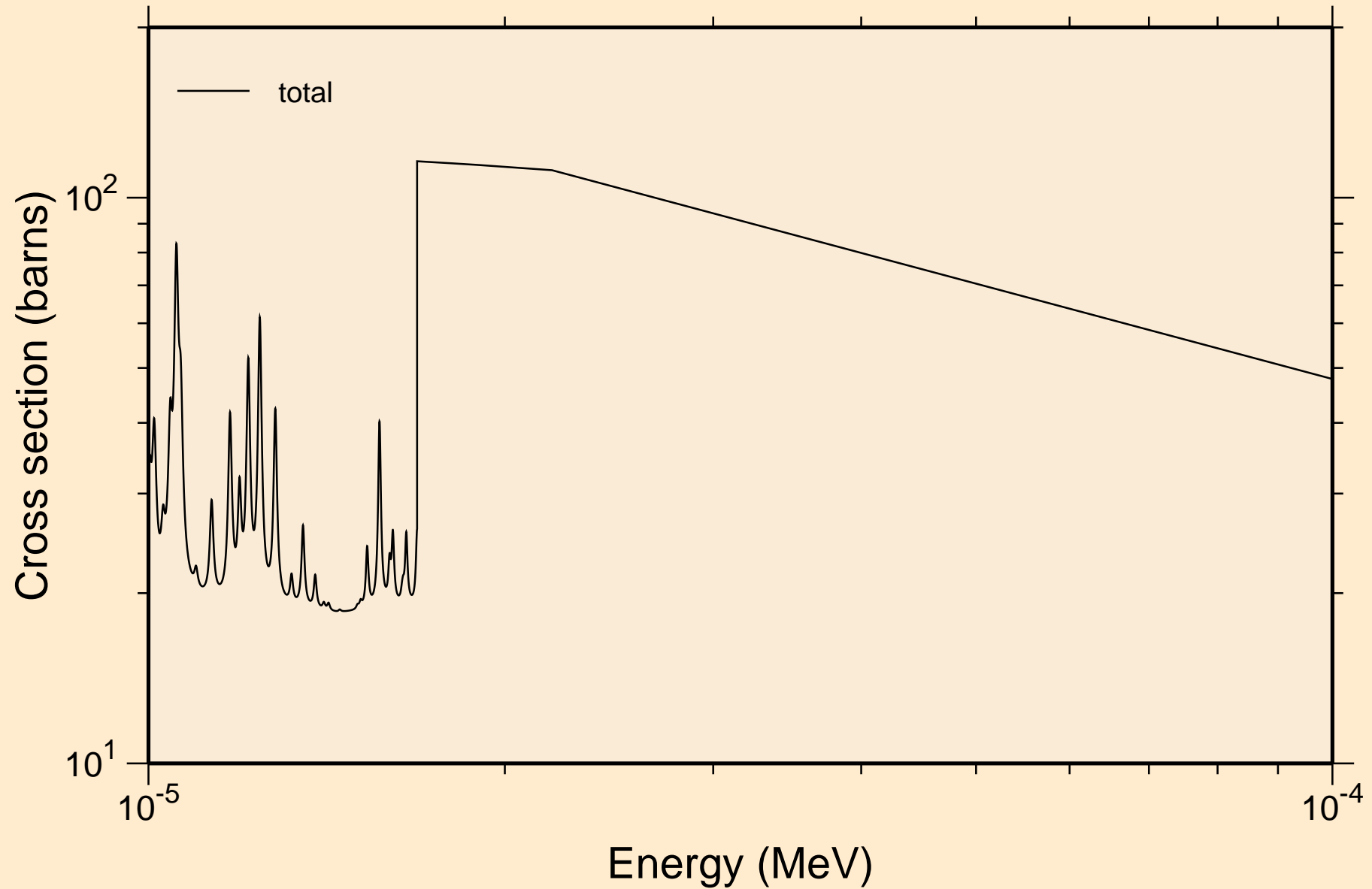

TL183 NEUTRON ACER TENDL-2024 LIBRARY; T=0.K
resonance total cross section

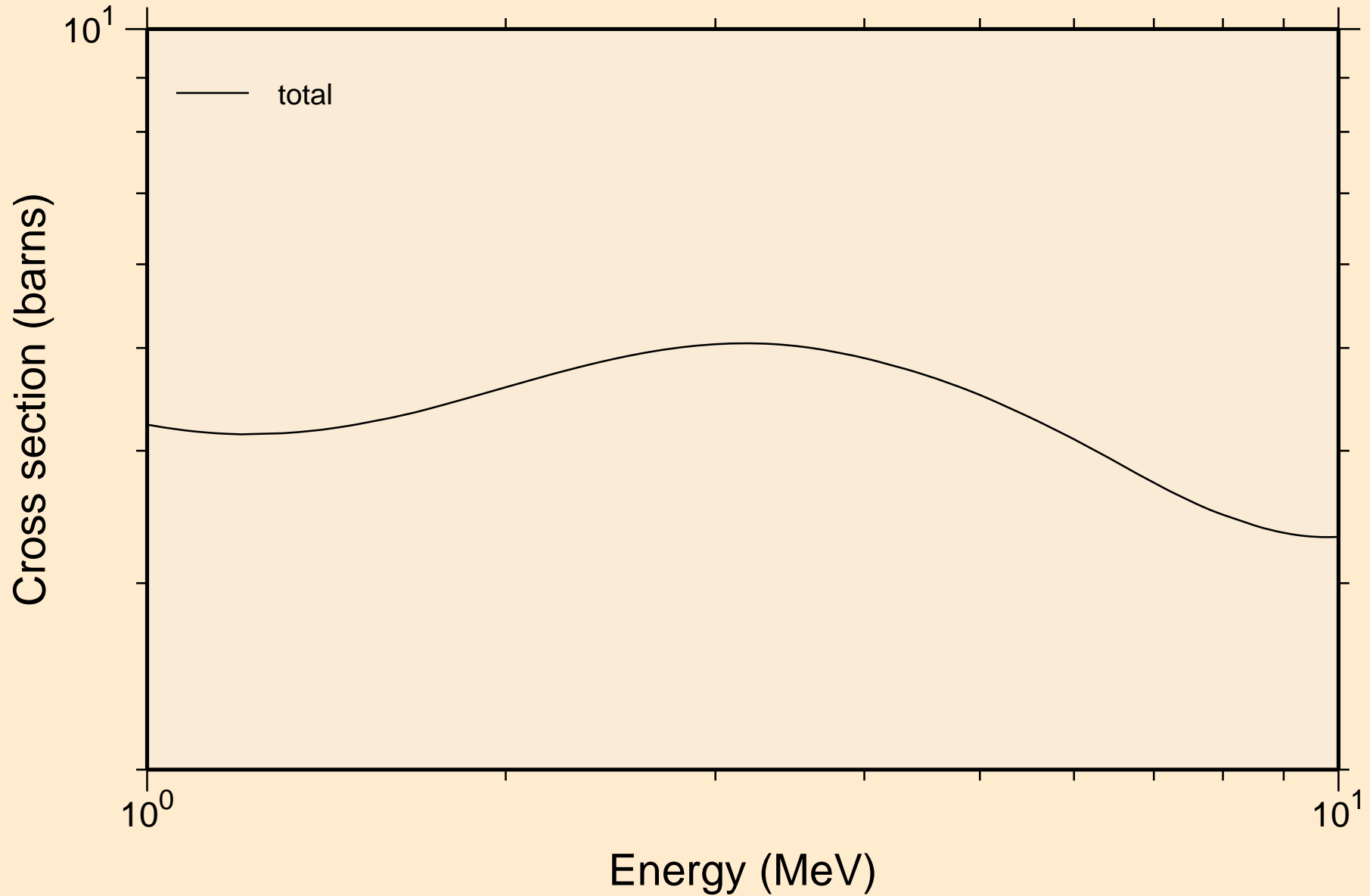

TL183 NEUTRON ACER TENDL-2024 LIBRARY; T=0.K
resonance absorption cross sections

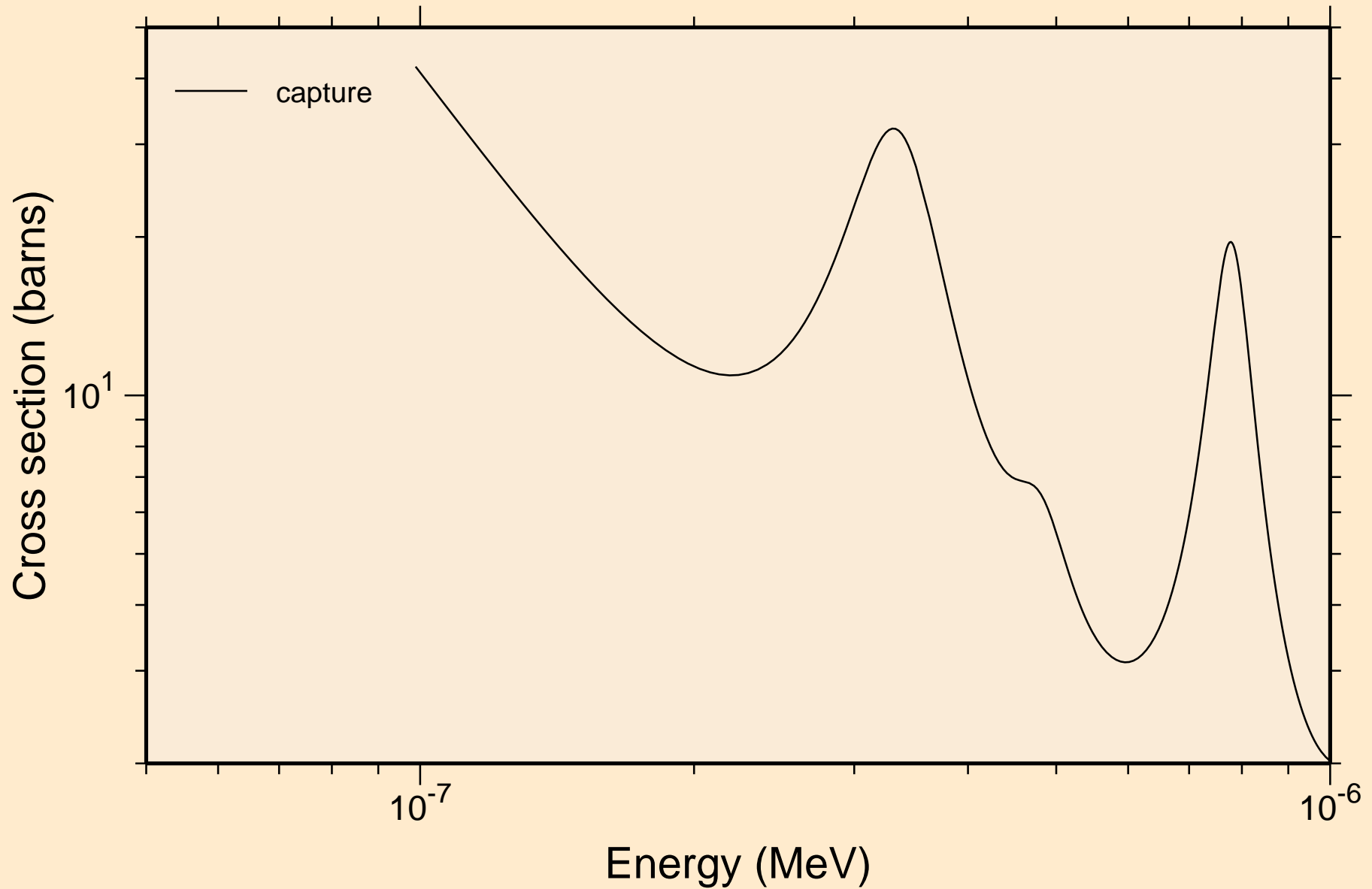

TL183 NEUTRON ACER TENDL-2024 LIBRARY; T=0.K
resonance absorption cross sections

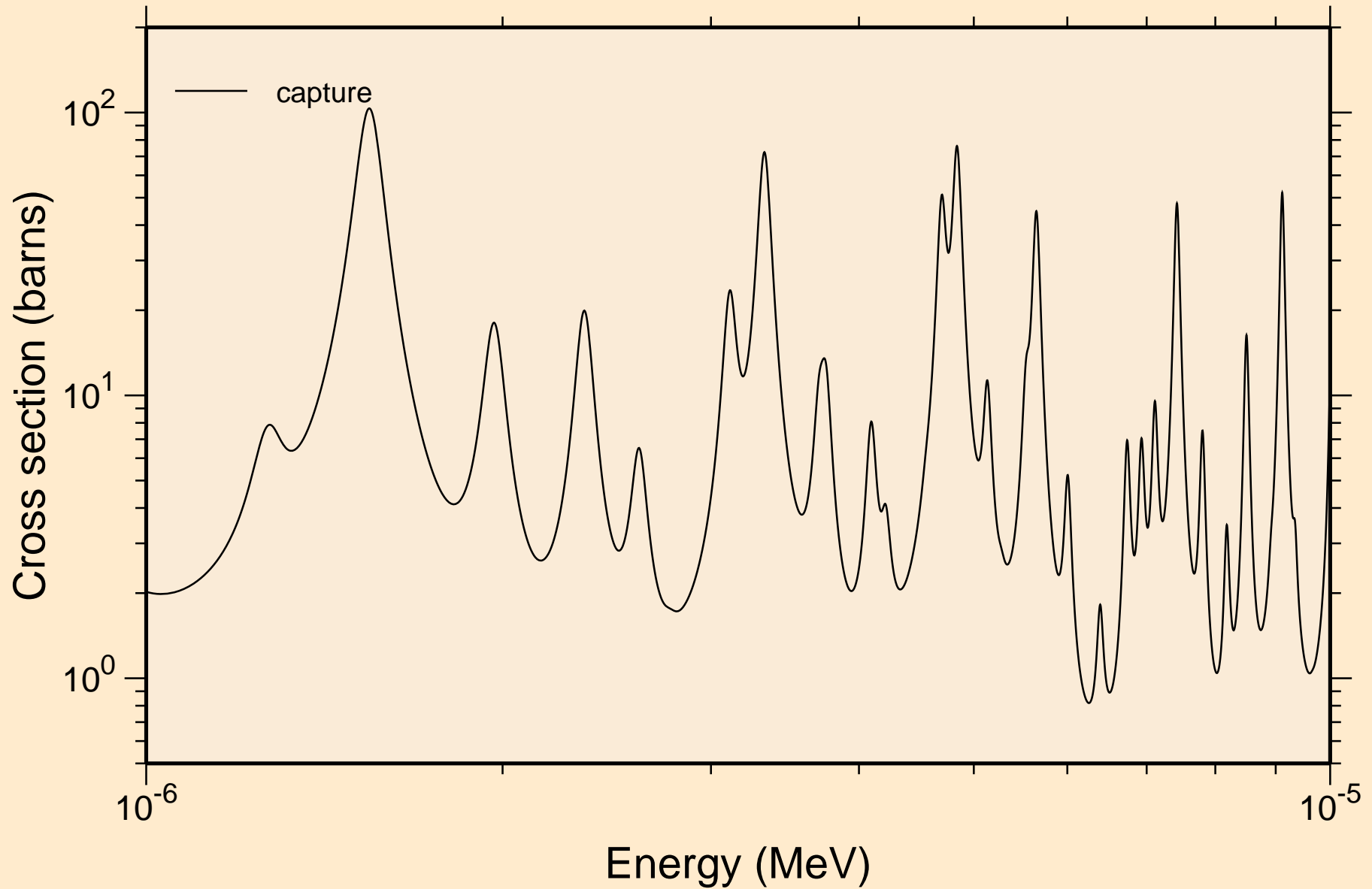

TL183 NEUTRON ACER TENDL-2024 LIBRARY; T=0.K
resonance absorption cross sections

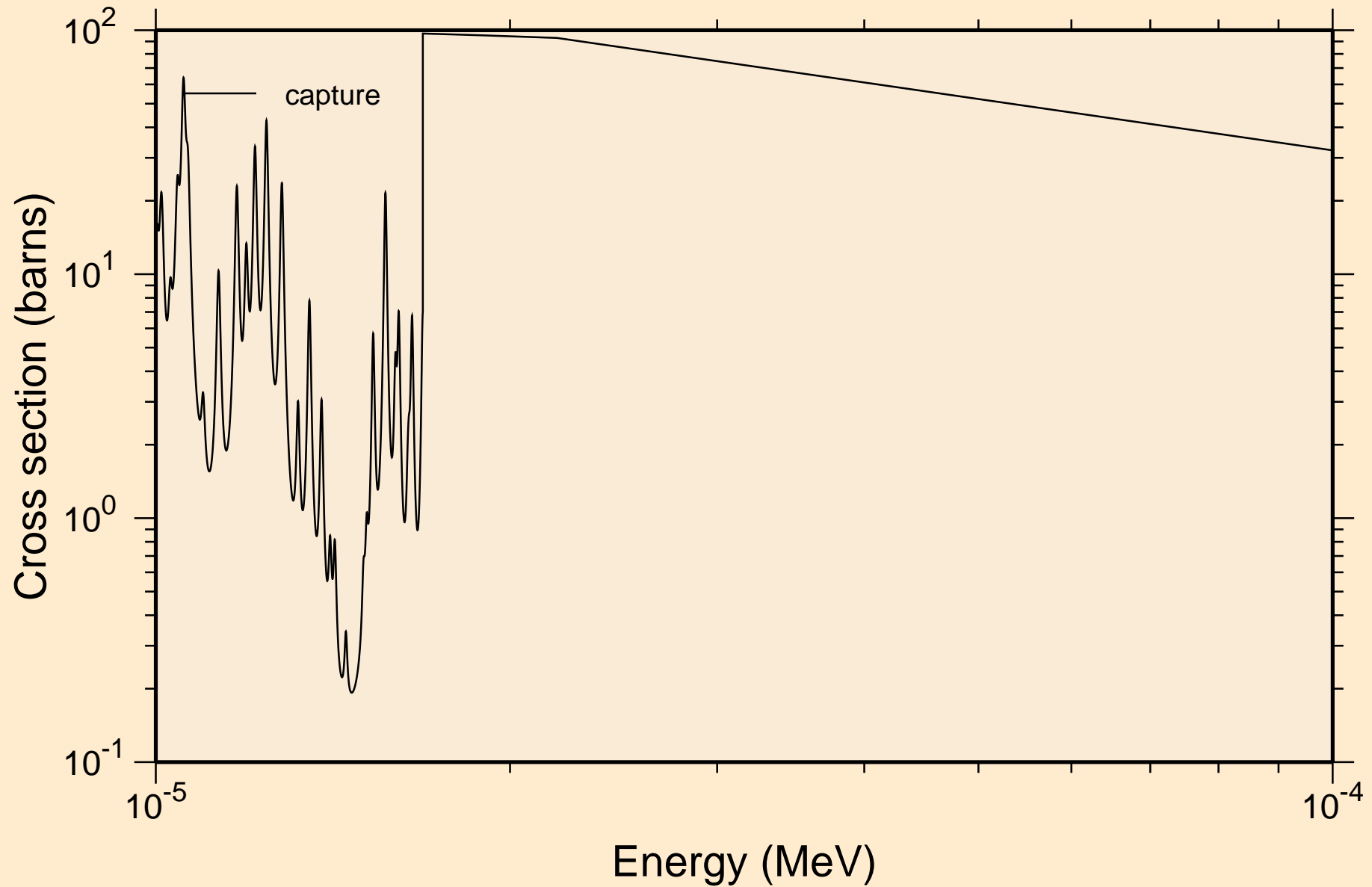

TL183 NEUTRON ACER TENDL-2024 LIBRARY; T=0.K
resonance absorption cross sections

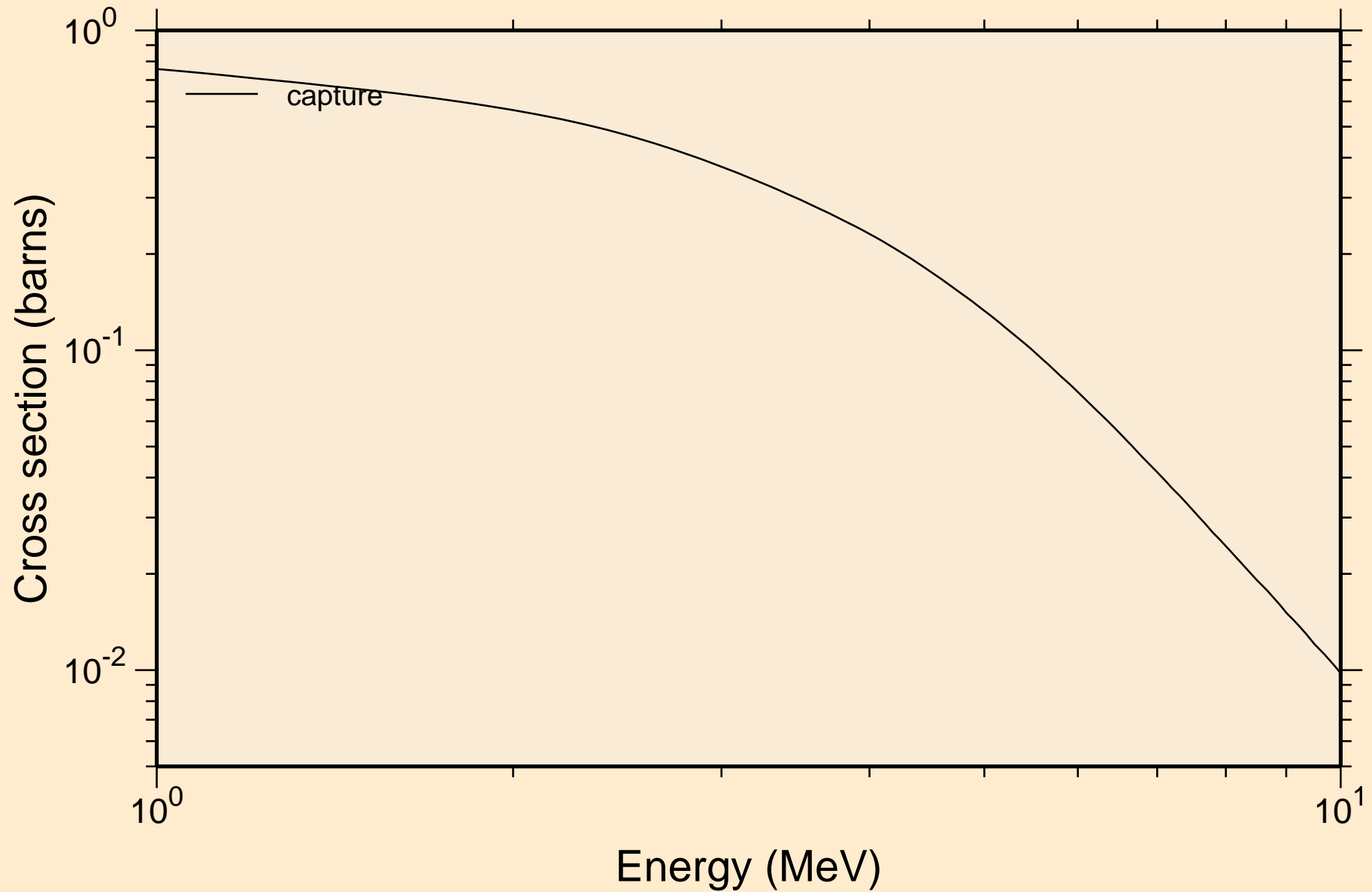

TL183 NEUTRON ACER TENDL-2024 LIBRARY; T=0.K
Heating

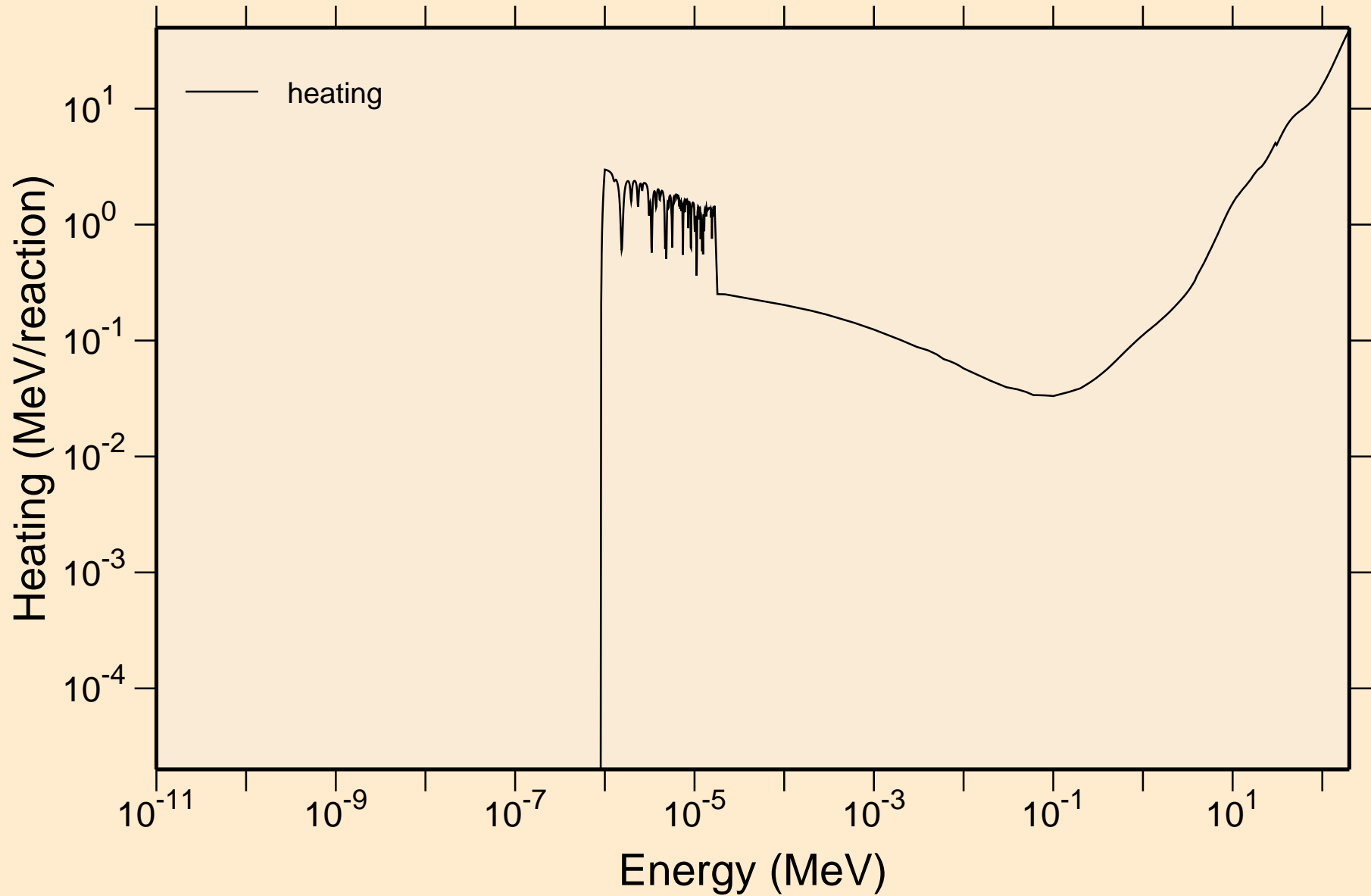

TL183 NEUTRON ACER TENDL-2024 LIBRARY; T=0.K
Damage

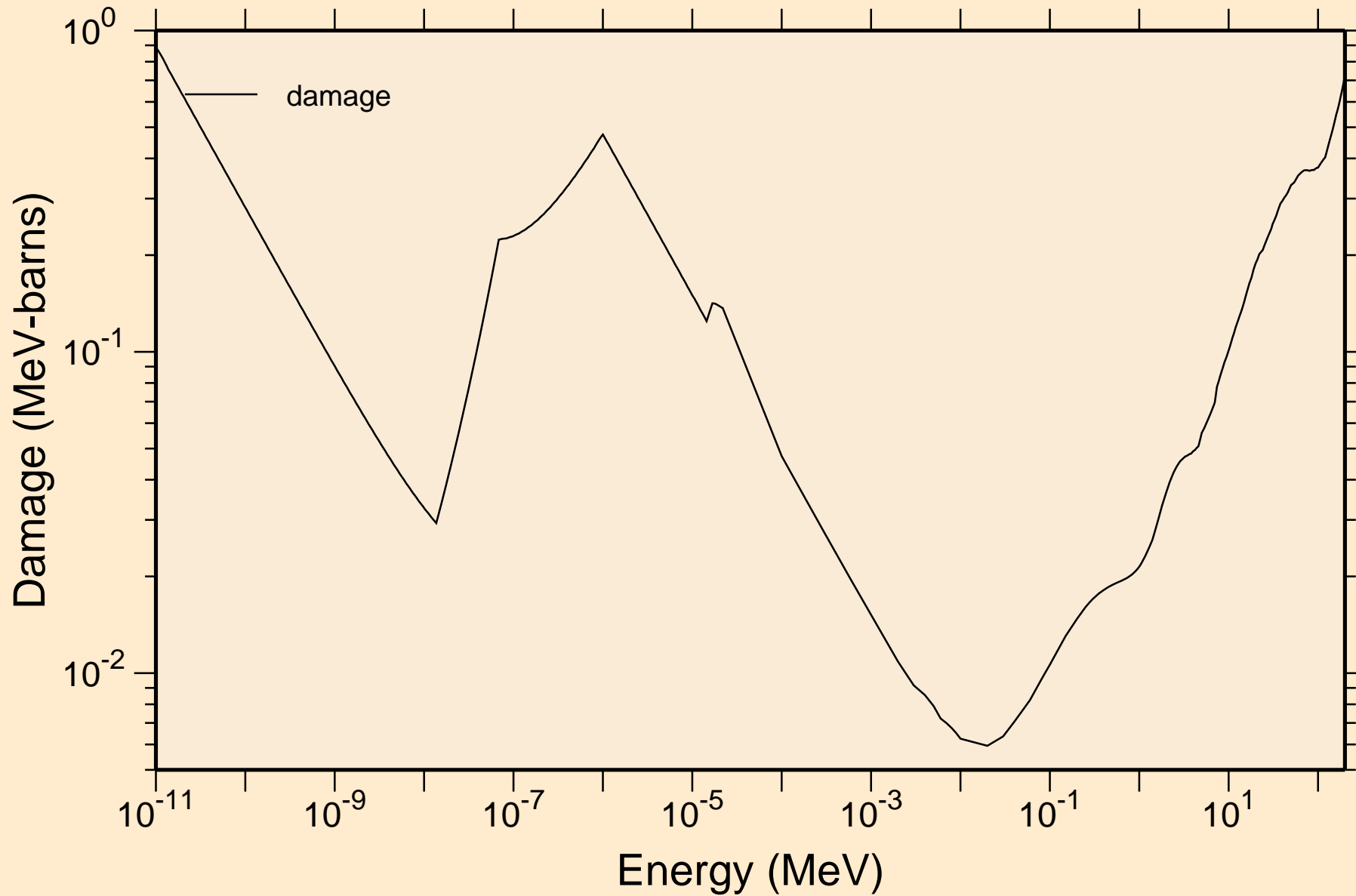

TL183 NEUTRON ACER TENDL-2024 LIBRARY; T=0.K
Non-threshold reactions

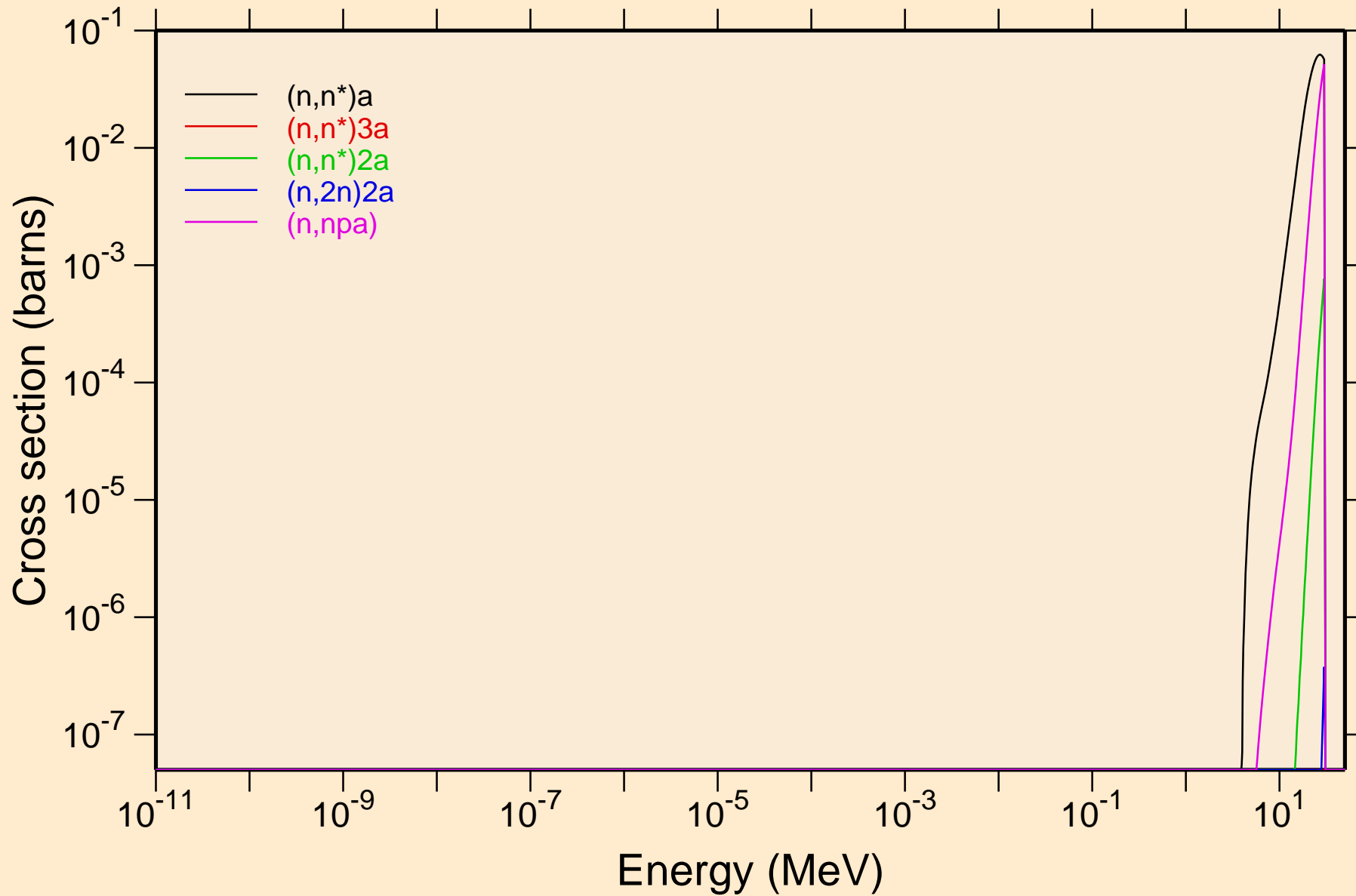

TL183 NEUTRON ACER TENDL-2024 LIBRARY; T=0.K
Non-threshold reactions

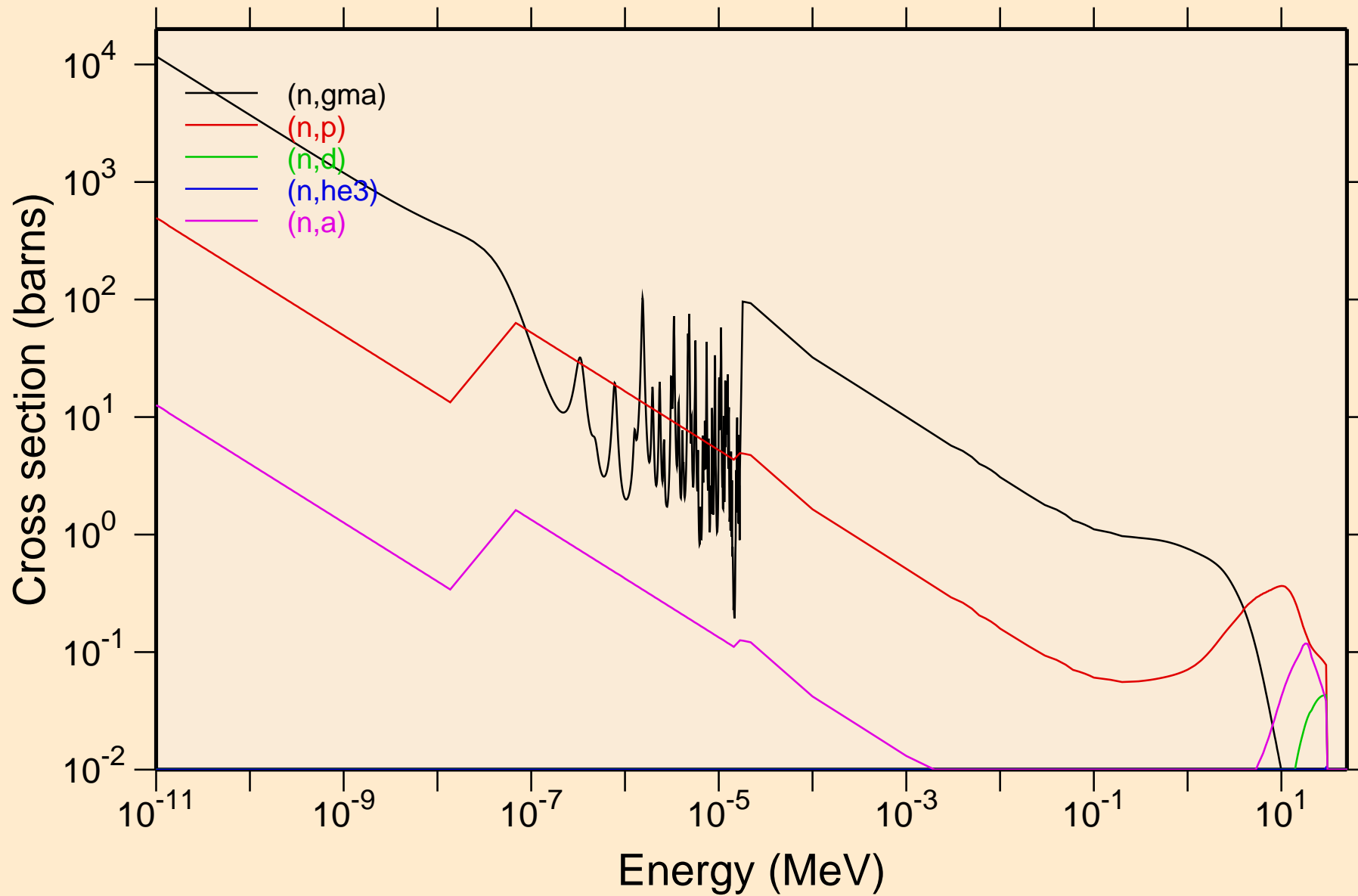

TL183 NEUTRON ACER TENDL-2024 LIBRARY; T=0.K
Non-threshold reactions

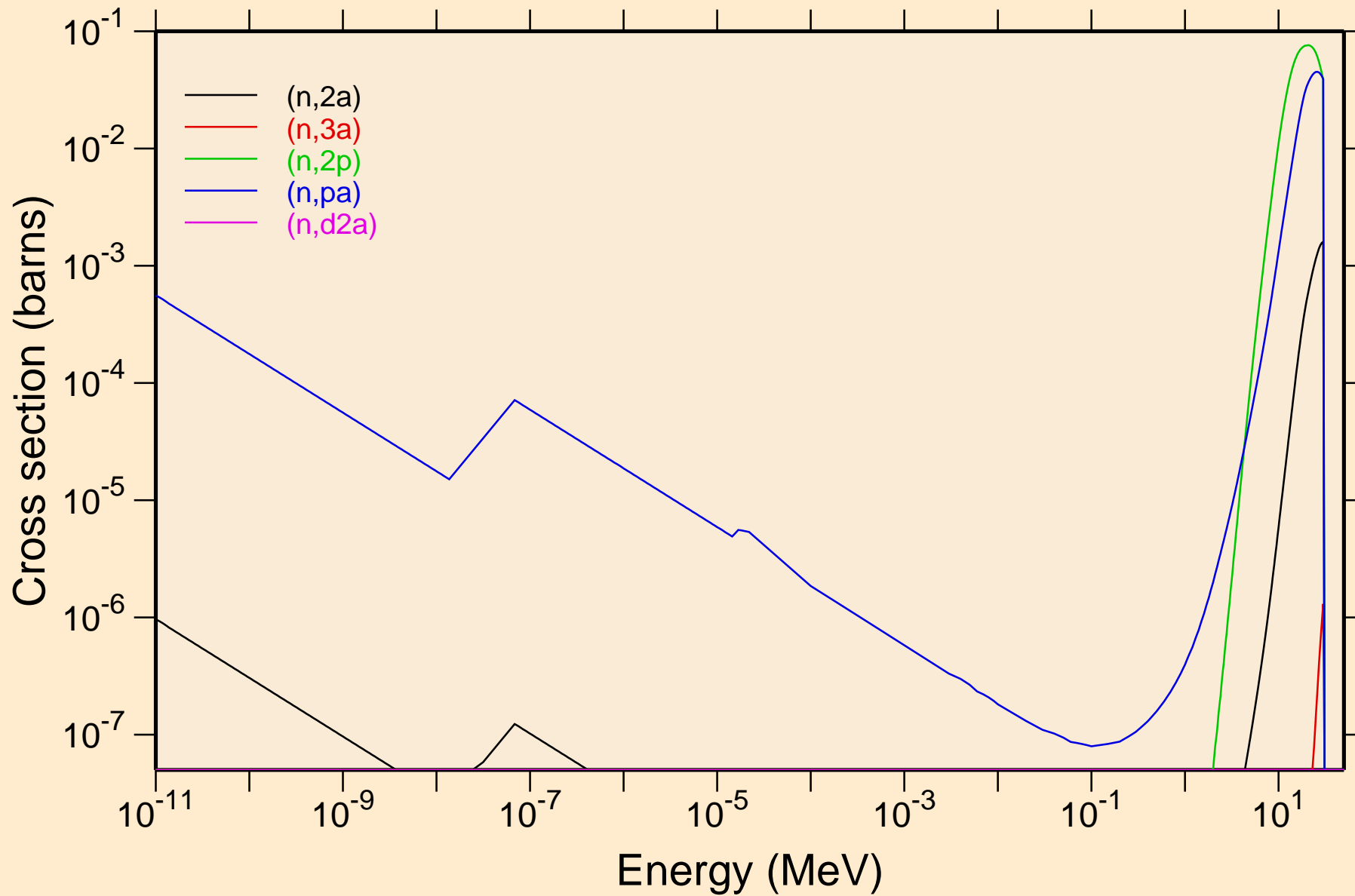

TL183 NEUTRON ACER TENDL-2024 LIBRARY; T=0.K
Non-threshold reactions

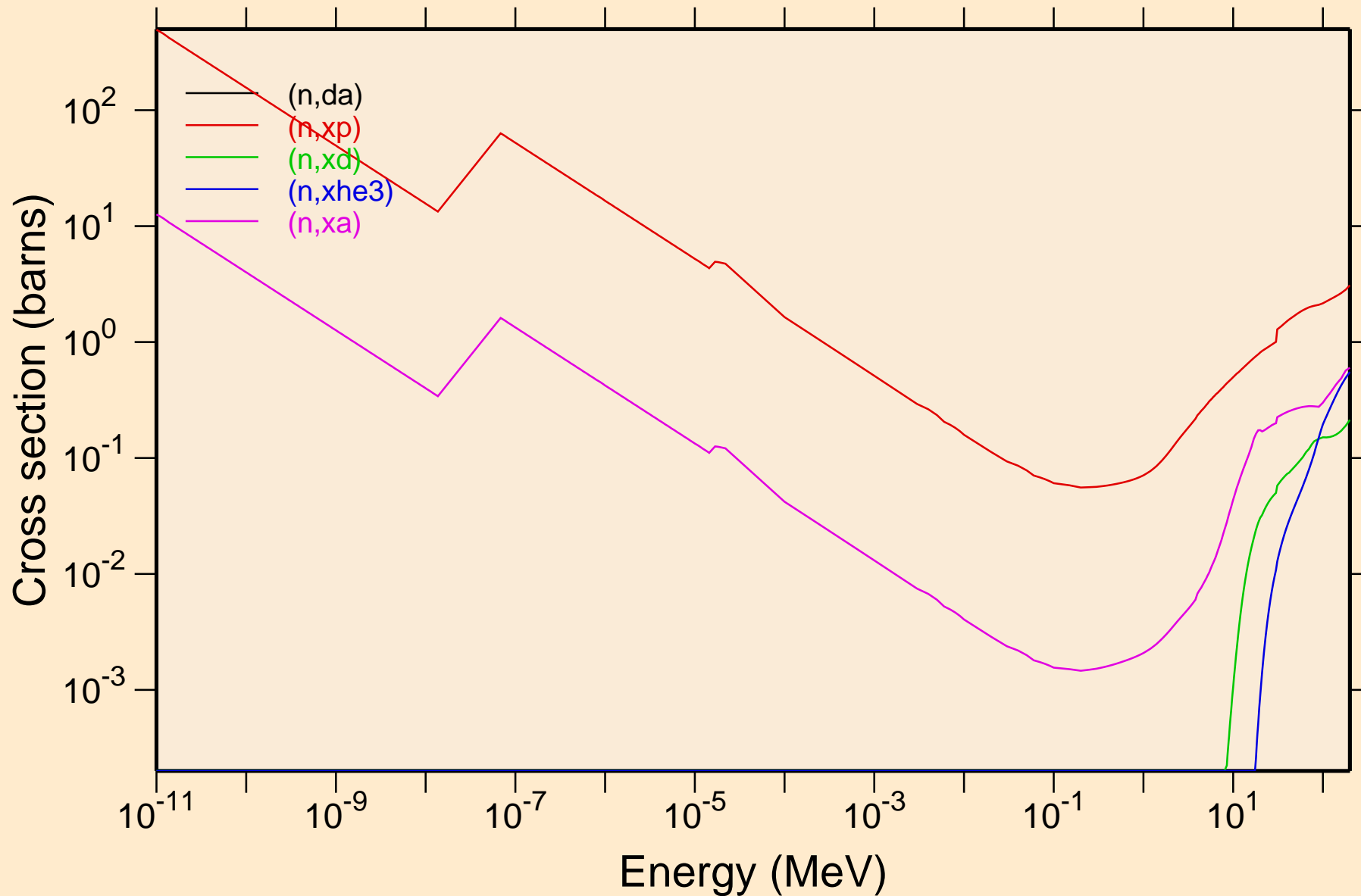

TL183 NEUTRON ACER TENDL-2024 LIBRARY; T=0.K
Principal cross sections

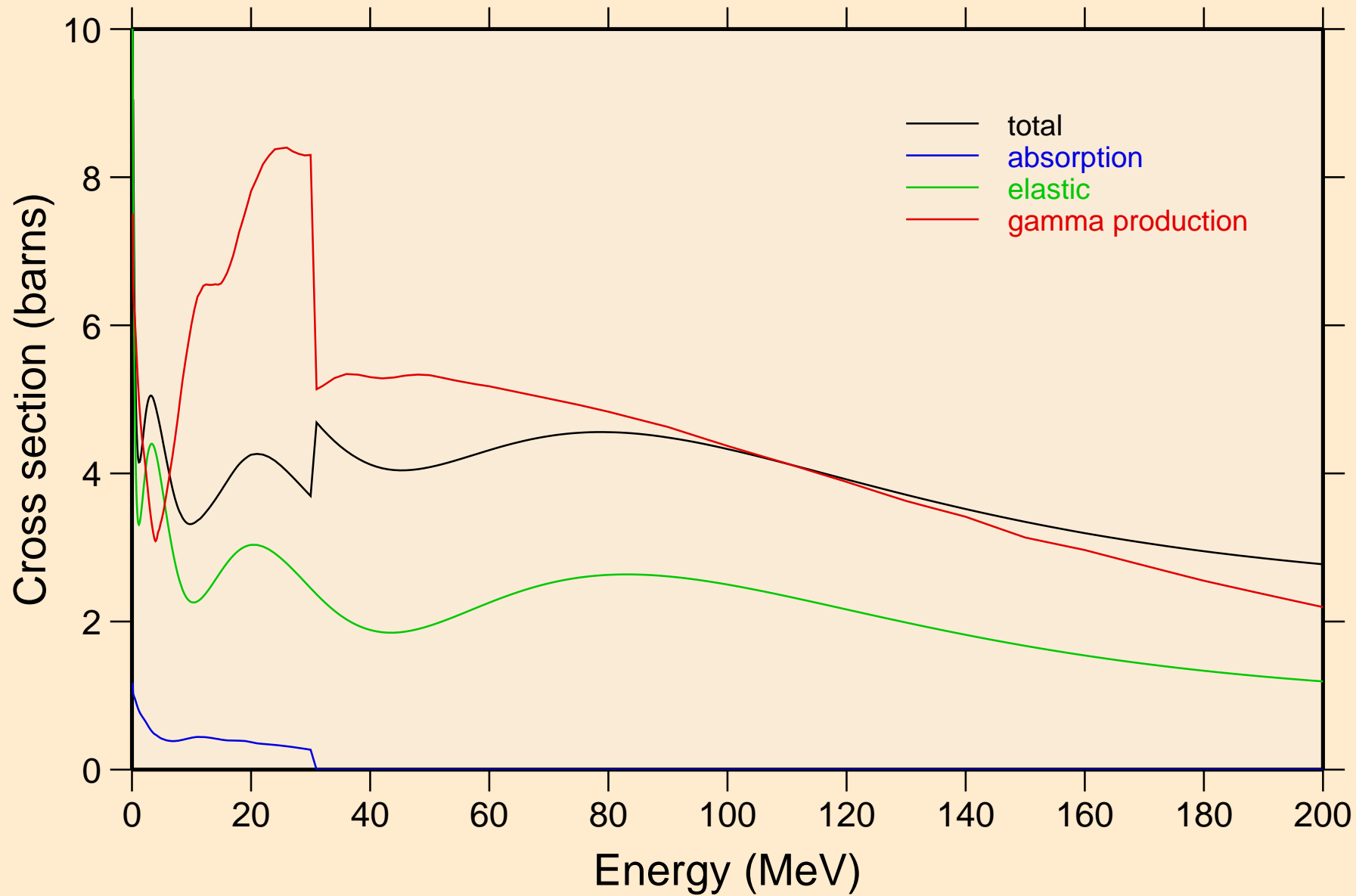

TL183 NEUTRON ACER TENDL-2024 LIBRARY; T=0.K

Heating

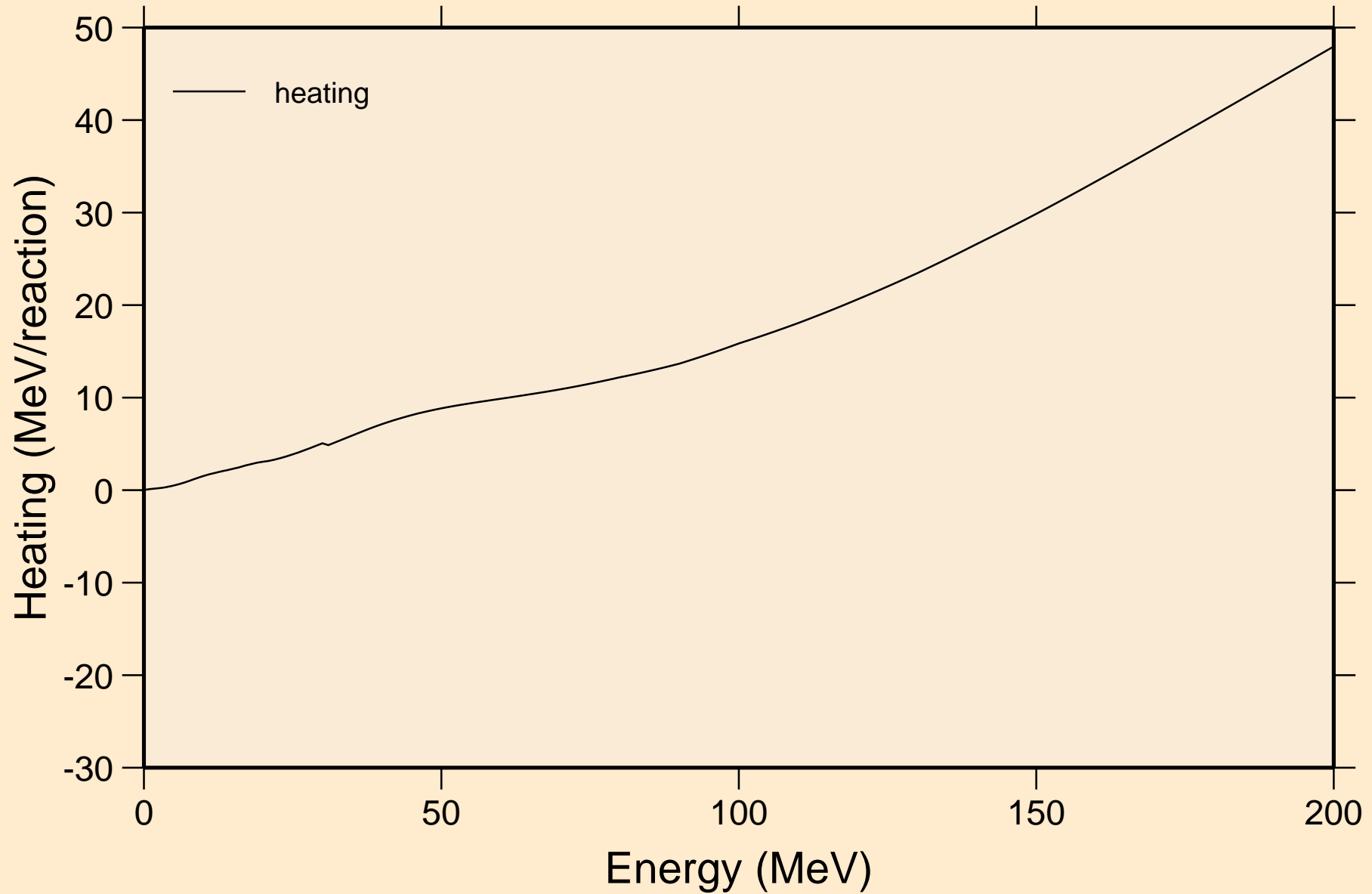

TL183 NEUTRON ACER TENDL-2024 LIBRARY; T=0.K
Damage

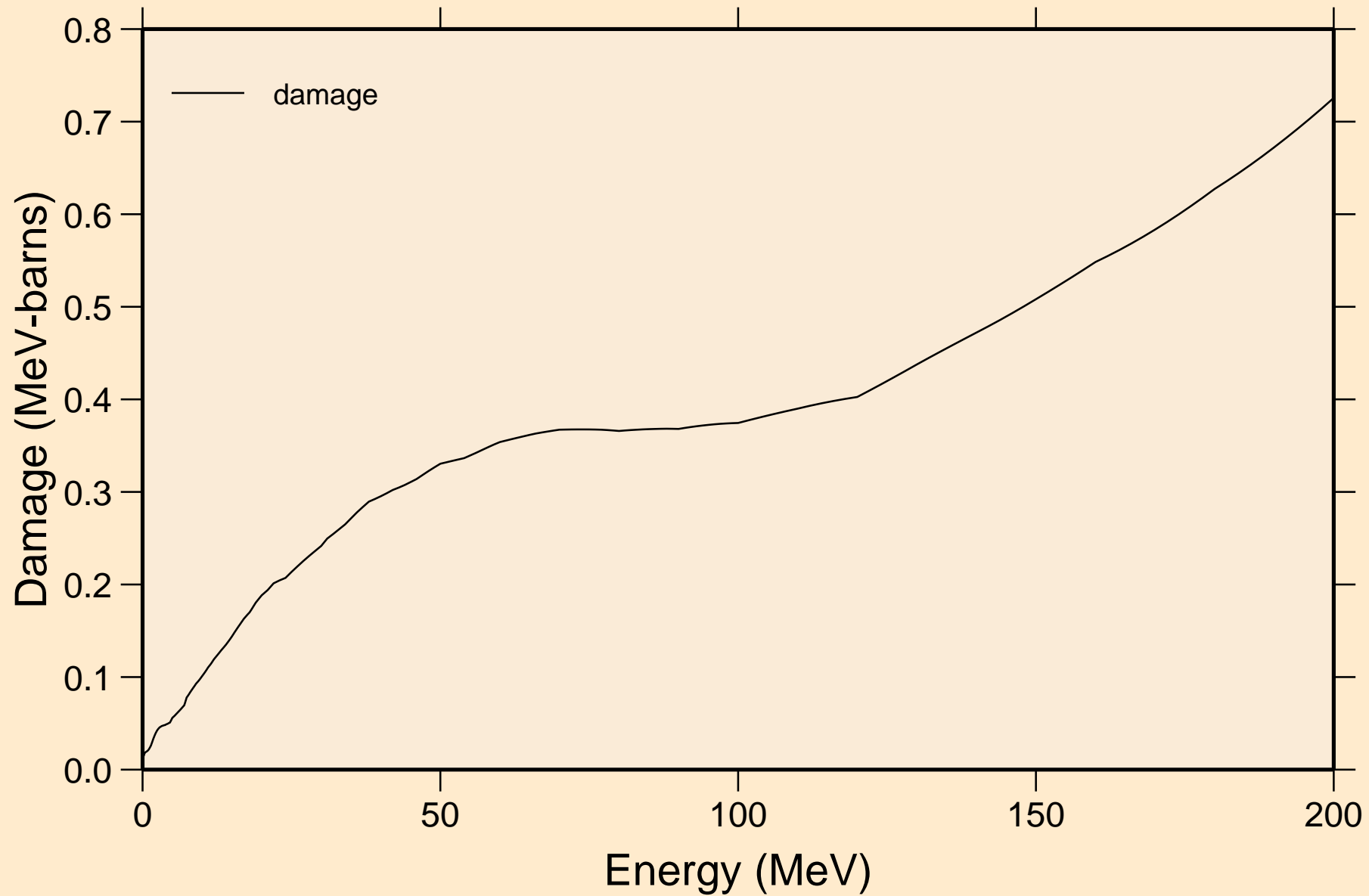

TL183 NEUTRON ACER TENDL-2024 LIBRARY; T=0.K
Non-threshold reactions

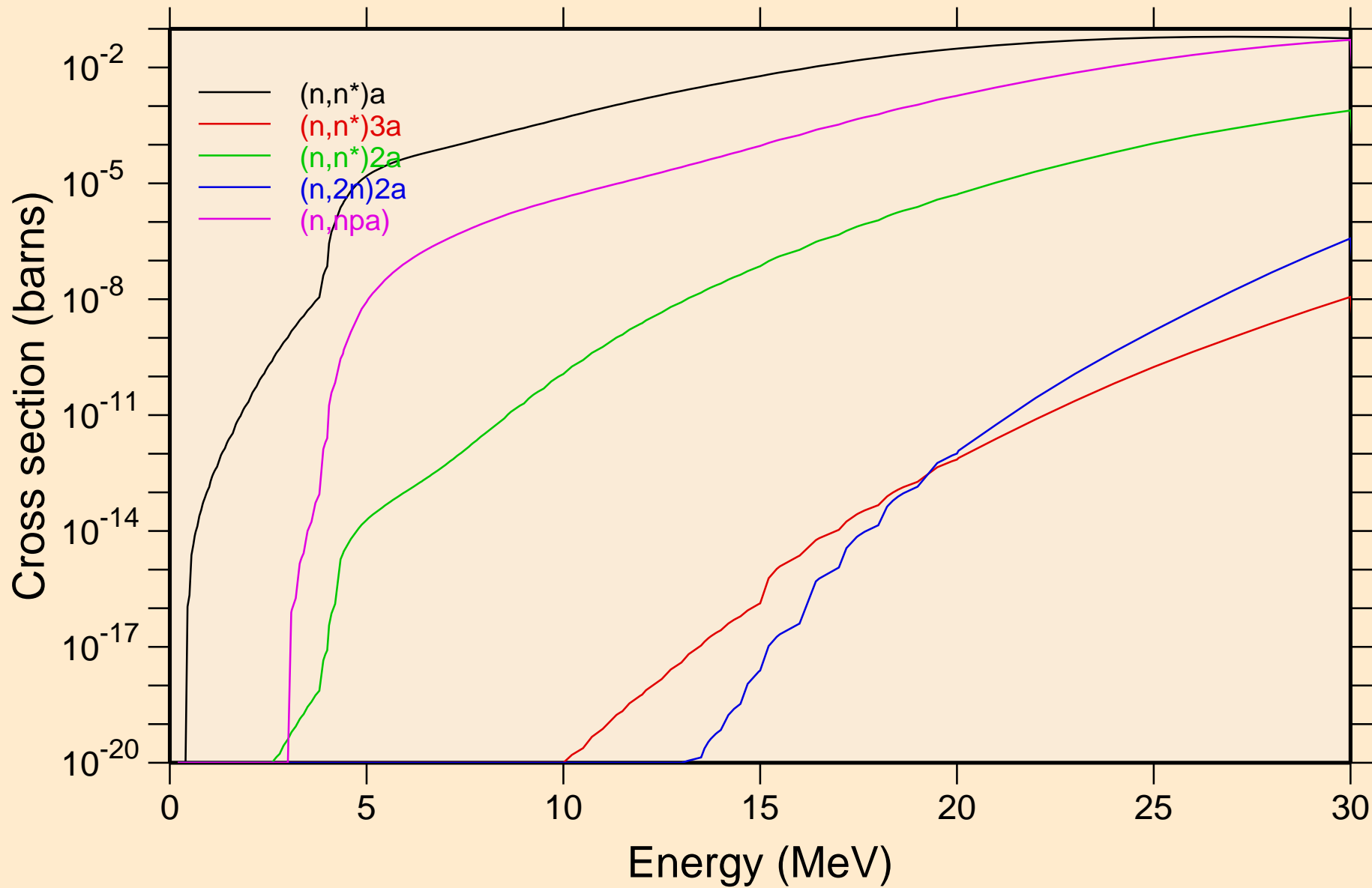

TL183 NEUTRON ACER TENDL-2024 LIBRARY; T=0.K
Non-threshold reactions

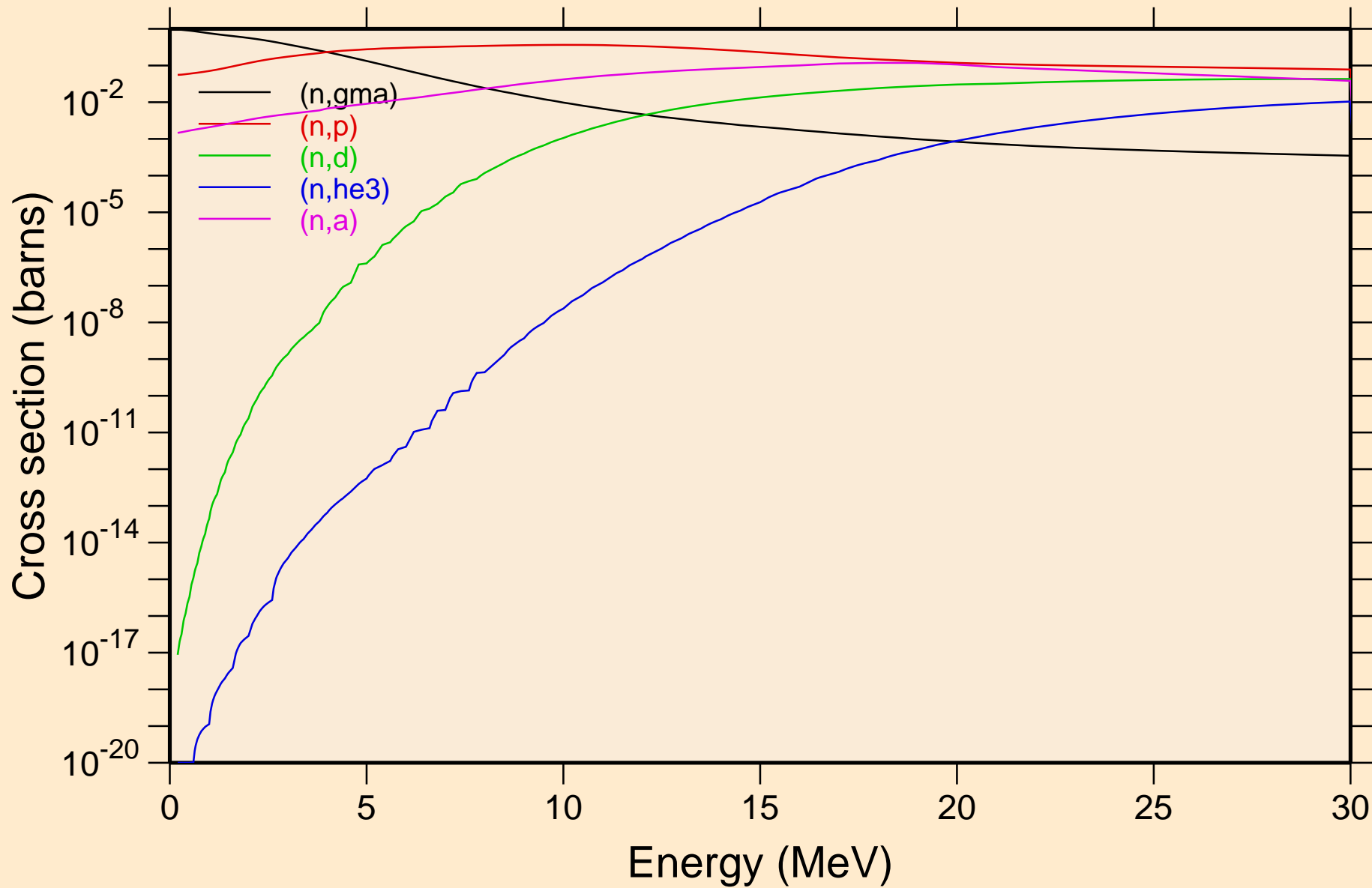

TL183 NEUTRON ACER TENDL-2024 LIBRARY; T=0.K
Non-threshold reactions

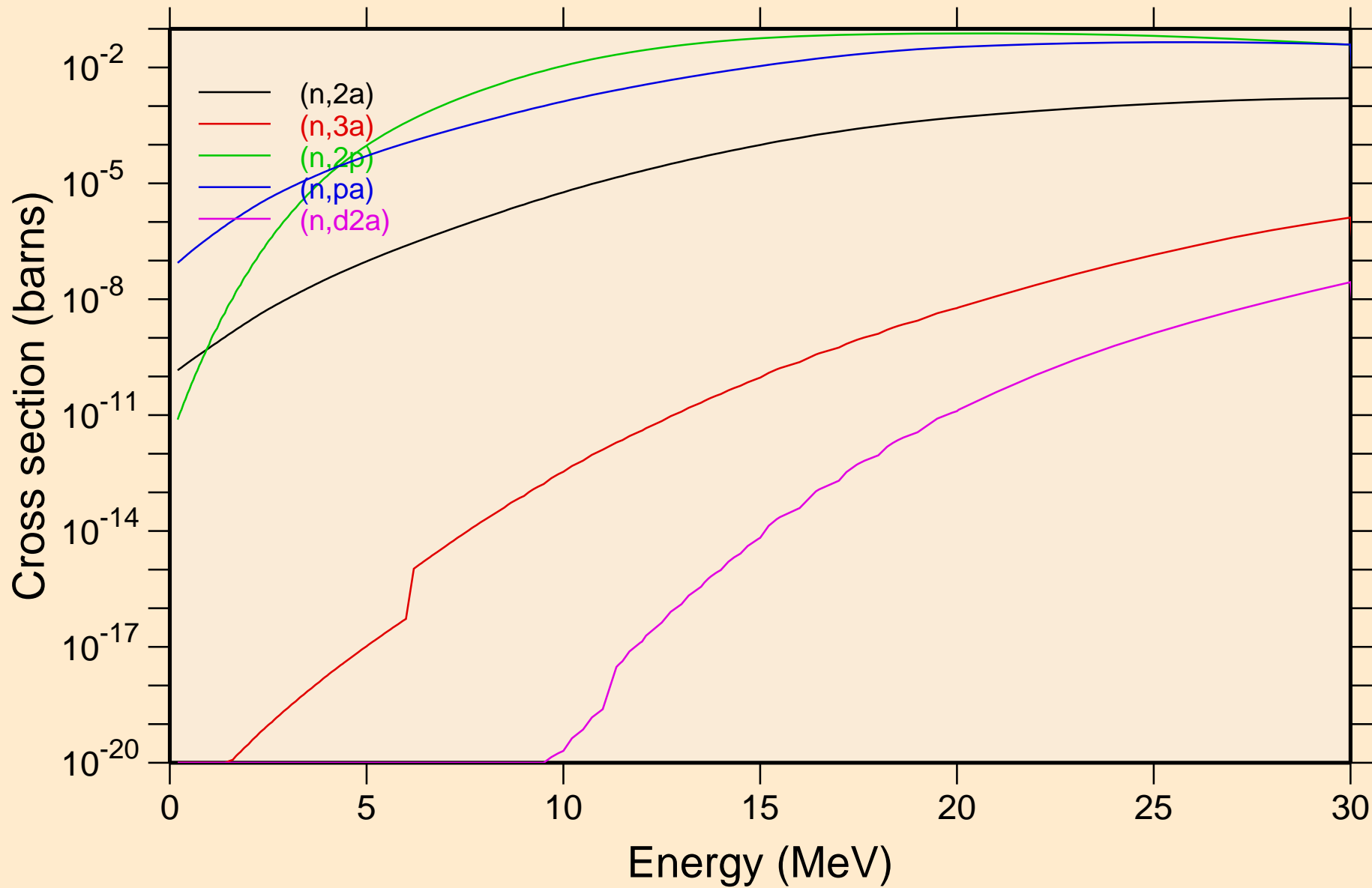

TL183 NEUTRON ACER TENDL-2024 LIBRARY; T=0.K
Non-threshold reactions

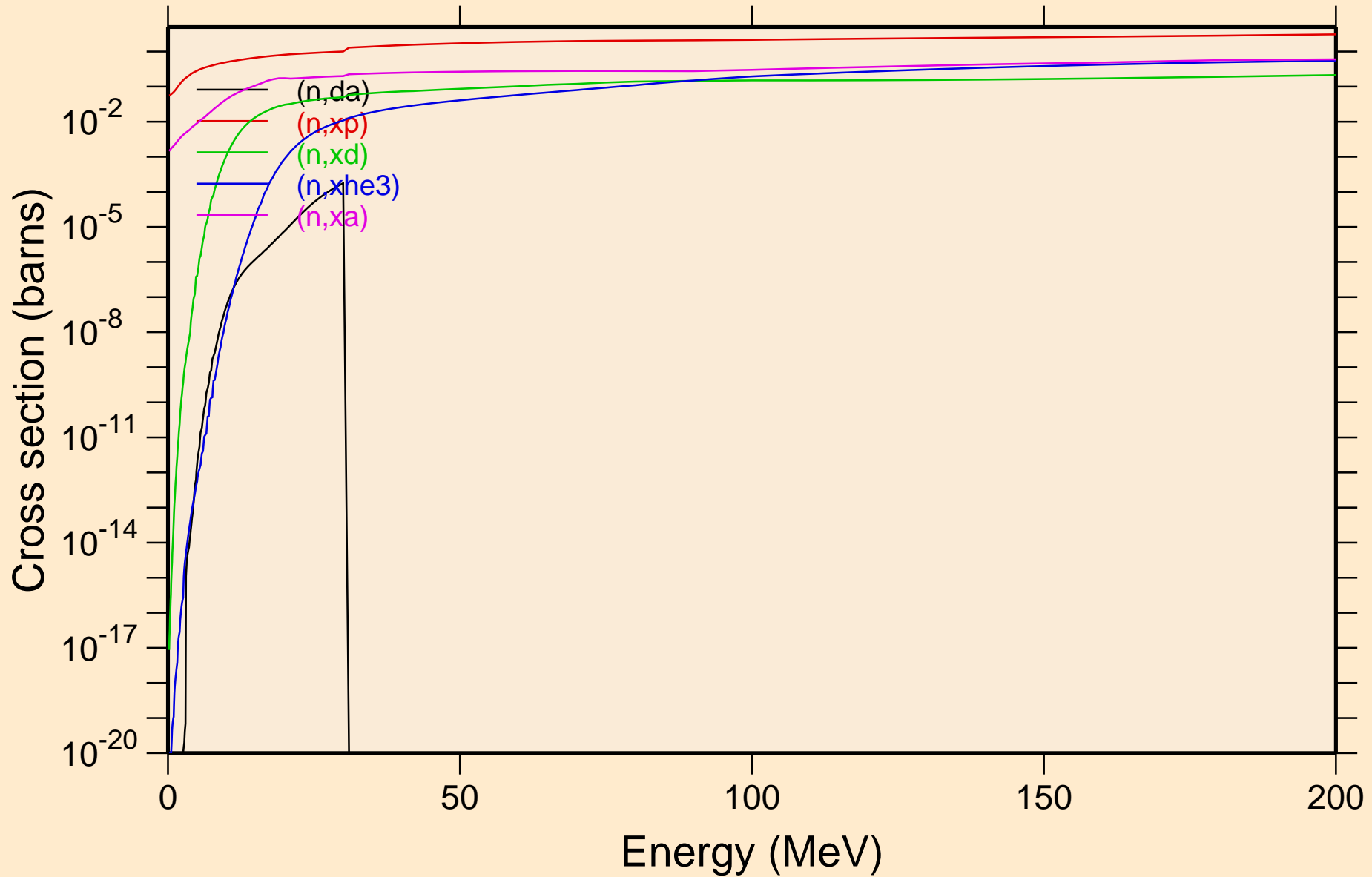

TL183 NEUTRON ACER TENDL-2024 LIBRARY; T=0.K
Inelastic levels

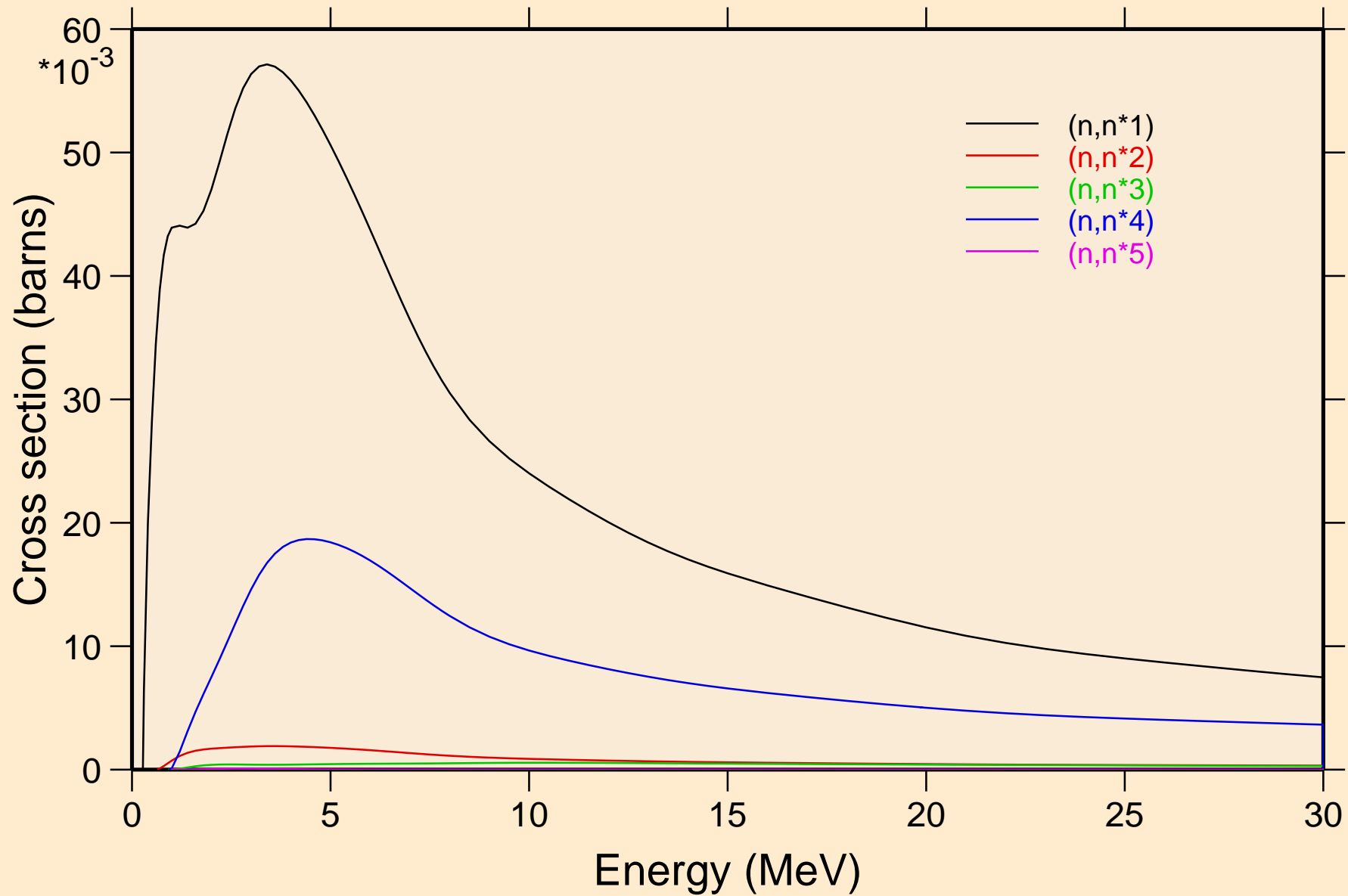

TL183 NEUTRON ACER TENDL-2024 LIBRARY; T=0.K
Inelastic levels

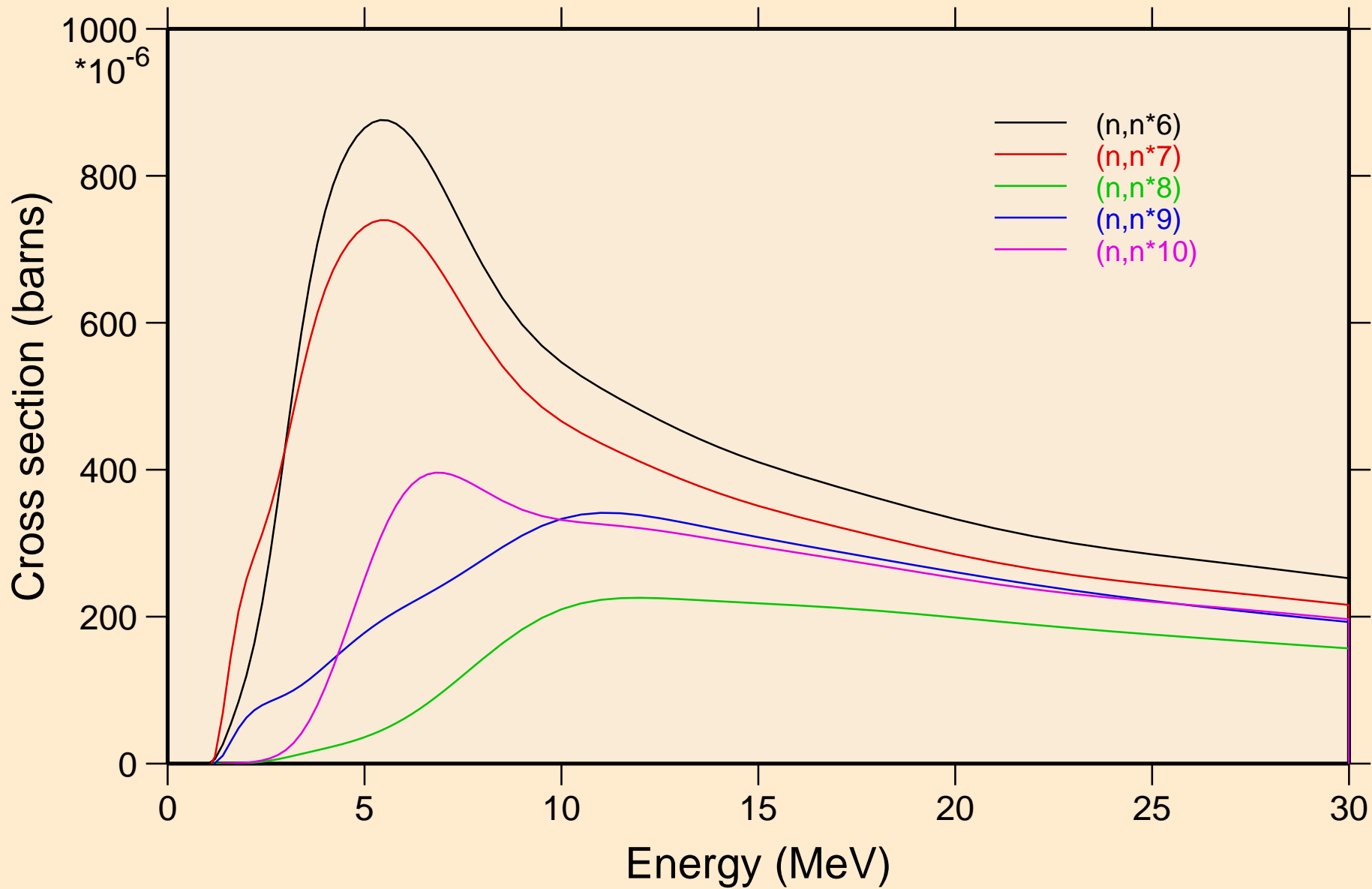

TL183 NEUTRON ACER TENDL-2024 LIBRARY; T=0.K
Inelastic levels

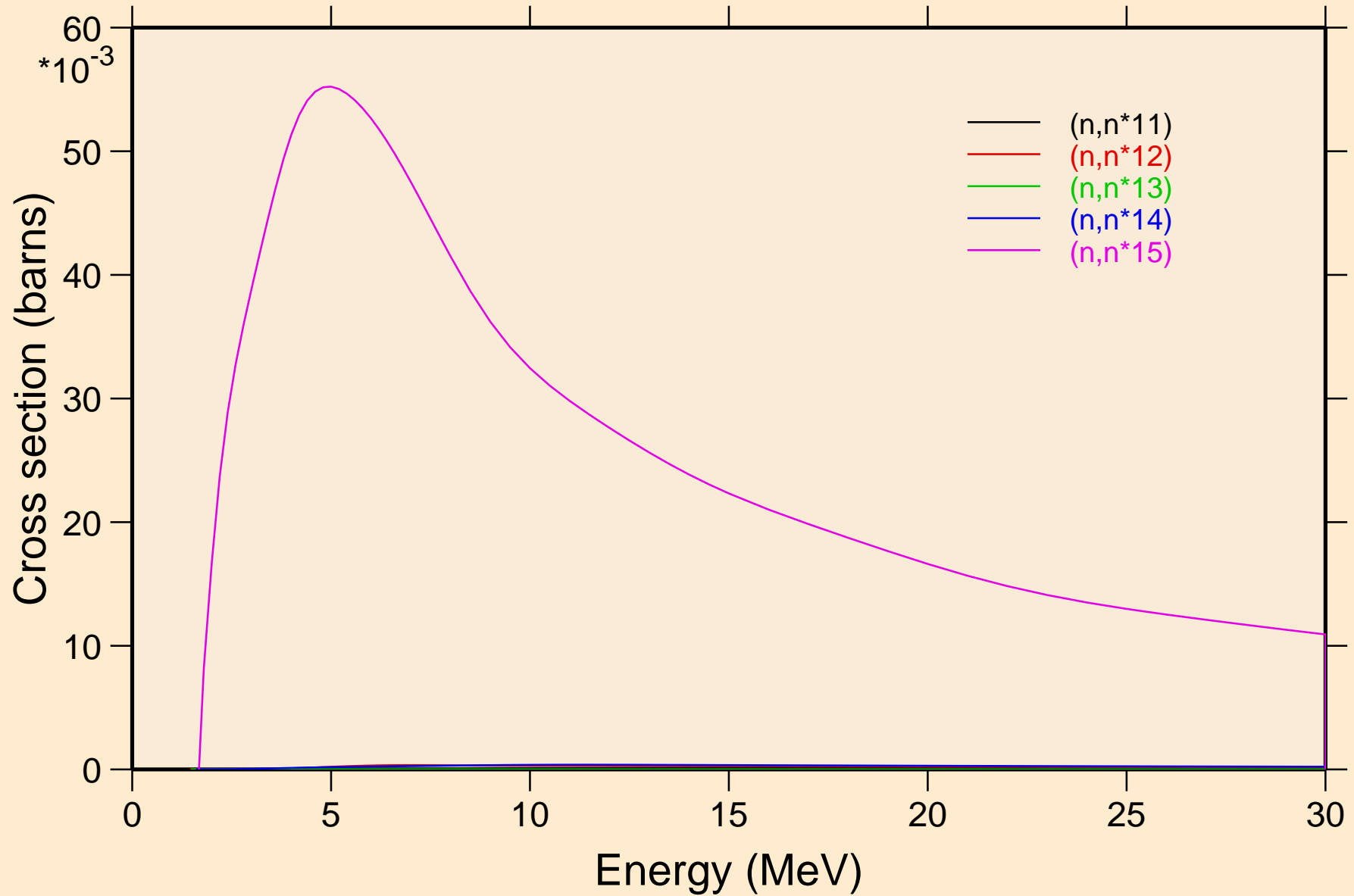

TL183 NEUTRON ACER TENDL-2024 LIBRARY; T=0.K
Threshold reactions

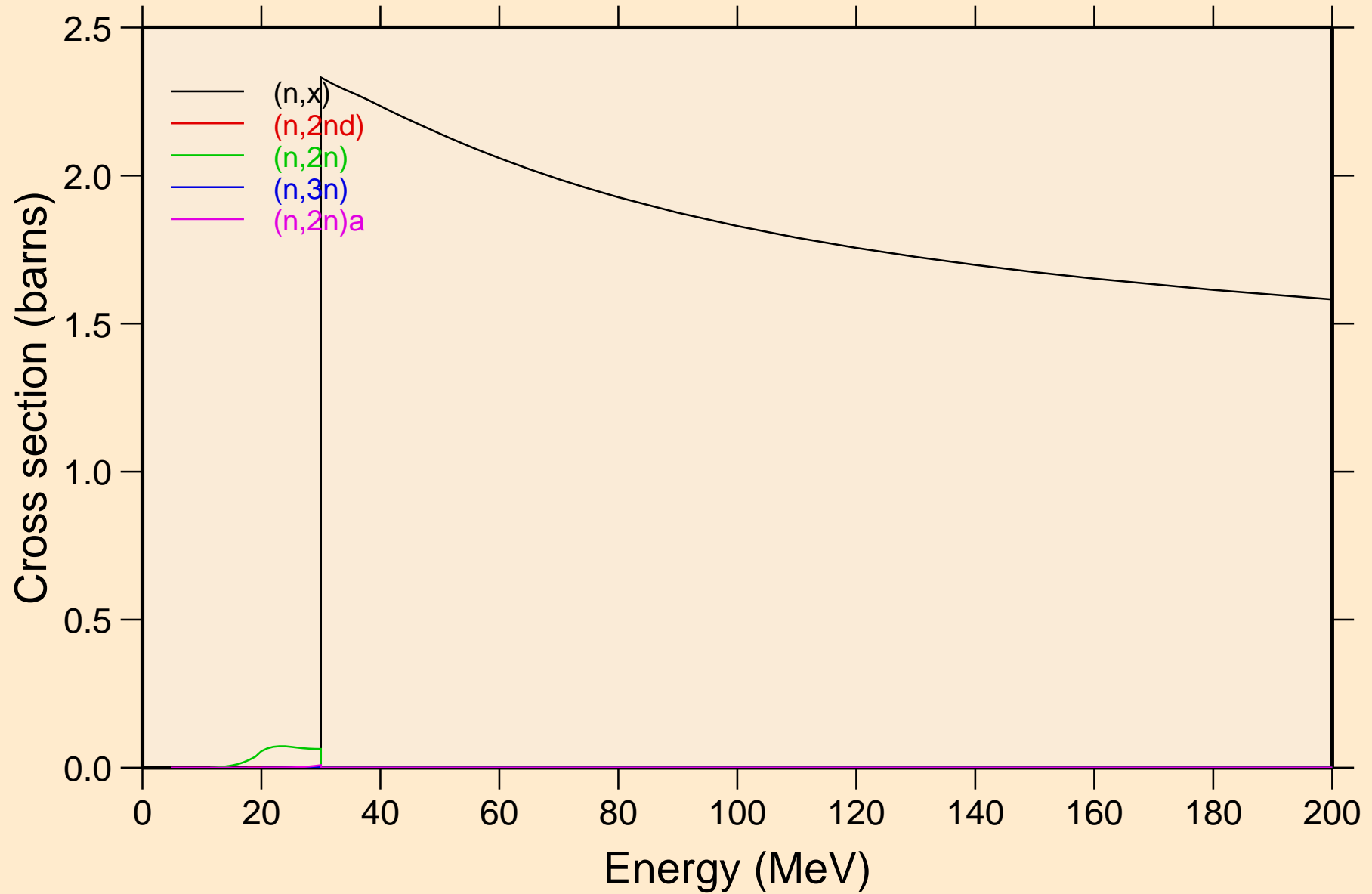

TL183 NEUTRON ACER TENDL-2024 LIBRARY; T=0.K
Threshold reactions

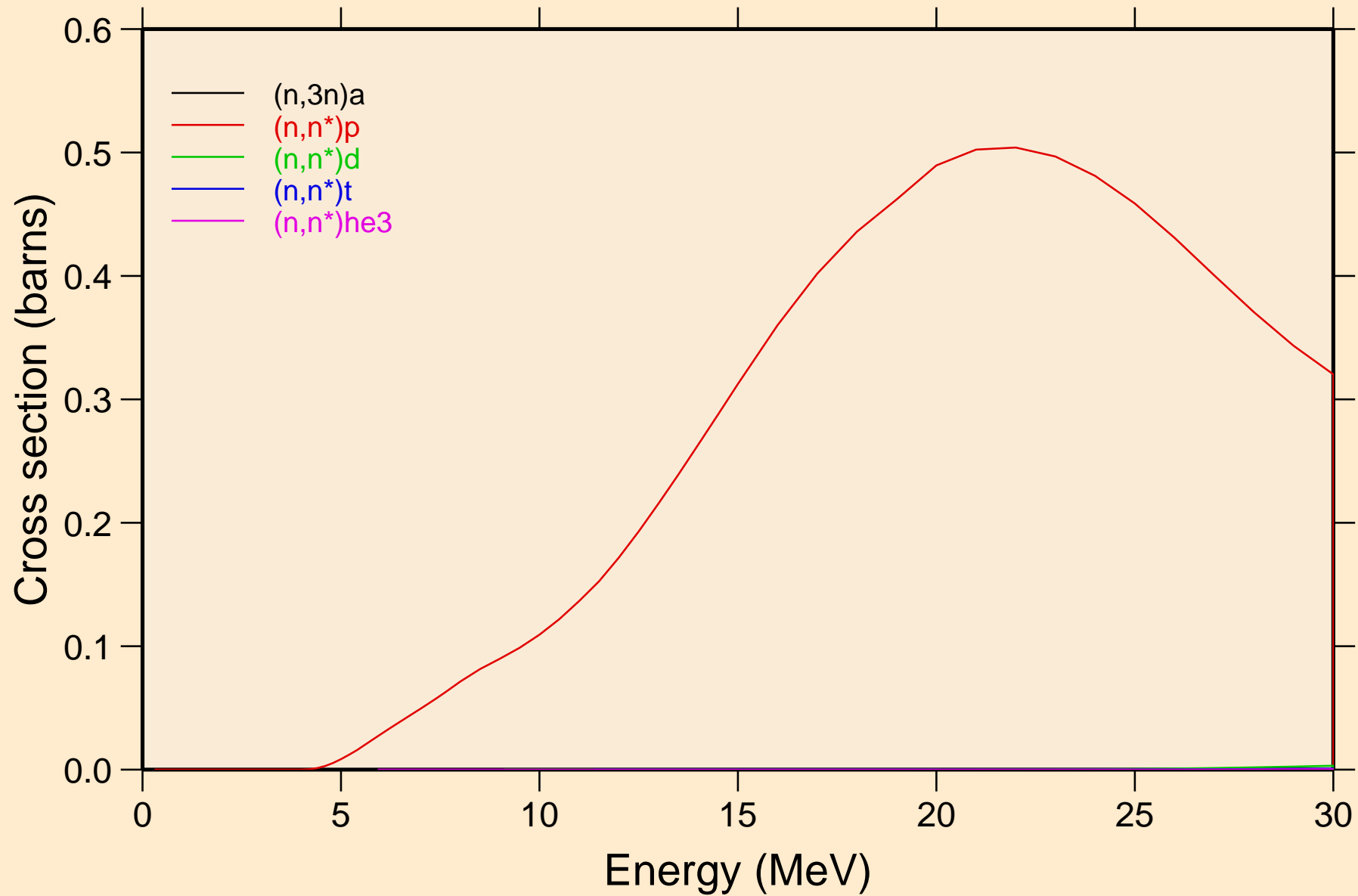

TL183 NEUTRON ACER TENDL-2024 LIBRARY; T=0.K
Threshold reactions

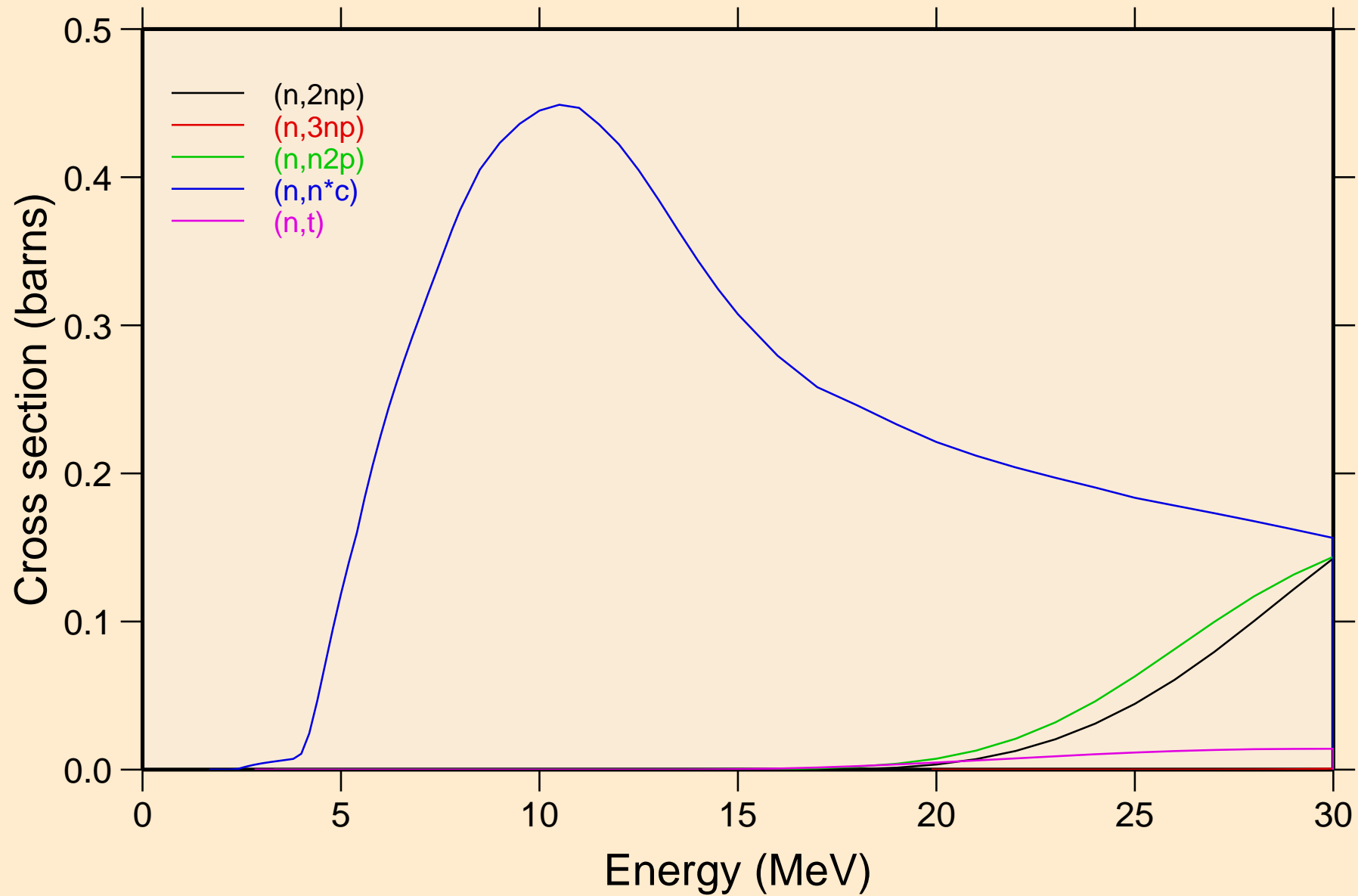

TL183 NEUTRON ACER TENDL-2024 LIBRARY; T=0.K
Threshold reactions

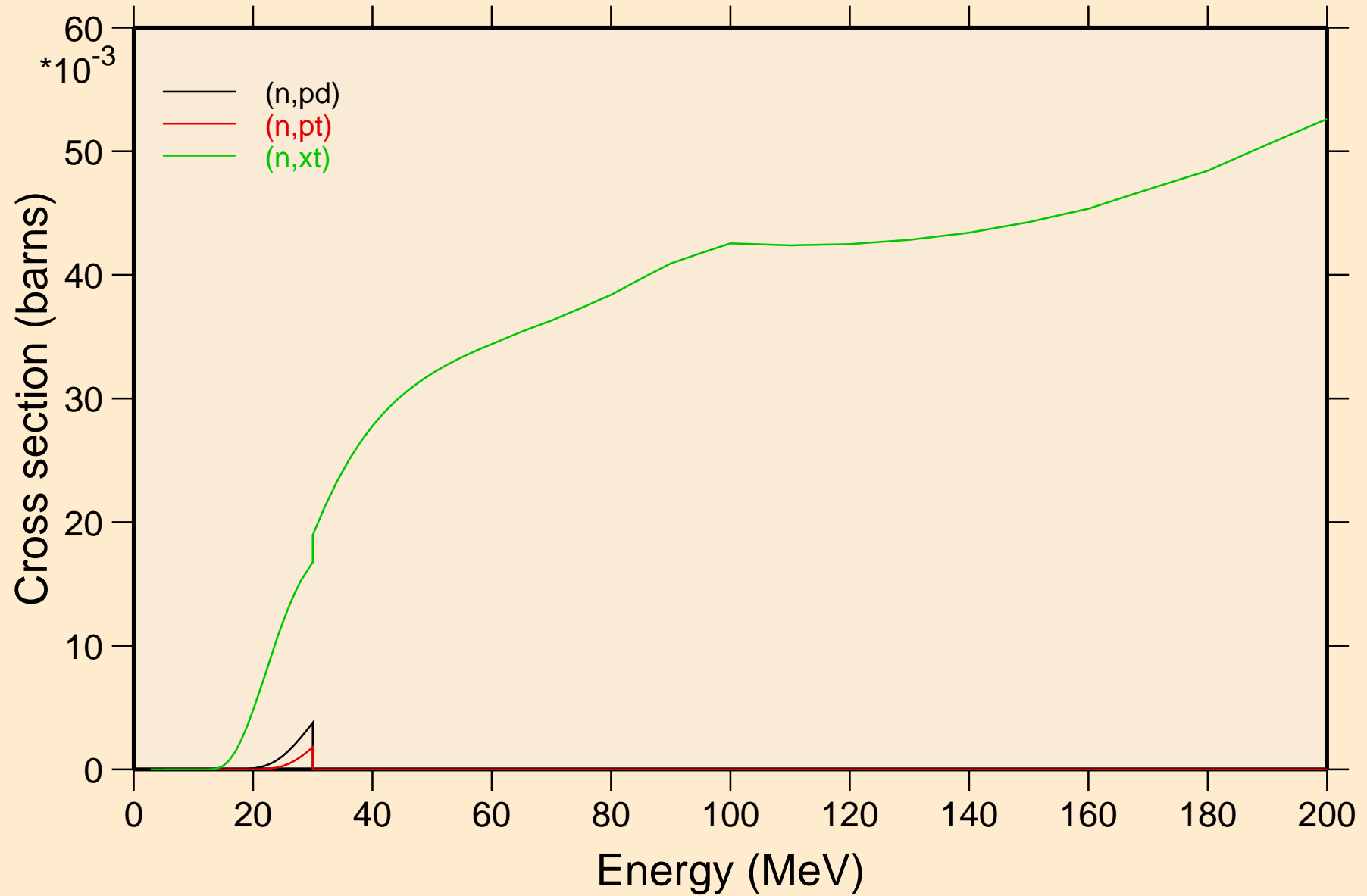

TL183 NEUTRON ACER TENDL-2024 LIBRARY; T=0.K
angular distribution for elastic

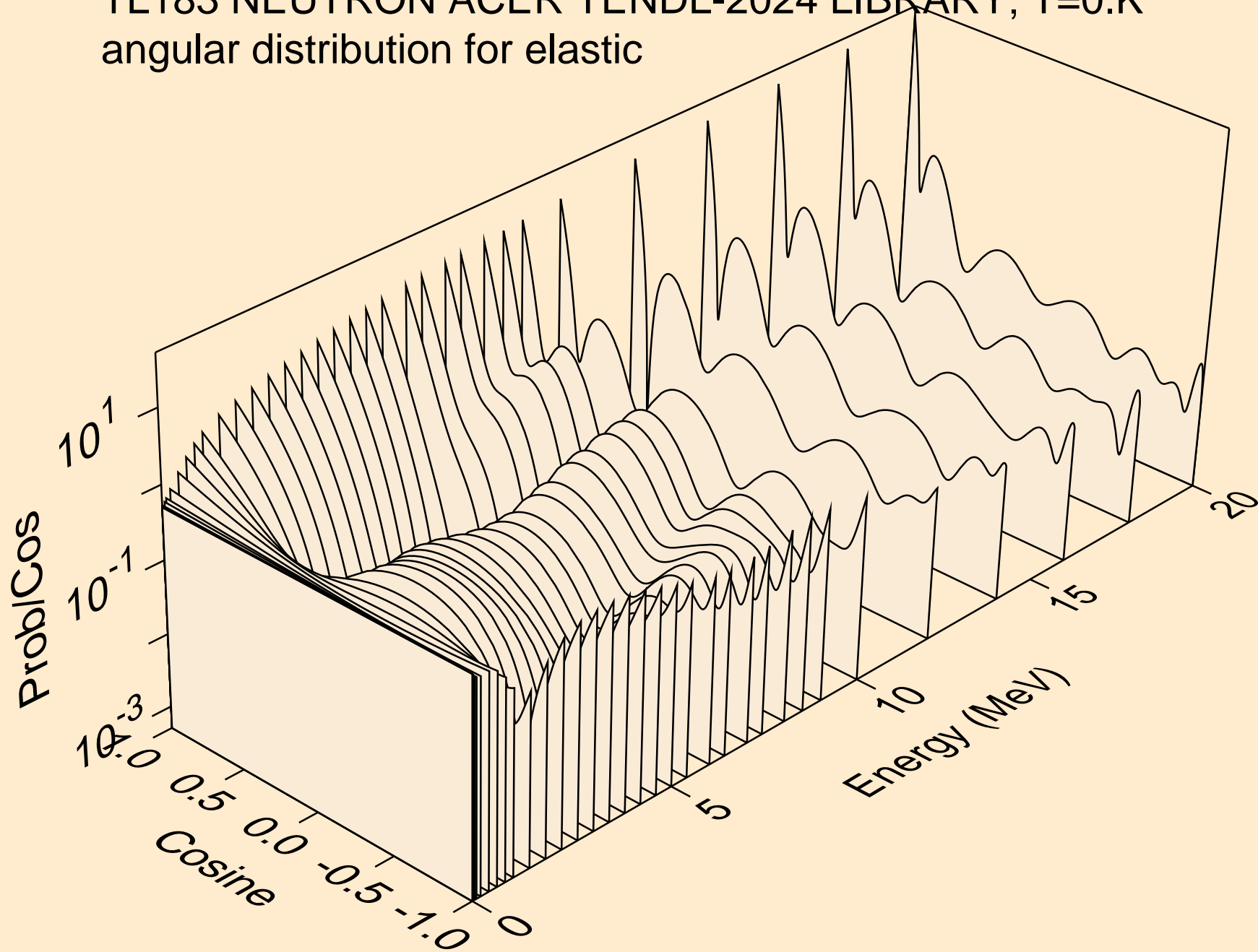

TL183 NEUTRON ACER TENDL-2024 LIBRARY; T=0.K
angular distribution for elastic

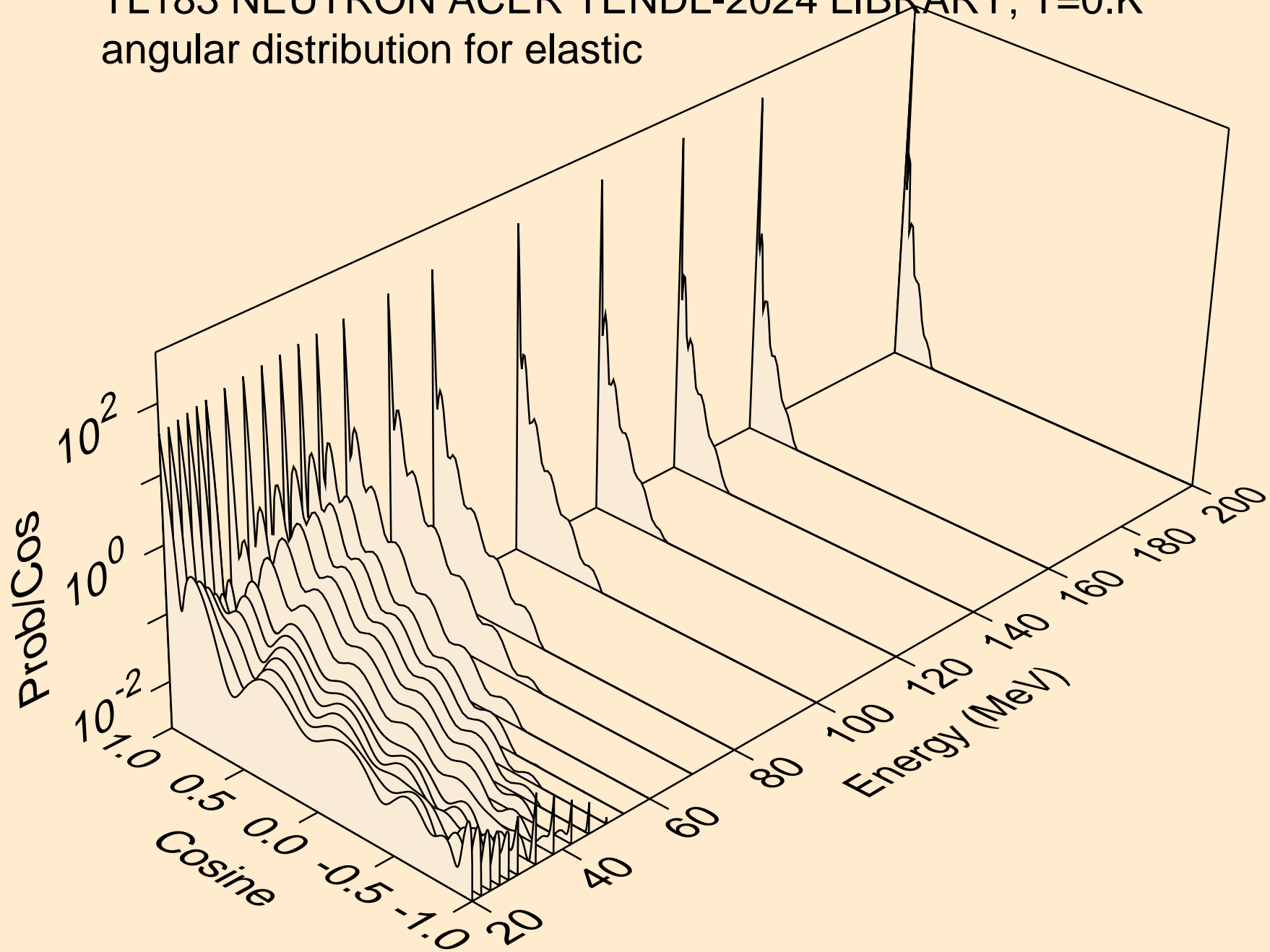

TL183 NEUTRON ACER TENDL-2024 LIBRARY; T=0.K
angular distribution for (n,n*1)

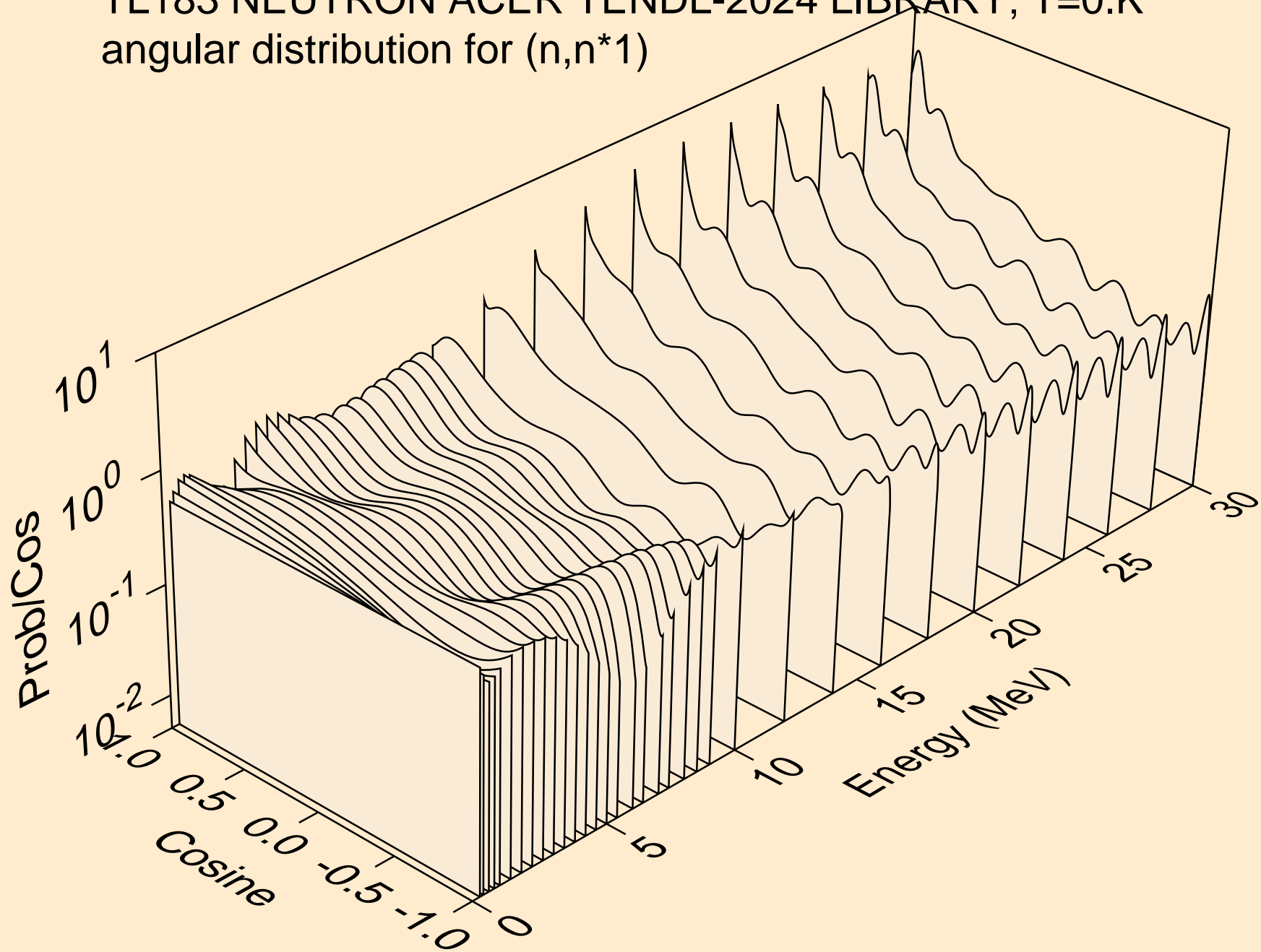

TL183 NEUTRON ACER TENDL-2024 LIBRARY; T=0.K
angular distribution for (n,n*2)

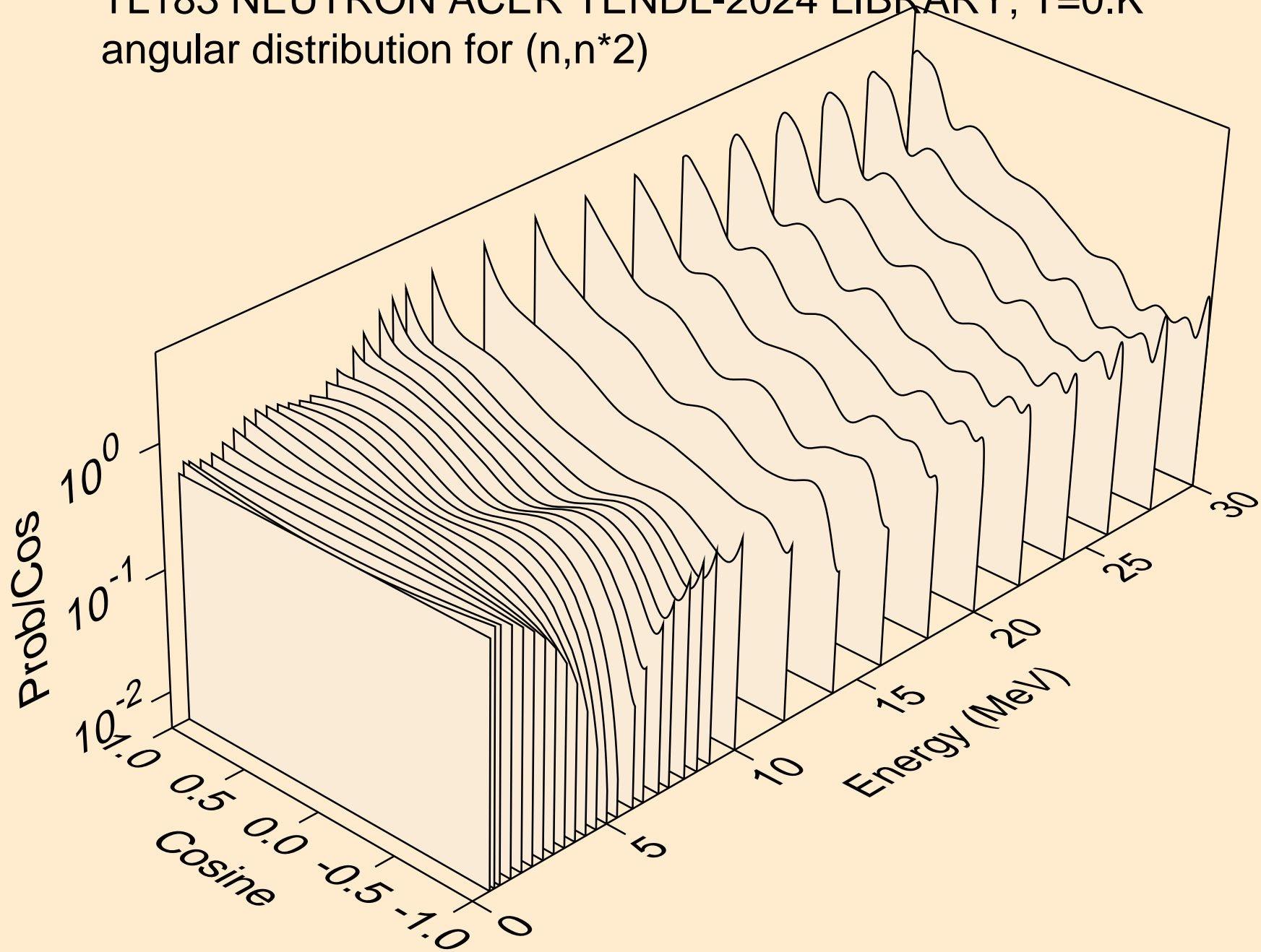

TL183 NEUTRON ACER TENDL-2024 LIBRARY; T=0.K
angular distribution for (n,n*3)

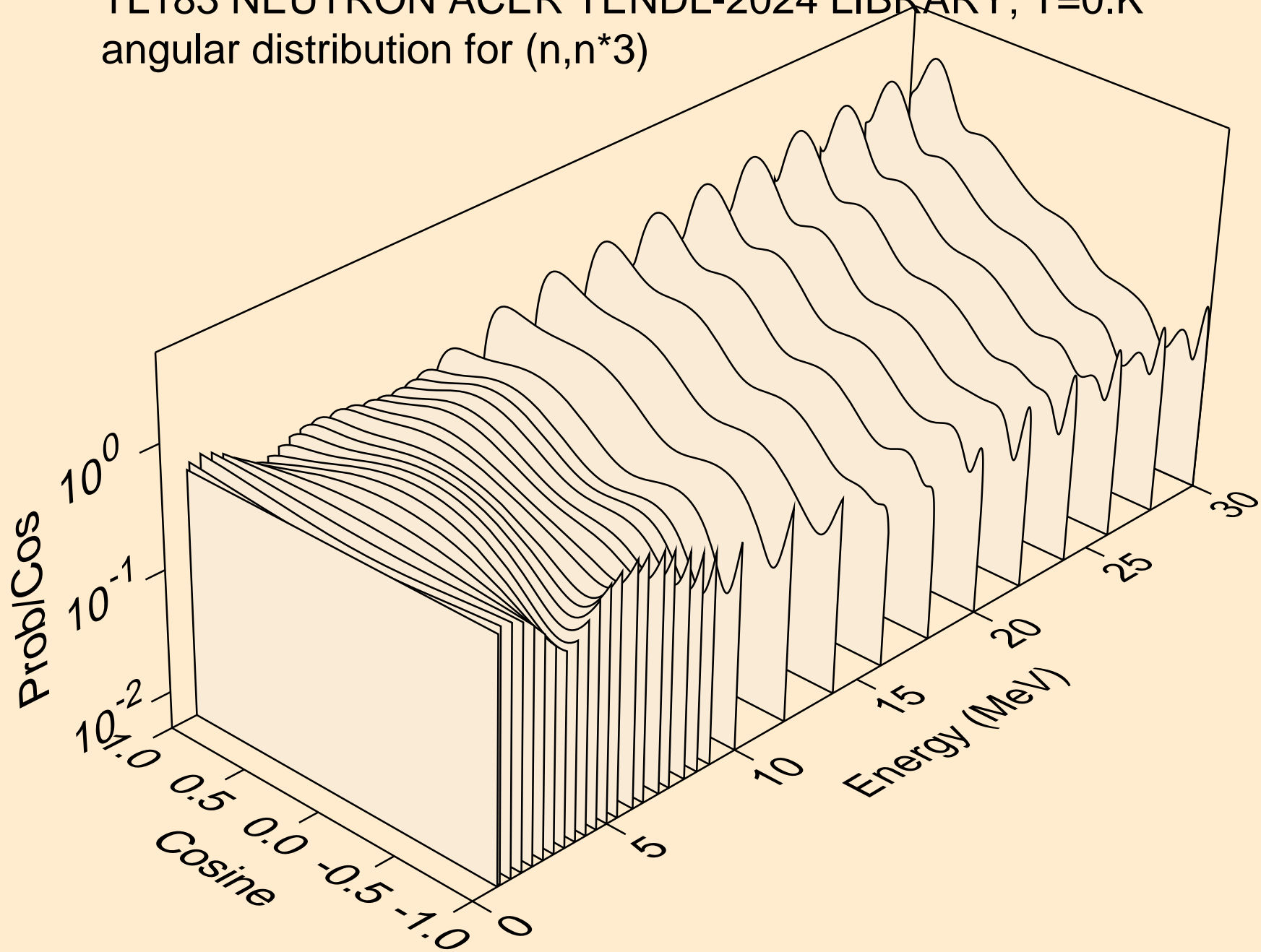

TL183 NEUTRON ACER TENDL-2024 LIBRARY; T=0.K
angular distribution for (n,n*4)

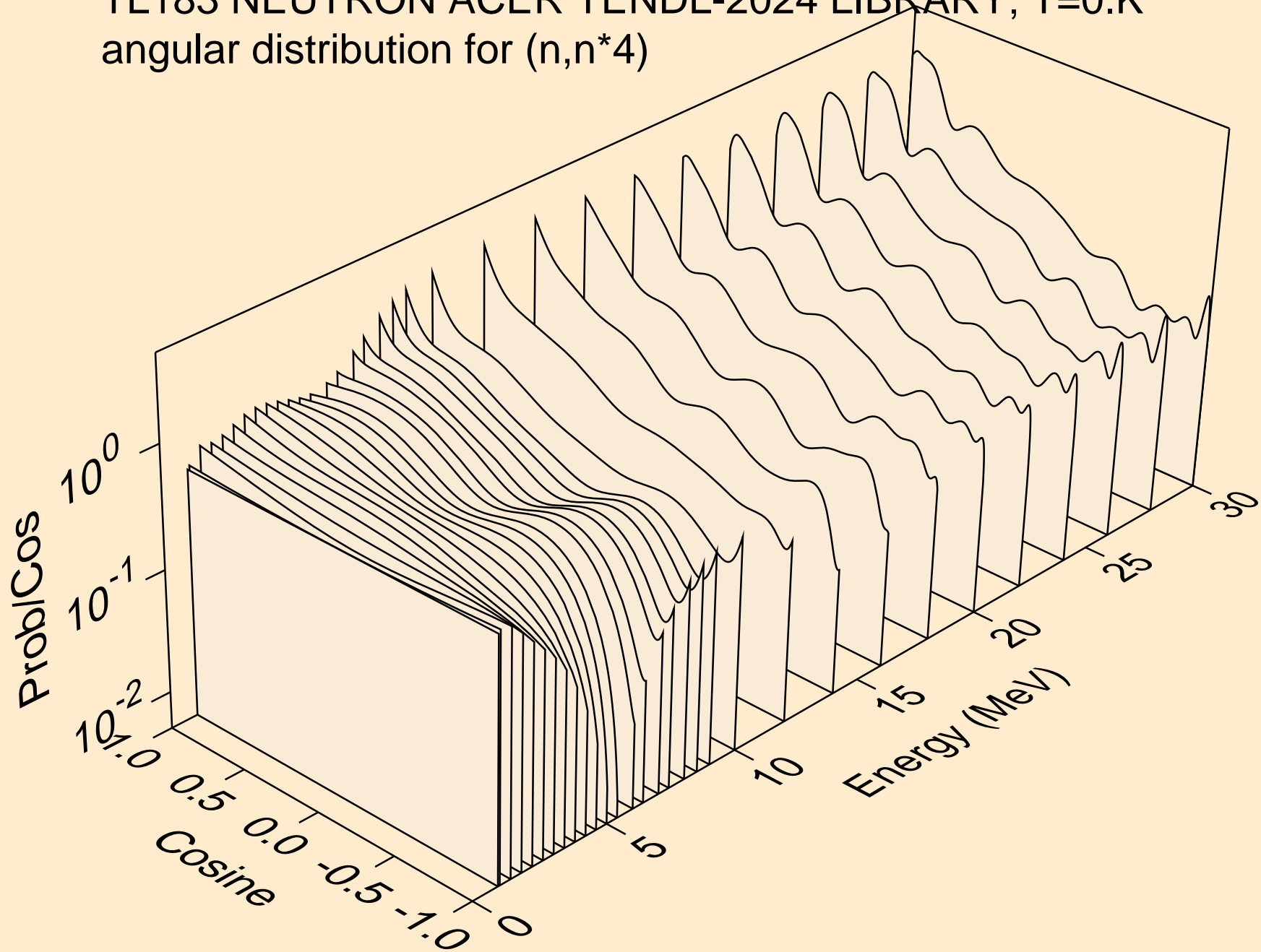

TL183 NEUTRON ACER TENDL-2024 LIBRARY; T=0.K
angular distribution for (n,n*5)

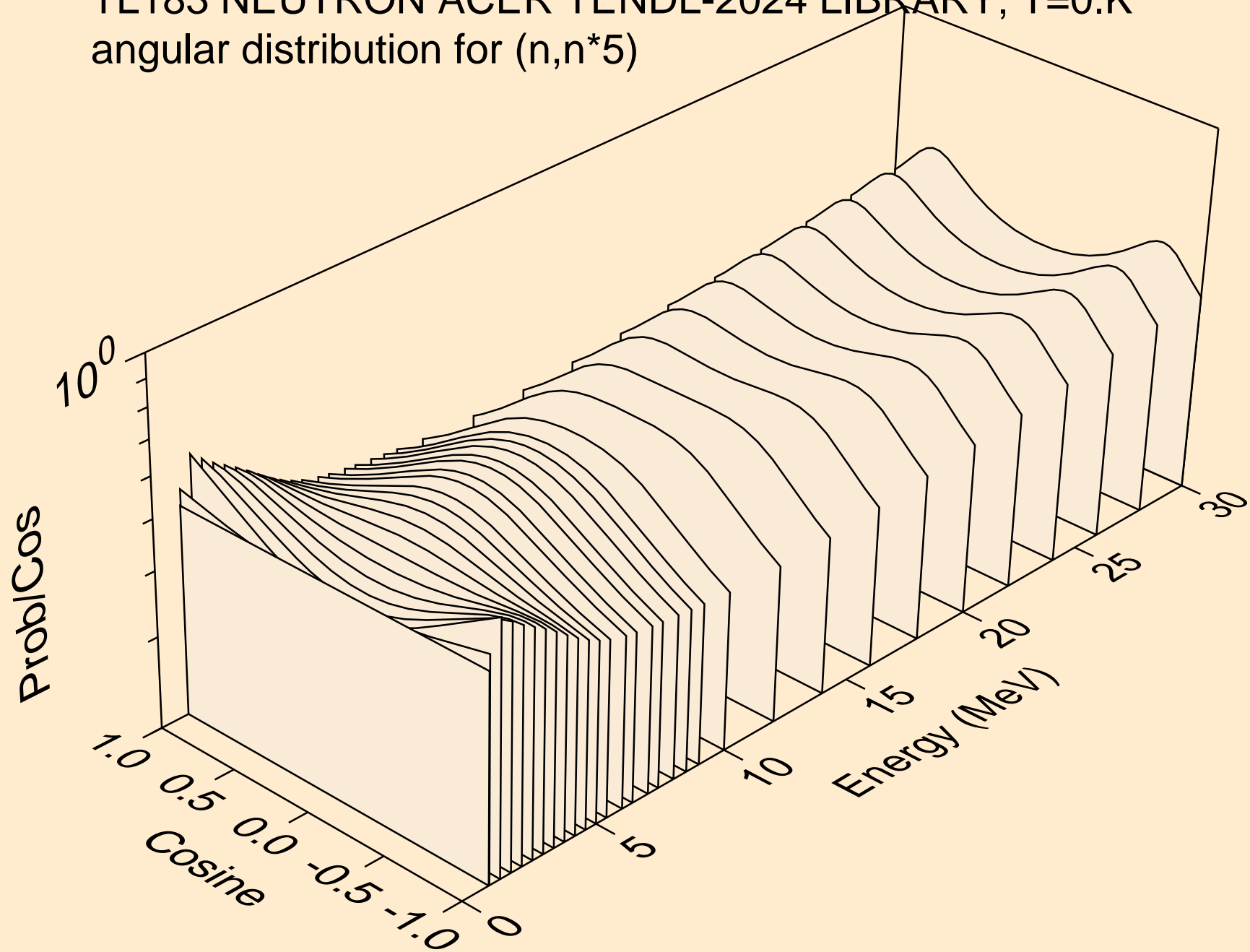

TL183 NEUTRON ACER TENDL-2024 LIBRARY; T=0.K
angular distribution for (n,n*6)

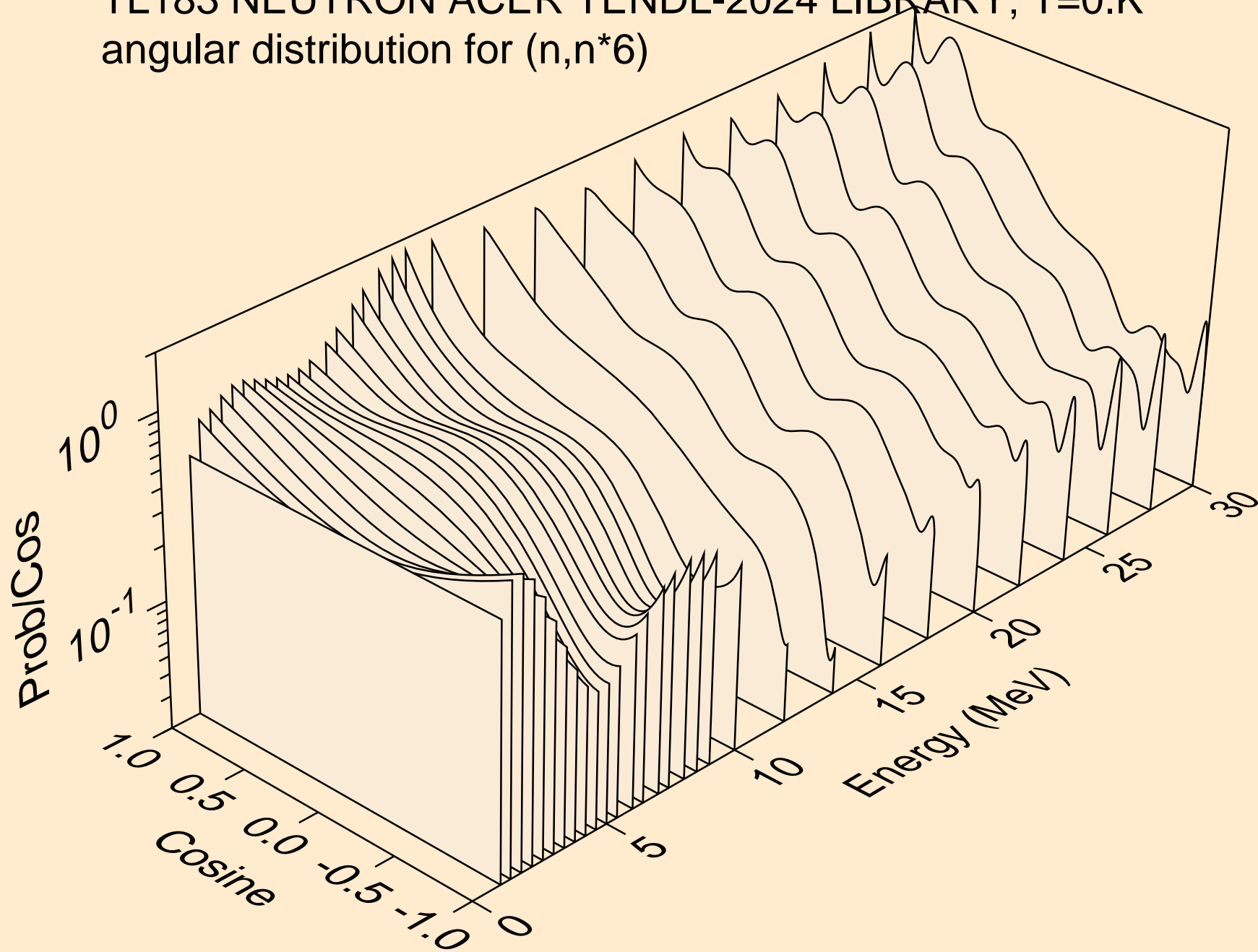

TL183 NEUTRON ACER TENDL-2024 LIBRARY; T=0.K
angular distribution for (n,n*7)

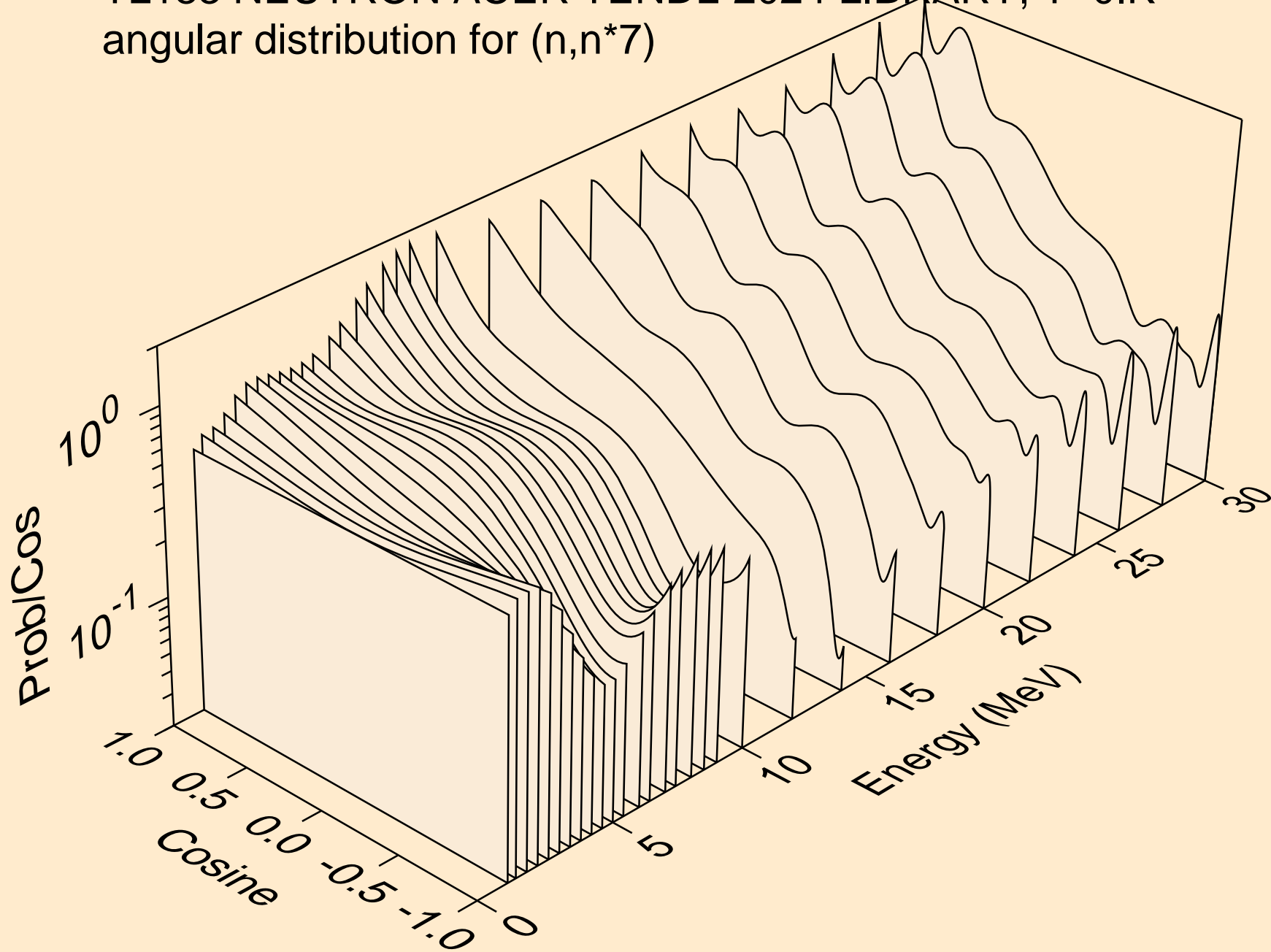

TL183 NEUTRON ACER TENDL-2024 LIBRARY; T=0.K
angular distribution for (n,n*8)

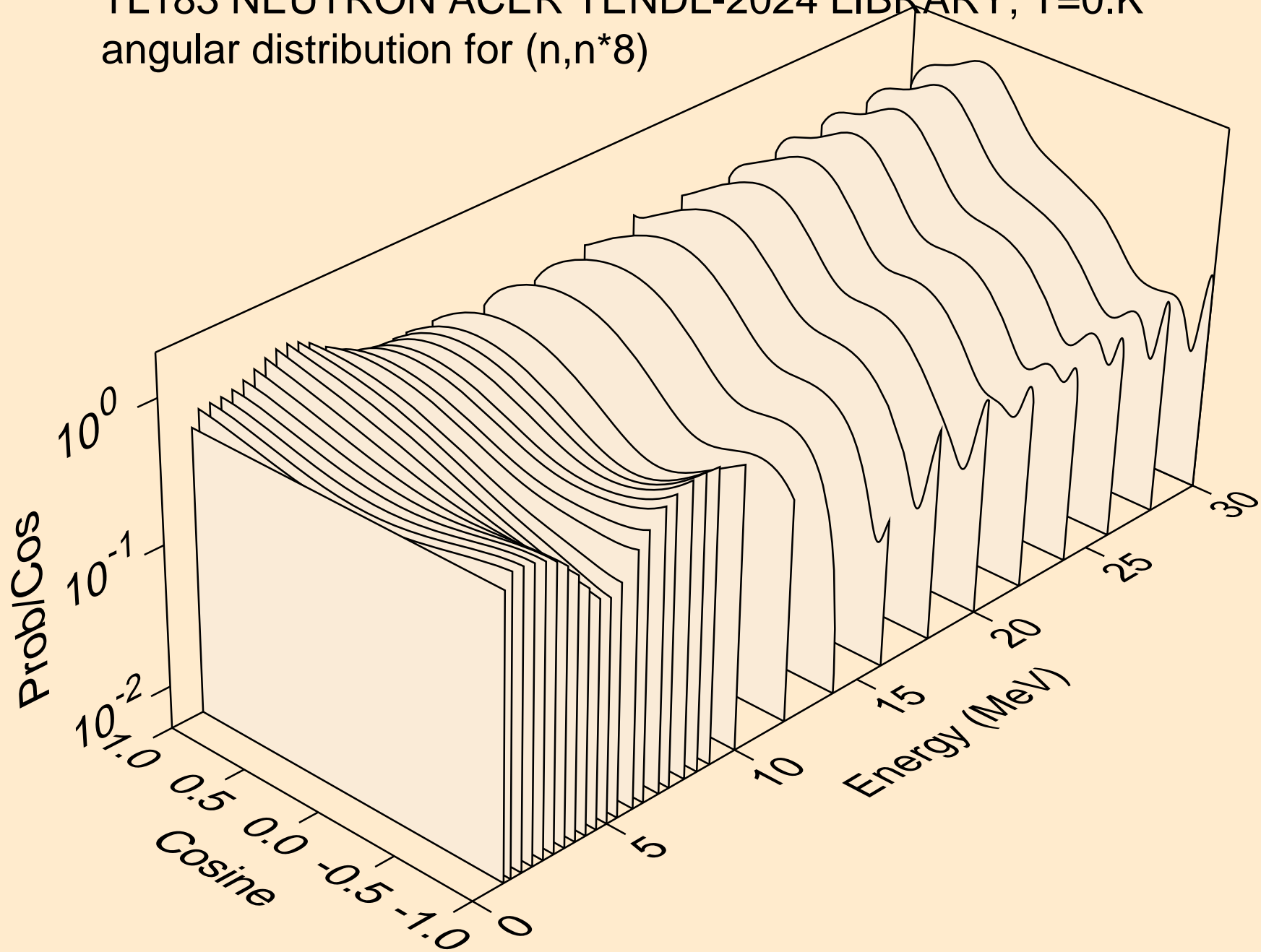

TL183 NEUTRON ACER TENDL-2024 LIBRARY; T=0.K
angular distribution for (n,n*9)

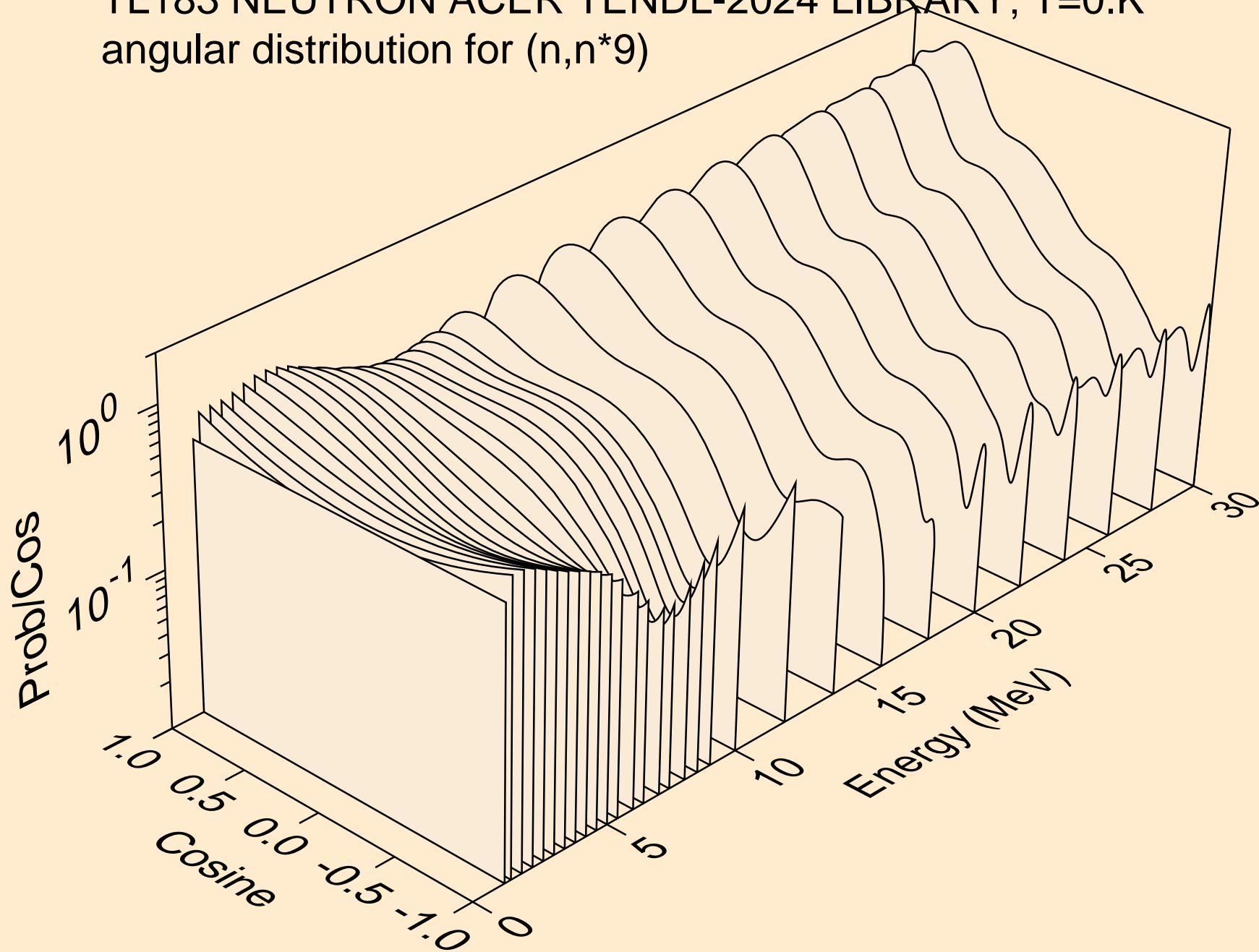

TL183 NEUTRON ACER TENDL-2024 LIBRARY; T=0.K
angular distribution for (n,n*10)

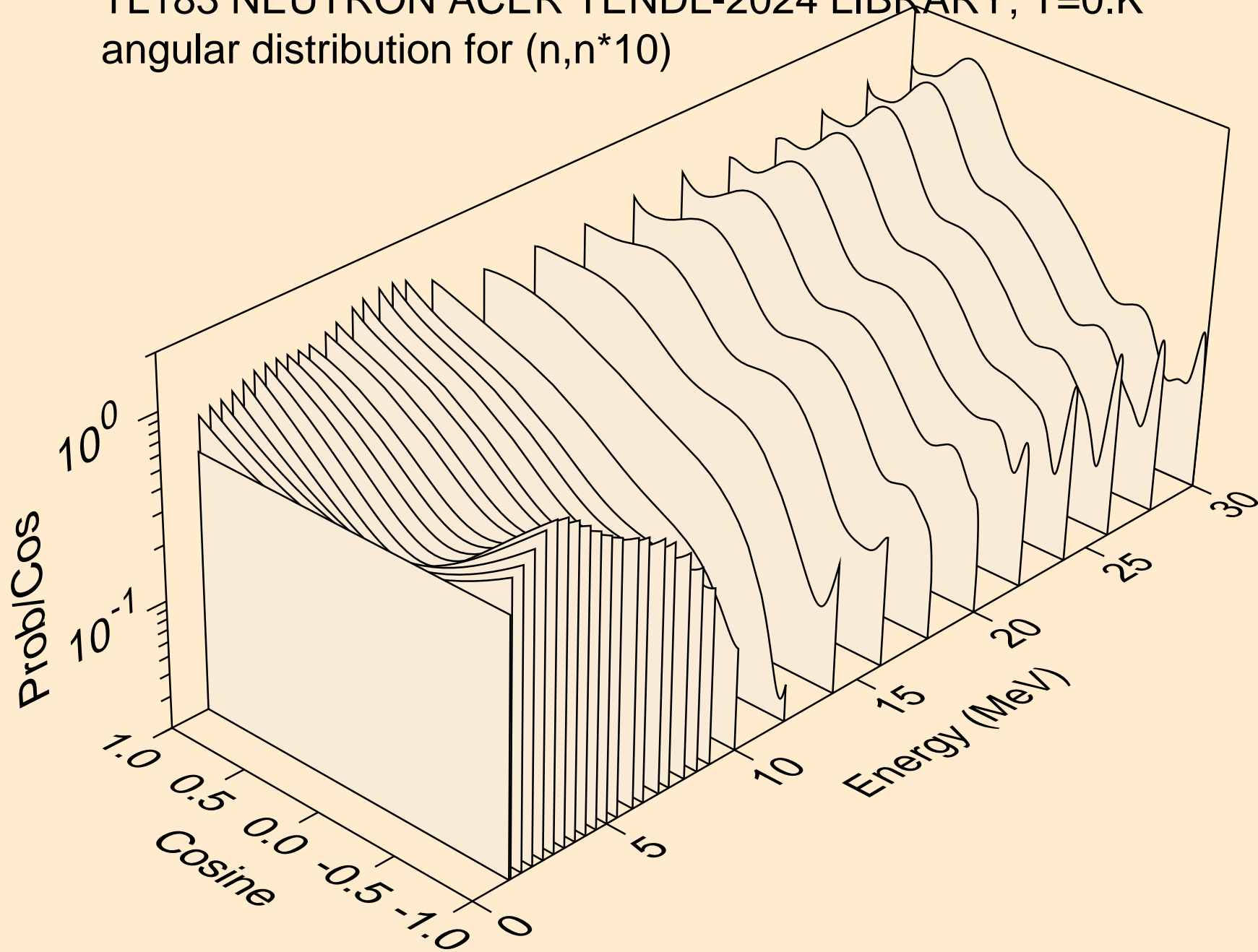

TL183 NEUTRON ACER TENDL-2024 LIBRARY; T=0.K
angular distribution for (n,n*11)

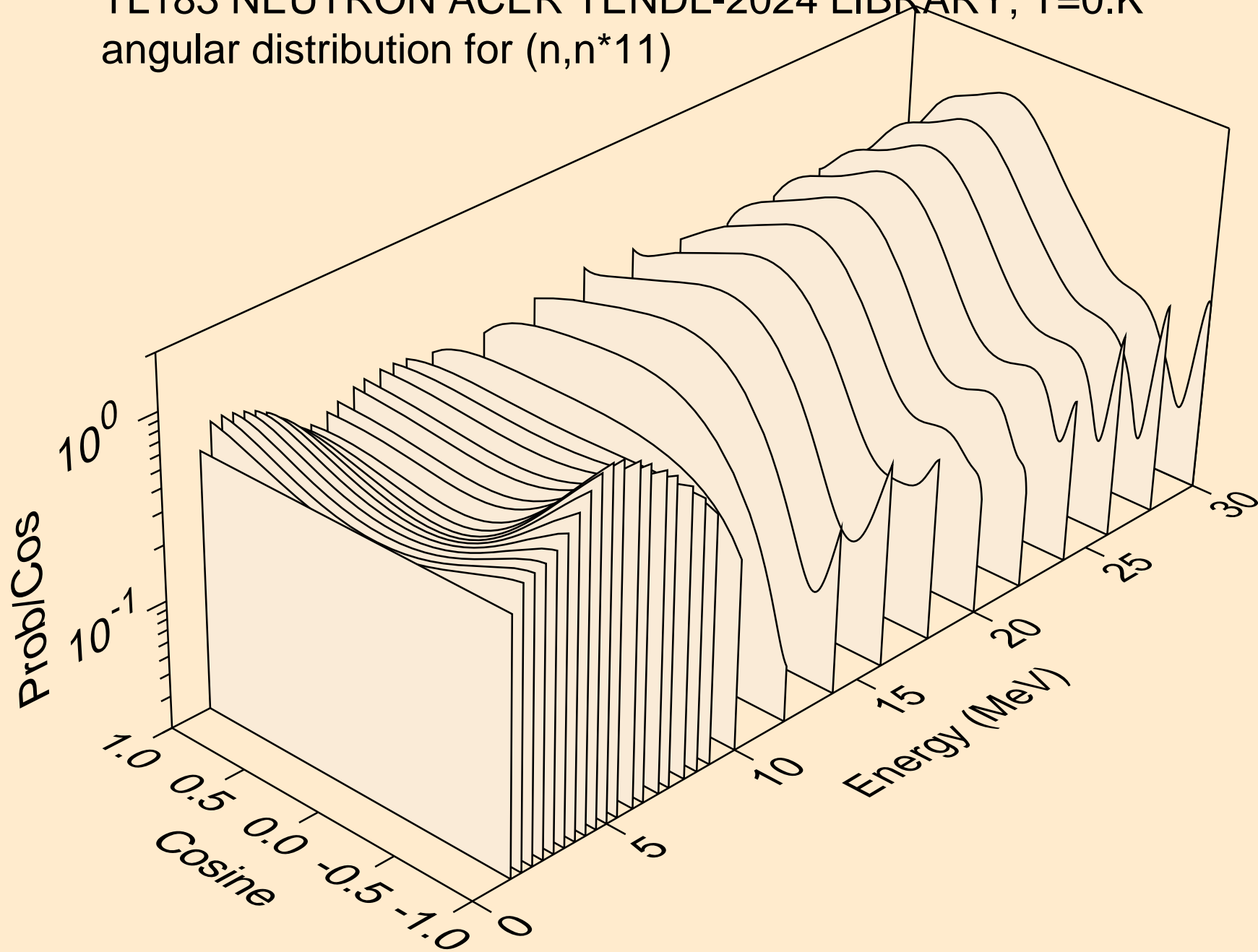

TL183 NEUTRON ACER TENDL-2024 LIBRARY; T=0.K
angular distribution for (n,n*12)

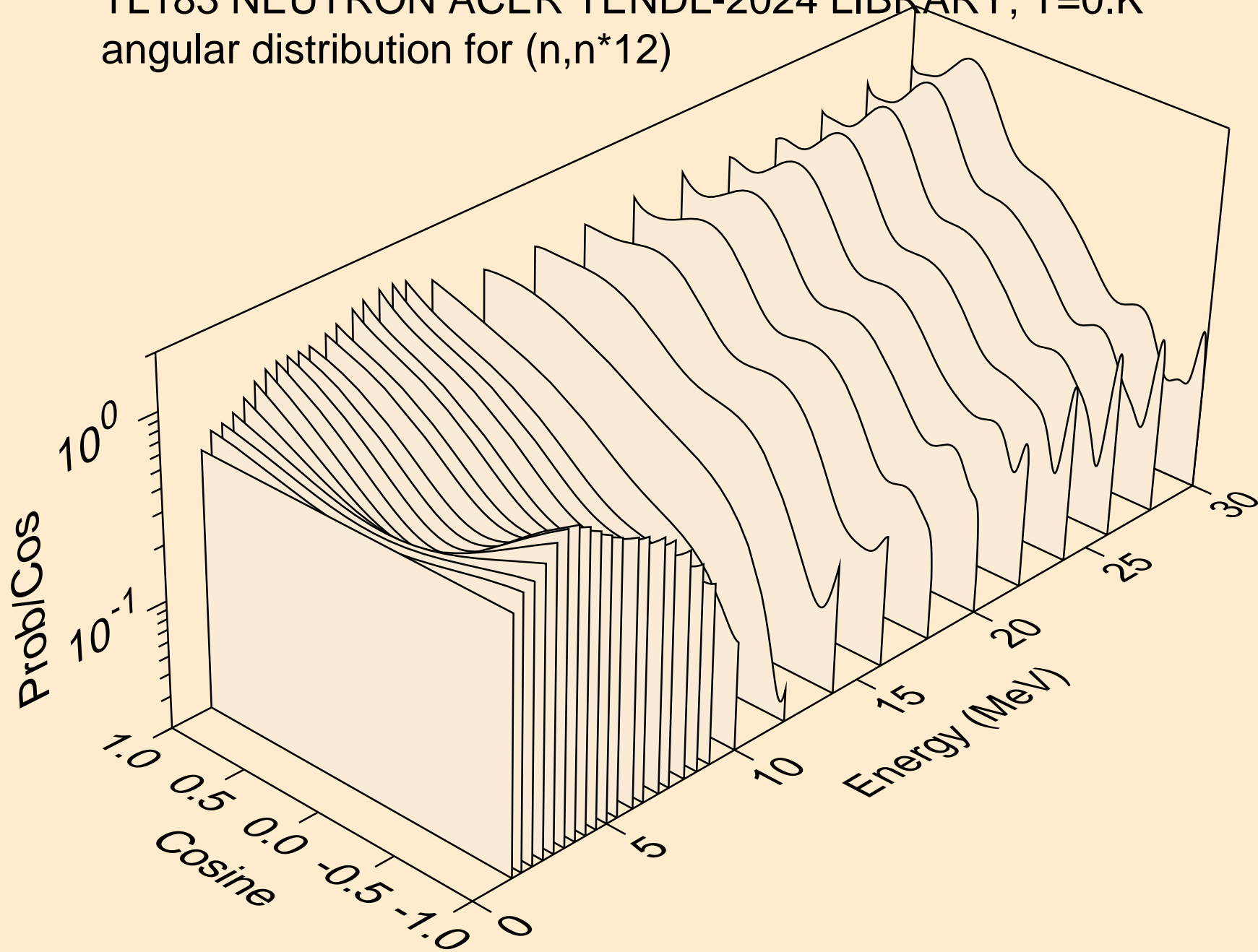

TL183 NEUTRON ACER TENDL-2024 LIBRARY; T=0.K
angular distribution for (n,n*13)

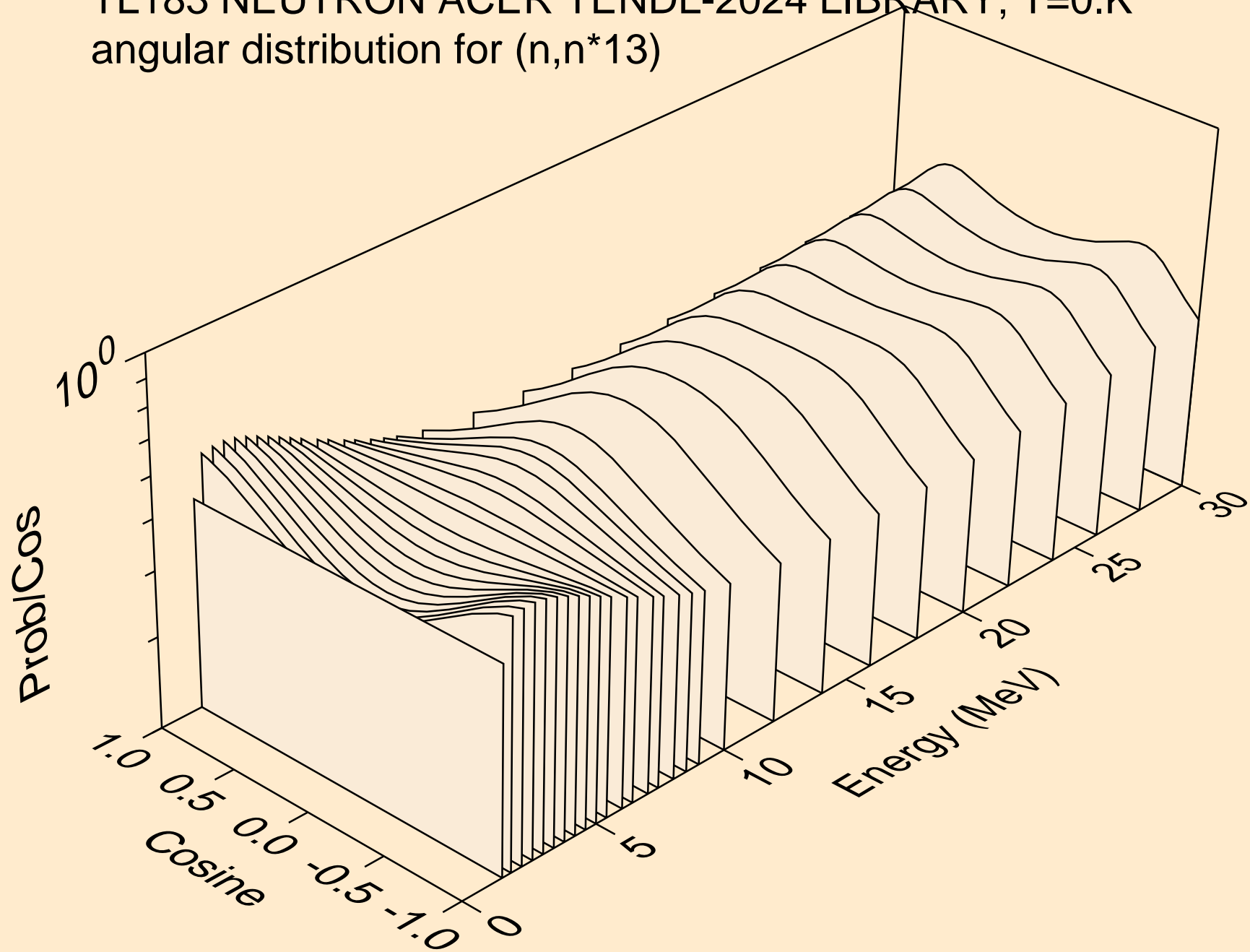

TL183 NEUTRON ACER TENDL-2024 LIBRARY; T=0.K
angular distribution for (n,n*14)

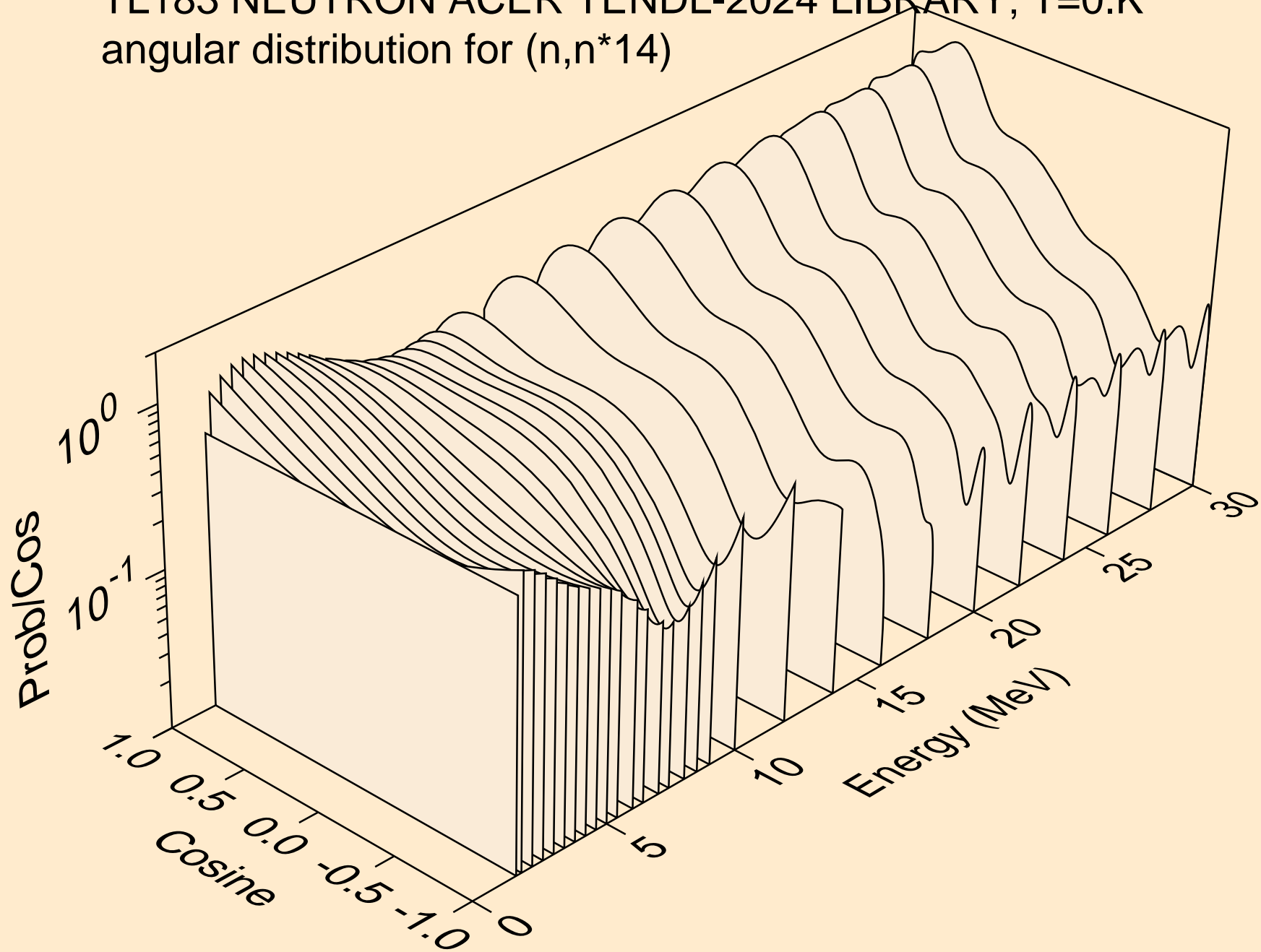

TL183 NEUTRON ACER TENDL-2024 LIBRARY; T=0.K
angular distribution for (n,n*15)

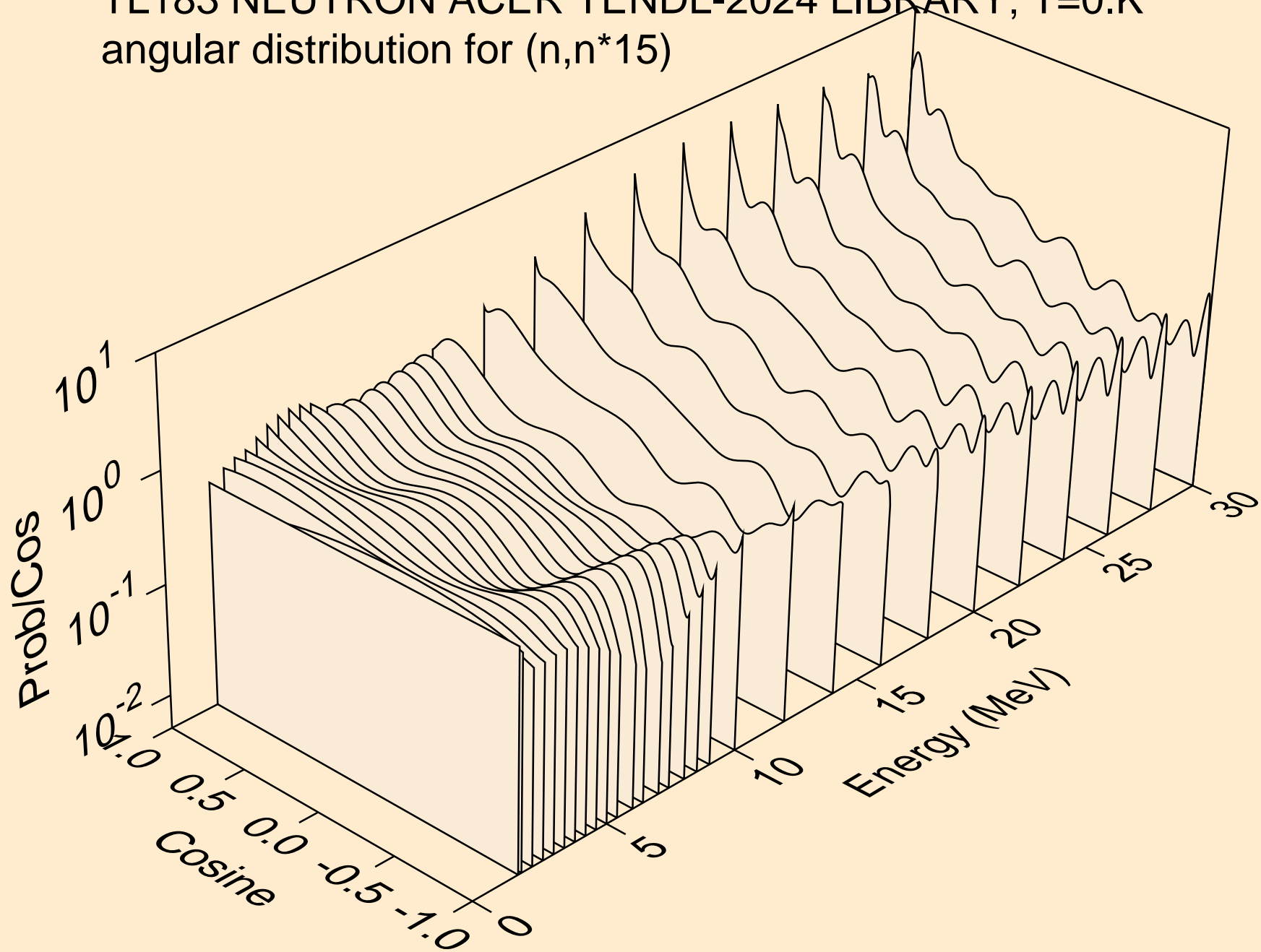

TL183 NEUTRON ACER TENDL-2024 LIBRARY; T=0.K
Neutron emission for (n,x)

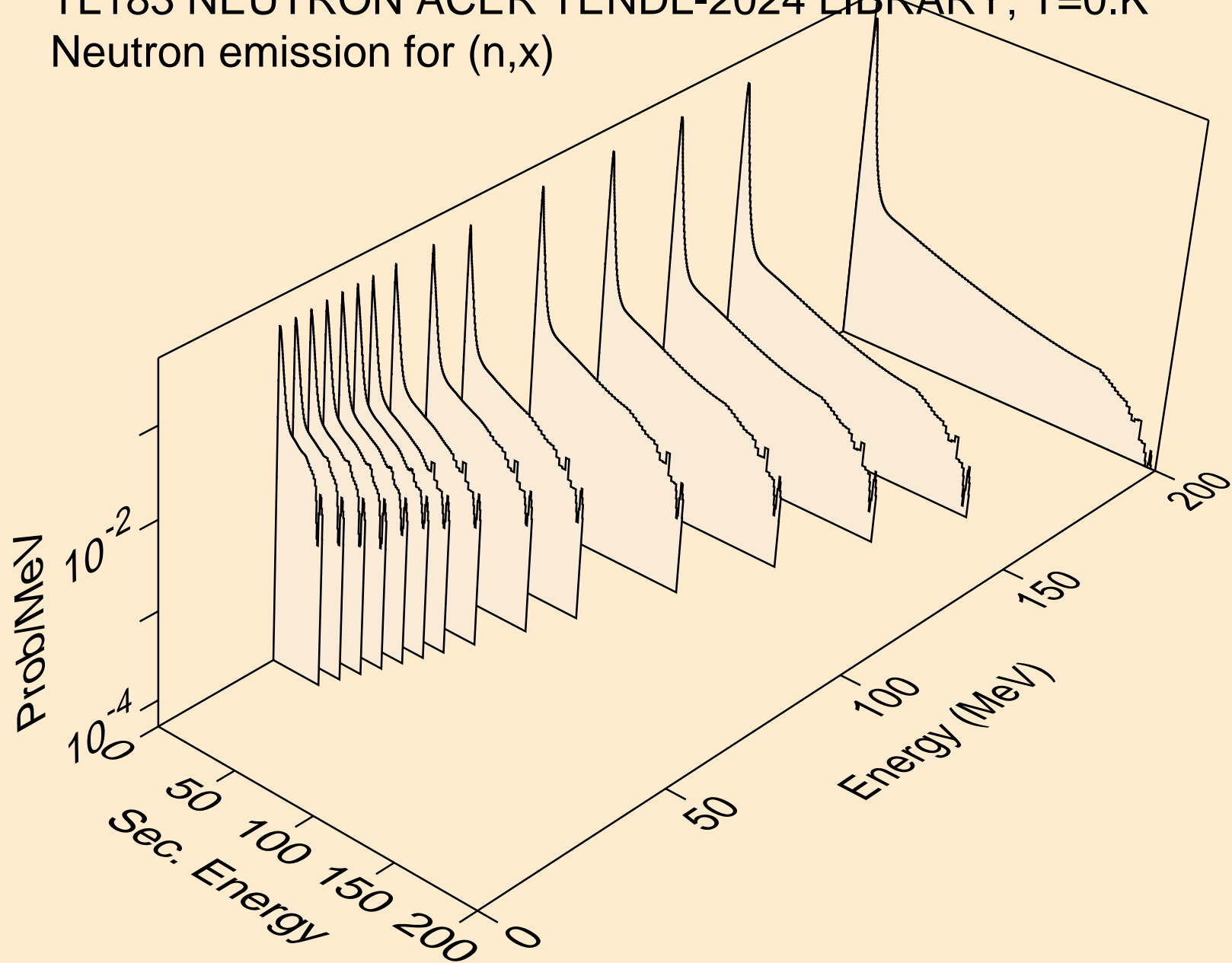

TL183 NEUTRON ACER TENDL-2024 LIBRARY; T=0.K
Neutron emission for (n,2nd)

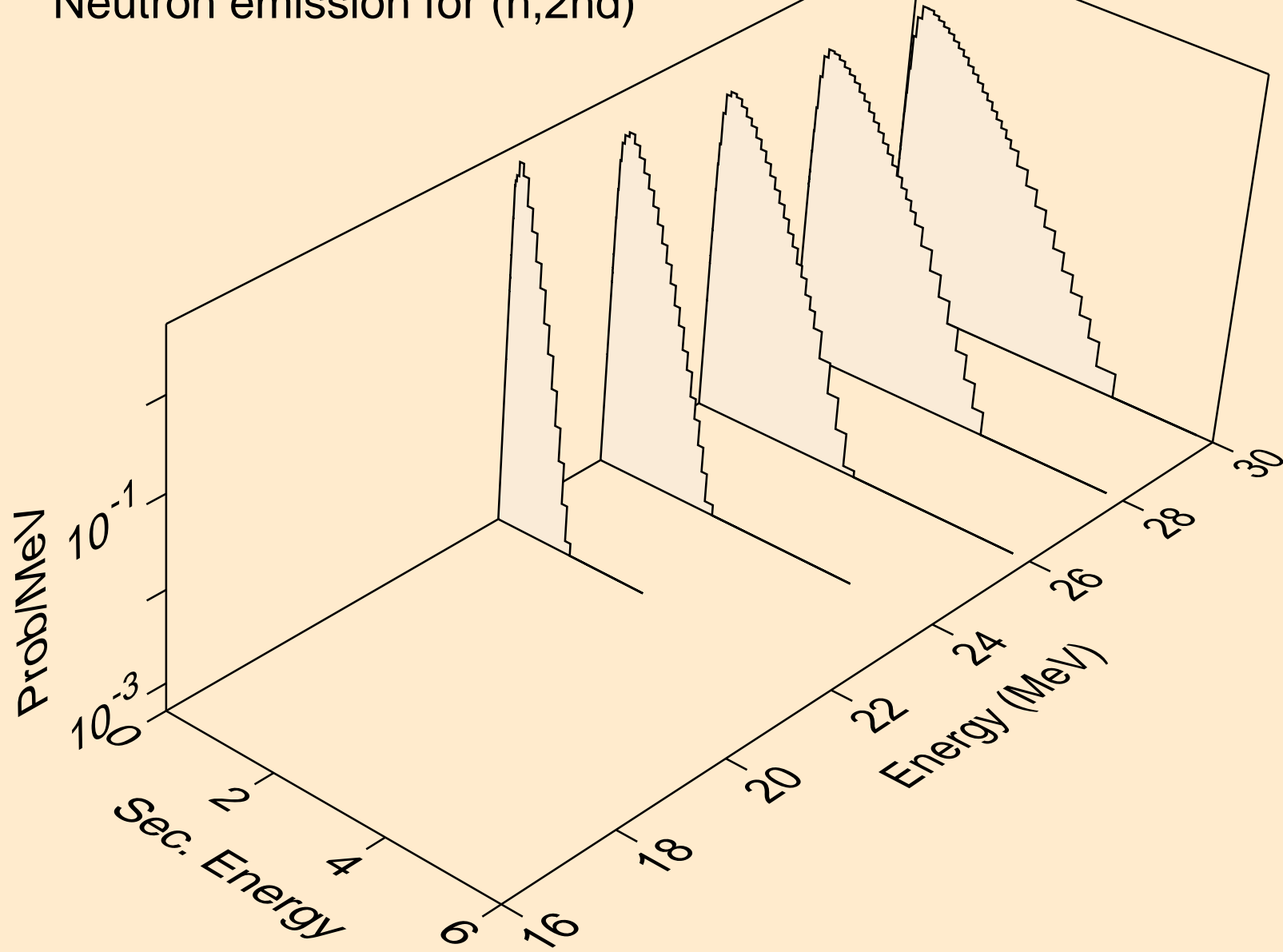

TL183 NEUTRON ACER TENDL-2024 LIBRARY; T=0.K
Neutron emission for (n,2n)

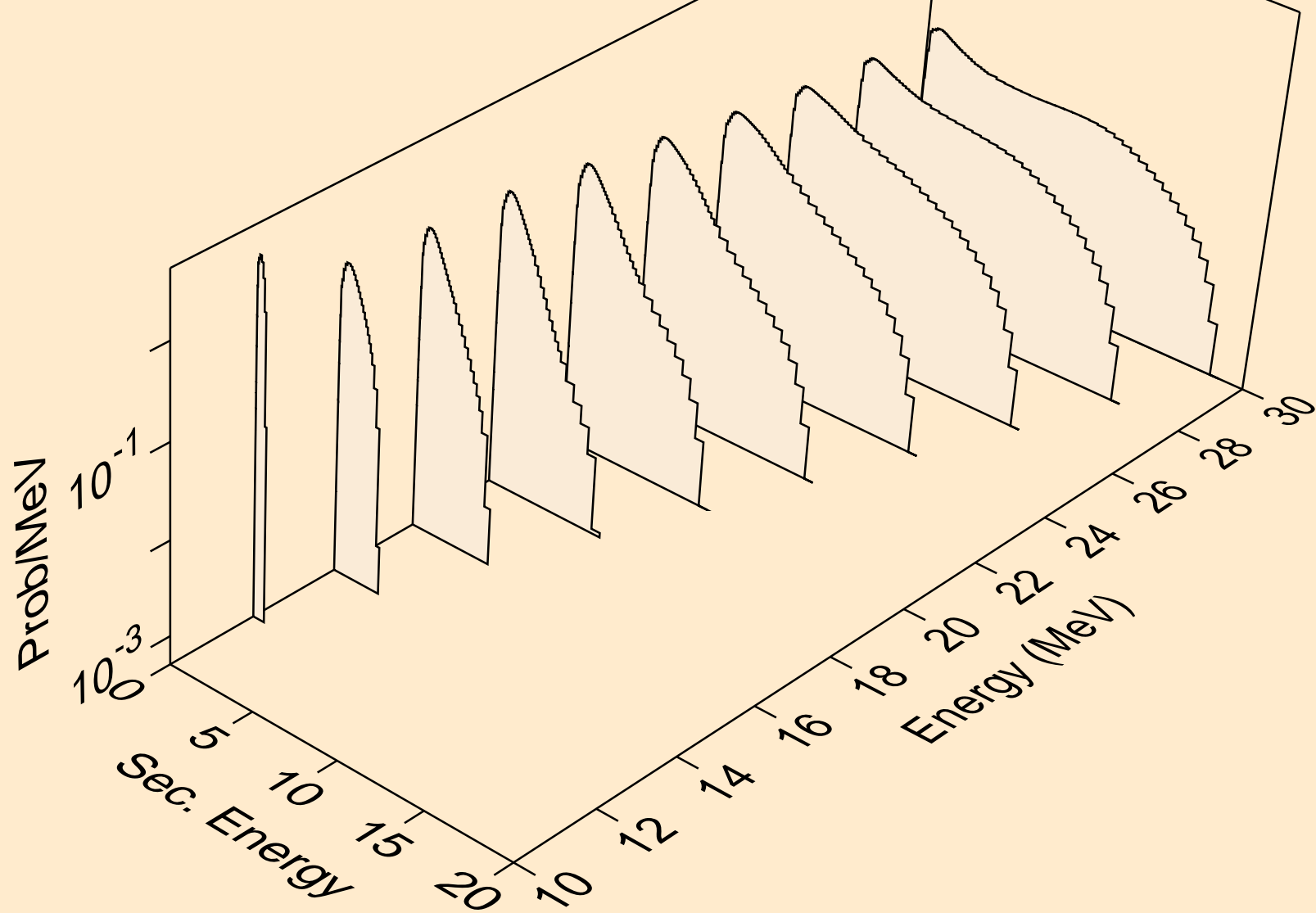

TL183 NEUTRON ACER TENDL-2024 LIBRARY; T=0.K
Neutron emission for (n,3n)

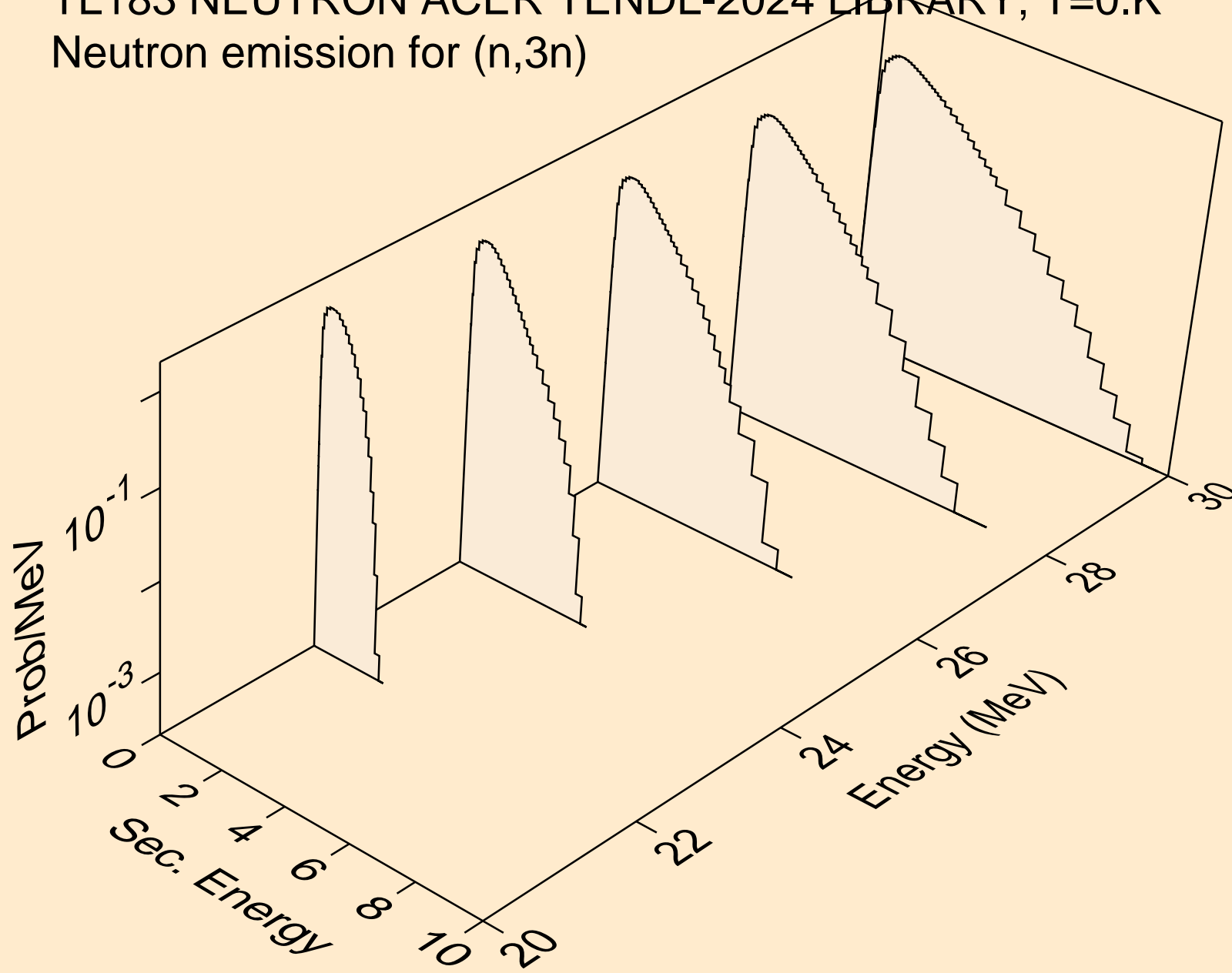

TL183 NEUTRON ACER TENDL-2024 LIBRARY; T=0.K
Neutron emission for (n,n*)a

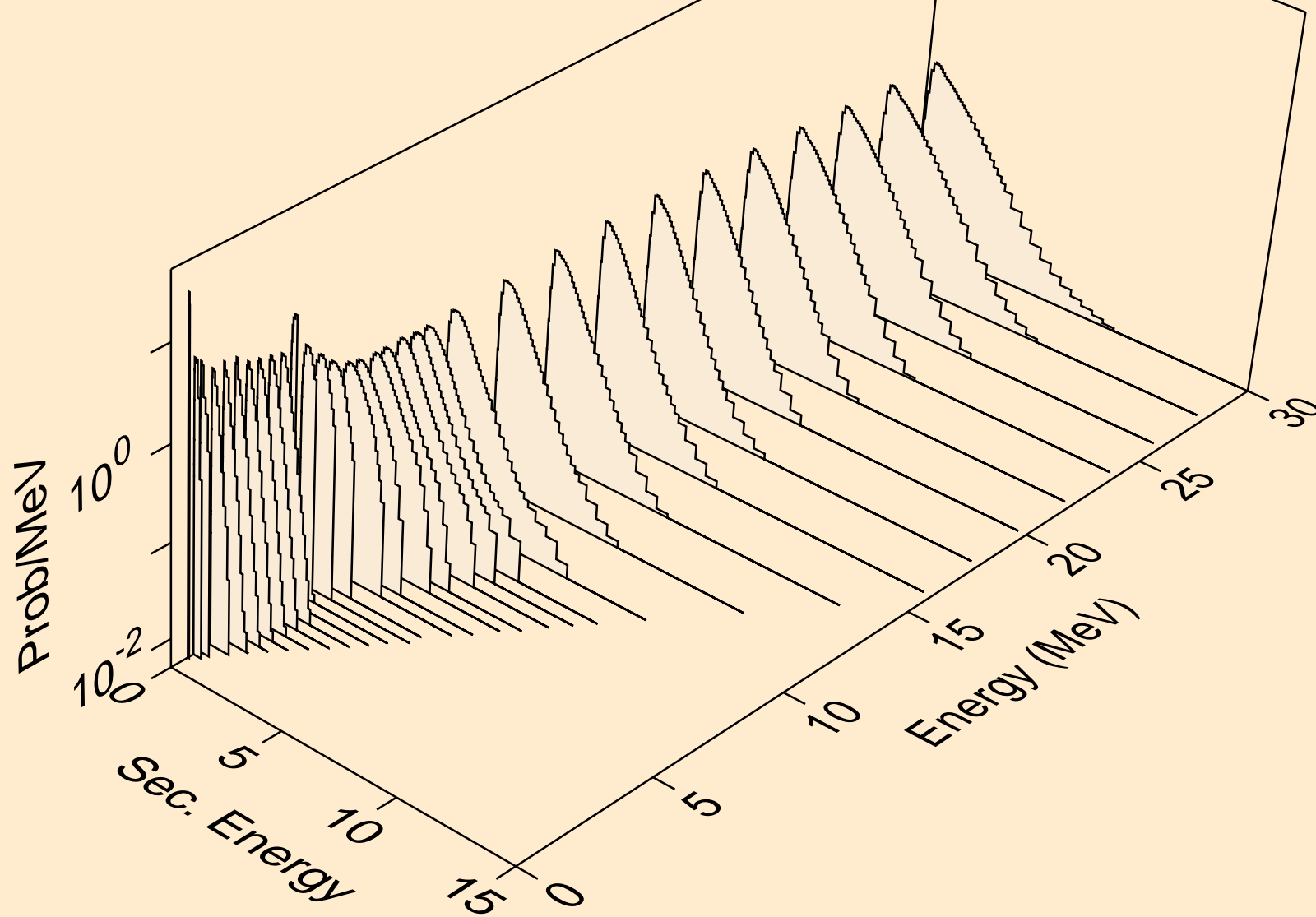

TL183 NEUTRON ACER TENDL-2024 LIBRARY; T=0.K
Neutron emission for (n,n*)3a

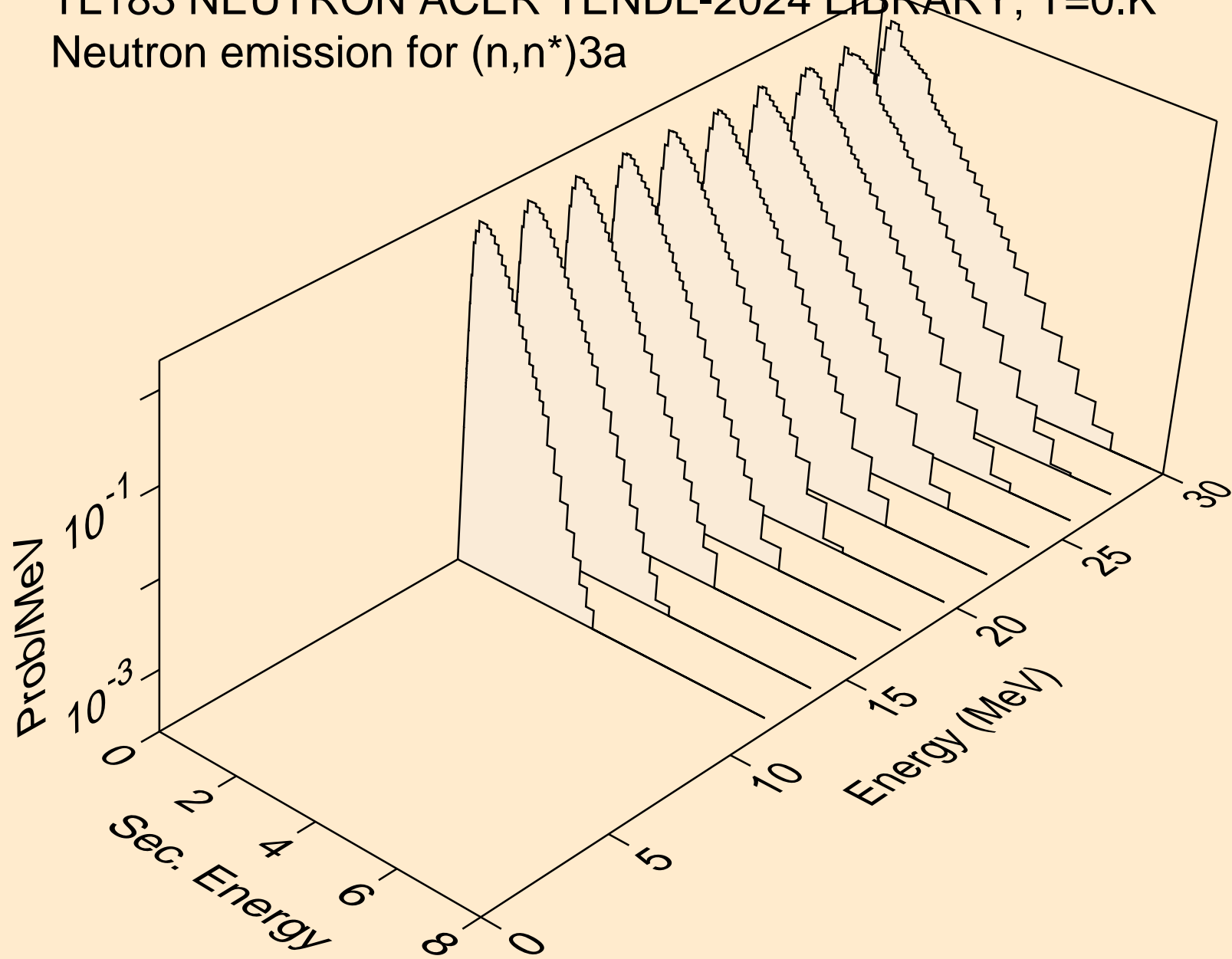

TL183 NEUTRON ACER TENDL-2024 LIBRARY; T=0.K
Neutron emission for (n,2n)a

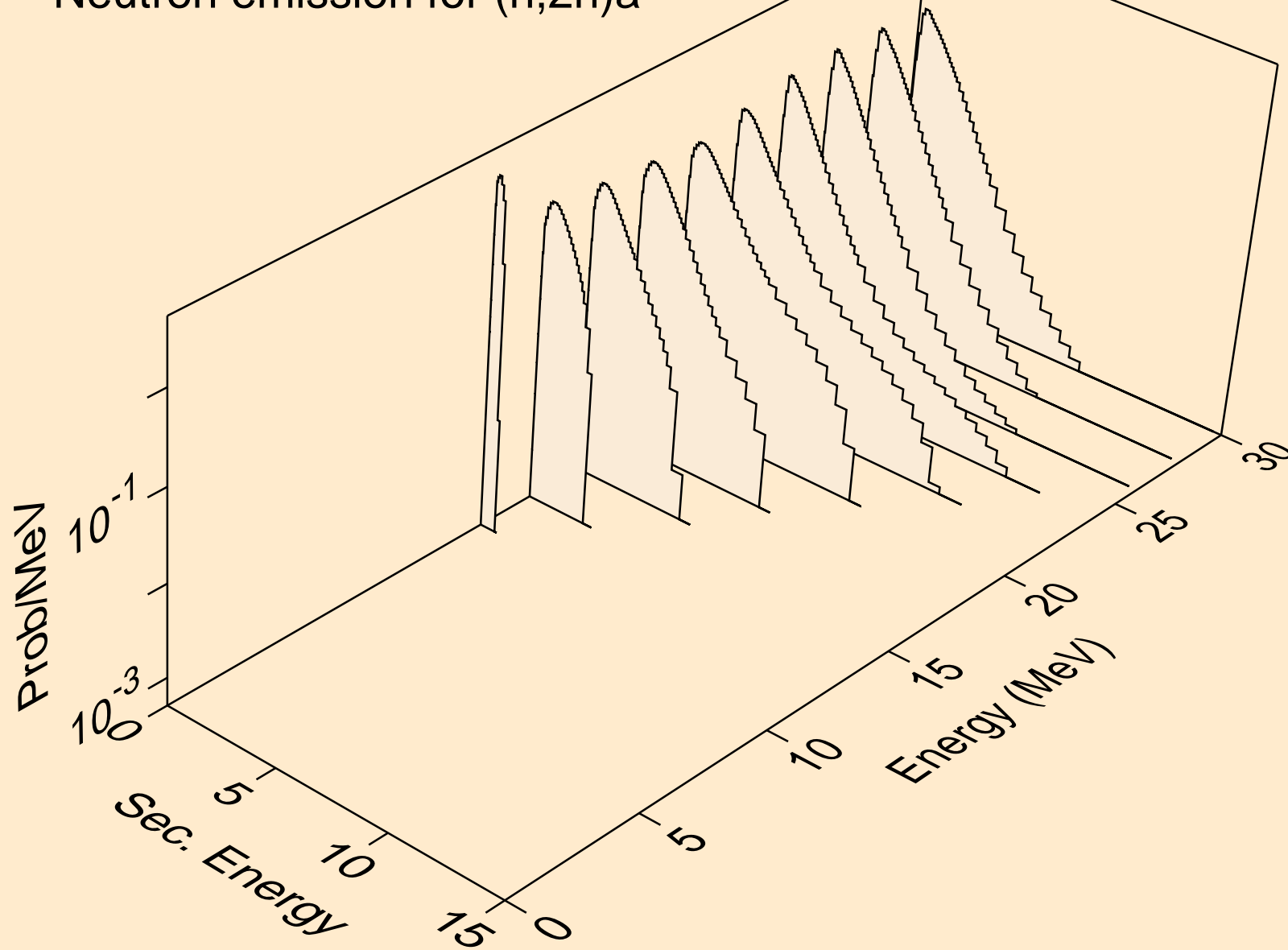

TL183 NEUTRON ACER TENDL-2024 LIBRARY; T=0.K
Neutron emission for (n,3n)a

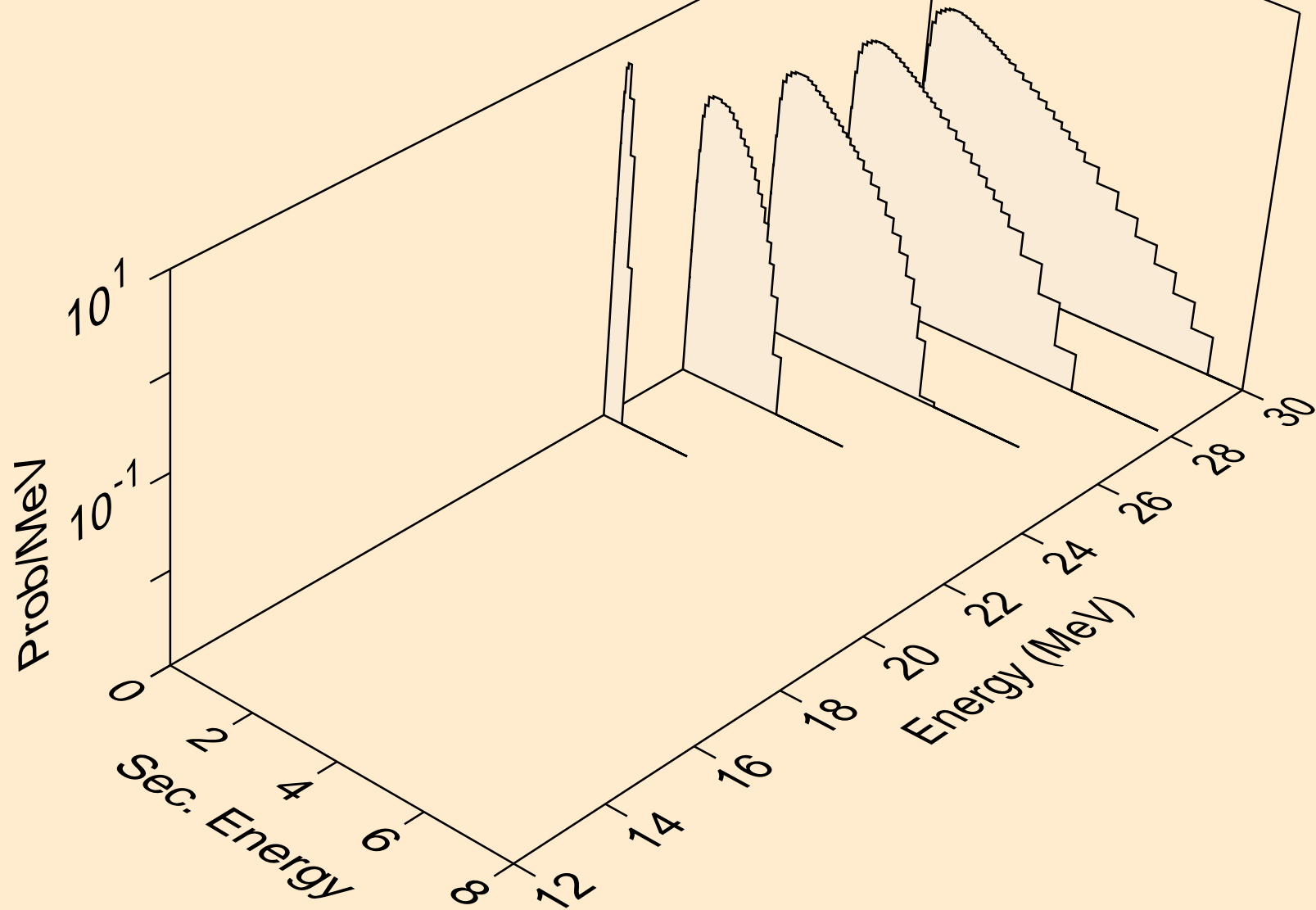

TL183 NEUTRON ACER TENDL-2024 LIBRARY; T=0.K
Neutron emission for (n,n*)p

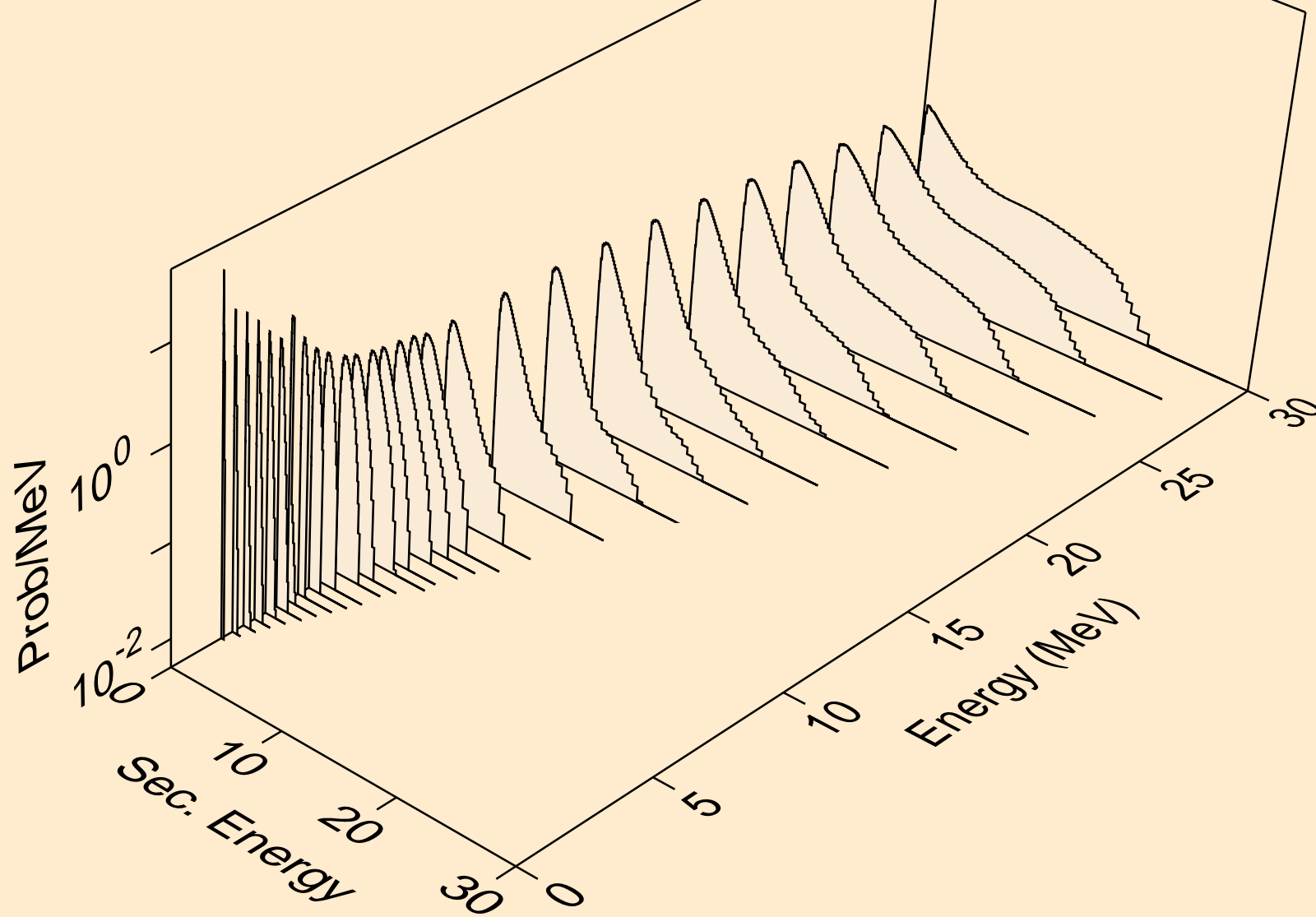

TL183 NEUTRON ACER TENDL-2024 LIBRARY; T=0.K
Neutron emission for (n,n*)2a

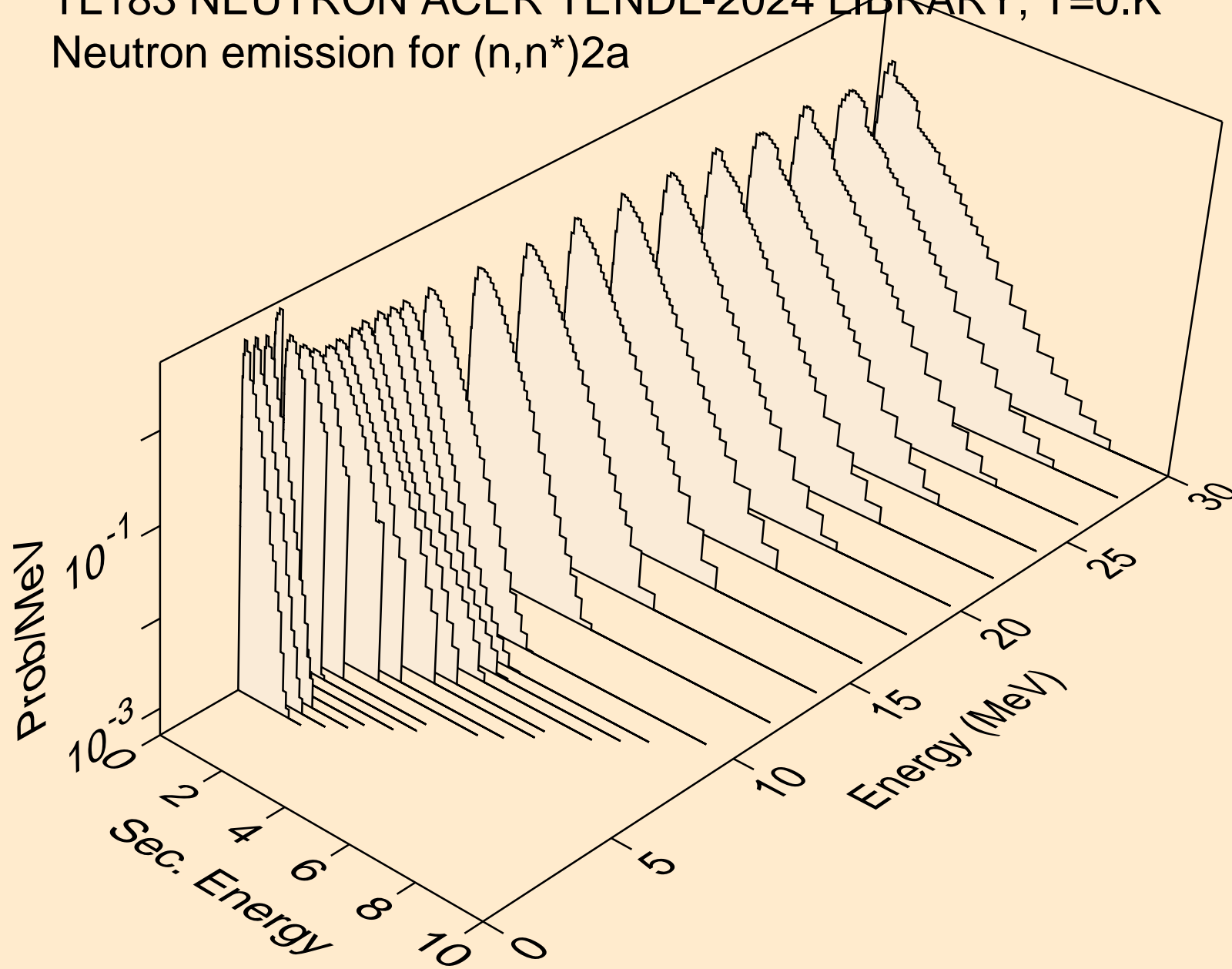

TL183 NEUTRON ACER TENDL-2024 LIBRARY; T=0.K
Neutron emission for (n,2n)2a

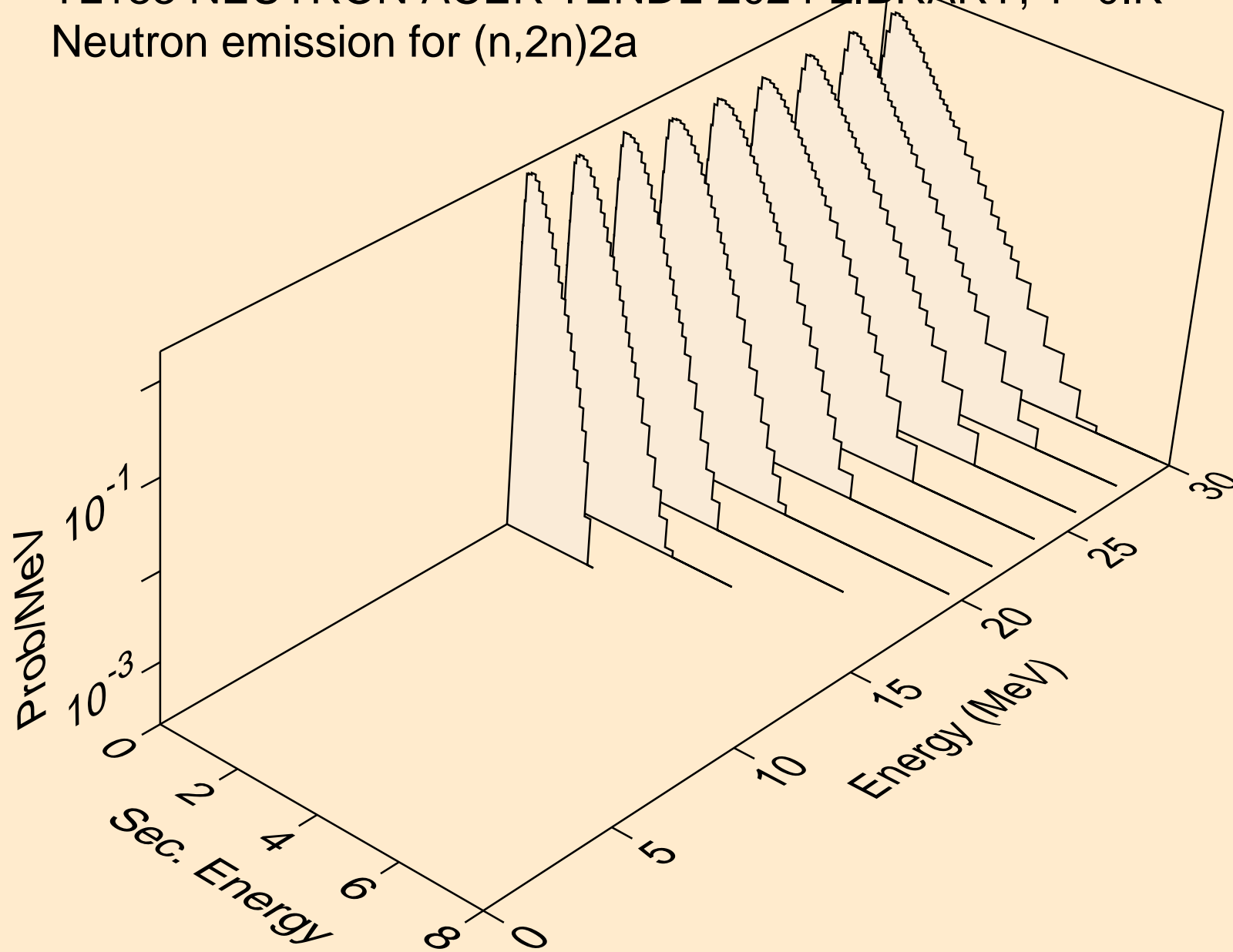

TL183 NEUTRON ACER TENDL-2024 LIBRARY; T=0.K
Neutron emission for (n,n*)d

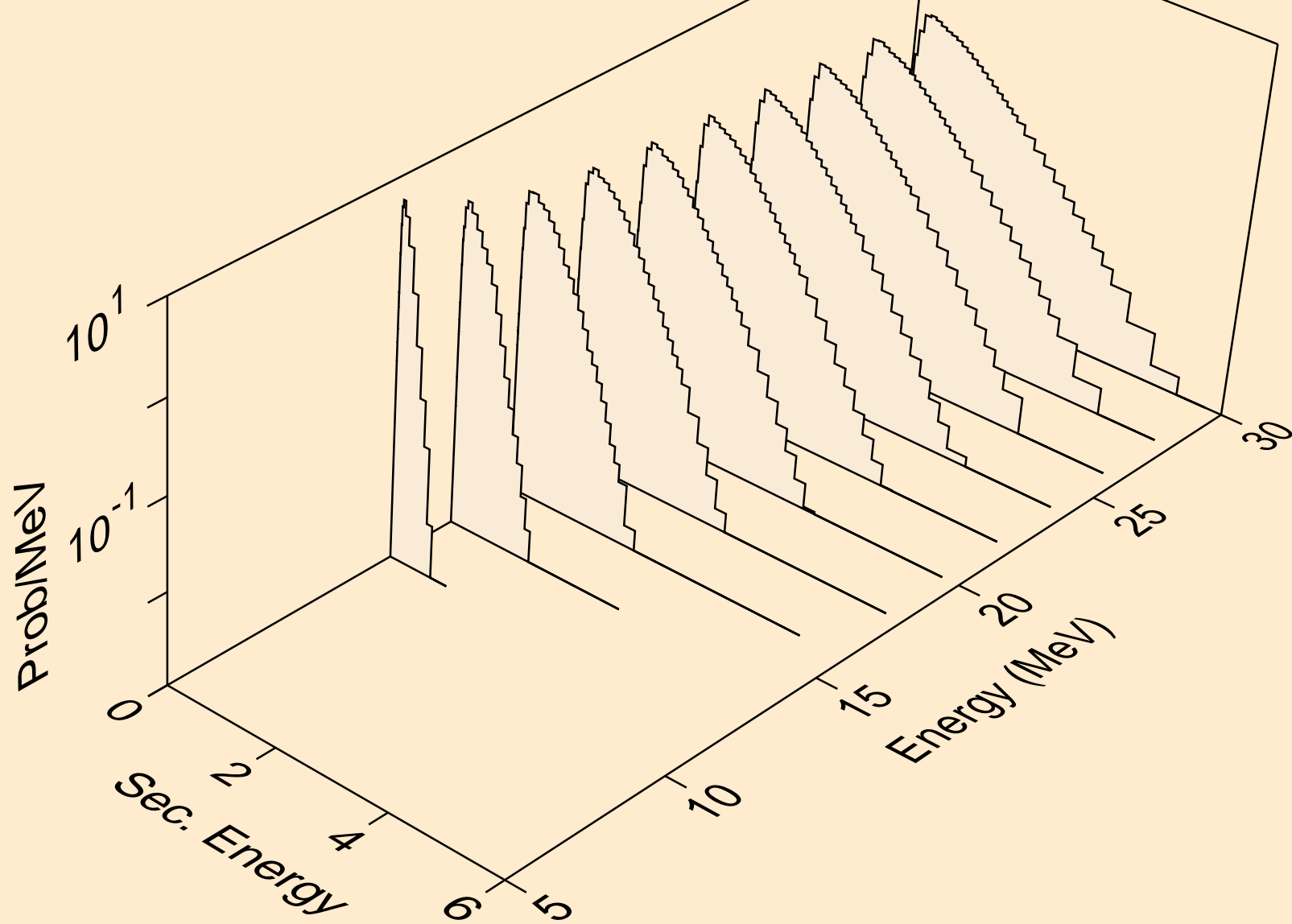

TL183 NEUTRON ACER TENDL-2024 LIBRARY; T=0.K
Neutron emission for (n,n*)t

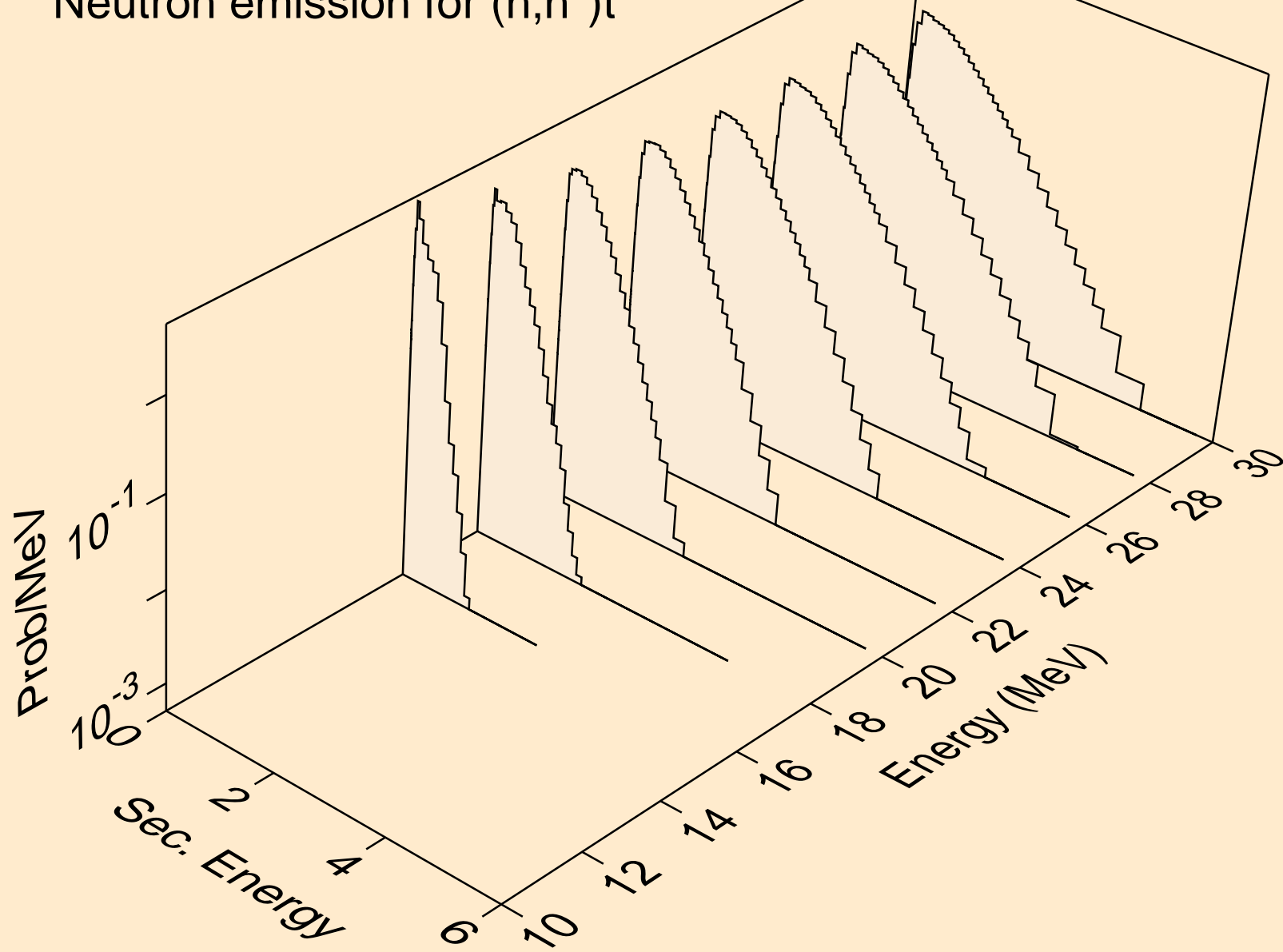

TL183 NEUTRON ACER TENDL-2024 LIBRARY; T=0.K
Neutron emission for (n,n*)he3

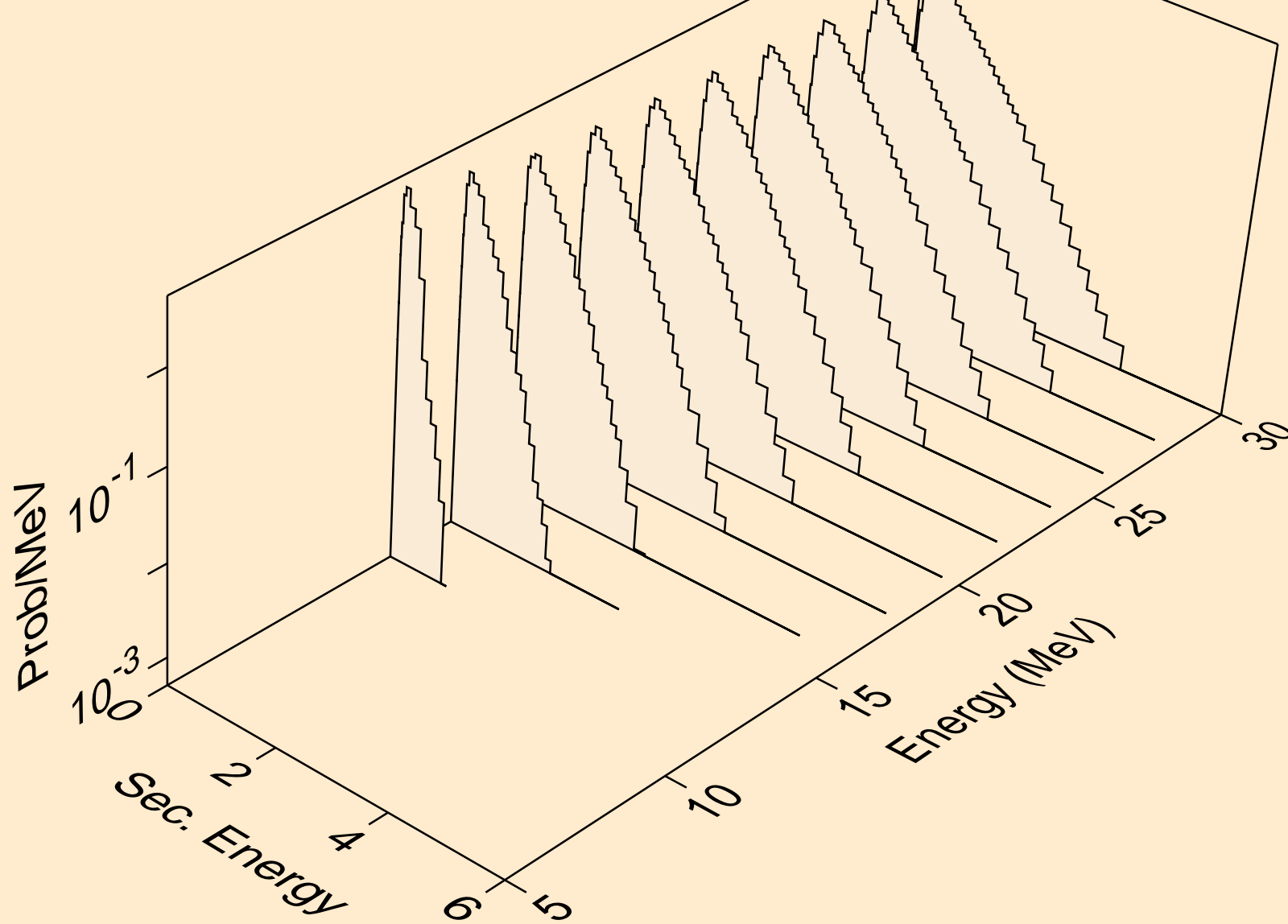

TL183 NEUTRON ACER TENDL-2024 LIBRARY; T=0.K
Neutron emission for (n,2np)

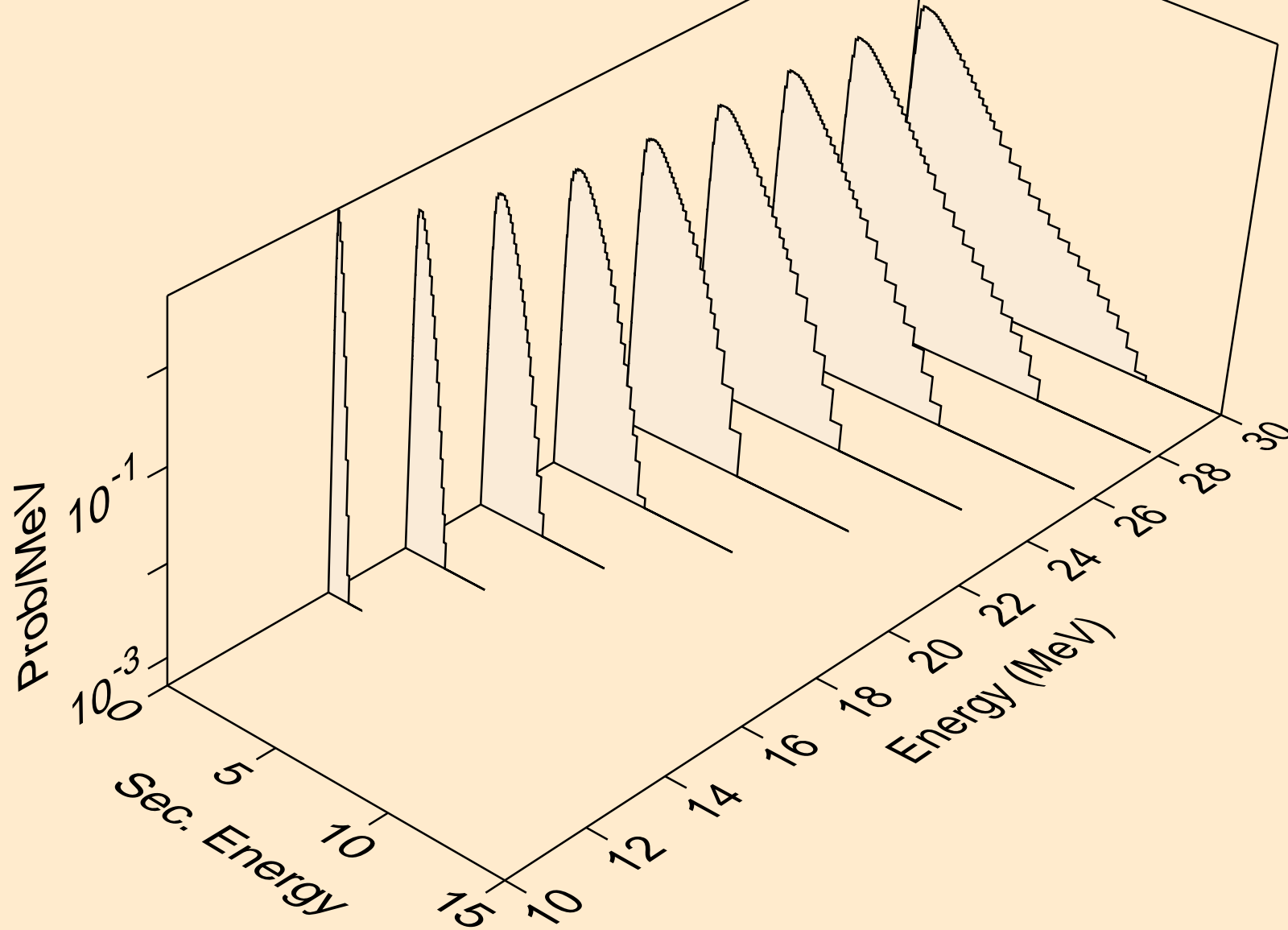

TL183 NEUTRON ACER TENDL-2024 LIBRARY; T=0.K
Neutron emission for (n,3np)

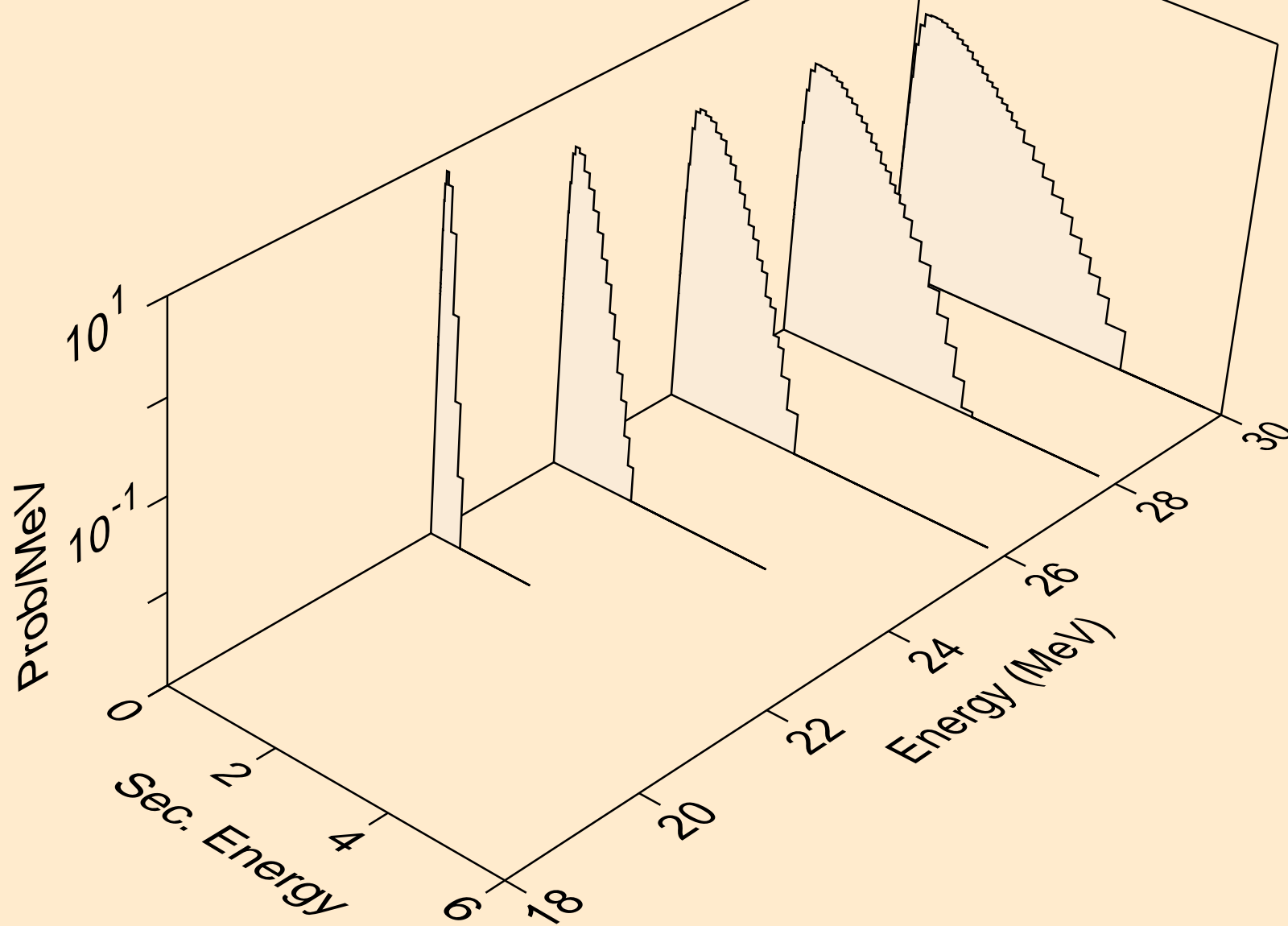

TL183 NEUTRON ACER TENDL-2024 LIBRARY; T=0.K
Neutron emission for (n,n2p)

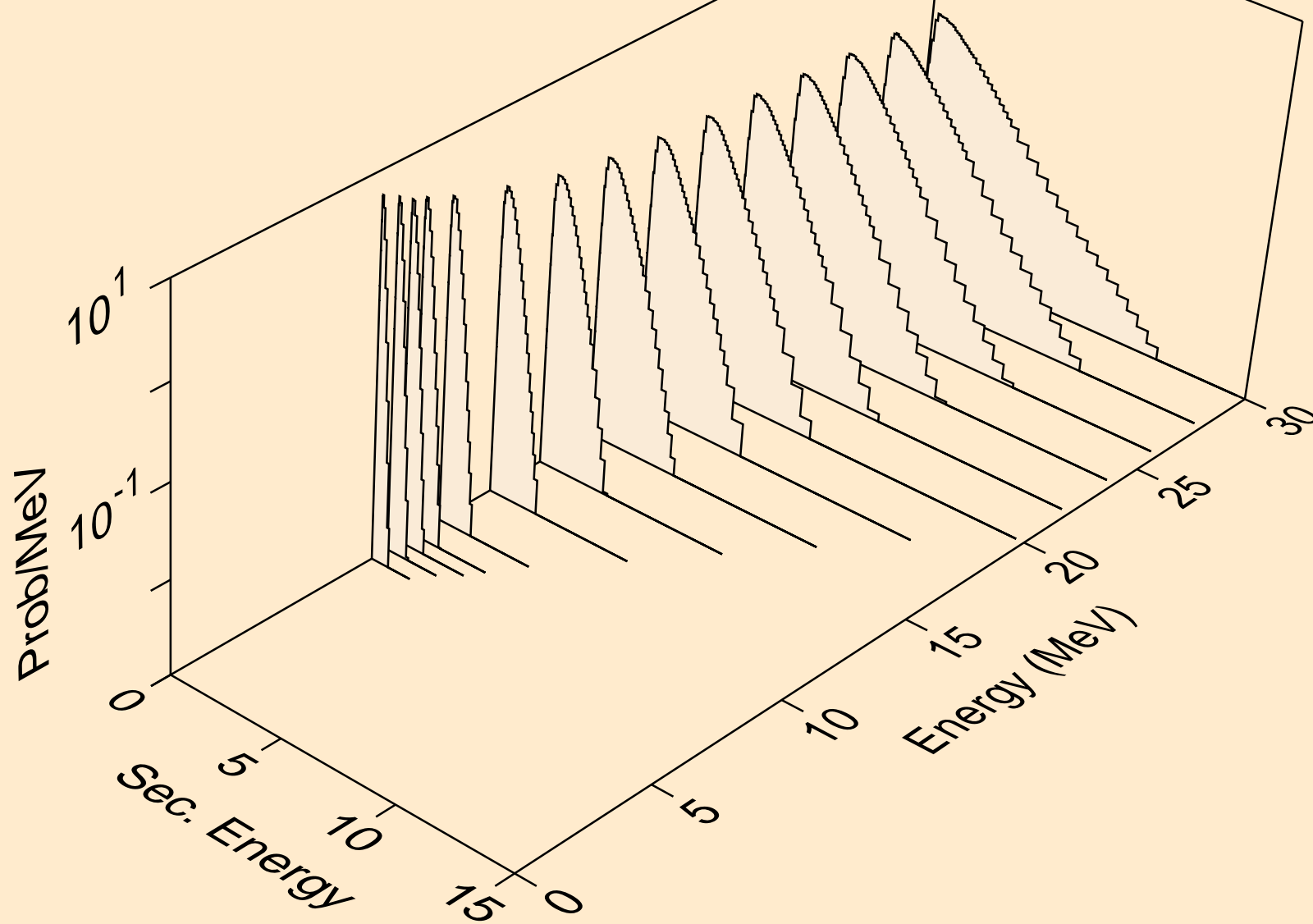

TL183 NEUTRON ACER TENDL-2024 LIBRARY; T=0.K
Neutron emission for (n,npa)

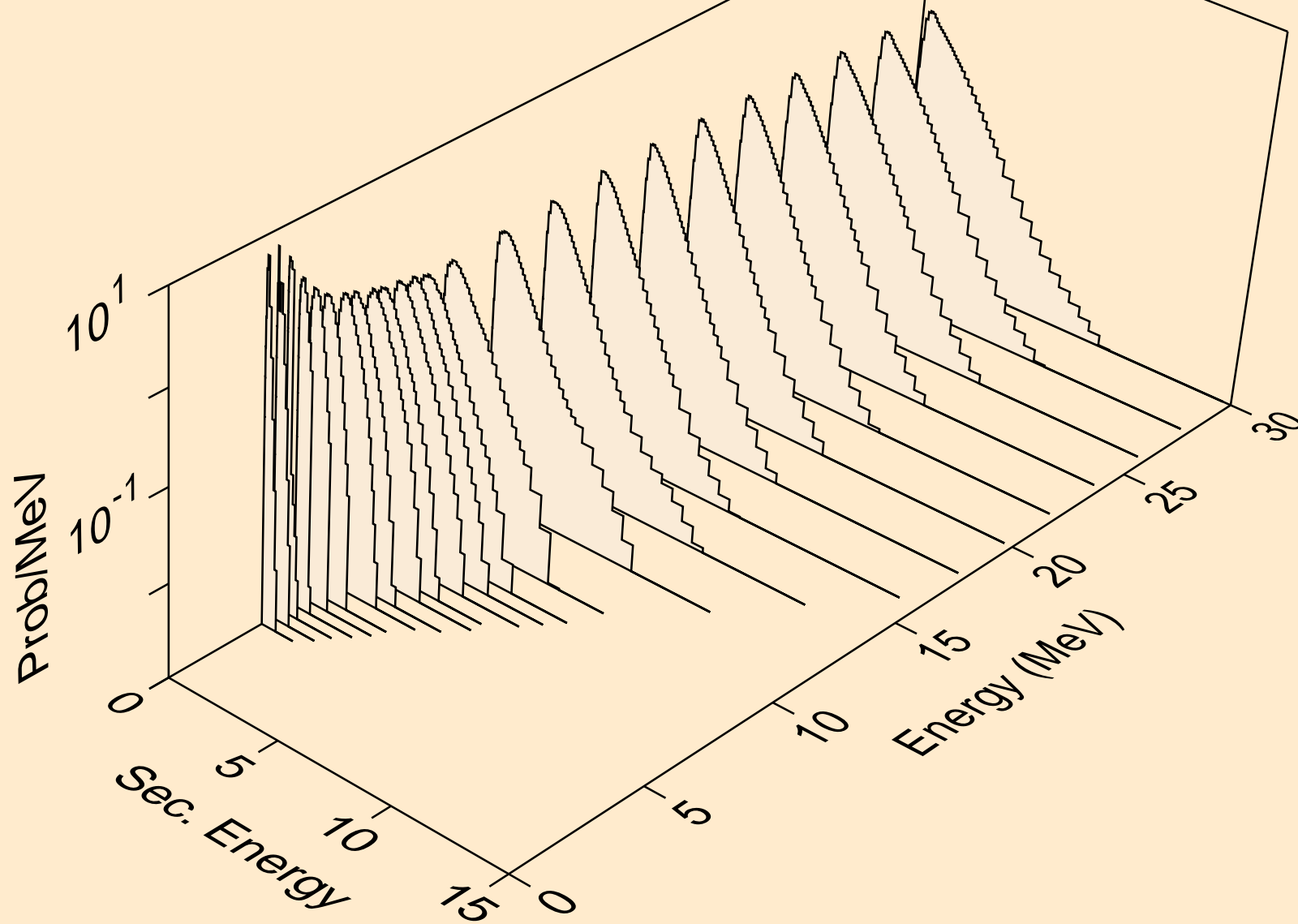

TL183 NEUTRON ACER TENDL-2024 LIBRARY; T=0.K
Neutron emission for (n,n*c)

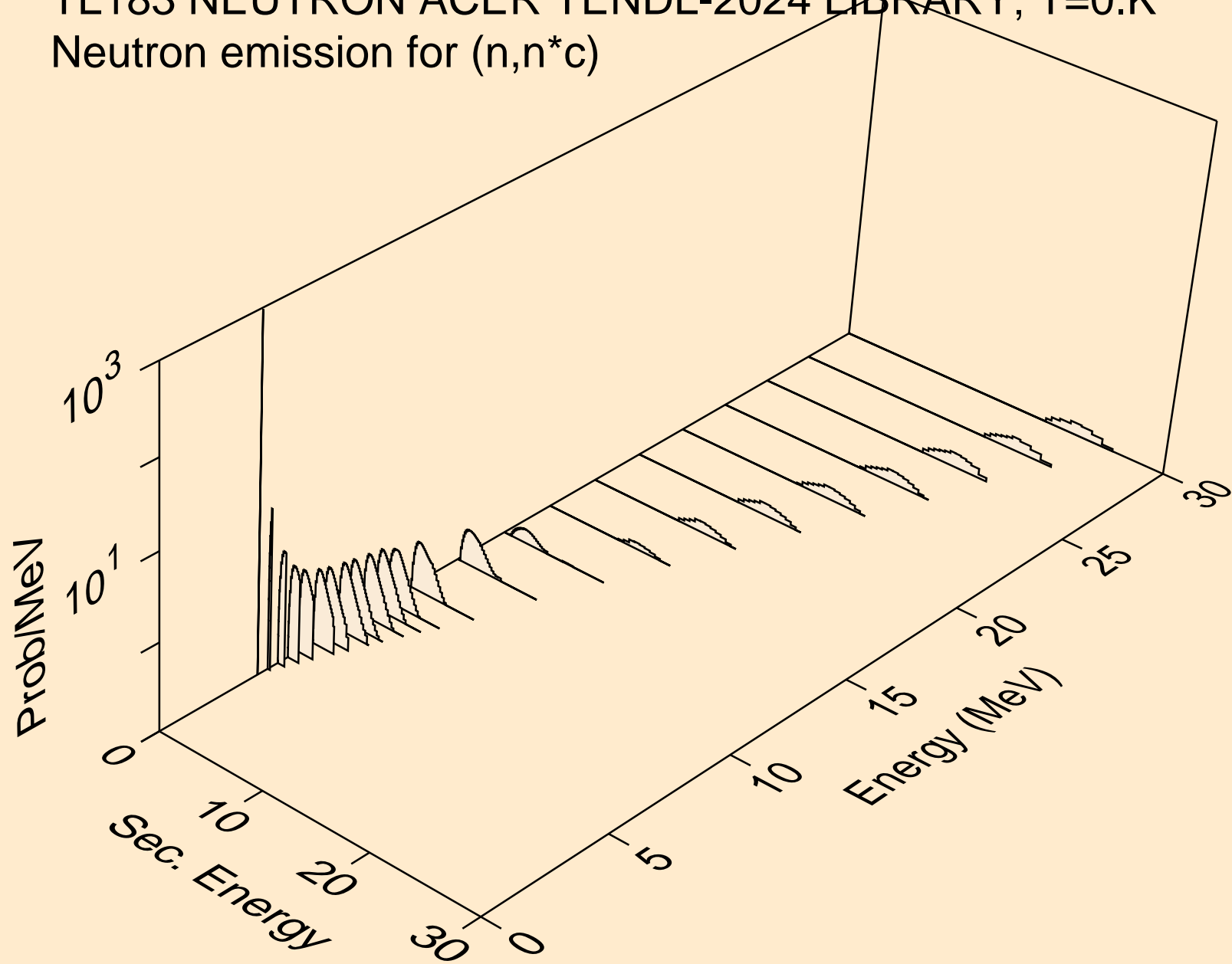

TL183 NEUTRON ACER TENDL-2024 LIBRARY; T=0.K
Photon emission for (n,x)

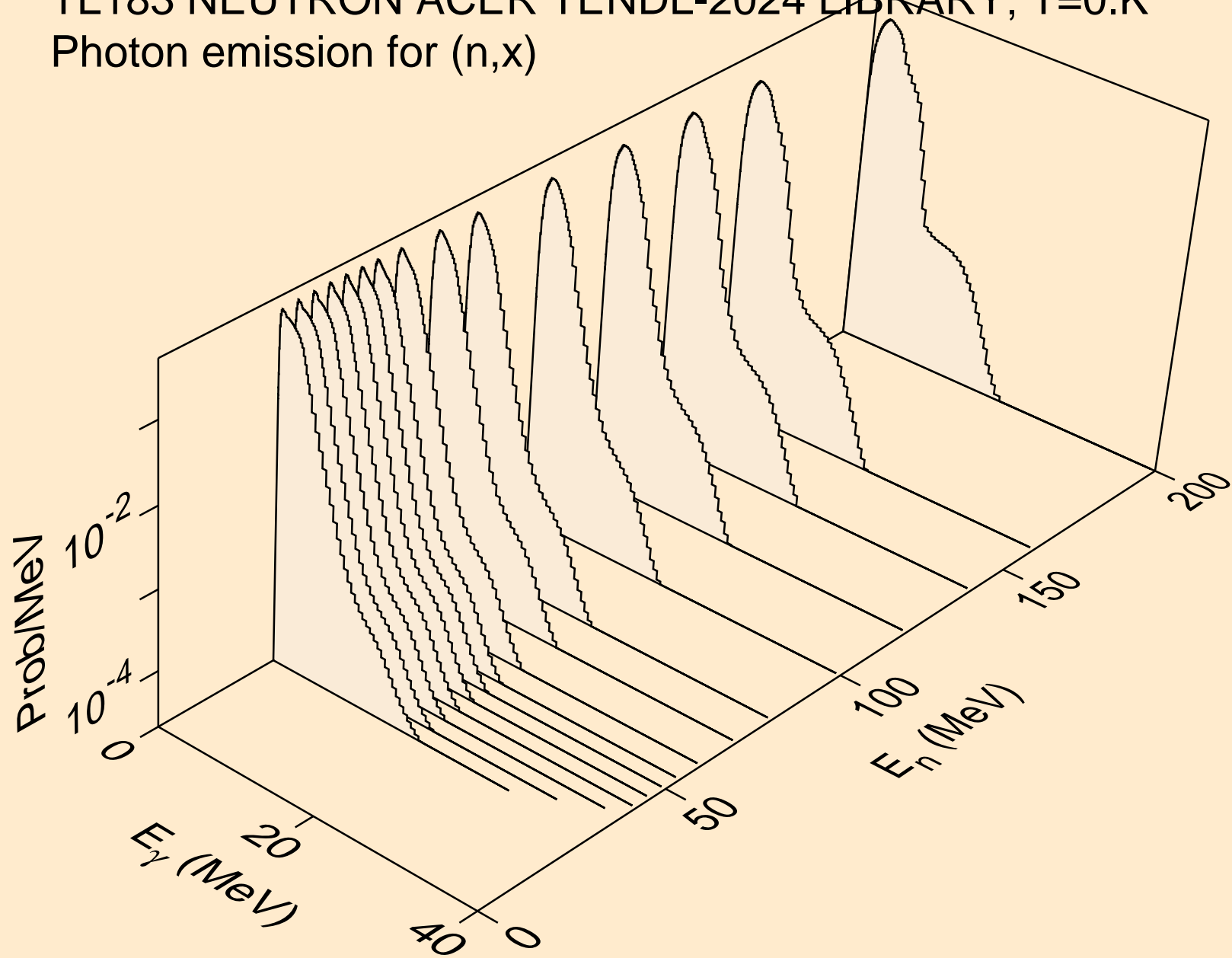

TL183 NEUTRON ACER TENDL-2024 LIBRARY; T=0.K
Photon emission for (n,2nd)

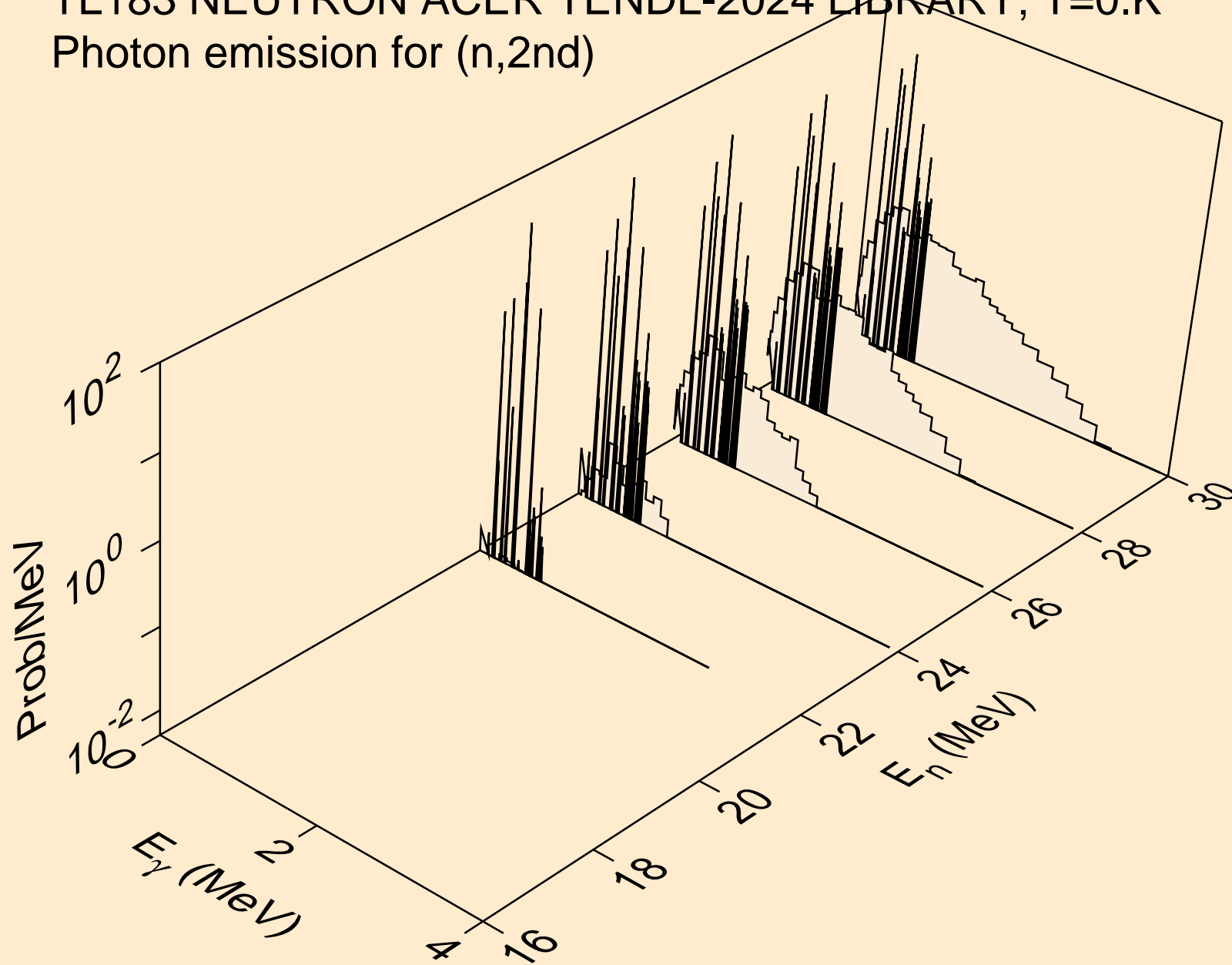

TL183 NEUTRON ACER TENDL-2024 LIBRARY; T=0.K
Photon emission for (n,2n)

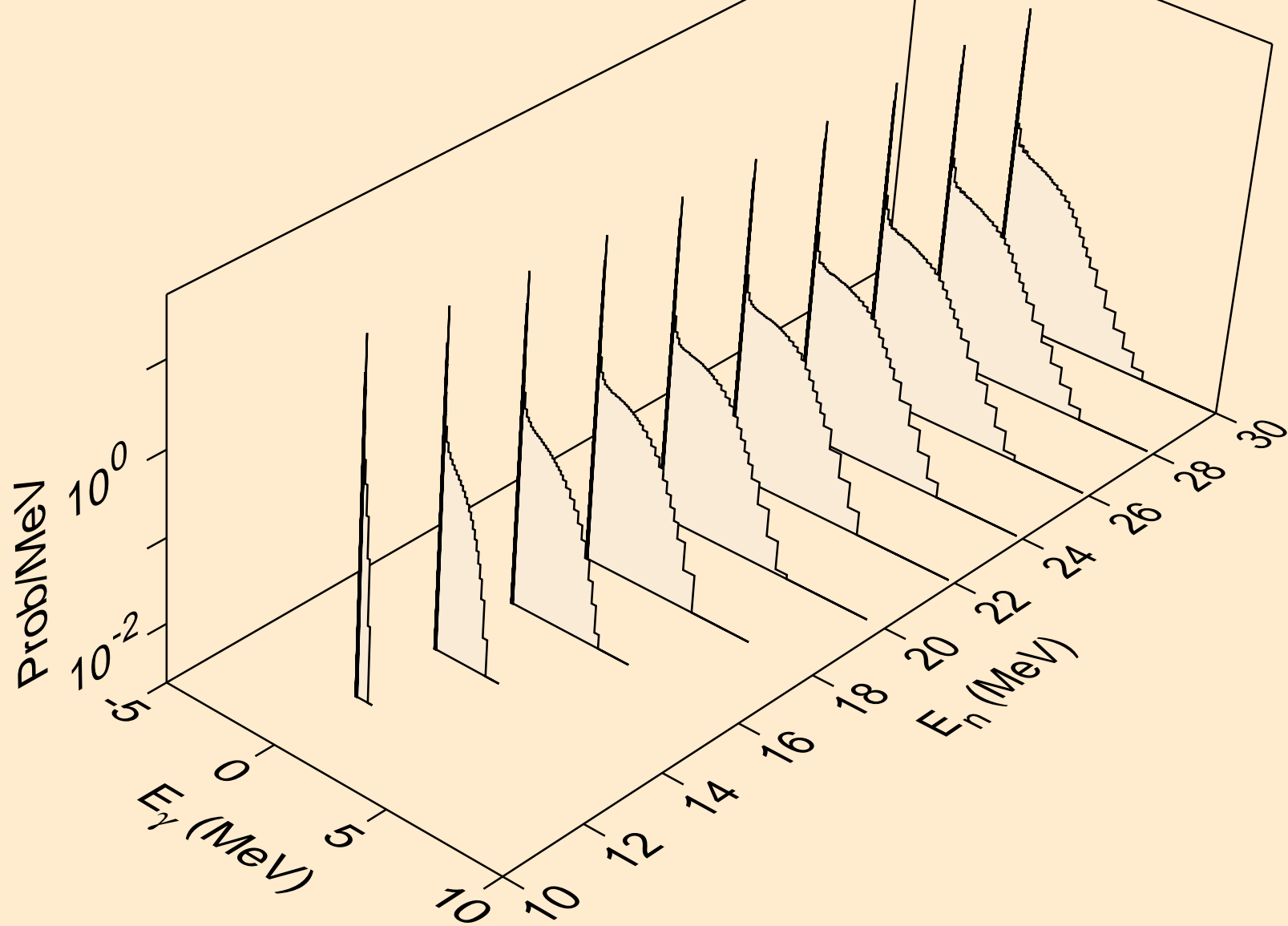

TL183 NEUTRON ACER TENDL-2024 LIBRARY; T=0.K
Photon emission for (n,3n)

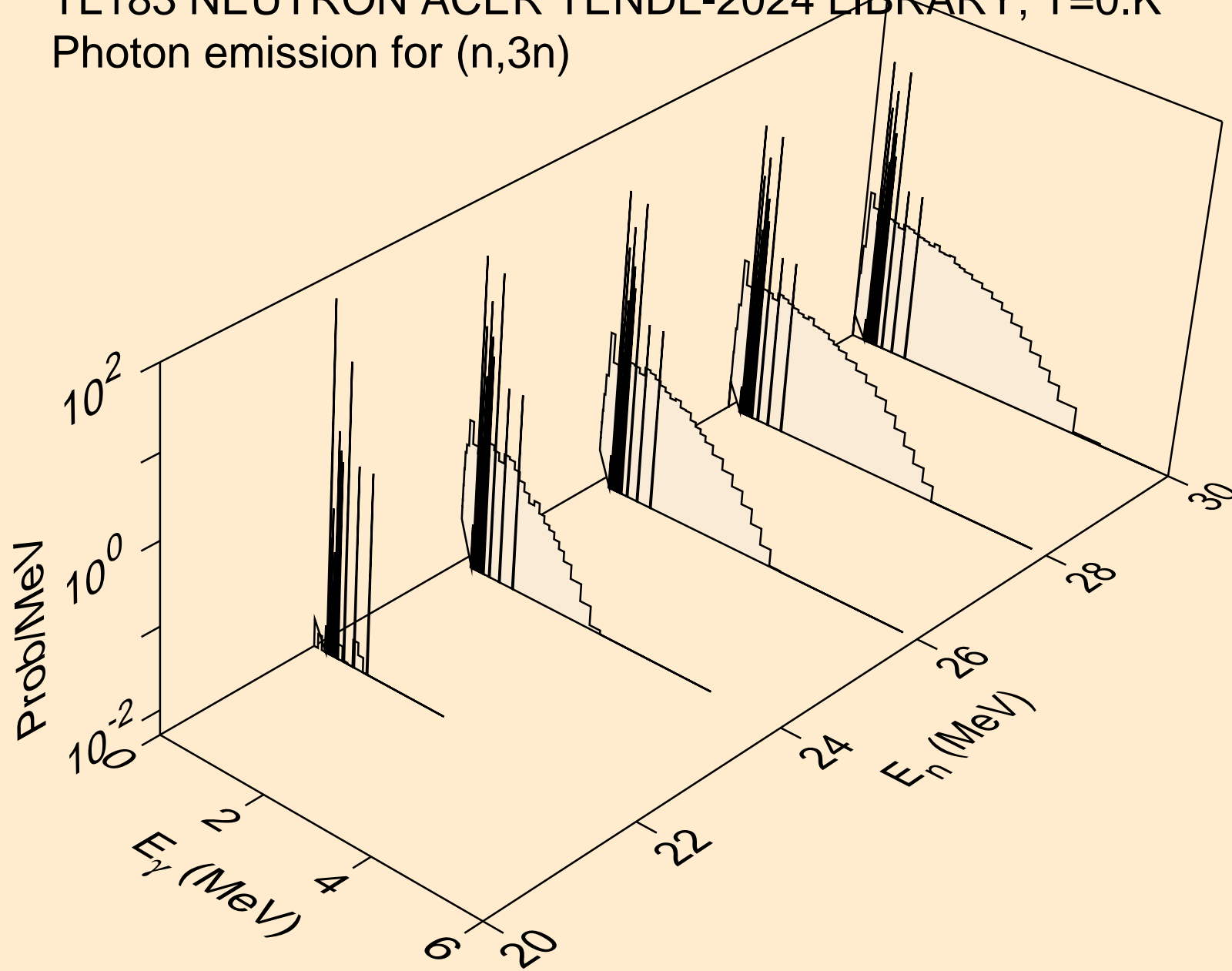

TL183 NEUTRON ACER TENDL-2024 LIBRARY; T=0.K
Photon emission for (n,n*)a

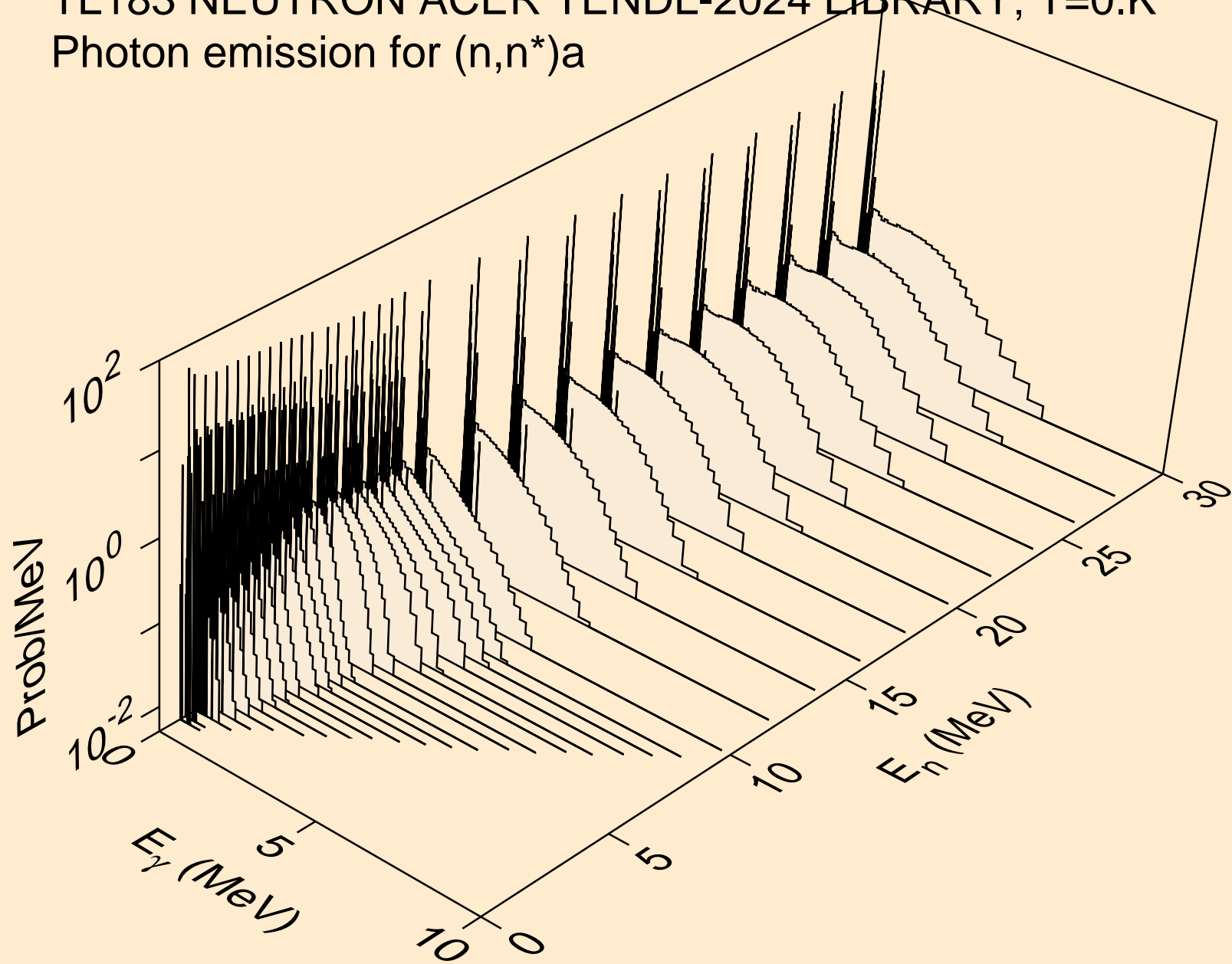

TL183 NEUTRON ACER TENDL-2024 LIBRARY; T=0.K
Photon emission for (n,n*)3a

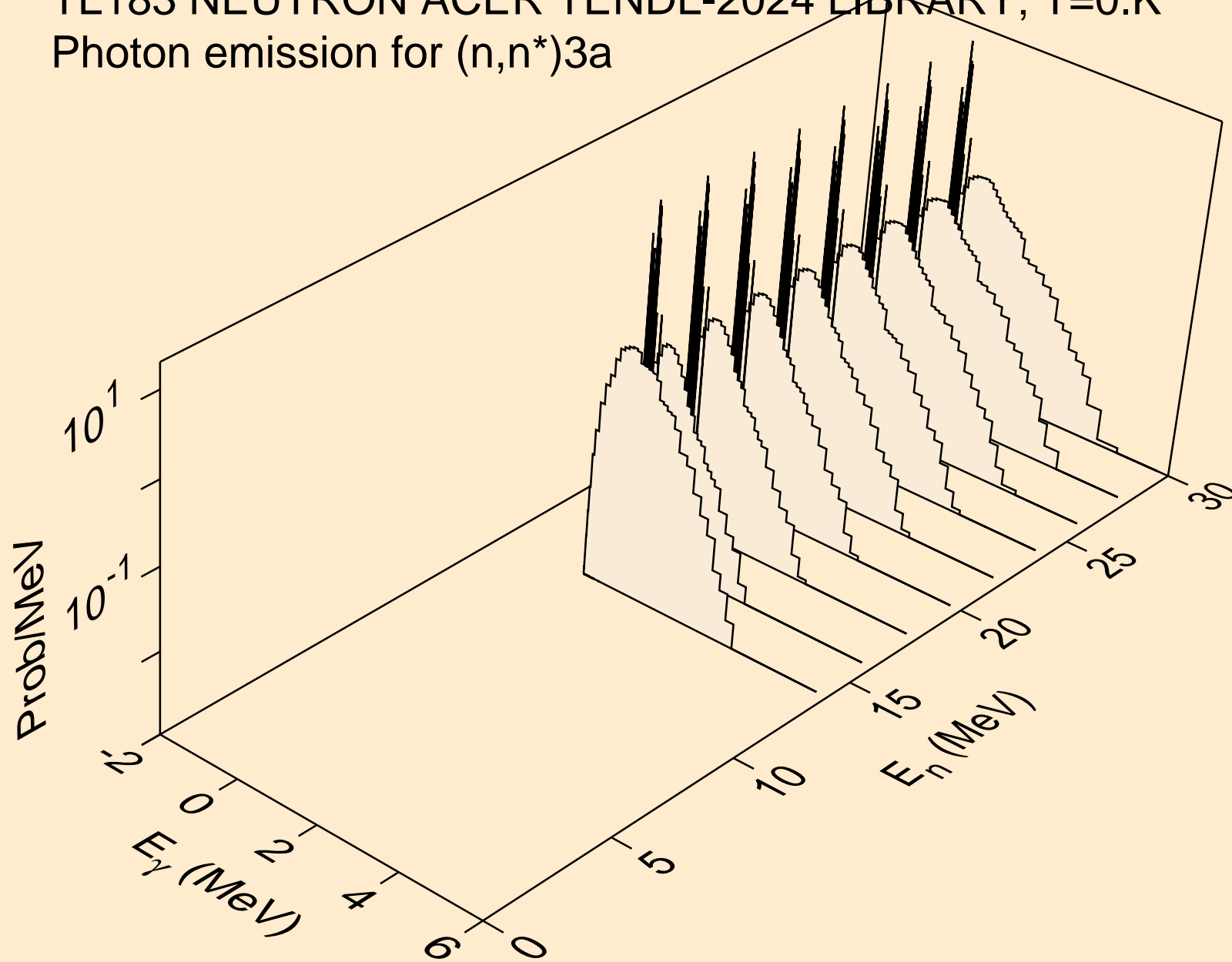

TL183 NEUTRON ACER TENDL-2024 LIBRARY; T=0.K
Photon emission for (n,2n)a

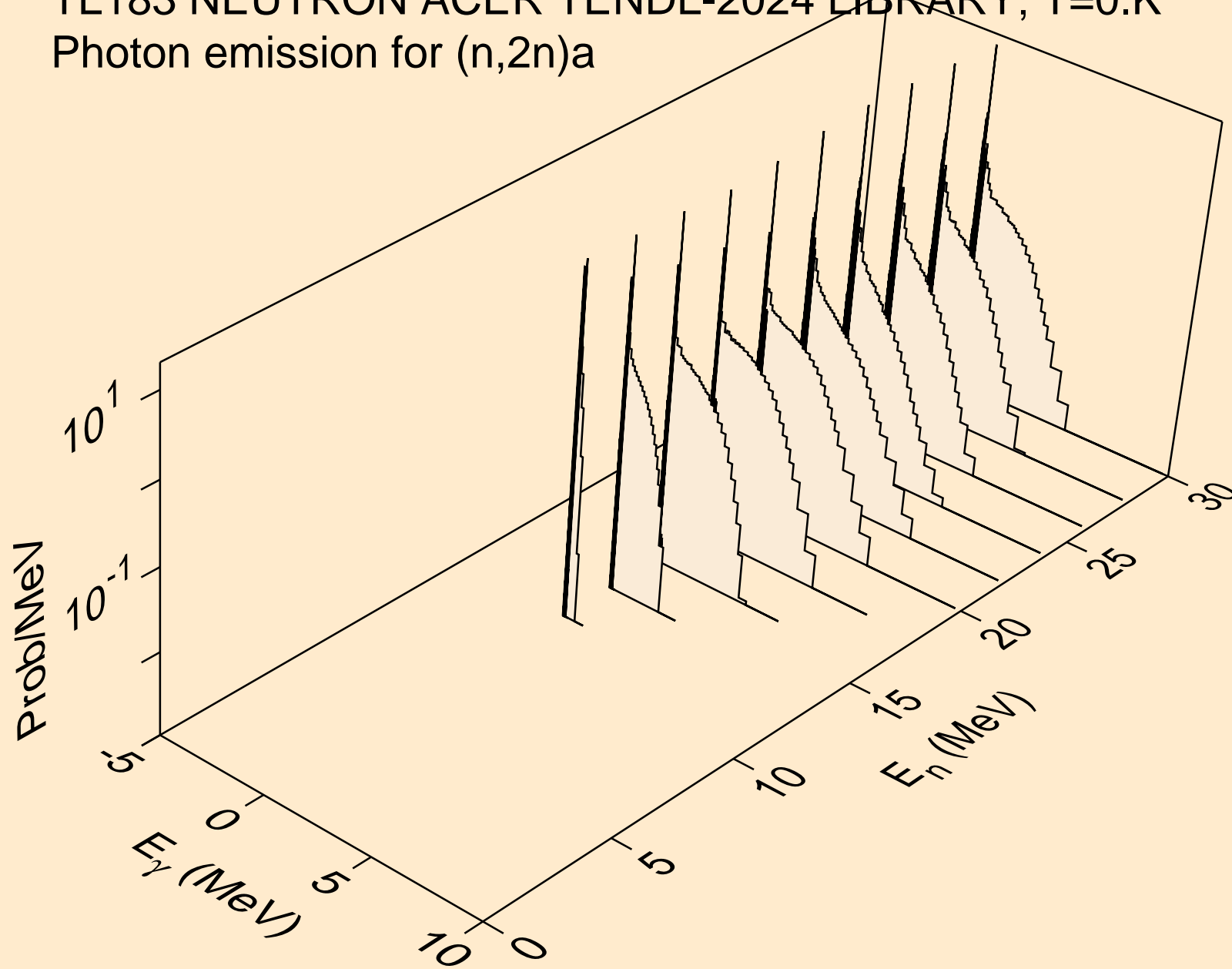

TL183 NEUTRON ACER TENDL-2024 LIBRARY; T=0.K
Photon emission for (n,3n)a

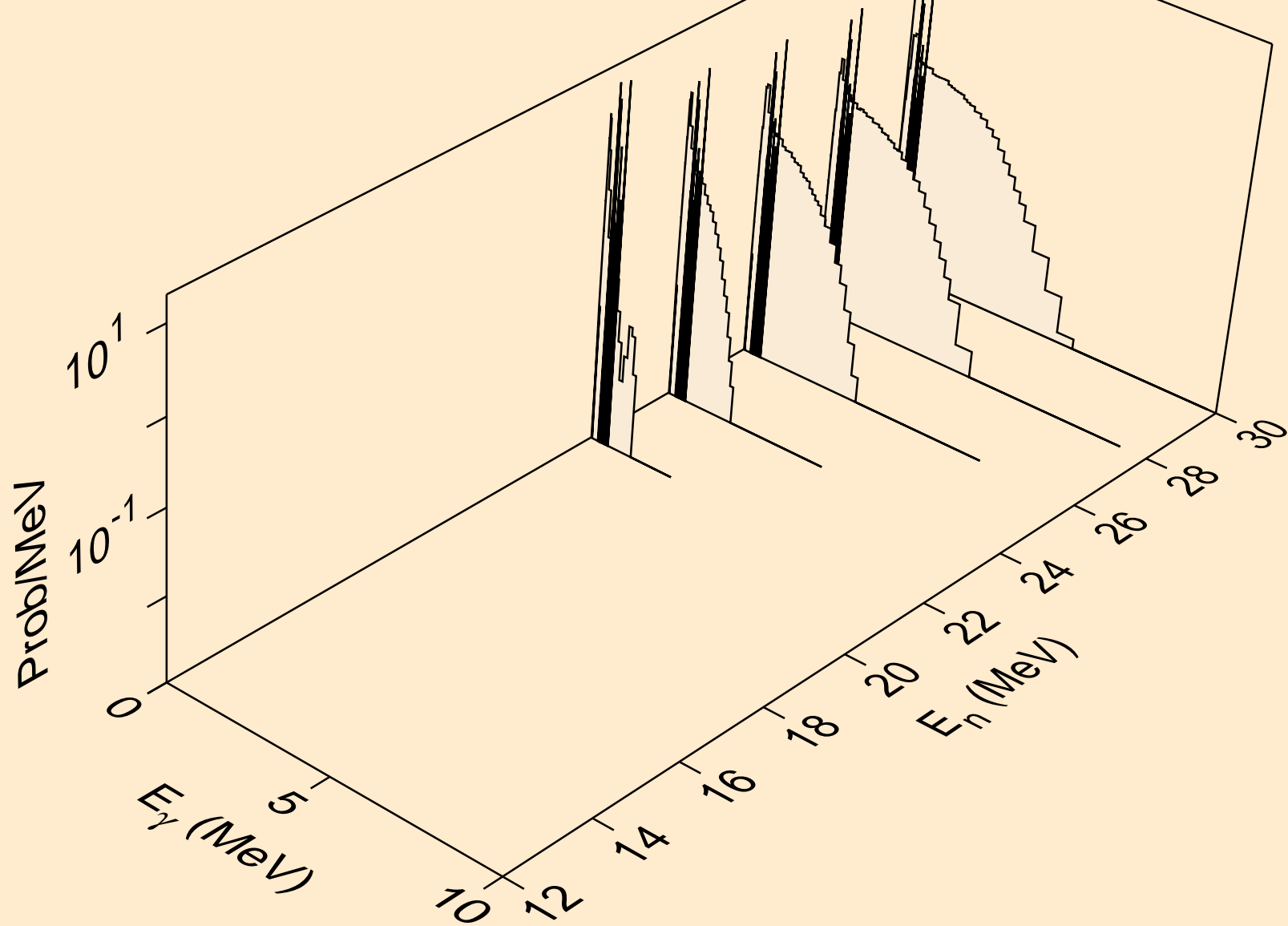

TL183 NEUTRON ACER TENDL-2024 LIBRARY; T=0.K
Photon emission for (n,n*)p

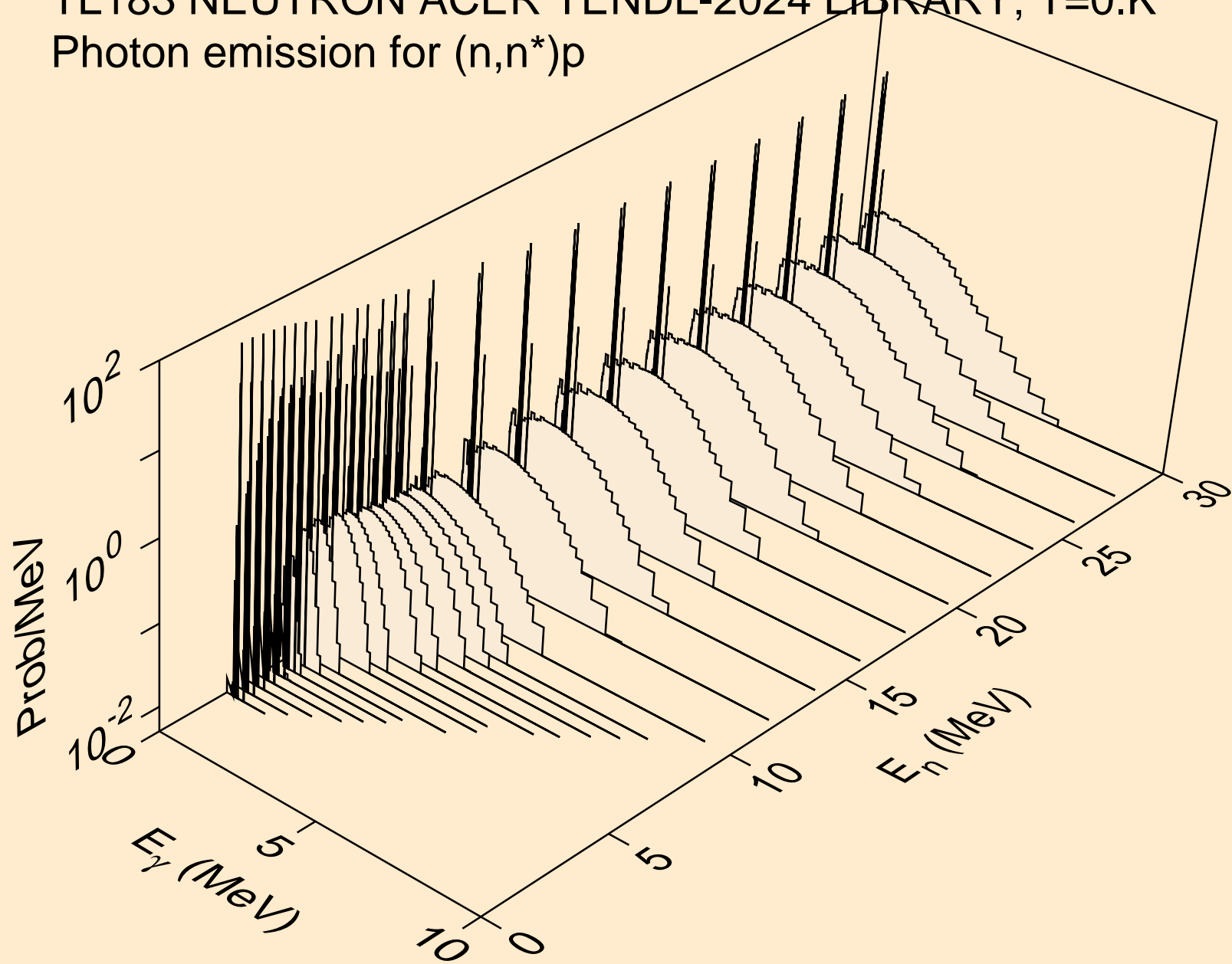

TL183 NEUTRON ACER TENDL-2024 LIBRARY; T=0.K
Photon emission for (n,n*)2a

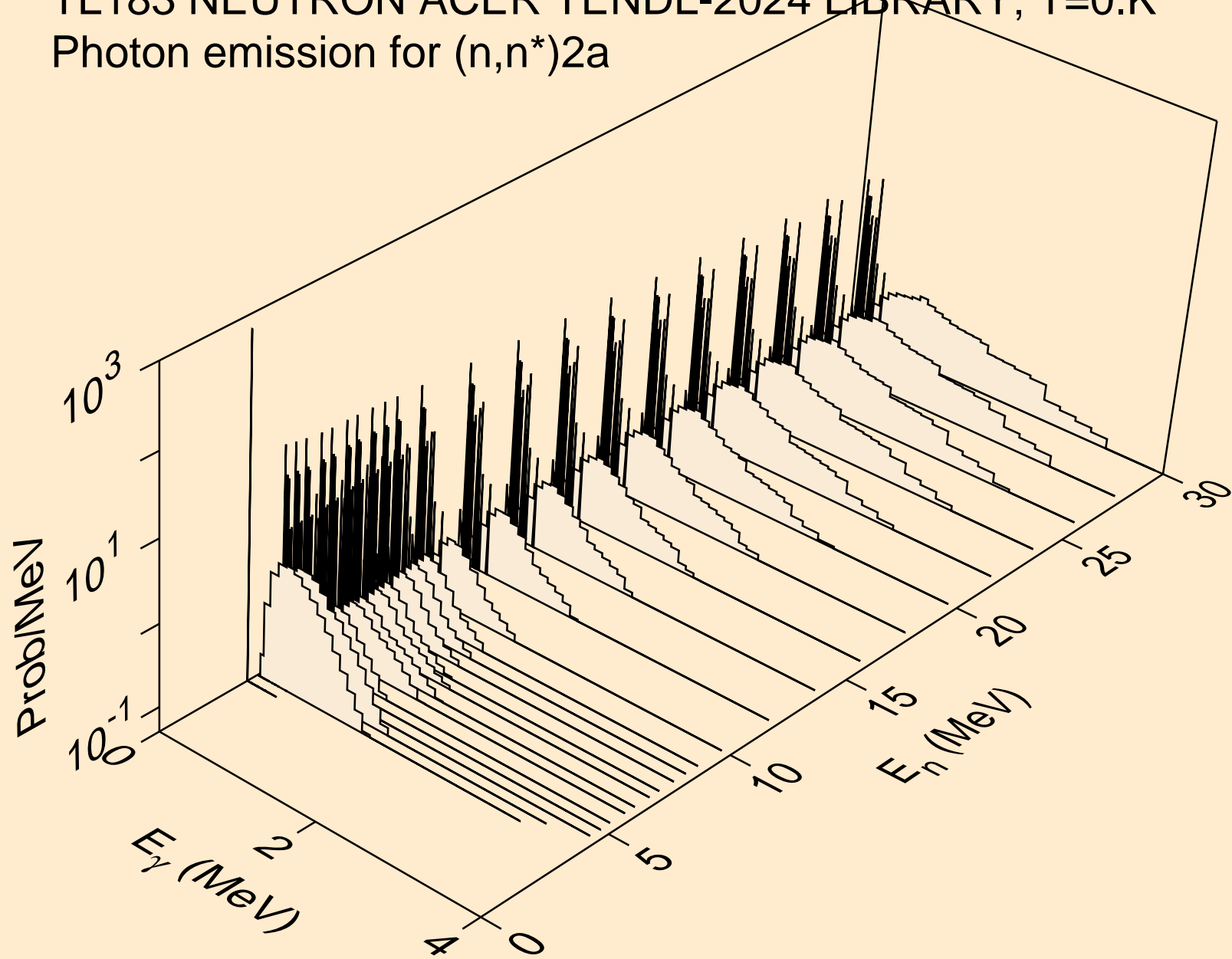

TL183 NEUTRON ACER TENDL-2024 LIBRARY; T=0.K
Photon emission for (n,2n)2a

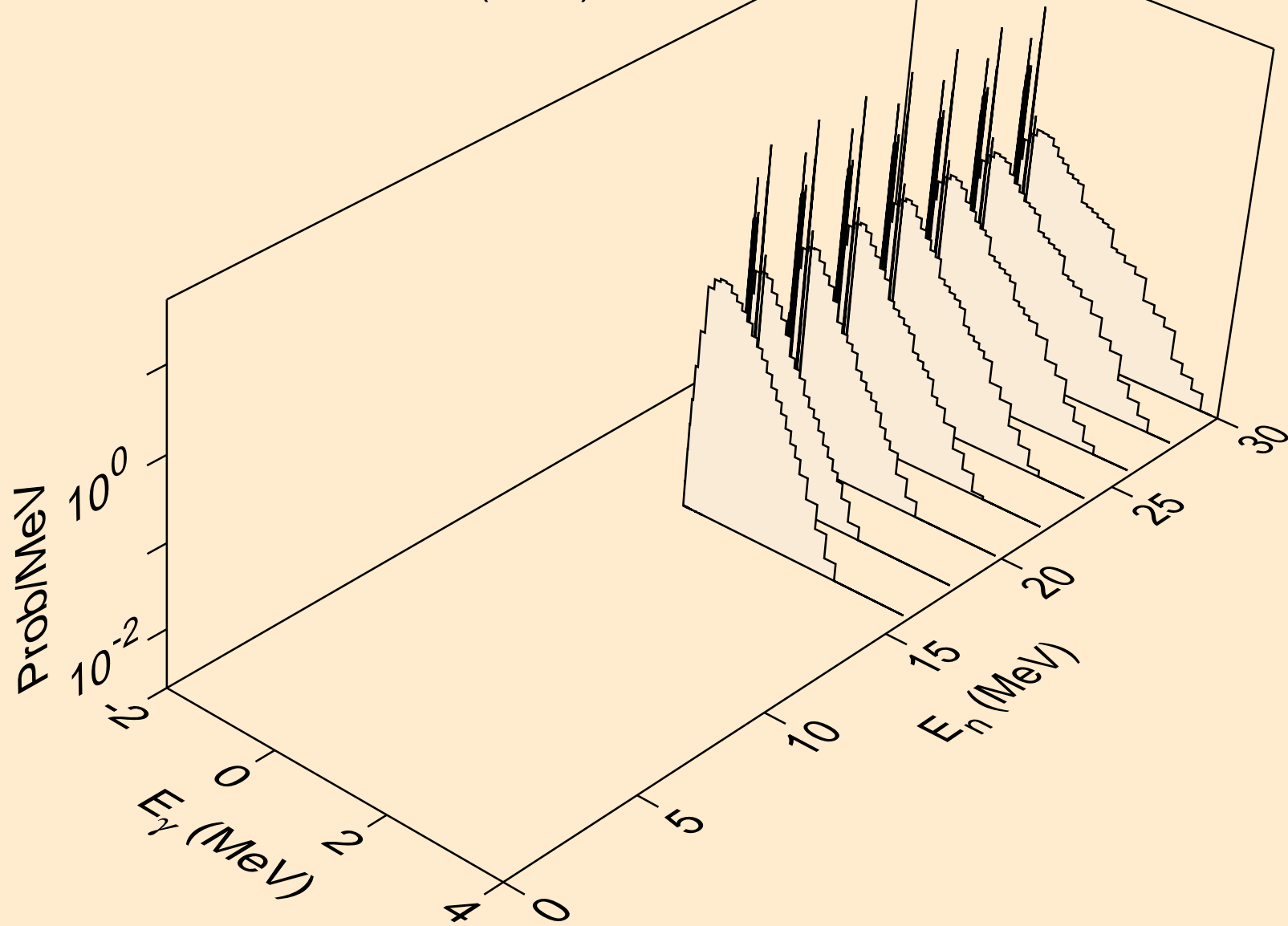

TL183 NEUTRON ACER TENDL-2024 LIBRARY; T=0.K
Photon emission for (n,n*)d

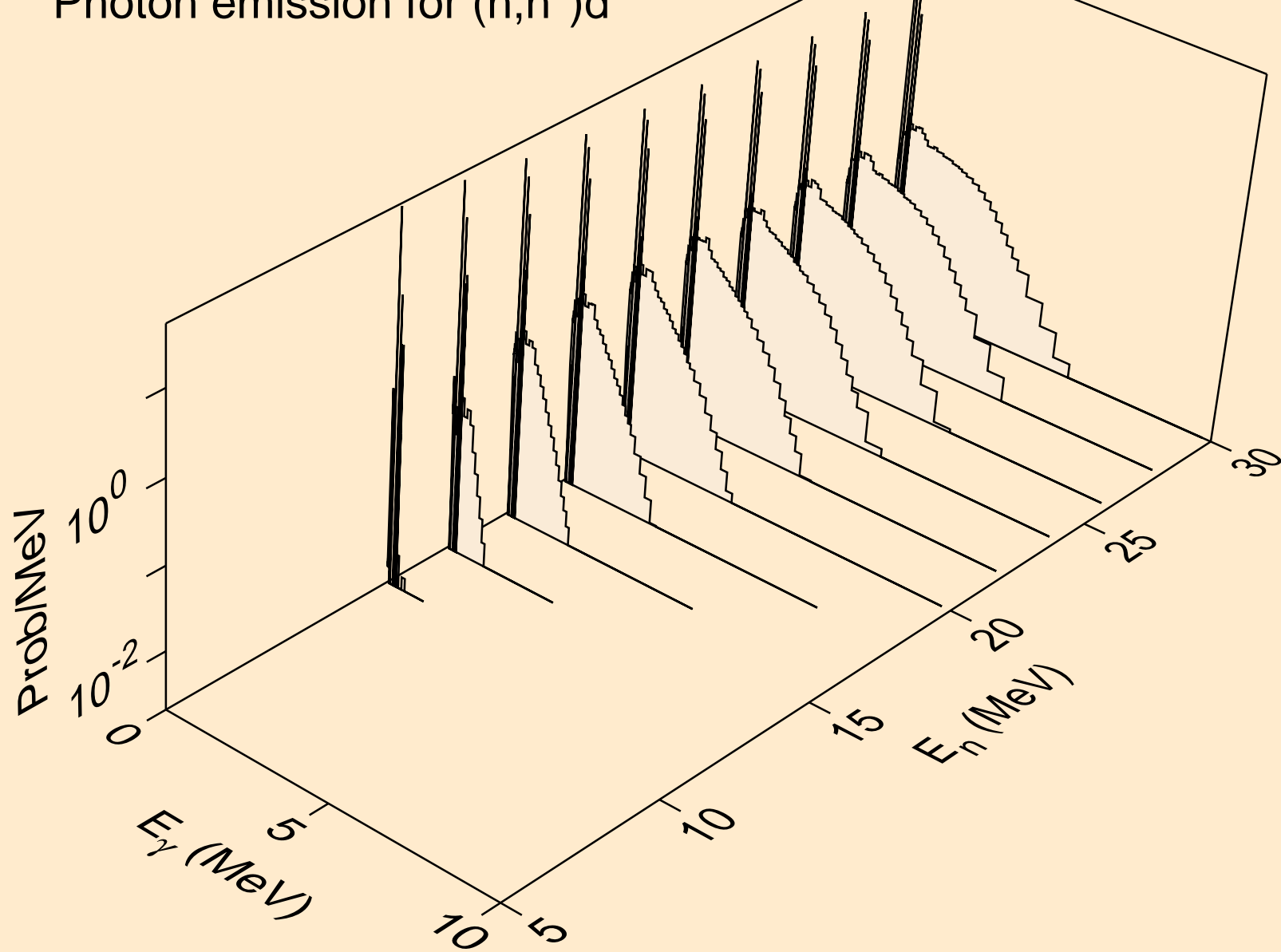

TL183 NEUTRON ACER TENDL-2024 LIBRARY; T=0.K
Photon emission for (n,n*)t

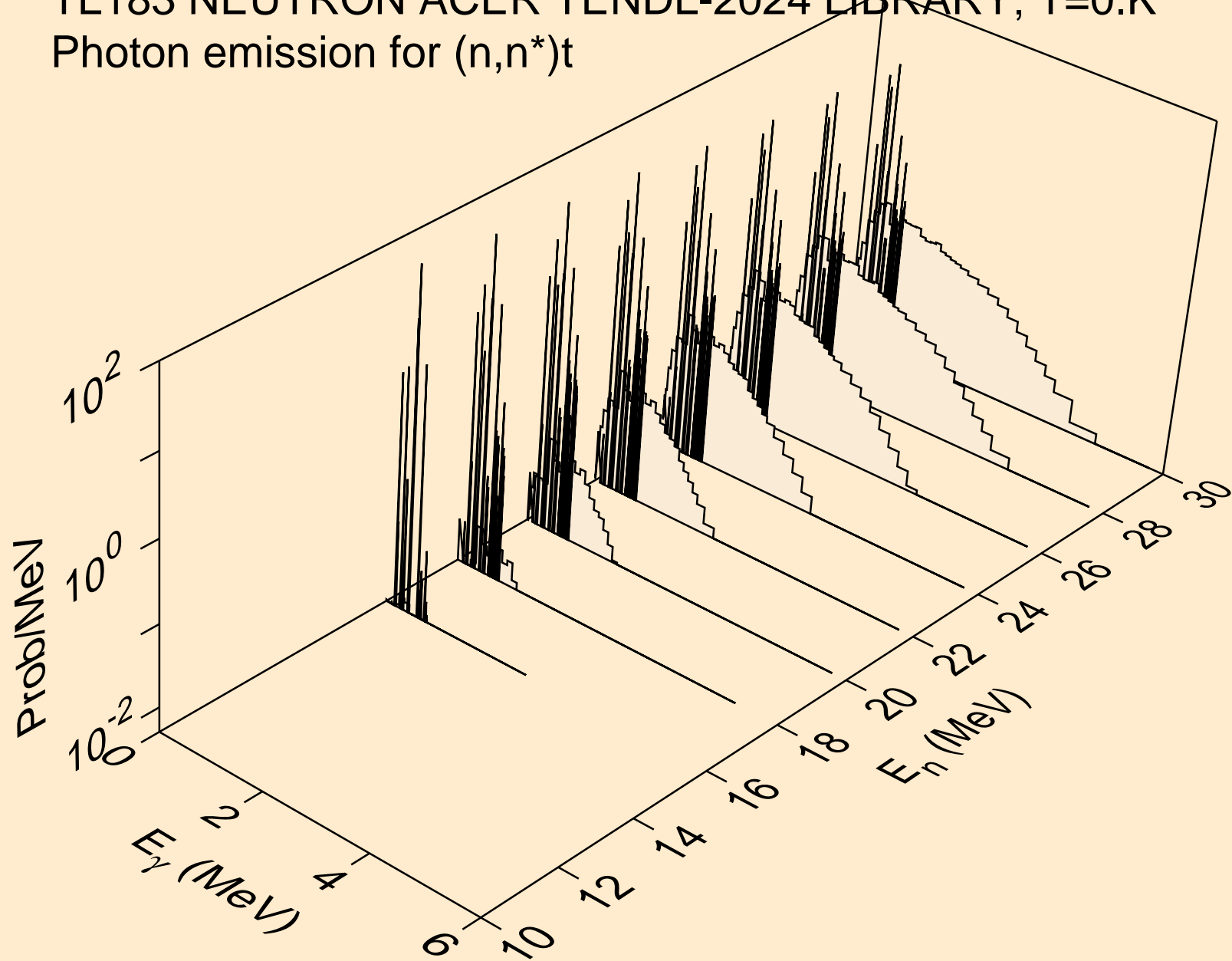

TL183 NEUTRON ACER TENDL-2024 LIBRARY; T=0.K
Photon emission for (n,n*)he3

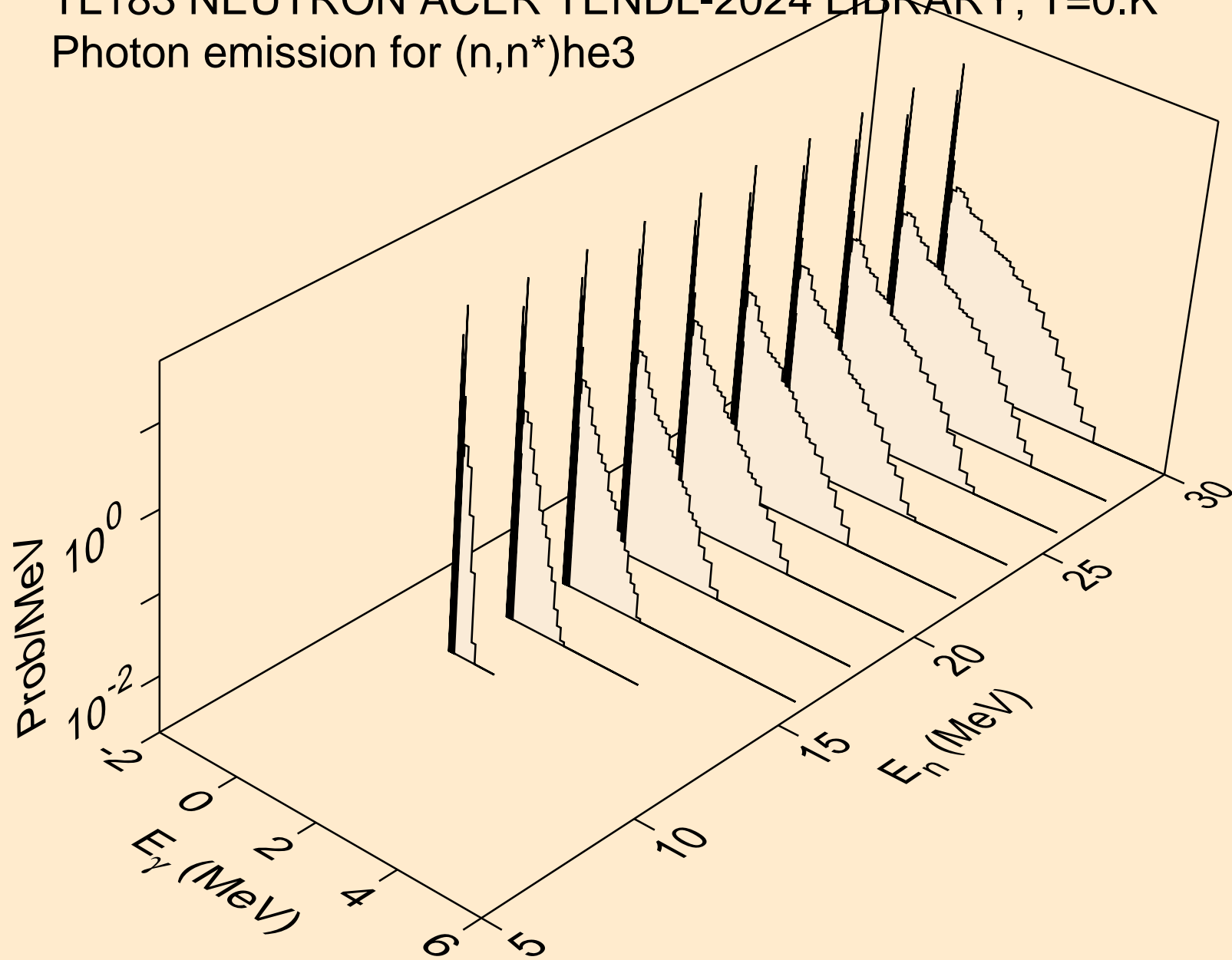

TL183 NEUTRON ACER TENDL-2024 LIBRARY; T=0.K
Photon emission for (n,2np)

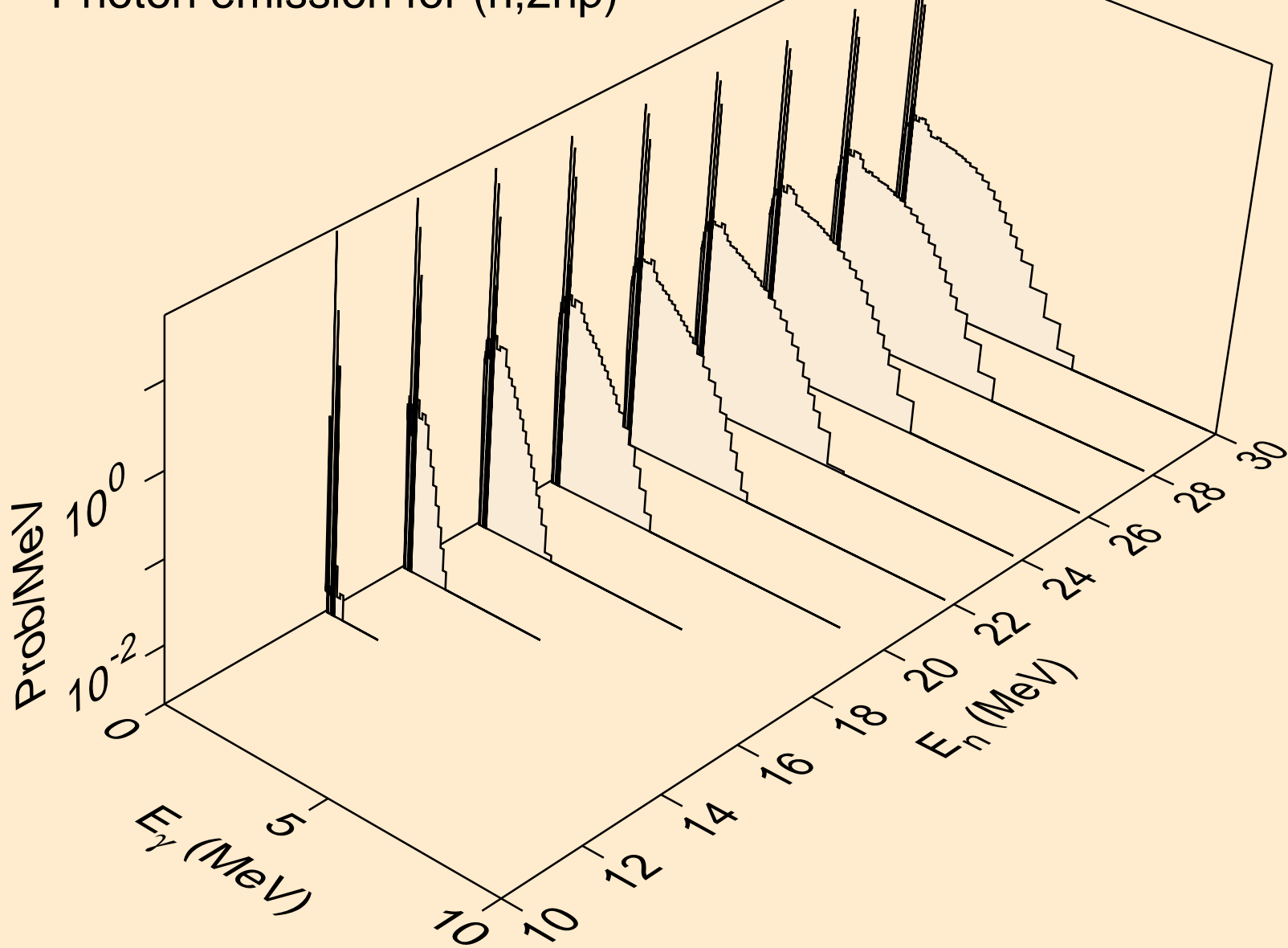

TL183 NEUTRON ACER TENDL-2024 LIBRARY; T=0.K
Photon emission for (n,3np)

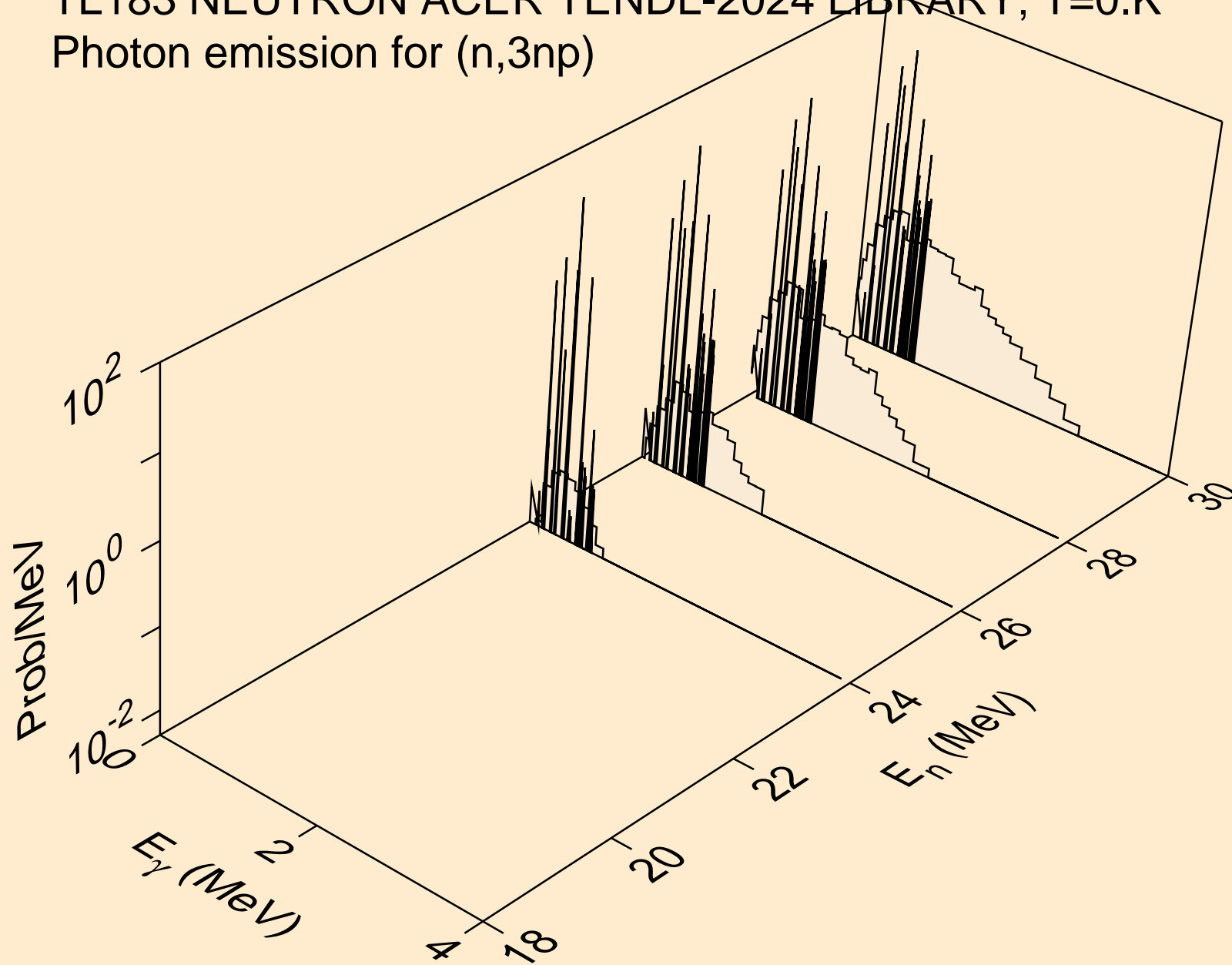

TL183 NEUTRON ACER TENDL-2024 LIBRARY; T=0.K
Photon emission for (n,n2p)

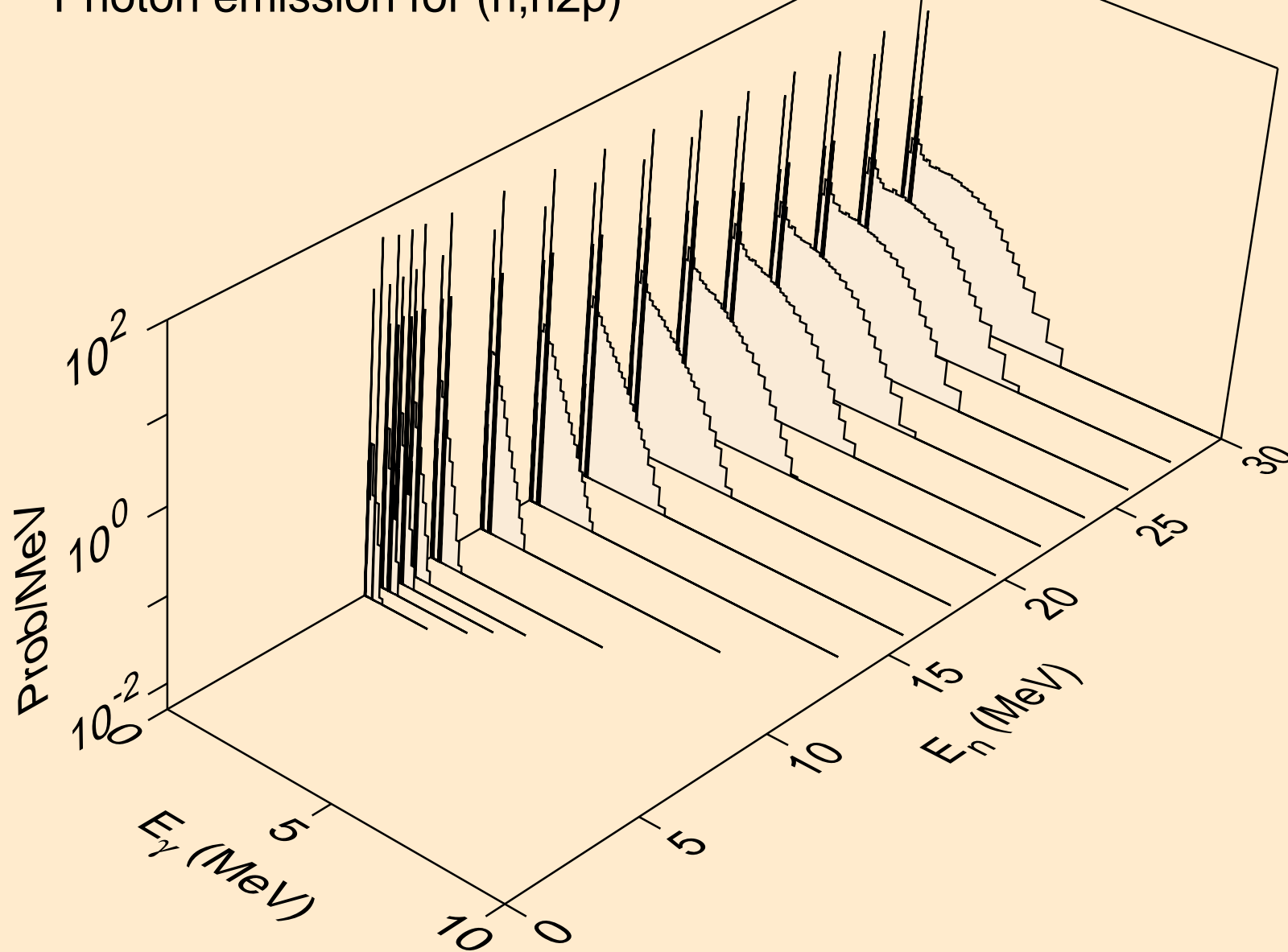

TL183 NEUTRON ACER TENDL-2024 LIBRARY; T=0.K
Photon emission for (n,npa)

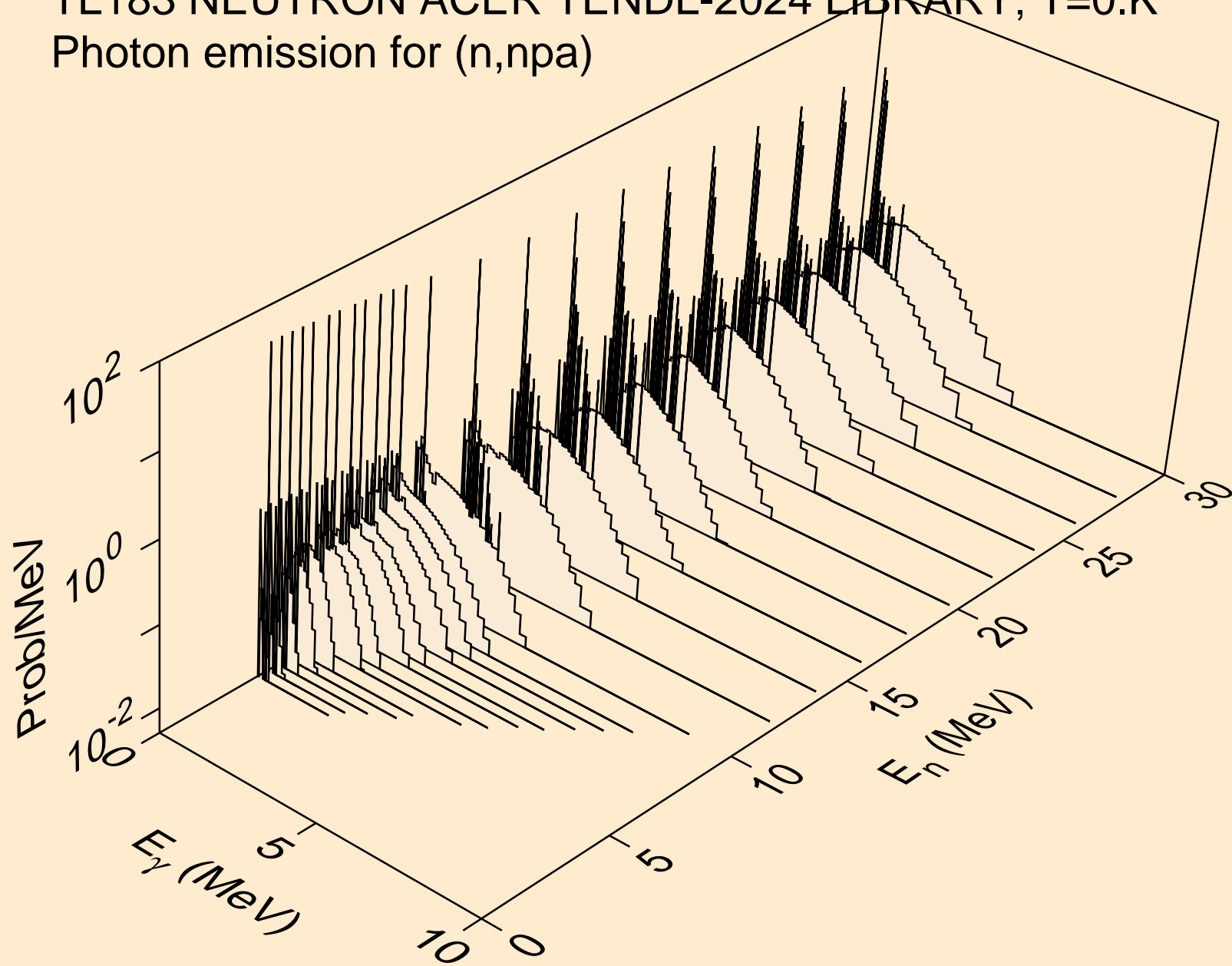

TL183 NEUTRON ACER TENDL-2024 LIBRARY; T=0.K
Photon emission for (n,n*c)

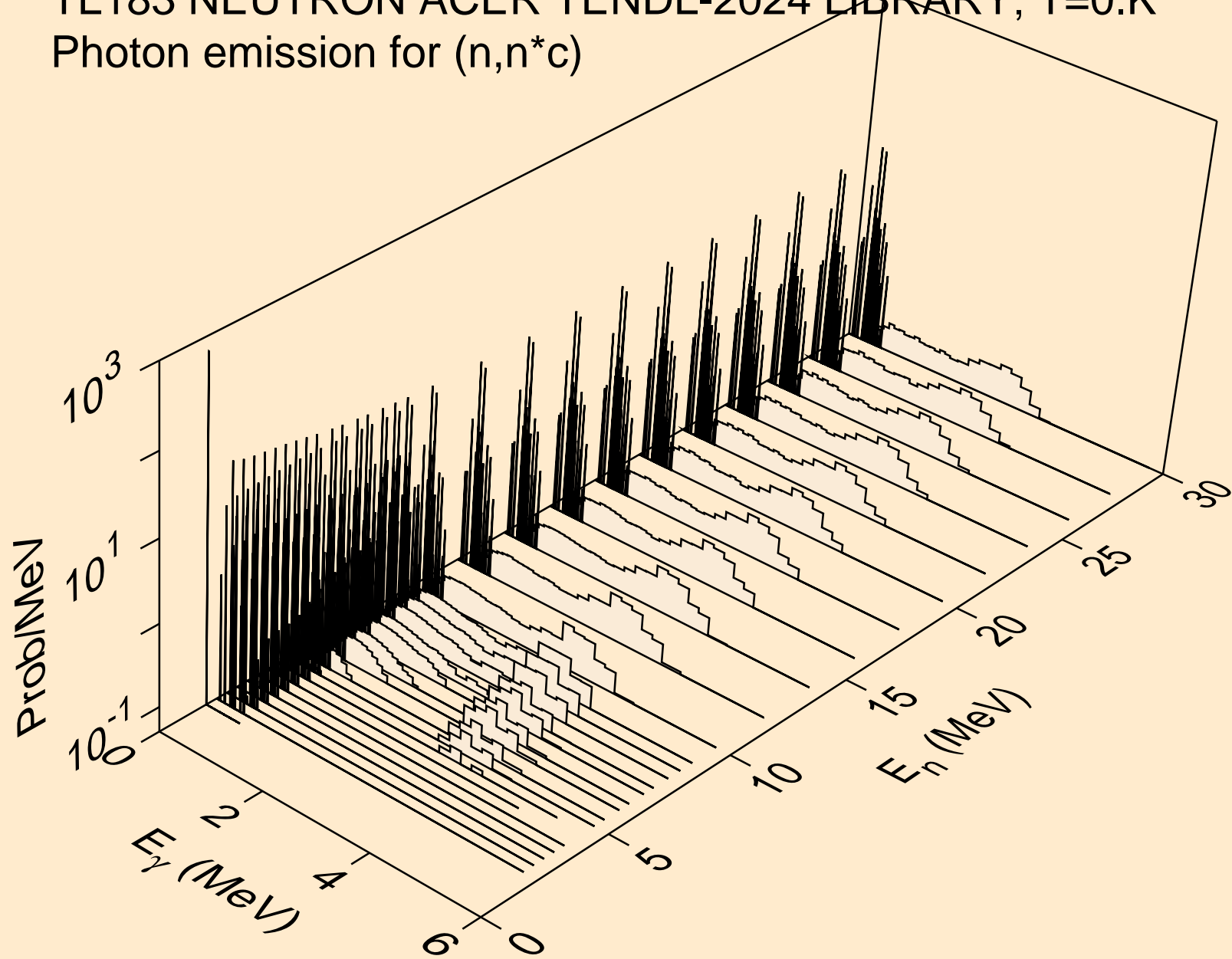

TL183 NEUTRON ACER TENDL-2024 LIBRARY; T=0.K
Photon emission for (n,gma)

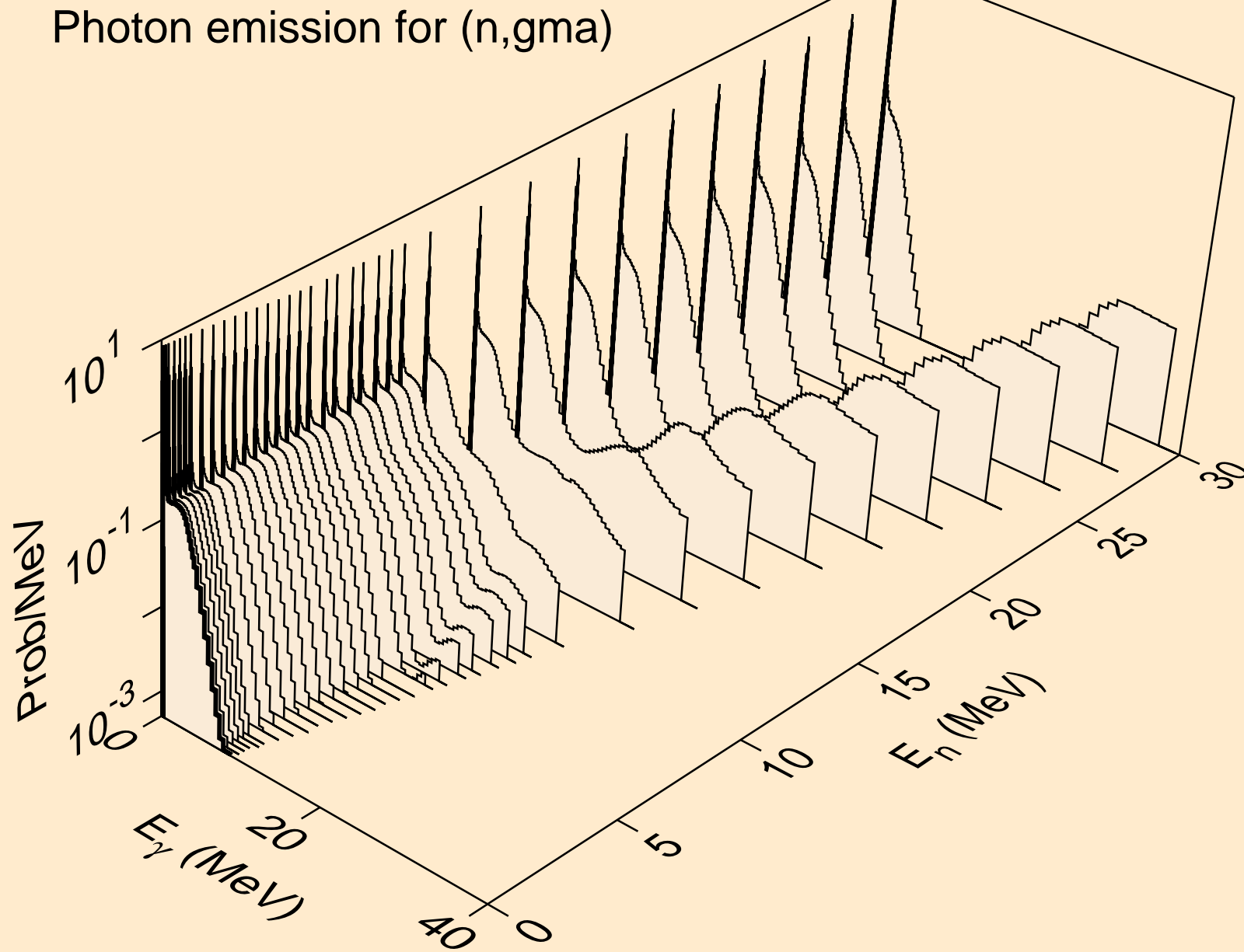

TL183 NEUTRON ACER TENDL-2024 LIBRARY; T=0.K
Photon emission for (n,p)

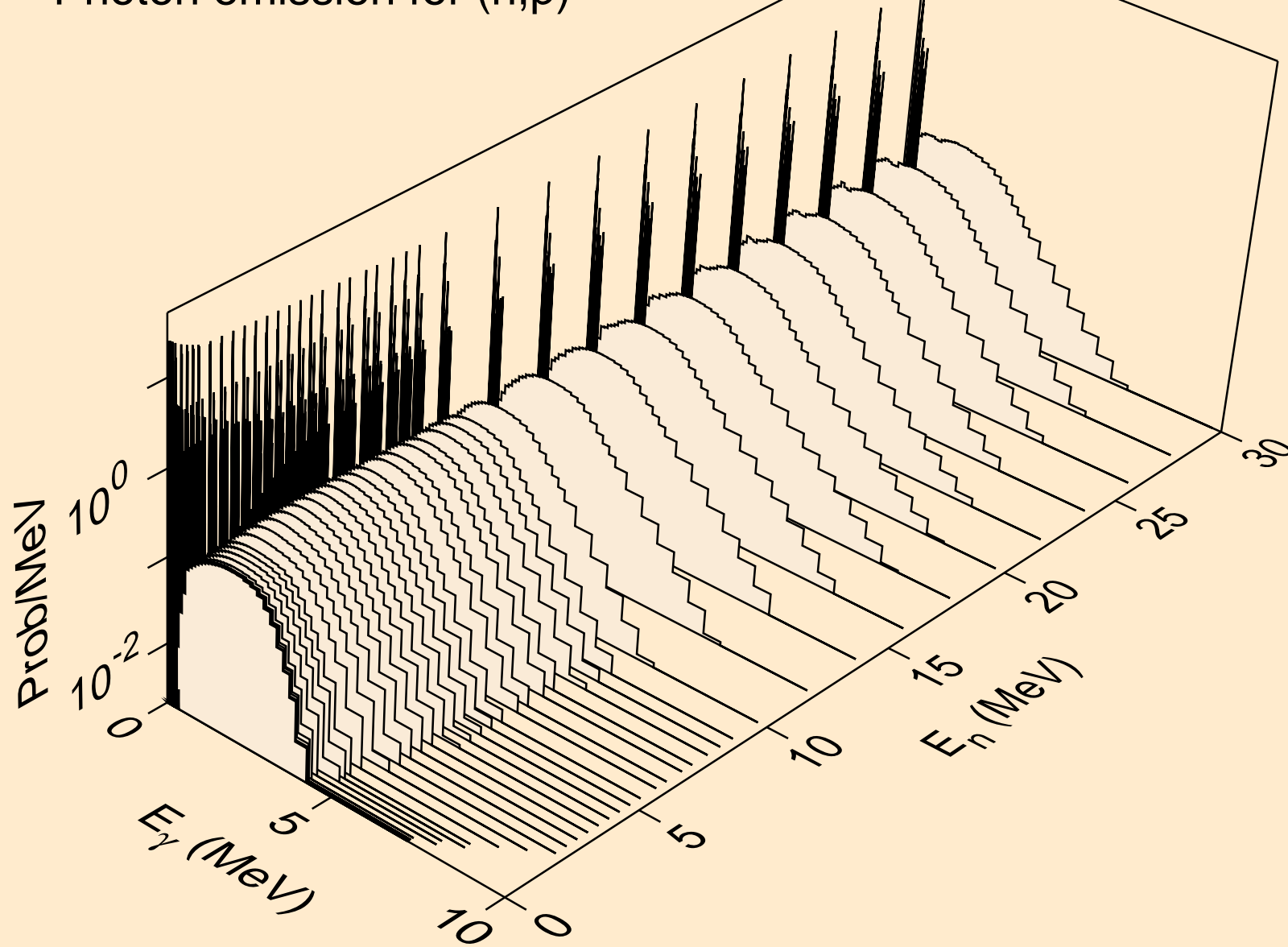

TL183 NEUTRON ACER TENDL-2024 LIBRARY; T=0.K
Photon emission for (n,d)

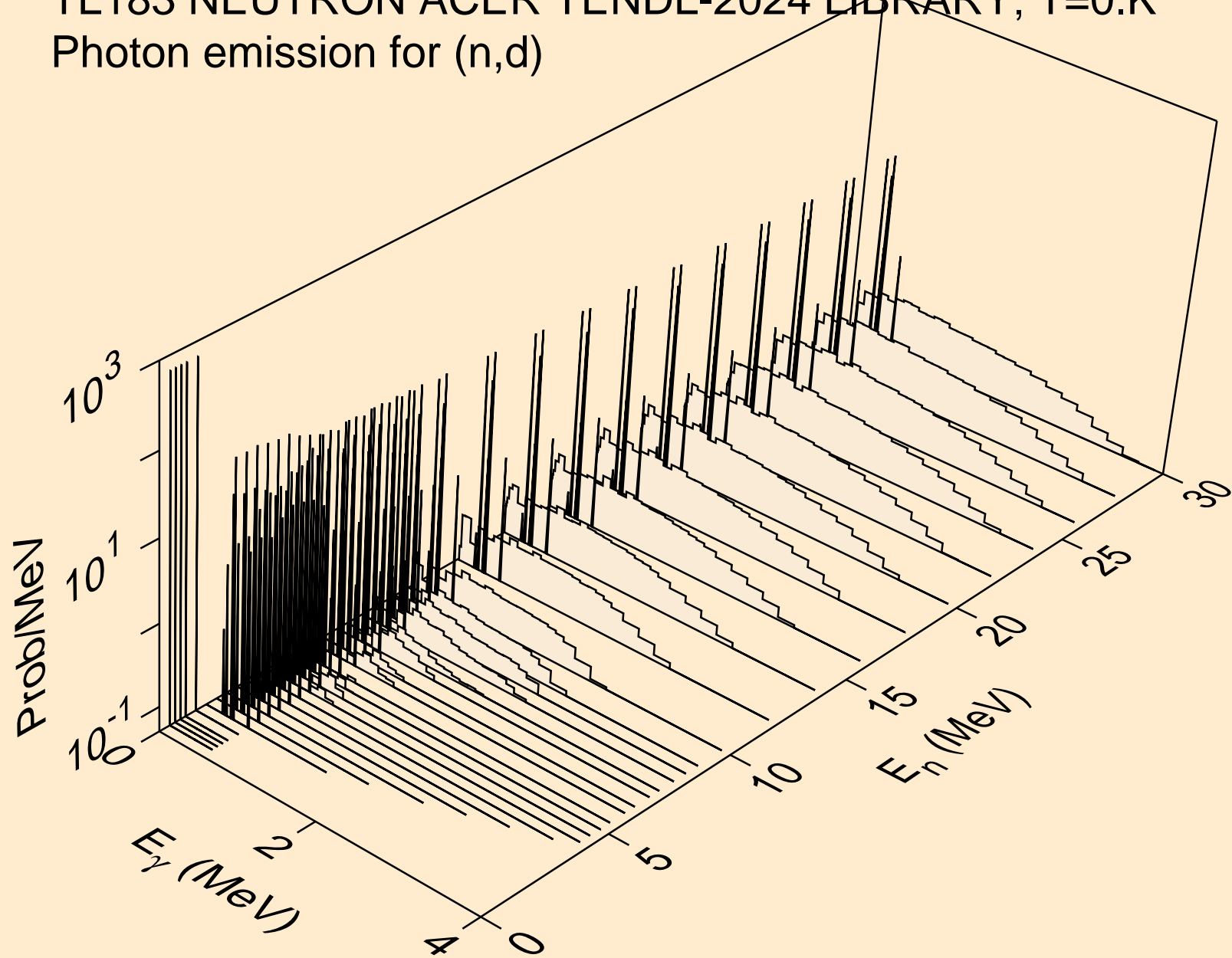

TL183 NEUTRON ACER TENDL-2024 LIBRARY; T=0.K
Photon emission for (n,t)

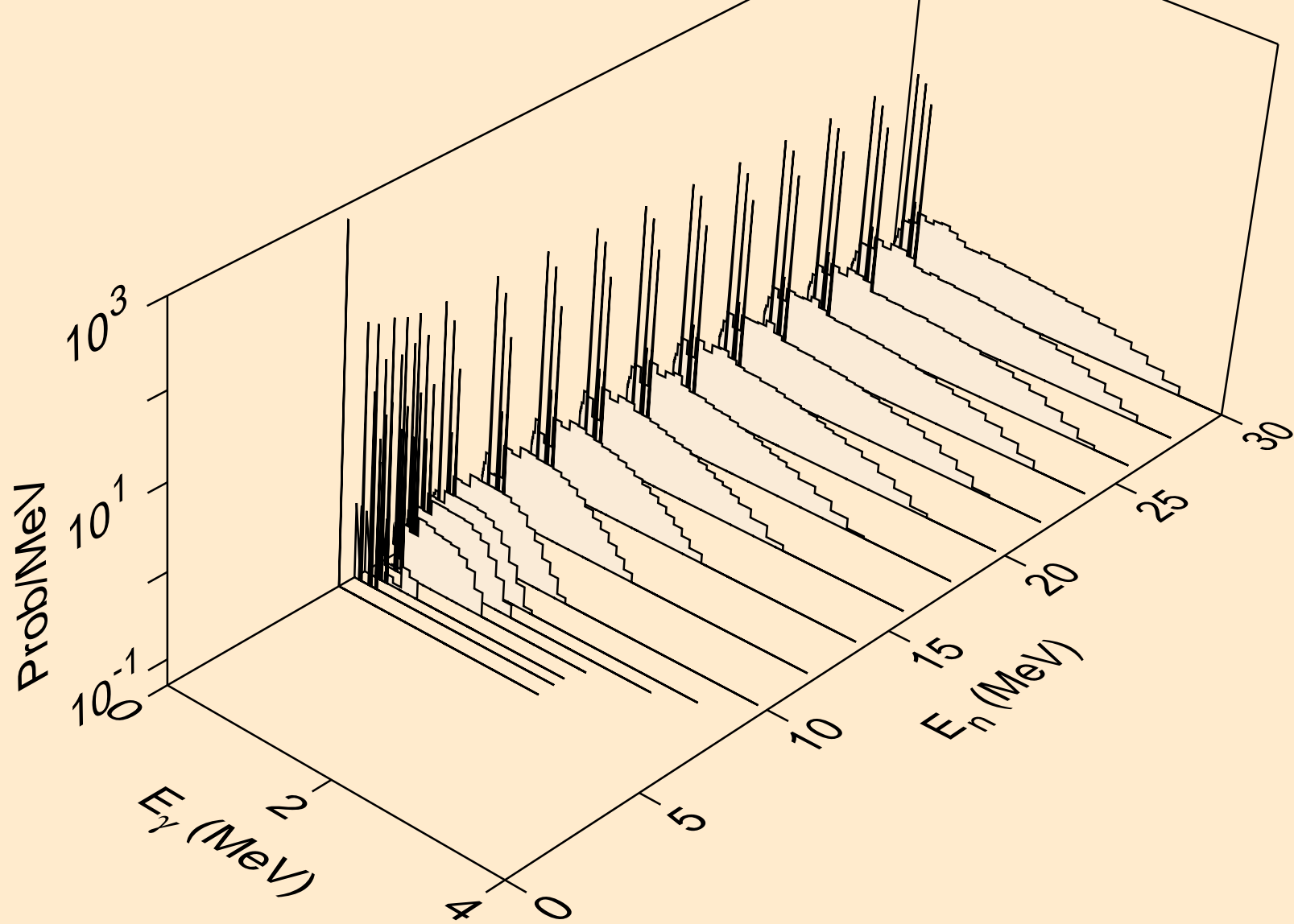

TL183 NEUTRON ACER TENDL-2024 LIBRARY; T=0.K
Photon emission for (n,he3)

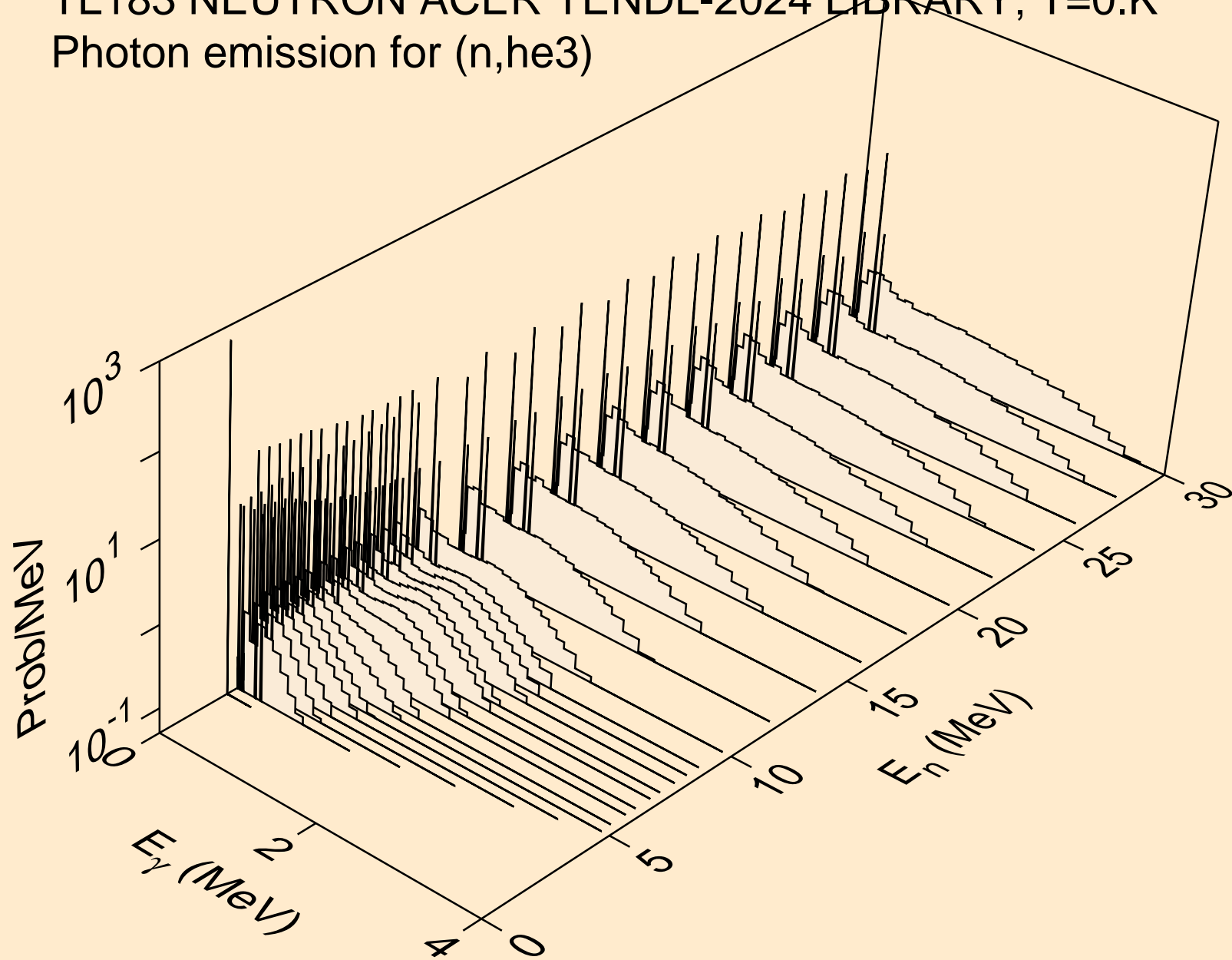

TL183 NEUTRON ACER TENDL-2024 LIBRARY; T=0.K
Photon emission for (n,a)

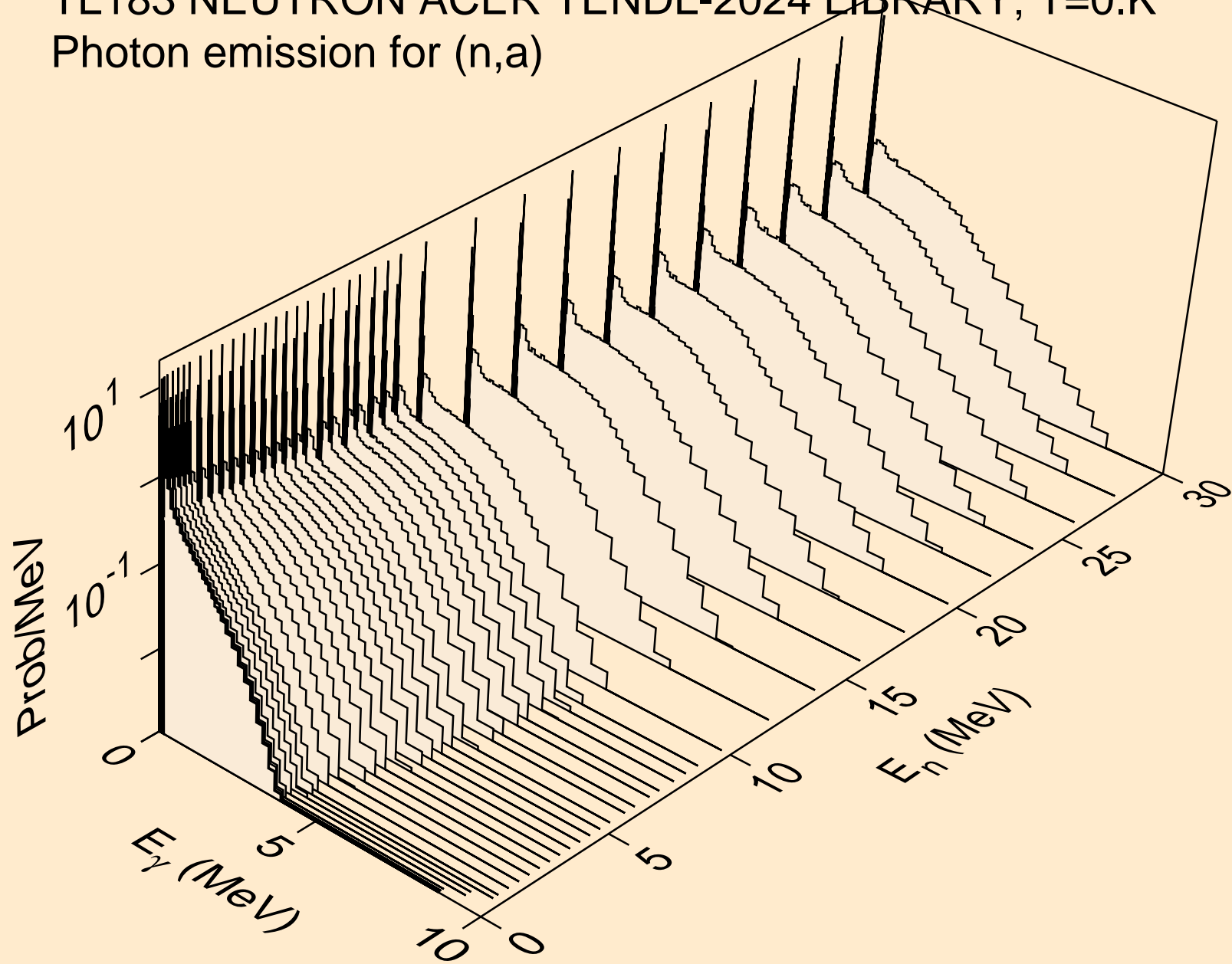

TL183 NEUTRON ACER TENDL-2024 LIBRARY; T=0.K
Photon emission for (n,2a)

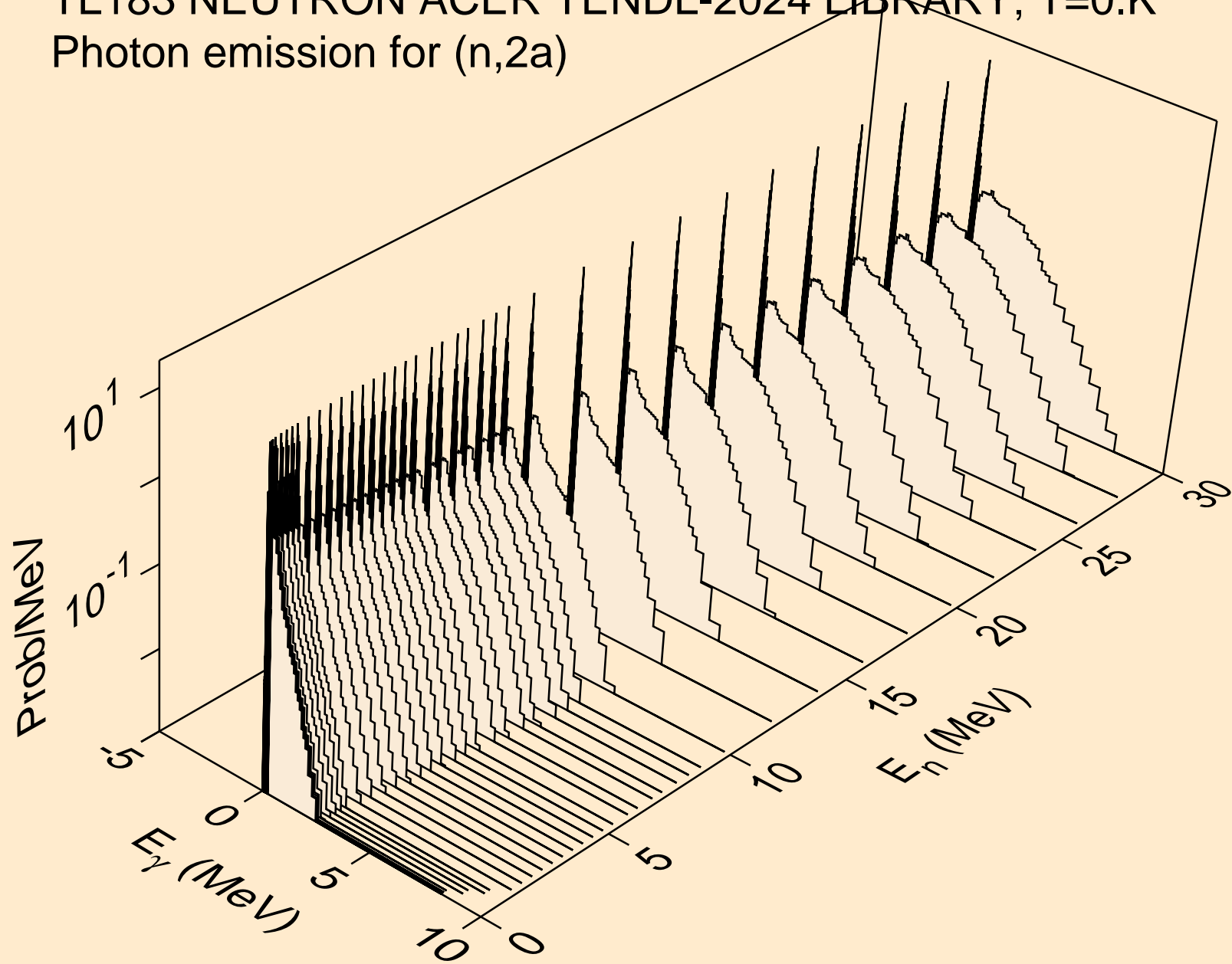

TL183 NEUTRON ACER TENDL-2024 LIBRARY; T=0.K
Photon emission for (n,3a)

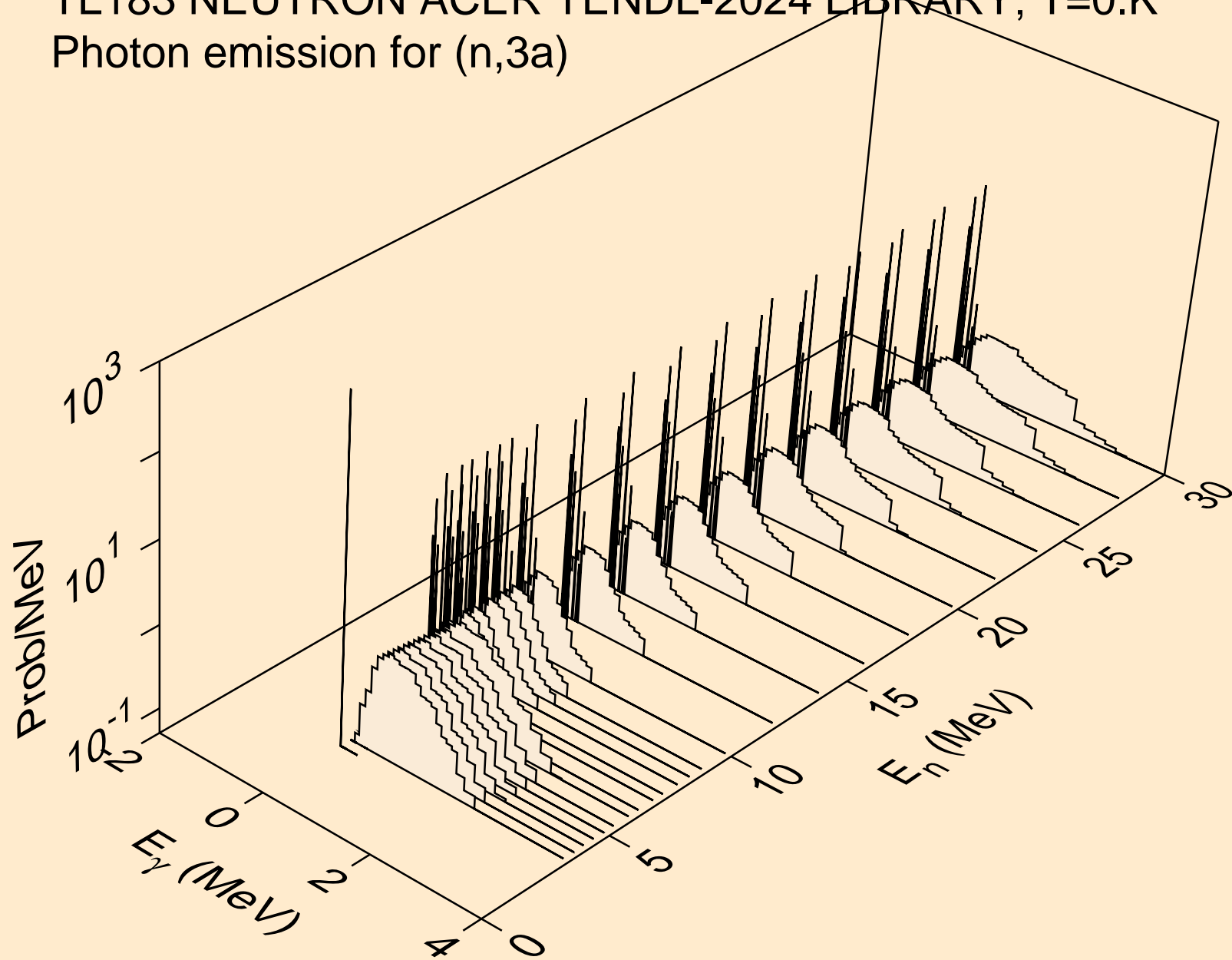

TL183 NEUTRON ACER TENDL-2024 LIBRARY; T=0.K
Photon emission for (n,2p)

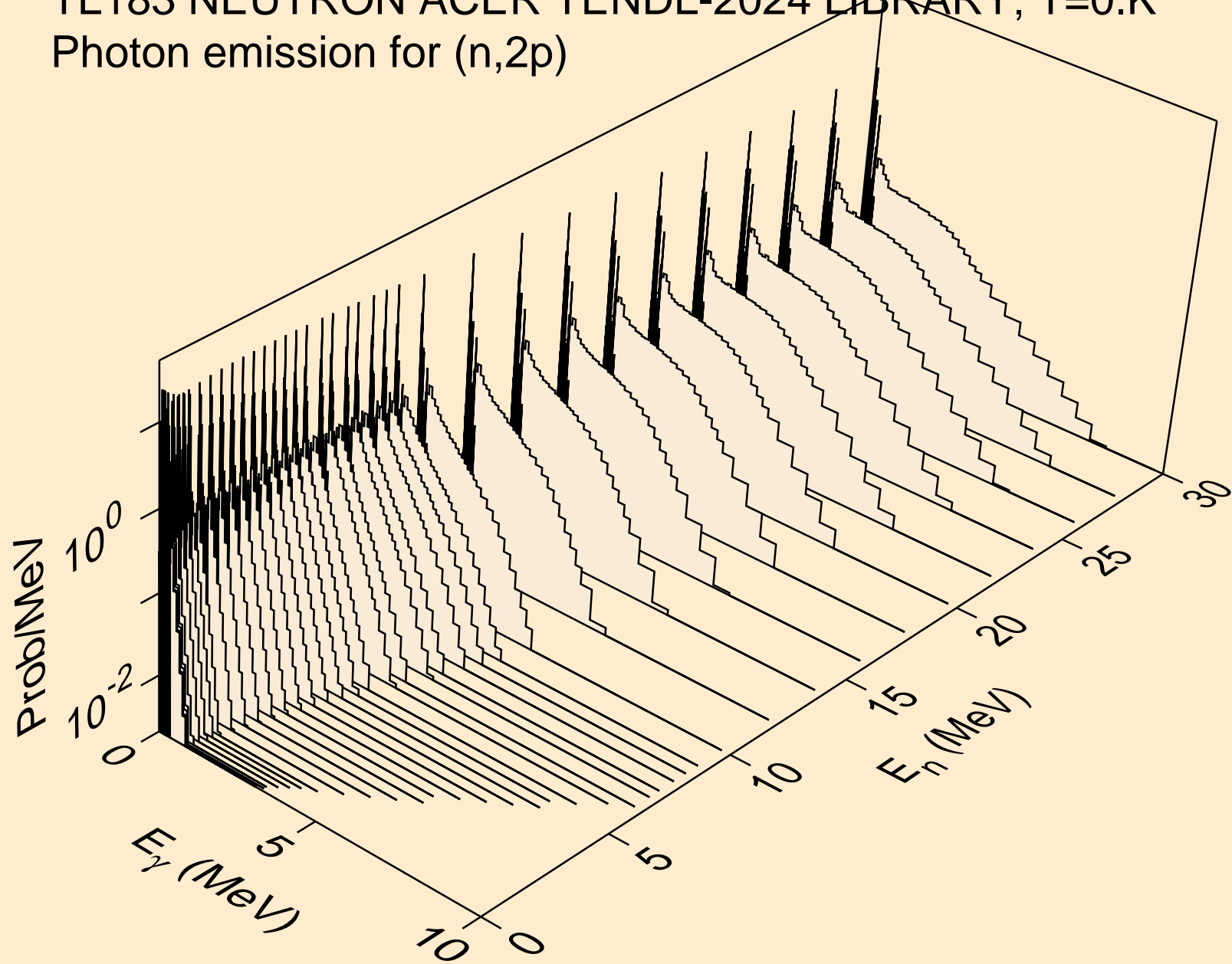

TL183 NEUTRON ACER TENDL-2024 LIBRARY; T=0.K
Photon emission for (n,p α)

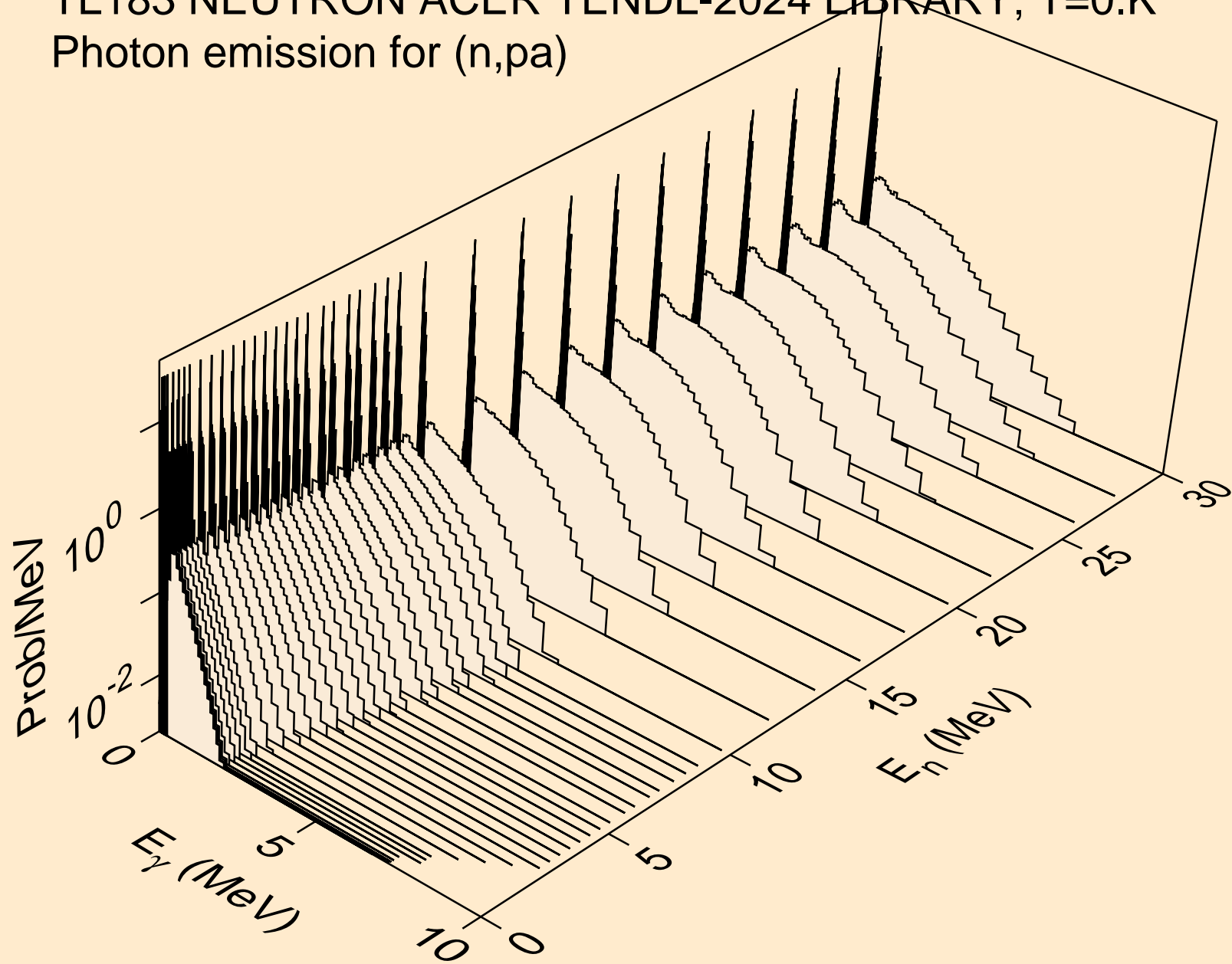

TL183 NEUTRON ACER TENDL-2024 LIBRARY; T=0.K
Photon emission for (n,d2a)

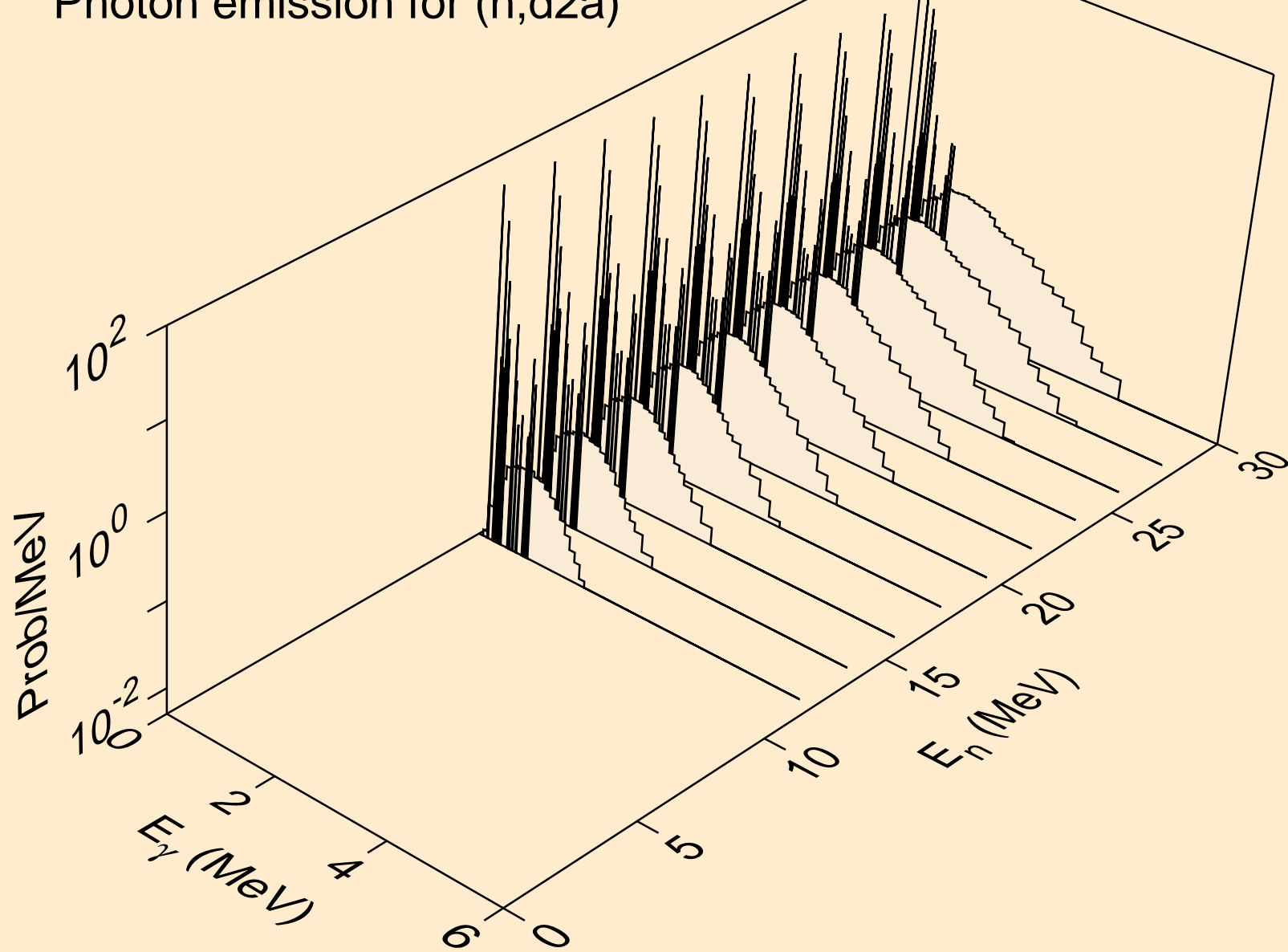

TL183 NEUTRON ACER TENDL-2024 LIBRARY; T=0.K
Photon emission for (n,pd)

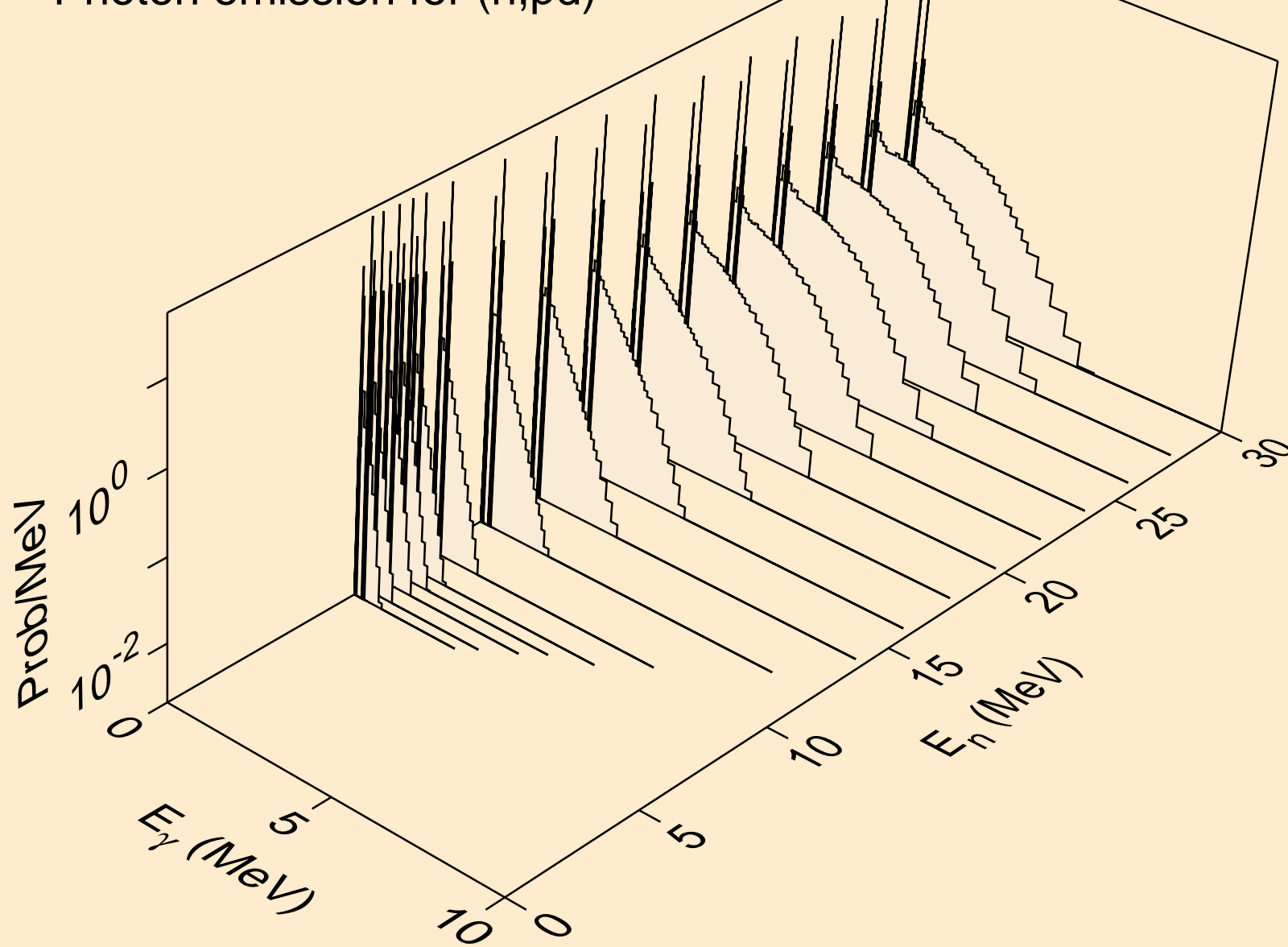

TL183 NEUTRON ACER TENDL-2024 LIBRARY; T=0.K
Photon emission for (n,pt)

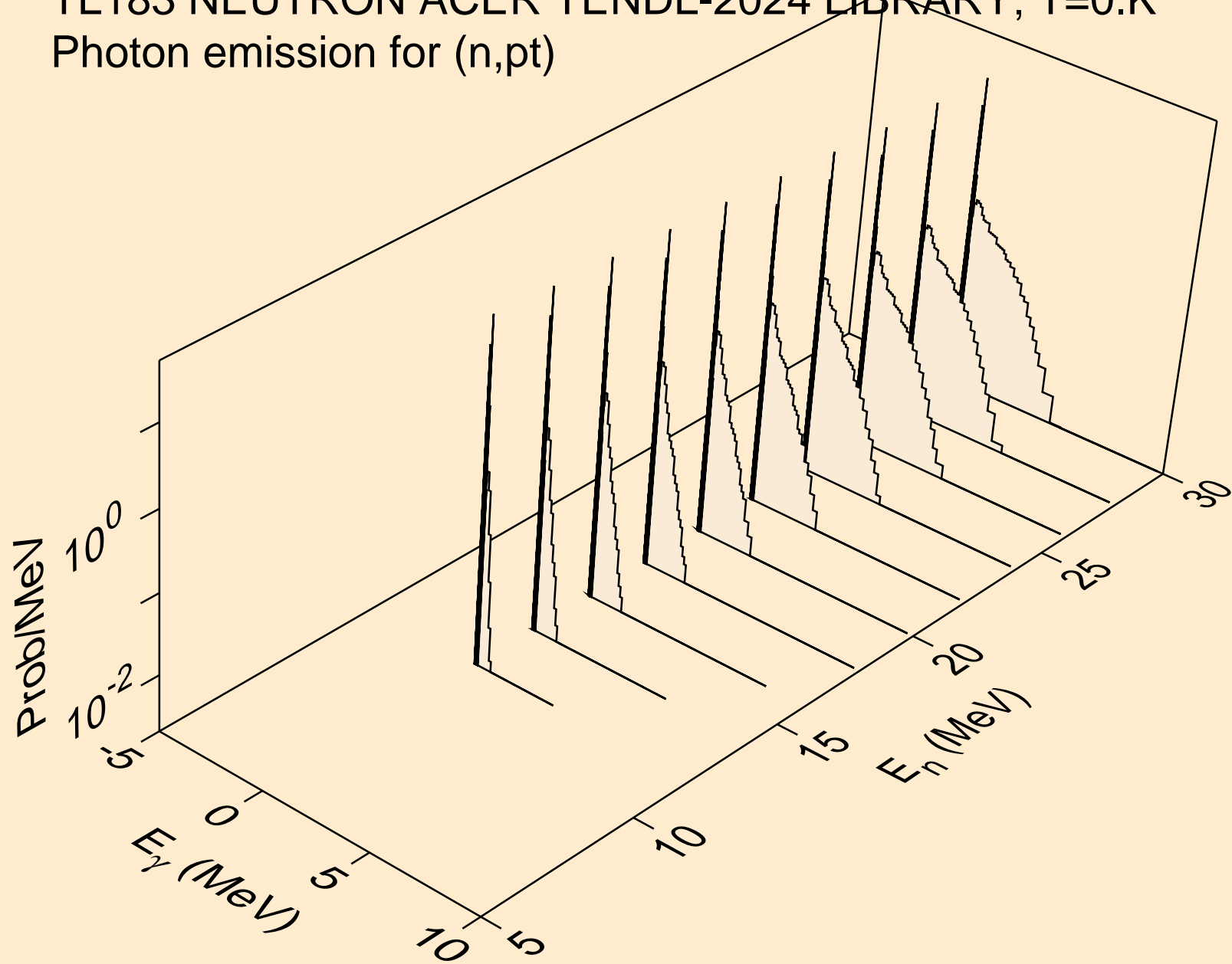

TL183 NEUTRON ACER TENDL-2024 LIBRARY; T=0.K
Photon emission for (n,da)

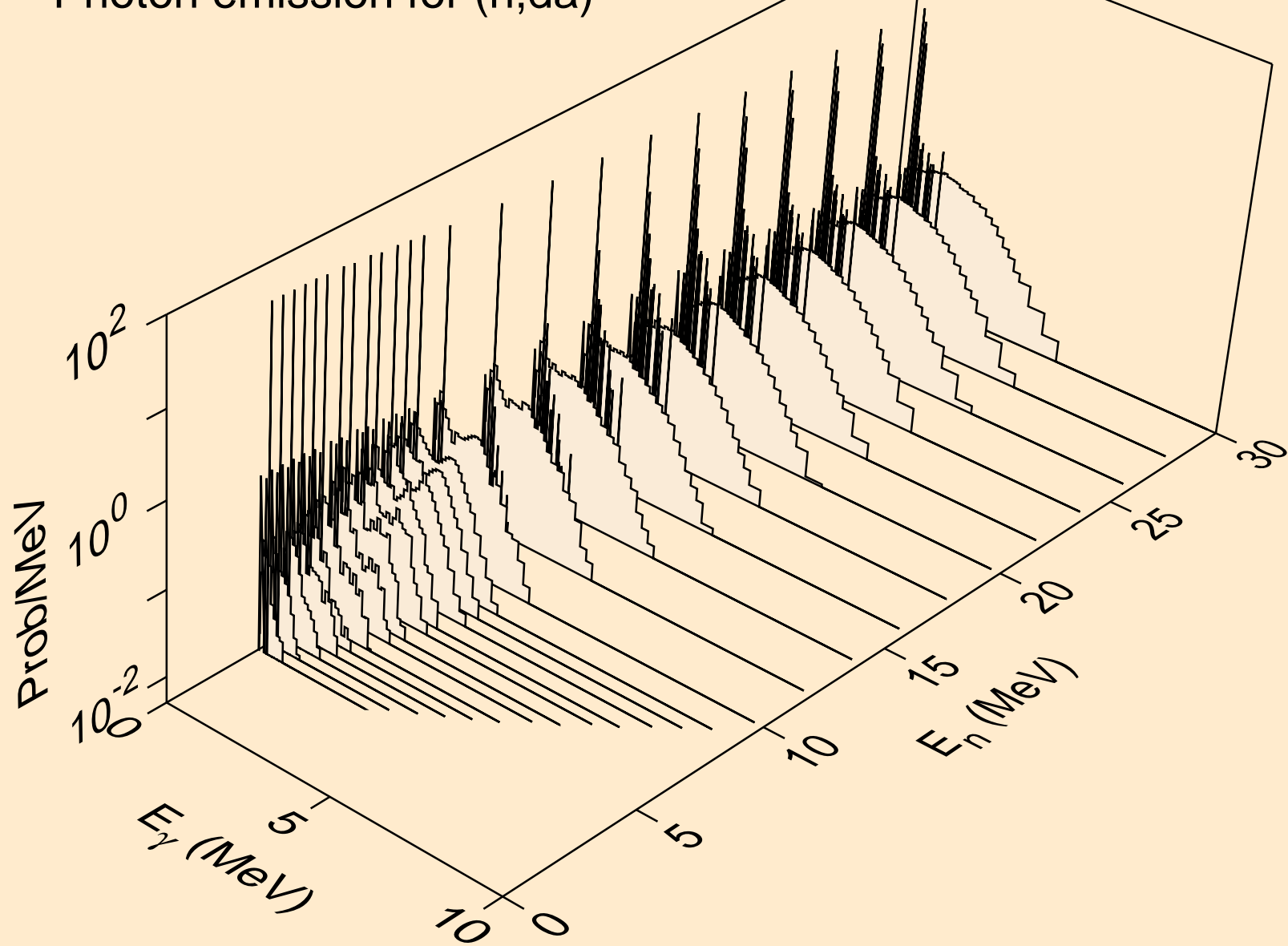

TL183 NEUTRON ACER TENDL-2024 LIBRARY; T=0.K
thermal capture photon spectrum

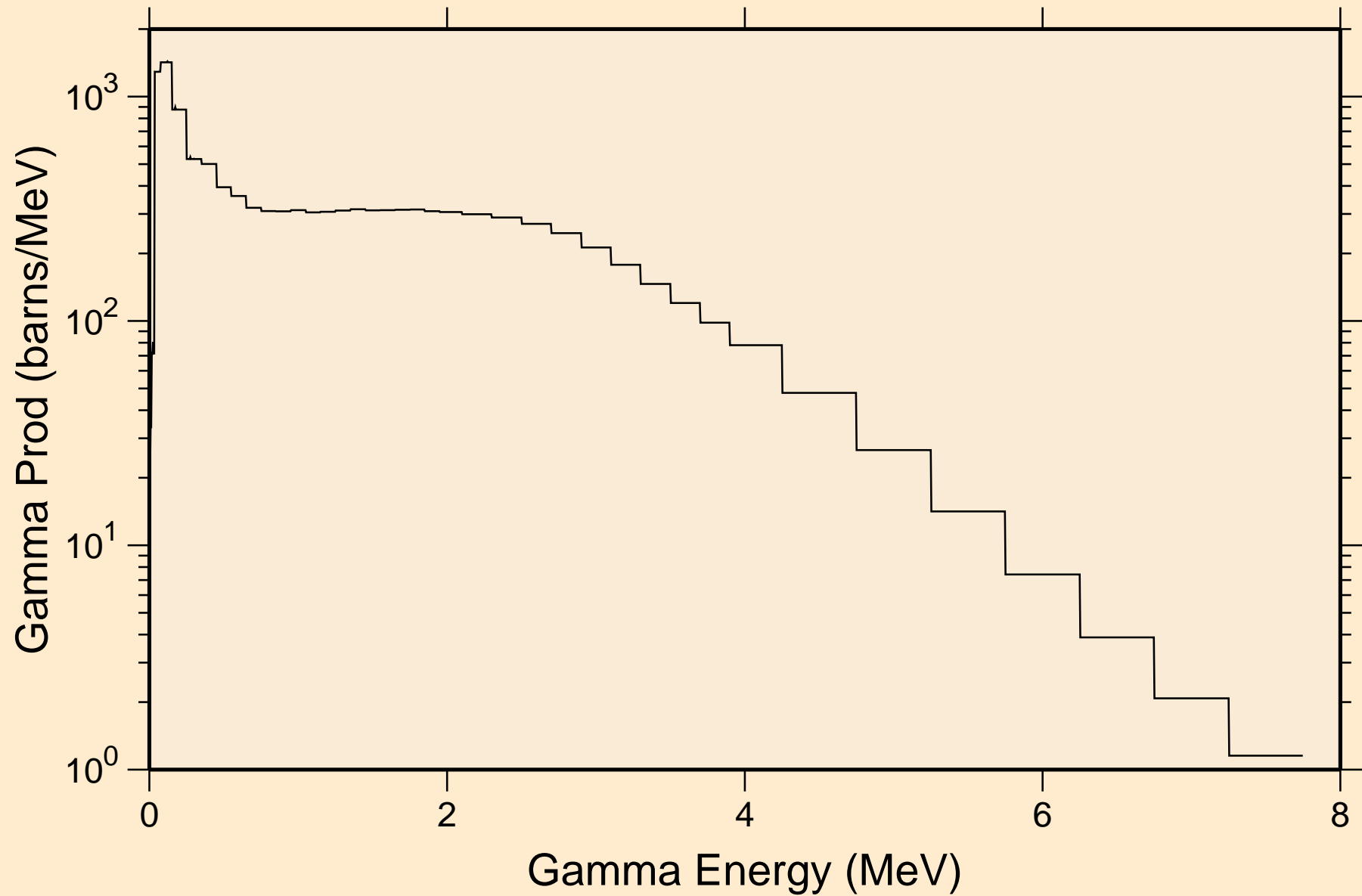

TL183 NEUTRON ACER TENDL-2024 LIBRARY; T=0.K
14 MeV photon spectrum

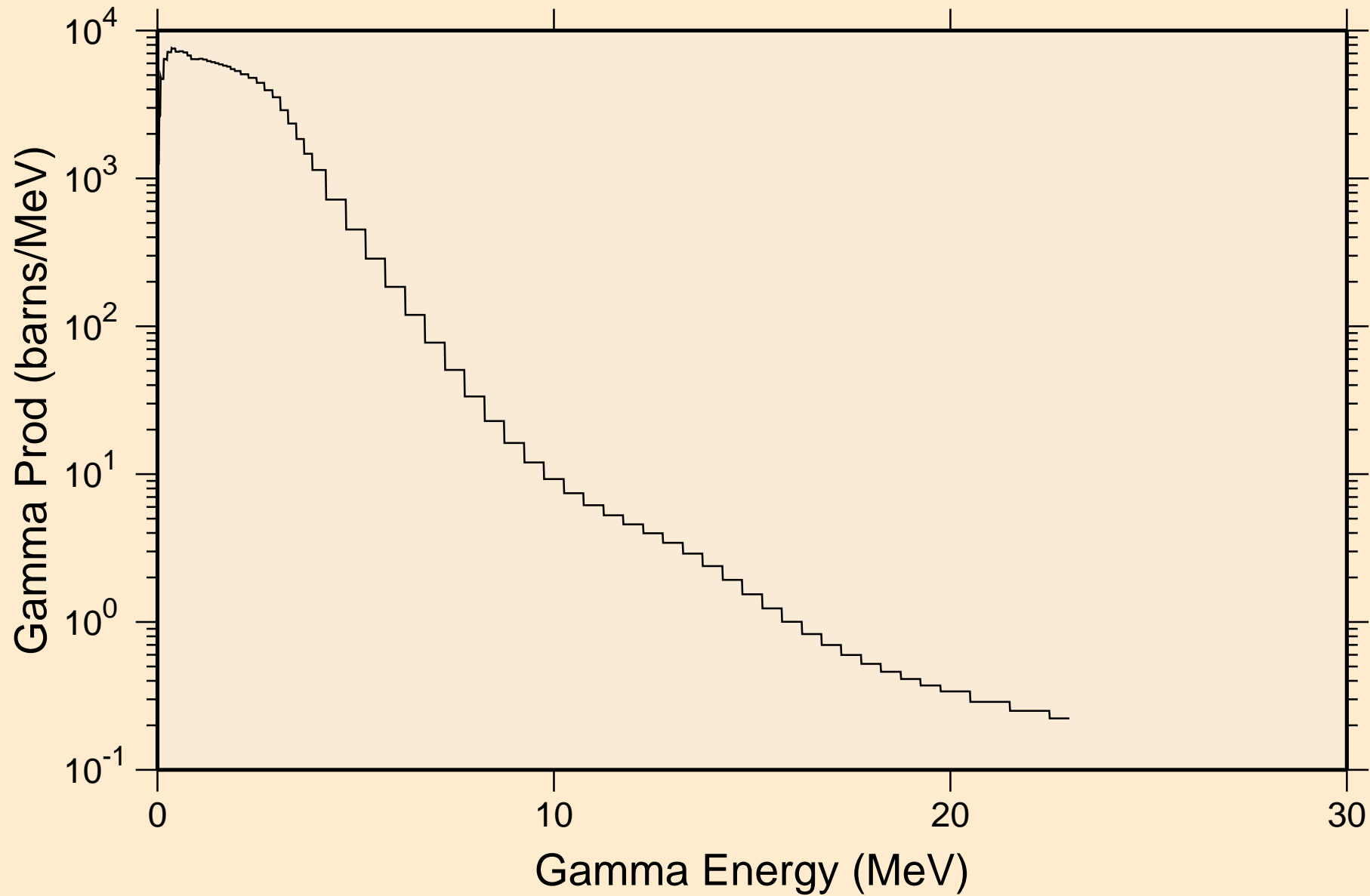

TL183 NEUTRON ACER TENDL-2024 LIBRARY; T=0.K

Particle heating contributions

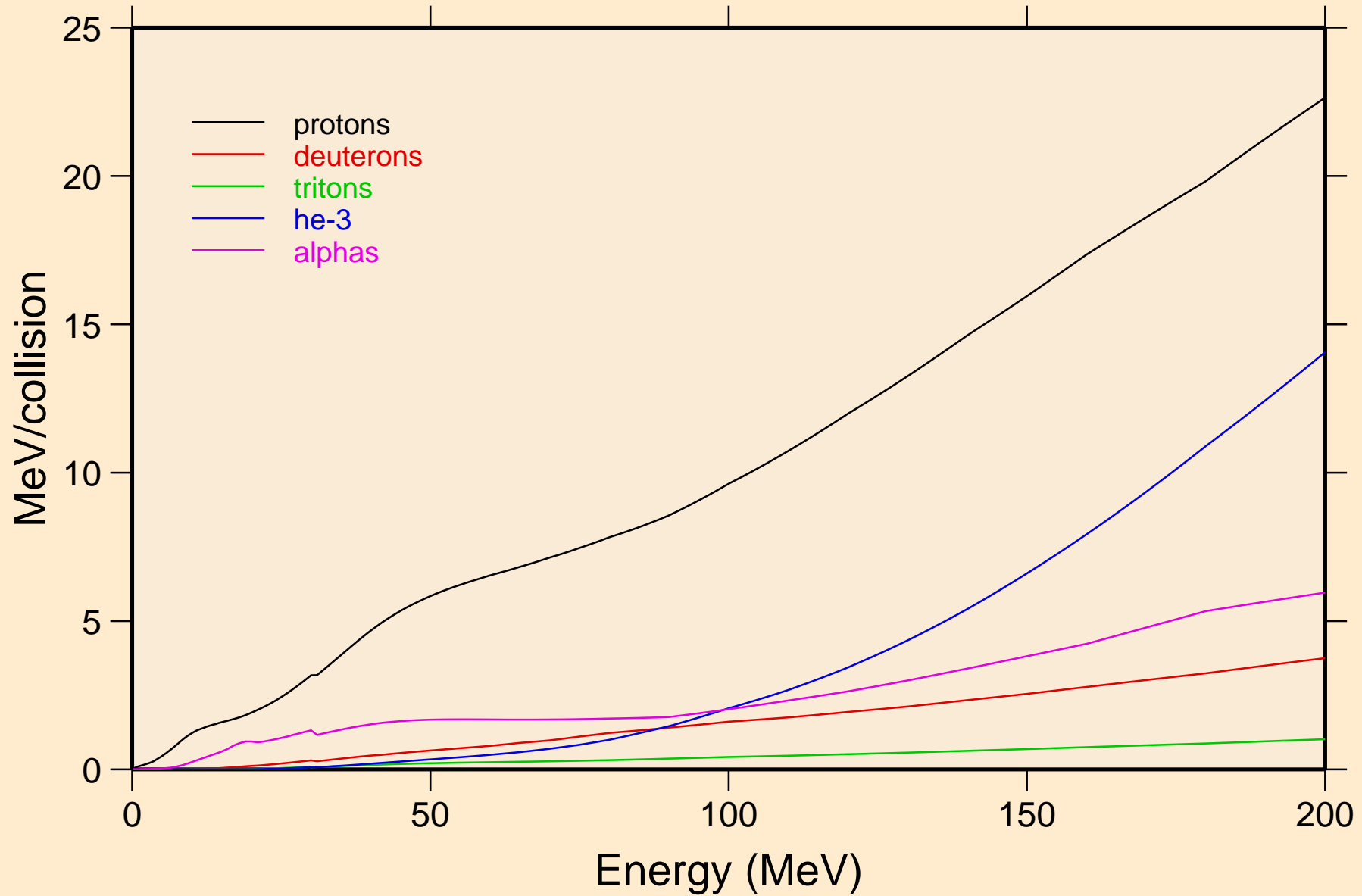

TL183 NEUTRON ACER TENDL-2024 LIBRARY; T=0.K
Recoil Heating

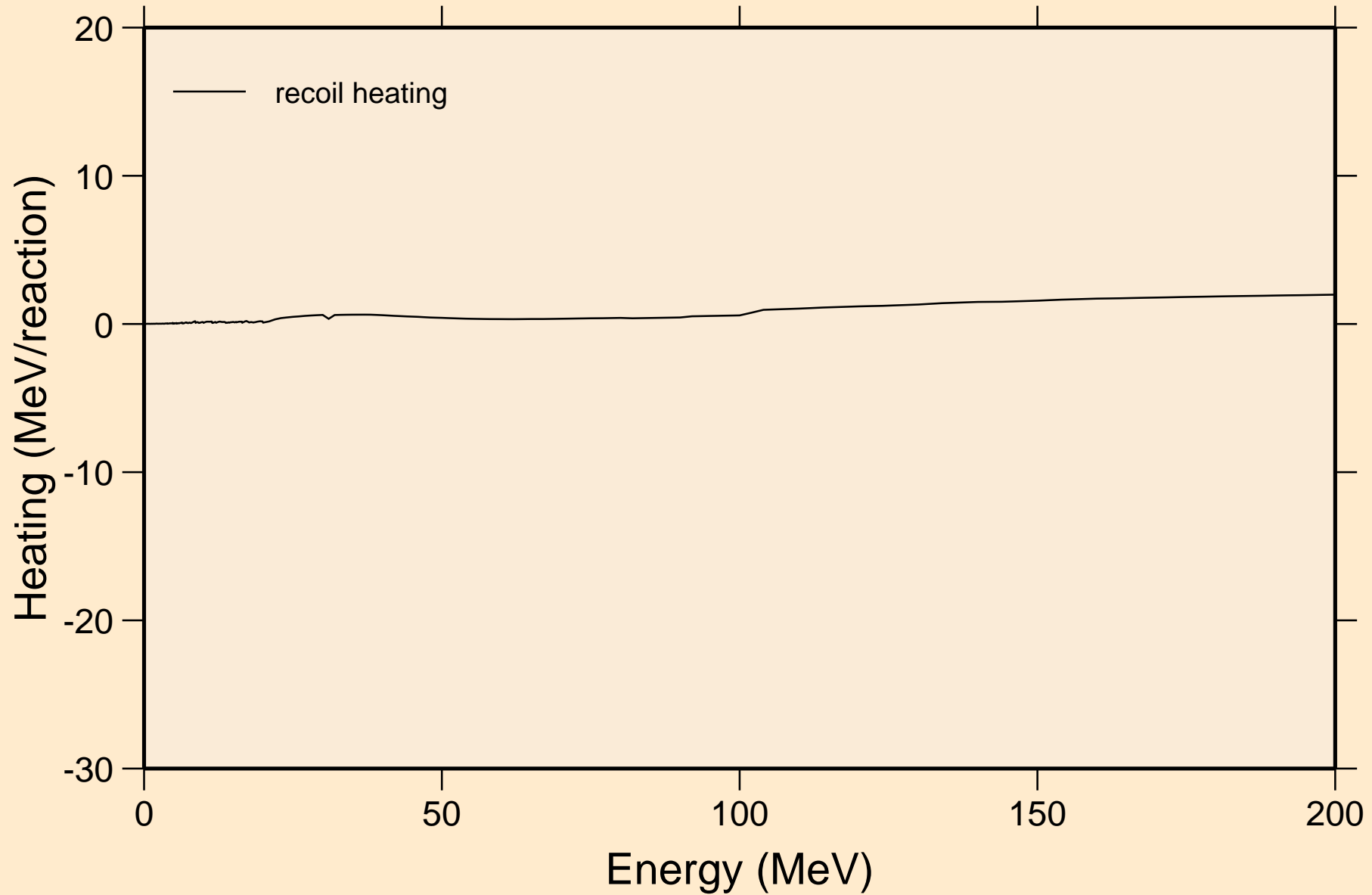

TL183 NEUTRON ACER TENDL-2024 LIBRARY; T=0.K
Particle production cross sections

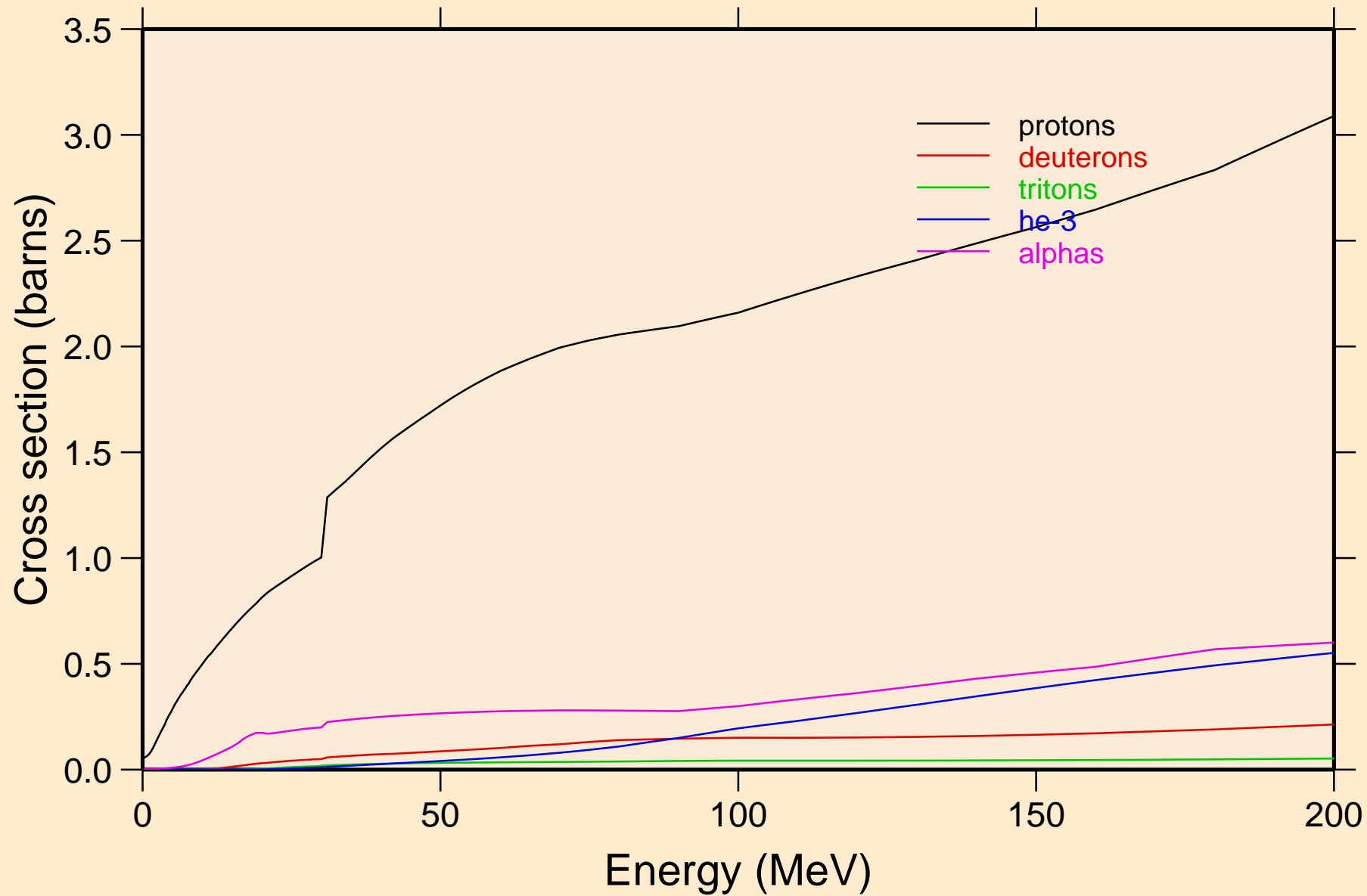

TL183 NEUTRON ACER TENDL-2024 LIBRARY; T=0.K
protons from (n,x)

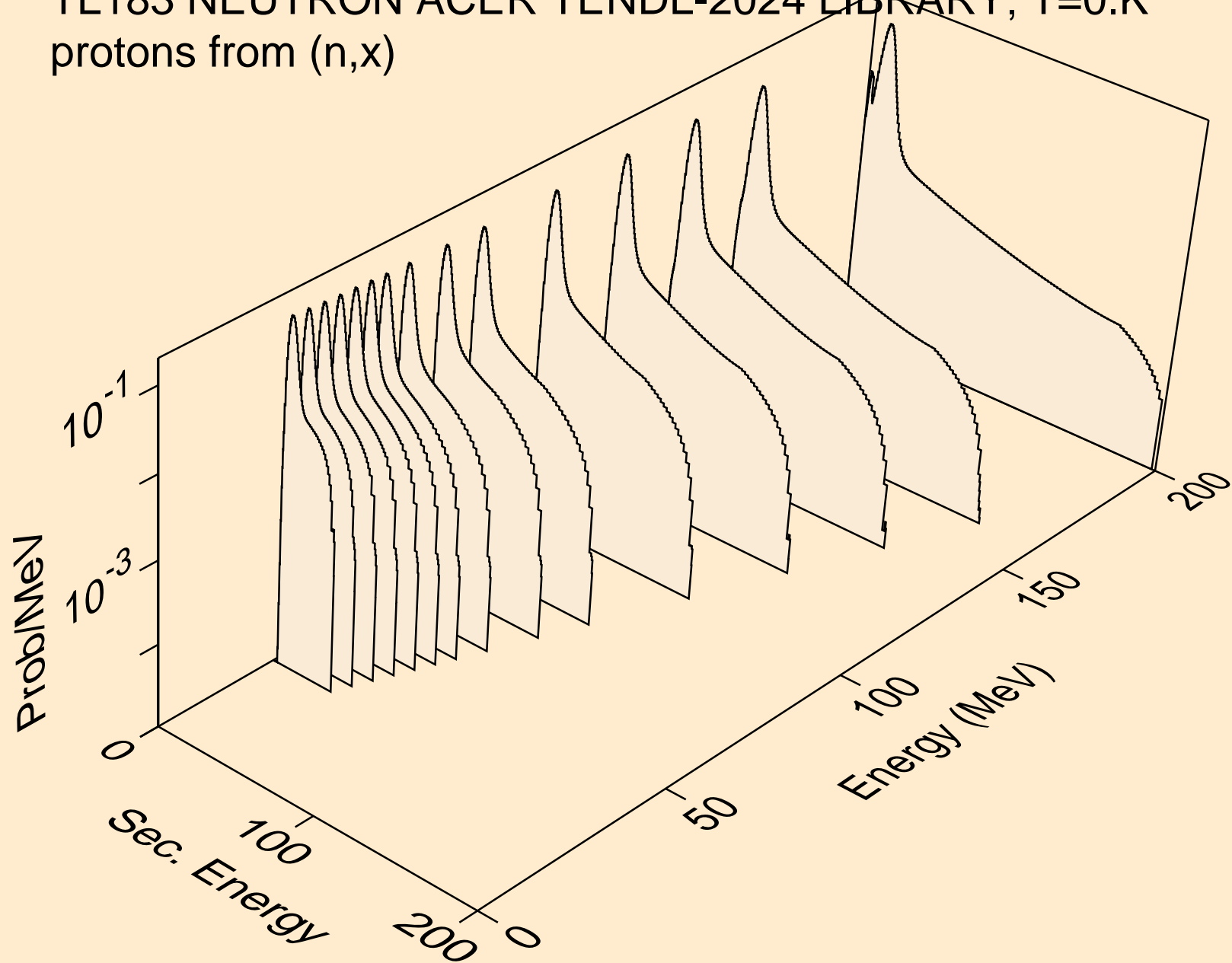

TL183 NEUTRON ACER TENDL-2024 LIBRARY; T=0.K
protons from (n,n*)p

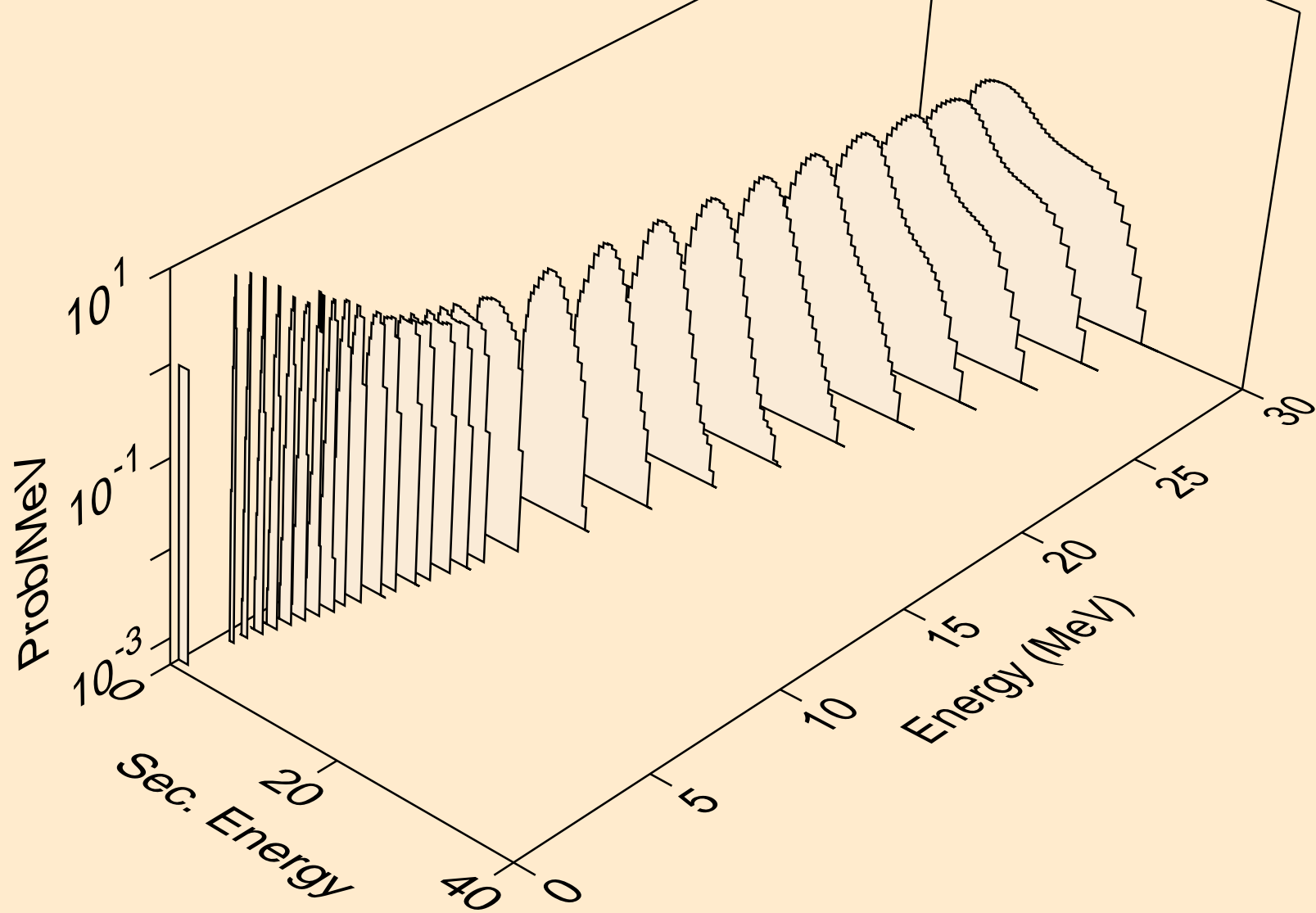

TL183 NEUTRON ACER TENDL-2024 LIBRARY; T=0.K
protons from (n,2np)

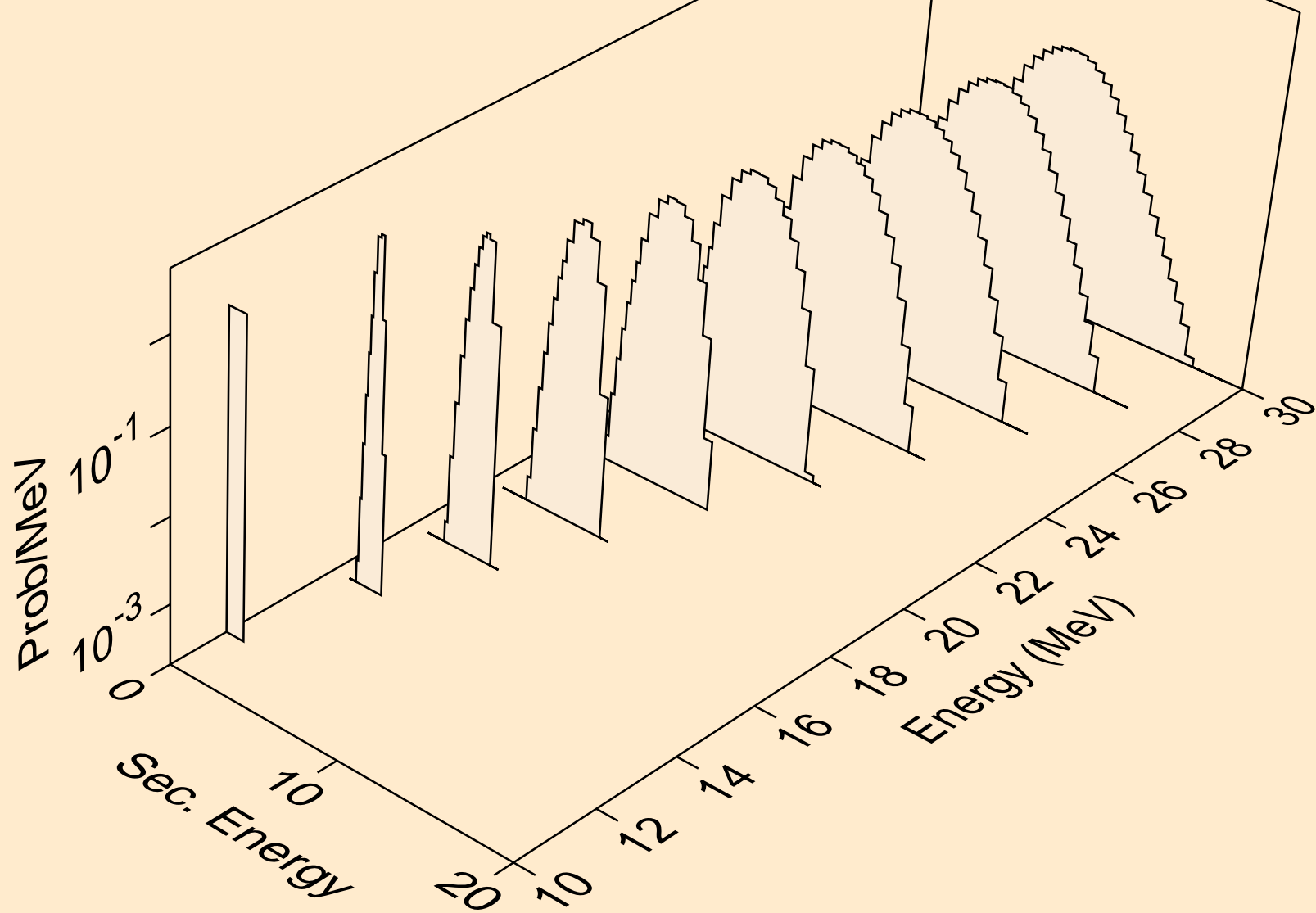

TL183 NEUTRON ACER TENDL-2024 LIBRARY; T=0.K
protons from (n,3np)

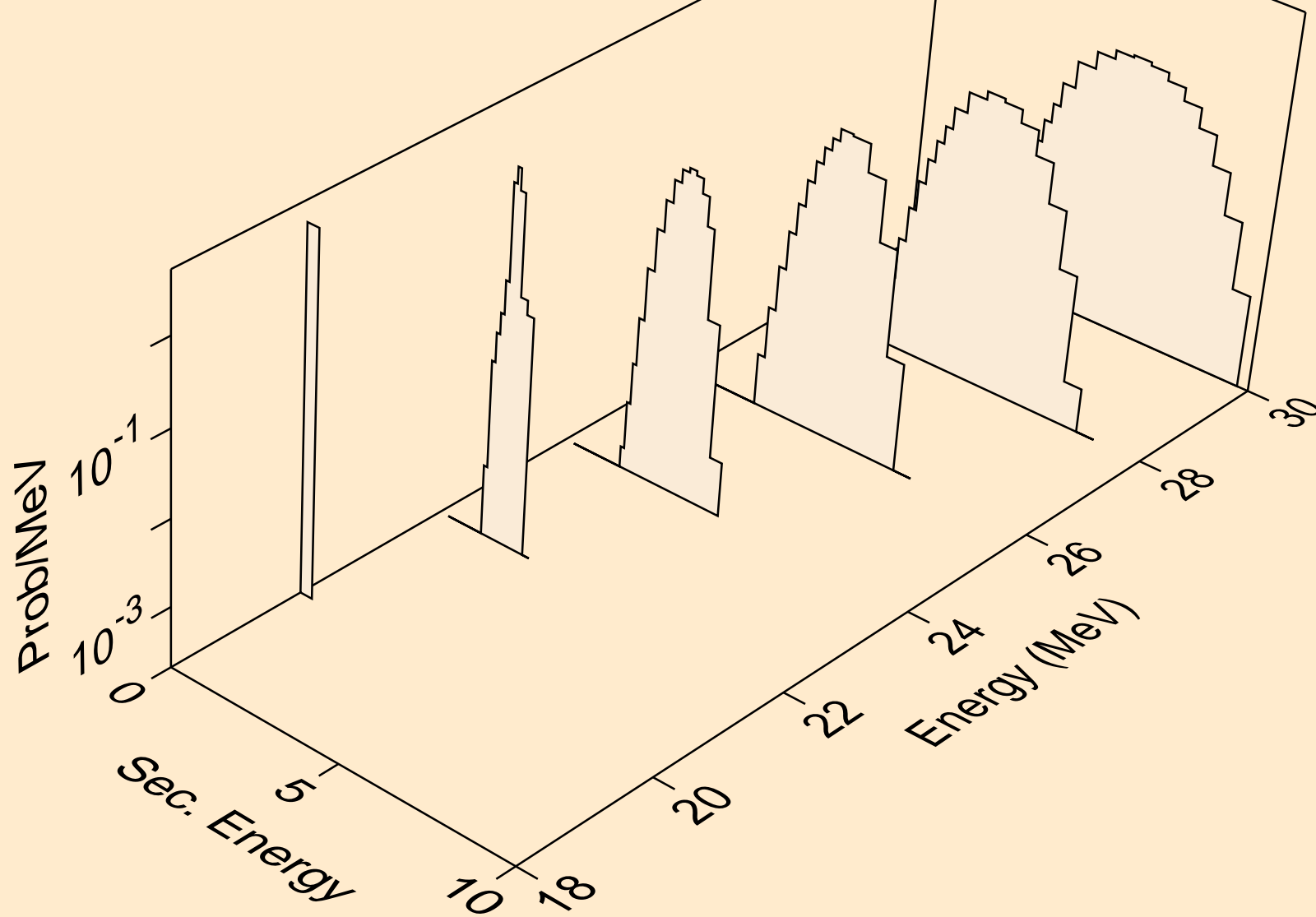

TL183 NEUTRON ACER TENDL-2024 LIBRARY; T=0.K
protons from (n,n2p)

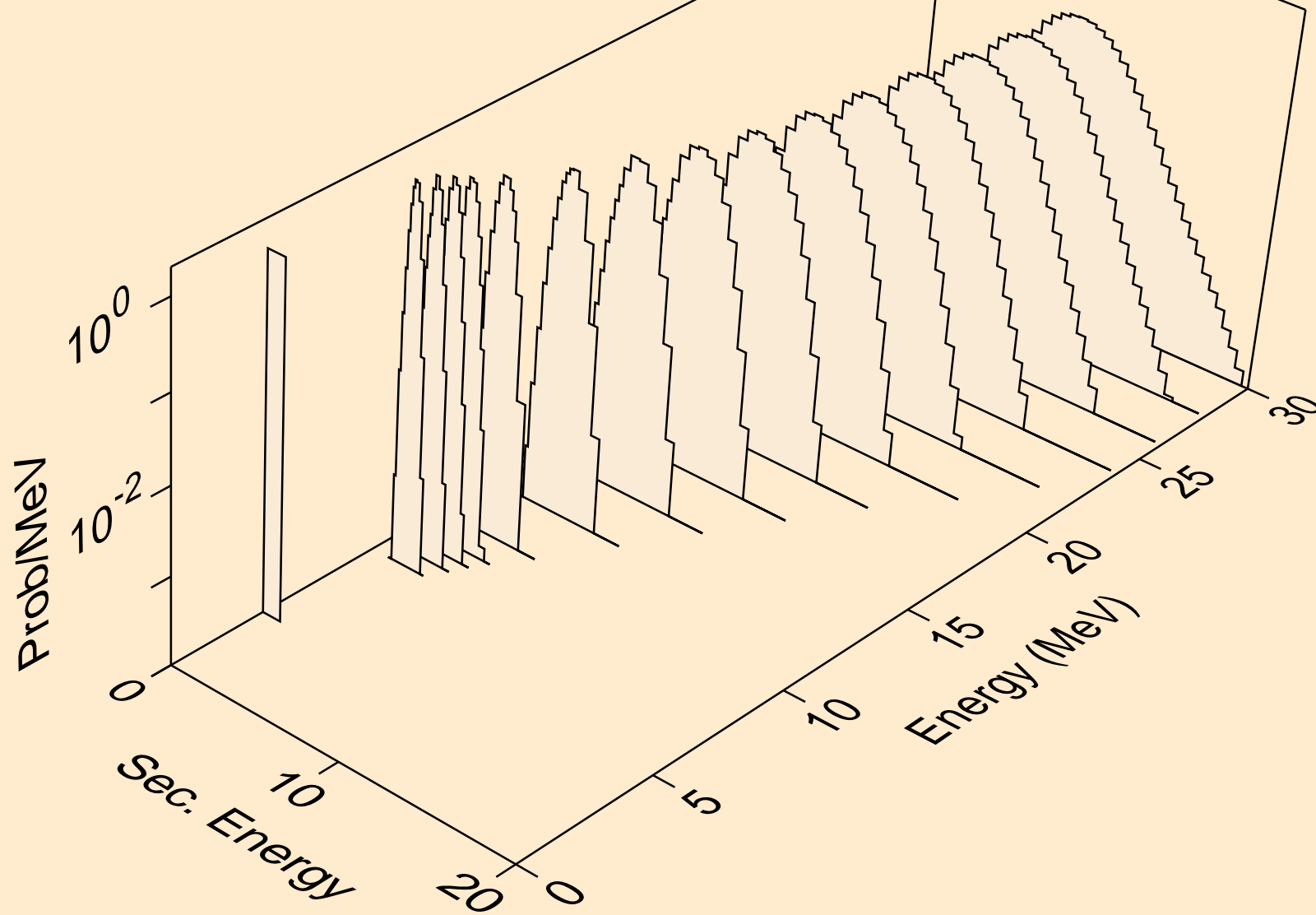

TL183 NEUTRON ACER TENDL-2024 LIBRARY; T=0.K
protons from (n,npa)

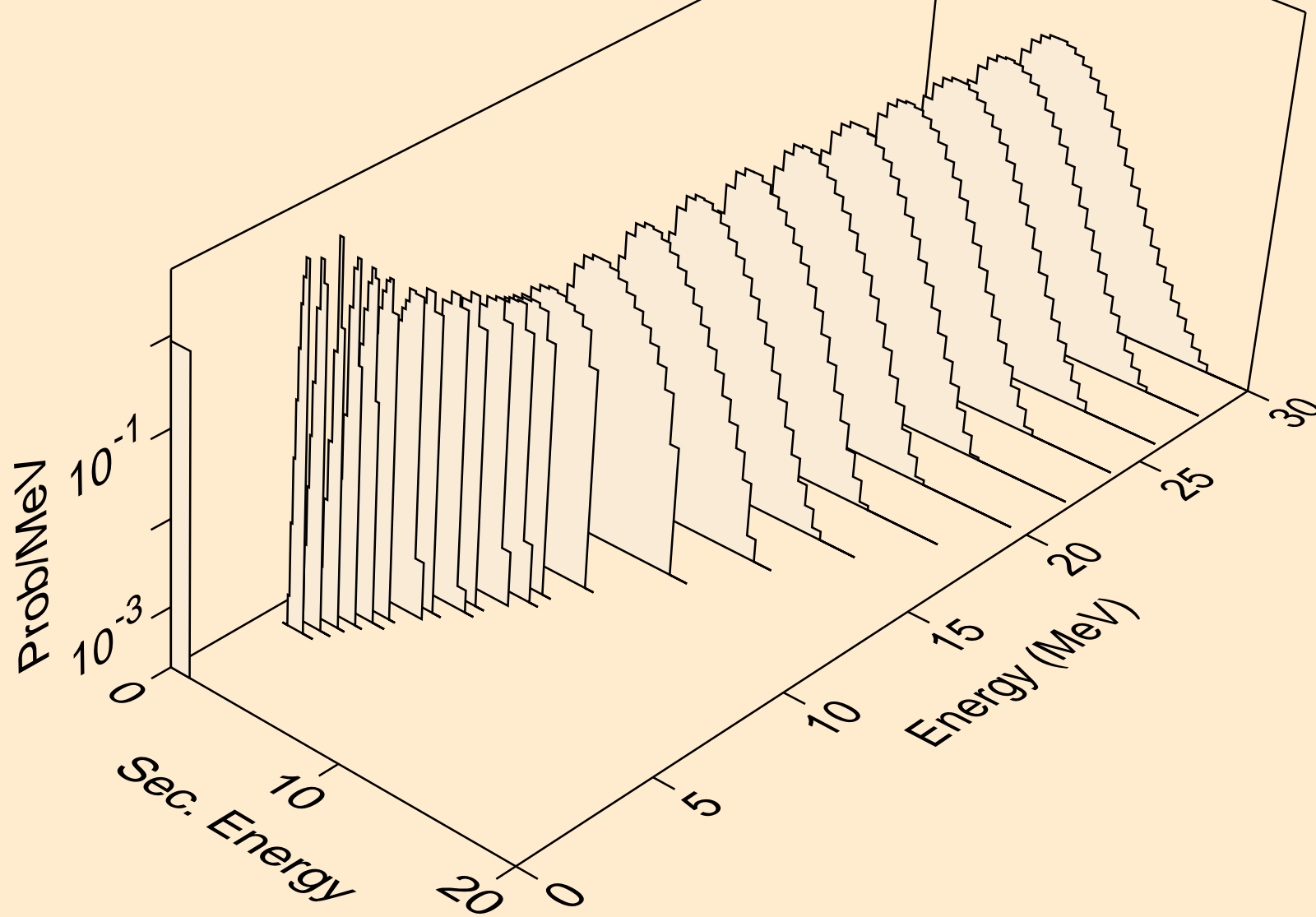

TL183 NEUTRON ACER TENDL-2024 LIBRARY; T=0.K
protons from (n,p)

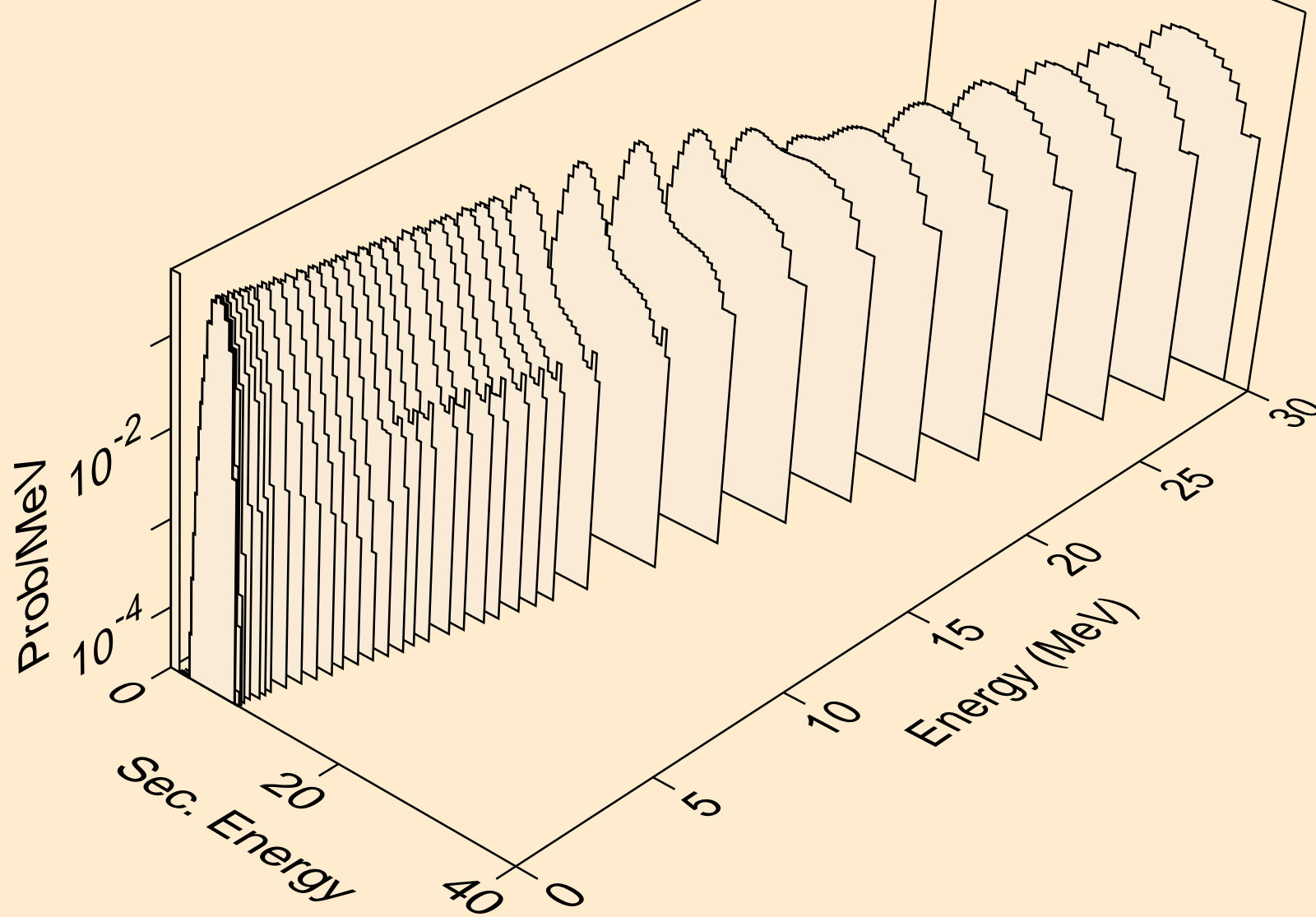

TL183 NEUTRON ACER TENDL-2024 LIBRARY; T=0.K
protons from (n,2p)

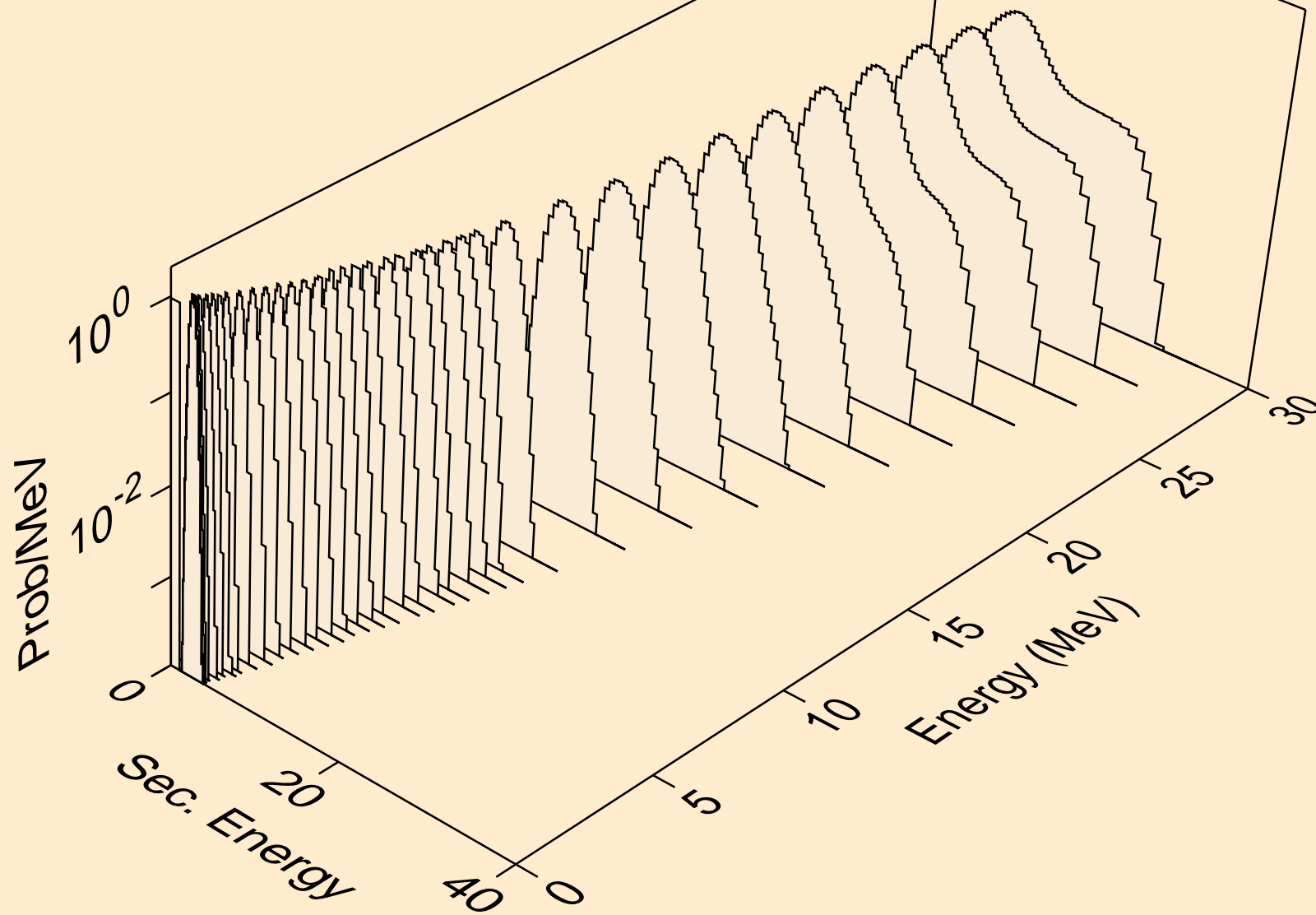

TL183 NEUTRON ACER TENDL-2024 LIBRARY; T=0.K
protons from (n,p)

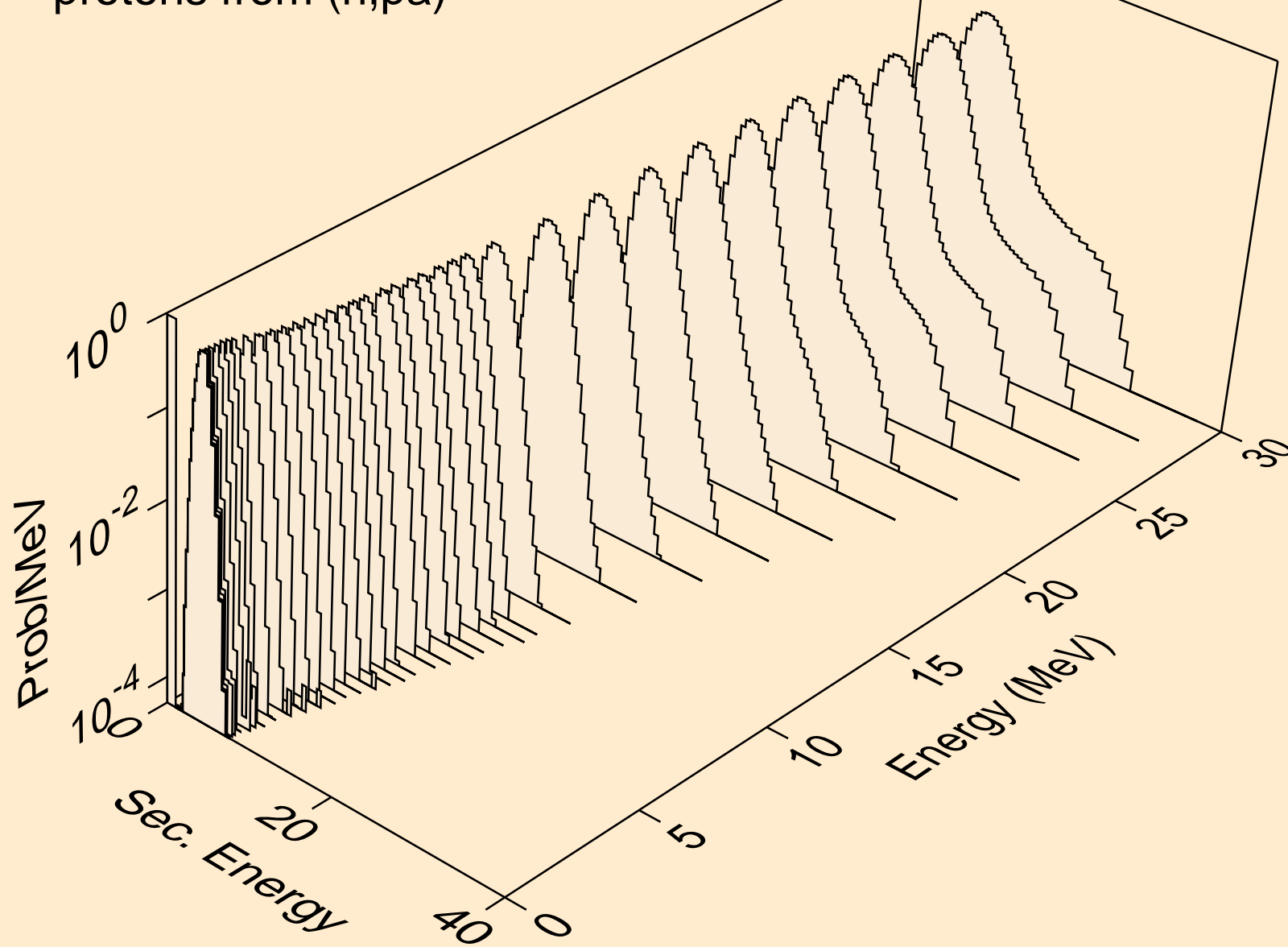

TL183 NEUTRON ACER TENDL-2024 LIBRARY; T=0.K
protons from (n,pd)

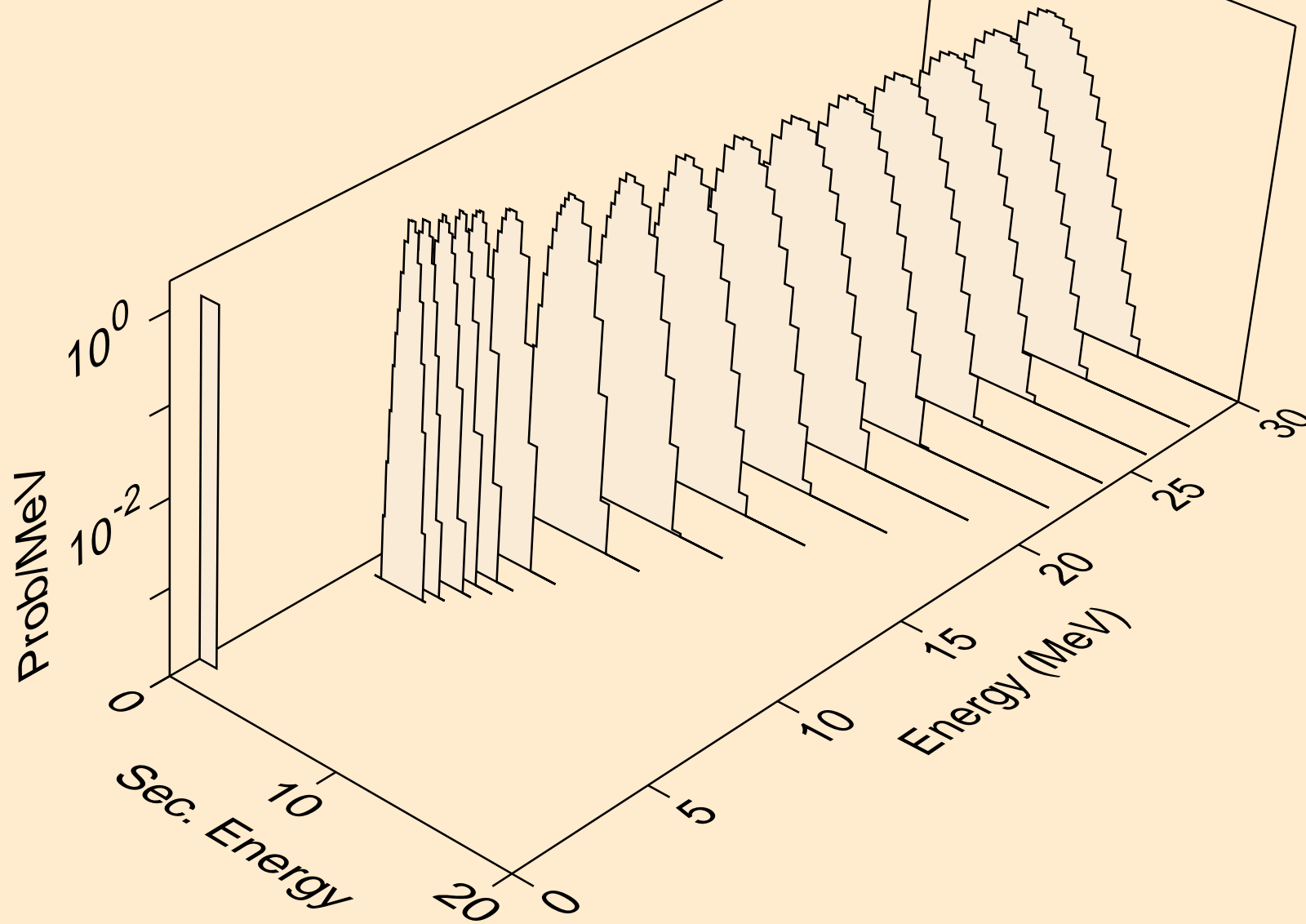

TL183 NEUTRON ACER TENDL-2024 LIBRARY; T=0.K
protons from (n,pt)

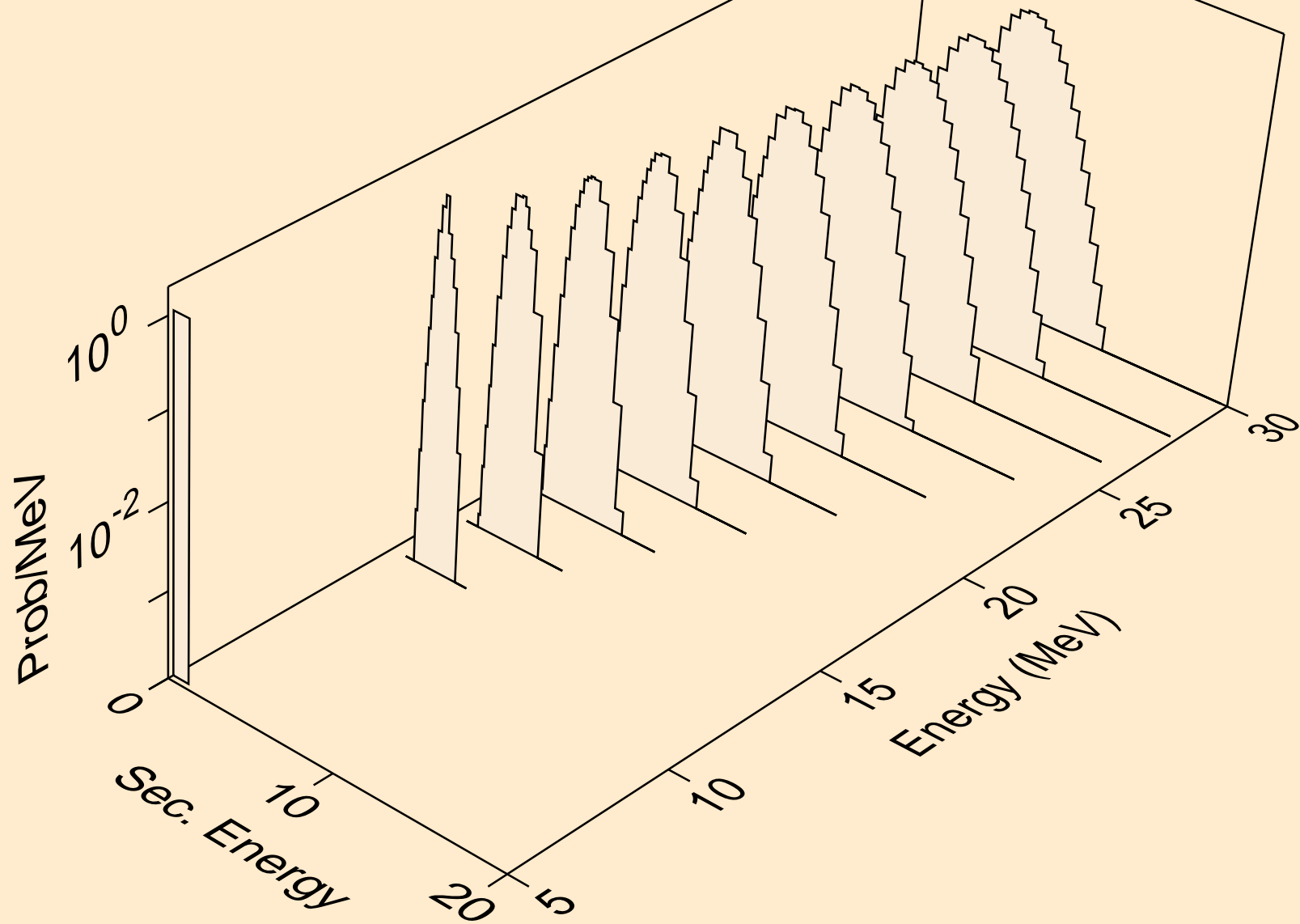

TL183 NEUTRON ACER TENDL-2024 LIBRARY; T=0.K
deuterons from (n,x)

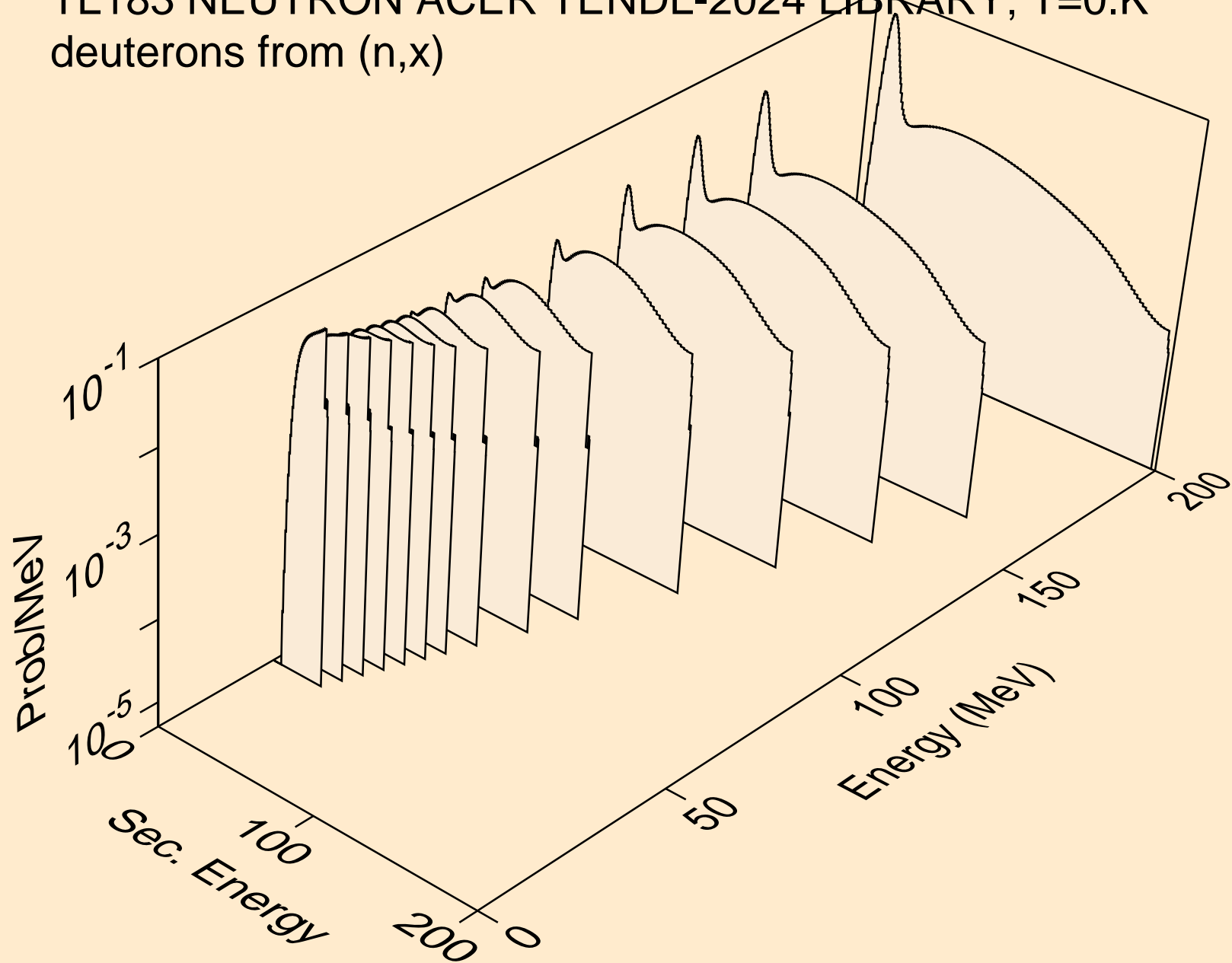

TL183 NEUTRON ACER TENDL-2024 LIBRARY; T=0.K
deuterons from (n,2nd)

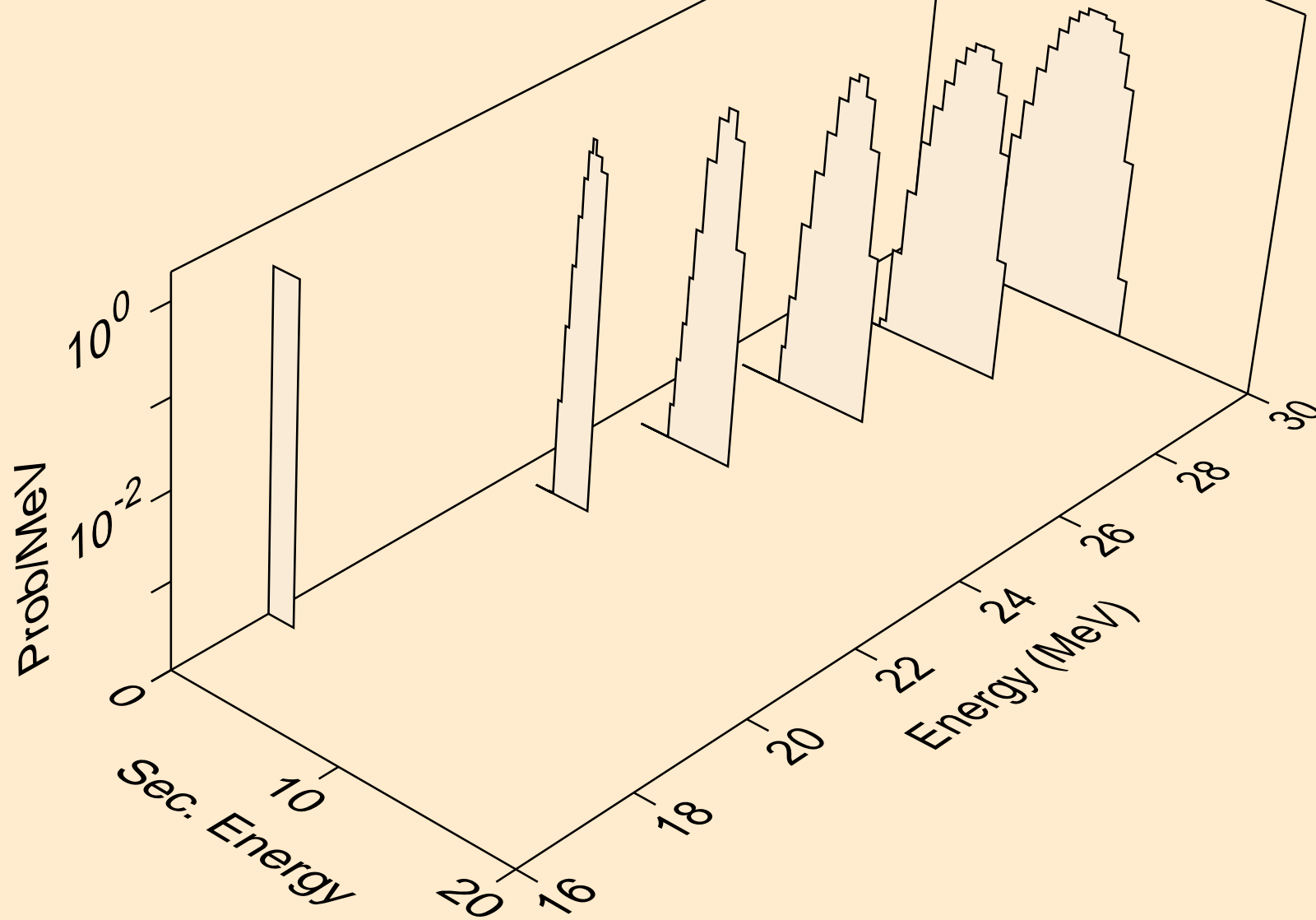

TL183 NEUTRON ACER TENDL-2024 LIBRARY; T=0.K
deuterons from (n,n*)d

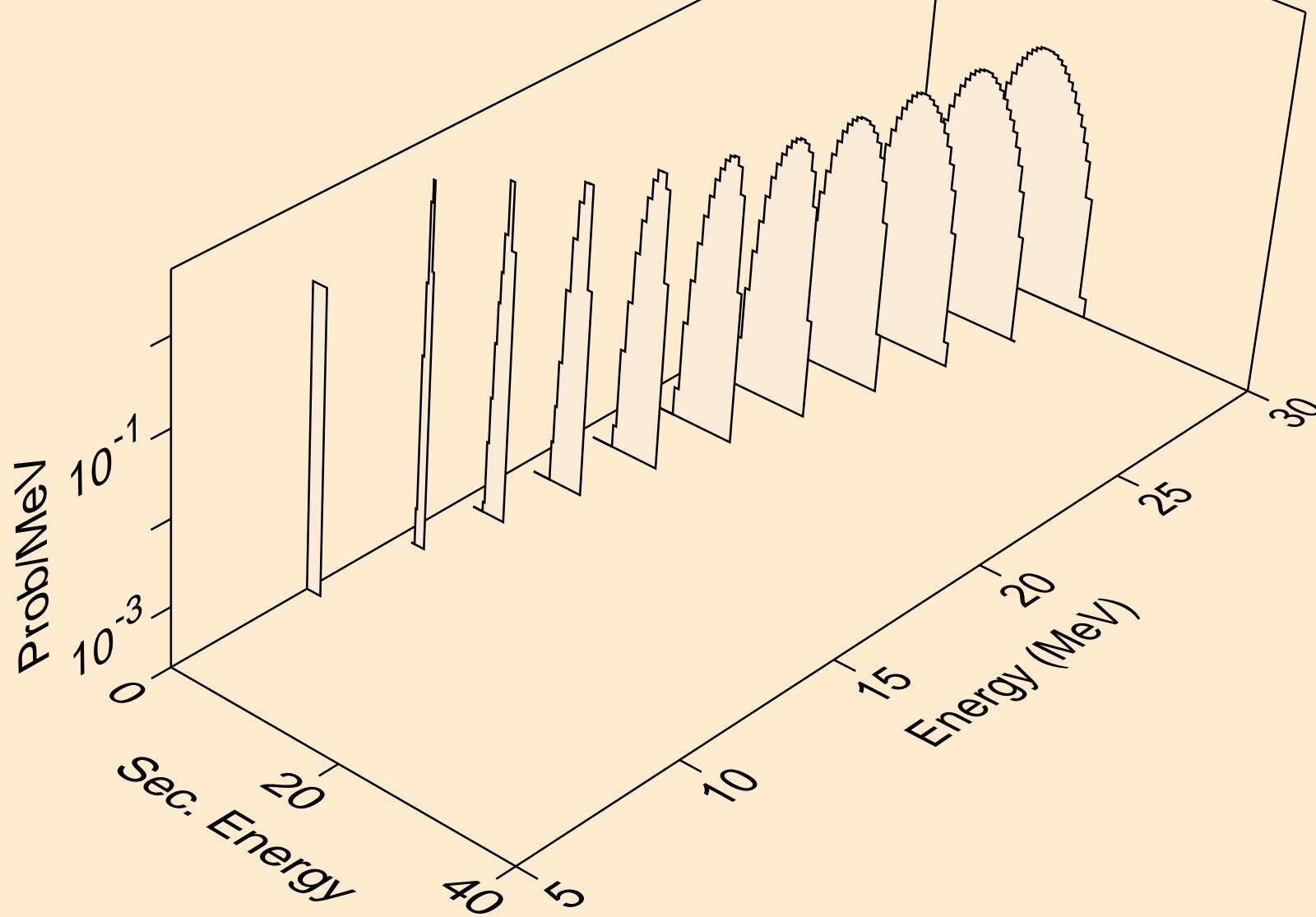

TL183 NEUTRON ACER TENDL-2024 LIBRARY; T=0.K
deuterons from (n,d)

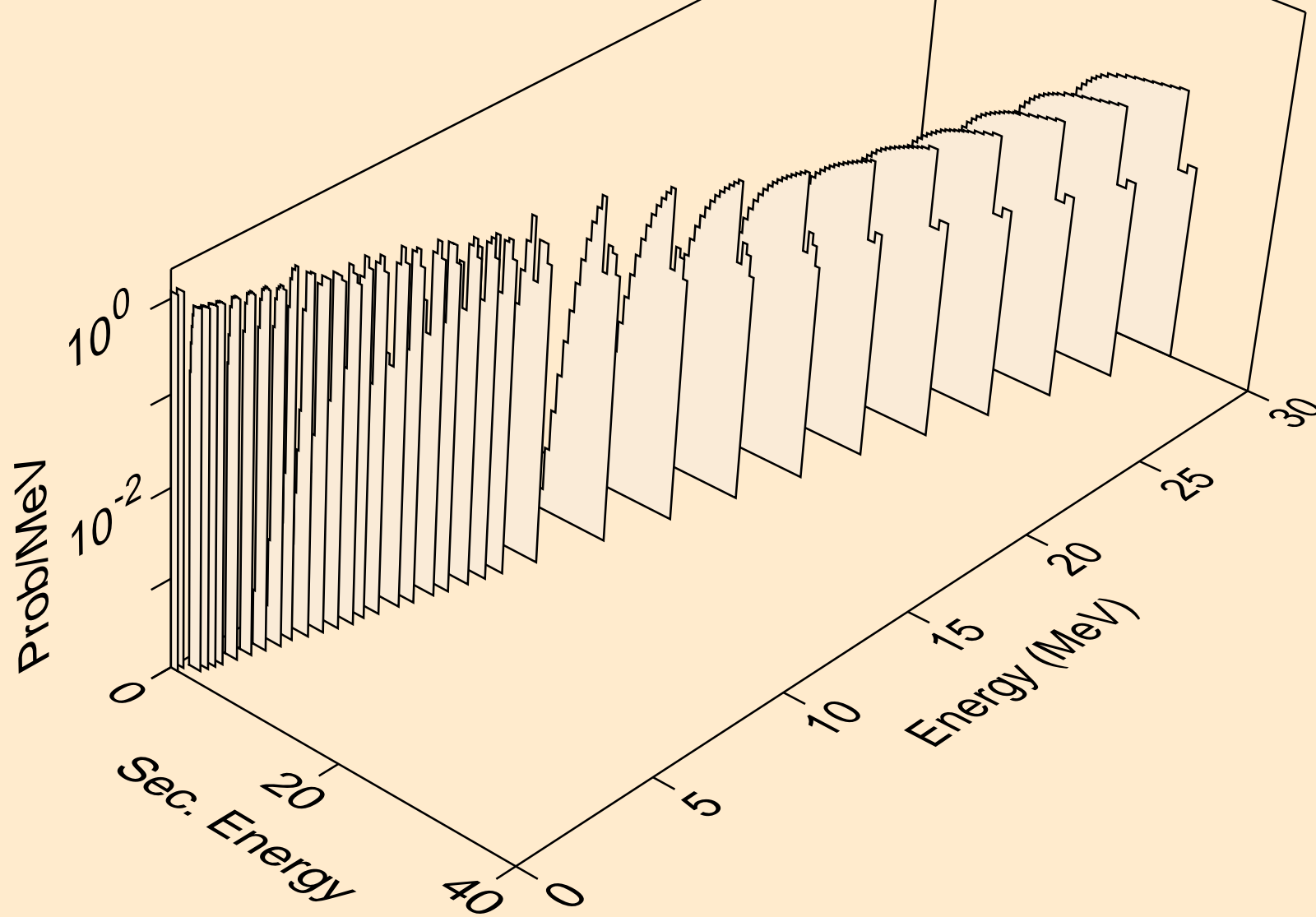

TL183 NEUTRON ACER TENDL-2024 LIBRARY; T=0.K
deuterons from (n,d2a)

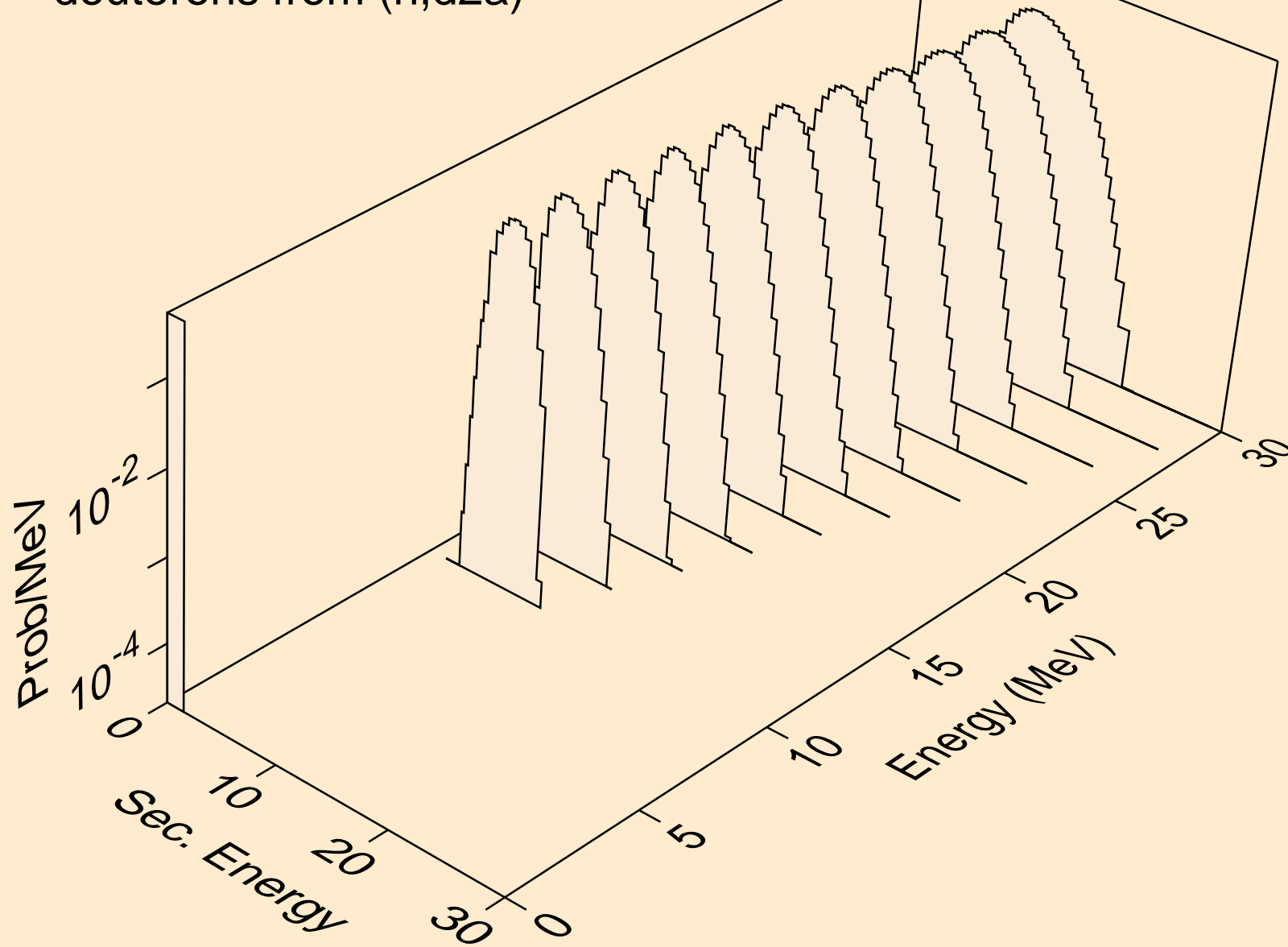

TL183 NEUTRON ACER TENDL-2024 LIBRARY; T=0.K
deuterons from (n,pd)

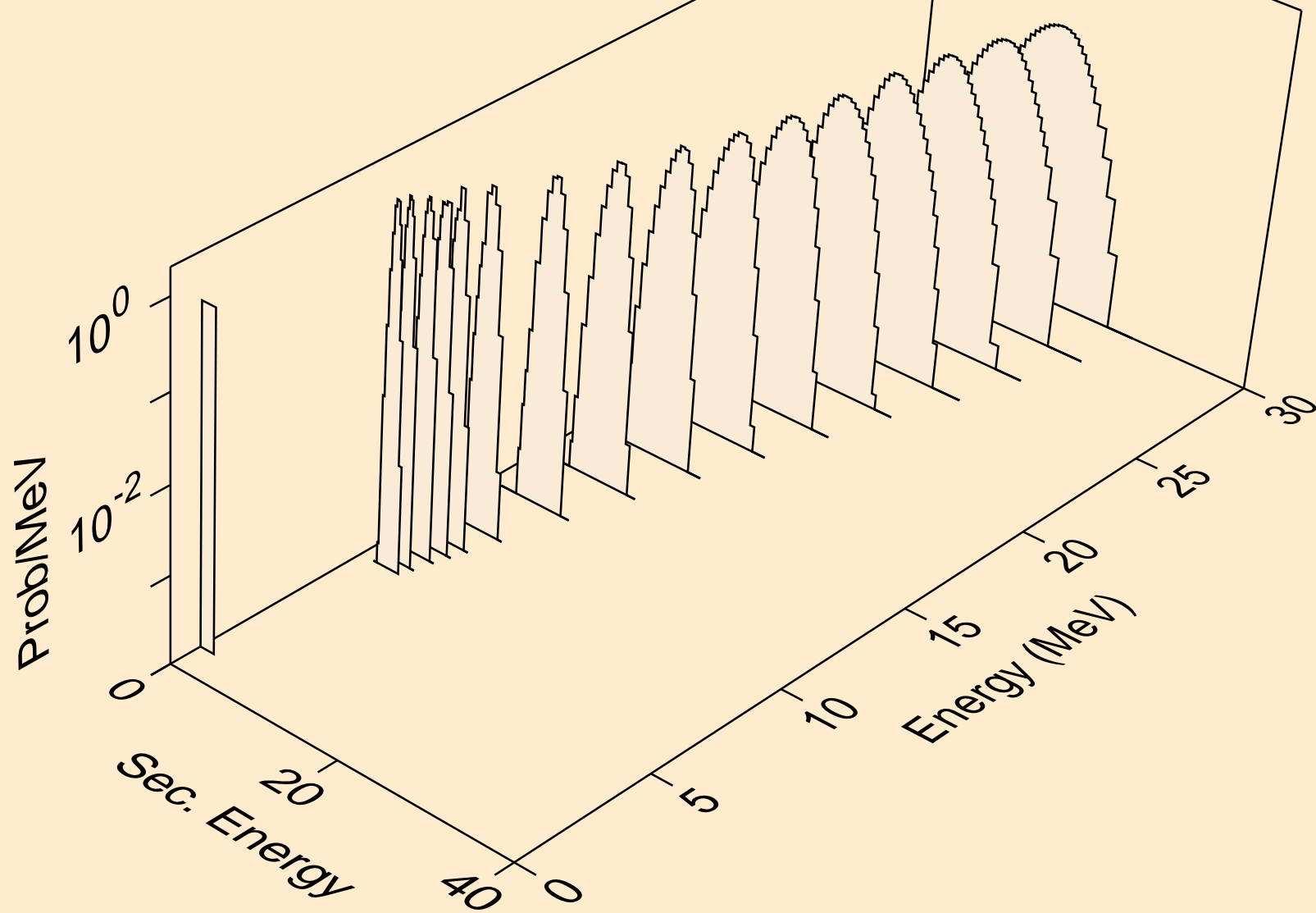

TL183 NEUTRON ACER TENDL-2024 LIBRARY; T=0.K
deuterons from (n,da)

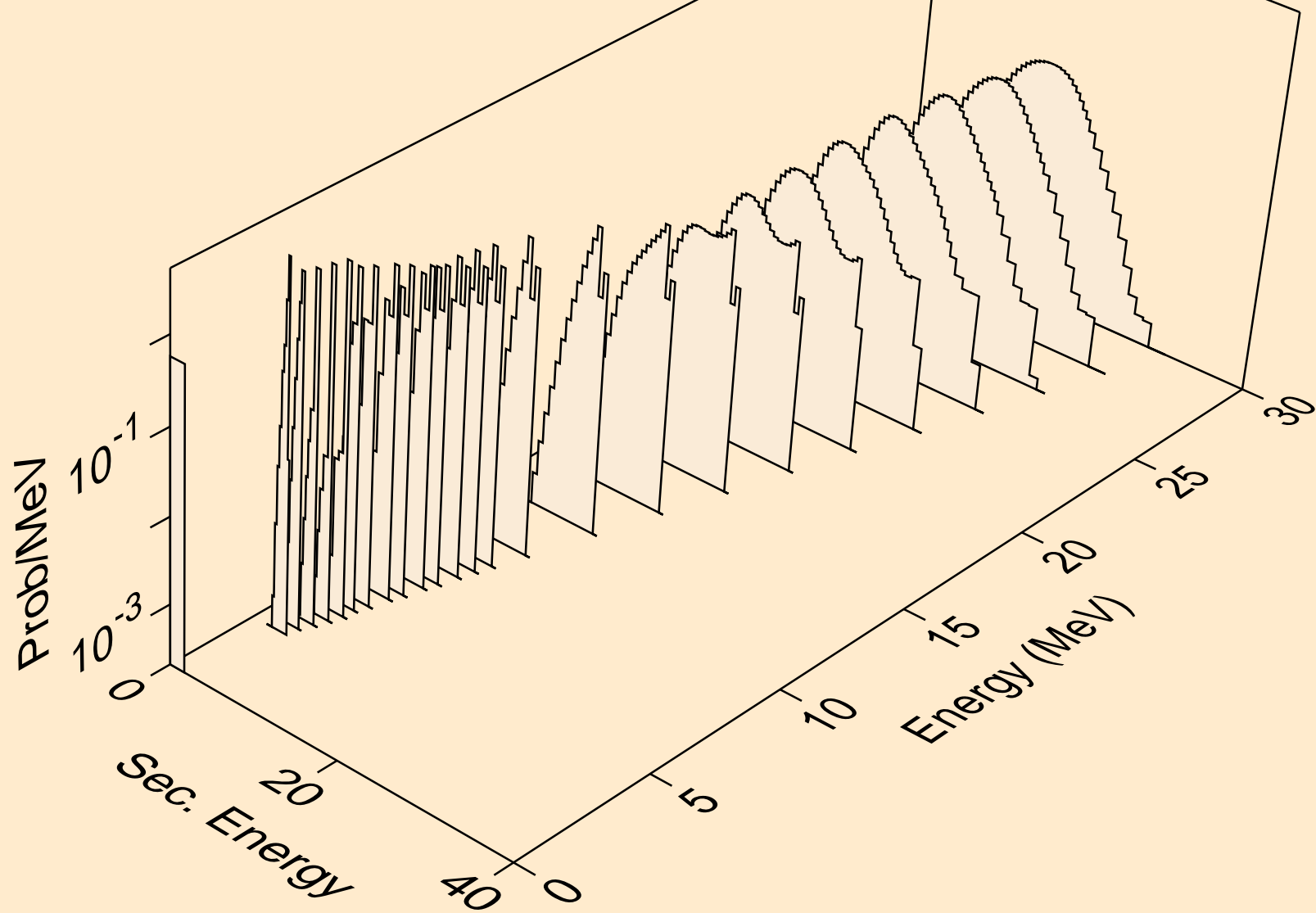

TL183 NEUTRON ACER TENDL-2024 LIBRARY; T=0.K
tritons from (n,x)

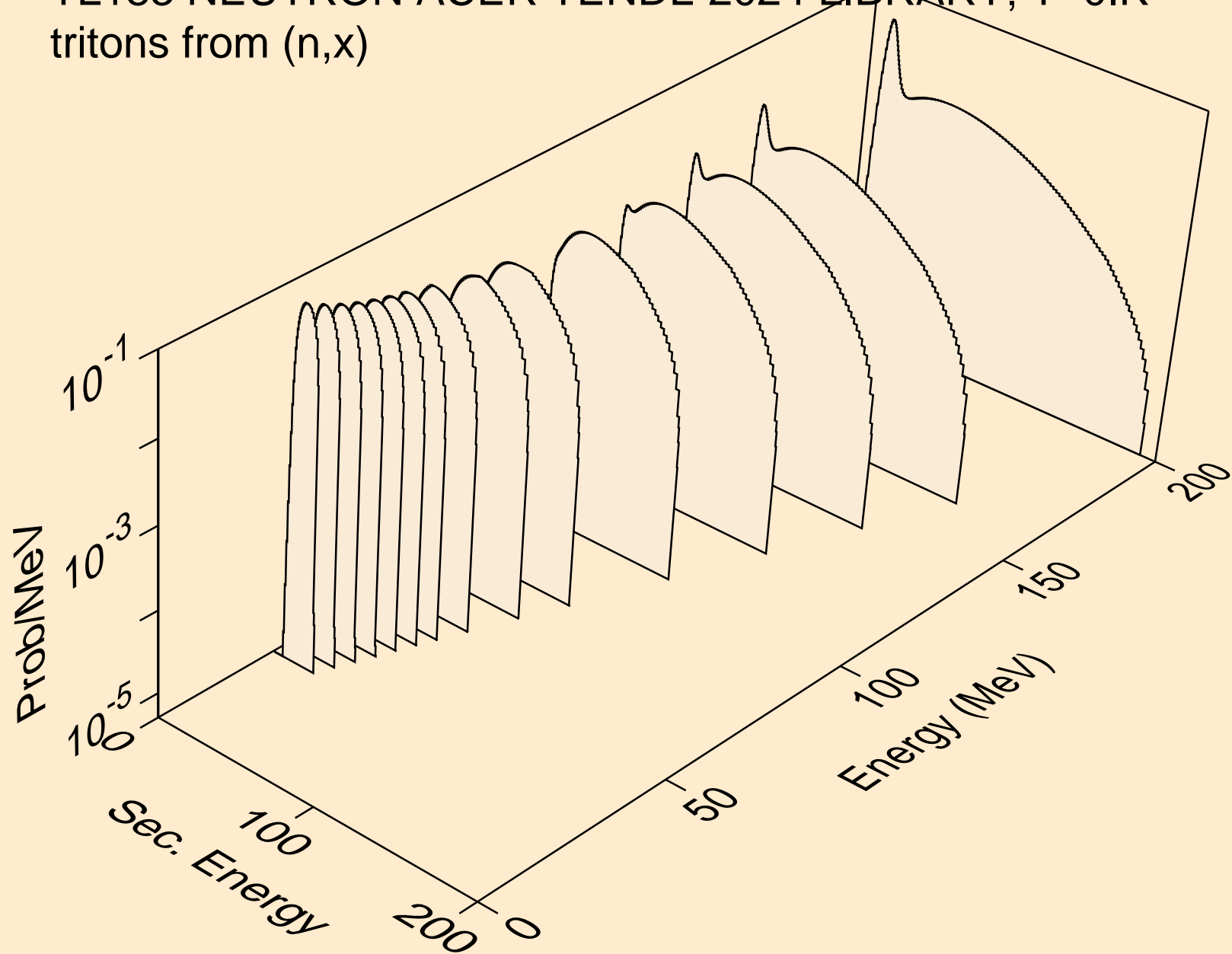

TL183 NEUTRON ACER TENDL-2024 LIBRARY; T=0.K
tritons from (n,n*)t

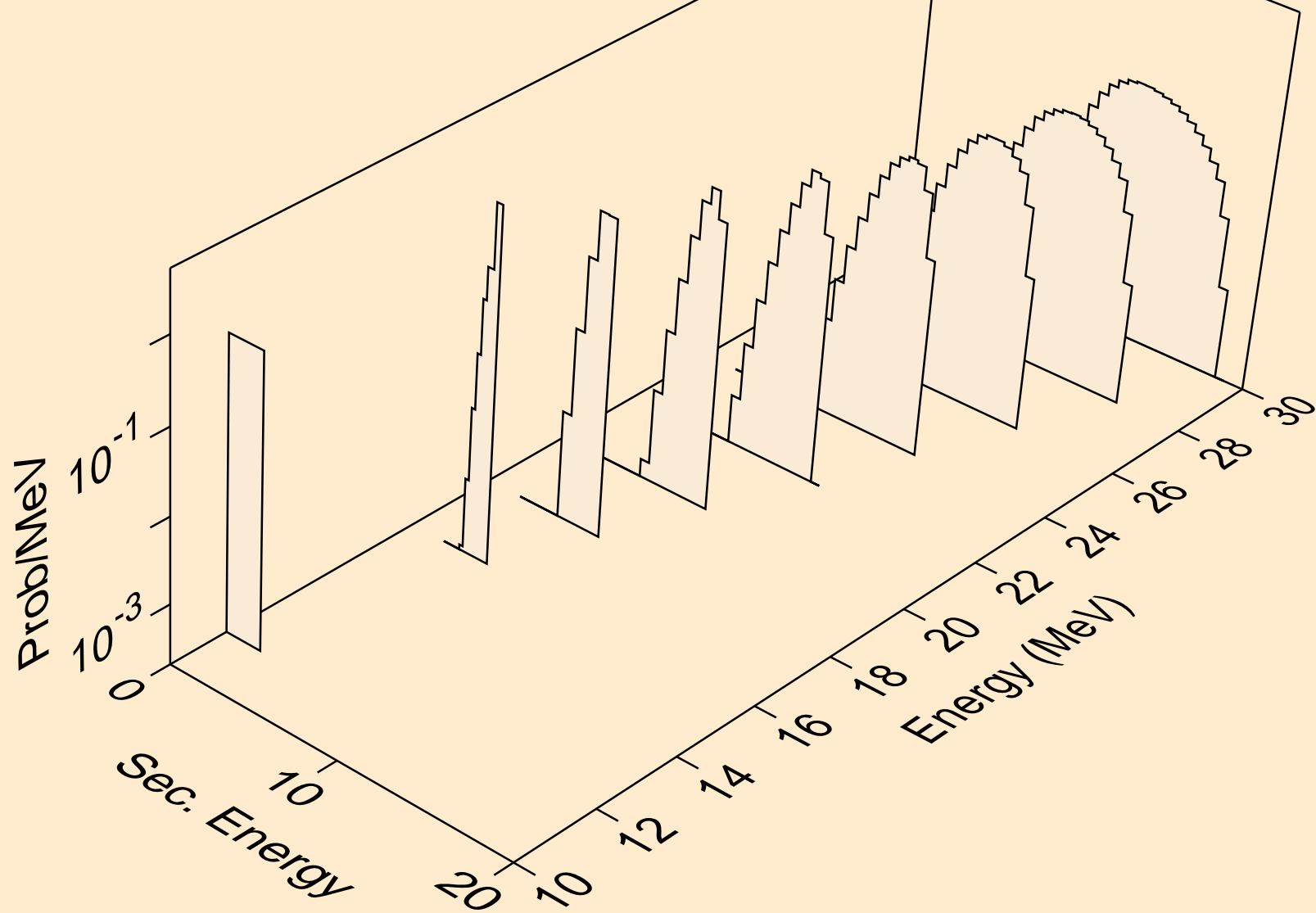

TL183 NEUTRON ACER TENDL-2024 LIBRARY; T=0.K
tritons from (n,t)

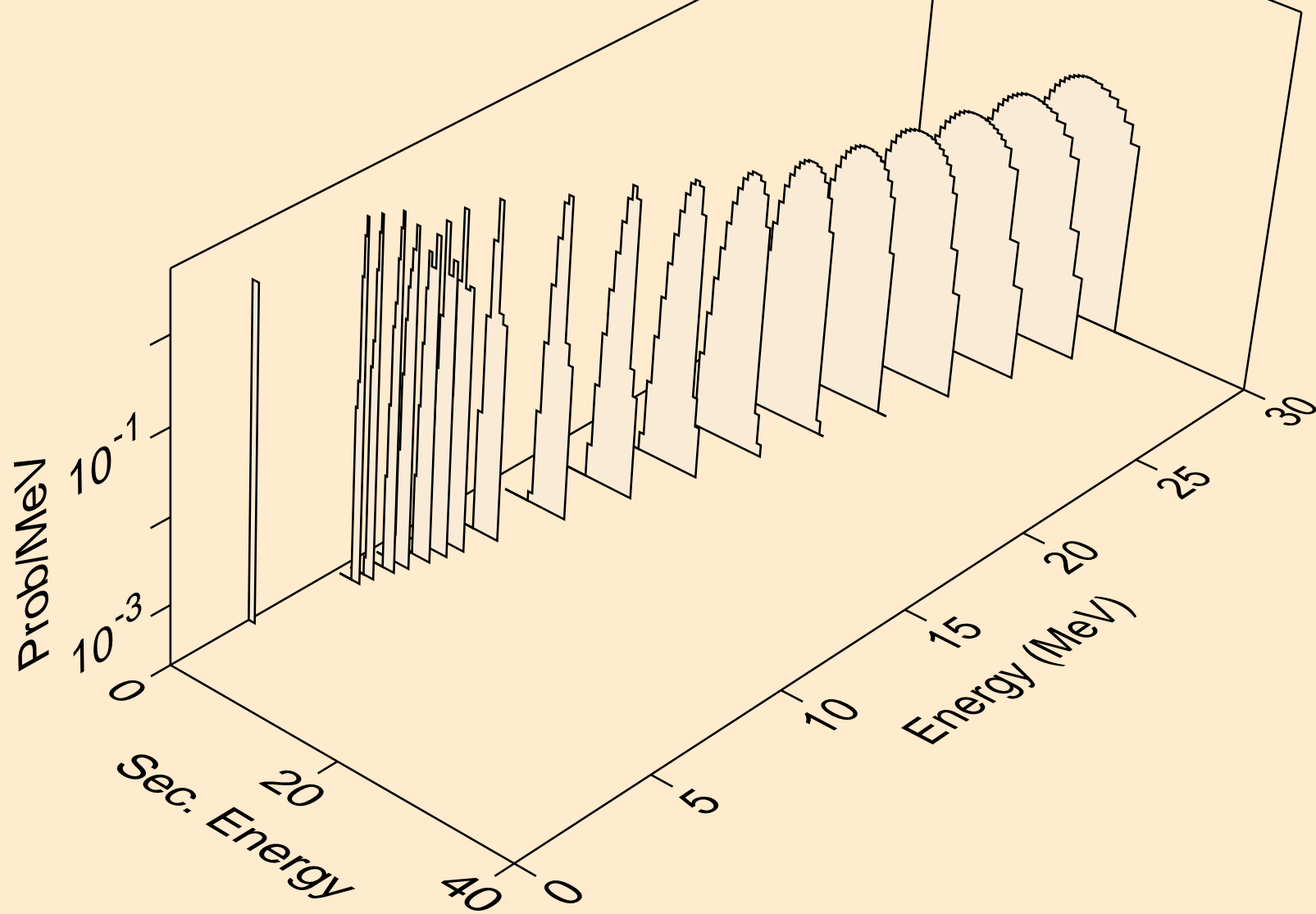

TL183 NEUTRON ACER TENDL-2024 LIBRARY; T=0.K
tritons from (n,pt)

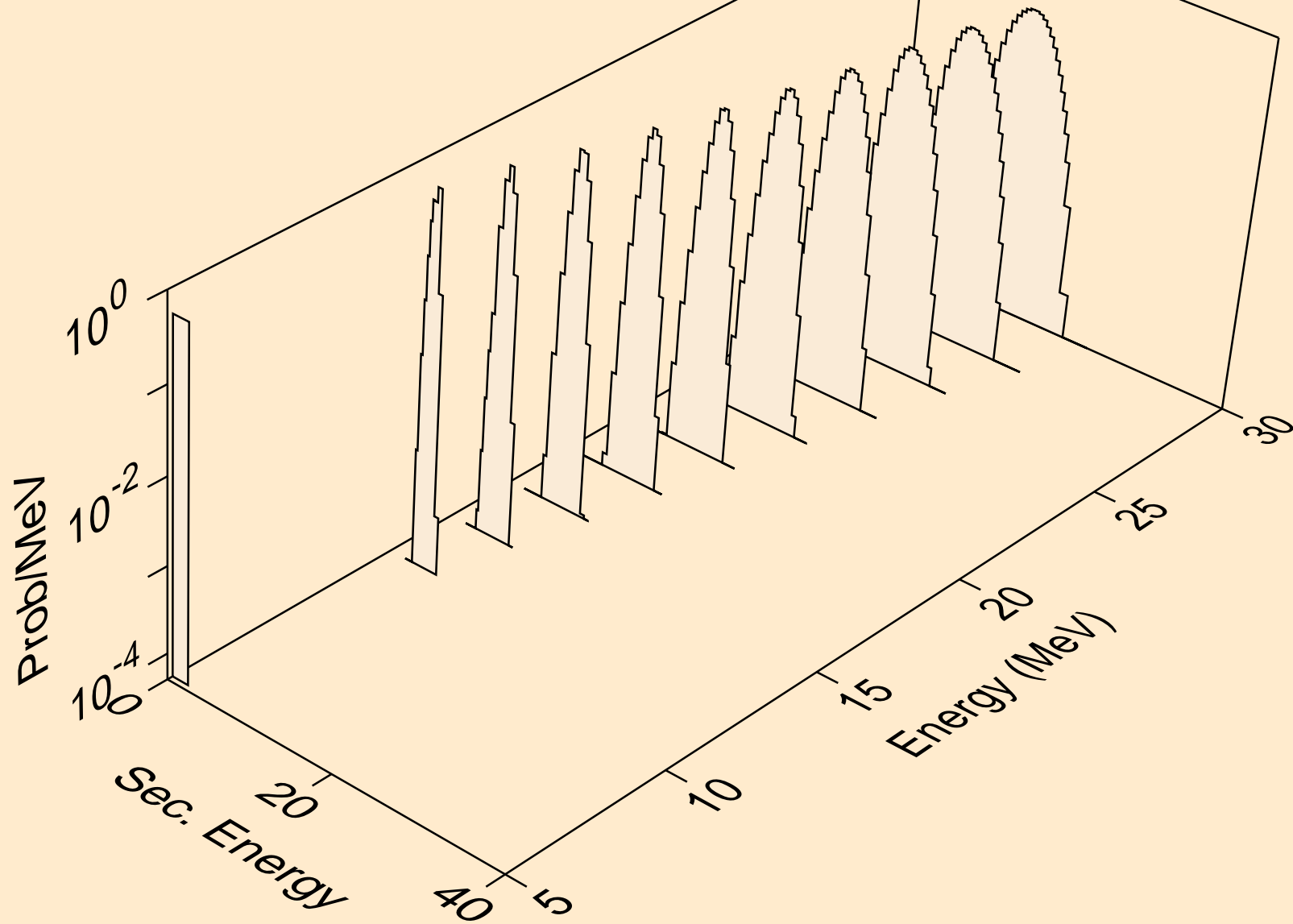

TL183 NEUTRON ACER TENDL-2024 LIBRARY; T=0.K
he3s from (n,x)

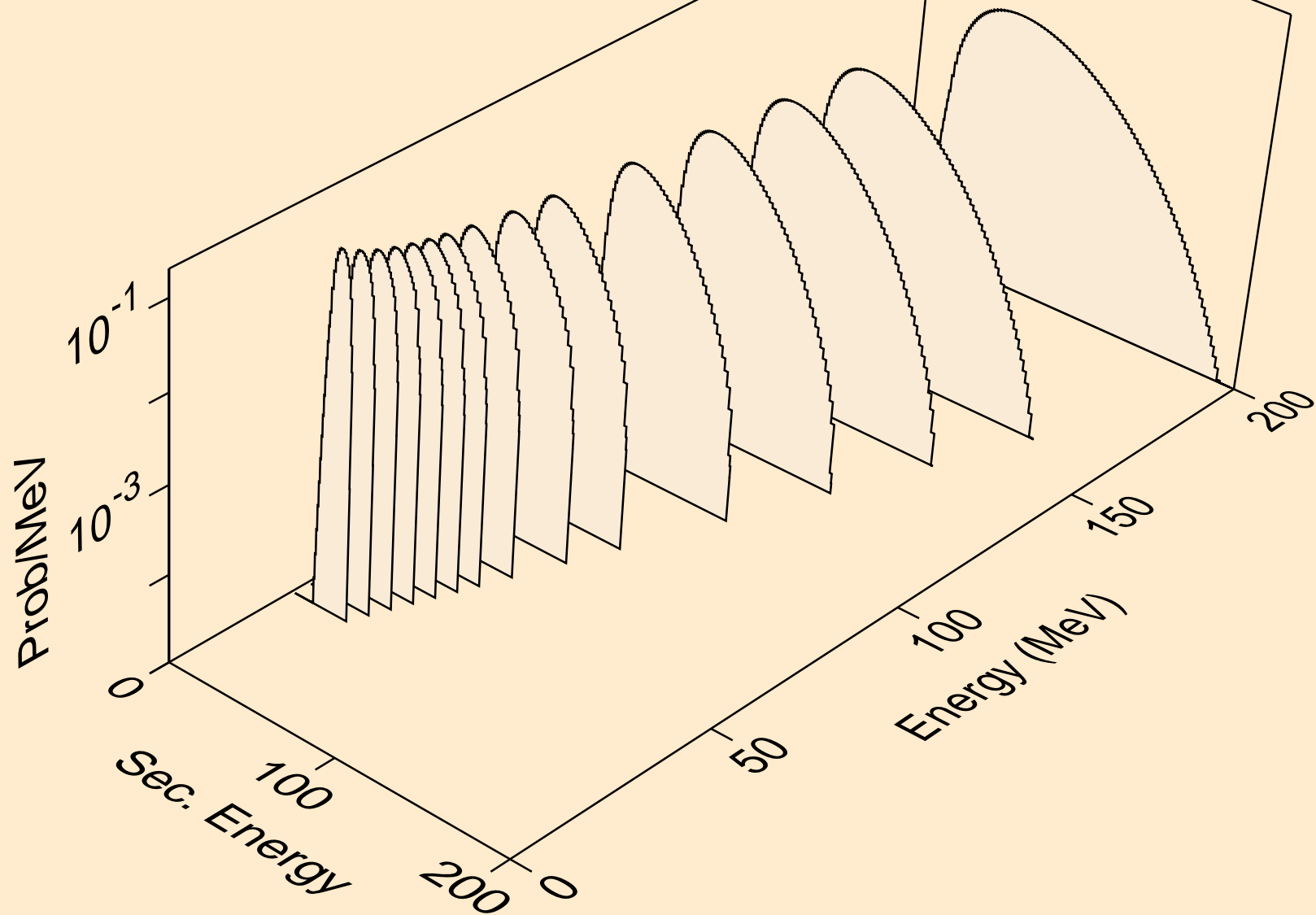

TL183 NEUTRON ACER TENDL-2024 LIBRARY; T=0.K
he3s from (n,n*)he3

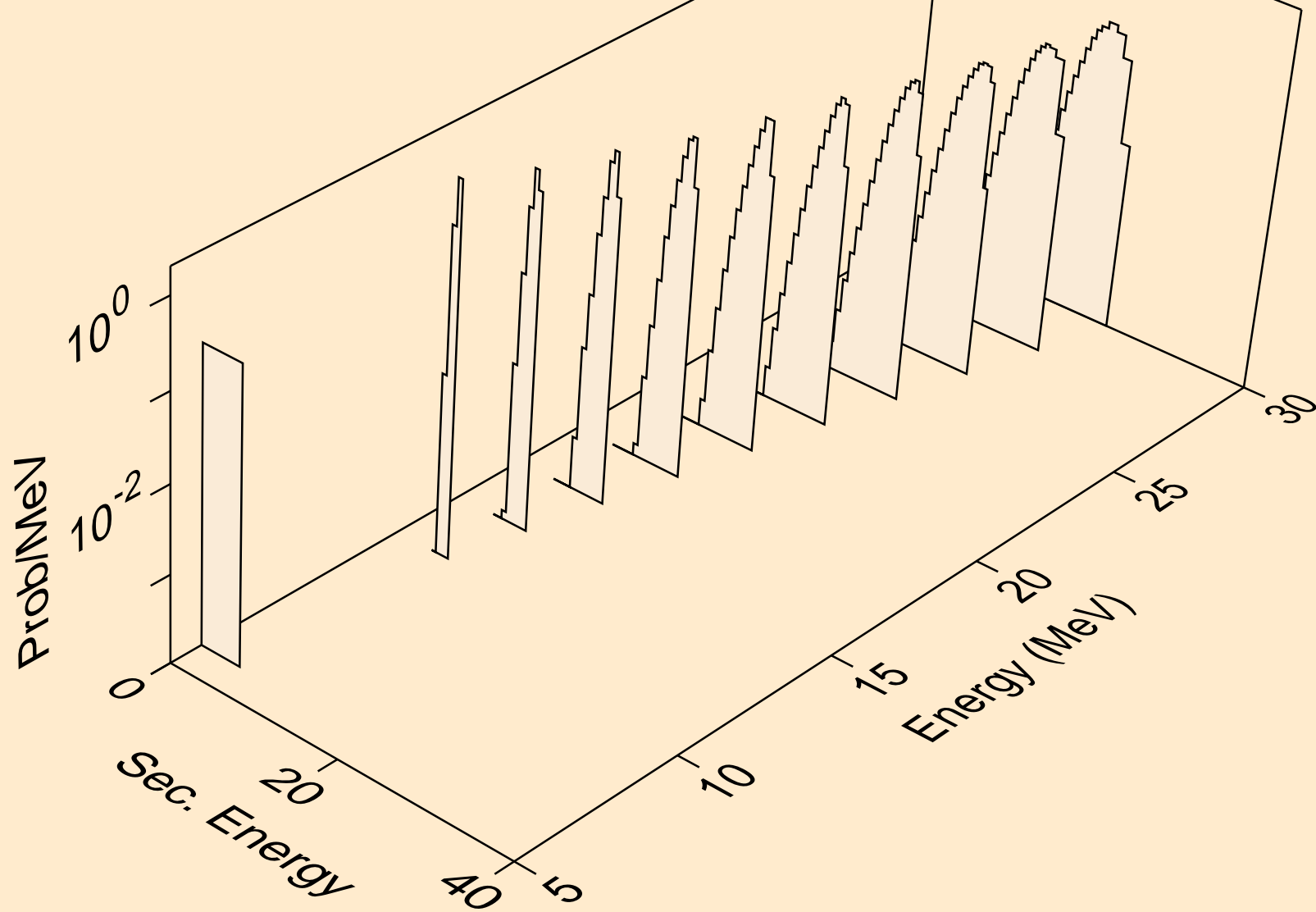

TL183 NEUTRON ACER TENDL-2024 LIBRARY; T=0.K
he3s from (n,he3)

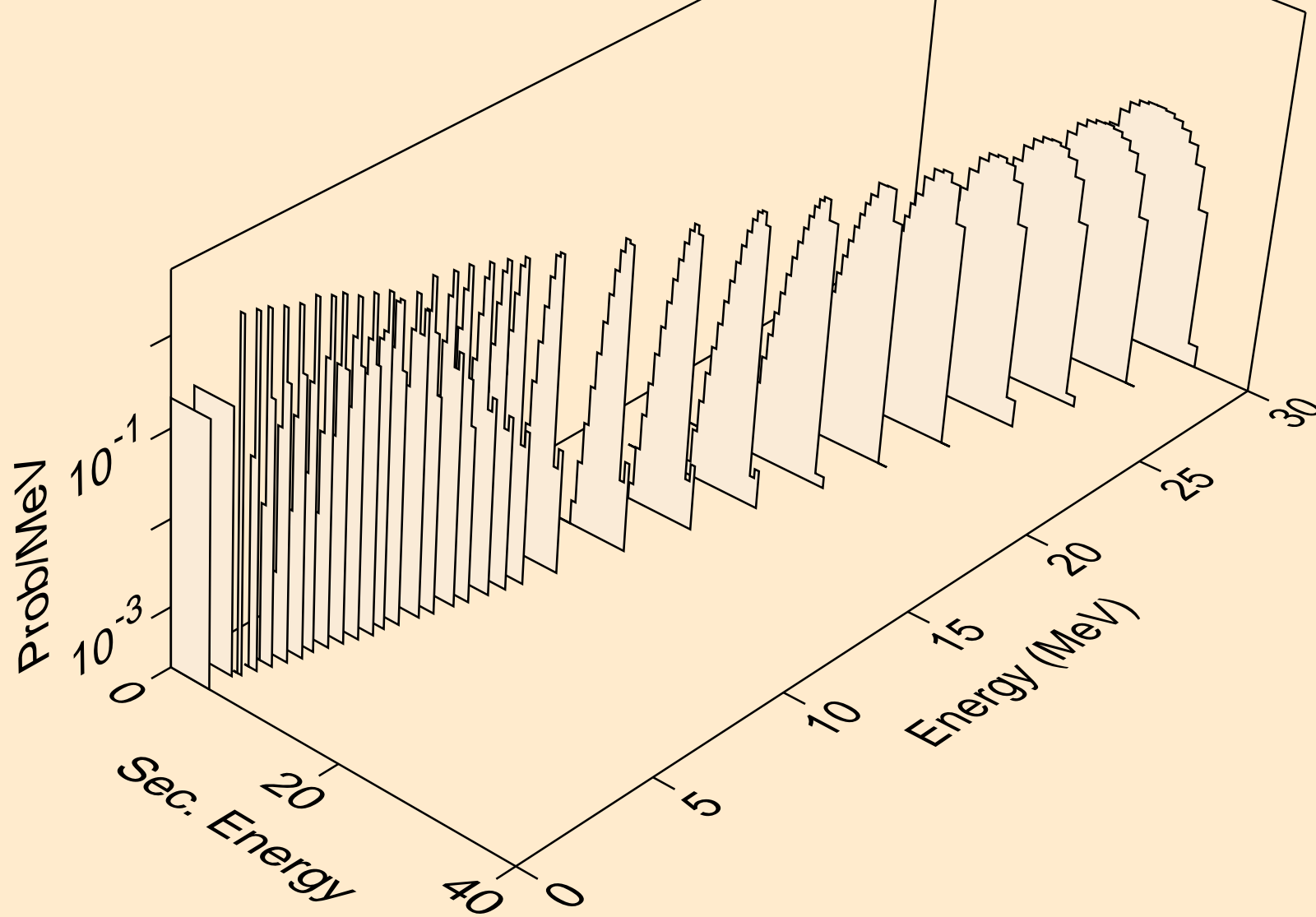

TL183 NEUTRON ACER TENDL-2024 LIBRARY; T=0.K
alphas from (n,x)

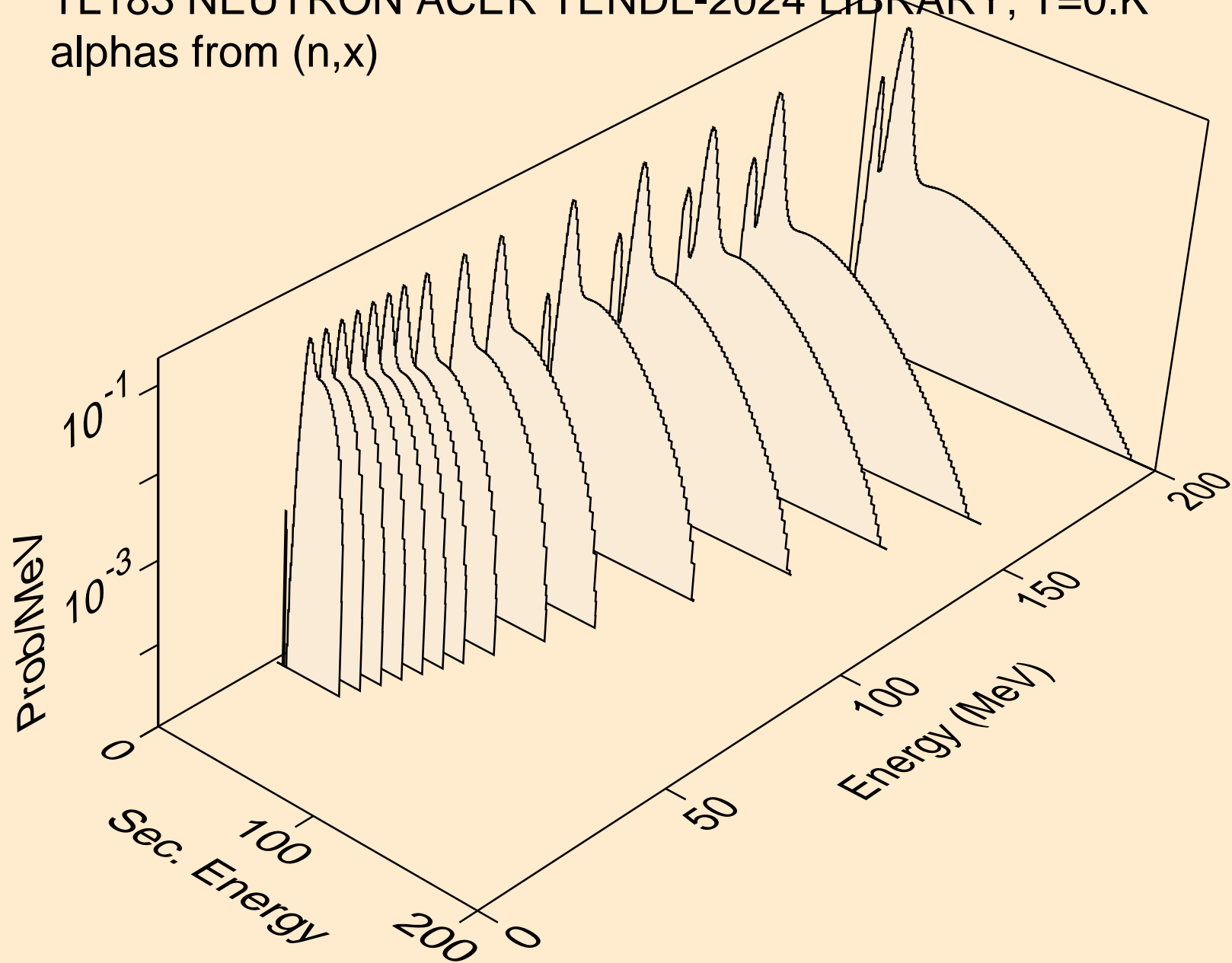

TL183 NEUTRON ACER TENDL-2024 LIBRARY; T=0.K
alphas from (n,n*)a

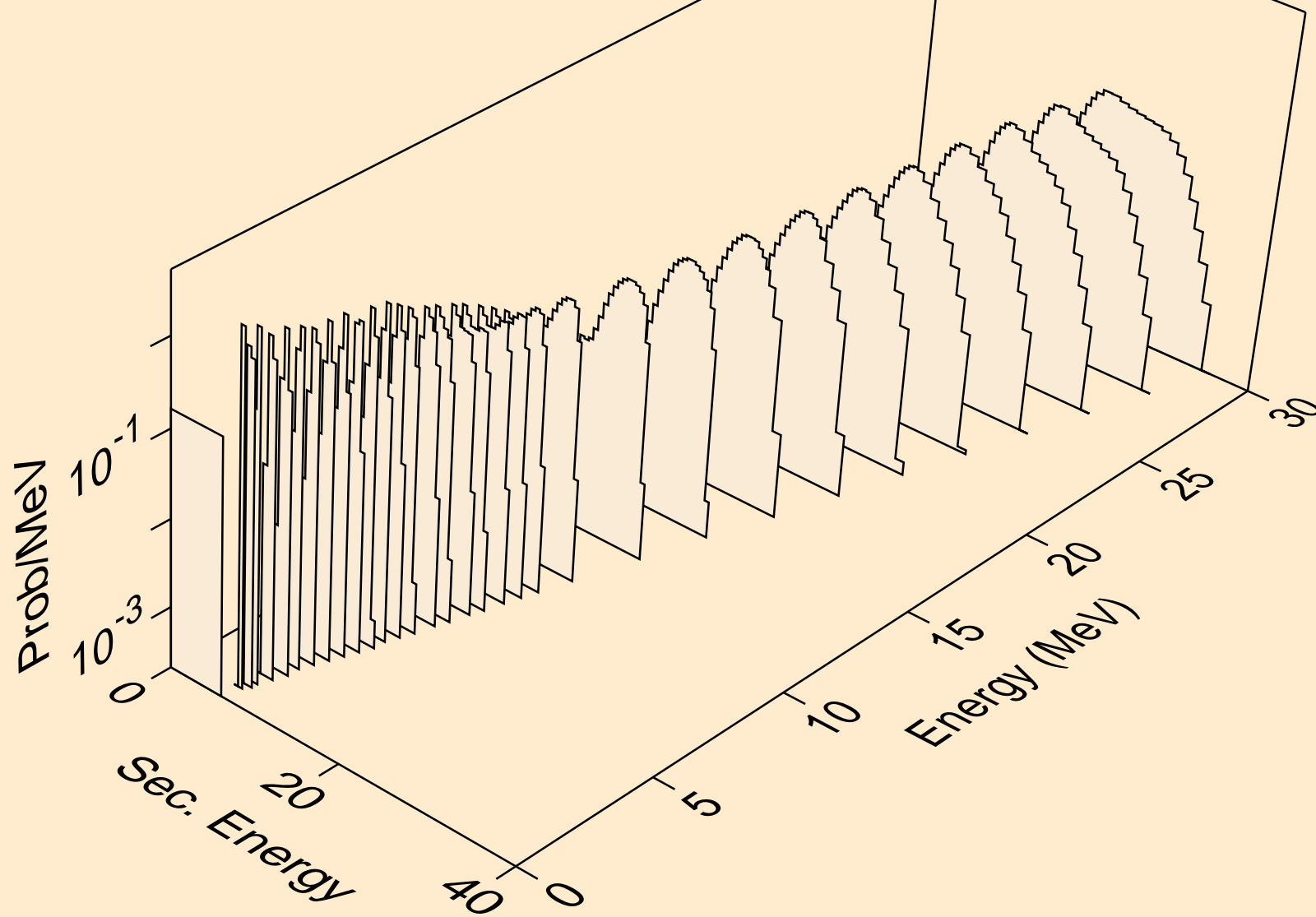

TL183 NEUTRON ACER TENDL-2024 LIBRARY; T=0.K
alphas from (n,n*)3a

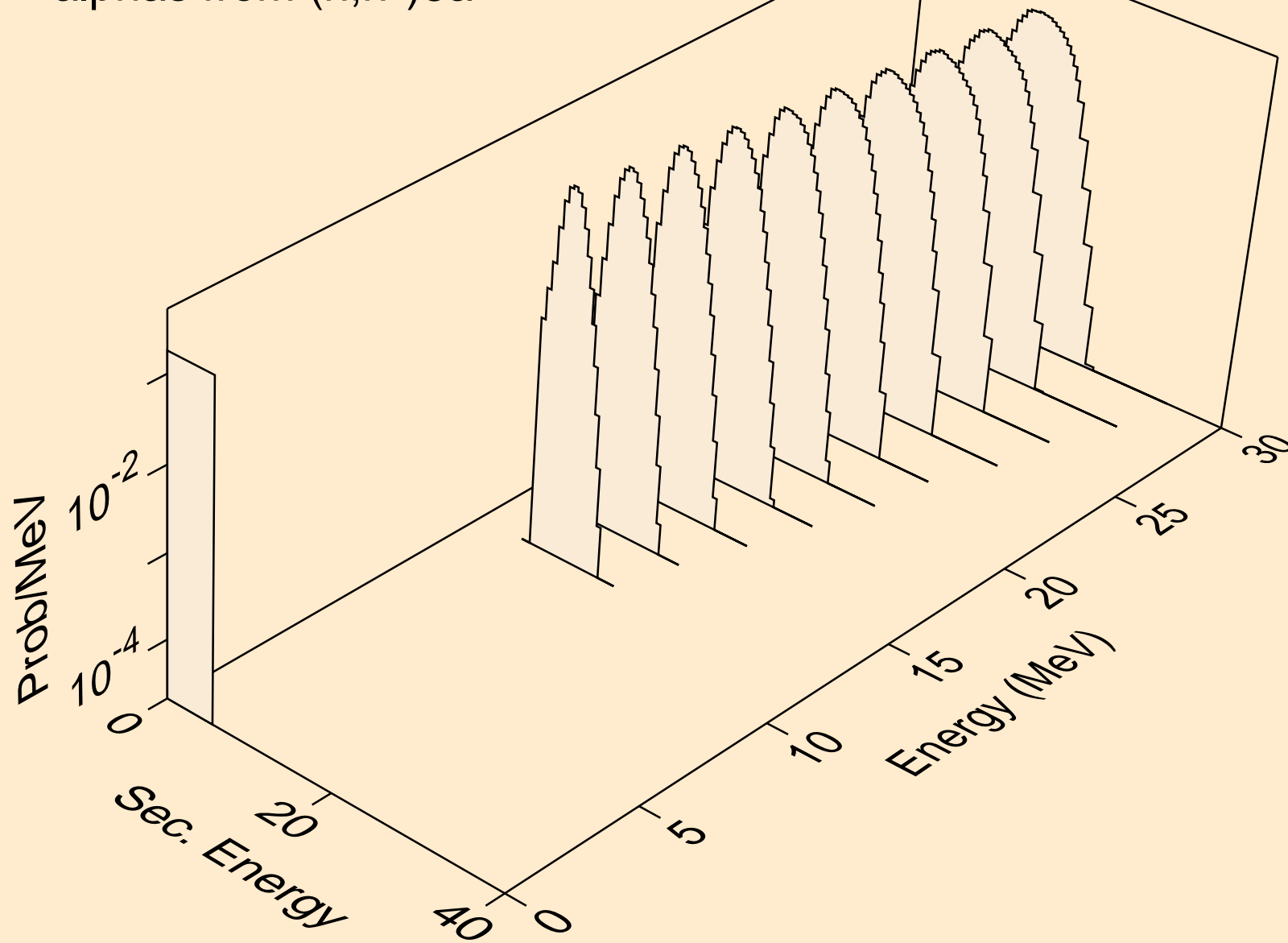

TL183 NEUTRON ACER TENDL-2024 LIBRARY; T=0.K
alphas from (n,2n)a

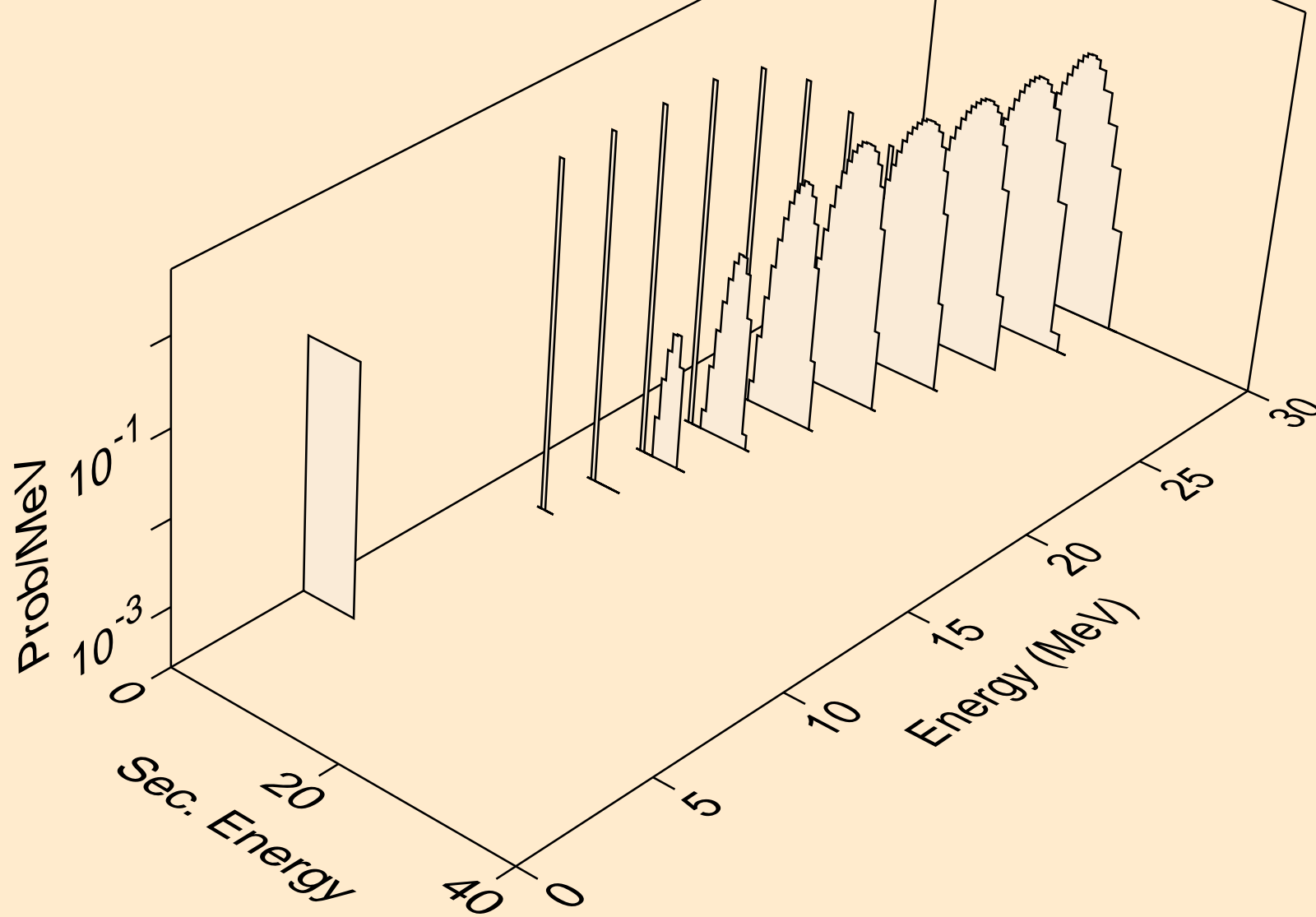

TL183 NEUTRON ACER TENDL-2024 LIBRARY; T=0.K
alphas from (n,3n)a

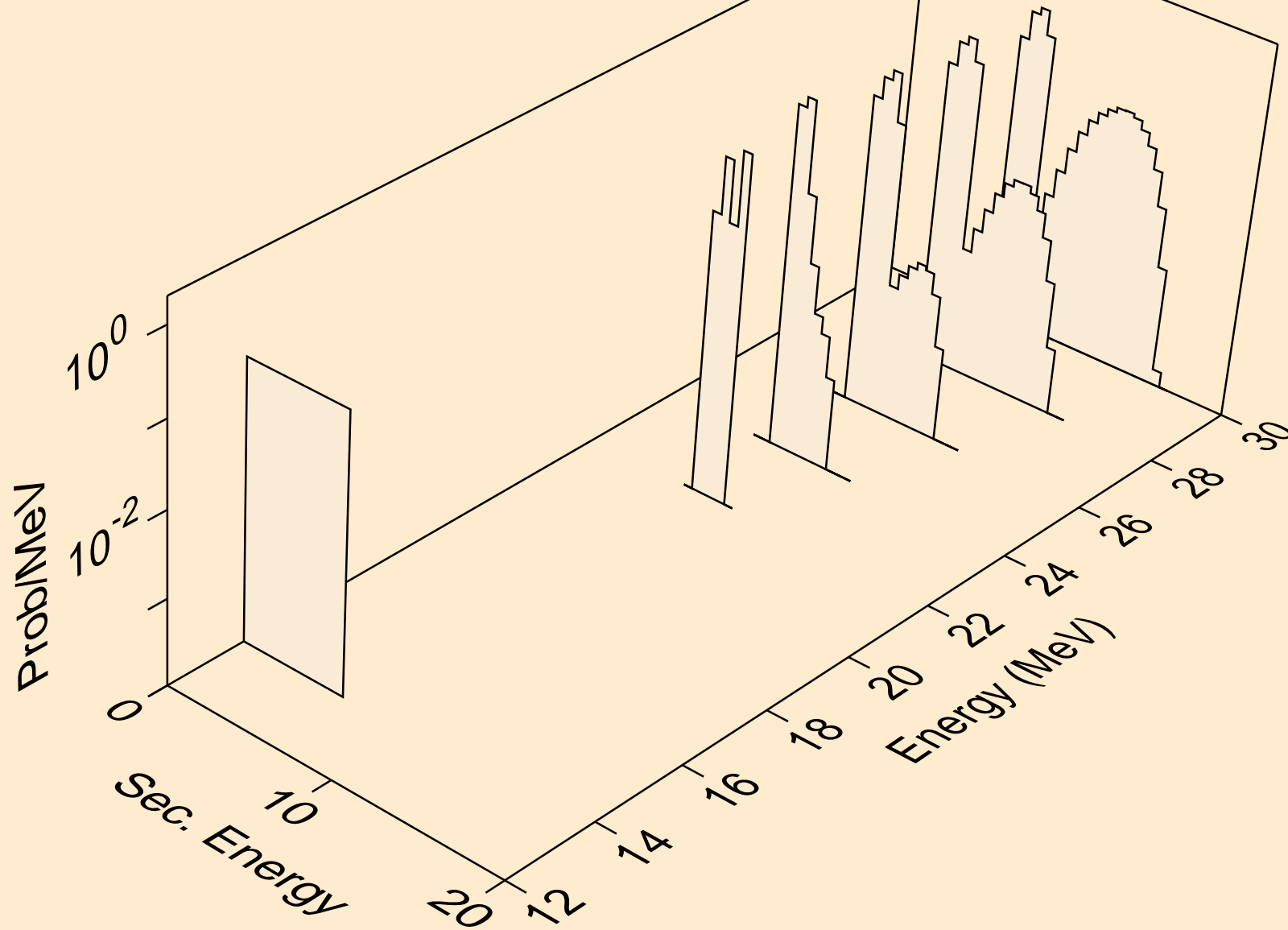

TL183 NEUTRON ACER TENDL-2024 LIBRARY; T=0.K
alphas from (n,n*)2a

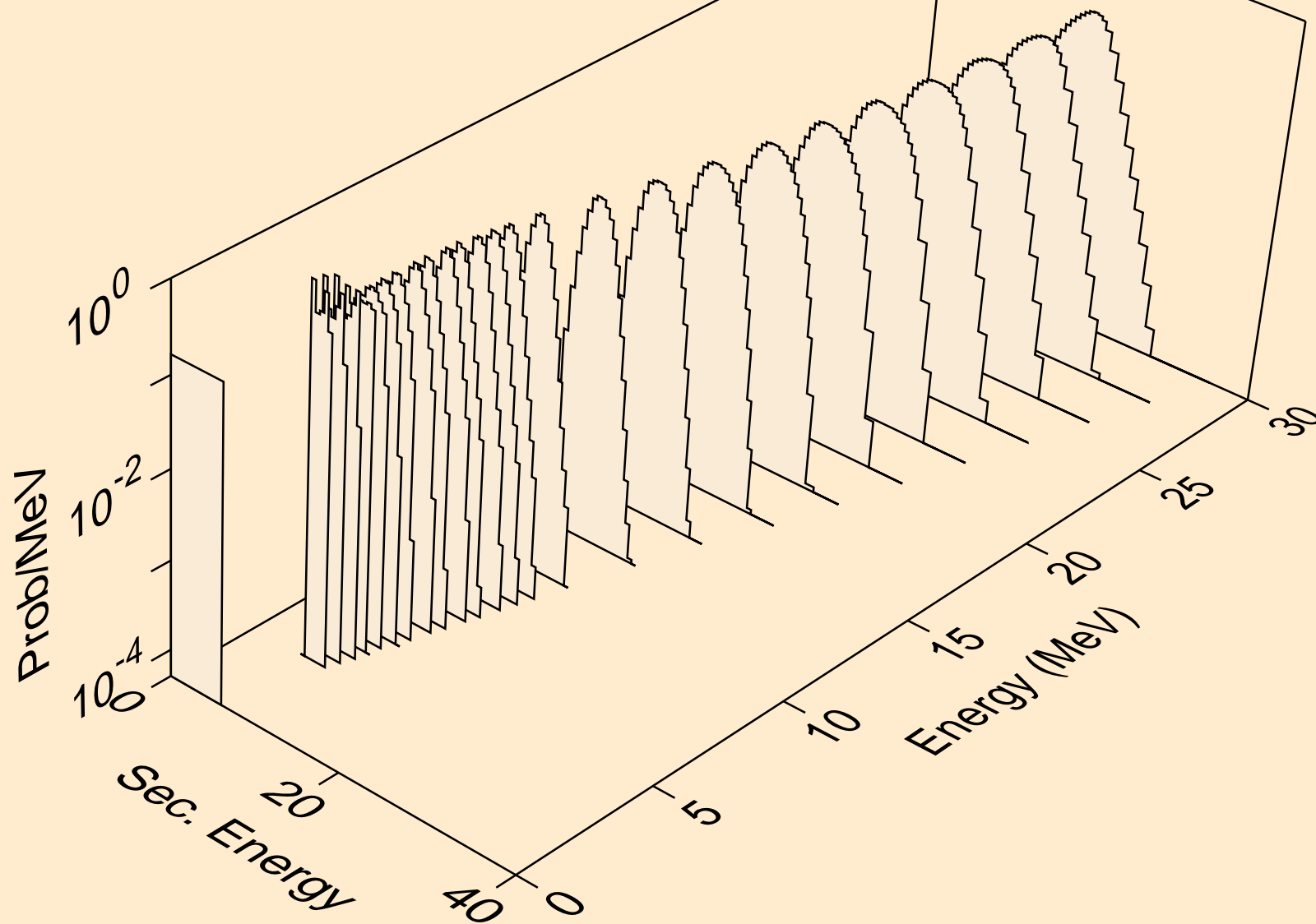

TL183 NEUTRON ACER TENDL-2024 LIBRARY; T=0.K
alphas from (n,2n)2a

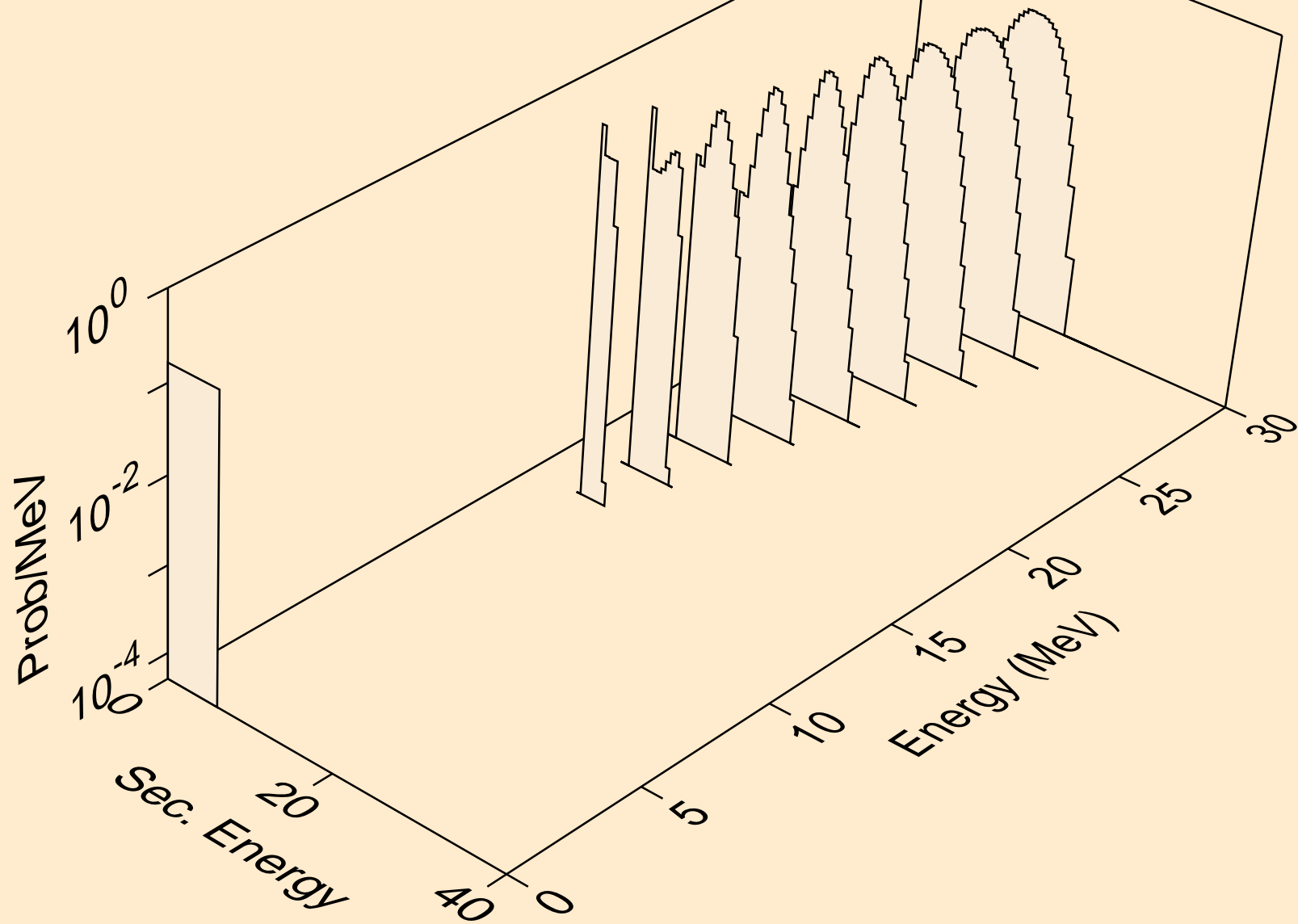

TL183 NEUTRON ACER TENDL-2024 LIBRARY; T=0.K
alphas from (n,npa)

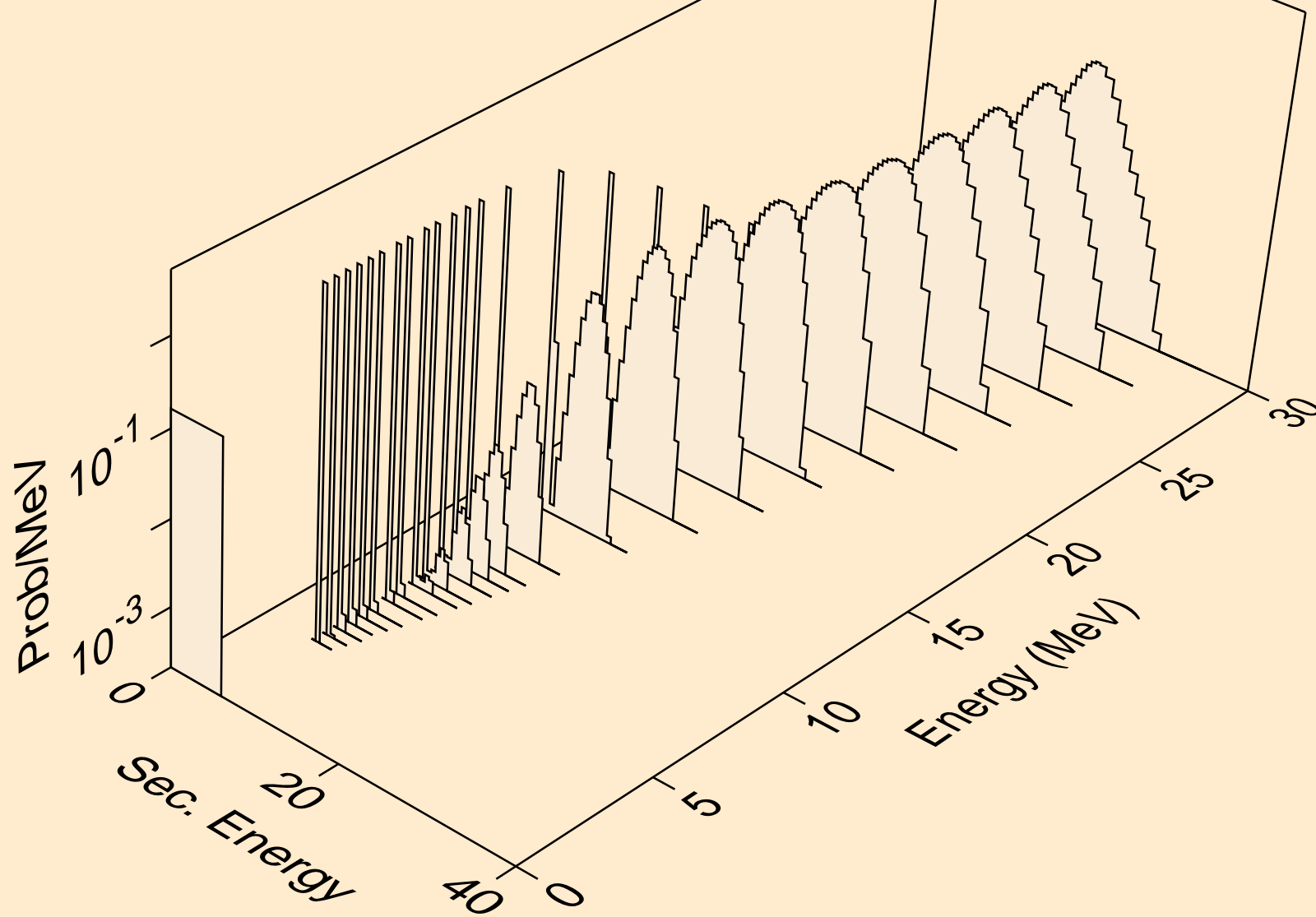

TL183 NEUTRON ACER TENDL-2024 LIBRARY; T=0.K
alphas from (n,a)

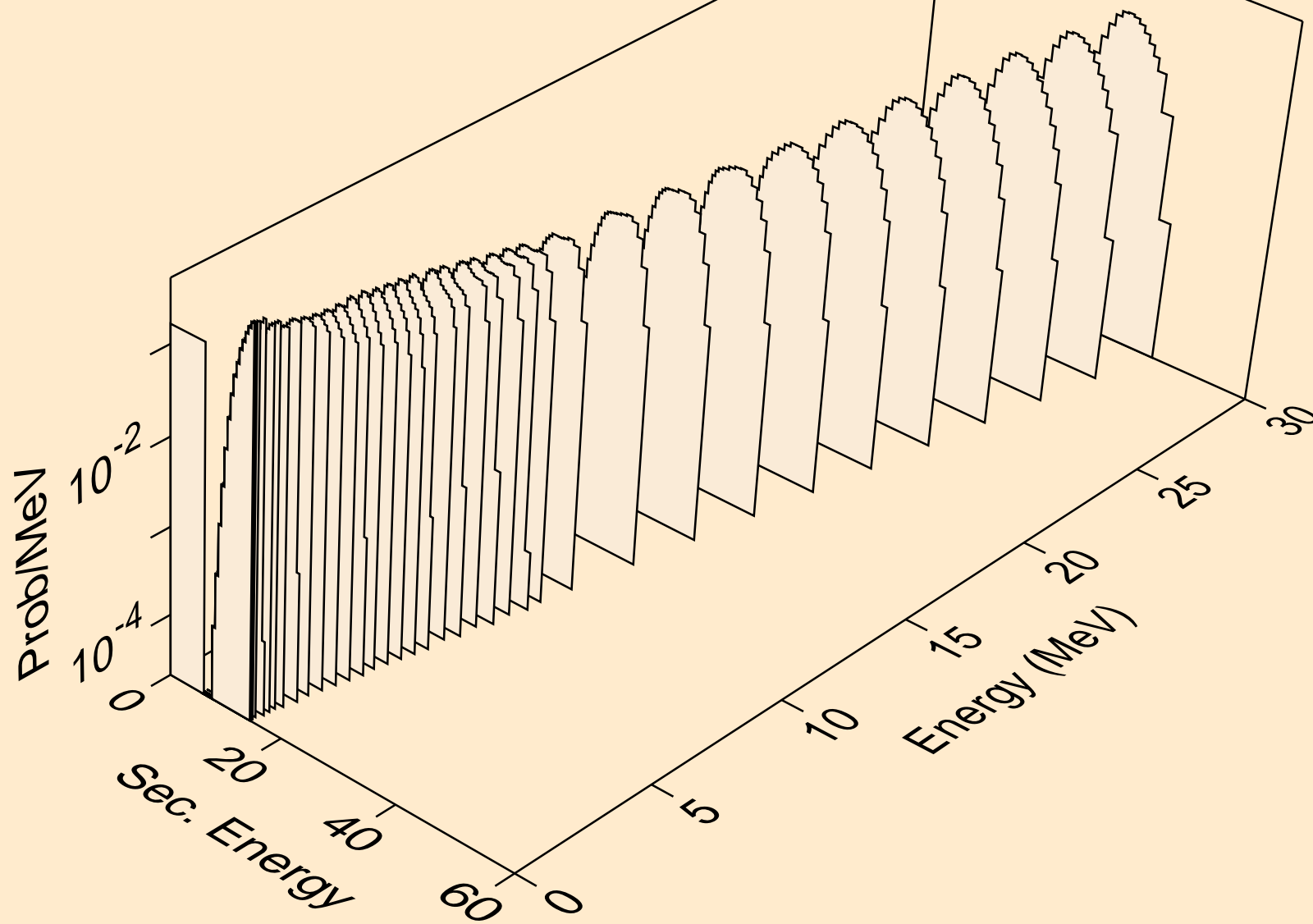

TL183 NEUTRON ACER TENDL-2024 LIBRARY; T=0.K
alphas from (n,2a)

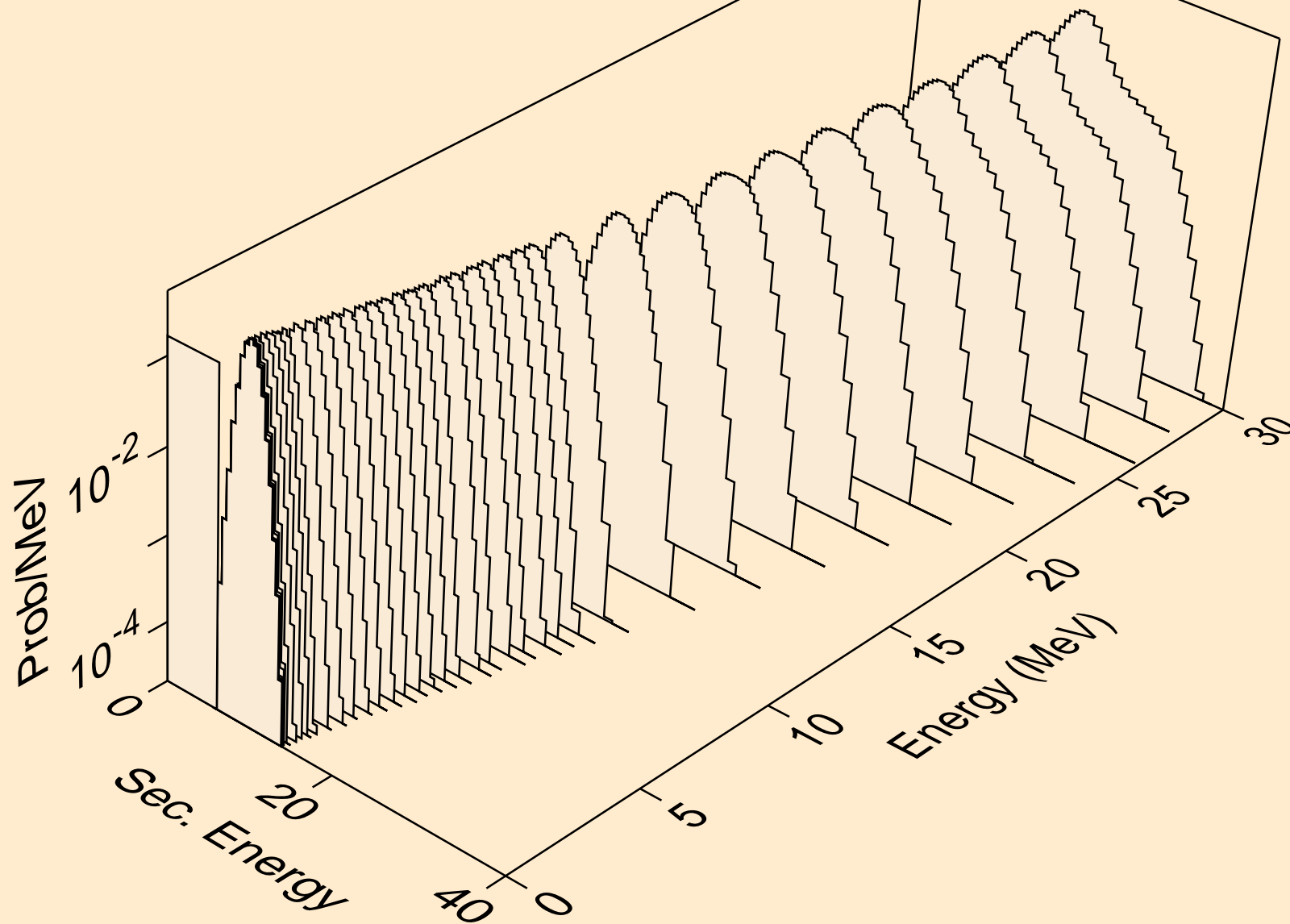

TL183 NEUTRON ACER TENDL-2024 LIBRARY; T=0.K
alphas from (n,3a)

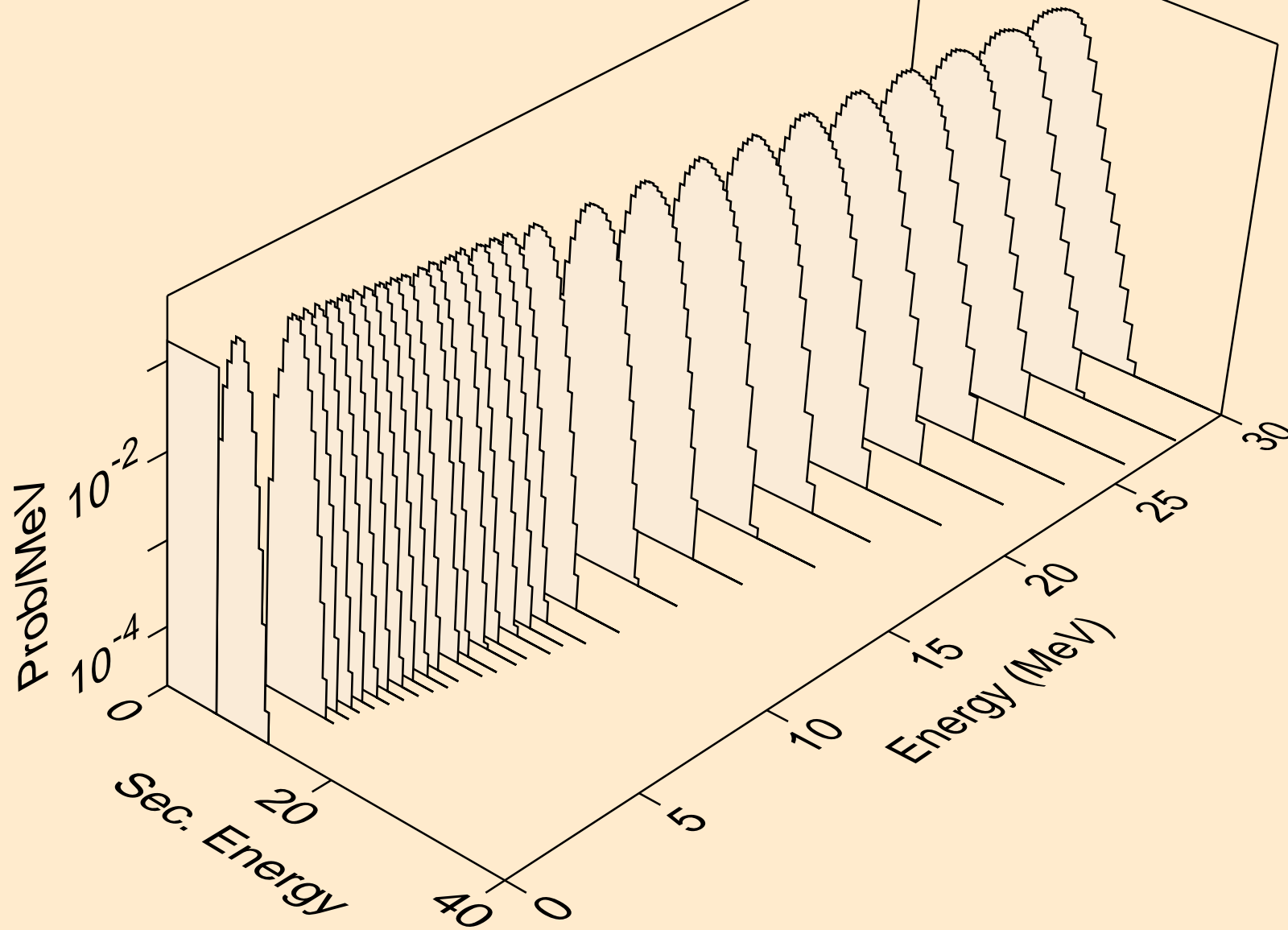

TL183 NEUTRON ACER TENDL-2024 LIBRARY; T=0.K
alphas from (n,pa)

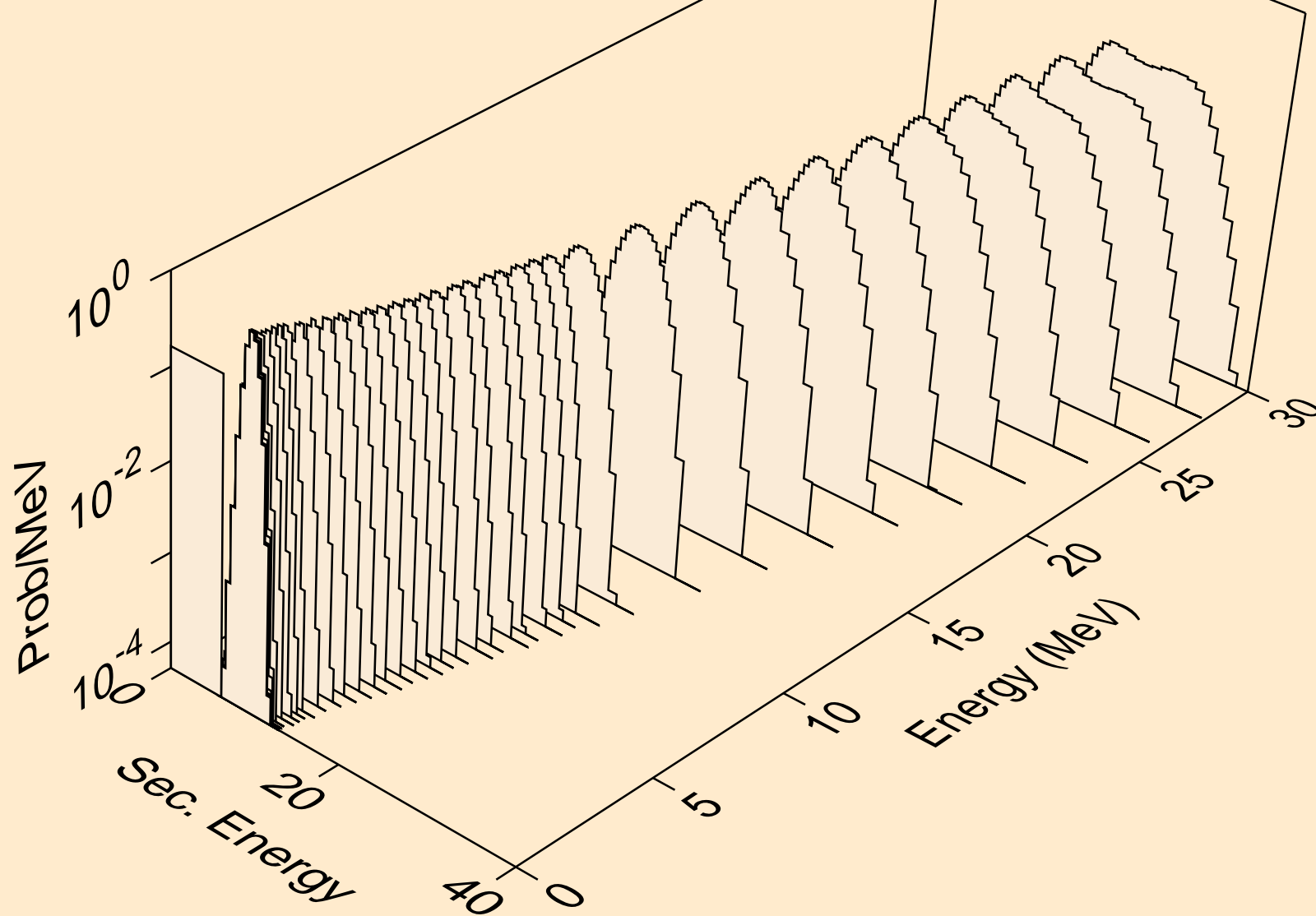

TL183 NEUTRON ACER TENDL-2024 LIBRARY; T=0.K
alphas from (n,d2a)

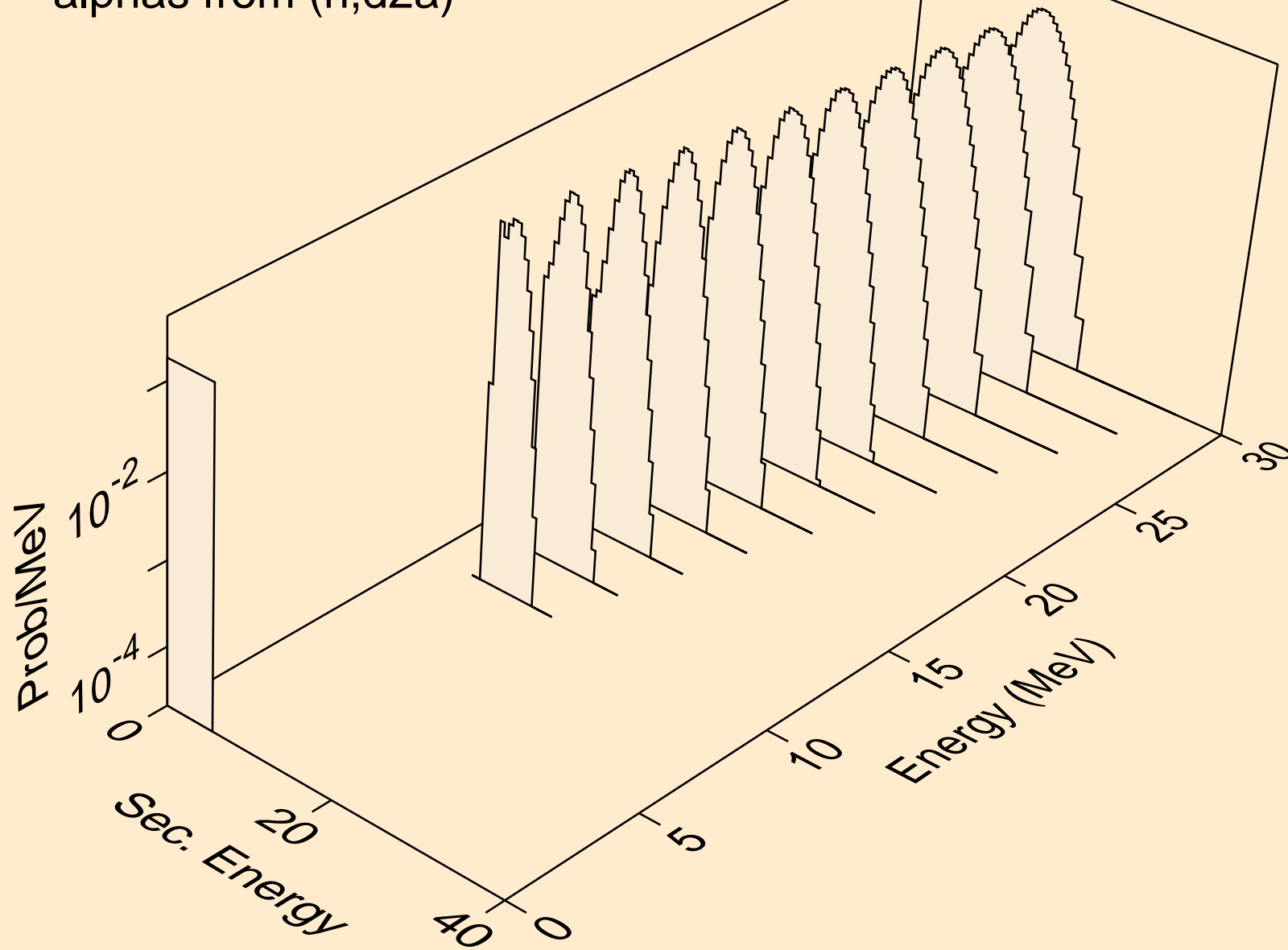

TL183 NEUTRON ACER TENDL-2024 LIBRARY; T=0.K
alphas from (n,da)

