

# XE127M NEUTRON ACER TENDL-2024 LIBRARY; T=0.K

## Principal cross sections

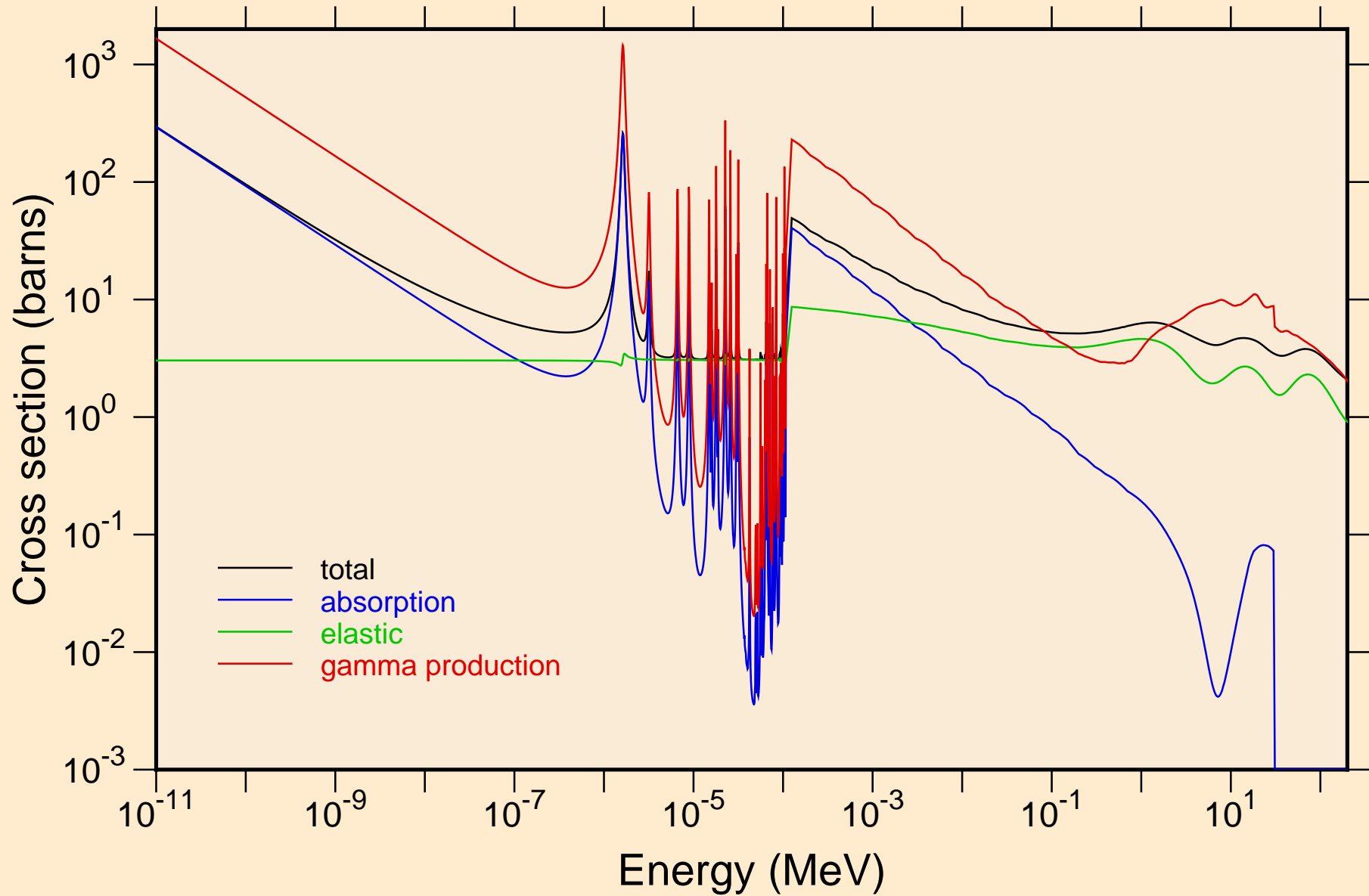

XE127M NEUTRON ACER TENDL-2024 LIBRARY; T=0.K  
resonance total cross section

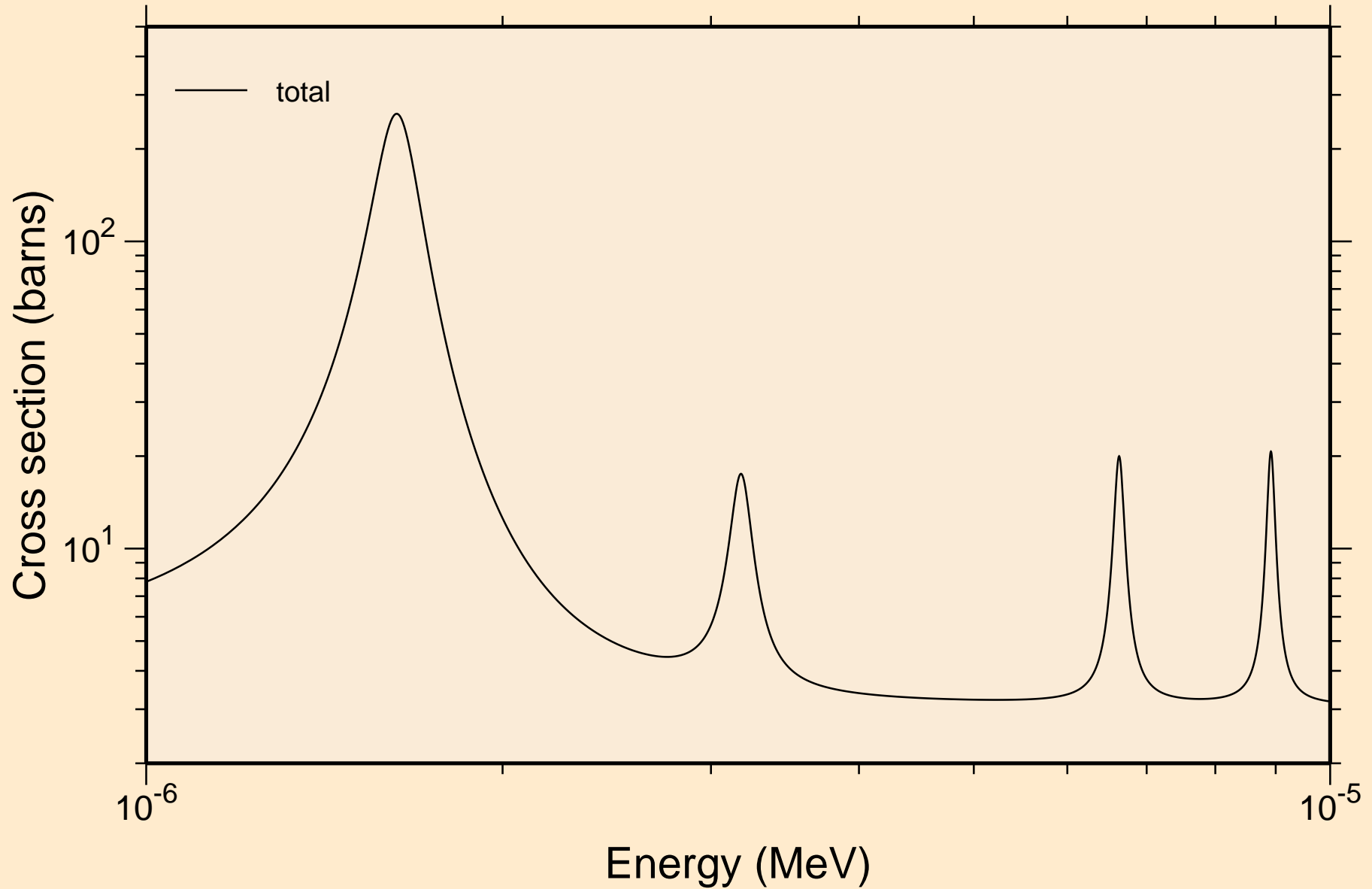

XE127M NEUTRON ACER TENDL-2024 LIBRARY; T=0.K  
resonance total cross section

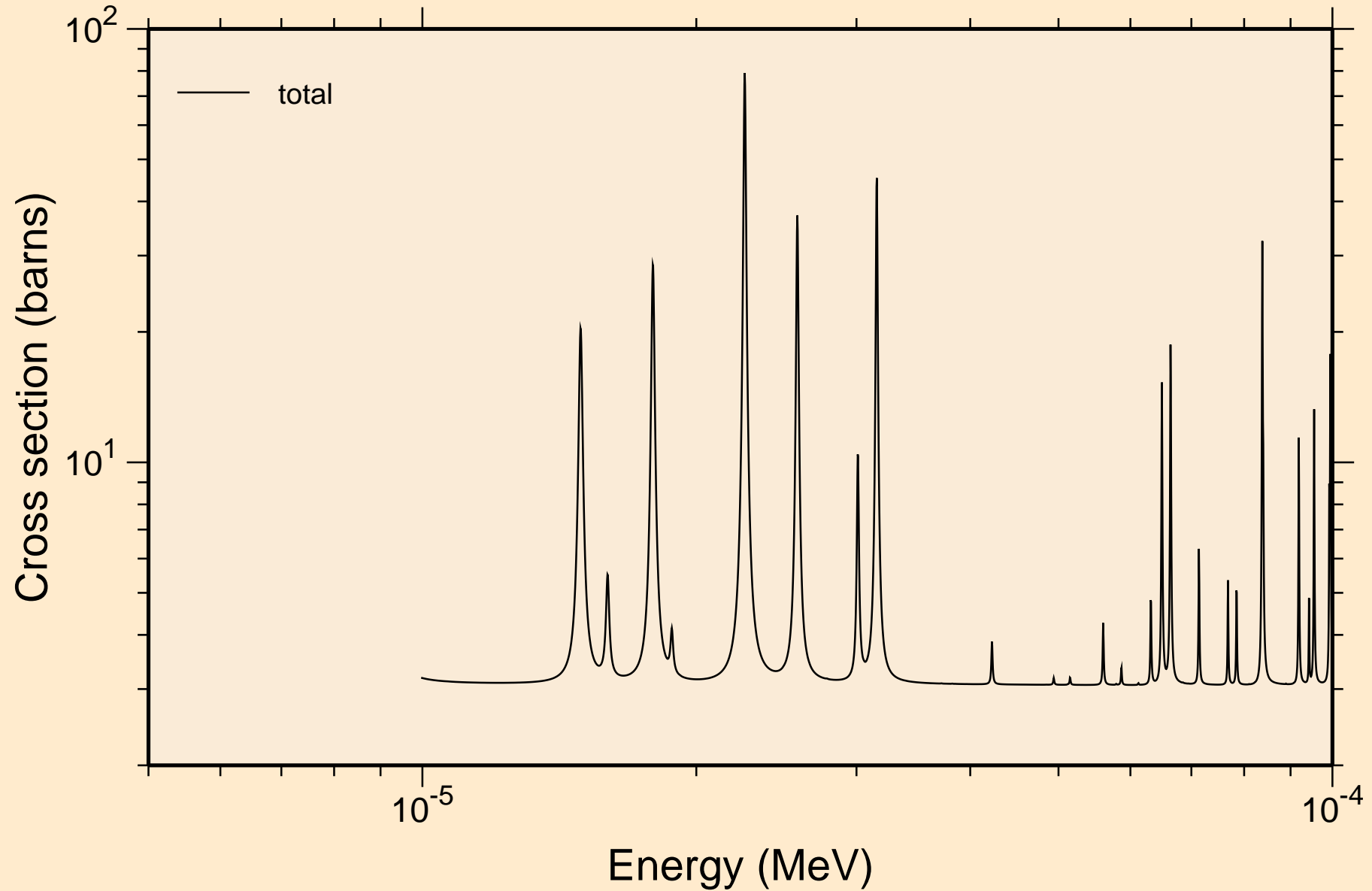

XE127M NEUTRON ACER TENDL-2024 LIBRARY; T=0.K  
resonance total cross section

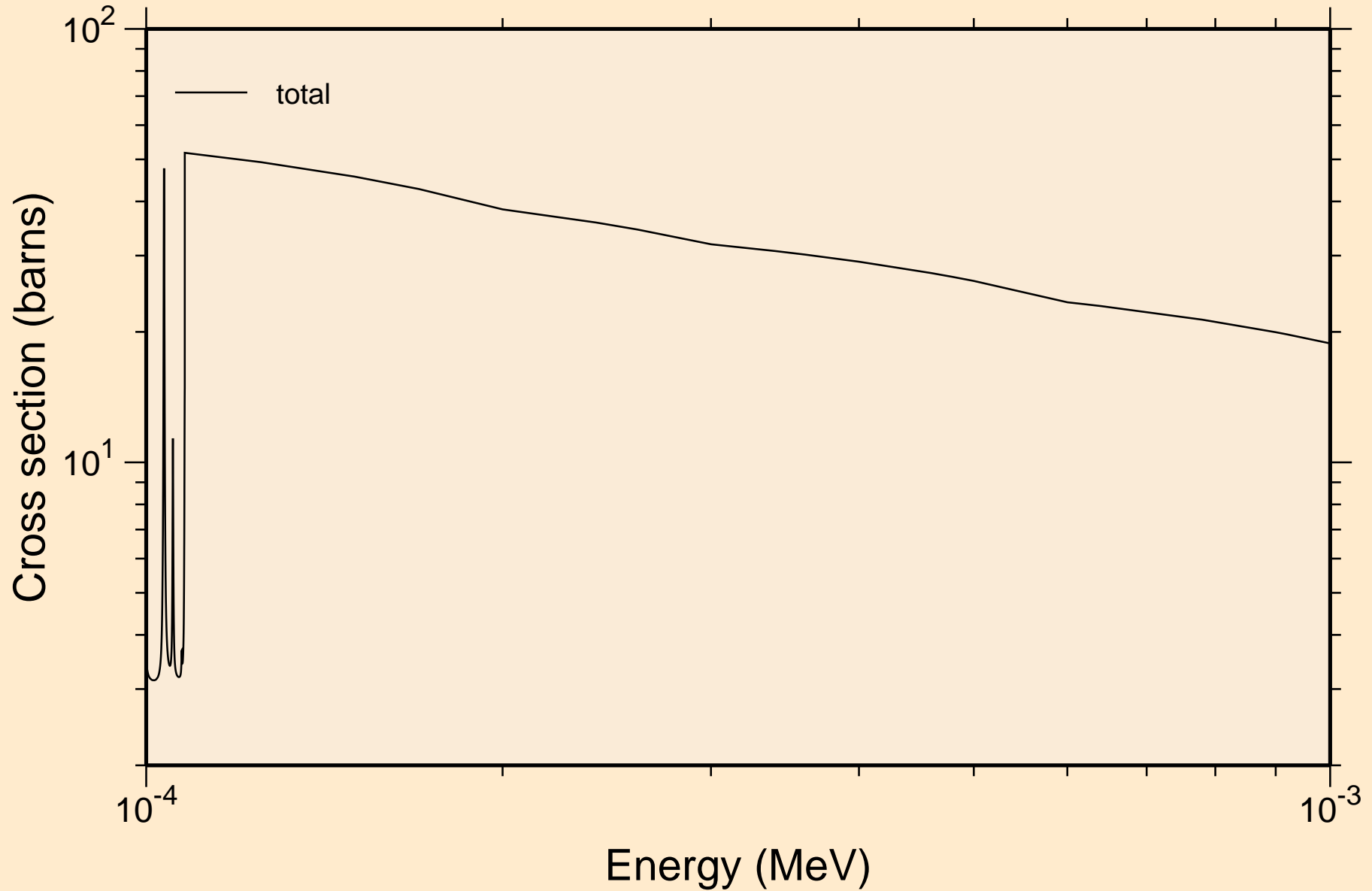

XE127M NEUTRON ACER TENDL-2024 LIBRARY; T=0.K  
resonance total cross section

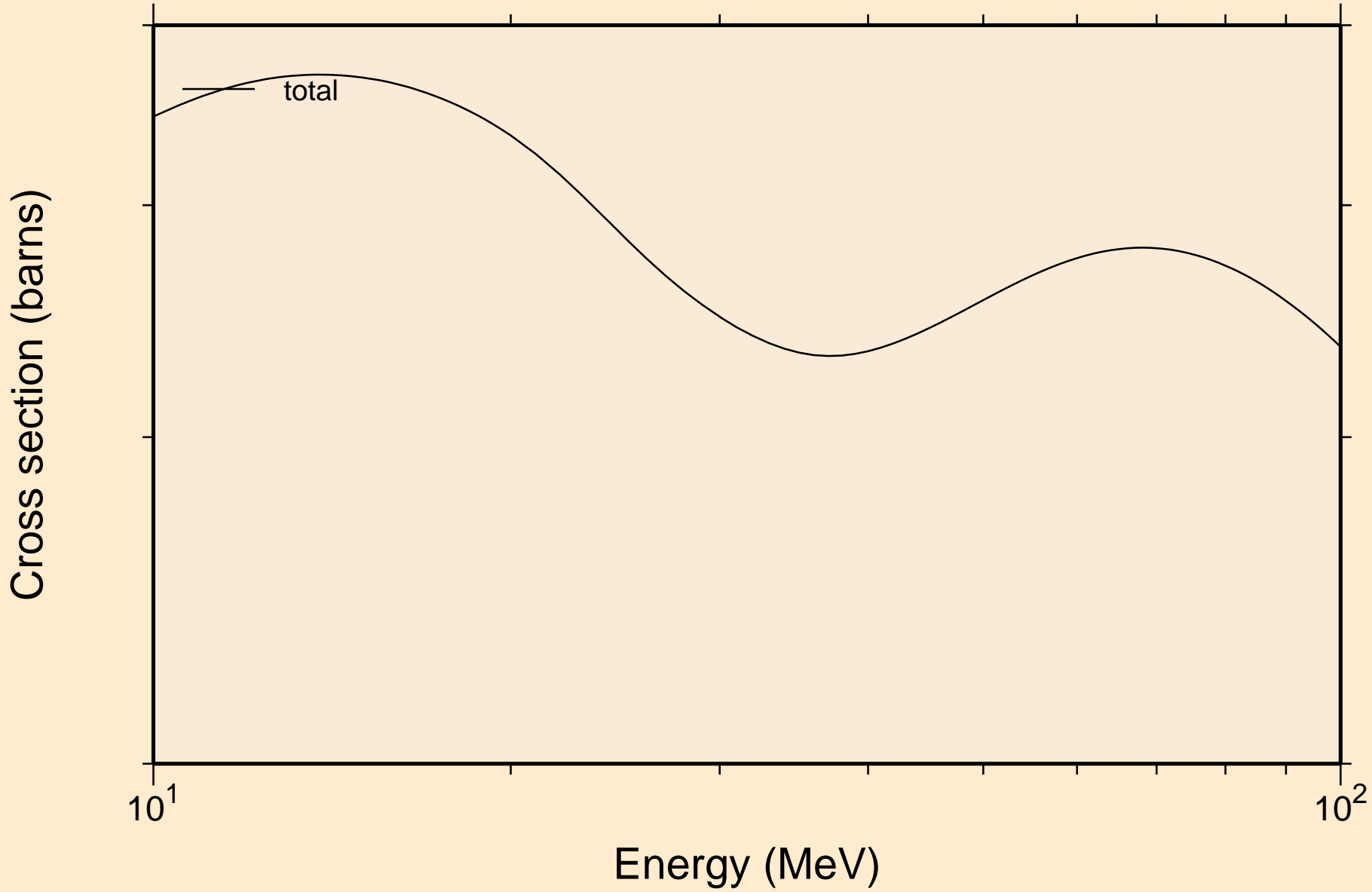

XE127M NEUTRON ACER TENDL-2024 LIBRARY; T=0.K  
resonance absorption cross sections

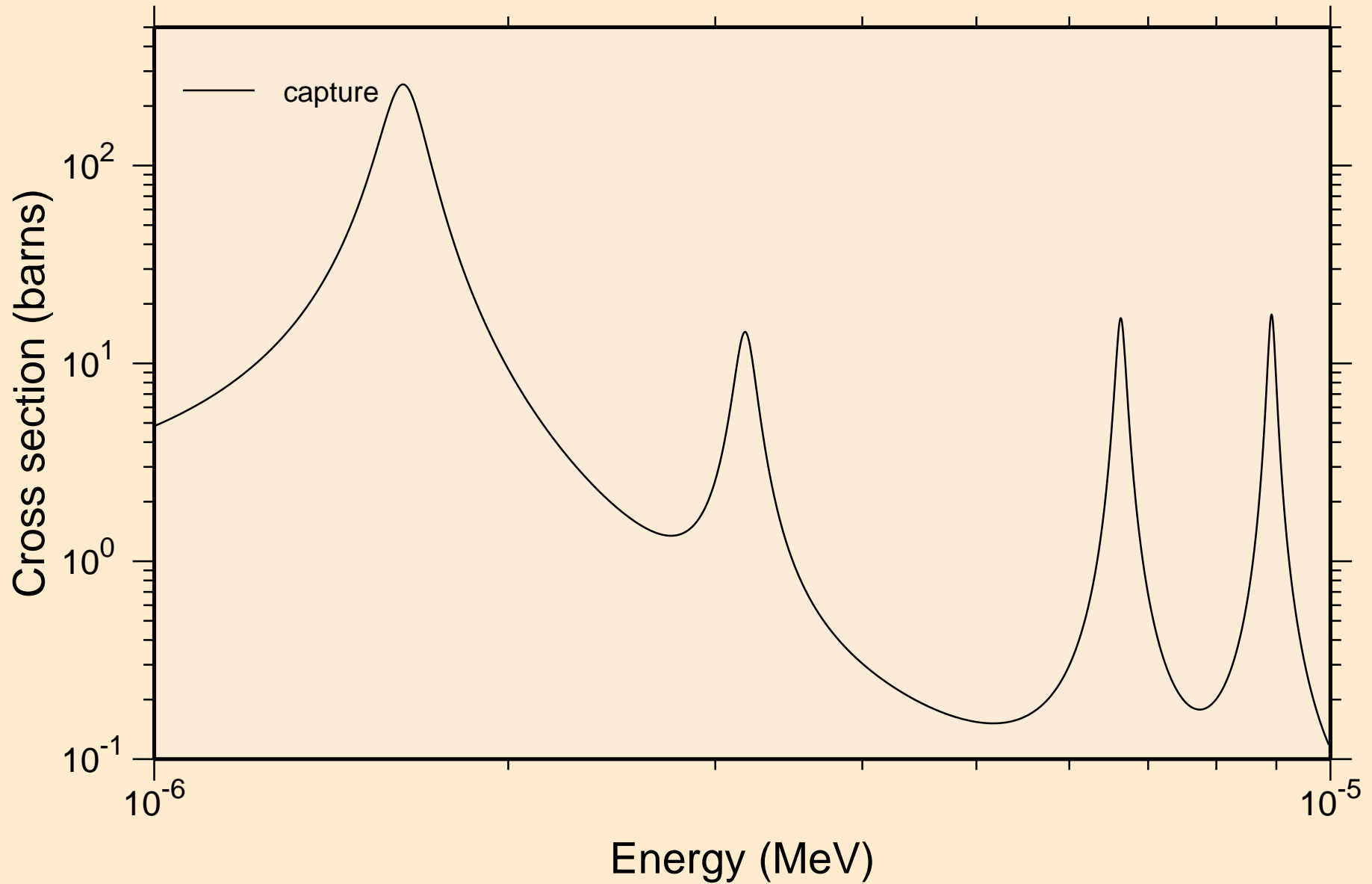

XE127M NEUTRON ACER TENDL-2024 LIBRARY; T=0.K  
resonance absorption cross sections

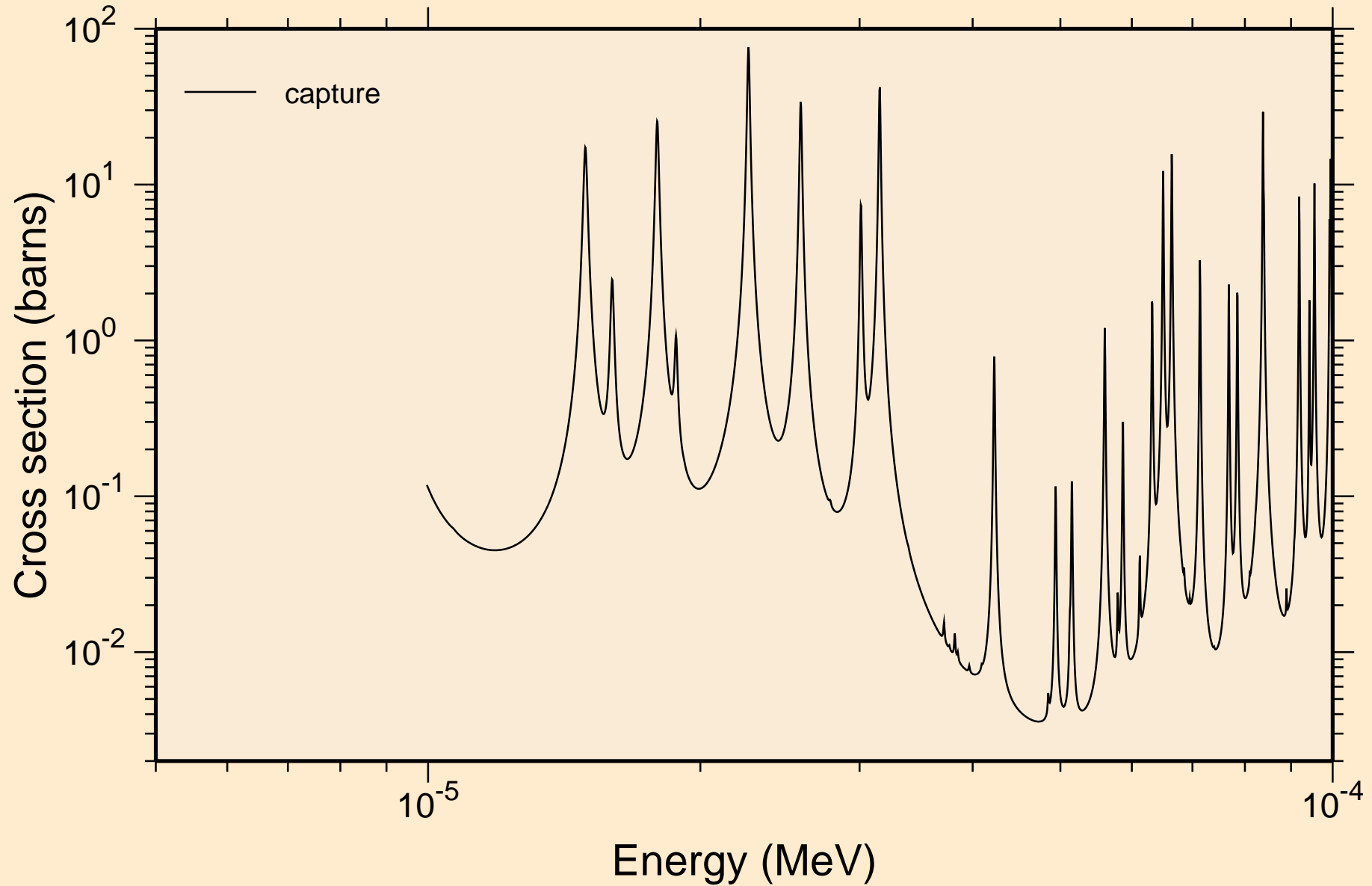

XE127M NEUTRON ACER TENDL-2024 LIBRARY; T=0.K  
resonance absorption cross sections

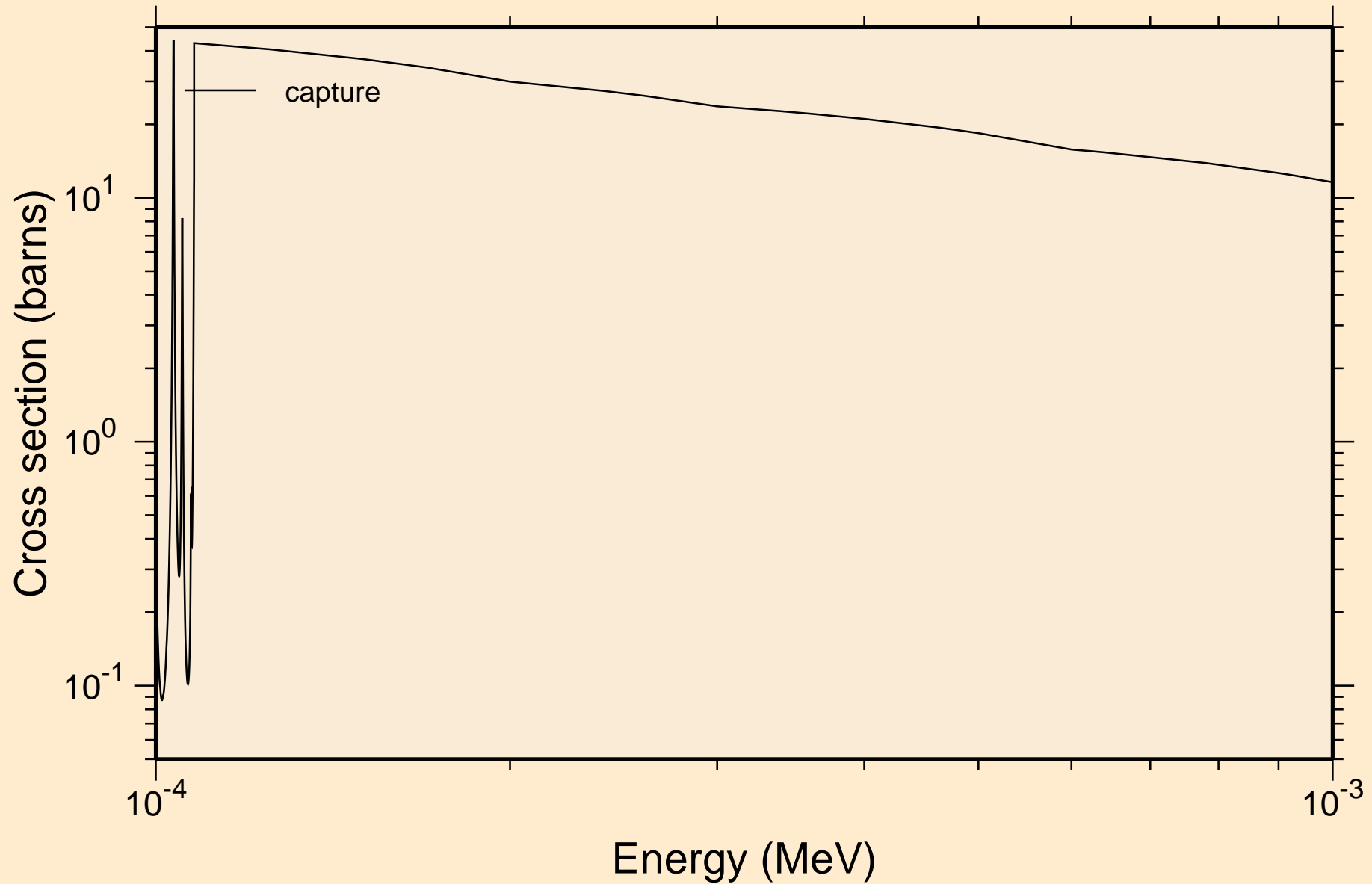



XE127M NEUTRON ACER TENDL-2024 LIBRARY; T=0.K  
resonance absorption cross sections

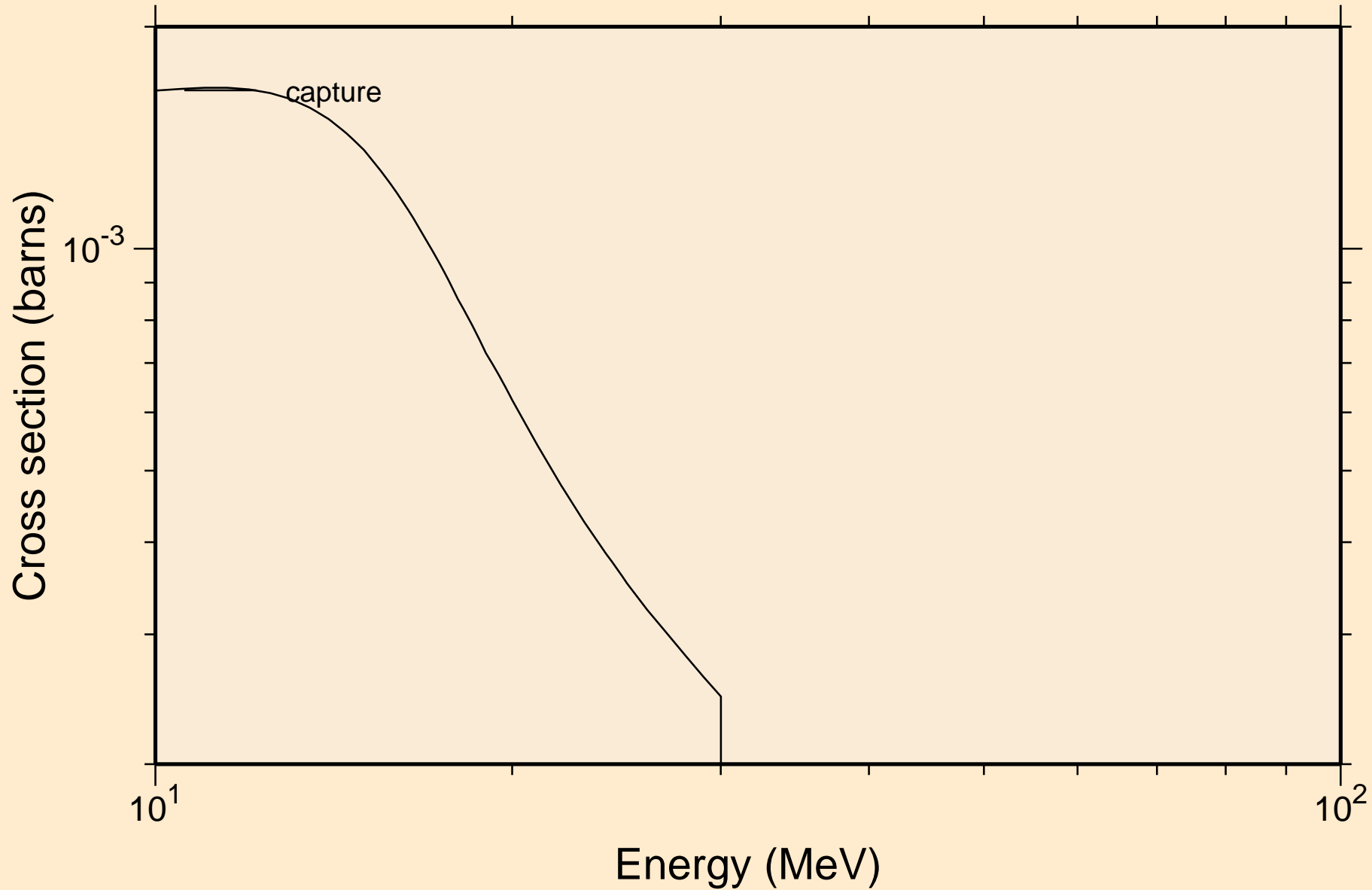

XE127M NEUTRON ACER TENDL-2024 LIBRARY; T=0.K  
Heating

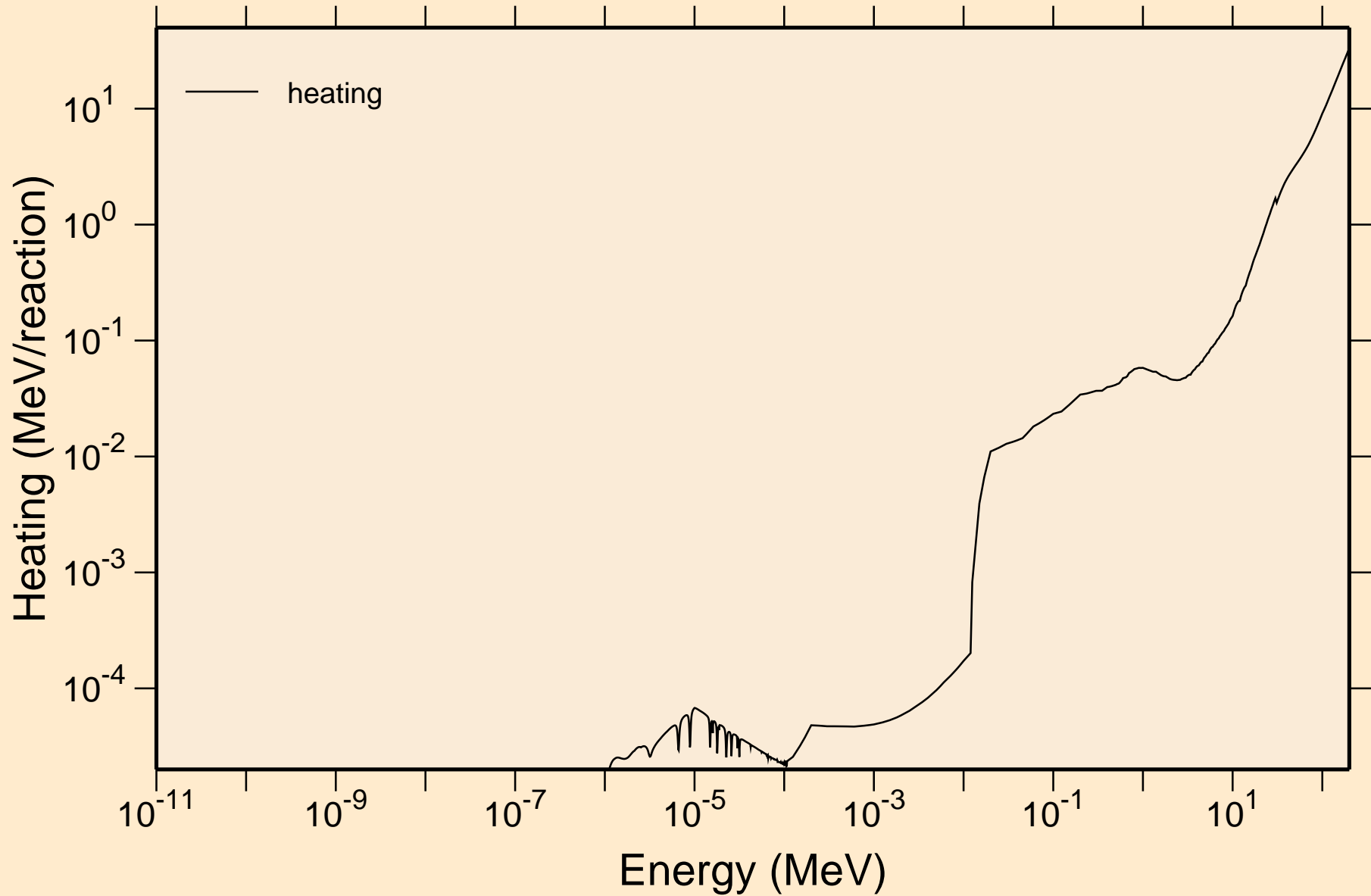

# XE127M NEUTRON ACER TENDL-2024 LIBRARY; T=0.K

## Damage

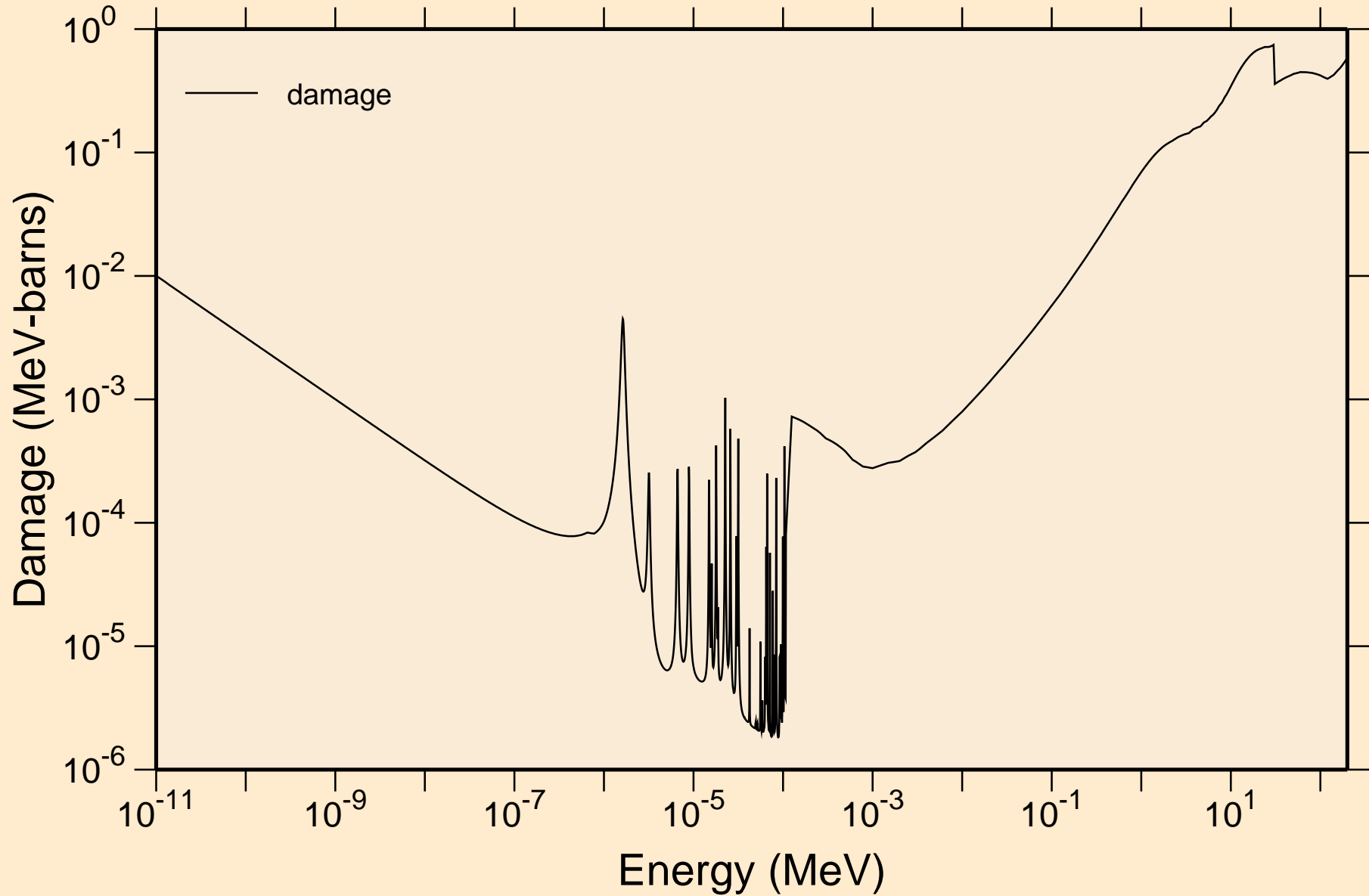

# XE127M NEUTRON ACER TENDL-2024 LIBRARY; T=0.K

## Non-threshold reactions

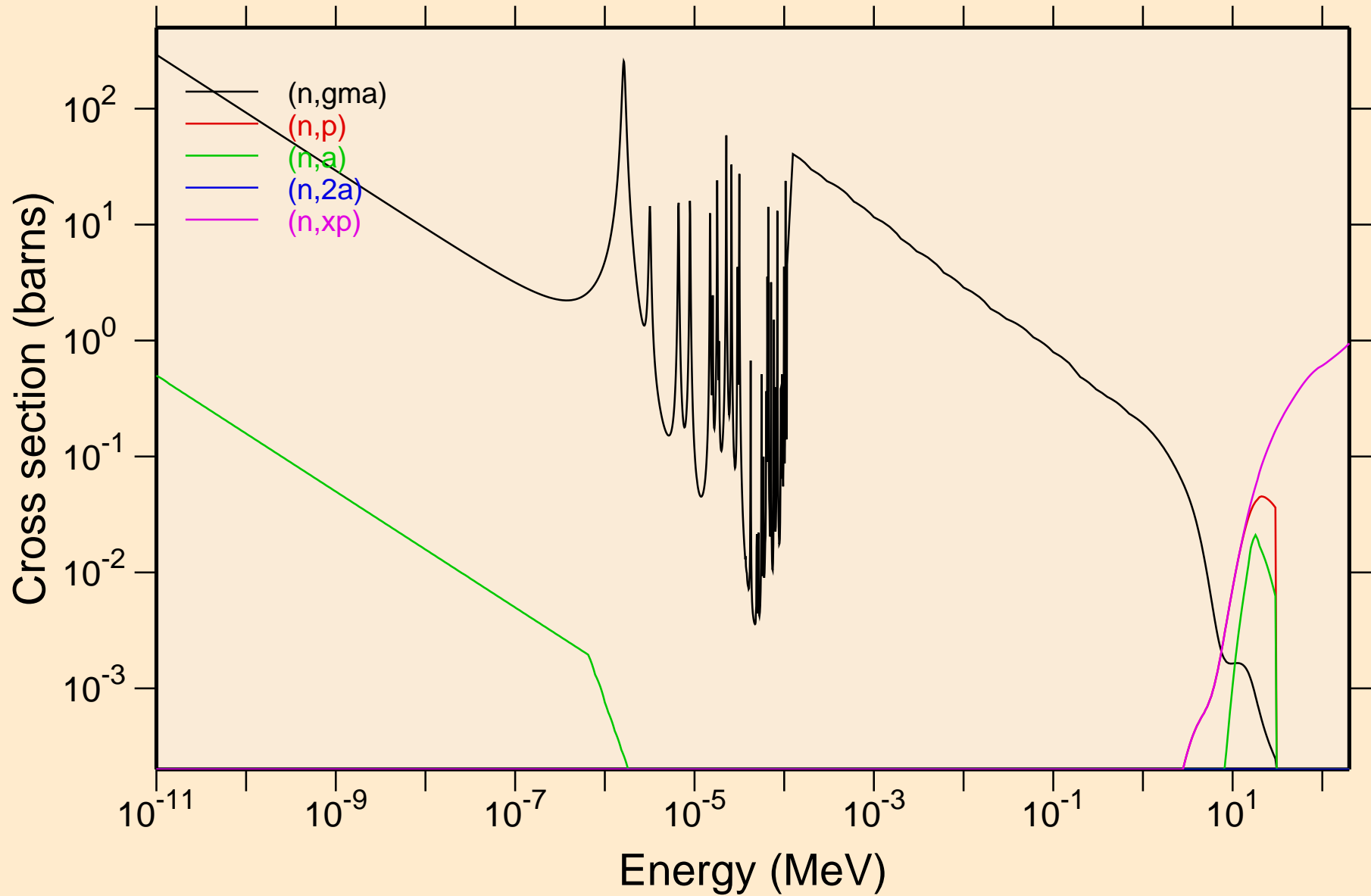

XE127M NEUTRON ACER TENDL-2024 LIBRARY; T=0.K  
Non-threshold reactions

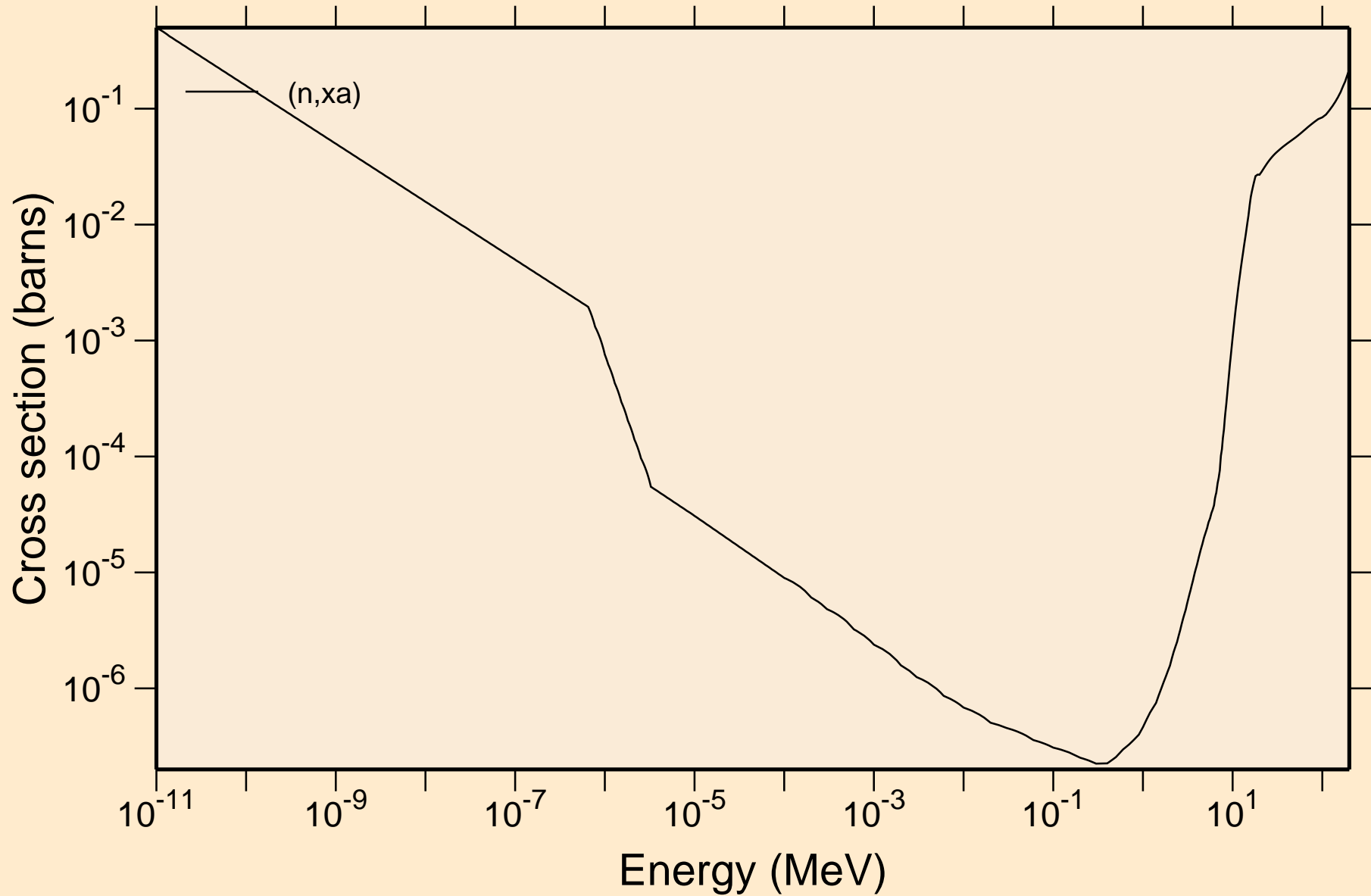

# XE127M NEUTRON ACER TENDL-2024 LIBRARY; T=0.K

## Principal cross sections

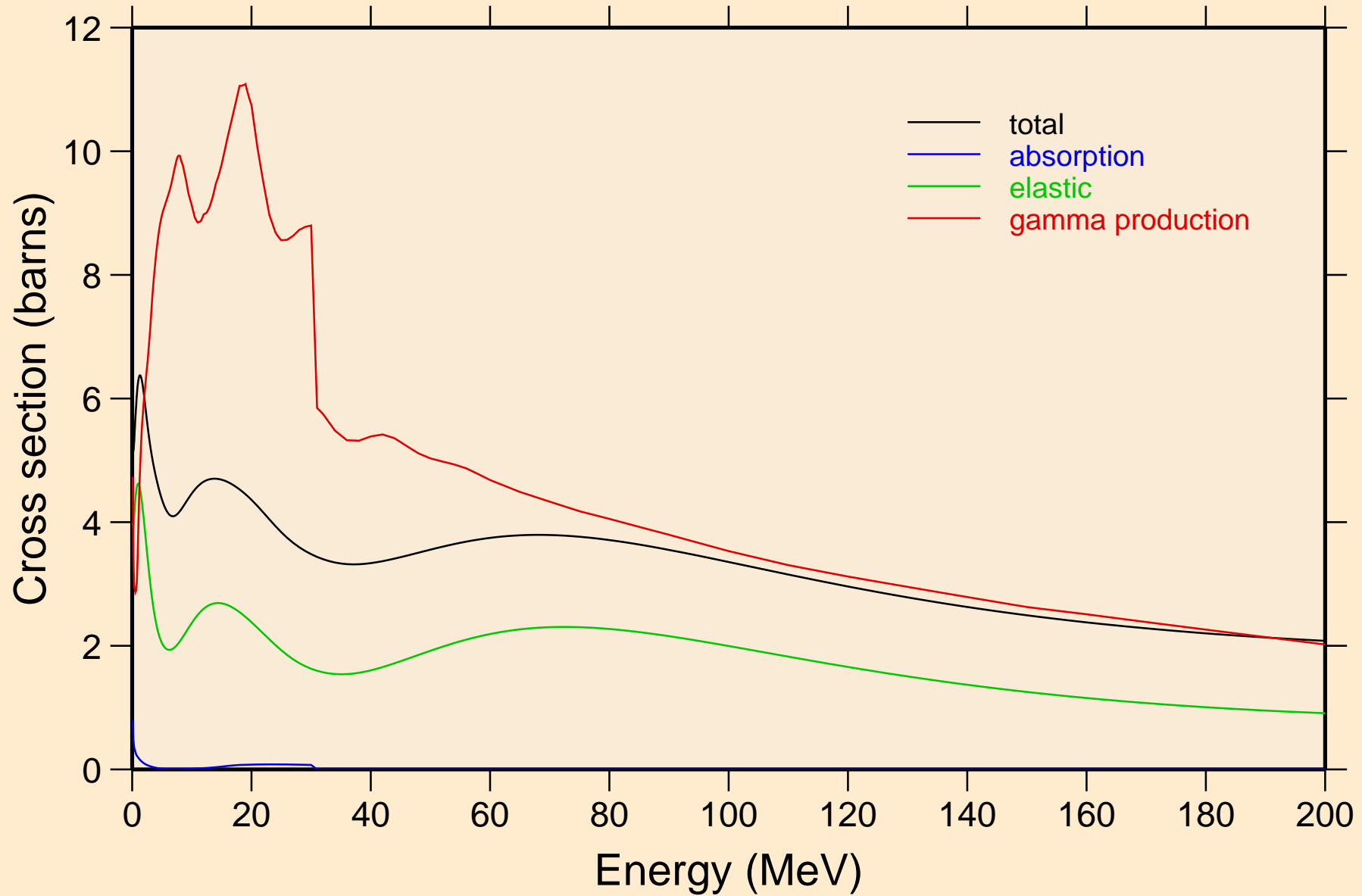

# XE127M NEUTRON ACER TENDL-2024 LIBRARY; T=0.K

## Heating

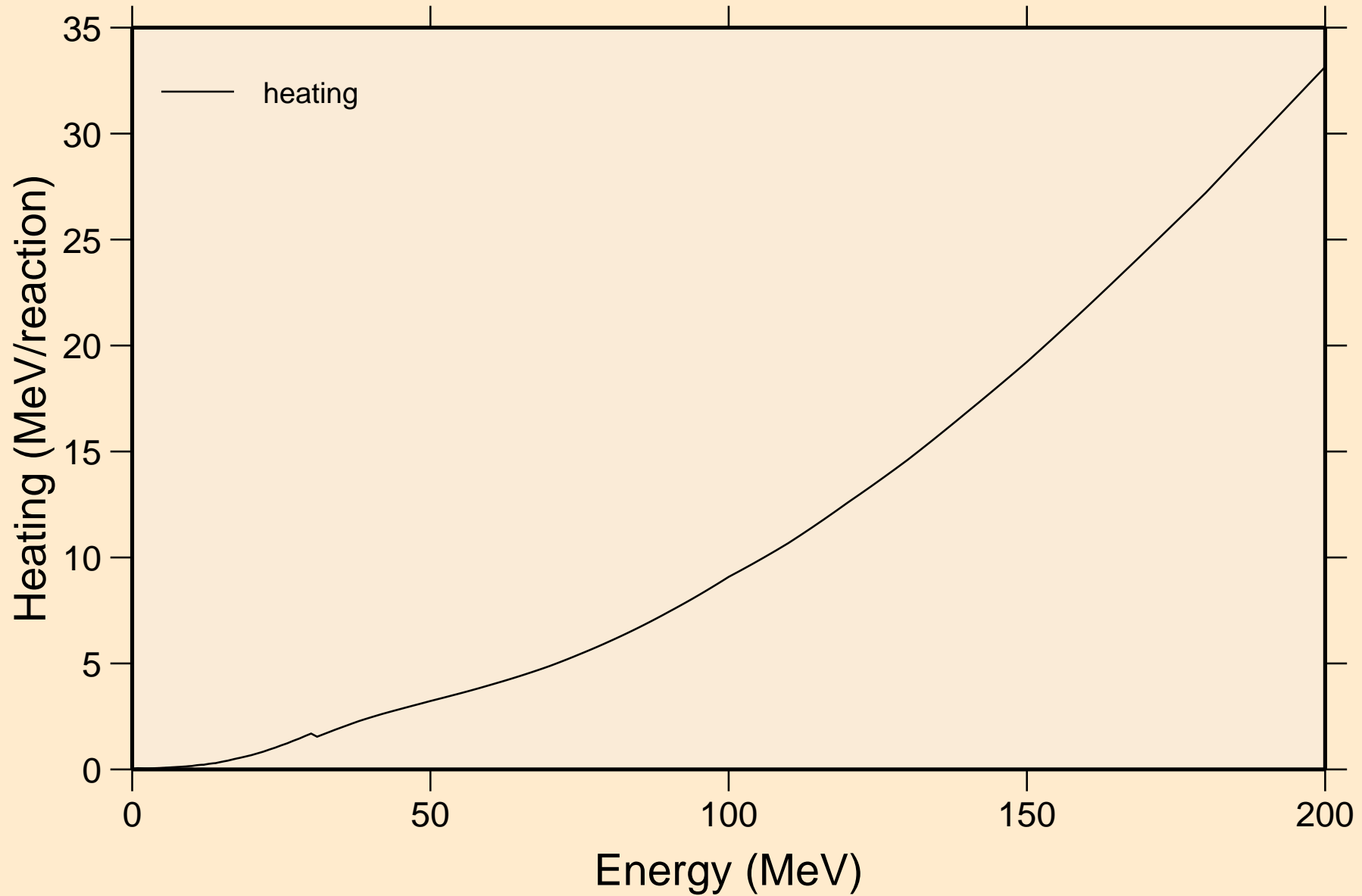

XE127M NEUTRON ACER TENDL-2024 LIBRARY; T=0.K  
Damage

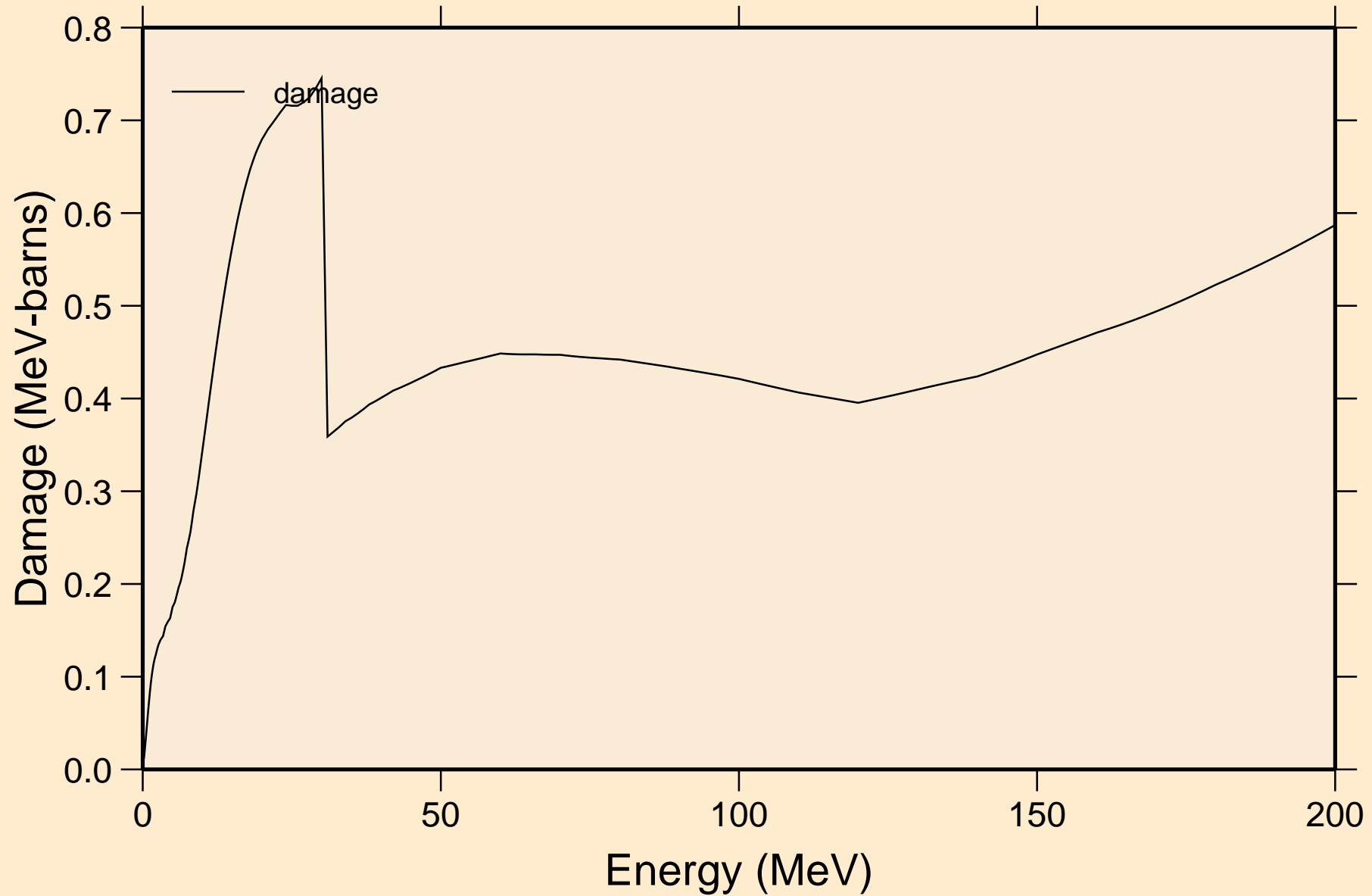



# XE127M NEUTRON ACER TENDL-2024 LIBRARY; T=0.K

## Non-threshold reactions

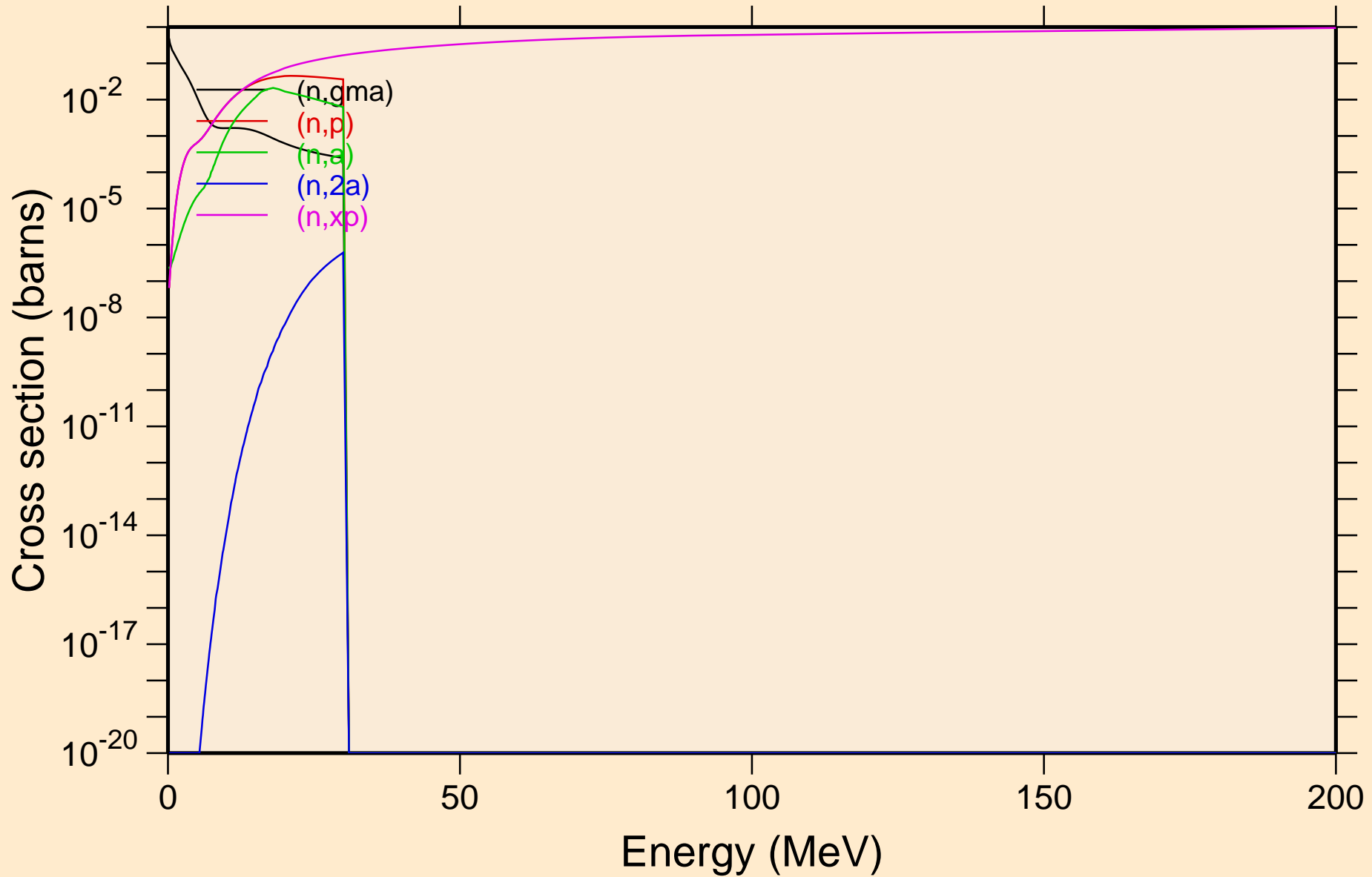

XE127M NEUTRON ACER TENDL-2024 LIBRARY; T=0.K  
Non-threshold reactions

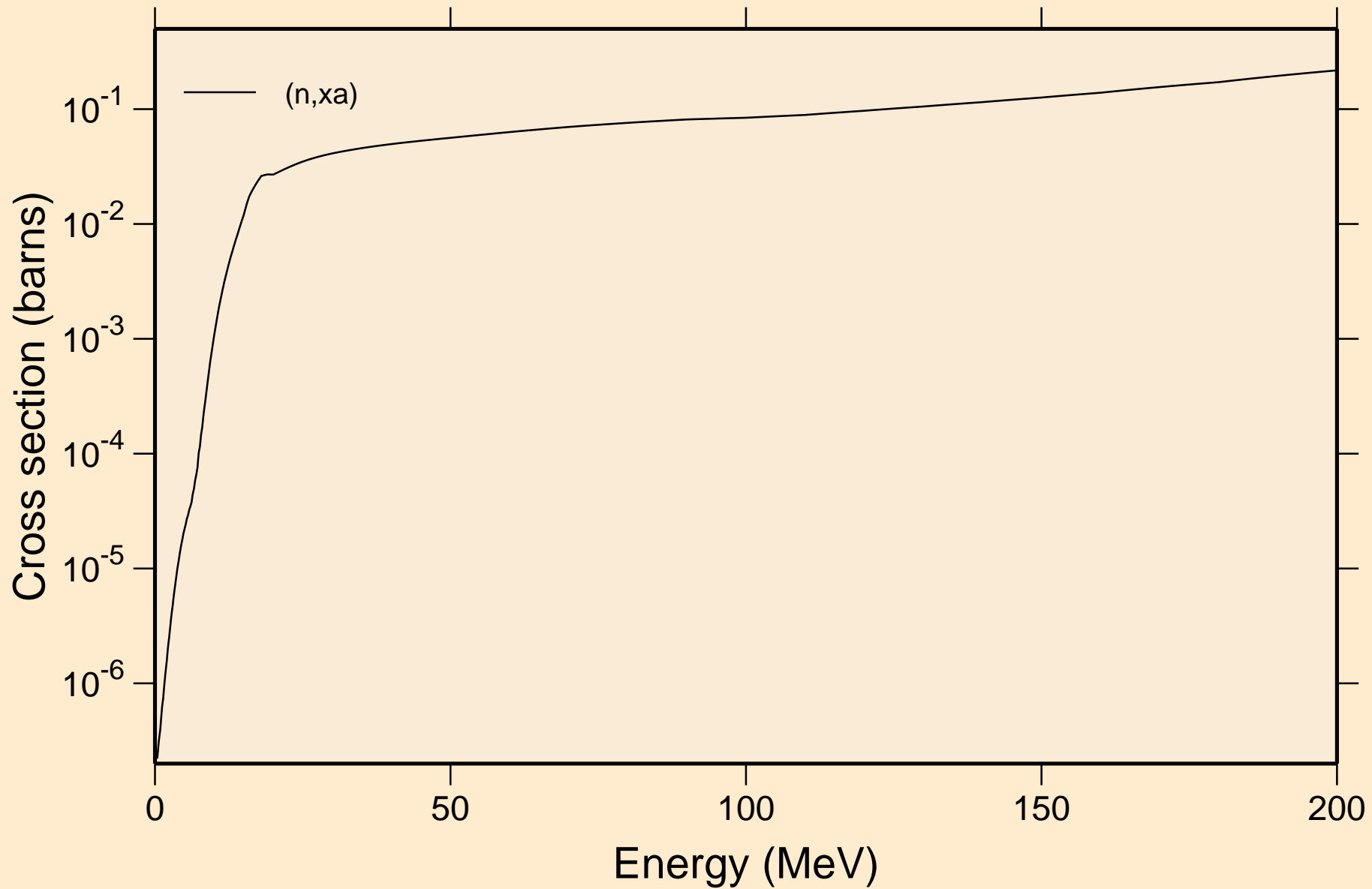

XE127M NEUTRON ACER TENDL-2024 LIBRARY; T=0.K  
Inelastic levels

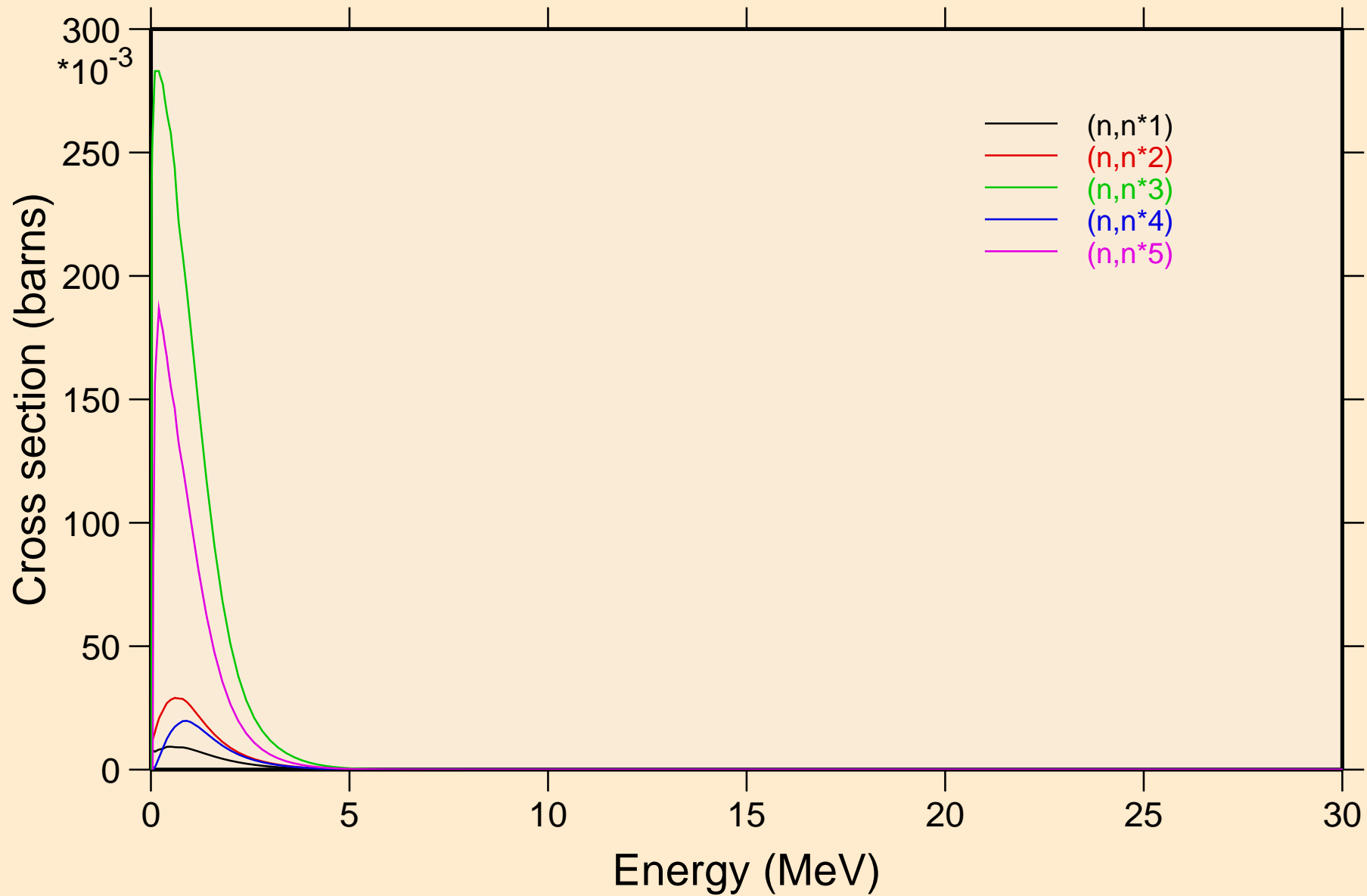

XE127M NEUTRON ACER TENDL-2024 LIBRARY; T=0.K  
Inelastic levels

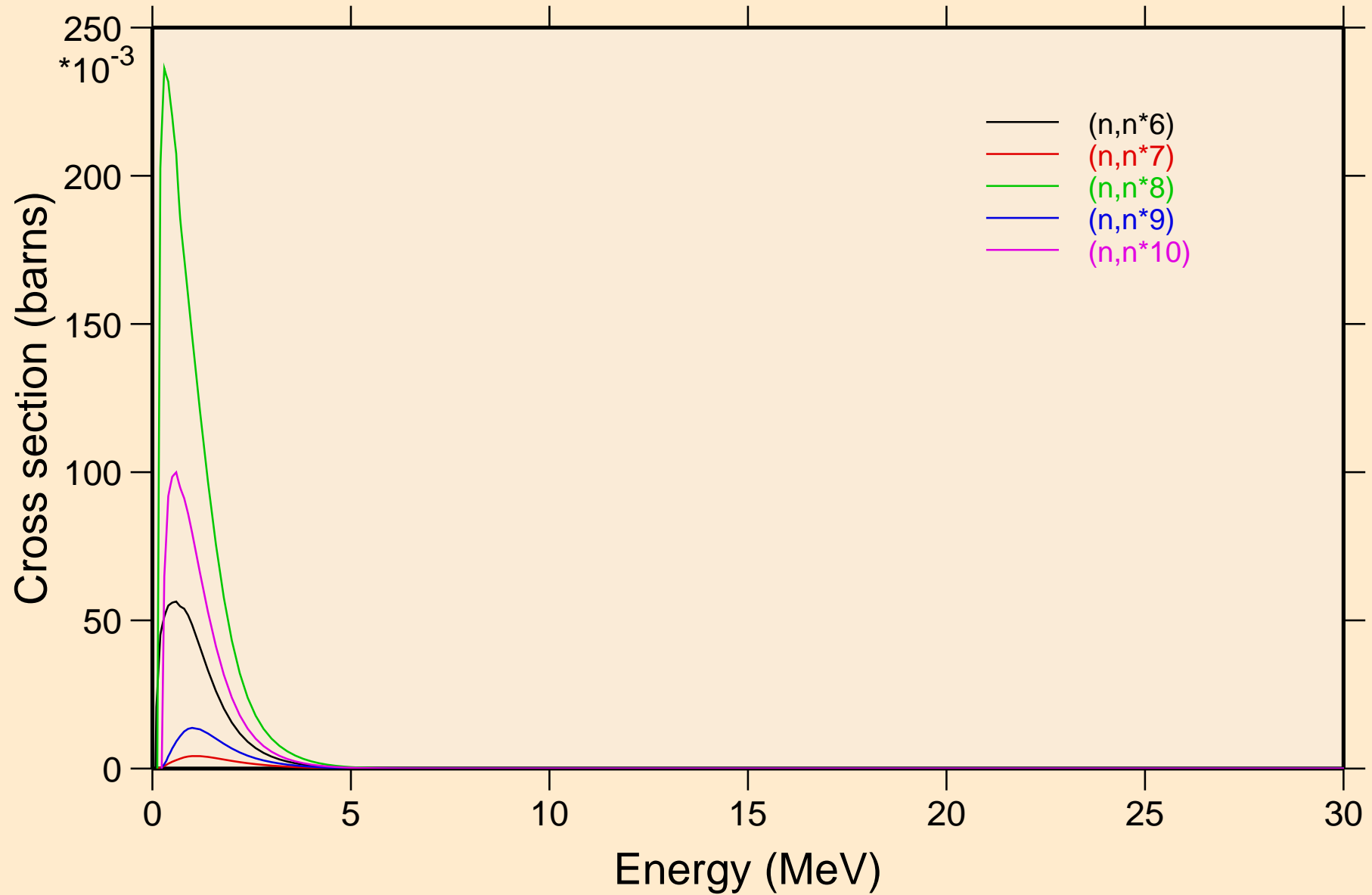

XE127M NEUTRON ACER TENDL-2024 LIBRARY; T=0.K  
Inelastic levels

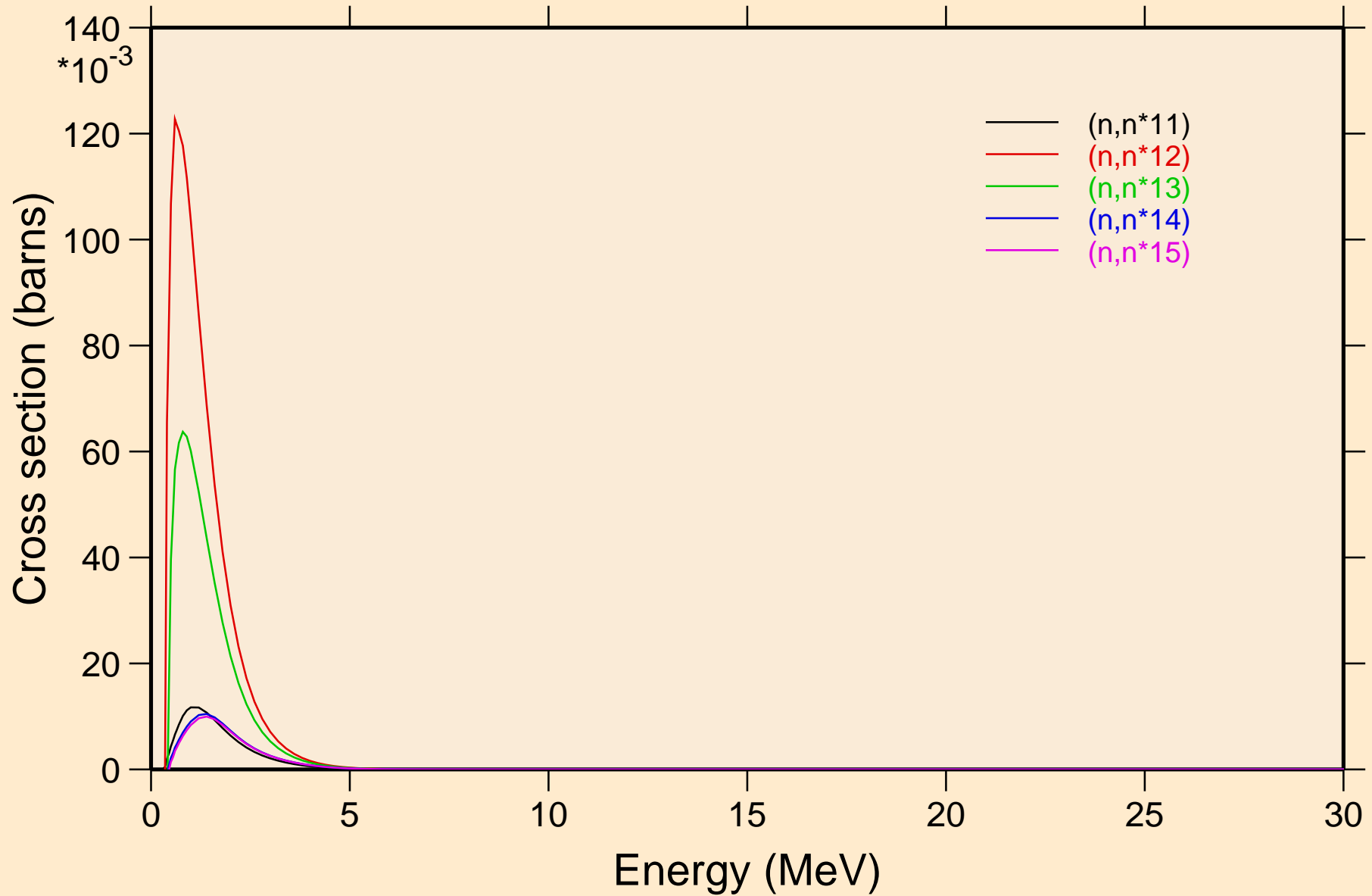

XE127M NEUTRON ACER TENDL-2024 LIBRARY; T=0.K  
Inelastic levels

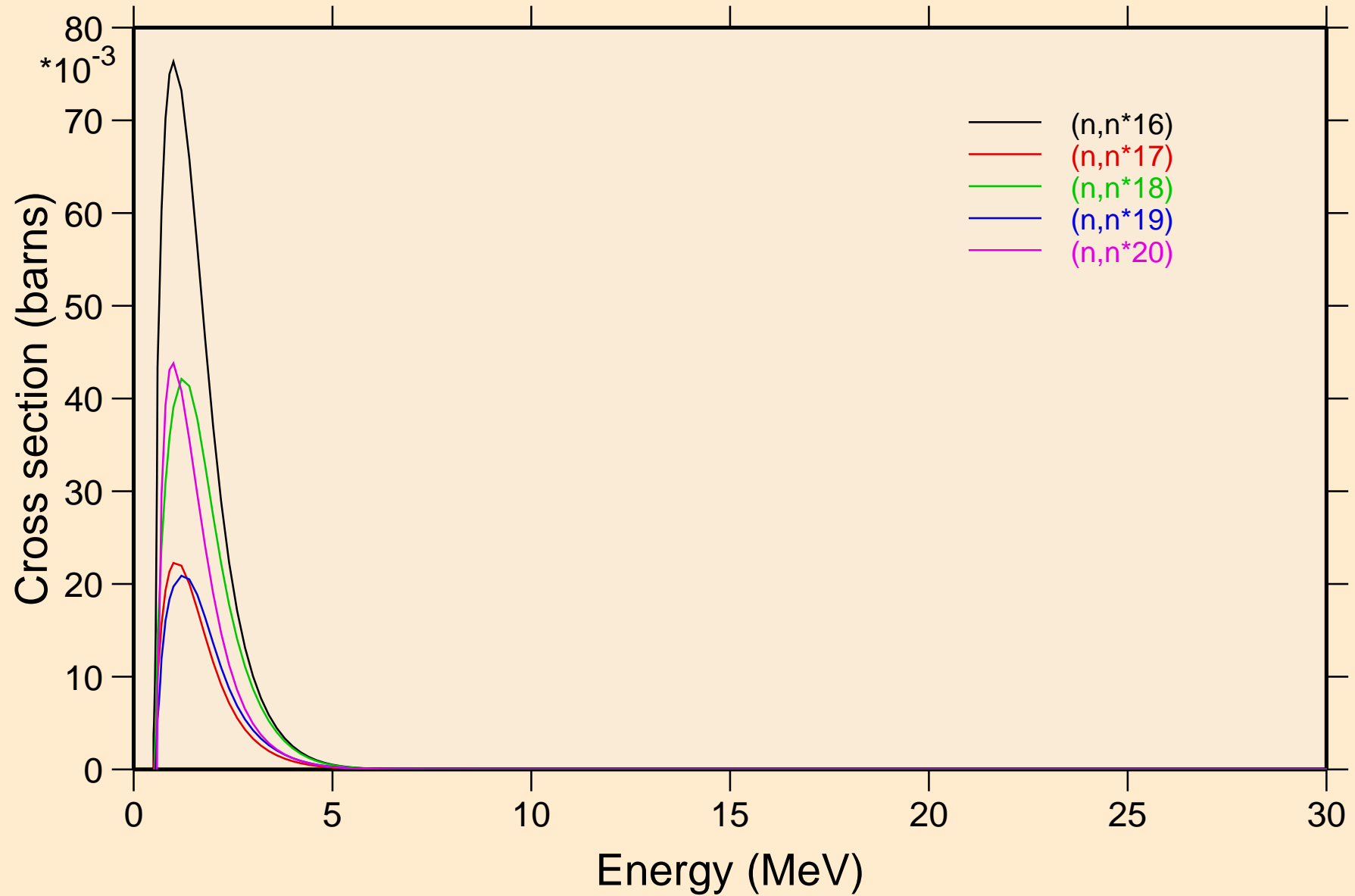

XE127M NEUTRON ACER TENDL-2024 LIBRARY; T=0.K  
Inelastic levels

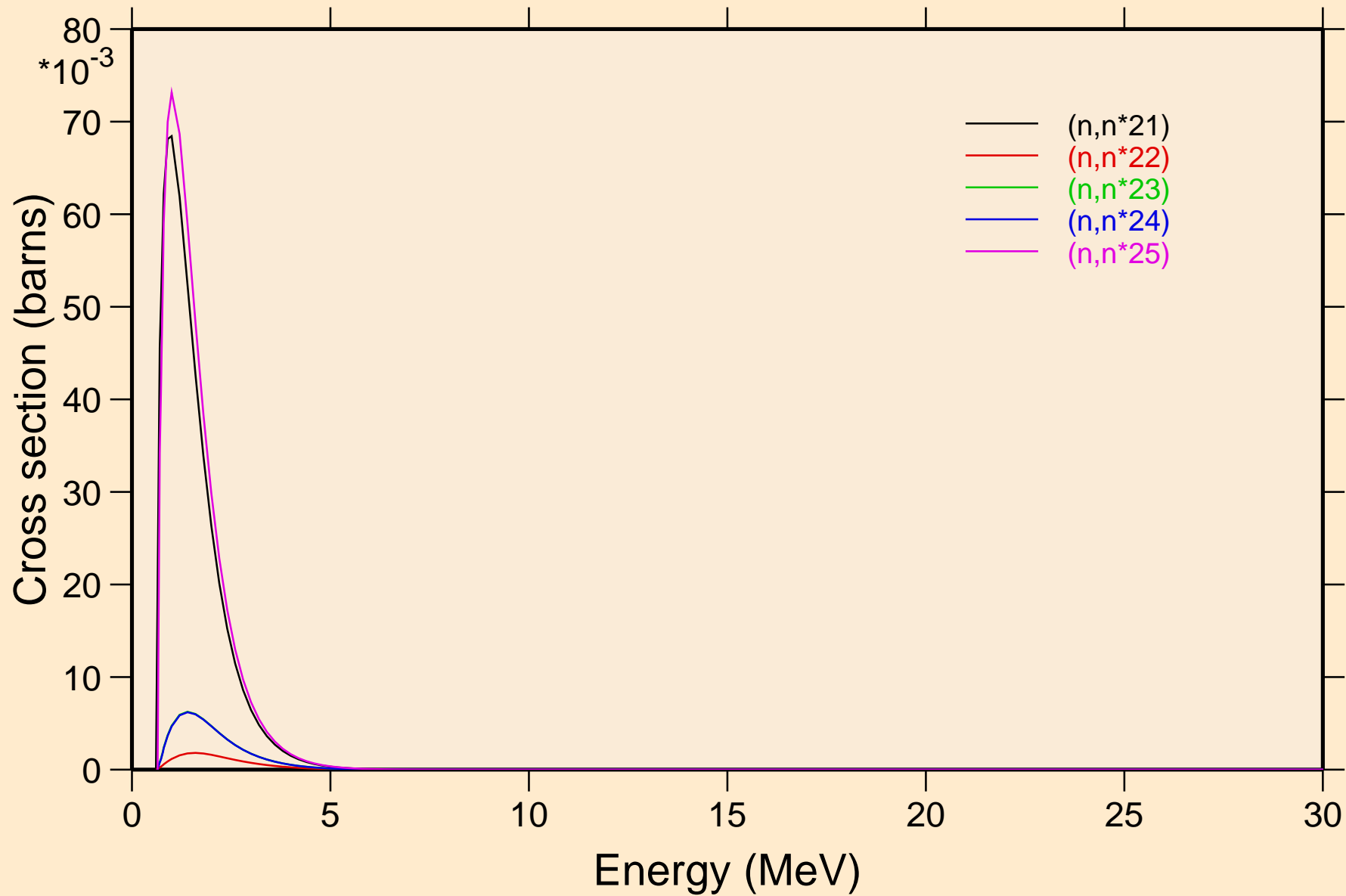

# XE127M NEUTRON ACER TENDL-2024 LIBRARY; T=0.K

## Inelastic levels

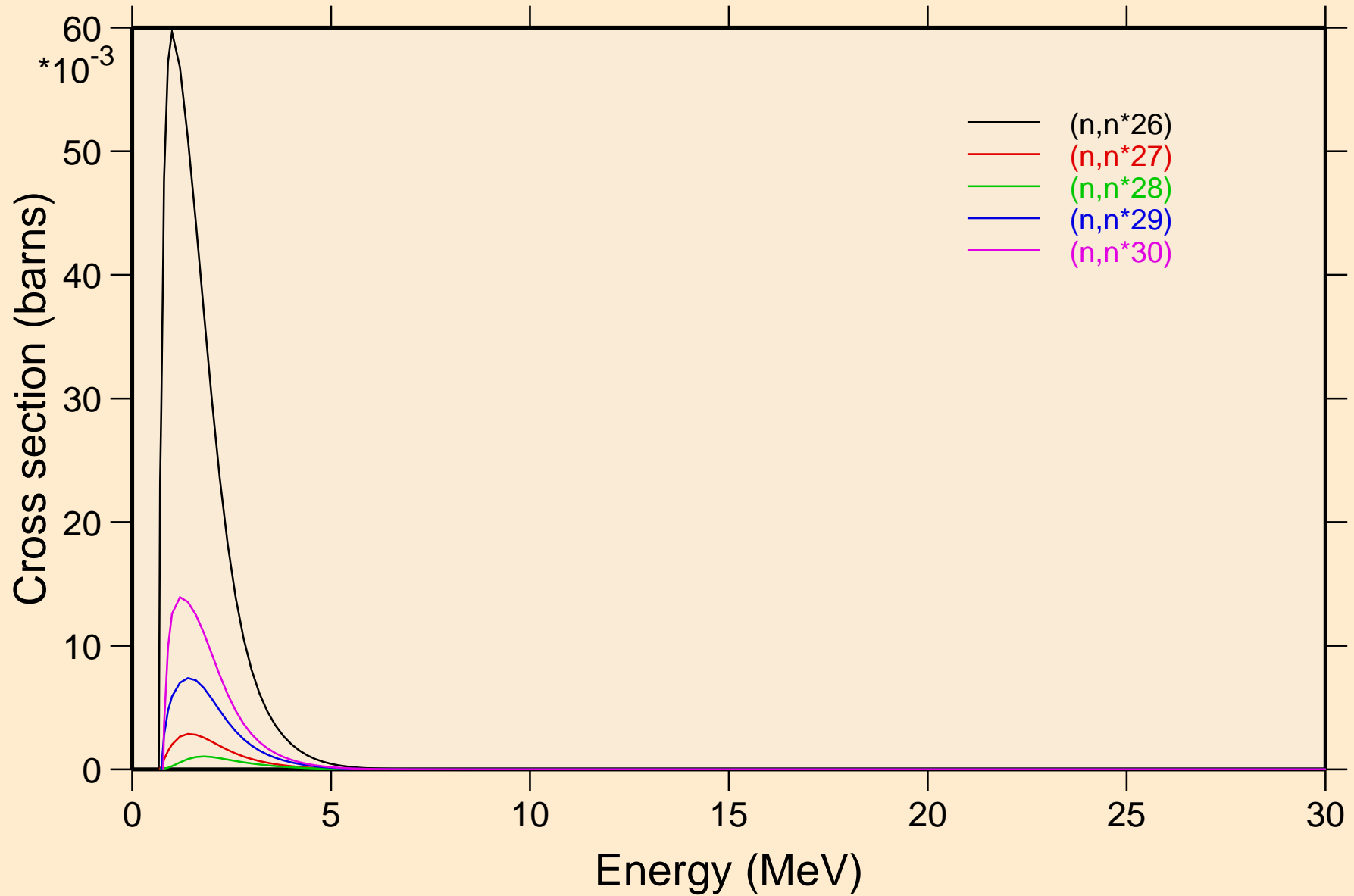



# XE127M NEUTRON ACER TENDL-2024 LIBRARY; T=0.K

## Threshold reactions

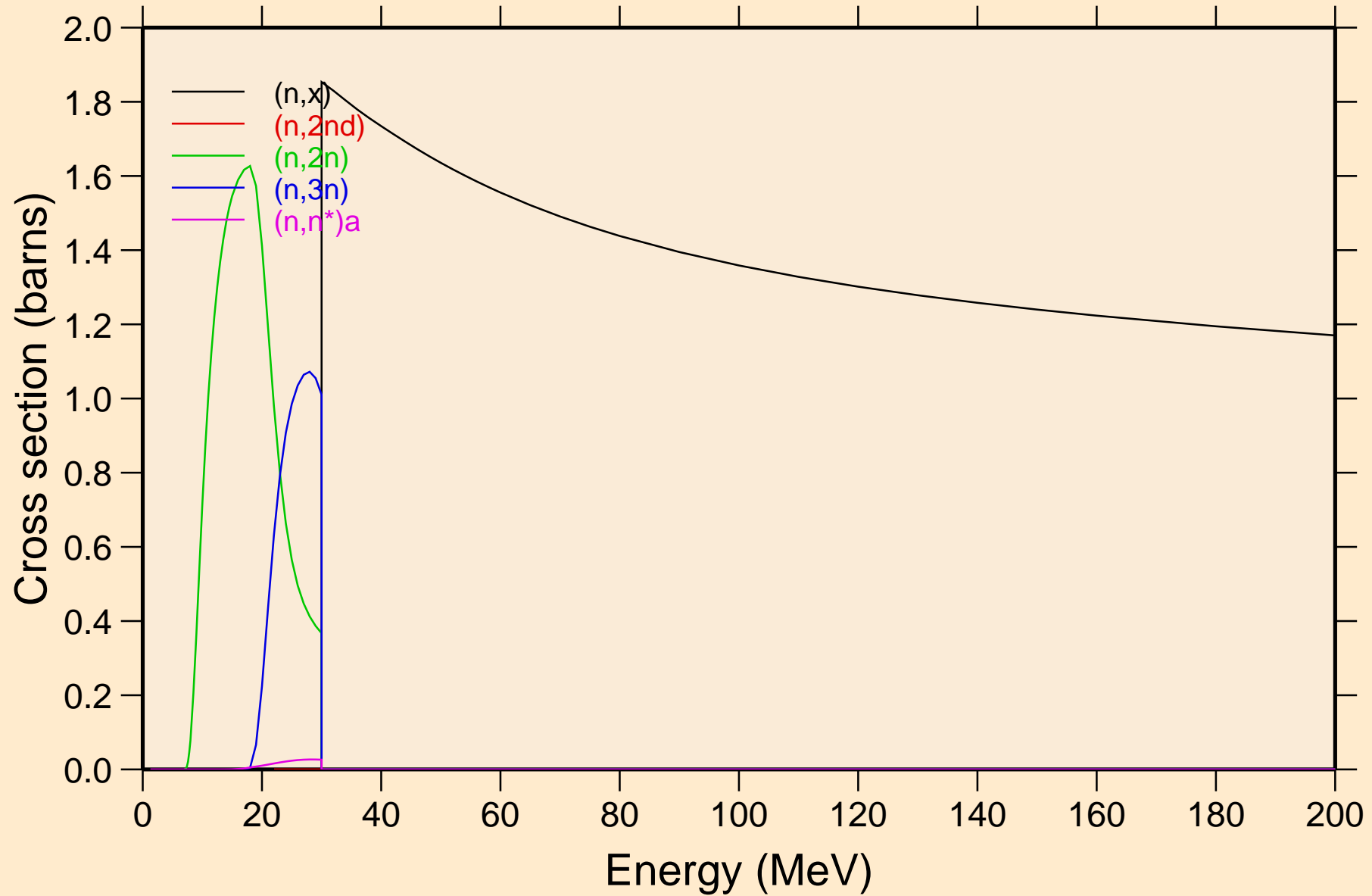

XE127M NEUTRON ACER TENDL-2024 LIBRARY; T=0.K  
Threshold reactions

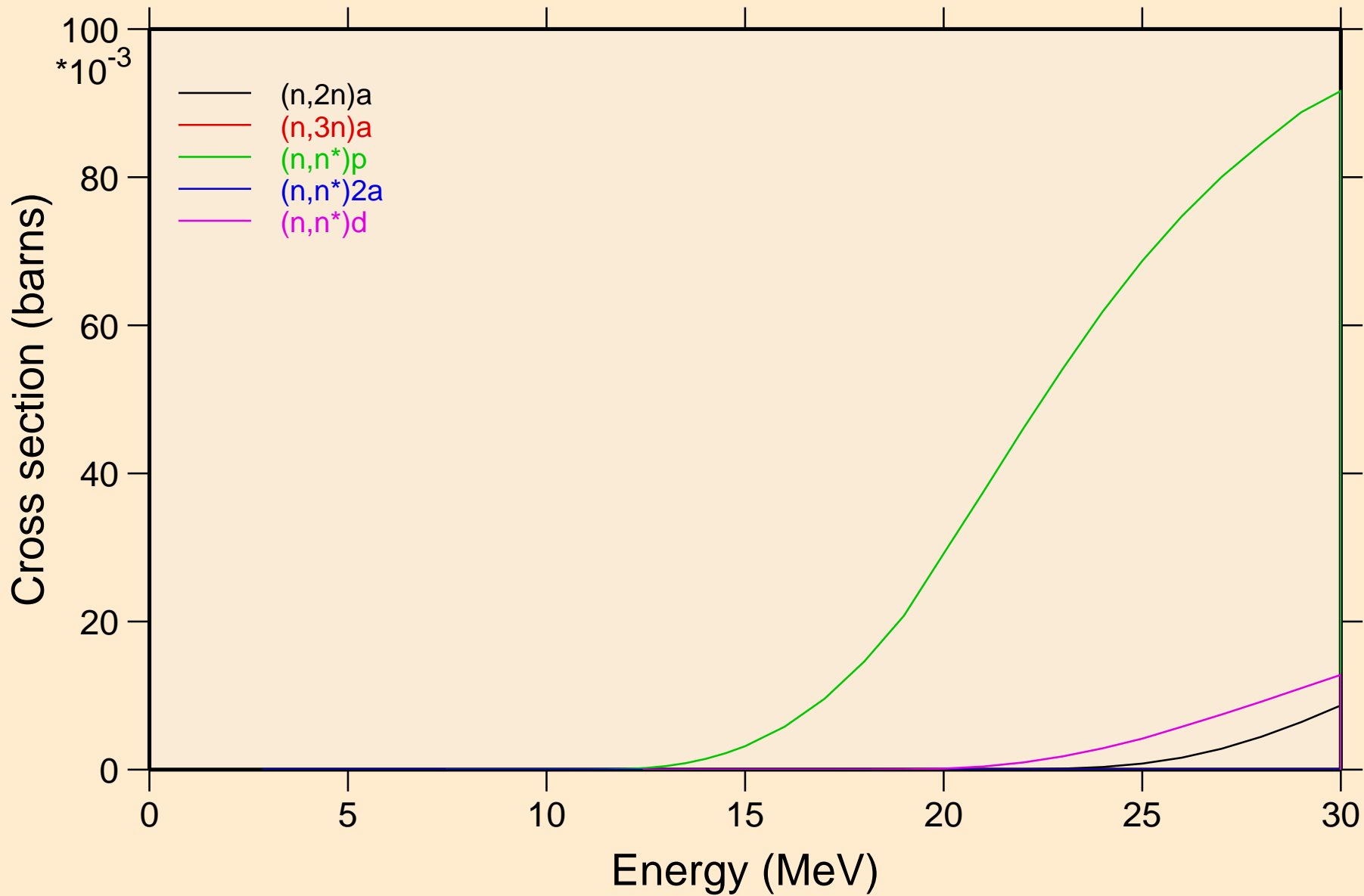

XE127M NEUTRON ACER TENDL-2024 LIBRARY; T=0.K  
Threshold reactions

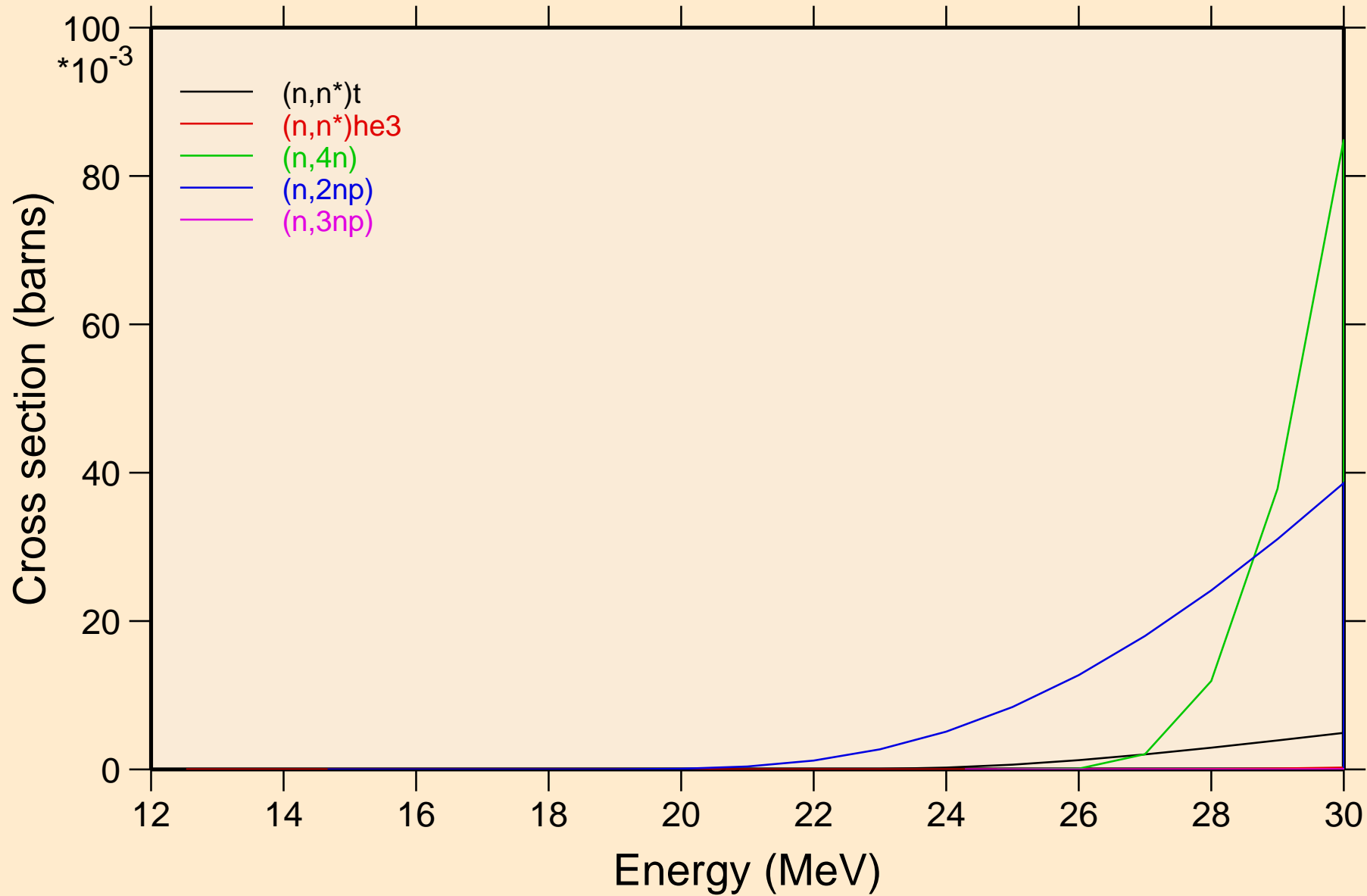

# XE127M NEUTRON ACER TENDL-2024 LIBRARY; T=0.K

## Threshold reactions

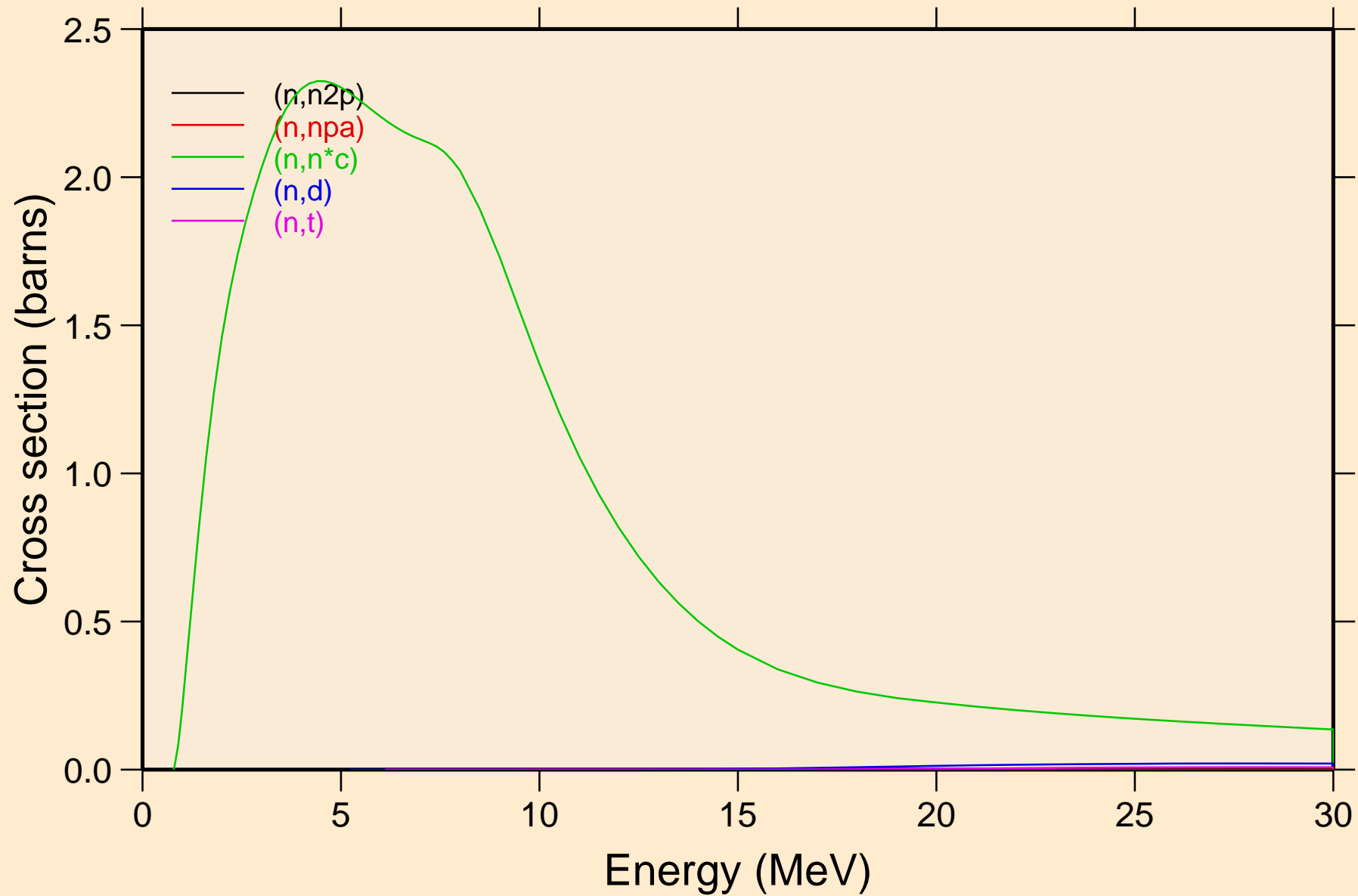

# XE127M NEUTRON ACER TENDL-2024 LIBRARY; T=0.K

## Threshold reactions

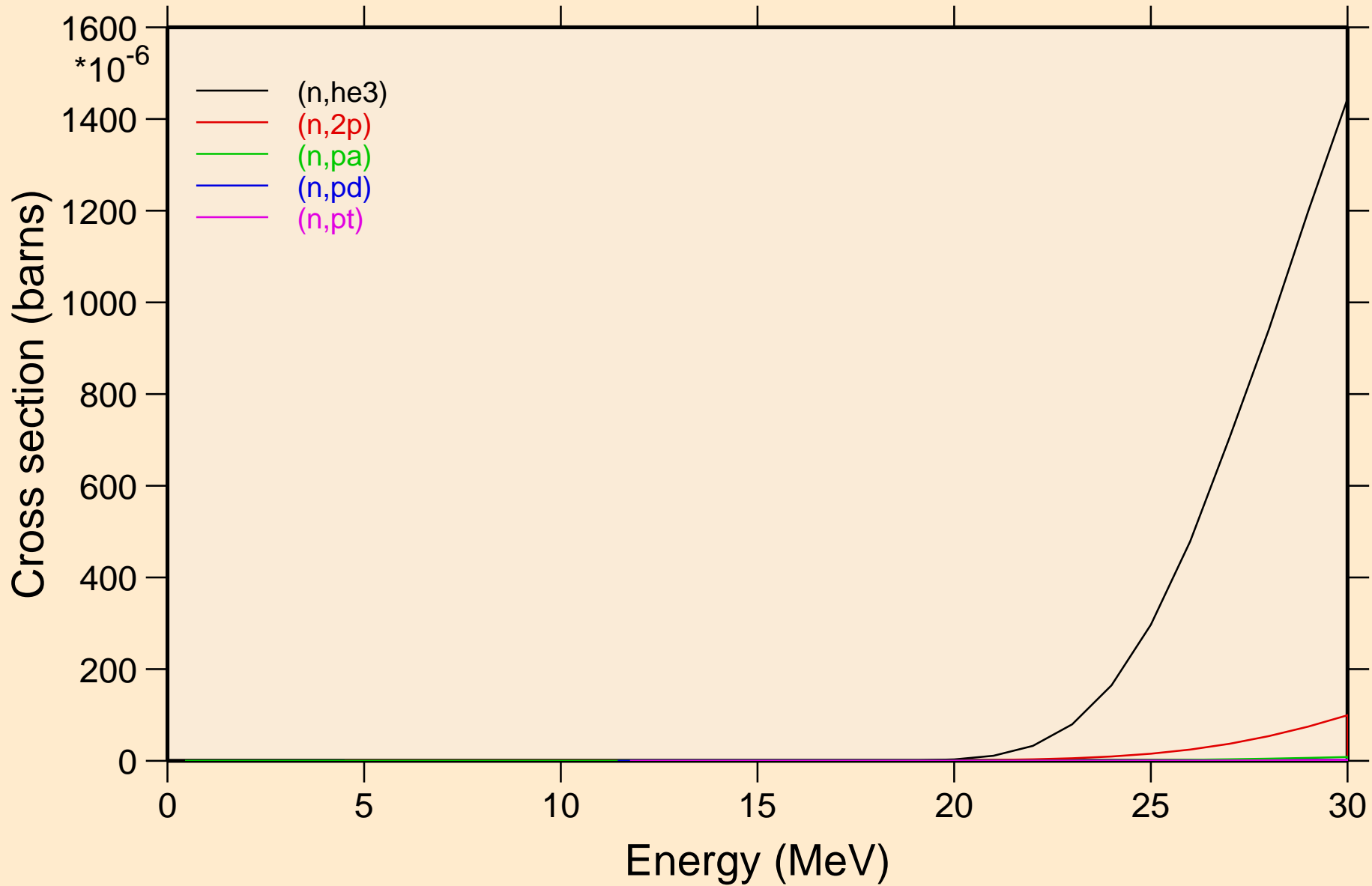

XE127M NEUTRON ACER TENDL-2024 LIBRARY; T=0.K  
Threshold reactions

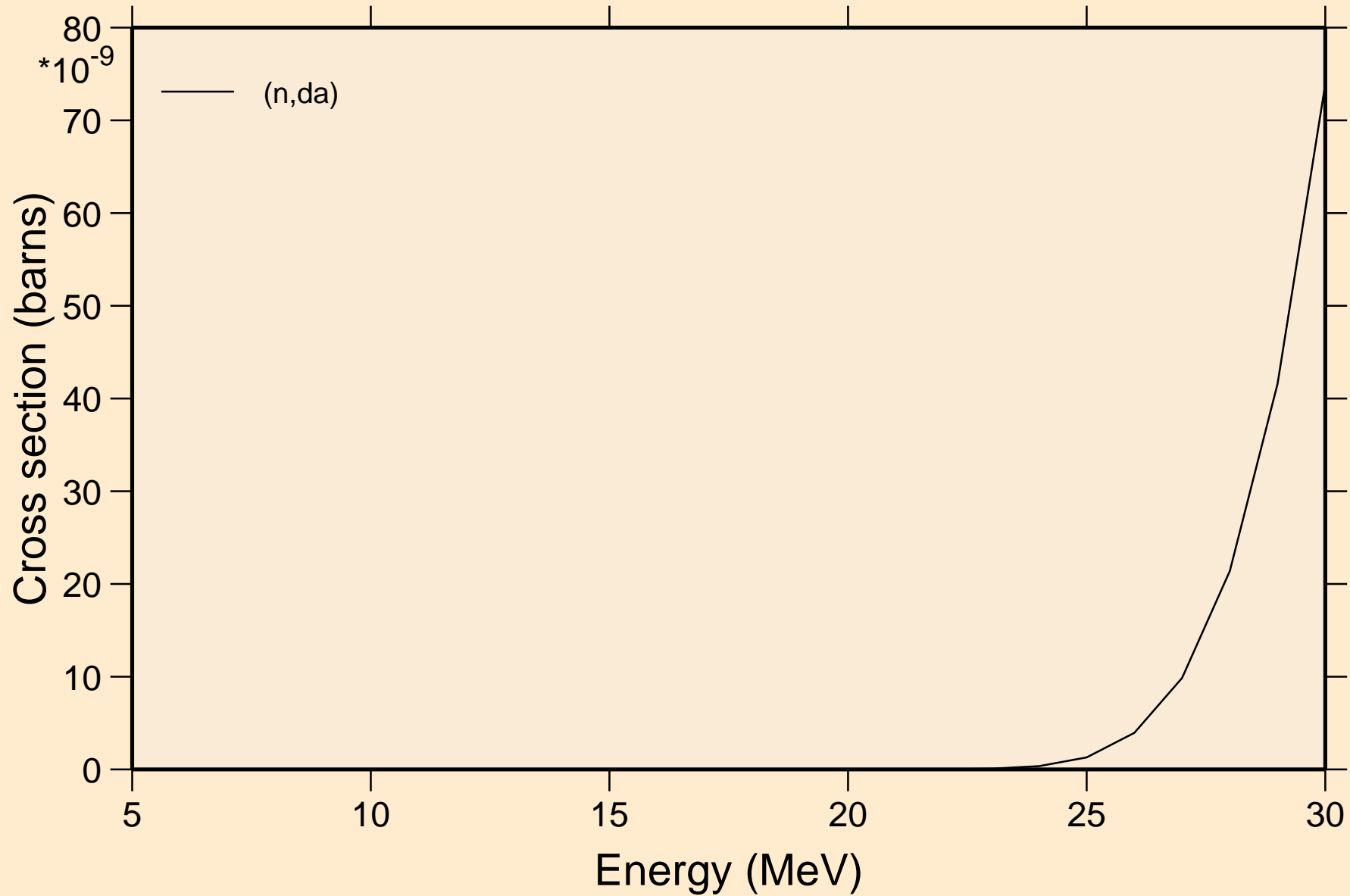

# XE127M NEUTRON ACER TENDL-2024 LIBRARY; T=0.K

## Threshold reactions

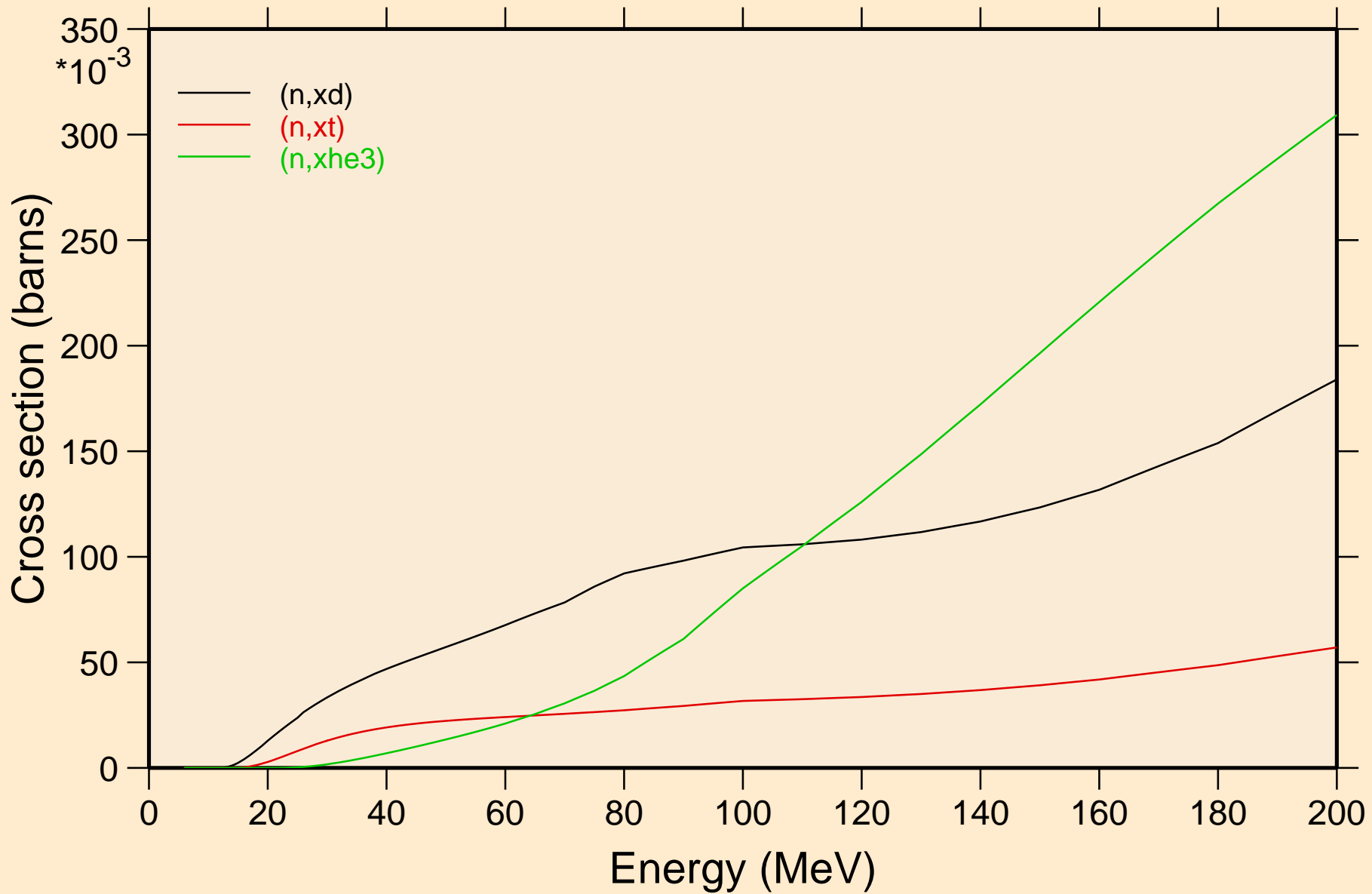

XE127M NEUTRON ACER TENDL-2024 LIBRARY; T=0.K  
angular distribution for elastic

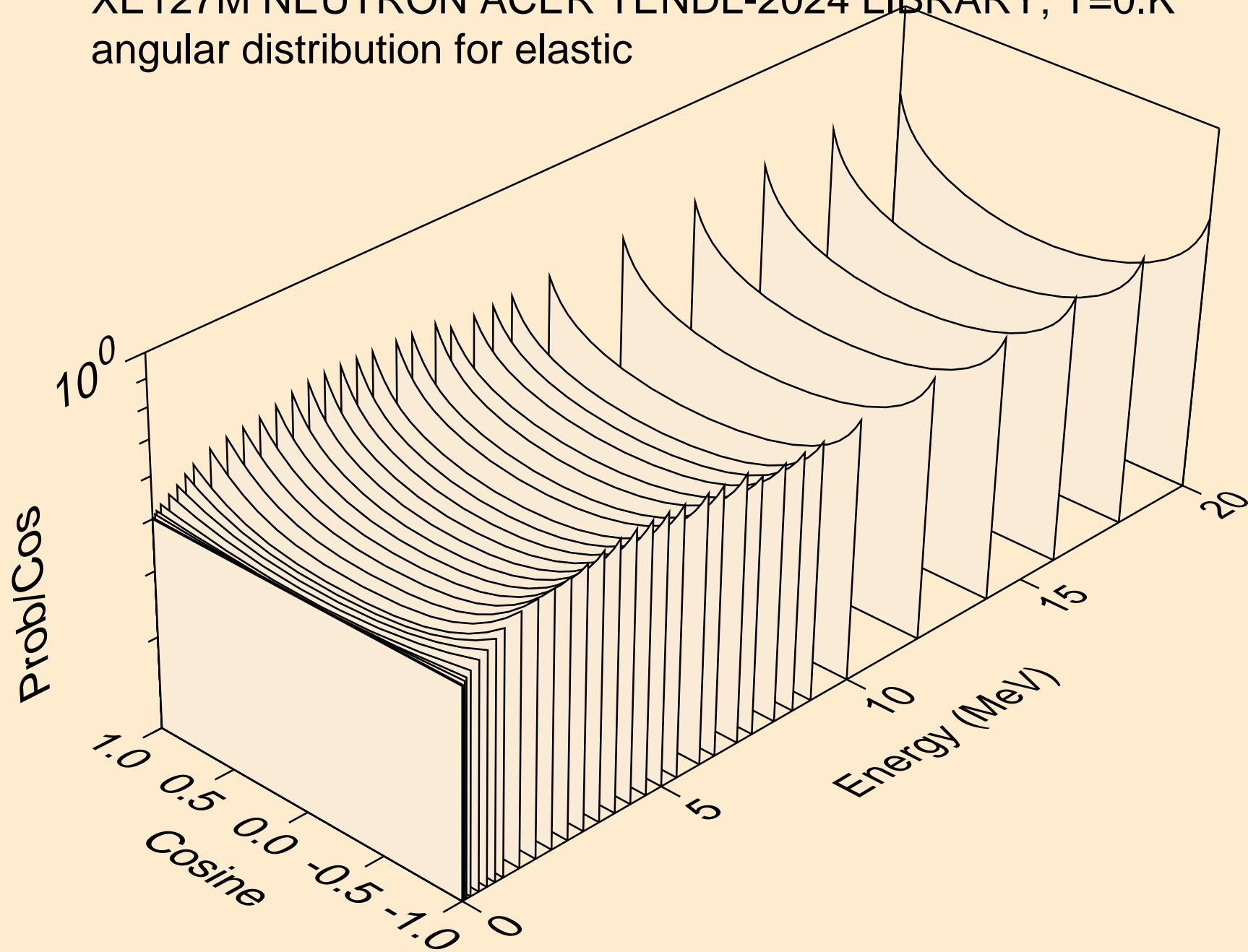



XE127M NEUTRON ACER TENDL-2024 LIBRARY; T=0.K  
angular distribution for elastic

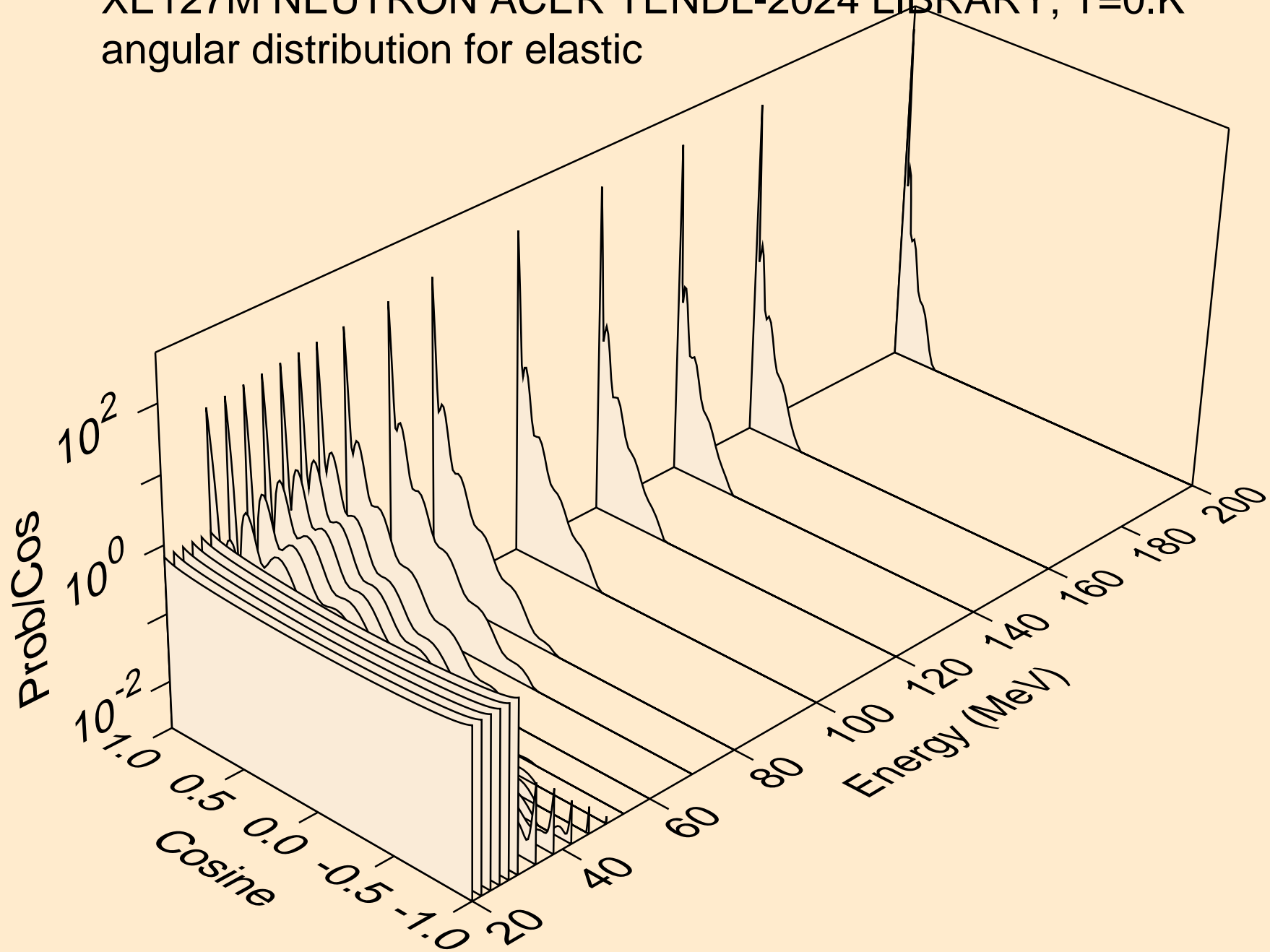

XE127M NEUTRON ACER TENDL-2024 LIBRARY; T=0.K  
angular distribution for (n,n\*1)

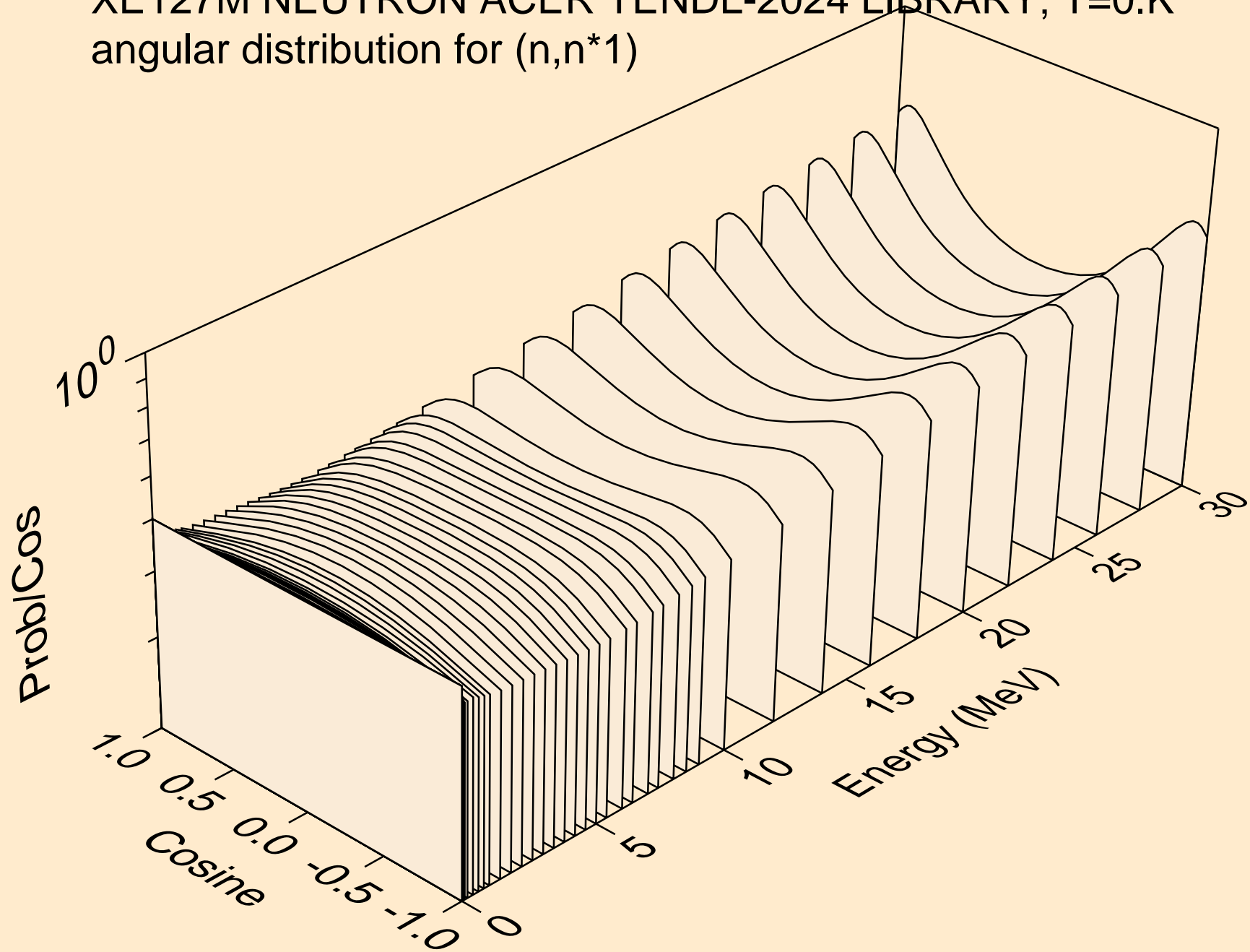

XE127M NEUTRON ACER TENDL-2024 LIBRARY; T=0.K  
angular distribution for (n,n\*2)

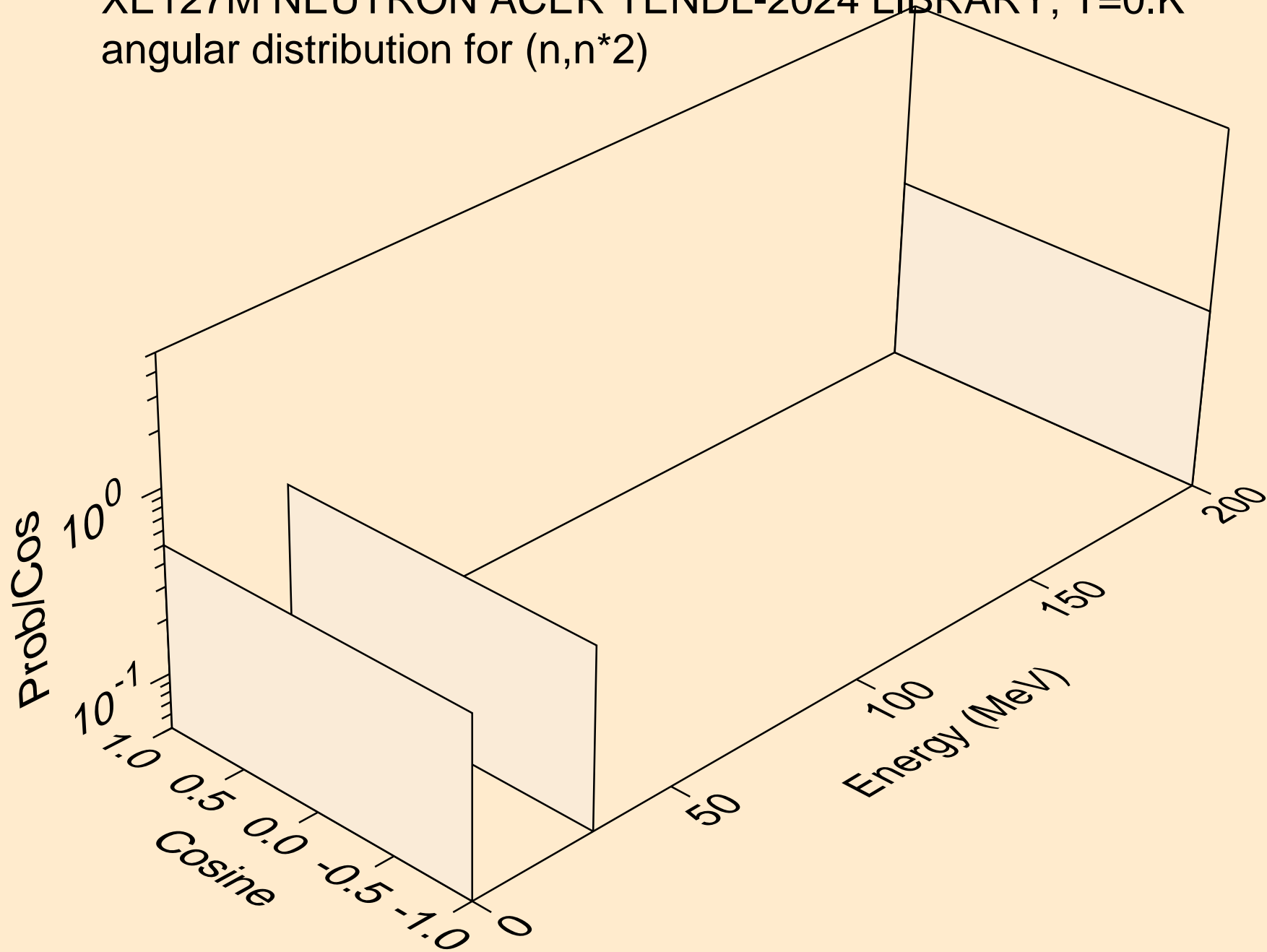

XE127M NEUTRON ACER TENDL-2024 LIBRARY; T=0.K  
angular distribution for (n,n\*3)

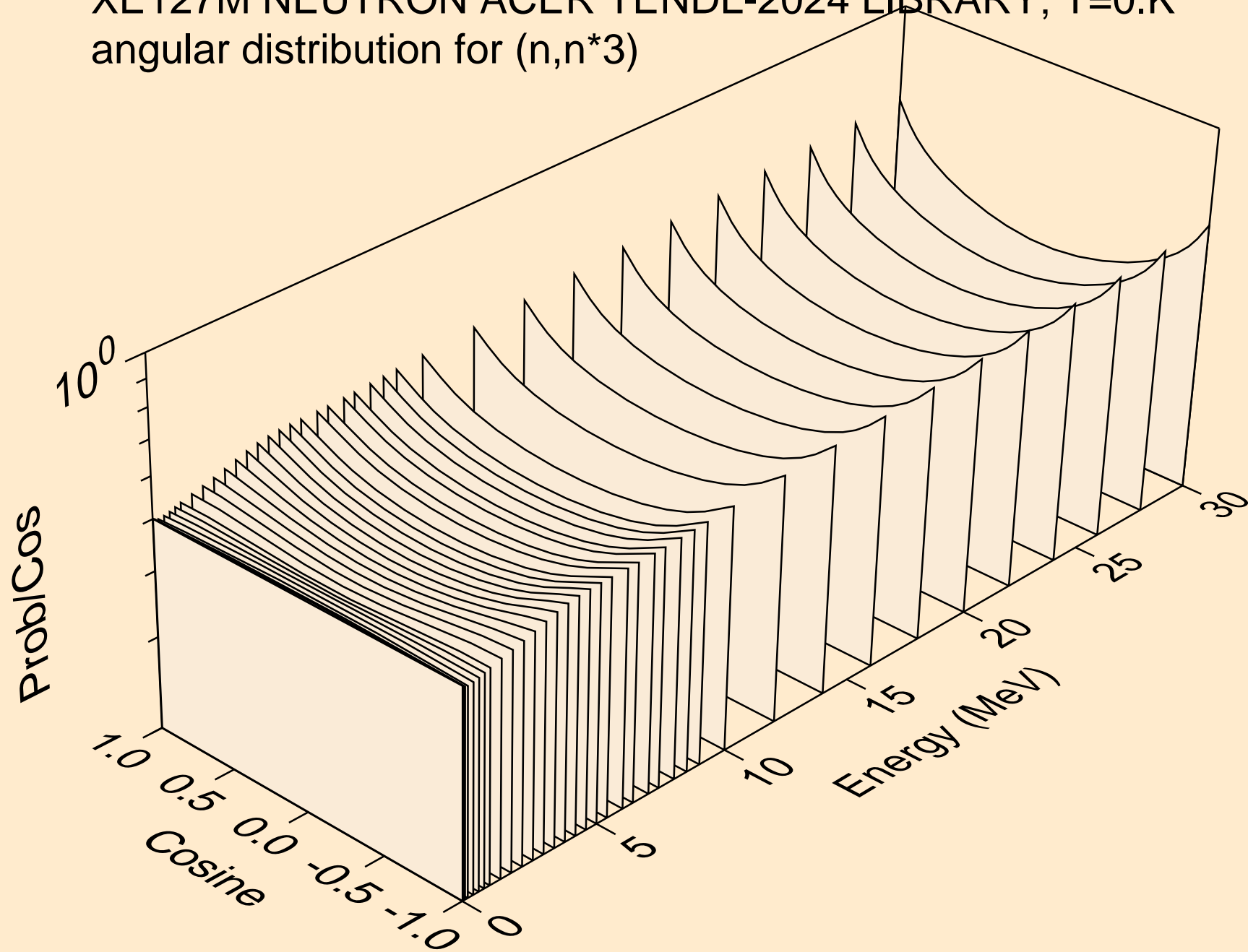

XE127M NEUTRON ACER TENDL-2024 LIBRARY; T=0.K  
angular distribution for (n,n\*4)

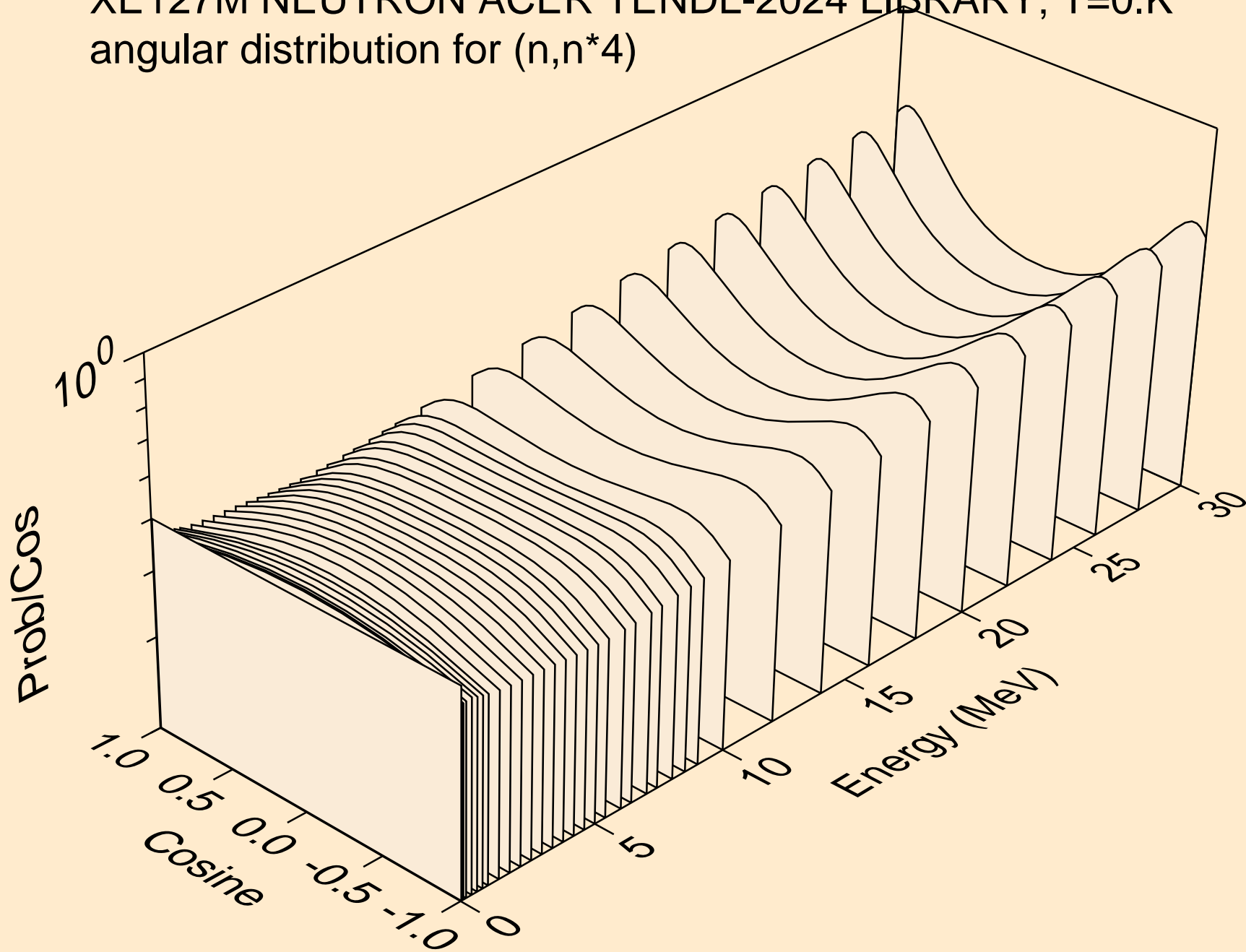

XE127M NEUTRON ACER TENDL-2024 LIBRARY; T=0.K  
angular distribution for (n,n\*5)

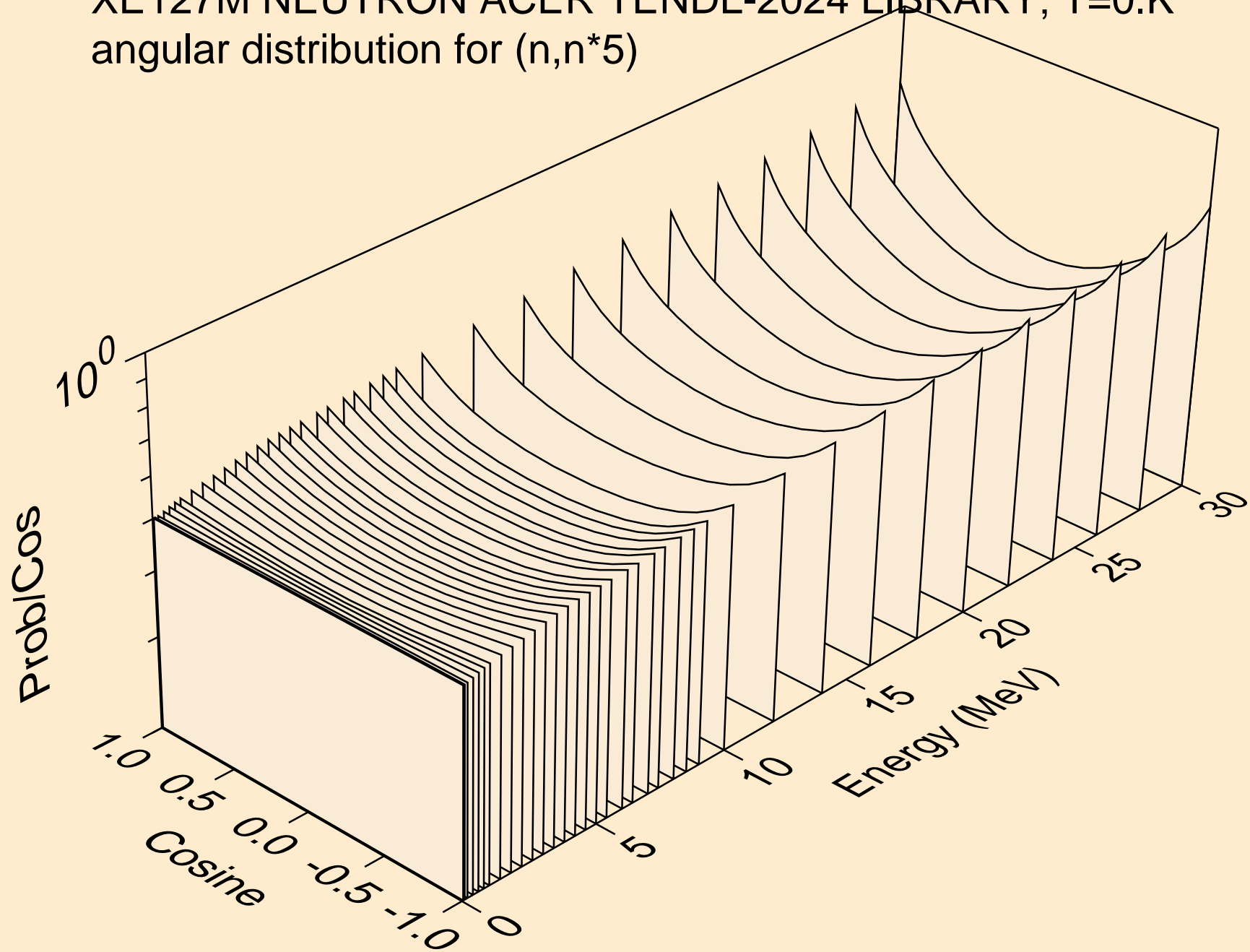

XE127M NEUTRON ACER TENDL-2024 LIBRARY; T=0.K  
angular distribution for (n,n\*6)

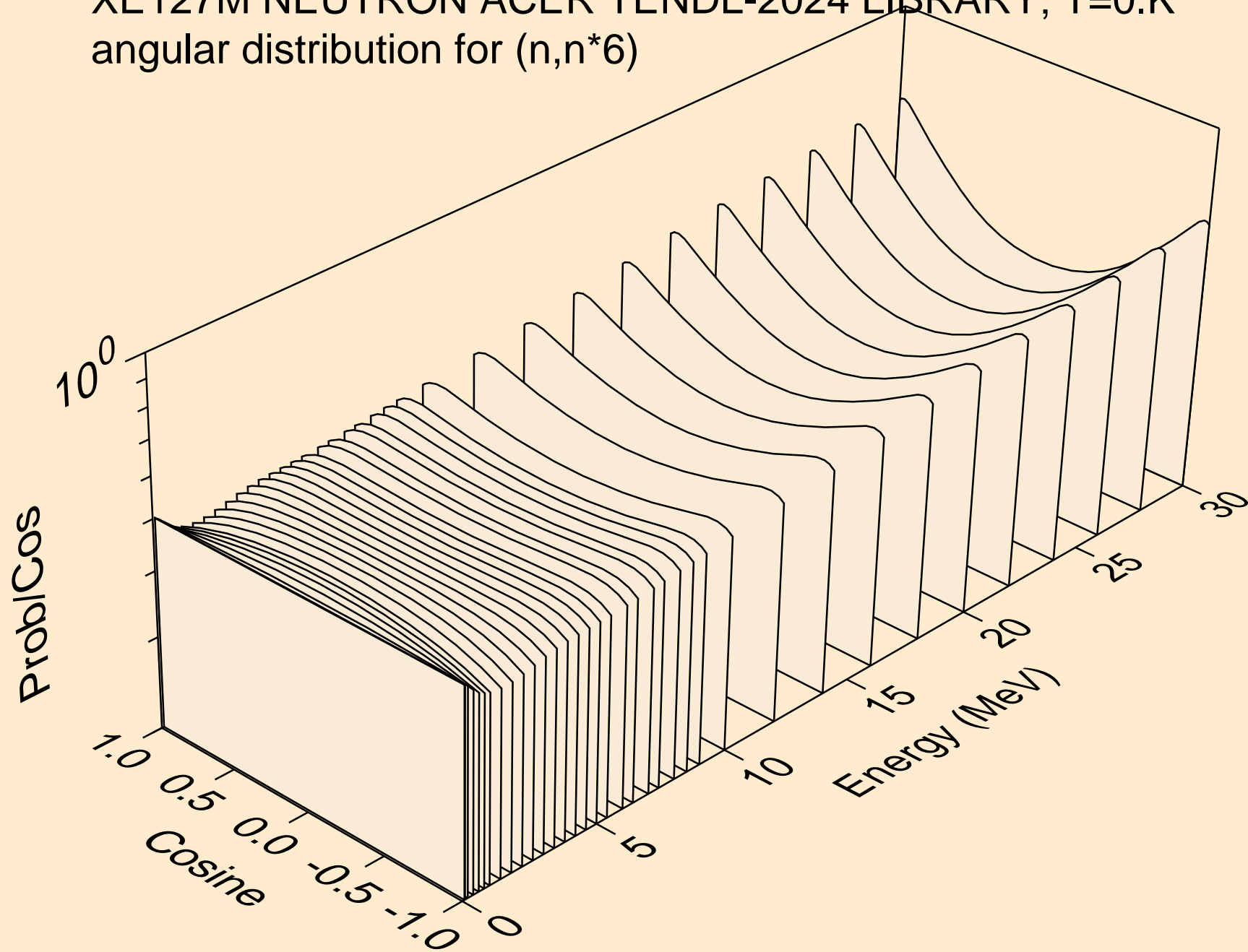

XE127M NEUTRON ACER TENDL-2024 LIBRARY; T=0.K  
angular distribution for (n,n\*7)

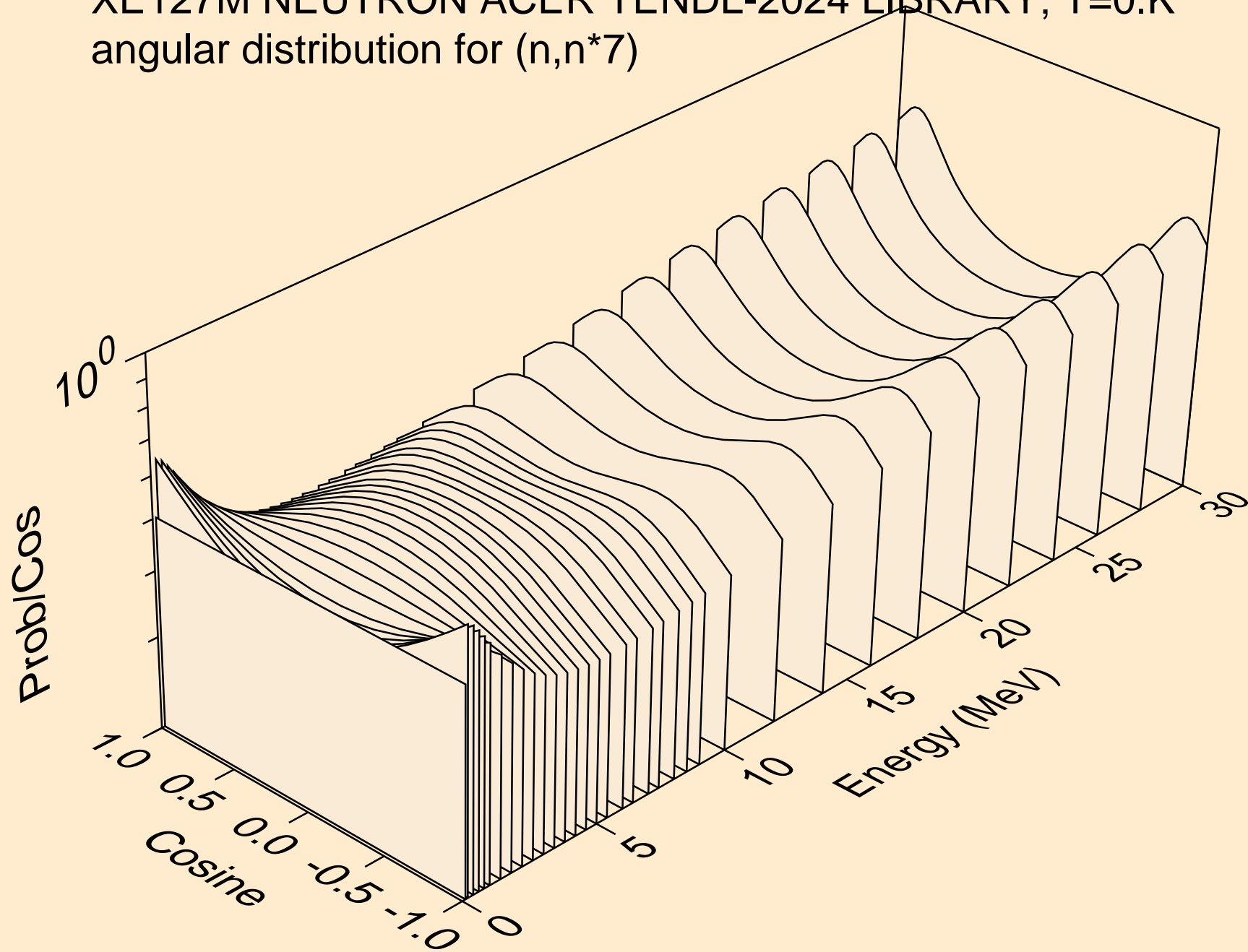



XE127M NEUTRON ACER TENDL-2024 LIBRARY; T=0.K  
angular distribution for (n,n\*8)

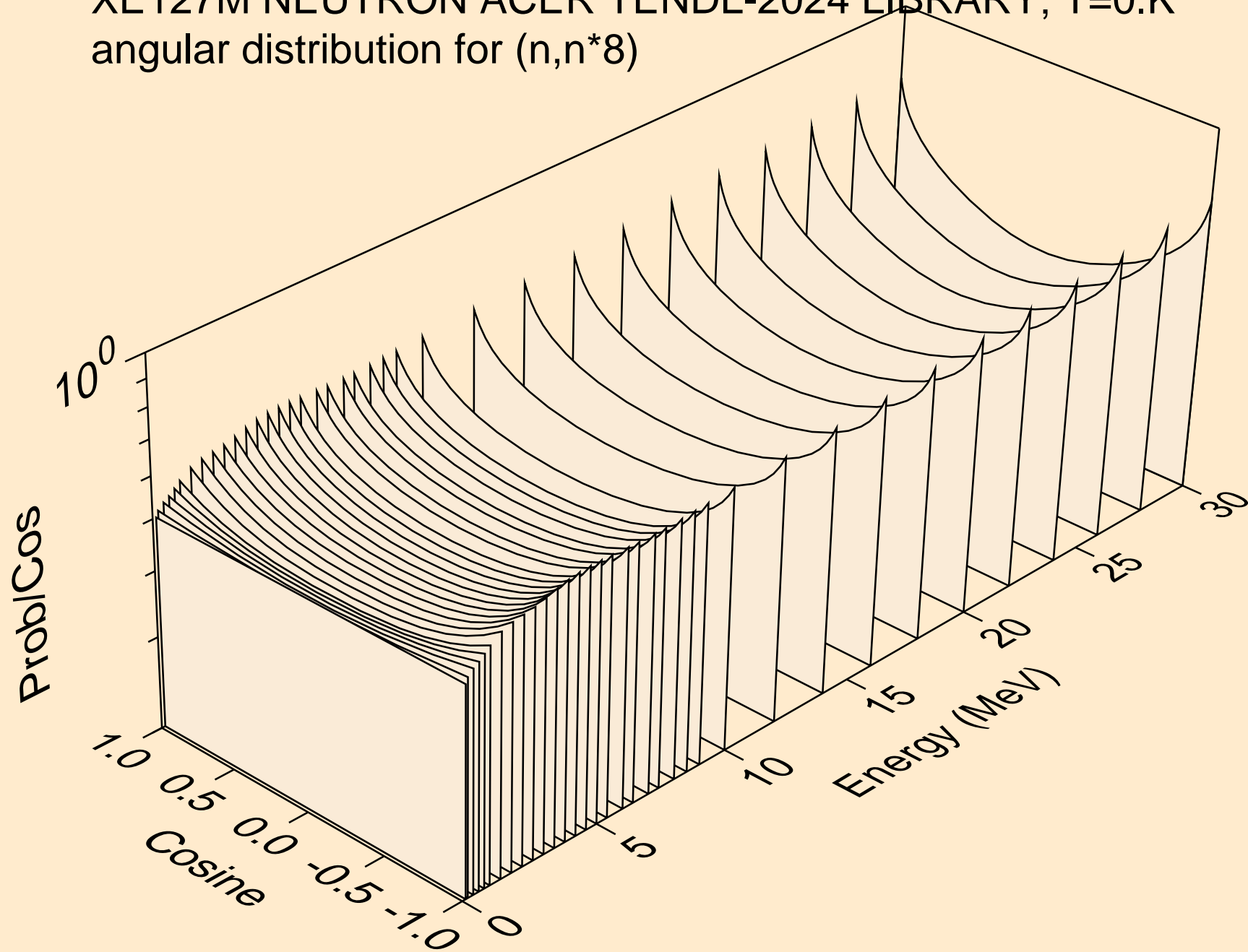

XE127M NEUTRON ACER TENDL-2024 LIBRARY; T=0.K  
angular distribution for (n,n\*9)

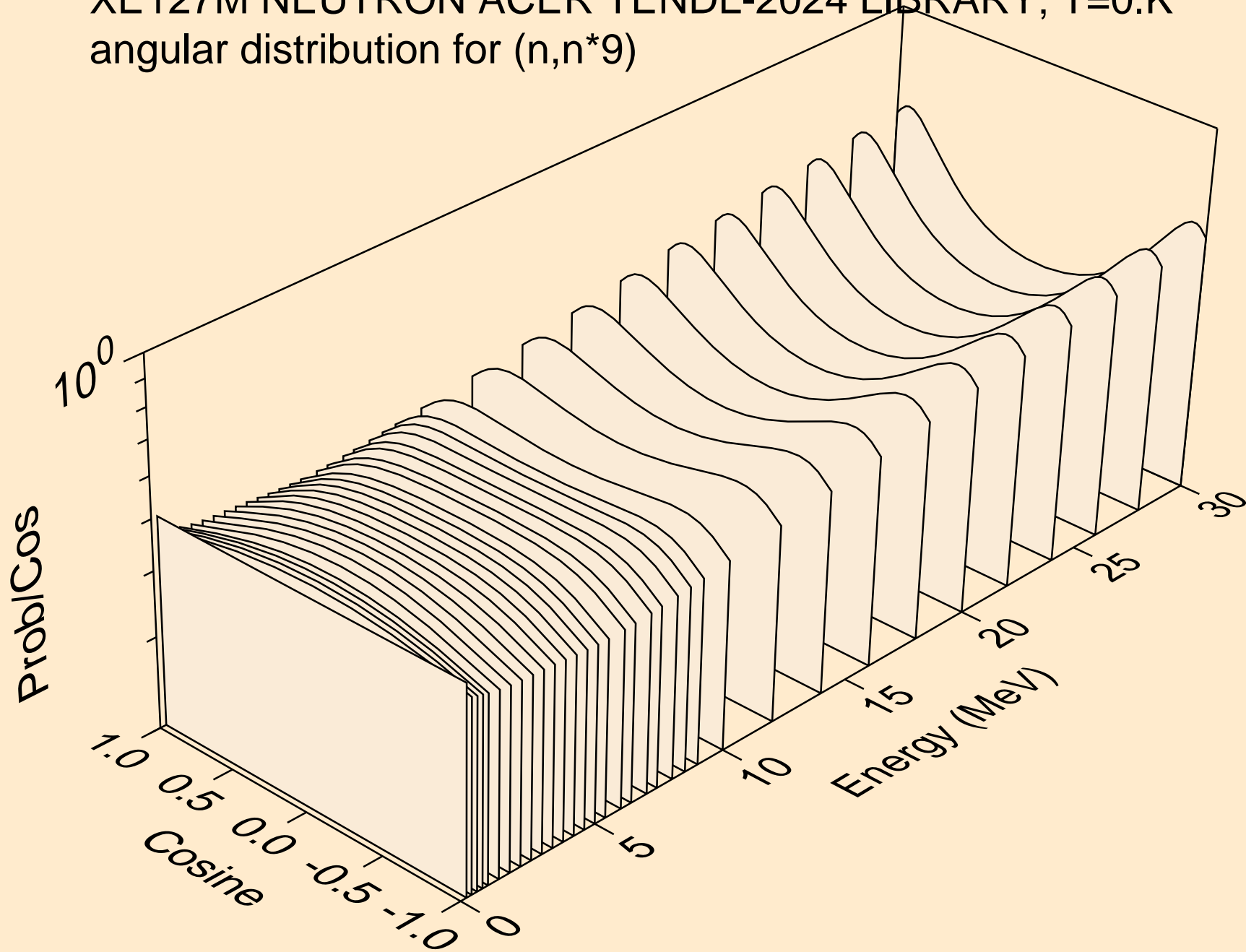

XE127M NEUTRON ACER TENDL-2024 LIBRARY; T=0.K  
angular distribution for (n,n\*10)

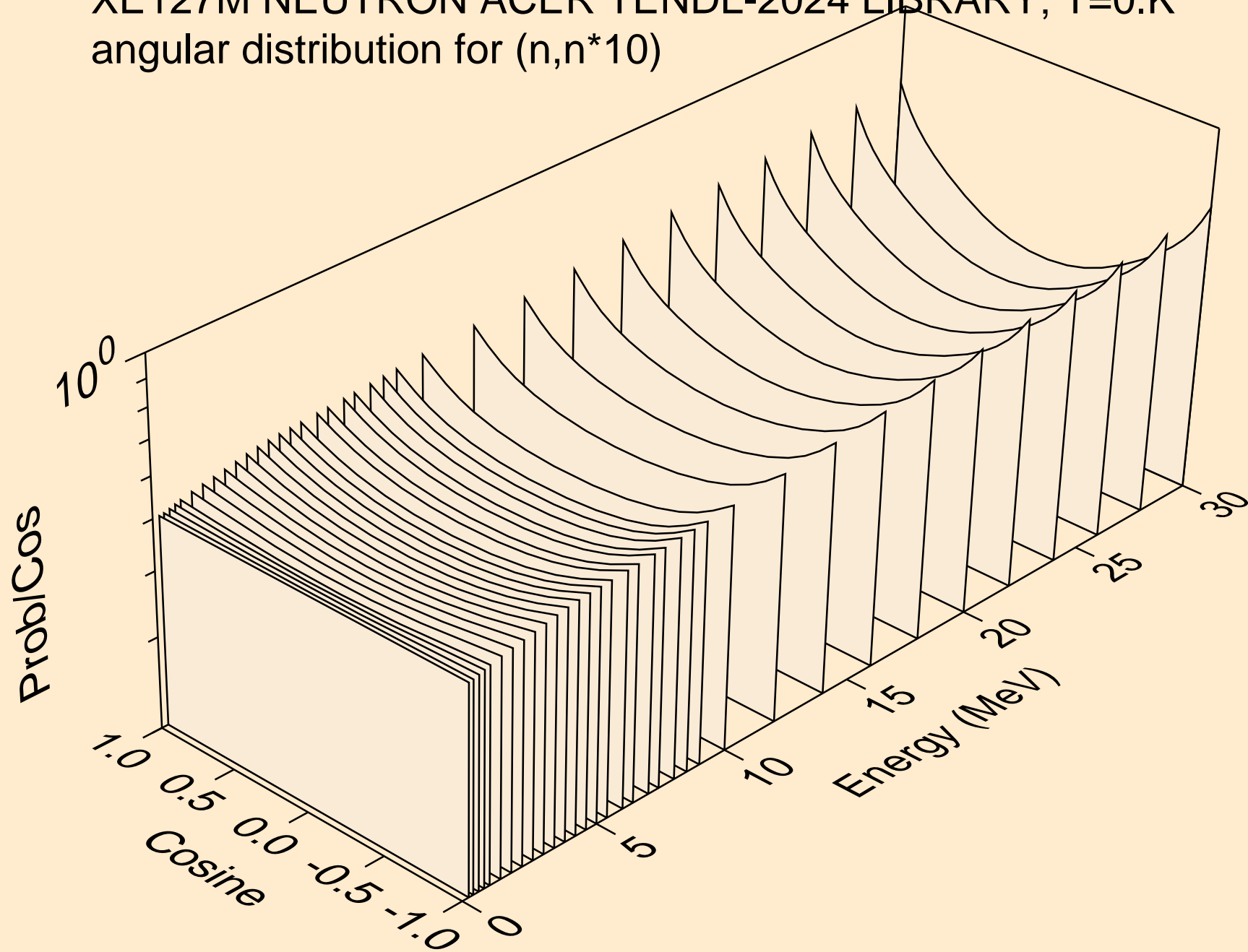

XE127M NEUTRON ACER TENDL-2024 LIBRARY; T=0.K  
angular distribution for (n,n\*11)

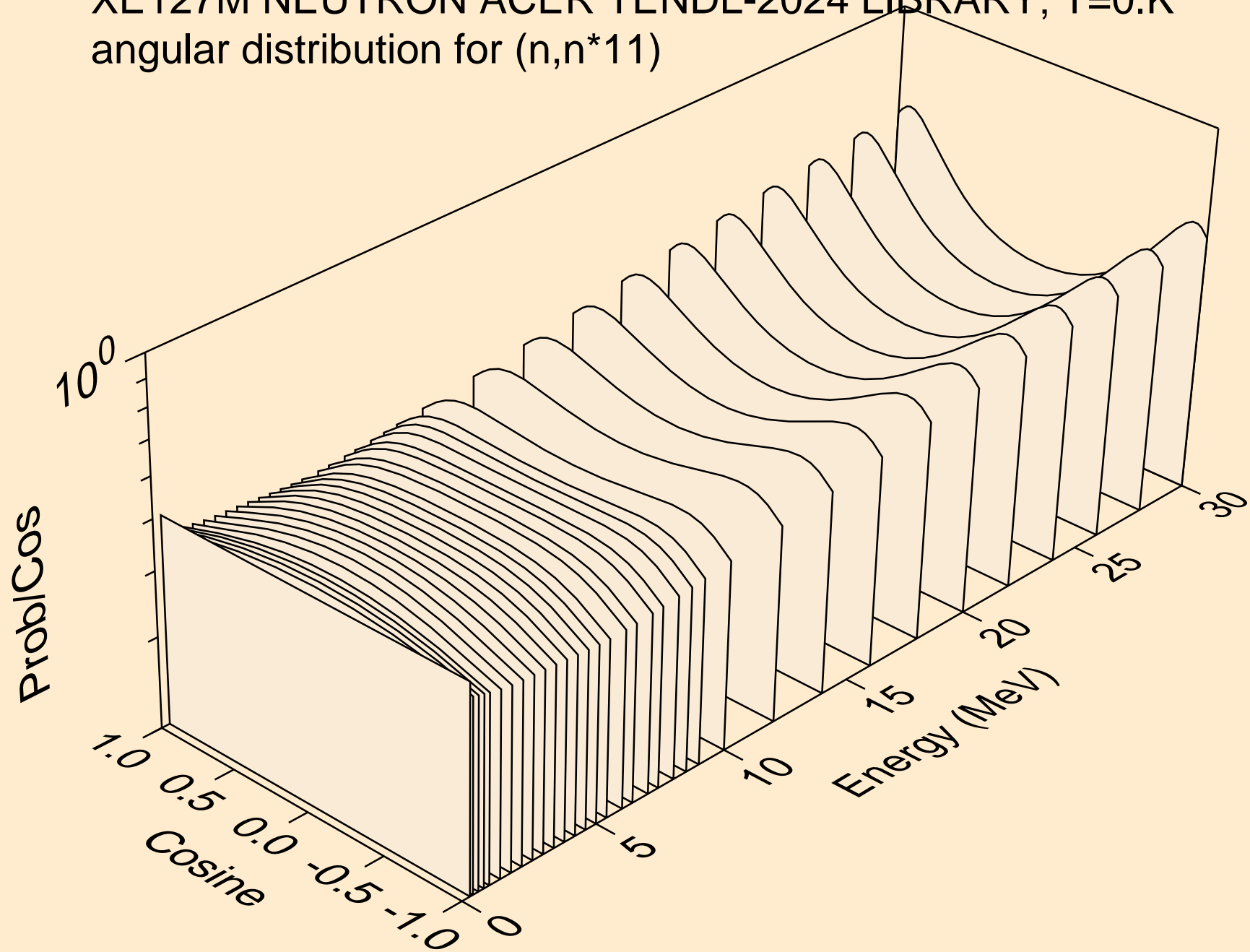

XE127M NEUTRON ACER TENDL-2024 LIBRARY; T=0.K  
angular distribution for (n,n\*12)

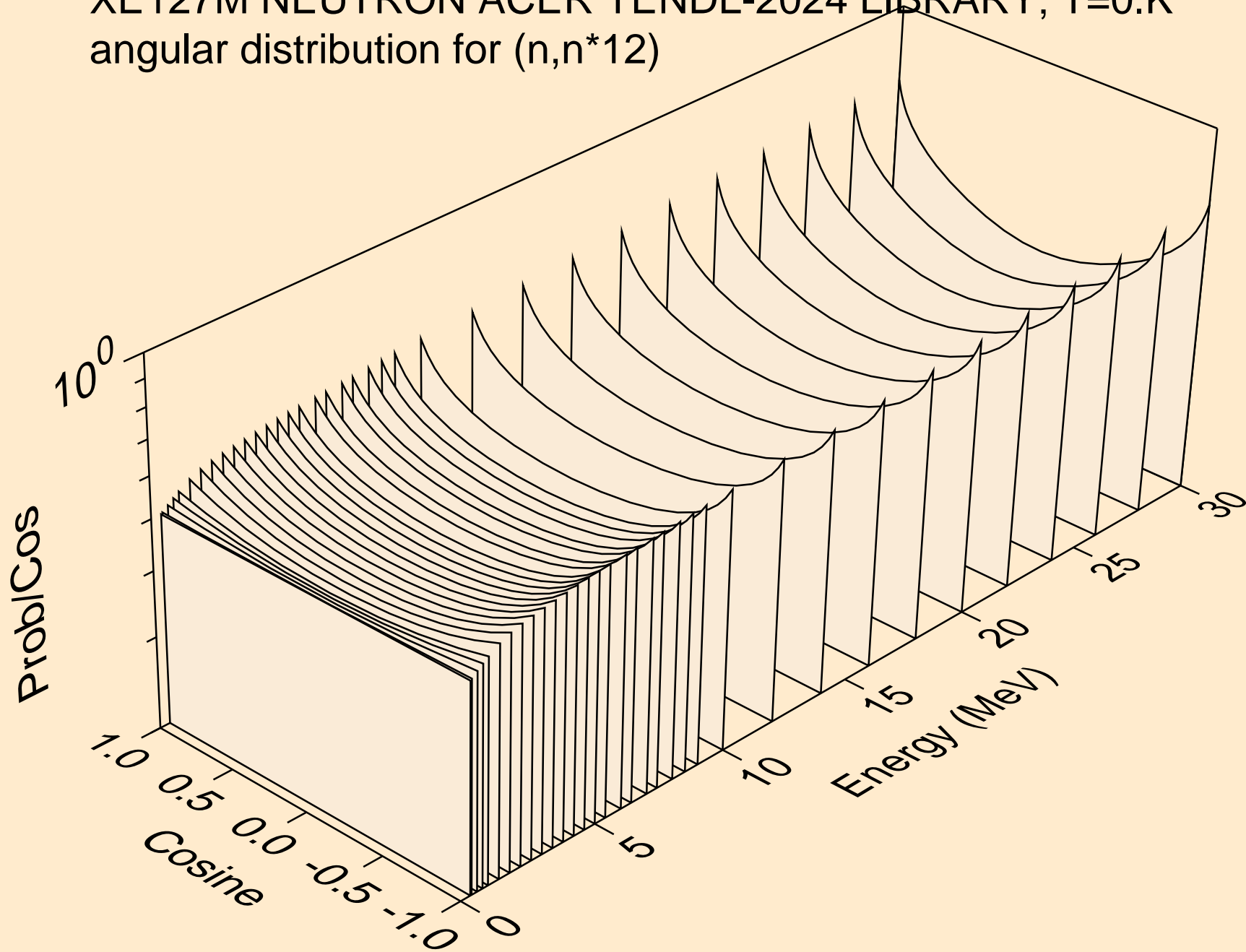

XE127M NEUTRON ACER TENDL-2024 LIBRARY; T=0.K  
angular distribution for (n,n\*13)

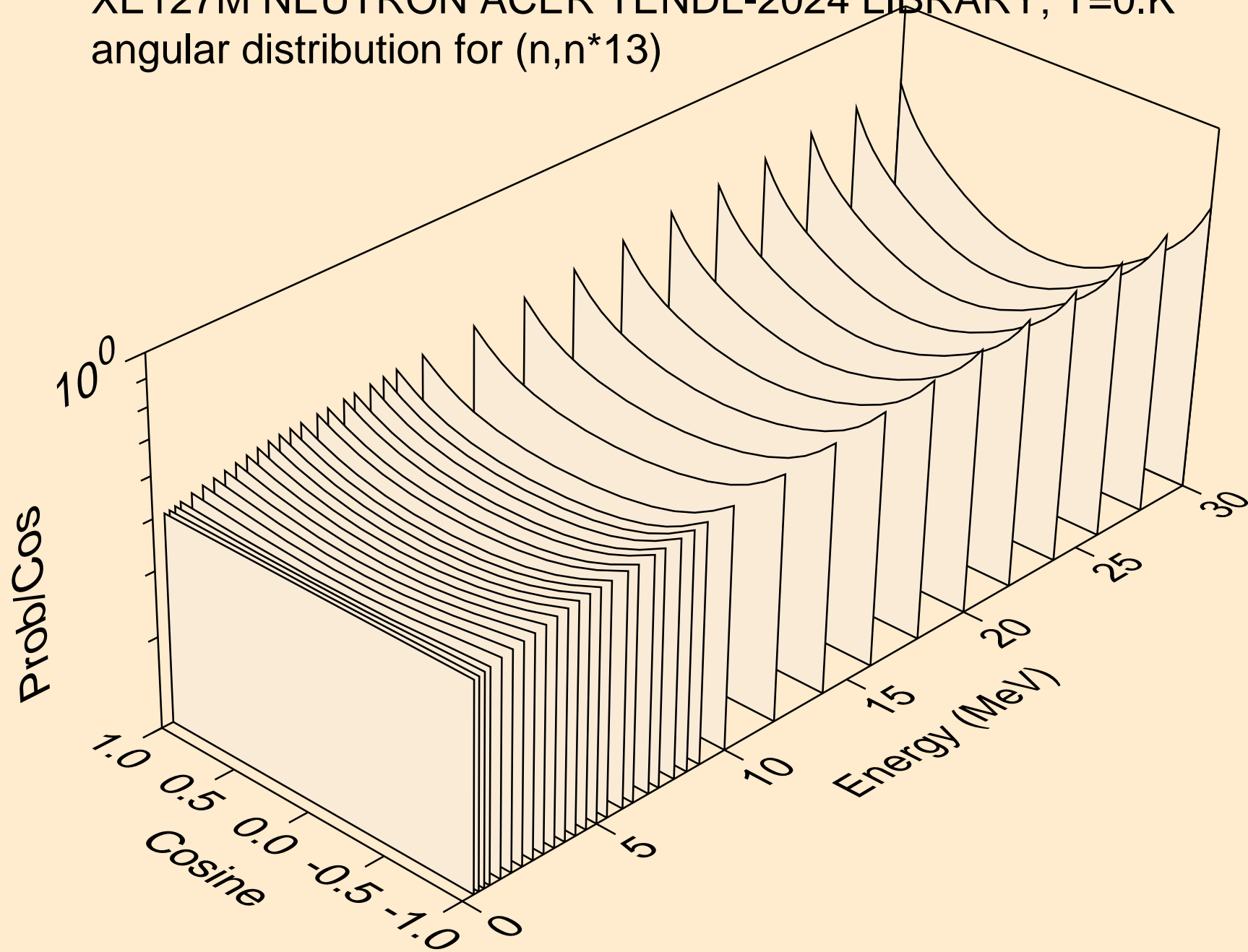

XE127M NEUTRON ACER TENDL-2024 LIBRARY; T=0.K  
angular distribution for (n,n\*14)

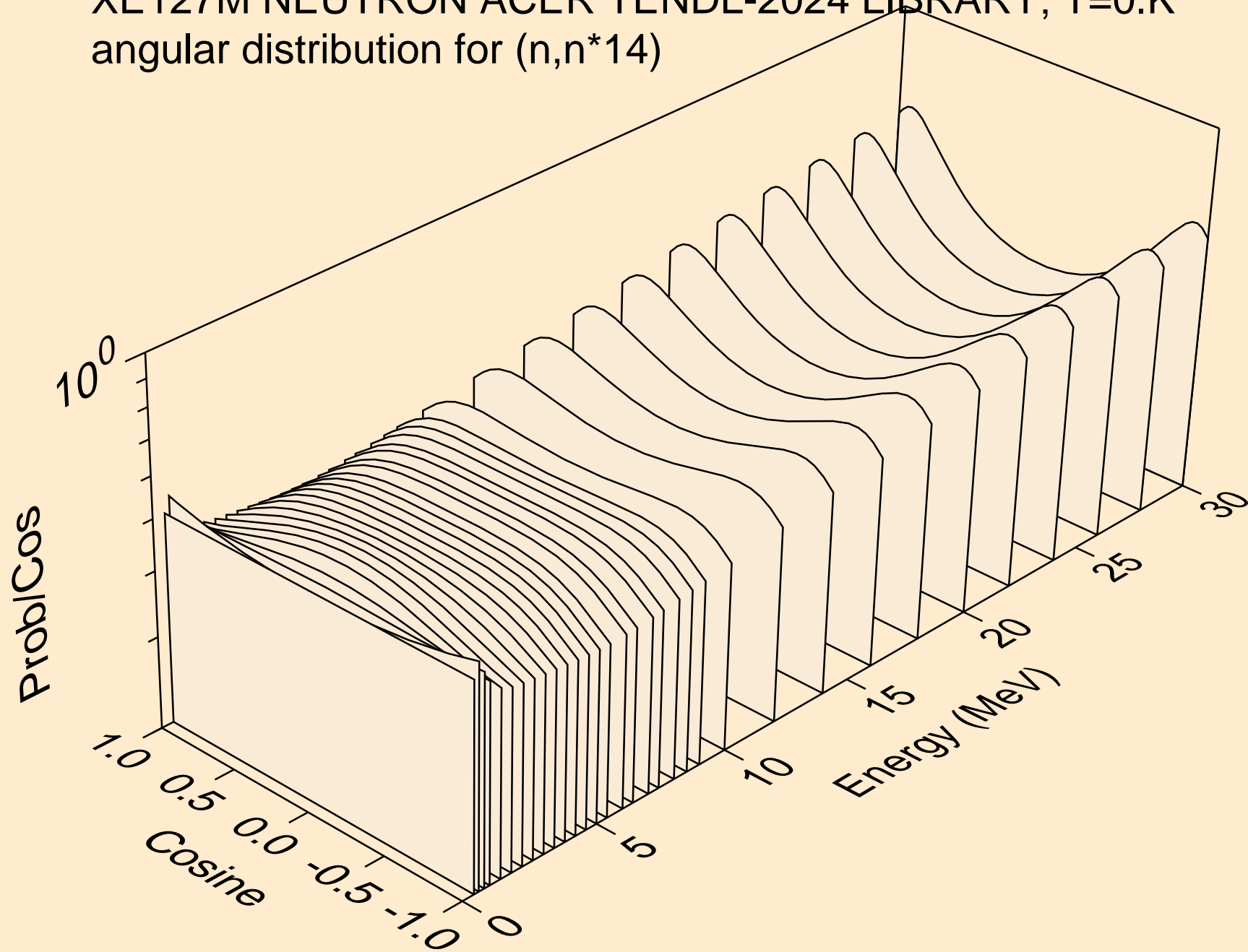

XE127M NEUTRON ACER TENDL-2024 LIBRARY; T=0.K  
angular distribution for (n,n\*15)

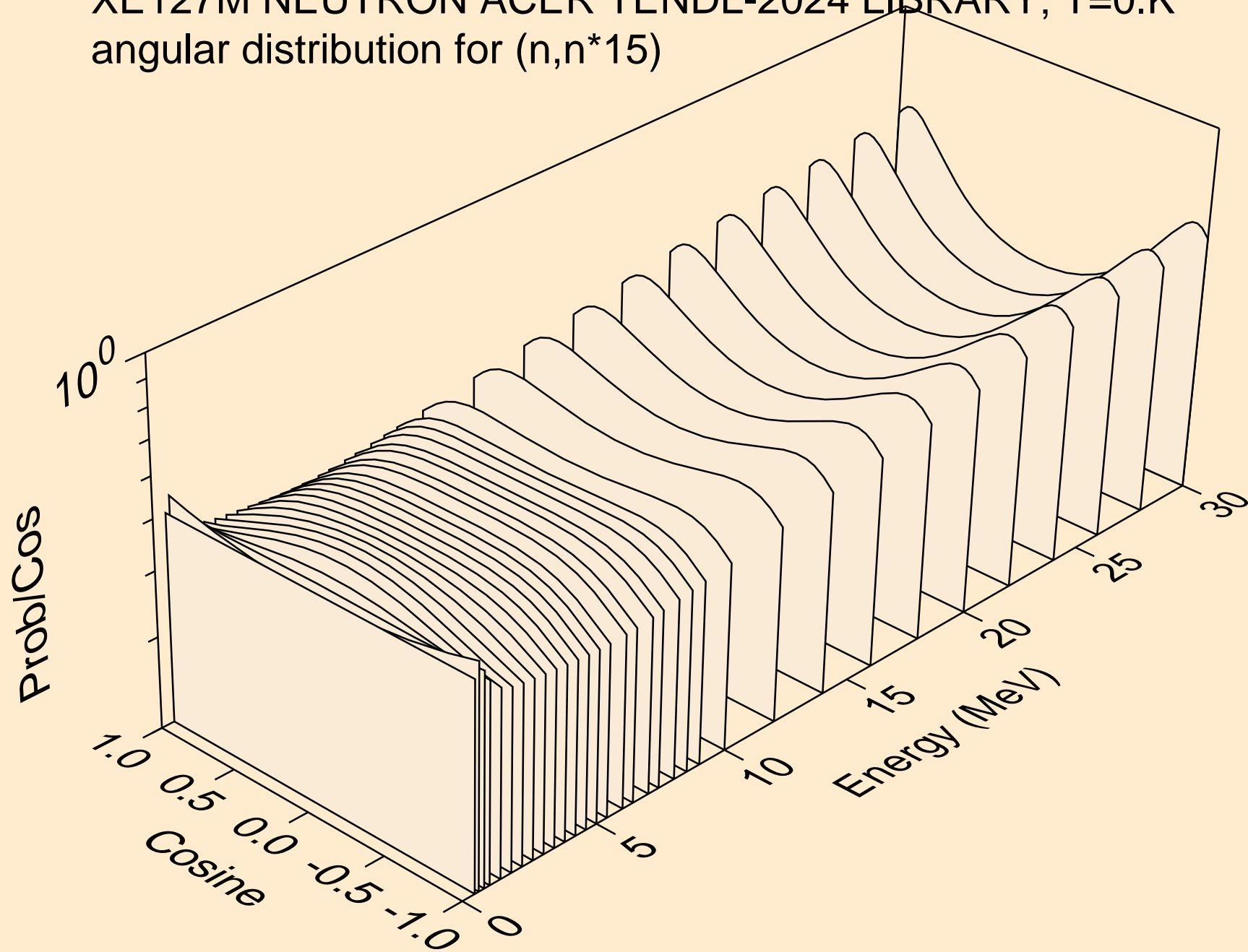



XE127M NEUTRON ACER TENDL-2024 LIBRARY; T=0.K  
angular distribution for (n,n\*16)

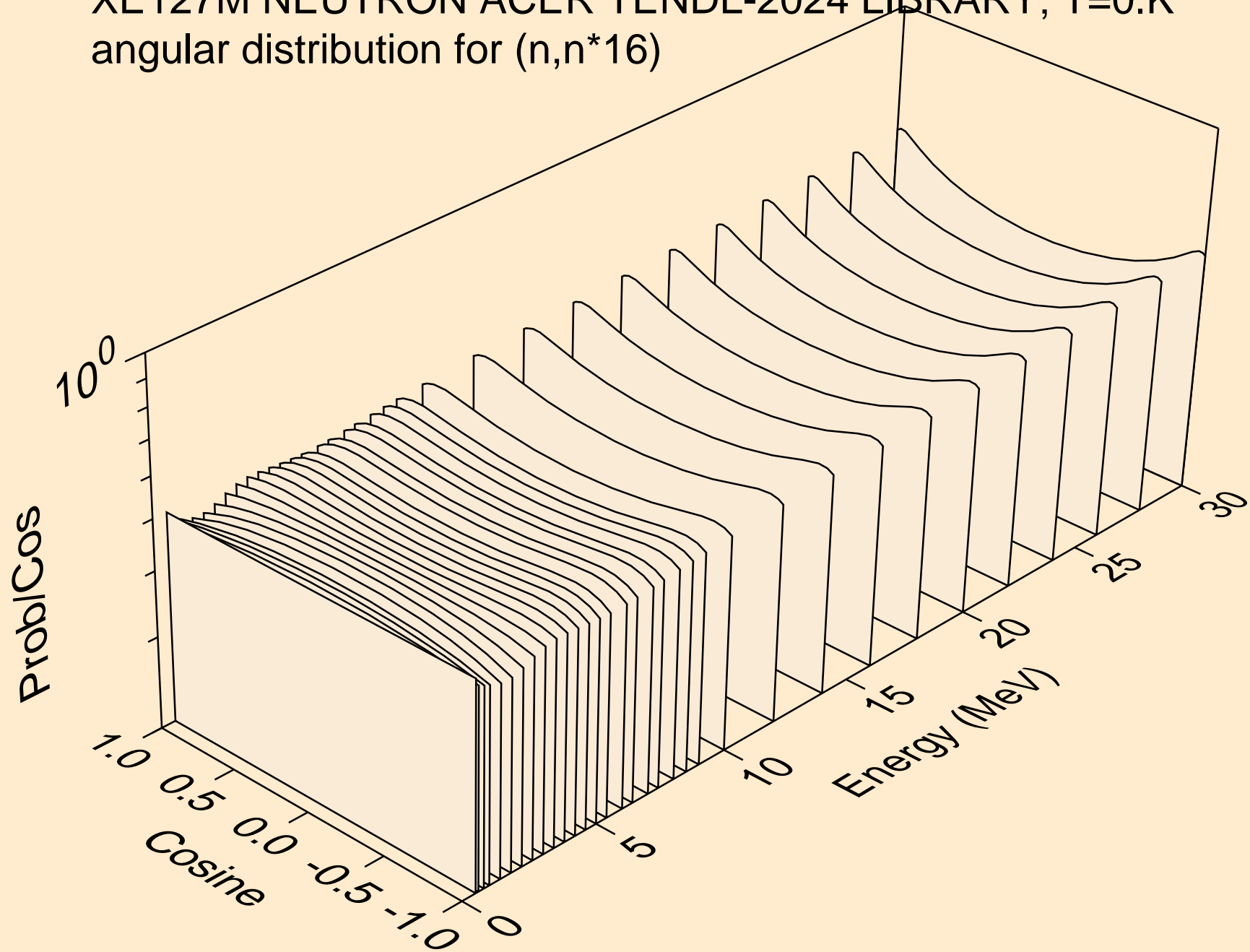

XE127M NEUTRON ACER TENDL-2024 LIBRARY; T=0.K  
angular distribution for (n,n\*17)

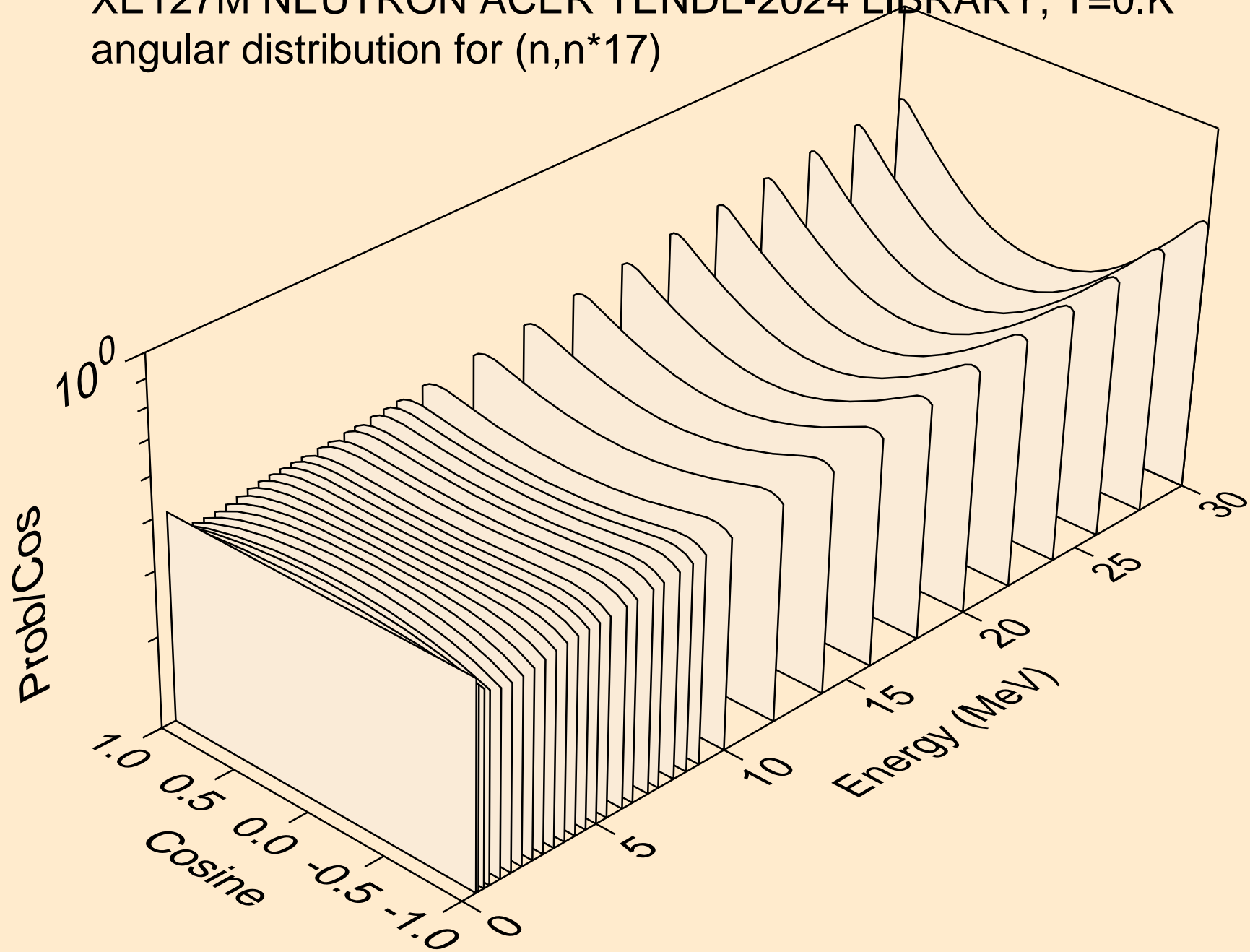

XE127M NEUTRON ACER TENDL-2024 LIBRARY; T=0.K  
angular distribution for (n,n\*18)

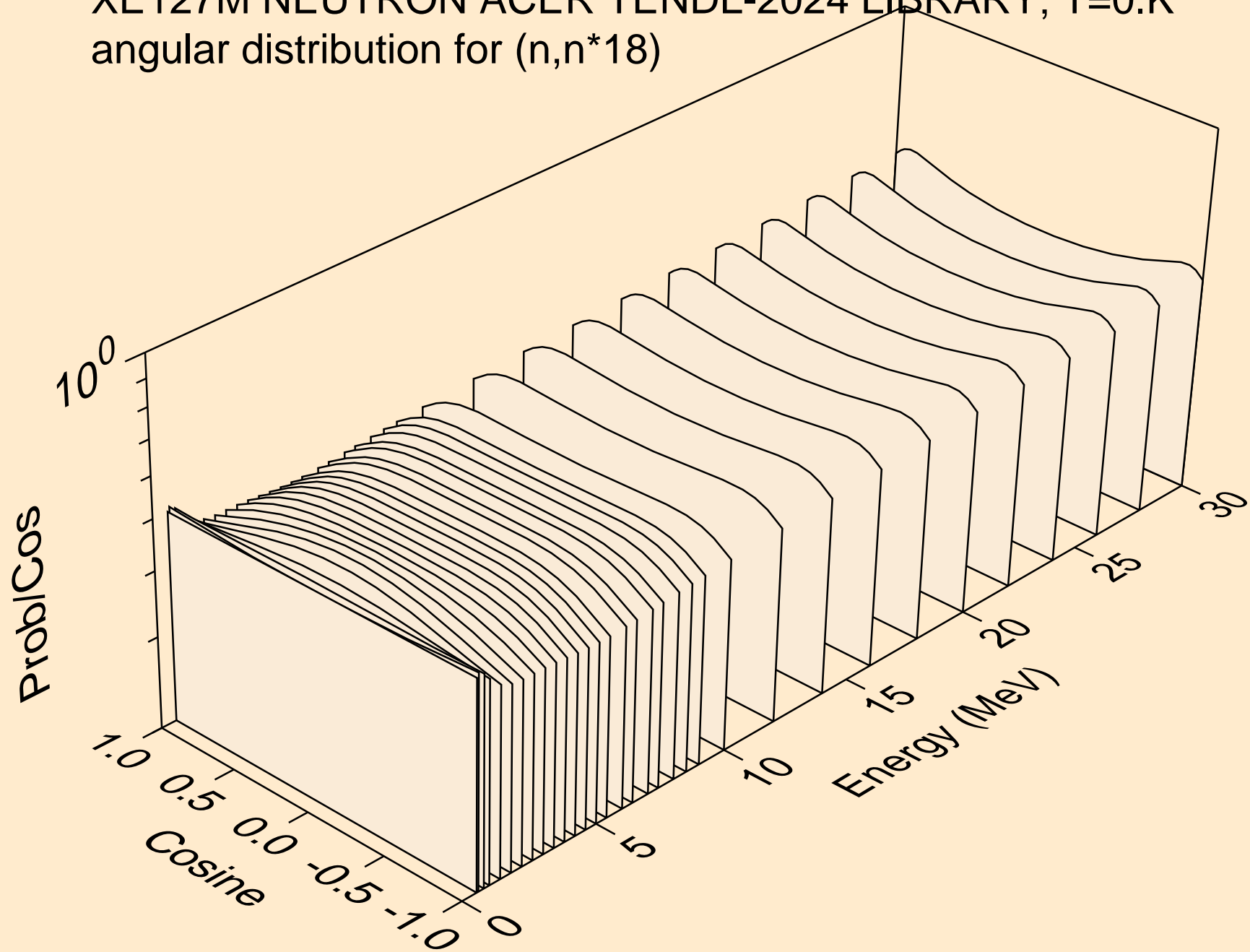

XE127M NEUTRON ACER TENDL-2024 LIBRARY; T=0.K  
angular distribution for (n,n\*19)

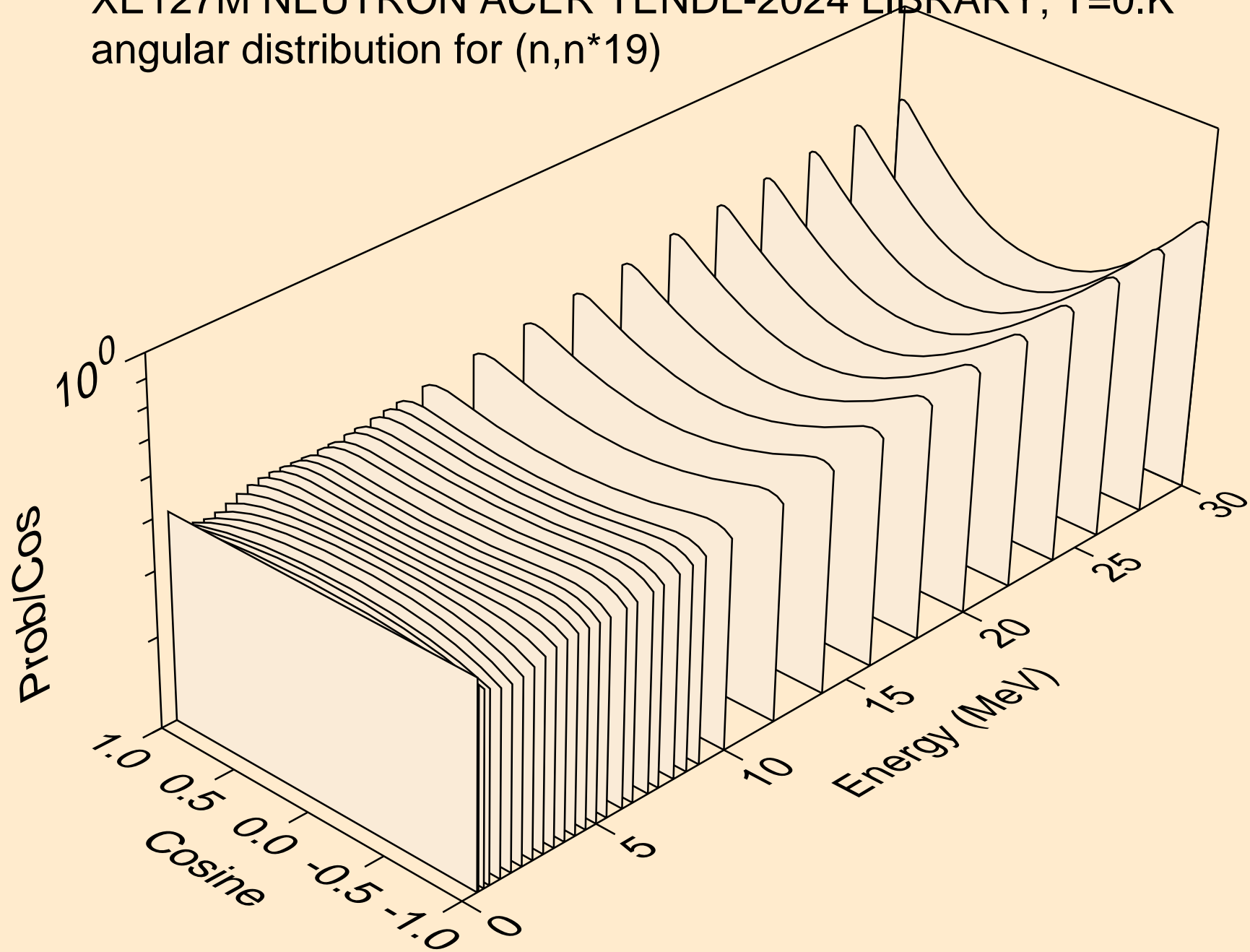

XE127M NEUTRON ACER TENDL-2024 LIBRARY; T=0.K  
angular distribution for (n,n\*20)

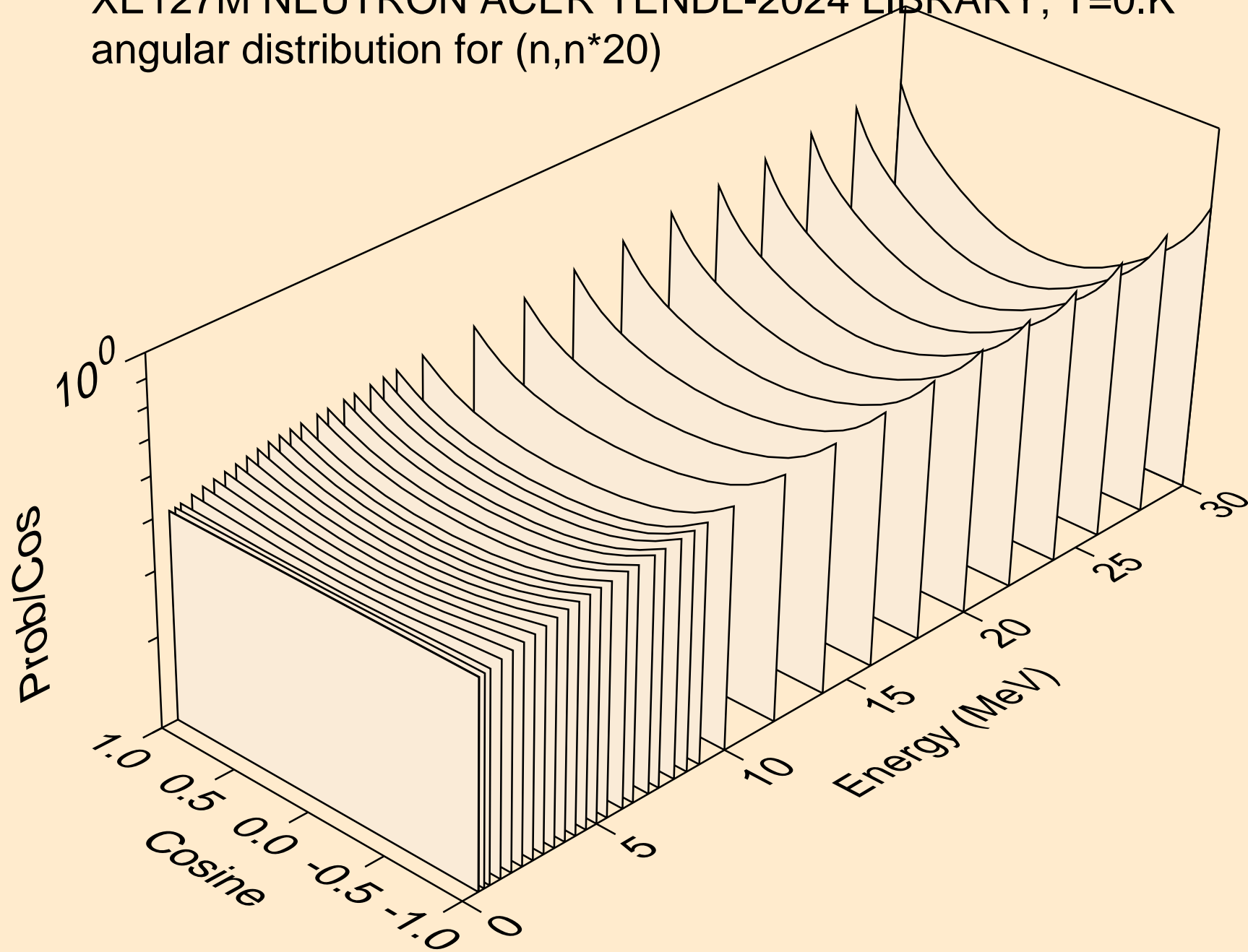

XE127M NEUTRON ACER TENDL-2024 LIBRARY; T=0.K  
angular distribution for (n,n\*21)

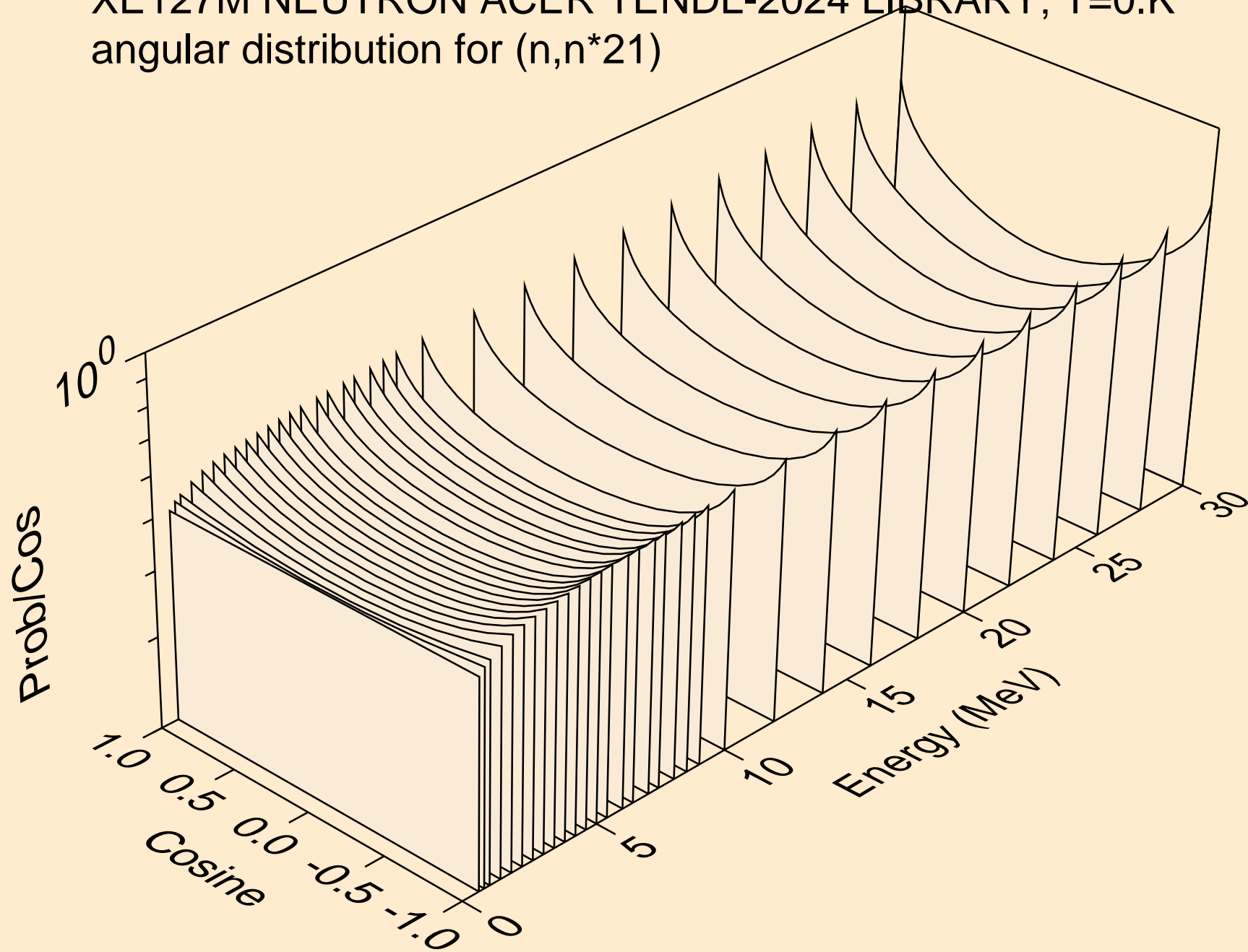

XE127M NEUTRON ACER TENDL-2024 LIBRARY; T=0.K  
angular distribution for (n,n\*22)

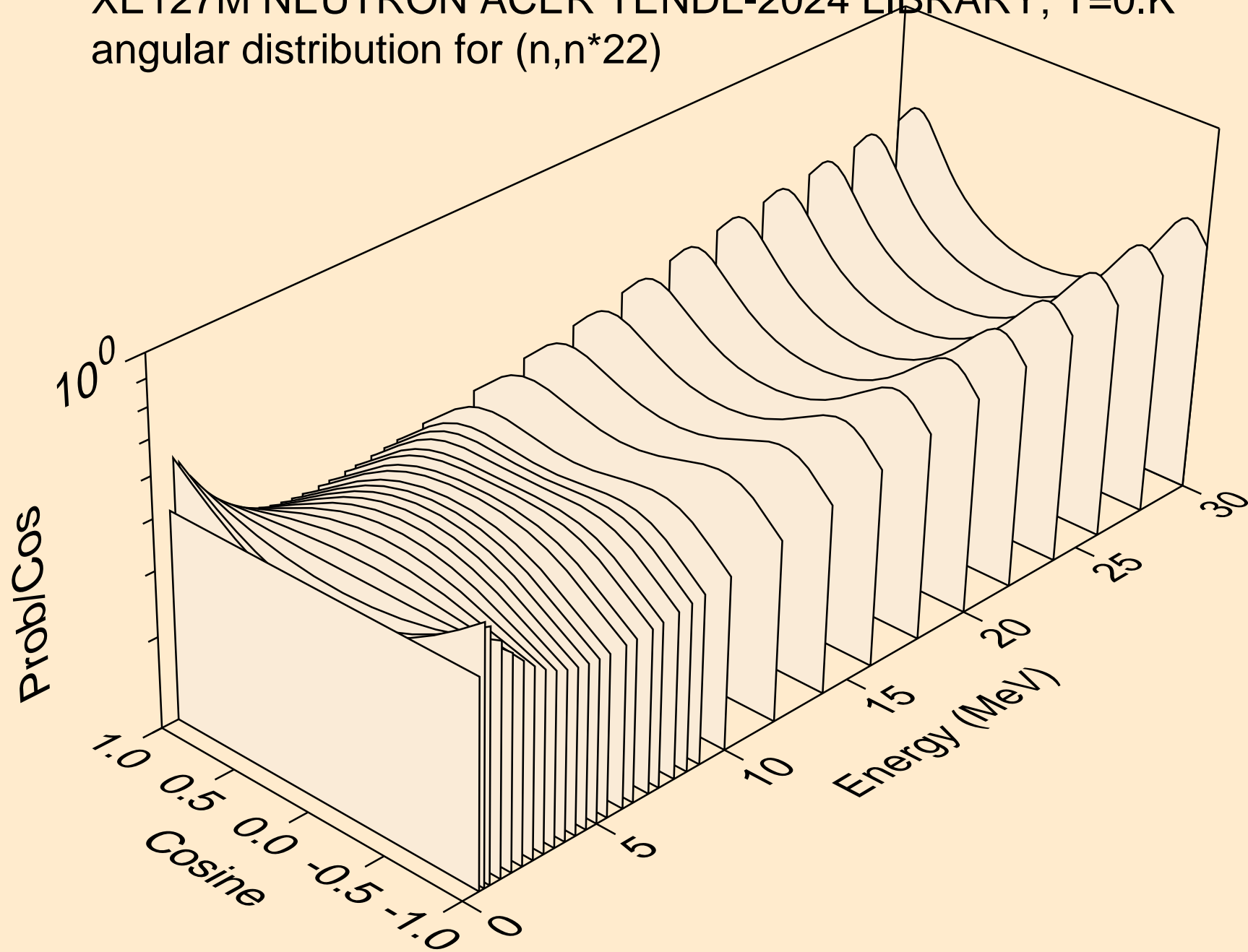

XE127M NEUTRON ACER TENDL-2024 LIBRARY; T=0.K  
angular distribution for (n,n\*23)

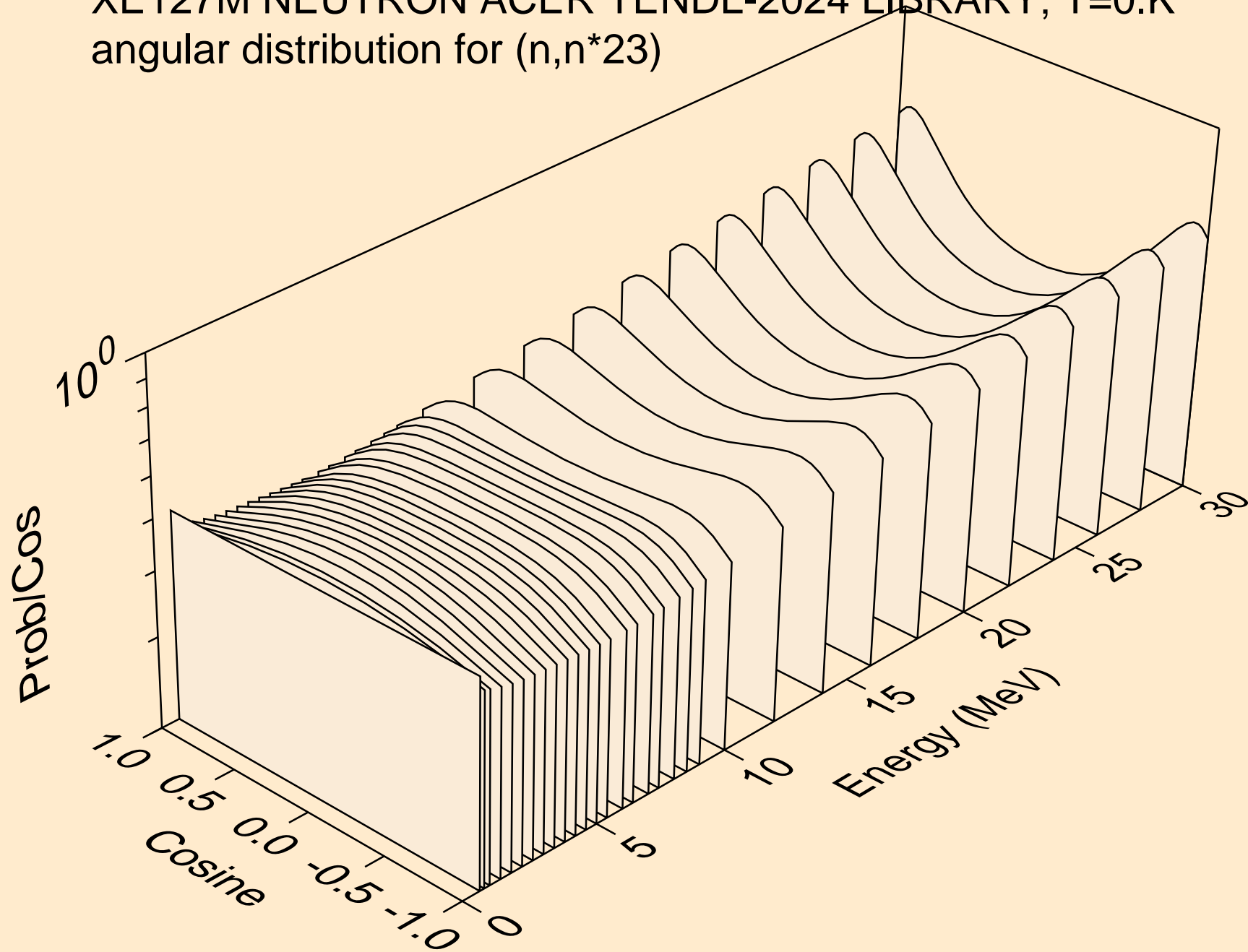



XE127M NEUTRON ACER TENDL-2024 LIBRARY; T=0.K  
angular distribution for (n,n\*24)

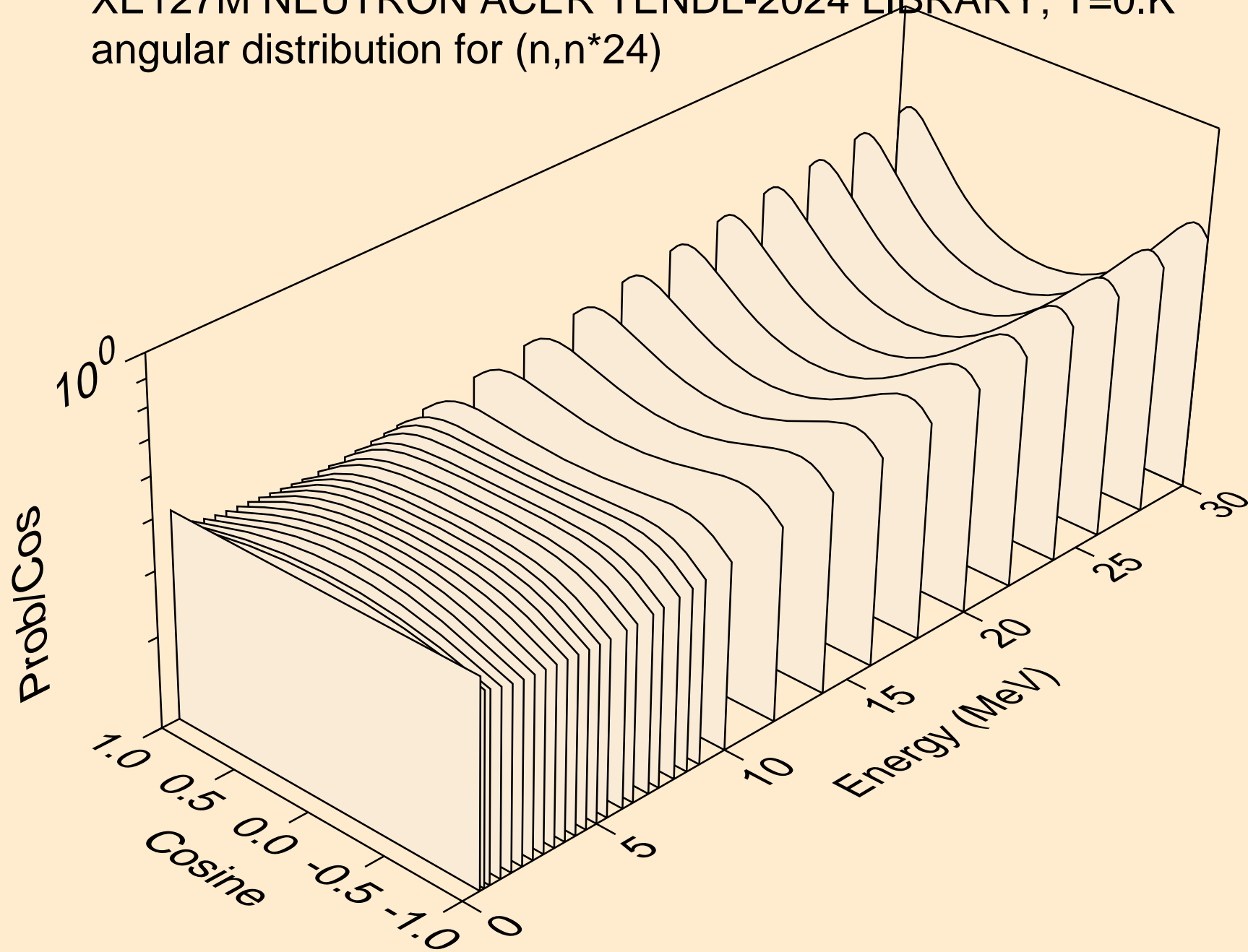

XE127M NEUTRON ACER TENDL-2024 LIBRARY; T=0.K  
angular distribution for (n,n\*25)

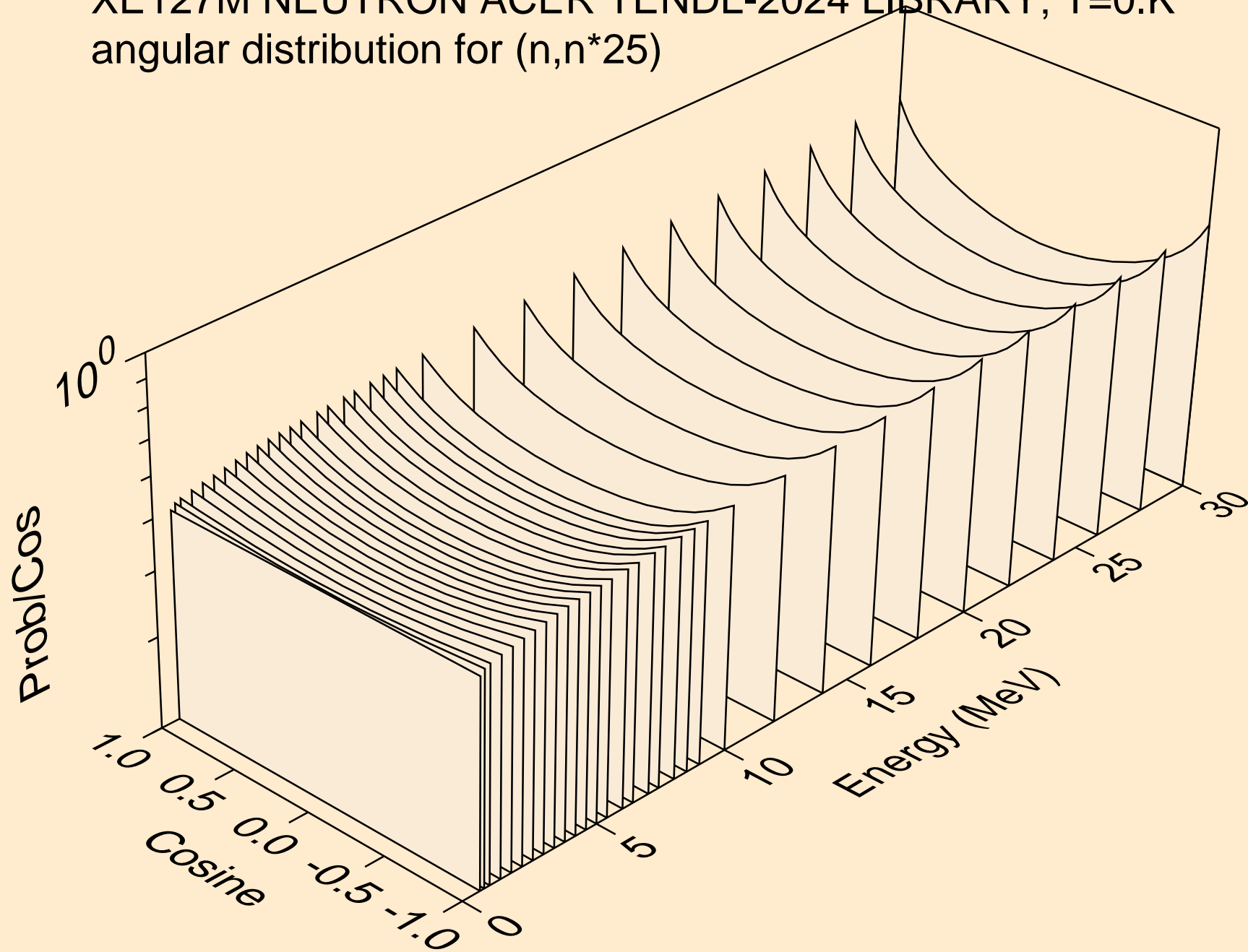

XE127M NEUTRON ACER TENDL-2024 LIBRARY; T=0.K  
angular distribution for (n,n\*26)

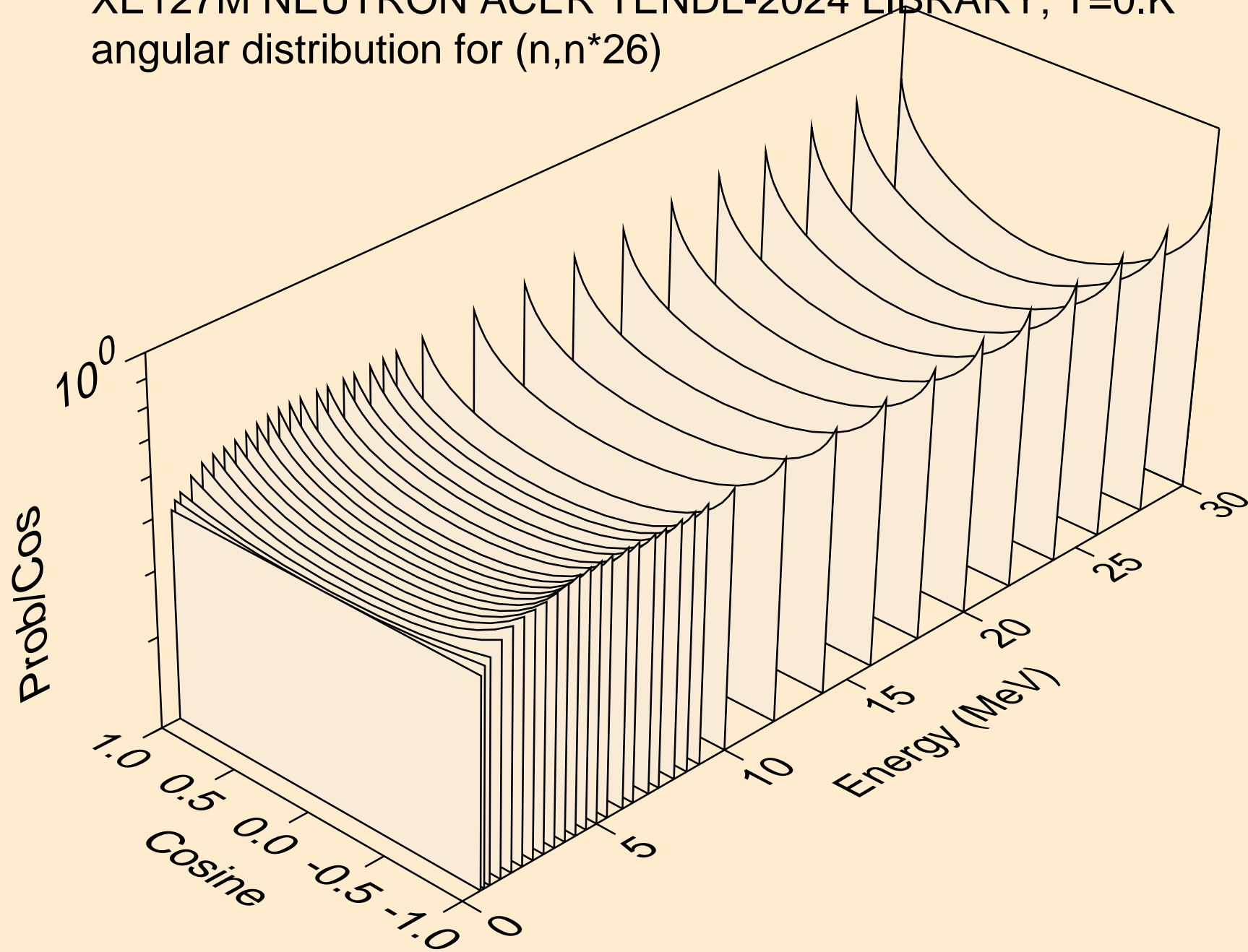

XE127M NEUTRON ACER TENDL-2024 LIBRARY; T=0.K  
angular distribution for (n,n\*27)

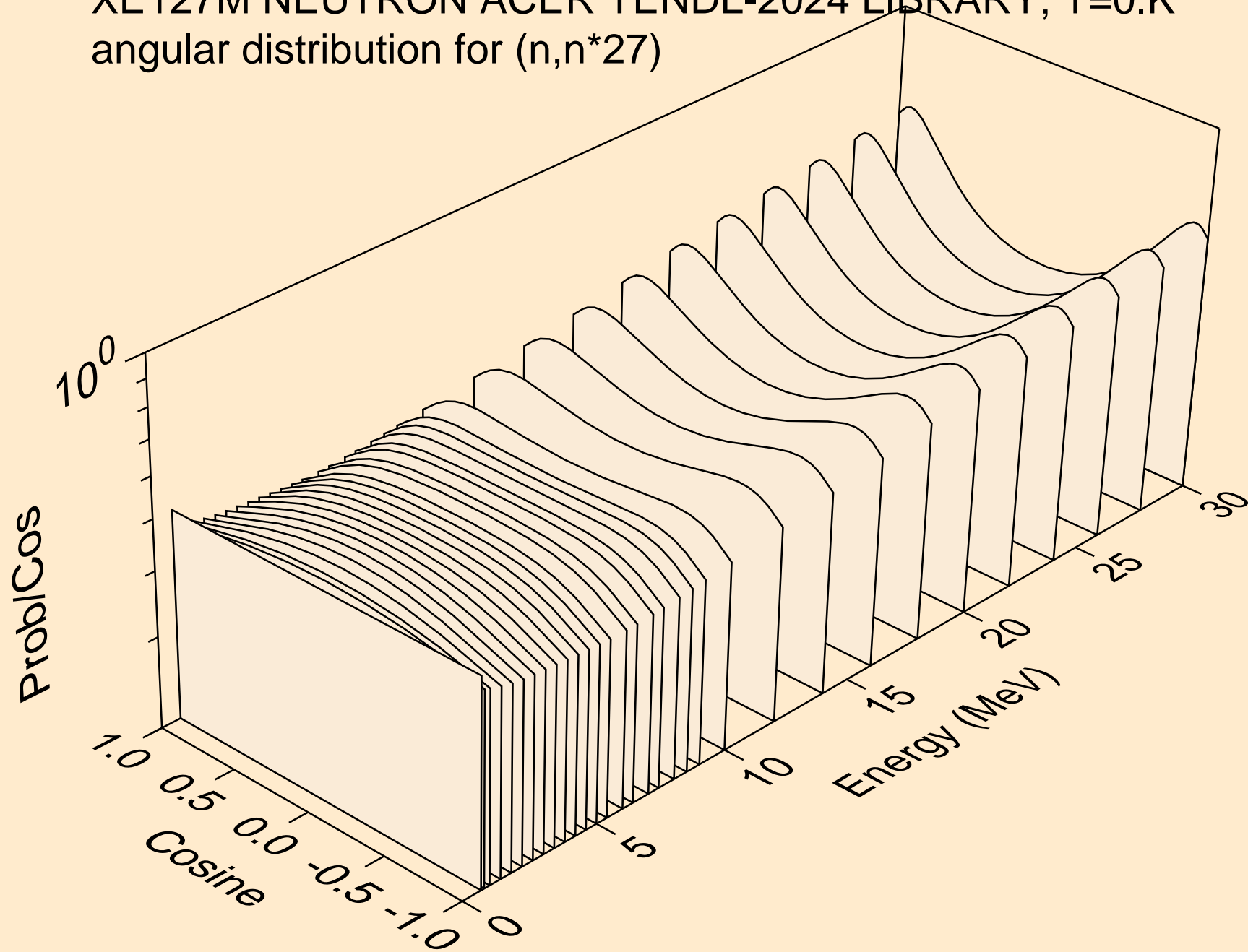

XE127M NEUTRON ACER TENDL-2024 LIBRARY; T=0.K  
angular distribution for (n,n\*28)

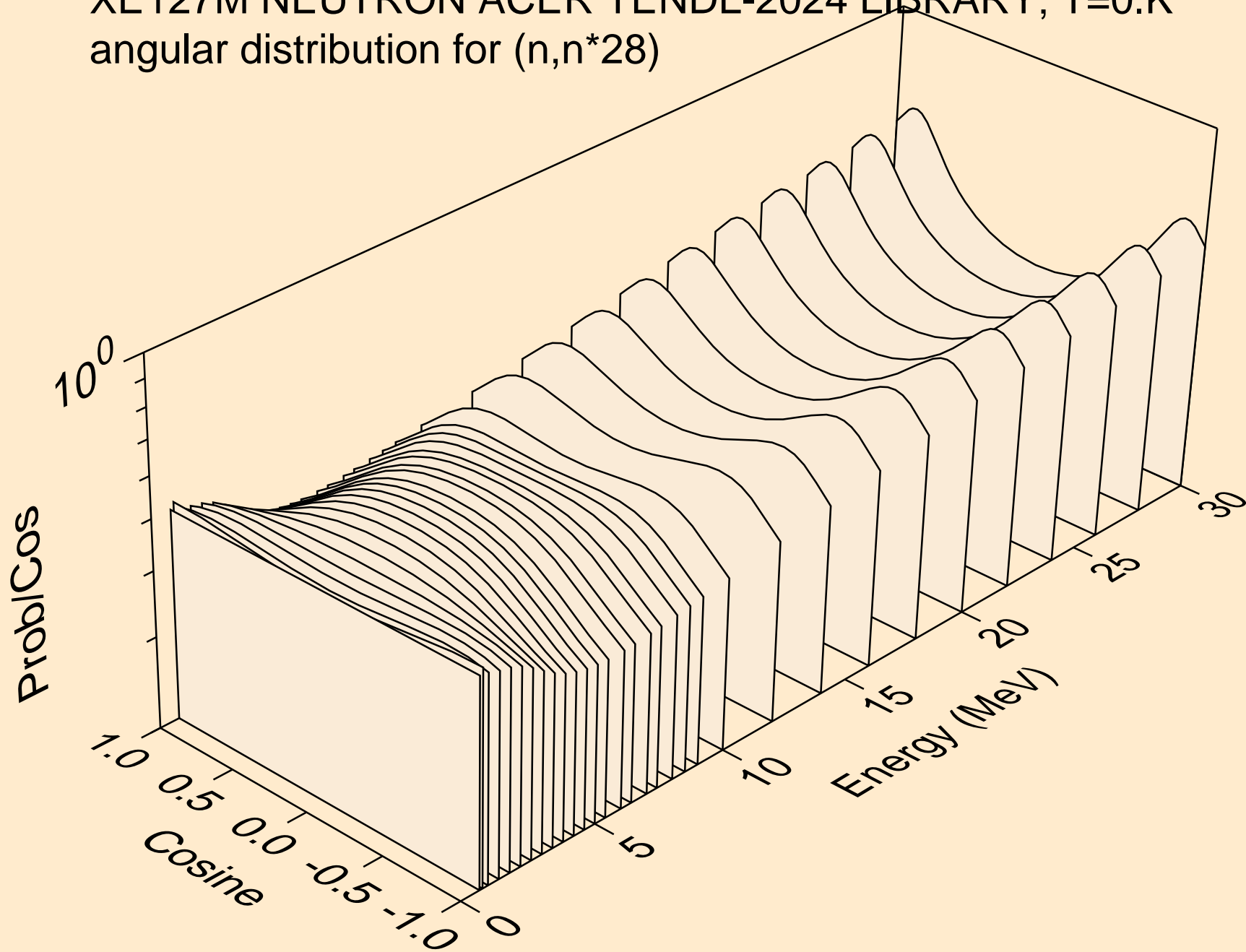

XE127M NEUTRON ACER TENDL-2024 LIBRARY; T=0.K  
angular distribution for (n,n\*29)

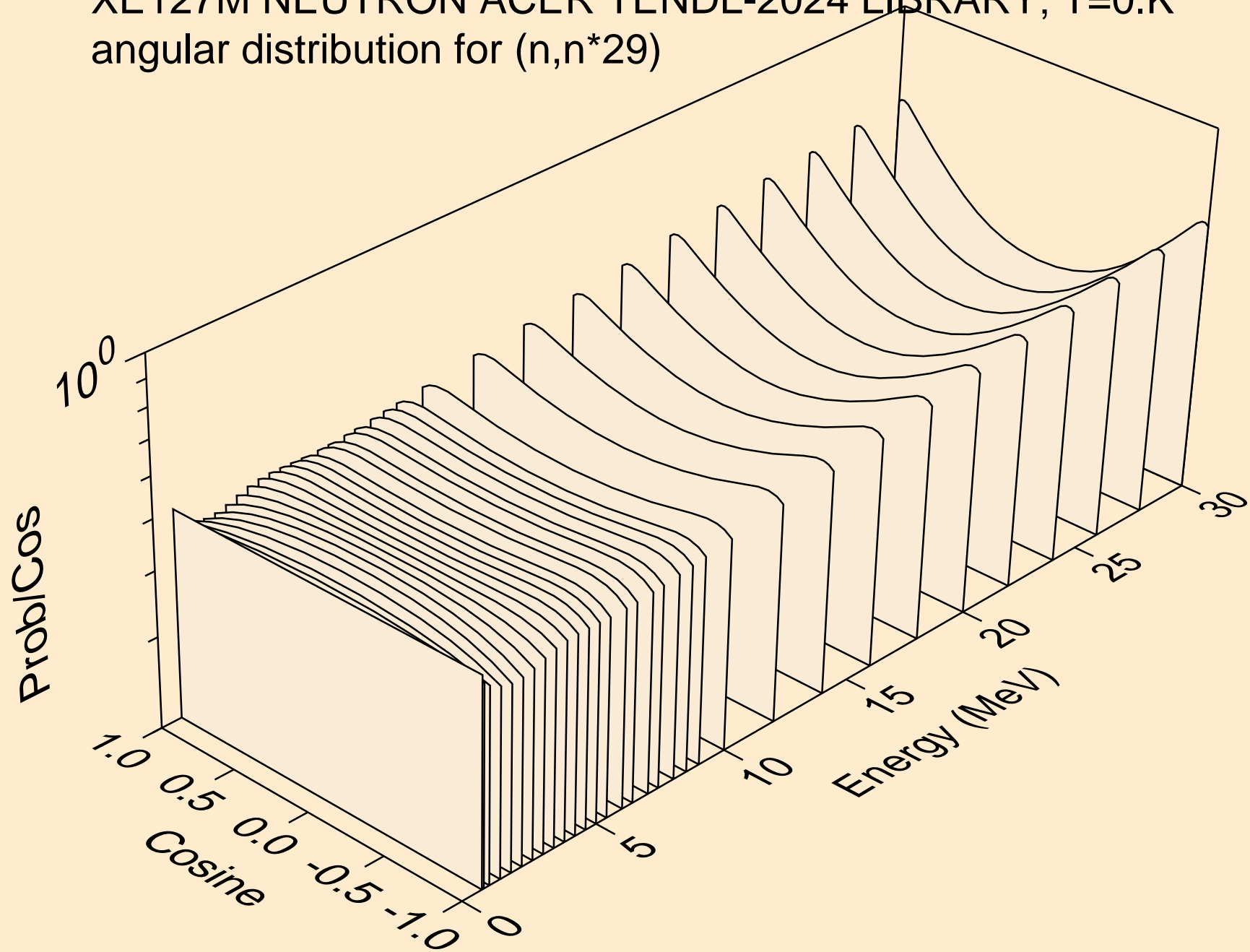

XE127M NEUTRON ACER TENDL-2024 LIBRARY; T=0.K  
angular distribution for (n,n\*30)

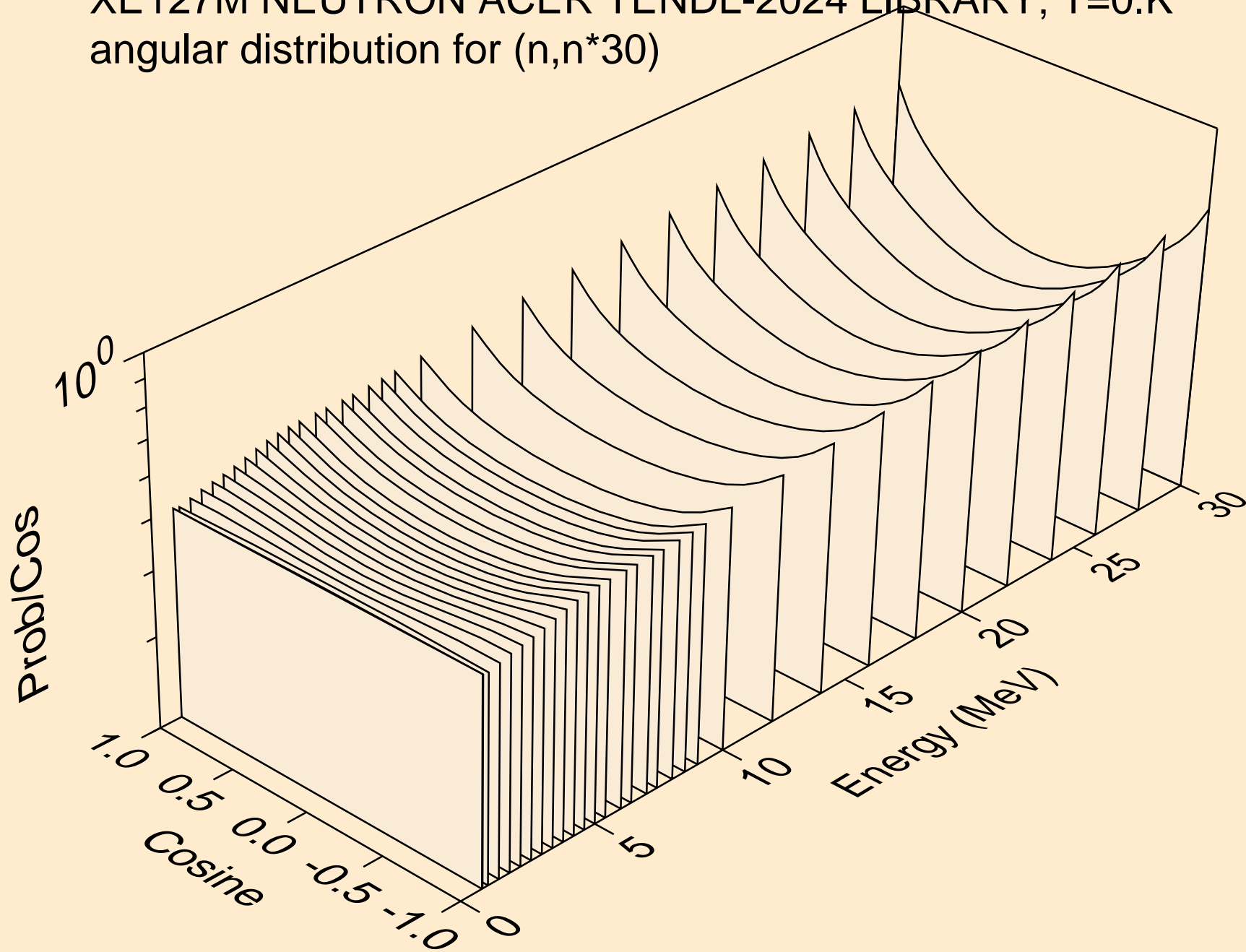

XE127M NEUTRON ACER TENDL-2024 LIBRARY; T=0.K  
Neutron emission for (n,x)

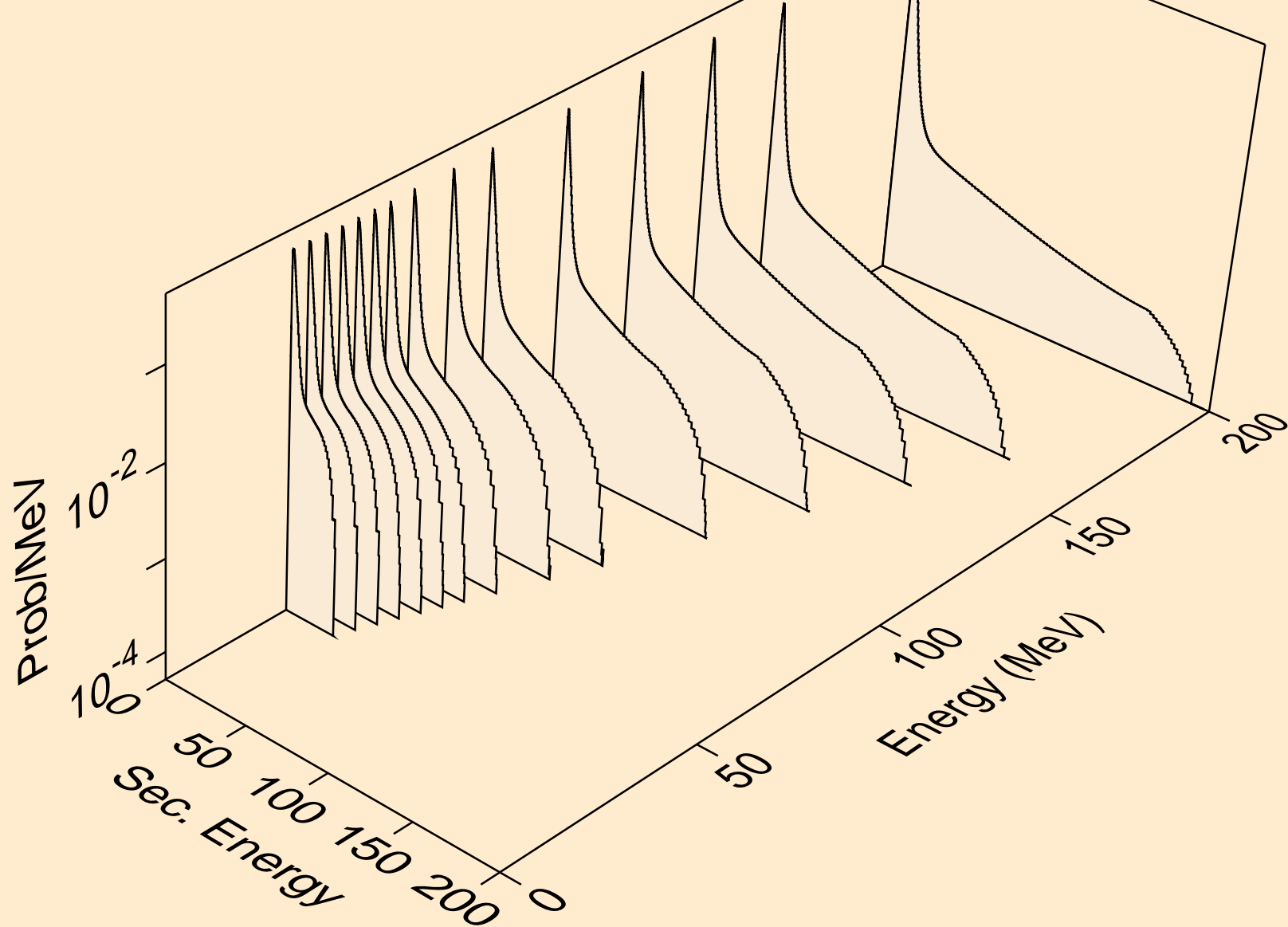



XE127M NEUTRON ACER TENDL-2024 LIBRARY; T=0.K  
Neutron emission for (n,2nd)

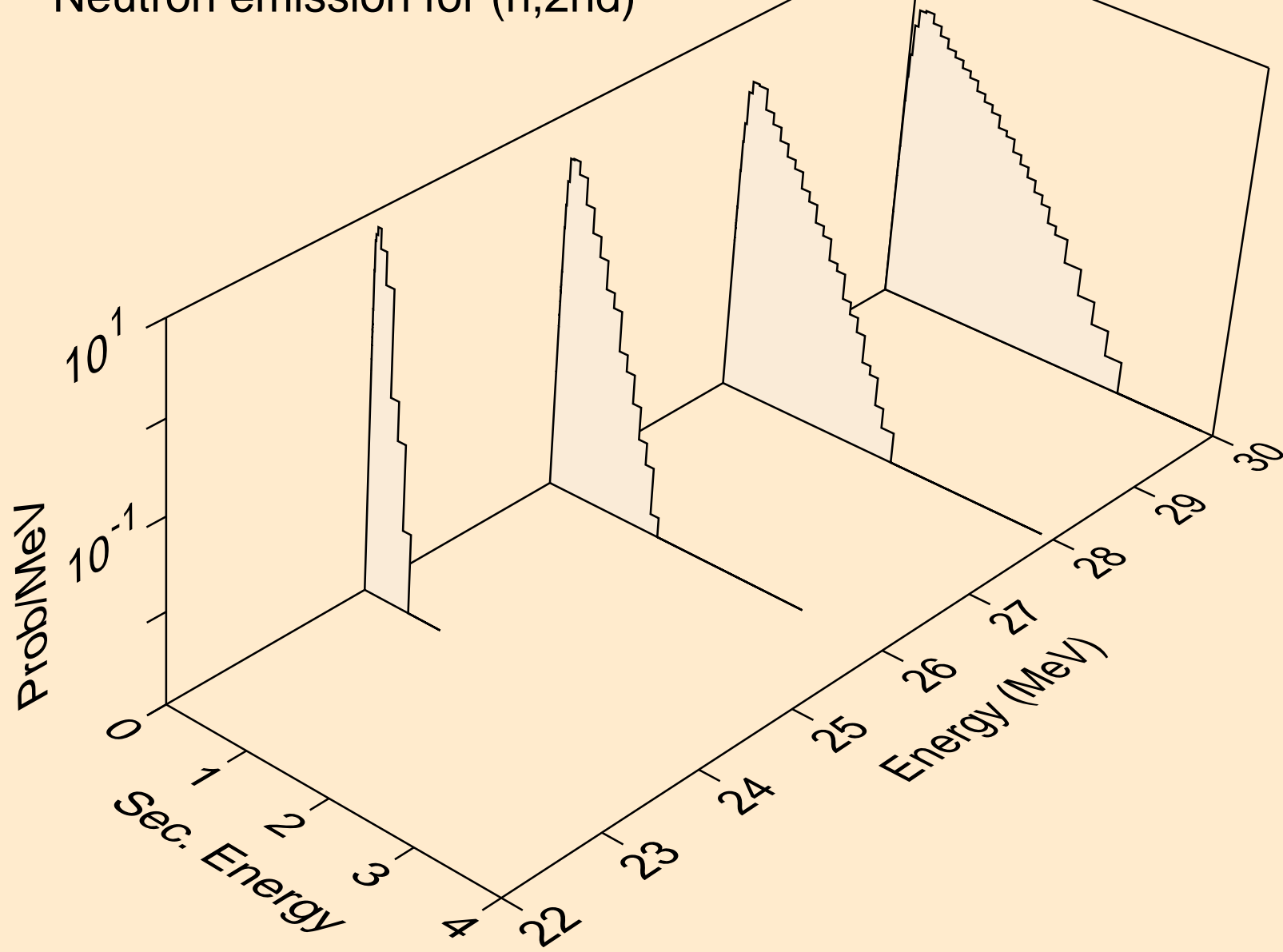

XE127M NEUTRON ACER TENDL-2024 LIBRARY; T=0.K  
Neutron emission for (n,2n)

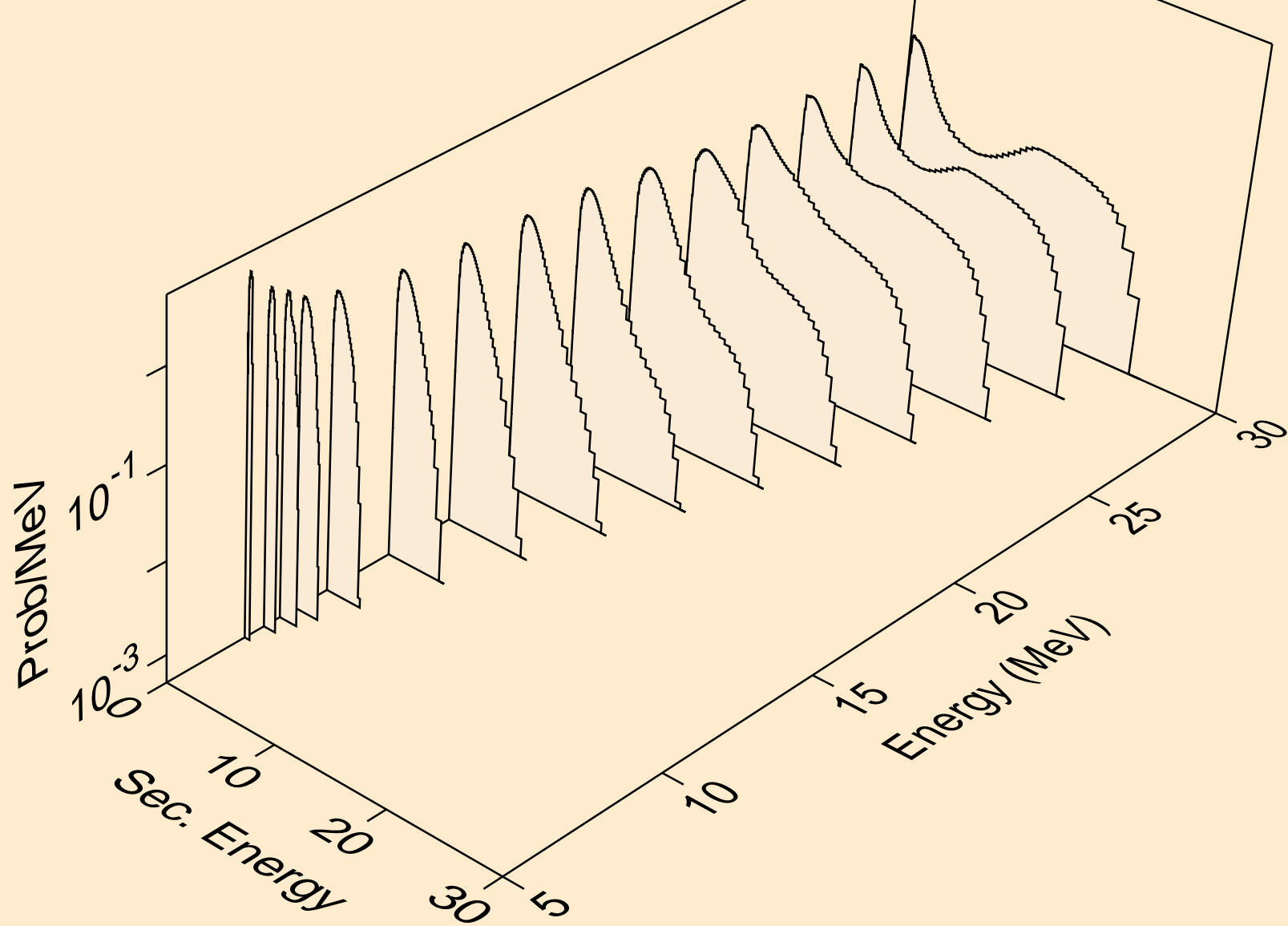

XE127M NEUTRON ACER TENDL-2024 LIBRARY; T=0.K  
Neutron emission for (n,3n)

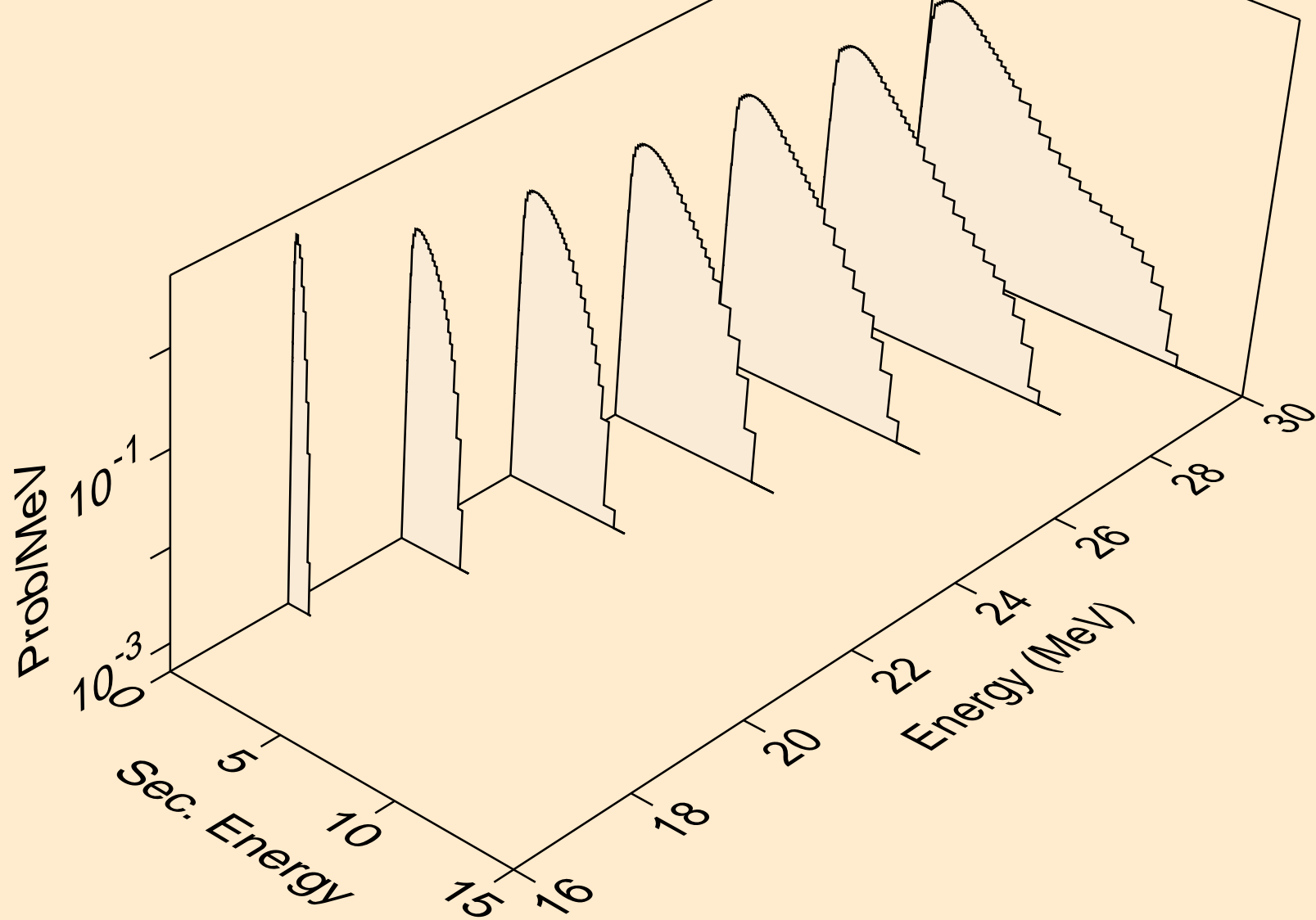

XE127M NEUTRON ACER TENDL-2024 LIBRARY; T=0.K  
Neutron emission for (n,n\*)a

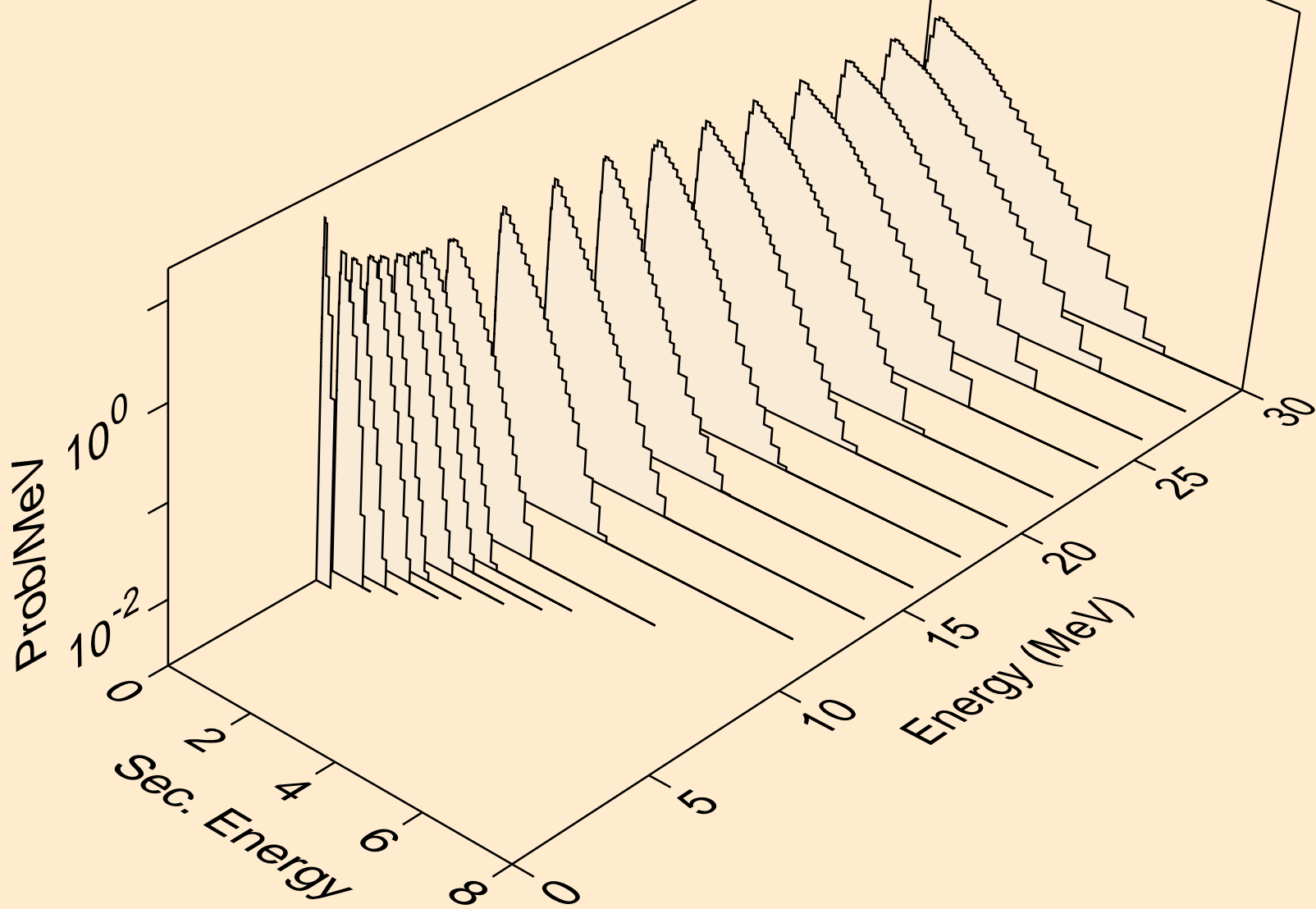

XE127M NEUTRON ACER TENDL-2024 LIBRARY; T=0.K  
Neutron emission for (n,2n)a

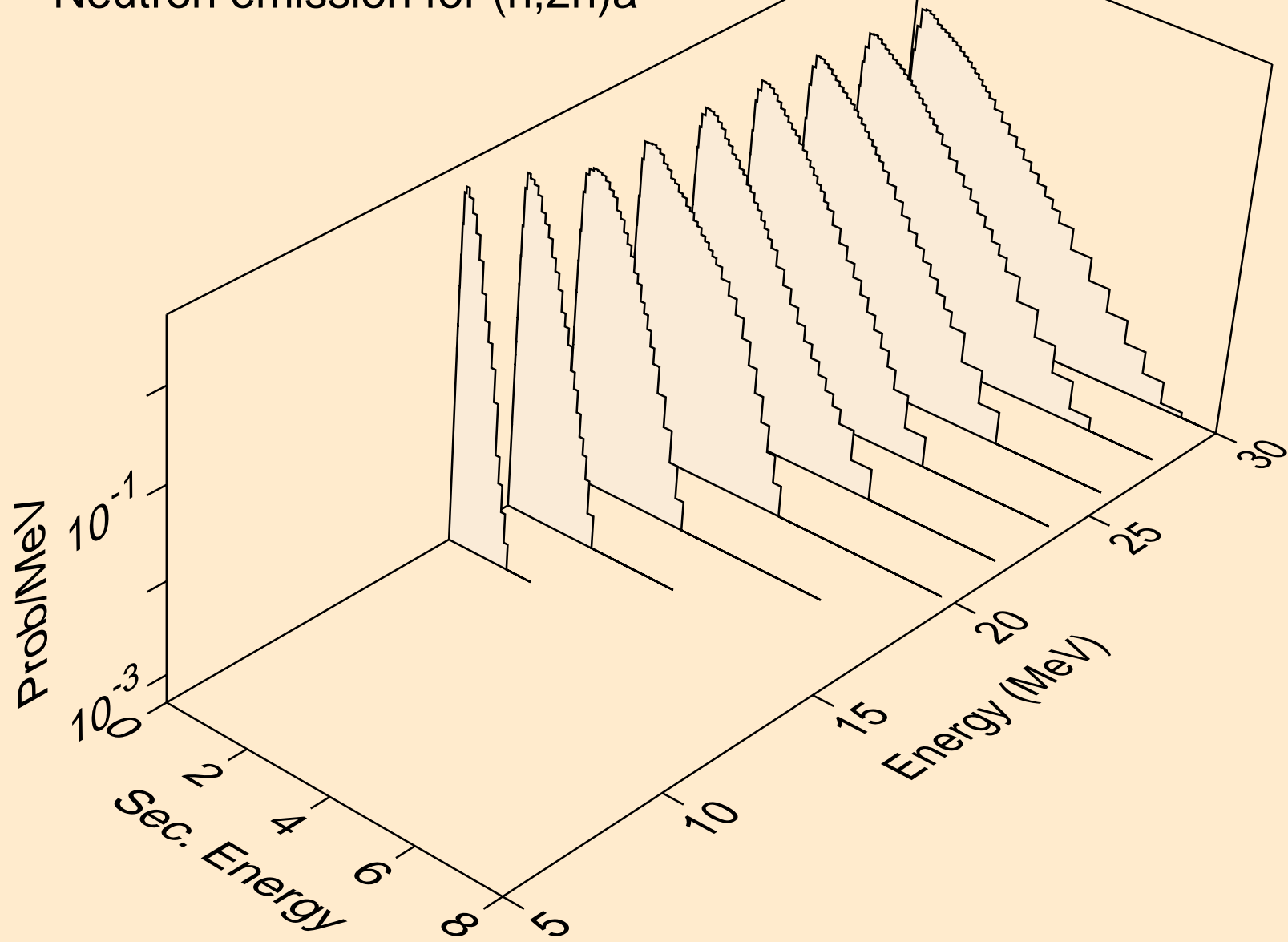

XE127M NEUTRON ACER TENDL-2024 LIBRARY; T=0.K  
Neutron emission for (n,3n)a

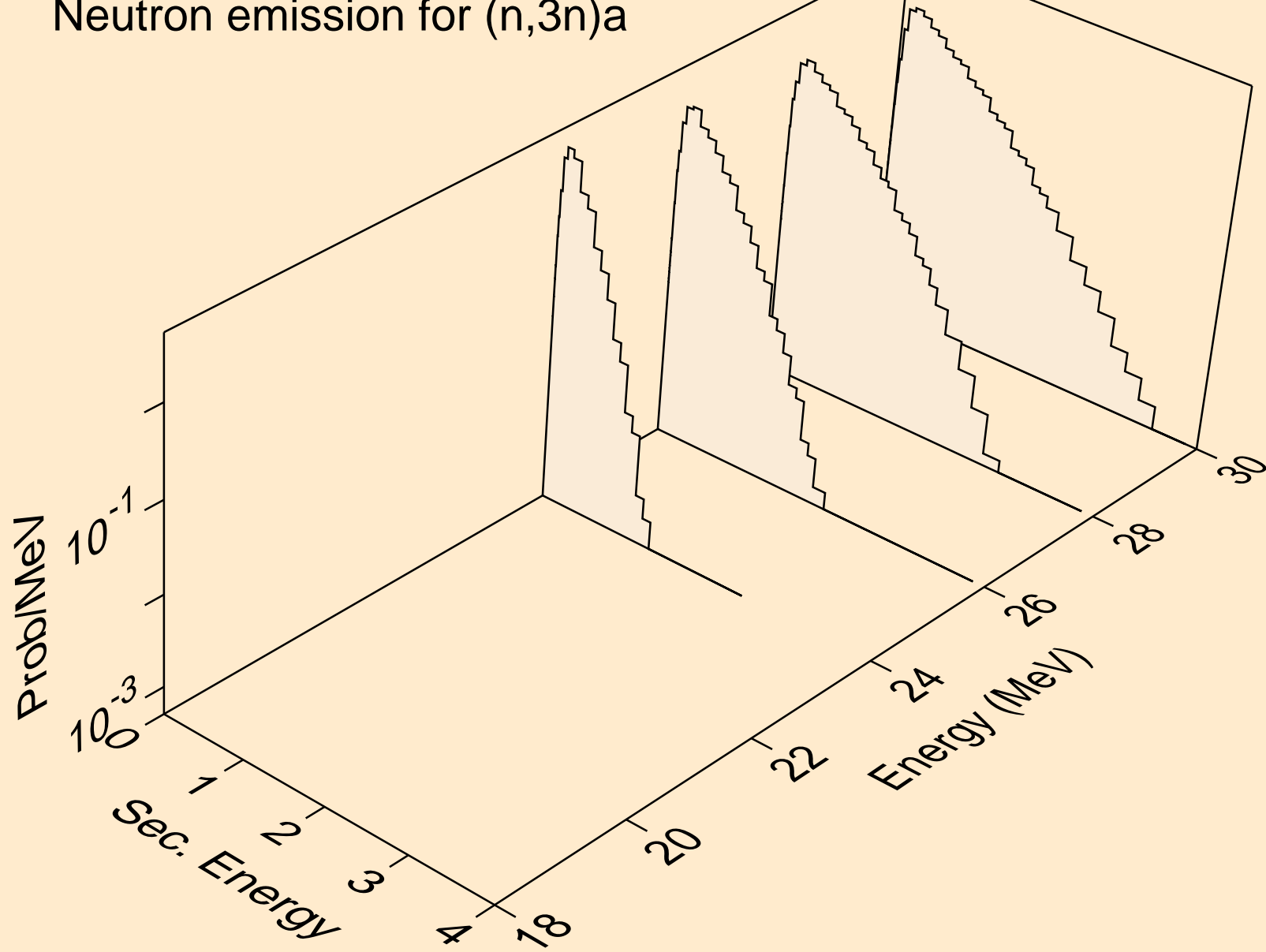

XE127M NEUTRON ACER TENDL-2024 LIBRARY; T=0.K  
Neutron emission for (n,n\*)p

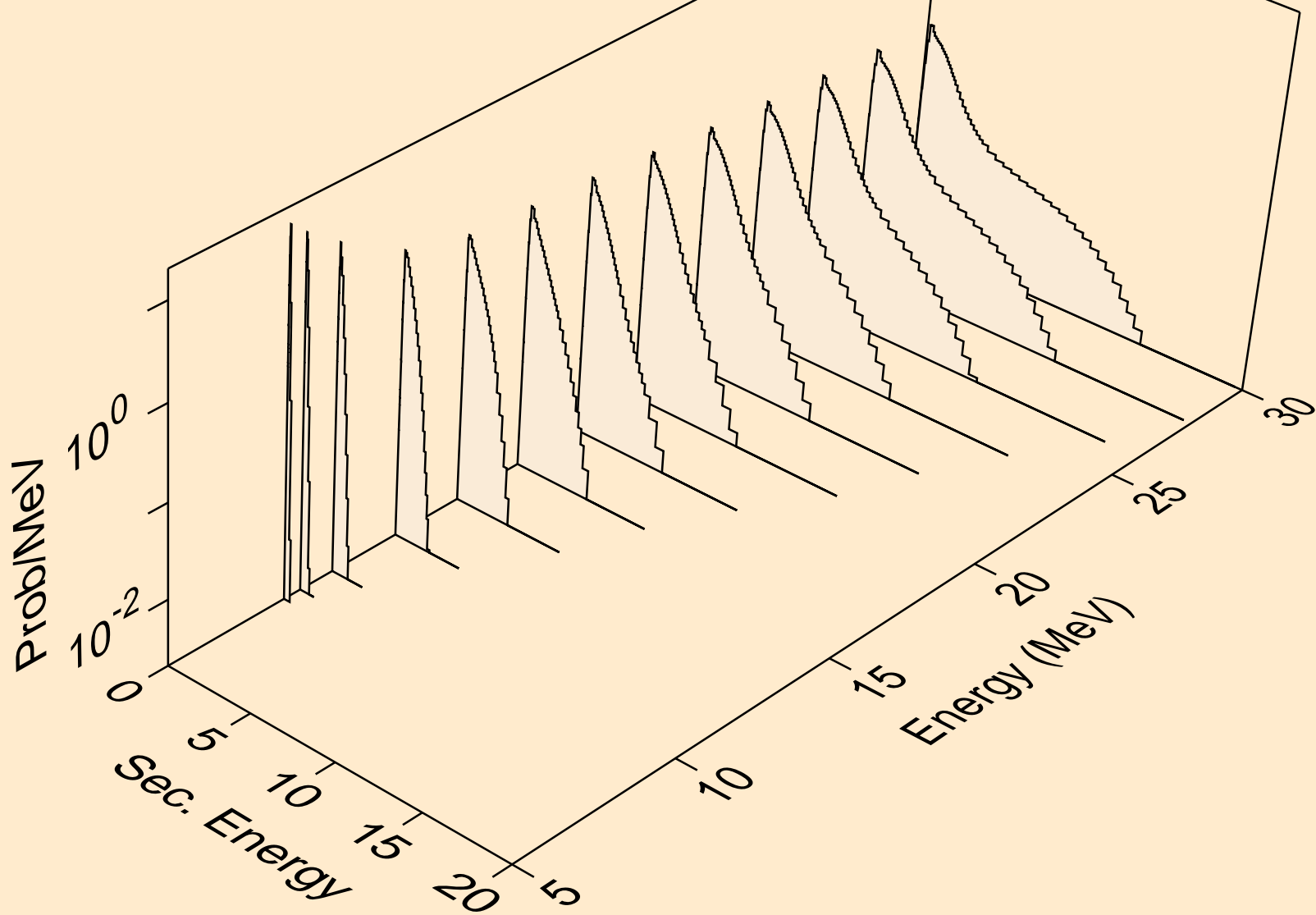

XE127M NEUTRON ACER TENDL-2024 LIBRARY; T=0.K  
Neutron emission for (n,n\*)2a

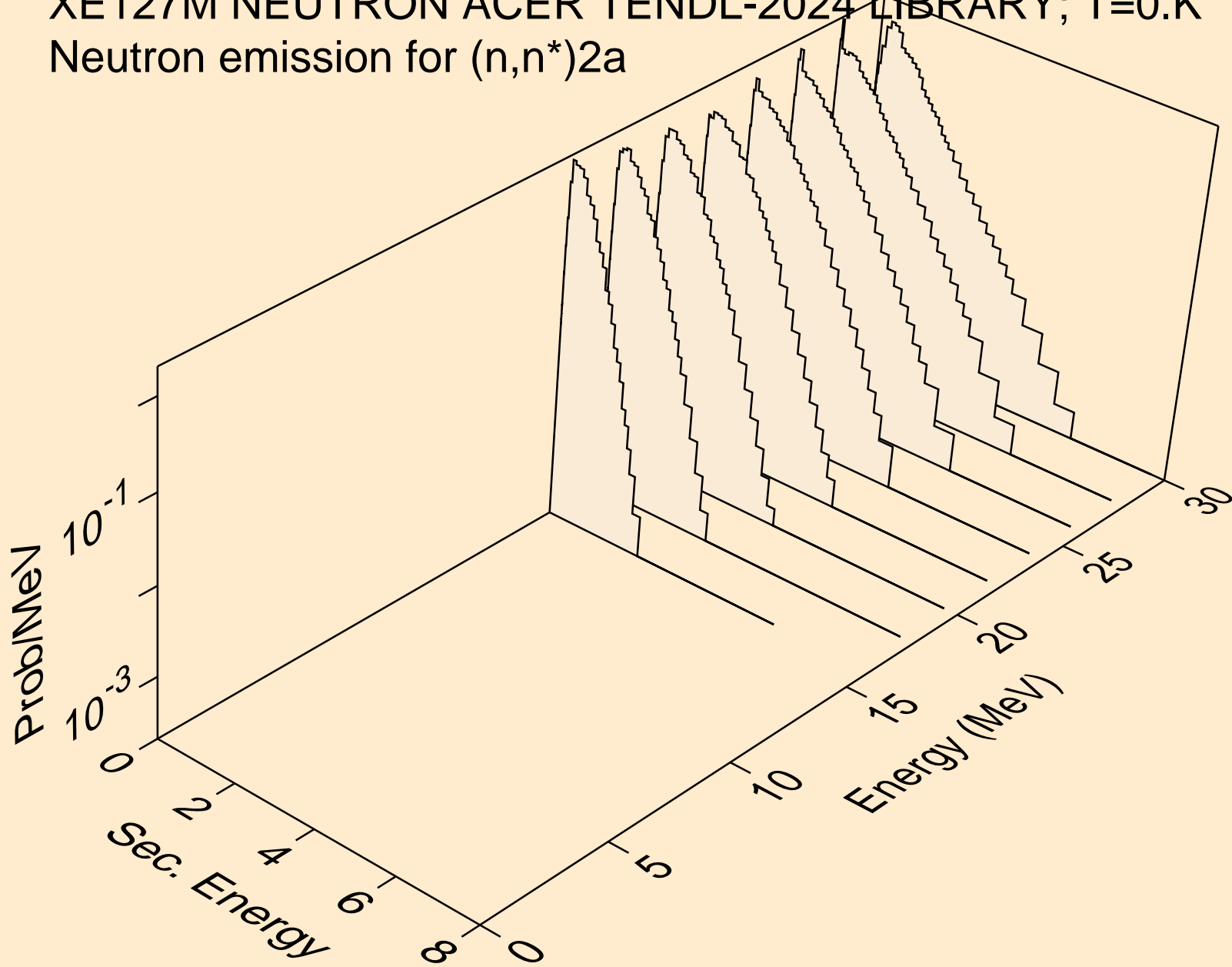



XE127M NEUTRON ACER TENDL-2024 LIBRARY; T=0.K  
Neutron emission for (n,n\*)d

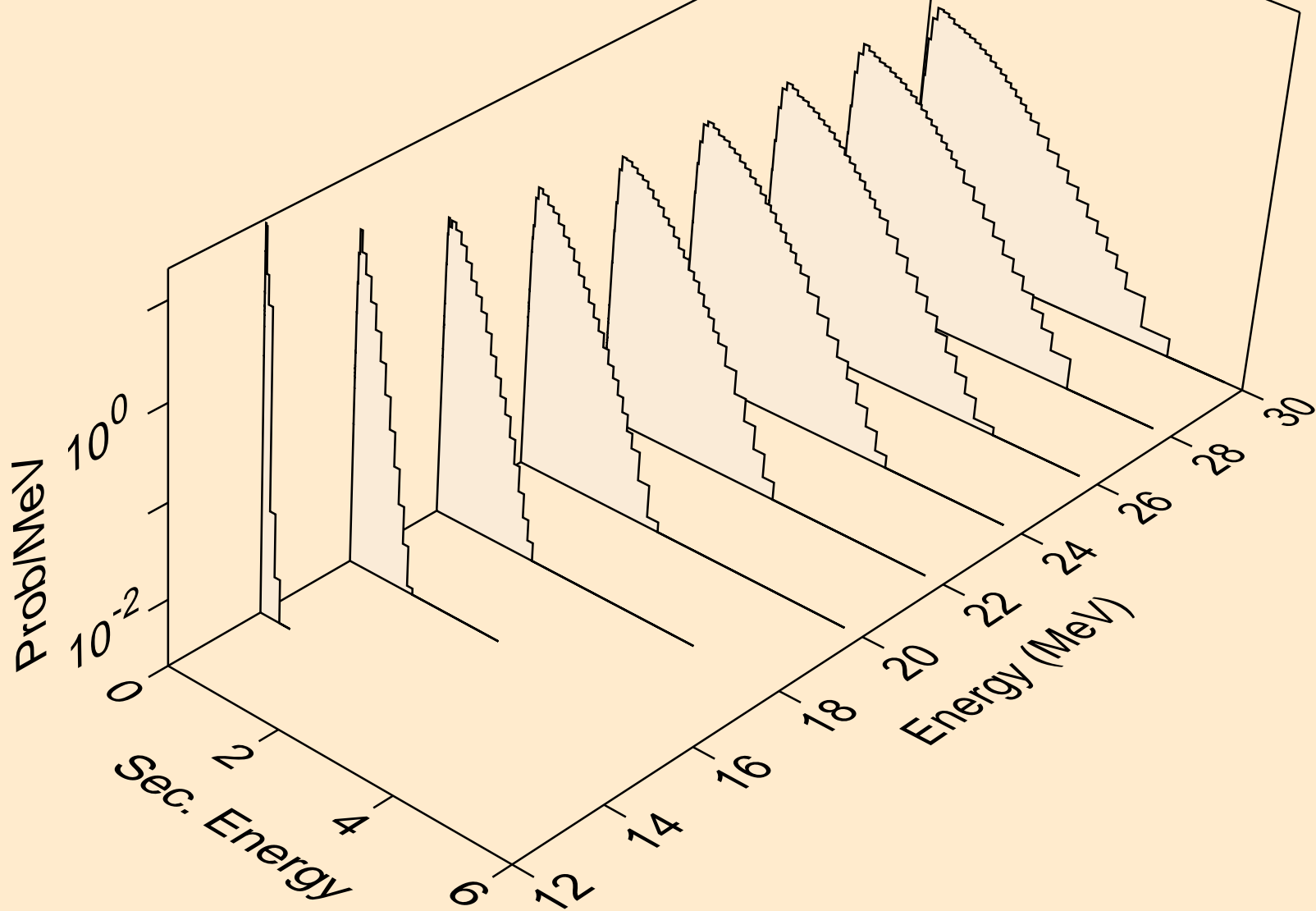

XE127M NEUTRON ACER TENDL-2024 LIBRARY; T=0.K  
Neutron emission for (n,n\*)t

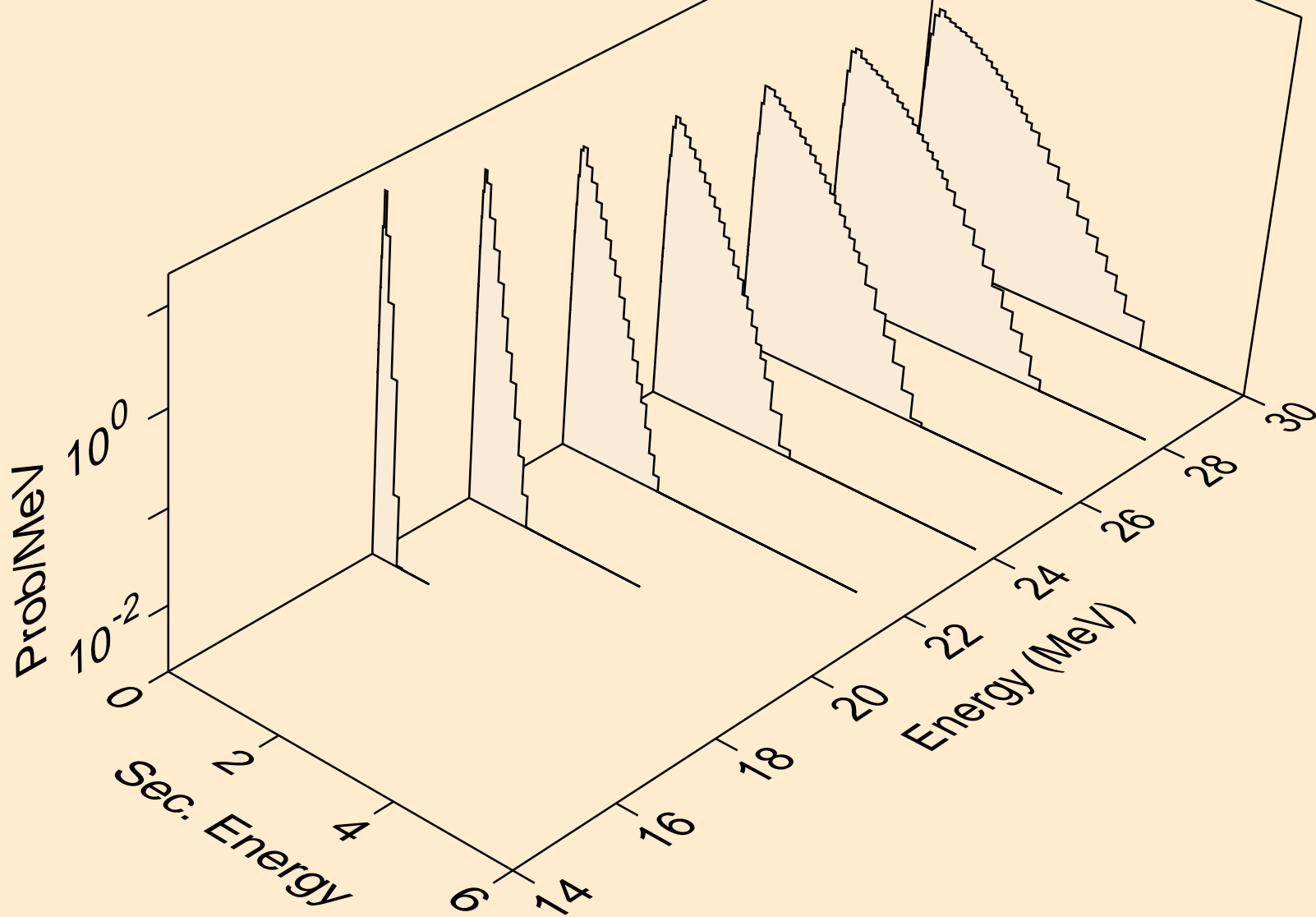

XE127M NEUTRON ACER TENDL-2024 LIBRARY; T=0.K  
Neutron emission for (n,n\*)he3

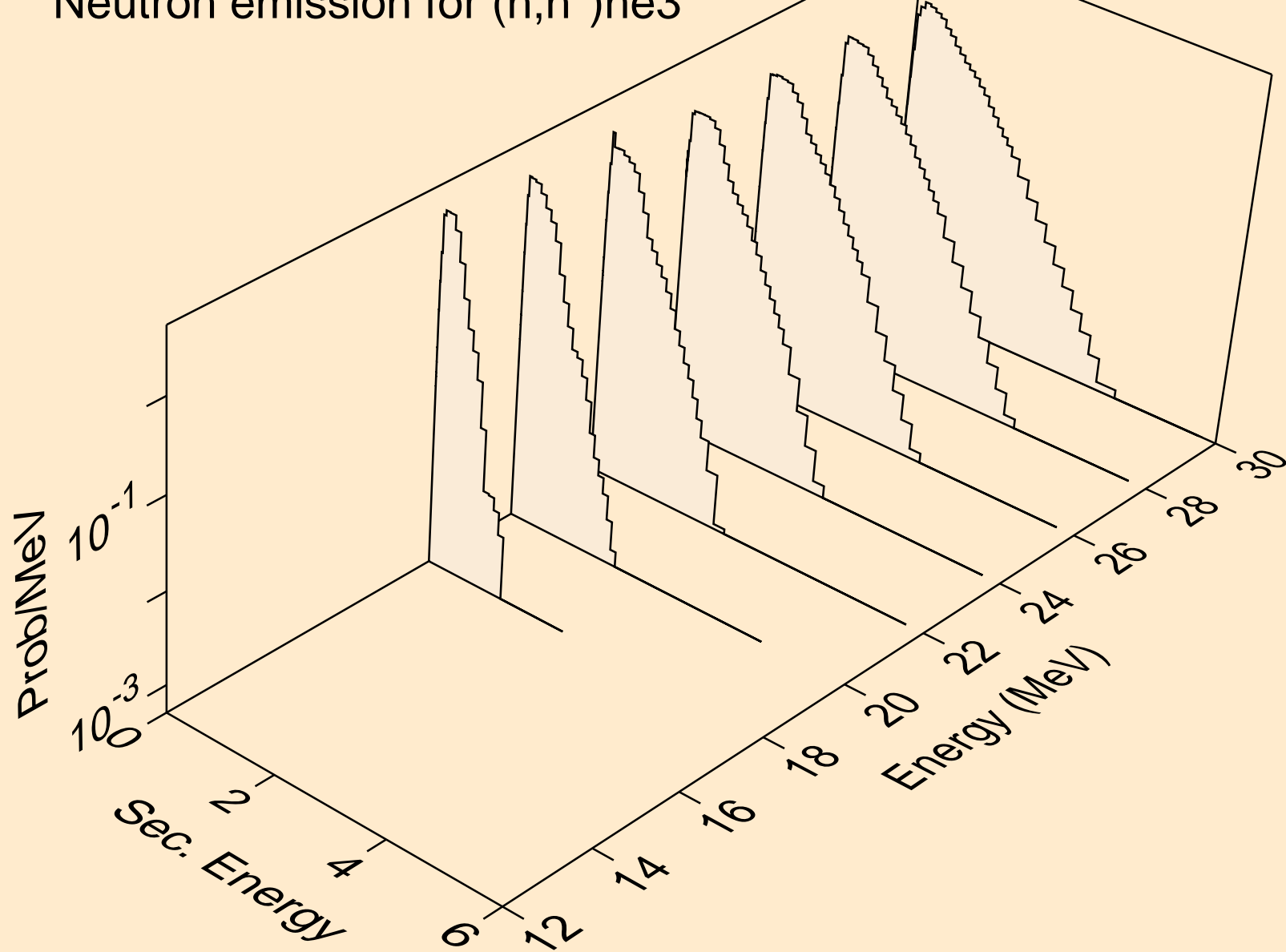

XE127M NEUTRON ACER TENDL-2024 LIBRARY; T=0.K  
Neutron emission for (n,4n)

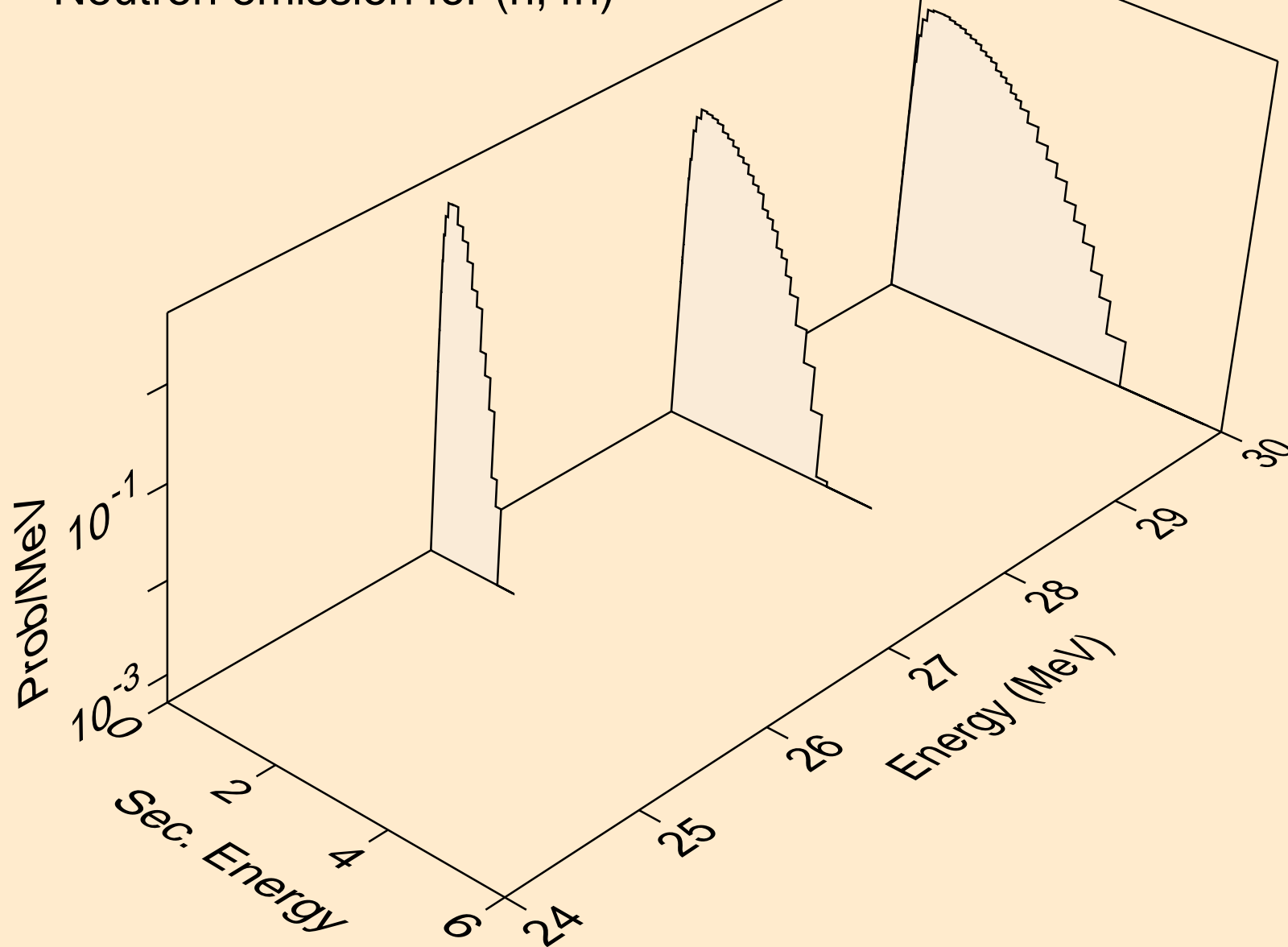

XE127M NEUTRON ACER TENDL-2024 LIBRARY; T=0.K  
Neutron emission for (n,2np)

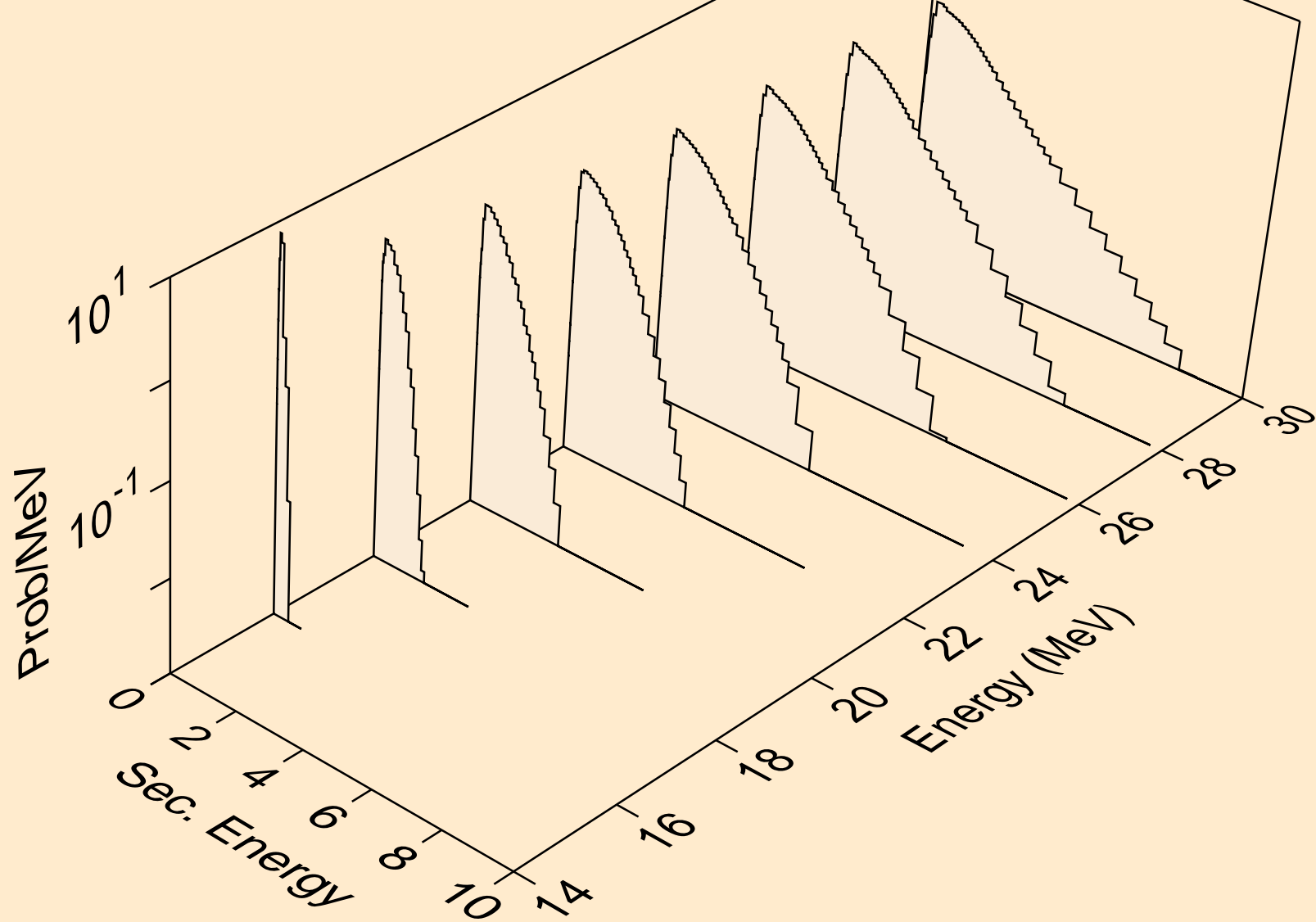

XE127M NEUTRON ACER TENDL-2024 LIBRARY; T=0.K  
Neutron emission for (n,3np)

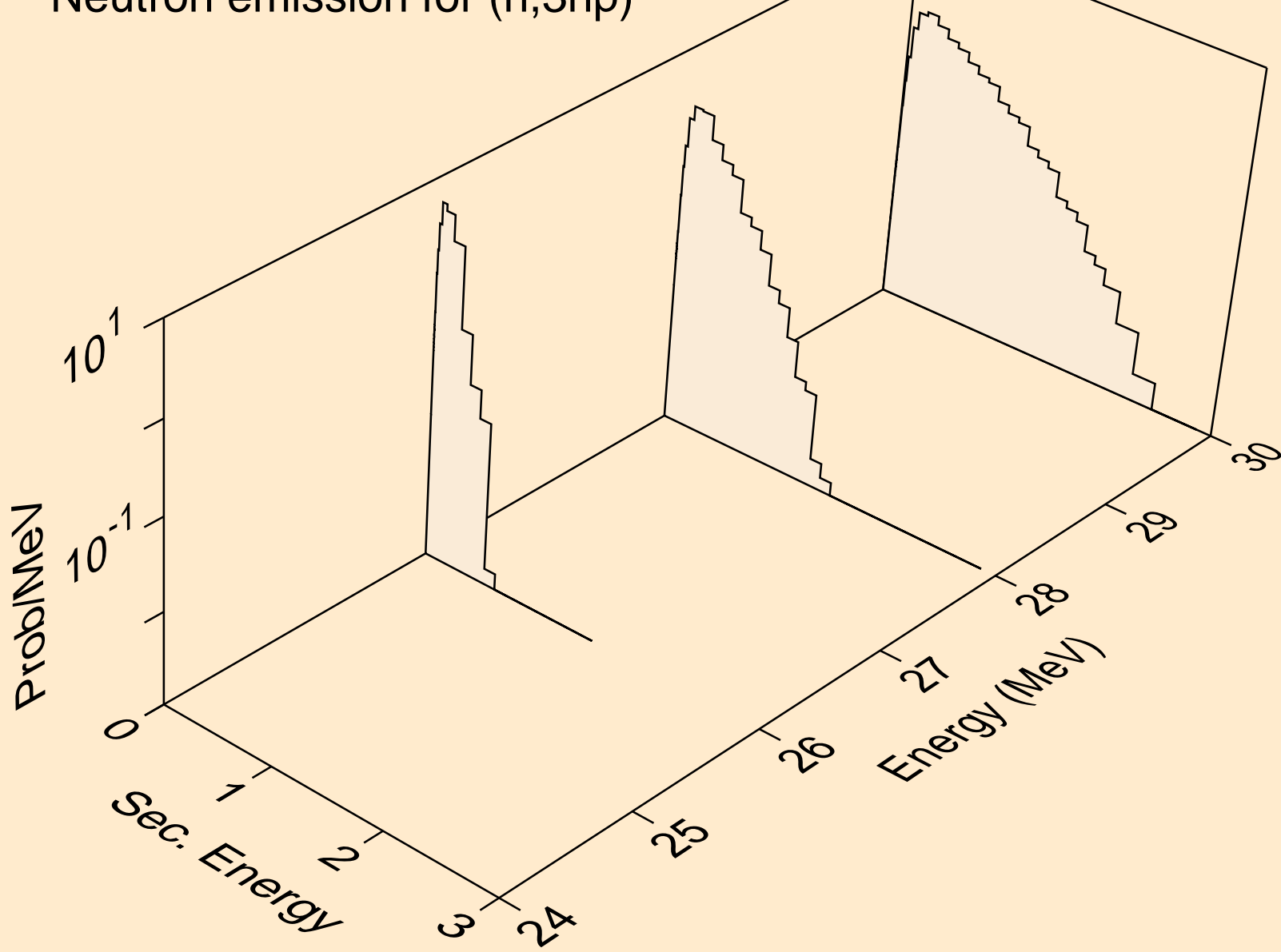

XE127M NEUTRON ACER TENDL-2024 LIBRARY; T=0.K  
Neutron emission for (n,n2p)

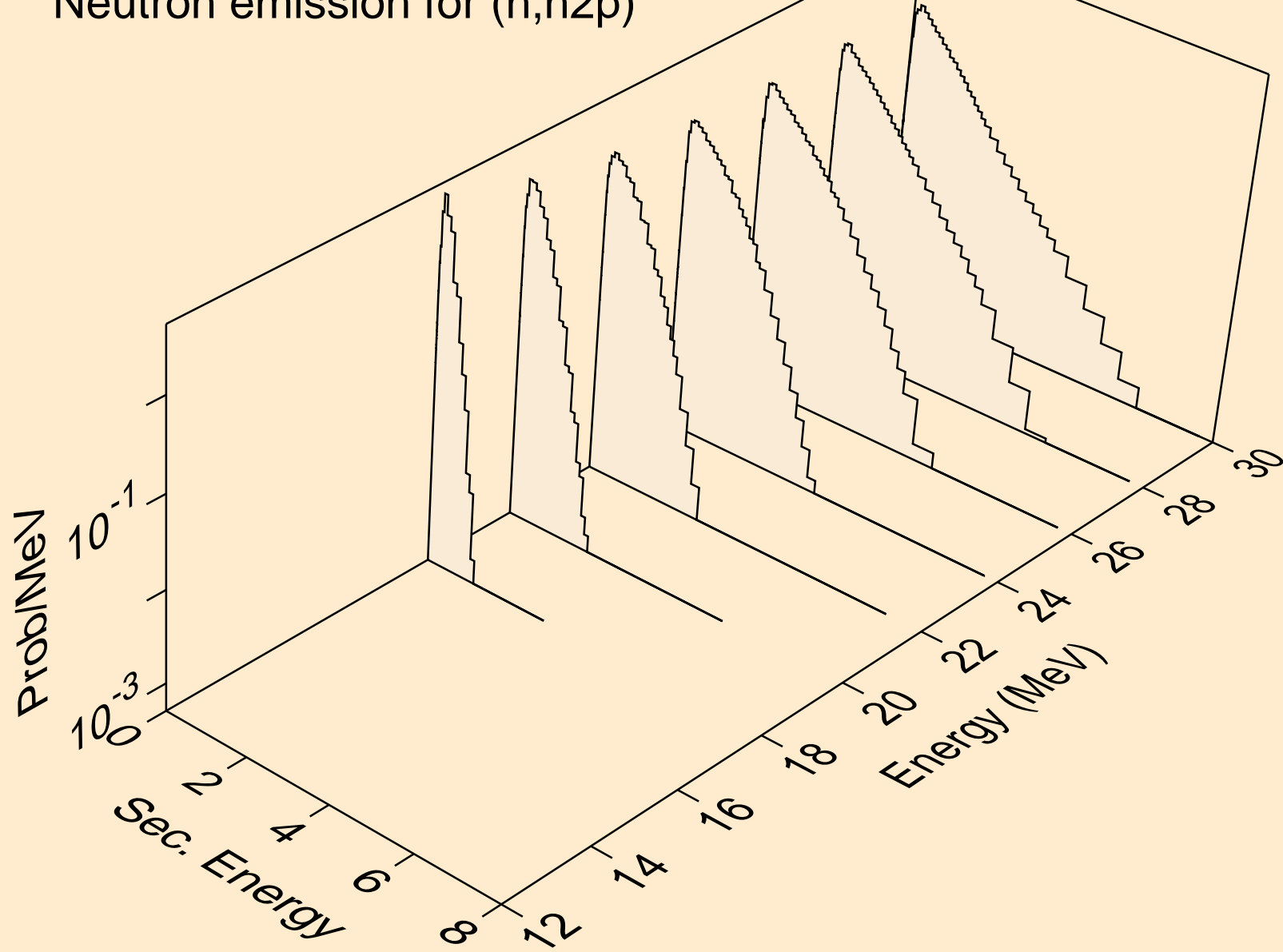

XE127M NEUTRON ACER TENDL-2024 LIBRARY; T=0.K  
Neutron emission for (n,npa)

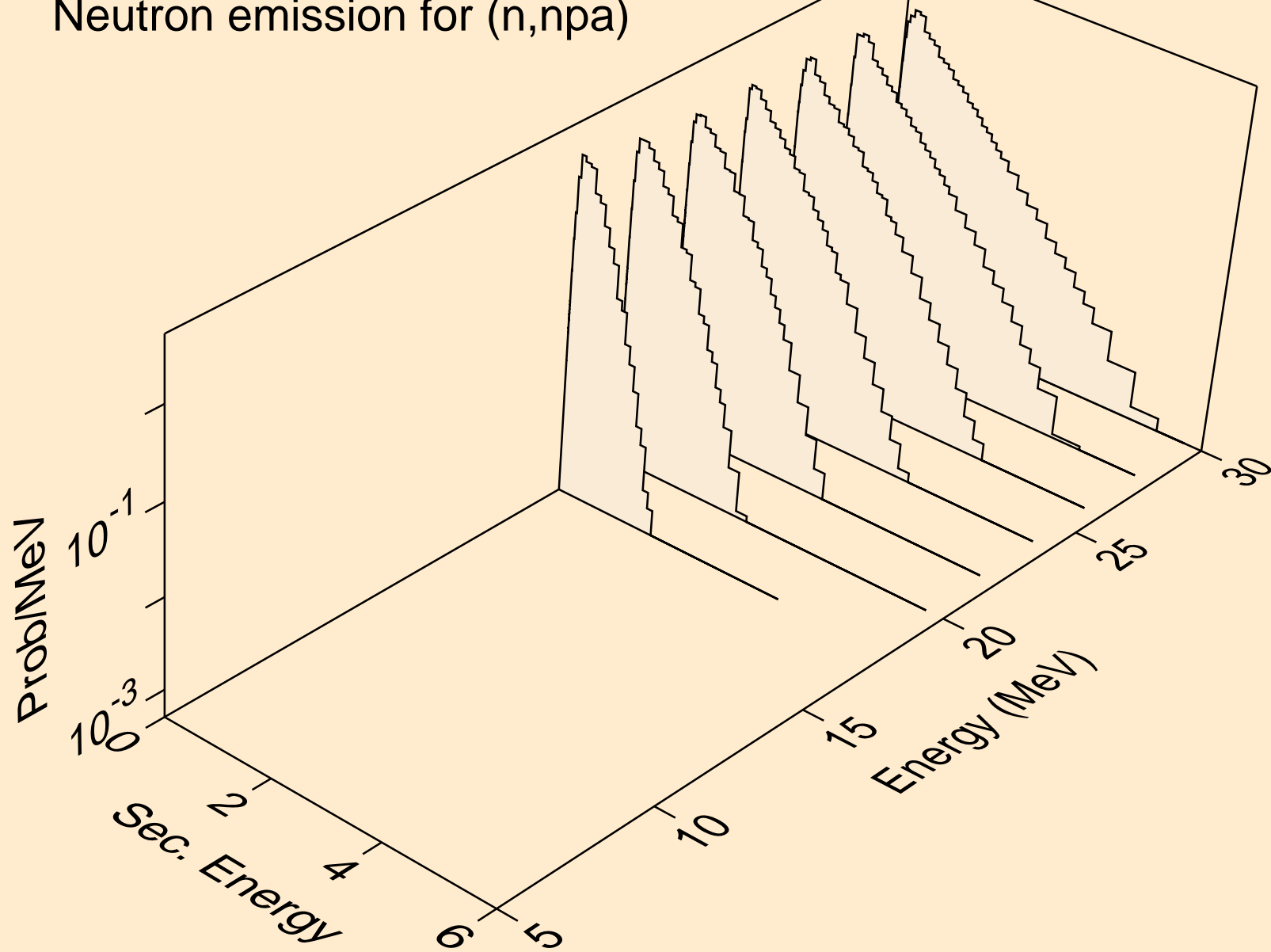



XE127M NEUTRON ACER TENDL-2024 LIBRARY; T=0.K  
Neutron emission for (n,n\*c)

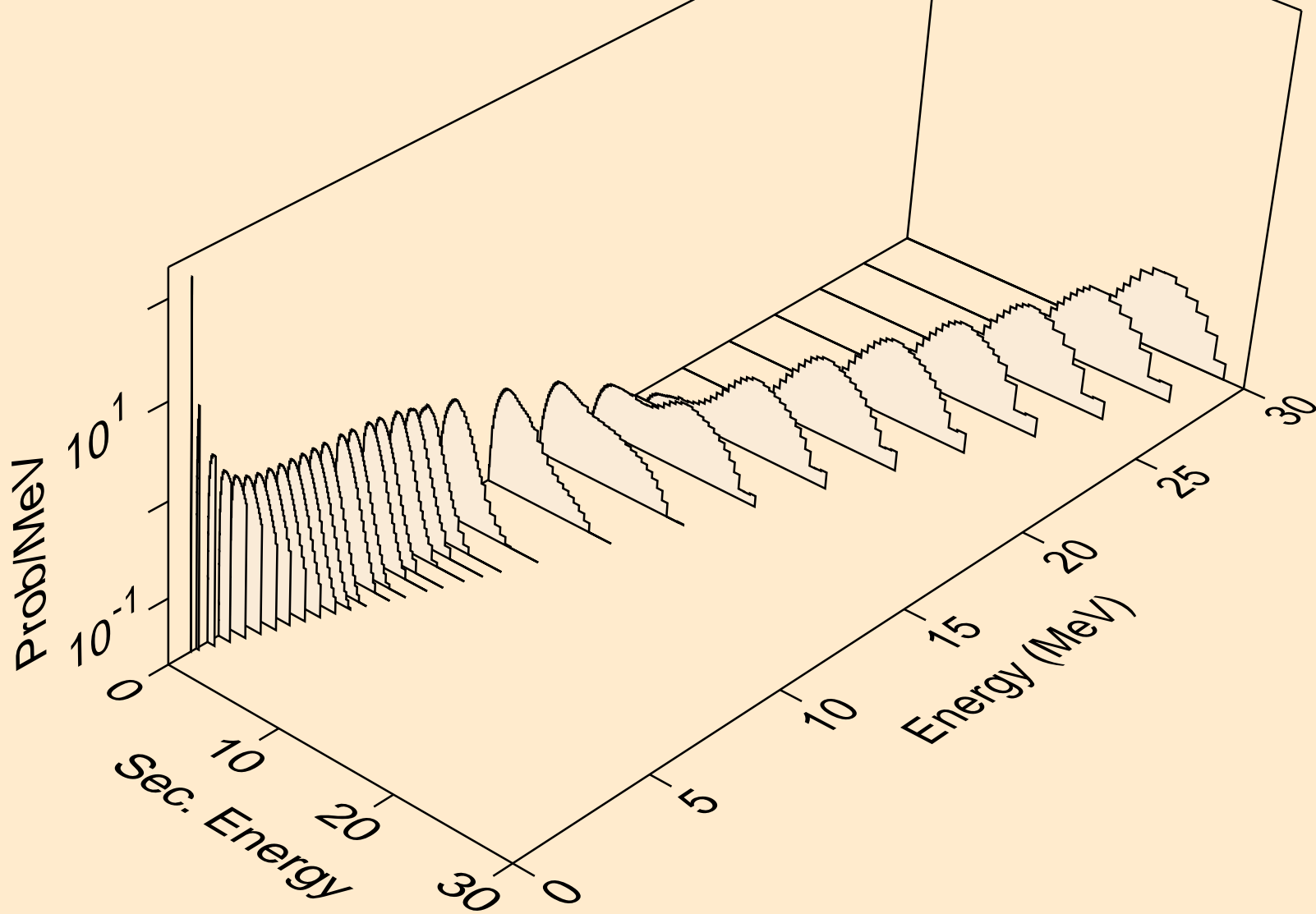

XE127M NEUTRON ACER TENDL-2024 LIBRARY; T=0.K  
Photon emission for (n,x)

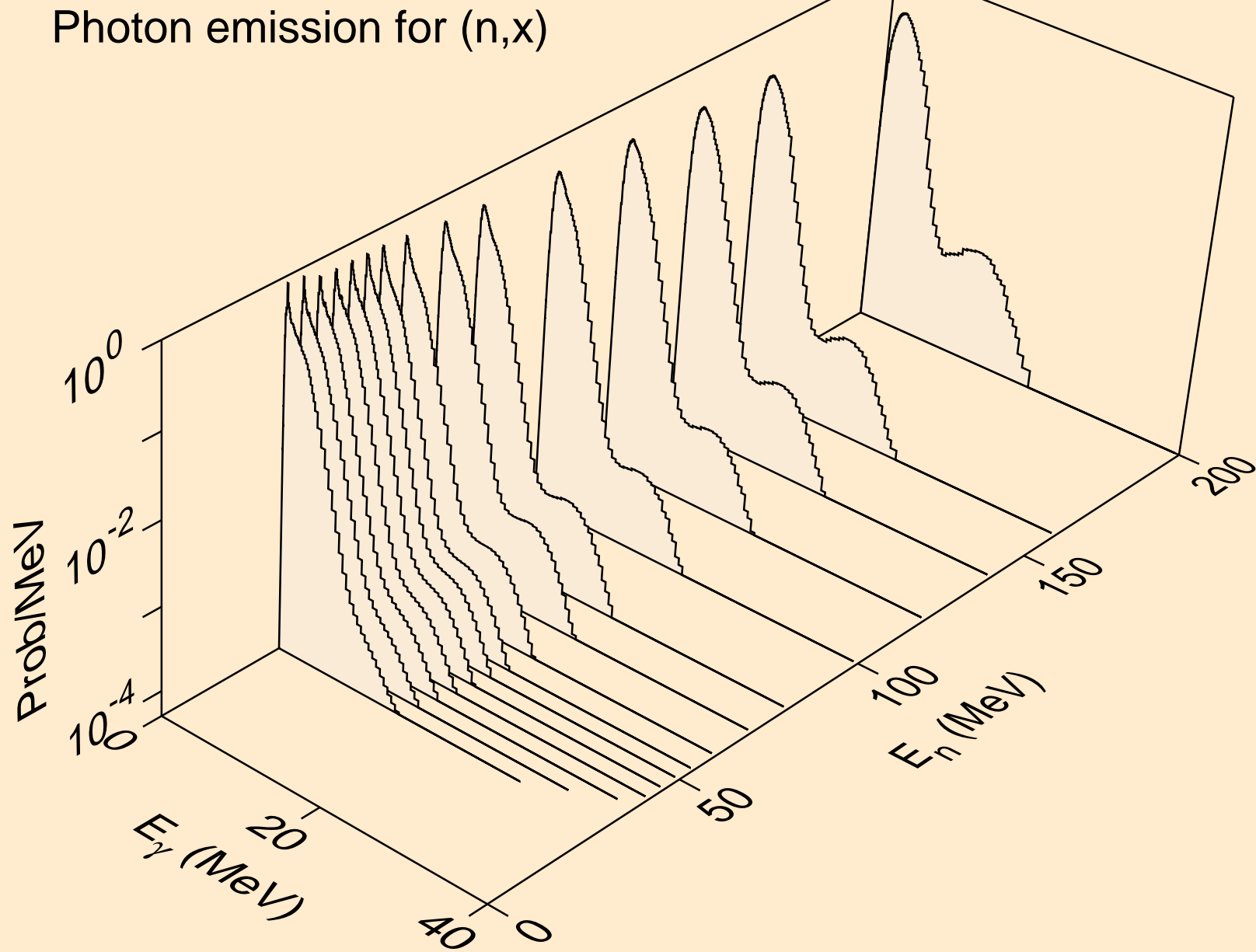

XE127M NEUTRON ACER TENDL-2024 LIBRARY; T=0.K  
Photon emission for (n,2nd)

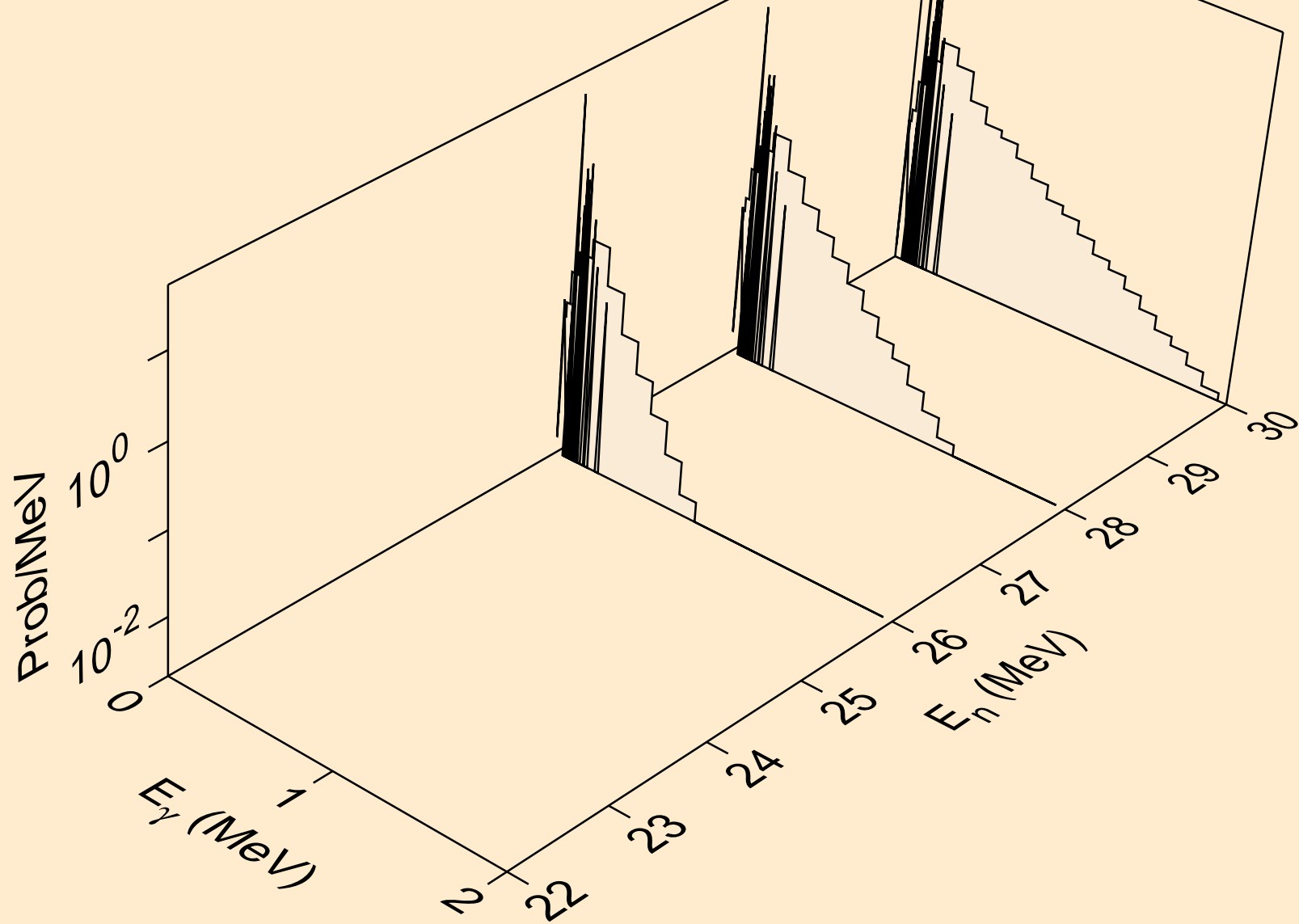

XE127M NEUTRON ACER TENDL-2024 LIBRARY; T=0.K  
Photon emission for (n,2n)

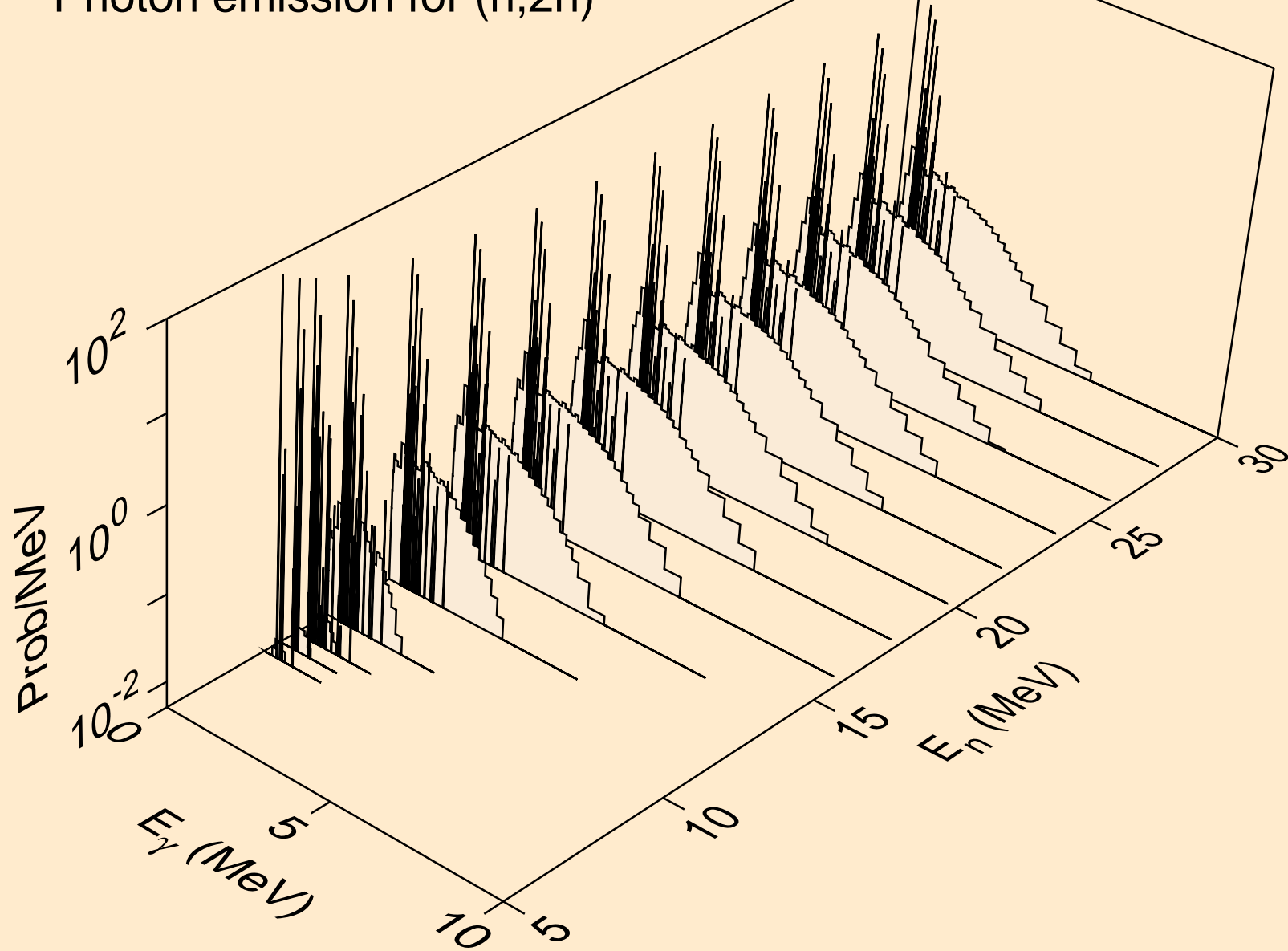

XE127M NEUTRON ACER TENDL-2024 LIBRARY; T=0.K  
Photon emission for (n,3n)

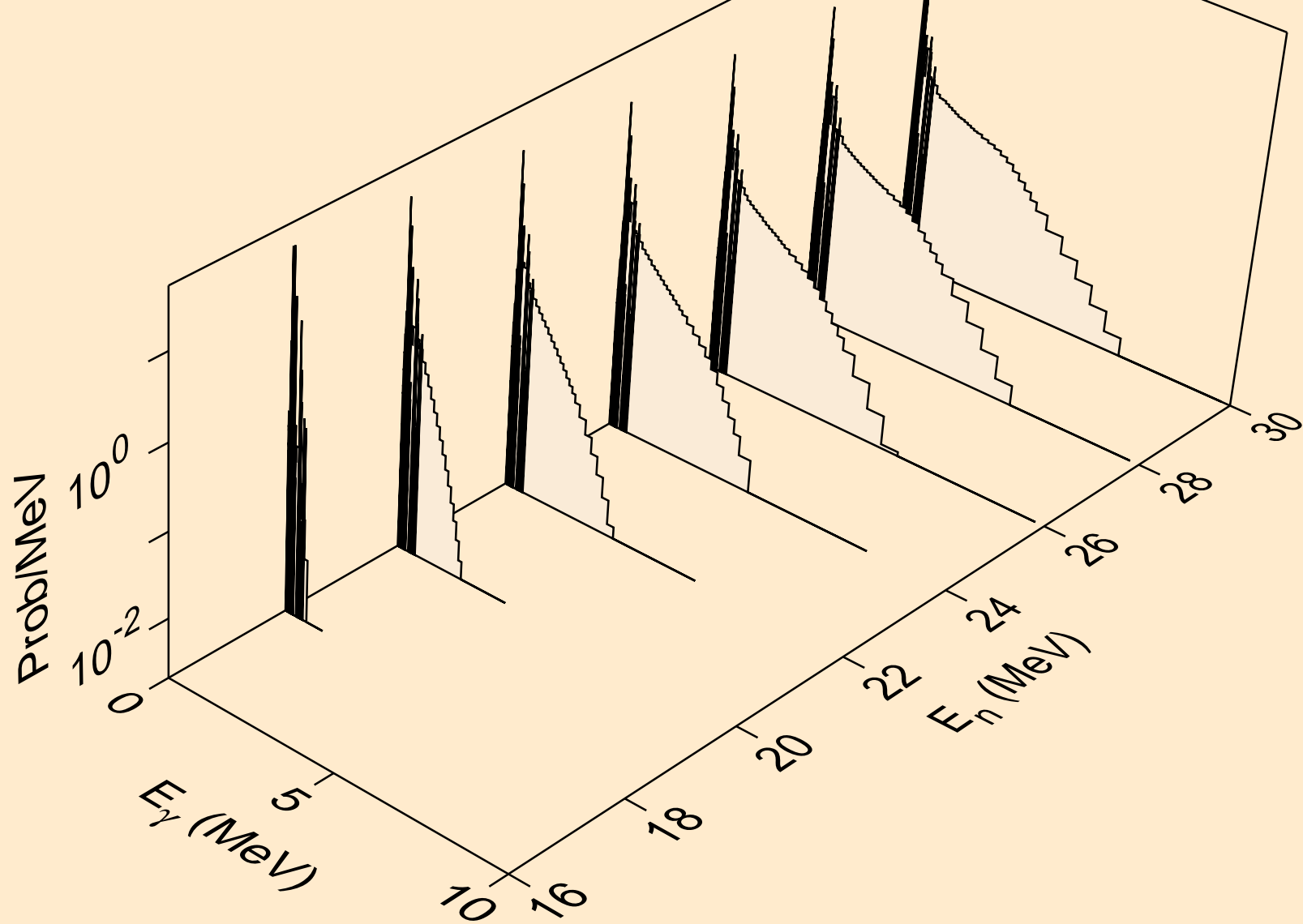

XE127M NEUTRON ACER TENDL-2024 LIBRARY; T=0.K  
Photon emission for (n,n\*)a

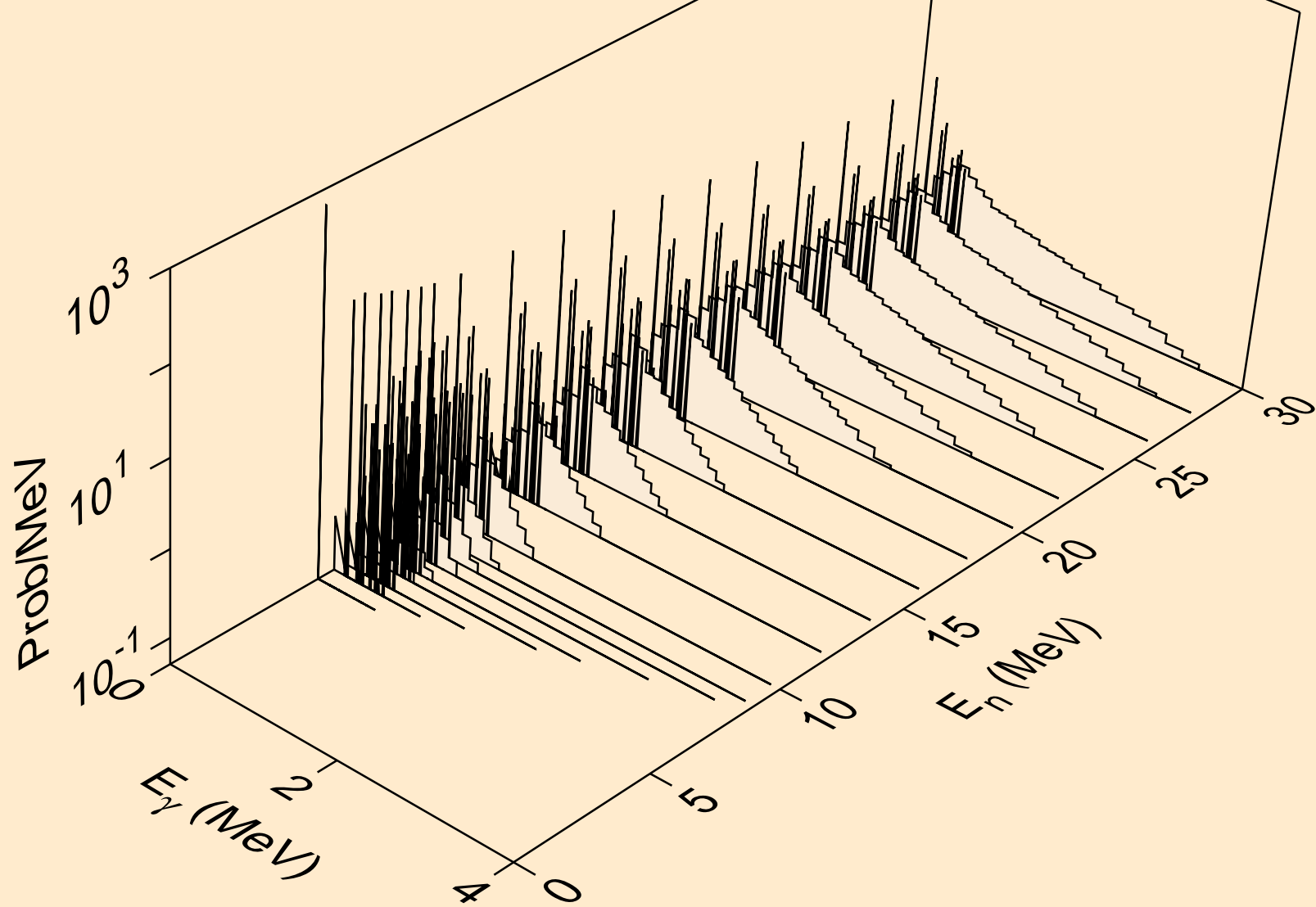

XE127M NEUTRON ACER TENDL-2024 LIBRARY; T=0.K  
Photon emission for (n,2n)a

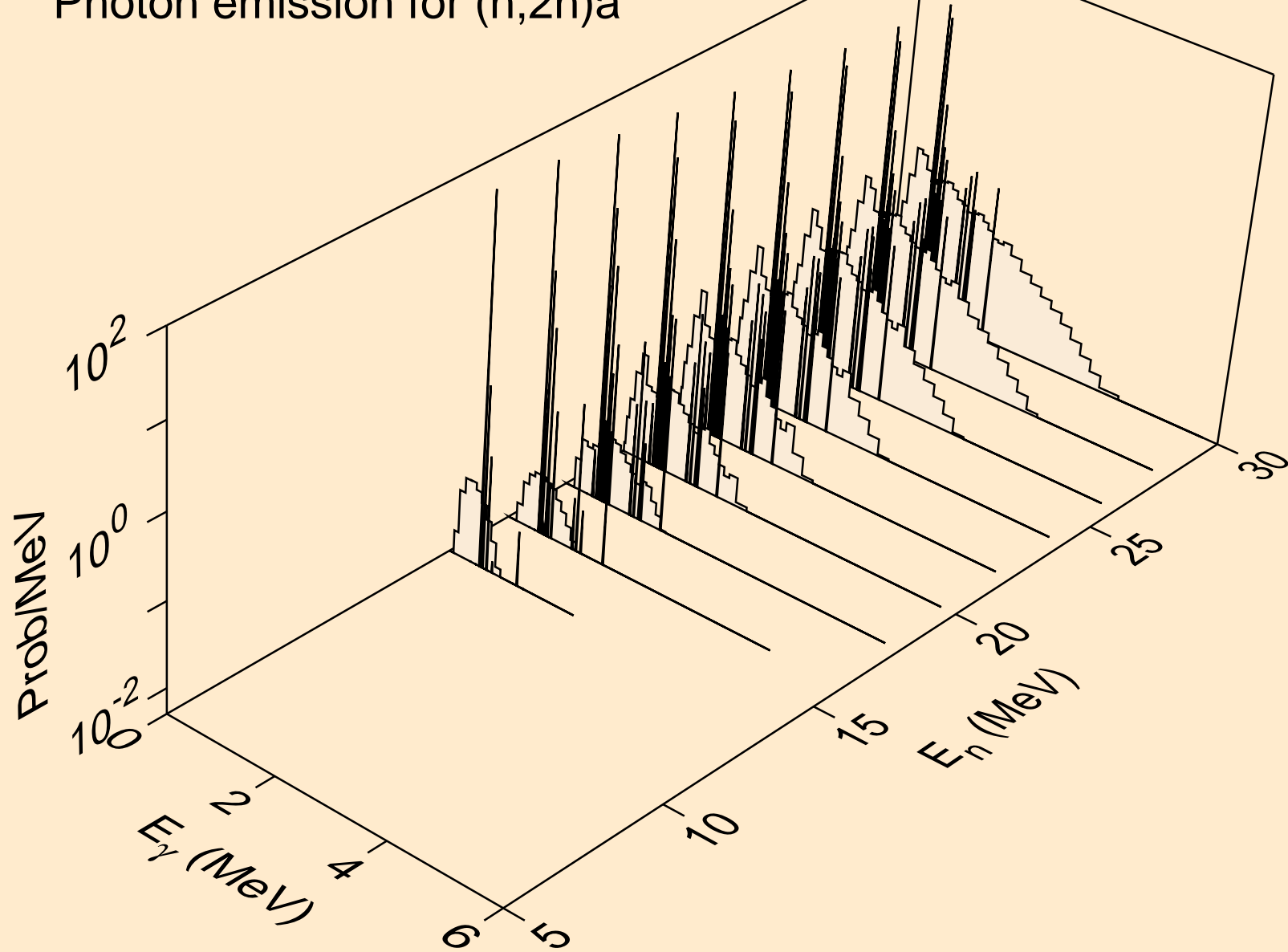

XE127M NEUTRON ACER TENDL-2024 LIBRARY; T=0.K  
Photon emission for (n,3n)a

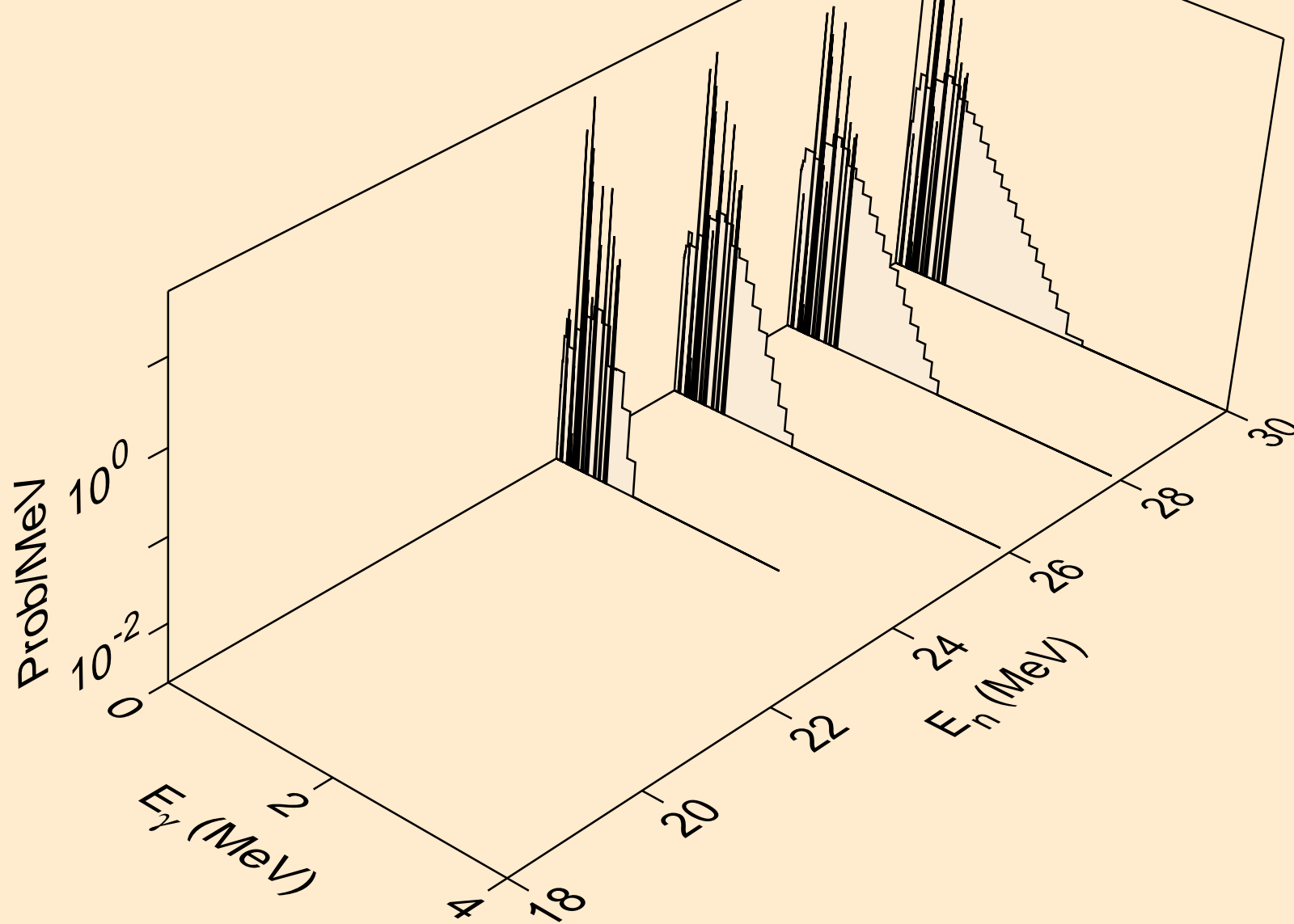



XE127M NEUTRON ACER TENDL-2024 LIBRARY; T=0.K  
Photon emission for (n,n\*)p

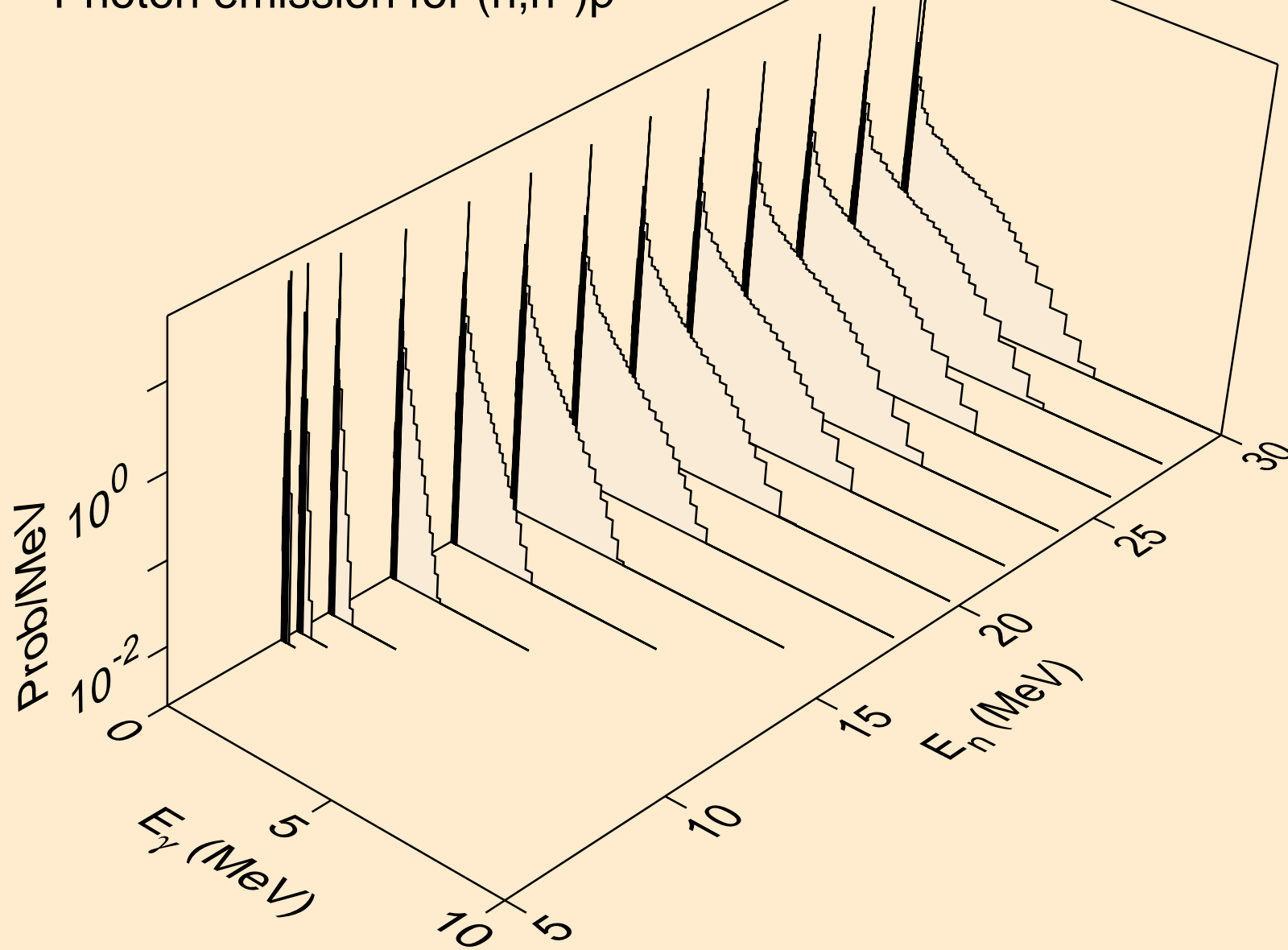

XE127M NEUTRON ACER TENDL-2024 LIBRARY; T=0.K  
Photon emission for (n,n\*)2a

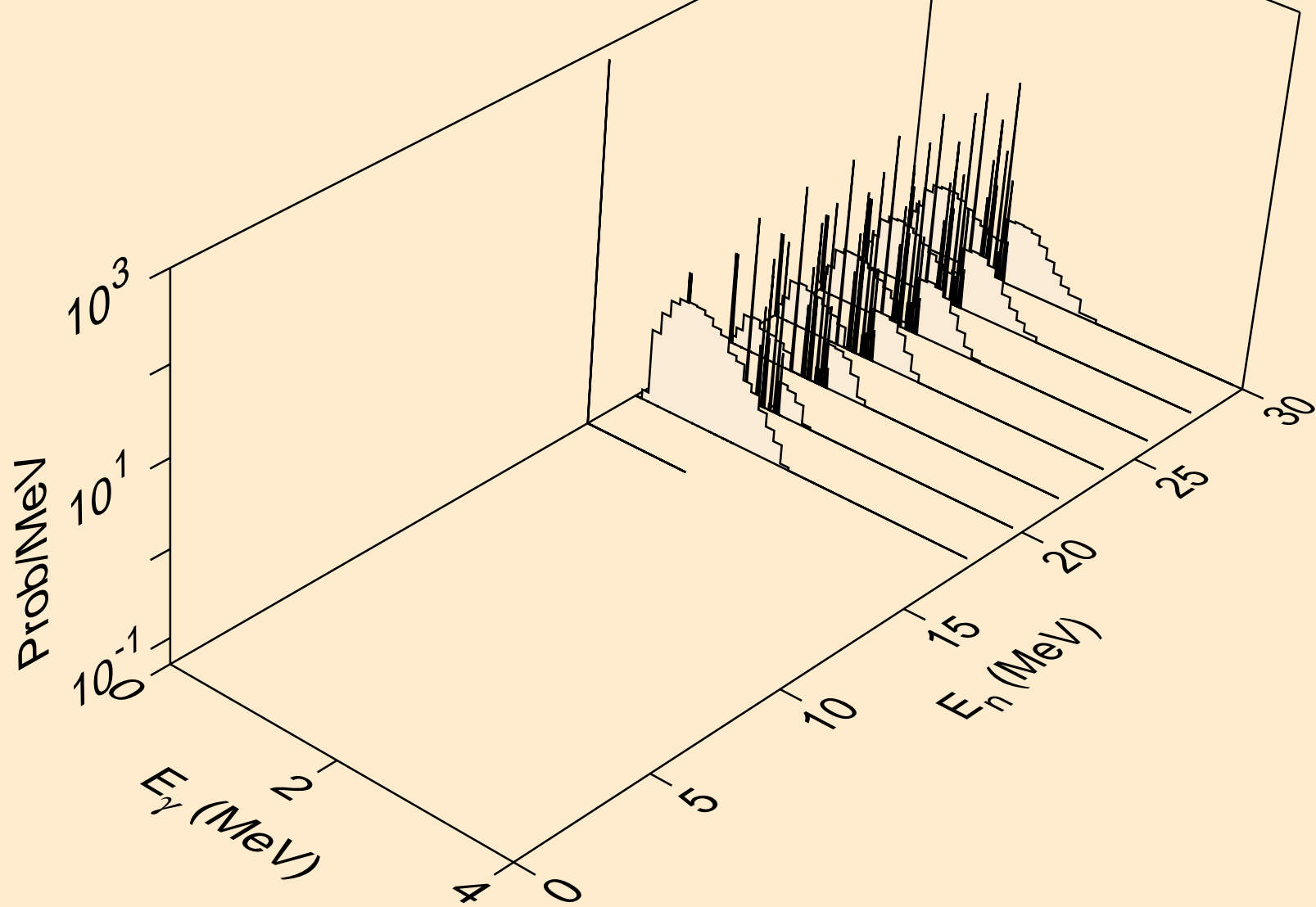

XE127M NEUTRON ACER TENDL-2024 LIBRARY; T=0.K  
Photon emission for (n,n\*)d

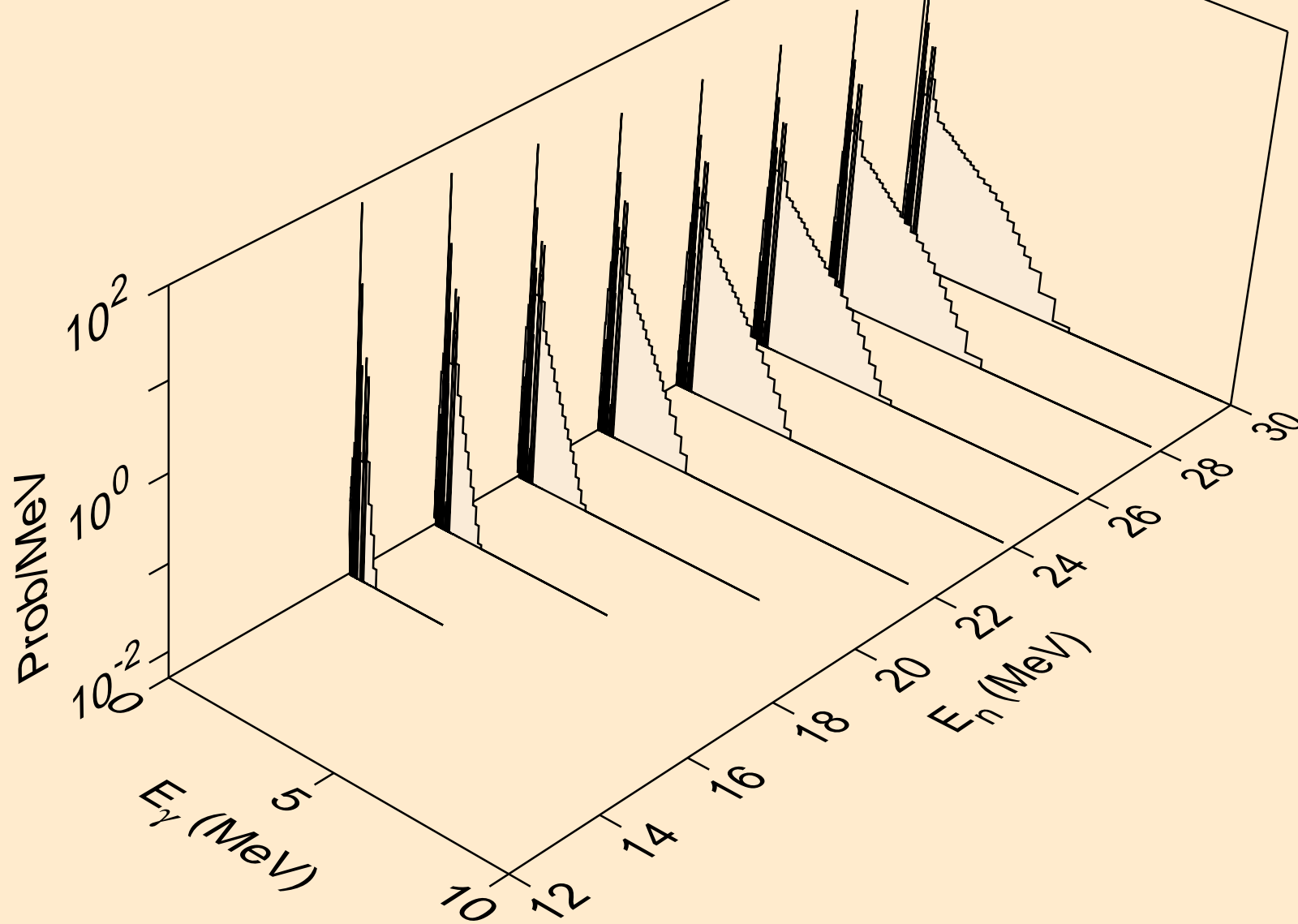

XE127M NEUTRON ACER TENDL-2024 LIBRARY; T=0.K  
Photon emission for (n,n\*)t

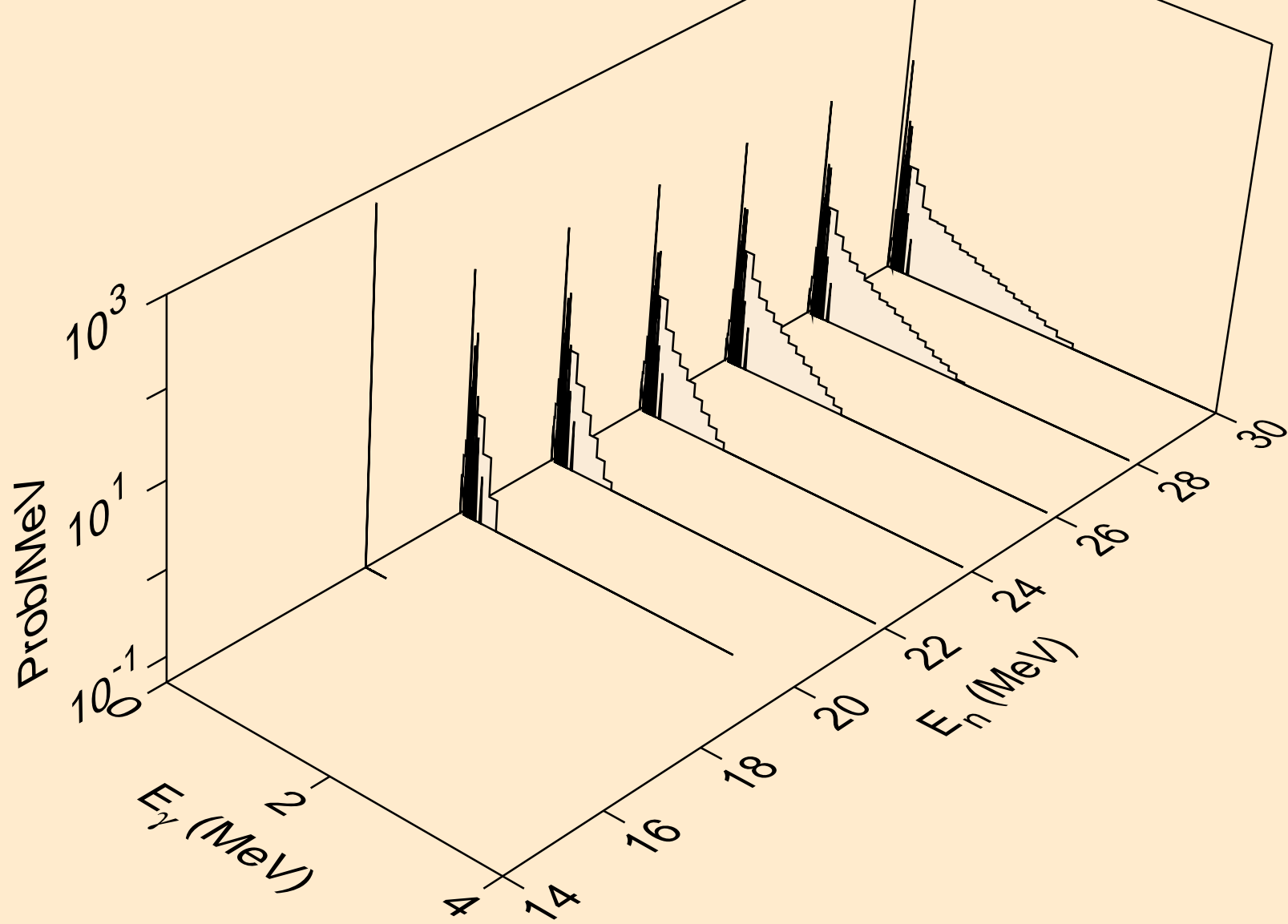

XE127M NEUTRON ACER TENDL-2024 LIBRARY; T=0.K  
Photon emission for (n,n\*)he3

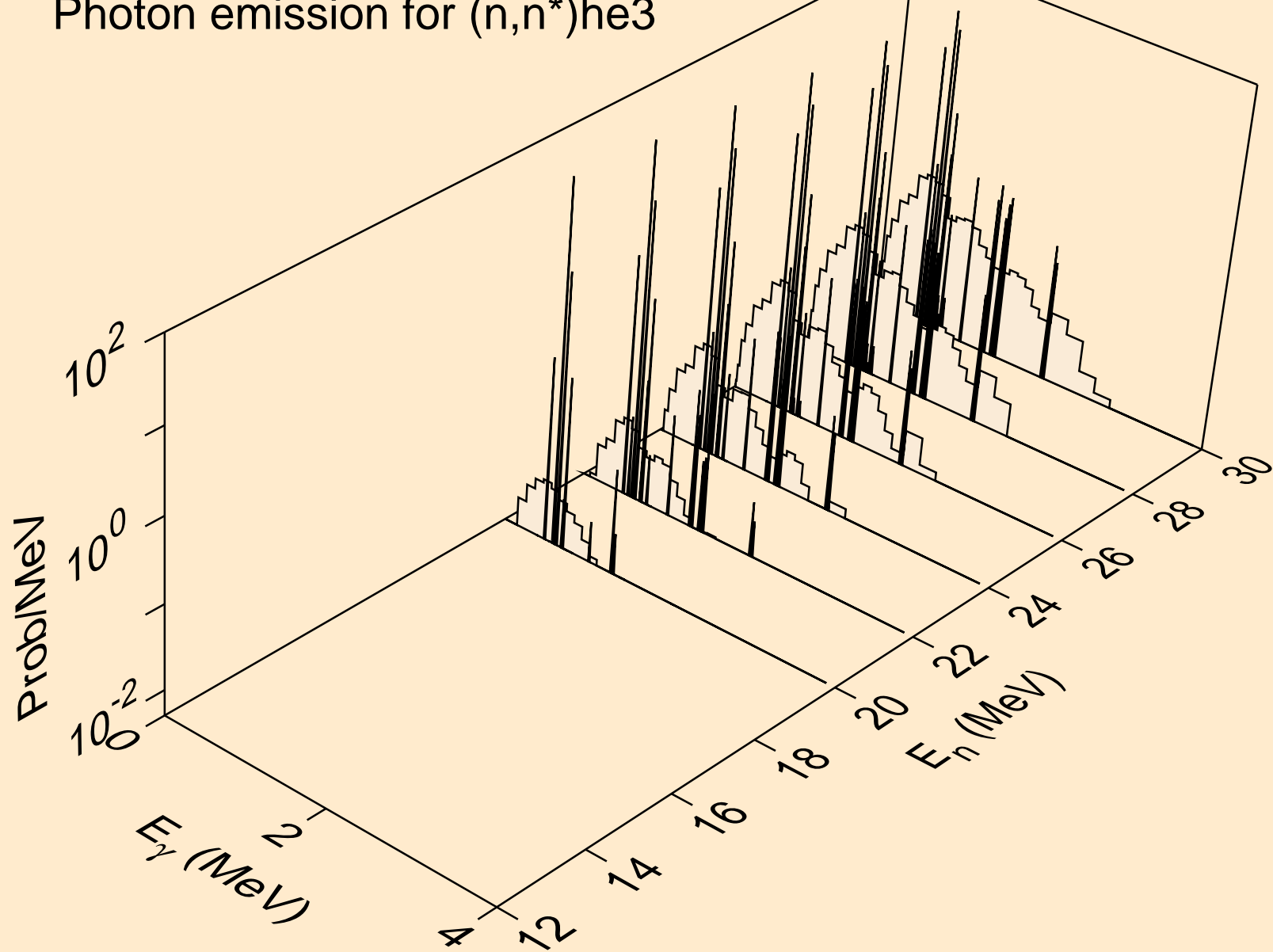

XE127M NEUTRON ACER TENDL-2024 LIBRARY; T=0.K  
Photon emission for (n,4n)

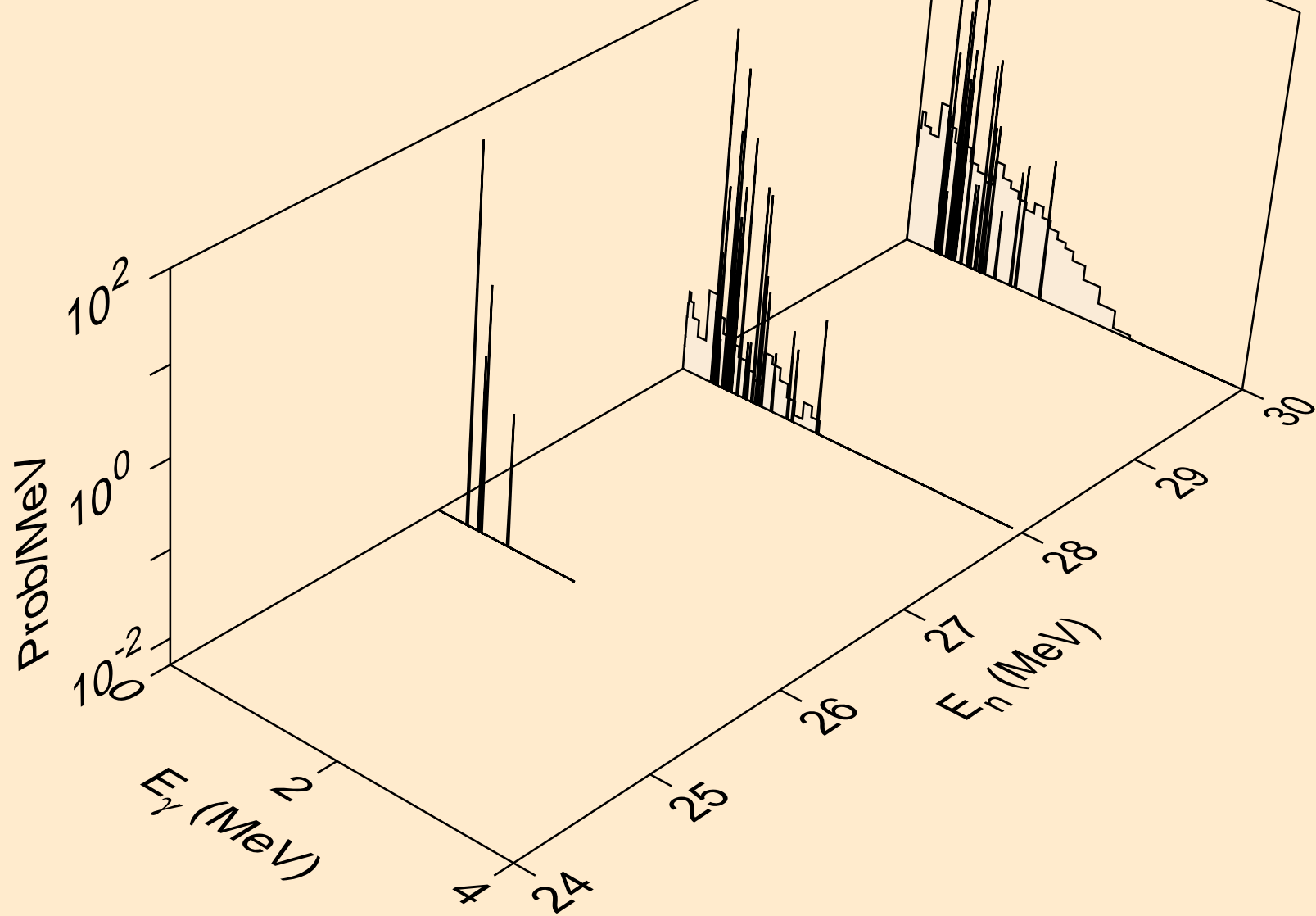

XE127M NEUTRON ACER TENDL-2024 LIBRARY; T=0.K  
Photon emission for (n,2np)

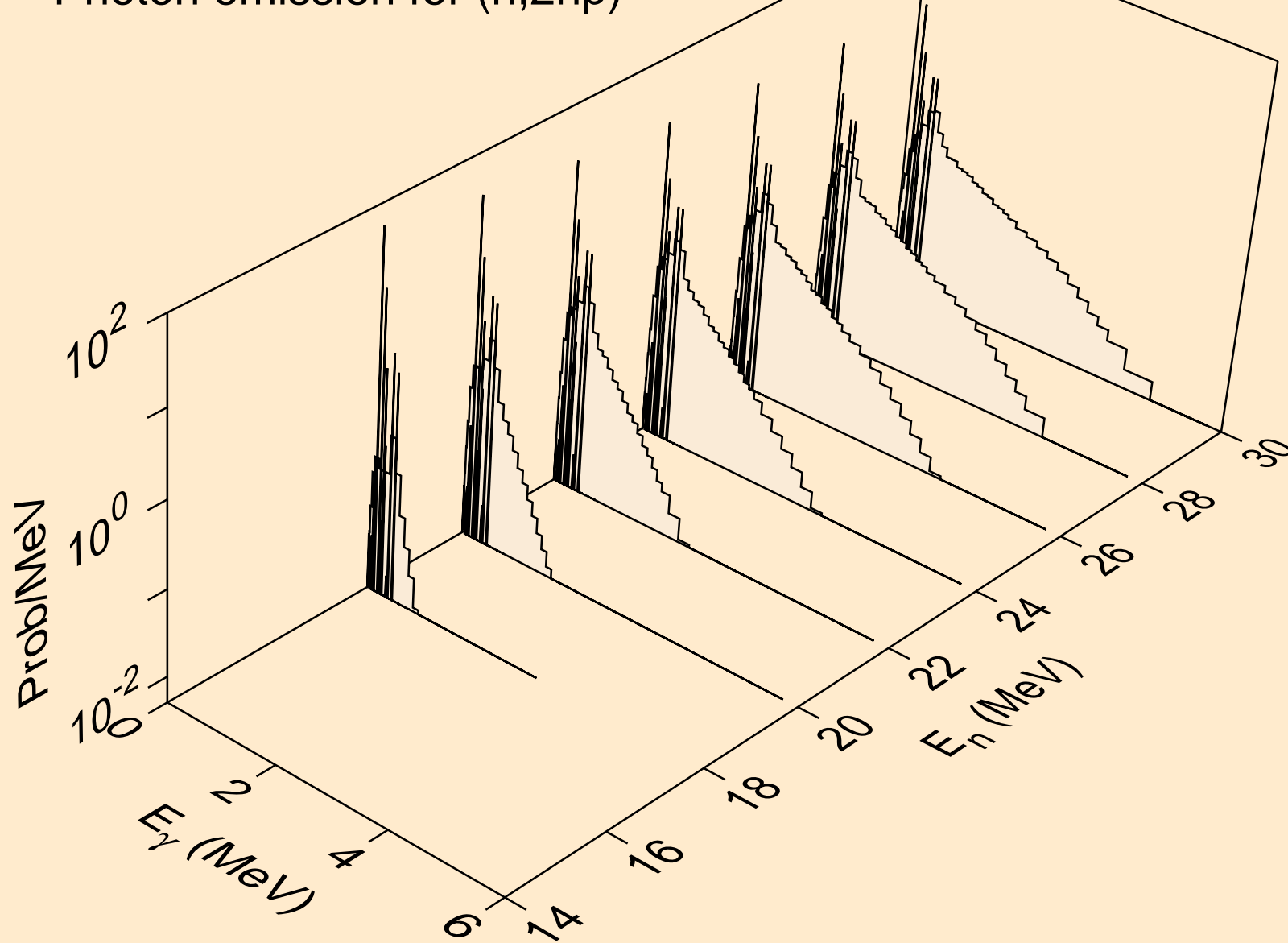

XE127M NEUTRON ACER TENDL-2024 LIBRARY; T=0.K  
Photon emission for (n,3np)

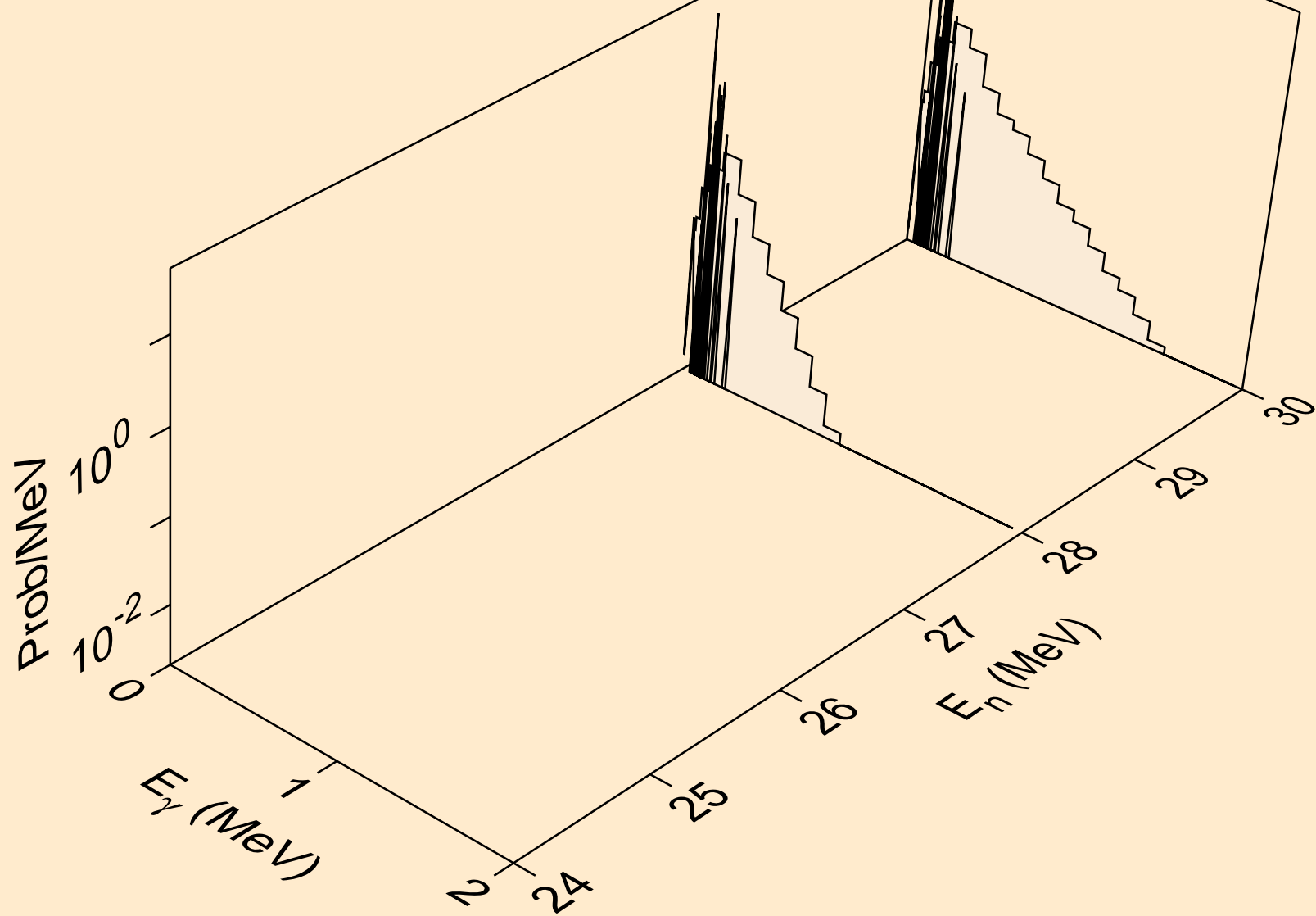



XE127M NEUTRON ACER TENDL-2024 LIBRARY; T=0.K  
Photon emission for (n,n2p)

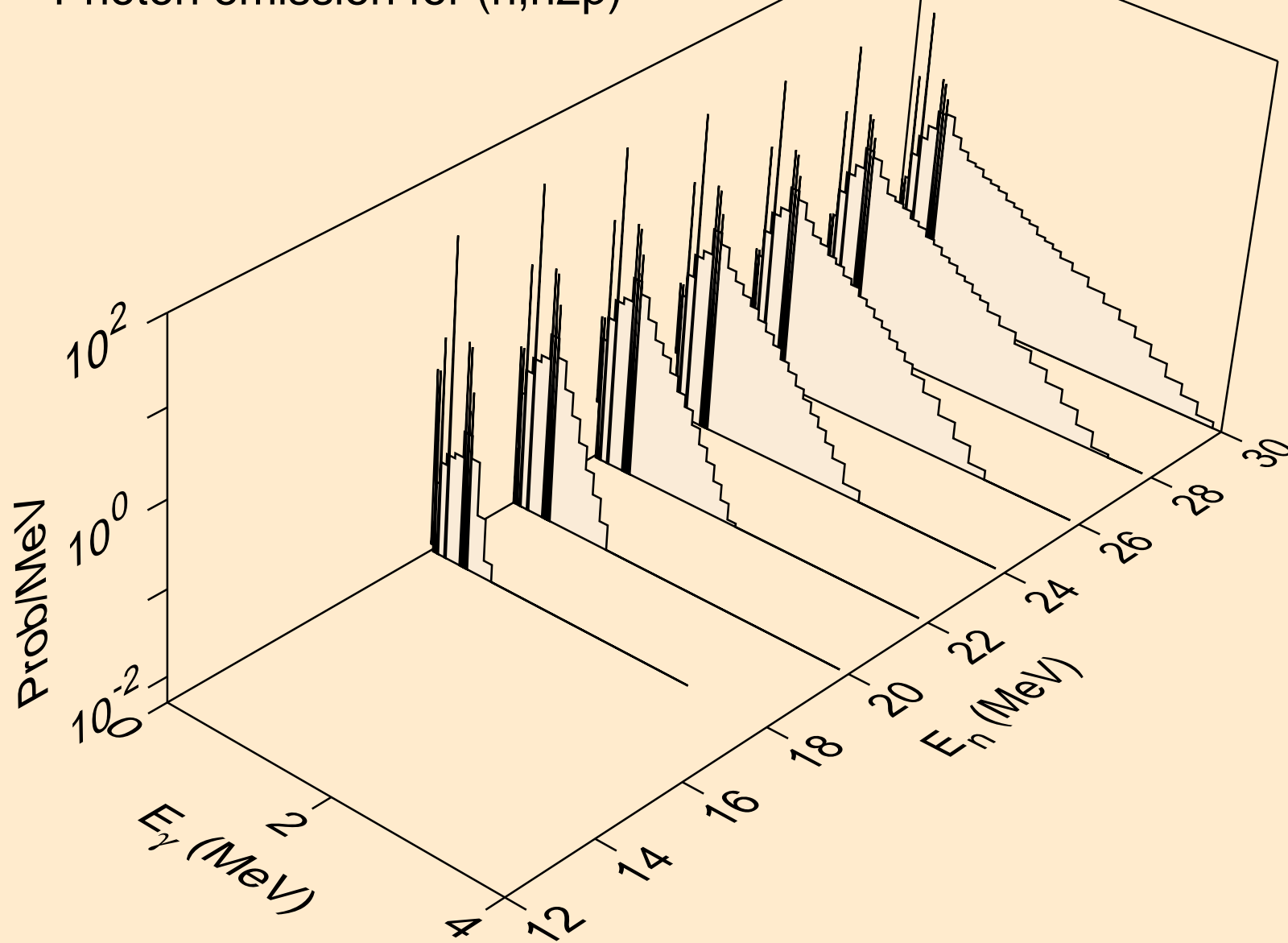

XE127M NEUTRON ACER TENDL-2024 LIBRARY; T=0.K  
Photon emission for (n,npa)

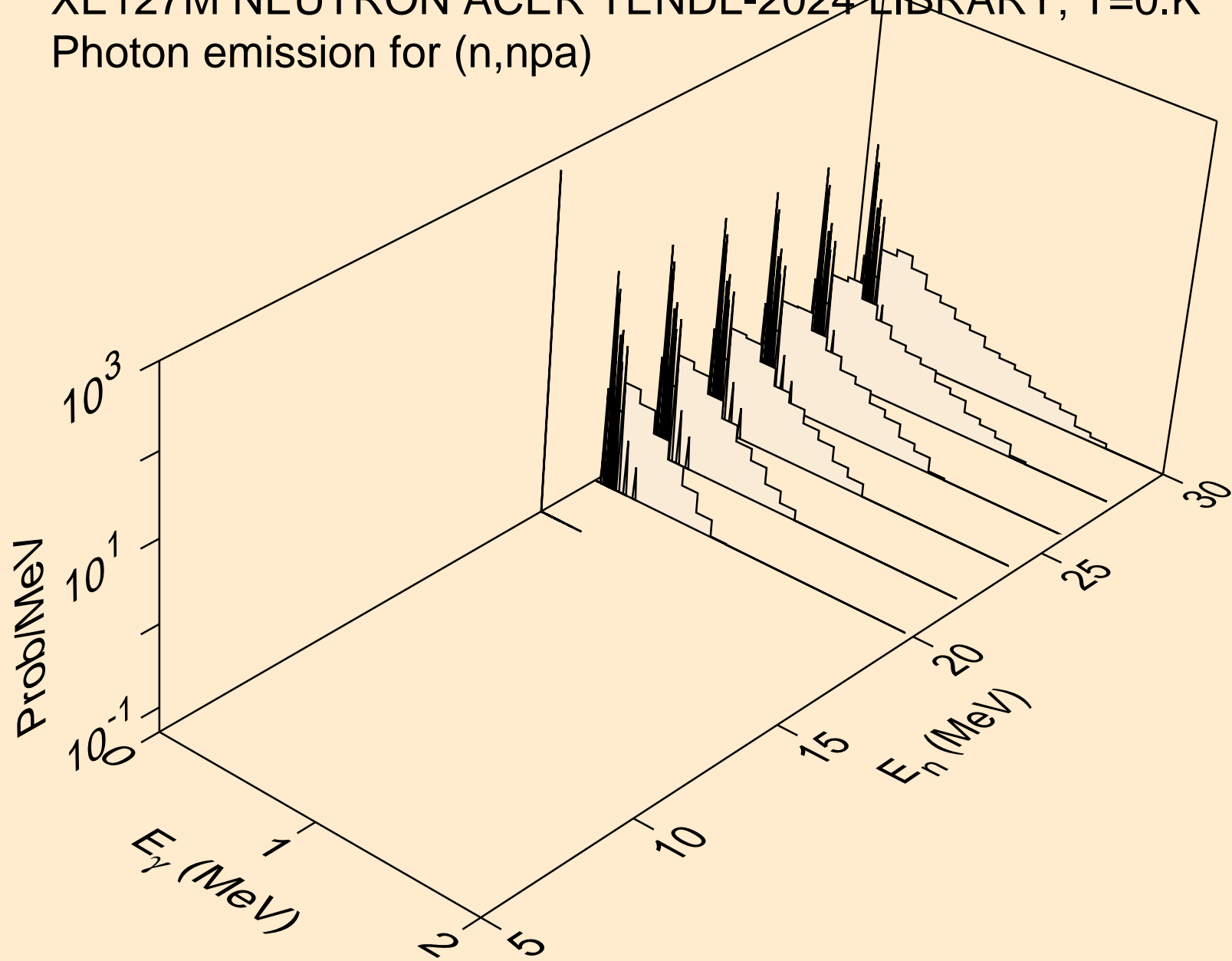

XE127M NEUTRON ACER TENDL-2024 LIBRARY; T=0.K  
Photon emission for (n,n\*1)

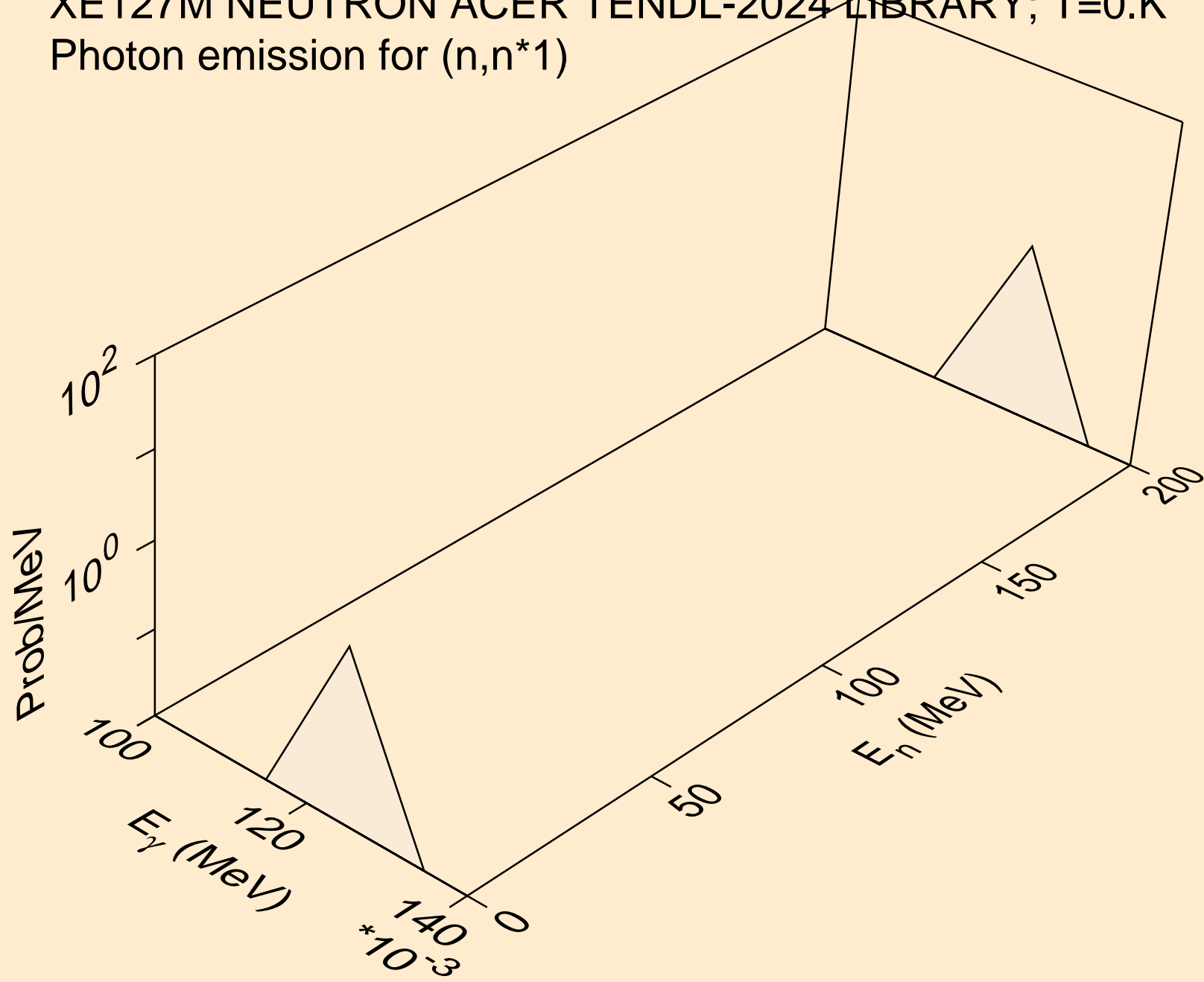

XE127M NEUTRON ACER TENDL-2024 LIBRARY; T=0.K  
Photon emission for (n,n\*3)

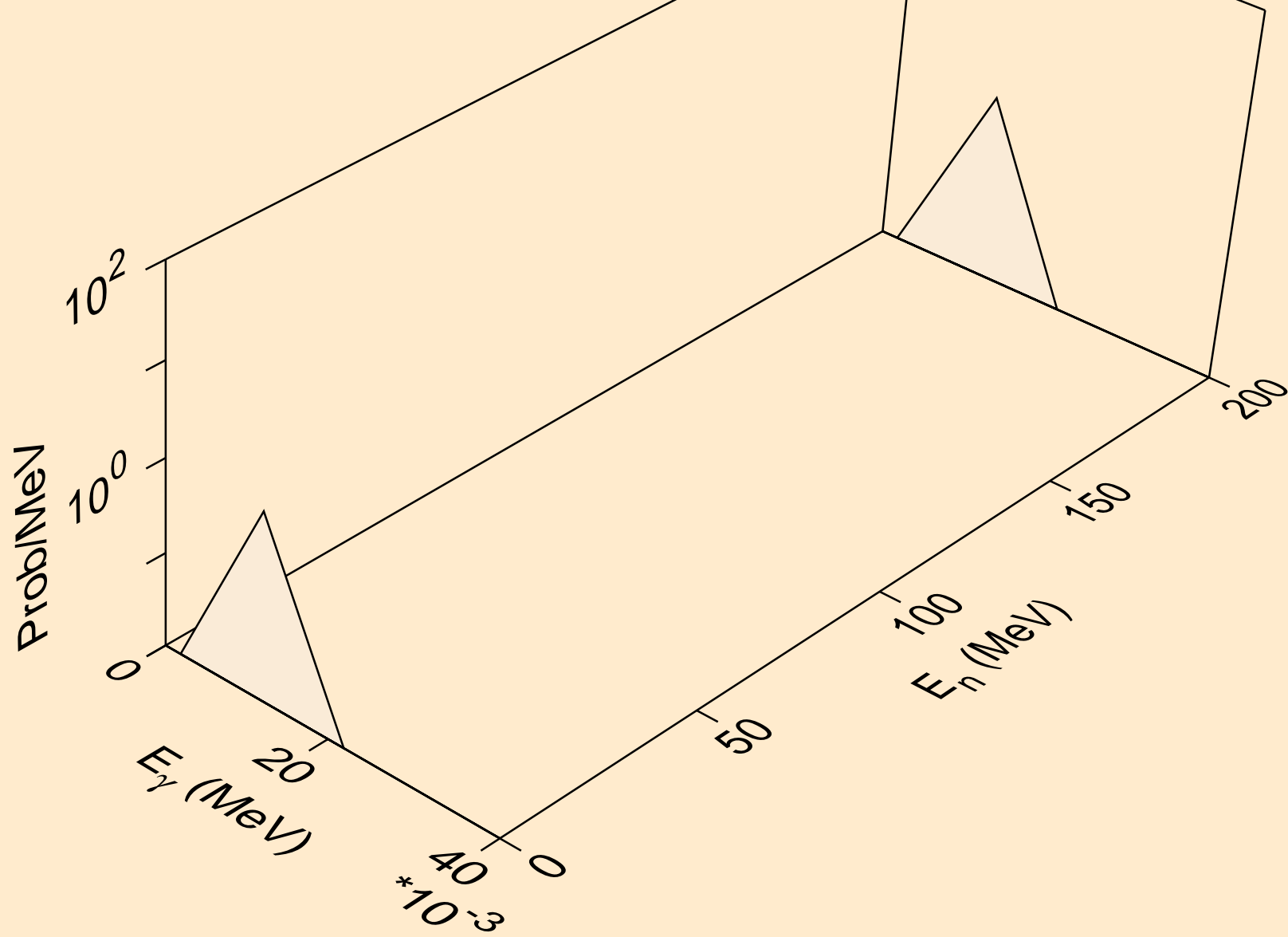

XE127M NEUTRON ACER TENDL-2024 LIBRARY; T=0.K  
Photon emission for (n,n\*4)

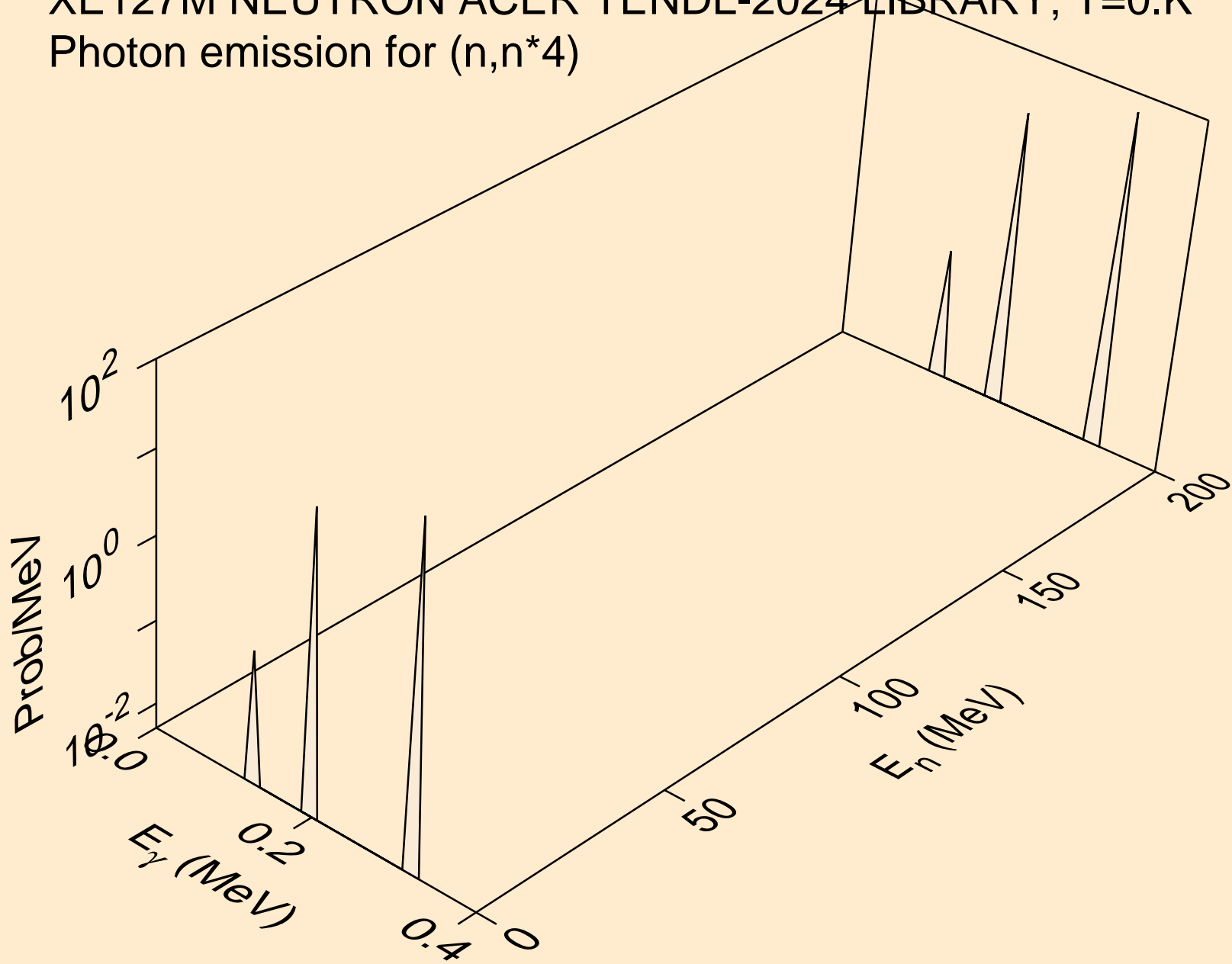

XE127M NEUTRON ACER TENDL-2024 LIBRARY; T=0.K  
Photon emission for (n,n\*5)

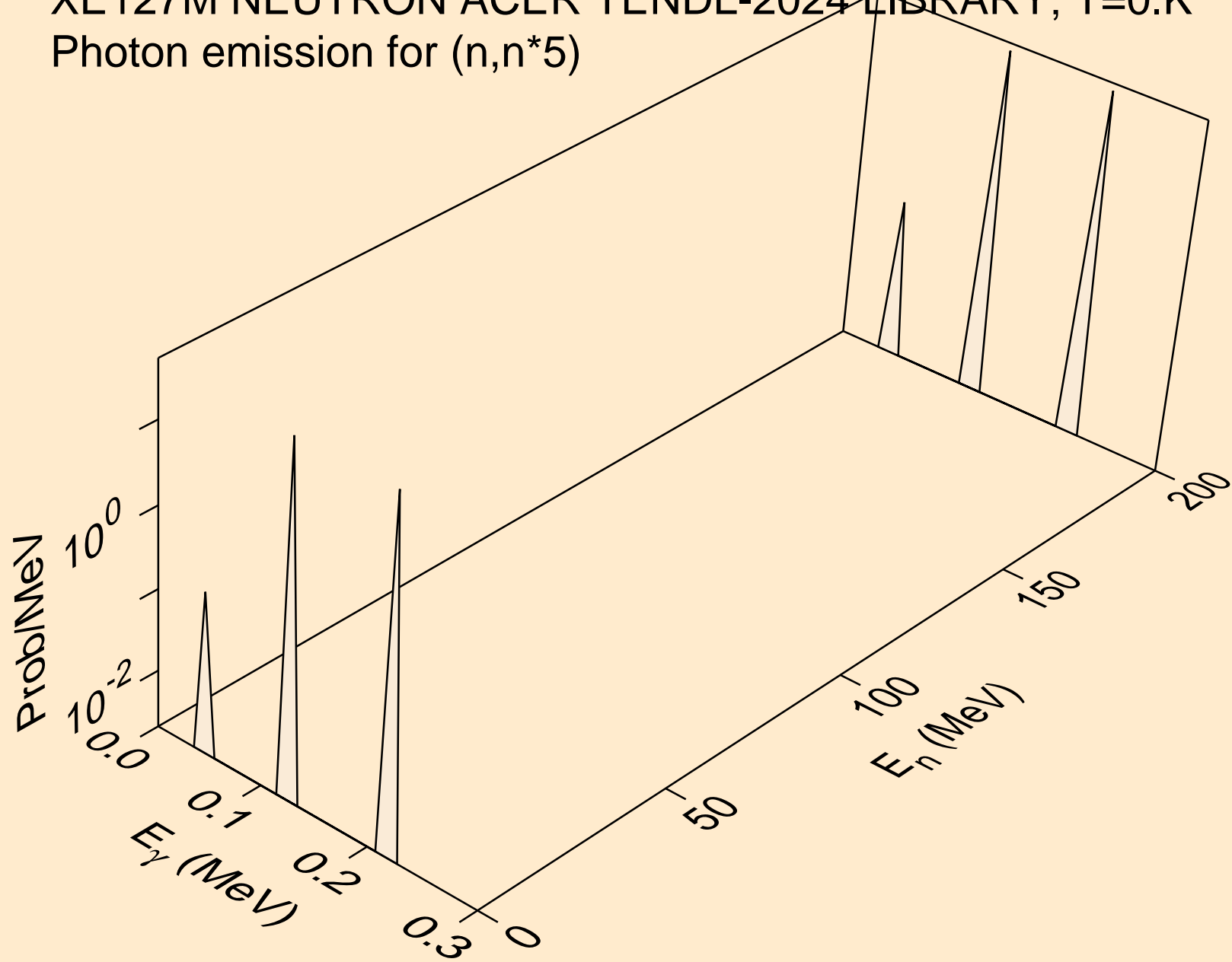

XE127M NEUTRON ACER TENDL-2024 LIBRARY; T=0.K  
Photon emission for (n,n\*6)

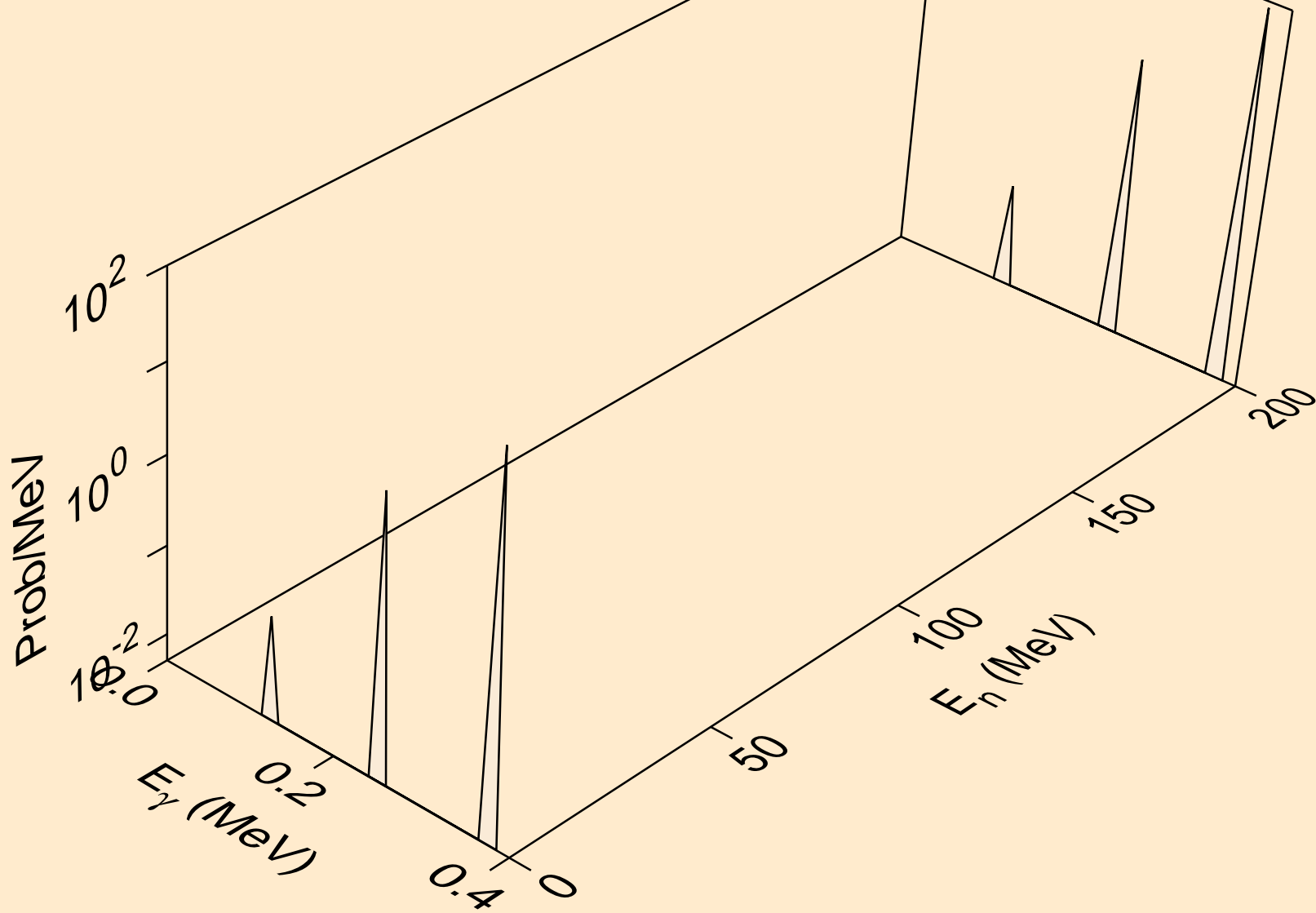

XE127M NEUTRON ACER TENDL-2024 LIBRARY; T=0.K  
Photon emission for (n,n\*7)

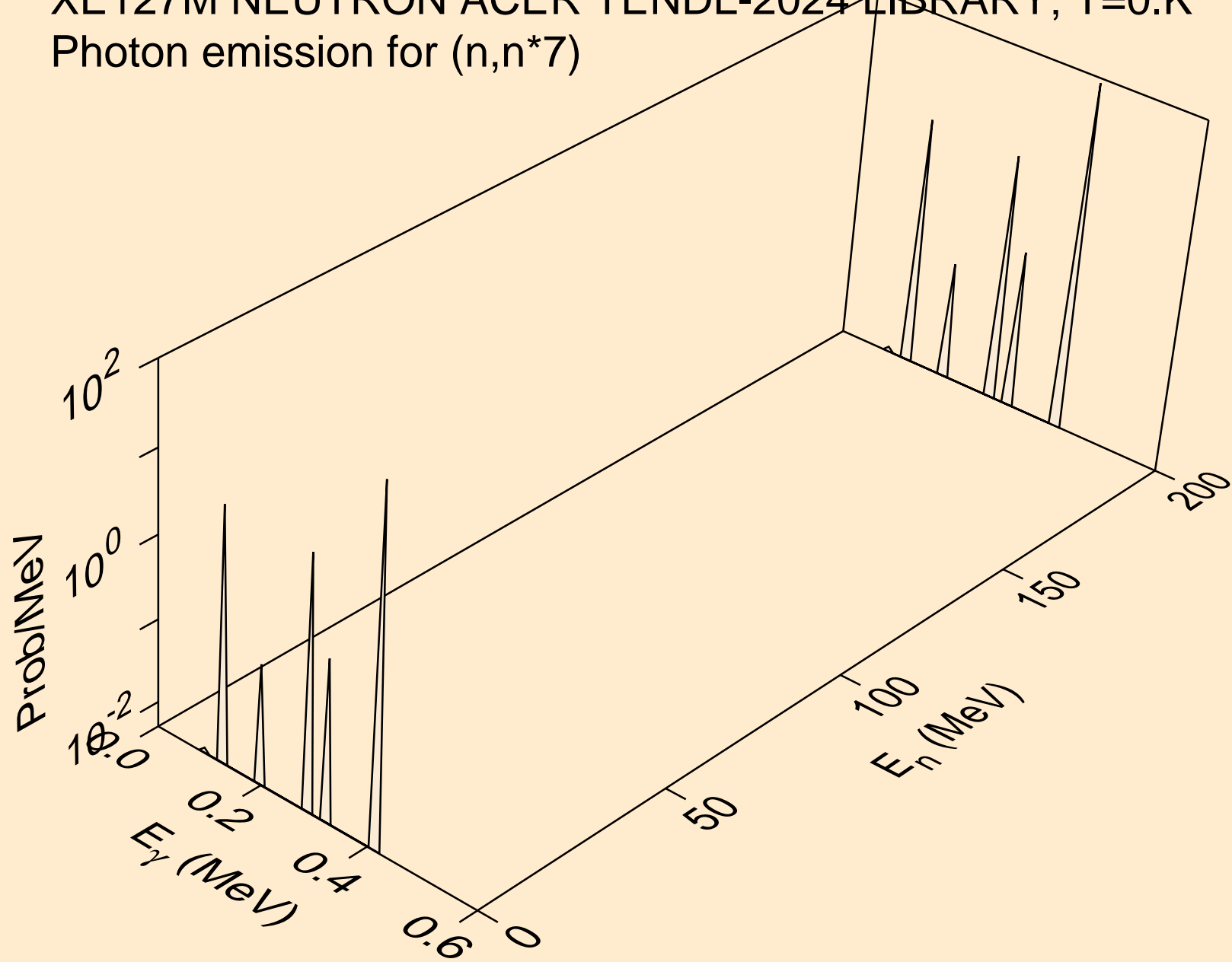



XE127M NEUTRON ACER TENDL-2024 LIBRARY; T=0.K  
Photon emission for (n,n\*8)

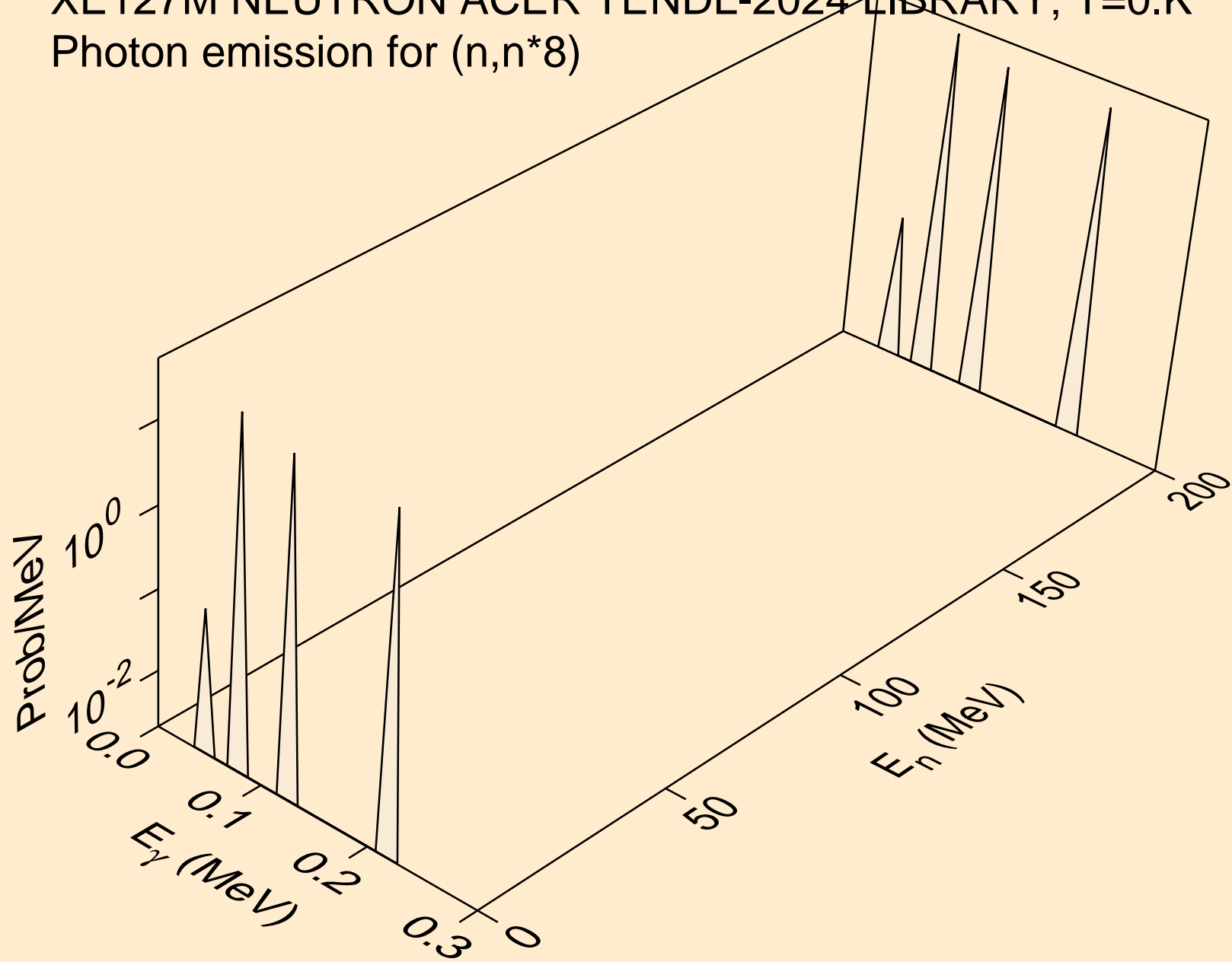

XE127M NEUTRON ACER TENDL-2024 LIBRARY; T=0.K  
Photon emission for (n,n\*9)

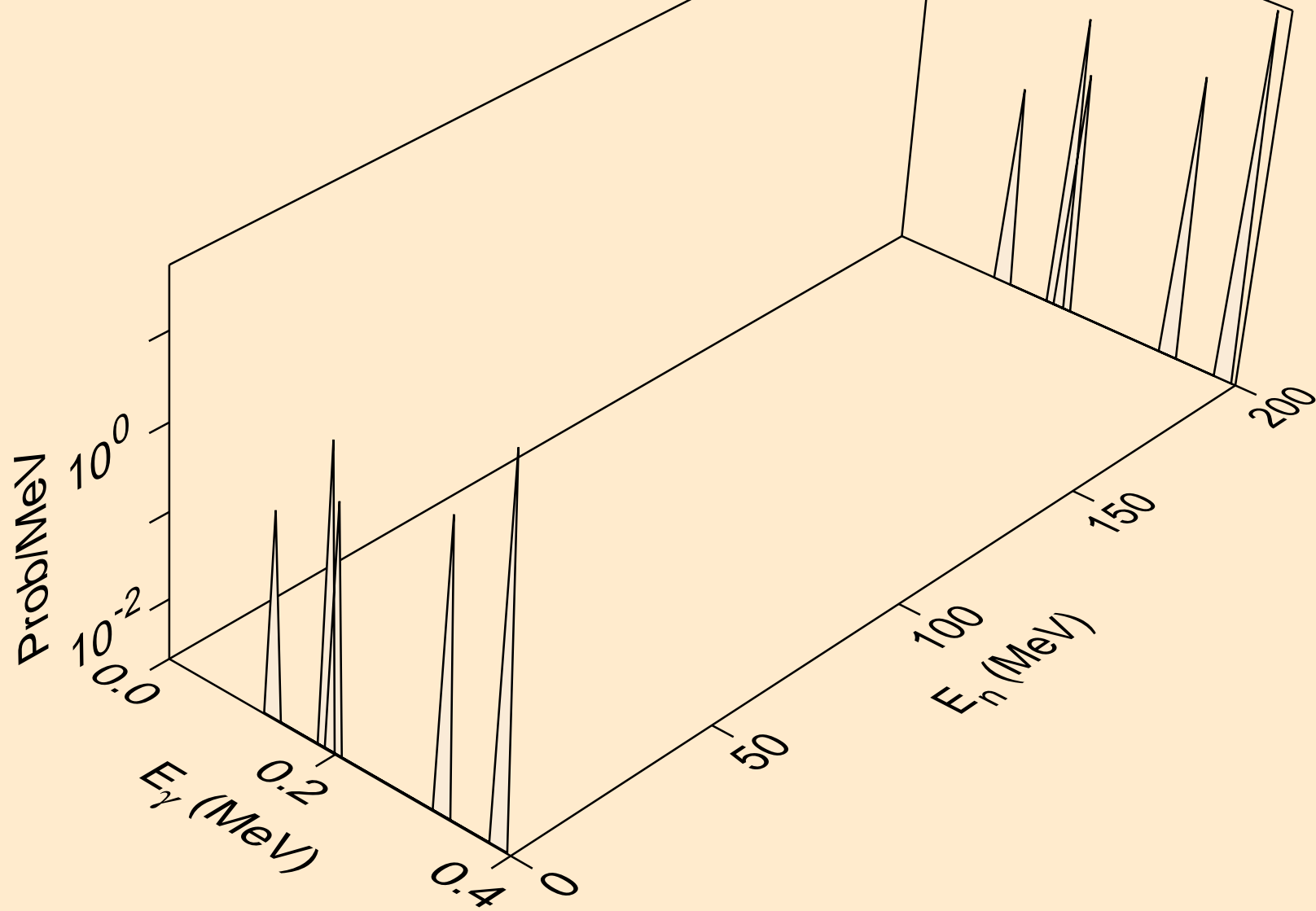

XE127M NEUTRON ACER TENDL-2024 LIBRARY; T=0.K  
Photon emission for (n,n\*10)

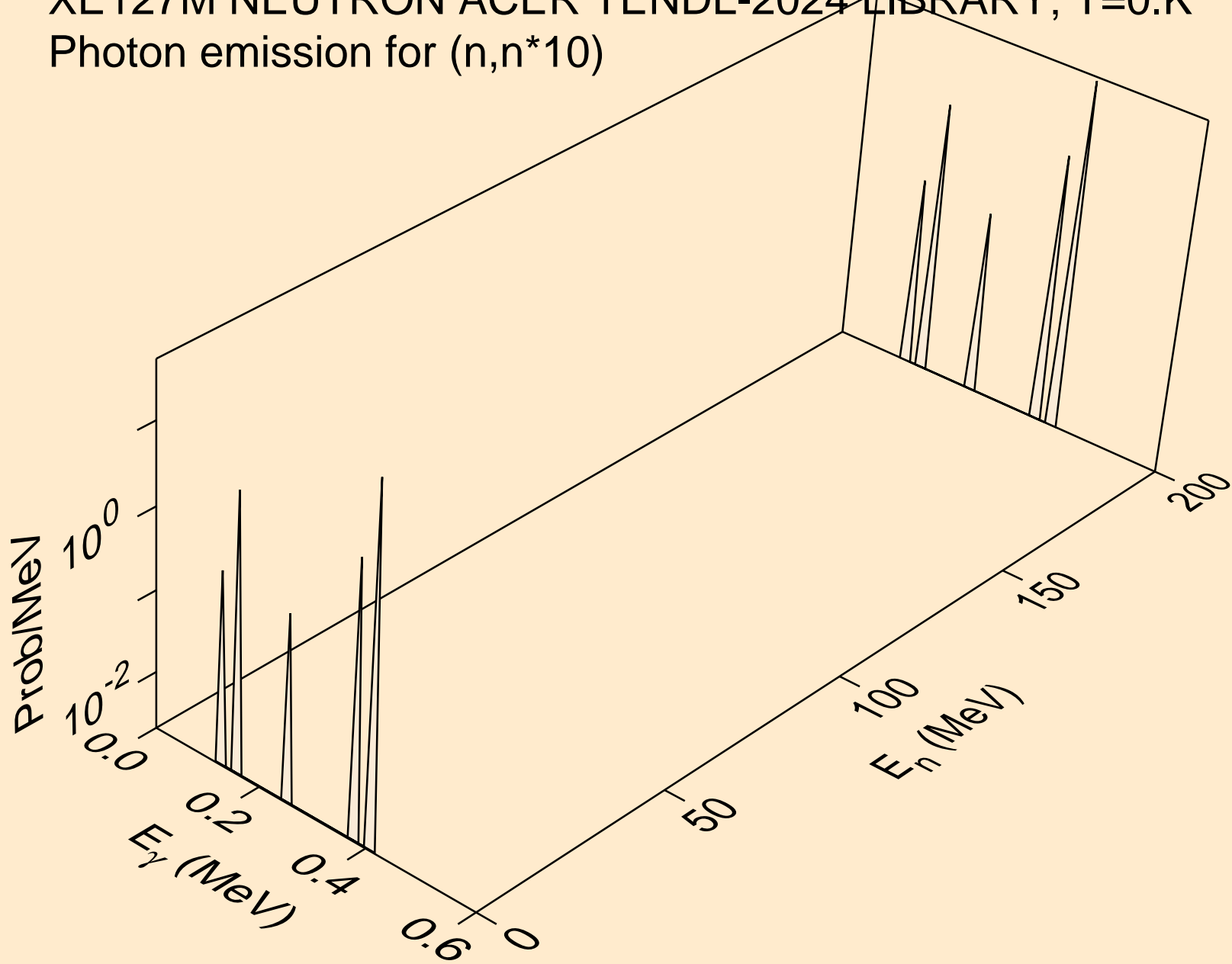

XE127M NEUTRON ACER TENDL-2024 LIBRARY; T=0.K  
Photon emission for (n,n\*11)

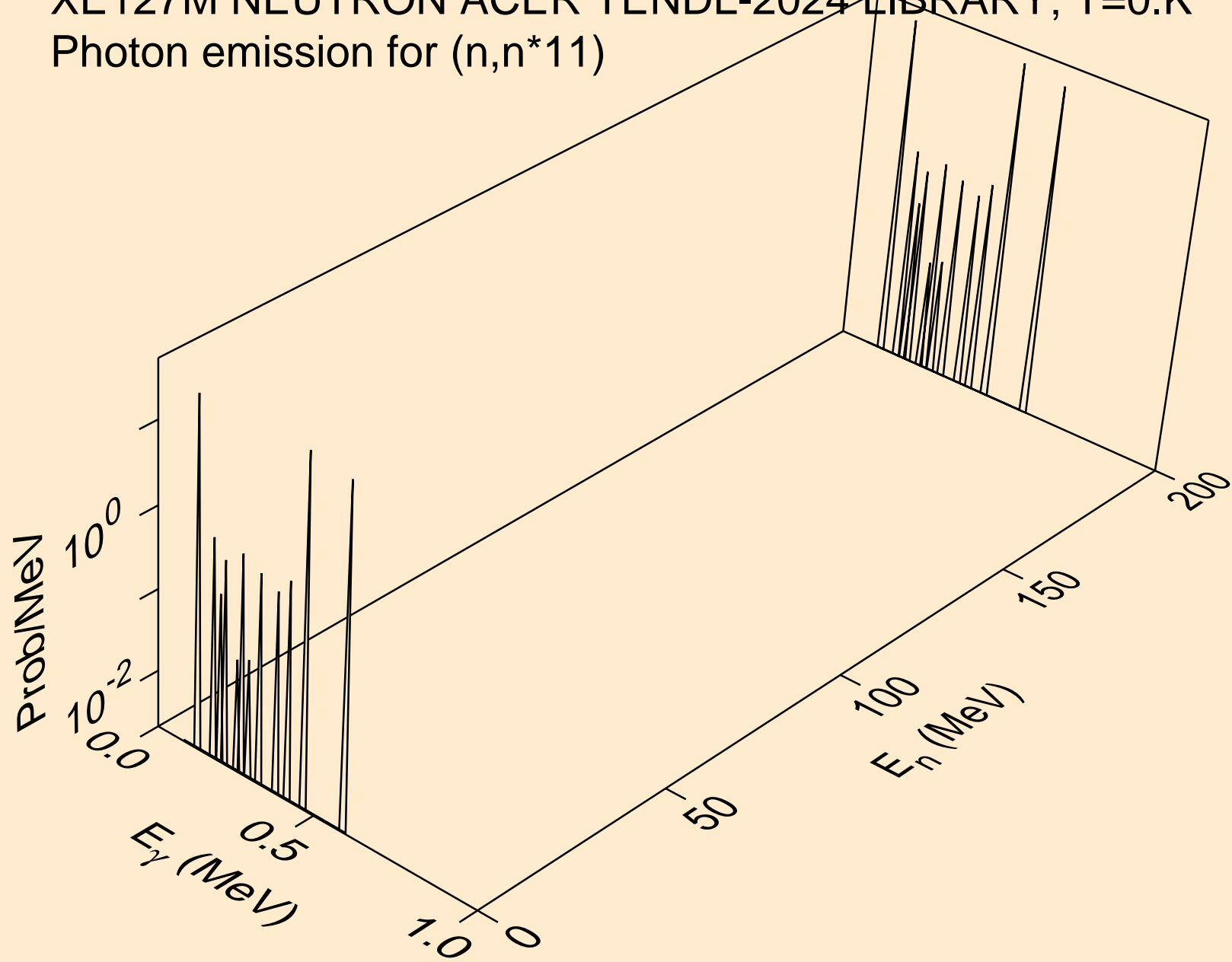

XE127M NEUTRON ACER TENDL-2024 LIBRARY; T=0.K  
Photon emission for (n,n\*12)

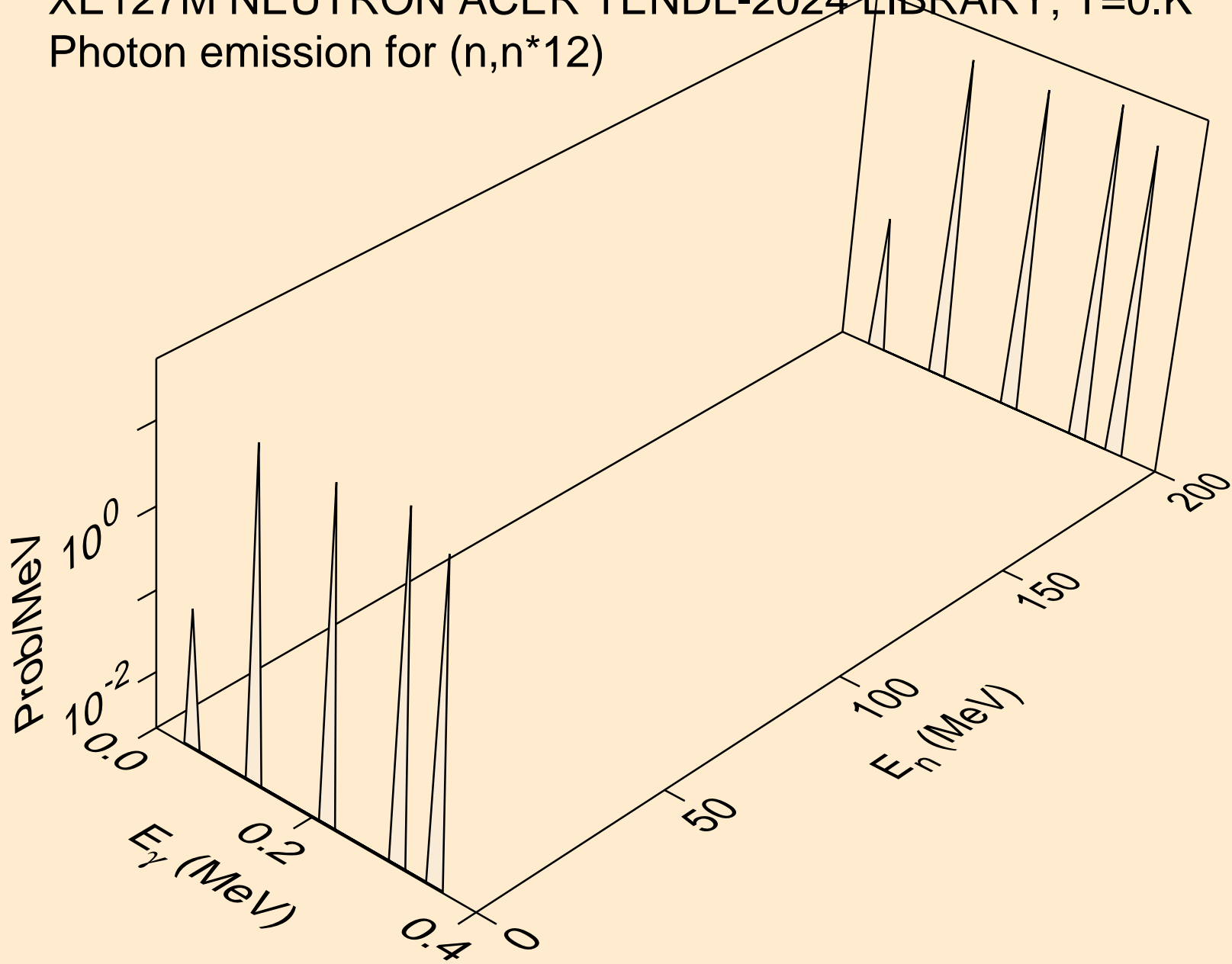

XE127M NEUTRON ACER TENDL-2024 LIBRARY; T=0.K  
Photon emission for (n,n\*13)

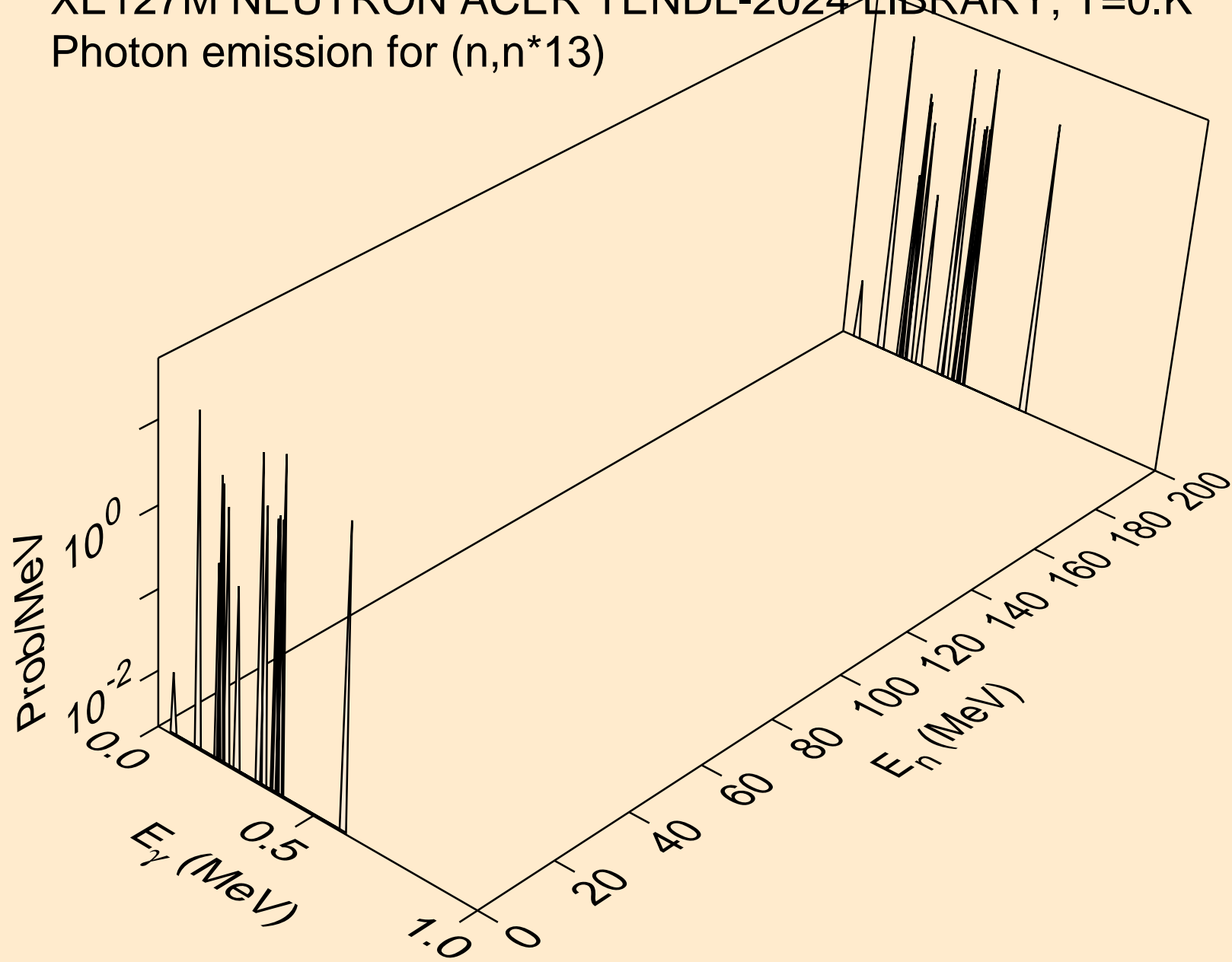

XE127M NEUTRON ACER TENDL-2024 LIBRARY; T=0.K  
Photon emission for (n,n\*14)

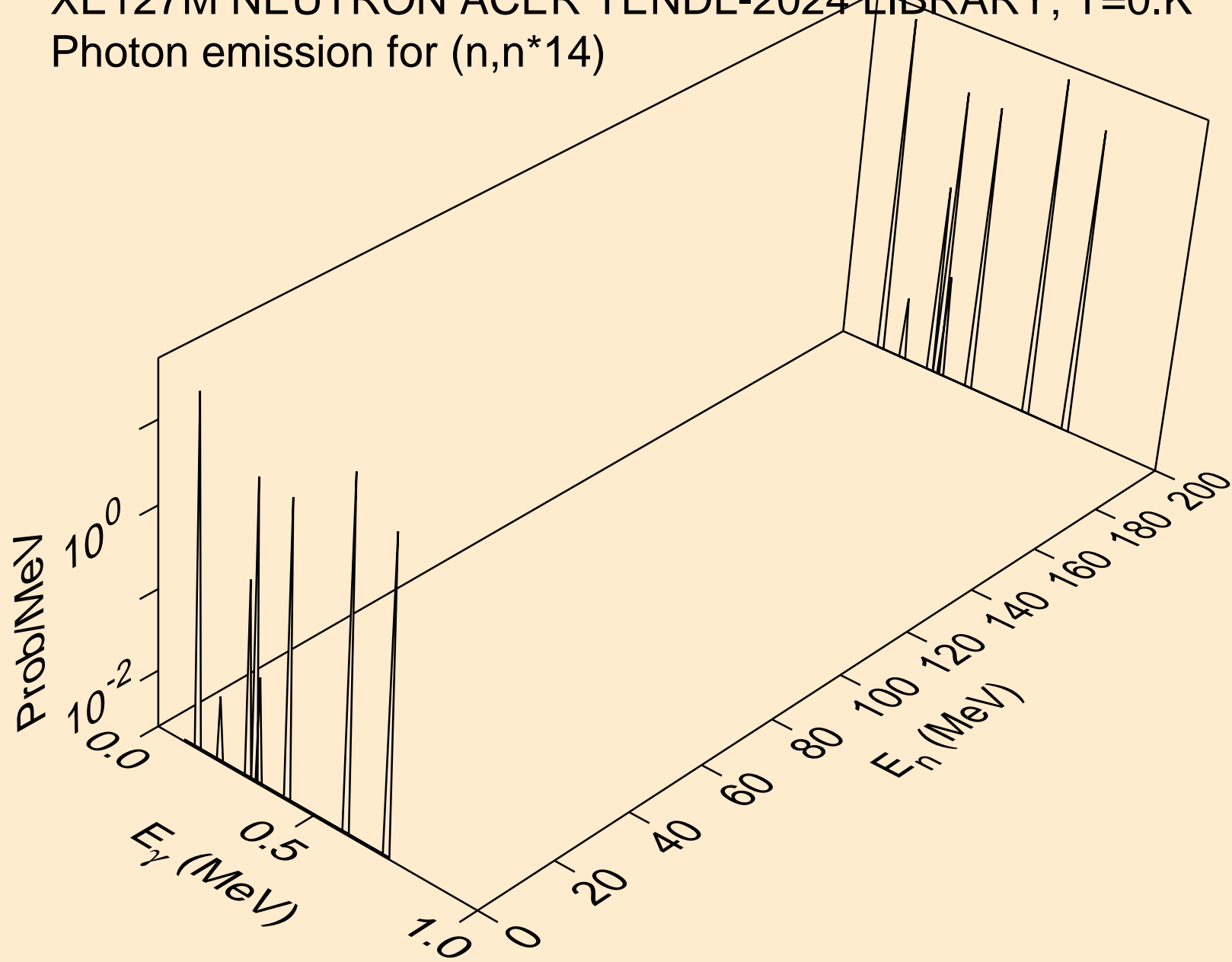

XE127M NEUTRON ACER TENDL-2024 LIBRARY; T=0.K  
Photon emission for (n,n\*15)

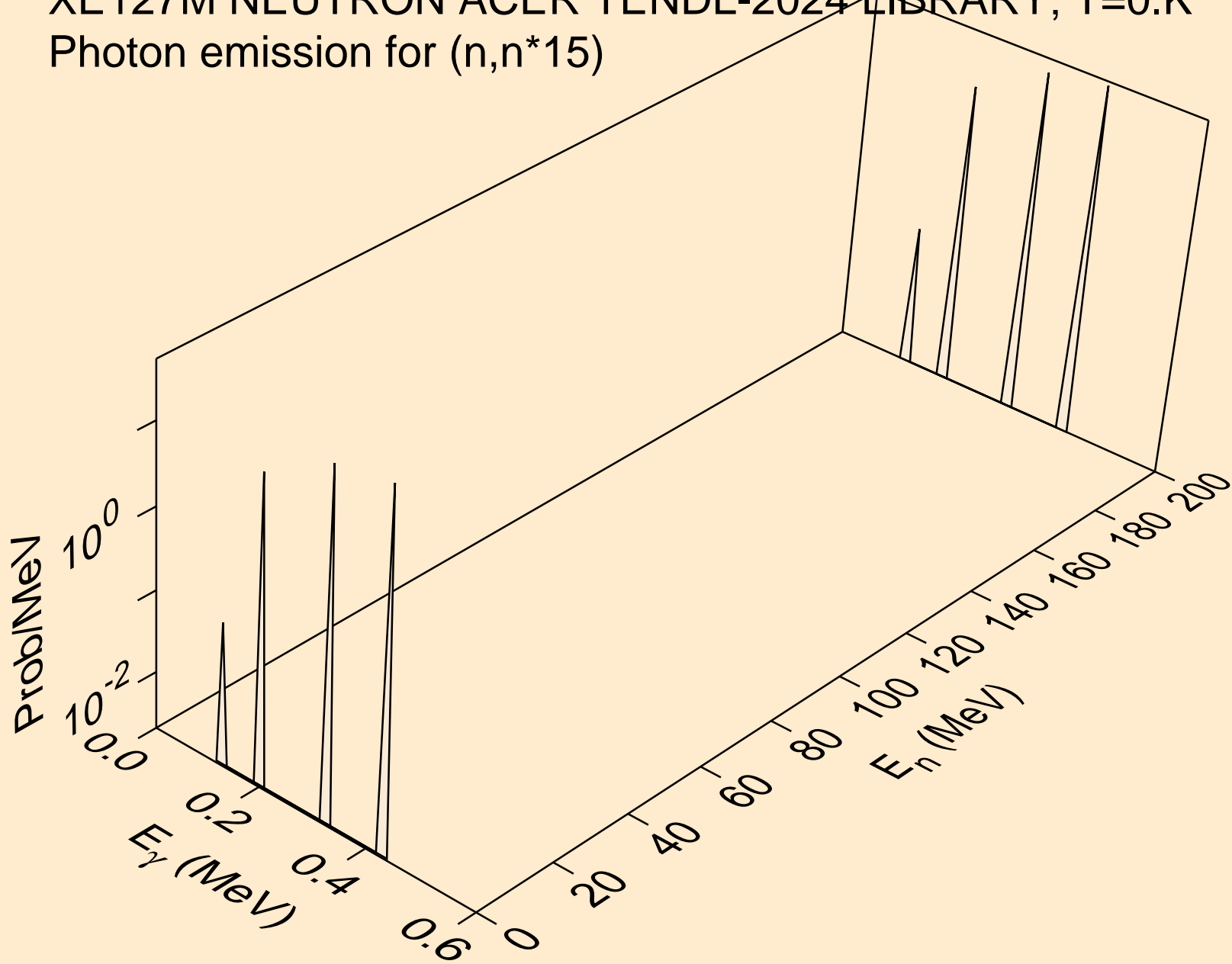



XE127M NEUTRON ACER TENDL-2024 LIBRARY; T=0.K  
Photon emission for (n,n\*16)

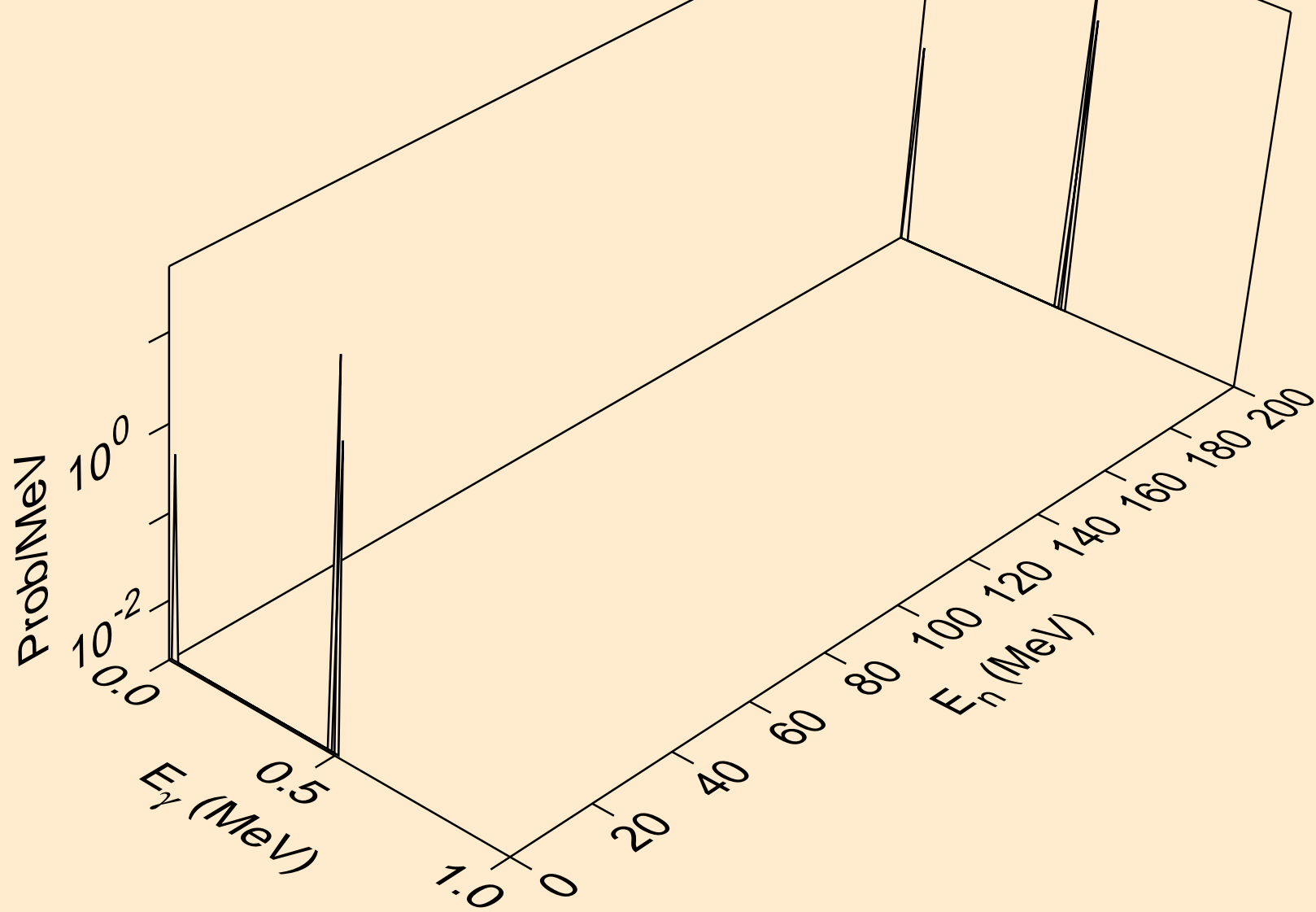

XE127M NEUTRON ACER TENDL-2024 LIBRARY; T=0.K  
Photon emission for (n,n\*17)

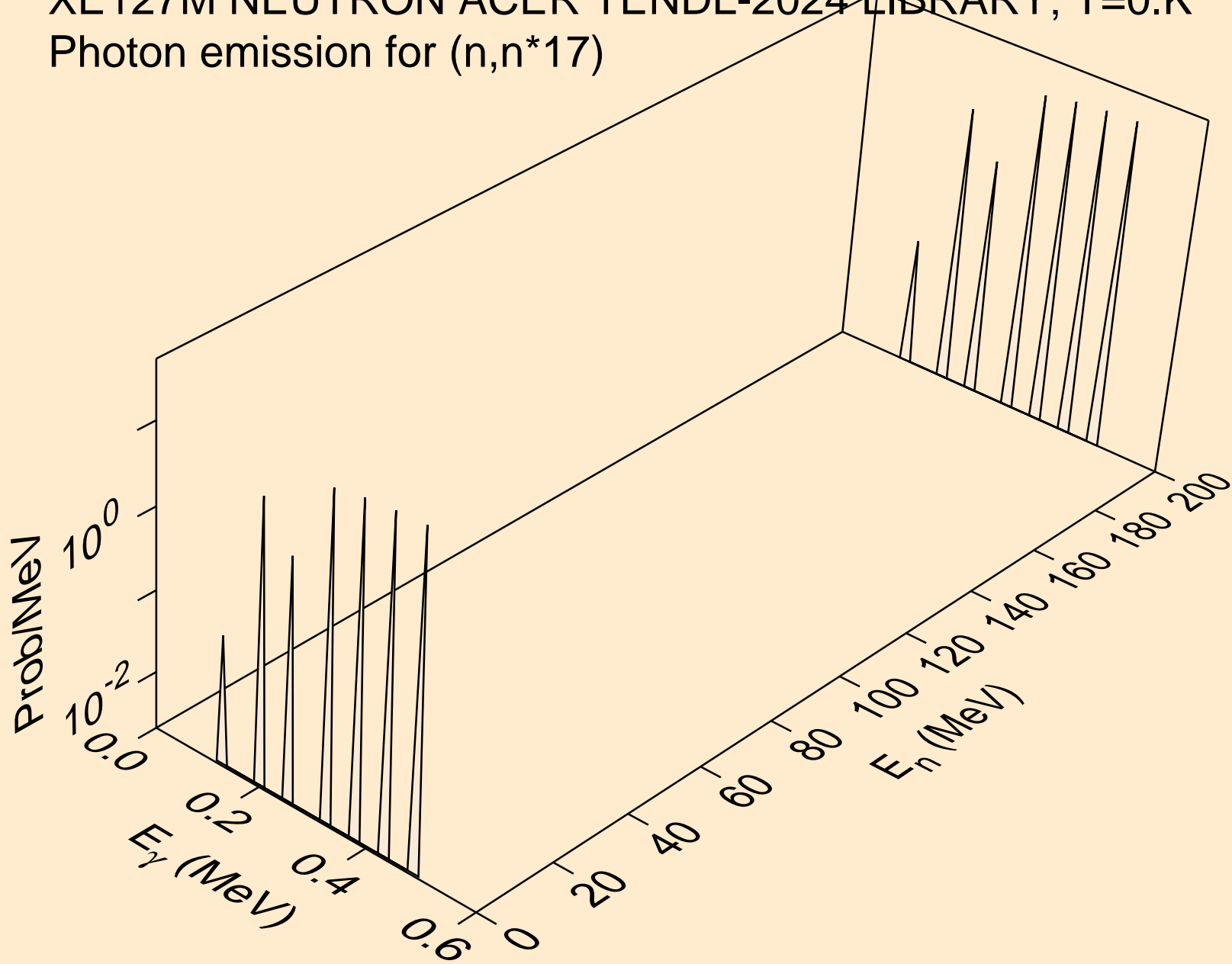

XE127M NEUTRON ACER TENDL-2024 LIBRARY; T=0.K  
Photon emission for (n,n\*18)

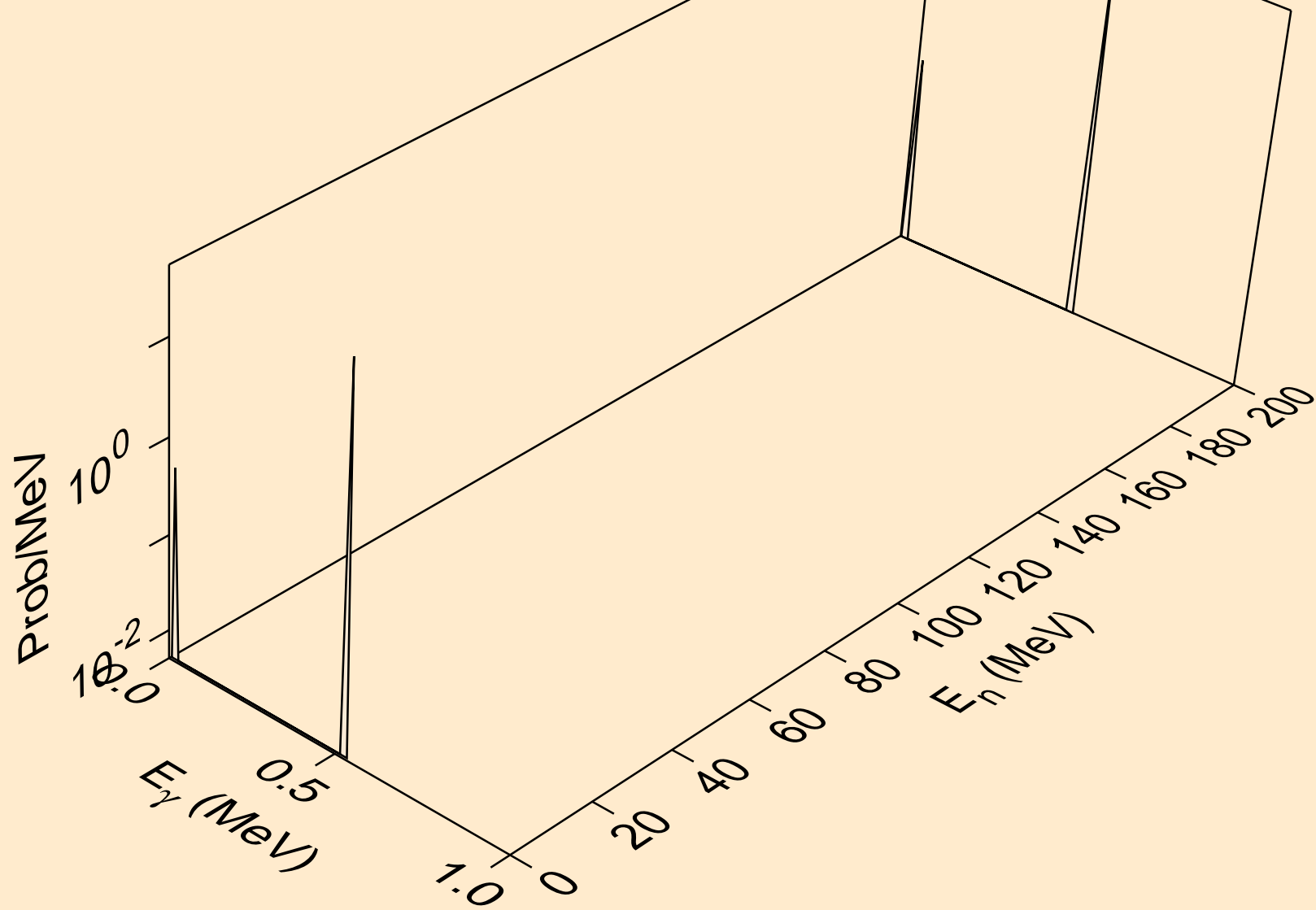

XE127M NEUTRON ACER TENDL-2024 LIBRARY; T=0.K  
Photon emission for (n,n\*19)

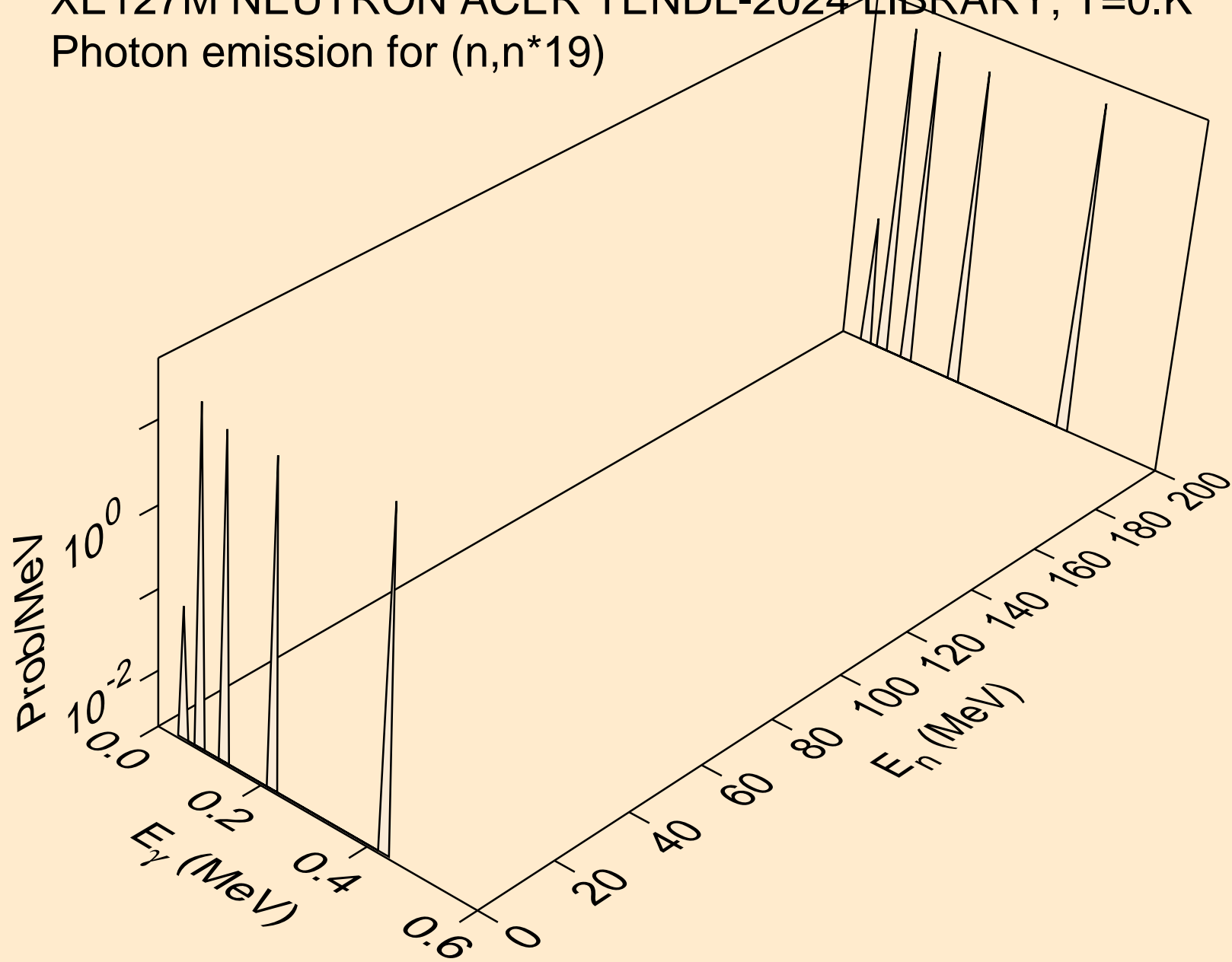

XE127M NEUTRON ACER TENDL-2024 LIBRARY; T=0.K  
Photon emission for (n,n\*20)

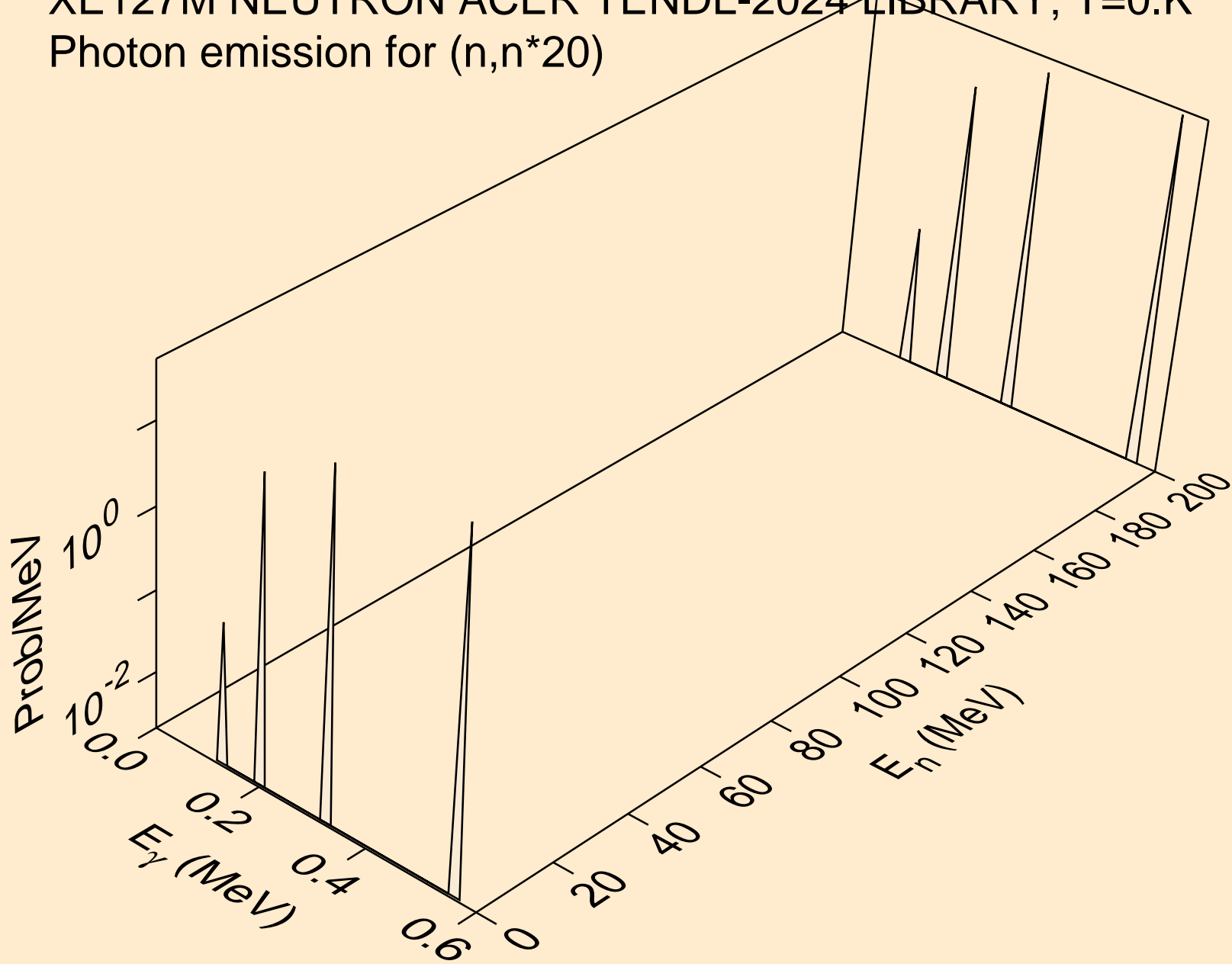

XE127M NEUTRON ACER TENDL-2024 LIBRARY; T=0.K  
Photon emission for (n,n\*21)

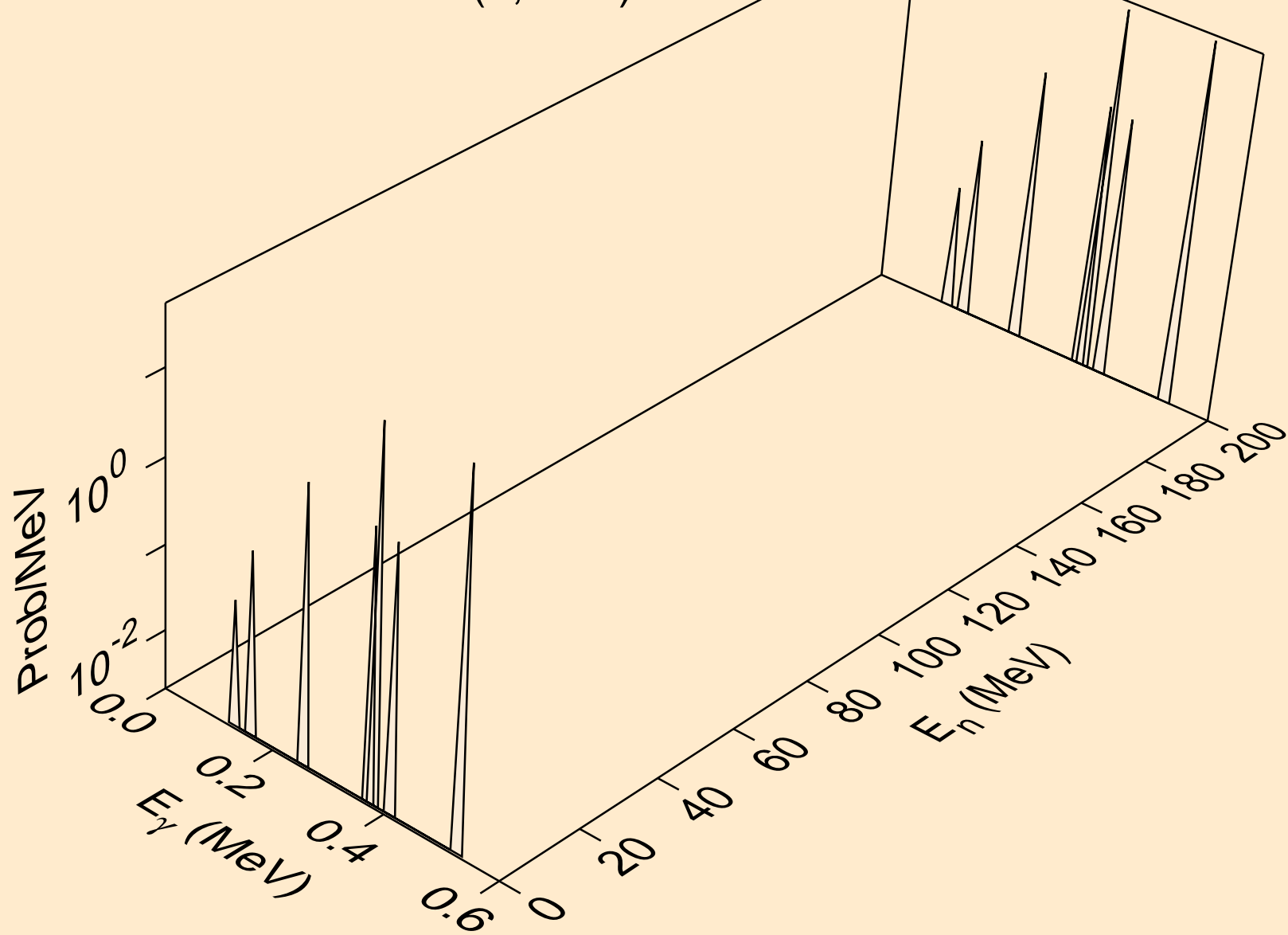

XE127M NEUTRON ACER TENDL-2024 LIBRARY; T=0.K  
Photon emission for (n,n\*22)

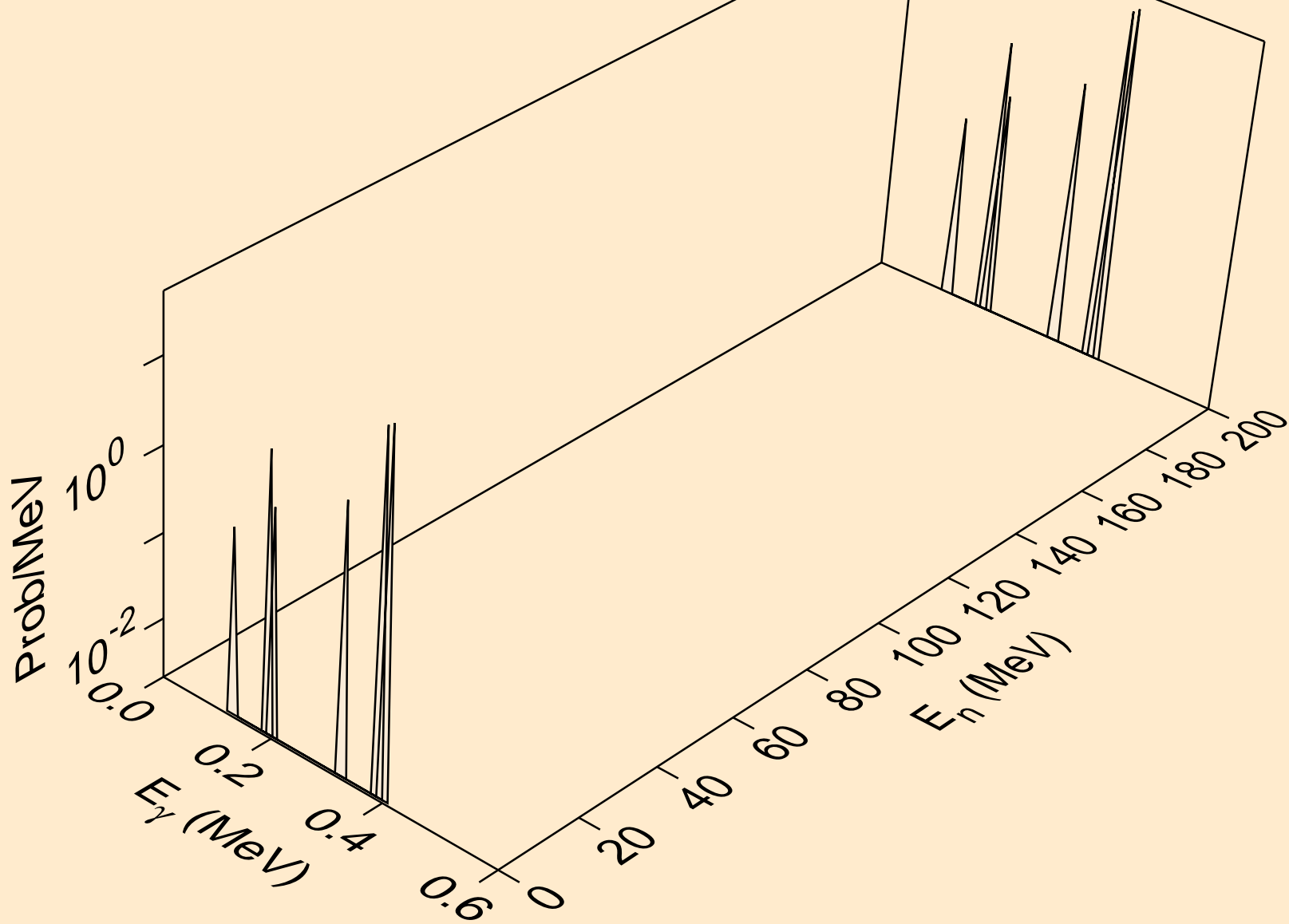

XE127M NEUTRON ACER TENDL-2024 LIBRARY; T=0.K  
Photon emission for (n,n\*23)

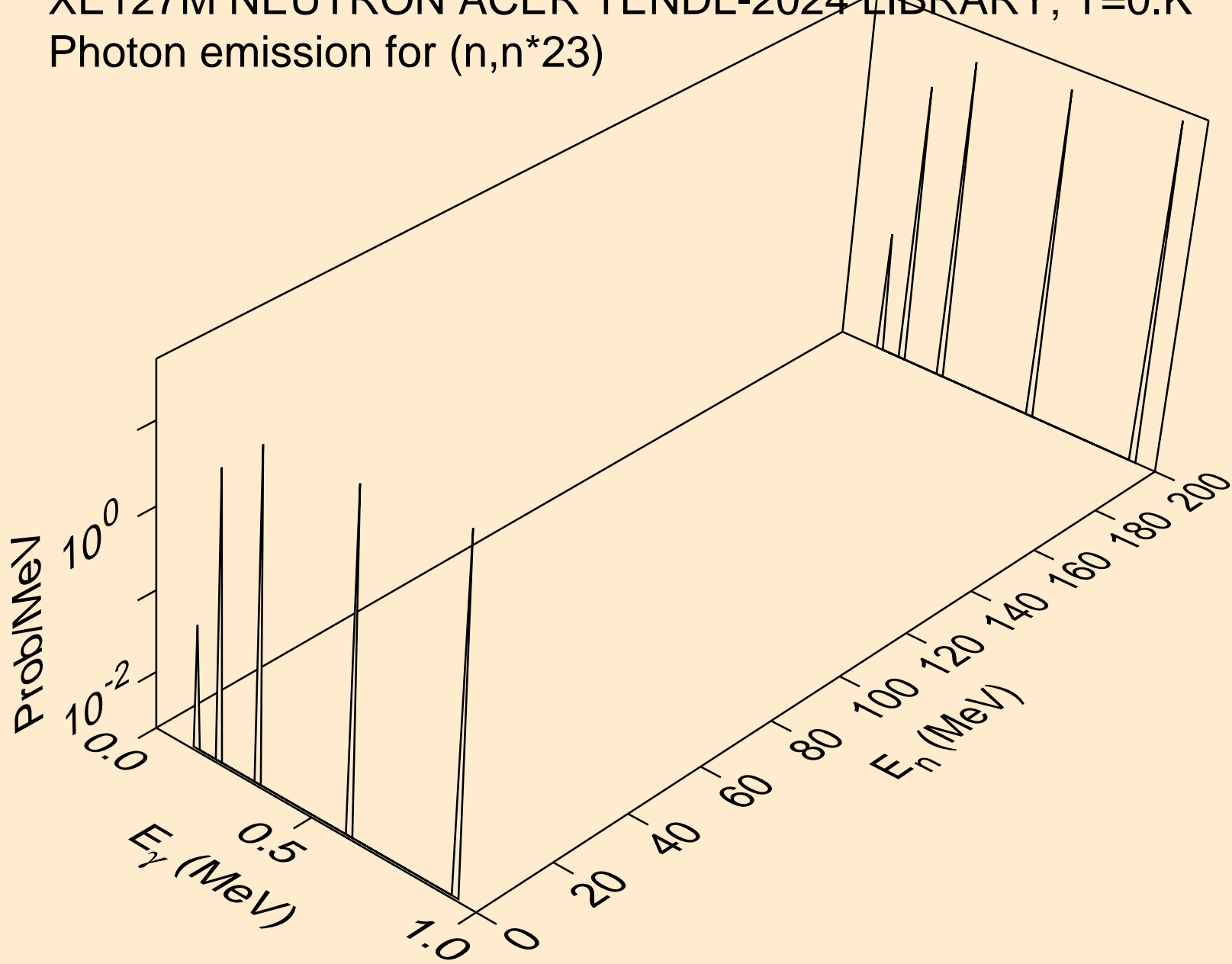



XE127M NEUTRON ACER TENDL-2024 LIBRARY; T=0.K  
Photon emission for (n,n\*24)

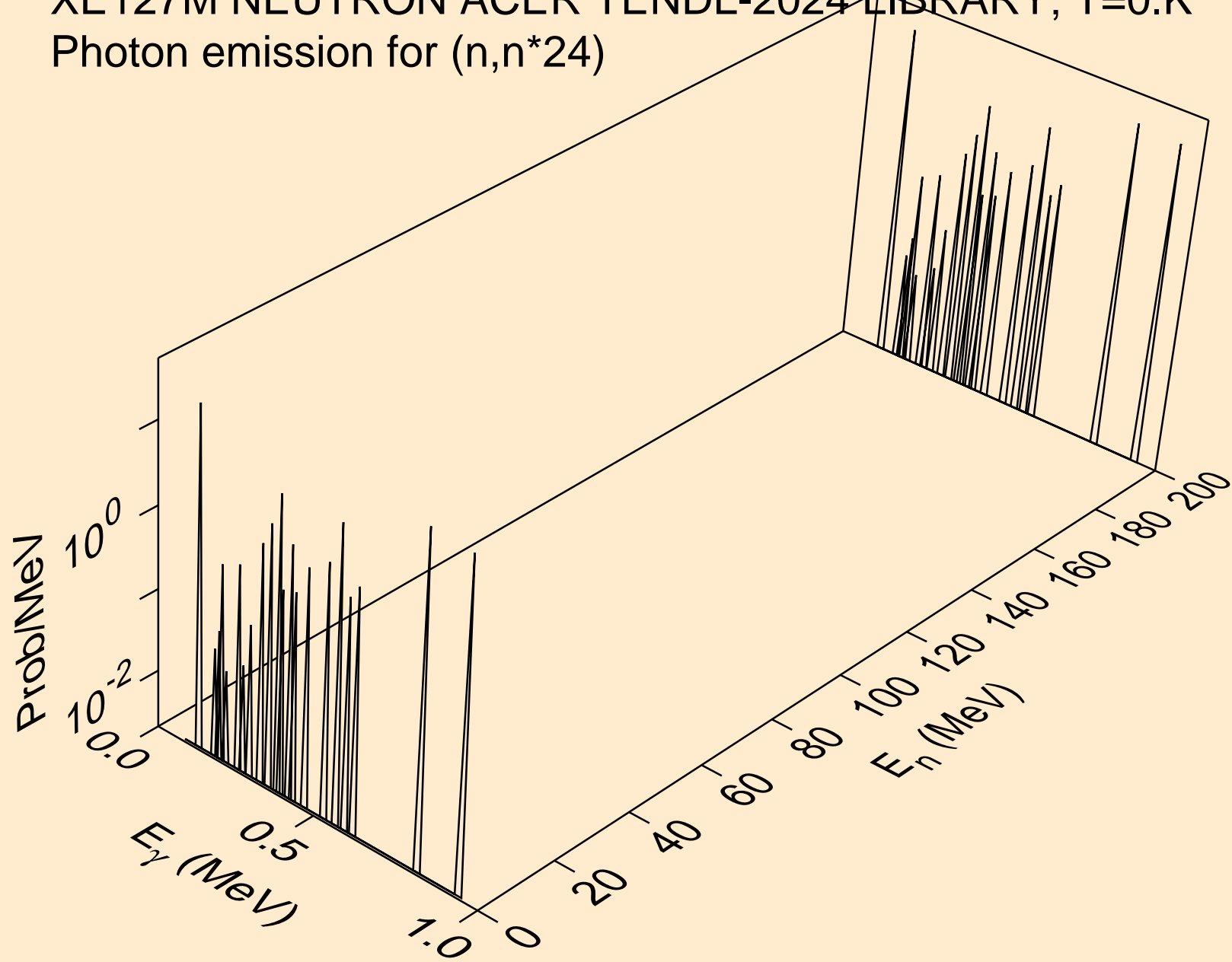

XE127M NEUTRON ACER TENDL-2024 LIBRARY; T=0.K  
Photon emission for (n,n\*25)

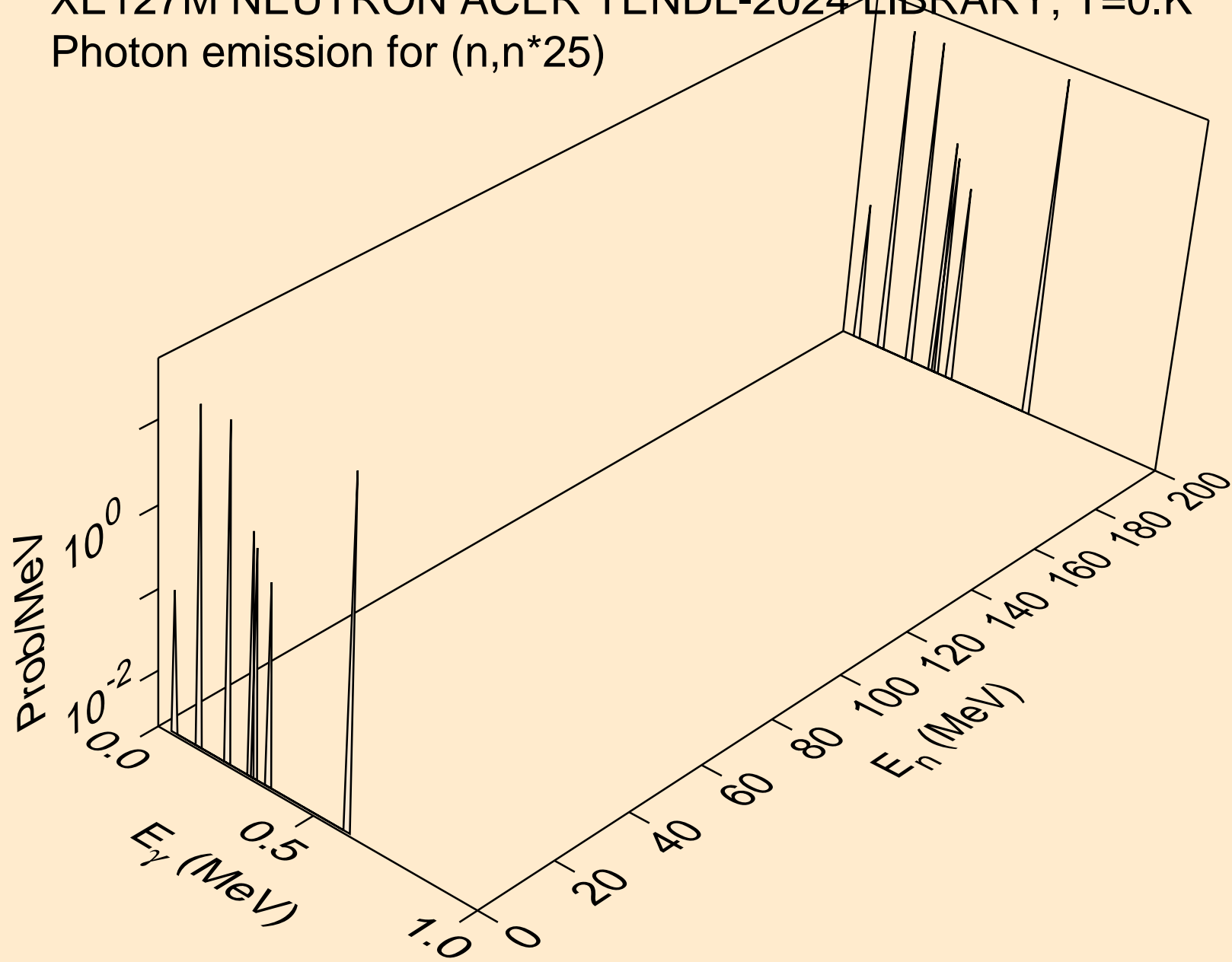

XE127M NEUTRON ACER TENDL-2024 LIBRARY; T=0.K  
Photon emission for (n,n\*26)

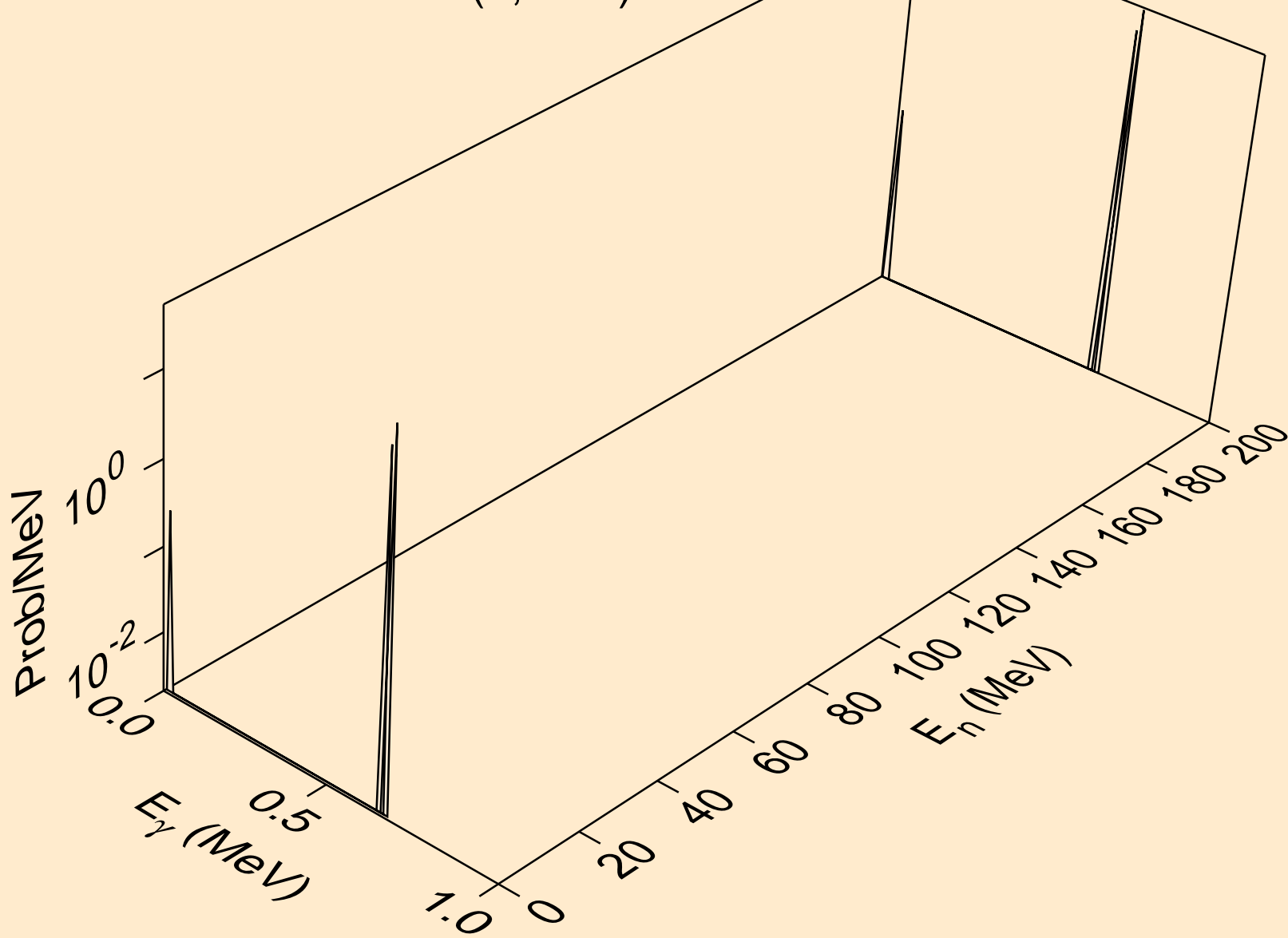

XE127M NEUTRON ACER TENDL-2024 LIBRARY; T=0.K  
Photon emission for (n,n\*27)

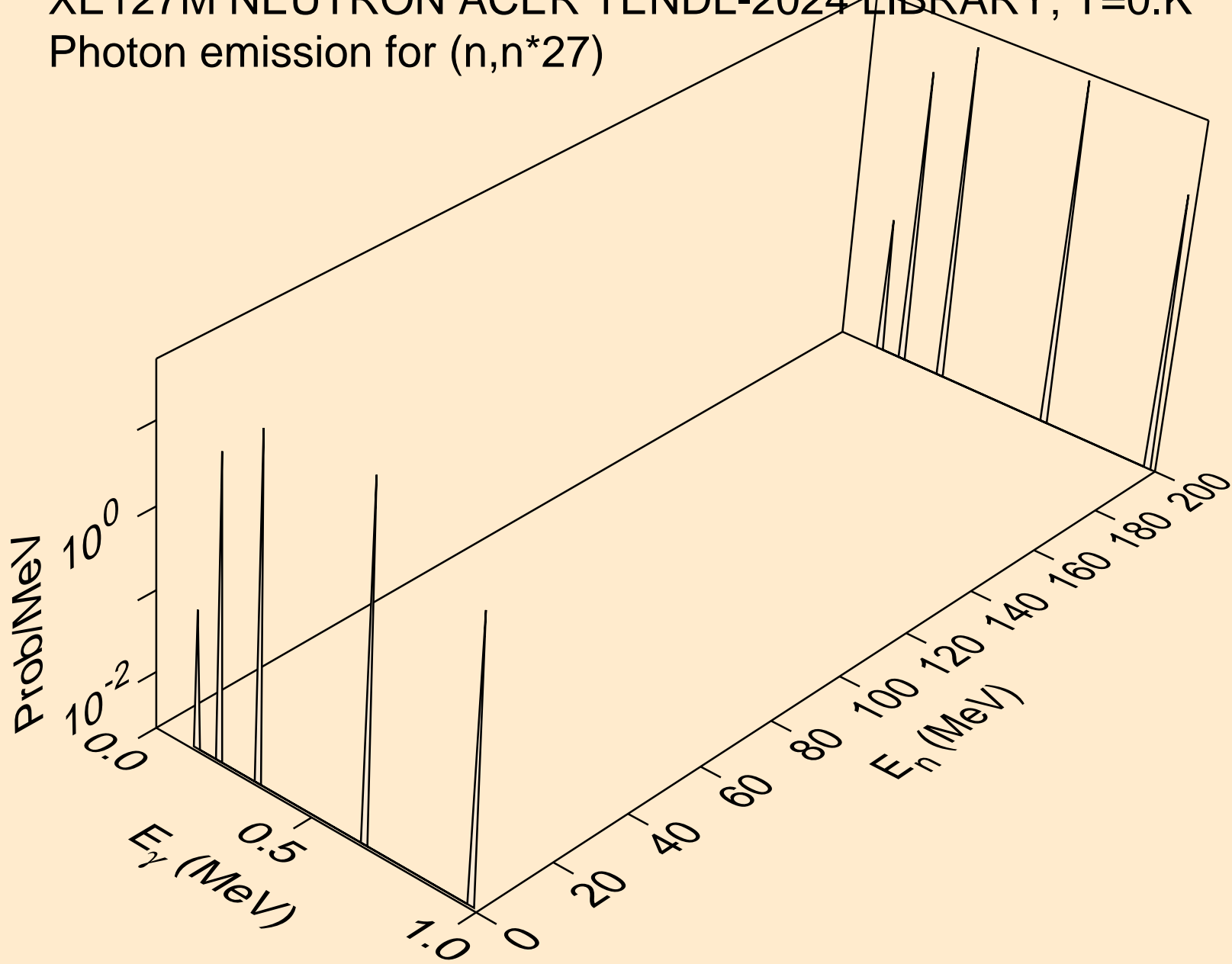

XE127M NEUTRON ACER TENDL-2024 LIBRARY; T=0.K  
Photon emission for (n,n\*28)

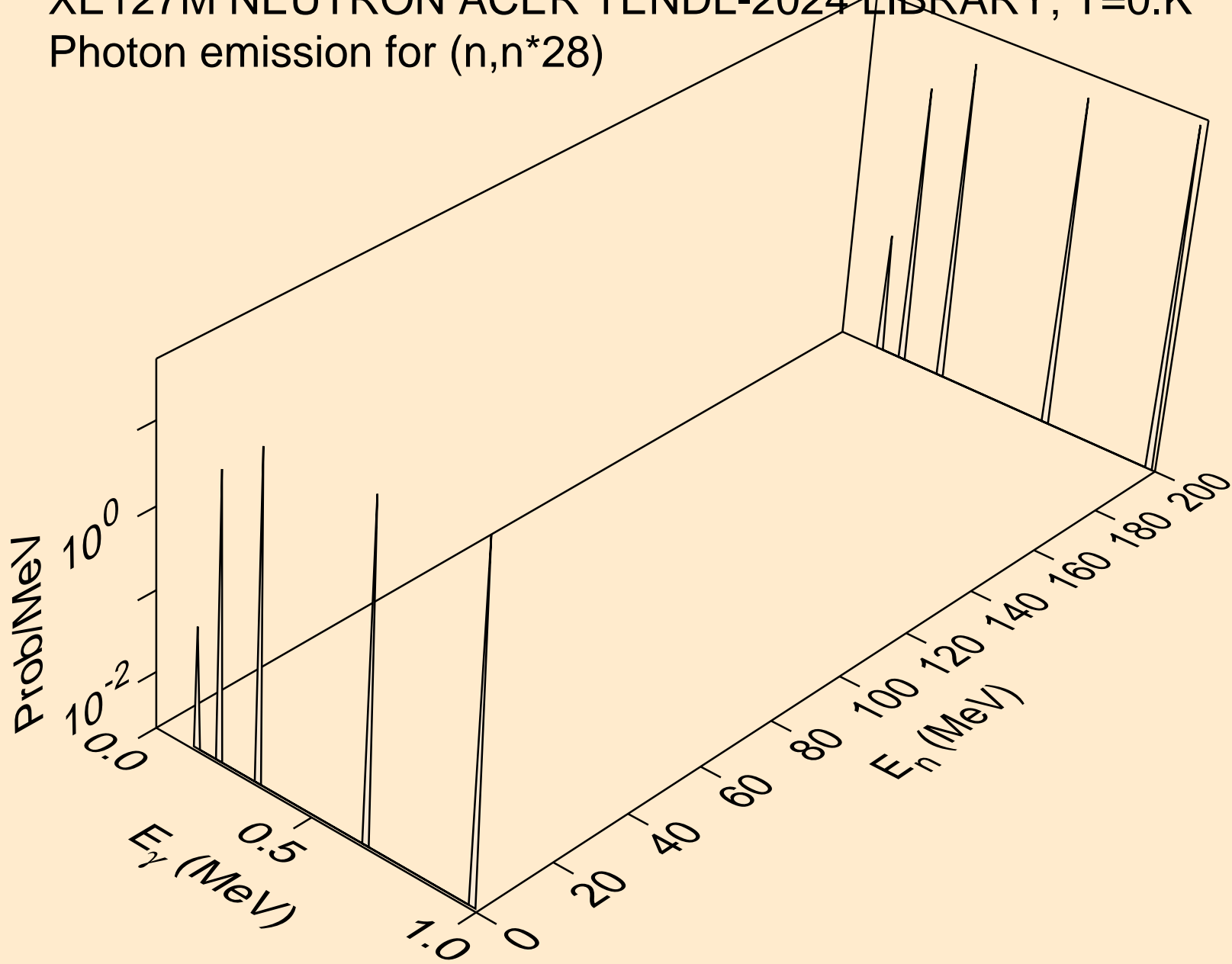

XE127M NEUTRON ACER TENDL-2024 LIBRARY; T=0.K  
Photon emission for (n,n\*29)

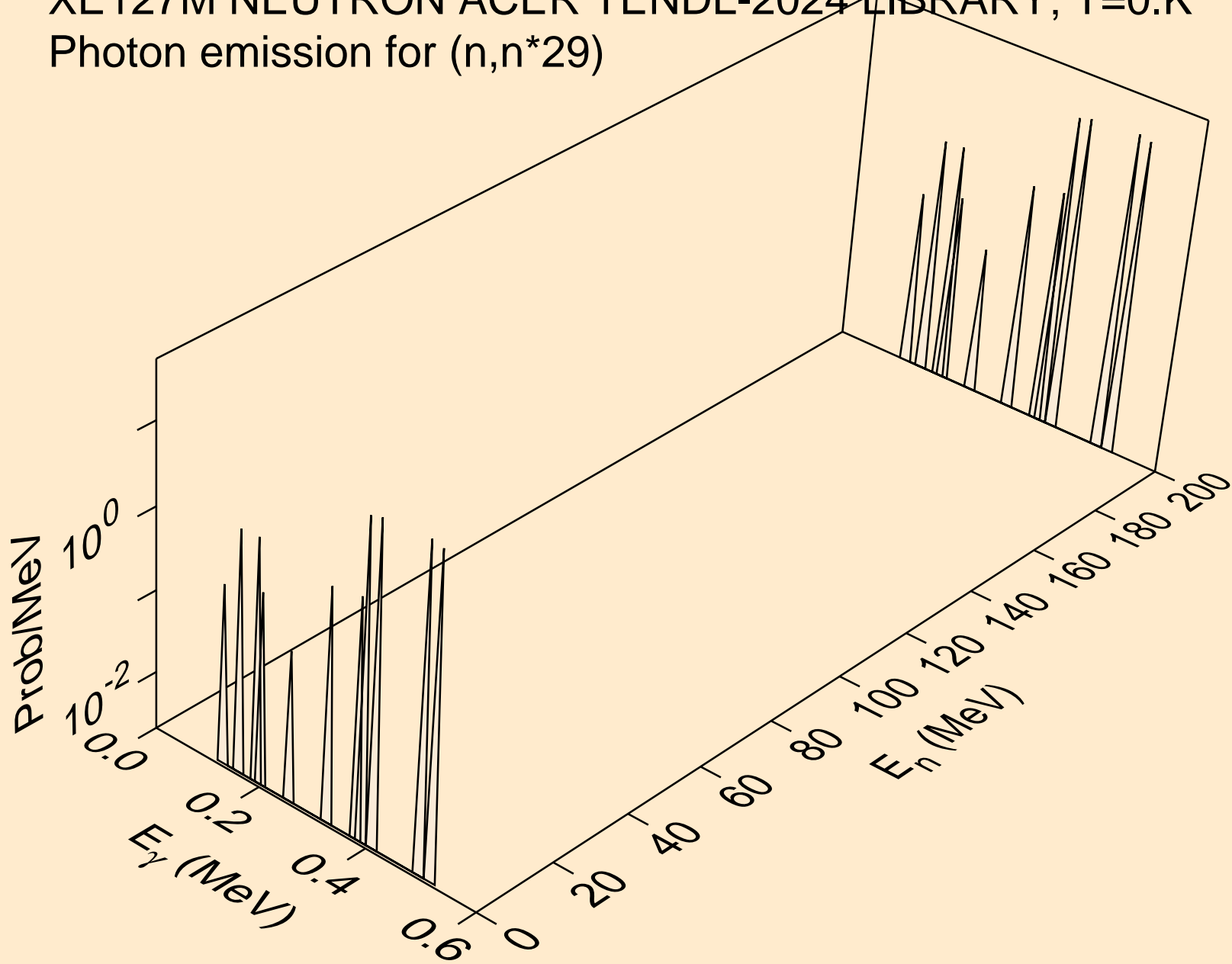

XE127M NEUTRON ACER TENDL-2024 LIBRARY; T=0.K  
Photon emission for (n,n\*30)

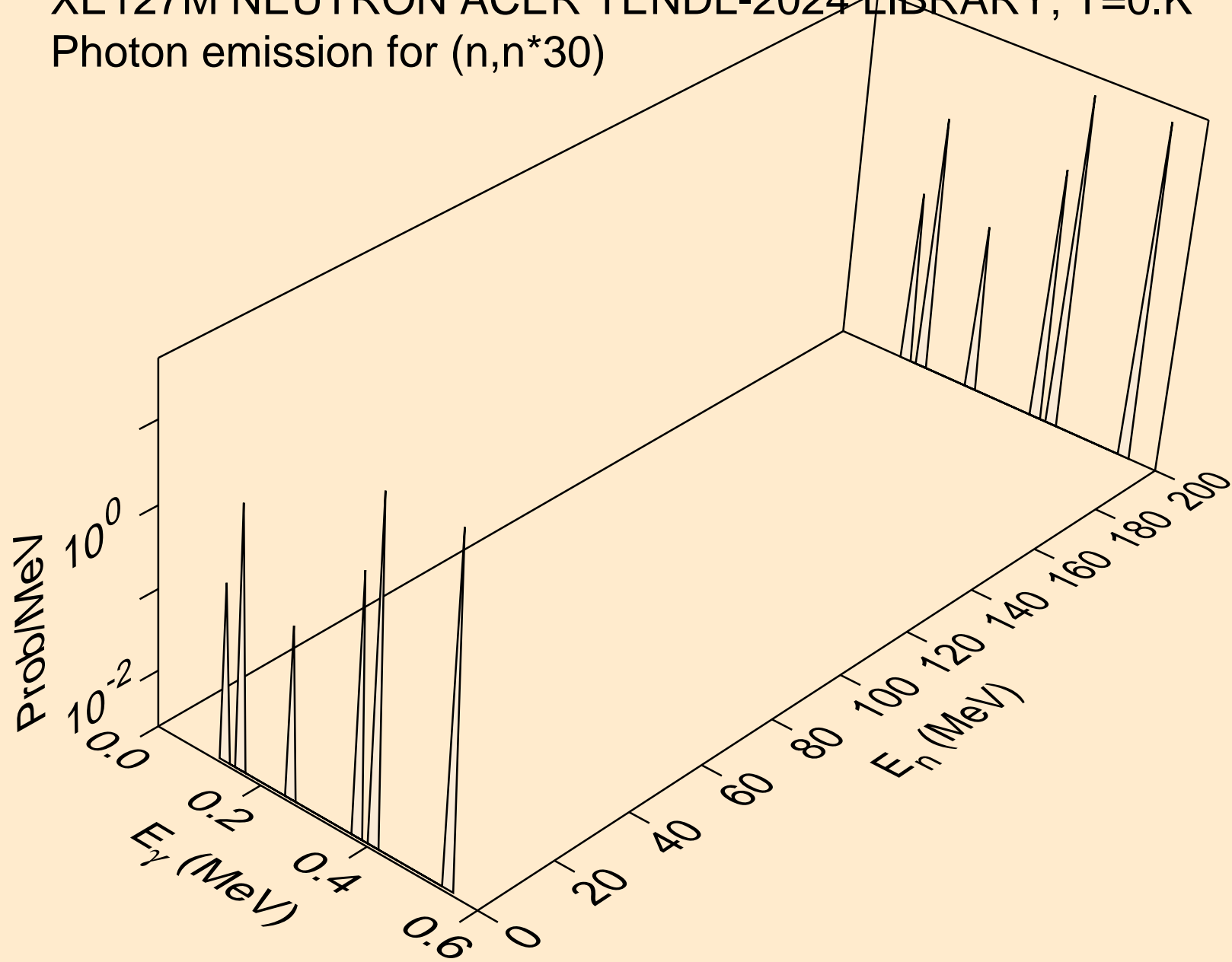

XE127M NEUTRON ACER TENDL-2024 LIBRARY; T=0.K  
Photon emission for (n,n\*c)

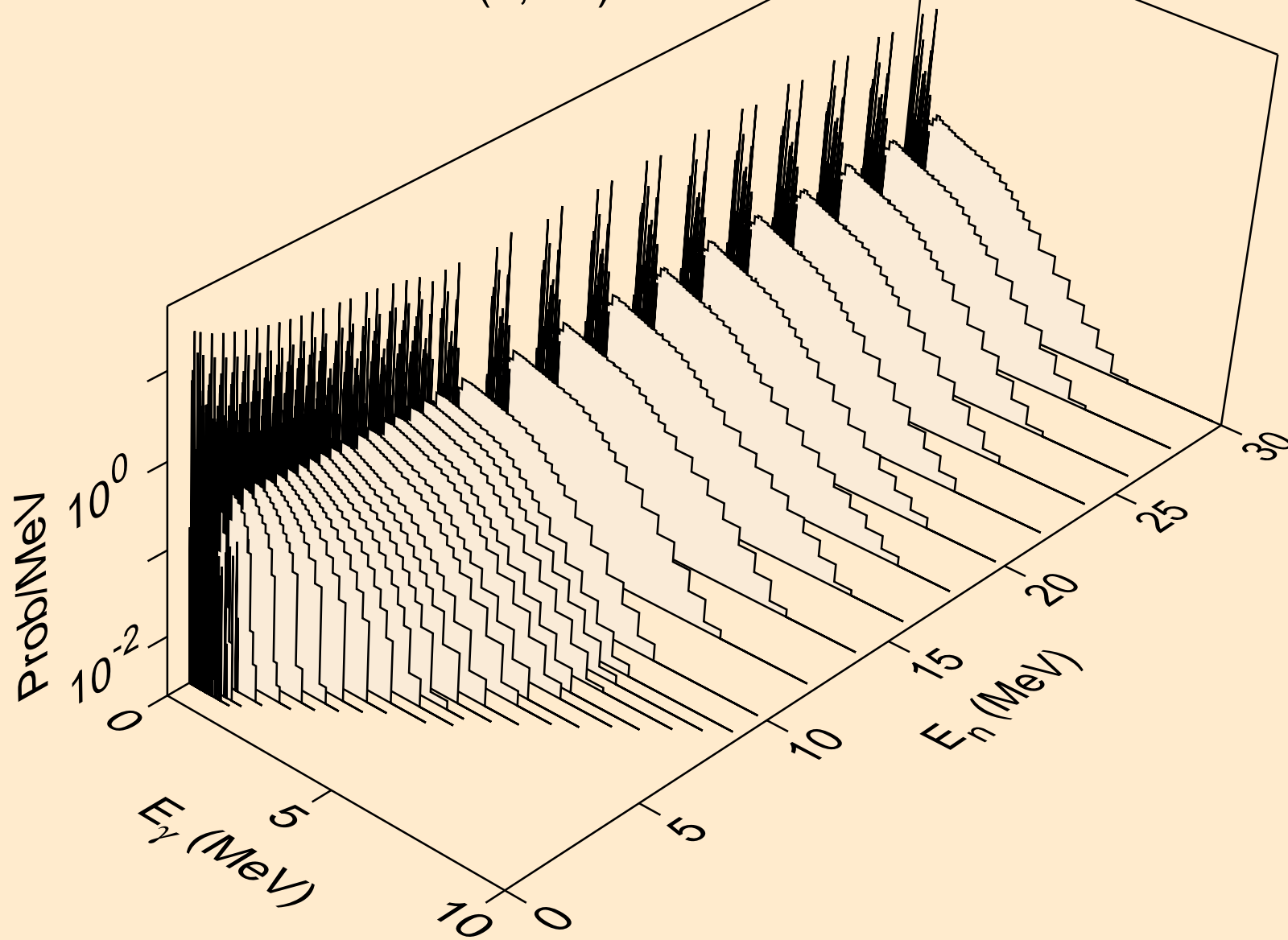



XE127M NEUTRON ACER TENDL-2024 LIBRARY; T=0.K  
Photon emission for (n,gma)

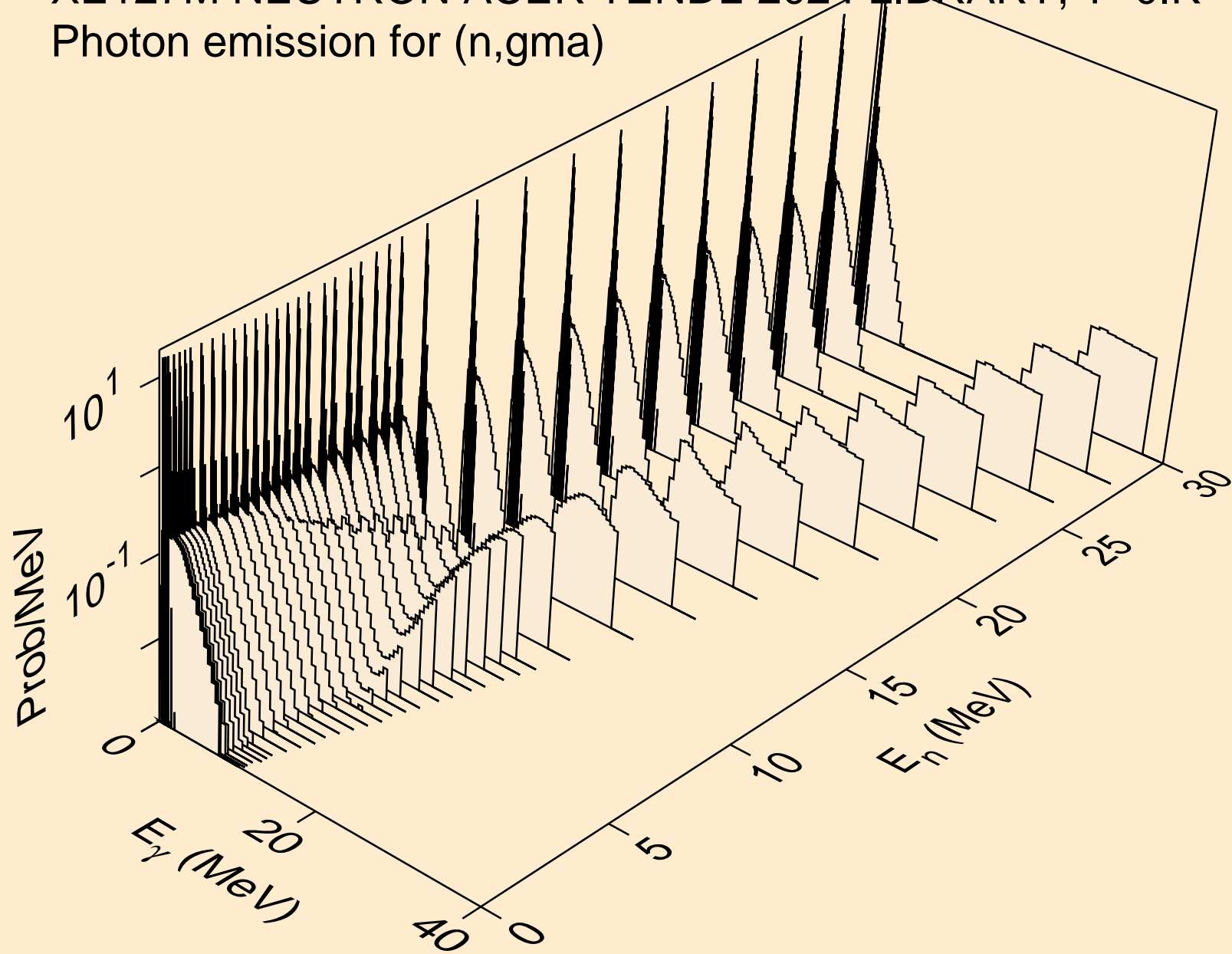

XE127M NEUTRON ACER TENDL-2024 LIBRARY; T=0.K  
Photon emission for (n,p)

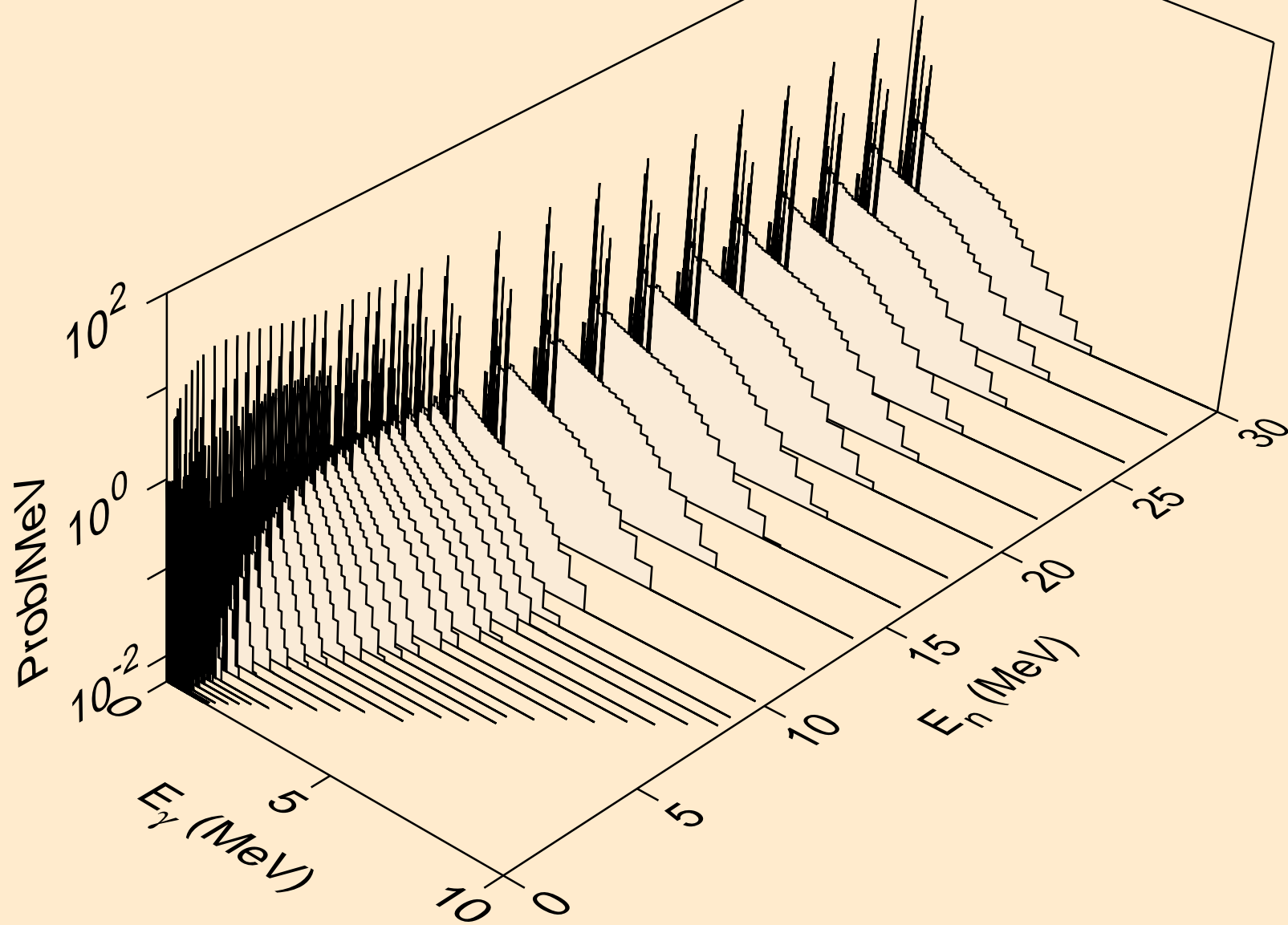

XE127M NEUTRON ACER TENDL-2024 LIBRARY; T=0.K  
Photon emission for (n,d)

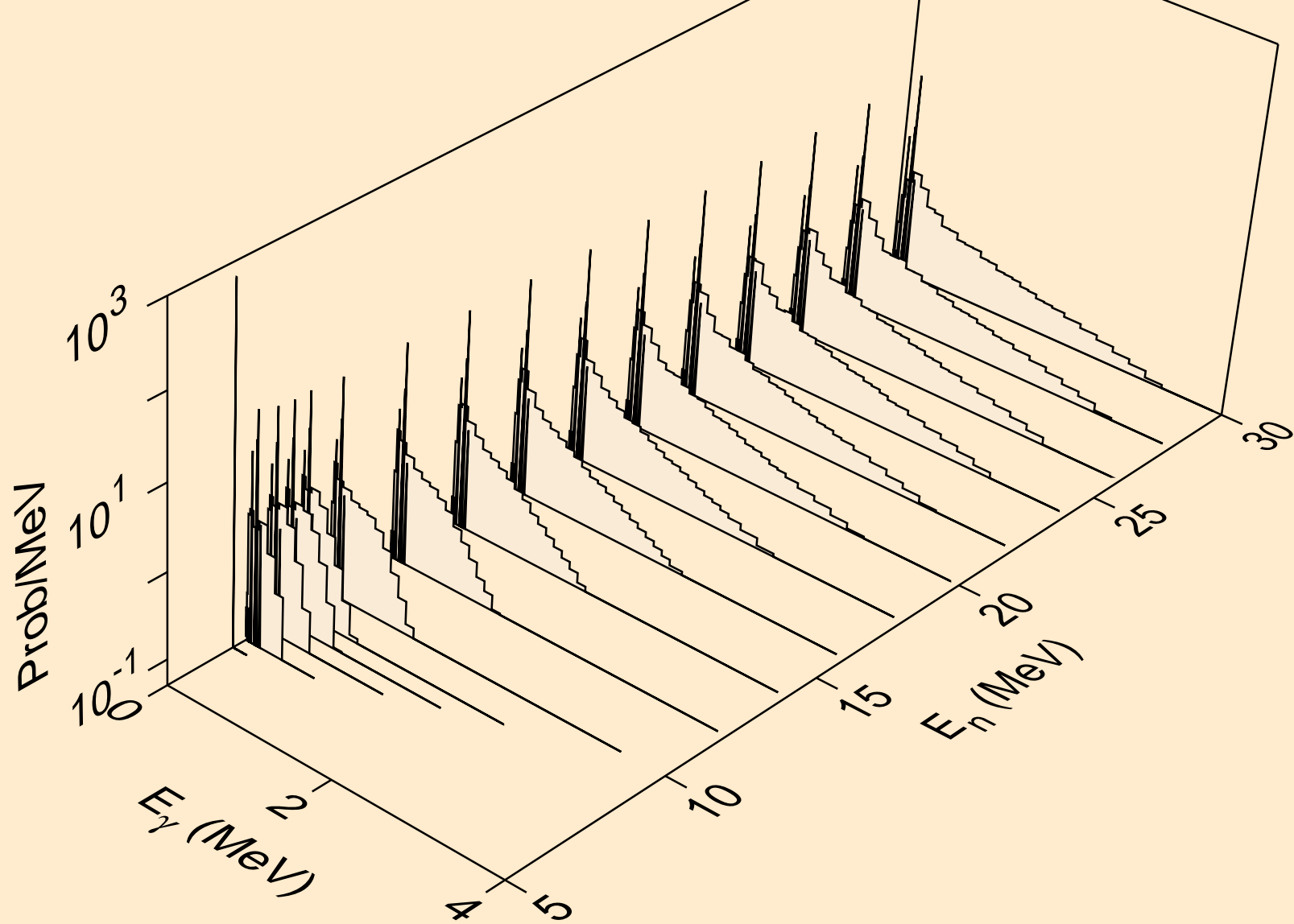

XE127M NEUTRON ACER TENDL-2024 LIBRARY; T=0.K  
Photon emission for (n,t)

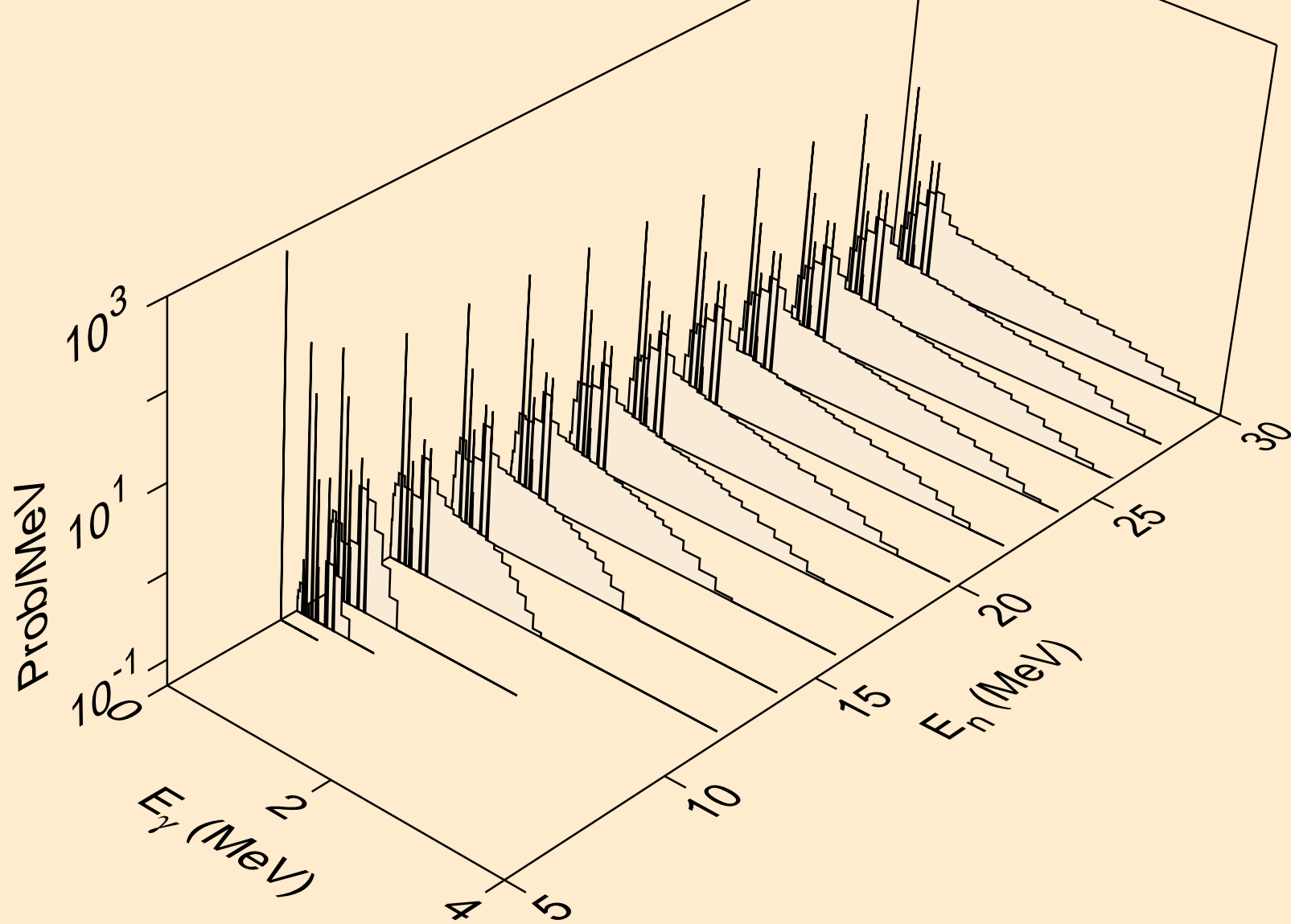

XE127M NEUTRON ACER TENDL-2024 LIBRARY; T=0.K  
Photon emission for (n,he3)

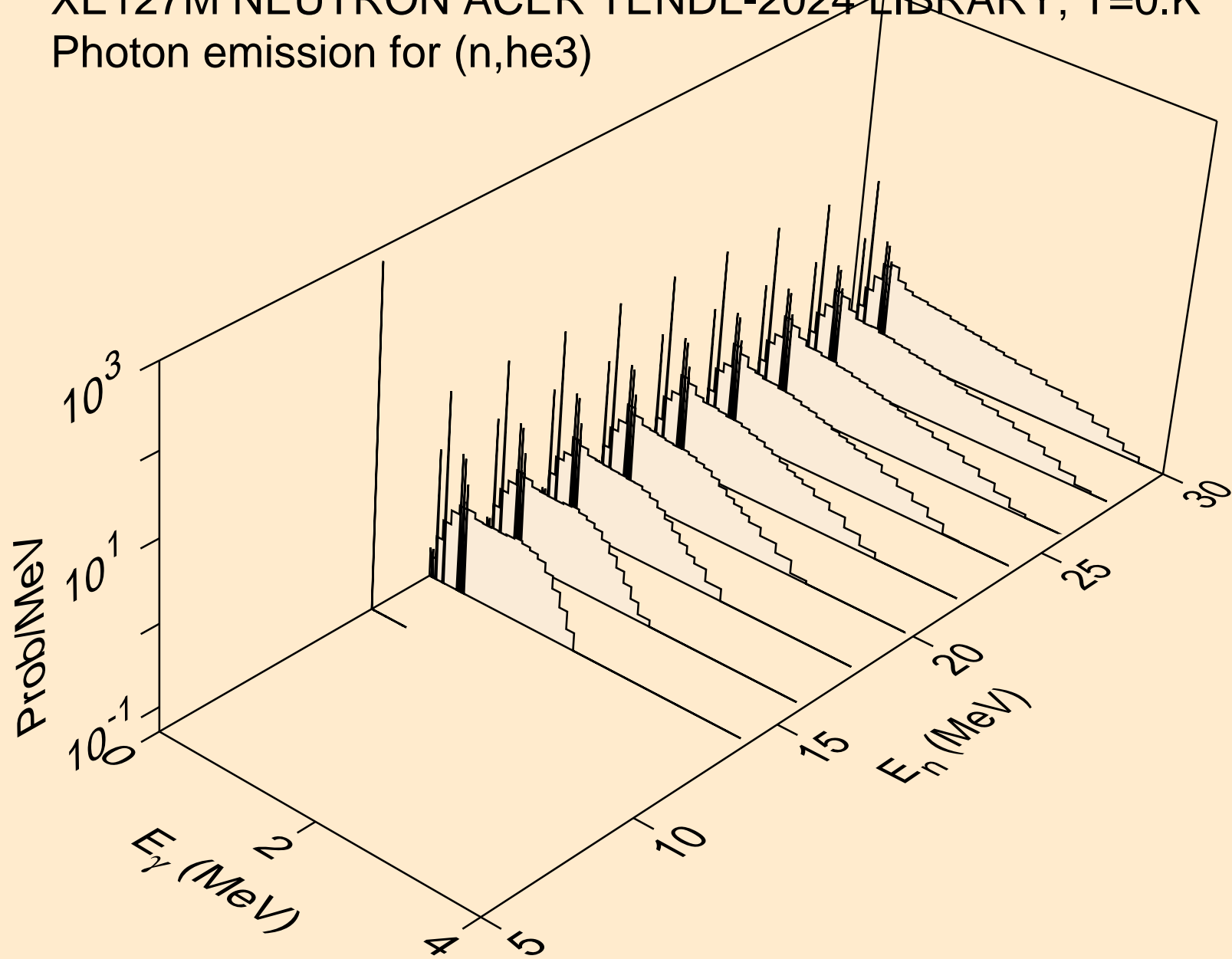

XE127M NEUTRON ACER TENDL-2024 LIBRARY; T=0.K  
Photon emission for (n,a)

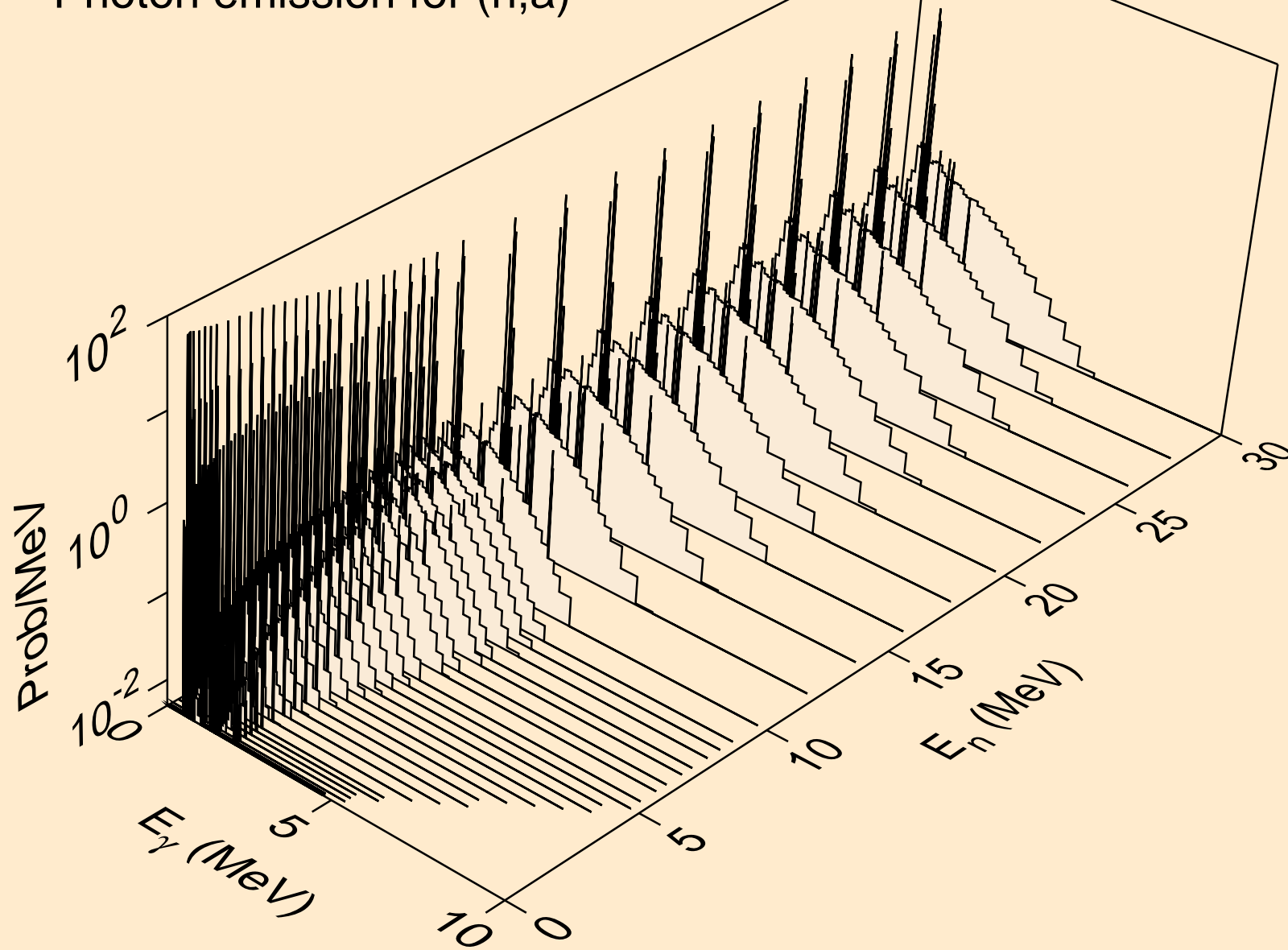

XE127M NEUTRON ACER TENDL-2024 LIBRARY; T=0.K  
Photon emission for (n,2a)

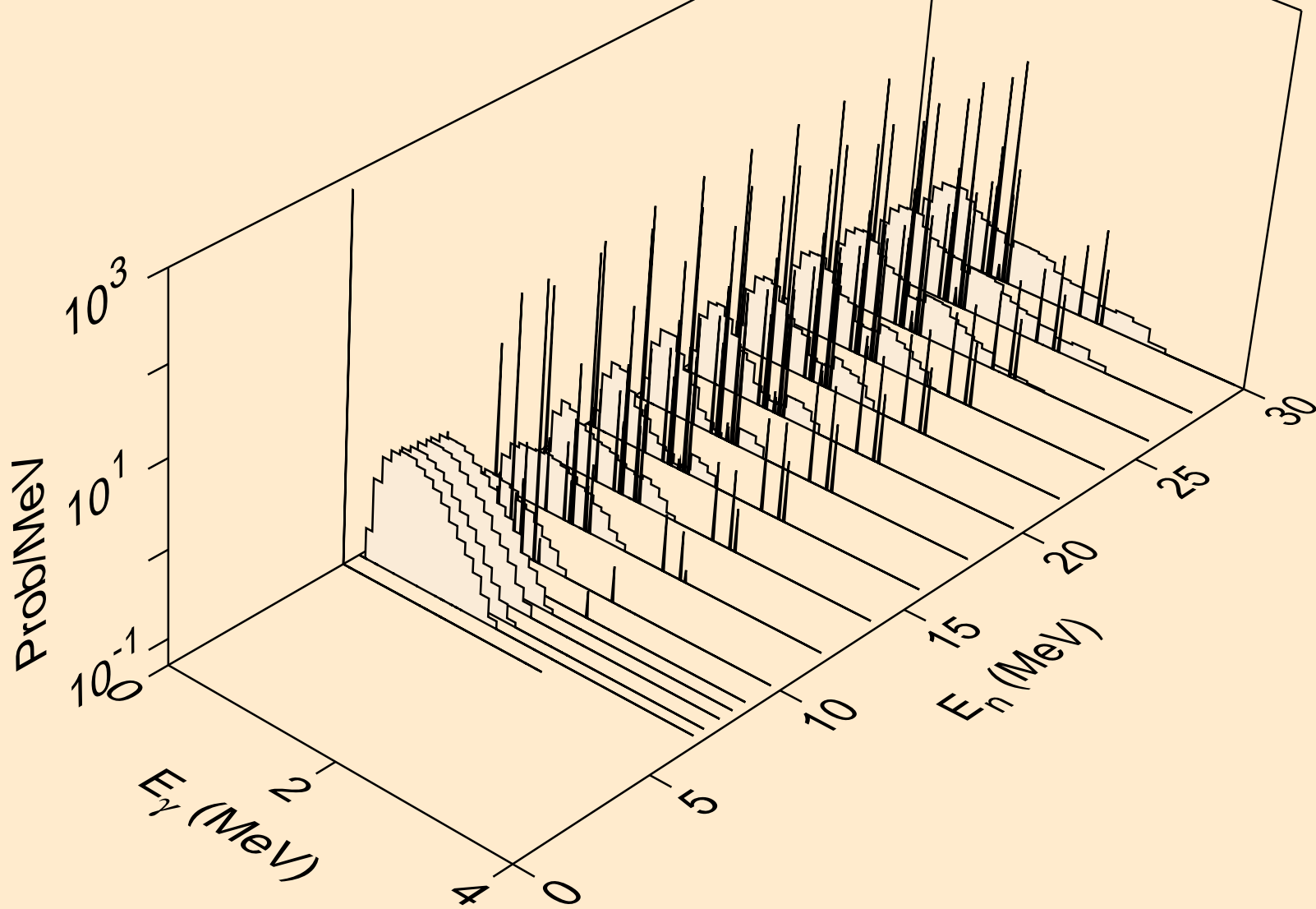

XE127M NEUTRON ACER TENDL-2024 LIBRARY; T=0.K  
Photon emission for (n,2p)

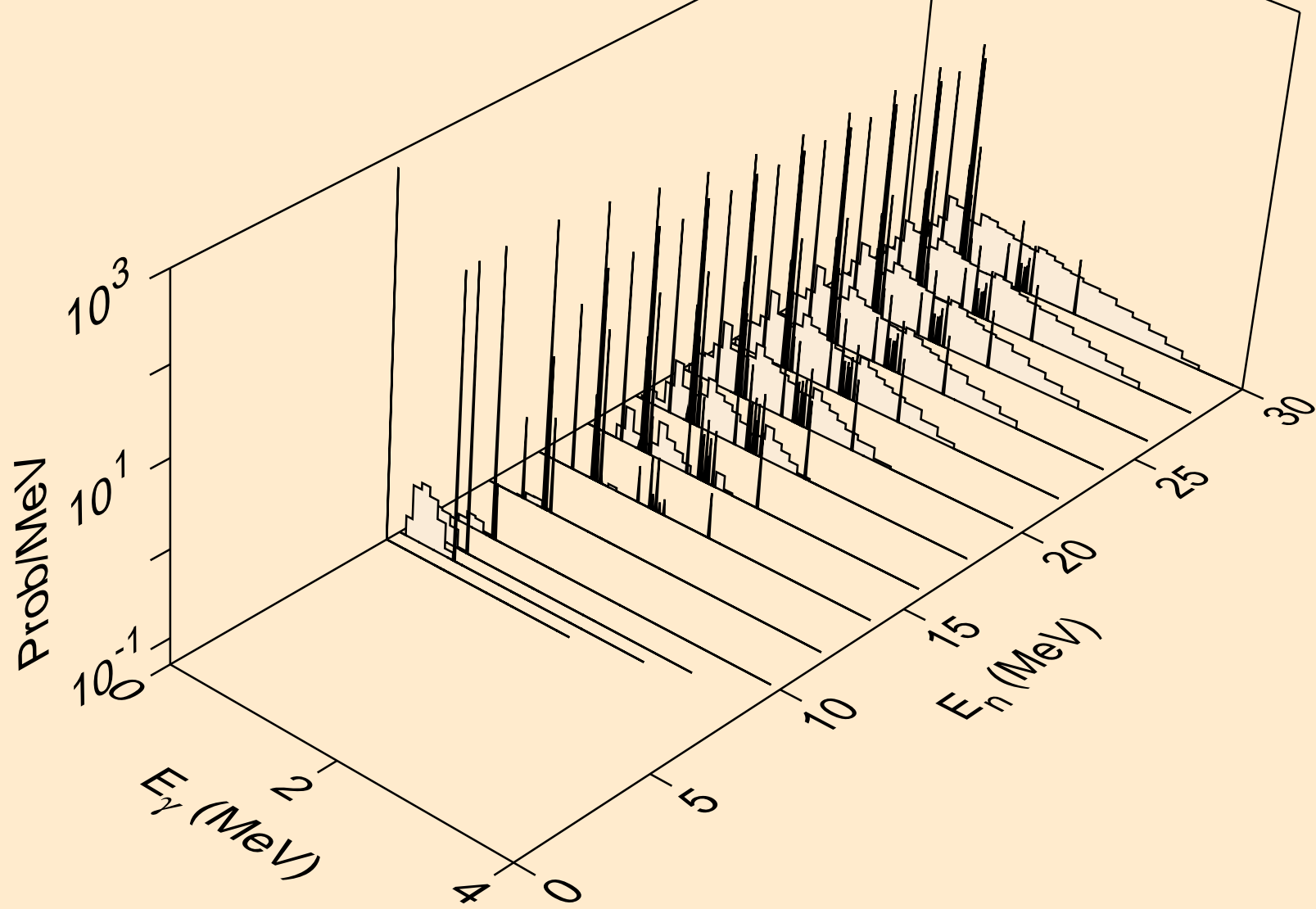



XE127M NEUTRON ACER TENDL-2024 LIBRARY; T=0.K  
Photon emission for (n,p $\alpha$ )

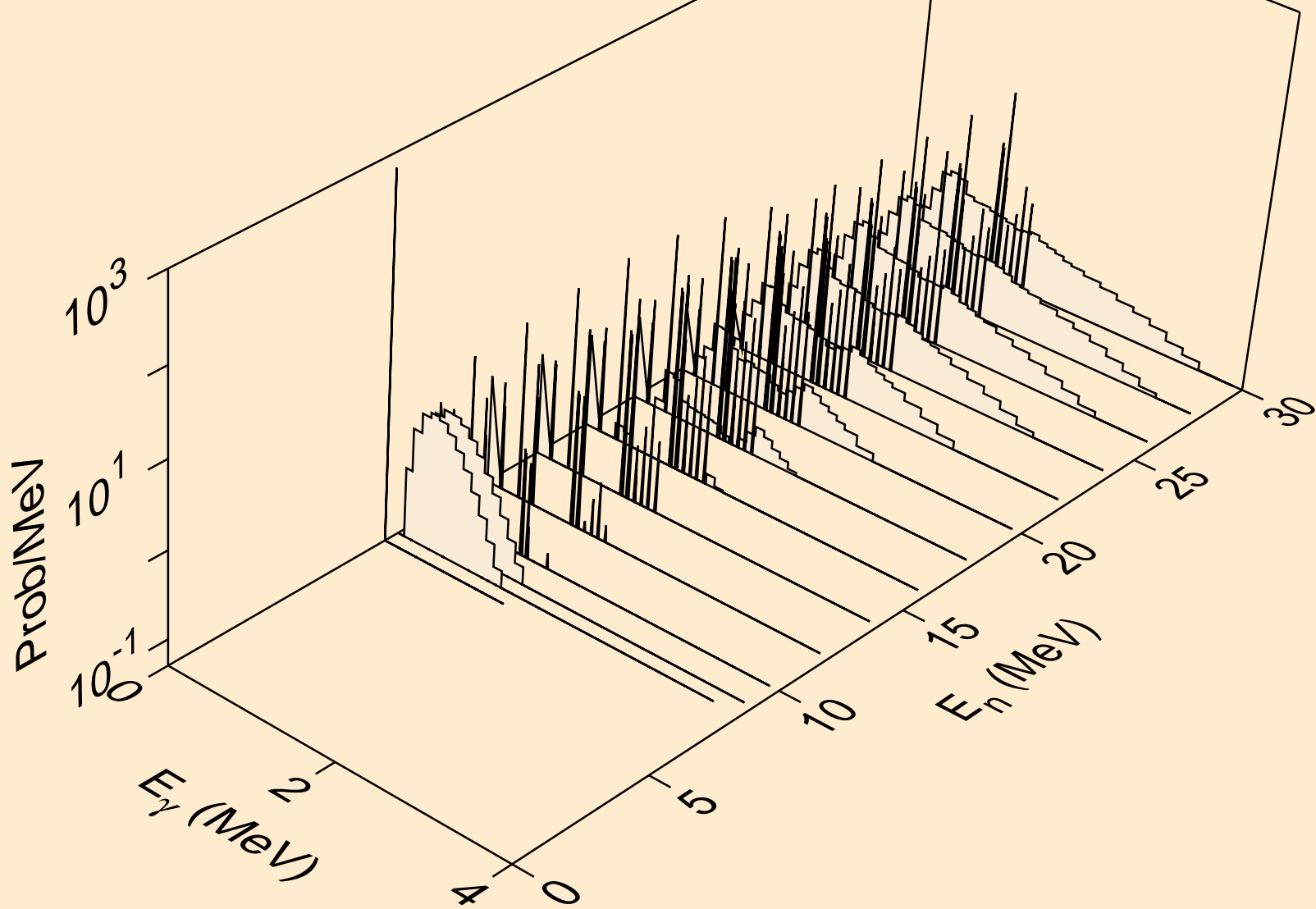

XE127M NEUTRON ACER TENDL-2024 LIBRARY; T=0.K  
Photon emission for (n,pd)

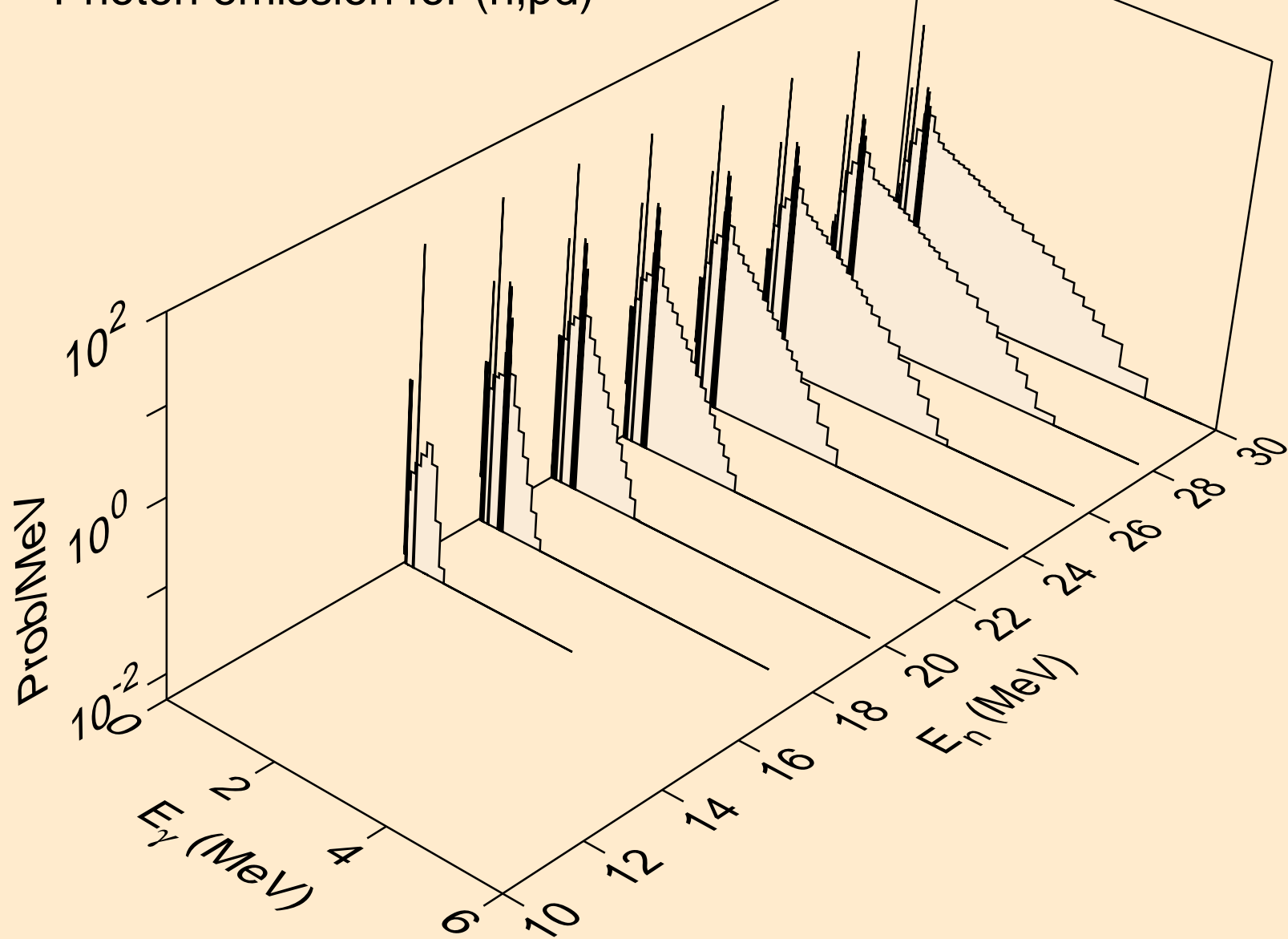

XE127M NEUTRON ACER TENDL-2024 LIBRARY; T=0.K  
Photon emission for (n,pt)

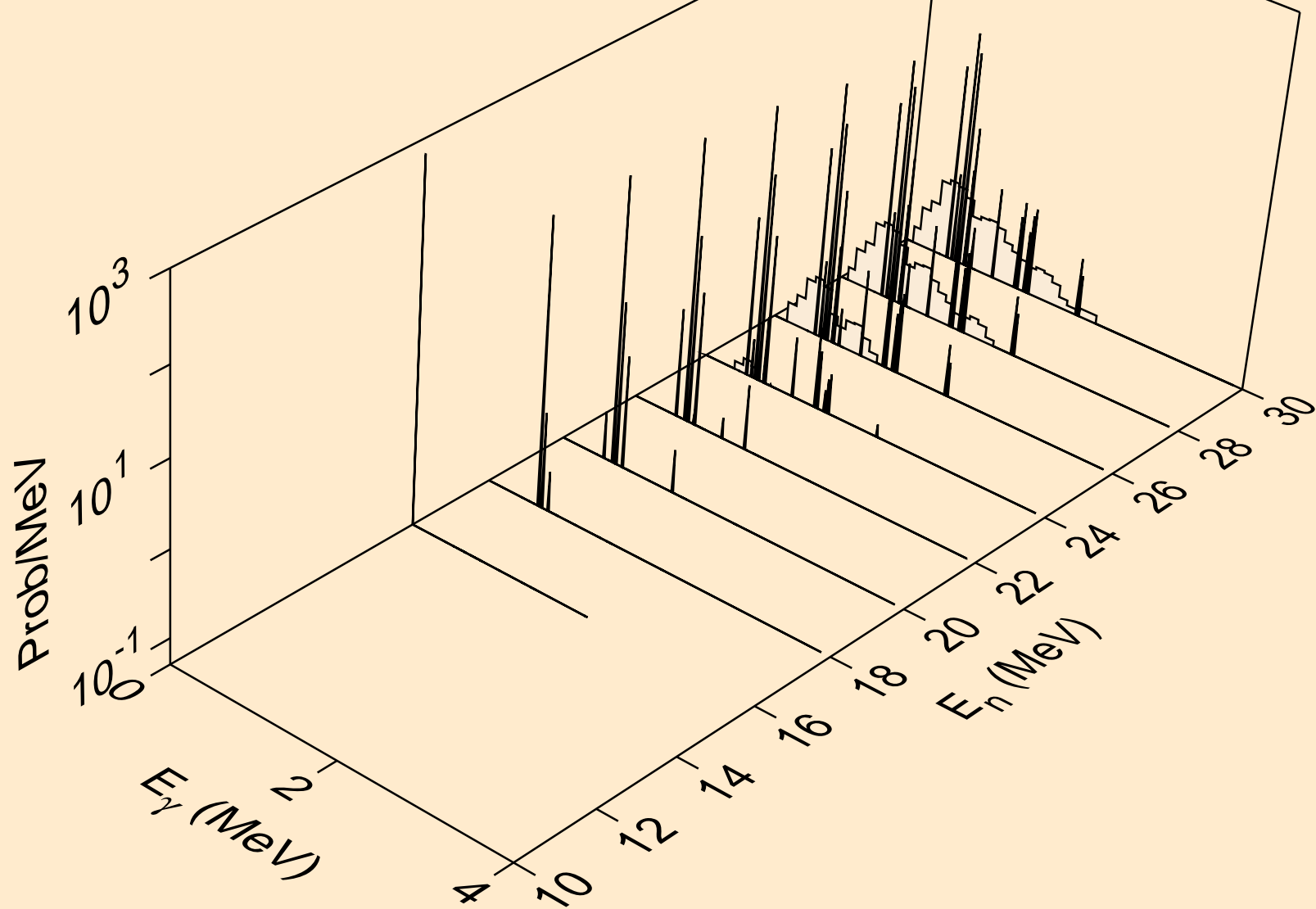

XE127M NEUTRON ACER TENDL-2024 LIBRARY; T=0.K  
Photon emission for (n,da)

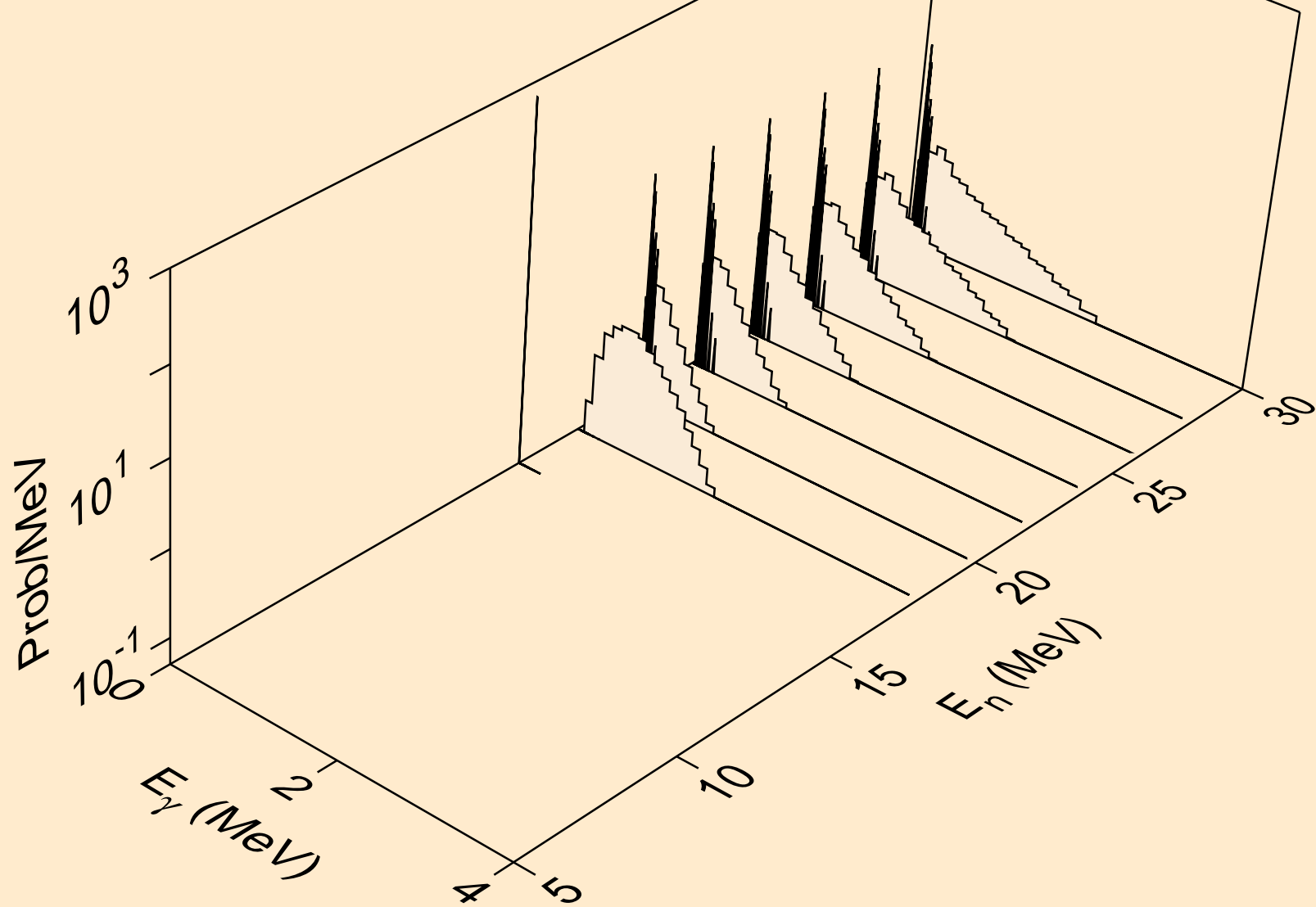

XE127M NEUTRON ACER TENDL-2024 LIBRARY; T=0.K  
thermal capture photon spectrum

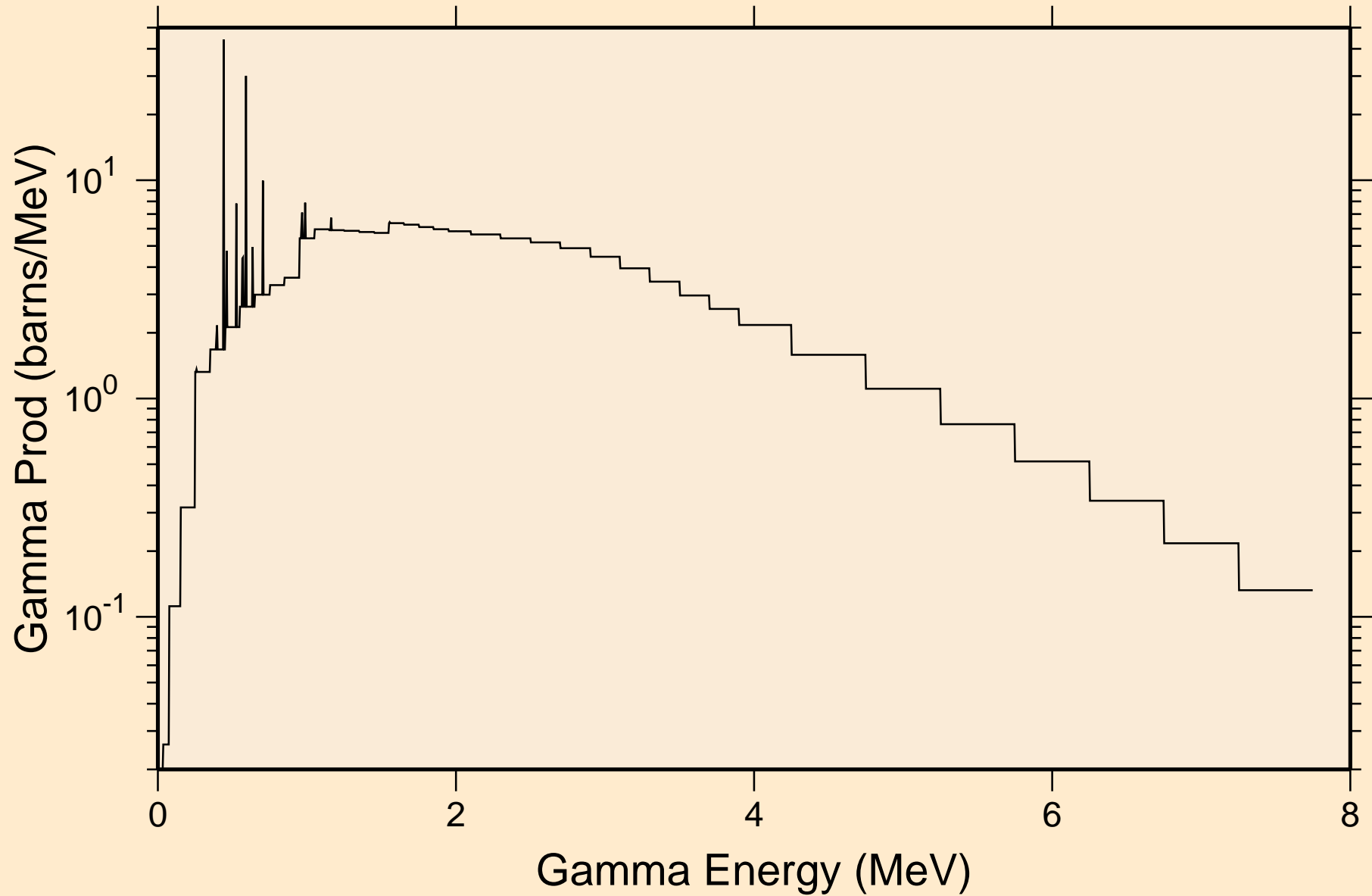

XE127M NEUTRON ACER TENDL-2024 LIBRARY; T=0.K  
14 MeV photon spectrum

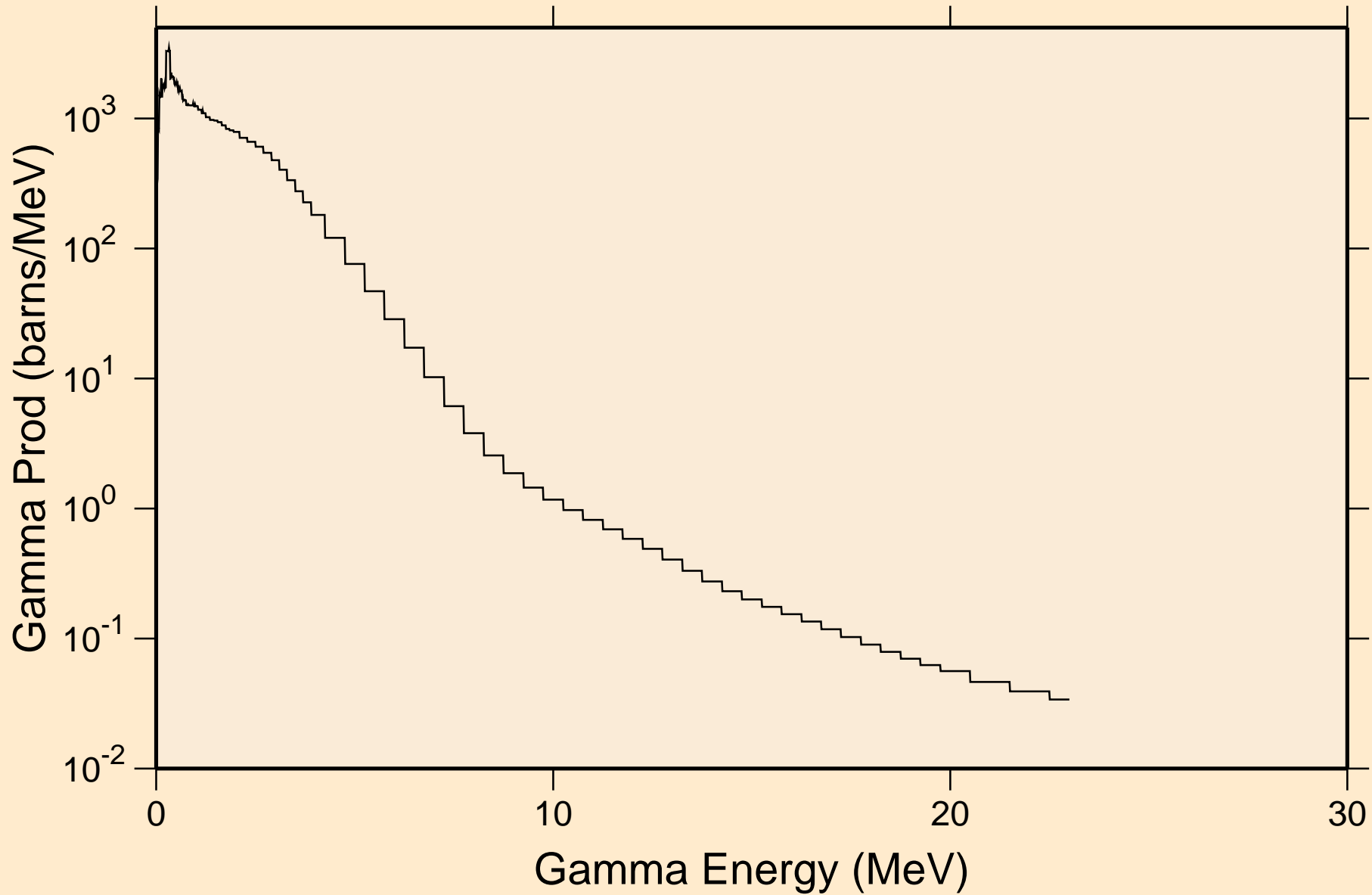

# XE127M NEUTRON ACER TENDL-2024 LIBRARY; T=0.K

## Particle heating contributions

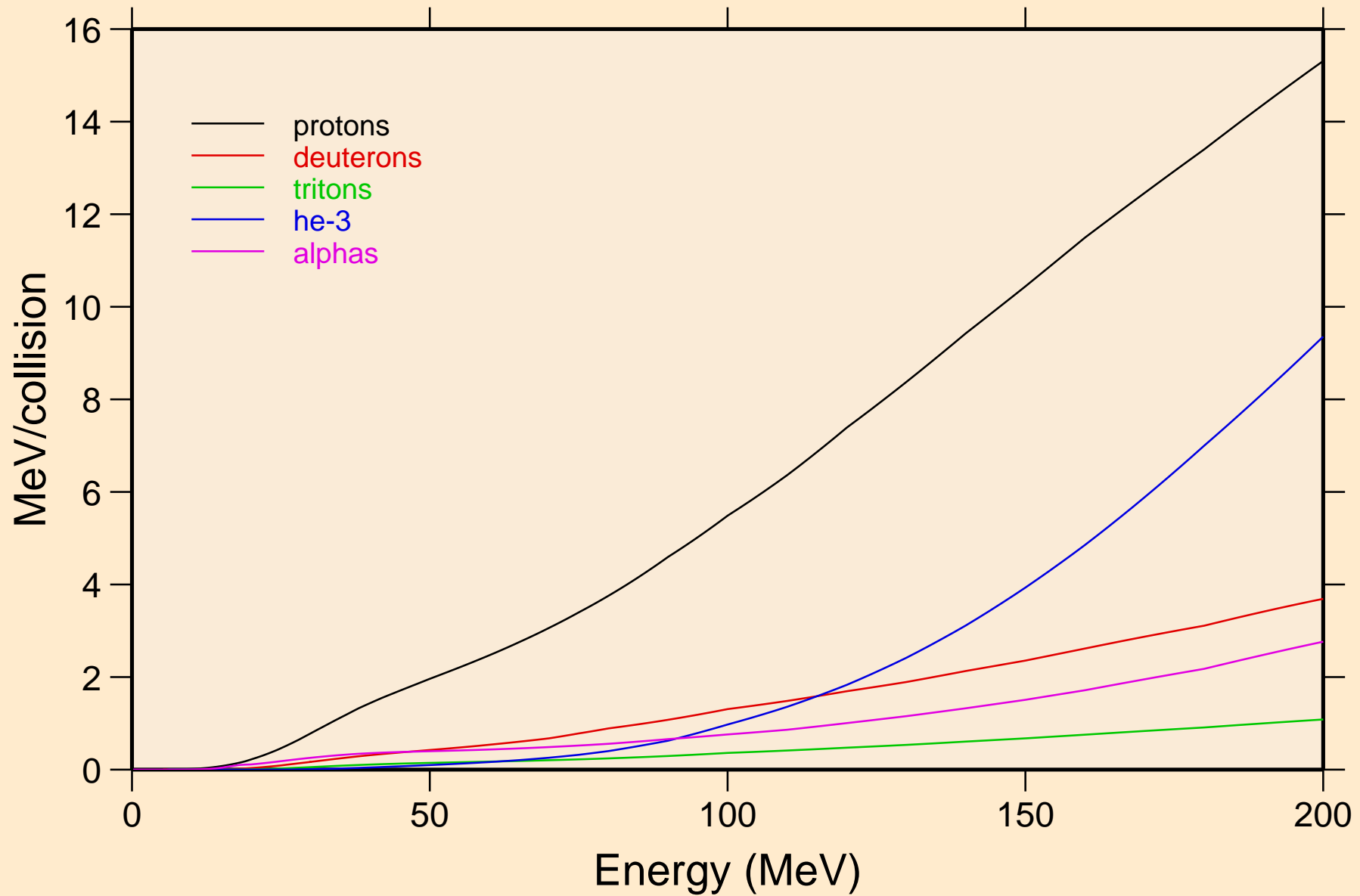

XE127M NEUTRON ACER TENDL-2024 LIBRARY; T=0.K  
Recoil Heating

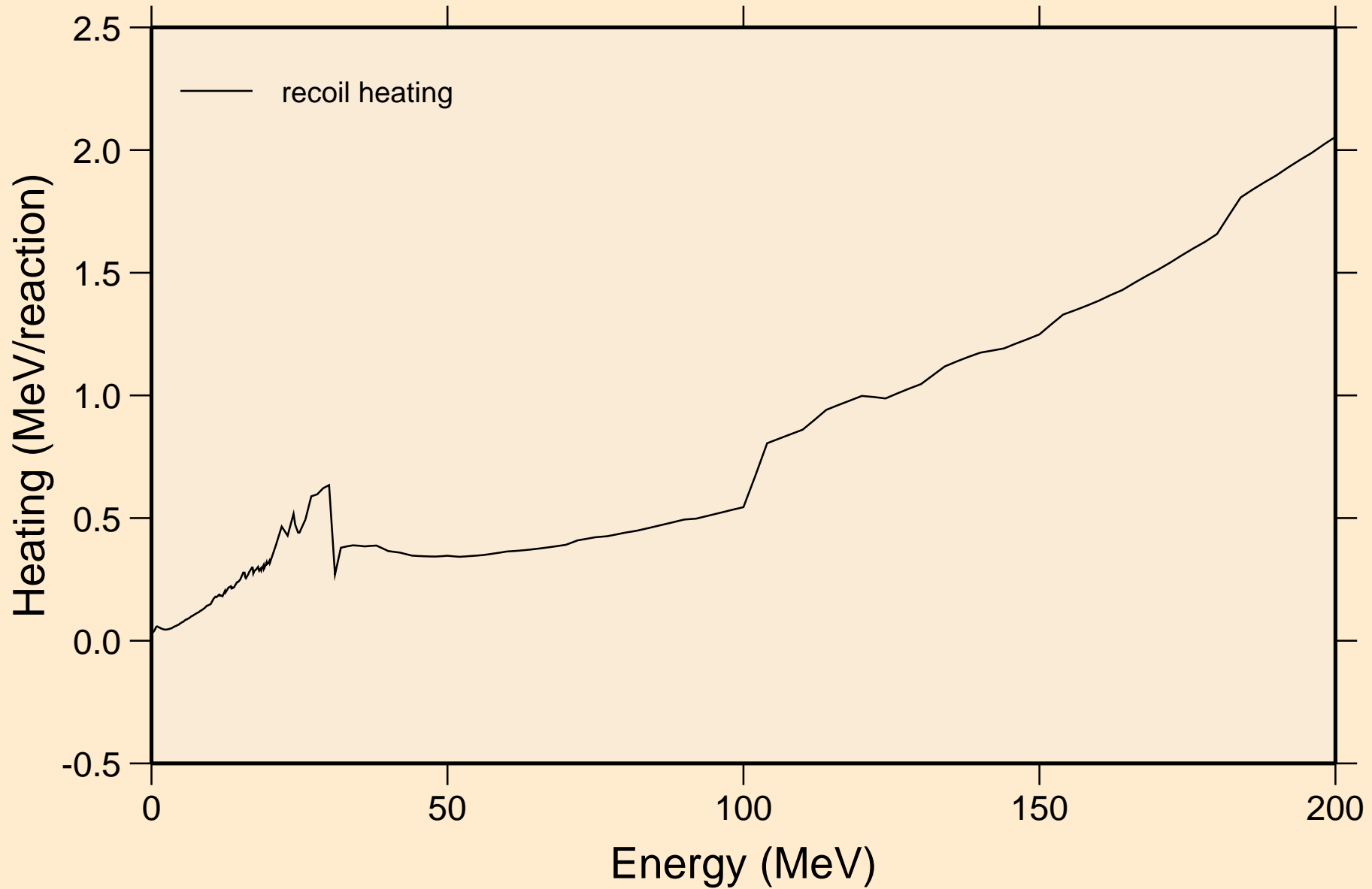



XE127M NEUTRON ACER TENDL-2024 LIBRARY; T=0.K  
Particle production cross sections

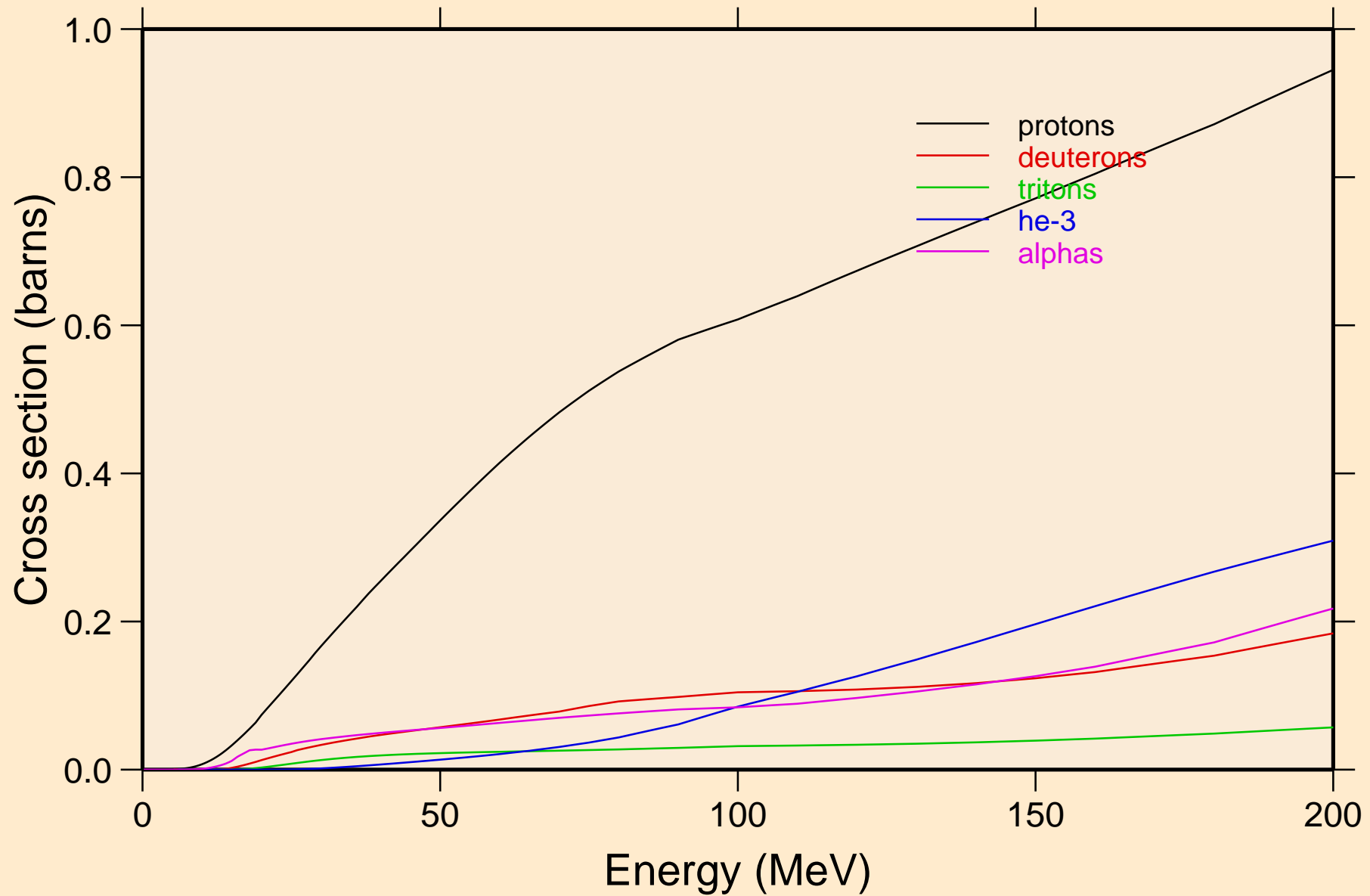

XE127M NEUTRON ACER TENDL-2024 LIBRARY; T=0.K  
protons from (n,x)

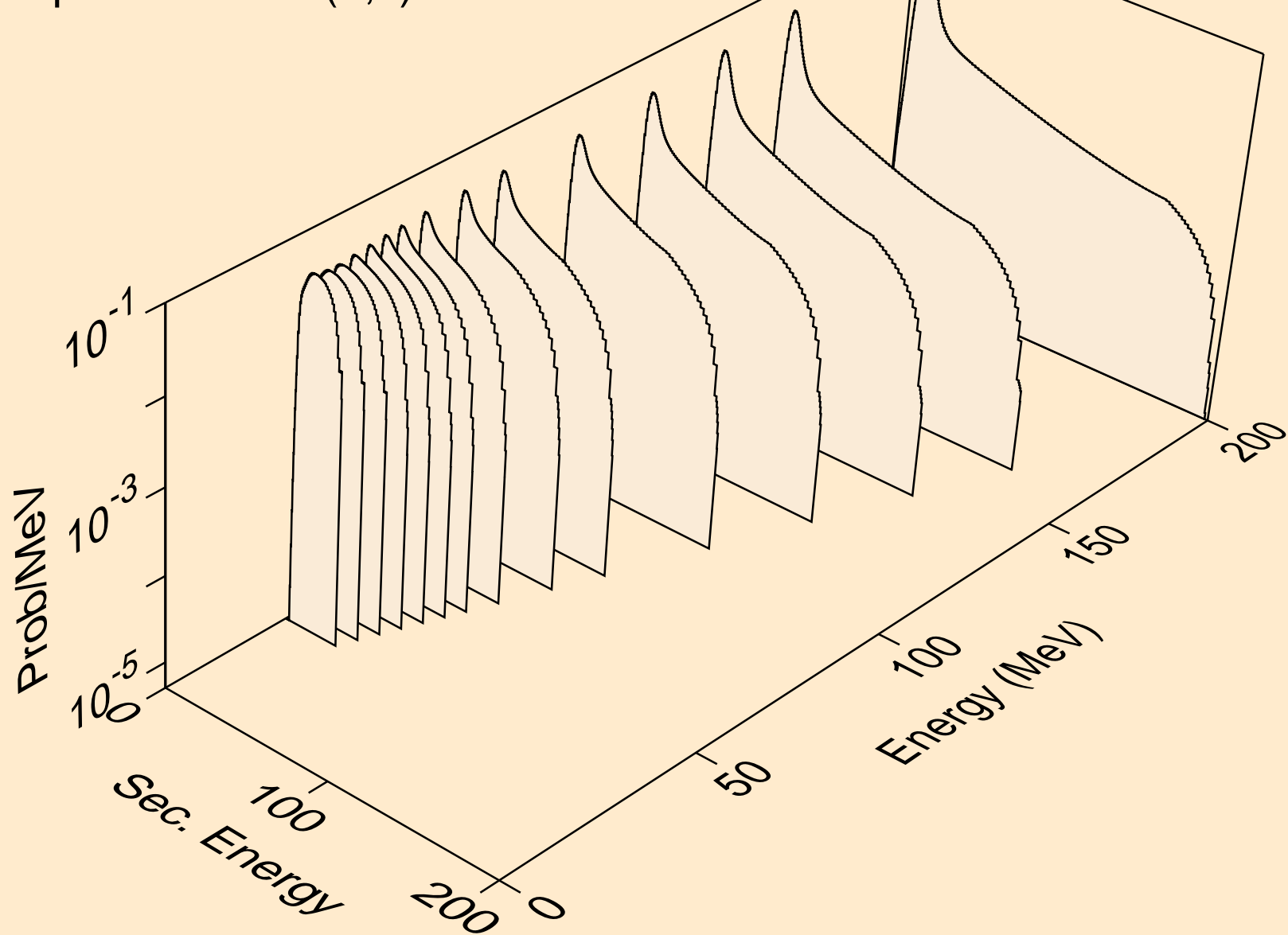

XE127M NEUTRON ACER TENDL-2024 LIBRARY; T=0.K  
protons from (n,n\*)p

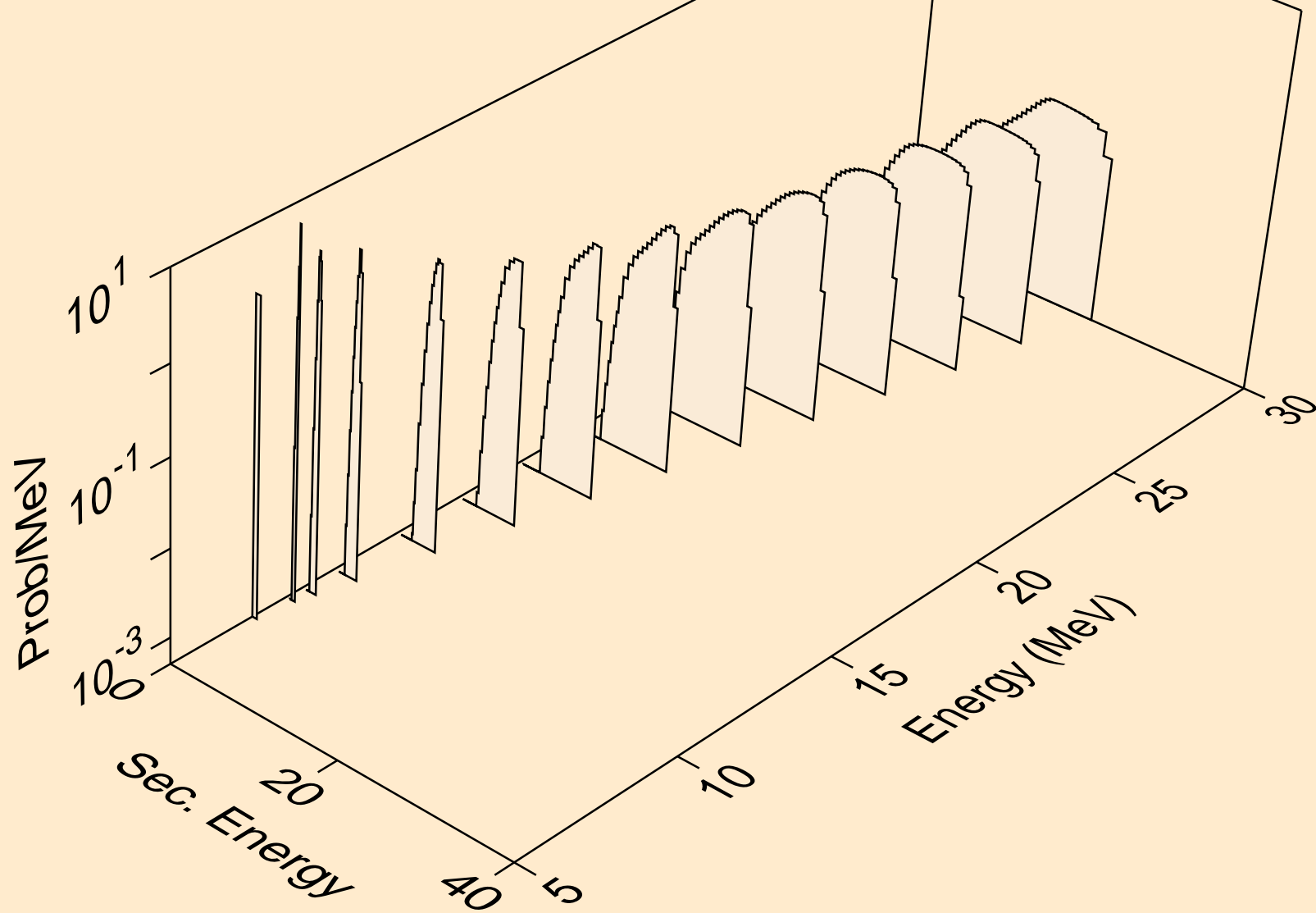

XE127M NEUTRON ACER TENDL-2024 LIBRARY; T=0.K  
protons from (n,2np)

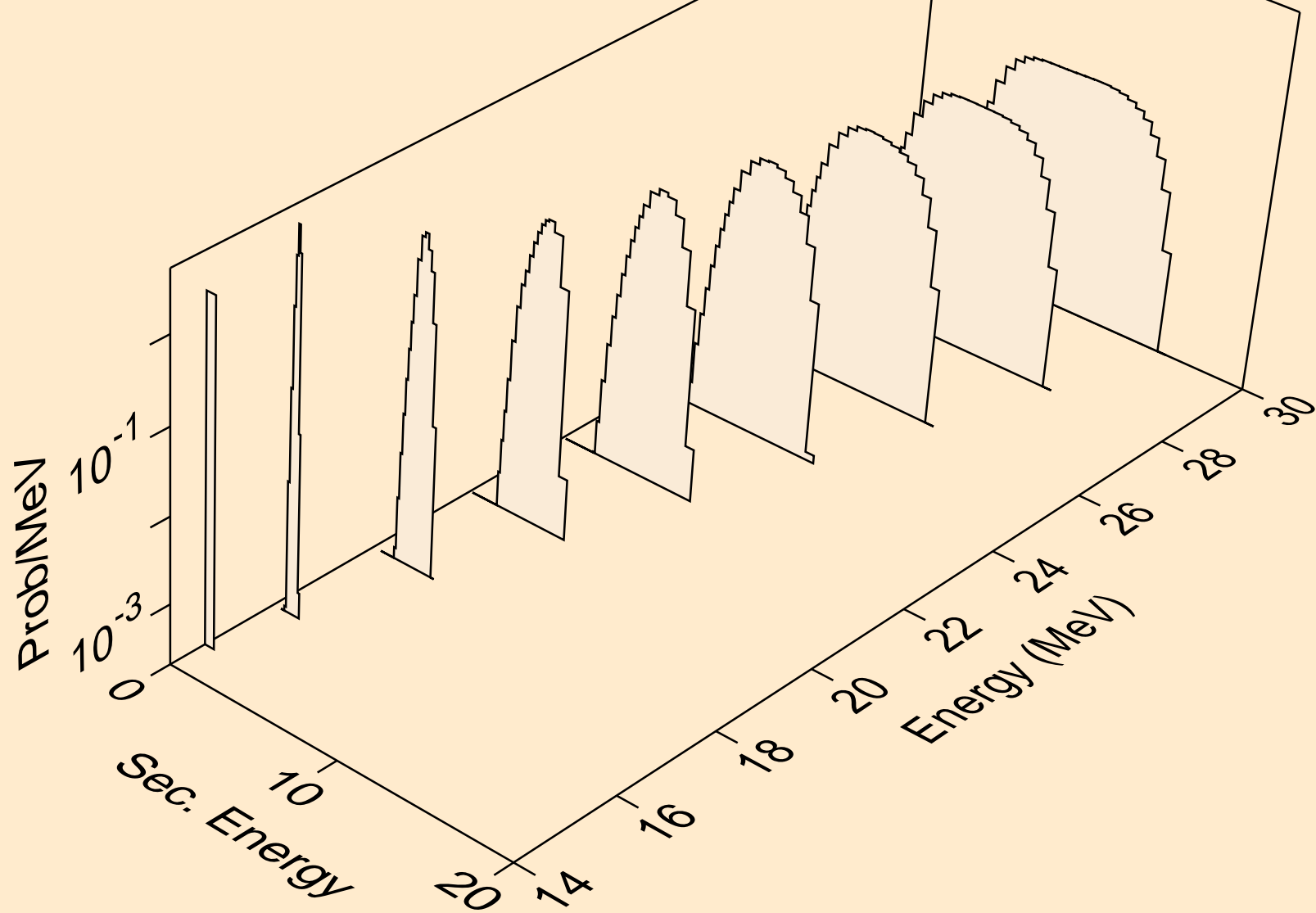

XE127M NEUTRON ACER TENDL-2024 LIBRARY; T=0.K  
protons from (n,3np)

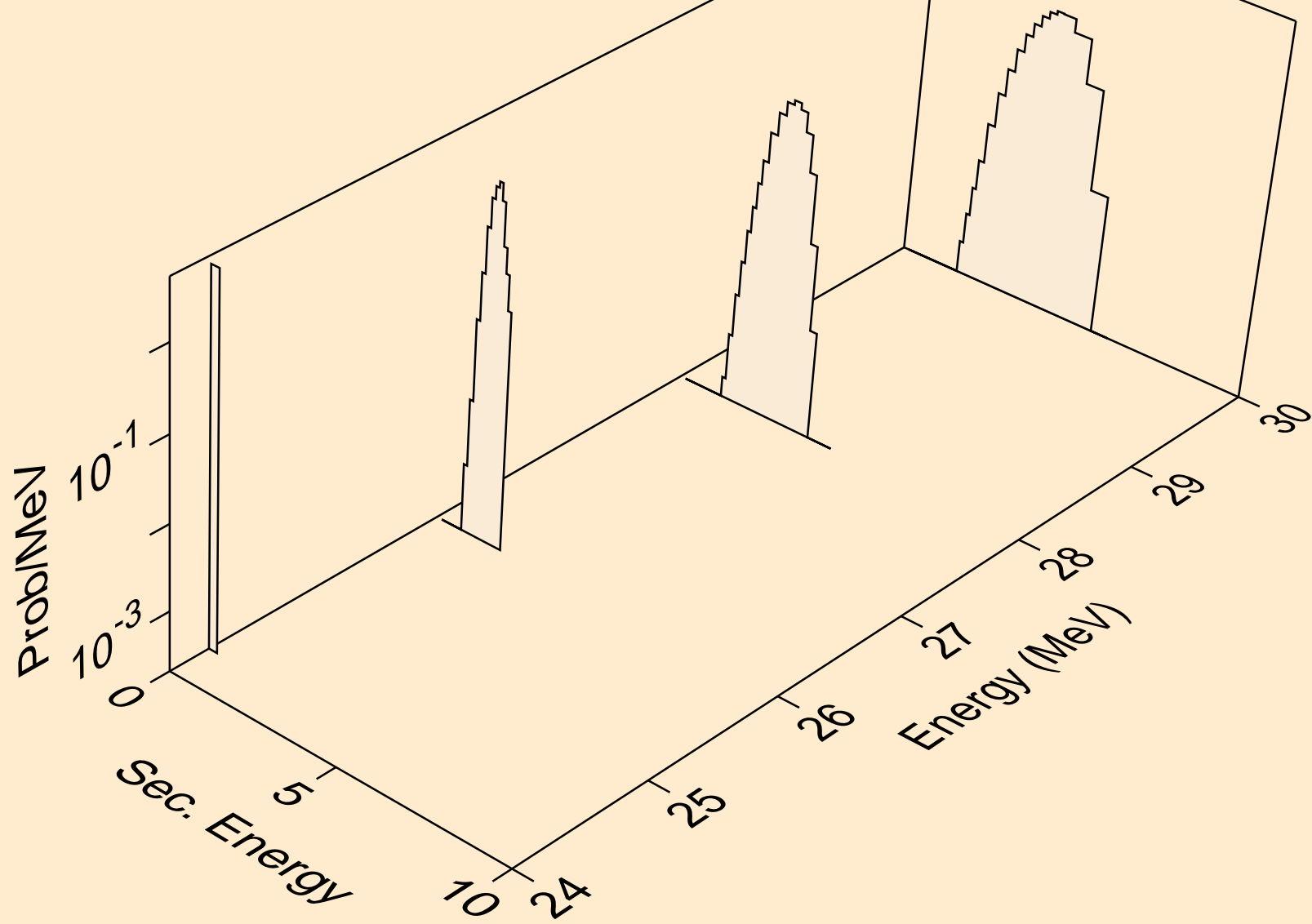

XE127M NEUTRON ACER TENDL-2024 LIBRARY; T=0.K  
protons from (n,n2p)

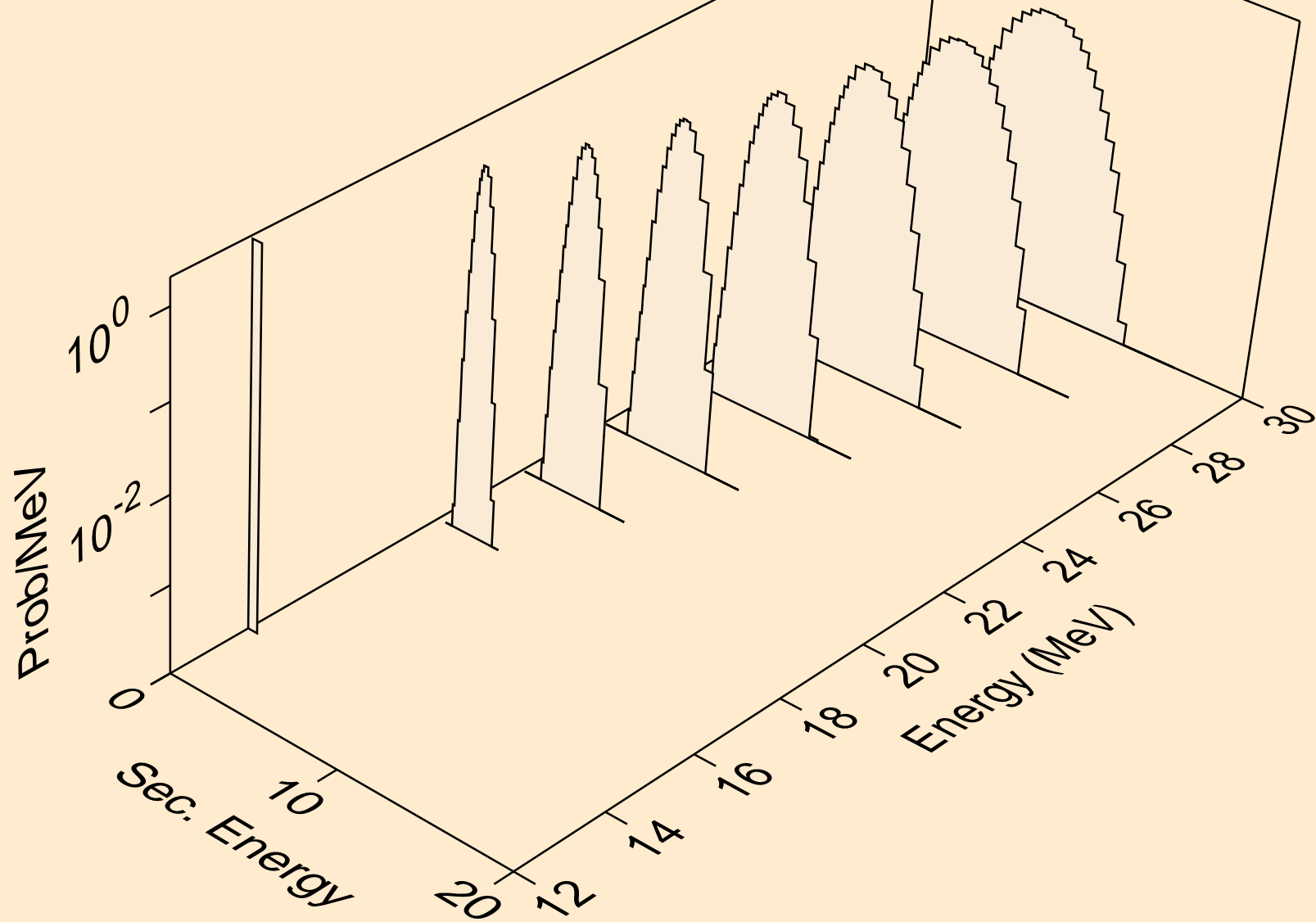

XE127M NEUTRON ACER TENDL-2024 LIBRARY; T=0.K  
protons from (n,npa)

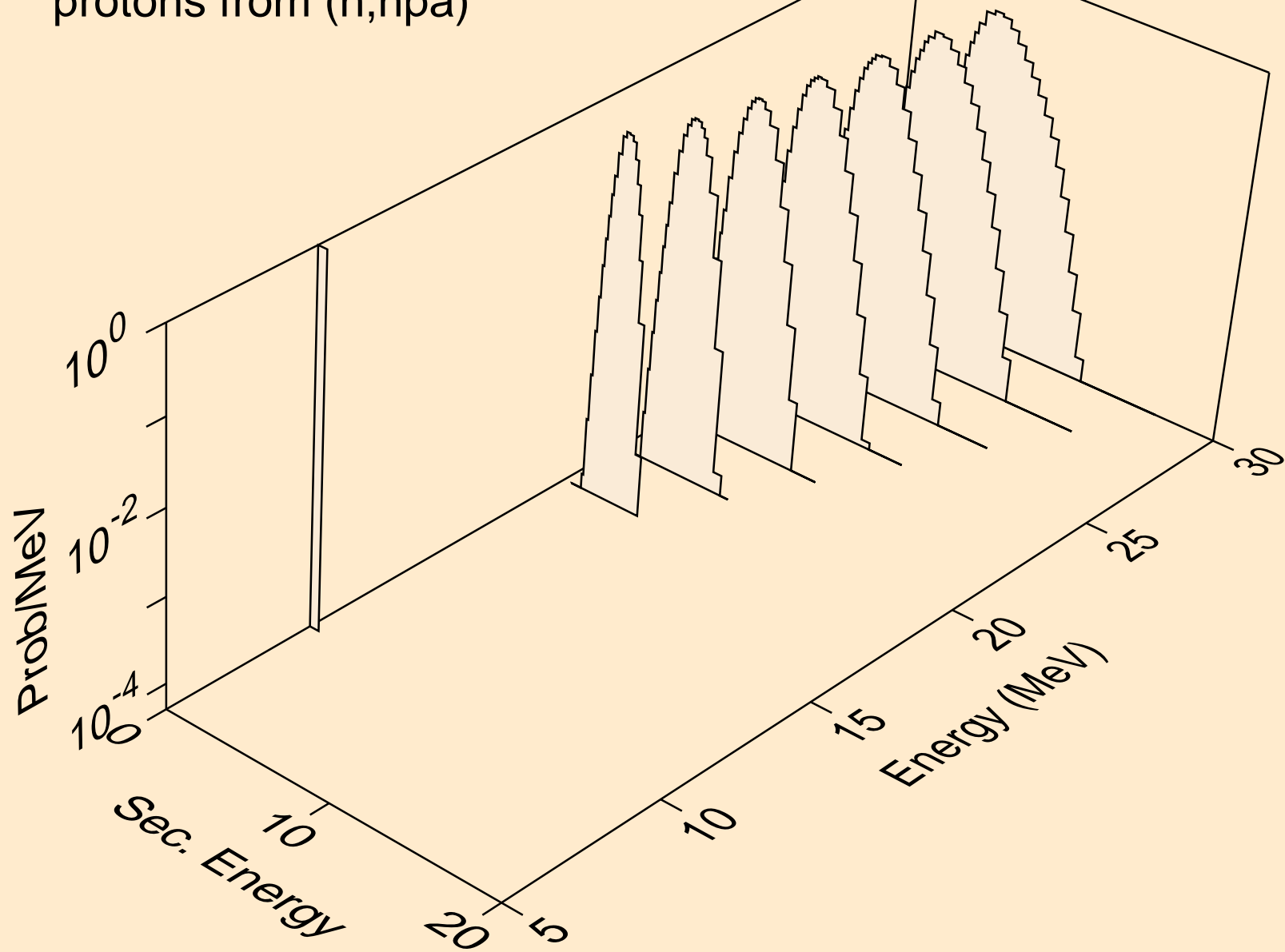

XE127M NEUTRON ACER TENDL-2024 LIBRARY; T=0.K  
protons from (n,p)

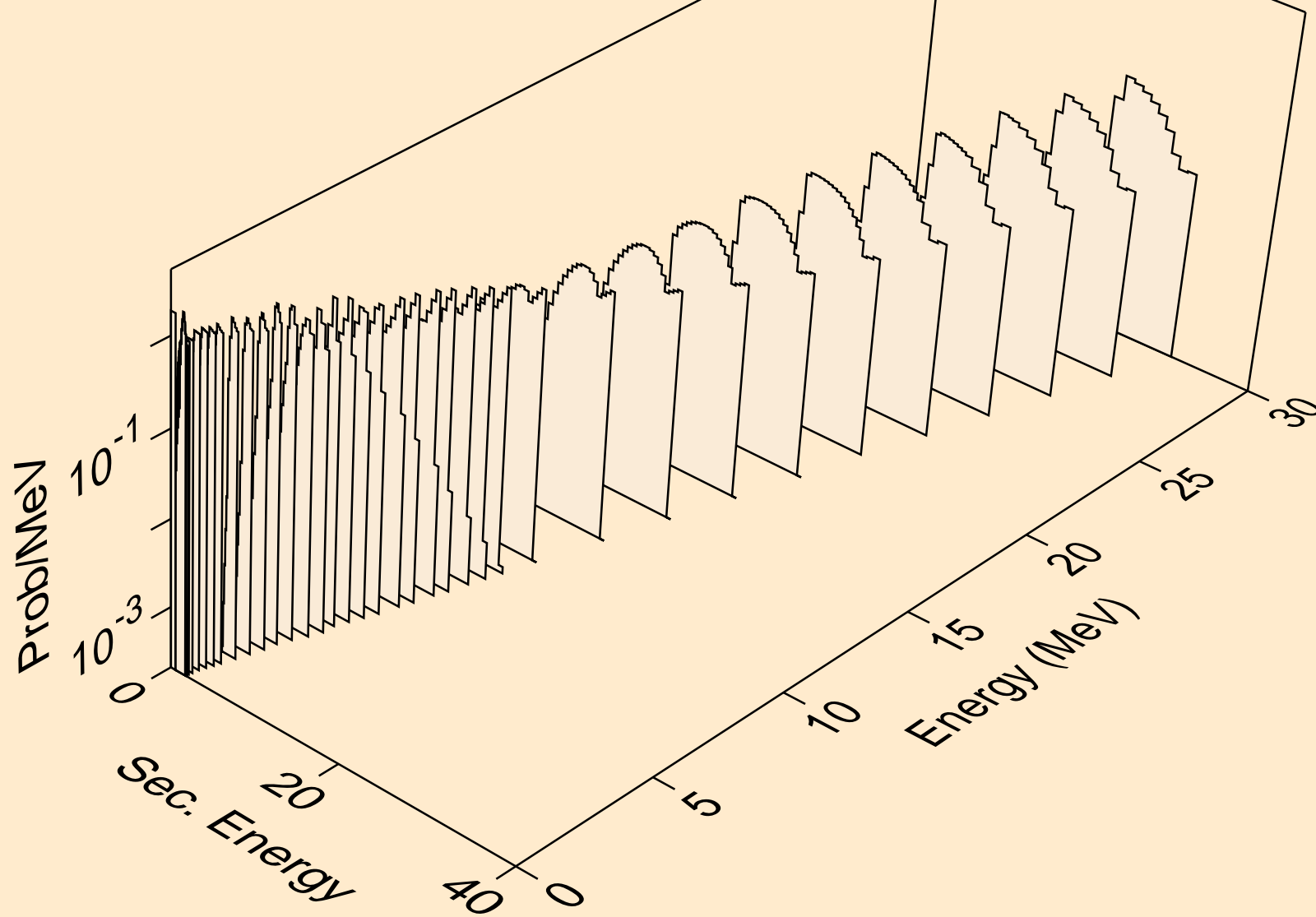



XE127M NEUTRON ACER TENDL-2024 LIBRARY; T=0.K  
protons from (n,2p)

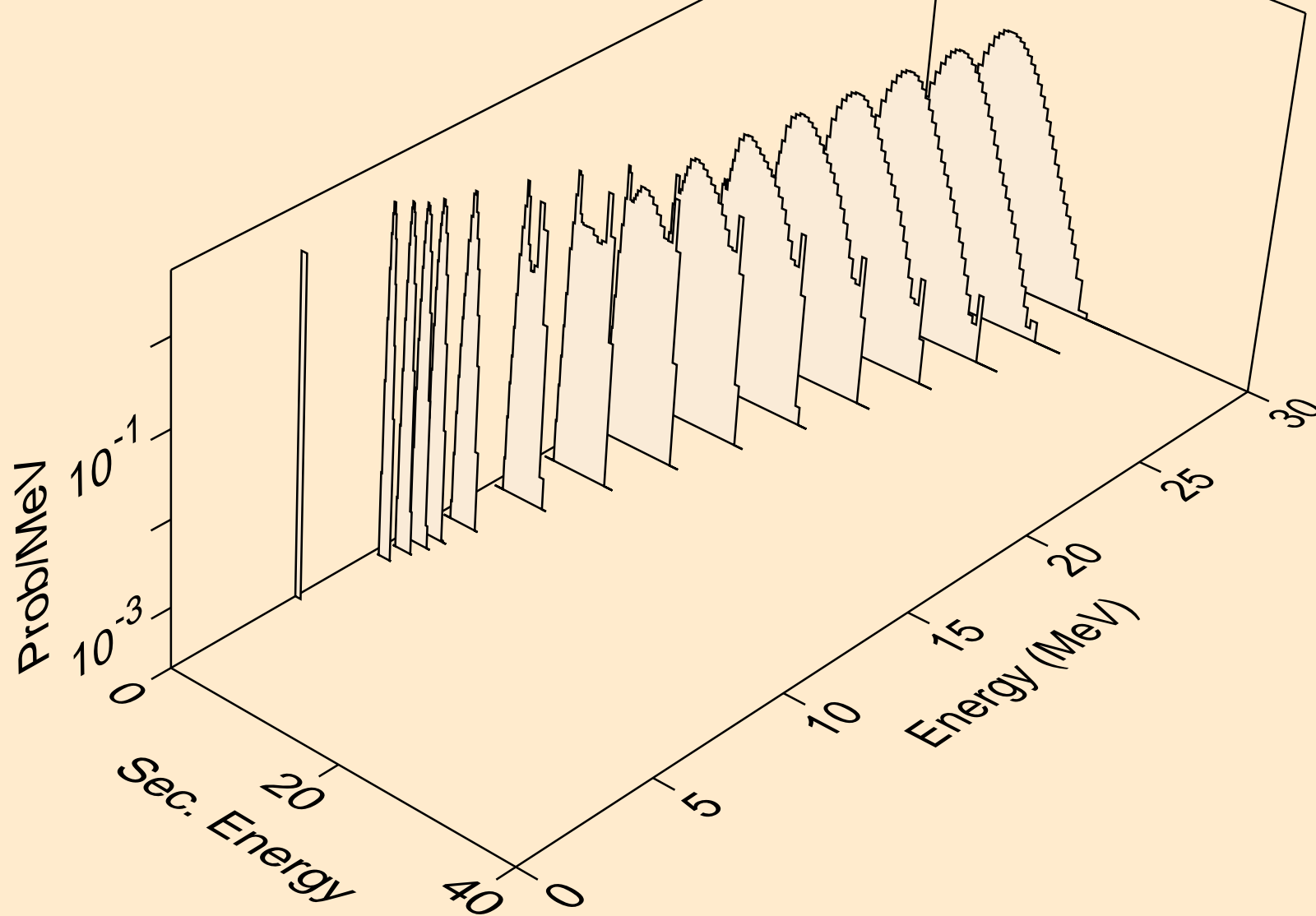

XE127M NEUTRON ACER TENDL-2024 LIBRARY; T=0.K  
protons from (n,p)

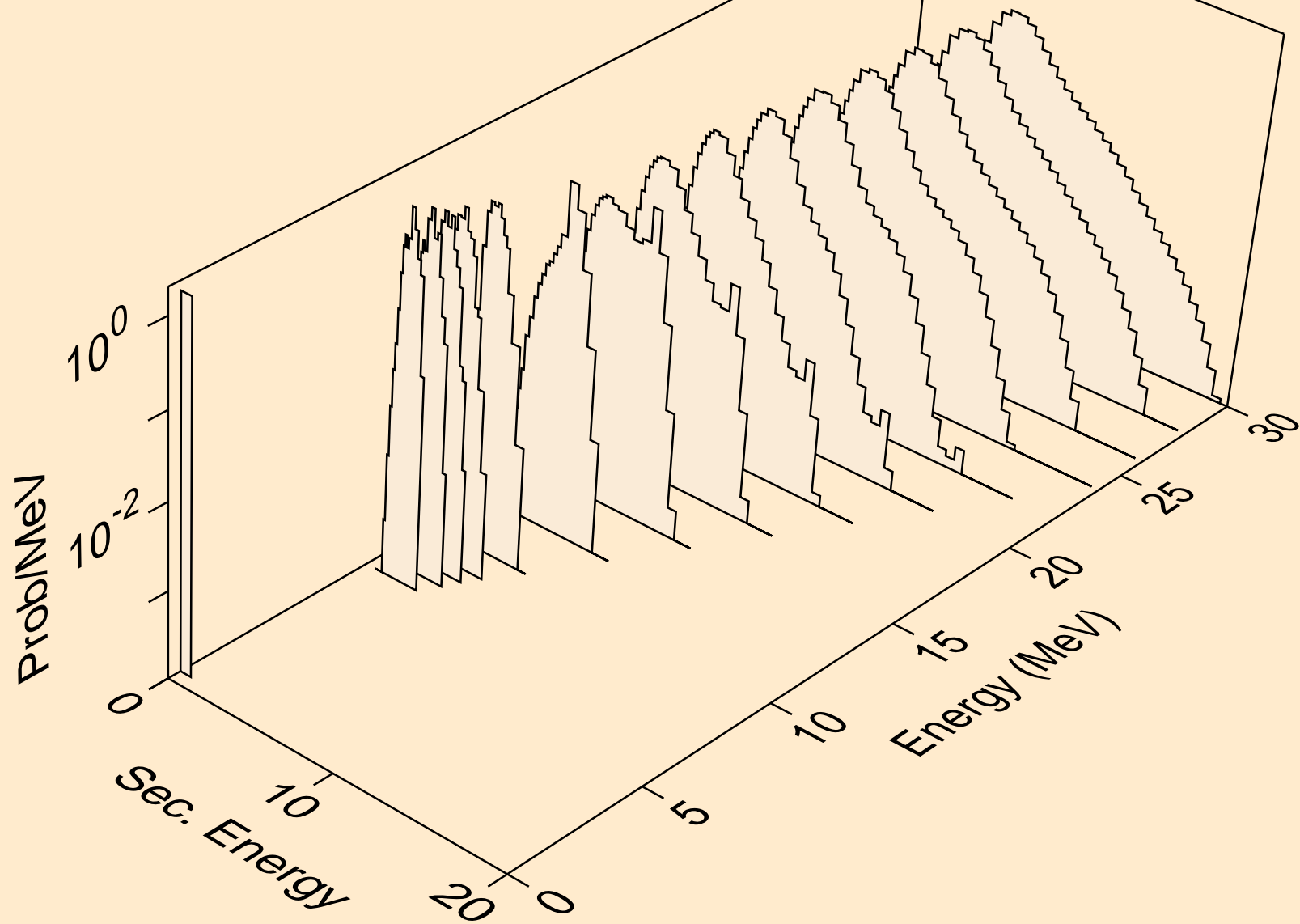

XE127M NEUTRON ACER TENDL-2024 LIBRARY; T=0.K  
protons from (n,pd)

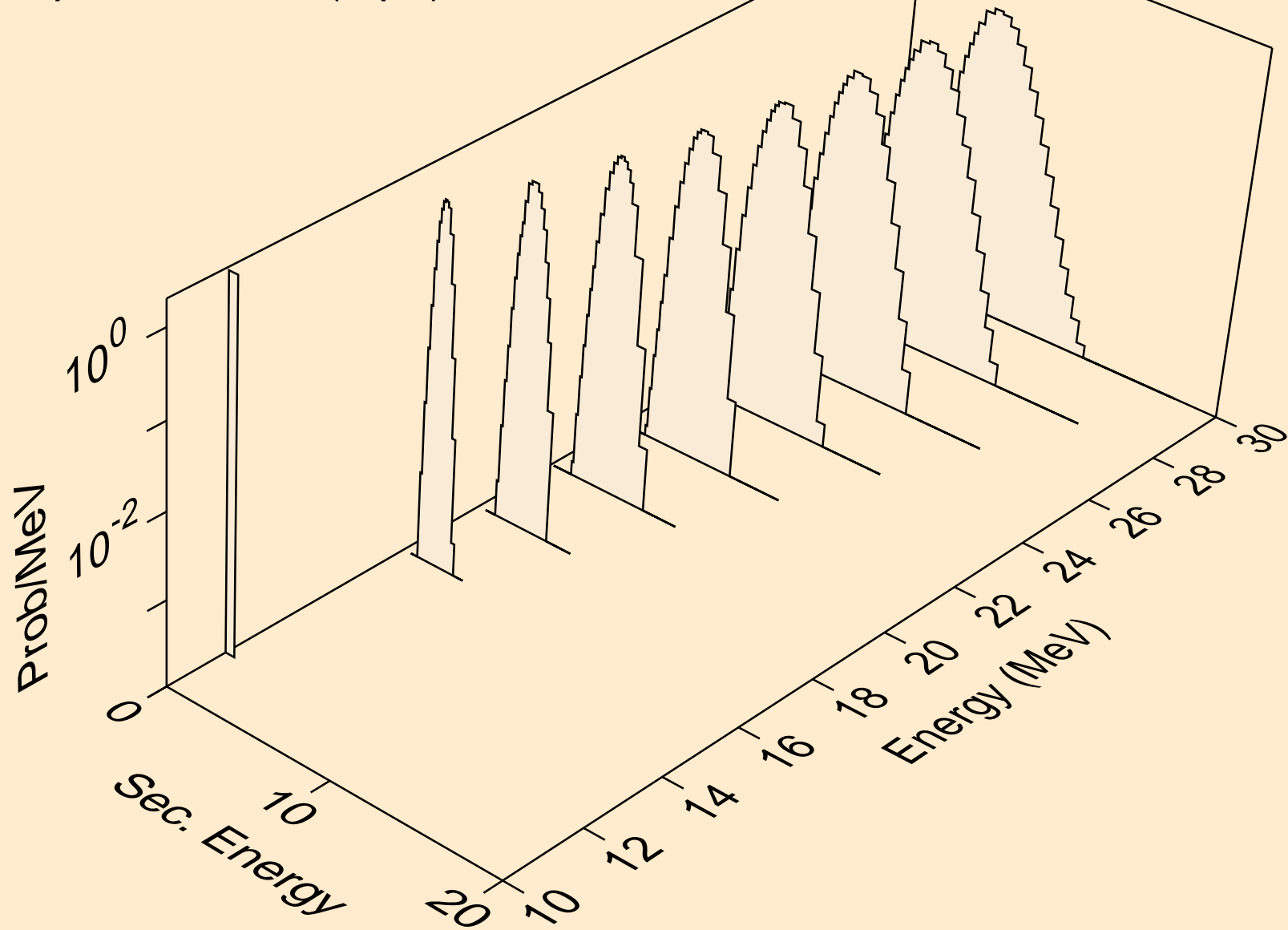

XE127M NEUTRON ACER TENDL-2024 LIBRARY; T=0.K  
protons from (n,pt)

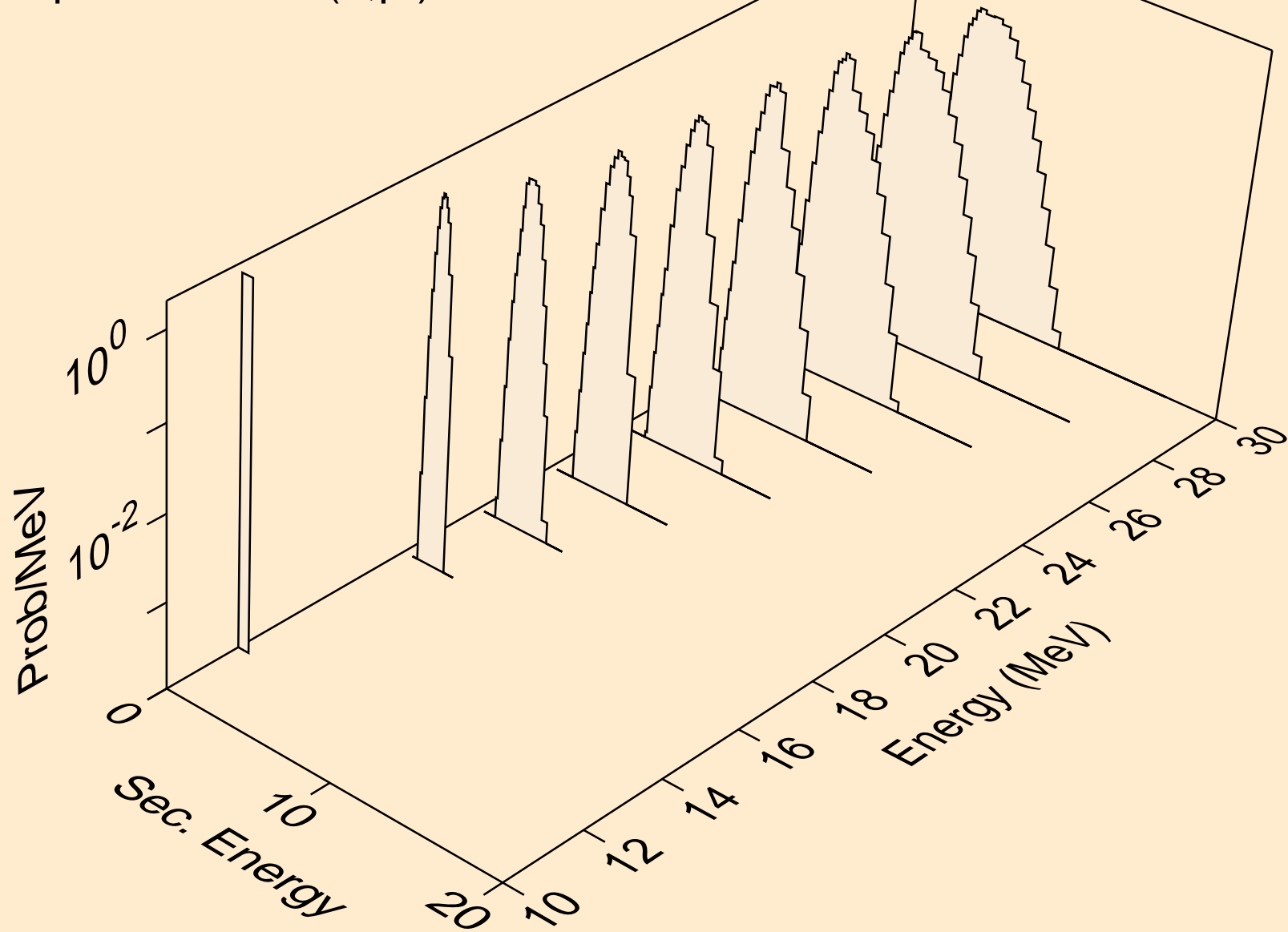

XE127M NEUTRON ACER TENDL-2024 LIBRARY; T=0.K  
deuterons from (n,x)

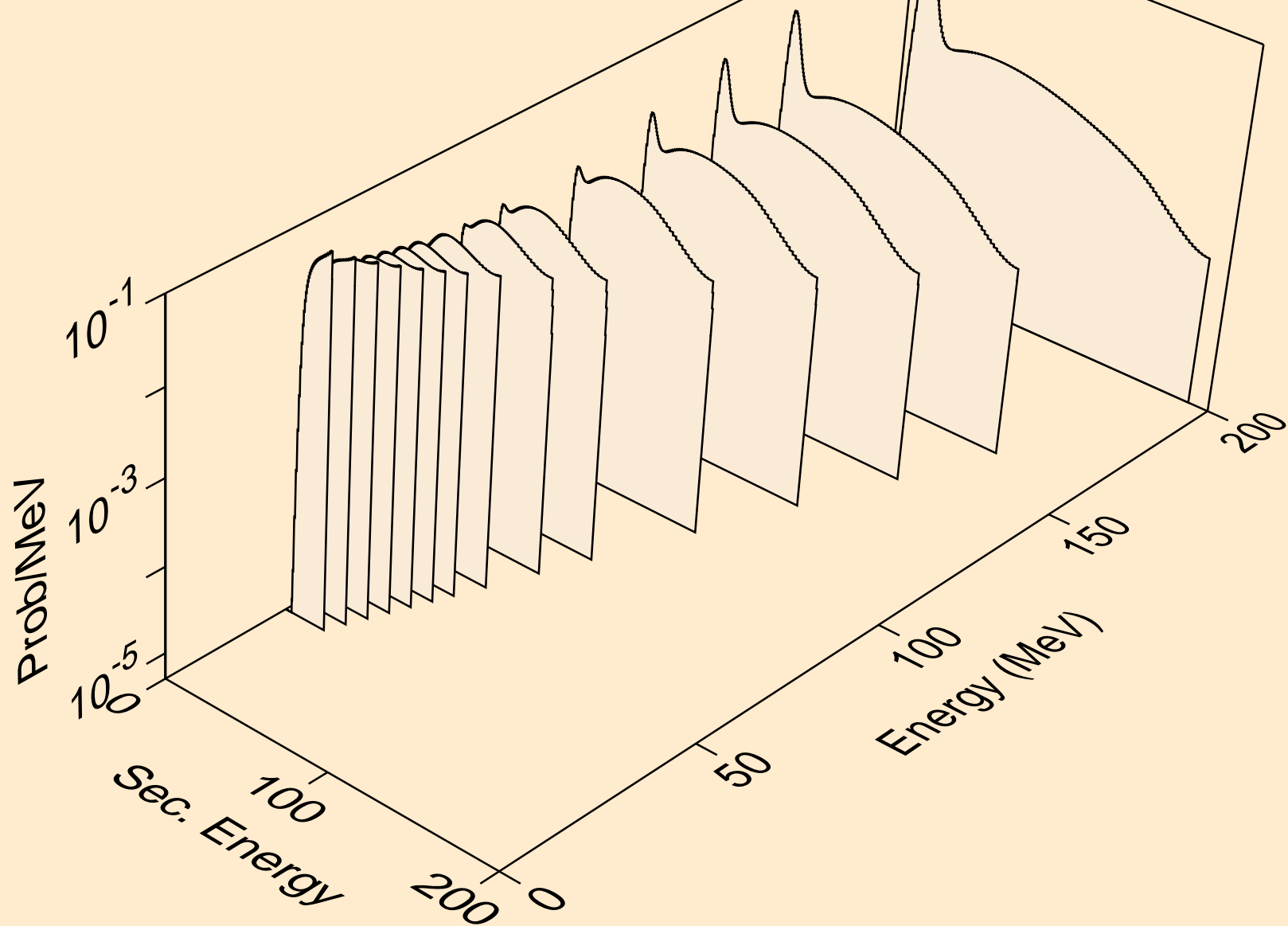

XE127M NEUTRON ACER TENDL-2024 LIBRARY; T=0.K  
deuterons from (n,2nd)

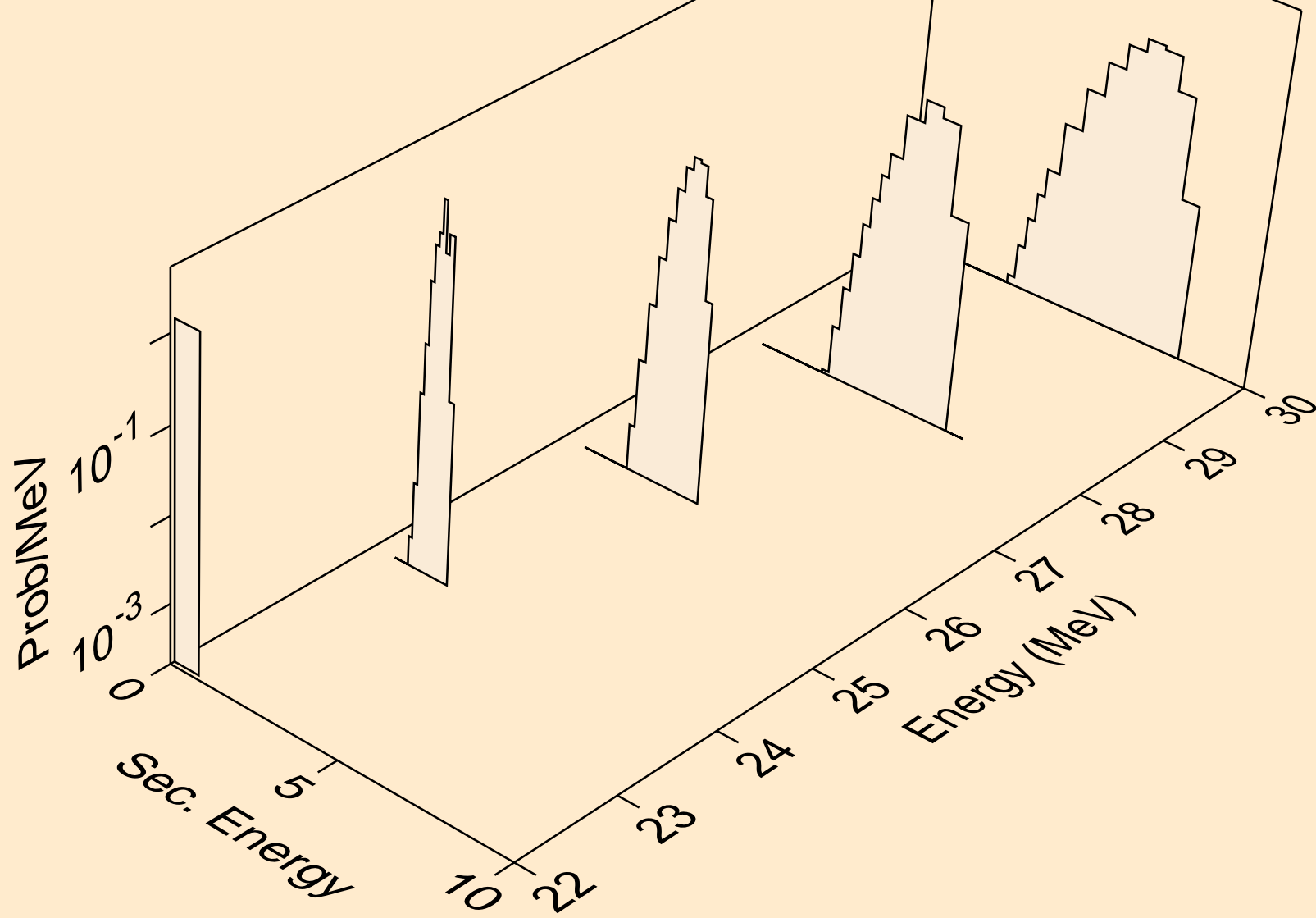

XE127M NEUTRON ACER TENDL-2024 LIBRARY; T=0.K  
deuterons from (n,n\*)d

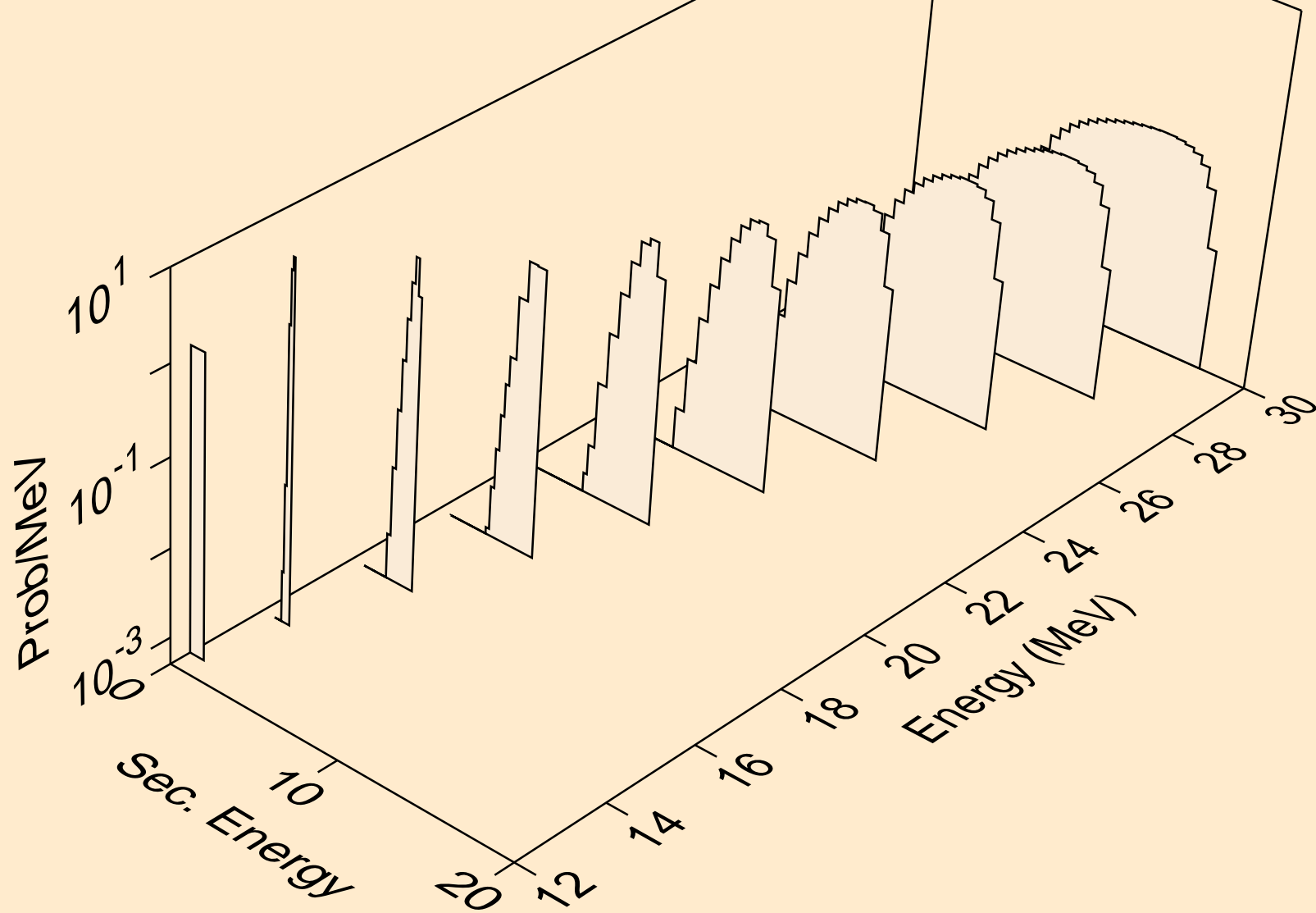

XE127M NEUTRON ACER TENDL-2024 LIBRARY; T=0.K  
deuterons from (n,d)

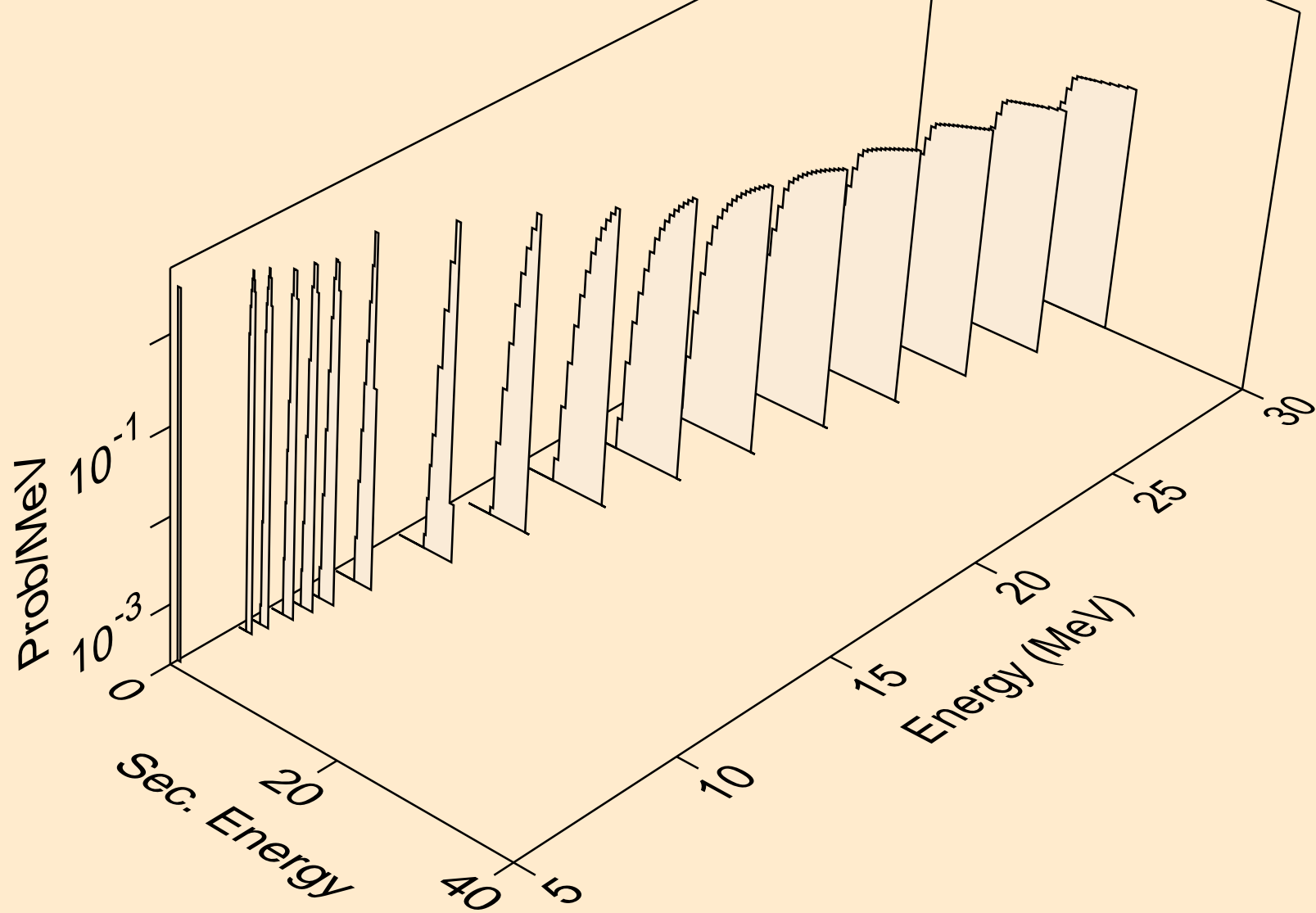



XE127M NEUTRON ACER TENDL-2024 LIBRARY; T=0.K  
deuterons from (n,pd)

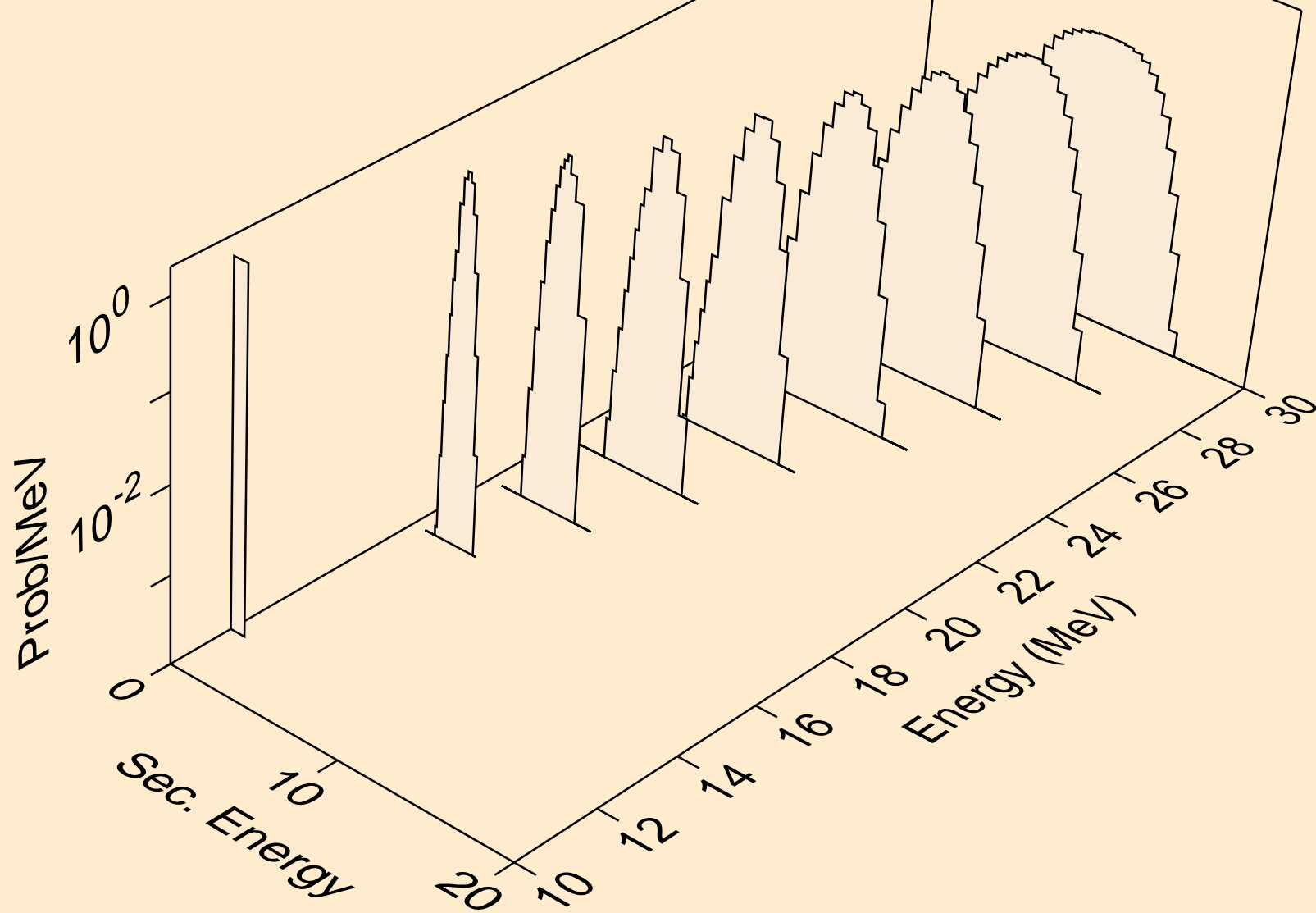

XE127M NEUTRON ACER TENDL-2024 LIBRARY; T=0.K  
deuterons from (n,da)

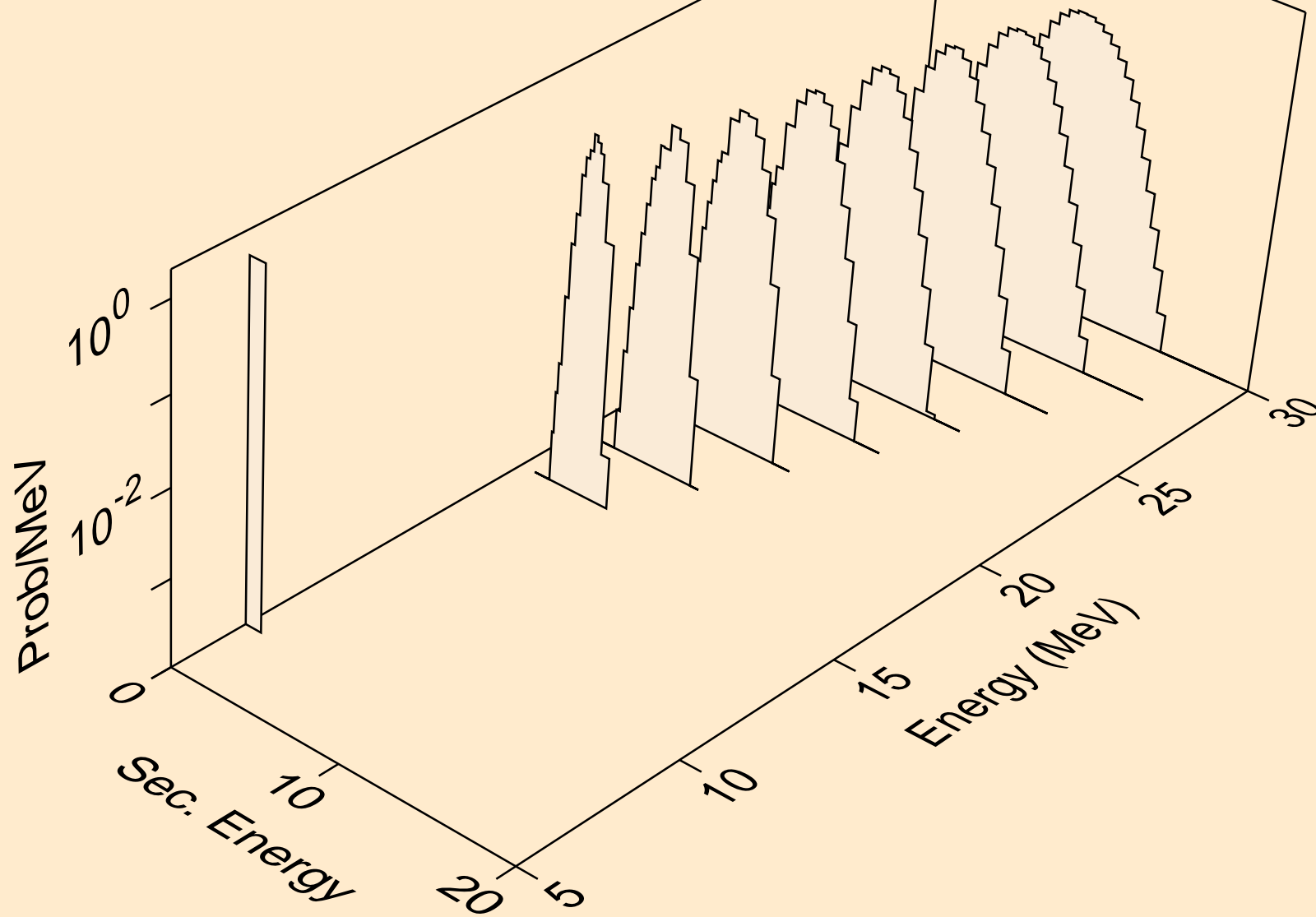

XE127M NEUTRON ACER TENDL-2024 LIBRARY; T=0.K  
tritons from (n,x)

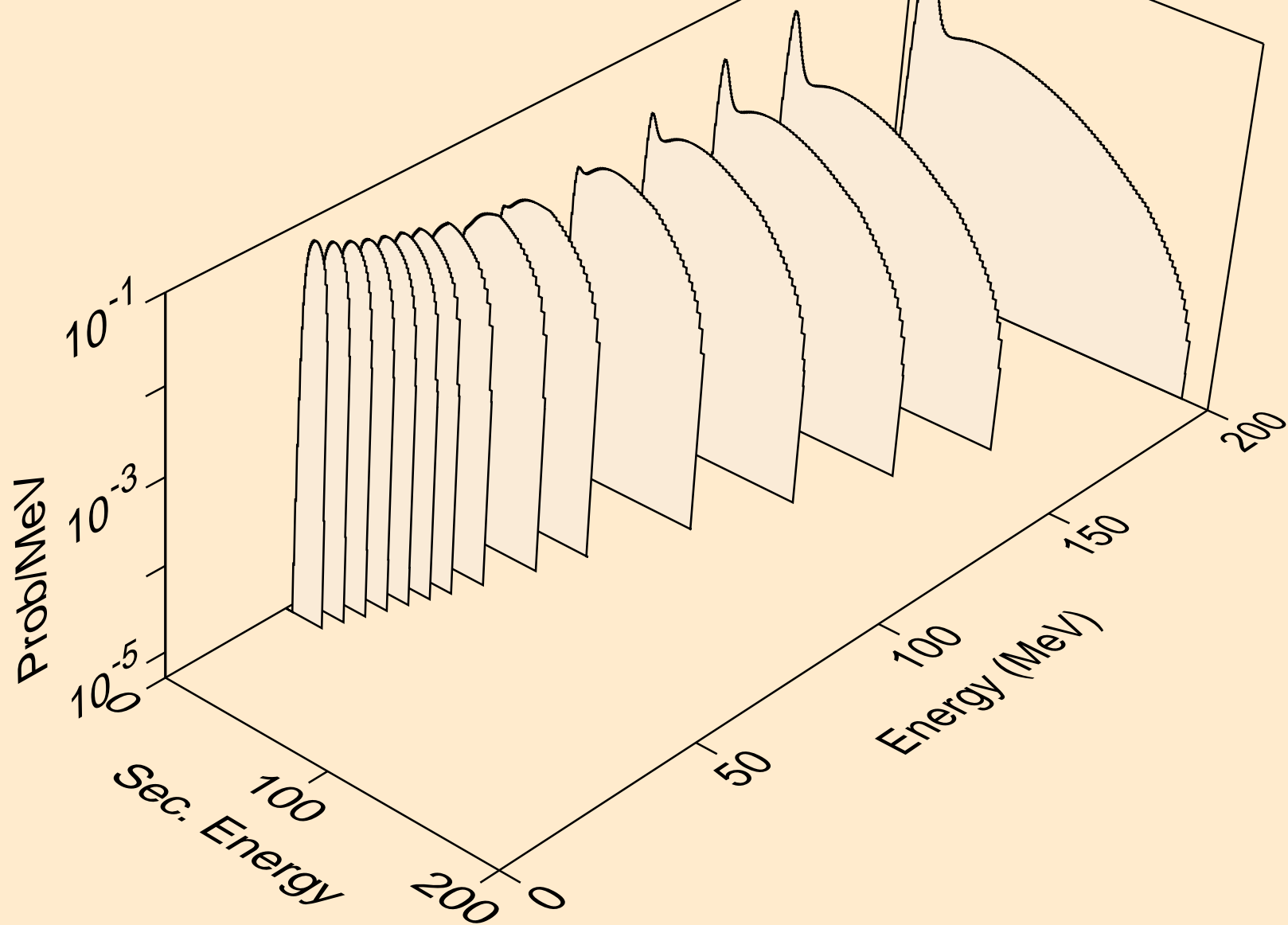

XE127M NEUTRON ACER TENDL-2024 LIBRARY; T=0.K  
tritons from (n,n\*)t

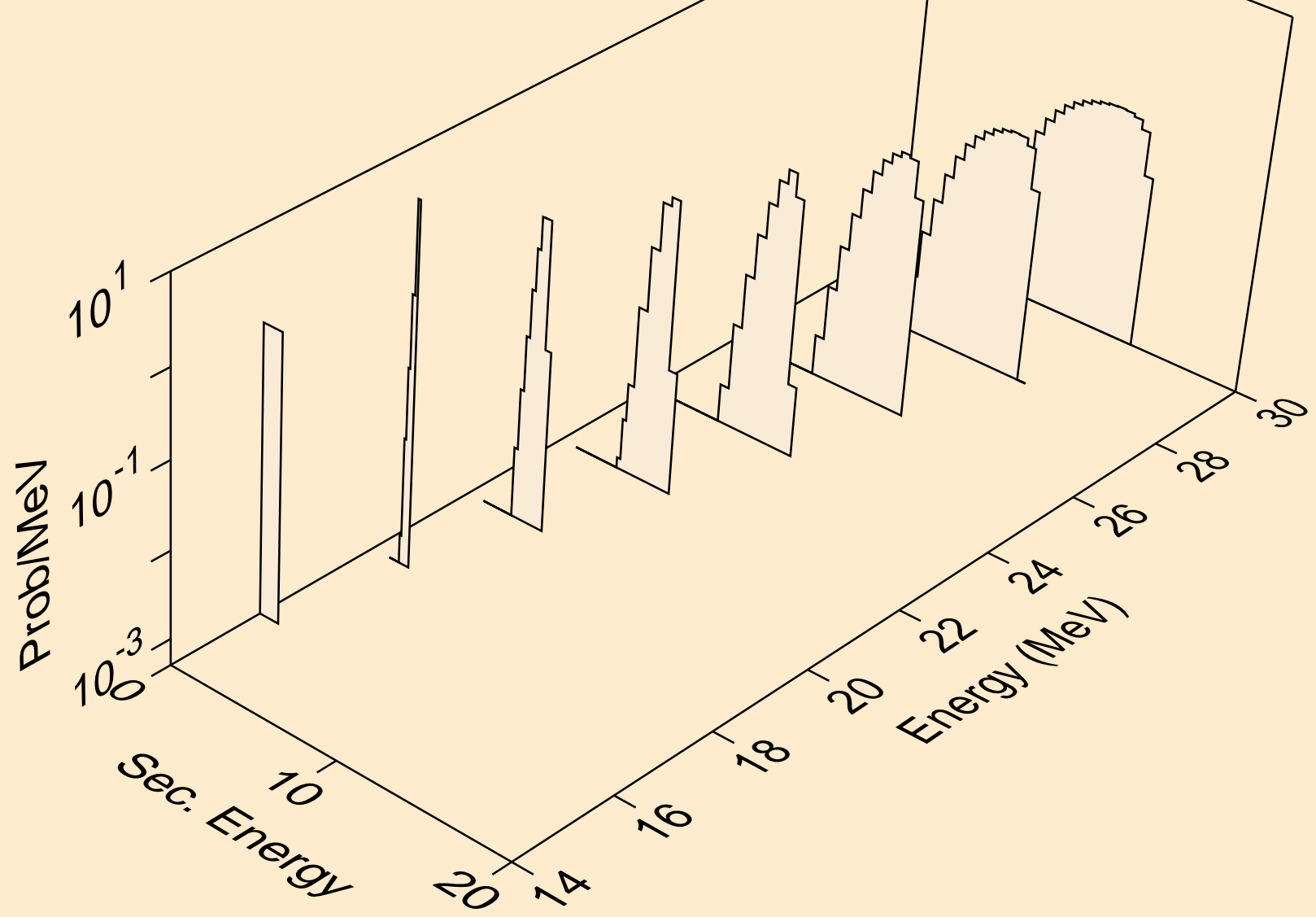

XE127M NEUTRON ACER TENDL-2024 LIBRARY; T=0.K  
tritons from (n,t)

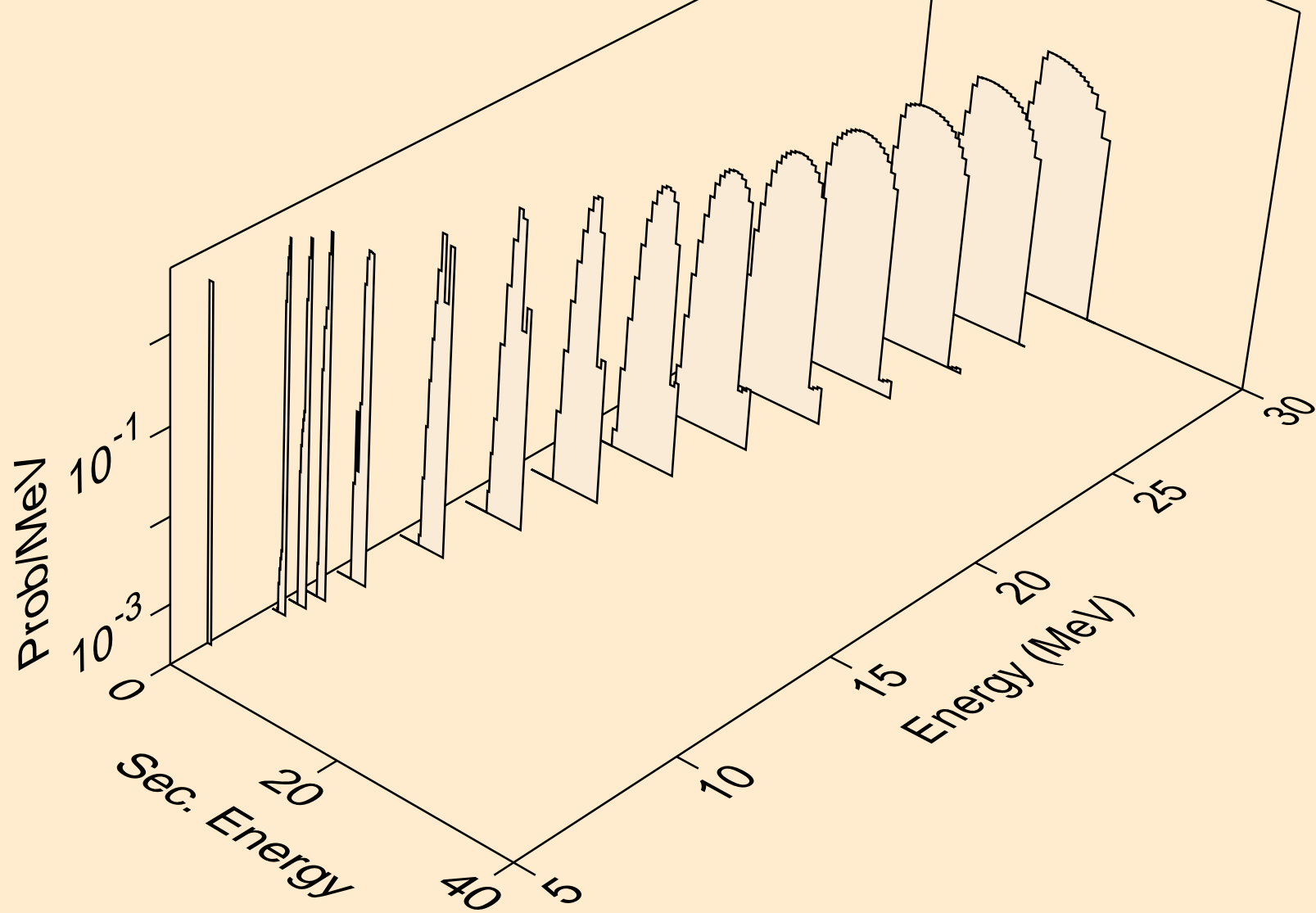

XE127M NEUTRON ACER TENDL-2024 LIBRARY; T=0.K  
tritons from (n,pt)

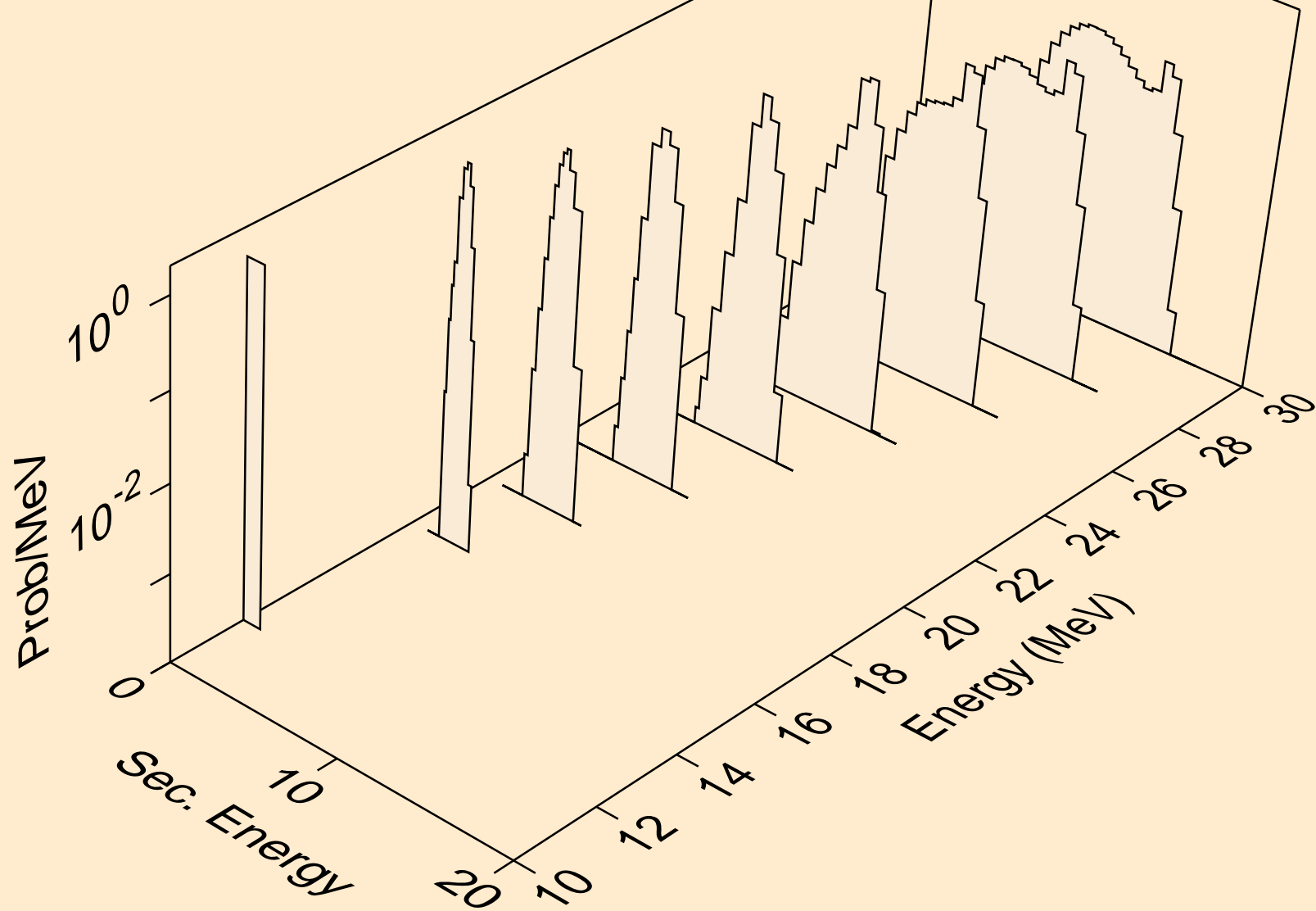

XE127M NEUTRON ACER TENDL-2024 LIBRARY; T=0.K  
he3s from (n,x)

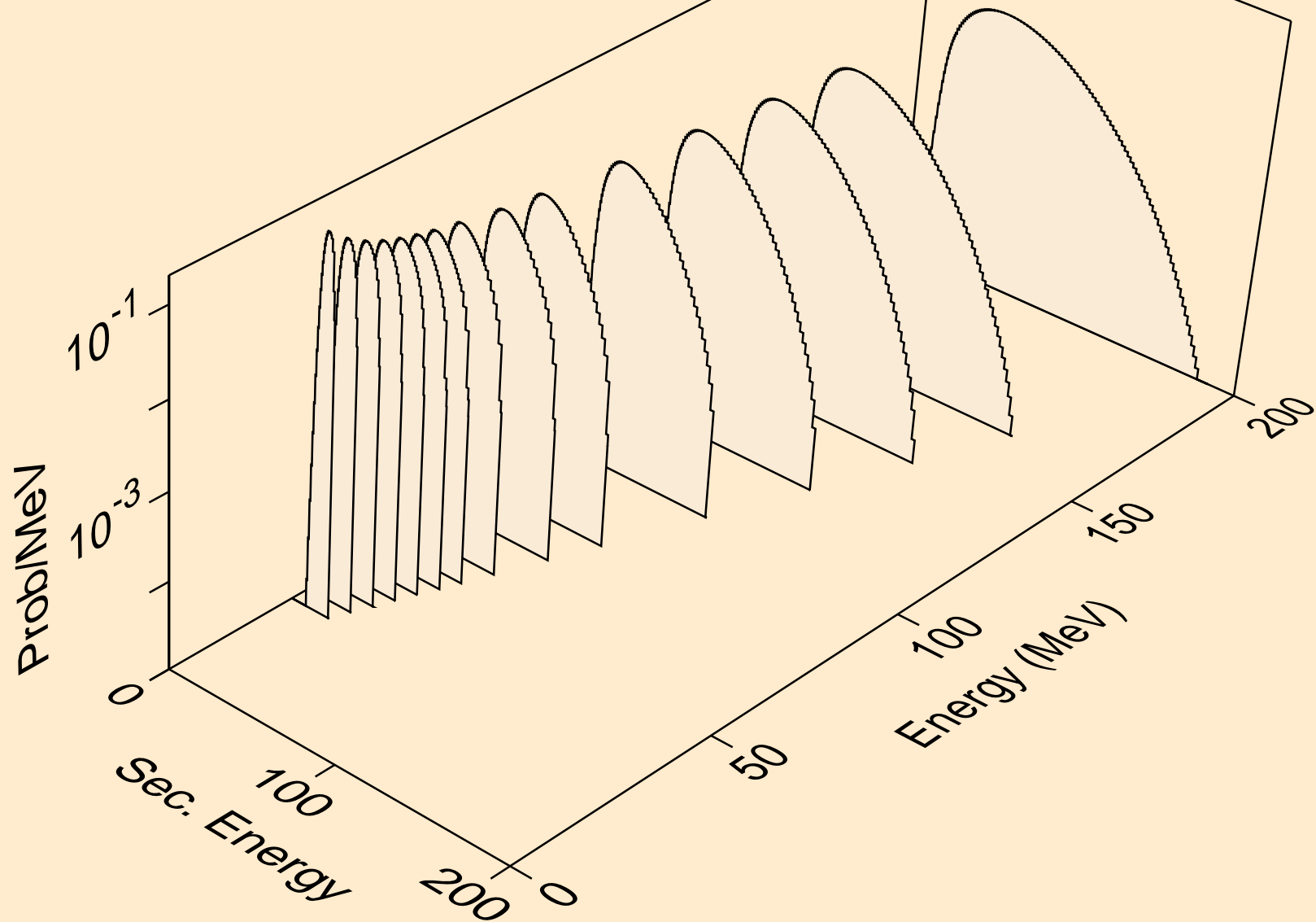

XE127M NEUTRON ACER TENDL-2024 LIBRARY; T=0.K  
he3s from (n,n\*)he3

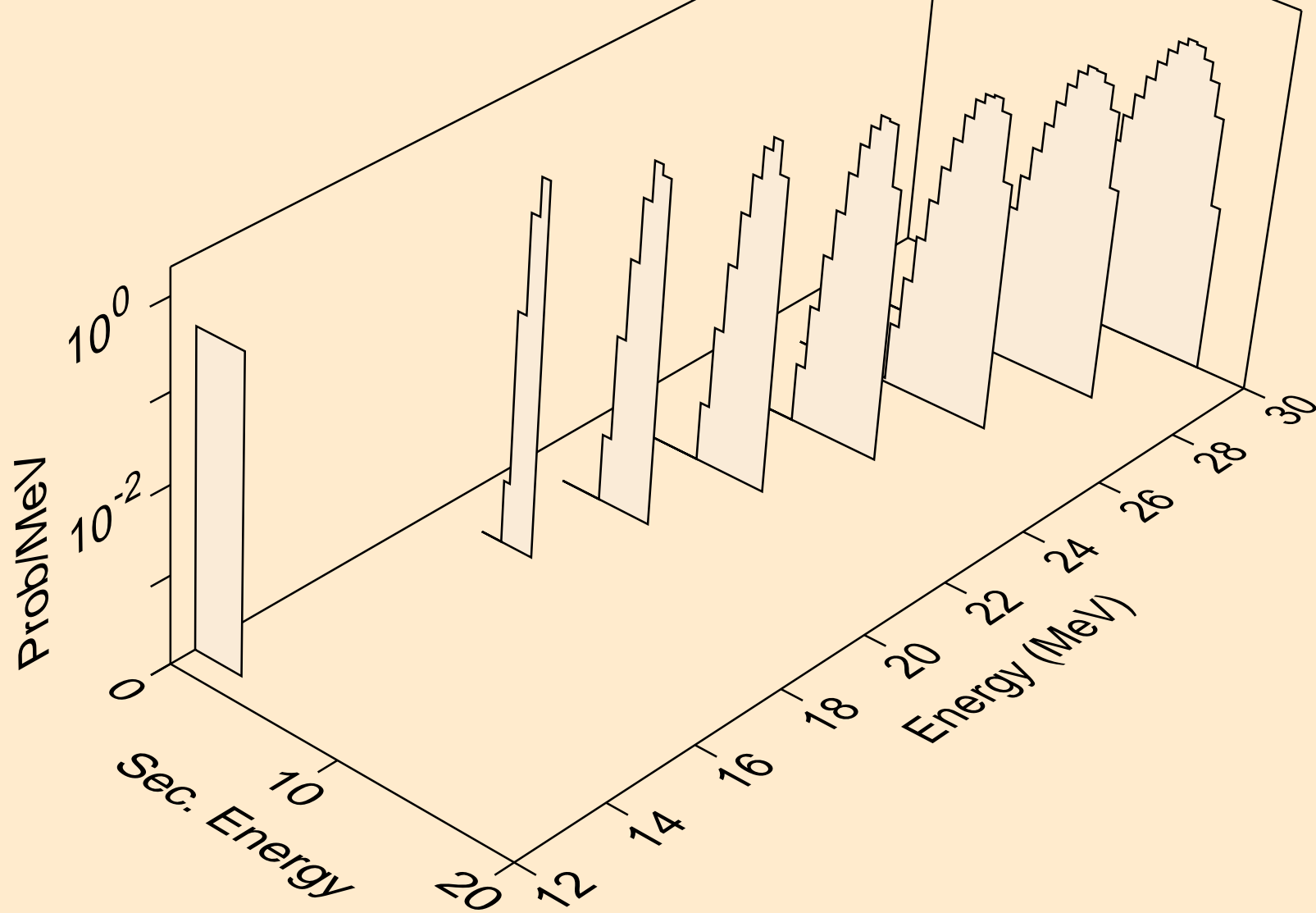



XE127M NEUTRON ACER TENDL-2024 LIBRARY; T=0.K  
he3s from (n,he3)

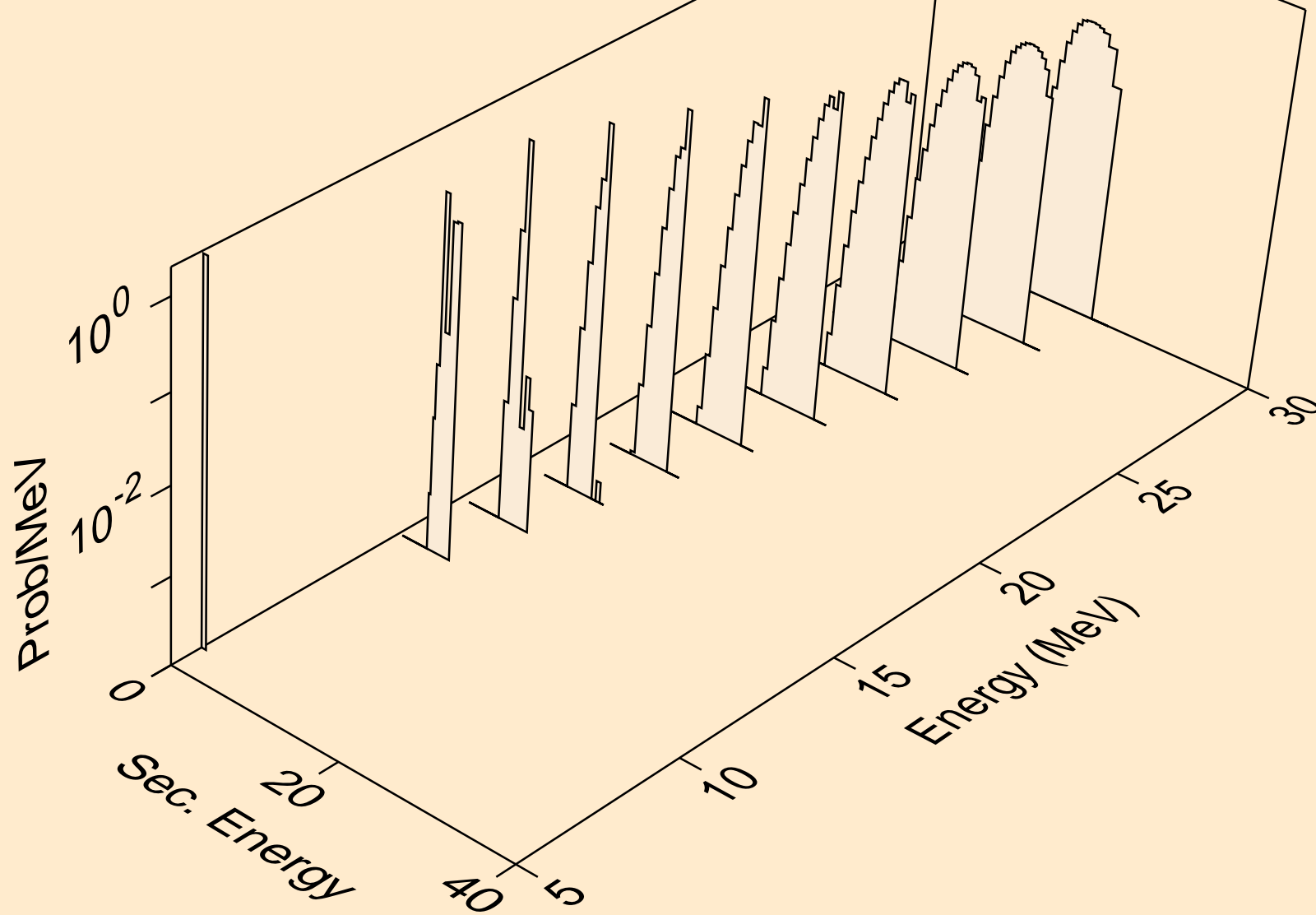

XE127M NEUTRON ACER TENDL-2024 LIBRARY; T=0.K  
alphas from (n,x)

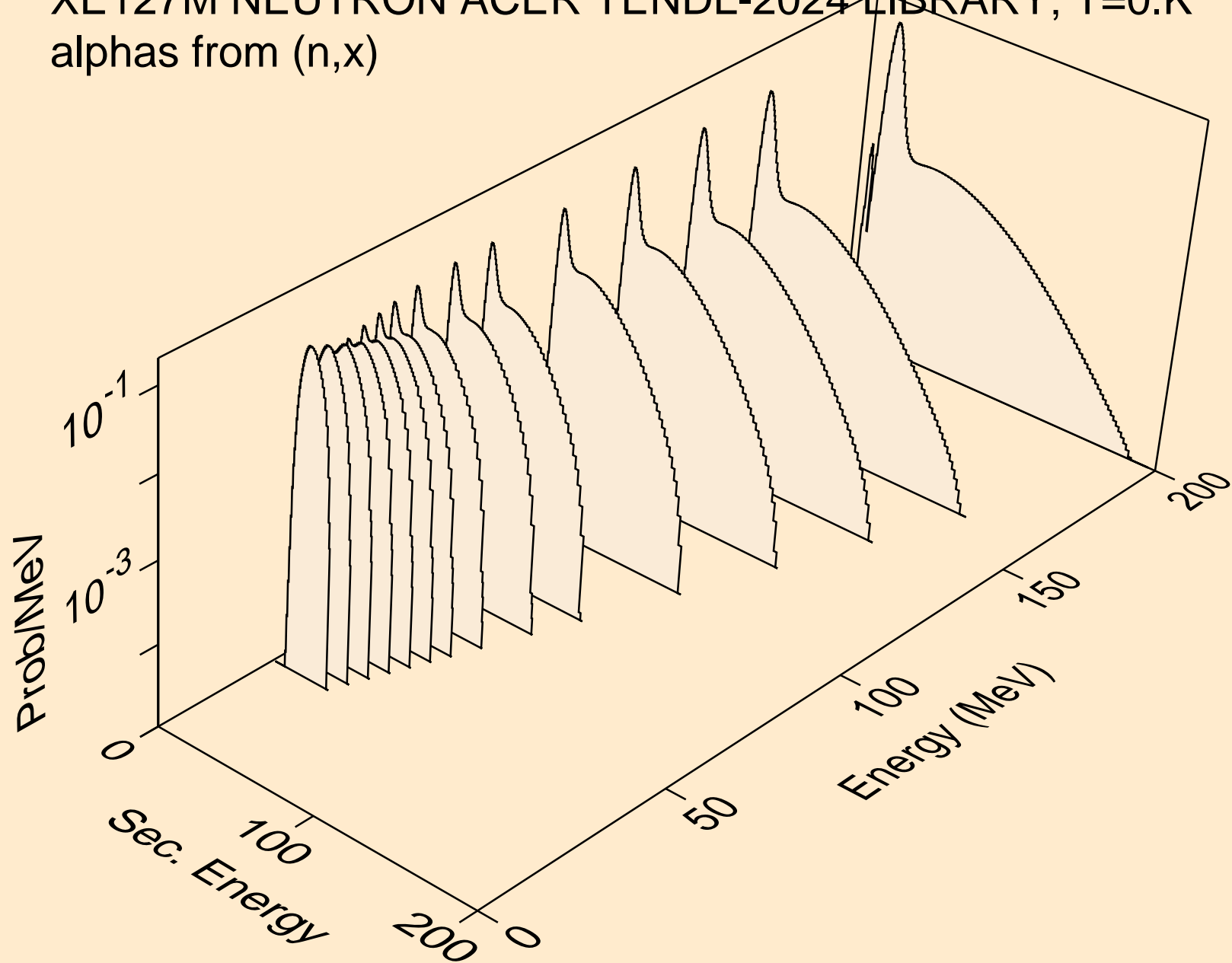

XE127M NEUTRON ACER TENDL-2024 LIBRARY; T=0.K  
alphas from (n,n\*)a

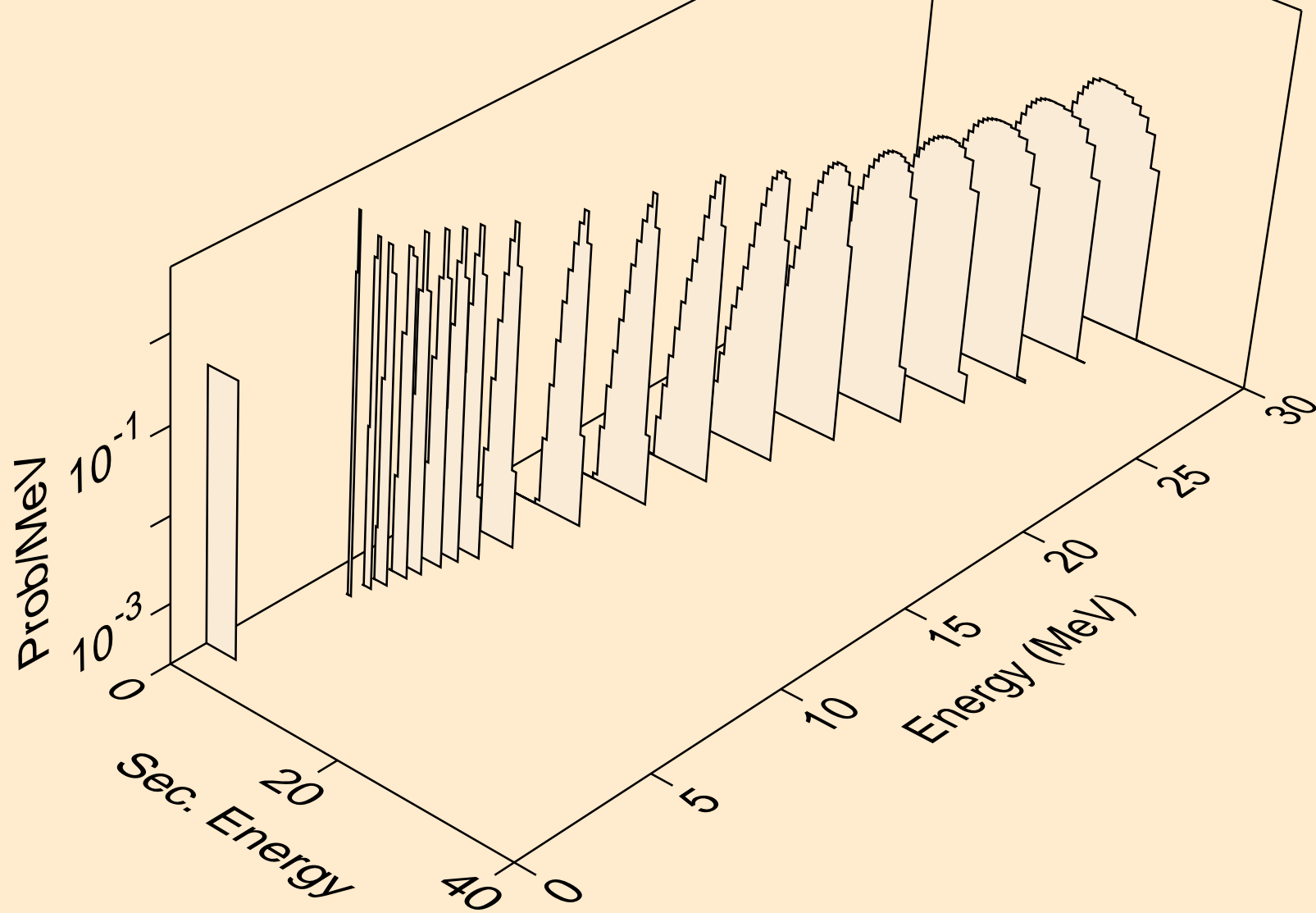

XE127M NEUTRON ACER TENDL-2024 LIBRARY; T=0.K  
alphas from (n,2n)a

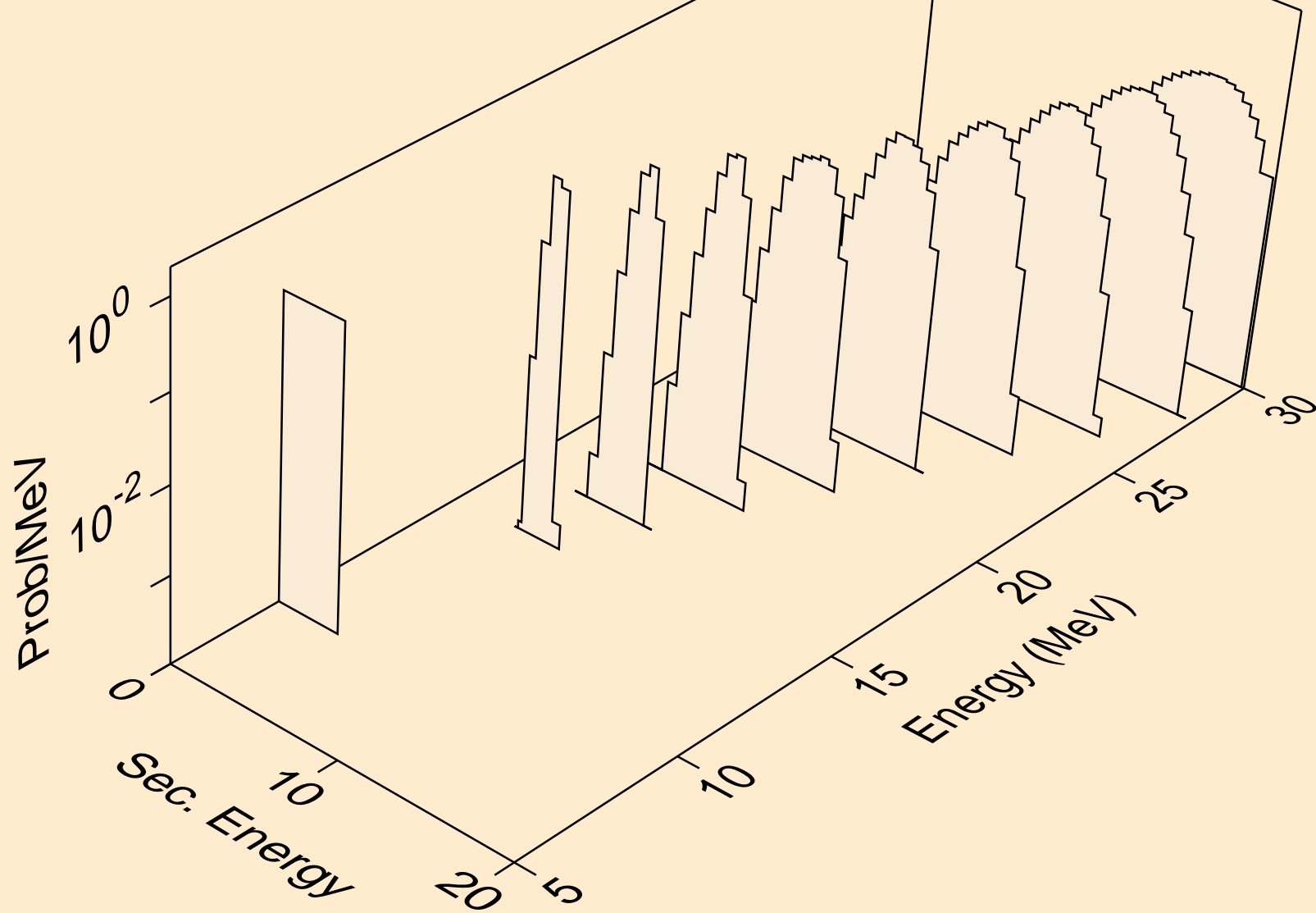

XE127M NEUTRON ACER TENDL-2024 LIBRARY; T=0.K  
alphas from (n,3n)a

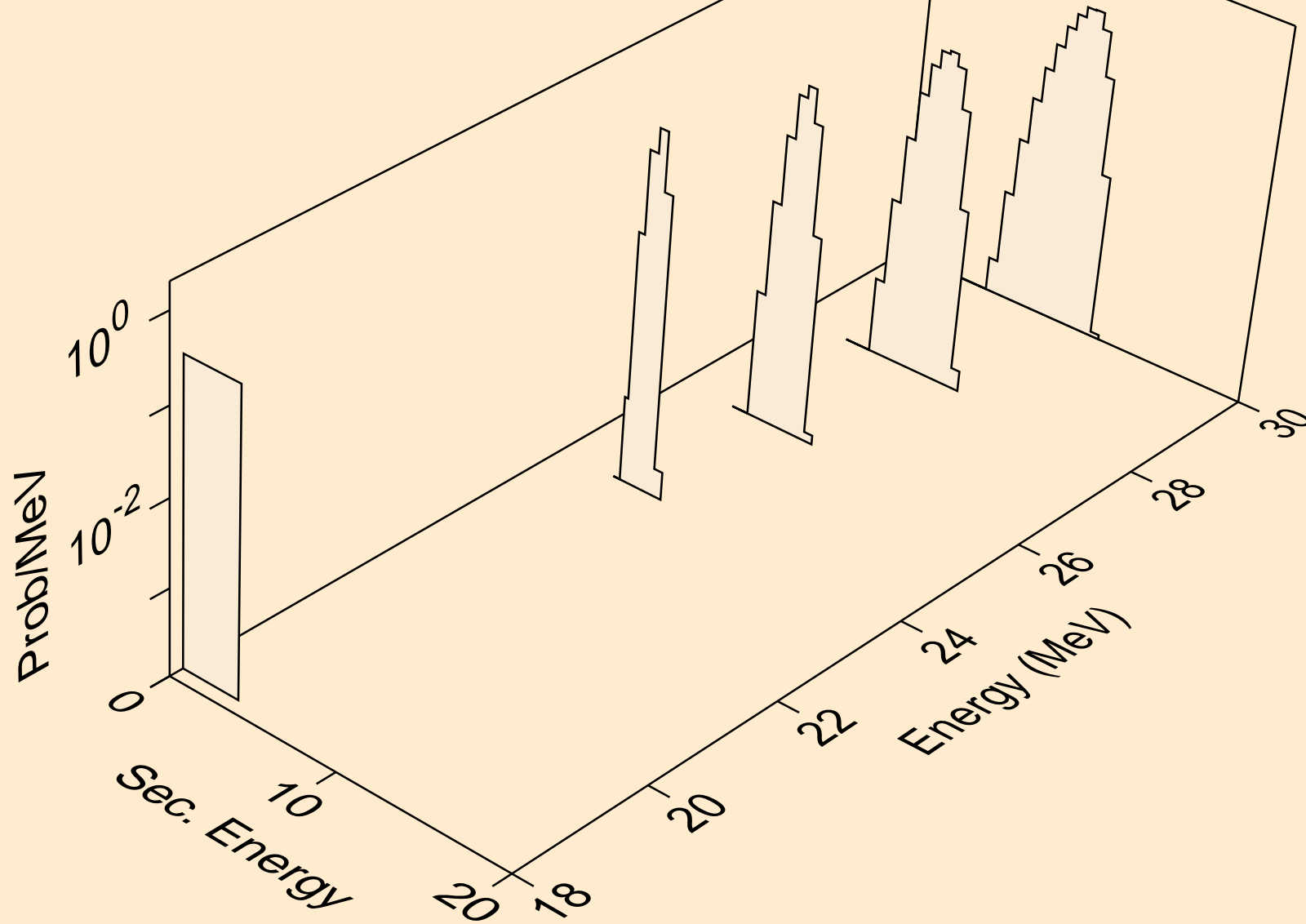

XE127M NEUTRON ACER TENDL-2024 LIBRARY; T=0.K  
alphas from (n,n\*)2a

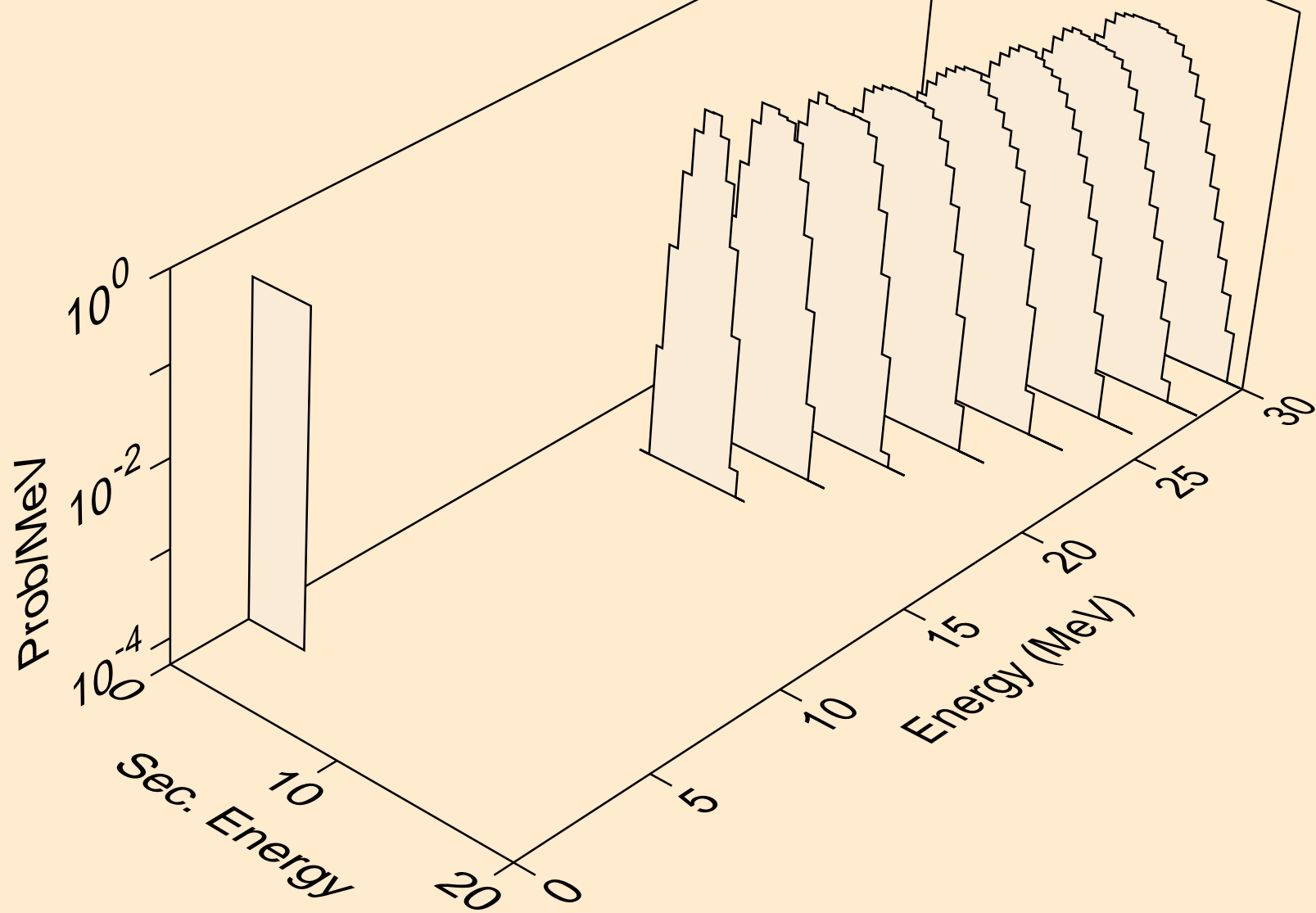

XE127M NEUTRON ACER TENDL-2024 LIBRARY; T=0.K  
alphas from (n,npa)

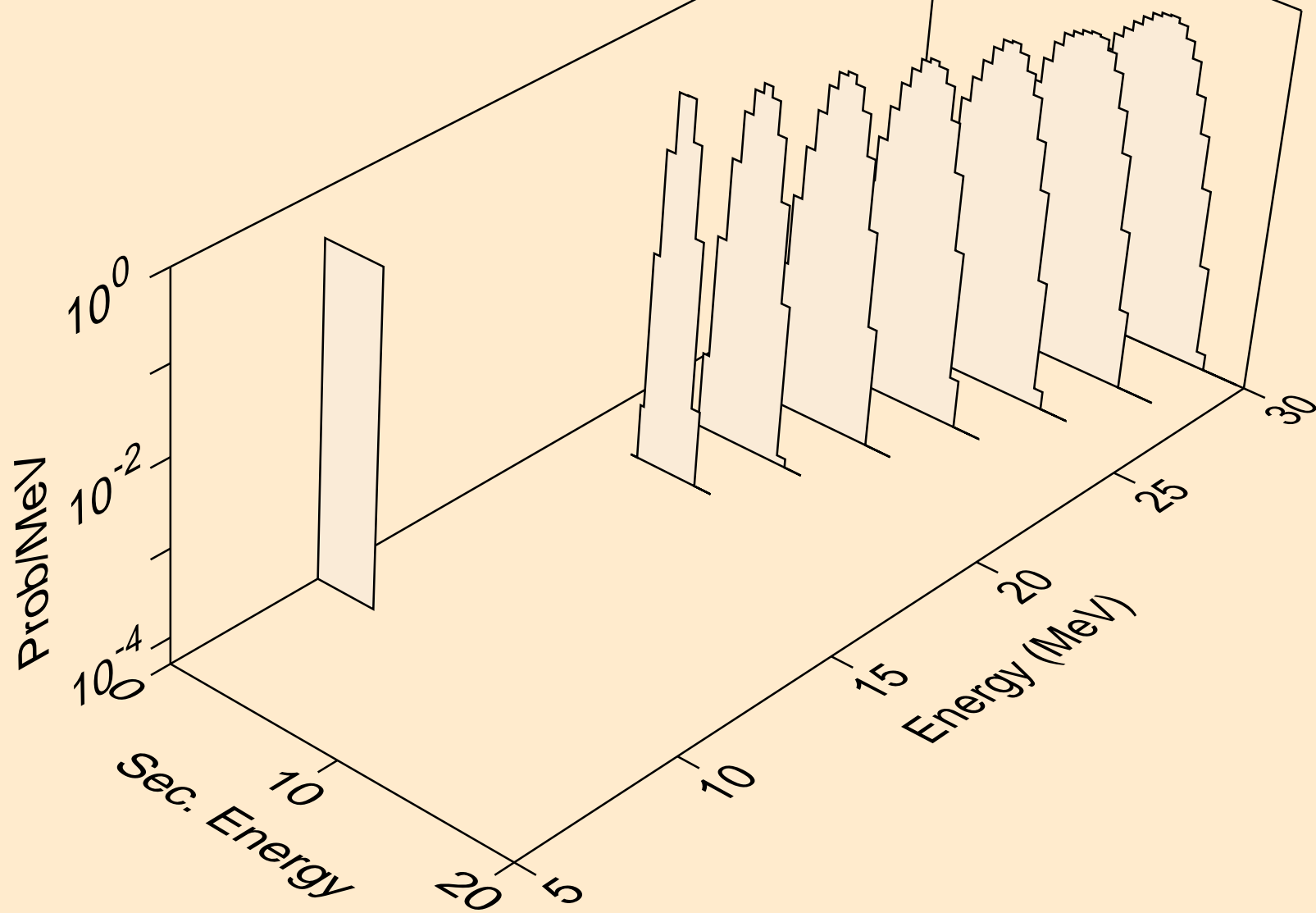

XE127M NEUTRON ACER TENDL-2024 LIBRARY; T=0.K  
alphas from (n,a)

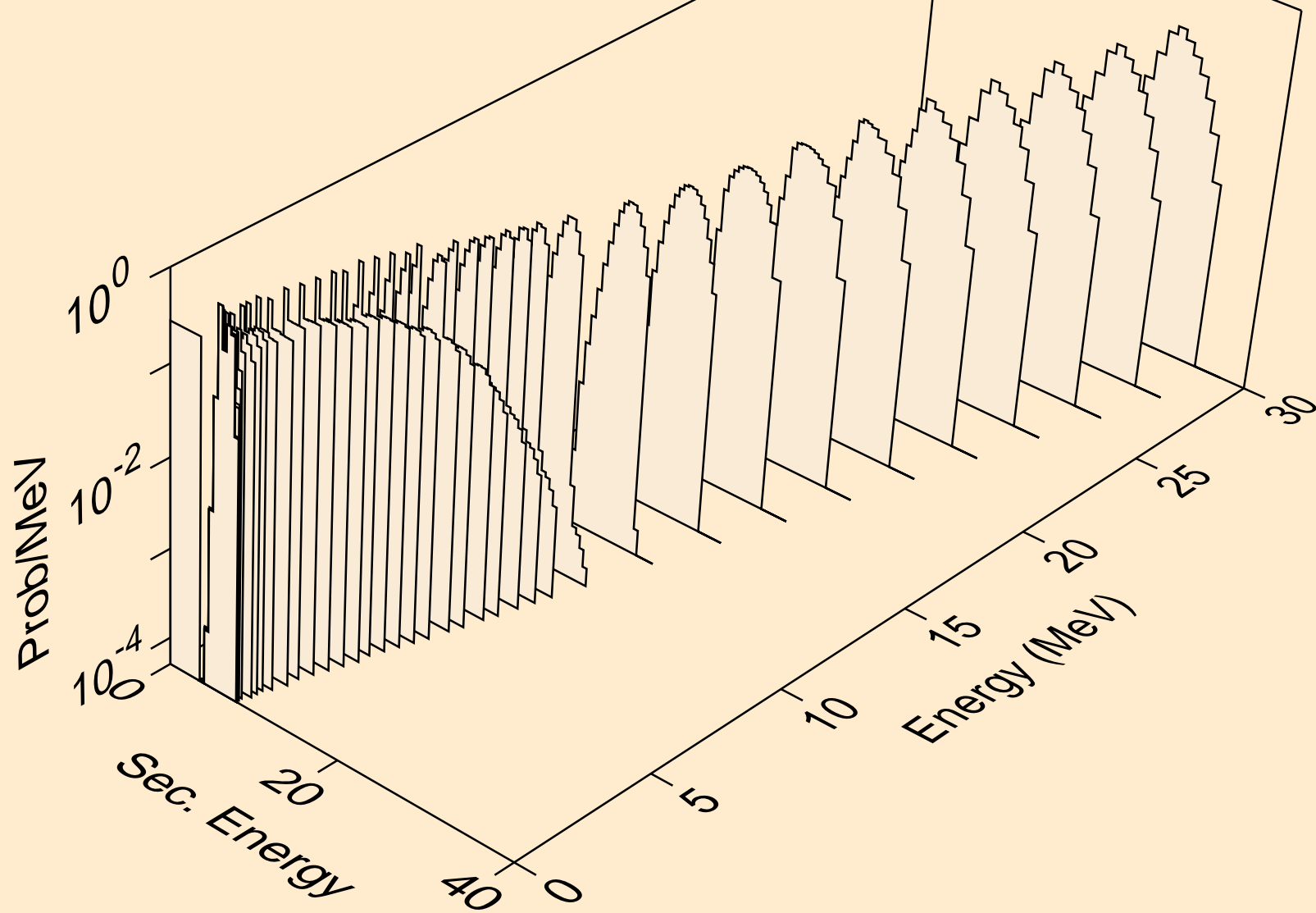



XE127M NEUTRON ACER TENDL-2024 LIBRARY; T=0.K  
alphas from (n,2a)

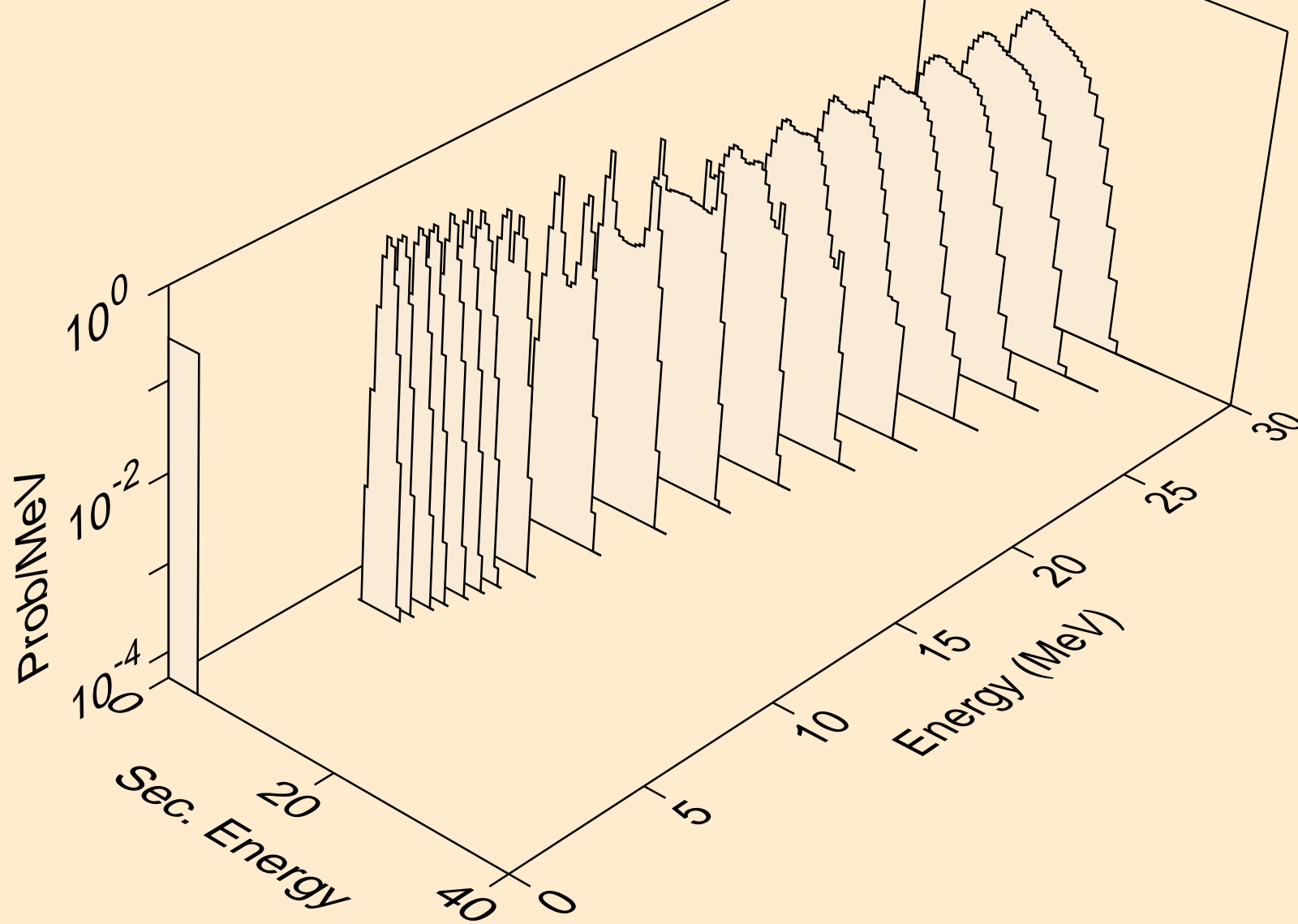

XE127M NEUTRON ACER TENDL-2024 LIBRARY; T=0.K  
alphas from (n,pa)

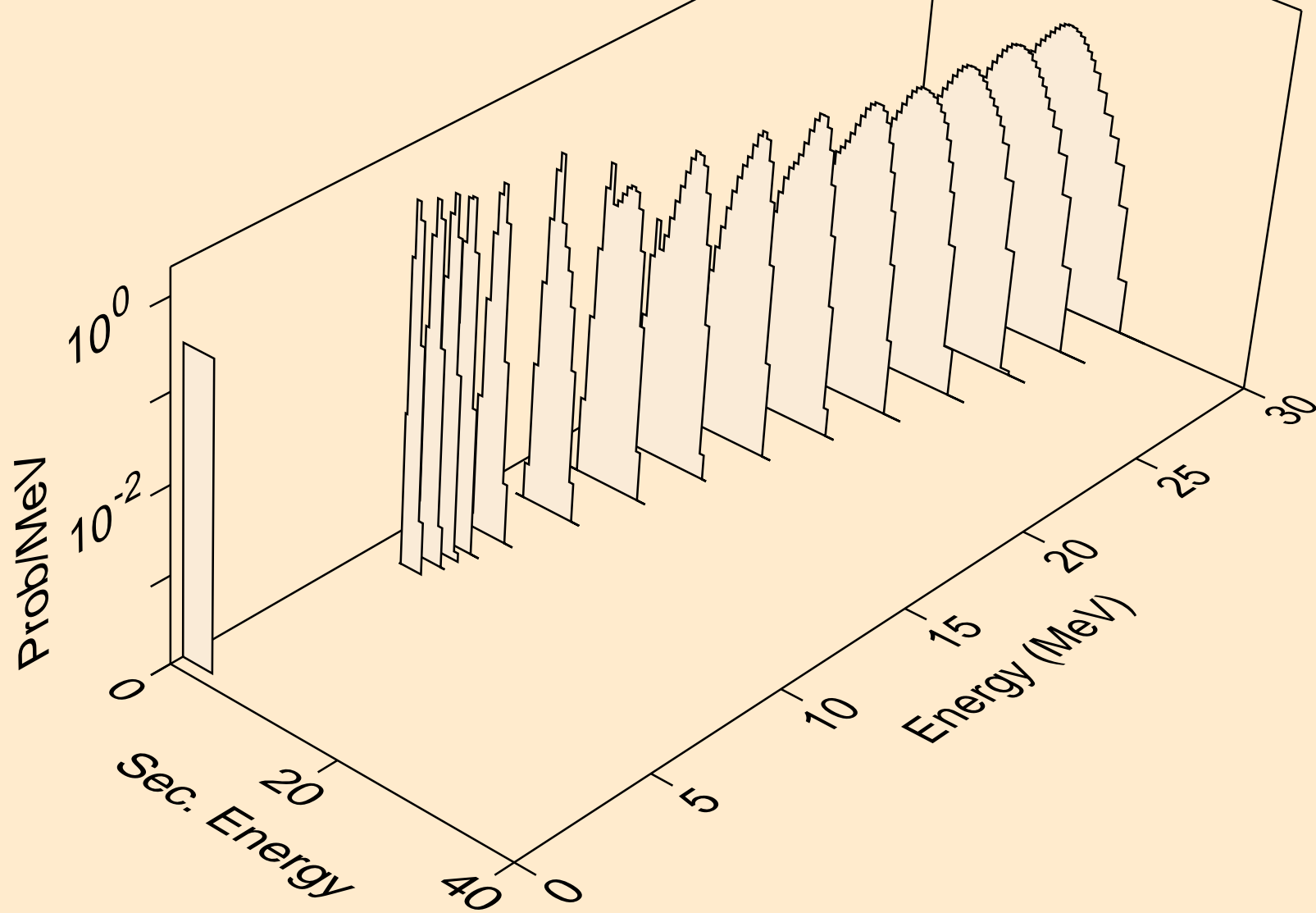

XE127M NEUTRON ACER TENDL-2024 LIBRARY; T=0.K  
alphas from (n,da)

