

Y080M NEUTRON ACER TENDL-2024 LIBRARY; T=0.K  
Principal cross sections

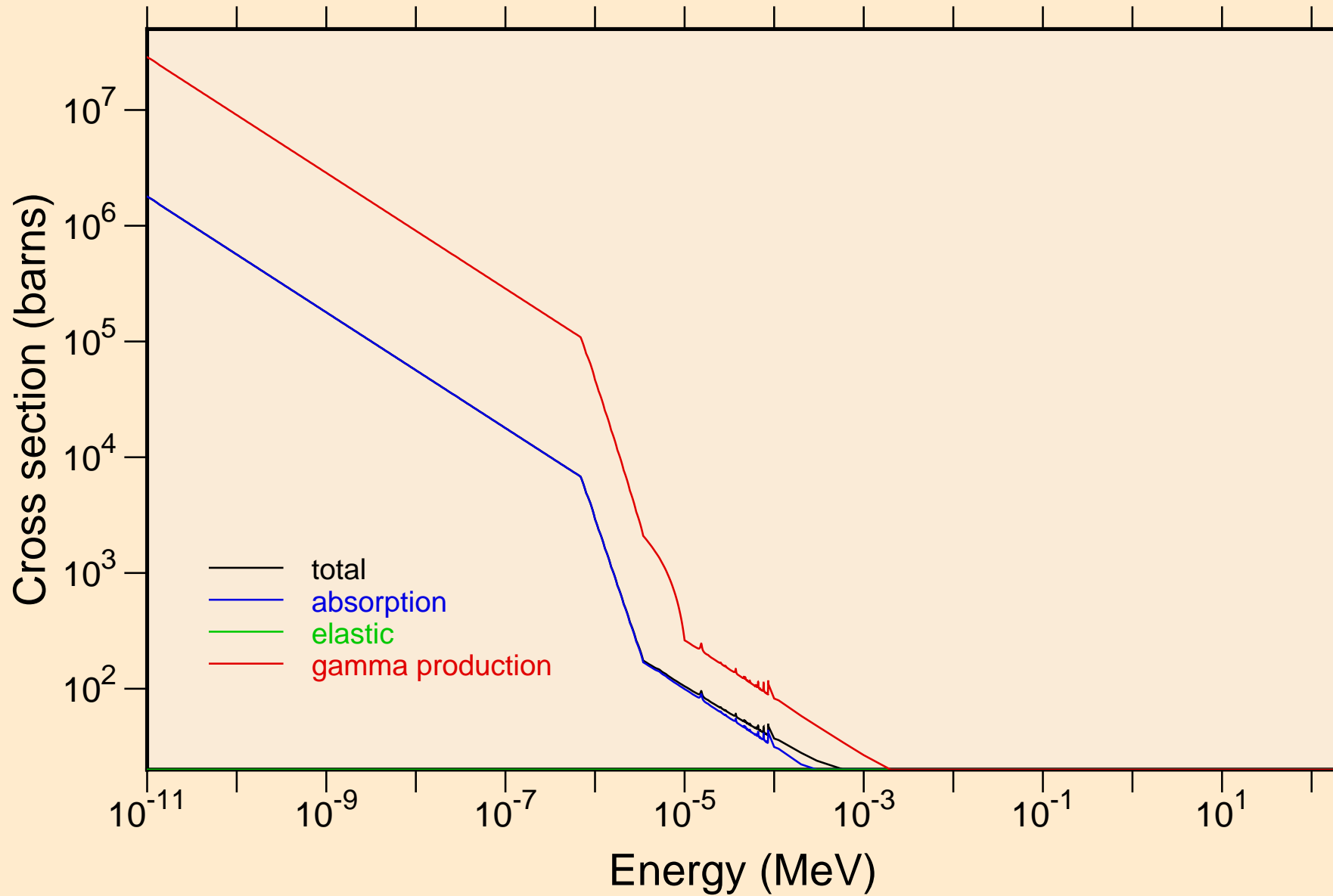

Y080M NEUTRON ACER TENDL-2024 LIBRARY; T=0.K  
resonance total cross section

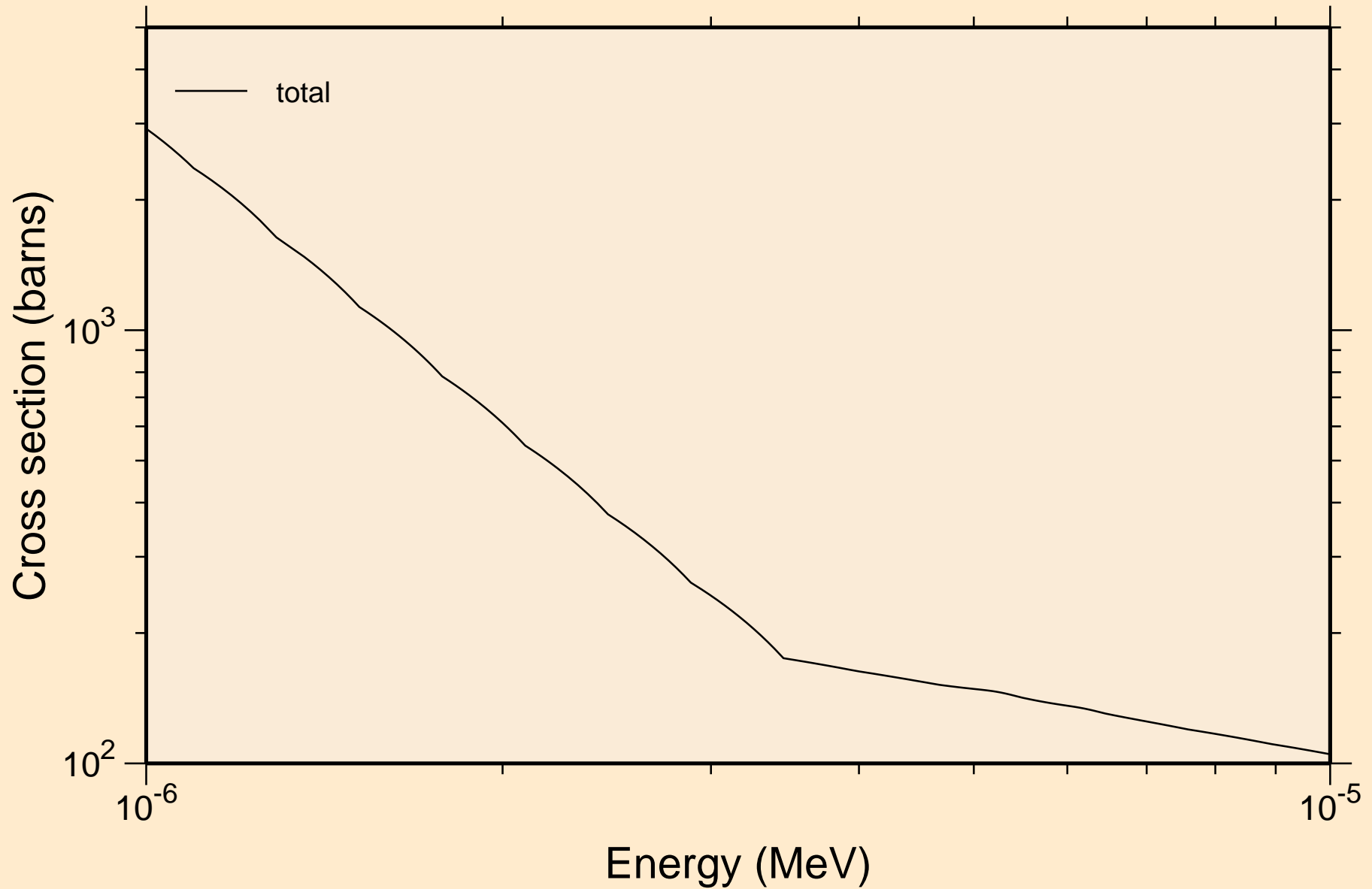

Y080M NEUTRON ACER TENDL-2024 LIBRARY; T=0.K  
resonance total cross section

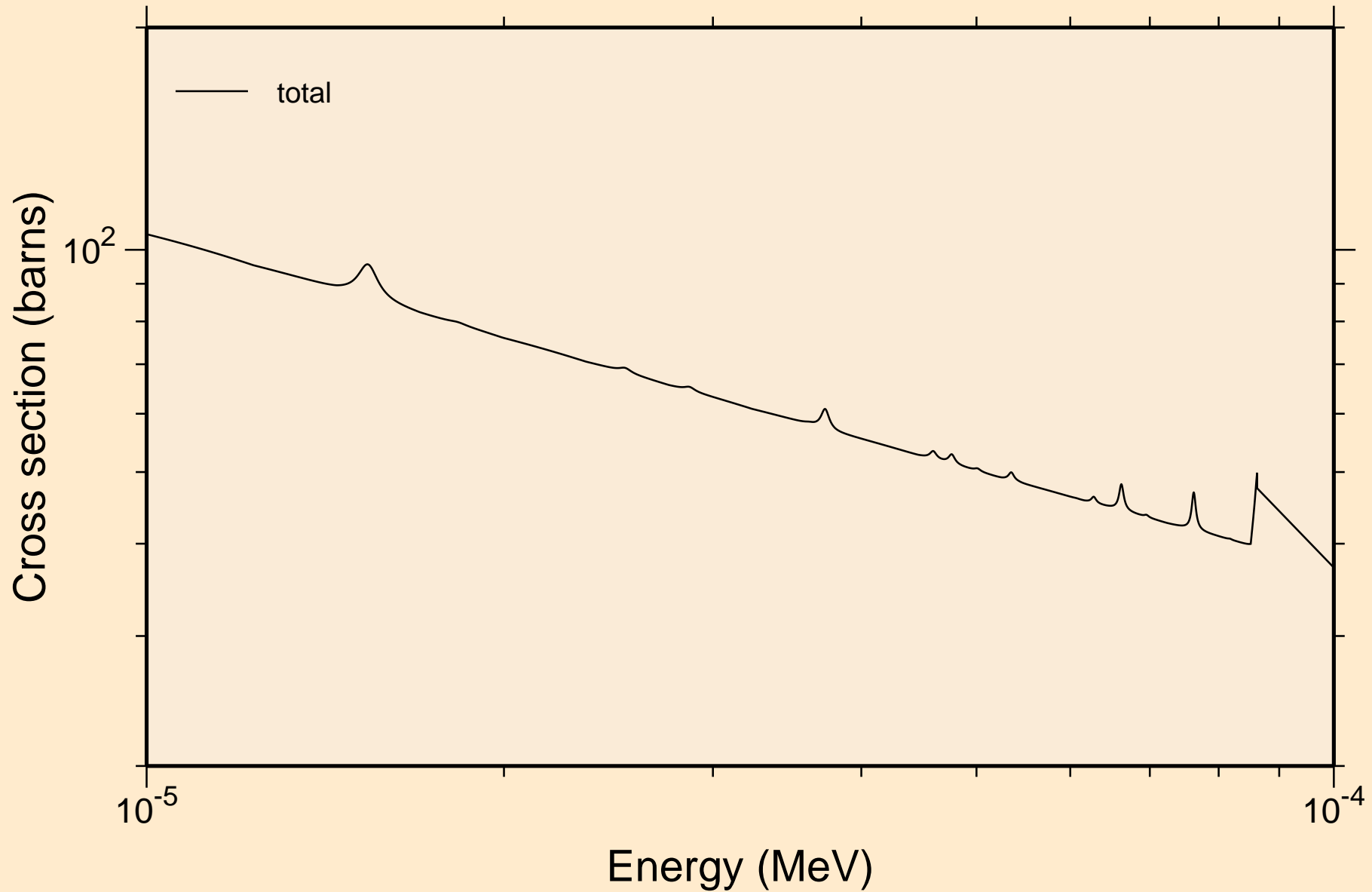

Y080M NEUTRON ACER TENDL-2024 LIBRARY; T=0.K  
resonance total cross section

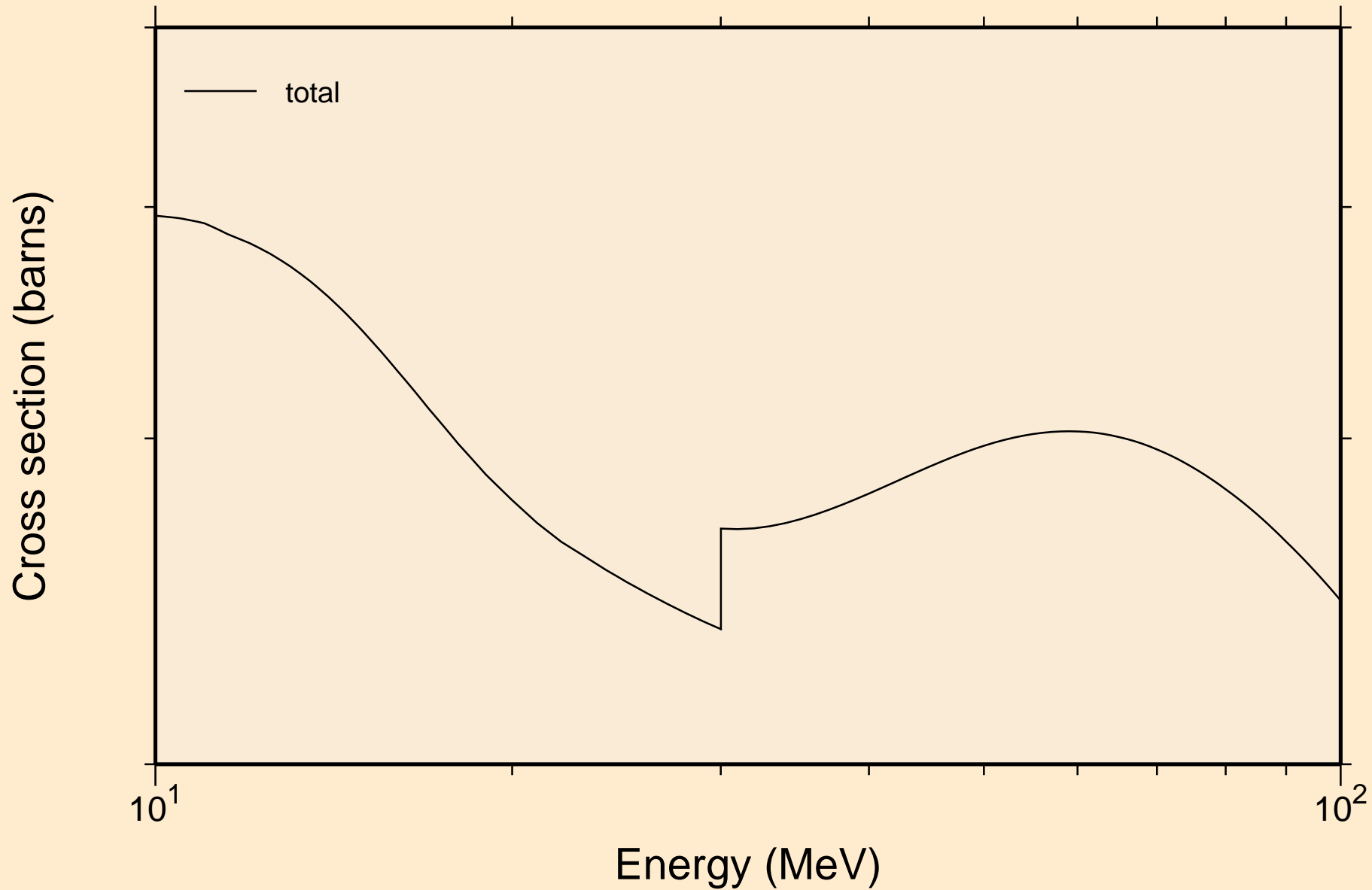

Y080M NEUTRON ACER TENDL-2024 LIBRARY; T=0.K  
resonance absorption cross sections

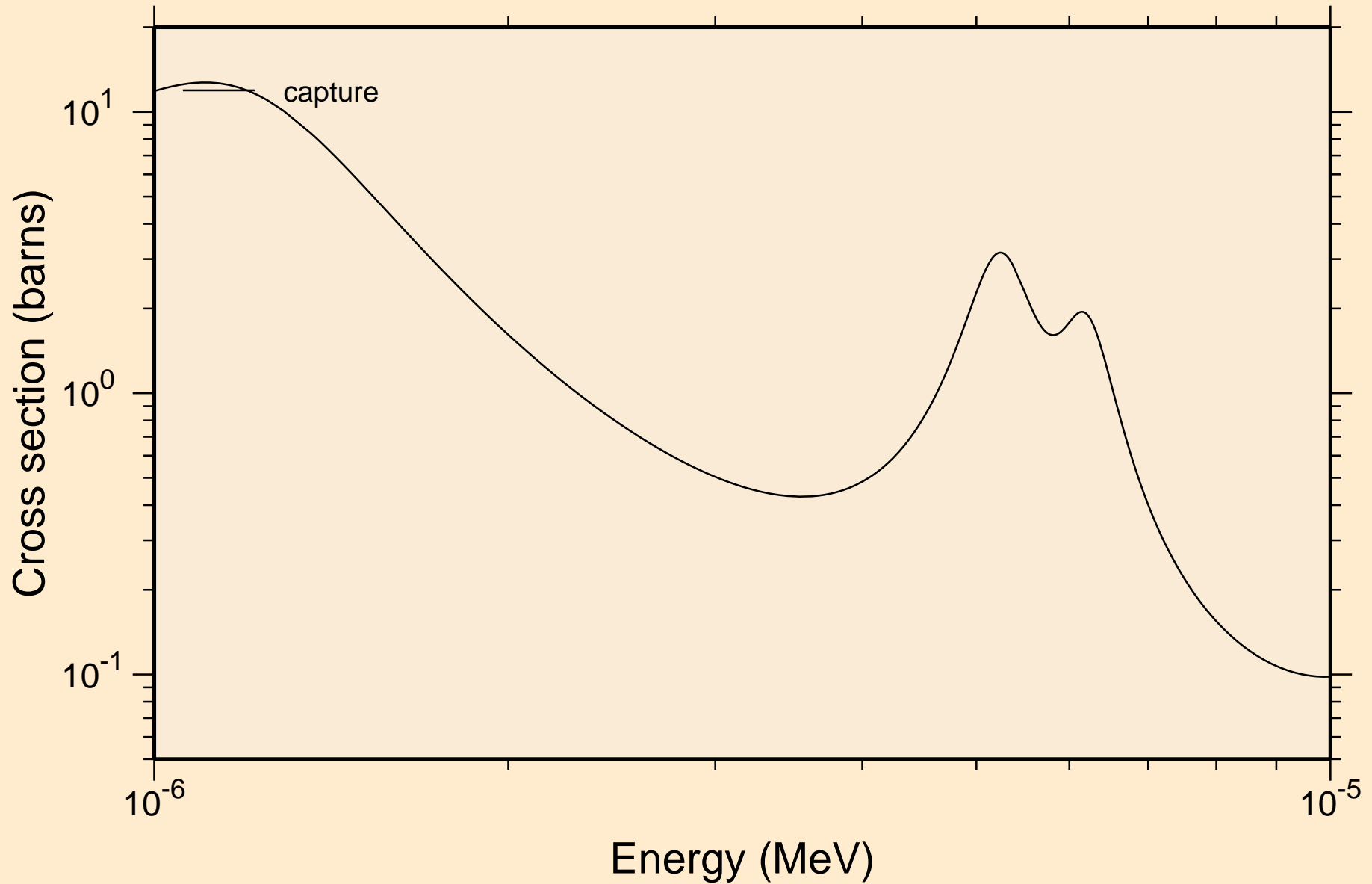

Y080M NEUTRON ACER TENDL-2024 LIBRARY; T=0.K  
resonance absorption cross sections

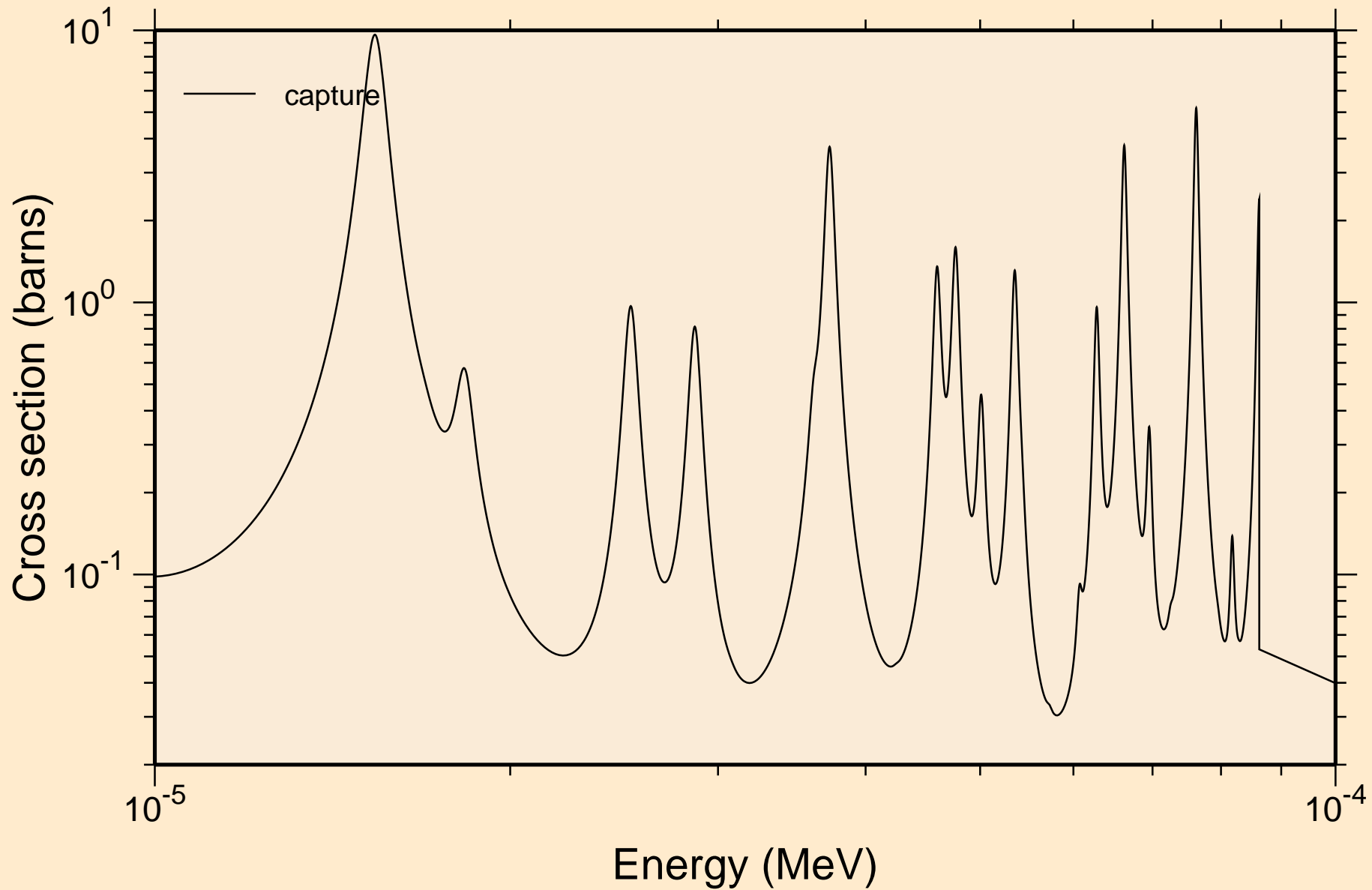

Y080M NEUTRON ACER TENDL-2024 LIBRARY; T=0.K  
resonance absorption cross sections

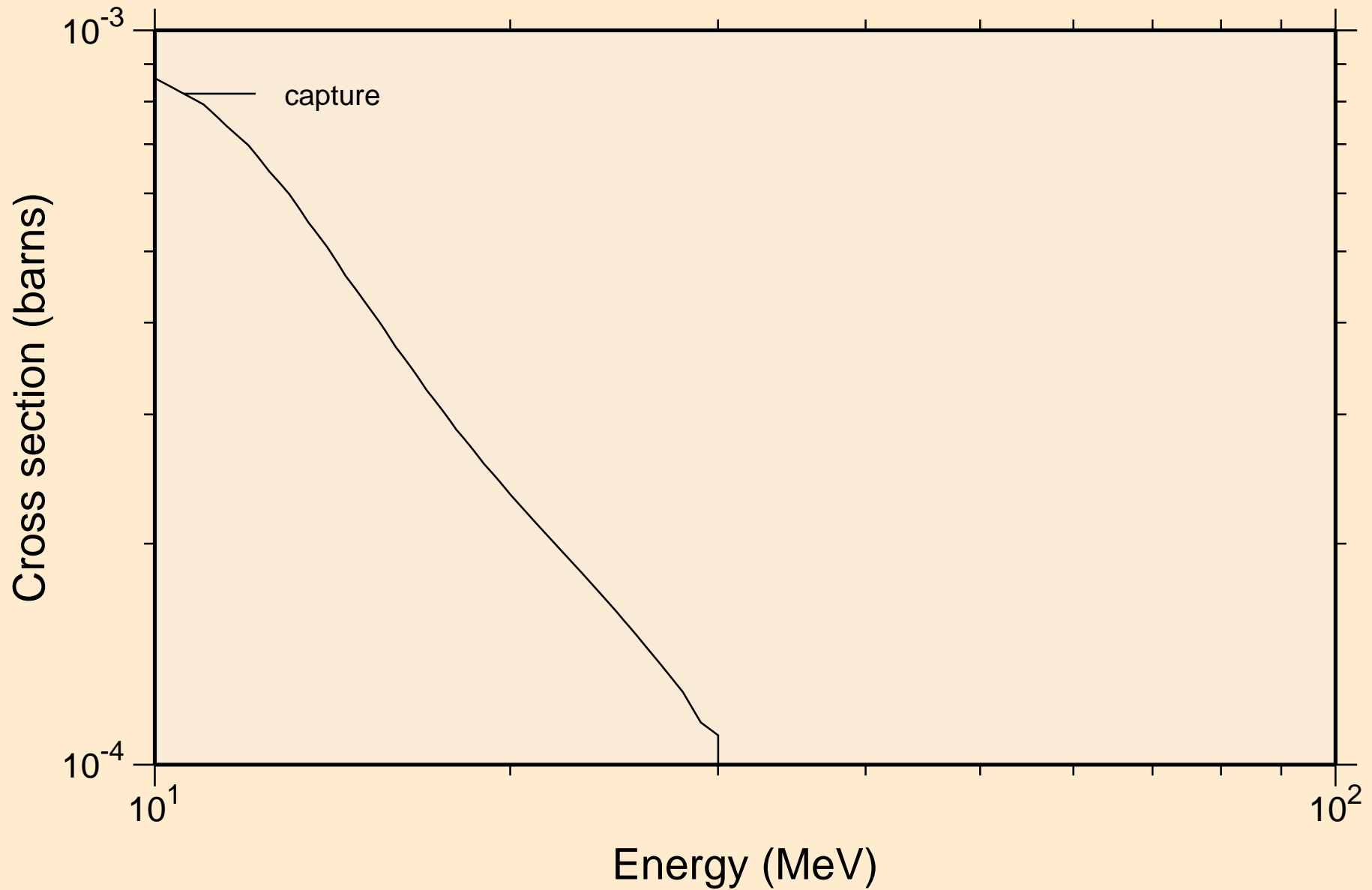

# Y080M NEUTRON ACER TENDL-2024 LIBRARY; T=0.K

## Heating

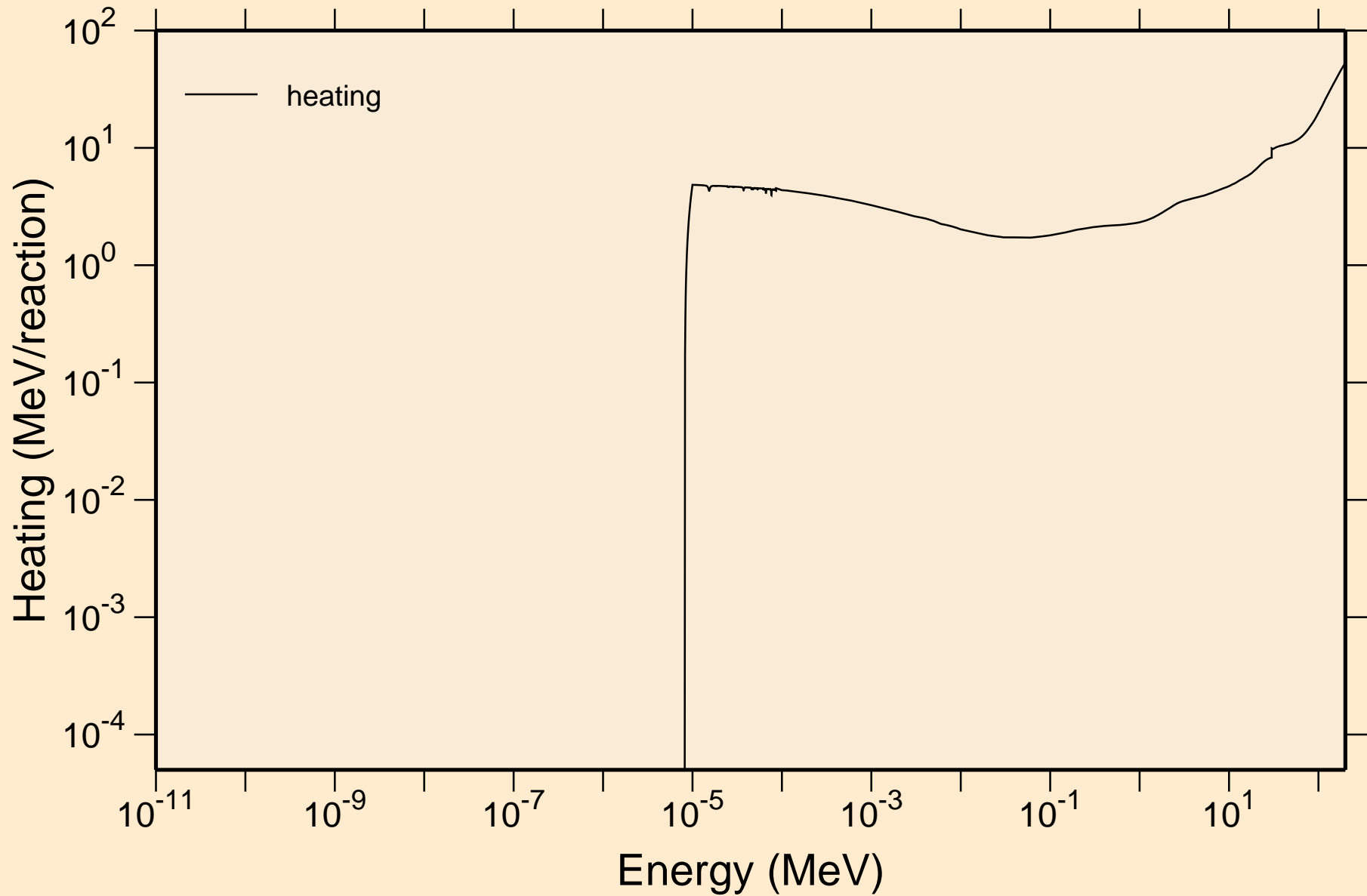



# Y080M NEUTRON ACER TENDL-2024 LIBRARY; T=0.K

## Damage

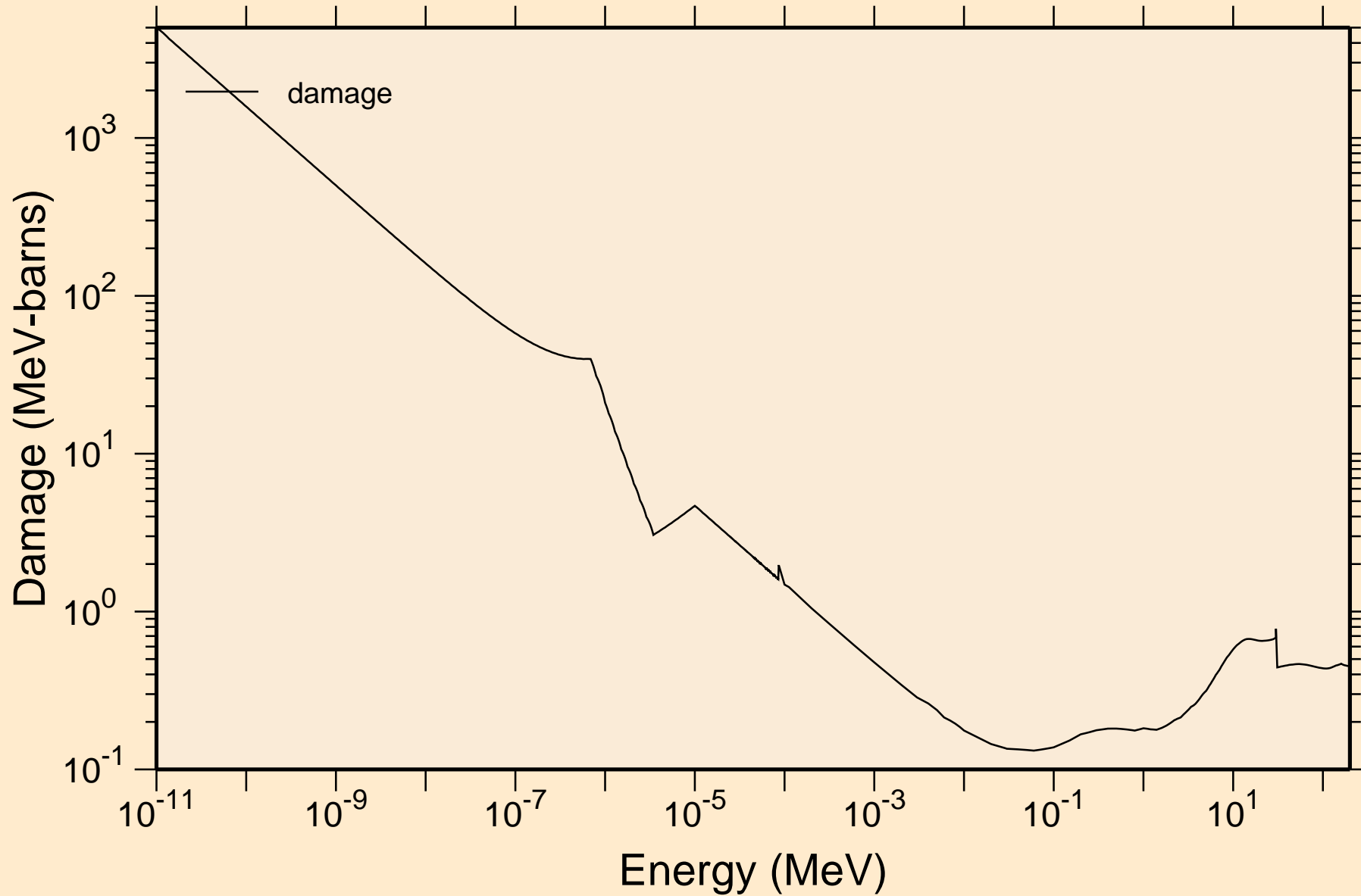

Y080M NEUTRON ACER TENDL-2024 LIBRARY; T=0.K  
Non-threshold reactions

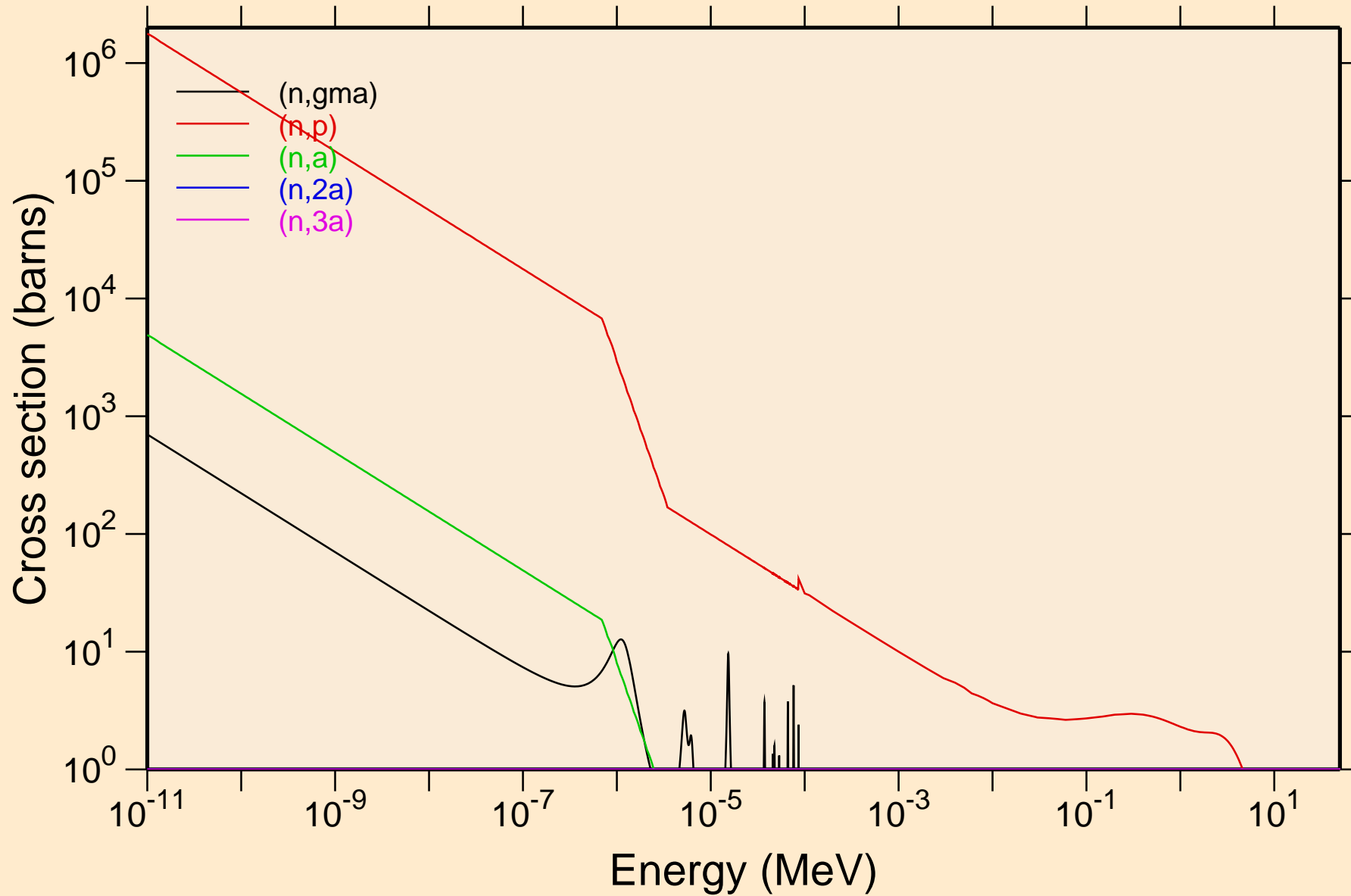

# Y080M NEUTRON ACER TENDL-2024 LIBRARY; T=0.K

## Non-threshold reactions

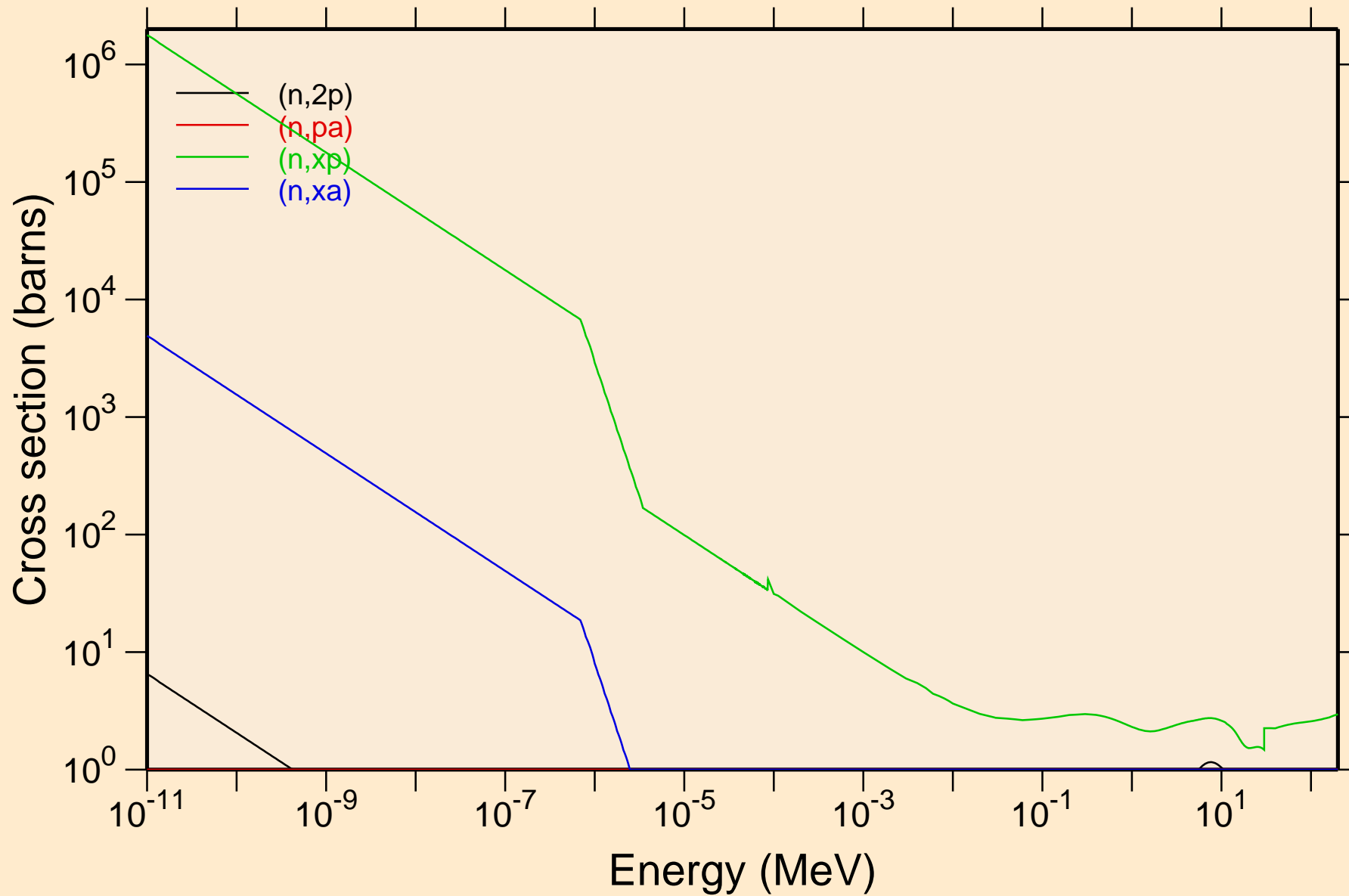

Y080M NEUTRON ACER TENDL-2024 LIBRARY; T=0.K  
Principal cross sections

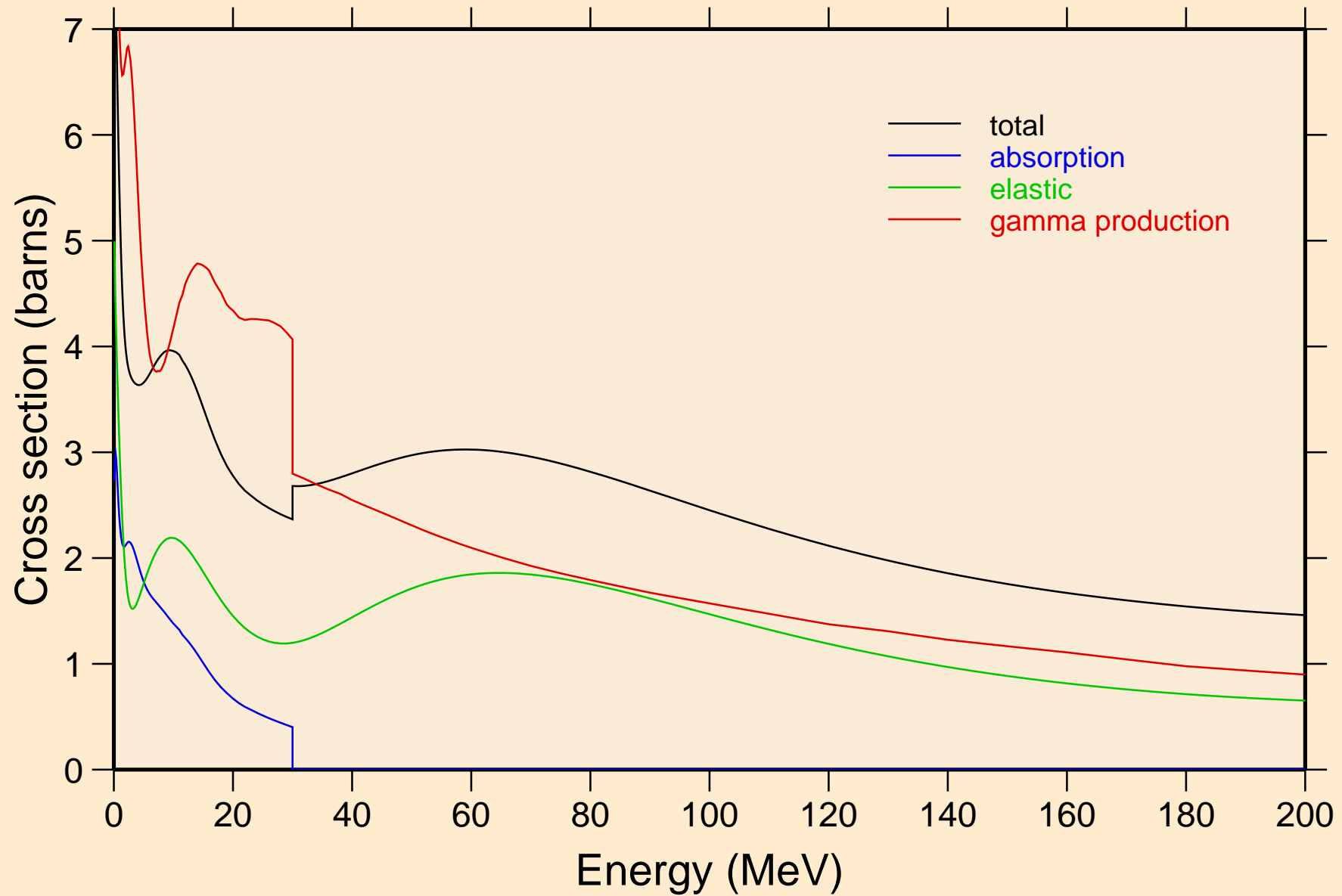

# Y080M NEUTRON ACER TENDL-2024 LIBRARY; T=0.K

## Heating

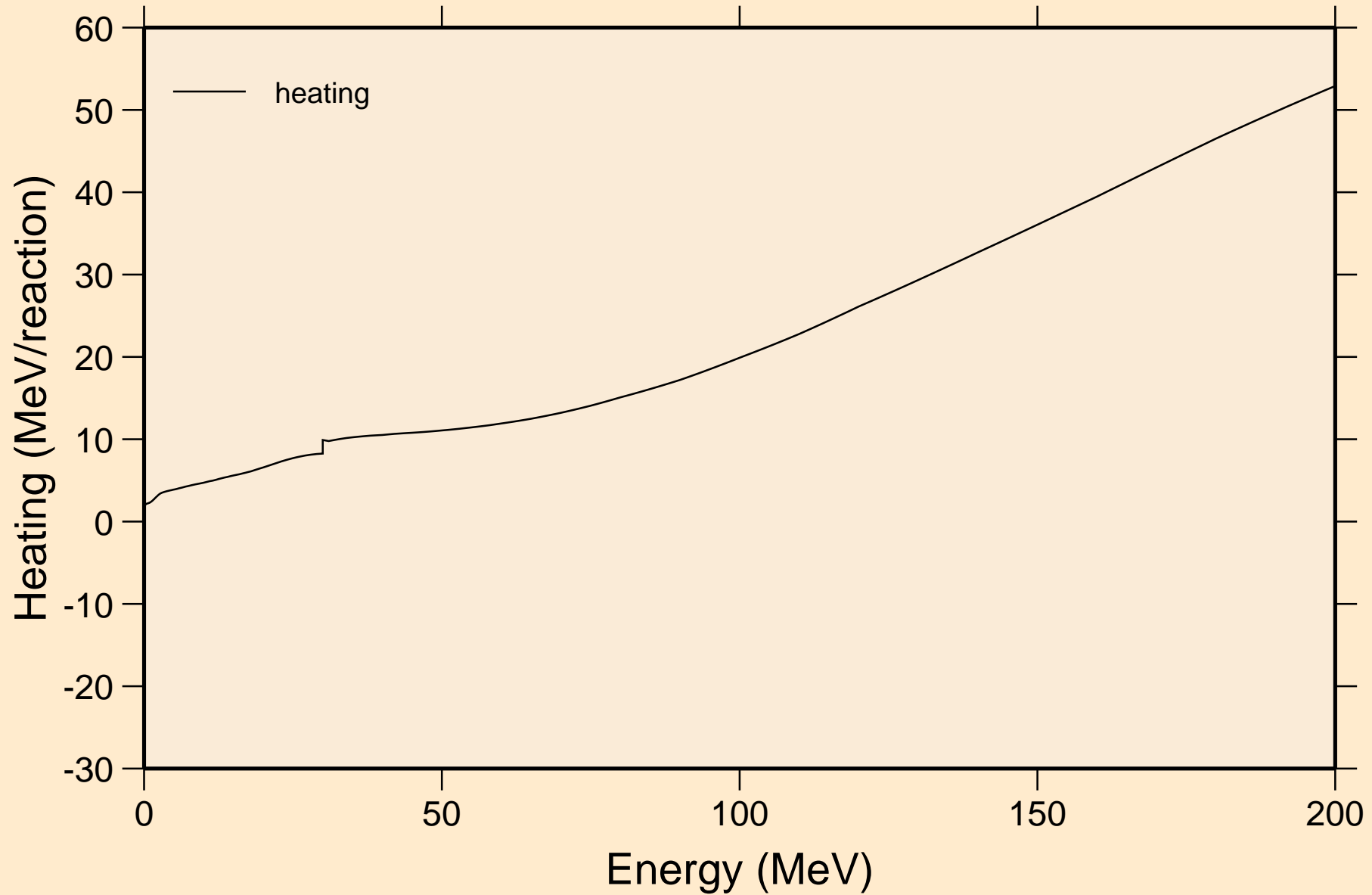

# Y080M NEUTRON ACER TENDL-2024 LIBRARY; T=0.K

## Damage

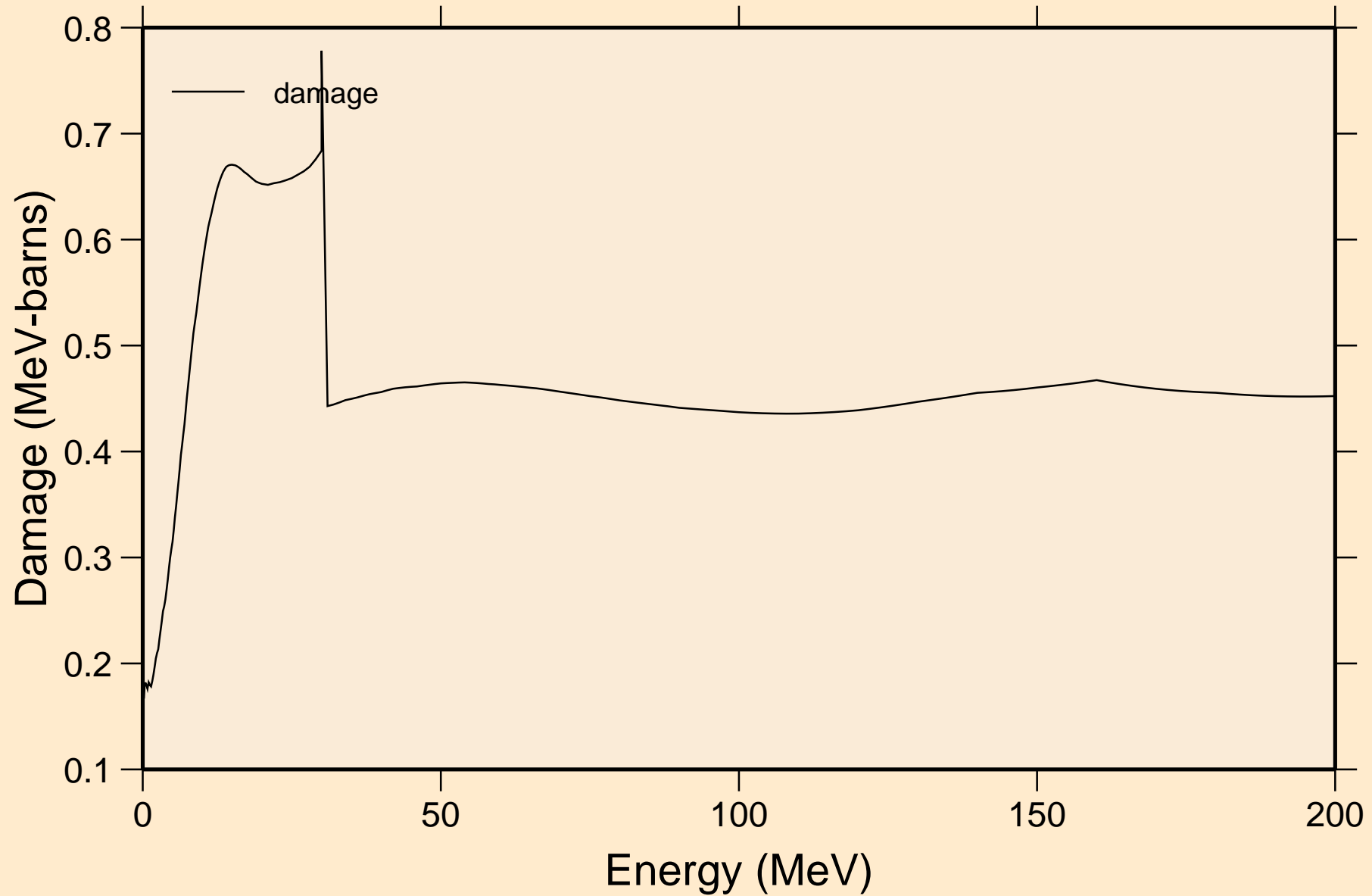

Y080M NEUTRON ACER TENDL-2024 LIBRARY; T=0.K  
Non-threshold reactions

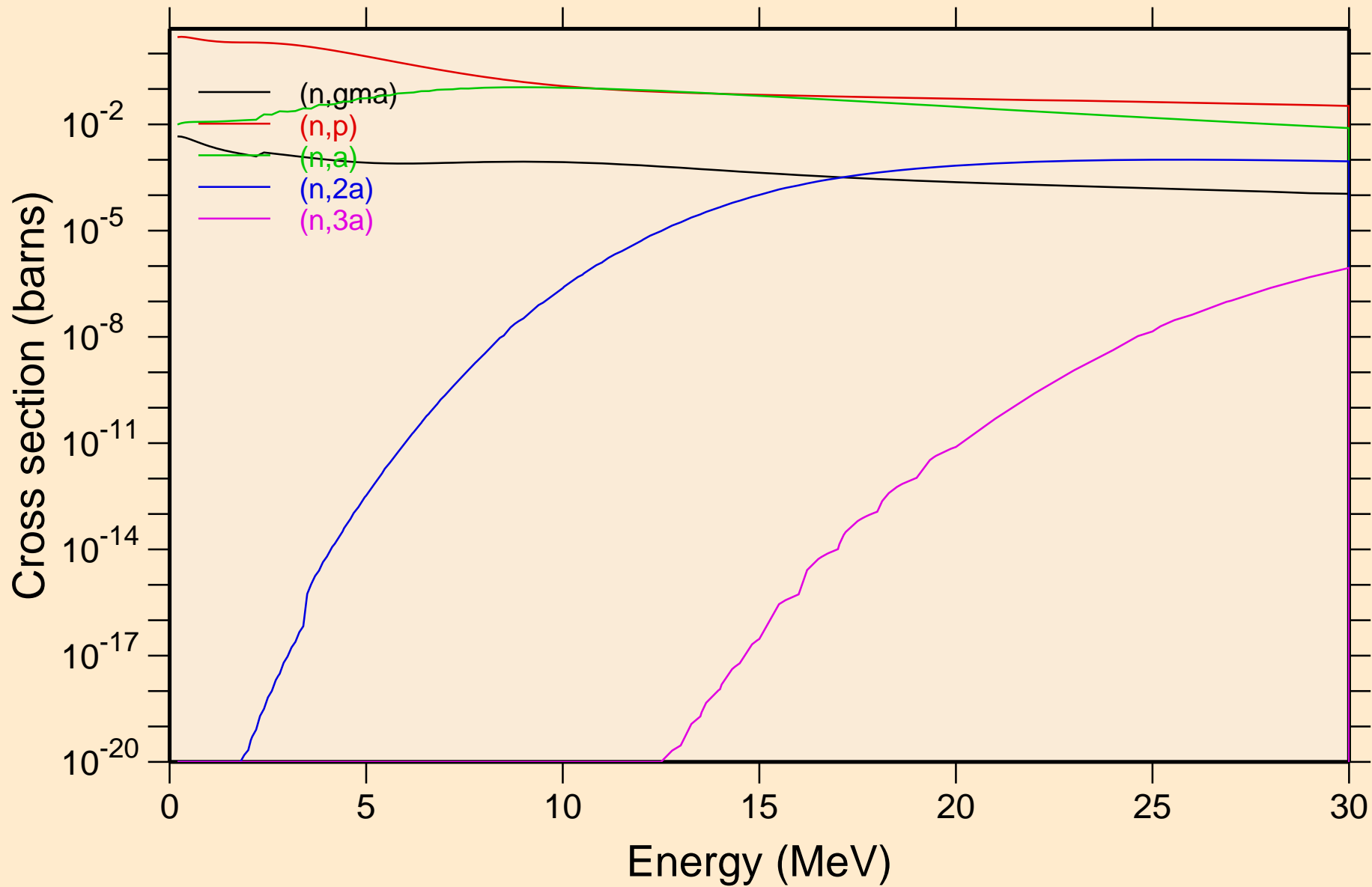

Y080M NEUTRON ACER TENDL-2024 LIBRARY; T=0.K  
Non-threshold reactions

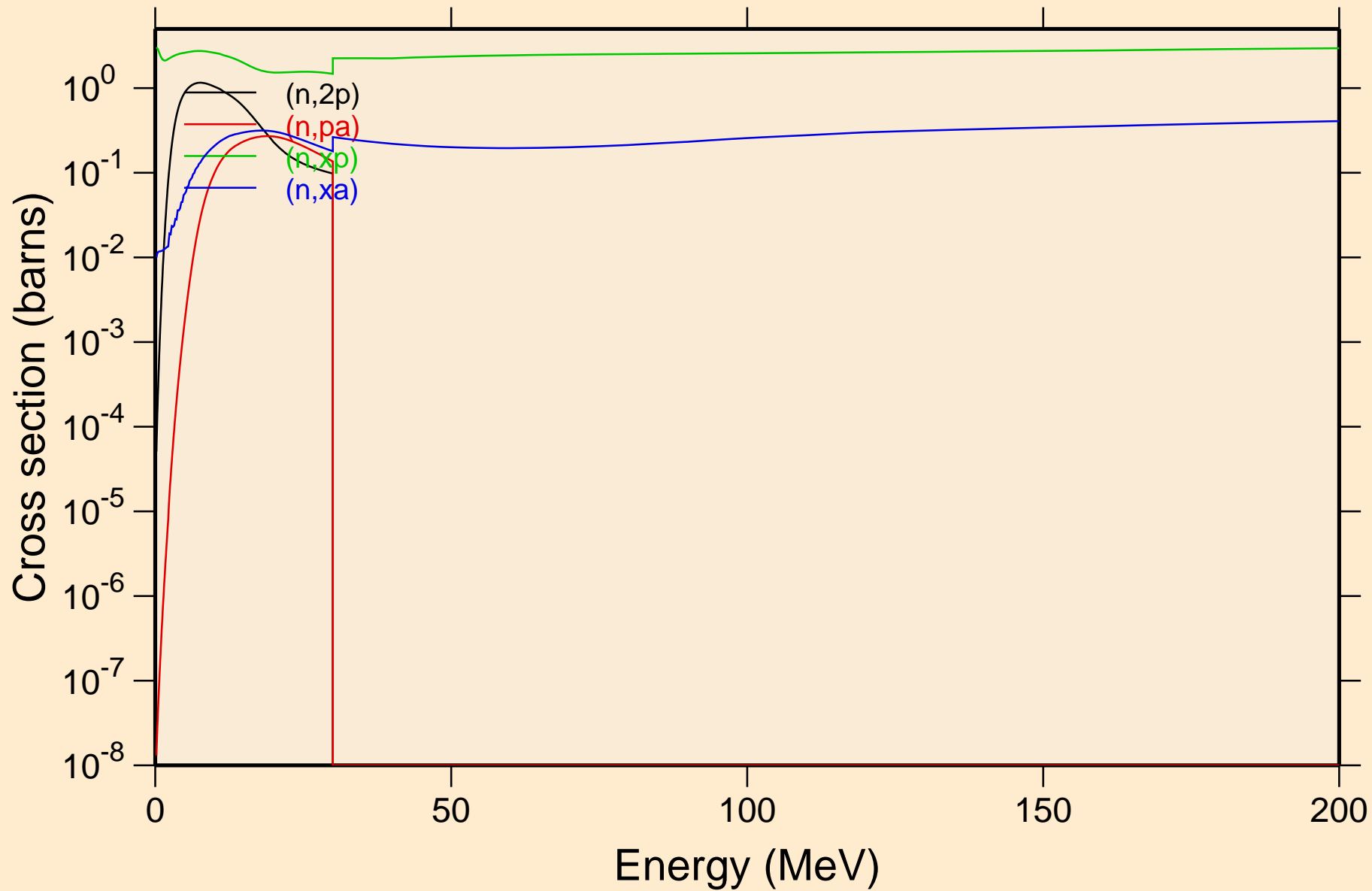



Y080M NEUTRON ACER TENDL-2024 LIBRARY; T=0.K  
Inelastic levels

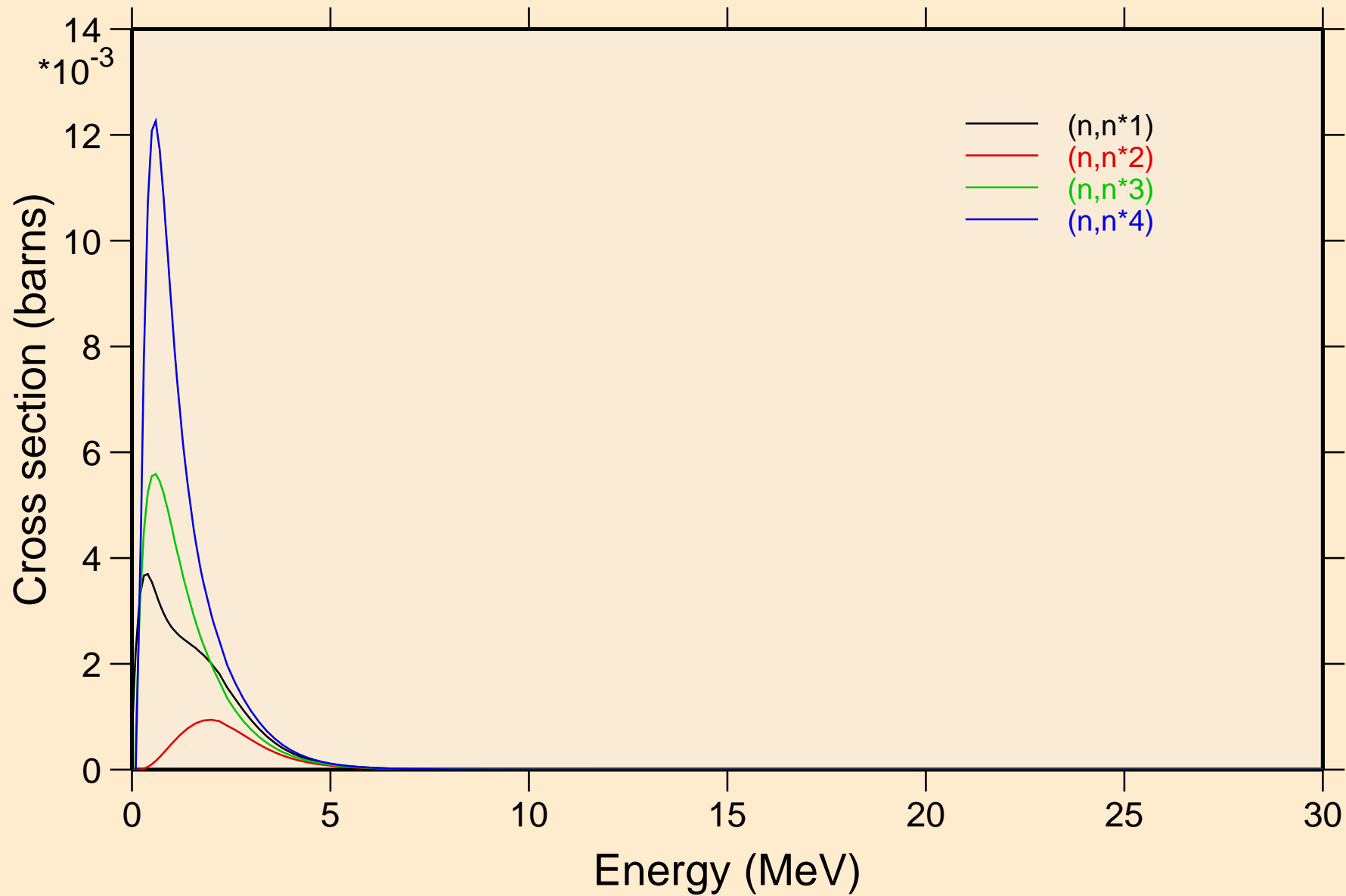

# Y080M NEUTRON ACER TENDL-2024 LIBRARY; T=0.K

## Threshold reactions

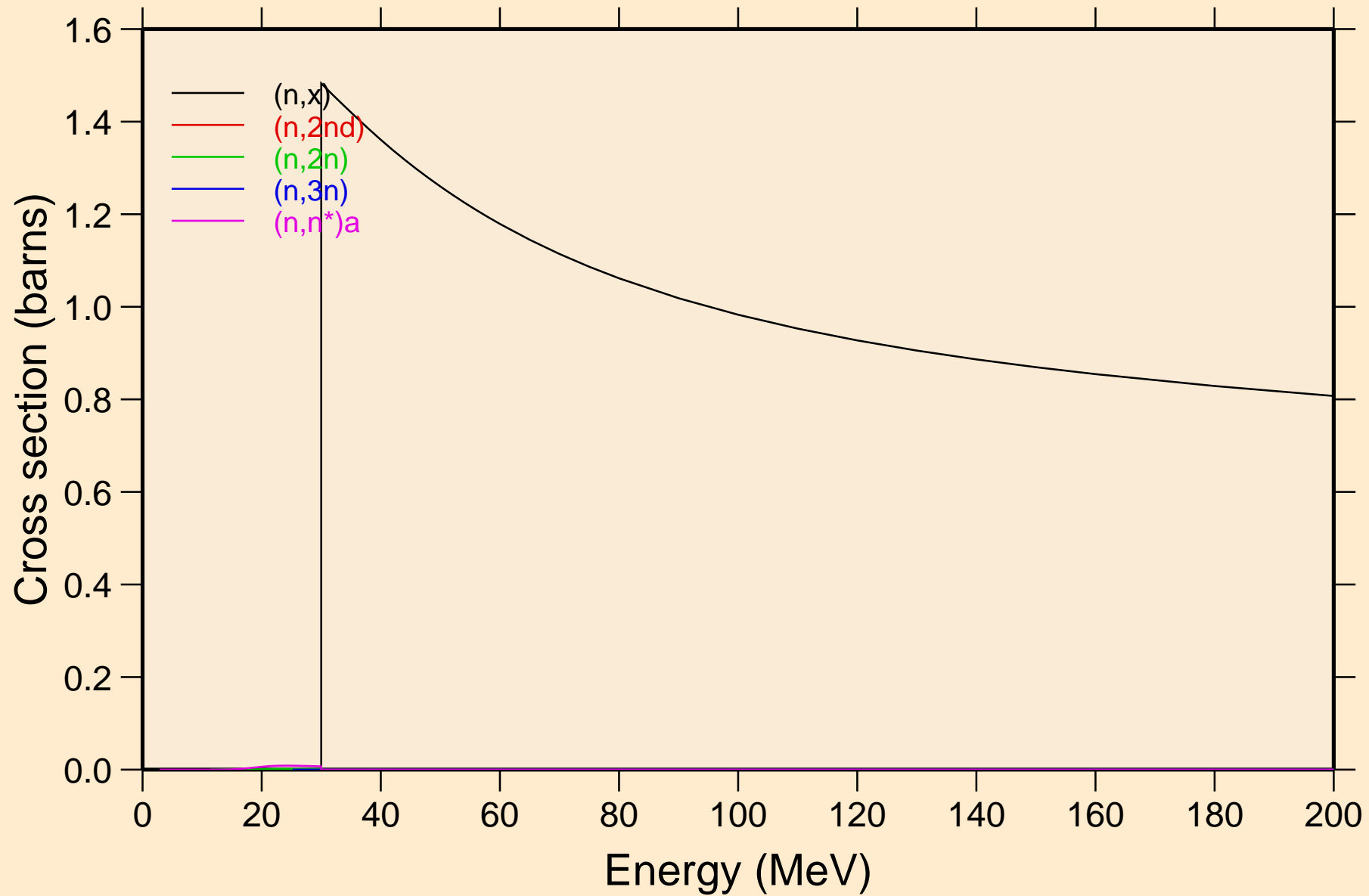

Y080M NEUTRON ACER TENDL-2024 LIBRARY; T=0.K  
Threshold reactions

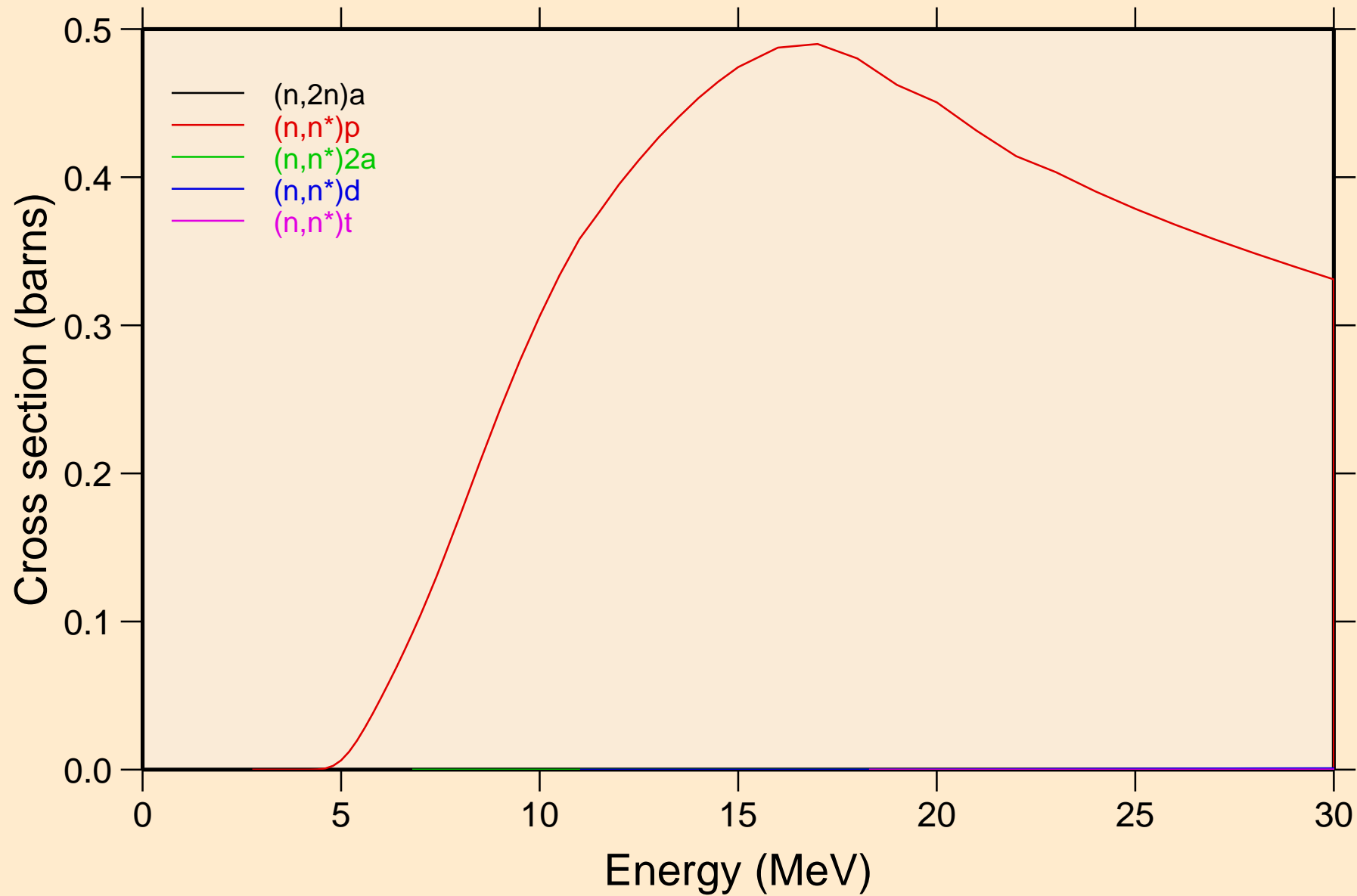

Y080M NEUTRON ACER TENDL-2024 LIBRARY; T=0.K  
Threshold reactions

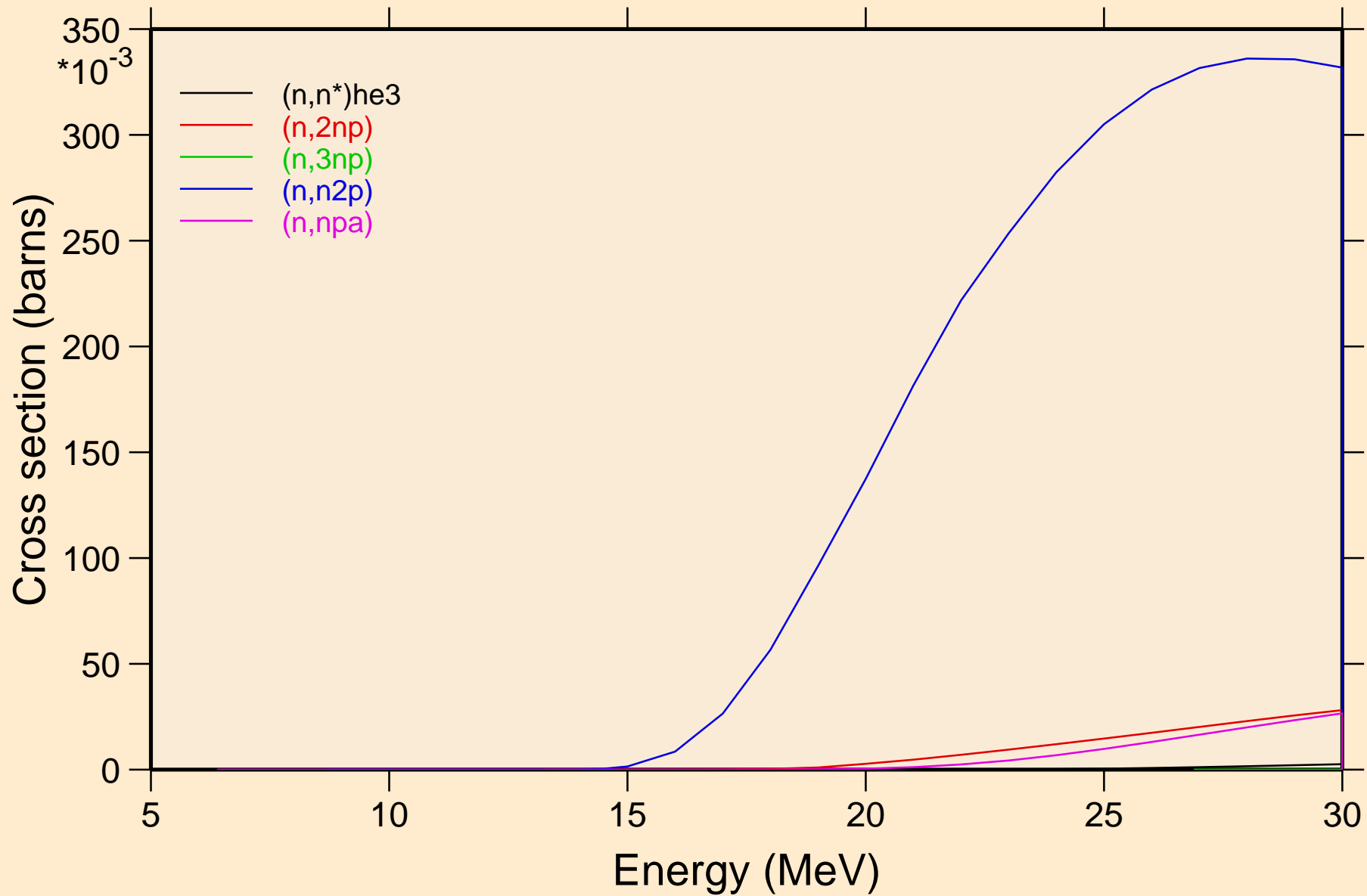

Y080M NEUTRON ACER TENDL-2024 LIBRARY; T=0.K  
Threshold reactions

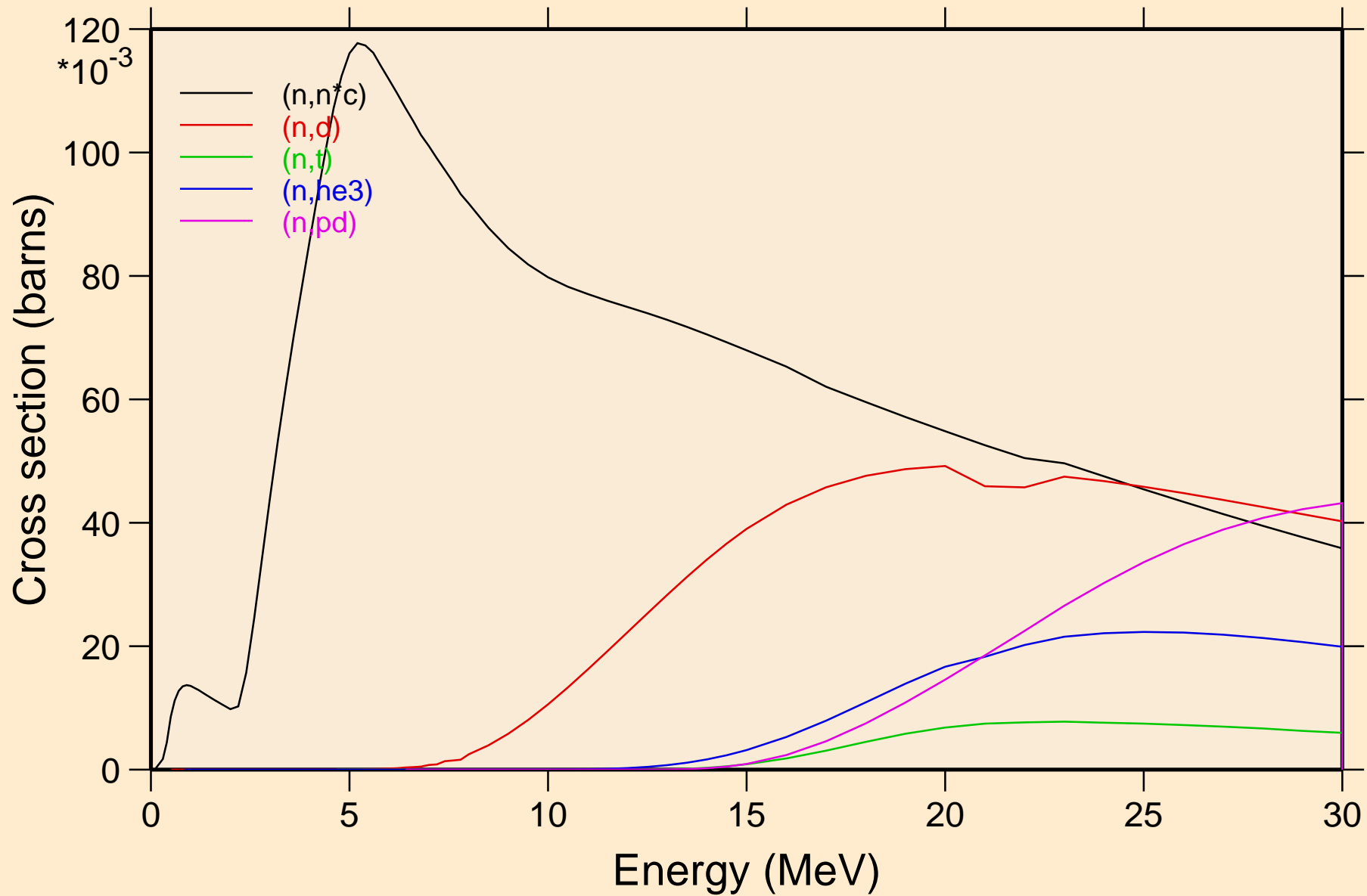

Y080M NEUTRON ACER TENDL-2024 LIBRARY; T=0.K  
Threshold reactions

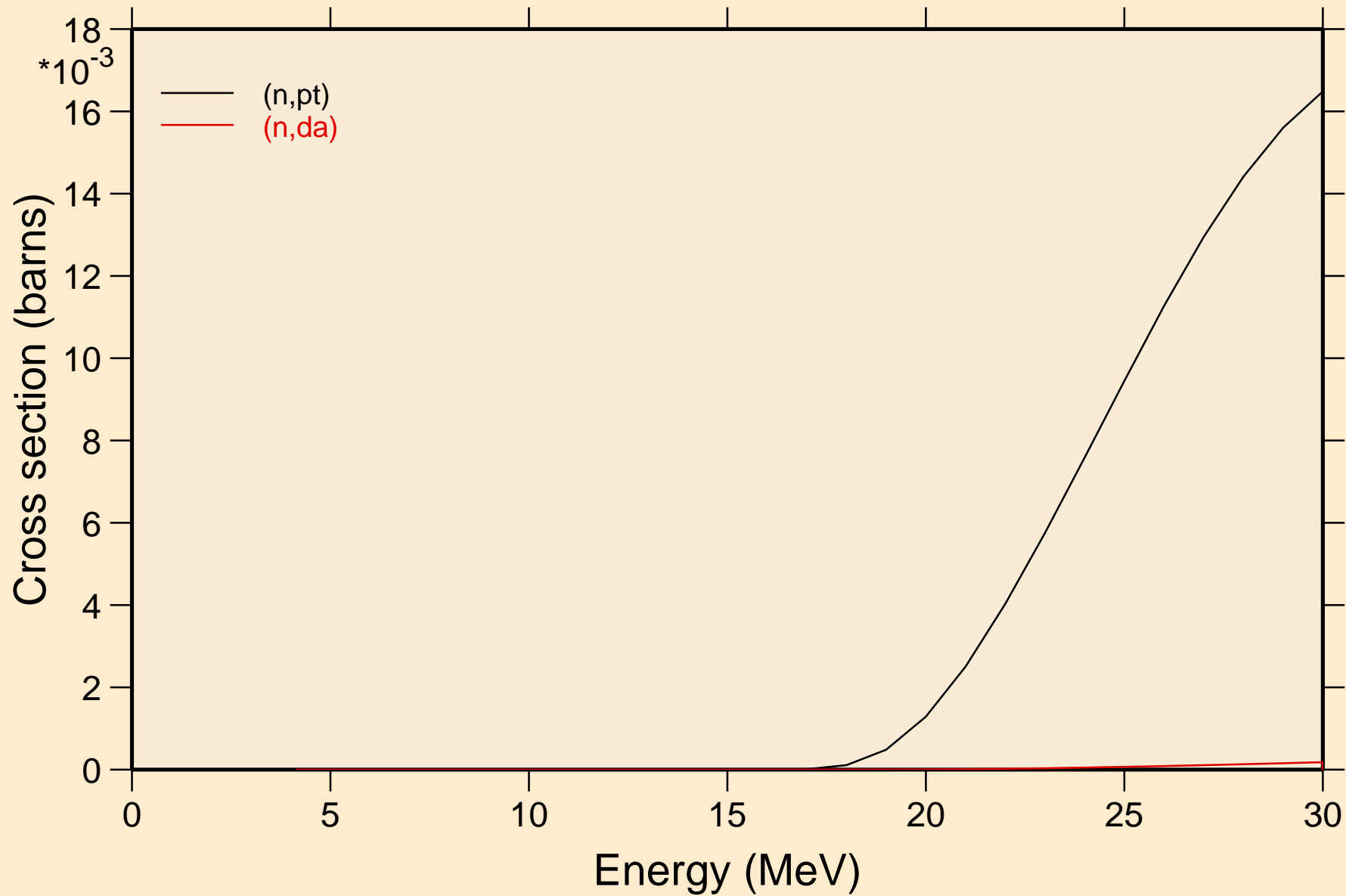

# Y080M NEUTRON ACER TENDL-2024 LIBRARY; T=0.K

## Threshold reactions

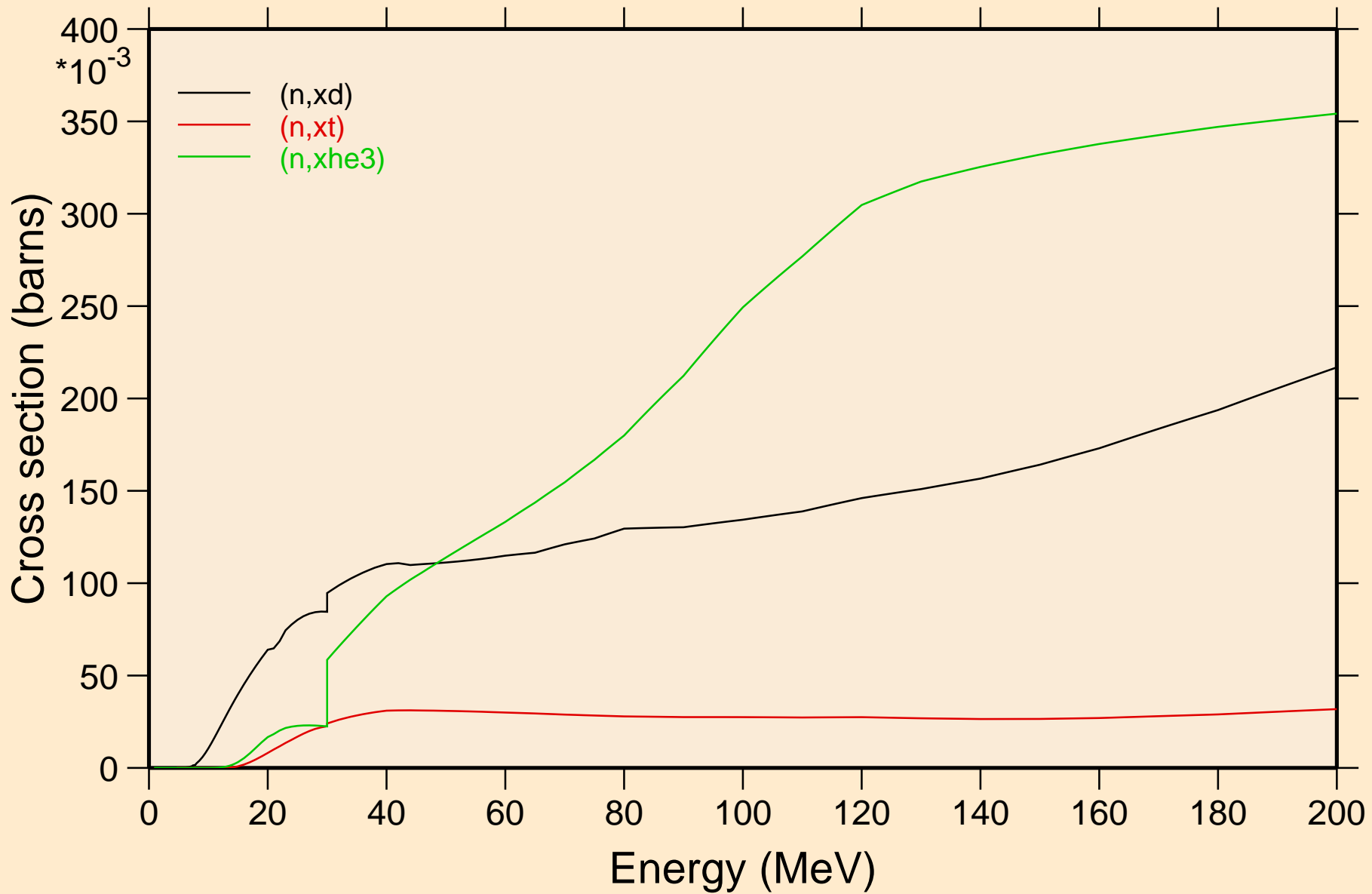

Y080M NEUTRON ACER TENDL-2024 LIBRARY; T=0.K  
angular distribution for elastic

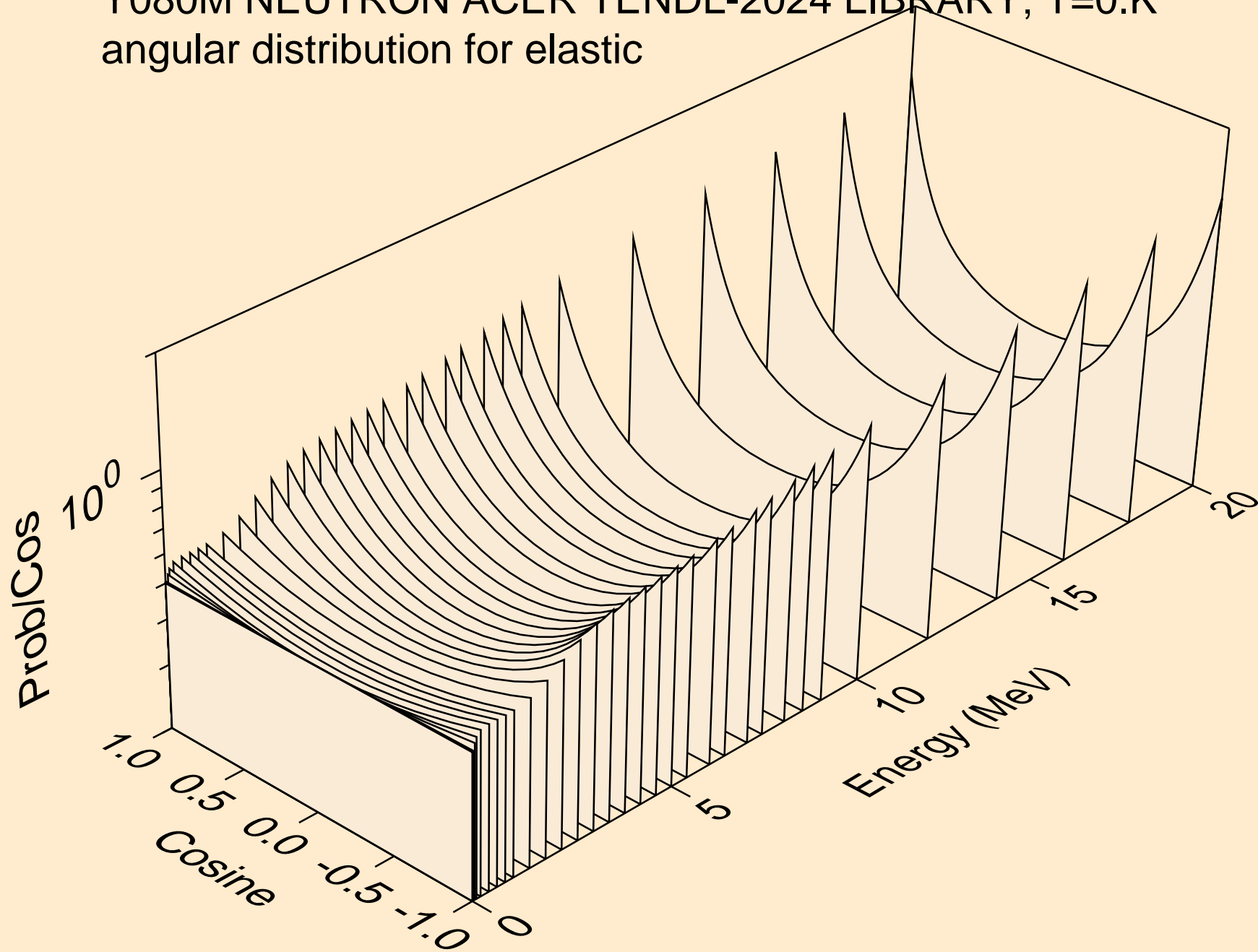



Y080M NEUTRON ACER TENDL-2024 LIBRARY; T=0.K  
angular distribution for elastic

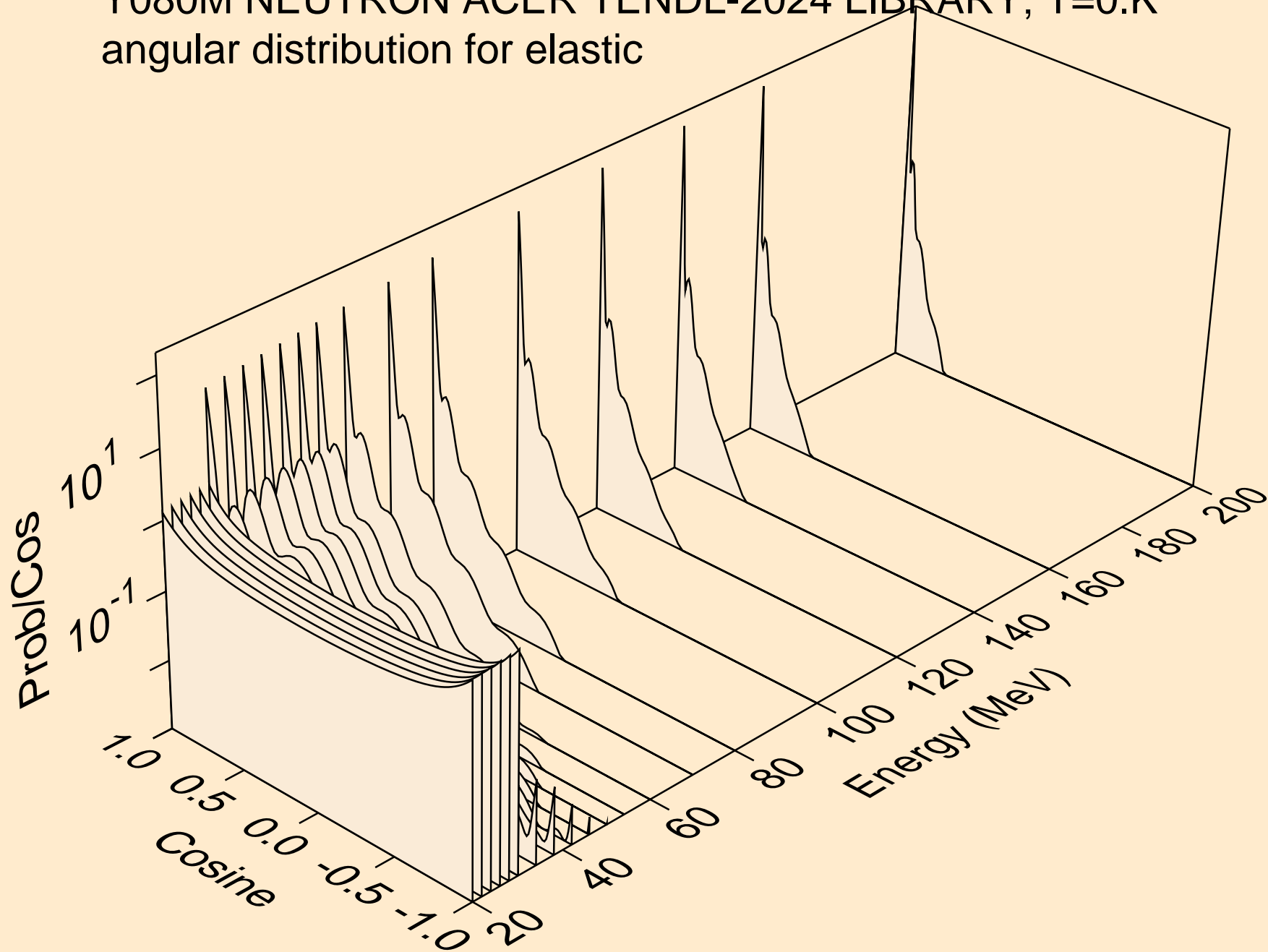

Y080M NEUTRON ACER TENDL-2024 LIBRARY; T=0.K  
angular distribution for (n,n\*1)

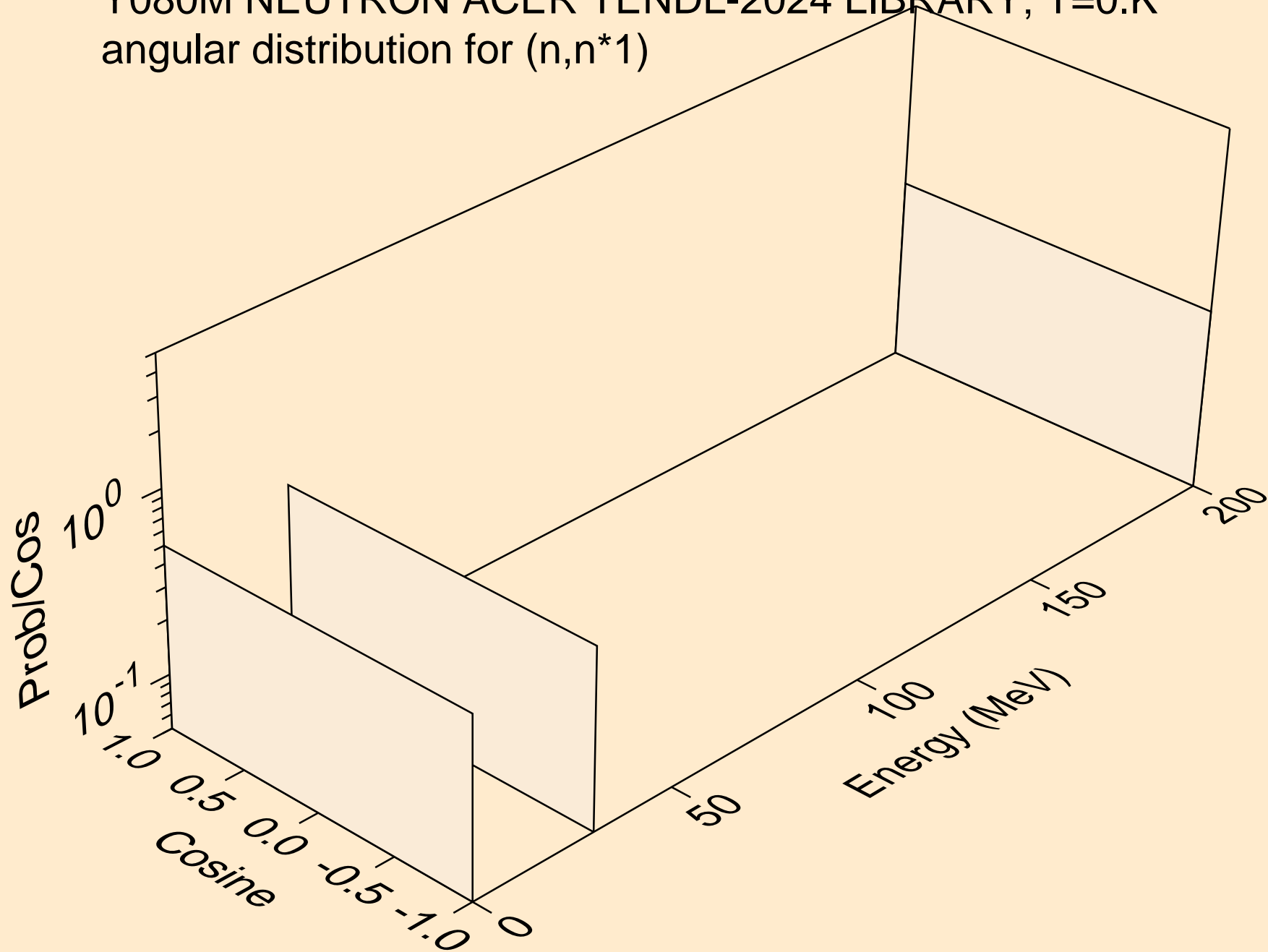

Y080M NEUTRON ACER TENDL-2024 LIBRARY; T=0.K  
angular distribution for (n,n\*2)

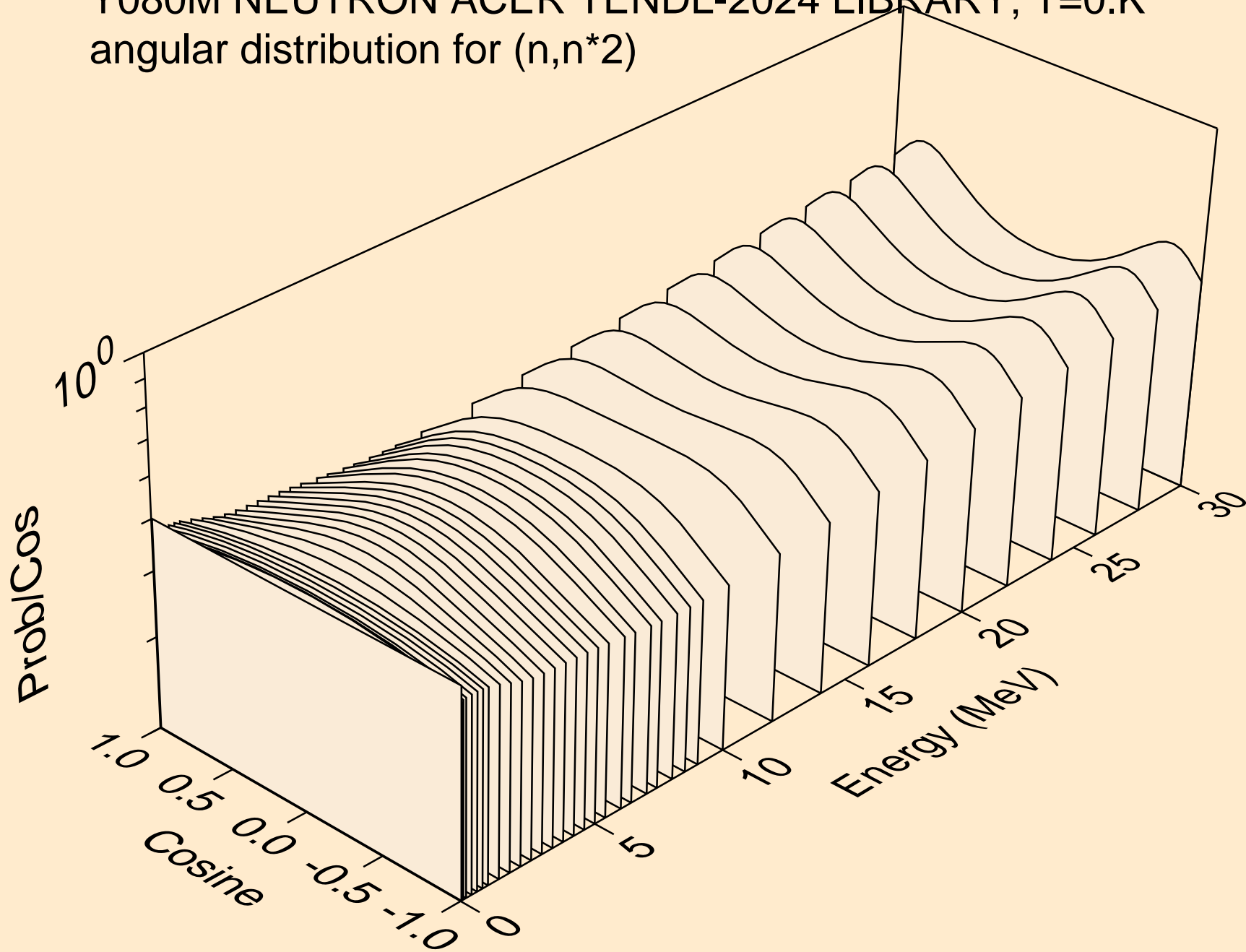

Y080M NEUTRON ACER TENDL-2024 LIBRARY; T=0.K  
angular distribution for (n,n\*3)

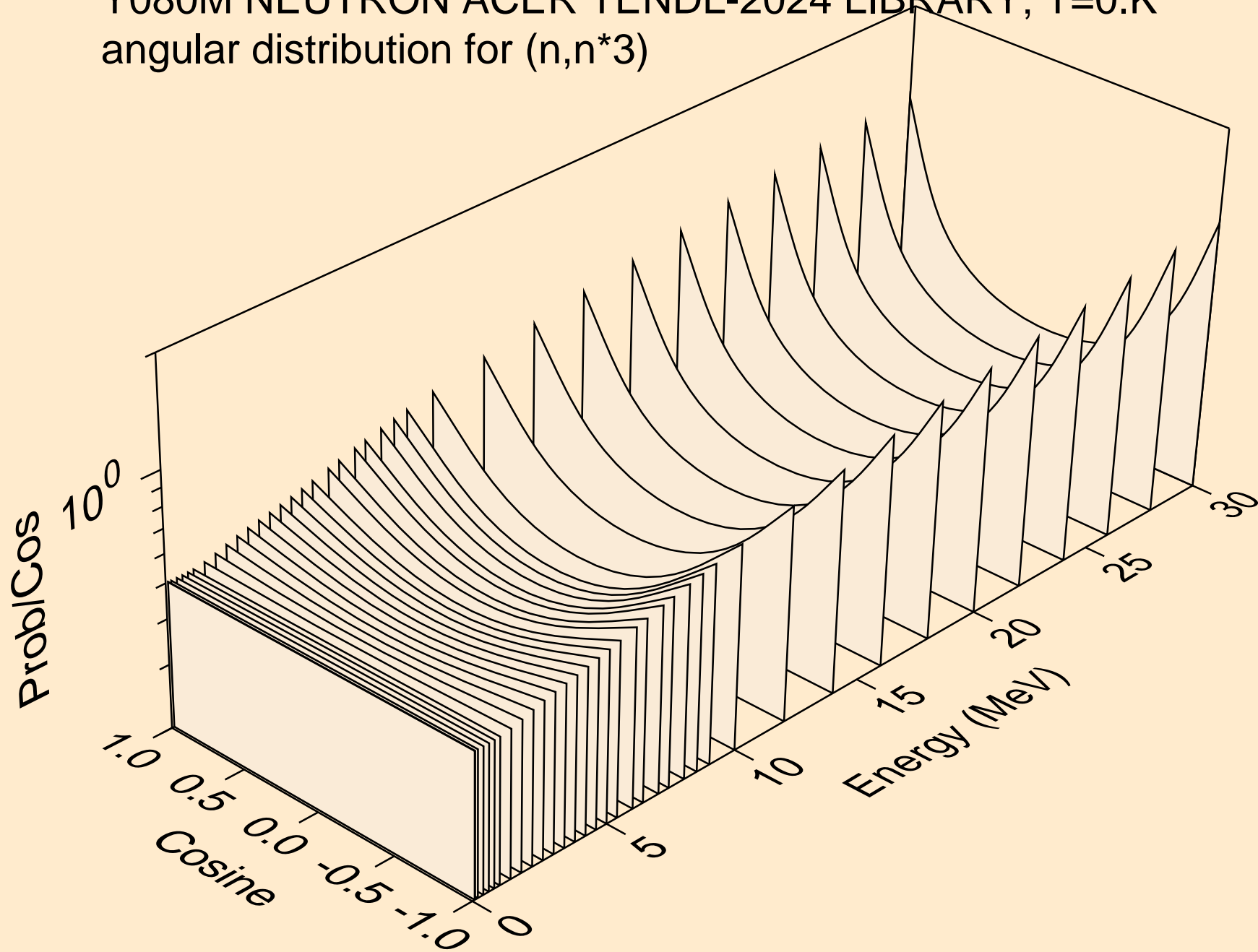

Y080M NEUTRON ACER TENDL-2024 LIBRARY; T=0.K  
angular distribution for (n,n\*4)

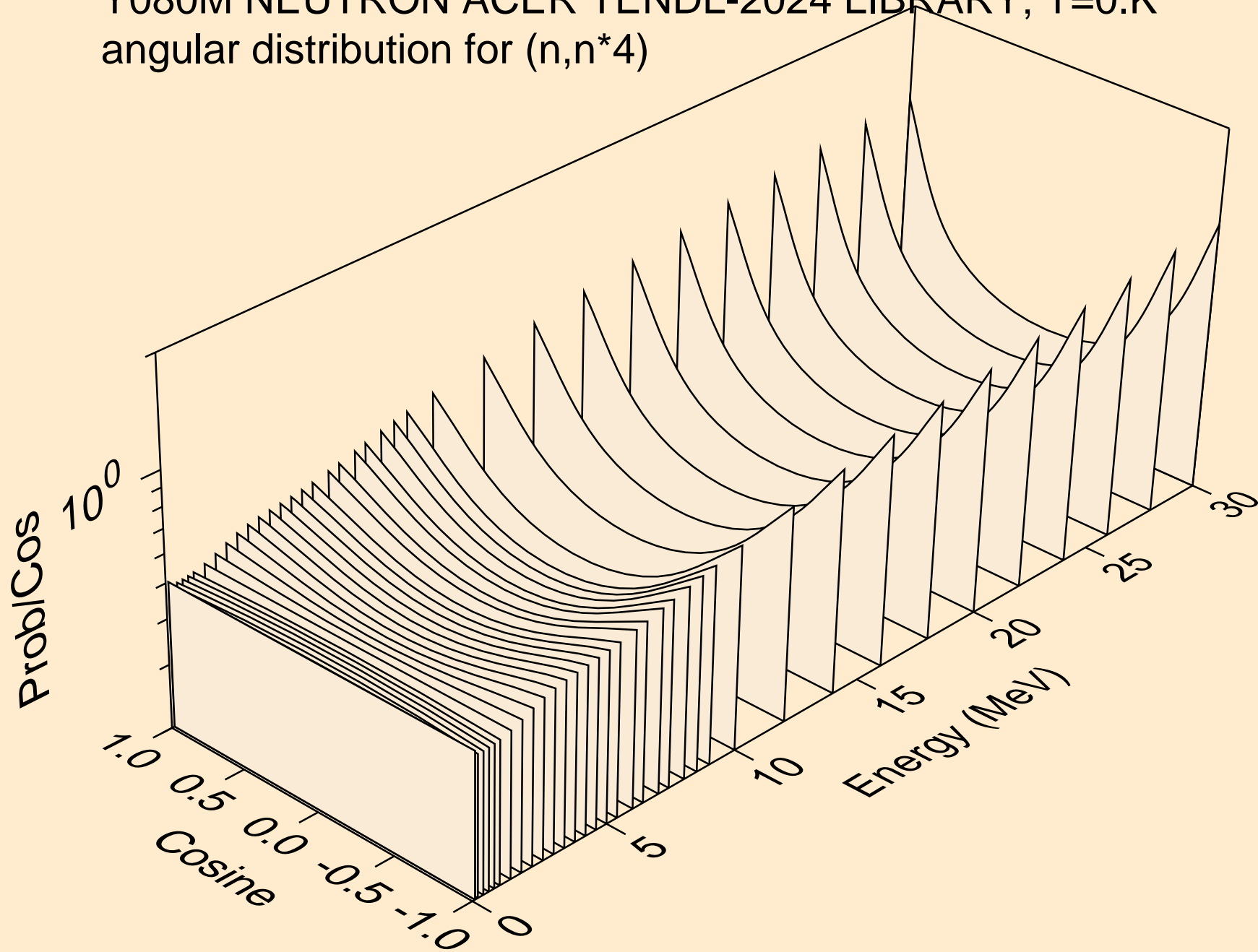

Y080M NEUTRON ACER TENDL-2024 LIBRARY; T=0.K  
Neutron emission for (n,x)

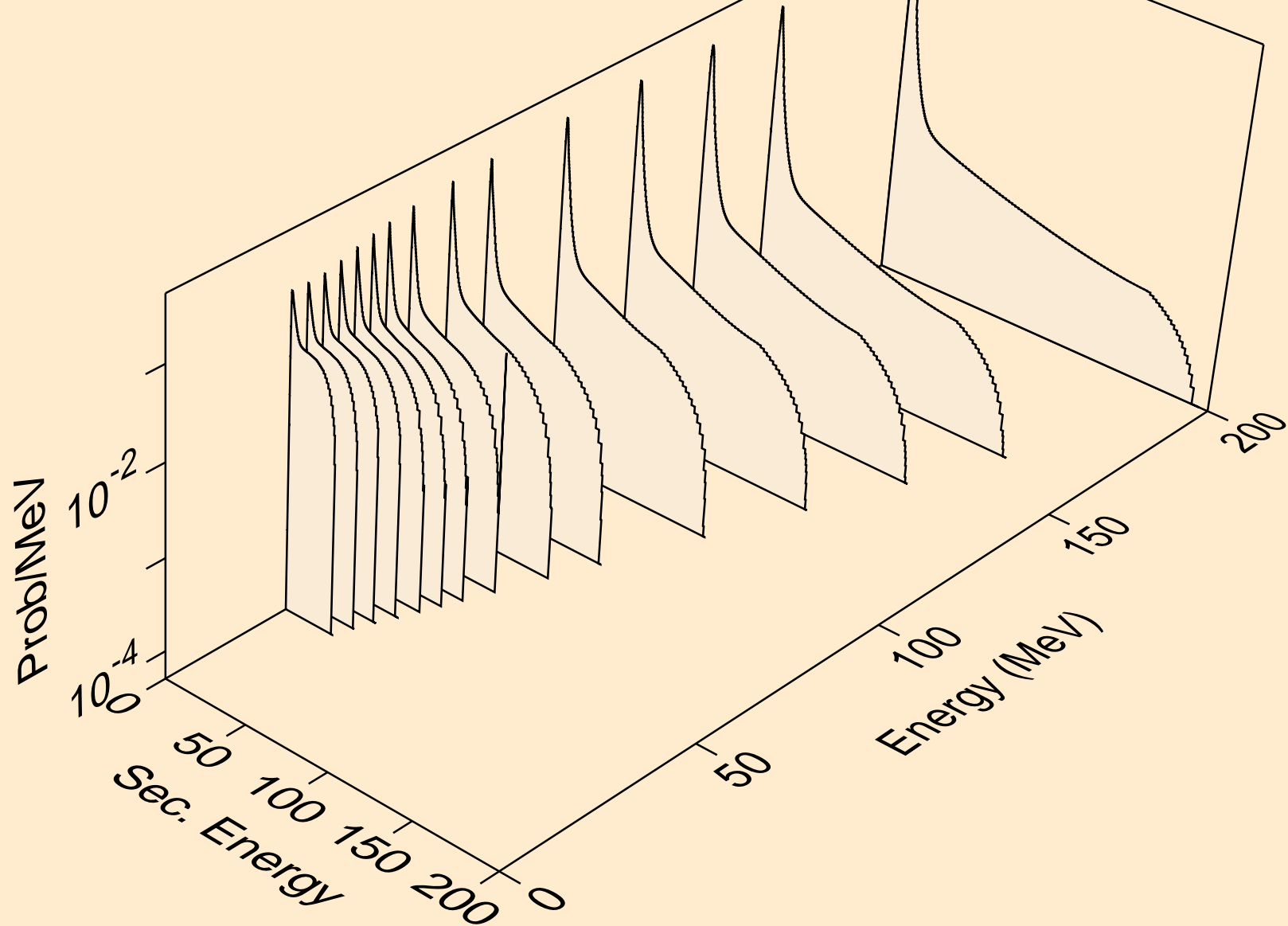

Y080M NEUTRON ACER TENDL-2024 LIBRARY; T=0.K  
Neutron emission for (n,2nd)

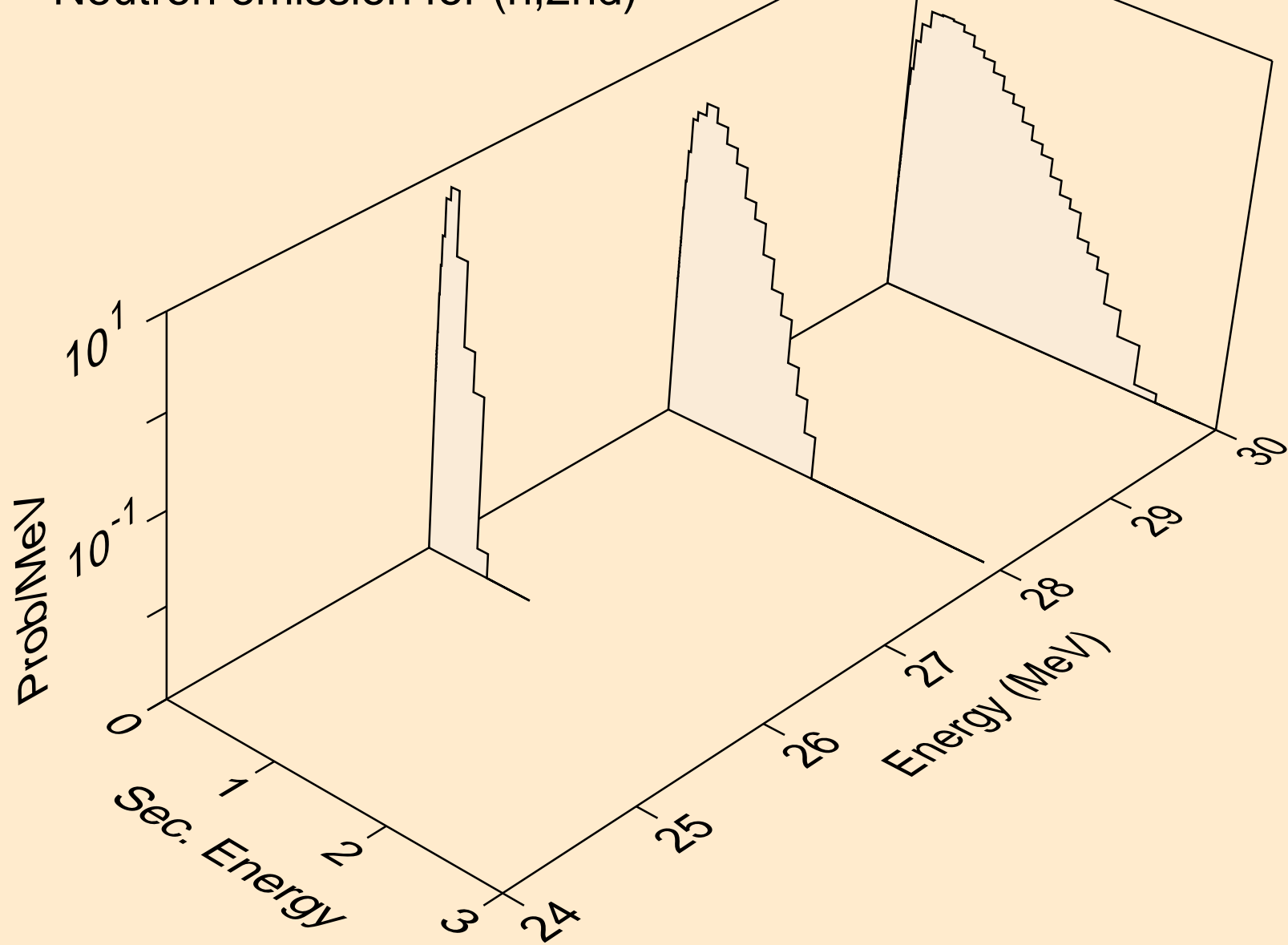

Y080M NEUTRON ACER TENDL-2024 LIBRARY; T=0.K  
Neutron emission for (n,2n)

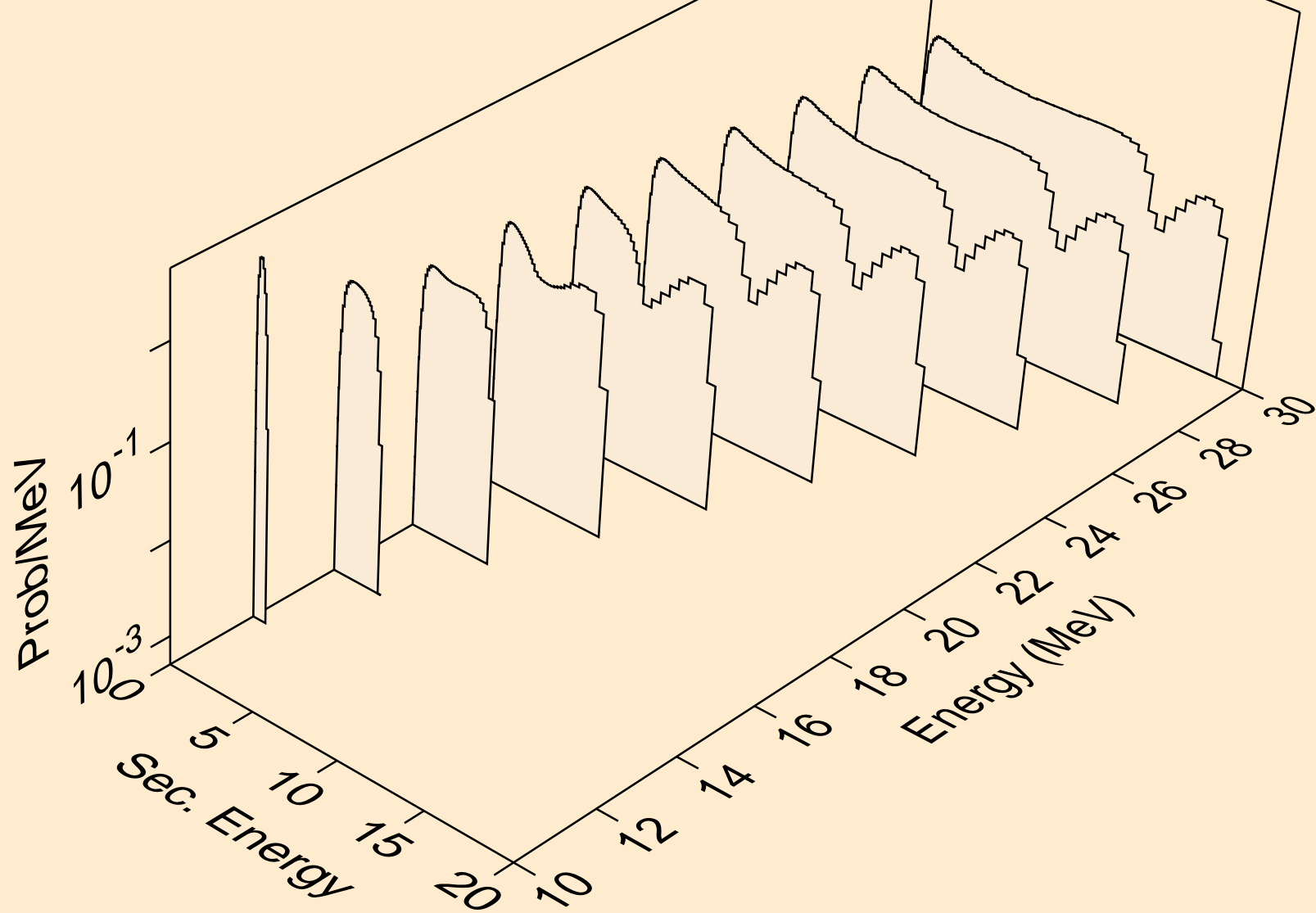



Y080M NEUTRON ACER TENDL-2024 LIBRARY; T=0.K  
Neutron emission for (n,3n)

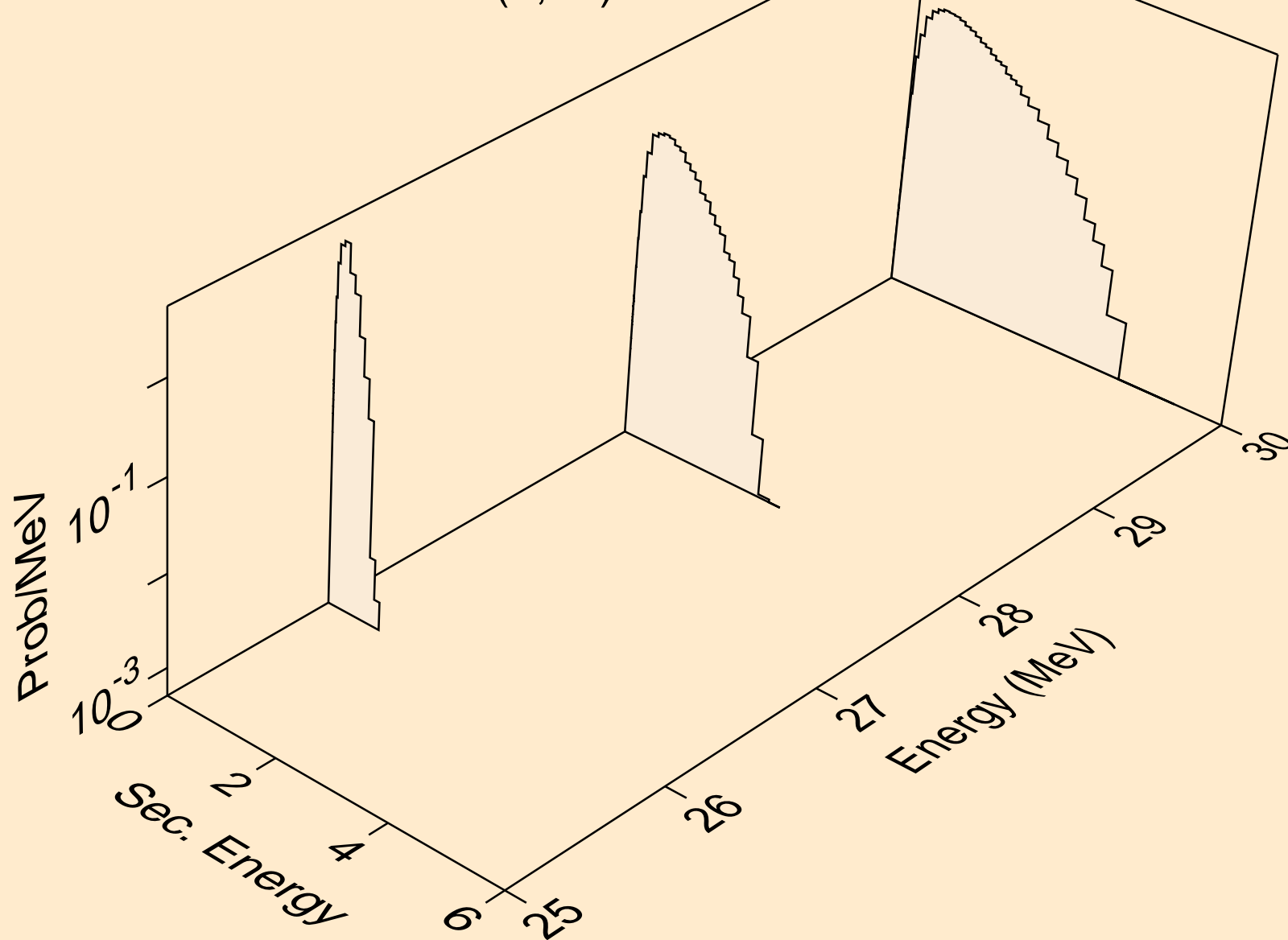

Y080M NEUTRON ACER TENDL-2024 LIBRARY; T=0.K  
Neutron emission for (n,n\*)a

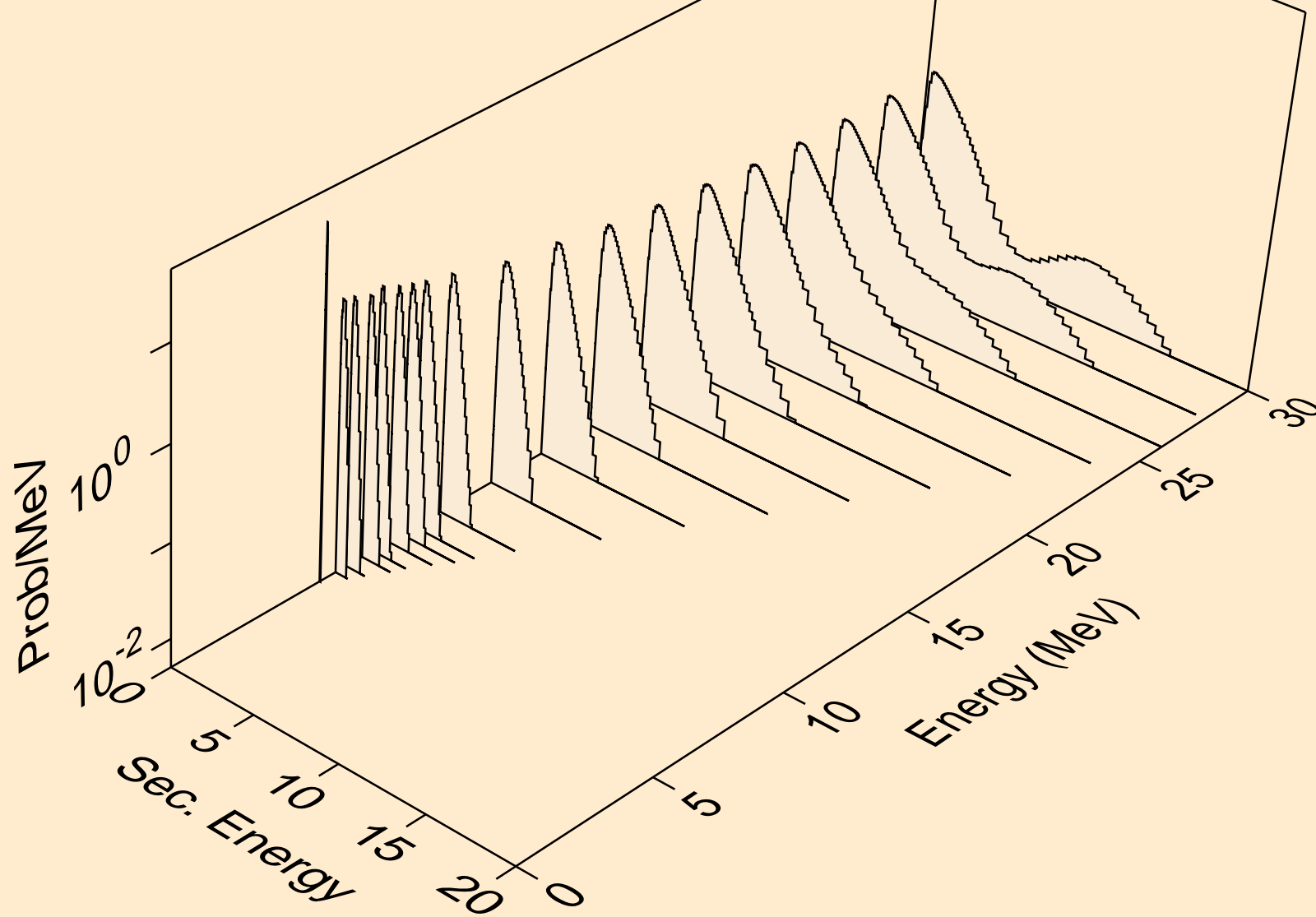

Y080M NEUTRON ACER TENDL-2024 LIBRARY; T=0.K  
Neutron emission for (n,2n)a

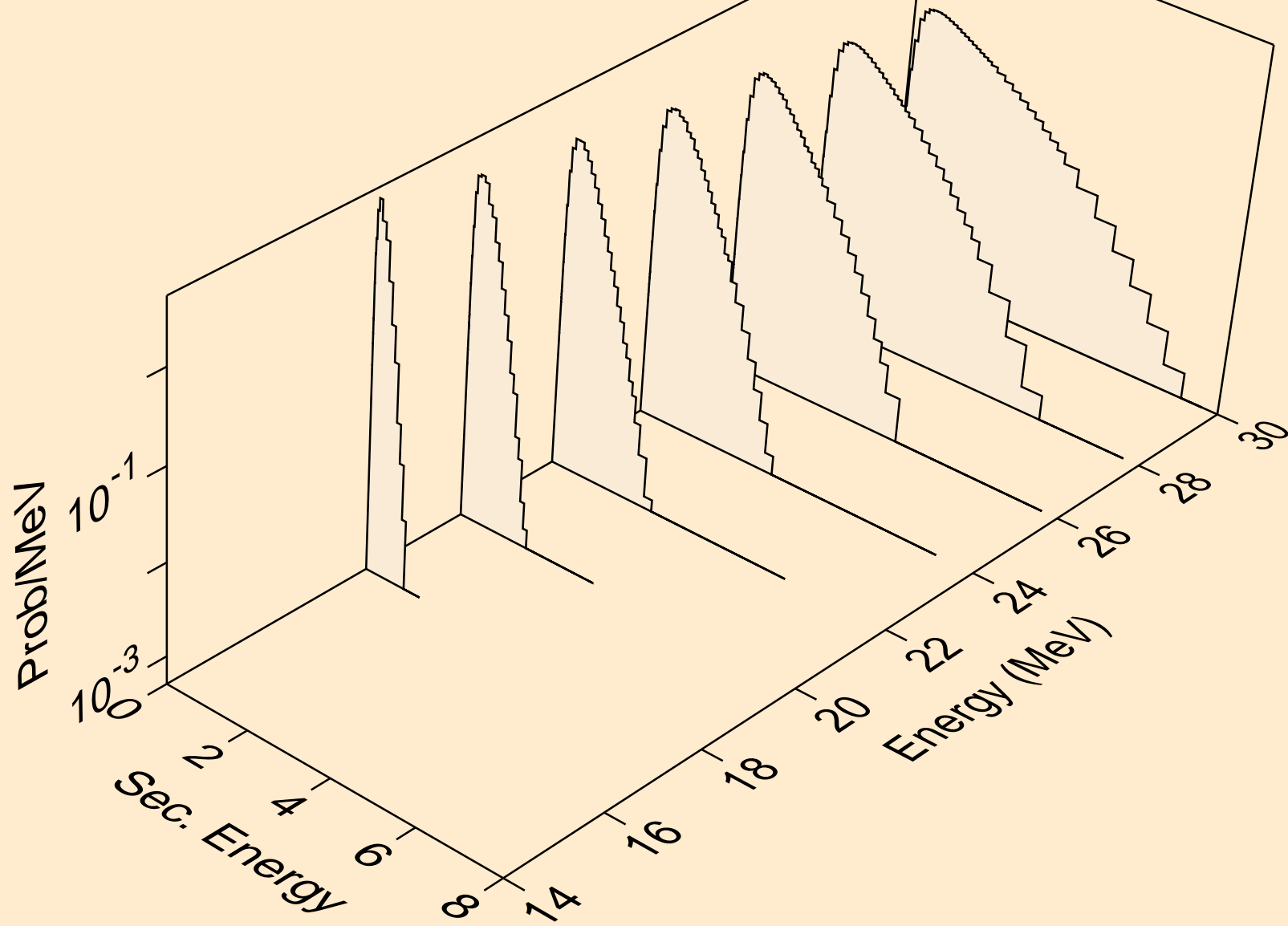

Y080M NEUTRON ACER TENDL-2024 LIBRARY; T=0.K  
Neutron emission for (n,n\*)p

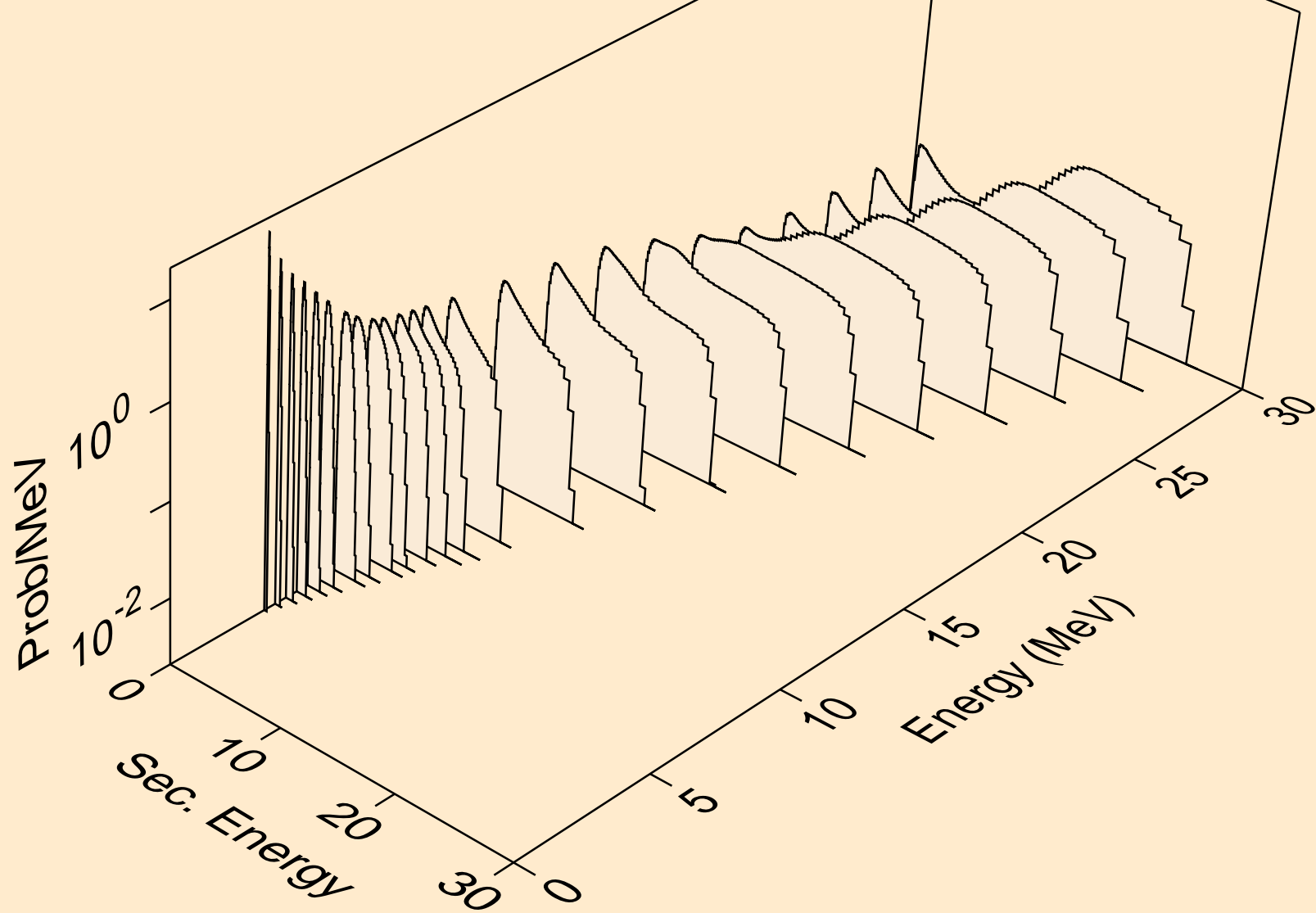

Y080M NEUTRON ACER TENDL-2024 LIBRARY; T=0.K  
Neutron emission for (n,n\*)2a

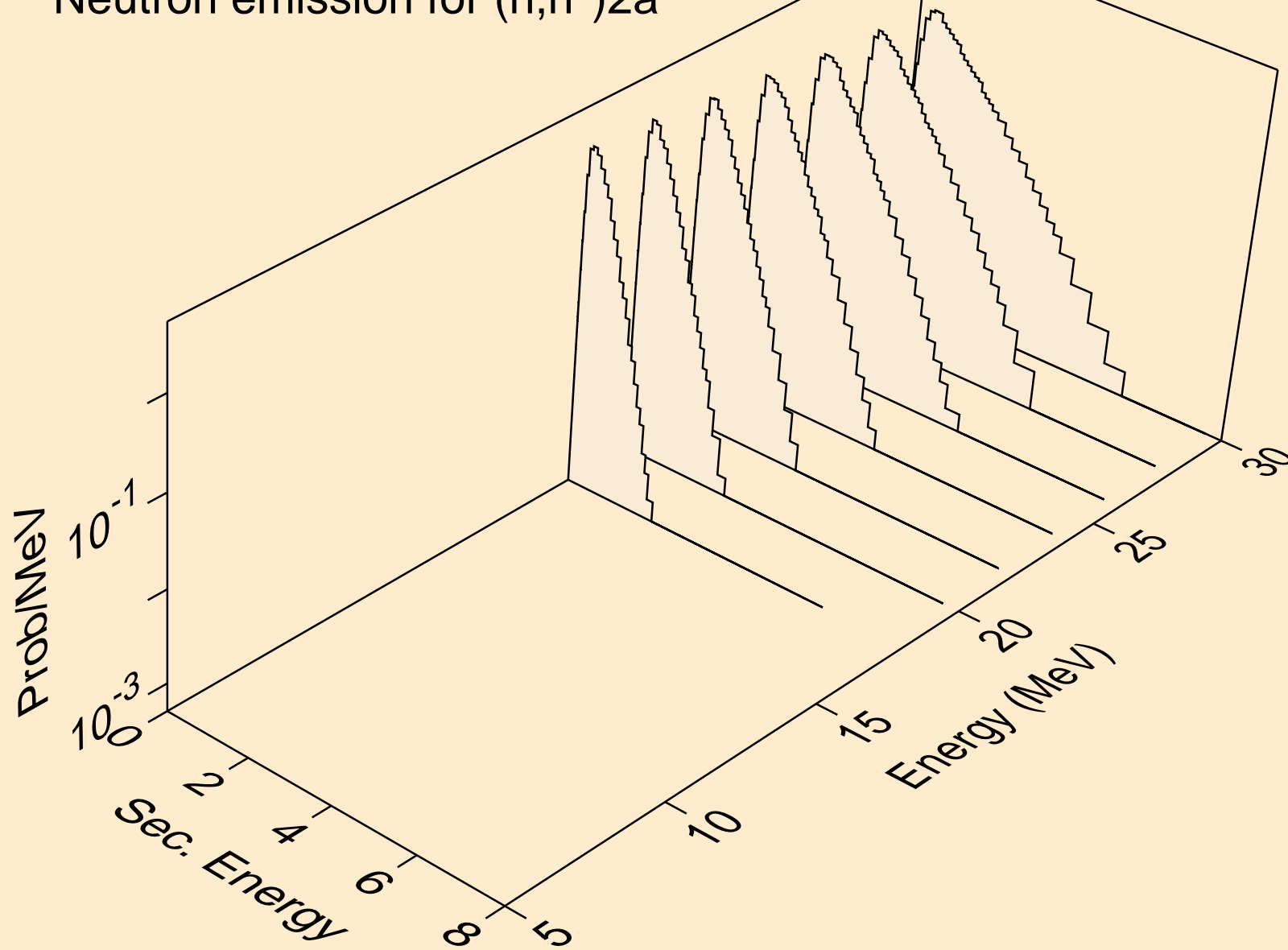

Y080M NEUTRON ACER TENDL-2024 LIBRARY; T=0.K  
Neutron emission for (n,n\*)d

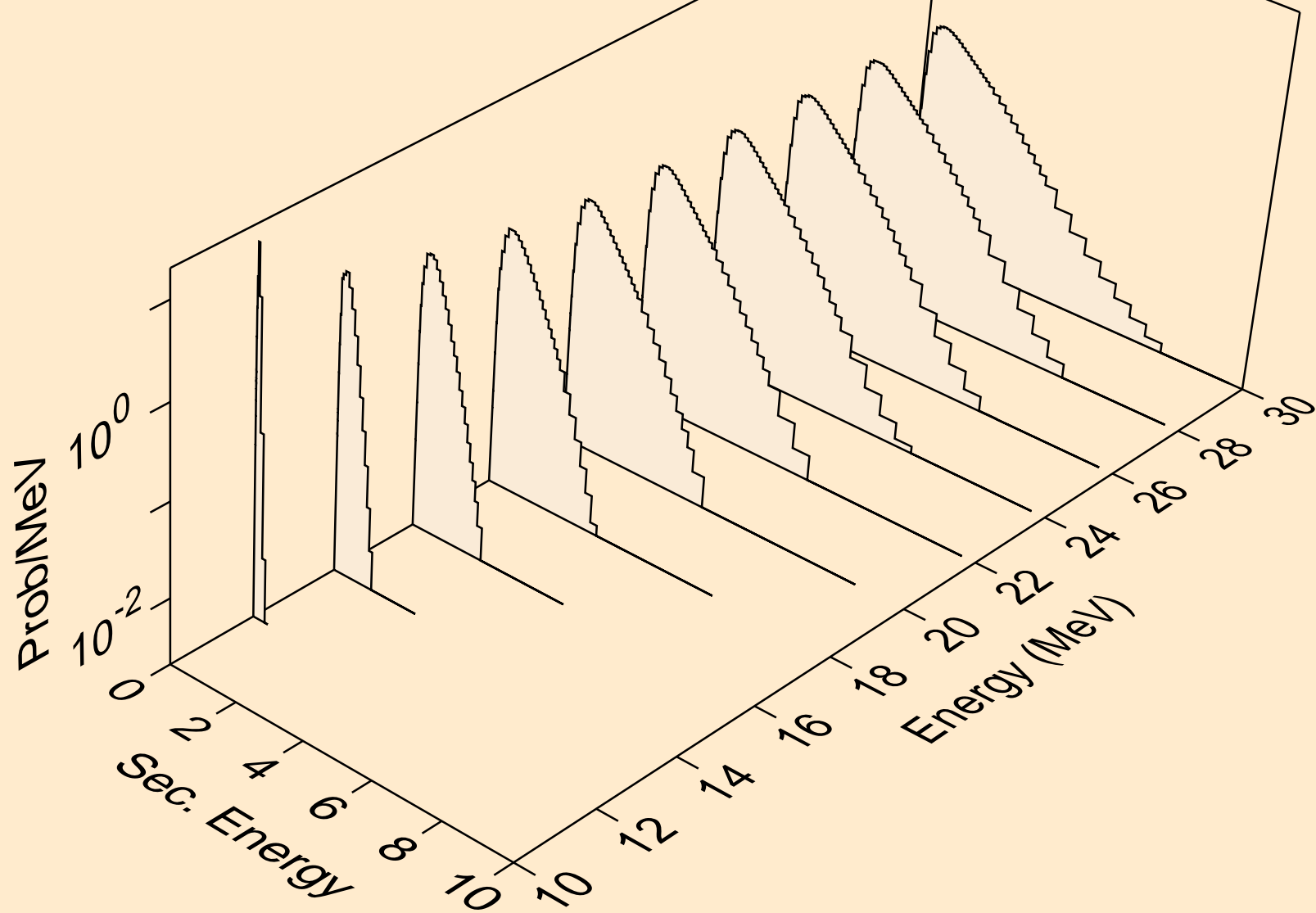

Y080M NEUTRON ACER TENDL-2024 LIBRARY; T=0.K  
Neutron emission for (n,n\*)t

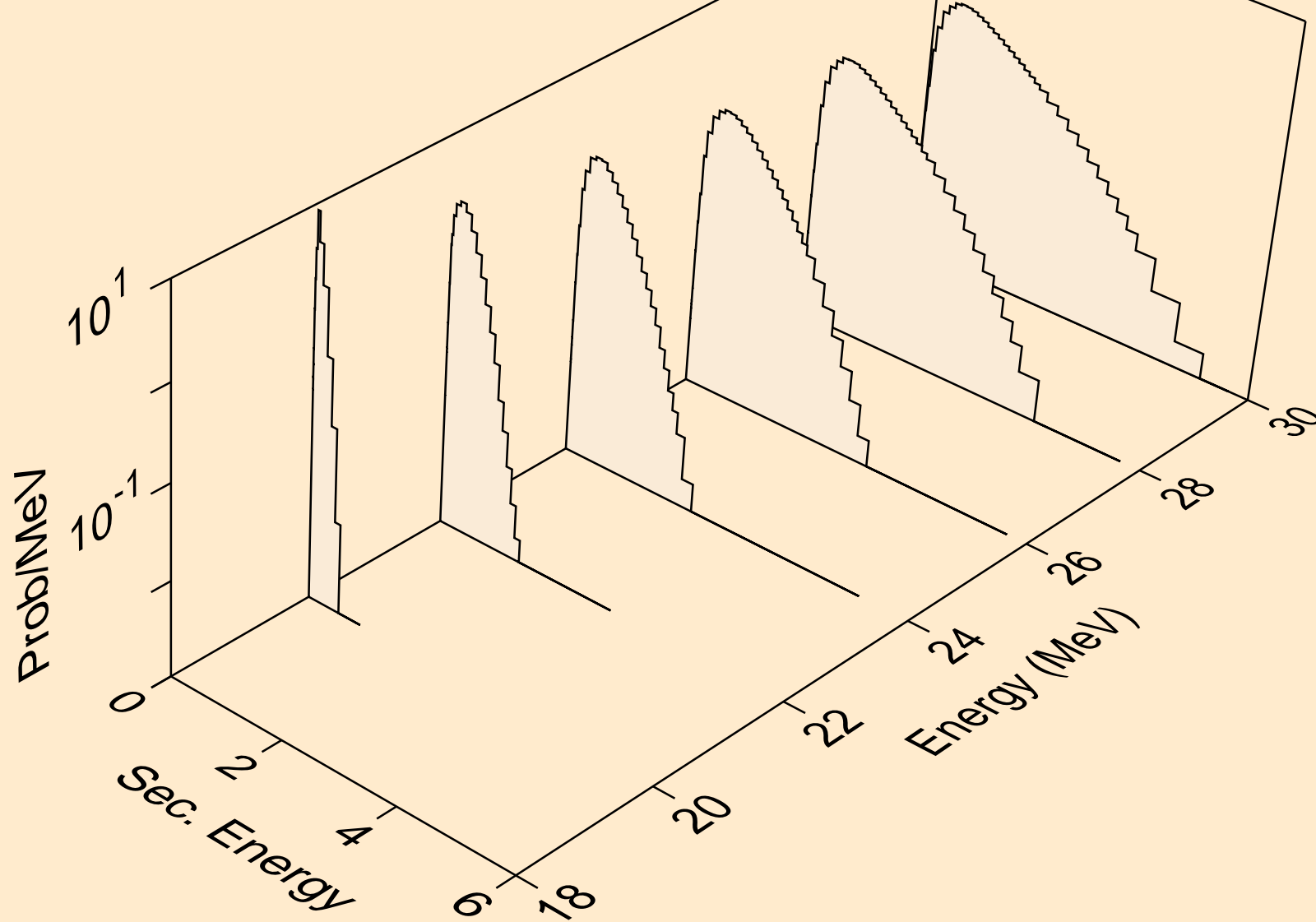

Y080M NEUTRON ACER TENDL-2024 LIBRARY; T=0.K  
Neutron emission for (n,n\*)he3

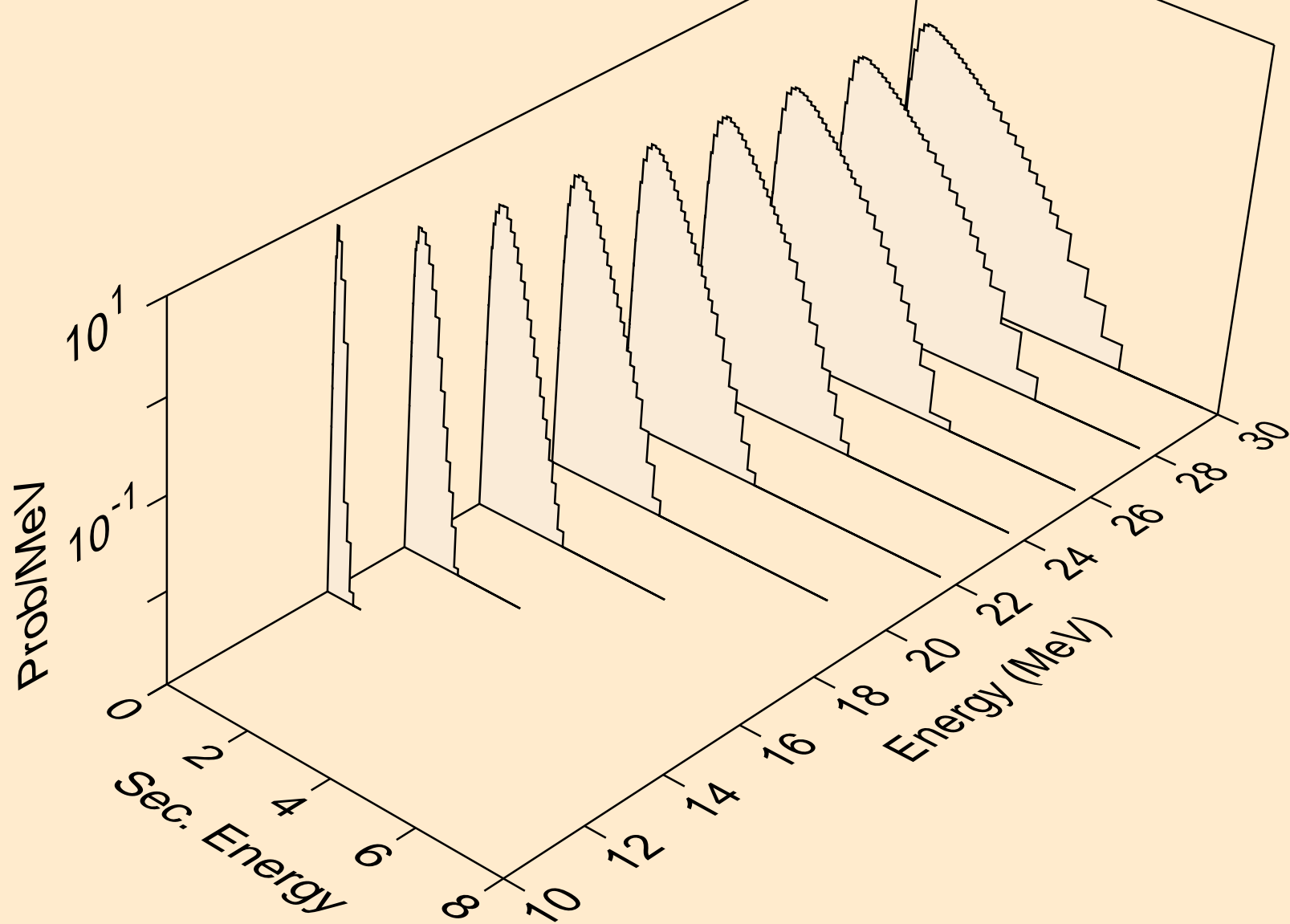



Y080M NEUTRON ACER TENDL-2024 LIBRARY; T=0.K  
Neutron emission for (n,2np)

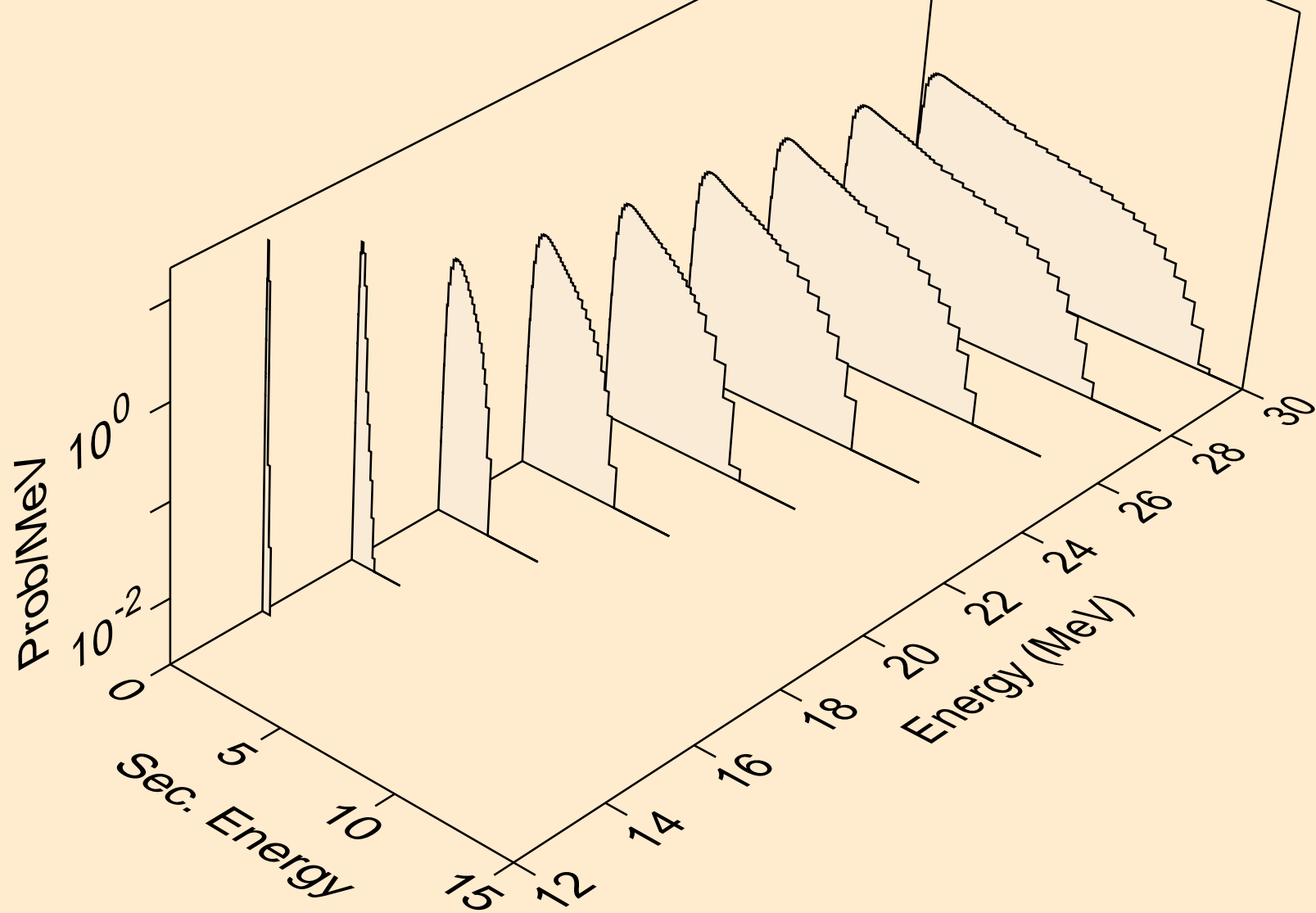

Y080M NEUTRON ACER TENDL-2024 LIBRARY; T=0.K  
Neutron emission for (n,3np)

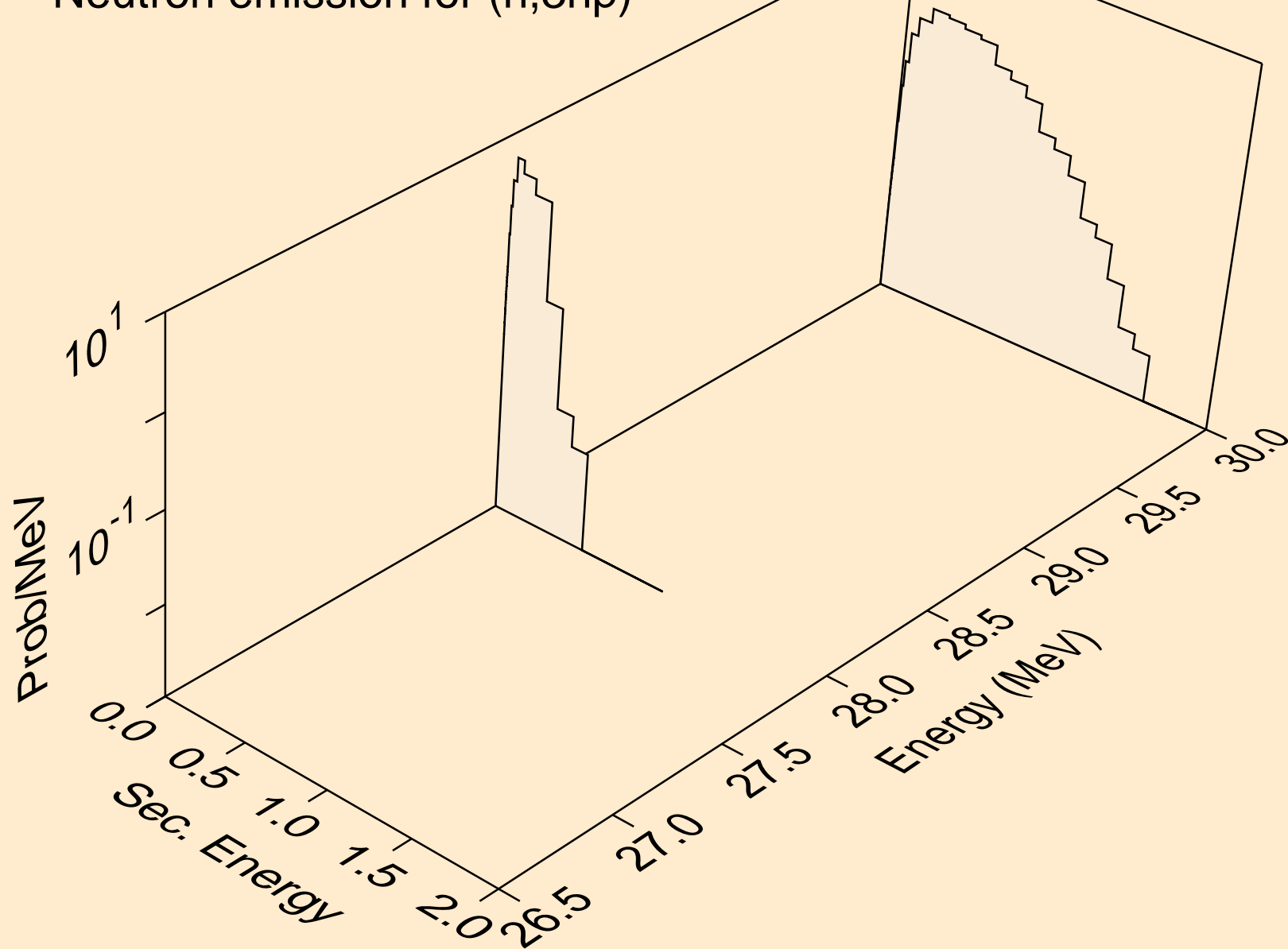

Y080M NEUTRON ACER TENDL-2024 LIBRARY; T=0.K  
Neutron emission for (n,n2p)

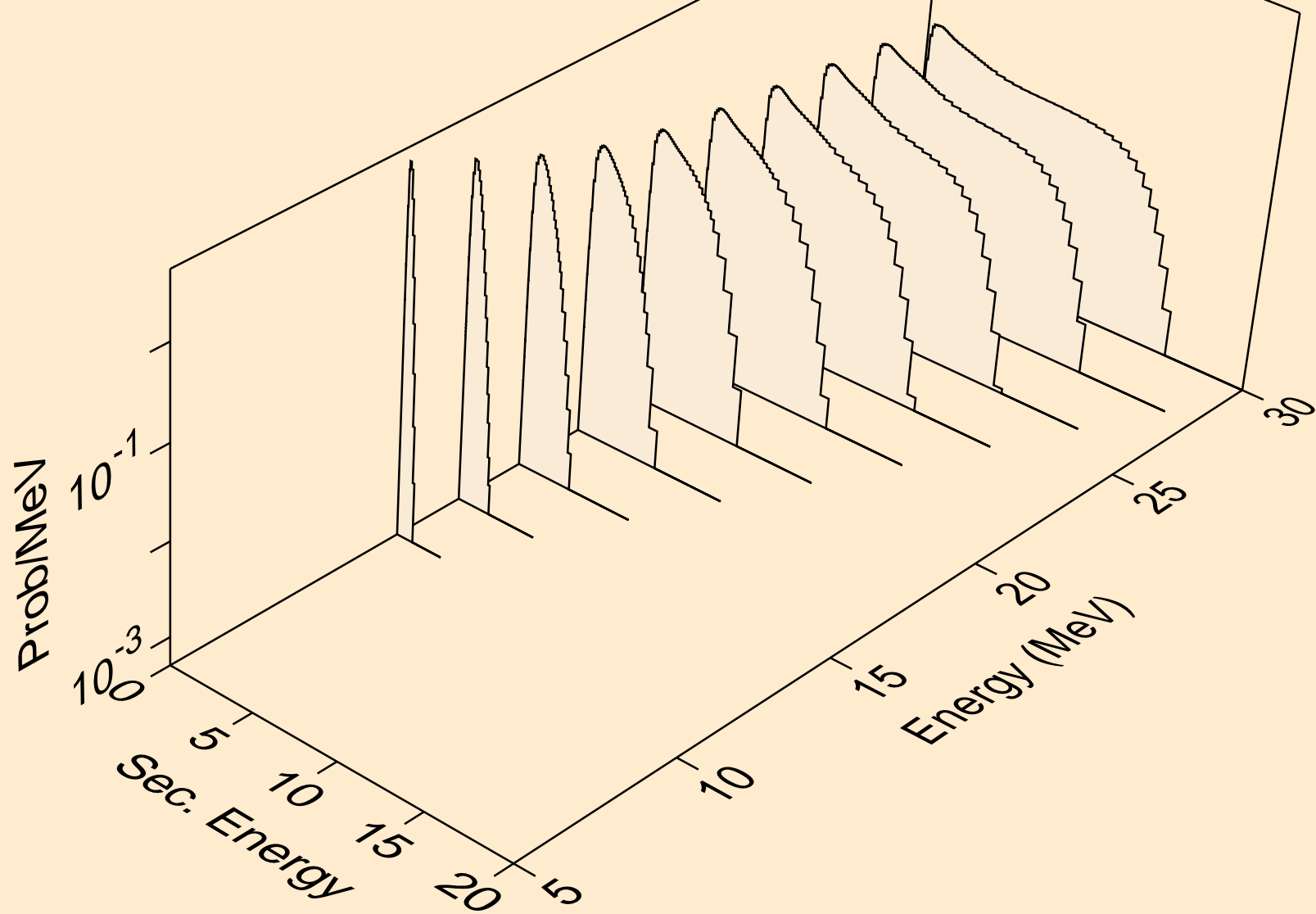

Y080M NEUTRON ACER TENDL-2024 LIBRARY; T=0.K  
Neutron emission for (n,npa)

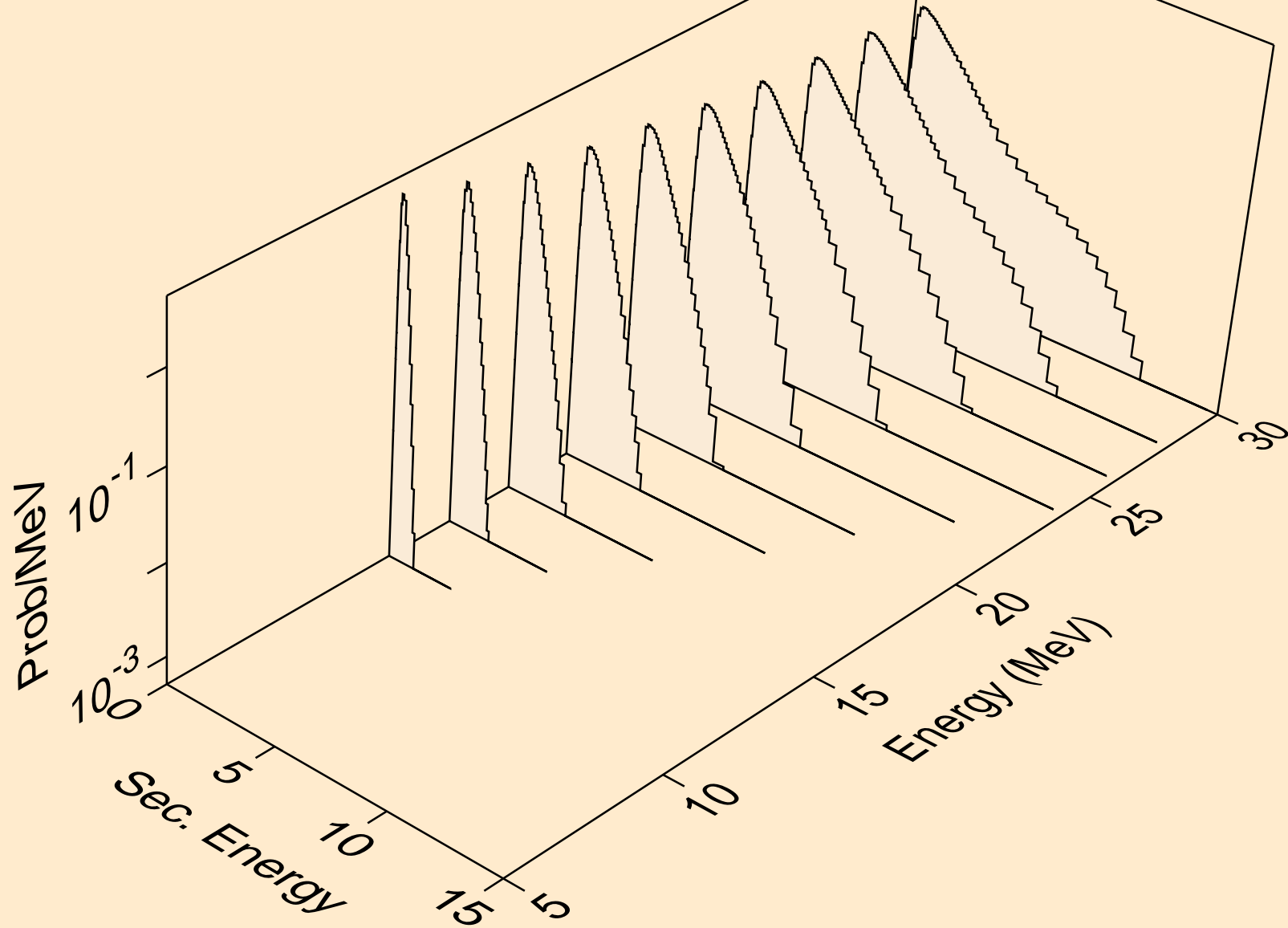

Y080M NEUTRON ACER TENDL-2024 LIBRARY; T=0.K  
Neutron emission for (n,n\*c)

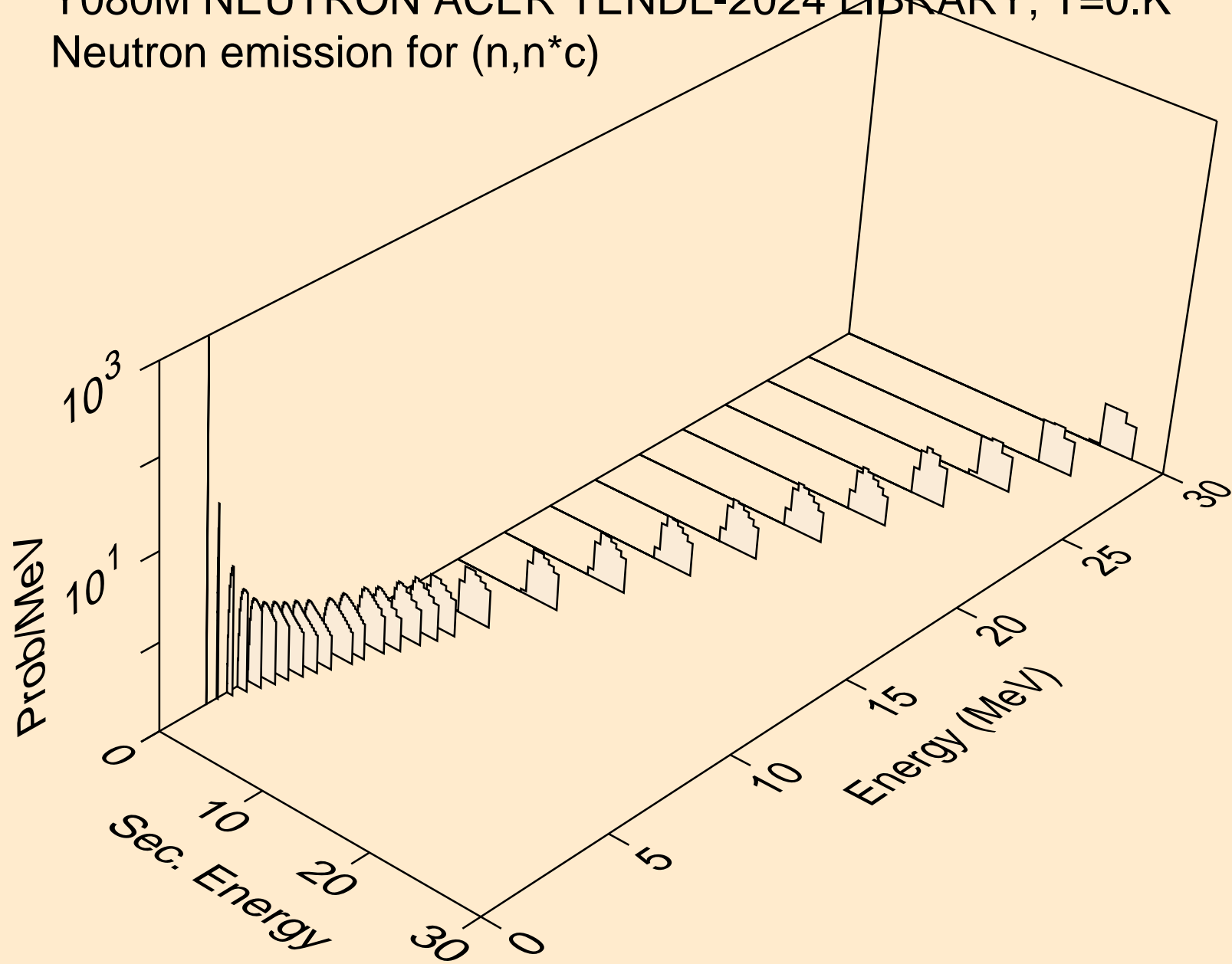

Y080M NEUTRON ACER TENDL-2024 LIBRARY; T=0.K  
Photon emission for (n,x)

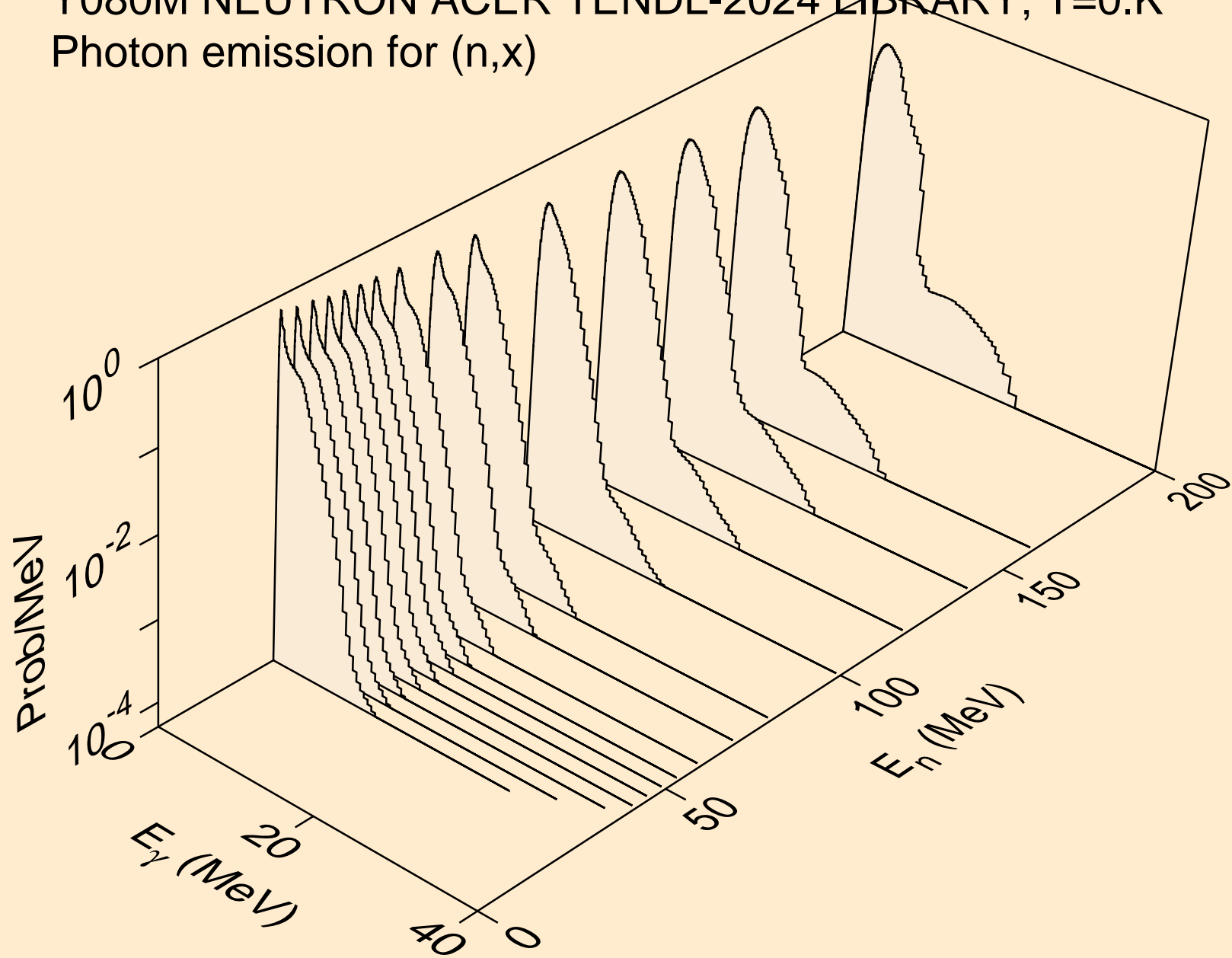

Y080M NEUTRON ACER TENDL-2024 LIBRARY; T=0.K  
Photon emission for (n,2nd)

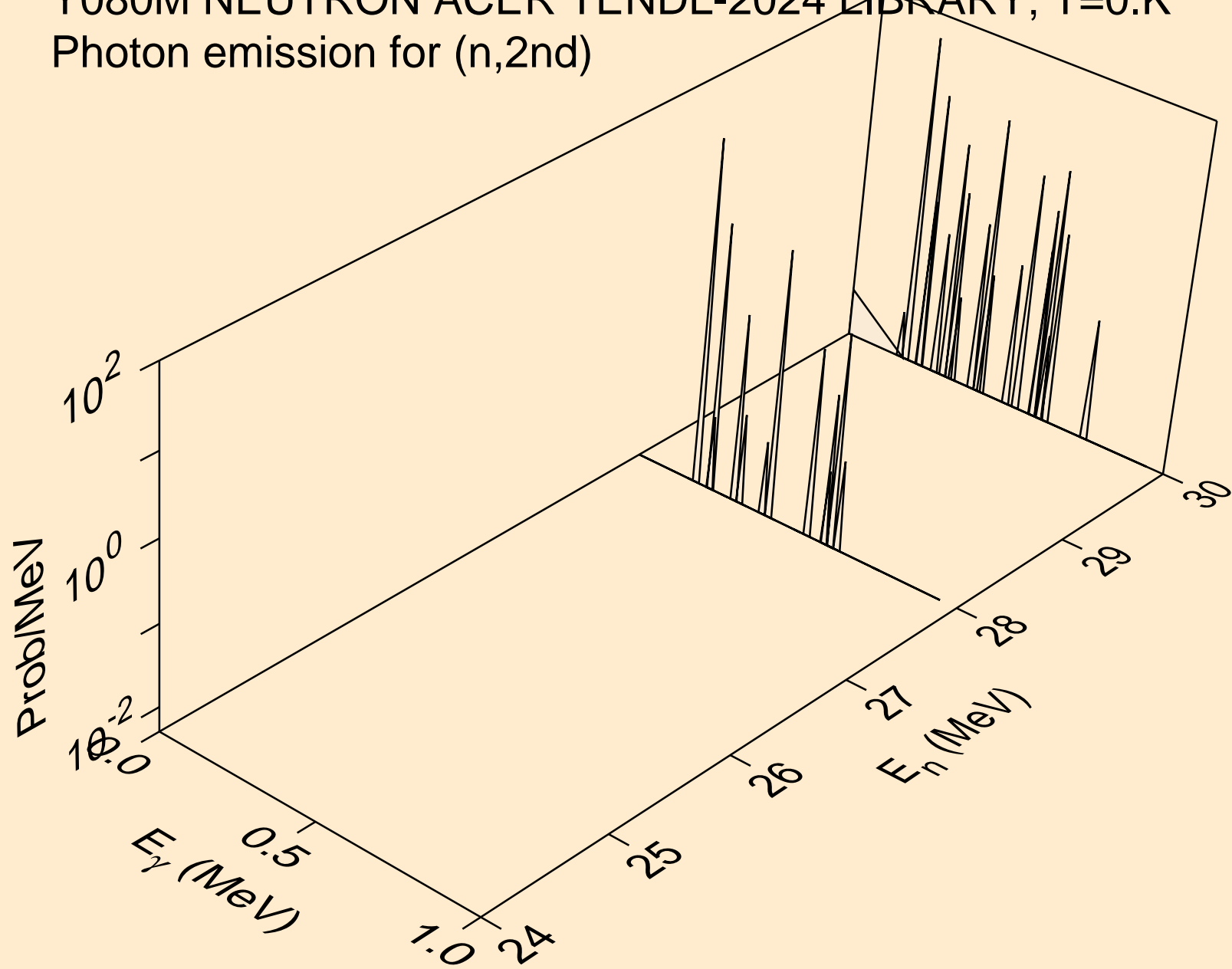

Y080M NEUTRON ACER TENDL-2024 LIBRARY; T=0.K  
Photon emission for (n,2n)

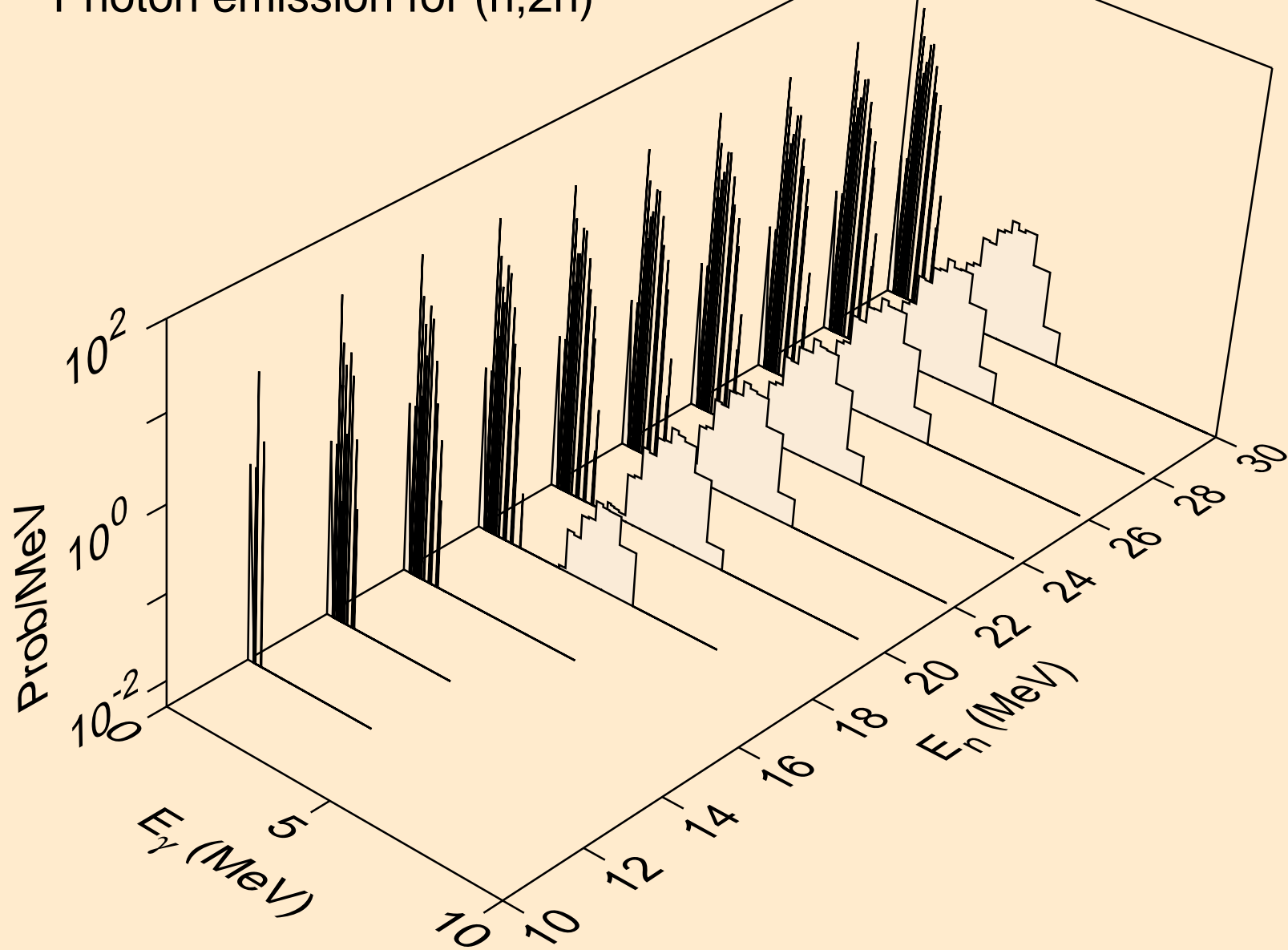



Y080M NEUTRON ACER TENDL-2024 LIBRARY; T=0.K  
Photon emission for (n,3n)

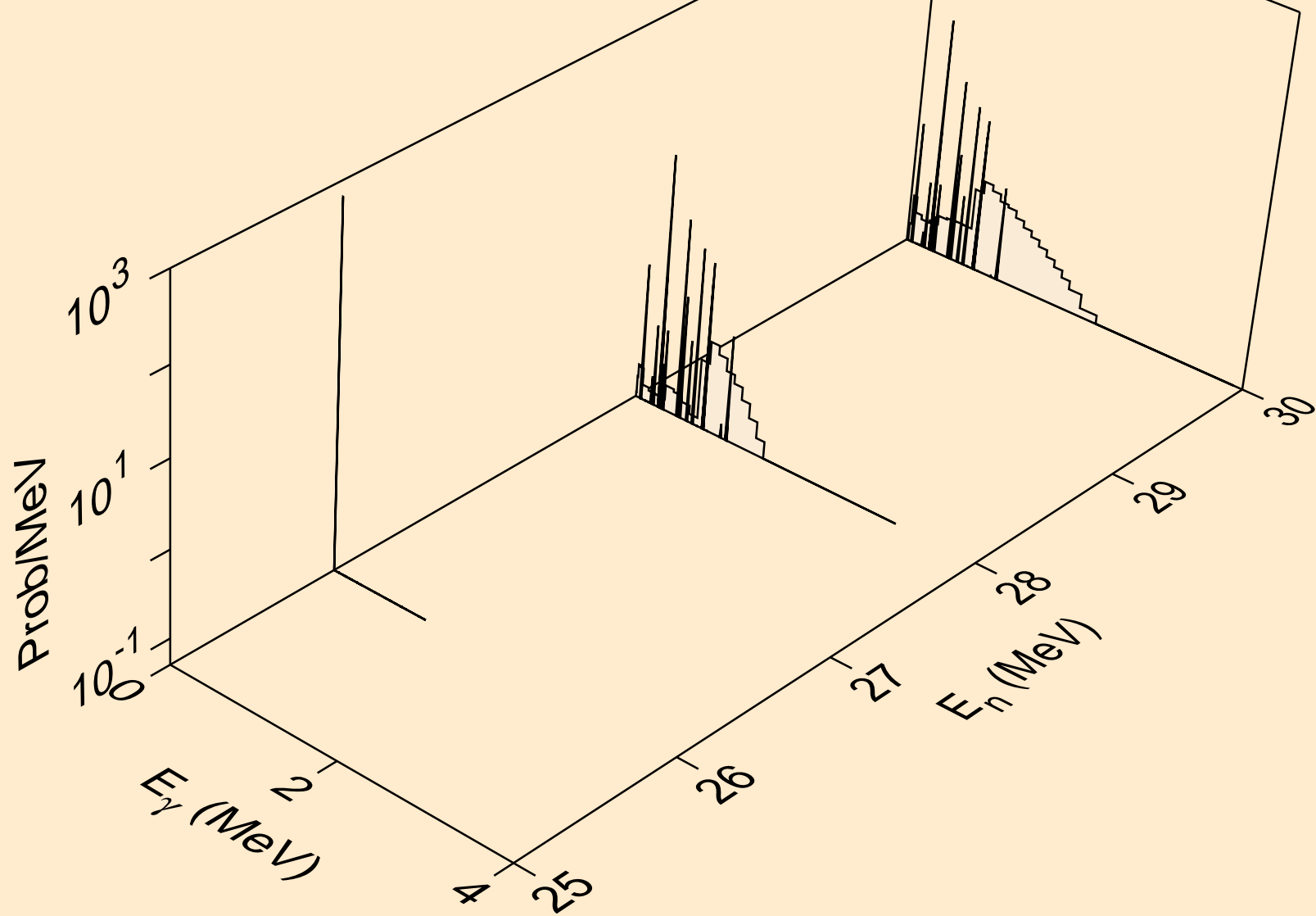

Y080M NEUTRON ACER TENDL-2024 LIBRARY; T=0.K  
Photon emission for (n,n\*)a

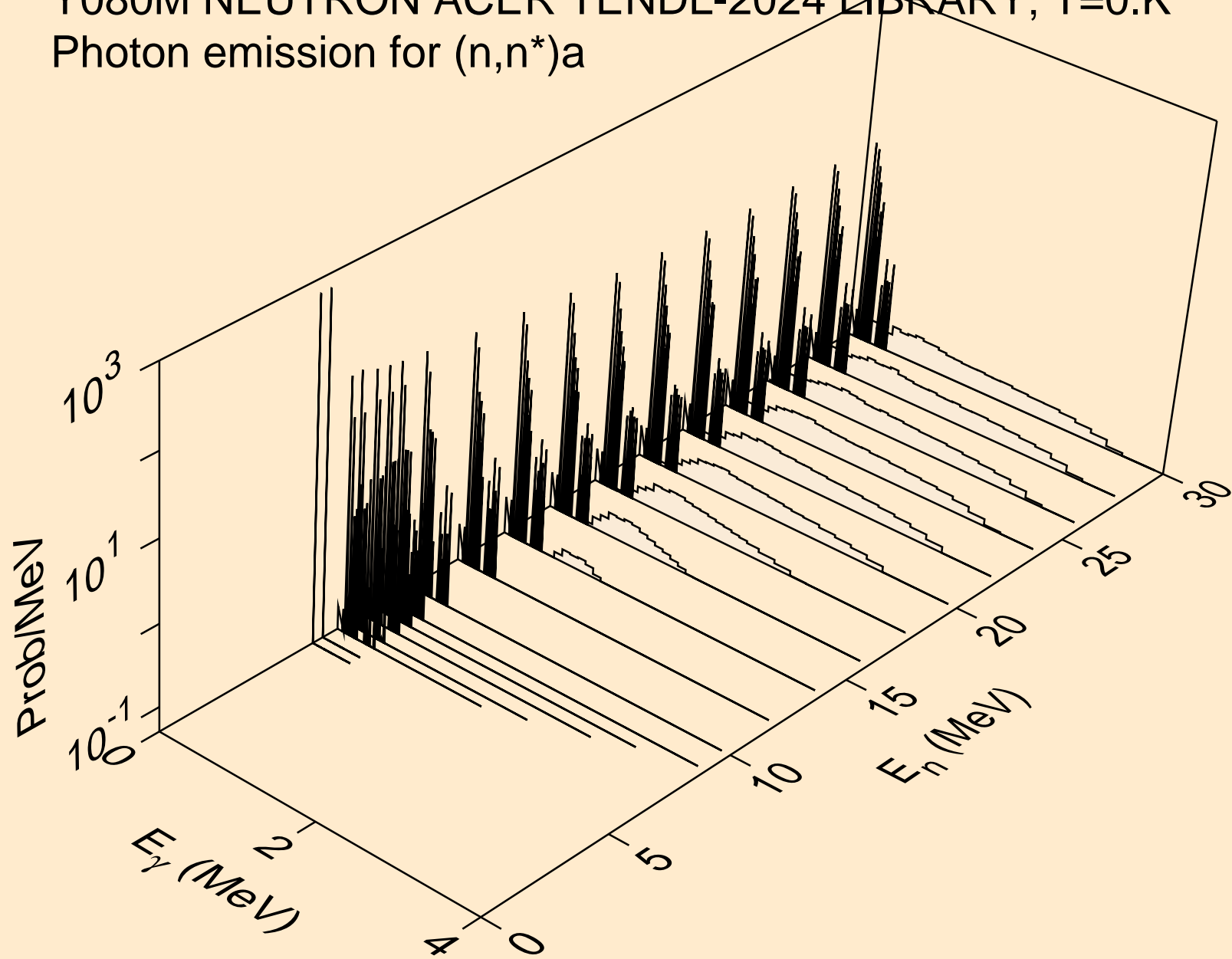

Y080M NEUTRON ACER TENDL-2024 LIBRARY; T=0.K  
Photon emission for (n,2n)a

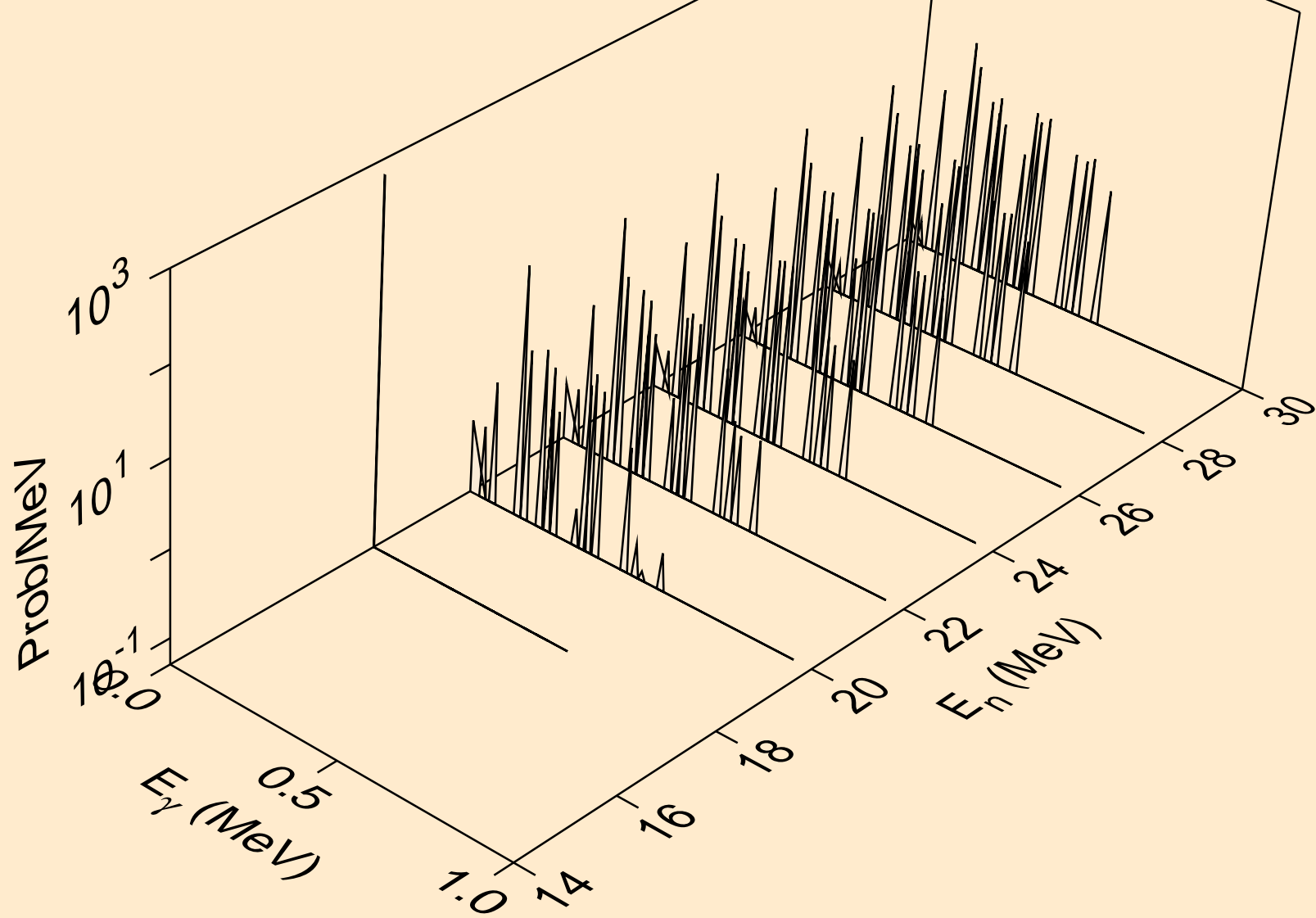

Y080M NEUTRON ACER TENDL-2024 LIBRARY; T=0.K  
Photon emission for (n,n\*)p

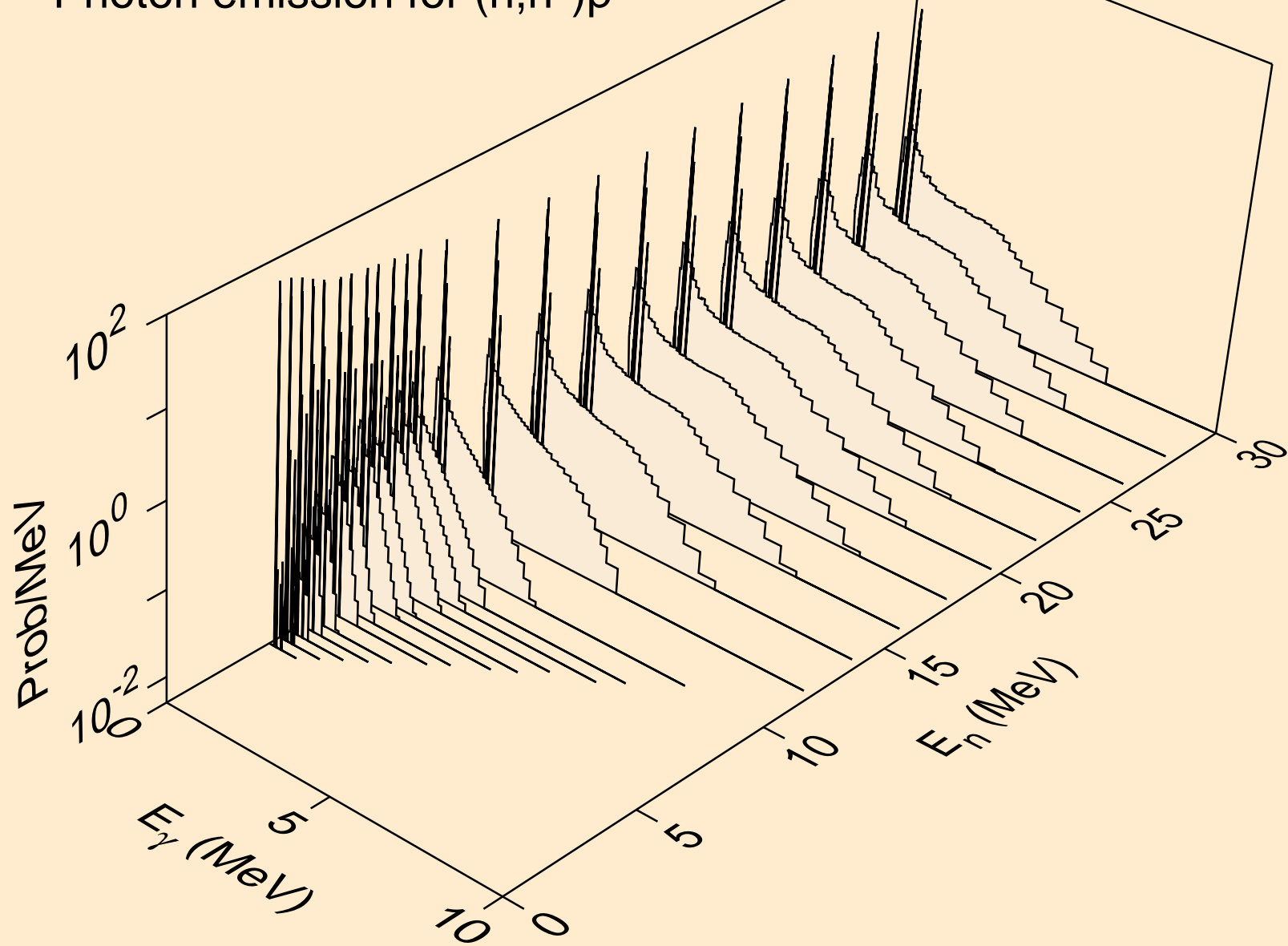

Y080M NEUTRON ACER TENDL-2024 LIBRARY; T=0.K  
Photon emission for (n,n\*)2a

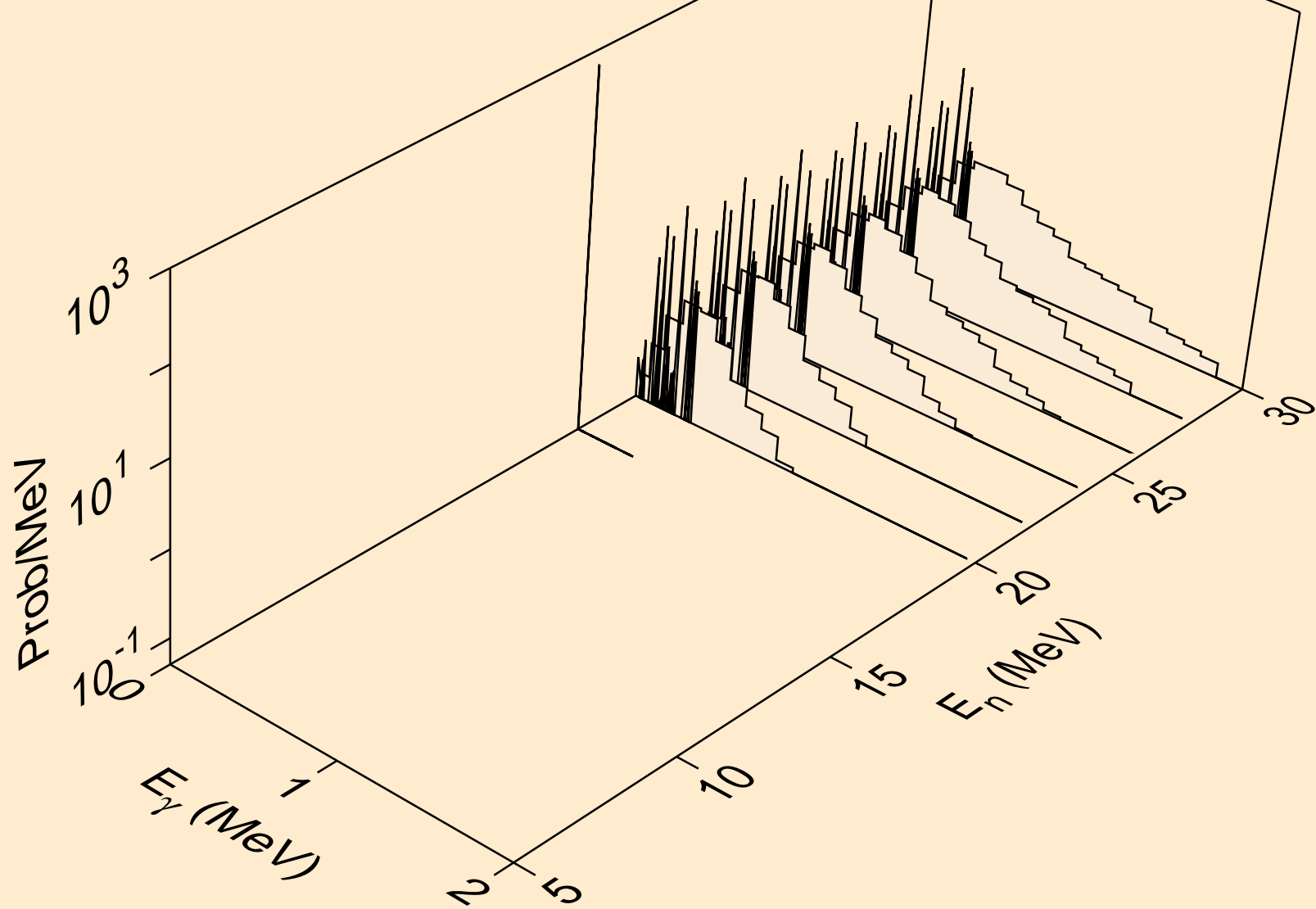

Y080M NEUTRON ACER TENDL-2024 LIBRARY; T=0.K  
Photon emission for (n,n\*)d

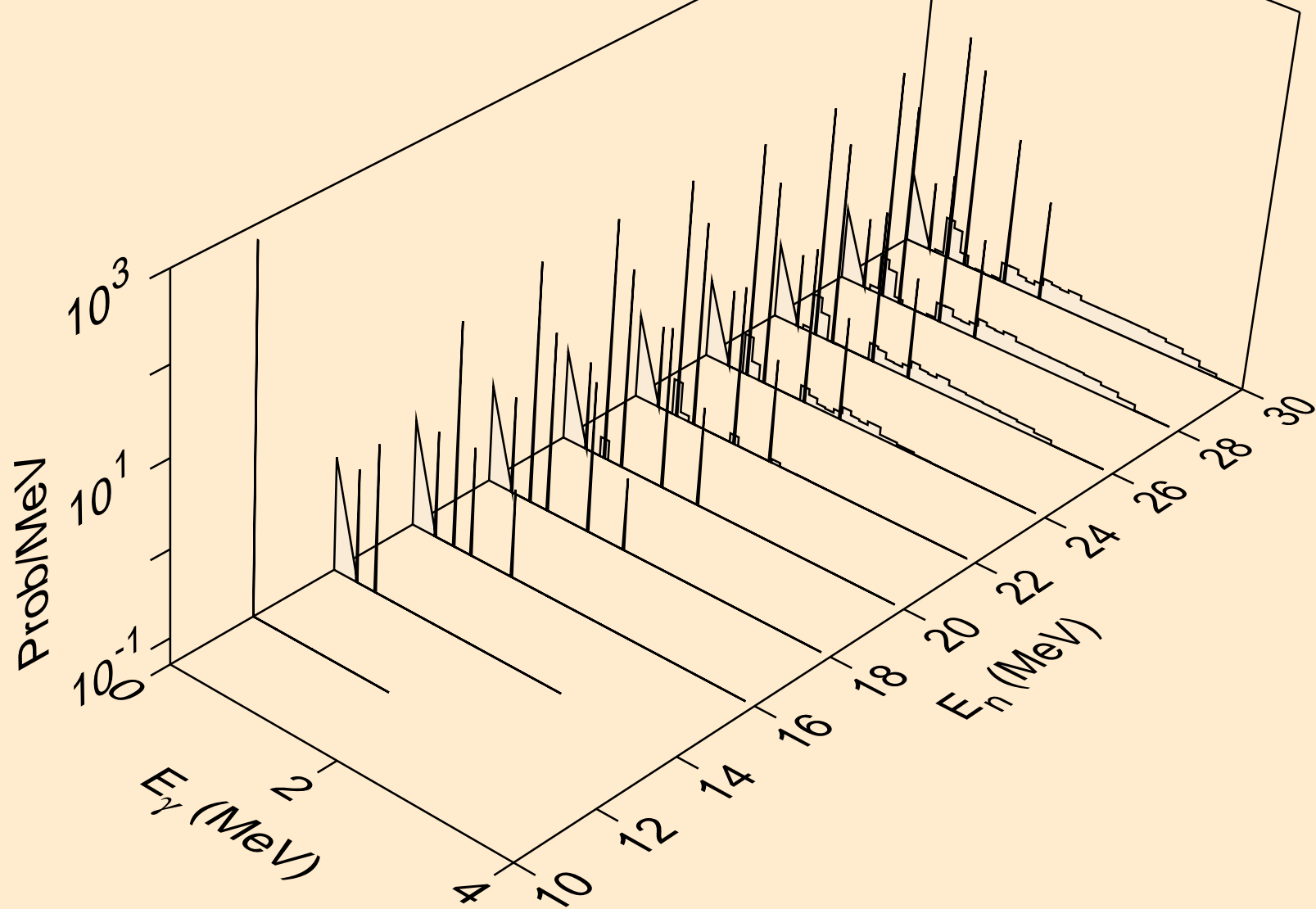

Y080M NEUTRON ACER TENDL-2024 LIBRARY; T=0.K  
Photon emission for (n,n\*)t

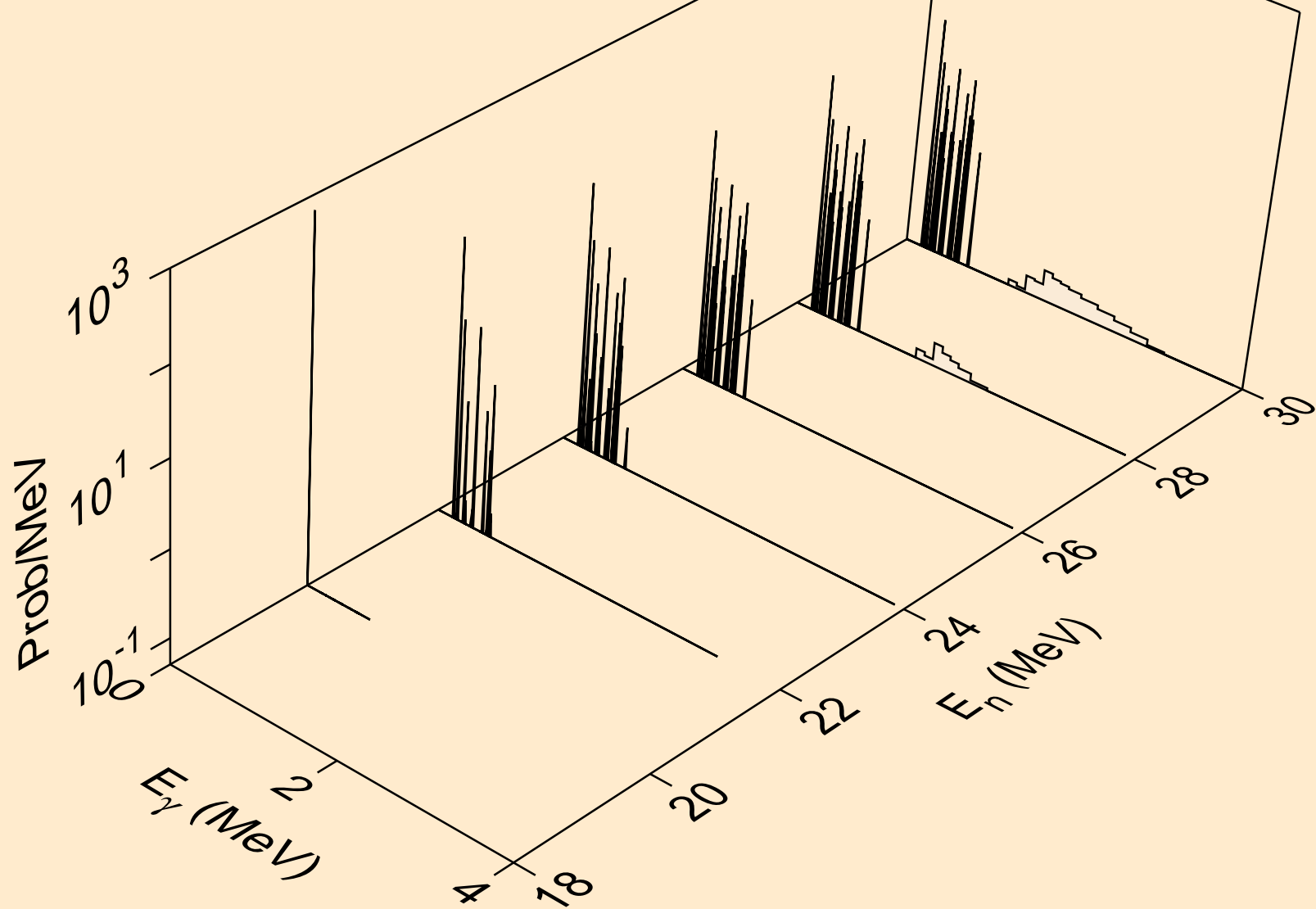

Y080M NEUTRON ACER TENDL-2024 LIBRARY; T=0.K  
Photon emission for (n,n\*)he3

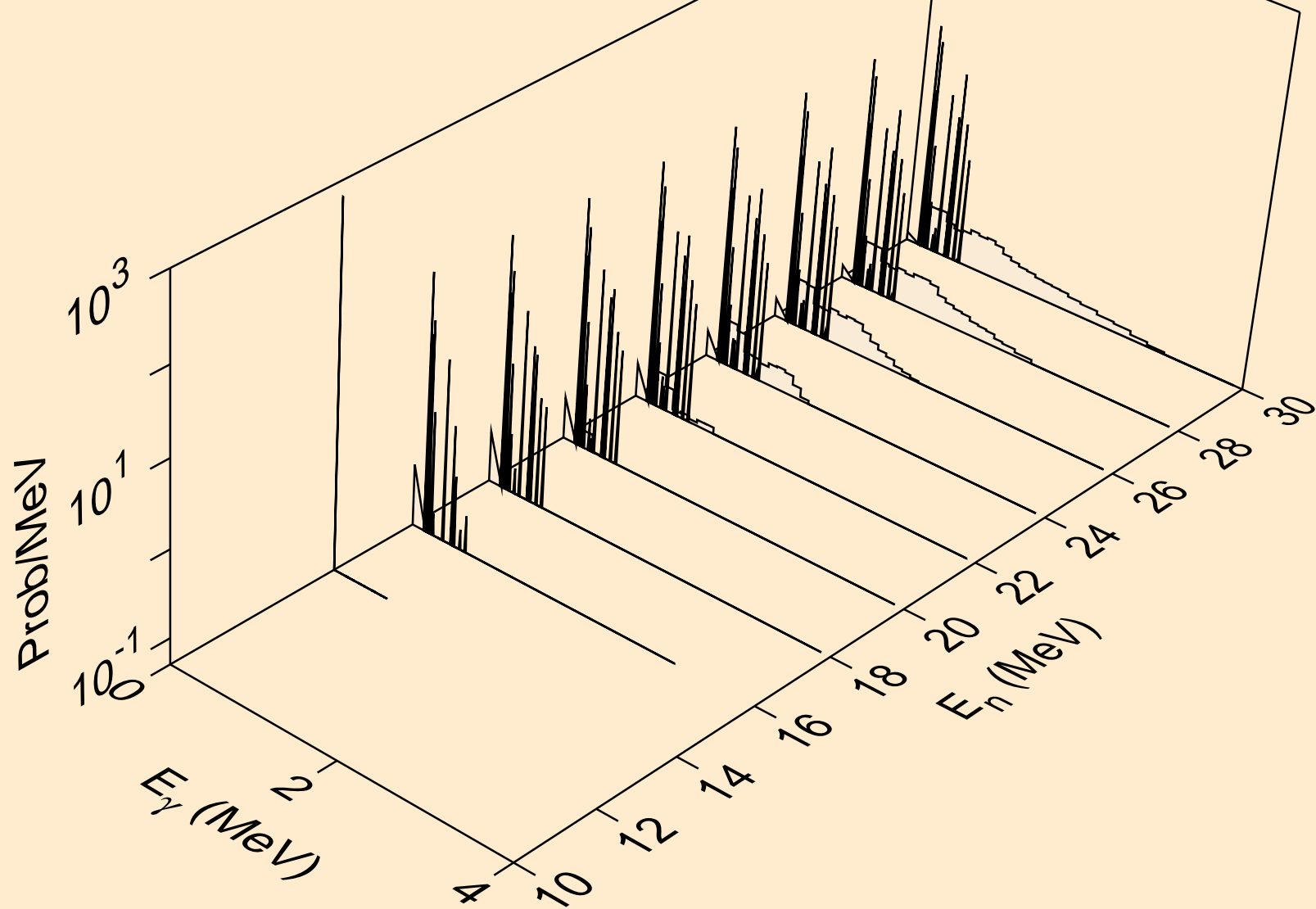



Y080M NEUTRON ACER TENDL-2024 LIBRARY; T=0.K  
Photon emission for (n,2np)

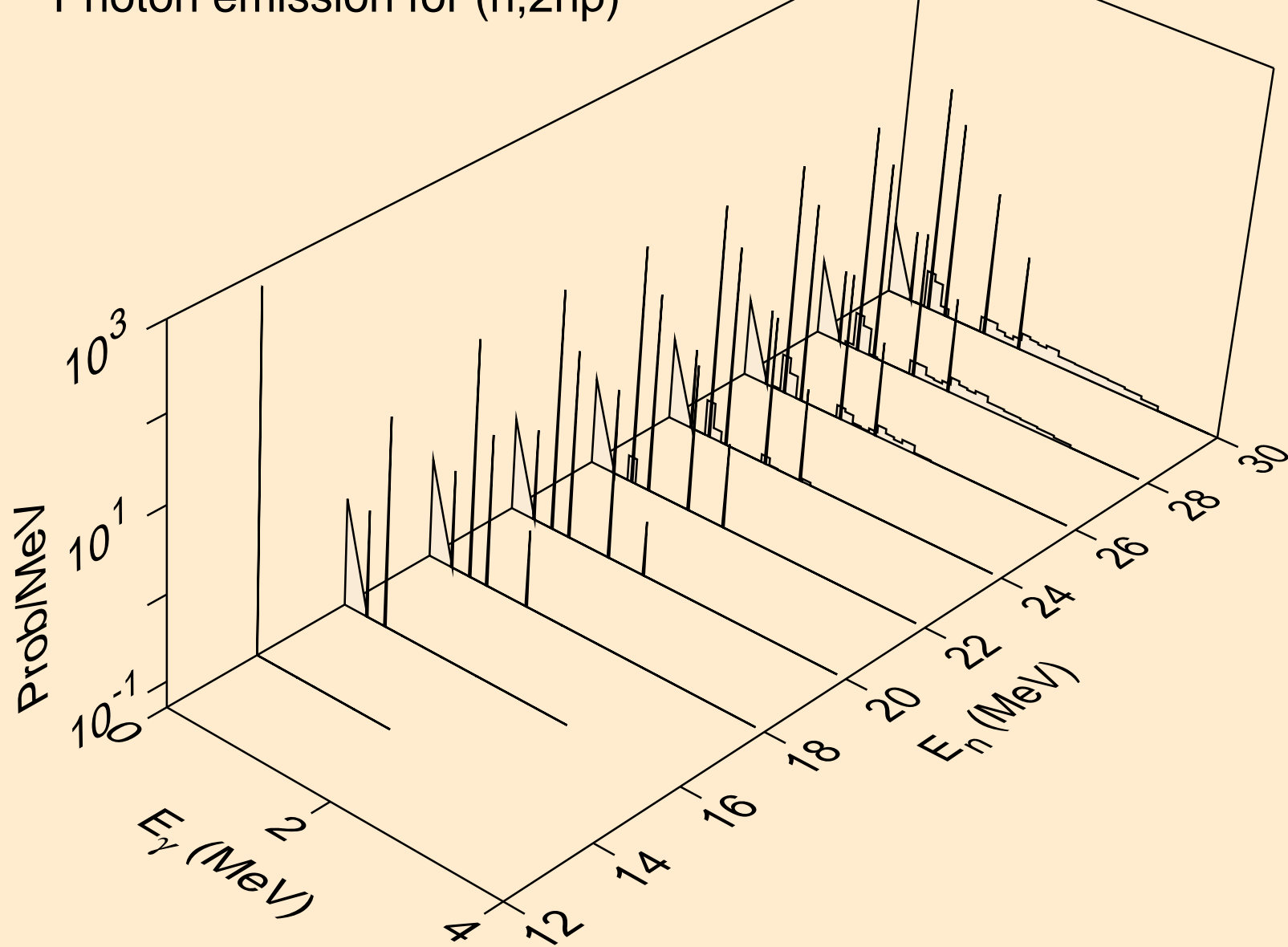

Y080M NEUTRON ACER TENDL-2024 LIBRARY; T=0.K  
Photon emission for (n,3np)

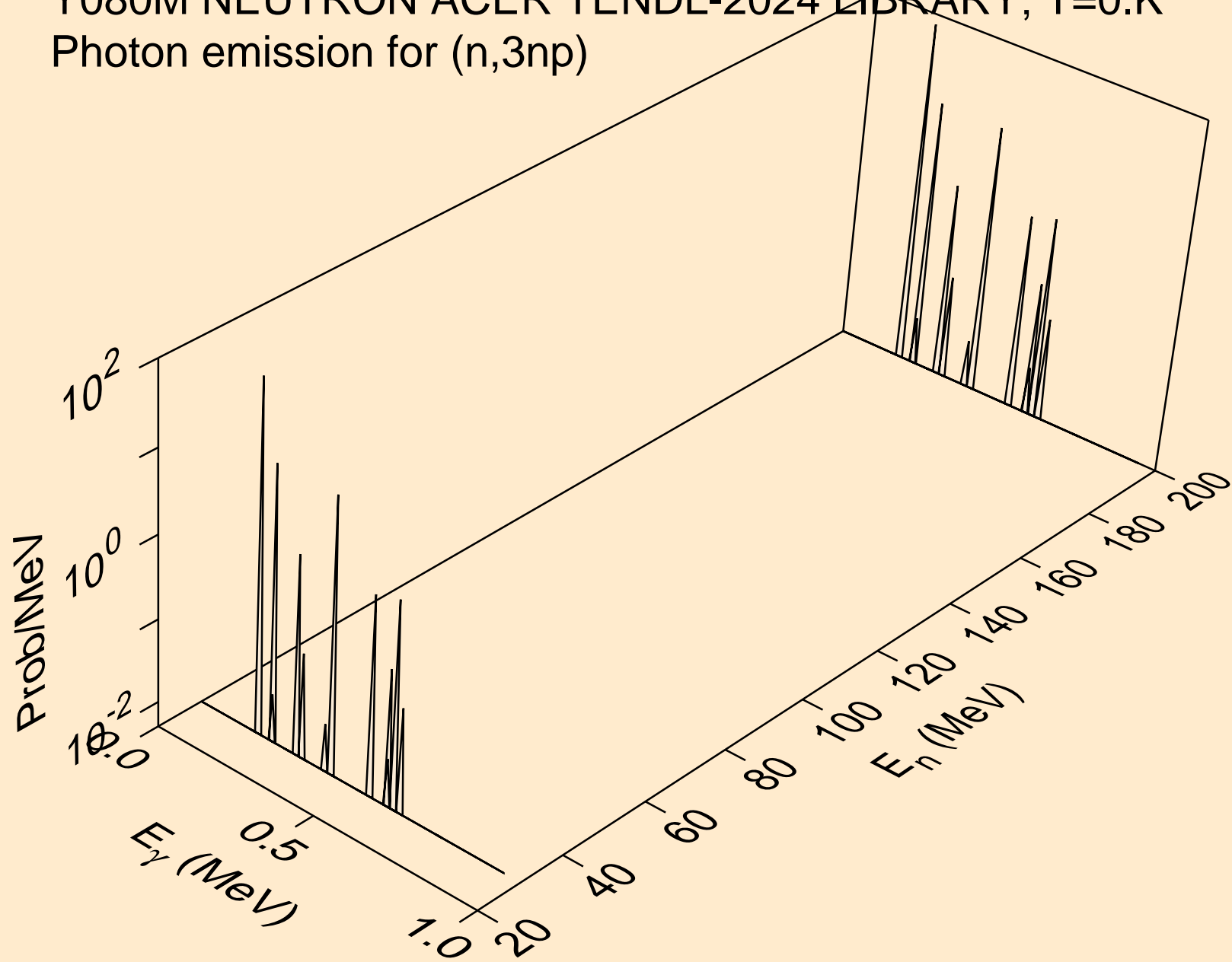

Y080M NEUTRON ACER TENDL-2024 LIBRARY; T=0.K  
Photon emission for (n,n2p)

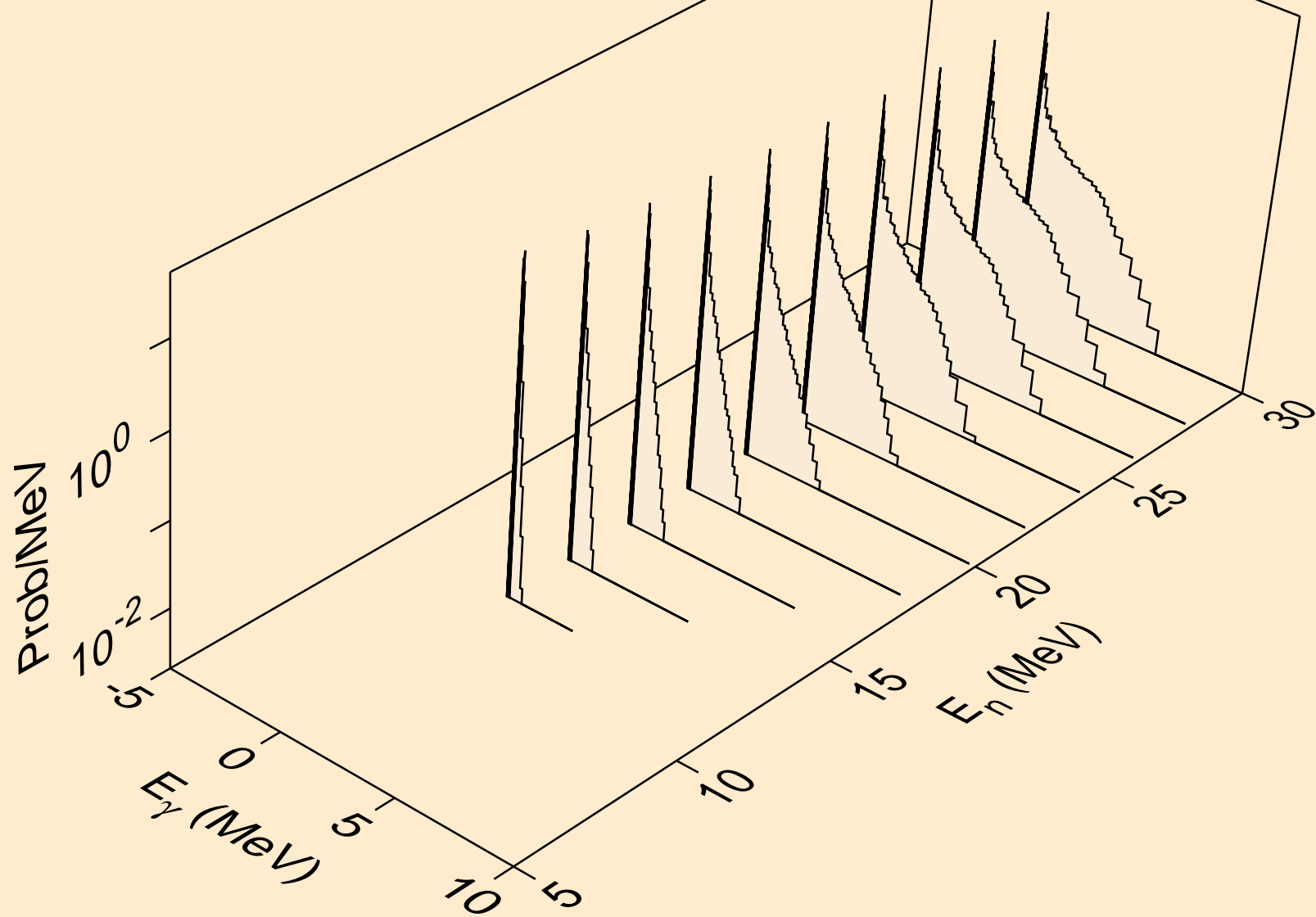

Y080M NEUTRON ACER TENDL-2024 LIBRARY; T=0.K  
Photon emission for (n,npa)

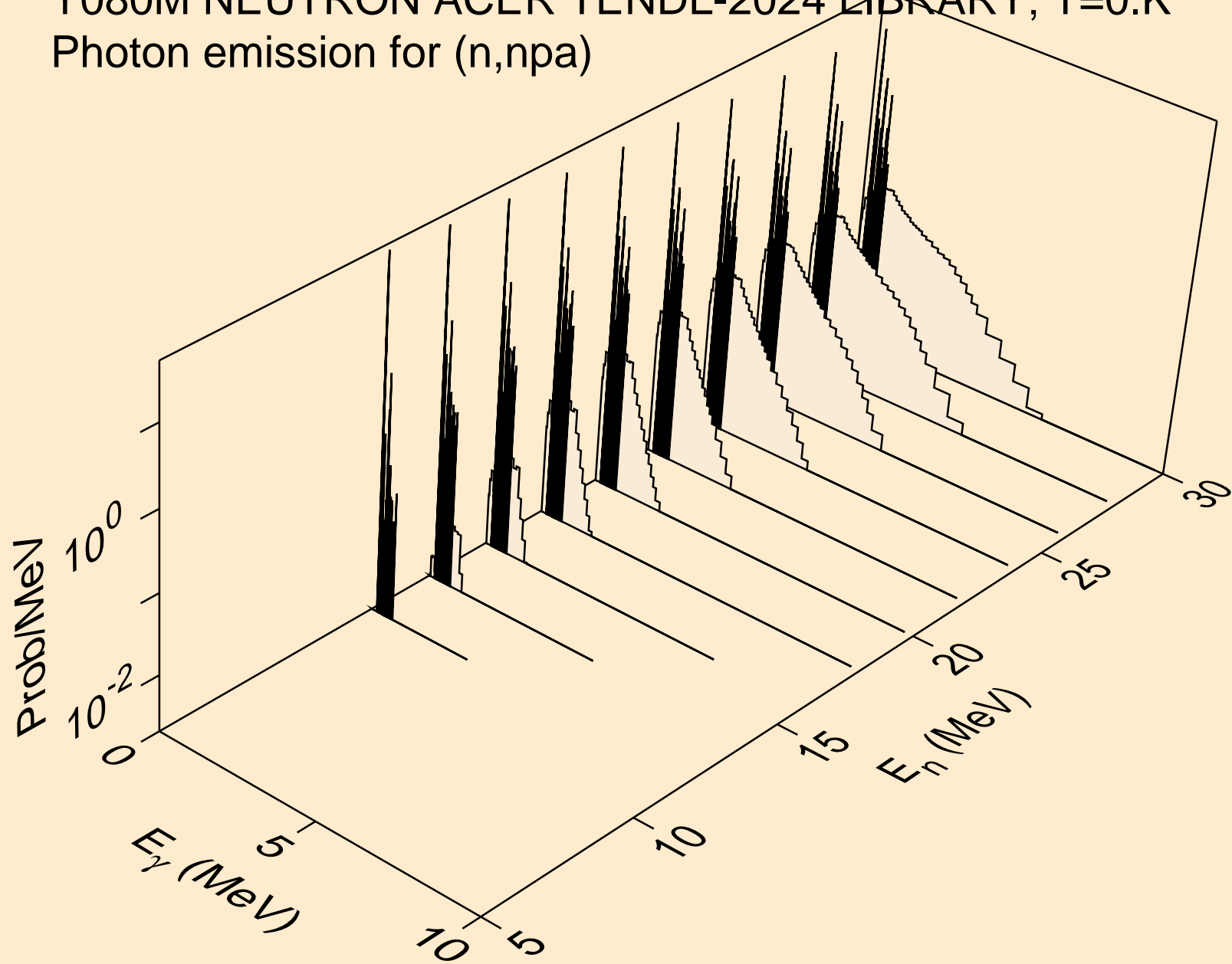

Y080M NEUTRON ACER TENDL-2024 LIBRARY; T=0.K  
Photon emission for (n,n\*2)

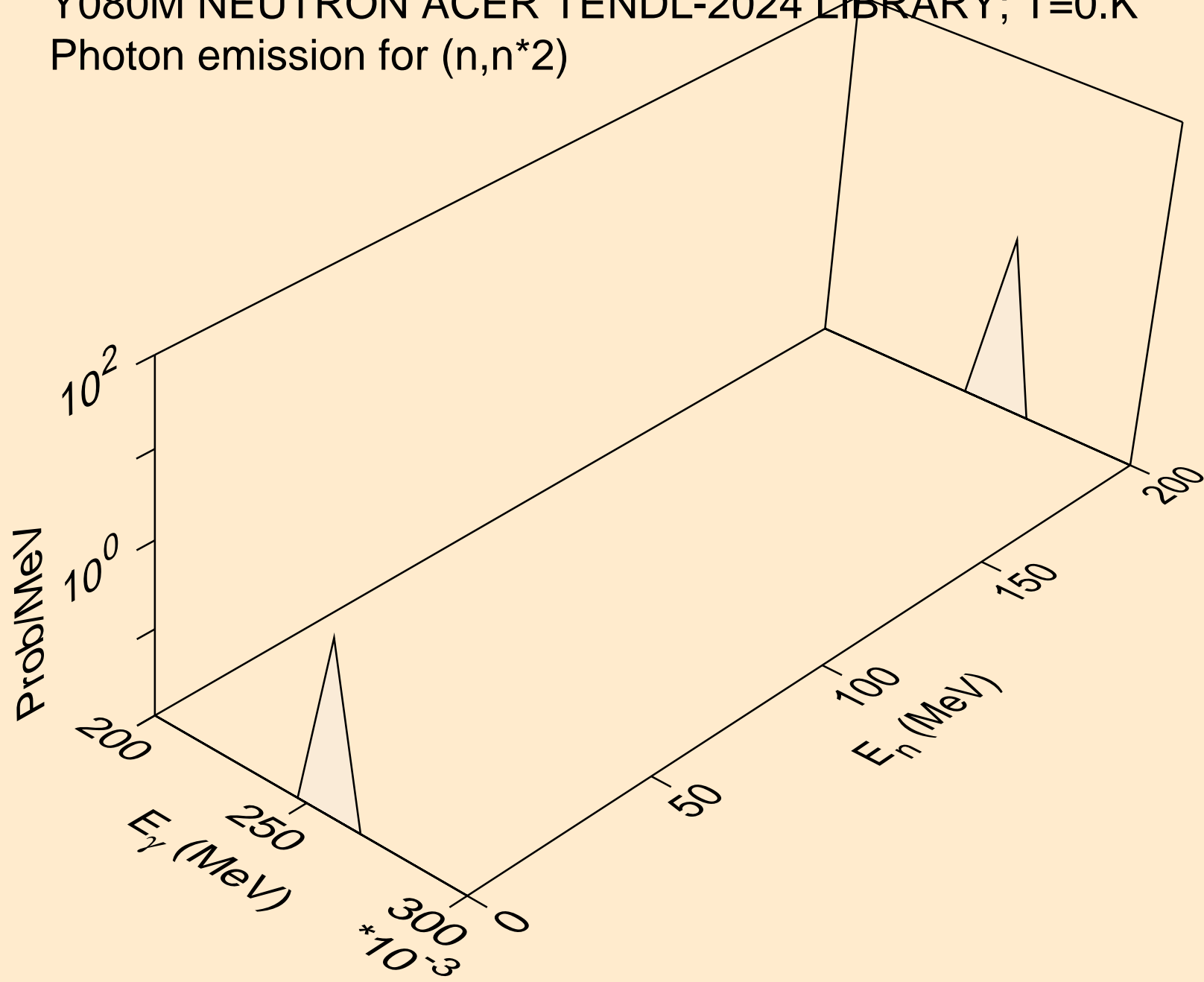

Y080M NEUTRON ACER TENDL-2024 LIBRARY; T=0.K  
Photon emission for (n,n\*3)

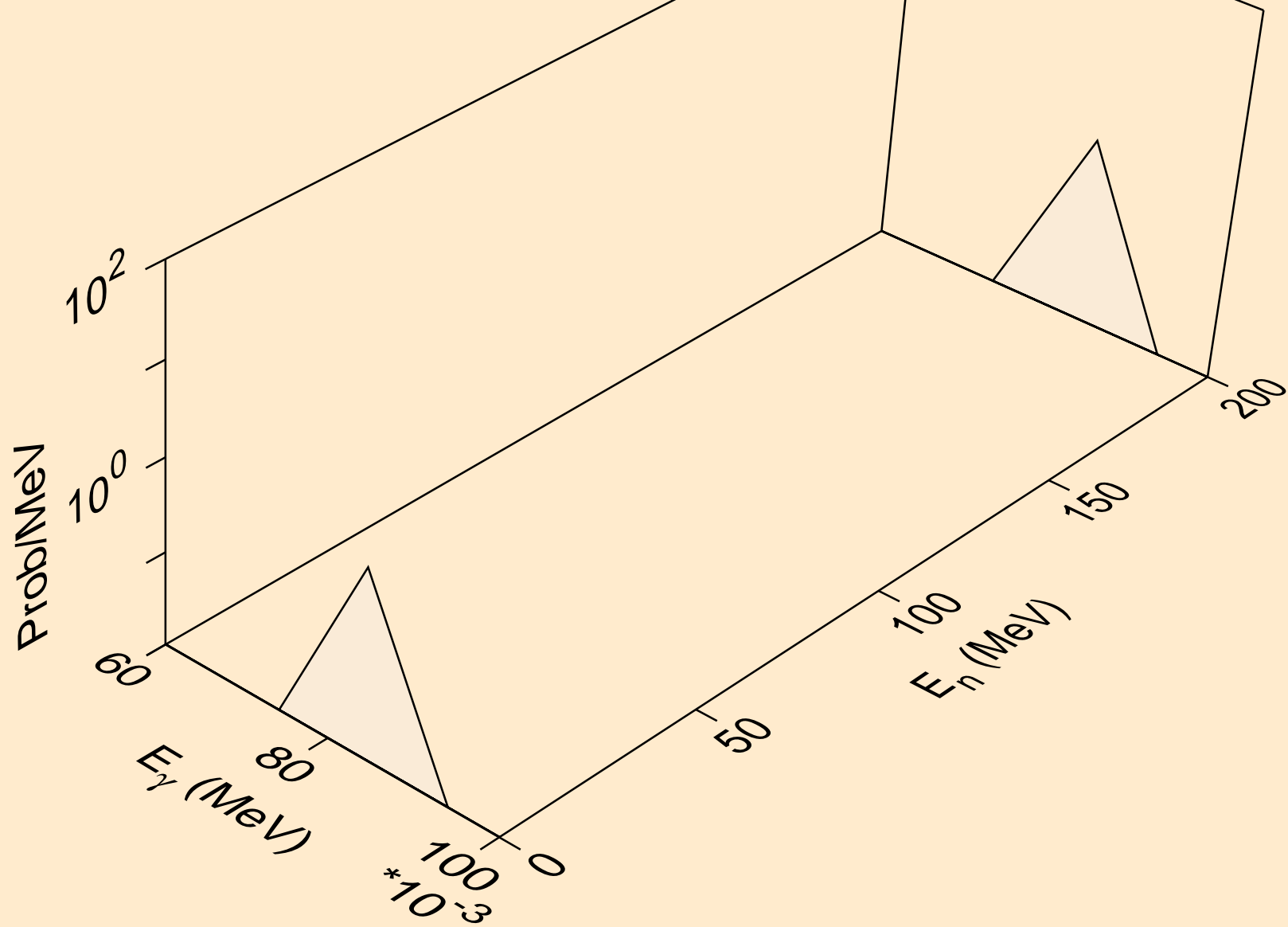

Y080M NEUTRON ACER TENDL-2024 LIBRARY; T=0.K  
Photon emission for (n,n\*4)

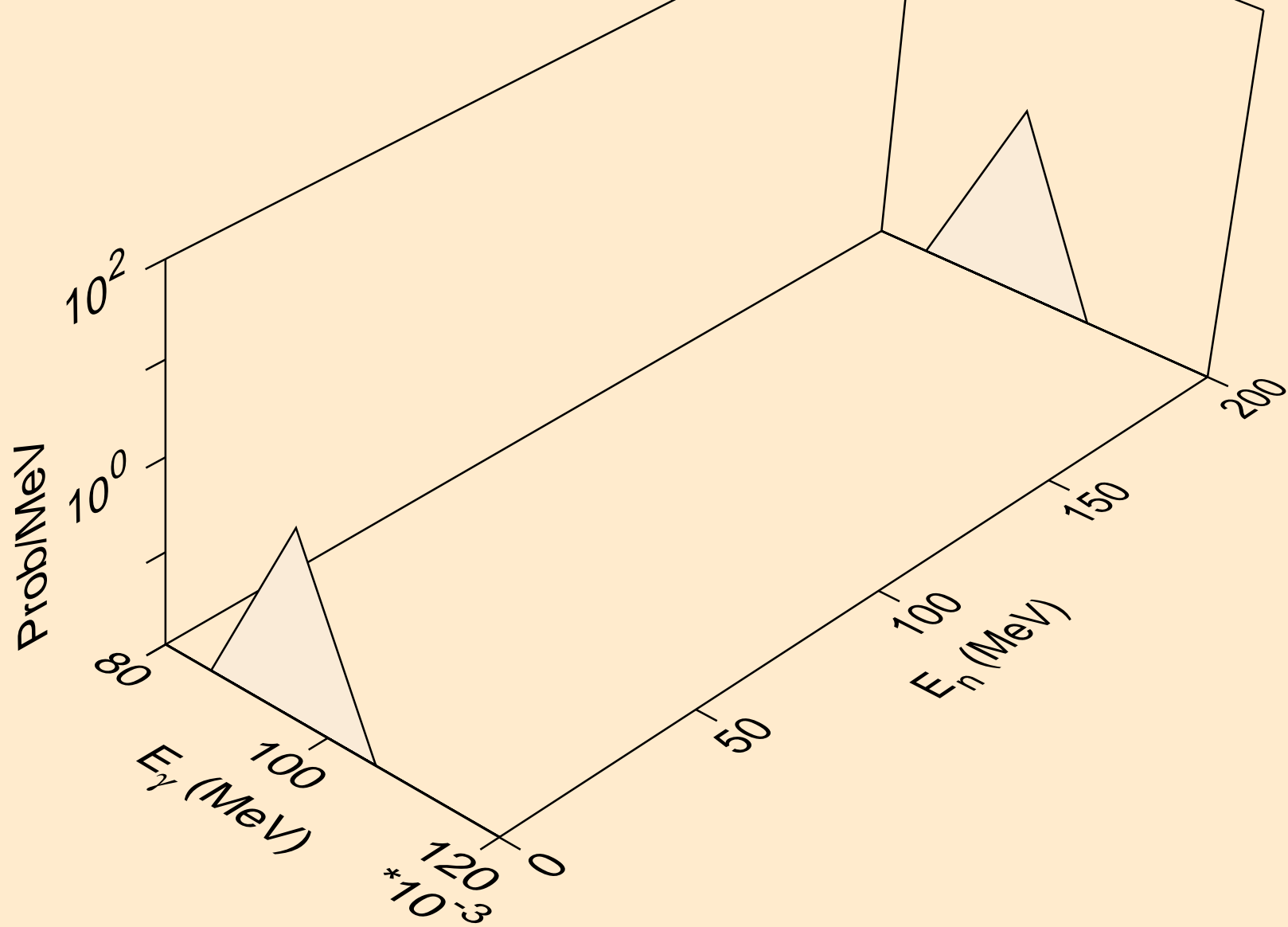

Y080M NEUTRON ACER TENDL-2024 LIBRARY; T=0.K  
Photon emission for (n,n\*c)

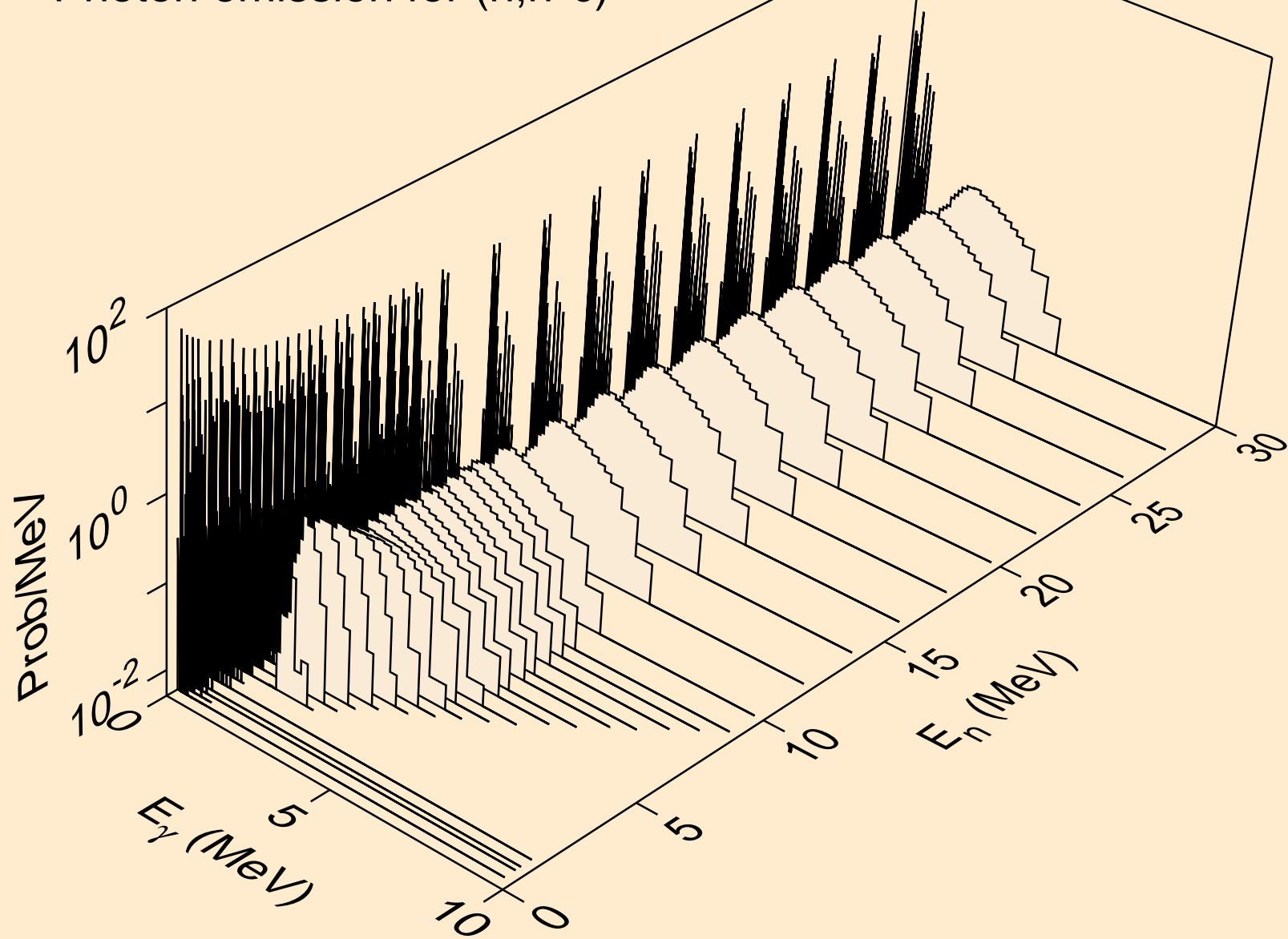



Y080M NEUTRON ACER TENDL-2024 LIBRARY; T=0.K  
Photon emission for (n,gma)

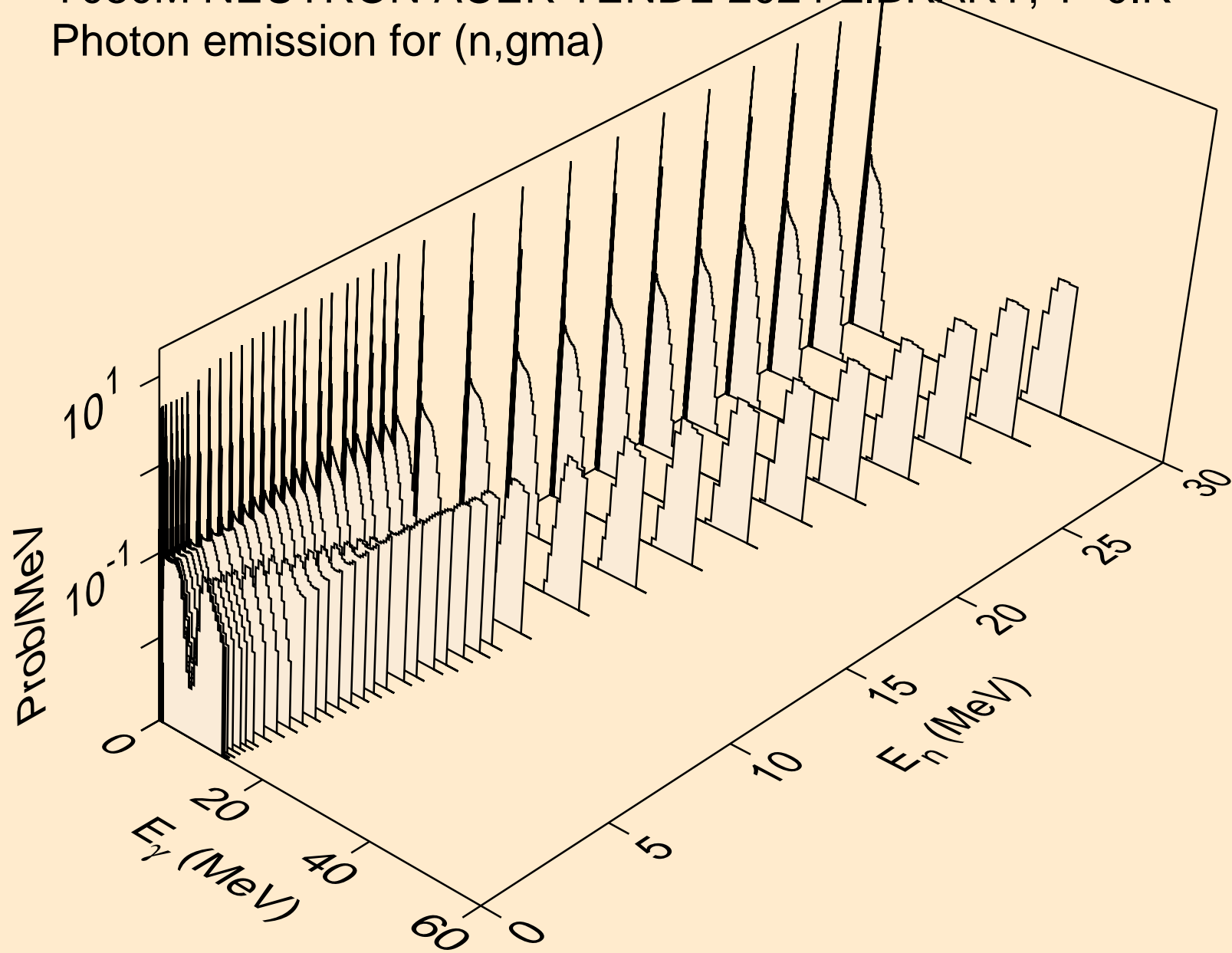

Y080M NEUTRON ACER TENDL-2024 LIBRARY; T=0.K  
Photon emission for (n,p)

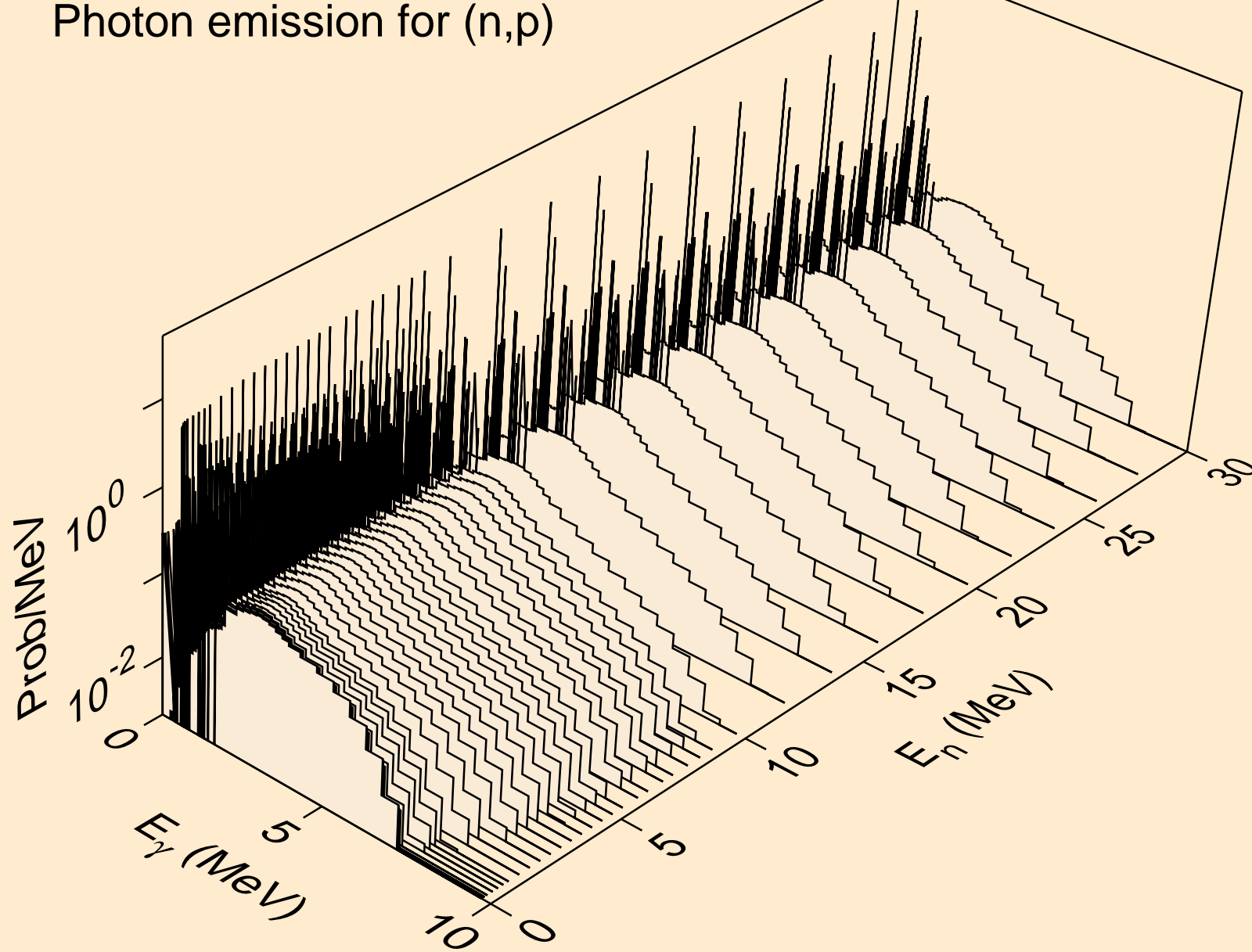

Y080M NEUTRON ACER TENDL-2024 LIBRARY; T=0.K  
Photon emission for (n,d)

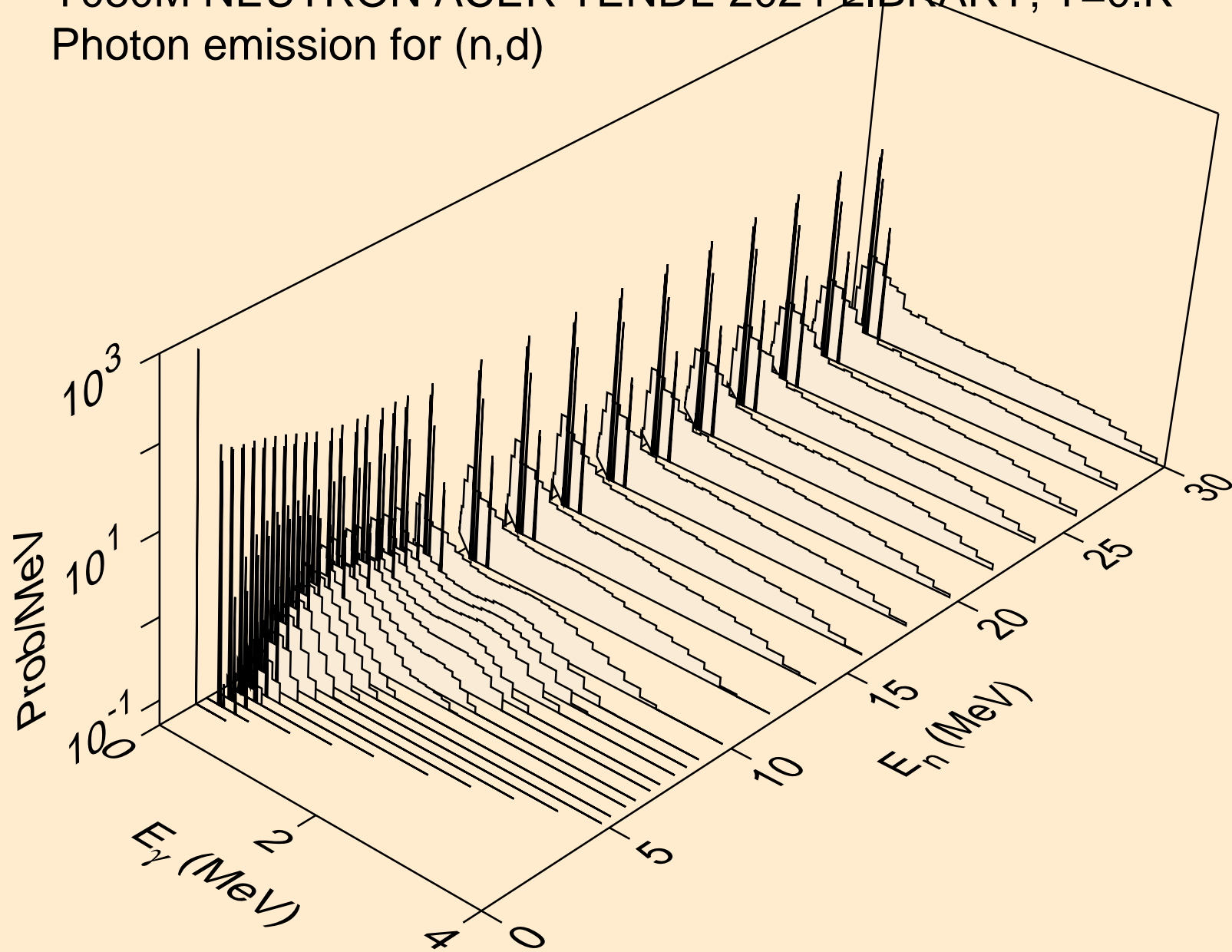

Y080M NEUTRON ACER TENDL-2024 LIBRARY; T=0.K  
Photon emission for (n,t)

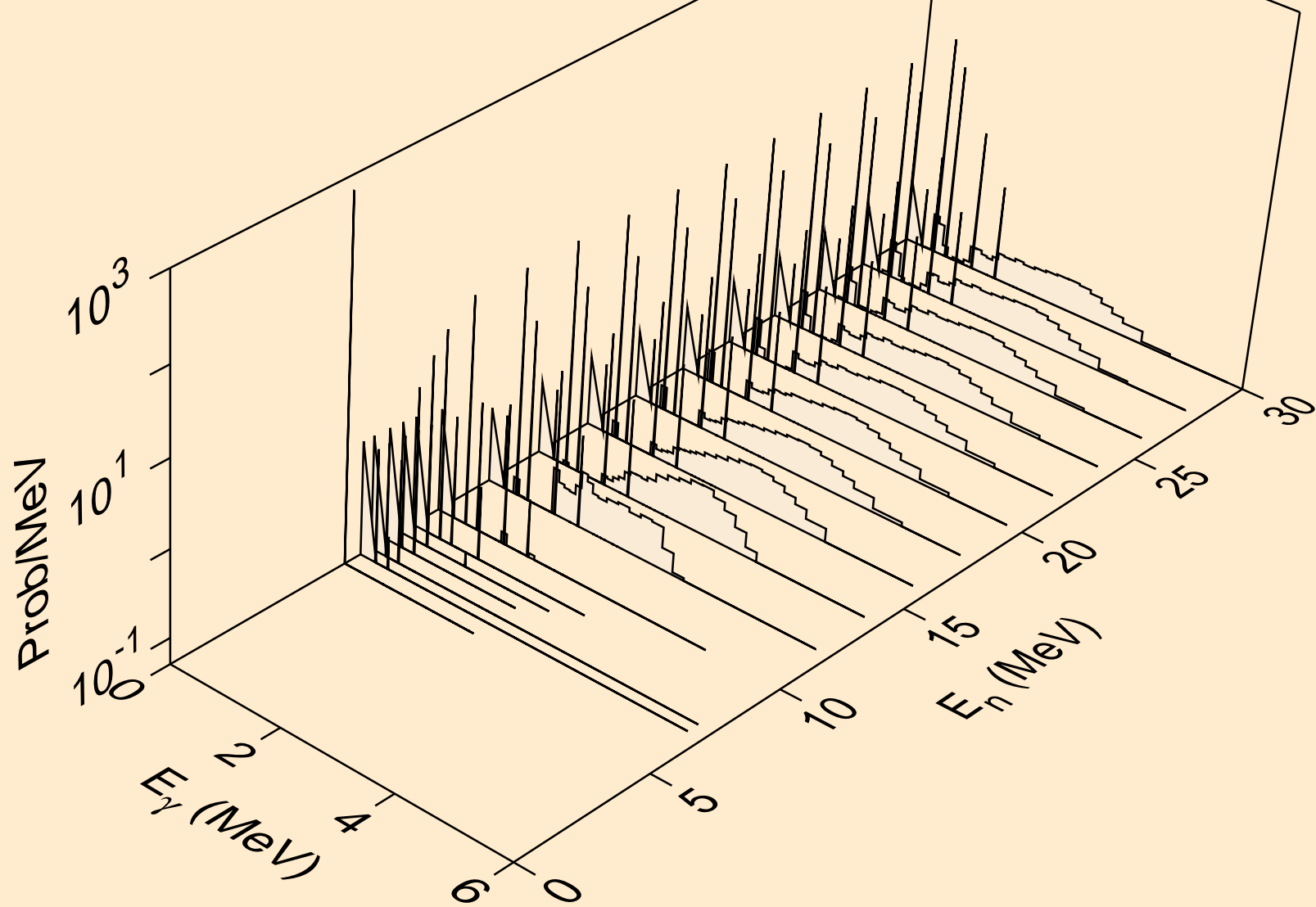

Y080M NEUTRON ACER TENDL-2024 LIBRARY; T=0.K  
Photon emission for (n,he3)

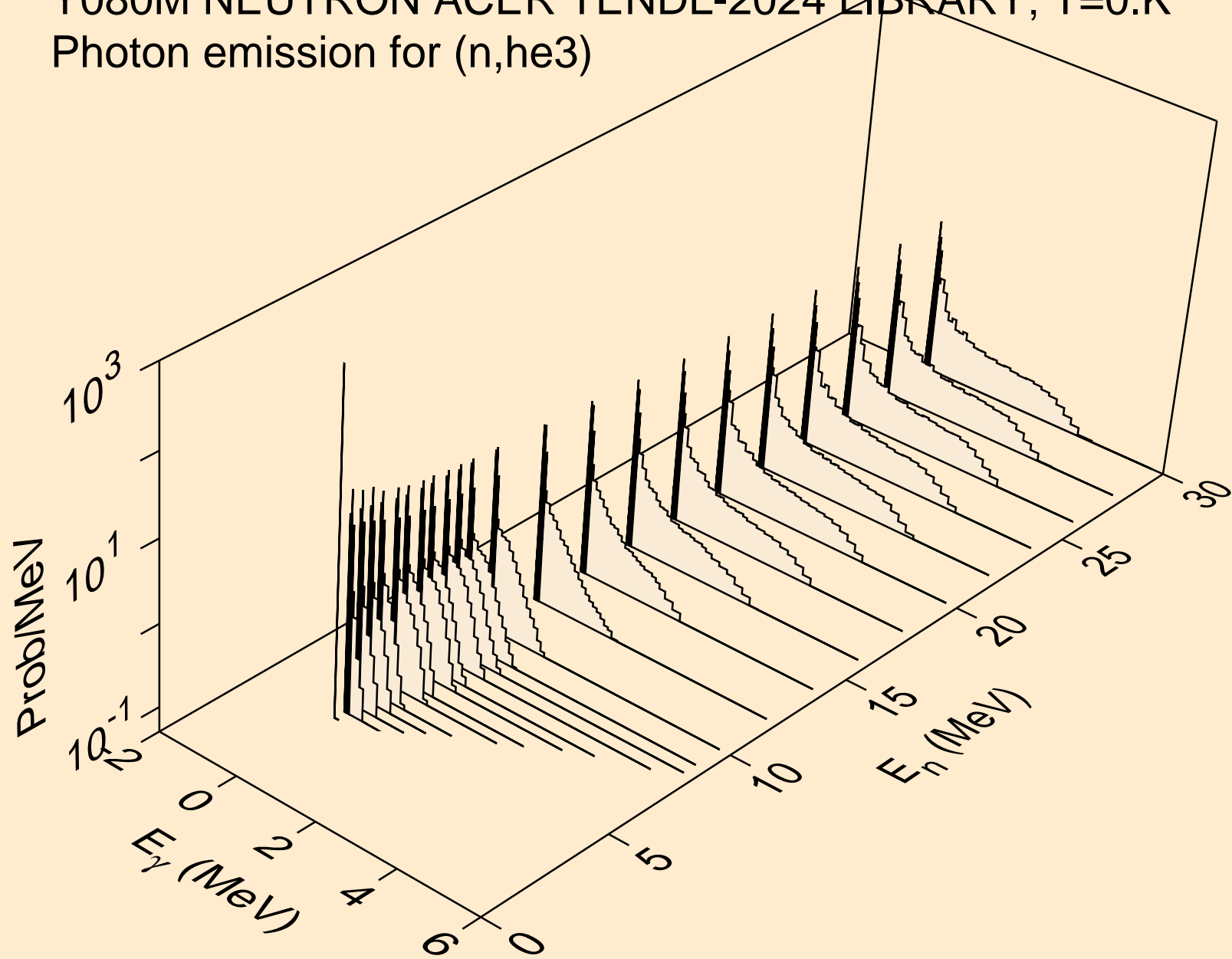

Y080M NEUTRON ACER TENDL-2024 LIBRARY; T=0.K  
Photon emission for (n,a)

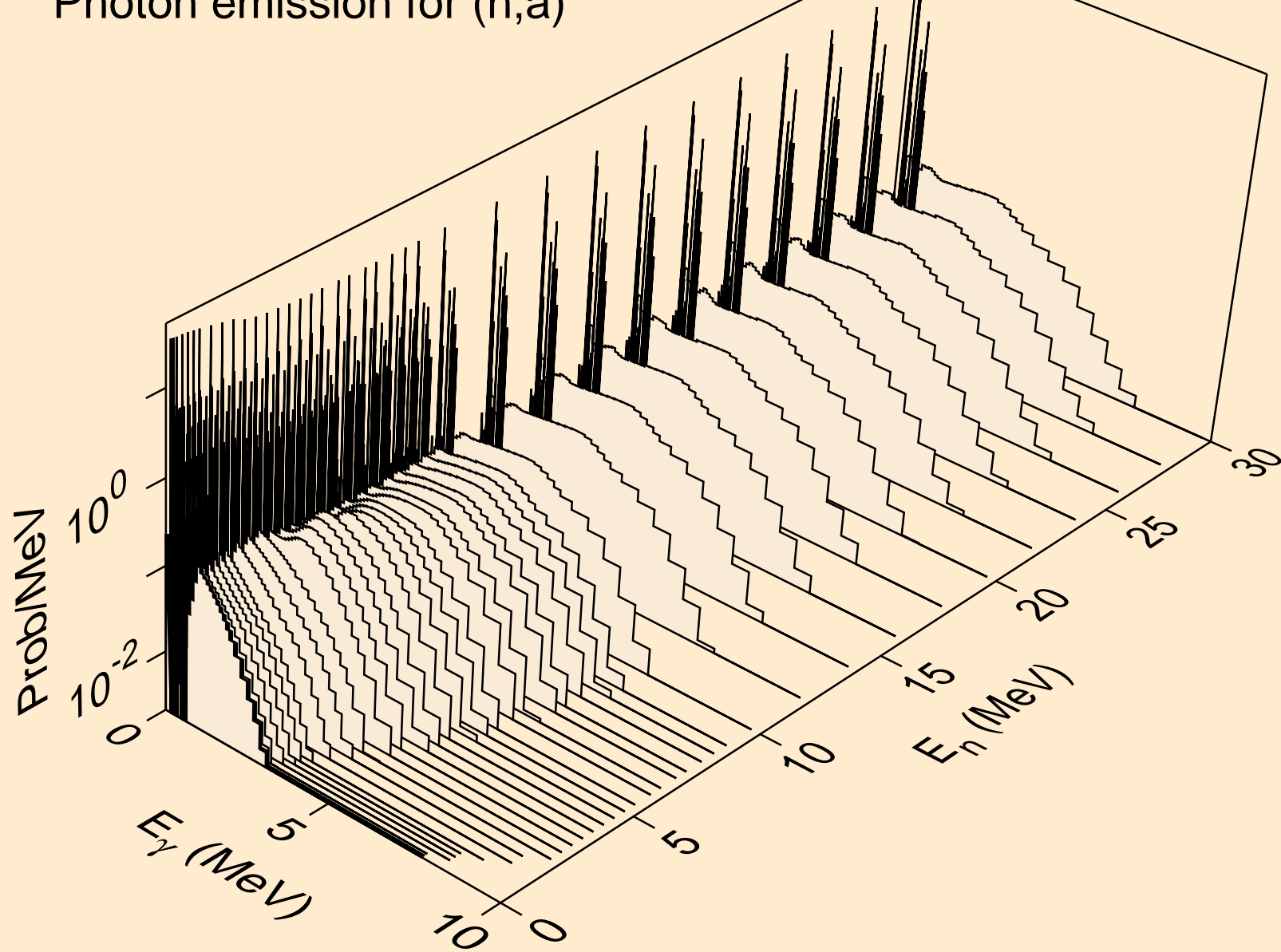

Y080M NEUTRON ACER TENDL-2024 LIBRARY; T=0.K  
Photon emission for (n,2a)

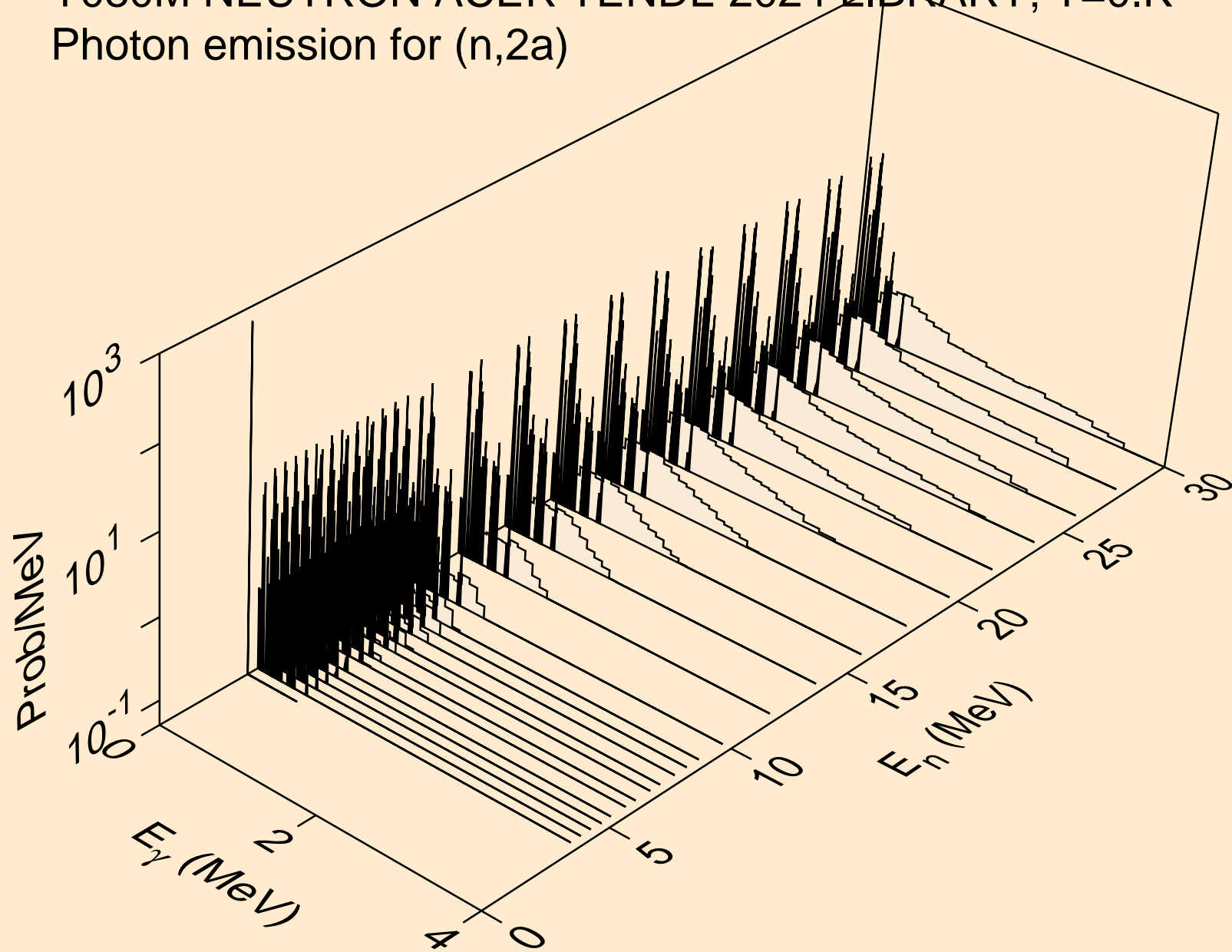

Y080M NEUTRON ACER TENDL-2024 LIBRARY; T=0.K  
Photon emission for (n,3a)

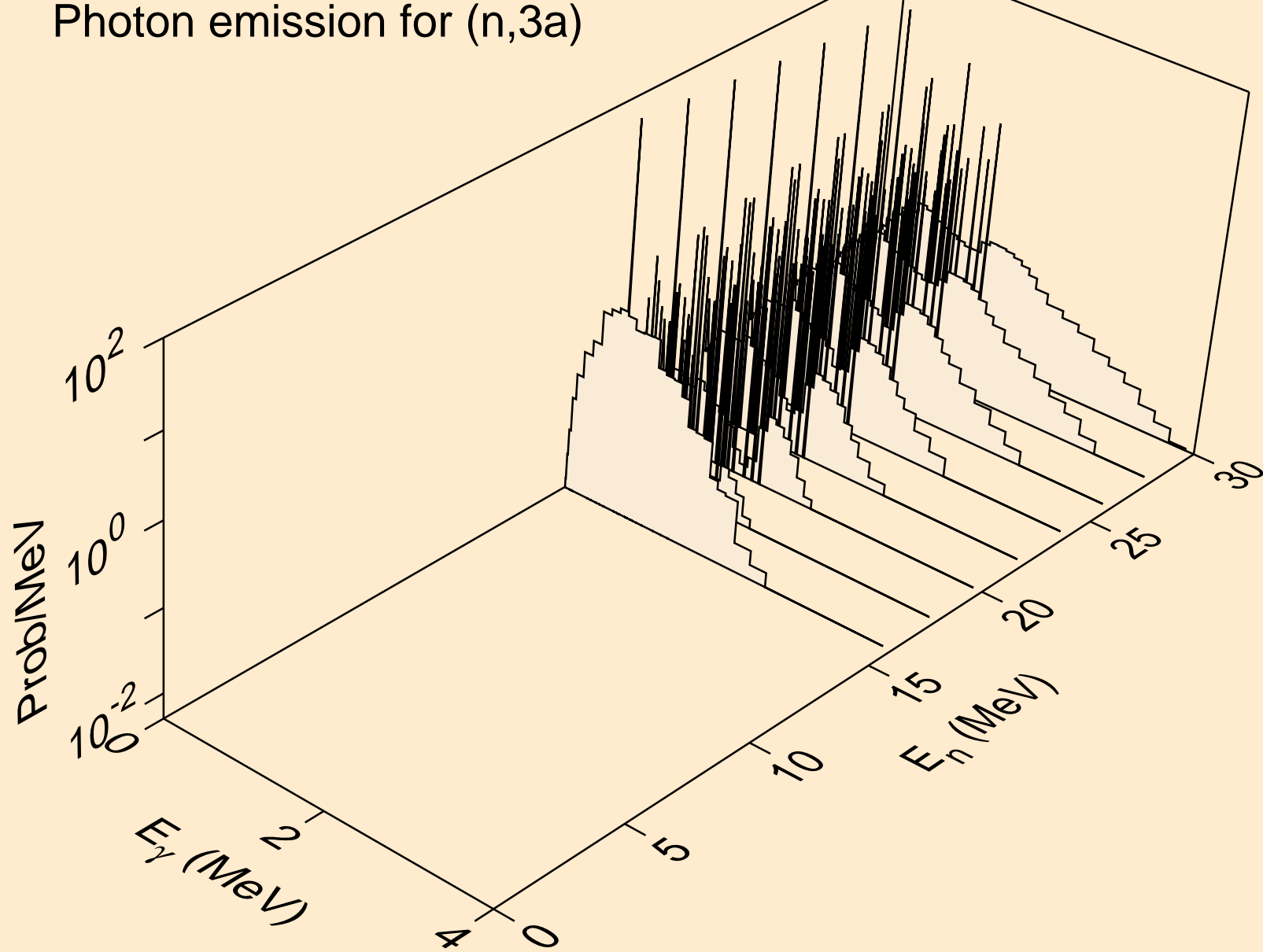



Y080M NEUTRON ACER TENDL-2024 LIBRARY; T=0.K  
Photon emission for (n,2p)

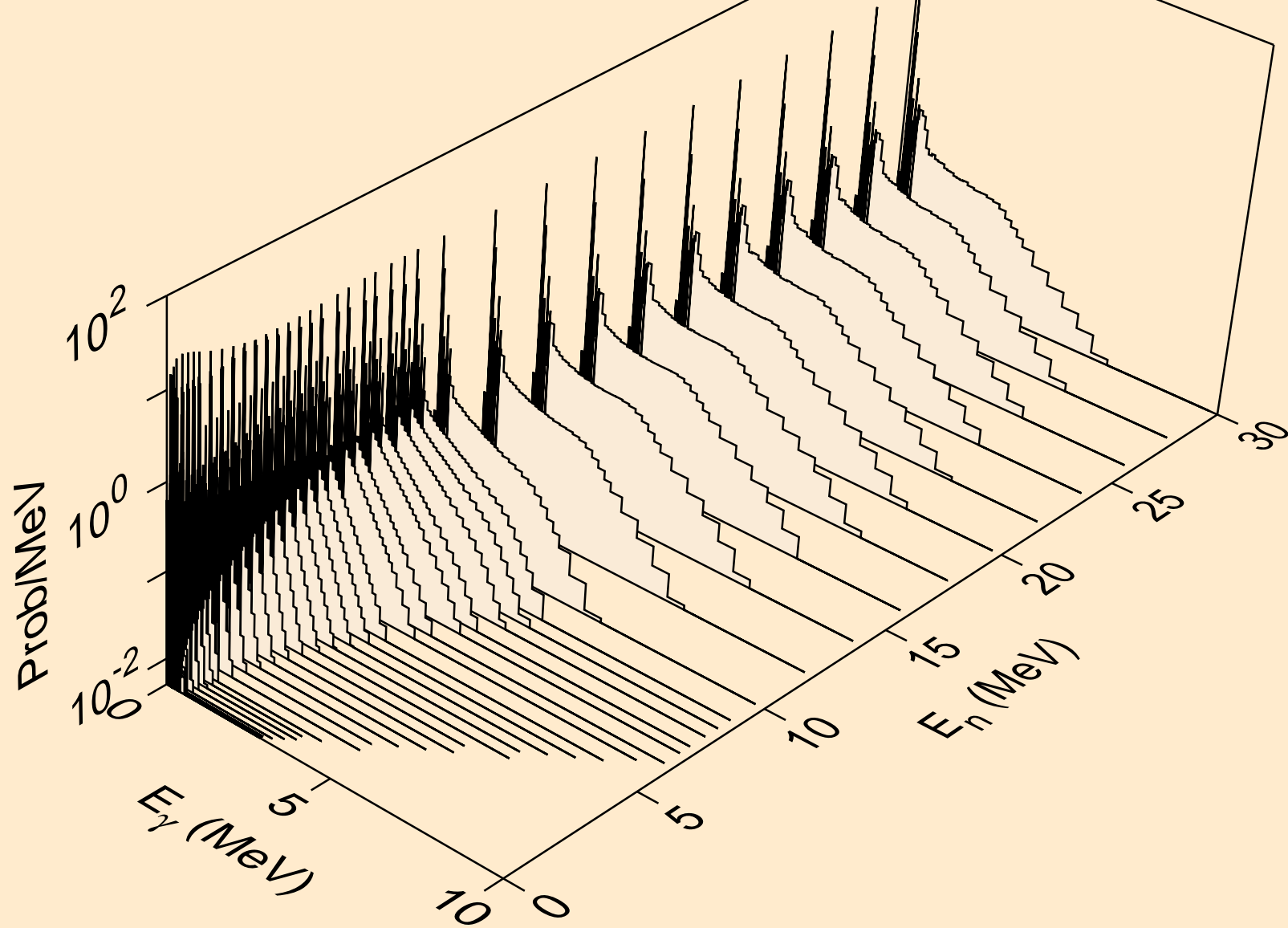

Y080M NEUTRON ACER TENDL-2024 LIBRARY; T=0.K  
Photon emission for (n,p $\alpha$ )

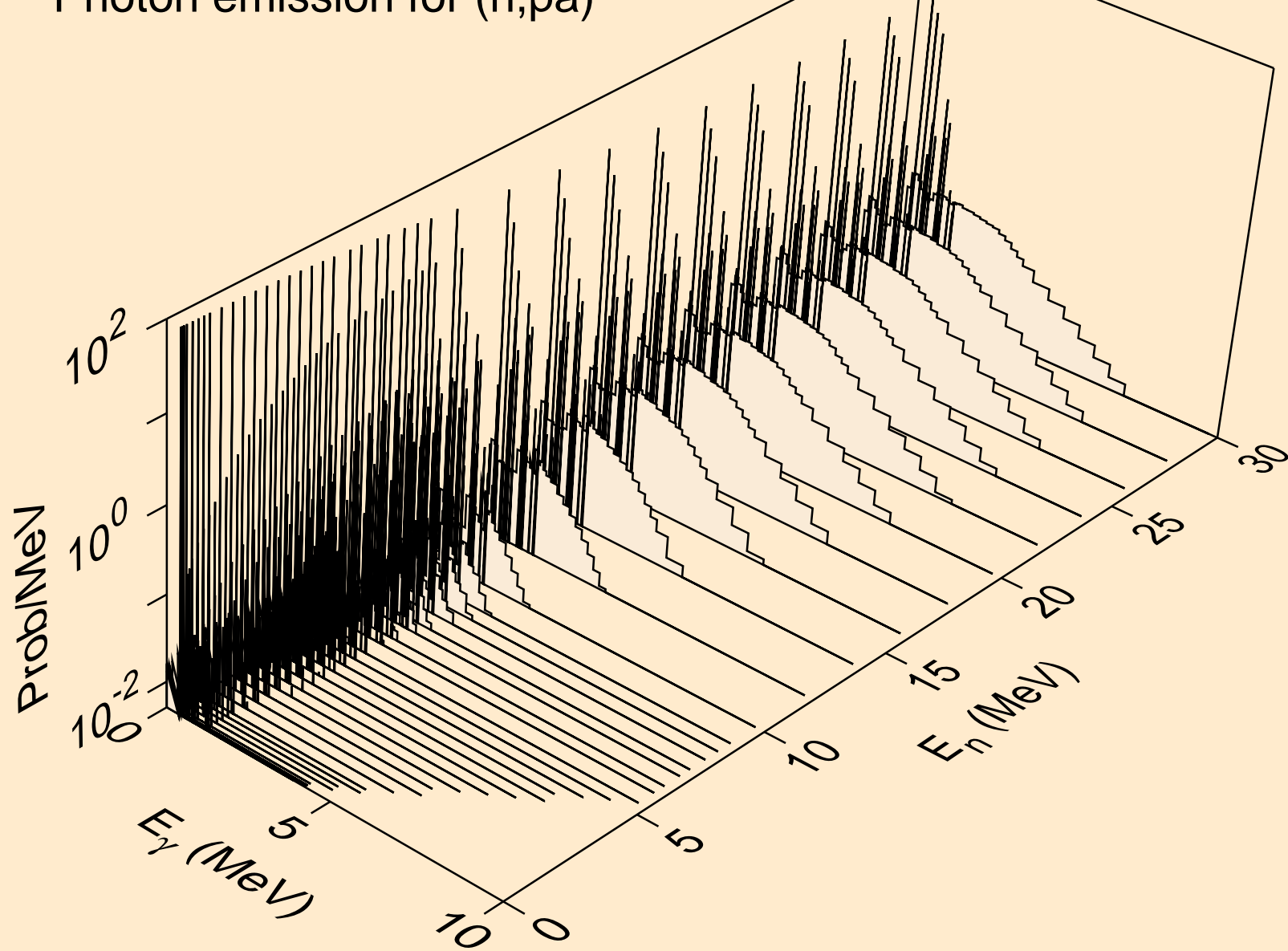

Y080M NEUTRON ACER TENDL-2024 LIBRARY; T=0.K  
Photon emission for (n,pd)

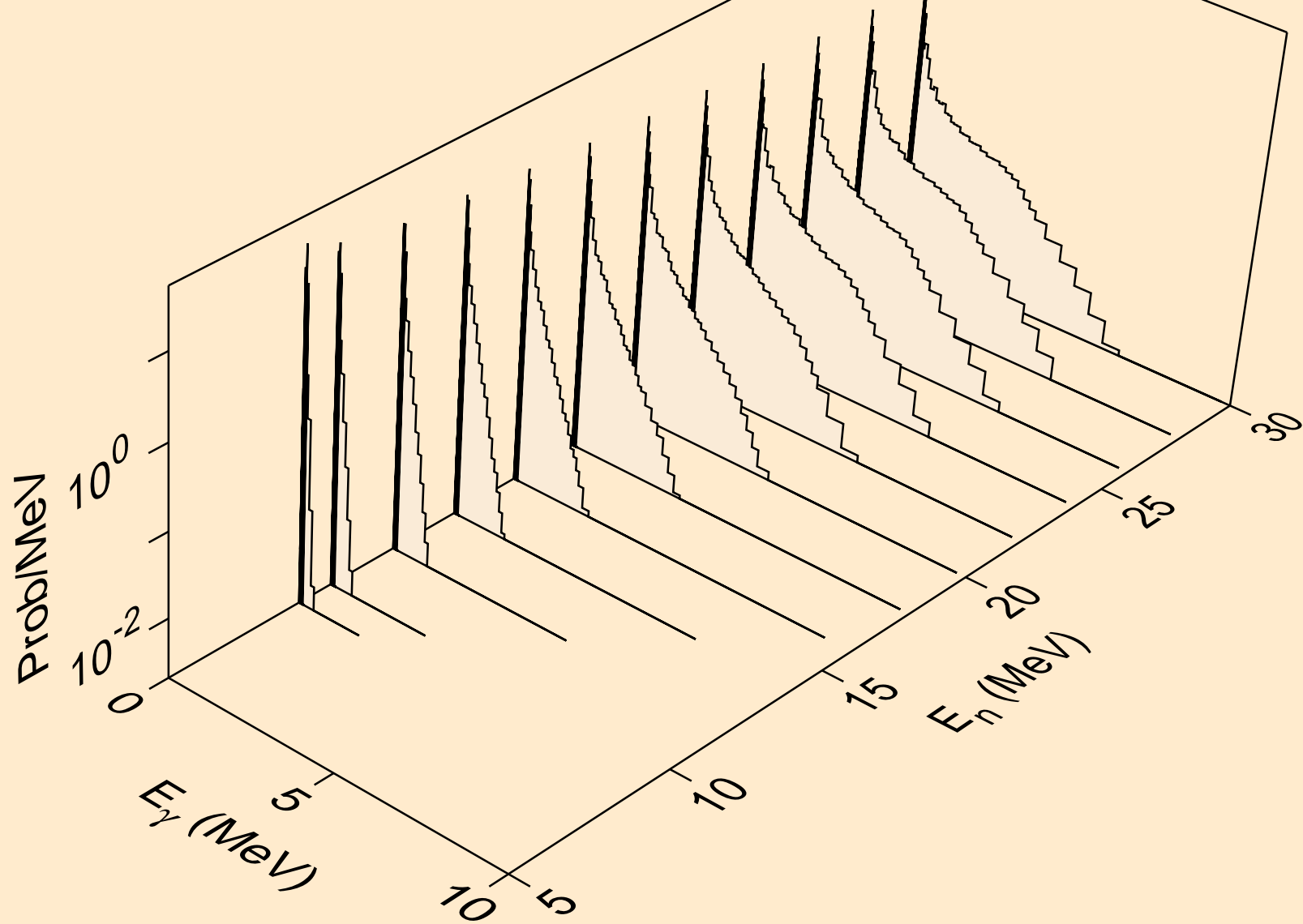

Y080M NEUTRON ACER TENDL-2024 LIBRARY; T=0.K  
Photon emission for (n,pt)

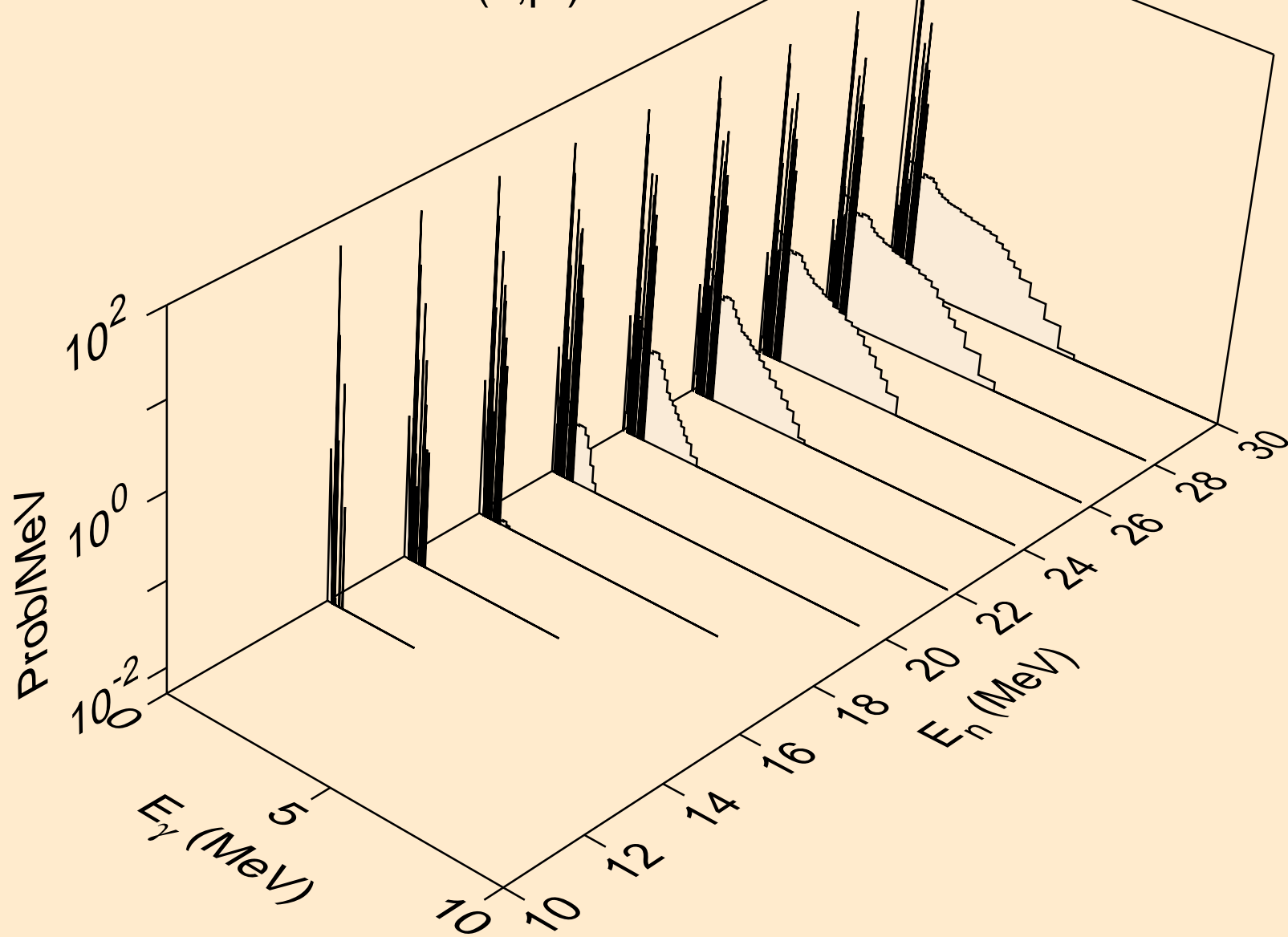

Y080M NEUTRON ACER TENDL-2024 LIBRARY; T=0.K  
Photon emission for (n,da)

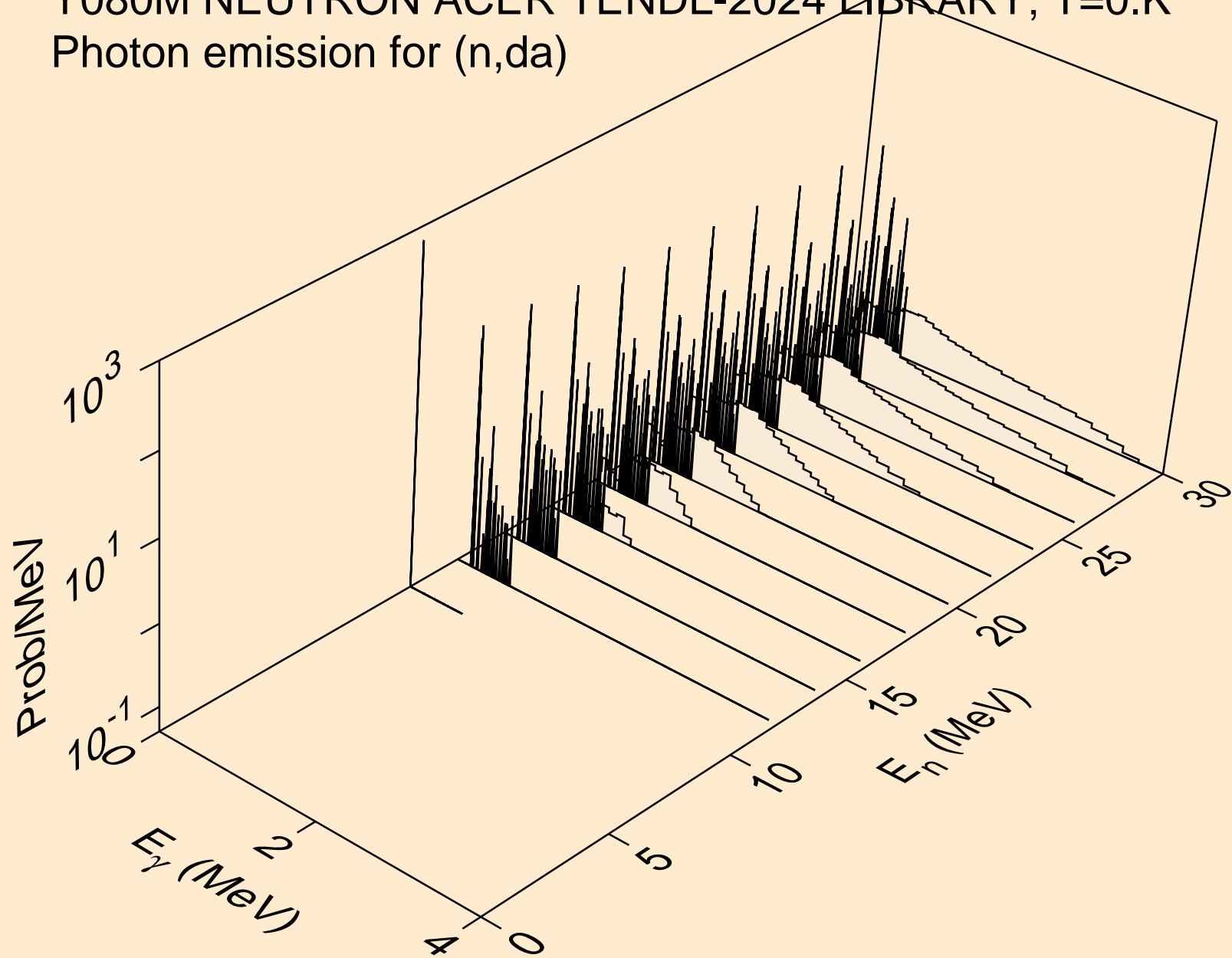

Y080M NEUTRON ACER TENDL-2024 LIBRARY; T=0.K  
thermal capture photon spectrum

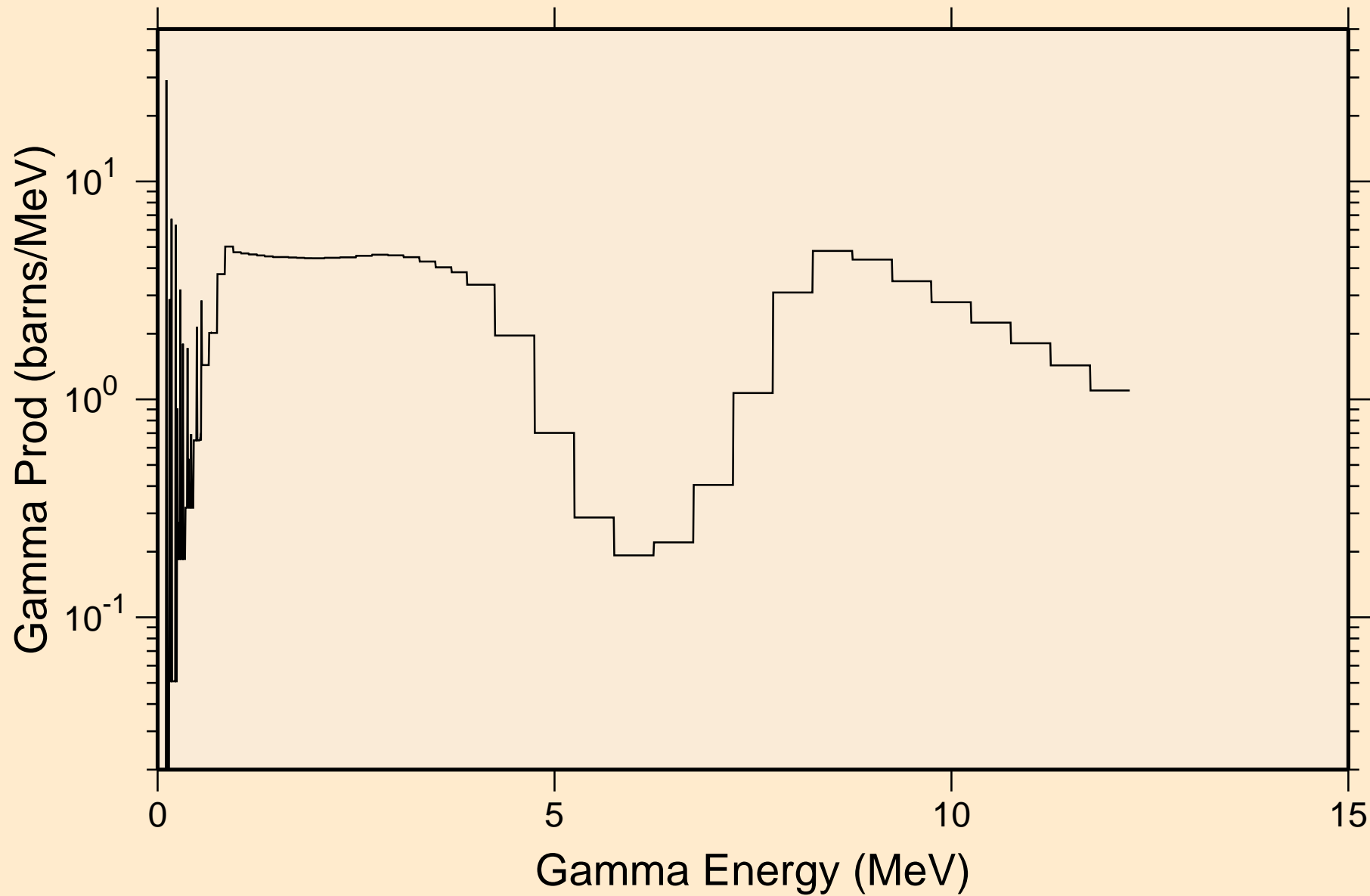

Y080M NEUTRON ACER TENDL-2024 LIBRARY; T=0.K  
14 MeV photon spectrum

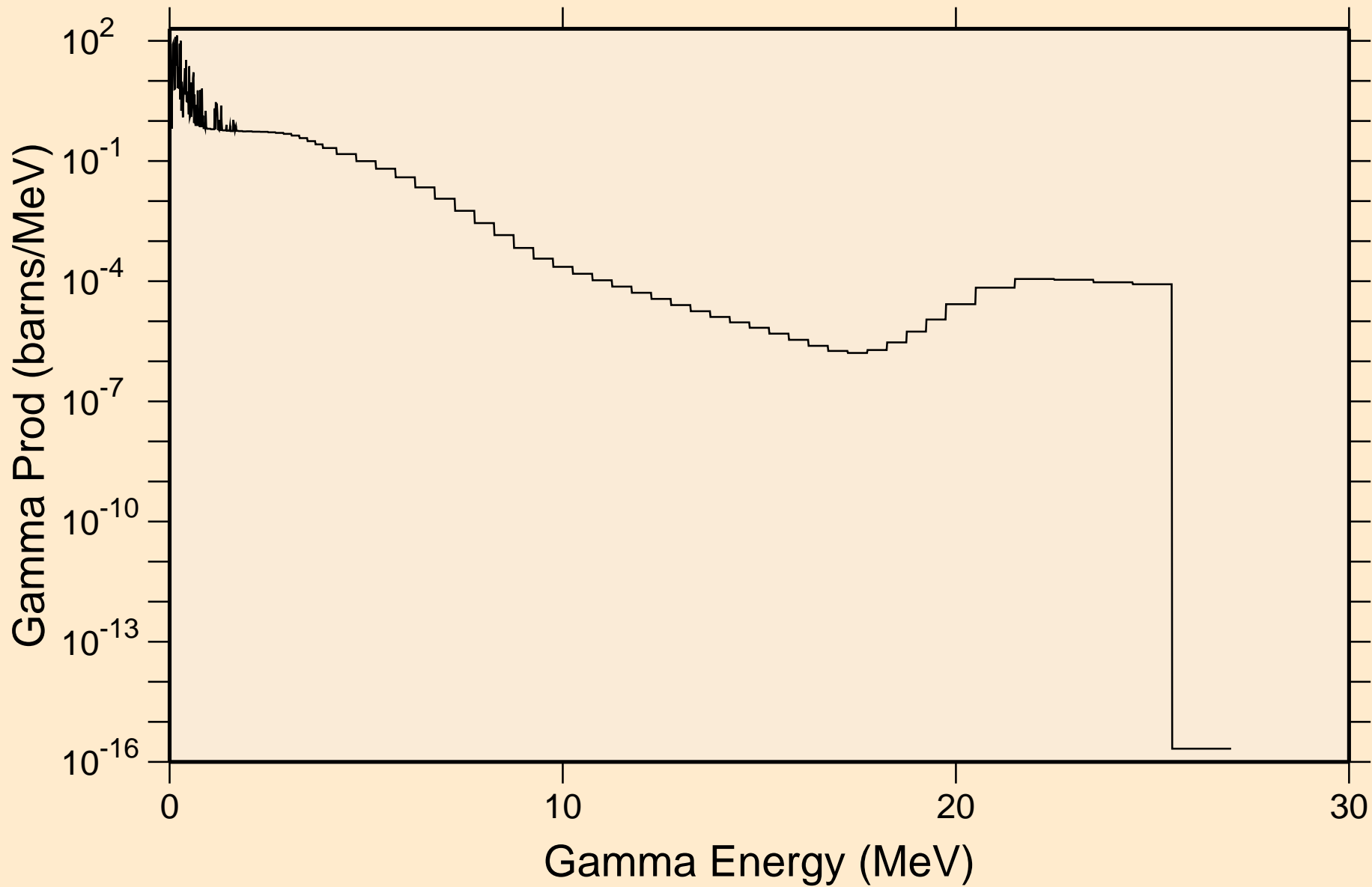

# Y080M NEUTRON ACER TENDL-2024 LIBRARY; T=0.K

## Particle heating contributions

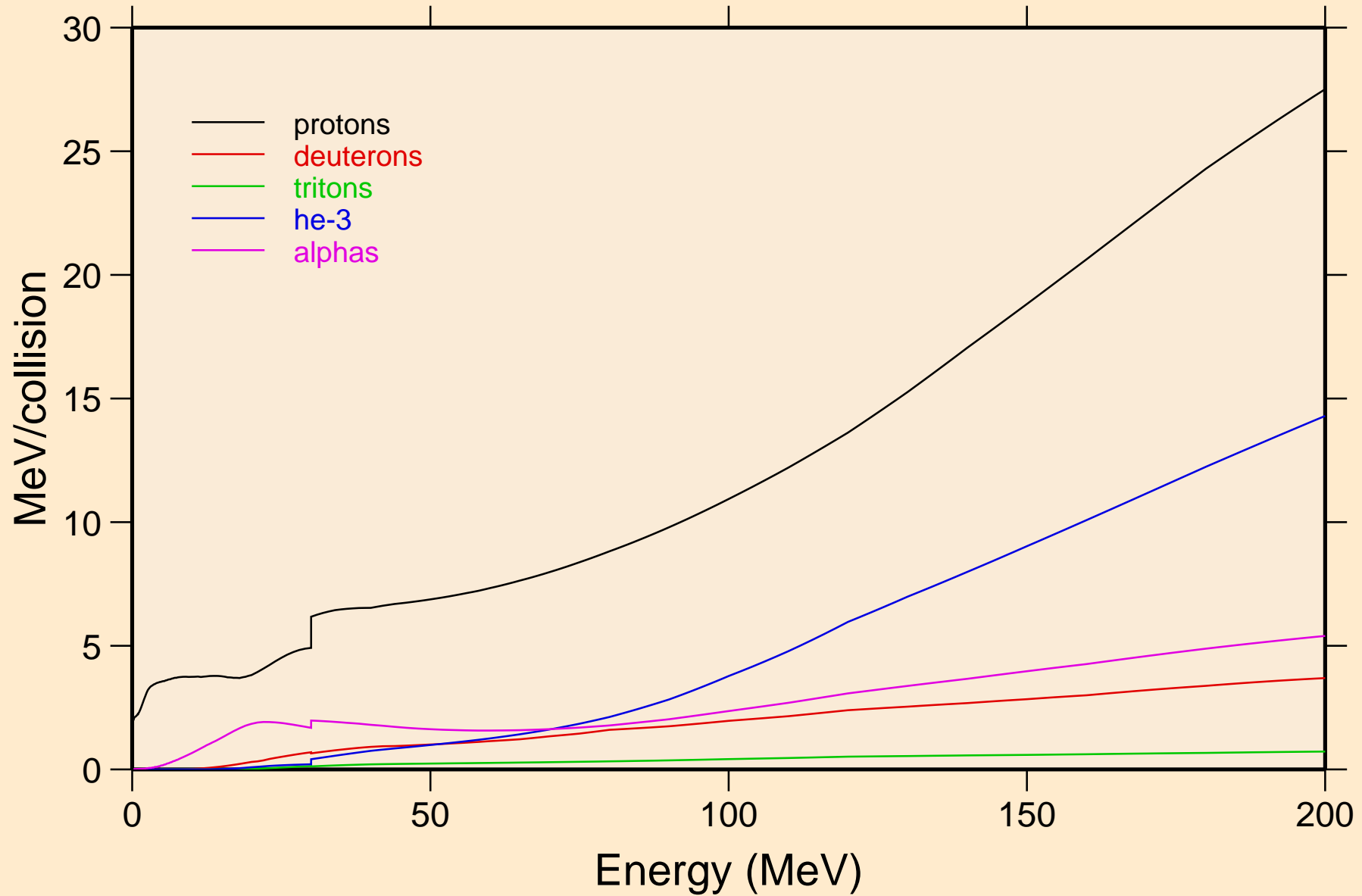



# Y080M NEUTRON ACER TENDL-2024 LIBRARY; T=0.K

## Recoil Heating

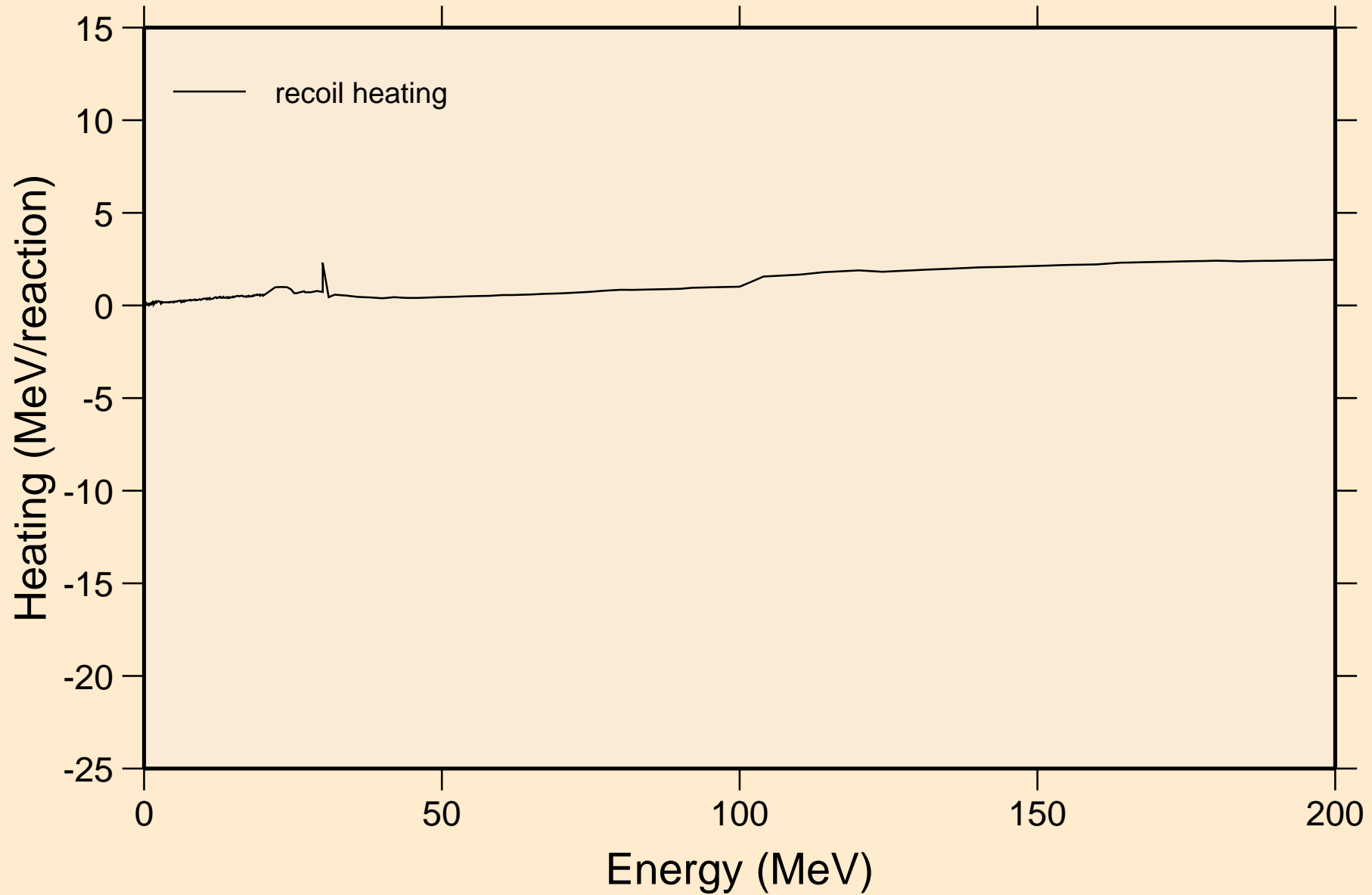

Y080M NEUTRON ACER TENDL-2024 LIBRARY; T=0.K  
Particle production cross sections

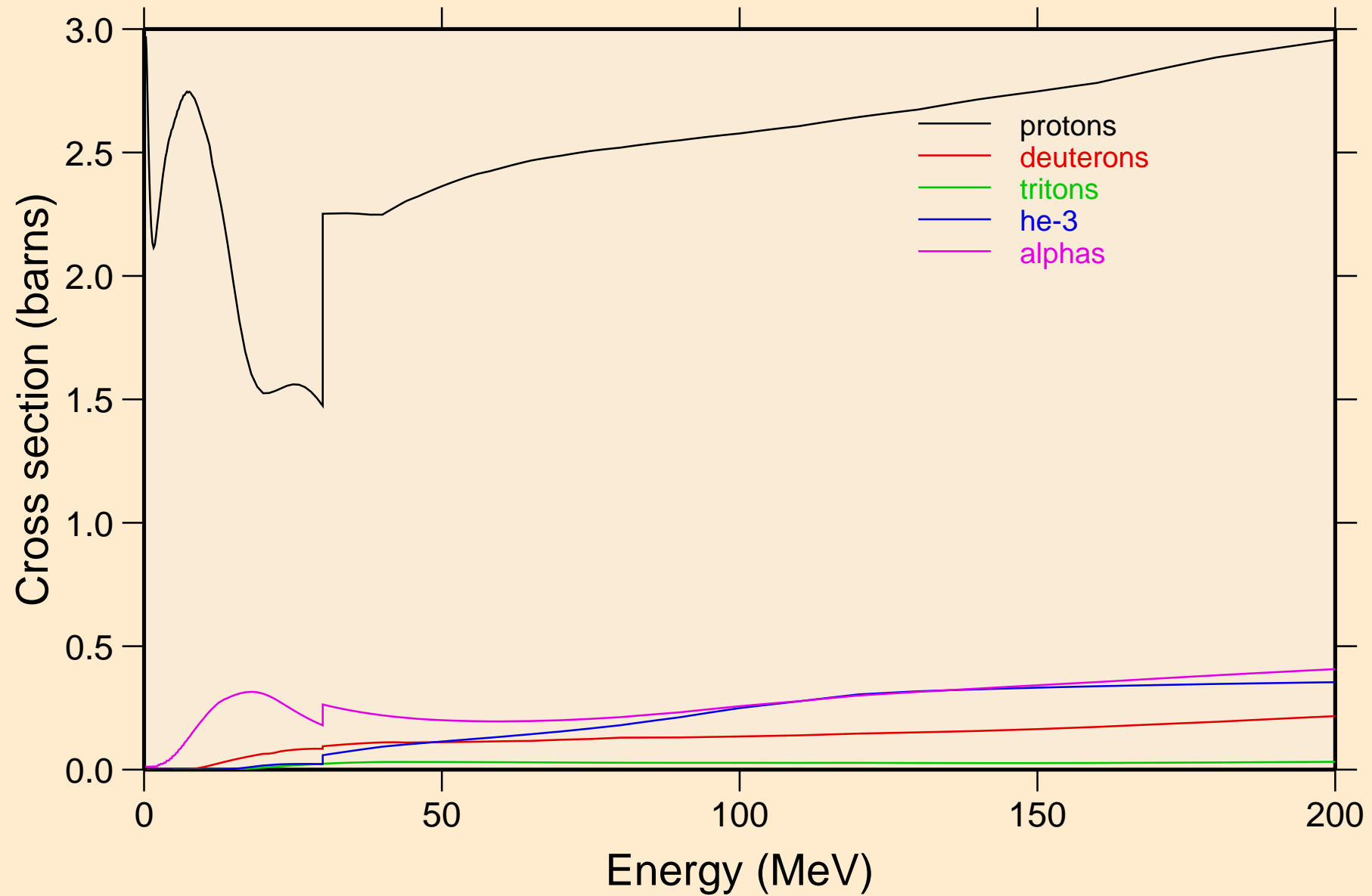

Y080M NEUTRON ACER TENDL-2024 LIBRARY; T=0.K  
protons from (n,x)

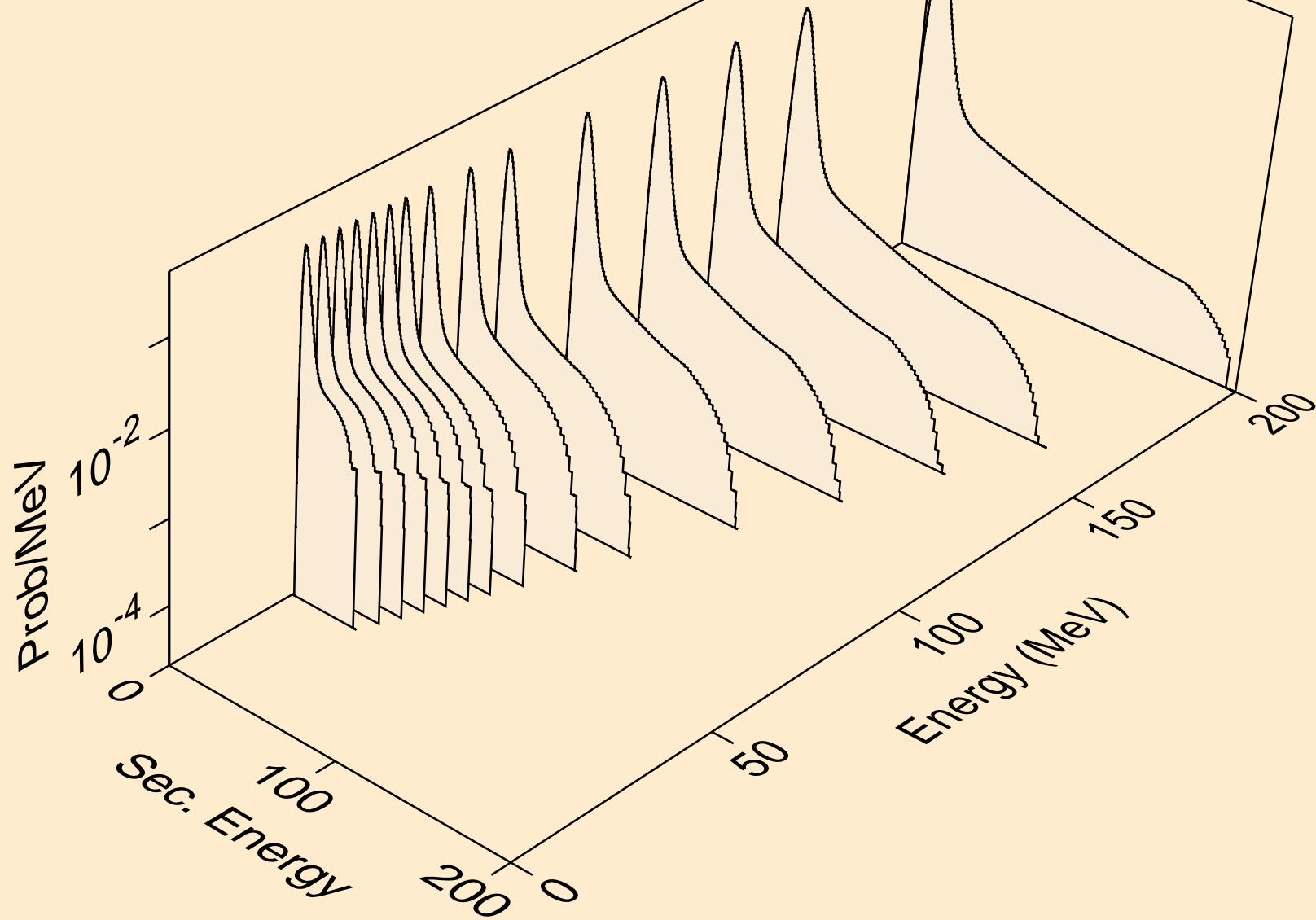

Y080M NEUTRON ACER TENDL-2024 LIBRARY; T=0.K  
protons from (n,n\*)p

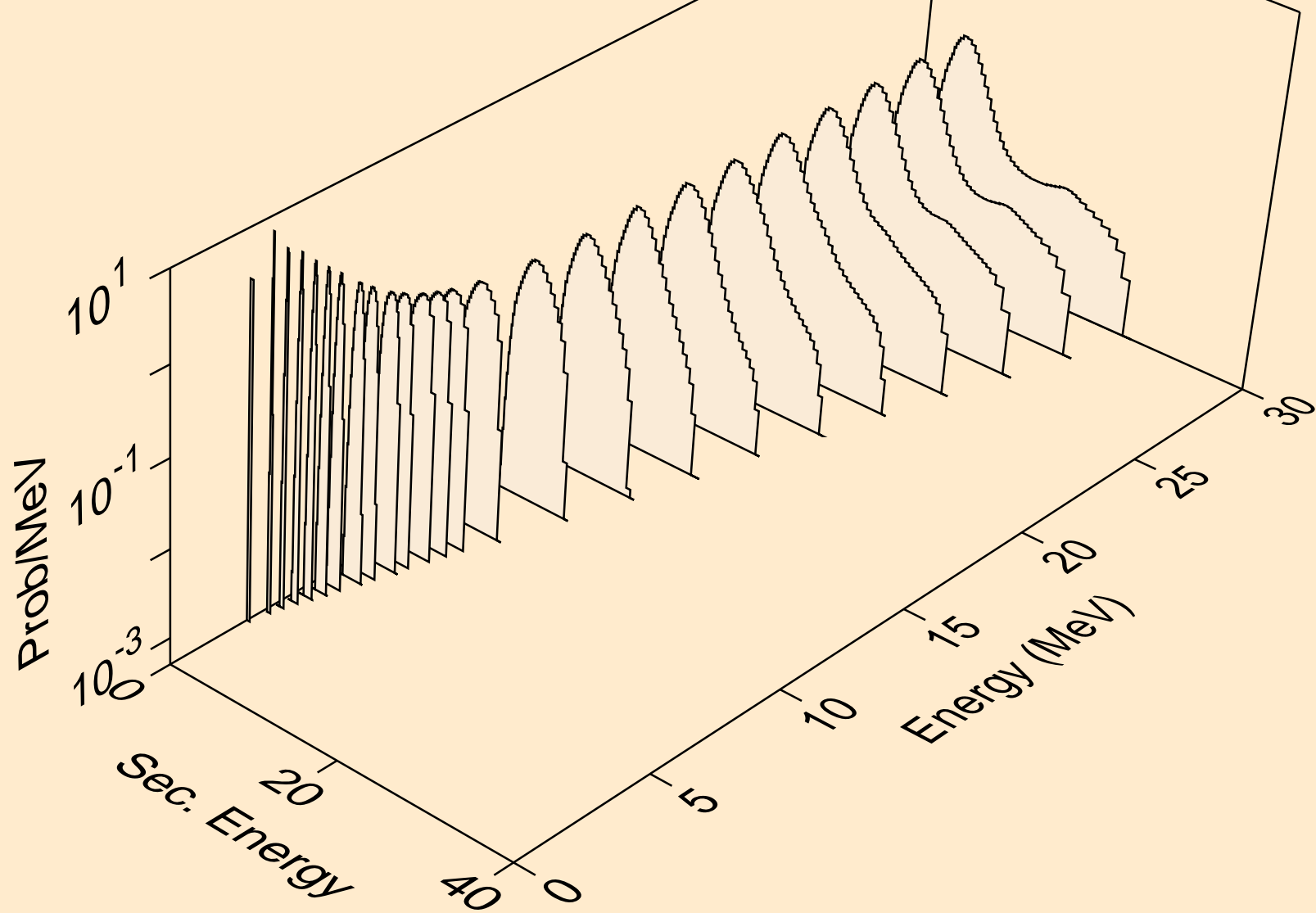

Y080M NEUTRON ACER TENDL-2024 LIBRARY; T=0.K  
protons from (n,2np)

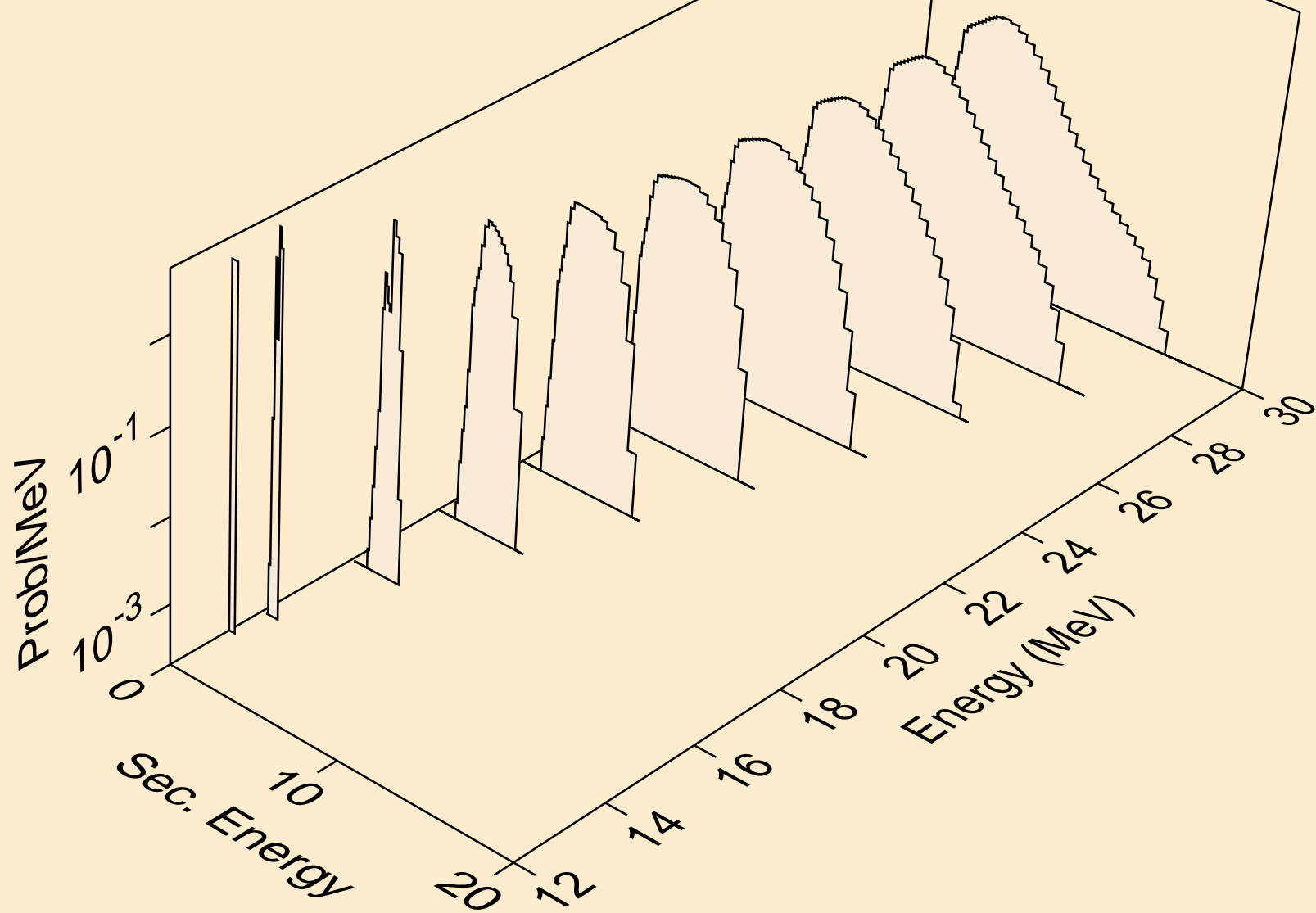

Y080M NEUTRON ACER TENDL-2024 LIBRARY; T=0.K  
protons from (n,3np)

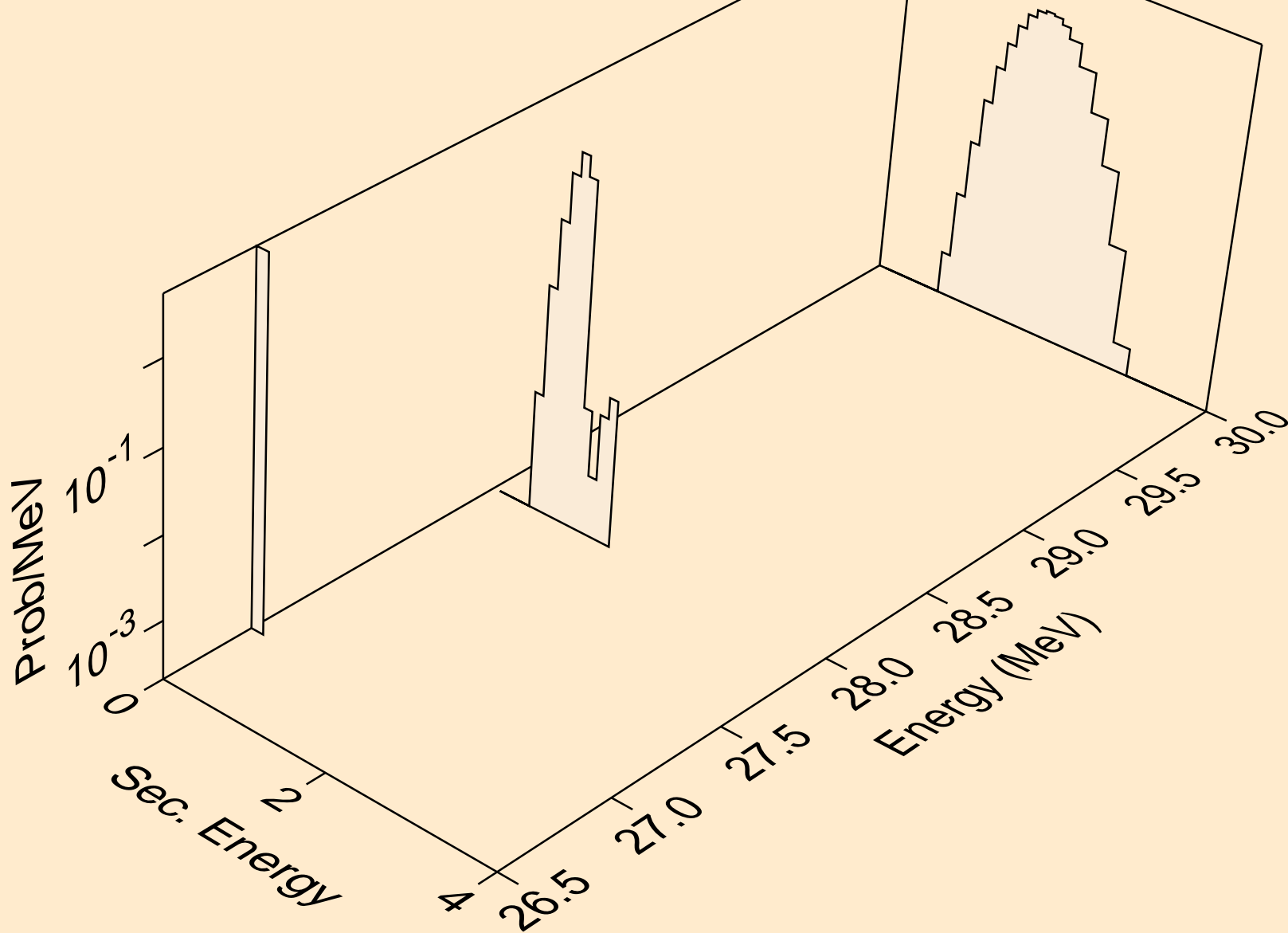

Y080M NEUTRON ACER TENDL-2024 LIBRARY; T=0.K  
protons from (n,n2p)

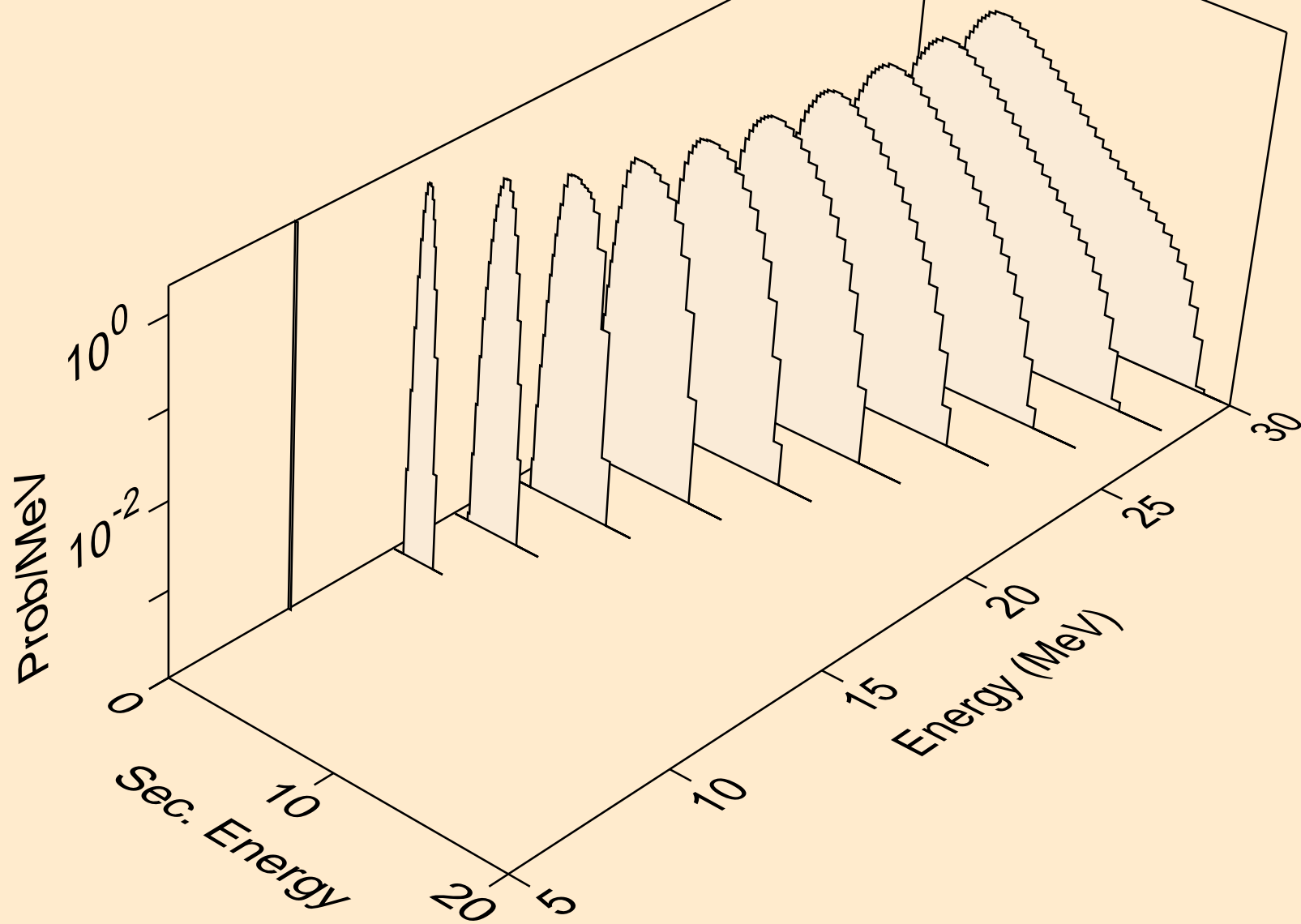

Y080M NEUTRON ACER TENDL-2024 LIBRARY; T=0.K  
protons from (n,npa)

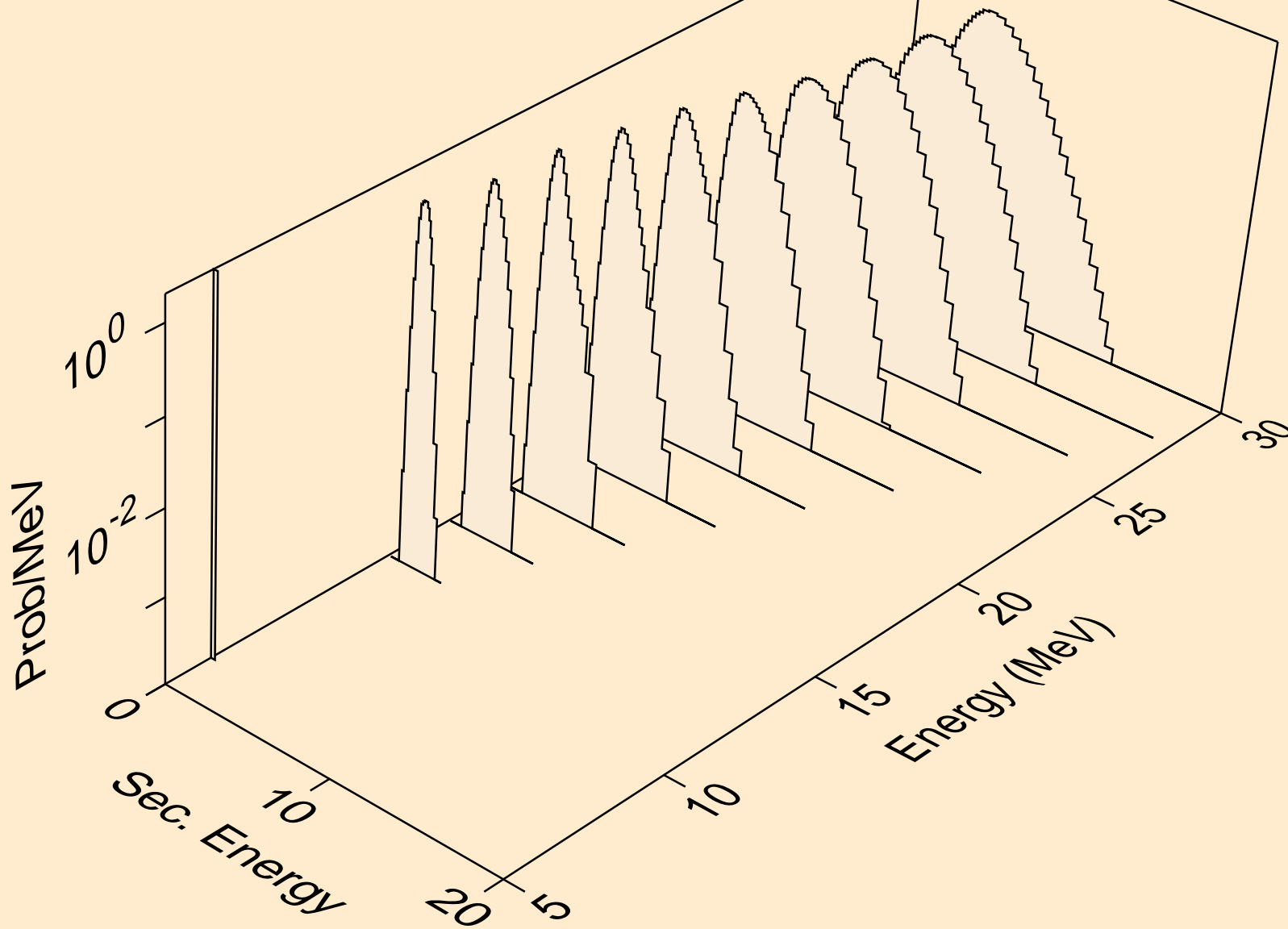



Y080M NEUTRON ACER TENDL-2024 LIBRARY; T=0.K  
protons from (n,p)

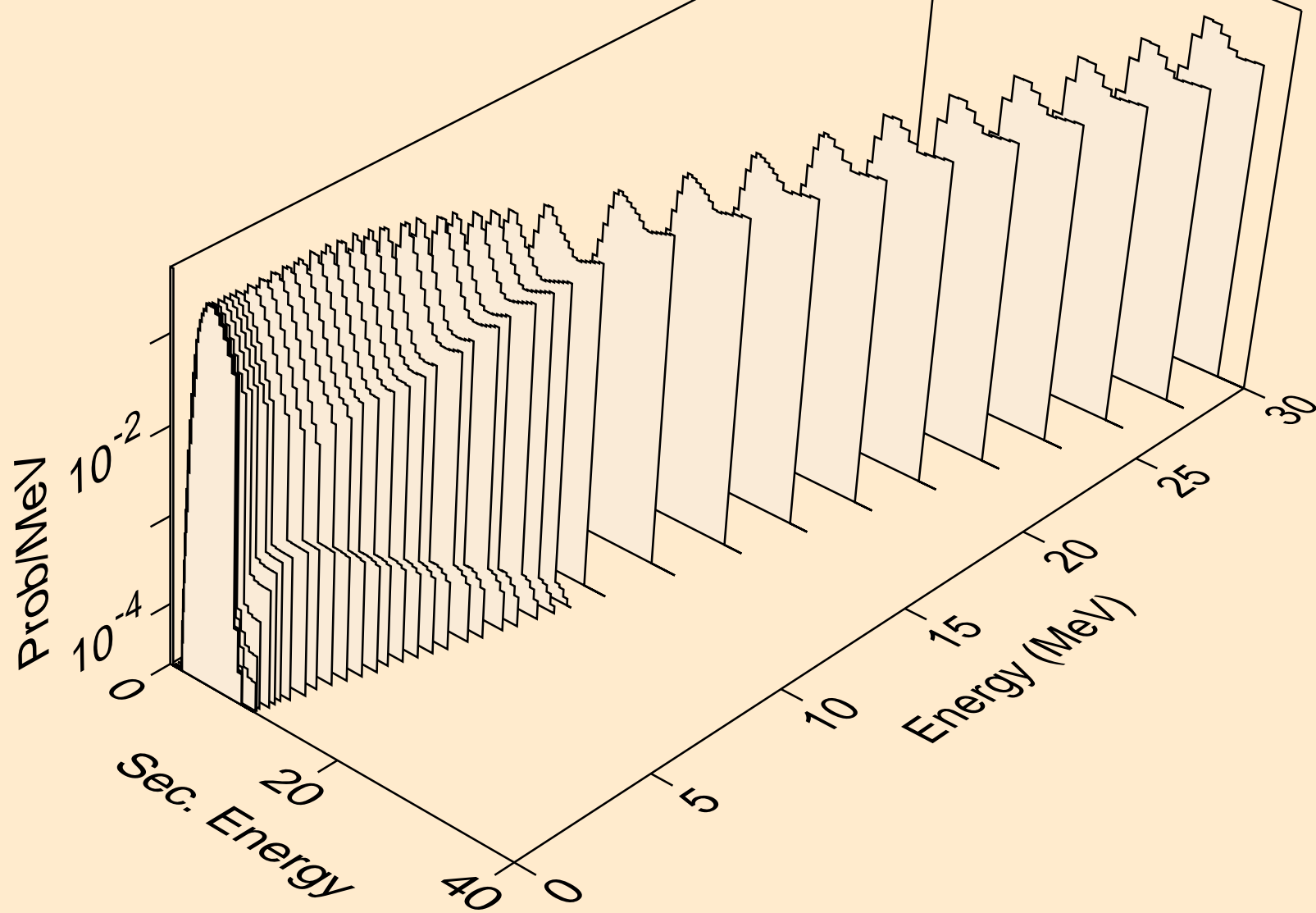

Y080M NEUTRON ACER TENDL-2024 LIBRARY; T=0.K  
protons from (n,2p)

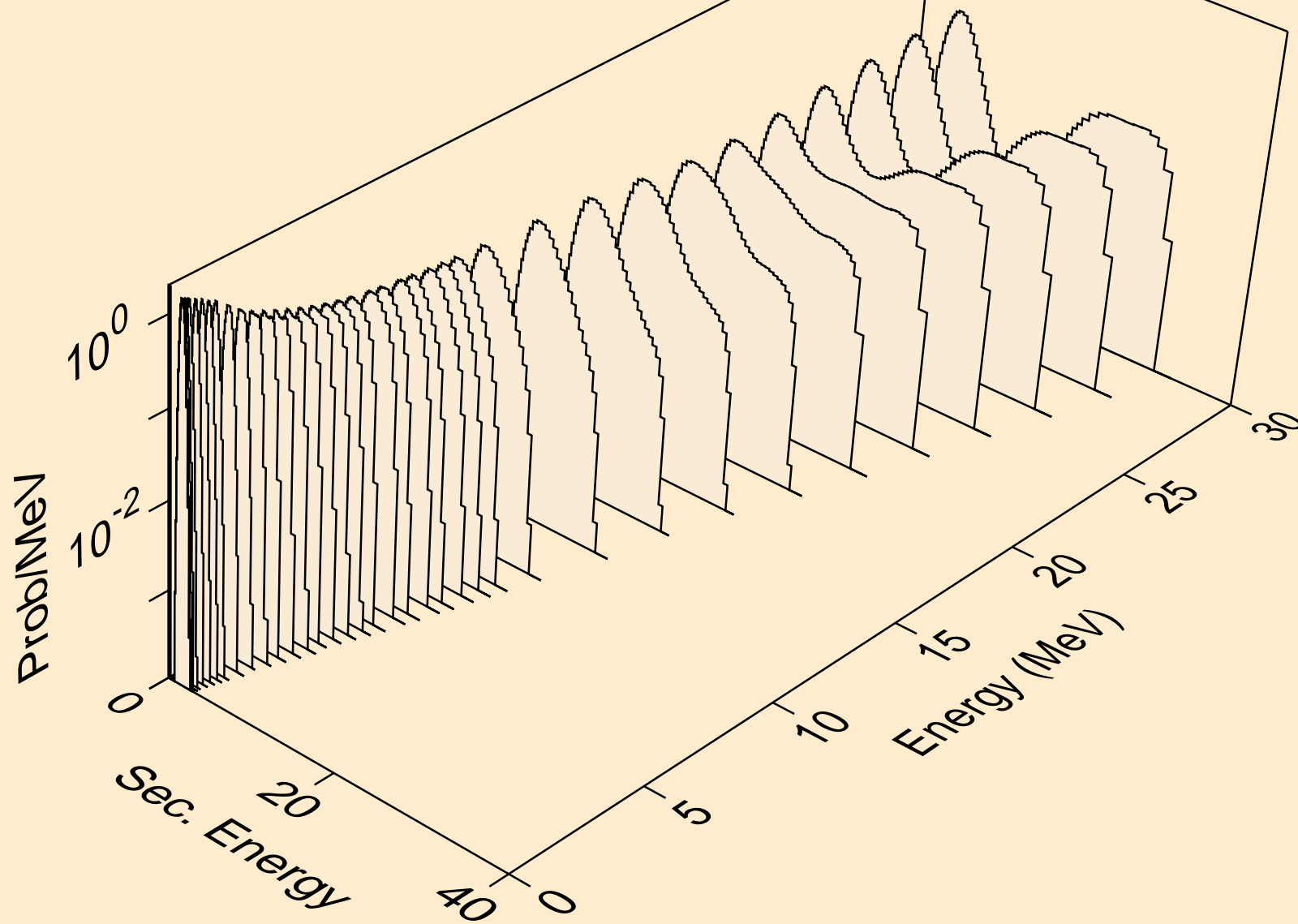

Y080M NEUTRON ACER TENDL-2024 LIBRARY; T=0.K  
protons from (n,p)

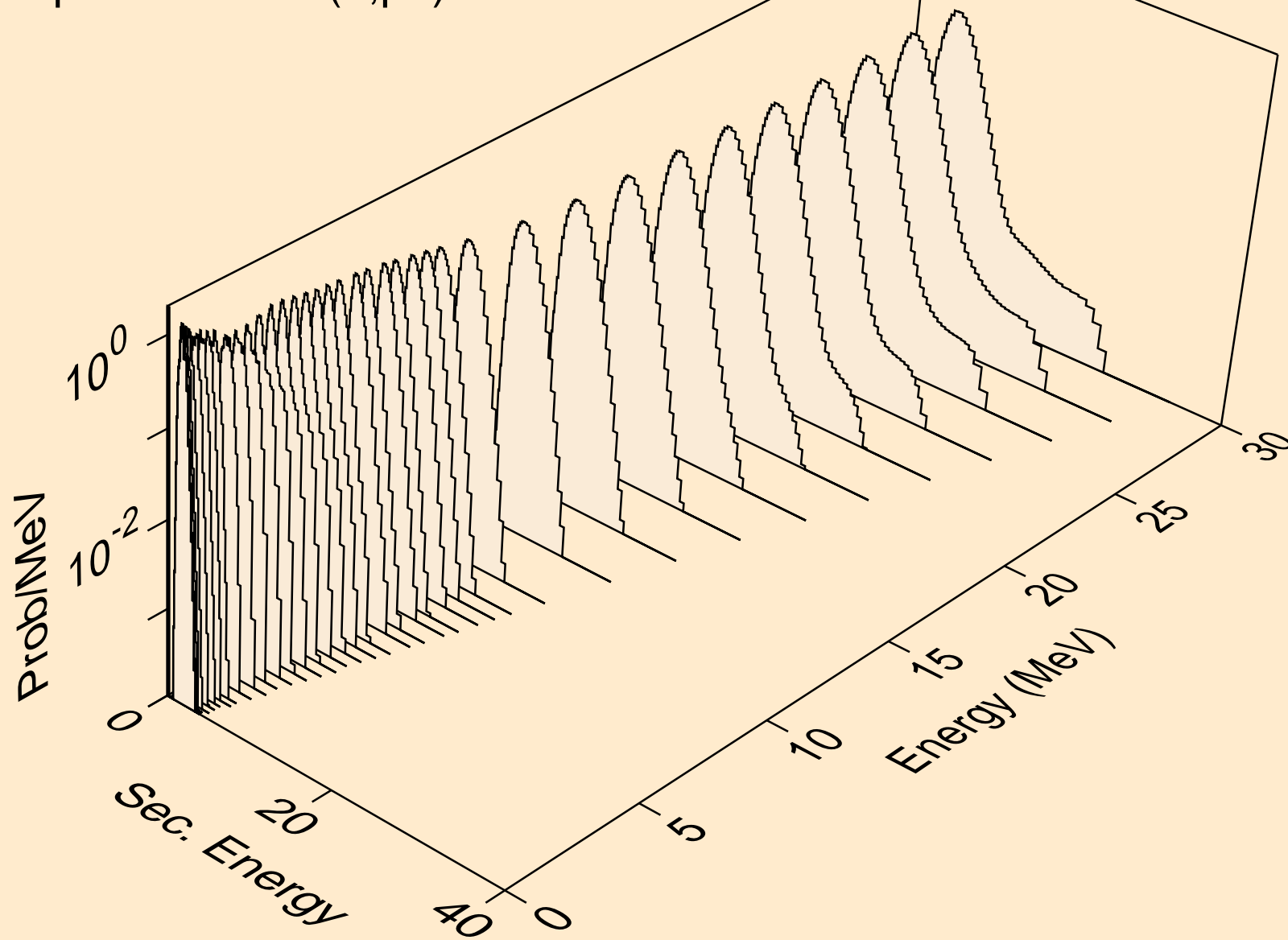

Y080M NEUTRON ACER TENDL-2024 LIBRARY; T=0.K  
protons from (n,pd)

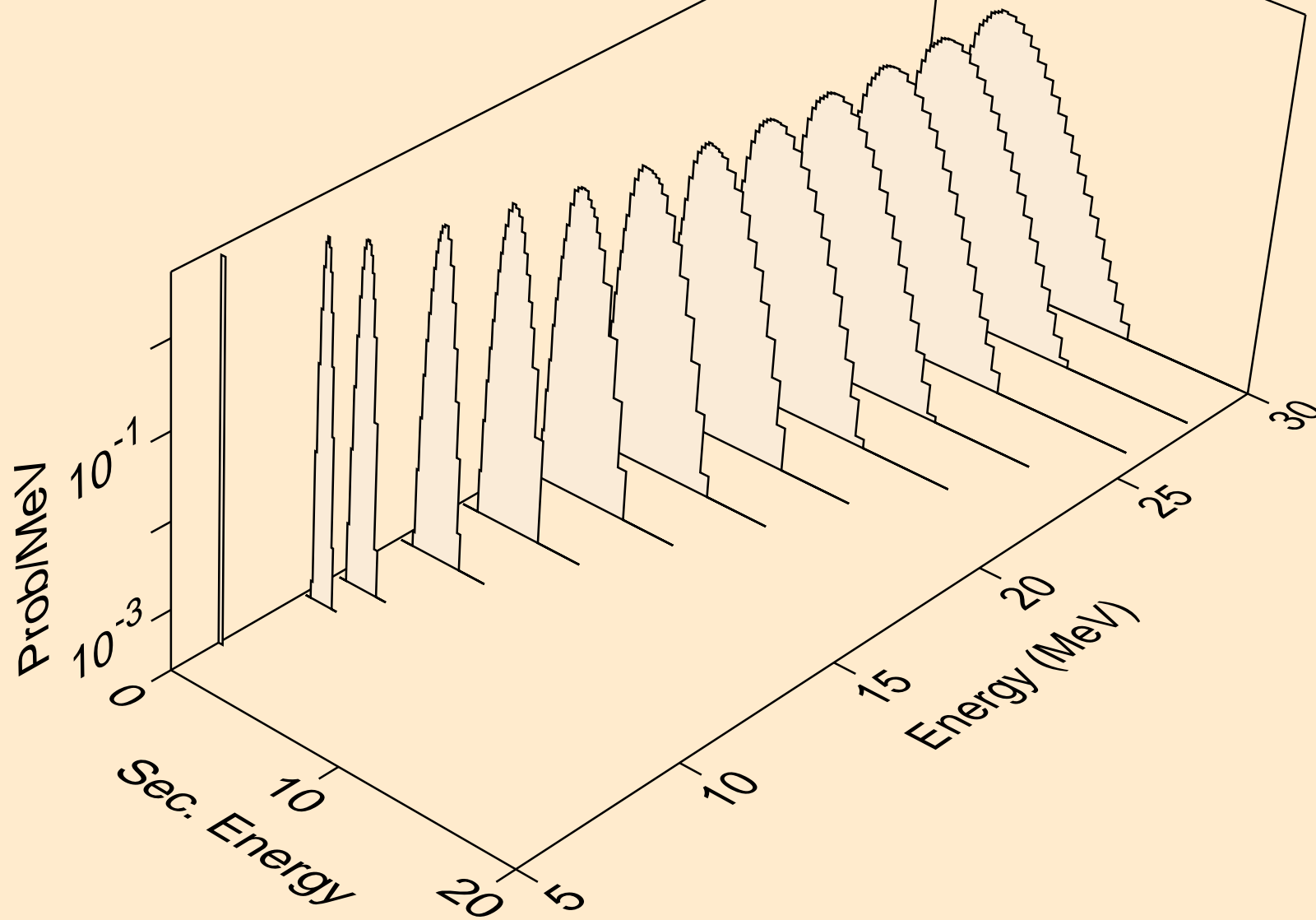

Y080M NEUTRON ACER TENDL-2024 LIBRARY; T=0.K  
protons from (n,pt)

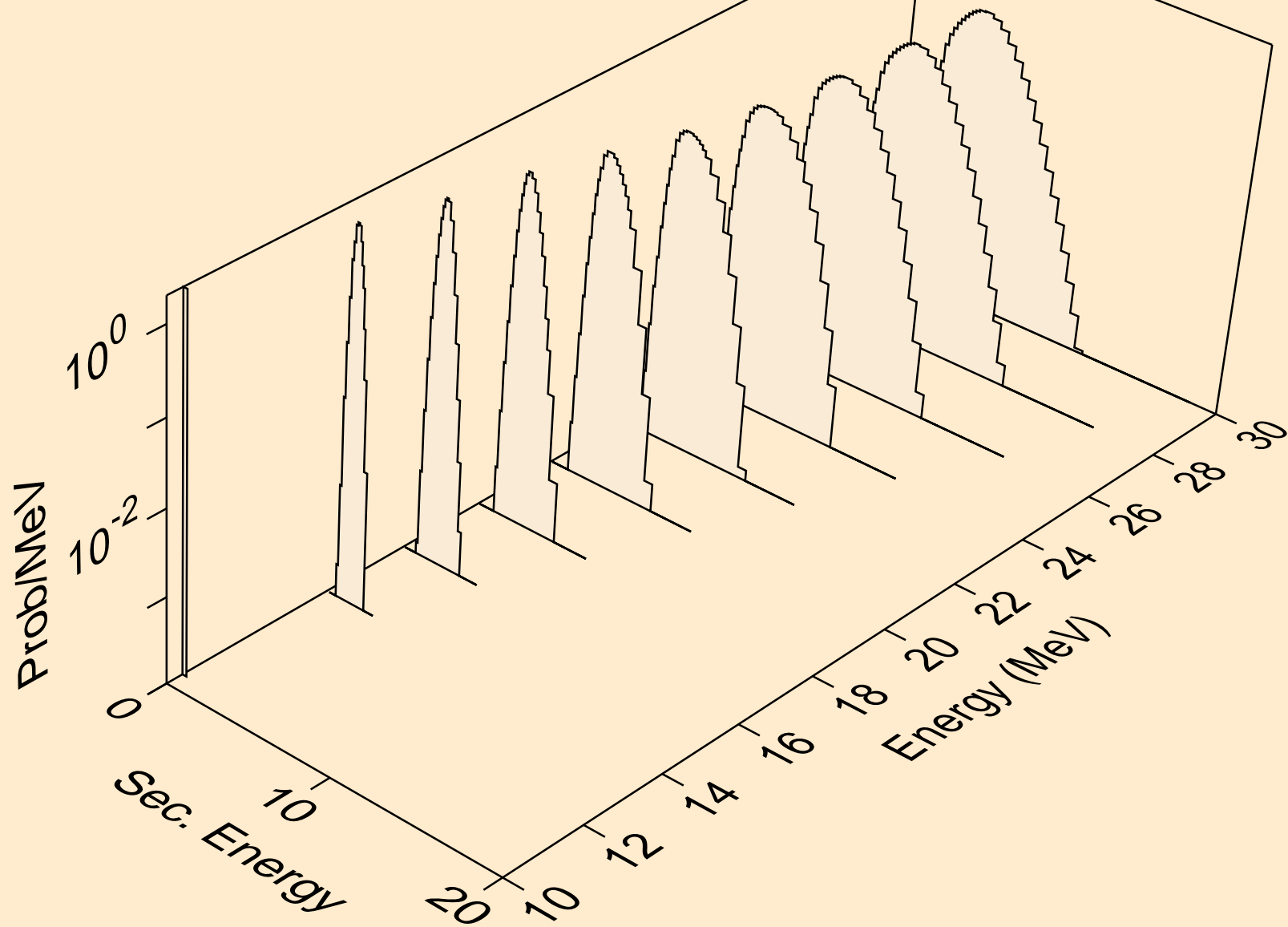

Y080M NEUTRON ACER TENDL-2024 LIBRARY; T=0.K  
deuterons from (n,x)

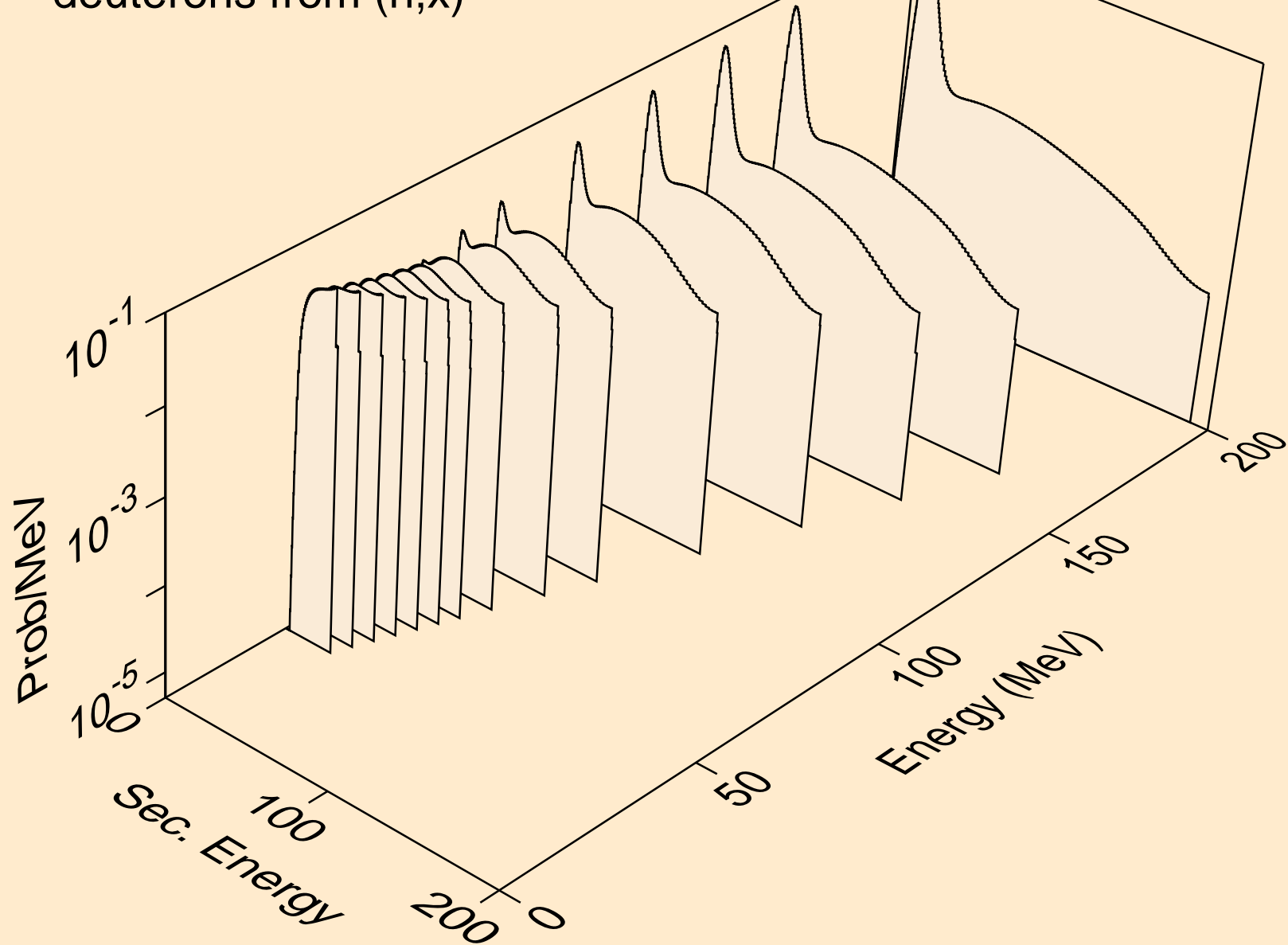

Y080M NEUTRON ACER TENDL-2024 LIBRARY; T=0.K  
deuterons from (n,2nd)

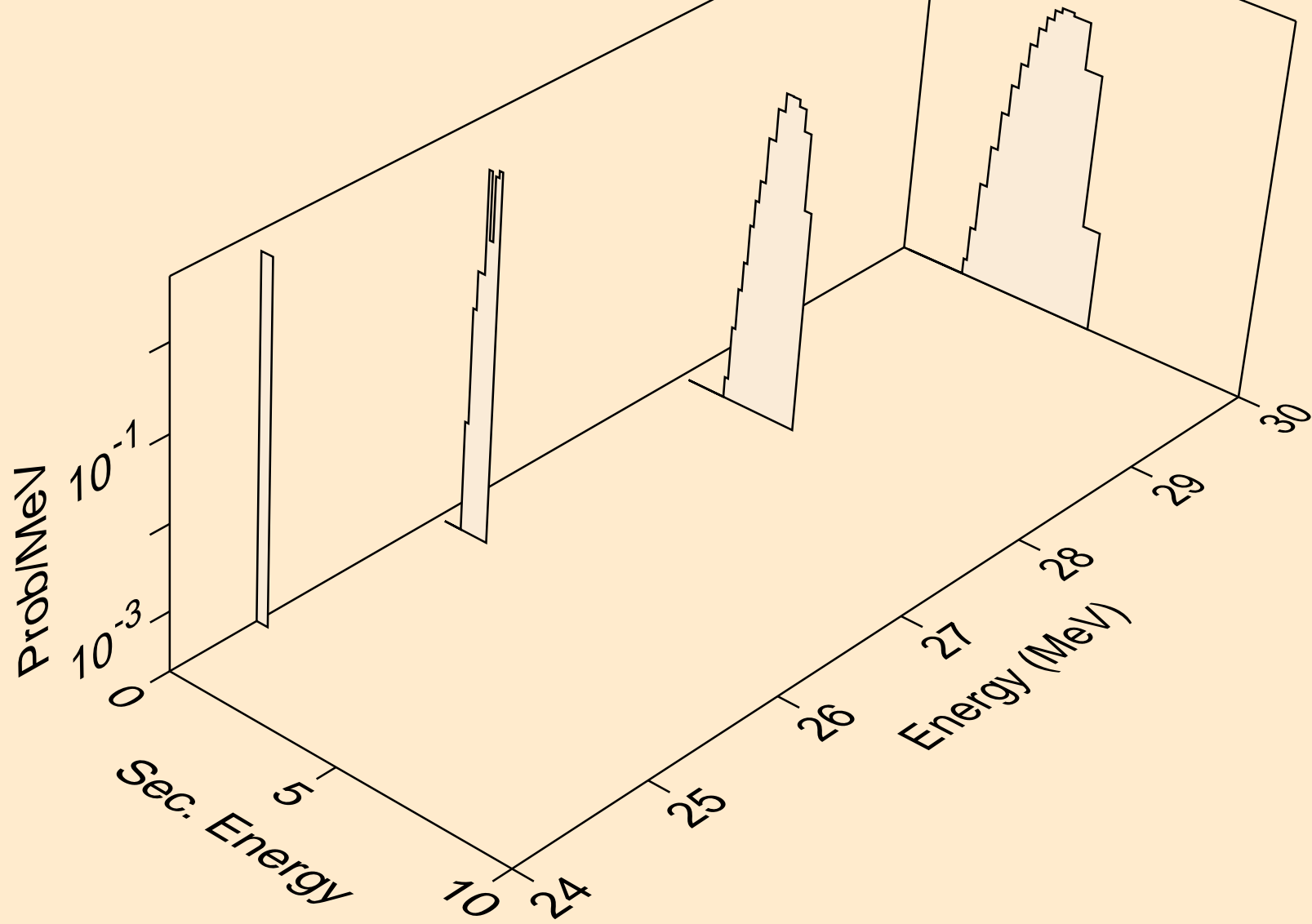

Y080M NEUTRON ACER TENDL-2024 LIBRARY; T=0.K  
deuterons from (n,n\*)d

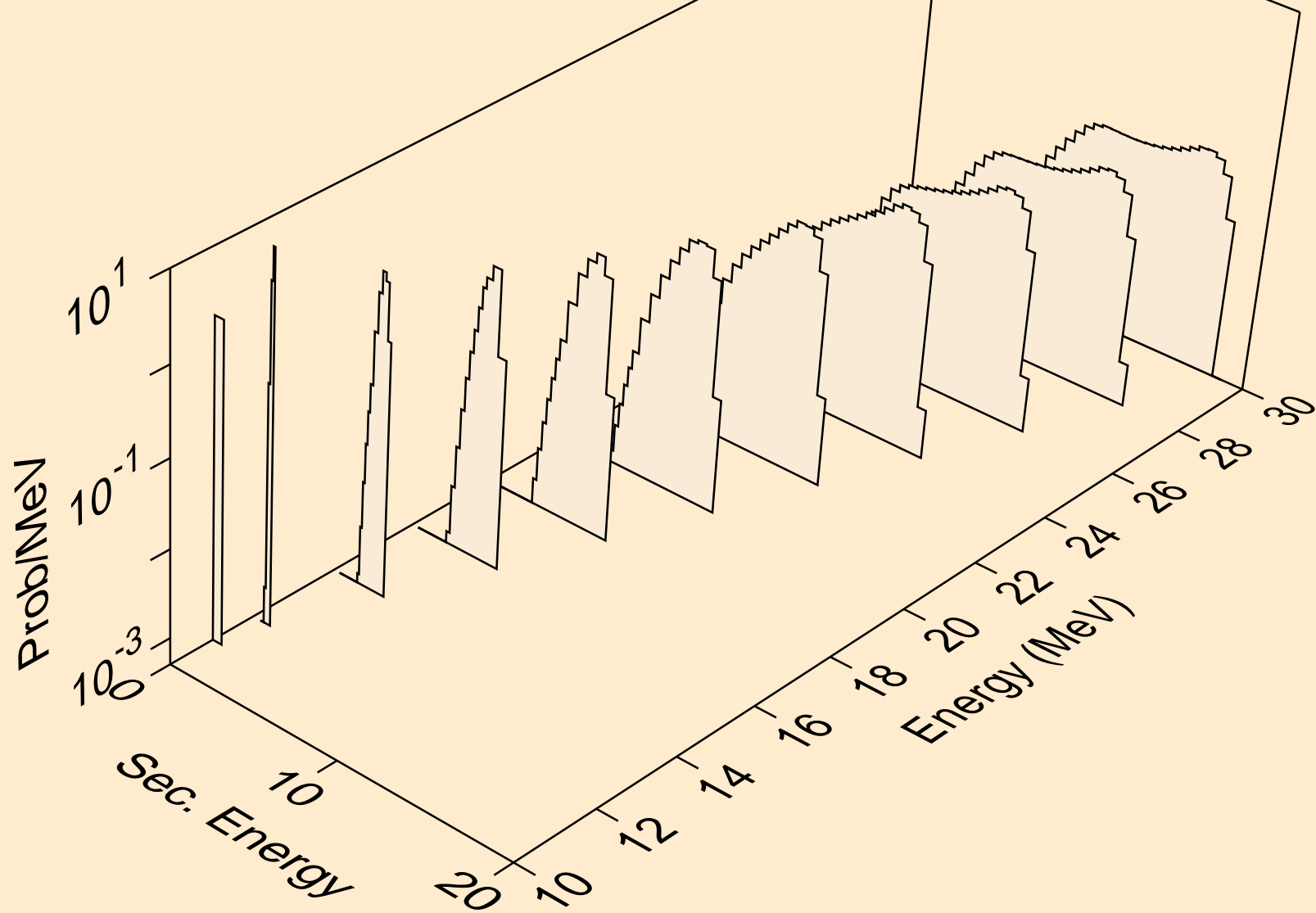



Y080M NEUTRON ACER TENDL-2024 LIBRARY; T=0.K  
deuterons from (n,d)

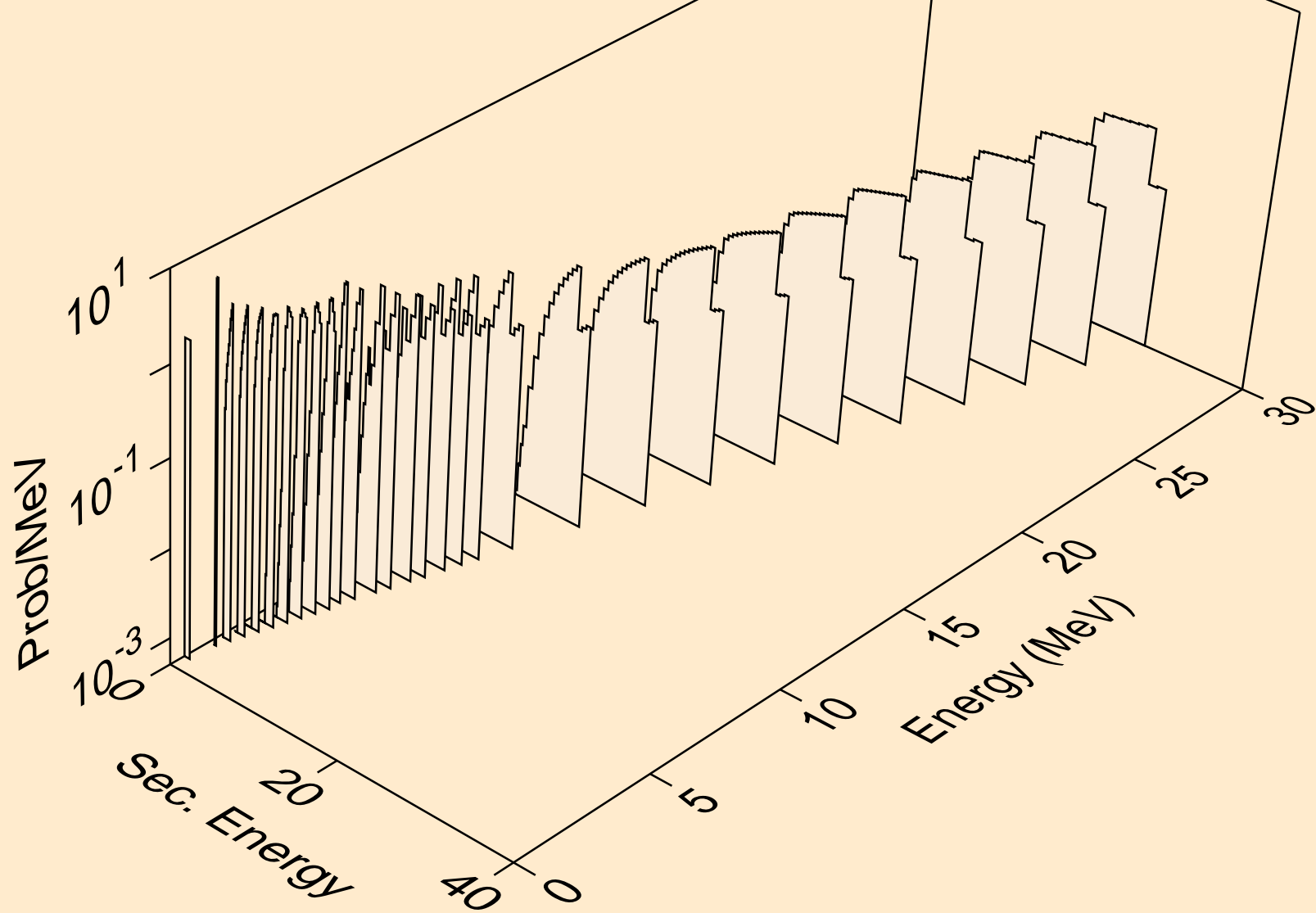

Y080M NEUTRON ACER TENDL-2024 LIBRARY; T=0.K  
deuterons from (n,pd)

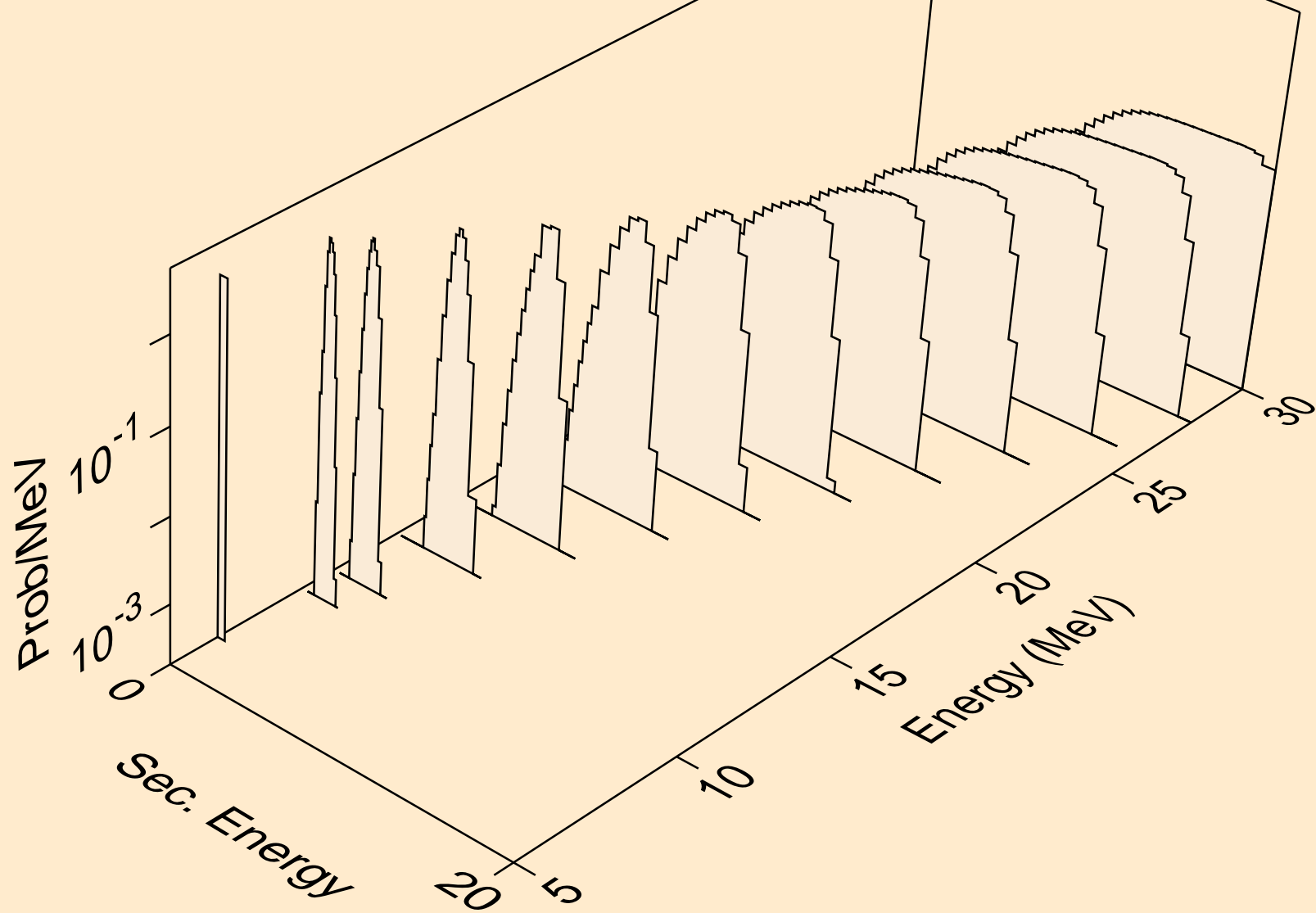

Y080M NEUTRON ACER TENDL-2024 LIBRARY; T=0.K  
deuterons from (n,da)

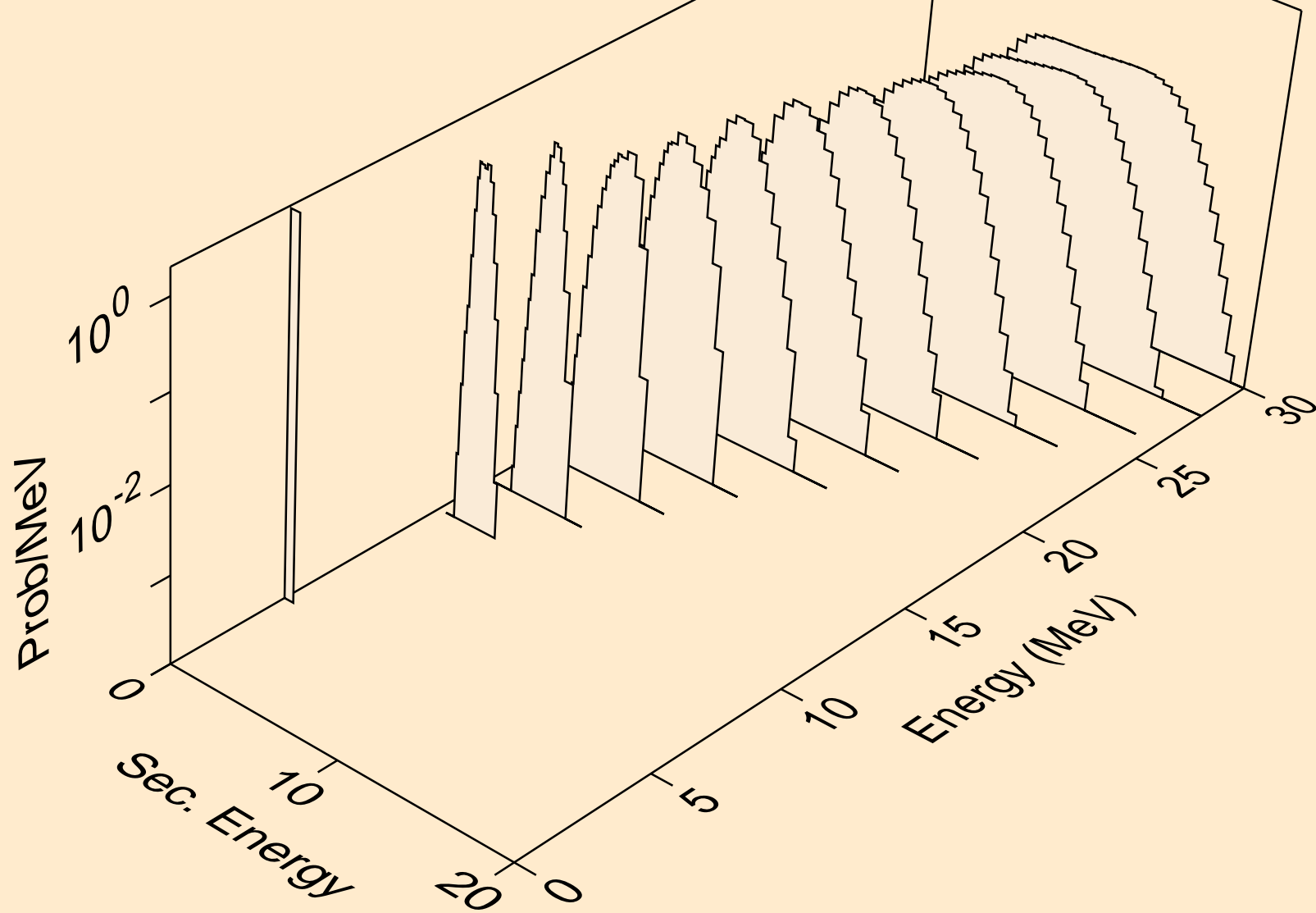

Y080M NEUTRON ACER TENDL-2024 LIBRARY; T=0.K  
tritons from (n,x)

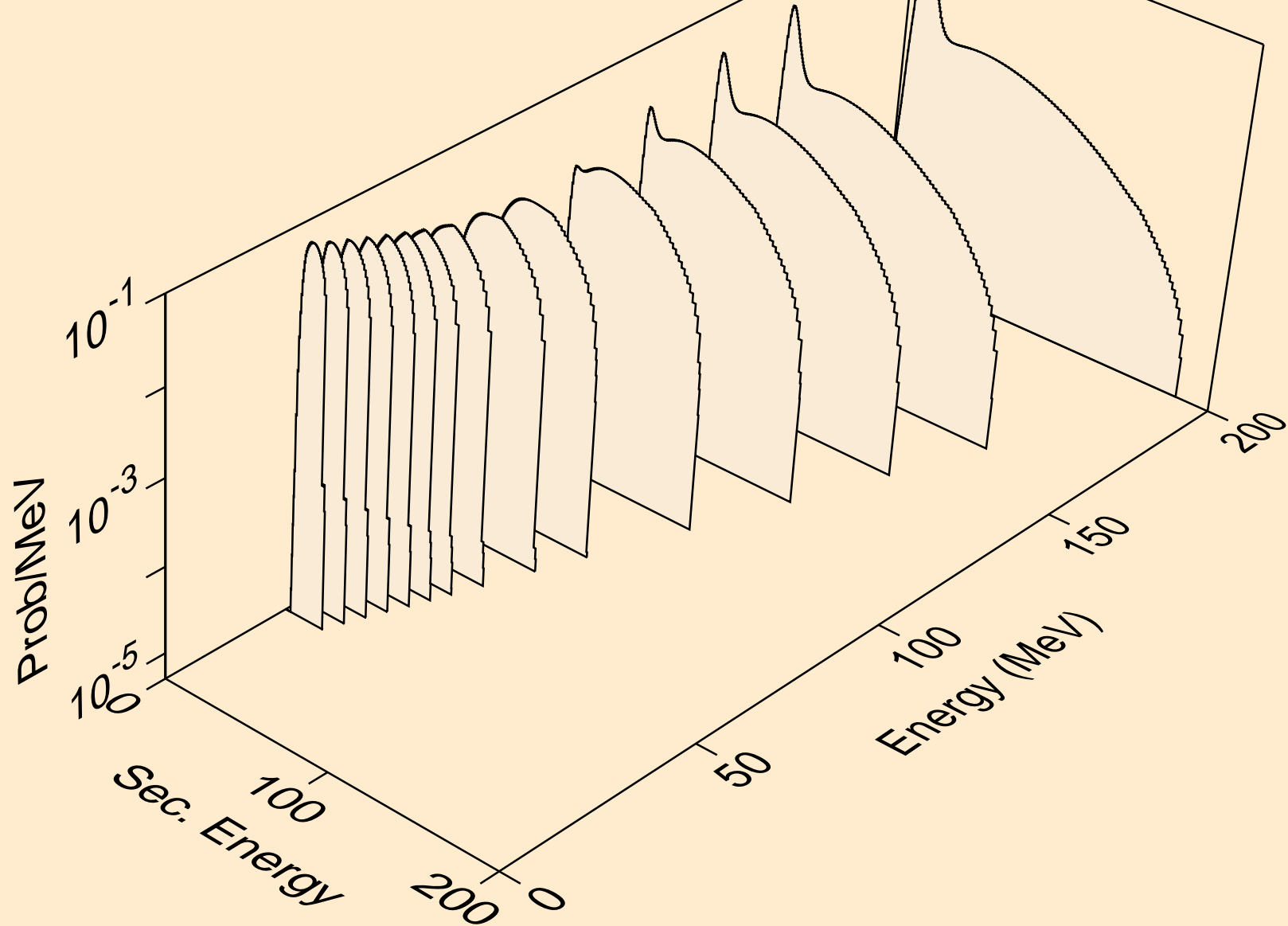

Y080M NEUTRON ACER TENDL-2024 LIBRARY; T=0.K  
tritons from (n,n\*)t

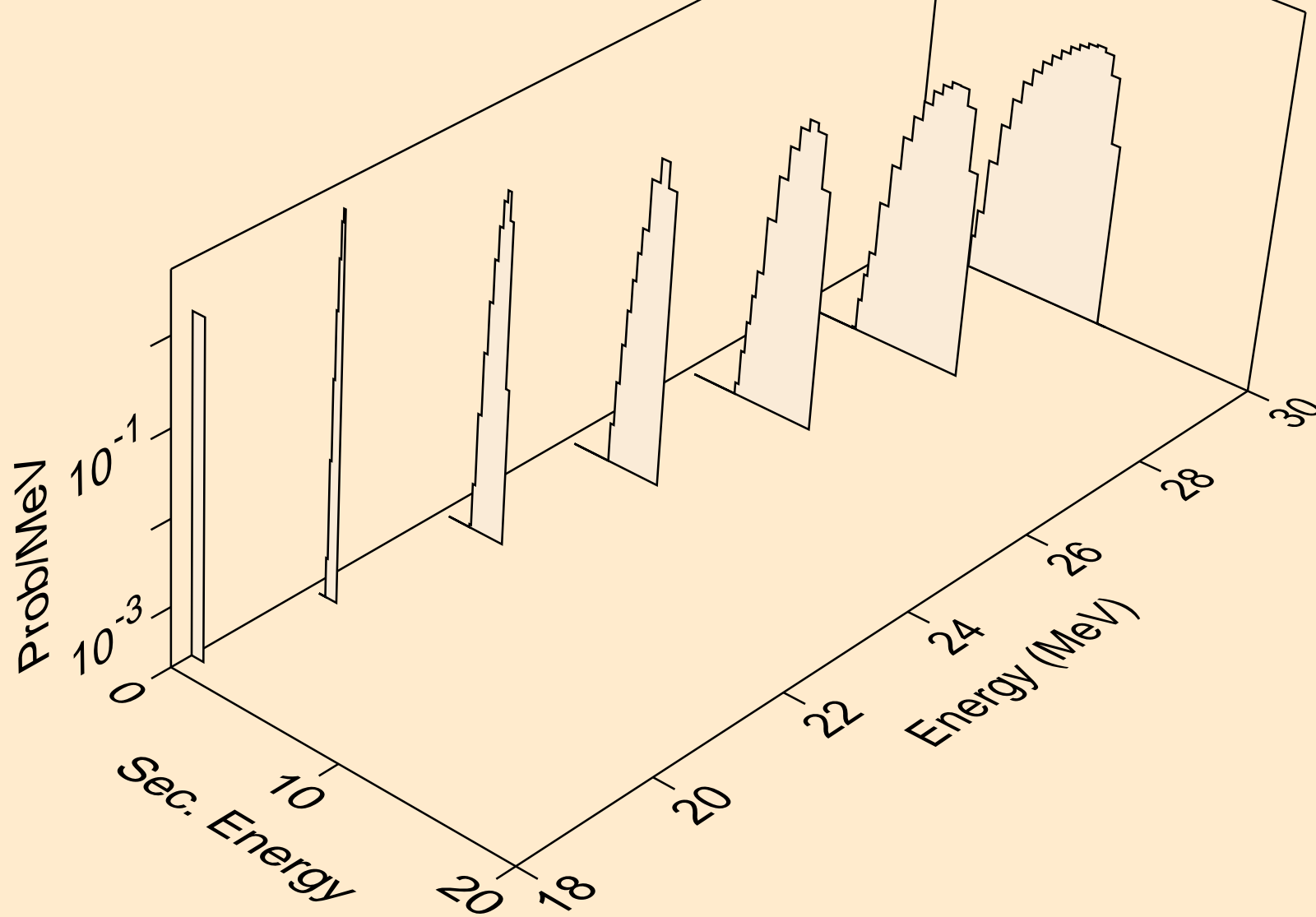

Y080M NEUTRON ACER TENDL-2024 LIBRARY; T=0.K  
tritons from (n,t)

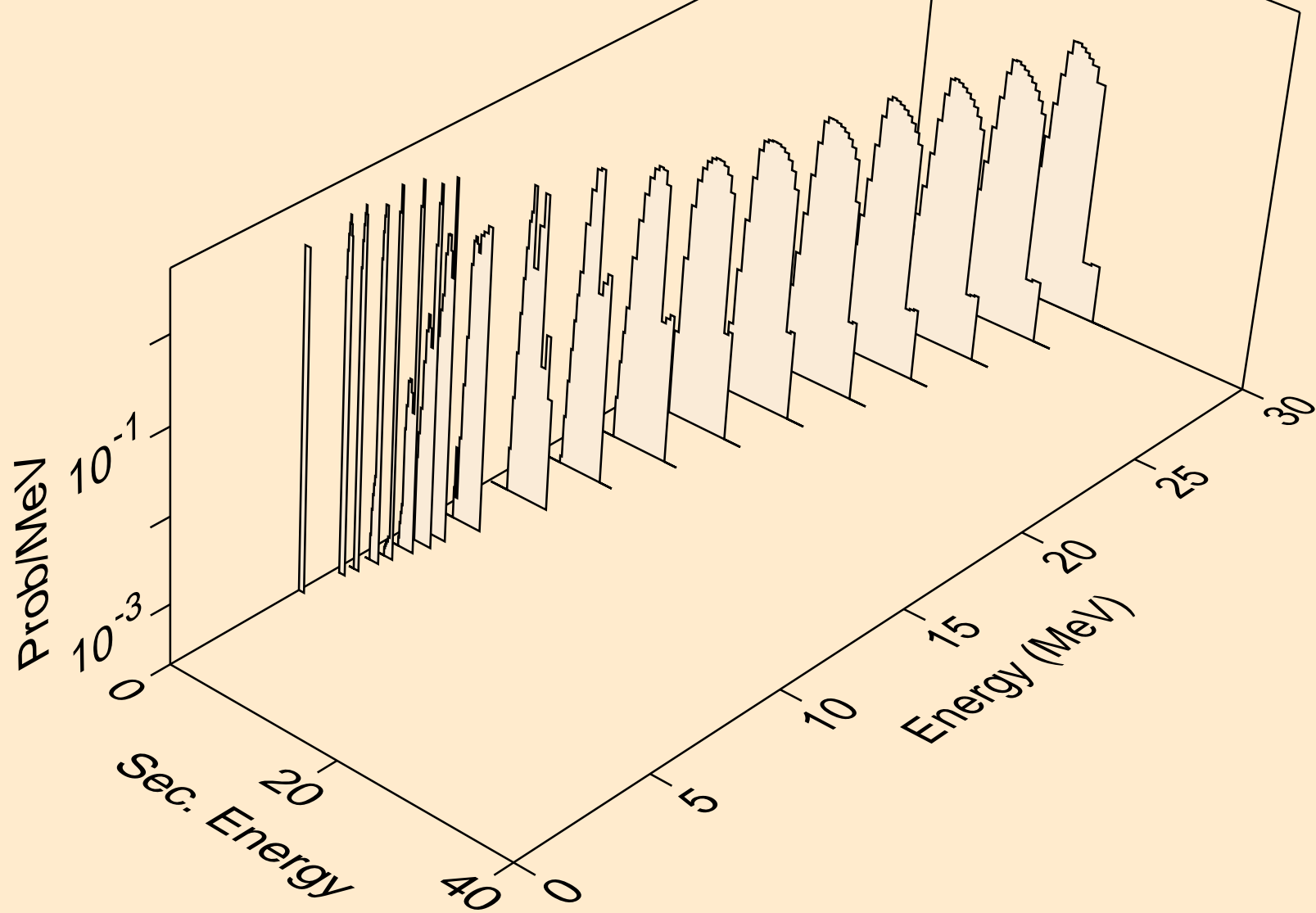

Y080M NEUTRON ACER TENDL-2024 LIBRARY; T=0.K  
tritons from (n,pt)

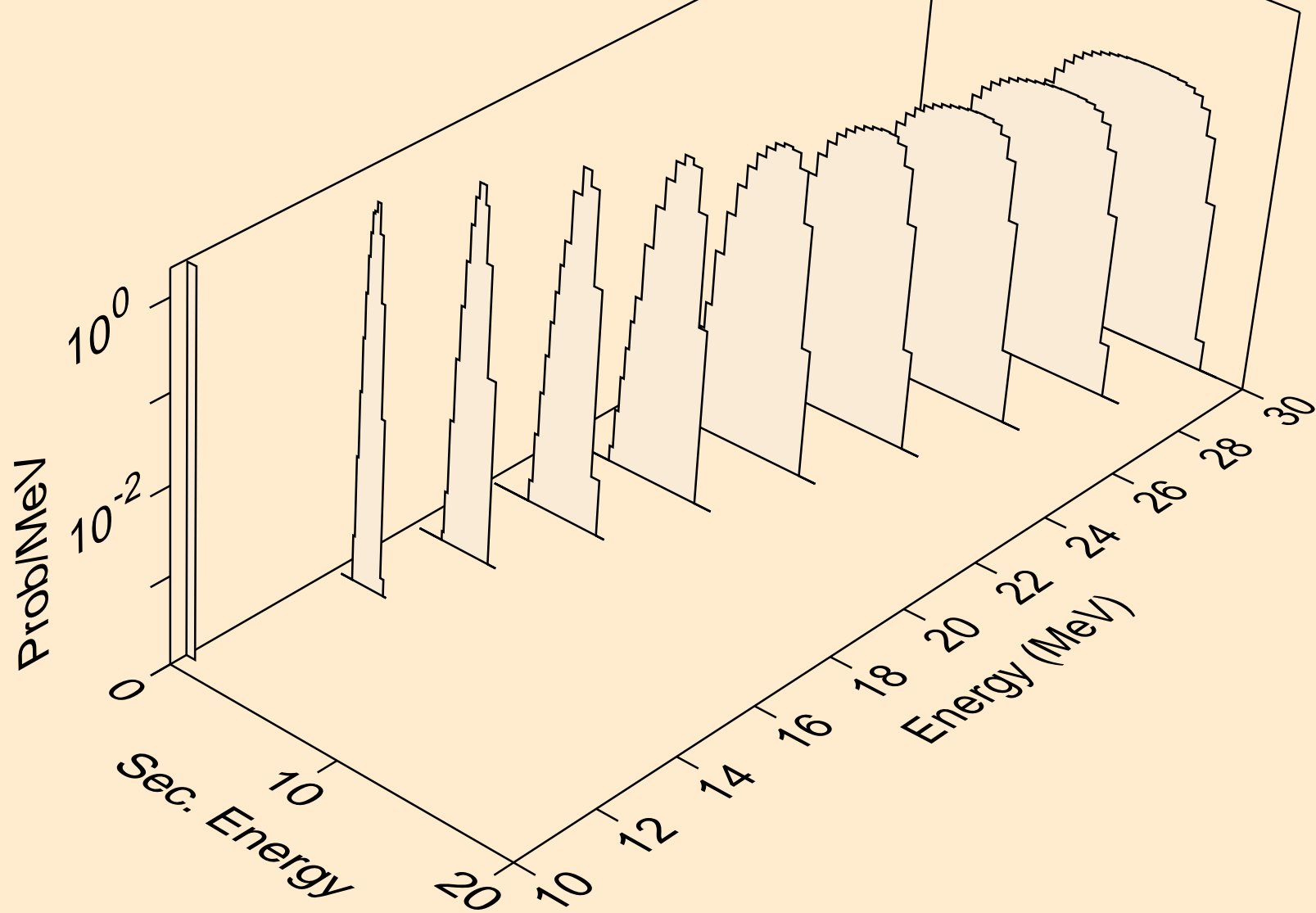

Y080M NEUTRON ACER TENDL-2024 LIBRARY; T=0.K  
he3s from (n,x)

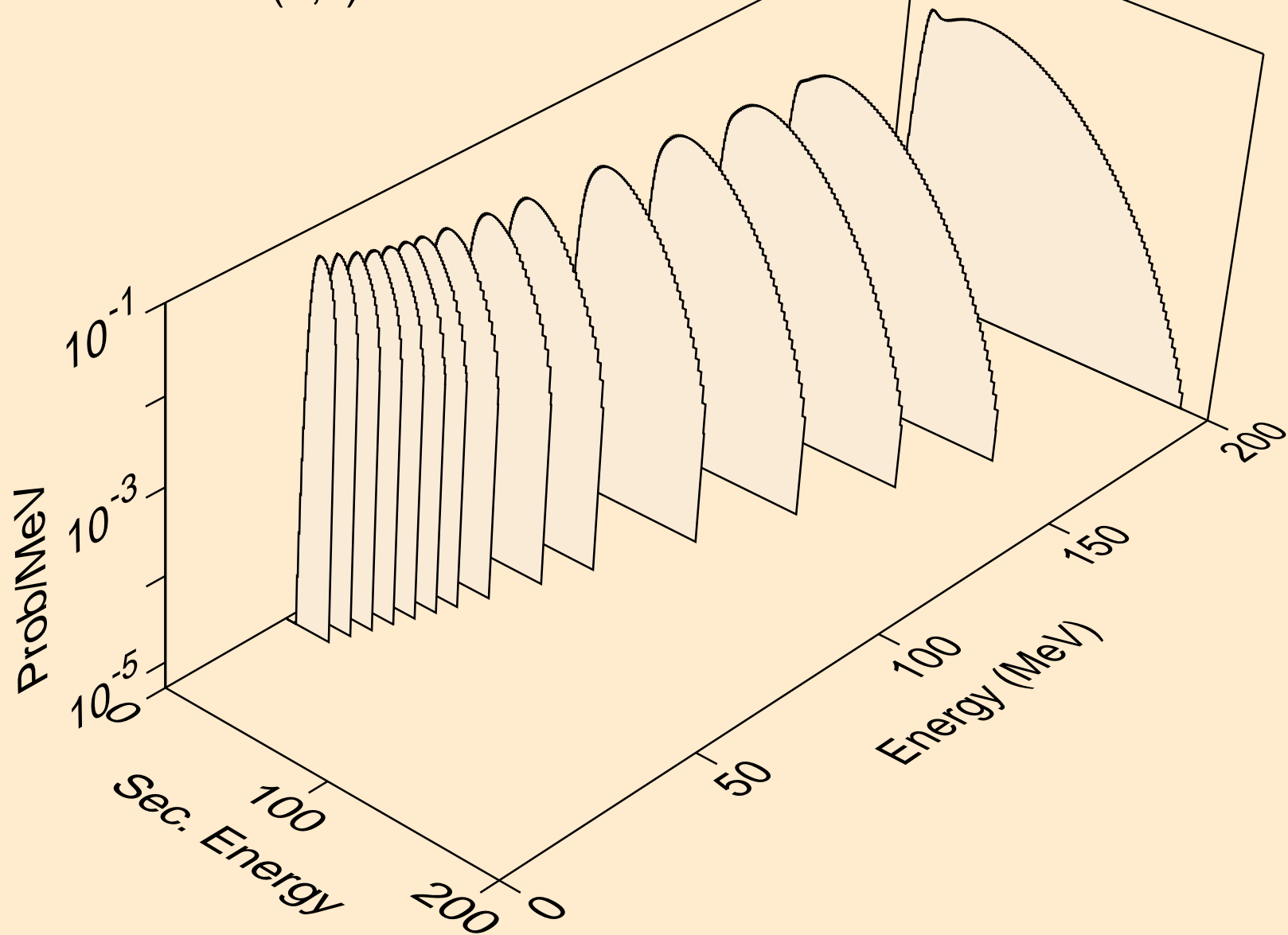



Y080M NEUTRON ACER TENDL-2024 LIBRARY; T=0.K  
he3s from (n,n\*)he3

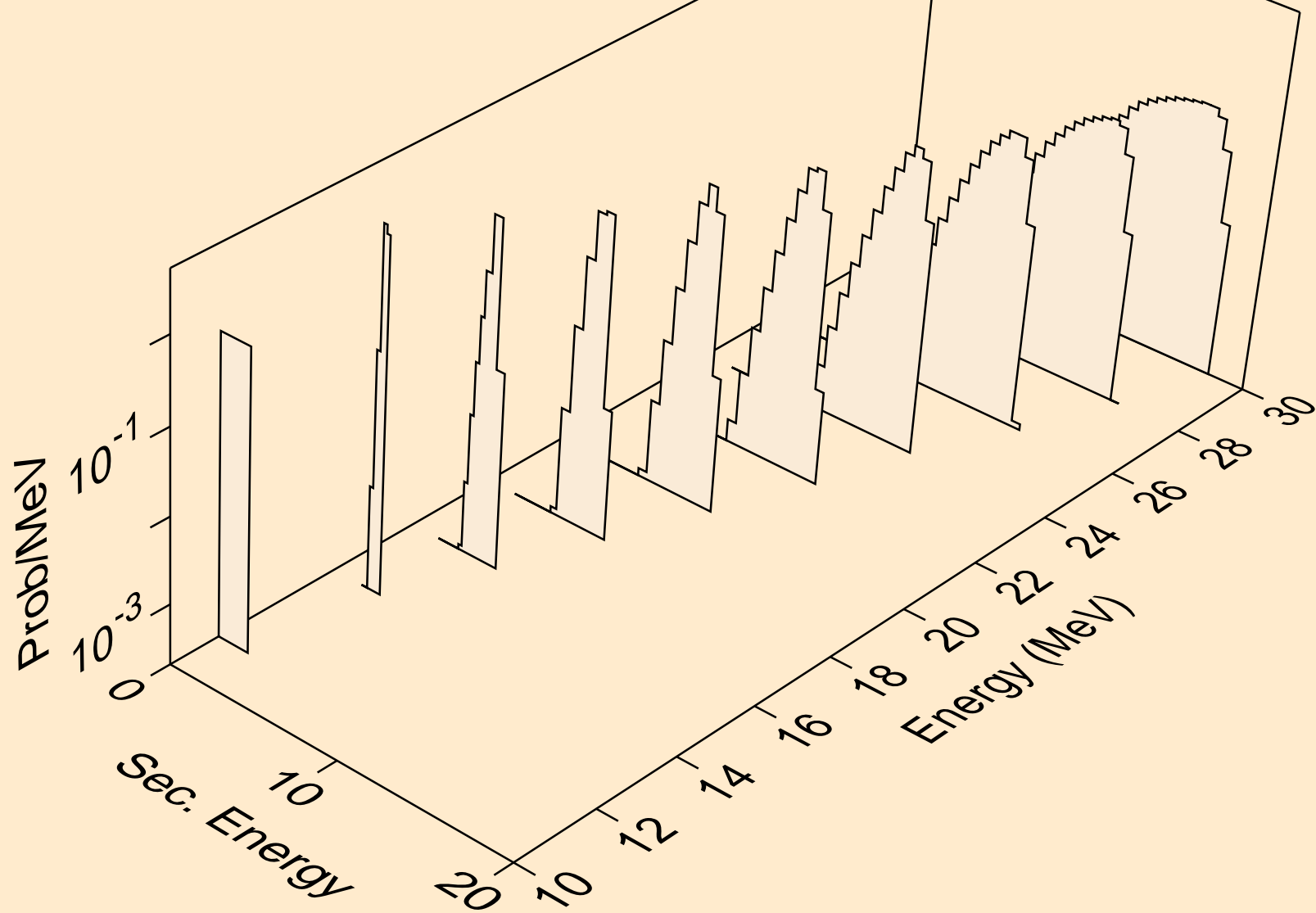

Y080M NEUTRON ACER TENDL-2024 LIBRARY; T=0.K  
he3s from (n,he3)

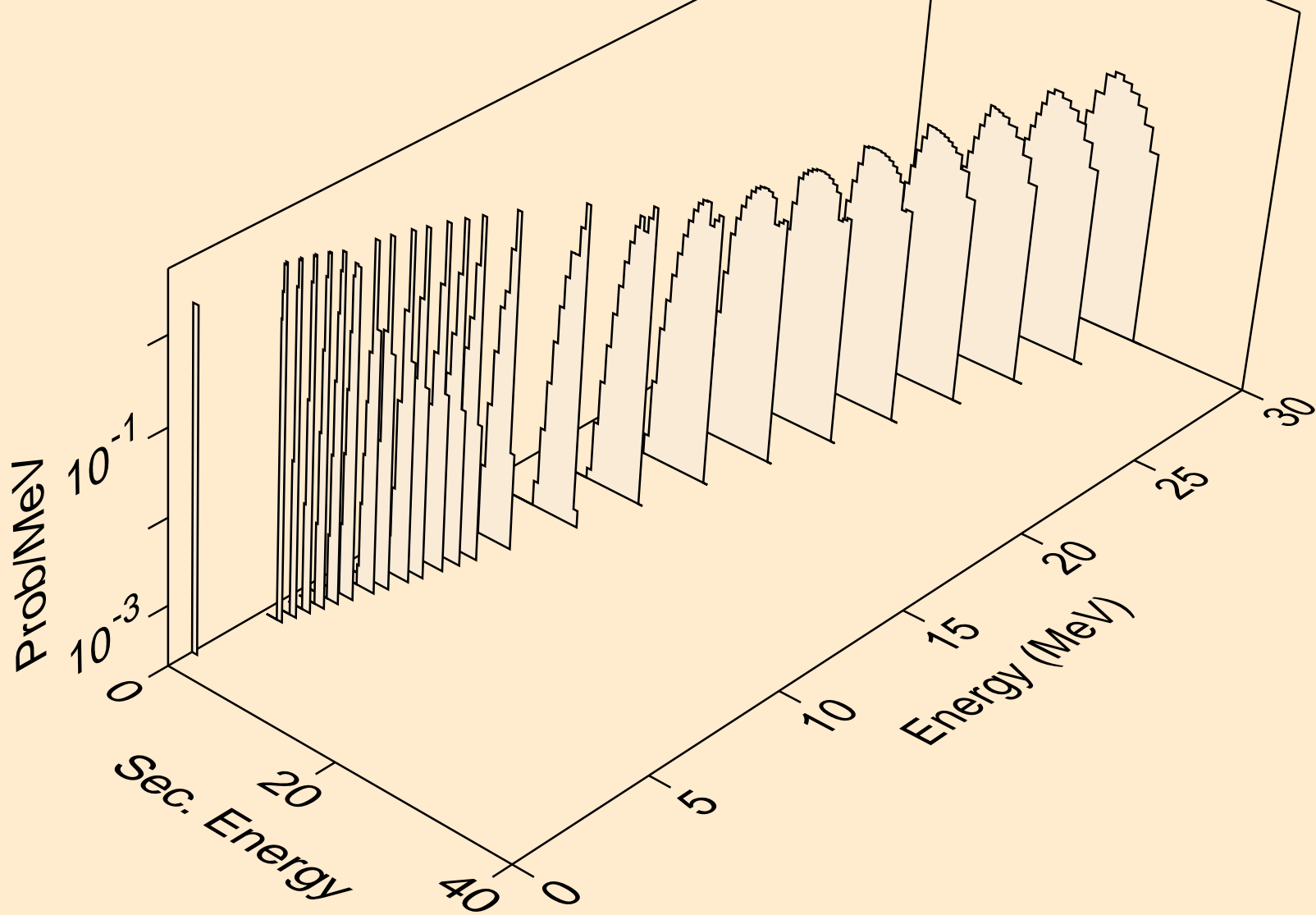

Y080M NEUTRON ACER TENDL-2024 LIBRARY; T=0.K  
alphas from (n,x)

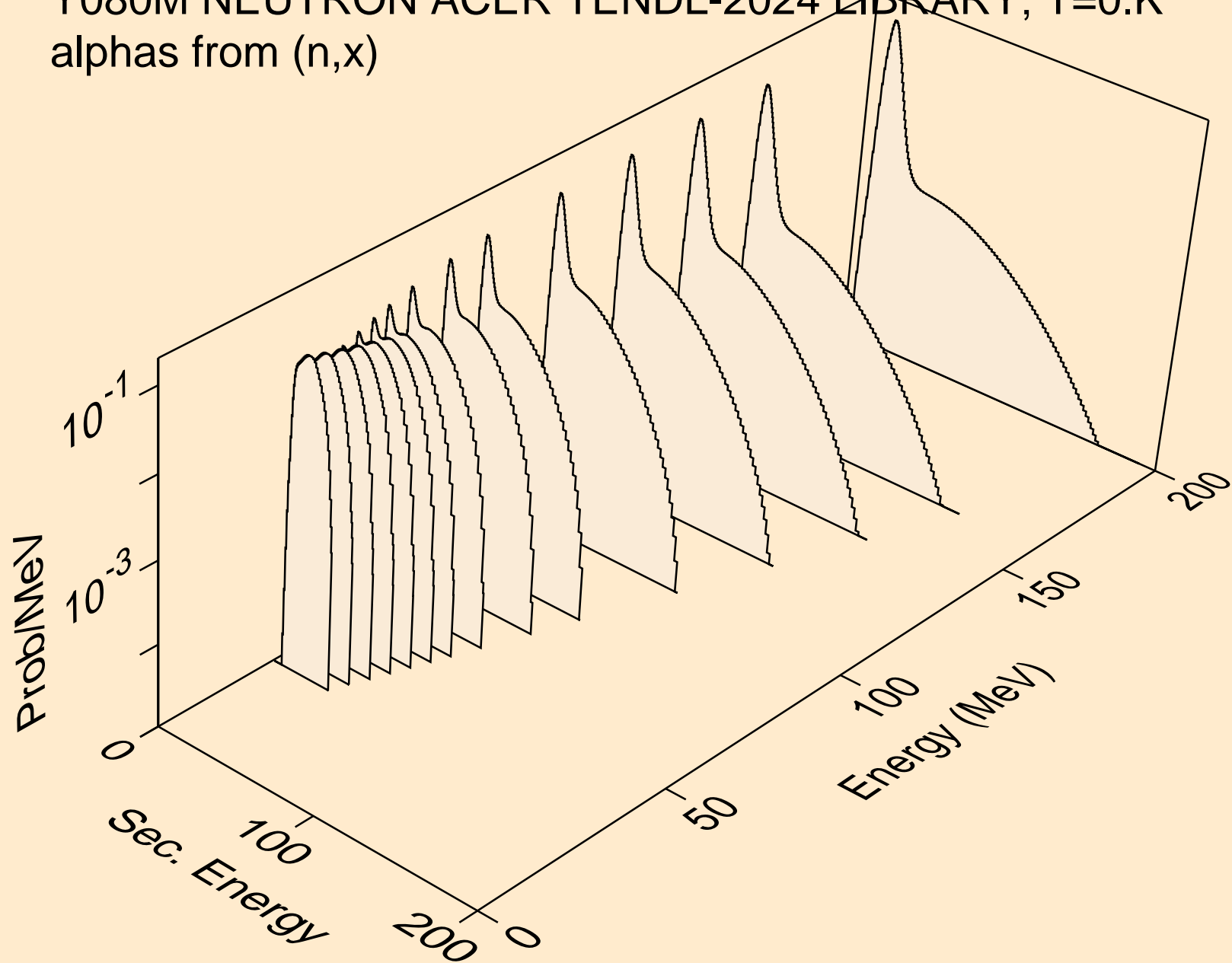

Y080M NEUTRON ACER TENDL-2024 LIBRARY; T=0.K  
alphas from (n,n\*)a

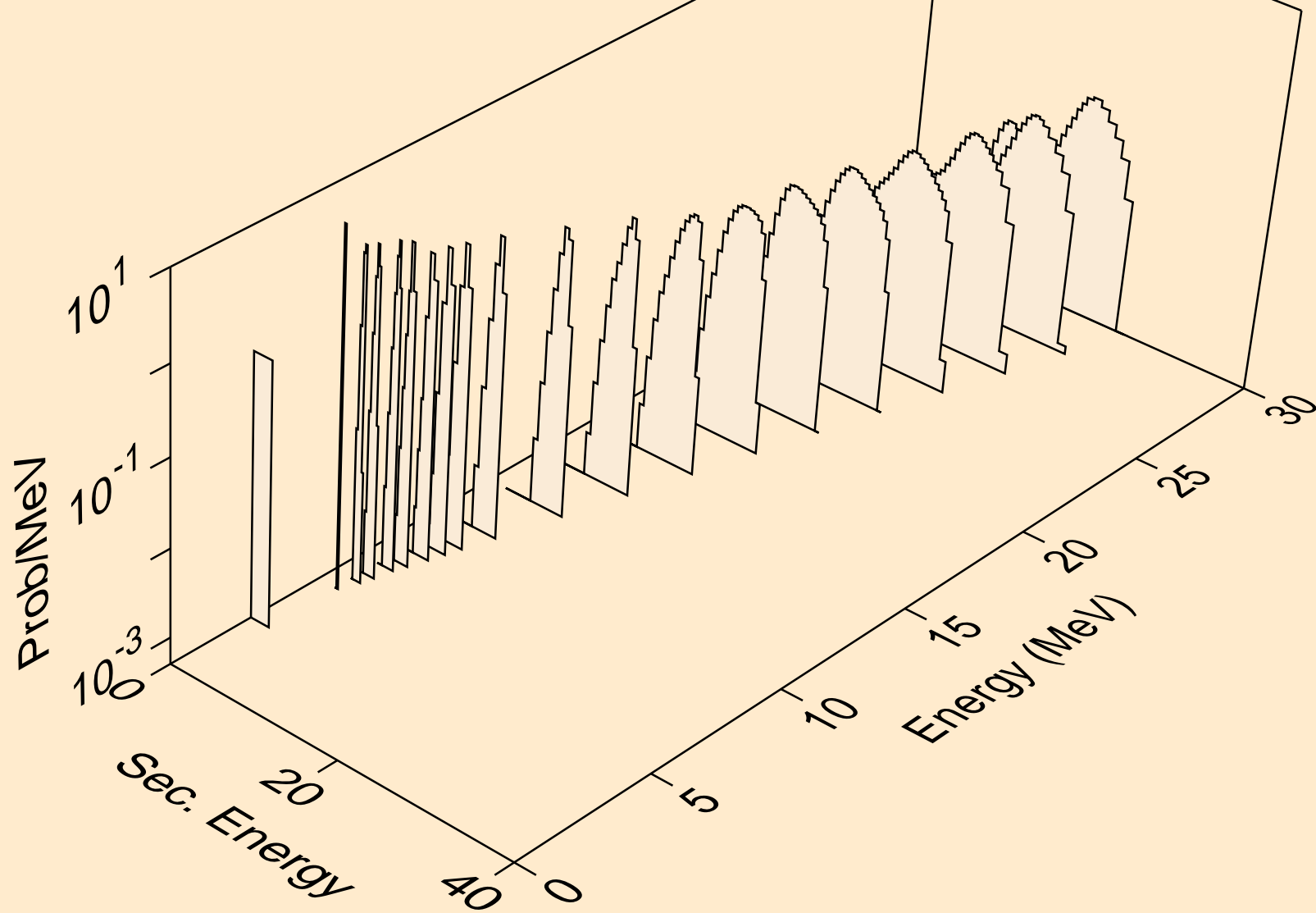

Y080M NEUTRON ACER TENDL-2024 LIBRARY; T=0.K  
alphas from (n,2n)a

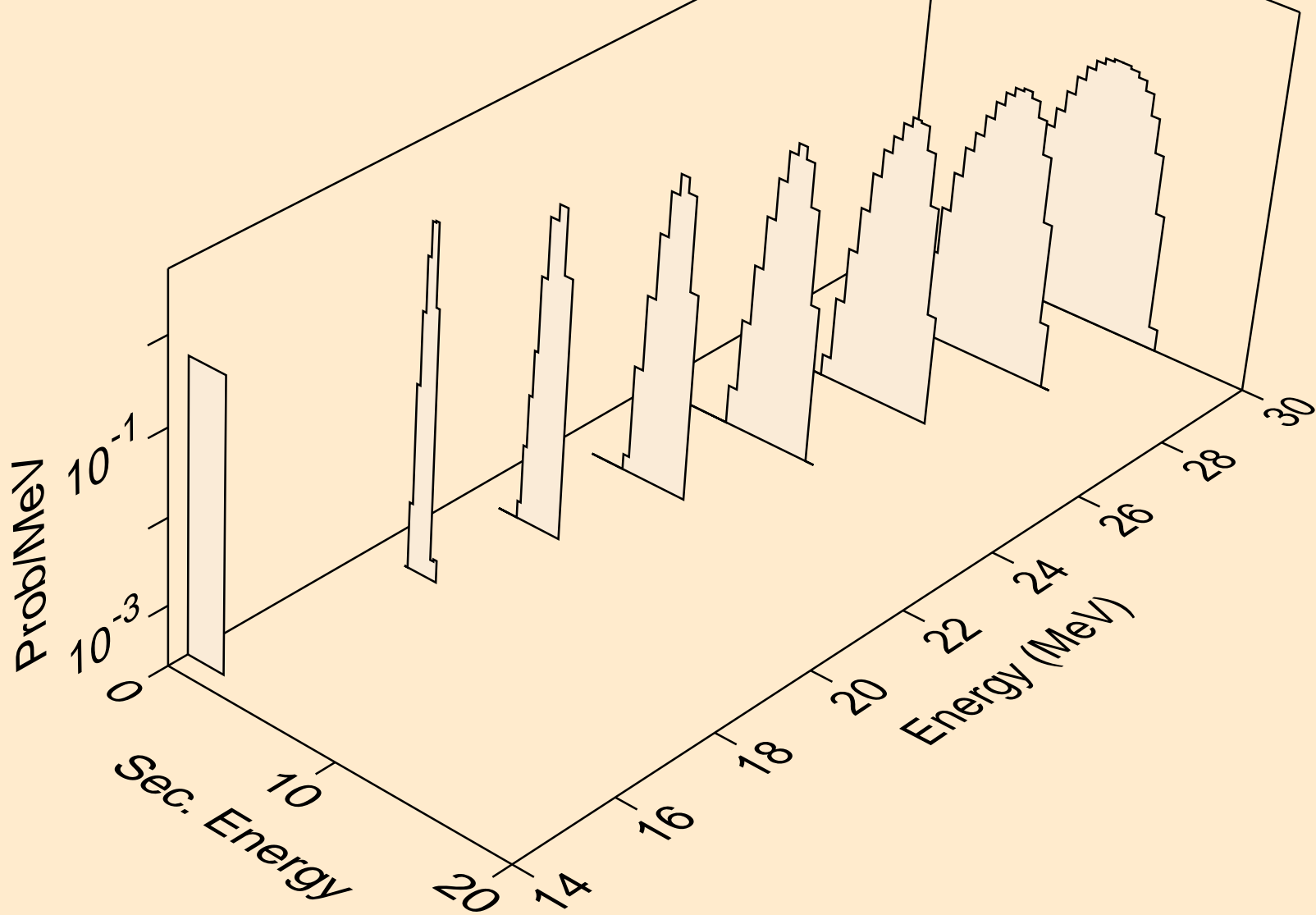

Y080M NEUTRON ACER TENDL-2024 LIBRARY; T=0.K  
alphas from (n,n\*)2a

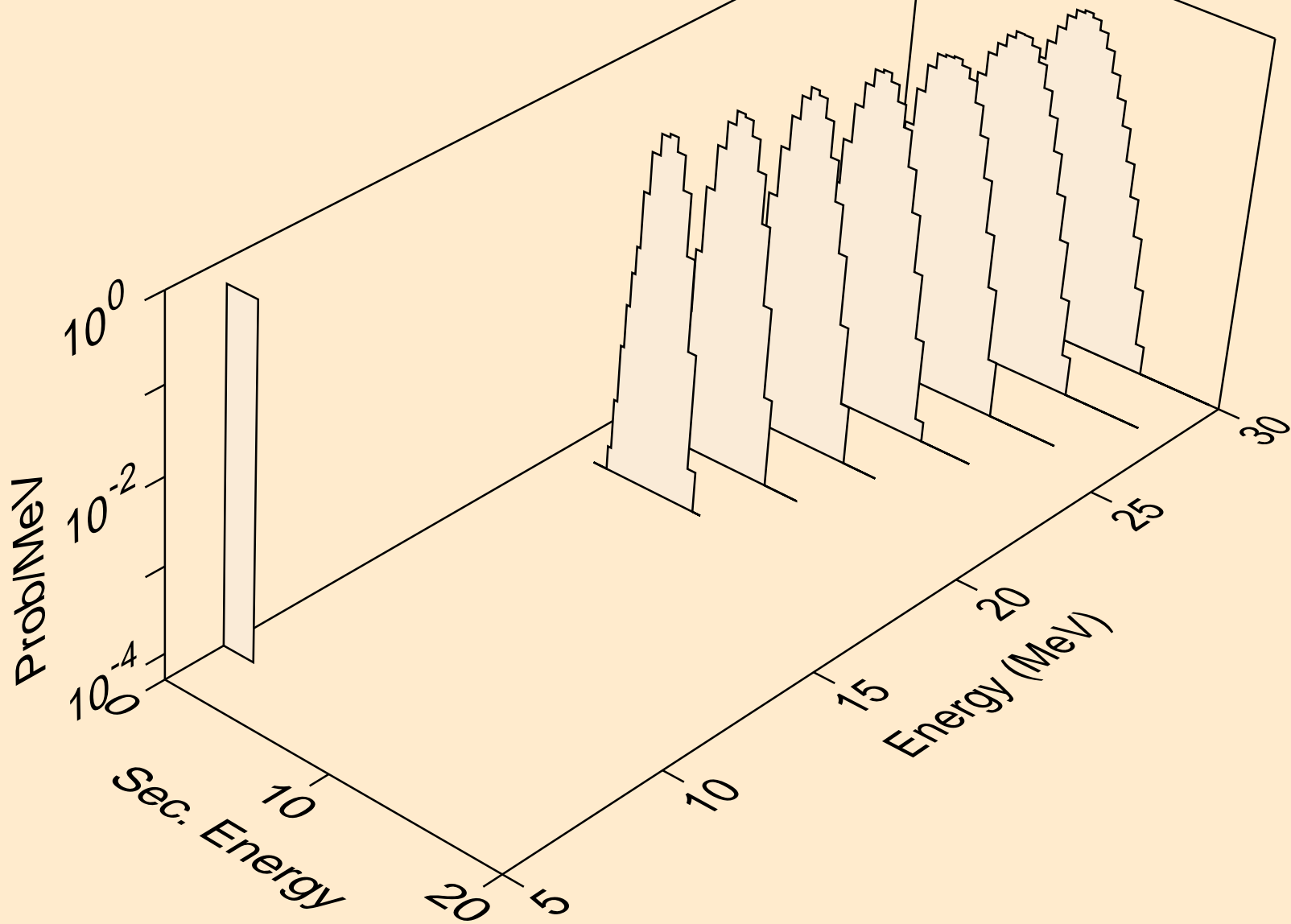

Y080M NEUTRON ACER TENDL-2024 LIBRARY; T=0.K  
alphas from (n,npa)

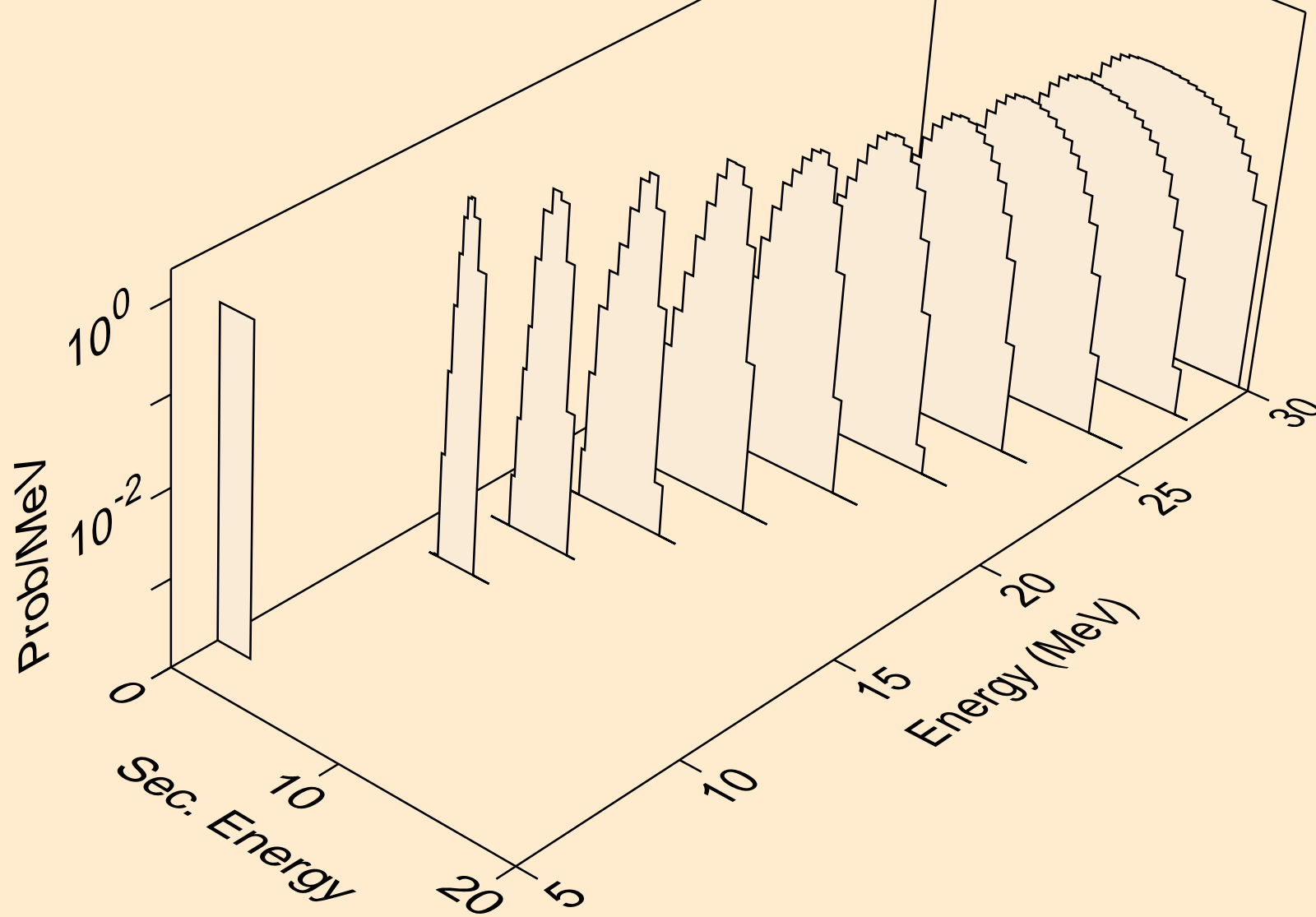

Y080M NEUTRON ACER TENDL-2024 LIBRARY; T=0.K  
alphas from (n,a)

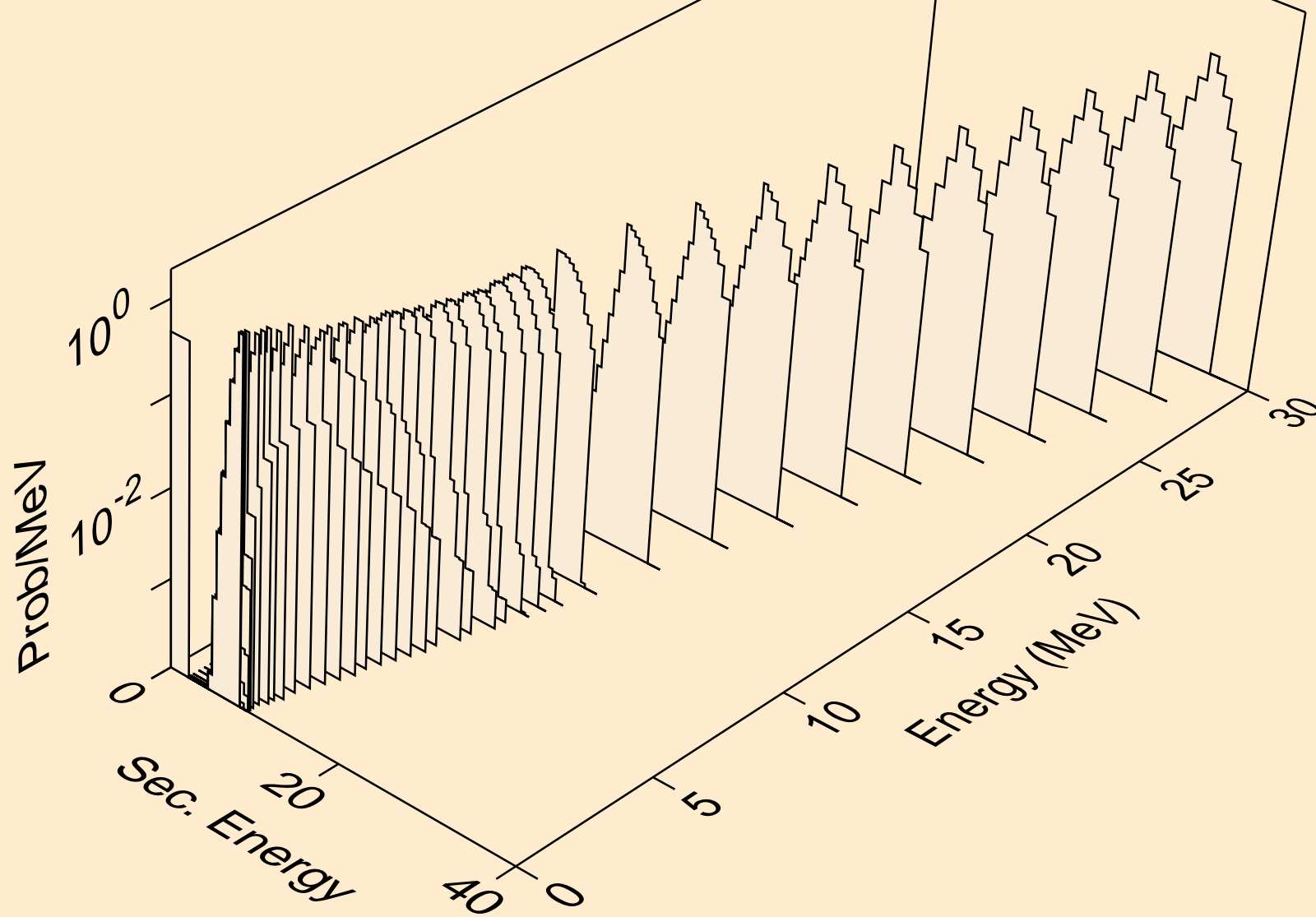



Y080M NEUTRON ACER TENDL-2024 LIBRARY; T=0.K  
alphas from (n,2a)

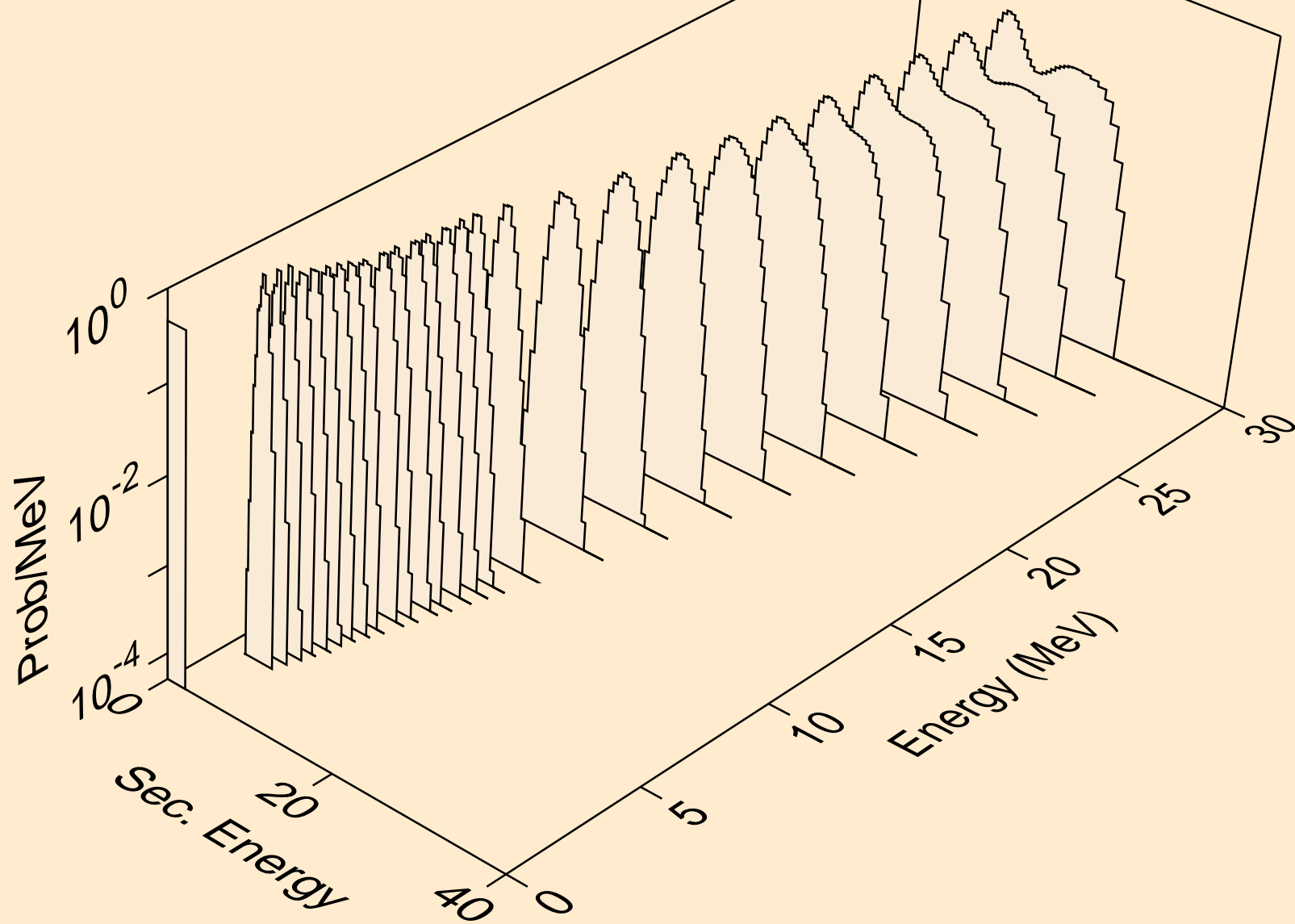

Y080M NEUTRON ACER TENDL-2024 LIBRARY; T=0.K  
alphas from (n,3a)

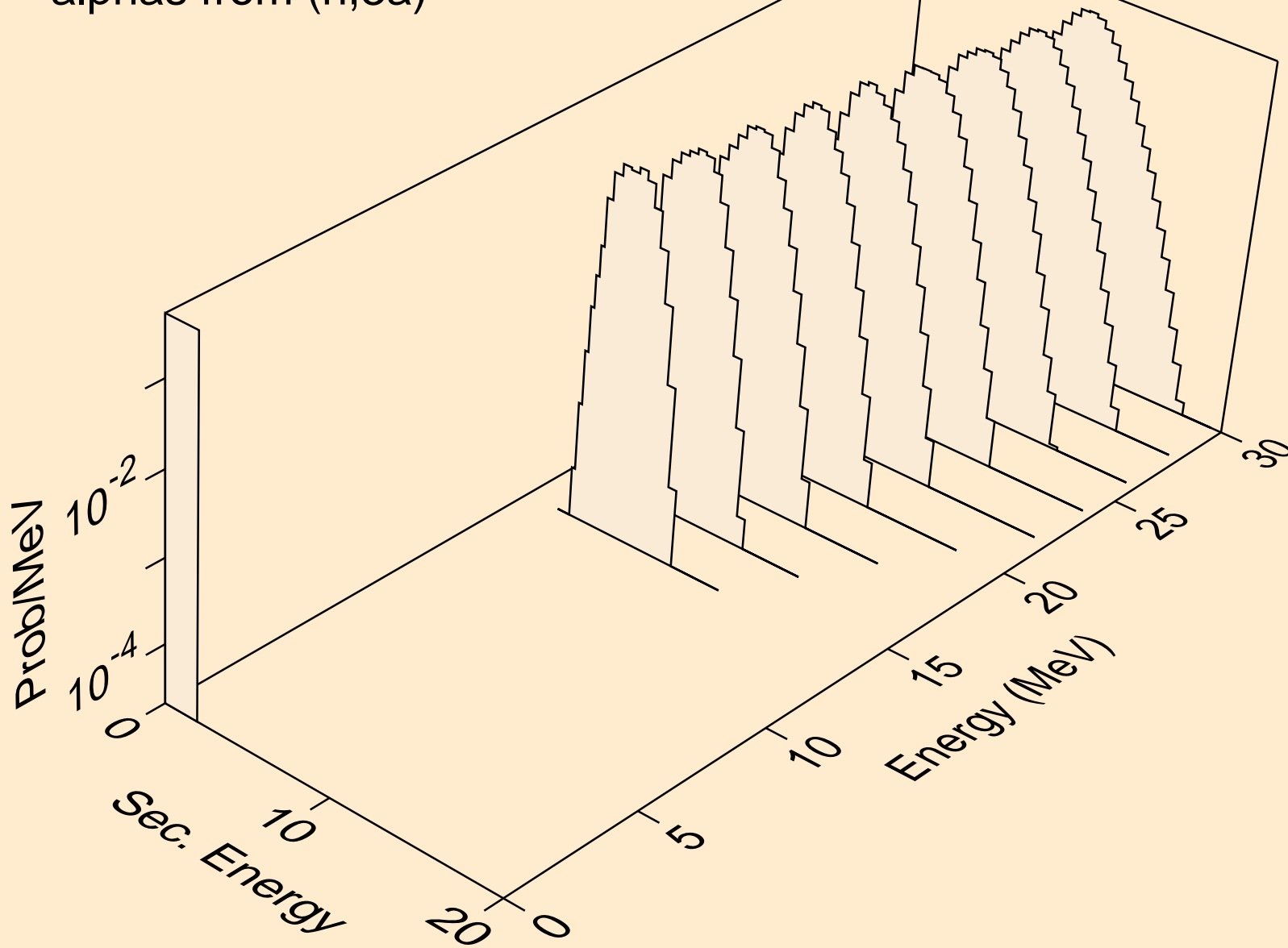

Y080M NEUTRON ACER TENDL-2024 LIBRARY; T=0.K  
alphas from (n,pa)

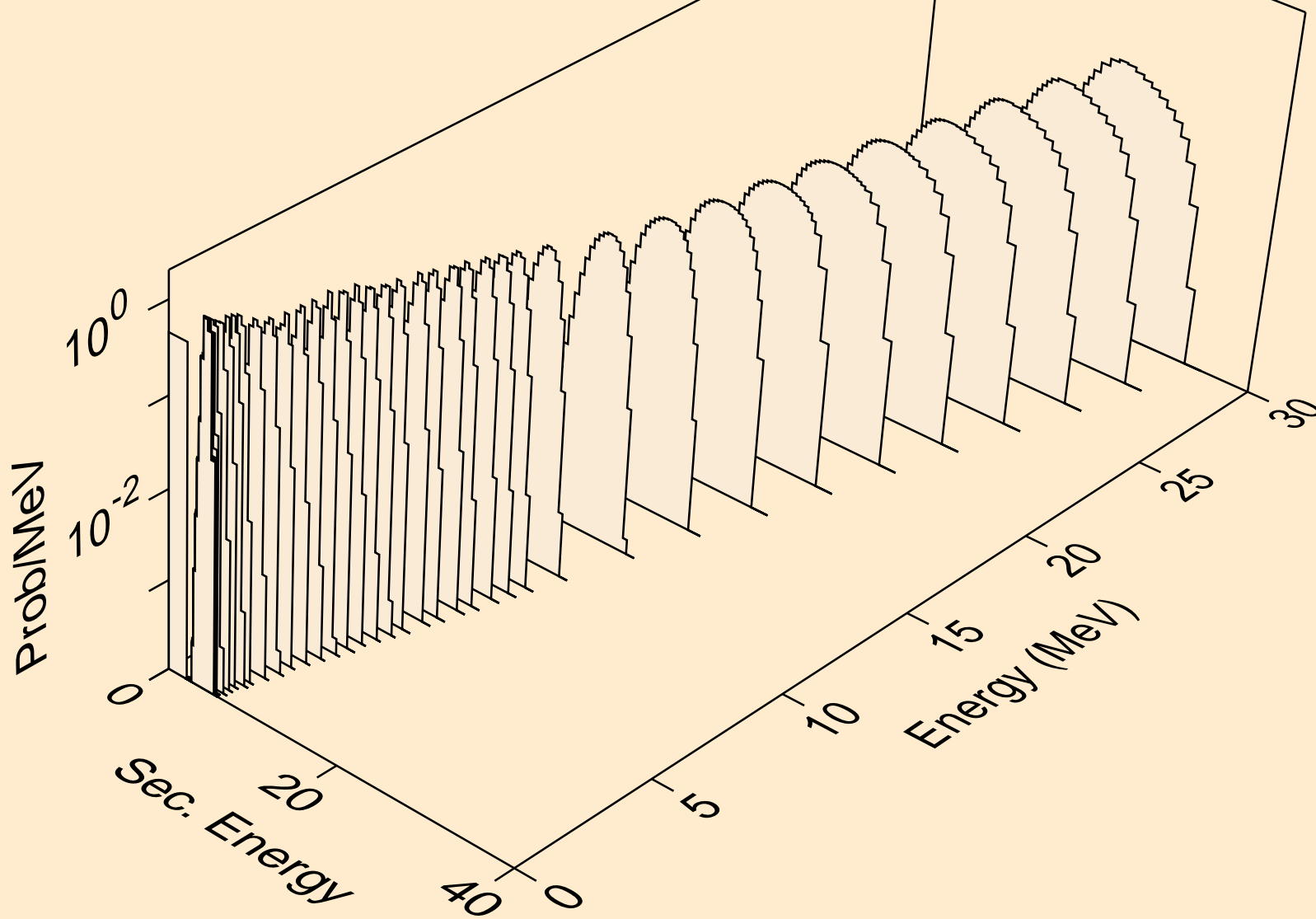

Y080M NEUTRON ACER TENDL-2024 LIBRARY; T=0.K  
alphas from (n,da)

