

Y084 NEUTRON ACER TENDL-2024 LIBRARY; T=0.K
Principal cross sections

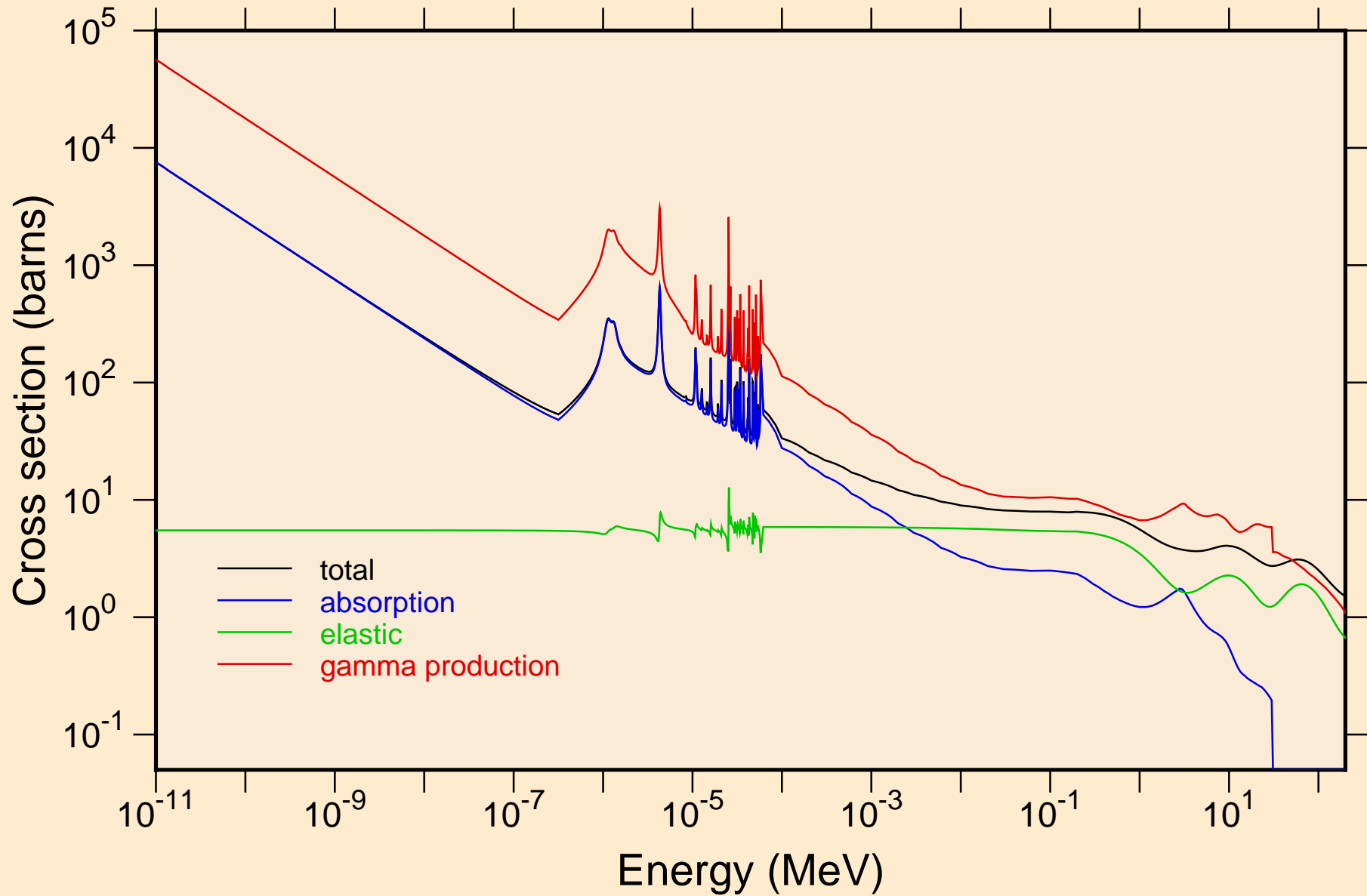

Y084 NEUTRON ACER TENDL-2024 LIBRARY; T=0.K
resonance total cross section

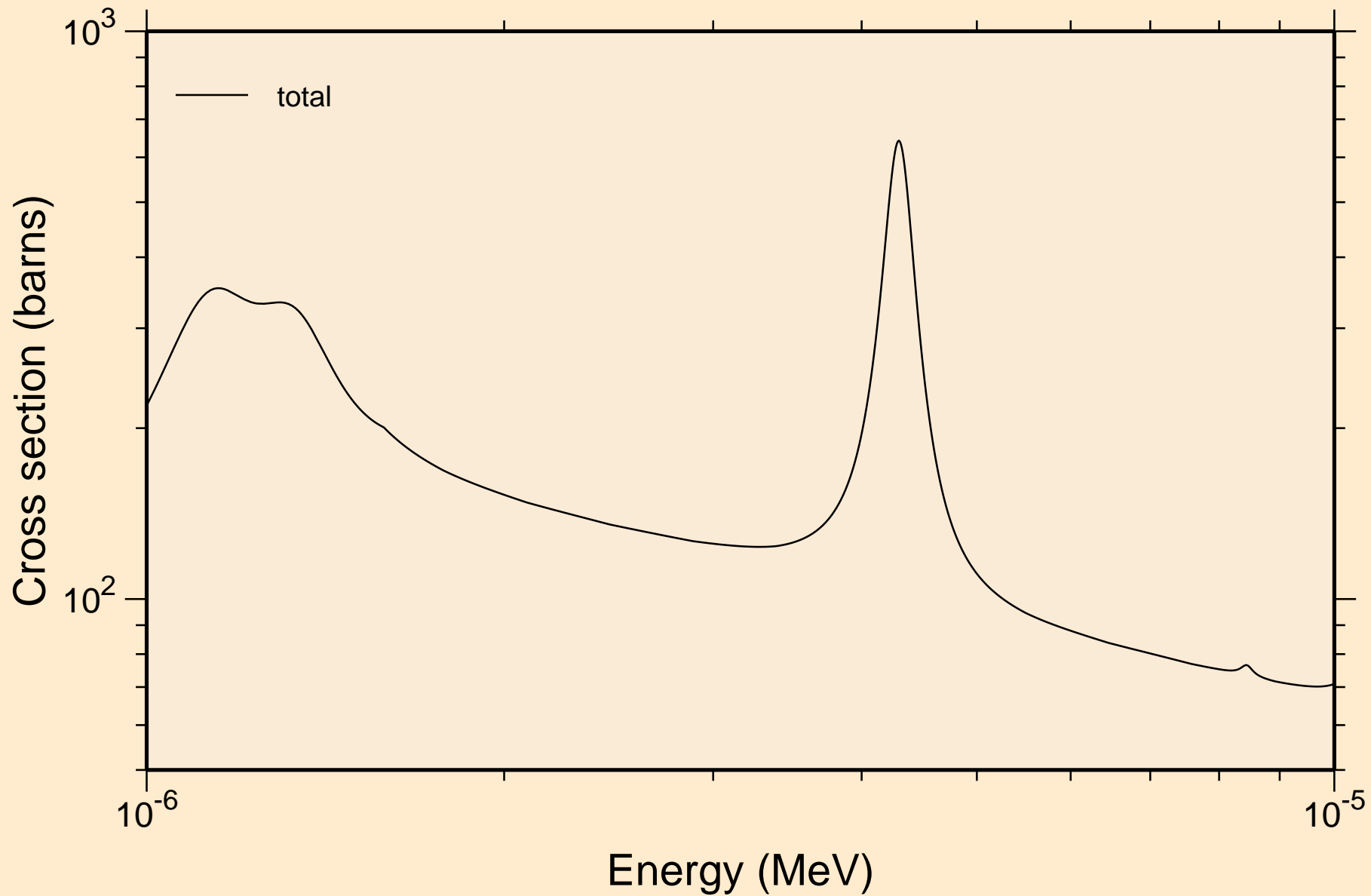

Y084 NEUTRON ACER TENDL-2024 LIBRARY; T=0.K
resonance total cross section

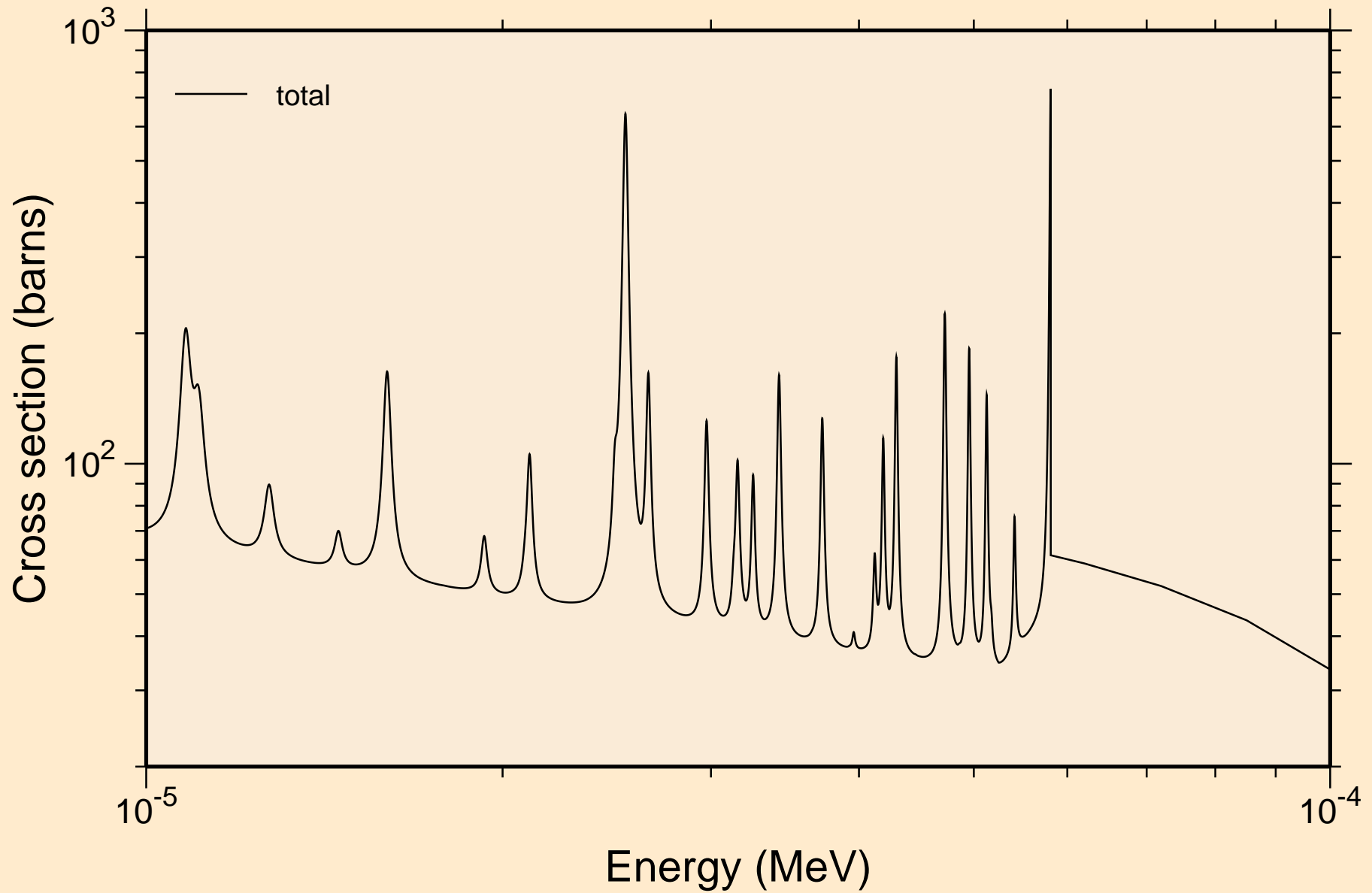

Y084 NEUTRON ACER TENDL-2024 LIBRARY; T=0.K
resonance total cross section

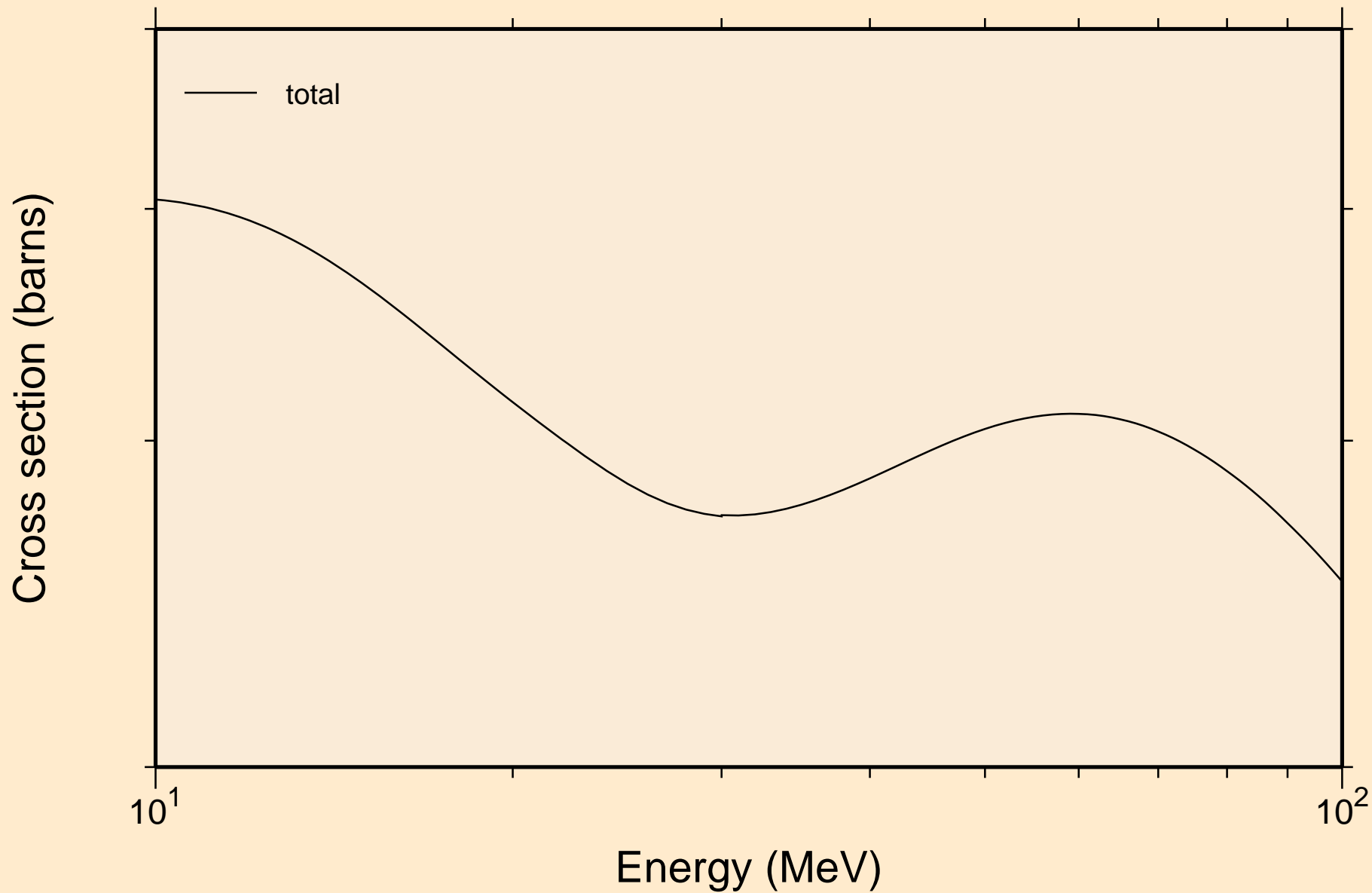

Y084 NEUTRON ACER TENDL-2024 LIBRARY; T=0.K
resonance absorption cross sections

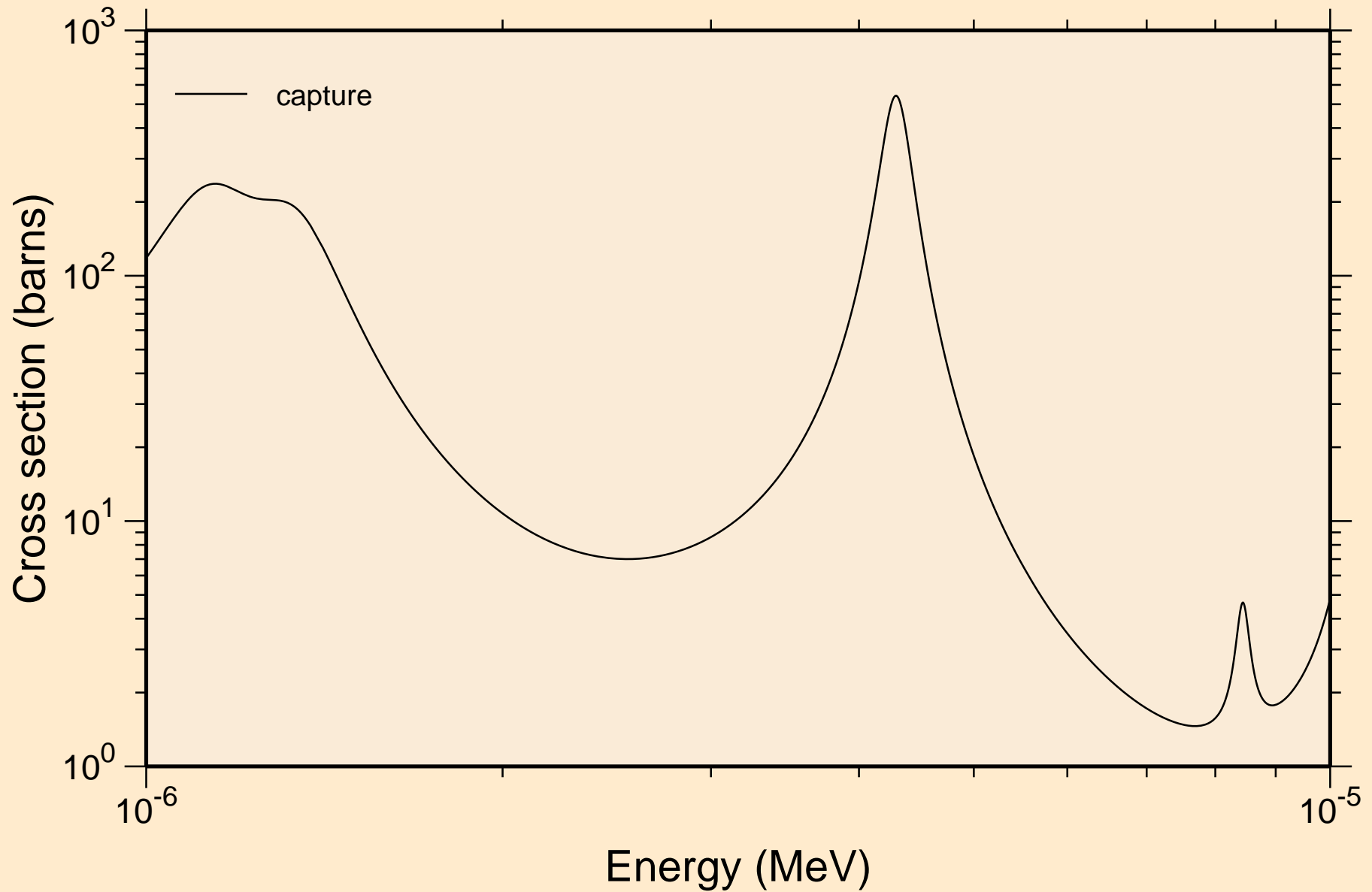

Y084 NEUTRON ACER TENDL-2024 LIBRARY; T=0.K
resonance absorption cross sections

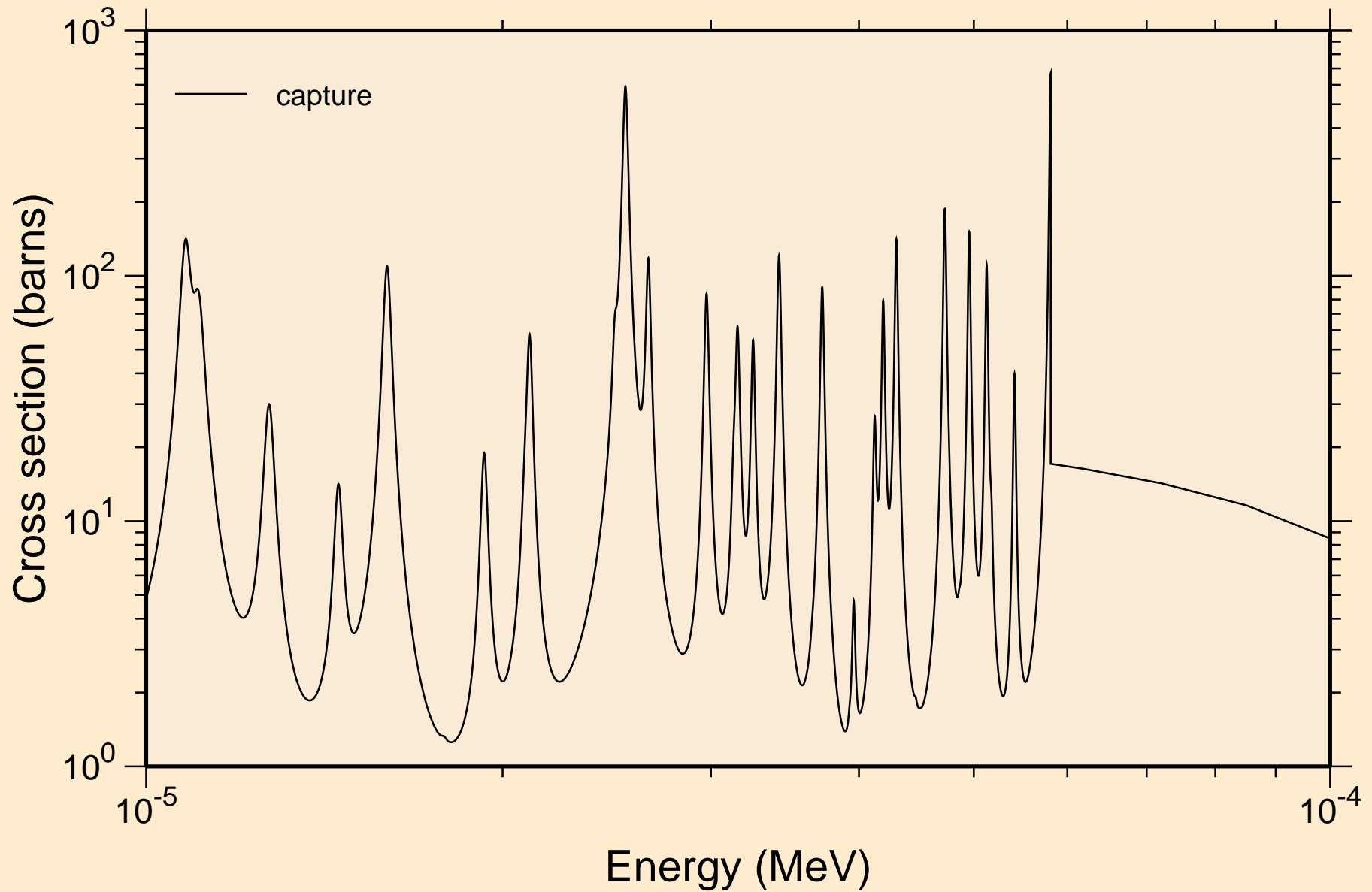

Y084 NEUTRON ACER TENDL-2024 LIBRARY; T=0.K
resonance absorption cross sections

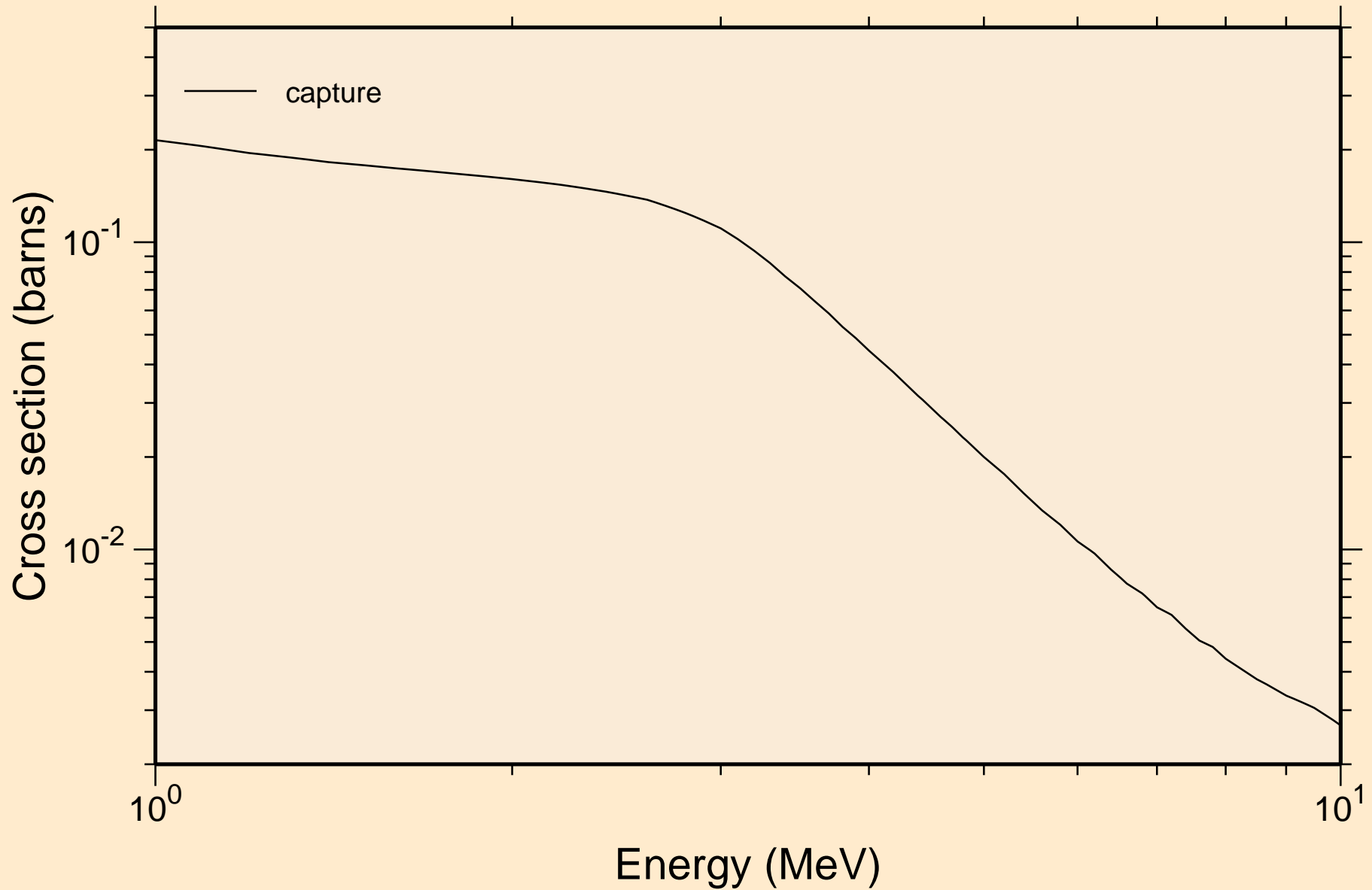

Y084 NEUTRON ACER TENDL-2024 LIBRARY; T=0.K

Heating

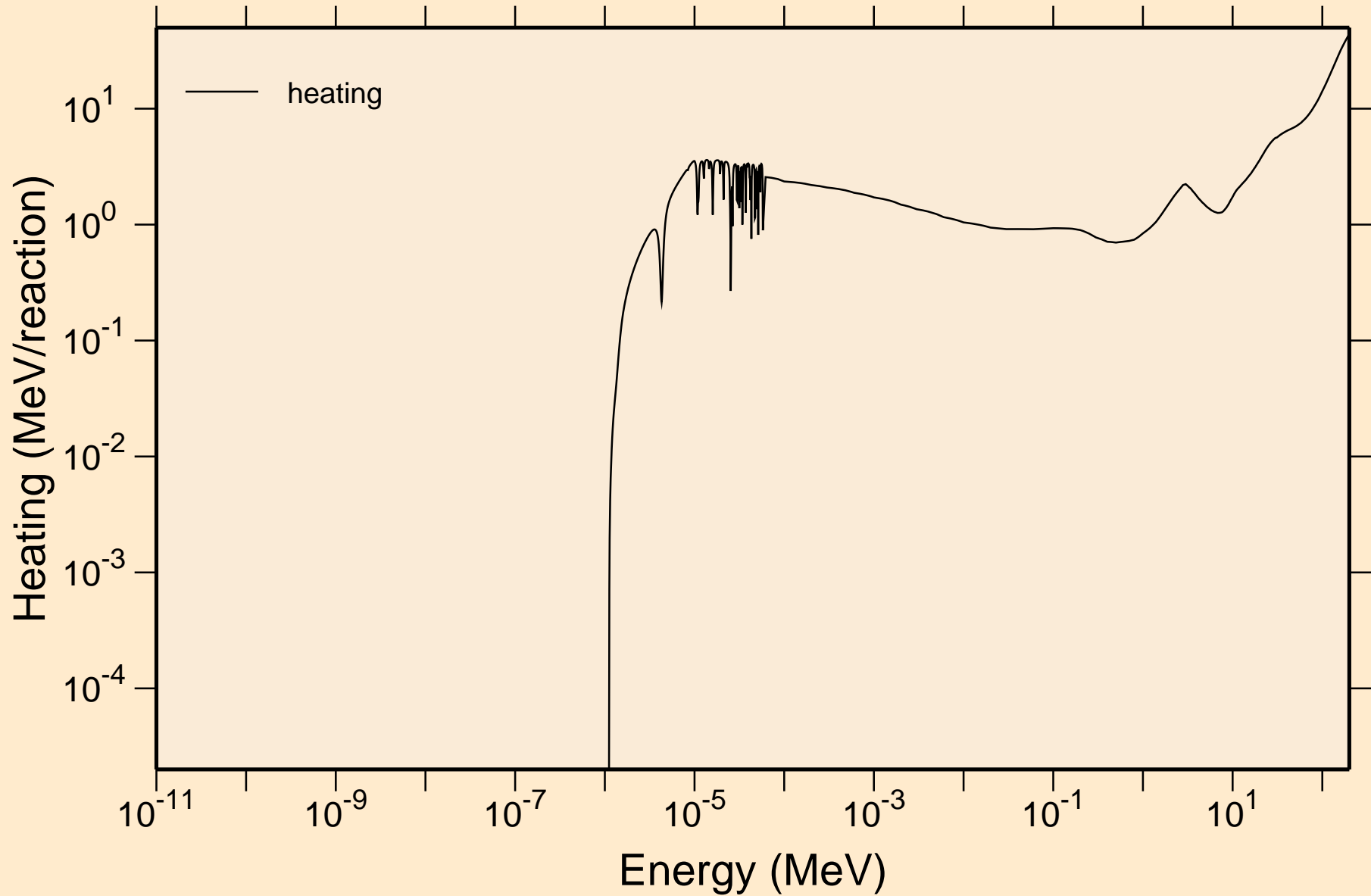

Y084 NEUTRON ACER TENDL-2024 LIBRARY; T=0.K
Damage

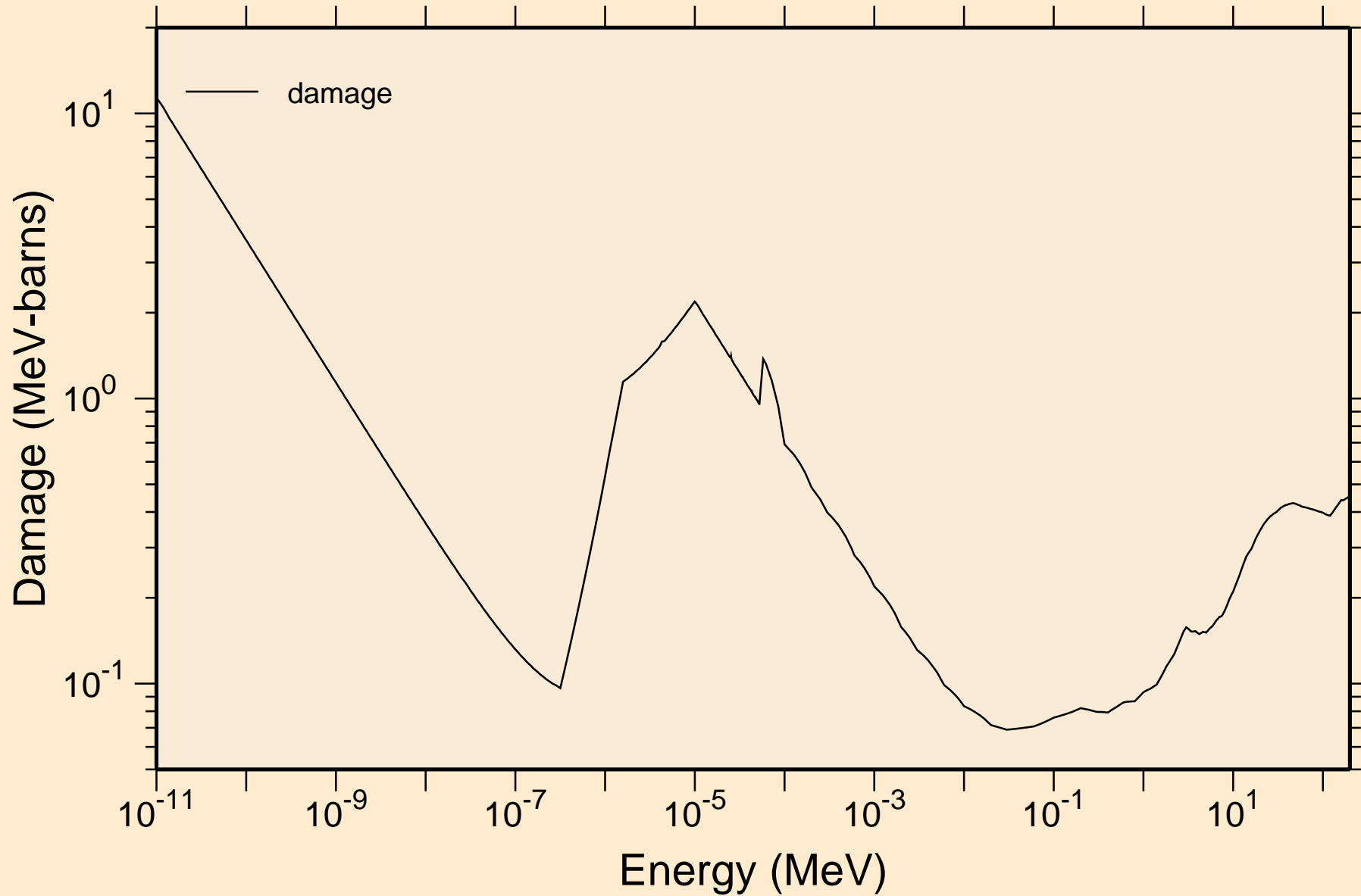

Y084 NEUTRON ACER TENDL-2024 LIBRARY; T=0.K

Non-threshold reactions

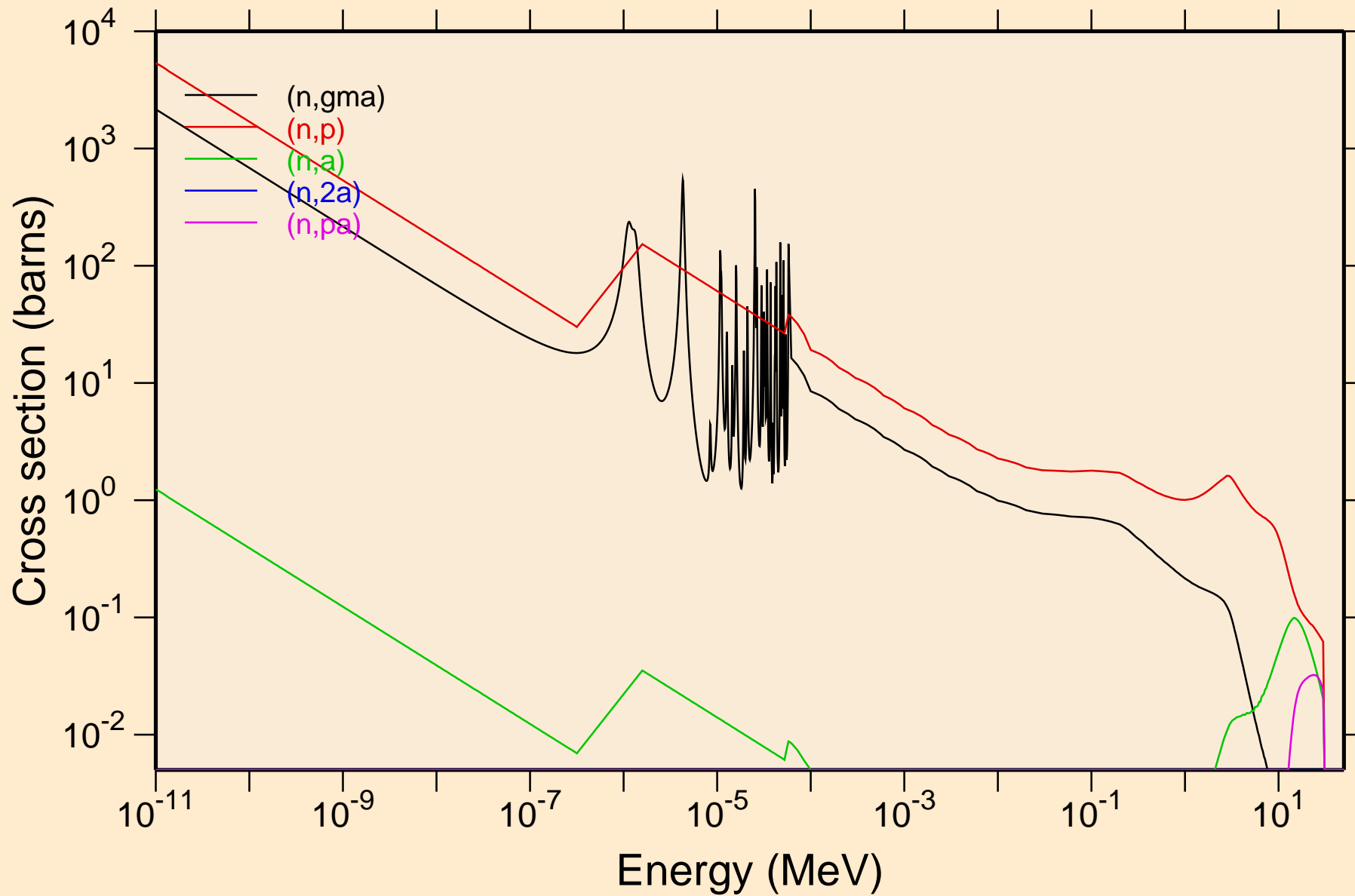

Y084 NEUTRON ACER TENDL-2024 LIBRARY; T=0.K
Non-threshold reactions

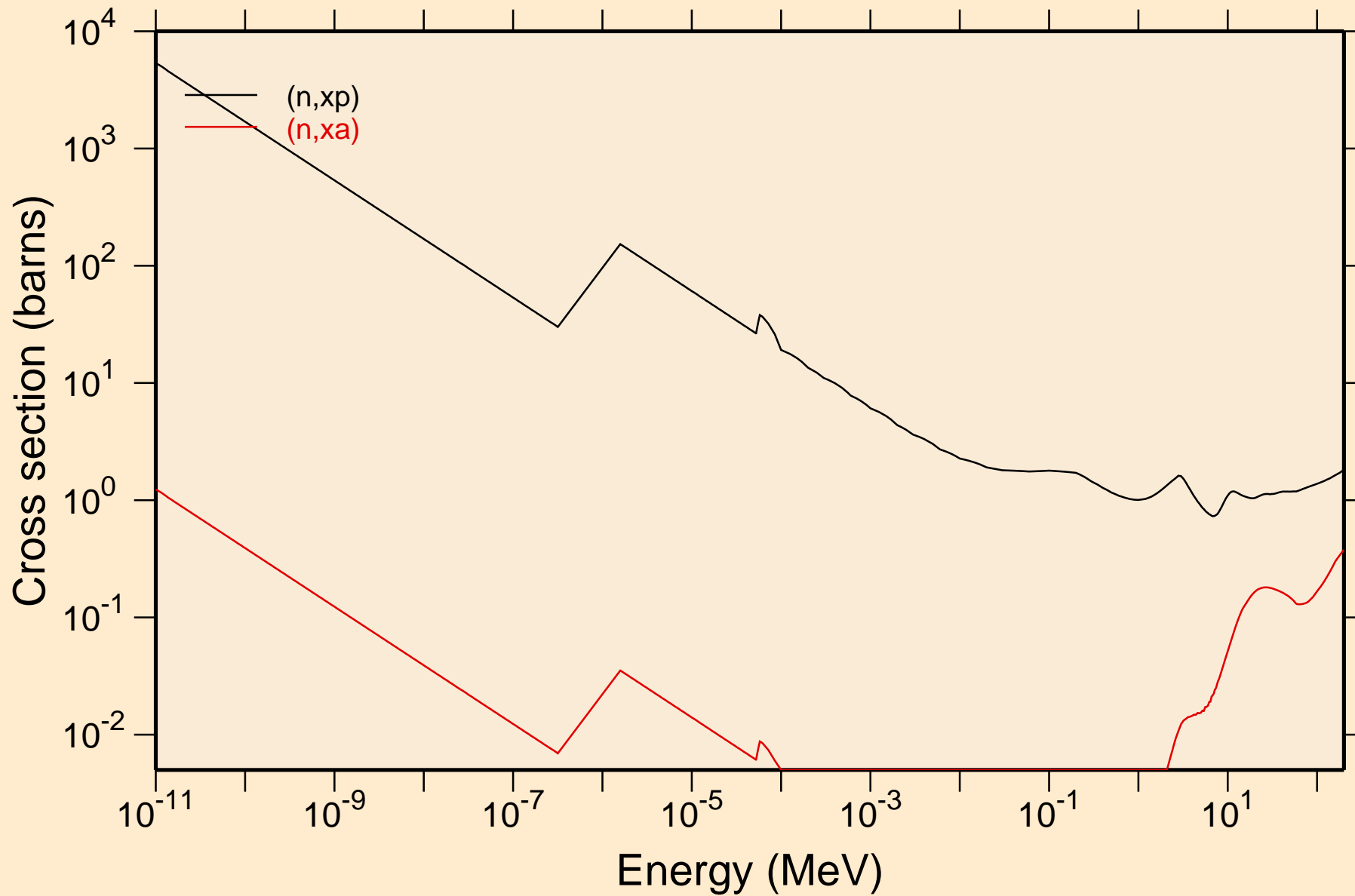

Y084 NEUTRON ACER TENDL-2024 LIBRARY; T=0.K

Principal cross sections

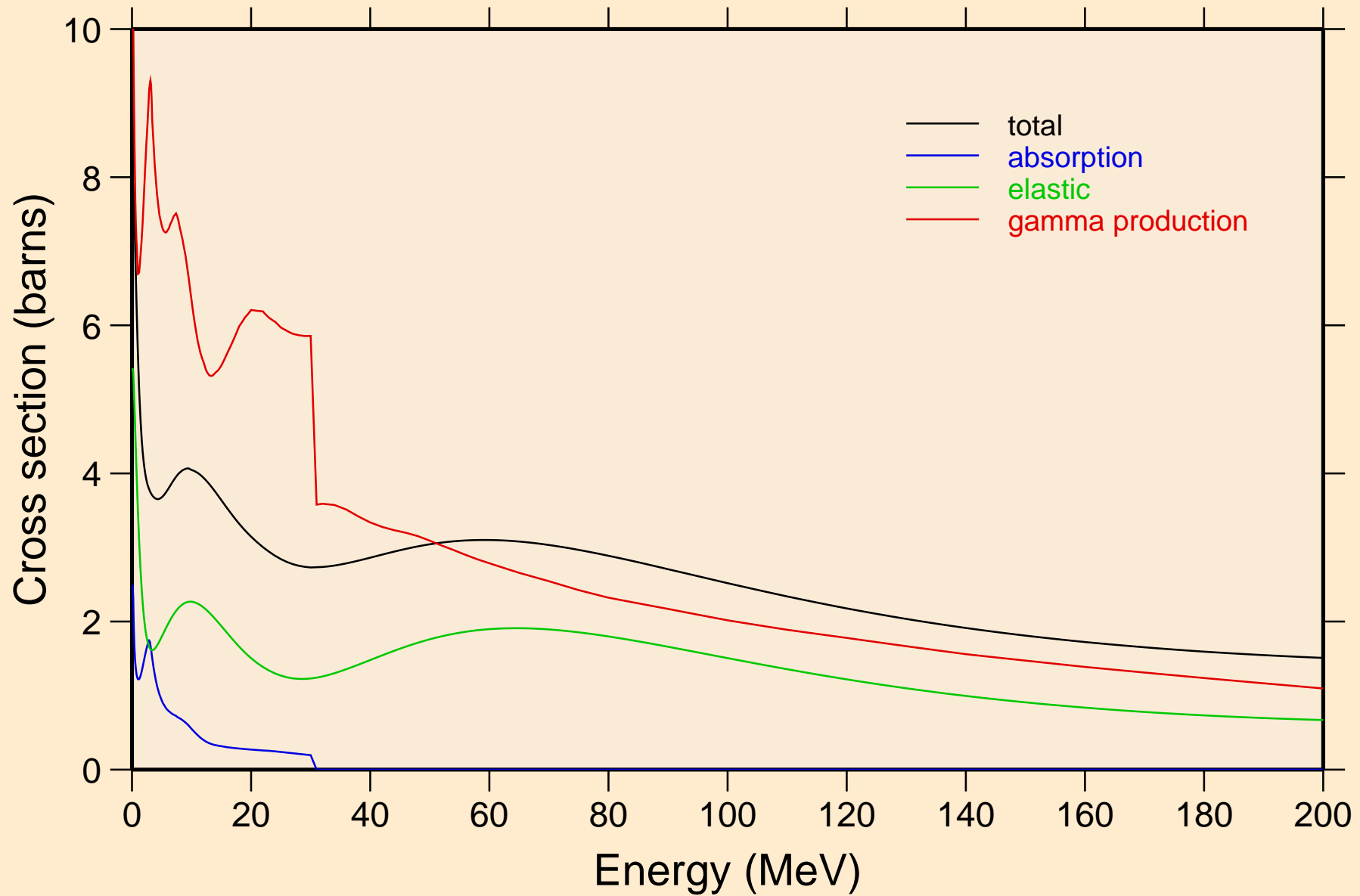

Y084 NEUTRON ACER TENDL-2024 LIBRARY; T=0.K

Heating

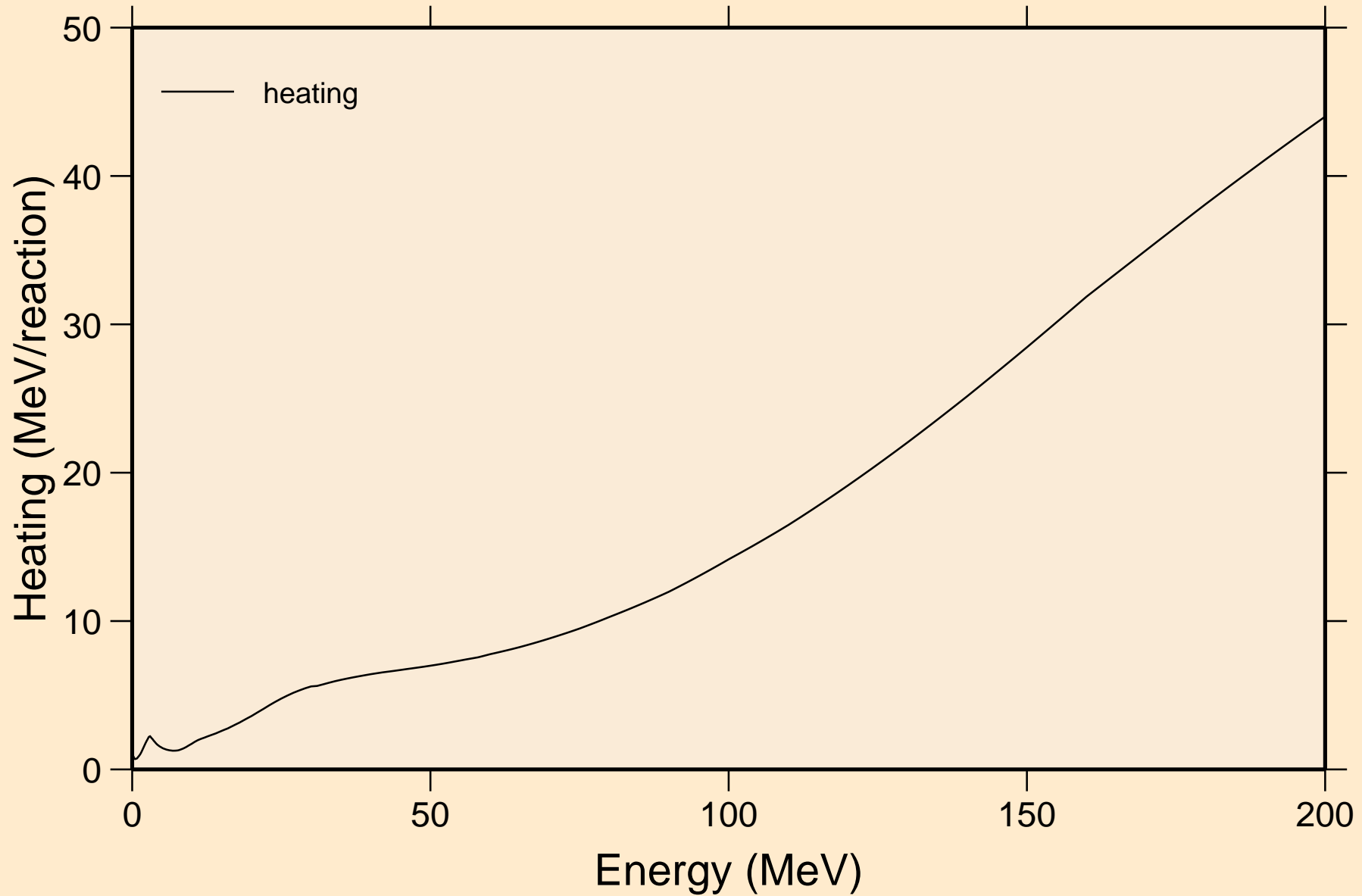

Y084 NEUTRON ACER TENDL-2024 LIBRARY; T=0.K

Damage

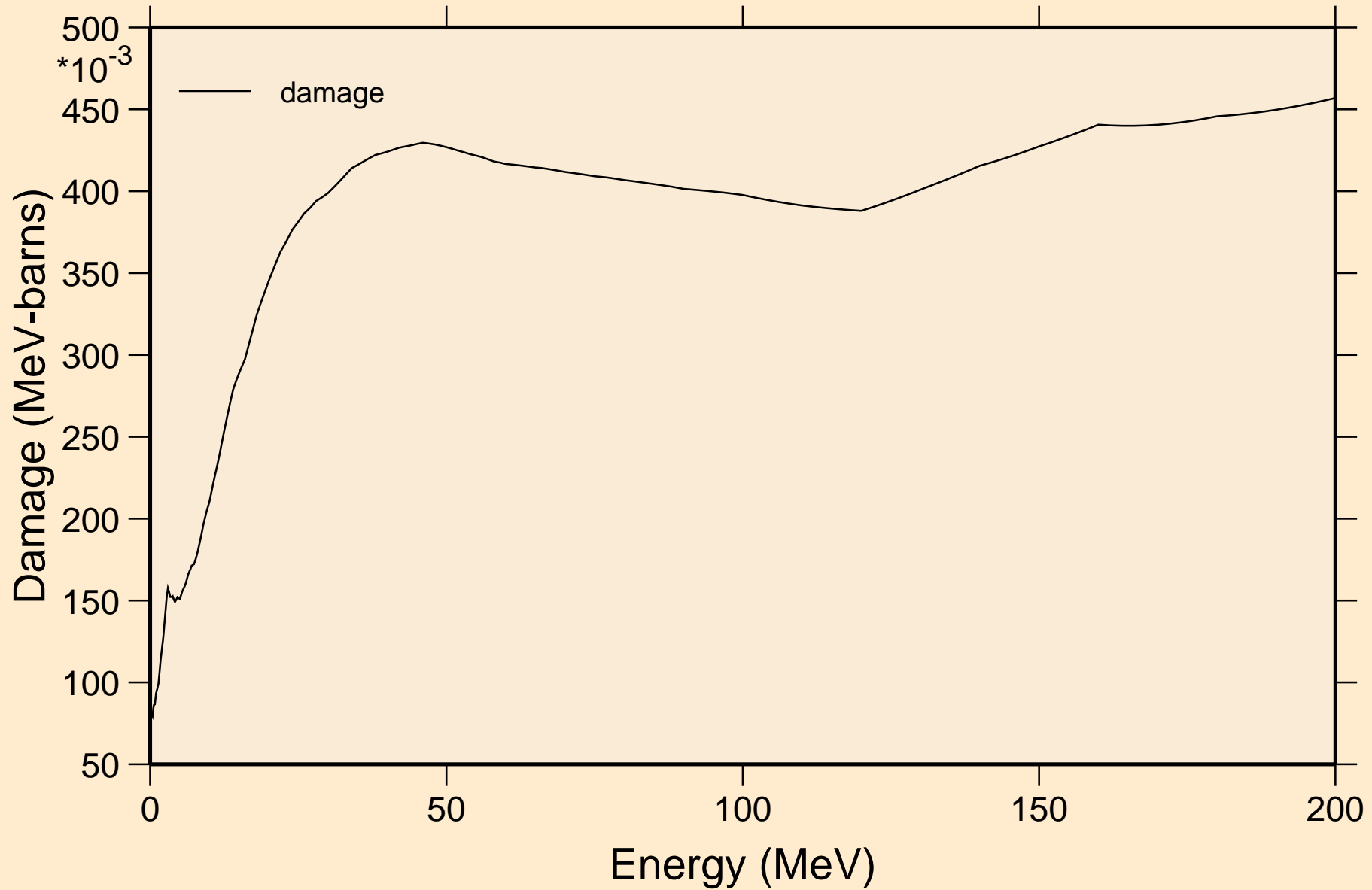

Y084 NEUTRON ACER TENDL-2024 LIBRARY; T=0.K
Non-threshold reactions

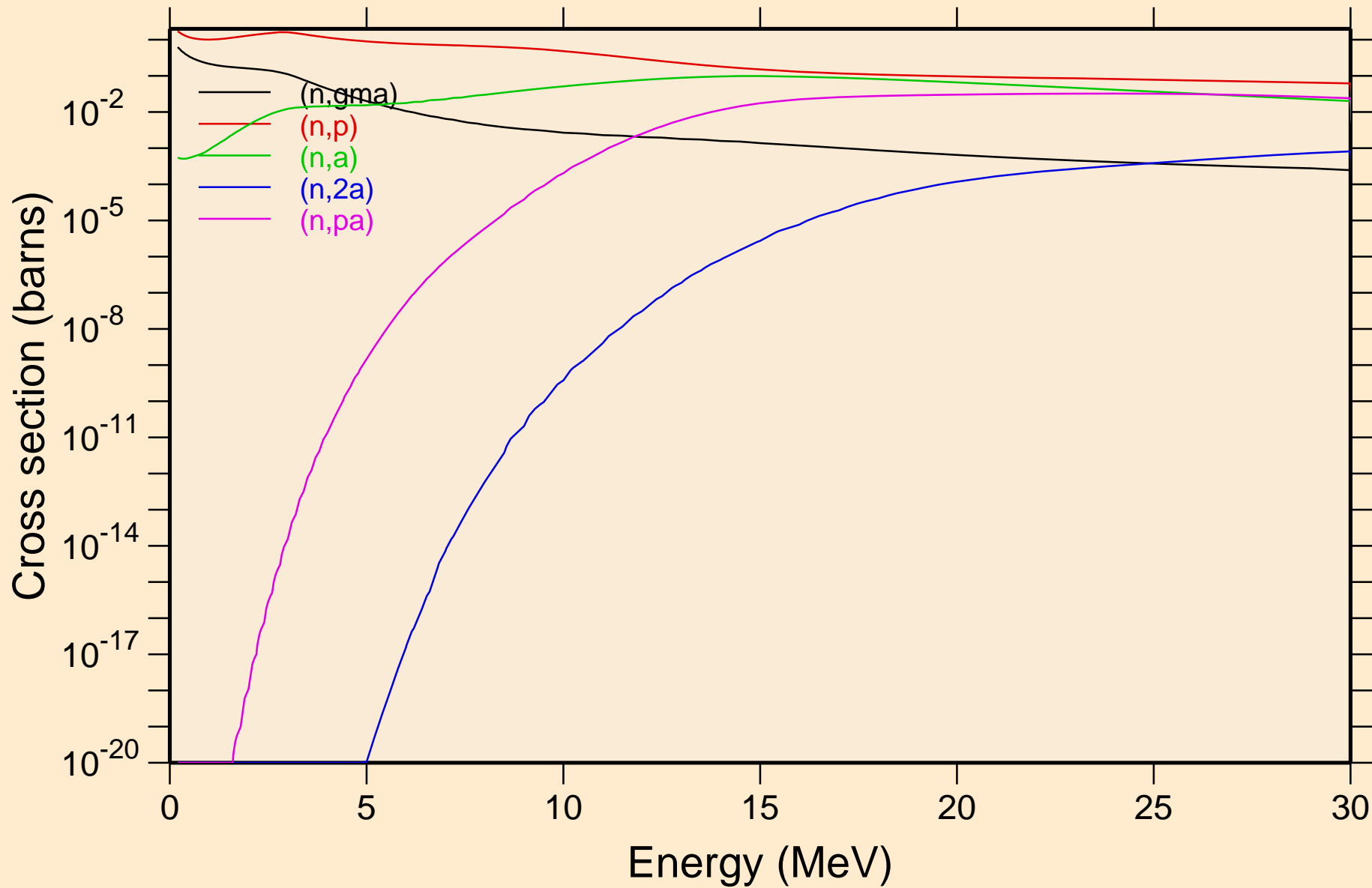

Y084 NEUTRON ACER TENDL-2024 LIBRARY; T=0.K
Non-threshold reactions

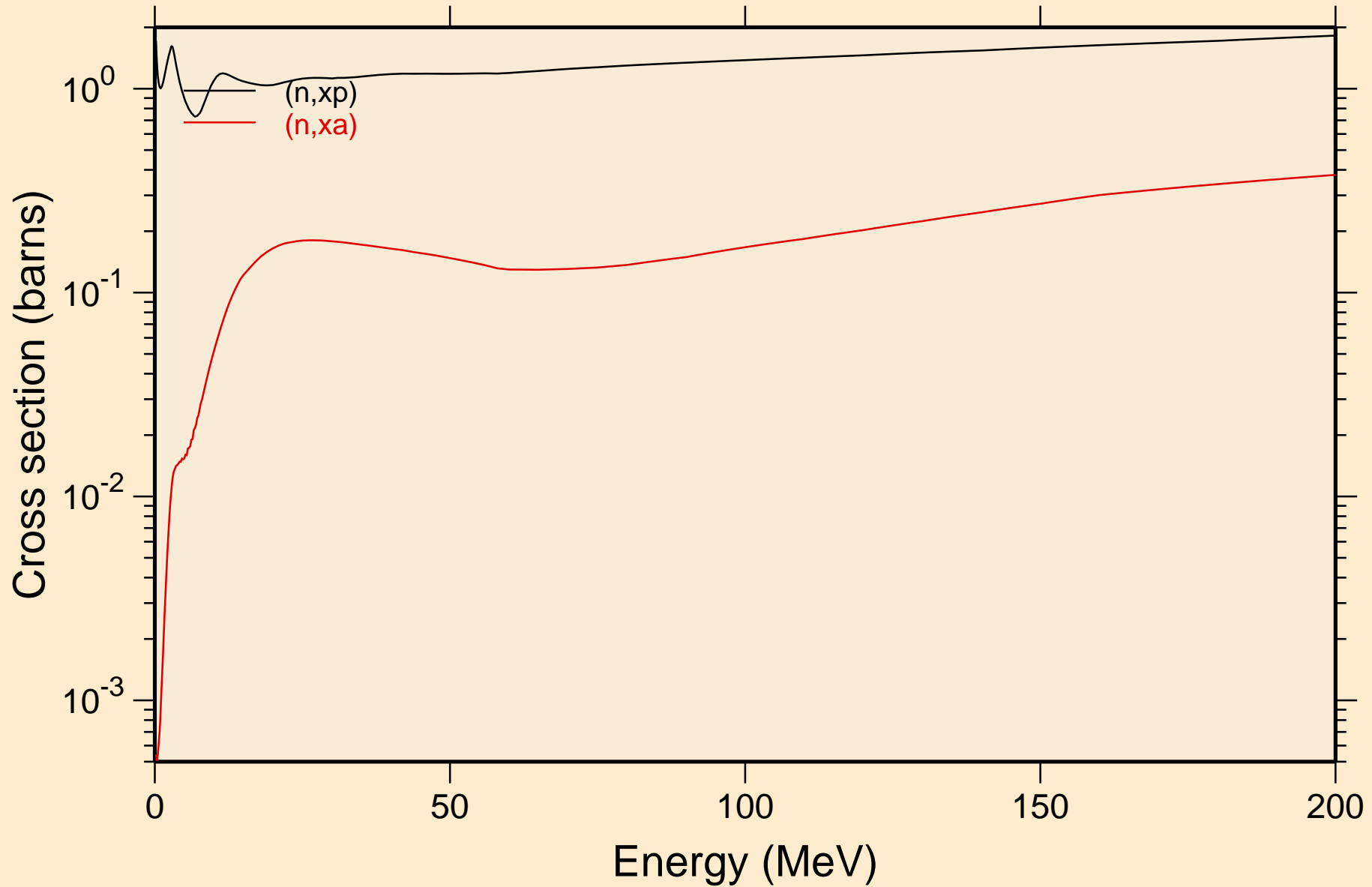

Y084 NEUTRON ACER TENDL-2024 LIBRARY; T=0.K
Inelastic levels

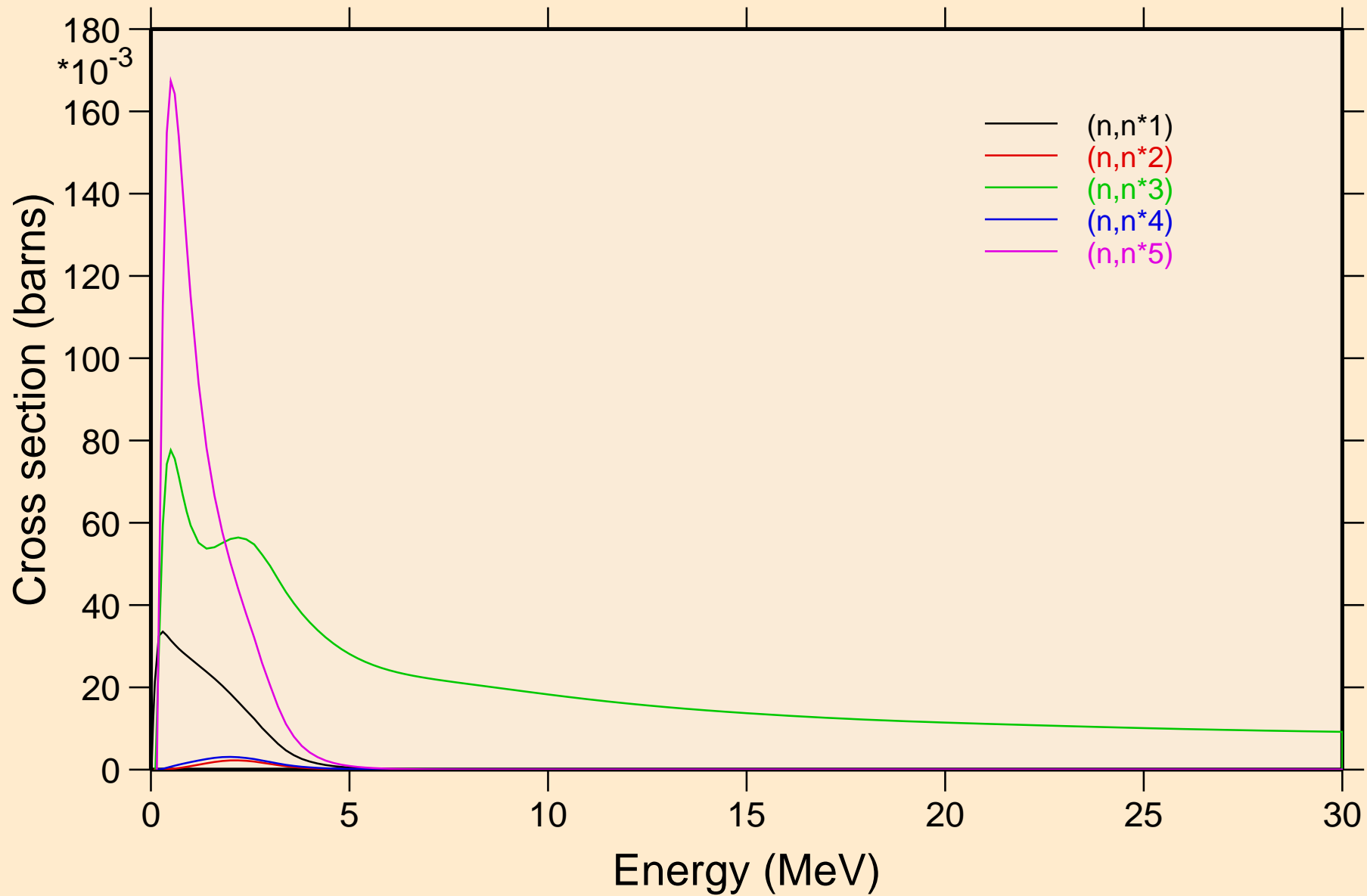

Y084 NEUTRON ACER TENDL-2024 LIBRARY; T=0.K
Inelastic levels

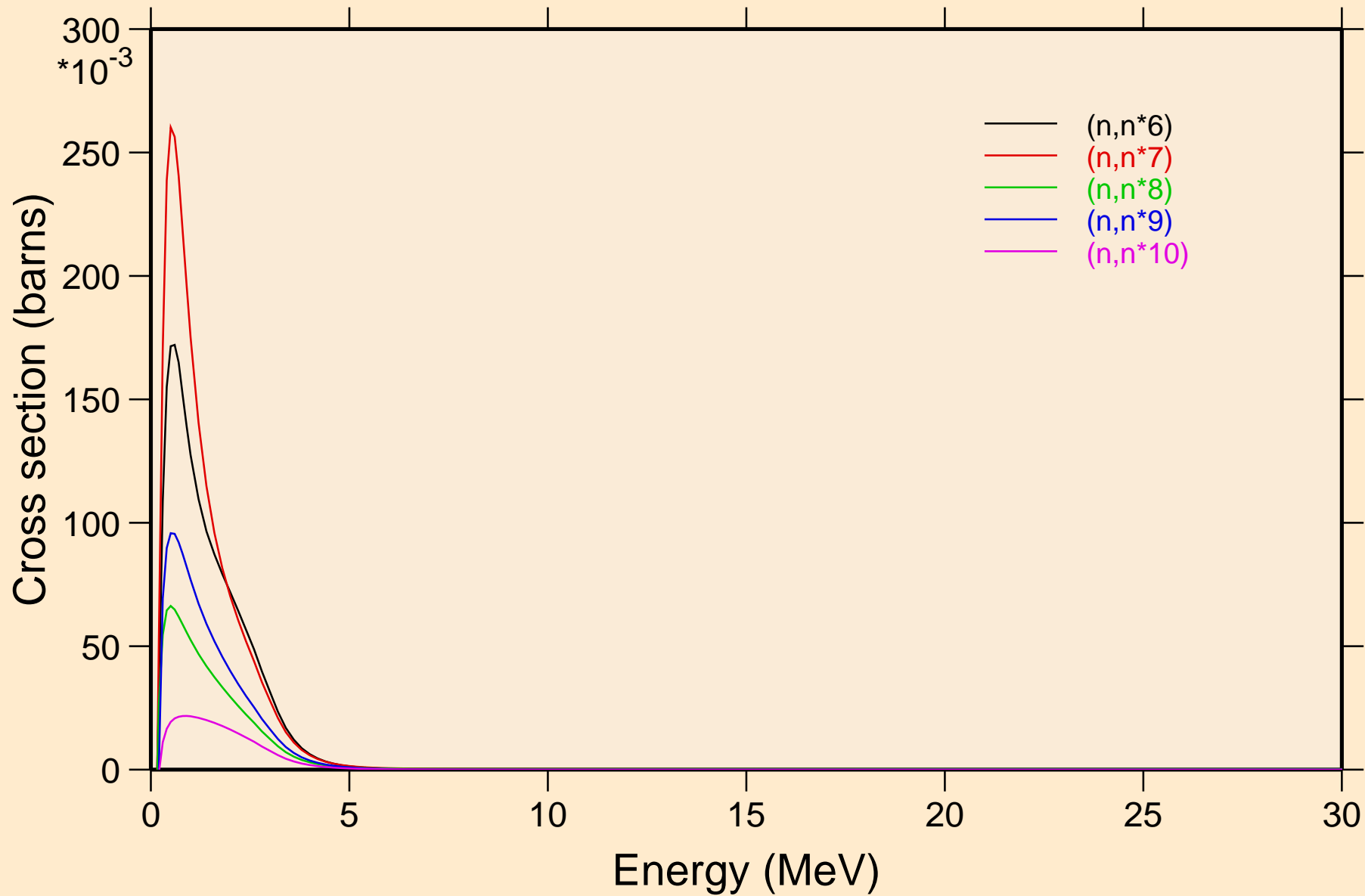

Y084 NEUTRON ACER TENDL-2024 LIBRARY; T=0.K
Inelastic levels

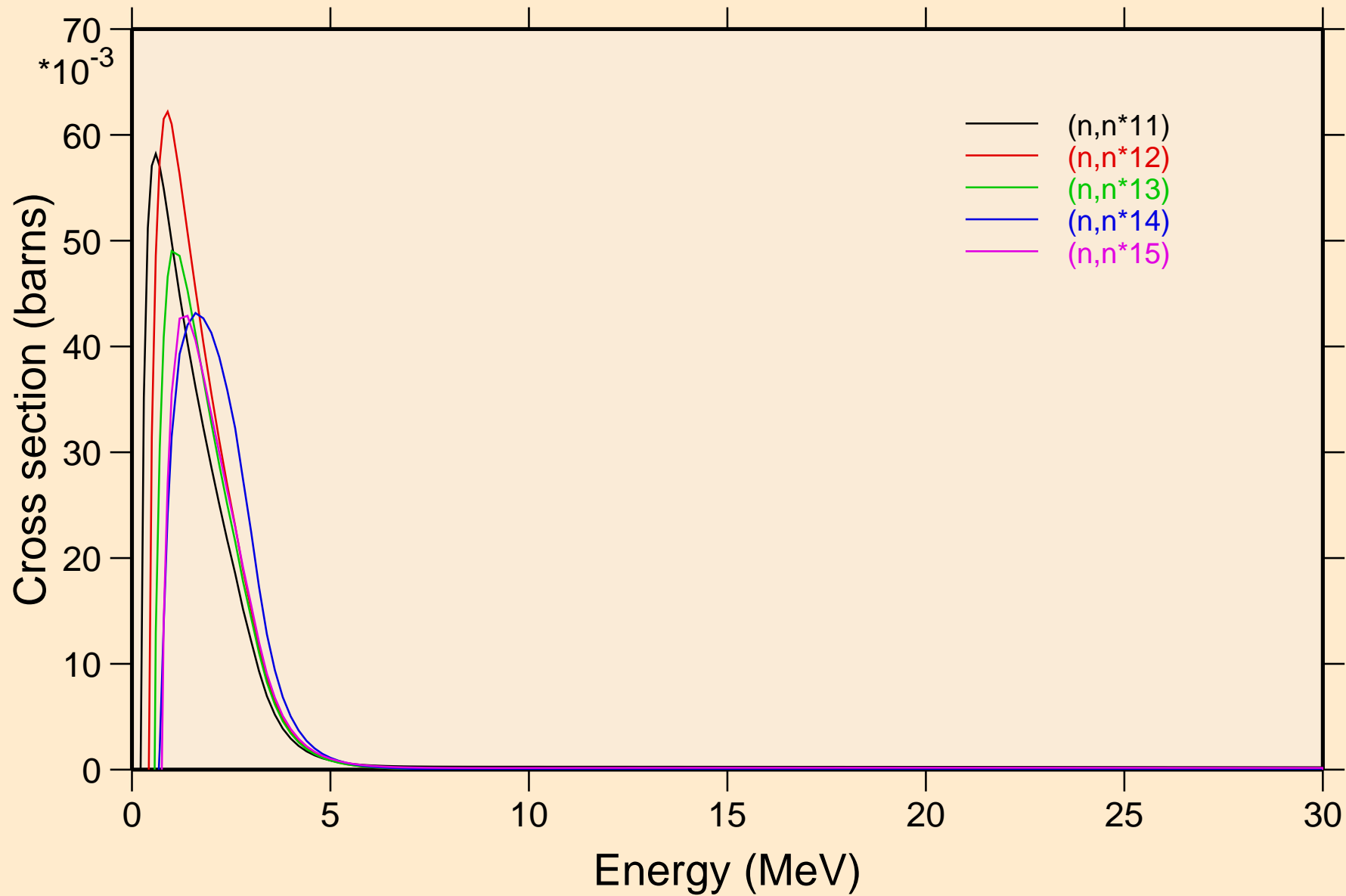

Y084 NEUTRON ACER TENDL-2024 LIBRARY; T=0.K
Inelastic levels

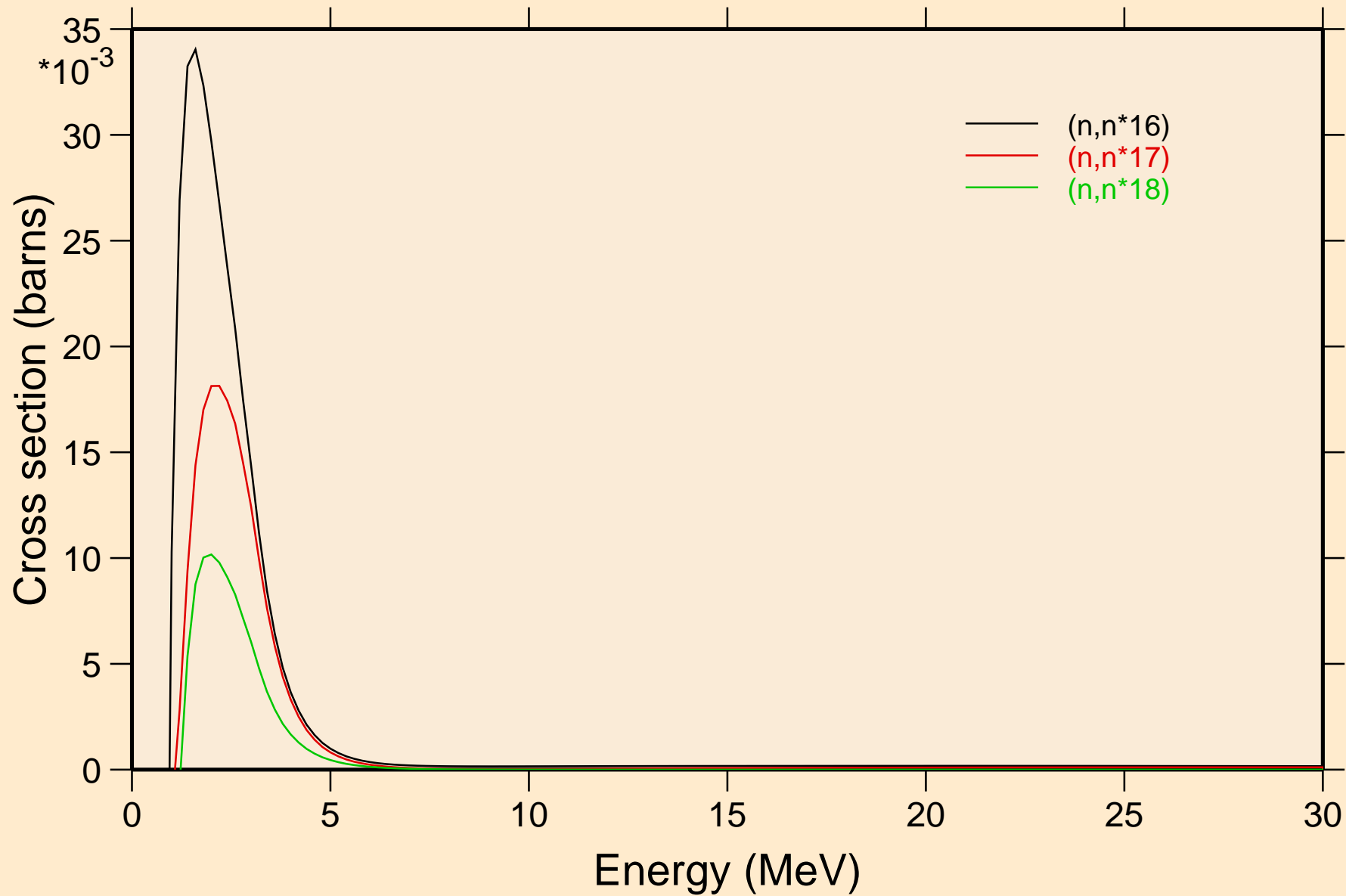

Y084 NEUTRON ACER TENDL-2024 LIBRARY; T=0.K

Threshold reactions

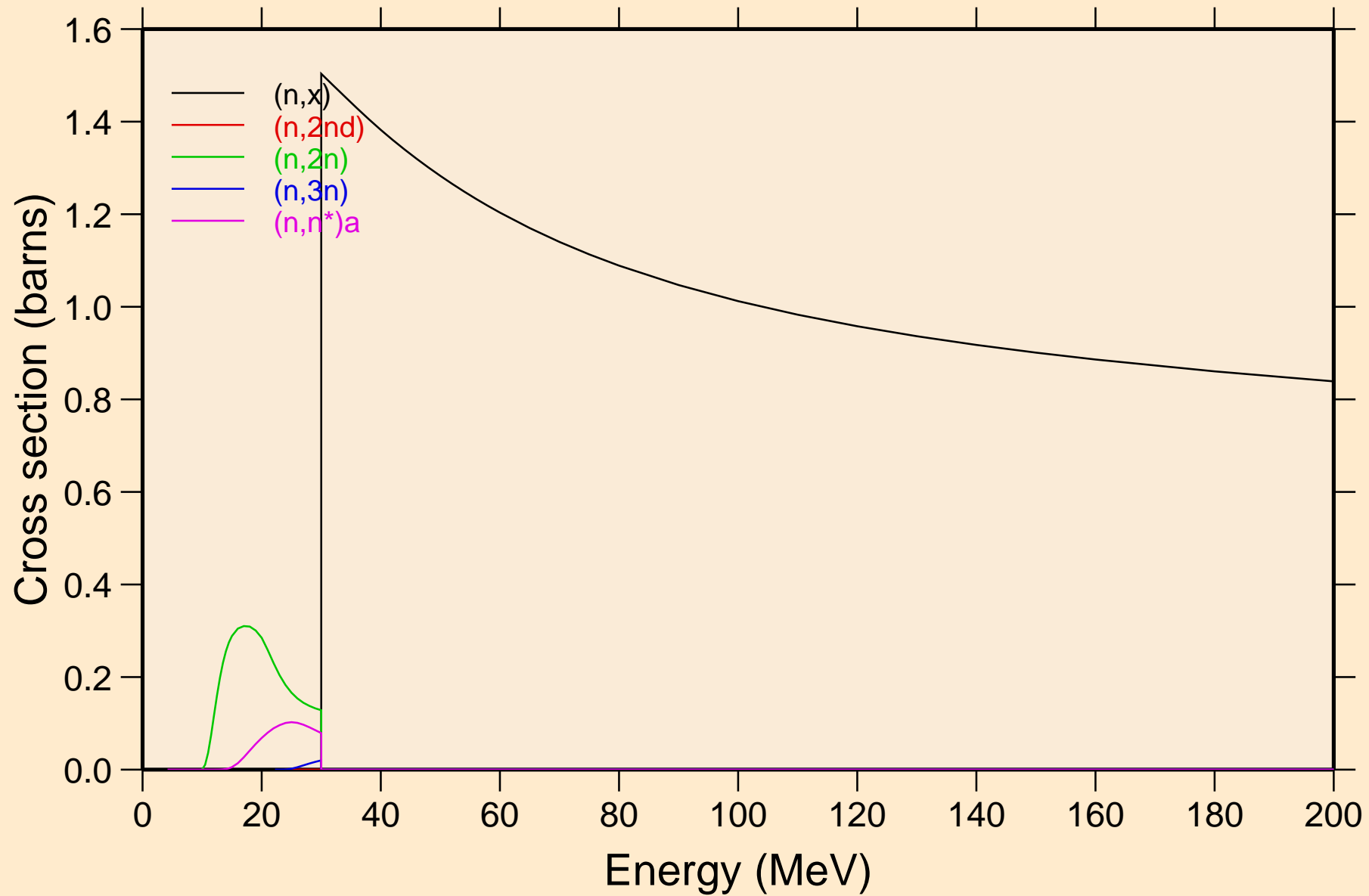

Y084 NEUTRON ACER TENDL-2024 LIBRARY; T=0.K
Threshold reactions

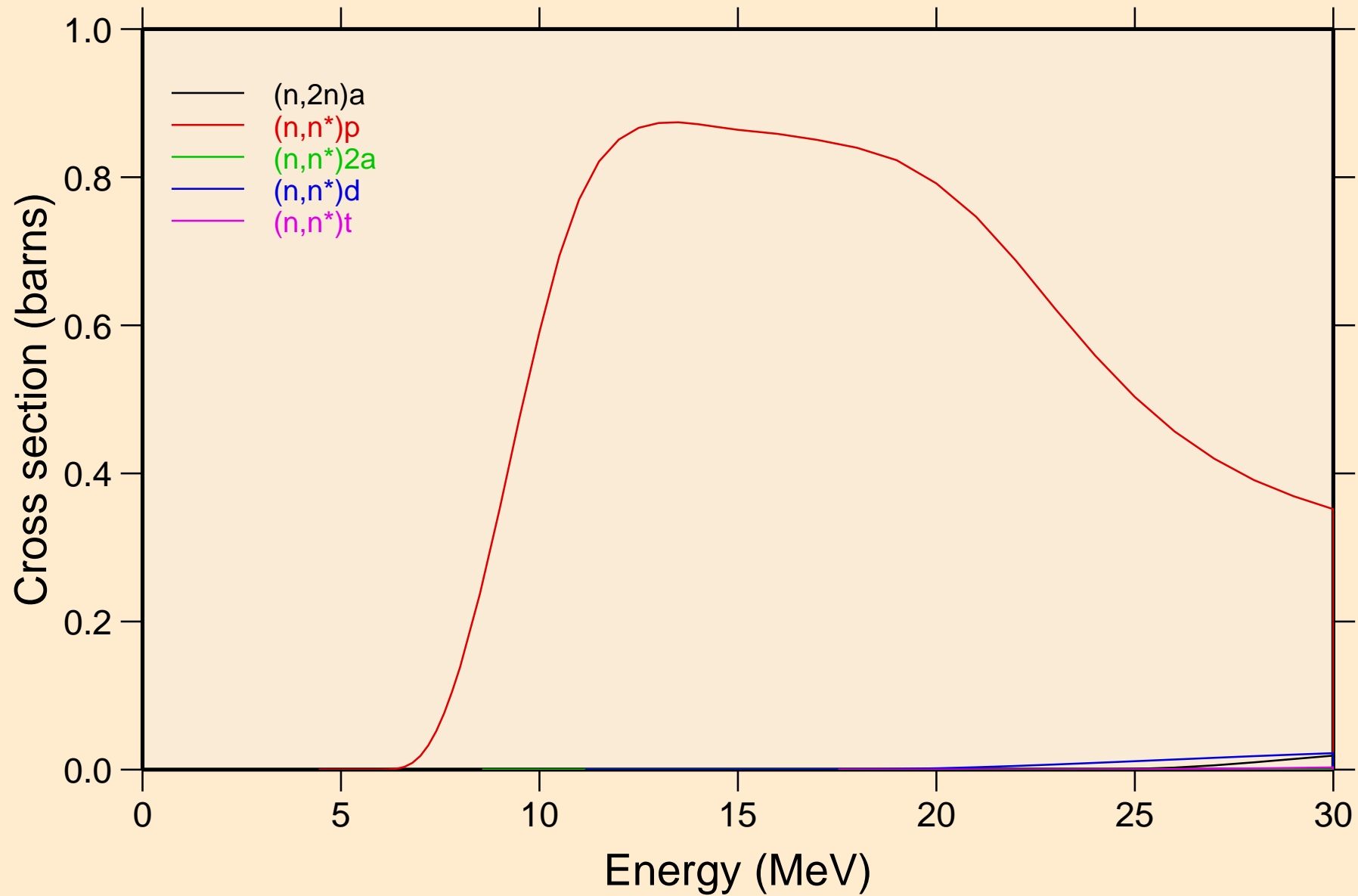

Y084 NEUTRON ACER TENDL-2024 LIBRARY; T=0.K
Threshold reactions

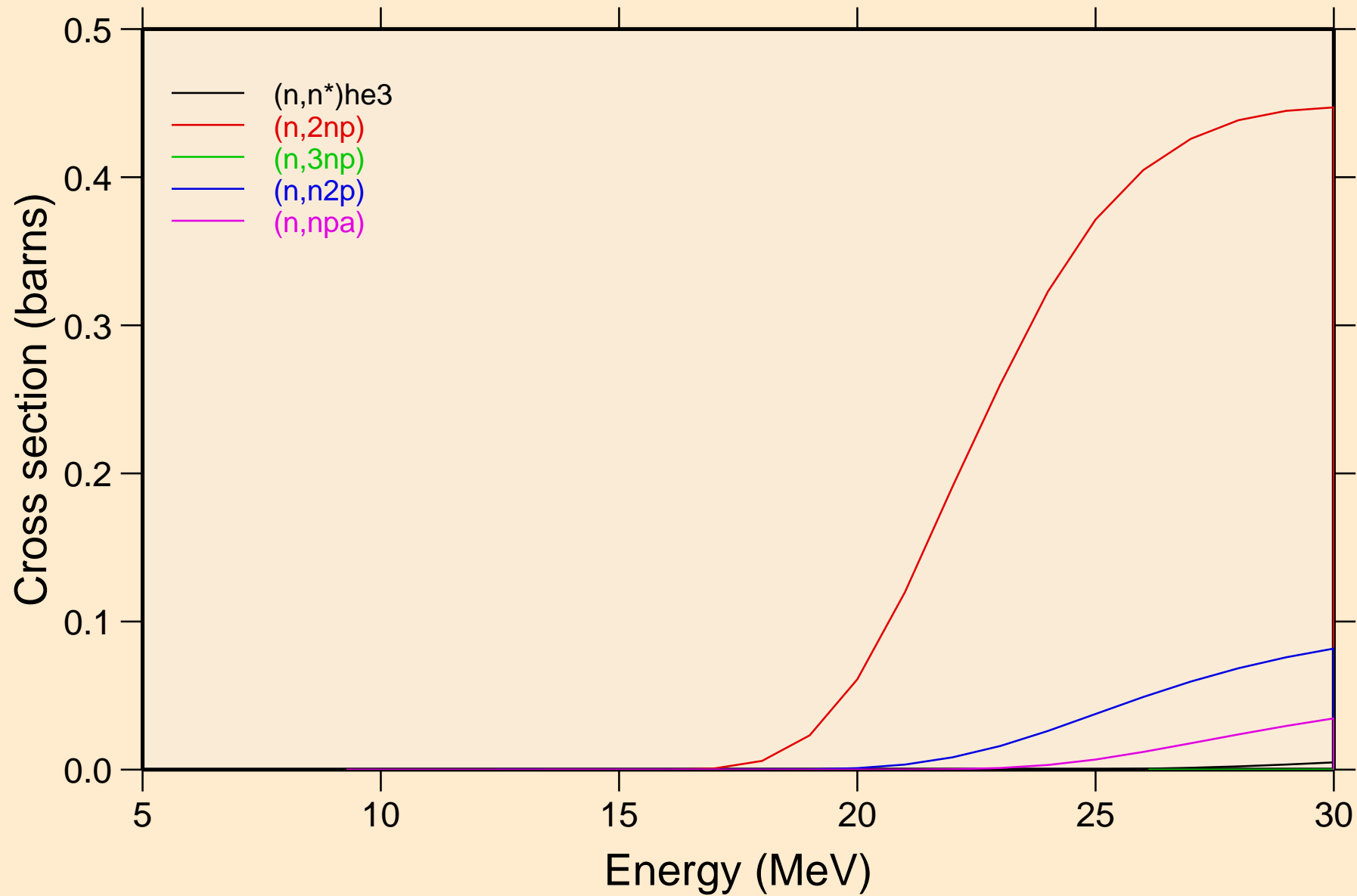

Y084 NEUTRON ACER TENDL-2024 LIBRARY; T=0.K
Threshold reactions

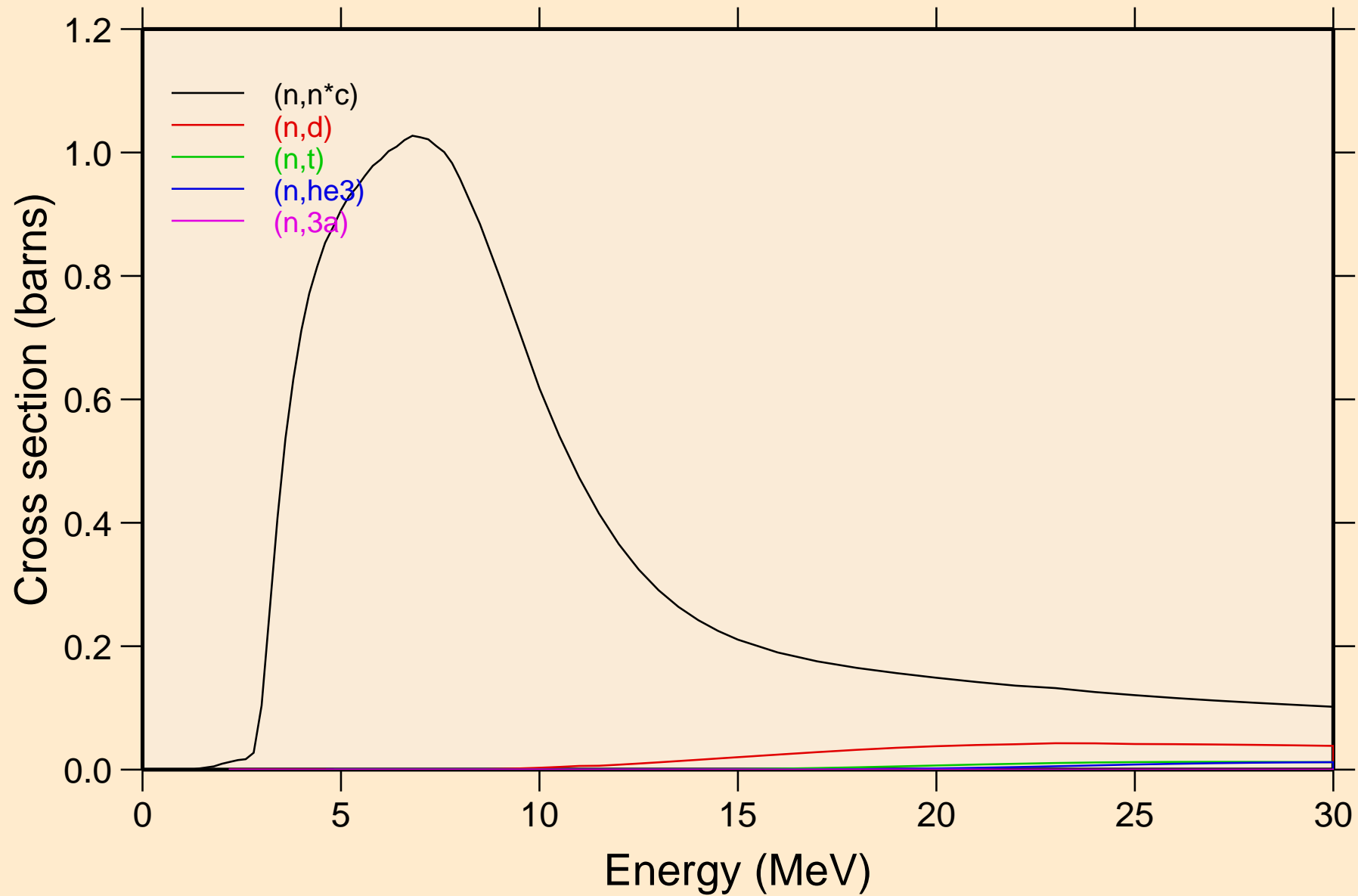

Y084 NEUTRON ACER TENDL-2024 LIBRARY; T=0.K
Threshold reactions

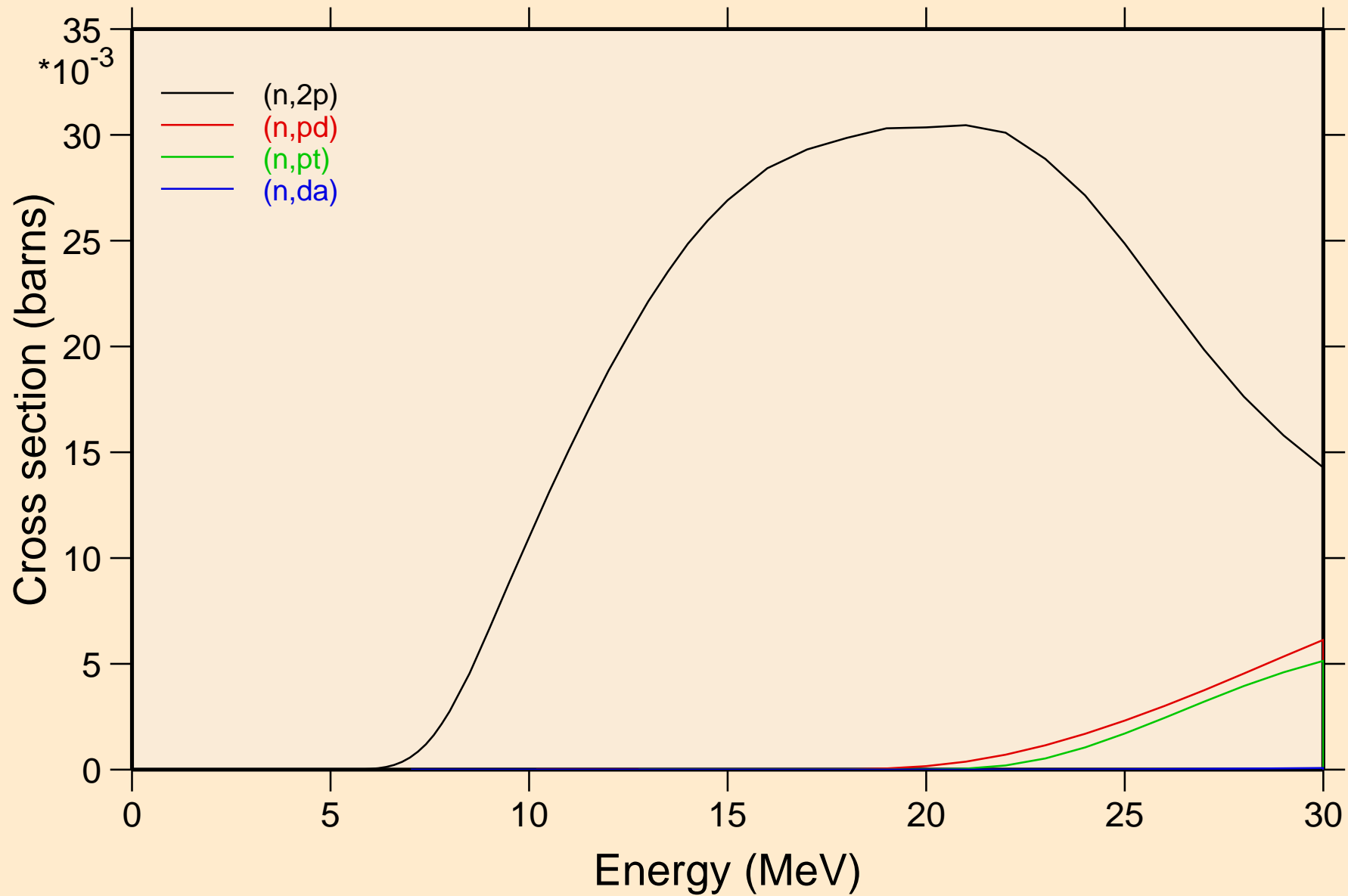

Y084 NEUTRON ACER TENDL-2024 LIBRARY; T=0.K
Threshold reactions

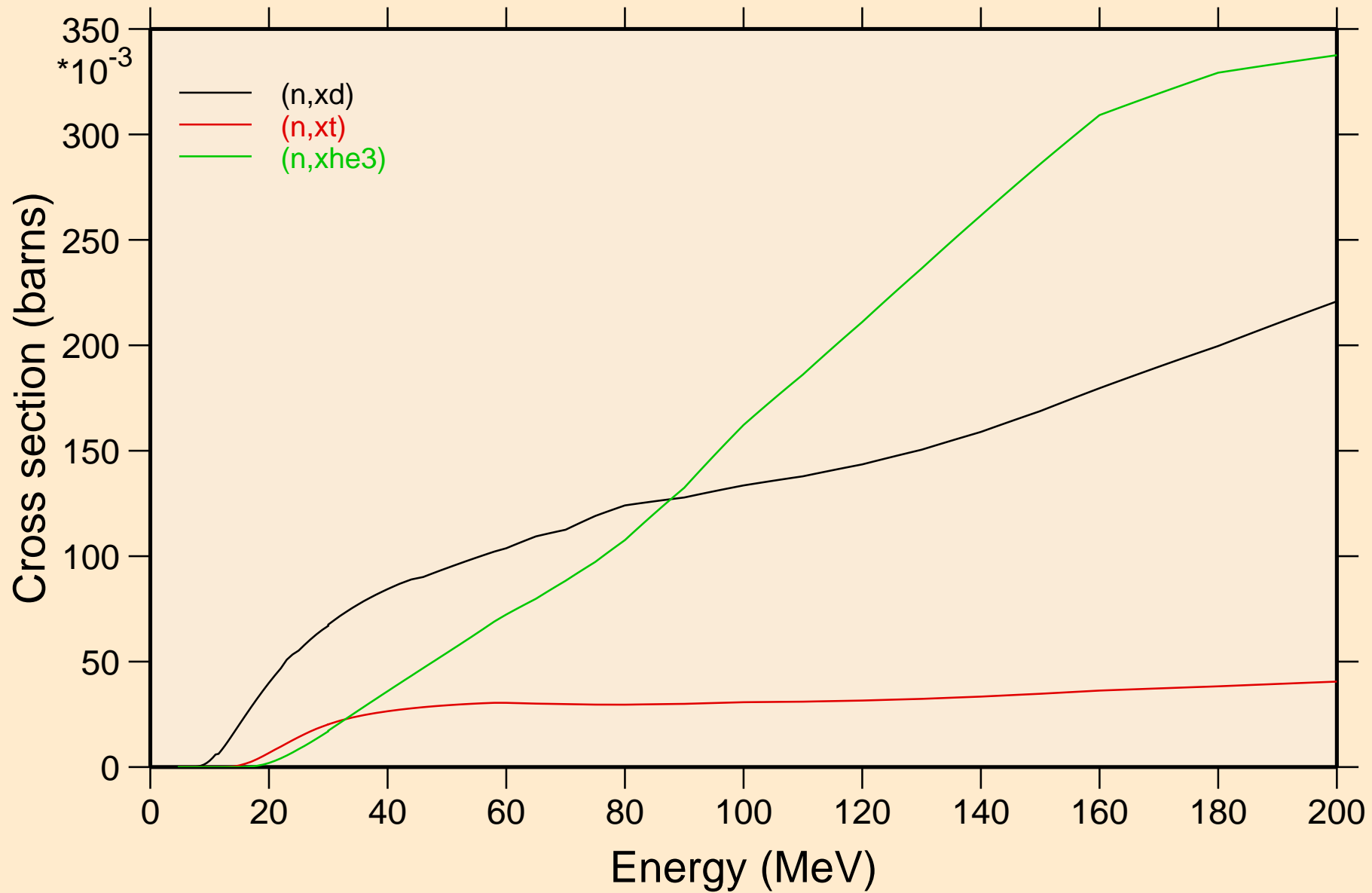

Y084 NEUTRON ACER TENDL-2024 LIBRARY; T=0.K
angular distribution for elastic

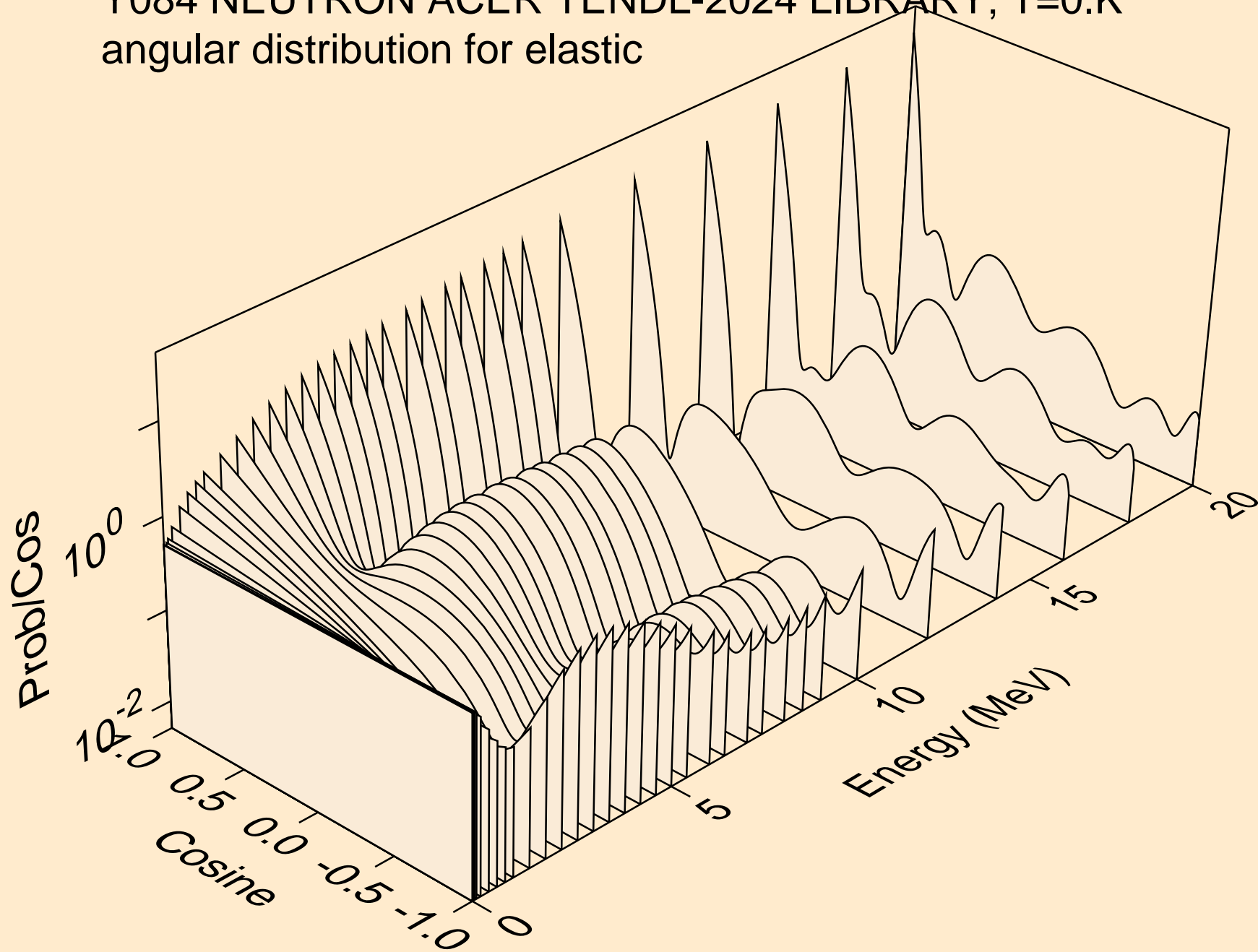

Y084 NEUTRON ACER TENDL-2024 LIBRARY; T=0.K
angular distribution for elastic

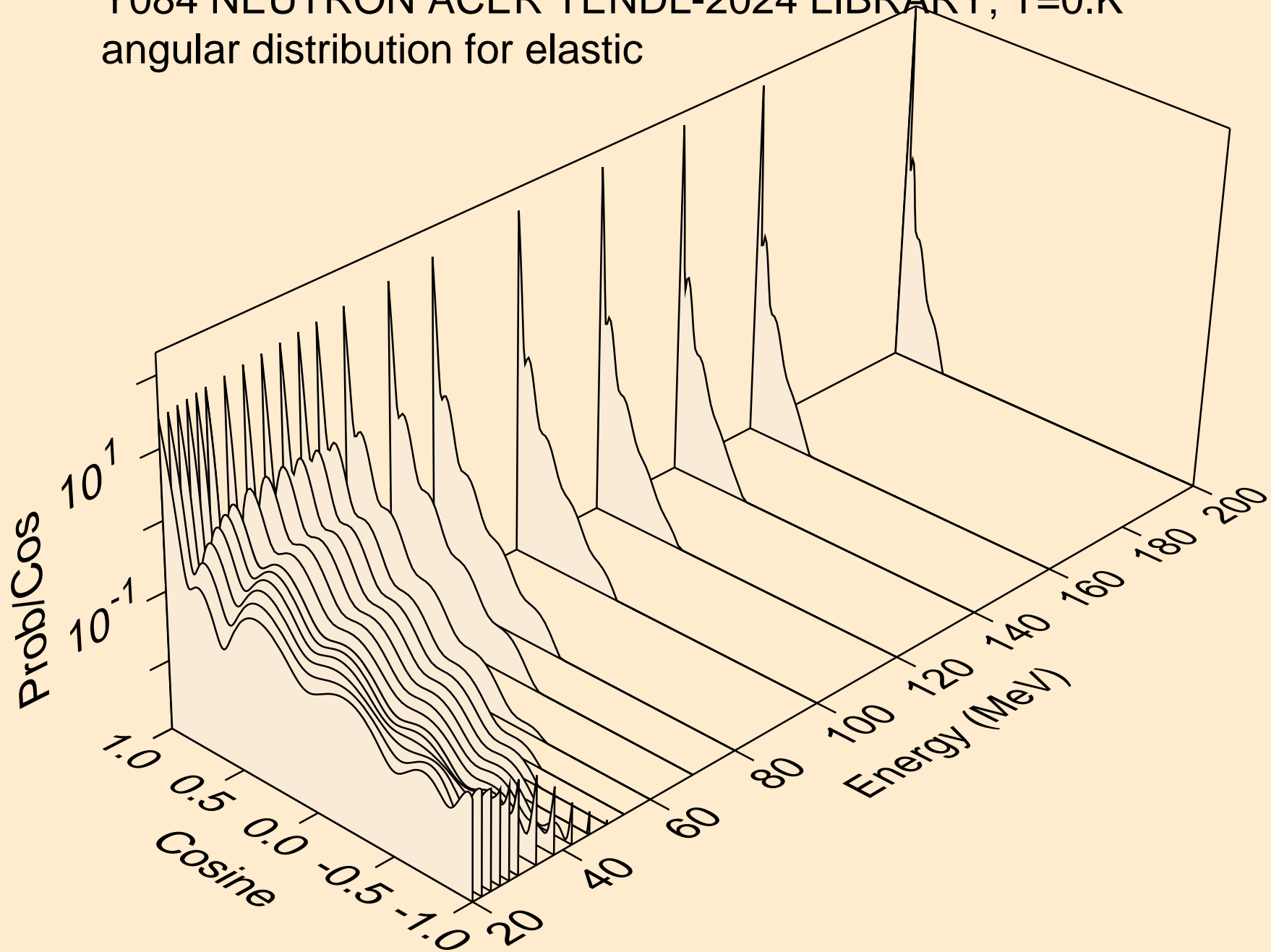

Y084 NEUTRON ACER TENDL-2024 LIBRARY; T=0.K
angular distribution for (n,n*1)

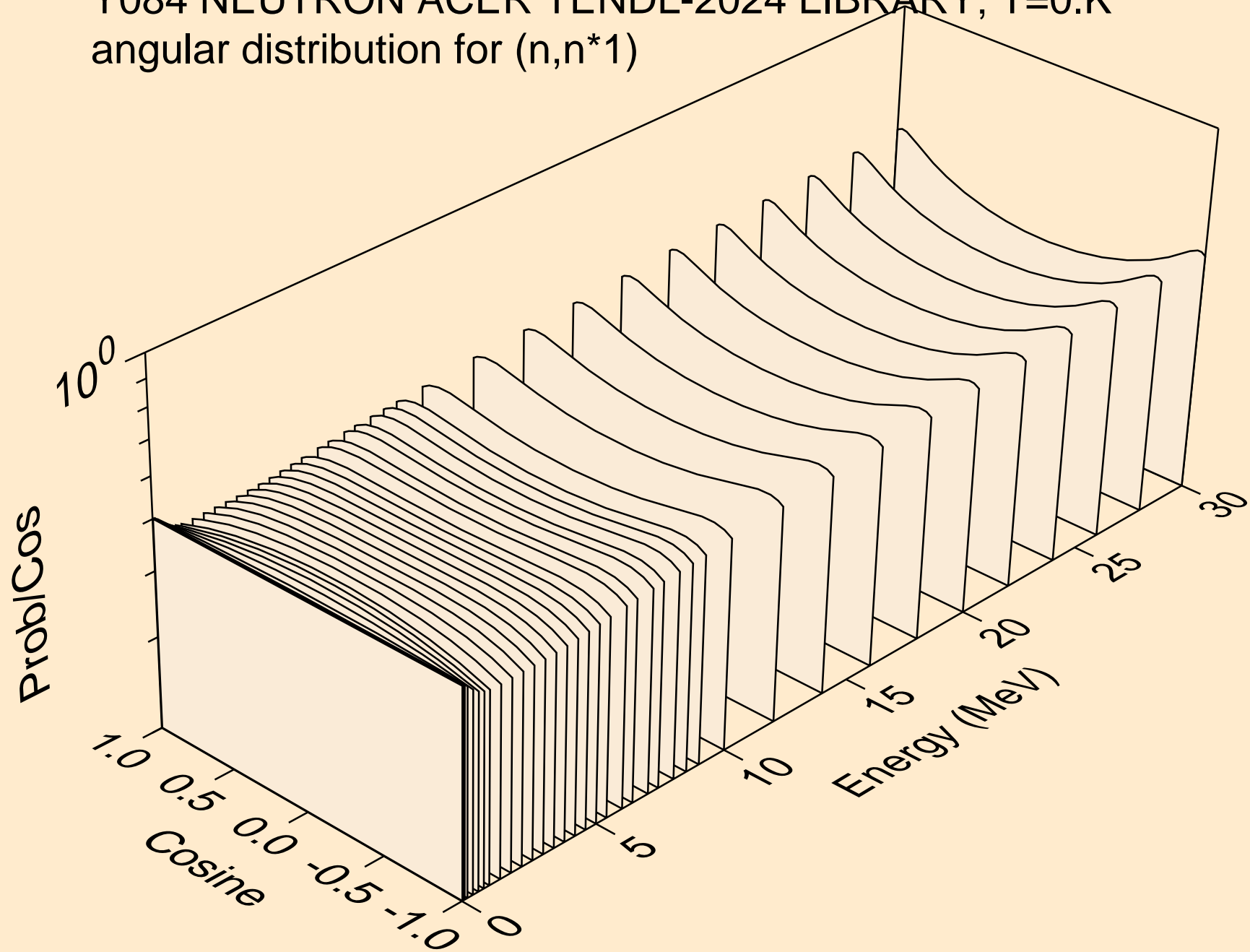

Y084 NEUTRON ACER TENDL-2024 LIBRARY; T=0.K
angular distribution for (n,n*2)

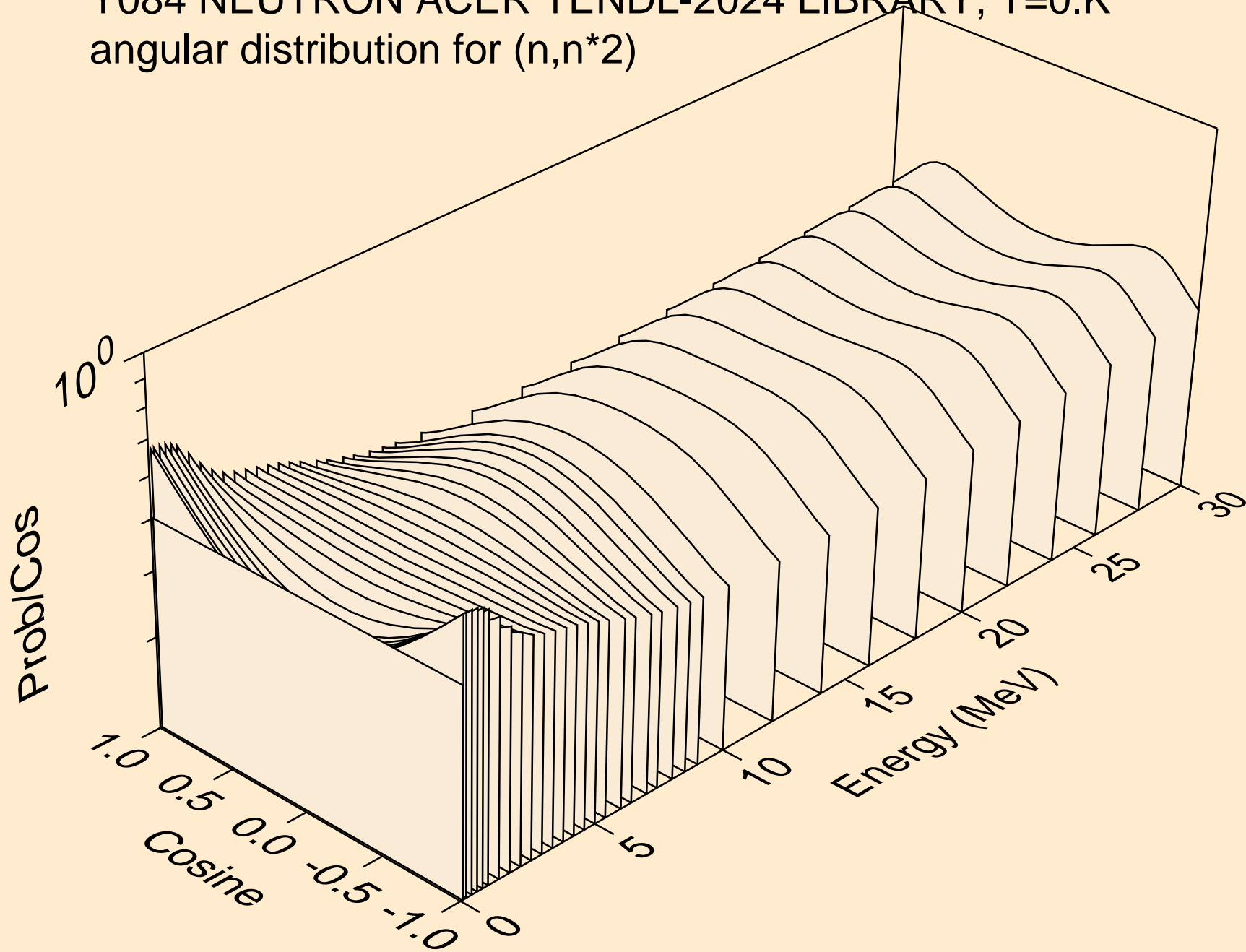

Y084 NEUTRON ACER TENDL-2024 LIBRARY; T=0.K
angular distribution for (n,n*3)

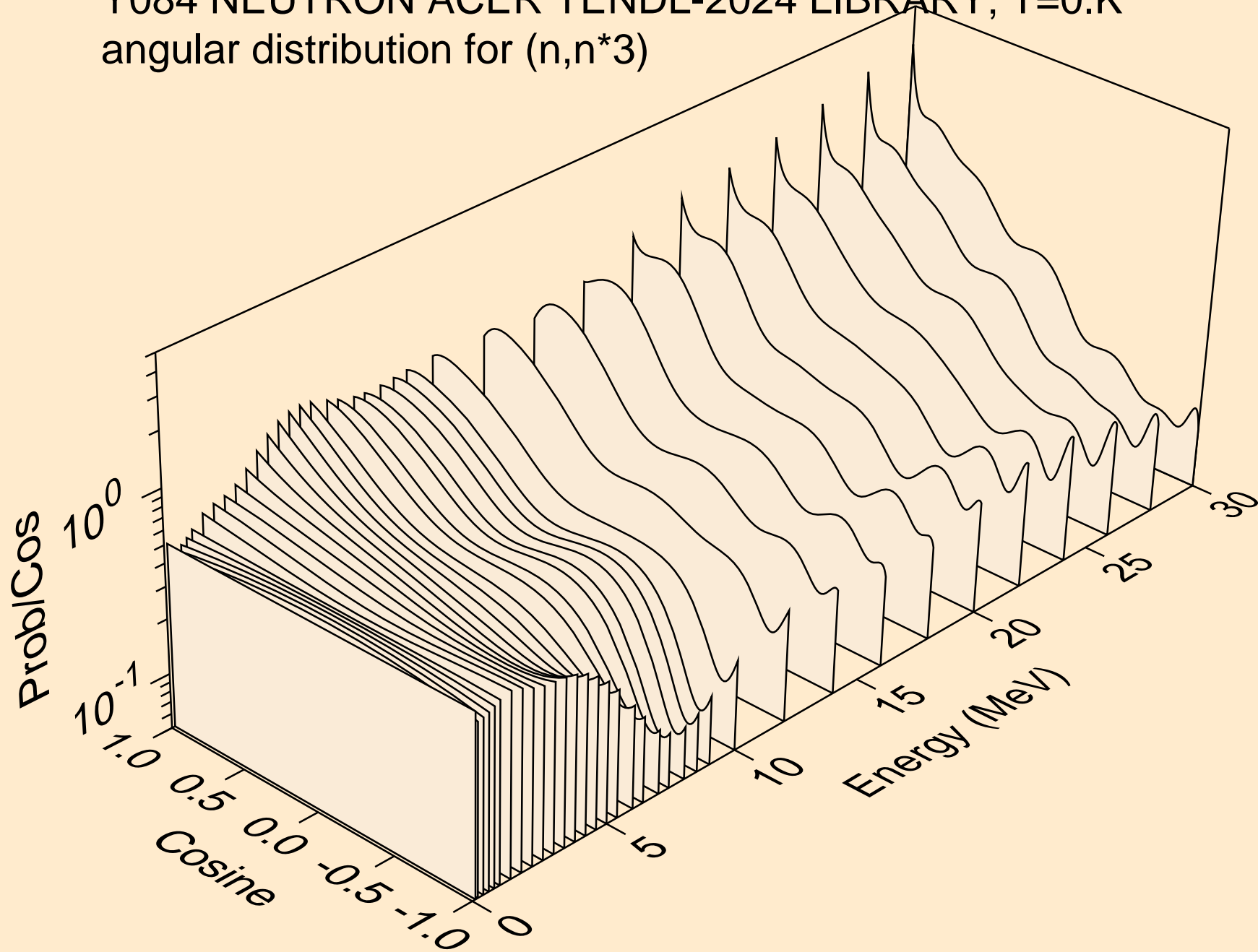

Y084 NEUTRON ACER TENDL-2024 LIBRARY; T=0.K
angular distribution for (n,n*4)

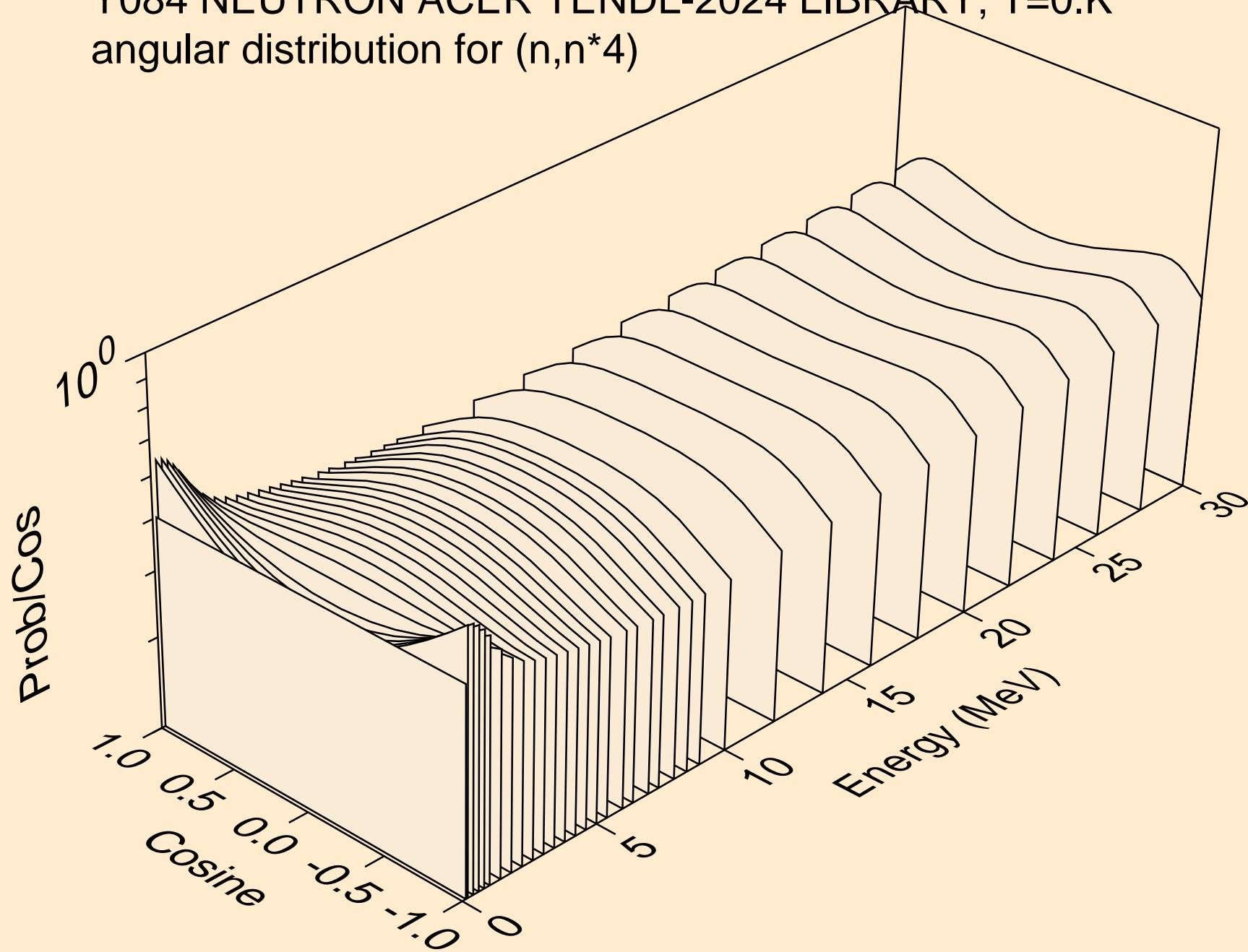

Y084 NEUTRON ACER TENDL-2024 LIBRARY; T=0.K
angular distribution for (n,n*5)

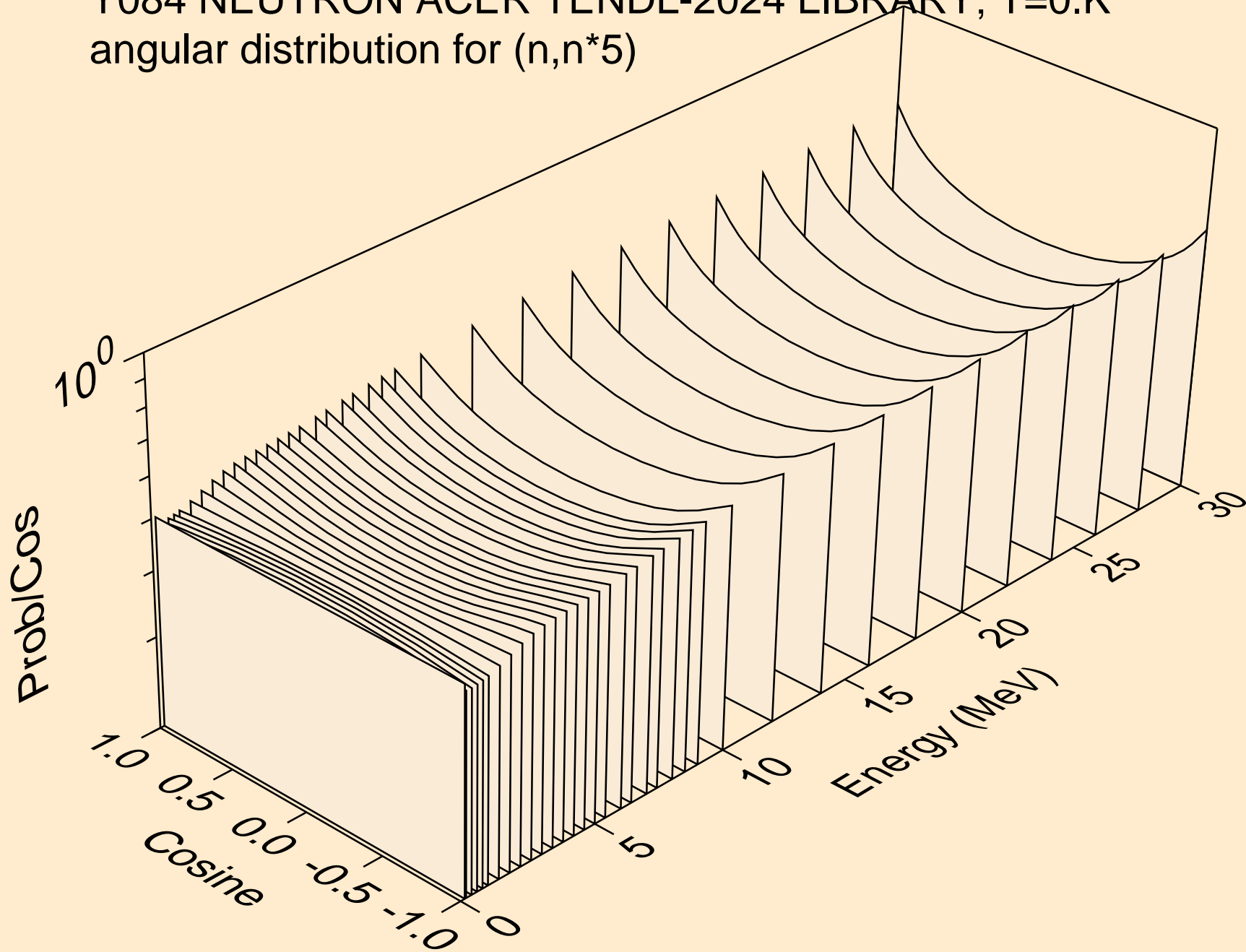

Y084 NEUTRON ACER TENDL-2024 LIBRARY; T=0.K
angular distribution for (n,n*6)

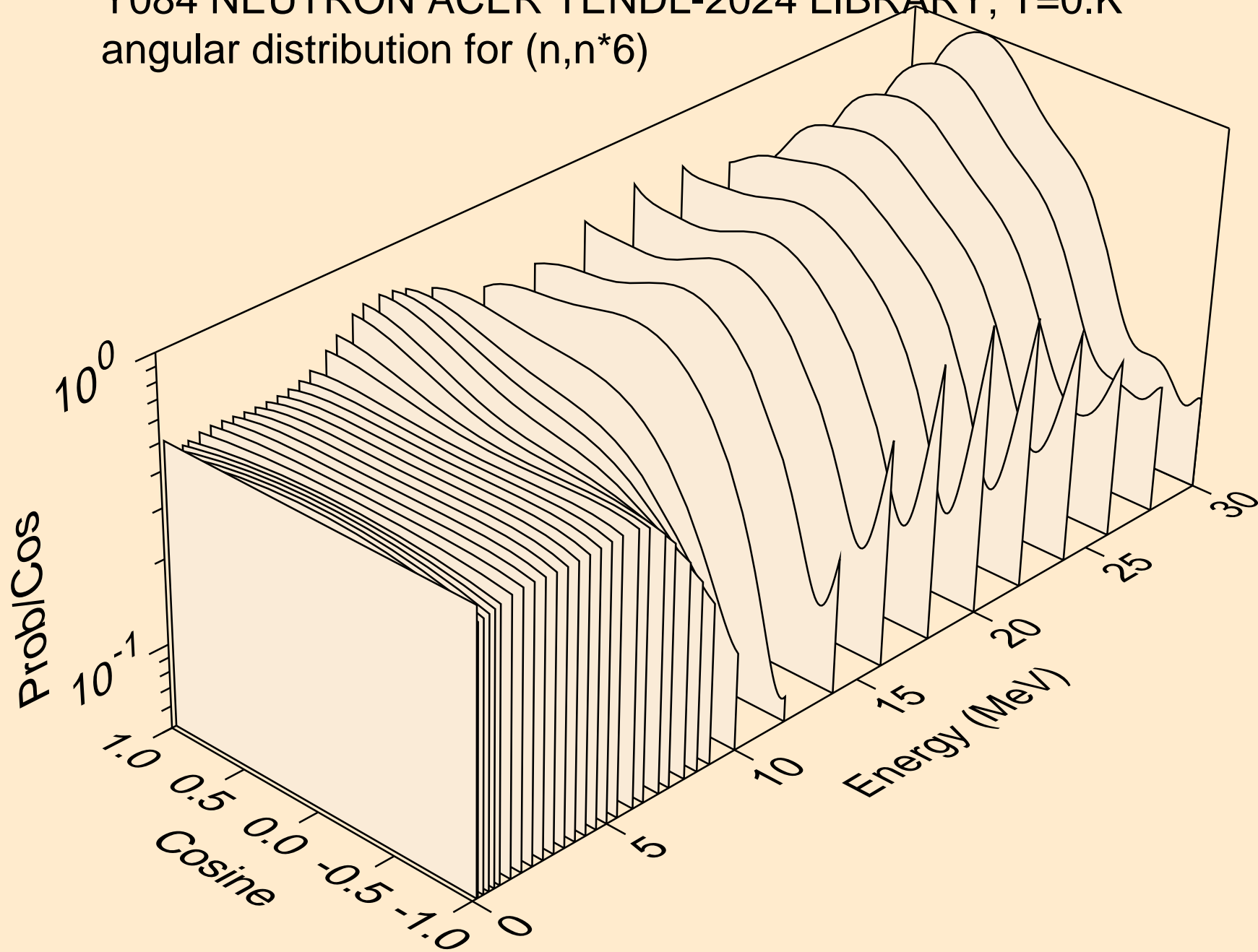

Y084 NEUTRON ACER TENDL-2024 LIBRARY; T=0.K
angular distribution for (n,n*7)

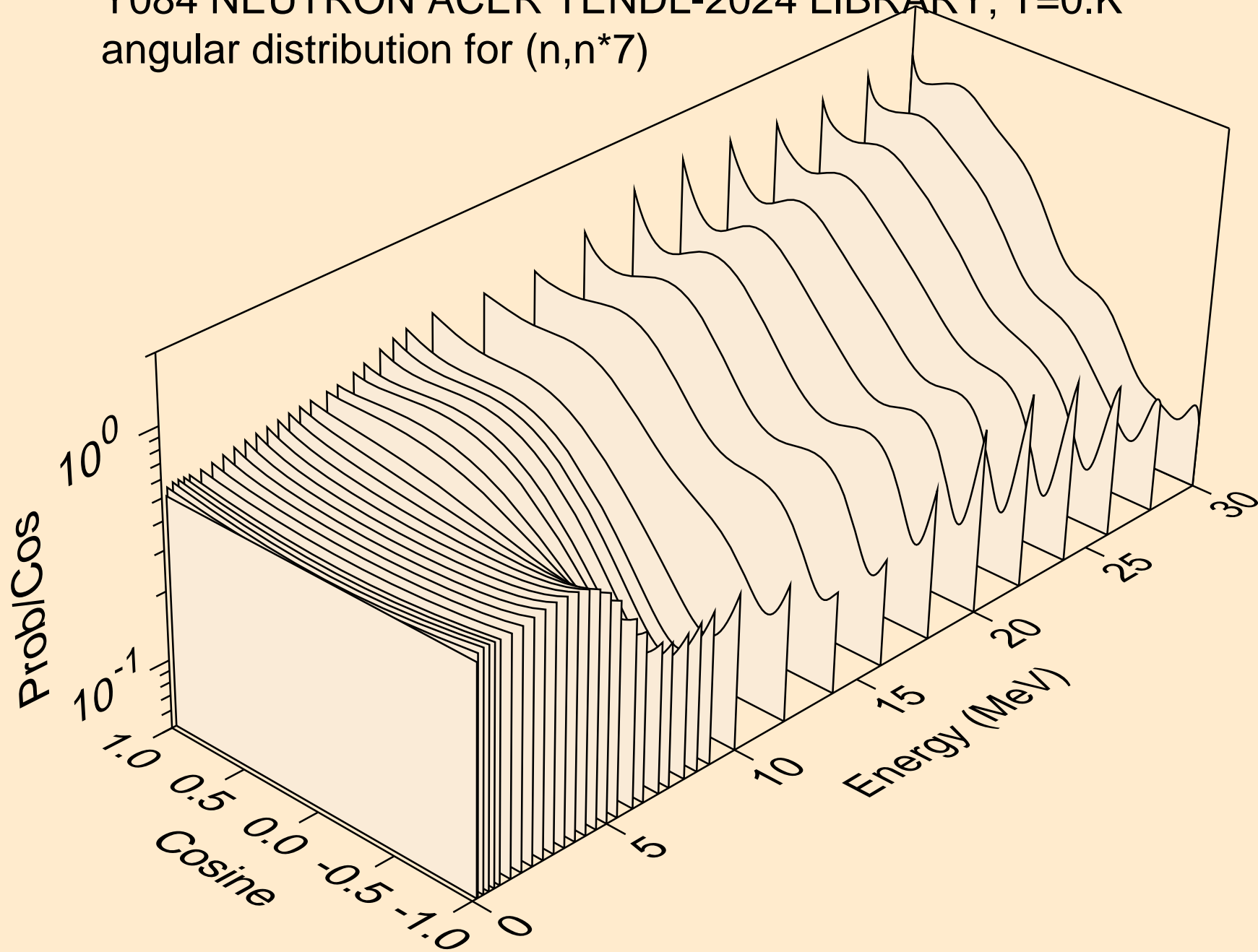

Y084 NEUTRON ACER TENDL-2024 LIBRARY; T=0.K
angular distribution for (n,n*8)

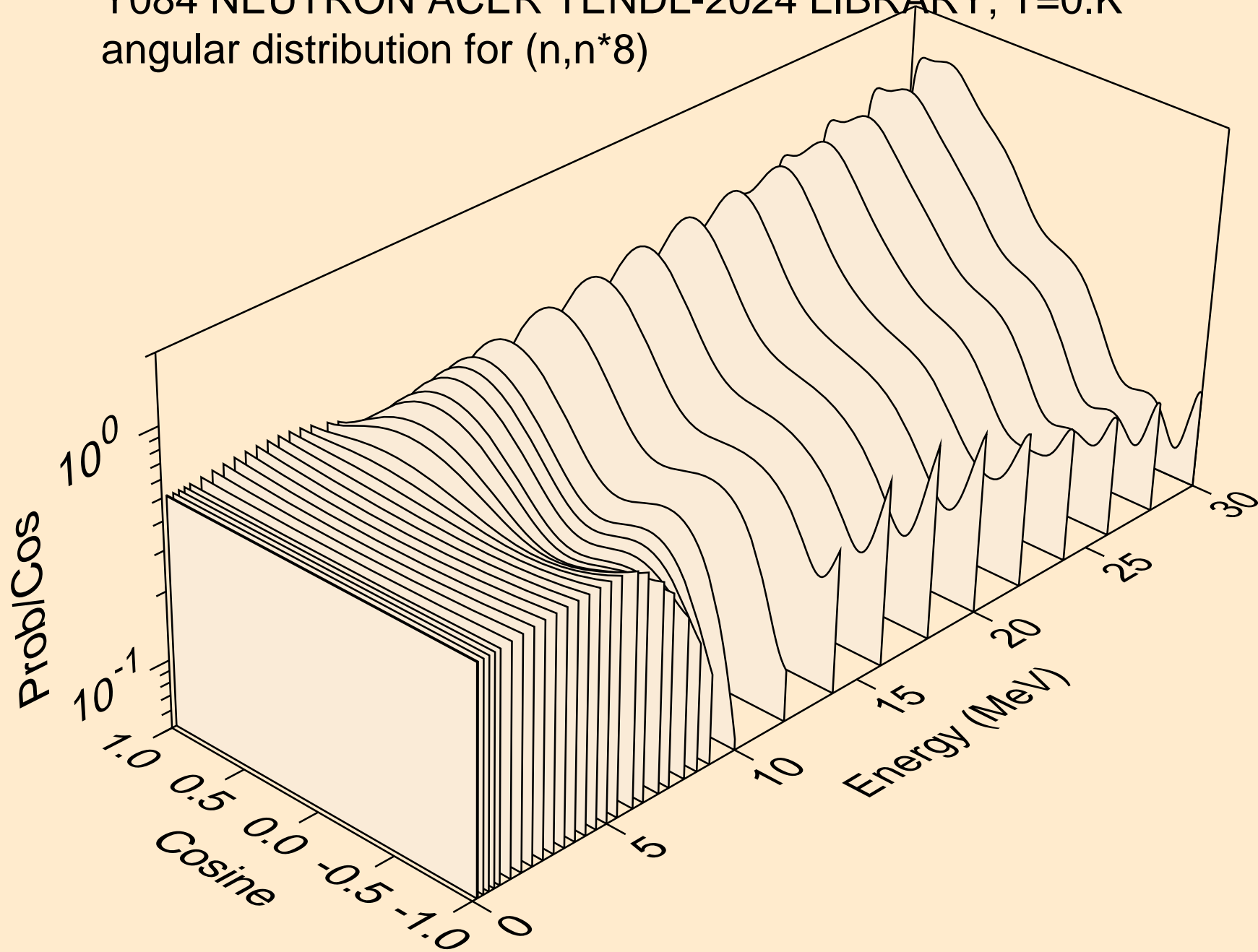

Y084 NEUTRON ACER TENDL-2024 LIBRARY; T=0.K
angular distribution for (n,n*9)

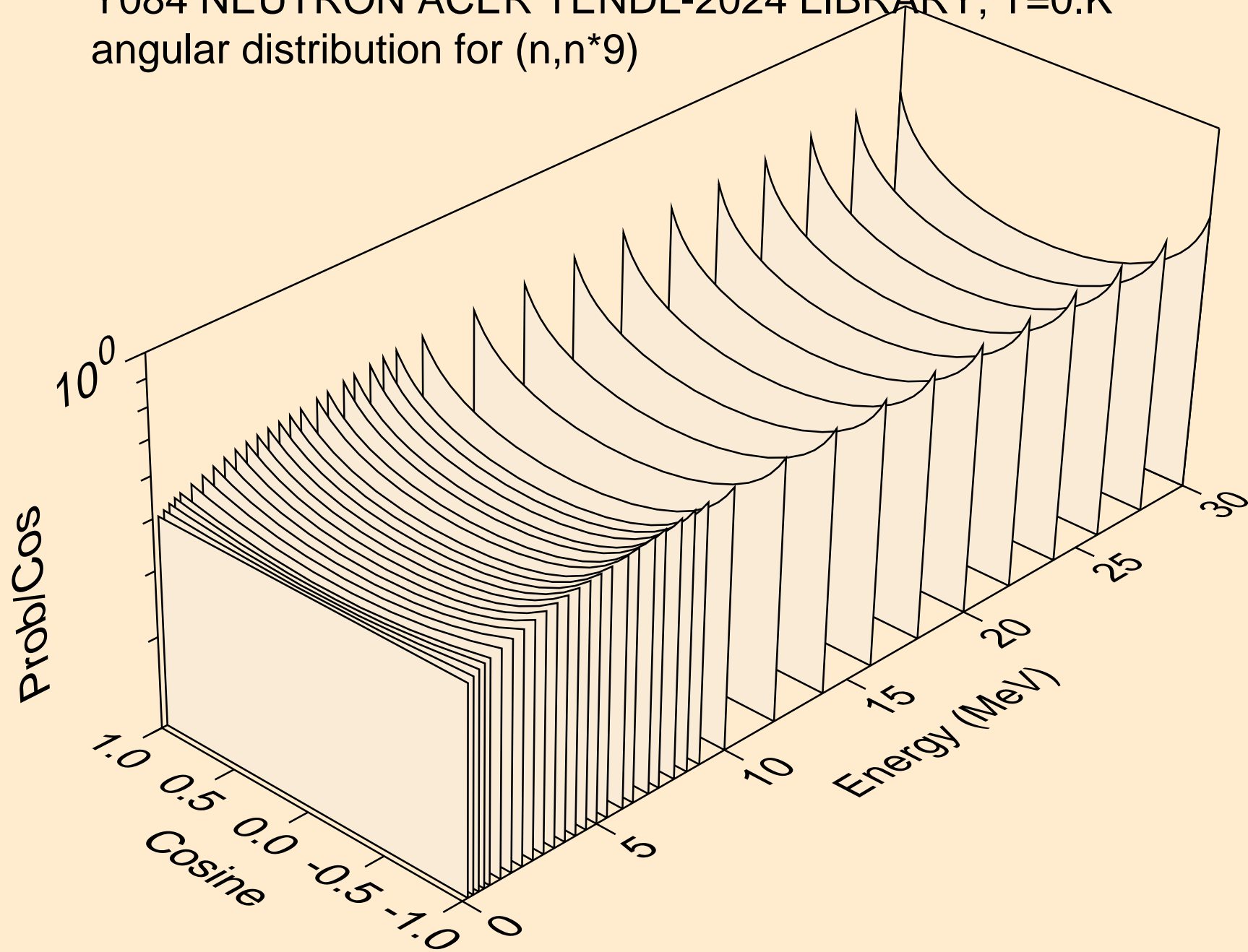

Y084 NEUTRON ACER TENDL-2024 LIBRARY; T=0.K
angular distribution for (n,n*10)

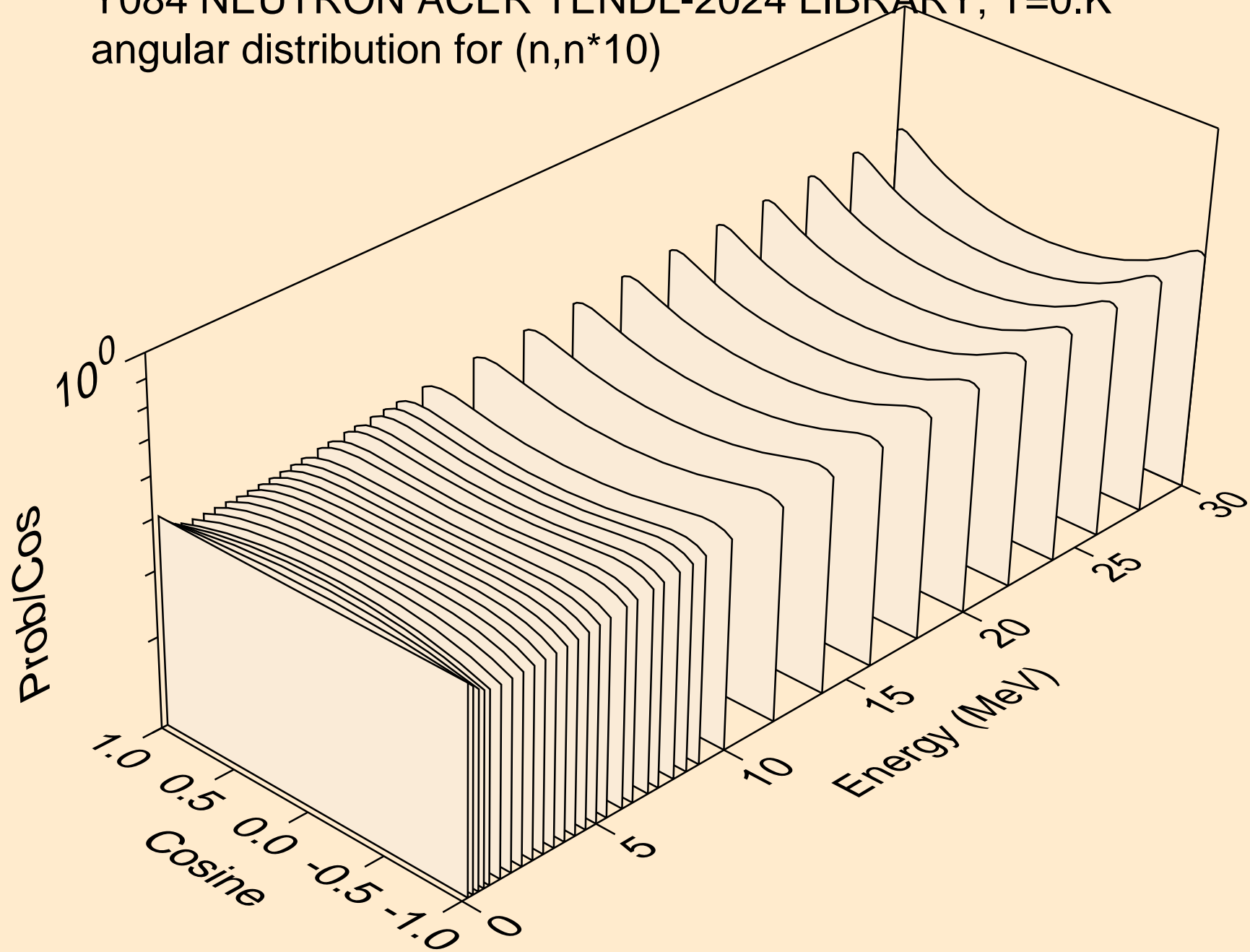

Y084 NEUTRON ACER TENDL-2024 LIBRARY; T=0.K
angular distribution for (n,n*11)

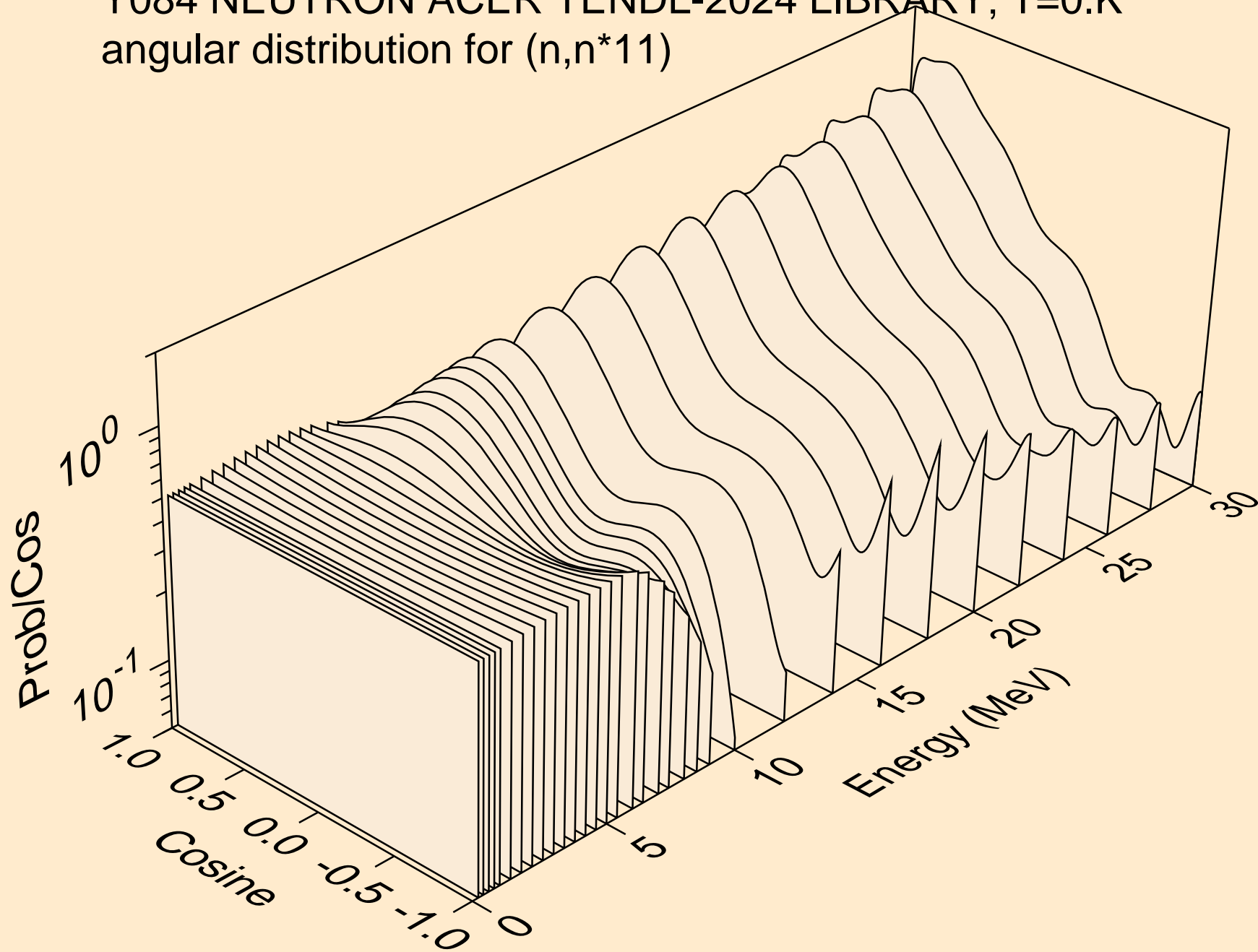

Y084 NEUTRON ACER TENDL-2024 LIBRARY; T=0.K
angular distribution for (n,n*12)

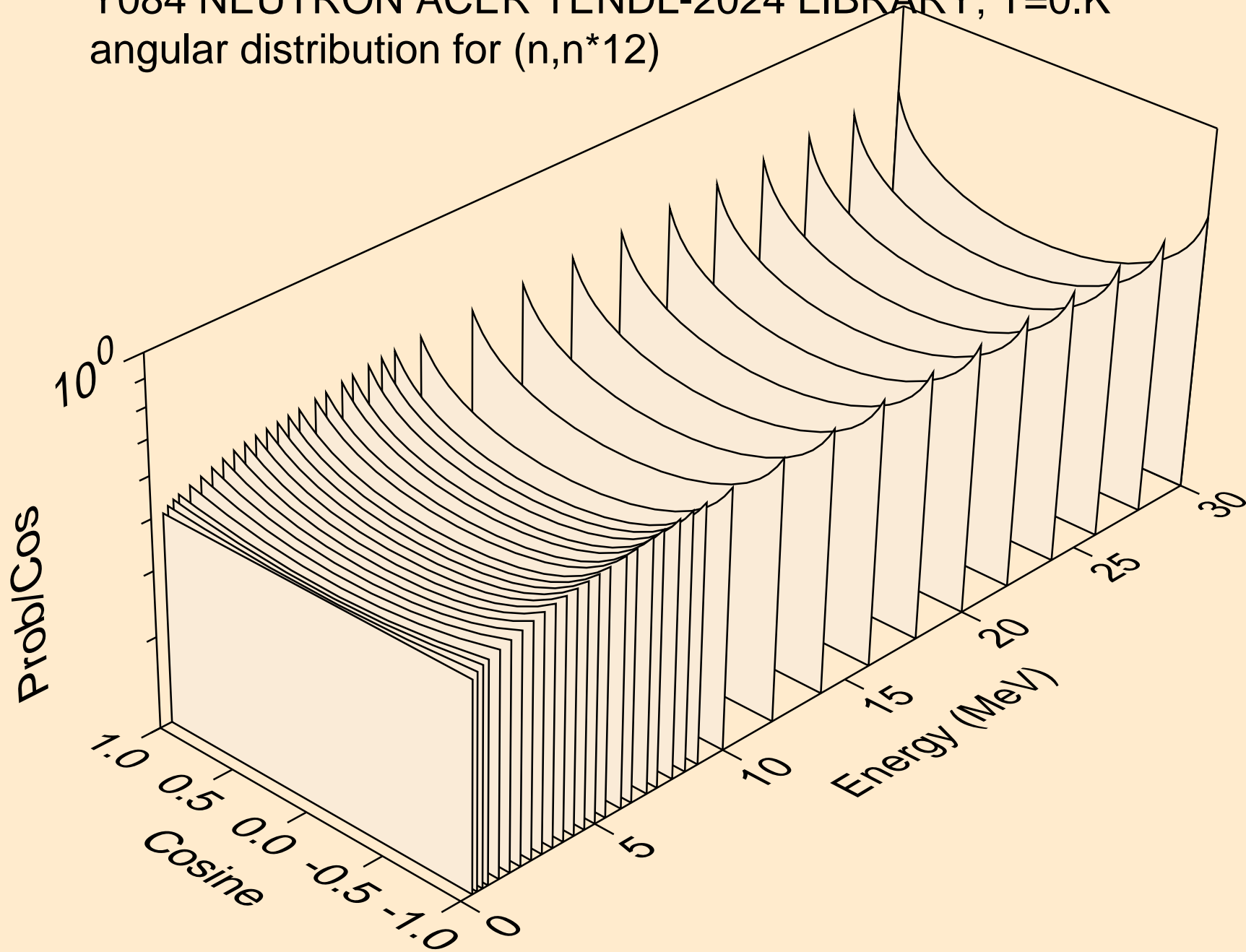

Y084 NEUTRON ACER TENDL-2024 LIBRARY; T=0.K
angular distribution for (n,n*13)

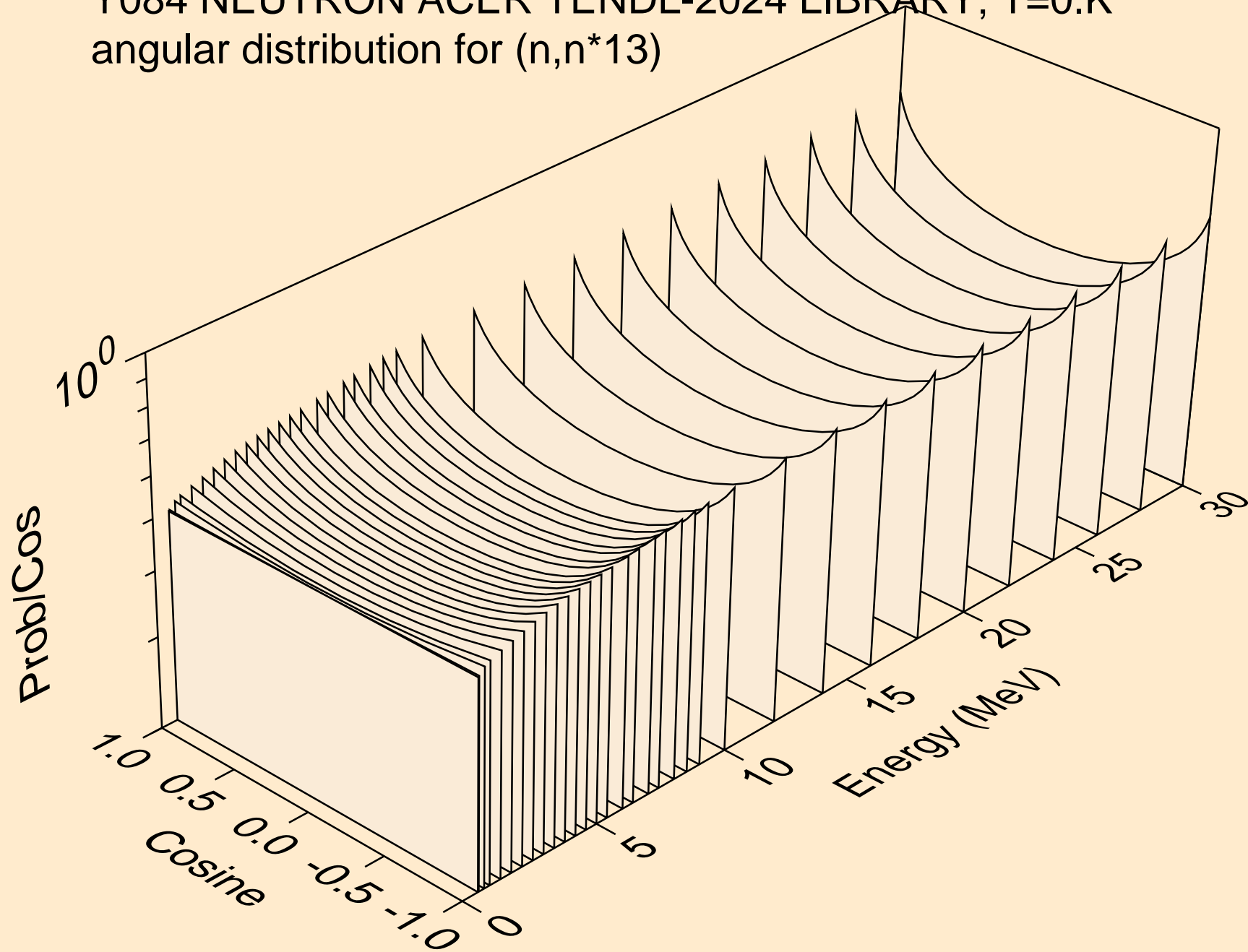

Y084 NEUTRON ACER TENDL-2024 LIBRARY; T=0.K
angular distribution for (n,n*14)

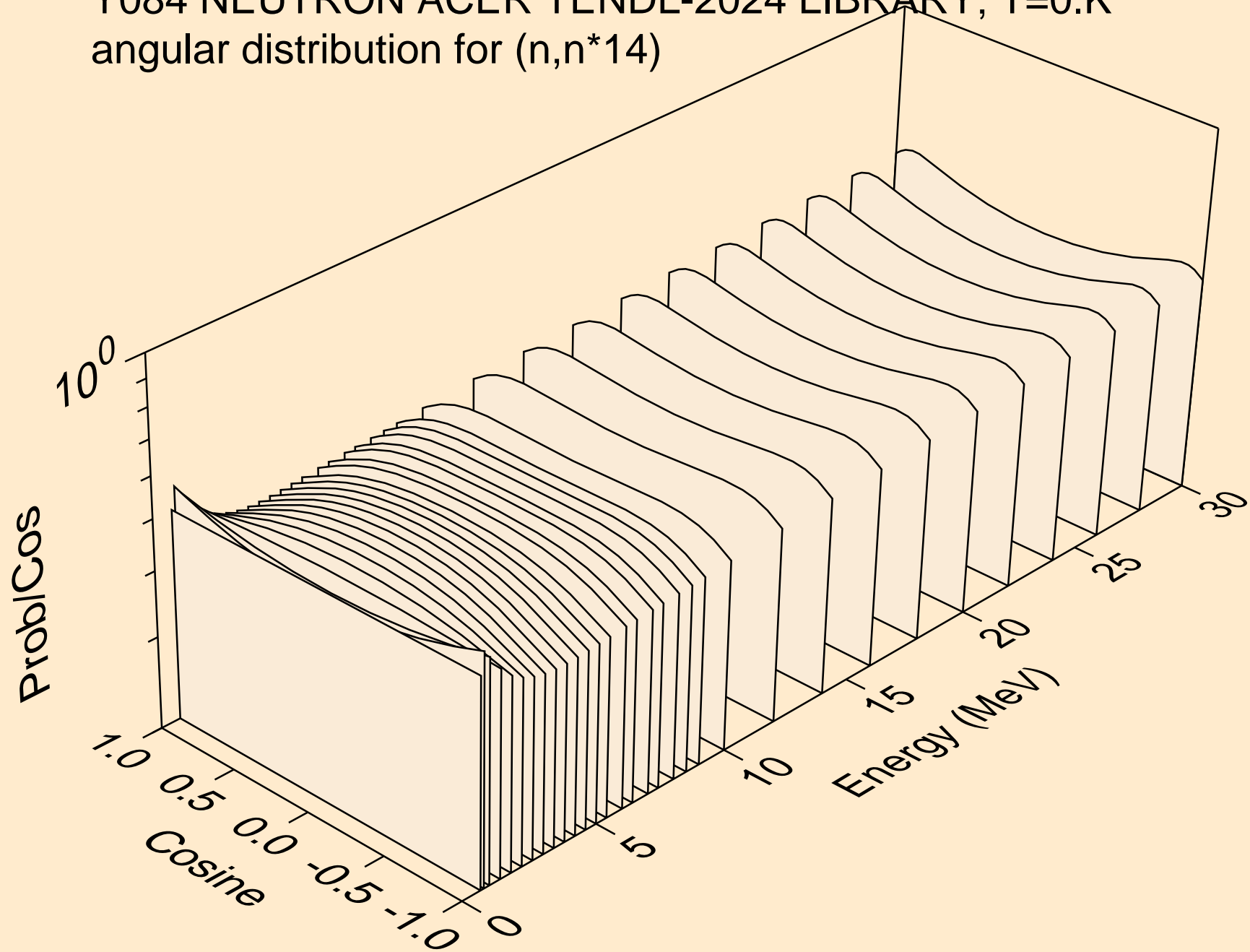

Y084 NEUTRON ACER TENDL-2024 LIBRARY; T=0.K
angular distribution for (n,n*15)

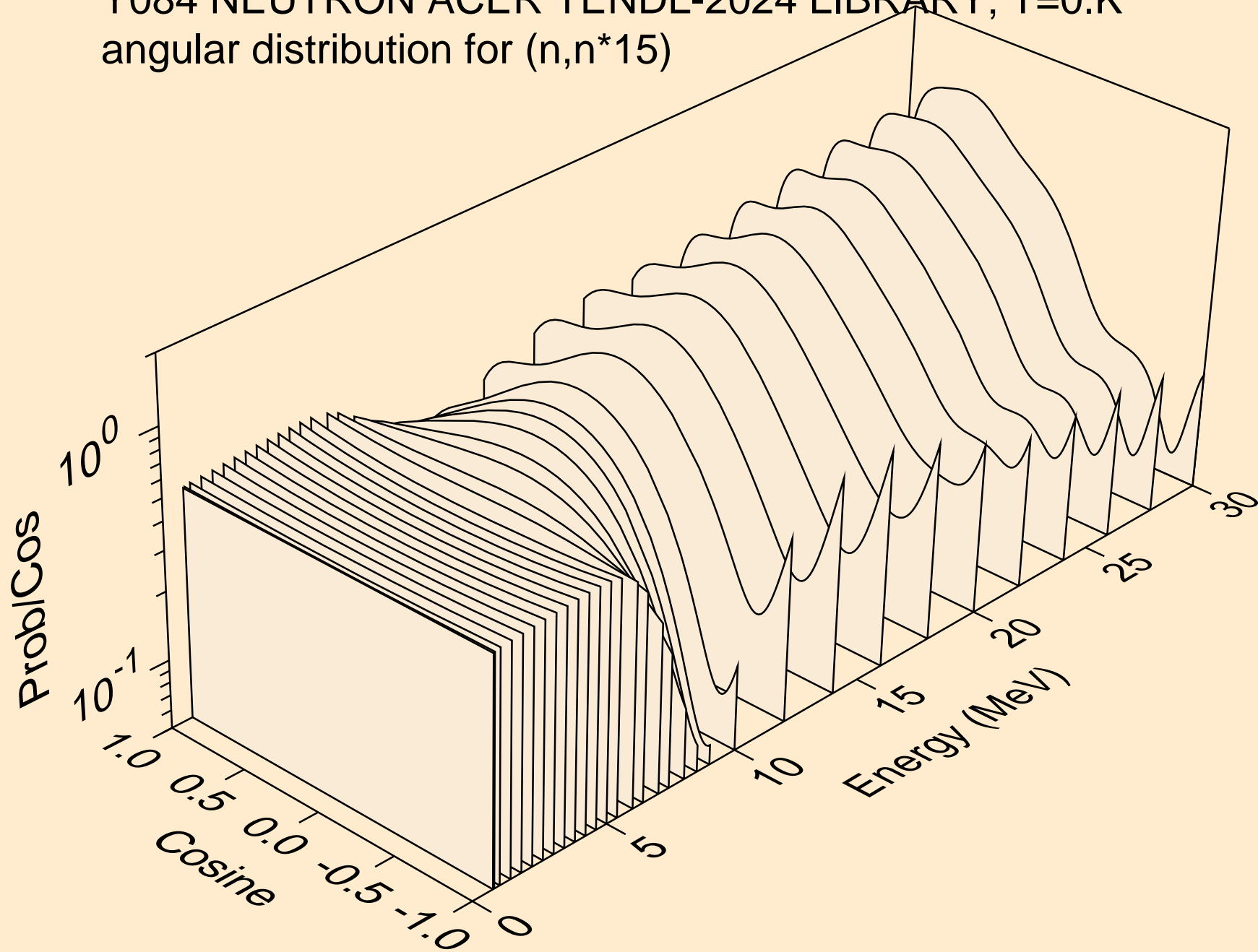

Y084 NEUTRON ACER TENDL-2024 LIBRARY; T=0.K
angular distribution for (n,n*16)

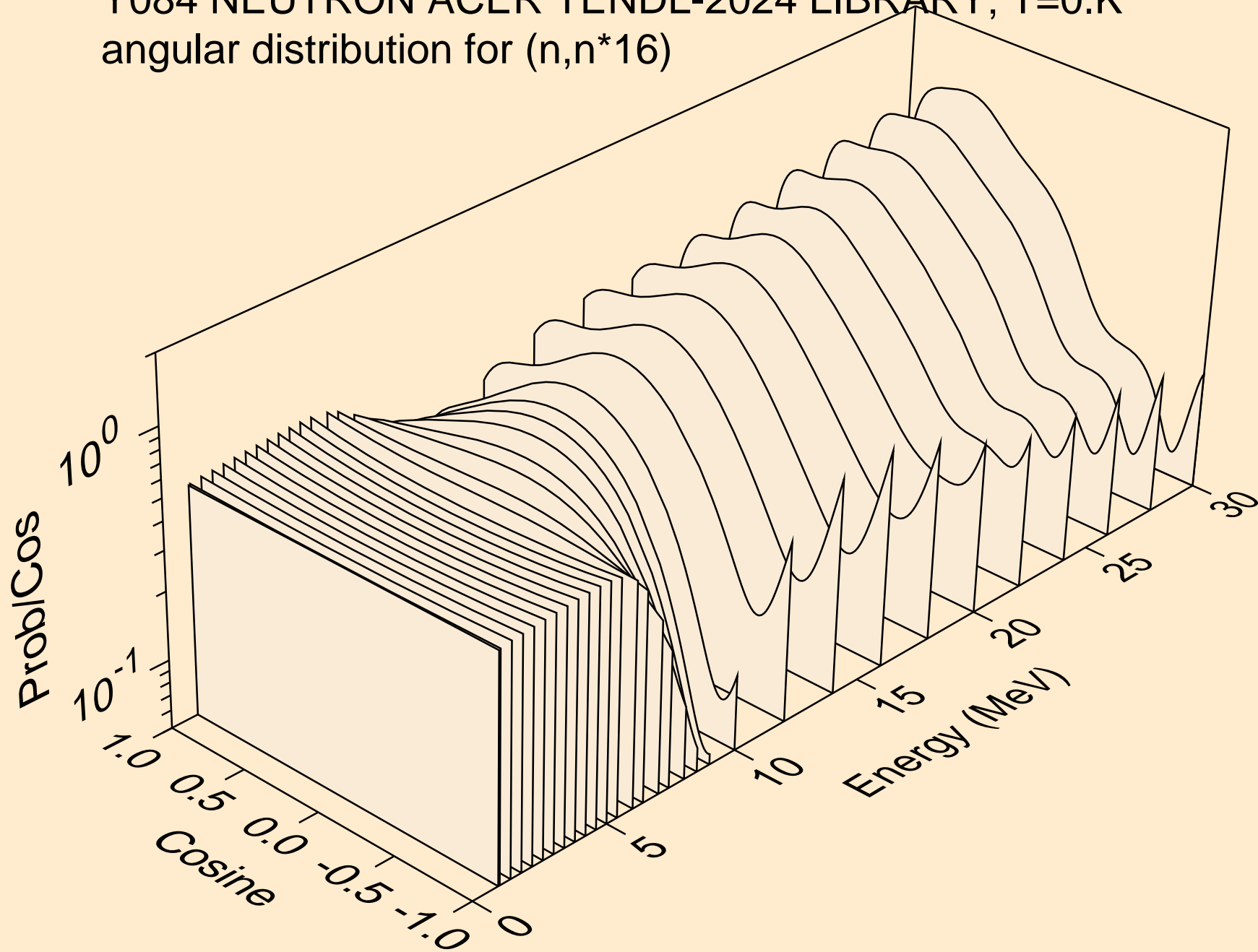

Y084 NEUTRON ACER TENDL-2024 LIBRARY; T=0.K
angular distribution for (n,n*17)

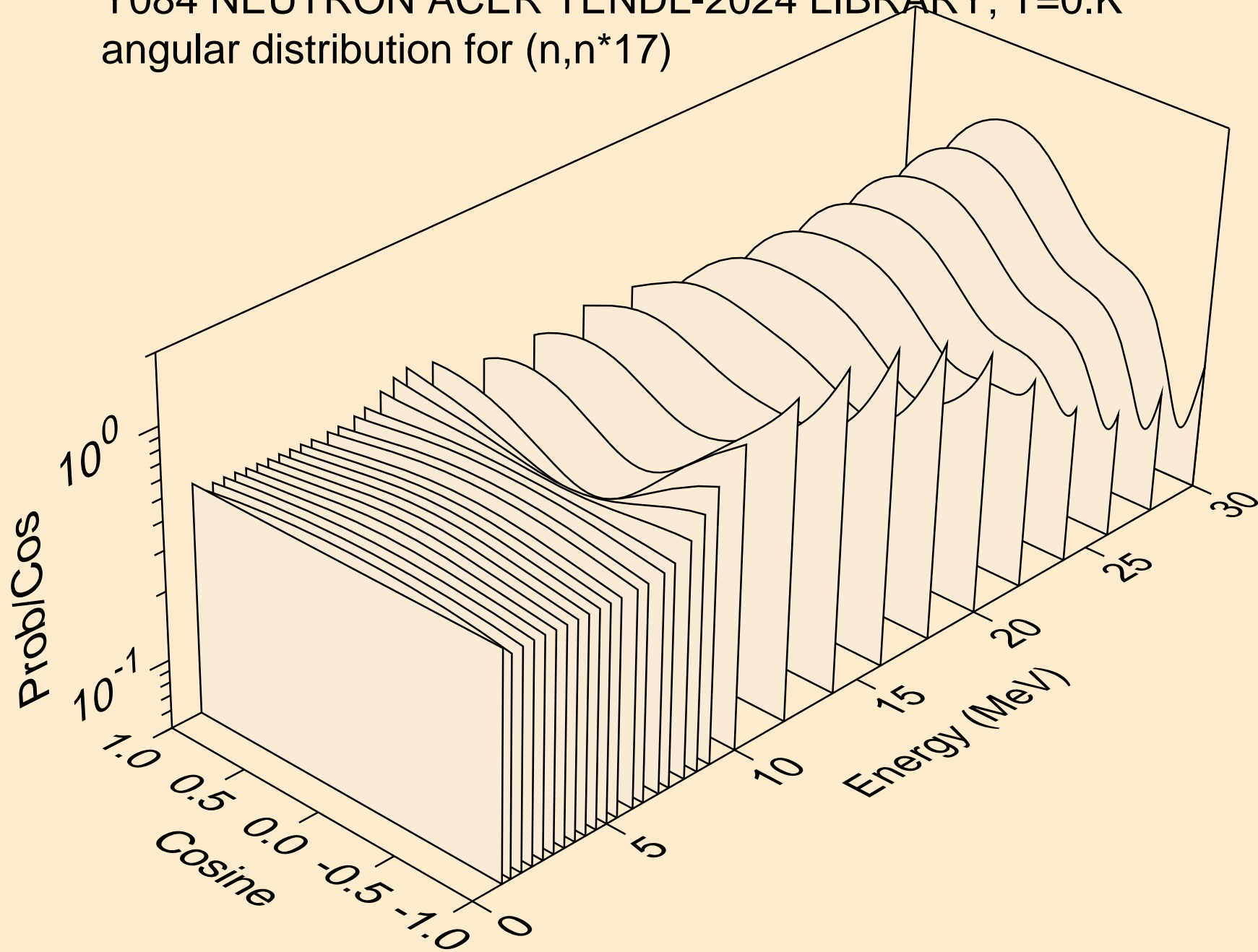

Y084 NEUTRON ACER TENDL-2024 LIBRARY; T=0.K
angular distribution for (n,n*18)

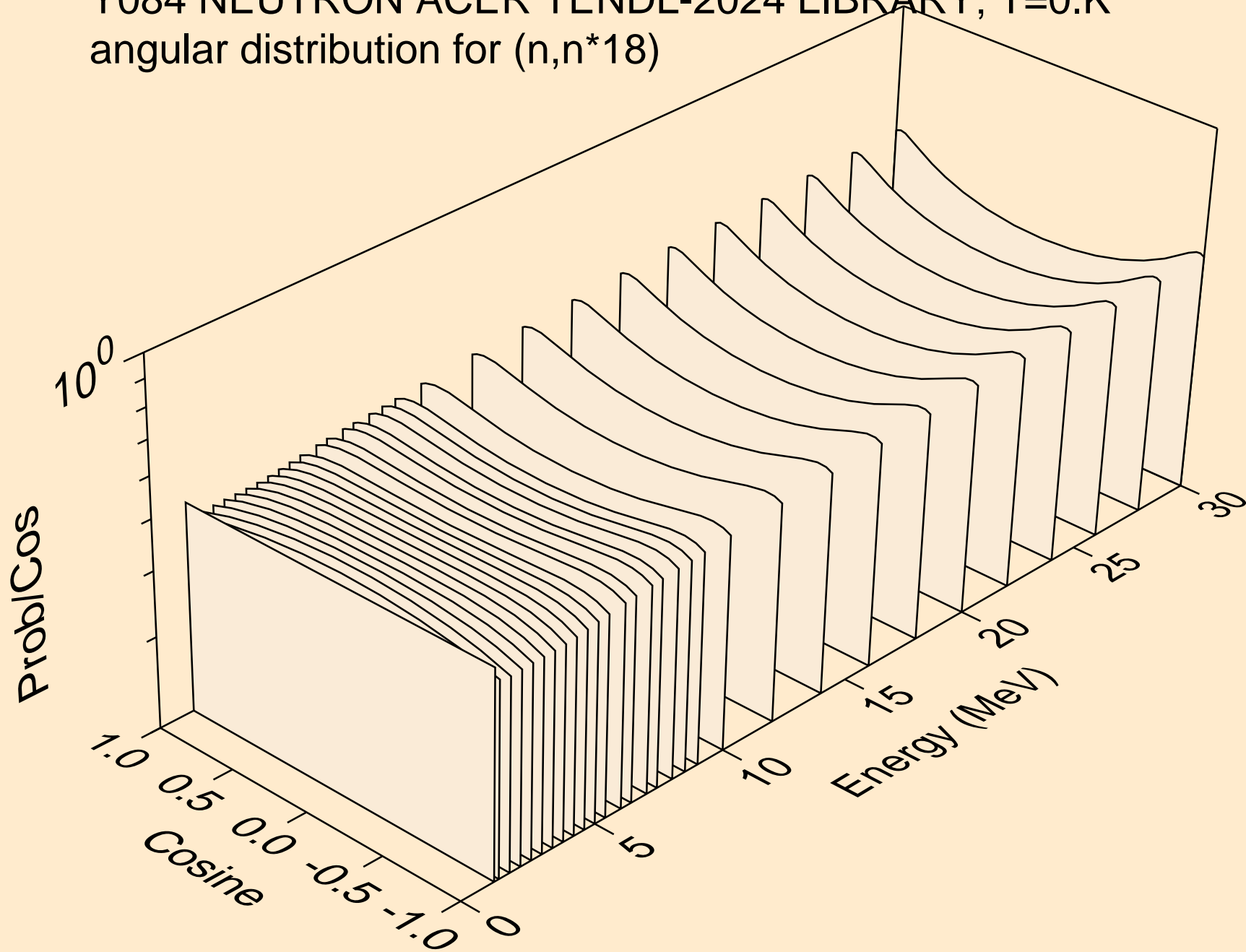

Y084 NEUTRON ACER TENDL-2024 LIBRARY; T=0.K
Neutron emission for (n,x)

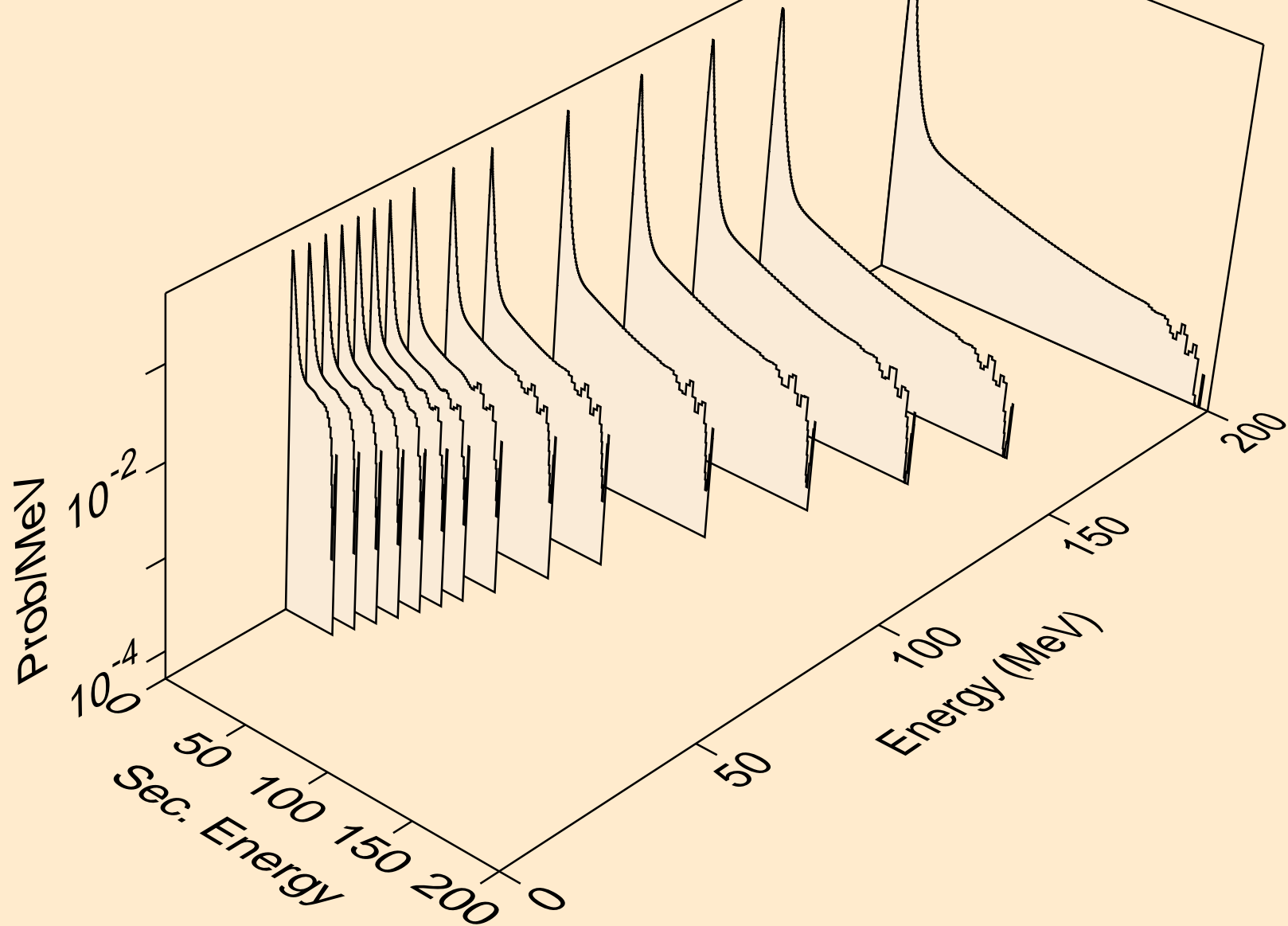

Y084 NEUTRON ACER TENDL-2024 LIBRARY; T=0.K
Neutron emission for (n,2nd)

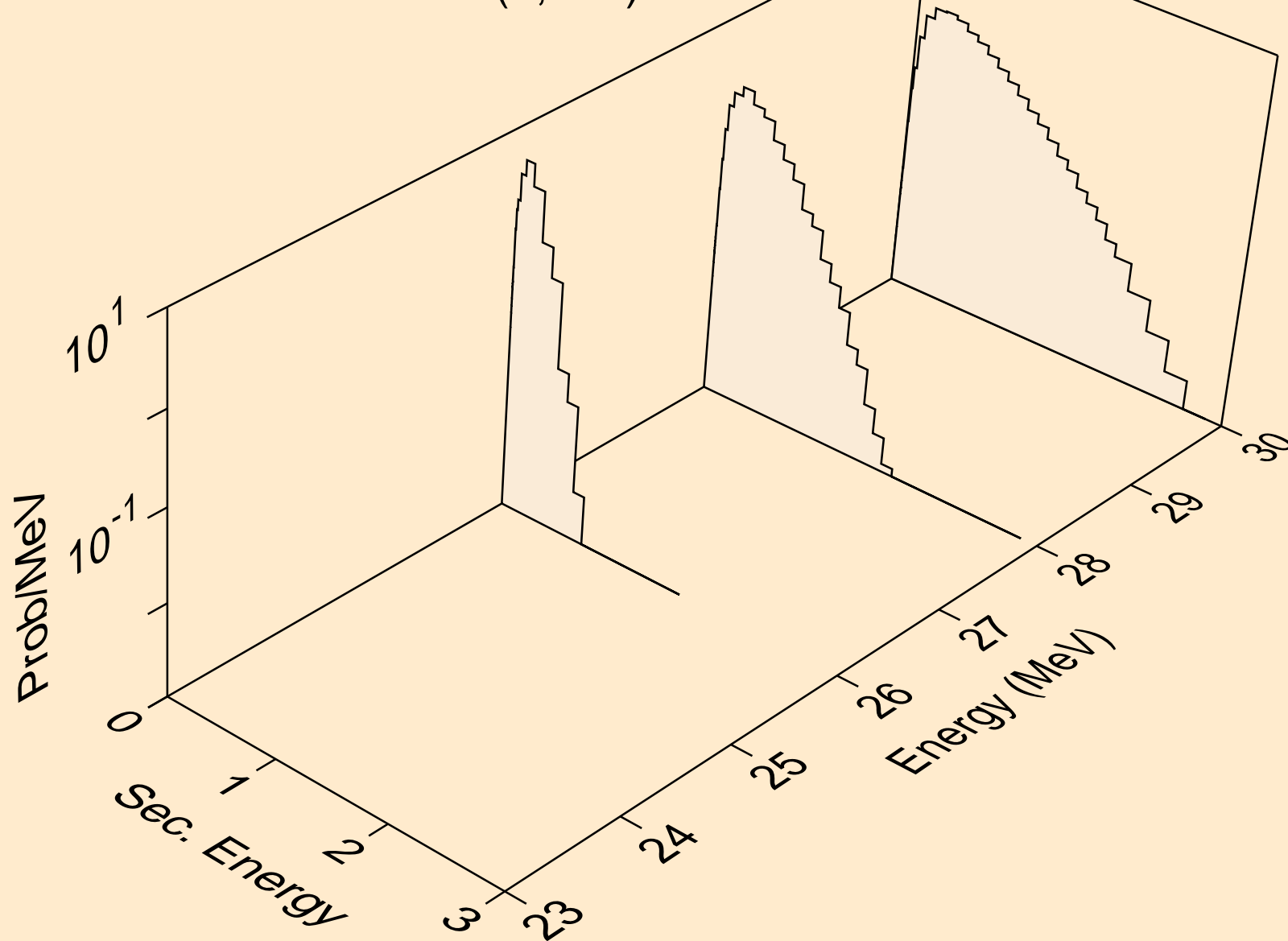

Y084 NEUTRON ACER TENDL-2024 LIBRARY; T=0.K
Neutron emission for (n,2n)

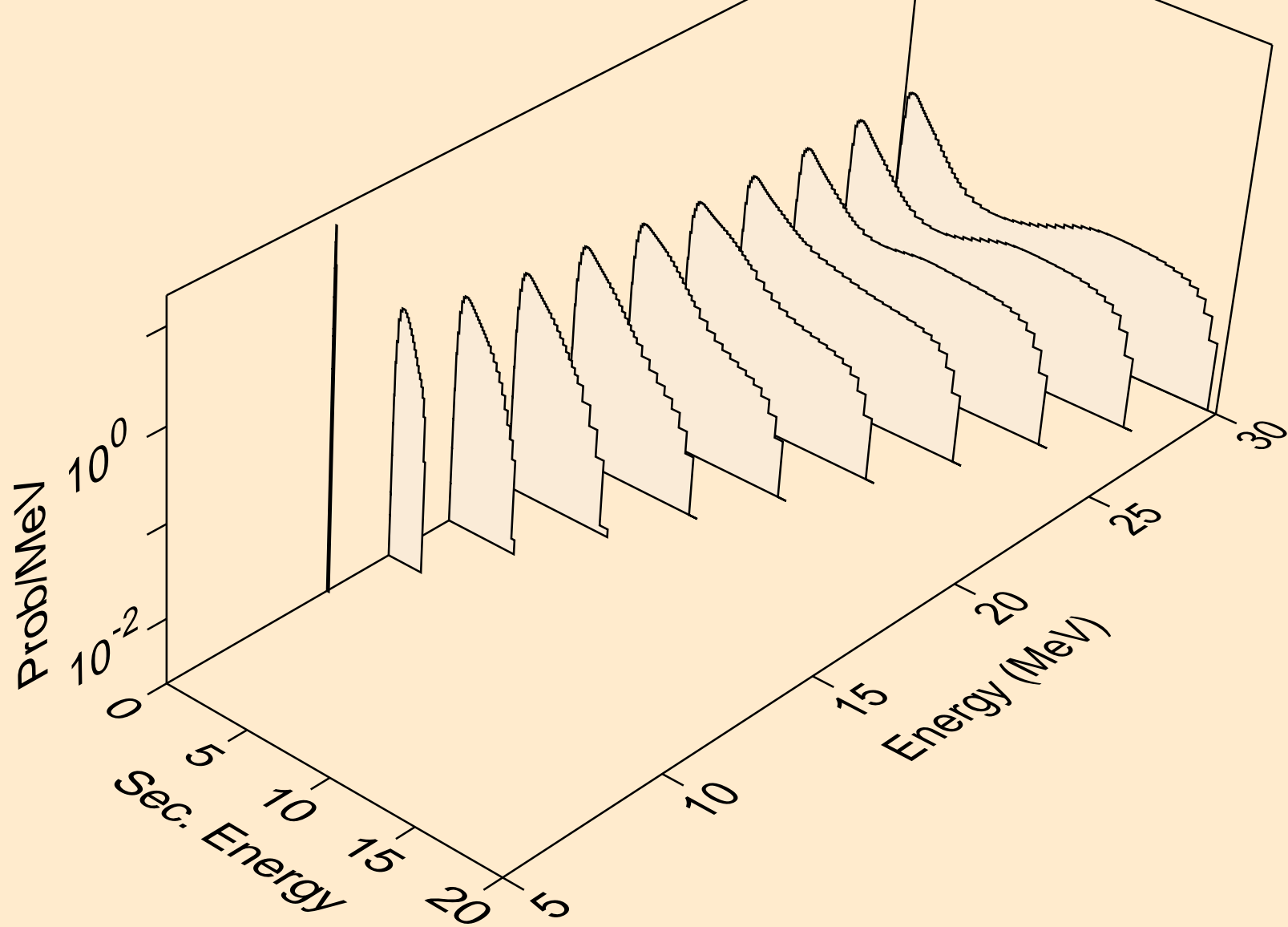

Y084 NEUTRON ACER TENDL-2024 LIBRARY; T=0.K
Neutron emission for (n,3n)

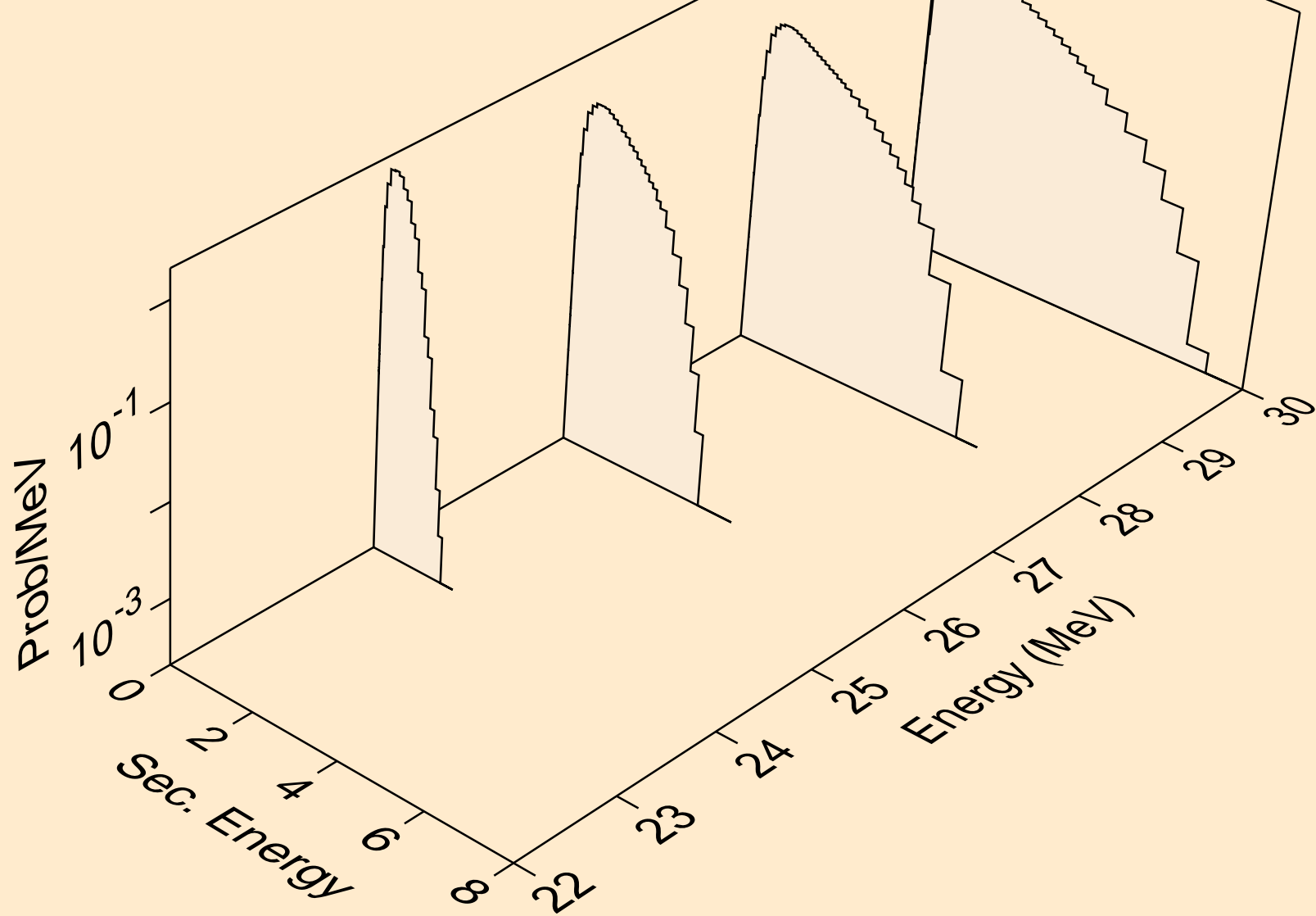

Y084 NEUTRON ACER TENDL-2024 LIBRARY; T=0.K
Neutron emission for (n,n*)a

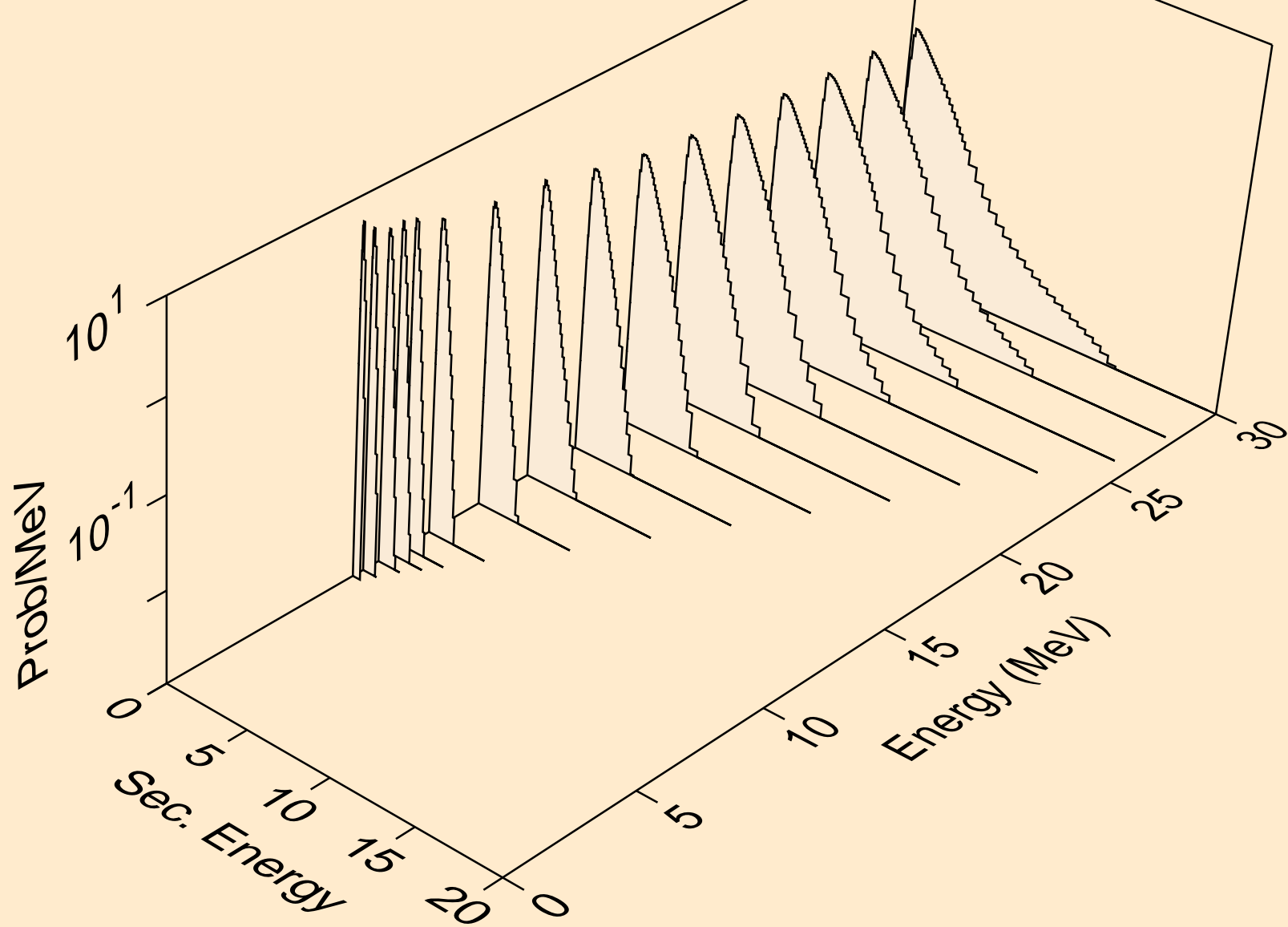

Y084 NEUTRON ACER TENDL-2024 LIBRARY; T=0.K
Neutron emission for (n,2n)a

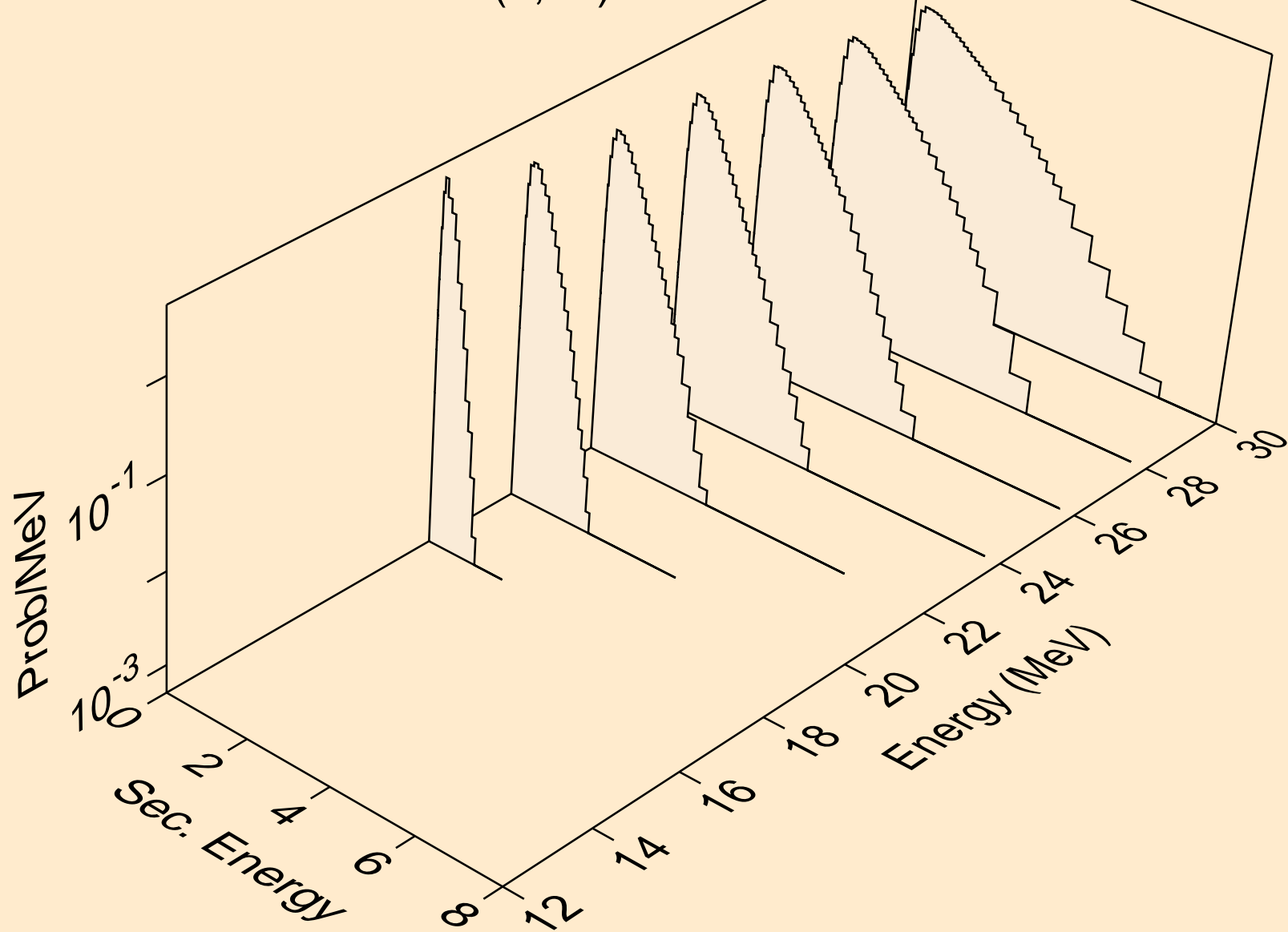

Y084 NEUTRON ACER TENDL-2024 LIBRARY; T=0.K
Neutron emission for (n,n*)p

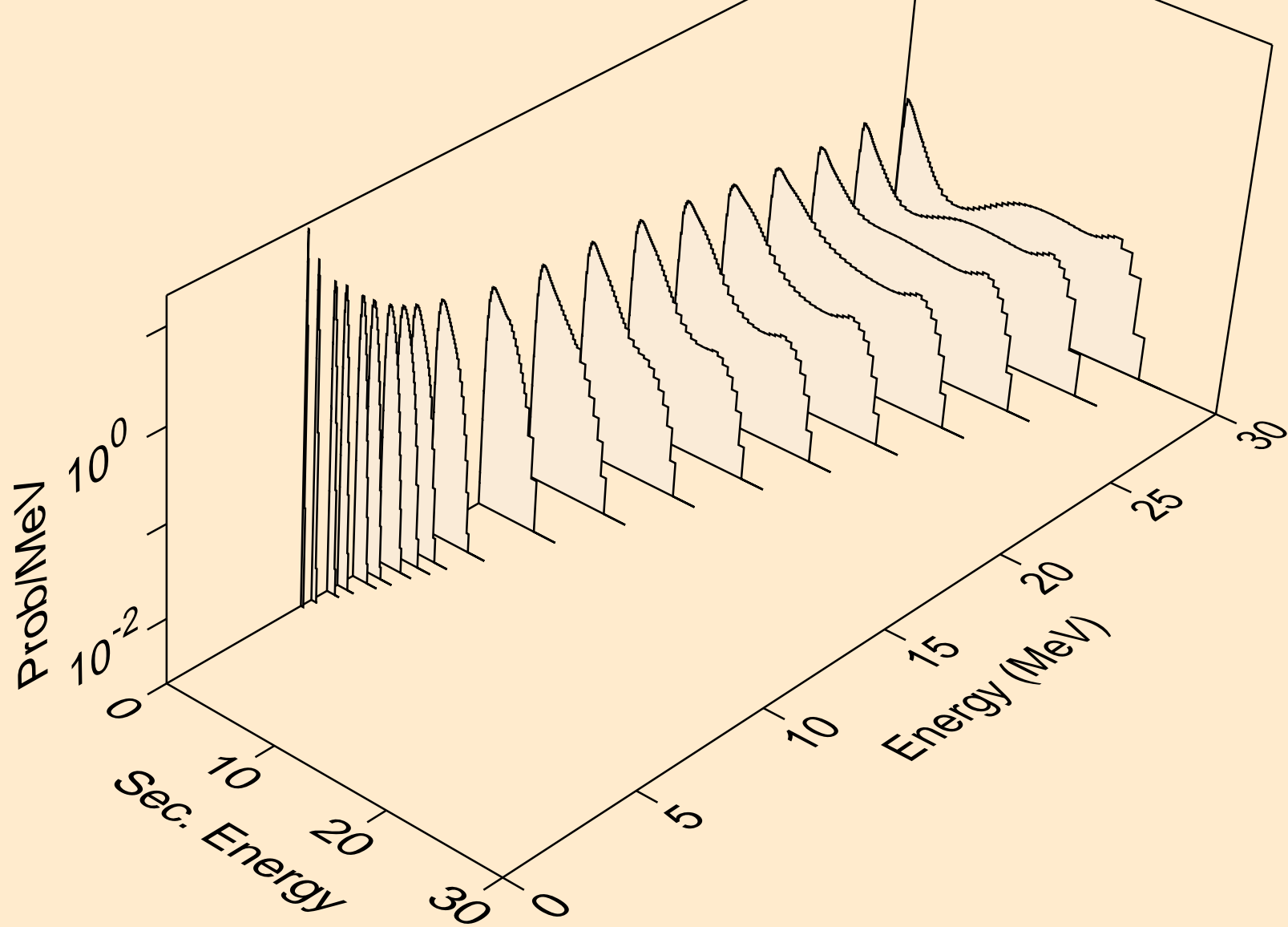

Y084 NEUTRON ACER TENDL-2024 LIBRARY; T=0.K
Neutron emission for (n,n*)2a

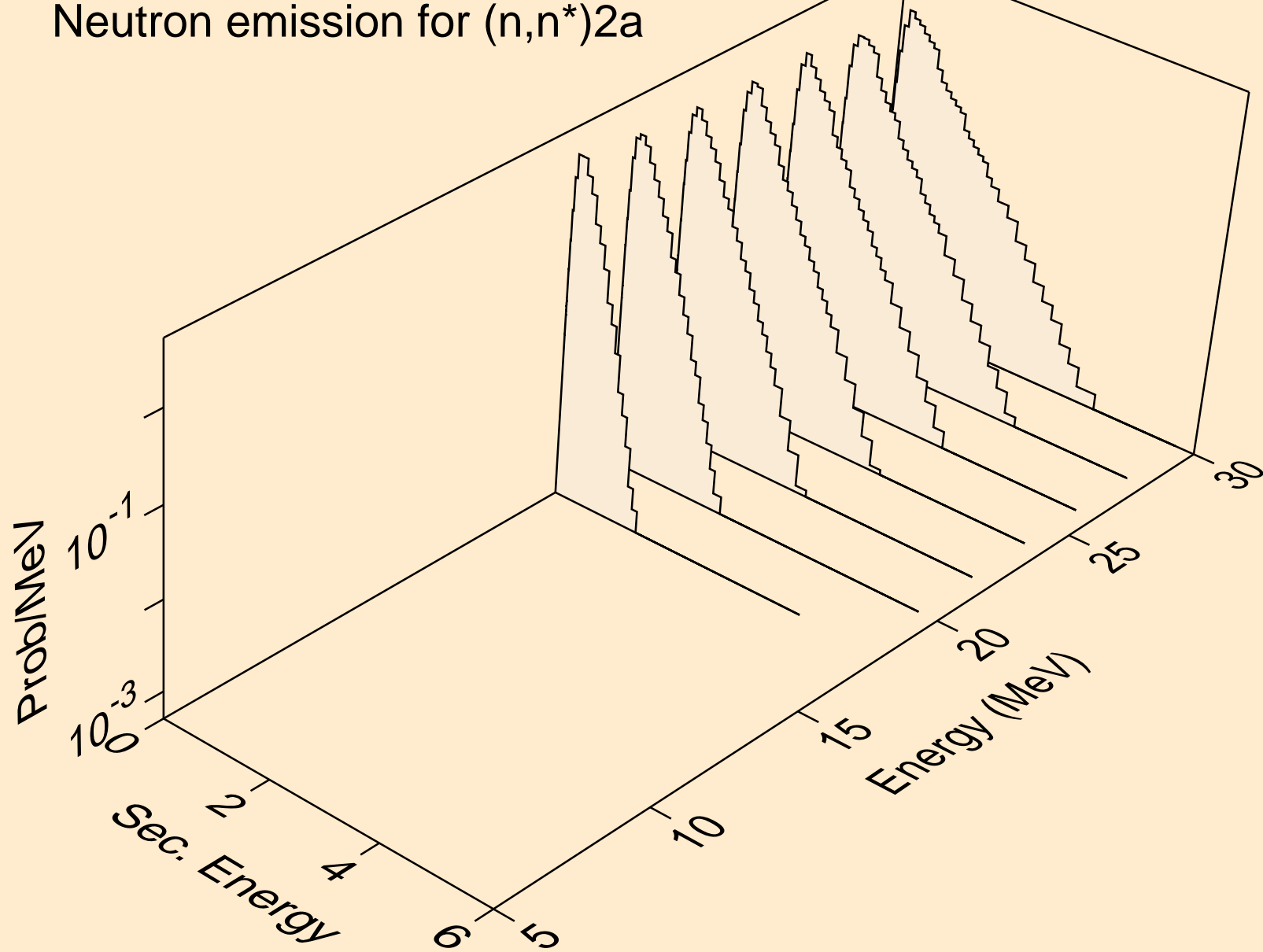

Y084 NEUTRON ACER TENDL-2024 LIBRARY; T=0.K
Neutron emission for (n,n*)d

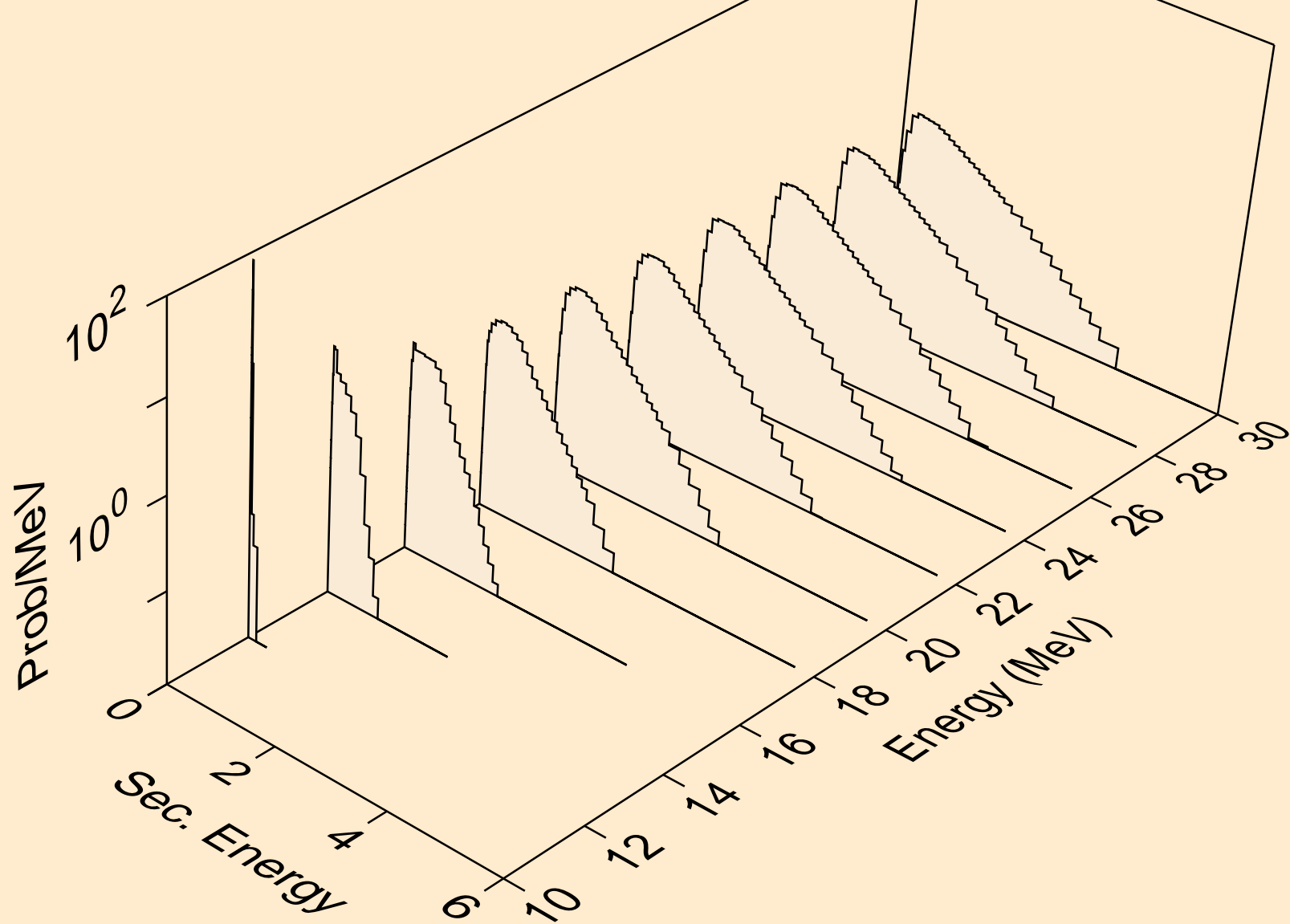

Y084 NEUTRON ACER TENDL-2024 LIBRARY; T=0.K
Neutron emission for (n,n*)t

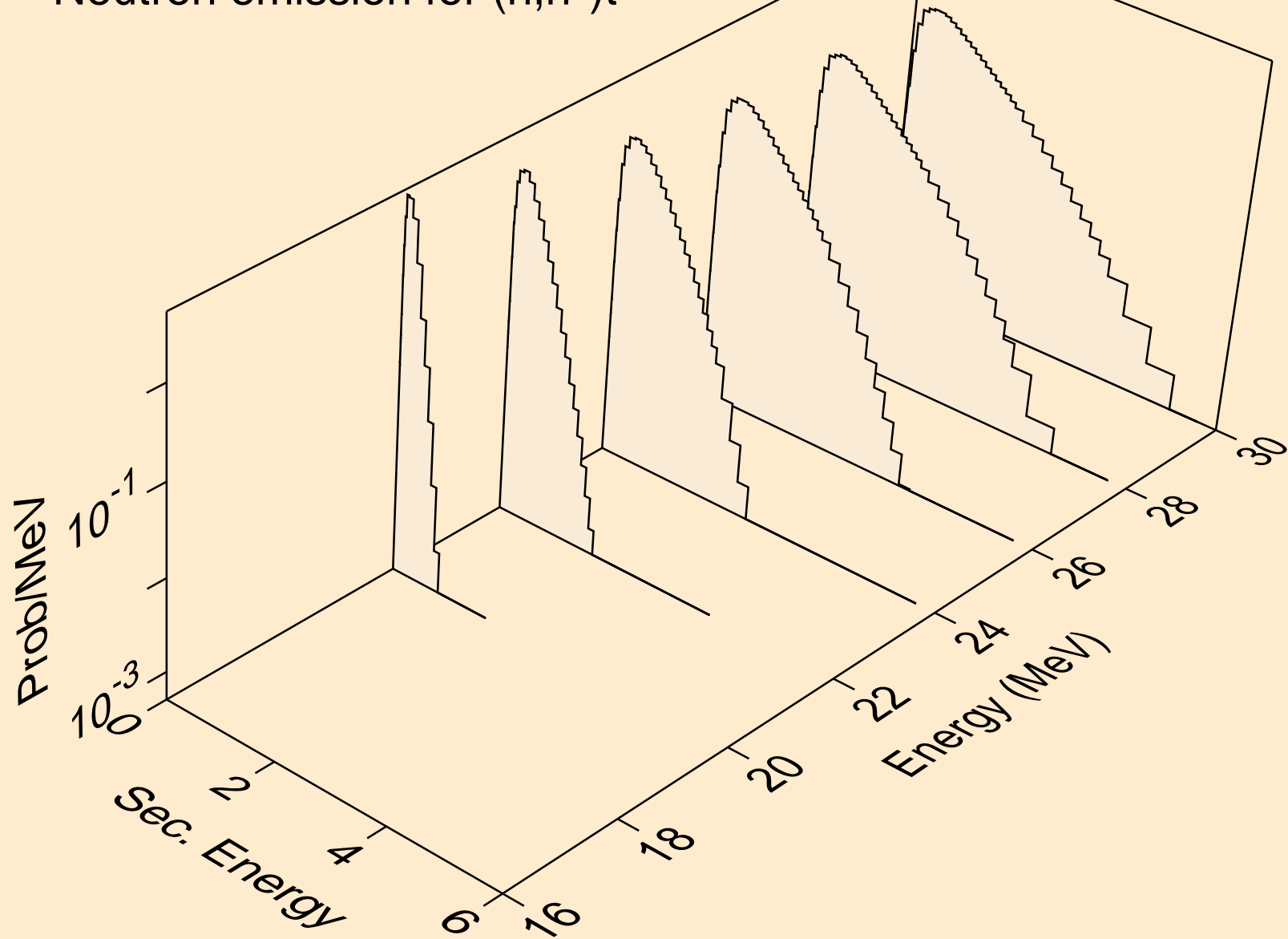

Y084 NEUTRON ACER TENDL-2024 LIBRARY; T=0.K
Neutron emission for (n,n*)he3

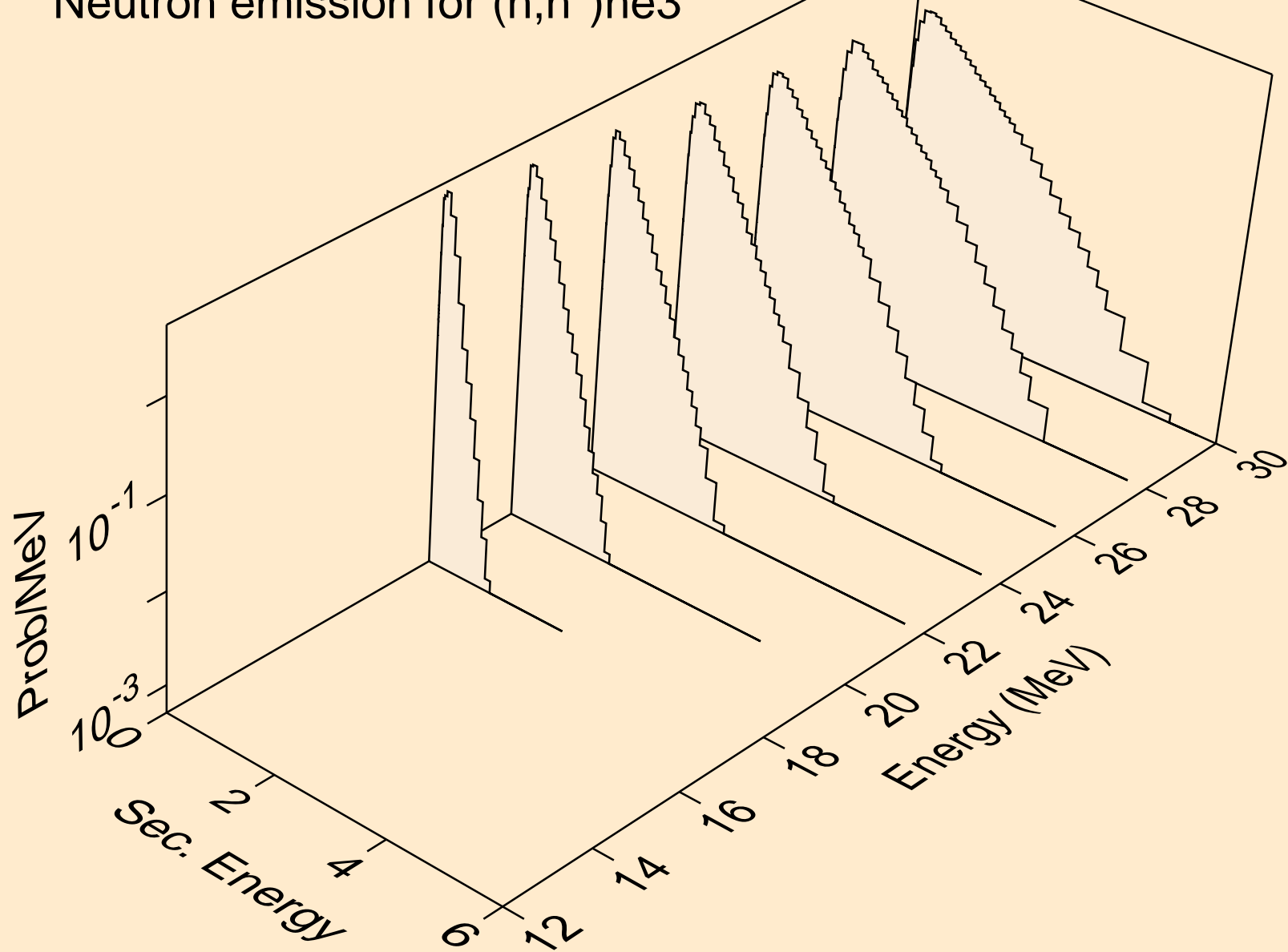

Y084 NEUTRON ACER TENDL-2024 LIBRARY; T=0.K
Neutron emission for (n,2np)

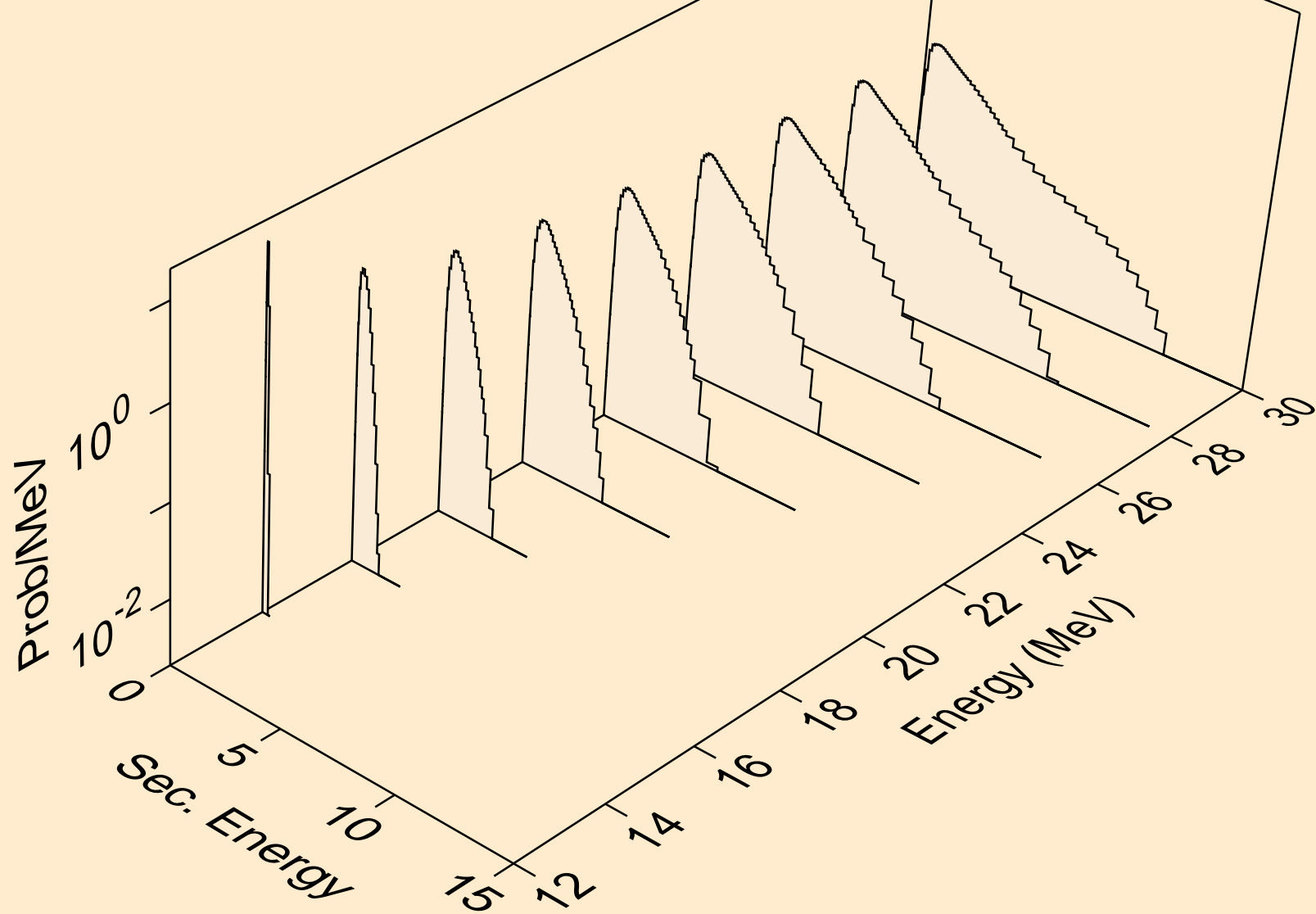

Y084 NEUTRON ACER TENDL-2024 LIBRARY; T=0.K
Neutron emission for (n,3np)

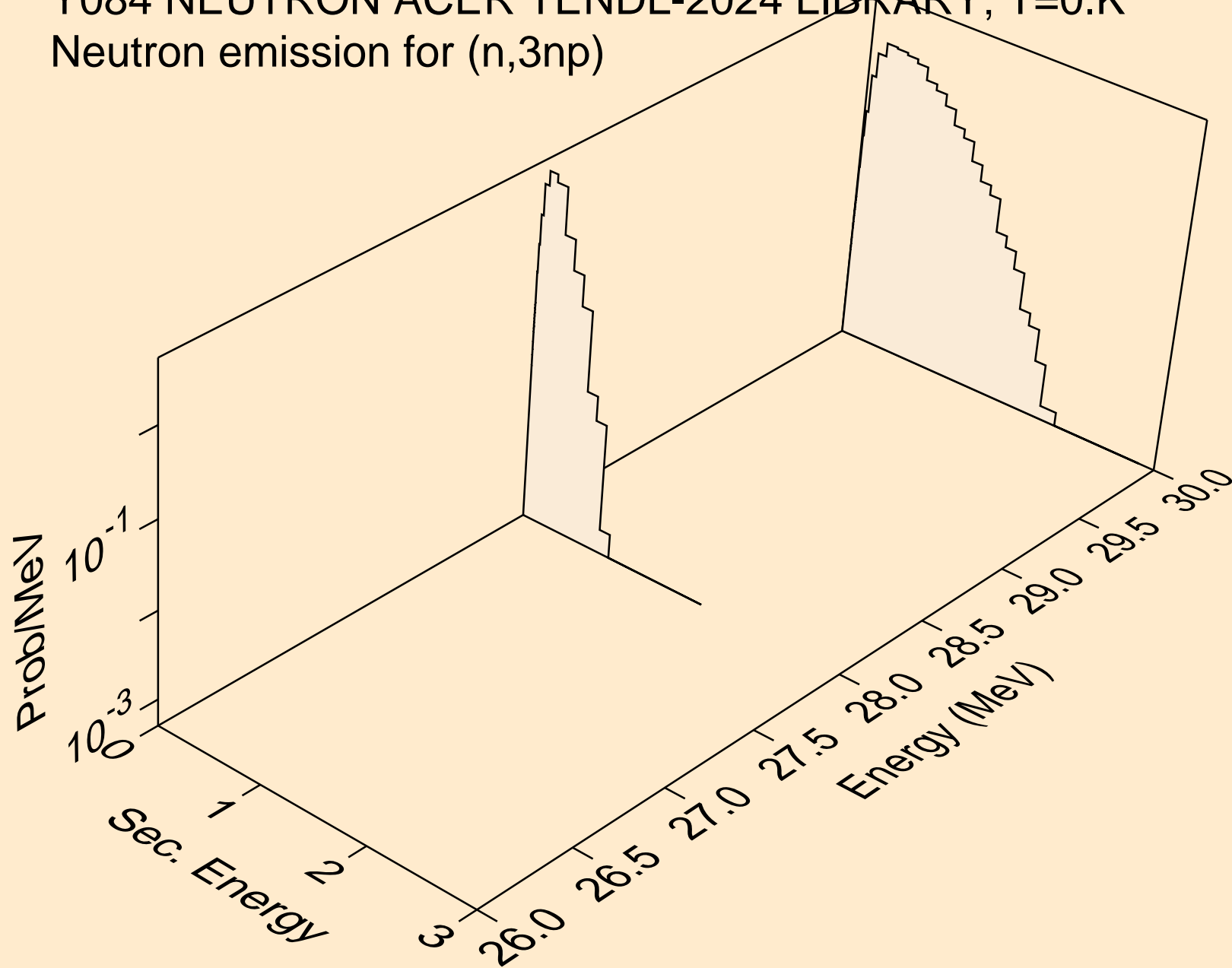

Y084 NEUTRON ACER TENDL-2024 LIBRARY; T=0.K
Neutron emission for (n,n2p)

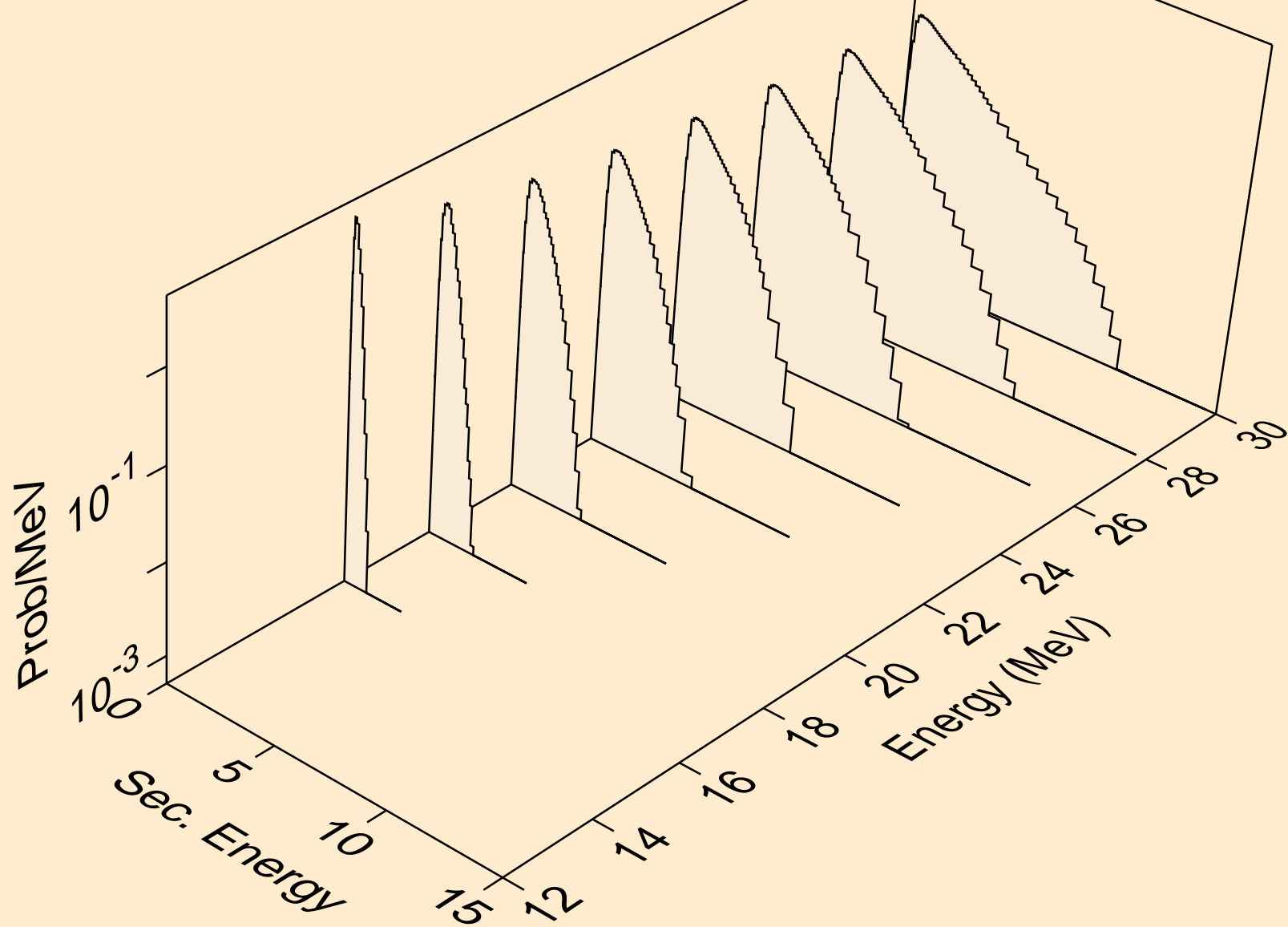

Y084 NEUTRON ACER TENDL-2024 LIBRARY; T=0.K
Neutron emission for (n,npa)

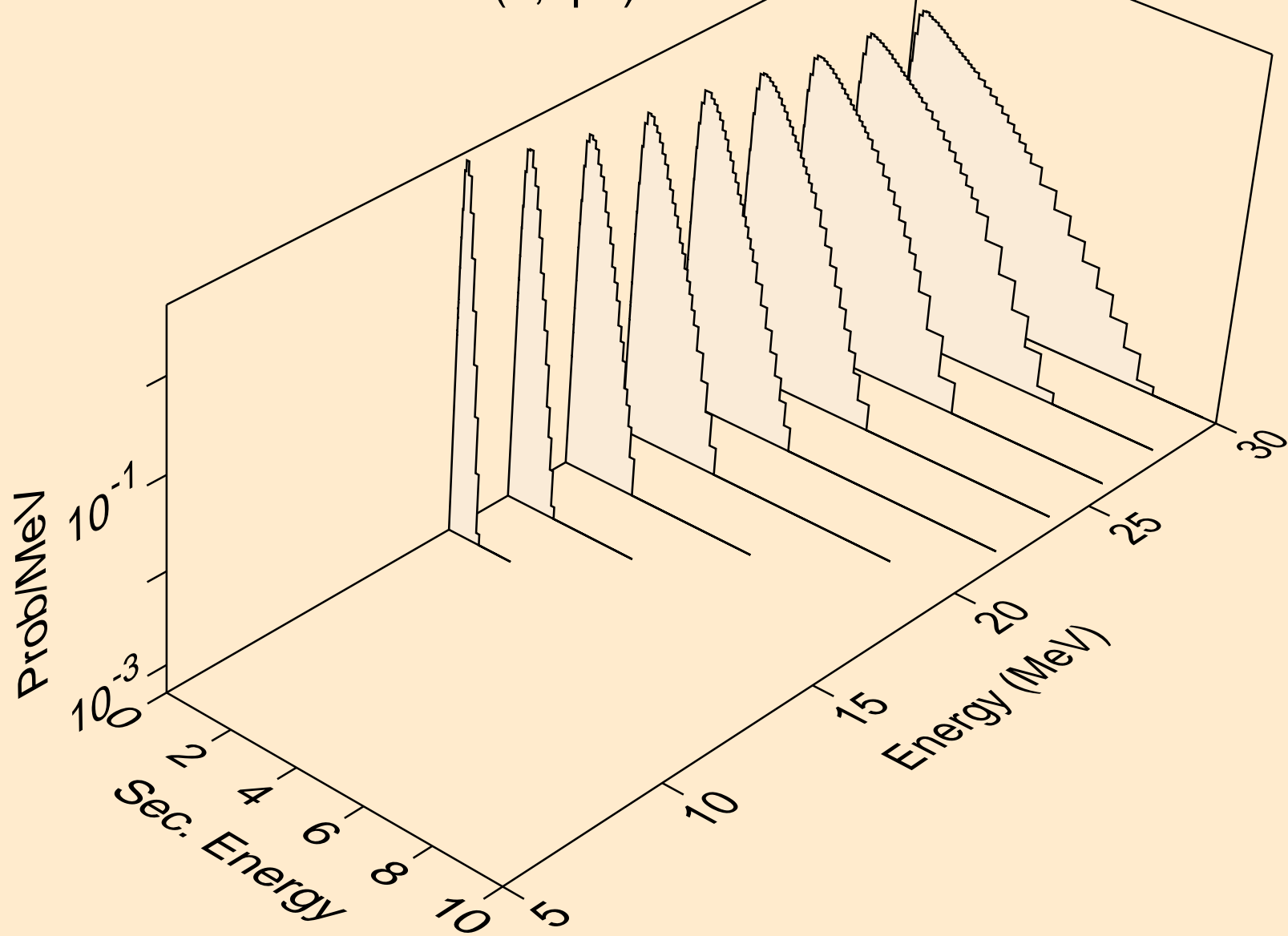

Y084 NEUTRON ACER TENDL-2024 LIBRARY; T=0.K
Neutron emission for (n,n*c)

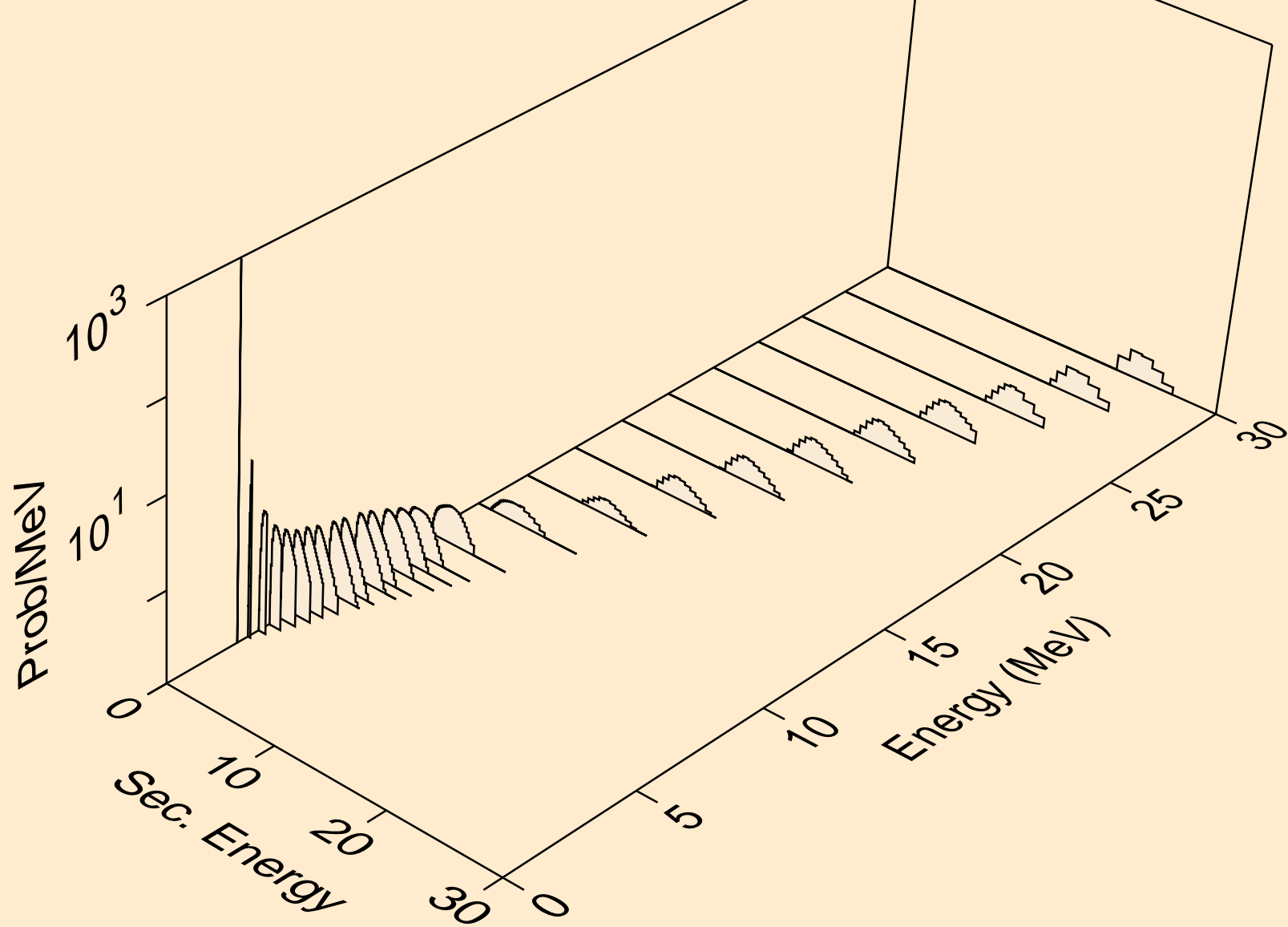

Y084 NEUTRON ACER TENDL-2024 LIBRARY; T=0.K
Photon emission for (n,x)

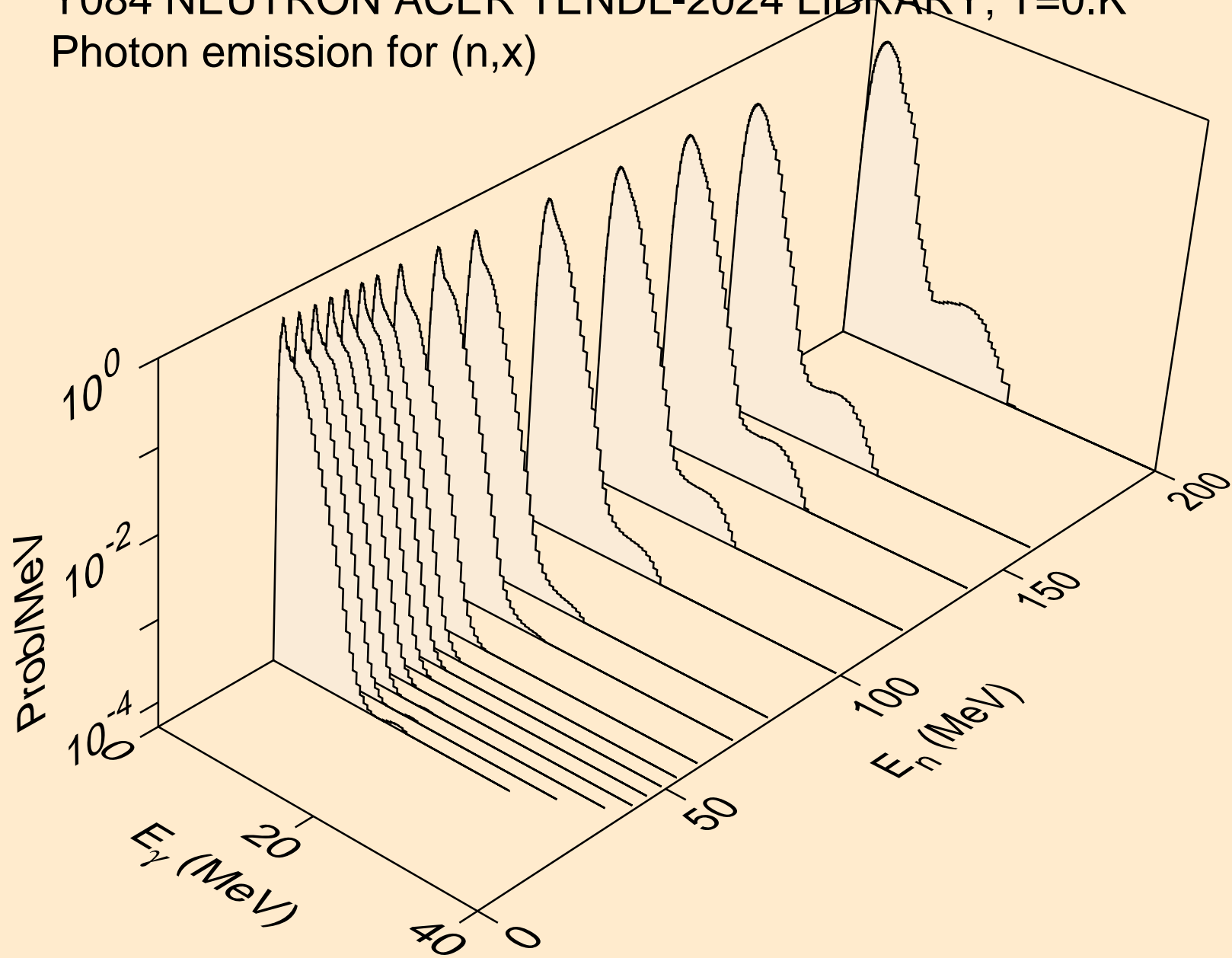

Y084 NEUTRON ACER TENDL-2024 LIBRARY; T=0.K
Photon emission for (n,2nd)

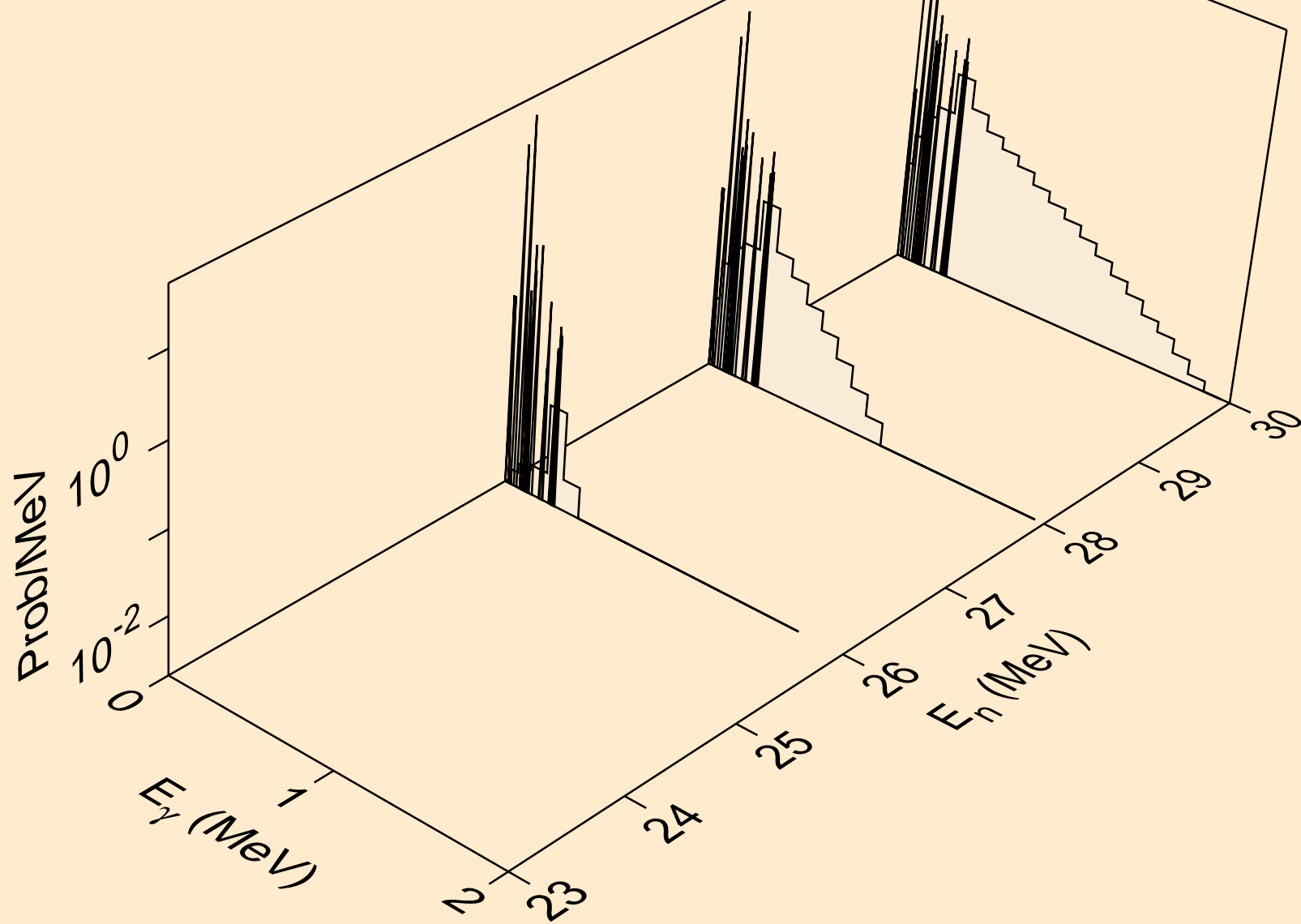

Y084 NEUTRON ACER TENDL-2024 LIBRARY; T=0.K
Photon emission for (n,2n)

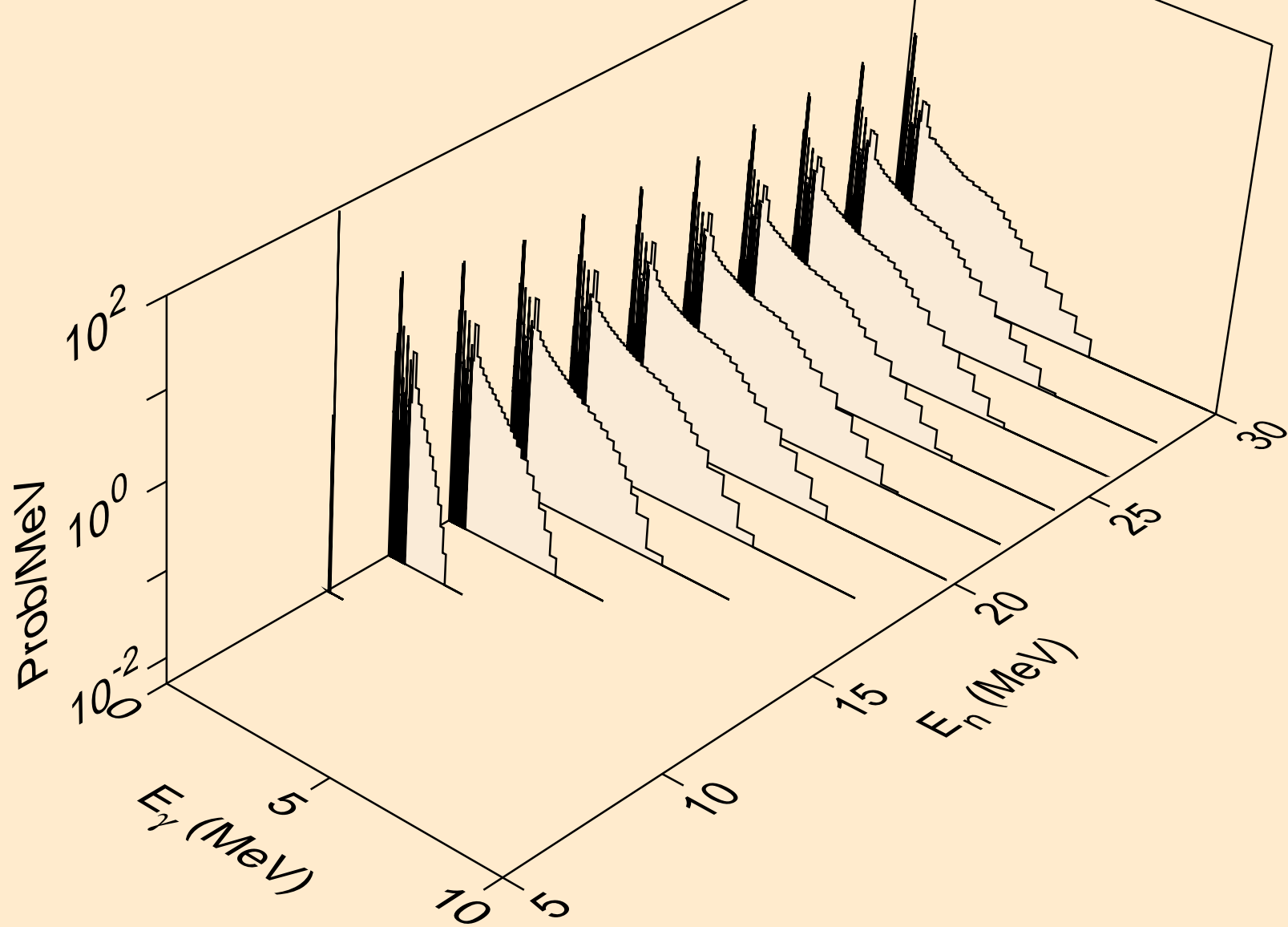

Y084 NEUTRON ACER TENDL-2024 LIBRARY; T=0.K
Photon emission for (n,3n)

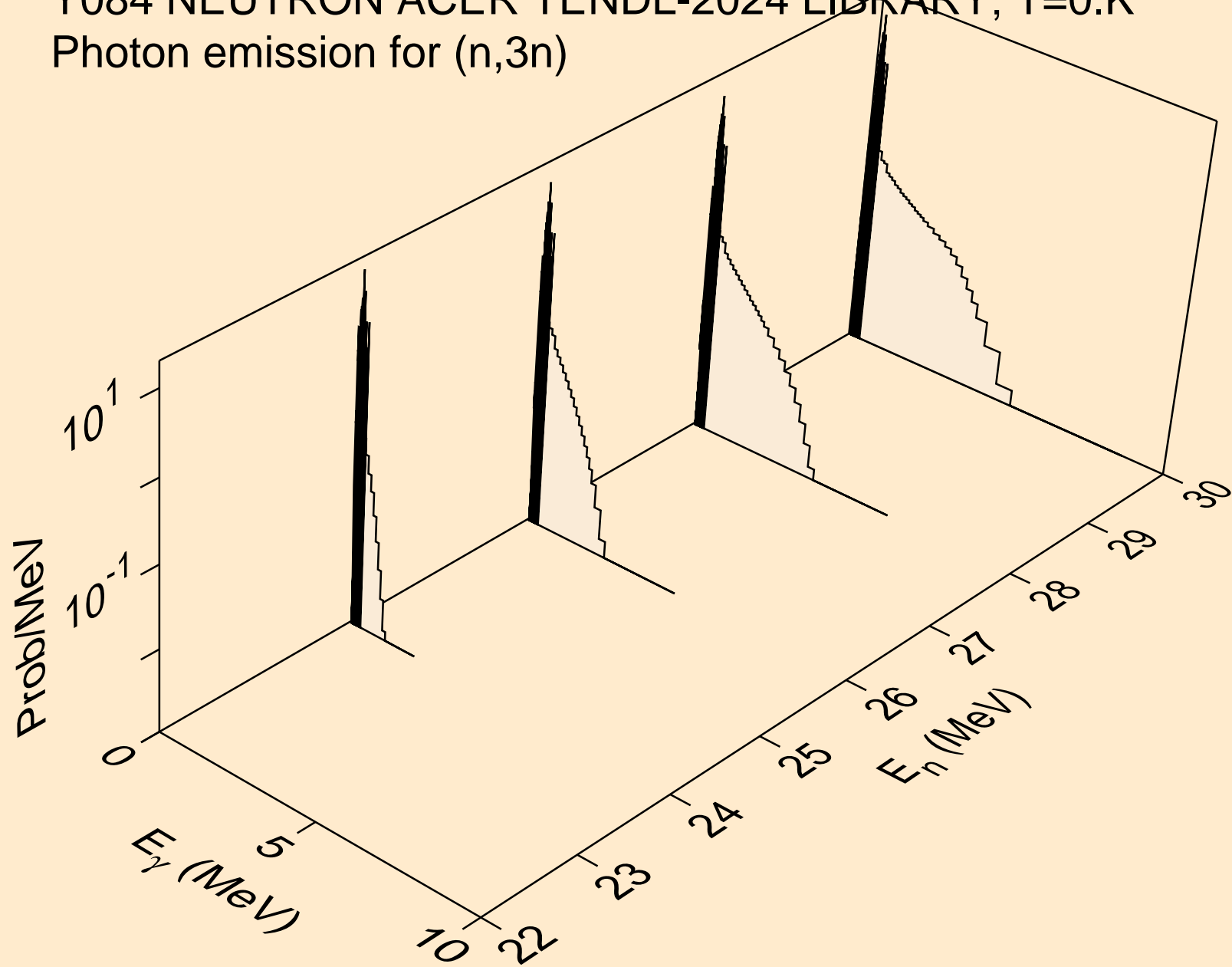

Y084 NEUTRON ACER TENDL-2024 LIBRARY; T=0.K
Photon emission for (n,n*)a

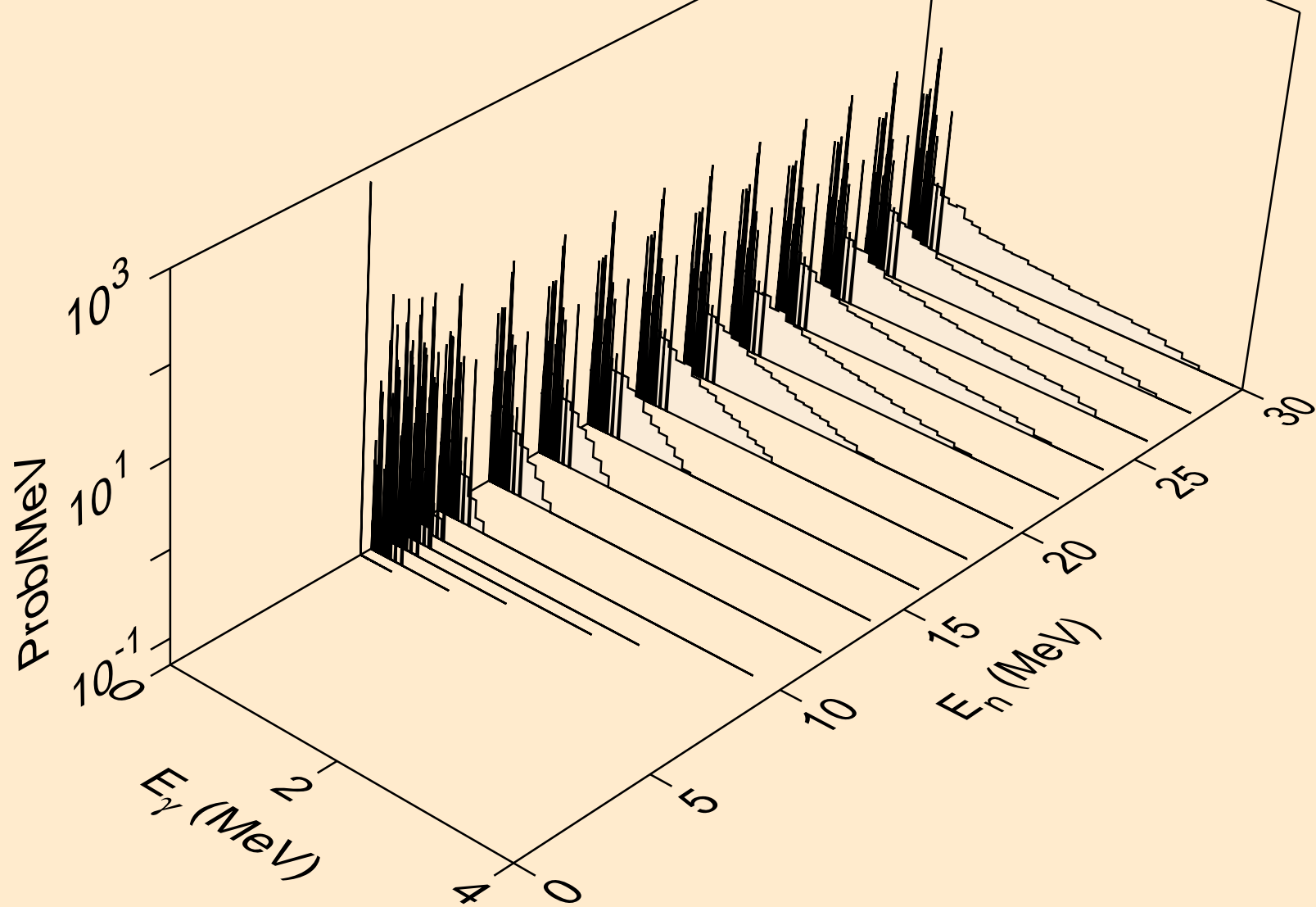

Y084 NEUTRON ACER TENDL-2024 LIBRARY; T=0.K
Photon emission for (n,2n)a

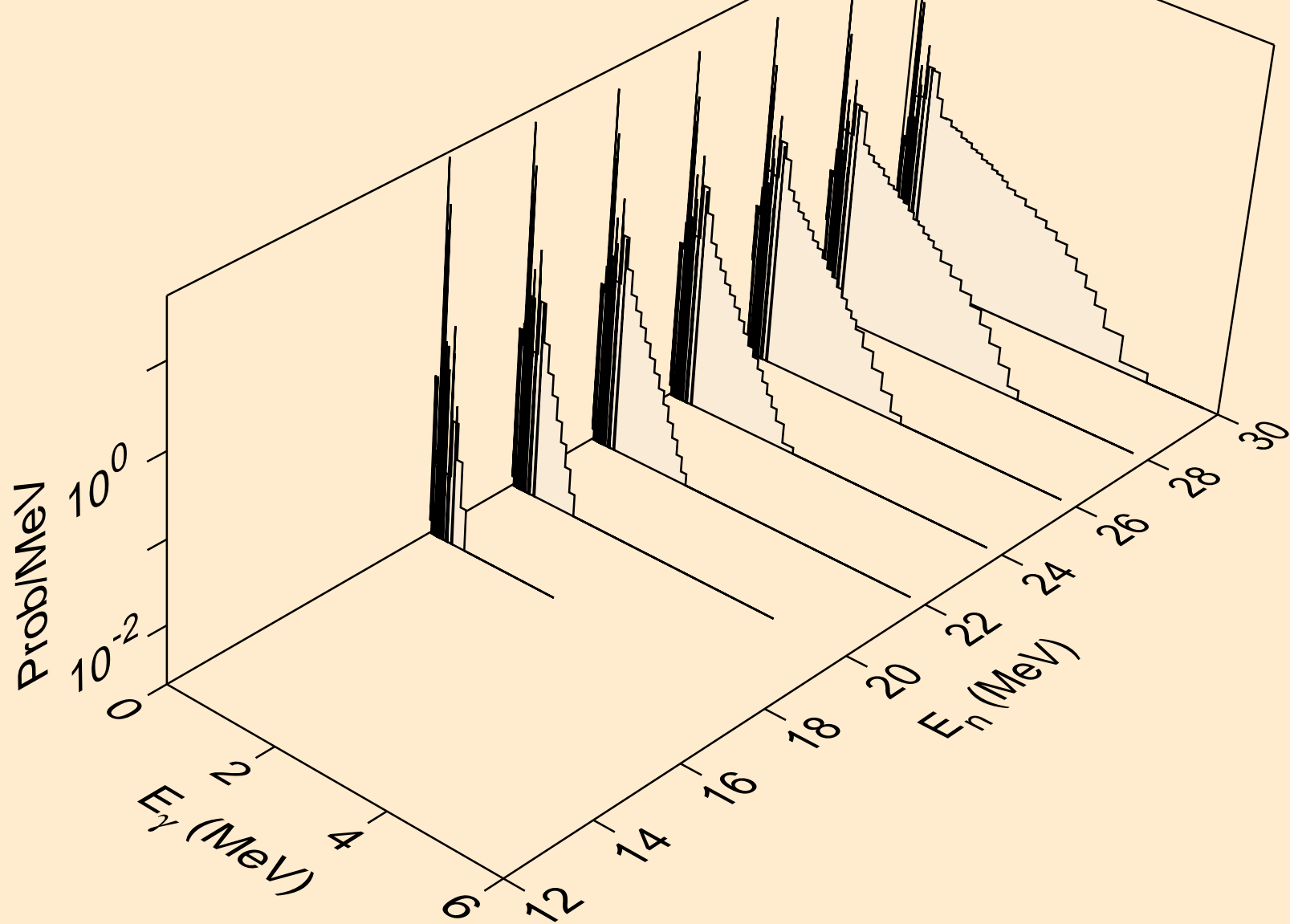

Y084 NEUTRON ACER TENDL-2024 LIBRARY; T=0.K
Photon emission for (n,n*)p

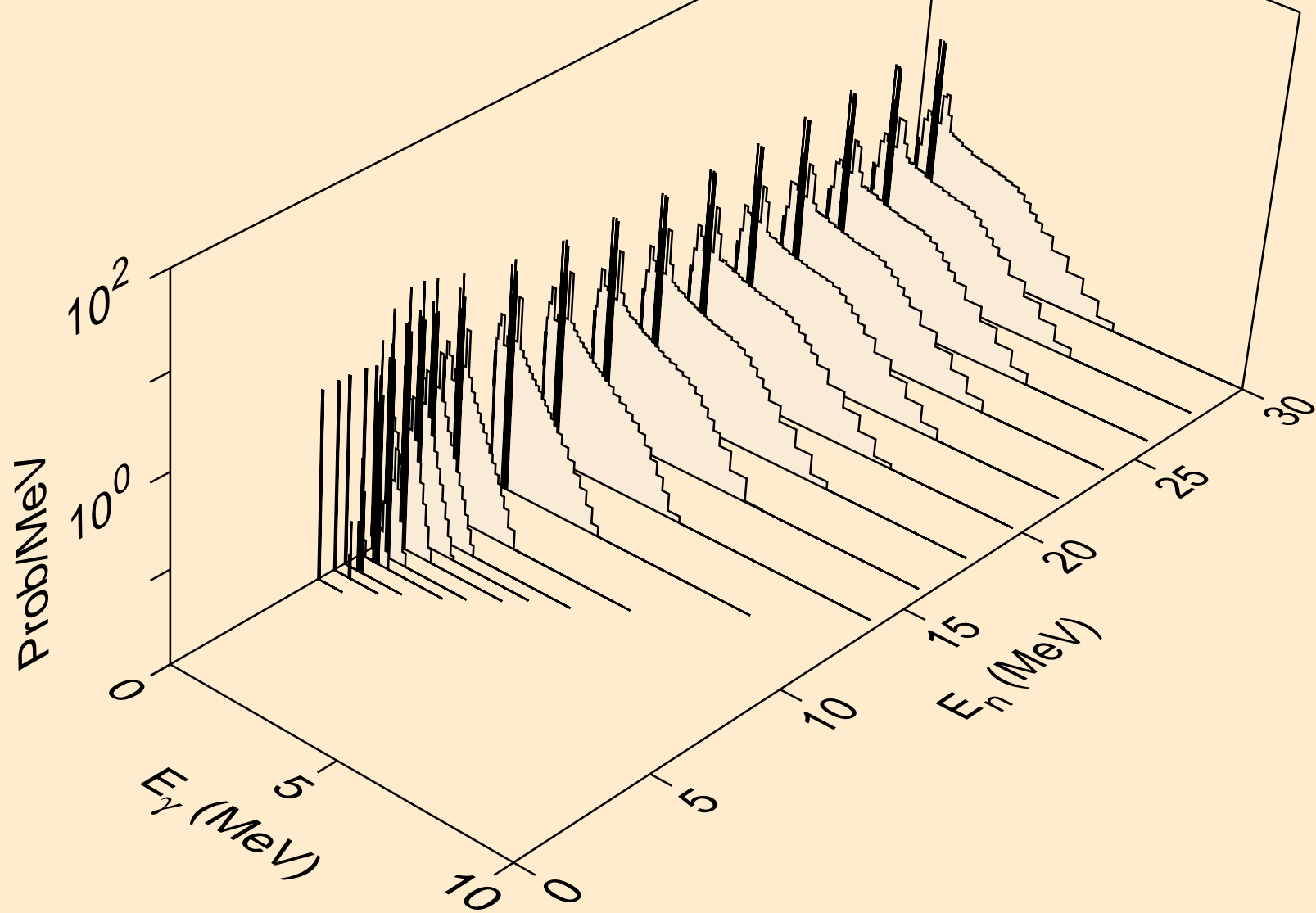

Y084 NEUTRON ACER TENDL-2024 LIBRARY; T=0.K
Photon emission for (n,n*)2a

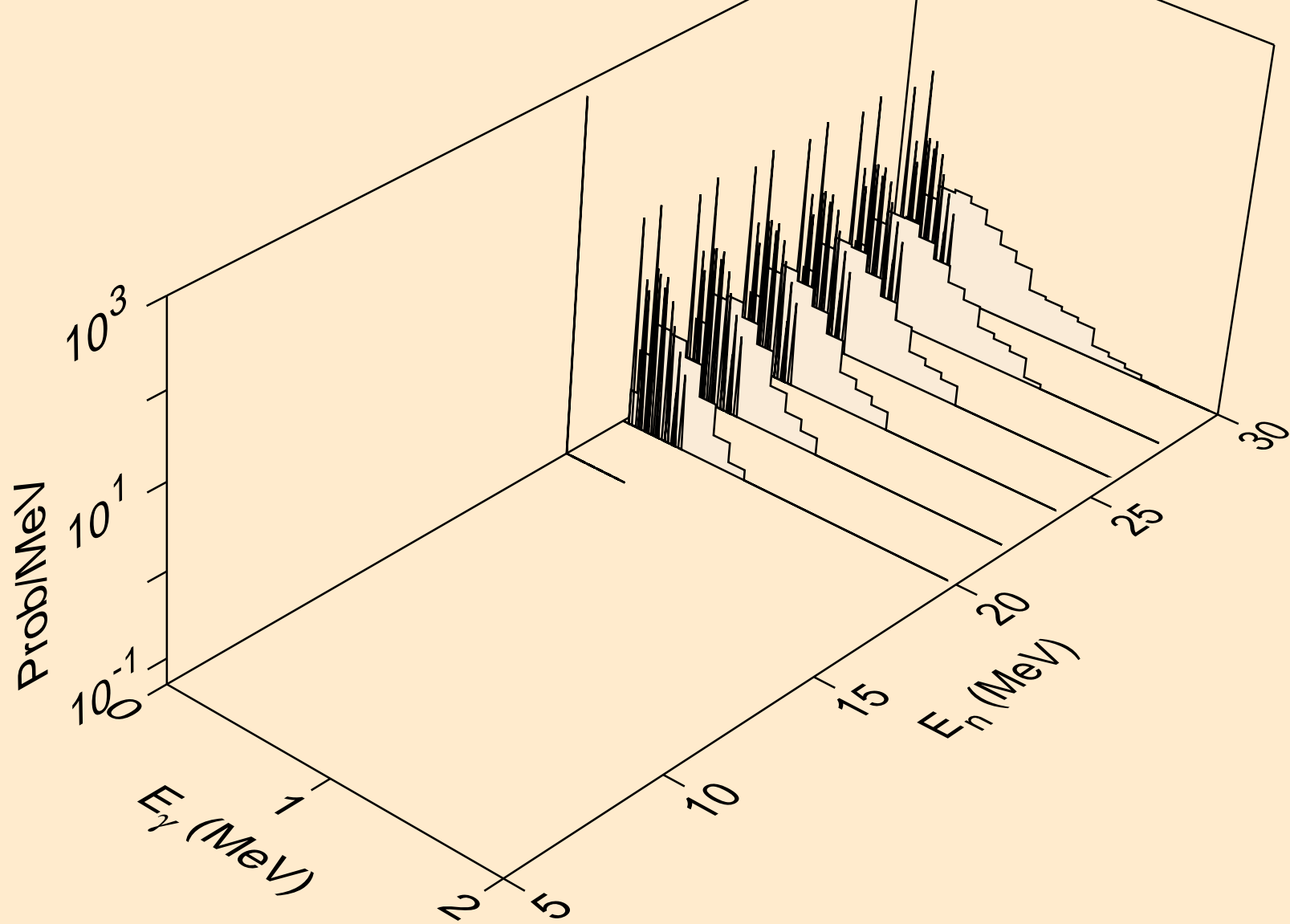

Y084 NEUTRON ACER TENDL-2024 LIBRARY; T=0.K
Photon emission for (n,n*)d

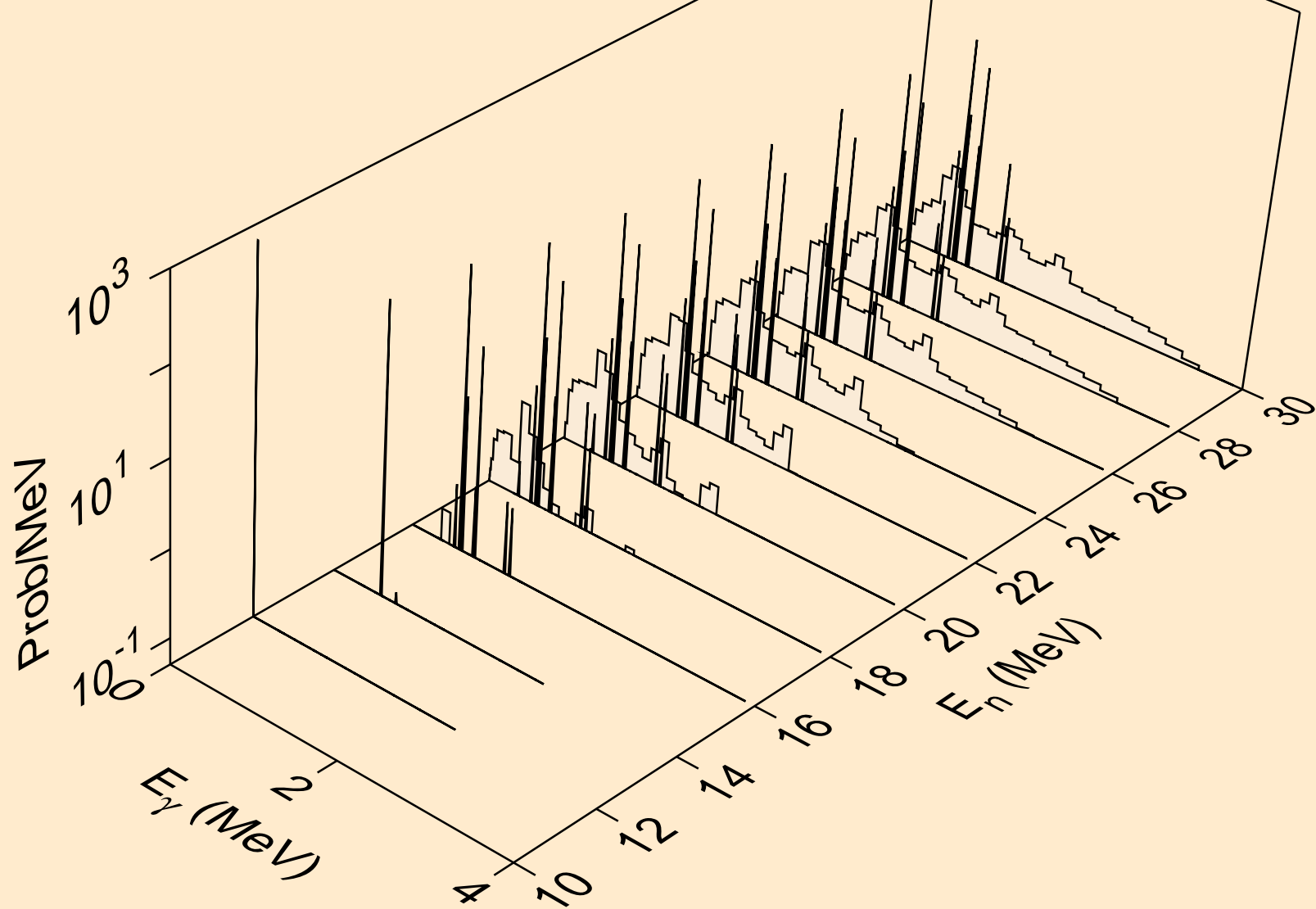

Y084 NEUTRON ACER TENDL-2024 LIBRARY; T=0.K
Photon emission for (n,n*)t

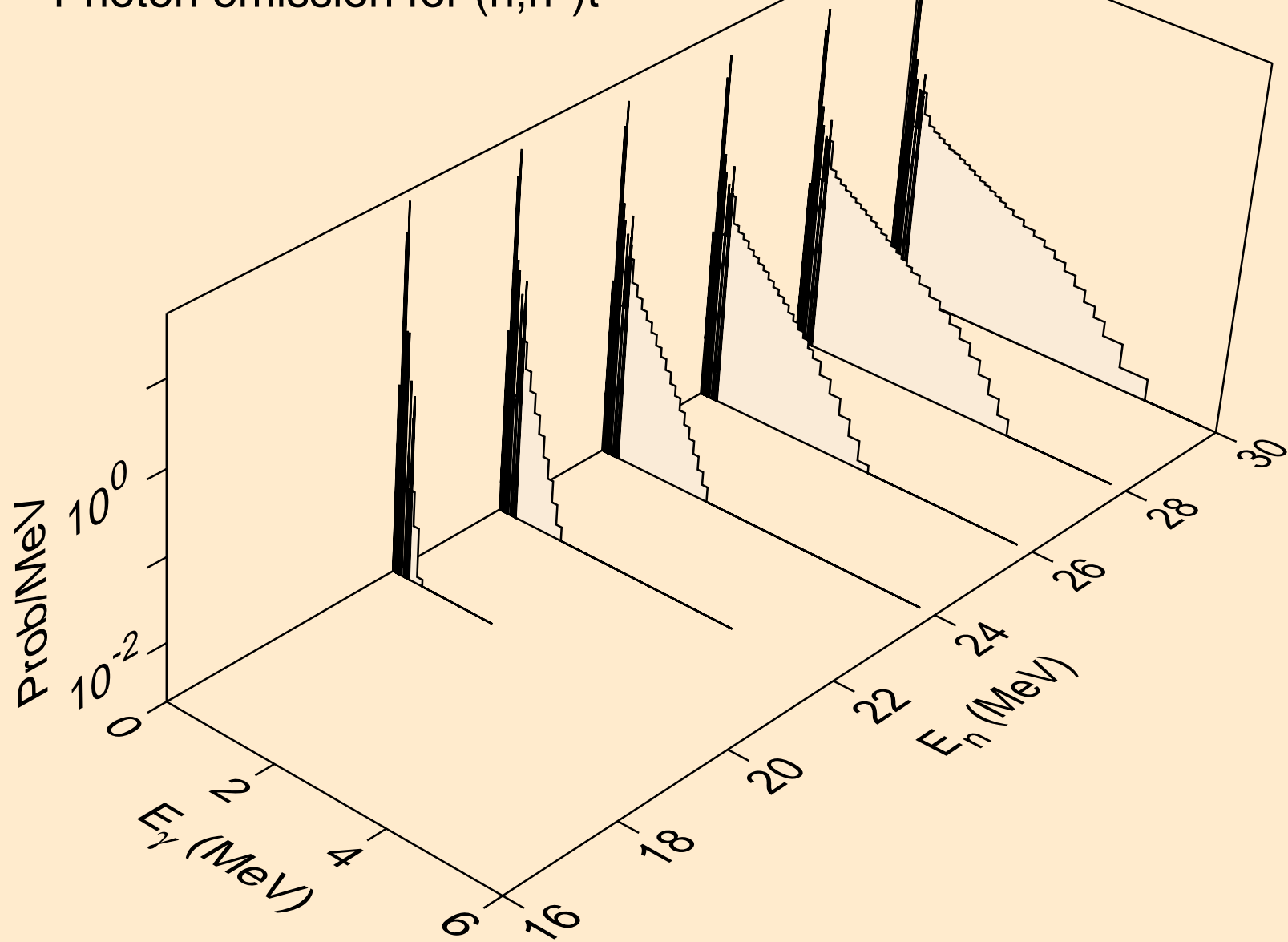

Y084 NEUTRON ACER TENDL-2024 LIBRARY; T=0.K
Photon emission for (n,n*)he3

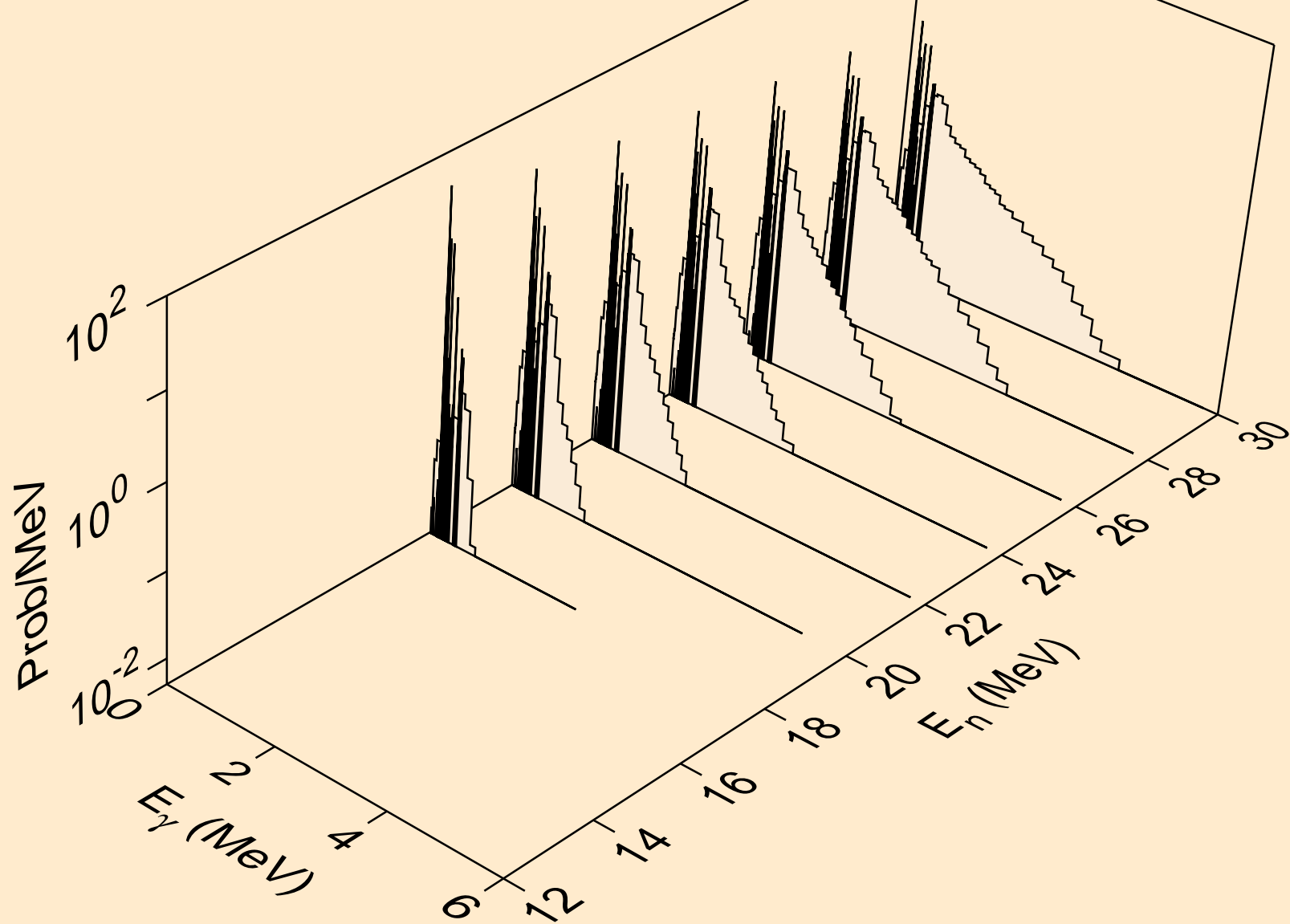

Y084 NEUTRON ACER TENDL-2024 LIBRARY; T=0.K
Photon emission for (n,2np)

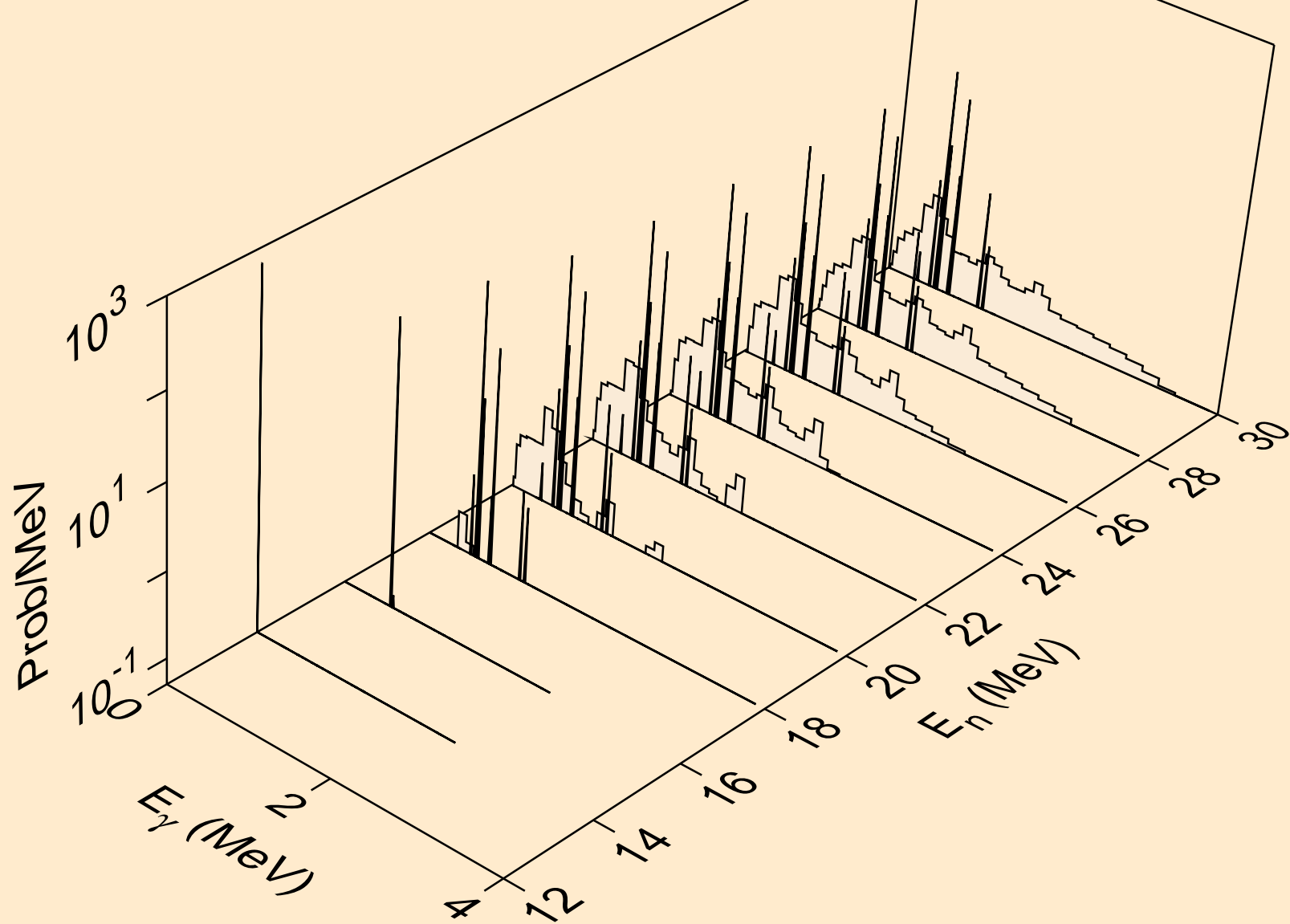

Y084 NEUTRON ACER TENDL-2024 LIBRARY; T=0.K
Photon emission for (n,3np)

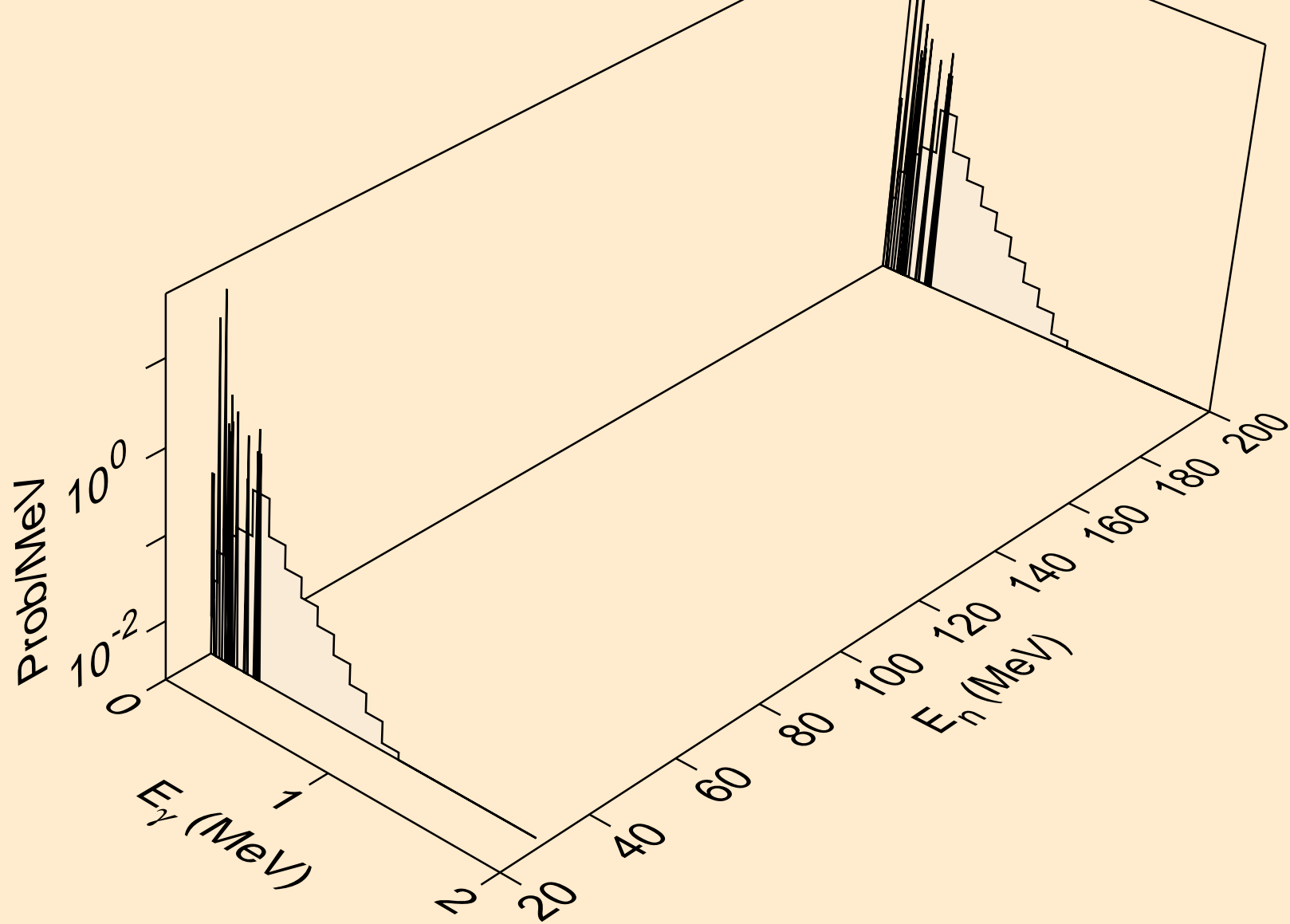

Y084 NEUTRON ACER TENDL-2024 LIBRARY; T=0.K
Photon emission for (n,n2p)

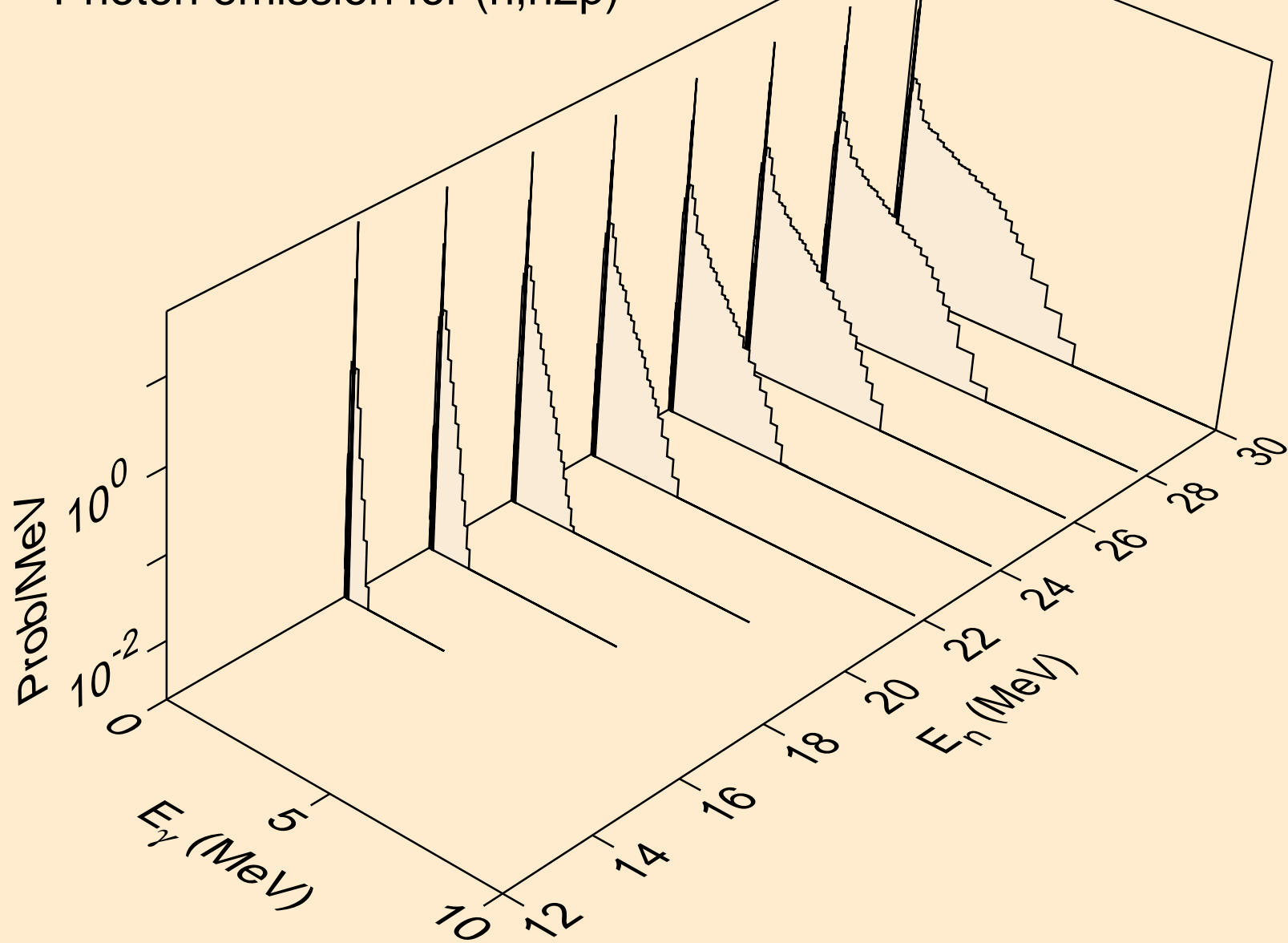

Y084 NEUTRON ACER TENDL-2024 LIBRARY; T=0.K
Photon emission for (n,npa)

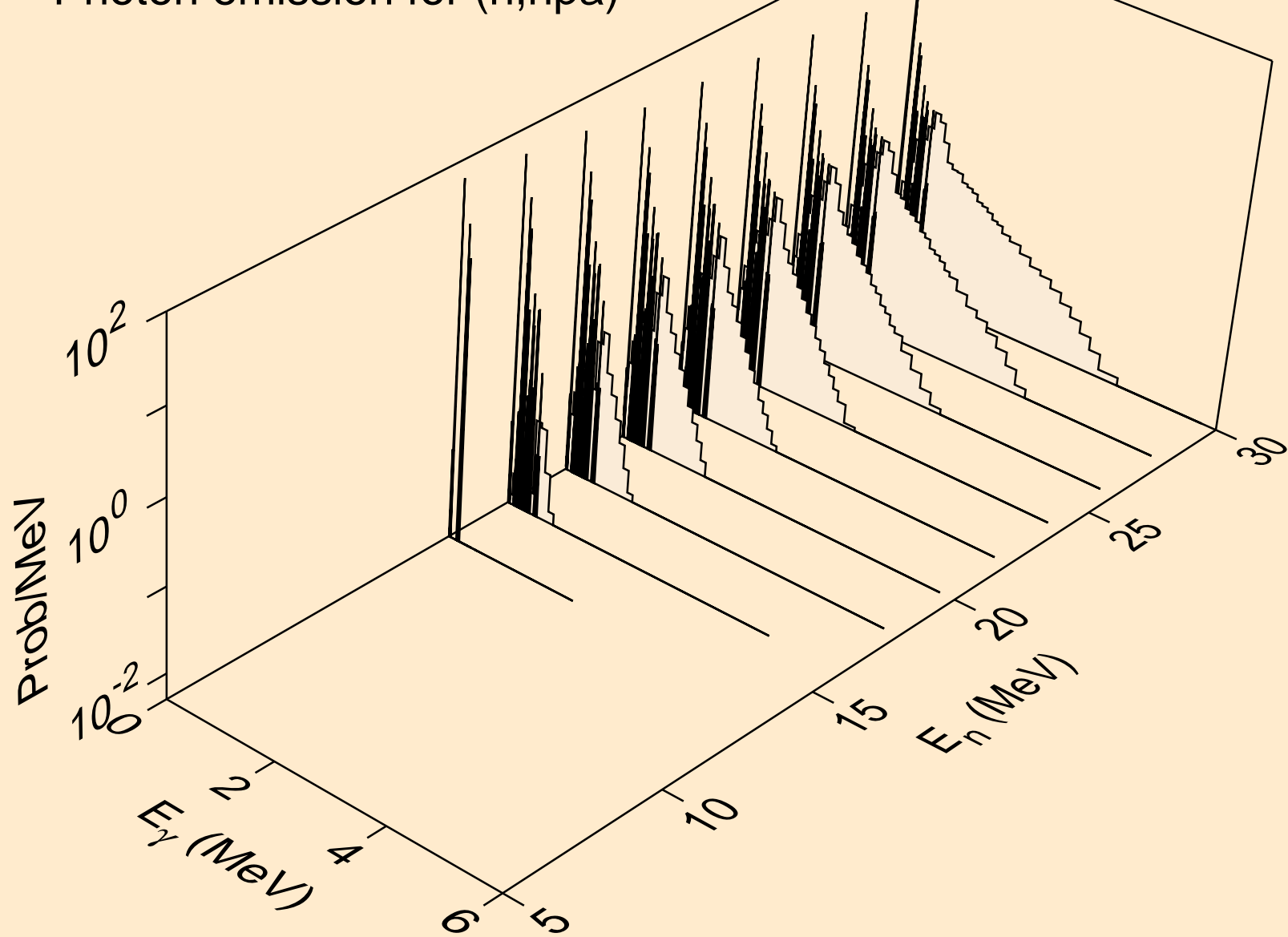

Y084 NEUTRON ACER TENDL-2024 LIBRARY; T=0.K
Photon emission for (n,n*c)

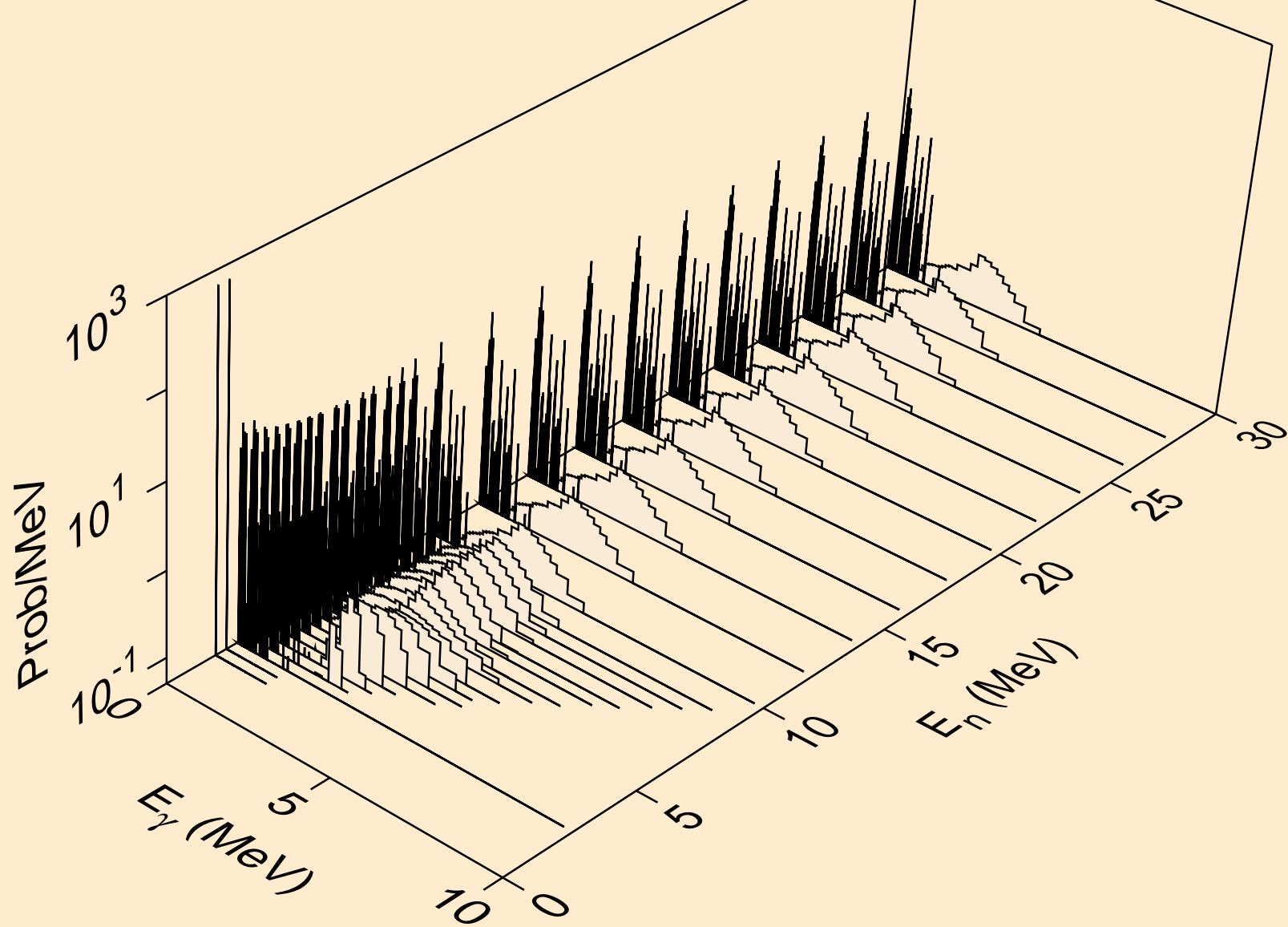

Y084 NEUTRON ACER TENDL-2024 LIBRARY; T=0.K
Photon emission for (n,gma)

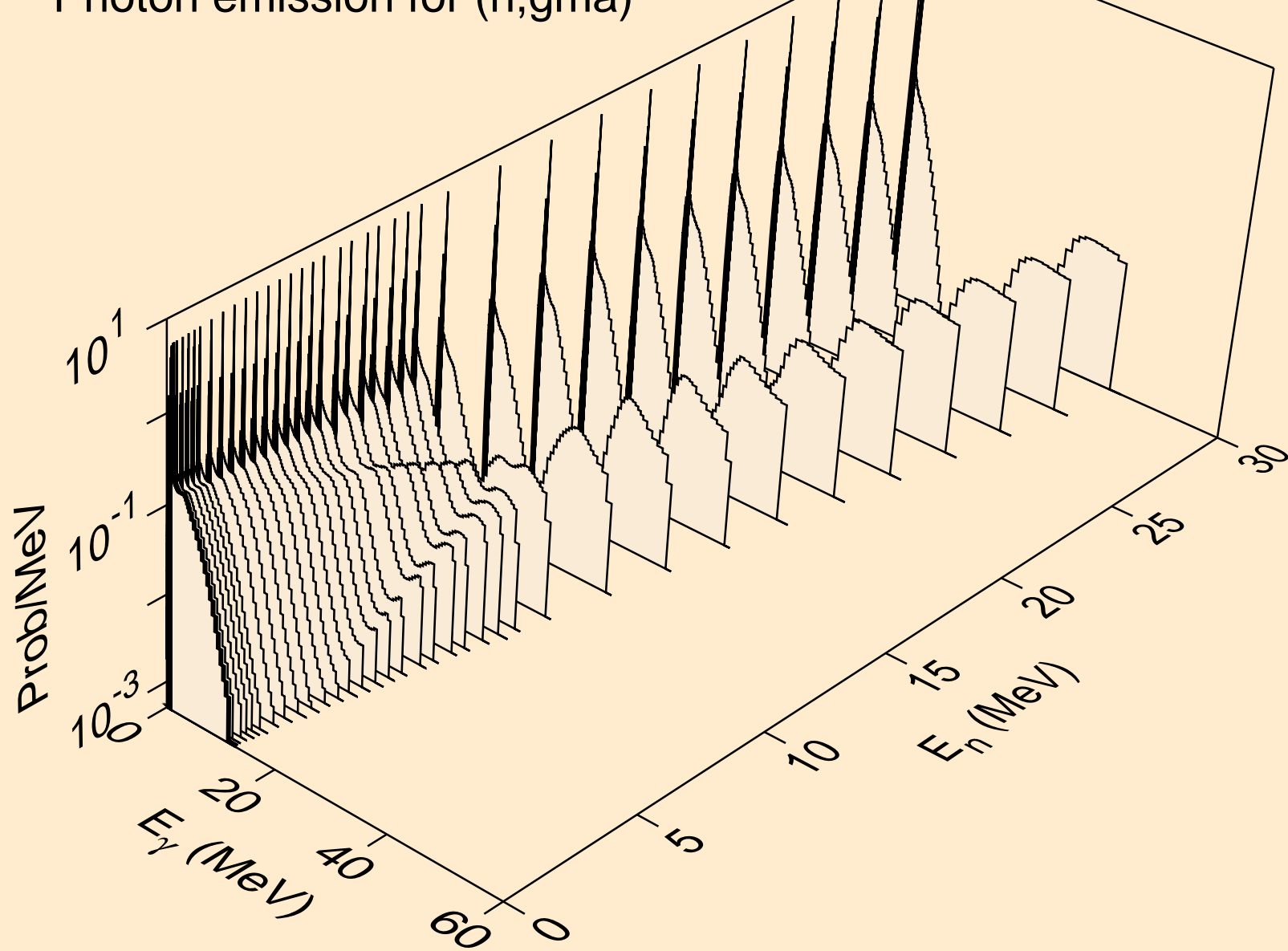

Y084 NEUTRON ACER TENDL-2024 LIBRARY; T=0.K
Photon emission for (n,p)

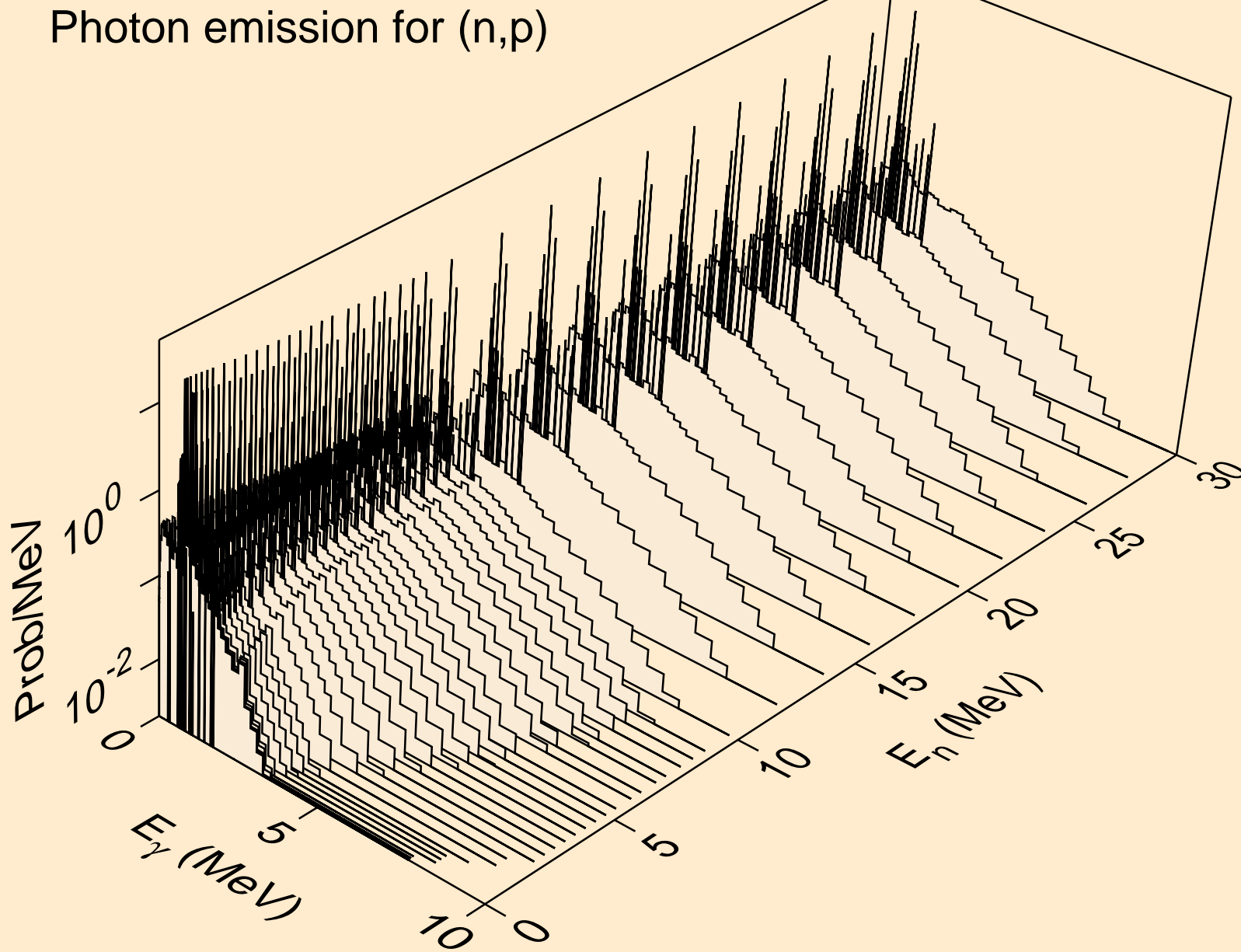

Y084 NEUTRON ACER TENDL-2024 LIBRARY; T=0.K
Photon emission for (n,d)

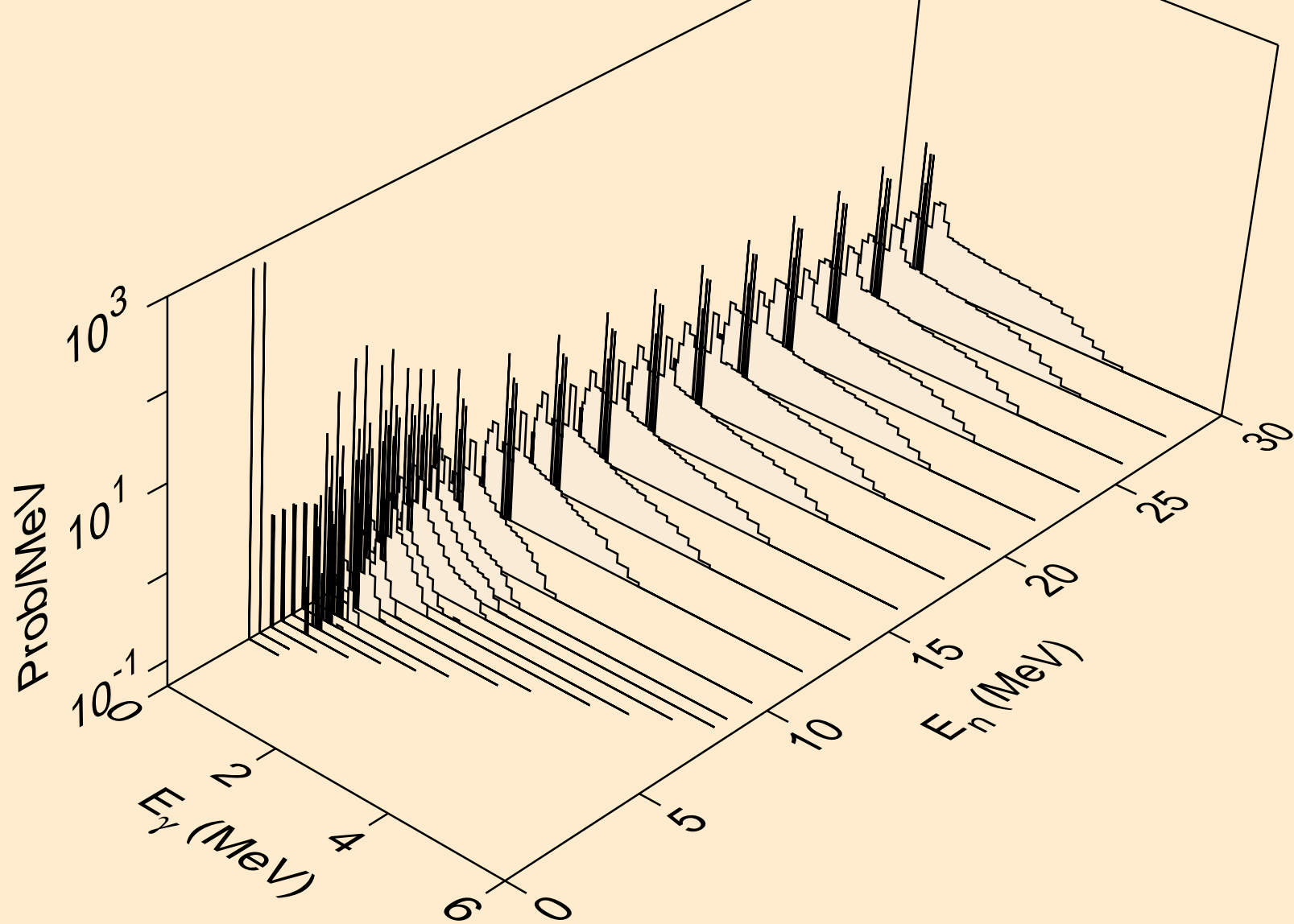

Y084 NEUTRON ACER TENDL-2024 LIBRARY; T=0.K
Photon emission for (n,t)

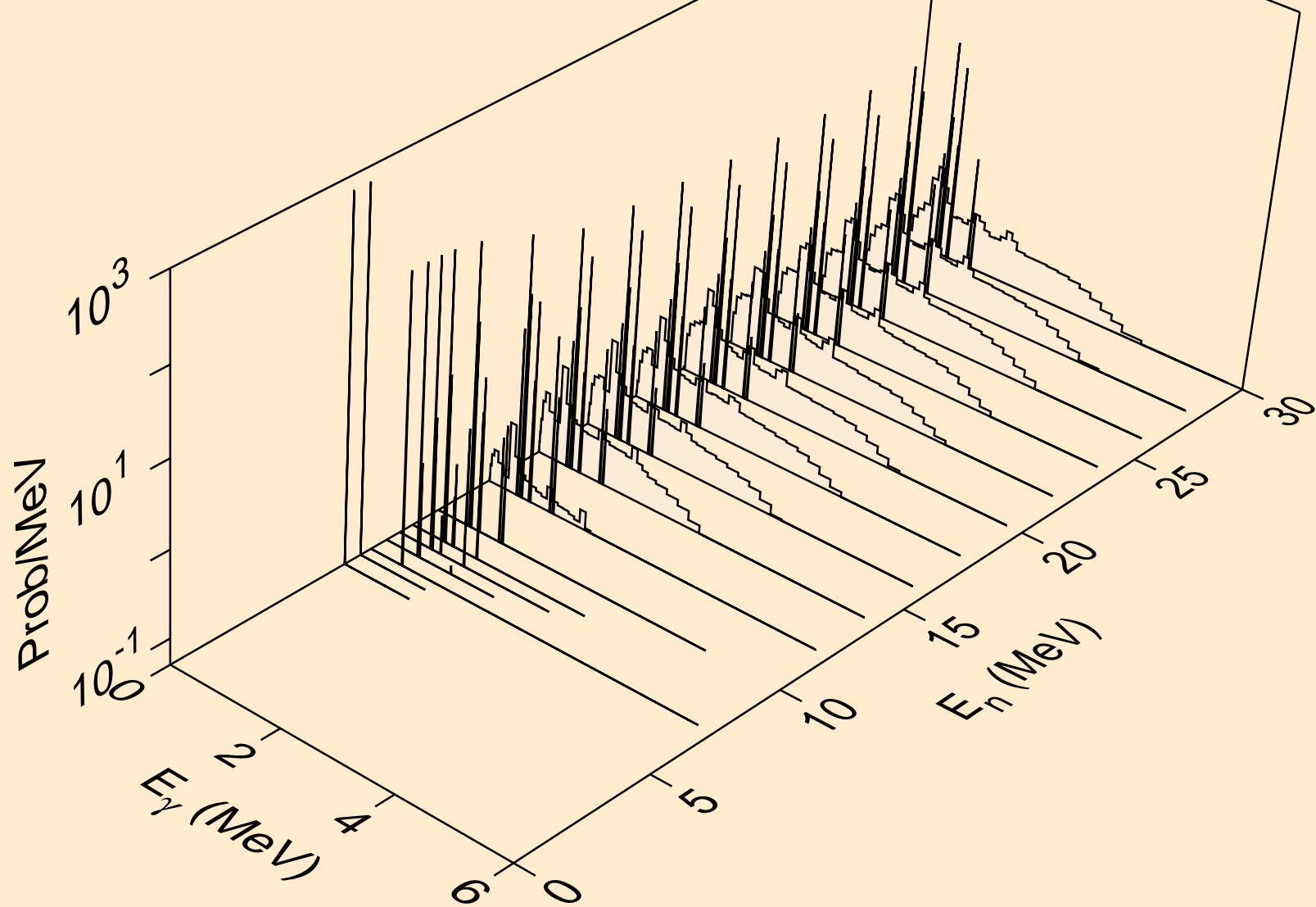

Y084 NEUTRON ACER TENDL-2024 LIBRARY; T=0.K
Photon emission for (n,he3)

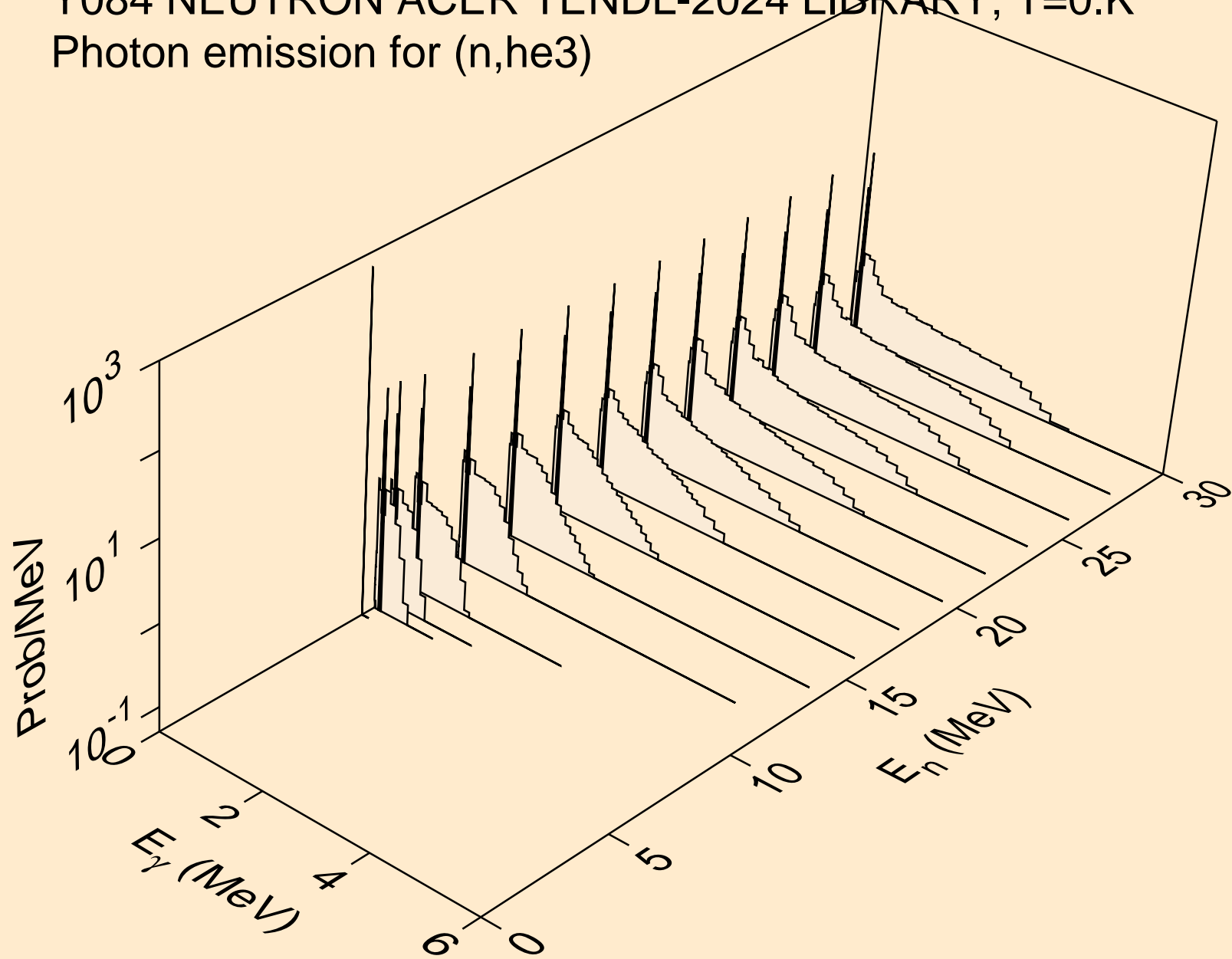

Y084 NEUTRON ACER TENDL-2024 LIBRARY; T=0.K
Photon emission for (n,a)

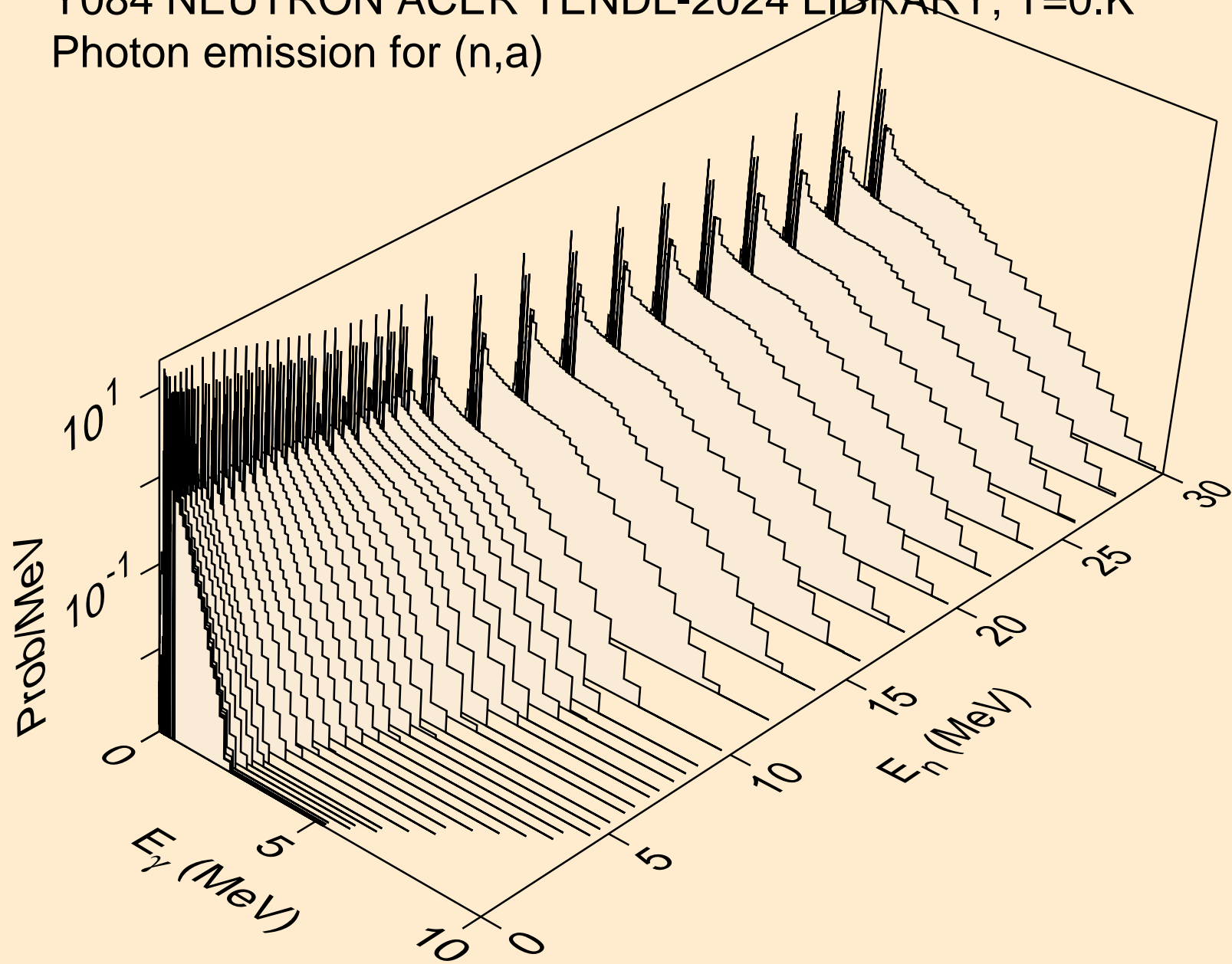

Y084 NEUTRON ACER TENDL-2024 LIBRARY; T=0.K
Photon emission for (n,2a)

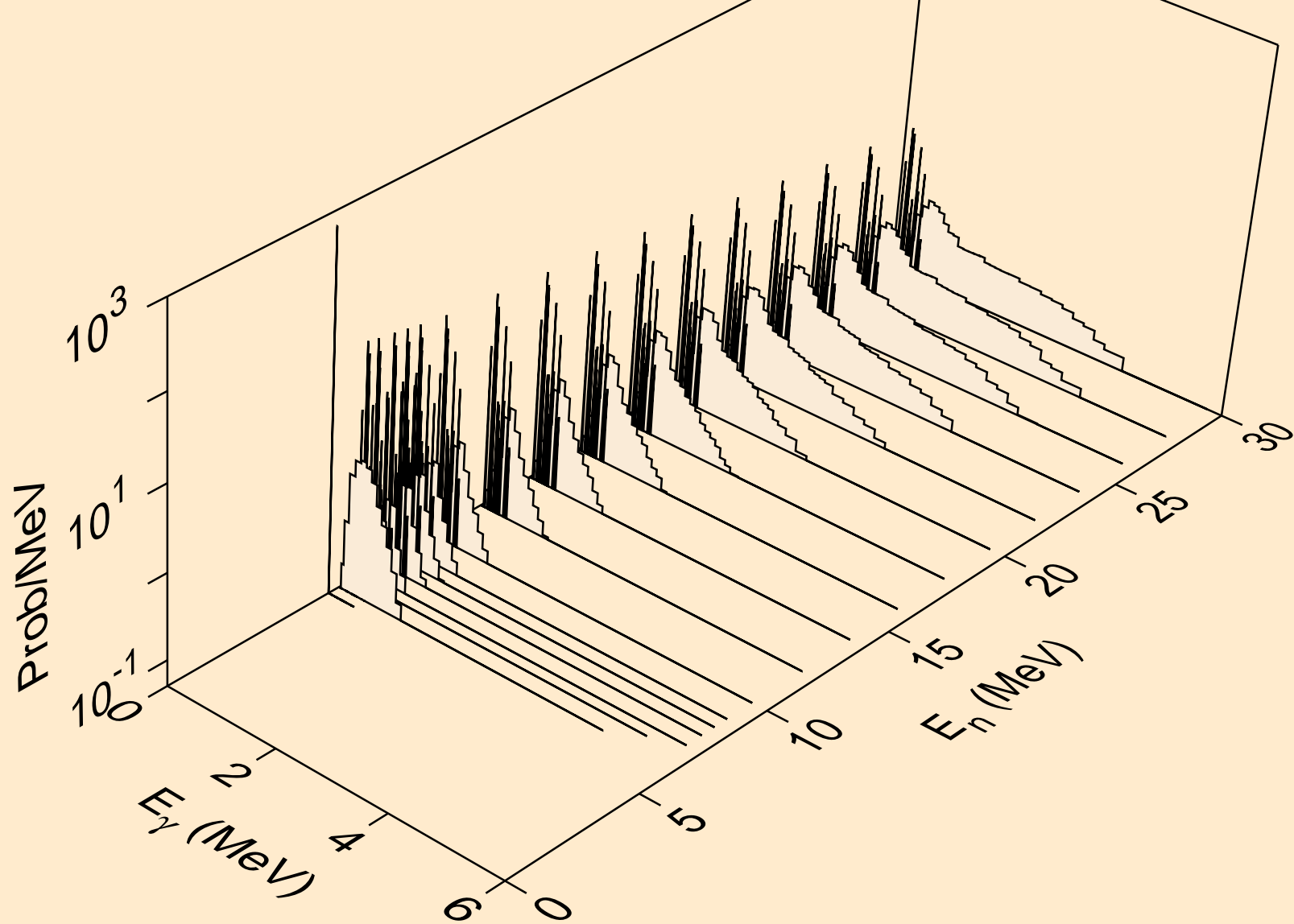

Y084 NEUTRON ACER TENDL-2024 LIBRARY; T=0.K
Photon emission for (n,3a)

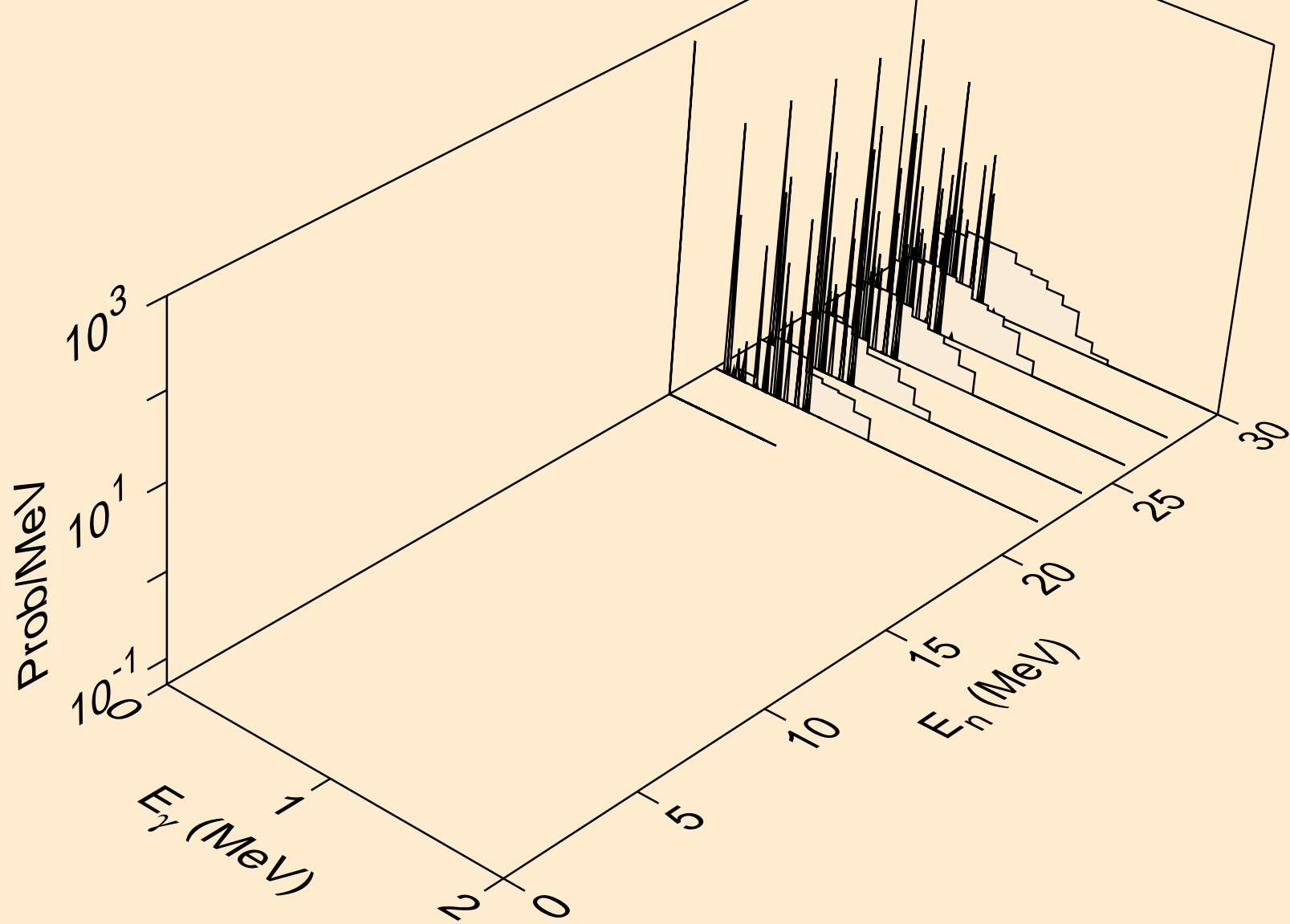

Y084 NEUTRON ACER TENDL-2024 LIBRARY; T=0.K
Photon emission for (n,2p)

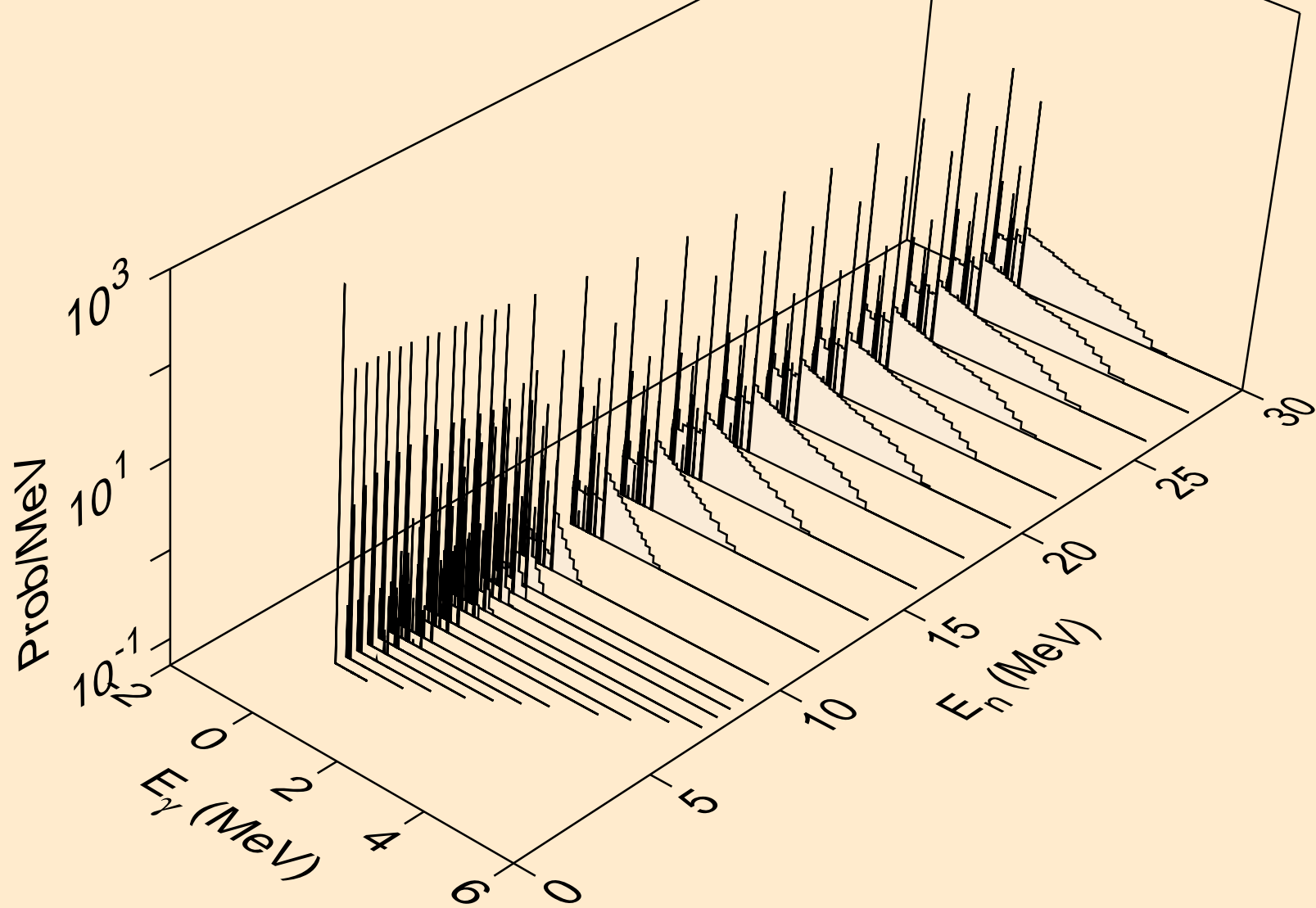

Y084 NEUTRON ACER TENDL-2024 LIBRARY; T=0.K
Photon emission for (n,p)

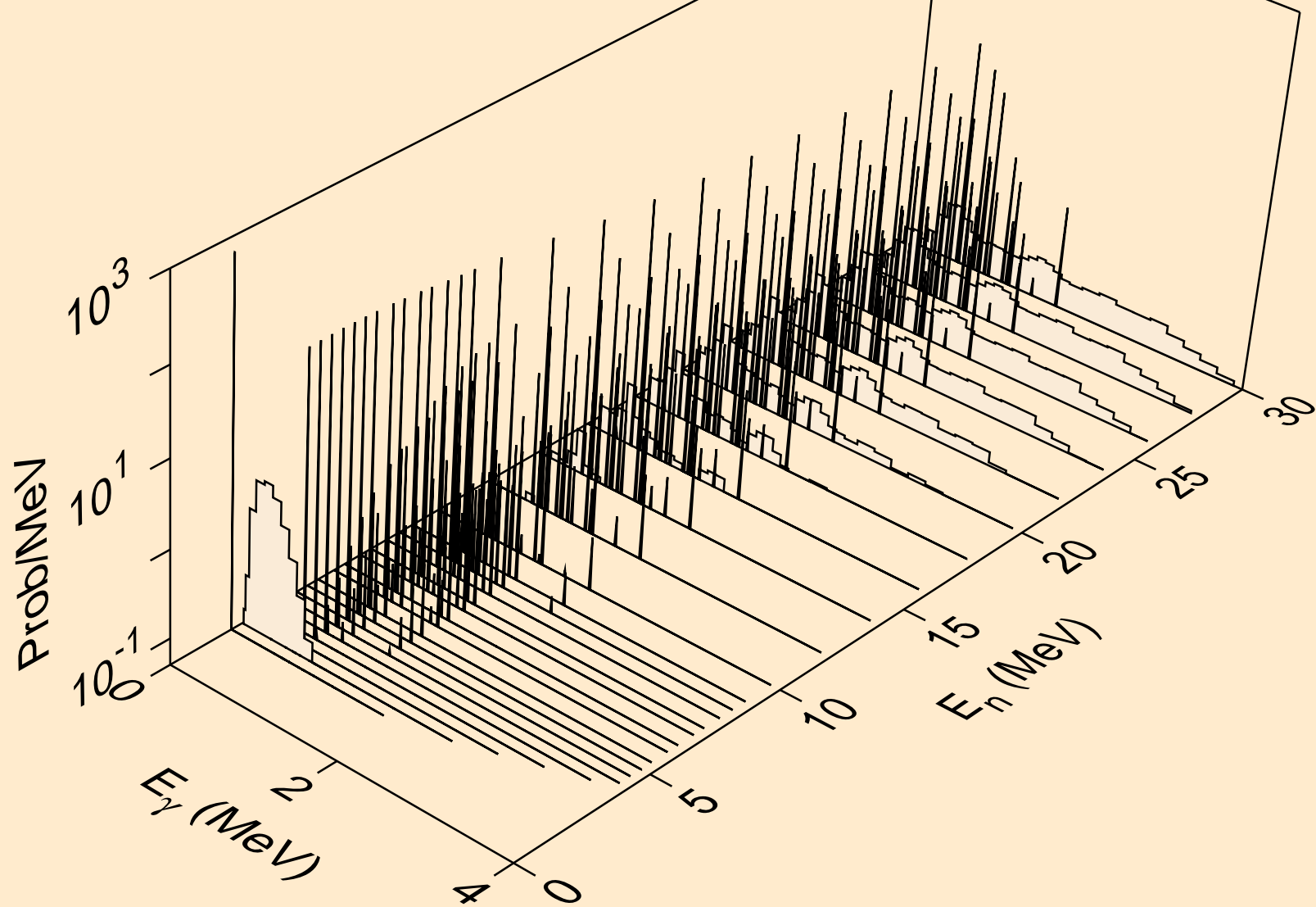

Y084 NEUTRON ACER TENDL-2024 LIBRARY; T=0.K
Photon emission for (n,pd)

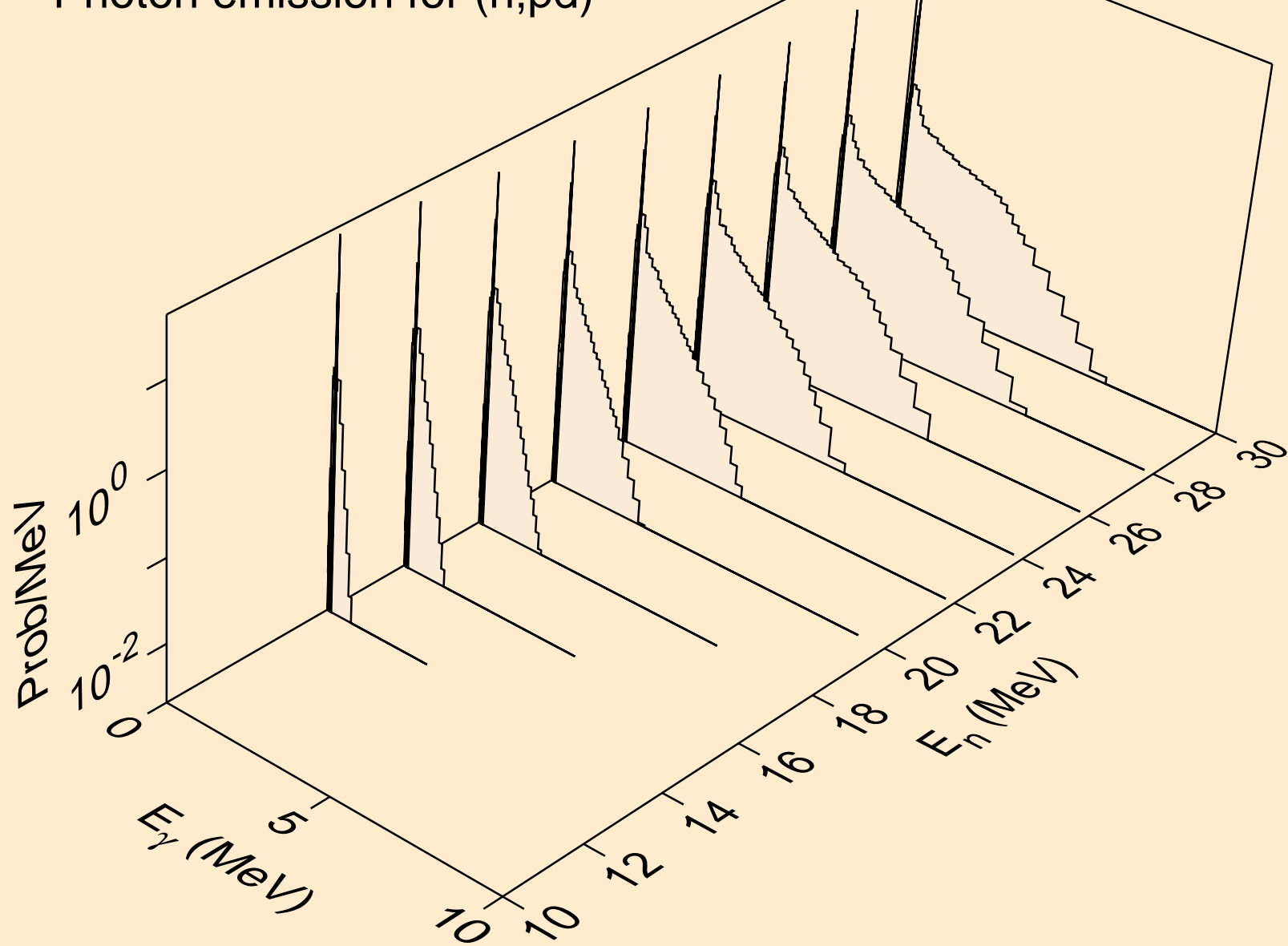

Y084 NEUTRON ACER TENDL-2024 LIBRARY; T=0.K
Photon emission for (n,pt)

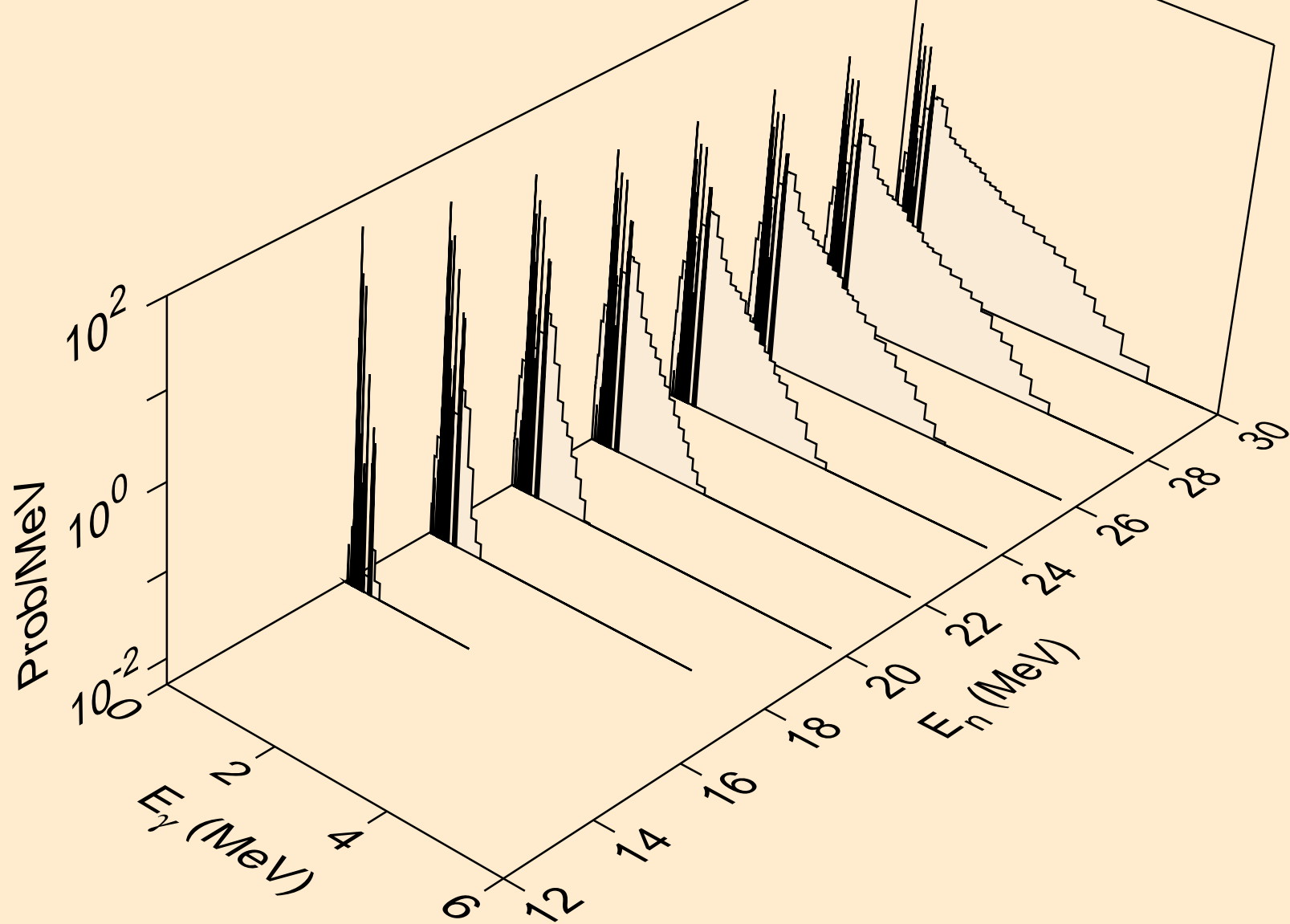

Y084 NEUTRON ACER TENDL-2024 LIBRARY; T=0.K
Photon emission for (n,da)

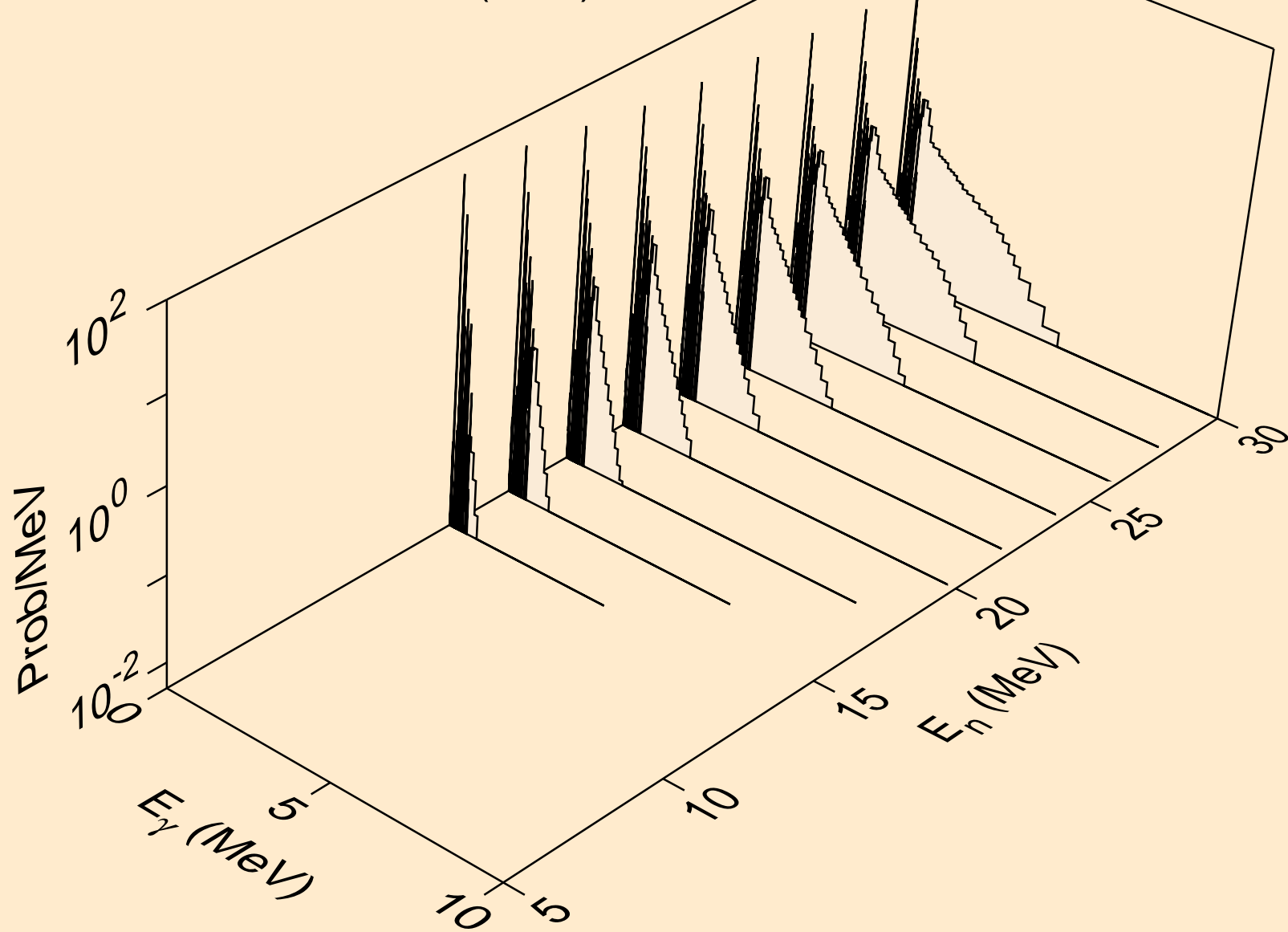

Y084 NEUTRON ACER TENDL-2024 LIBRARY; T=0.K
thermal capture photon spectrum

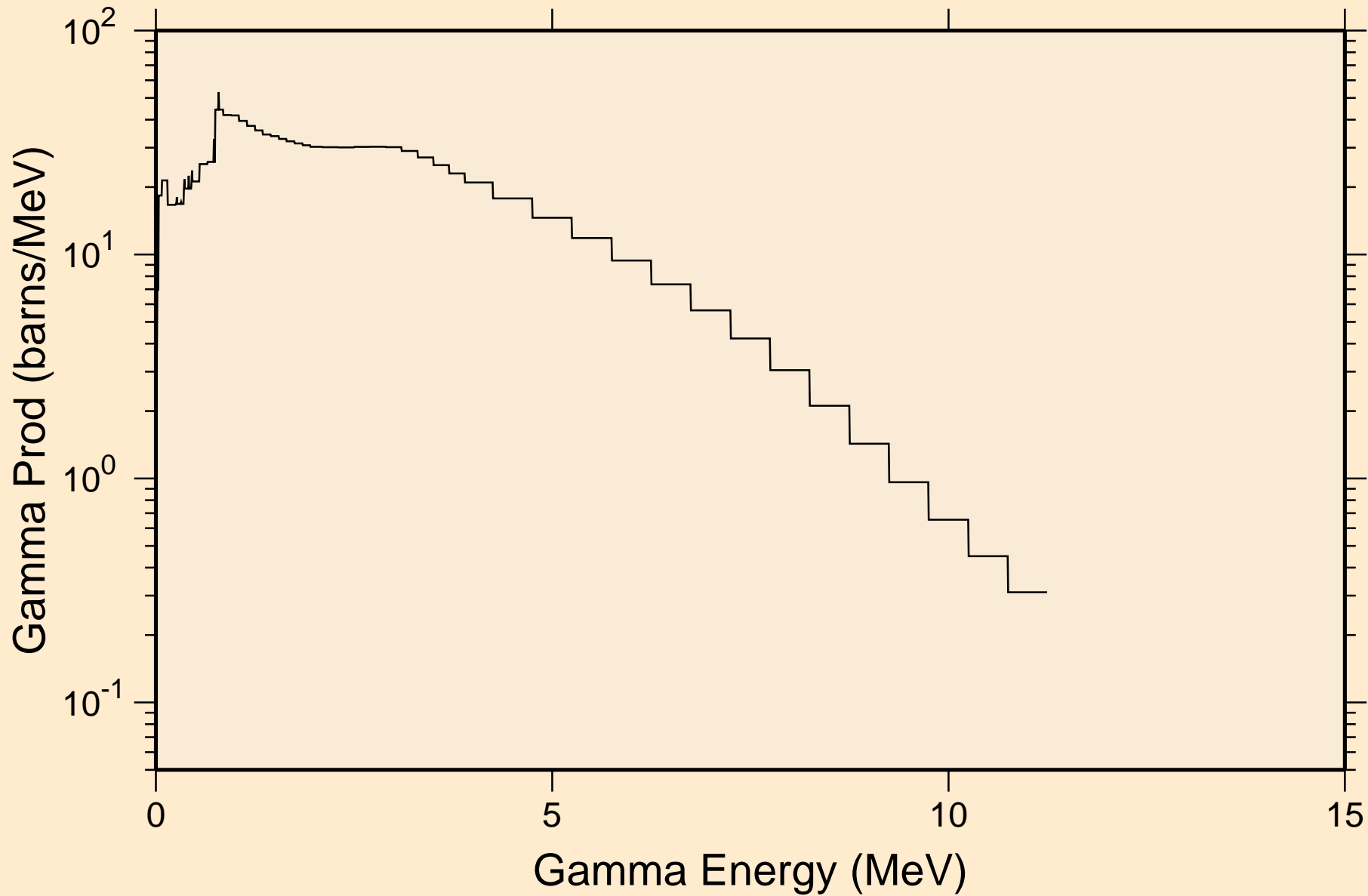

Y084 NEUTRON ACER TENDL-2024 LIBRARY; T=0.K
14 MeV photon spectrum

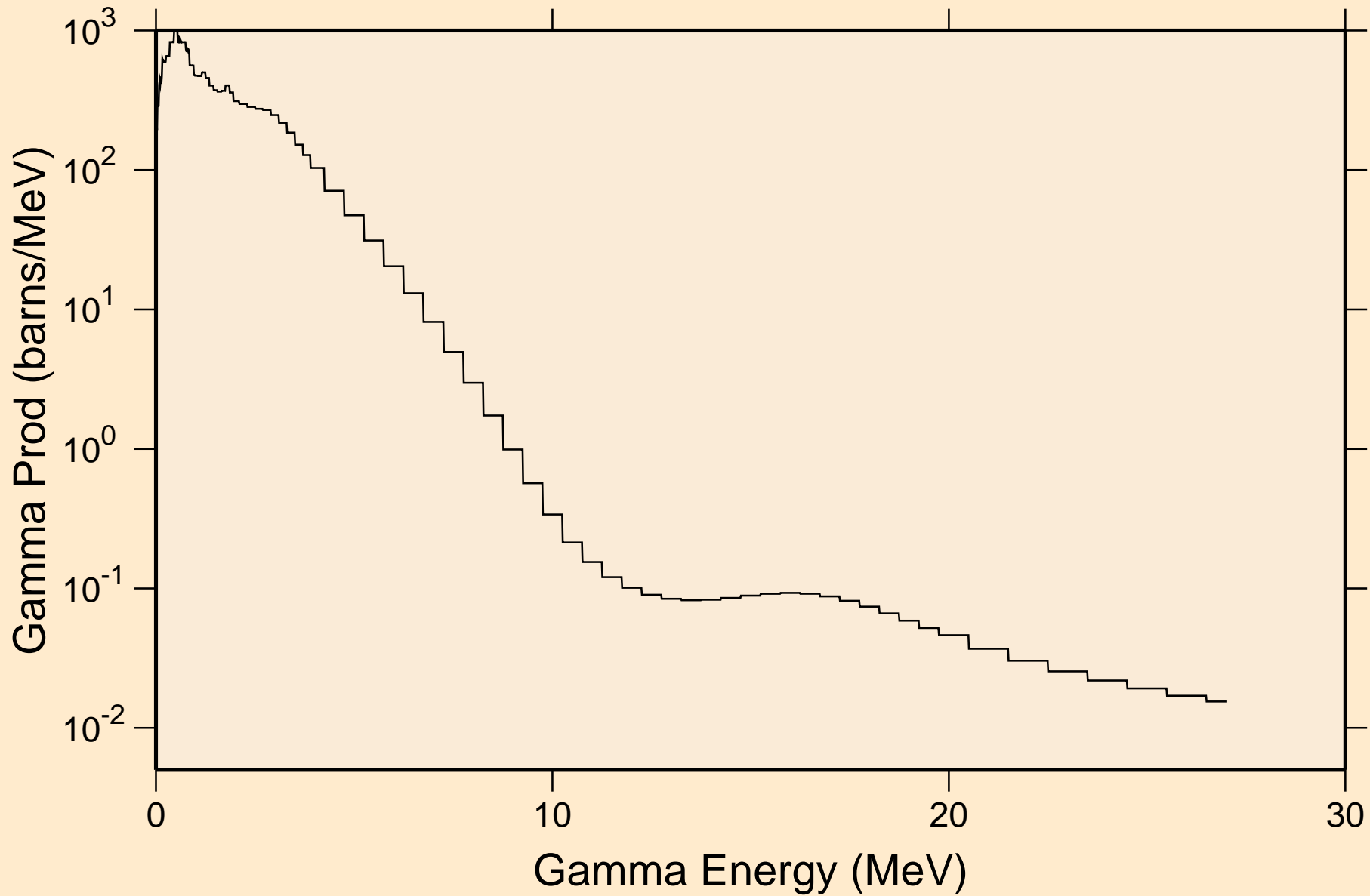

Y084 NEUTRON ACER TENDL-2024 LIBRARY; T=0.K

Particle heating contributions

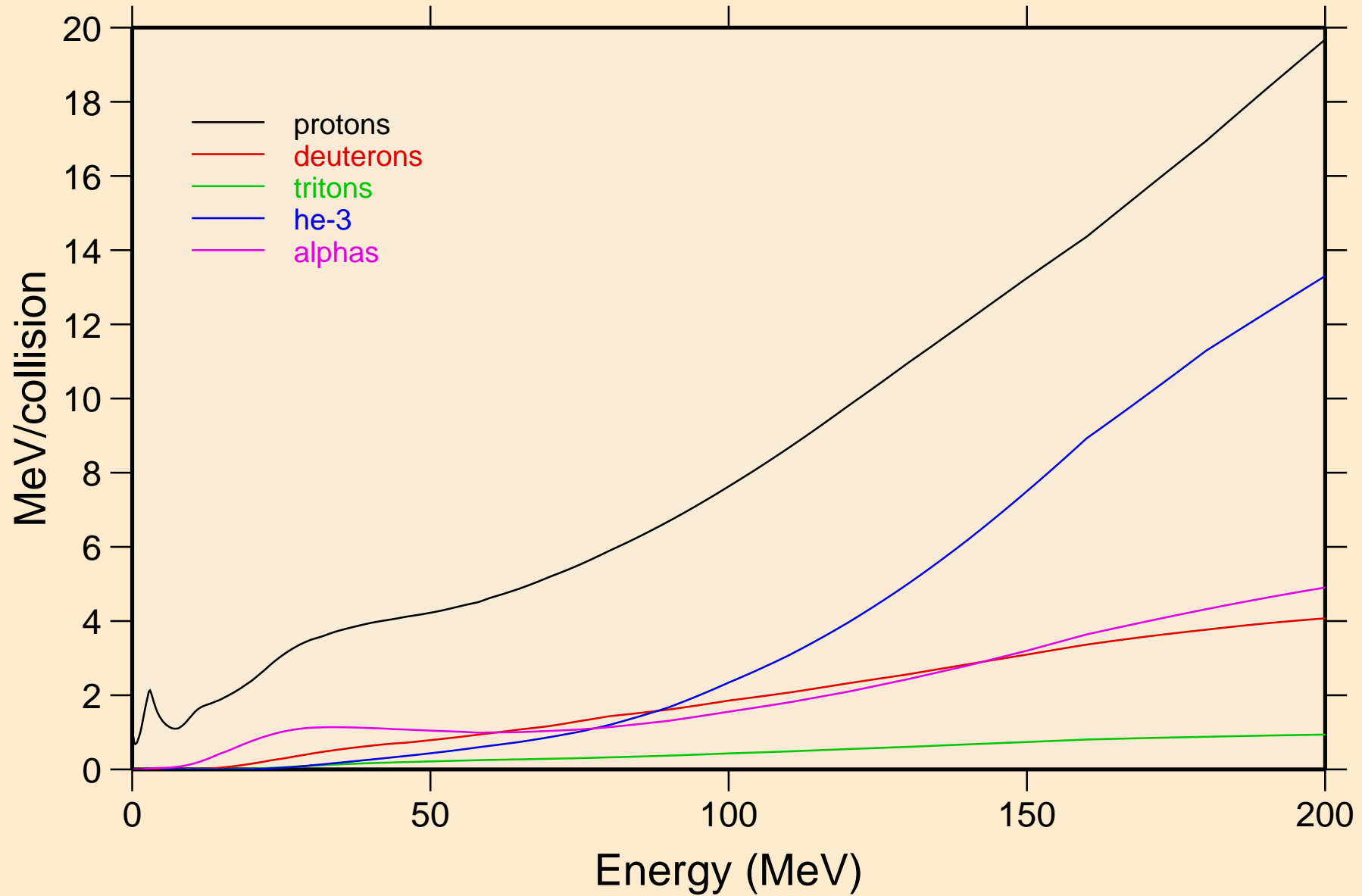

Y084 NEUTRON ACER TENDL-2024 LIBRARY; T=0.K
Recoil Heating

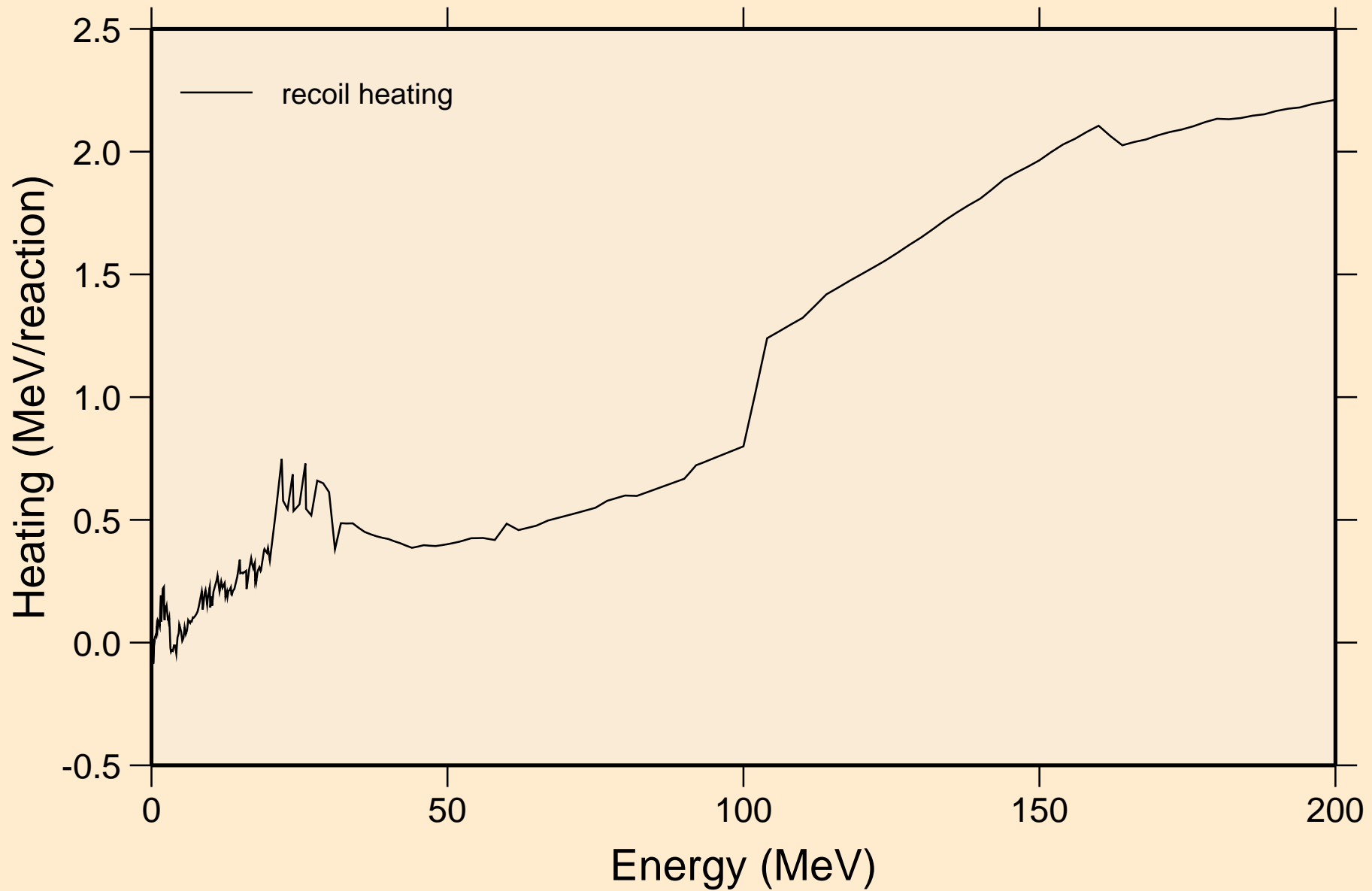

Y084 NEUTRON ACER TENDL-2024 LIBRARY; T=0.K

Particle production cross sections

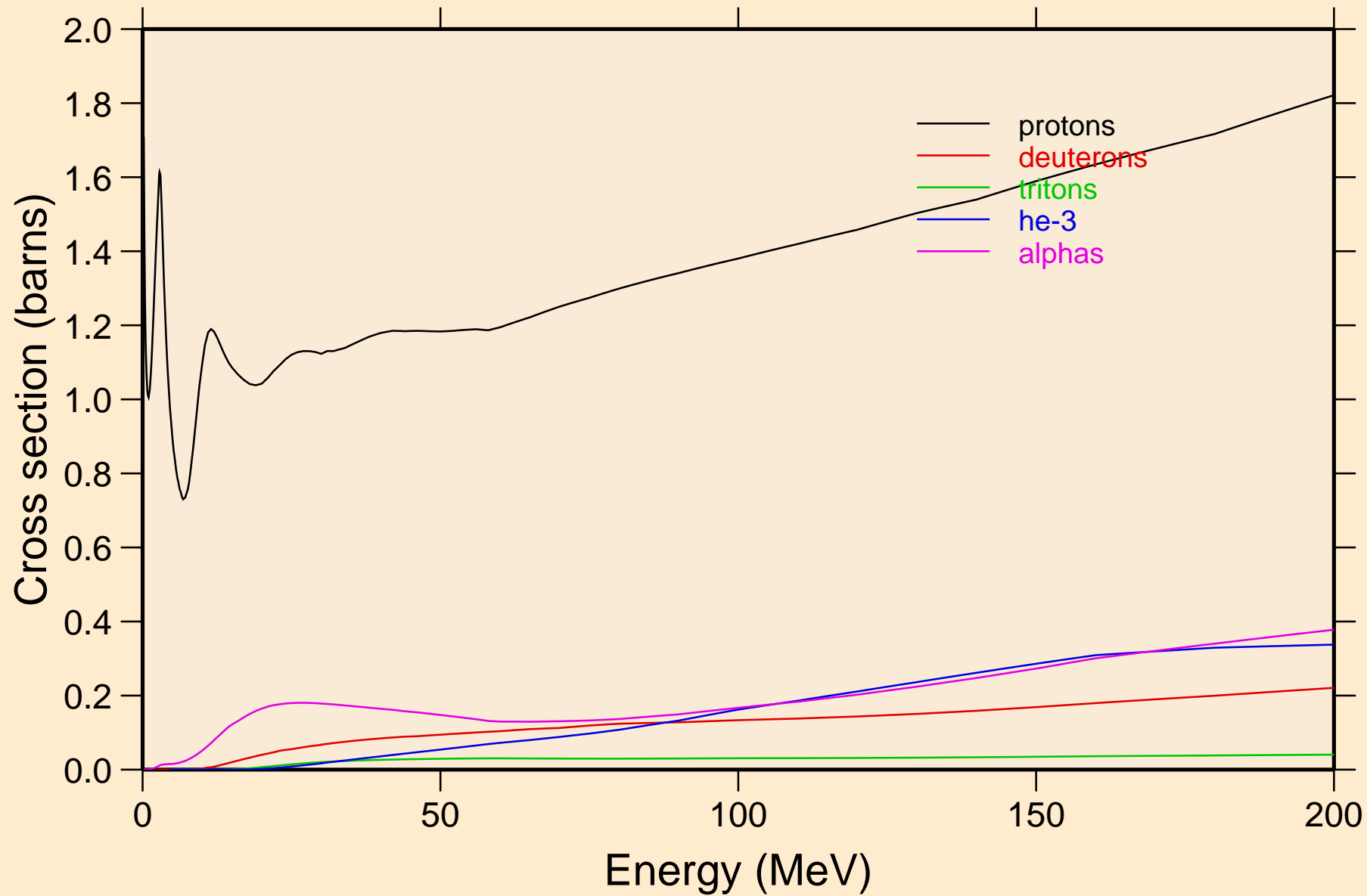

Y084 NEUTRON ACER TENDL-2024 LIBRARY; T=0.K
protons from (n,x)

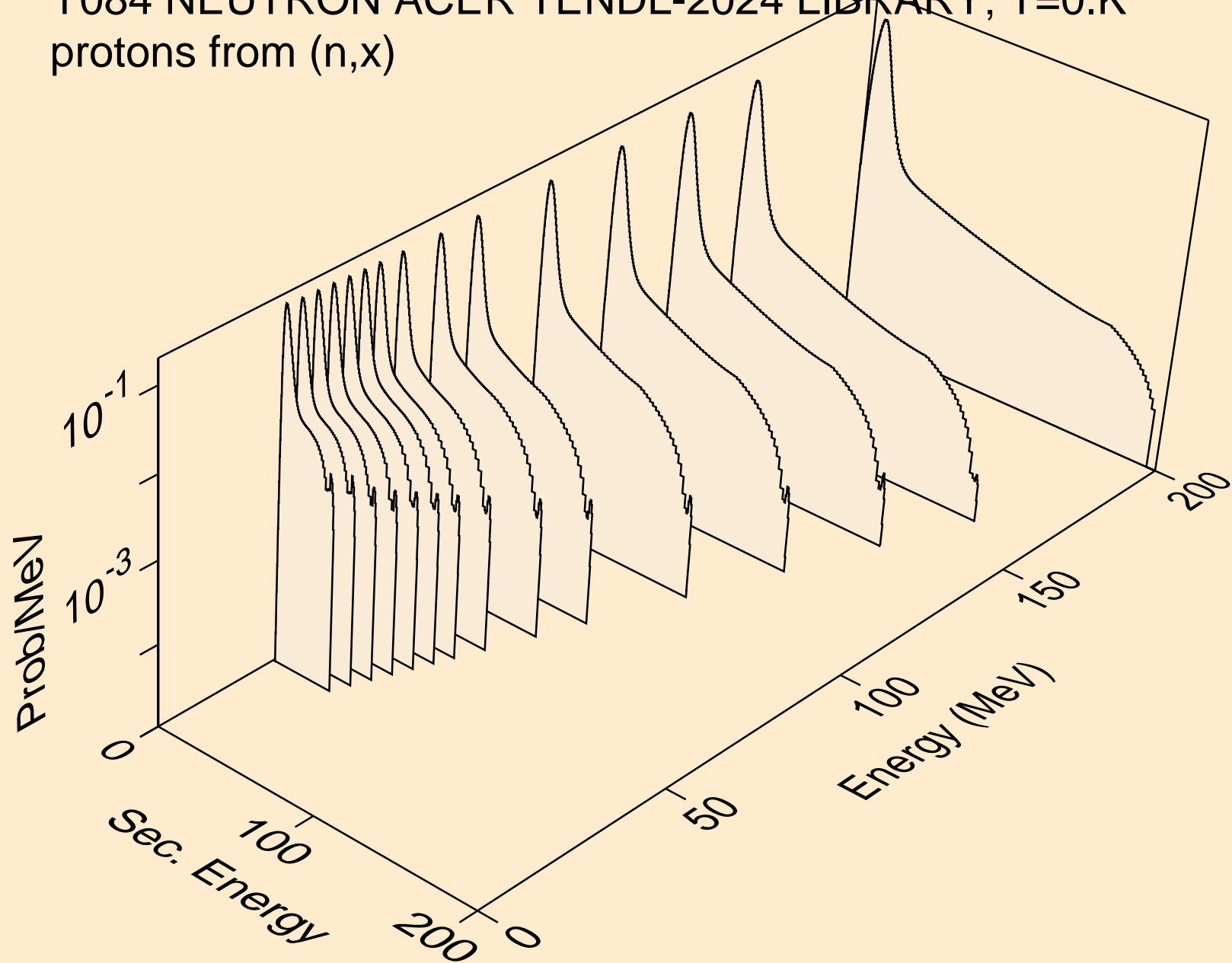

Y084 NEUTRON ACER TENDL-2024 LIBRARY; T=0.K
protons from (n,n*)p

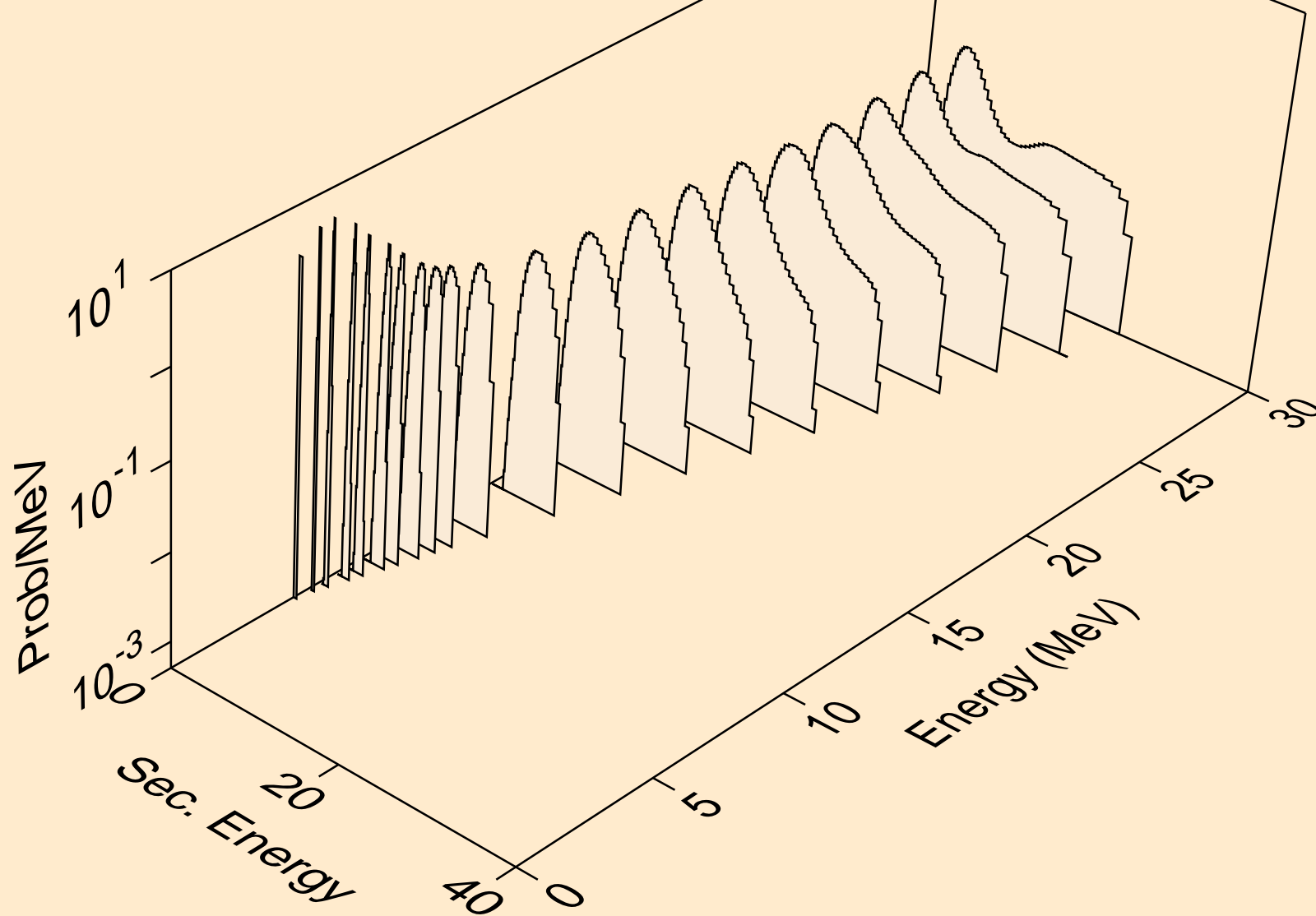

Y084 NEUTRON ACER TENDL-2024 LIBRARY; T=0.K
protons from (n,2np)

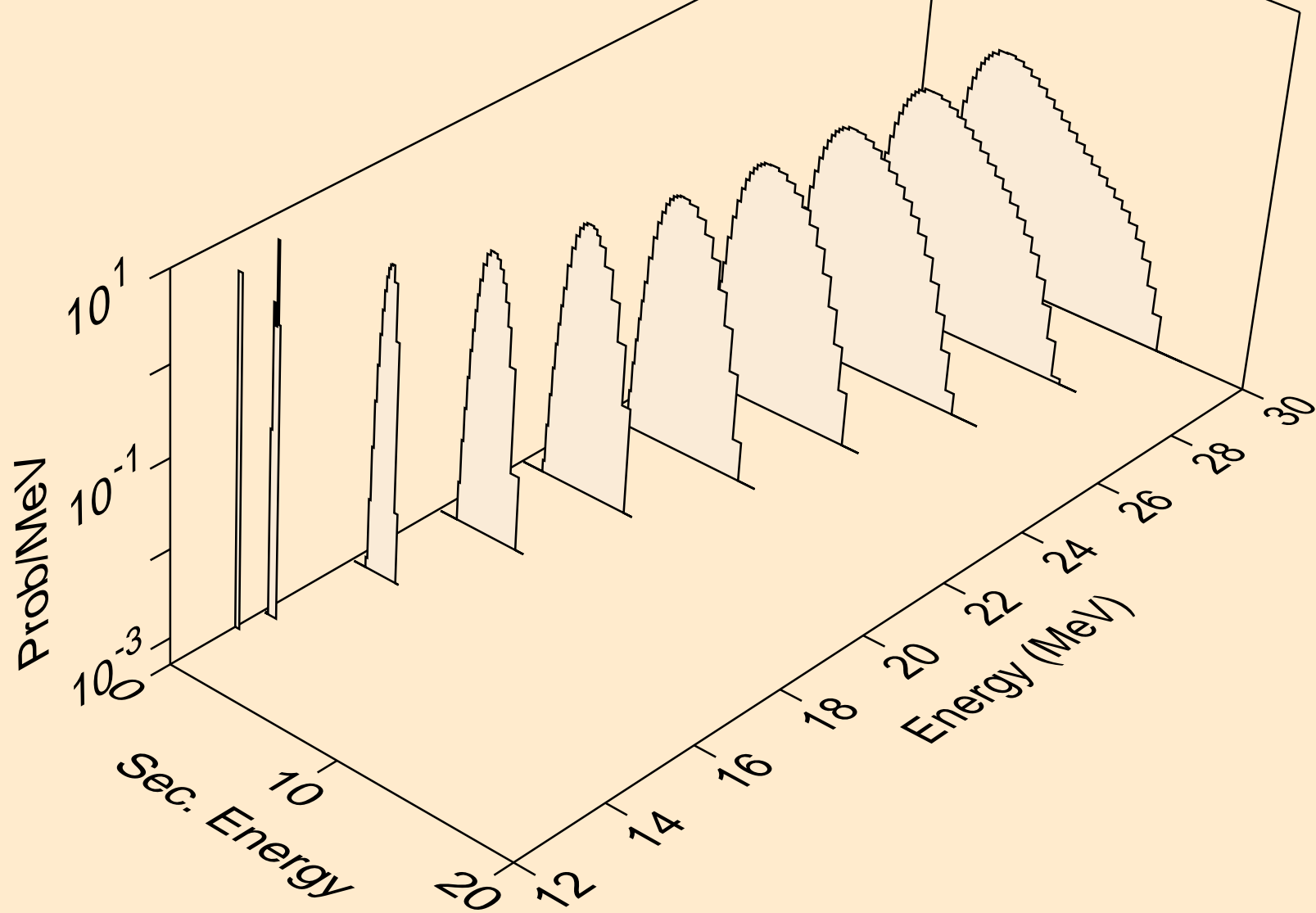

Y084 NEUTRON ACER TENDL-2024 LIBRARY; T=0.K
protons from (n,3np)

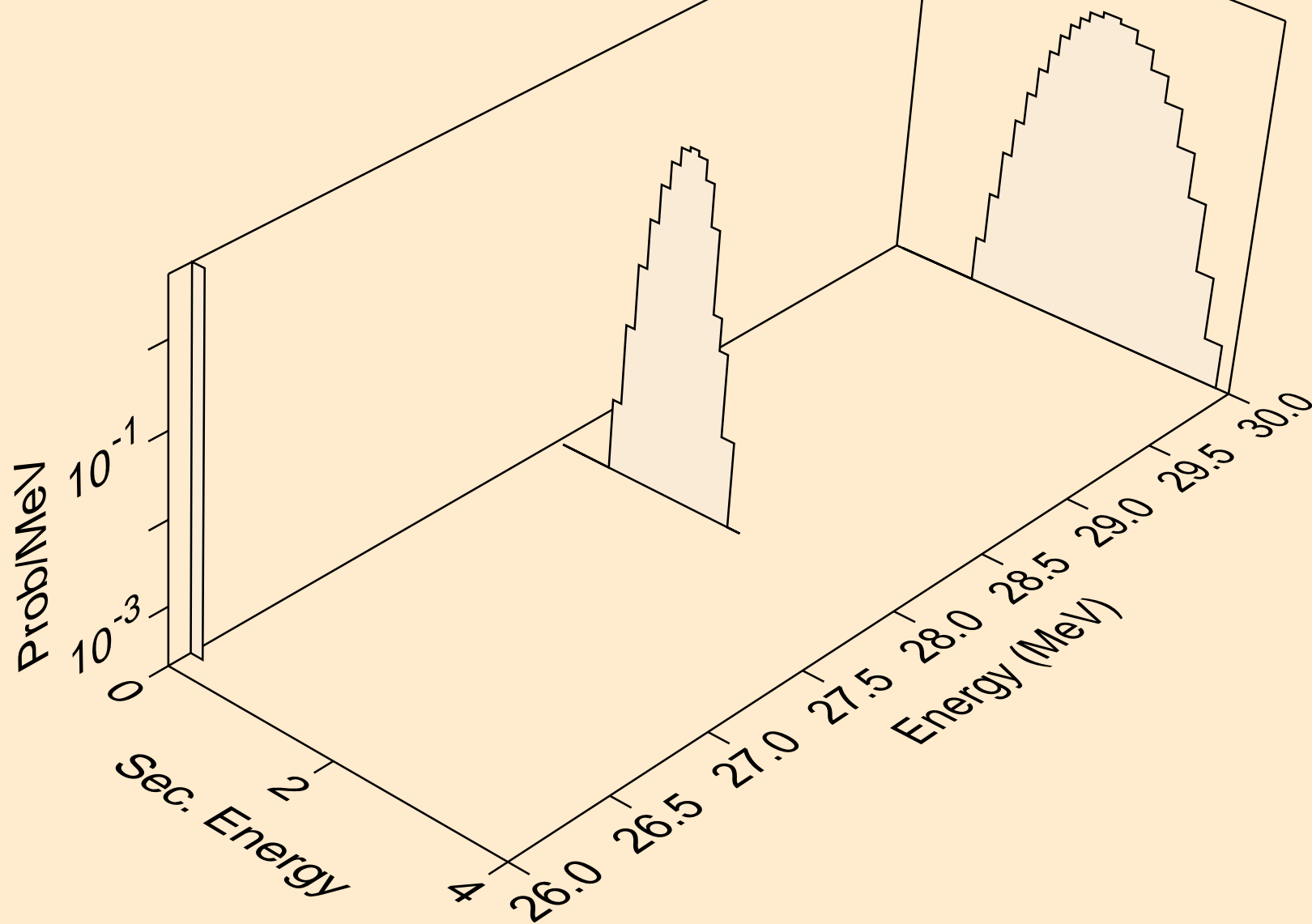

Y084 NEUTRON ACER TENDL-2024 LIBRARY; T=0.K
protons from (n,n2p)

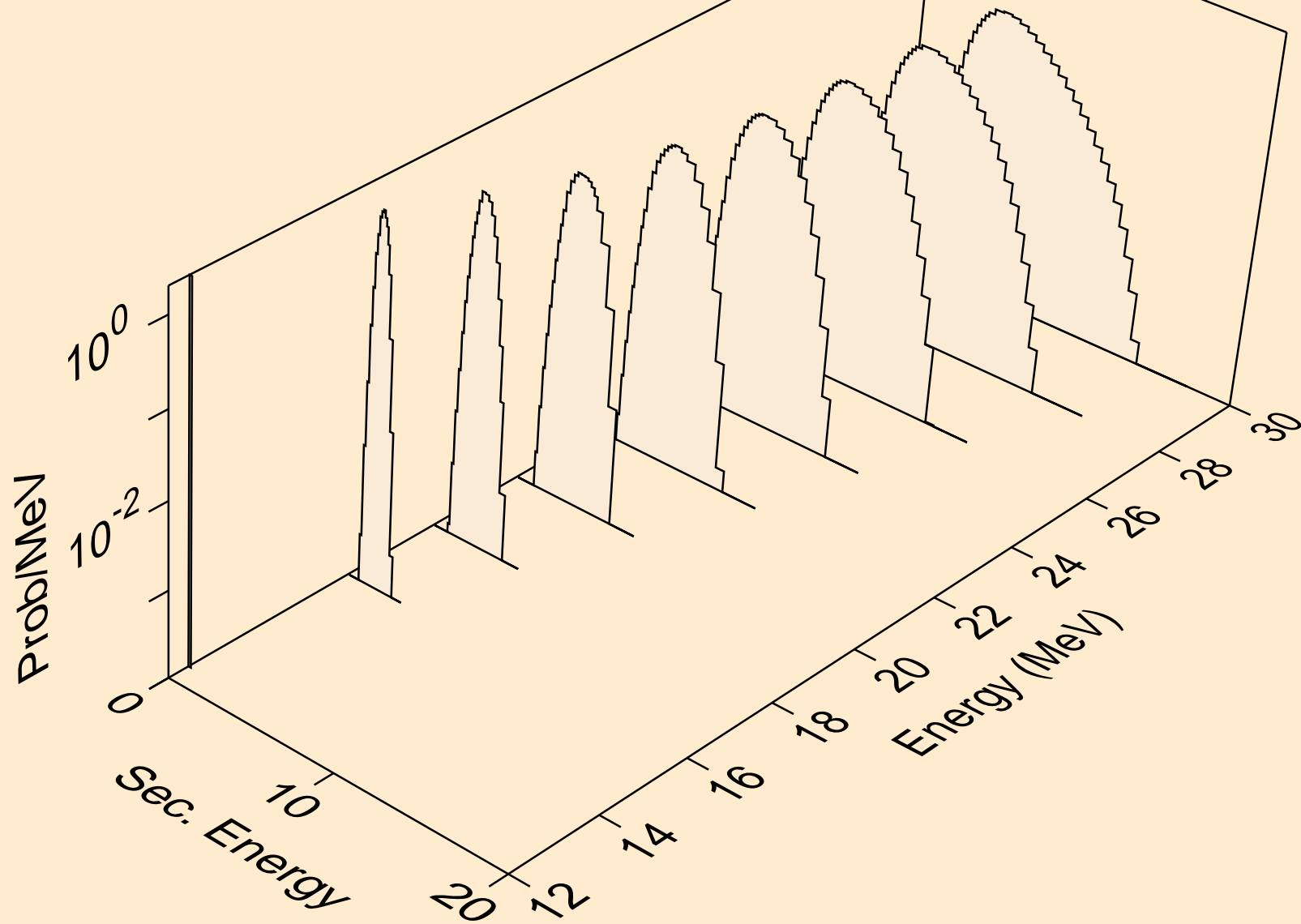

Y084 NEUTRON ACER TENDL-2024 LIBRARY; T=0.K
protons from (n,npa)

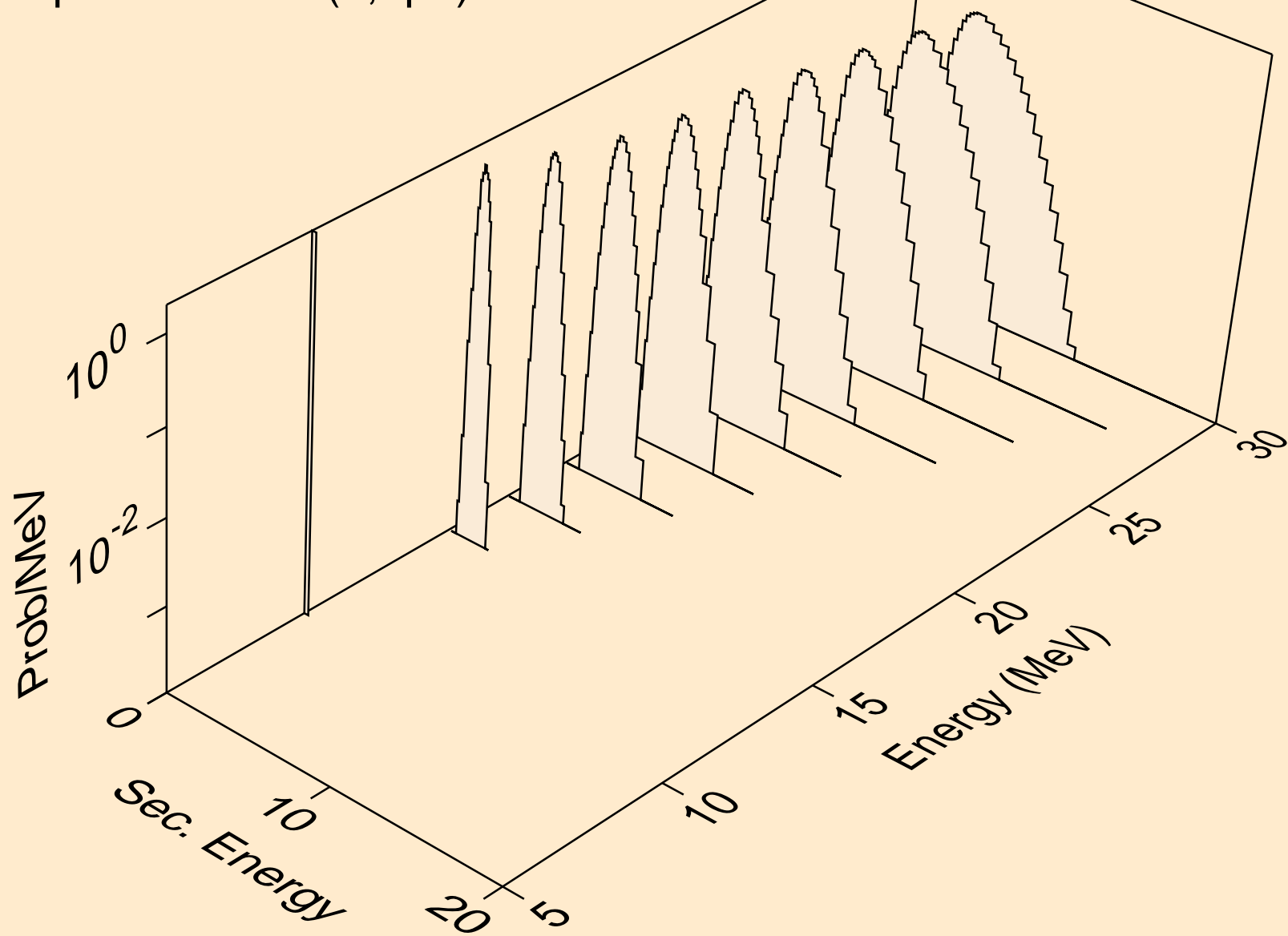

Y084 NEUTRON ACER TENDL-2024 LIBRARY; T=0.K
protons from (n,p)

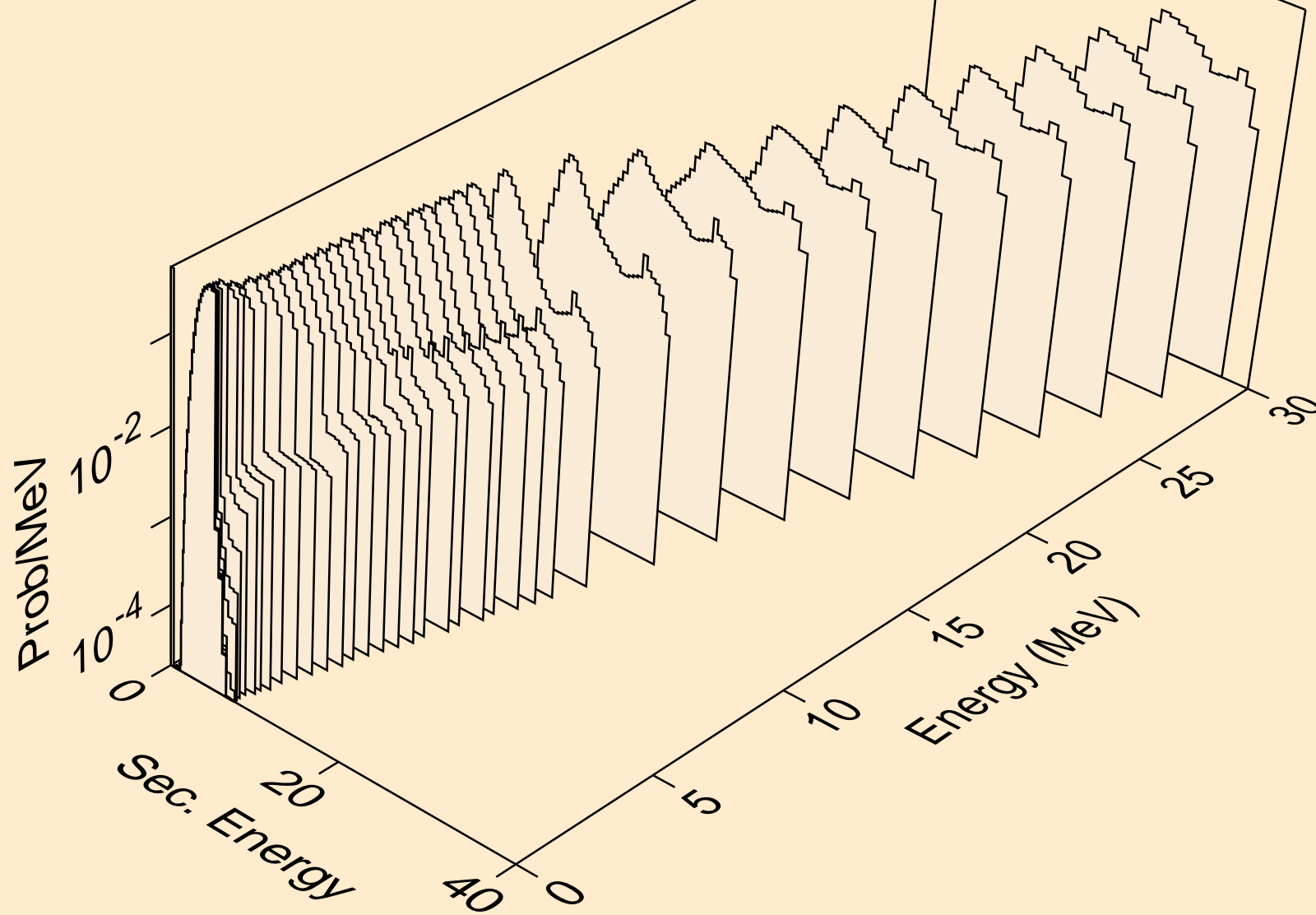

Y084 NEUTRON ACER TENDL-2024 LIBRARY; T=0.K
protons from (n,2p)

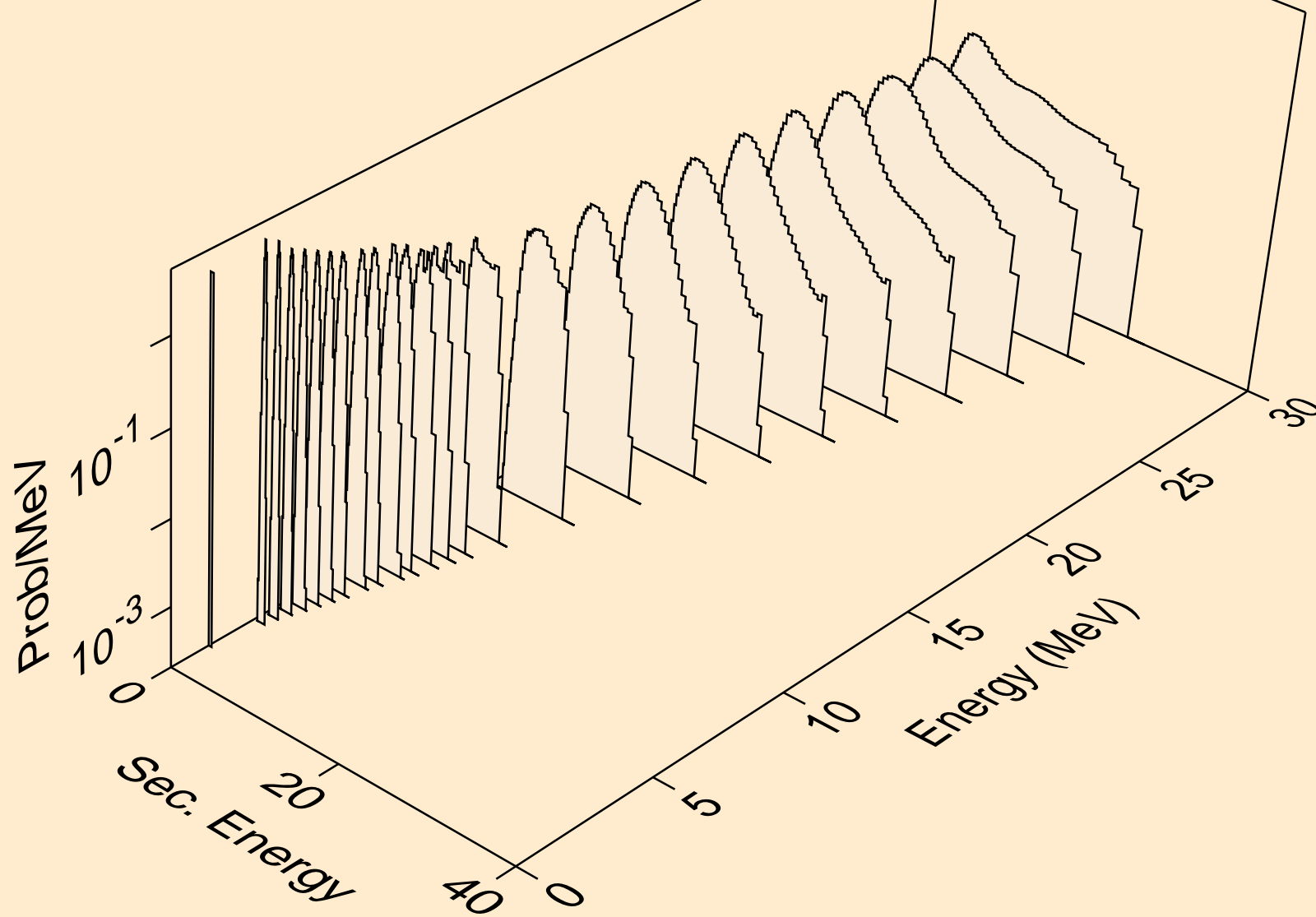

Y084 NEUTRON ACER TENDL-2024 LIBRARY; T=0.K
protons from (n,p)

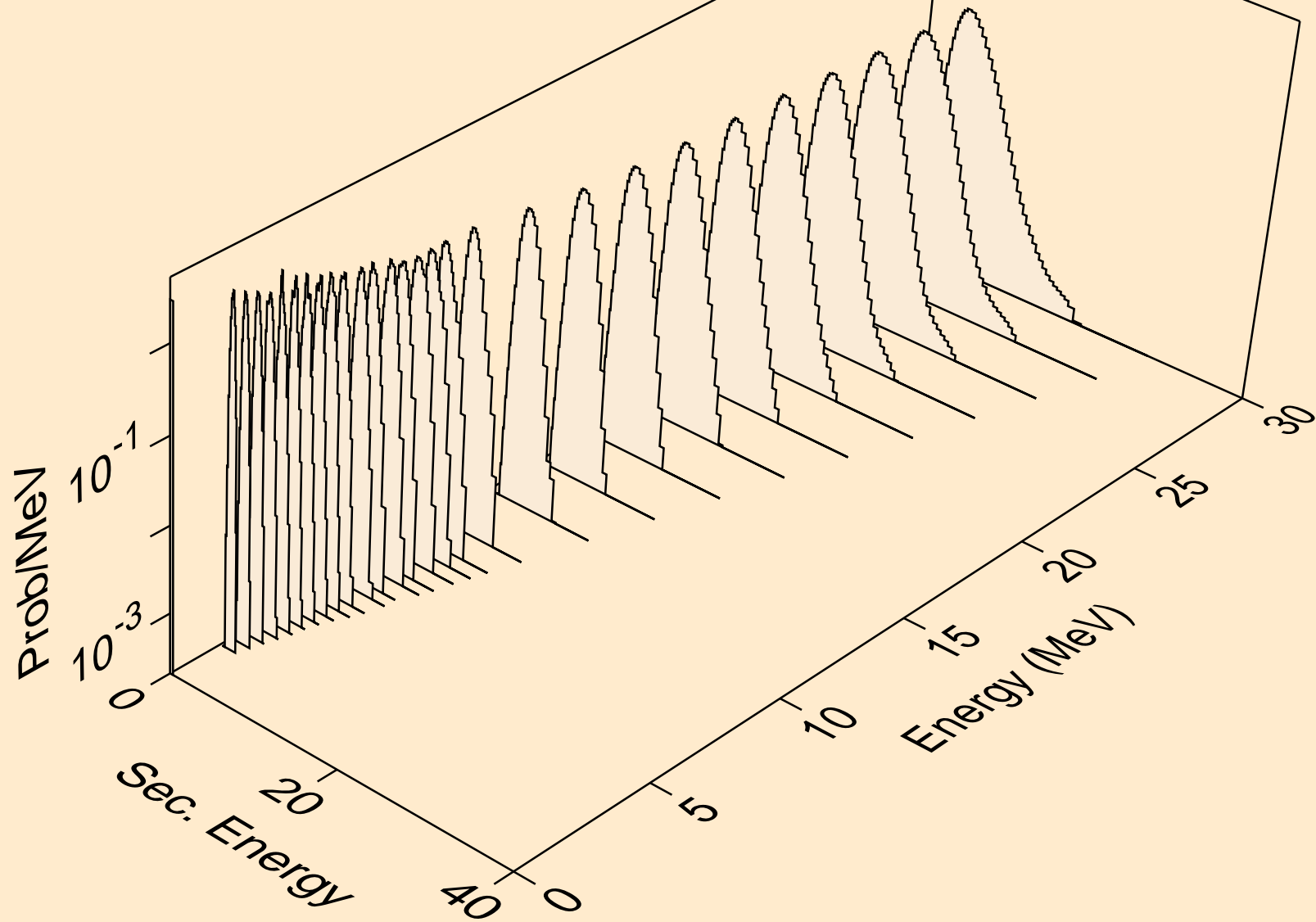

Y084 NEUTRON ACER TENDL-2024 LIBRARY; T=0.K
protons from (n,pd)

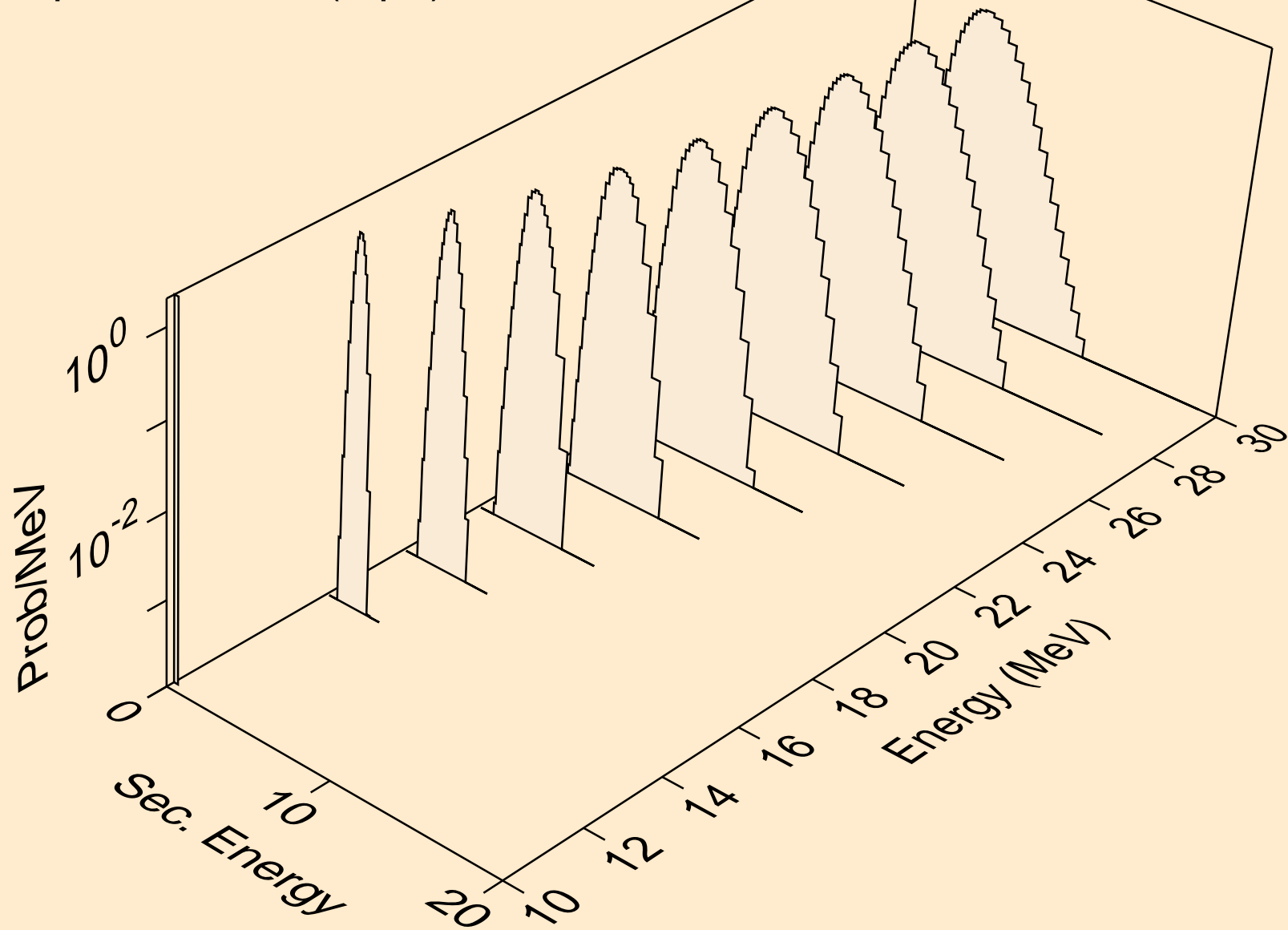

Y084 NEUTRON ACER TENDL-2024 LIBRARY; T=0.K
protons from (n,pt)

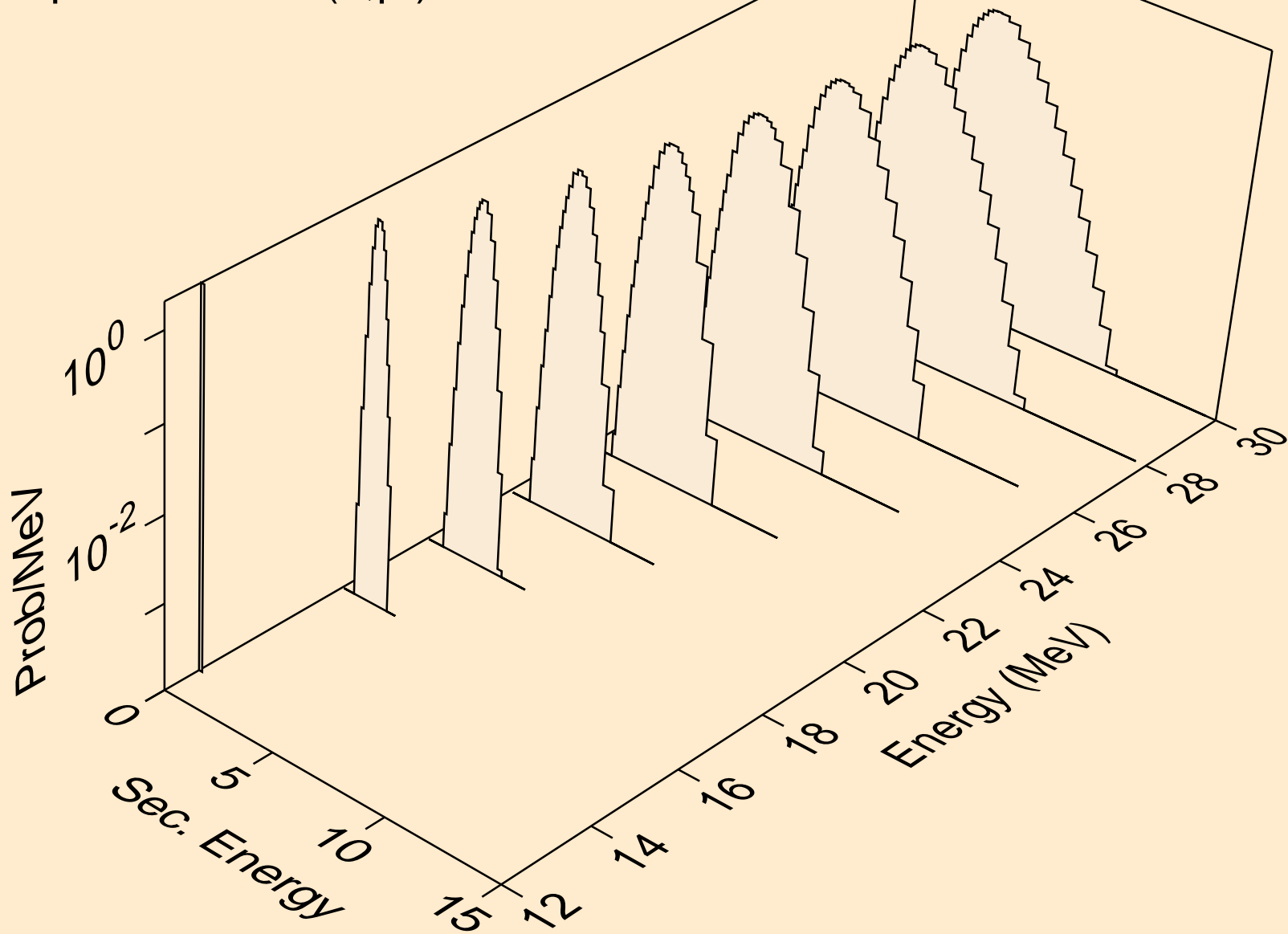

Y084 NEUTRON ACER TENDL-2024 LIBRARY; T=0.K
deuterons from (n,x)

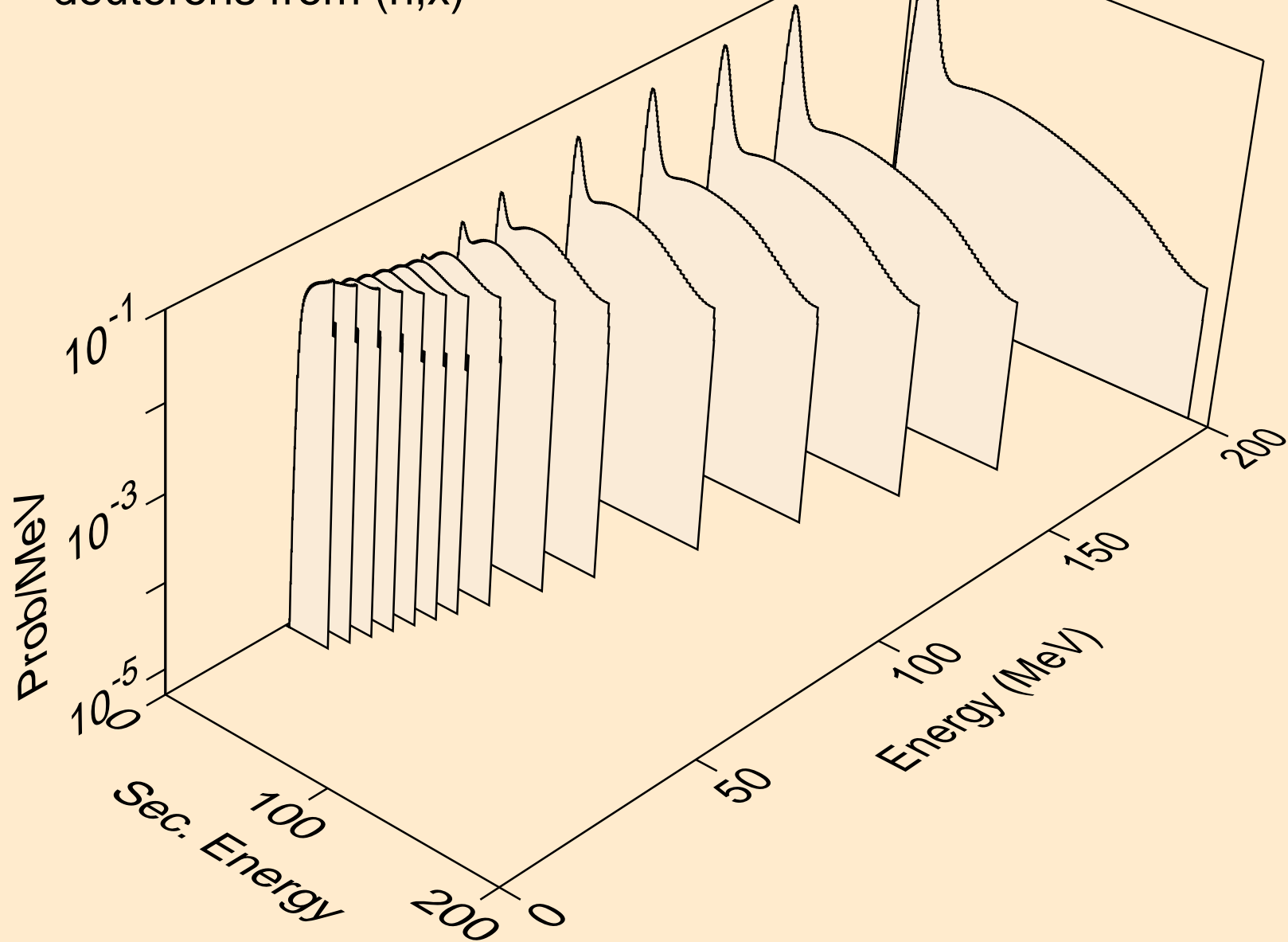

Y084 NEUTRON ACER TENDL-2024 LIBRARY; T=0.K
deuterons from (n,2nd)

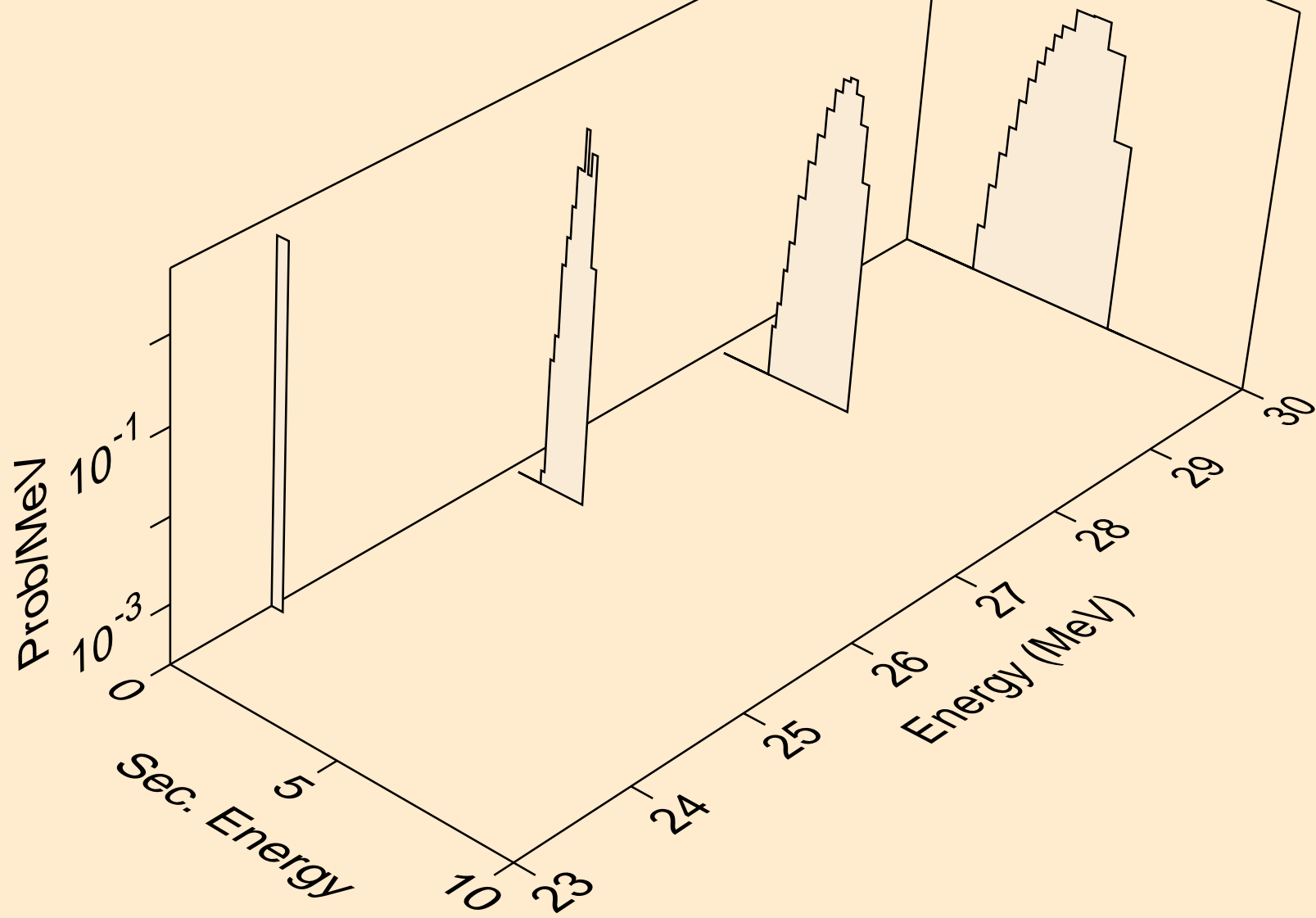

Y084 NEUTRON ACER TENDL-2024 LIBRARY; T=0.K
deuterons from (n,n*)d

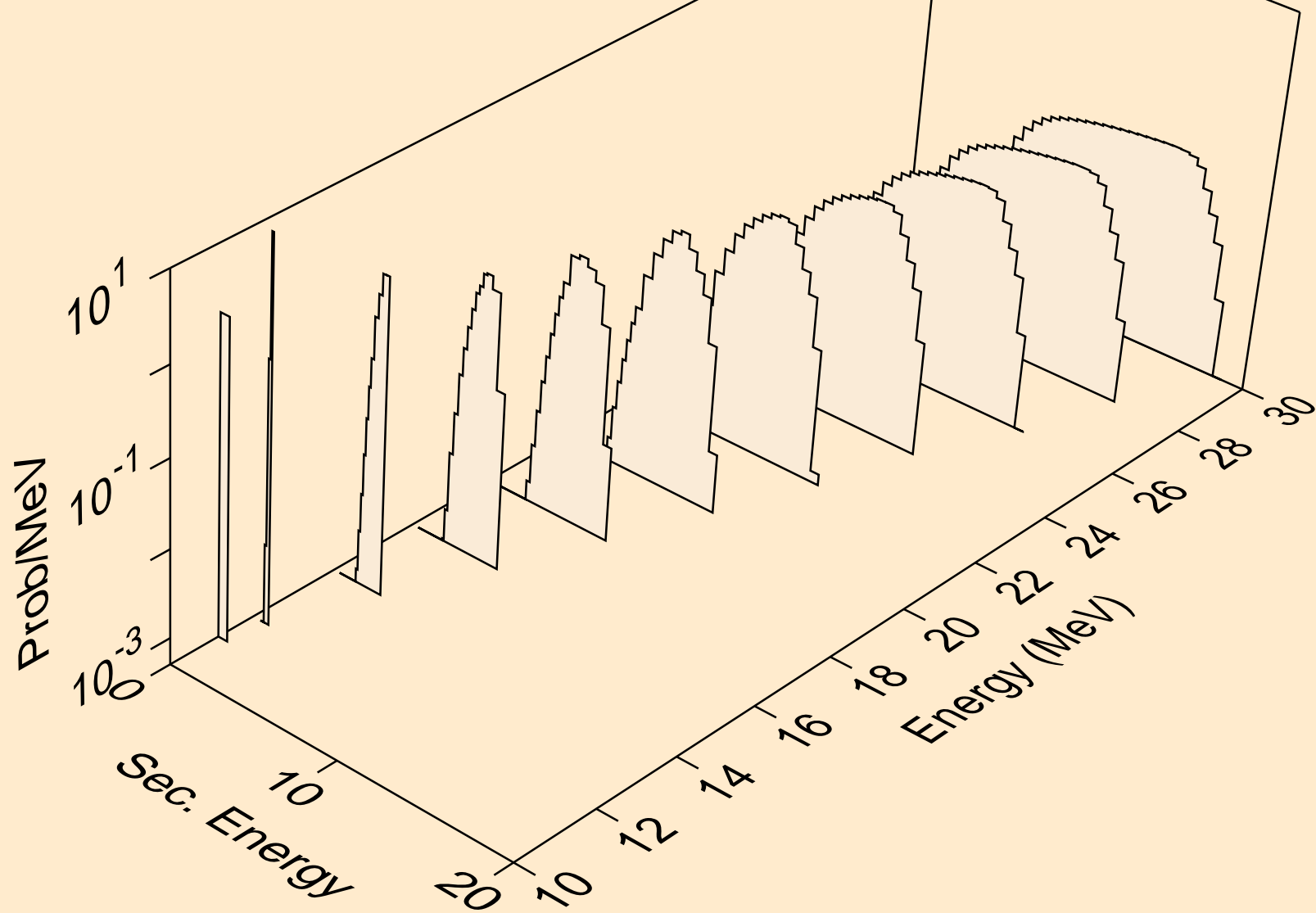

Y084 NEUTRON ACER TENDL-2024 LIBRARY; T=0.K
deuterons from (n,d)

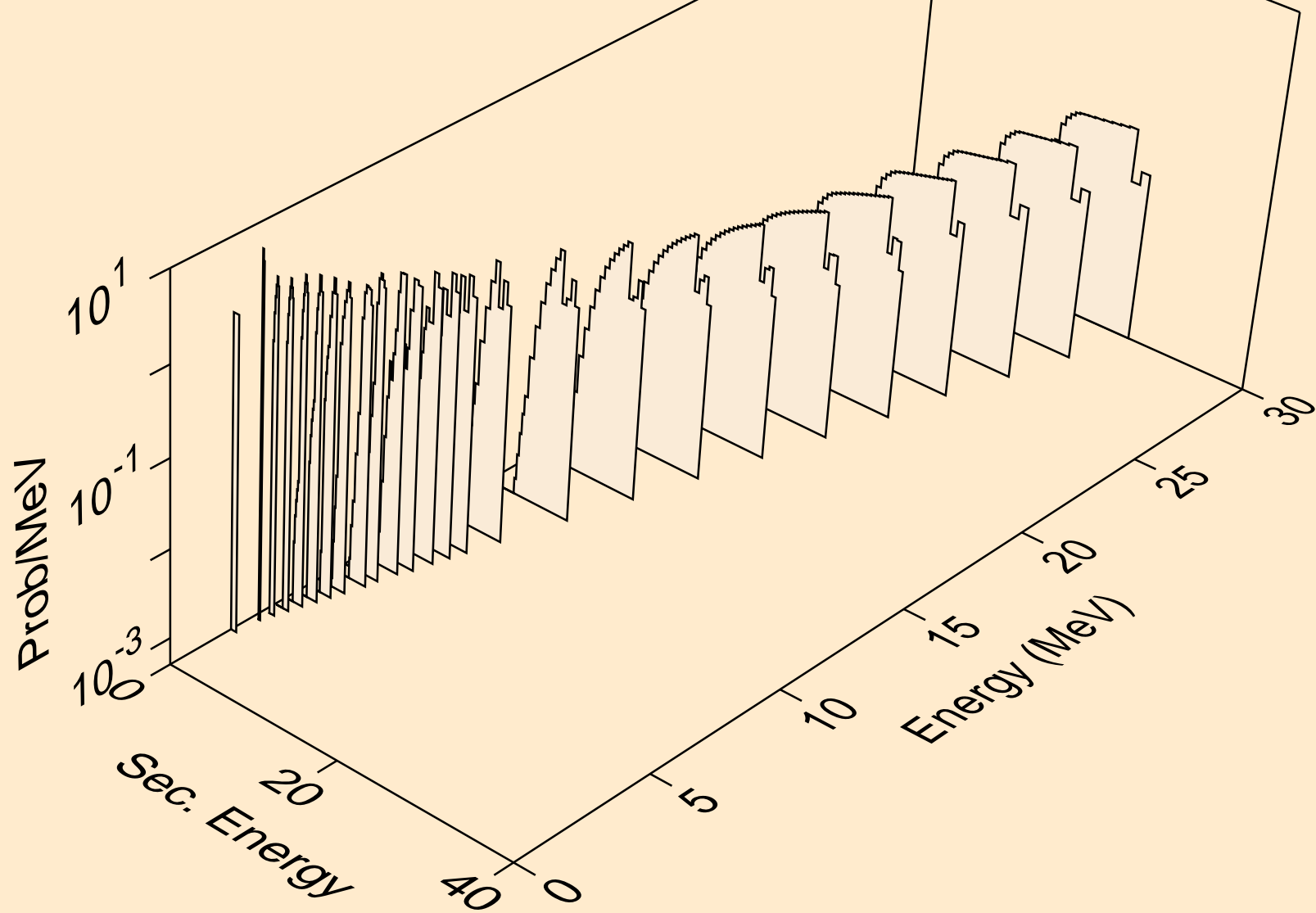

Y084 NEUTRON ACER TENDL-2024 LIBRARY; T=0.K
deuterons from (n,pd)

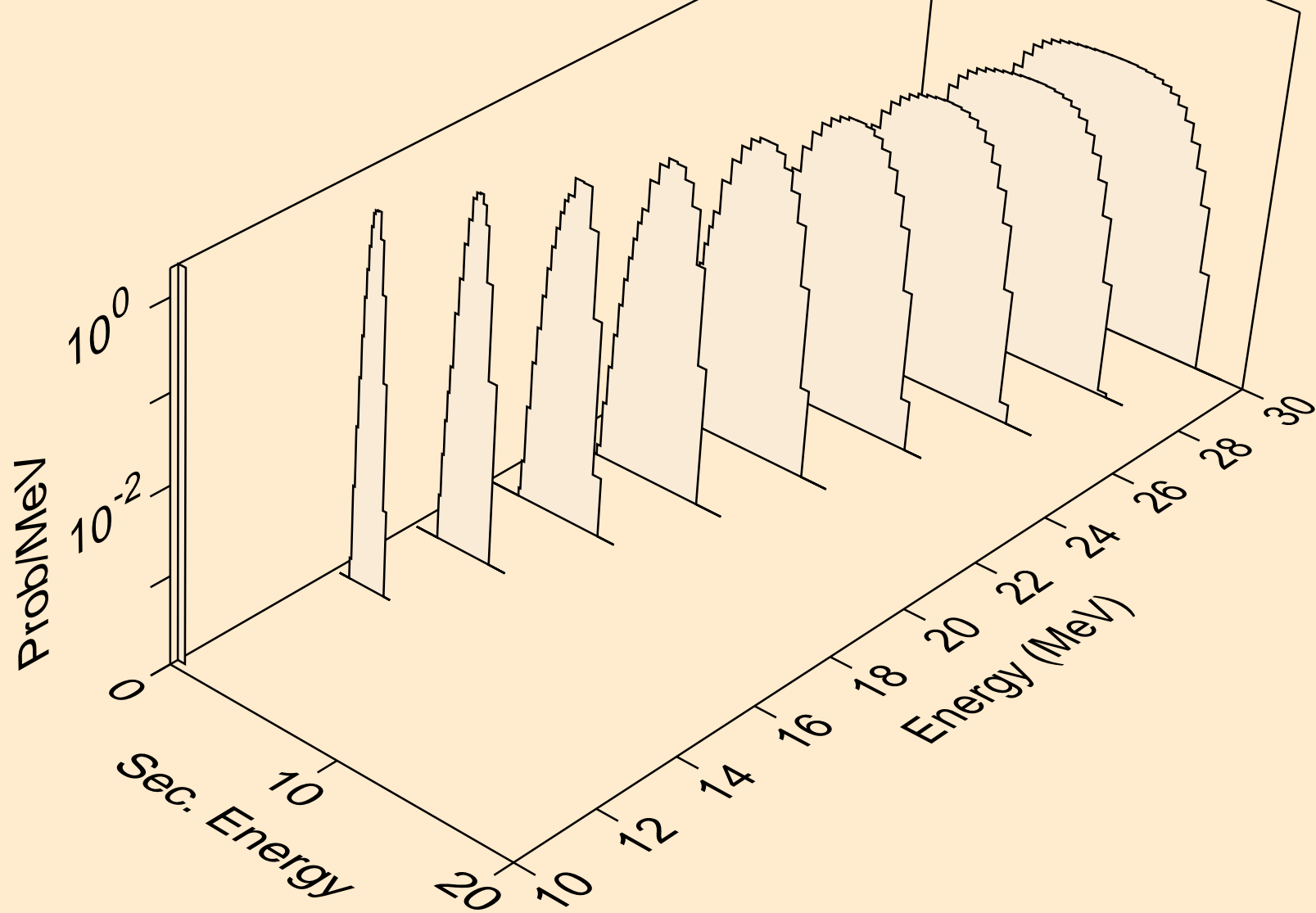

Y084 NEUTRON ACER TENDL-2024 LIBRARY; T=0.K
deuterons from (n,da)

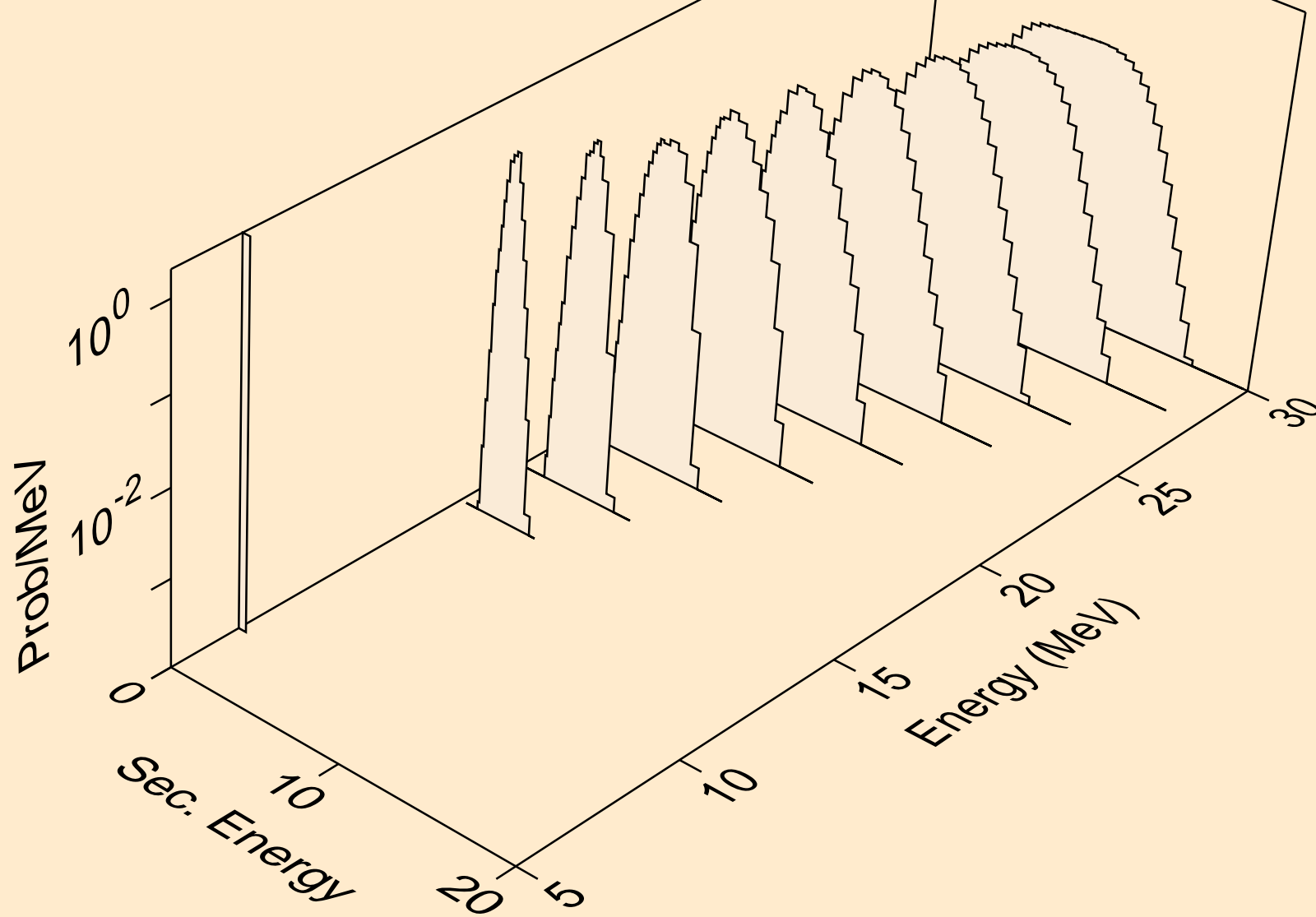

Y084 NEUTRON ACER TENDL-2024 LIBRARY; T=0.K
tritons from (n,x)

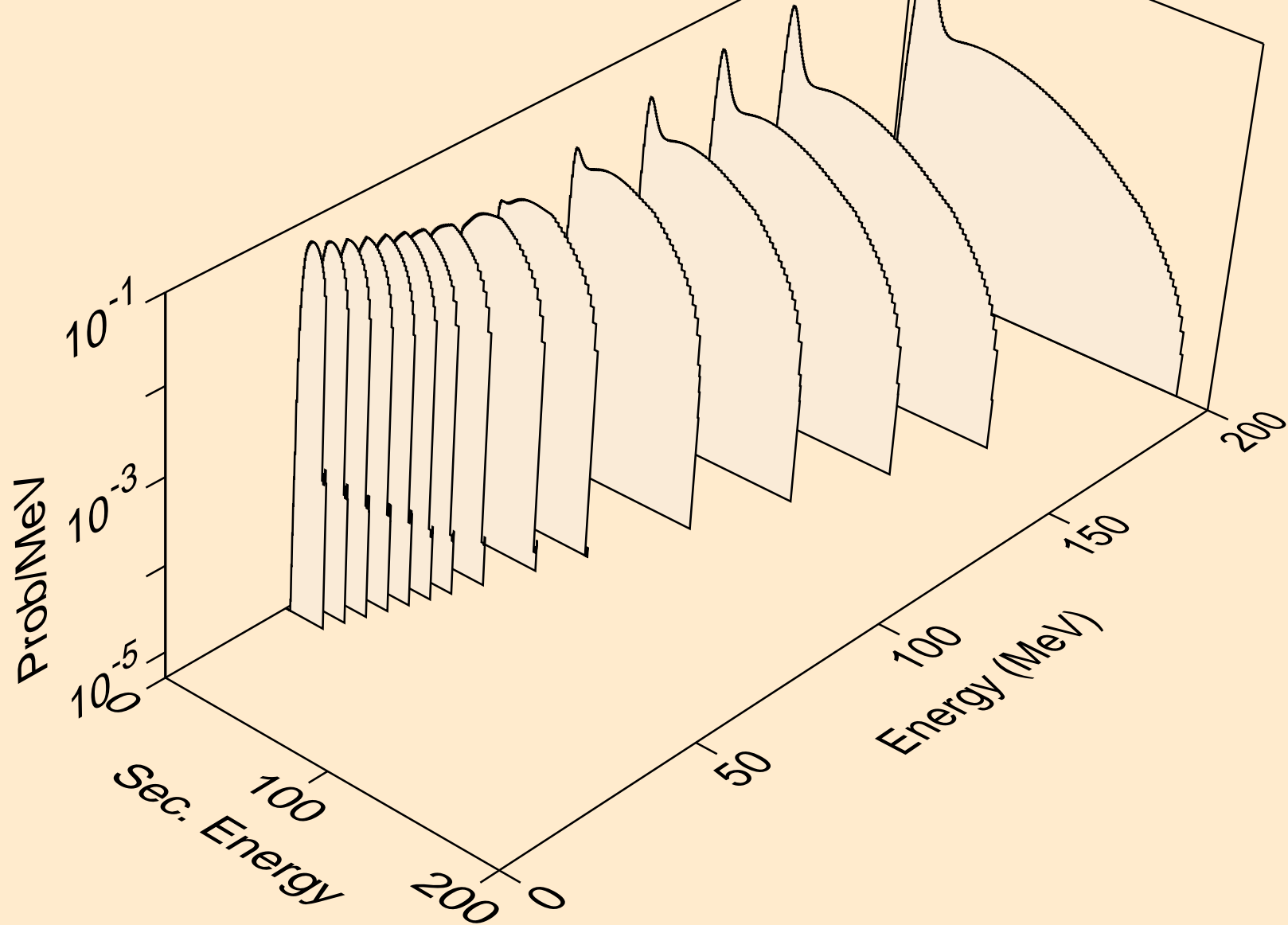

Y084 NEUTRON ACER TENDL-2024 LIBRARY; T=0.K
tritons from (n,n*)t

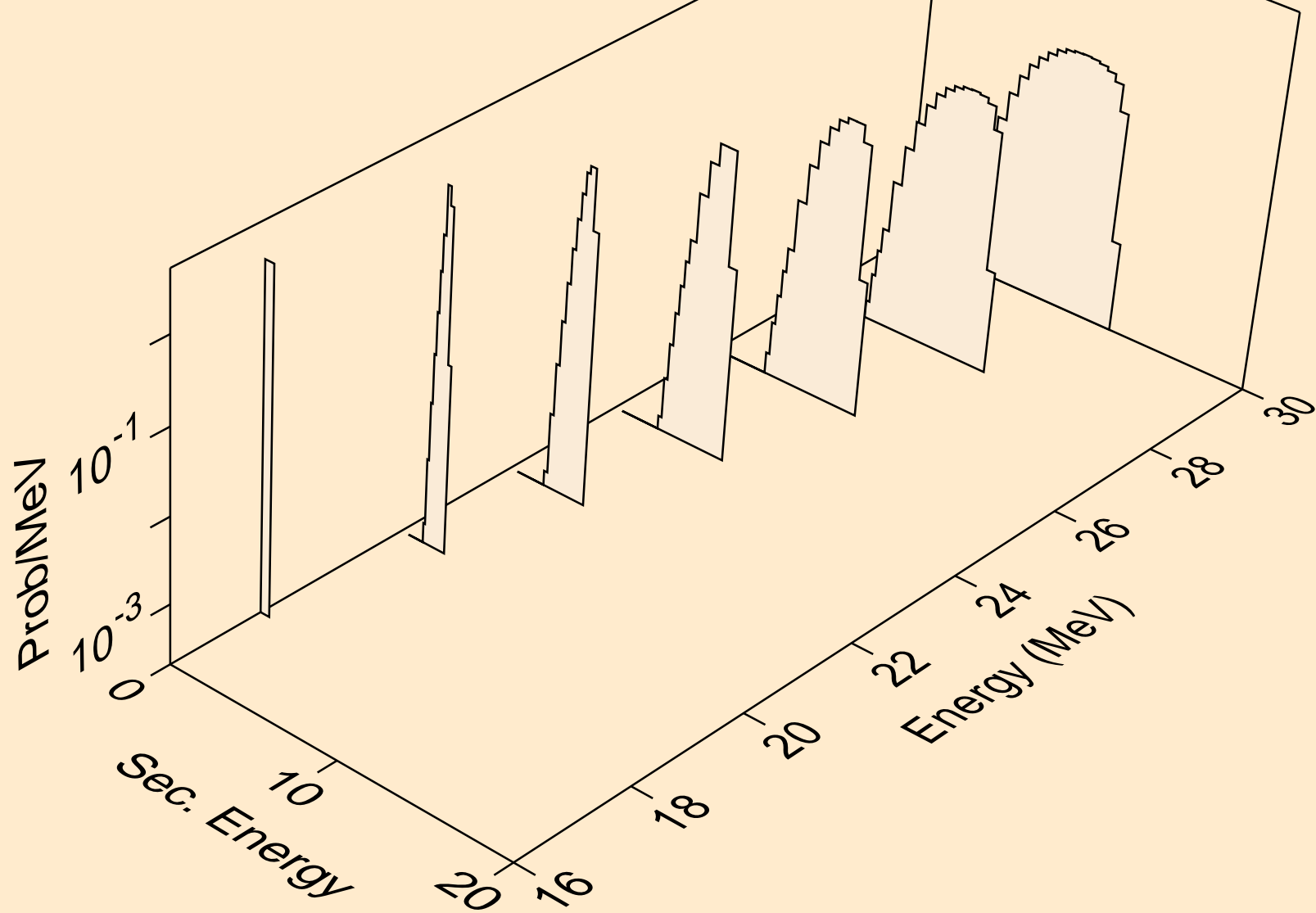

Y084 NEUTRON ACER TENDL-2024 LIBRARY; T=0.K
tritons from (n,t)

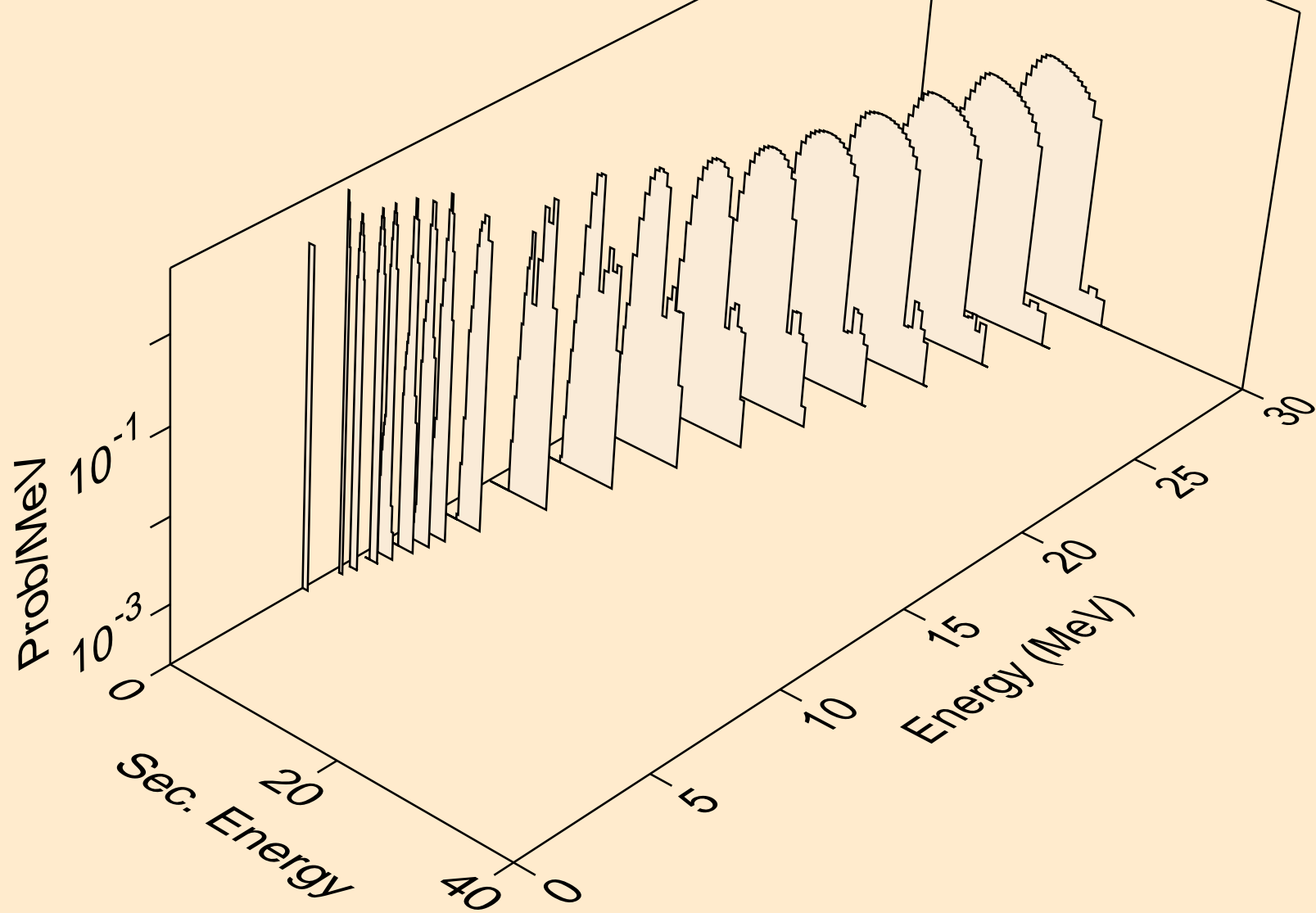

Y084 NEUTRON ACER TENDL-2024 LIBRARY; T=0.K
tritons from (n,pt)

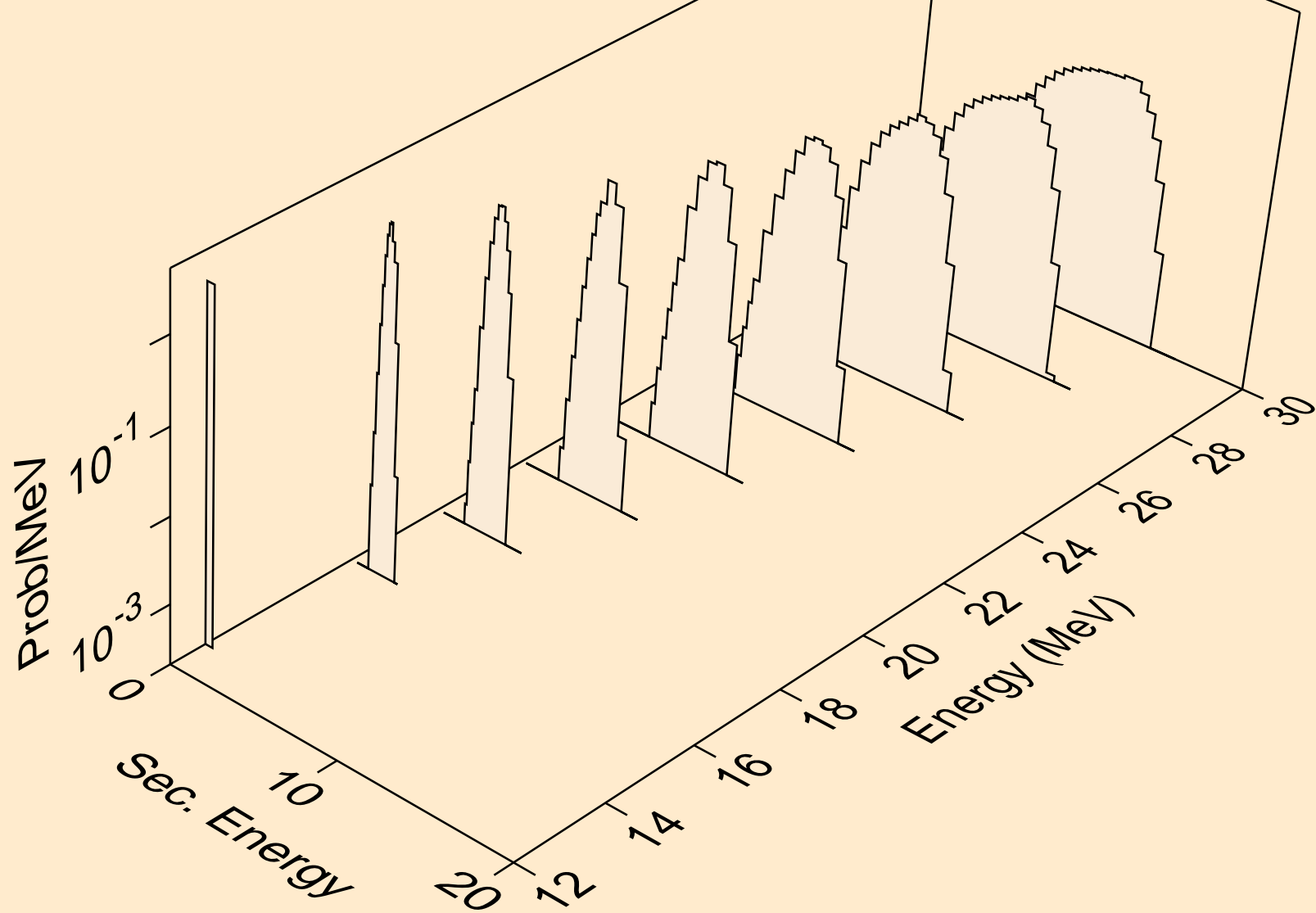

Y084 NEUTRON ACER TENDL-2024 LIBRARY; T=0.K
he3s from (n,x)

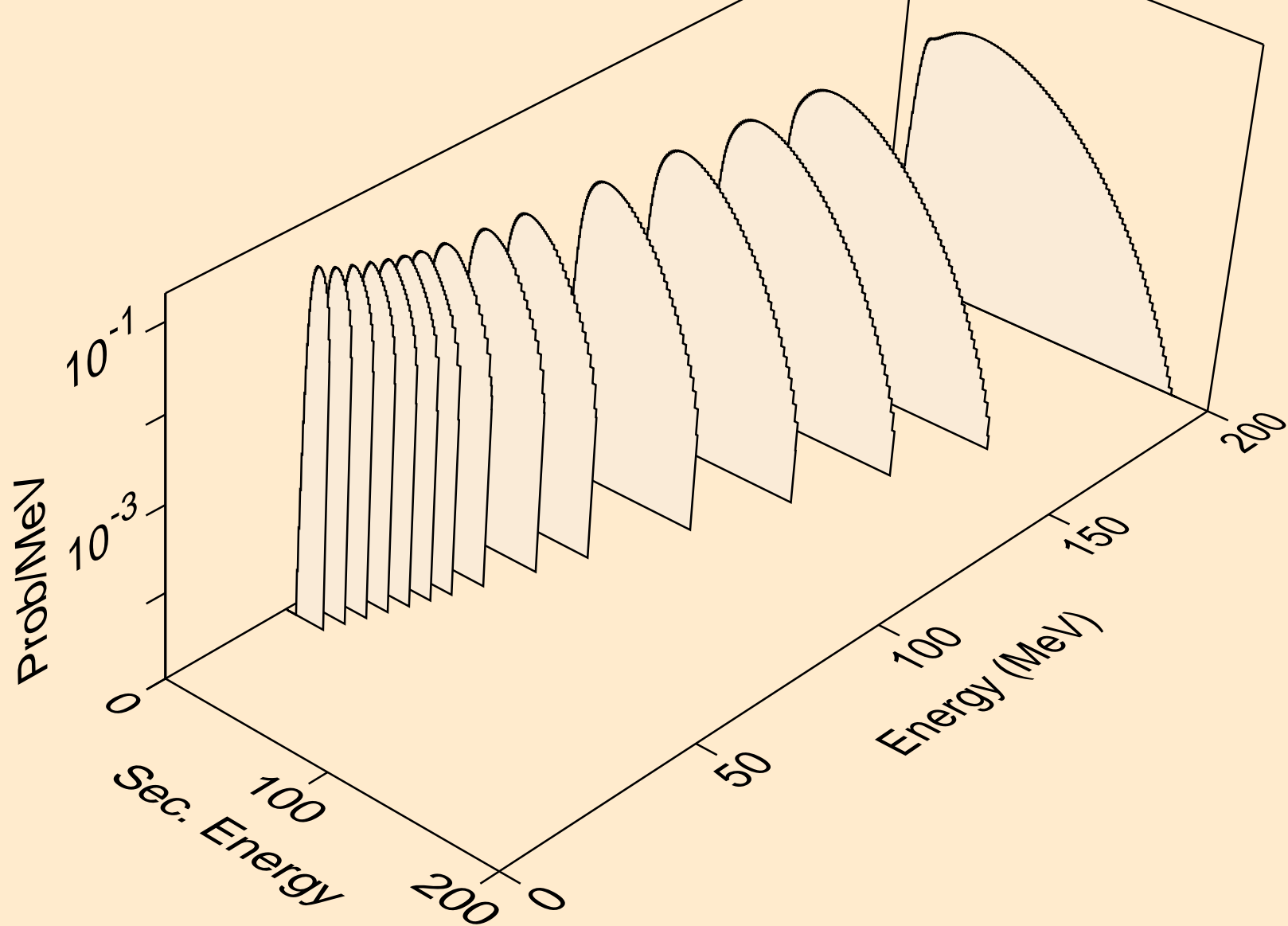

Y084 NEUTRON ACER TENDL-2024 LIBRARY; T=0.K
he3s from (n,n*)he3

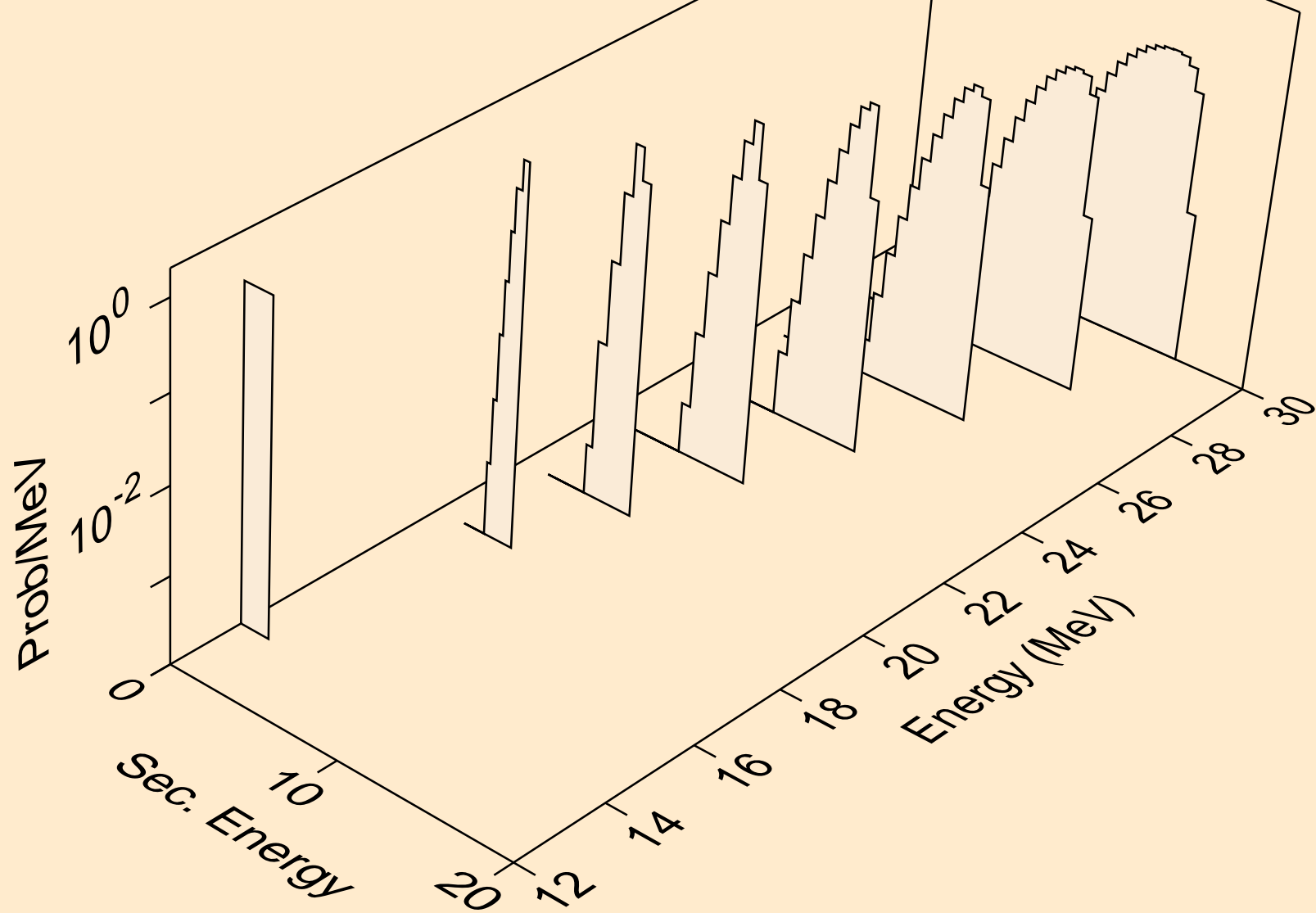

Y084 NEUTRON ACER TENDL-2024 LIBRARY; T=0.K
he3s from (n,he3)

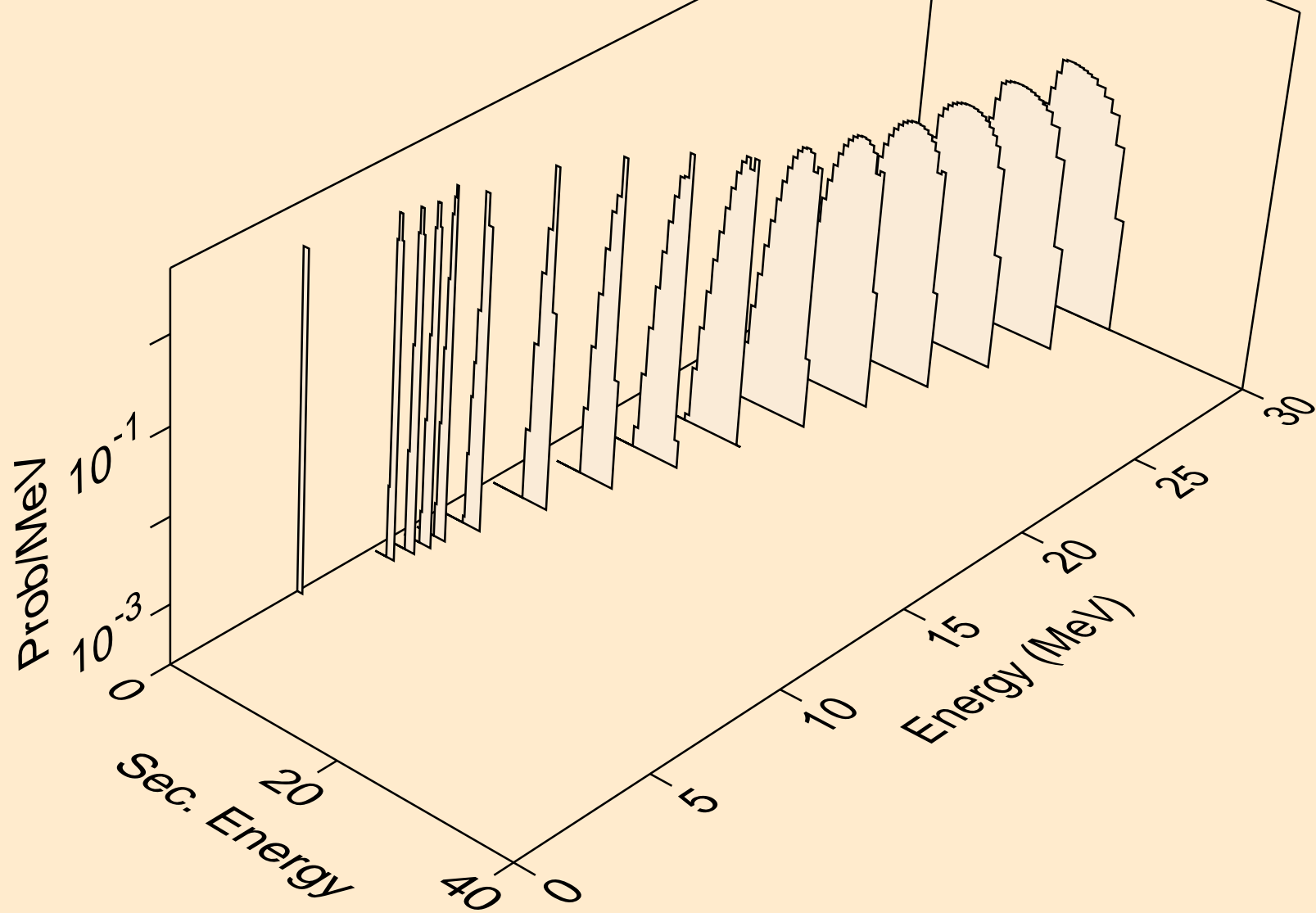

Y084 NEUTRON ACER TENDL-2024 LIBRARY; T=0.K
alphas from (n,x)

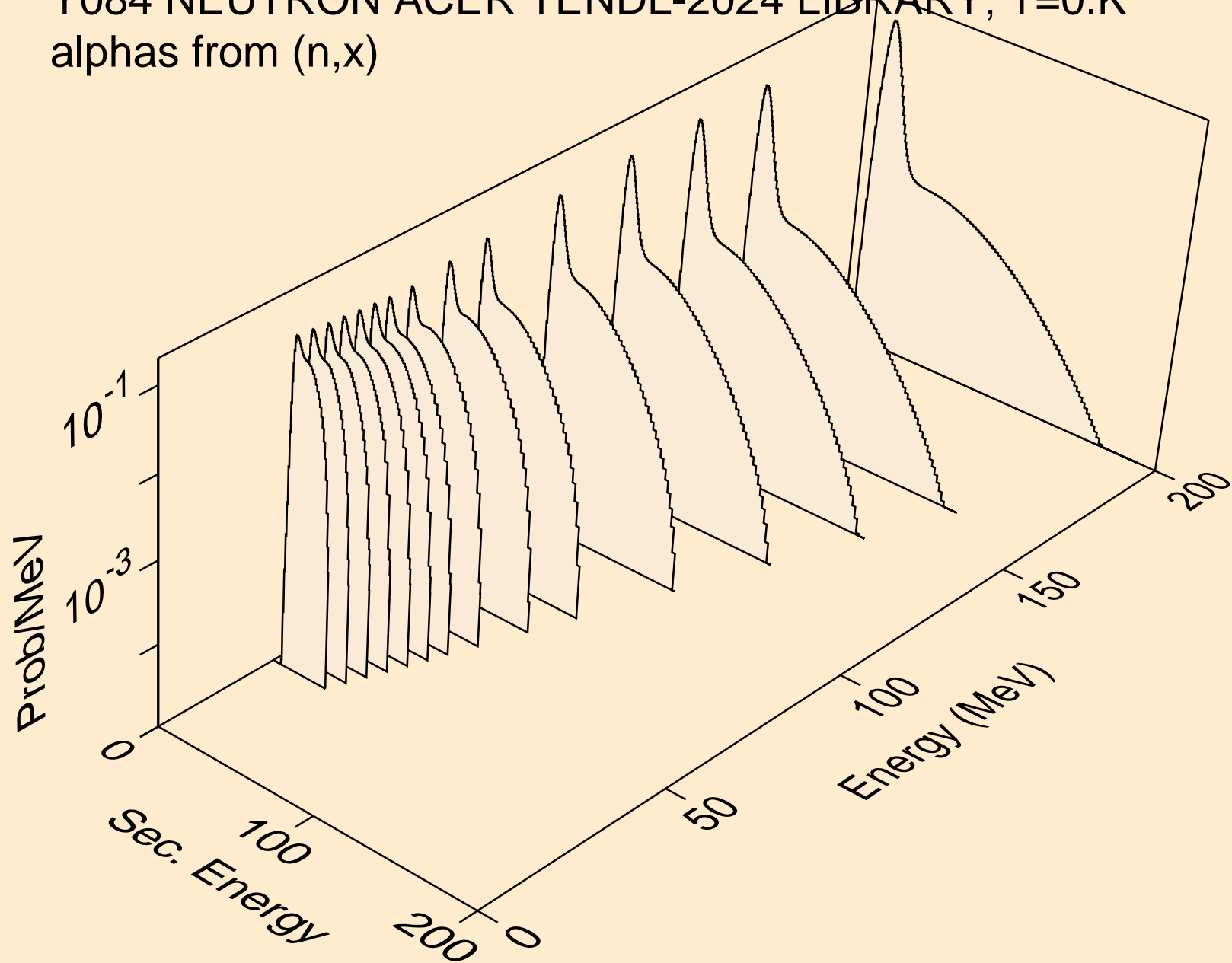

Y084 NEUTRON ACER TENDL-2024 LIBRARY; T=0.K
alphas from (n,n*)a

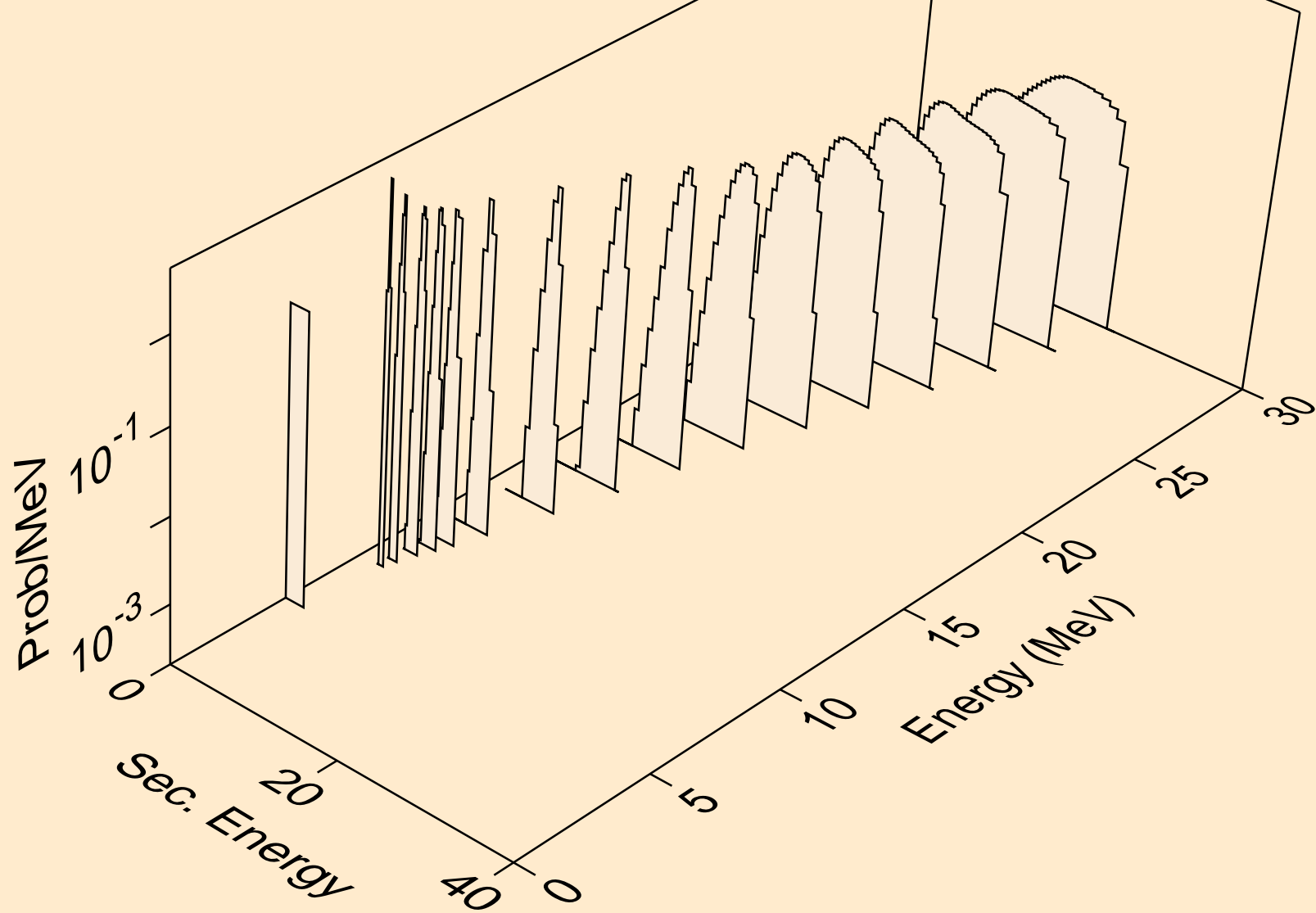

Y084 NEUTRON ACER TENDL-2024 LIBRARY; T=0.K
alphas from (n,2n)a

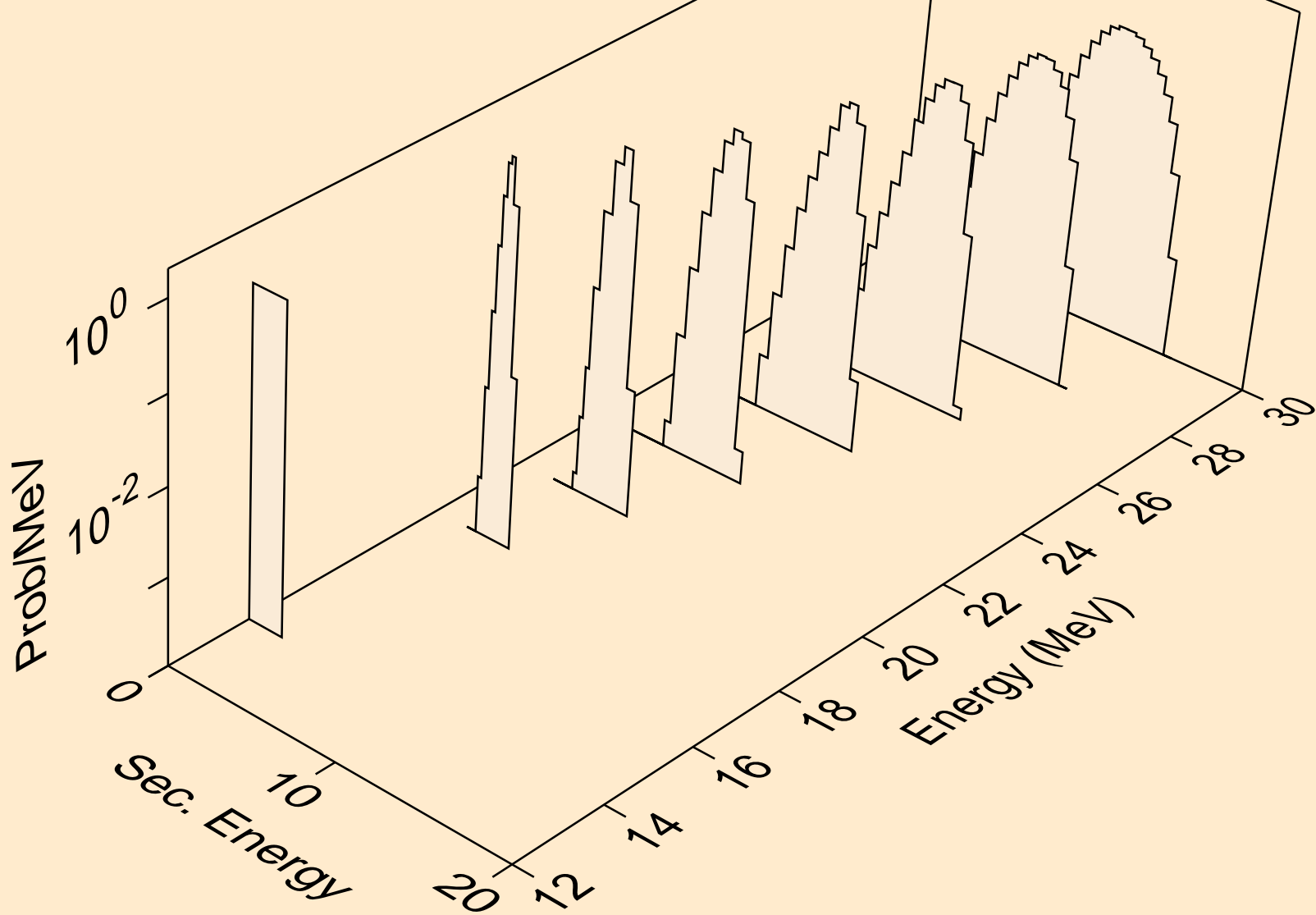

Y084 NEUTRON ACER TENDL-2024 LIBRARY; T=0.K
alphas from (n,n*)2a

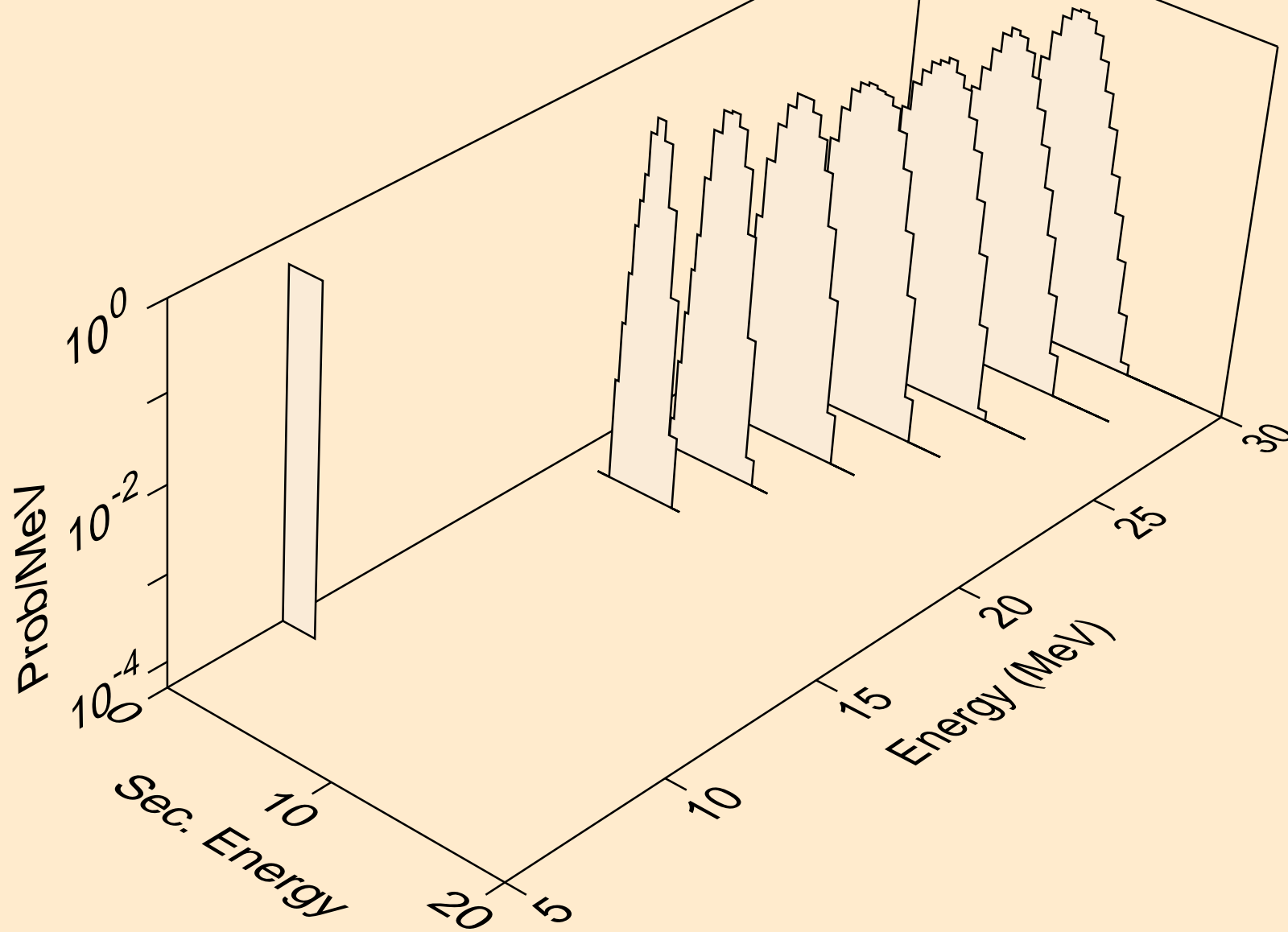

Y084 NEUTRON ACER TENDL-2024 LIBRARY; T=0.K
alphas from (n,npa)

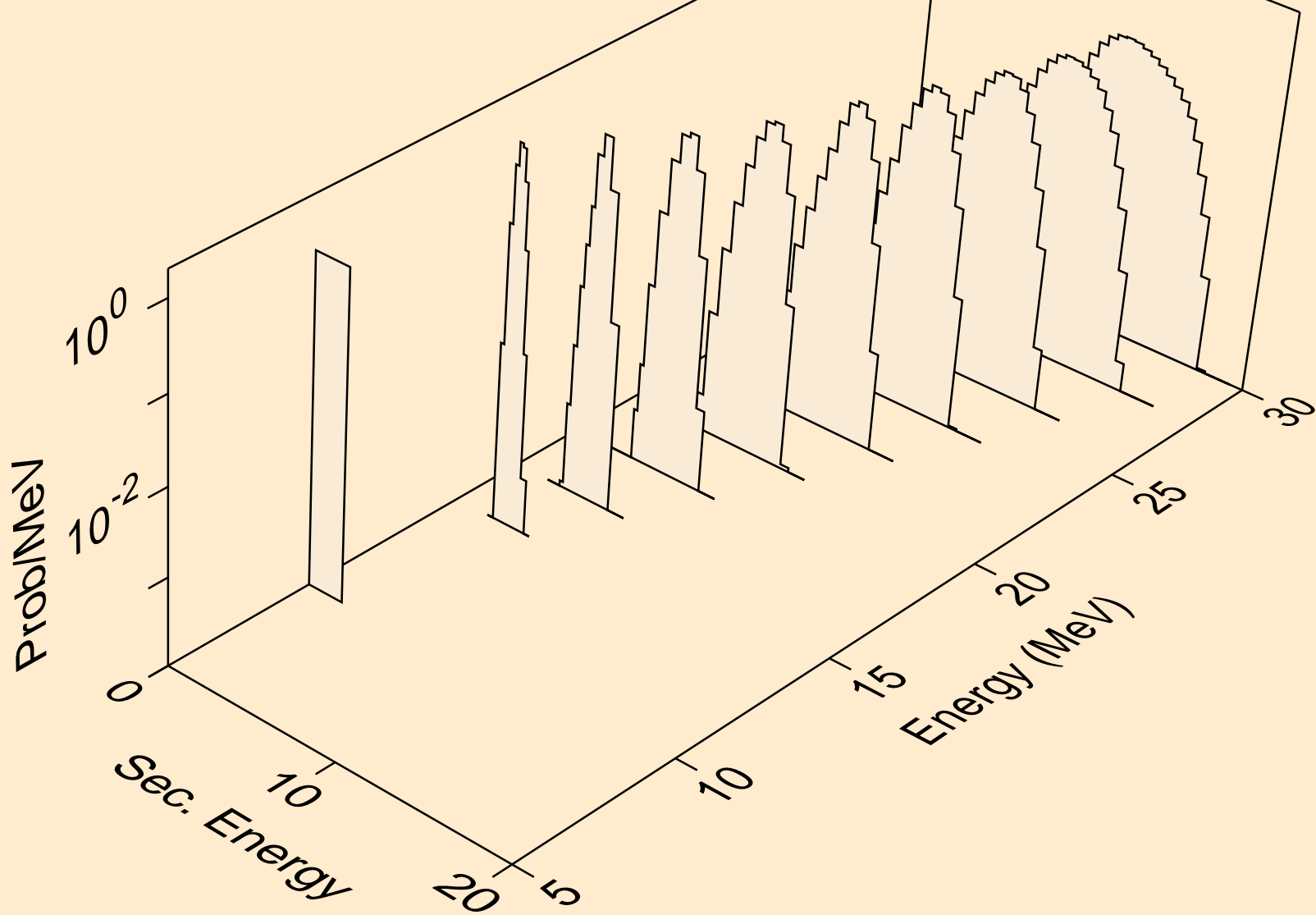

Y084 NEUTRON ACER TENDL-2024 LIBRARY; T=0.K
alphas from (n,a)

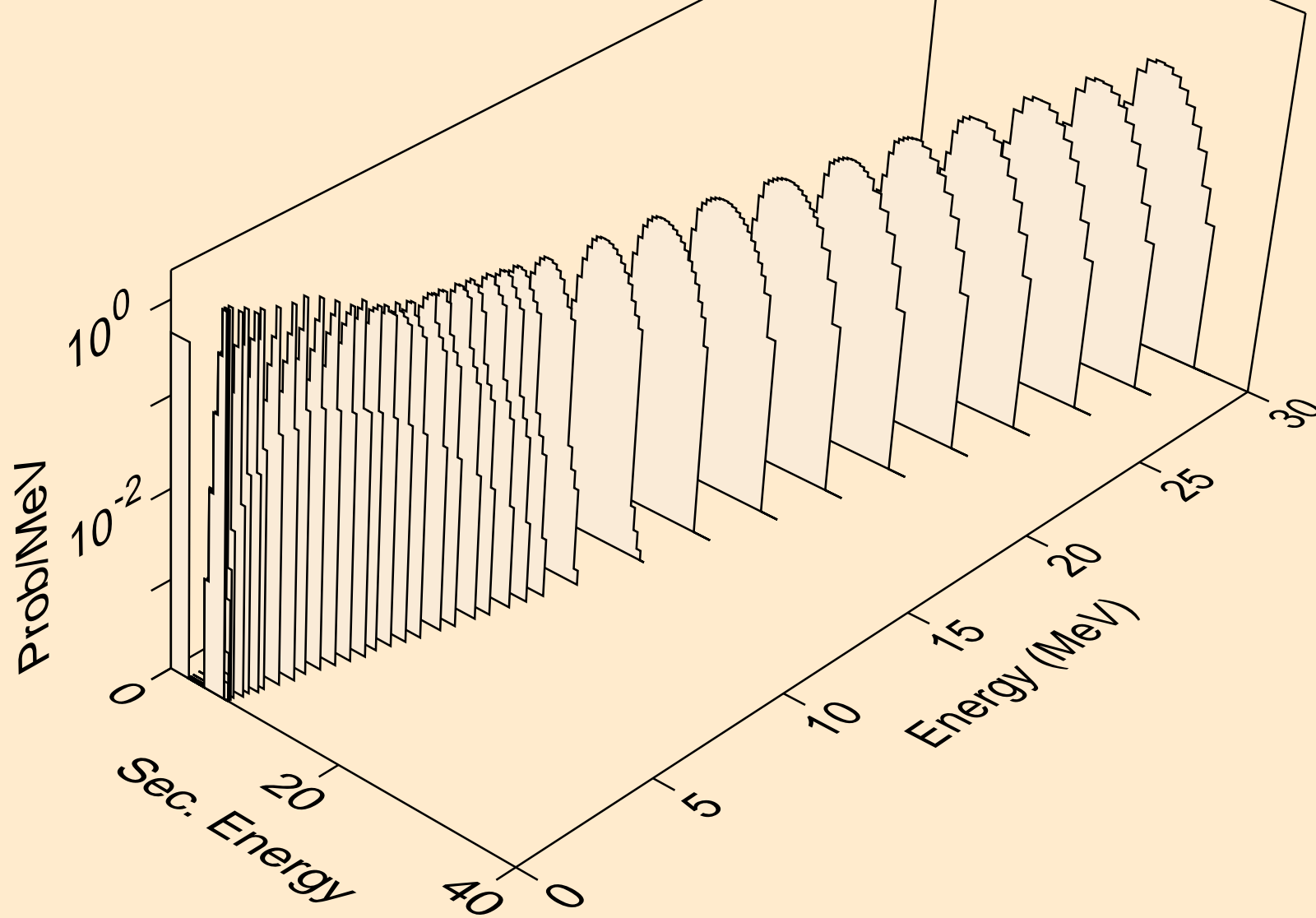

Y084 NEUTRON ACER TENDL-2024 LIBRARY; T=0.K
alphas from (n,2a)

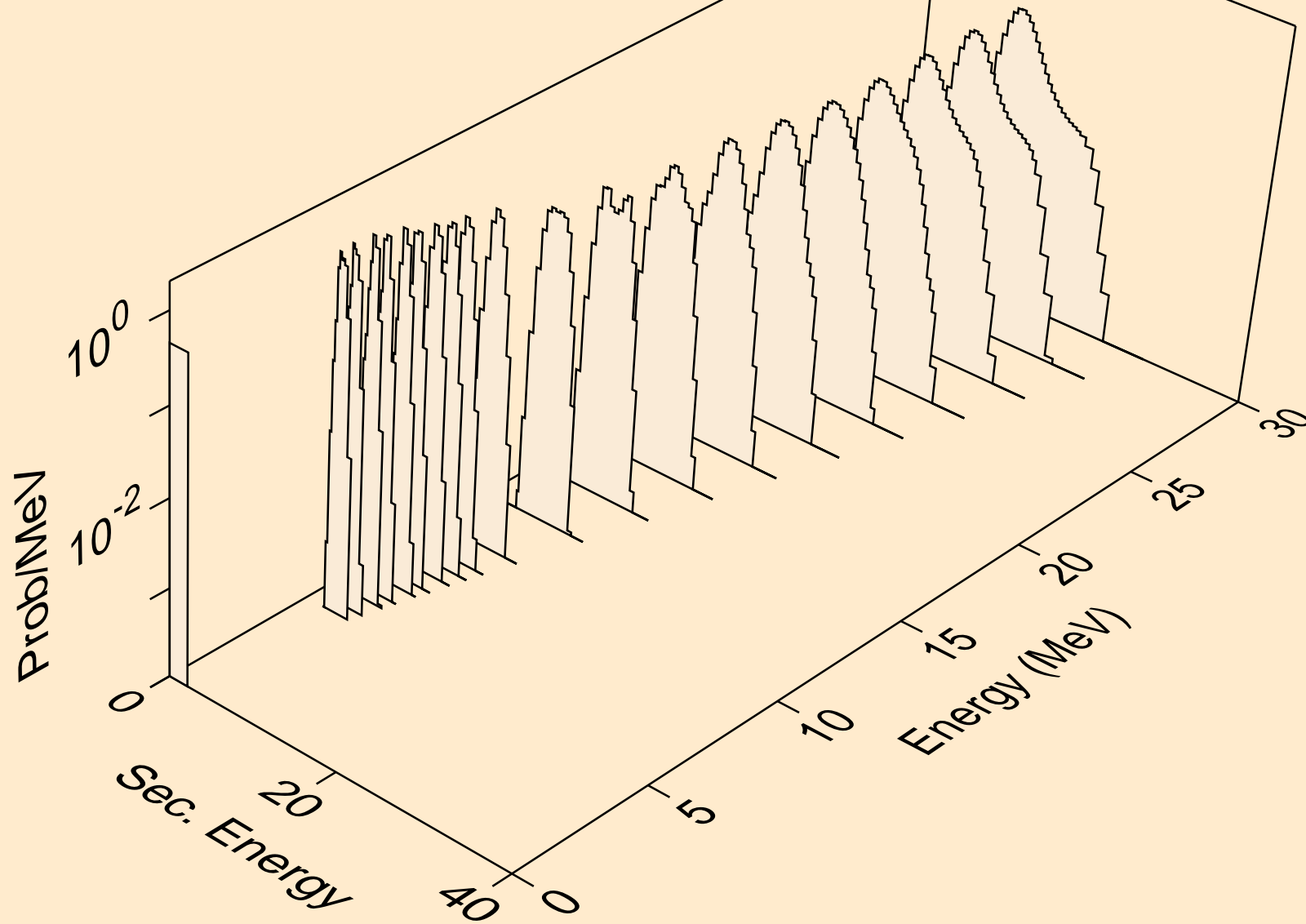

Y084 NEUTRON ACER TENDL-2024 LIBRARY; T=0.K
alphas from (n,3a)

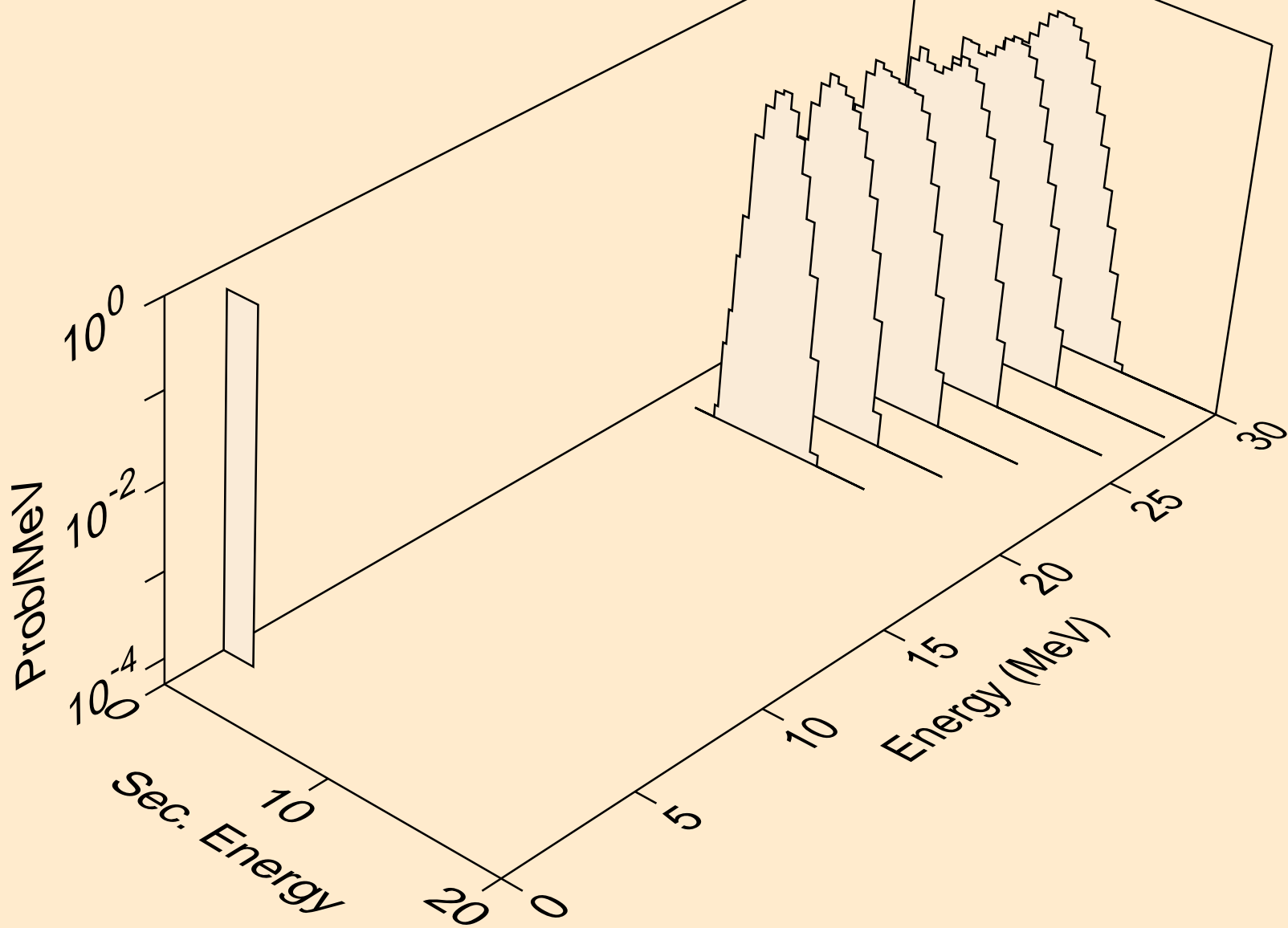

Y084 NEUTRON ACER TENDL-2024 LIBRARY; T=0.K
alphas from (n,pa)

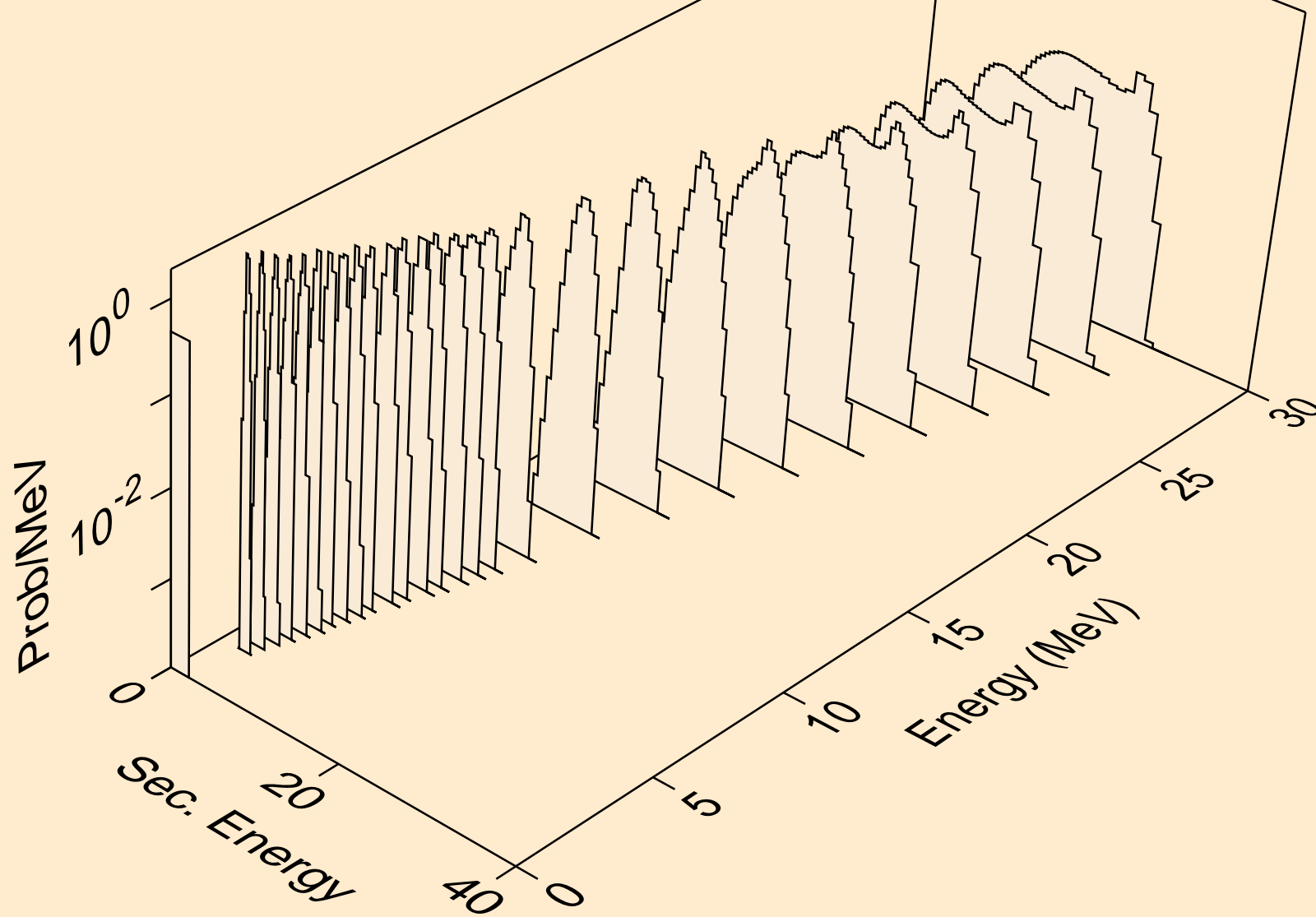

Y084 NEUTRON ACER TENDL-2024 LIBRARY; T=0.K
alphas from (n,da)

