

Y087 NEUTRON ACER TENDL-2024 LIBRARY; T=0.K

Principal cross sections

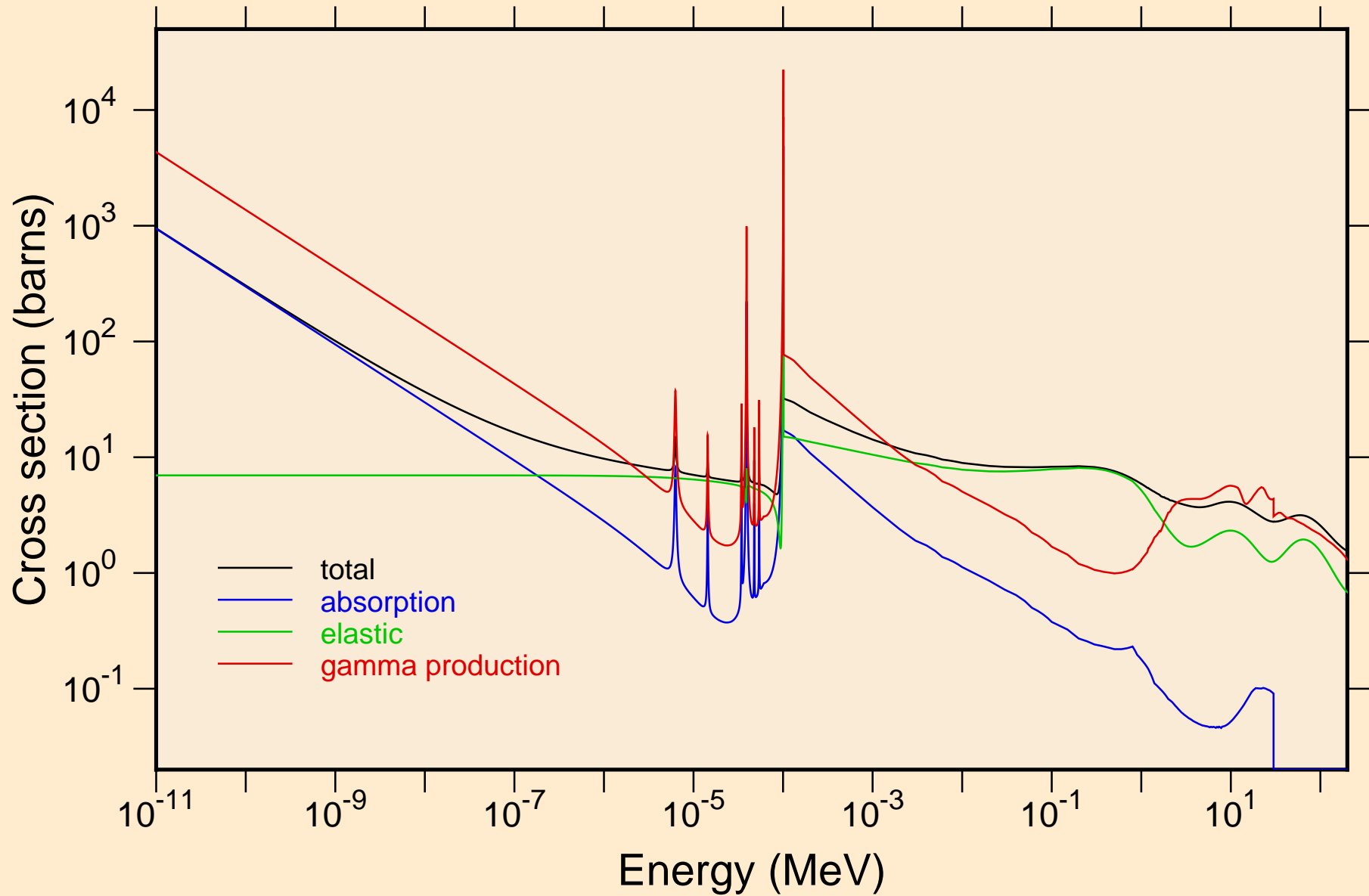

Y087 NEUTRON ACER TENDL-2024 LIBRARY; T=0.K
resonance total cross section

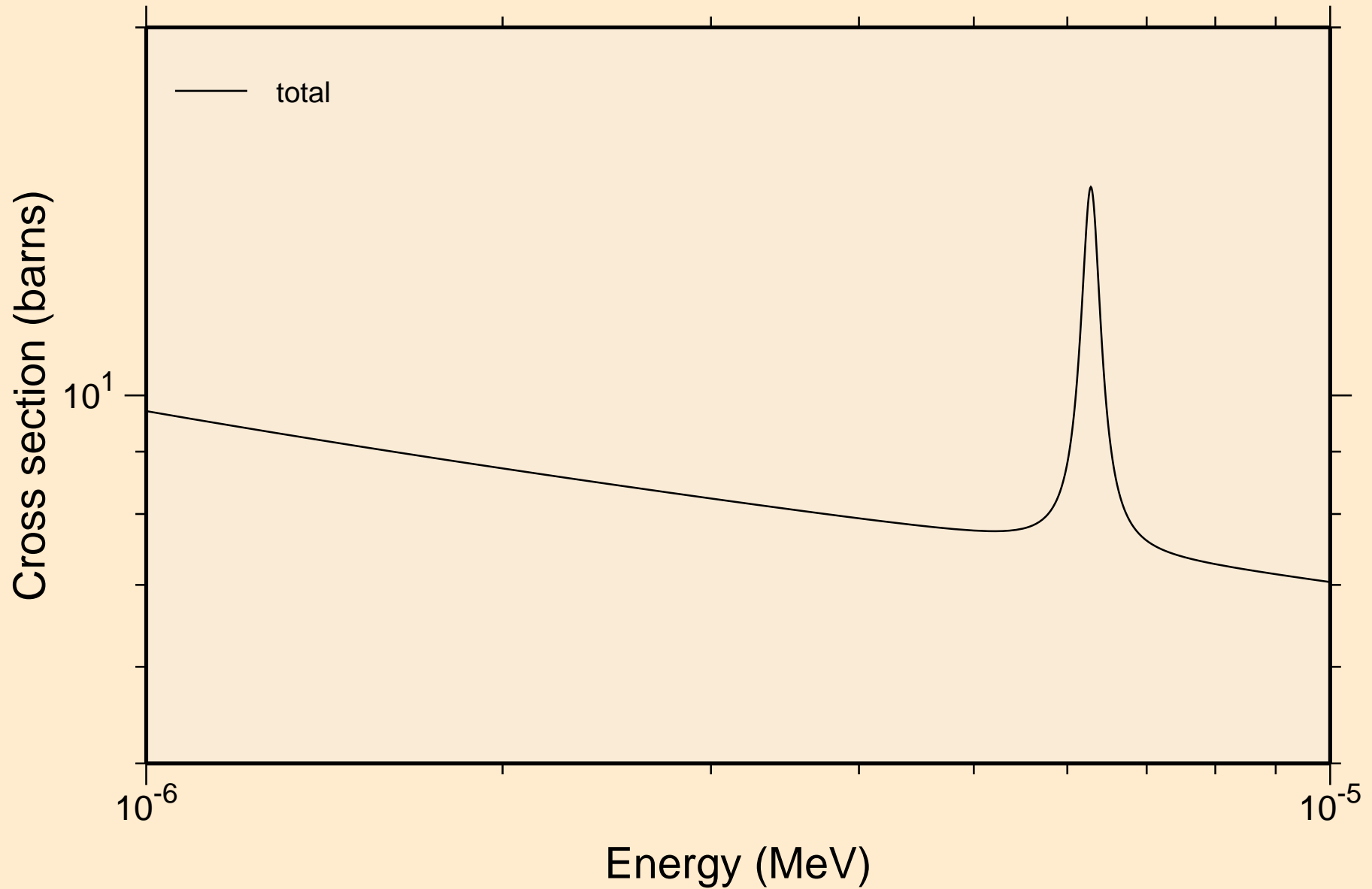

Y087 NEUTRON ACER TENDL-2024 LIBRARY; T=0.K
resonance total cross section

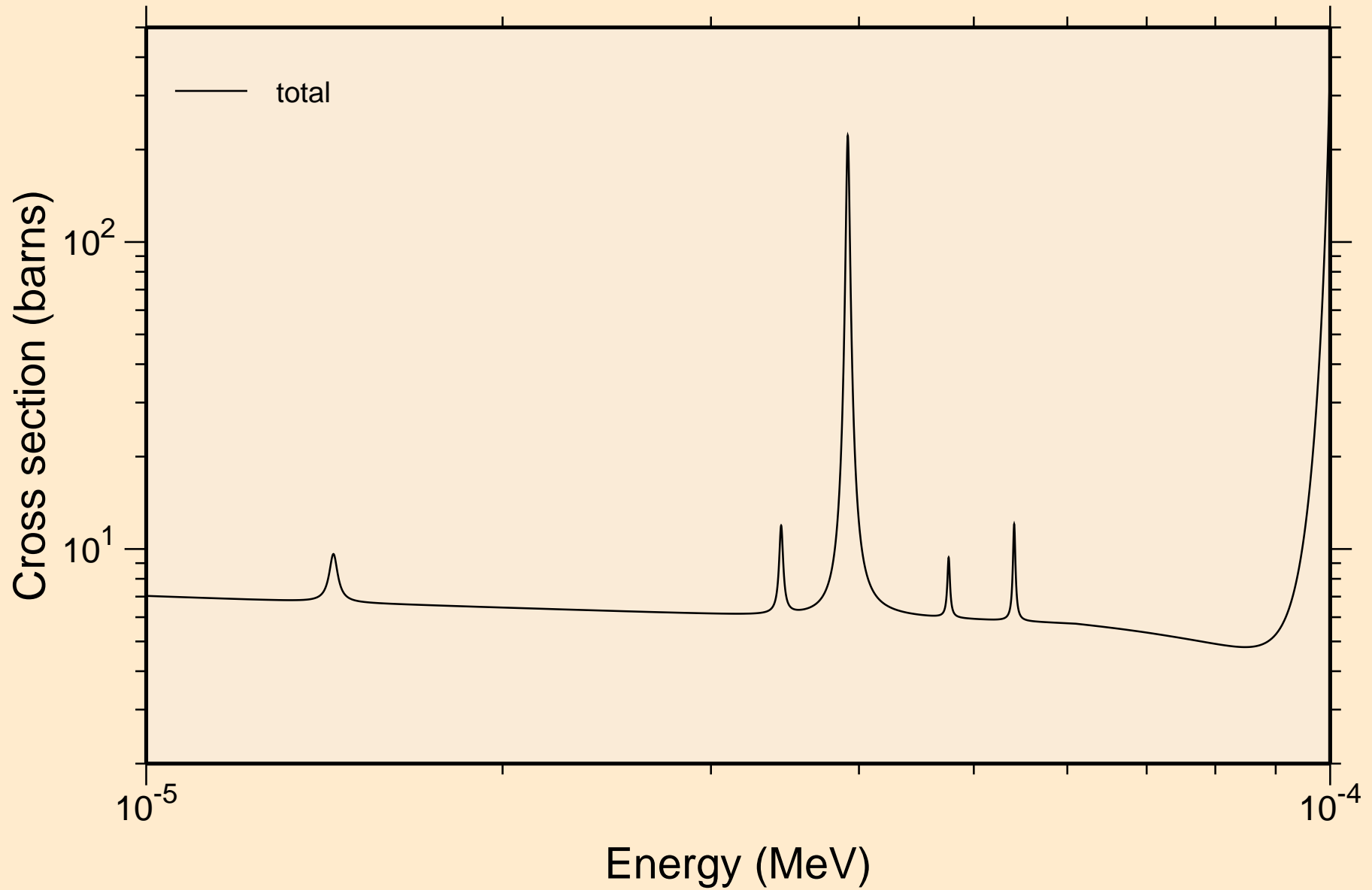

Y087 NEUTRON ACER TENDL-2024 LIBRARY; T=0.K
resonance total cross section

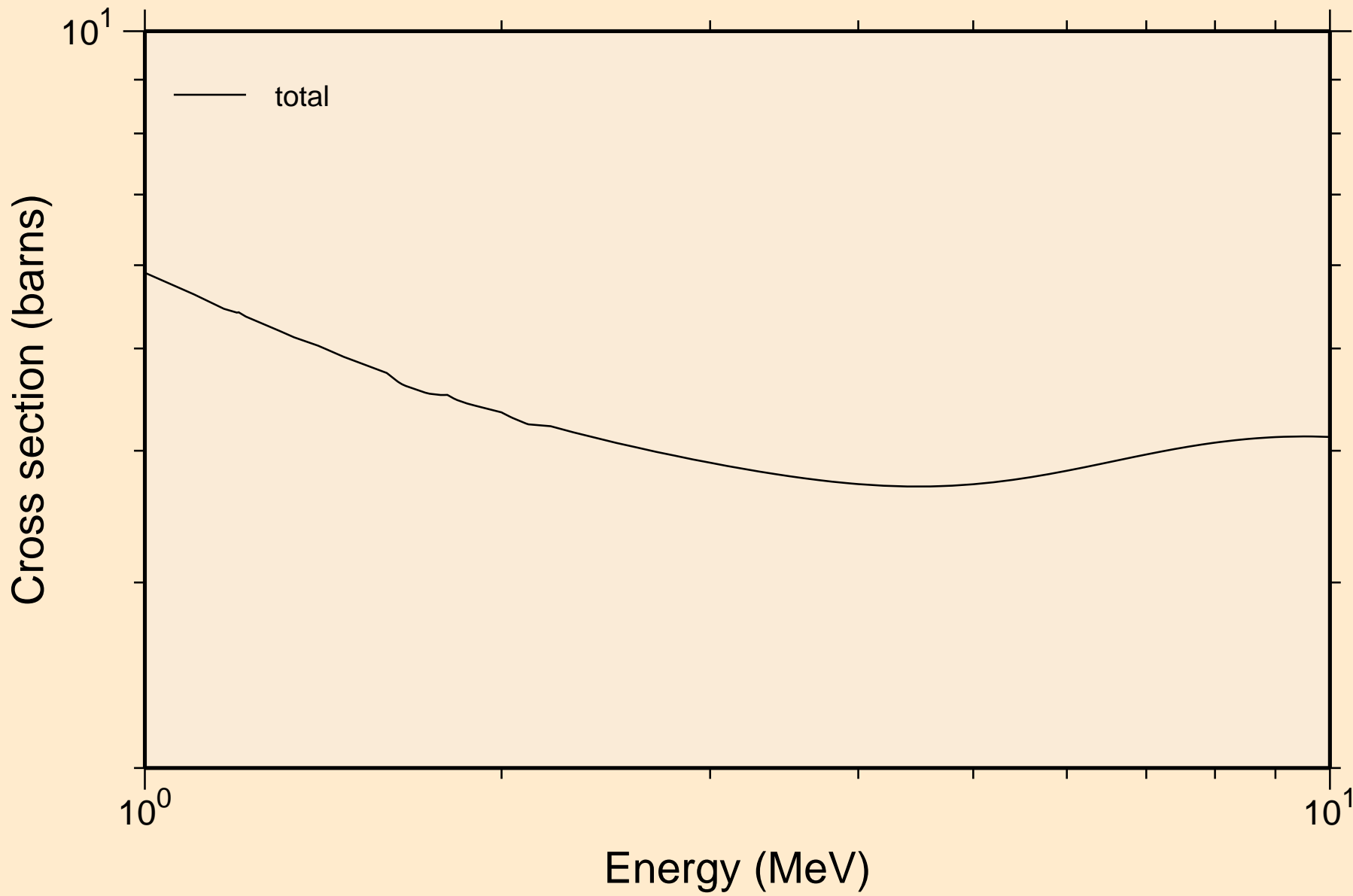

Y087 NEUTRON ACER TENDL-2024 LIBRARY; T=0.K
resonance absorption cross sections

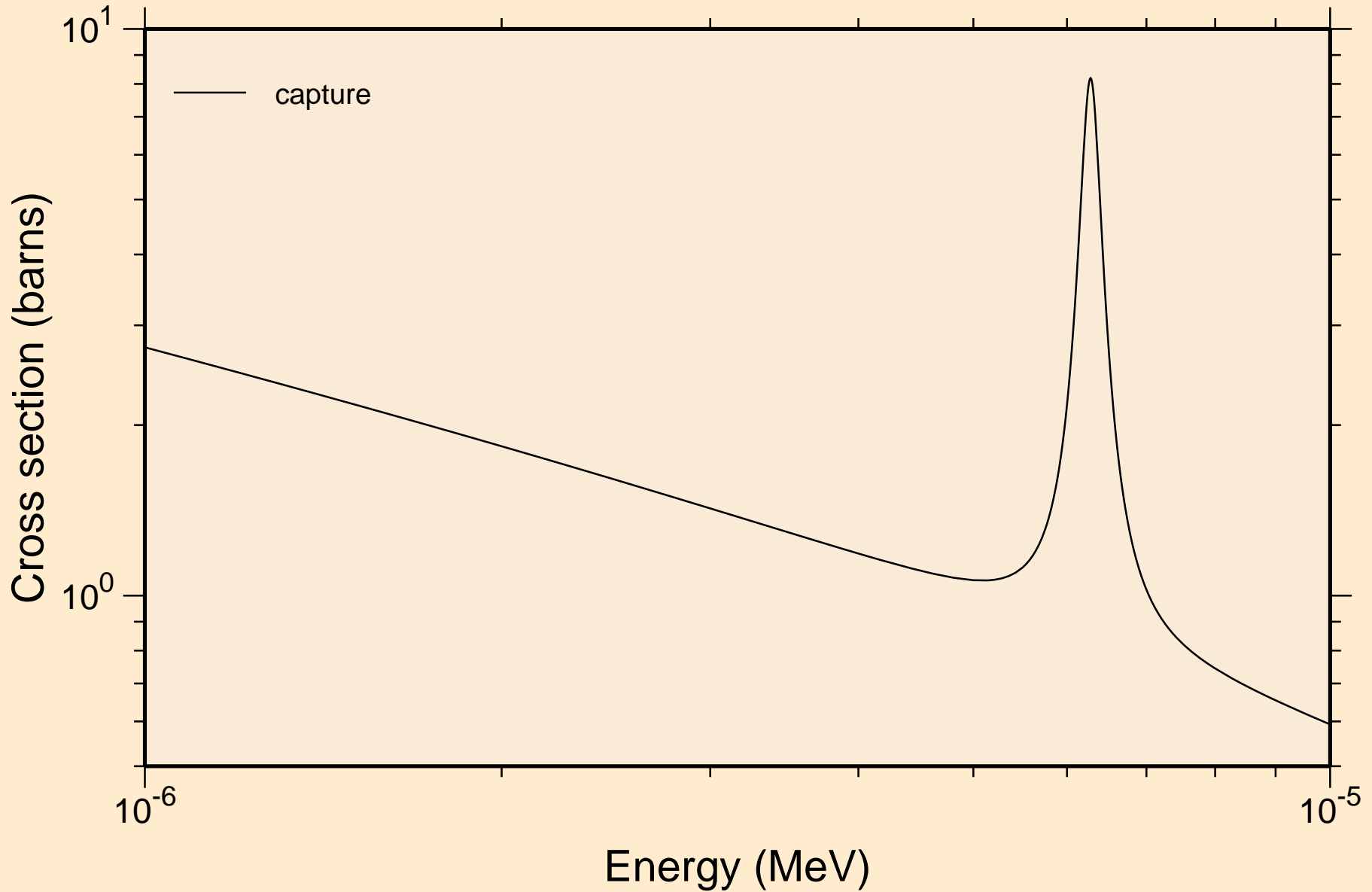

Y087 NEUTRON ACER TENDL-2024 LIBRARY; T=0.K
resonance absorption cross sections

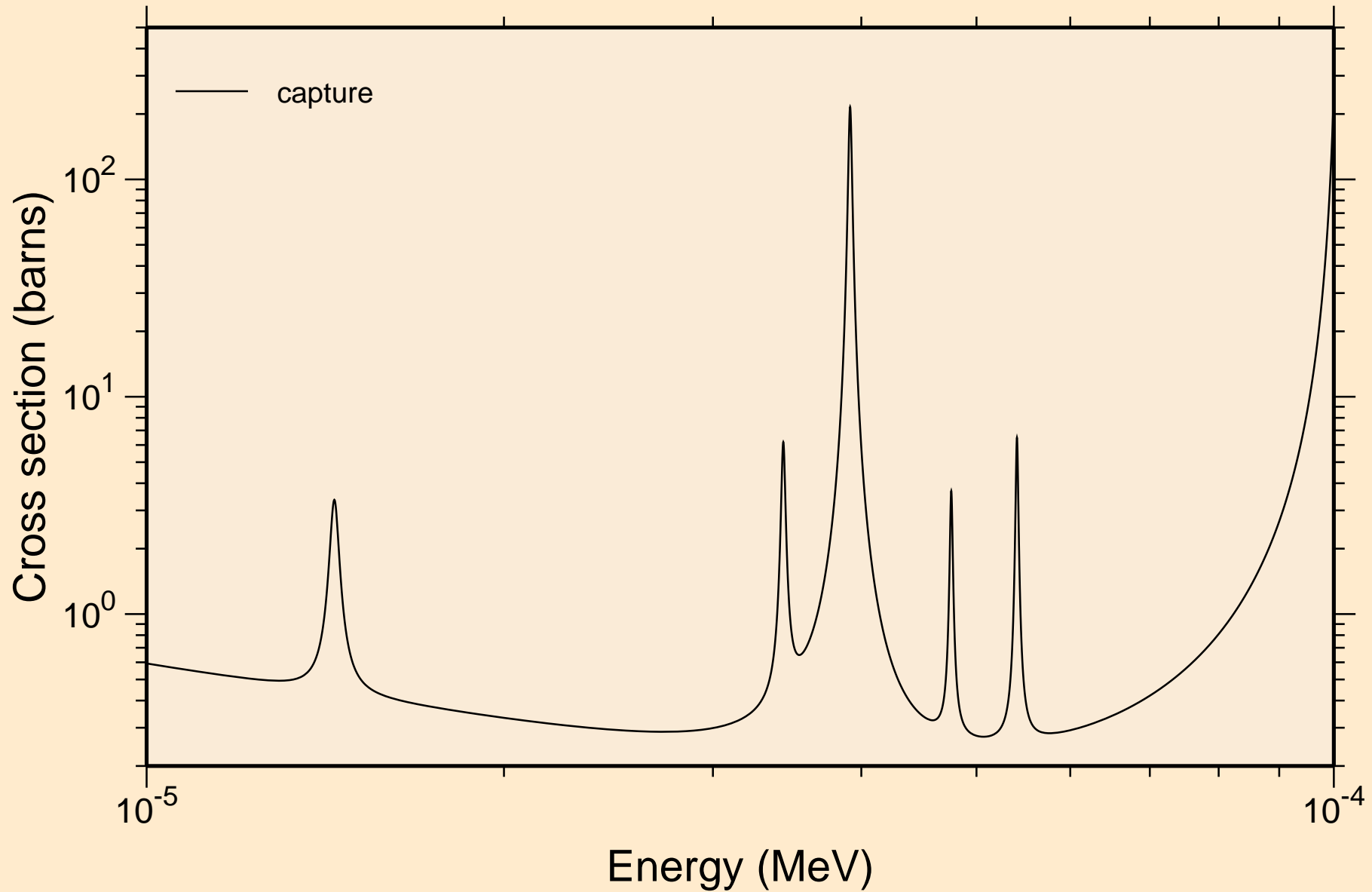

Y087 NEUTRON ACER TENDL-2024 LIBRARY; T=0.K
resonance absorption cross sections

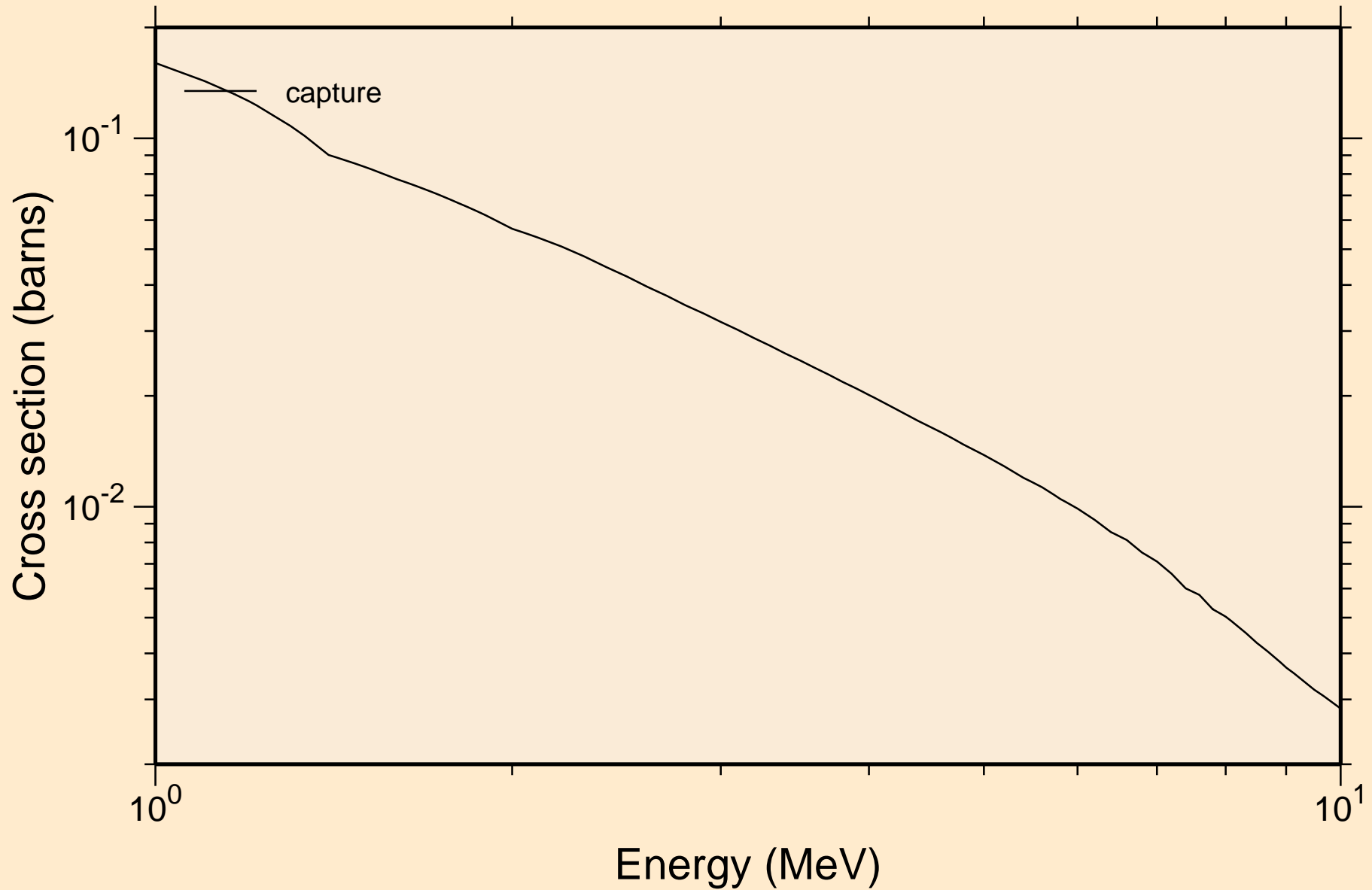

Y087 NEUTRON ACER TENDL-2024 LIBRARY; T=0.K

Heating

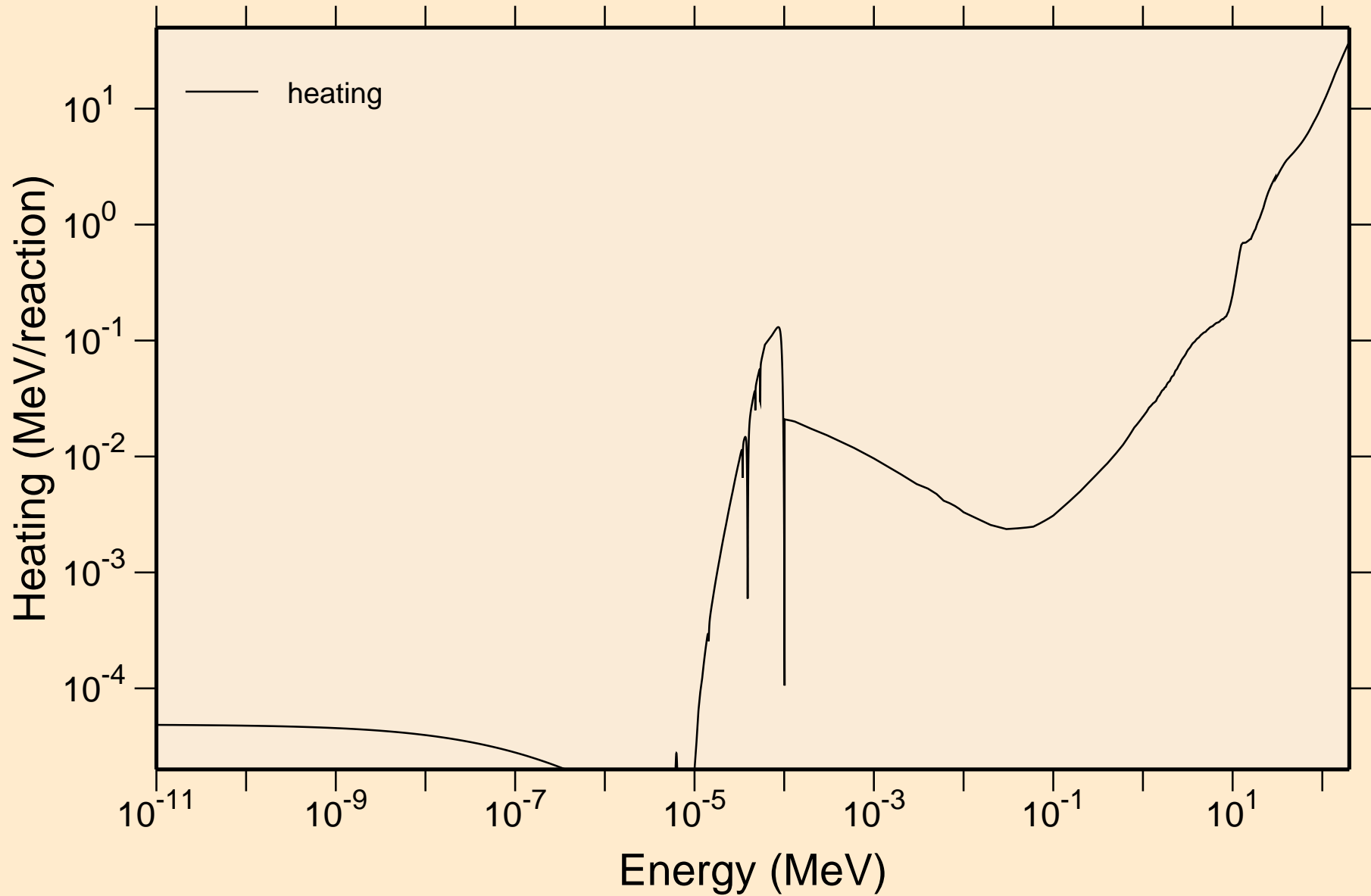

Y087 NEUTRON ACER TENDL-2024 LIBRARY; T=0.K

Damage

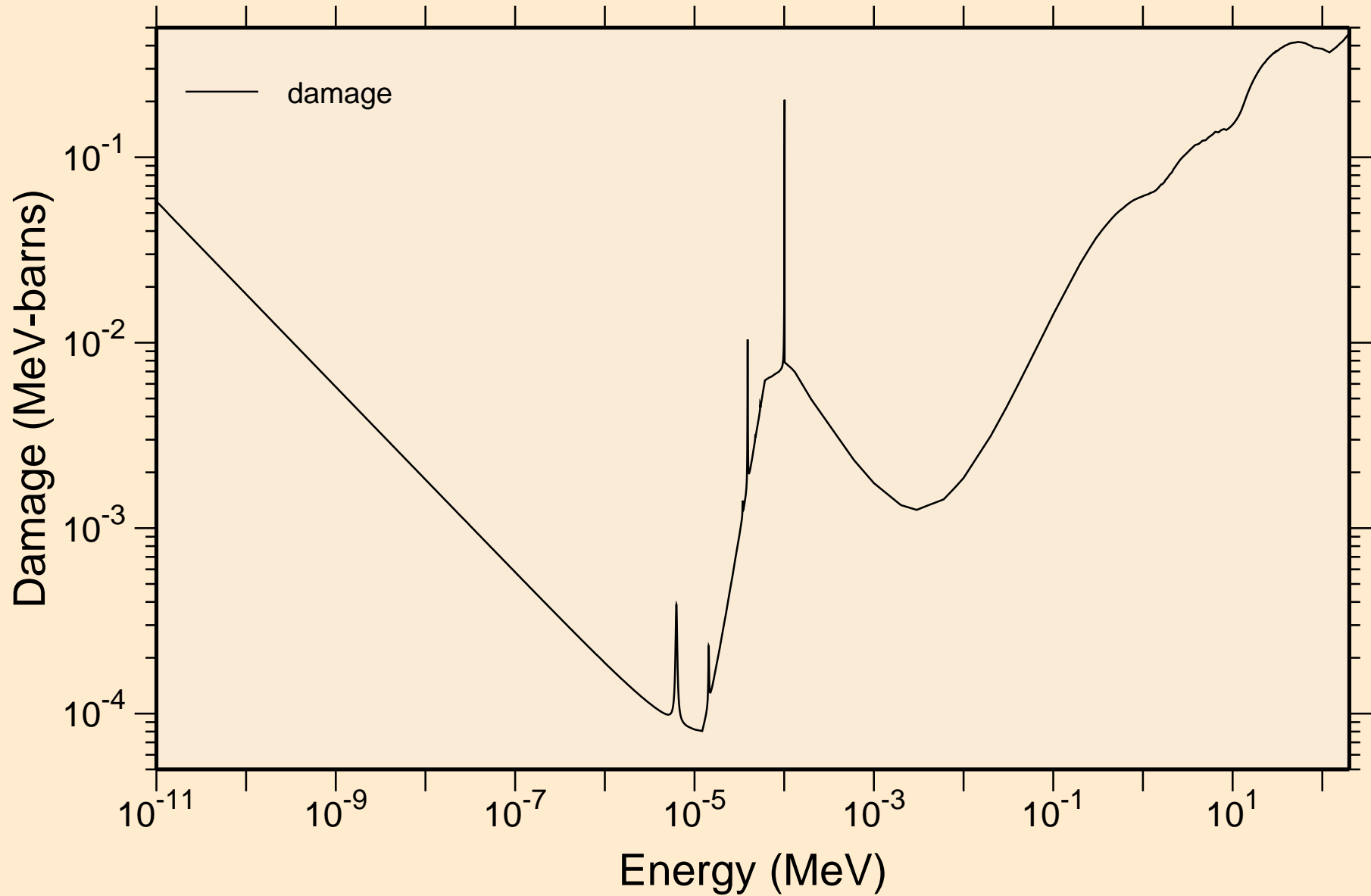

Y087 NEUTRON ACER TENDL-2024 LIBRARY; T=0.K
Non-threshold reactions

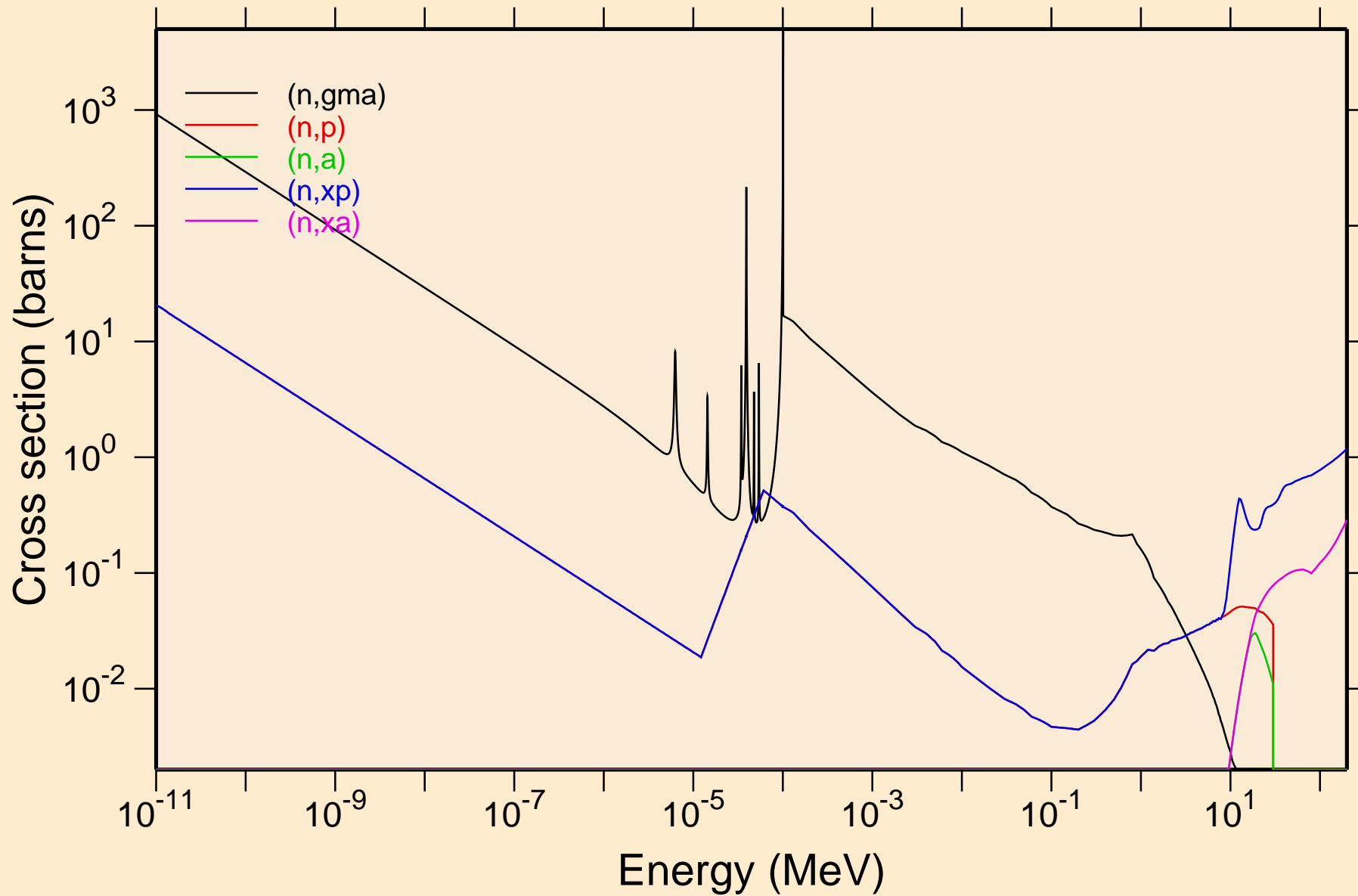

Y087 NEUTRON ACER TENDL-2024 LIBRARY; T=0.K

Principal cross sections

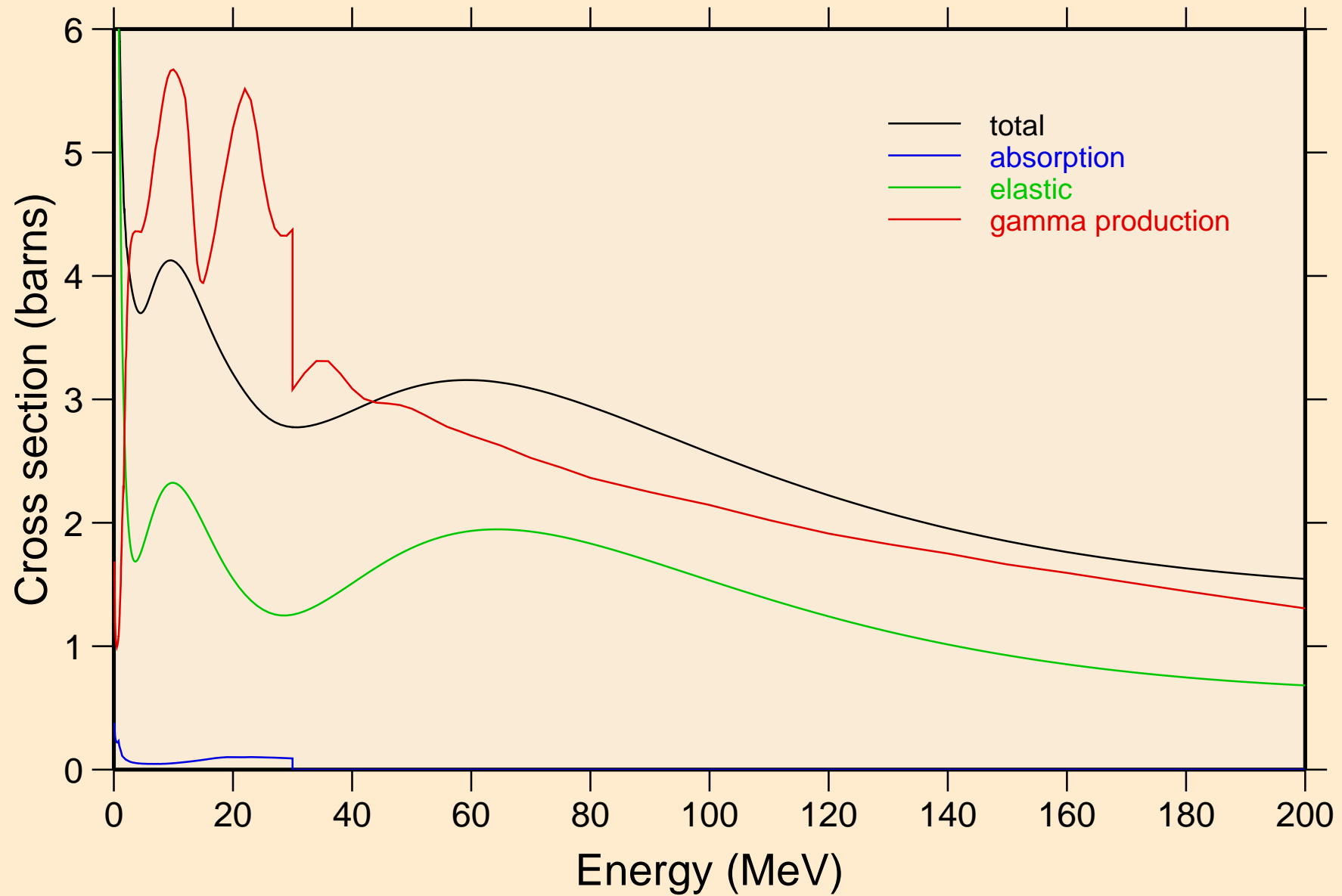

Y087 NEUTRON ACER TENDL-2024 LIBRARY; T=0.K

Heating

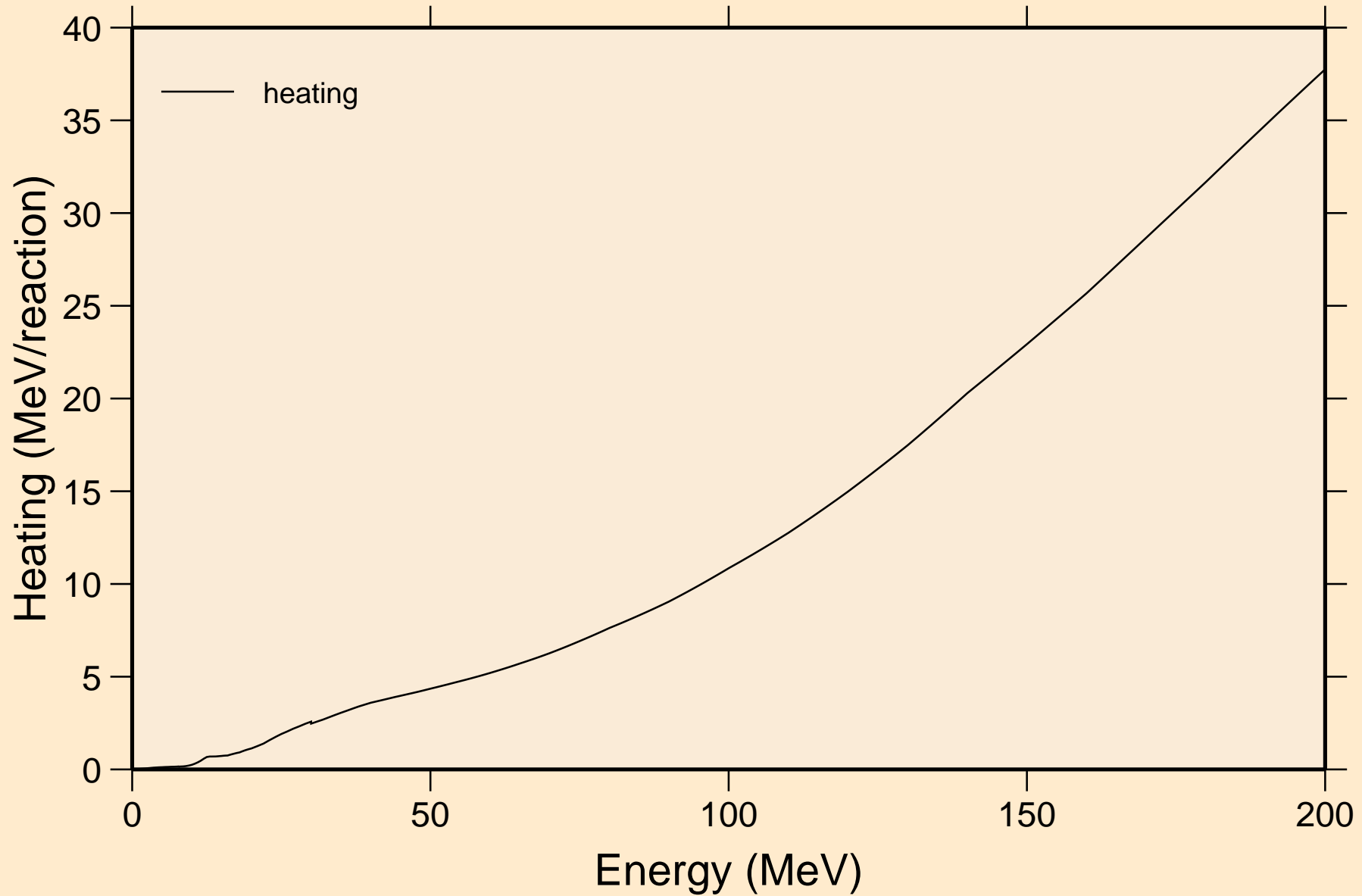

Y087 NEUTRON ACER TENDL-2024 LIBRARY; T=0.K

Damage

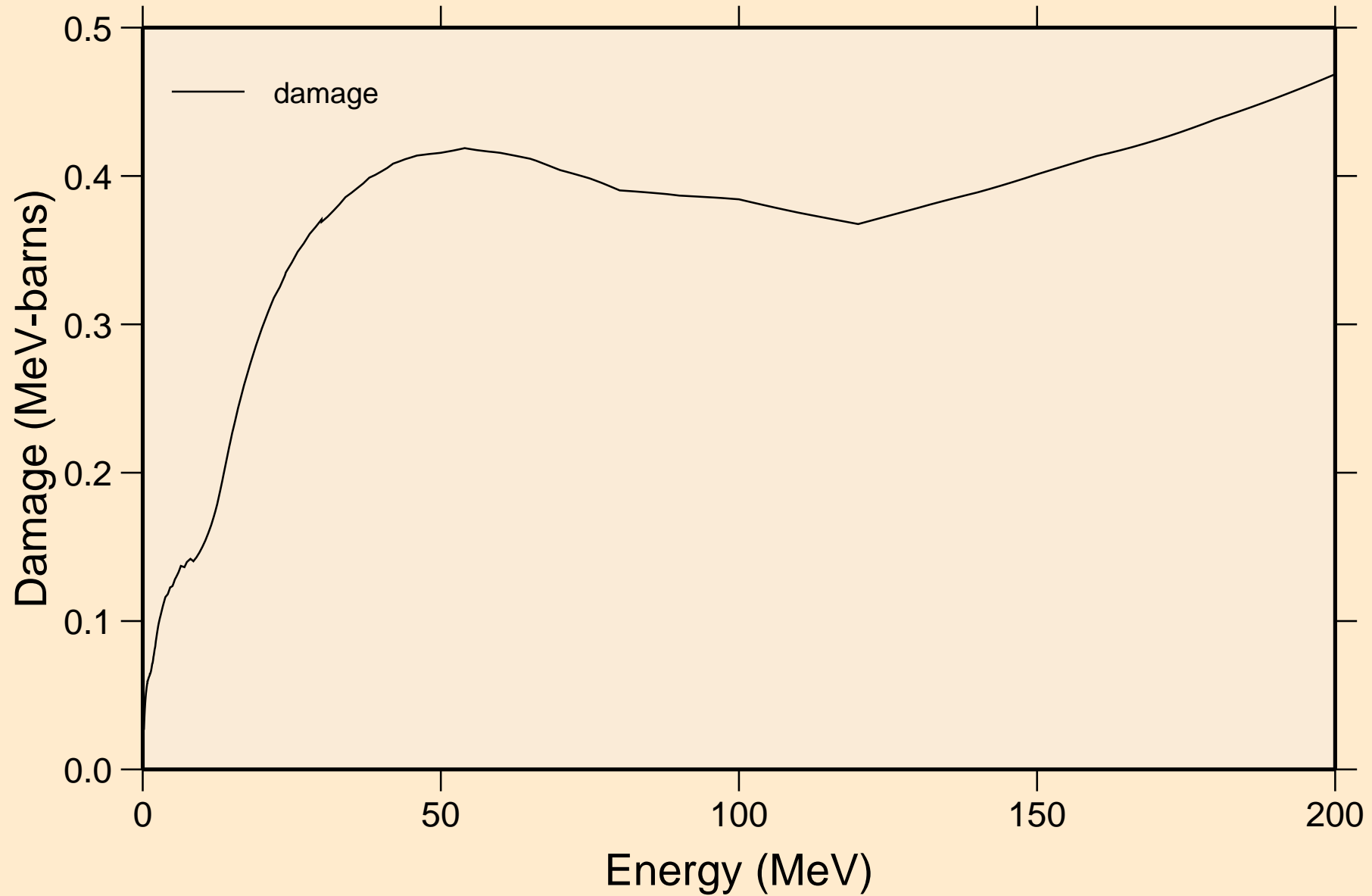

Y087 NEUTRON ACER TENDL-2024 LIBRARY; T=0.K
Non-threshold reactions

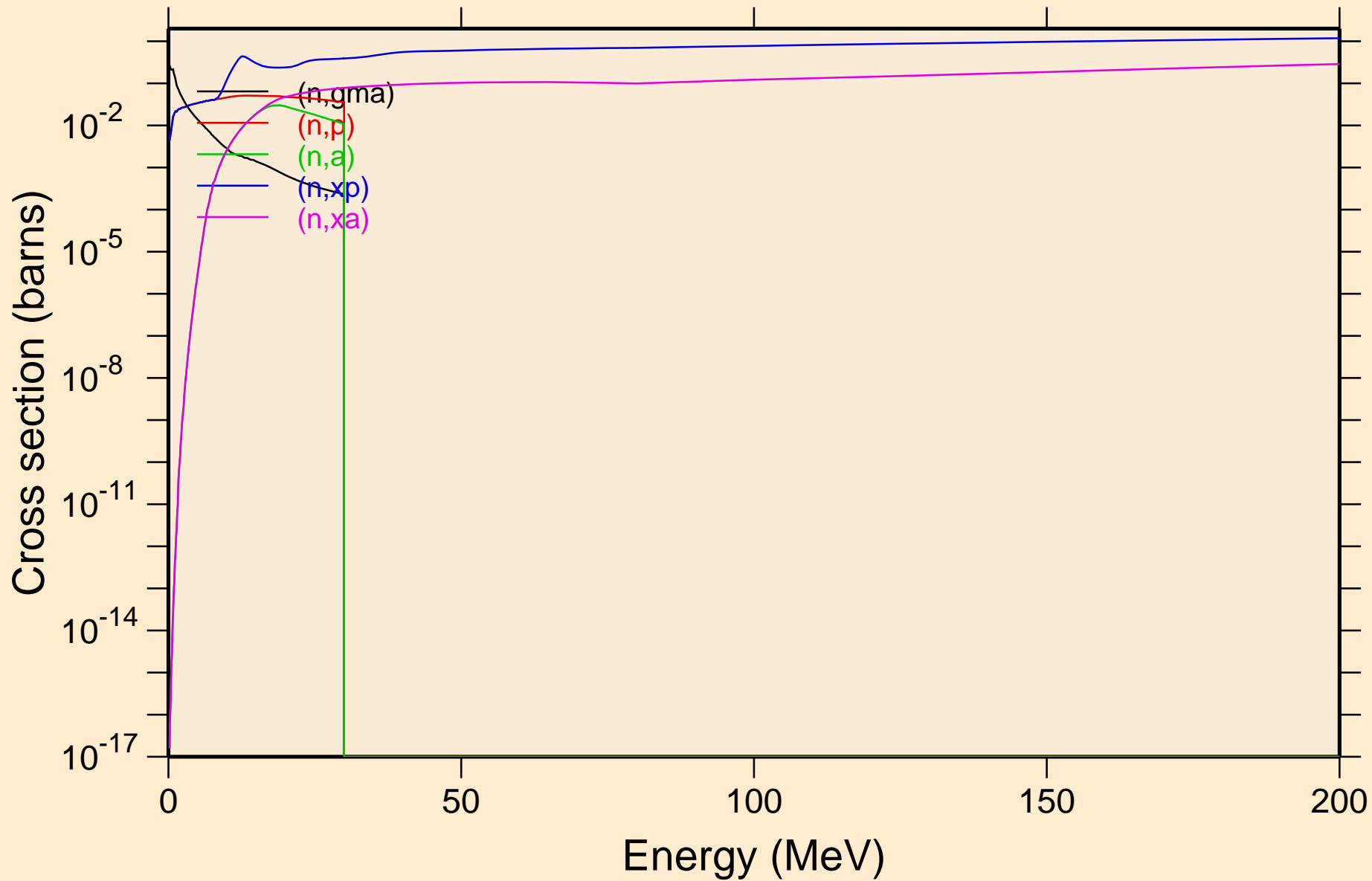

Y087 NEUTRON ACER TENDL-2024 LIBRARY; T=0.K
Inelastic levels

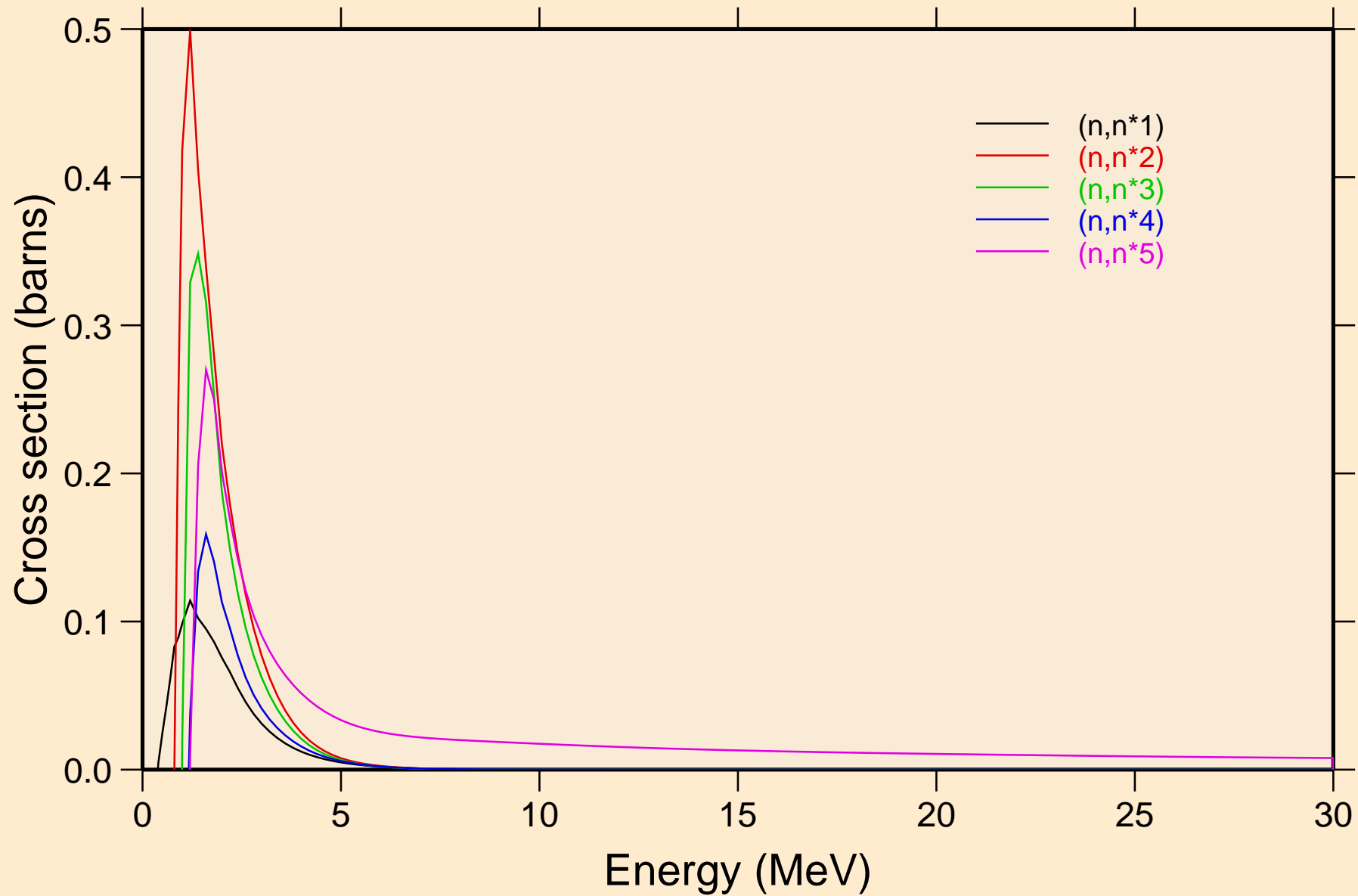

Y087 NEUTRON ACER TENDL-2024 LIBRARY; T=0.K

Inelastic levels

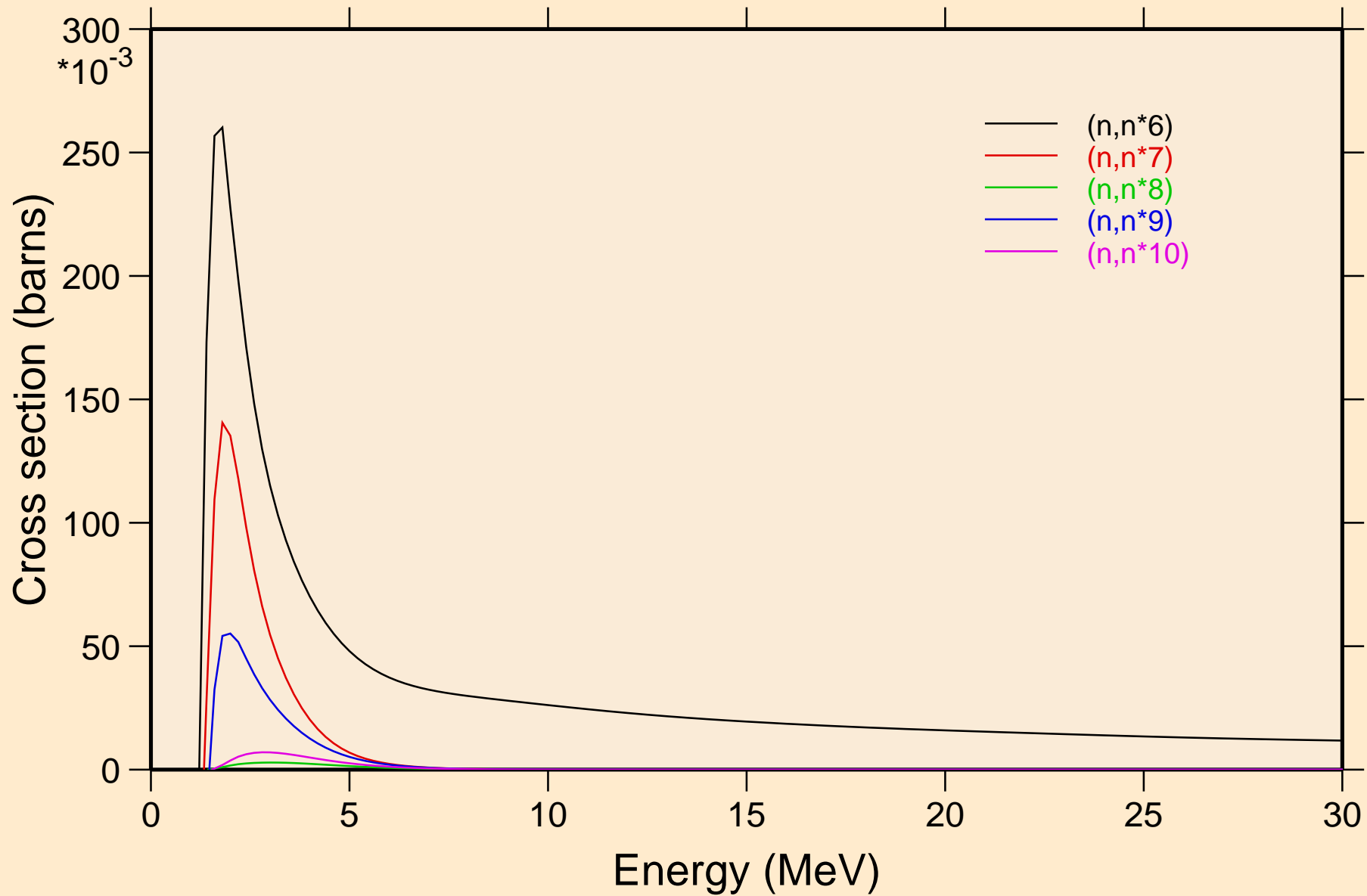

Y087 NEUTRON ACER TENDL-2024 LIBRARY; T=0.K
Inelastic levels

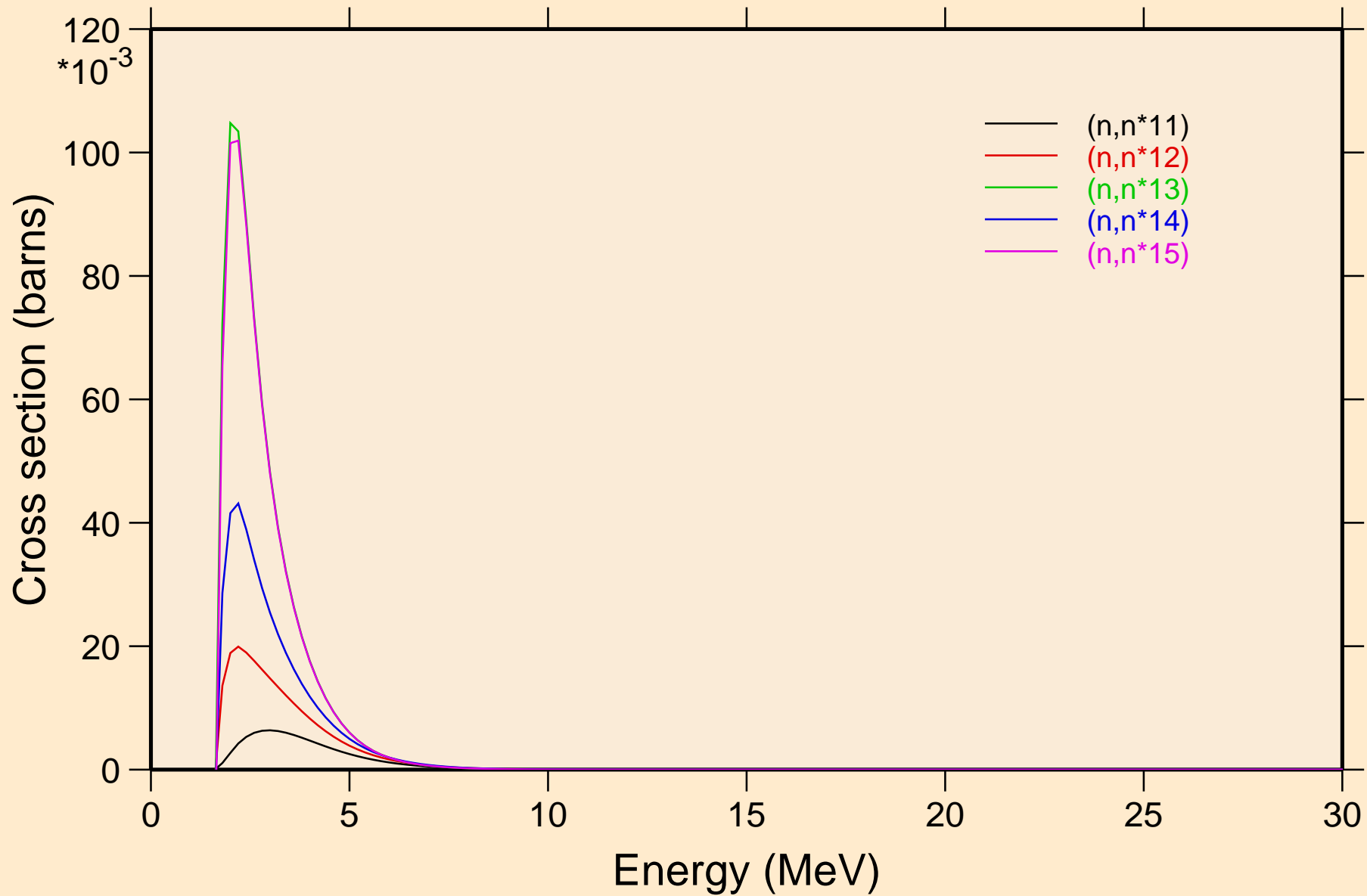

Y087 NEUTRON ACER TENDL-2024 LIBRARY; T=0.K
Inelastic levels

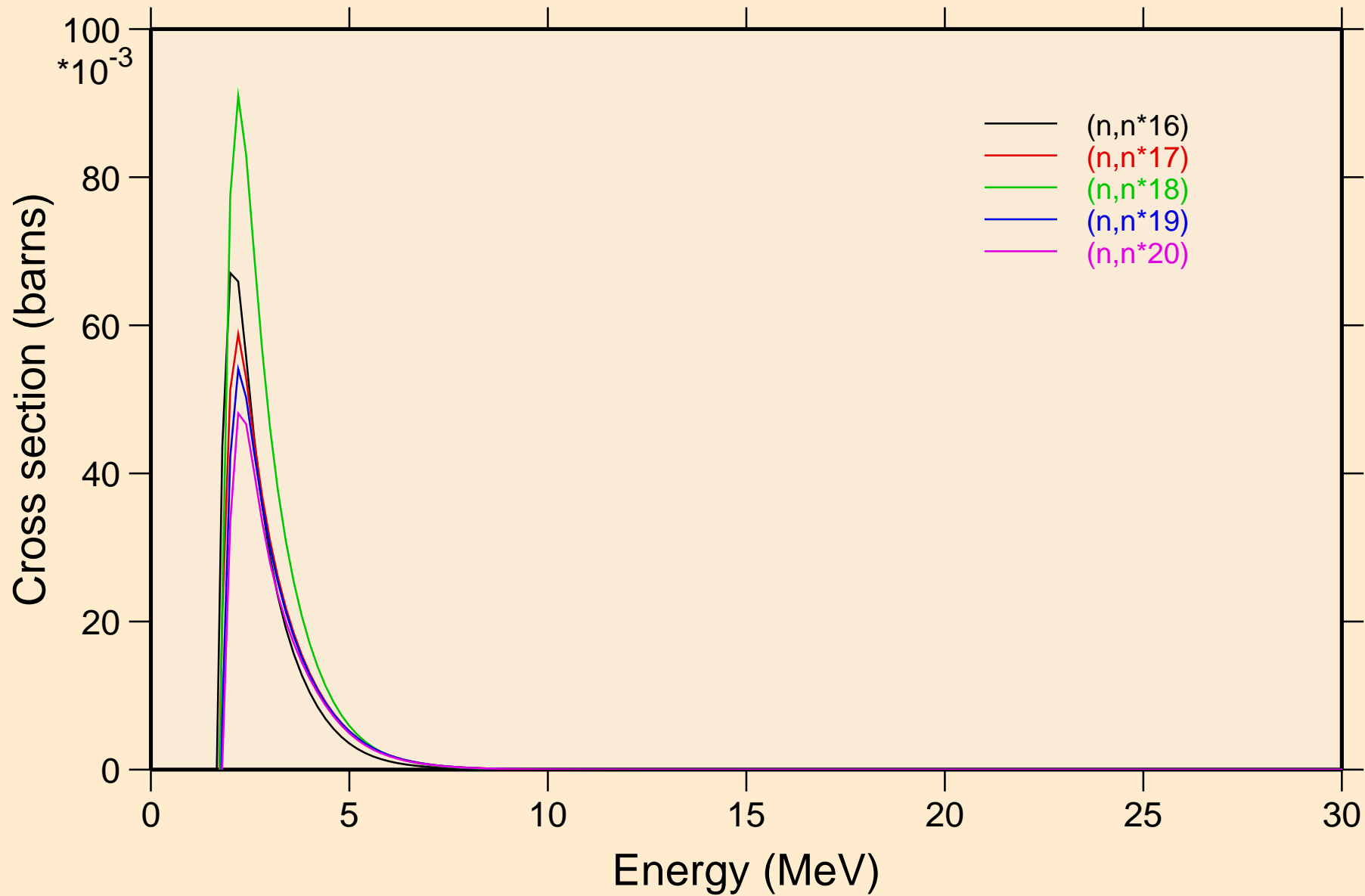

Y087 NEUTRON ACER TENDL-2024 LIBRARY; T=0.K
Inelastic levels

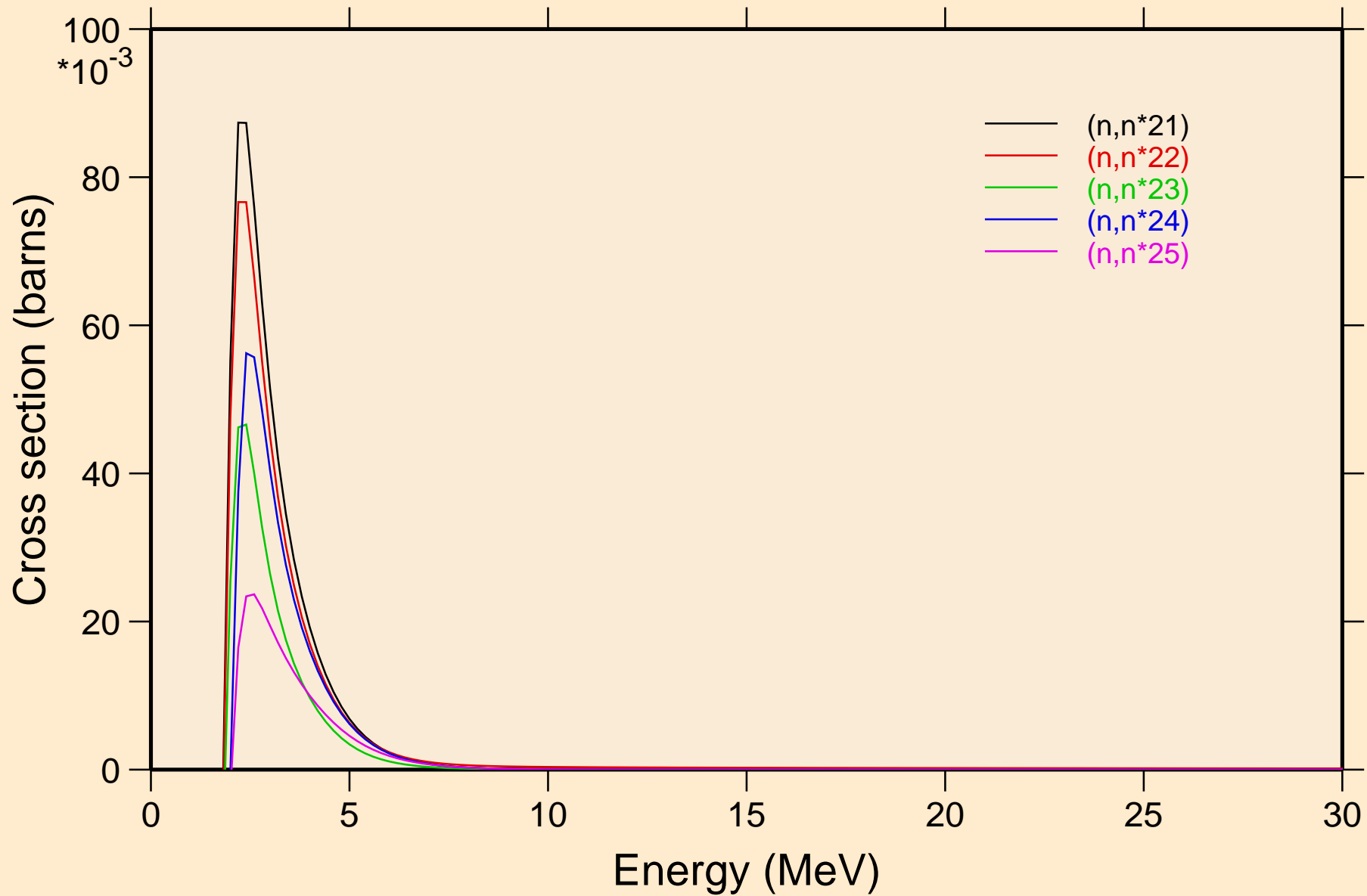

Y087 NEUTRON ACER TENDL-2024 LIBRARY; T=0.K
Inelastic levels

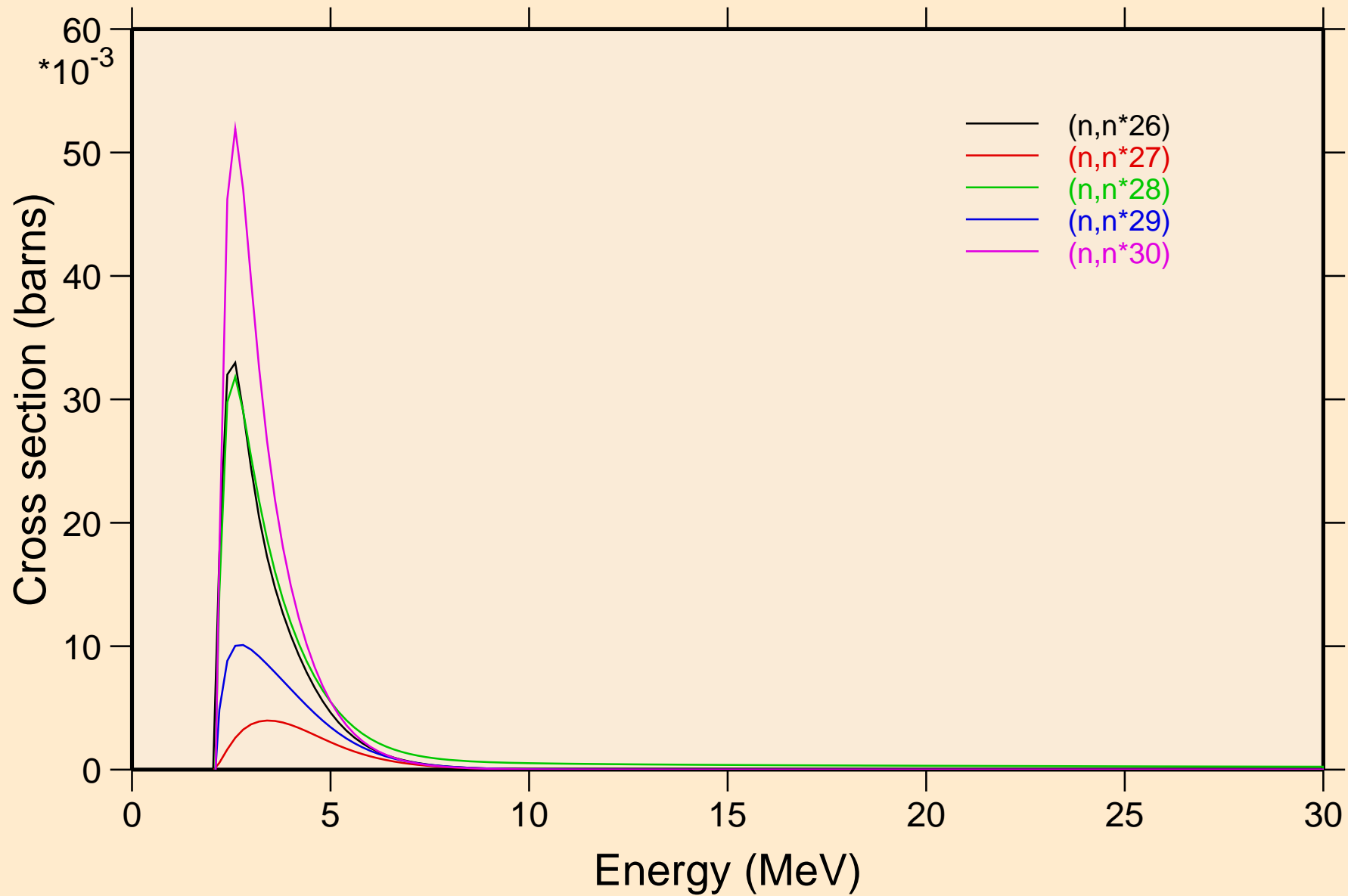

Y087 NEUTRON ACER TENDL-2024 LIBRARY; T=0.K

Threshold reactions

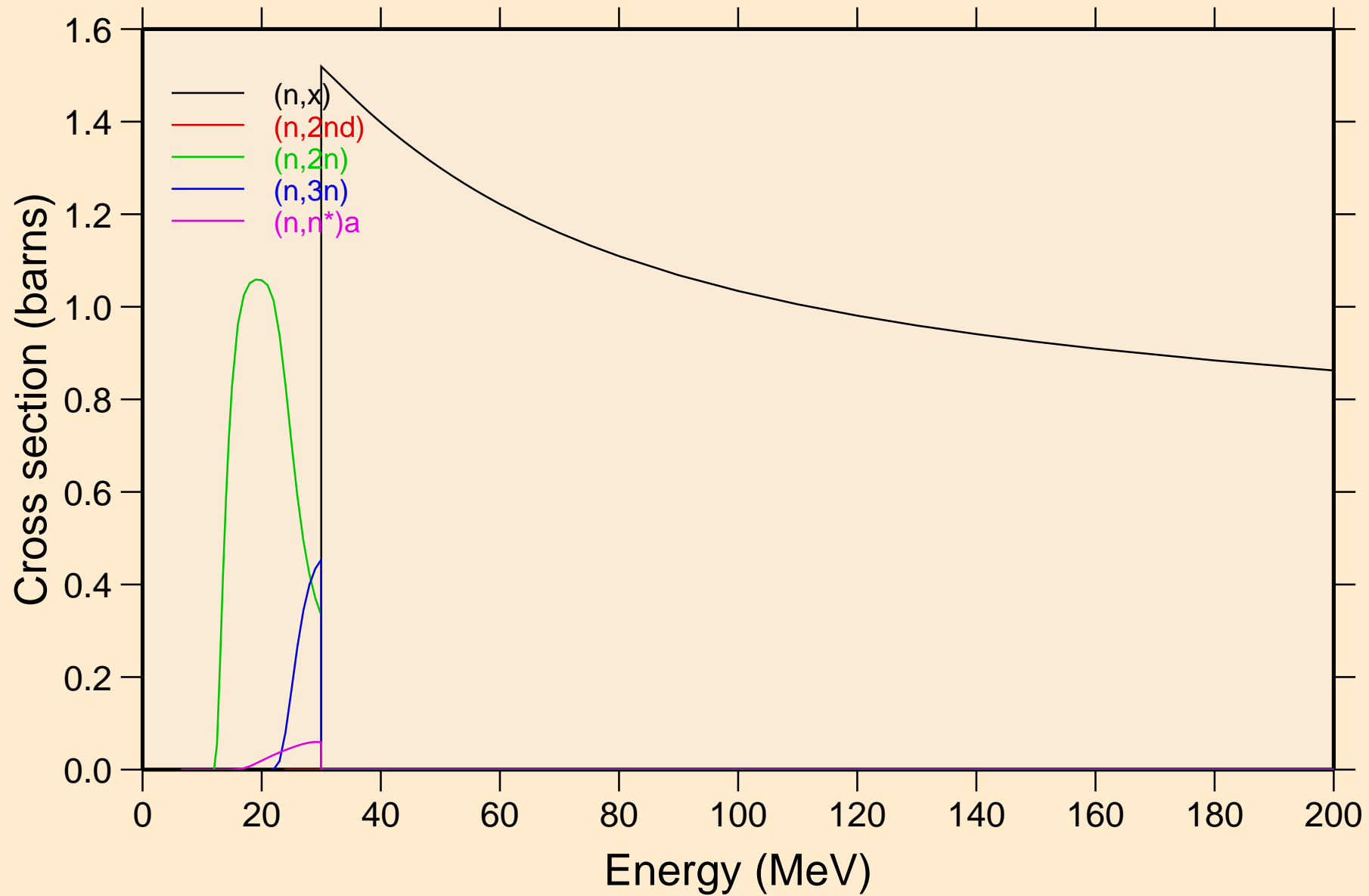

Y087 NEUTRON ACER TENDL-2024 LIBRARY; T=0.K

Threshold reactions

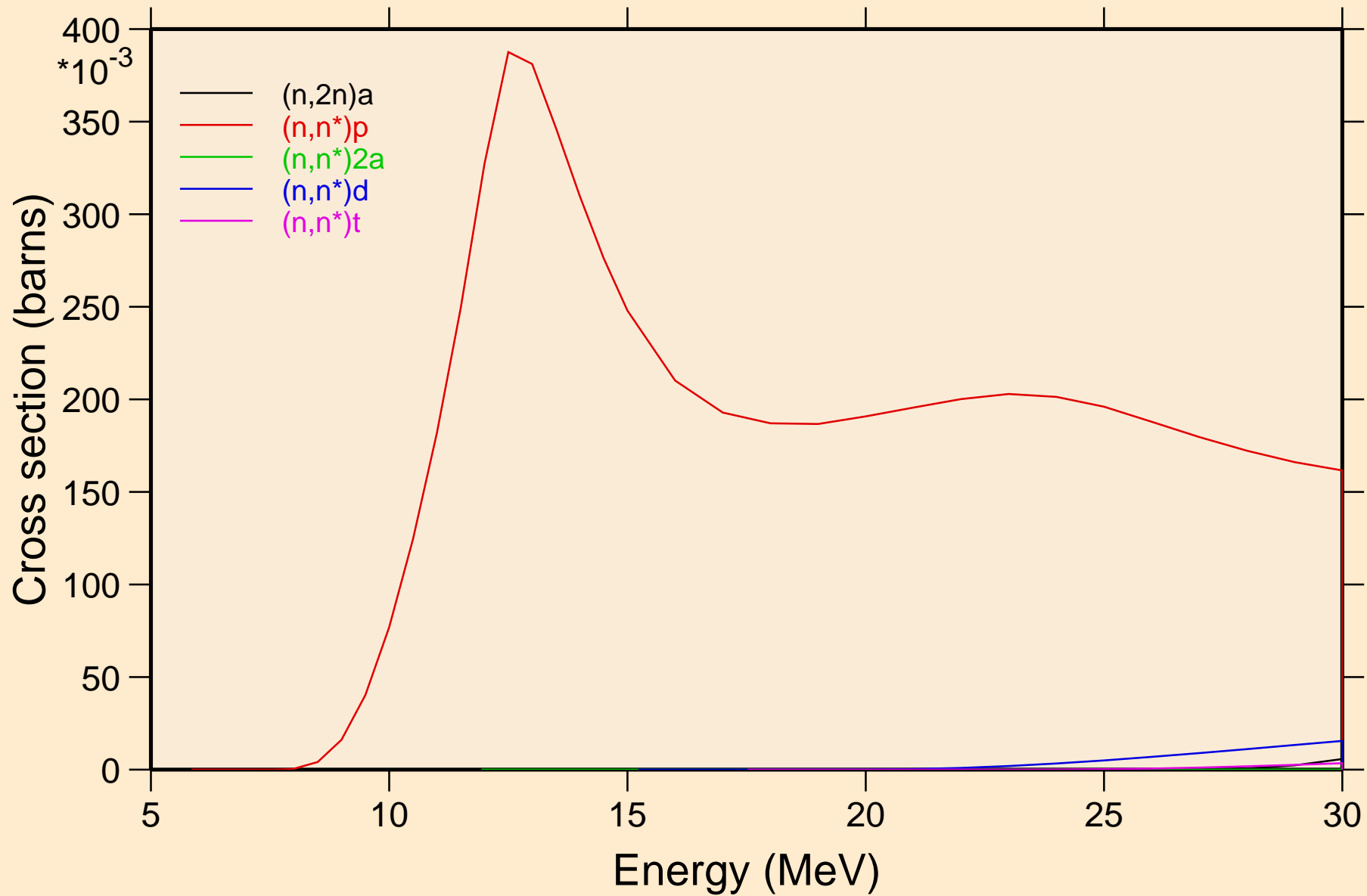

Y087 NEUTRON ACER TENDL-2024 LIBRARY; T=0.K
Threshold reactions

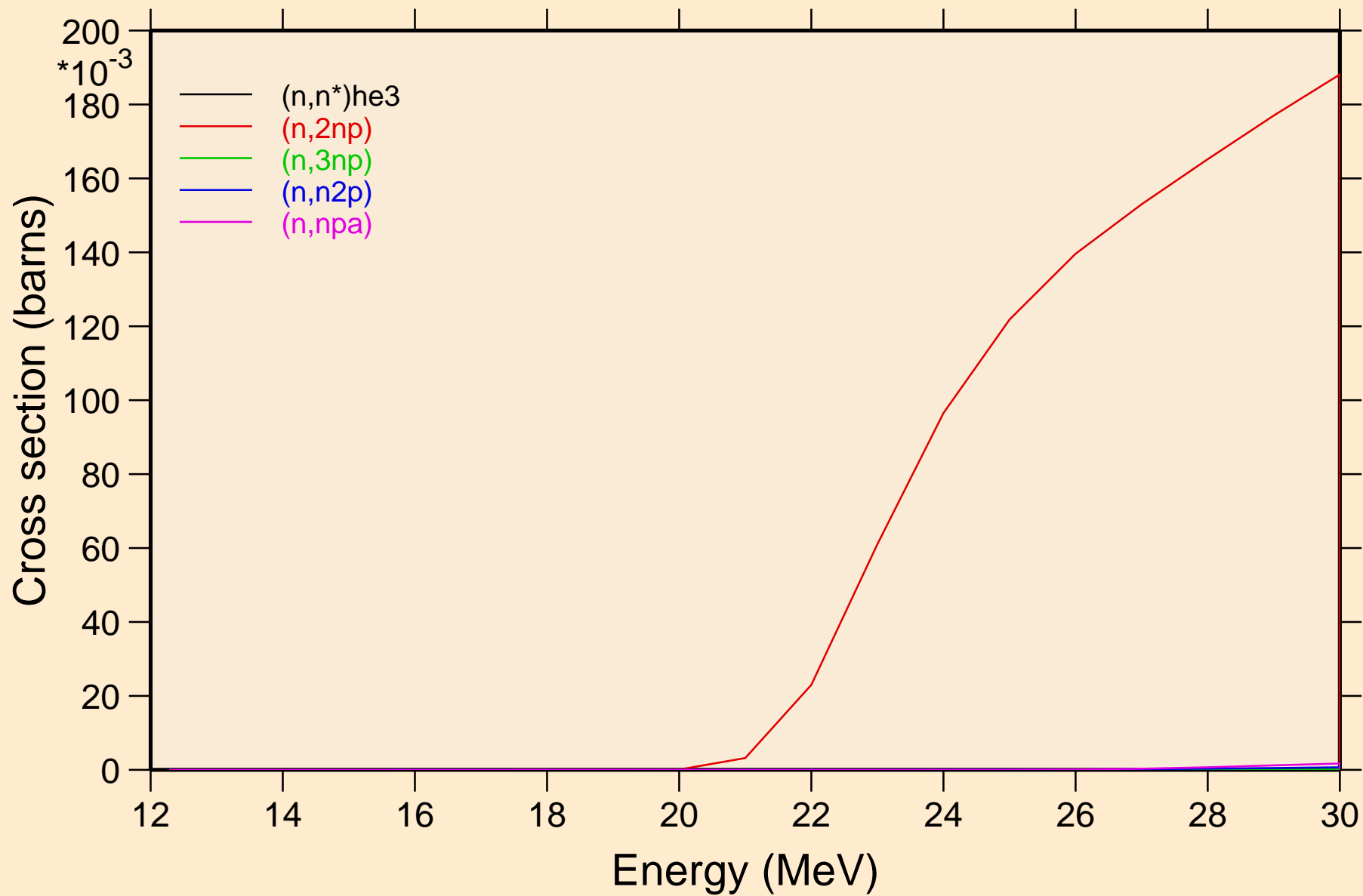

Y087 NEUTRON ACER TENDL-2024 LIBRARY; T=0.K

Threshold reactions

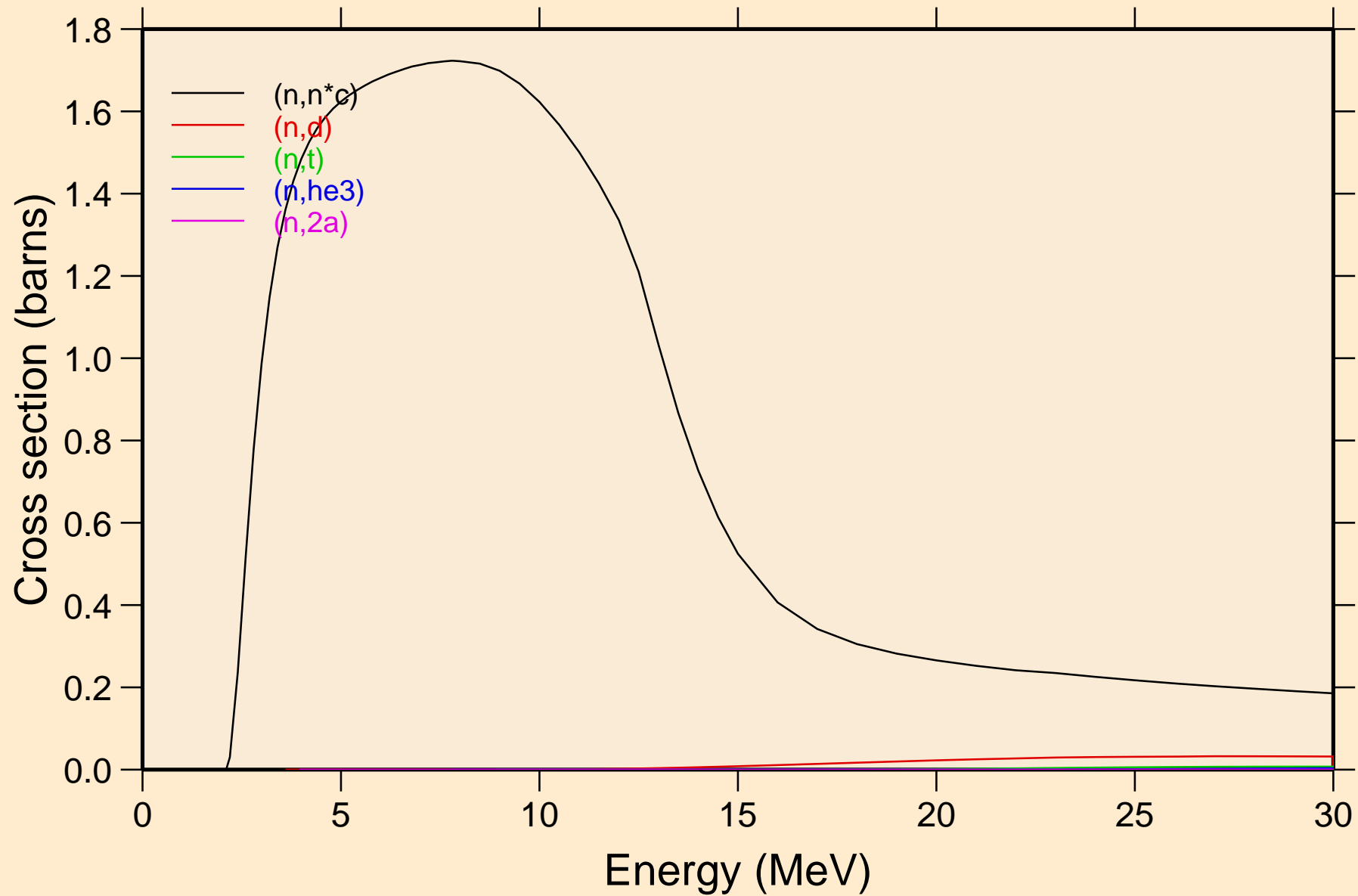

Y087 NEUTRON ACER TENDL-2024 LIBRARY; T=0.K
Threshold reactions

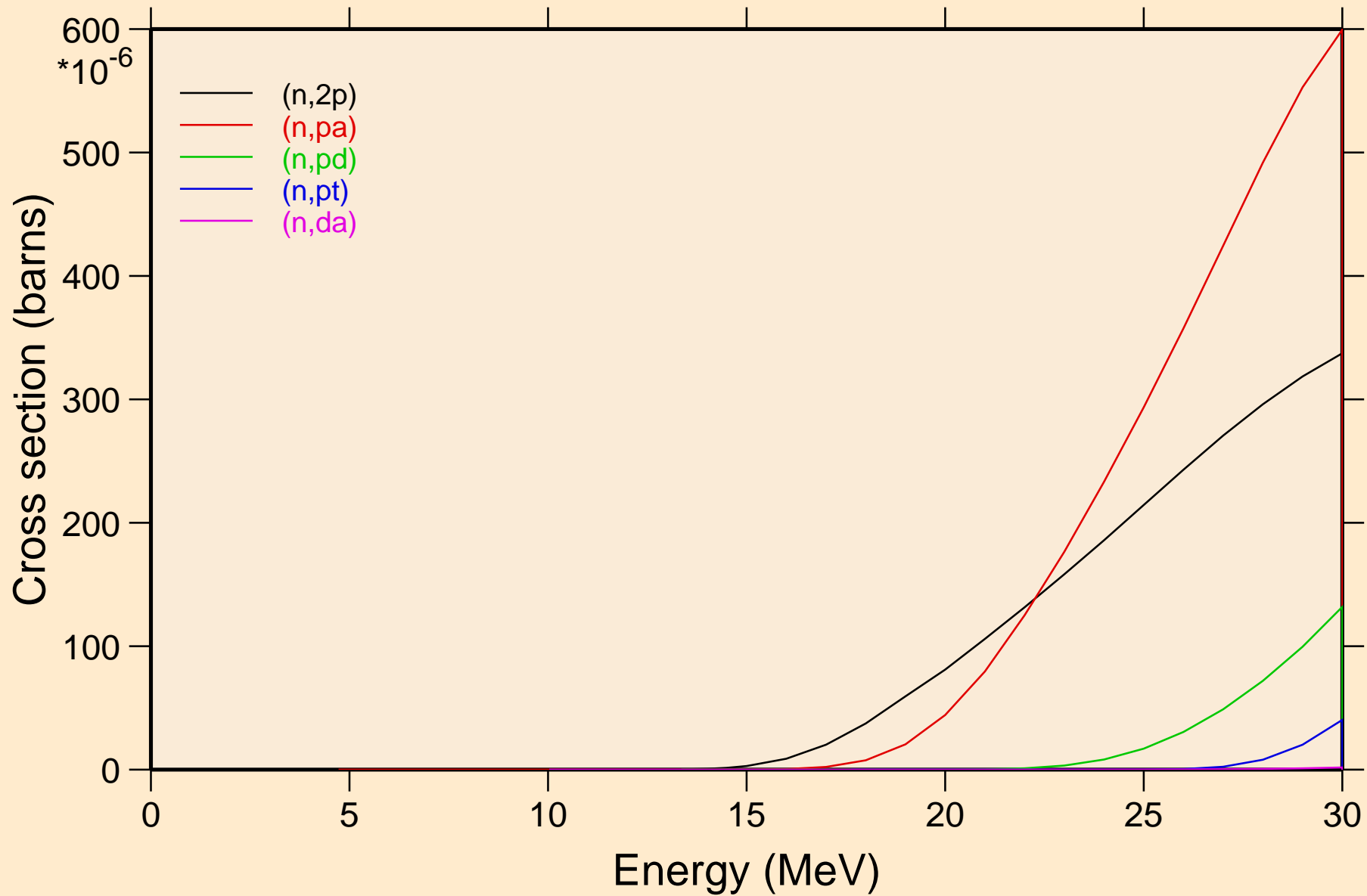

Y087 NEUTRON ACER TENDL-2024 LIBRARY; T=0.K

Threshold reactions

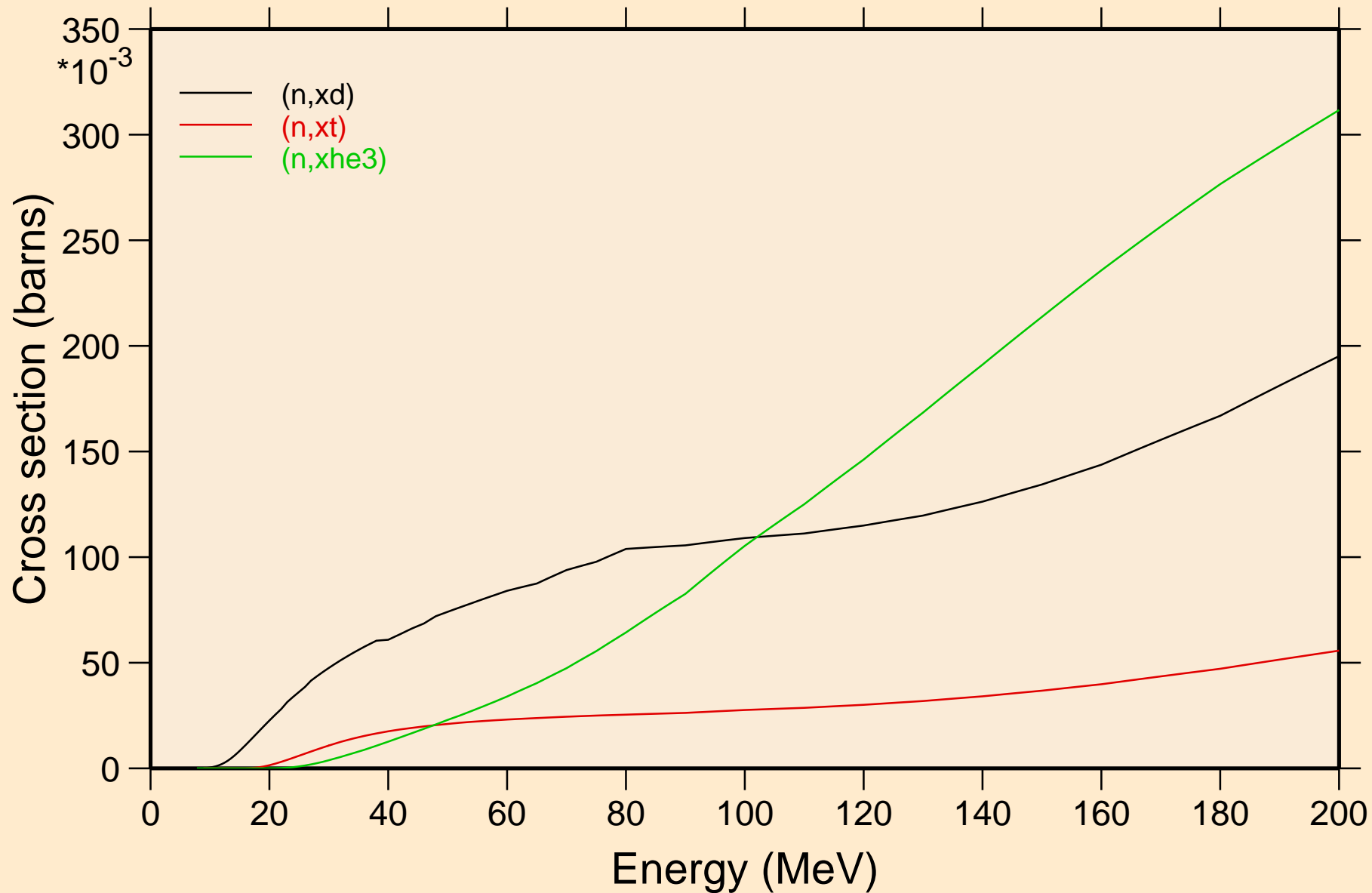

Y087 NEUTRON ACER TENDL-2024 LIBRARY; T=0.K
angular distribution for elastic

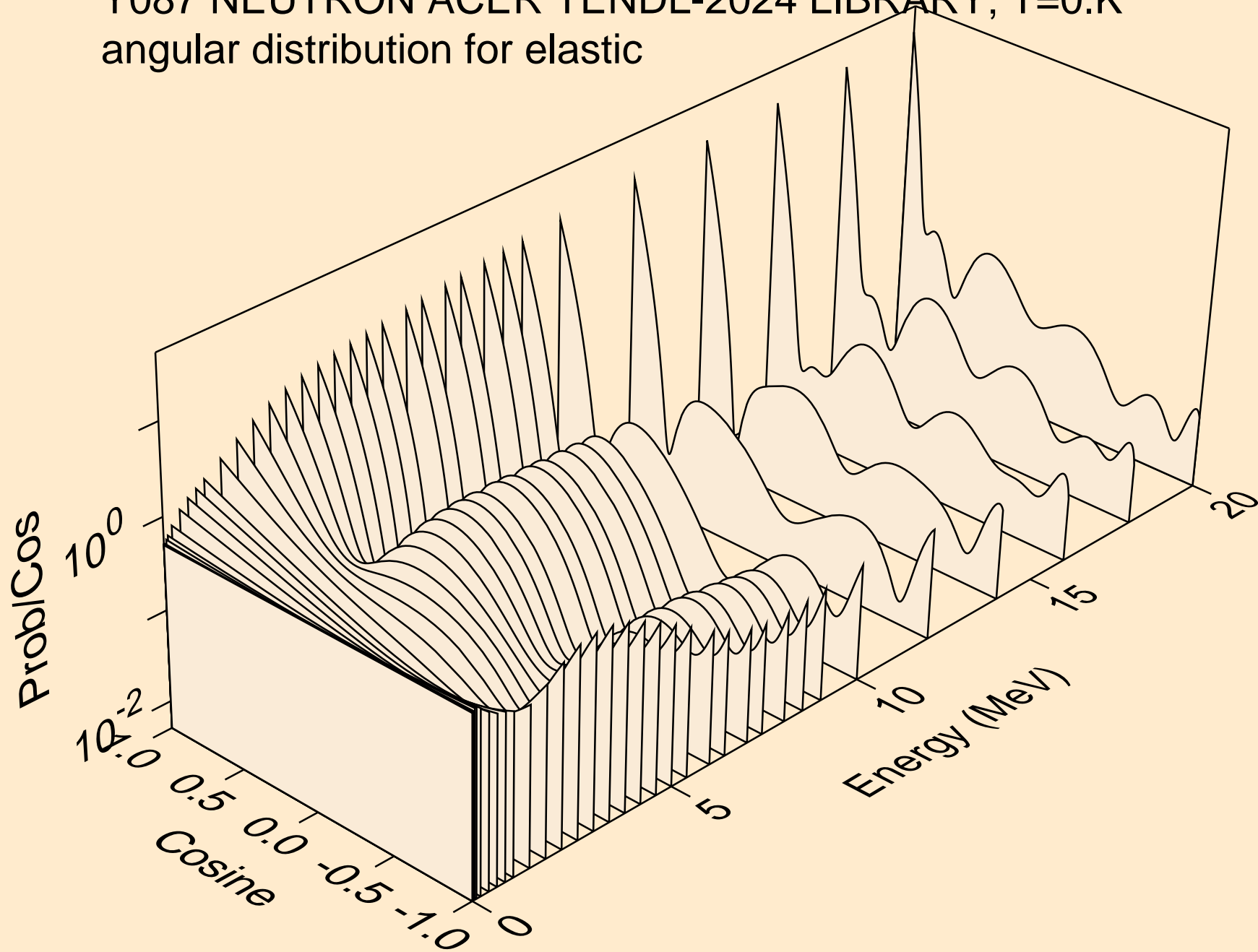

Y087 NEUTRON ACER TENDL-2024 LIBRARY; T=0.K
angular distribution for elastic

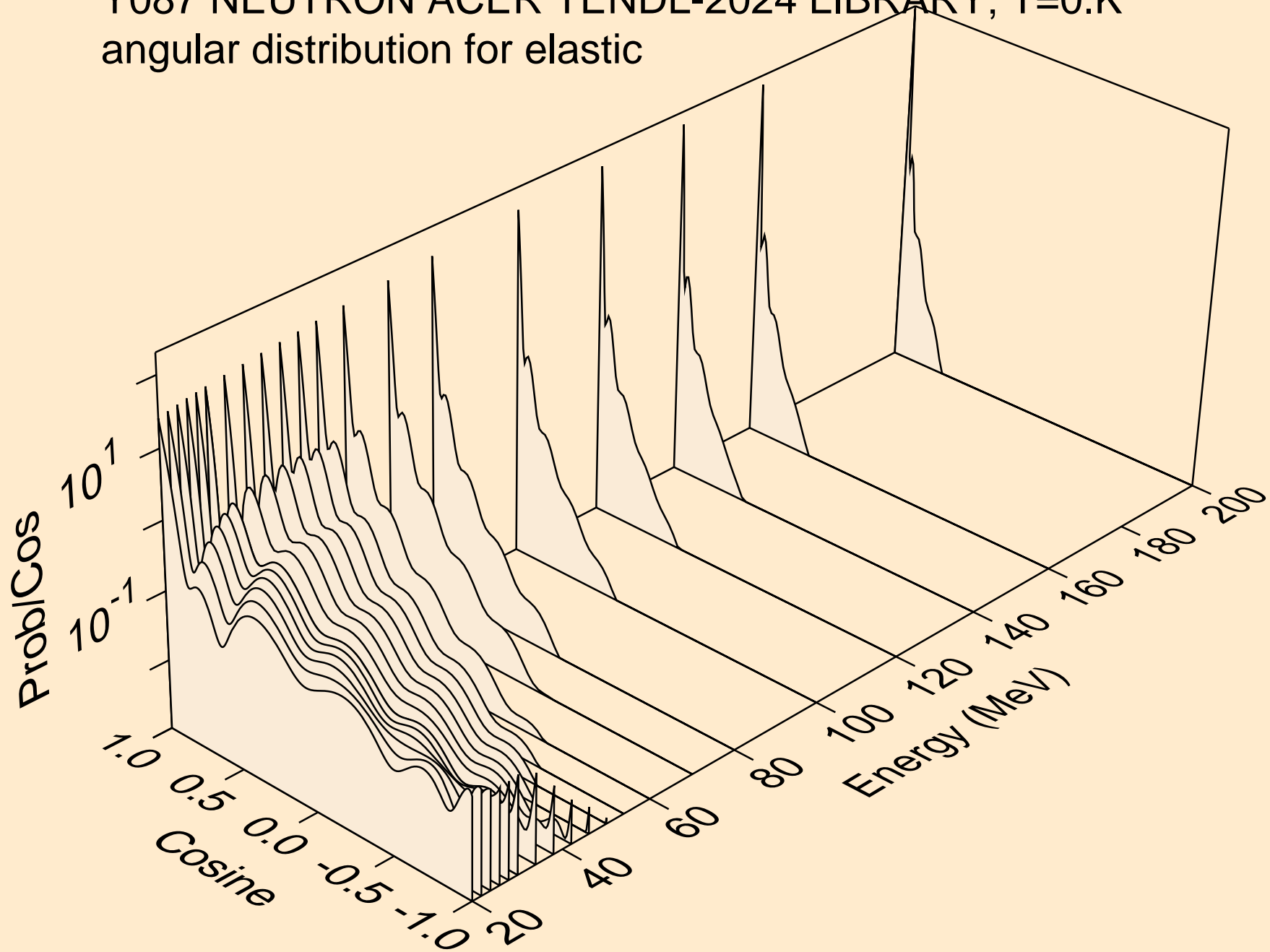

Y087 NEUTRON ACER TENDL-2024 LIBRARY; T=0.K
angular distribution for (n,n*1)

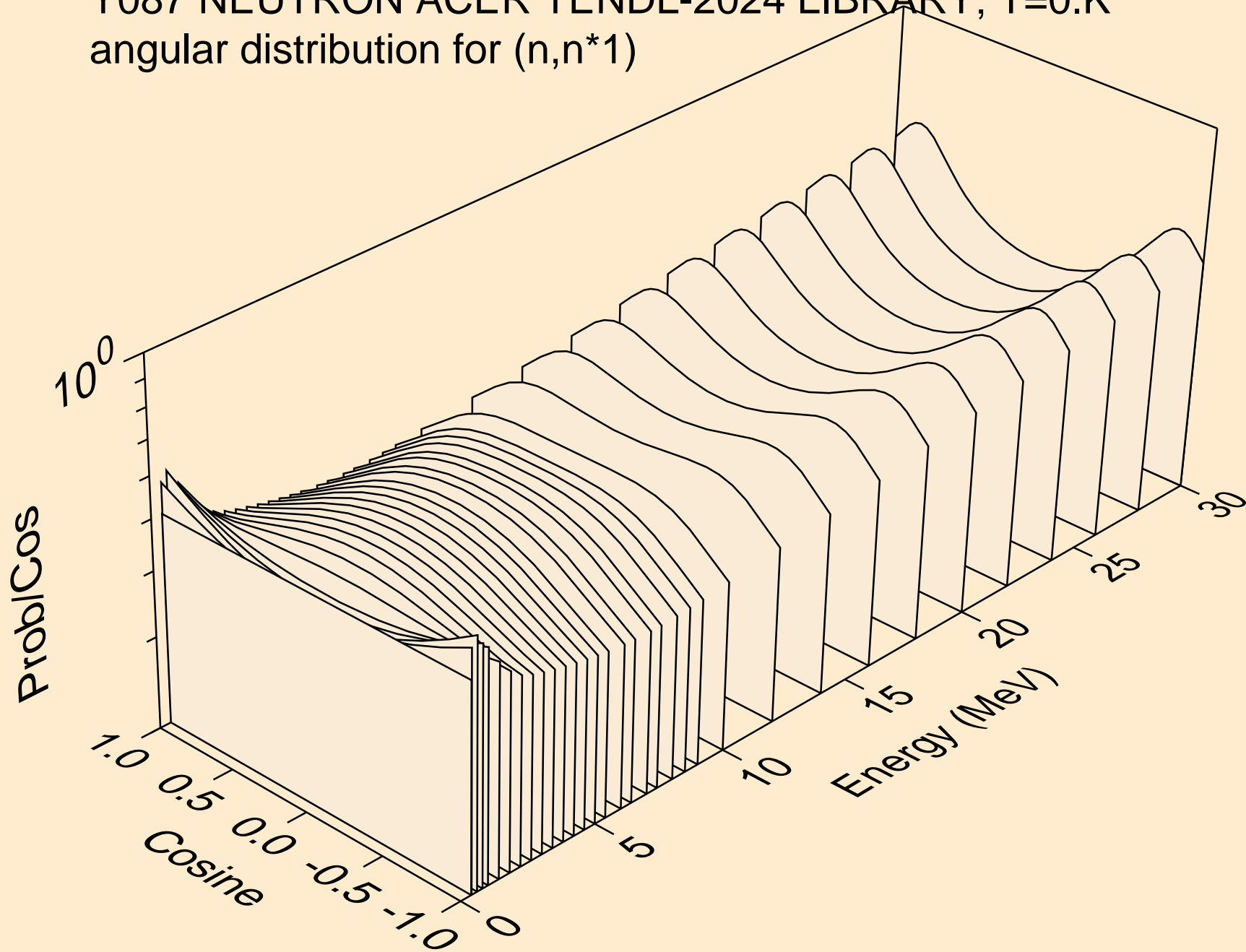

Y087 NEUTRON ACER TENDL-2024 LIBRARY; T=0.K
angular distribution for (n,n*2)

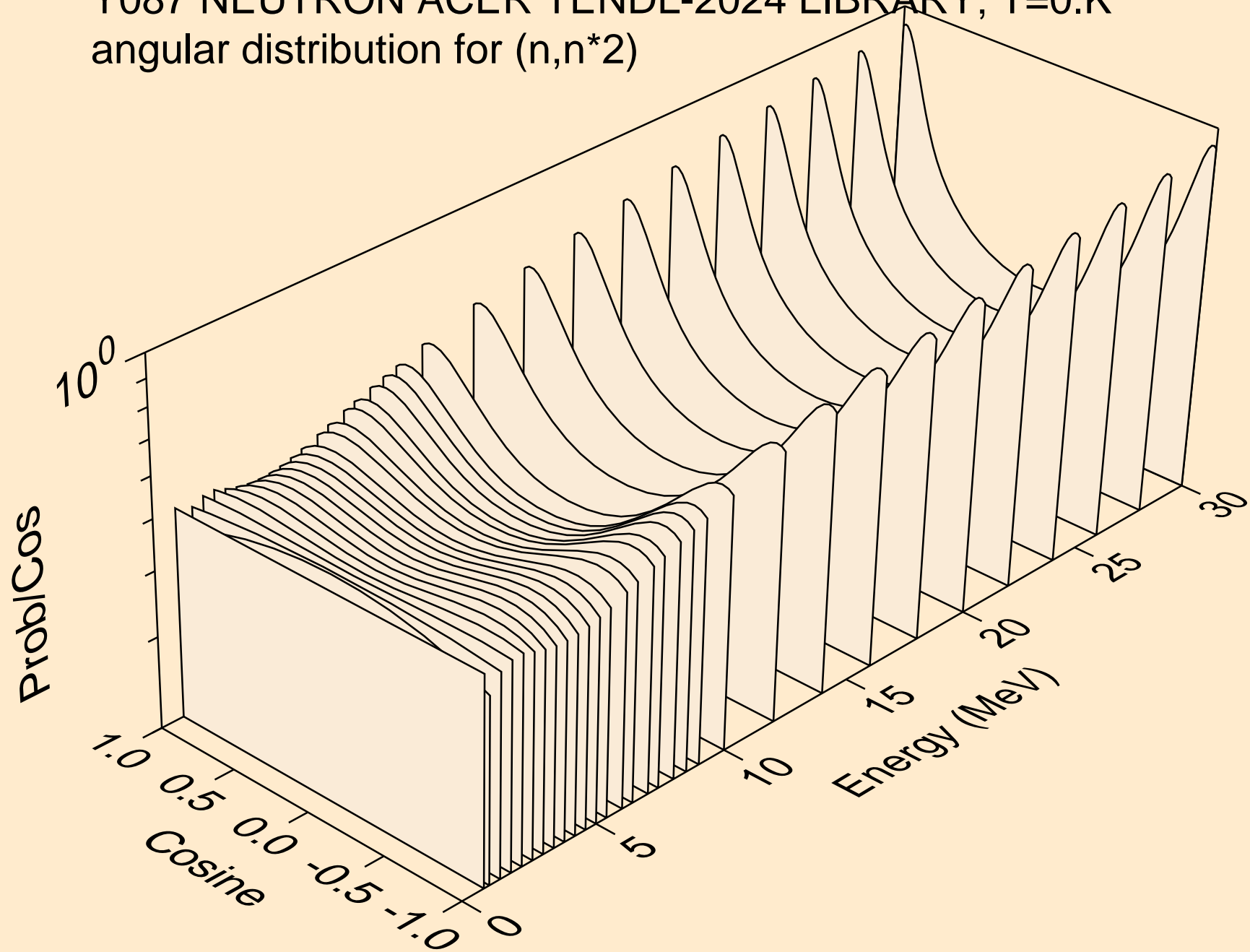

Y087 NEUTRON ACER TENDL-2024 LIBRARY; T=0.K
angular distribution for (n,n*3)

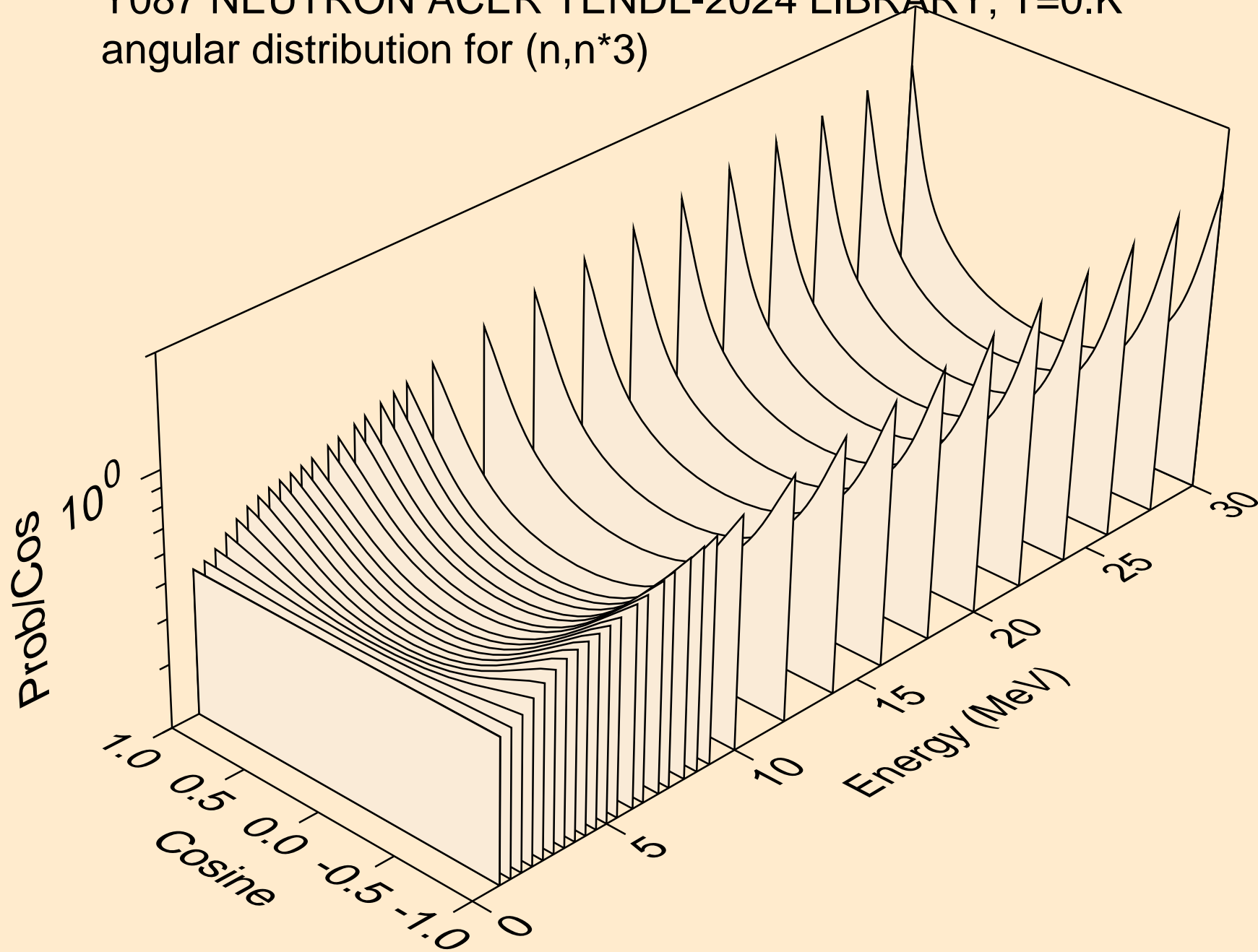

Y087 NEUTRON ACER TENDL-2024 LIBRARY; T=0.K
angular distribution for (n,n*4)

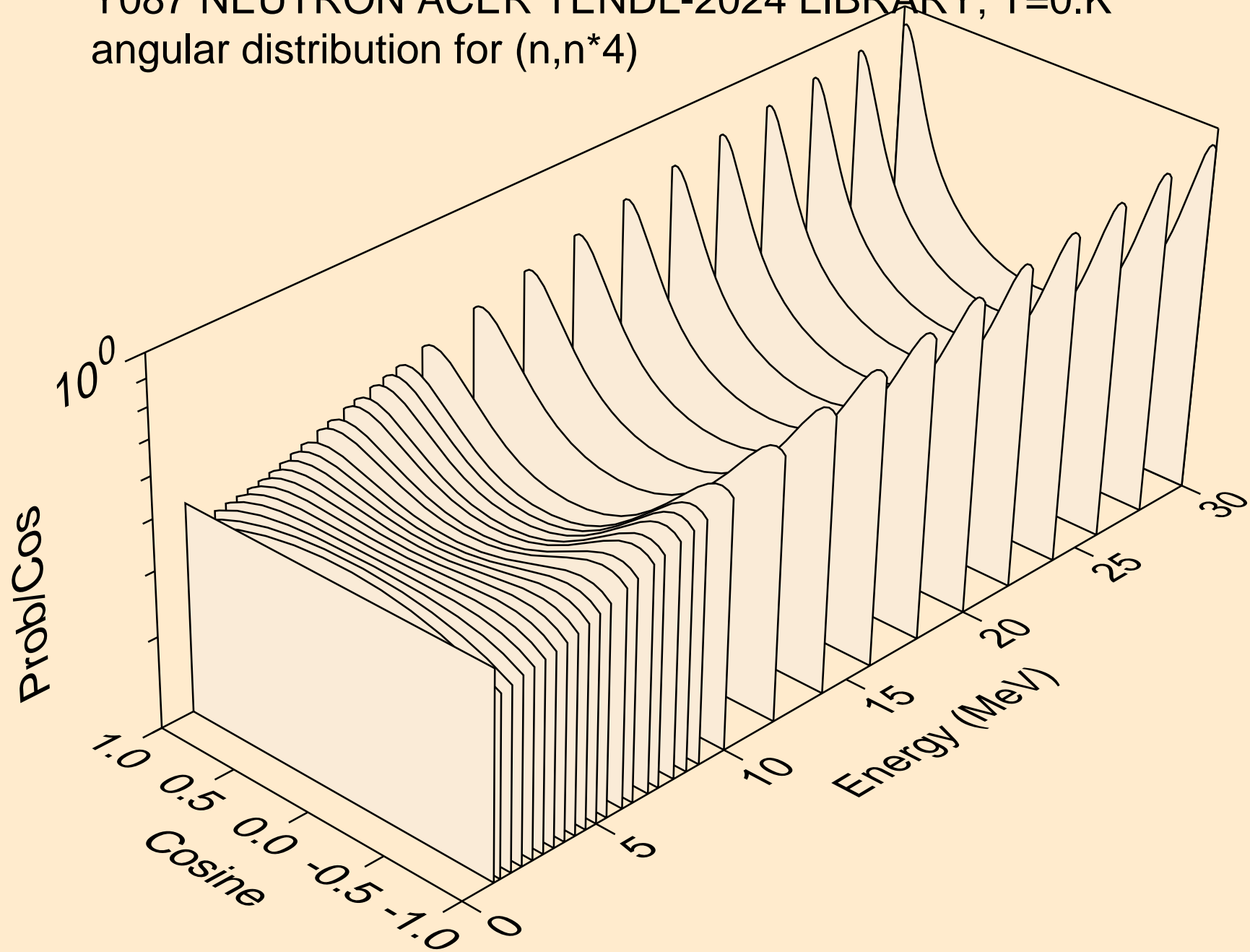

Y087 NEUTRON ACER TENDL-2024 LIBRARY; T=0.K
angular distribution for (n,n*5)

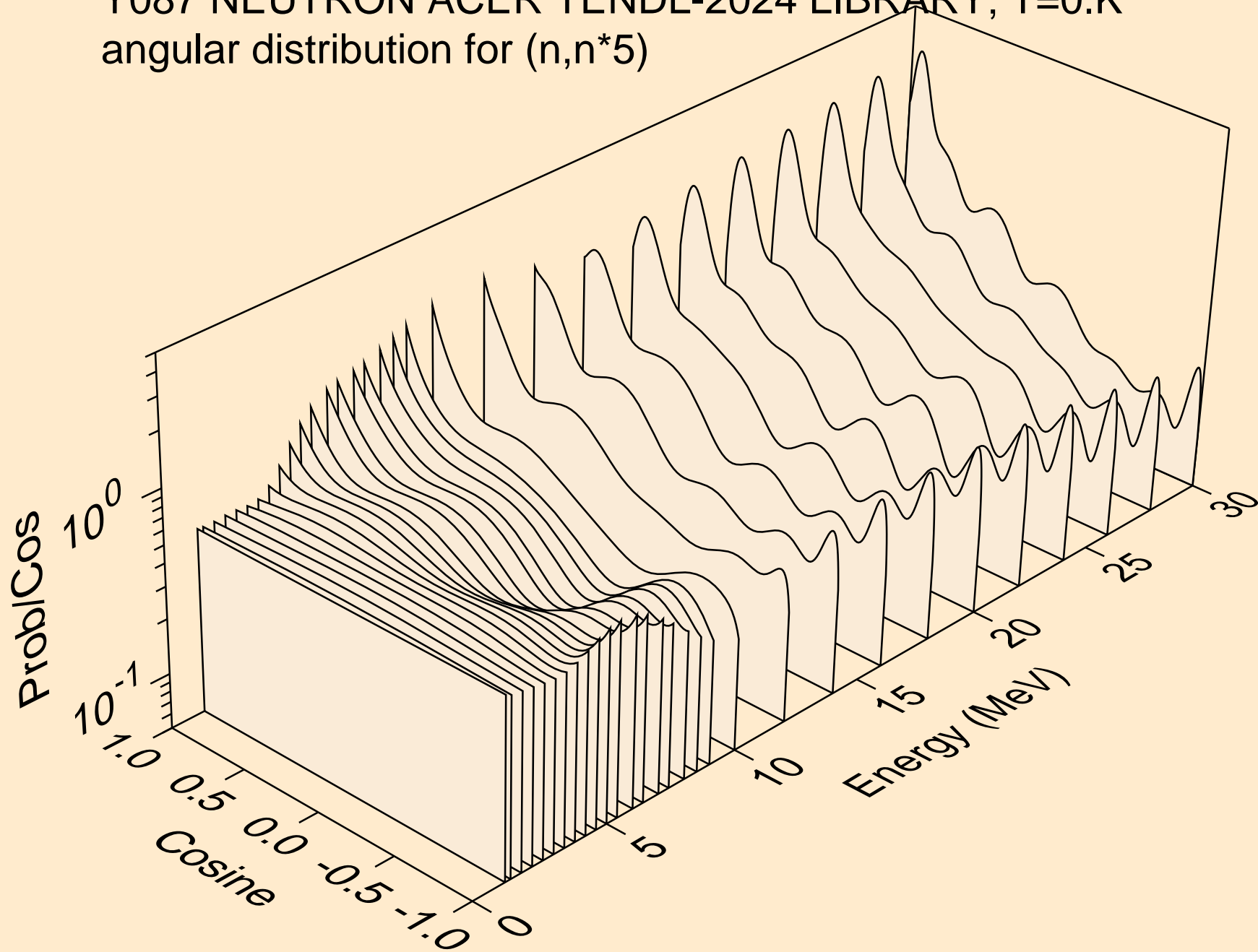

Y087 NEUTRON ACER TENDL-2024 LIBRARY; T=0.K
angular distribution for (n,n*6)

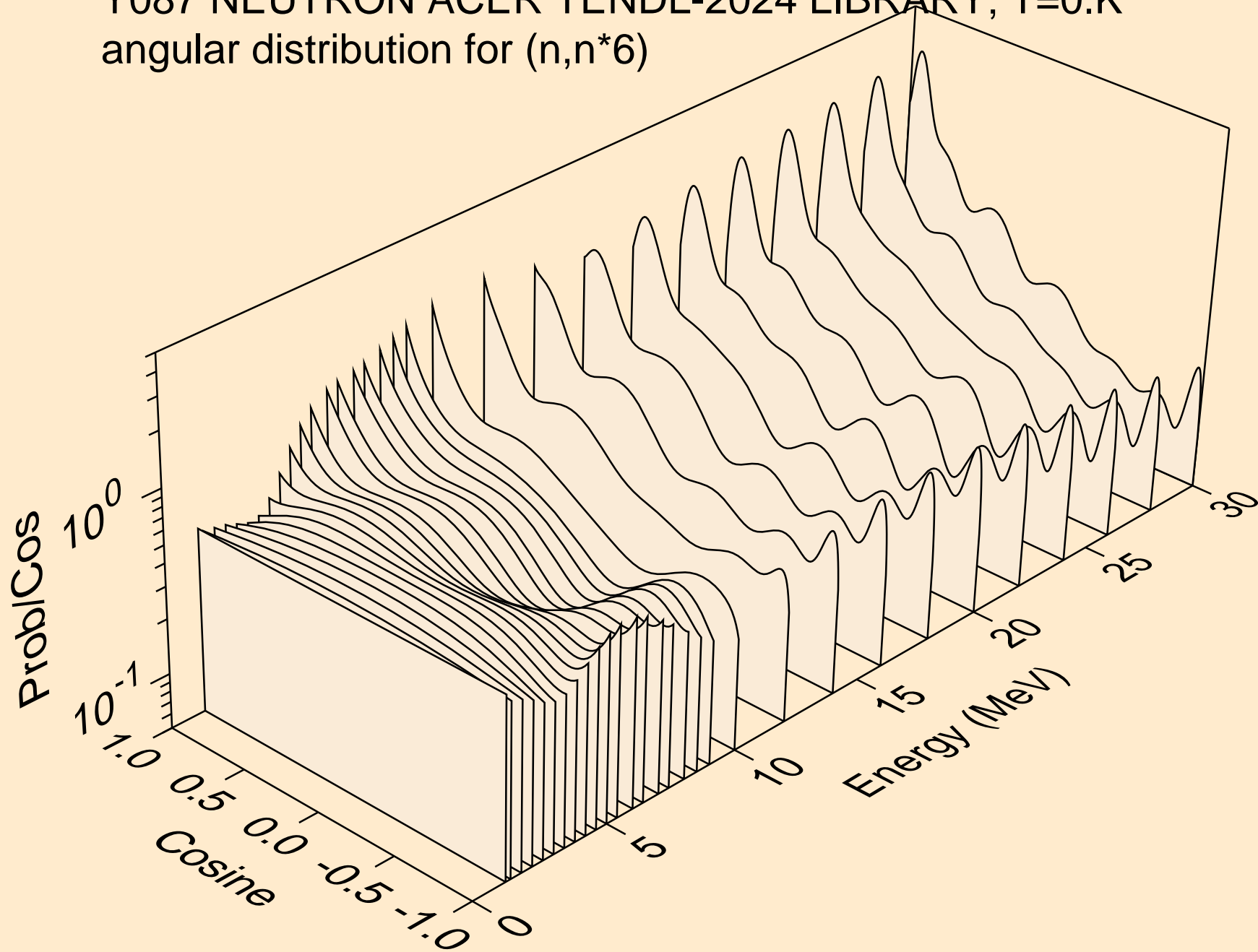

Y087 NEUTRON ACER TENDL-2024 LIBRARY; T=0.K
angular distribution for (n,n*7)

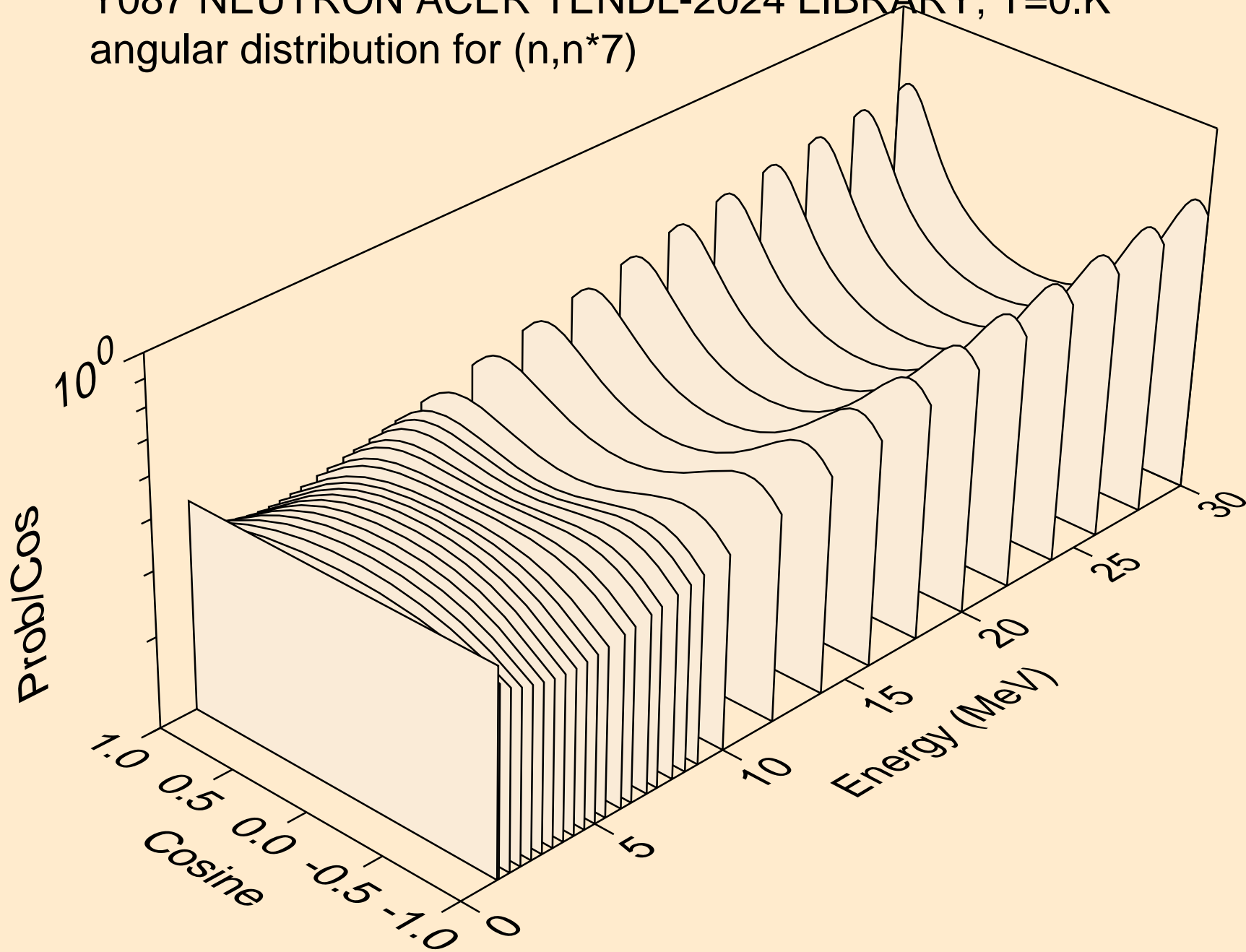

Y087 NEUTRON ACER TENDL-2024 LIBRARY; T=0.K
angular distribution for (n,n*8)

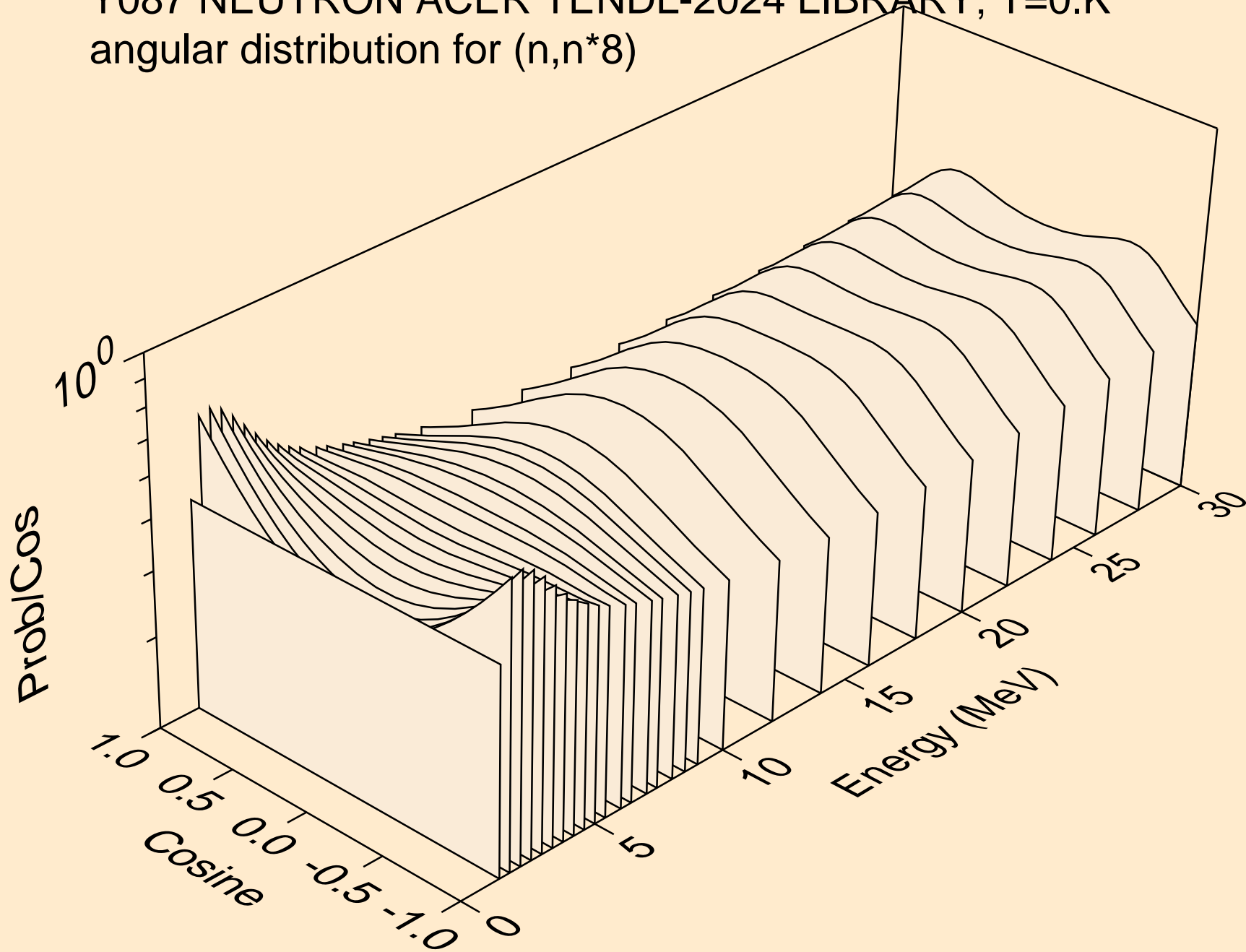

Y087 NEUTRON ACER TENDL-2024 LIBRARY; T=0.K
angular distribution for (n,n*9)

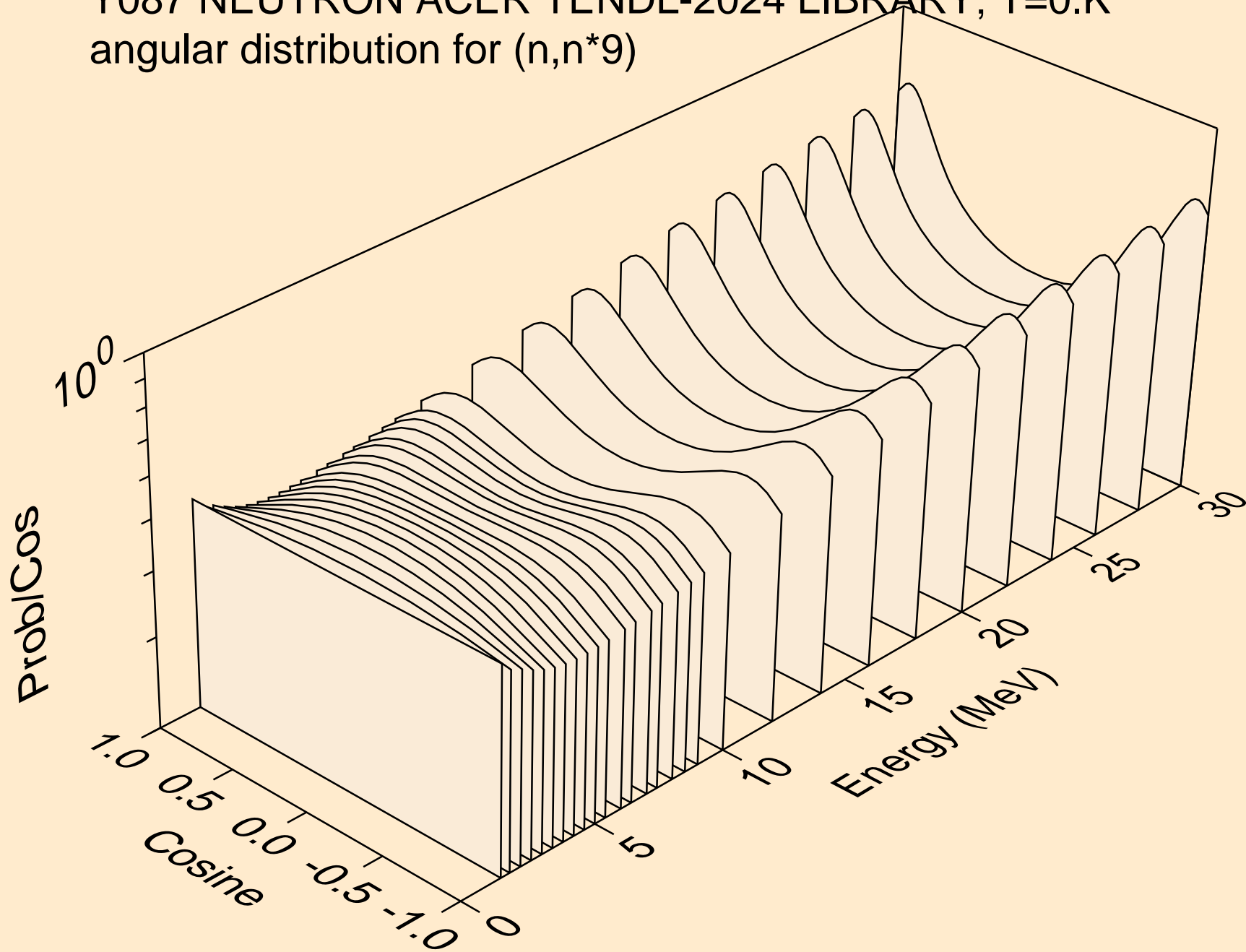

Y087 NEUTRON ACER TENDL-2024 LIBRARY; T=0.K
angular distribution for (n,n*10)

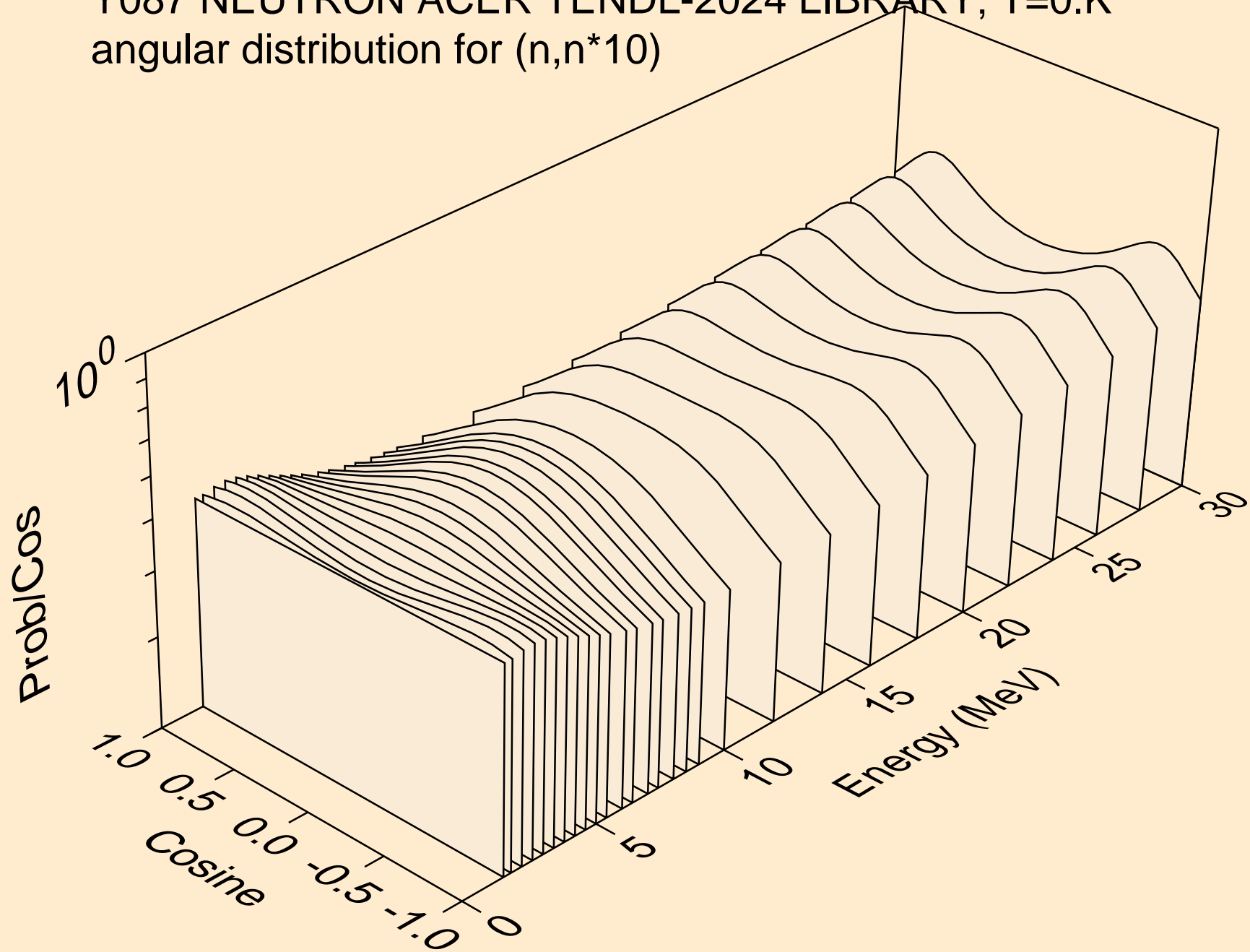

Y087 NEUTRON ACER TENDL-2024 LIBRARY; T=0.K
angular distribution for (n,n*11)

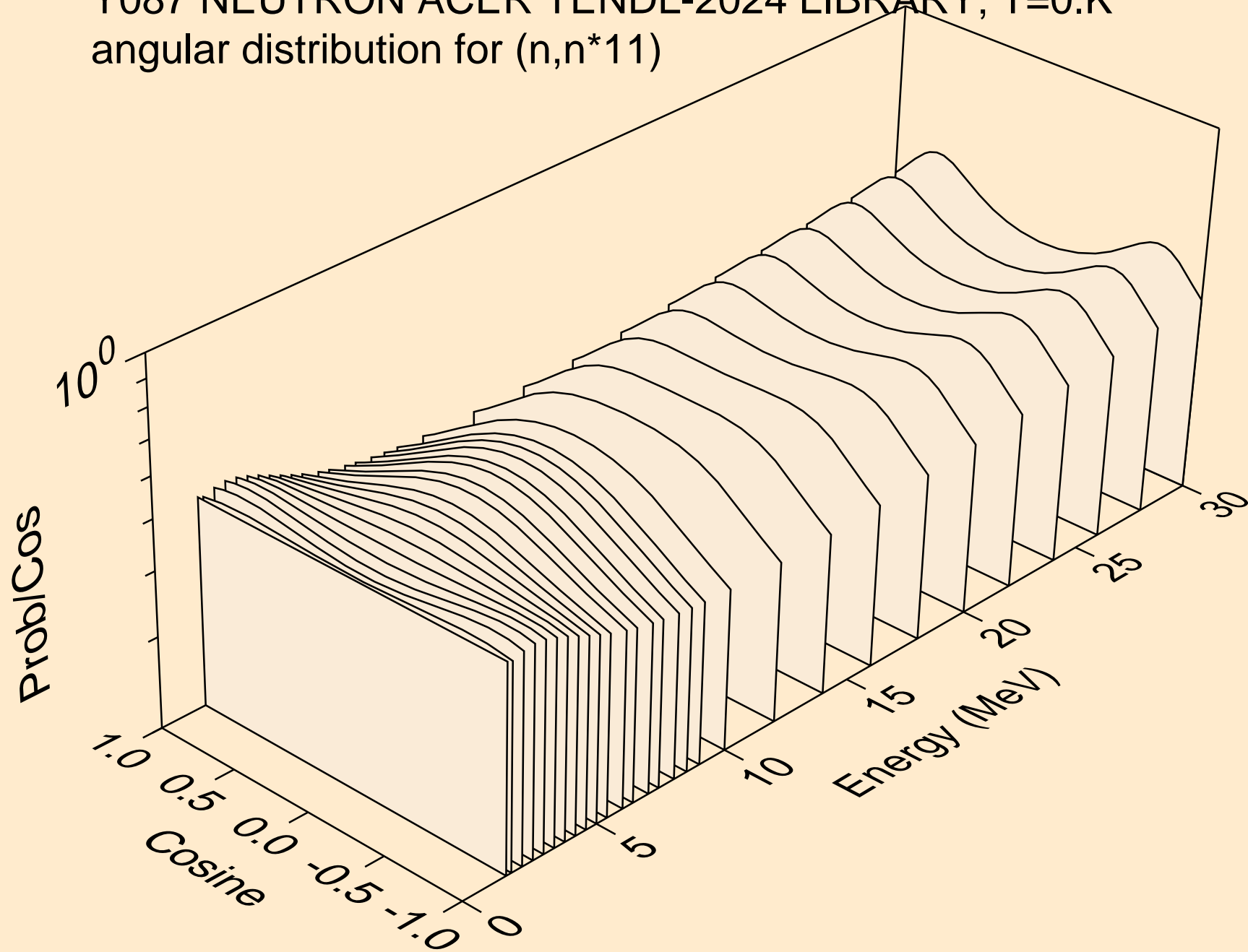

Y087 NEUTRON ACER TENDL-2024 LIBRARY; T=0.K
angular distribution for (n,n*12)

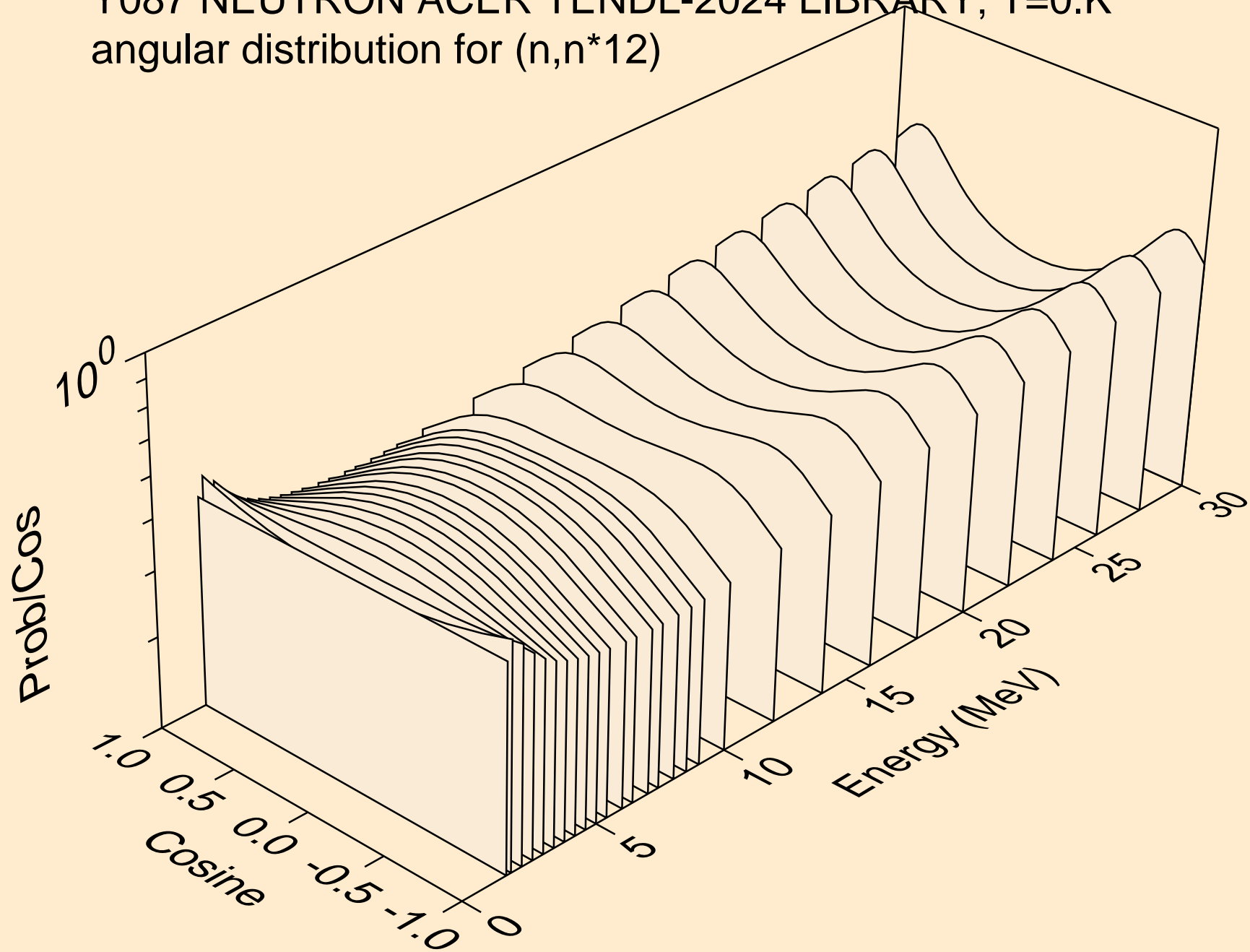

Y087 NEUTRON ACER TENDL-2024 LIBRARY; T=0.K
angular distribution for (n,n*13)

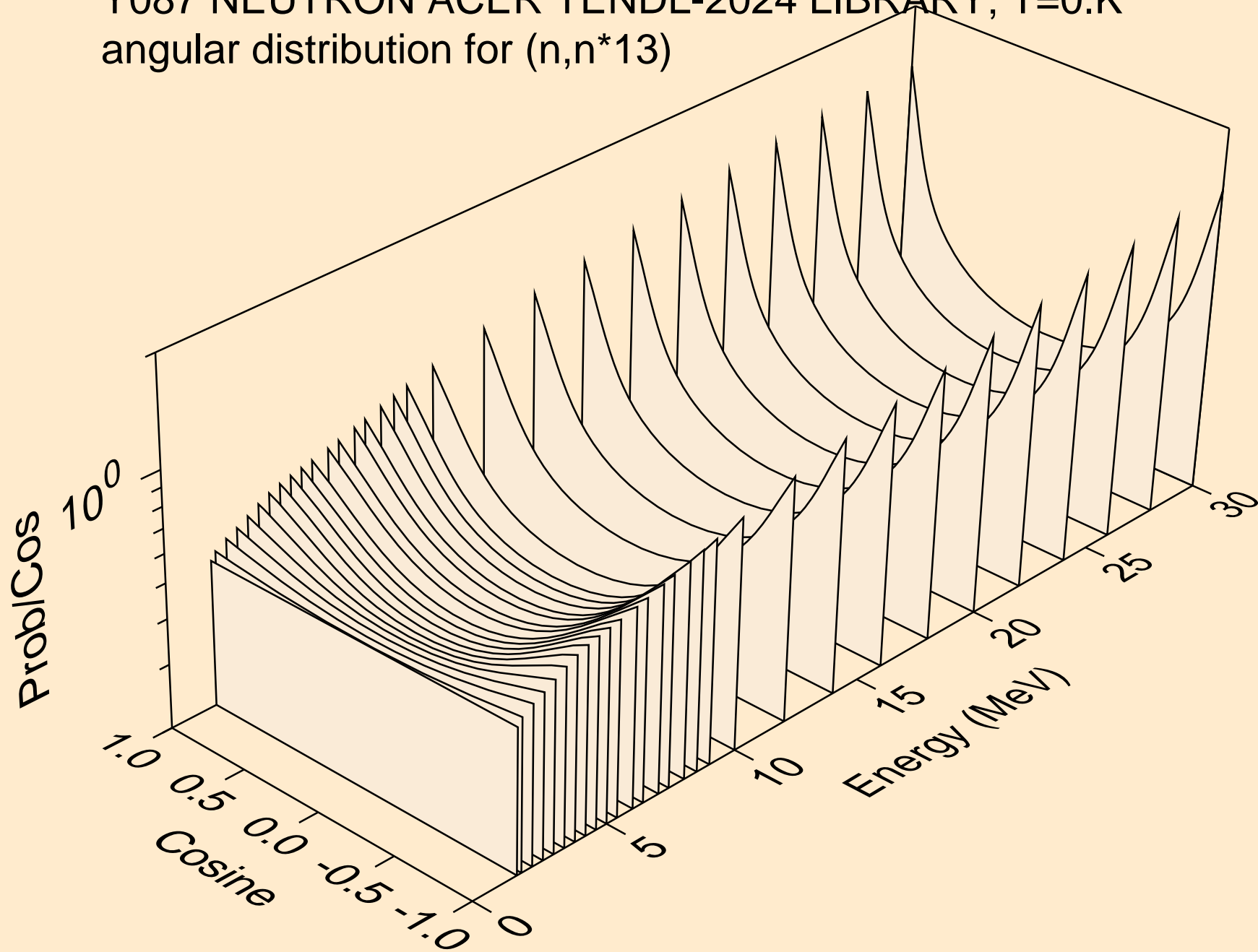

Y087 NEUTRON ACER TENDL-2024 LIBRARY; T=0.K
angular distribution for (n,n*14)

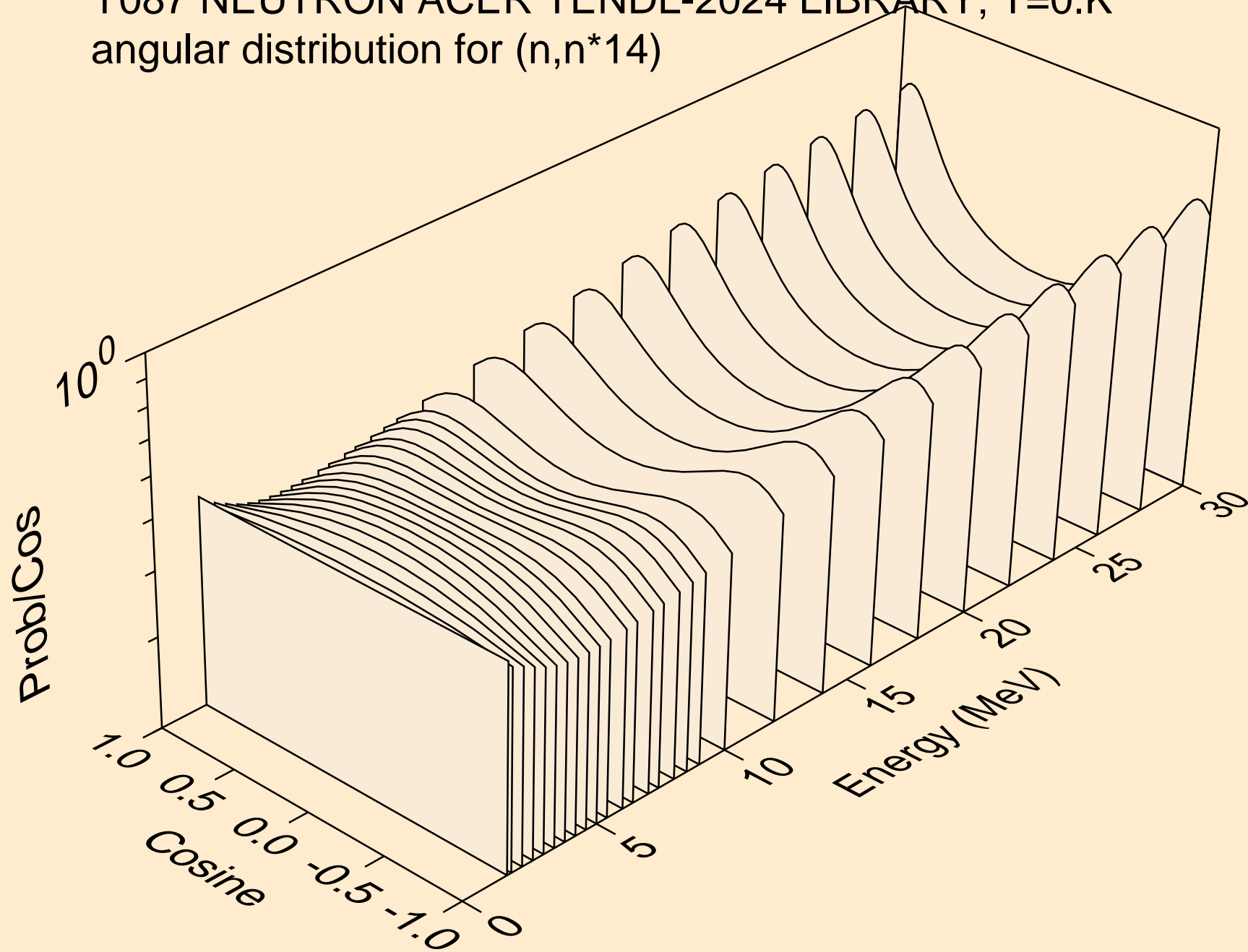

Y087 NEUTRON ACER TENDL-2024 LIBRARY; T=0.K
angular distribution for (n,n*15)

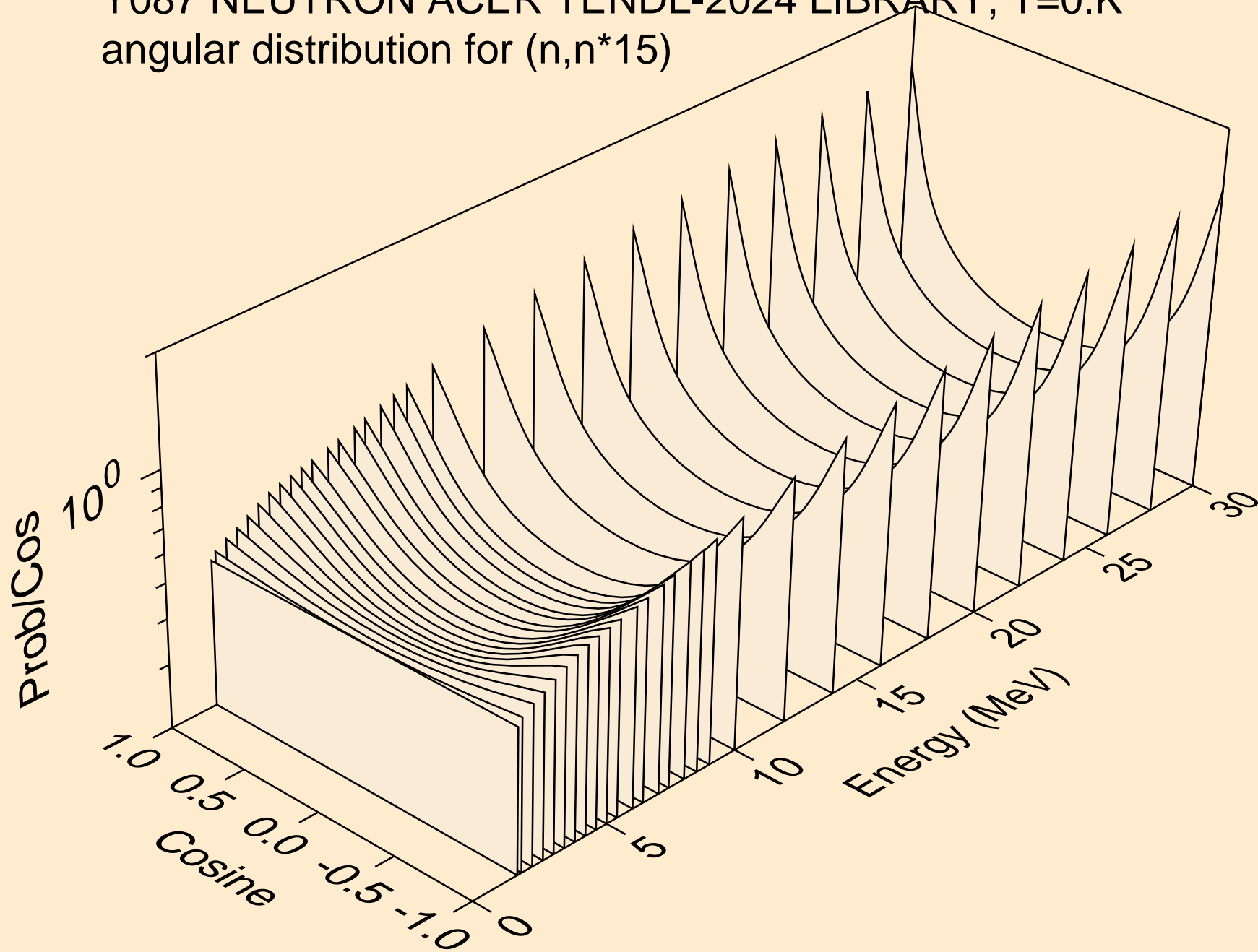

Y087 NEUTRON ACER TENDL-2024 LIBRARY; T=0.K
angular distribution for (n,n*16)

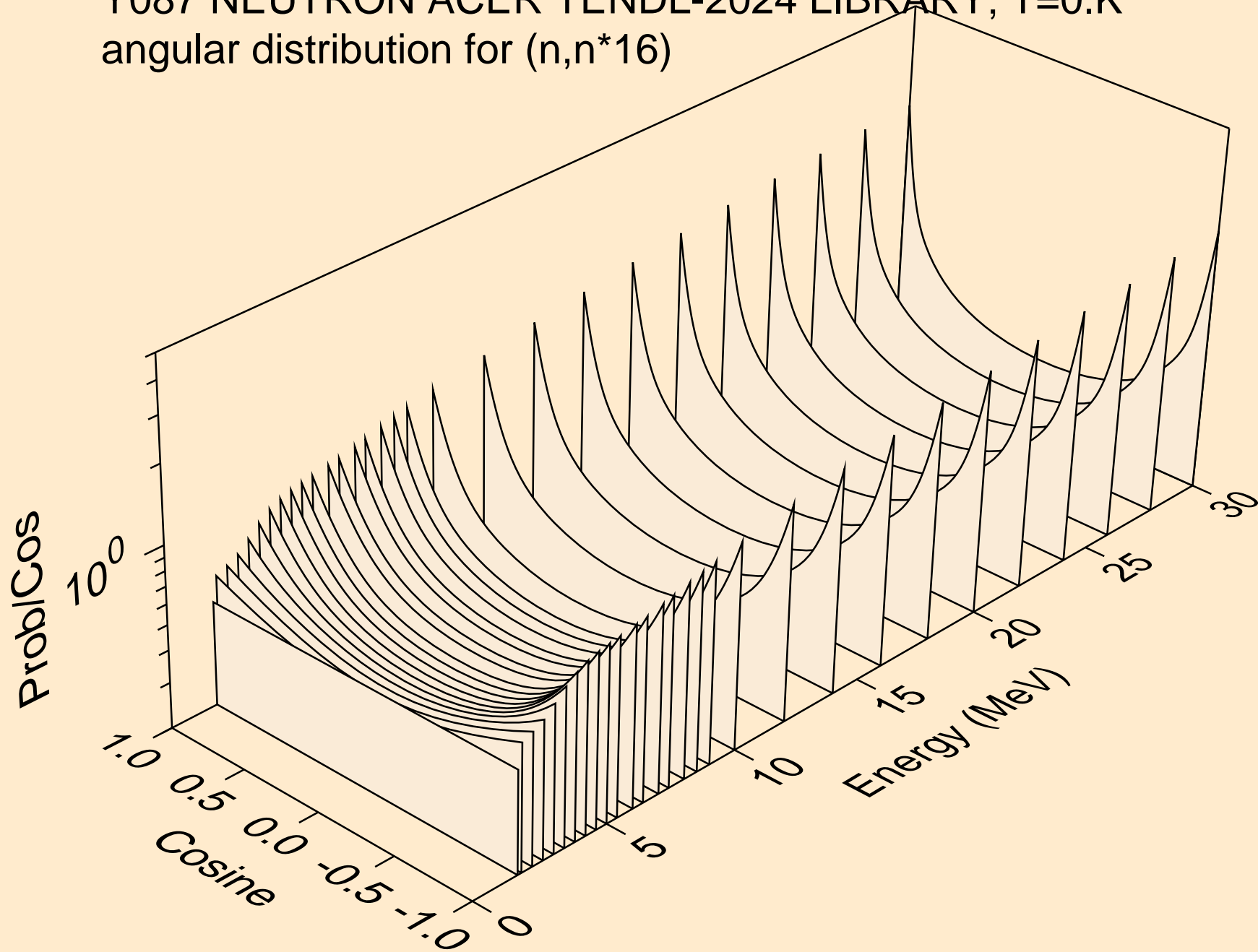

Y087 NEUTRON ACER TENDL-2024 LIBRARY; T=0.K
angular distribution for (n,n*17)

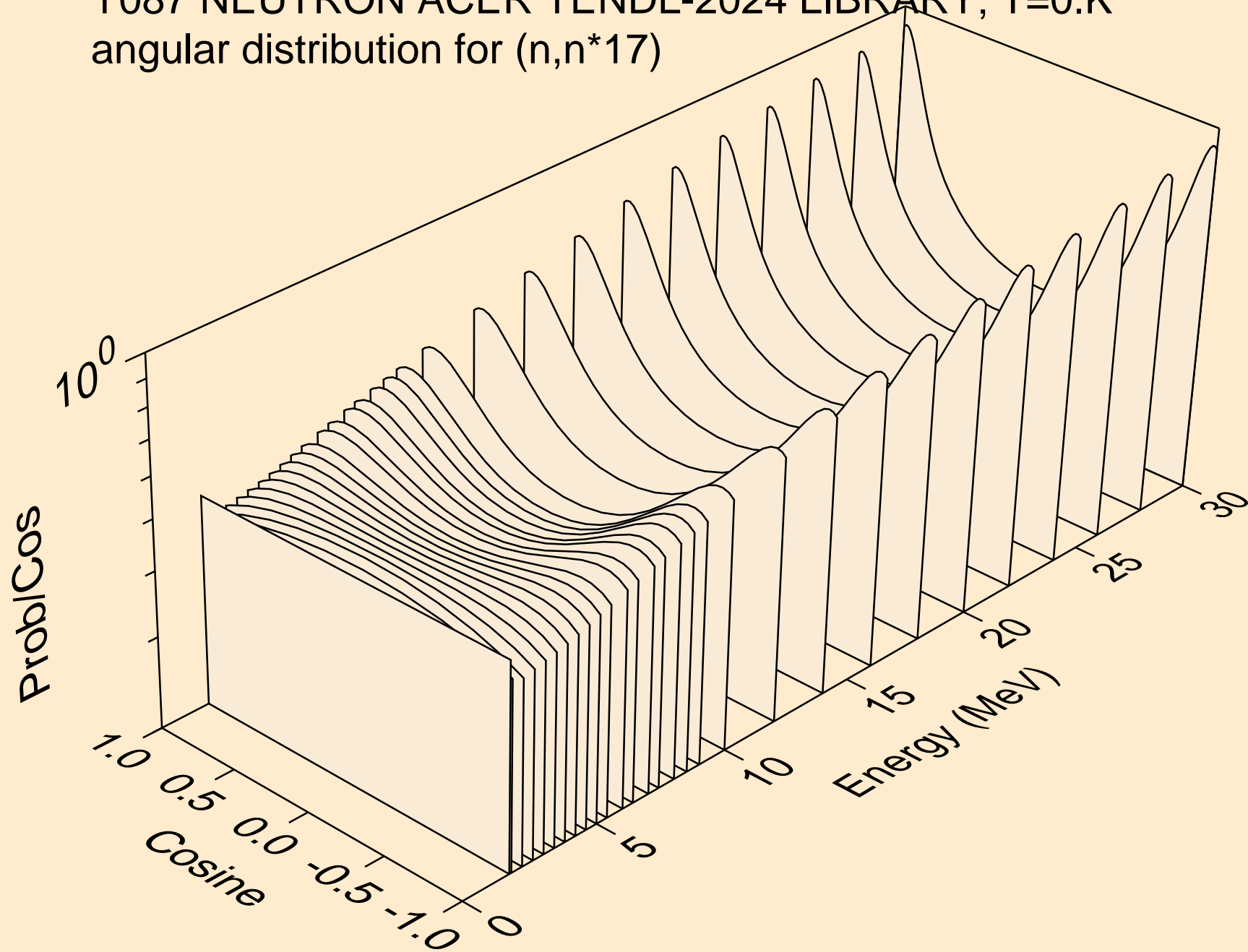

Y087 NEUTRON ACER TENDL-2024 LIBRARY; T=0.K
angular distribution for (n,n*18)

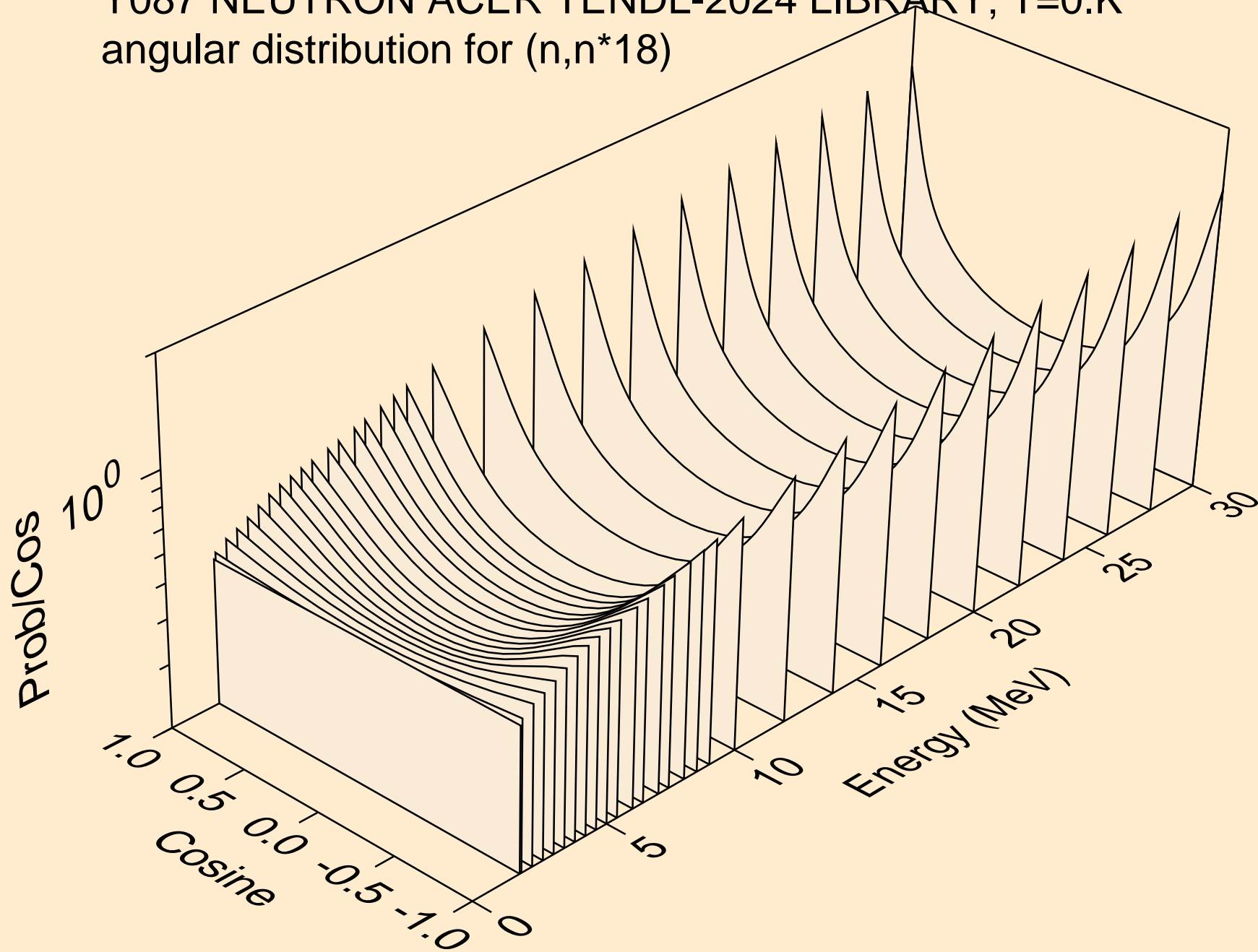

Y087 NEUTRON ACER TENDL-2024 LIBRARY; T=0.K
angular distribution for (n,n*19)

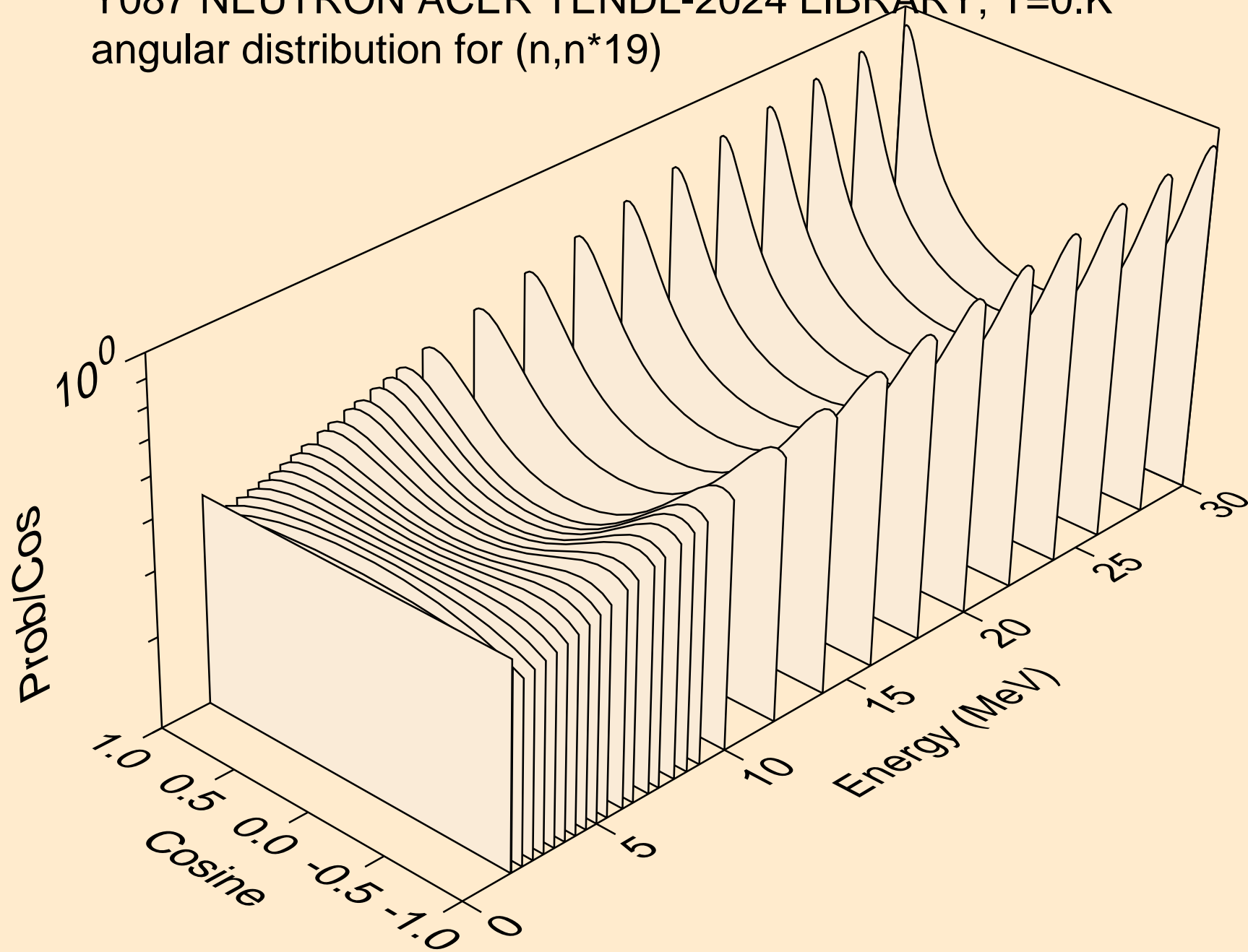

Y087 NEUTRON ACER TENDL-2024 LIBRARY; T=0.K
angular distribution for (n,n*20)

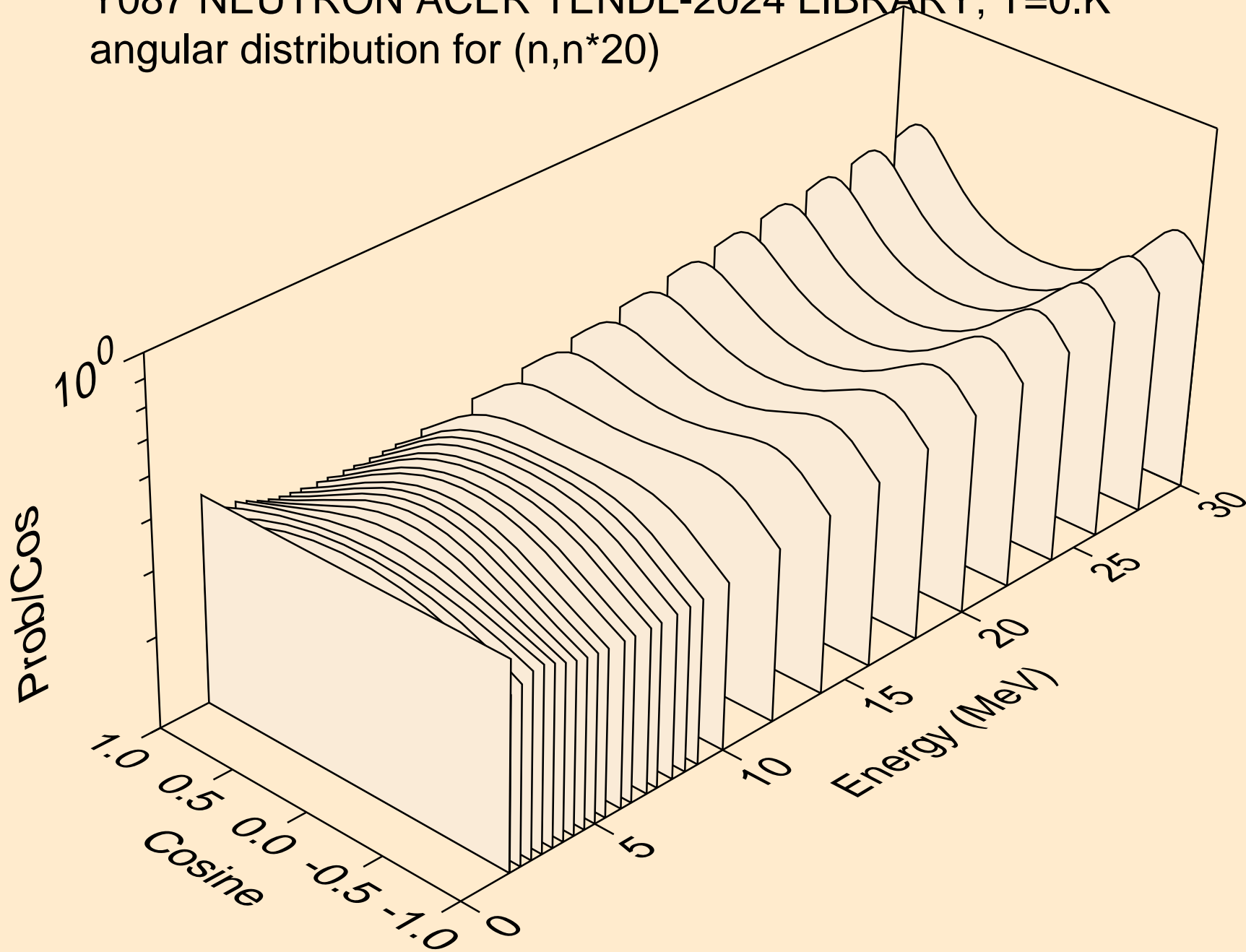

Y087 NEUTRON ACER TENDL-2024 LIBRARY; T=0.K
angular distribution for (n,n*21)

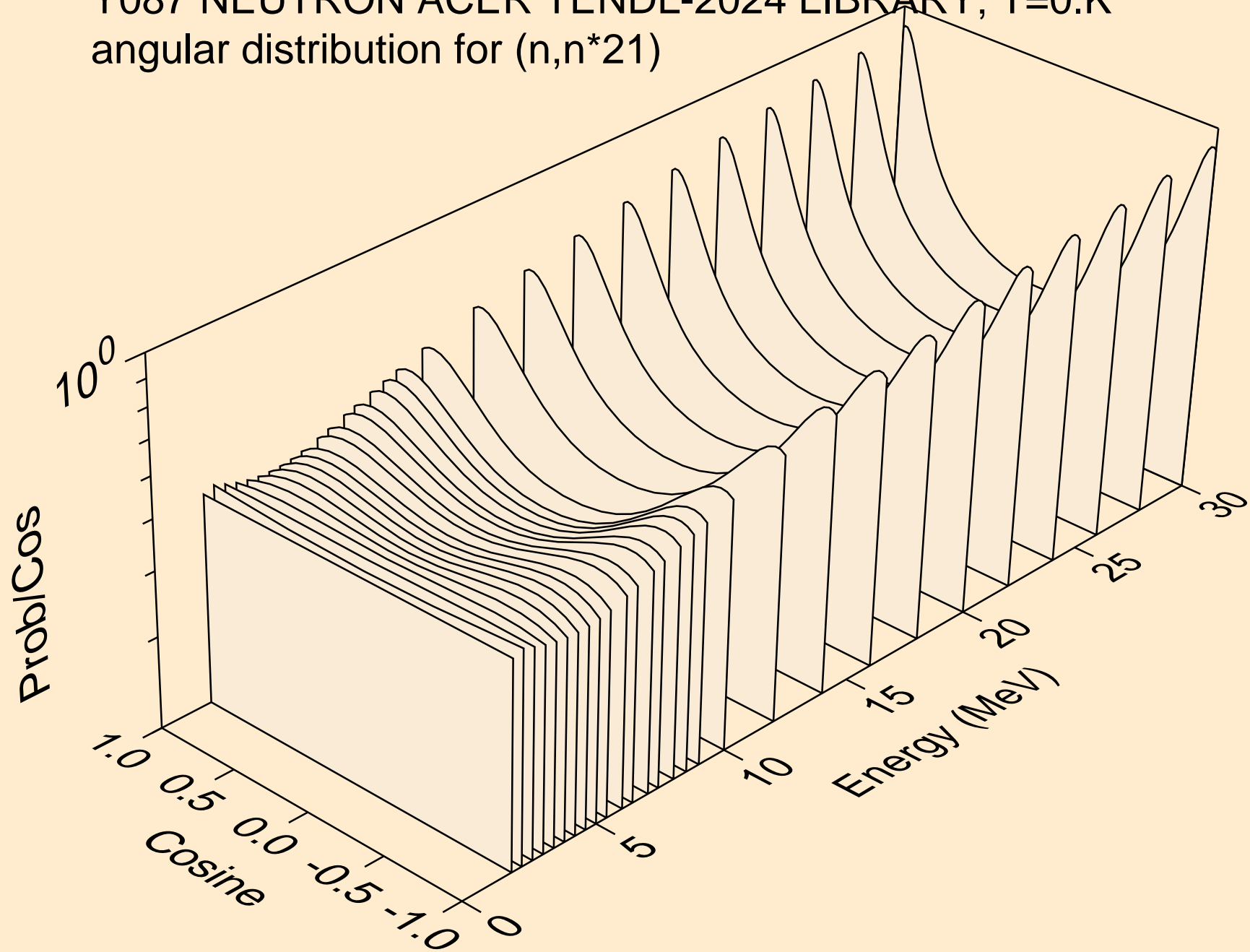

Y087 NEUTRON ACER TENDL-2024 LIBRARY; T=0.K
angular distribution for (n,n*22)

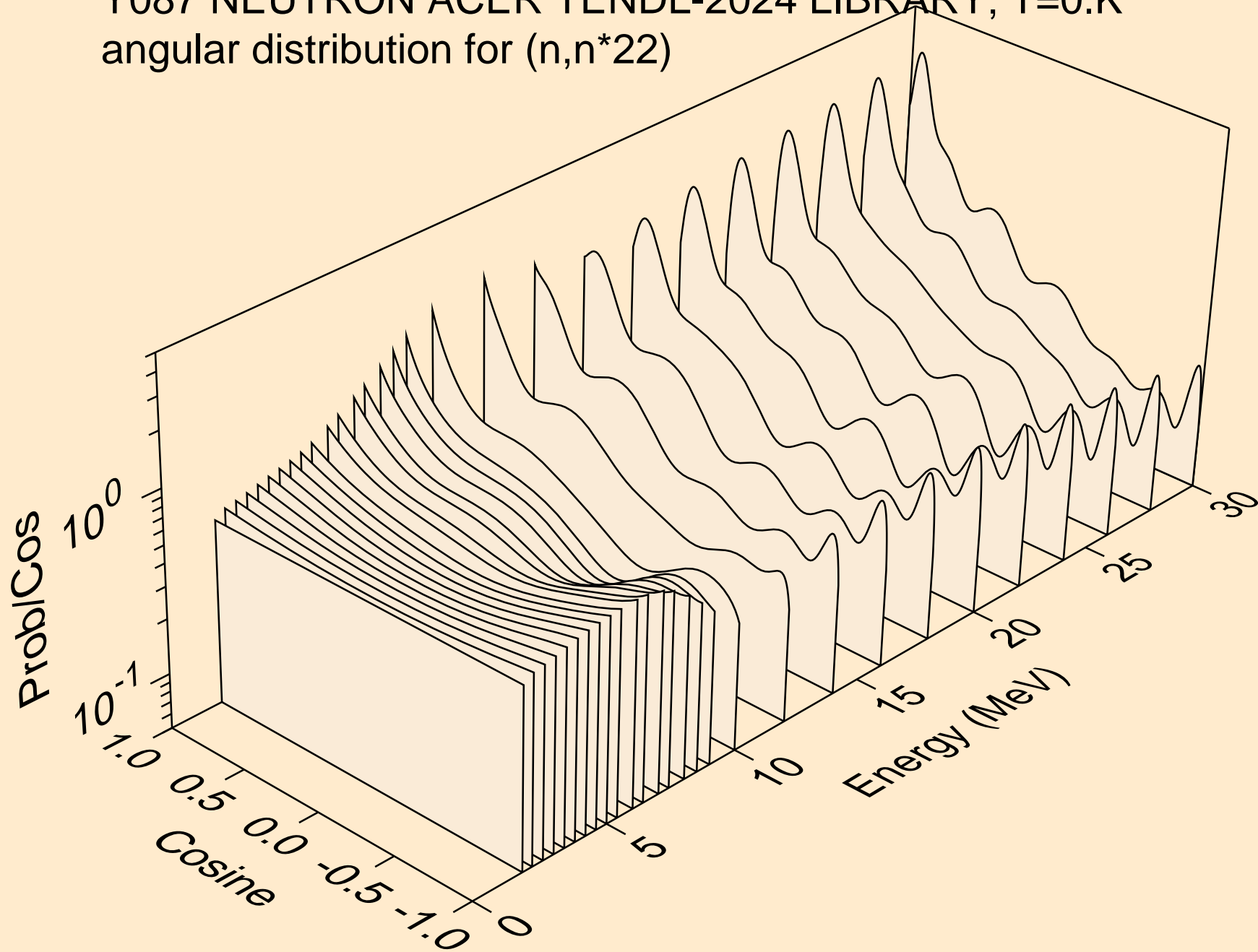

Y087 NEUTRON ACER TENDL-2024 LIBRARY; T=0.K
angular distribution for (n,n*23)

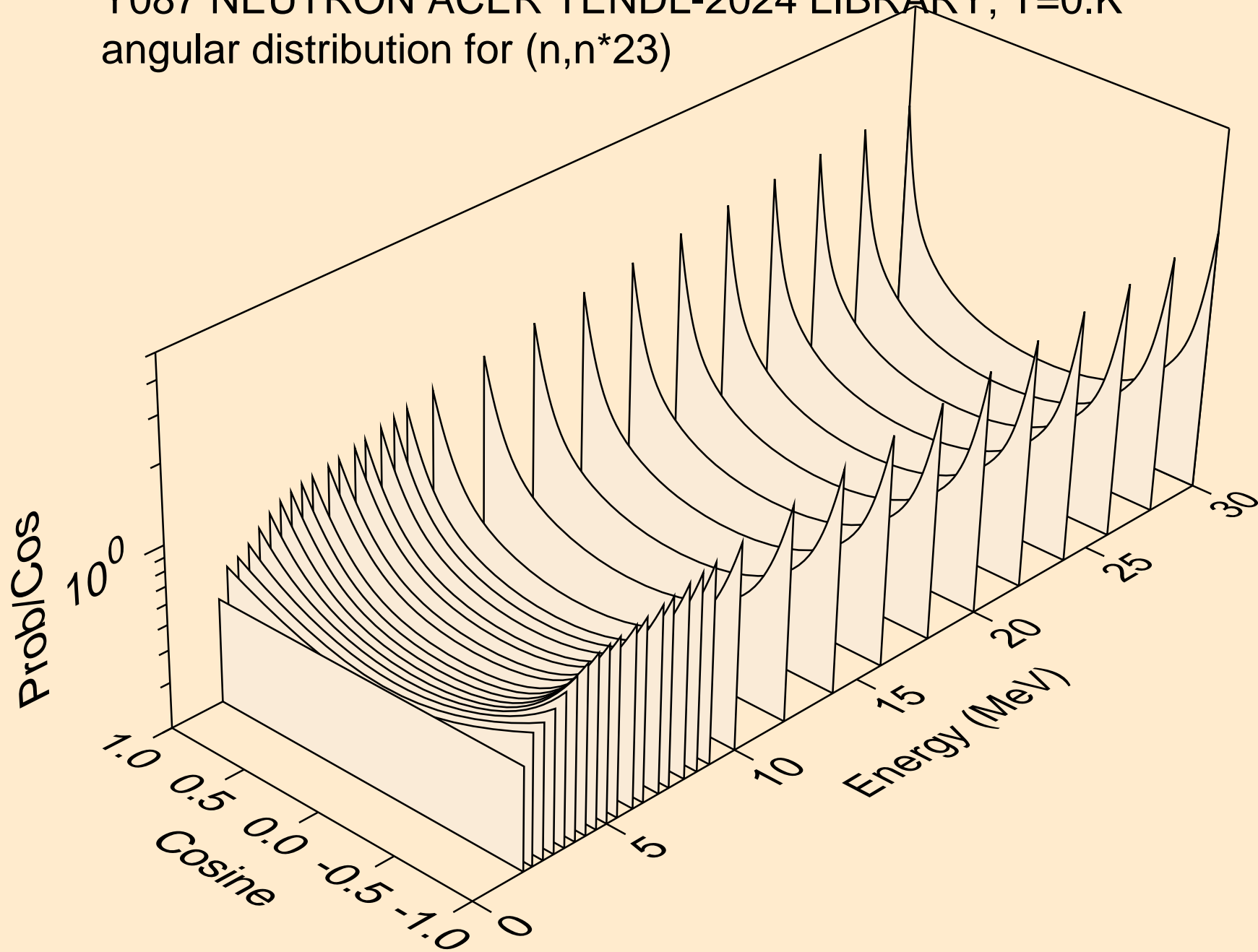

Y087 NEUTRON ACER TENDL-2024 LIBRARY; T=0.K
angular distribution for (n,n*24)

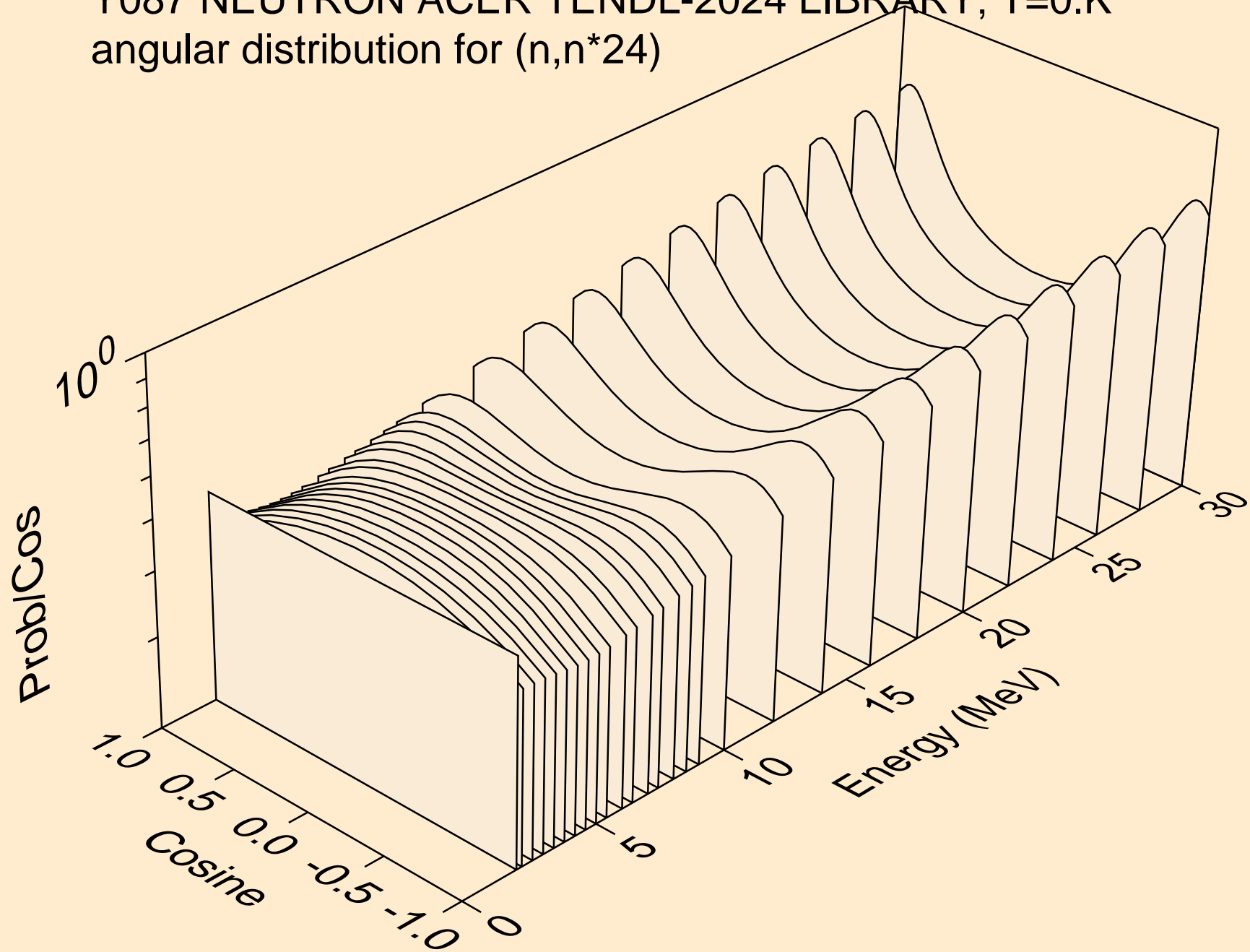

Y087 NEUTRON ACER TENDL-2024 LIBRARY; T=0.K
angular distribution for (n,n*25)

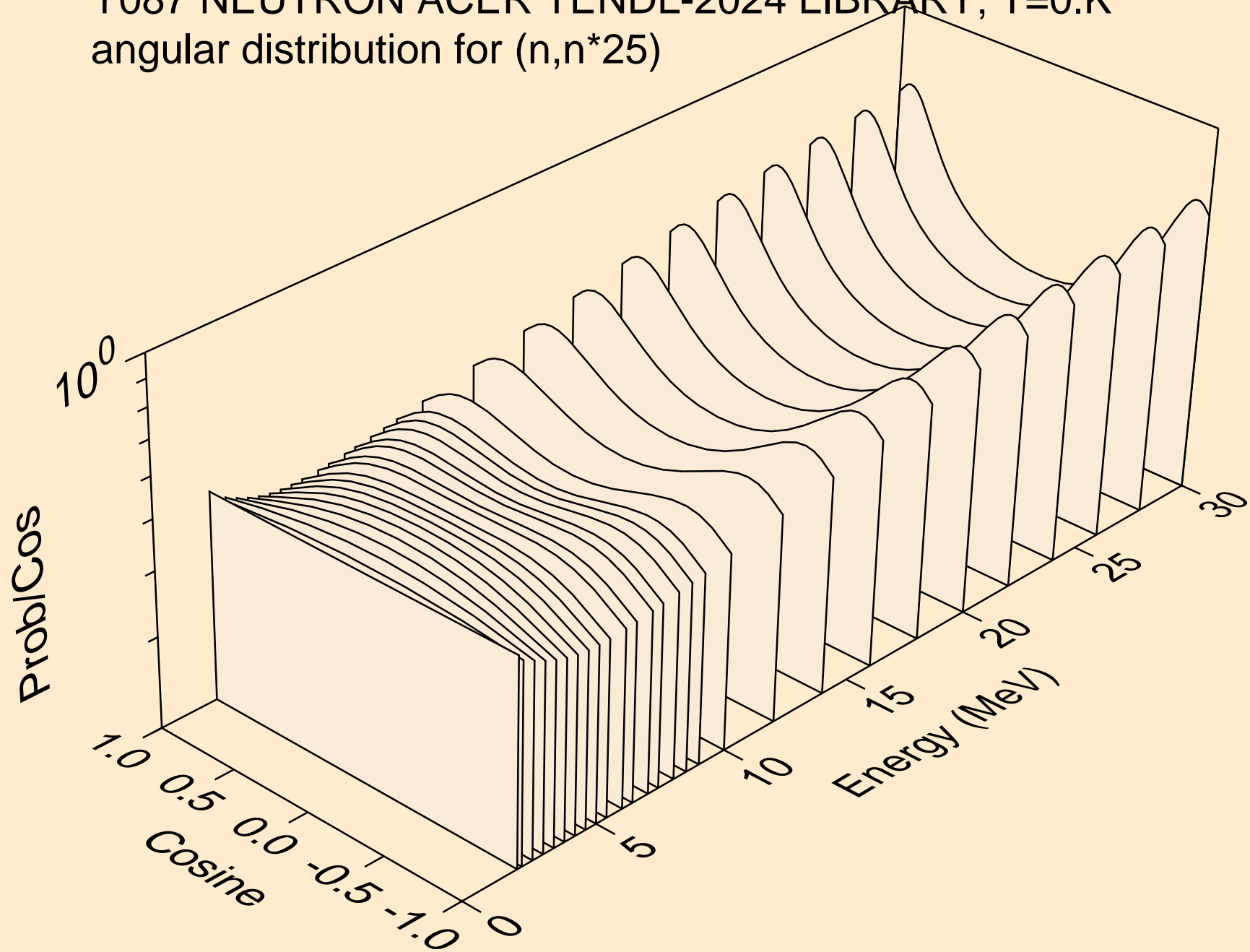

Y087 NEUTRON ACER TENDL-2024 LIBRARY; T=0.K
angular distribution for (n,n*26)

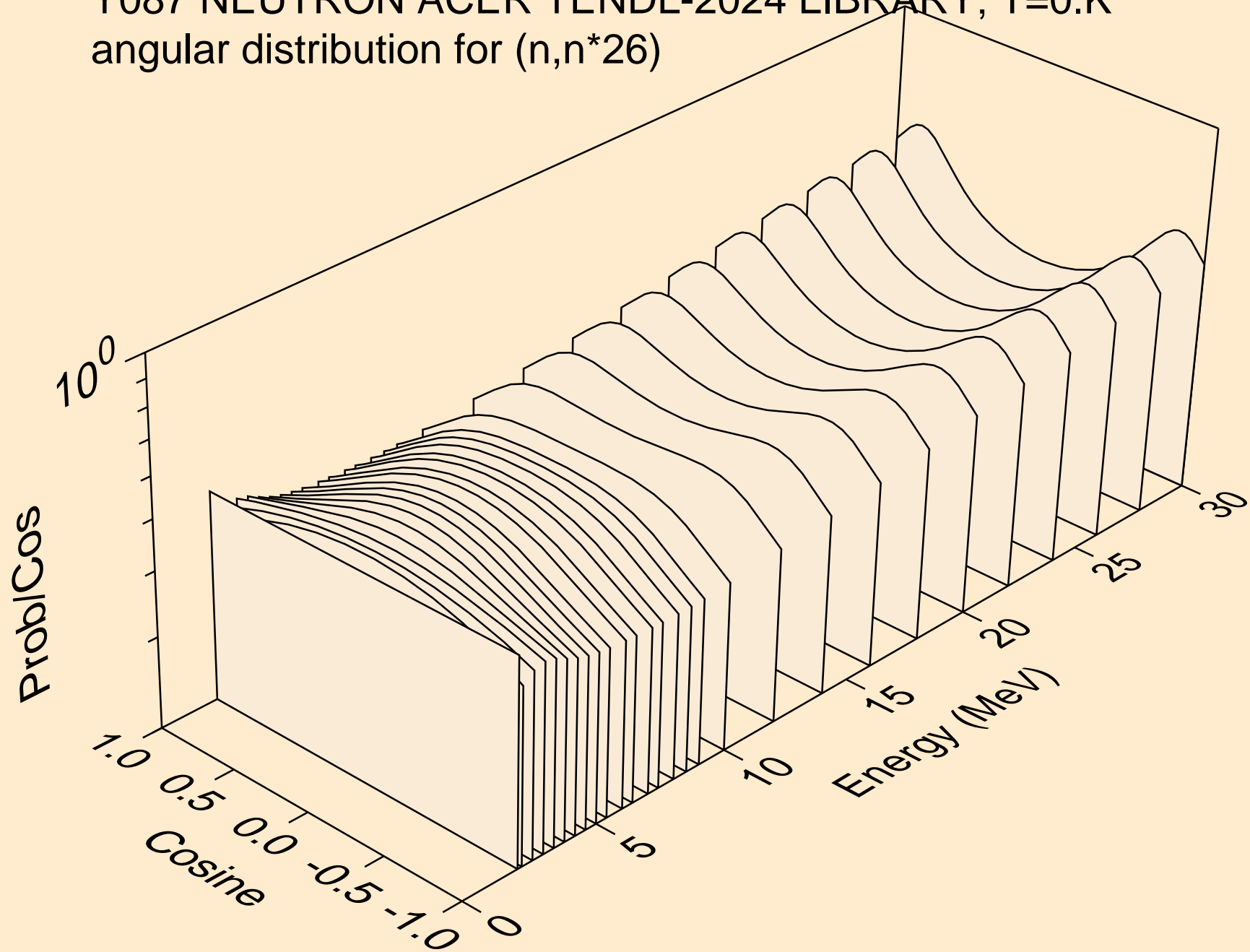

Y087 NEUTRON ACER TENDL-2024 LIBRARY; T=0.K
angular distribution for (n,n*27)

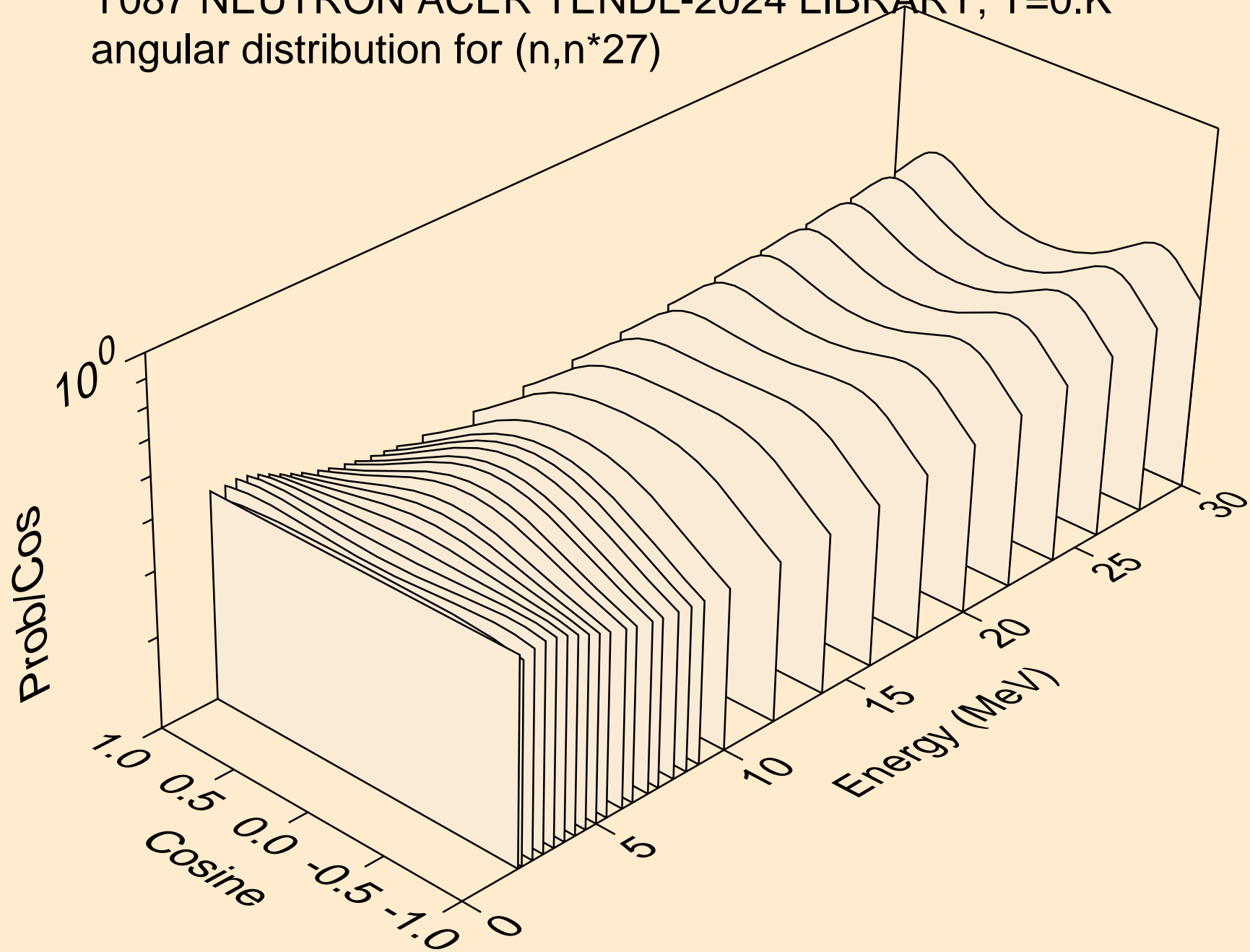

Y087 NEUTRON ACER TENDL-2024 LIBRARY; T=0.K
angular distribution for (n,n*28)

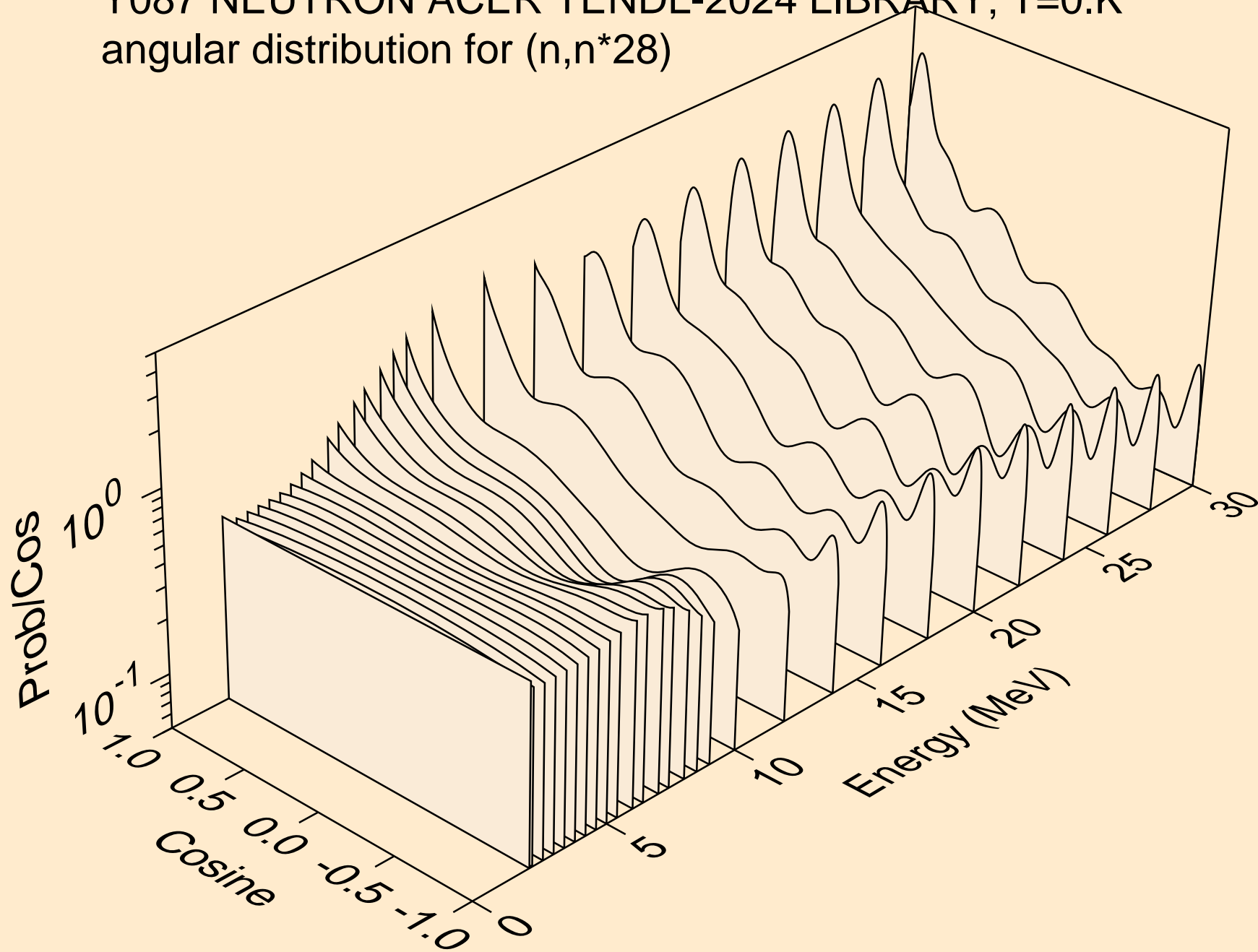

Y087 NEUTRON ACER TENDL-2024 LIBRARY; T=0.K
angular distribution for (n,n*29)

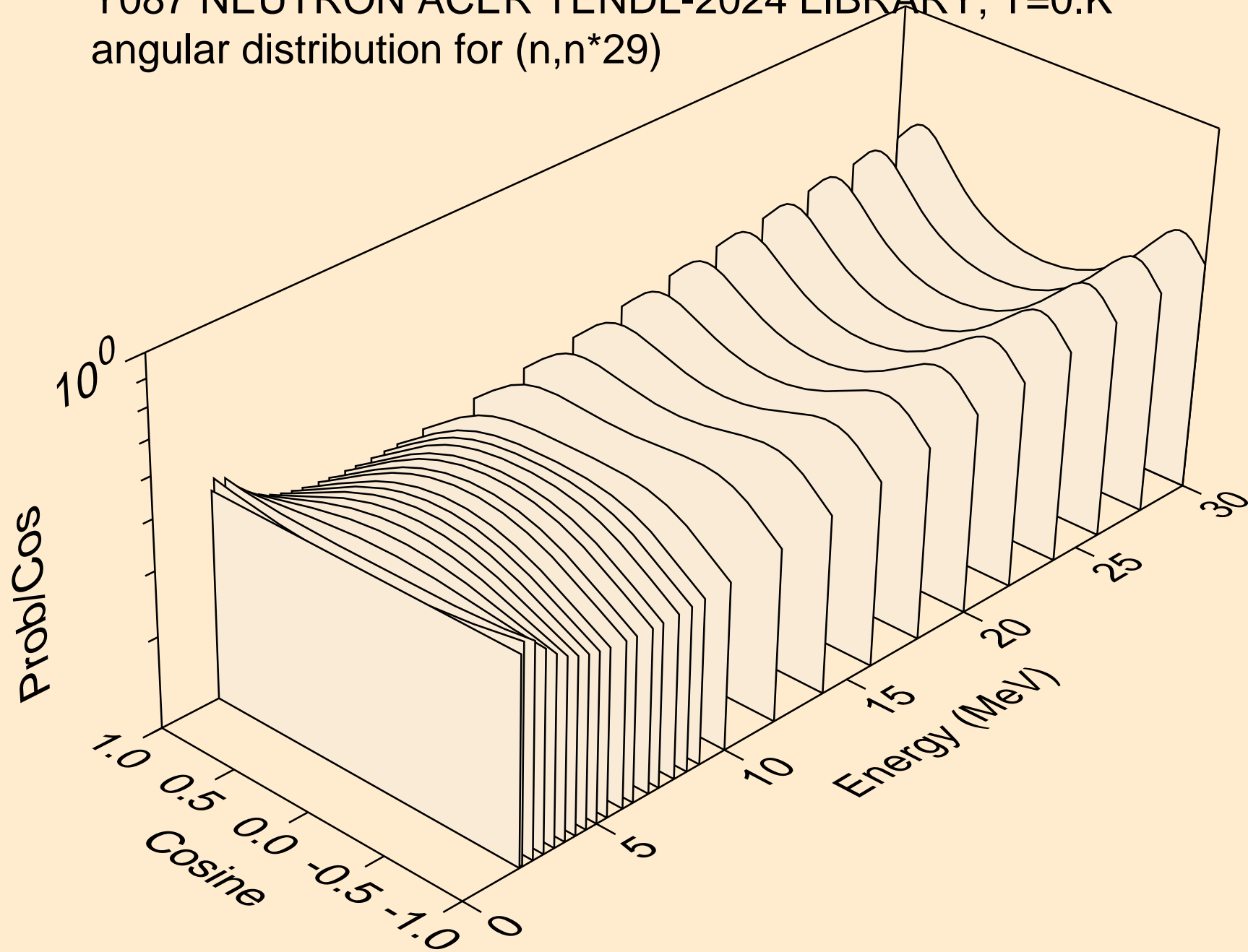

Y087 NEUTRON ACER TENDL-2024 LIBRARY; T=0.K
angular distribution for (n,n*30)

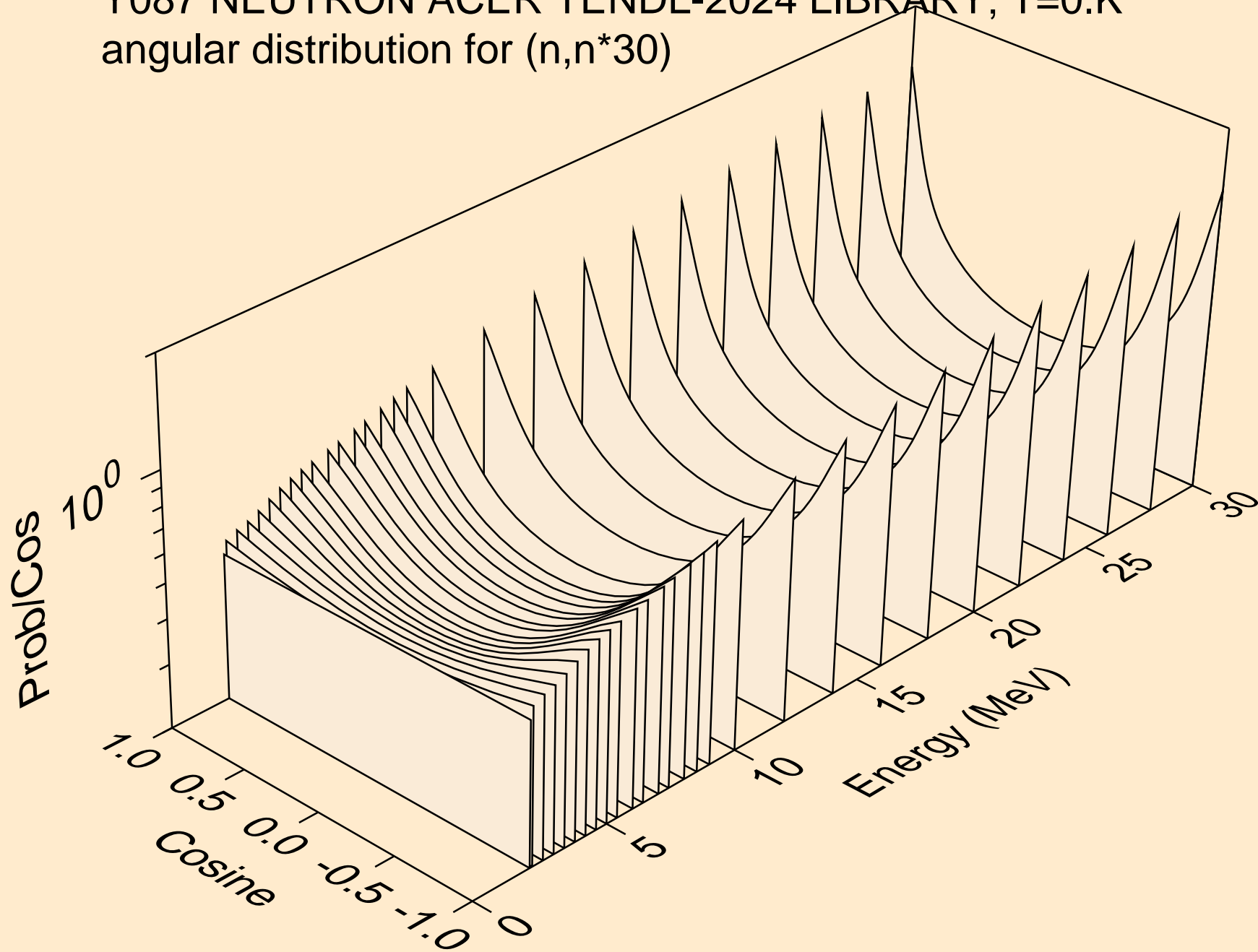

Y087 NEUTRON ACER TENDL-2024 LIBRARY; T=0.K
Neutron emission for (n,x)

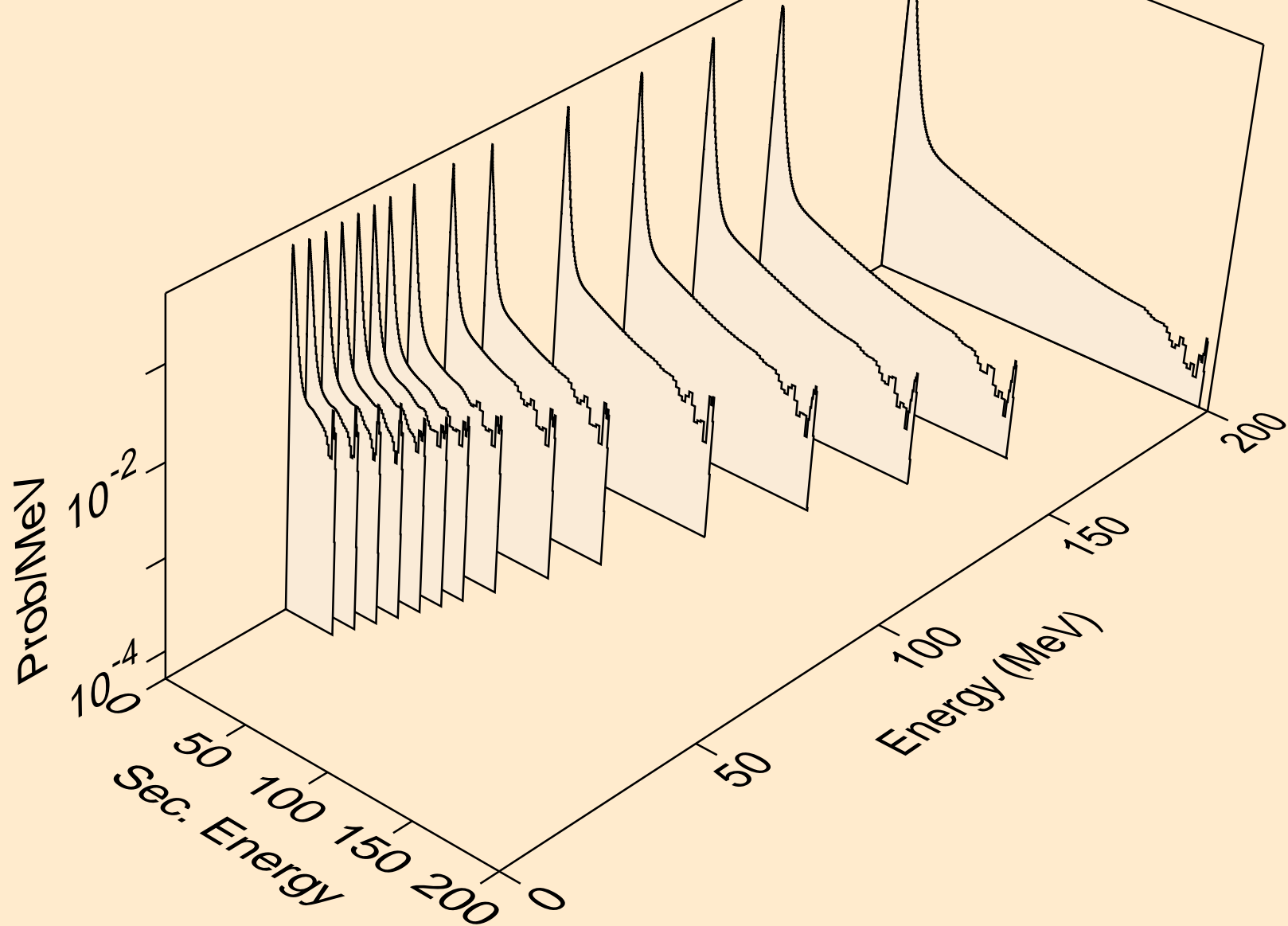

Y087 NEUTRON ACER TENDL-2024 LIBRARY; T=0.K
Neutron emission for (n,2nd)

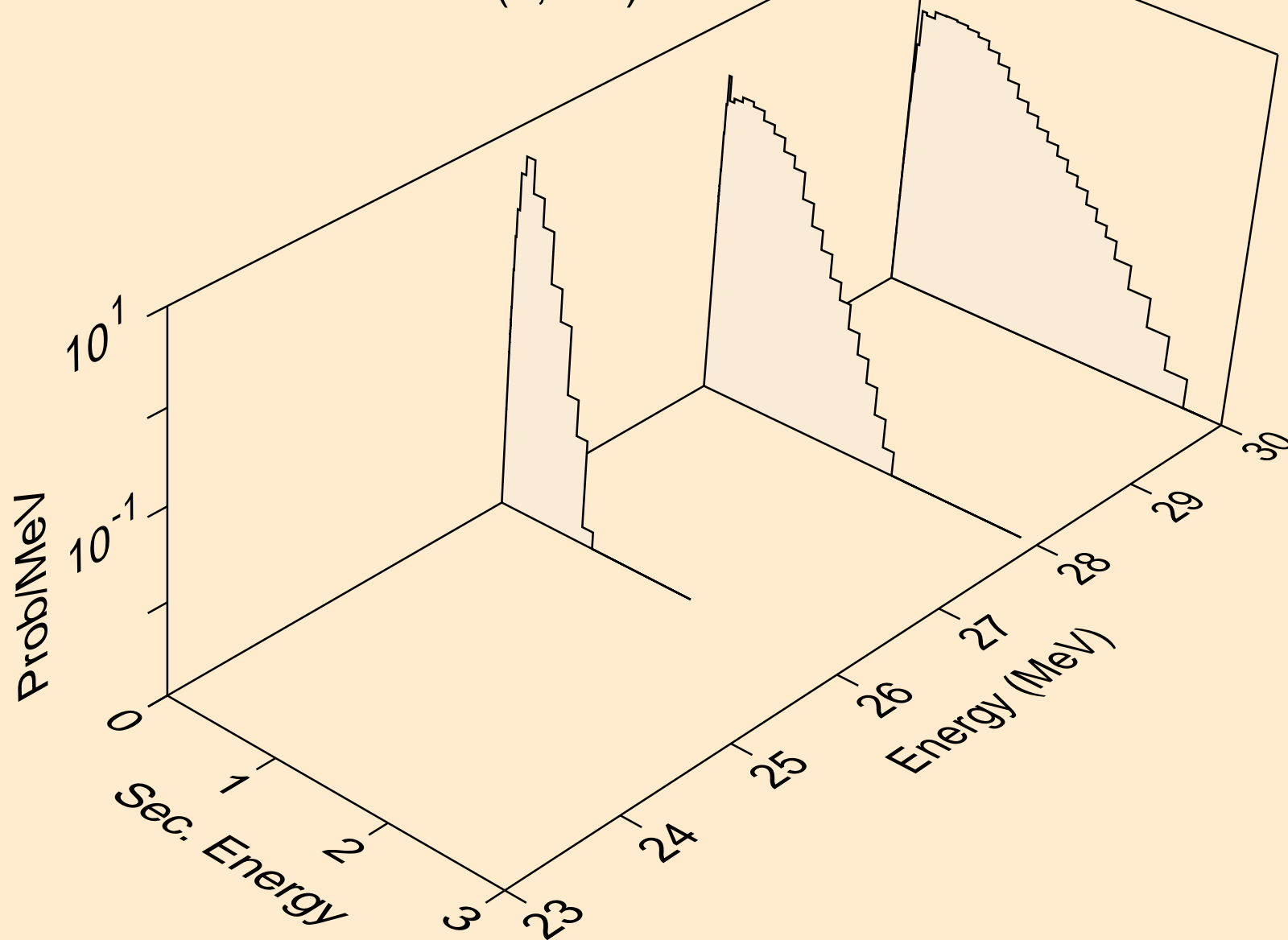

Y087 NEUTRON ACER TENDL-2024 LIBRARY; T=0.K
Neutron emission for (n,2n)

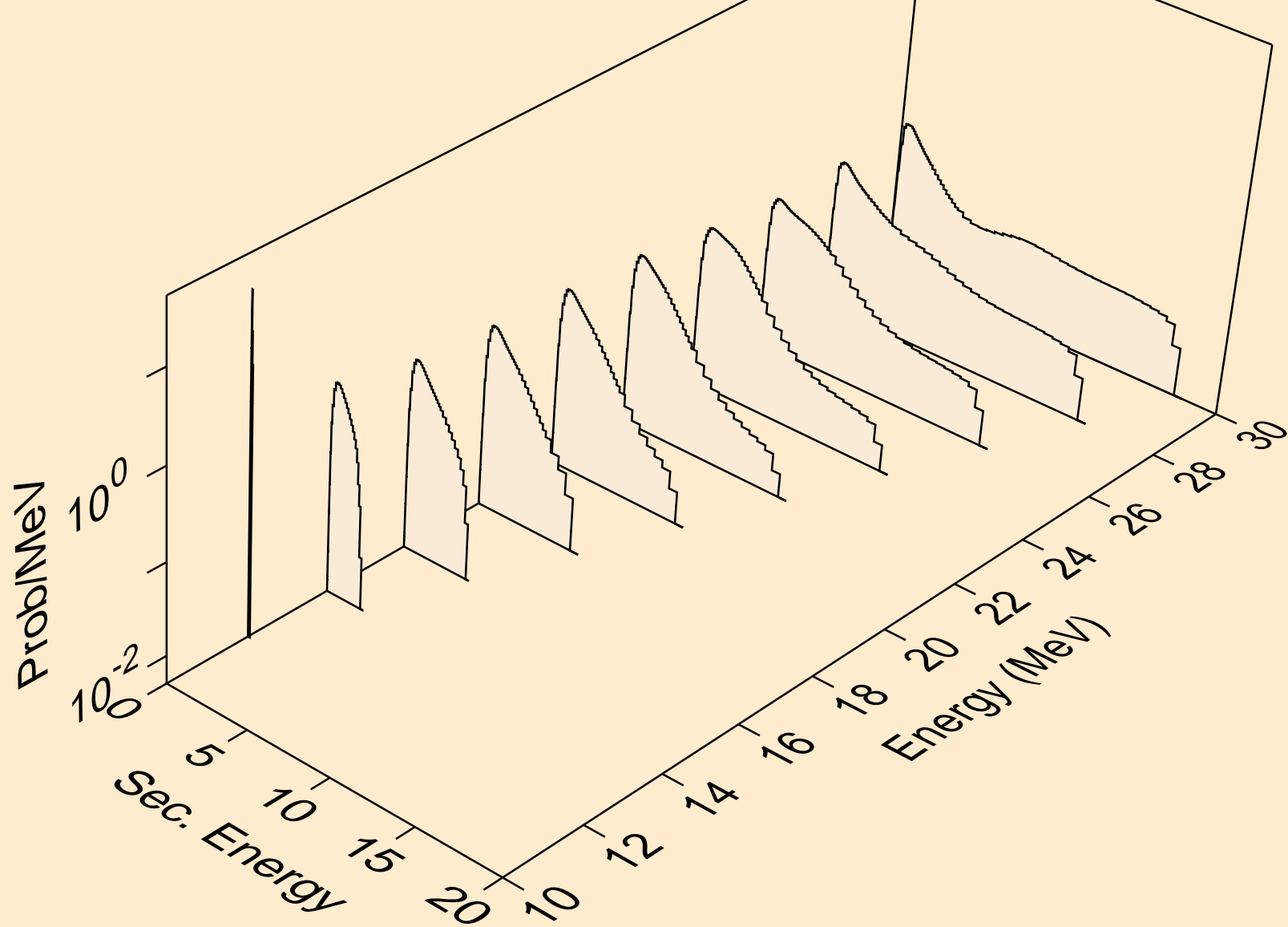

Y087 NEUTRON ACER TENDL-2024 LIBRARY; T=0.K
Neutron emission for (n,3n)

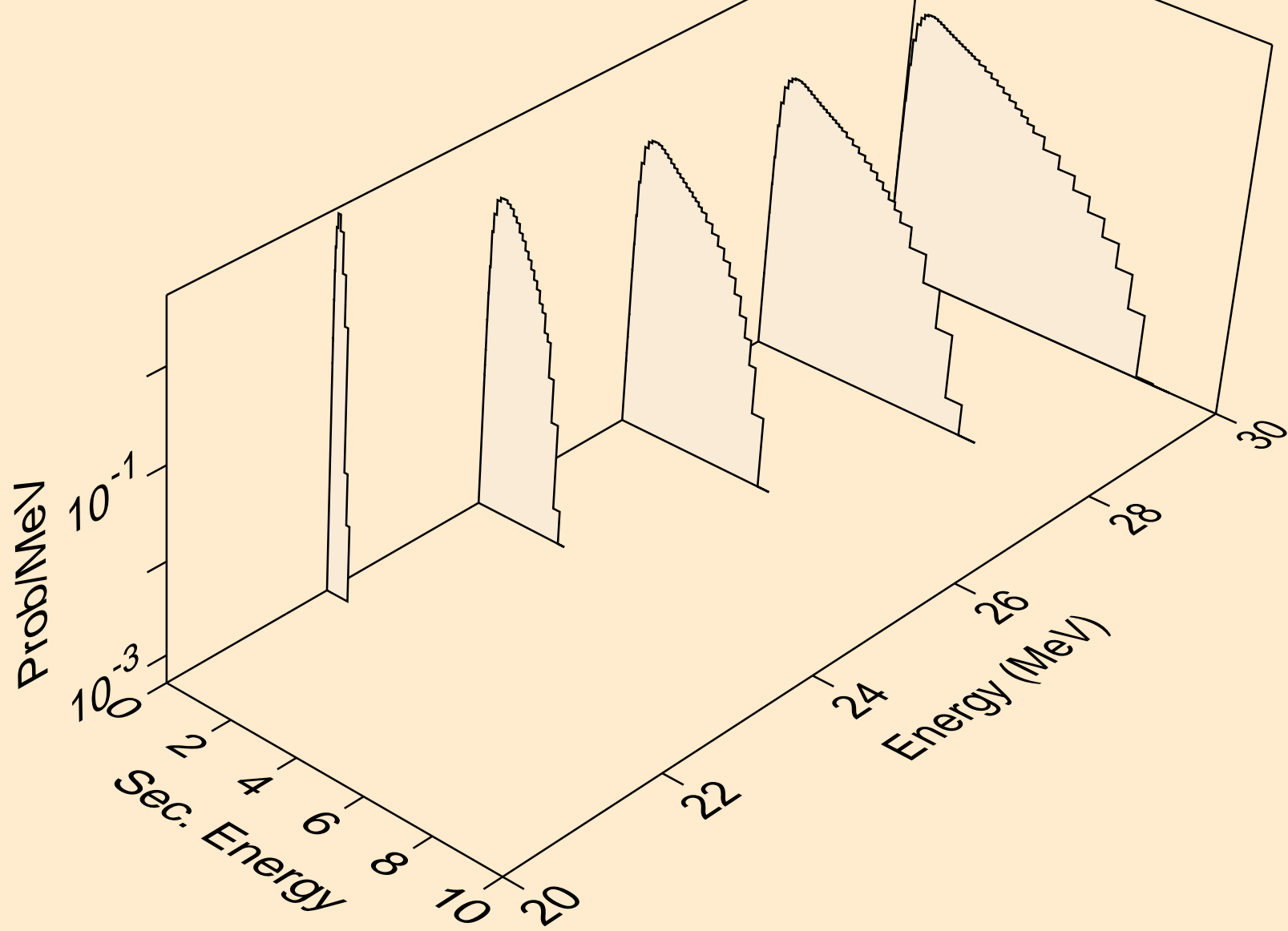

Y087 NEUTRON ACER TENDL-2024 LIBRARY; T=0.K
Neutron emission for (n,n*)a

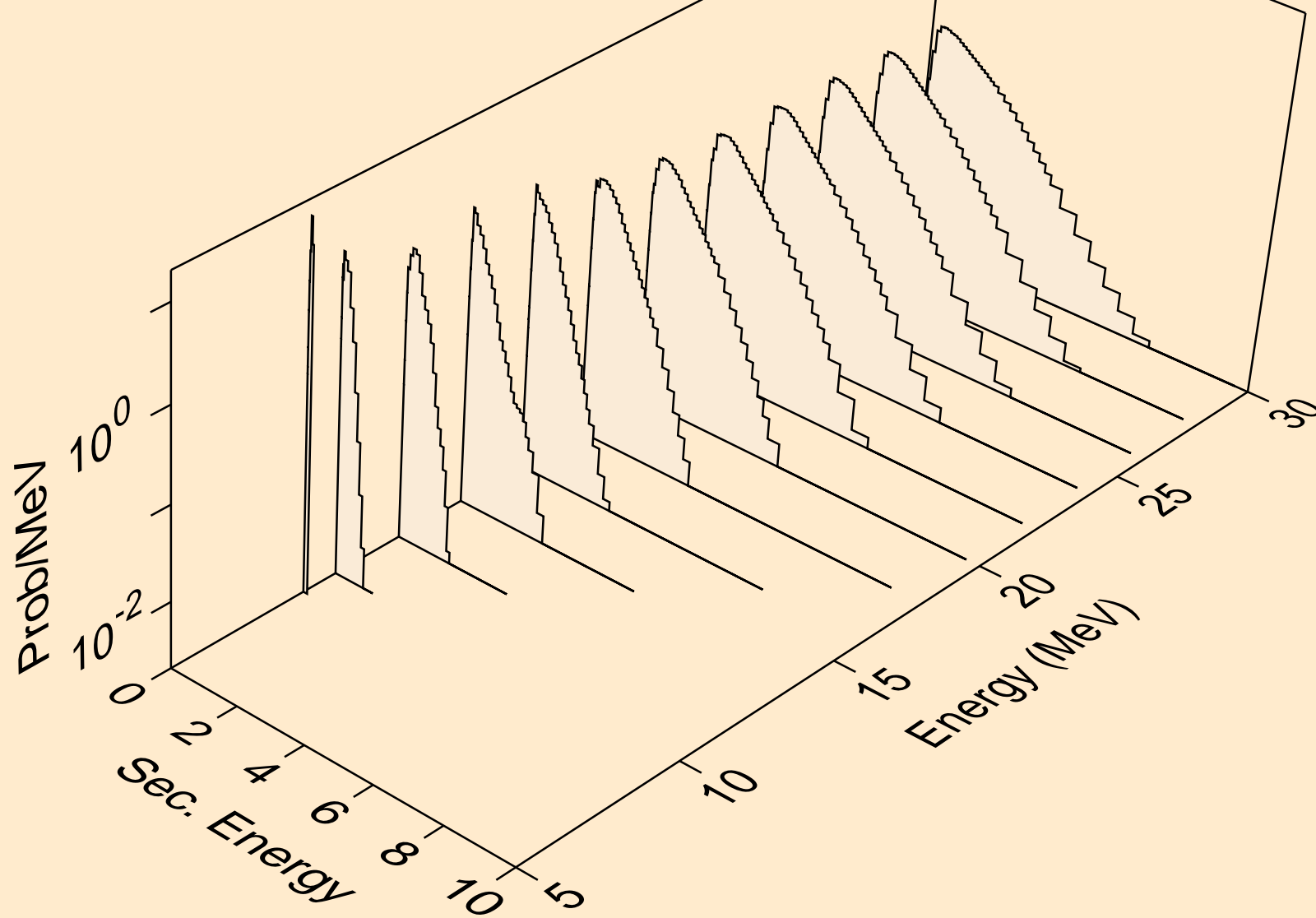

Y087 NEUTRON ACER TENDL-2024 LIBRARY; T=0.K
Neutron emission for (n,2n)a

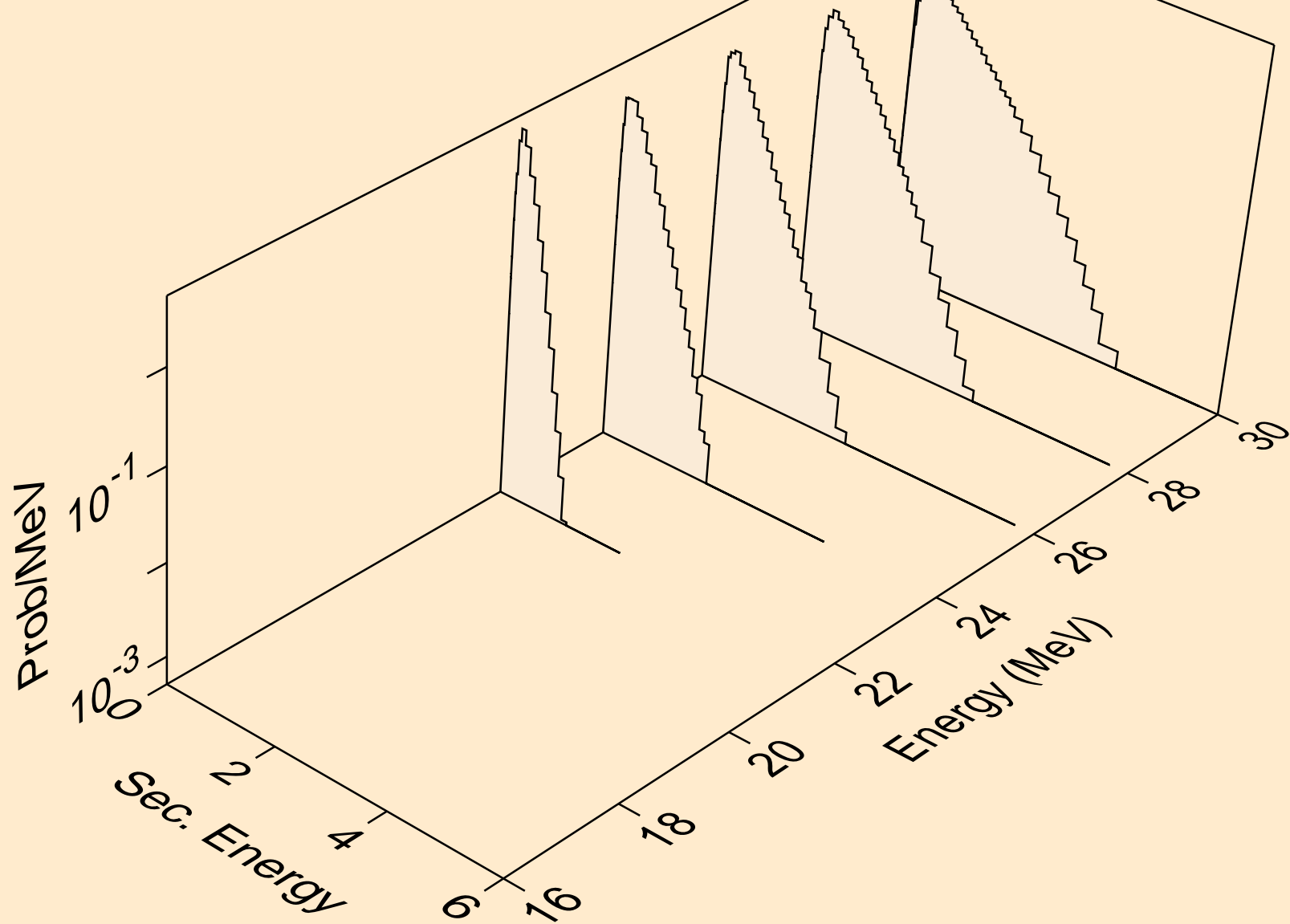

Y087 NEUTRON ACER TENDL-2024 LIBRARY; T=0.K
Neutron emission for (n,n*)p

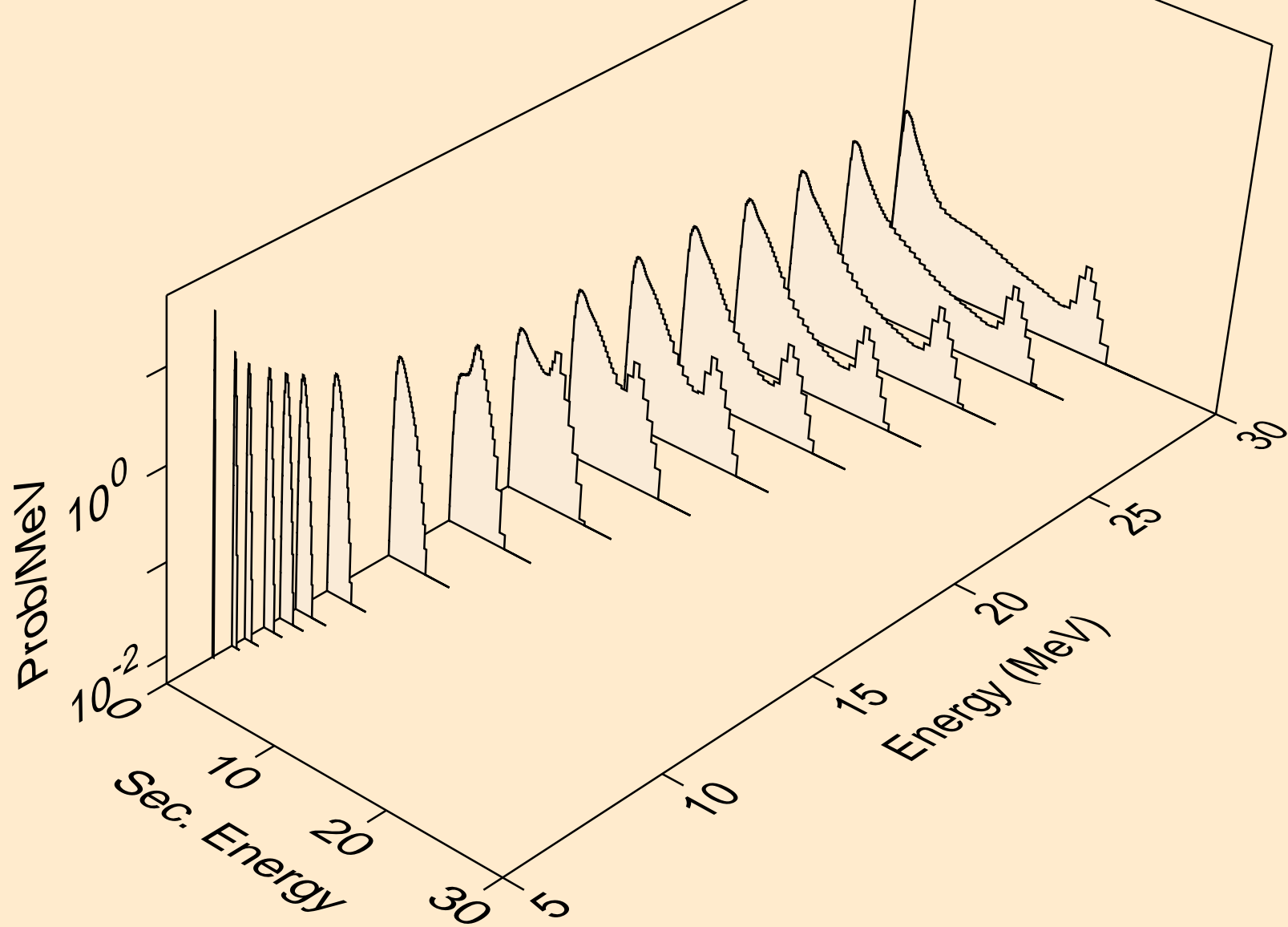

Y087 NEUTRON ACER TENDL-2024 LIBRARY; T=0.K
Neutron emission for (n,n*)2a

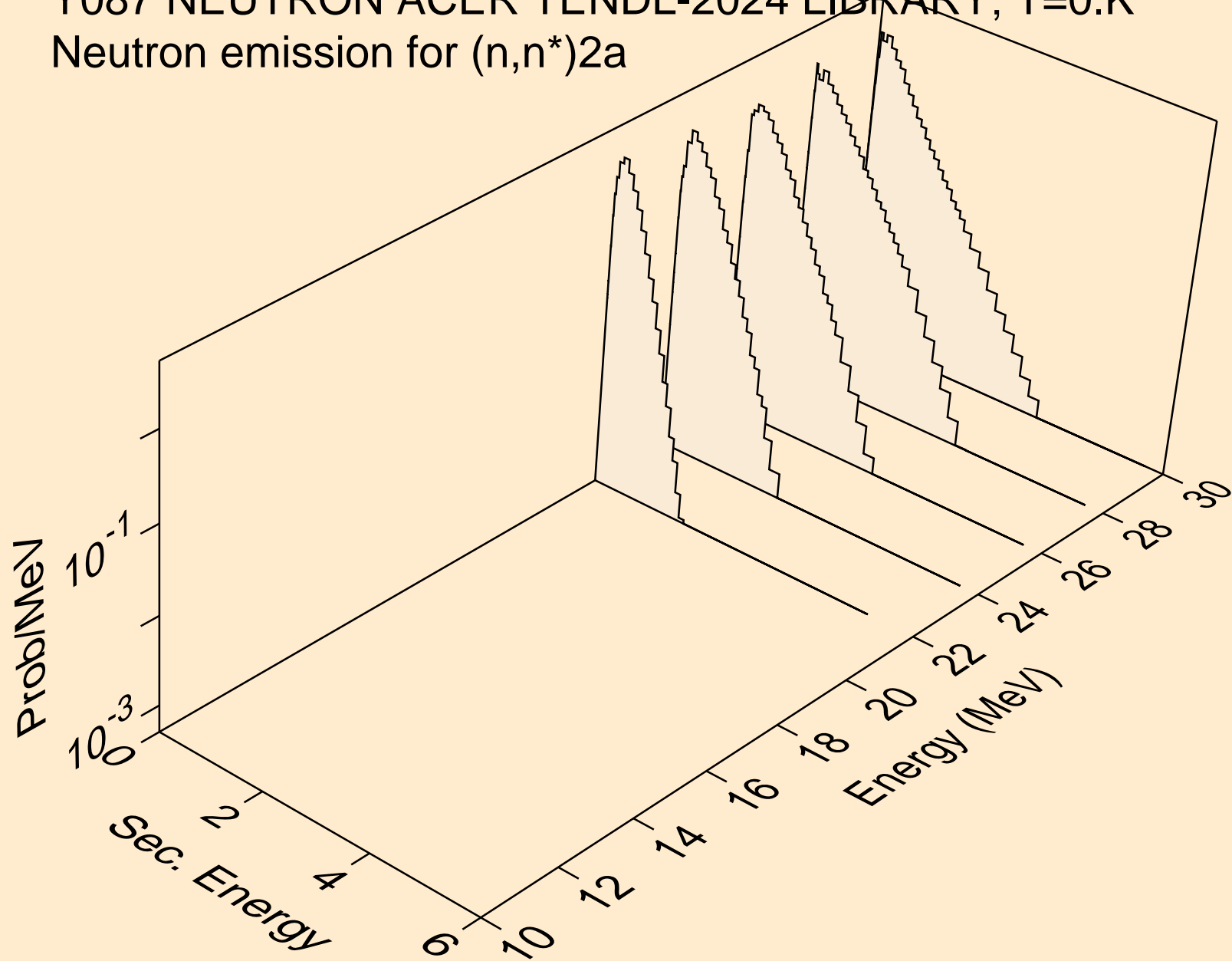

Y087 NEUTRON ACER TENDL-2024 LIBRARY; T=0.K
Neutron emission for (n,n*)d

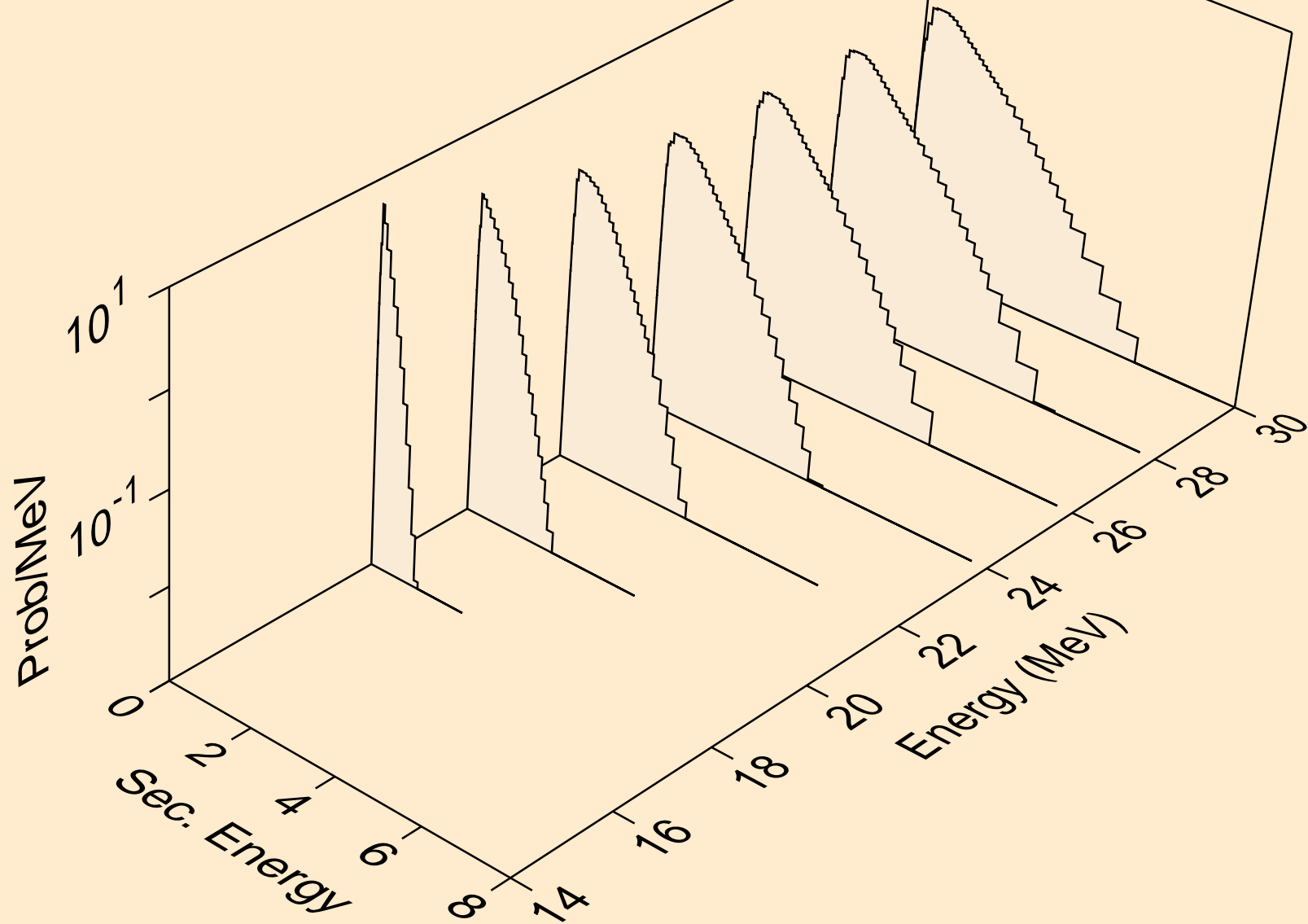

Y087 NEUTRON ACER TENDL-2024 LIBRARY; T=0.K
Neutron emission for (n,n*)t

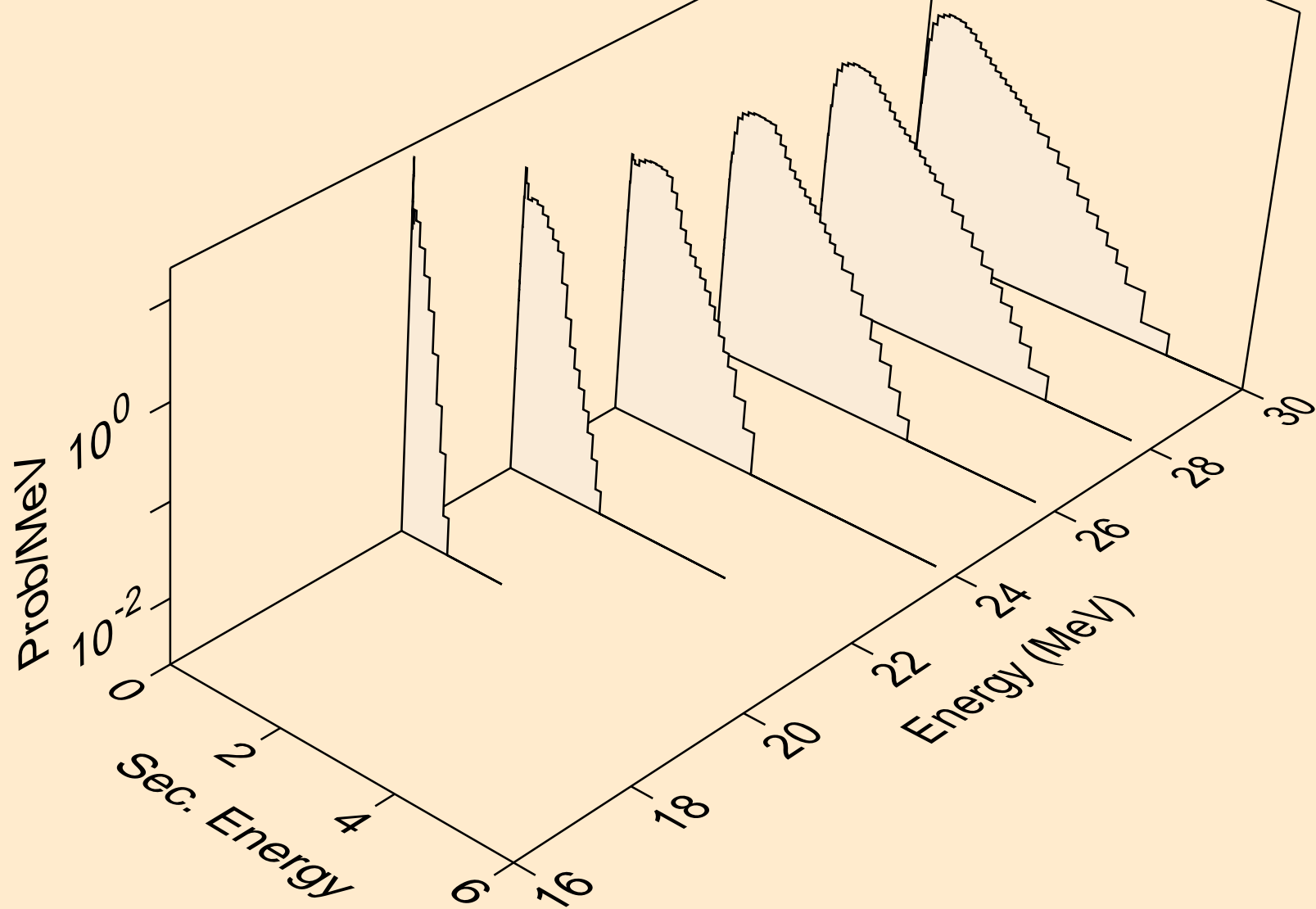

Y087 NEUTRON ACER TENDL-2024 LIBRARY; T=0.K
Neutron emission for (n,n*)he3

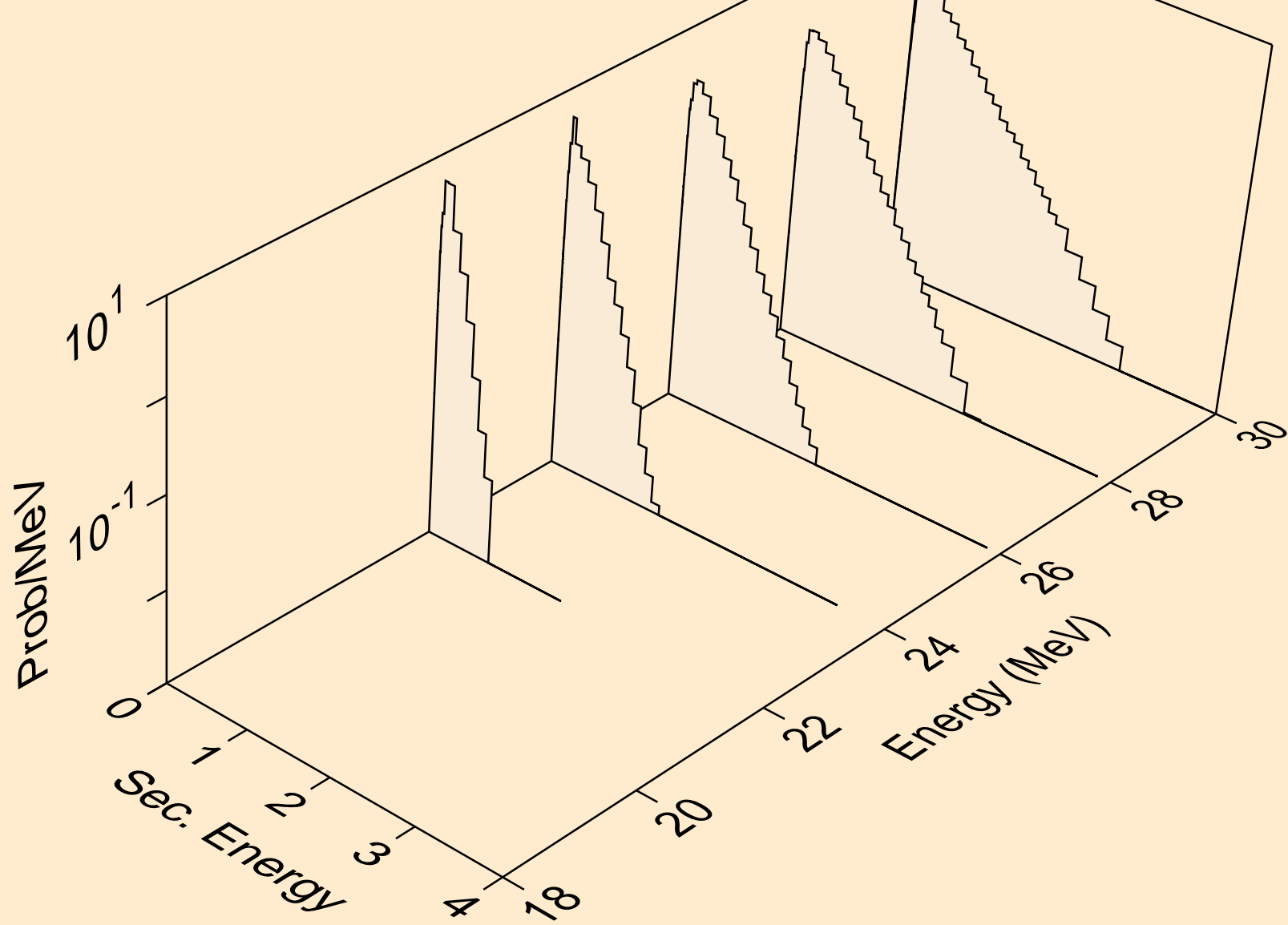

Y087 NEUTRON ACER TENDL-2024 LIBRARY; T=0.K
Neutron emission for (n,2np)

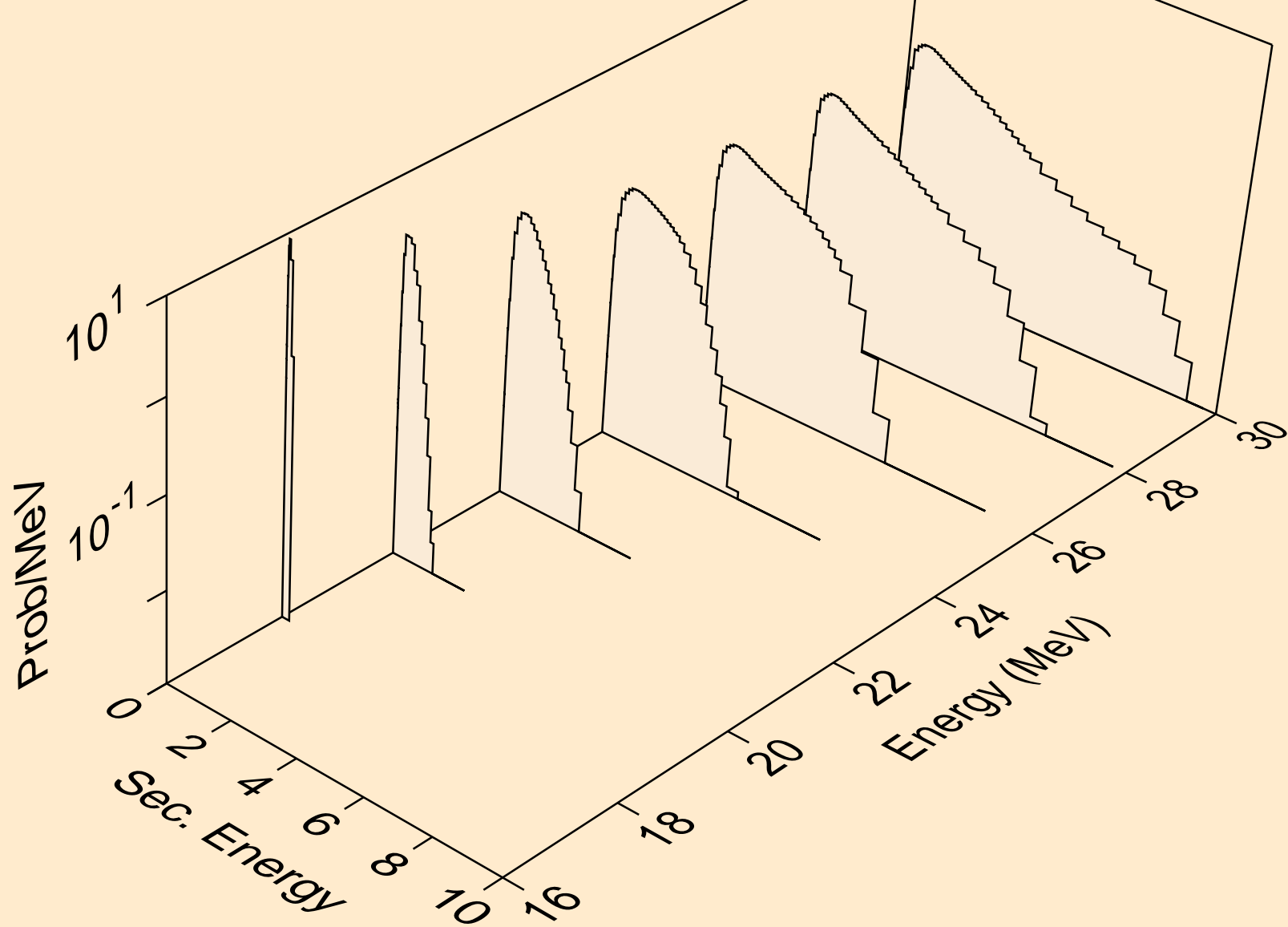

Y087 NEUTRON ACER TENDL-2024 LIBRARY; T=0.K
Neutron emission for (n,3np)

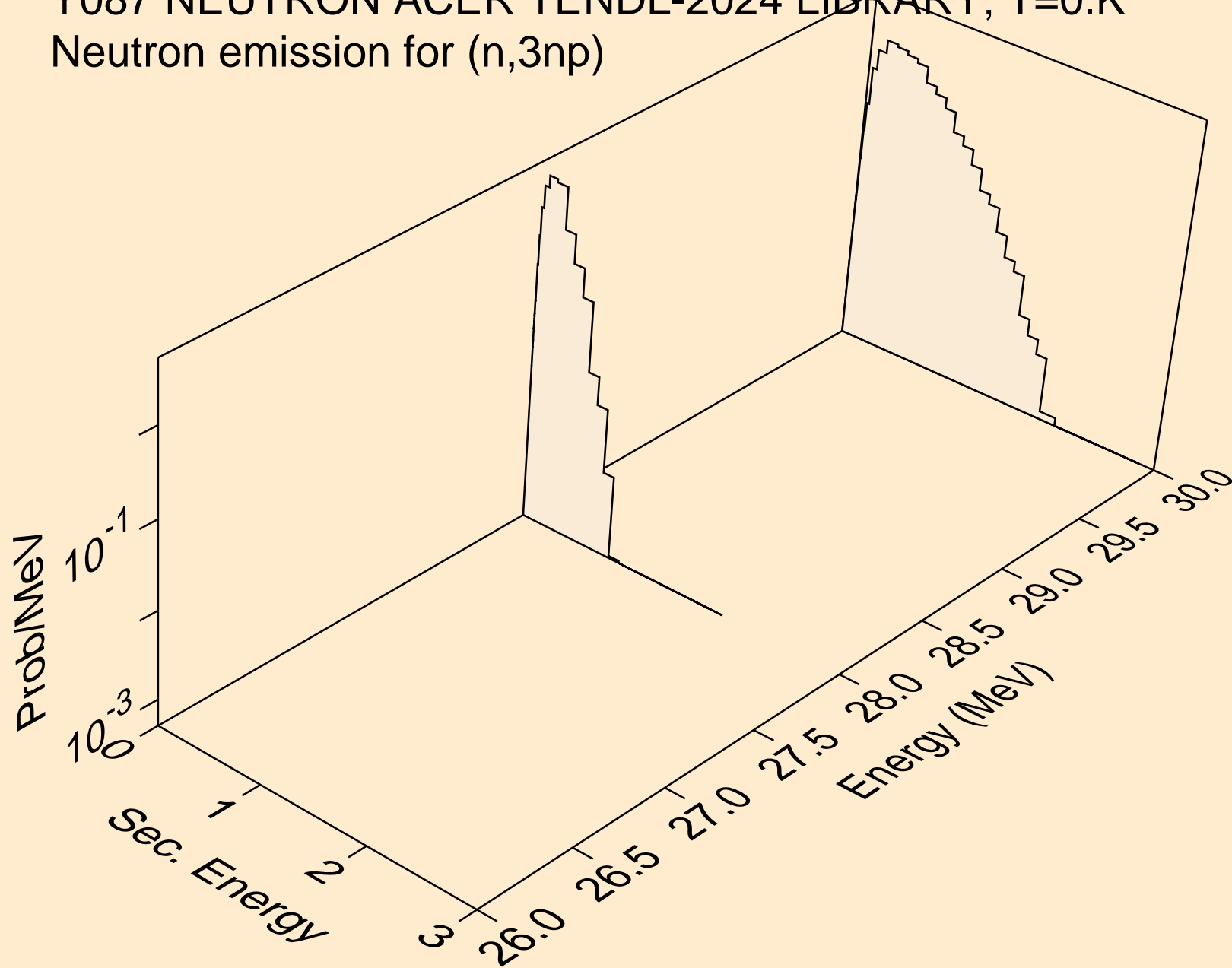

Y087 NEUTRON ACER TENDL-2024 LIBRARY; T=0.K
Neutron emission for (n,n2p)

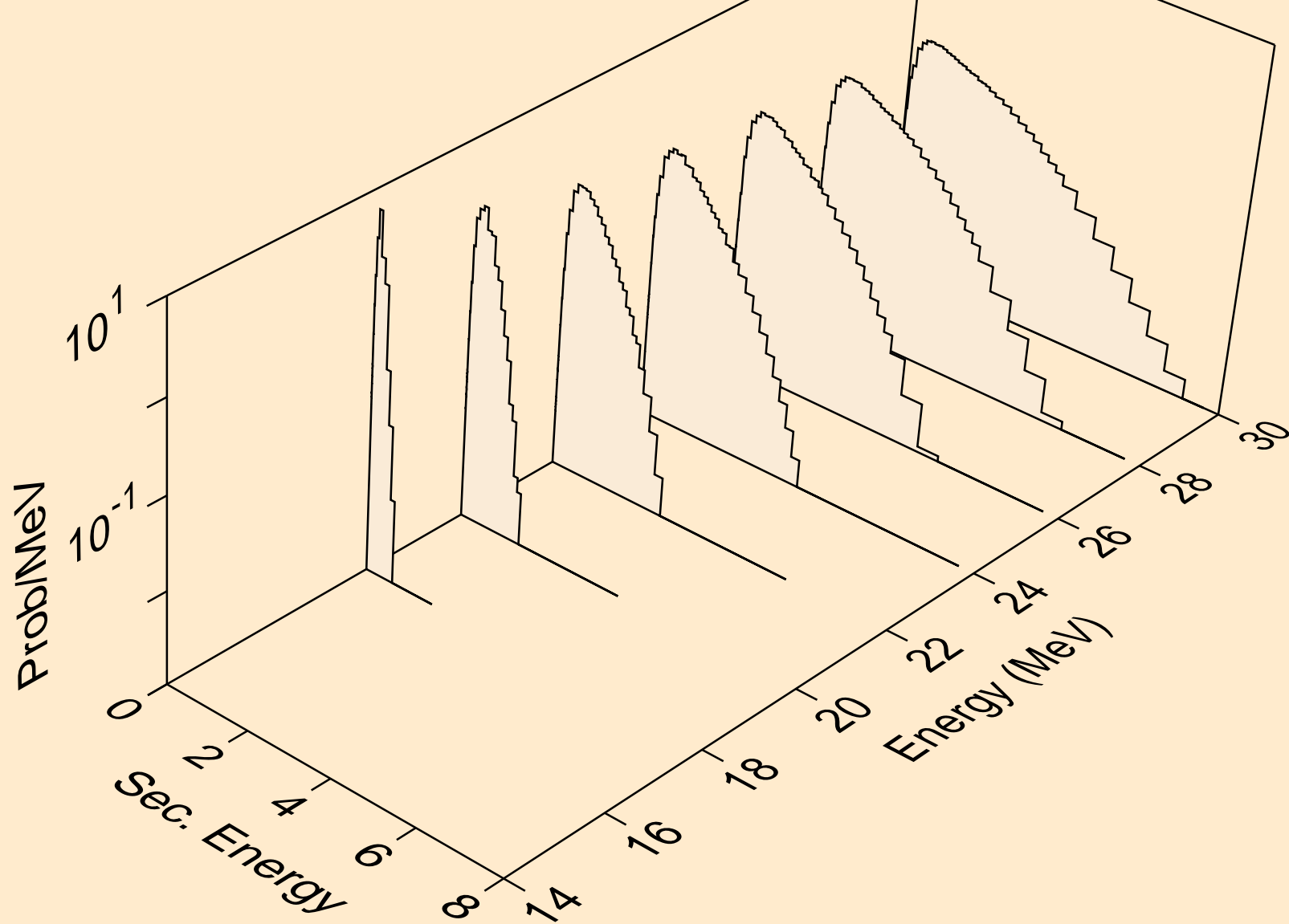

Y087 NEUTRON ACER TENDL-2024 LIBRARY; T=0.K
Neutron emission for (n,npa)

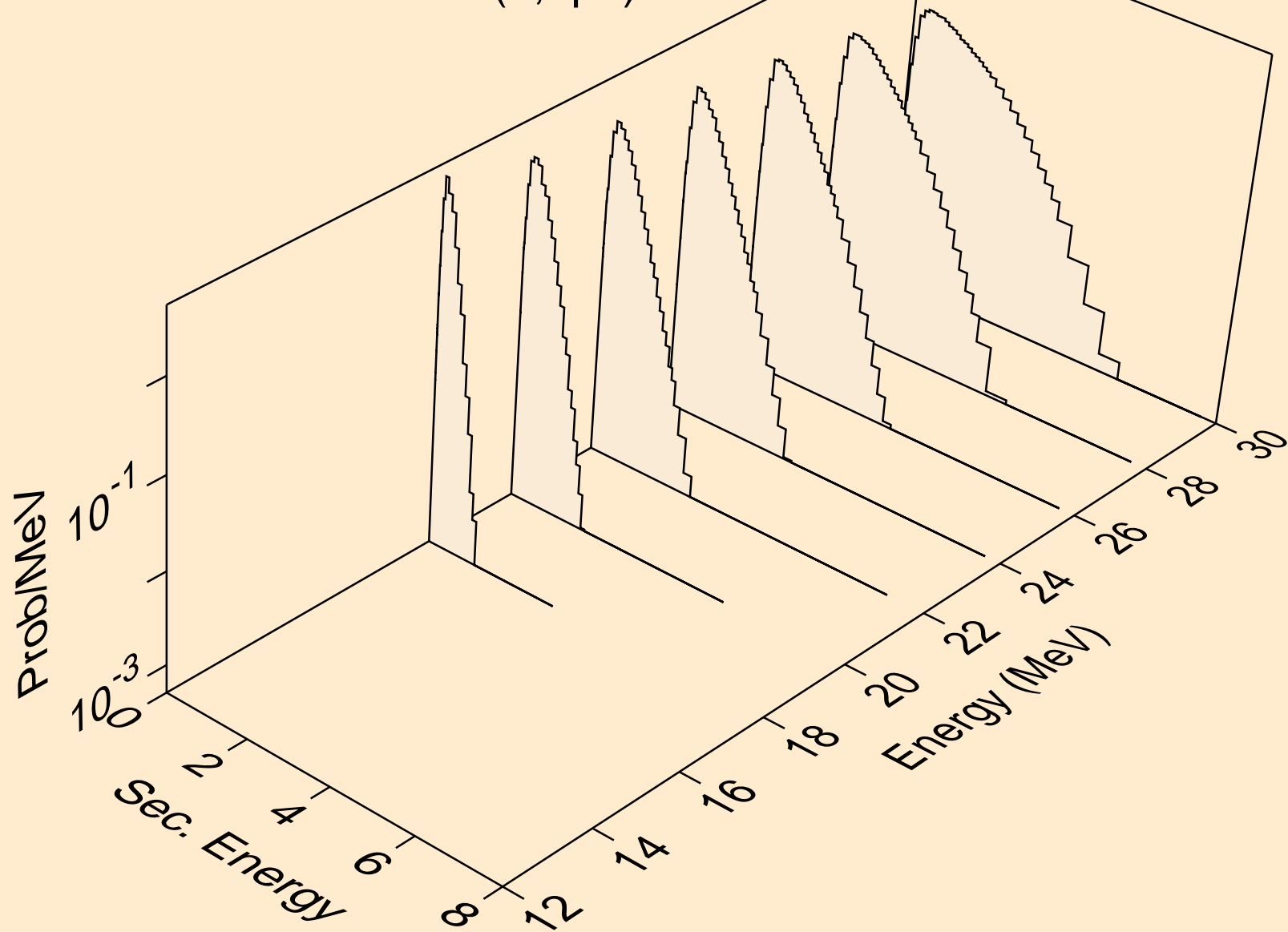

Y087 NEUTRON ACER TENDL-2024 LIBRARY; T=0.K
Neutron emission for (n,n*c)

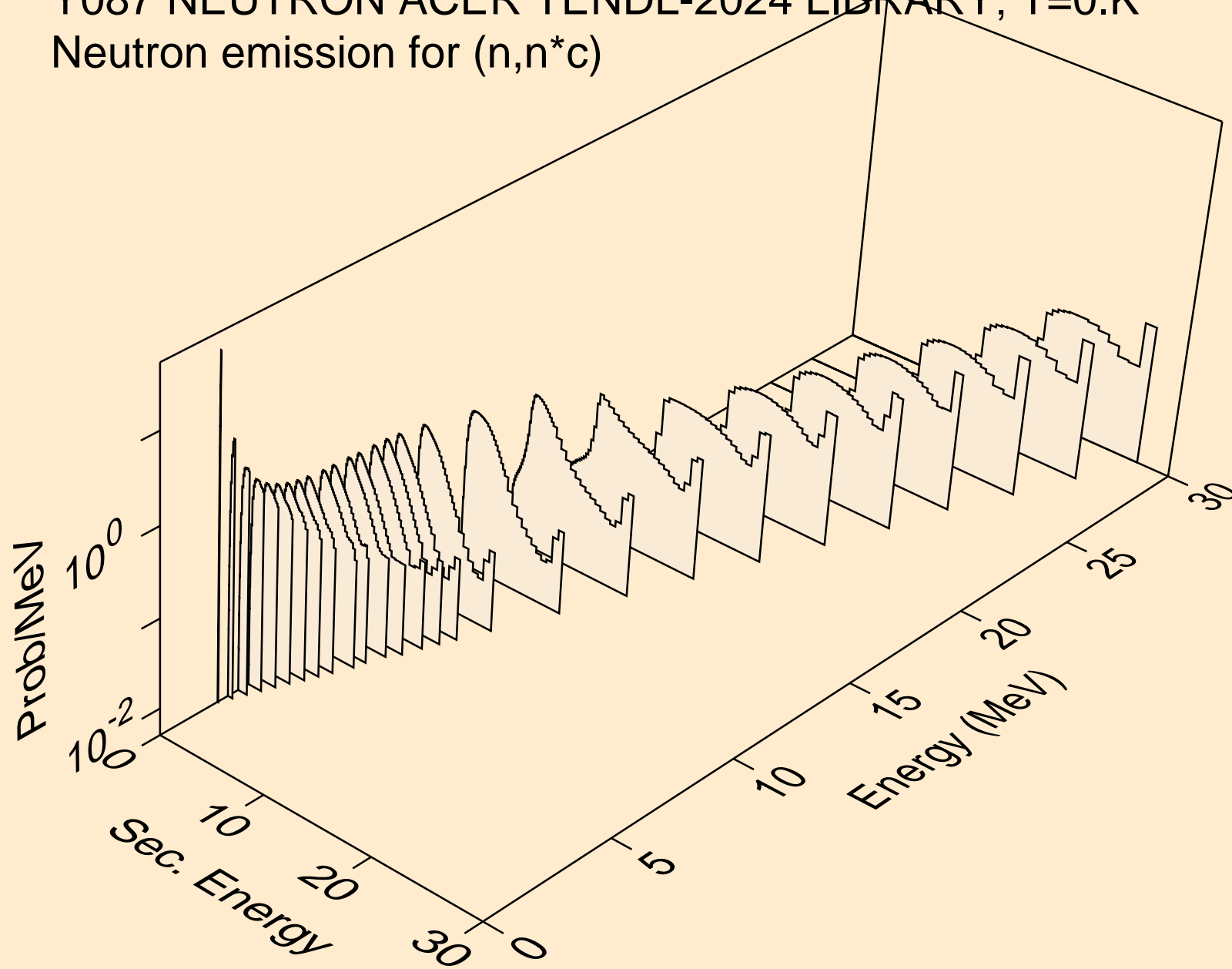

Y087 NEUTRON ACER TENDL-2024 LIBRARY; T=0.K
Photon emission for (n,x)

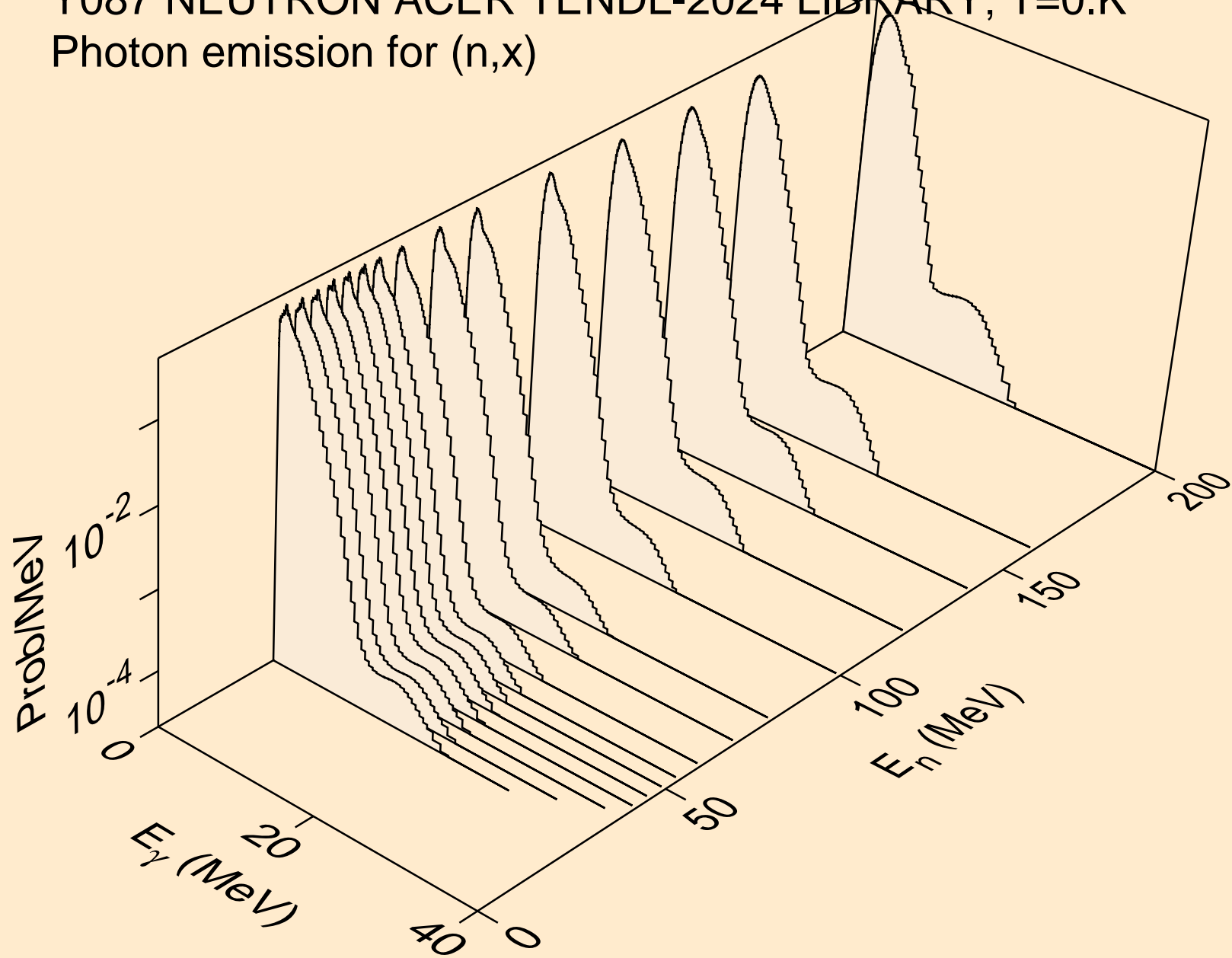

Y087 NEUTRON ACER TENDL-2024 LIBRARY; T=0.K
Photon emission for (n,2nd)

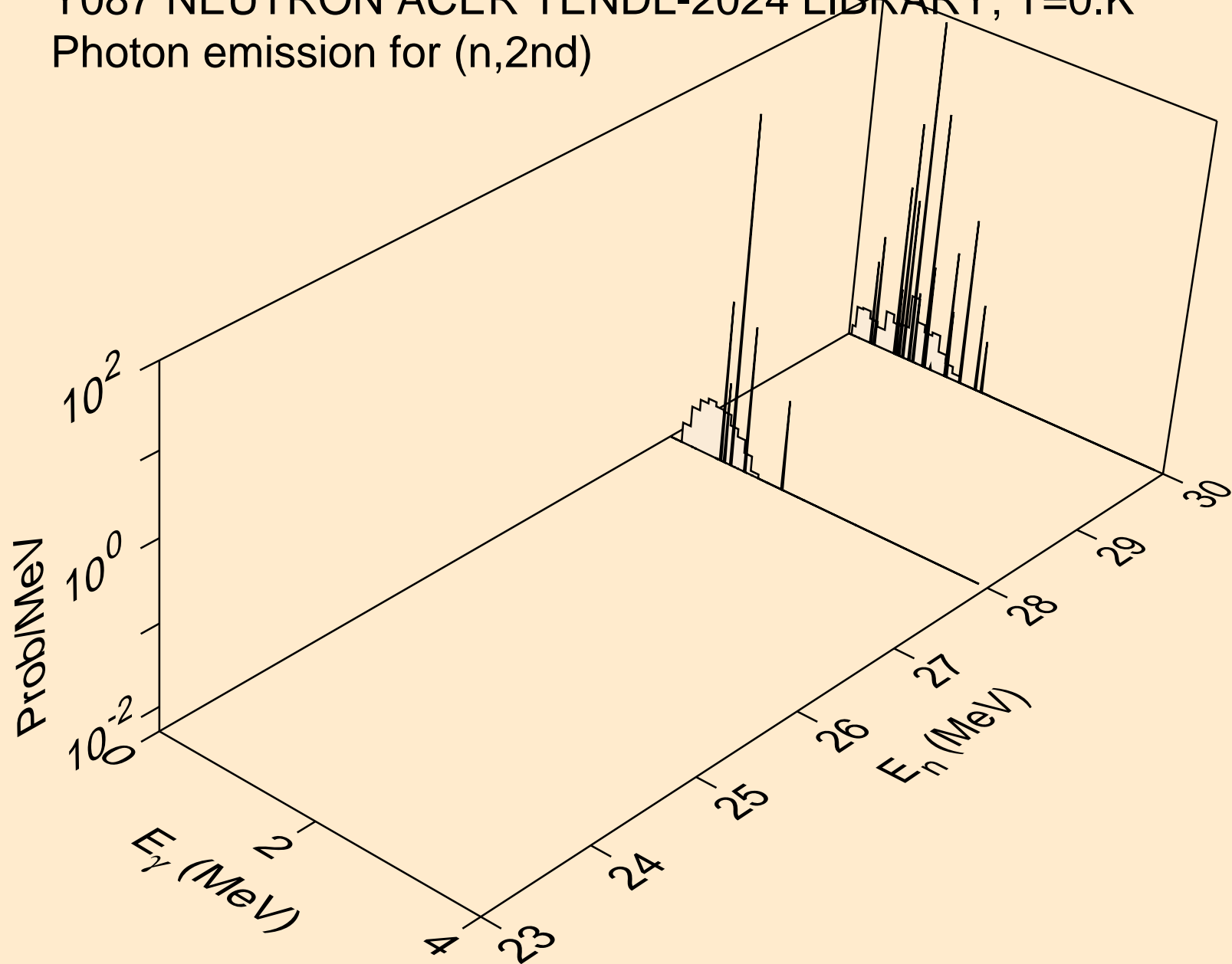

Y087 NEUTRON ACER TENDL-2024 LIBRARY; T=0.K
Photon emission for (n,2n)

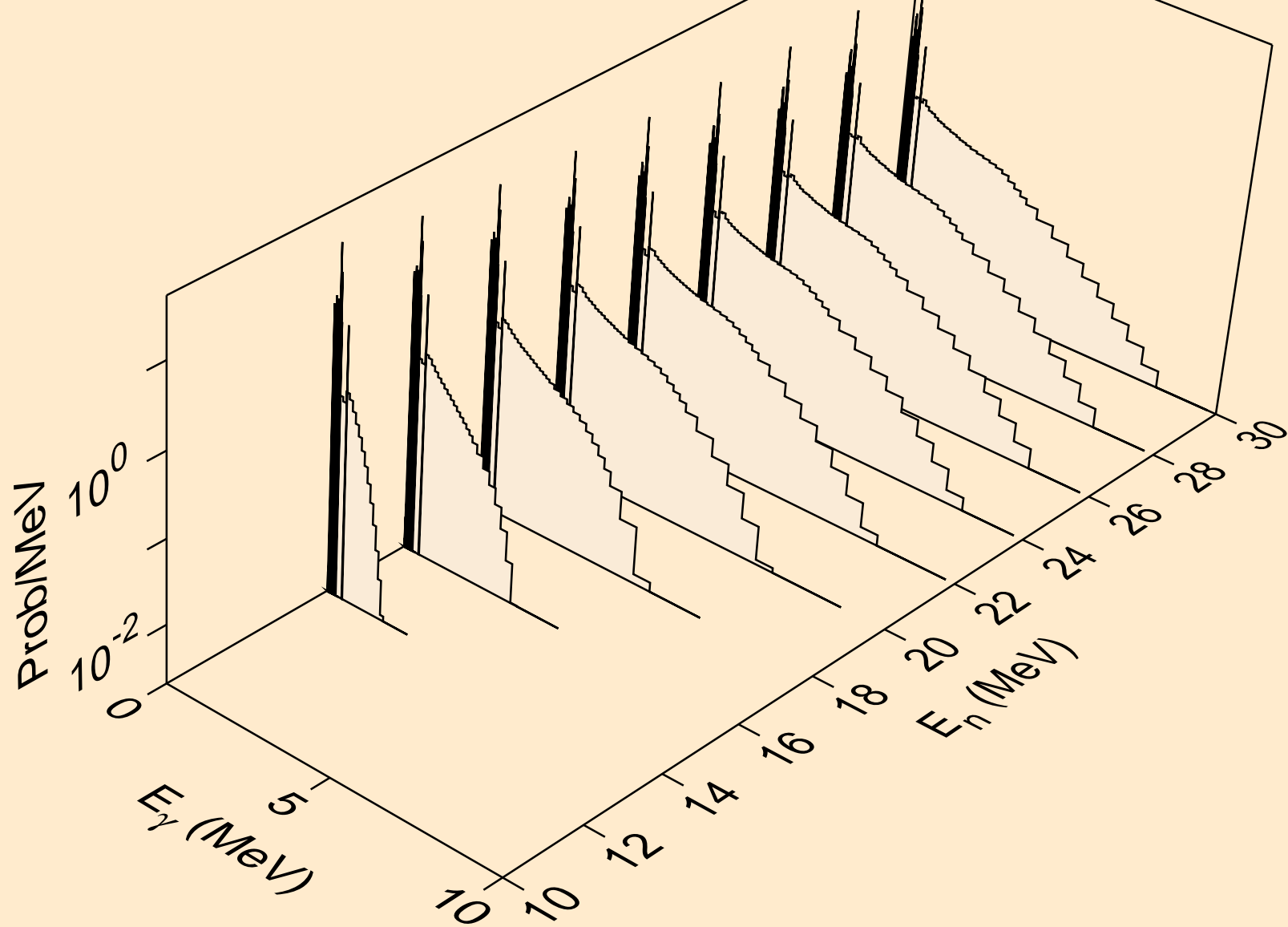

Y087 NEUTRON ACER TENDL-2024 LIBRARY; T=0.K
Photon emission for (n,3n)

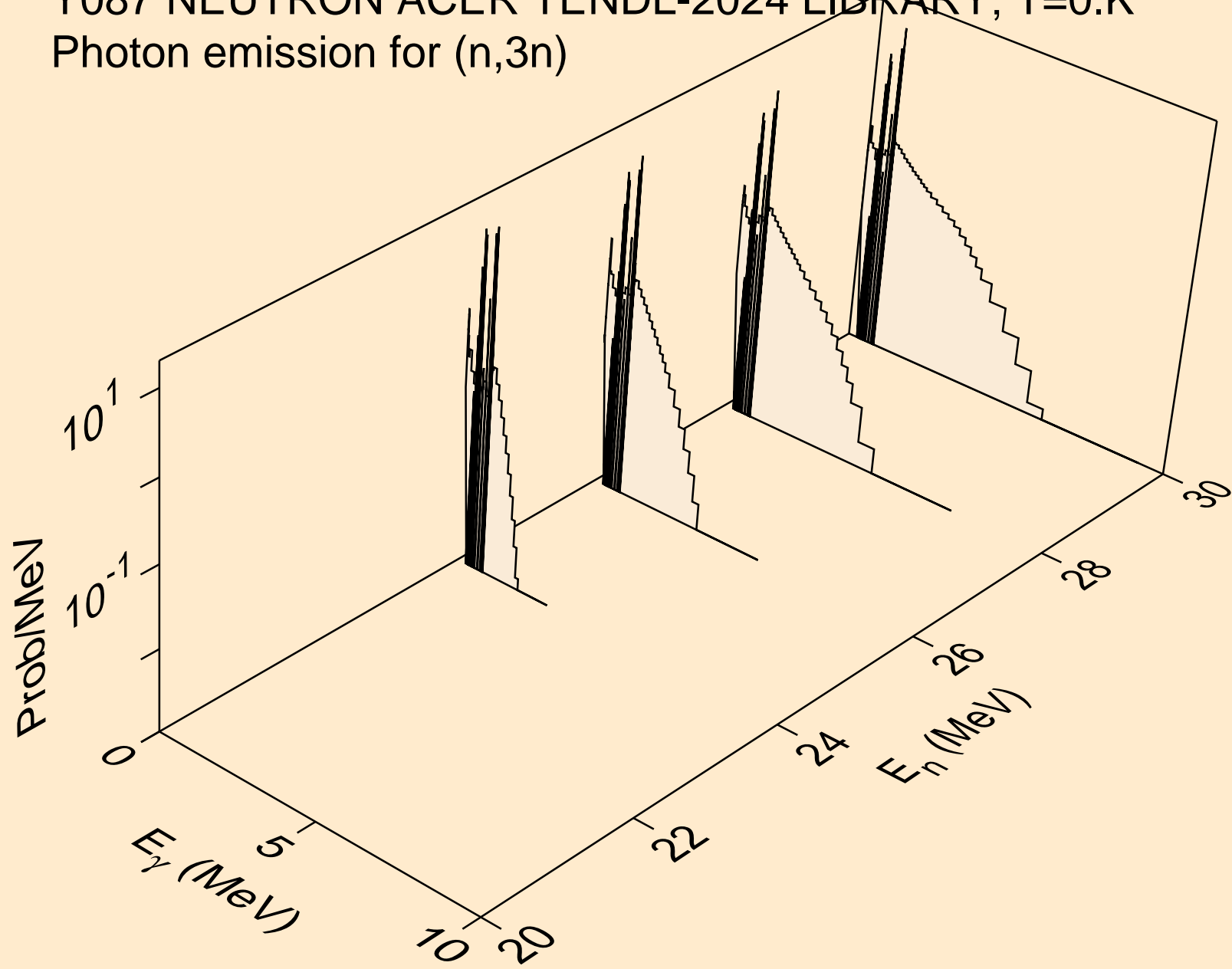

Y087 NEUTRON ACER TENDL-2024 LIBRARY; T=0.K
Photon emission for (n,n*)a

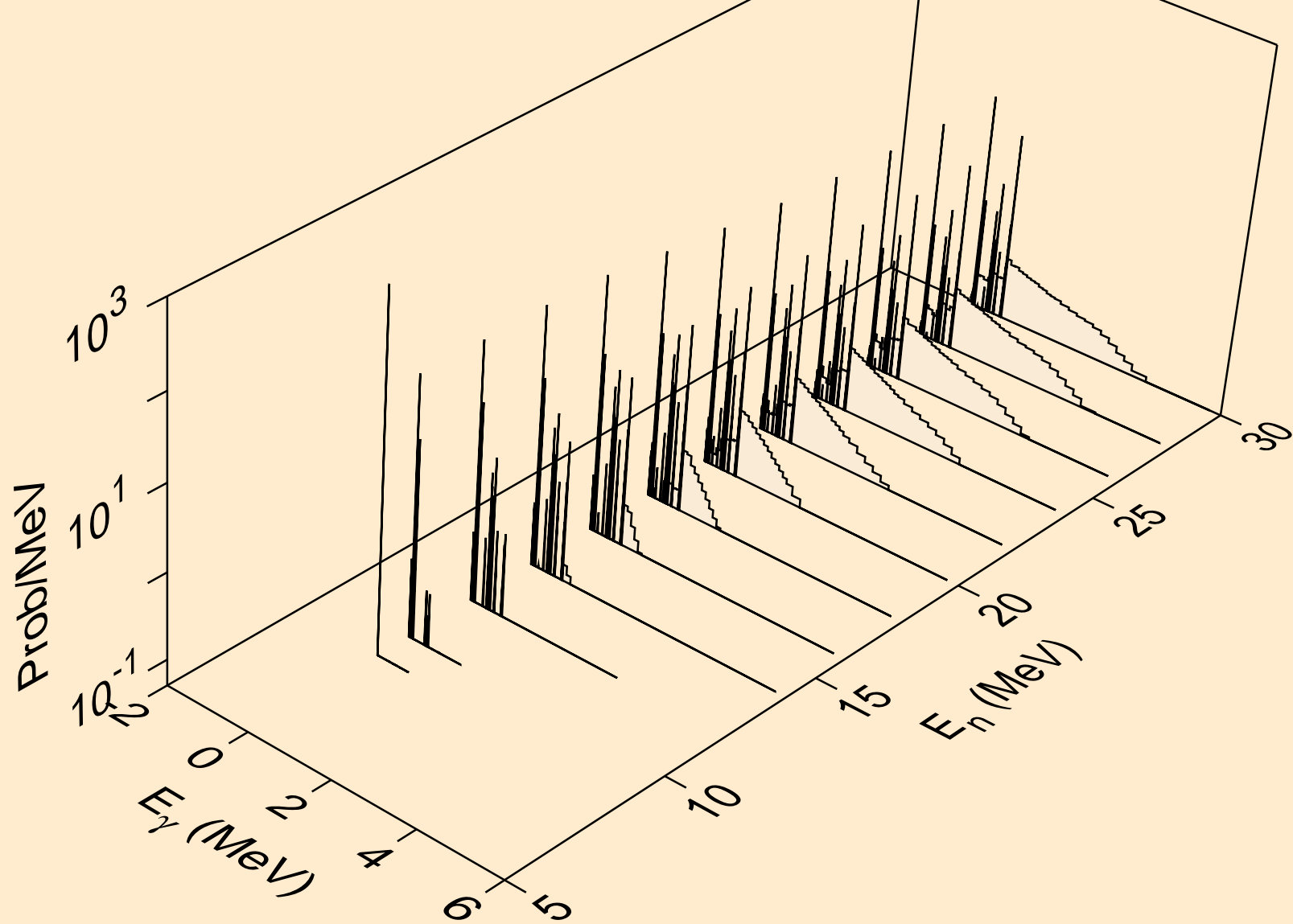

Y087 NEUTRON ACER TENDL-2024 LIBRARY; T=0.K
Photon emission for (n,2n)a

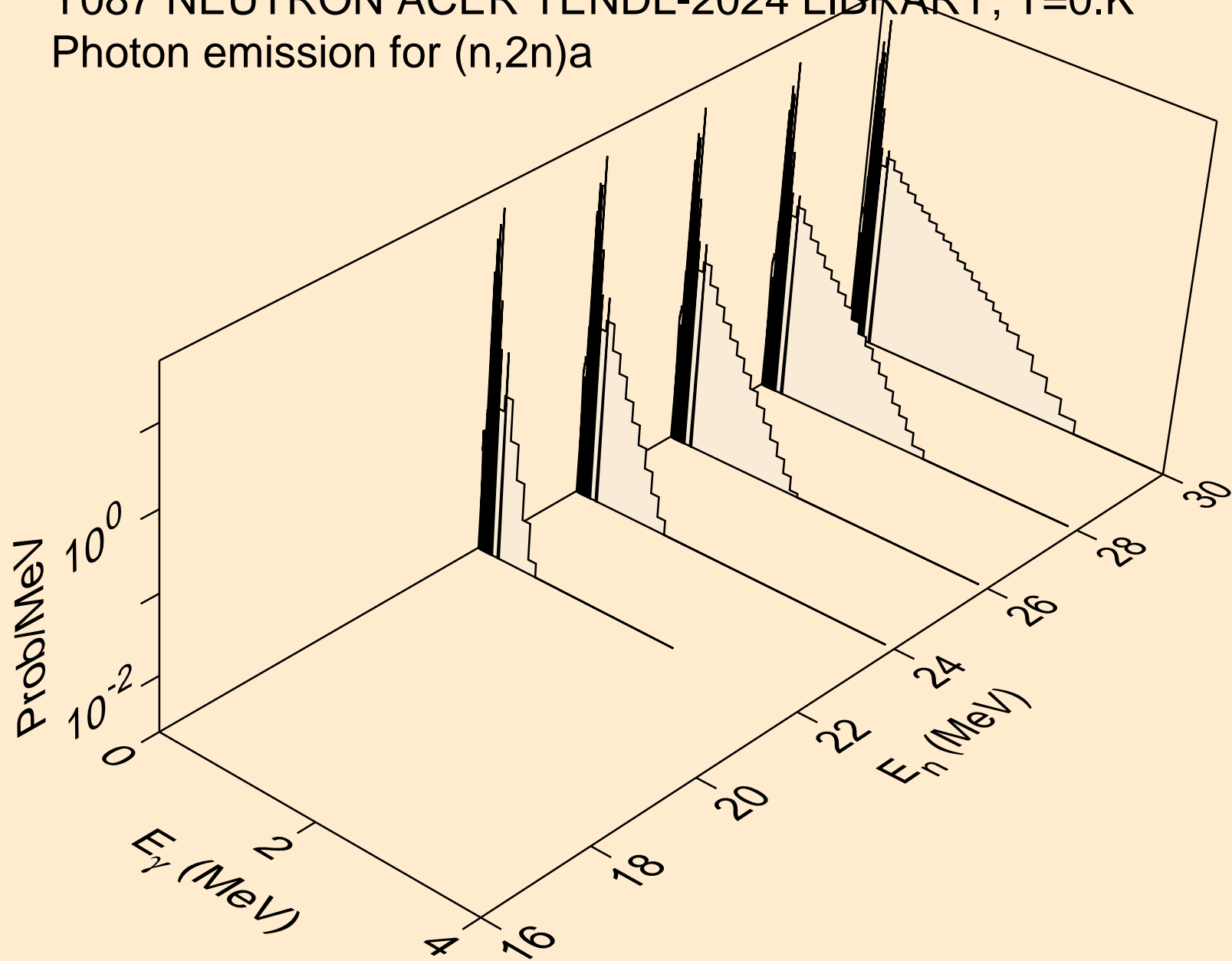

Y087 NEUTRON ACER TENDL-2024 LIBRARY; T=0.K
Photon emission for (n,n*)p

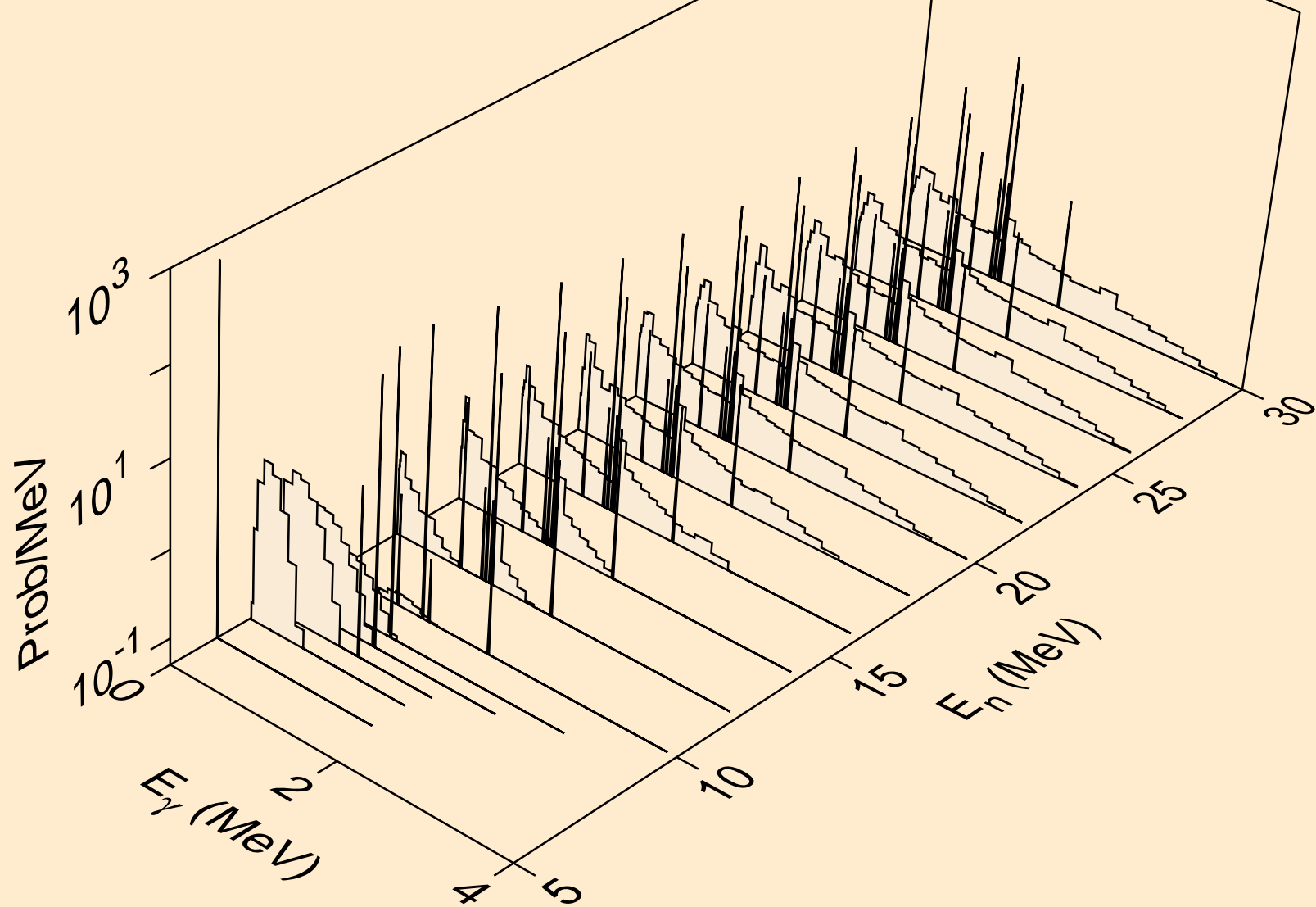

Y087 NEUTRON ACER TENDL-2024 LIBRARY; T=0.K
Photon emission for (n,n*)2a

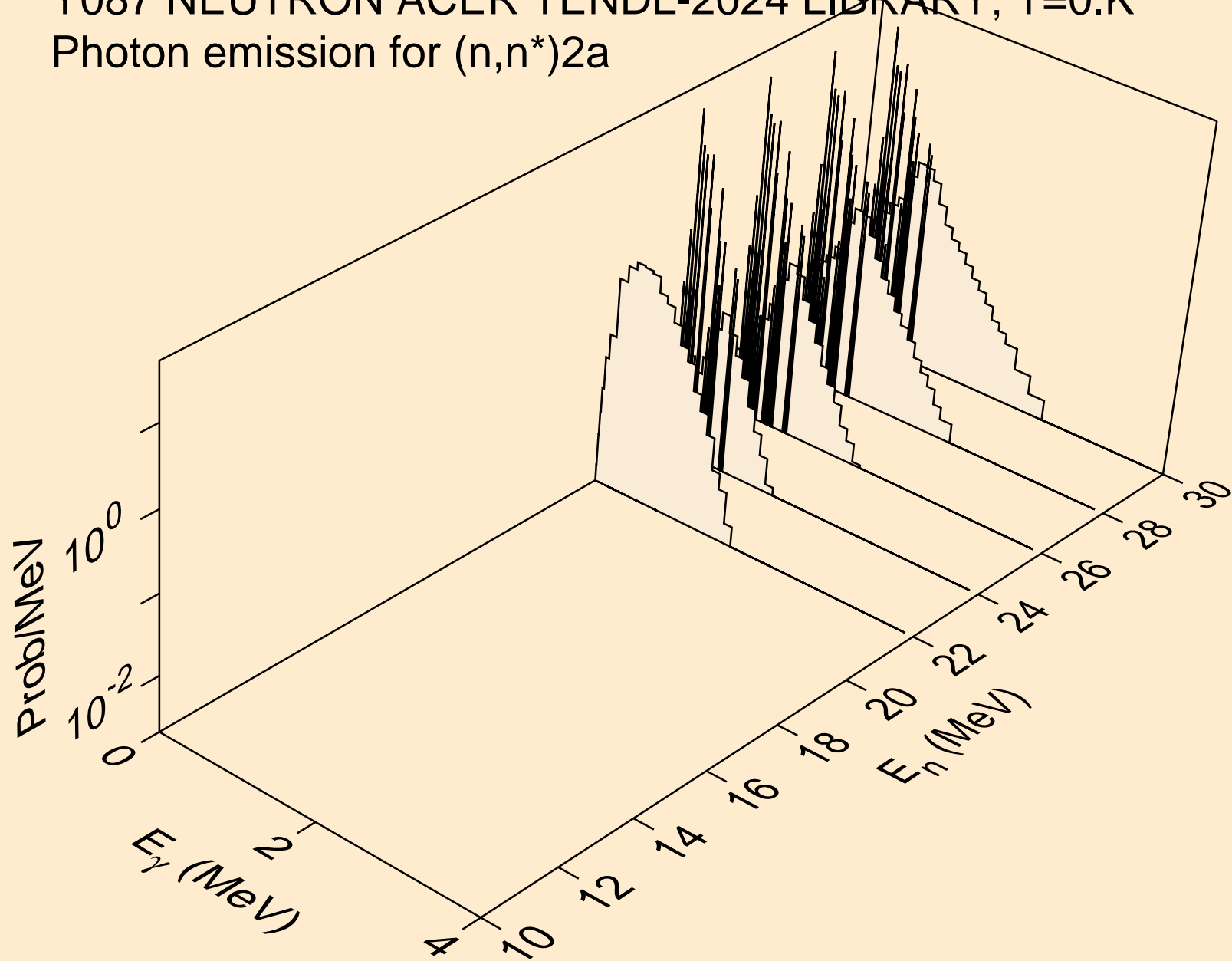

Y087 NEUTRON ACER TENDL-2024 LIBRARY; T=0.K
Photon emission for (n,n*)d

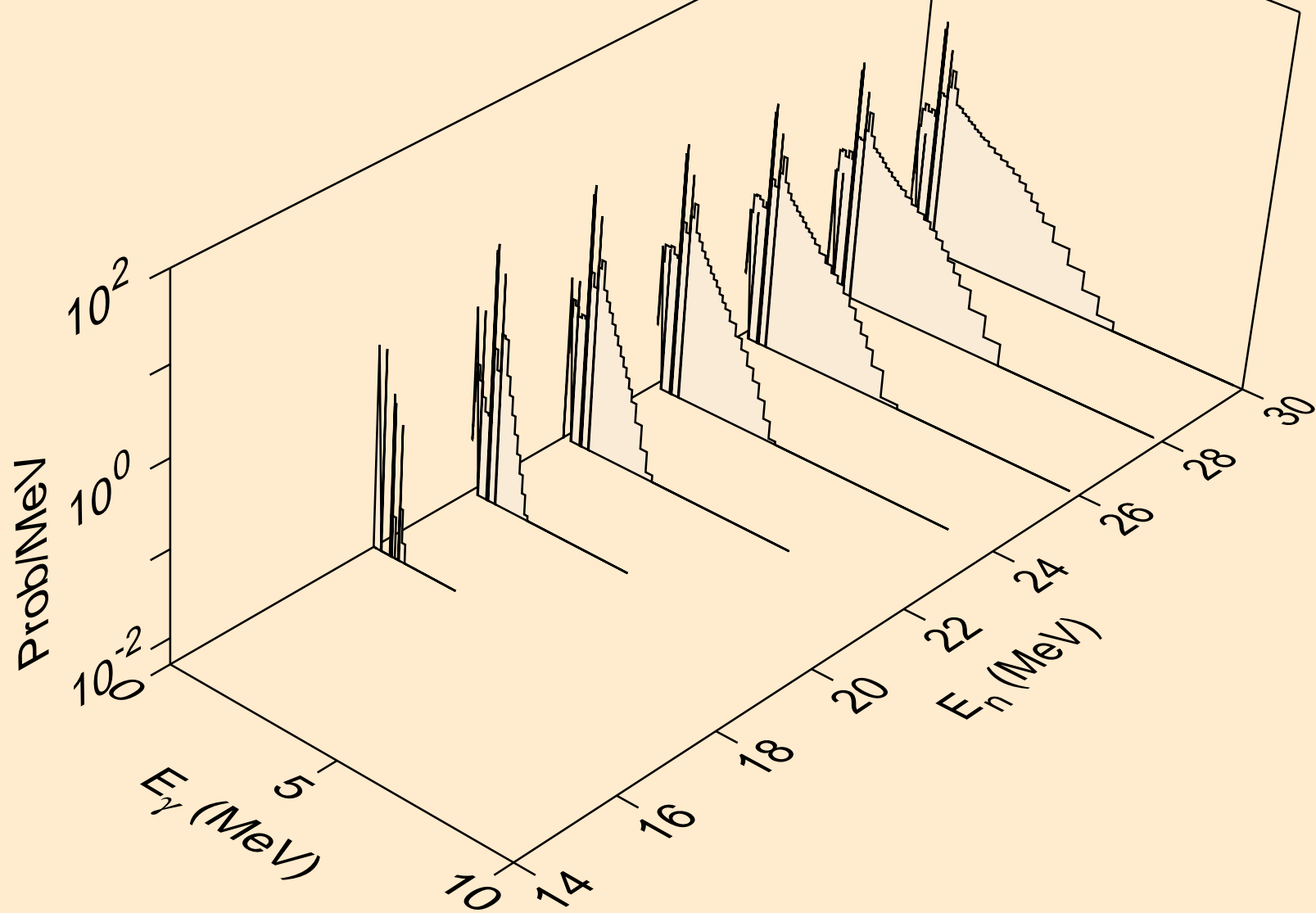

Y087 NEUTRON ACER TENDL-2024 LIBRARY; T=0.K
Photon emission for (n,n*)t

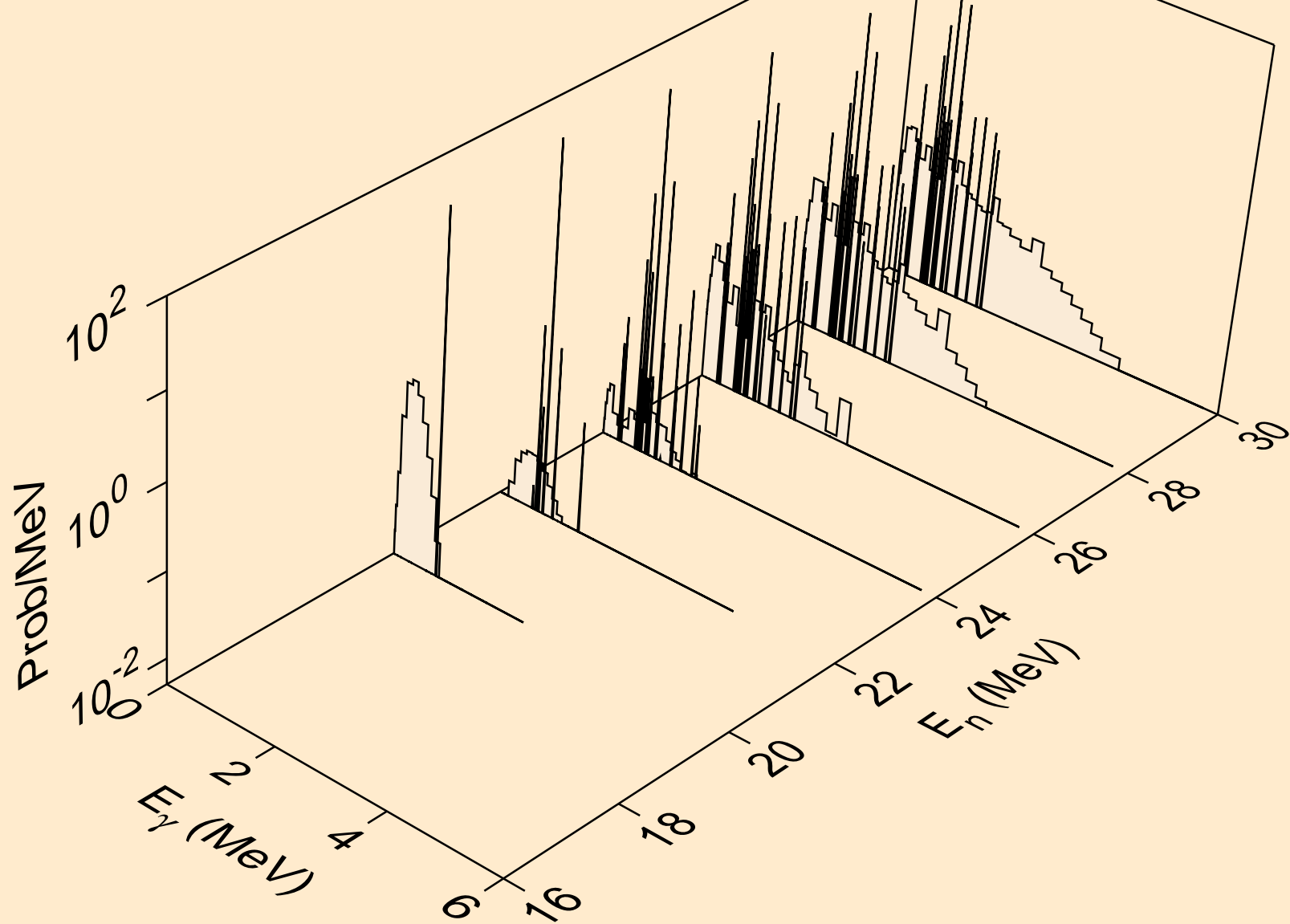

Y087 NEUTRON ACER TENDL-2024 LIBRARY; T=0.K
Photon emission for (n,n*)he3

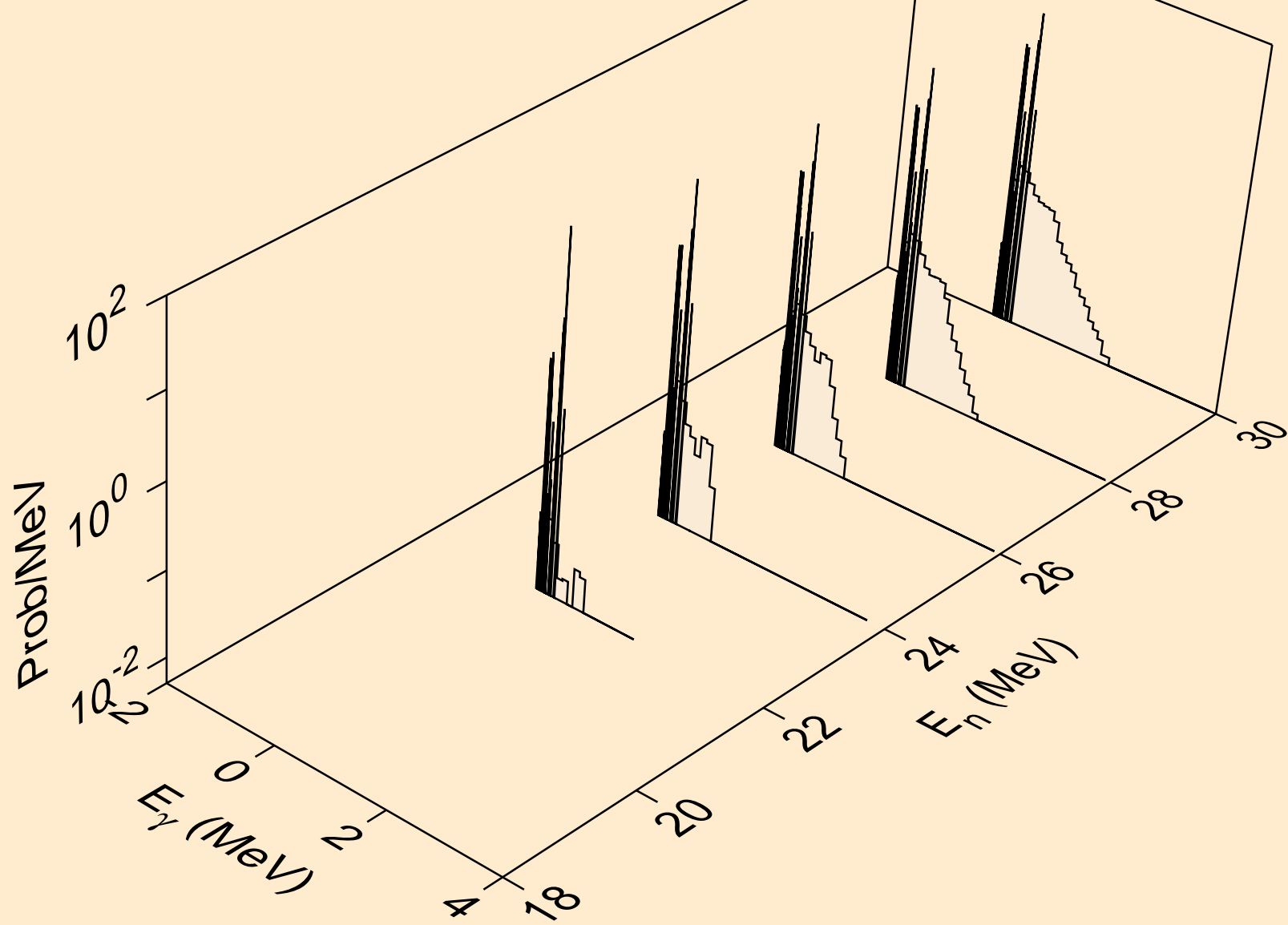

Y087 NEUTRON ACER TENDL-2024 LIBRARY; T=0.K
Photon emission for (n,2np)

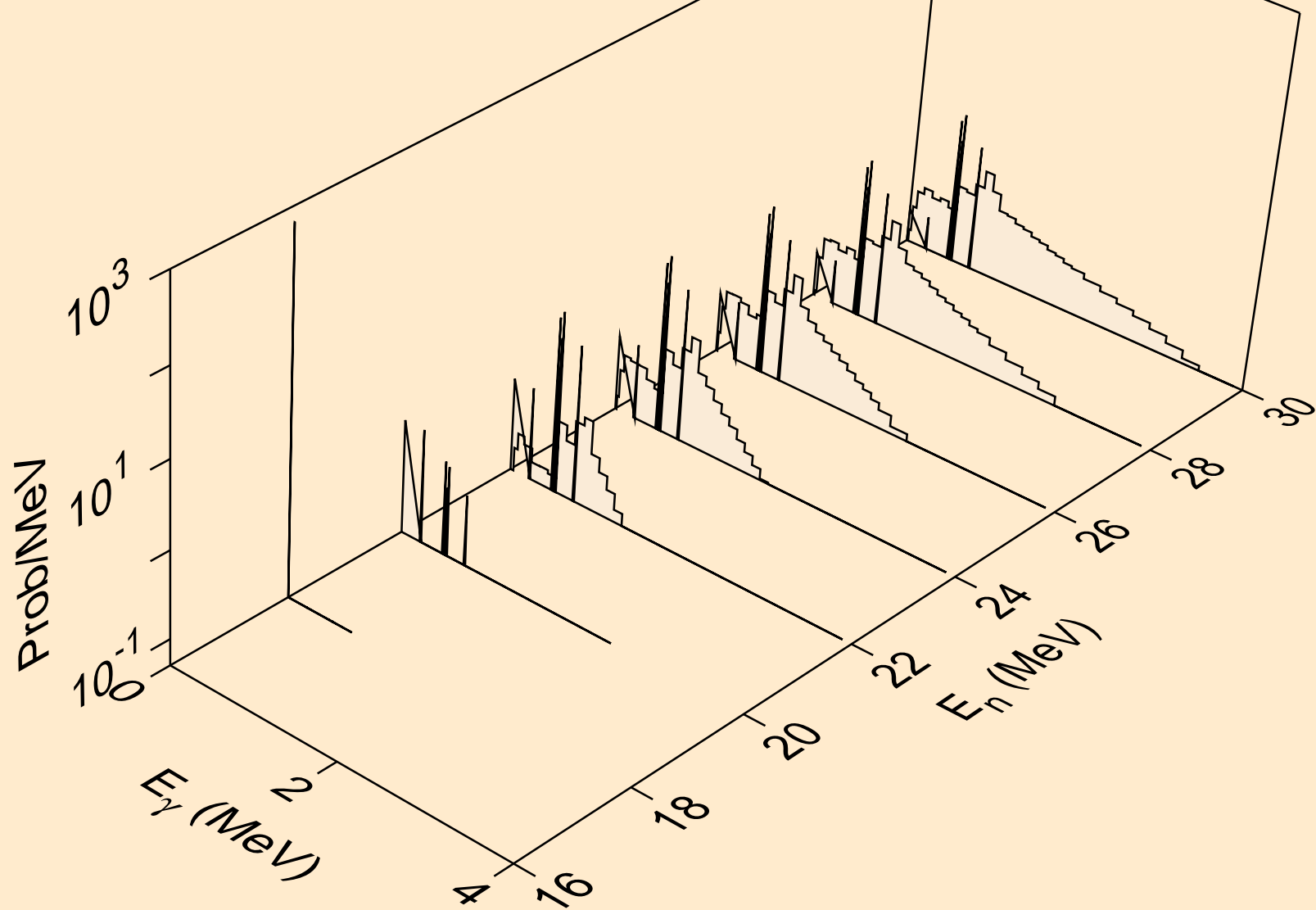

Y087 NEUTRON ACER TENDL-2024 LIBRARY; T=0.K
Photon emission for (n,3np)

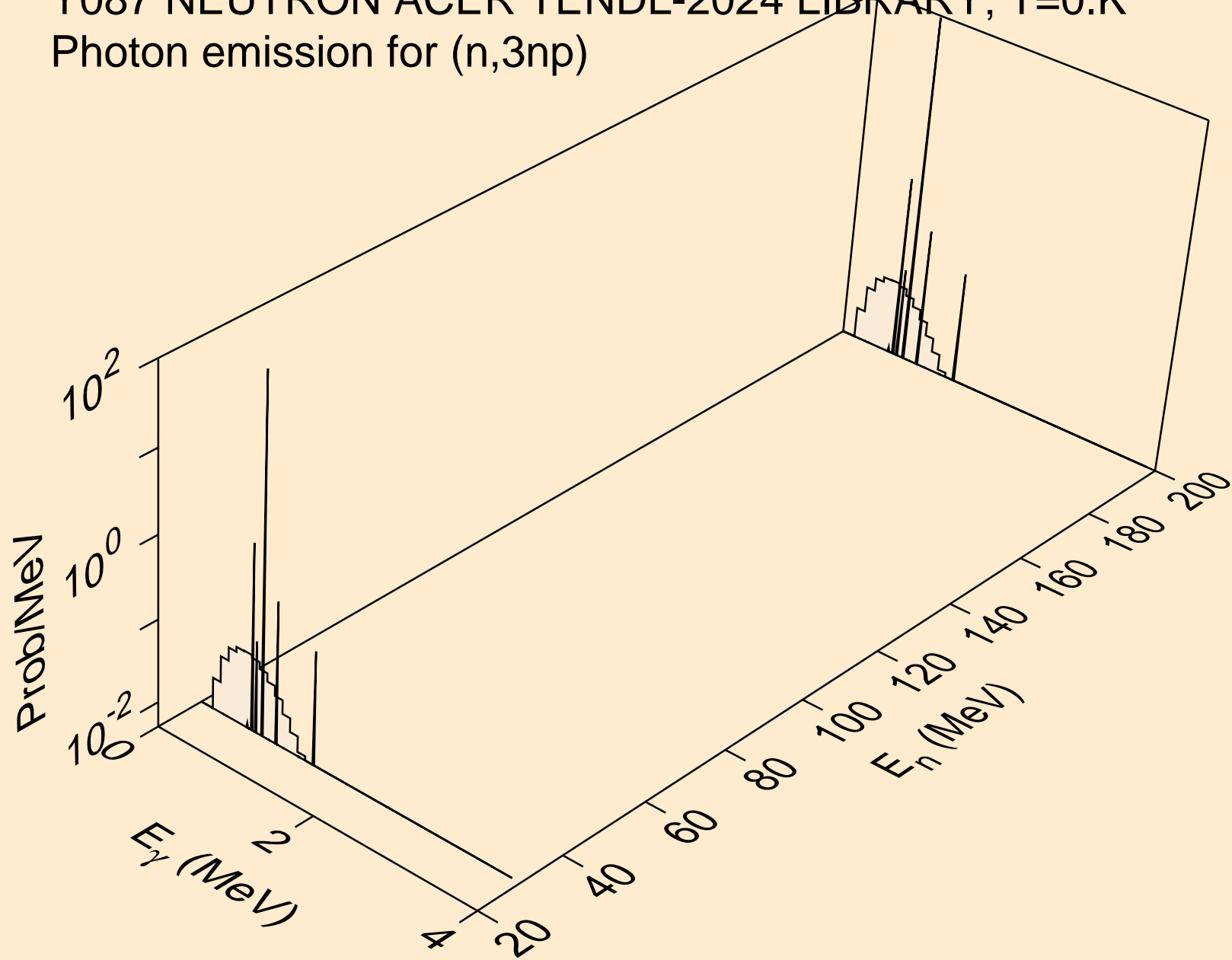

Y087 NEUTRON ACER TENDL-2024 LIBRARY; T=0.K
Photon emission for (n,n2p)

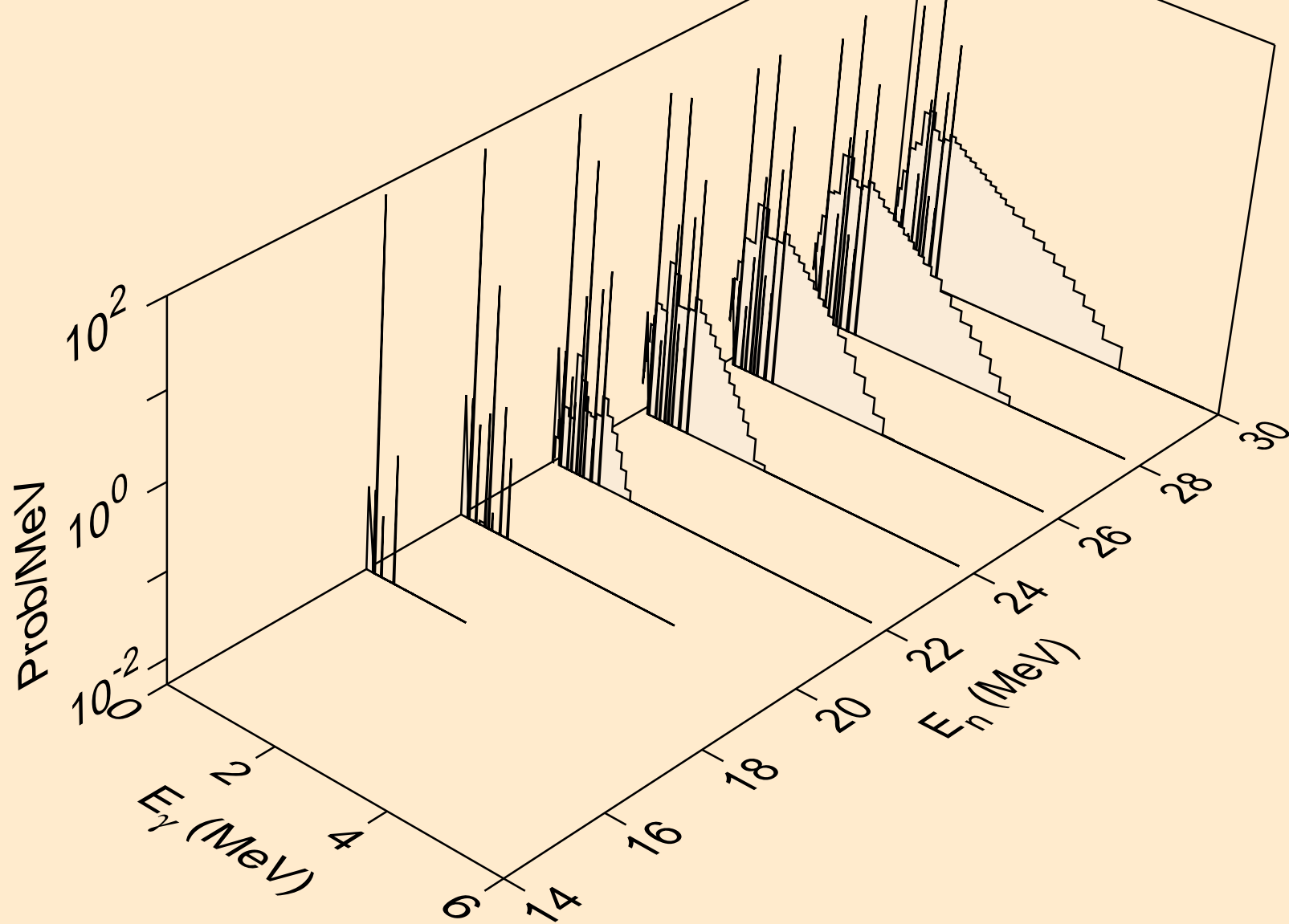

Y087 NEUTRON ACER TENDL-2024 LIBRARY; T=0.K
Photon emission for (n,npa)

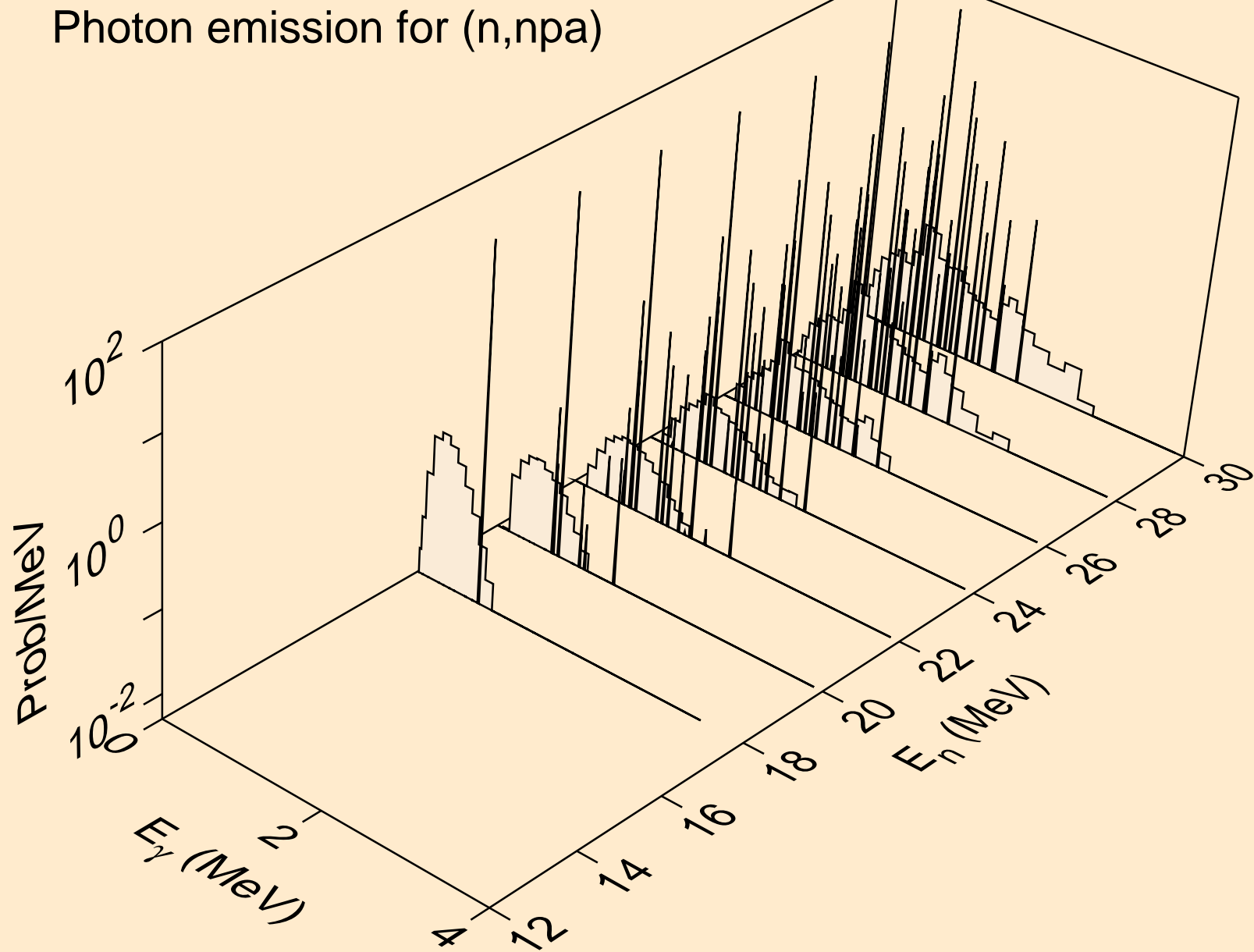

Y087 NEUTRON ACER TENDL-2024 LIBRARY; T=0.K
Photon emission for (n,n*c)

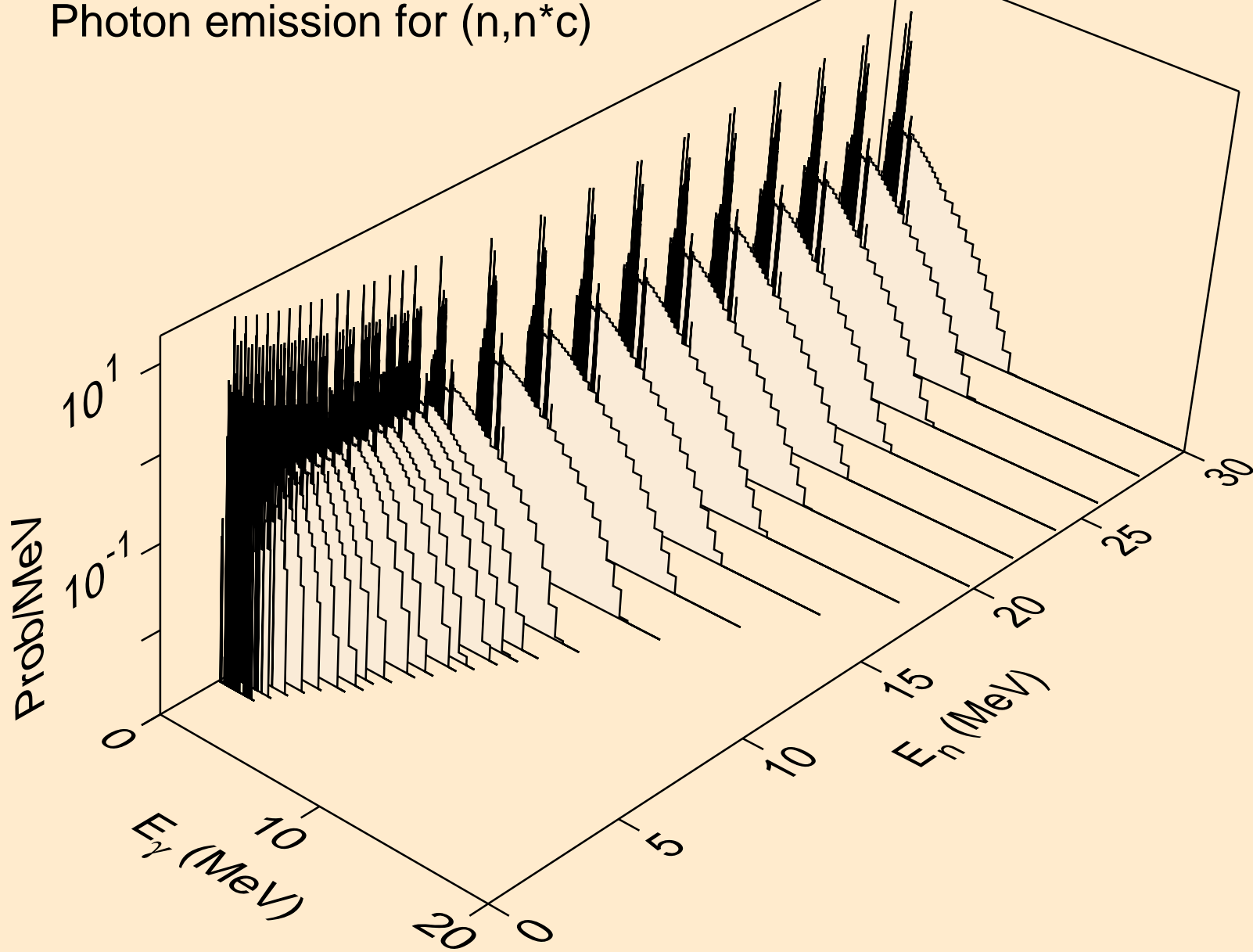

Y087 NEUTRON ACER TENDL-2024 LIBRARY; T=0.K
Photon emission for (n,gma)

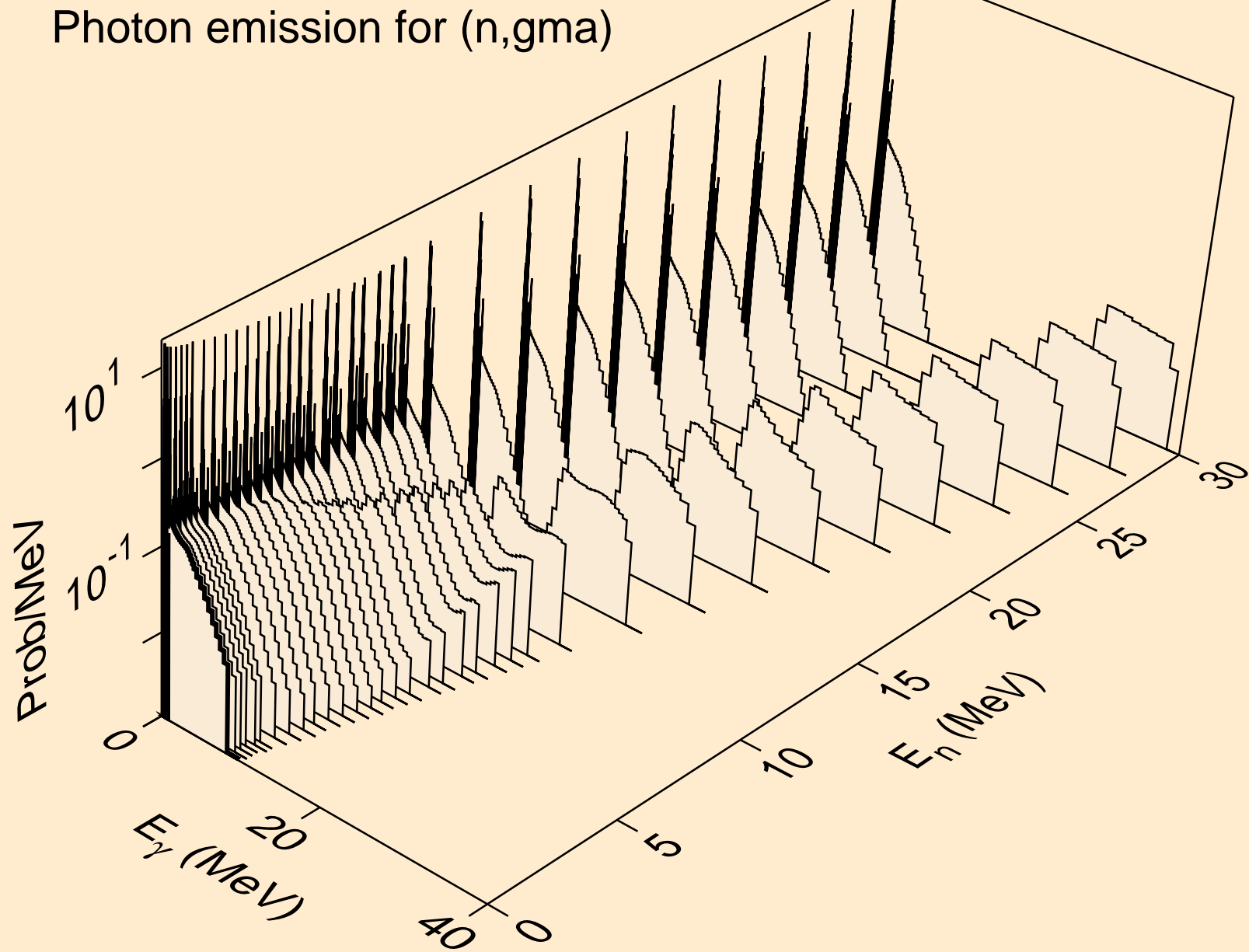

Y087 NEUTRON ACER TENDL-2024 LIBRARY; T=0.K
Photon emission for (n,p)

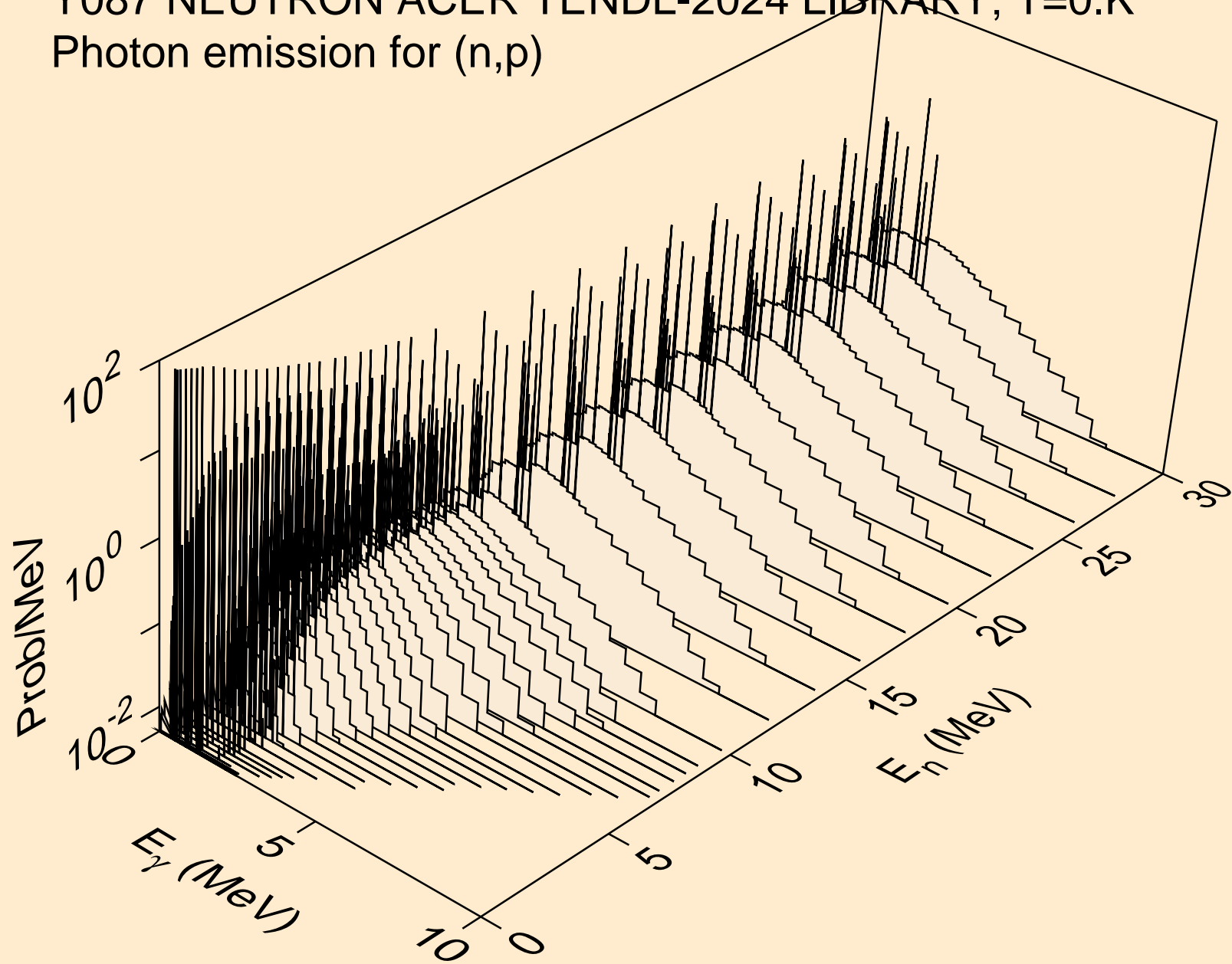

Y087 NEUTRON ACER TENDL-2024 LIBRARY; T=0.K
Photon emission for (n,d)

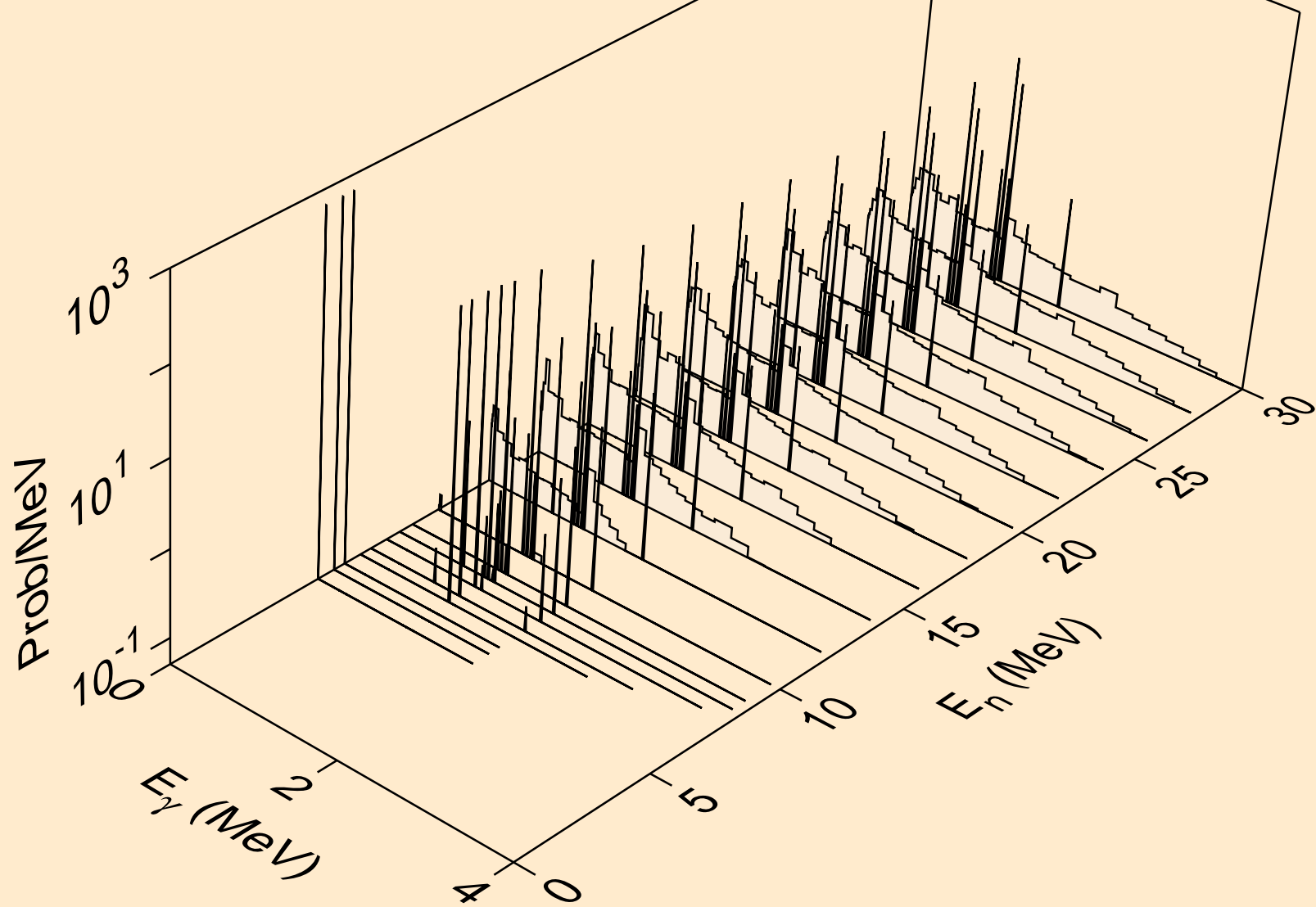

Y087 NEUTRON ACER TENDL-2024 LIBRARY; T=0.K
Photon emission for (n,t)

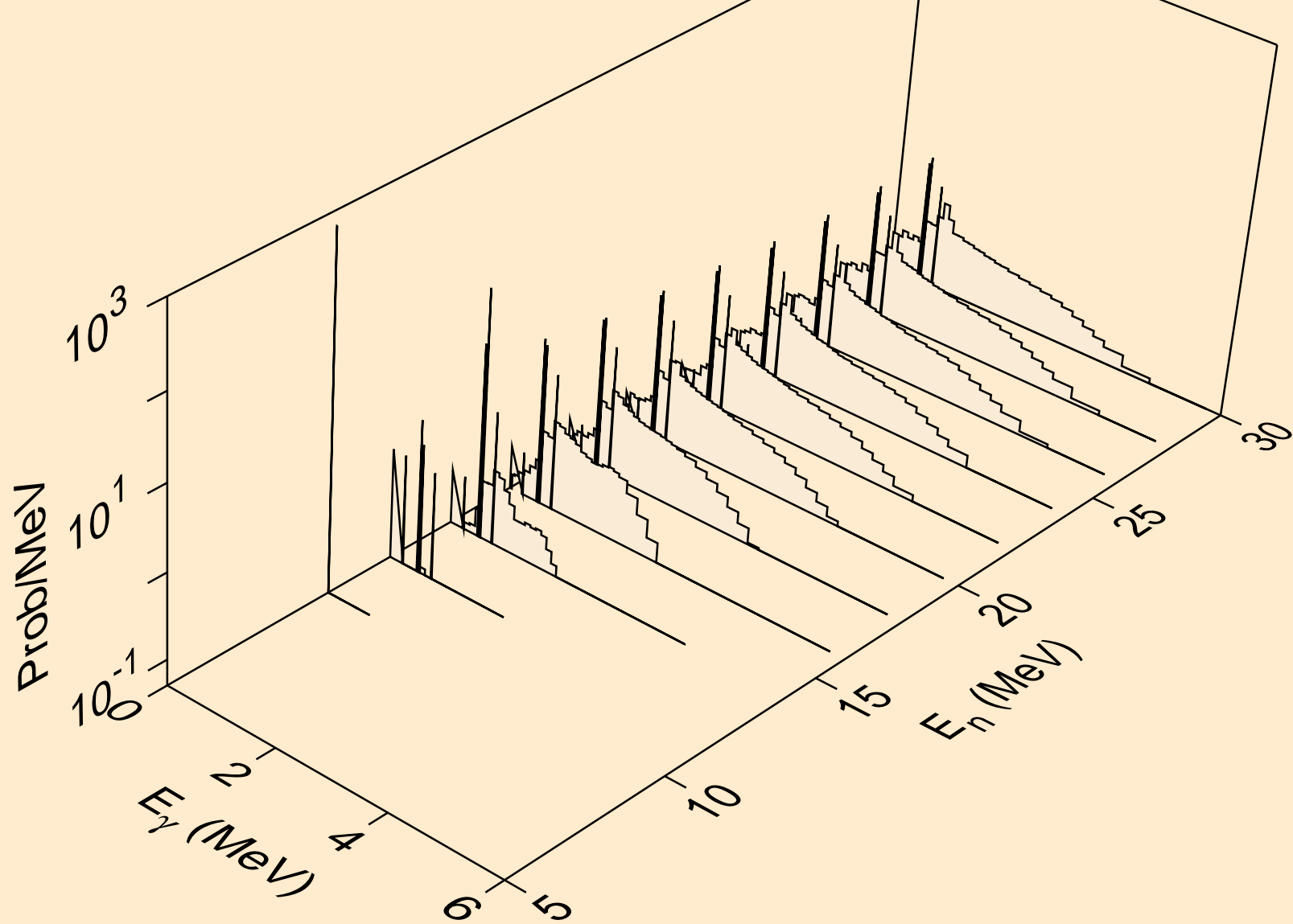

Y087 NEUTRON ACER TENDL-2024 LIBRARY; T=0.K
Photon emission for (n,he3)

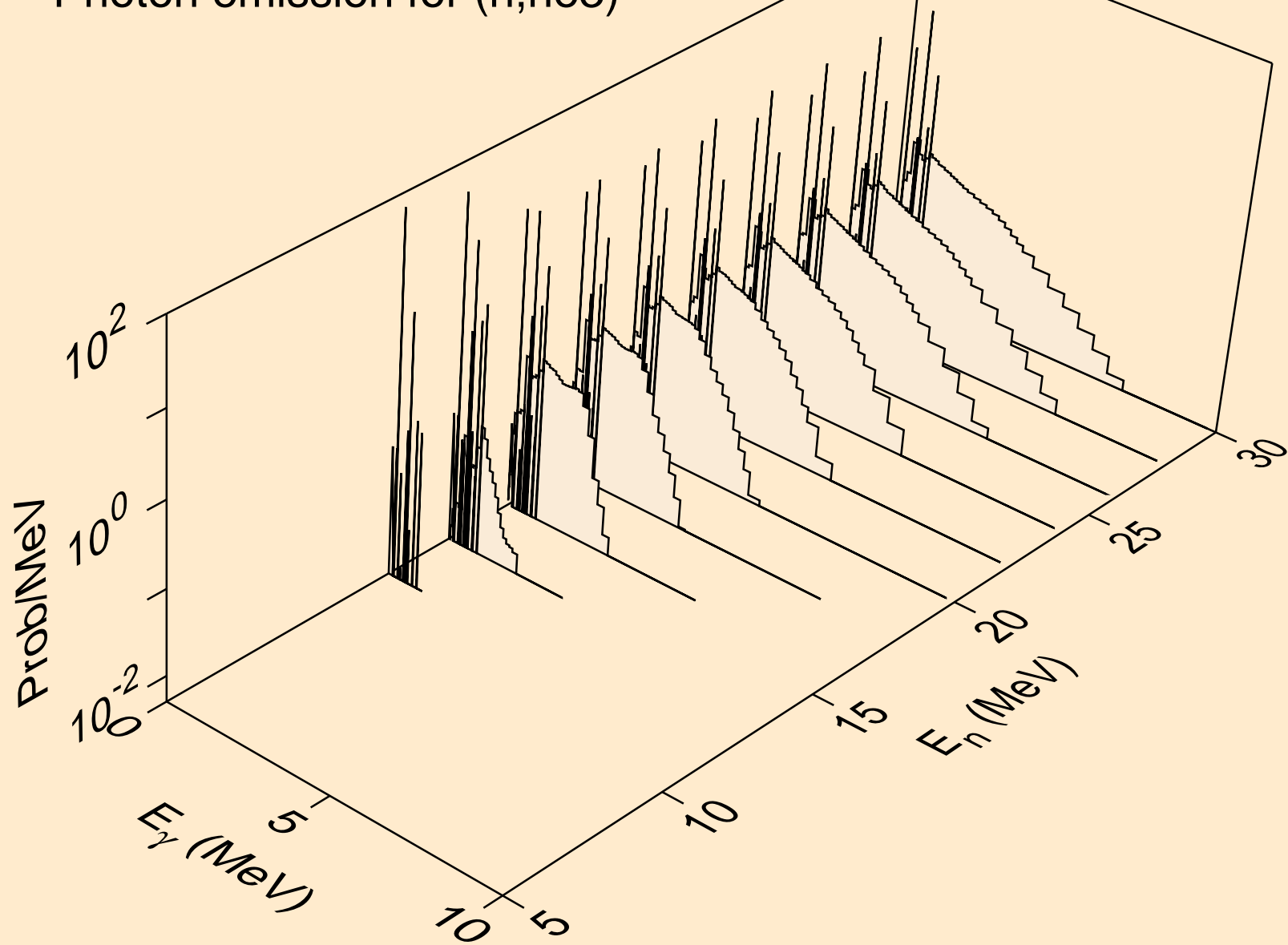

Y087 NEUTRON ACER TENDL-2024 LIBRARY; T=0.K
Photon emission for (n,a)

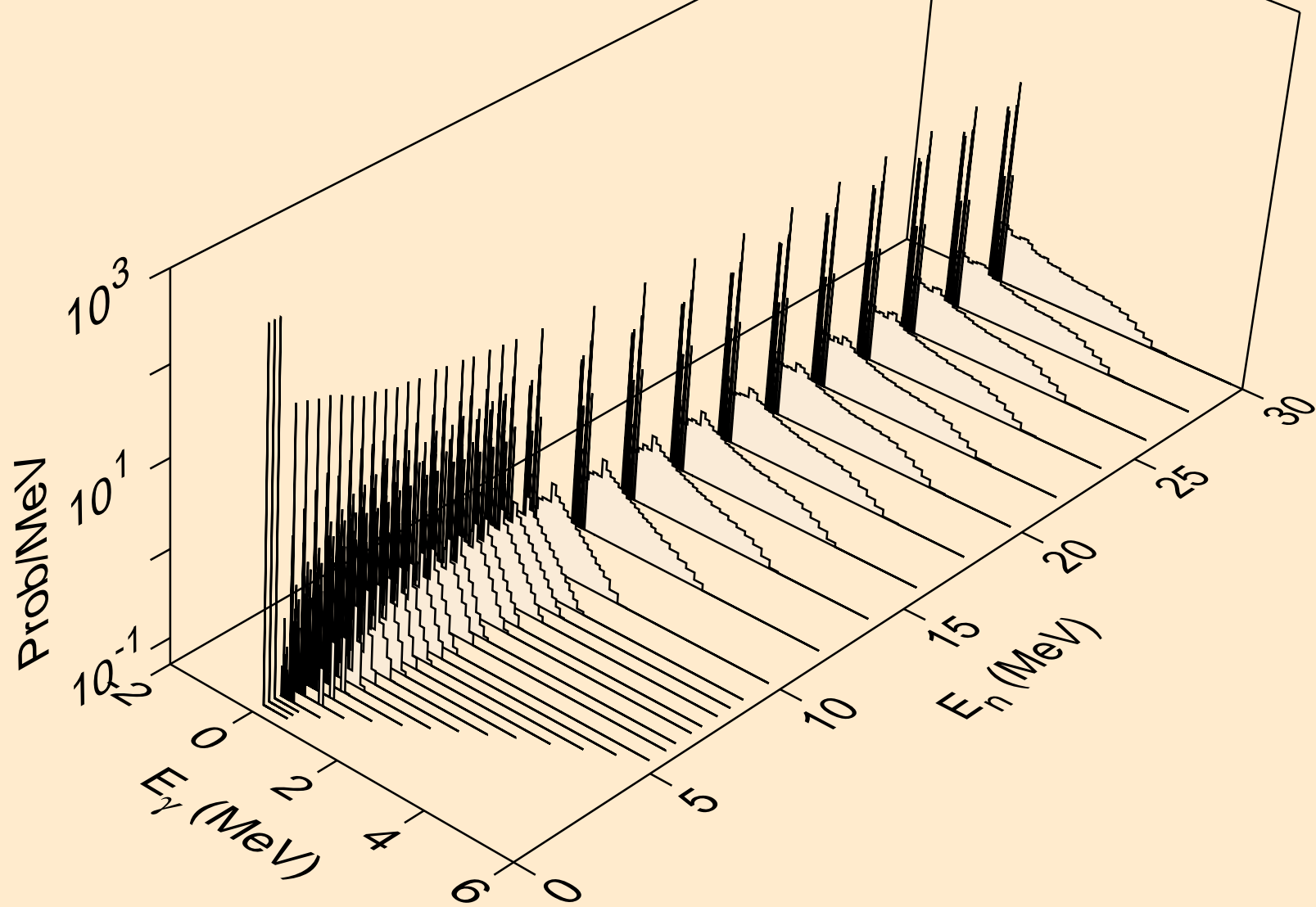

Y087 NEUTRON ACER TENDL-2024 LIBRARY; T=0.K
Photon emission for (n,2a)

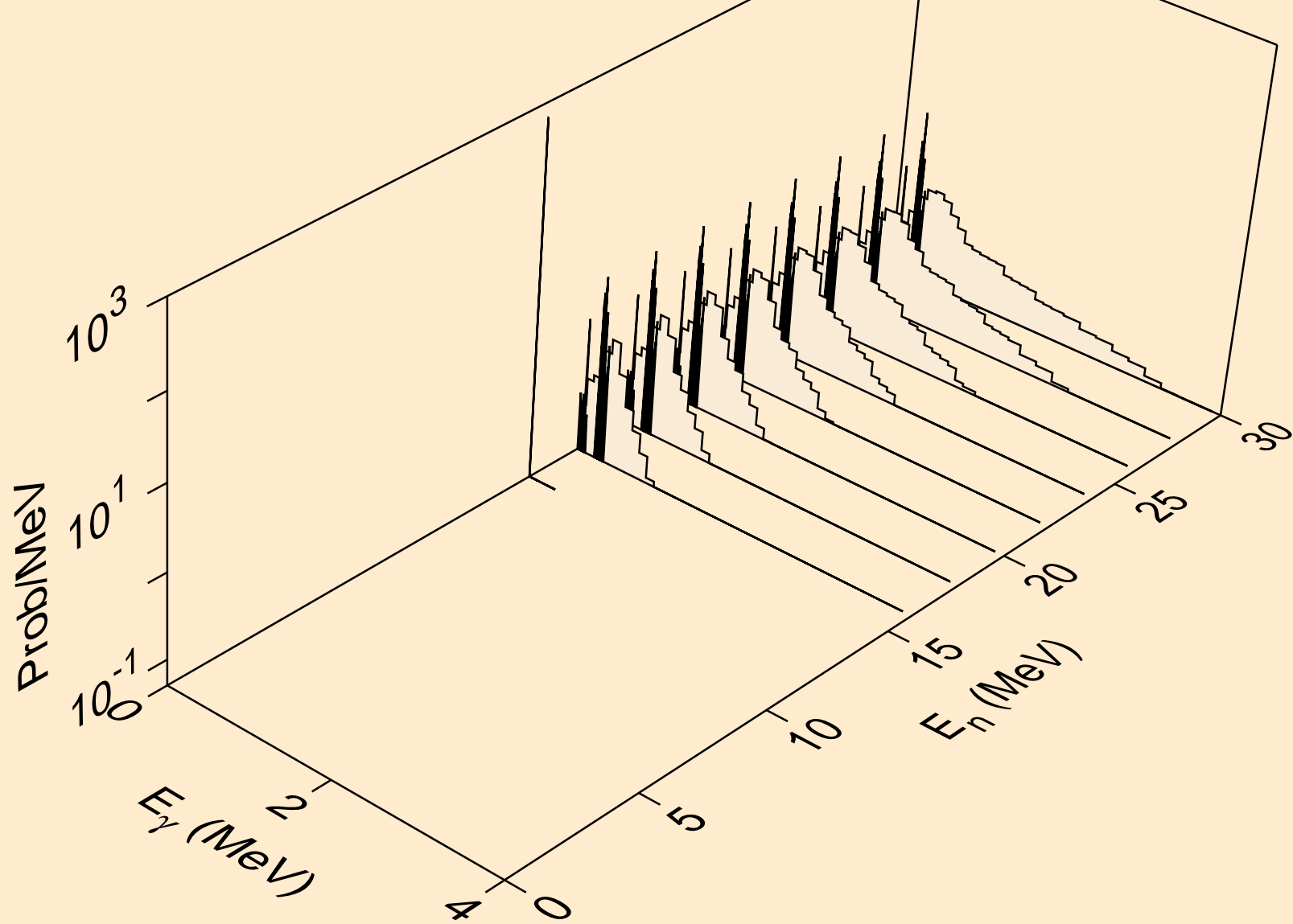

Y087 NEUTRON ACER TENDL-2024 LIBRARY; T=0.K
Photon emission for (n,2p)

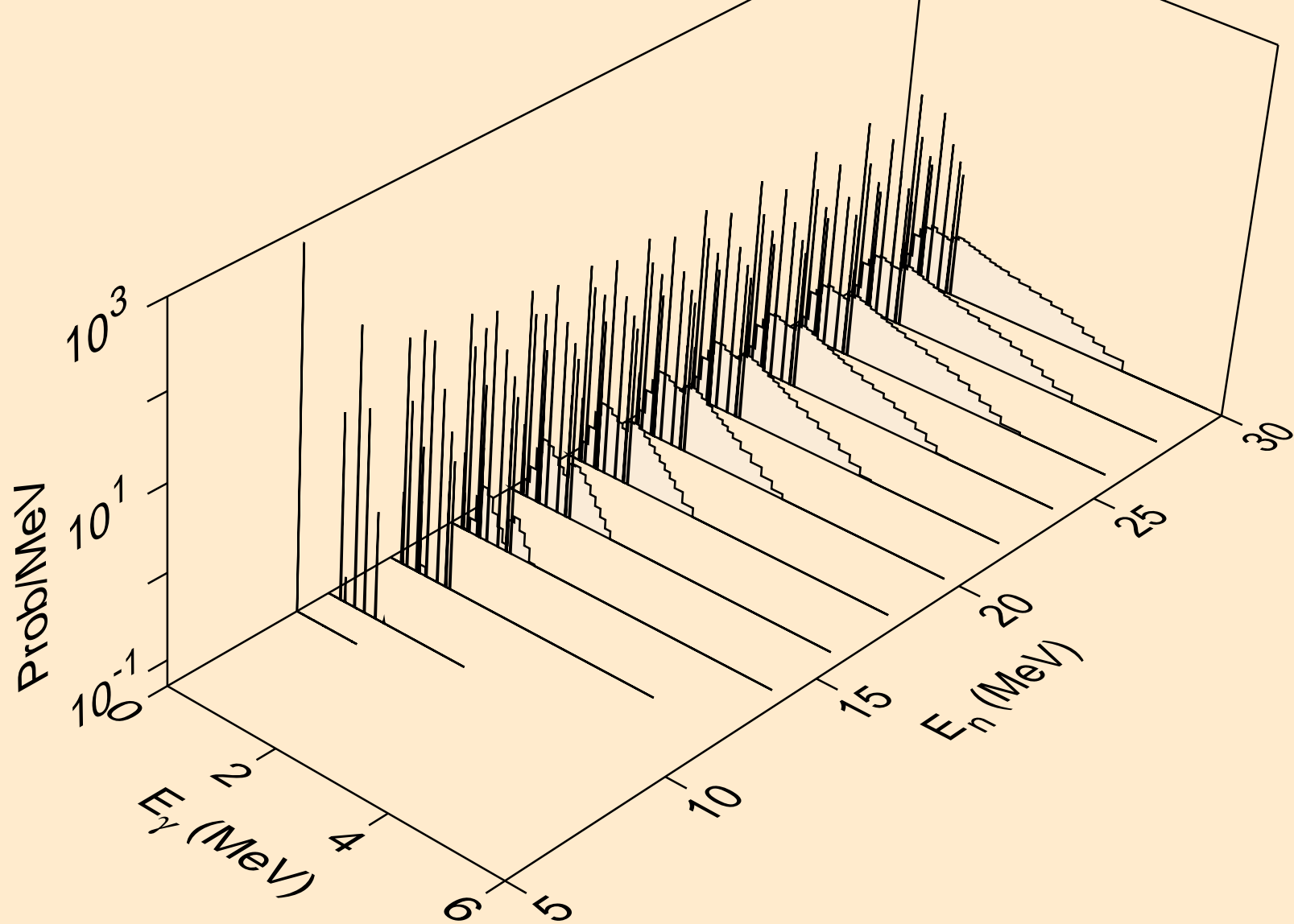

Y087 NEUTRON ACER TENDL-2024 LIBRARY; T=0.K
Photon emission for (n,p α)

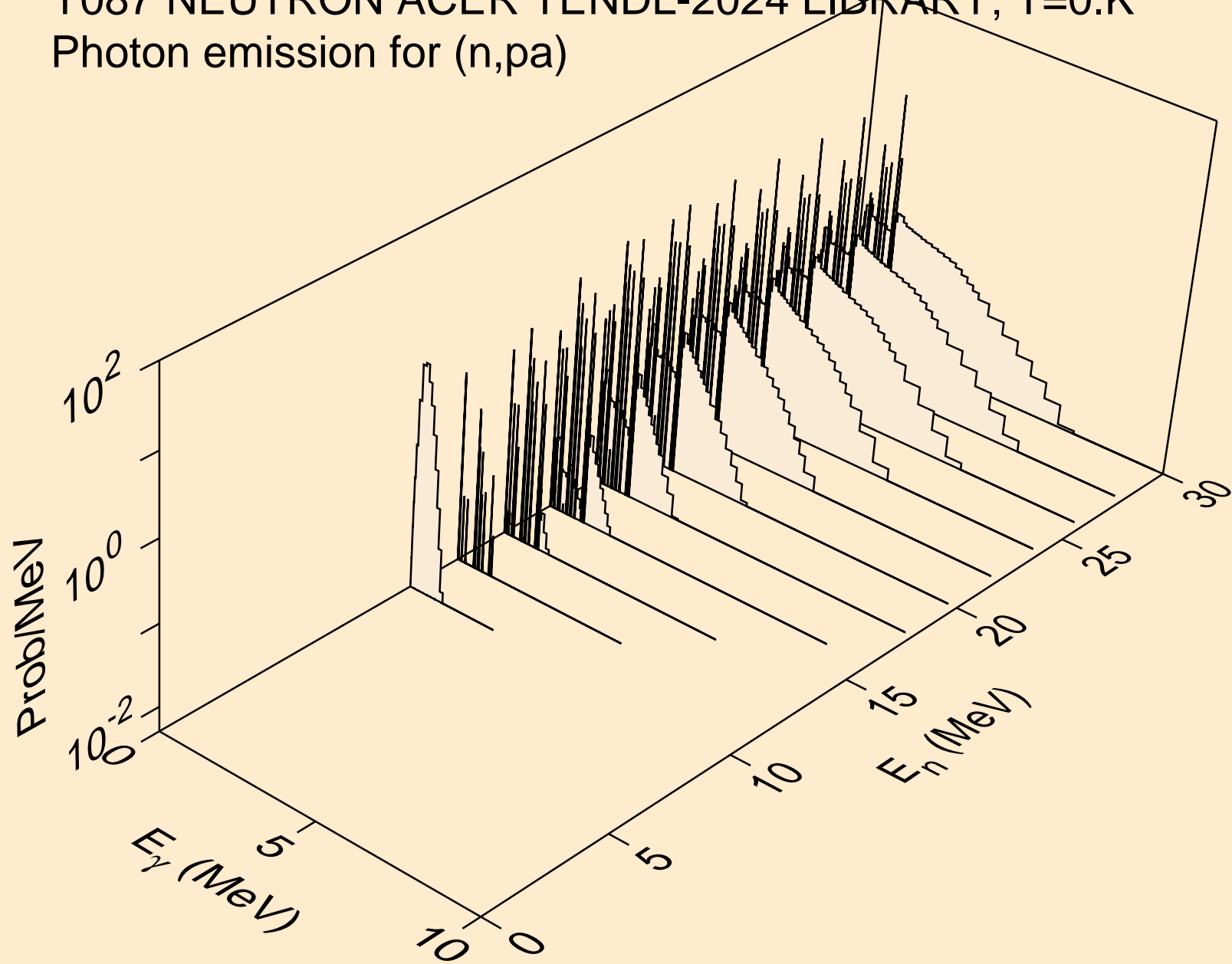

Y087 NEUTRON ACER TENDL-2024 LIBRARY; T=0.K
Photon emission for (n,pd)

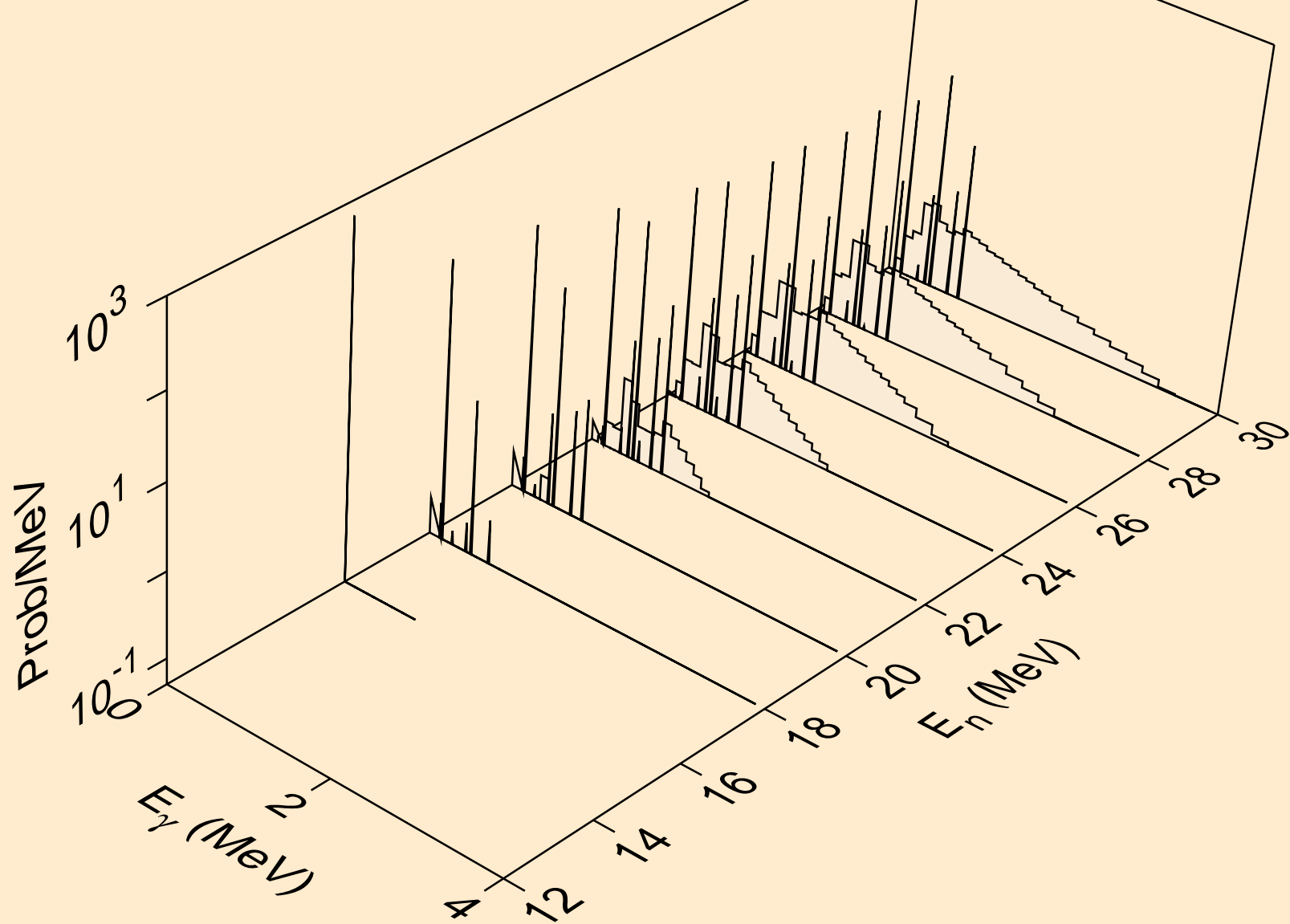

Y087 NEUTRON ACER TENDL-2024 LIBRARY; T=0.K
Photon emission for (n,pt)

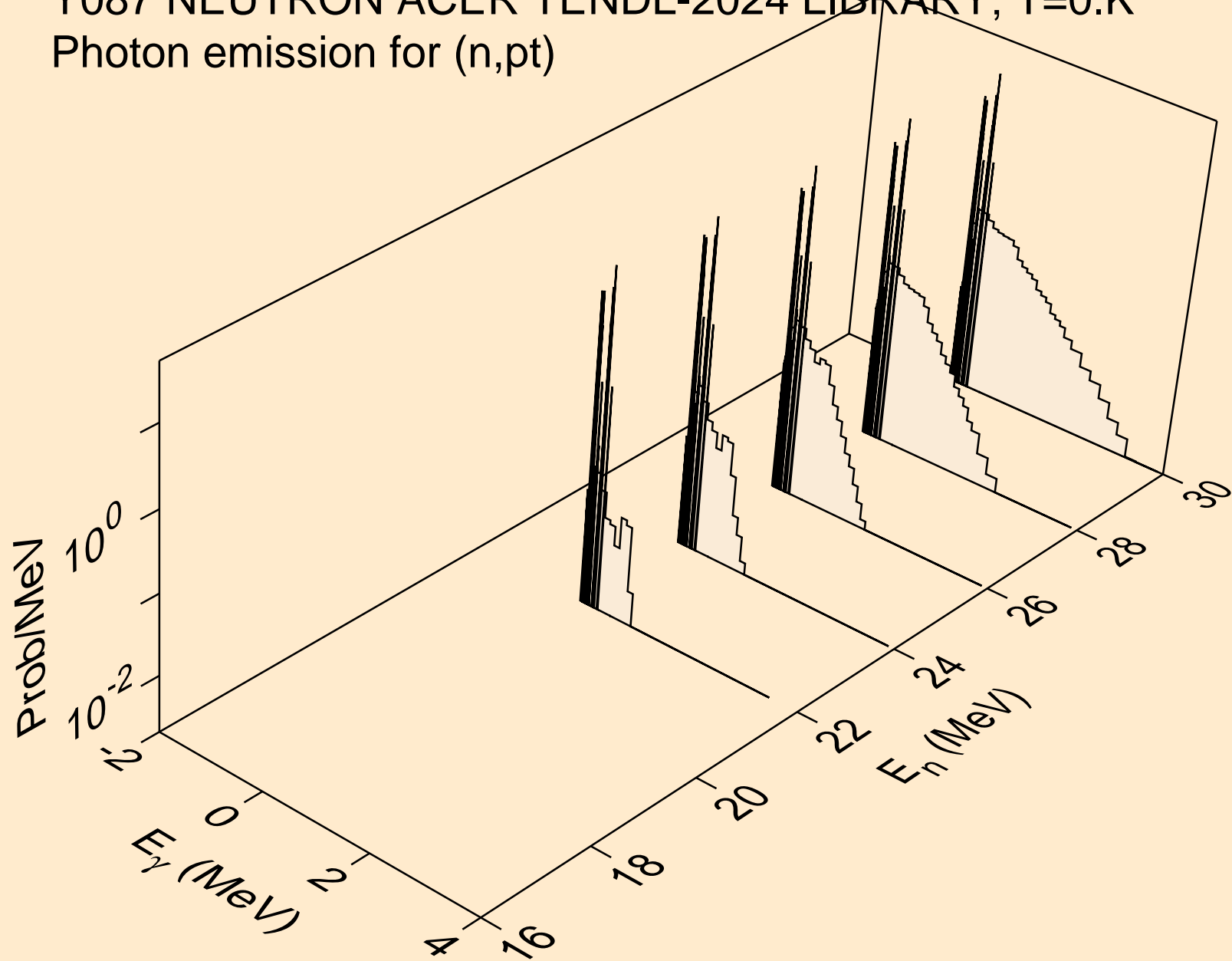

Y087 NEUTRON ACER TENDL-2024 LIBRARY; T=0.K
Photon emission for (n,da)

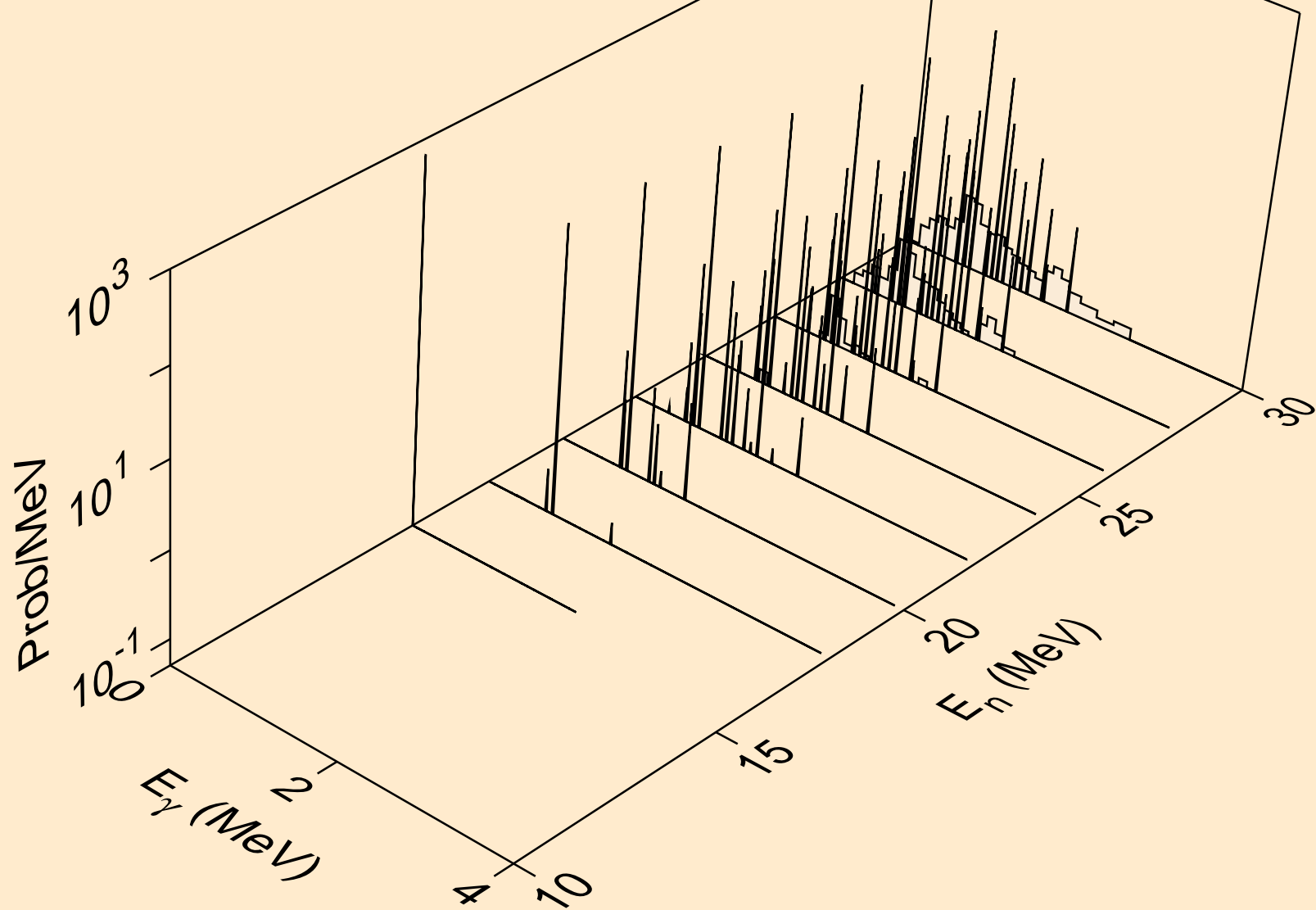

Y087 NEUTRON ACER TENDL-2024 LIBRARY; T=0.K
thermal capture photon spectrum

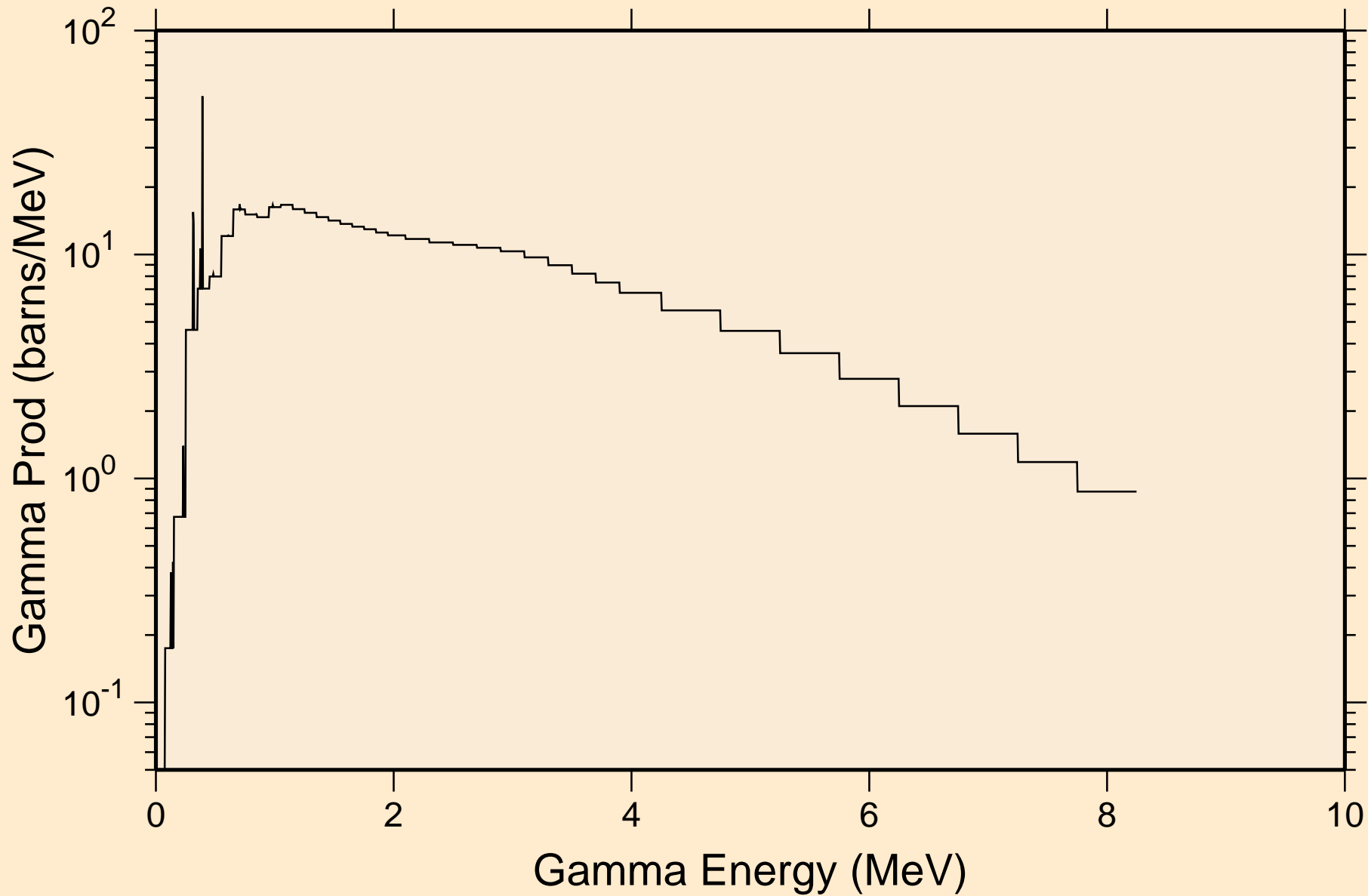

Y087 NEUTRON ACER TENDL-2024 LIBRARY; T=0.K
14 MeV photon spectrum

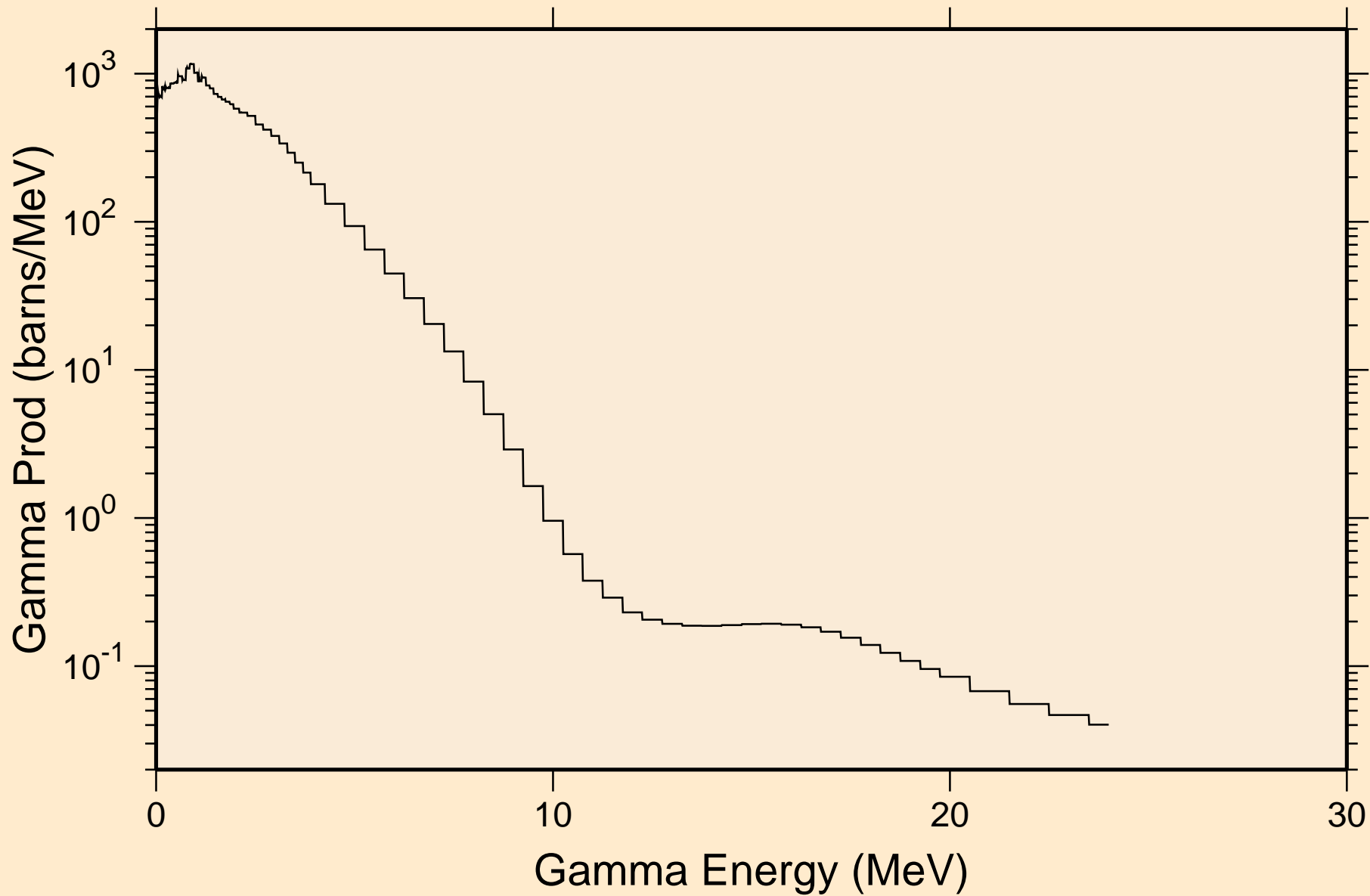

Y087 NEUTRON ACER TENDL-2024 LIBRARY; T=0.K
Particle heating contributions

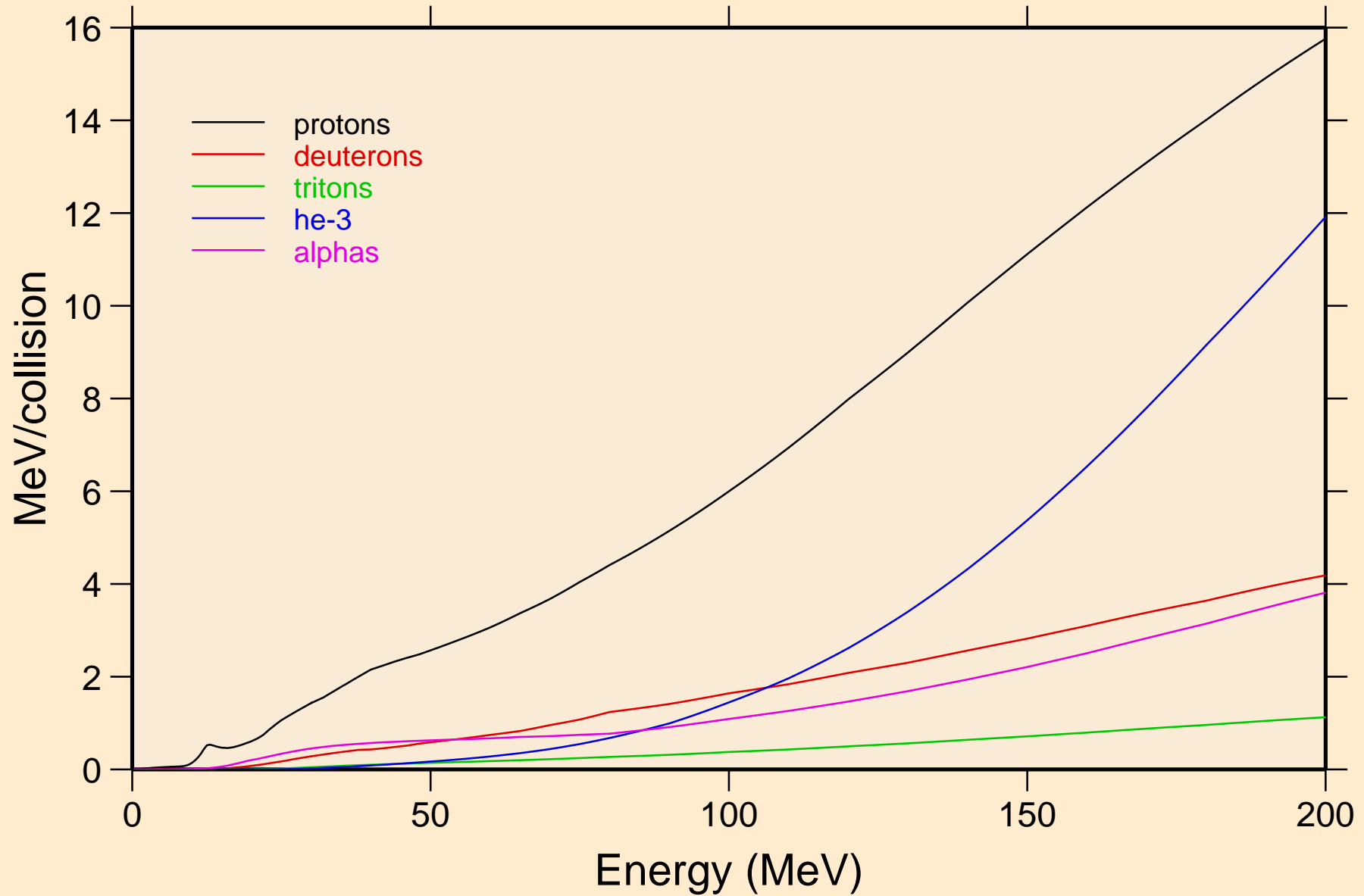

Y087 NEUTRON ACER TENDL-2024 LIBRARY; T=0.K
Recoil Heating

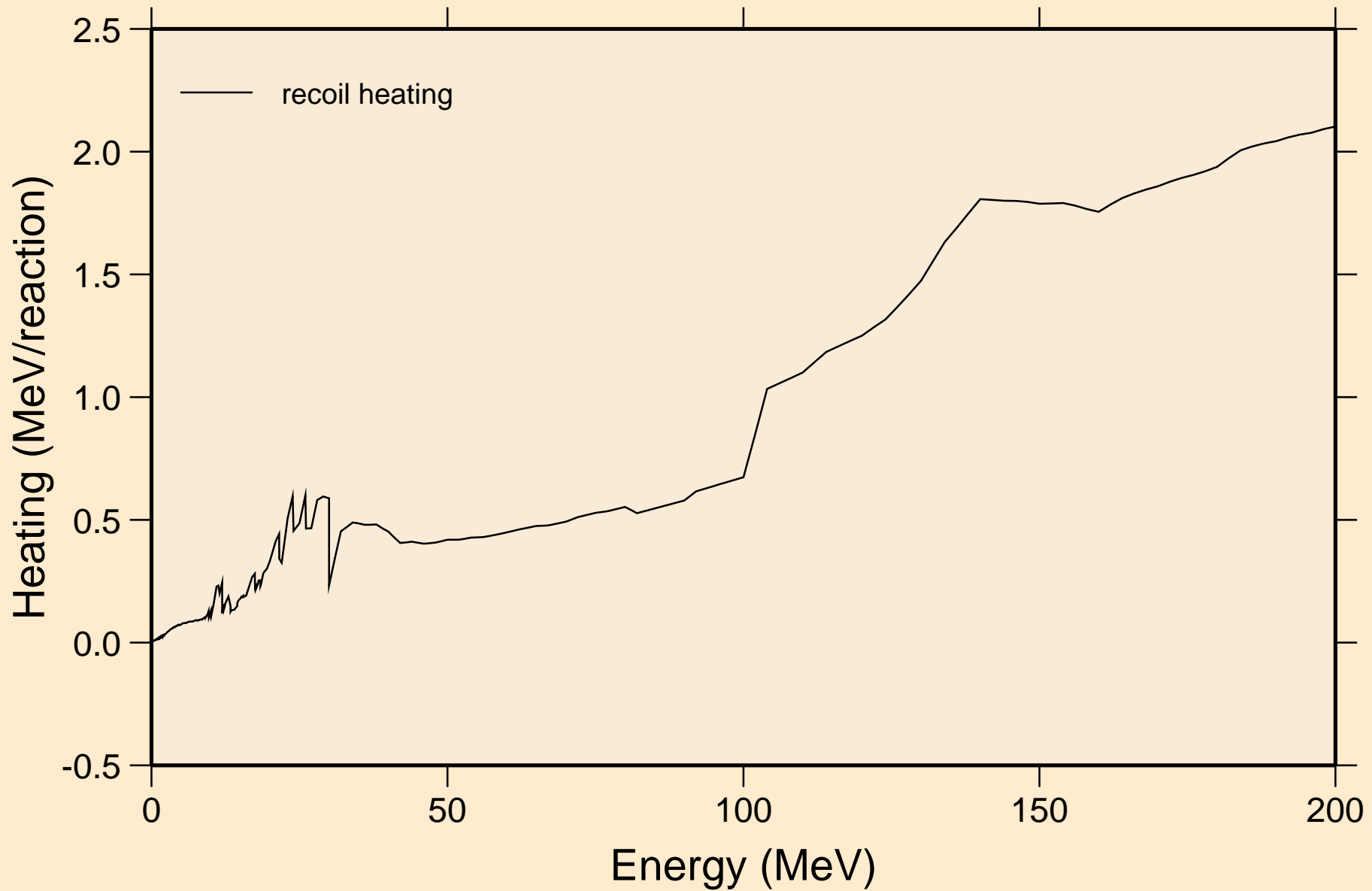

Y087 NEUTRON ACER TENDL-2024 LIBRARY; T=0.K
Particle production cross sections

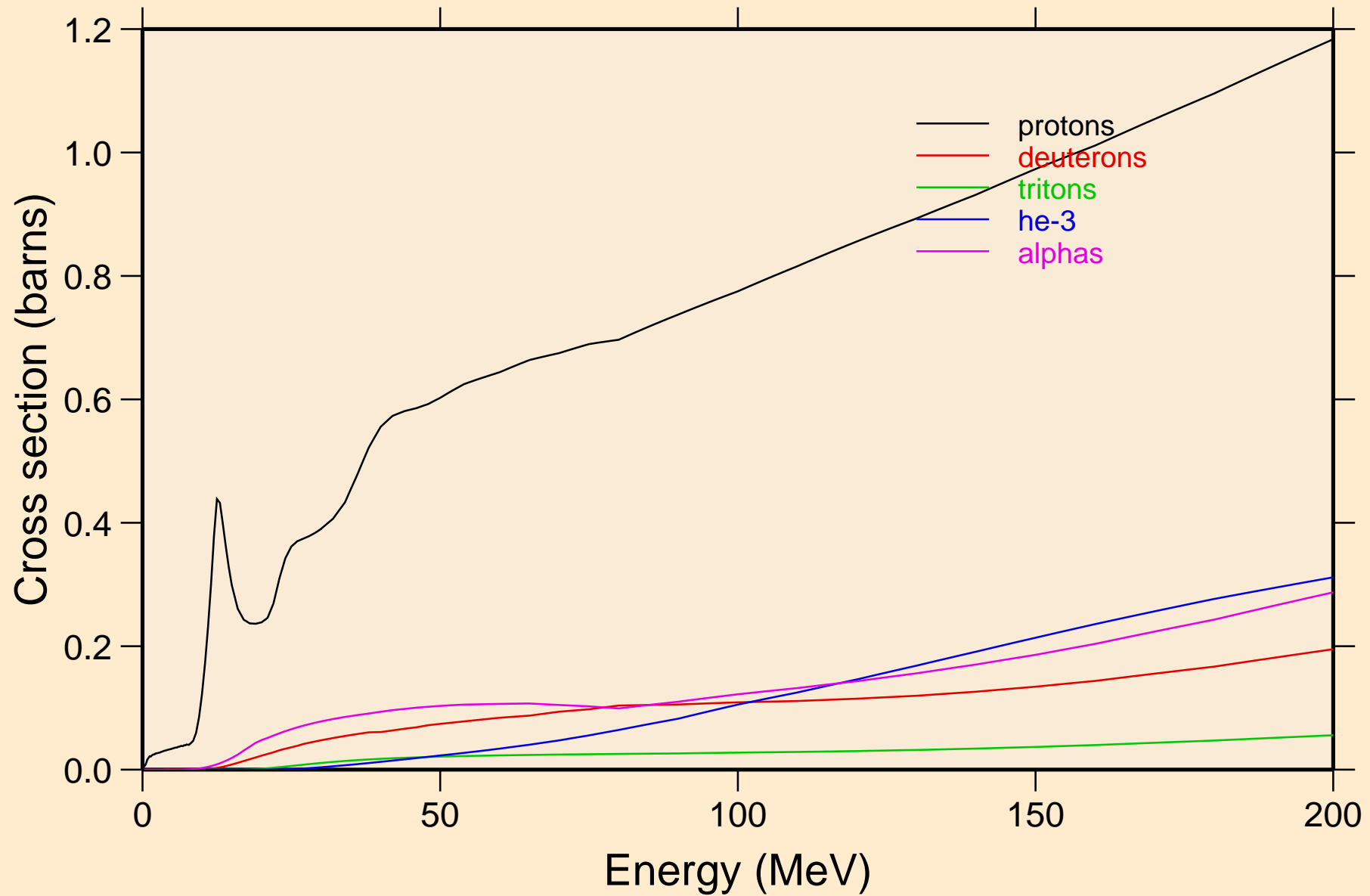

Y087 NEUTRON ACER TENDL-2024 LIBRARY; T=0.K
protons from (n,x)

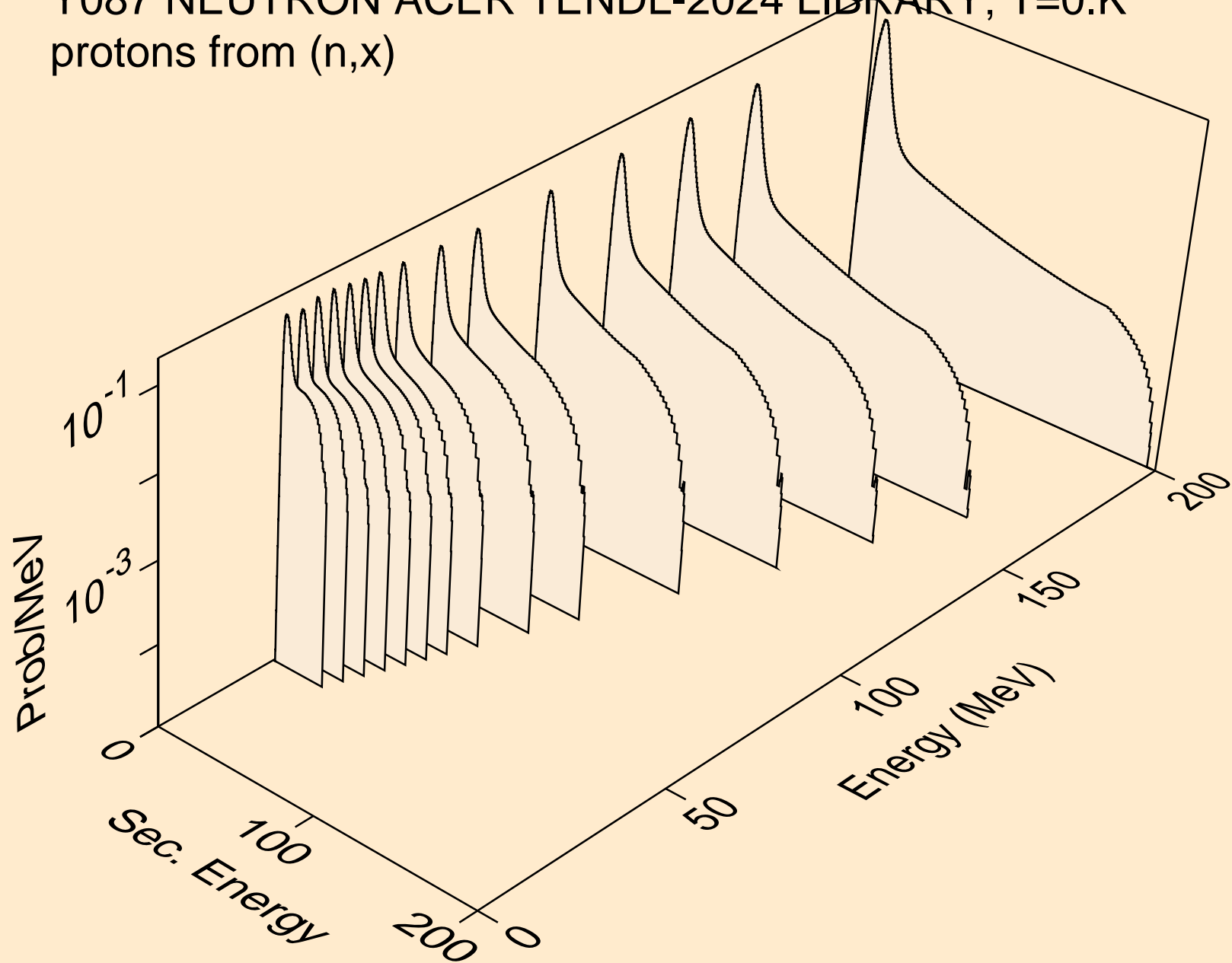

Y087 NEUTRON ACER TENDL-2024 LIBRARY; T=0.K
protons from (n,n*)p

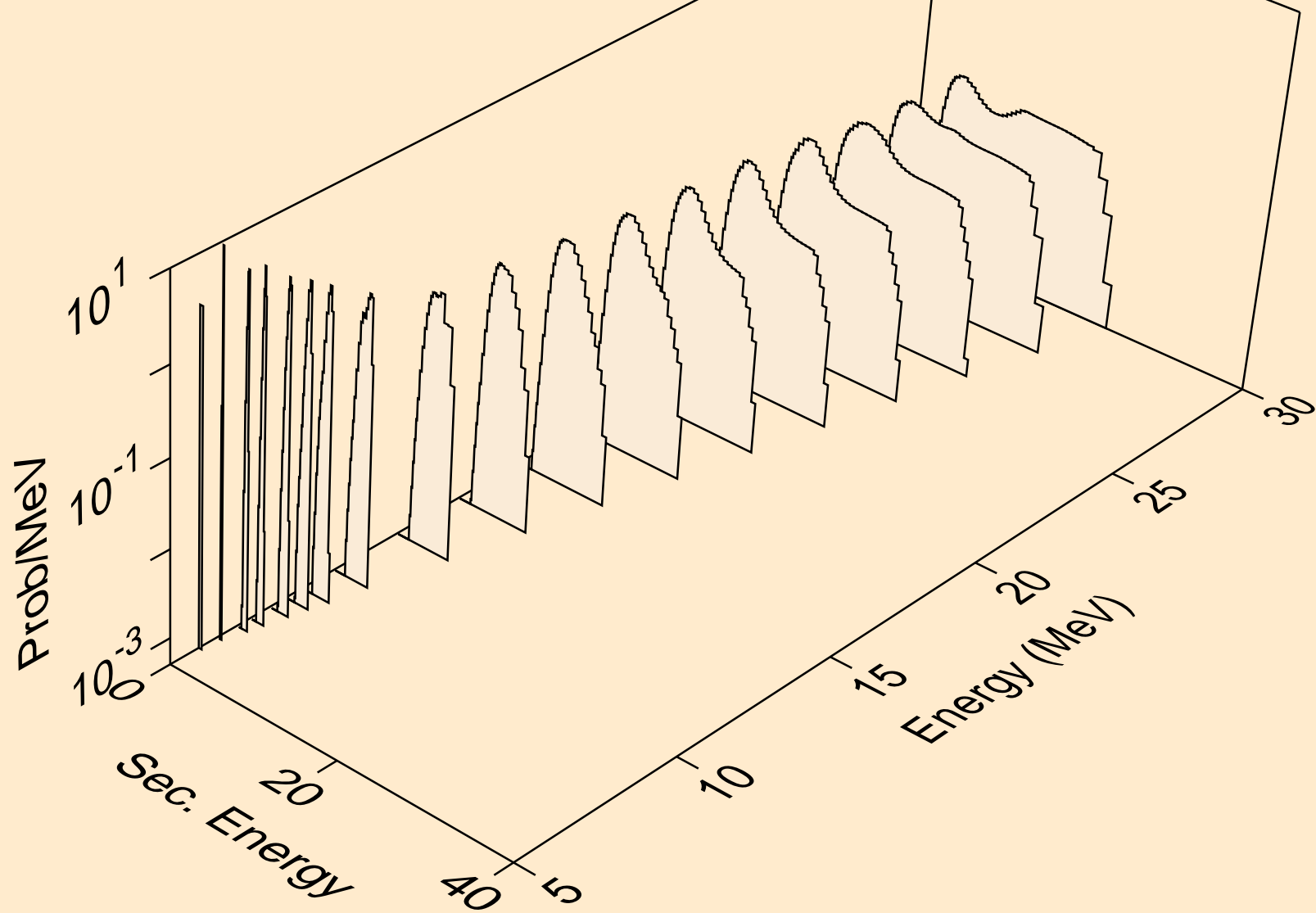

Y087 NEUTRON ACER TENDL-2024 LIBRARY; T=0.K
protons from (n,2np)

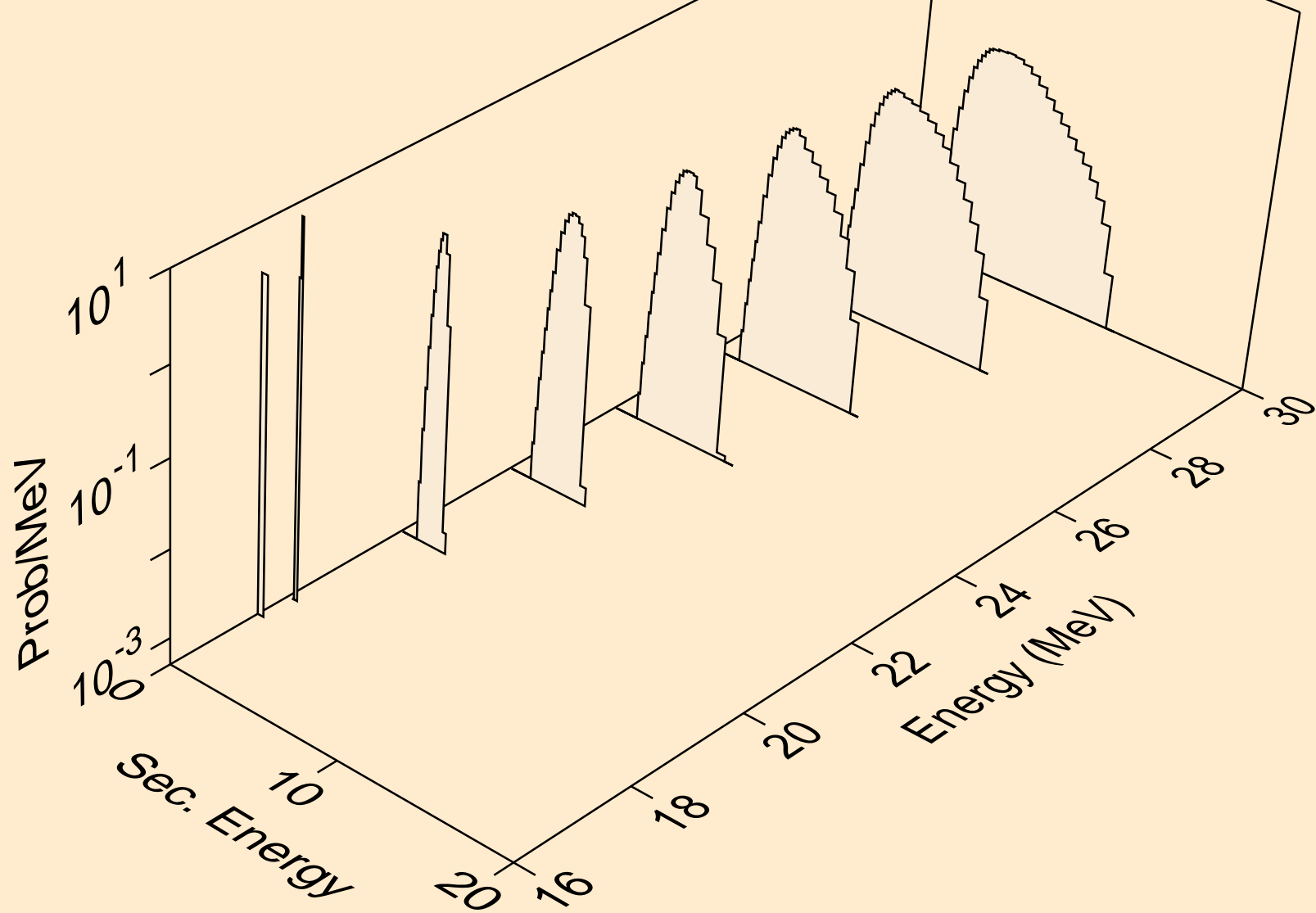

Y087 NEUTRON ACER TENDL-2024 LIBRARY; T=0.K
protons from (n,3np)

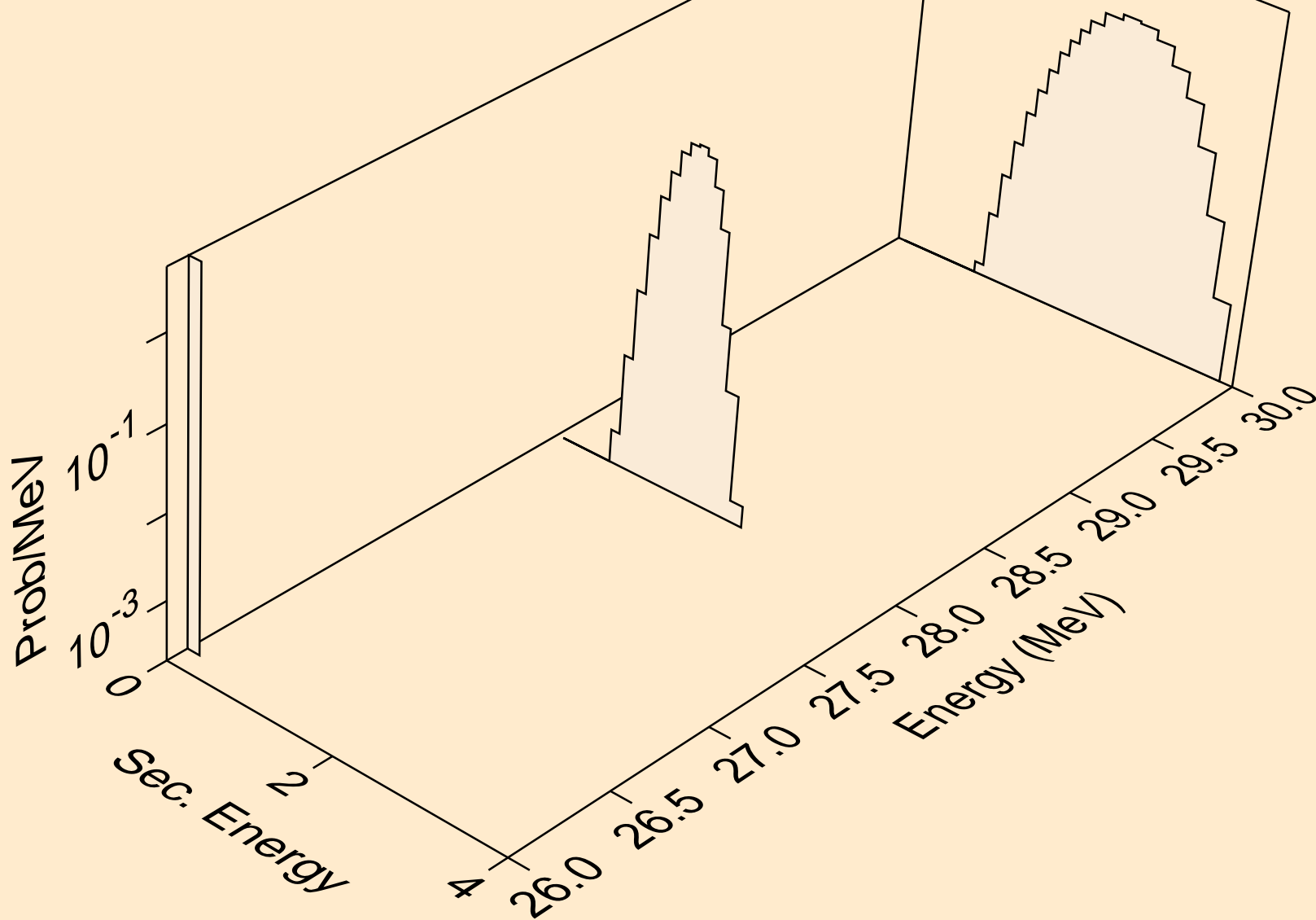

Y087 NEUTRON ACER TENDL-2024 LIBRARY; T=0.K
protons from (n,n2p)

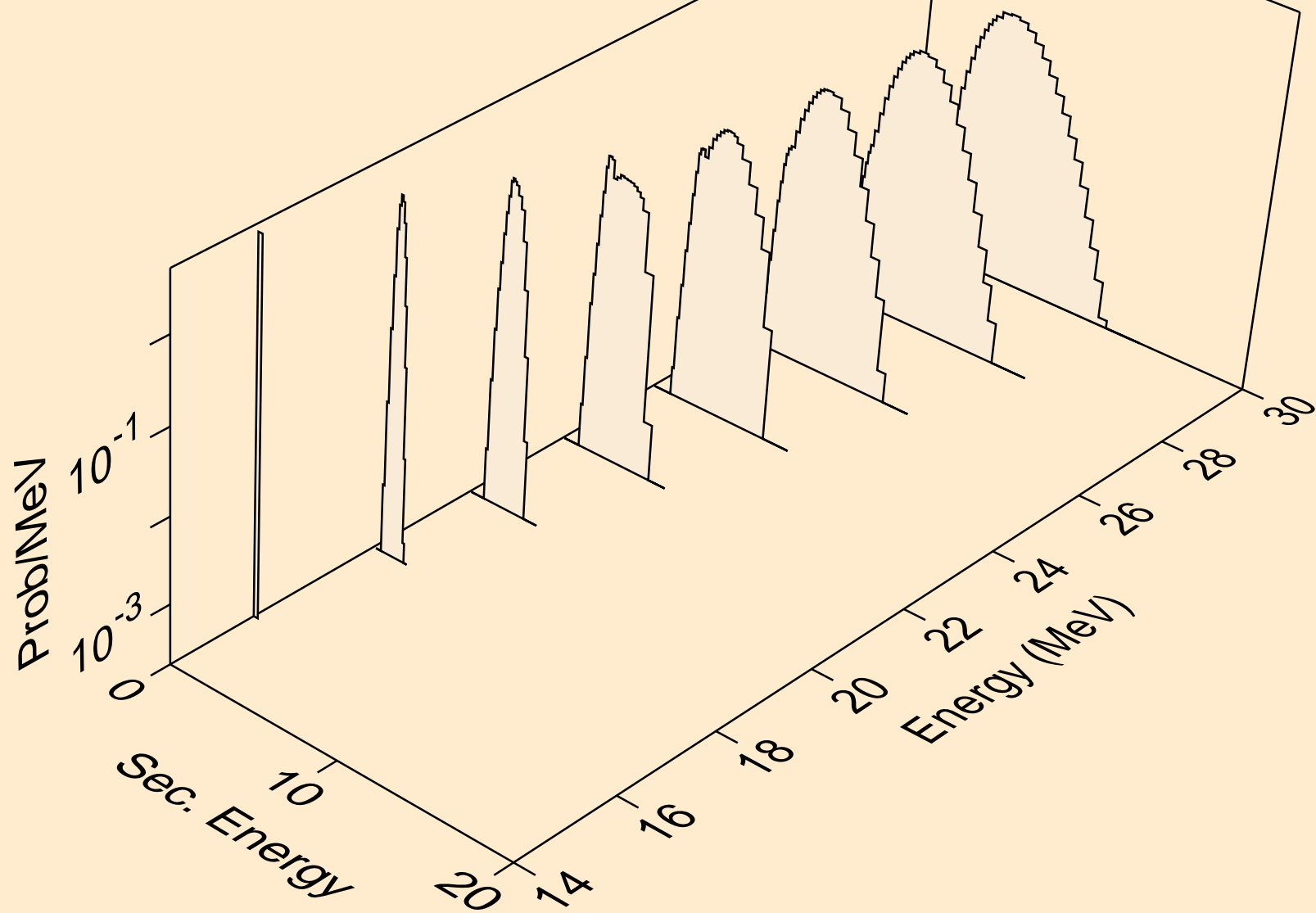

Y087 NEUTRON ACER TENDL-2024 LIBRARY; T=0.K
protons from (n,npa)

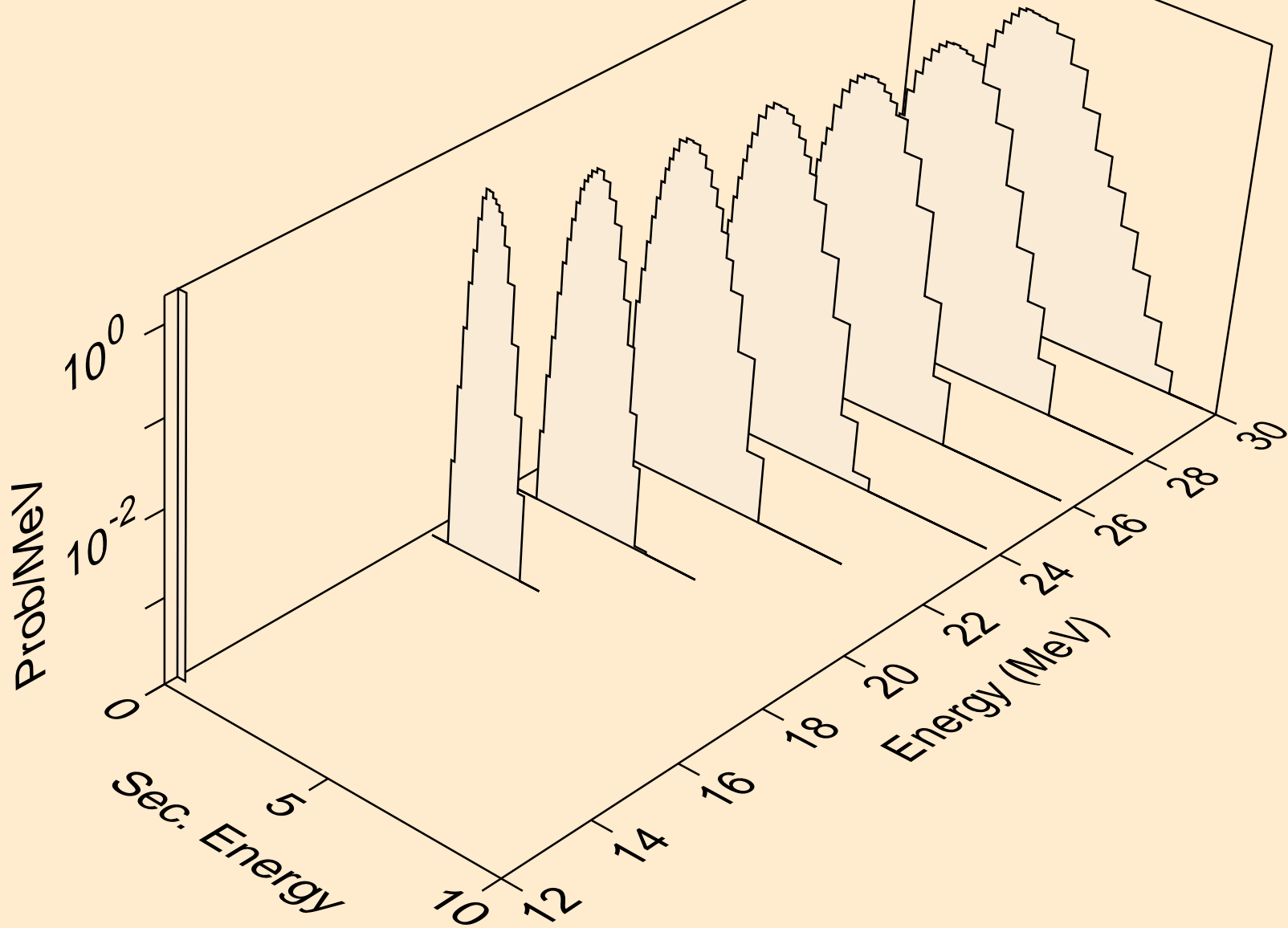

Y087 NEUTRON ACER TENDL-2024 LIBRARY; T=0.K
protons from (n,p)

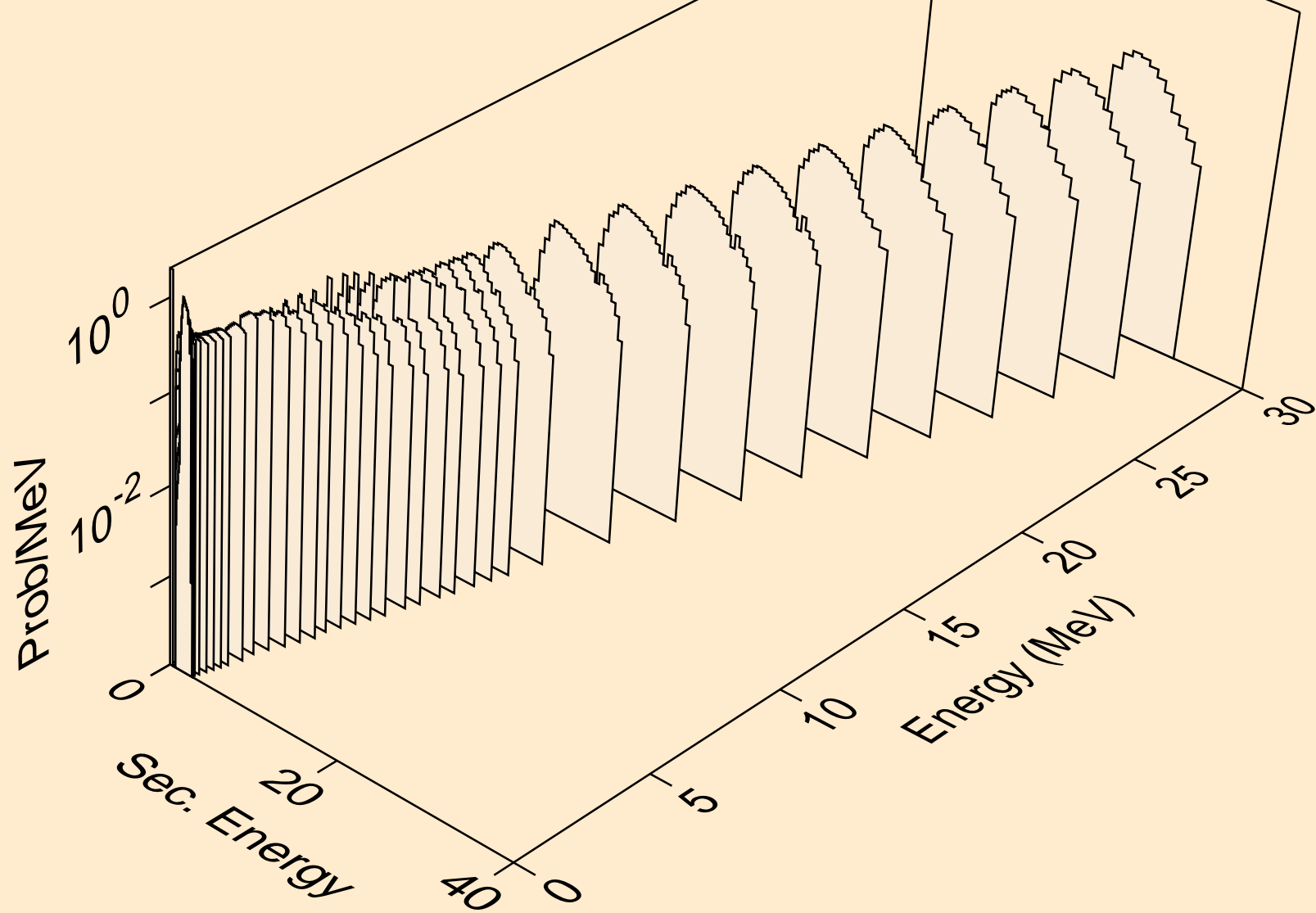

Y087 NEUTRON ACER TENDL-2024 LIBRARY; T=0.K
protons from (n,2p)

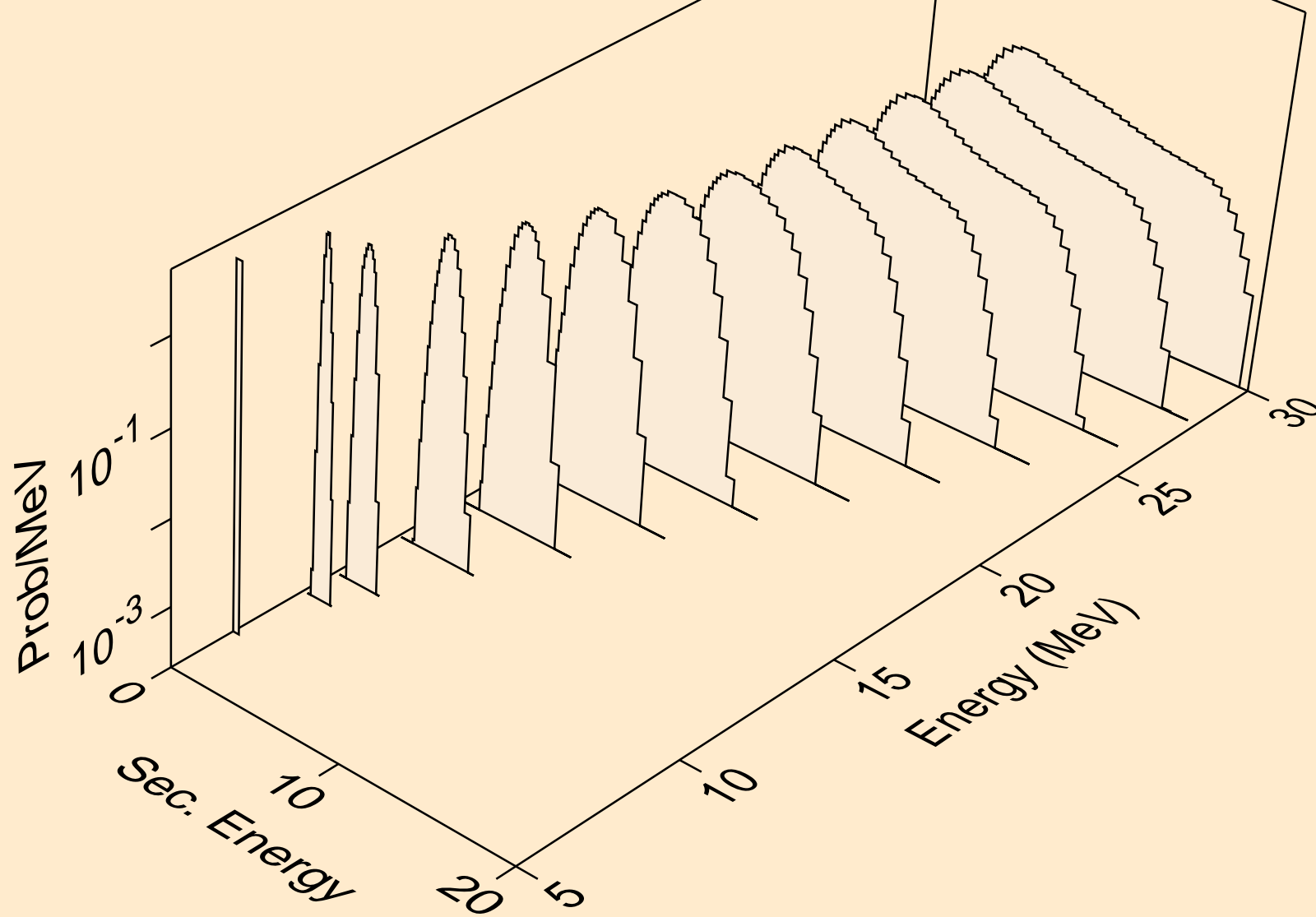

Y087 NEUTRON ACER TENDL-2024 LIBRARY; T=0.K
protons from (n,p)

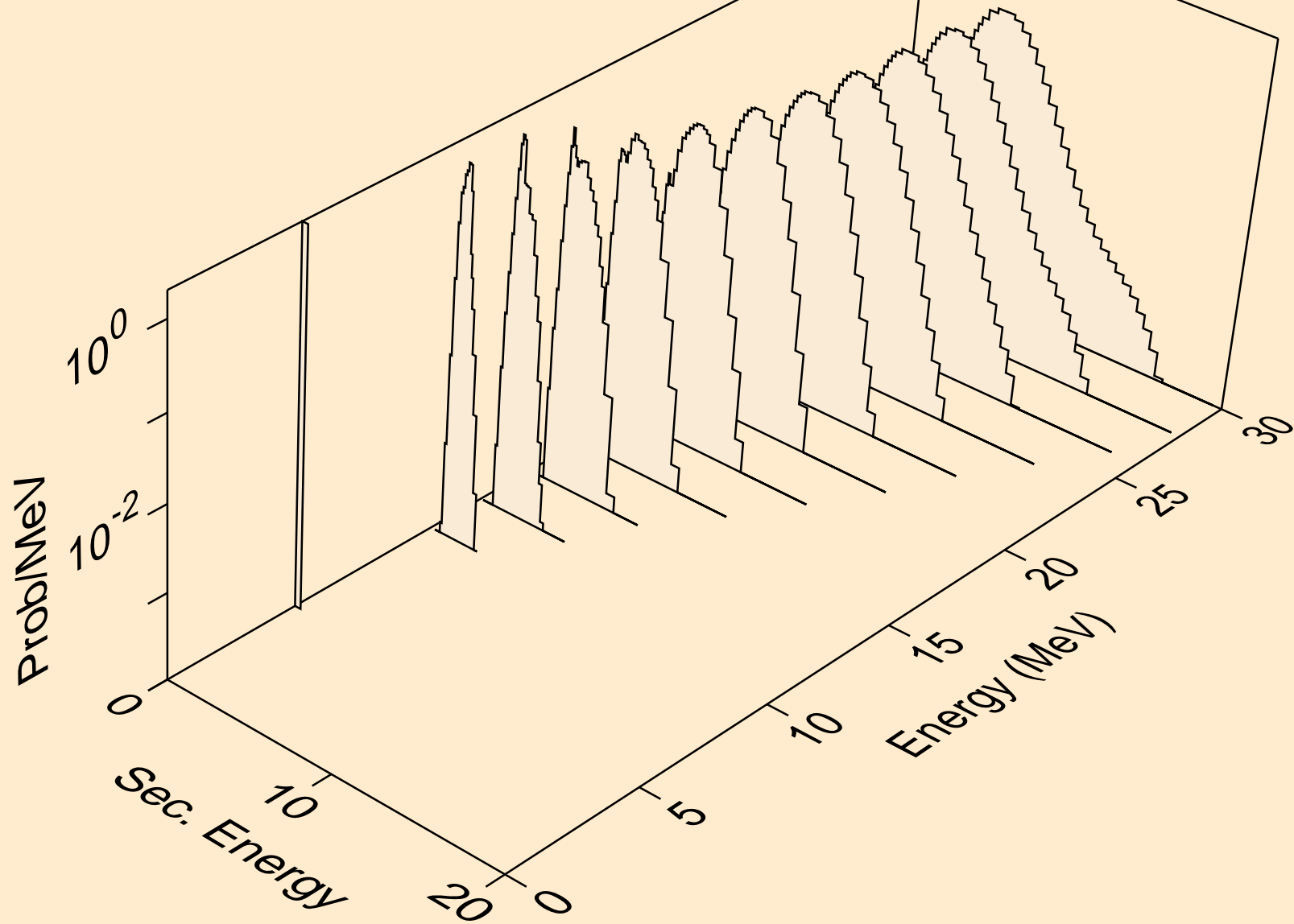

Y087 NEUTRON ACER TENDL-2024 LIBRARY; T=0.K
protons from (n,pd)

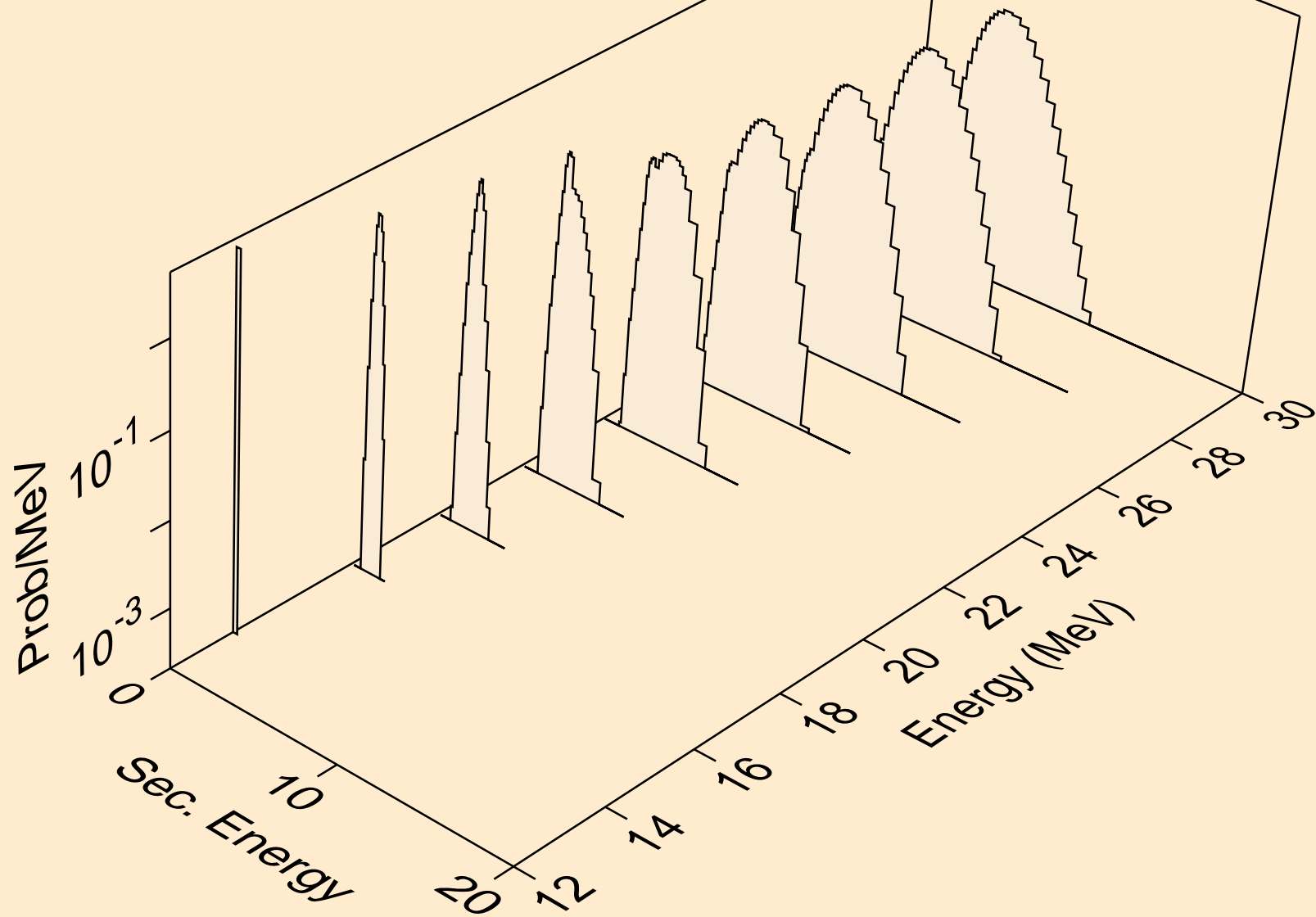

Y087 NEUTRON ACER TENDL-2024 LIBRARY; T=0.K
protons from (n,pt)

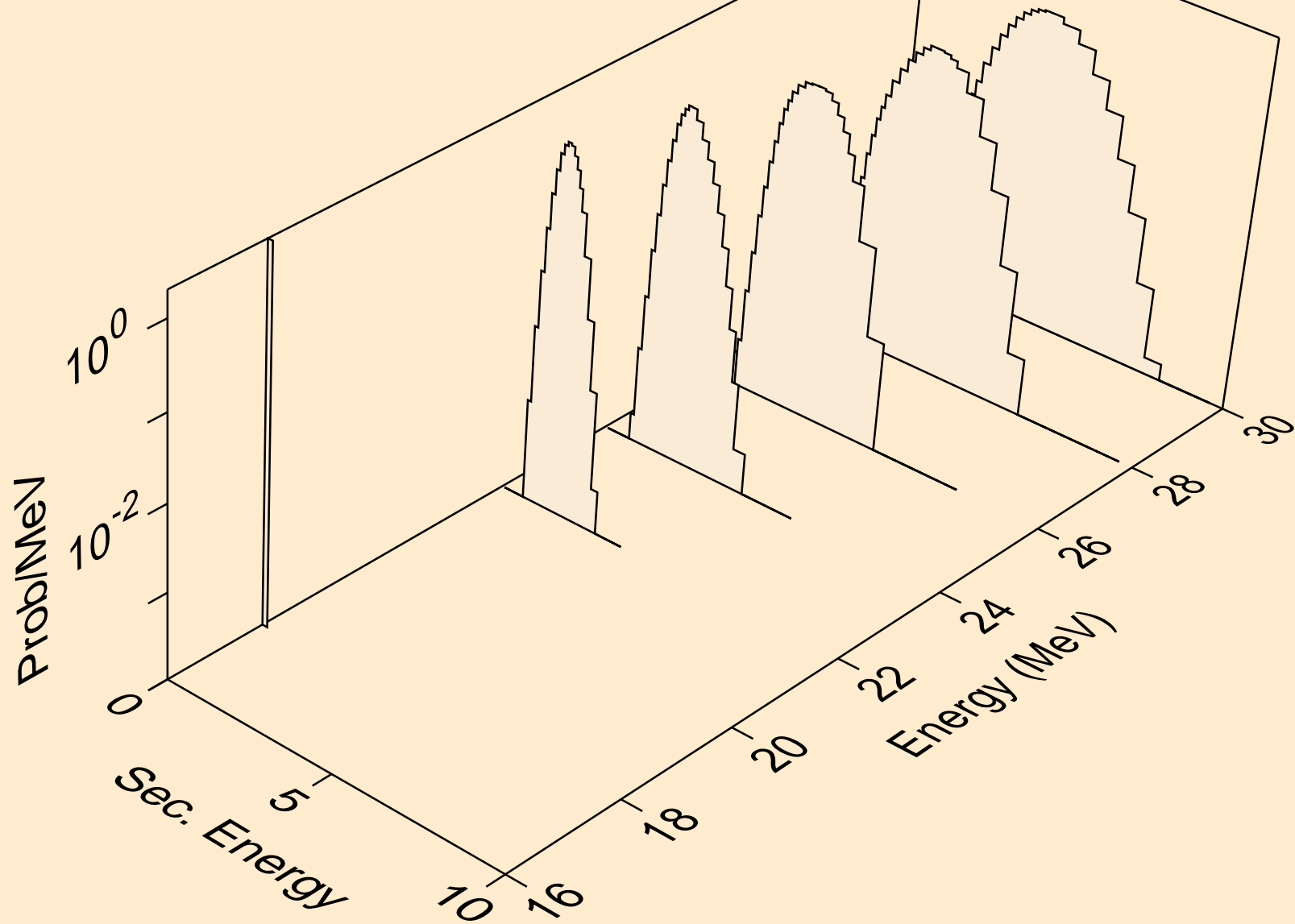

Y087 NEUTRON ACER TENDL-2024 LIBRARY; T=0.K
deuterons from (n,x)

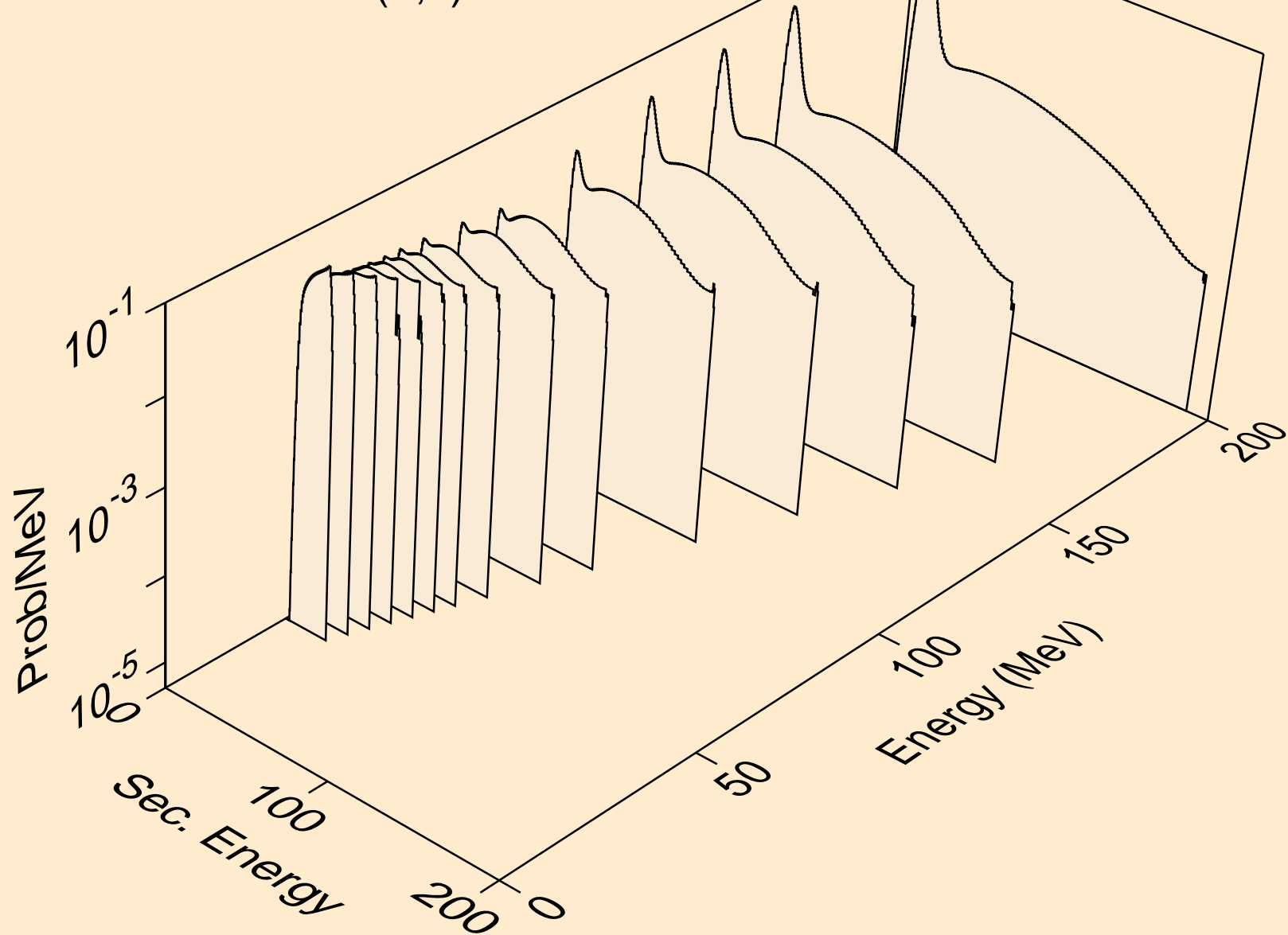

Y087 NEUTRON ACER TENDL-2024 LIBRARY; T=0.K
deuterons from (n,2nd)

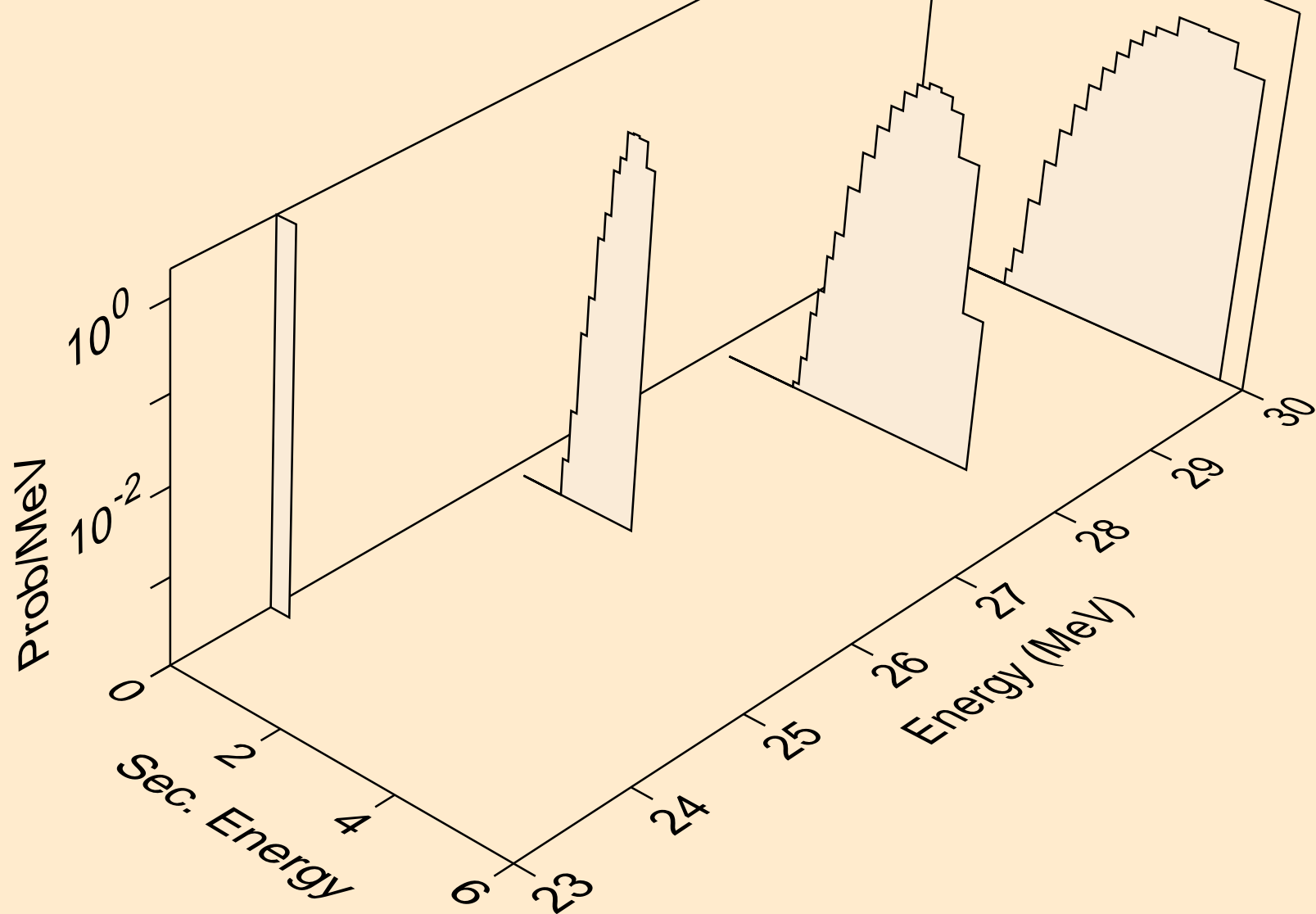

Y087 NEUTRON ACER TENDL-2024 LIBRARY; T=0.K
deuterons from (n,n*)d

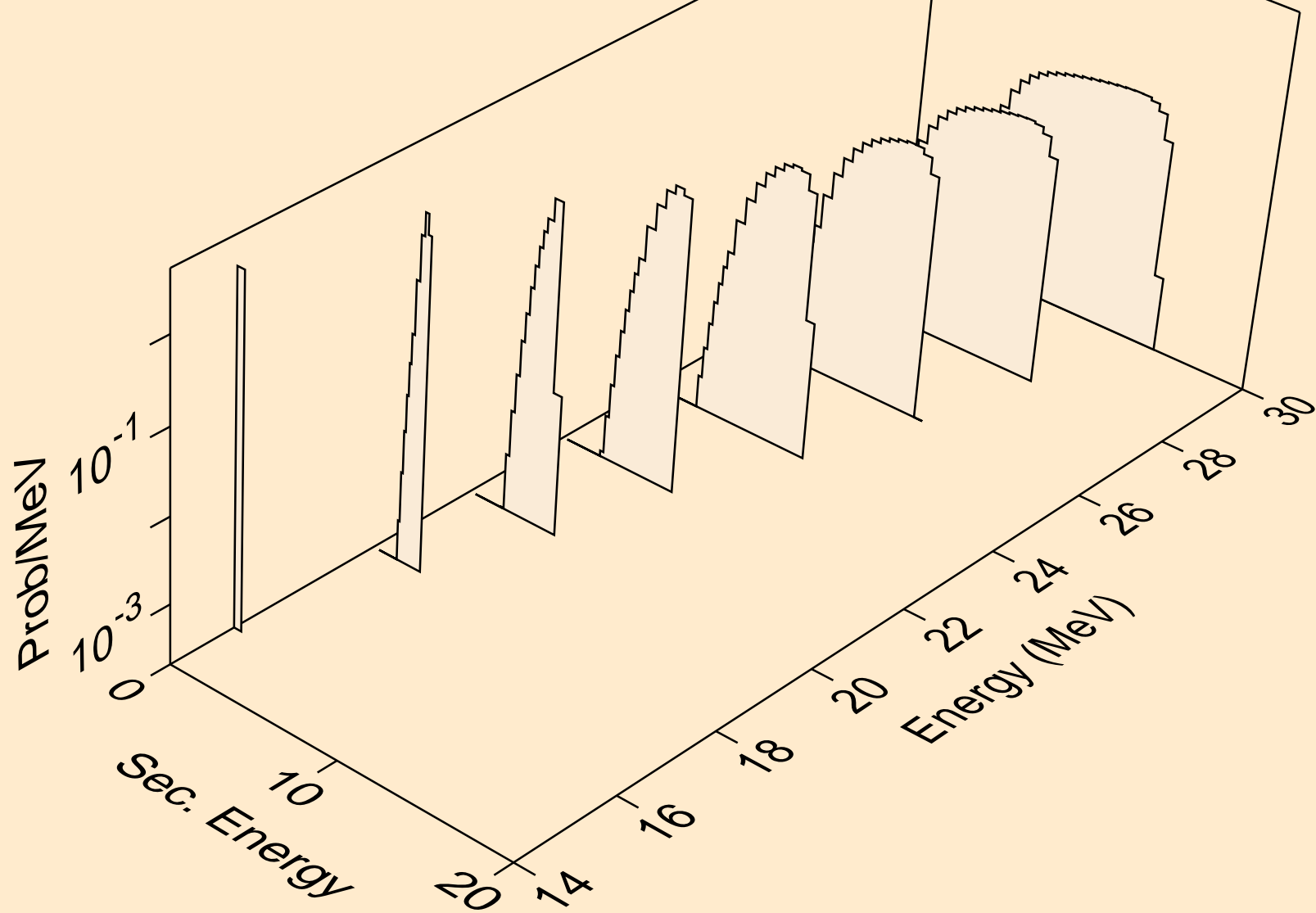

Y087 NEUTRON ACER TENDL-2024 LIBRARY; T=0.K
deuterons from (n,d)

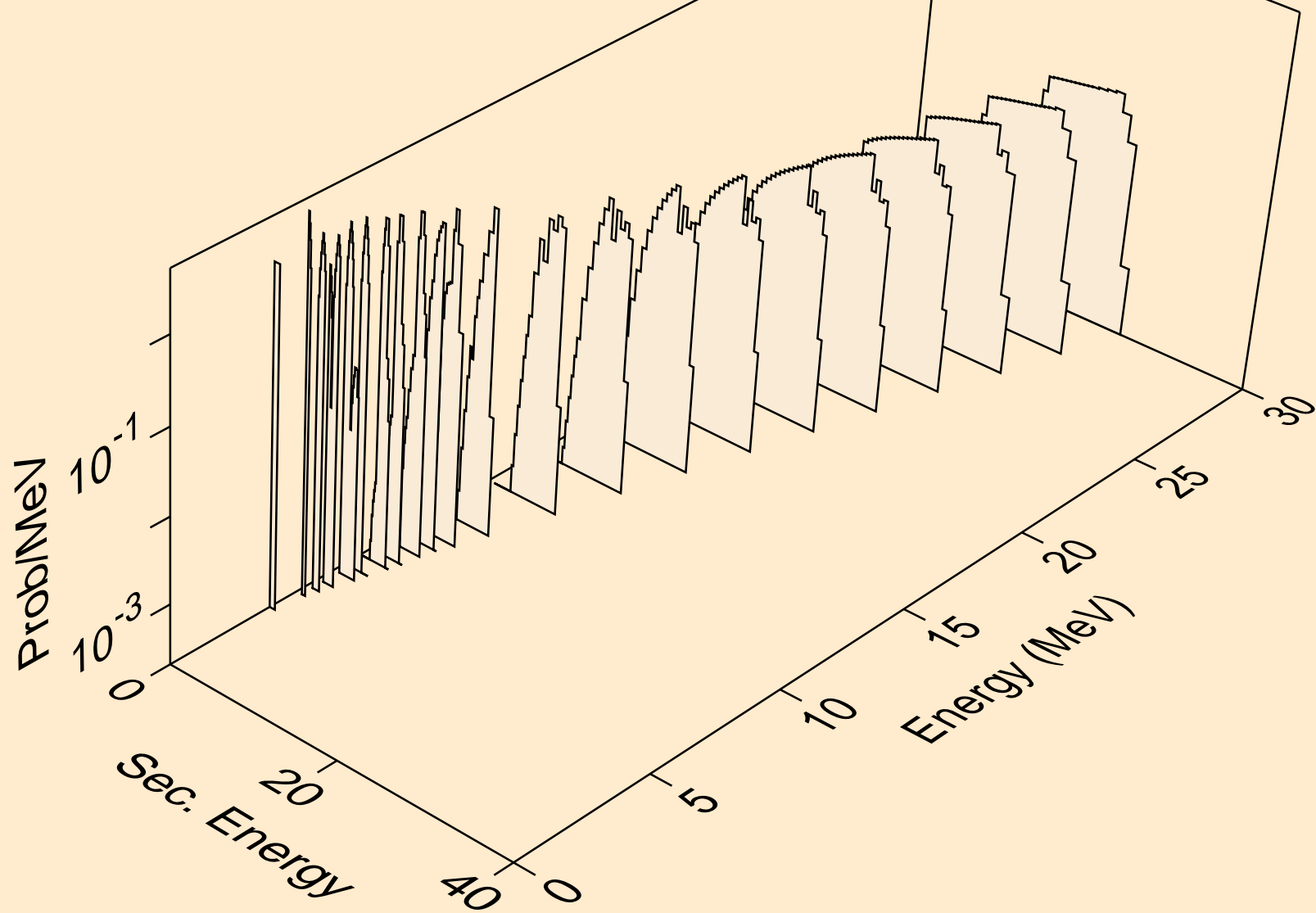

Y087 NEUTRON ACER TENDL-2024 LIBRARY; T=0.K
deuterons from (n,pd)

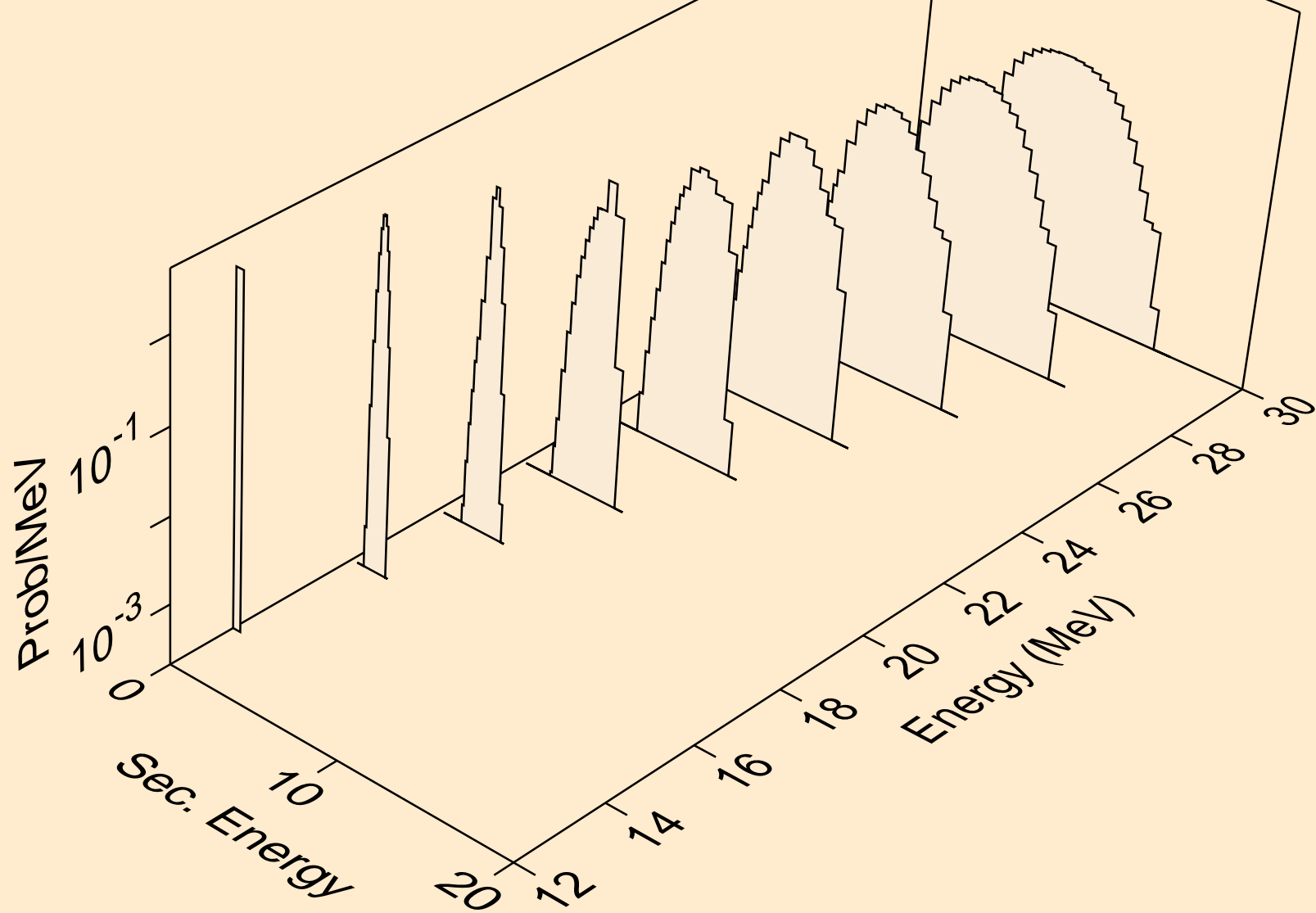

Y087 NEUTRON ACER TENDL-2024 LIBRARY; T=0.K
deuterons from (n,da)

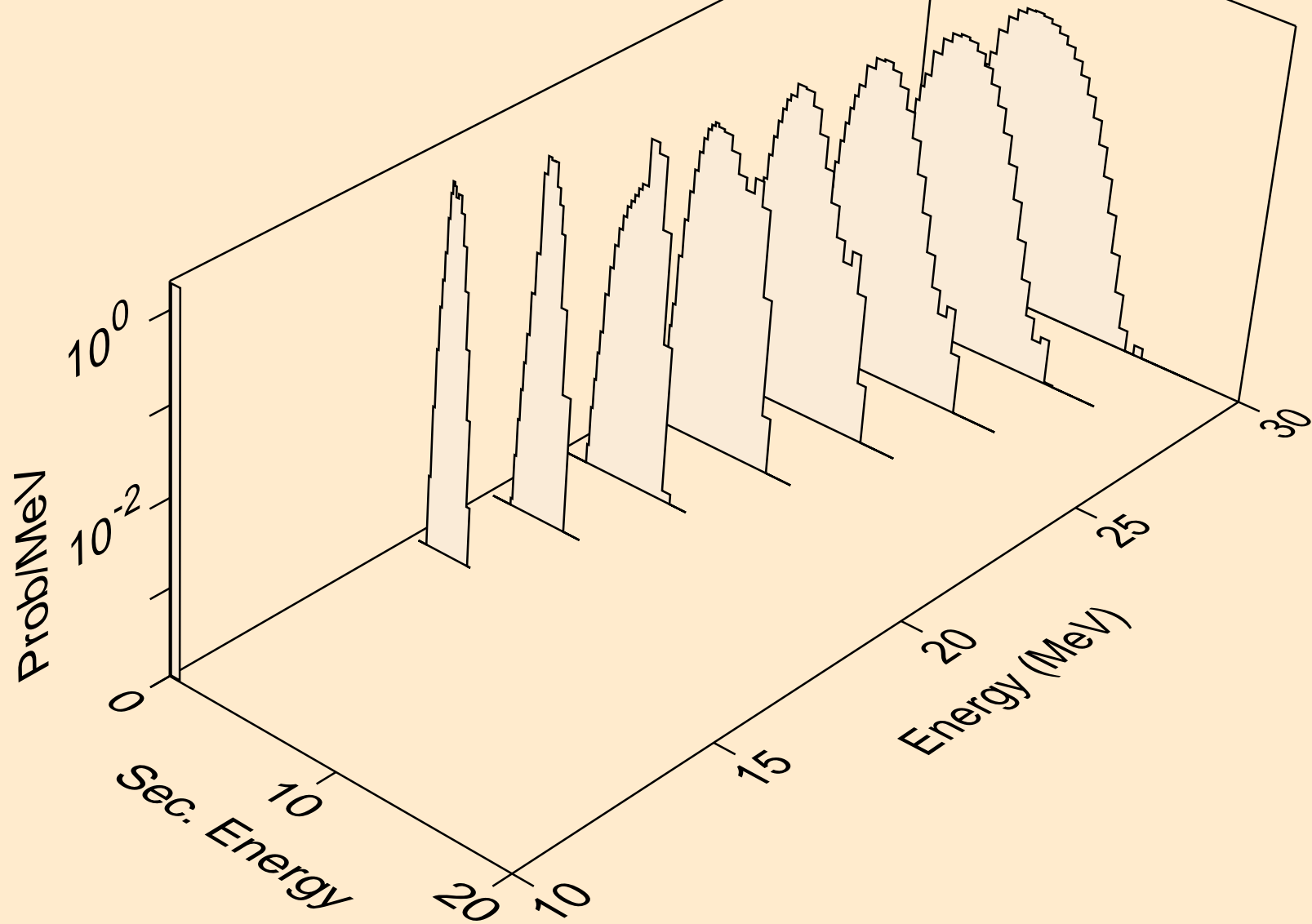

Y087 NEUTRON ACER TENDL-2024 LIBRARY; T=0.K
tritons from (n,x)

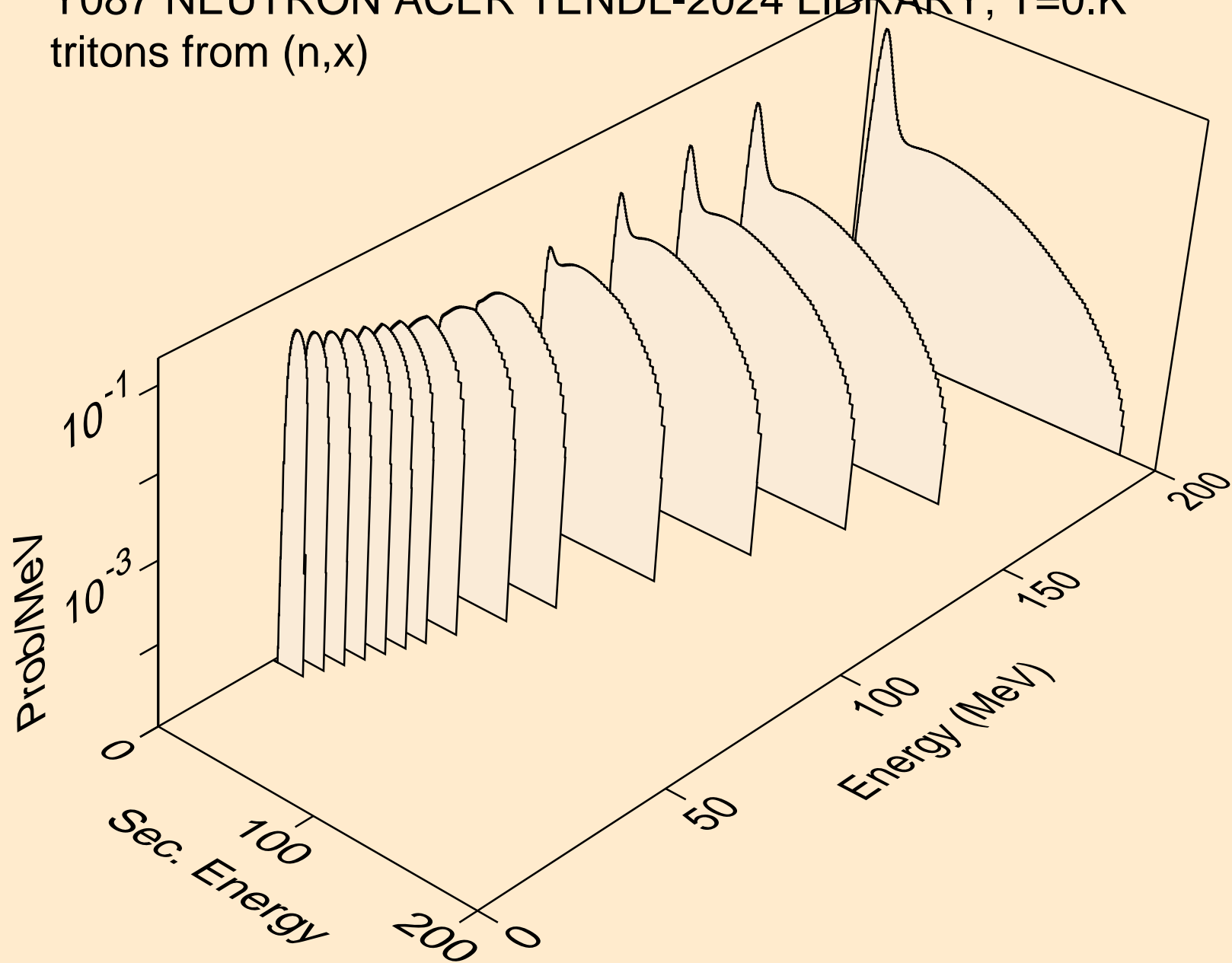

Y087 NEUTRON ACER TENDL-2024 LIBRARY; T=0.K
tritons from (n,n*)t

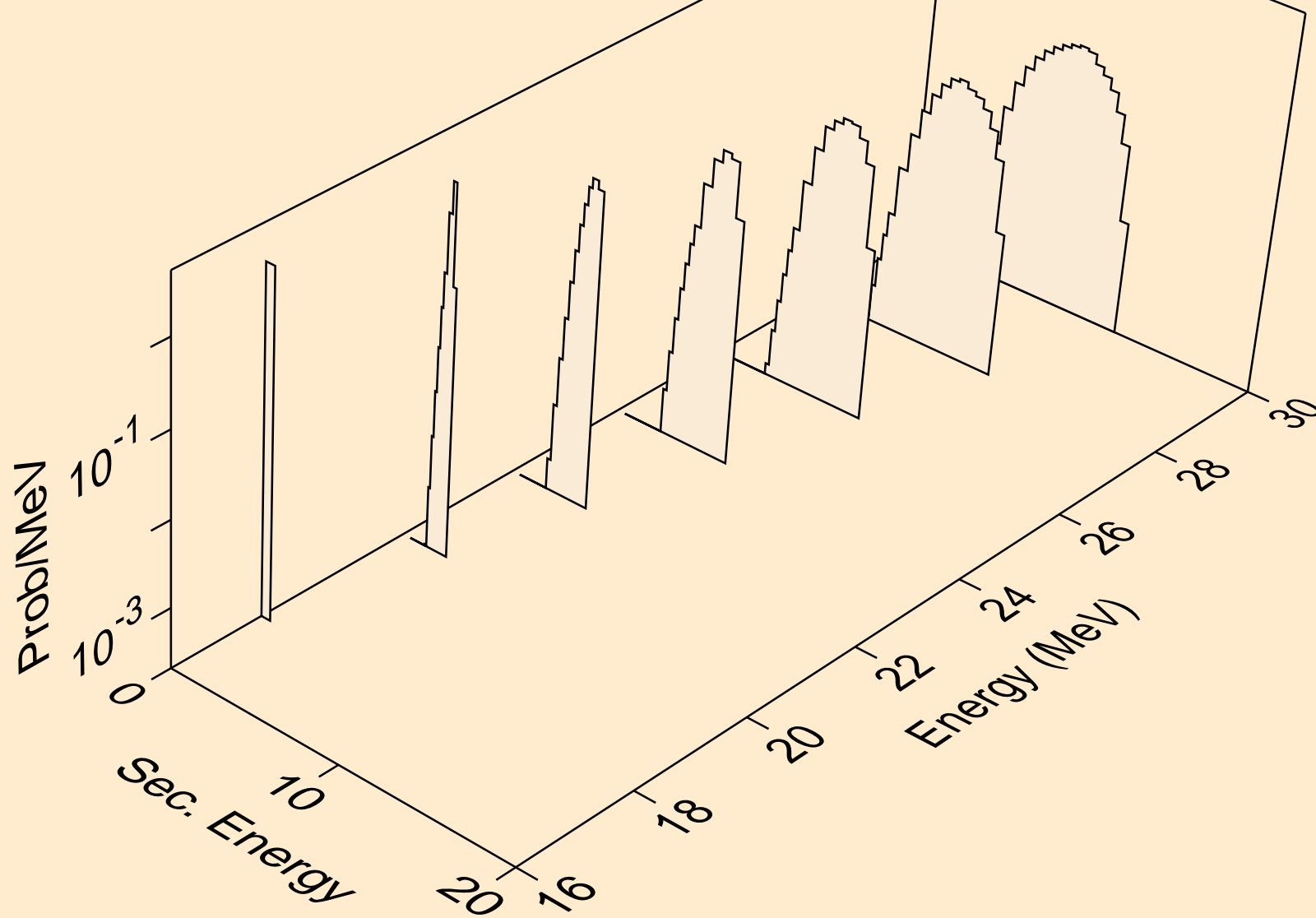

Y087 NEUTRON ACER TENDL-2024 LIBRARY; T=0.K
tritons from (n,t)

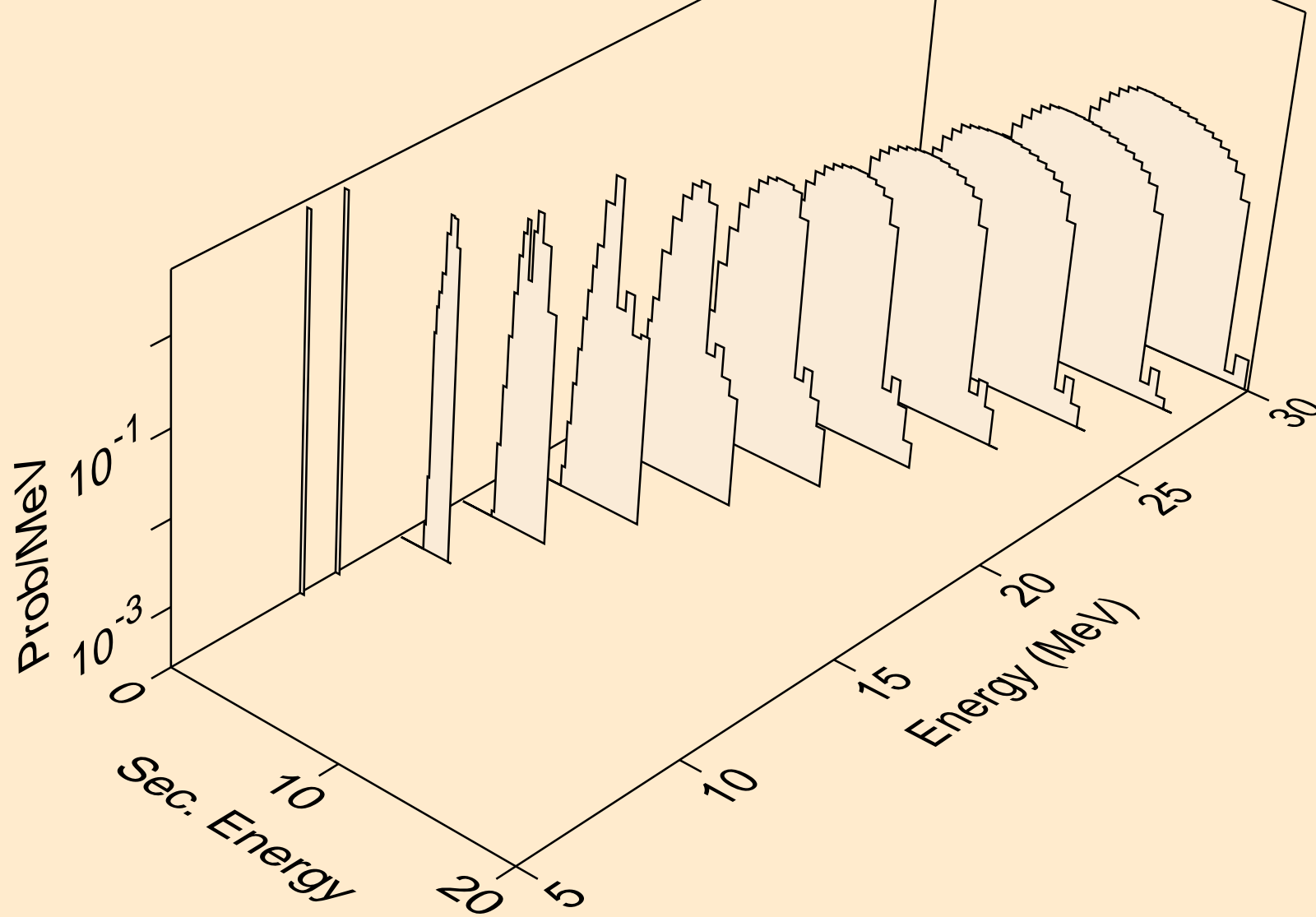

Y087 NEUTRON ACER TENDL-2024 LIBRARY; T=0.K
tritons from (n,pt)

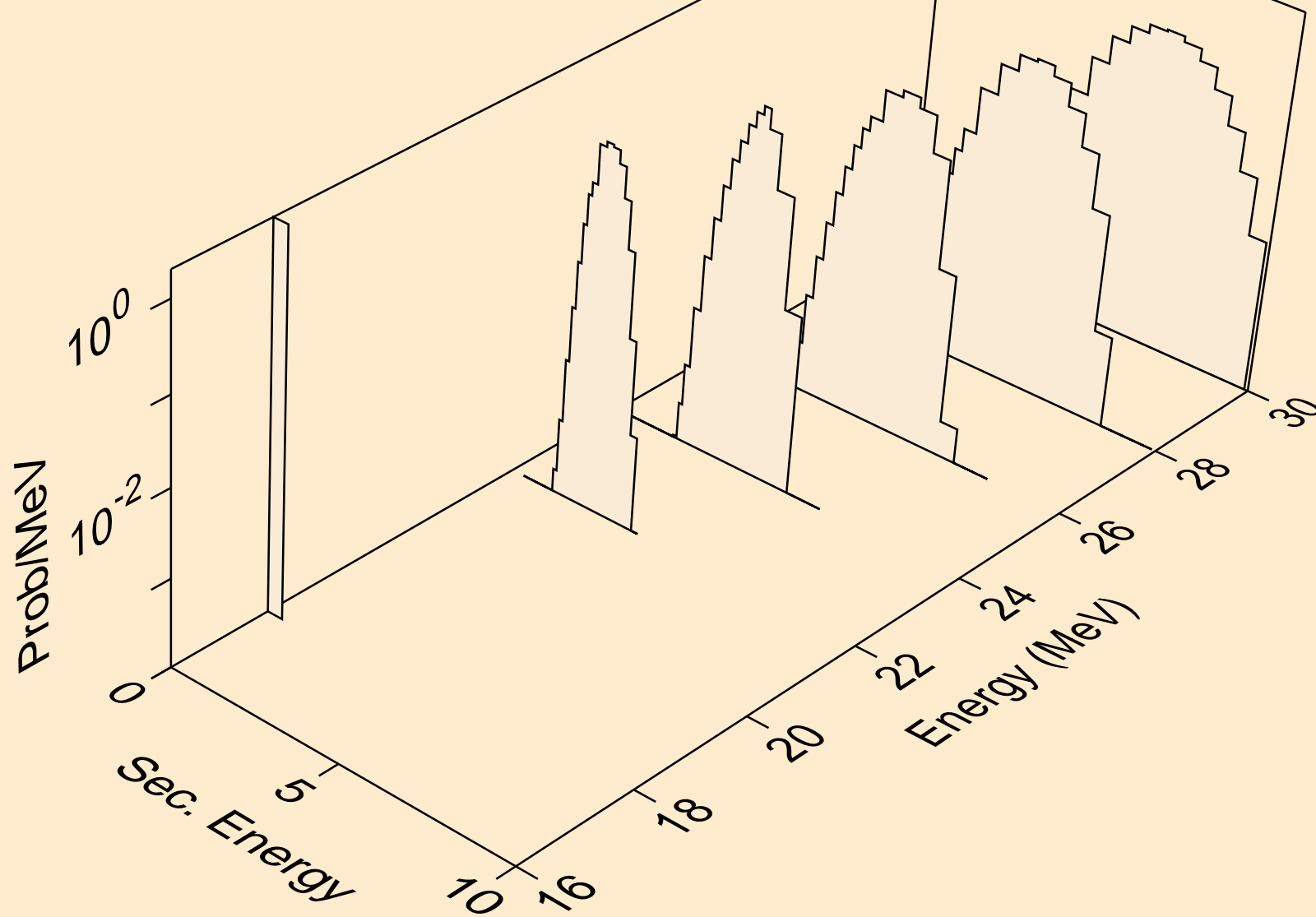

Y087 NEUTRON ACER TENDL-2024 LIBRARY; T=0.K
he3s from (n,x)

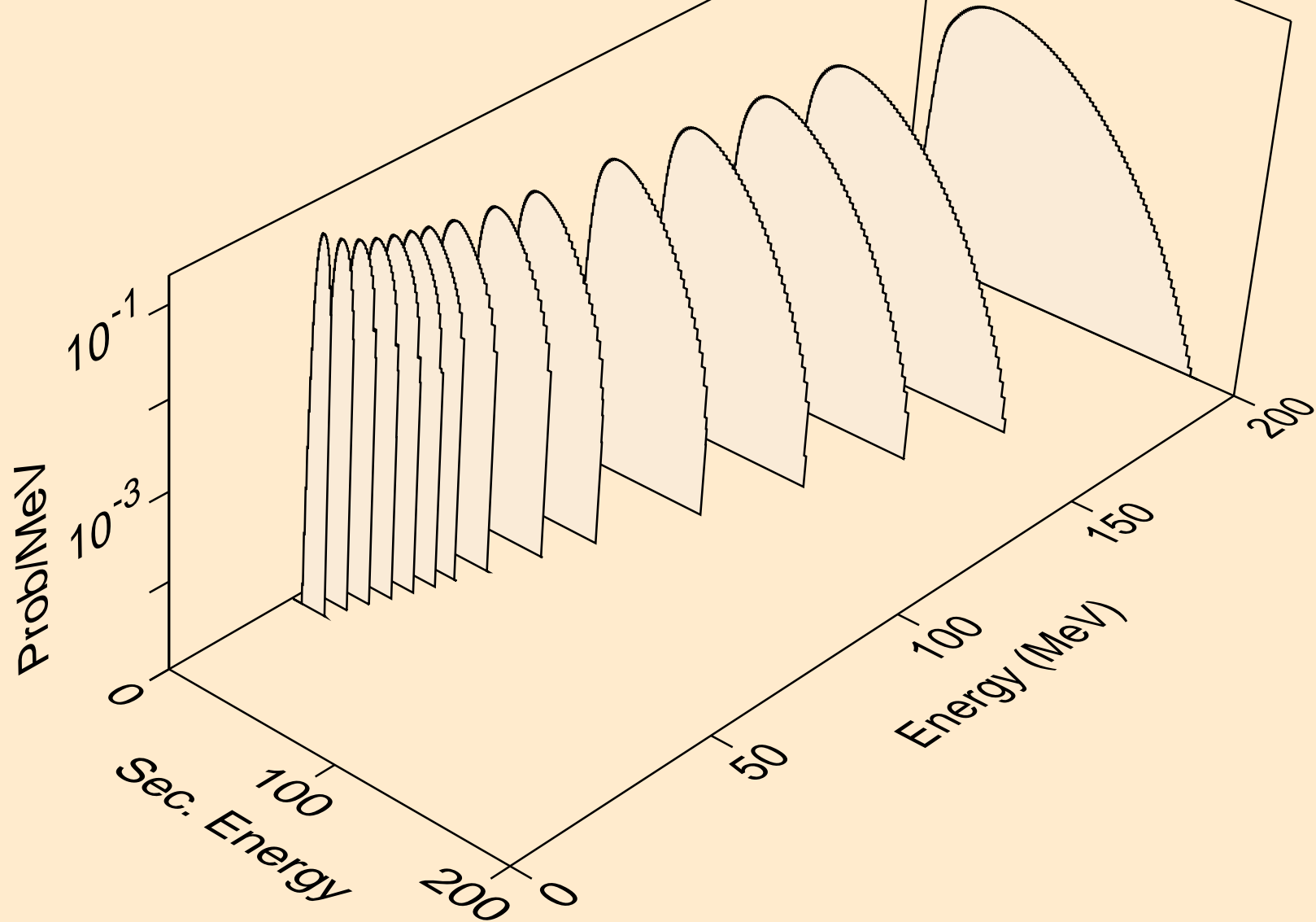

Y087 NEUTRON ACER TENDL-2024 LIBRARY; T=0.K
he3s from (n,n*)he3

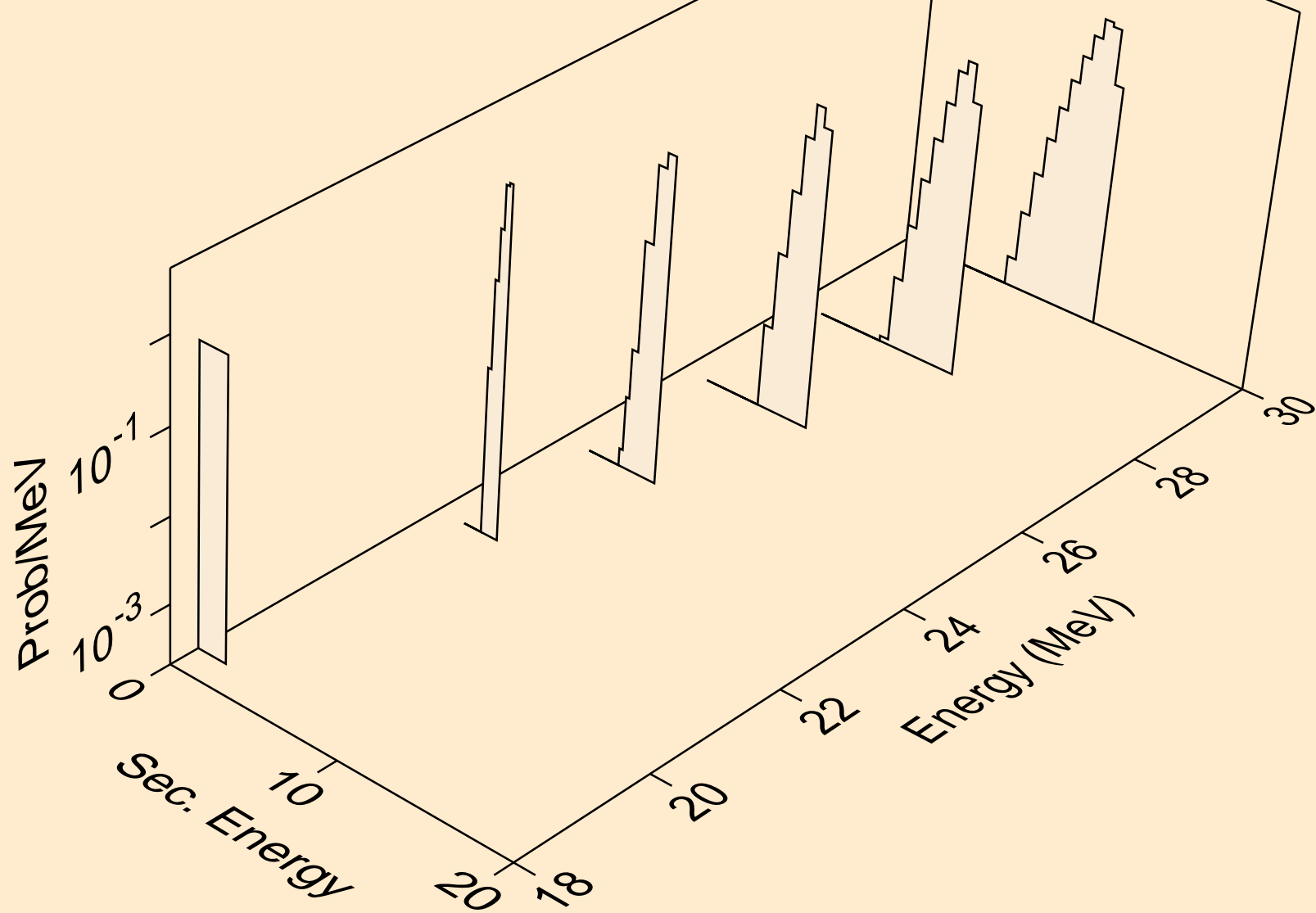

Y087 NEUTRON ACER TENDL-2024 LIBRARY; T=0.K
he3s from (n,he3)

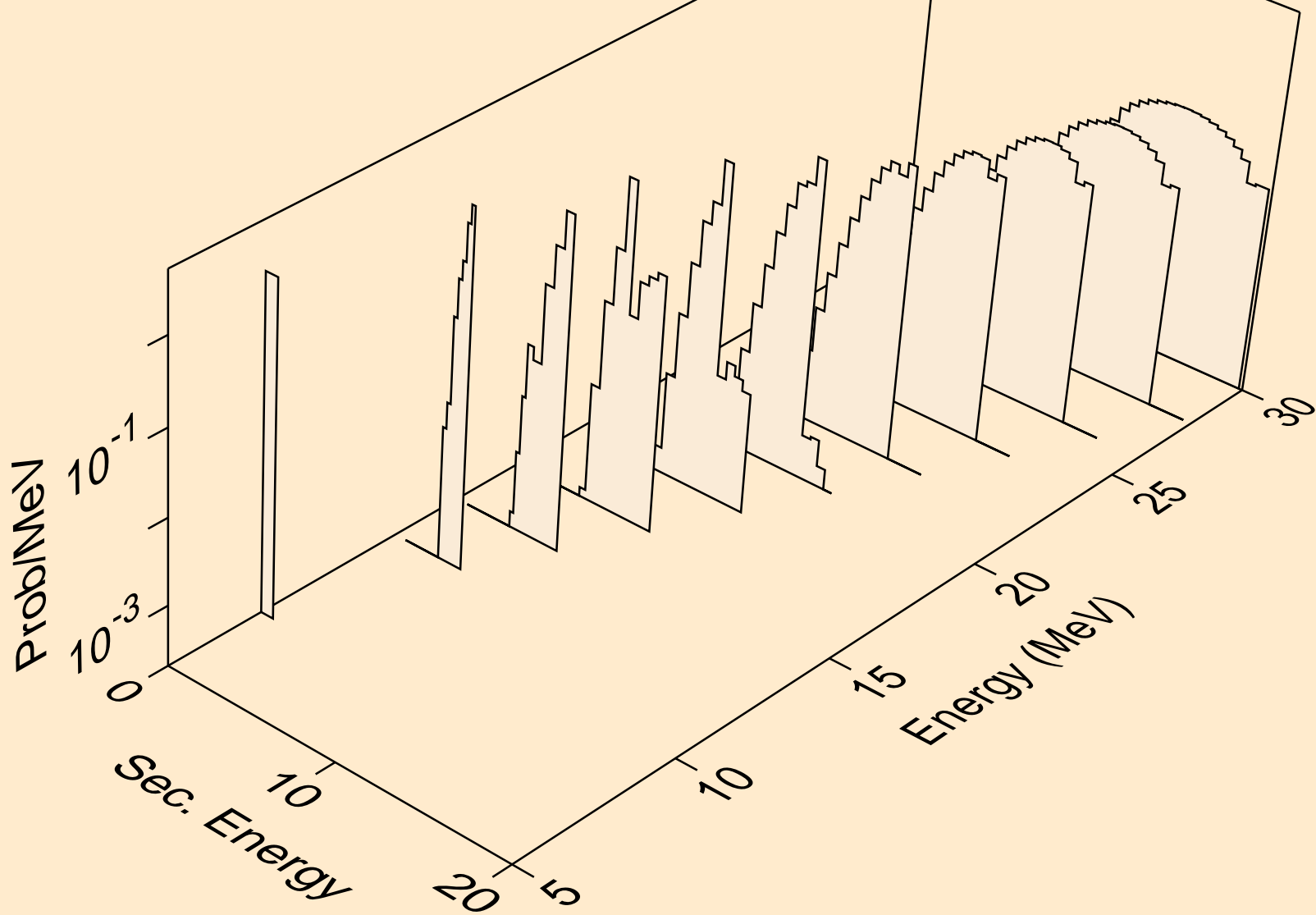

Y087 NEUTRON ACER TENDL-2024 LIBRARY; T=0.K
alphas from (n,x)

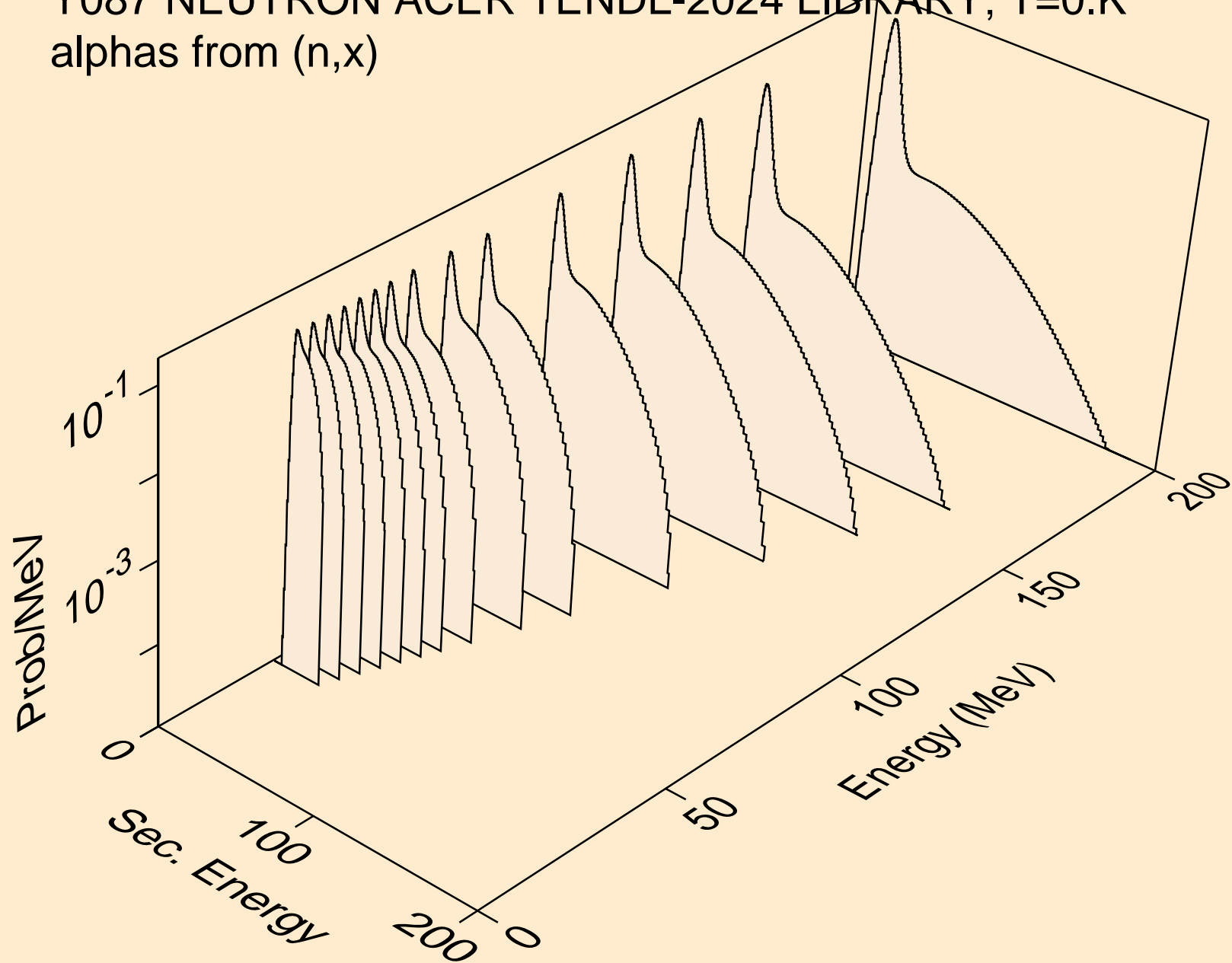

Y087 NEUTRON ACER TENDL-2024 LIBRARY; T=0.K
alphas from (n,n*)a

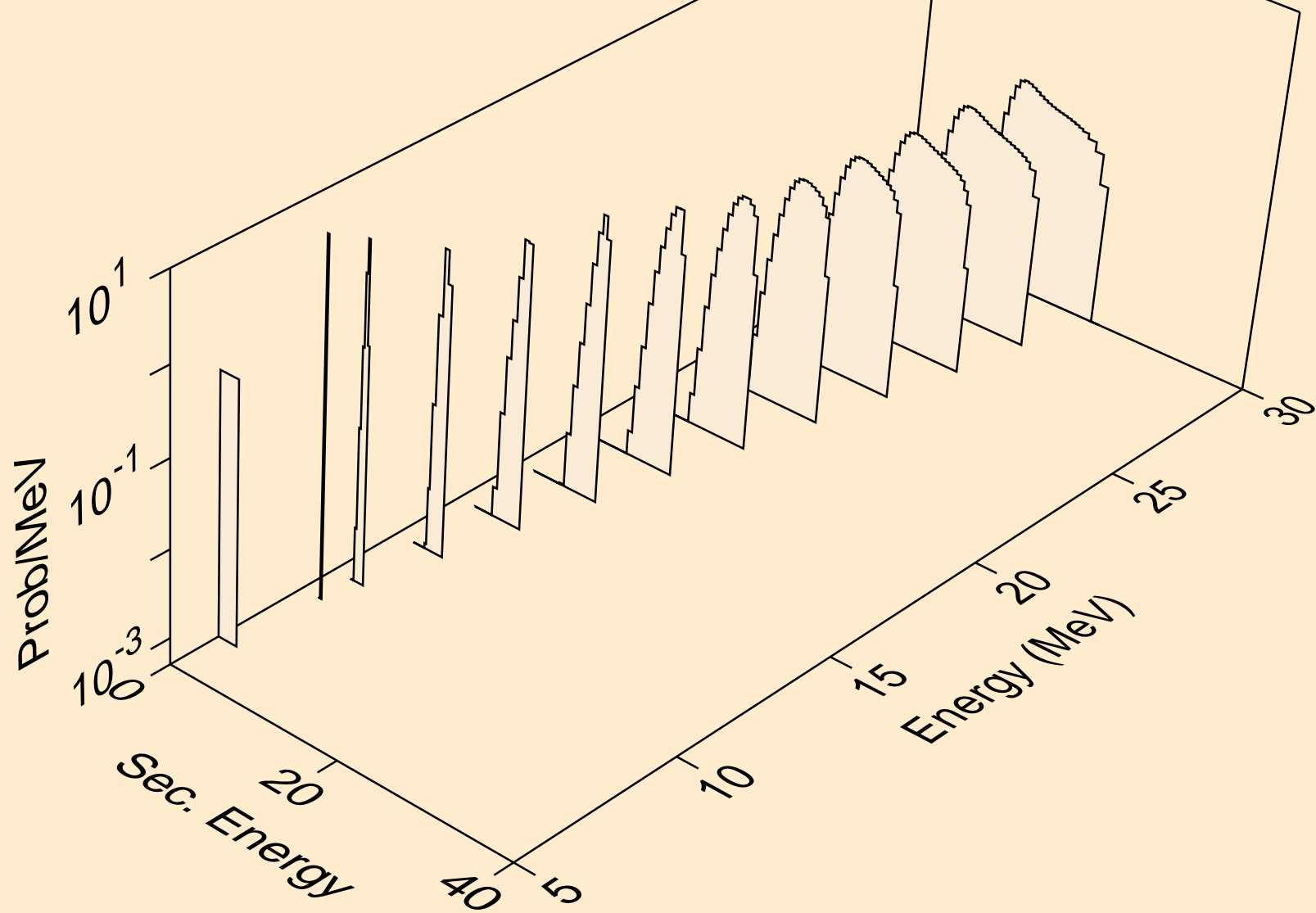

Y087 NEUTRON ACER TENDL-2024 LIBRARY; T=0.K
alphas from (n,2n)a

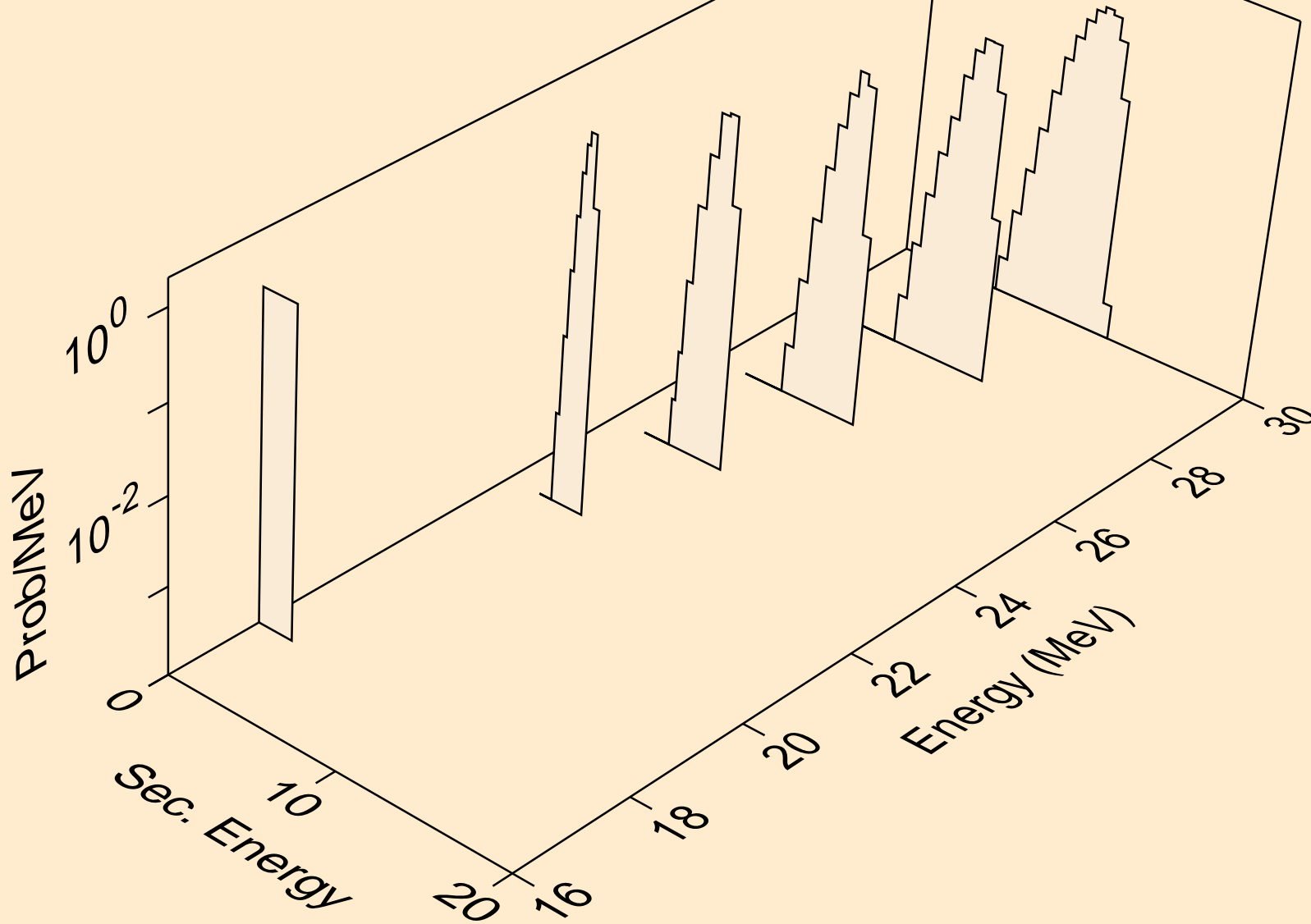

Y087 NEUTRON ACER TENDL-2024 LIBRARY; T=0.K
alphas from (n,n*)2a

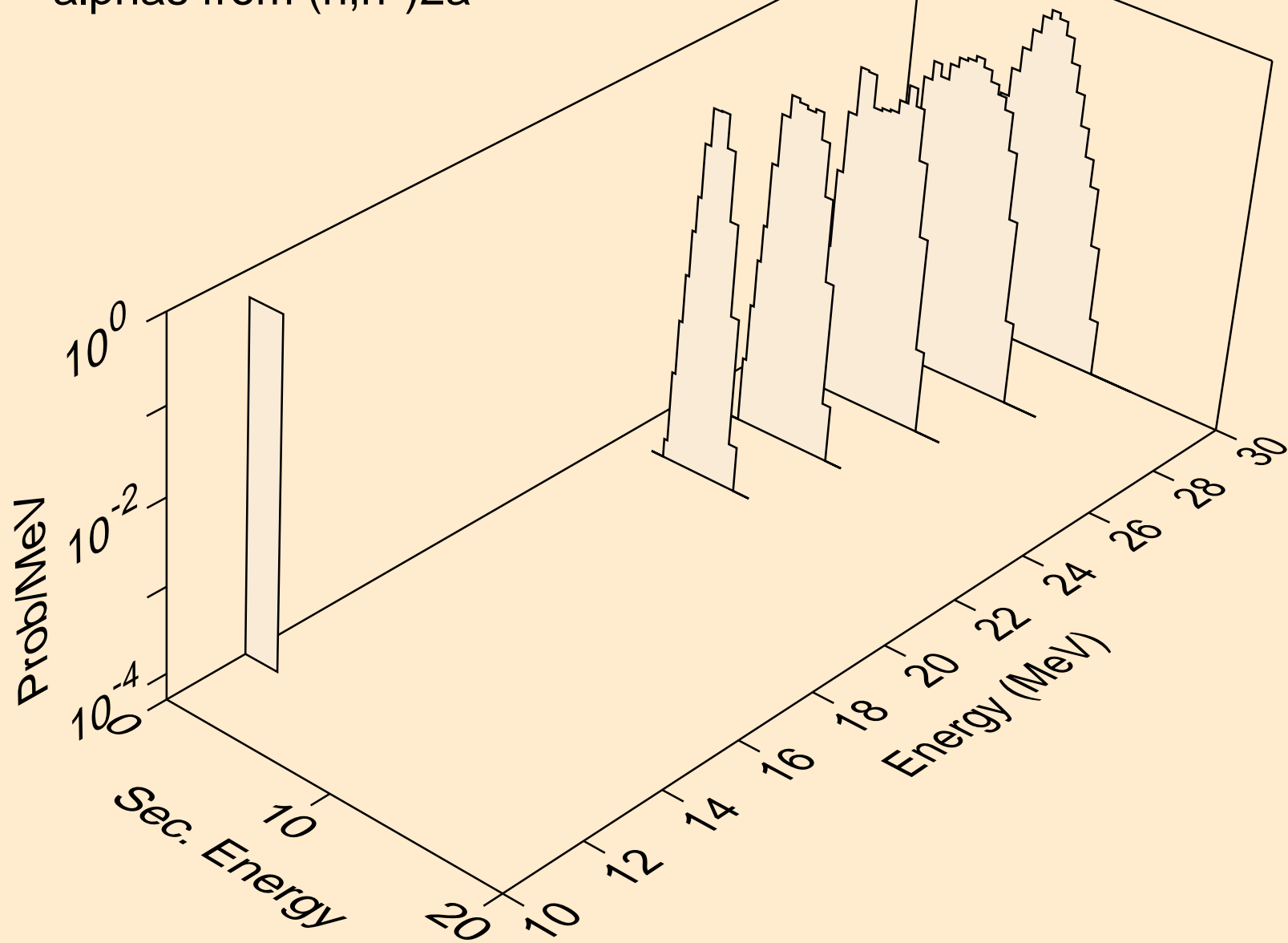

Y087 NEUTRON ACER TENDL-2024 LIBRARY; T=0.K
alphas from (n,npa)

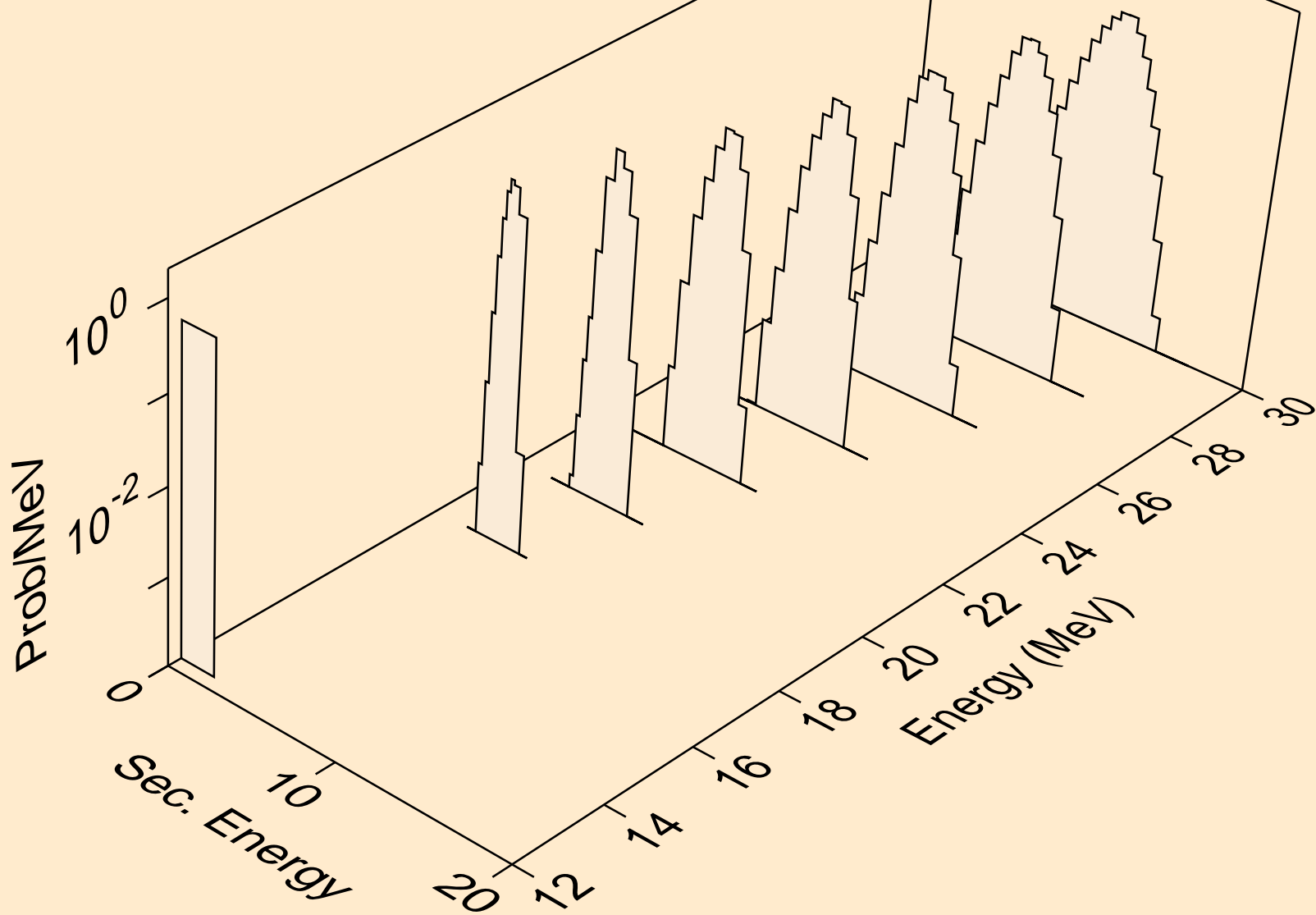

Y087 NEUTRON ACER TENDL-2024 LIBRARY; T=0.K
alphas from (n,a)

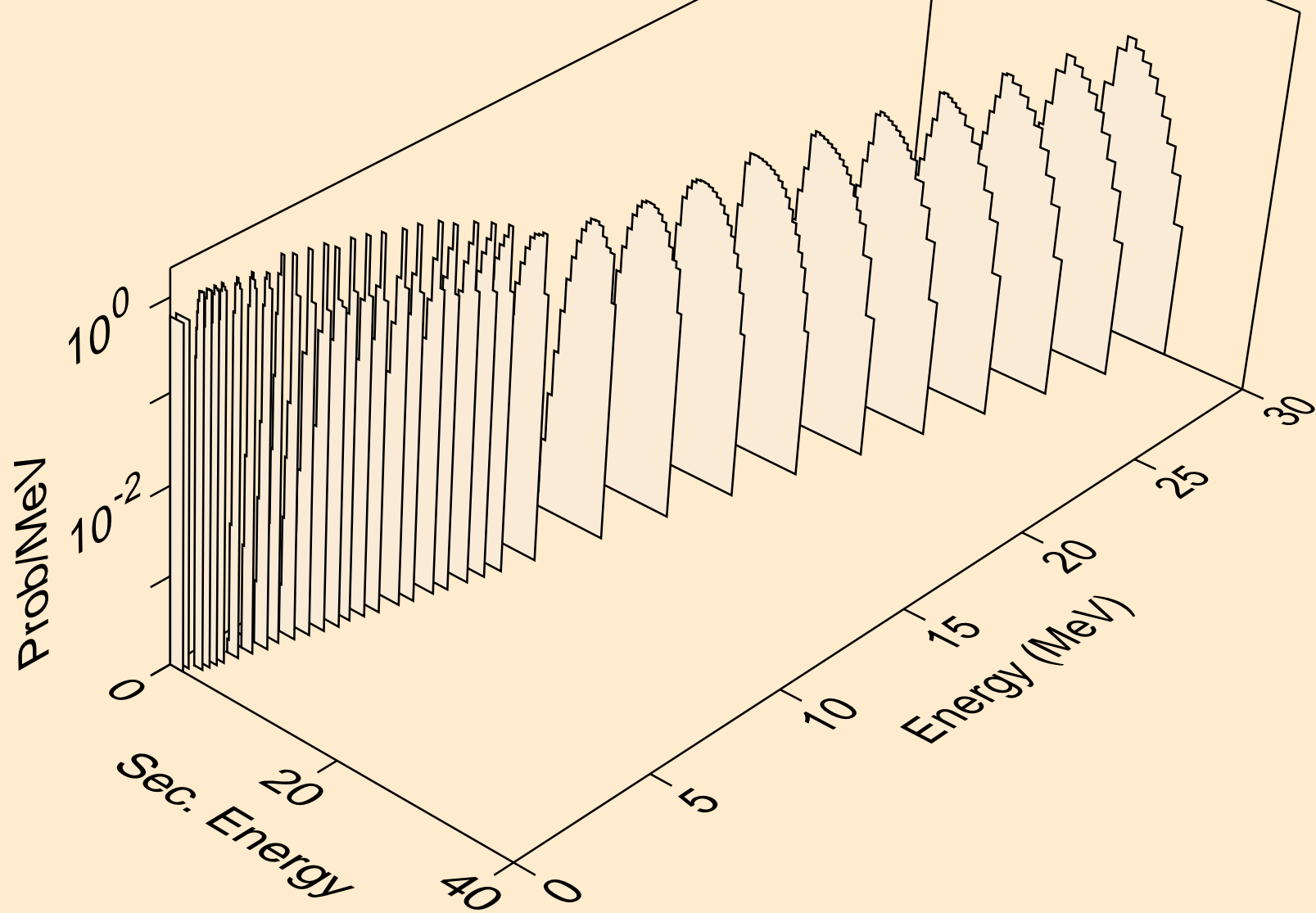

Y087 NEUTRON ACER TENDL-2024 LIBRARY; T=0.K
alphas from (n,2a)

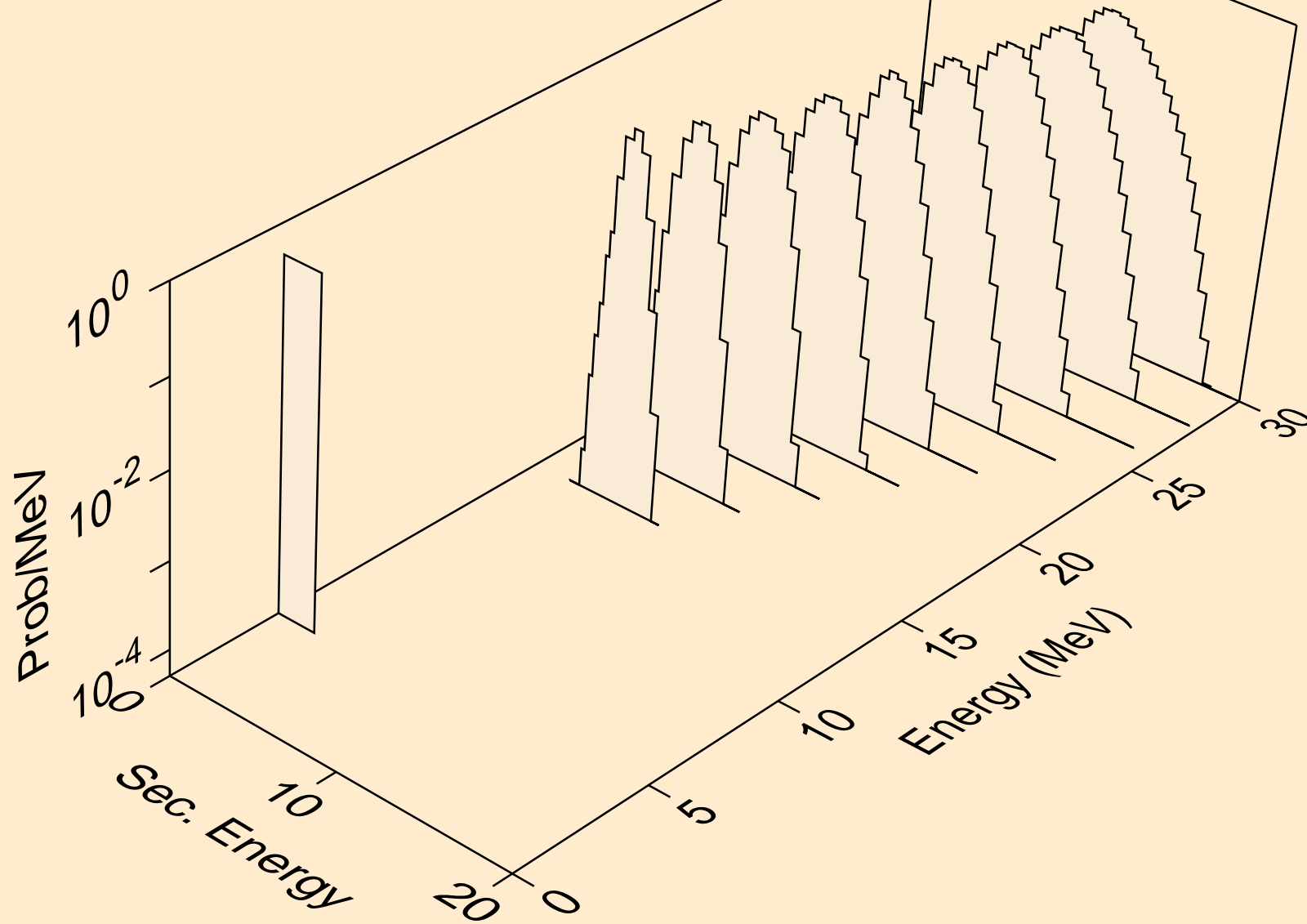

Y087 NEUTRON ACER TENDL-2024 LIBRARY; T=0.K
alphas from (n,pa)

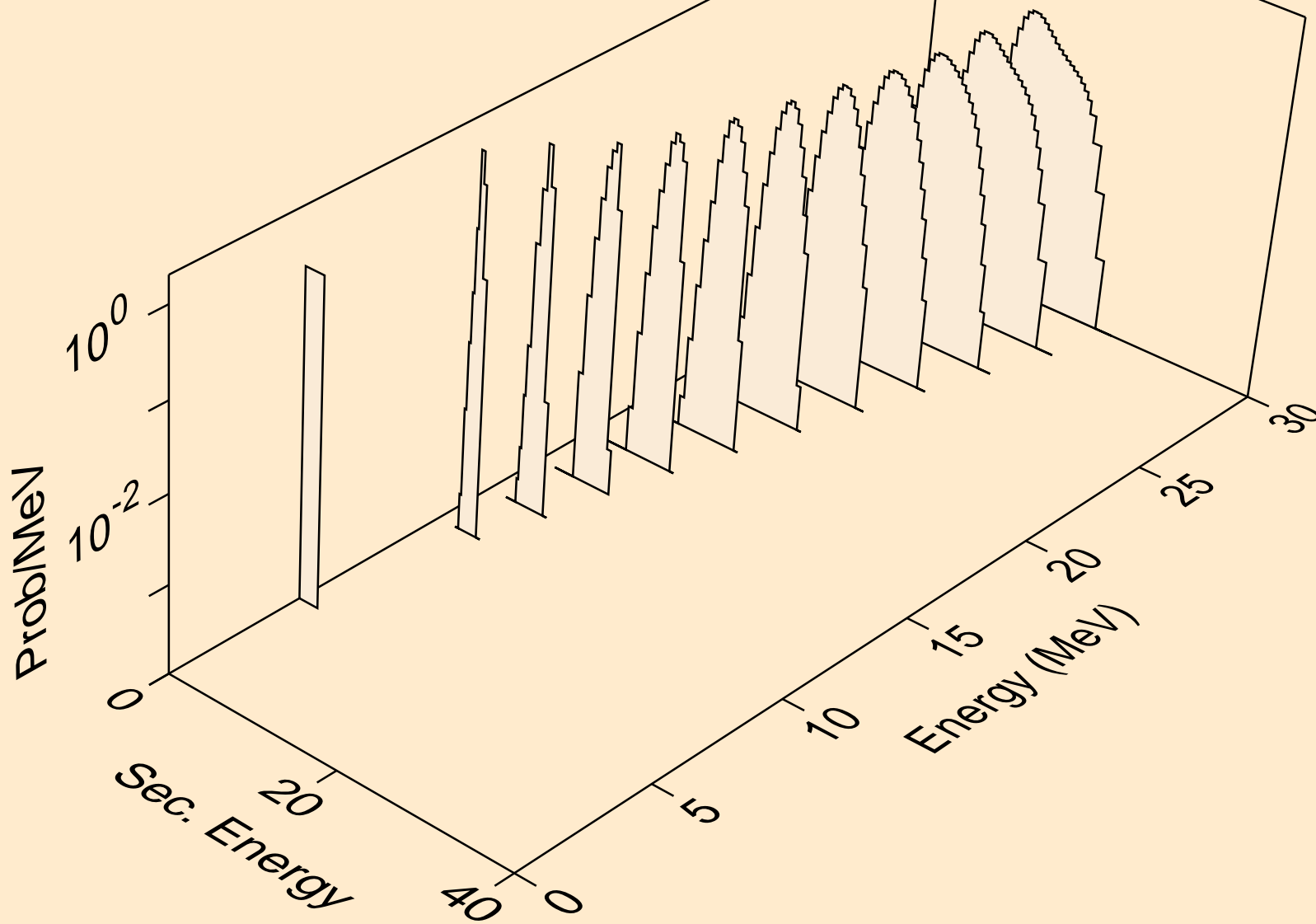

Y087 NEUTRON ACER TENDL-2024 LIBRARY; T=0.K
alphas from (n,da)

