

YB151 NEUTRON ACER TENDL-2024 LIBRARY; T=0.K

Principal cross sections

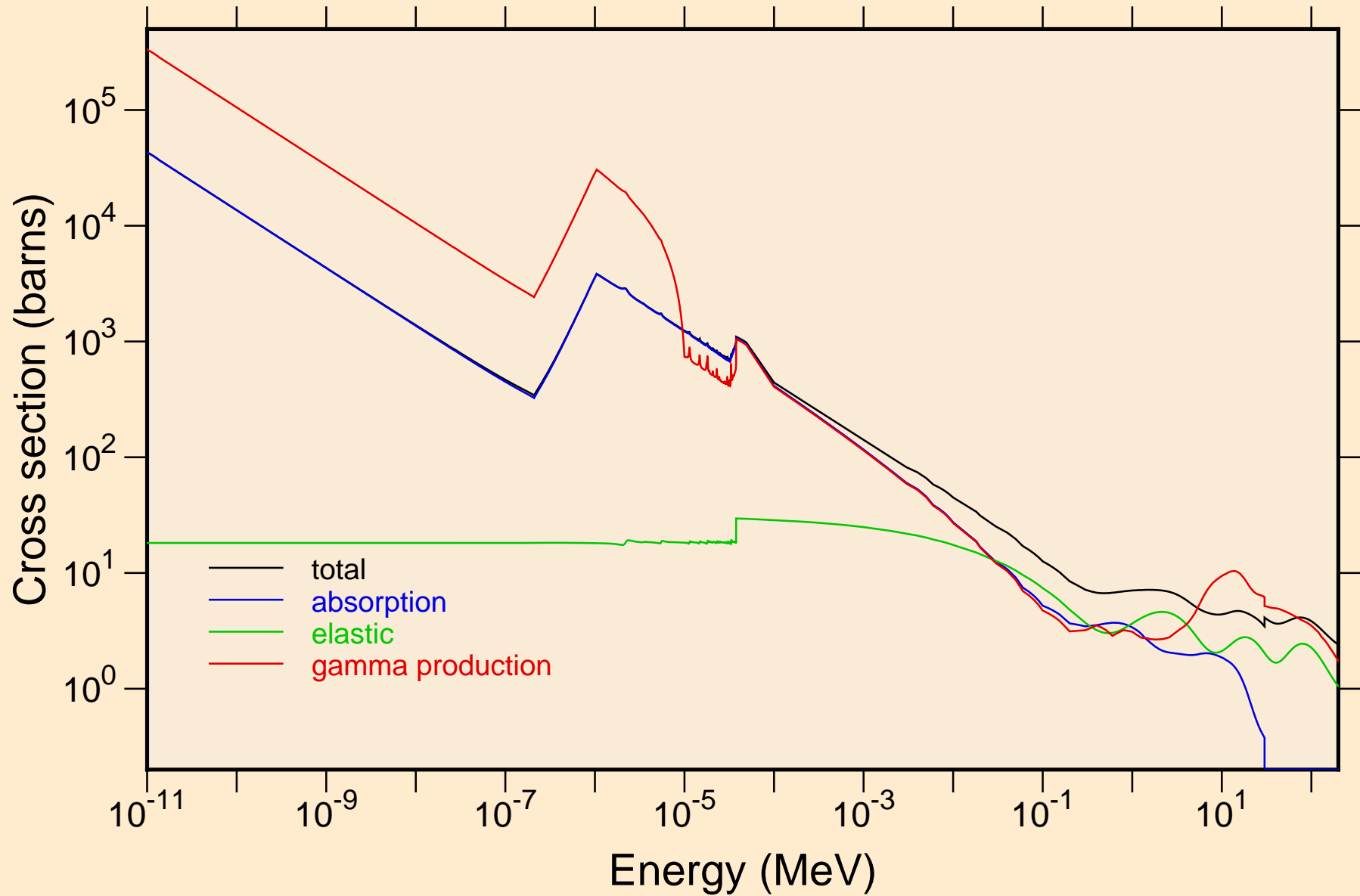

YB151 NEUTRON ACER TENDL-2024 LIBRARY; T=0.K
resonance total cross section

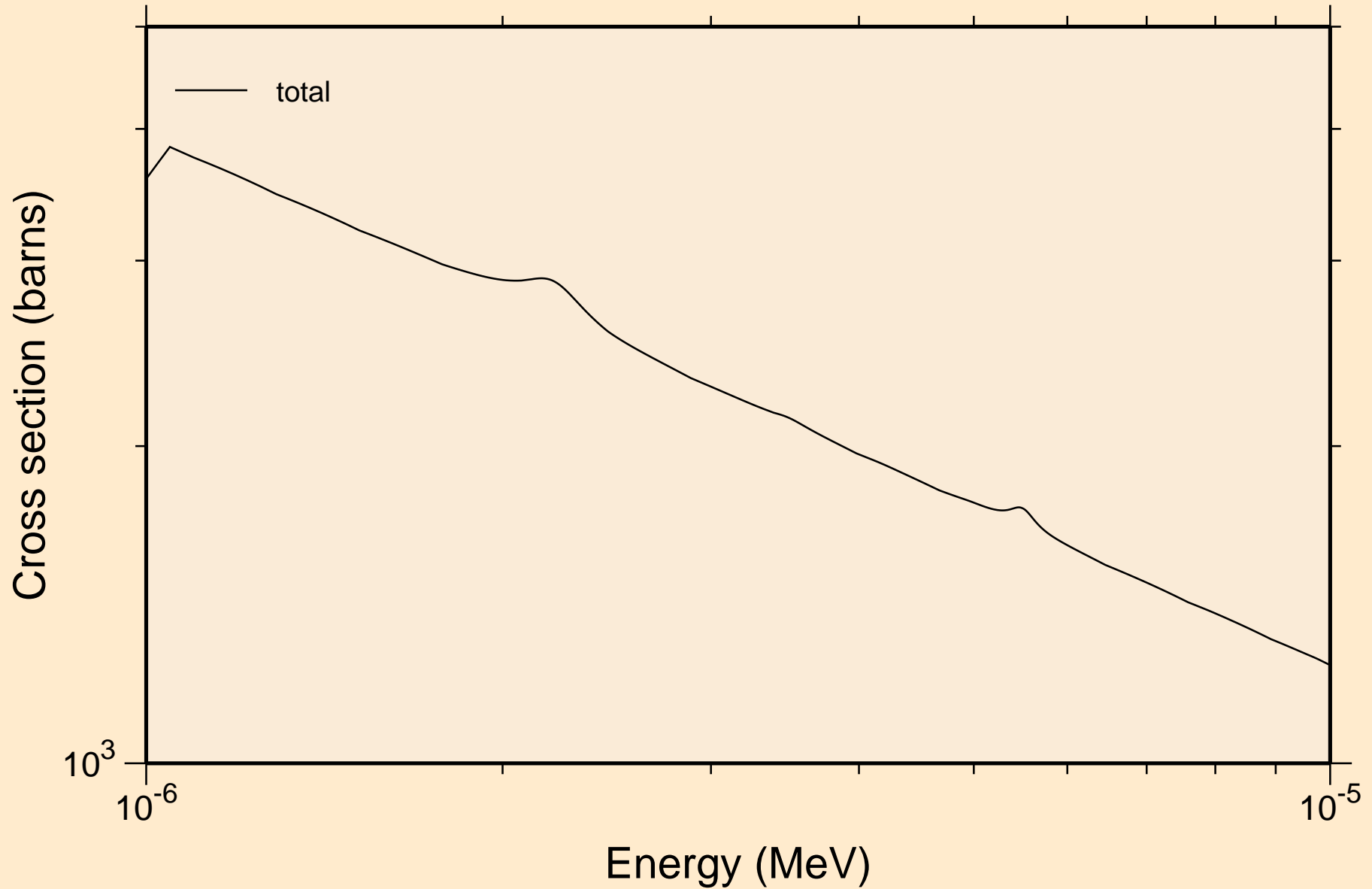

YB151 NEUTRON ACER TENDL-2024 LIBRARY; T=0.K
resonance total cross section

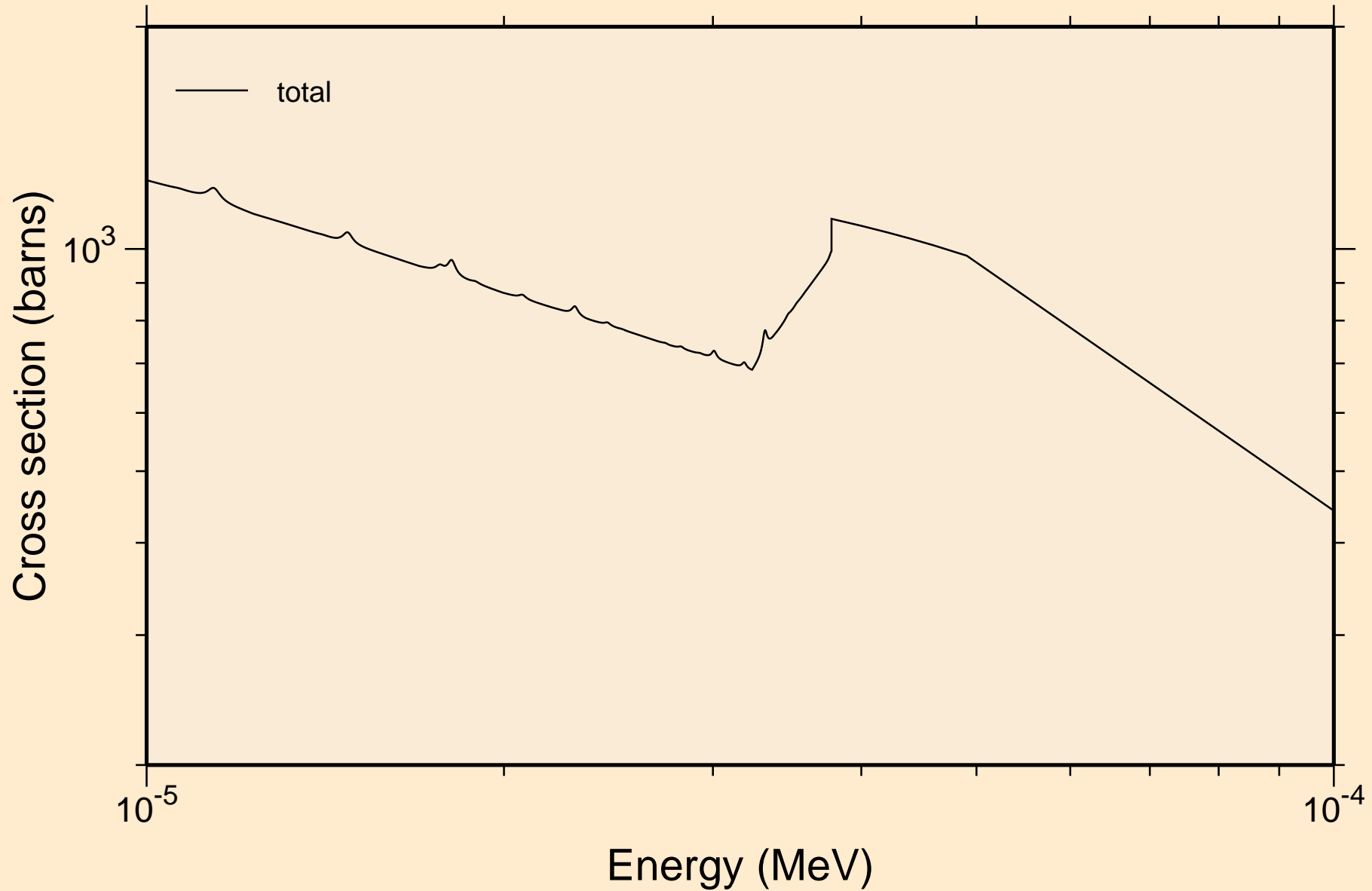

YB151 NEUTRON ACER TENDL-2024 LIBRARY; T=0.K
resonance total cross section

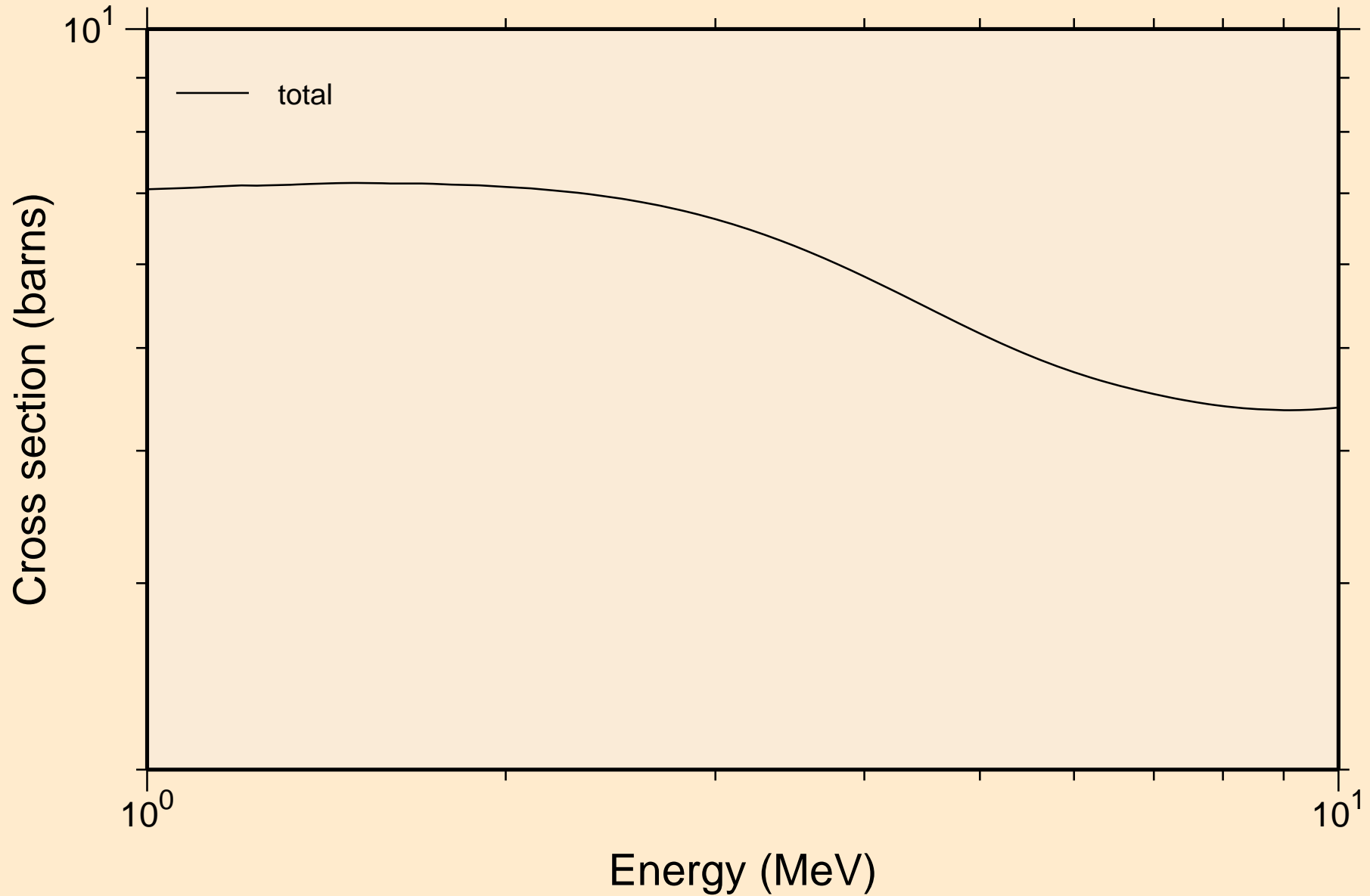

YB151 NEUTRON ACER TENDL-2024 LIBRARY; T=0.K
resonance absorption cross sections

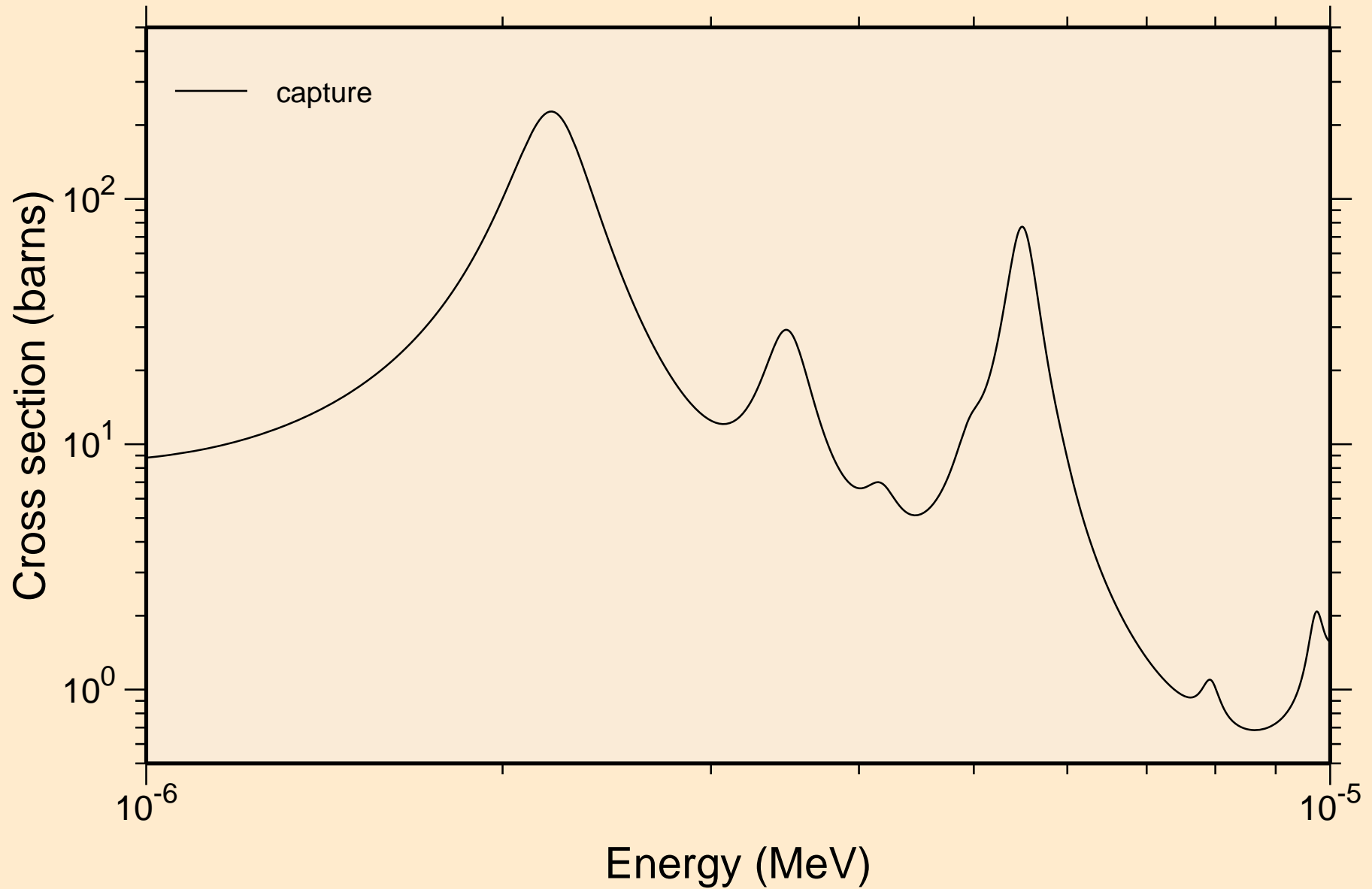

YB151 NEUTRON ACER TENDL-2024 LIBRARY; T=0.K
resonance absorption cross sections

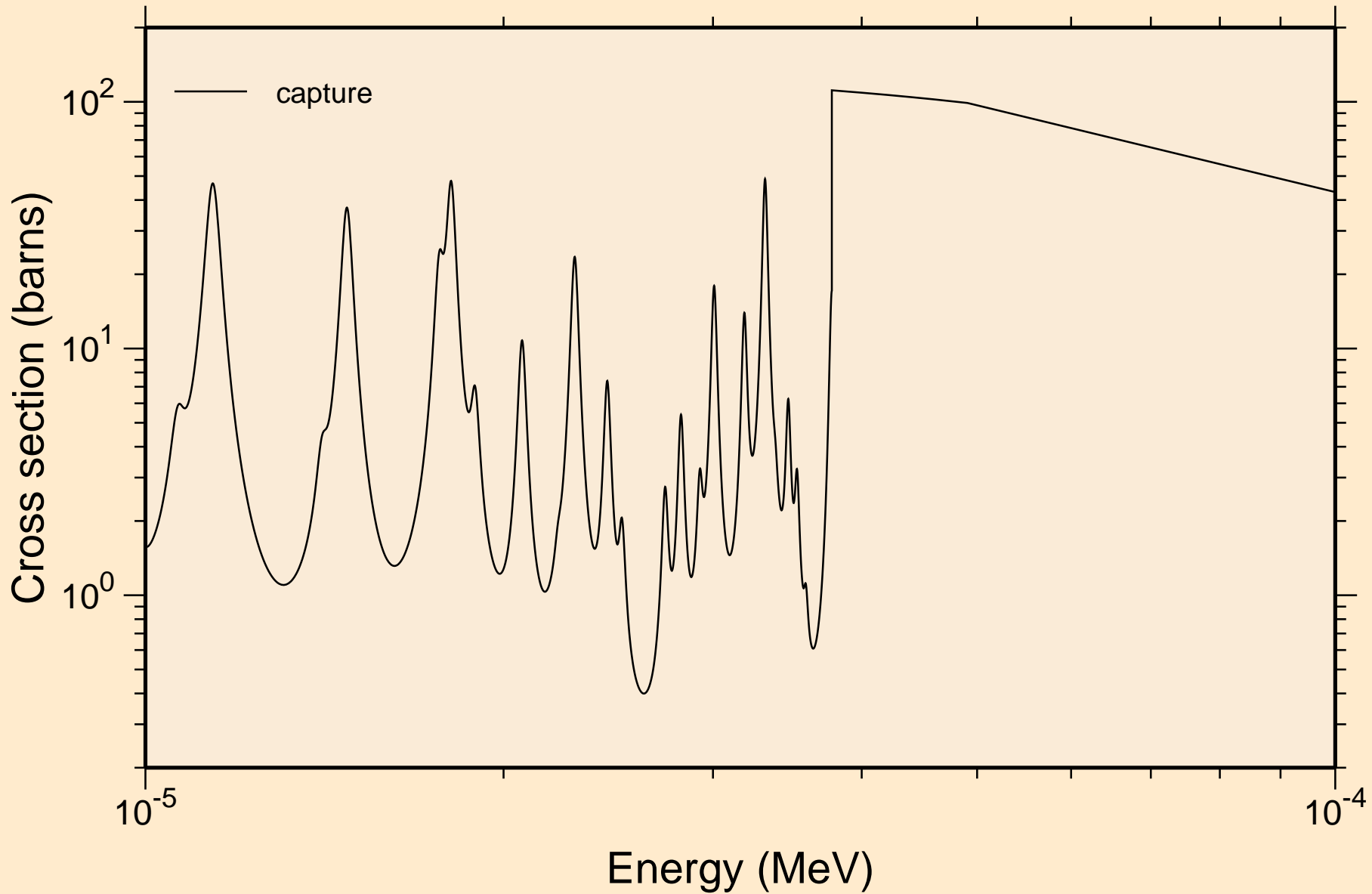

YB151 NEUTRON ACER TENDL-2024 LIBRARY; T=0.K
resonance absorption cross sections

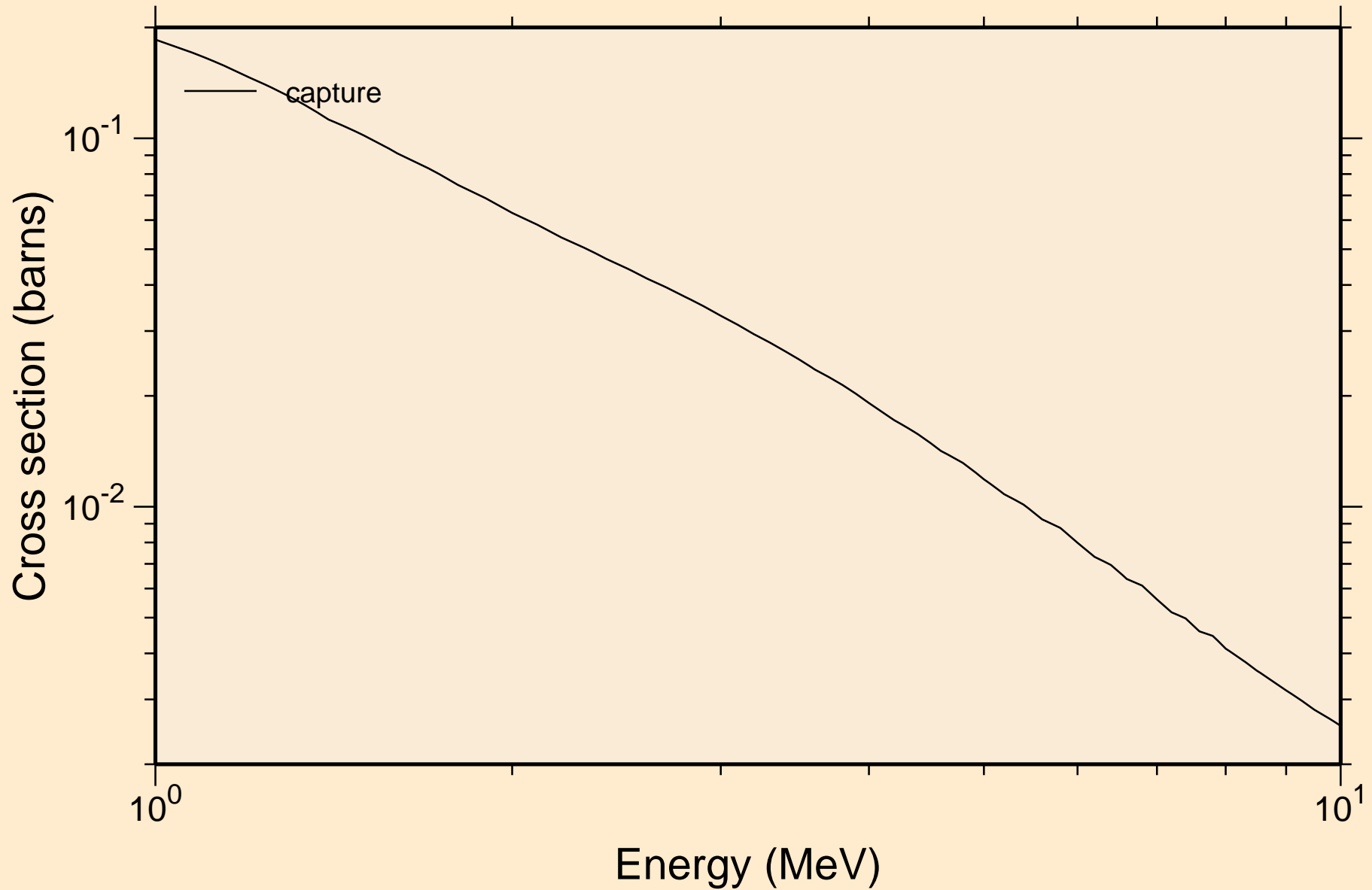

YB151 NEUTRON ACER TENDL-2024 LIBRARY; T=0.K

Heating

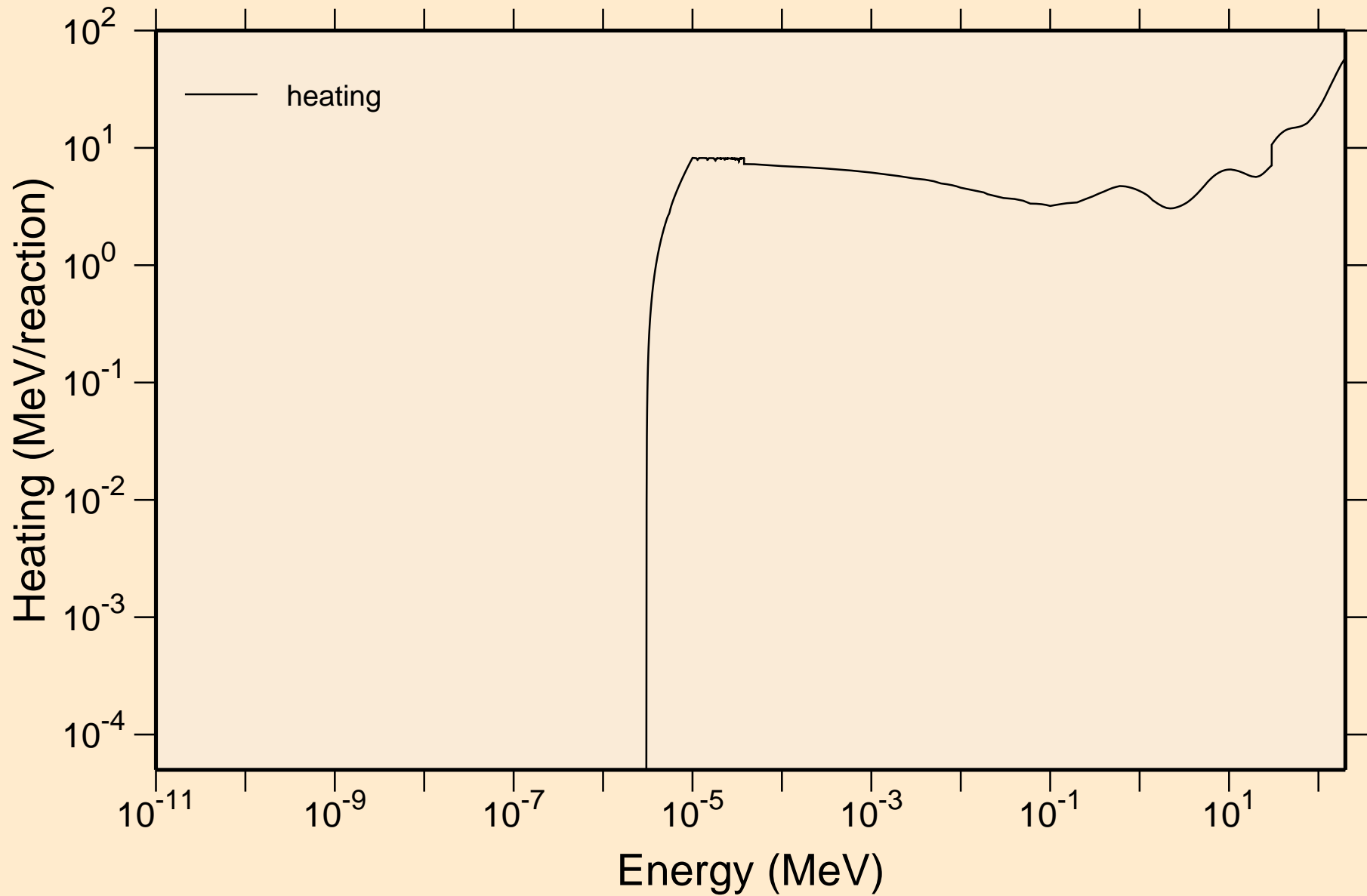

YB151 NEUTRON ACER TENDL-2024 LIBRARY; T=0.K
Damage

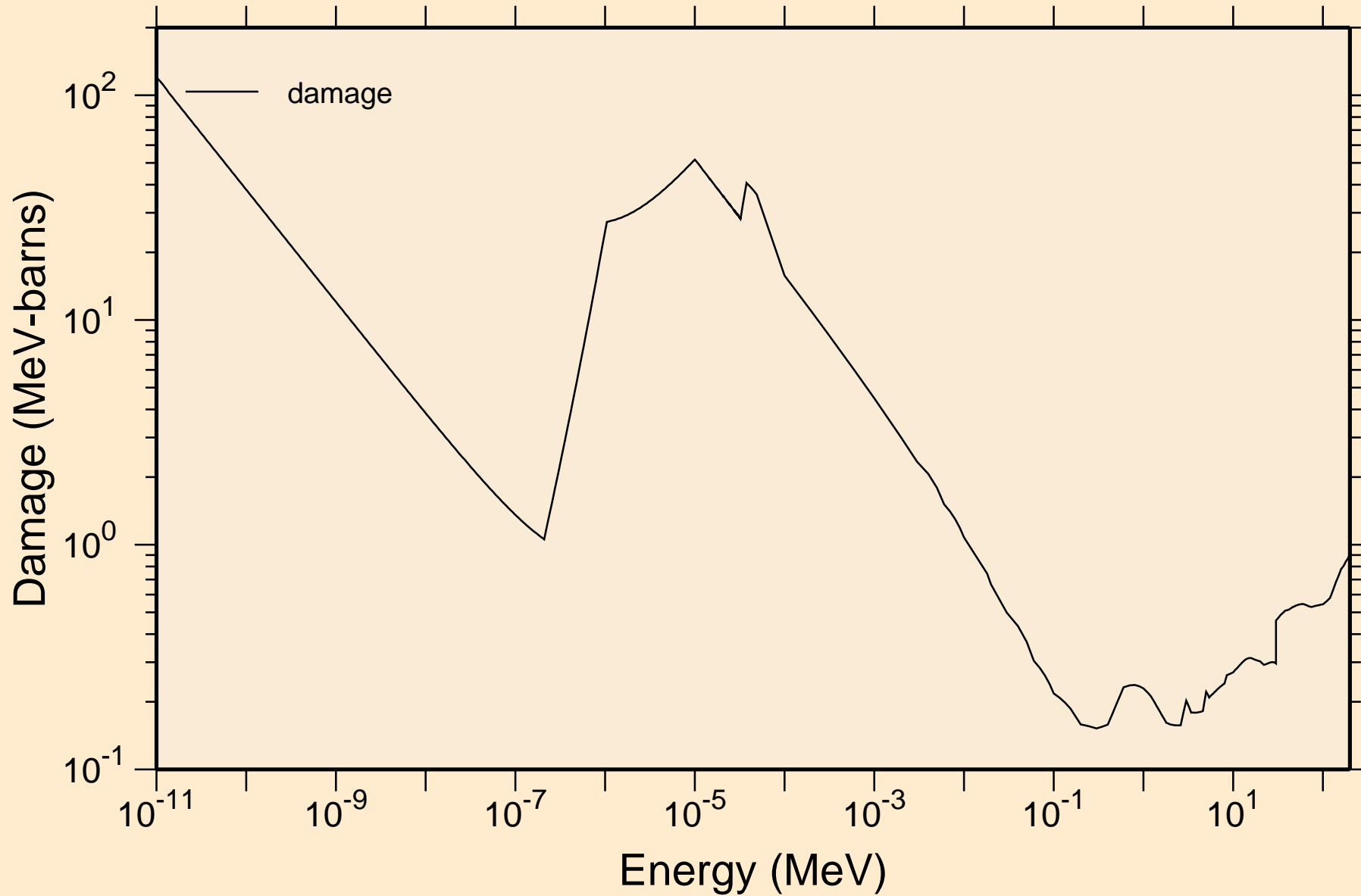

YB151 NEUTRON ACER TENDL-2024 LIBRARY; T=0.K

Non-threshold reactions

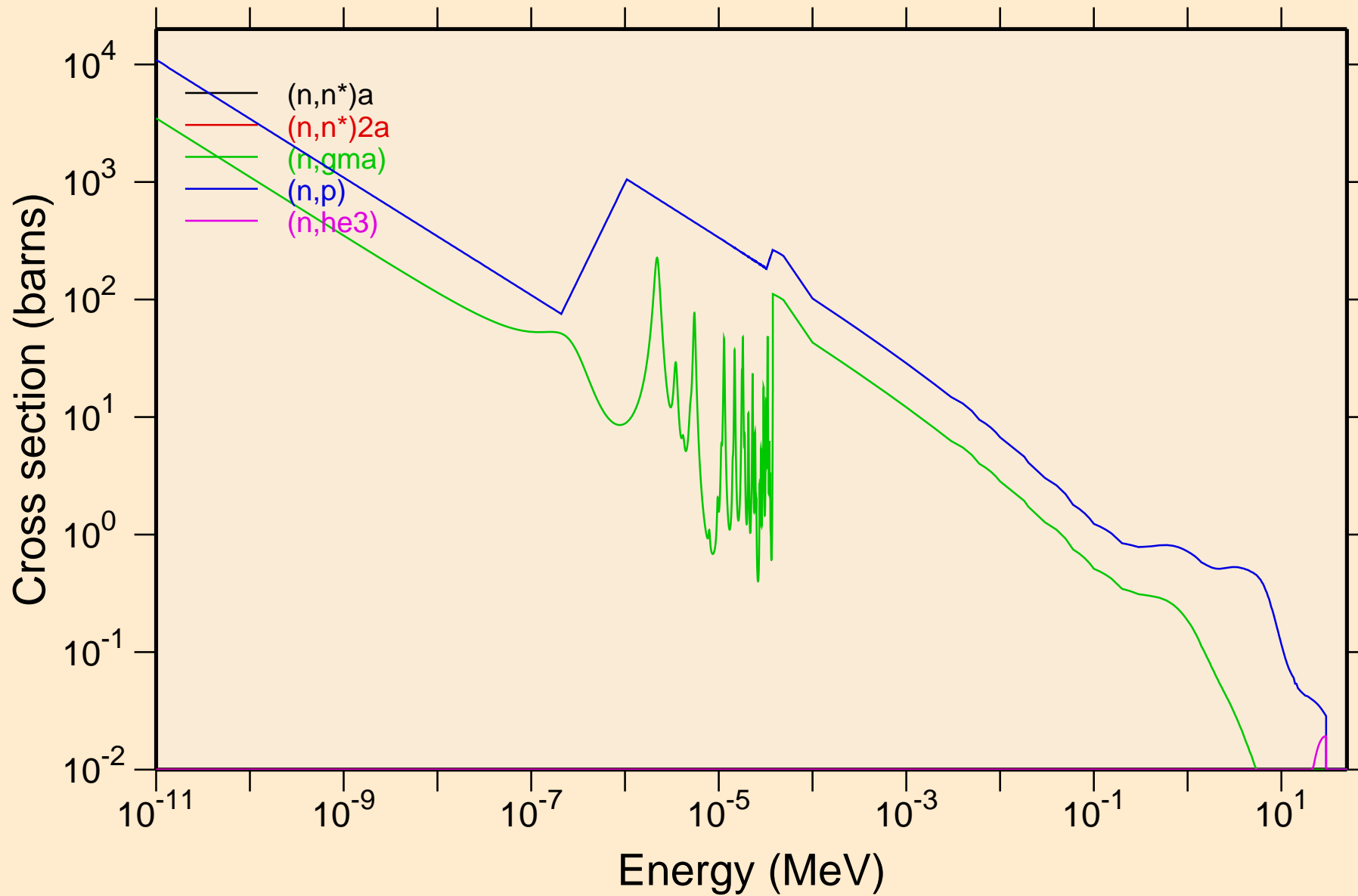

YB151 NEUTRON ACER TENDL-2024 LIBRARY; T=0.K
Non-threshold reactions

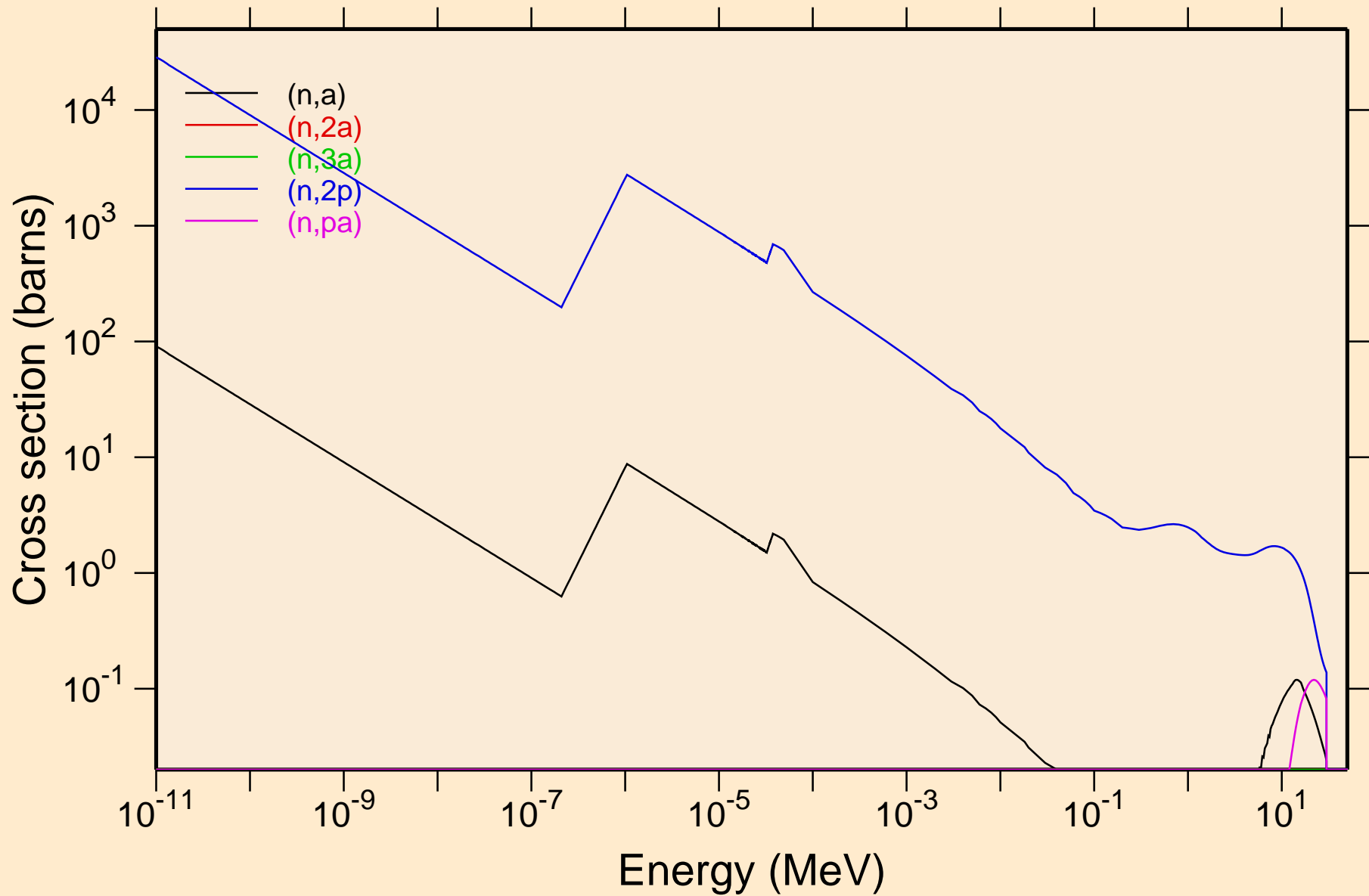

YB151 NEUTRON ACER TENDL-2024 LIBRARY; T=0.K

Non-threshold reactions

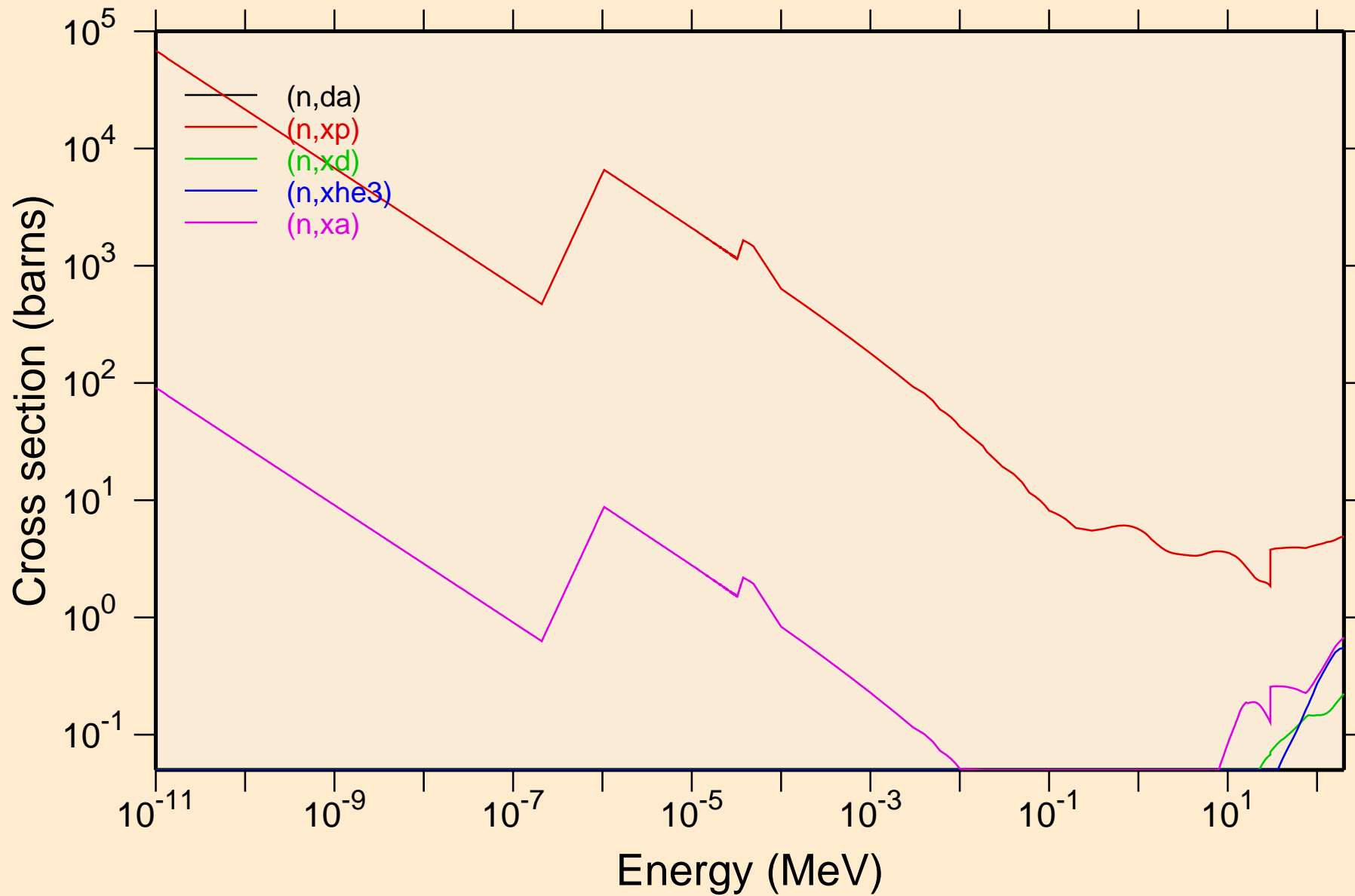

YB151 NEUTRON ACER TENDL-2024 LIBRARY; T=0.K

Principal cross sections

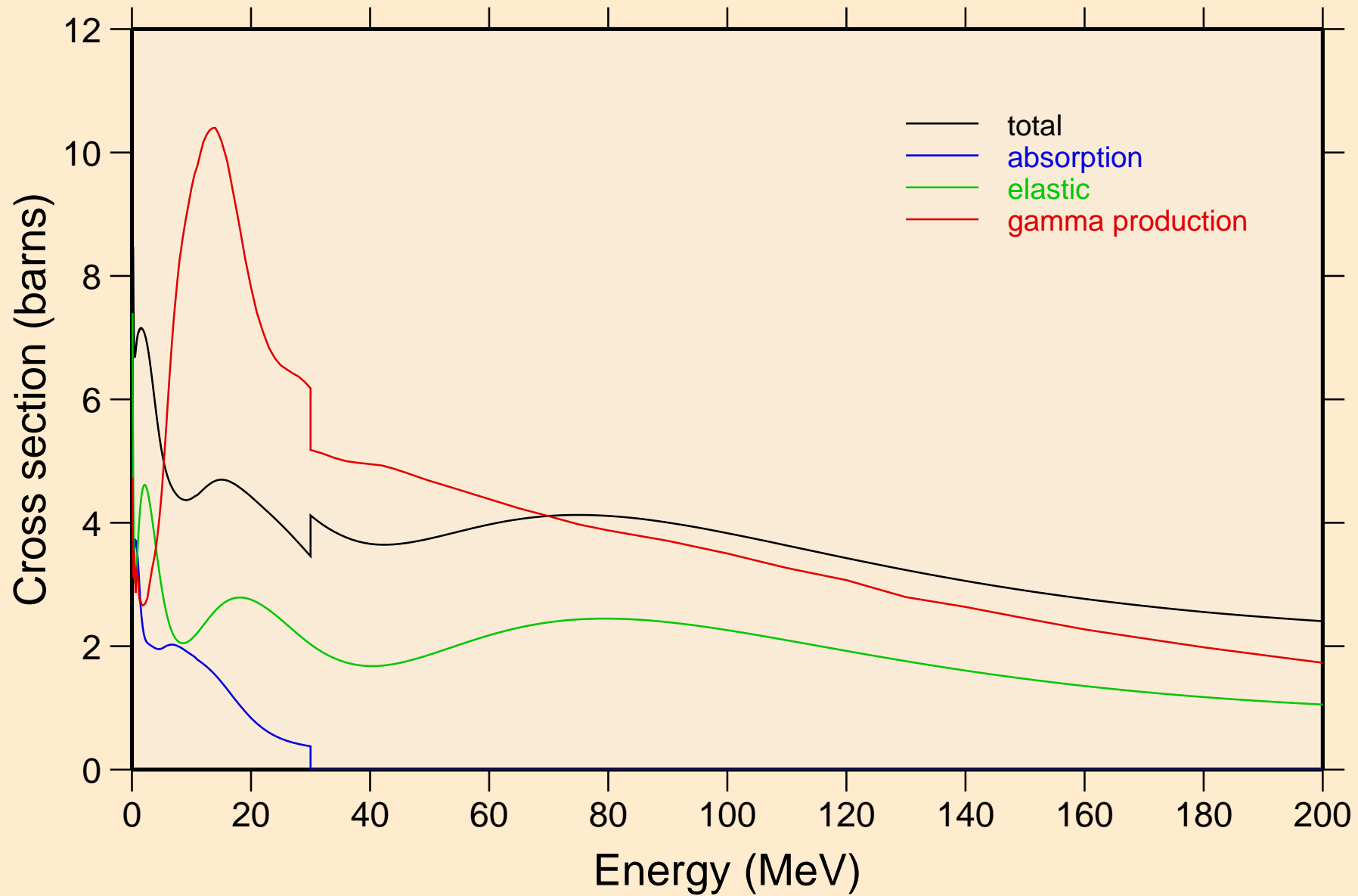

YB151 NEUTRON ACER TENDL-2024 LIBRARY; T=0.K

Heating

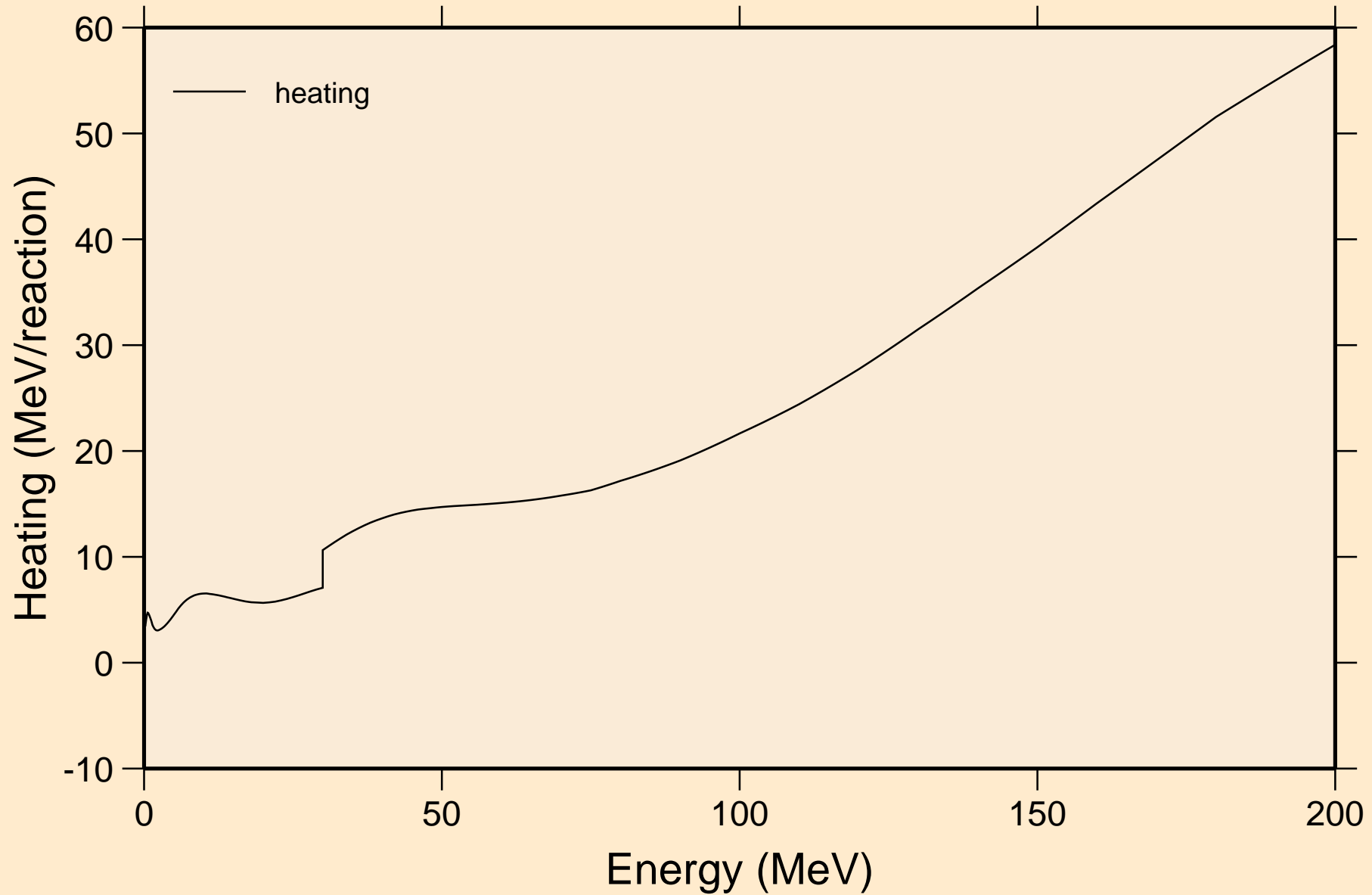

YB151 NEUTRON ACER TENDL-2024 LIBRARY; T=0.K

Damage

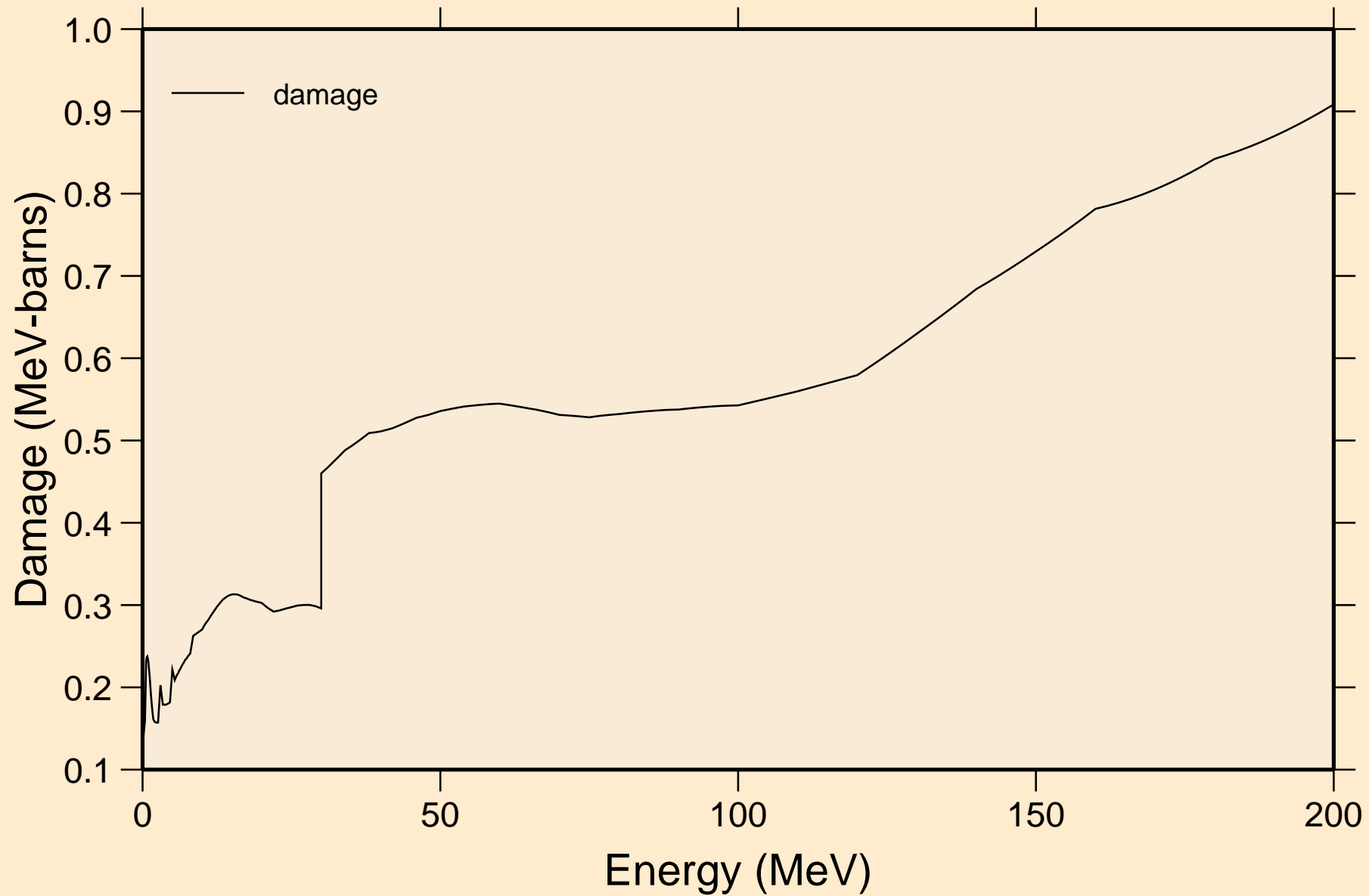

YB151 NEUTRON ACER TENDL-2024 LIBRARY; T=0.K

Non-threshold reactions

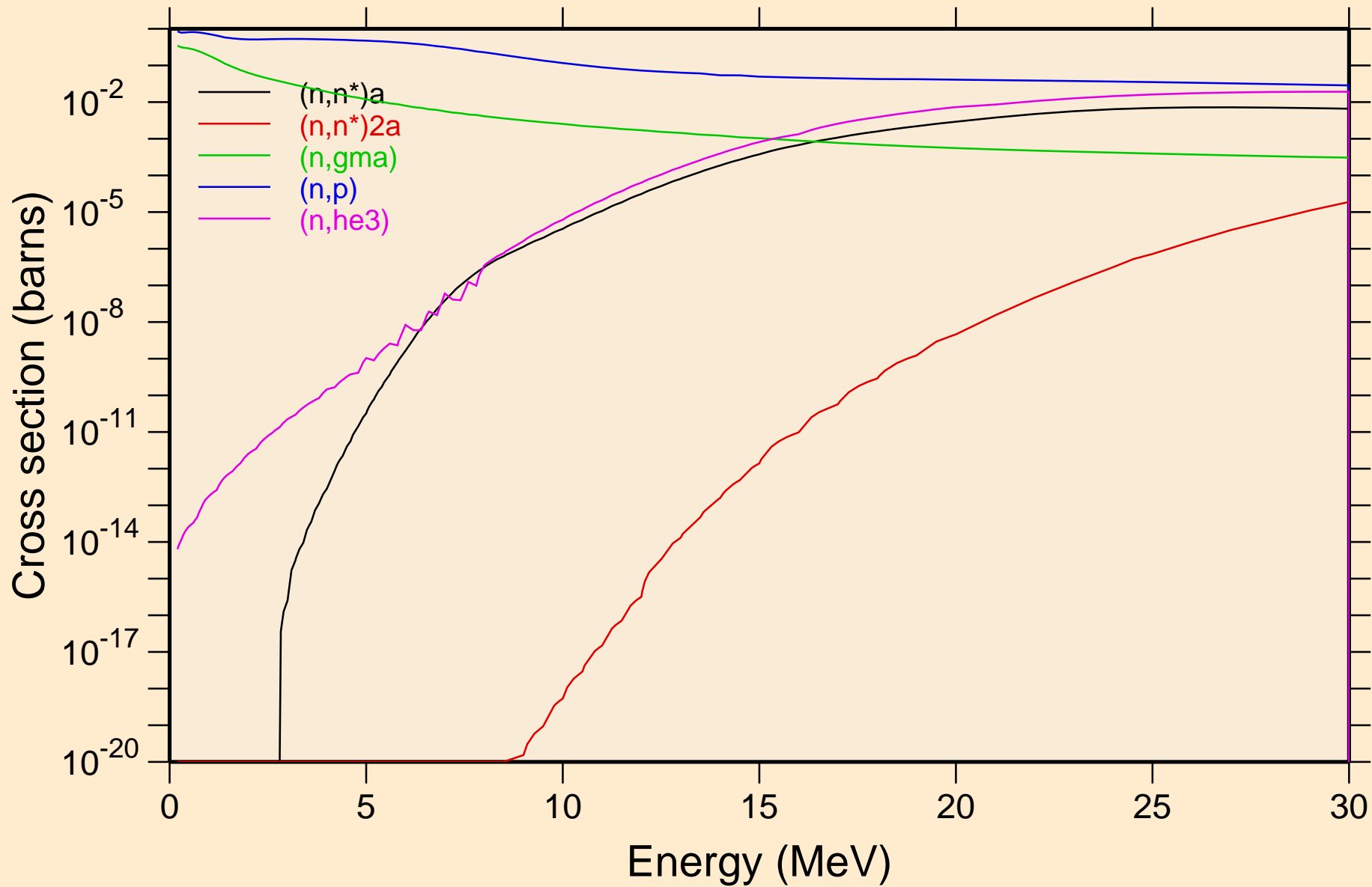

YB151 NEUTRON ACER TENDL-2024 LIBRARY; T=0.K
Non-threshold reactions

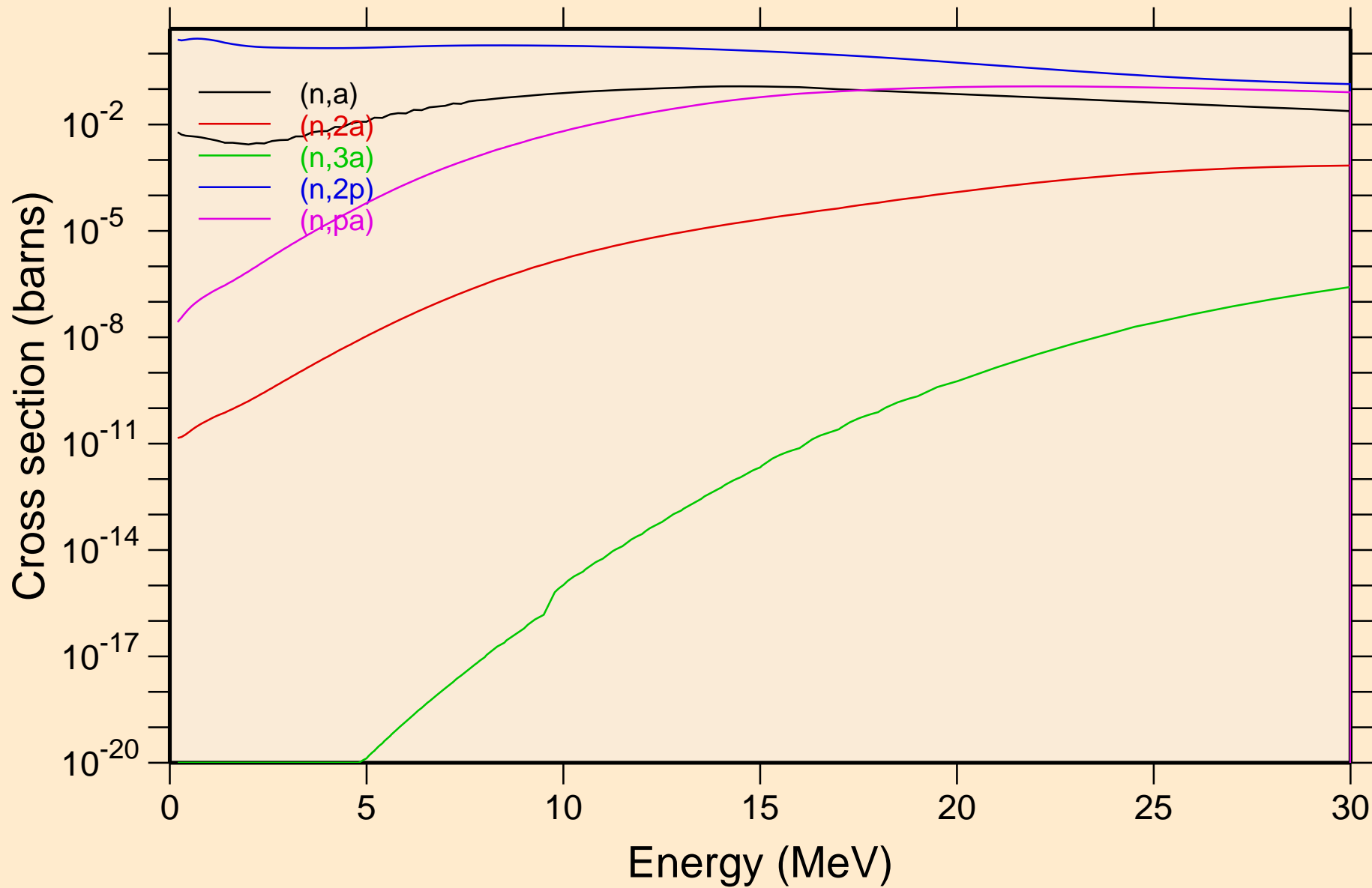

YB151 NEUTRON ACER TENDL-2024 LIBRARY; T=0.K
Non-threshold reactions

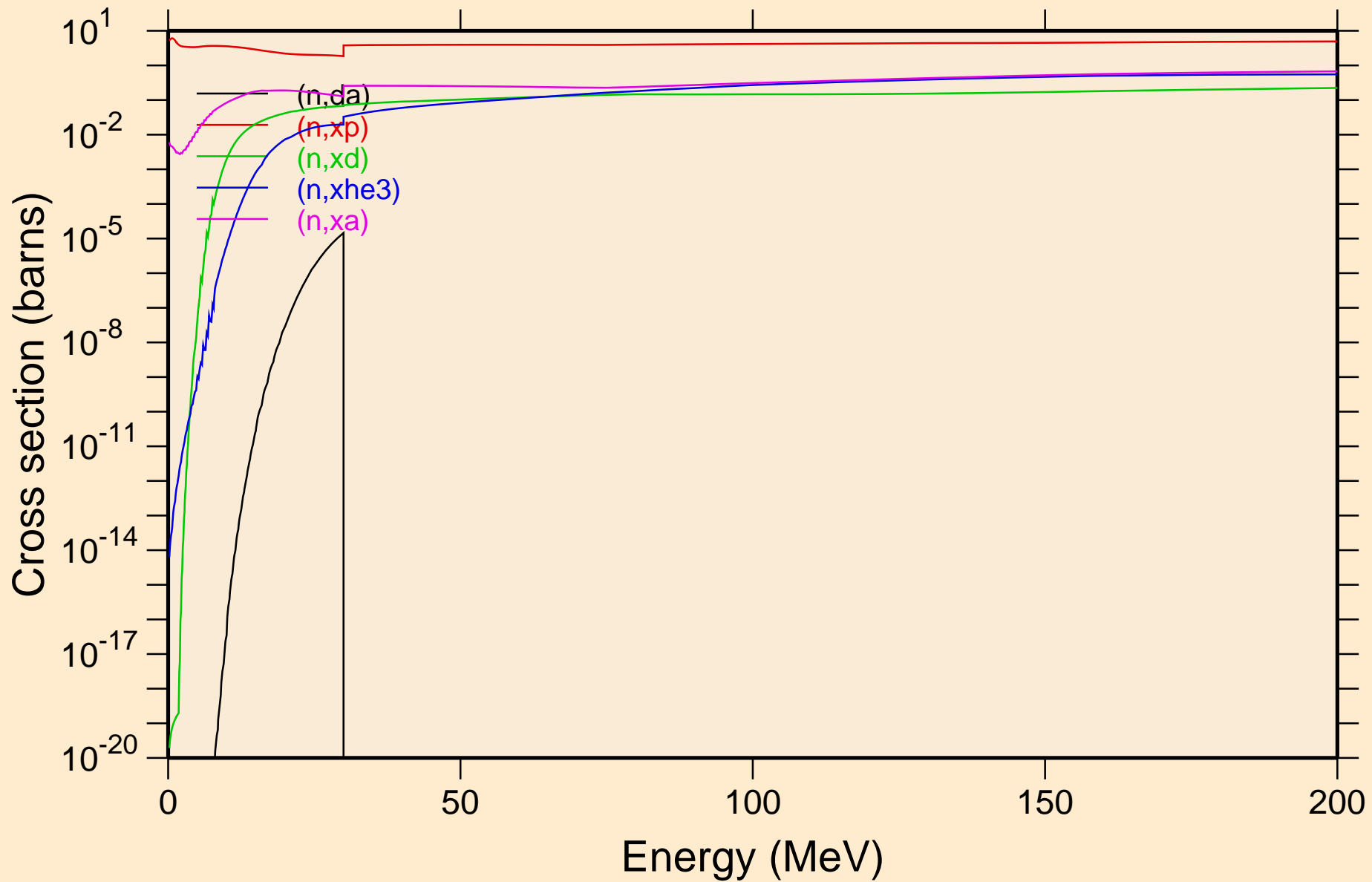

YB151 NEUTRON ACER TENDL-2024 LIBRARY; T=0.K
Inelastic levels

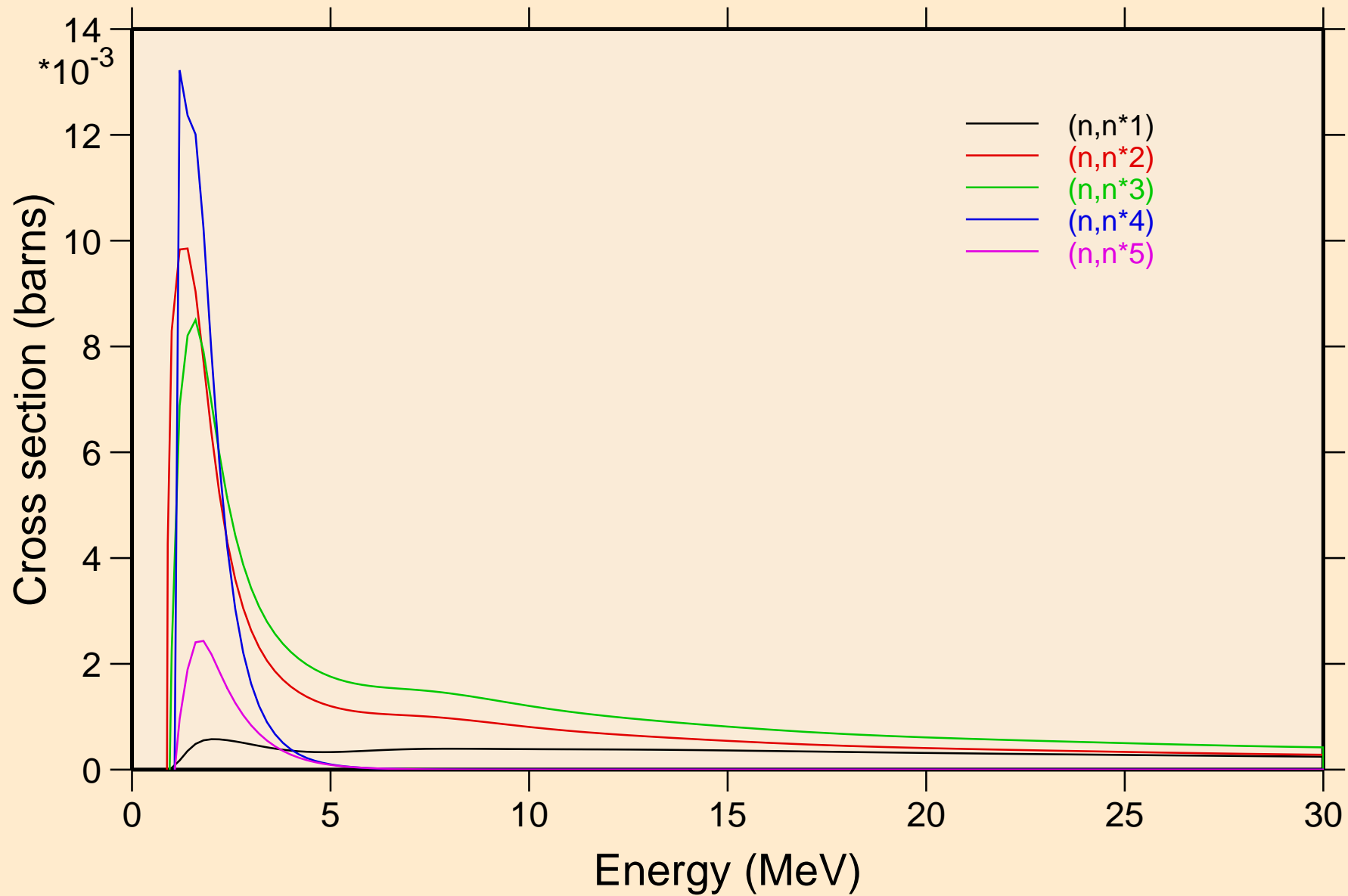

YB151 NEUTRON ACER TENDL-2024 LIBRARY; T=0.K

Inelastic levels

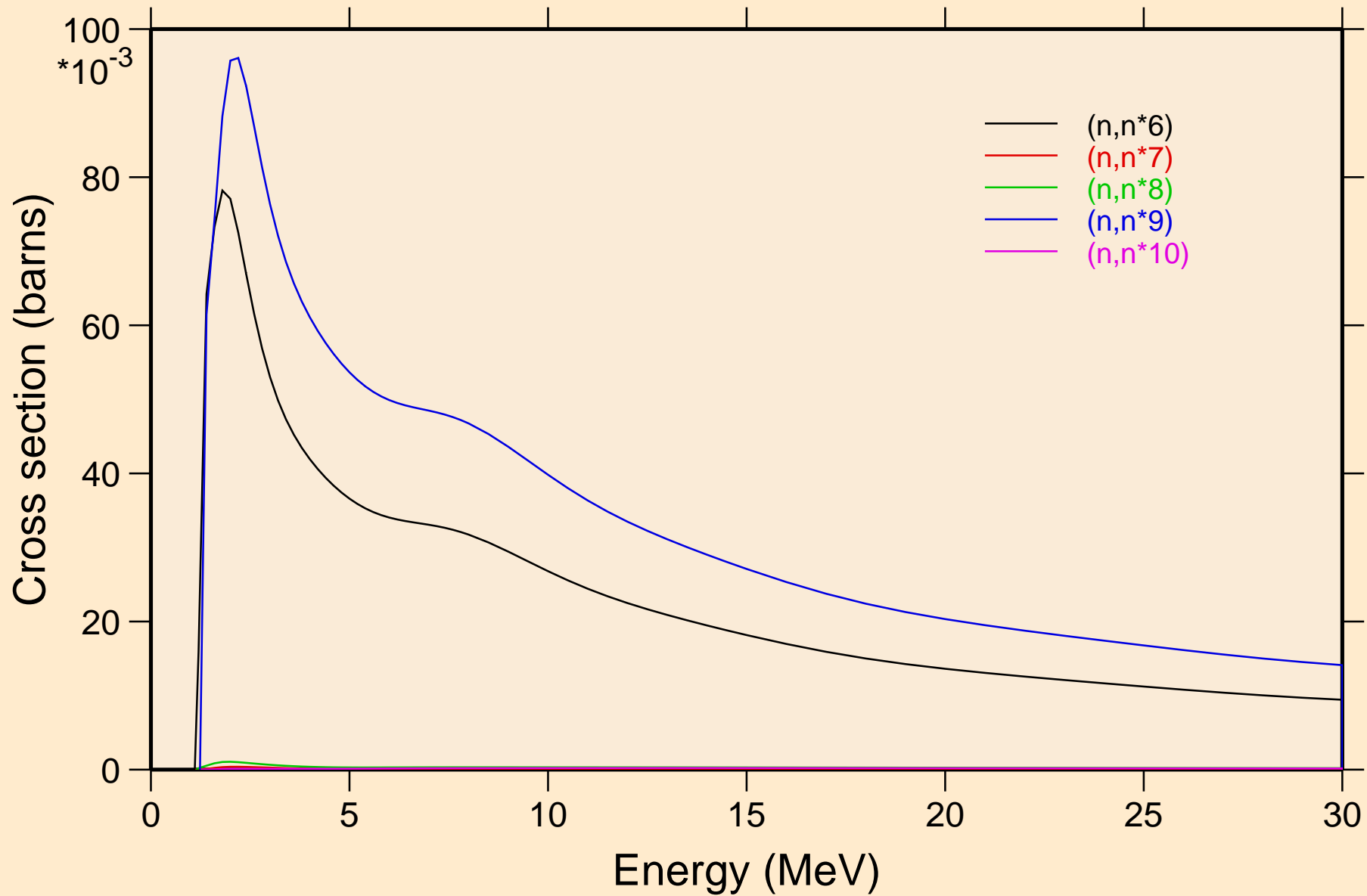

YB151 NEUTRON ACER TENDL-2024 LIBRARY; T=0.K
Inelastic levels

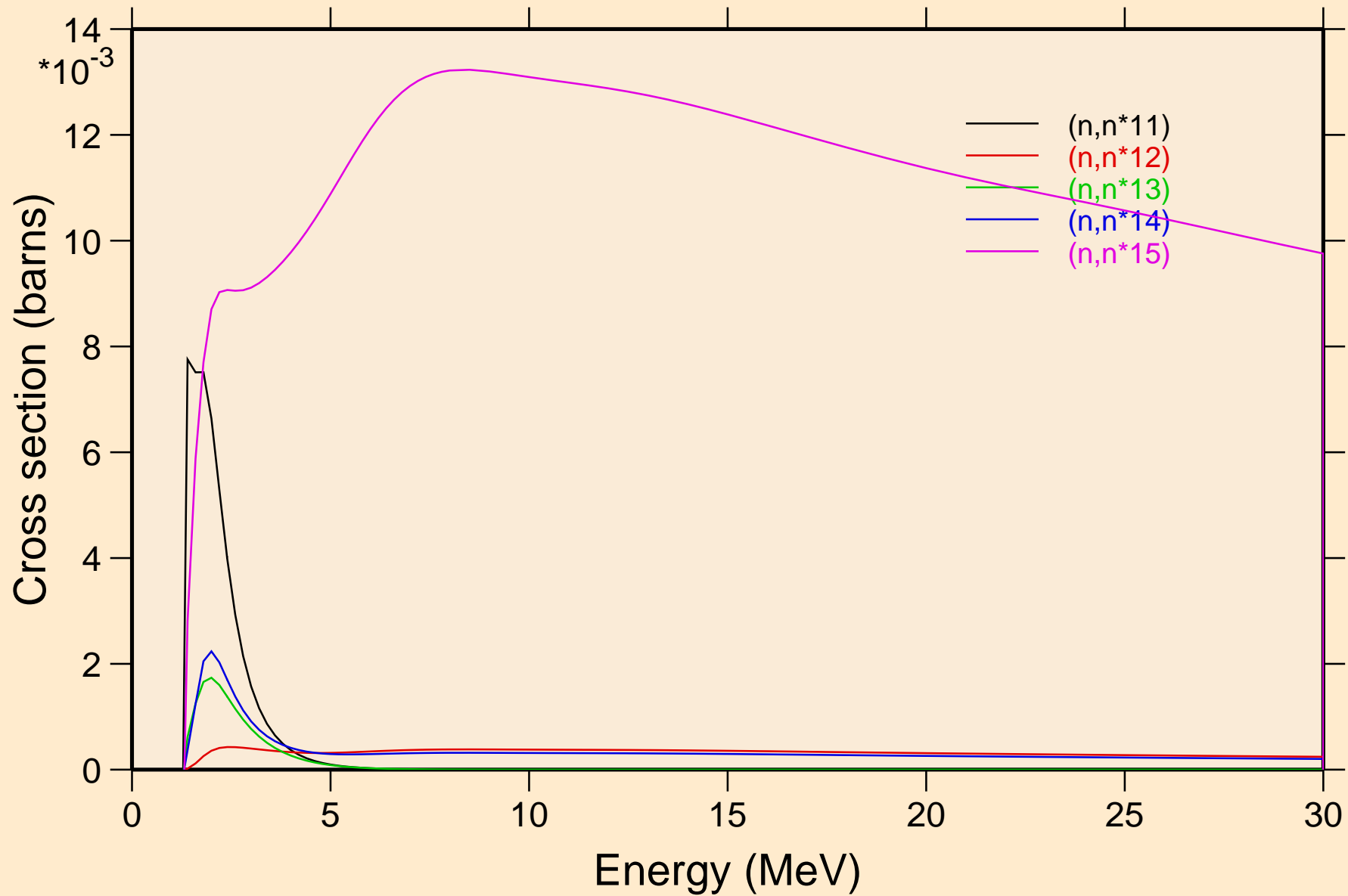

YB151 NEUTRON ACER TENDL-2024 LIBRARY; T=0.K
Threshold reactions

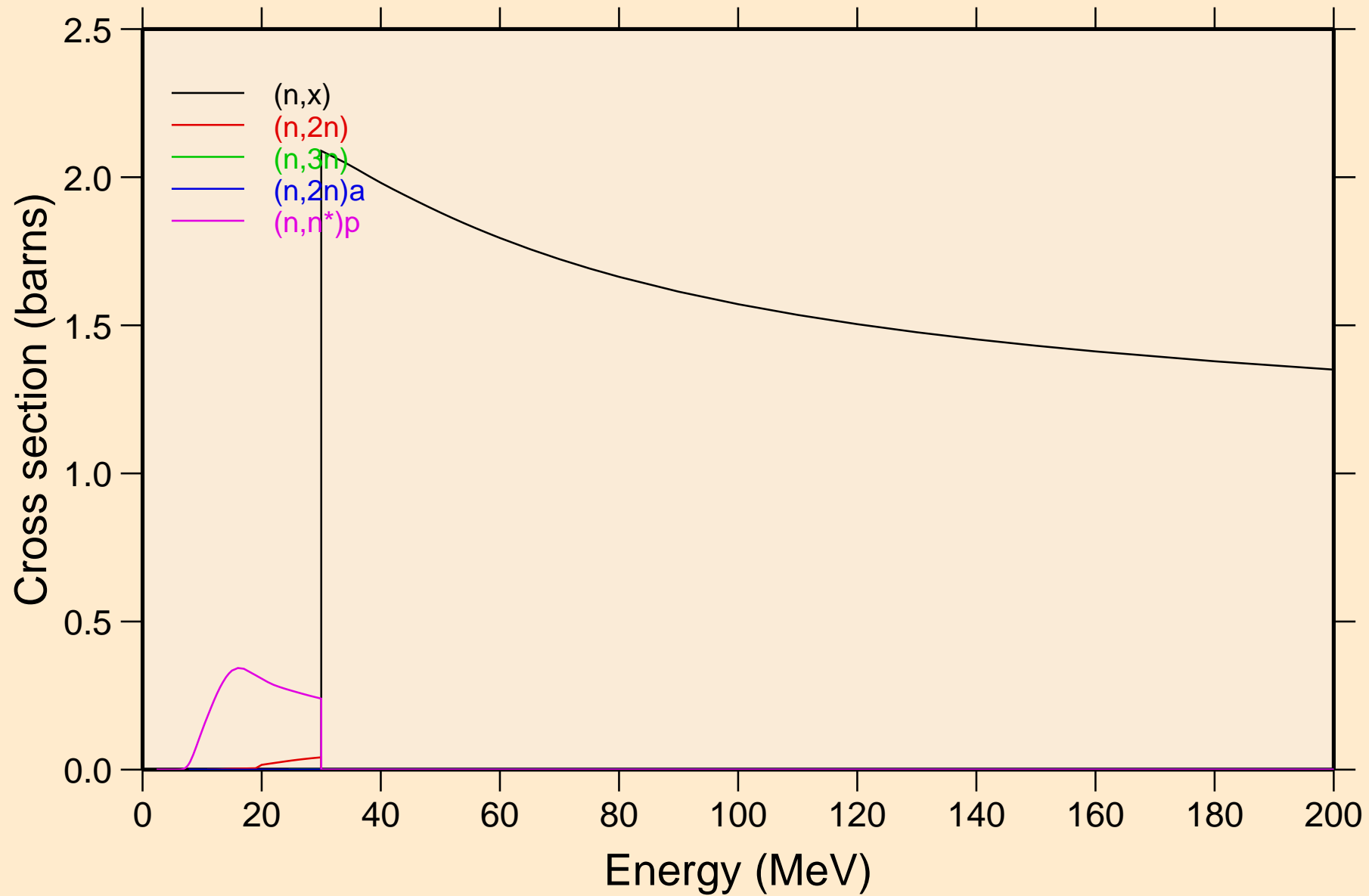

YB151 NEUTRON ACER TENDL-2024 LIBRARY; T=0.K
Threshold reactions

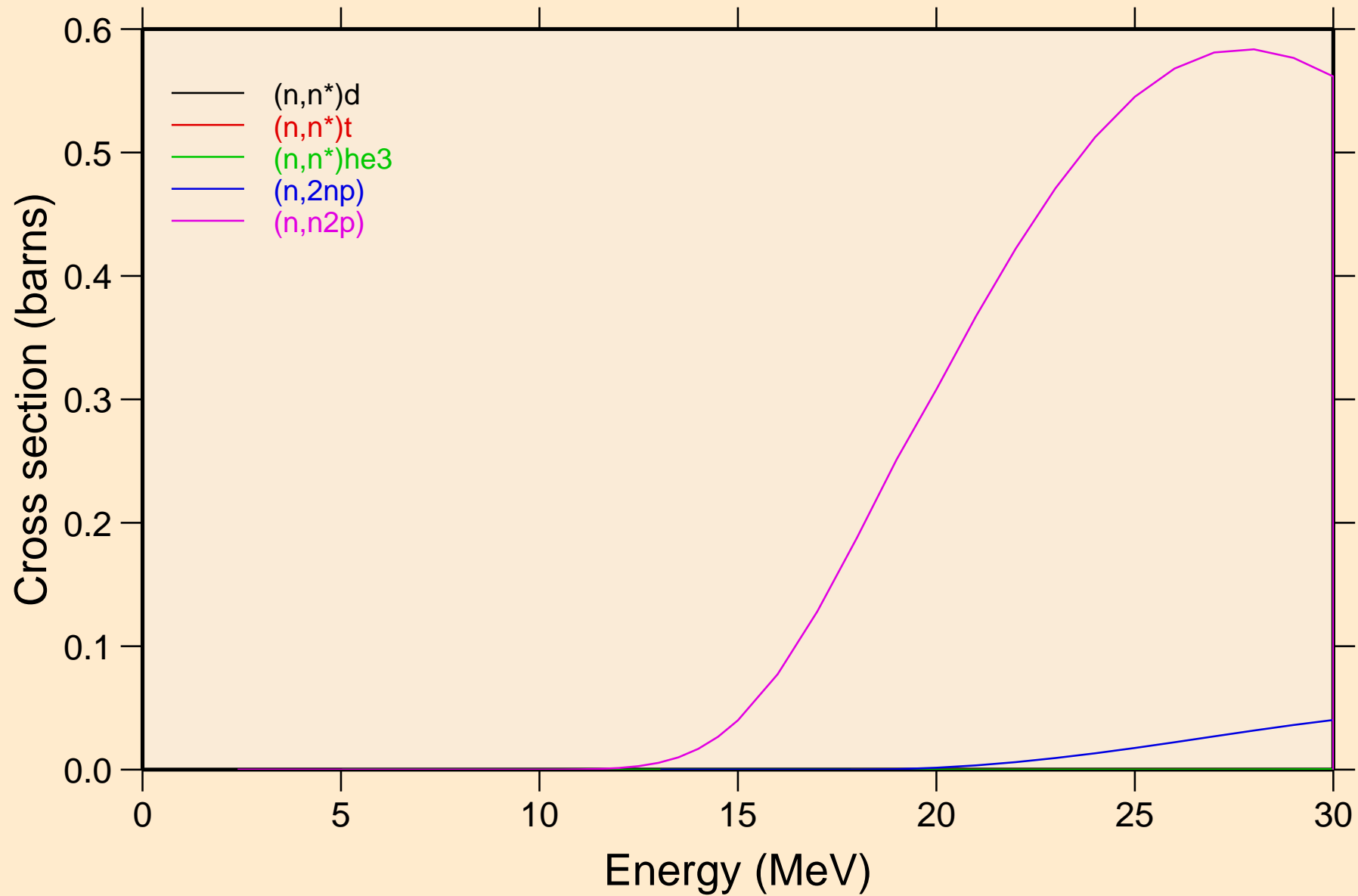

YB151 NEUTRON ACER TENDL-2024 LIBRARY; T=0.K

Threshold reactions

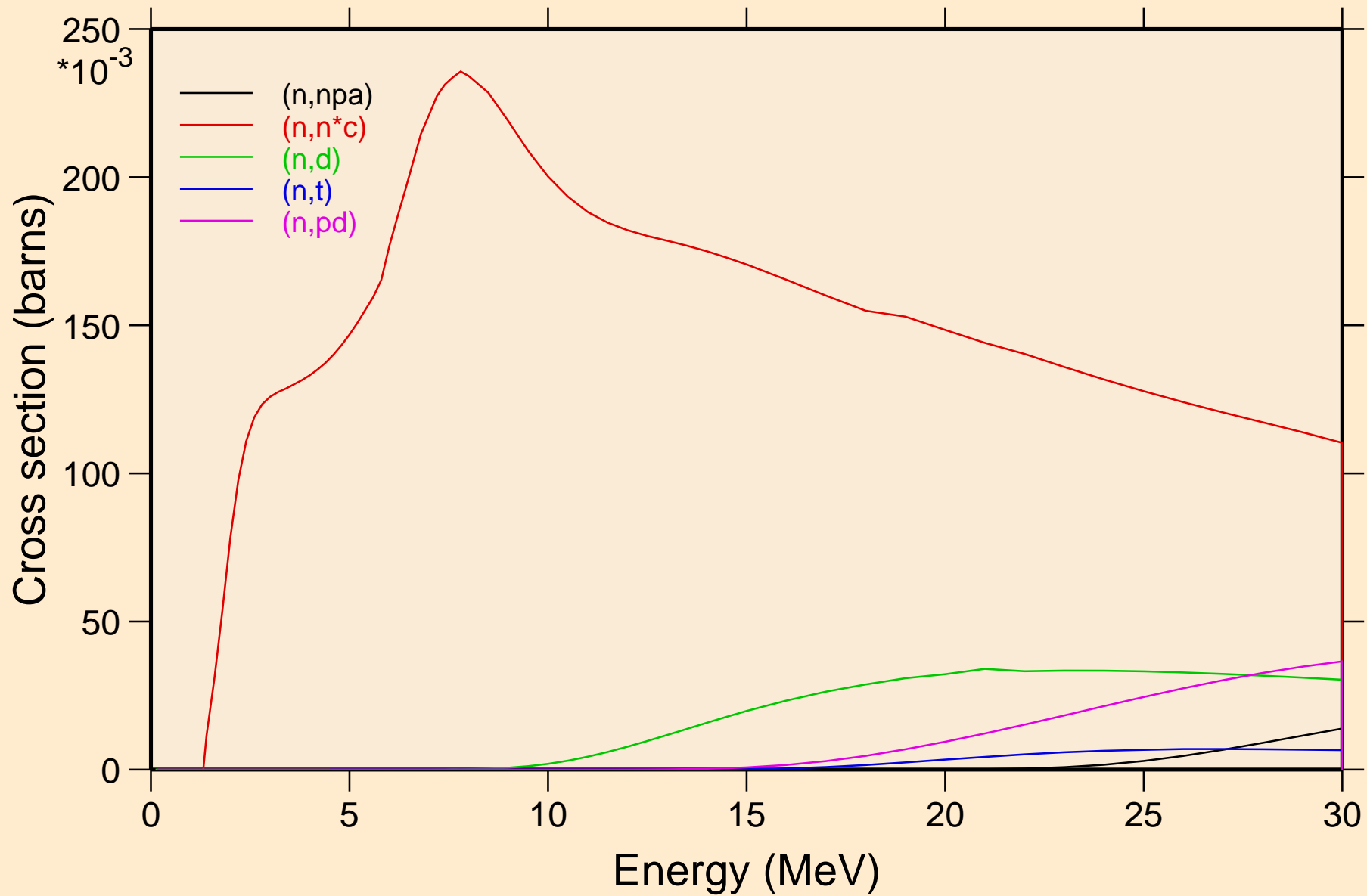

YB151 NEUTRON ACER TENDL-2024 LIBRARY; T=0.K
Threshold reactions

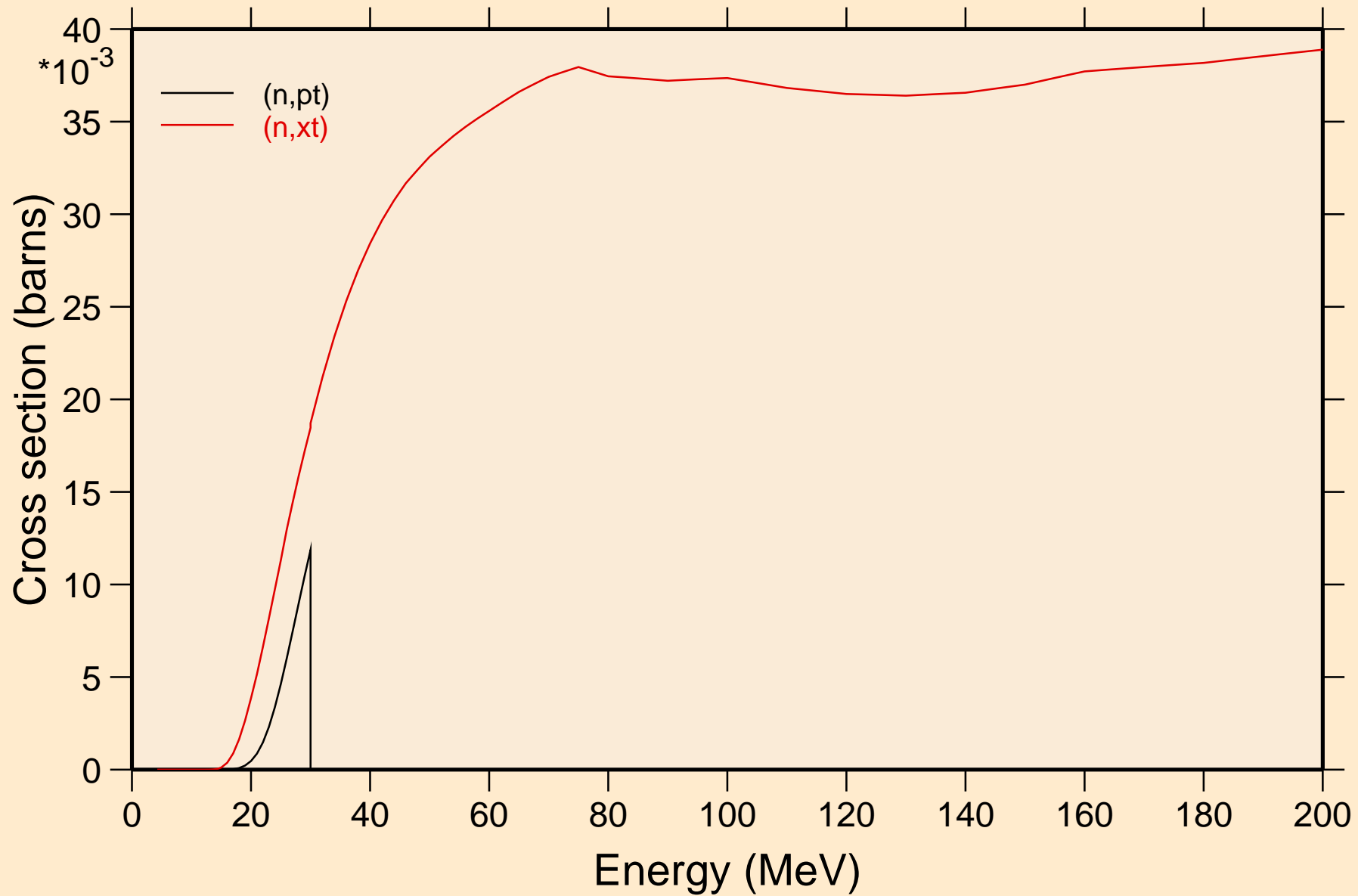

YB151 NEUTRON ACER TENDL-2024 LIBRARY; T=0.K
angular distribution for elastic

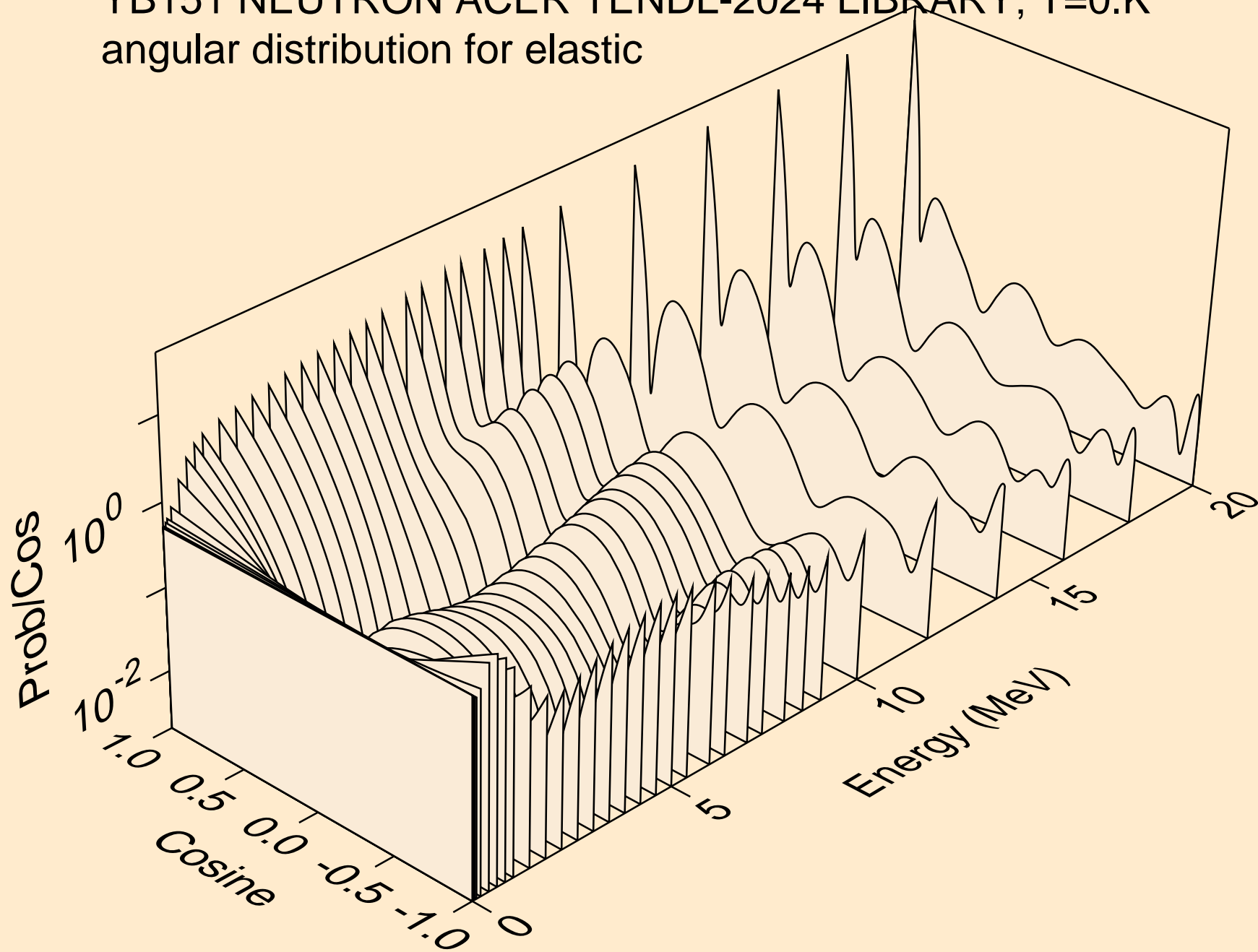

YB151 NEUTRON ACER TENDL-2024 LIBRARY; T=0.K
angular distribution for elastic

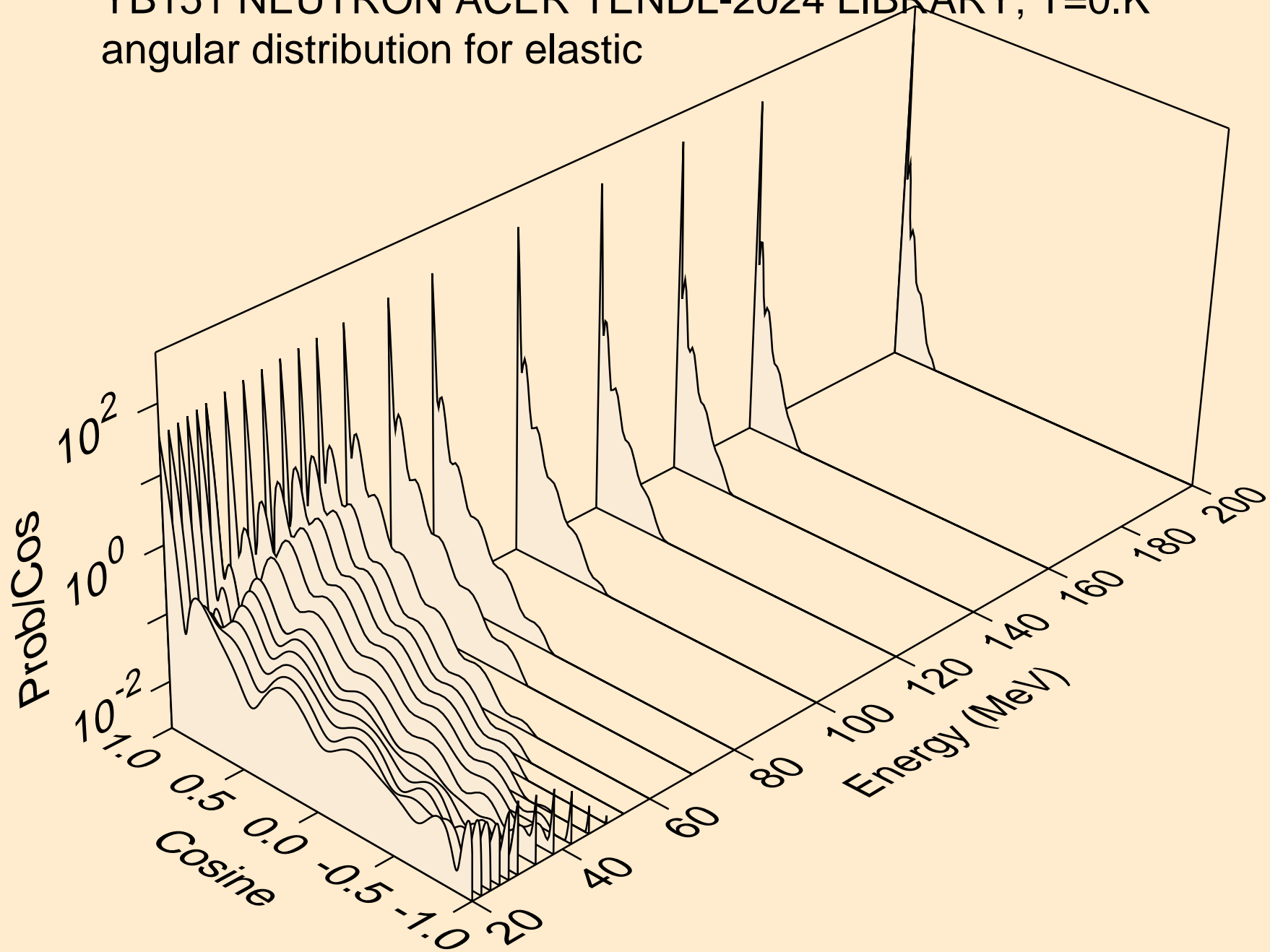

YB151 NEUTRON ACER TENDL-2024 LIBRARY; T=0.K
angular distribution for (n,n*1)

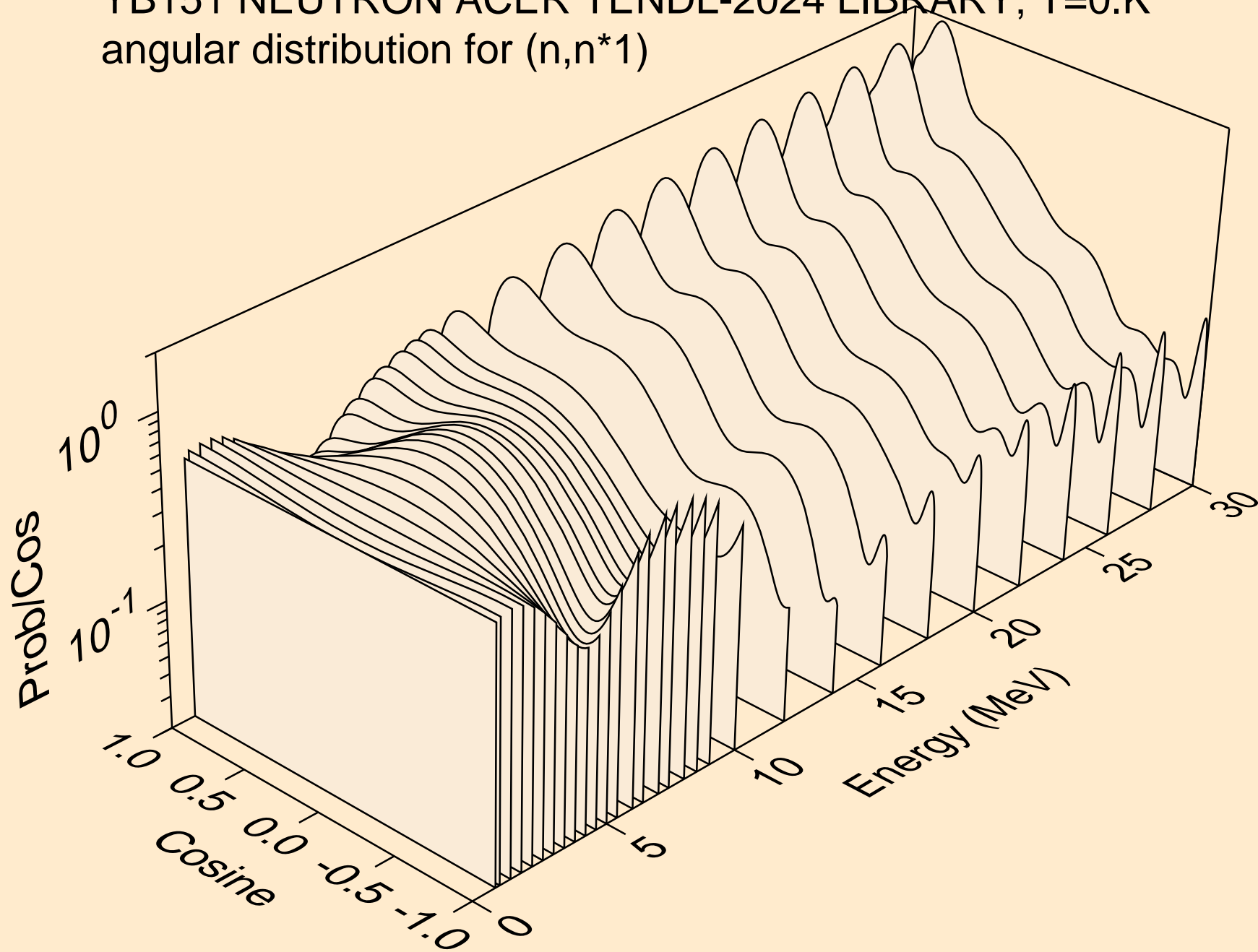

YB151 NEUTRON ACER TENDL-2024 LIBRARY; T=0.K
angular distribution for (n,n*2)

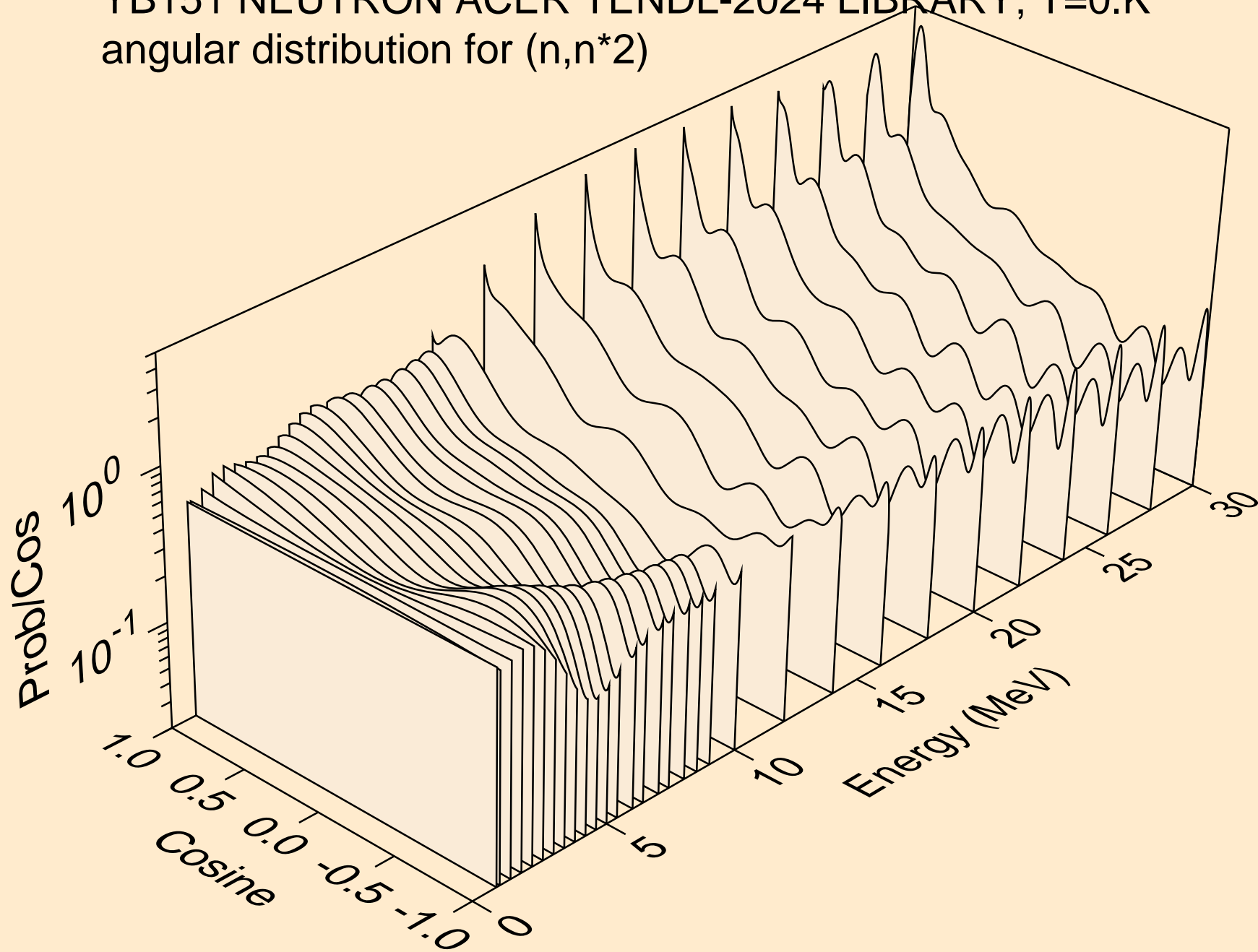

YB151 NEUTRON ACER TENDL-2024 LIBRARY; T=0.K
angular distribution for (n,n*3)

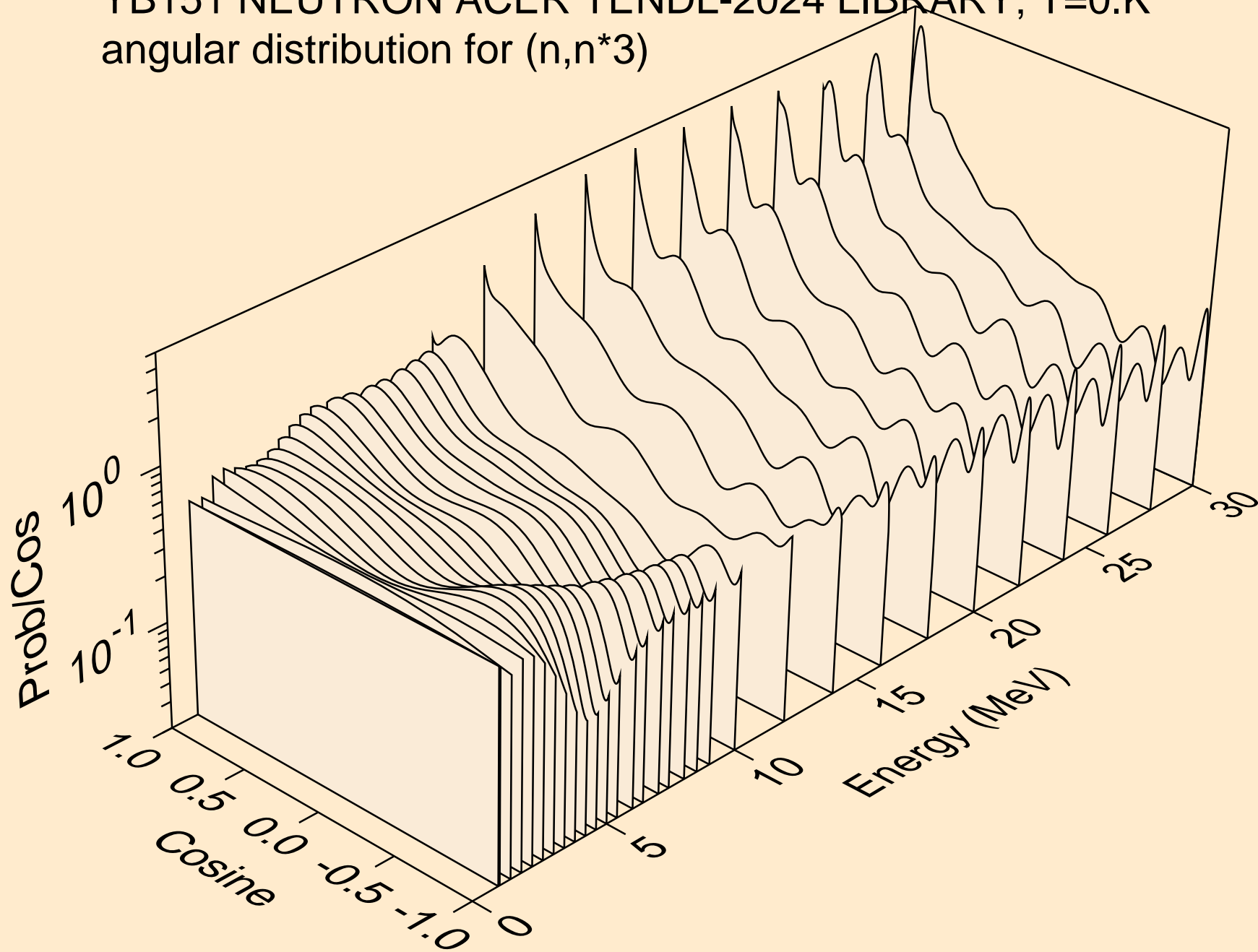

YB151 NEUTRON ACER TENDL-2024 LIBRARY; T=0.K
angular distribution for (n,n*4)

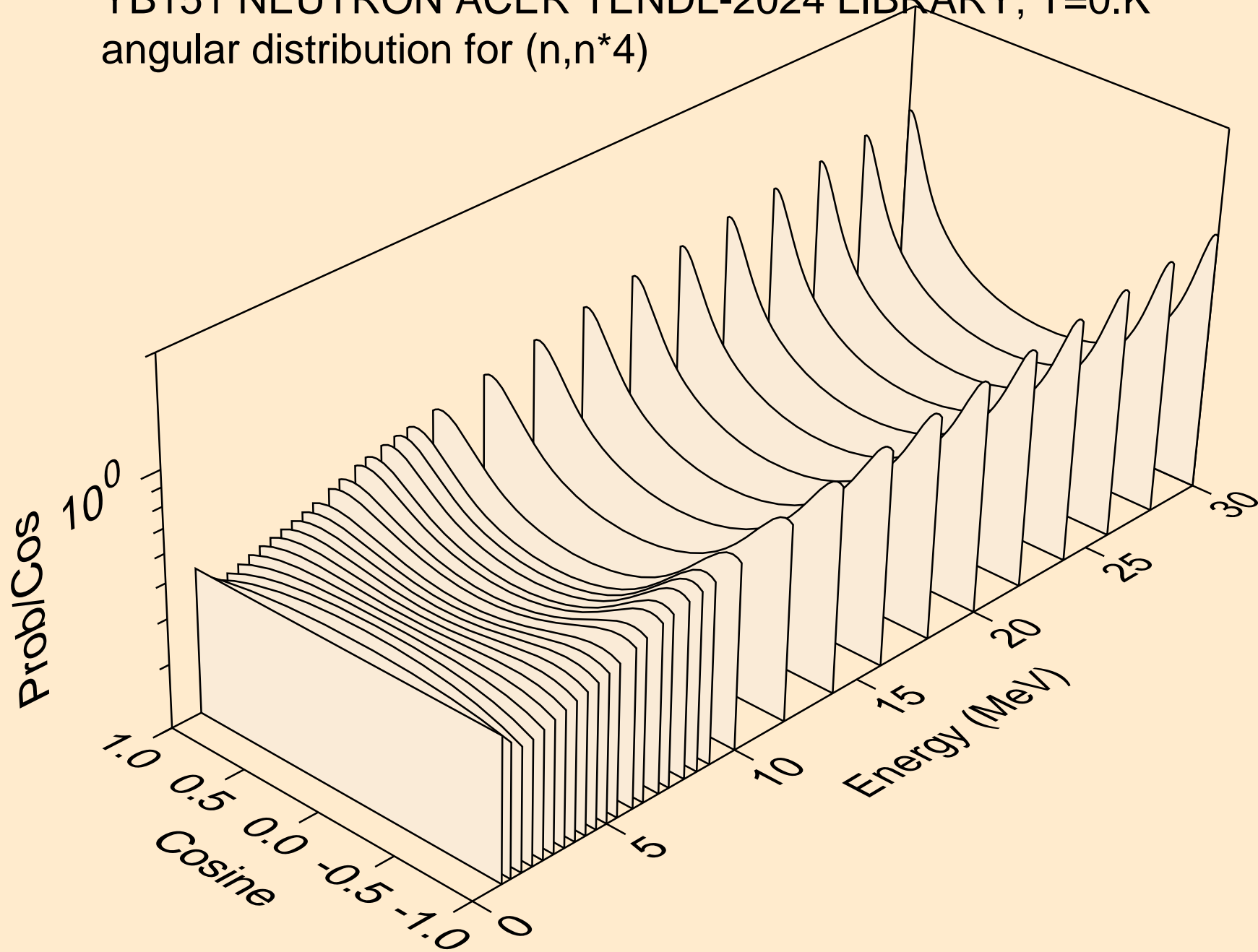

YB151 NEUTRON ACER TENDL-2024 LIBRARY; T=0.K
angular distribution for (n,n*5)

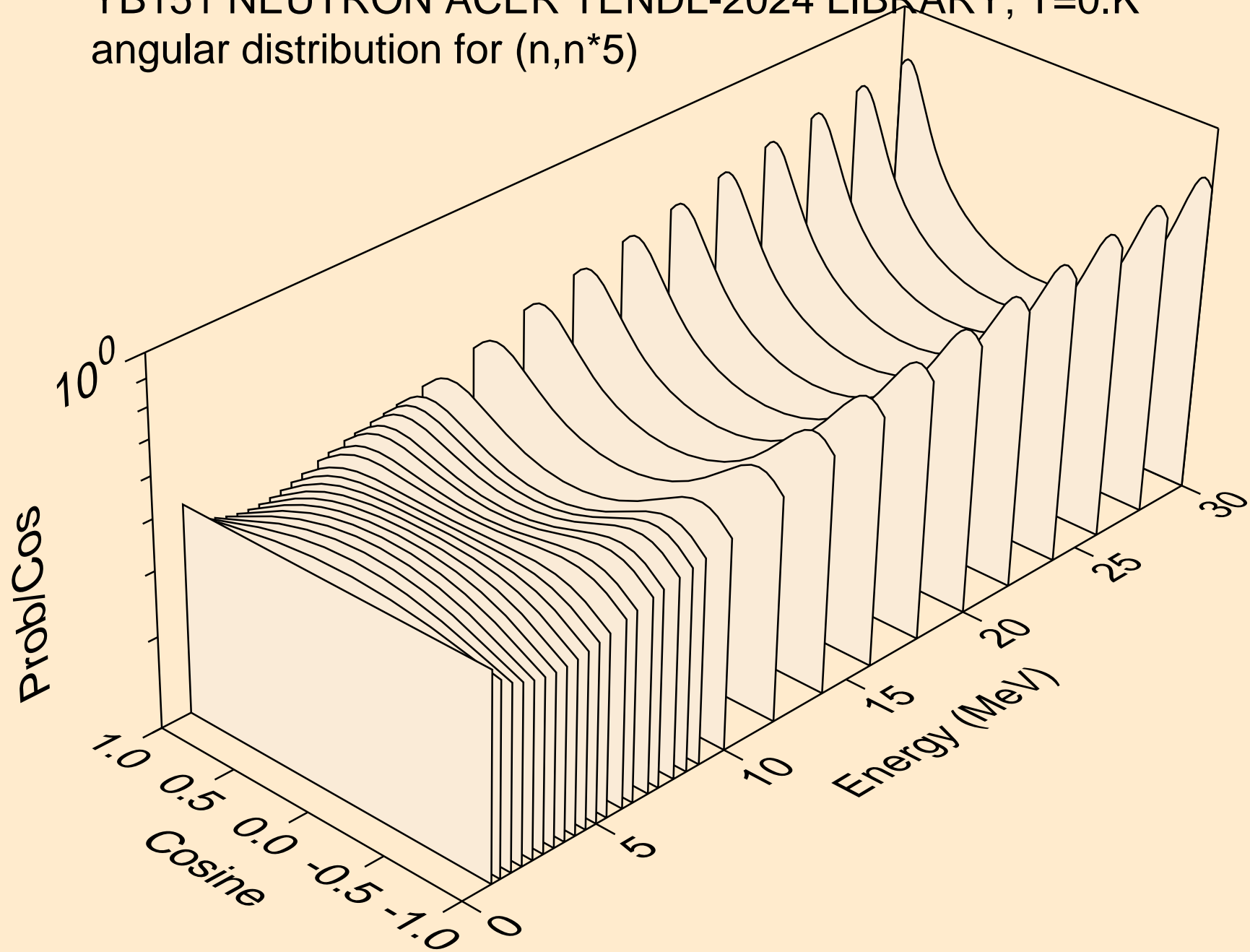

YB151 NEUTRON ACER TENDL-2024 LIBRARY; T=0.K
angular distribution for (n,n*6)

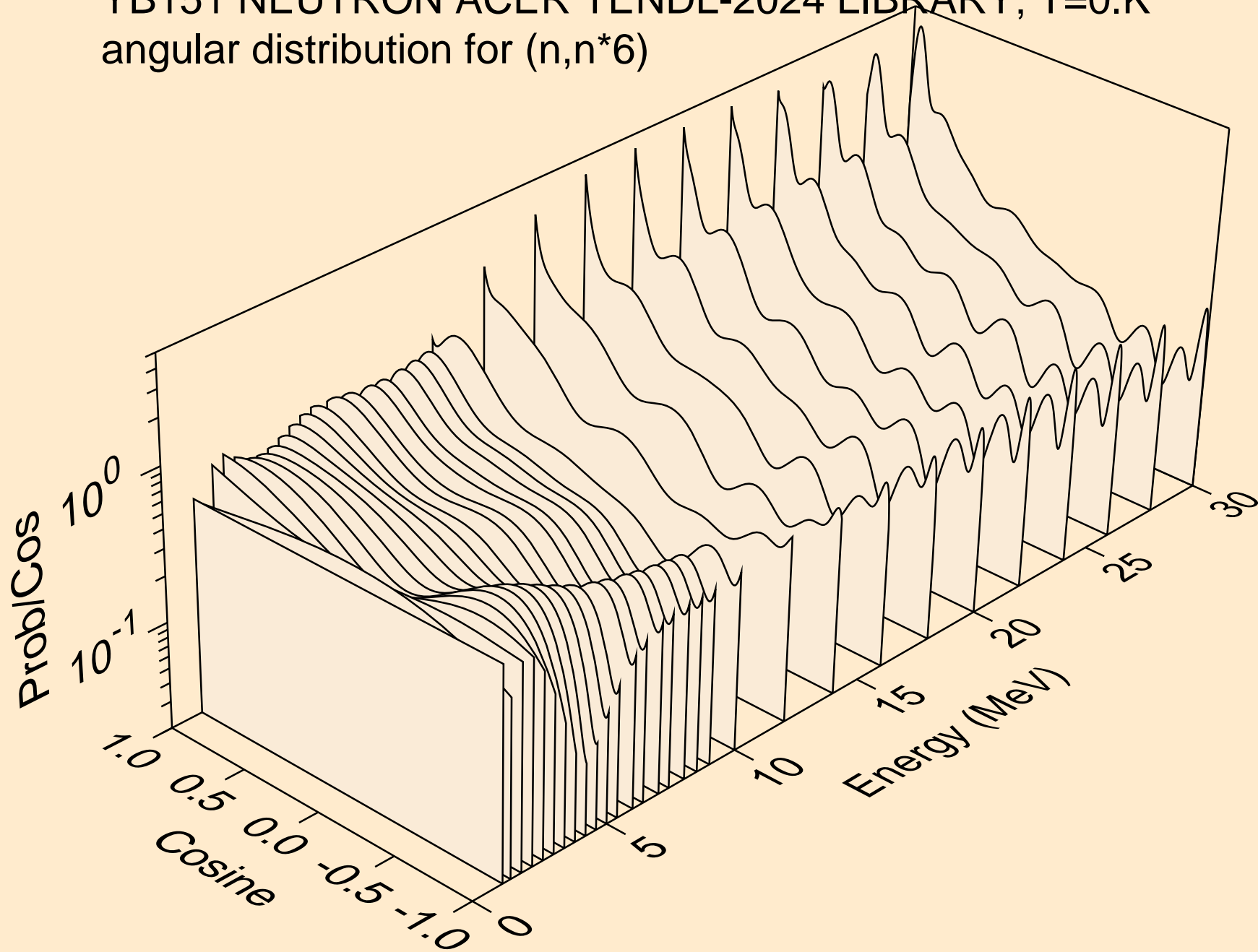

YB151 NEUTRON ACER TENDL-2024 LIBRARY; T=0.K
angular distribution for (n,n*7)

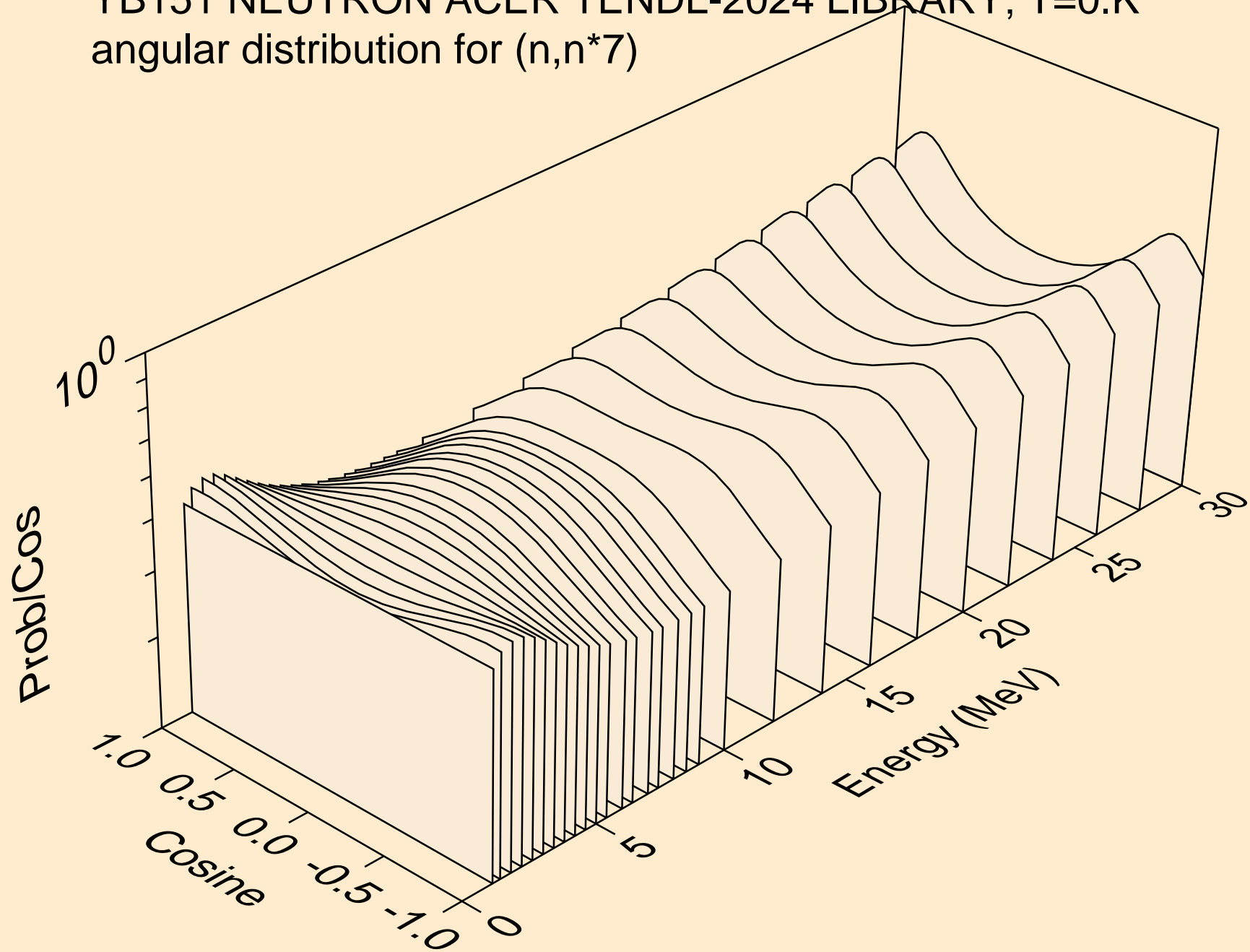

YB151 NEUTRON ACER TENDL-2024 LIBRARY; T=0.K
angular distribution for (n,n*8)

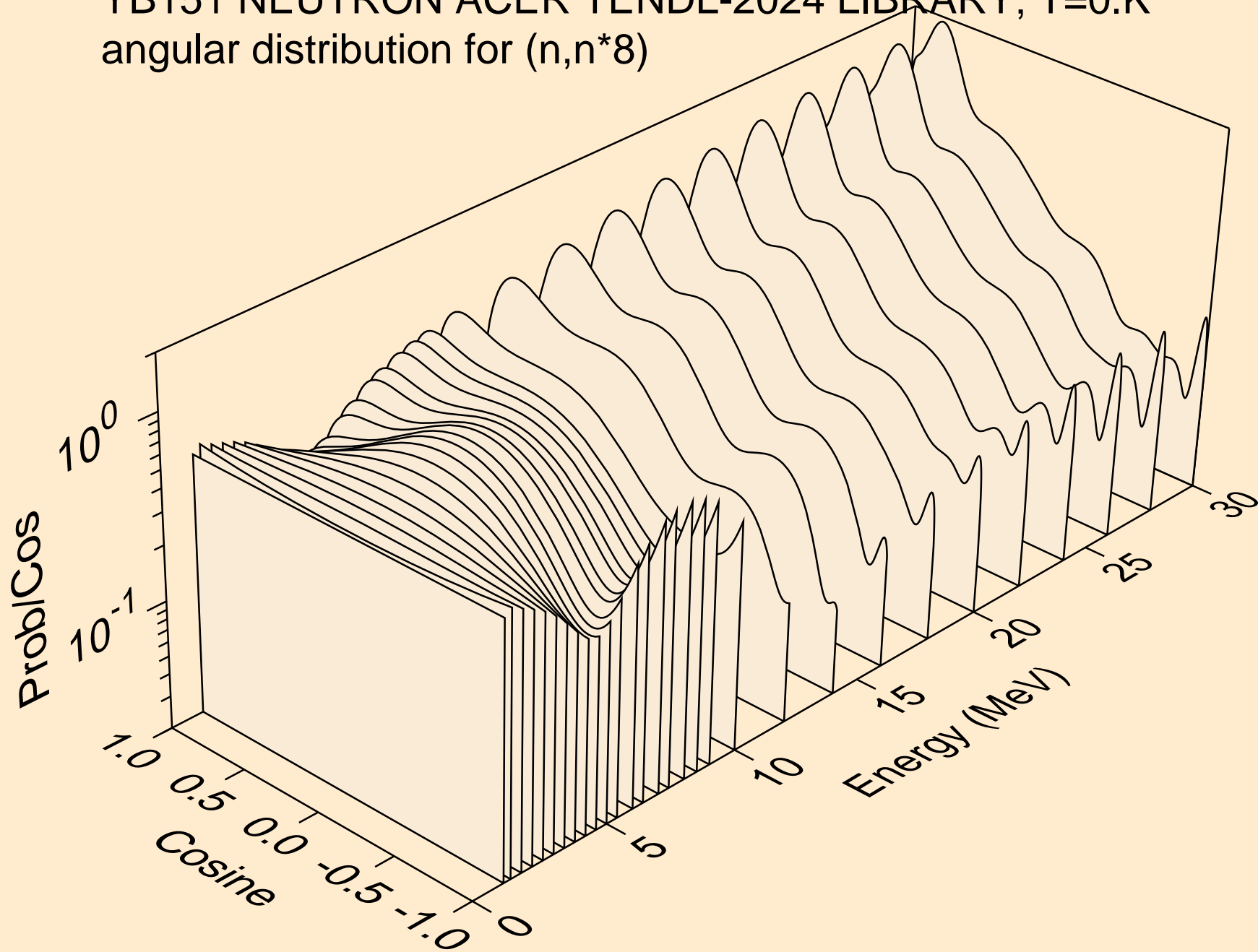

YB151 NEUTRON ACER TENDL-2024 LIBRARY; T=0.K
angular distribution for (n,n*9)

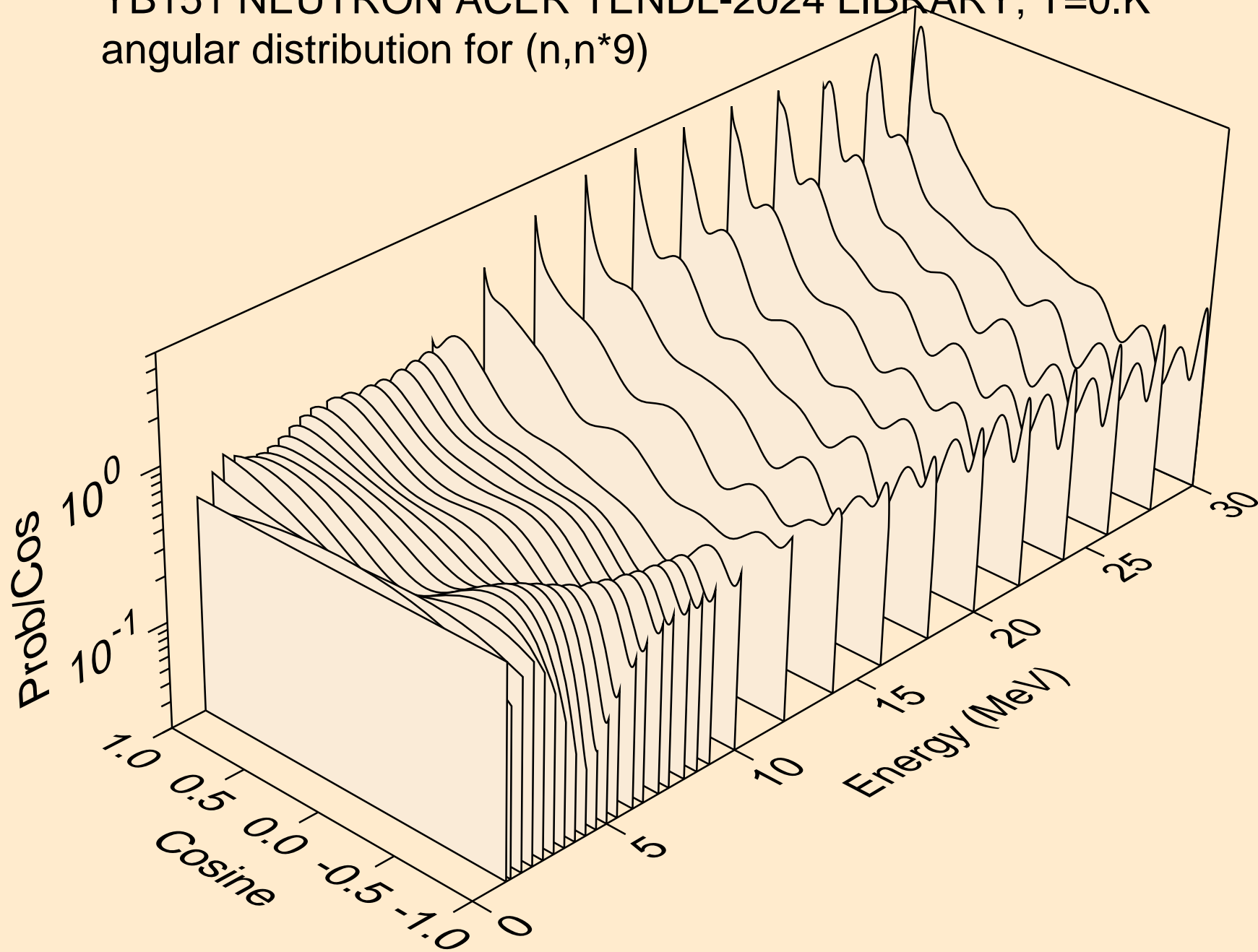

YB151 NEUTRON ACER TENDL-2024 LIBRARY; T=0.K
angular distribution for (n,n*10)

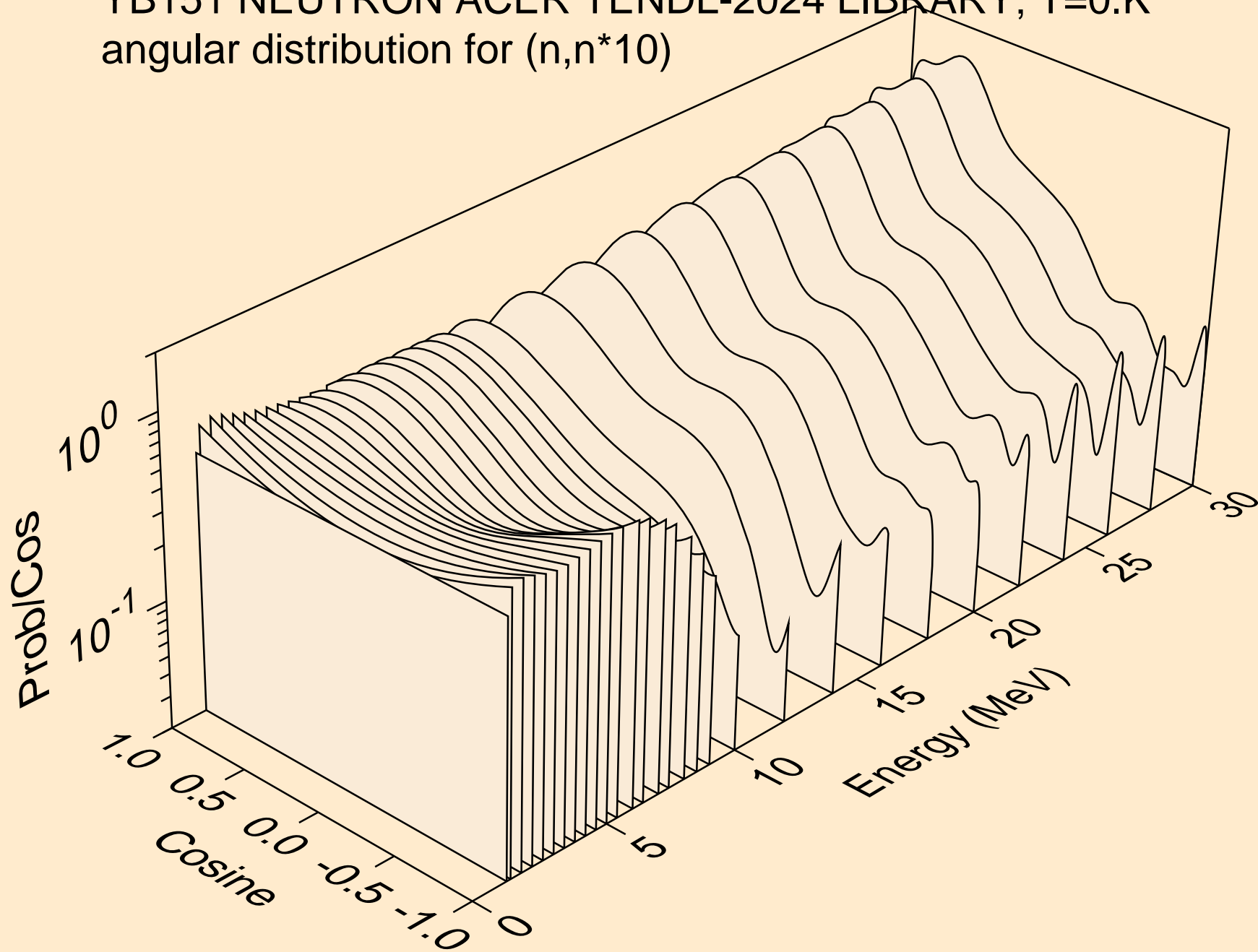

YB151 NEUTRON ACER TENDL-2024 LIBRARY; T=0.K
angular distribution for (n,n*11)

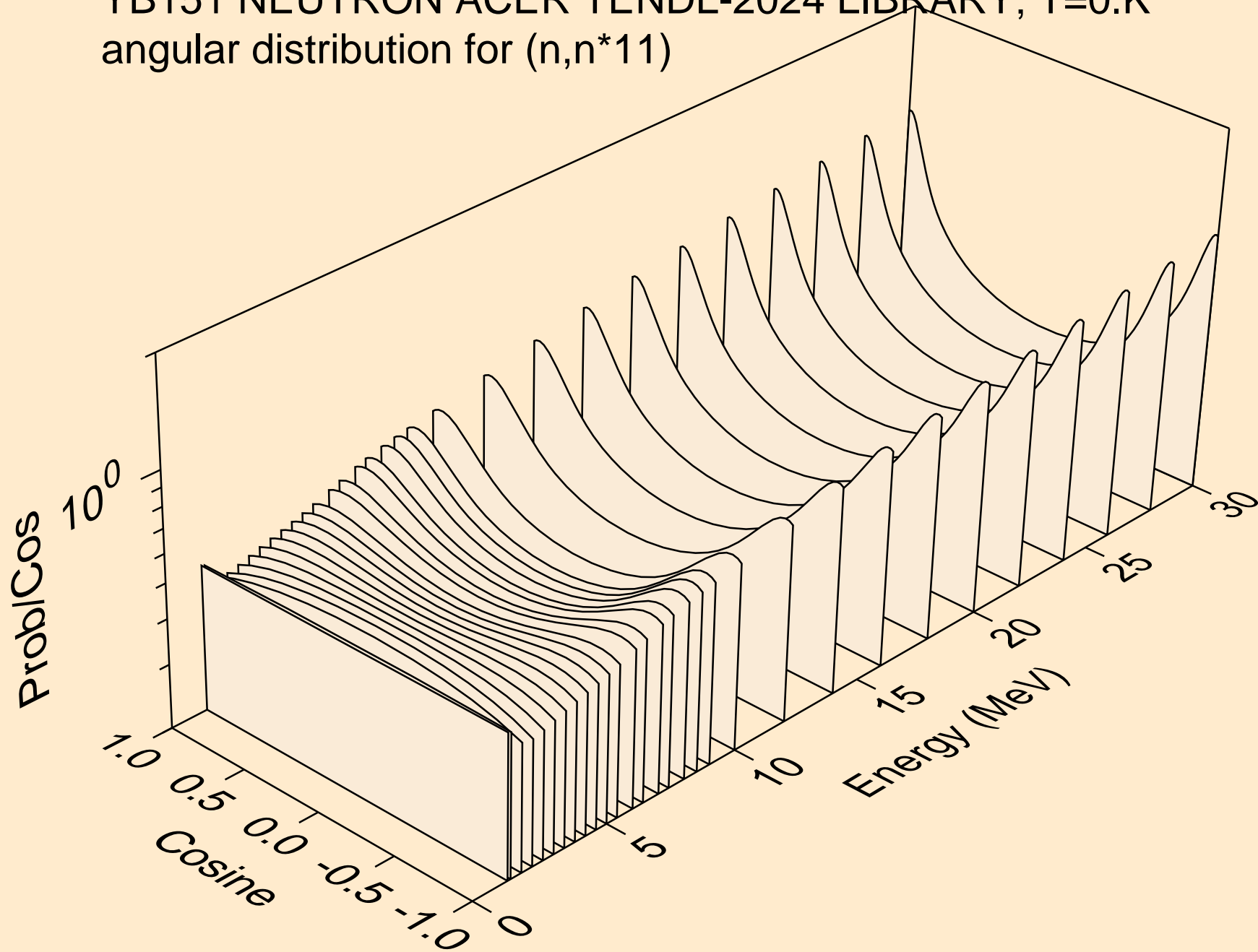

YB151 NEUTRON ACER TENDL-2024 LIBRARY; T=0.K
angular distribution for (n,n*12)

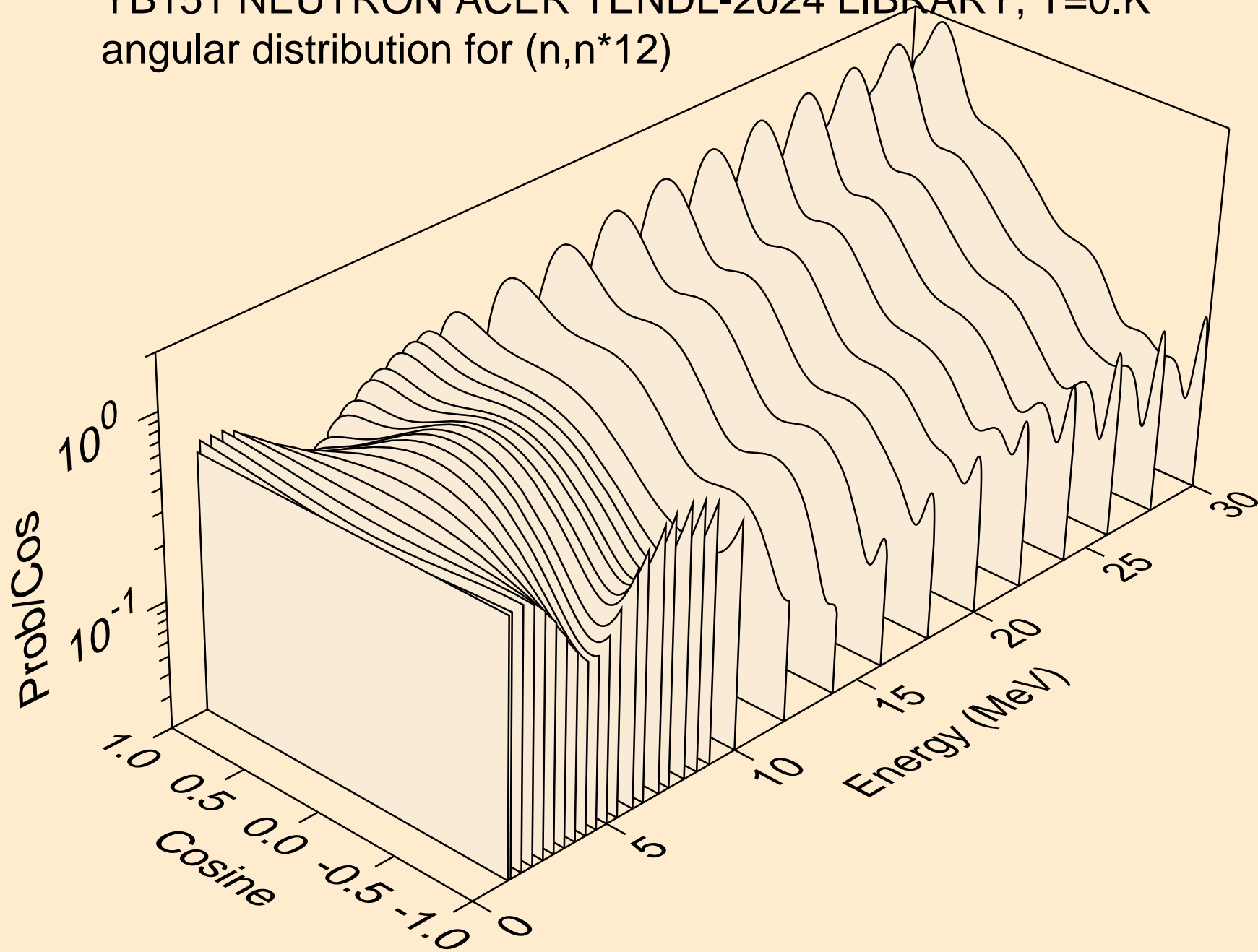

YB151 NEUTRON ACER TENDL-2024 LIBRARY; T=0.K
angular distribution for (n,n*13)

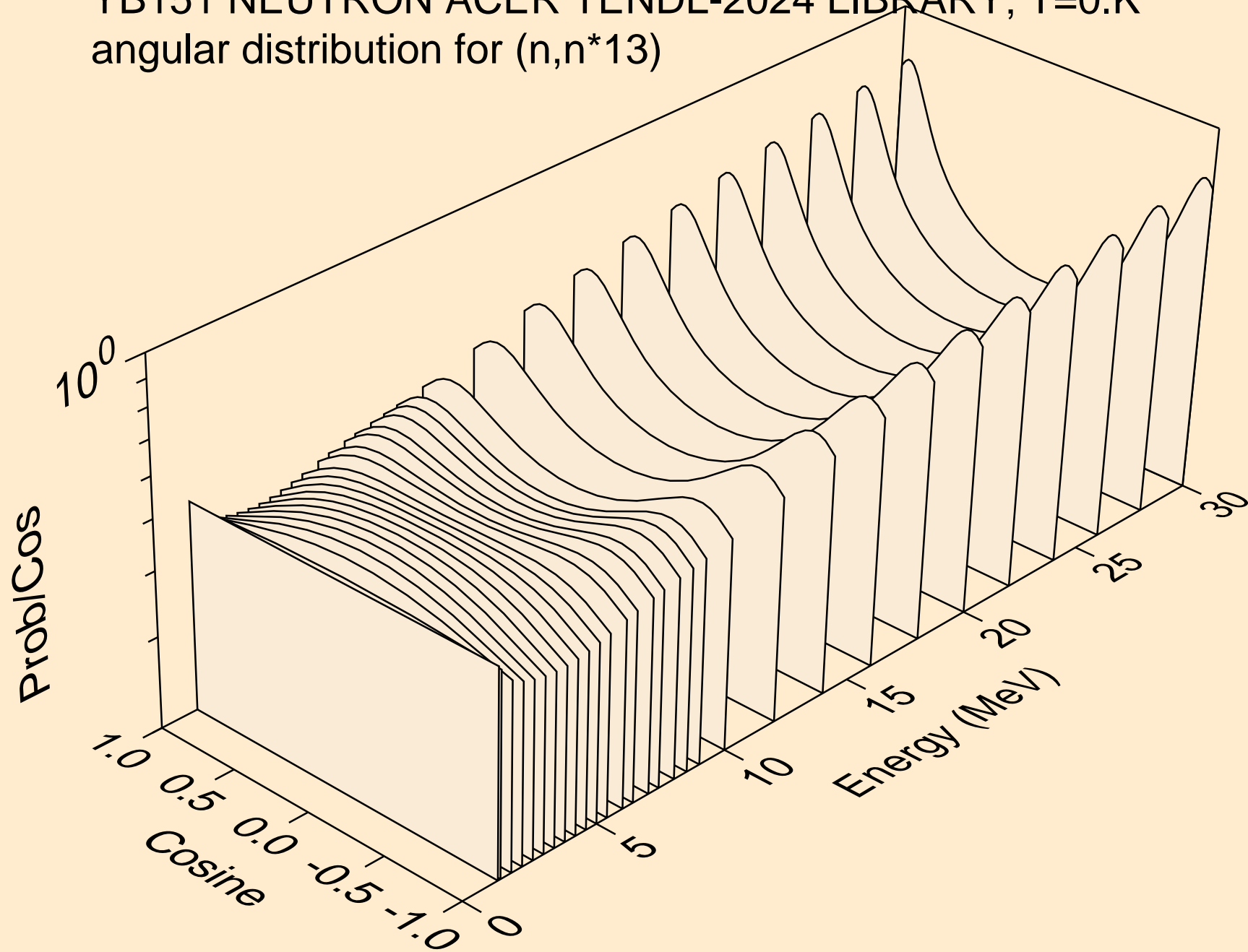

YB151 NEUTRON ACER TENDL-2024 LIBRARY; T=0.K
angular distribution for (n,n*14)

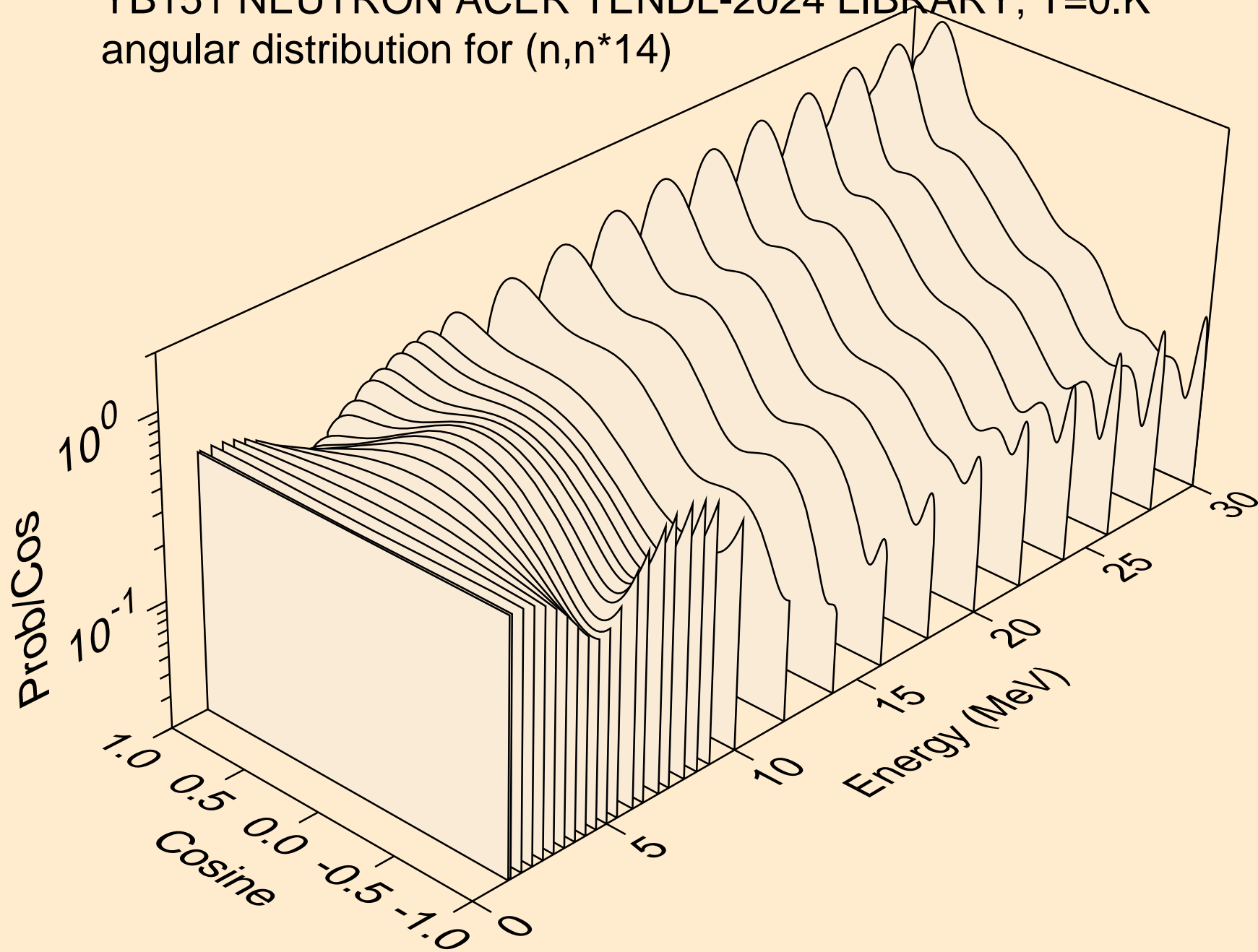

YB151 NEUTRON ACER TENDL-2024 LIBRARY; T=0.K
angular distribution for (n,n*15)

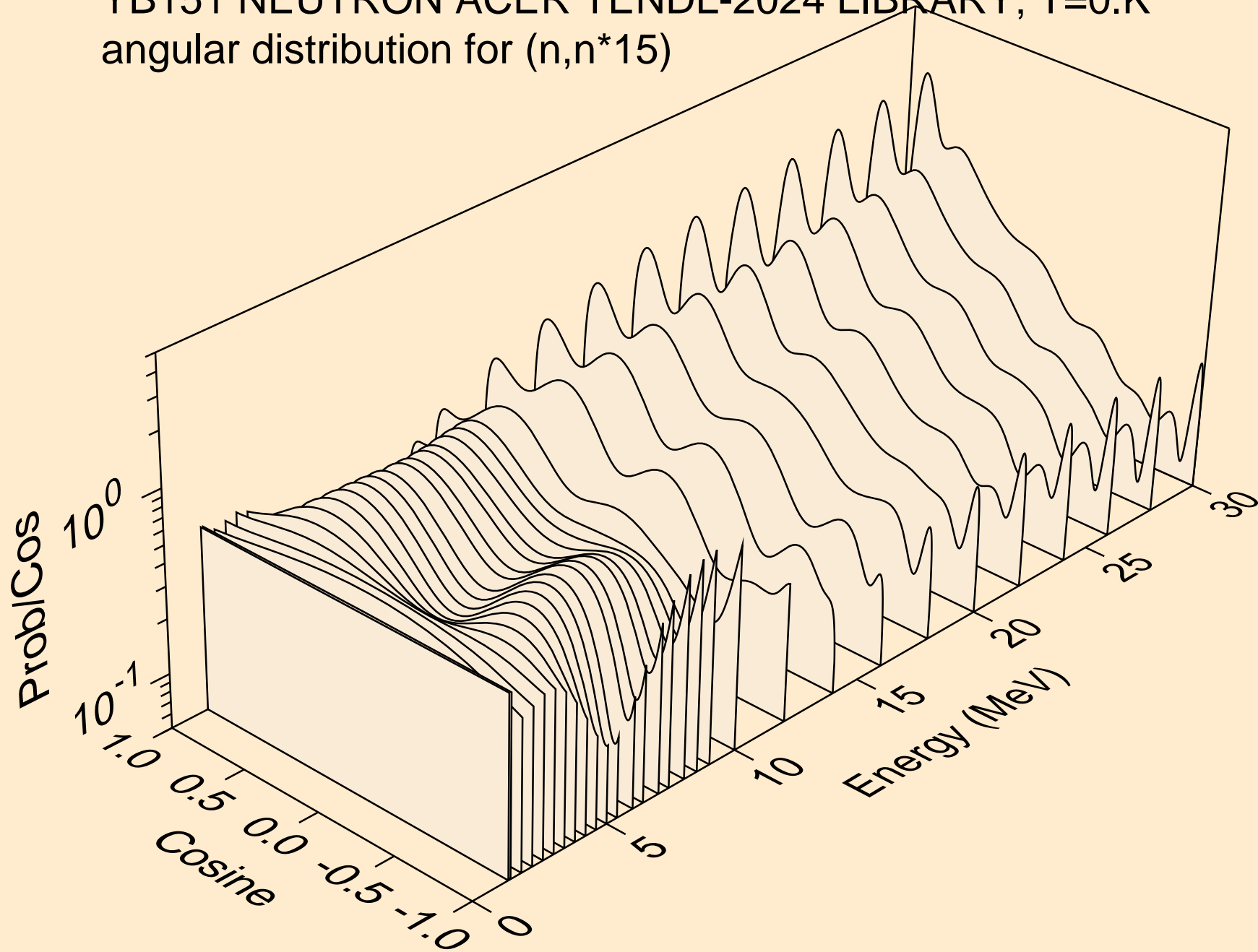

YB151 NEUTRON ACER TENDL-2024 LIBRARY; T=0.K
Neutron emission for (n,x)

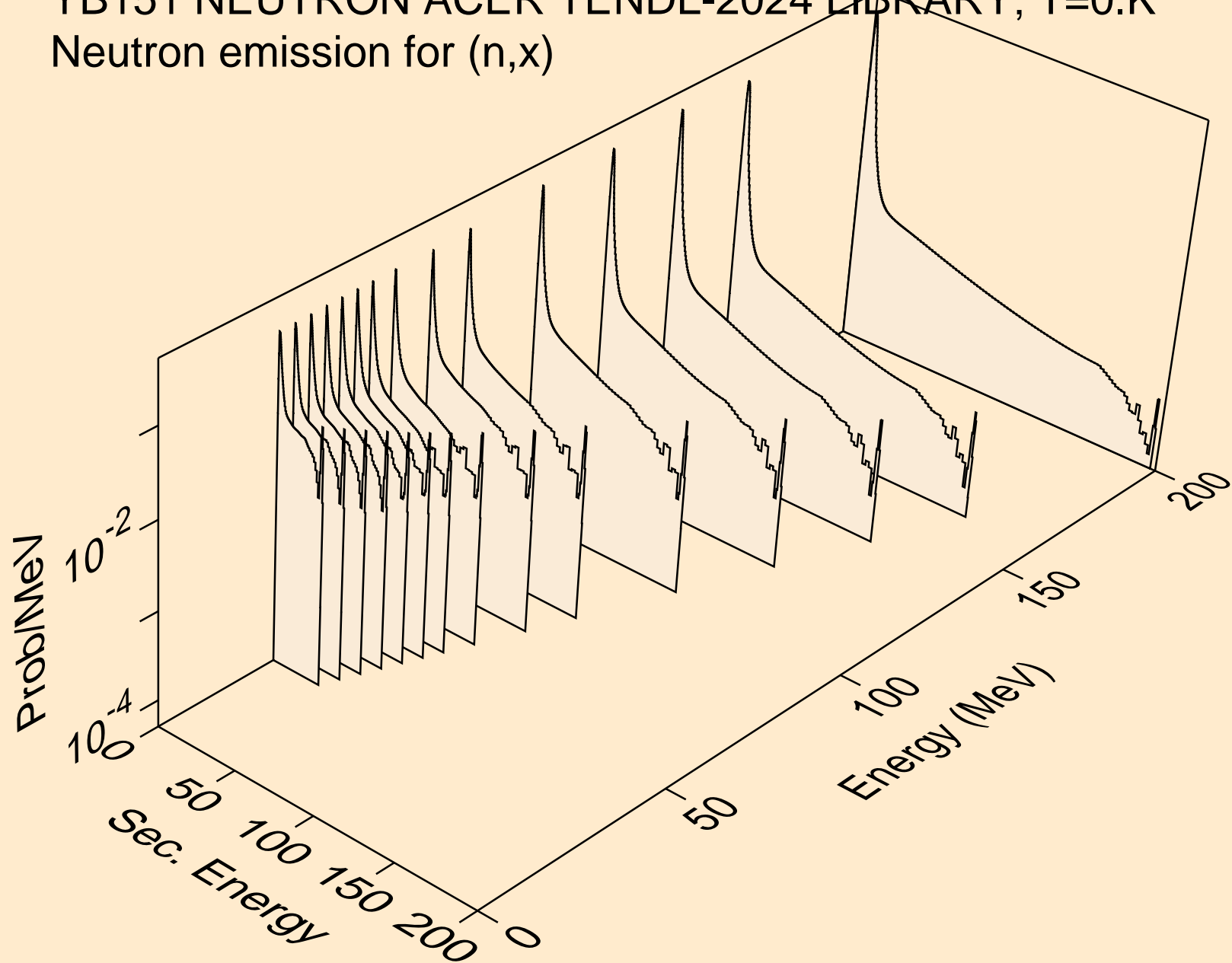

YB151 NEUTRON ACER TENDL-2024 LIBRARY; T=0.K
Neutron emission for (n,2n)

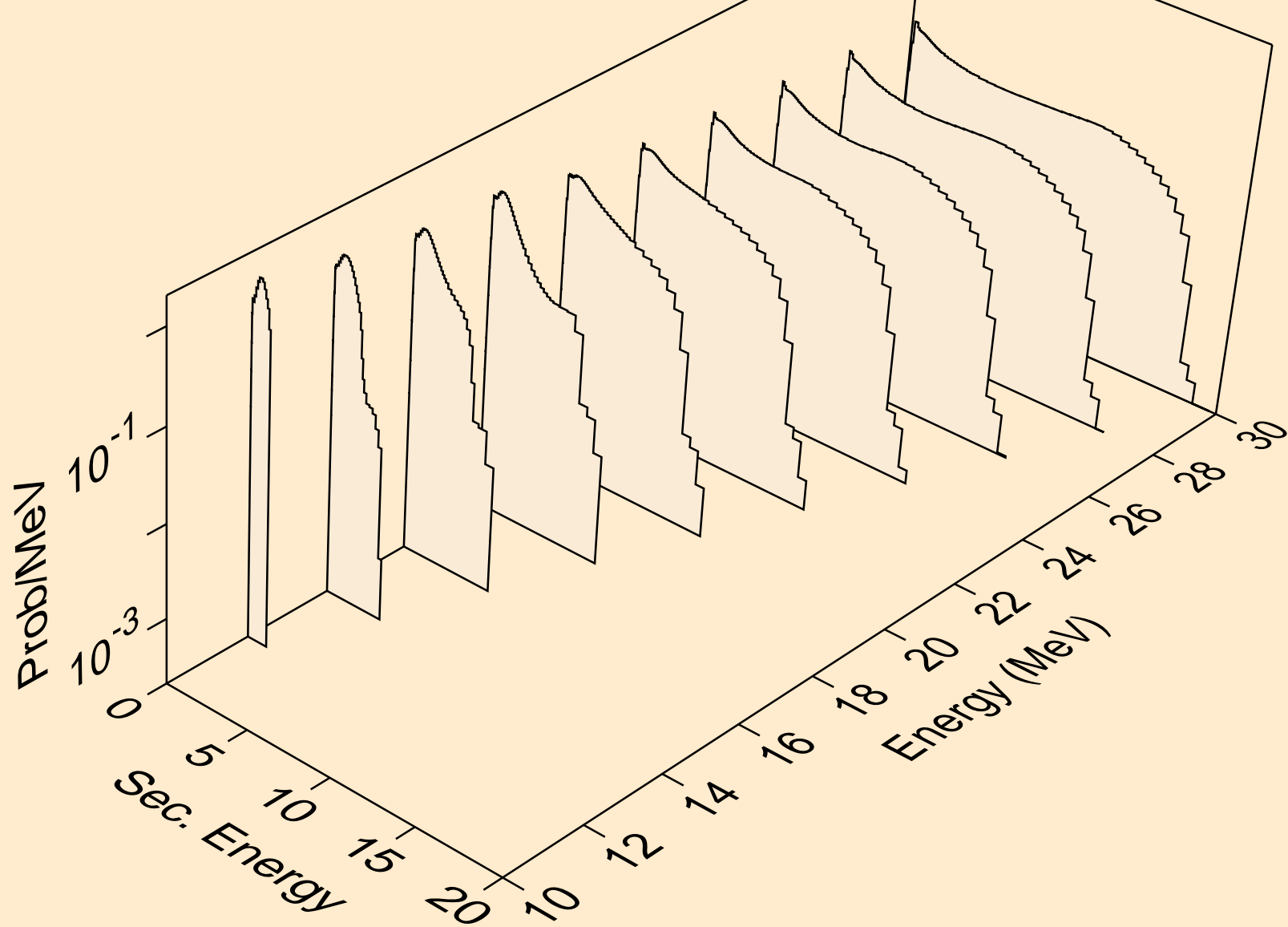

YB151 NEUTRON ACER TENDL-2024 LIBRARY; T=0.K
Neutron emission for (n,3n)

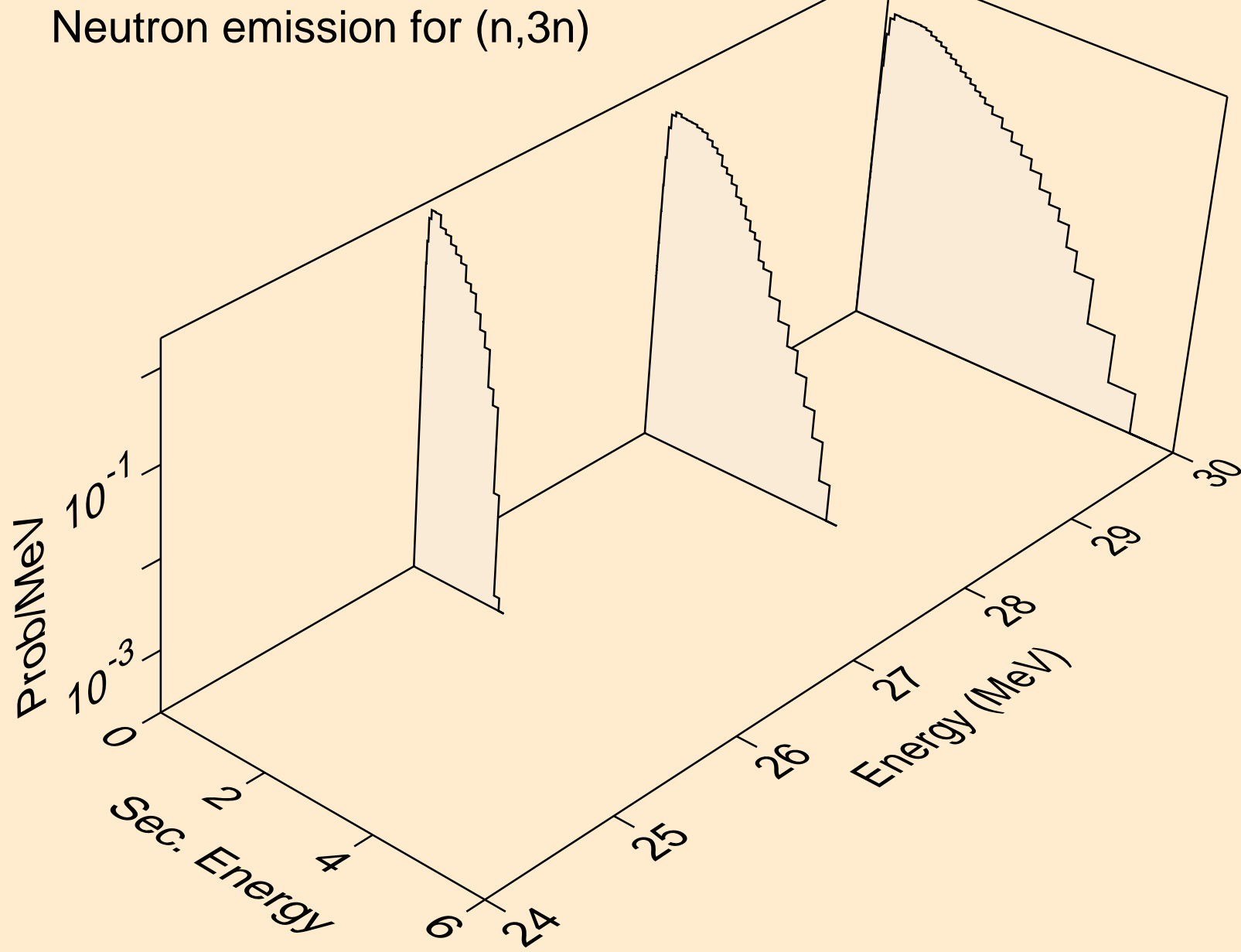

YB151 NEUTRON ACER TENDL-2024 LIBRARY; T=0.K
Neutron emission for (n,n*)a

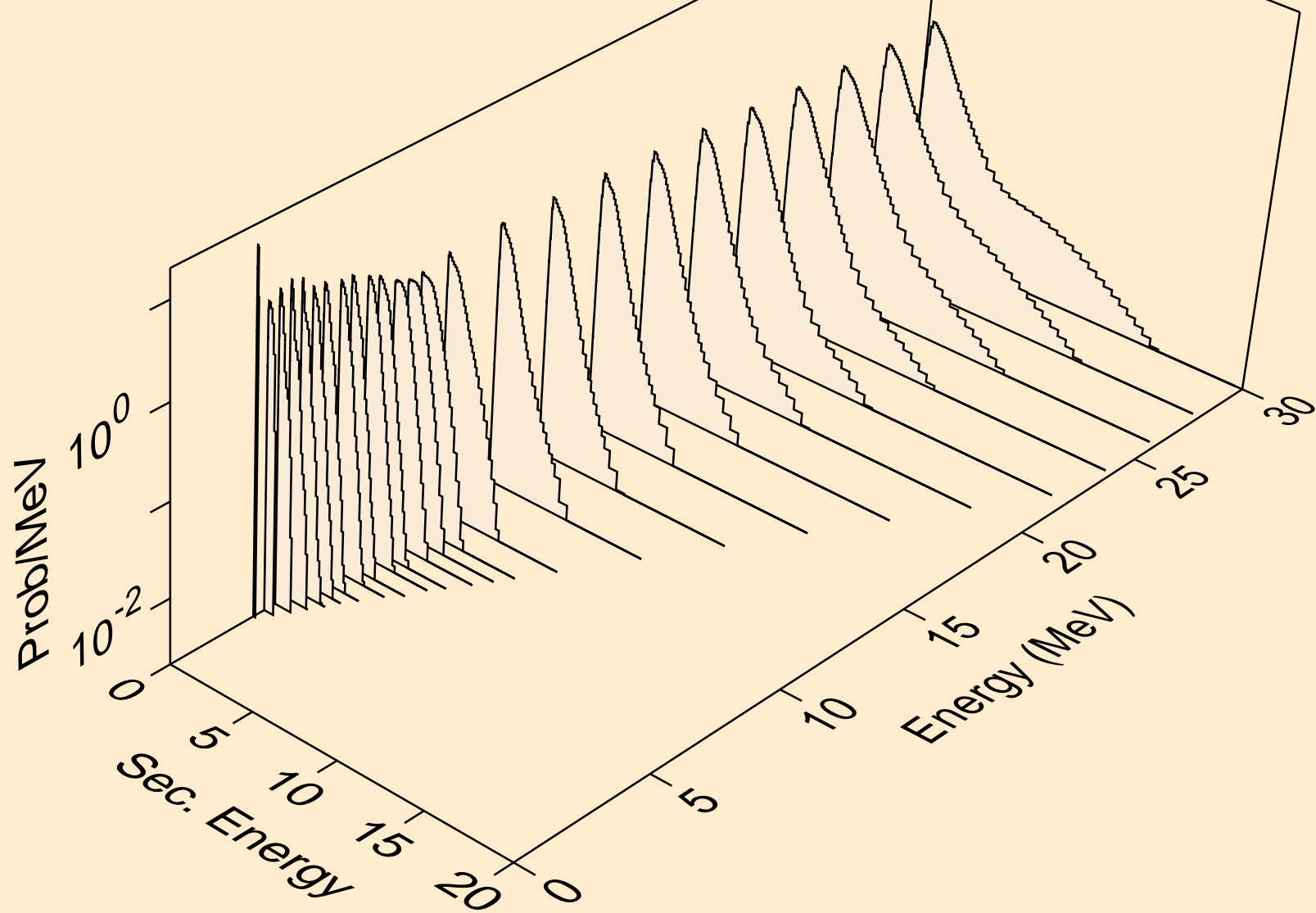

YB151 NEUTRON ACER TENDL-2024 LIBRARY; T=0.K
Neutron emission for (n,2n)a

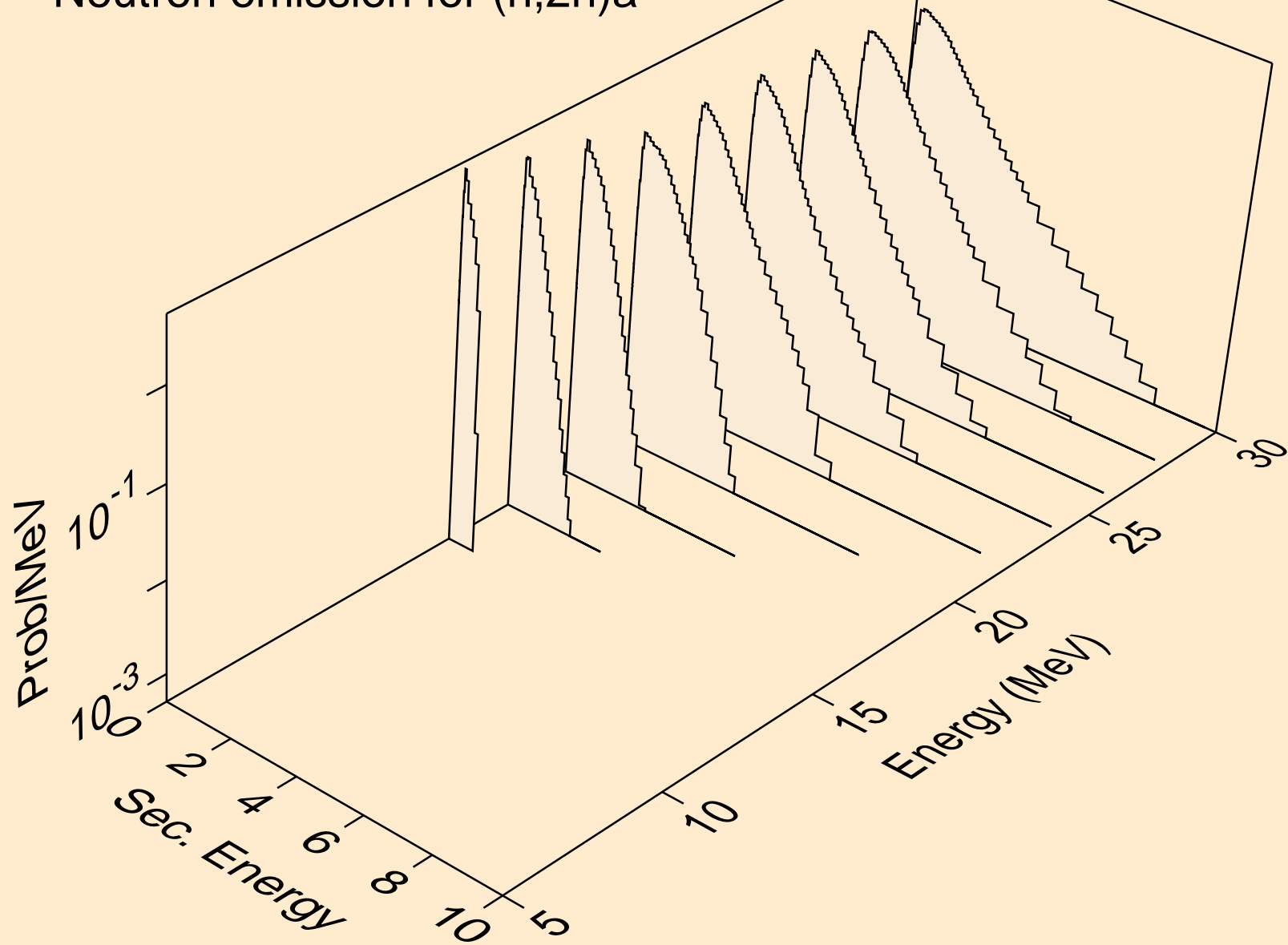

YB151 NEUTRON ACER TENDL-2024 LIBRARY; T=0.K
Neutron emission for (n,n*)p

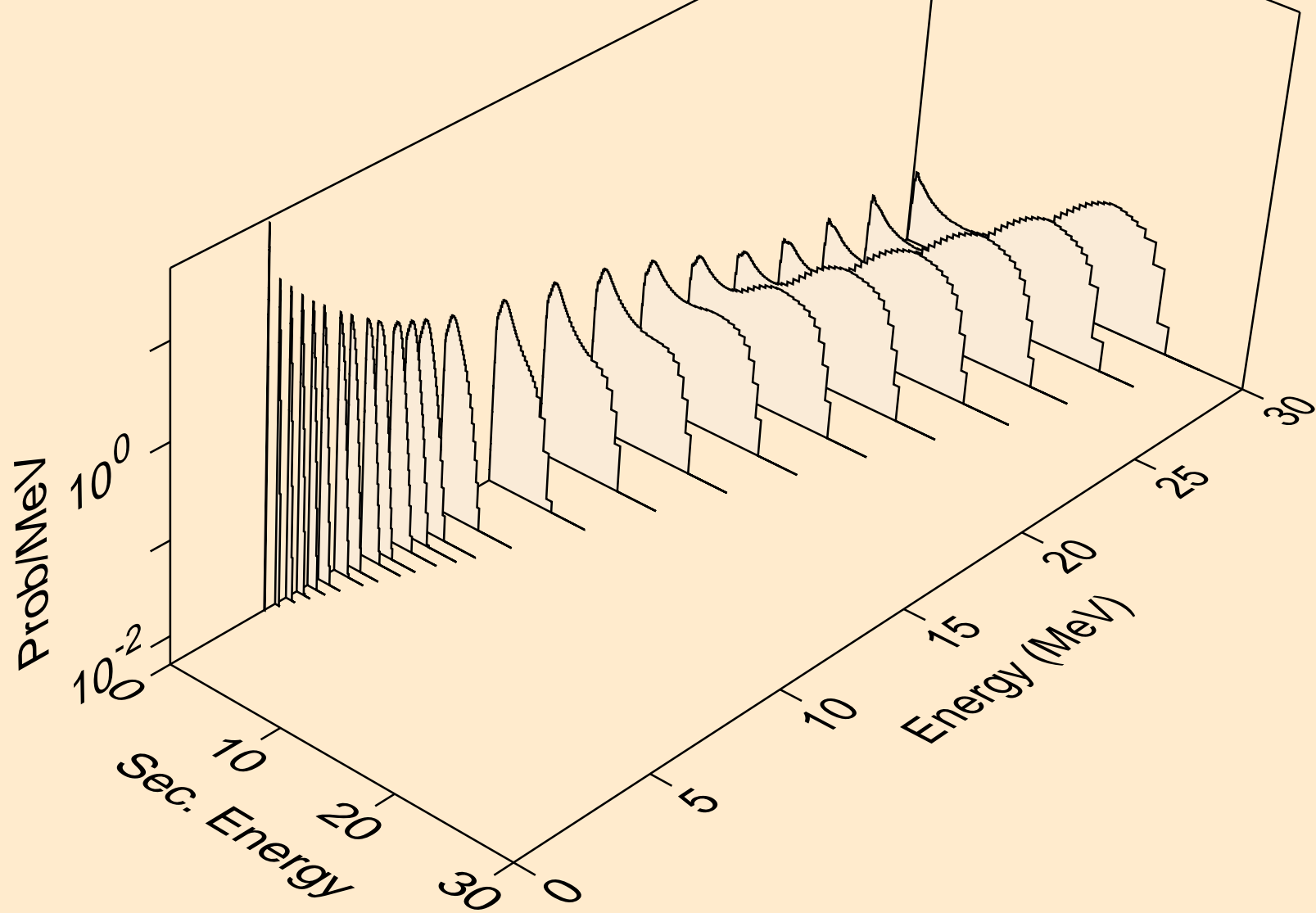

YB151 NEUTRON ACER TENDL-2024 LIBRARY; T=0.K
Neutron emission for (n,n*)2a

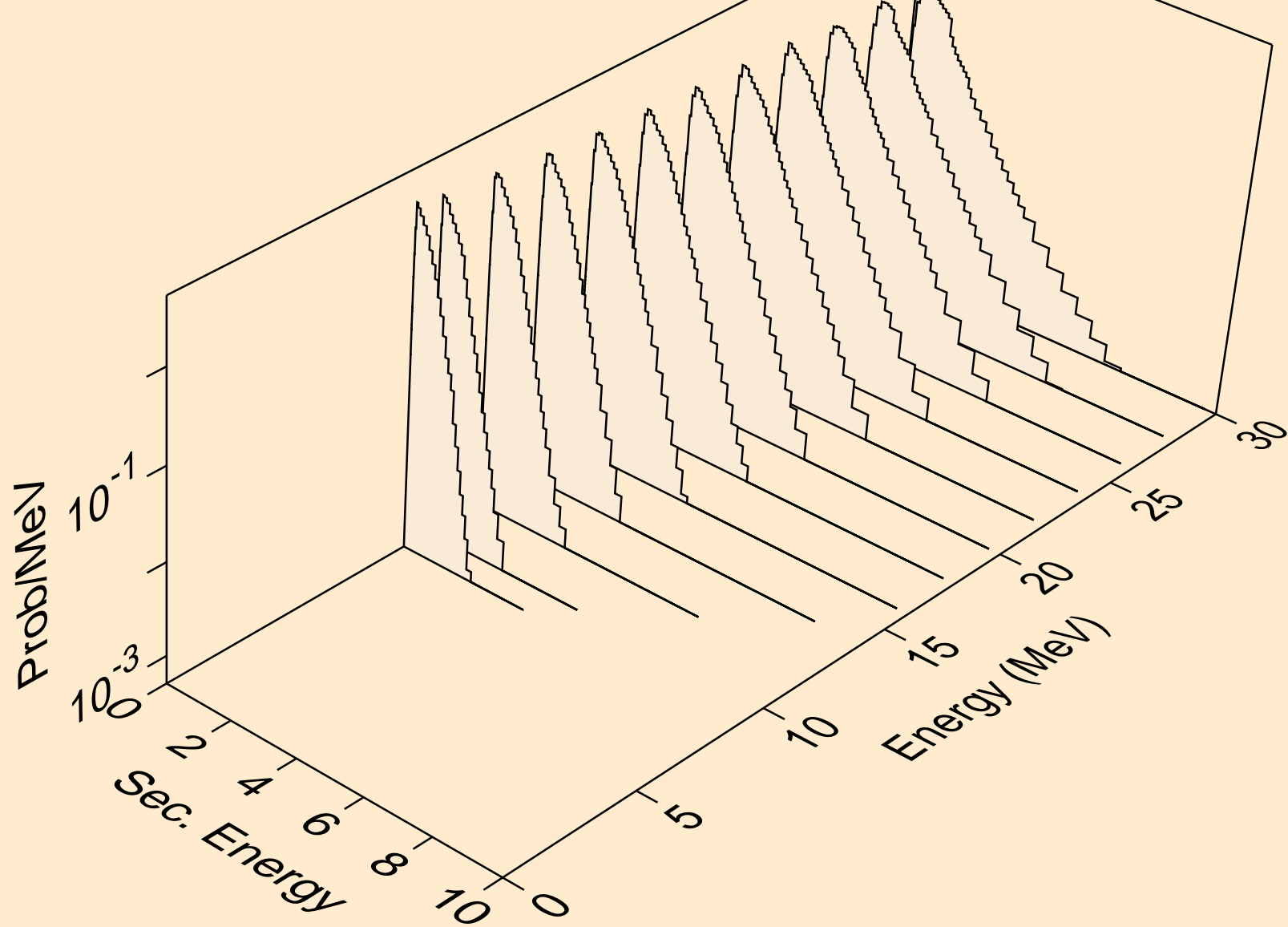

YB151 NEUTRON ACER TENDL-2024 LIBRARY; T=0.K
Neutron emission for (n,n*)d

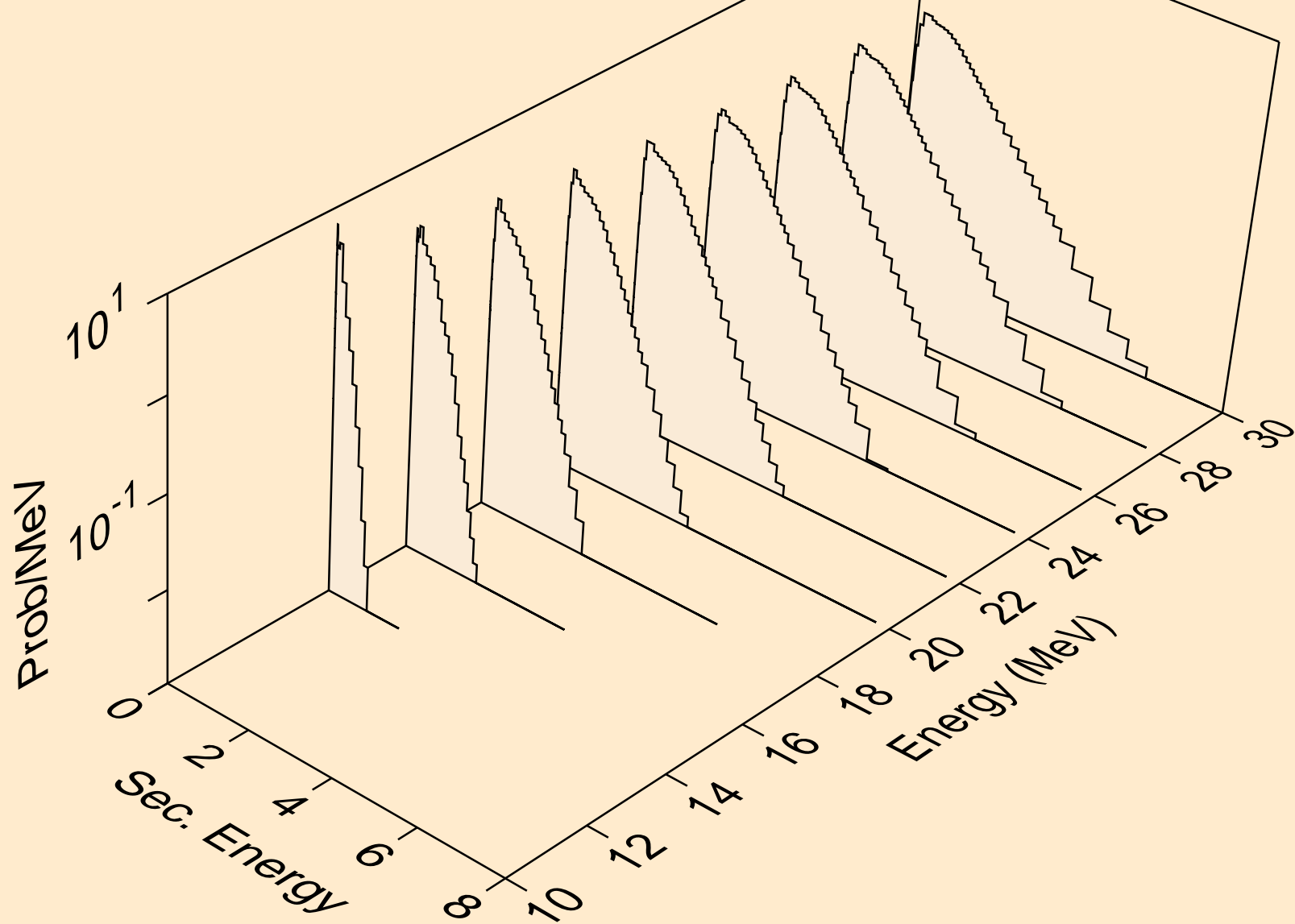

YB151 NEUTRON ACER TENDL-2024 LIBRARY; T=0.K
Neutron emission for (n,n*)t

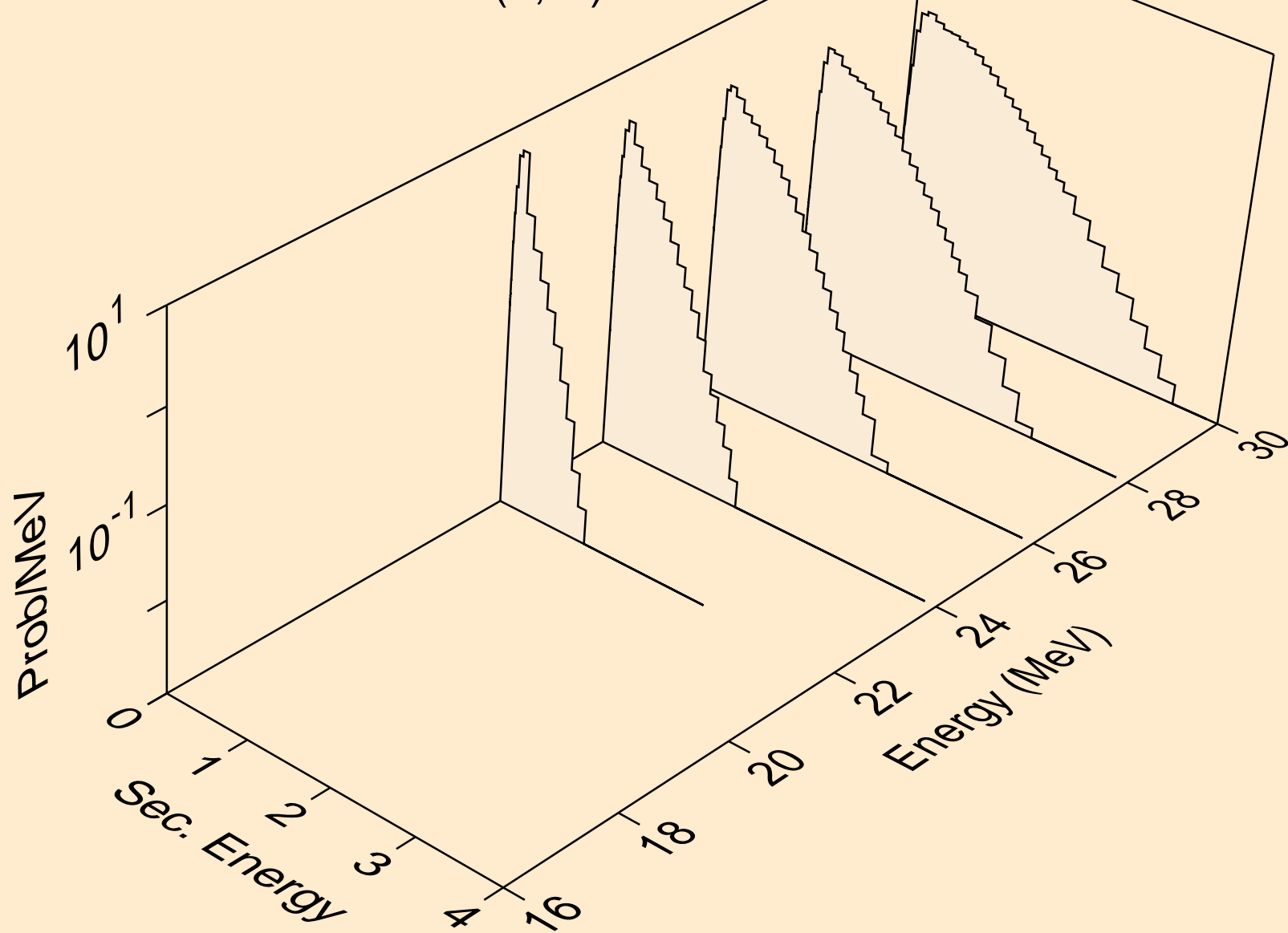

YB151 NEUTRON ACER TENDL-2024 LIBRARY; T=0.K
Neutron emission for (n,n*)he3

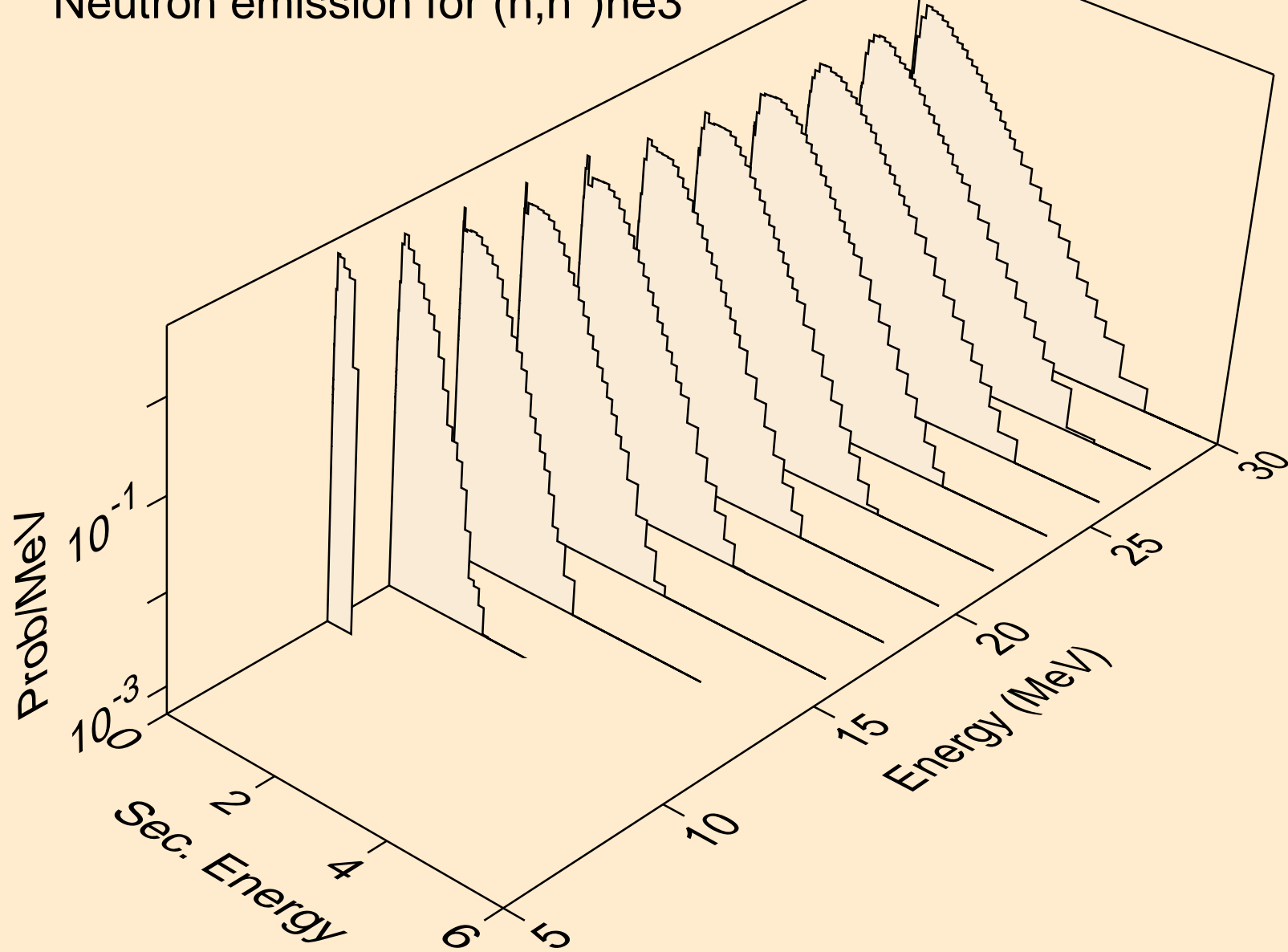

YB151 NEUTRON ACER TENDL-2024 LIBRARY; T=0.K
Neutron emission for (n,2np)

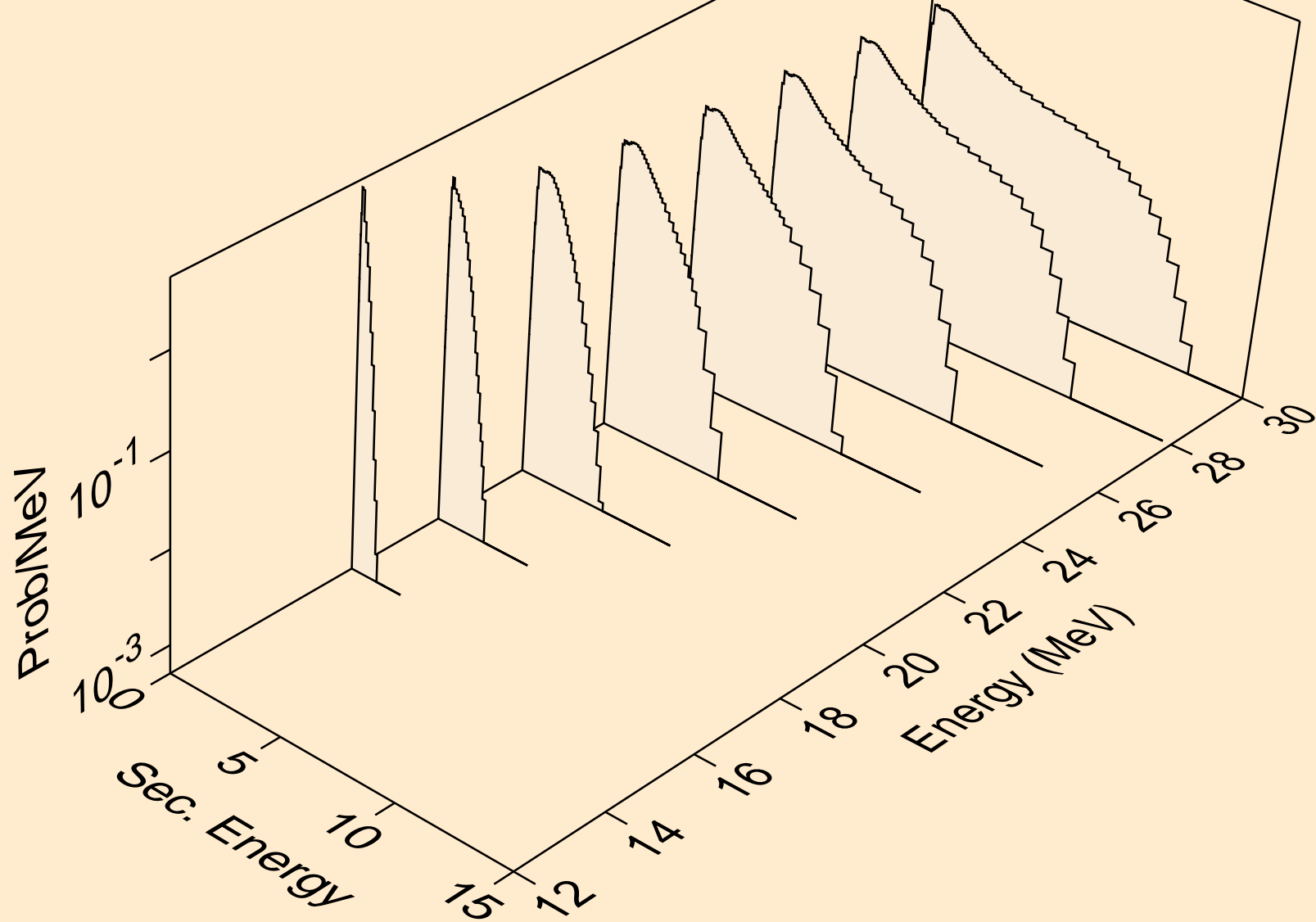

YB151 NEUTRON ACER TENDL-2024 LIBRARY; T=0.K
Neutron emission for (n,n2p)

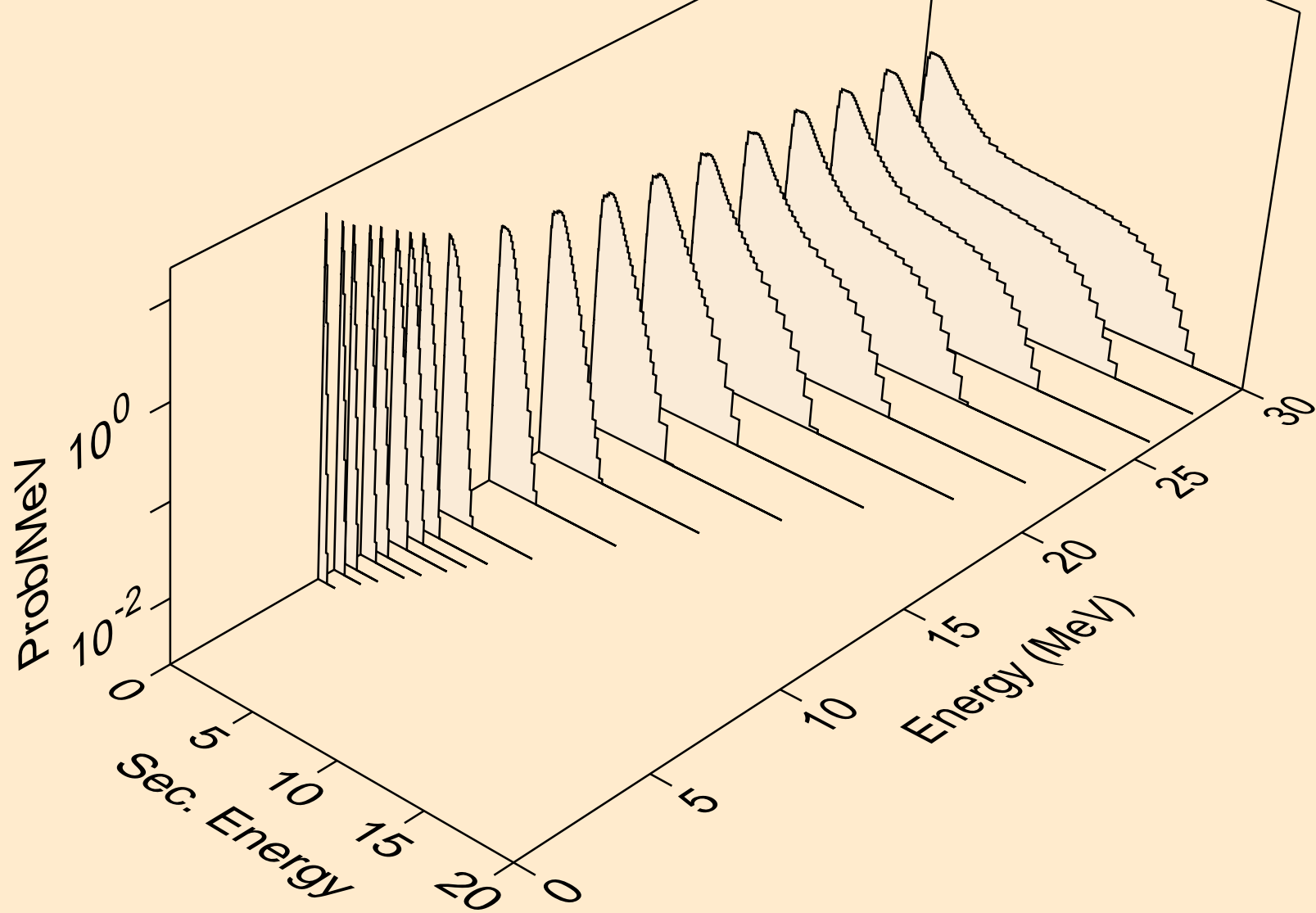

YB151 NEUTRON ACER TENDL-2024 LIBRARY; T=0.K
Neutron emission for (n,npa)

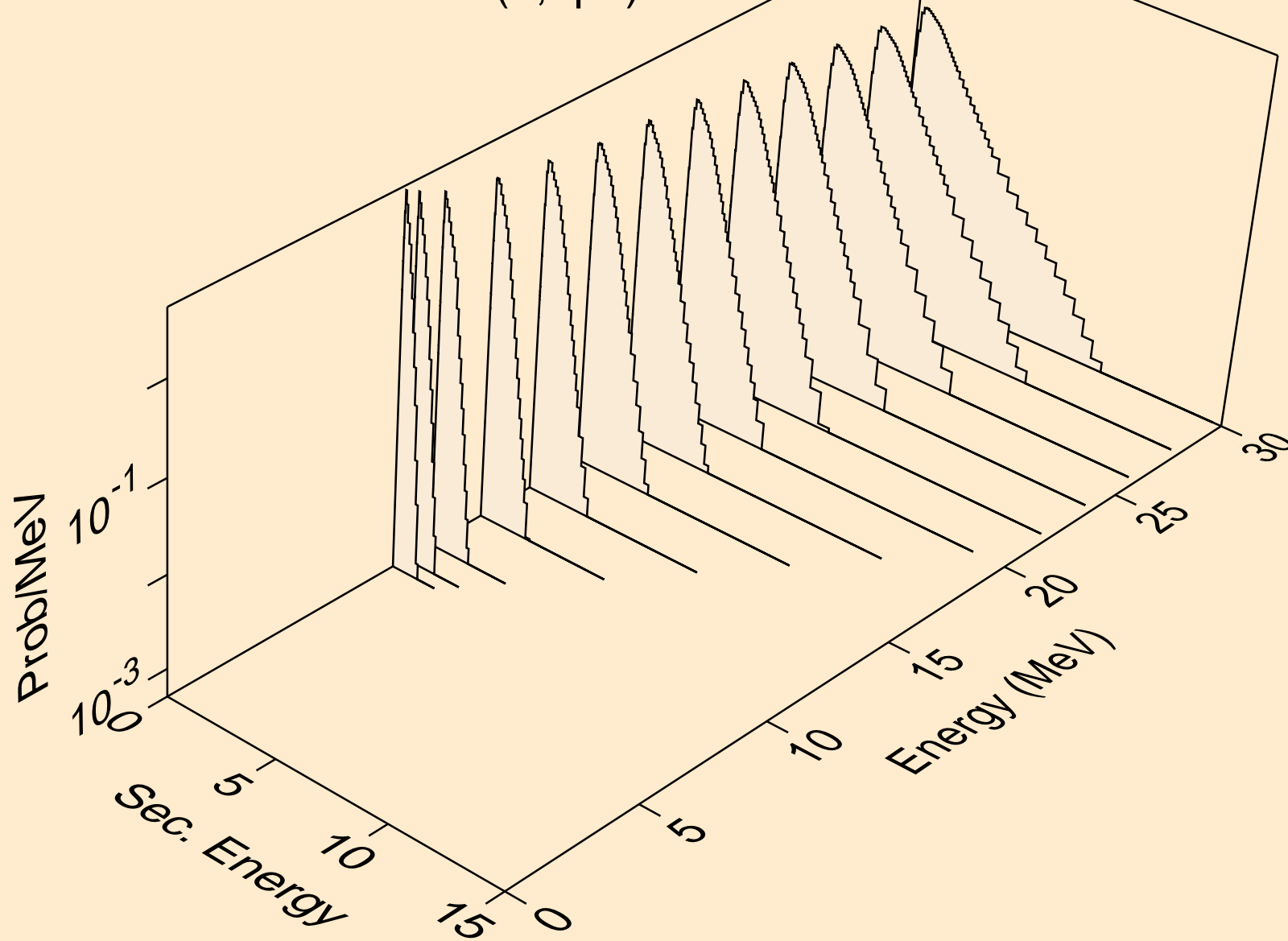

YB151 NEUTRON ACER TENDL-2024 LIBRARY; T=0.K
Neutron emission for (n,n*c)

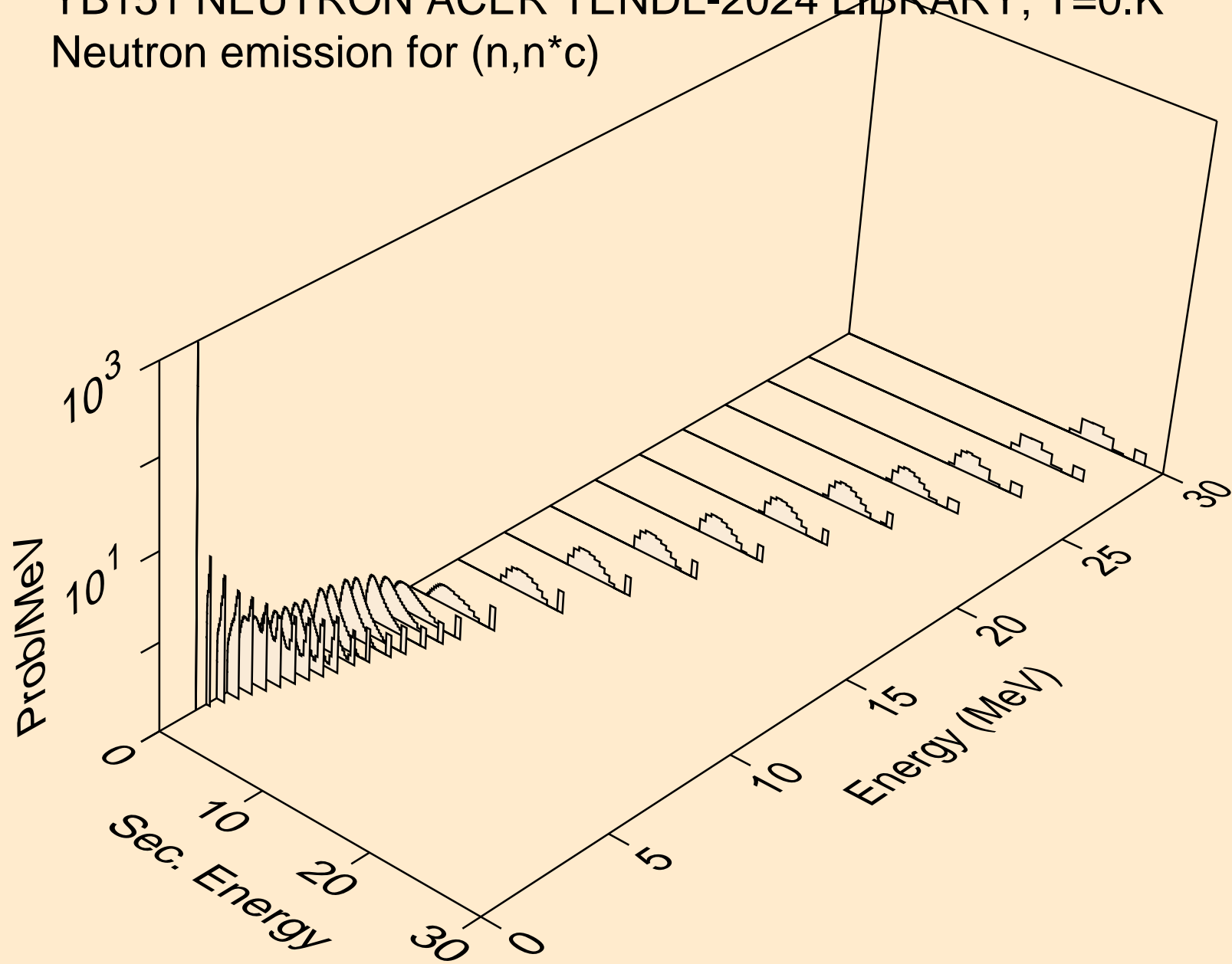

YB151 NEUTRON ACER TENDL-2024 LIBRARY; T=0.K
Photon emission for (n,x)

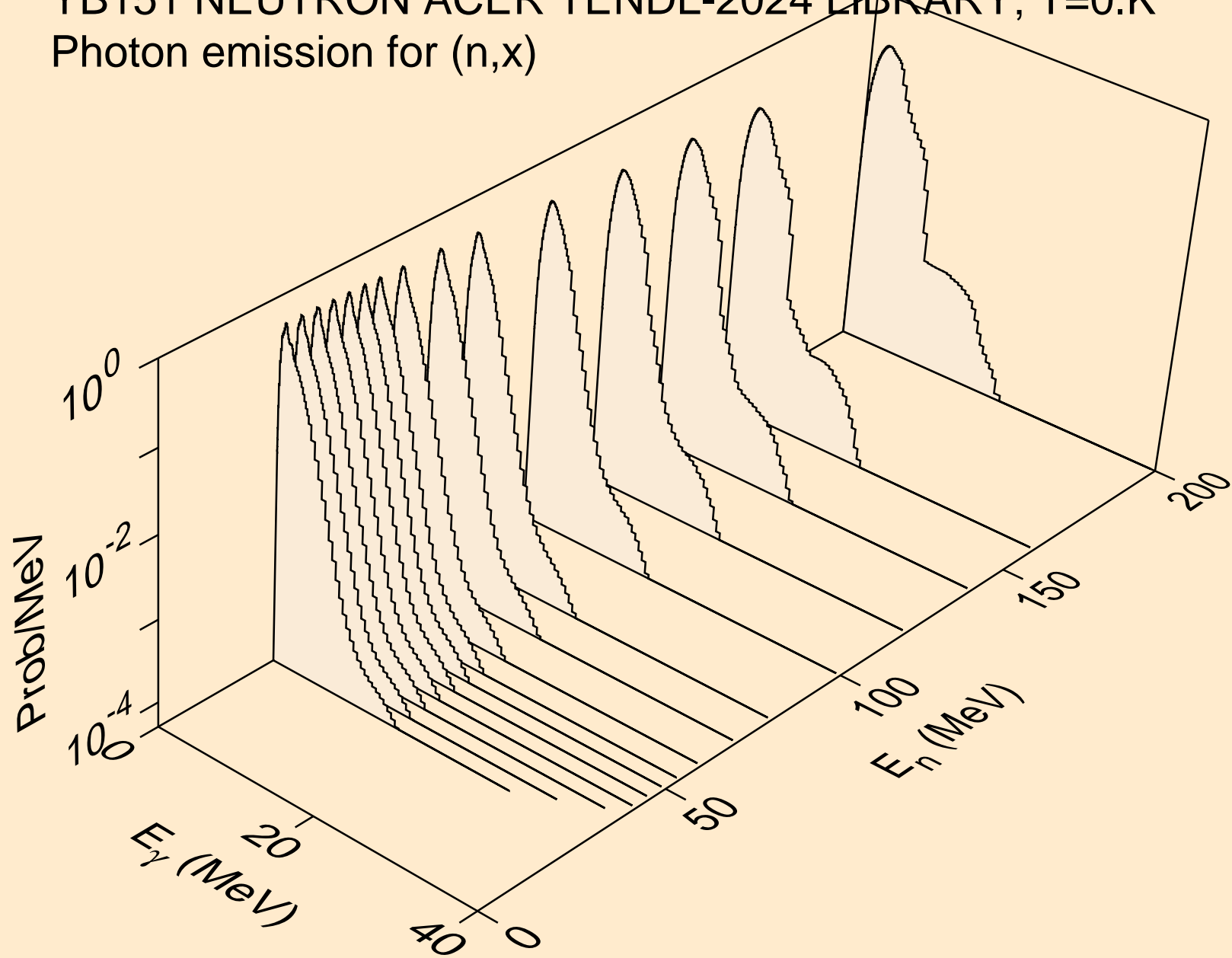

YB151 NEUTRON ACER TENDL-2024 LIBRARY; T=0.K
Photon emission for (n,2n)

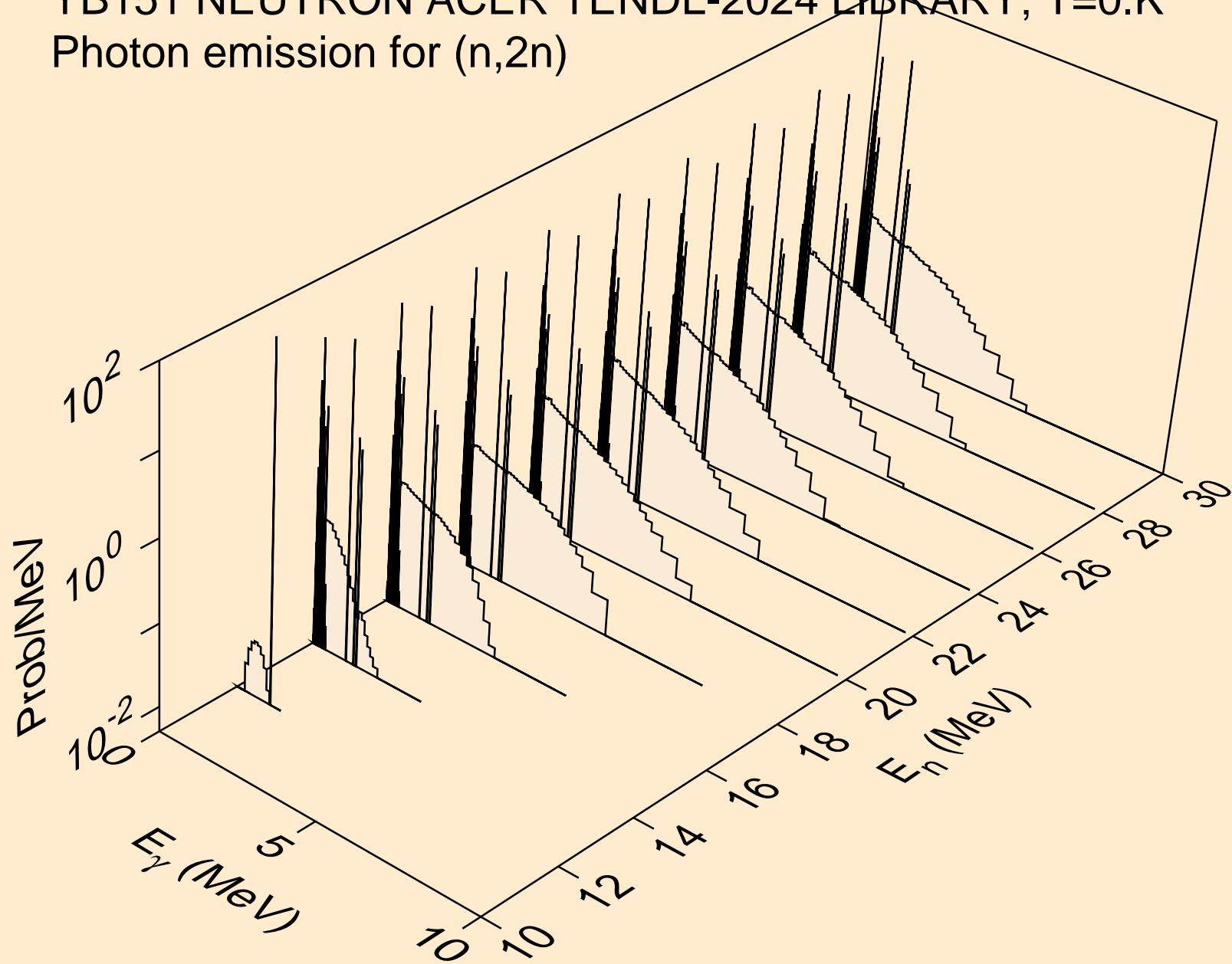

YB151 NEUTRON ACER TENDL-2024 LIBRARY; T=0.K
Photon emission for (n,3n)

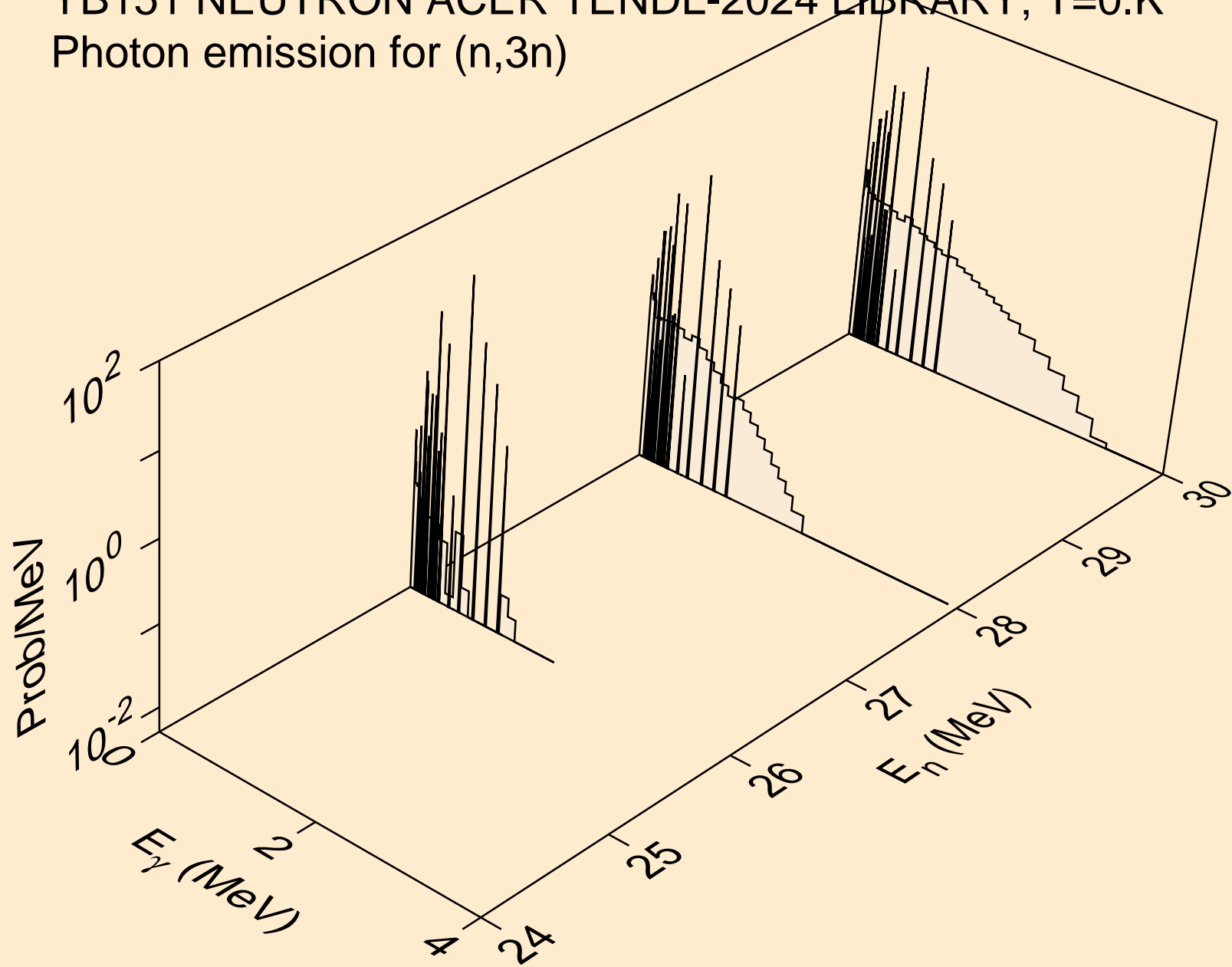

YB151 NEUTRON ACER TENDL-2024 LIBRARY; T=0.K
Photon emission for (n,n*)a

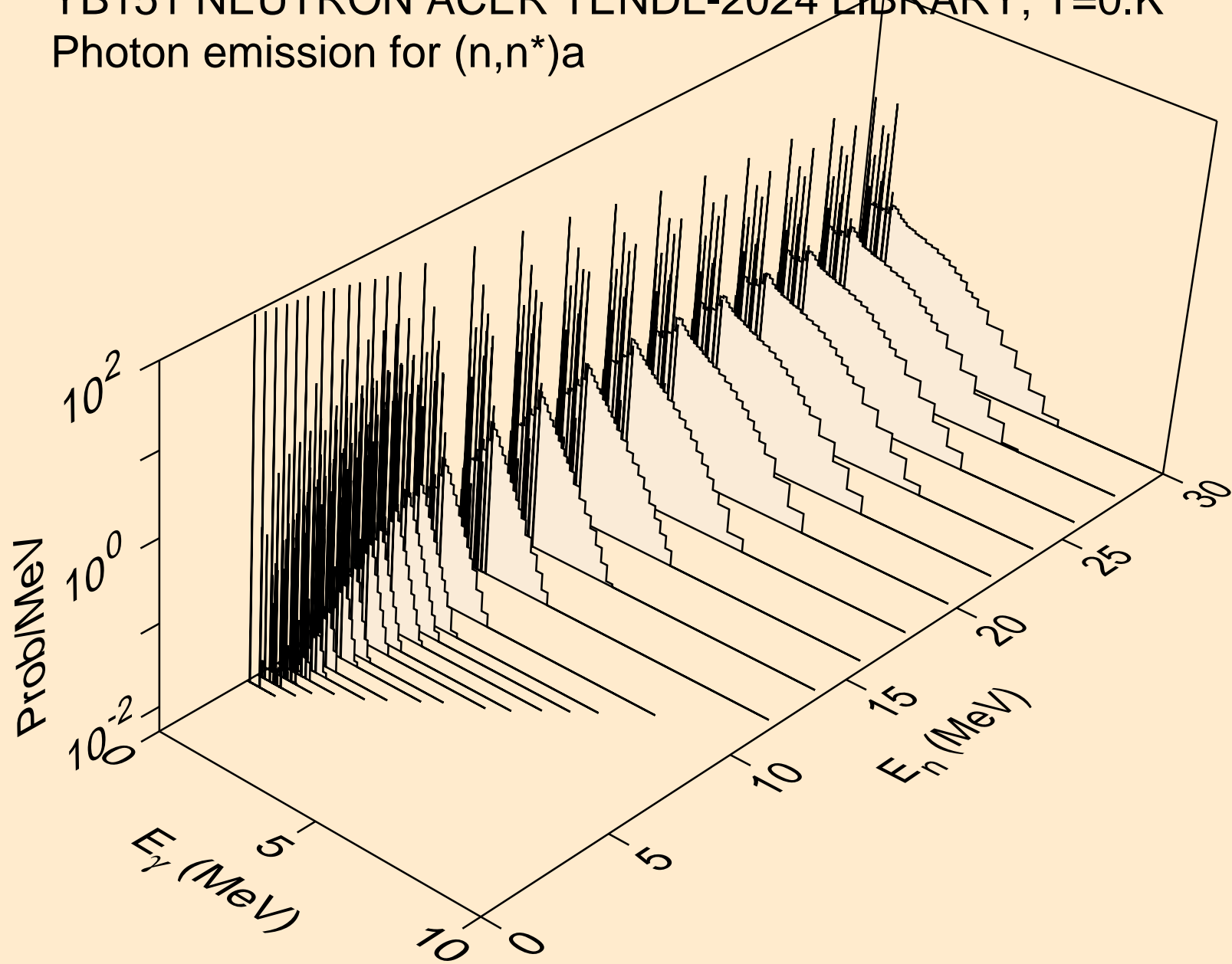

YB151 NEUTRON ACER TENDL-2024 LIBRARY; T=0.K
Photon emission for (n,2n)a

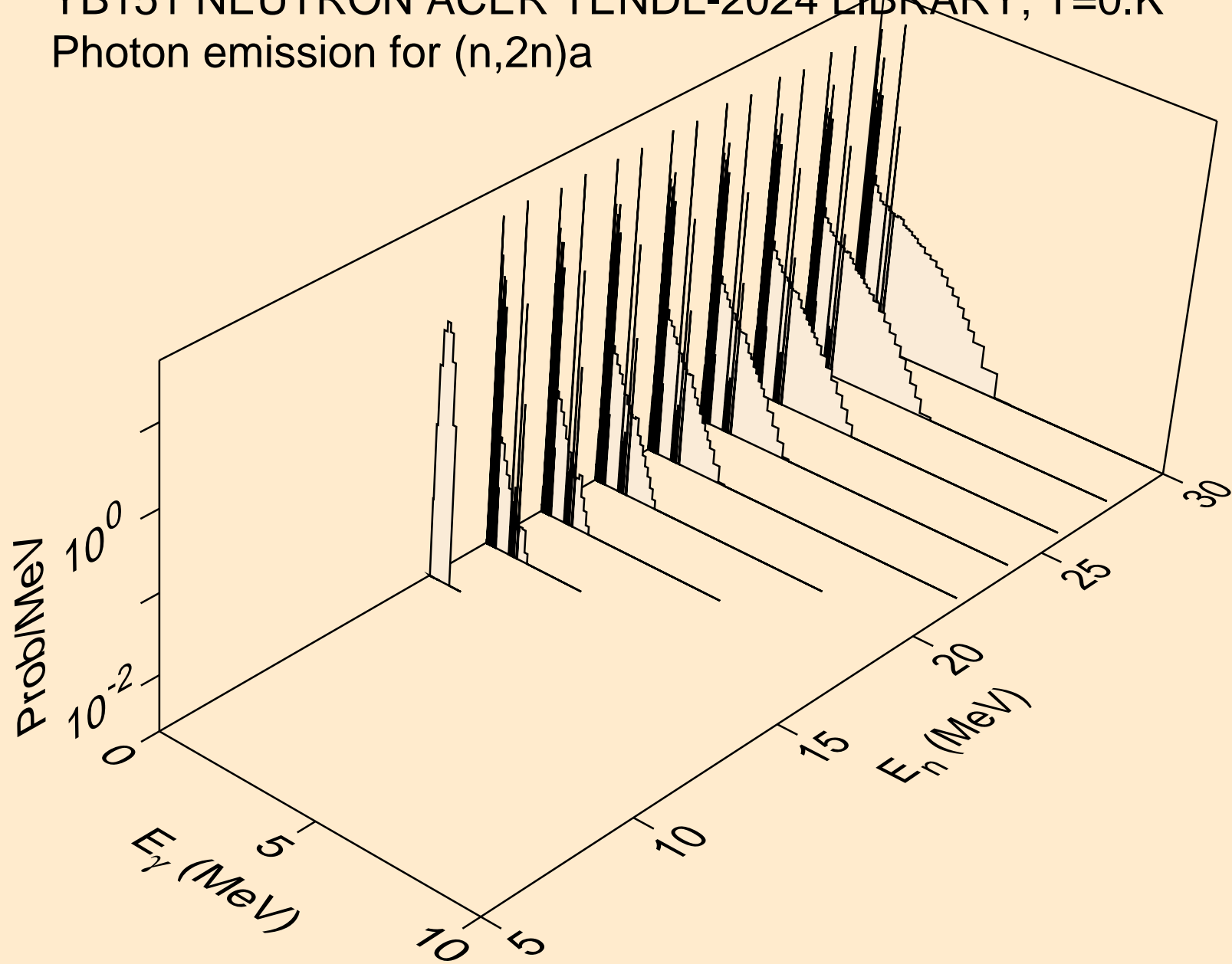

YB151 NEUTRON ACER TENDL-2024 LIBRARY; T=0.K
Photon emission for (n,n*)p

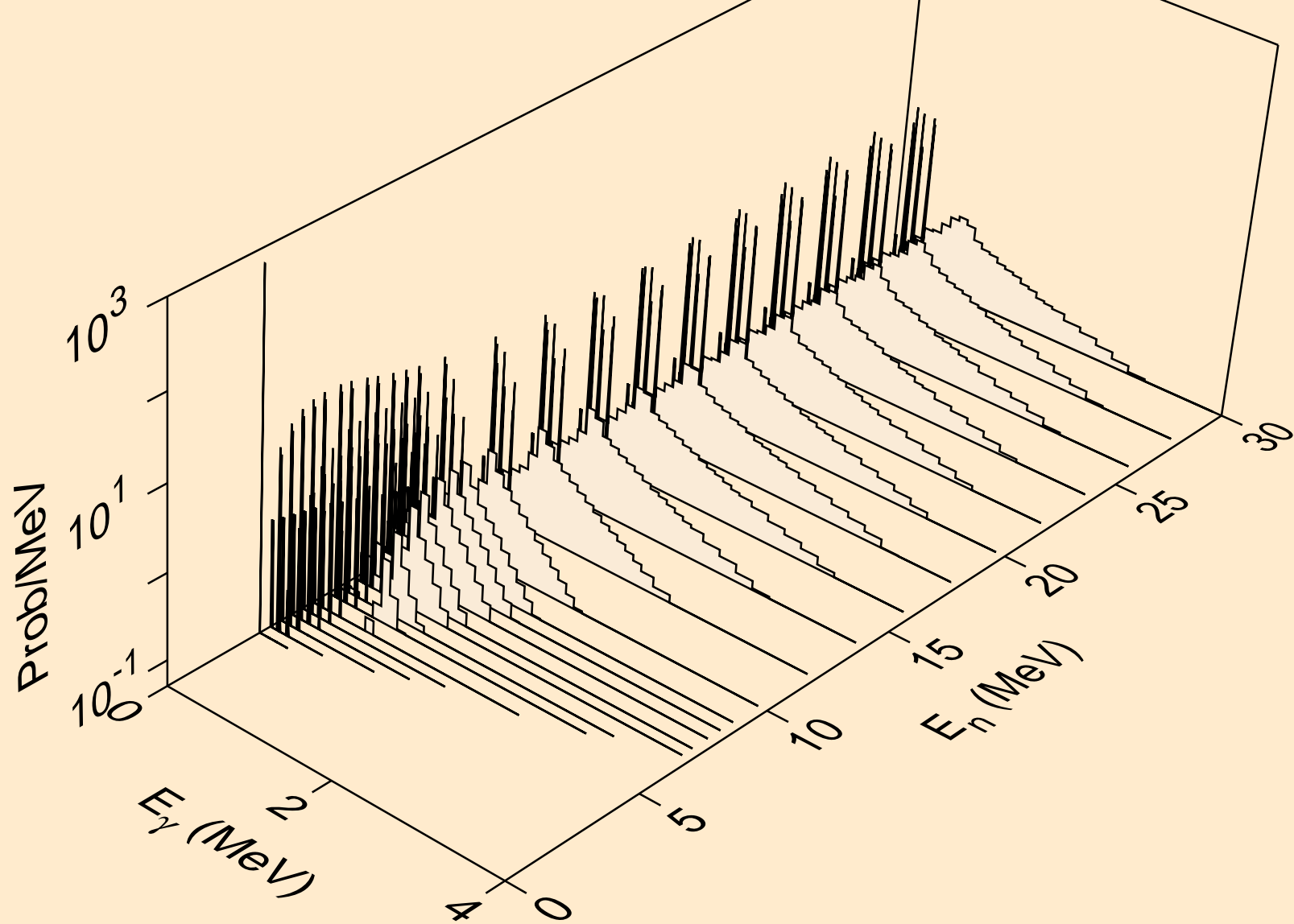

YB151 NEUTRON ACER TENDL-2024 LIBRARY; T=0.K
Photon emission for (n,n*)2a

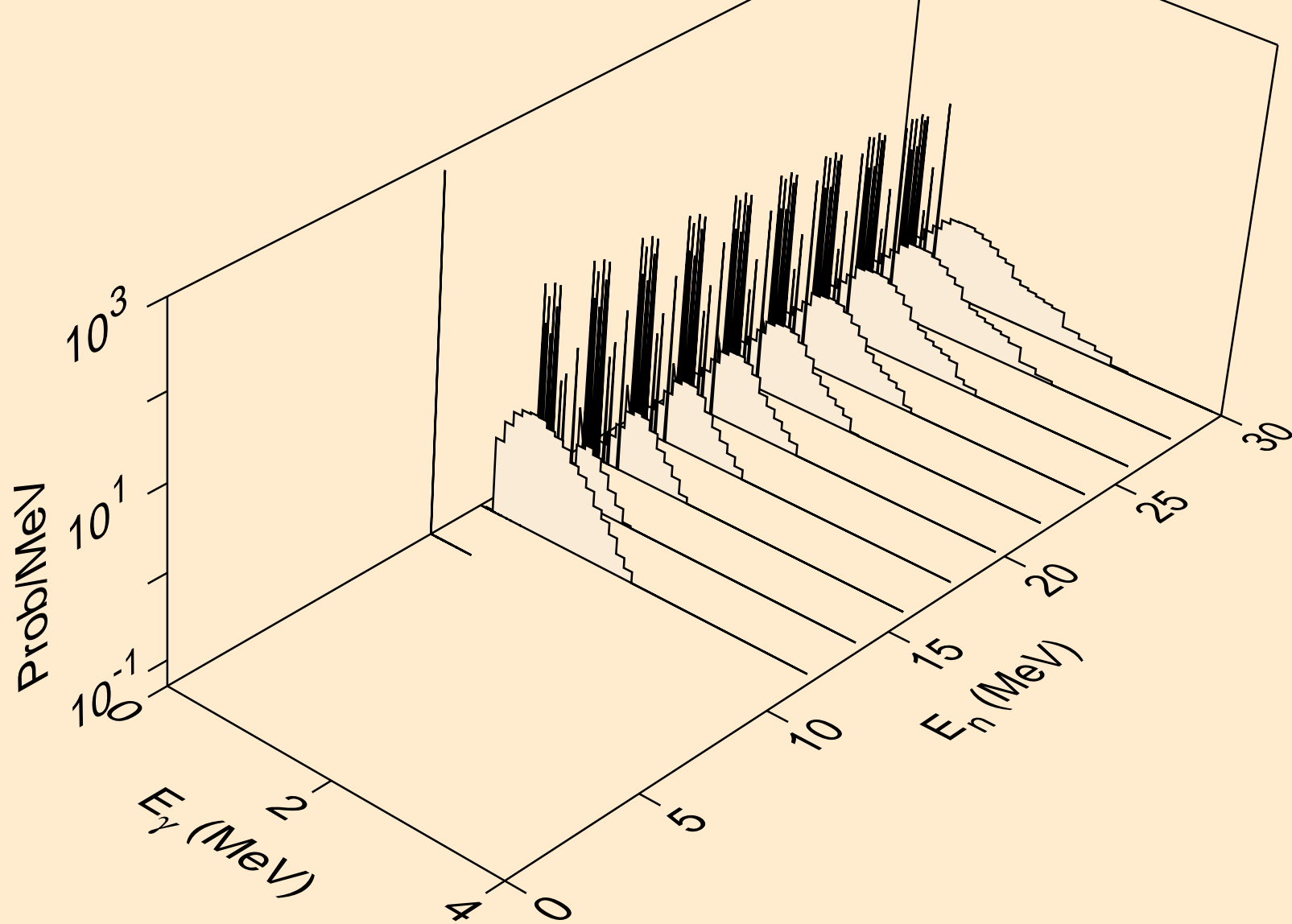

YB151 NEUTRON ACER TENDL-2024 LIBRARY; T=0.K
Photon emission for (n,n*)d

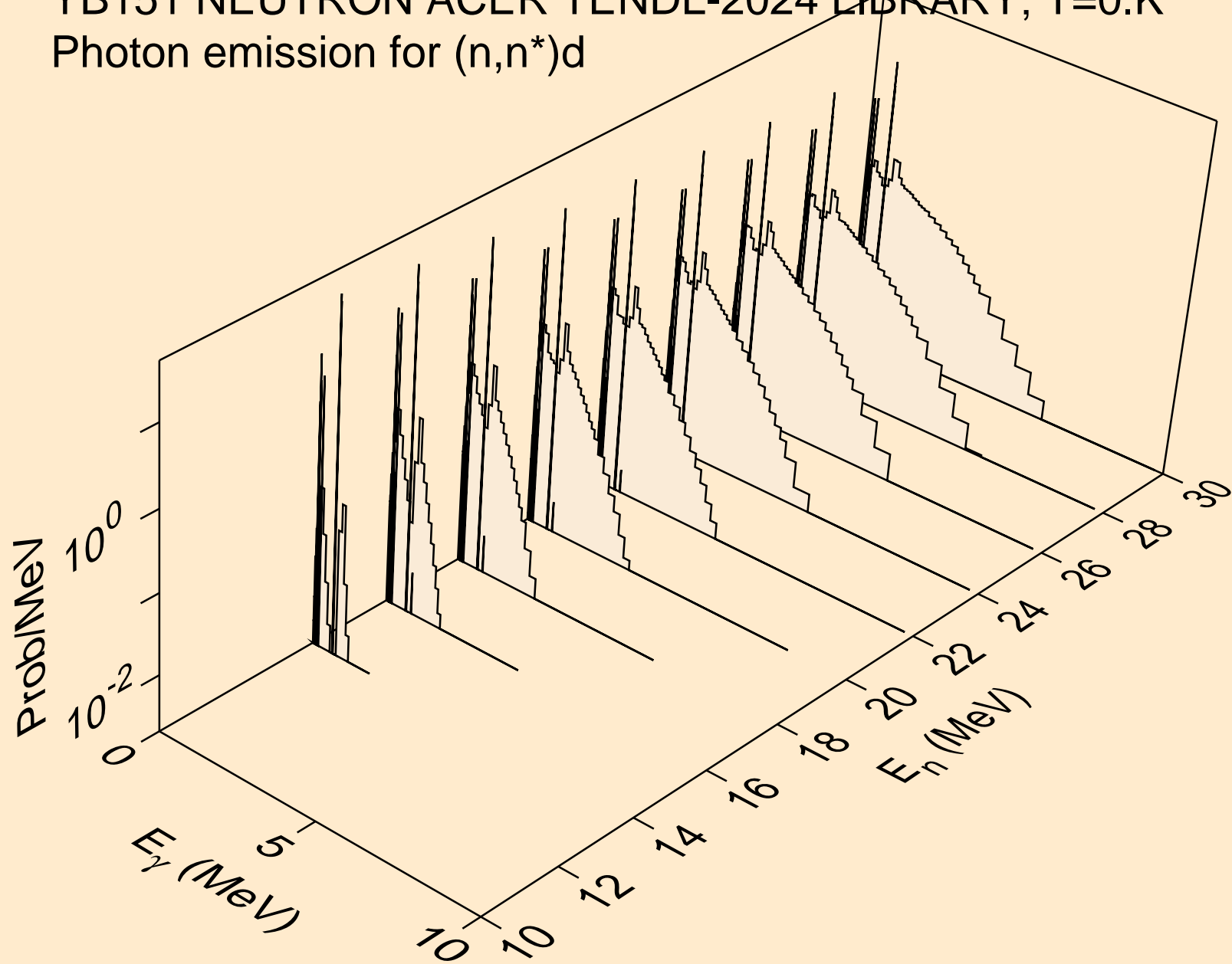

YB151 NEUTRON ACER TENDL-2024 LIBRARY; T=0.K
Photon emission for (n,n*)t

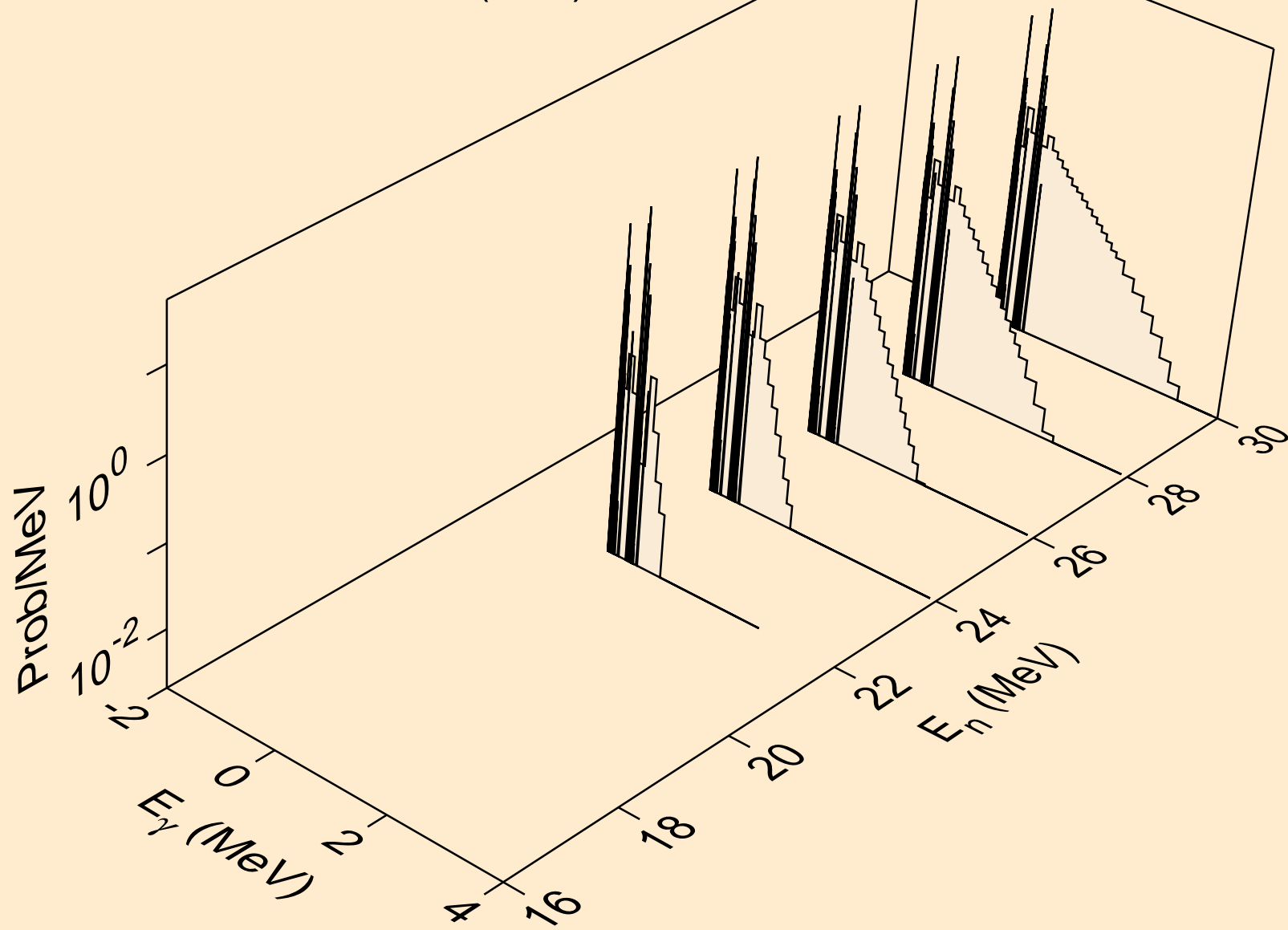

YB151 NEUTRON ACER TENDL-2024 LIBRARY; T=0.K
Photon emission for (n,n*)he3

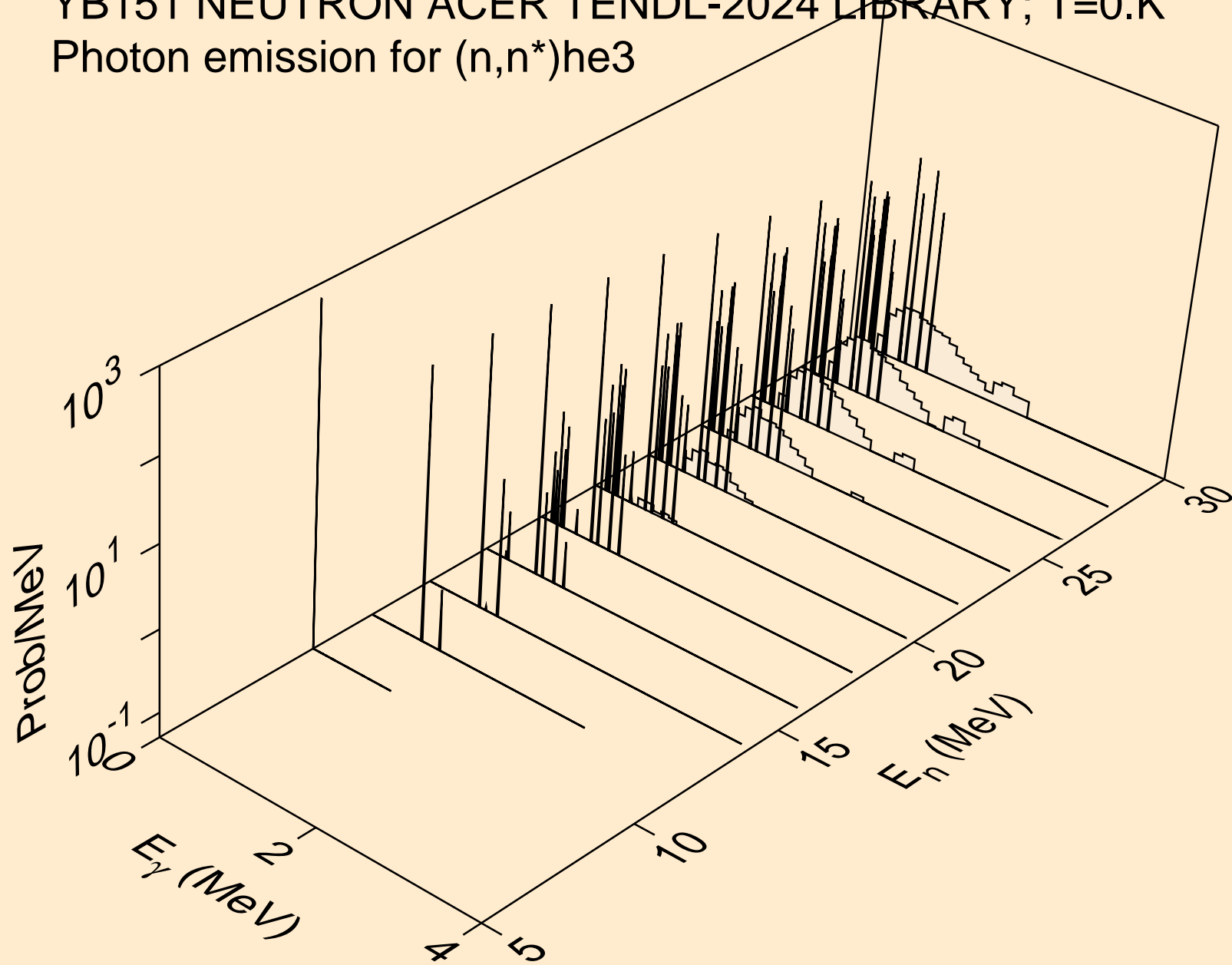

YB151 NEUTRON ACER TENDL-2024 LIBRARY; T=0.K
Photon emission for (n,2np)

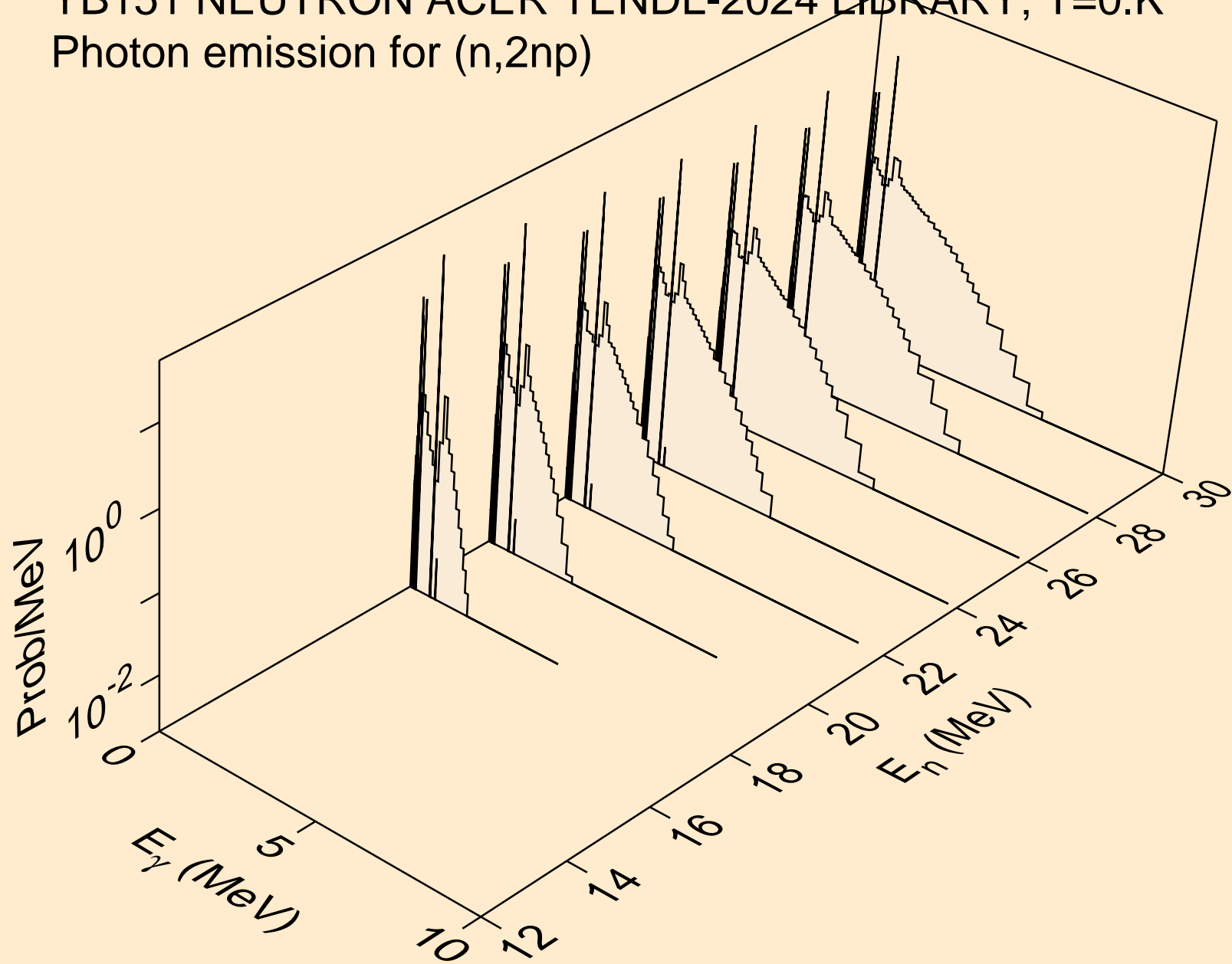

YB151 NEUTRON ACER TENDL-2024 LIBRARY; T=0.K
Photon emission for (n,n2p)

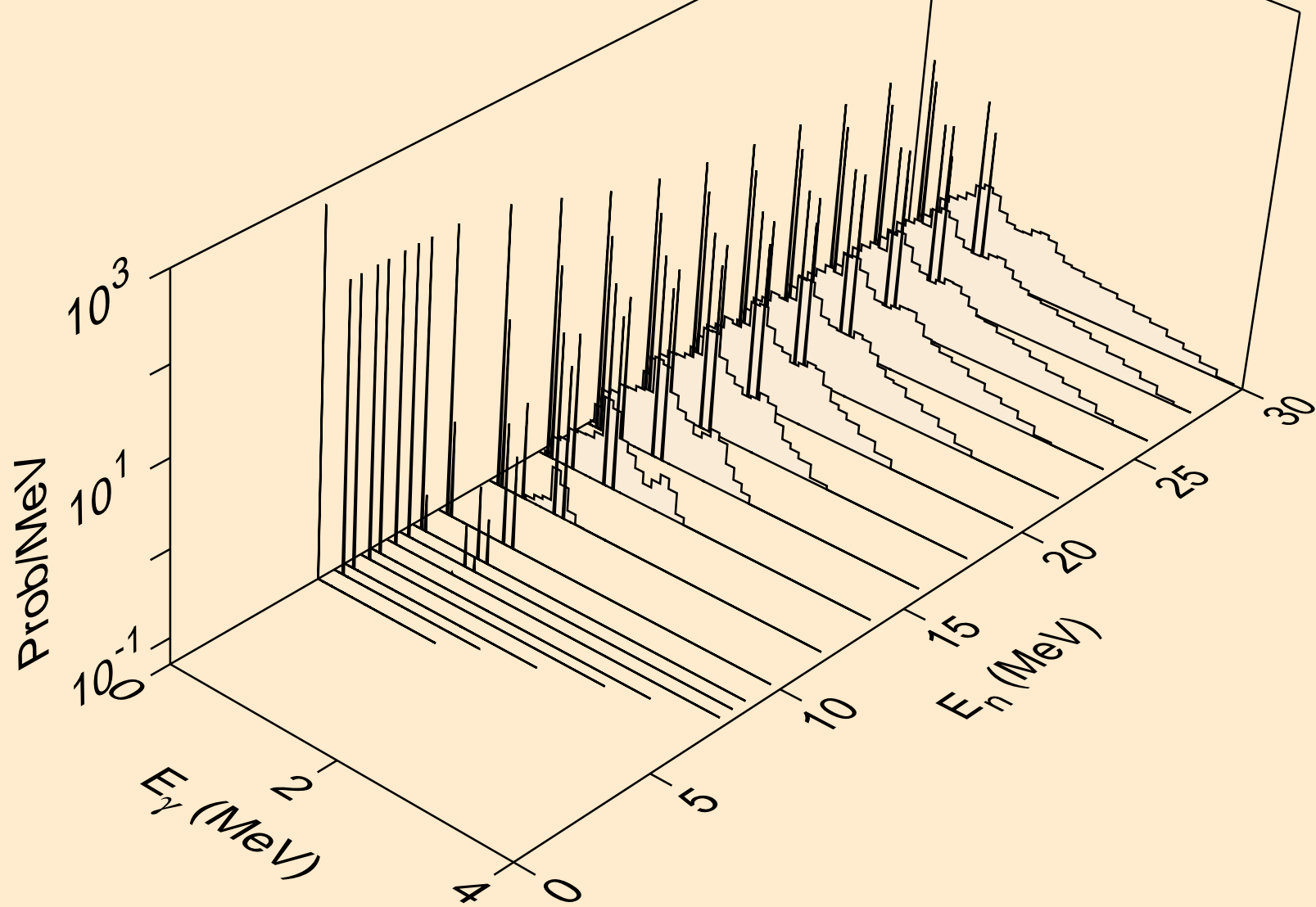

YB151 NEUTRON ACER TENDL-2024 LIBRARY; T=0.K
Photon emission for (n,npa)

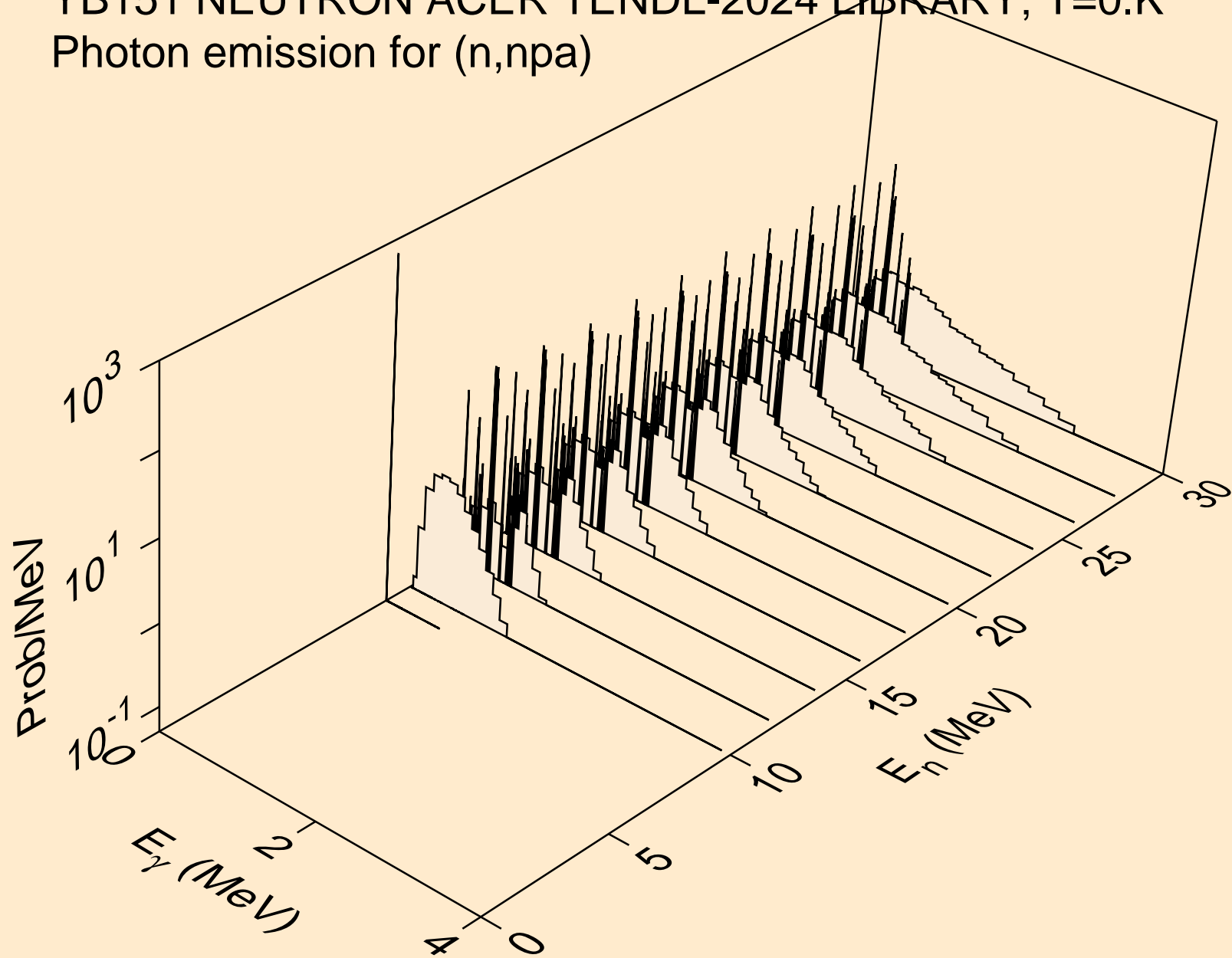

YB151 NEUTRON ACER TENDL-2024 LIBRARY; T=0.K
Photon emission for (n,n*c)

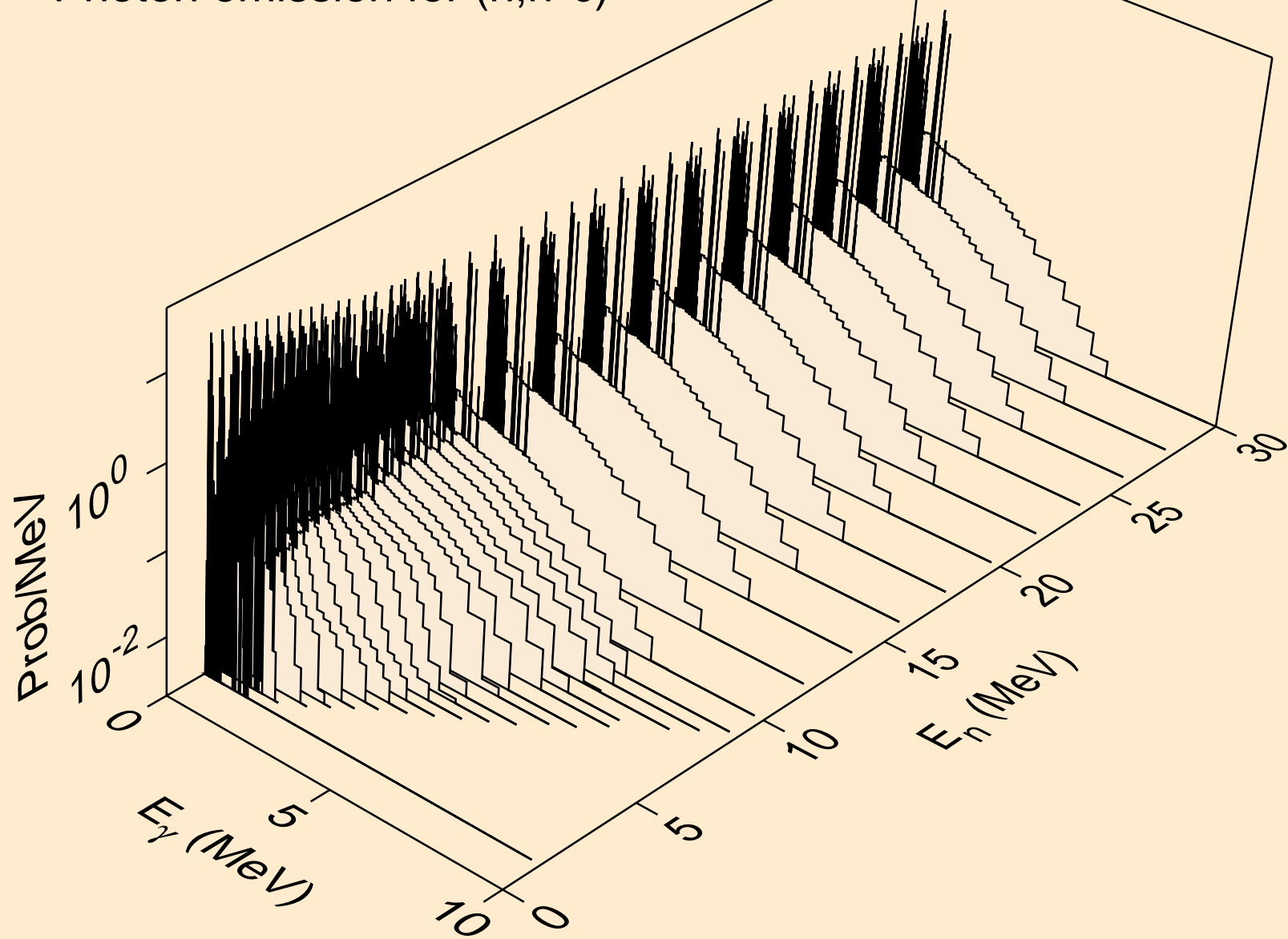

YB151 NEUTRON ACER TENDL-2024 LIBRARY; T=0.K
Photon emission for (n,gma)

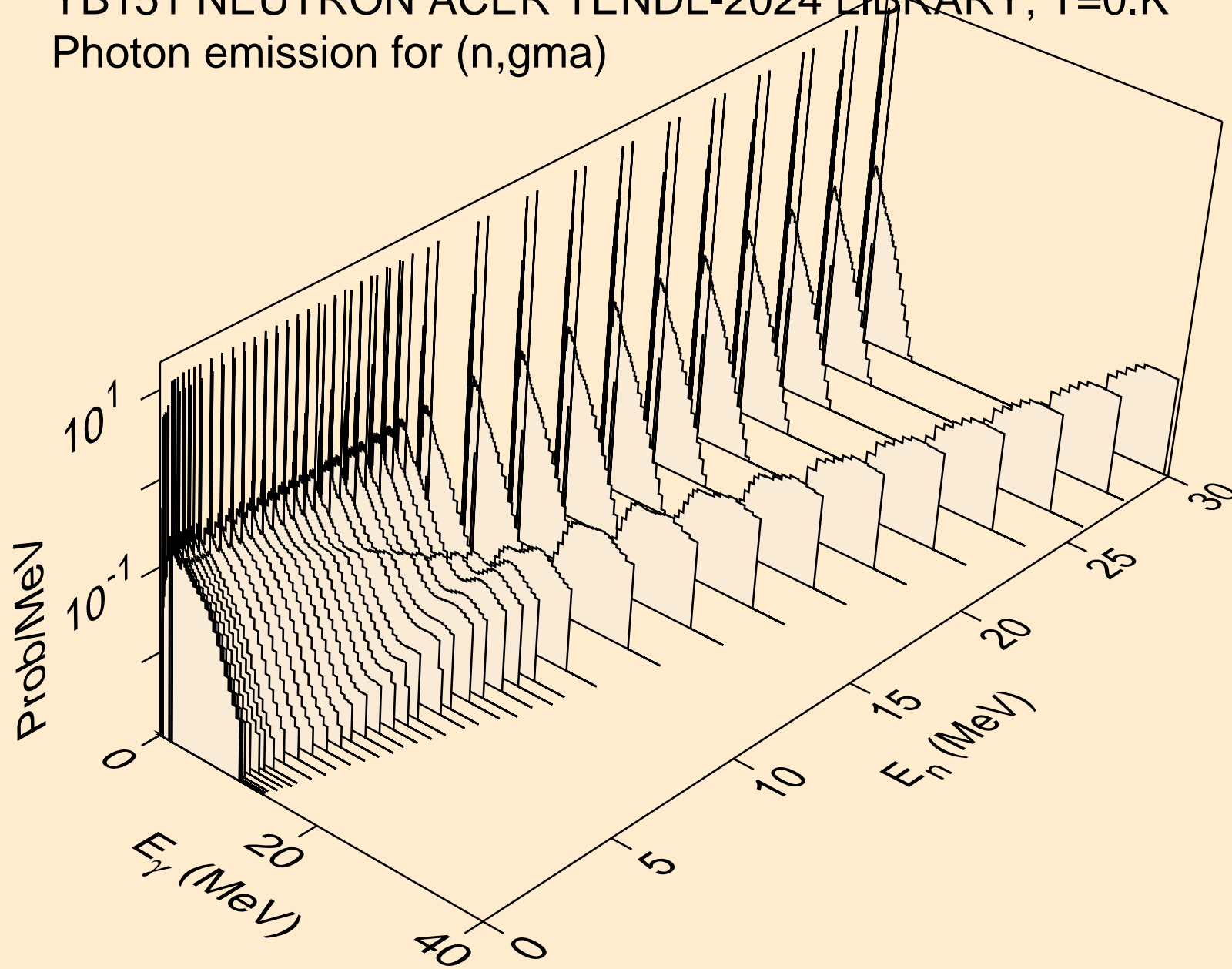

YB151 NEUTRON ACER TENDL-2024 LIBRARY; T=0.K
Photon emission for (n,p)

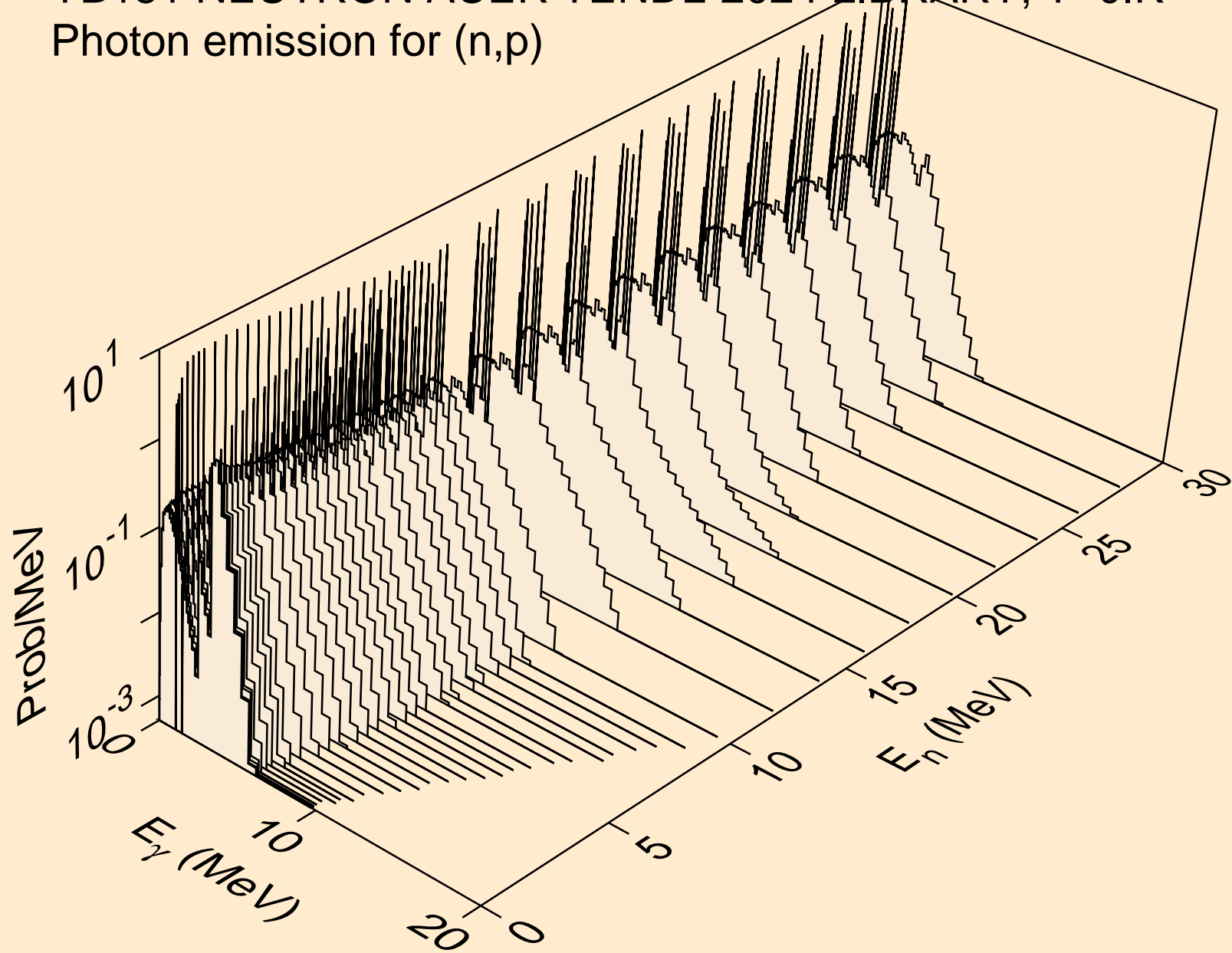

YB151 NEUTRON ACER TENDL-2024 LIBRARY; T=0.K
Photon emission for (n,d)

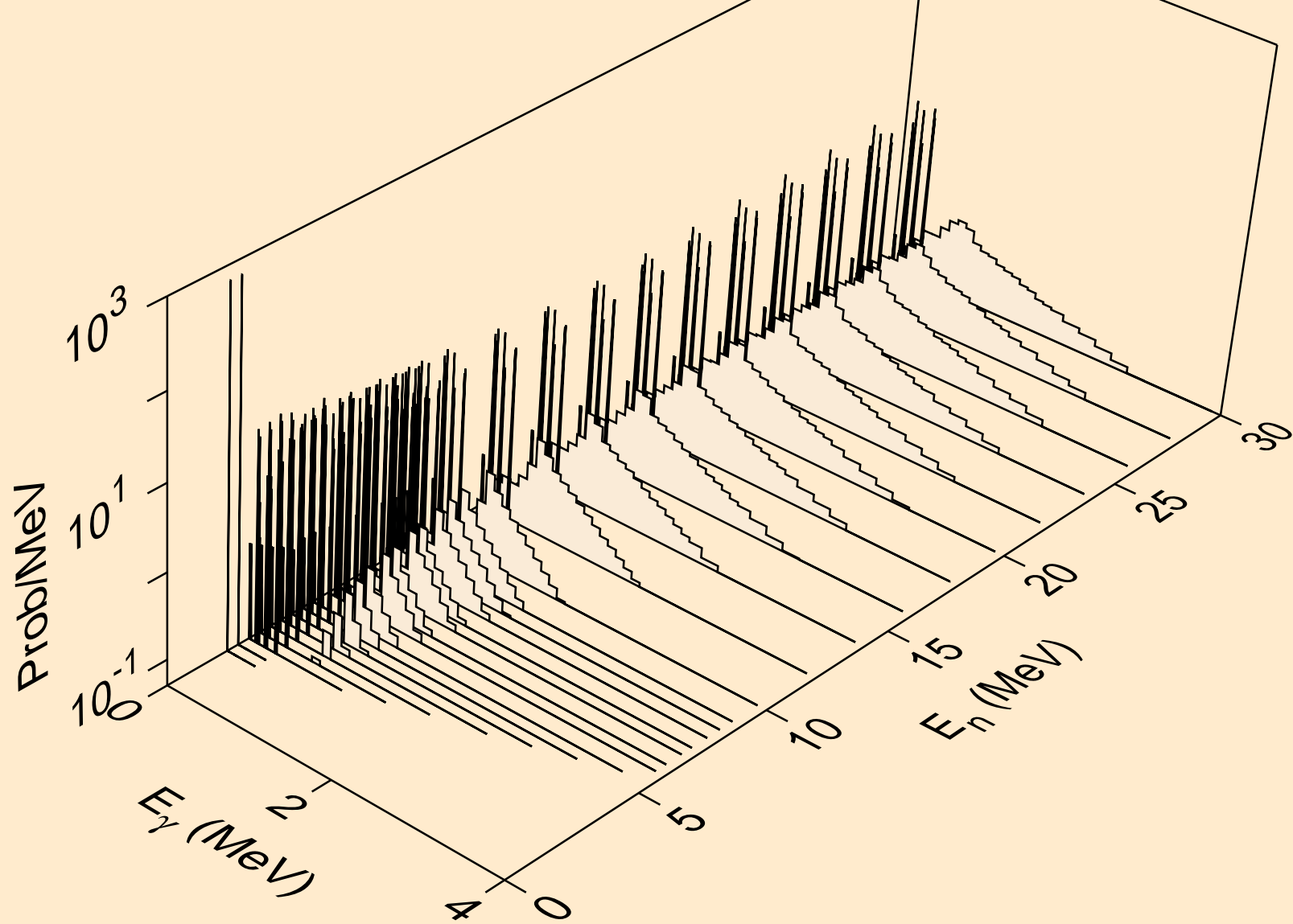

YB151 NEUTRON ACER TENDL-2024 LIBRARY; T=0.K
Photon emission for (n,t)

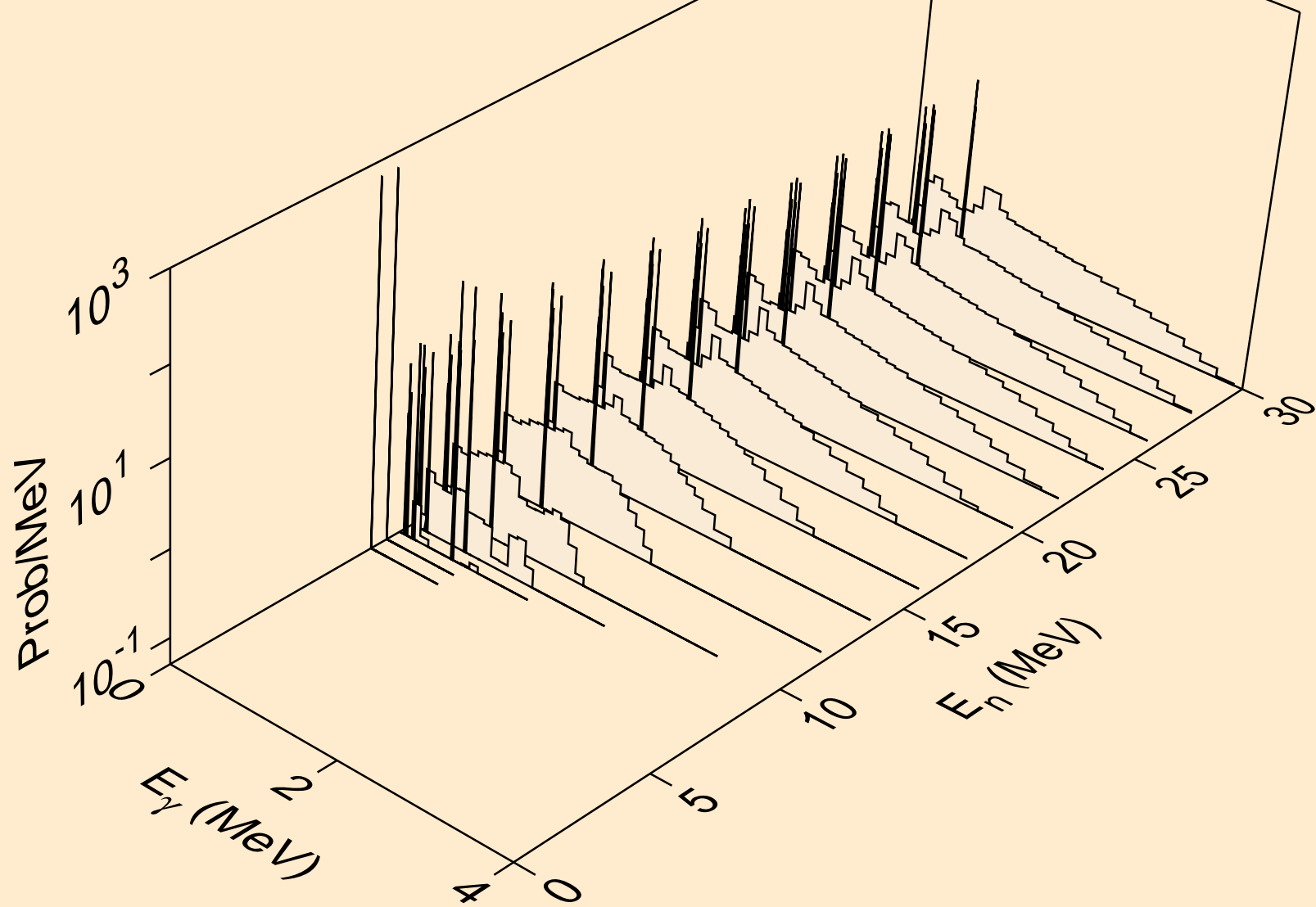

YB151 NEUTRON ACER TENDL-2024 LIBRARY; T=0.K
Photon emission for (n,he3)

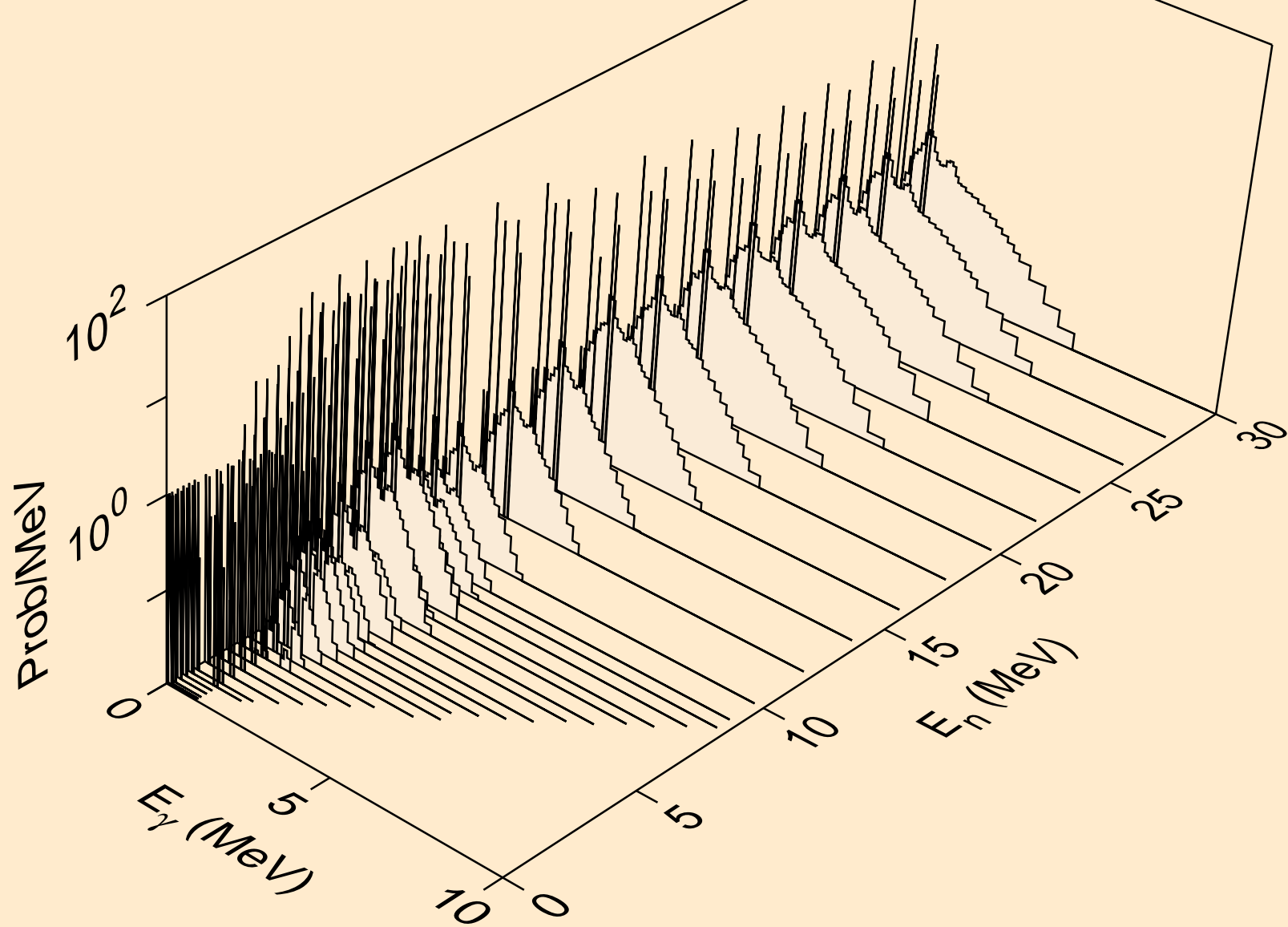

YB151 NEUTRON ACER TENDL-2024 LIBRARY; T=0.K
Photon emission for (n,a)

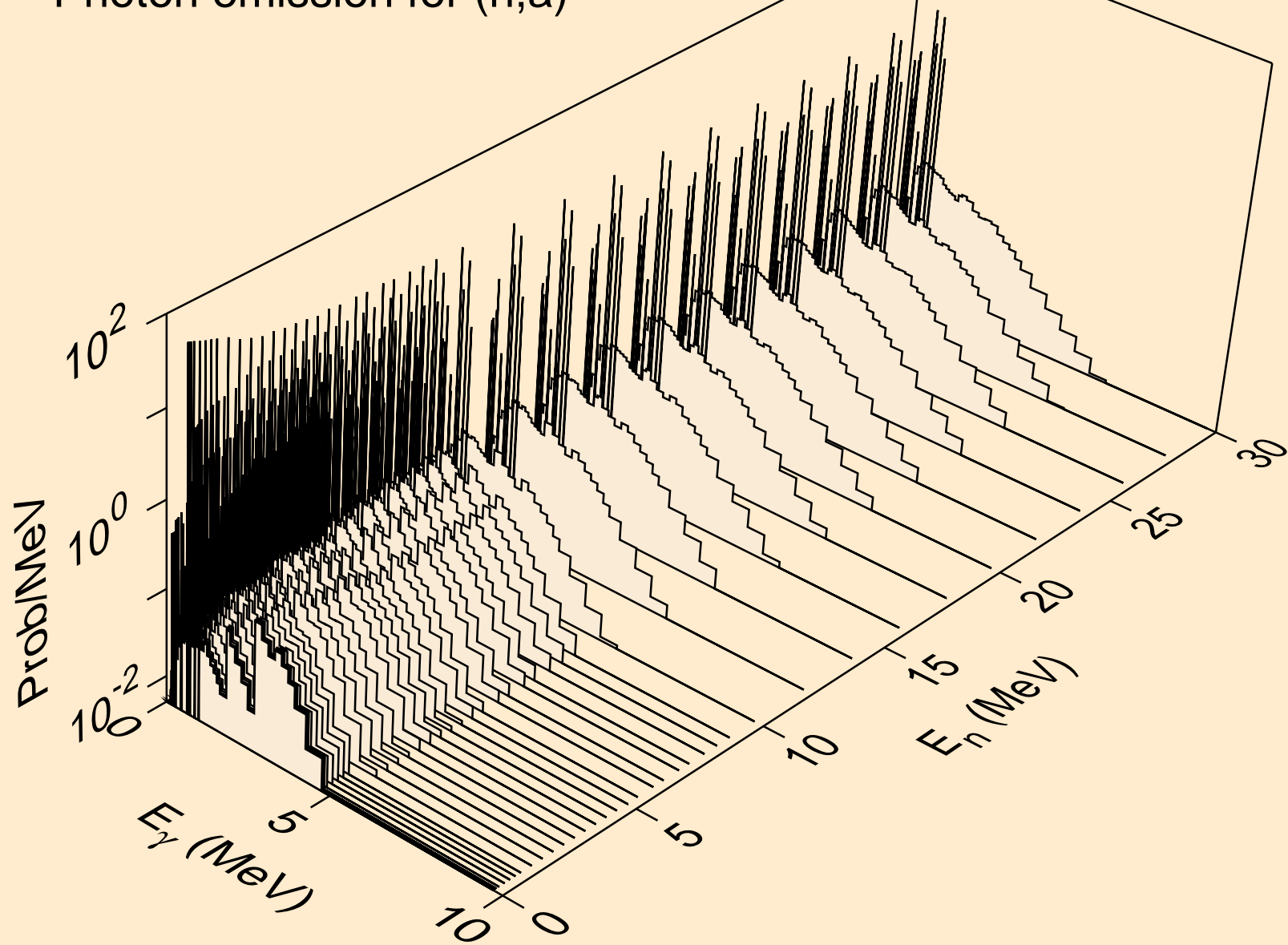

YB151 NEUTRON ACER TENDL-2024 LIBRARY; T=0.K
Photon emission for (n,2a)

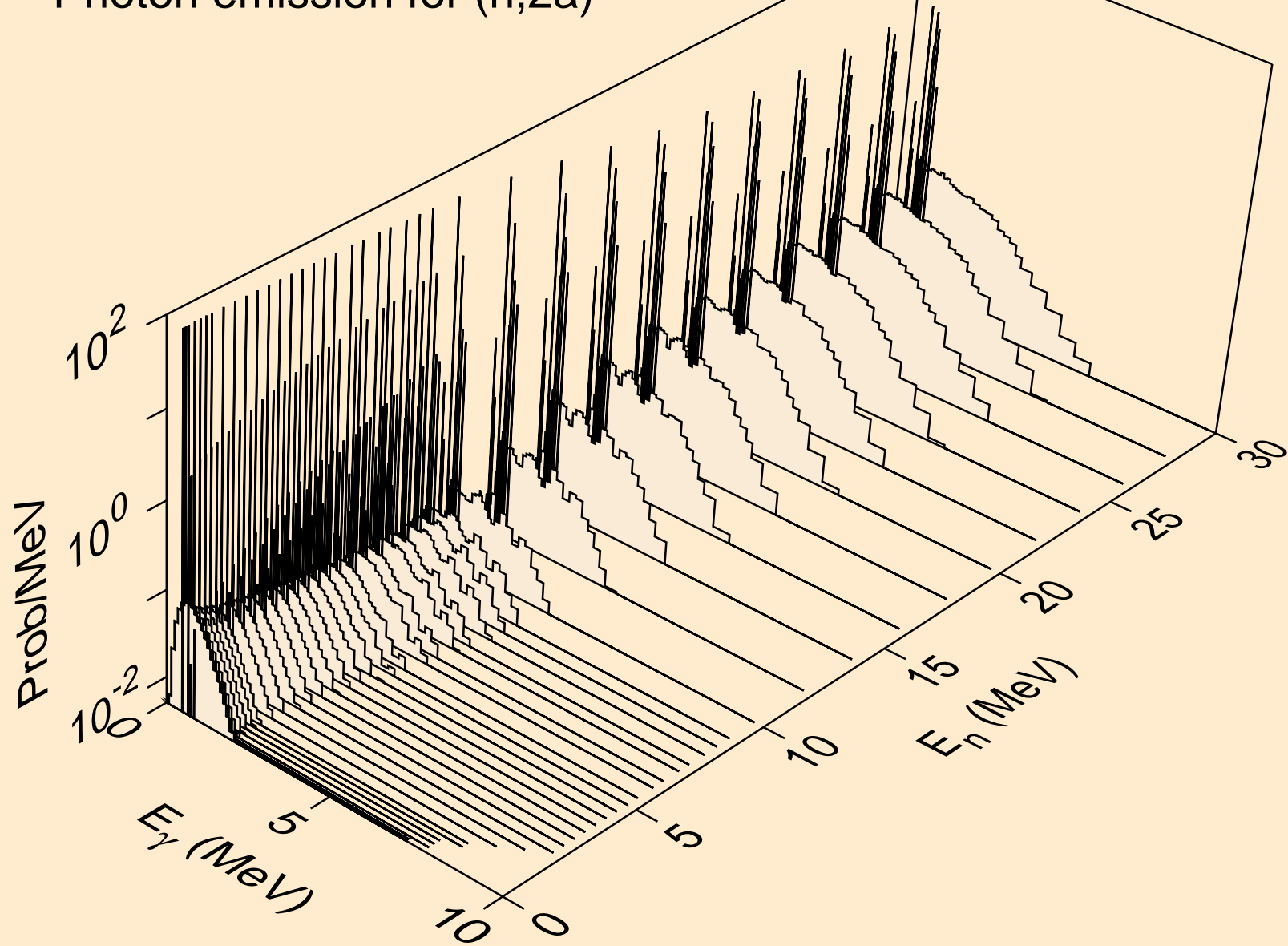

YB151 NEUTRON ACER TENDL-2024 LIBRARY; T=0.K
Photon emission for (n,3a)

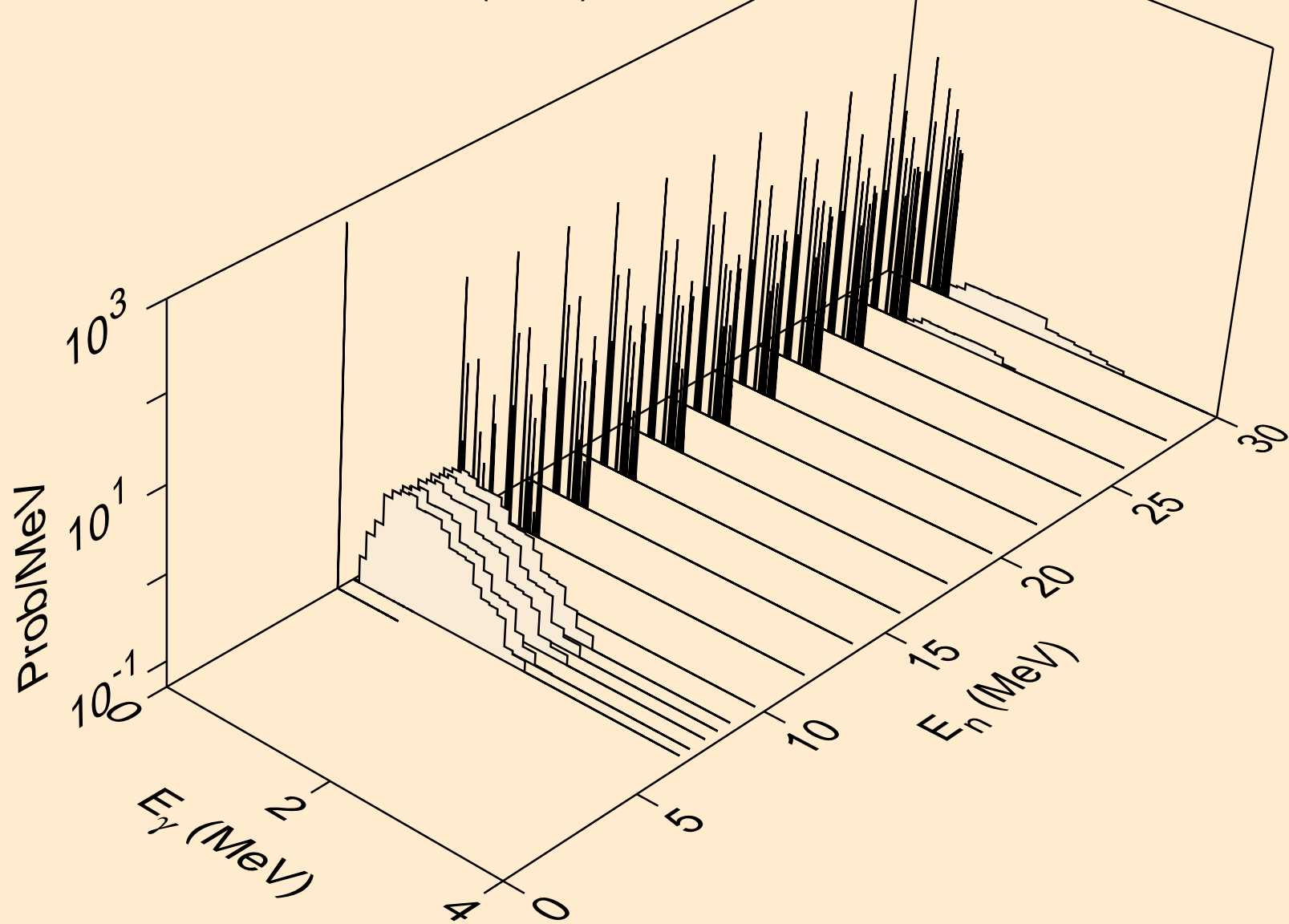

YB151 NEUTRON ACER TENDL-2024 LIBRARY; T=0.K
Photon emission for (n,2p)

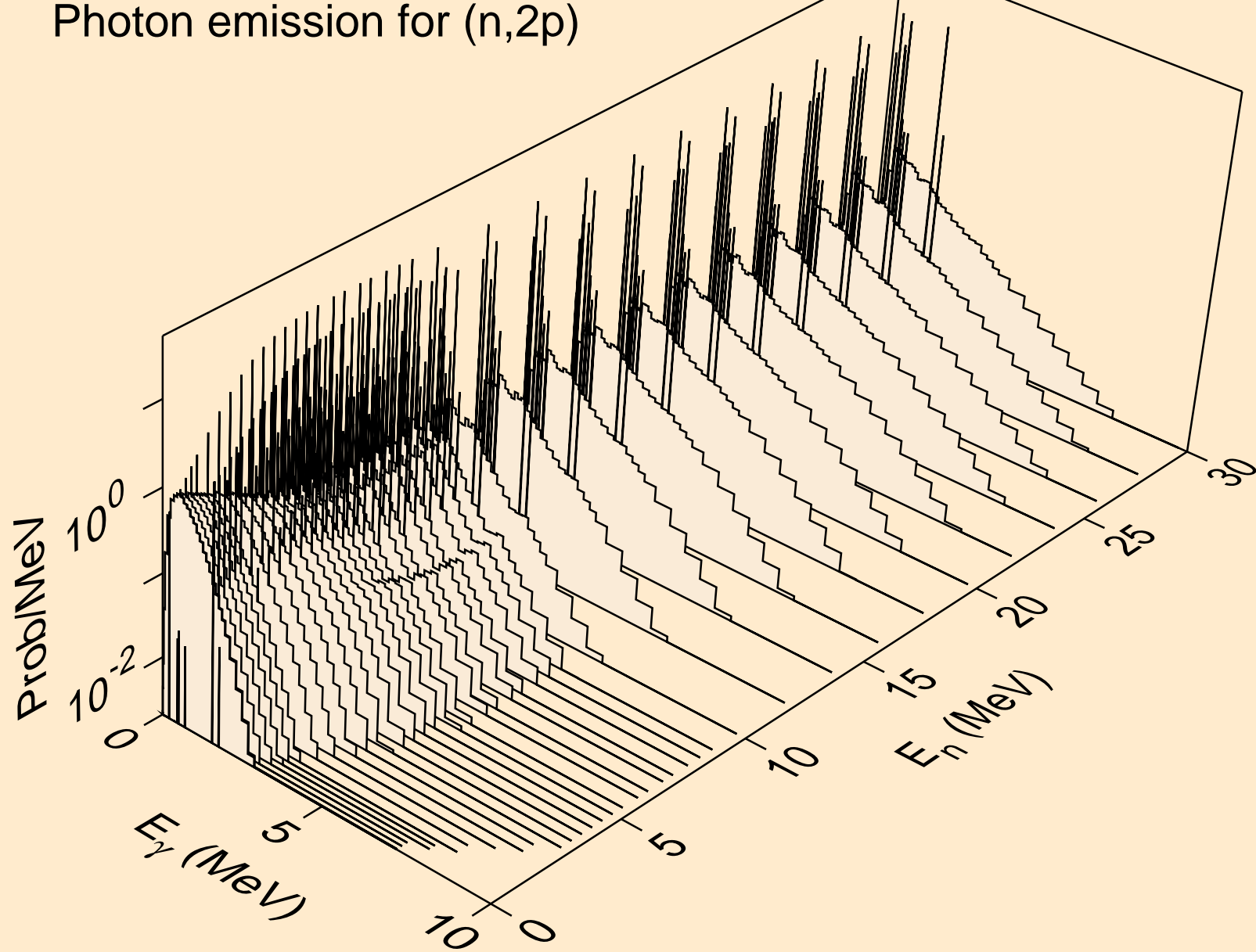

YB151 NEUTRON ACER TENDL-2024 LIBRARY; T=0.K
Photon emission for (n,p α)

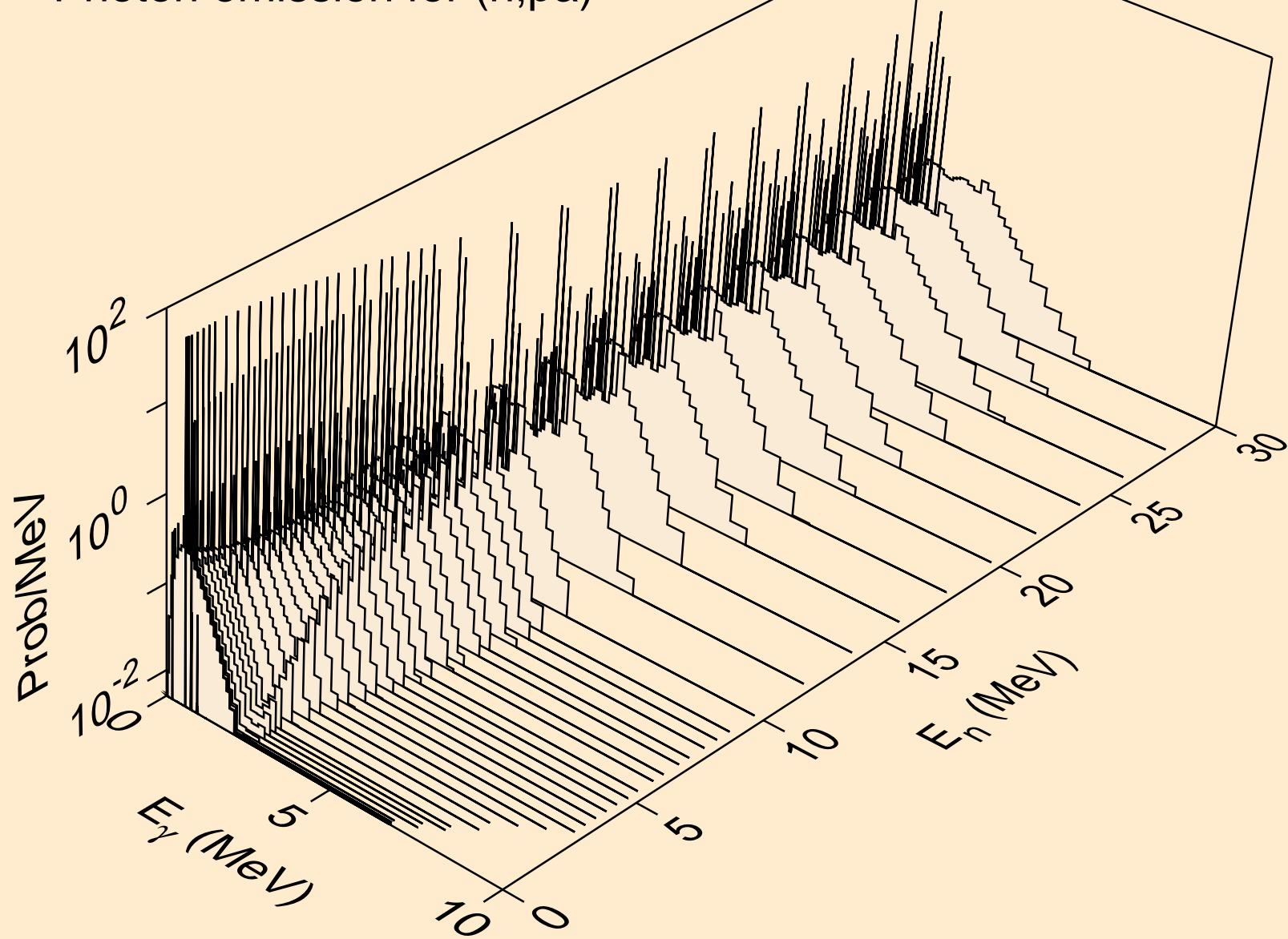

YB151 NEUTRON ACER TENDL-2024 LIBRARY; T=0.K
Photon emission for (n,pd)

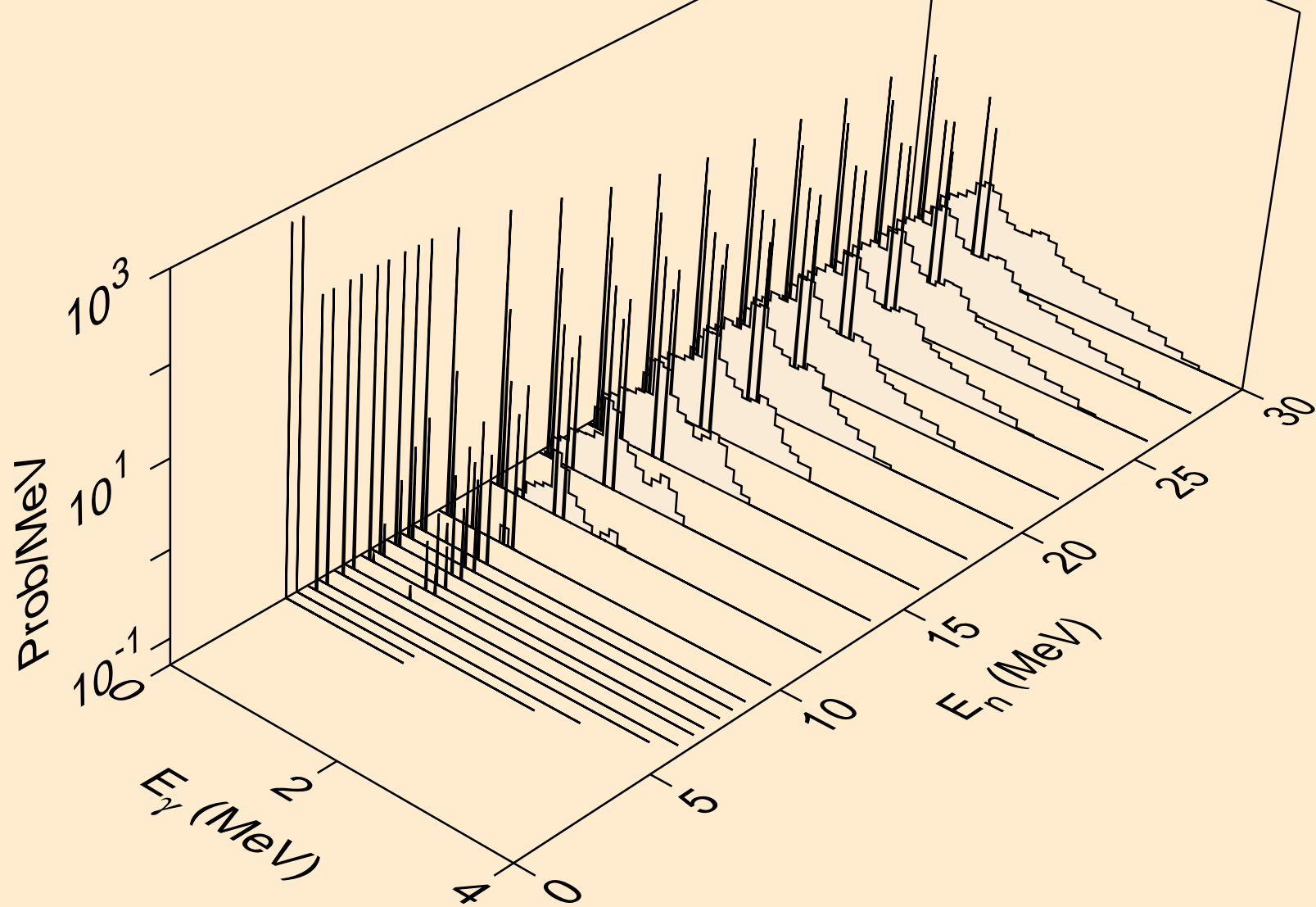

YB151 NEUTRON ACER TENDL-2024 LIBRARY; T=0.K
Photon emission for (n,pt)

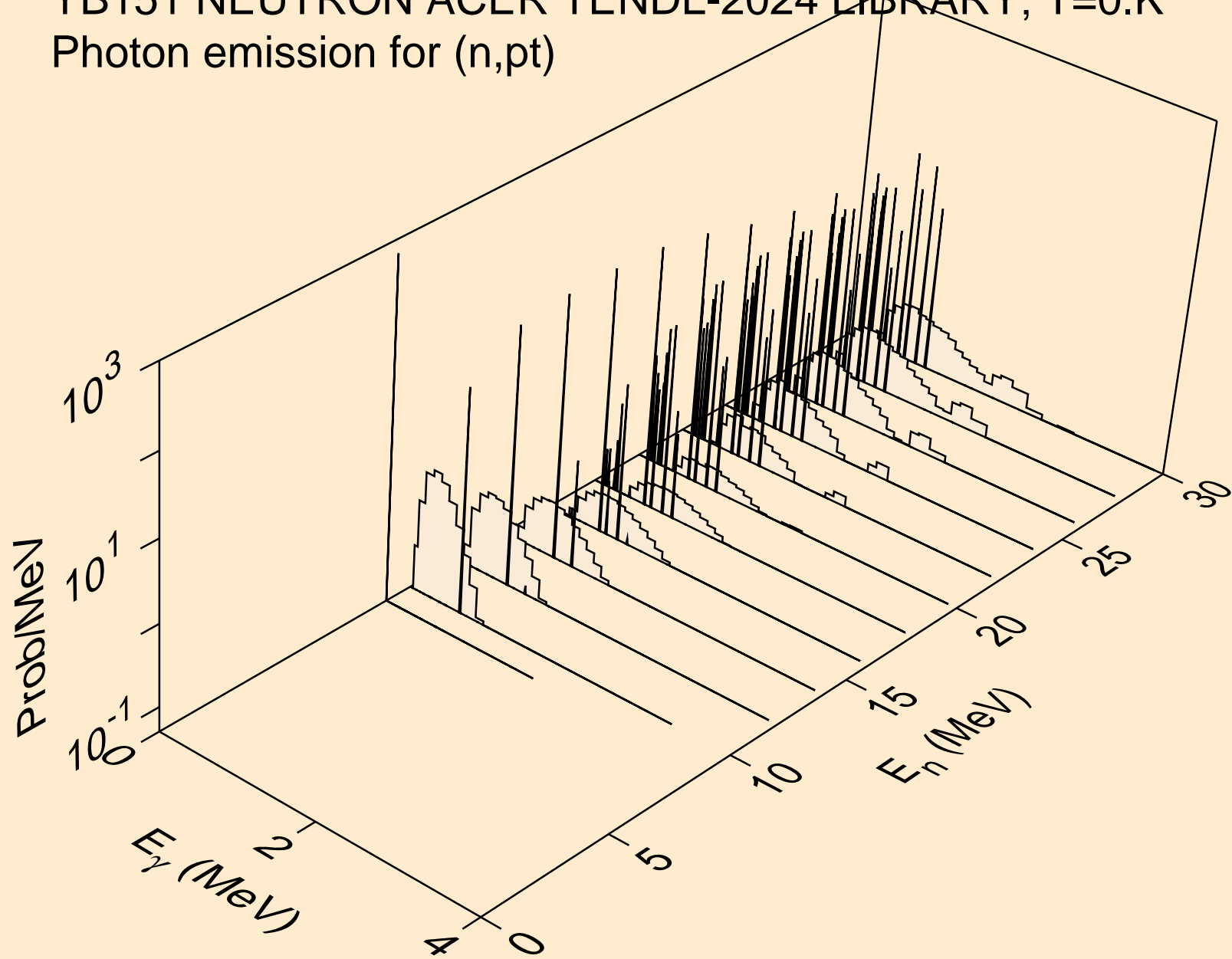

YB151 NEUTRON ACER TENDL-2024 LIBRARY; T=0.K
Photon emission for (n,da)

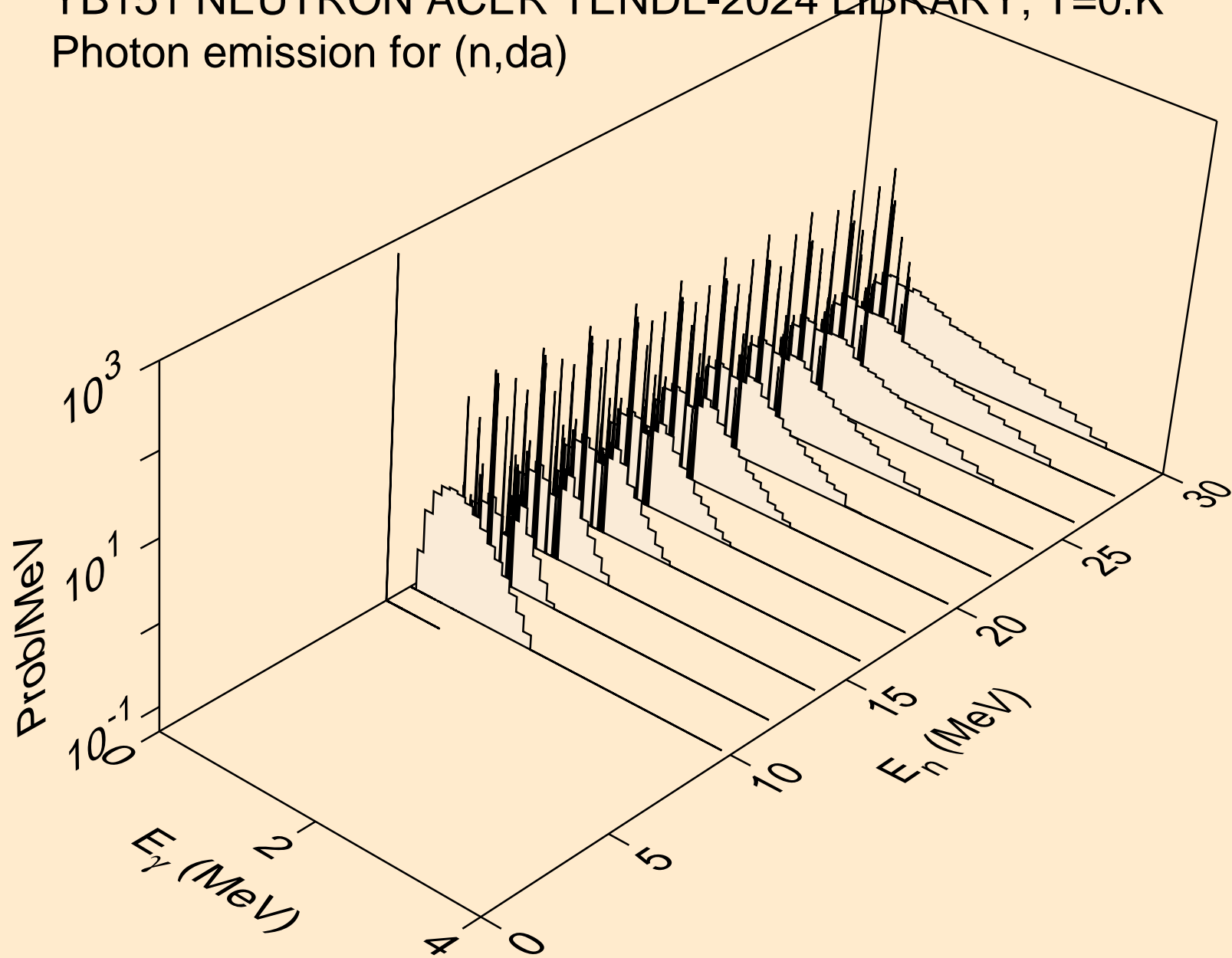

YB151 NEUTRON ACER TENDL-2024 LIBRARY; T=0.K
thermal capture photon spectrum

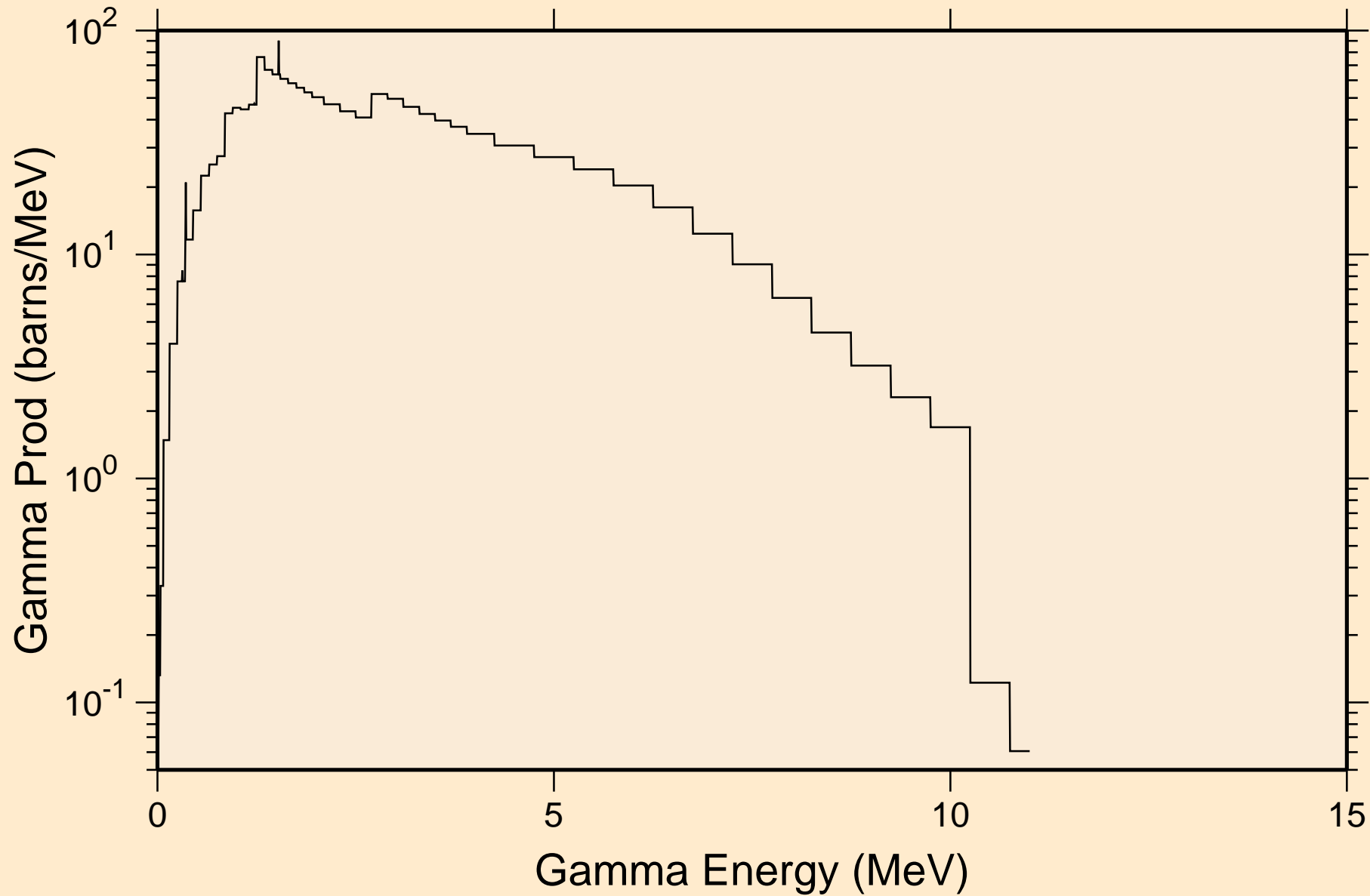

YB151 NEUTRON ACER TENDL-2024 LIBRARY; T=0.K
14 MeV photon spectrum

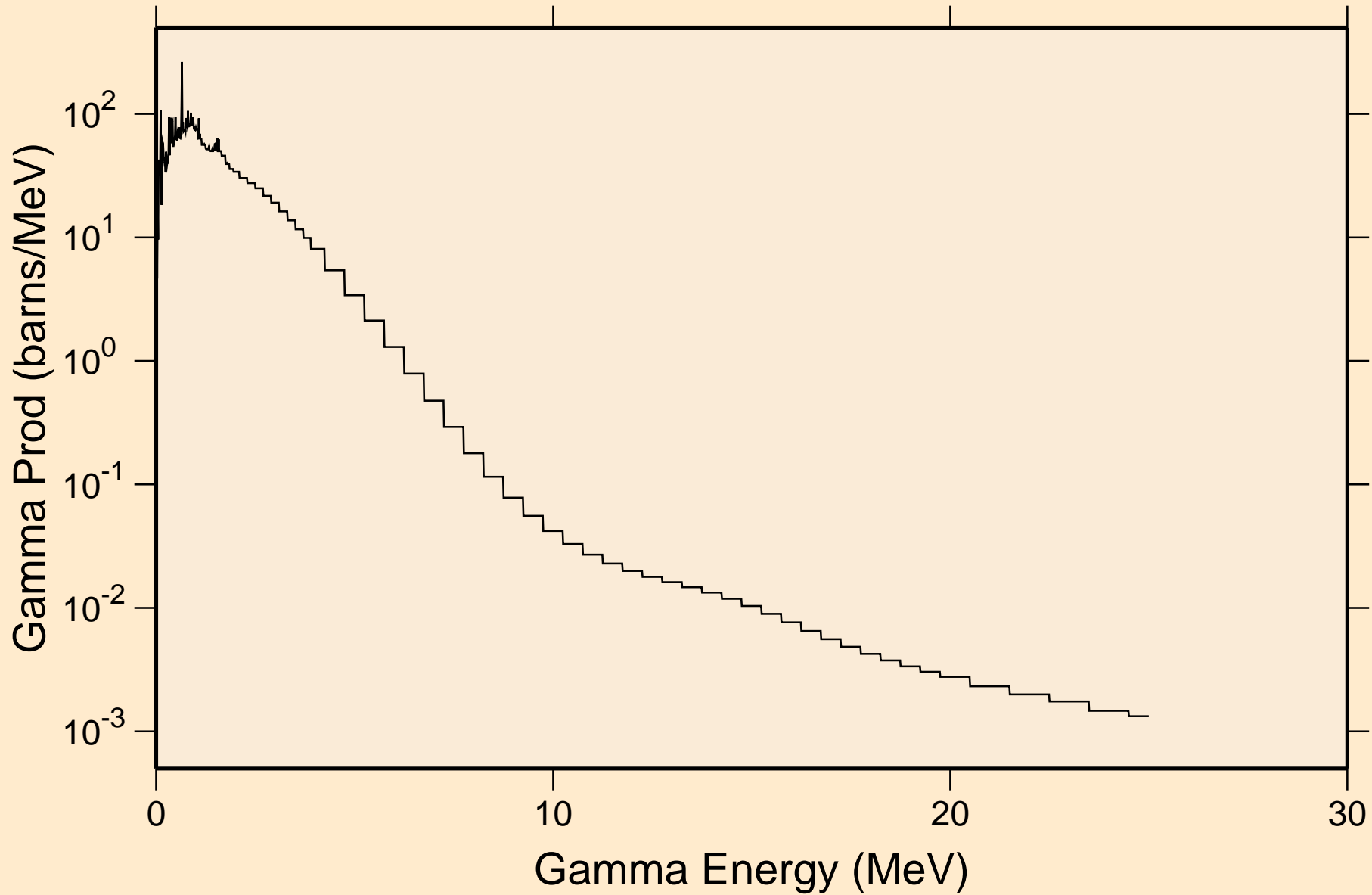

YB151 NEUTRON ACER TENDL-2024 LIBRARY; T=0.K

Particle heating contributions

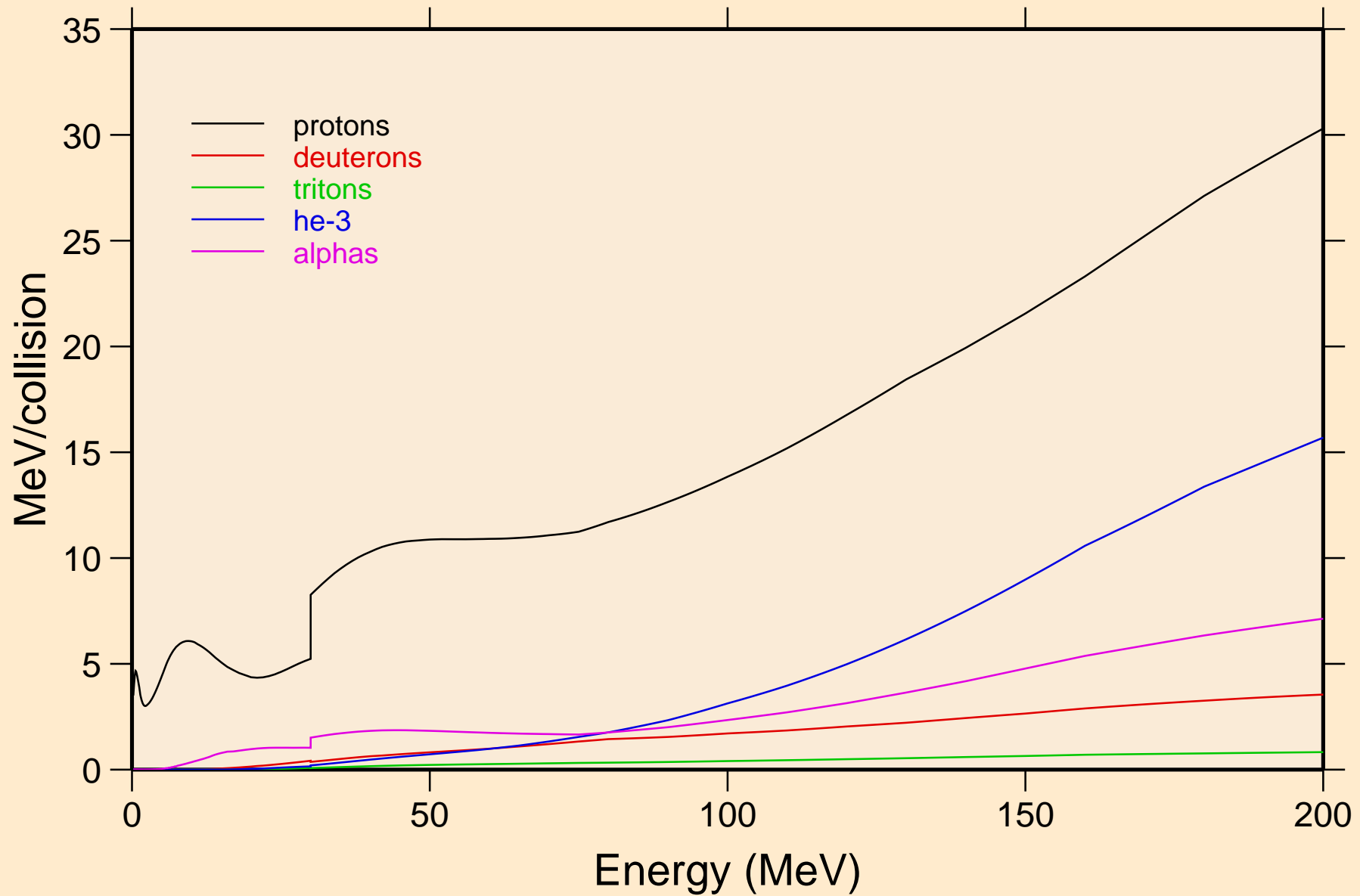

YB151 NEUTRON ACER TENDL-2024 LIBRARY; T=0.K
Recoil Heating

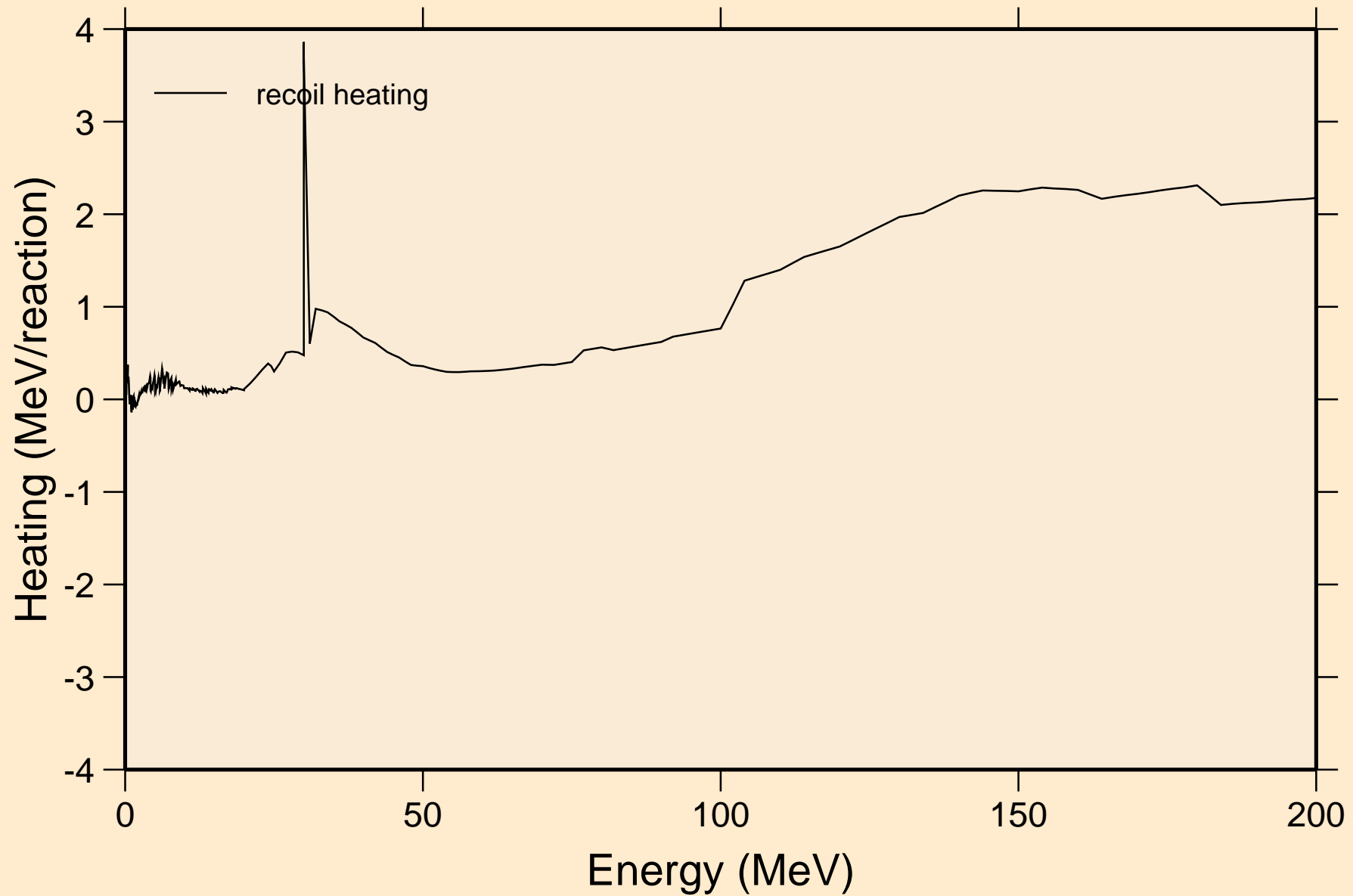

YB151 NEUTRON ACER TENDL-2024 LIBRARY; T=0.K

Particle production cross sections

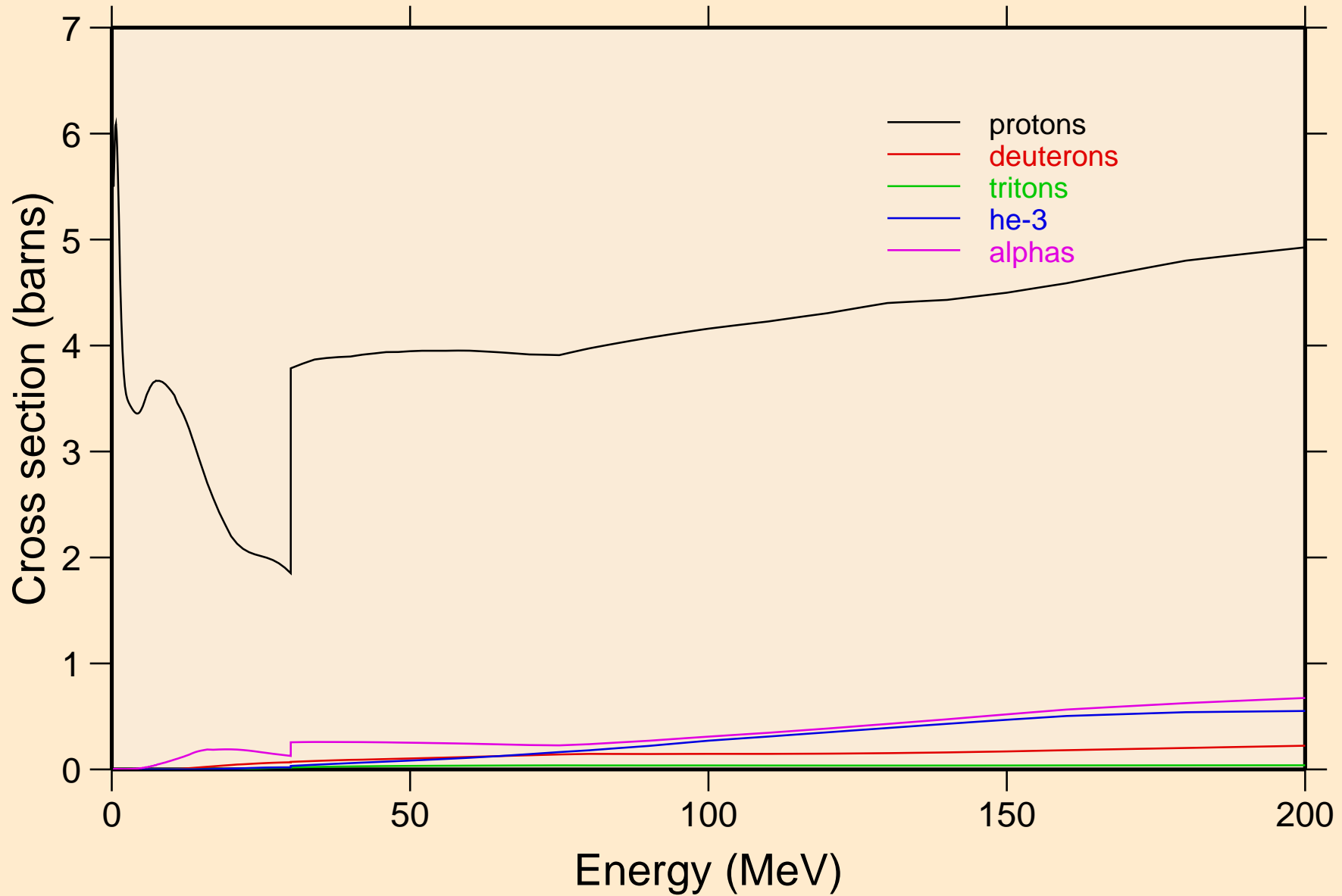

YB151 NEUTRON ACER TENDL-2024 LIBRARY; T=0.K
protons from (n,x)

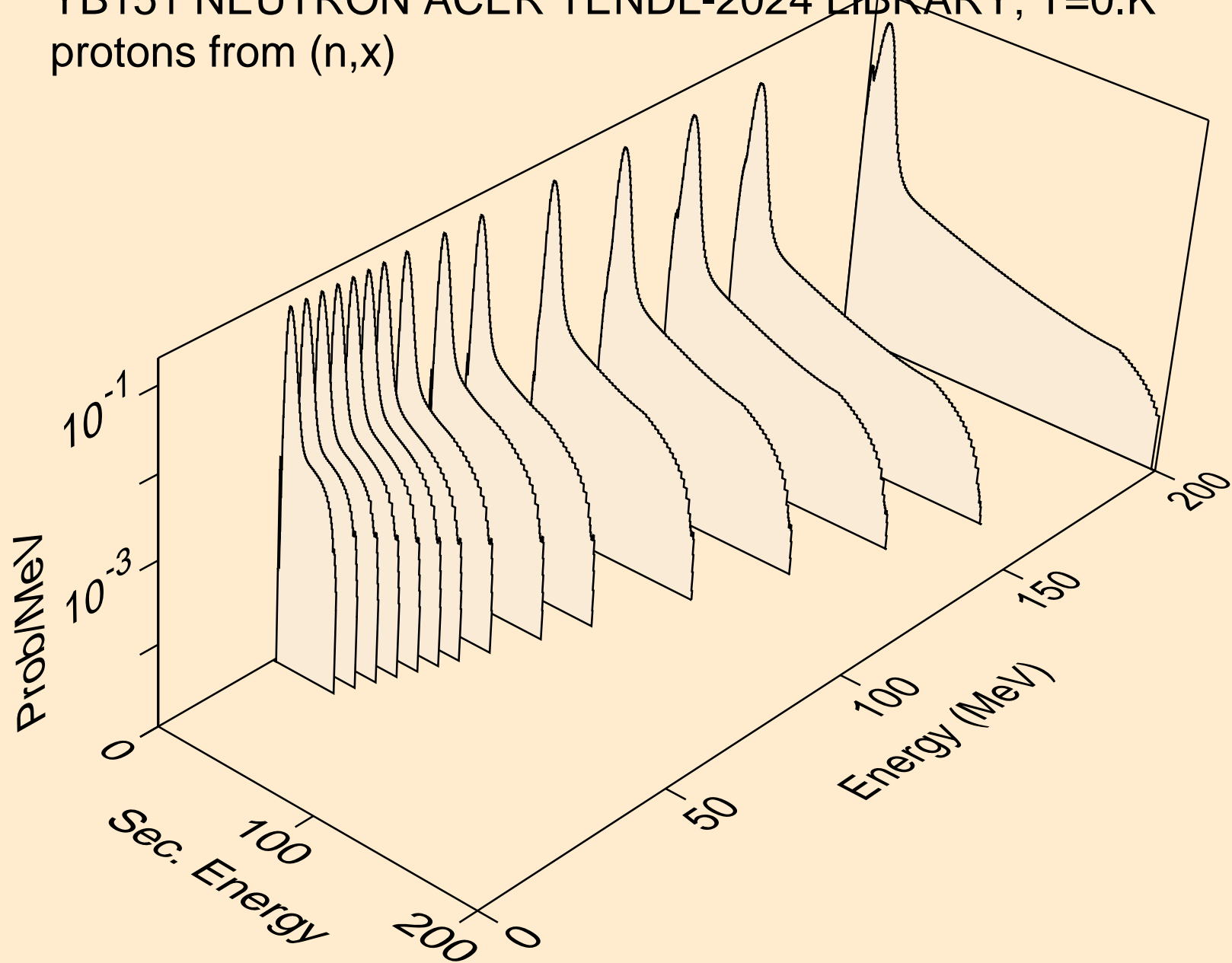

YB151 NEUTRON ACER TENDL-2024 LIBRARY; T=0.K
protons from (n,n*)p

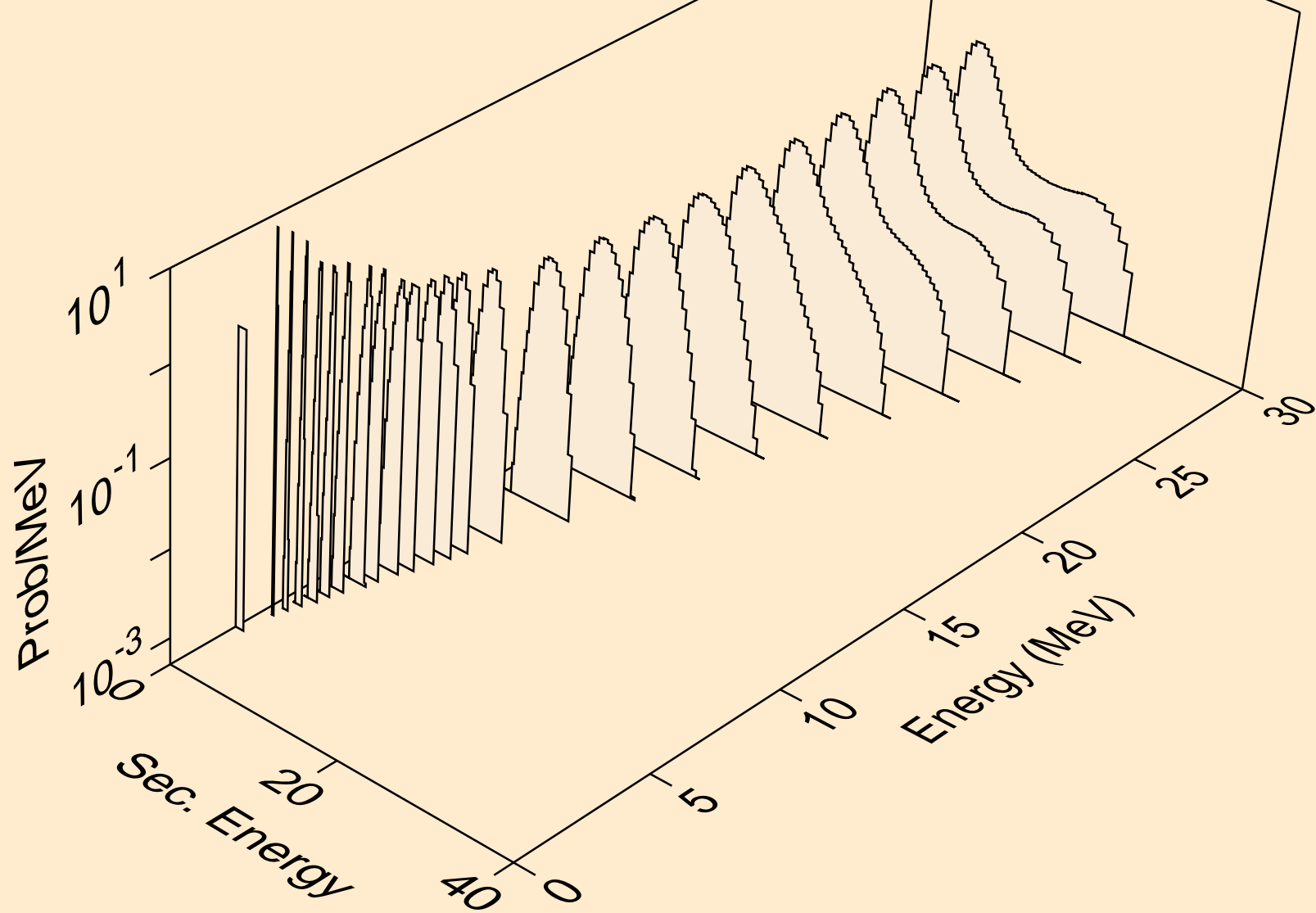

YB151 NEUTRON ACER TENDL-2024 LIBRARY; T=0.K
protons from (n,2np)

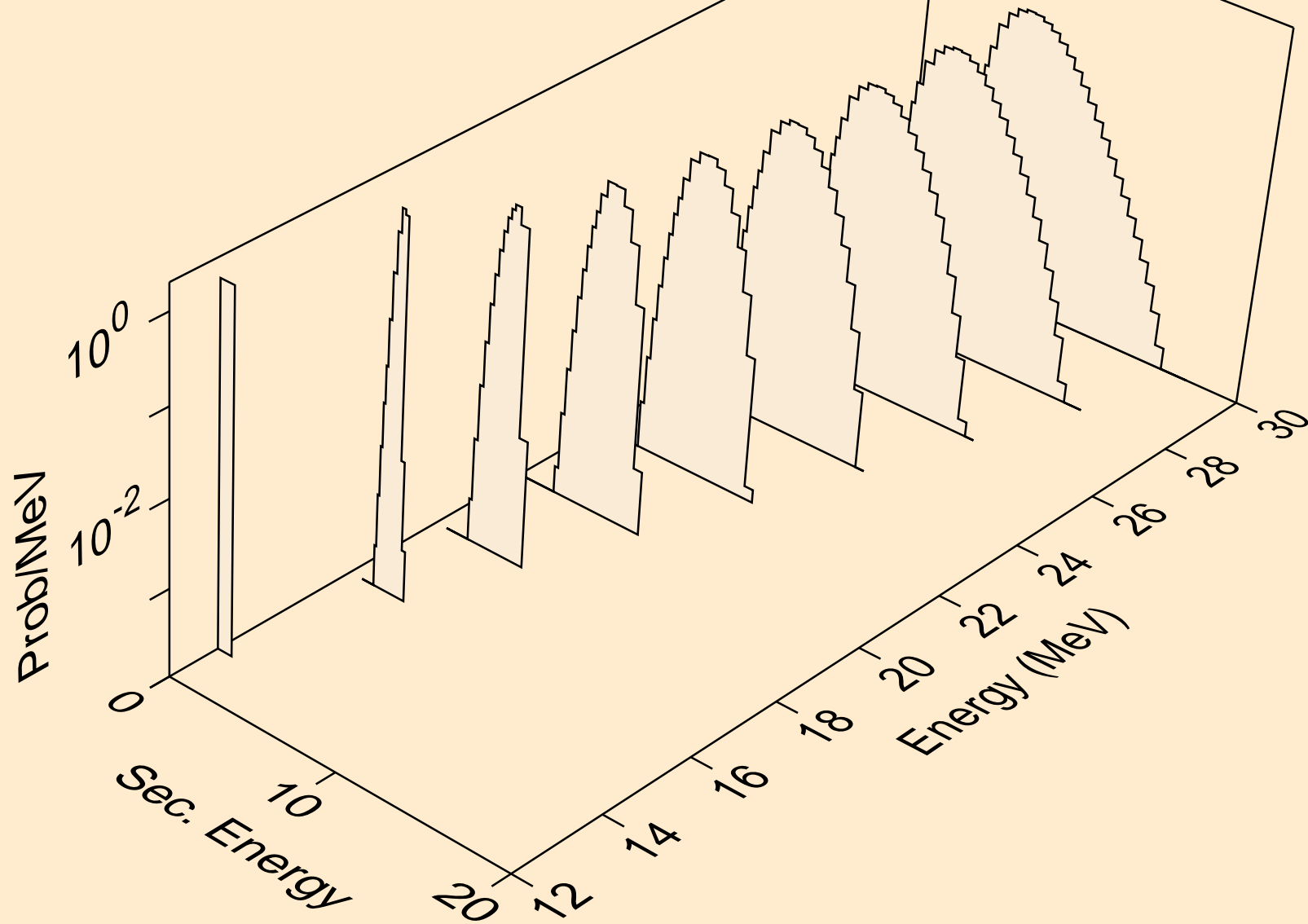

YB151 NEUTRON ACER TENDL-2024 LIBRARY; T=0.K
protons from (n,n2p)

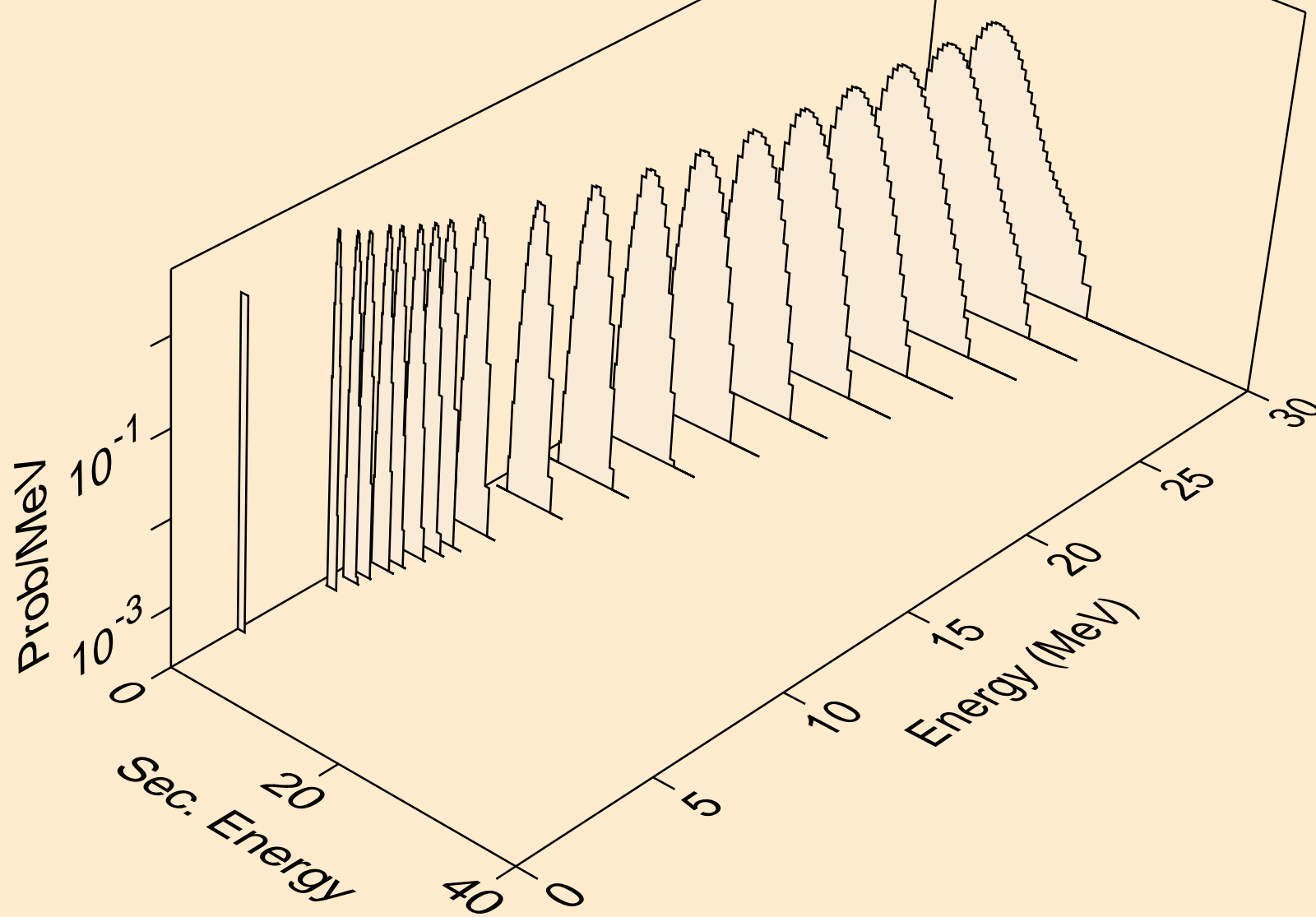

YB151 NEUTRON ACER TENDL-2024 LIBRARY; T=0.K
protons from (n,npa)

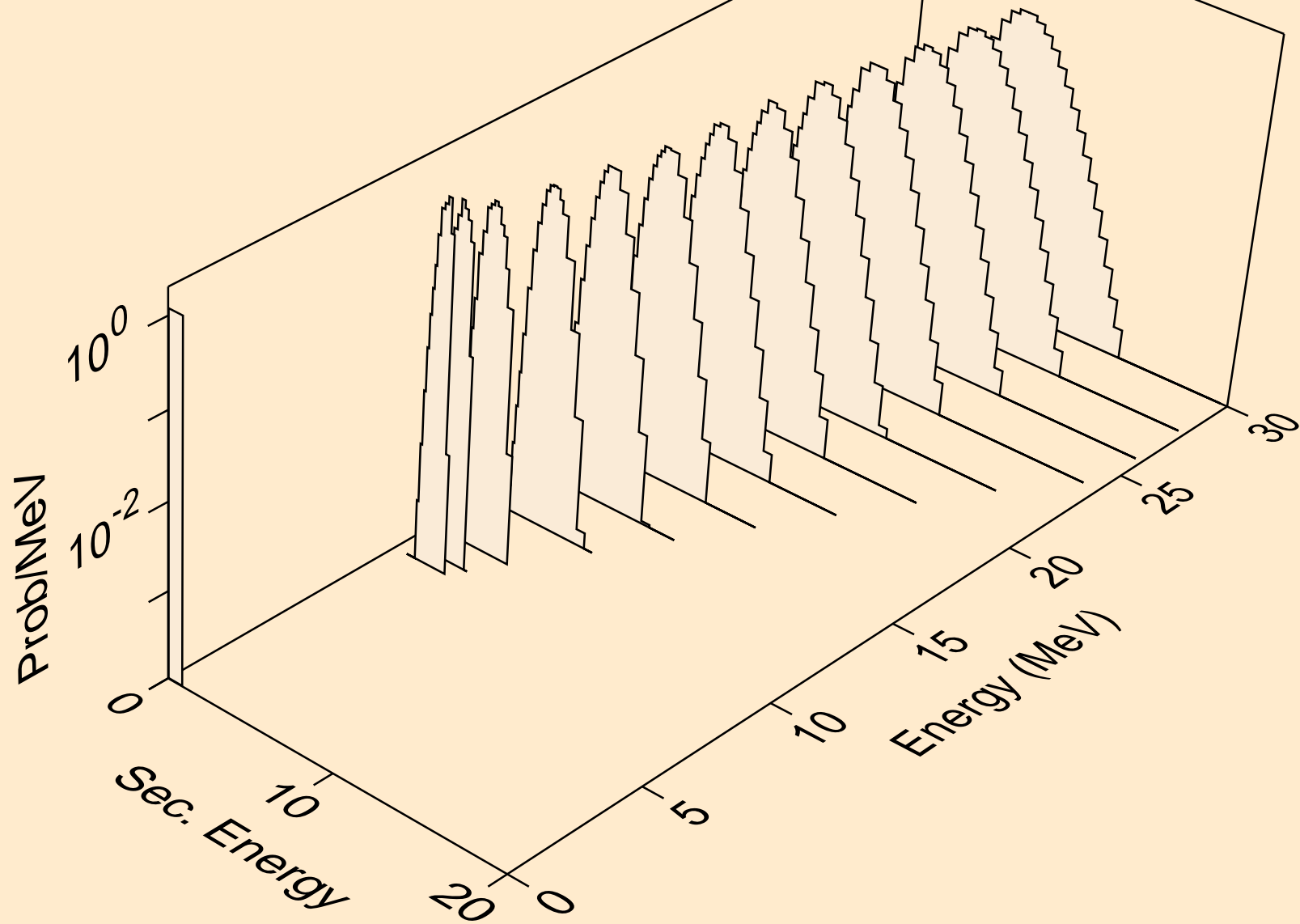

YB151 NEUTRON ACER TENDL-2024 LIBRARY; T=0.K
protons from (n,p)

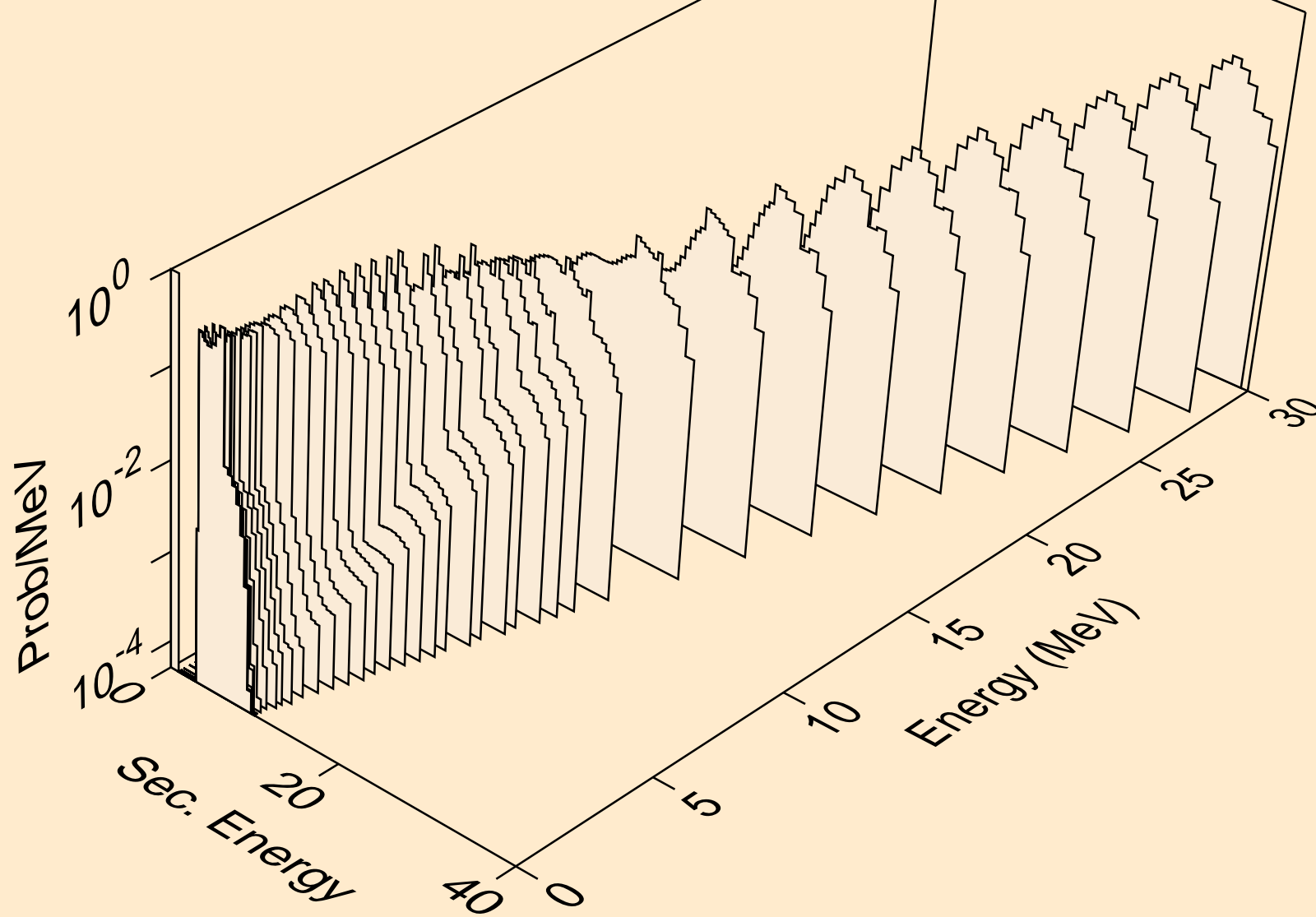

YB151 NEUTRON ACER TENDL-2024 LIBRARY; T=0.K
protons from (n,2p)

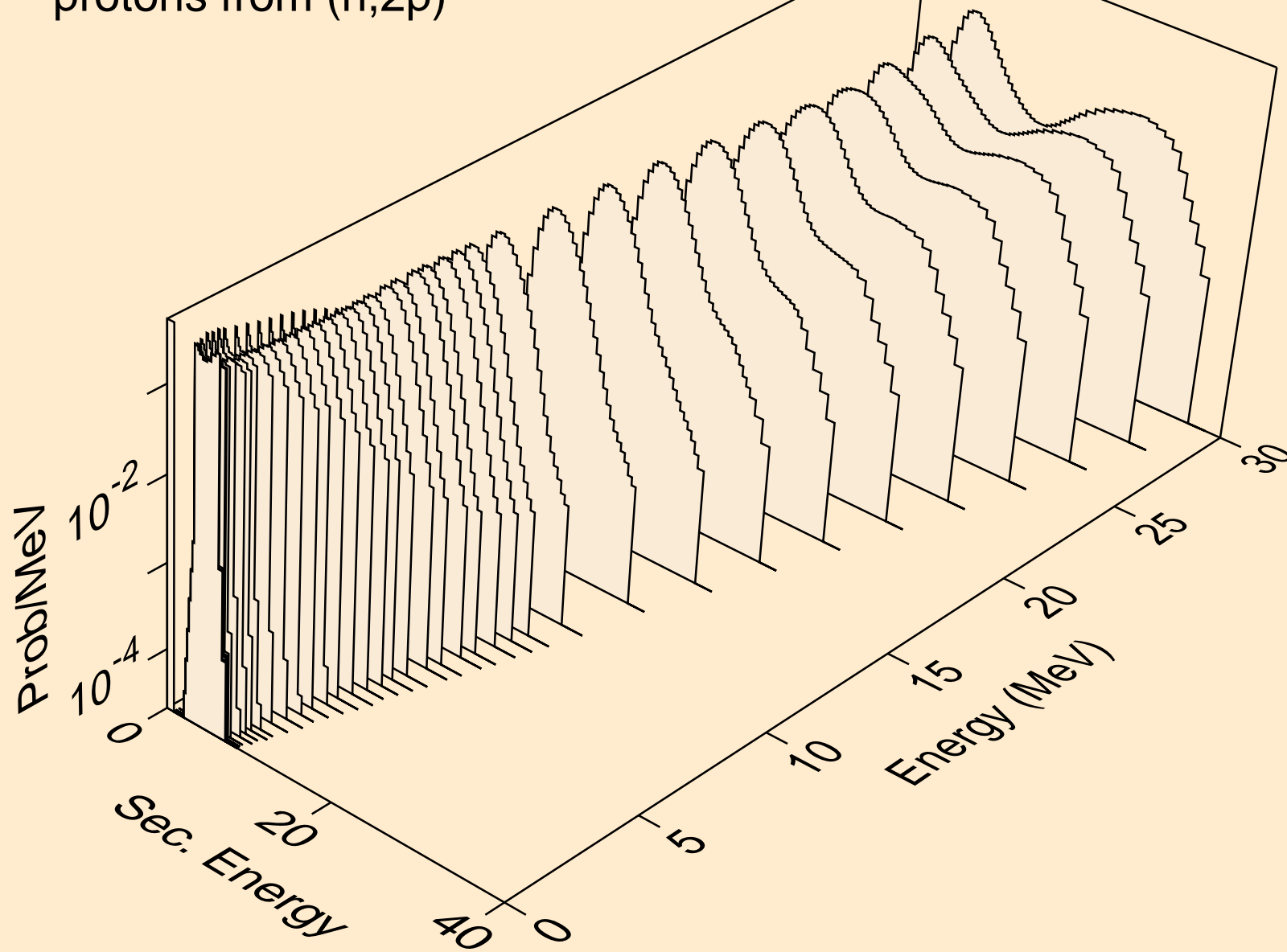

YB151 NEUTRON ACER TENDL-2024 LIBRARY; T=0.K
protons from (n,p)

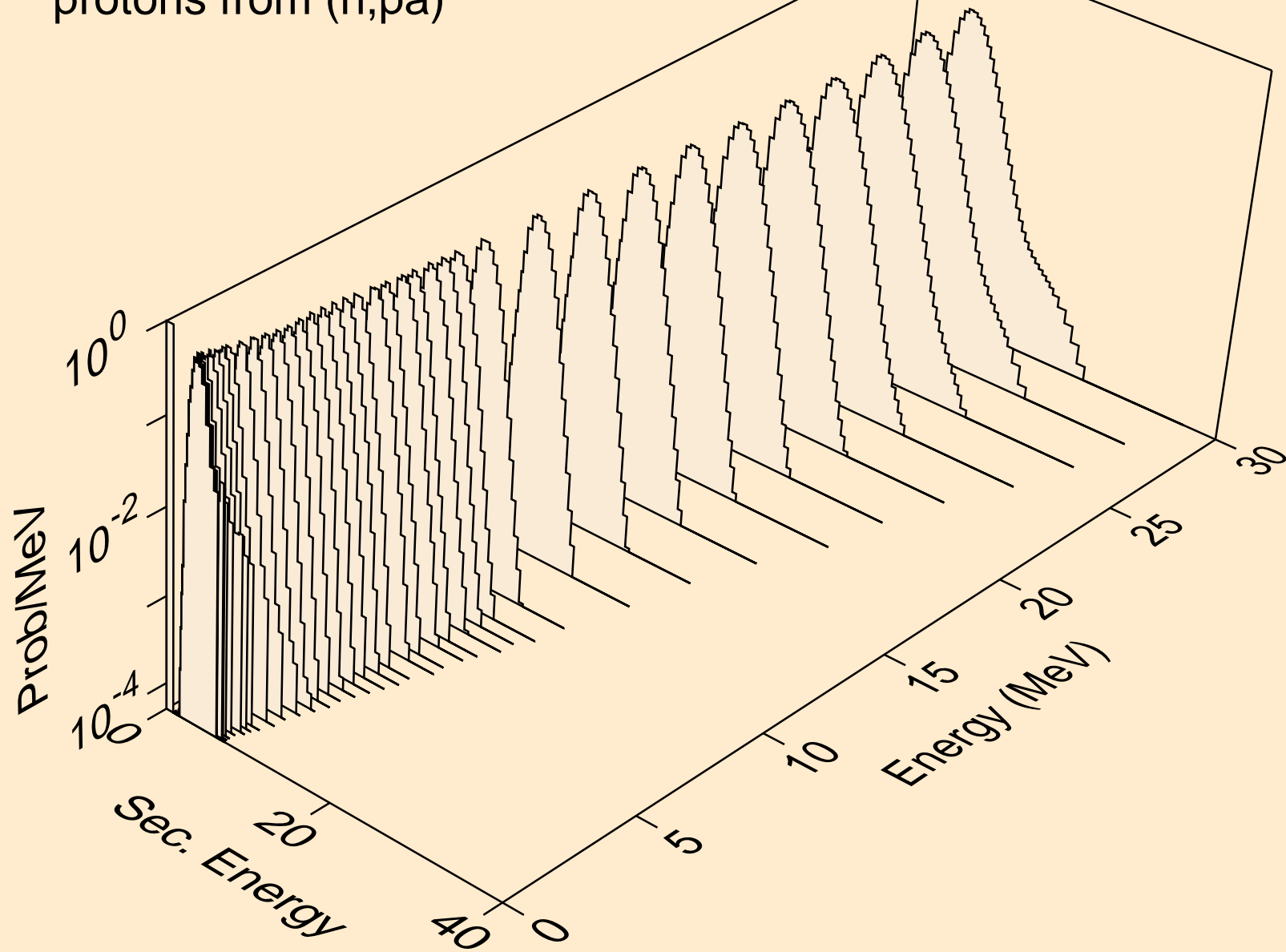

YB151 NEUTRON ACER TENDL-2024 LIBRARY; T=0.K
protons from (n,pd)

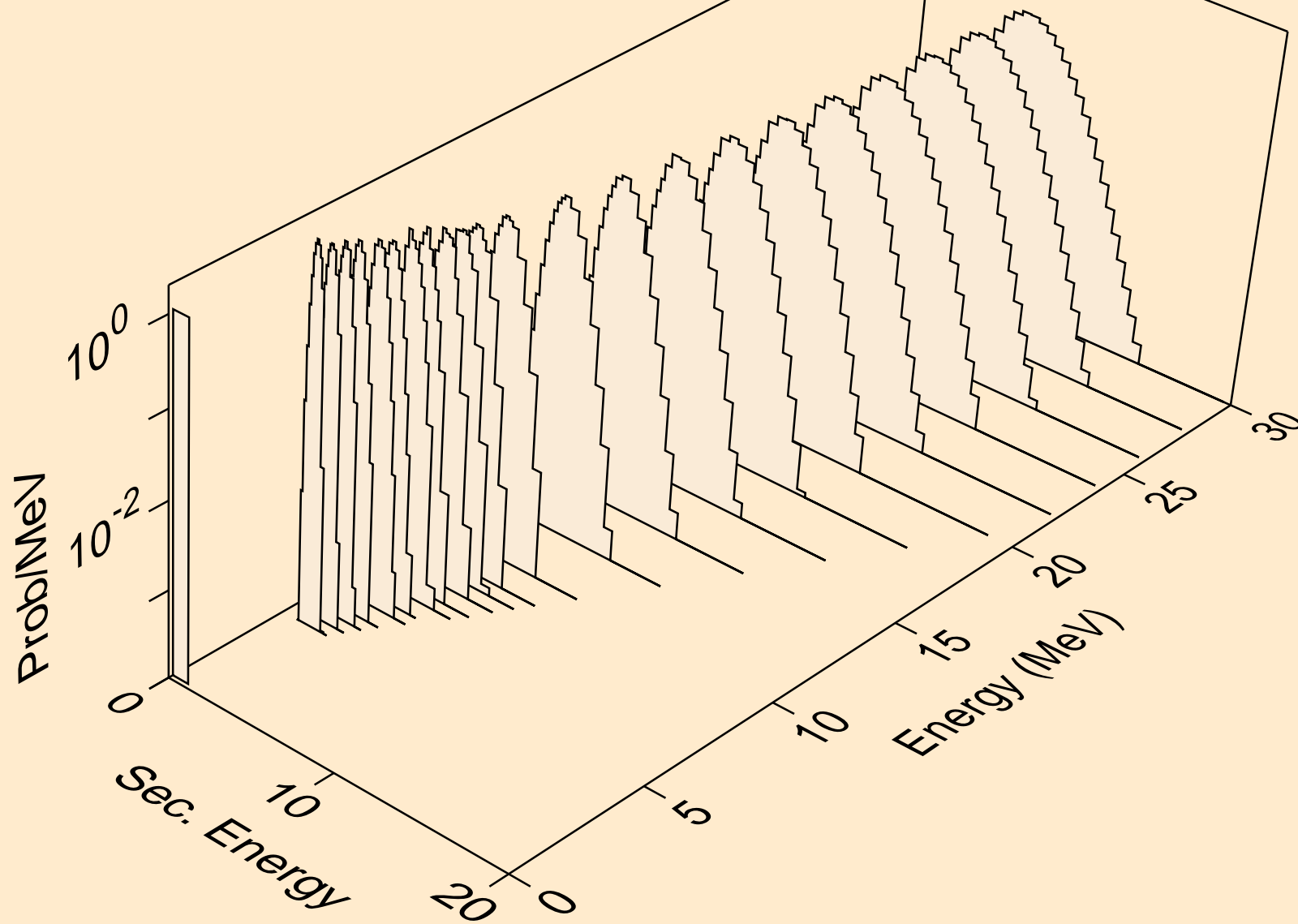

YB151 NEUTRON ACER TENDL-2024 LIBRARY; T=0.K
protons from (n,pt)

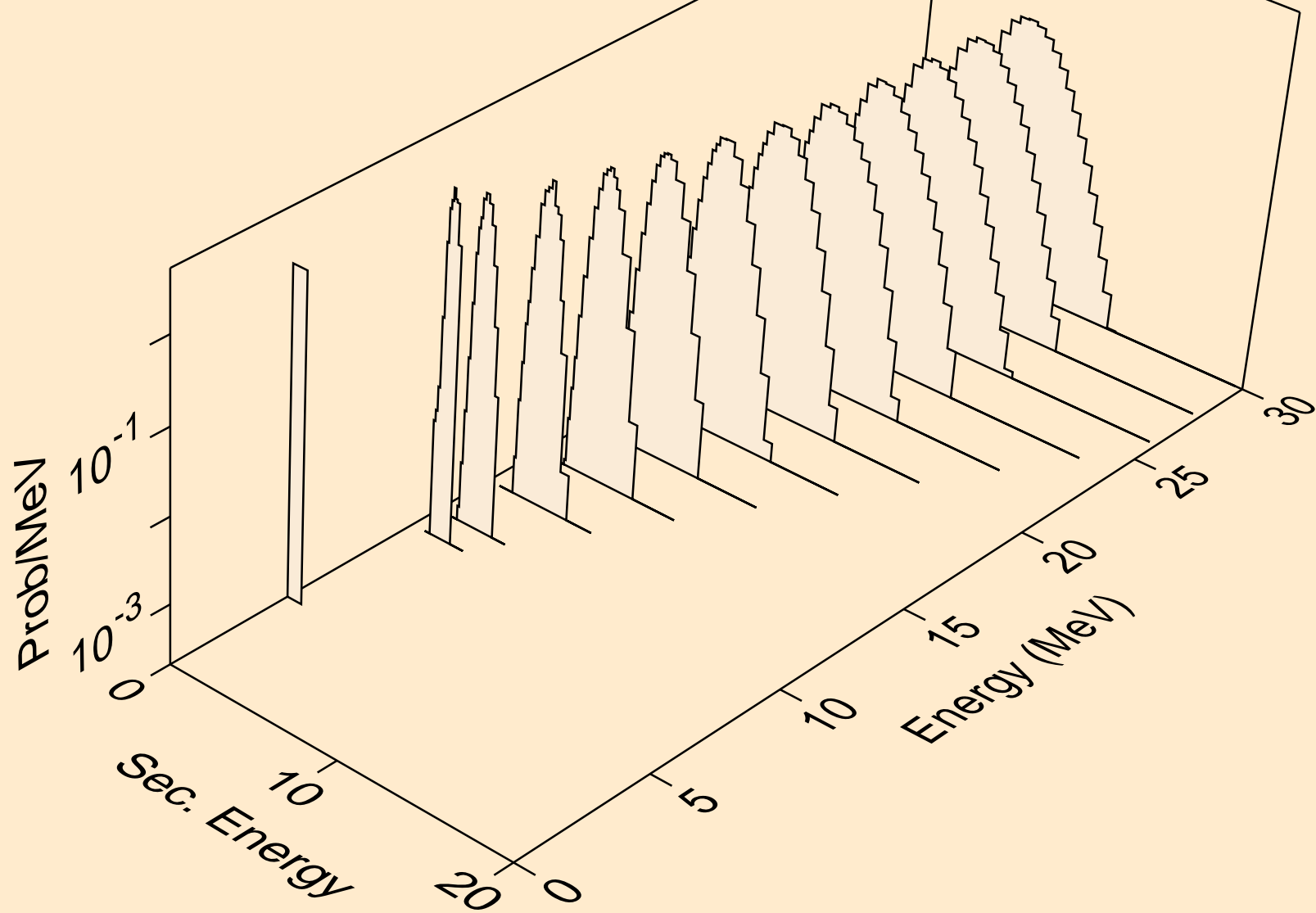

YB151 NEUTRON ACER TENDL-2024 LIBRARY; T=0.K
deuterons from (n,x)

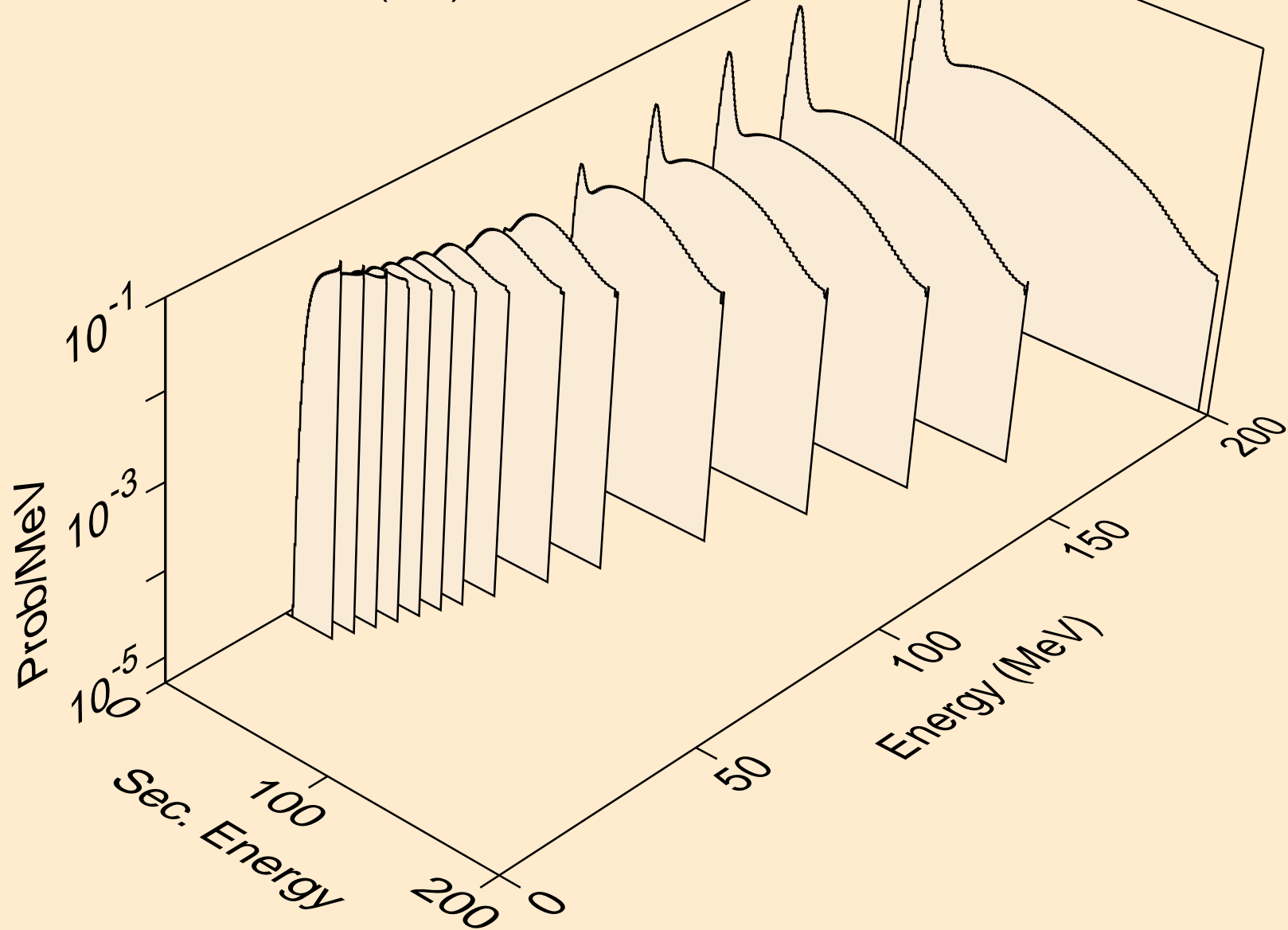

YB151 NEUTRON ACER TENDL-2024 LIBRARY; T=0.K
deuterons from (n,n*)d

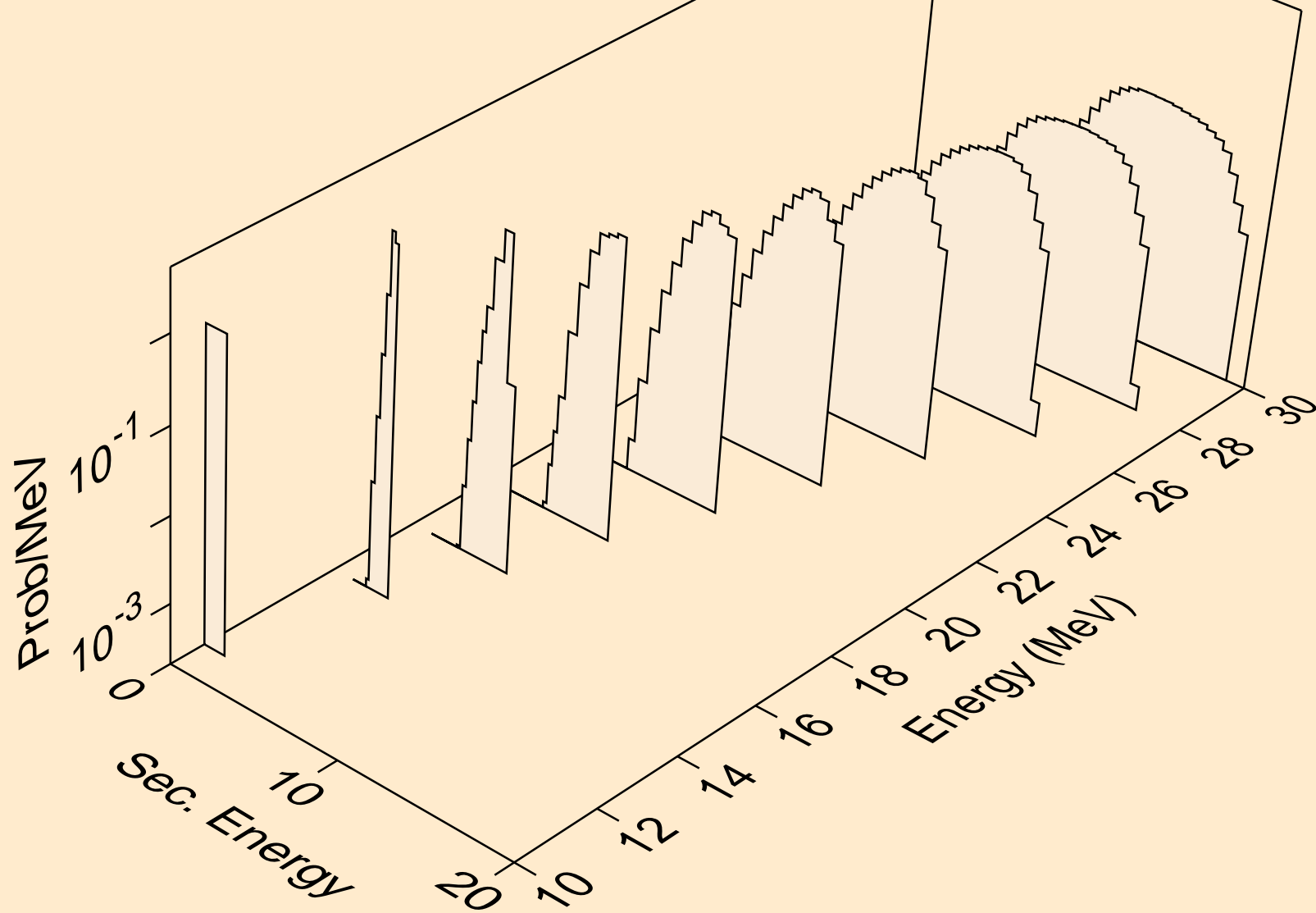

YB151 NEUTRON ACER TENDL-2024 LIBRARY; T=0.K
deuterons from (n,d)

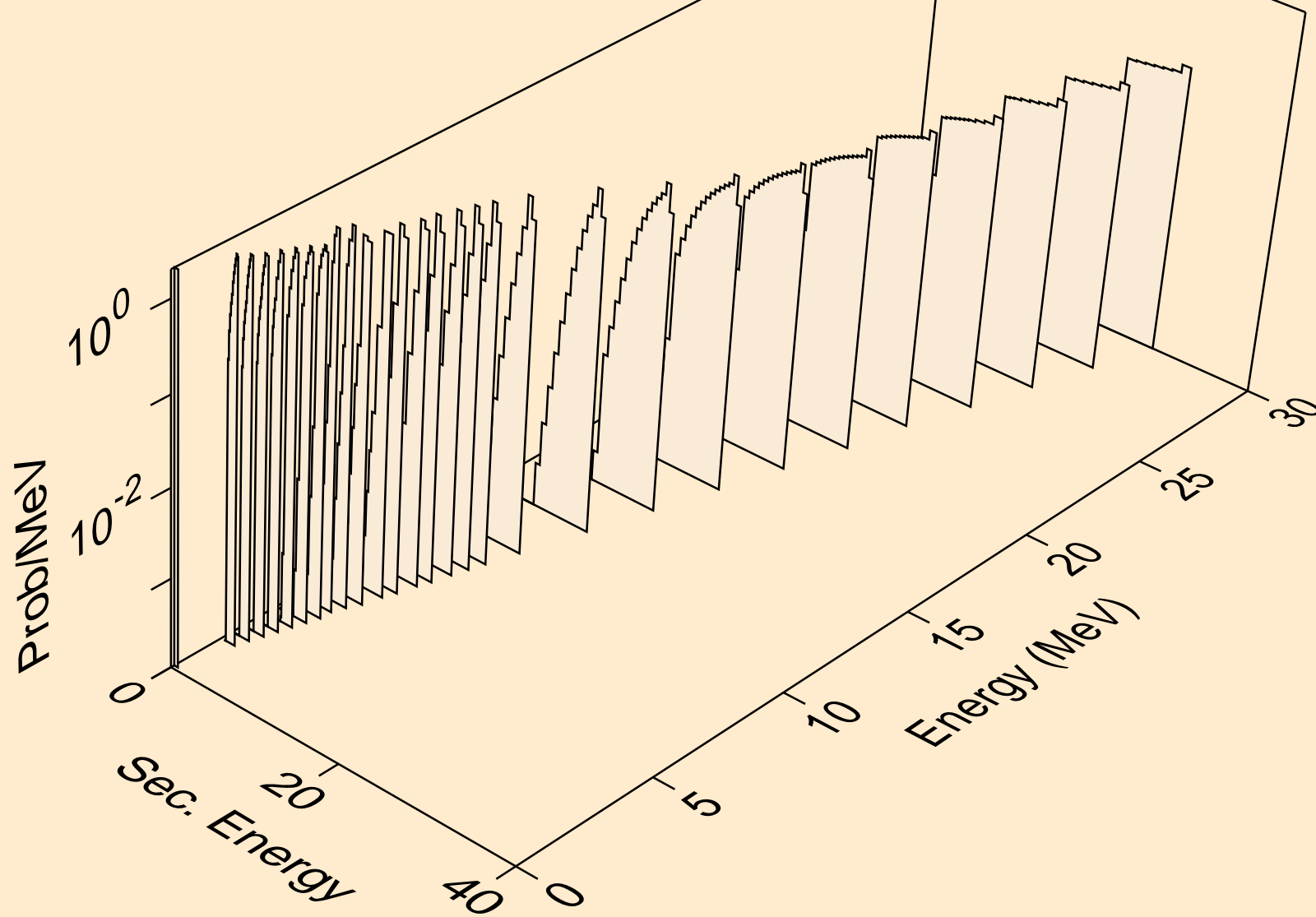

YB151 NEUTRON ACER TENDL-2024 LIBRARY; T=0.K
deuterons from (n,pd)

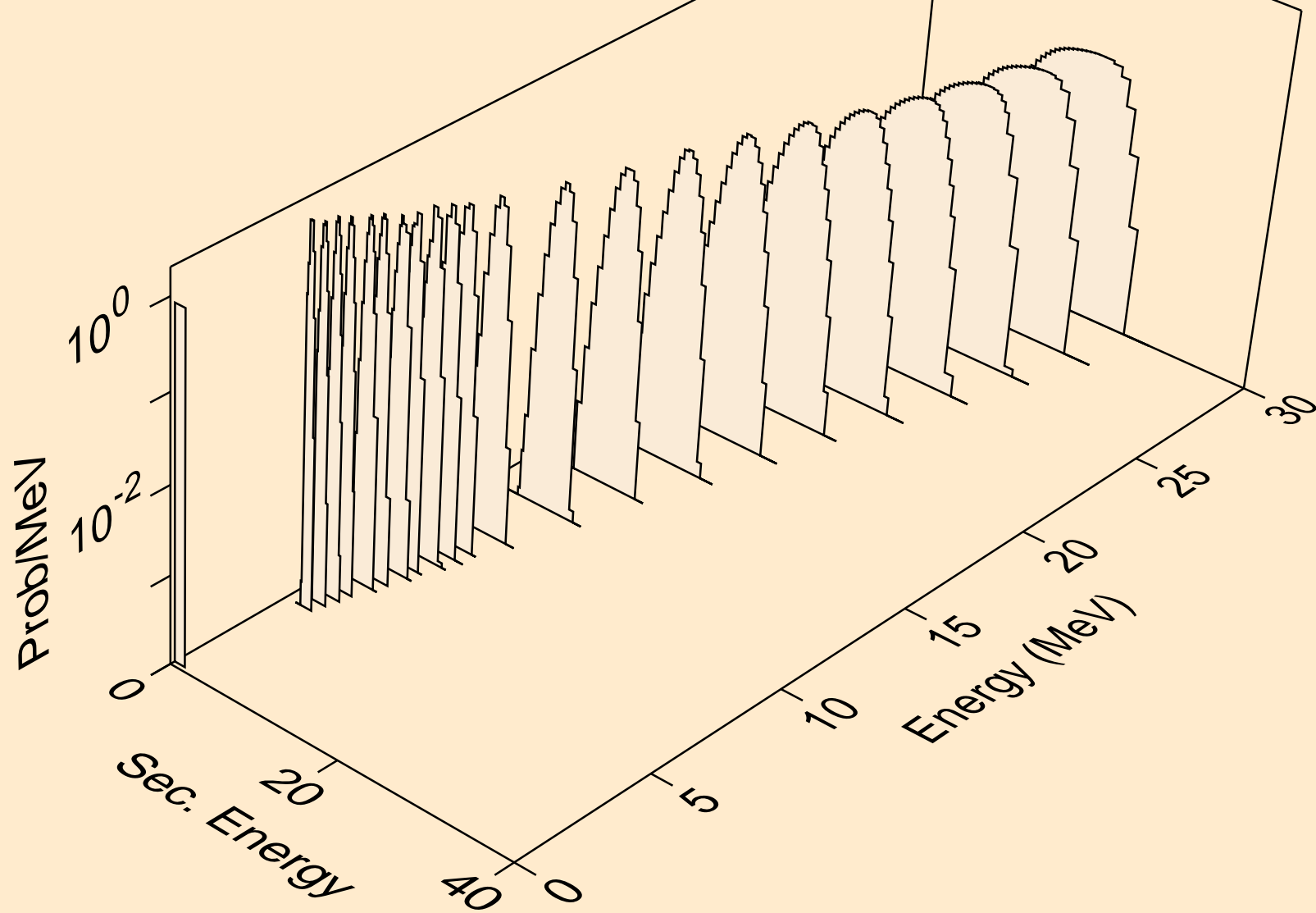

YB151 NEUTRON ACER TENDL-2024 LIBRARY; T=0.K
deuterons from (n,da)

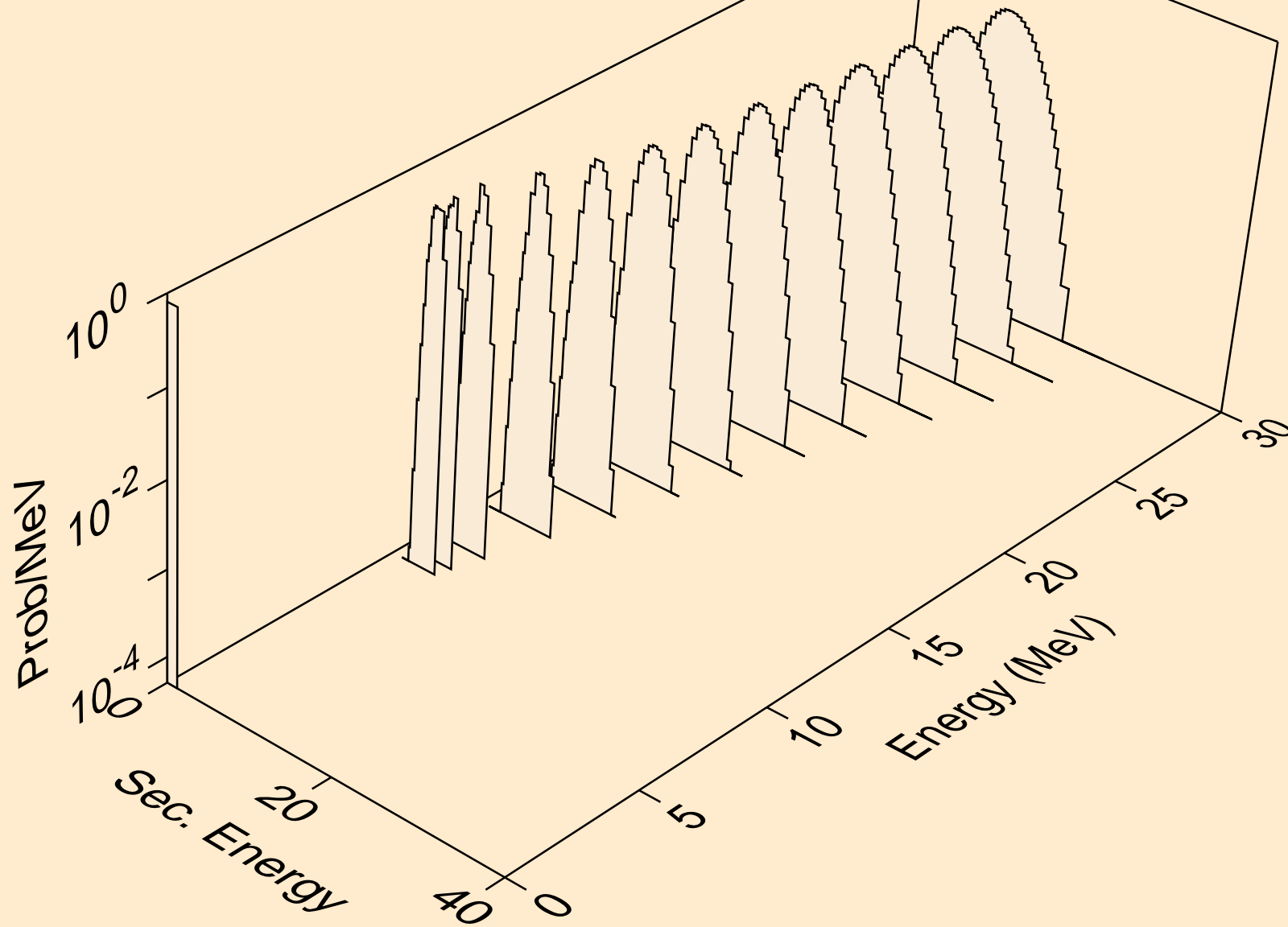

YB151 NEUTRON ACER TENDL-2024 LIBRARY; T=0.K
tritons from (n,x)

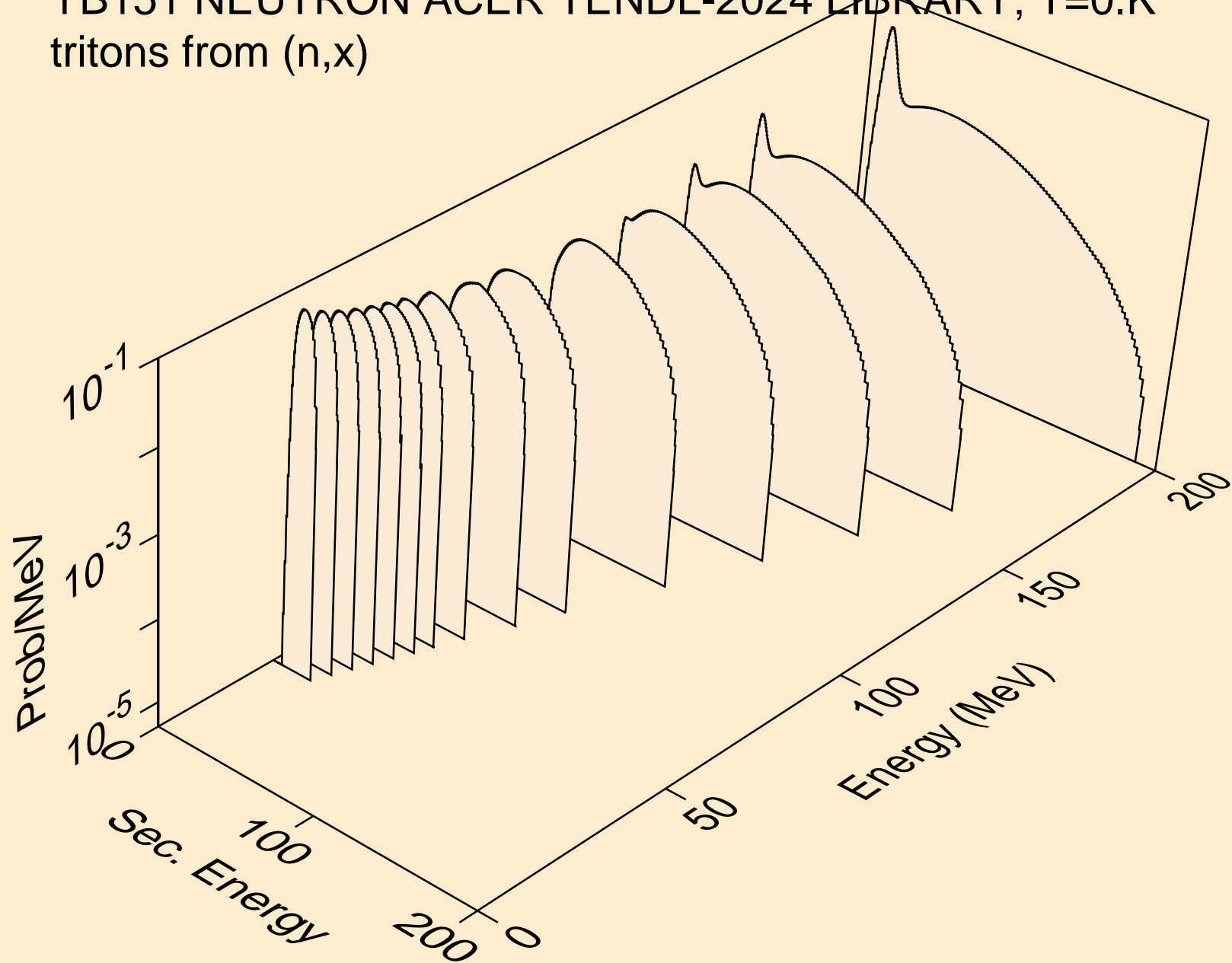

YB151 NEUTRON ACER TENDL-2024 LIBRARY; T=0.K
tritons from (n,n*)t

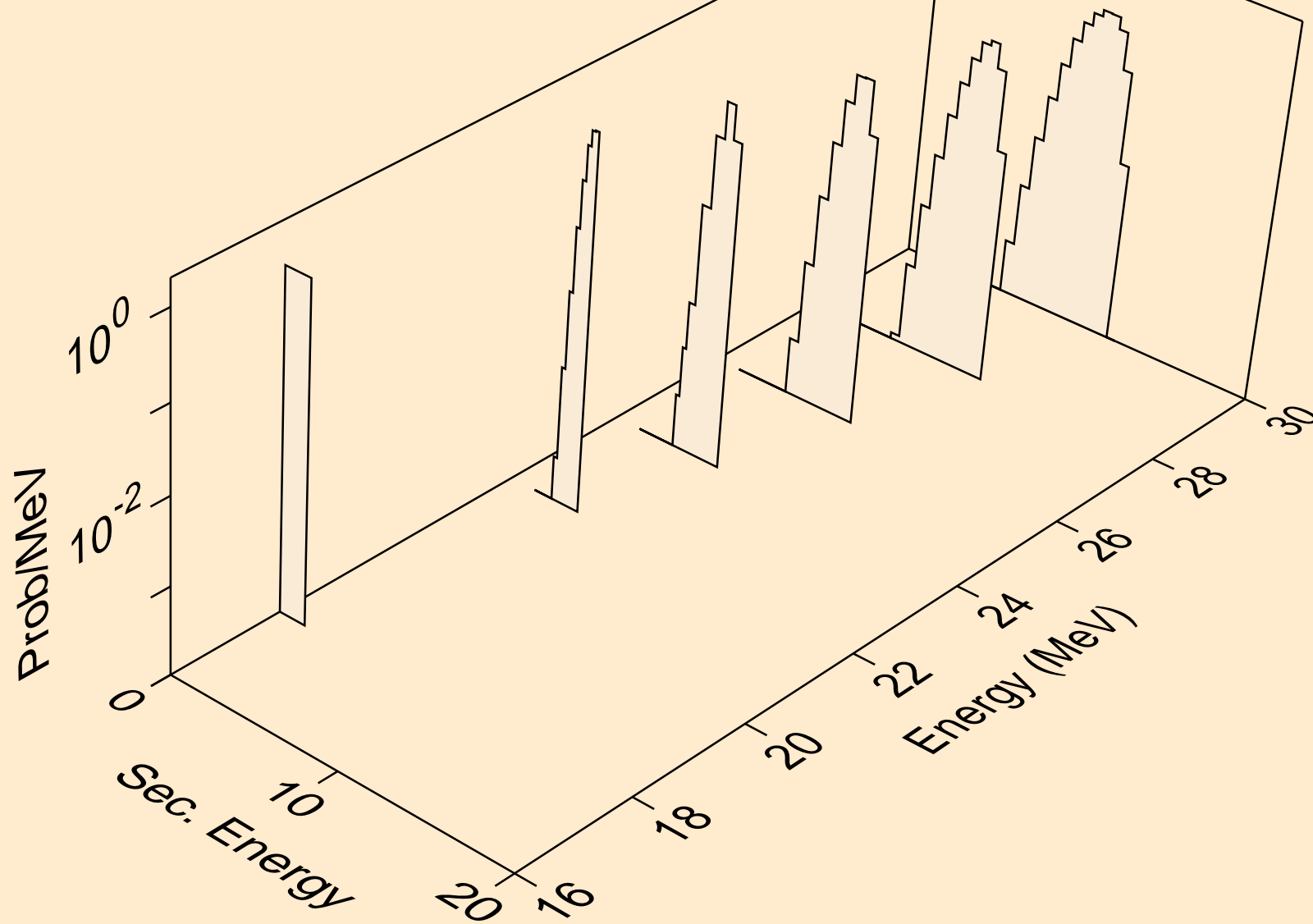

YB151 NEUTRON ACER TENDL-2024 LIBRARY; T=0.K
tritons from (n,t)

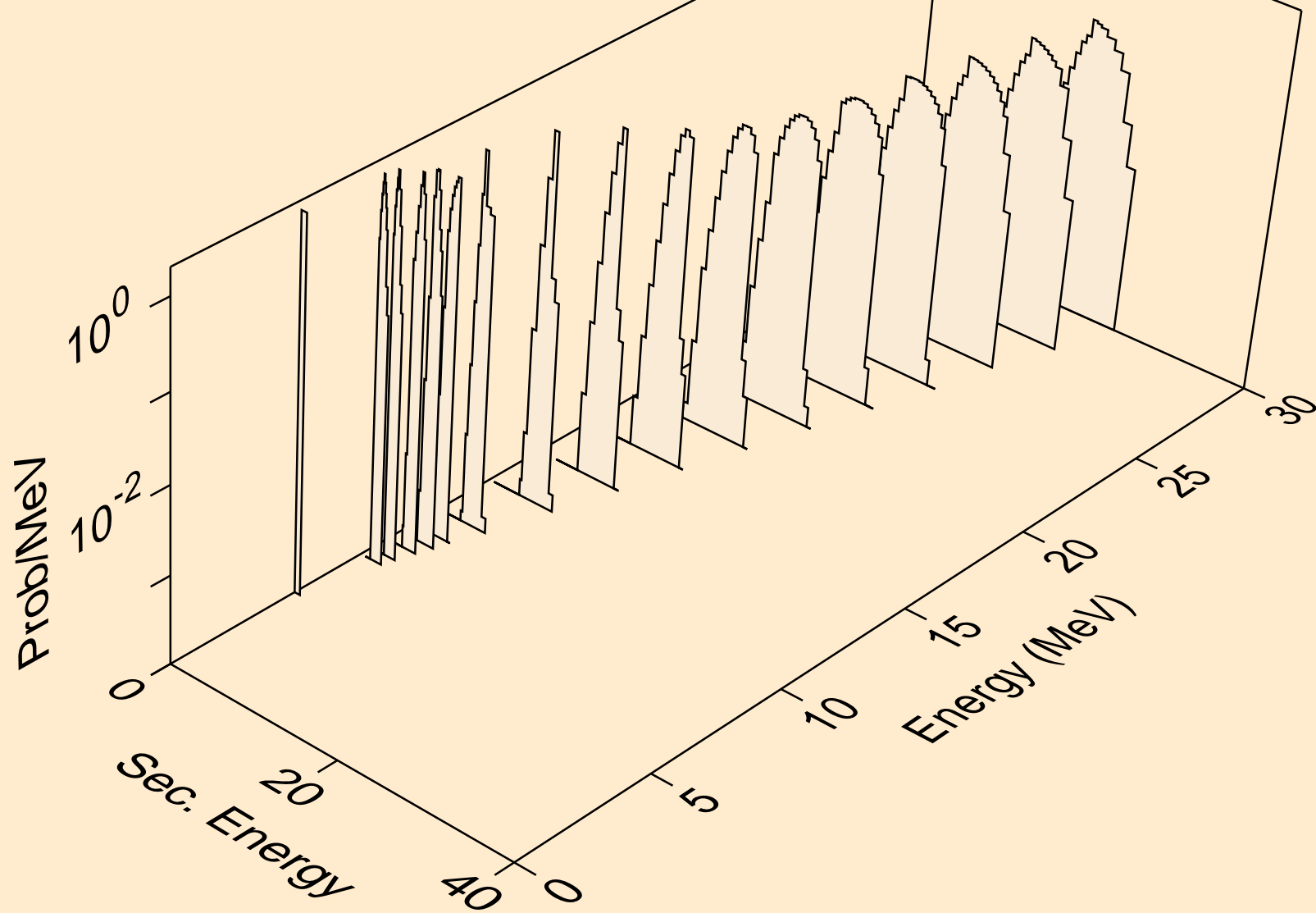

YB151 NEUTRON ACER TENDL-2024 LIBRARY; T=0.K
tritons from (n,pt)

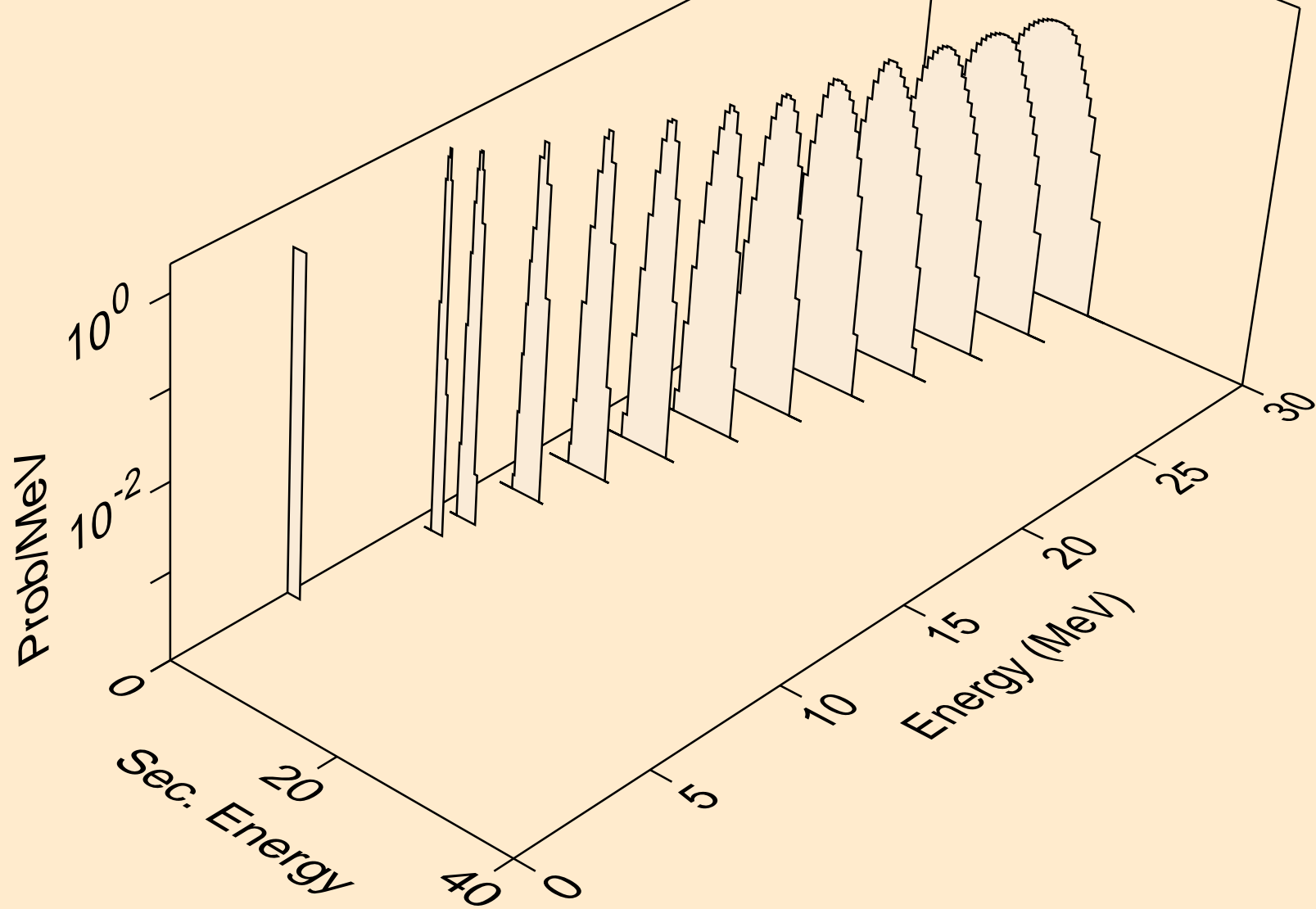

YB151 NEUTRON ACER TENDL-2024 LIBRARY; T=0.K
he3s from (n,x)

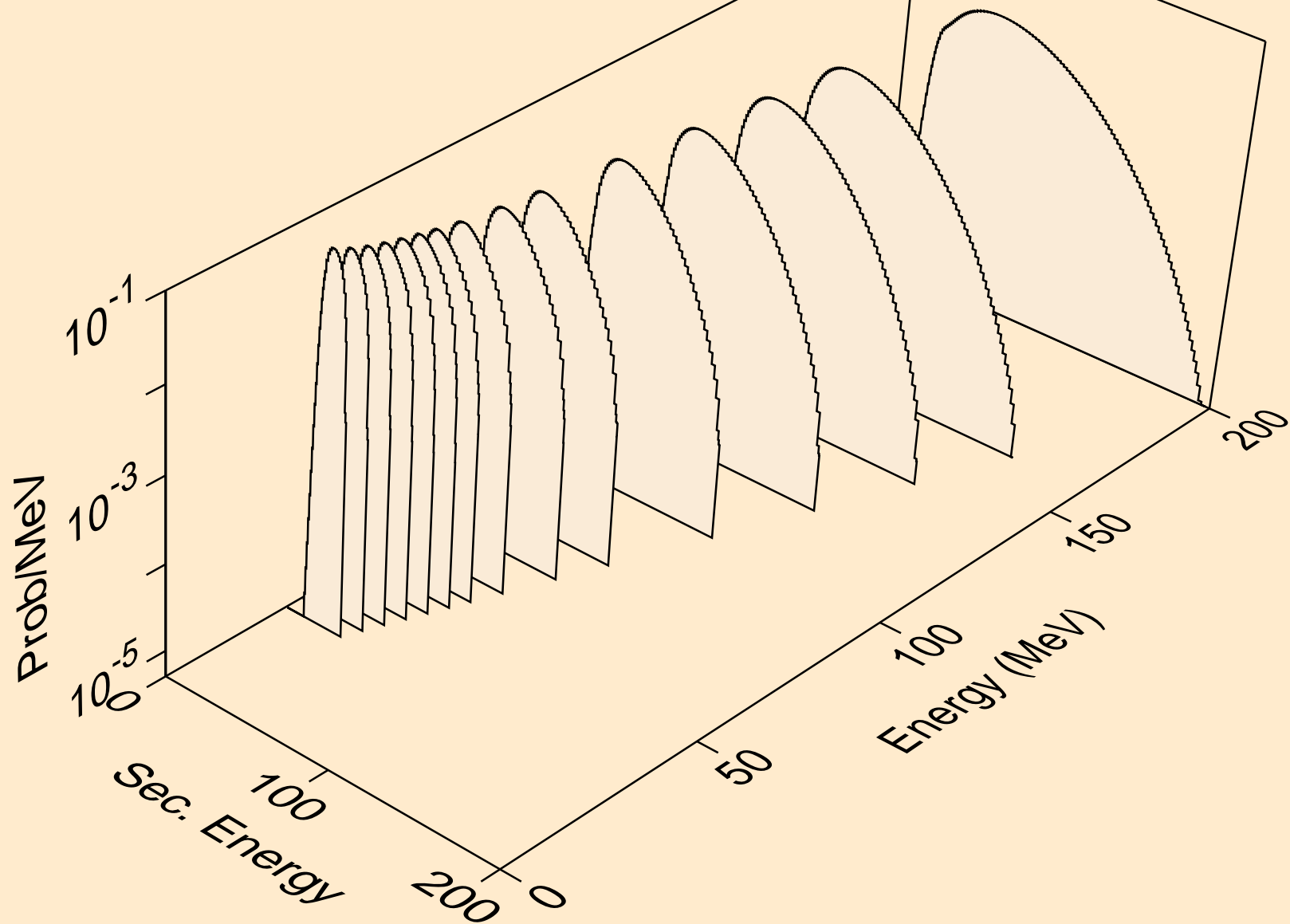

YB151 NEUTRON ACER TENDL-2024 LIBRARY; T=0.K
he3s from (n,n*)he3

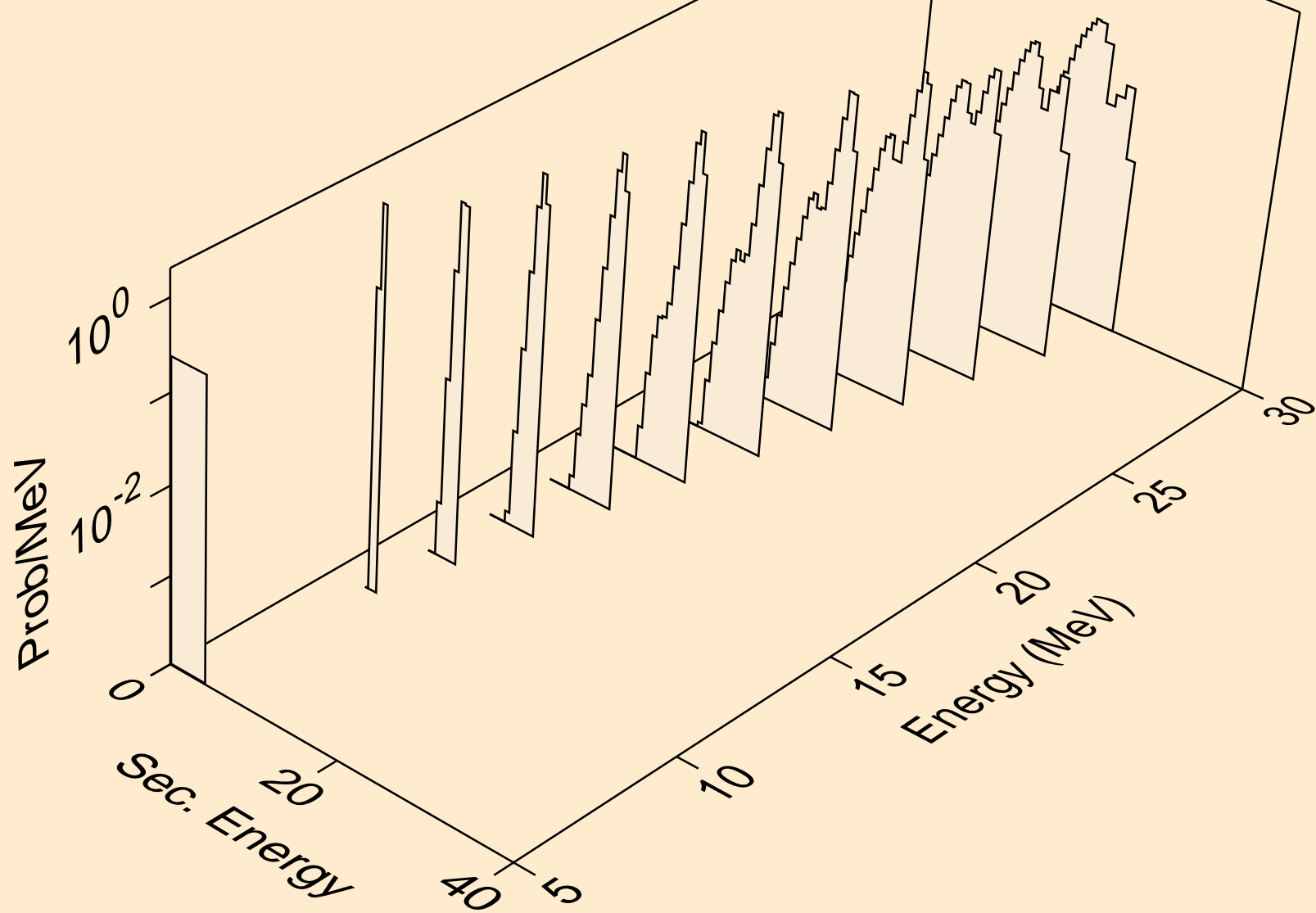

YB151 NEUTRON ACER TENDL-2024 LIBRARY; T=0.K
he3s from (n,he3)

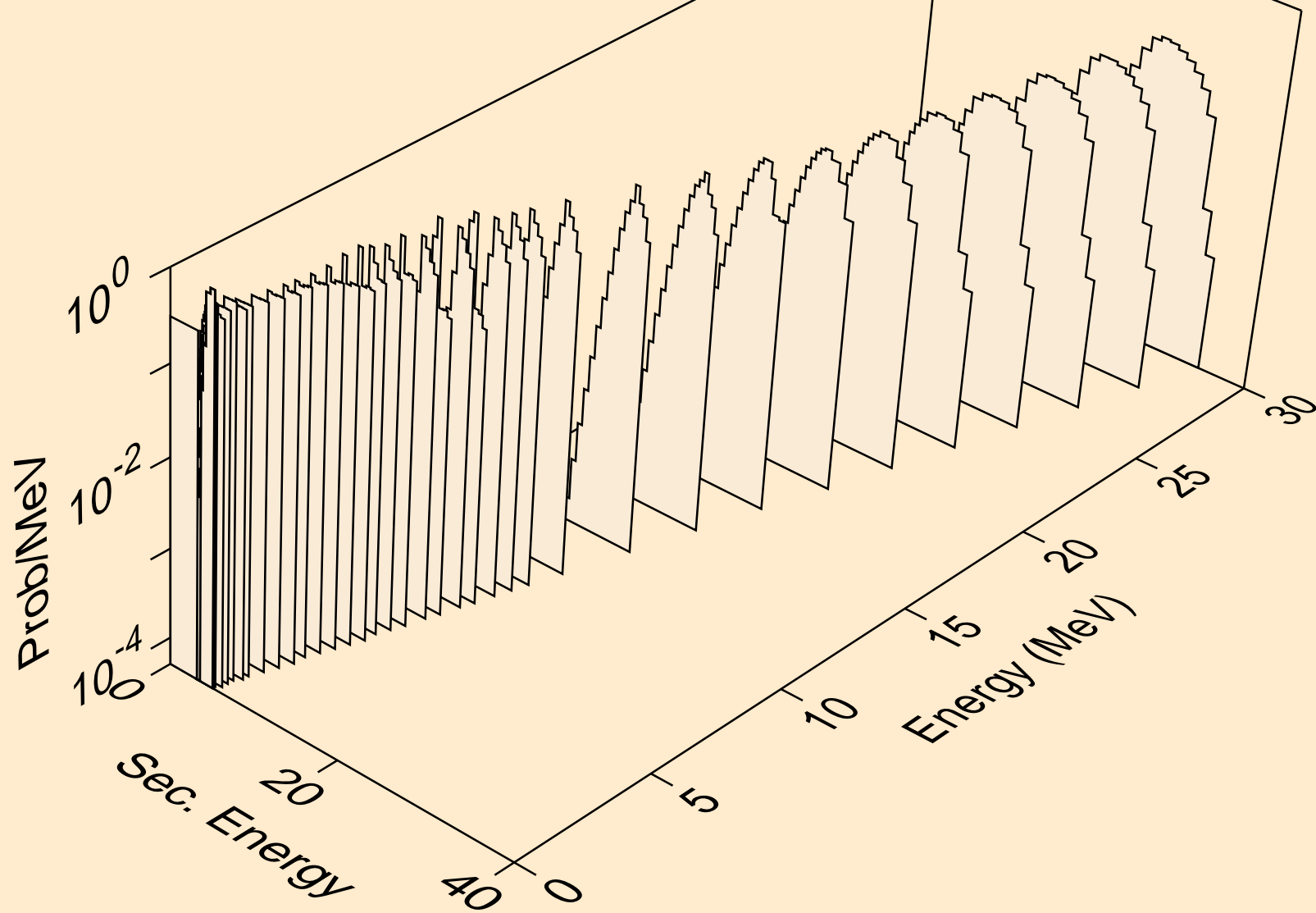

YB151 NEUTRON ACER TENDL-2024 LIBRARY; T=0.K
alphas from (n,x)

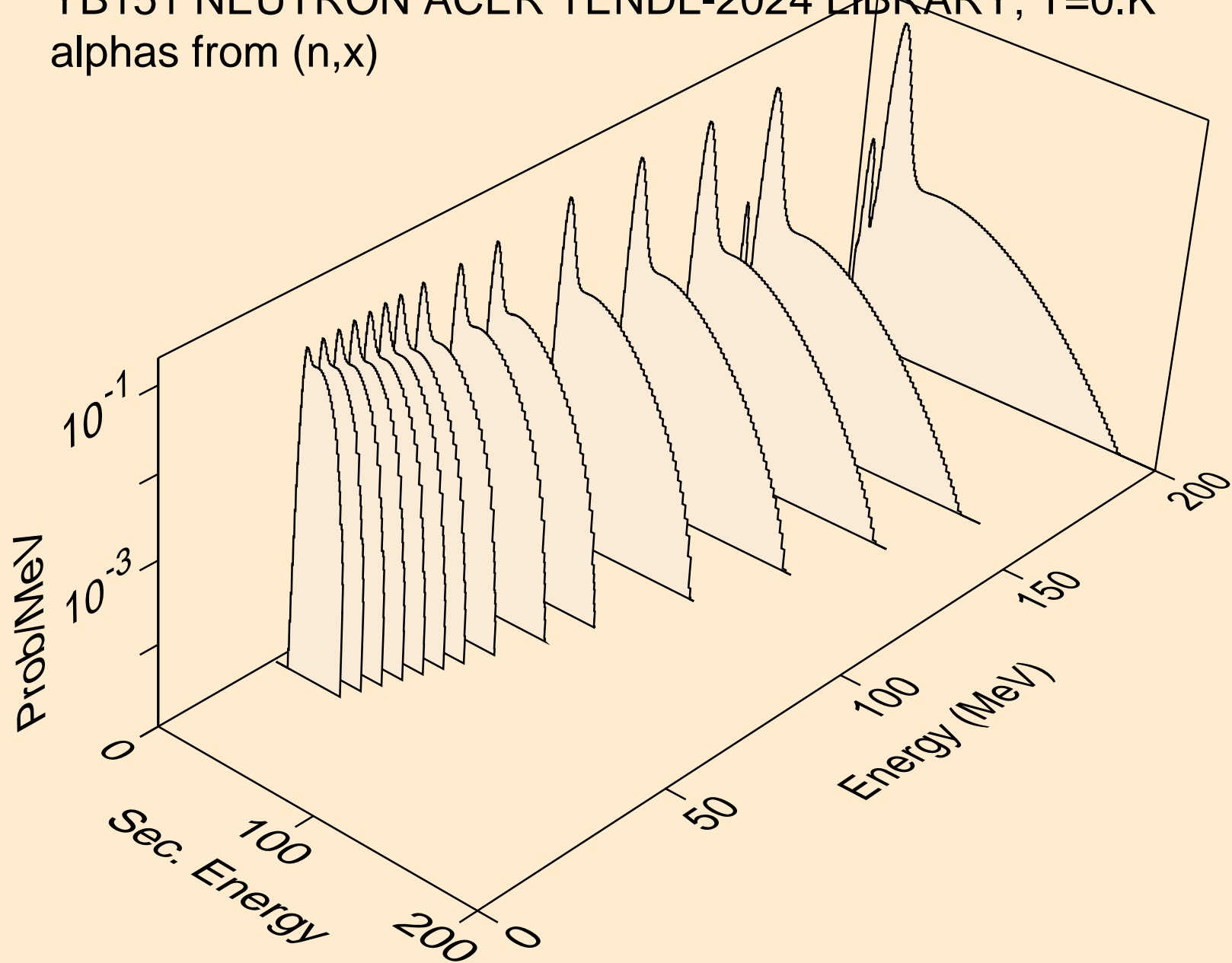

YB151 NEUTRON ACER TENDL-2024 LIBRARY; T=0.K
alphas from (n,n*)a

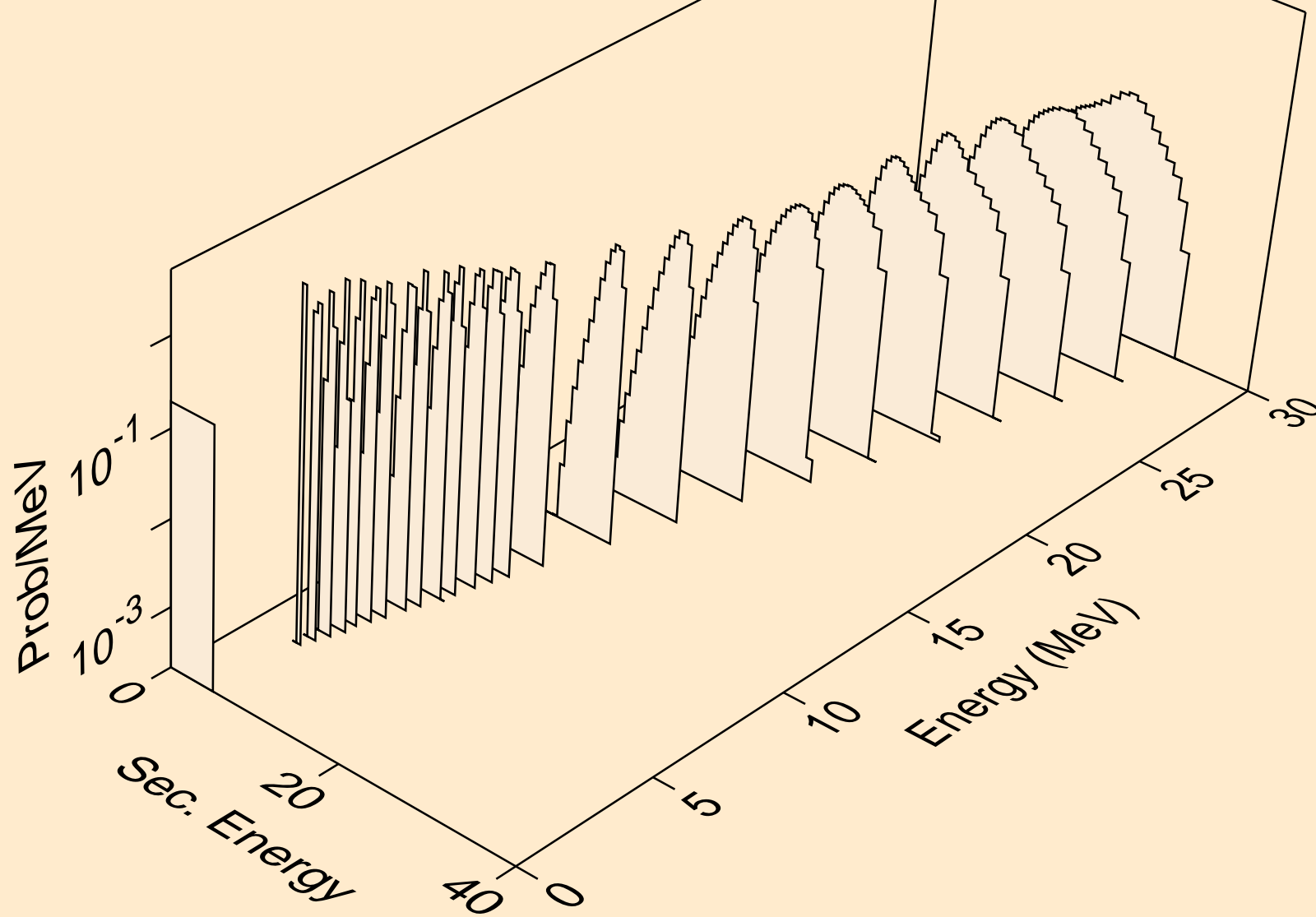

YB151 NEUTRON ACER TENDL-2024 LIBRARY; T=0.K
alphas from (n,2n)a

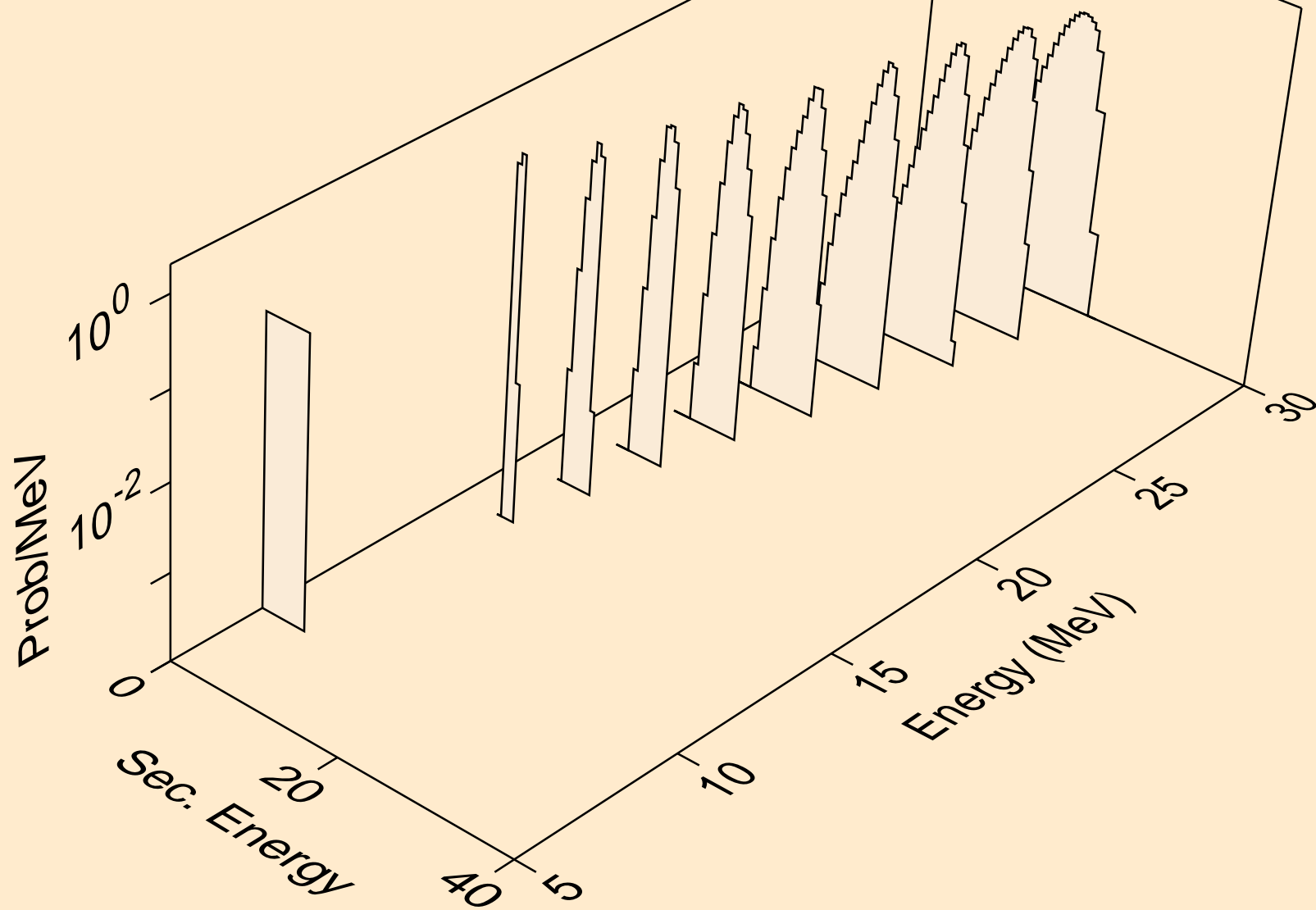

YB151 NEUTRON ACER TENDL-2024 LIBRARY; T=0.K
alphas from (n,n*)2a

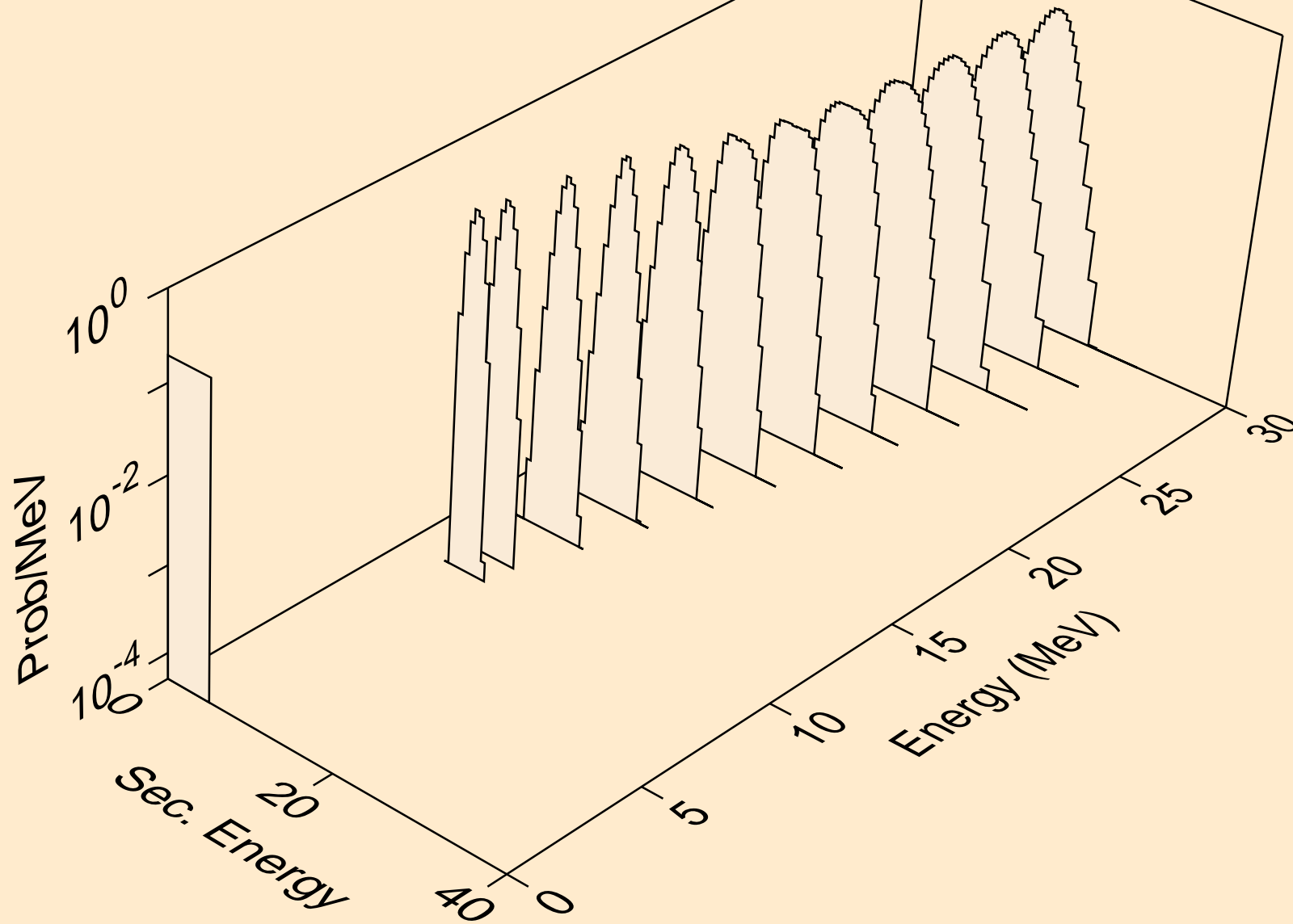

YB151 NEUTRON ACER TENDL-2024 LIBRARY; T=0.K
alphas from (n,npa)

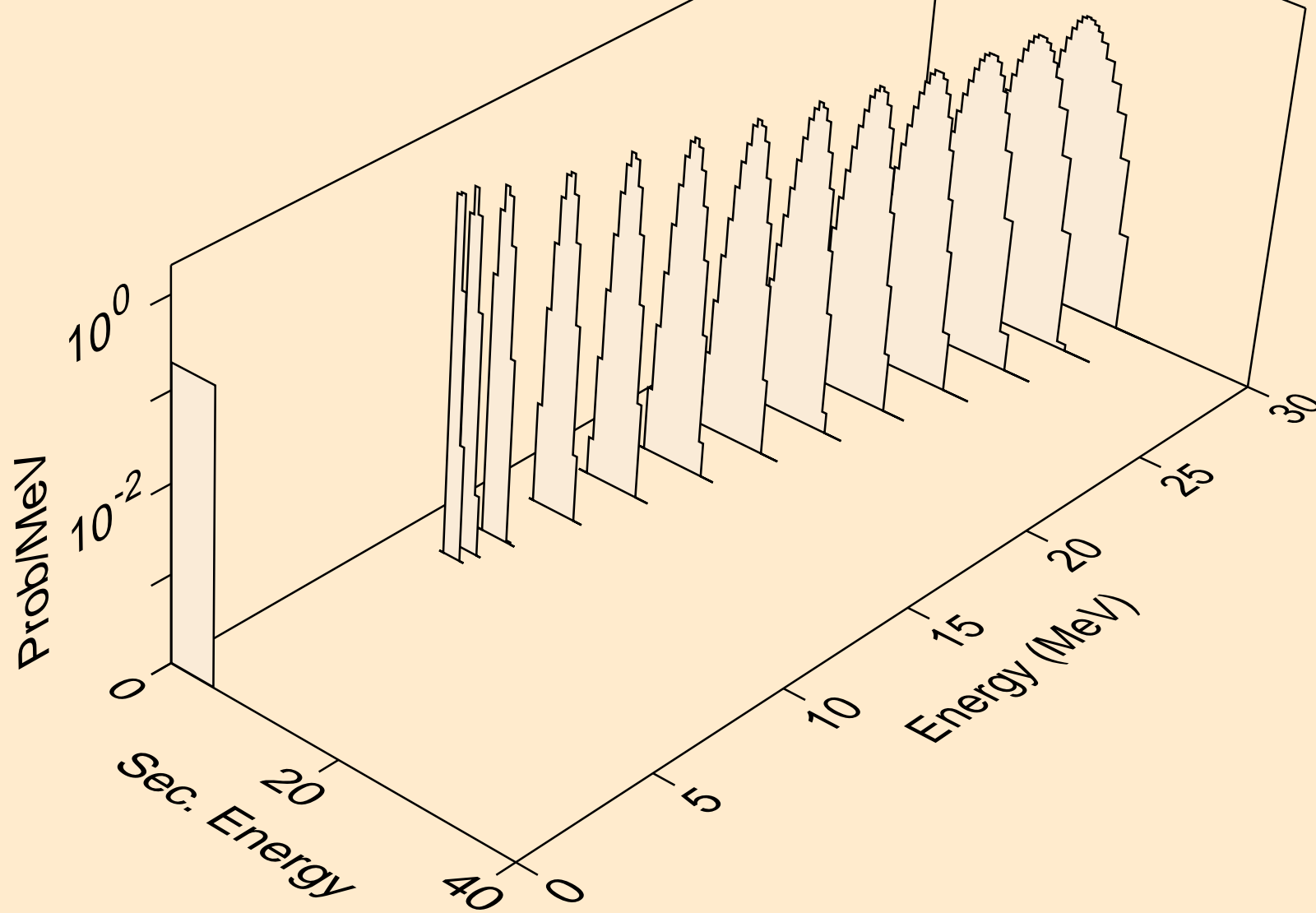

YB151 NEUTRON ACER TENDL-2024 LIBRARY; T=0.K
alphas from (n,a)

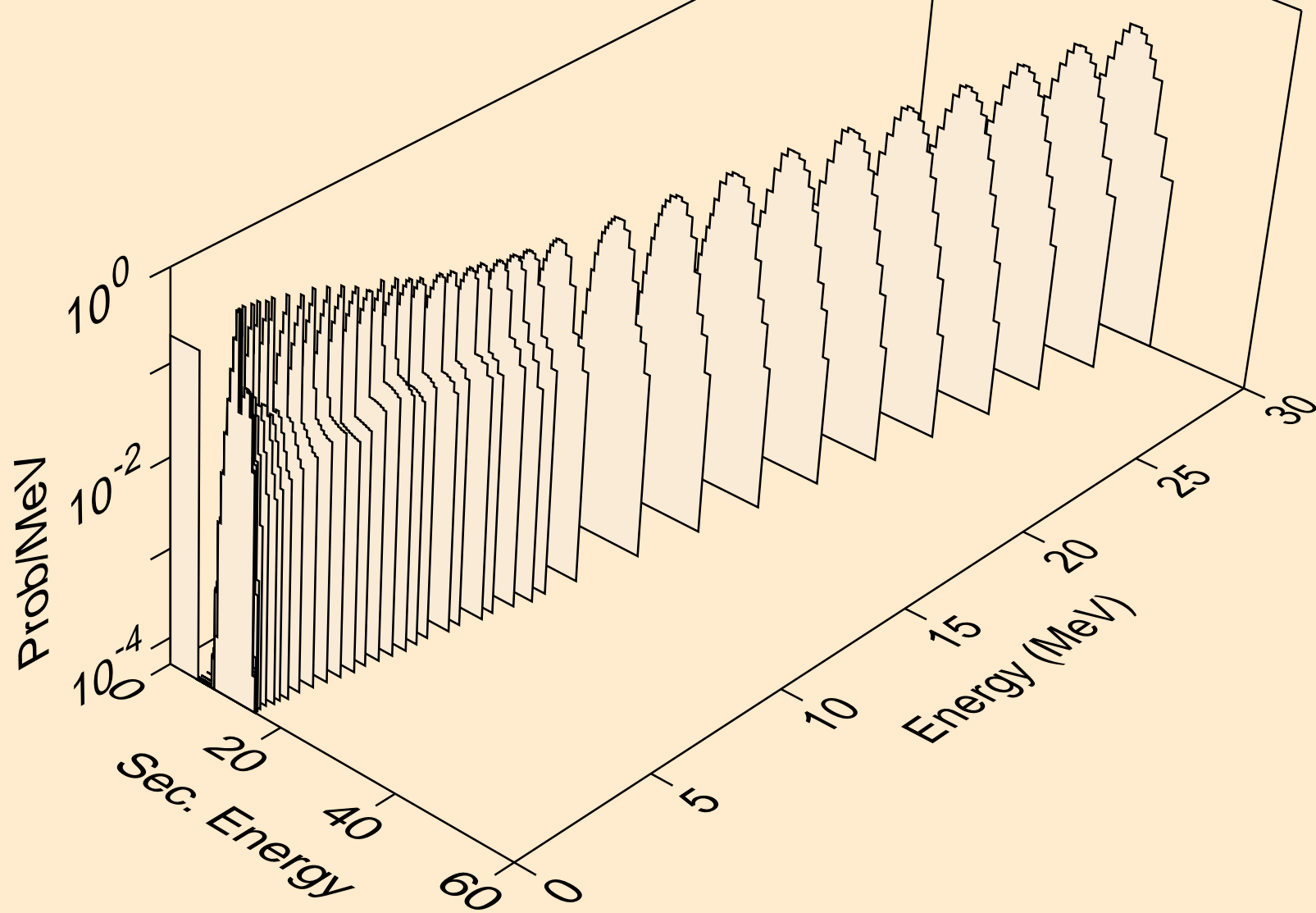

YB151 NEUTRON ACER TENDL-2024 LIBRARY; T=0.K
alphas from (n,2a)

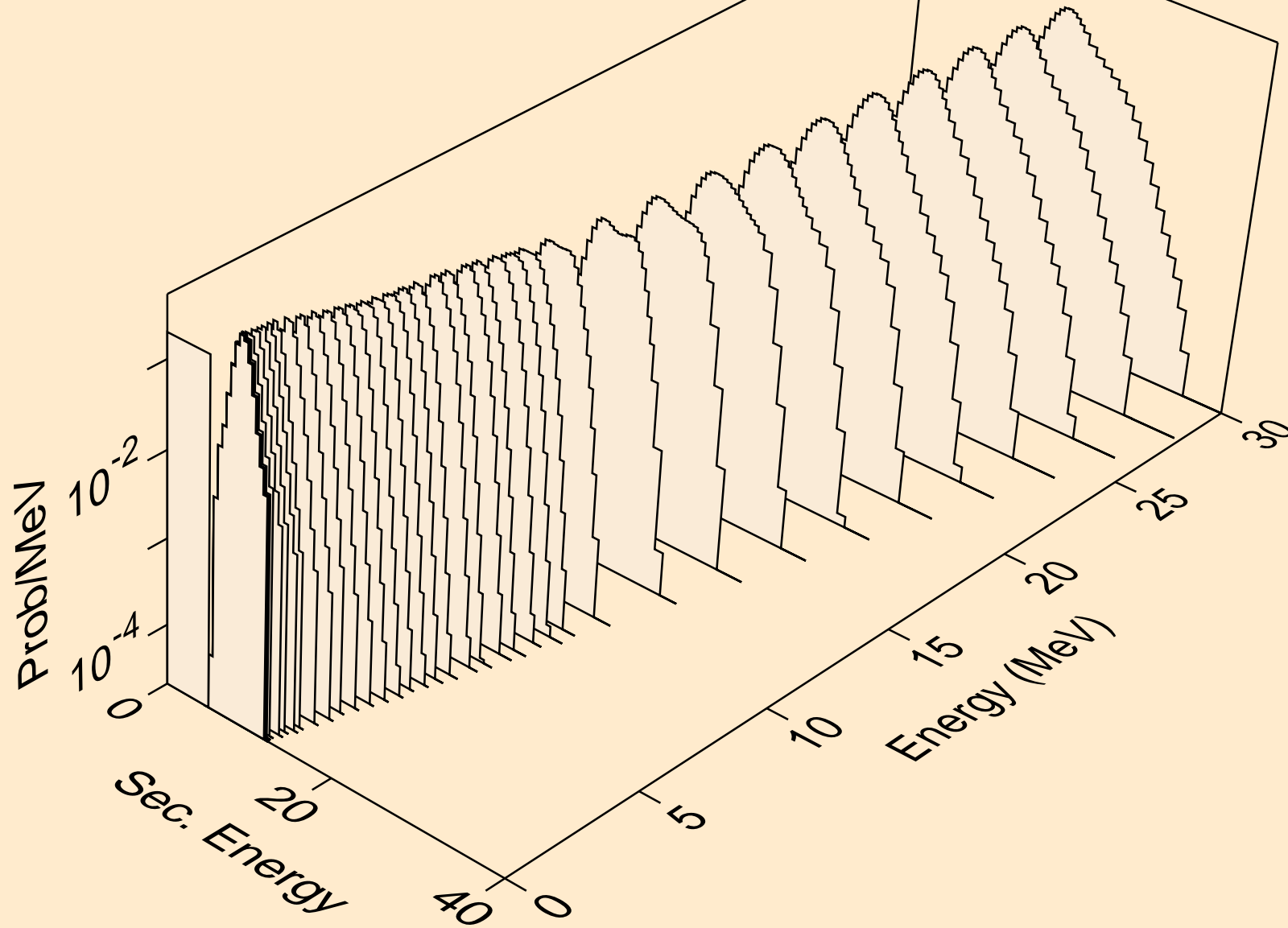

YB151 NEUTRON ACER TENDL-2024 LIBRARY; T=0.K
alphas from (n,3a)

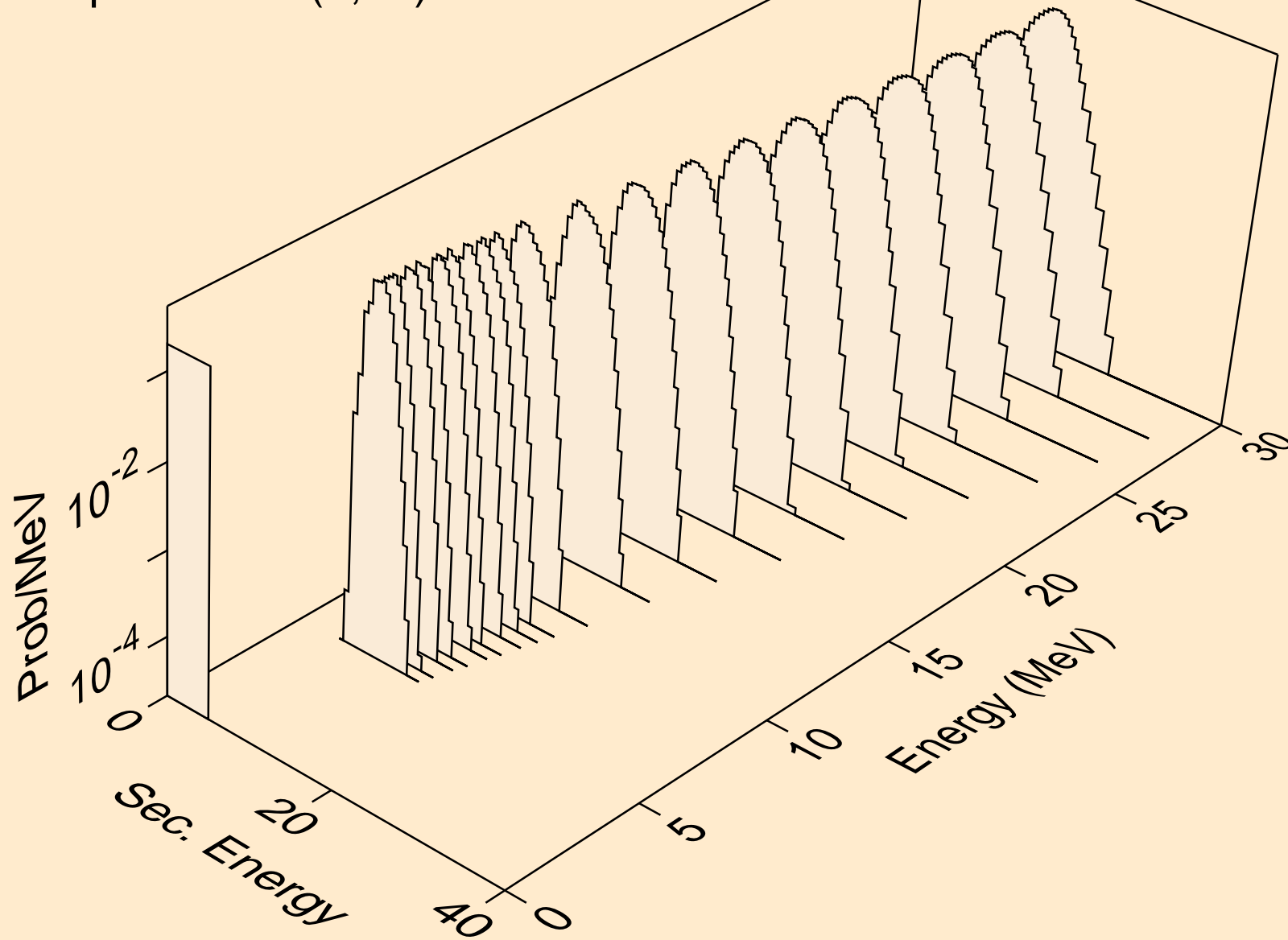

YB151 NEUTRON ACER TENDL-2024 LIBRARY; T=0.K
alphas from (n,pa)

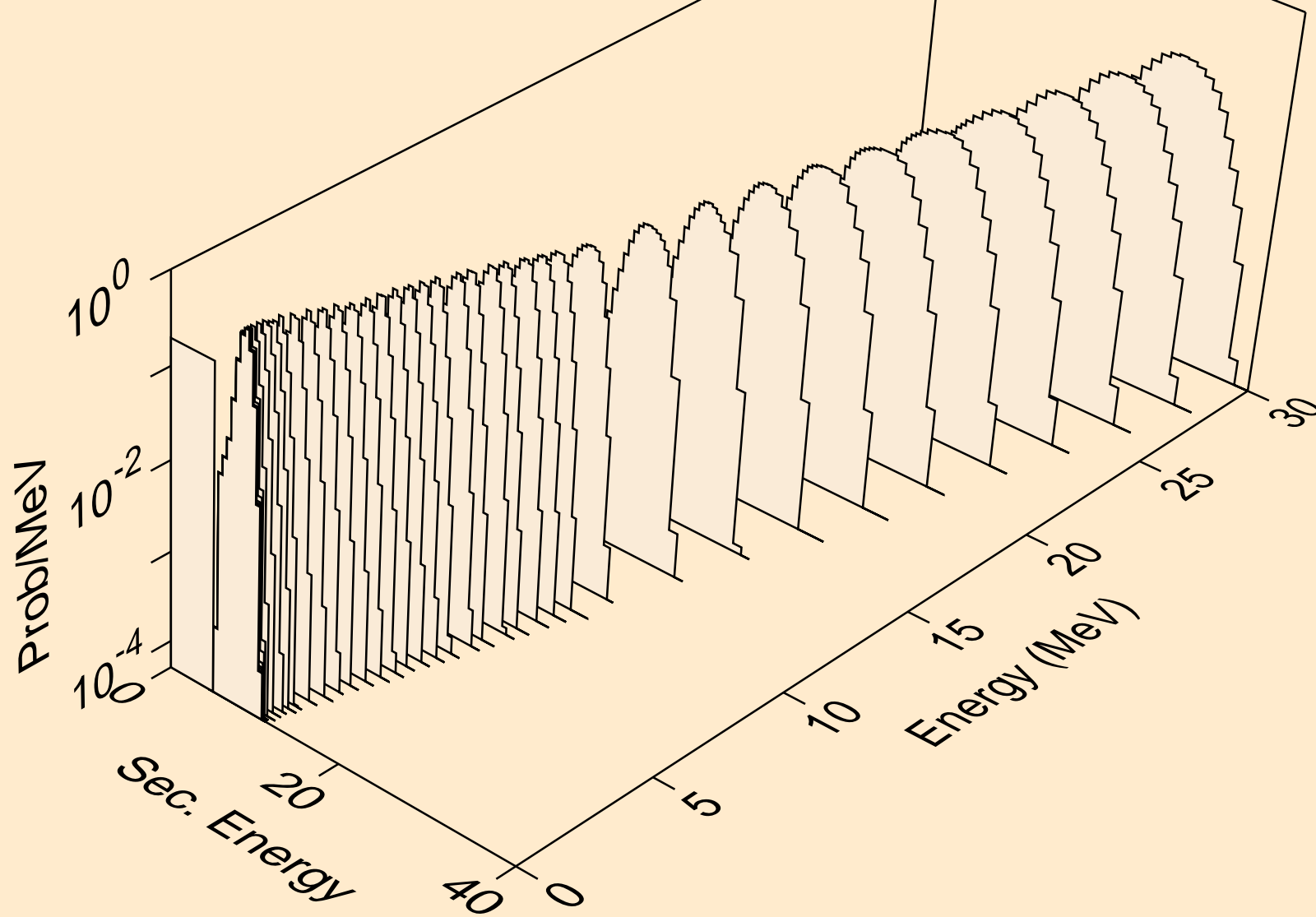

YB151 NEUTRON ACER TENDL-2024 LIBRARY; T=0.K
alphas from (n,da)

