

YB172 NEUTRON ACER TENDL-2024 LIBRARY; T=0.K

Principal cross sections

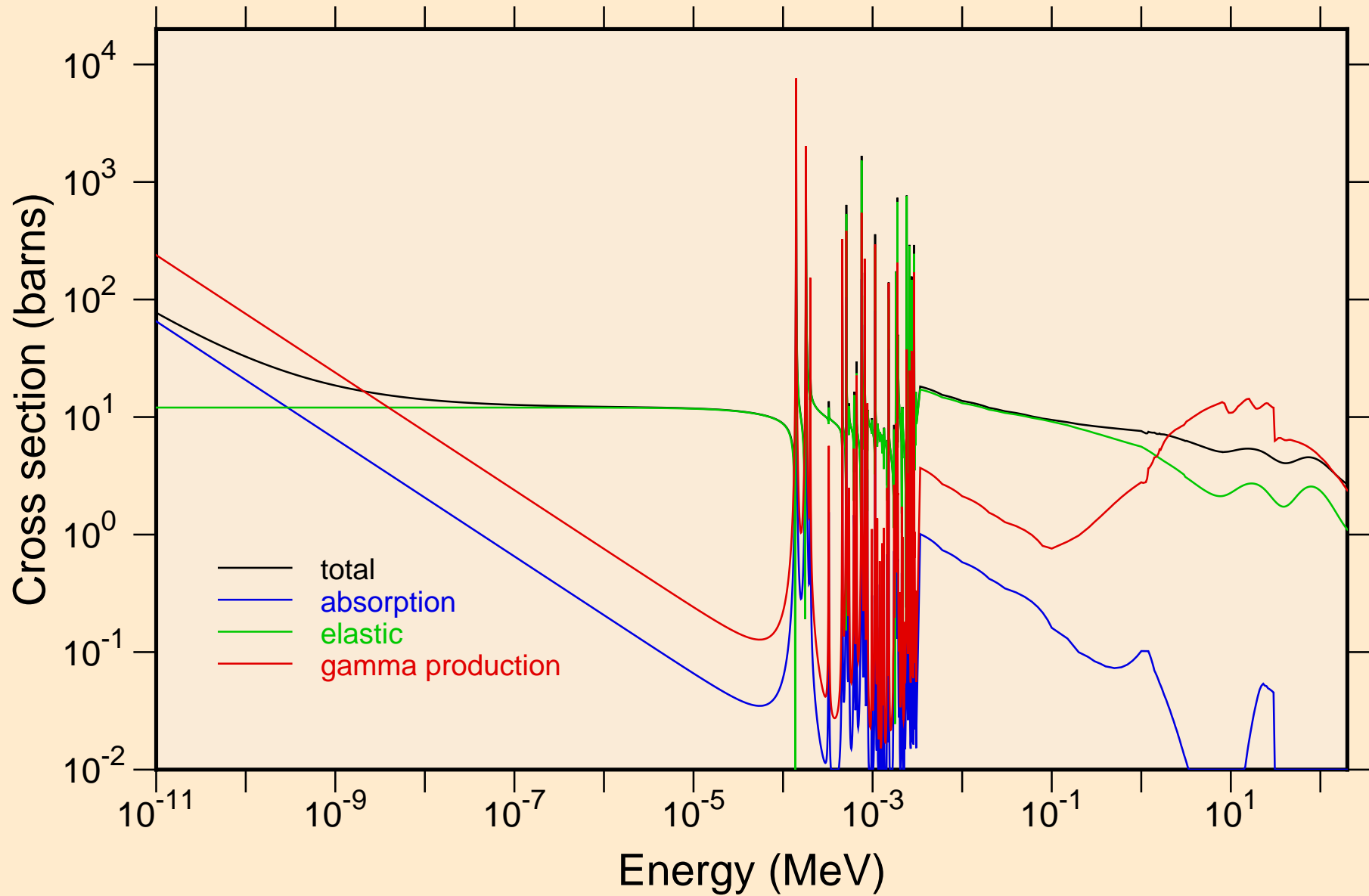

YB172 NEUTRON ACER TENDL-2024 LIBRARY; T=0.K
resonance total cross section

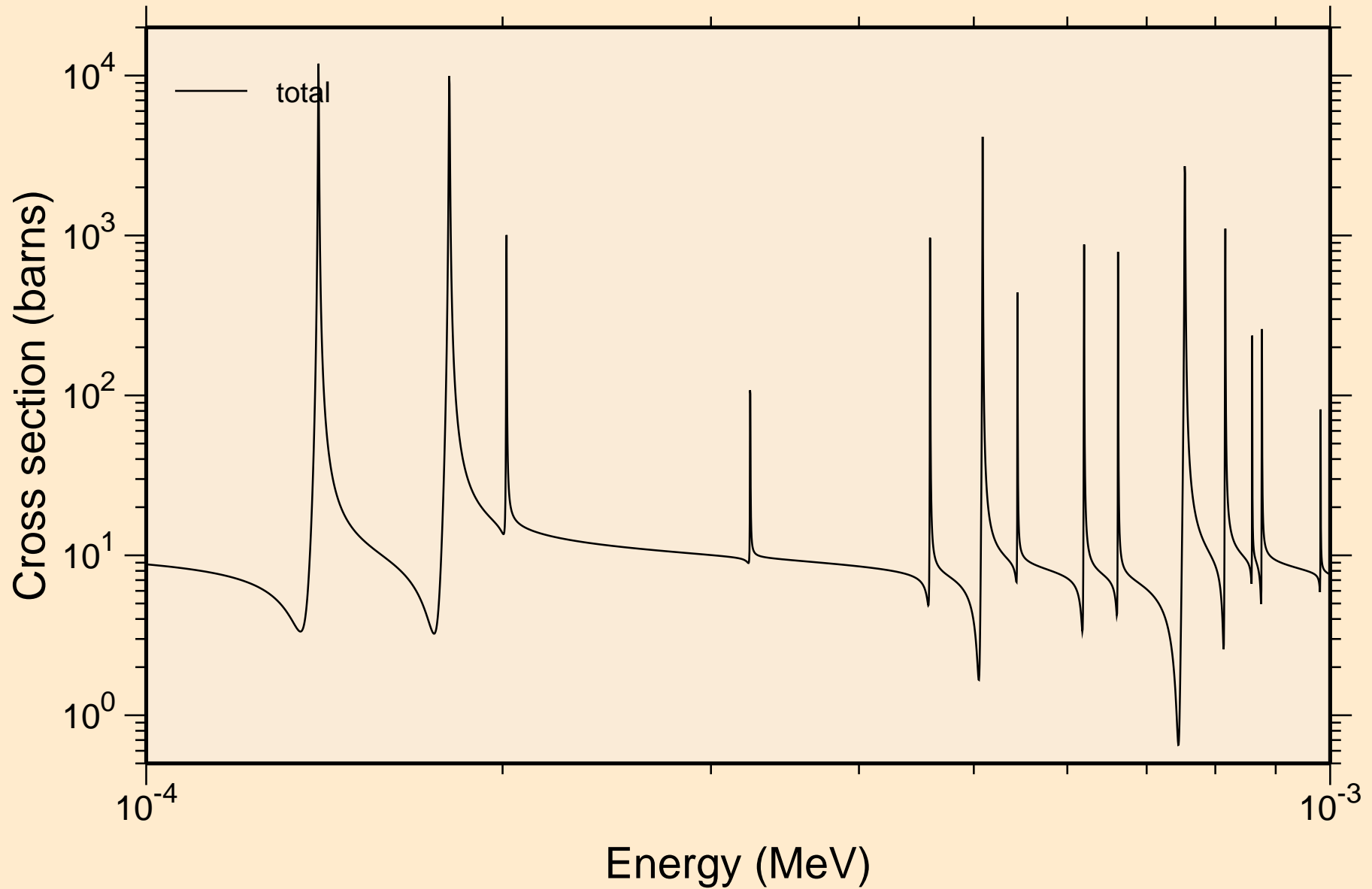

YB172 NEUTRON ACER TENDL-2024 LIBRARY; T=0.K
resonance total cross section

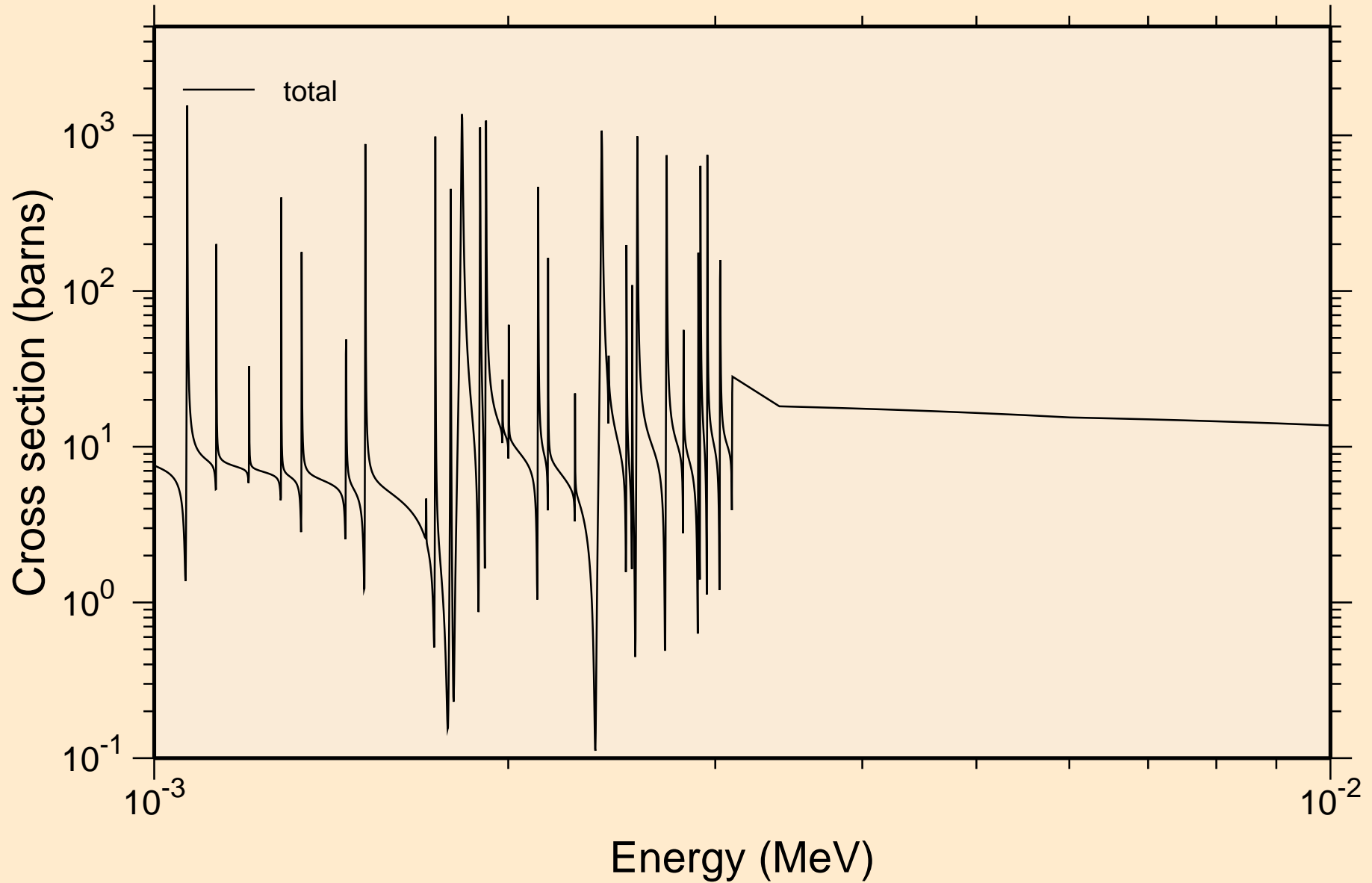

YB172 NEUTRON ACER TENDL-2024 LIBRARY; T=0.K
resonance total cross section

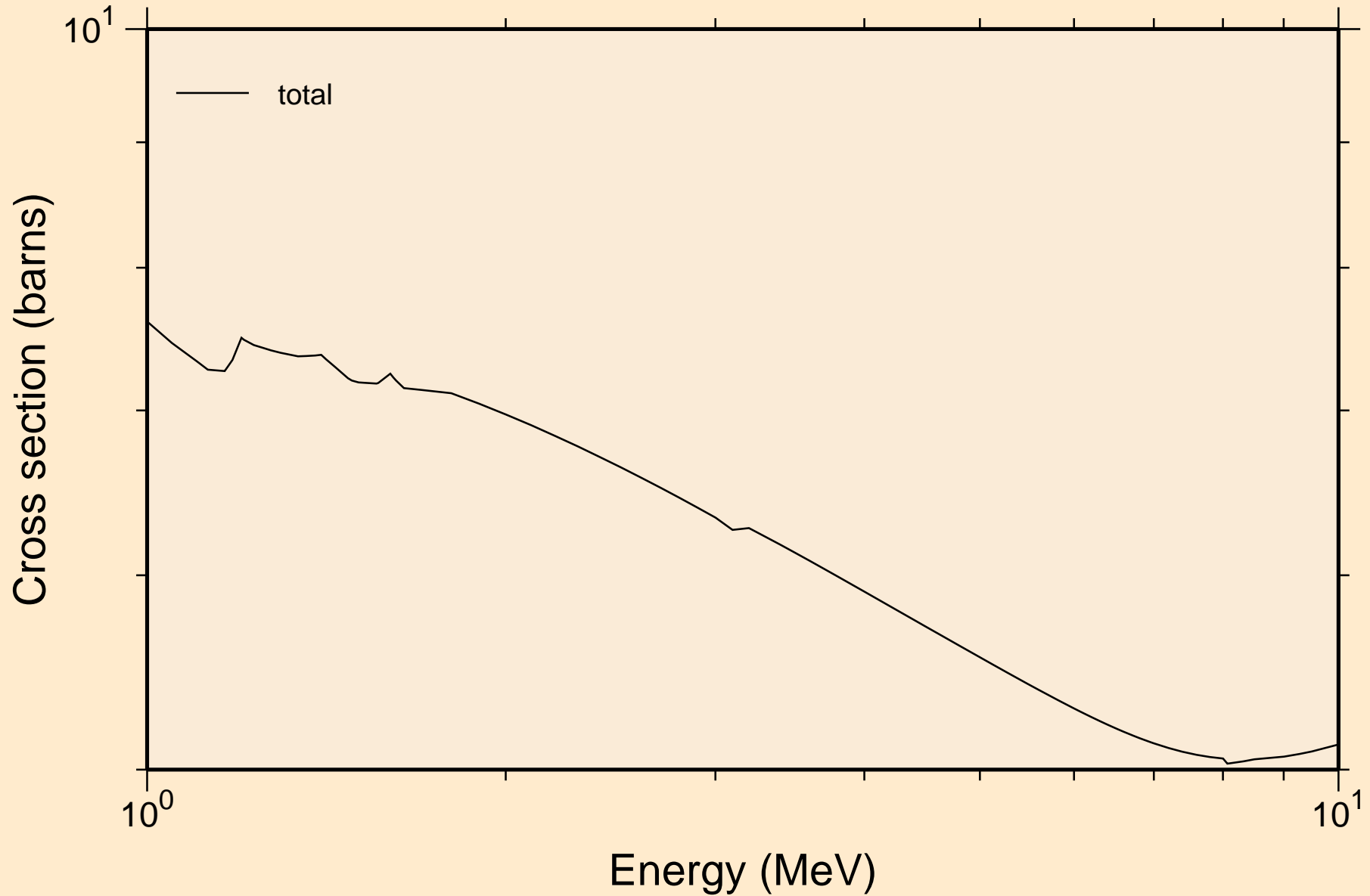

YB172 NEUTRON ACER TENDL-2024 LIBRARY; T=0.K
resonance absorption cross sections

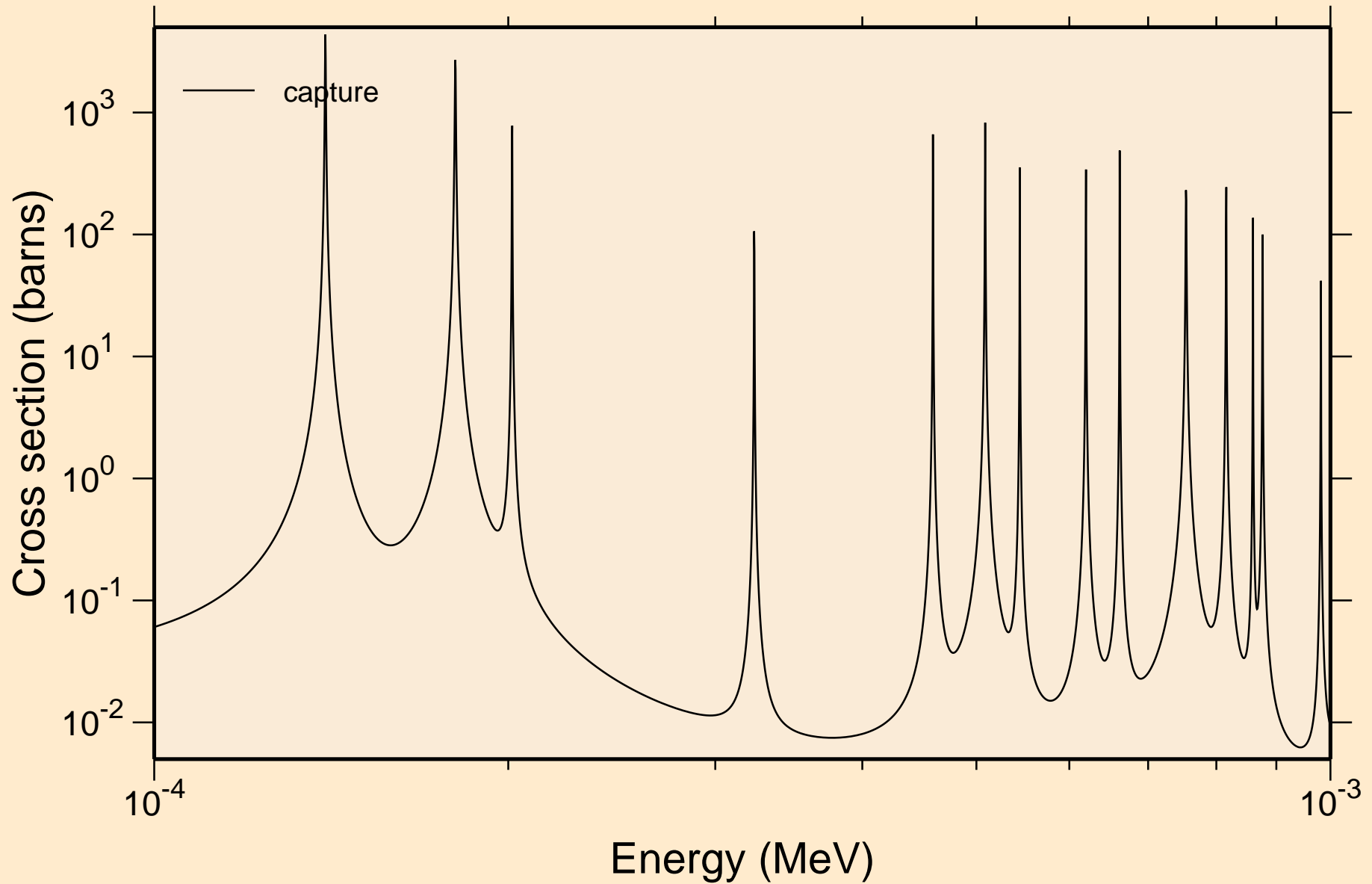

YB172 NEUTRON ACER TENDL-2024 LIBRARY; T=0.K
resonance absorption cross sections

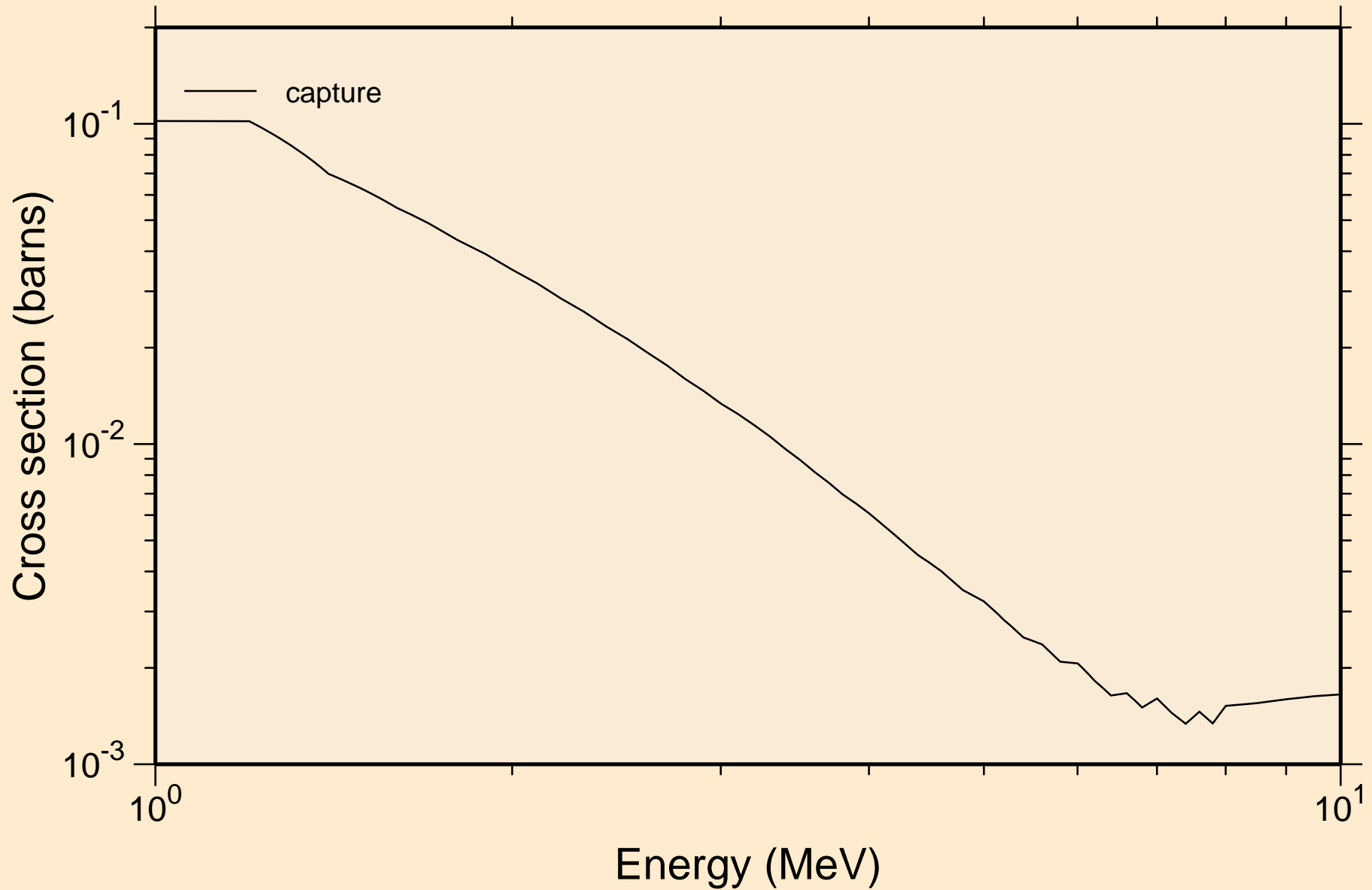

YB172 NEUTRON ACER TENDL-2024 LIBRARY; T=0.K
Heating

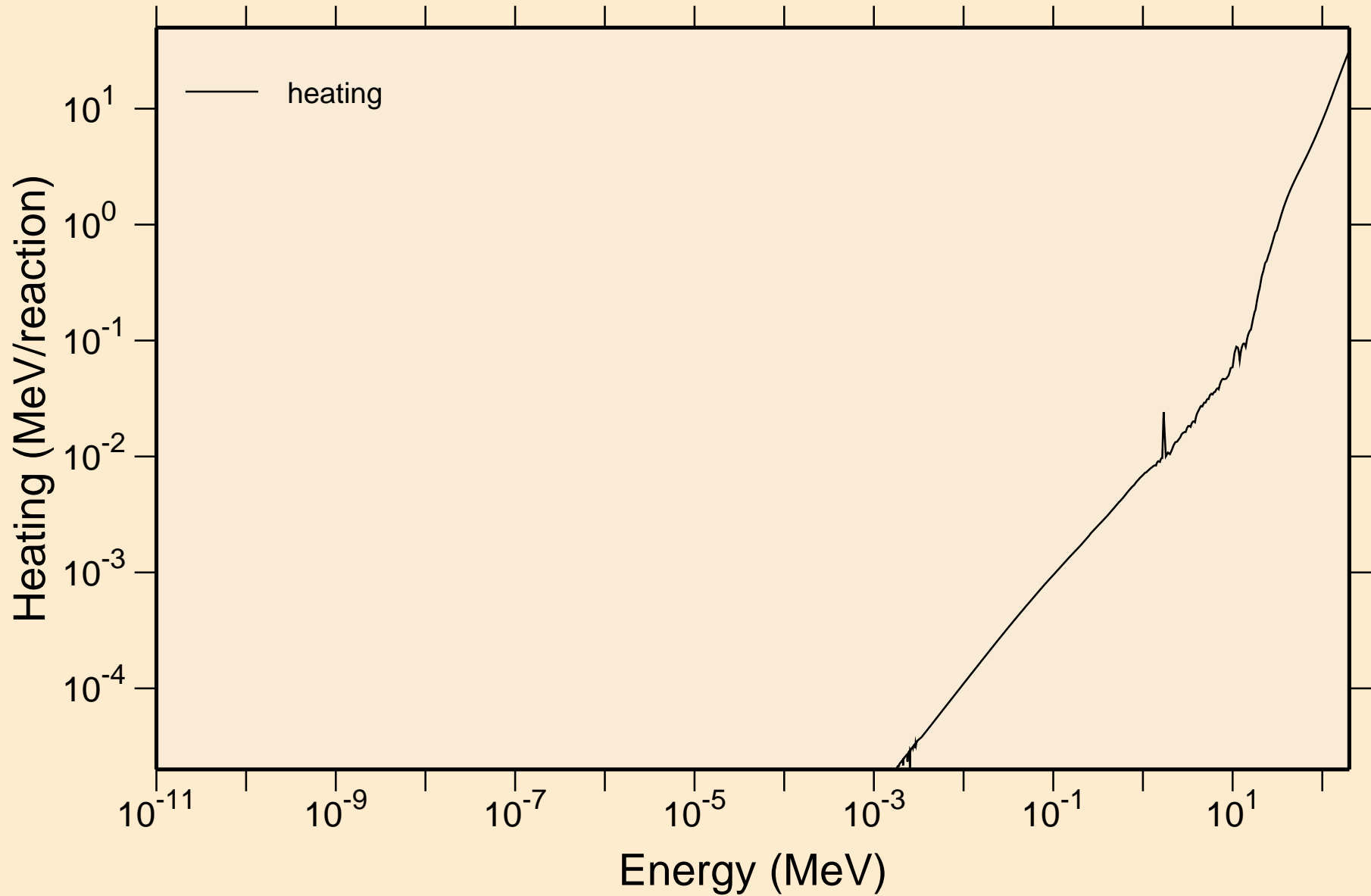

YB172 NEUTRON ACER TENDL-2024 LIBRARY; T=0.K

Damage

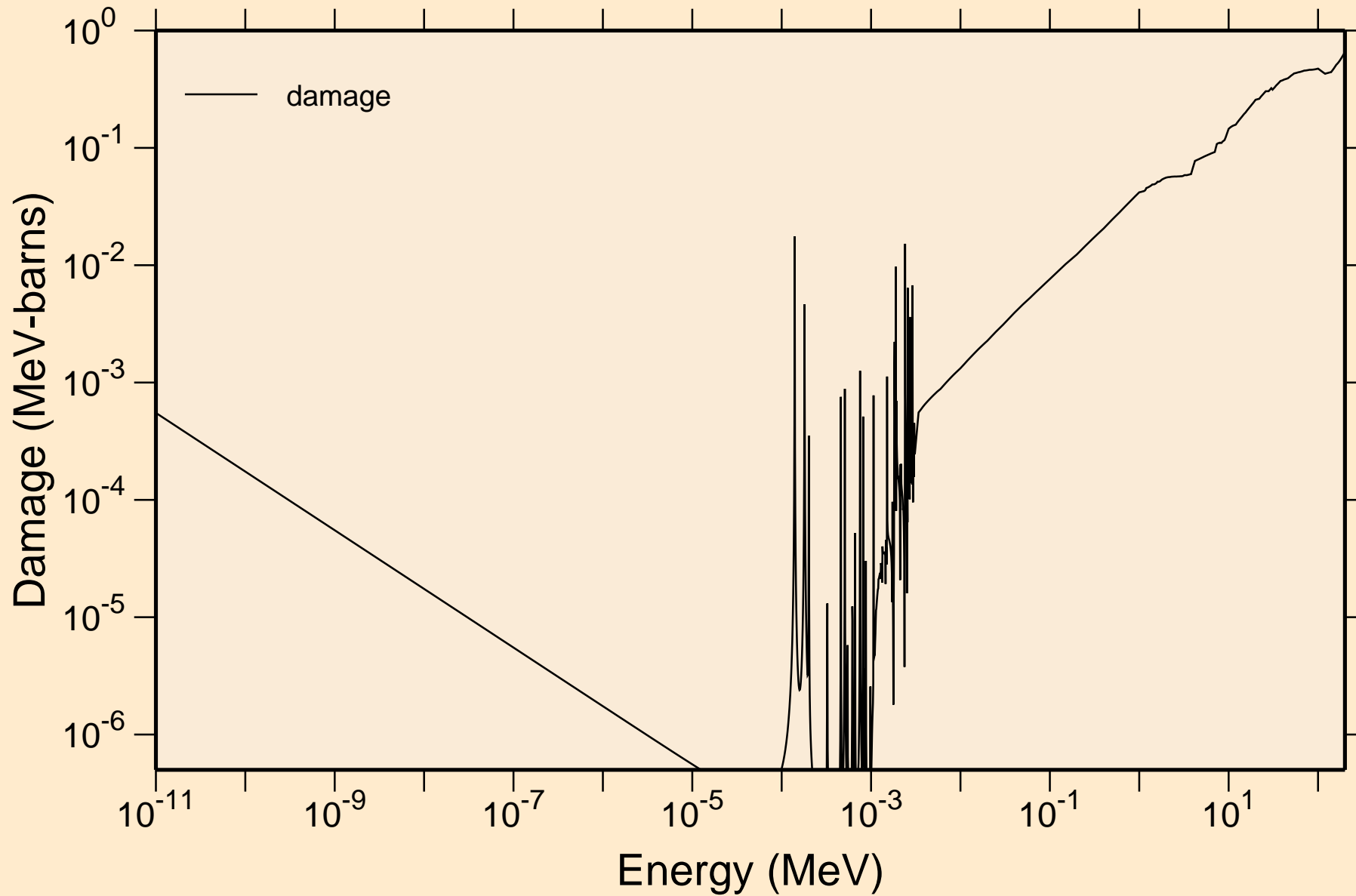

YB172 NEUTRON ACER TENDL-2024 LIBRARY; T=0.K
Non-threshold reactions

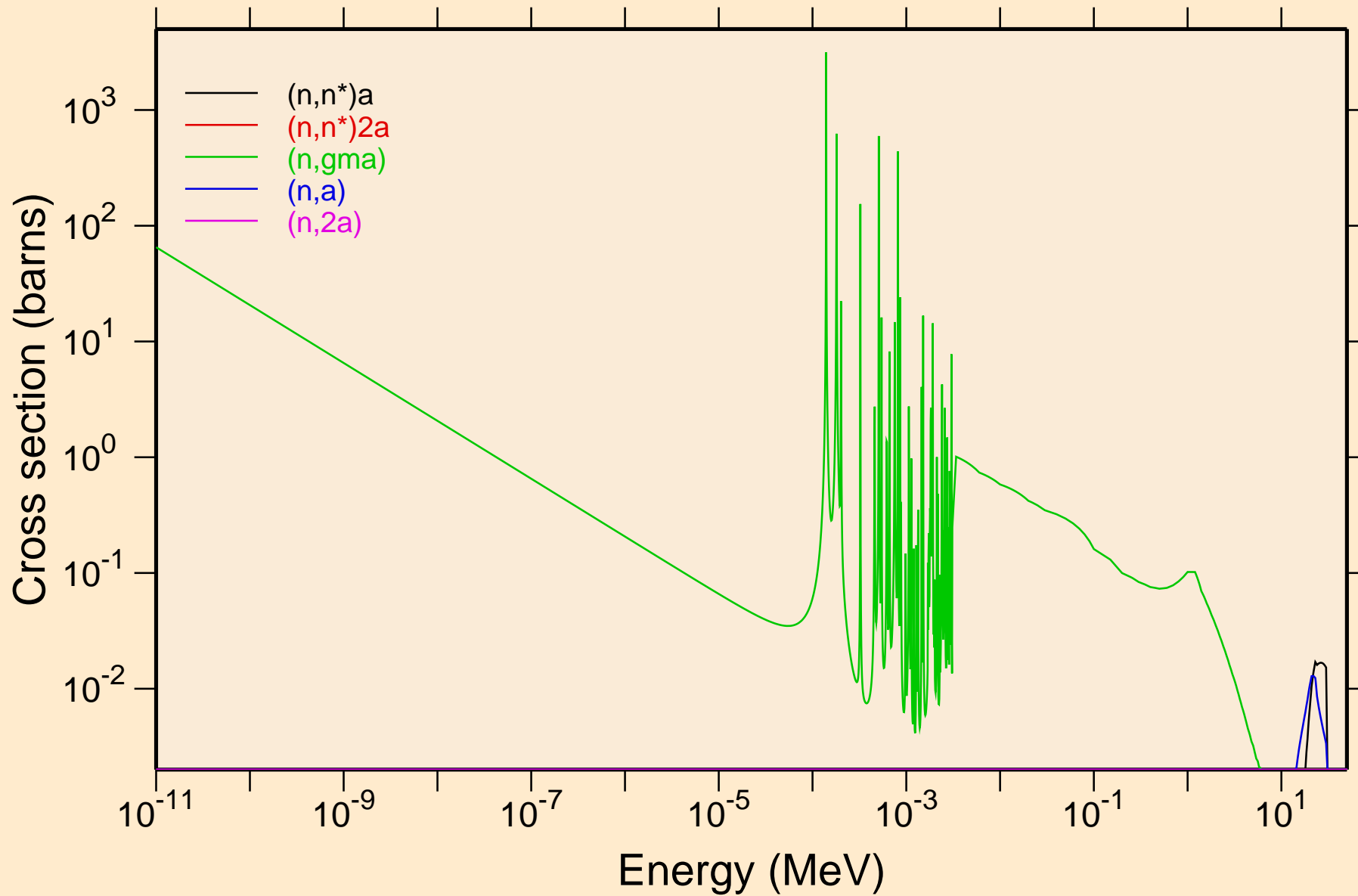

YB172 NEUTRON ACER TENDL-2024 LIBRARY; T=0.K
Non-threshold reactions

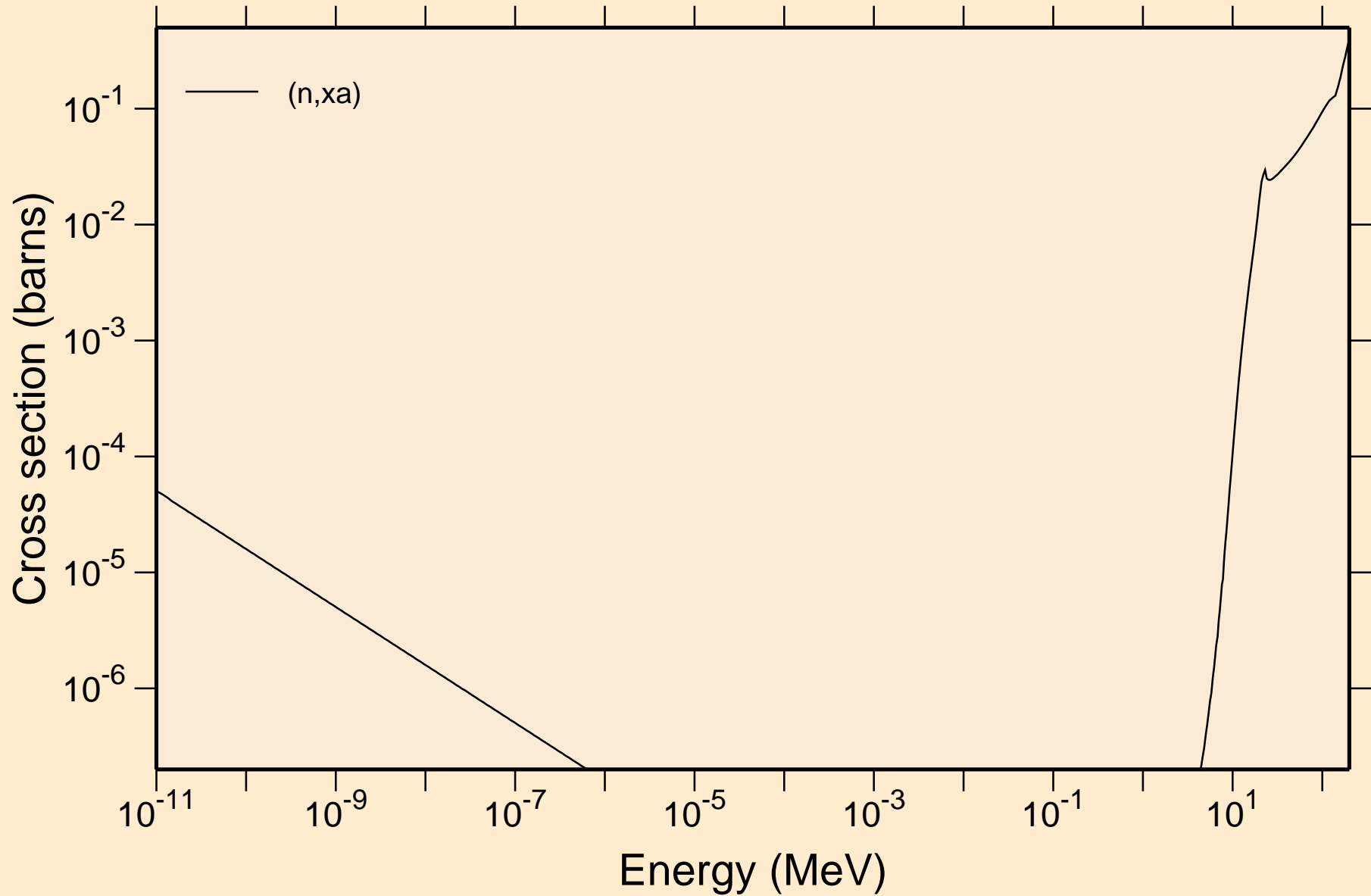

YB172 NEUTRON ACER TENDL-2024 LIBRARY; T=0.K

Principal cross sections

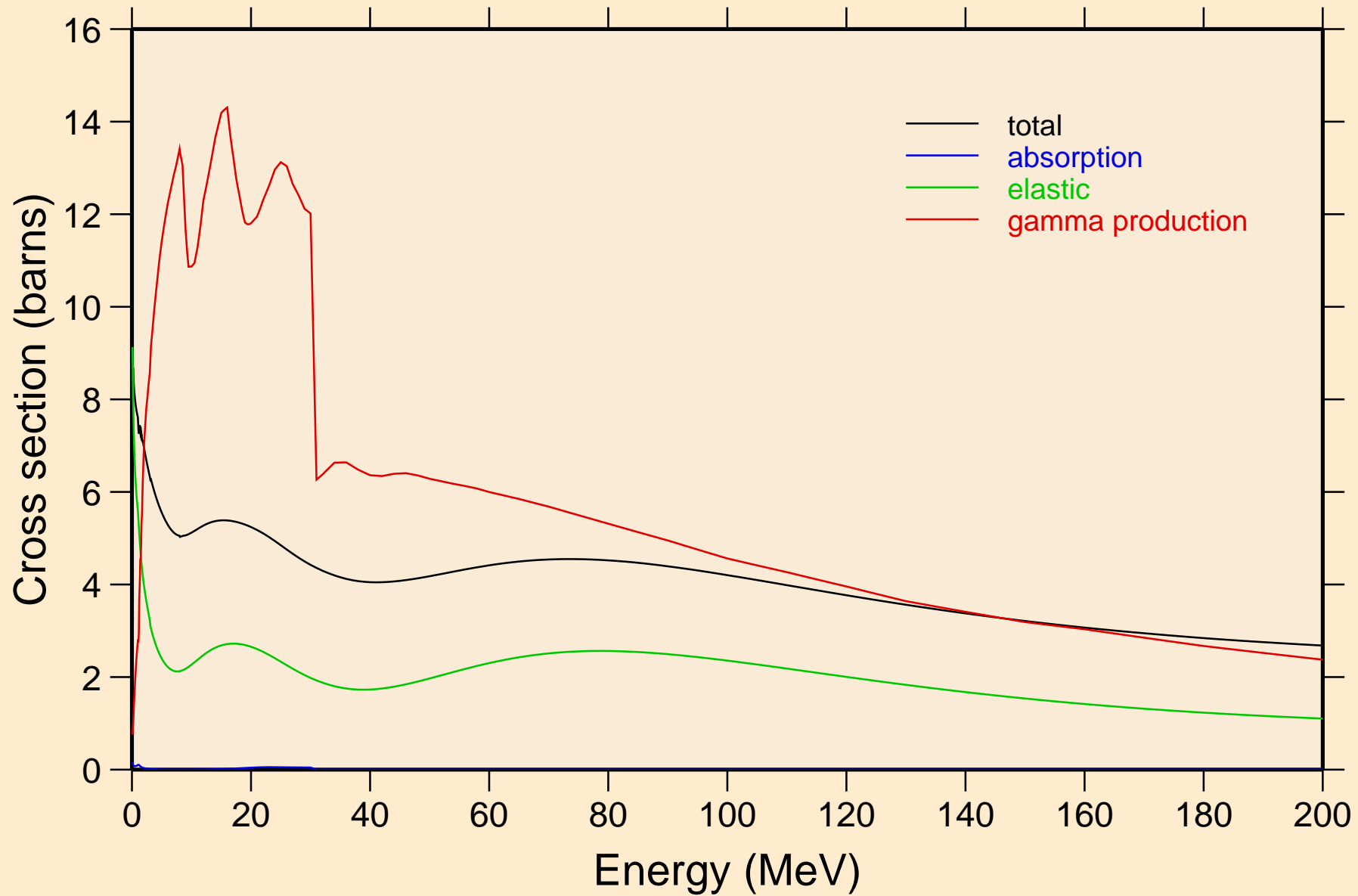

YB172 NEUTRON ACER TENDL-2024 LIBRARY; T=0.K

Heating

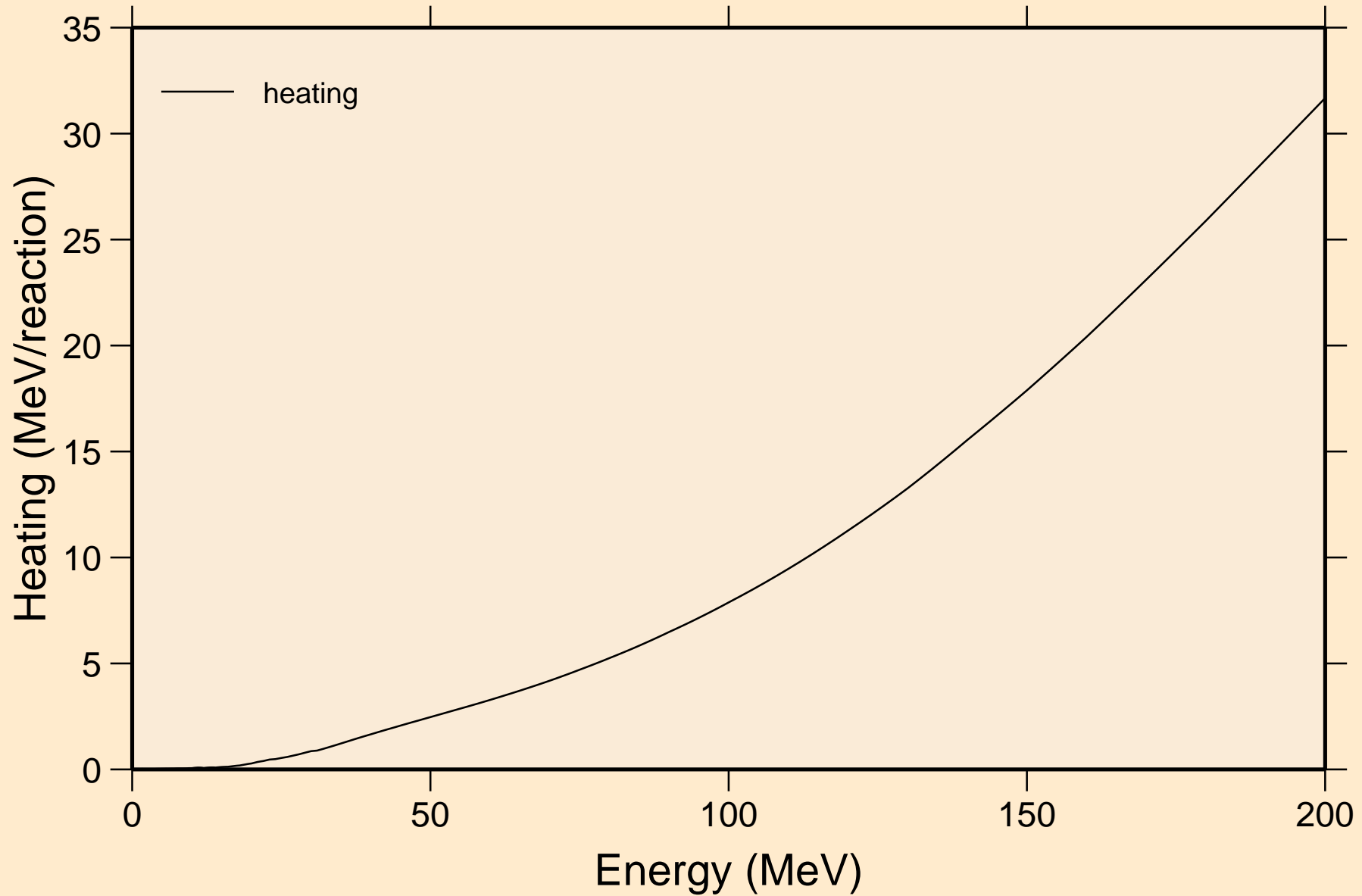

YB172 NEUTRON ACER TENDL-2024 LIBRARY; T=0.K

Damage

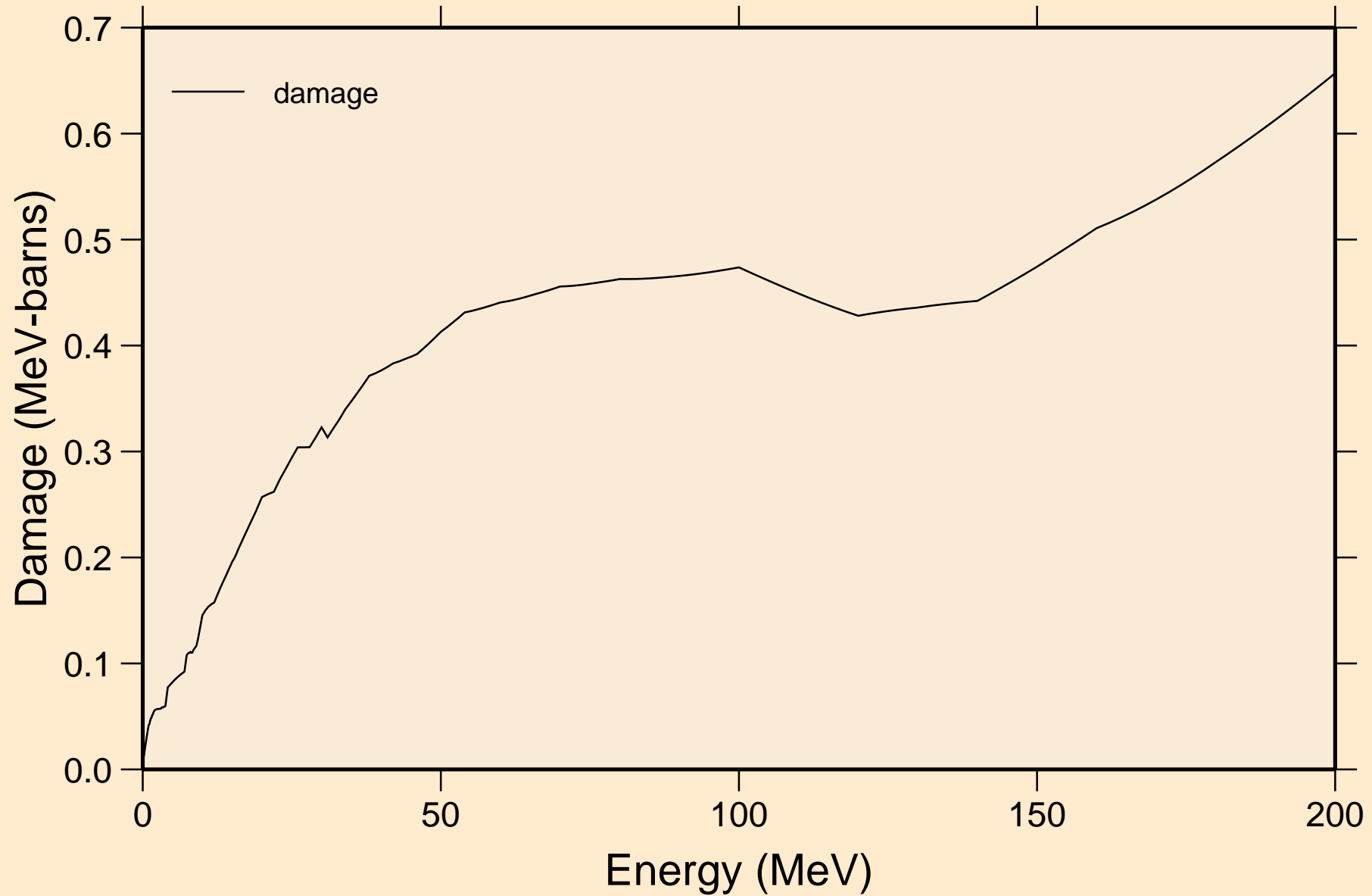

YB172 NEUTRON ACER TENDL-2024 LIBRARY; T=0.K
Non-threshold reactions

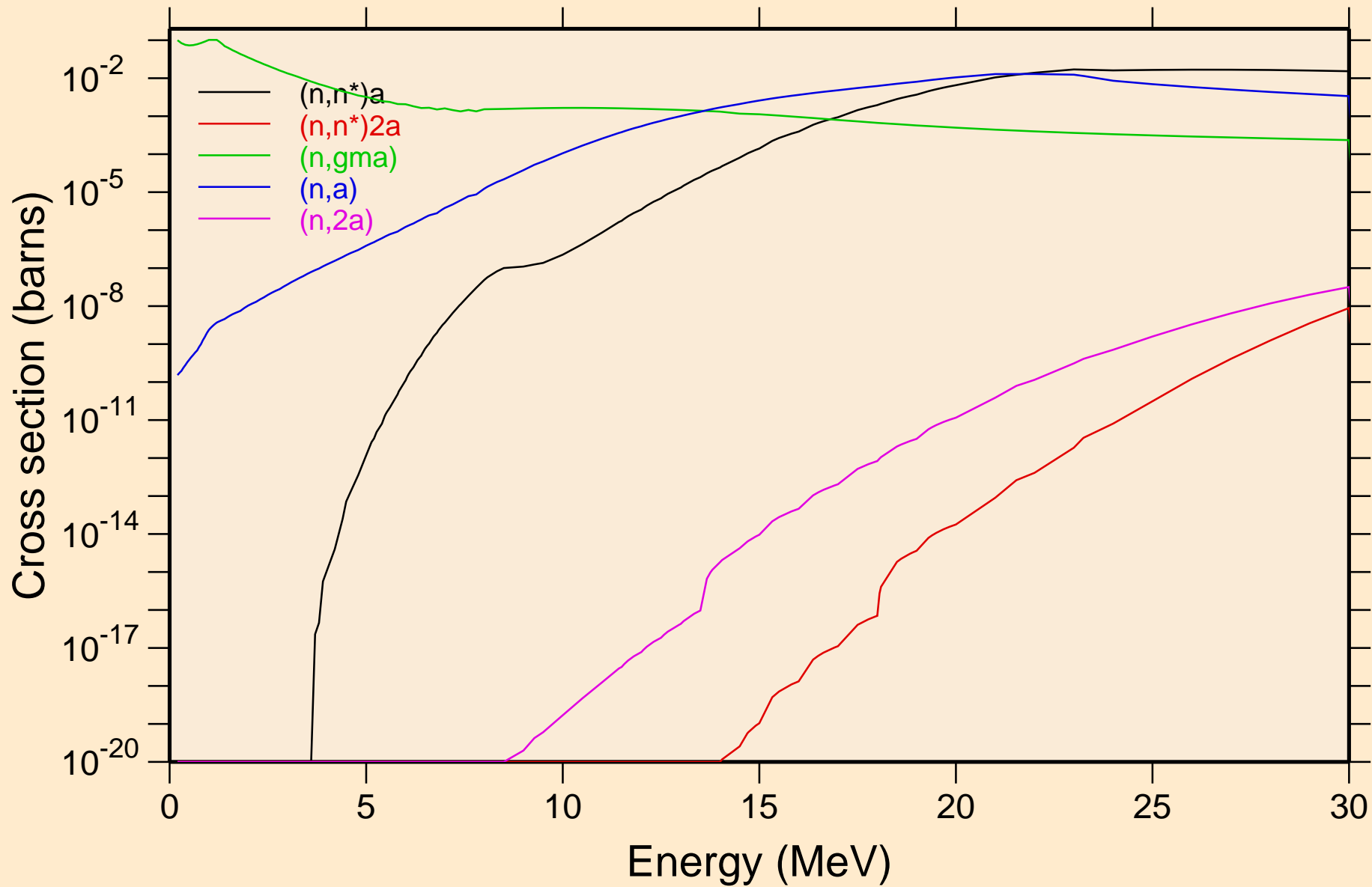

YB172 NEUTRON ACER TENDL-2024 LIBRARY; T=0.K
Non-threshold reactions

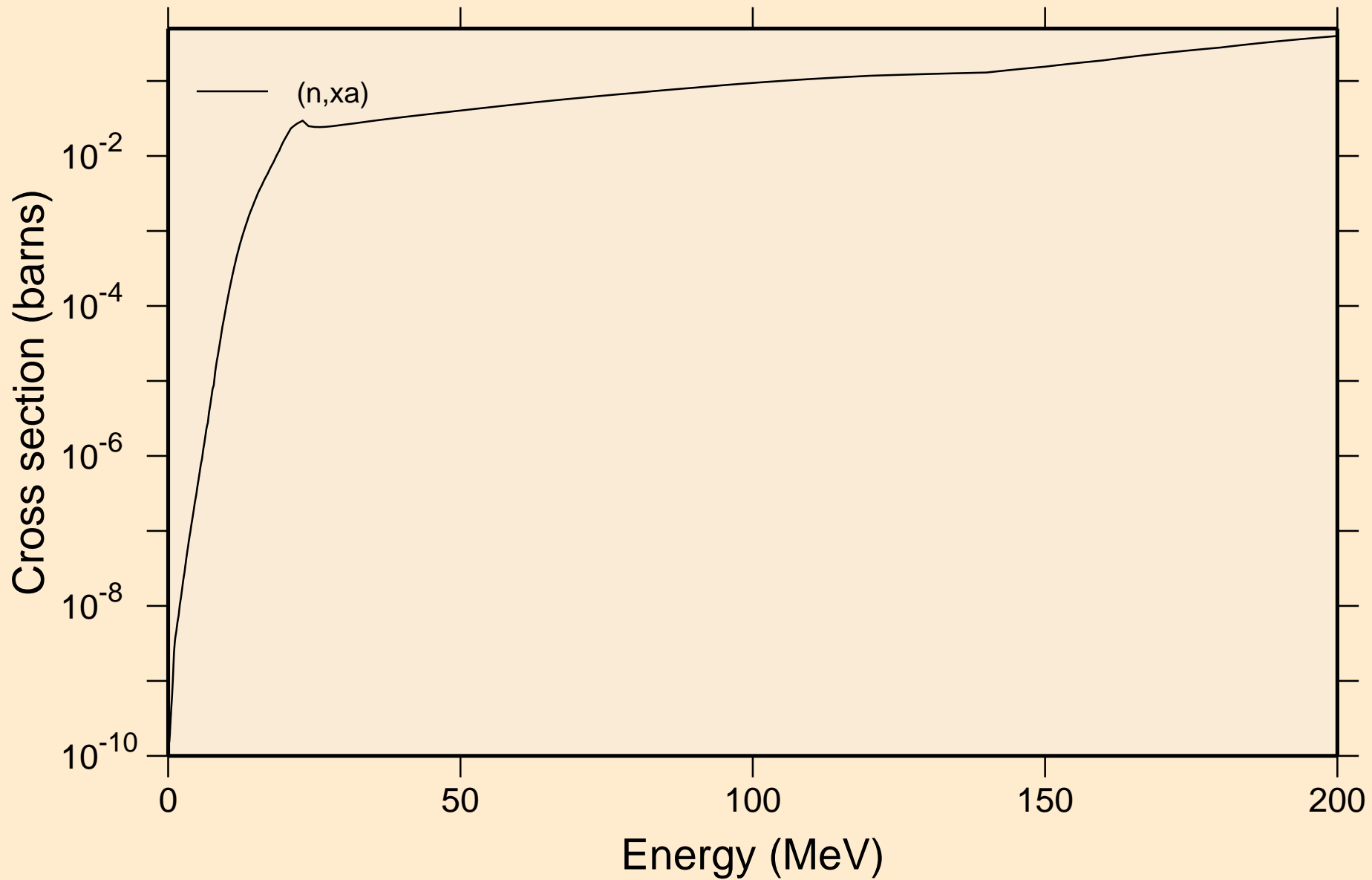

YB172 NEUTRON ACER TENDL-2024 LIBRARY; T=0.K
Inelastic levels

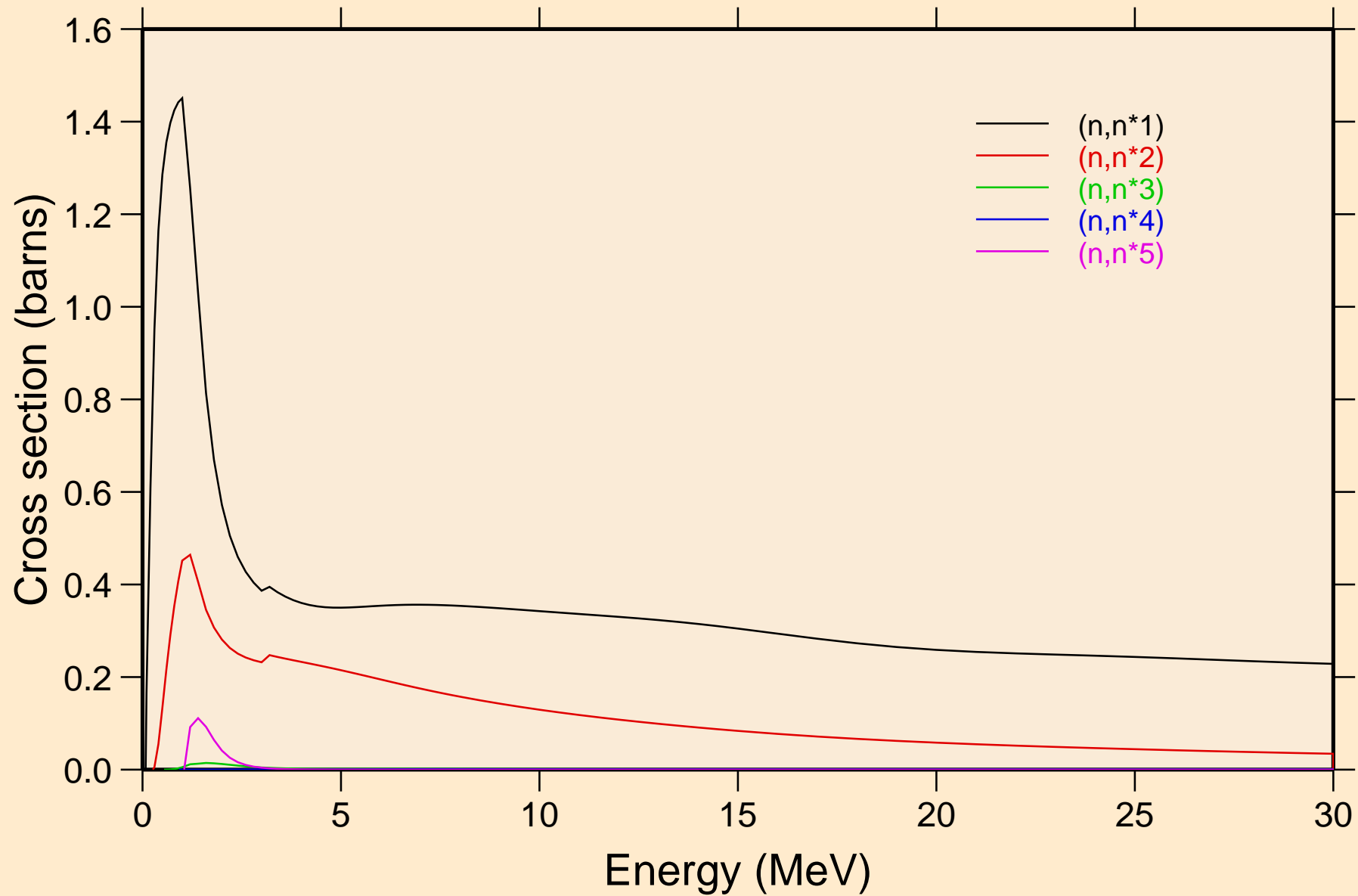

YB172 NEUTRON ACER TENDL-2024 LIBRARY; T=0.K
Inelastic levels

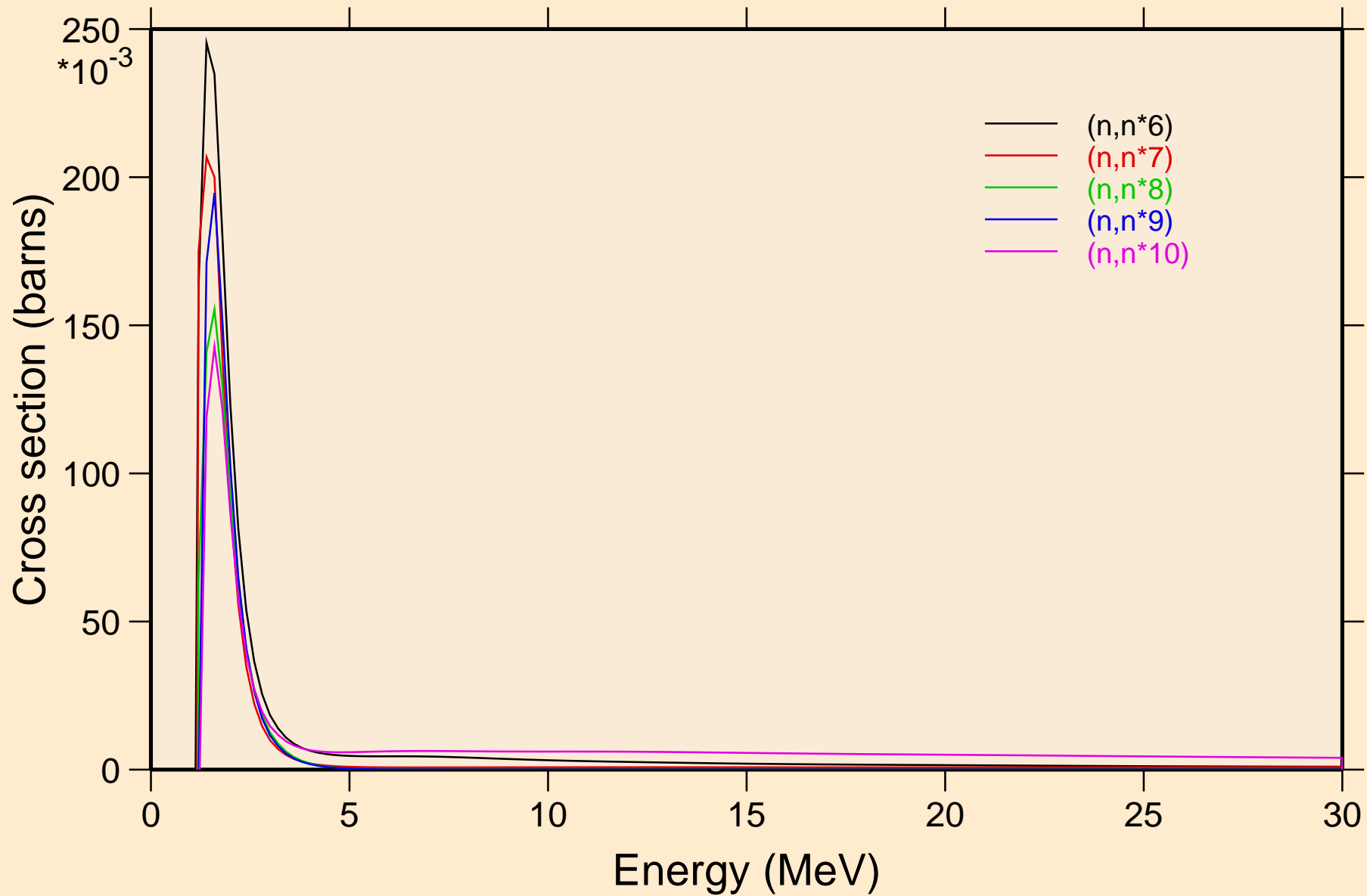

YB172 NEUTRON ACER TENDL-2024 LIBRARY; T=0.K
Inelastic levels

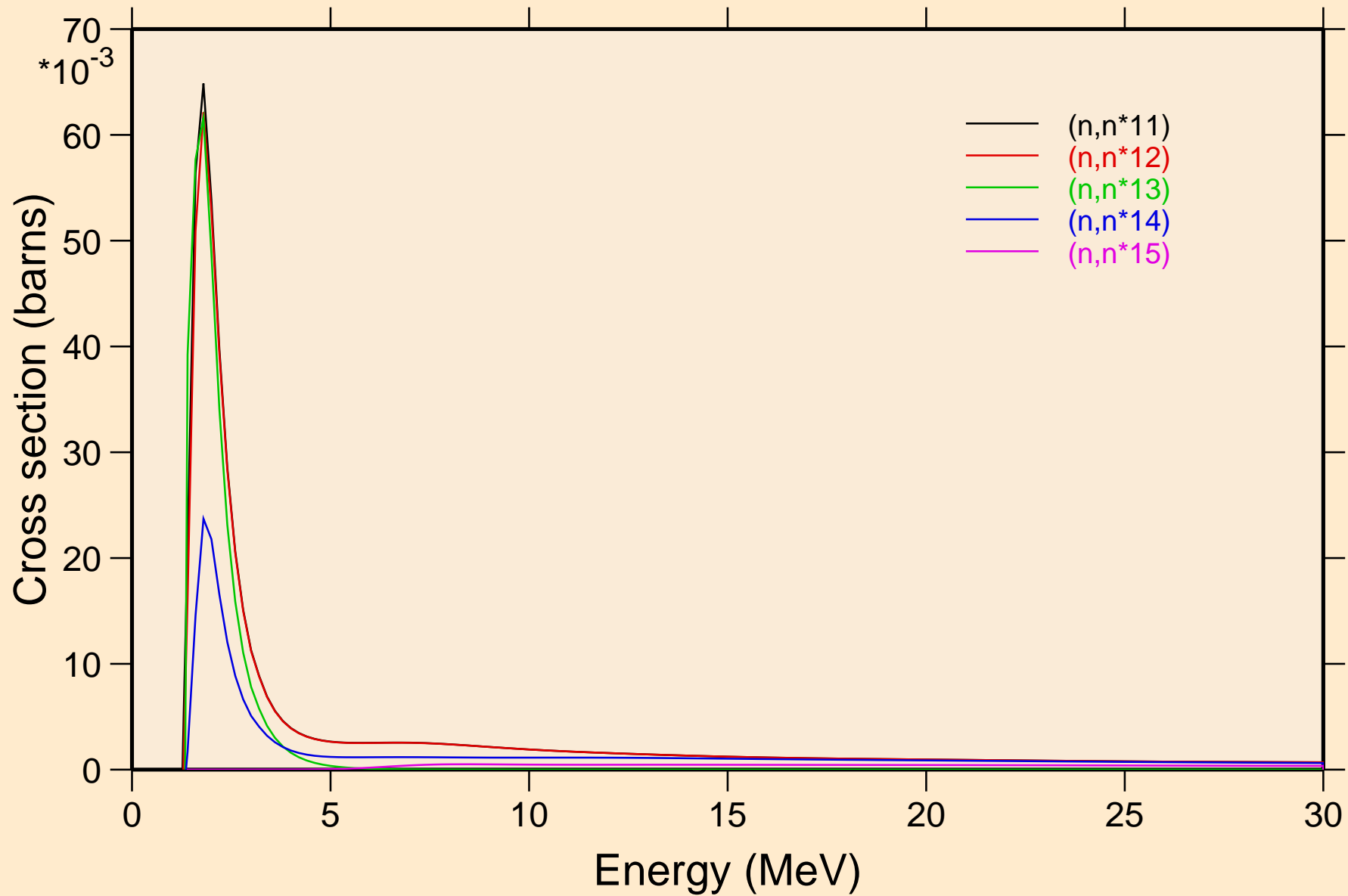

YB172 NEUTRON ACER TENDL-2024 LIBRARY; T=0.K
Inelastic levels

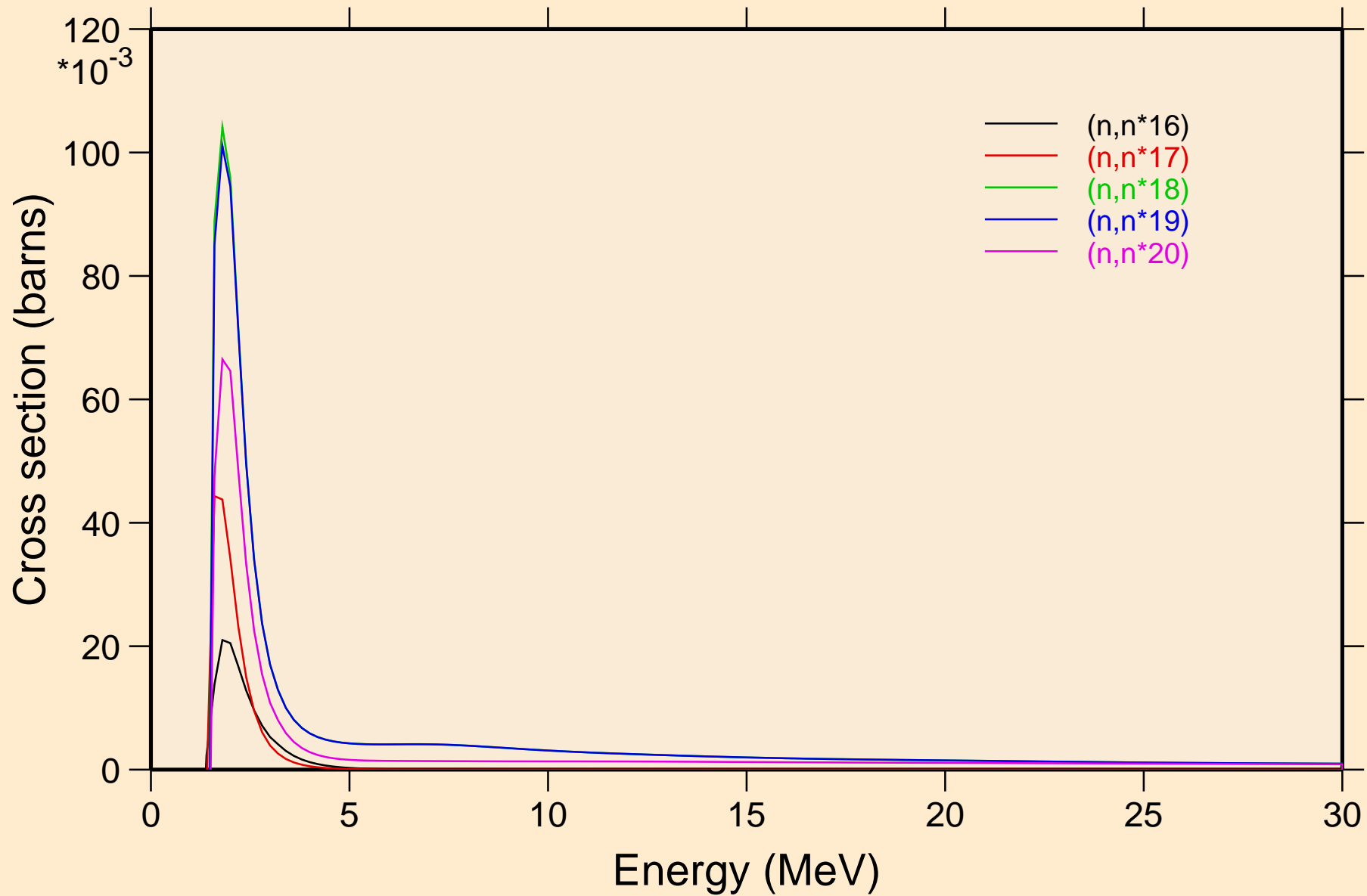

YB172 NEUTRON ACER TENDL-2024 LIBRARY; T=0.K
Inelastic levels

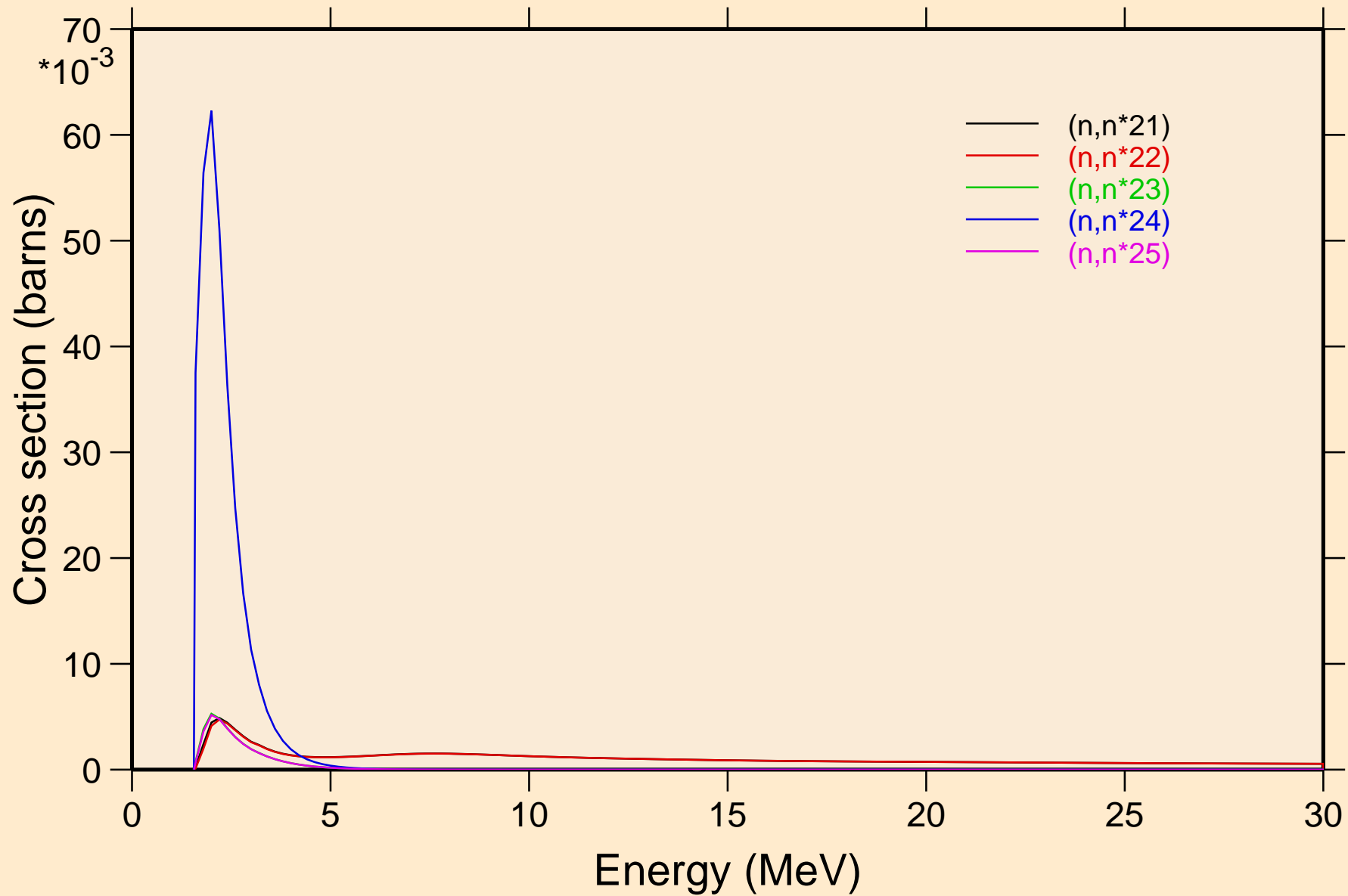

YB172 NEUTRON ACER TENDL-2024 LIBRARY; T=0.K
Inelastic levels

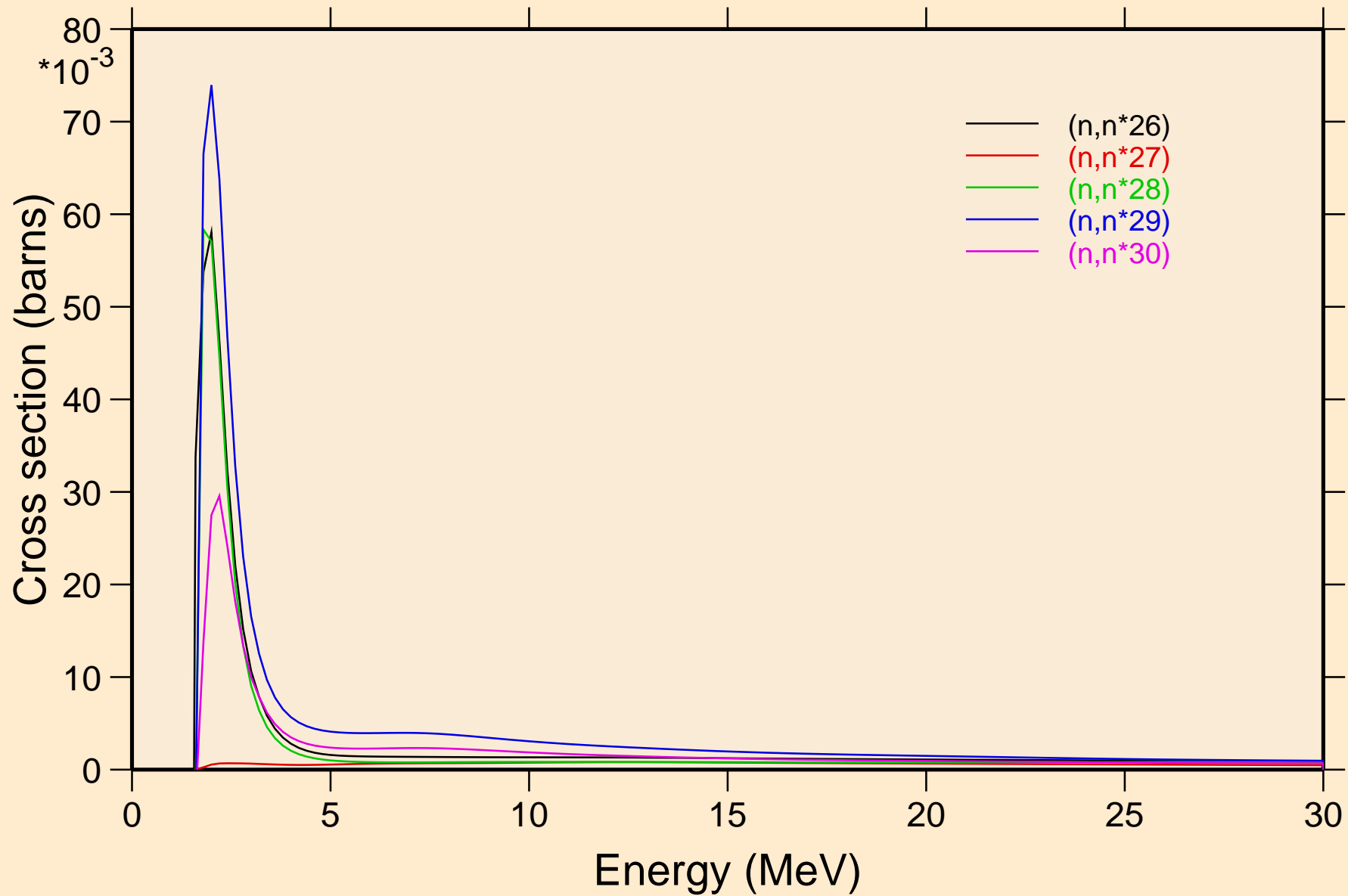

YB172 NEUTRON ACER TENDL-2024 LIBRARY; T=0.K
Threshold reactions

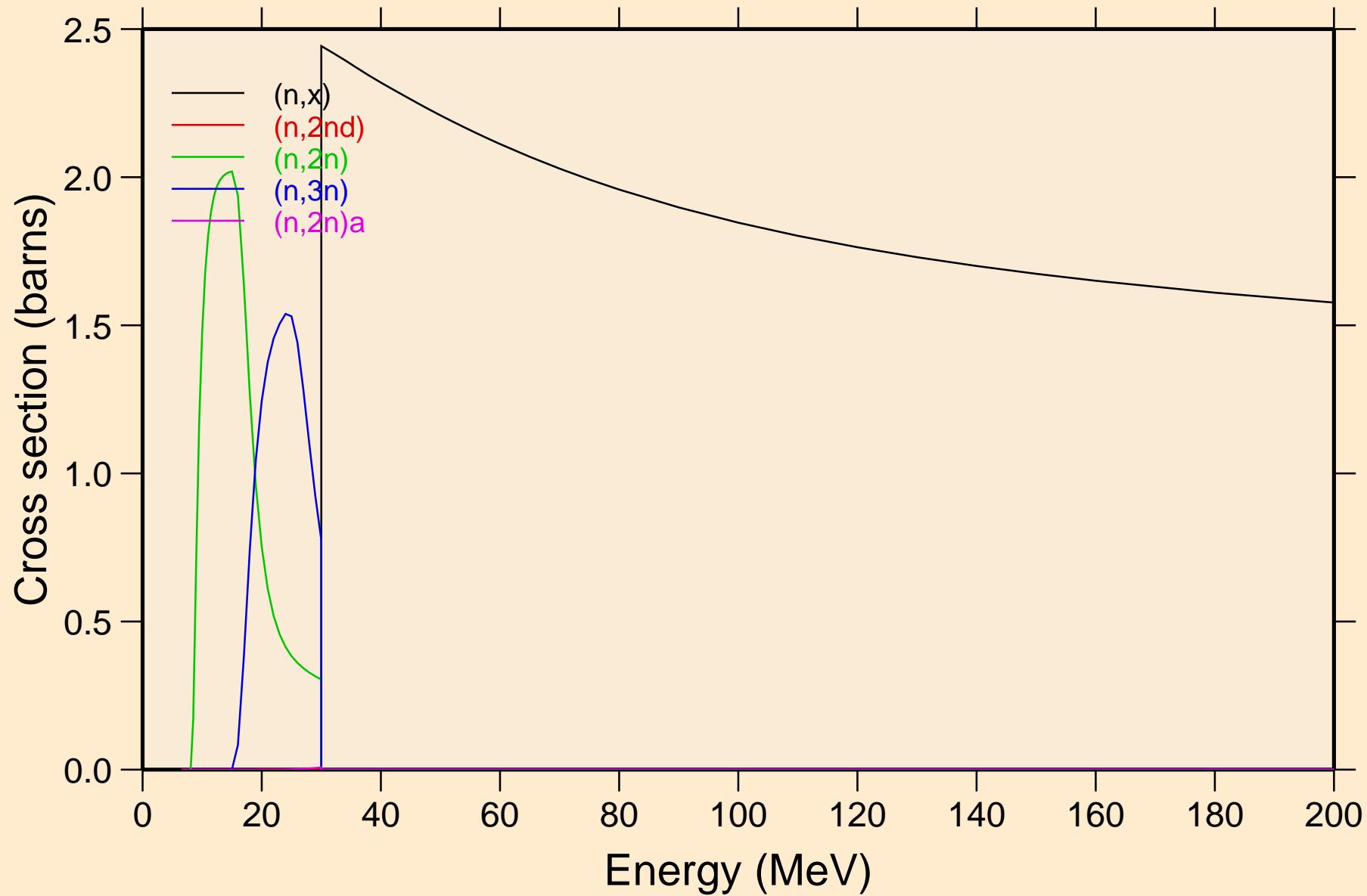

YB172 NEUTRON ACER TENDL-2024 LIBRARY; T=0.K
Threshold reactions

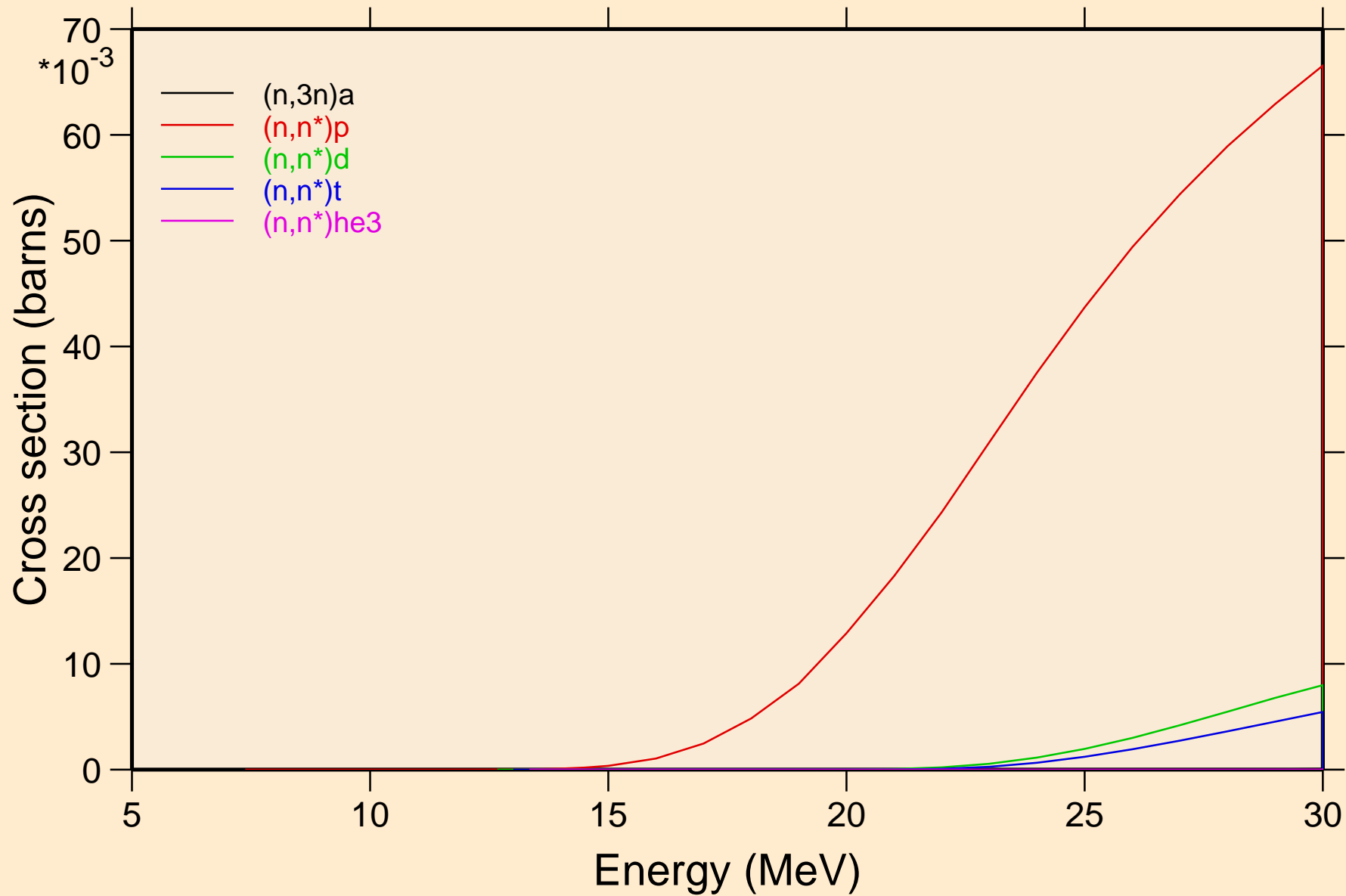

YB172 NEUTRON ACER TENDL-2024 LIBRARY; T=0.K

Threshold reactions

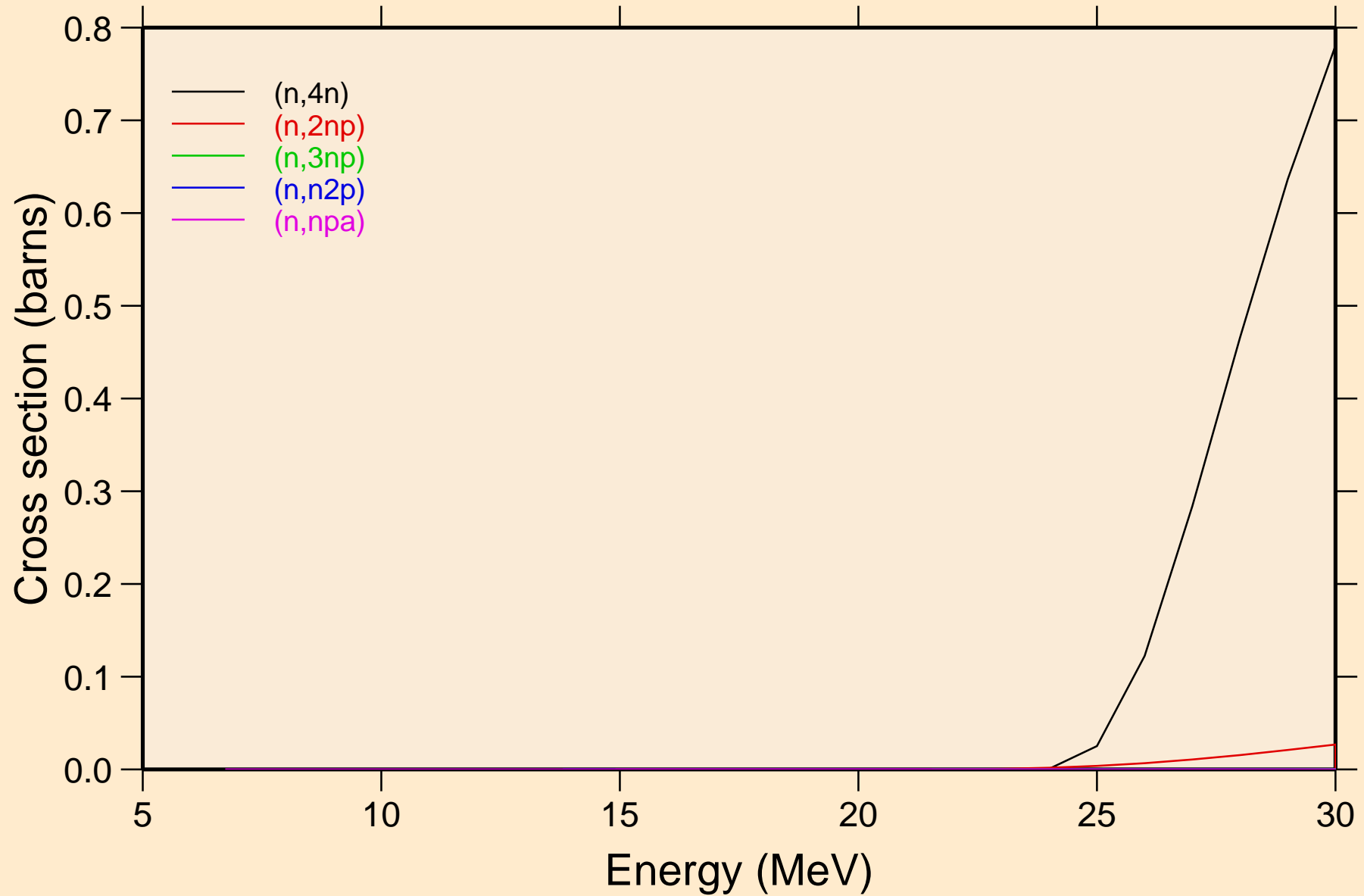

YB172 NEUTRON ACER TENDL-2024 LIBRARY; T=0.K
Threshold reactions

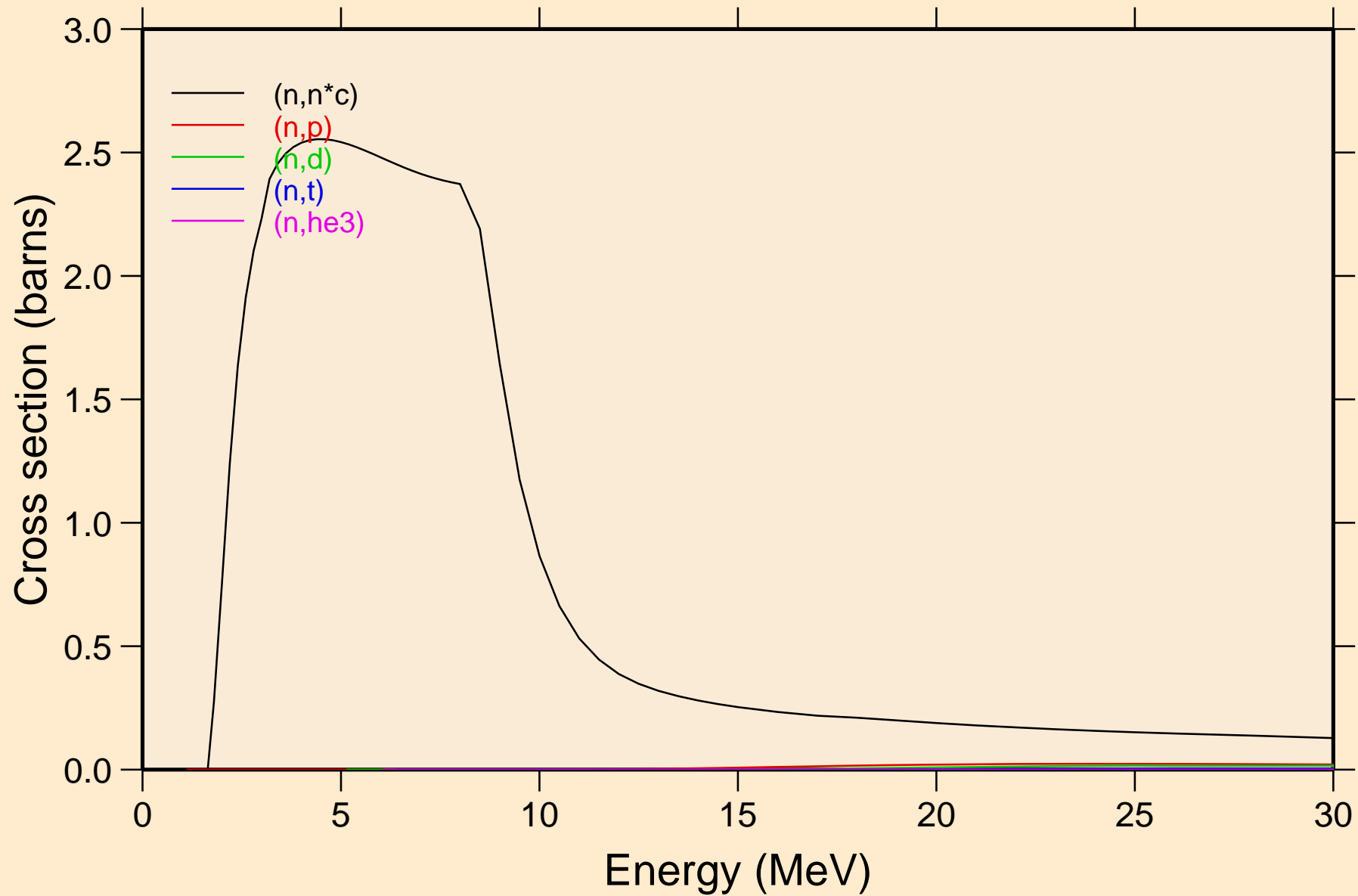

YB172 NEUTRON ACER TENDL-2024 LIBRARY; T=0.K
Threshold reactions

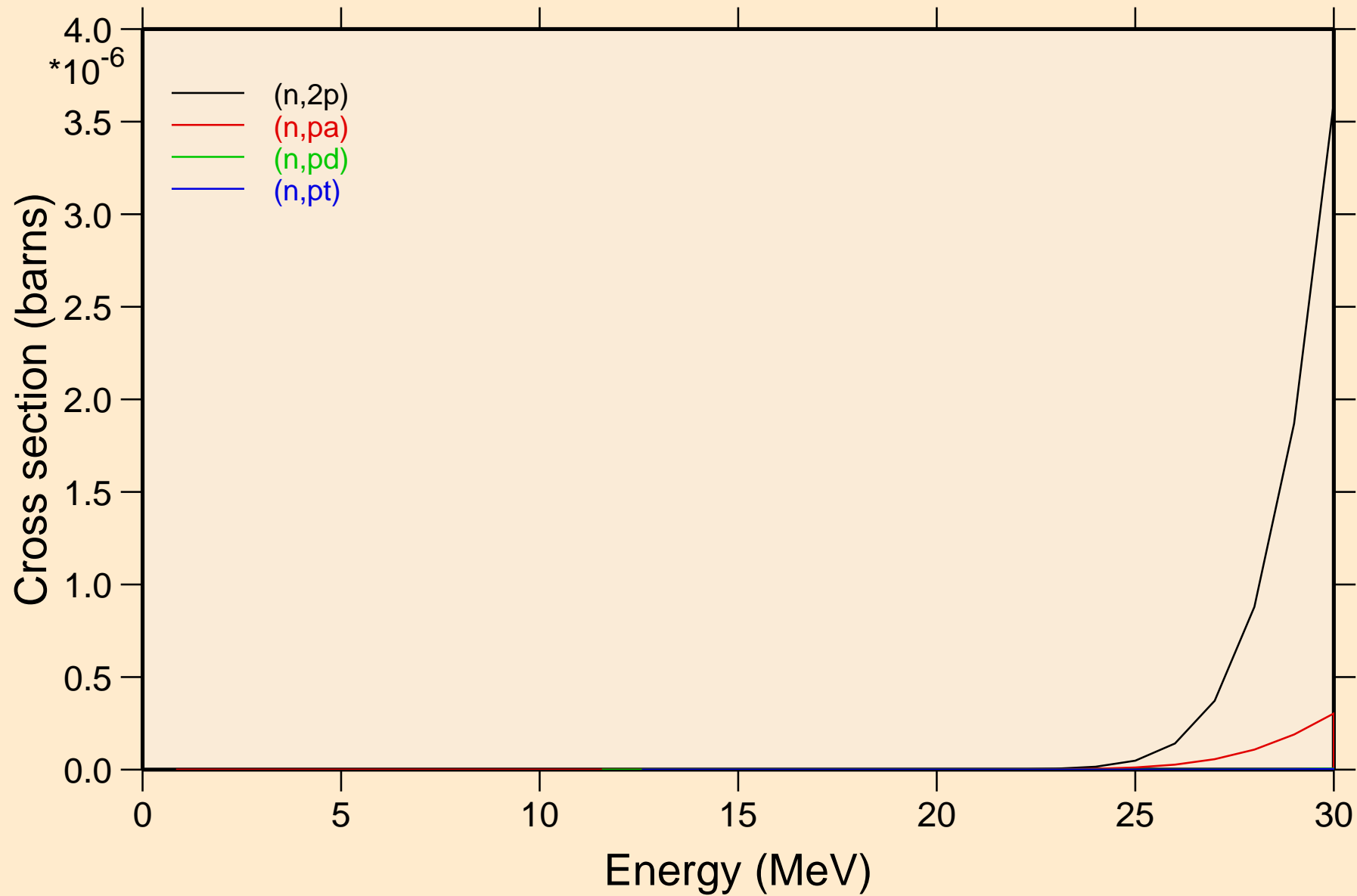

YB172 NEUTRON ACER TENDL-2024 LIBRARY; T=0.K
Threshold reactions

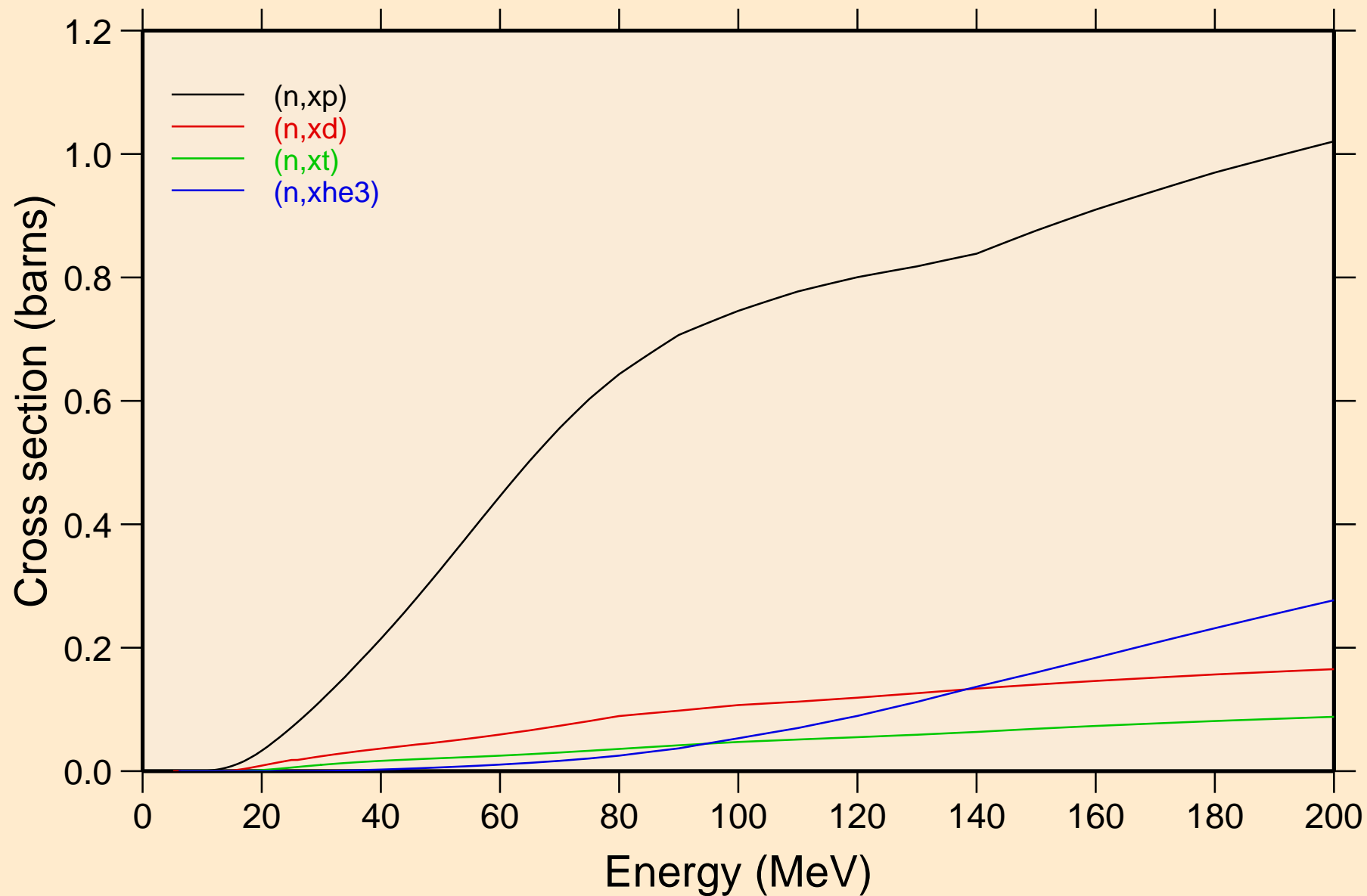

YB172 NEUTRON ACER TENDL-2024 LIBRARY; T=0.K
angular distribution for elastic

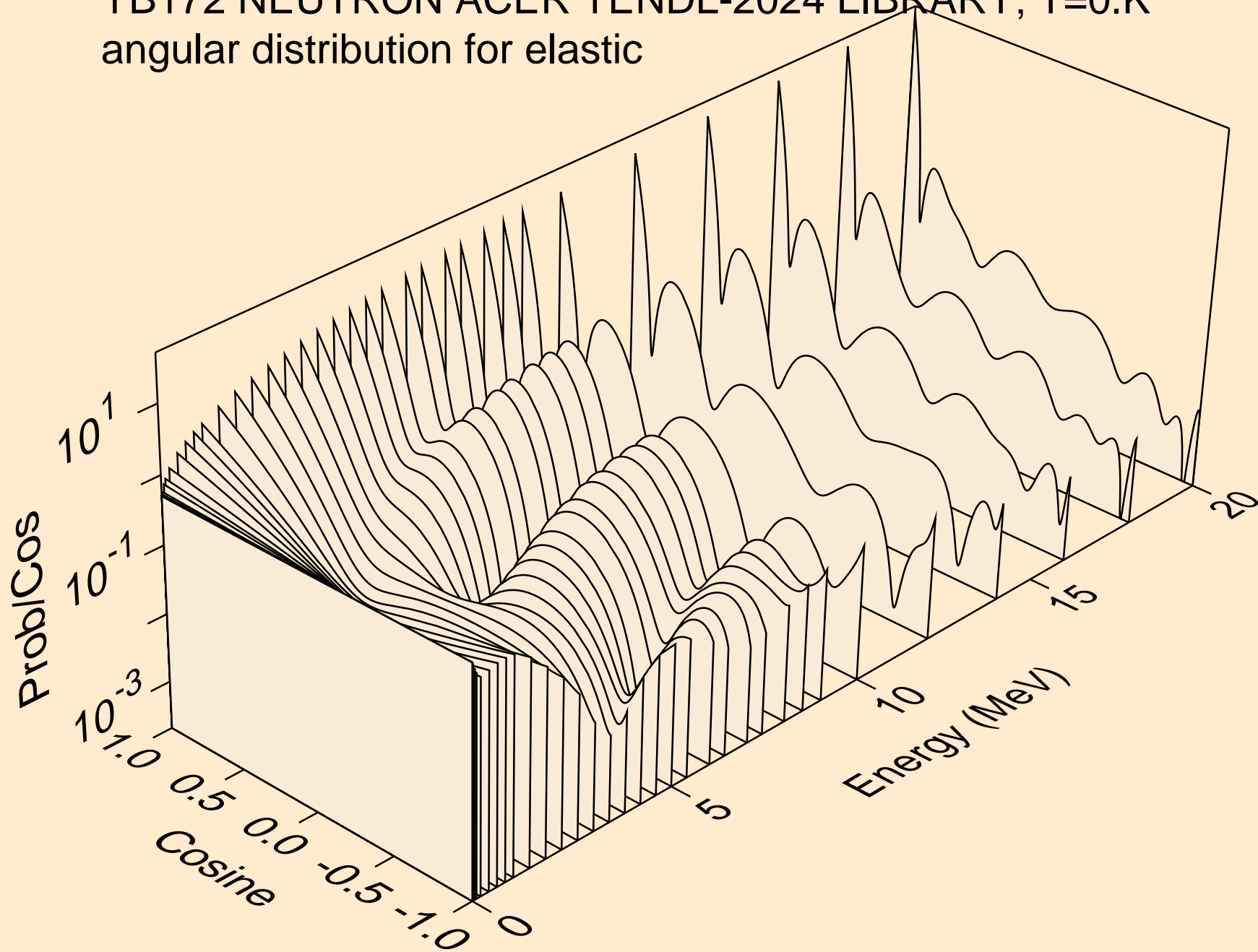

YB172 NEUTRON ACER TENDL-2024 LIBRARY; T=0.K
angular distribution for elastic

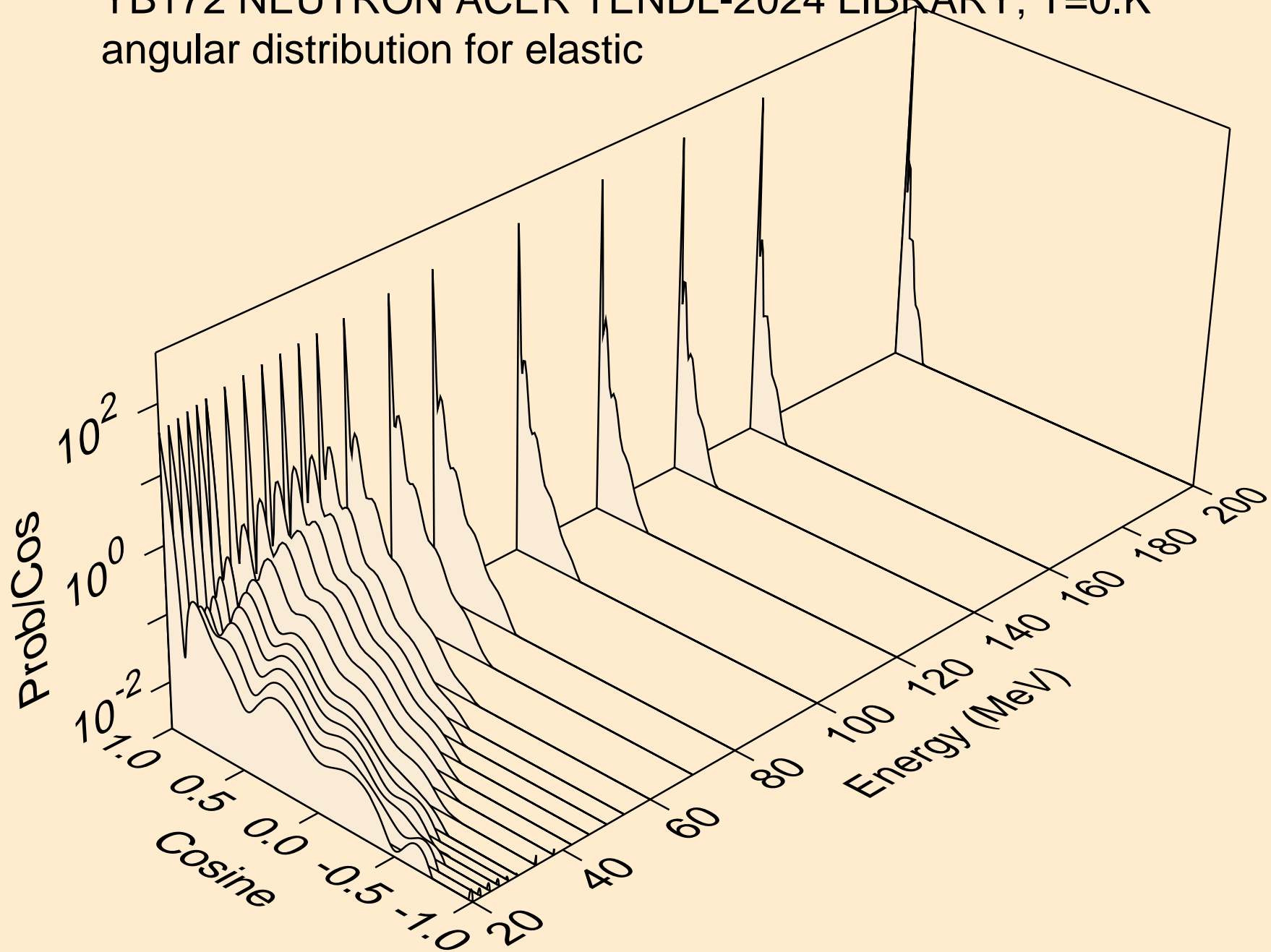

YB172 NEUTRON ACER TENDL-2024 LIBRARY; T=0.K
angular distribution for (n,n*1)

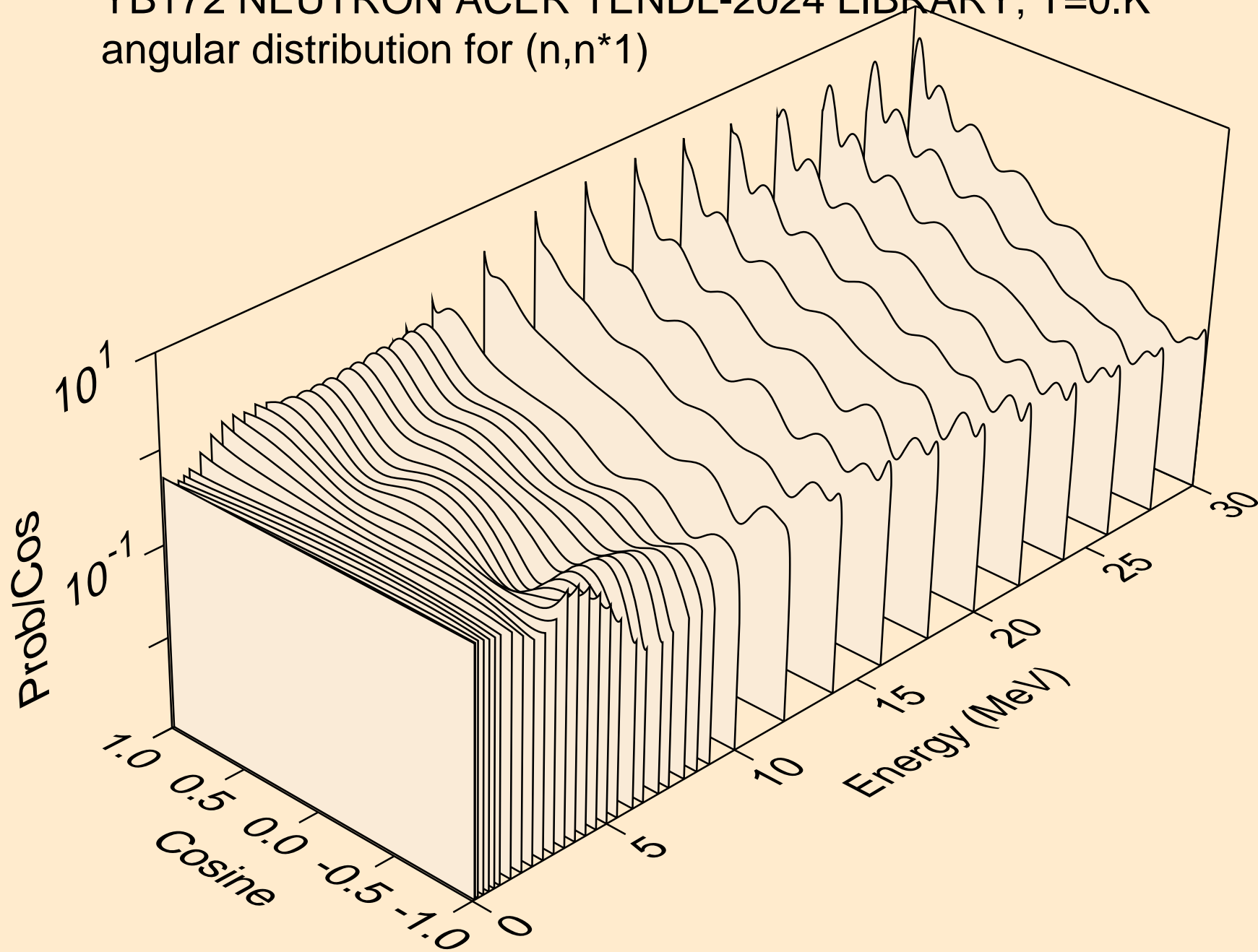

YB172 NEUTRON ACER TENDL-2024 LIBRARY; T=0.K
angular distribution for (n,n*2)

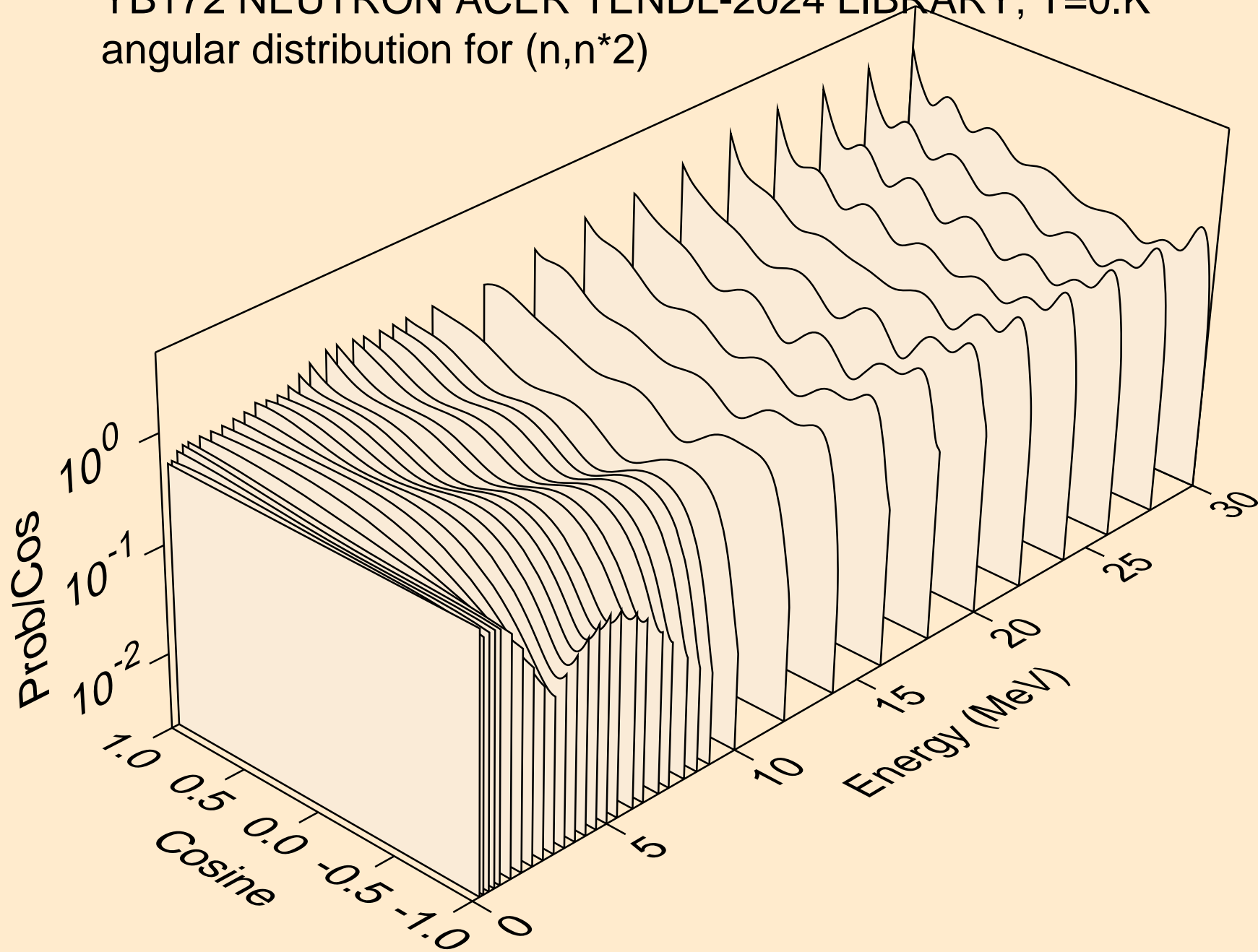

YB172 NEUTRON ACER TENDL-2024 LIBRARY; T=0.K
angular distribution for (n,n*3)

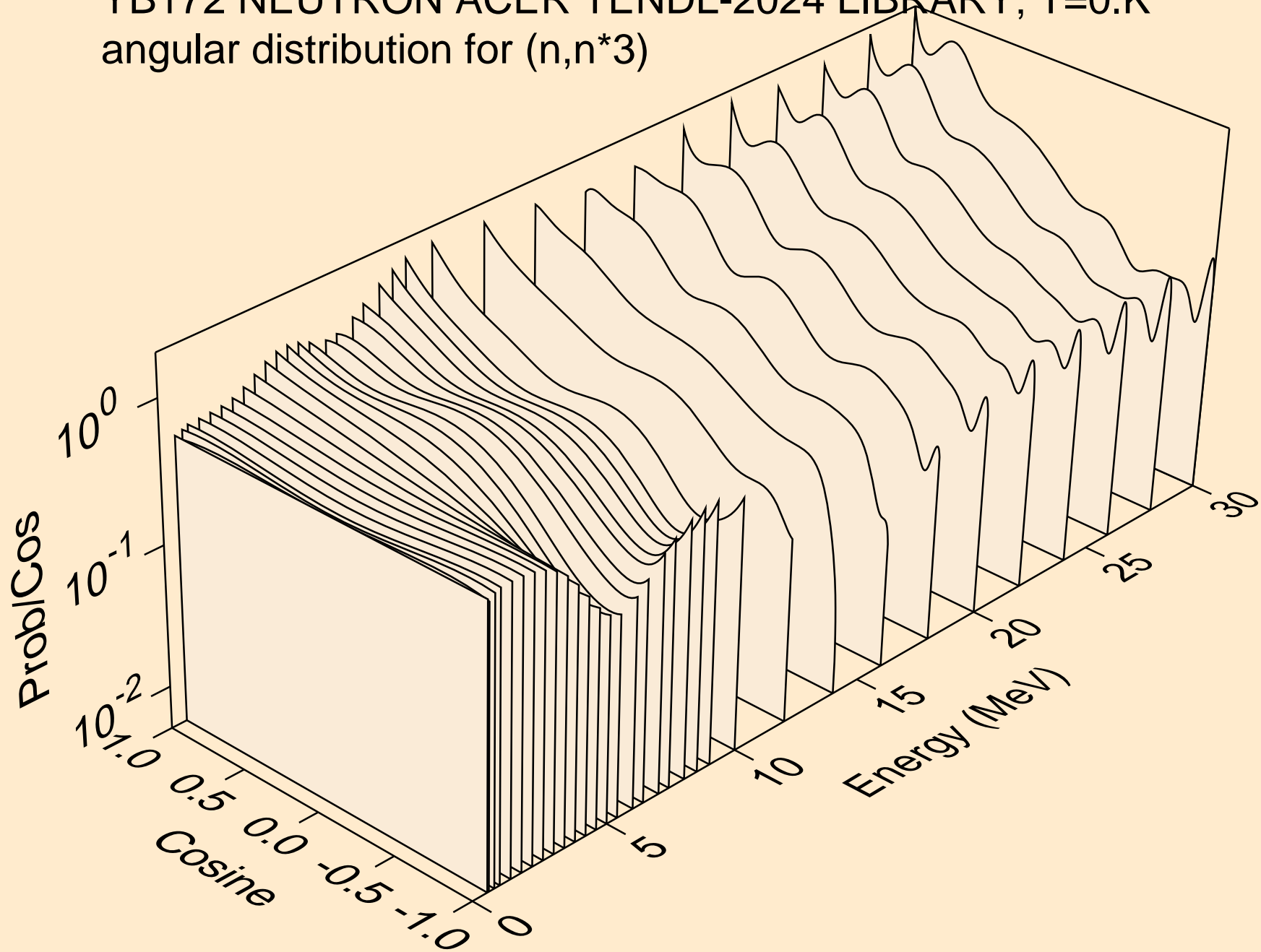

YB172 NEUTRON ACER TENDL-2024 LIBRARY; T=0.K
angular distribution for (n,n*4)

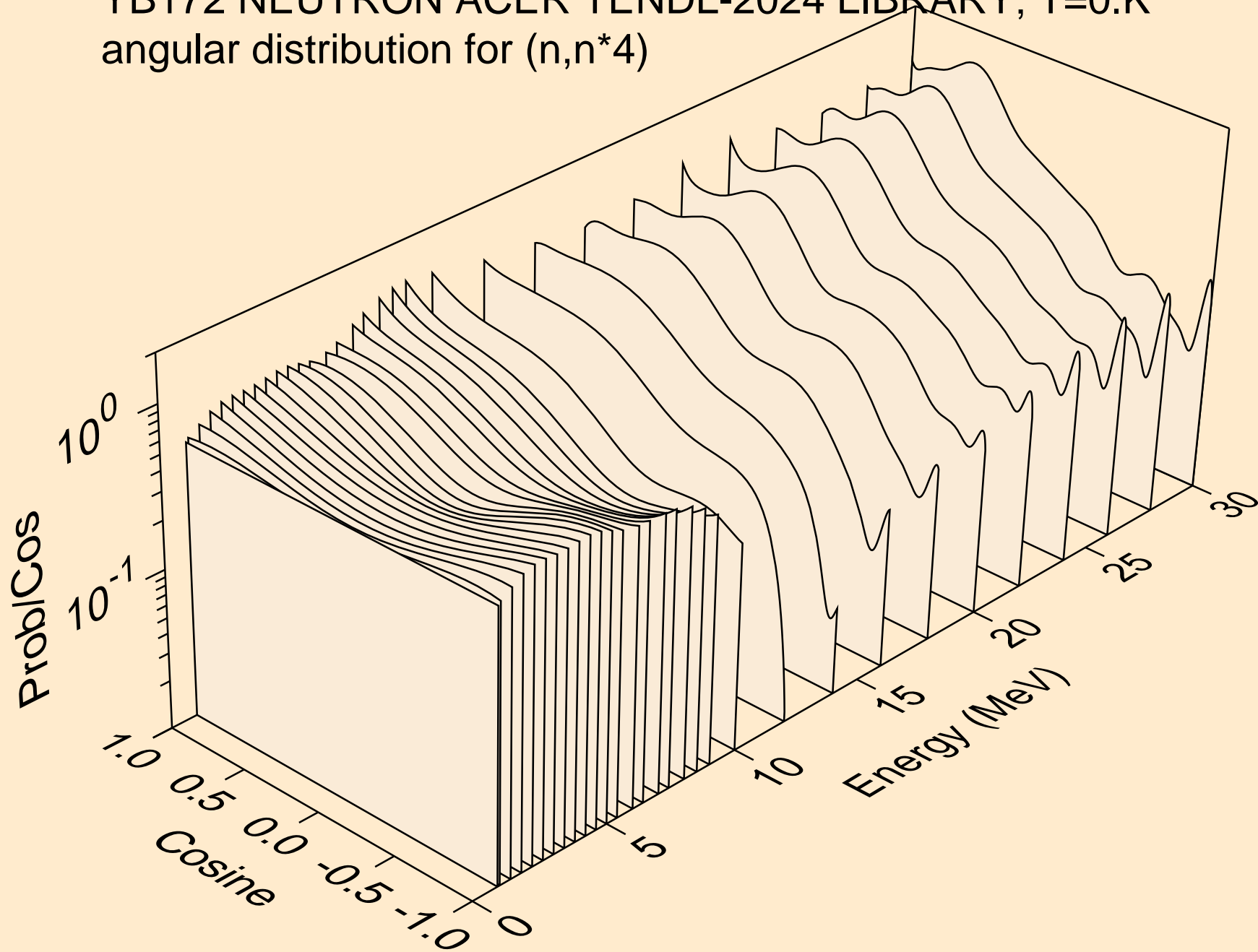

YB172 NEUTRON ACER TENDL-2024 LIBRARY; T=0.K
angular distribution for (n,n*5)

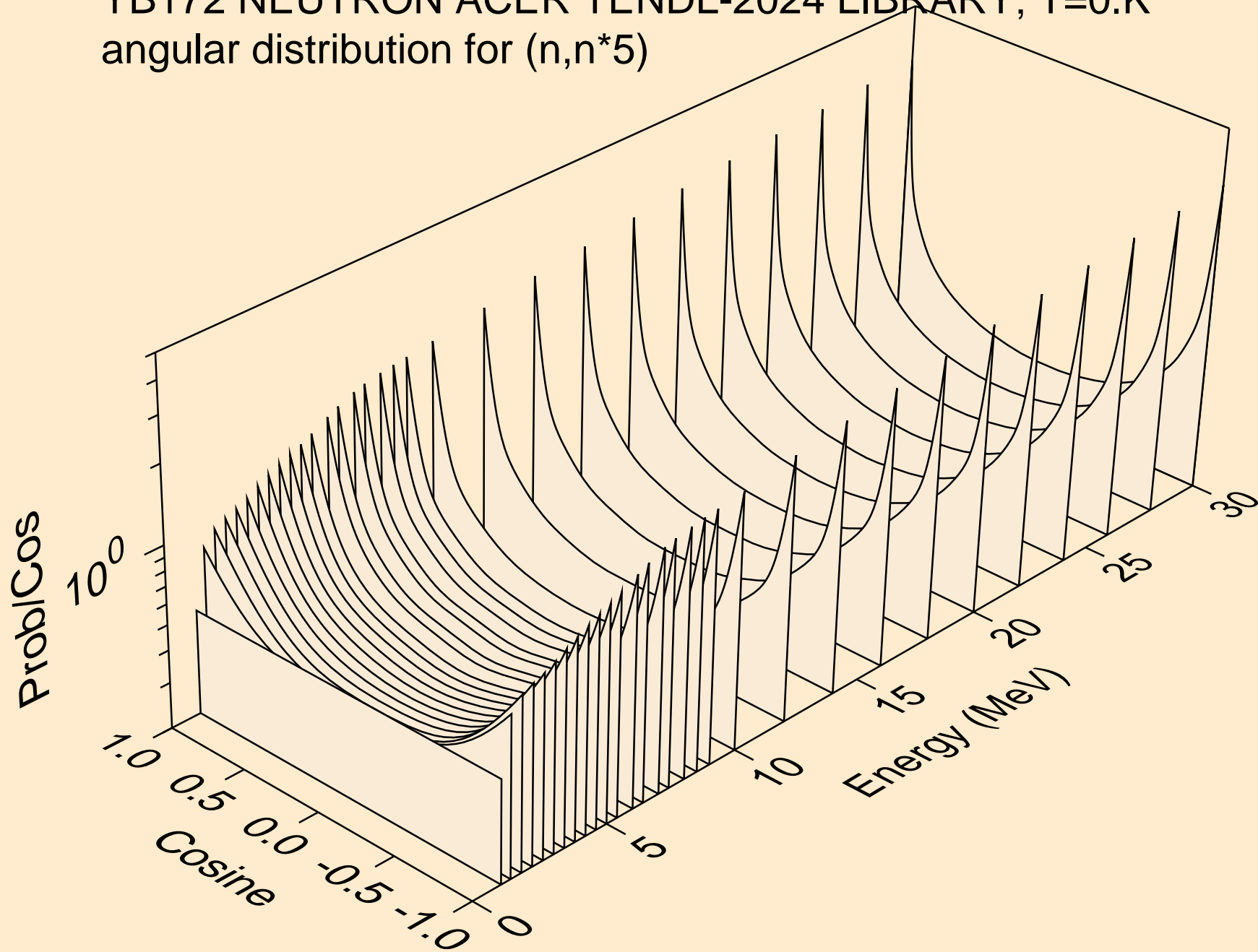

YB172 NEUTRON ACER TENDL-2024 LIBRARY; T=0.K
angular distribution for (n,n*6)

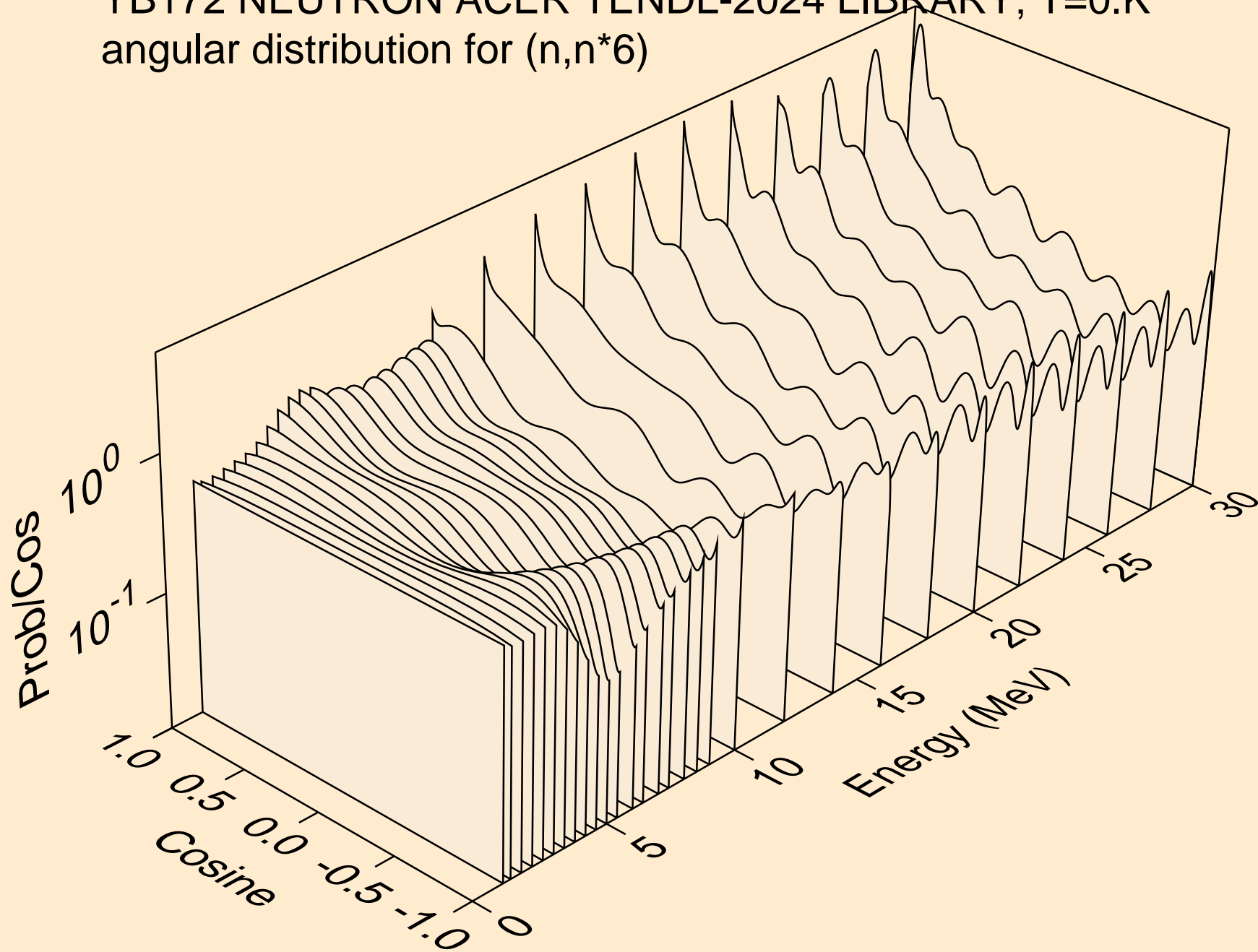

YB172 NEUTRON ACER TENDL-2024 LIBRARY; T=0.K
angular distribution for (n,n*7)

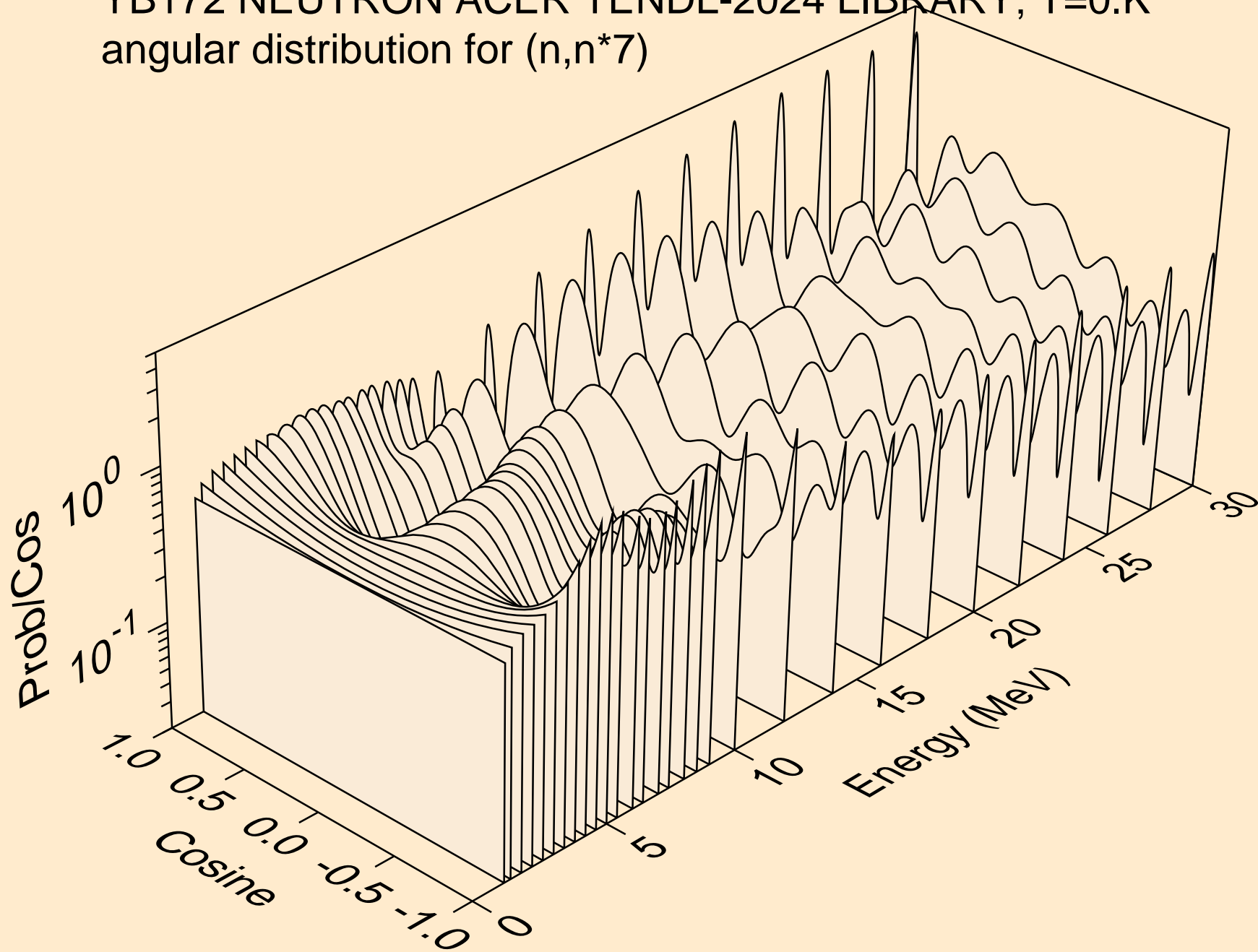

YB172 NEUTRON ACER TENDL-2024 LIBRARY; T=0.K
angular distribution for (n,n*8)

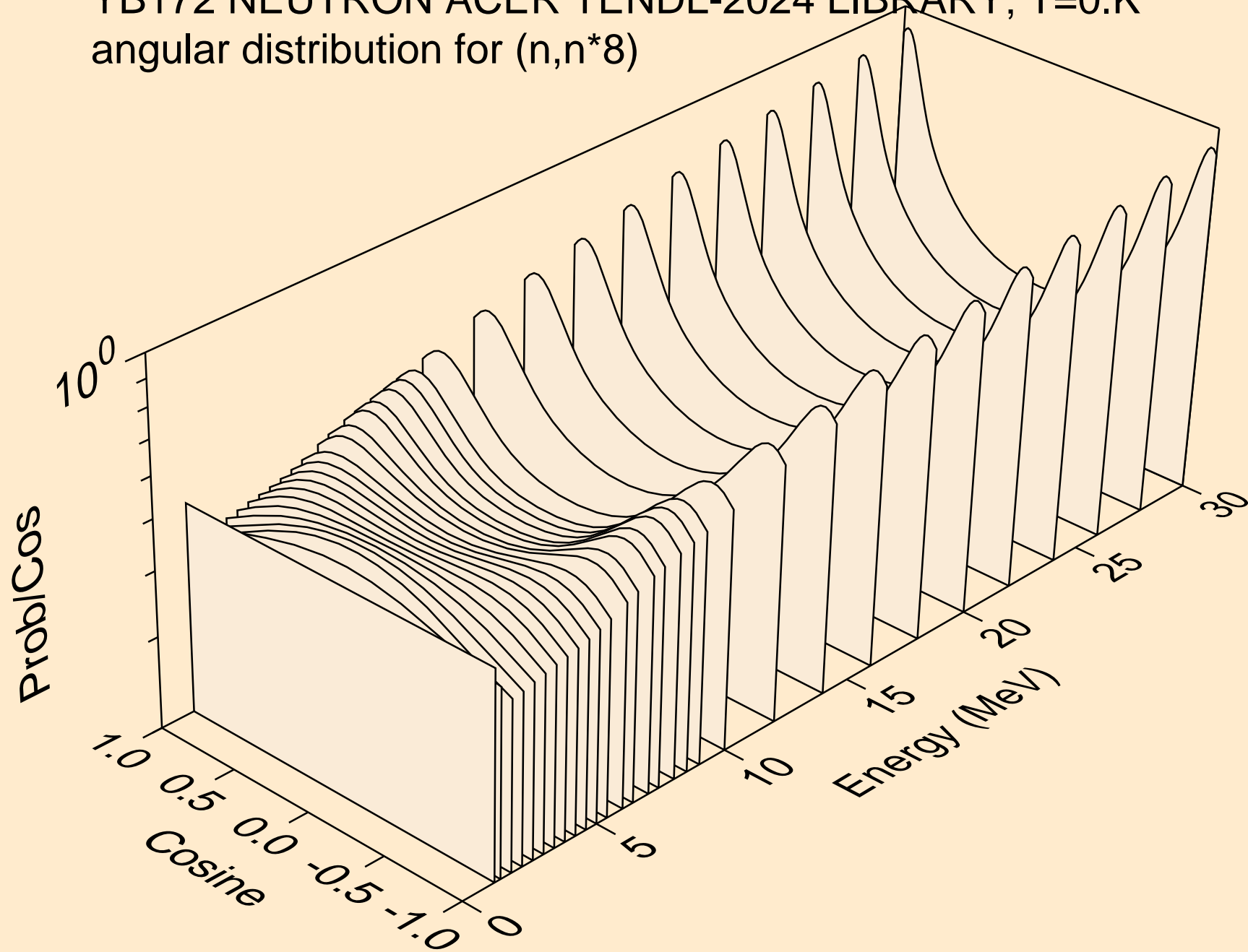

YB172 NEUTRON ACER TENDL-2024 LIBRARY; T=0.K
angular distribution for (n,n*9)

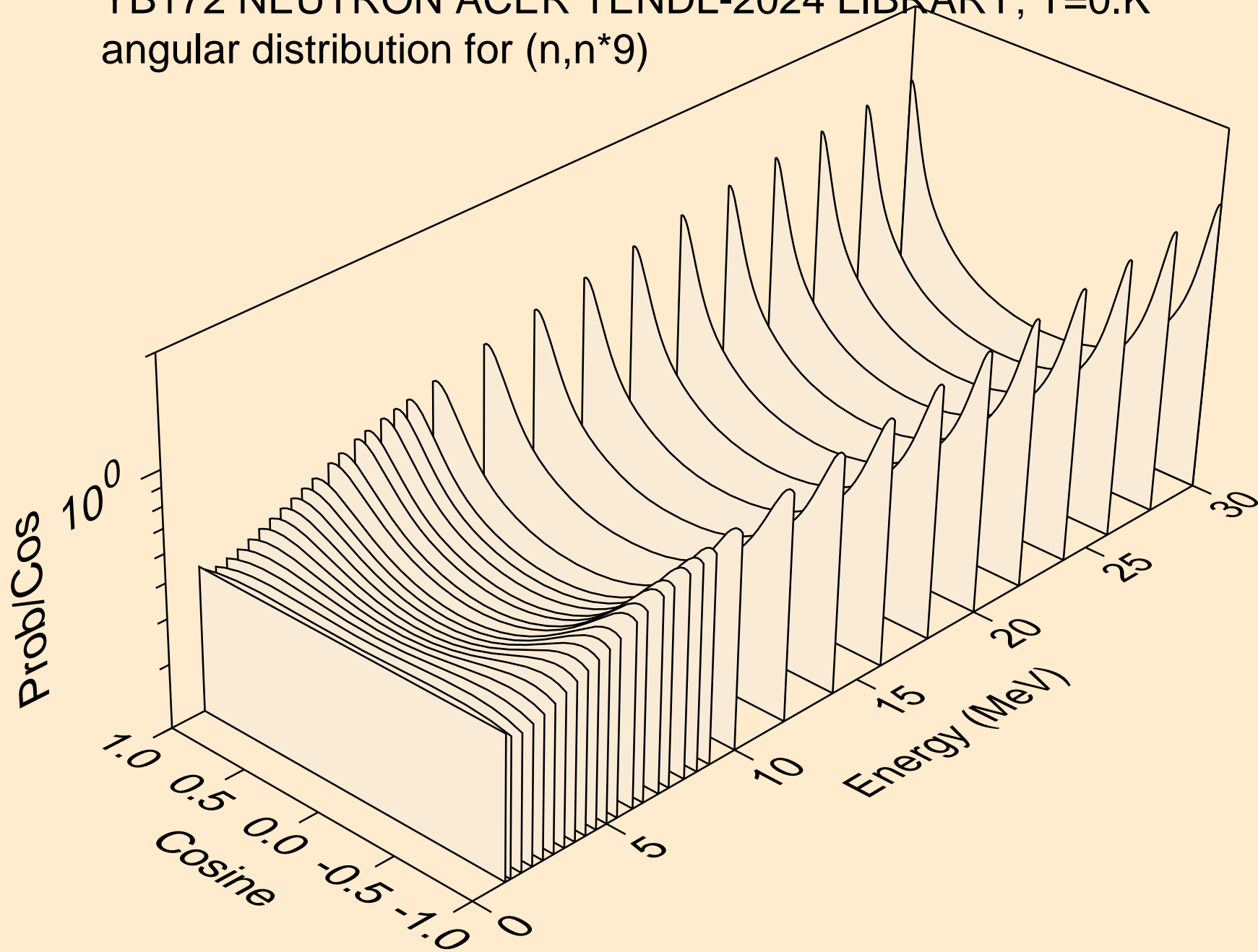

YB172 NEUTRON ACER TENDL-2024 LIBRARY; T=0.K
angular distribution for (n,n*10)

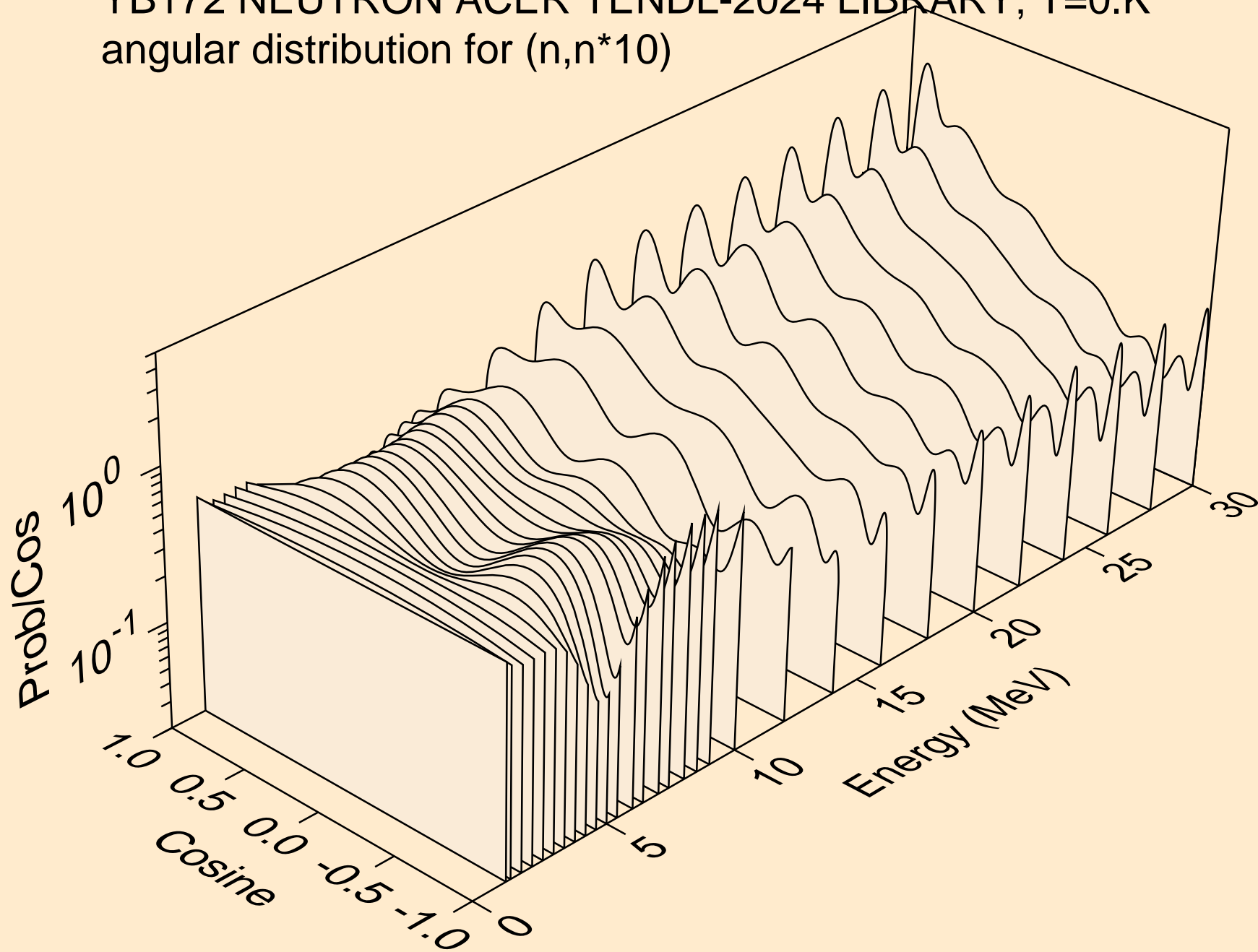

YB172 NEUTRON ACER TENDL-2024 LIBRARY; T=0.K
angular distribution for (n,n*11)

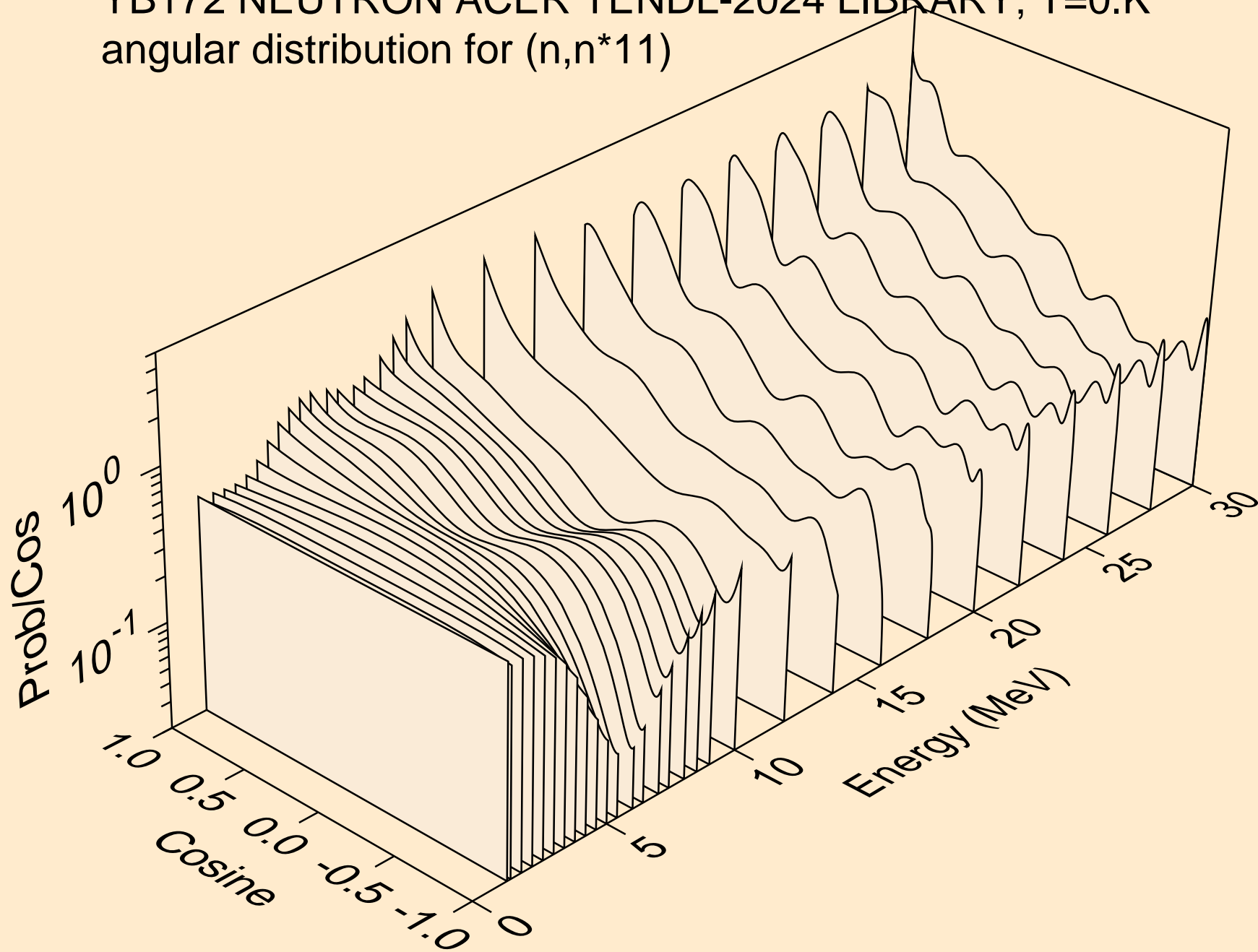

YB172 NEUTRON ACER TENDL-2024 LIBRARY; T=0.K
angular distribution for (n,n*12)

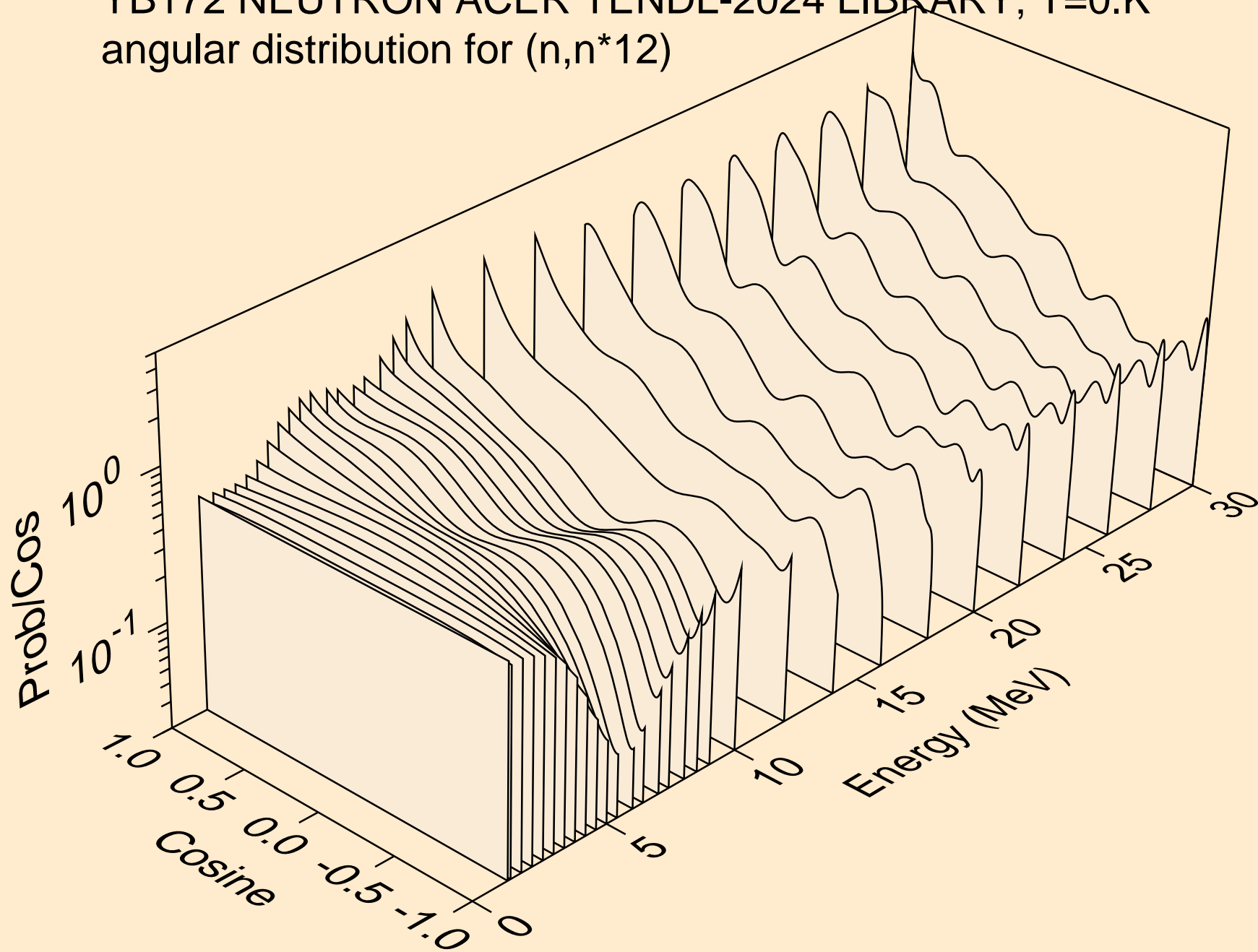

YB172 NEUTRON ACER TENDL-2024 LIBRARY; T=0.K
angular distribution for (n,n*13)

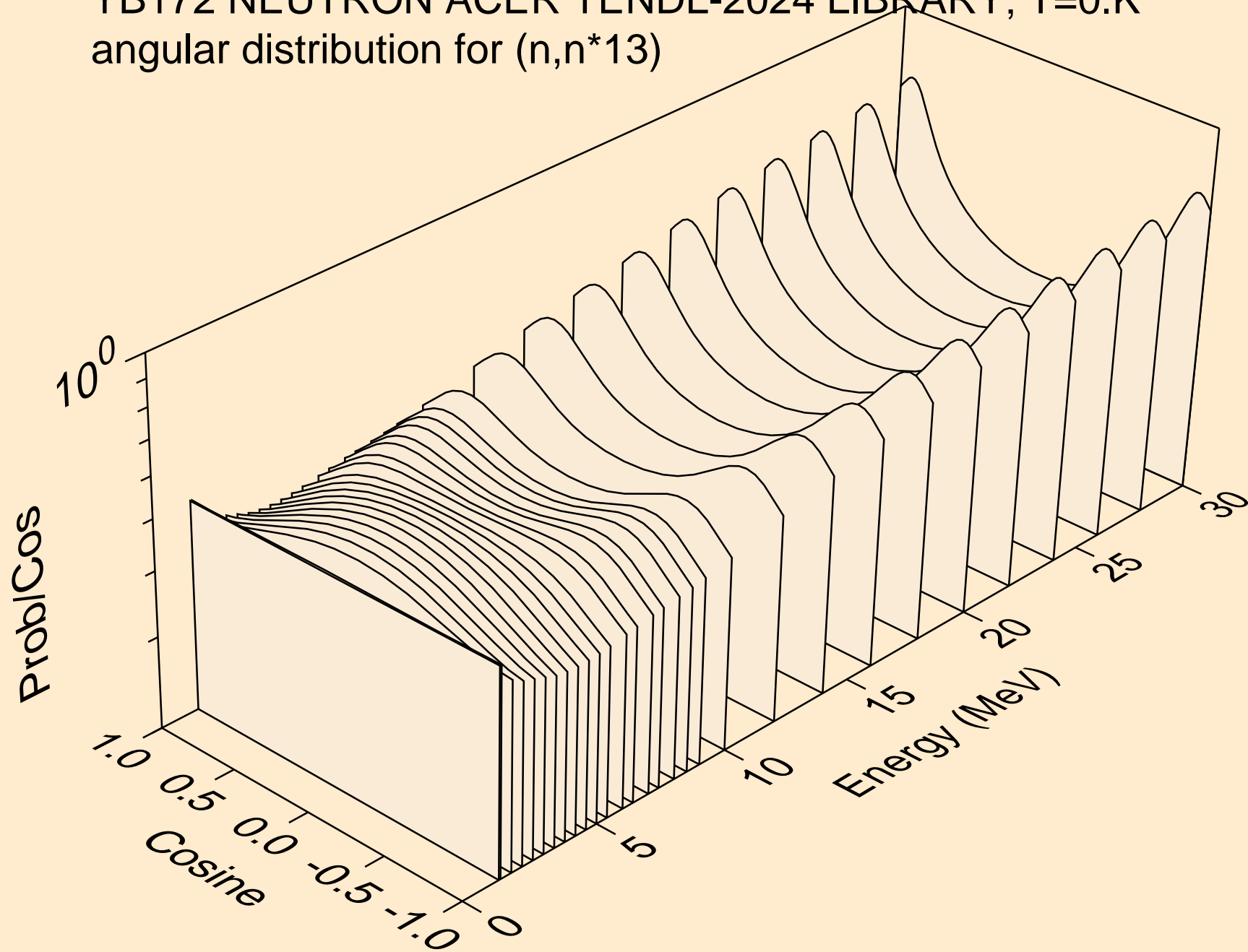

YB172 NEUTRON ACER TENDL-2024 LIBRARY; T=0.K
angular distribution for (n,n*14)

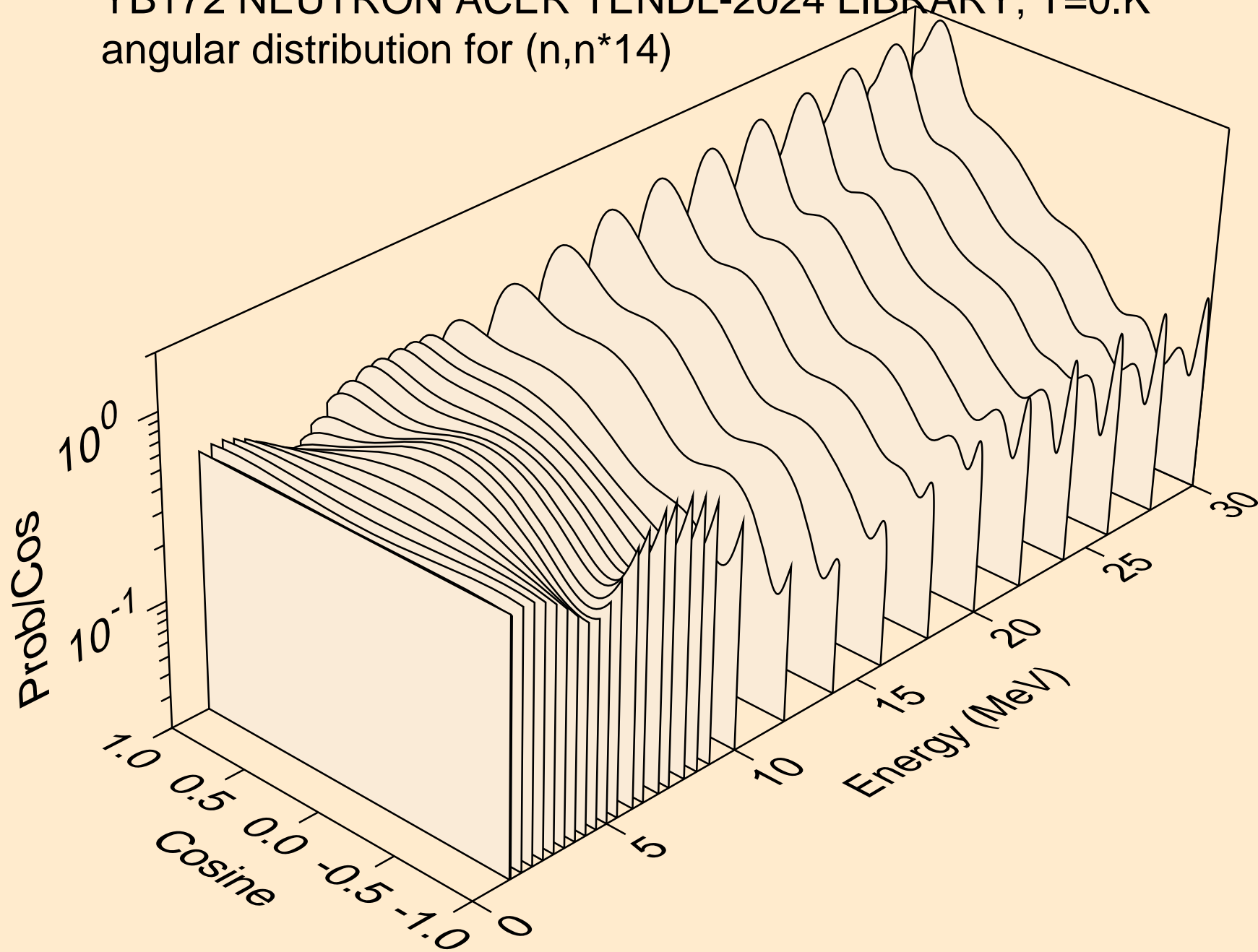

YB172 NEUTRON ACER TENDL-2024 LIBRARY; T=0.K
angular distribution for (n,n*15)

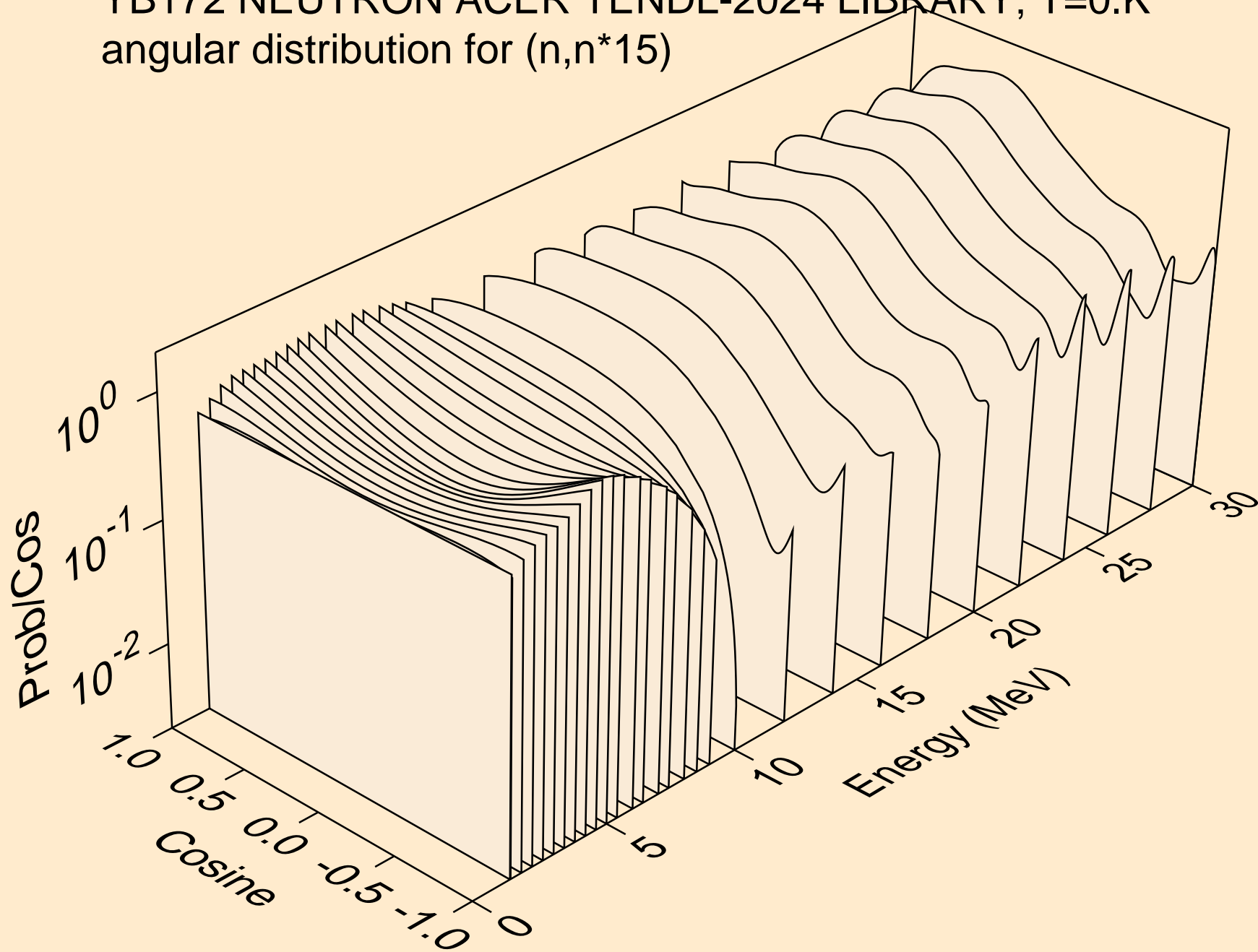

YB172 NEUTRON ACER TENDL-2024 LIBRARY; T=0.K
angular distribution for (n,n*16)

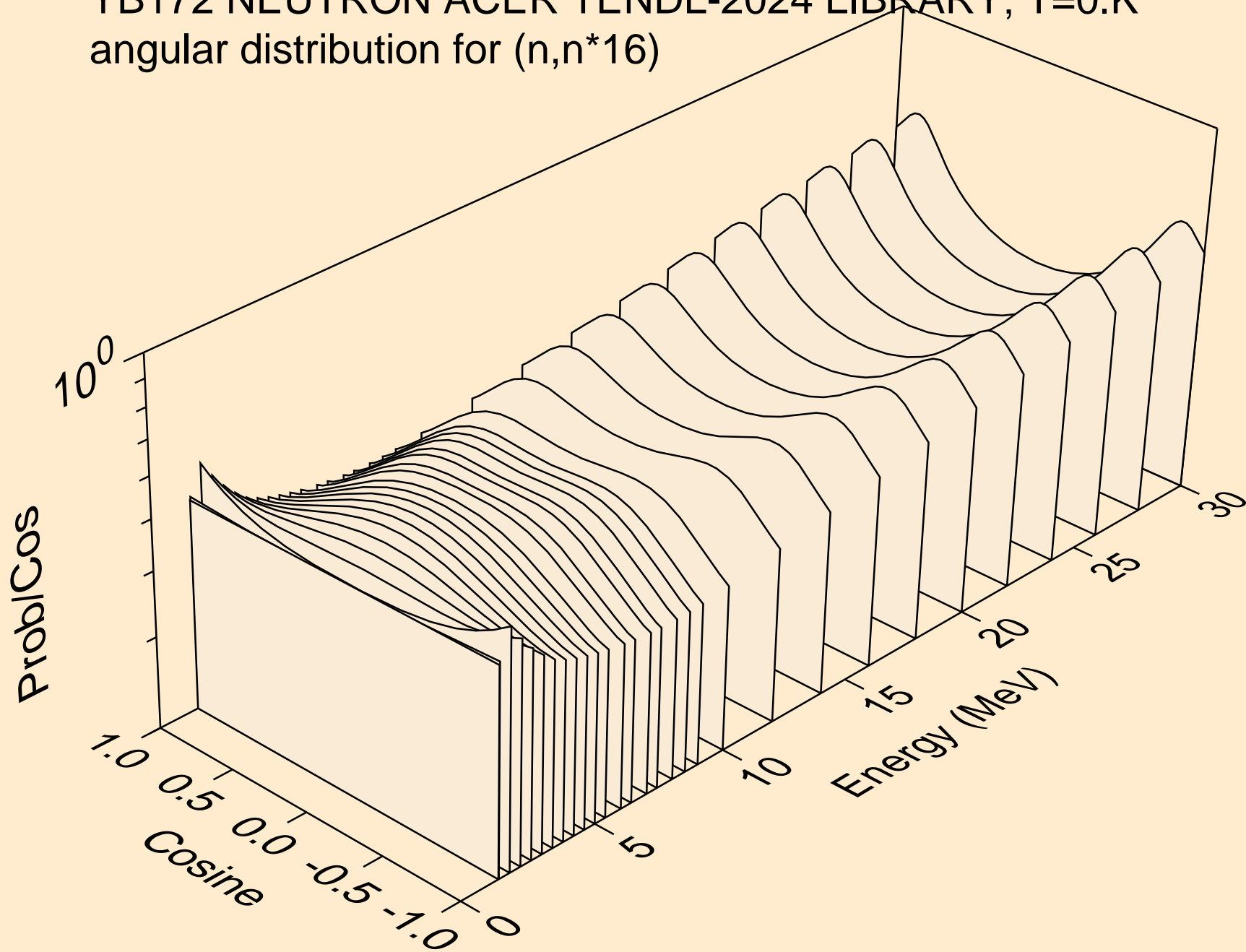

YB172 NEUTRON ACER TENDL-2024 LIBRARY; T=0.K
angular distribution for (n,n*17)

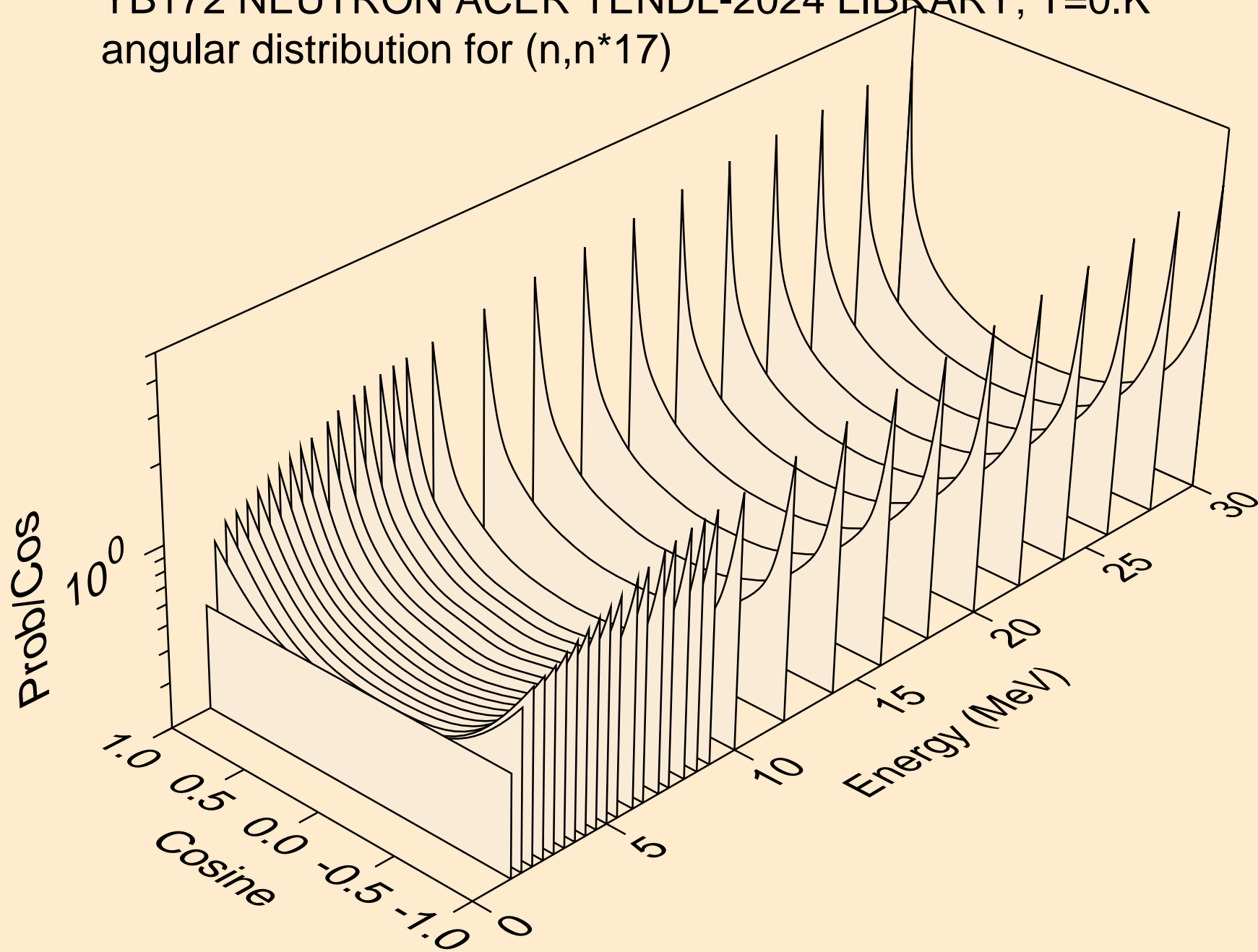

YB172 NEUTRON ACER TENDL-2024 LIBRARY; T=0.K
angular distribution for (n,n*18)

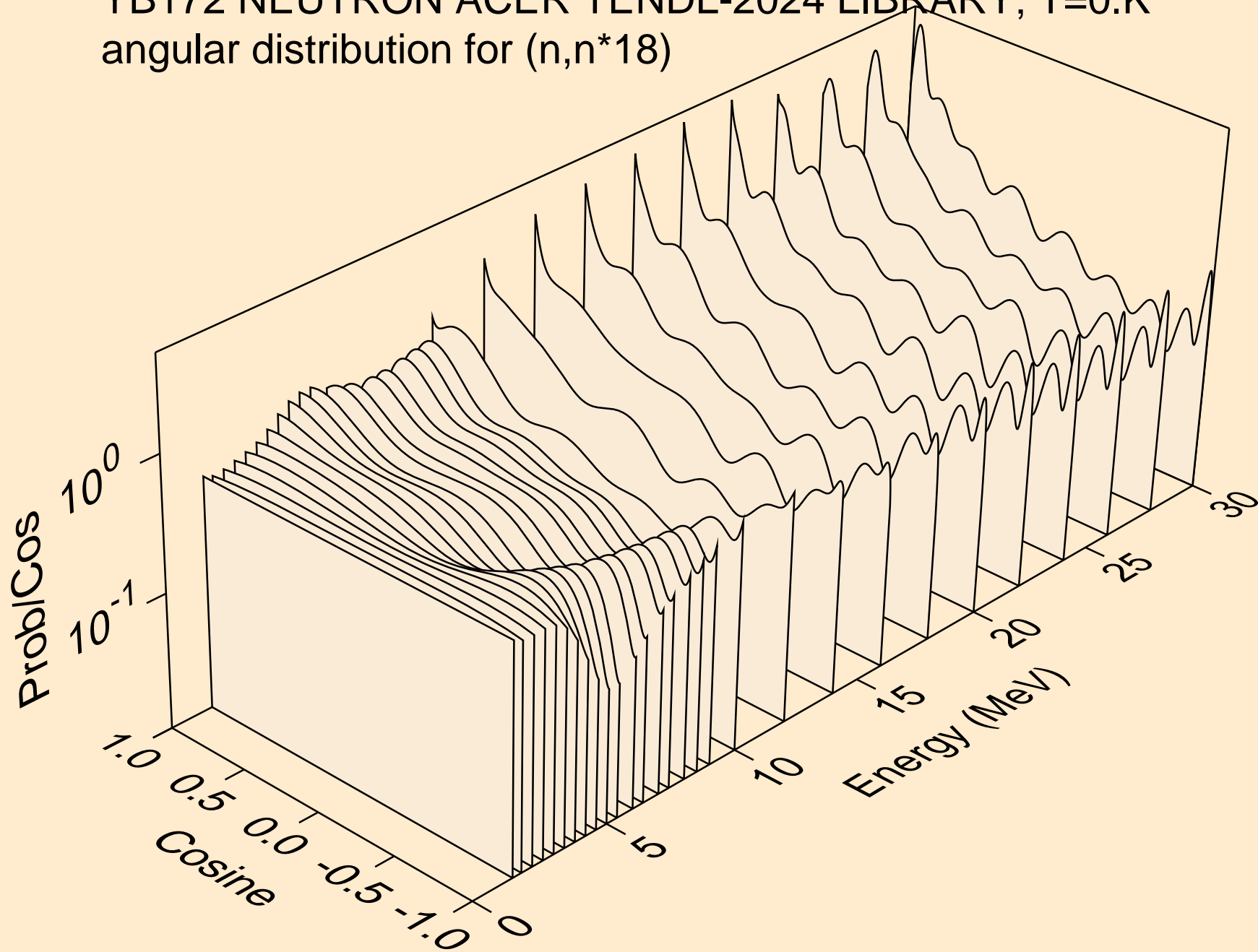

YB172 NEUTRON ACER TENDL-2024 LIBRARY; T=0.K
angular distribution for (n,n*19)

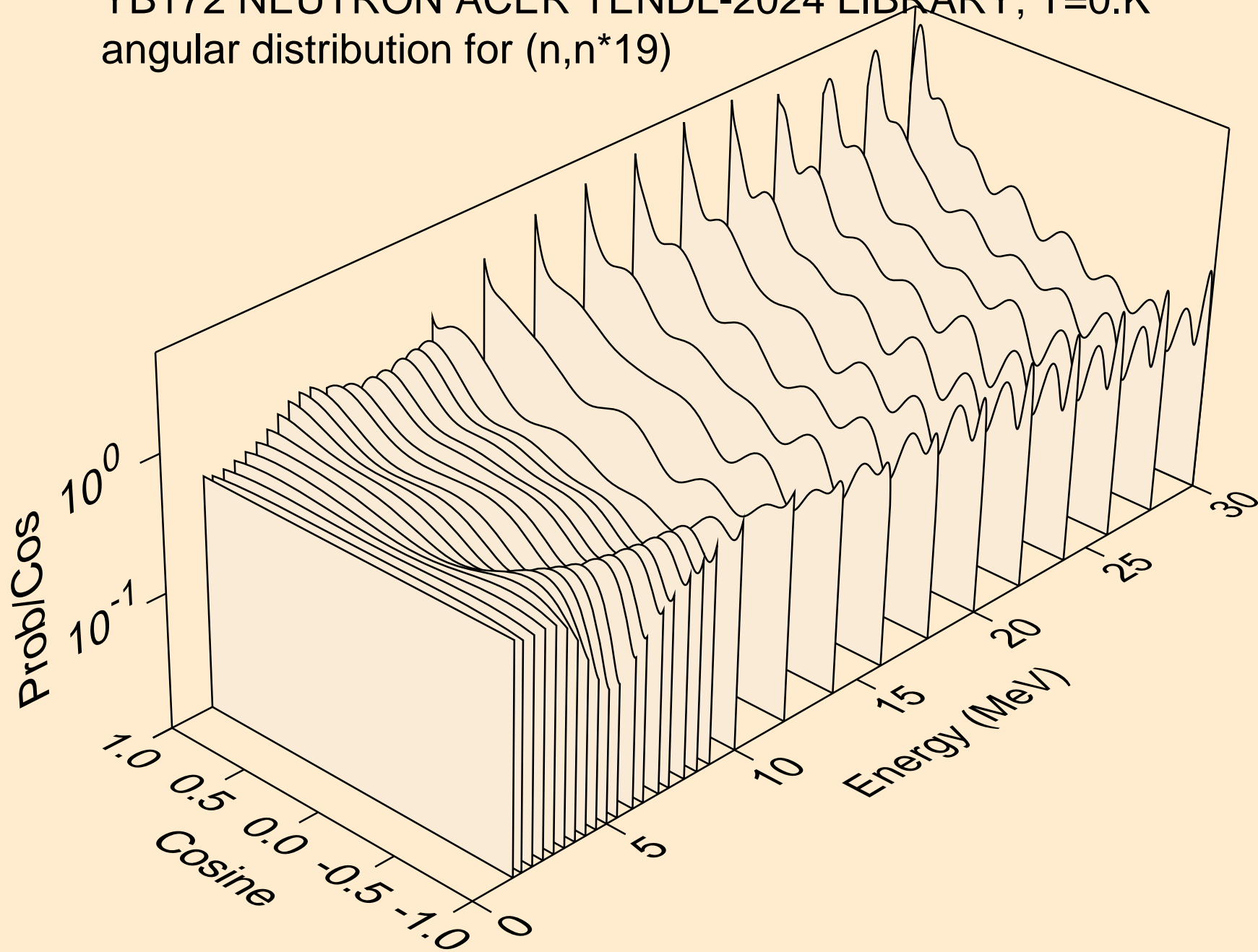

YB172 NEUTRON ACER TENDL-2024 LIBRARY; T=0.K
angular distribution for (n,n*20)

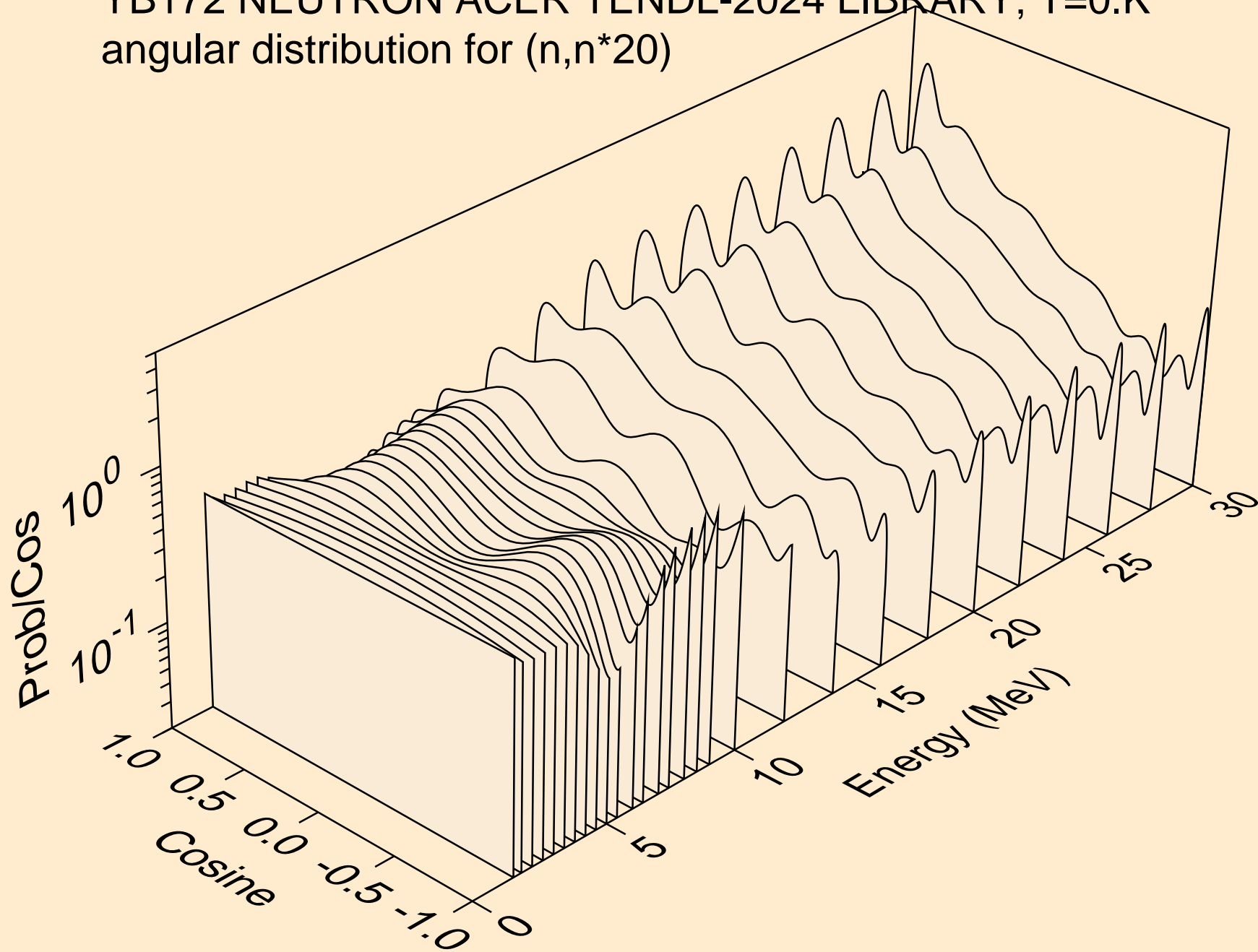

YB172 NEUTRON ACER TENDL-2024 LIBRARY; T=0.K
angular distribution for (n,n*21)

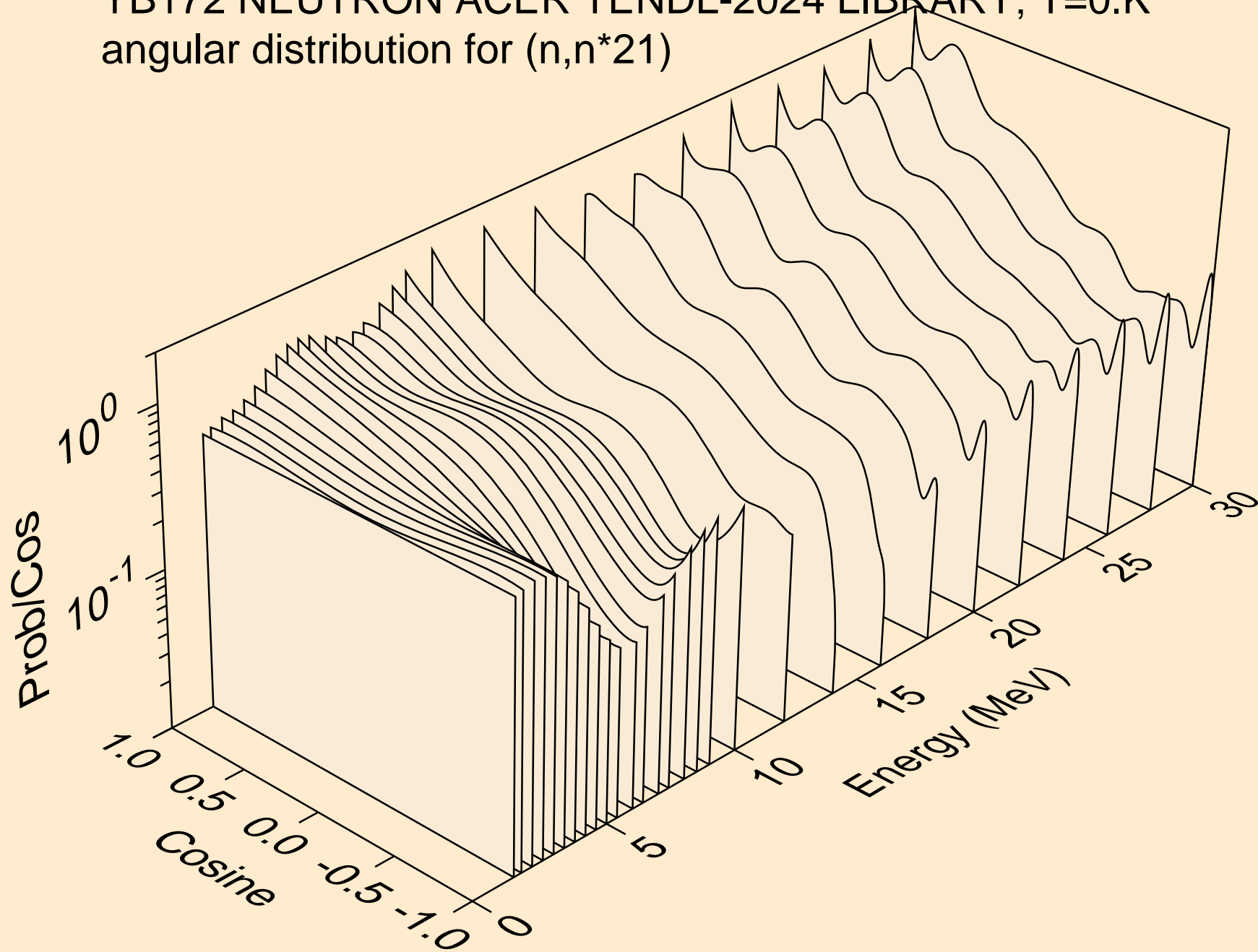

YB172 NEUTRON ACER TENDL-2024 LIBRARY; T=0.K
angular distribution for (n,n*22)

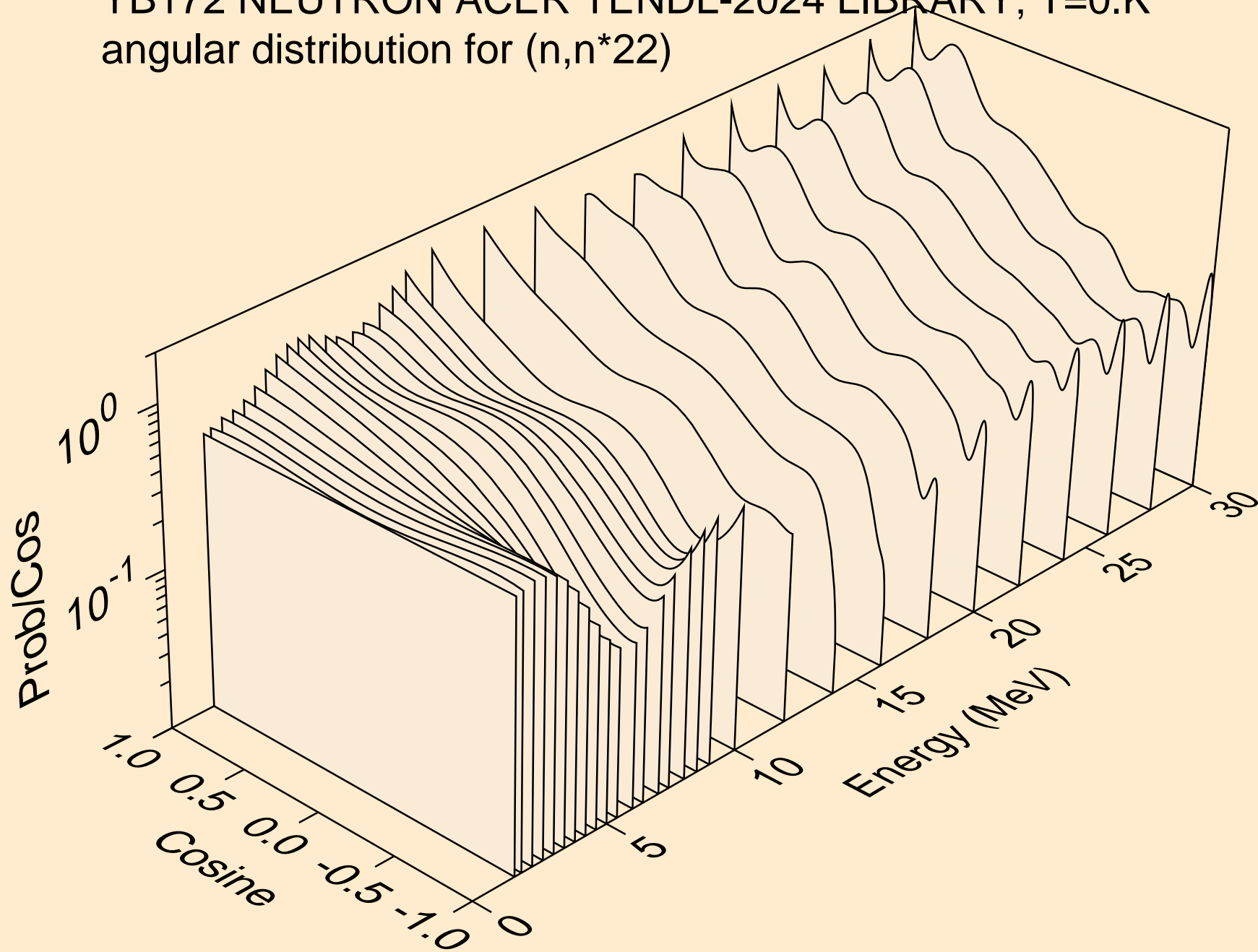

YB172 NEUTRON ACER TENDL-2024 LIBRARY; T=0.K
angular distribution for (n,n*23)

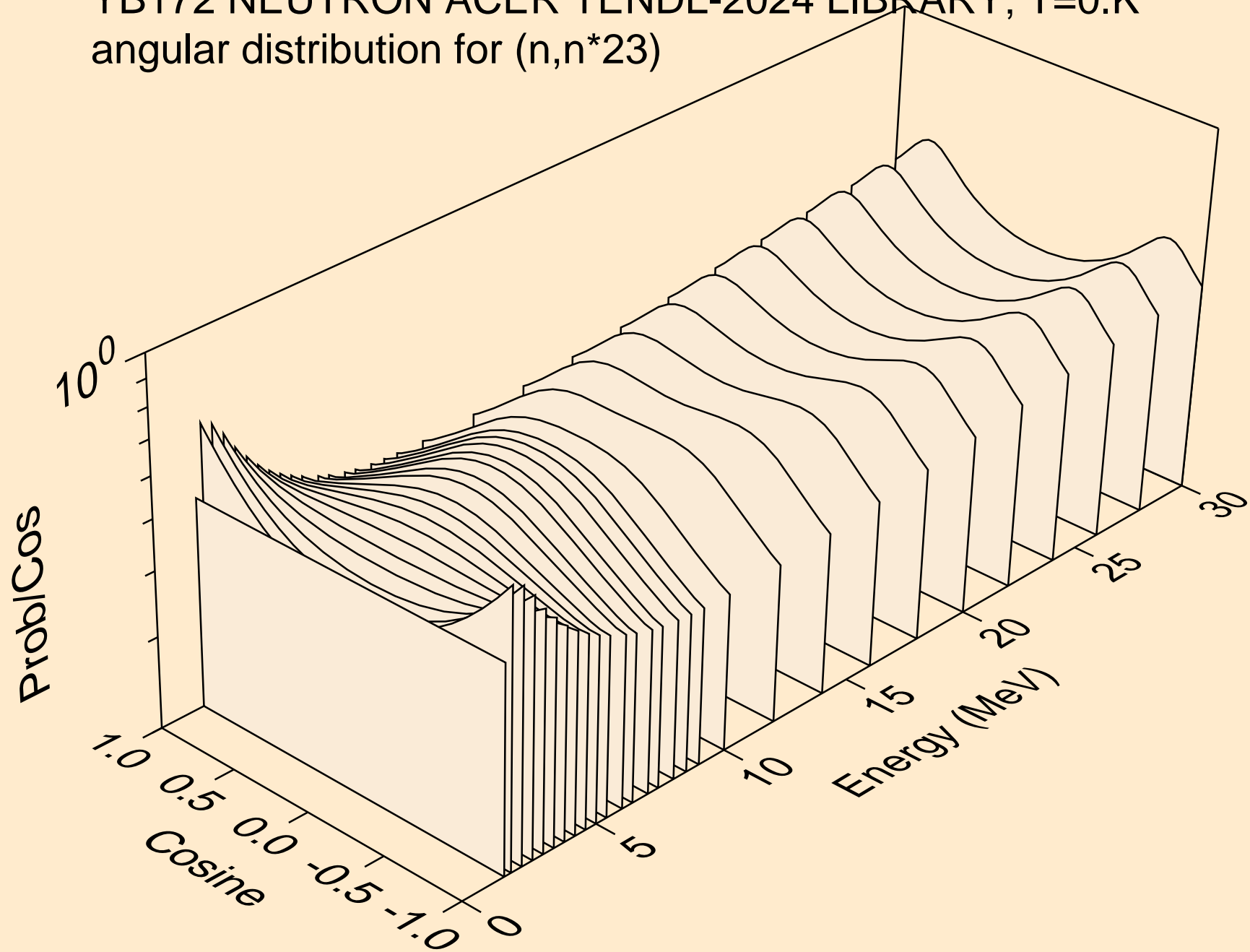

YB172 NEUTRON ACER TENDL-2024 LIBRARY; T=0.K
angular distribution for (n,n*24)

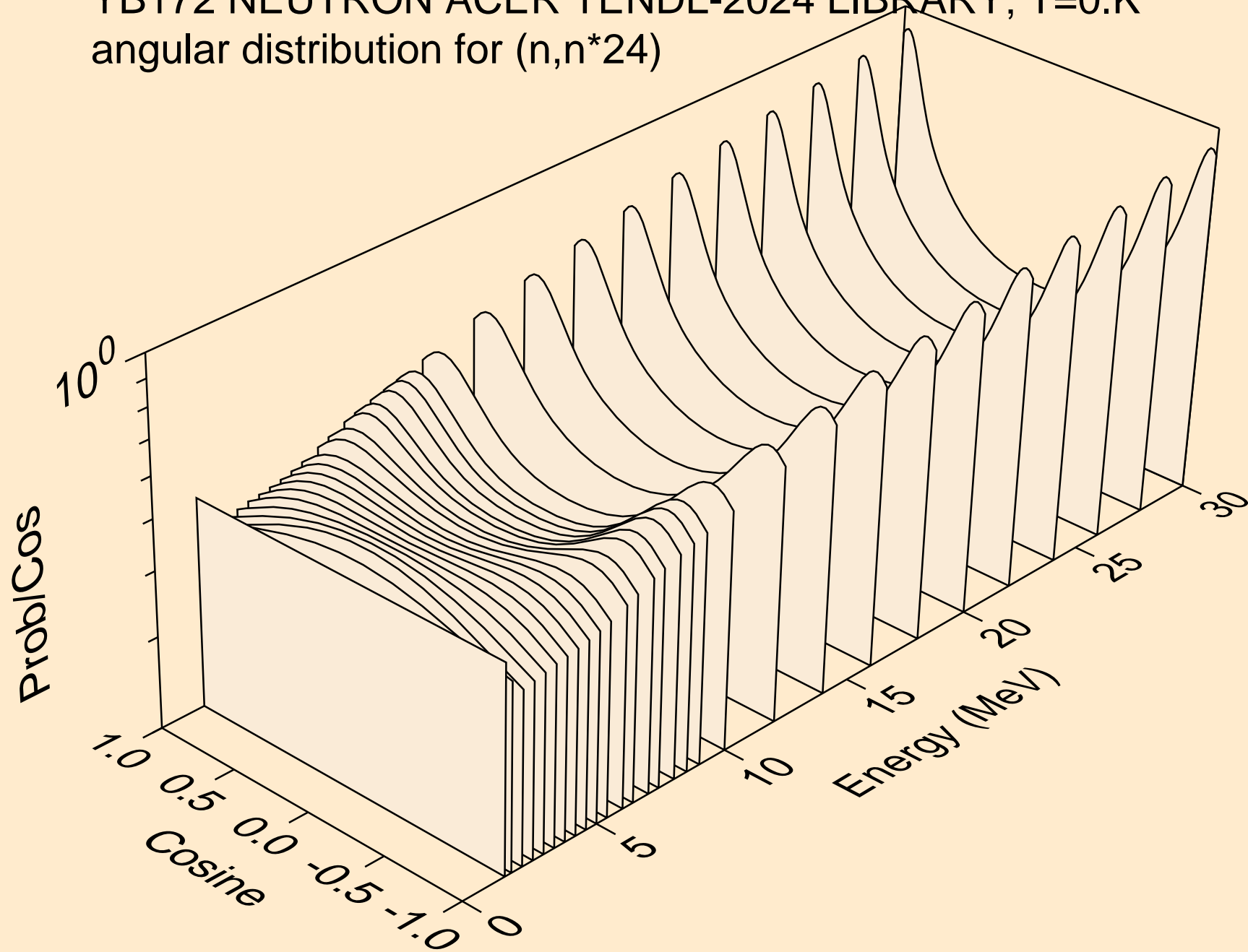

YB172 NEUTRON ACER TENDL-2024 LIBRARY; T=0.K
angular distribution for (n,n*25)

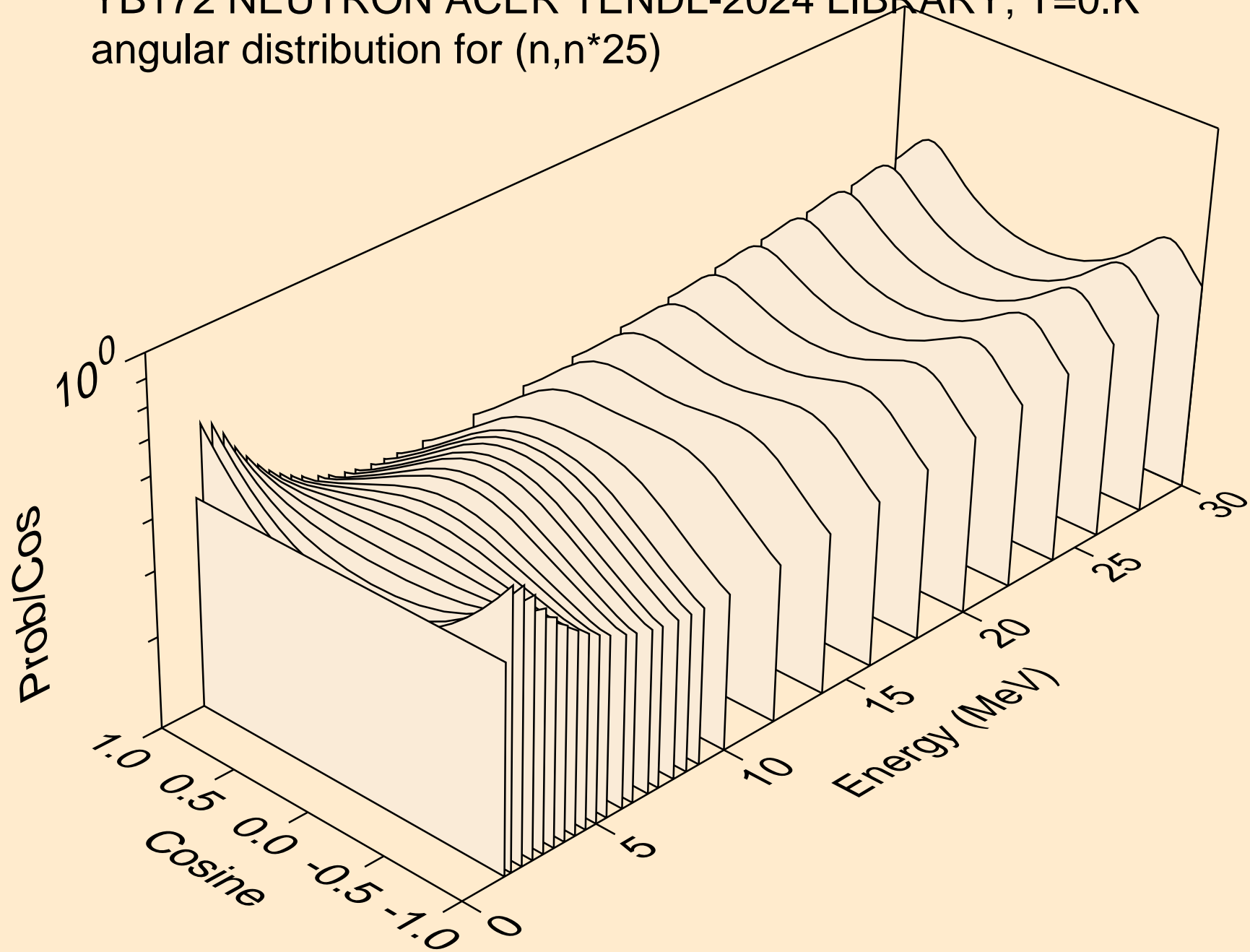

YB172 NEUTRON ACER TENDL-2024 LIBRARY; T=0.K
angular distribution for (n,n*26)

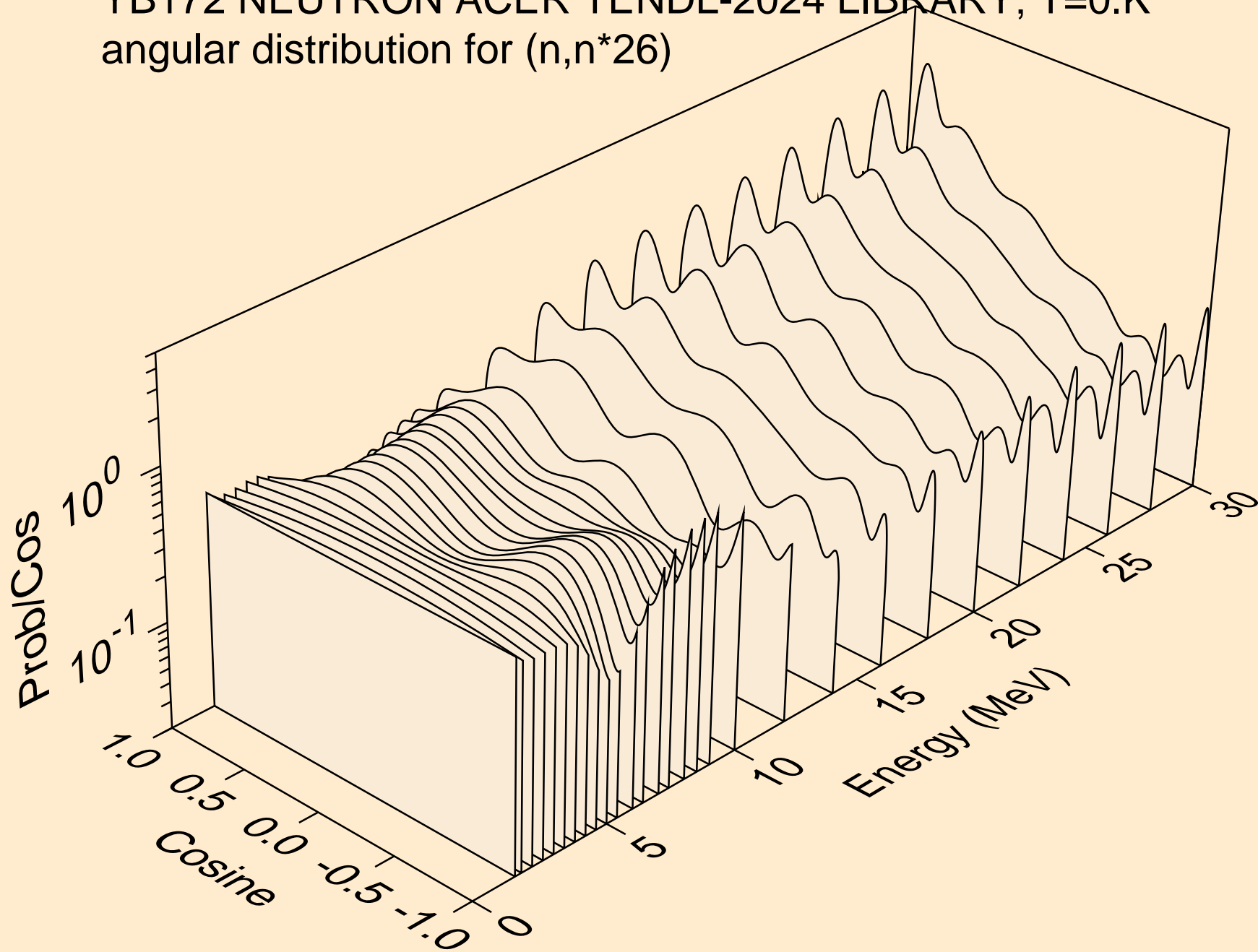

YB172 NEUTRON ACER TENDL-2024 LIBRARY; T=0.K
angular distribution for (n,n*27)

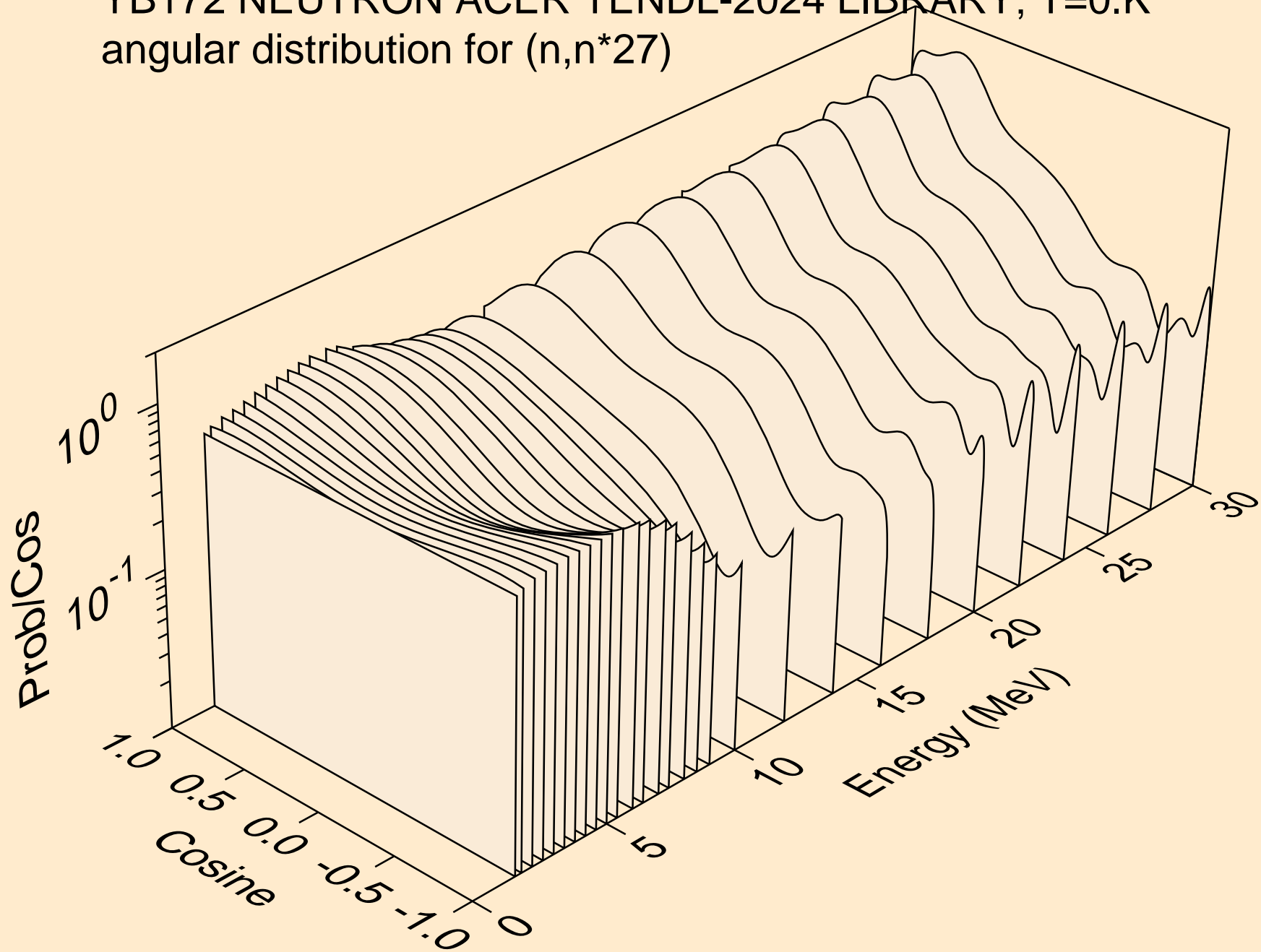

YB172 NEUTRON ACER TENDL-2024 LIBRARY; T=0.K
angular distribution for (n,n*28)

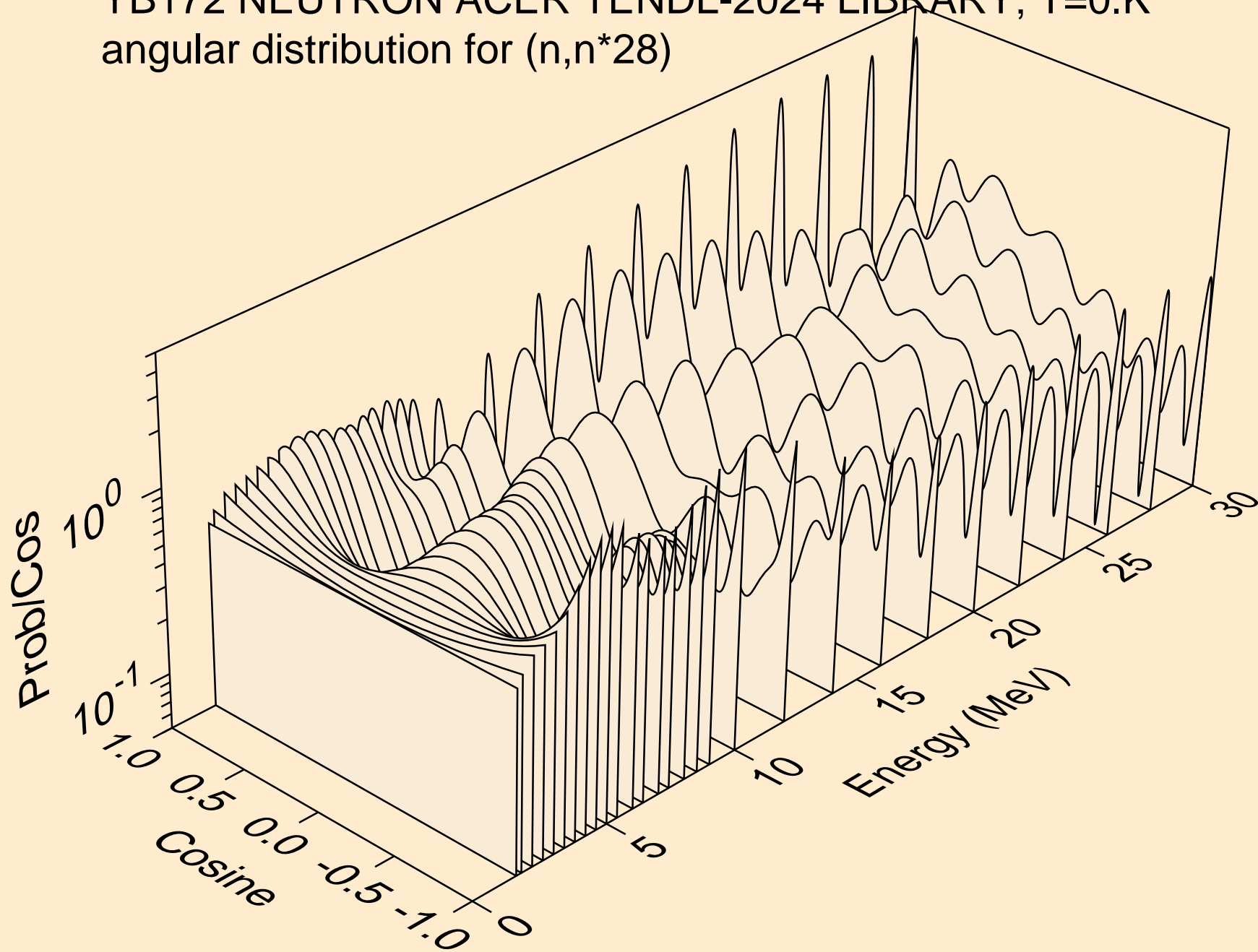

YB172 NEUTRON ACER TENDL-2024 LIBRARY; T=0.K
angular distribution for (n,n*29)

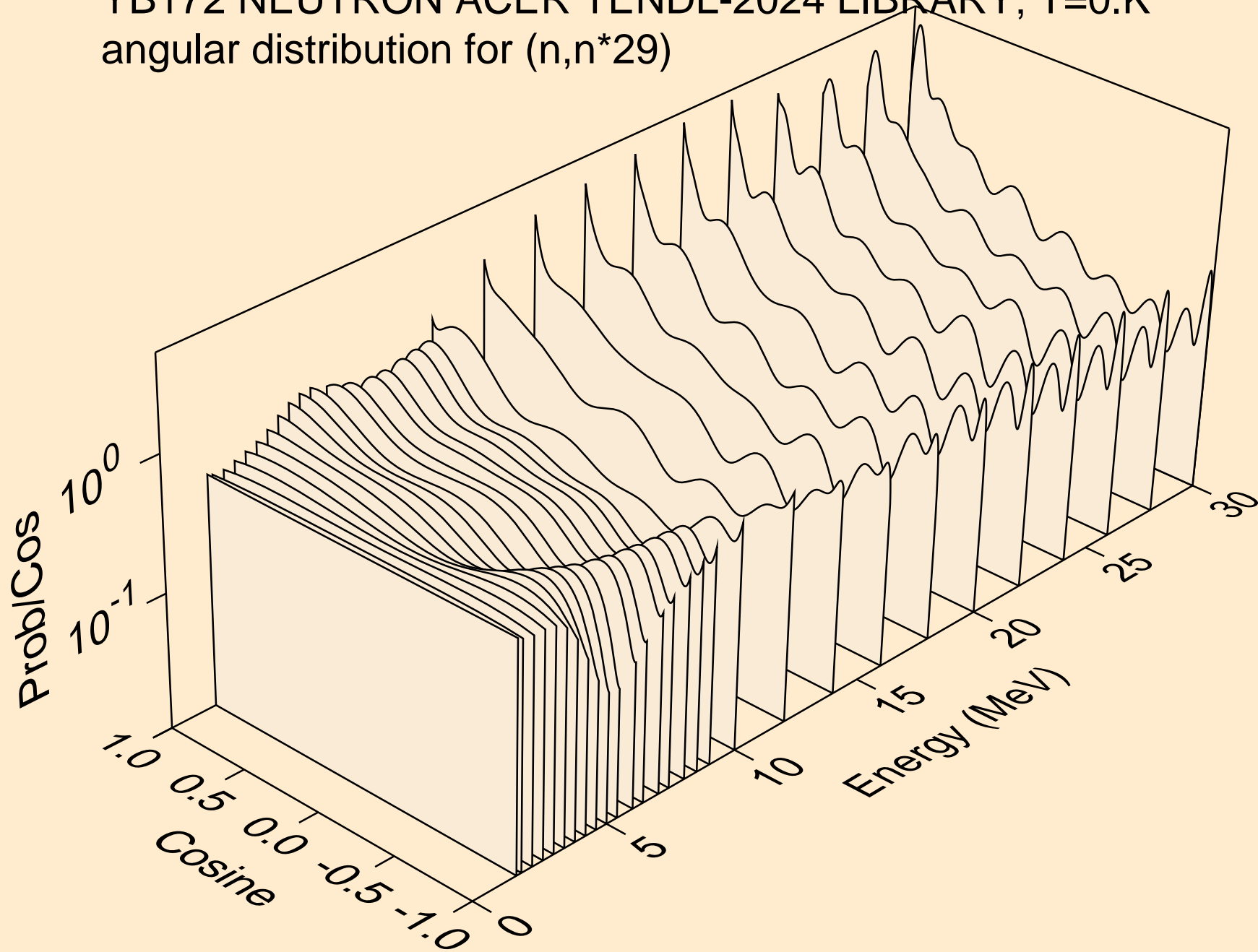

YB172 NEUTRON ACER TENDL-2024 LIBRARY; T=0.K
angular distribution for (n,n*30)

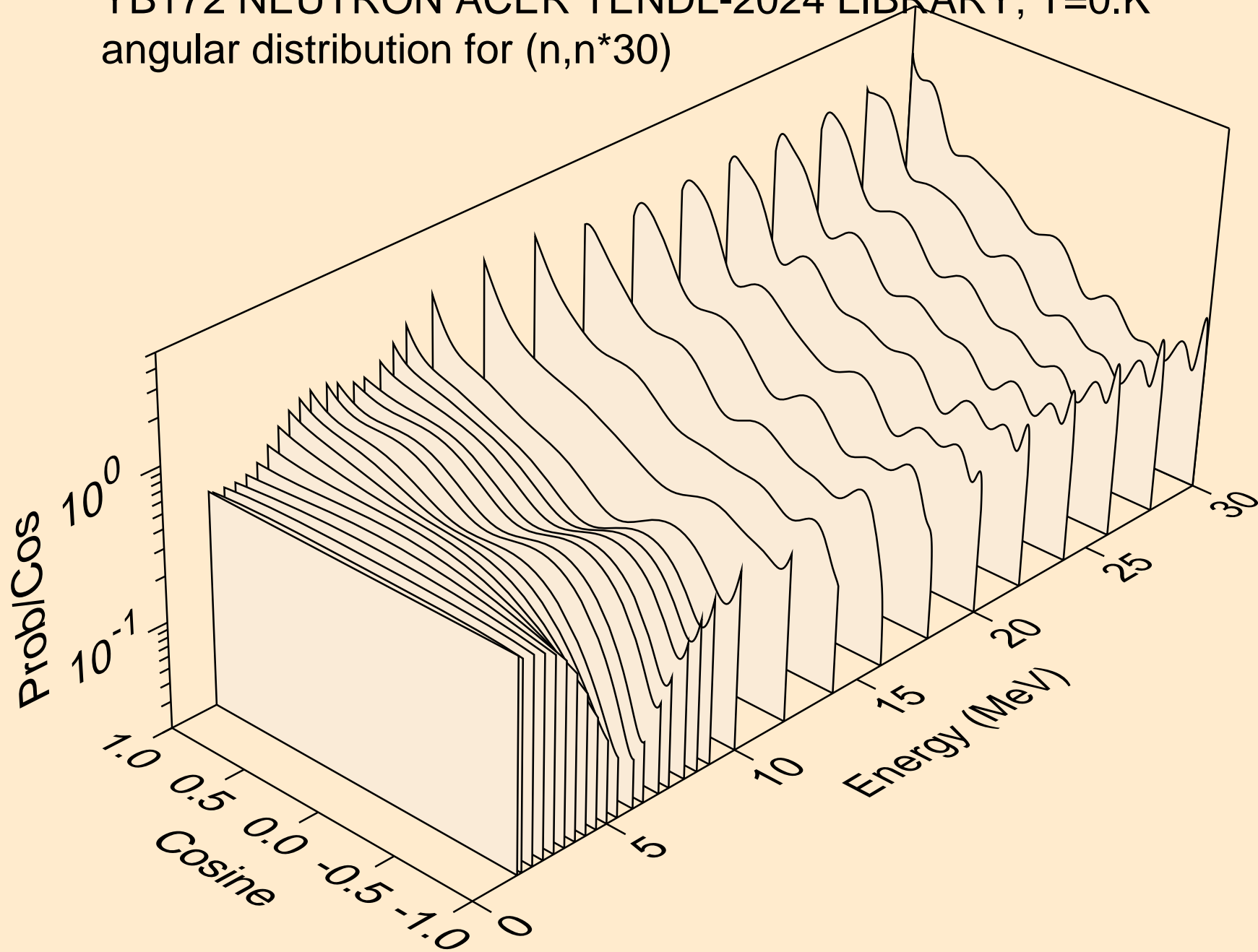

YB172 NEUTRON ACER TENDL-2024 LIBRARY; T=0.K
Neutron emission for (n,x)

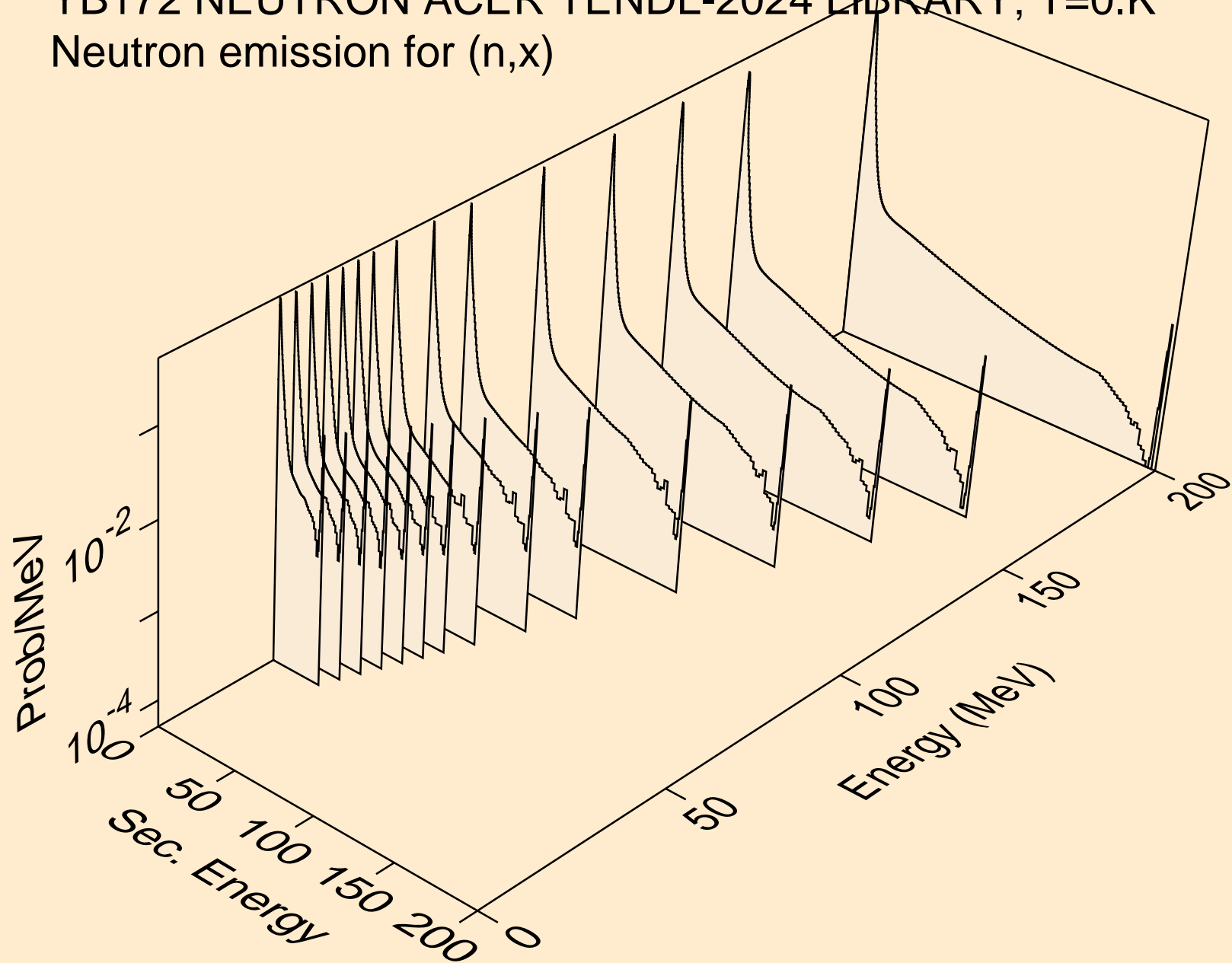

YB172 NEUTRON ACER TENDL-2024 LIBRARY; T=0.K
Neutron emission for (n,2nd)

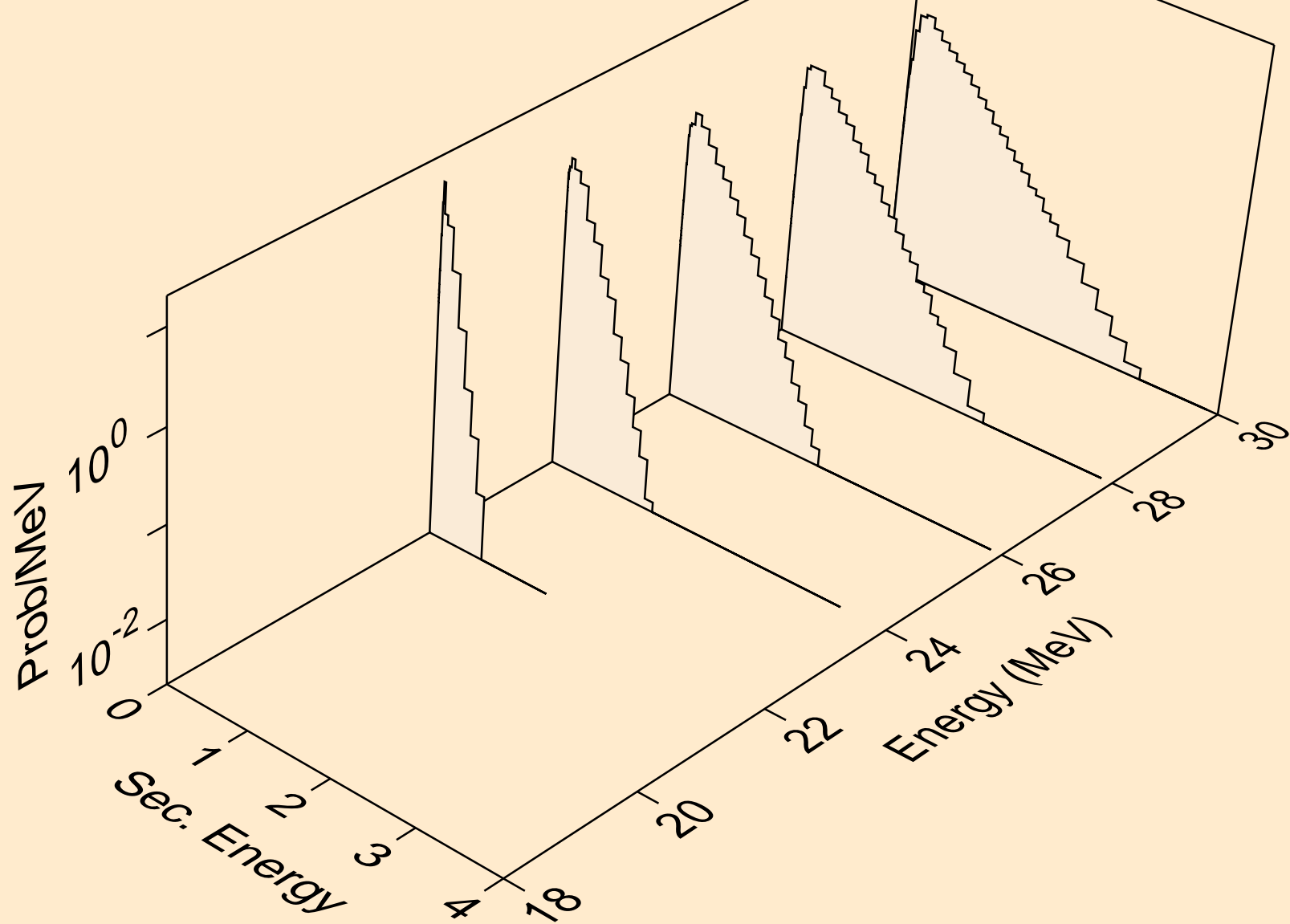

YB172 NEUTRON ACER TENDL-2024 LIBRARY; T=0.K
Neutron emission for (n,2n)

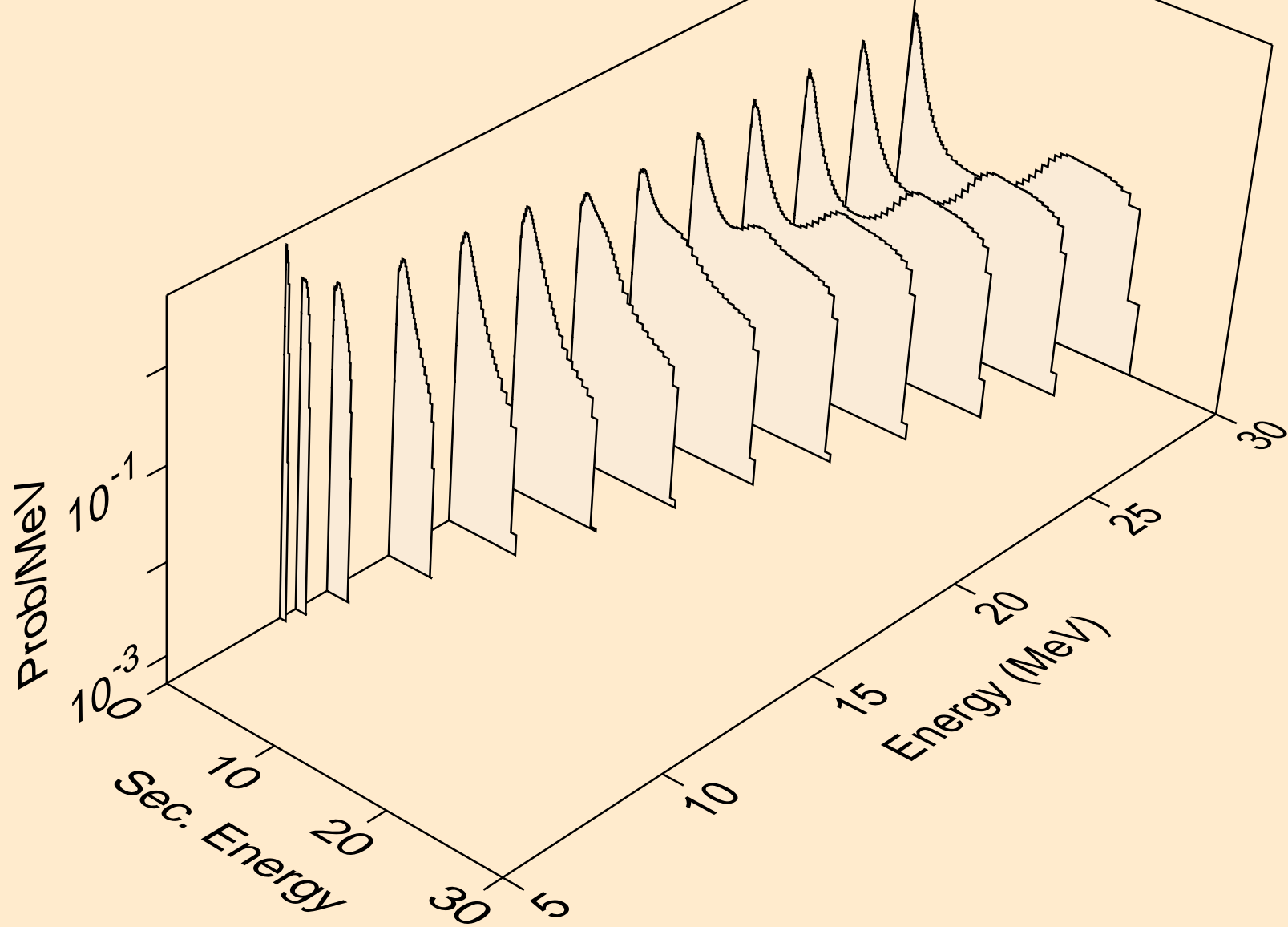

YB172 NEUTRON ACER TENDL-2024 LIBRARY; T=0.K
Neutron emission for (n,3n)

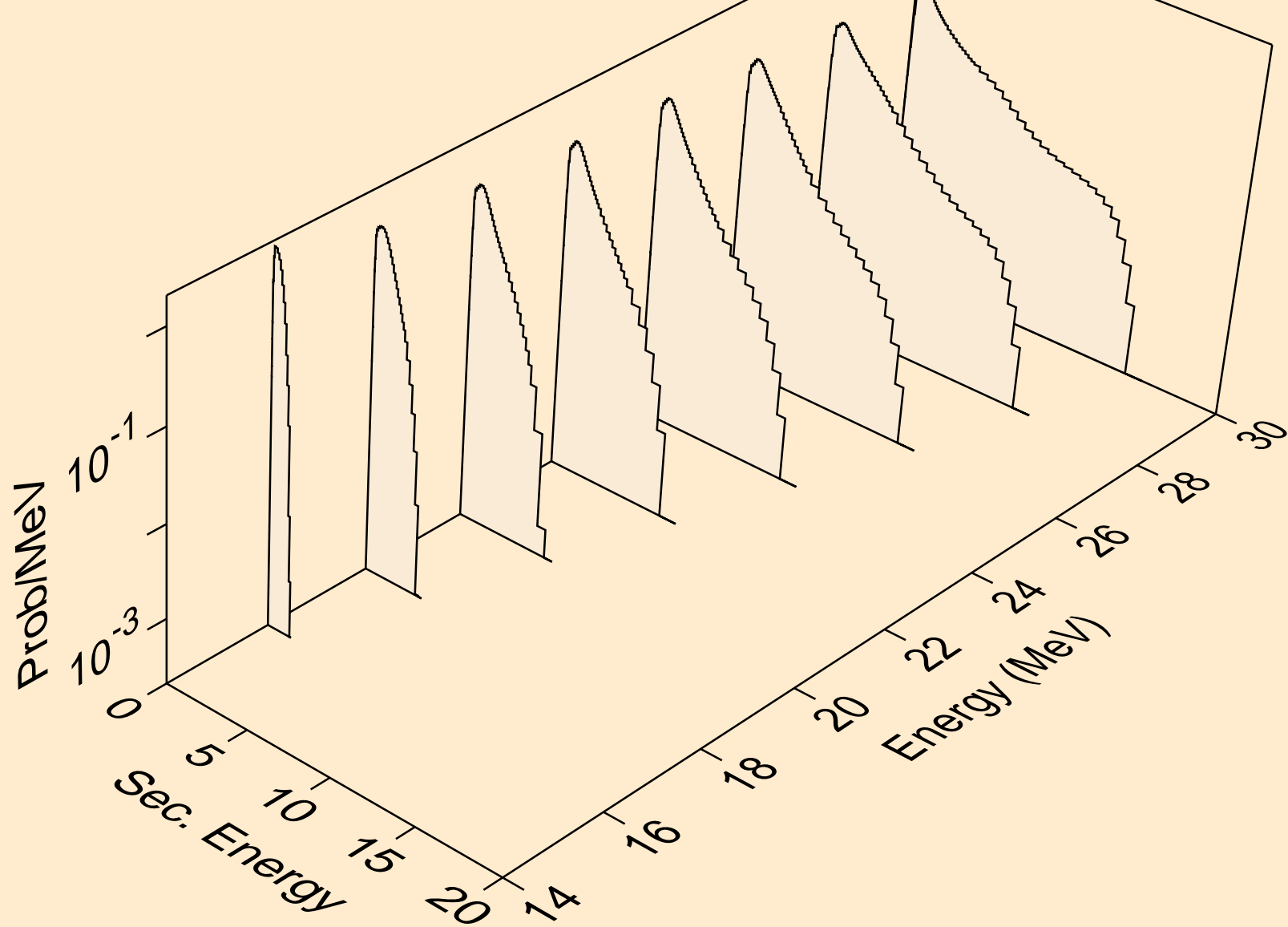

YB172 NEUTRON ACER TENDL-2024 LIBRARY; T=0.K
Neutron emission for (n,n*)a

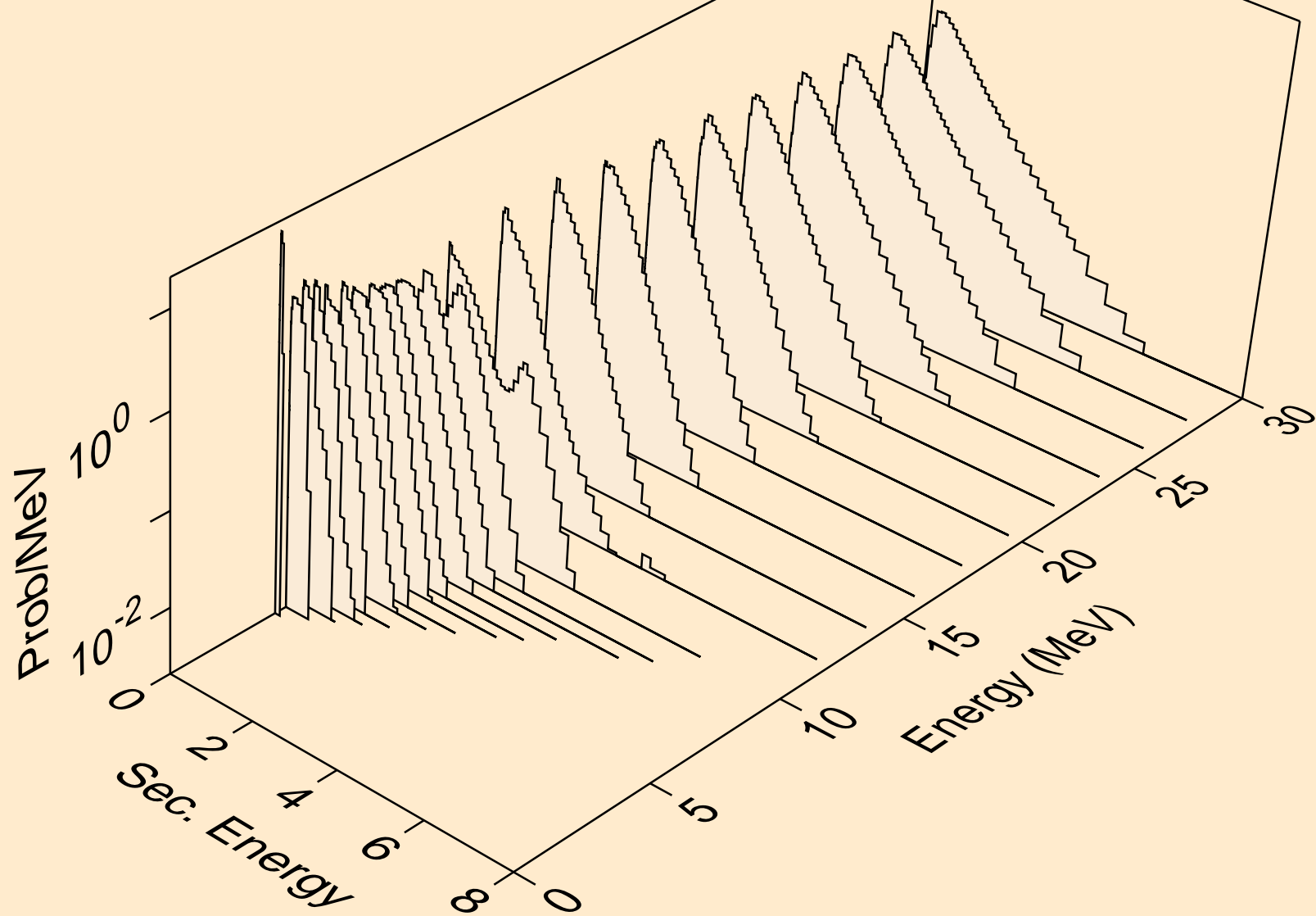

YB172 NEUTRON ACER TENDL-2024 LIBRARY; T=0.K
Neutron emission for (n,2n)a

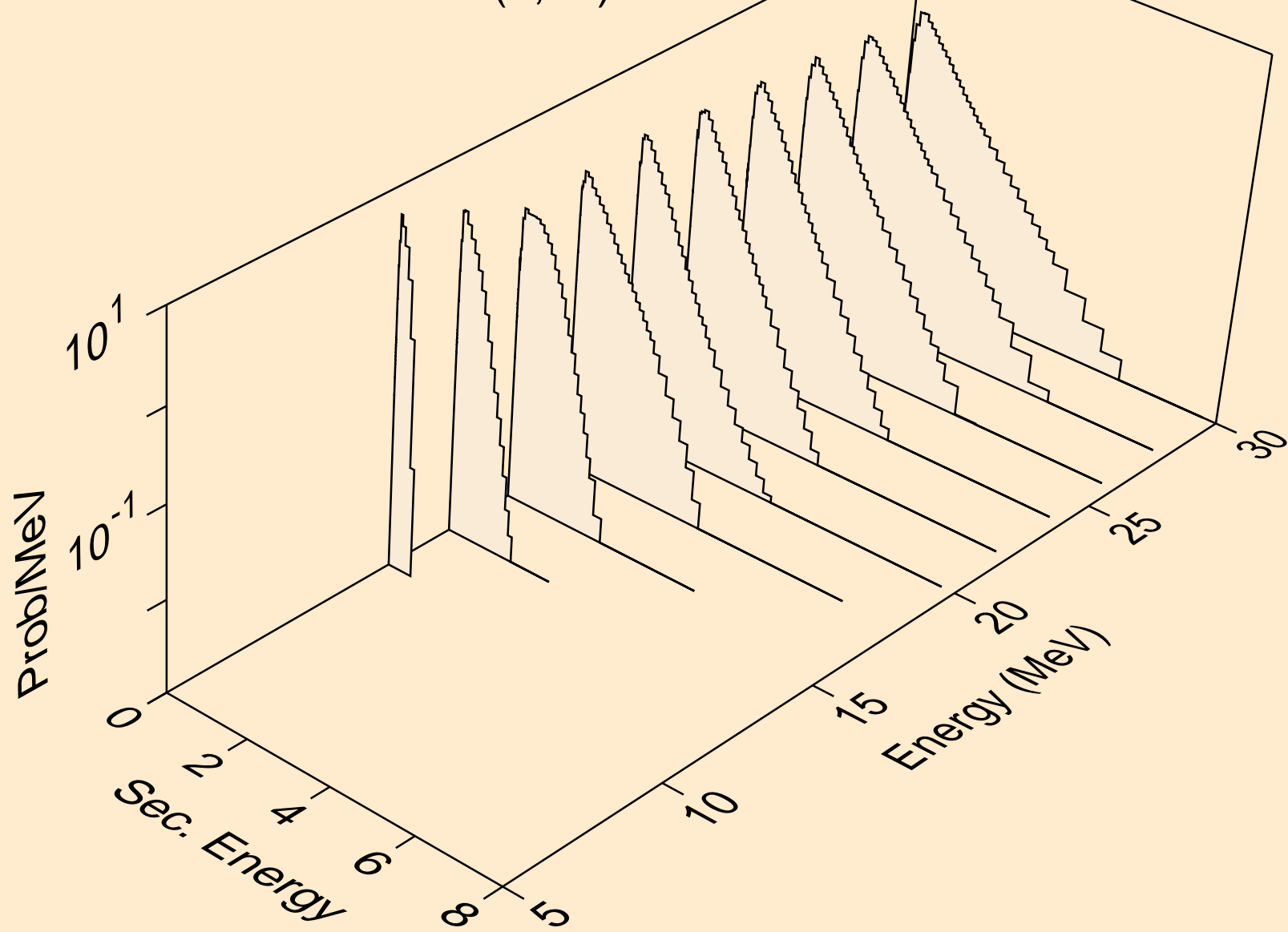

YB172 NEUTRON ACER TENDL-2024 LIBRARY; T=0.K
Neutron emission for (n,3n)a

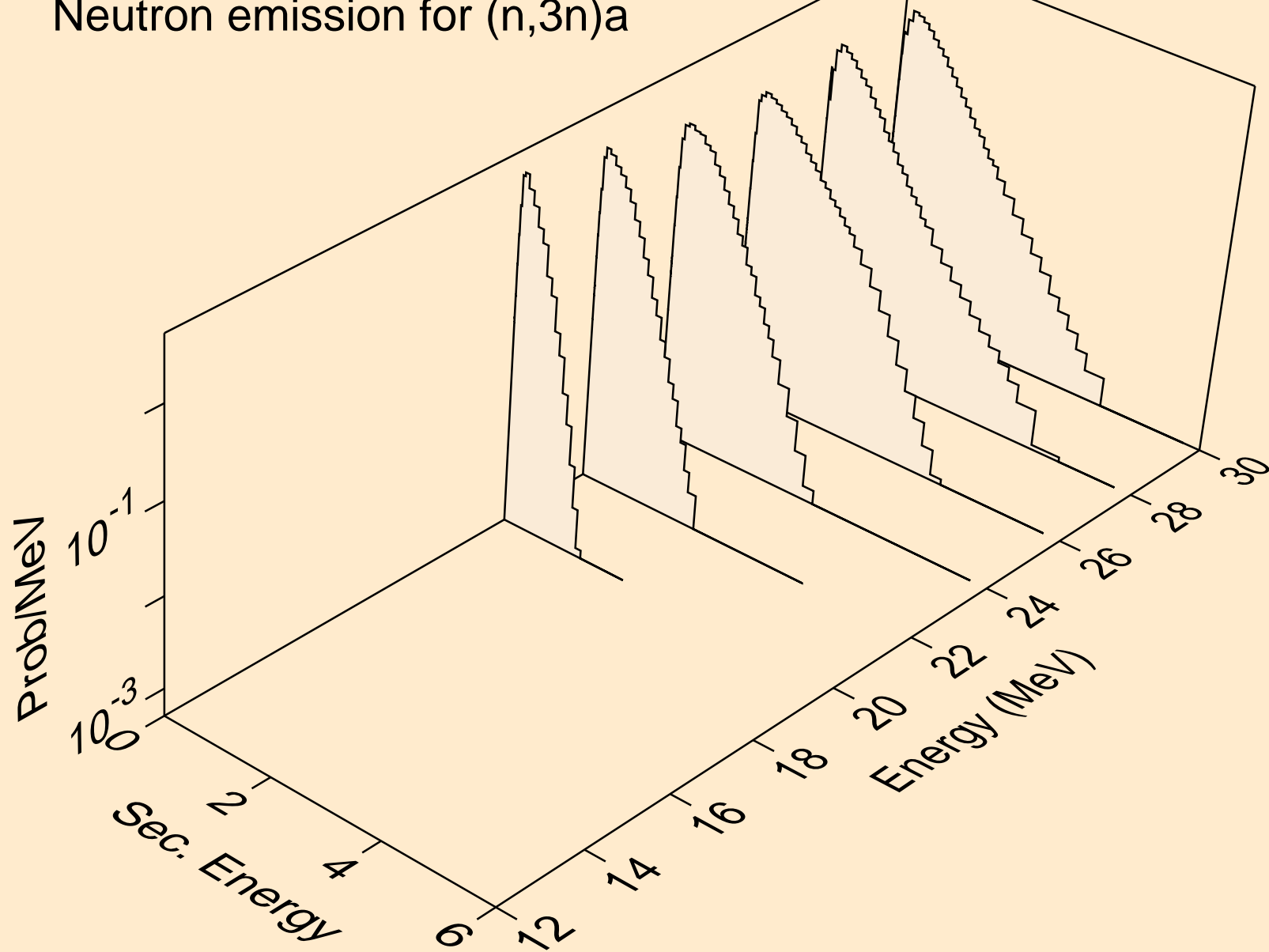

YB172 NEUTRON ACER TENDL-2024 LIBRARY; T=0.K
Neutron emission for (n,n*)p

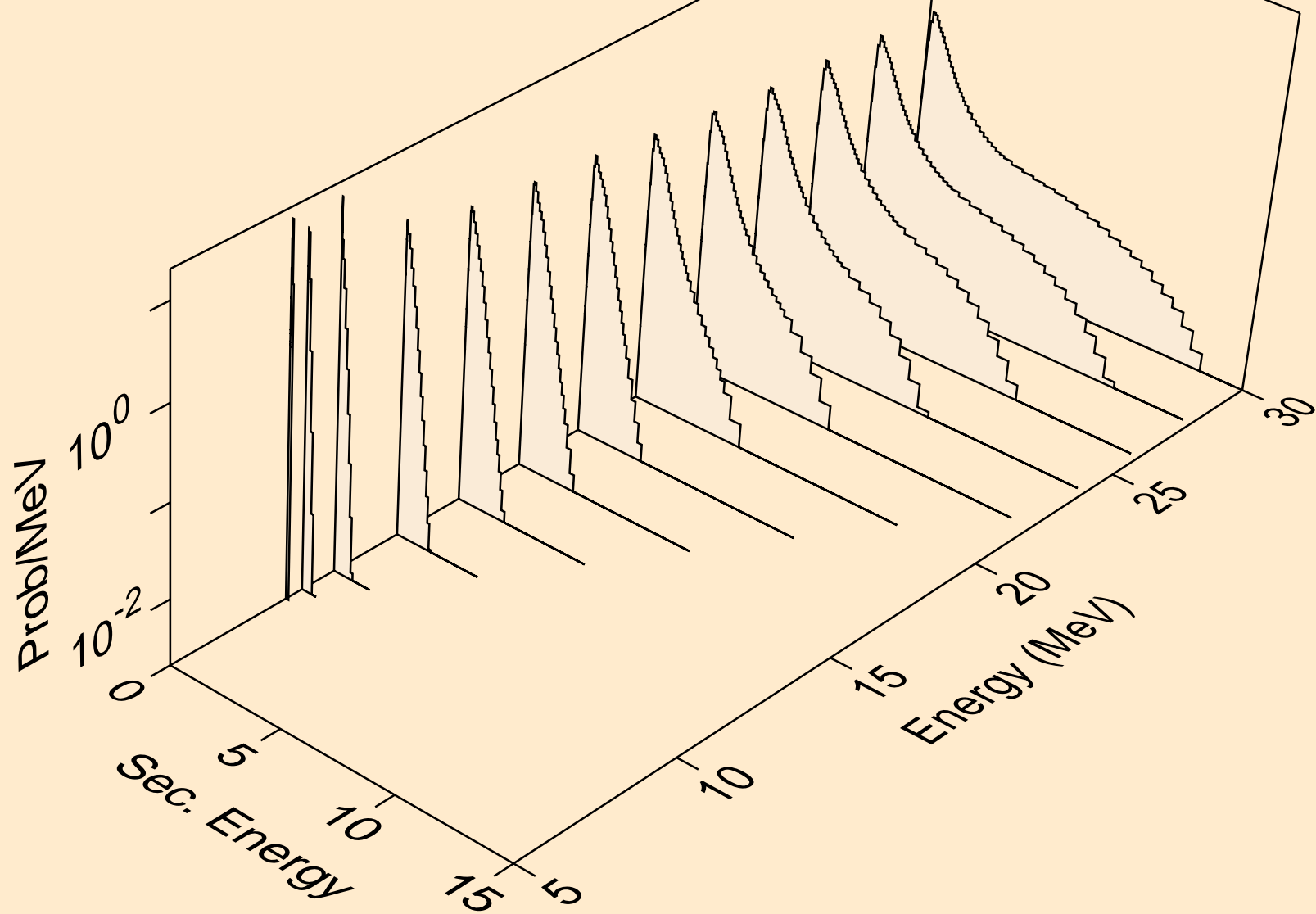

YB172 NEUTRON ACER TENDL-2024 LIBRARY; T=0.K
Neutron emission for (n,n*)2a

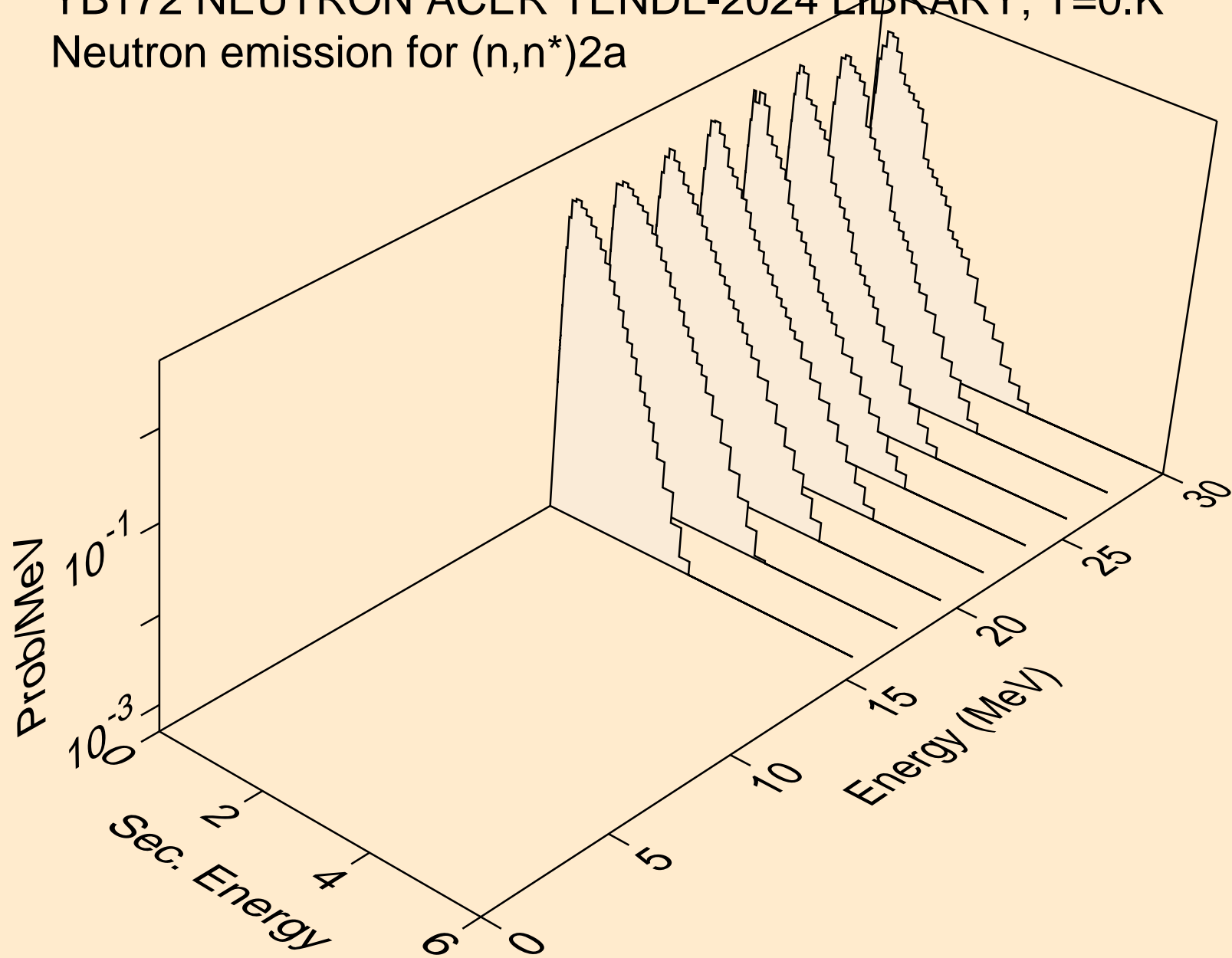

YB172 NEUTRON ACER TENDL-2024 LIBRARY; T=0.K
Neutron emission for (n,n*)d

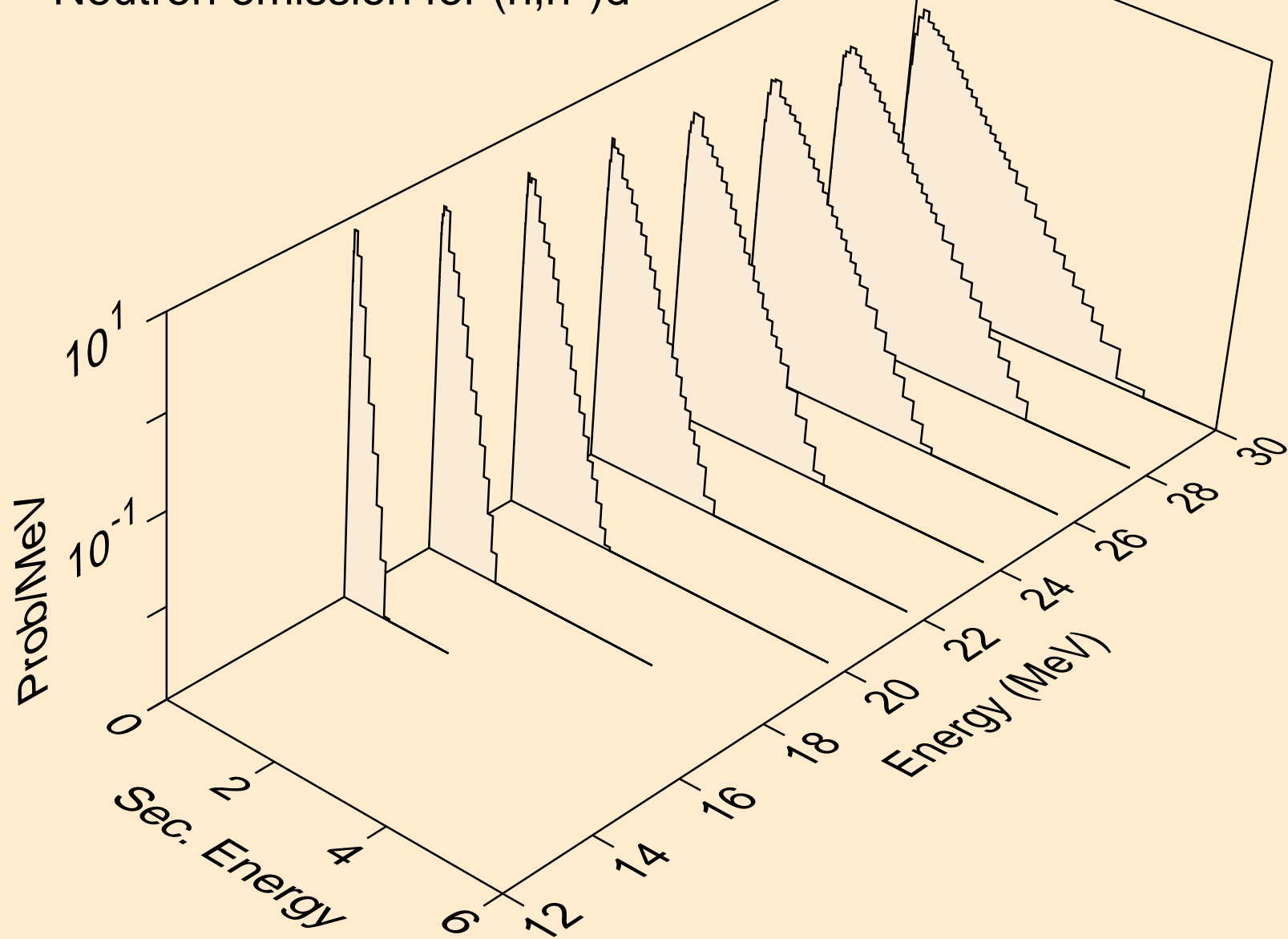

YB172 NEUTRON ACER TENDL-2024 LIBRARY; T=0.K
Neutron emission for (n,n*)t

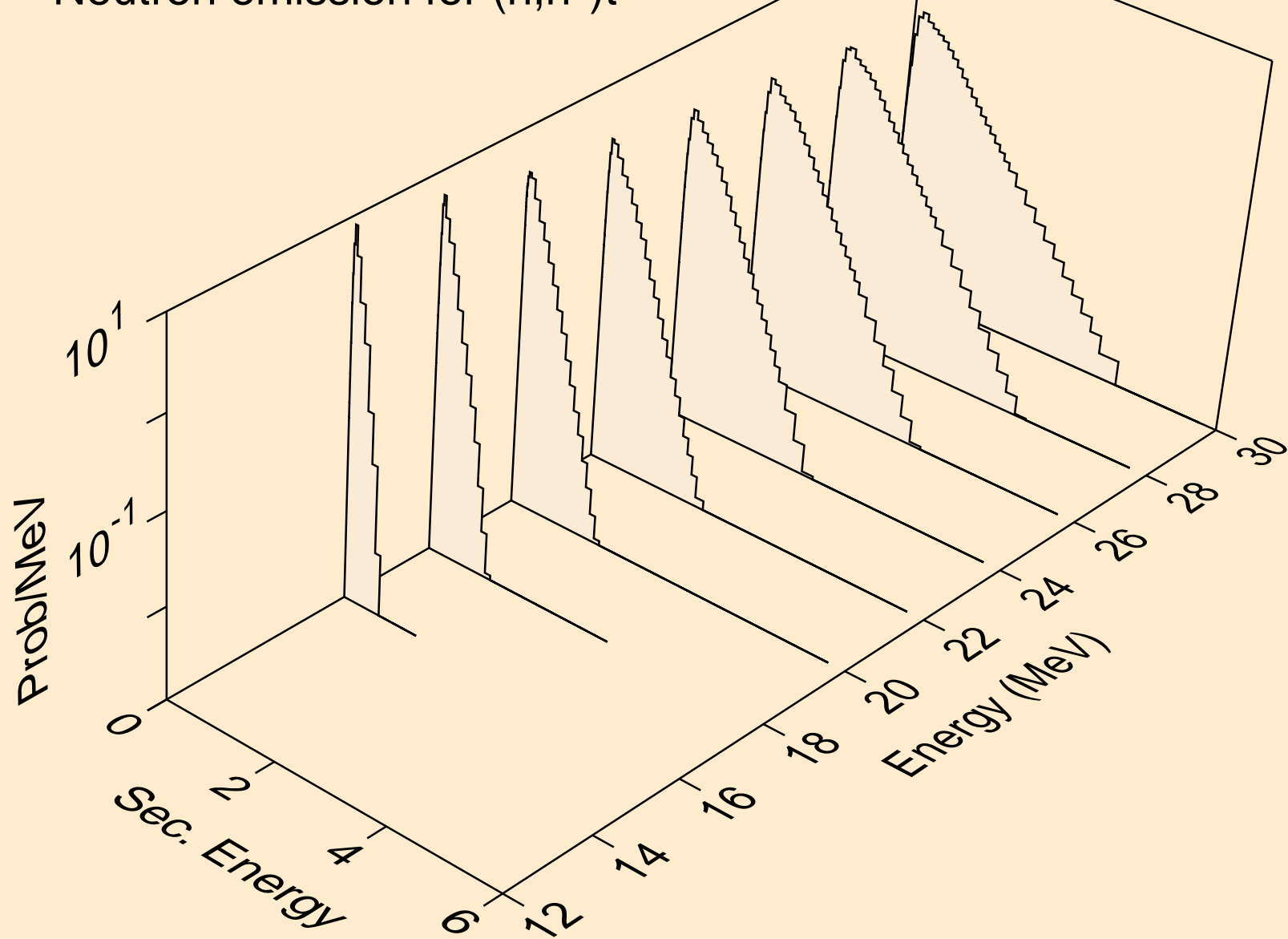

YB172 NEUTRON ACER TENDL-2024 LIBRARY; T=0.K
Neutron emission for (n,n*)he3

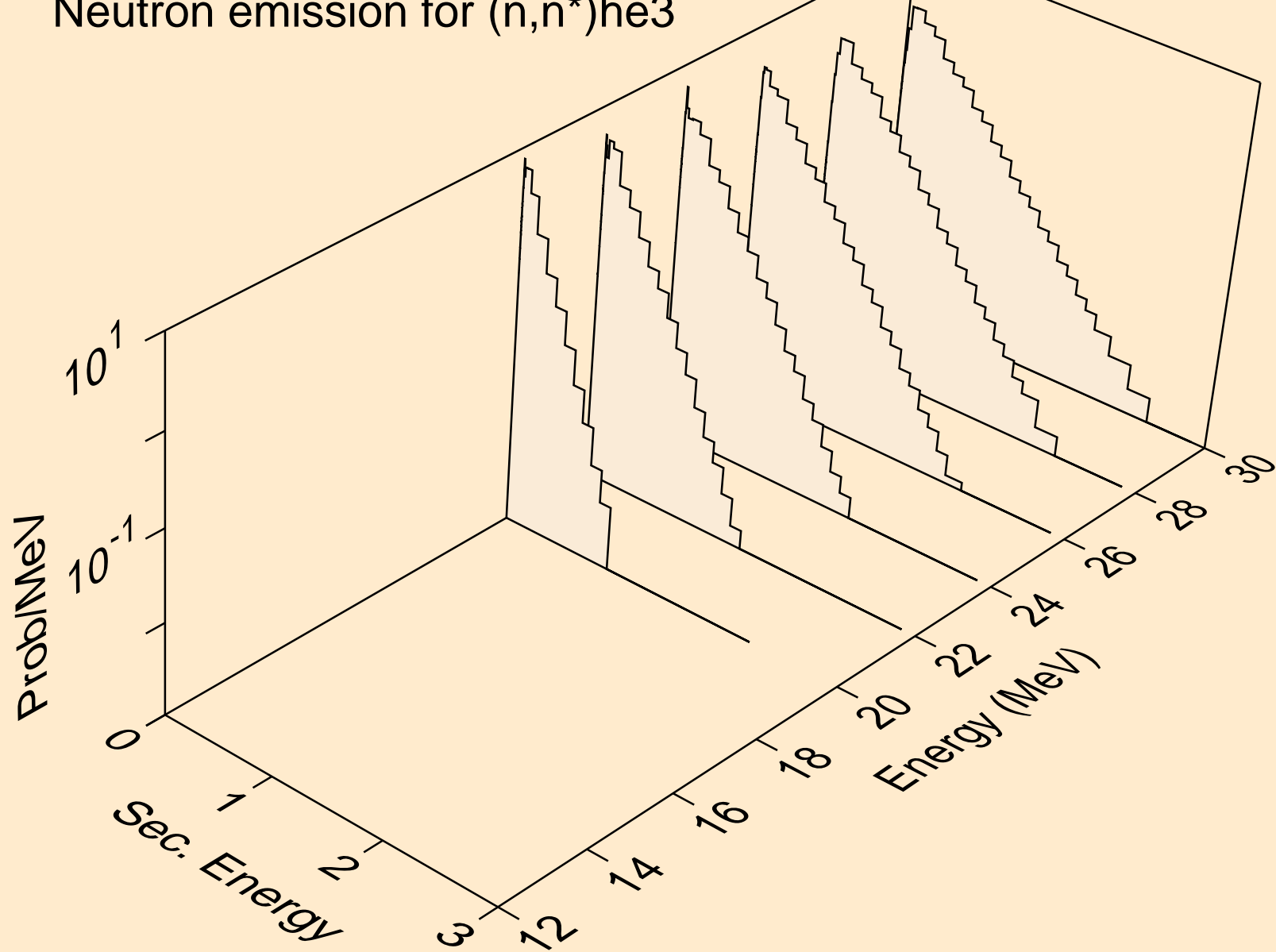

YB172 NEUTRON ACER TENDL-2024 LIBRARY; T=0.K
Neutron emission for (n,4n)

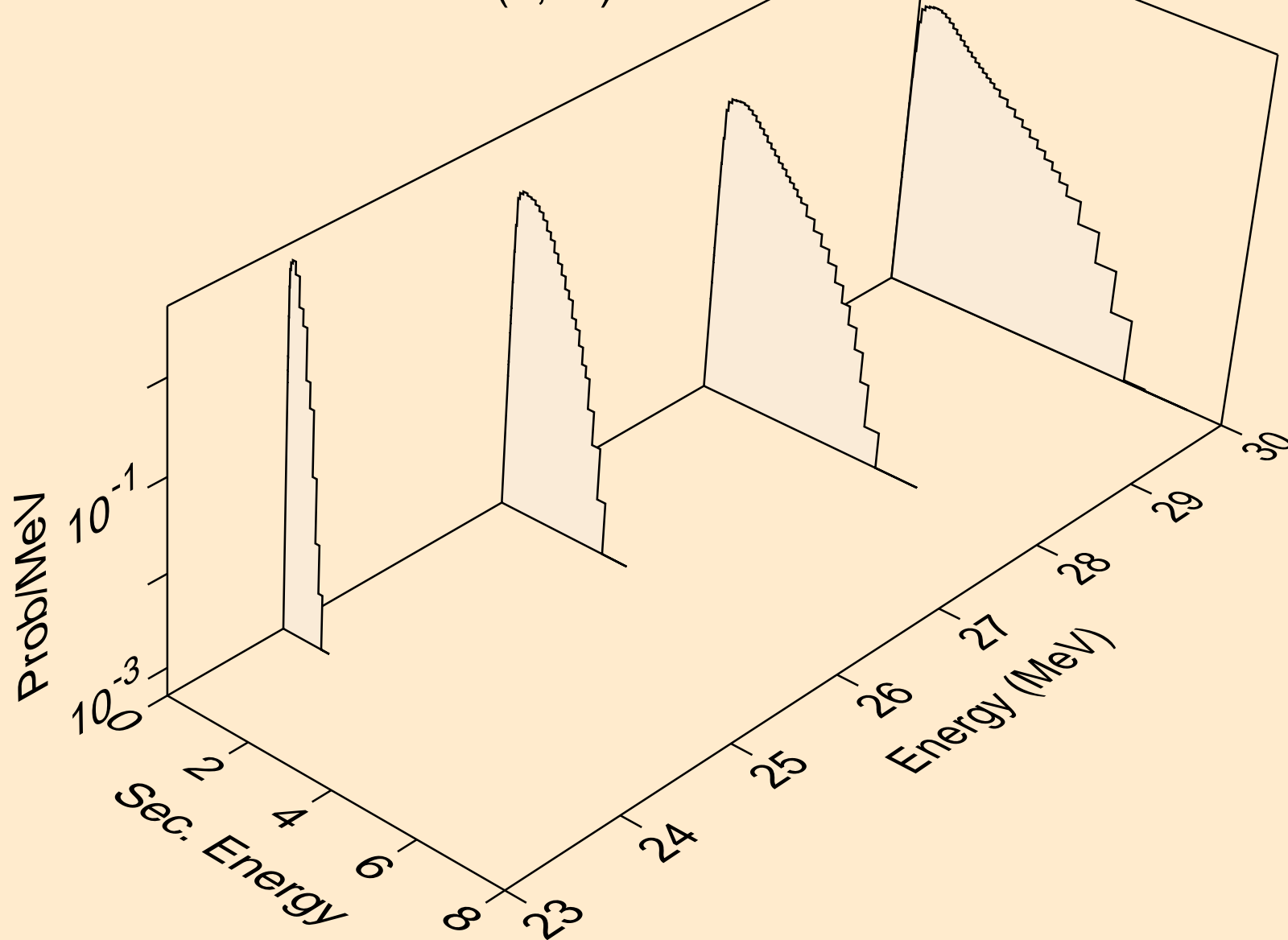

YB172 NEUTRON ACER TENDL-2024 LIBRARY; T=0.K
Neutron emission for (n,2np)

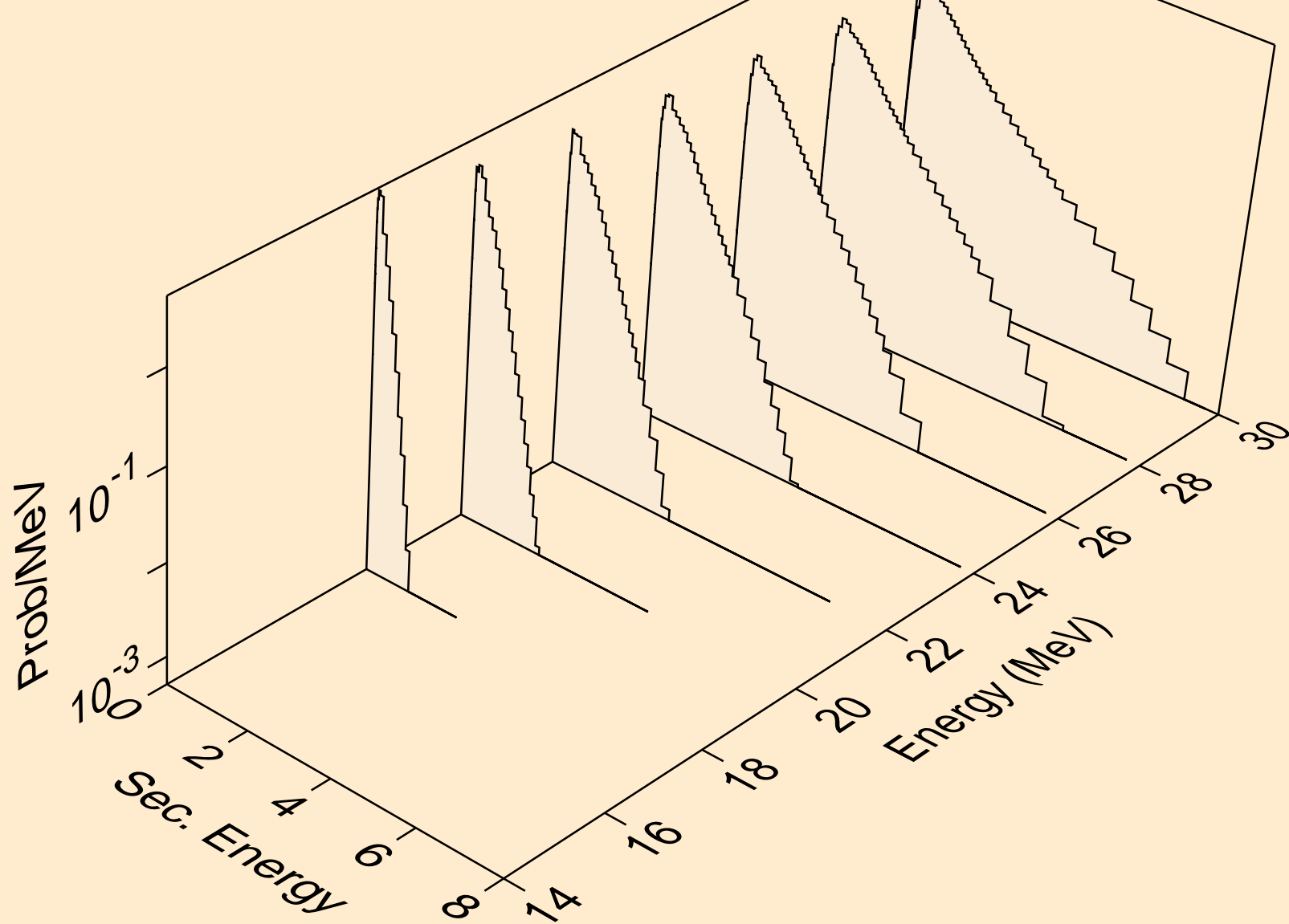

YB172 NEUTRON ACER TENDL-2024 LIBRARY; T=0.K
Neutron emission for (n,3np)

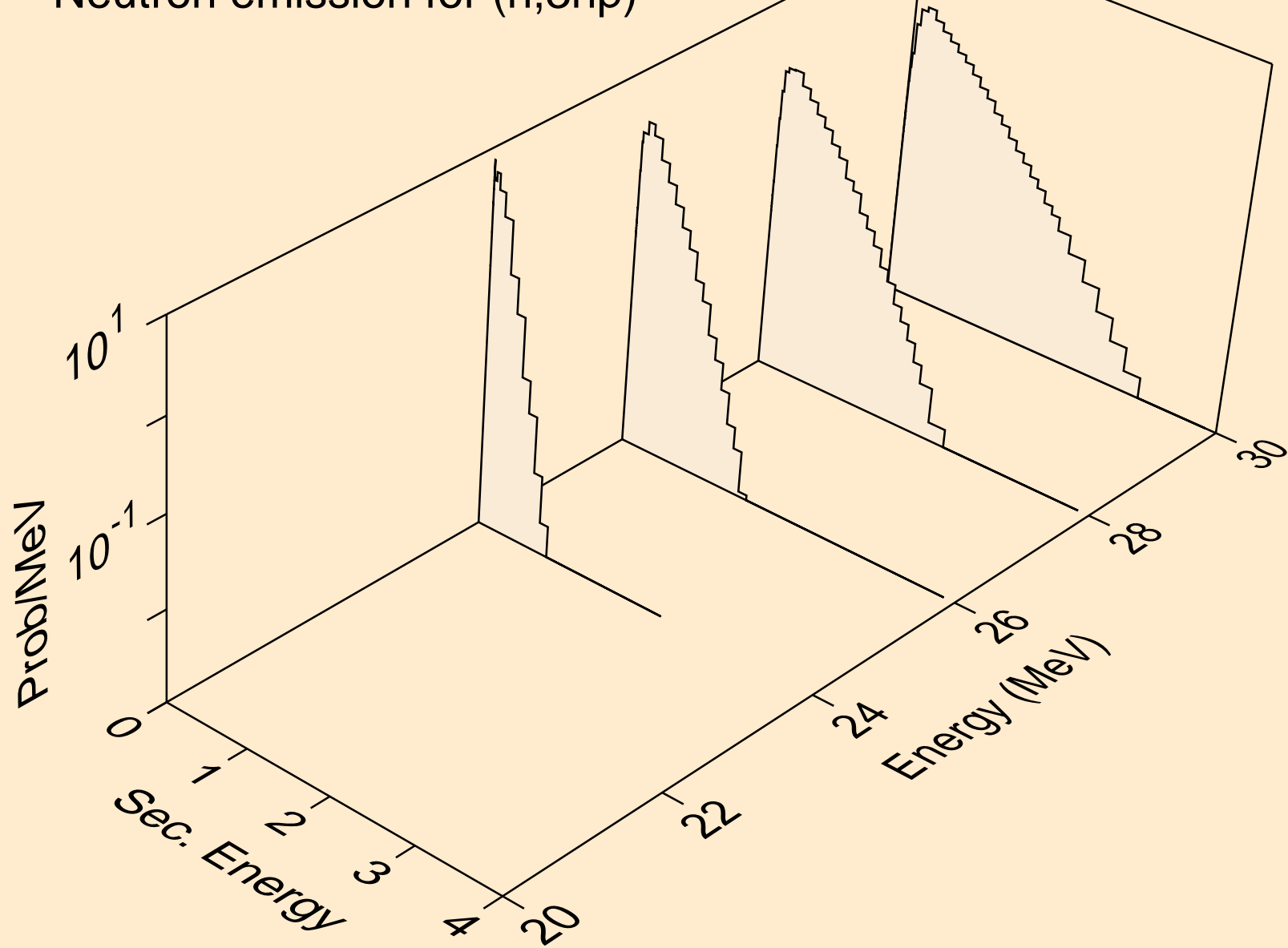

YB172 NEUTRON ACER TENDL-2024 LIBRARY; T=0.K
Neutron emission for (n,n2p)

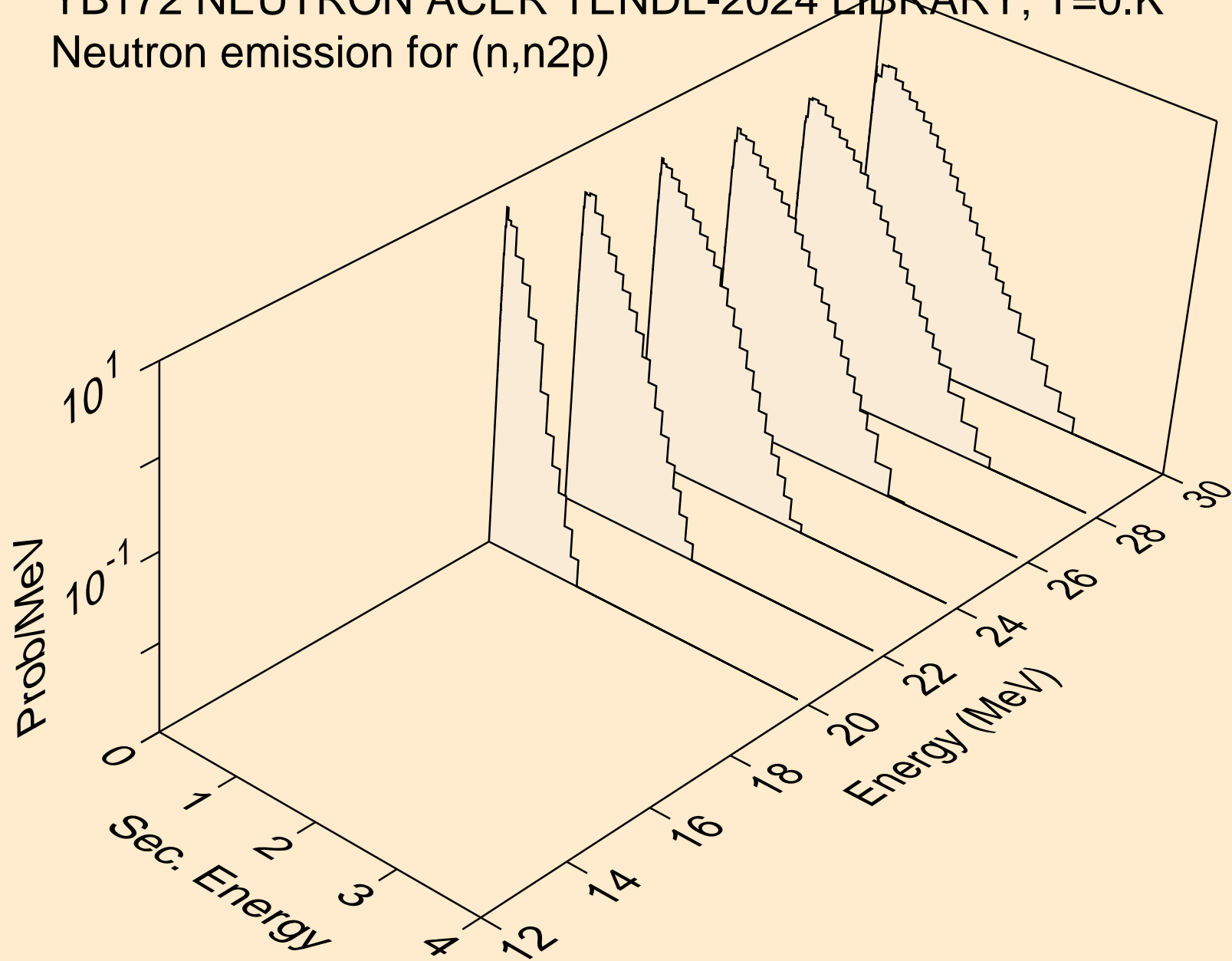

YB172 NEUTRON ACER TENDL-2024 LIBRARY; T=0.K
Neutron emission for (n,npa)

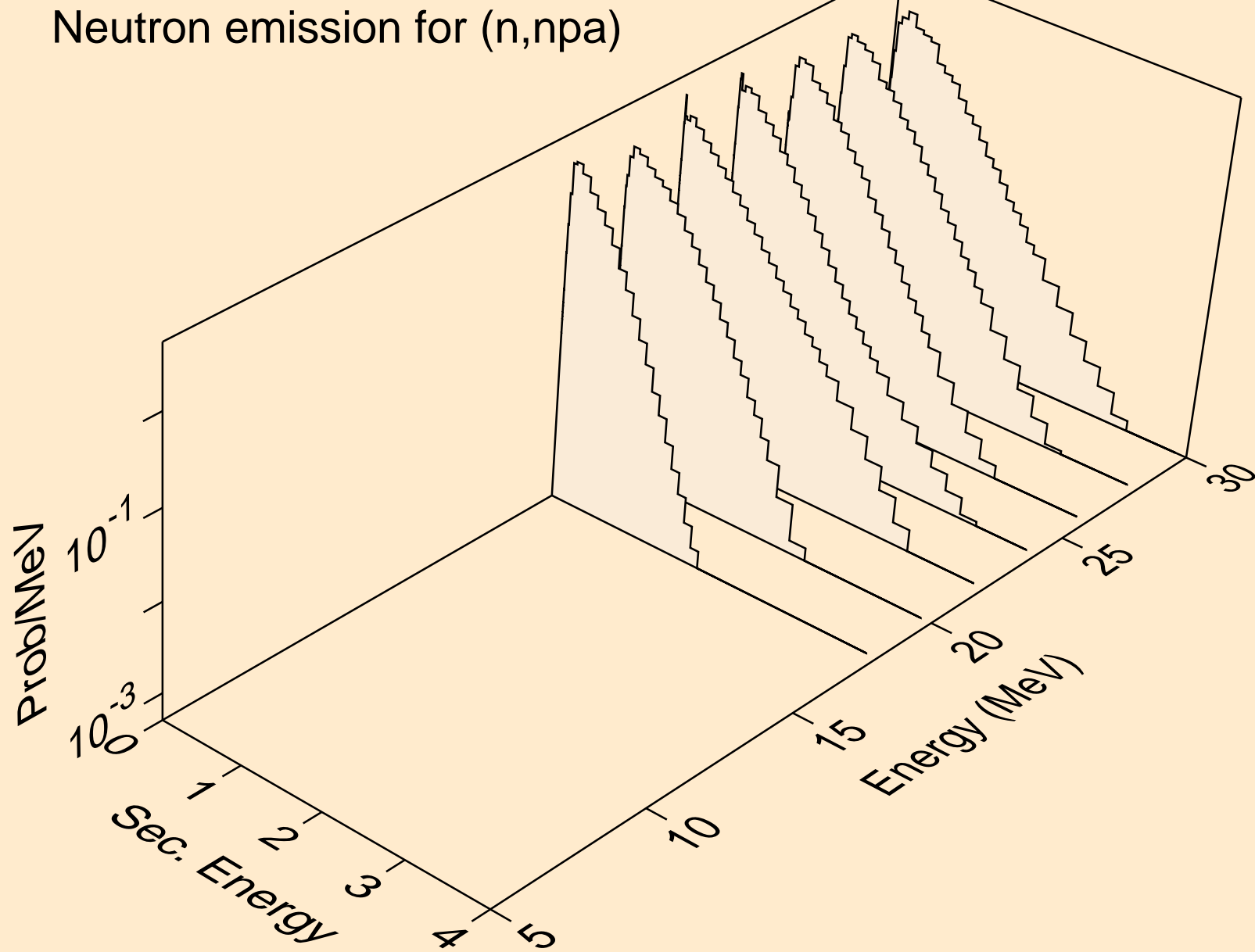

YB172 NEUTRON ACER TENDL-2024 LIBRARY; T=0.K
Neutron emission for (n,n*c)

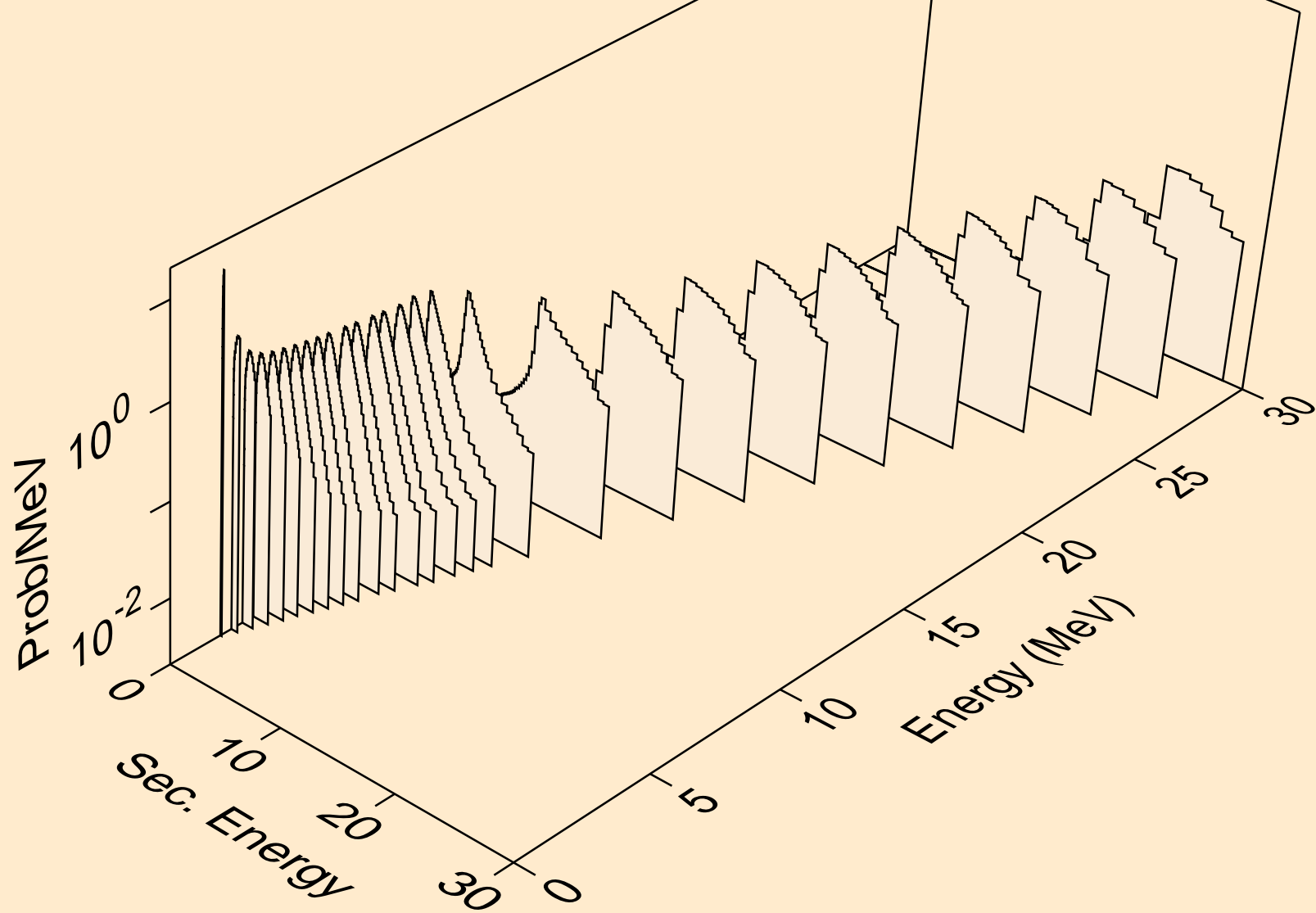

YB172 NEUTRON ACER TENDL-2024 LIBRARY; T=0.K
Photon emission for (n,x)

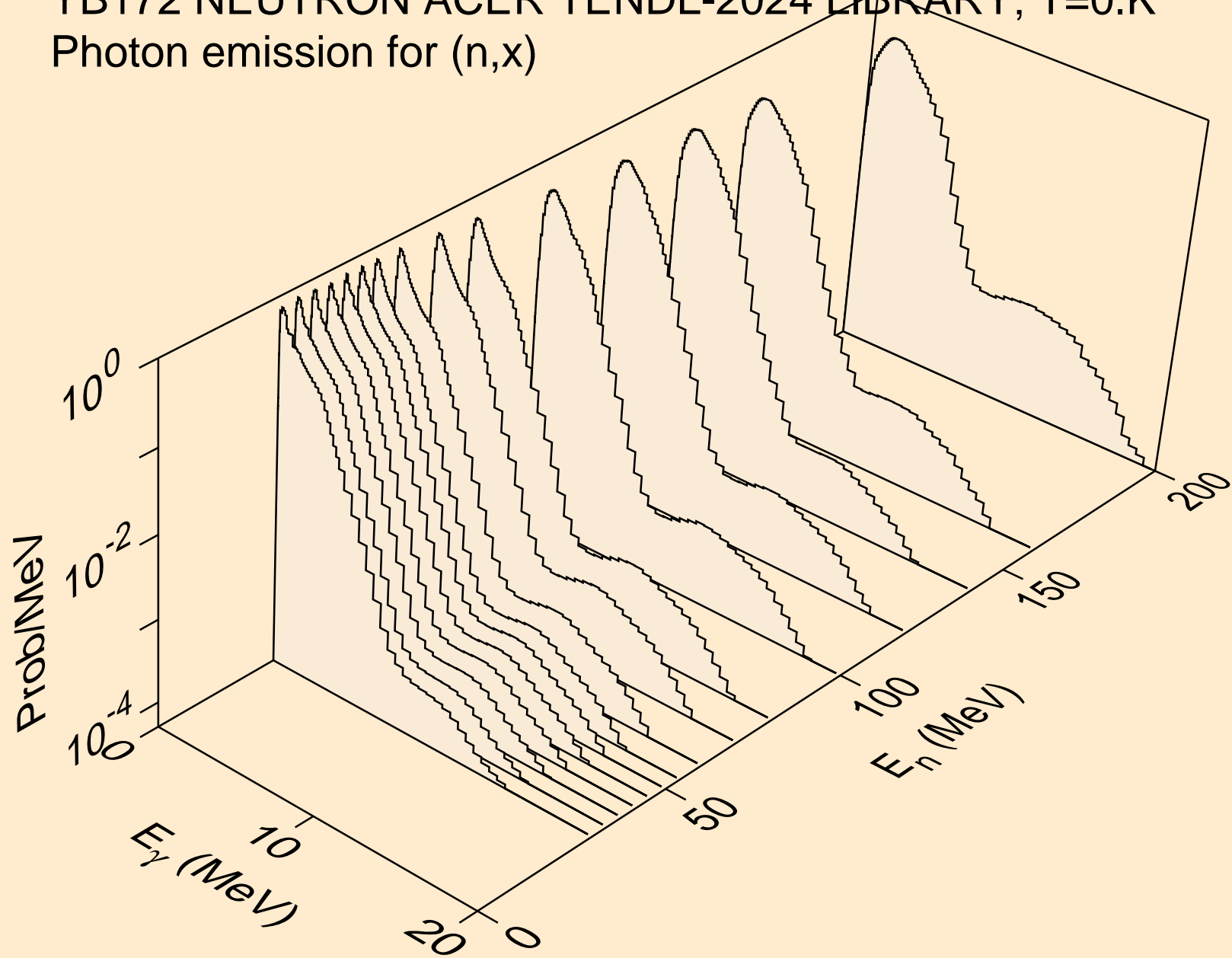

YB172 NEUTRON ACER TENDL-2024 LIBRARY; T=0.K
Photon emission for (n,2nd)

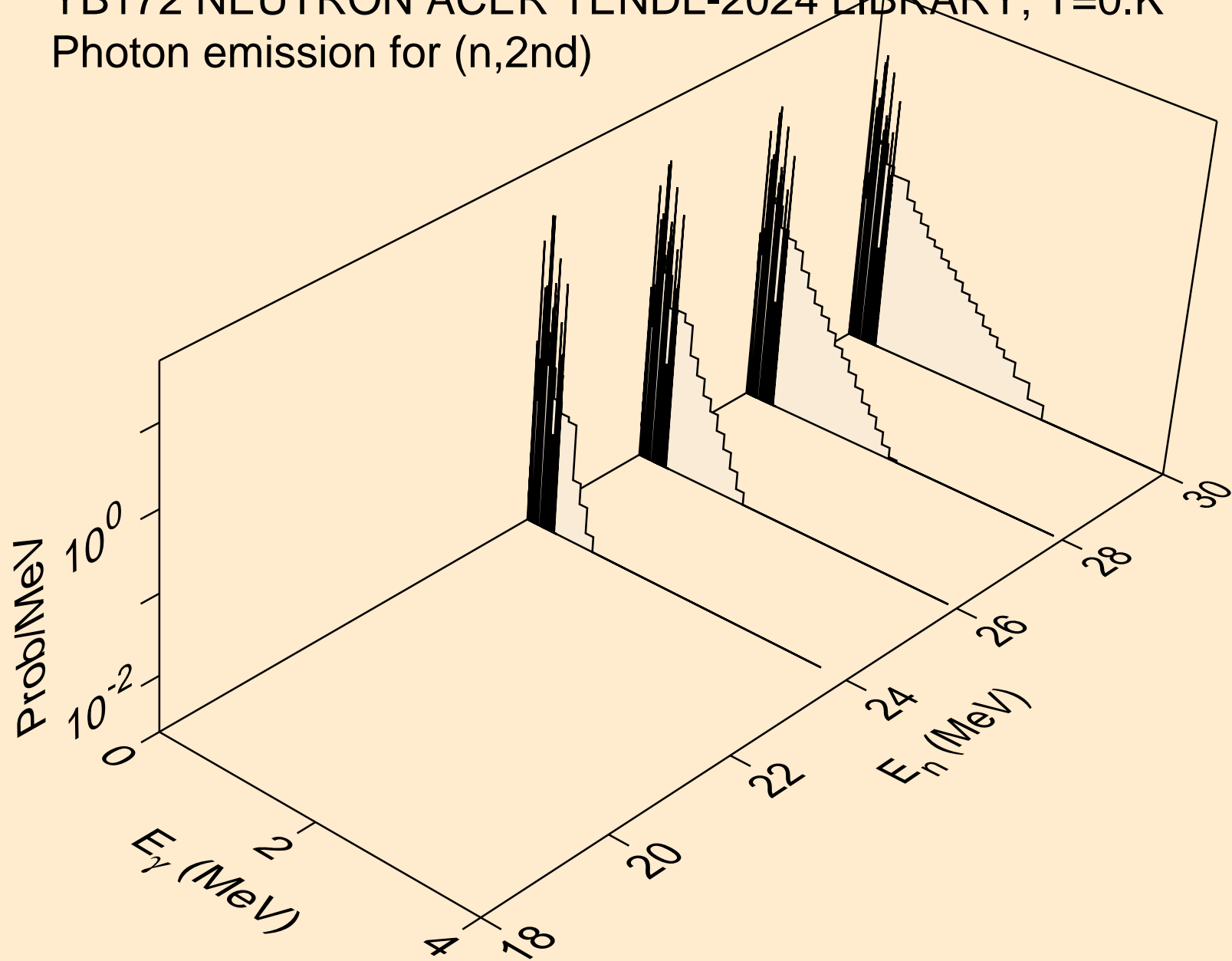

YB172 NEUTRON ACER TENDL-2024 LIBRARY; T=0.K
Photon emission for (n,2n)

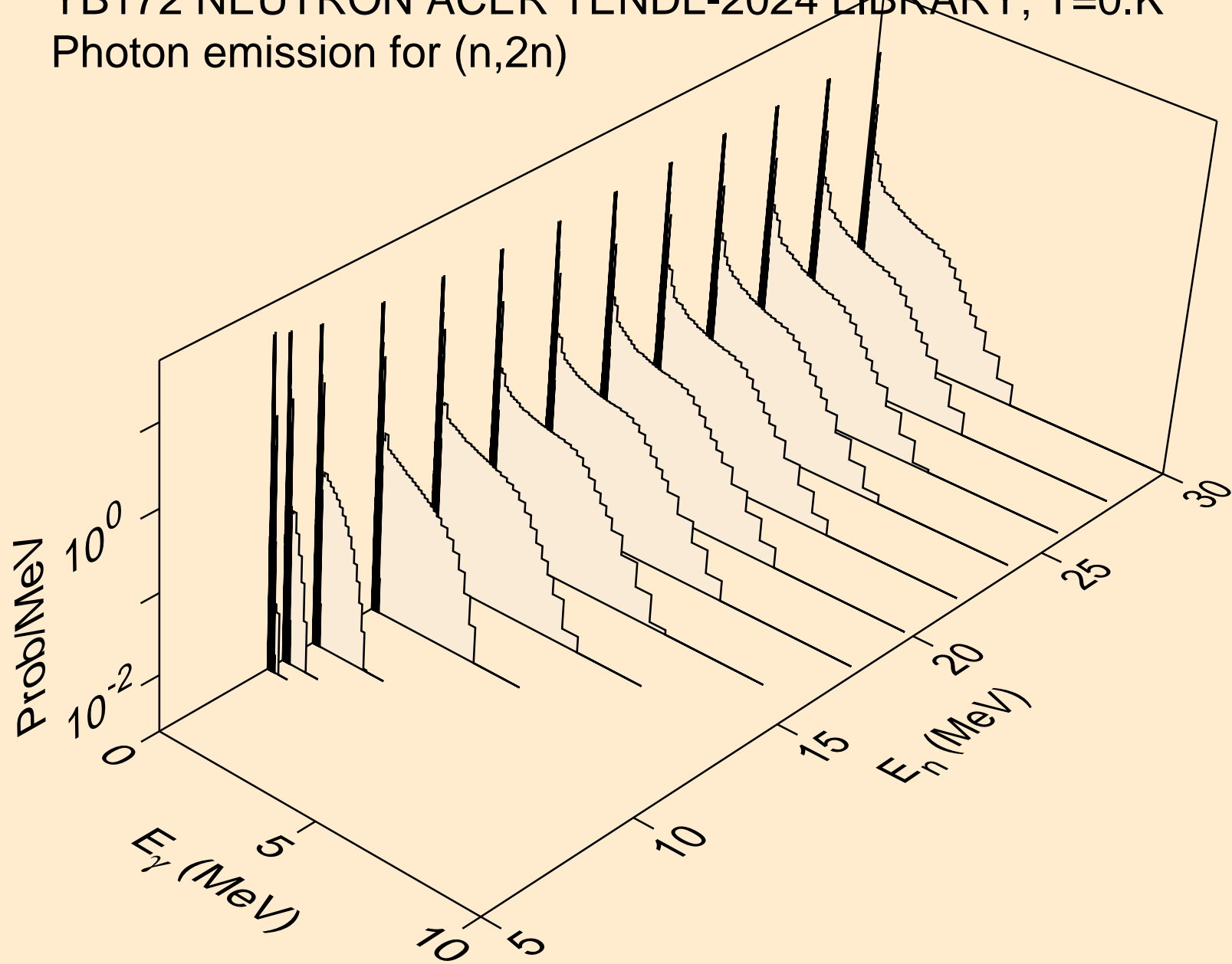

YB172 NEUTRON ACER TENDL-2024 LIBRARY; T=0.K
Photon emission for (n,3n)

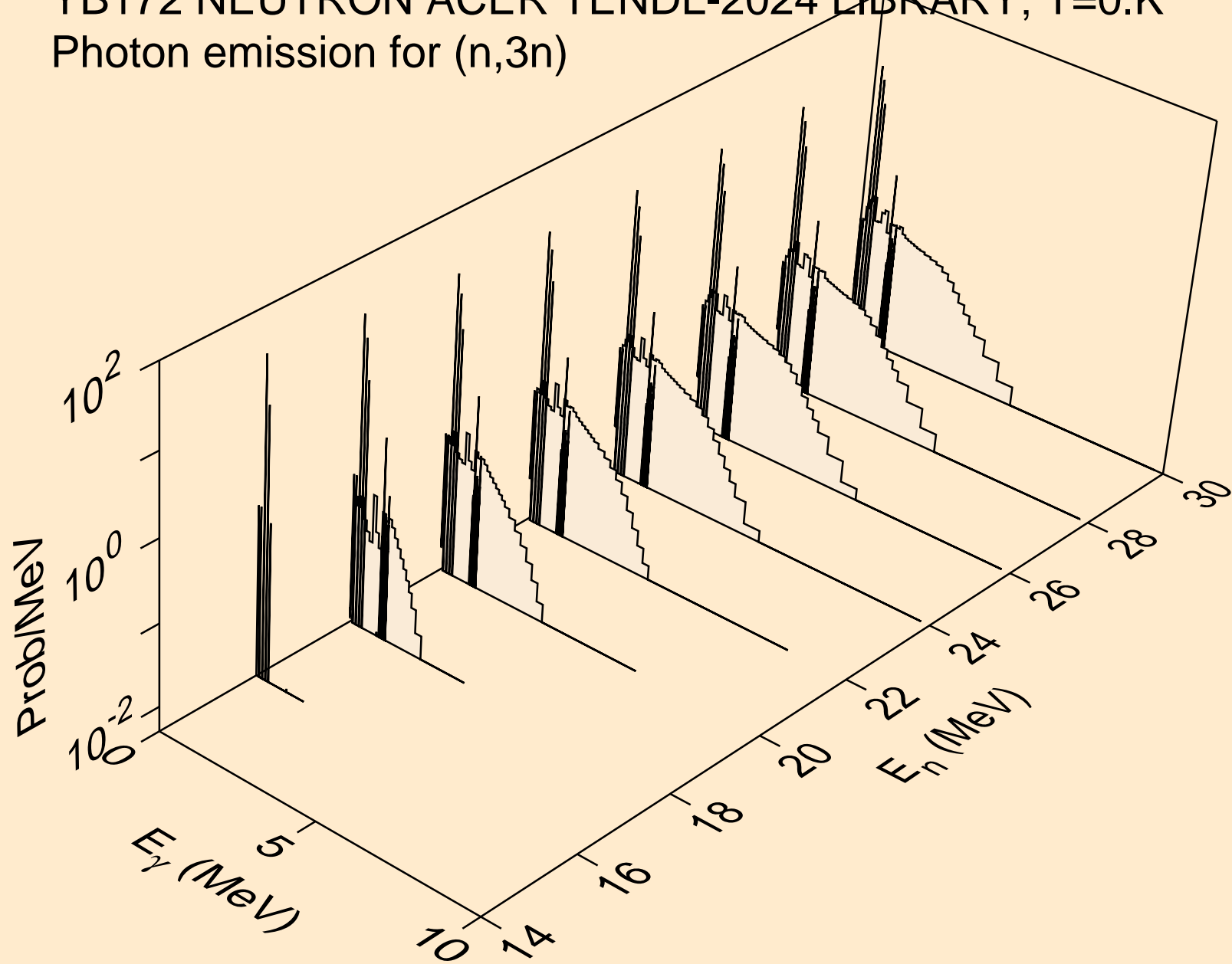

YB172 NEUTRON ACER TENDL-2024 LIBRARY; T=0.K
Photon emission for (n,n*)a

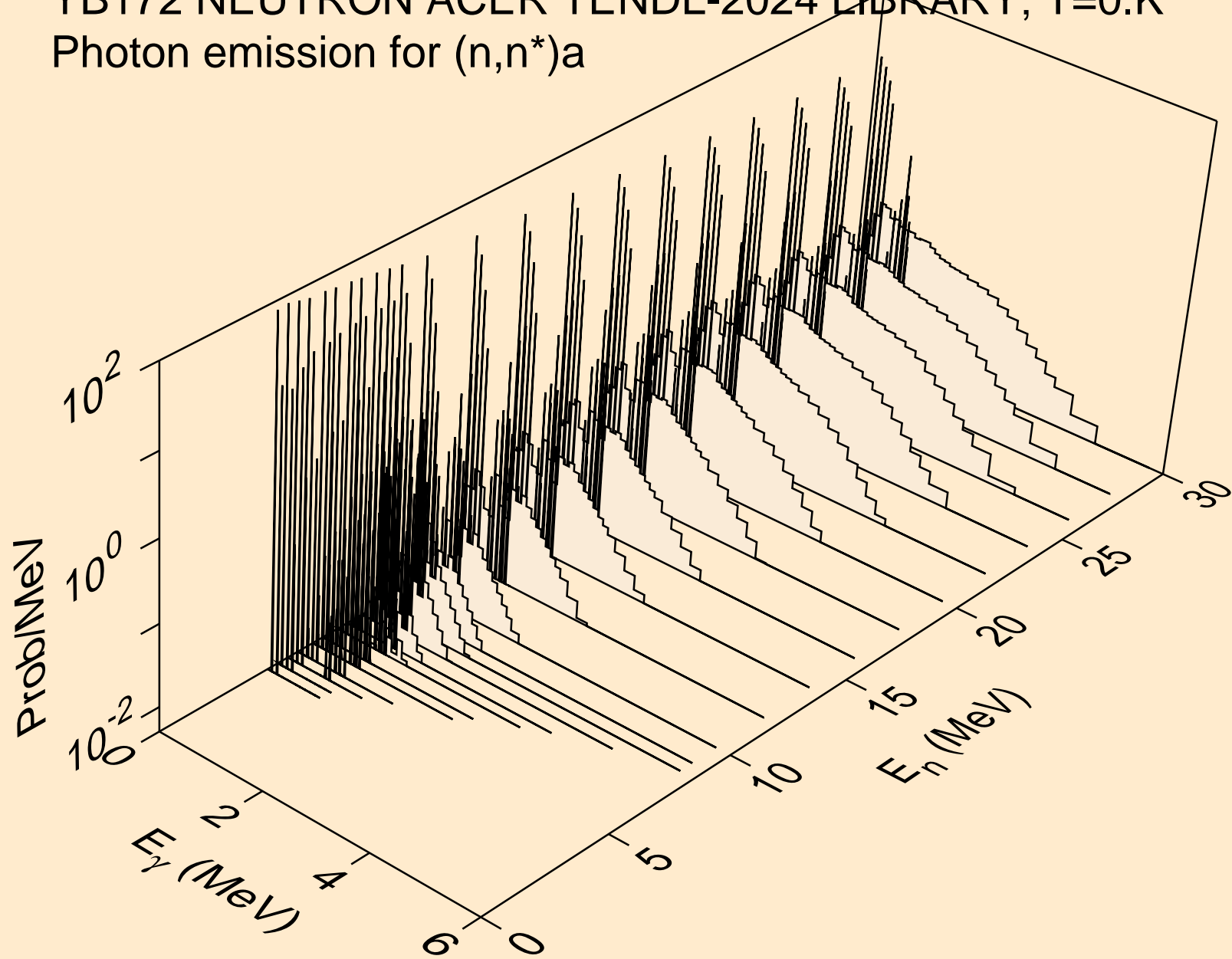

YB172 NEUTRON ACER TENDL-2024 LIBRARY; T=0.K
Photon emission for (n,2n)a

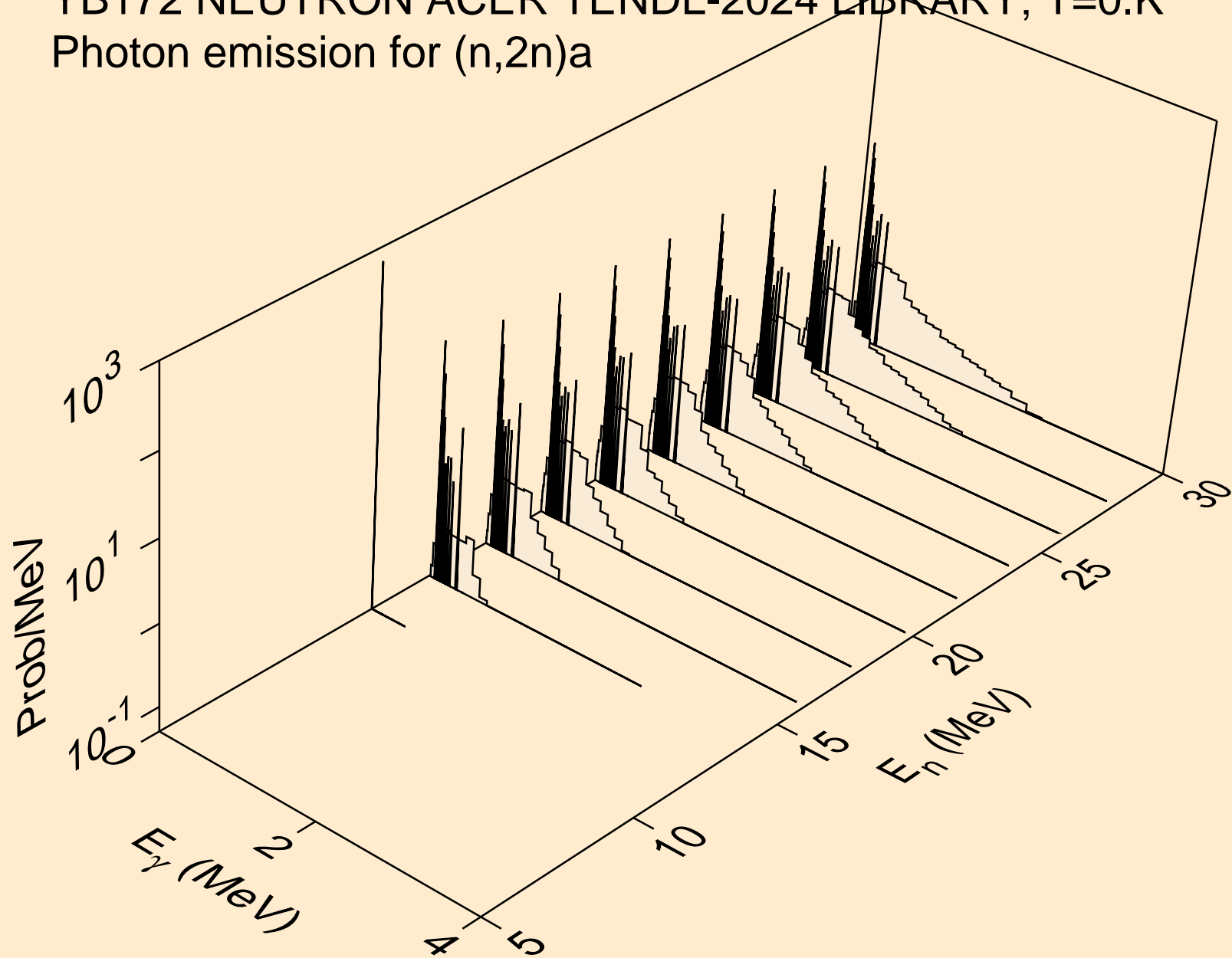

YB172 NEUTRON ACER TENDL-2024 LIBRARY; T=0.K
Photon emission for (n,3n)a

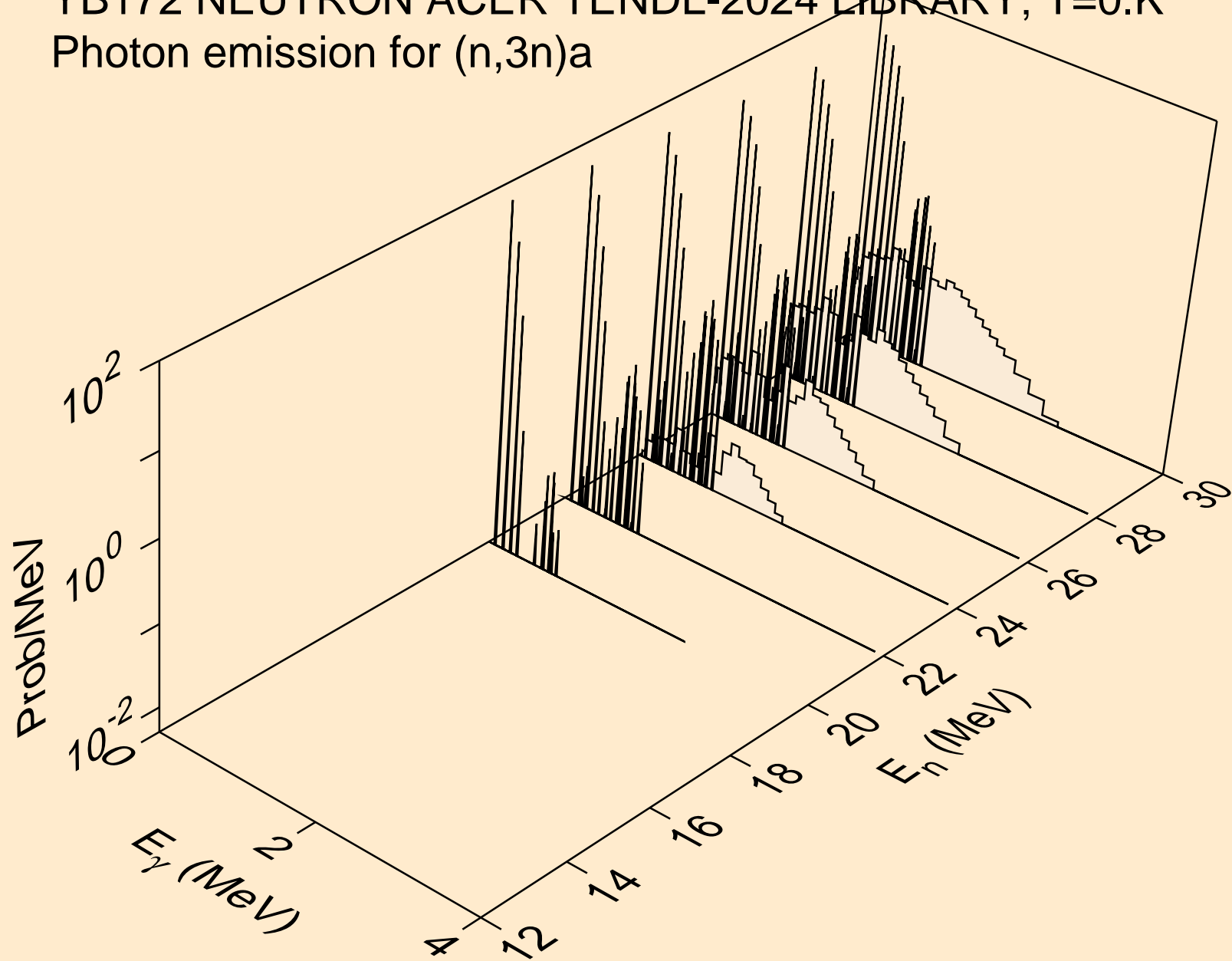

YB172 NEUTRON ACER TENDL-2024 LIBRARY; T=0.K
Photon emission for (n,n*)p

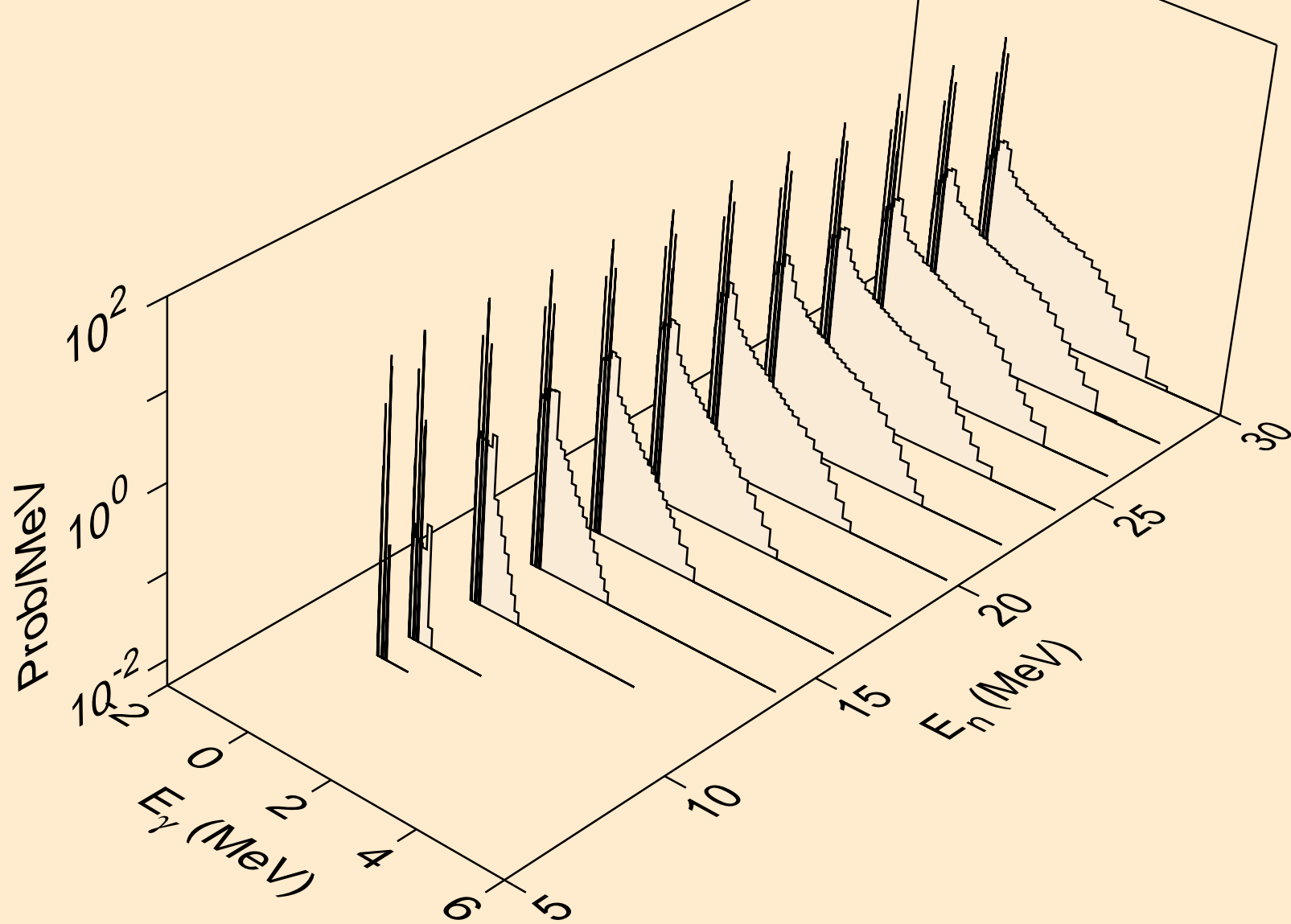

YB172 NEUTRON ACER TENDL-2024 LIBRARY; T=0.K
Photon emission for (n,n*)2a

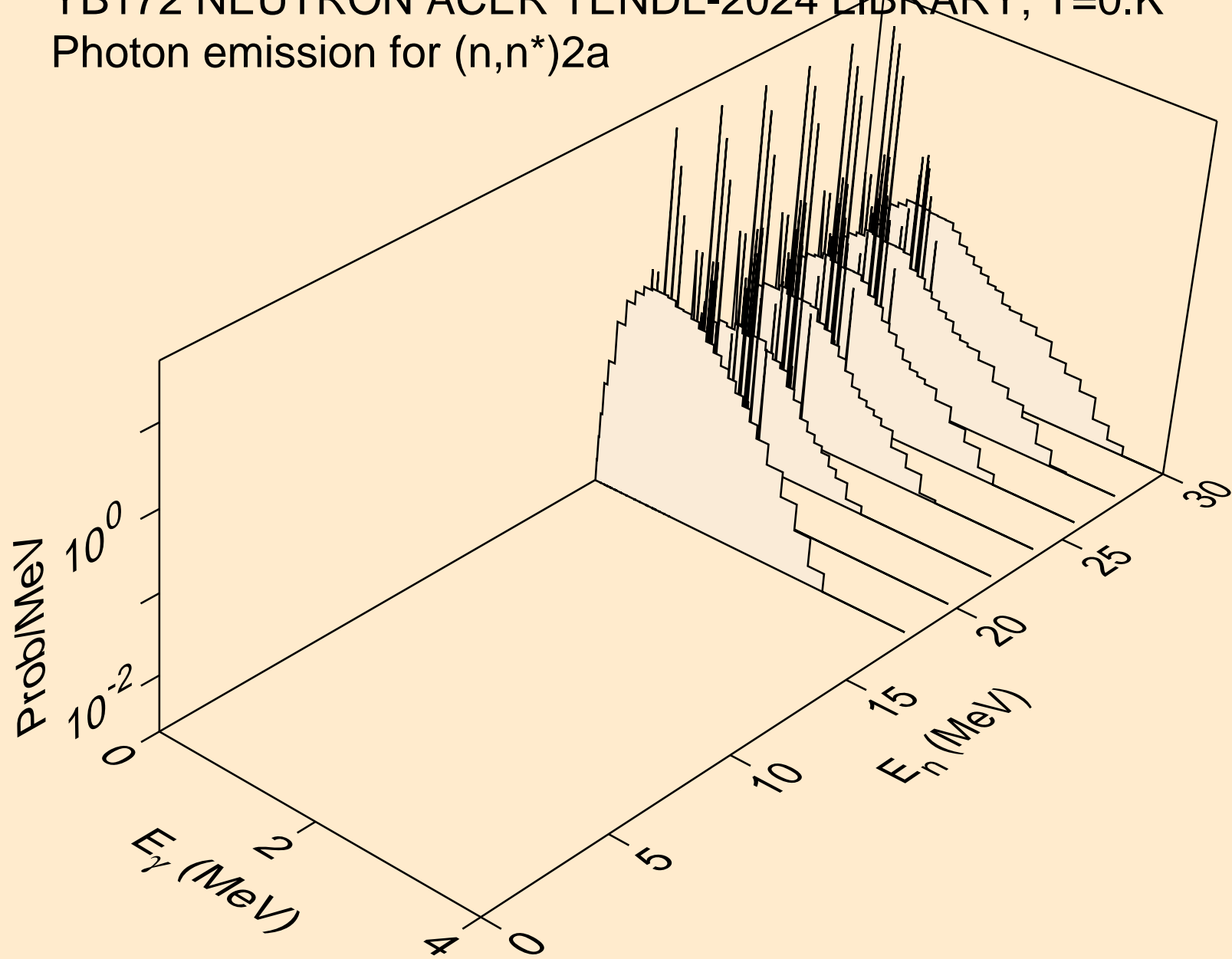

YB172 NEUTRON ACER TENDL-2024 LIBRARY; T=0.K
Photon emission for (n,n*)d

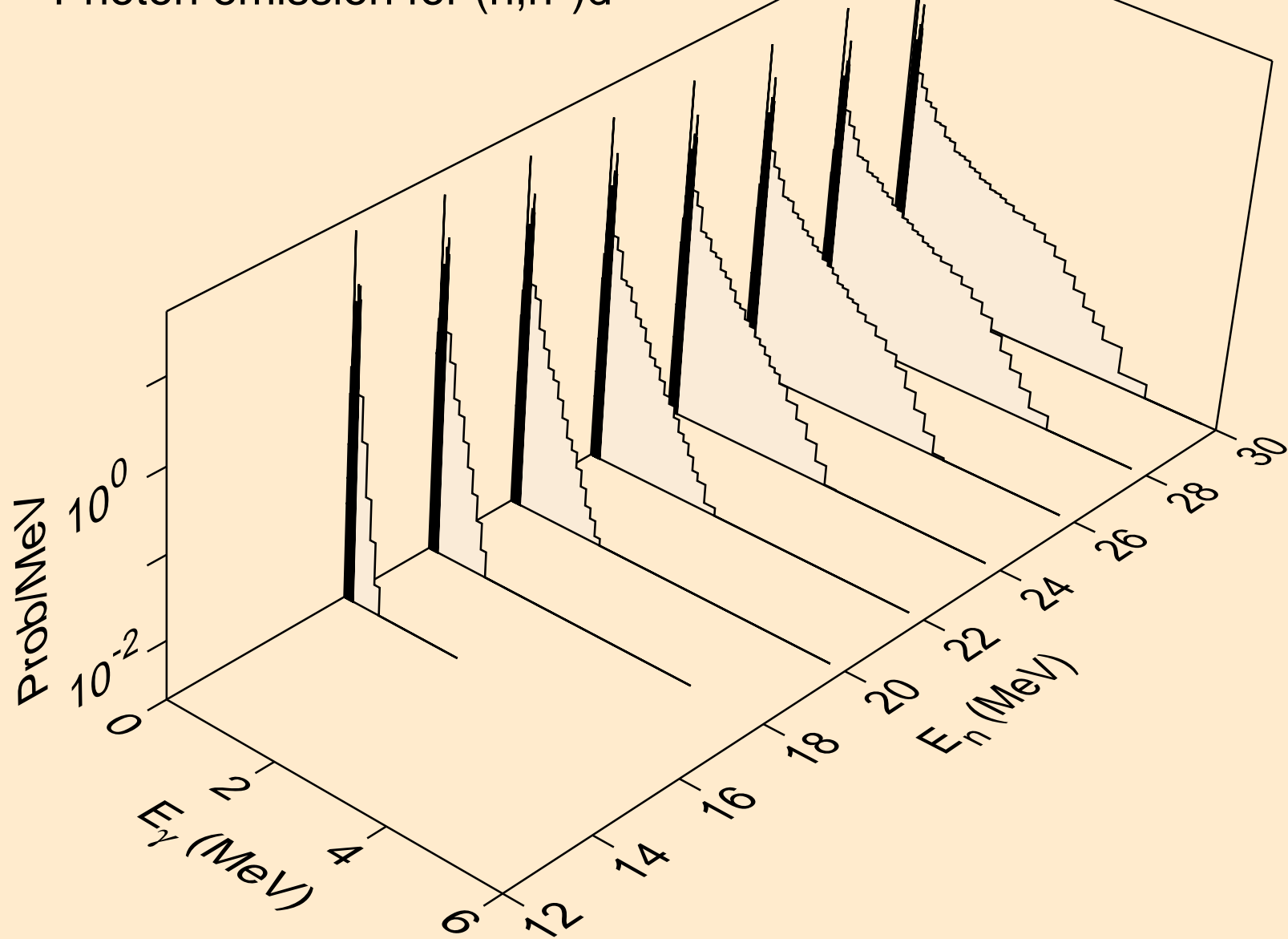

YB172 NEUTRON ACER TENDL-2024 LIBRARY; T=0.K
Photon emission for (n,n*)t

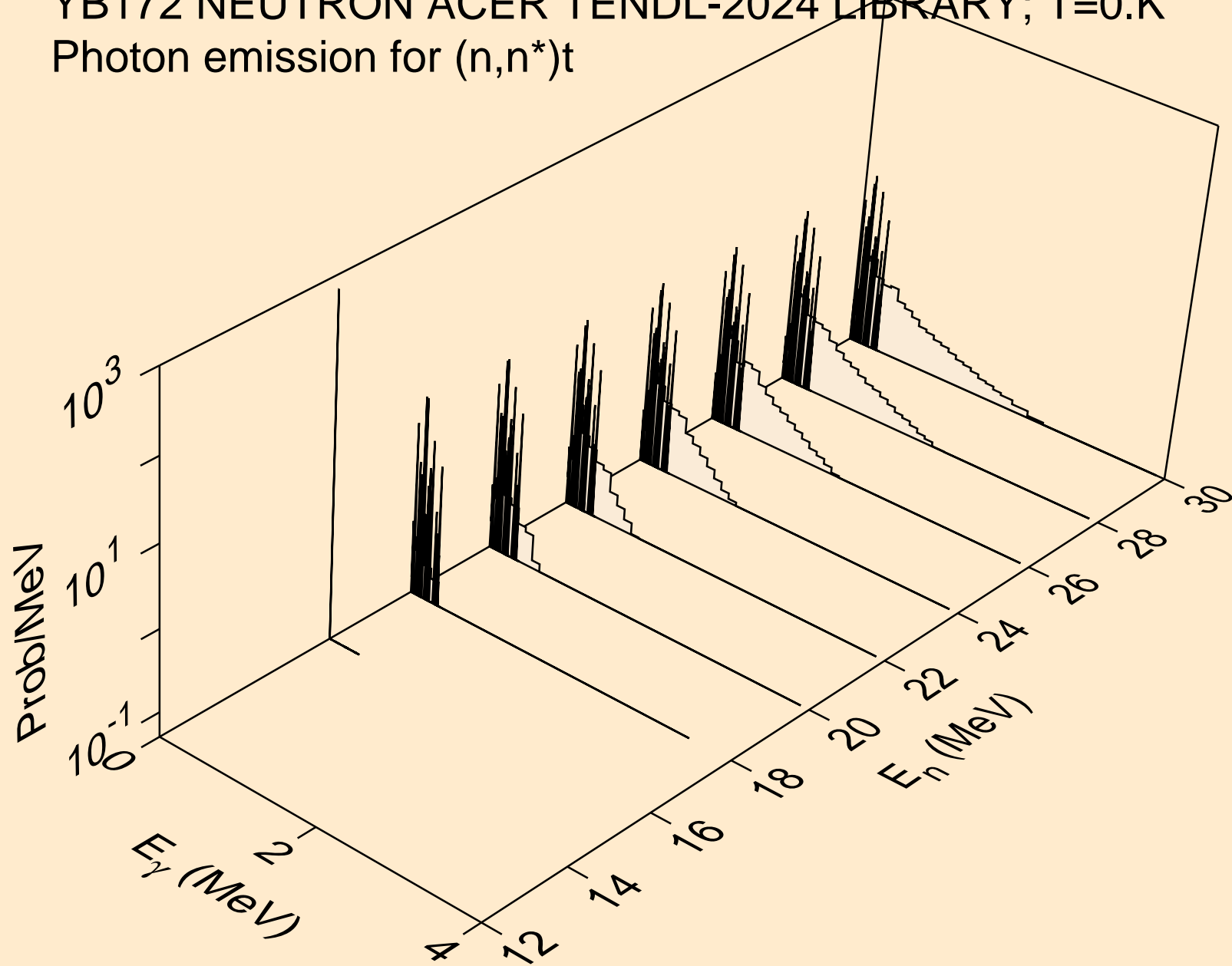

YB172 NEUTRON ACER TENDL-2024 LIBRARY; T=0.K
Photon emission for (n,n*)he3

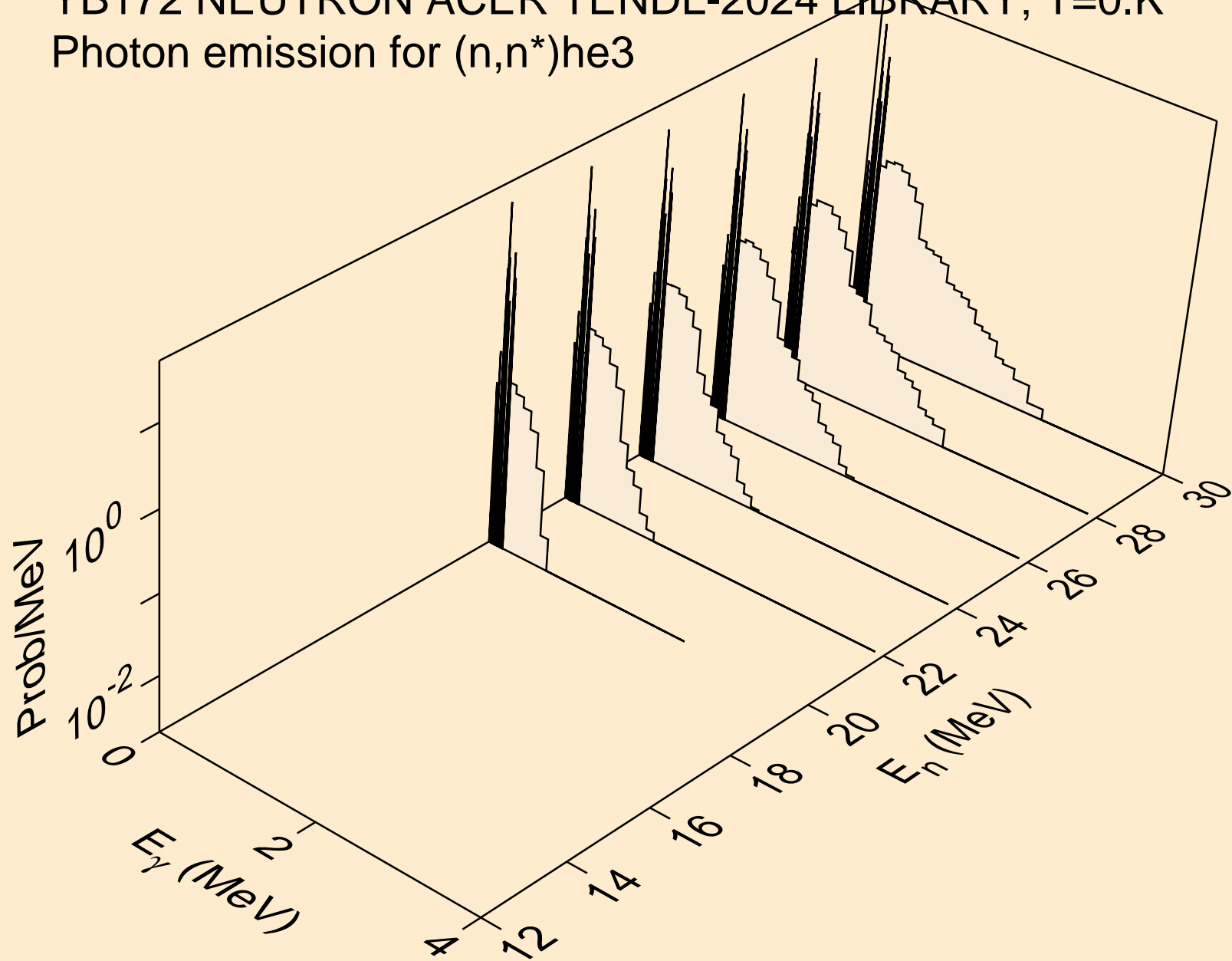

YB172 NEUTRON ACER TENDL-2024 LIBRARY; T=0.K
Photon emission for (n,4n)

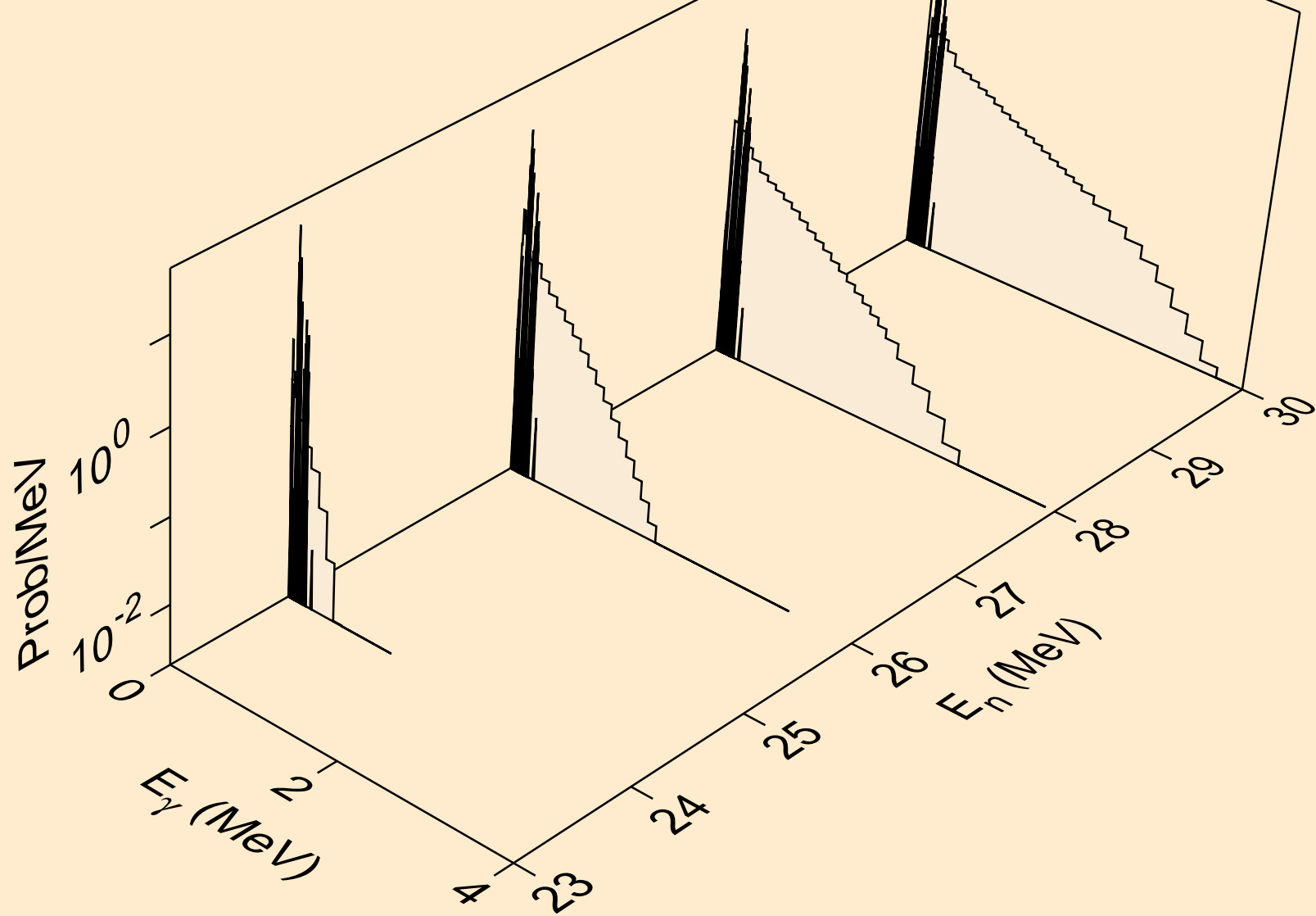

YB172 NEUTRON ACER TENDL-2024 LIBRARY; T=0.K
Photon emission for (n,2np)

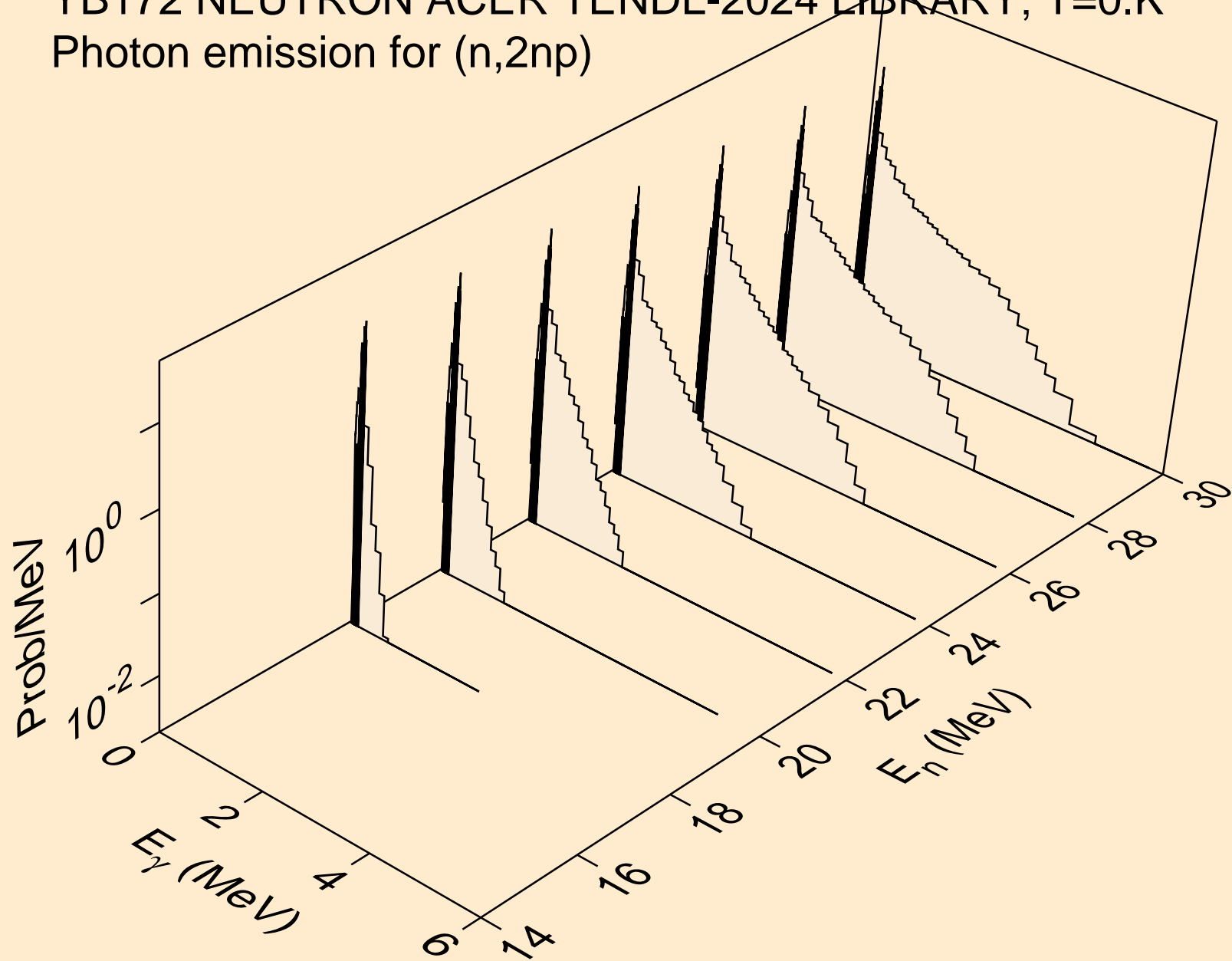

YB172 NEUTRON ACER TENDL-2024 LIBRARY; T=0.K
Photon emission for (n,3np)

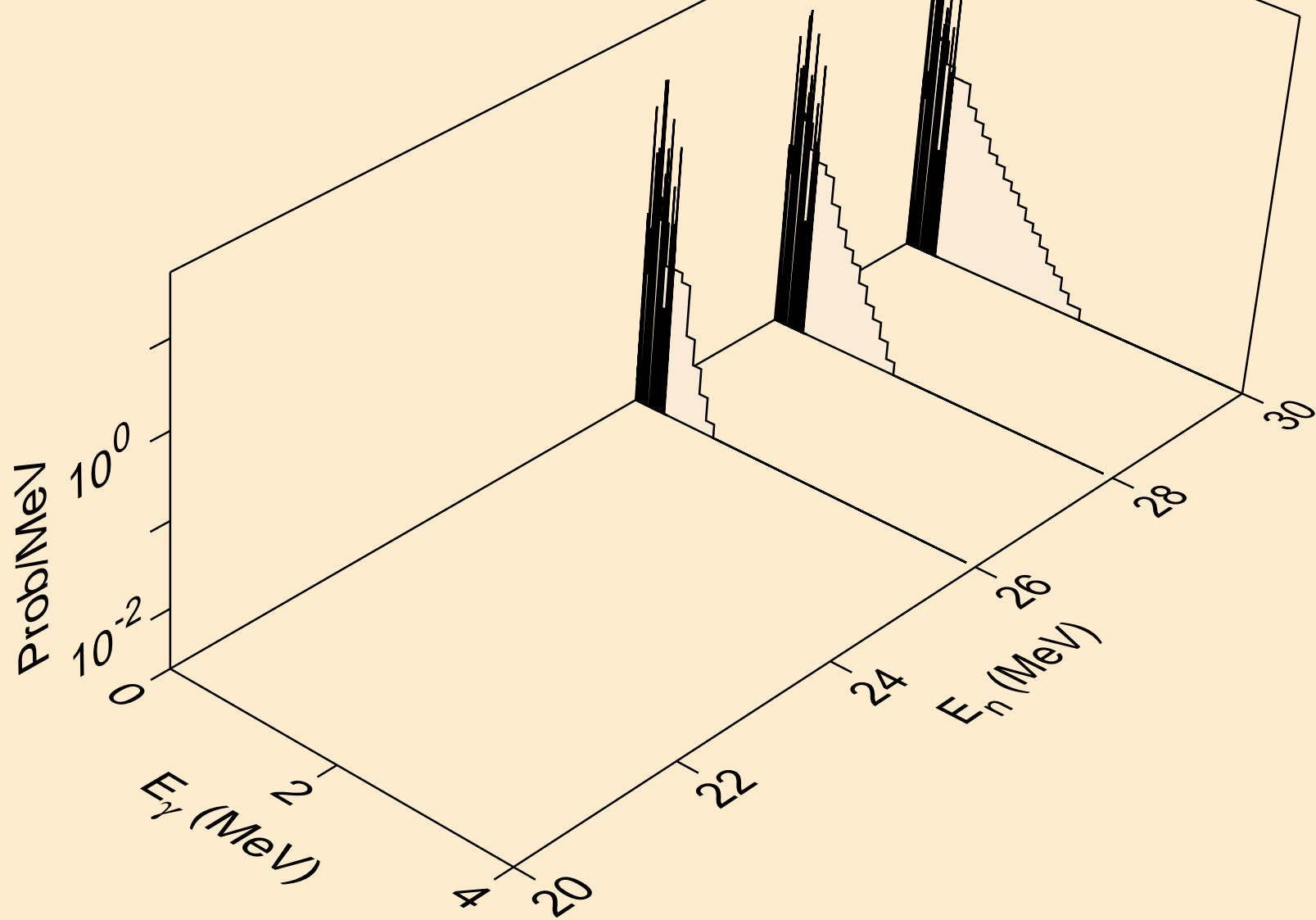

YB172 NEUTRON ACER TENDL-2024 LIBRARY; T=0.K
Photon emission for (n,n2p)

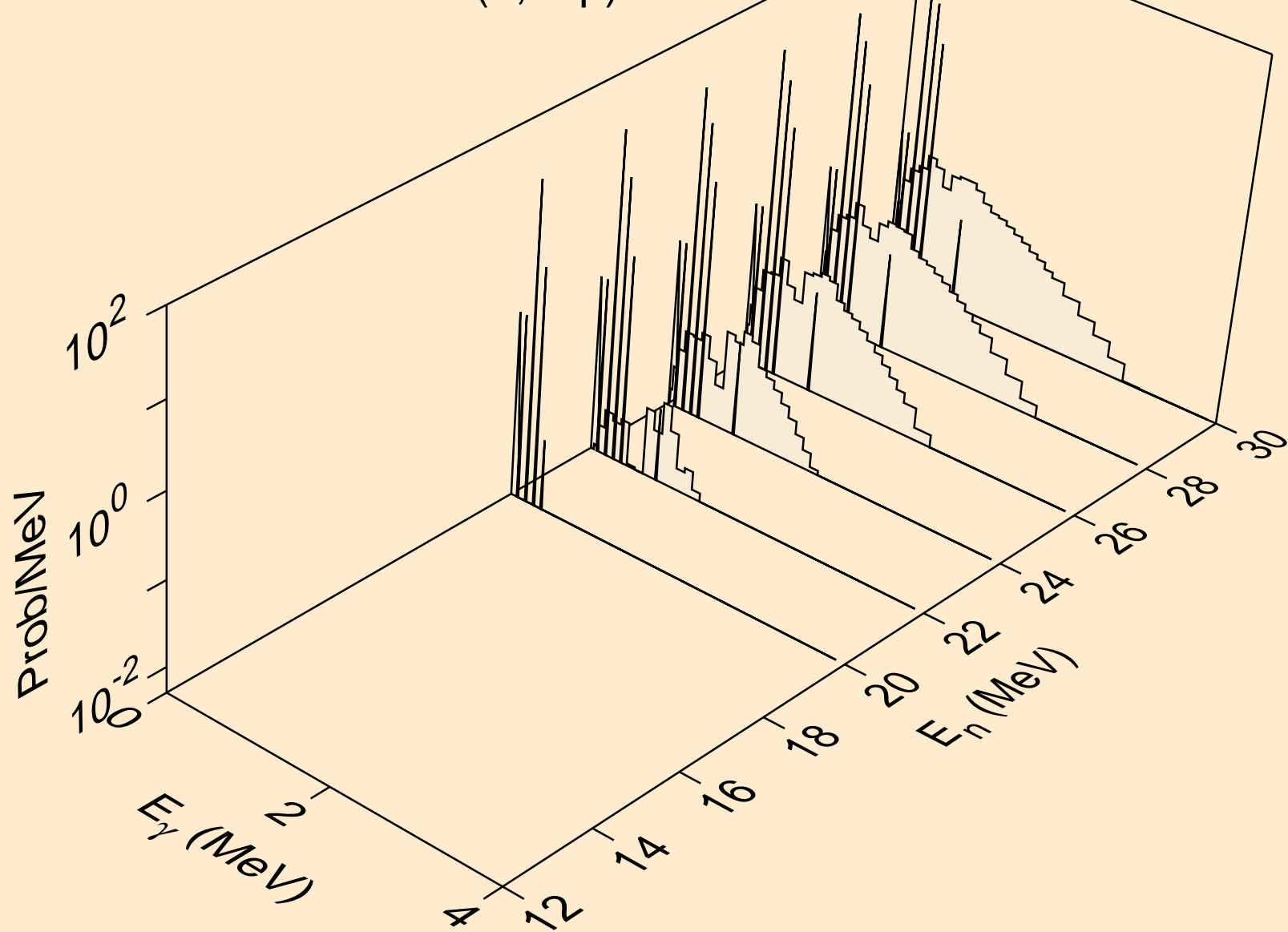

YB172 NEUTRON ACER TENDL-2024 LIBRARY; T=0.K
Photon emission for (n,npa)

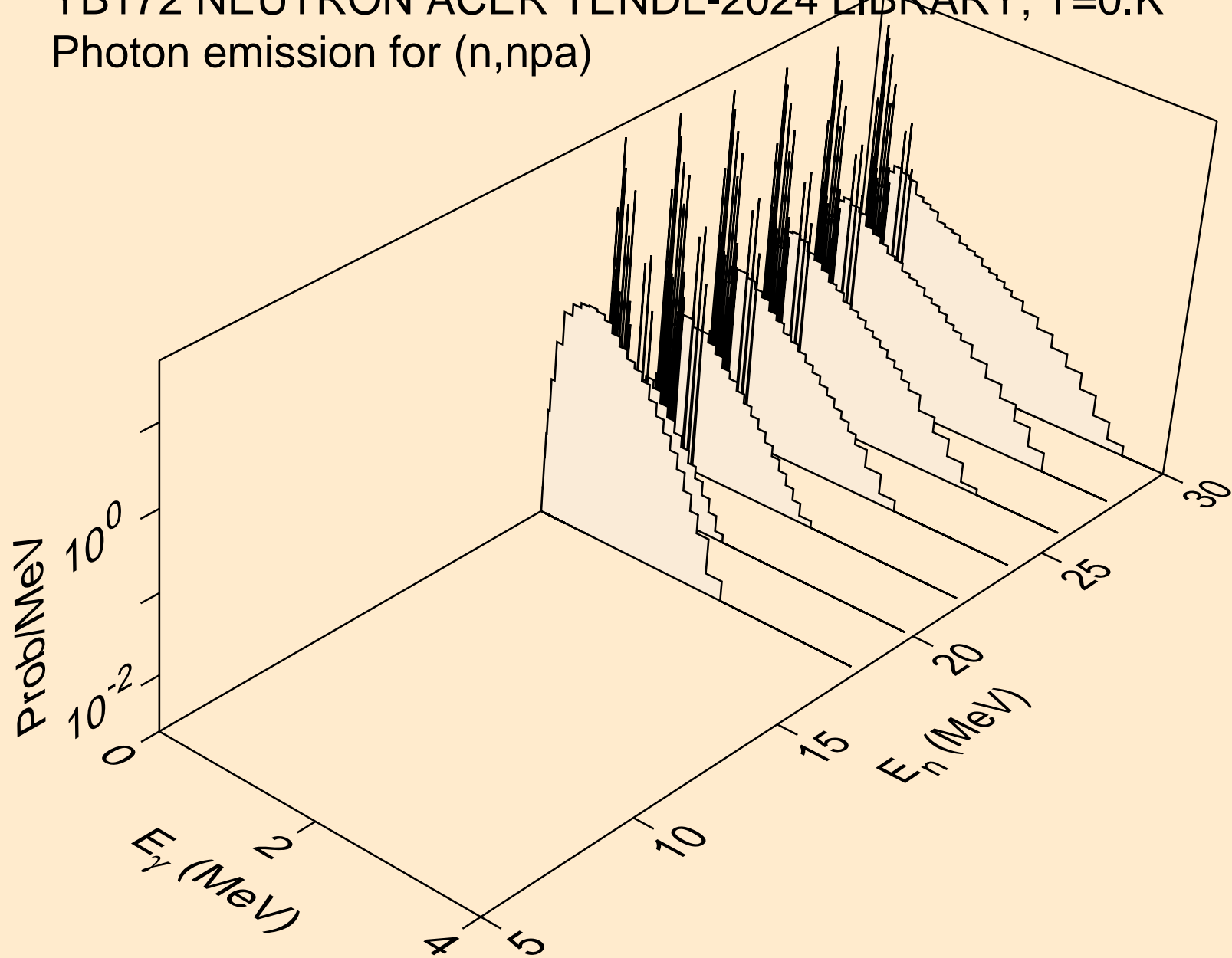

YB172 NEUTRON ACER TENDL-2024 LIBRARY; T=0.K
Photon emission for (n,n*c)

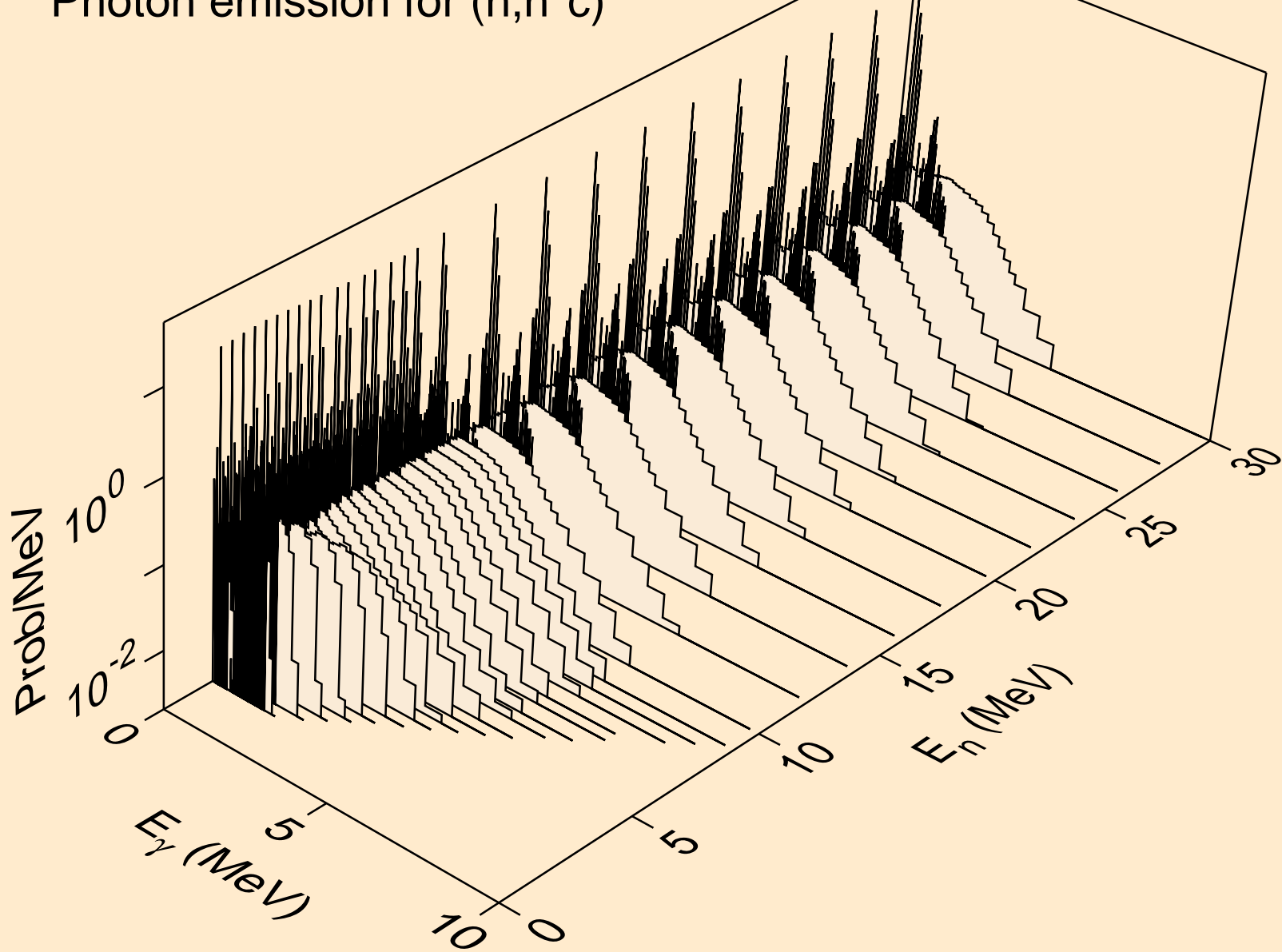

YB172 NEUTRON ACER TENDL-2024 LIBRARY; T=0.K
Photon emission for (n,gma)

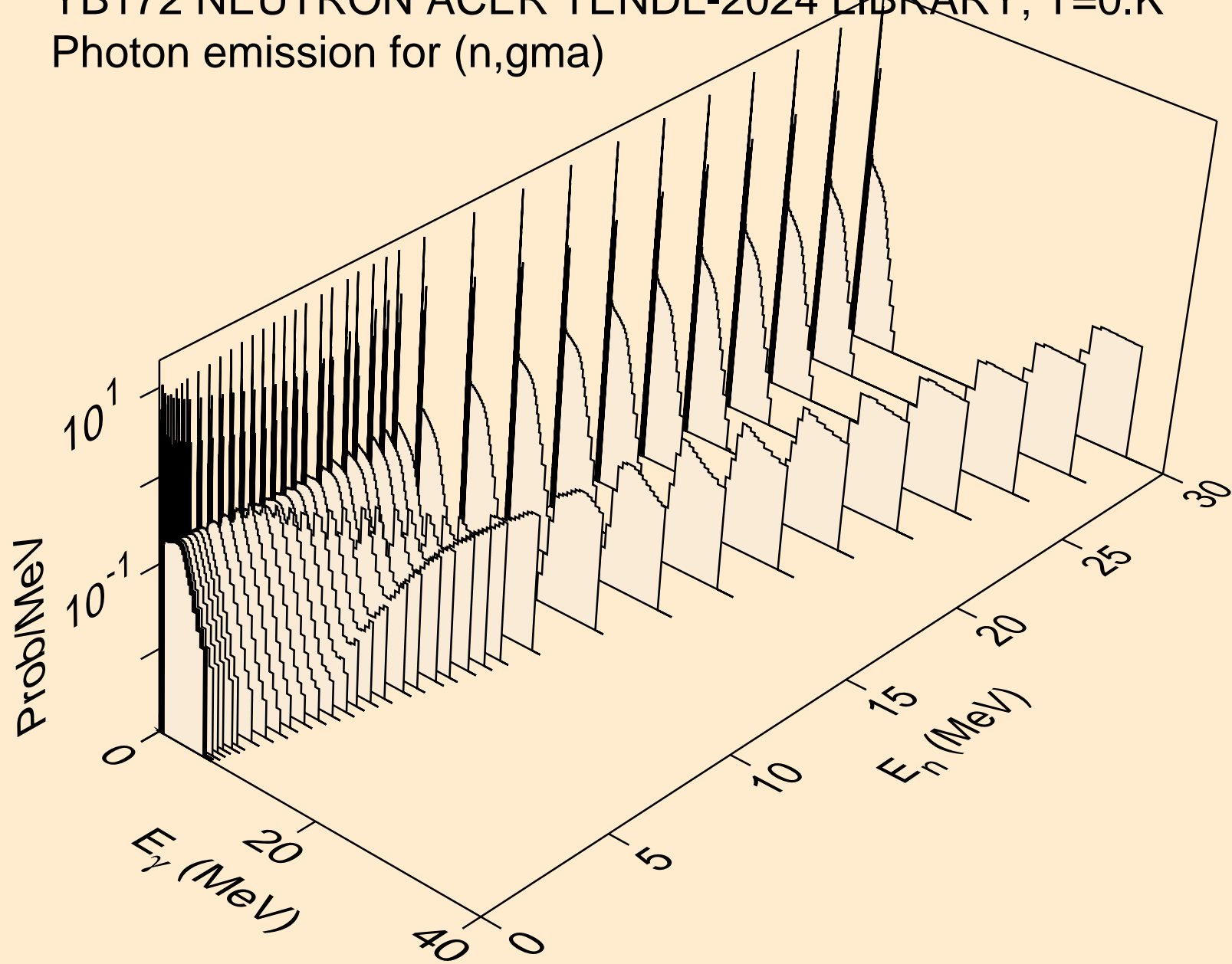

YB172 NEUTRON ACER TENDL-2024 LIBRARY; T=0.K
Photon emission for (n,p)

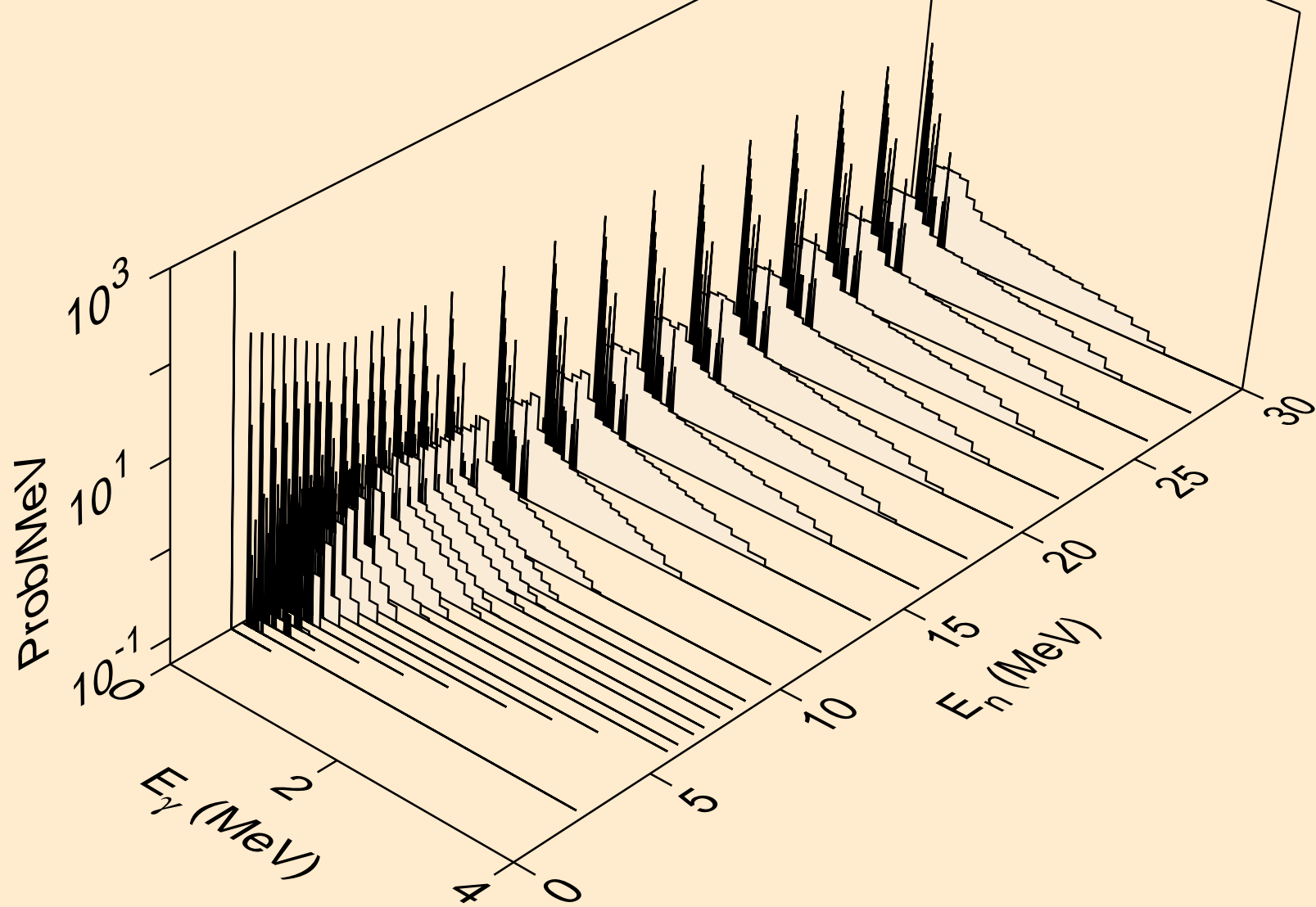

YB172 NEUTRON ACER TENDL-2024 LIBRARY; T=0.K
Photon emission for (n,d)

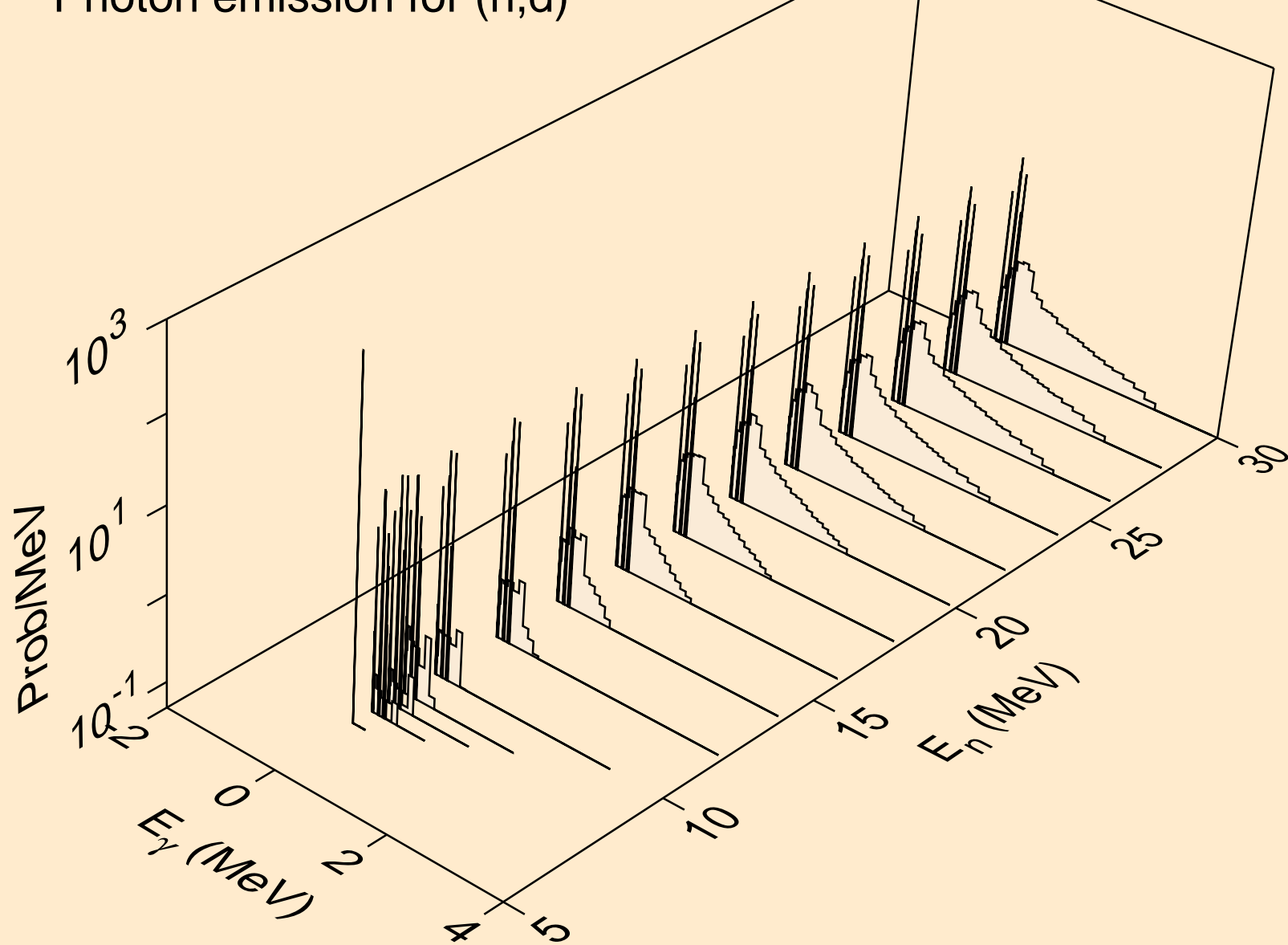

YB172 NEUTRON ACER TENDL-2024 LIBRARY; T=0.K
Photon emission for (n,t)

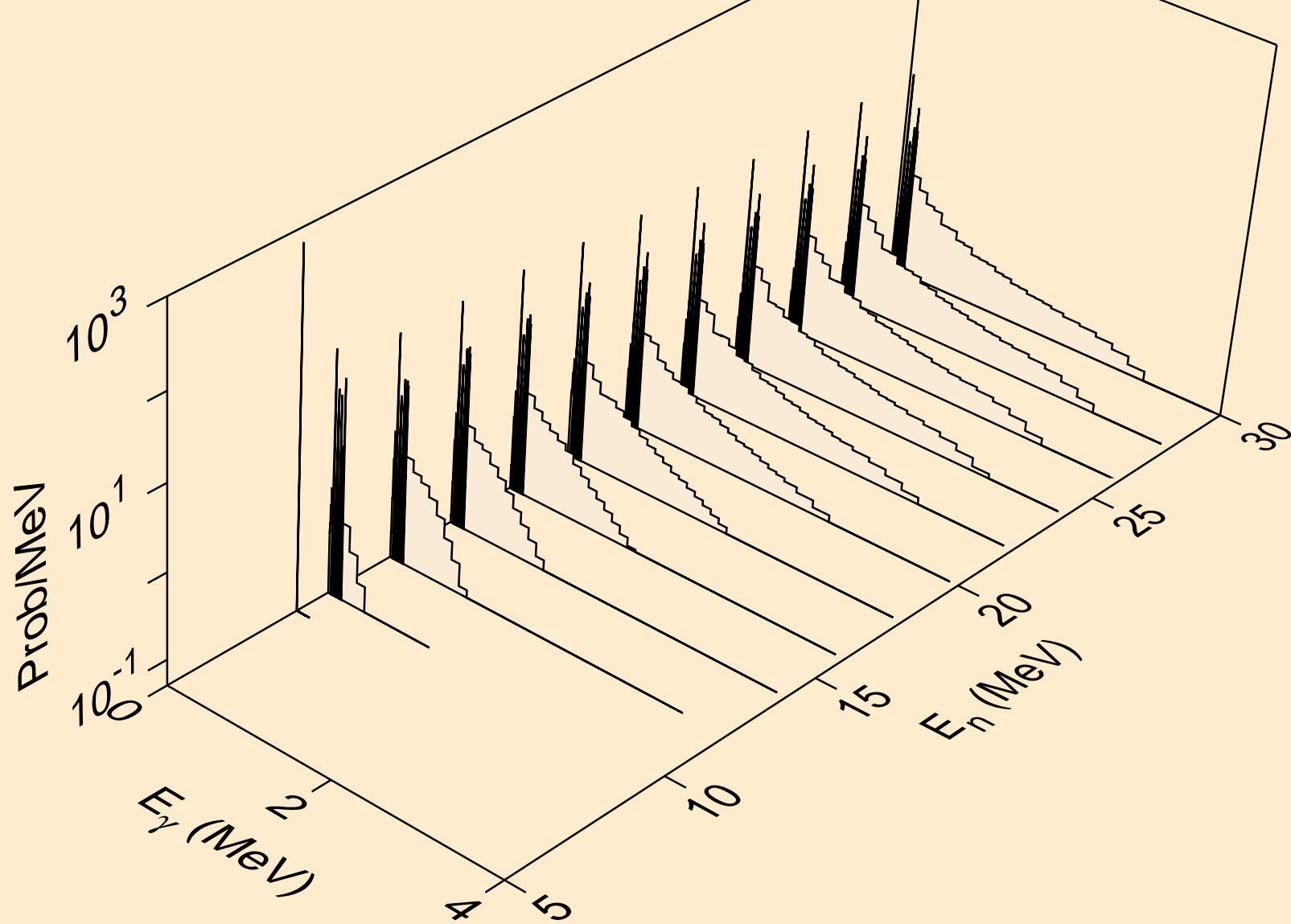

YB172 NEUTRON ACER TENDL-2024 LIBRARY; T=0.K
Photon emission for (n,he3)

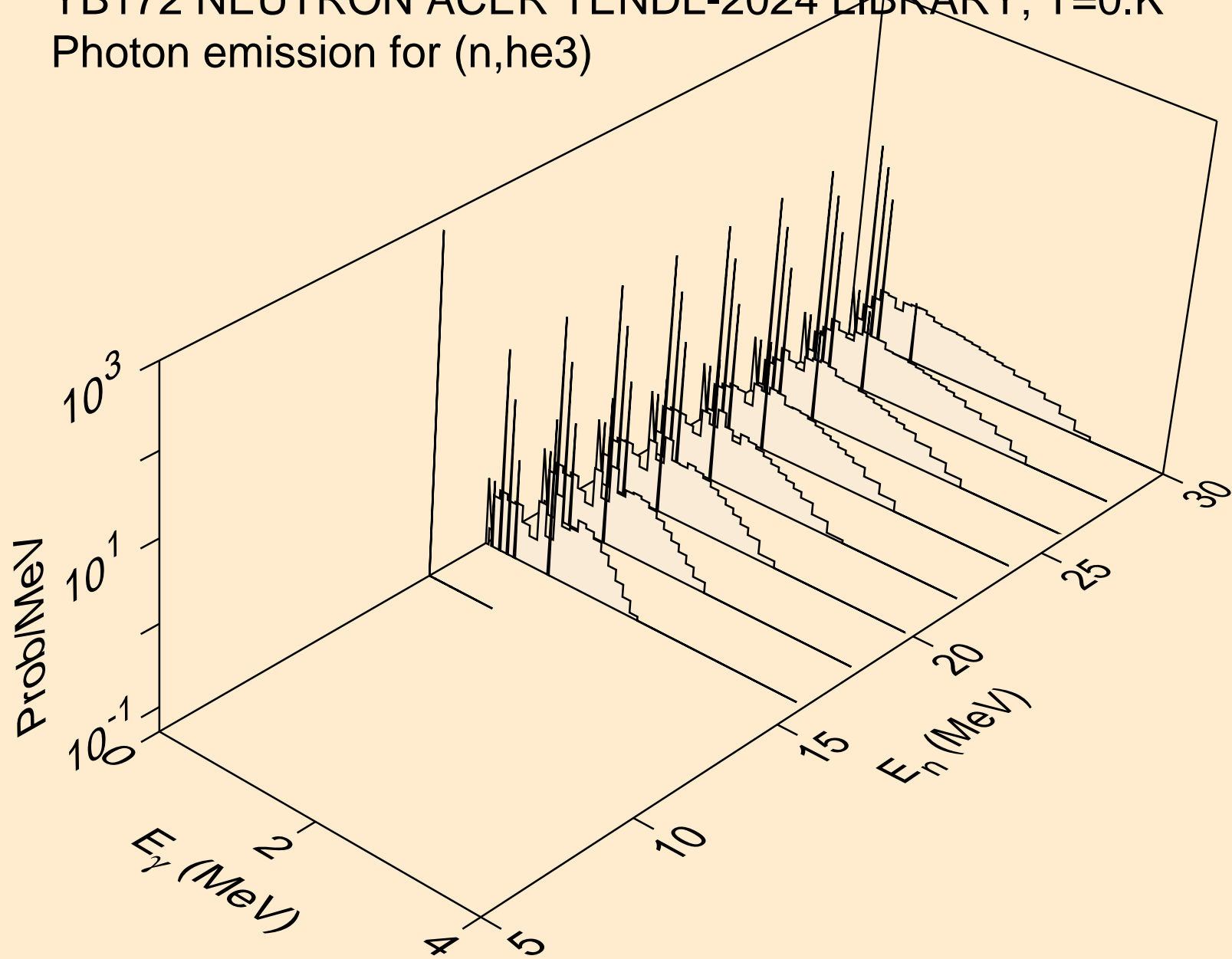

YB172 NEUTRON ACER TENDL-2024 LIBRARY; T=0.K
Photon emission for (n,a)

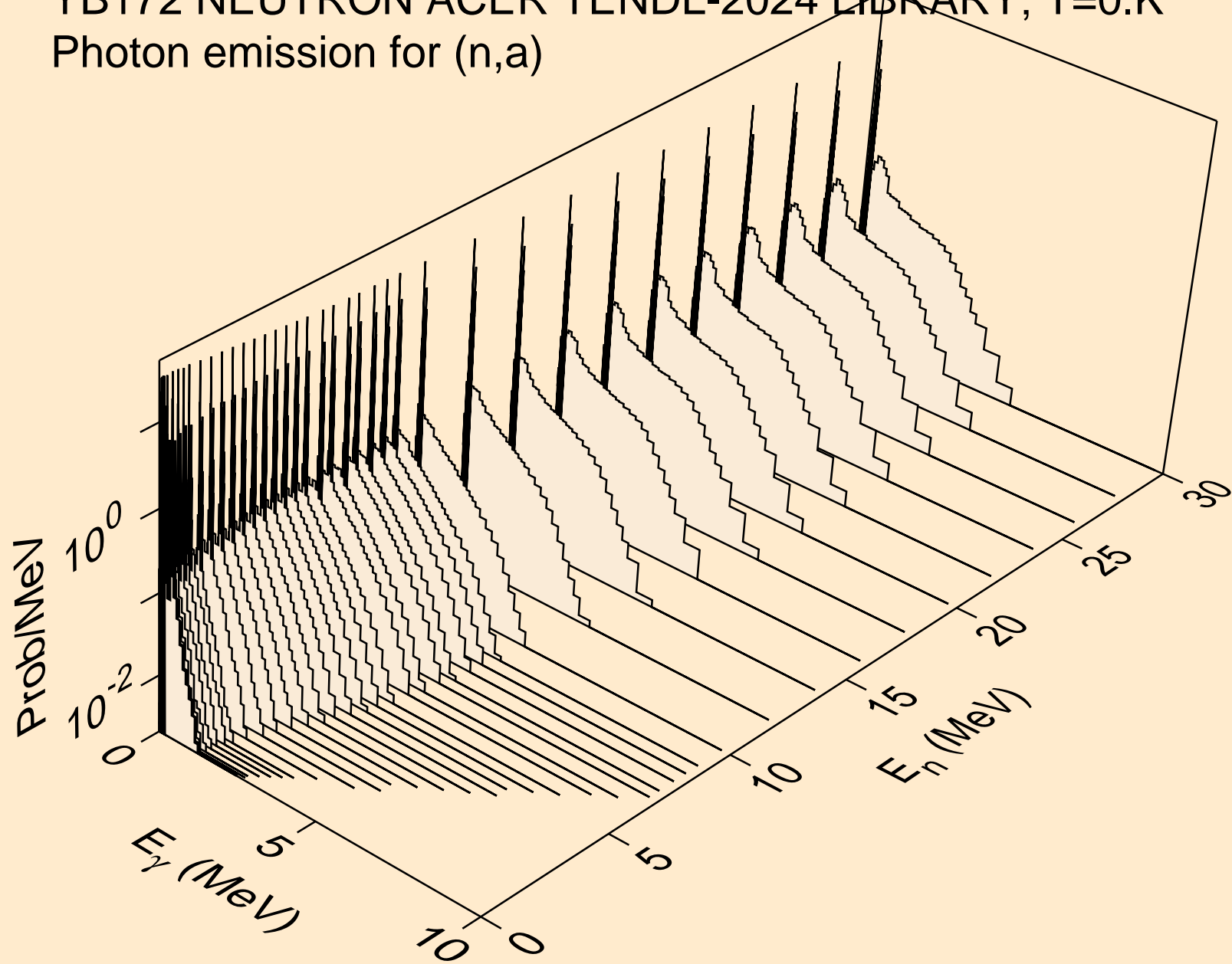

YB172 NEUTRON ACER TENDL-2024 LIBRARY; T=0.K
Photon emission for (n,2a)

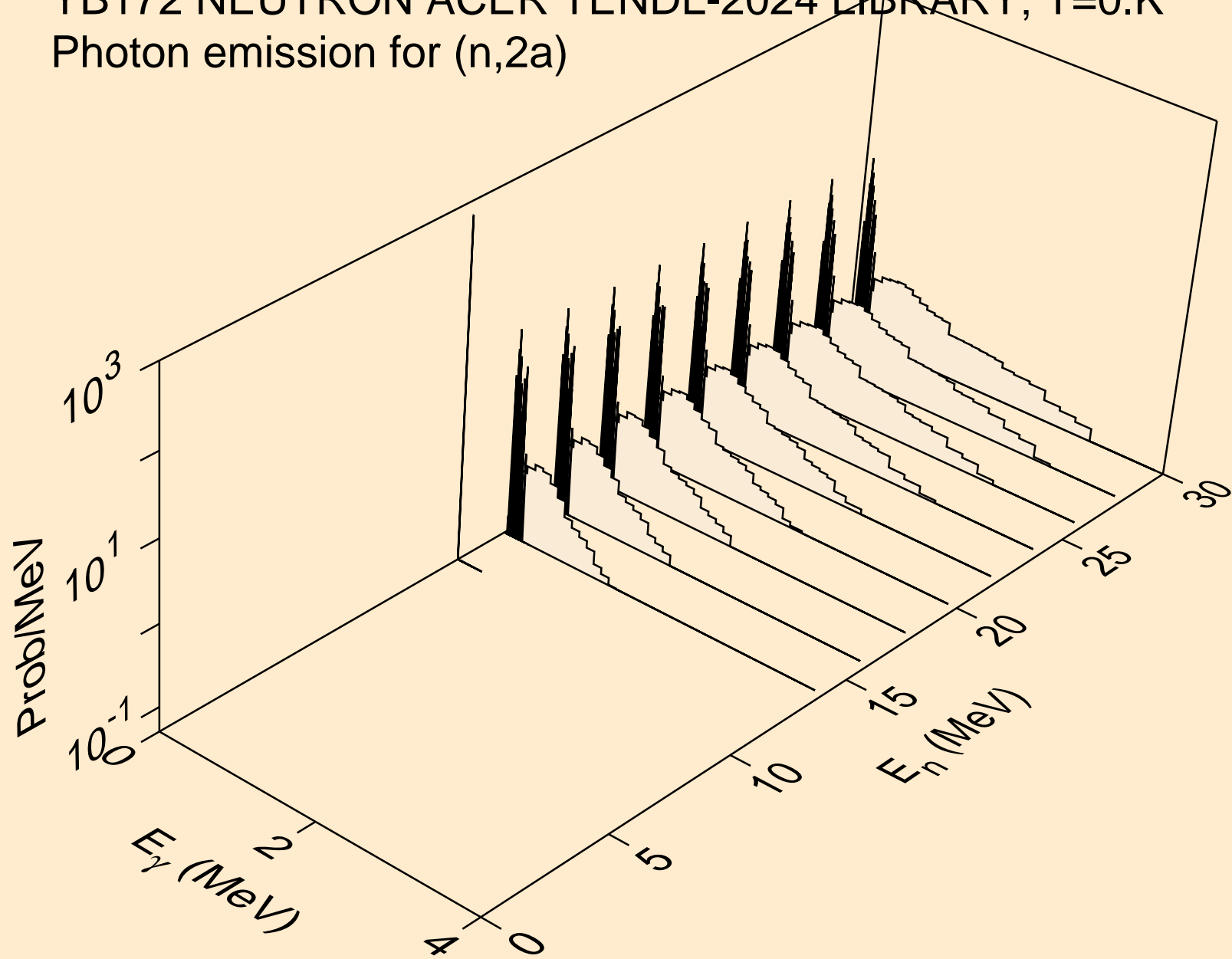

YB172 NEUTRON ACER TENDL-2024 LIBRARY; T=0.K
Photon emission for (n,2p)

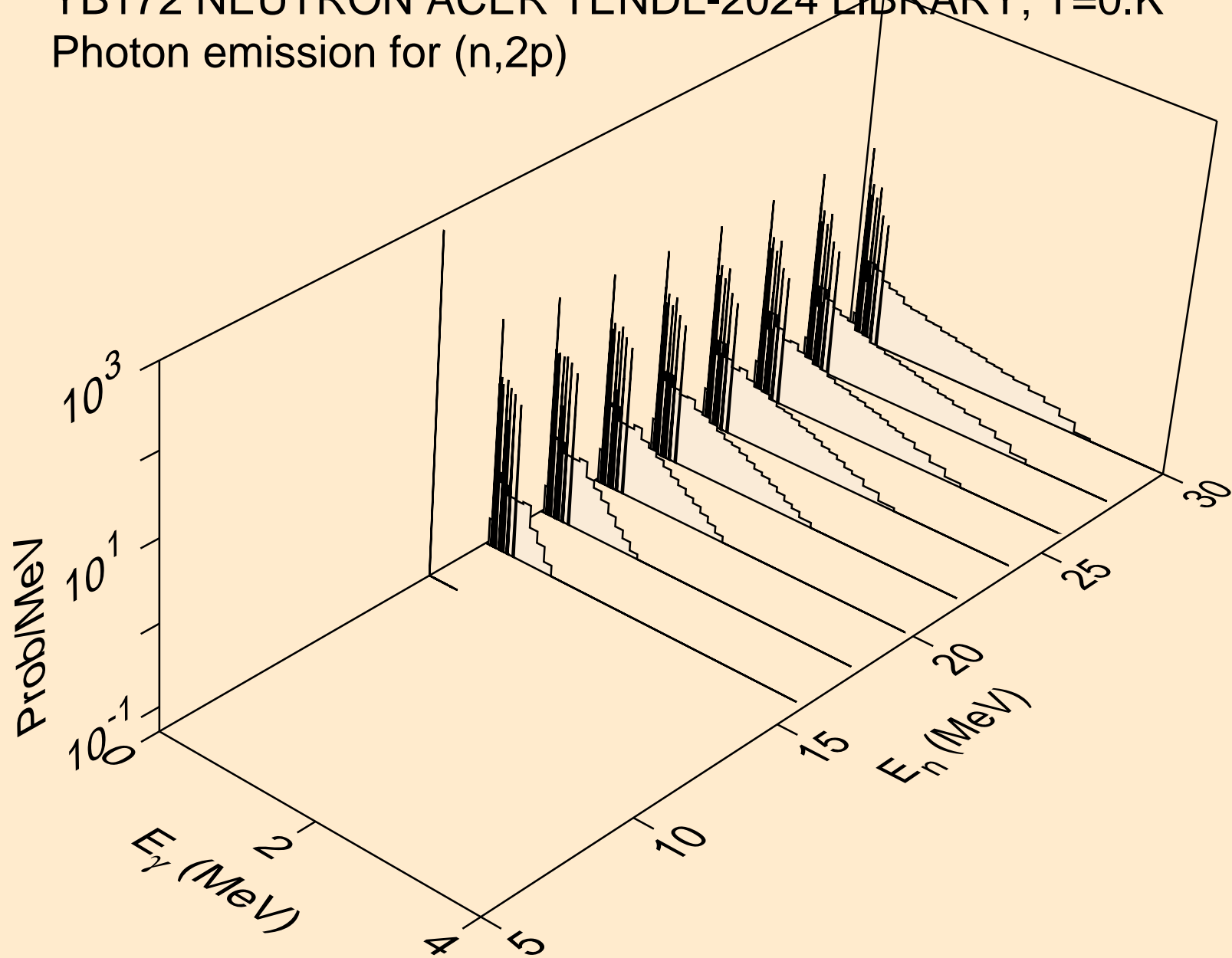

YB172 NEUTRON ACER TENDL-2024 LIBRARY; T=0.K
Photon emission for (n,p)

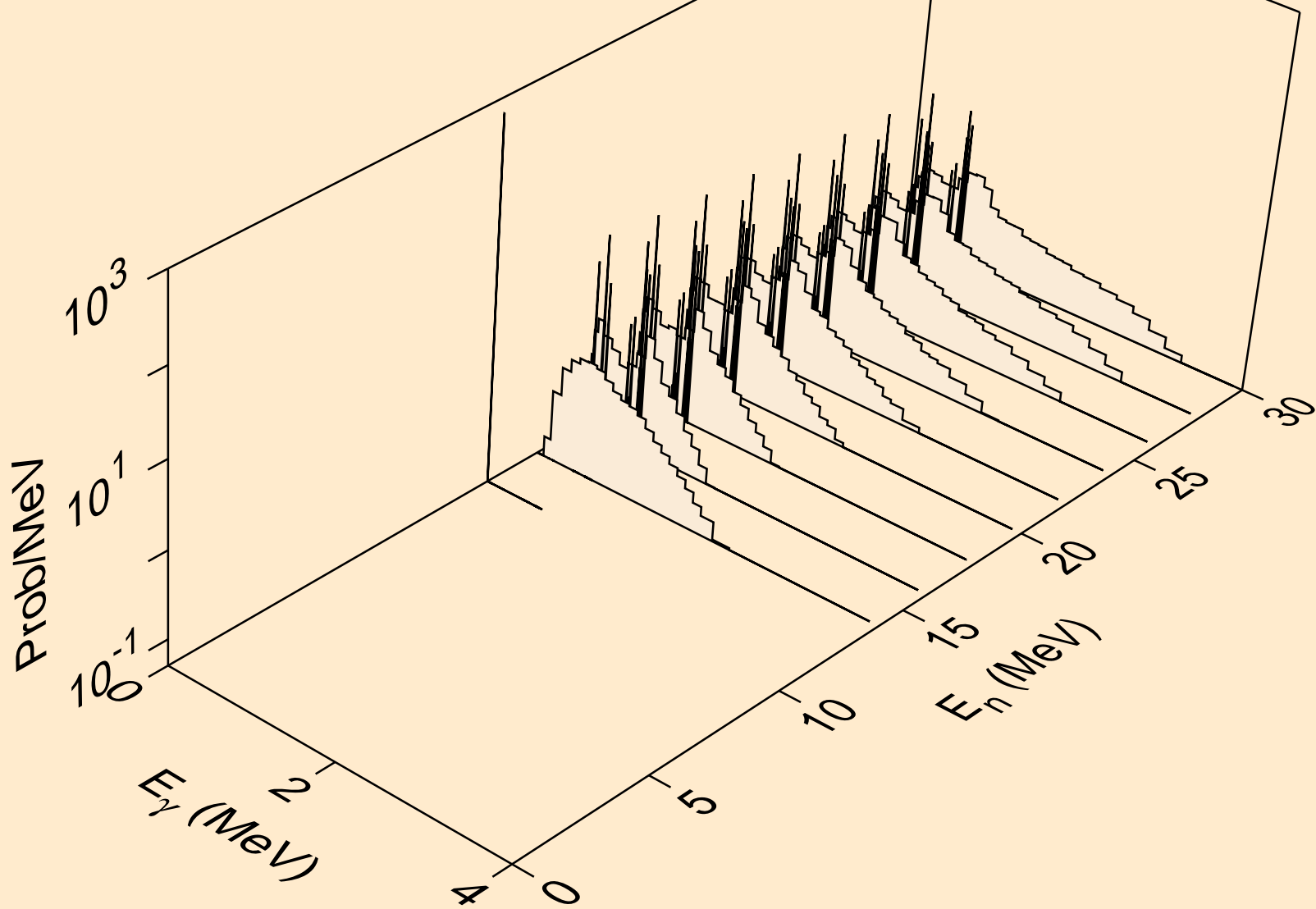

YB172 NEUTRON ACER TENDL-2024 LIBRARY; T=0.K
Photon emission for (n,pd)

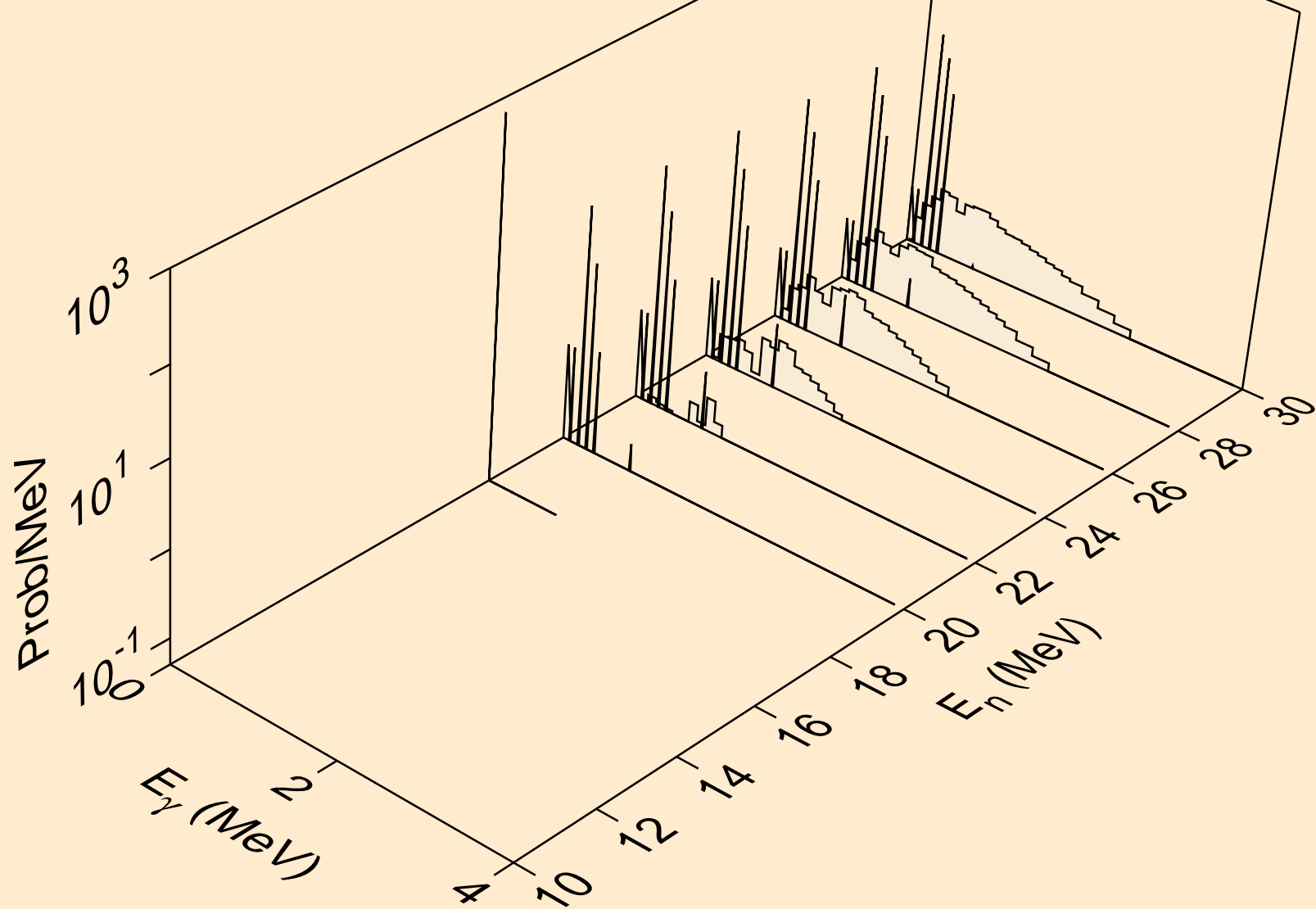

YB172 NEUTRON ACER TENDL-2024 LIBRARY; T=0.K
Photon emission for (n,pt)

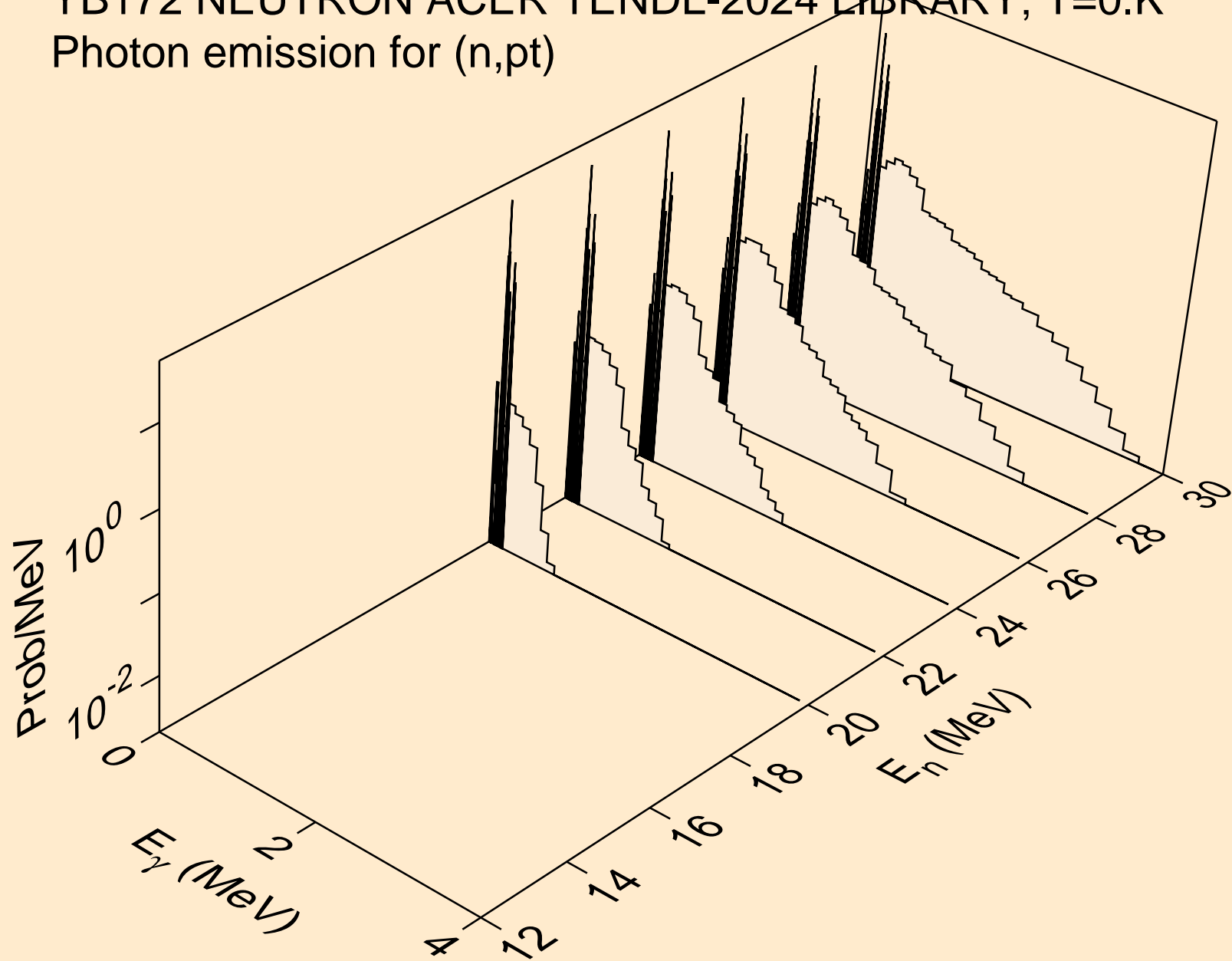

YB172 NEUTRON ACER TENDL-2024 LIBRARY; T=0.K
thermal capture photon spectrum

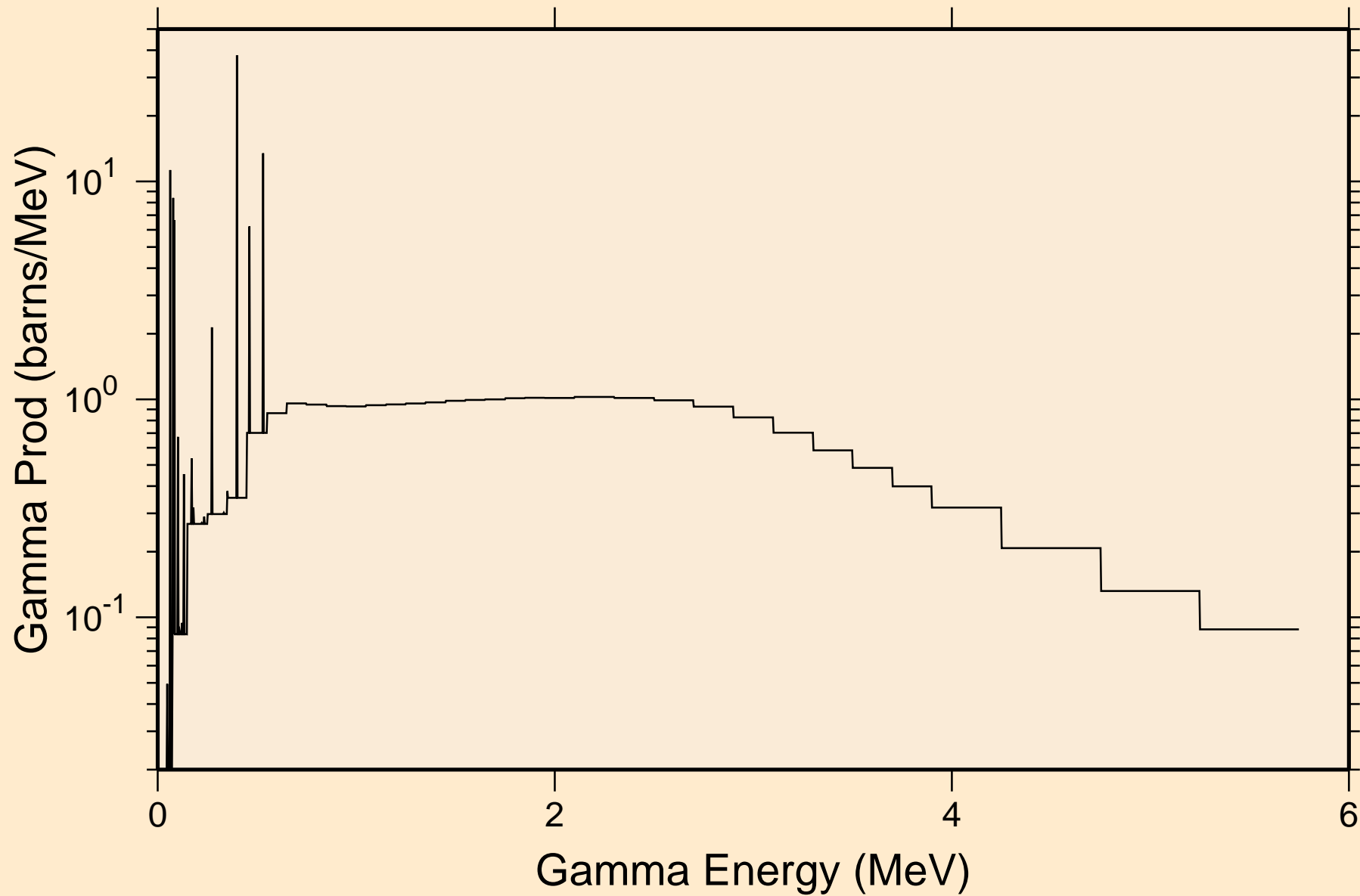

YB172 NEUTRON ACER TENDL-2024 LIBRARY; T=0.K
14 MeV photon spectrum

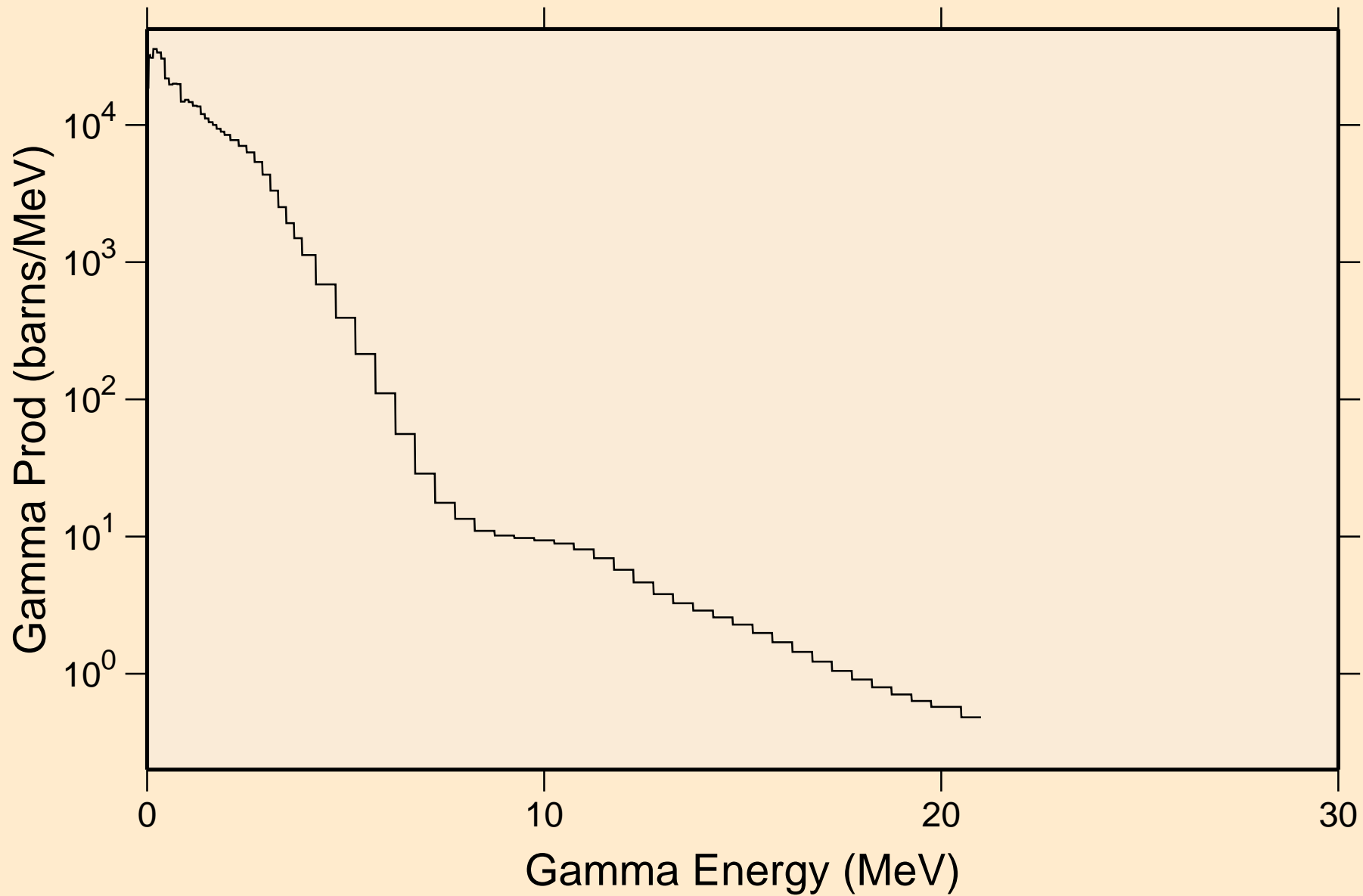

YB172 NEUTRON ACER TENDL-2024 LIBRARY; T=0.K

Particle heating contributions

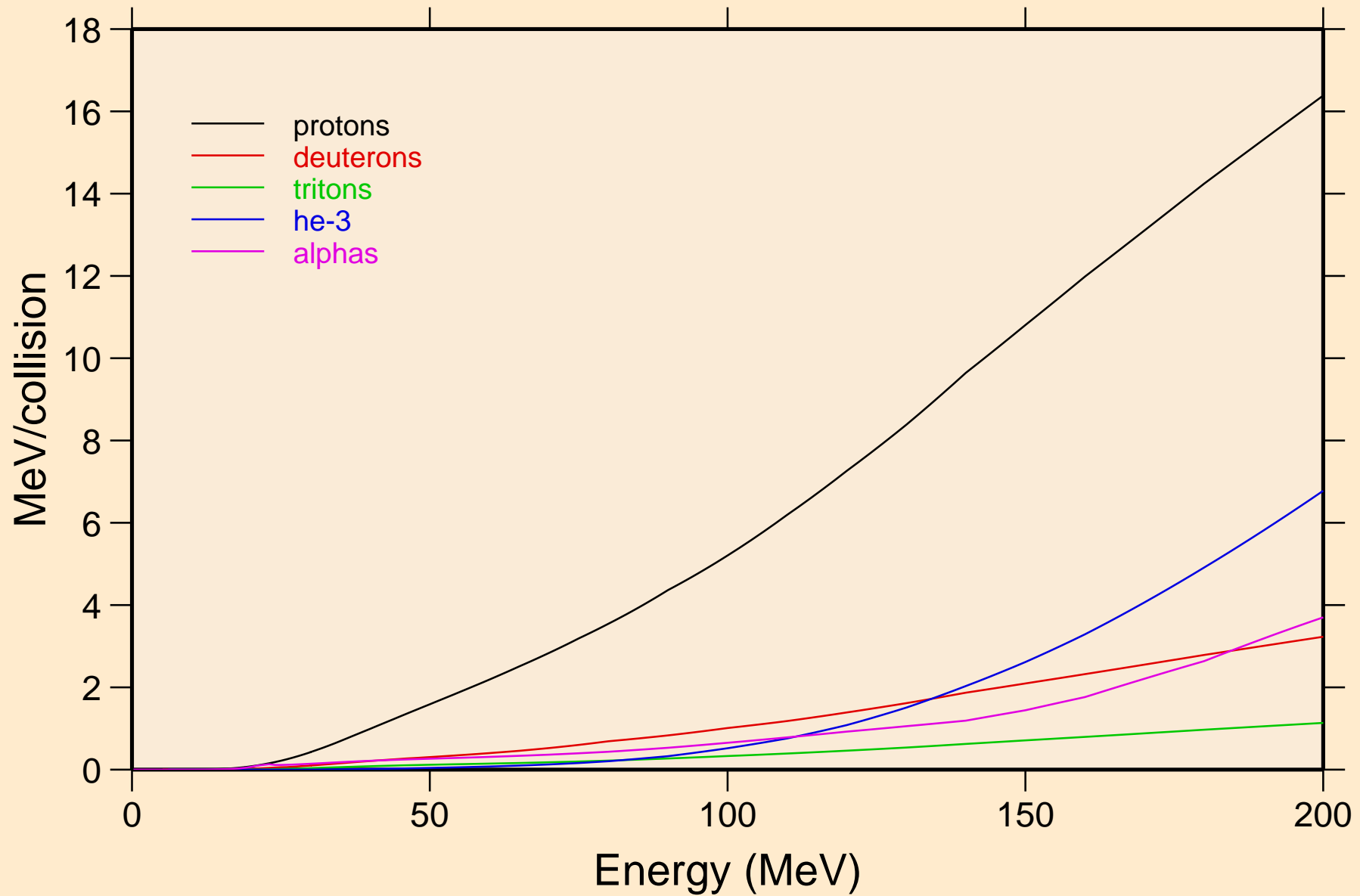

YB172 NEUTRON ACER TENDL-2024 LIBRARY; T=0.K
Recoil Heating

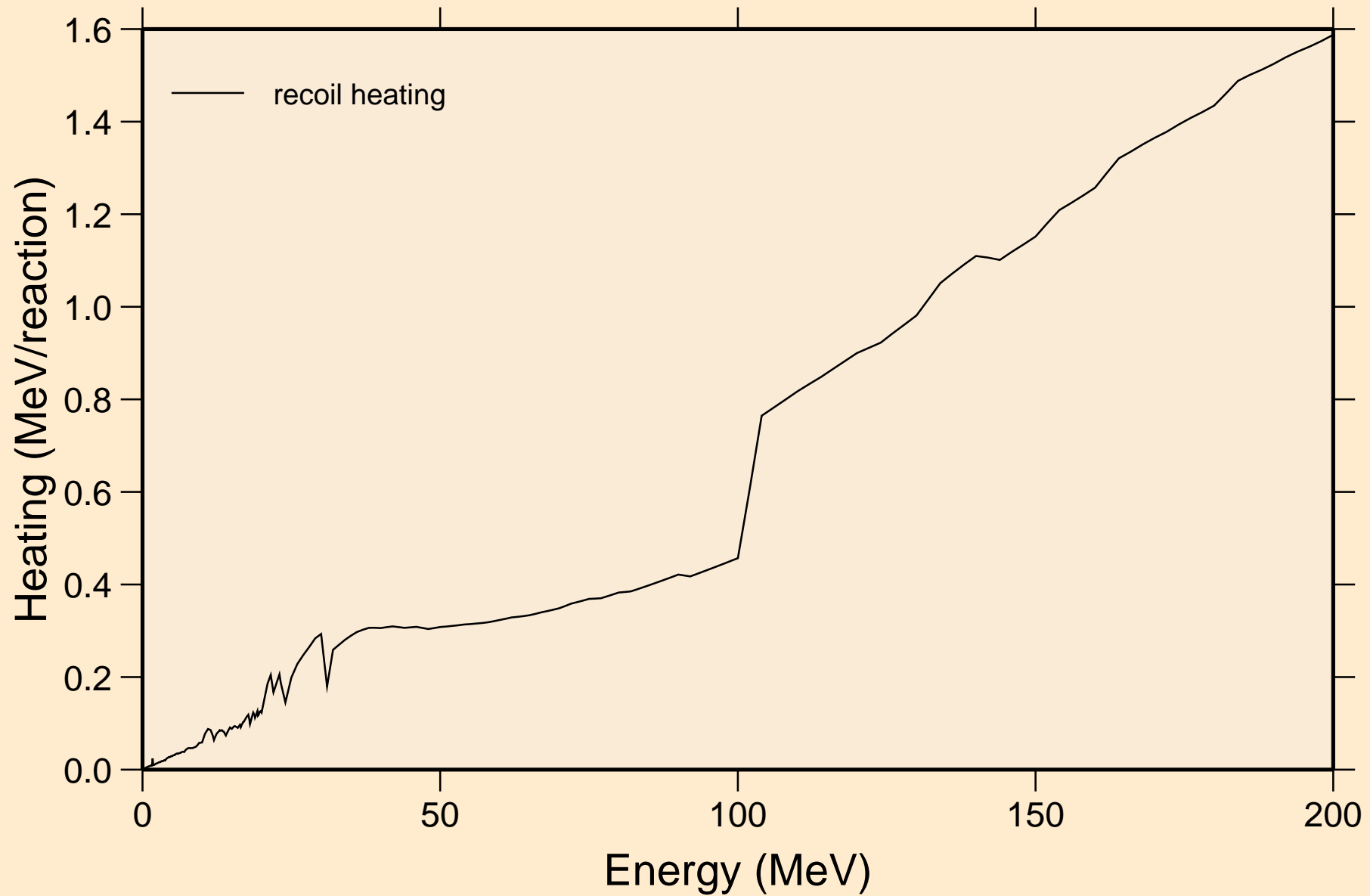

YB172 NEUTRON ACER TENDL-2024 LIBRARY; T=0.K
Particle production cross sections

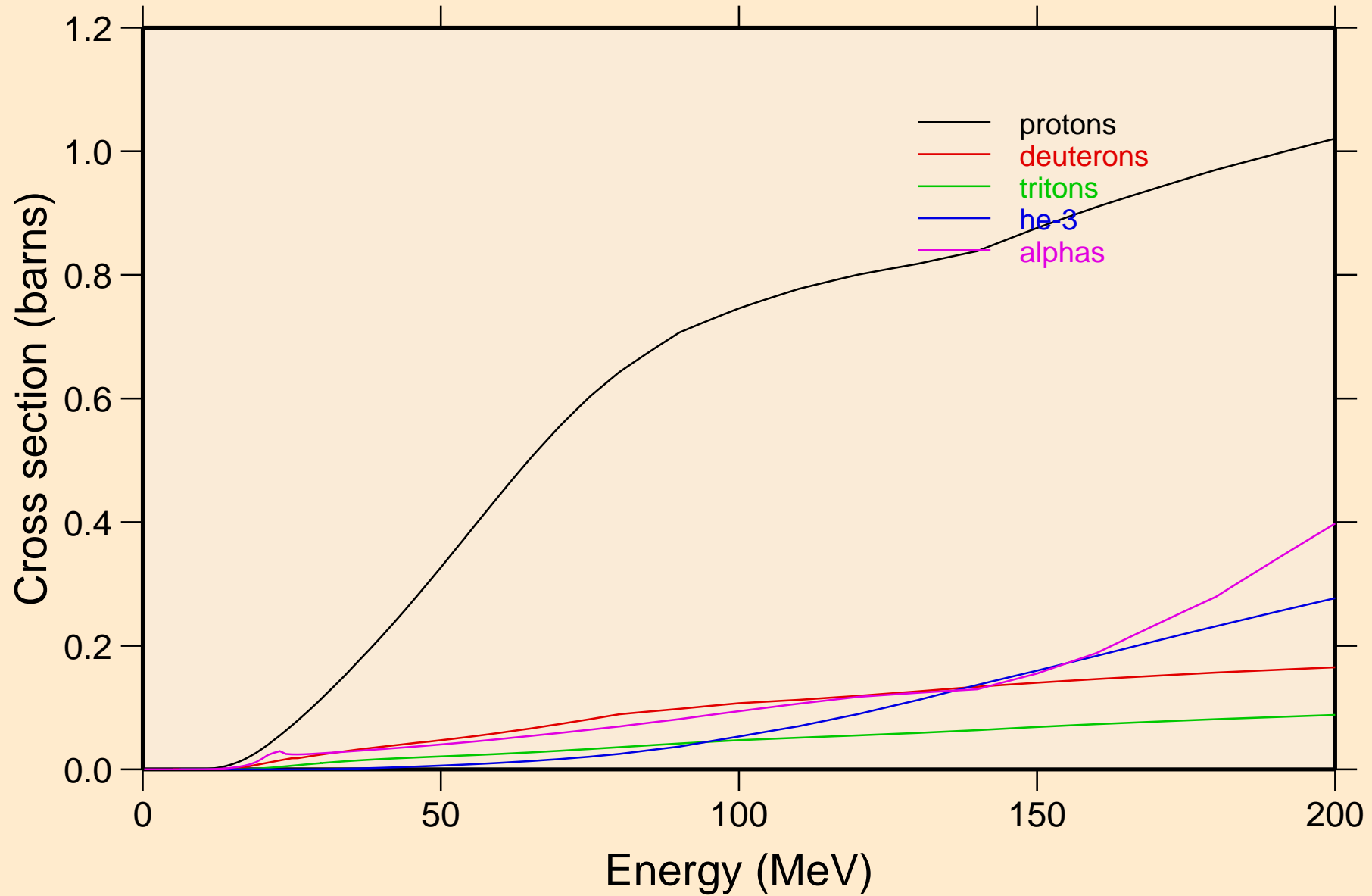

YB172 NEUTRON ACER TENDL-2024 LIBRARY; T=0.K
protons from (n,x)

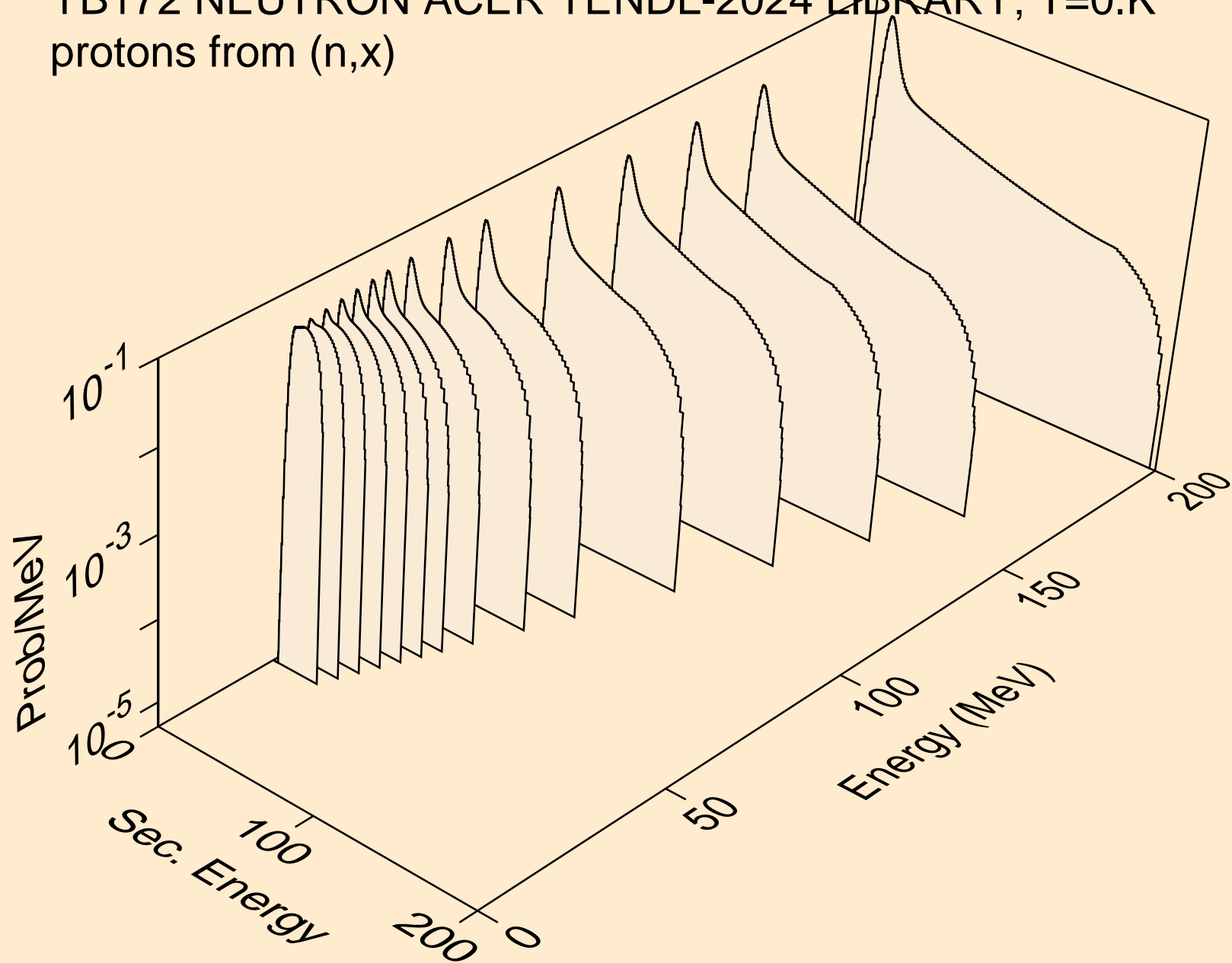

YB172 NEUTRON ACER TENDL-2024 LIBRARY; T=0.K
protons from (n,n*)p

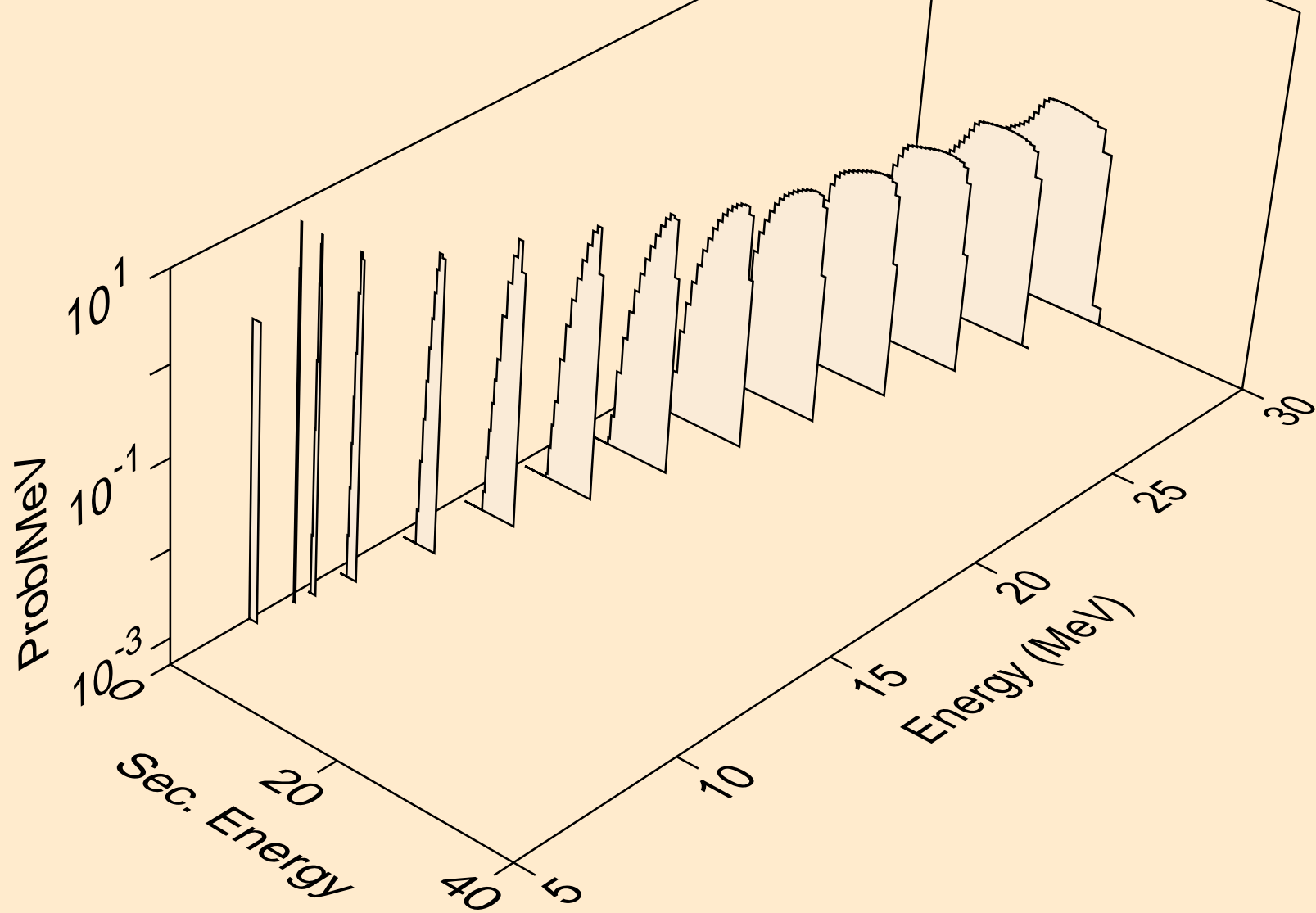

YB172 NEUTRON ACER TENDL-2024 LIBRARY; T=0.K
protons from (n,2np)

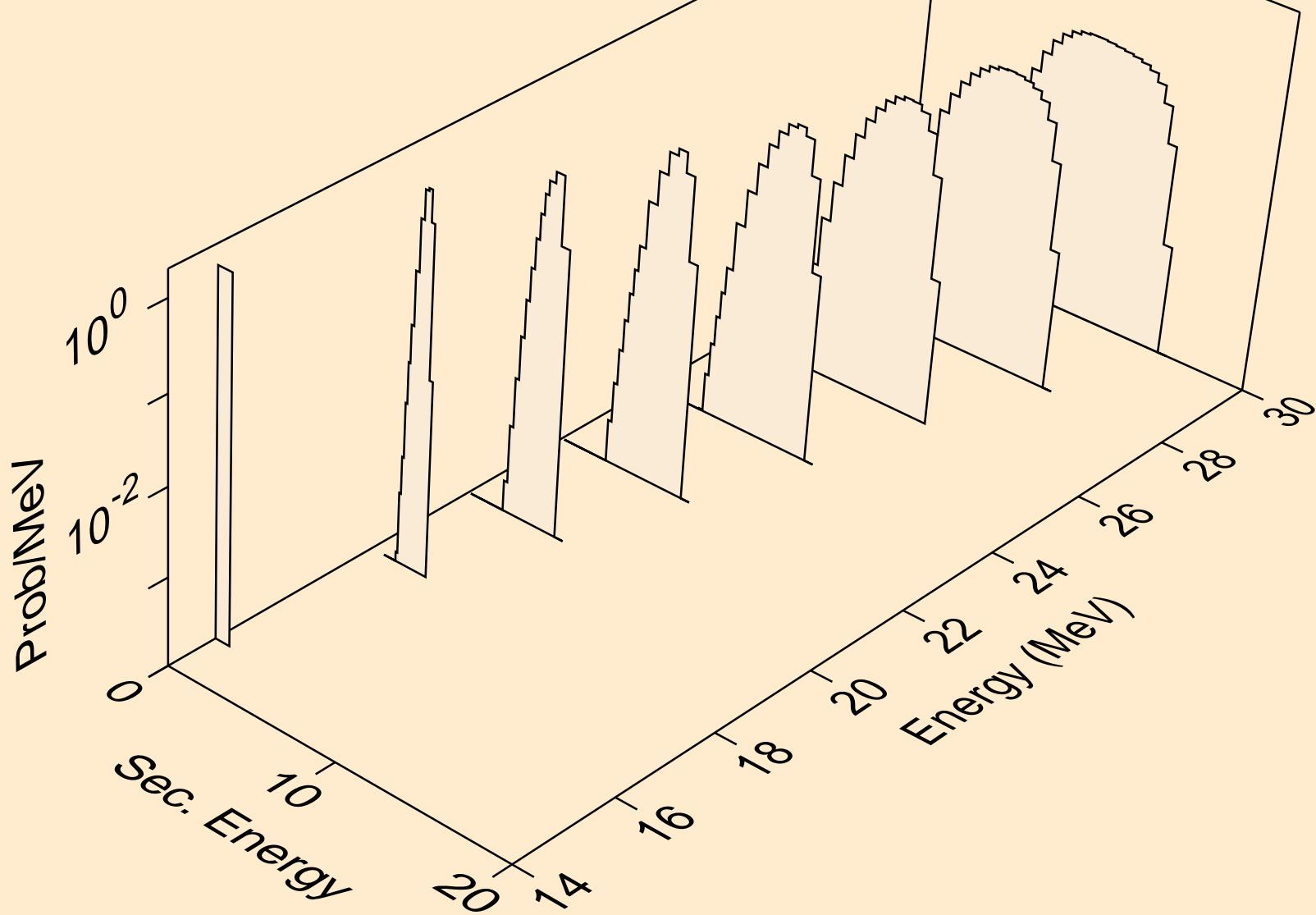

YB172 NEUTRON ACER TENDL-2024 LIBRARY; T=0.K
protons from (n,3np)

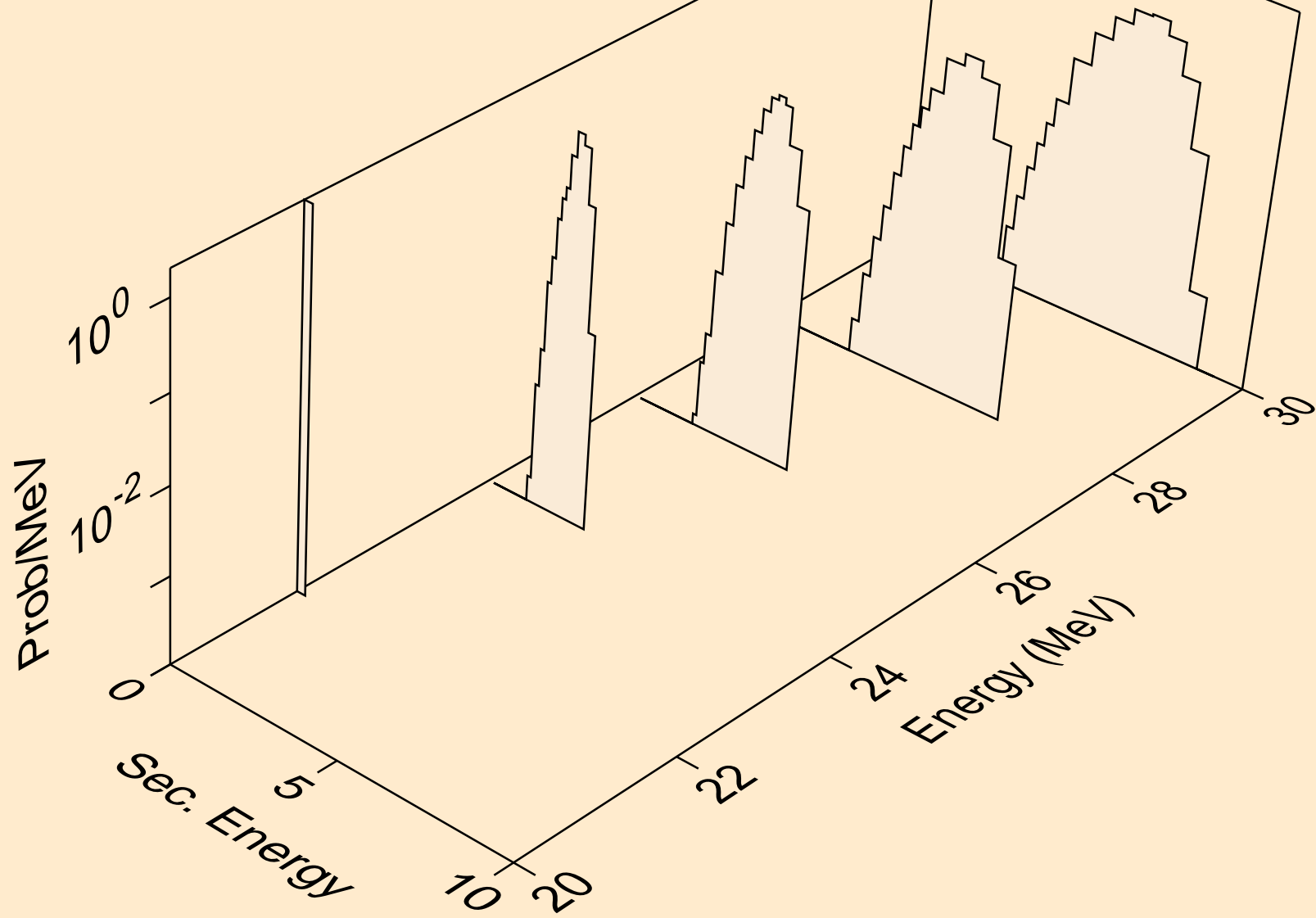

YB172 NEUTRON ACER TENDL-2024 LIBRARY; T=0.K
protons from (n,n2p)

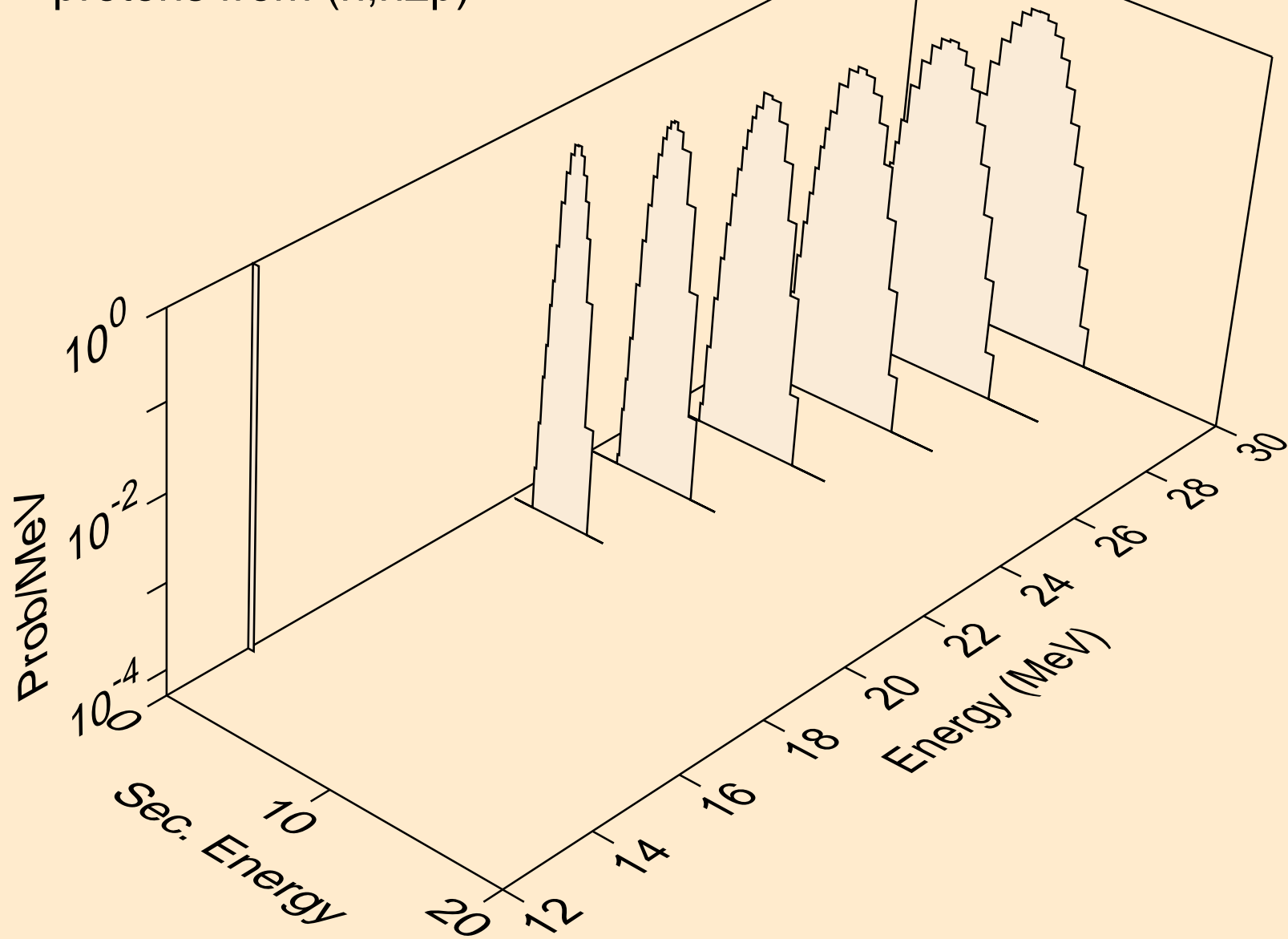

YB172 NEUTRON ACER TENDL-2024 LIBRARY; T=0.K
protons from (n,npa)

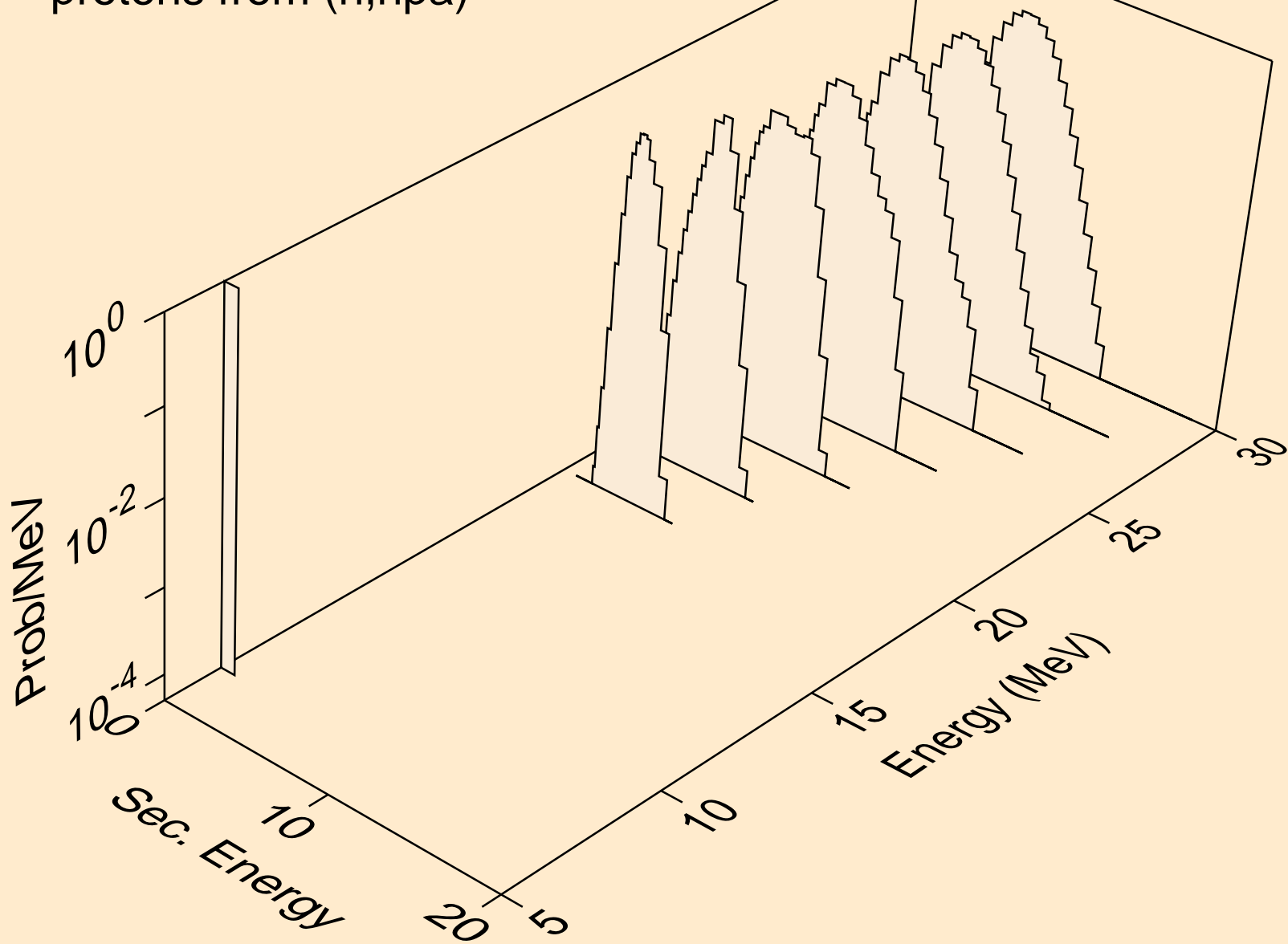

YB172 NEUTRON ACER TENDL-2024 LIBRARY; T=0.K
protons from (n,p)

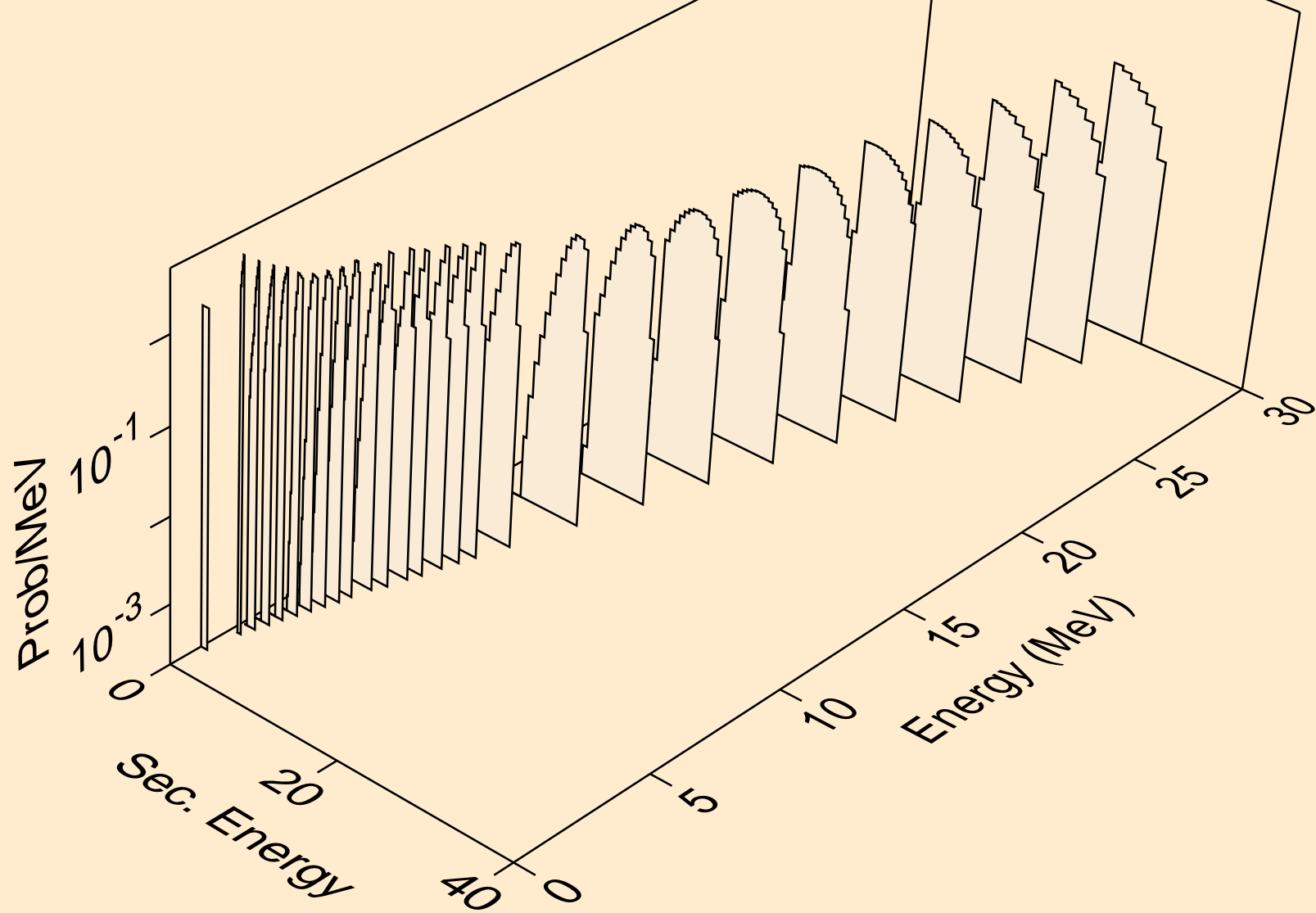

YB172 NEUTRON ACER TENDL-2024 LIBRARY; T=0.K
protons from (n,2p)

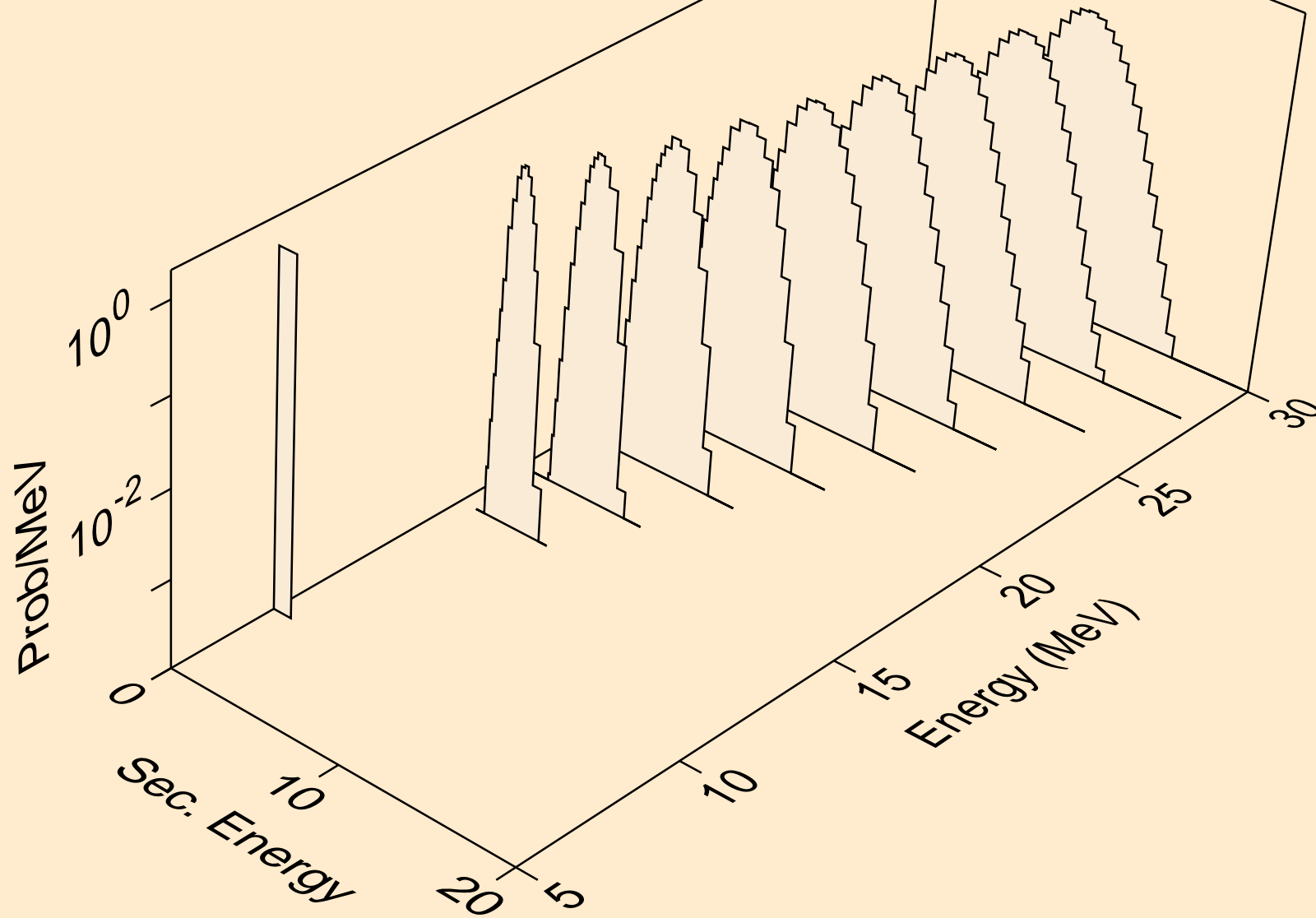

YB172 NEUTRON ACER TENDL-2024 LIBRARY; T=0.K
protons from (n,pa)

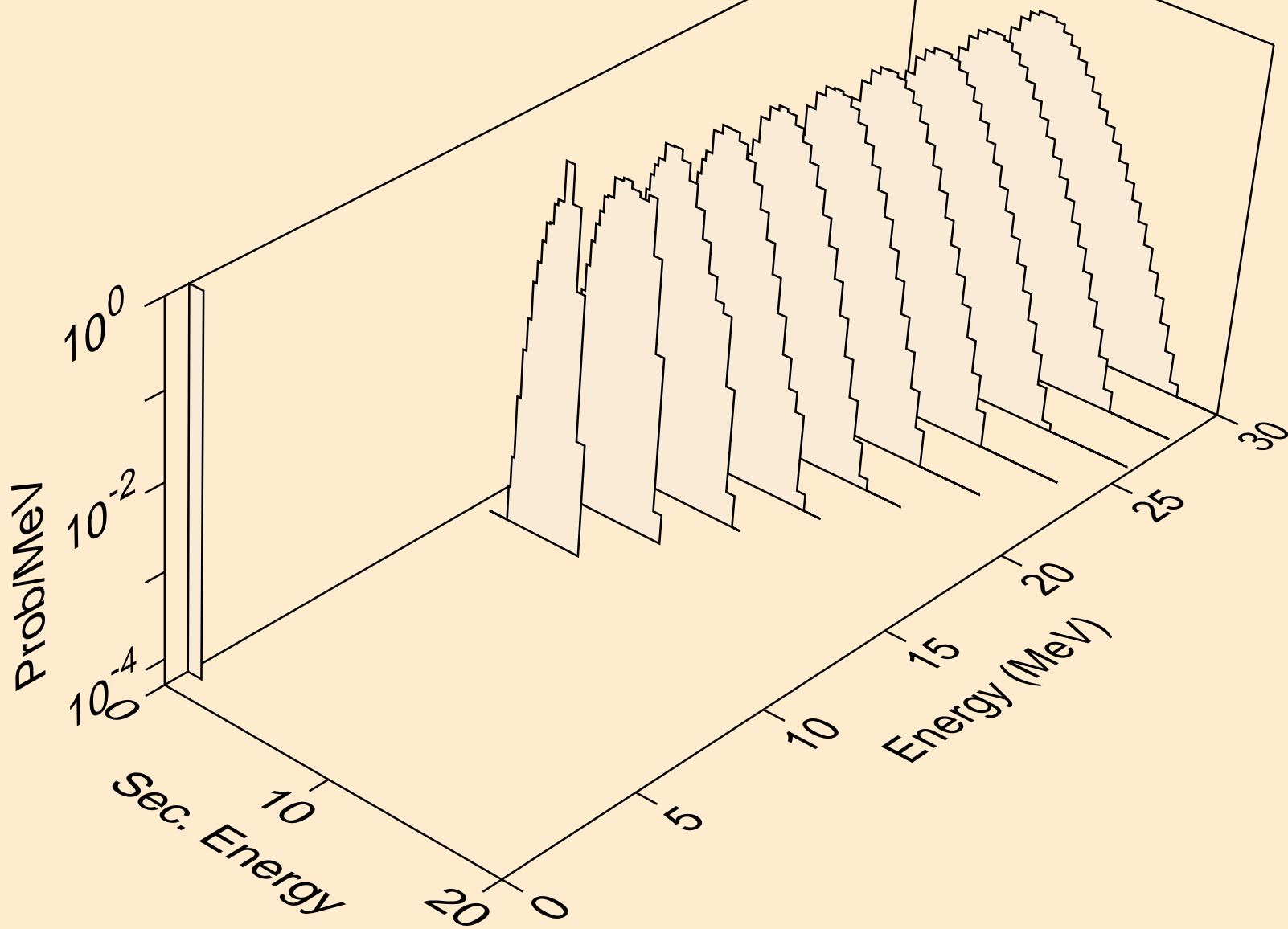

YB172 NEUTRON ACER TENDL-2024 LIBRARY; T=0.K
protons from (n,pd)

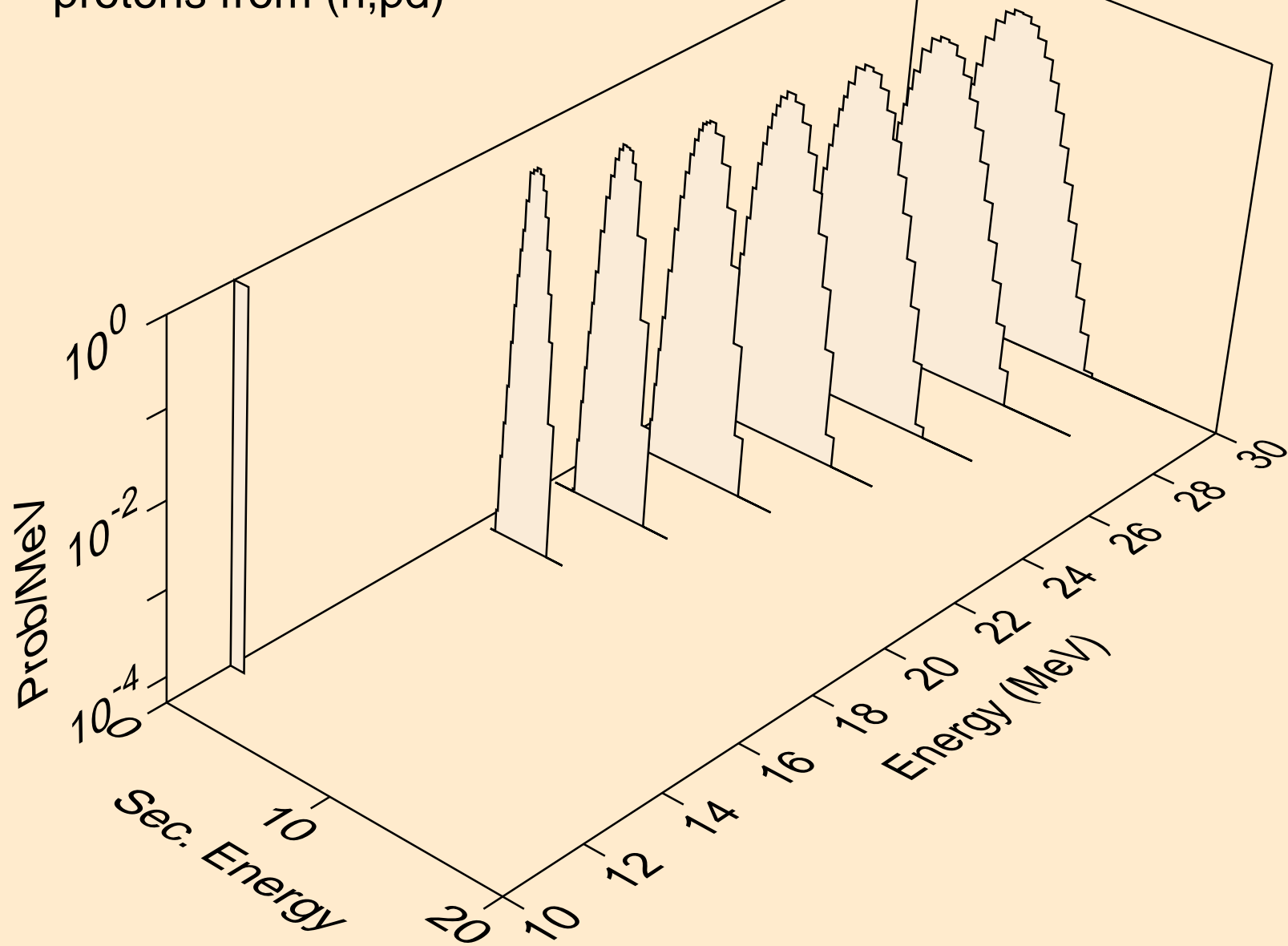

YB172 NEUTRON ACER TENDL-2024 LIBRARY; T=0.K
protons from (n,pt)

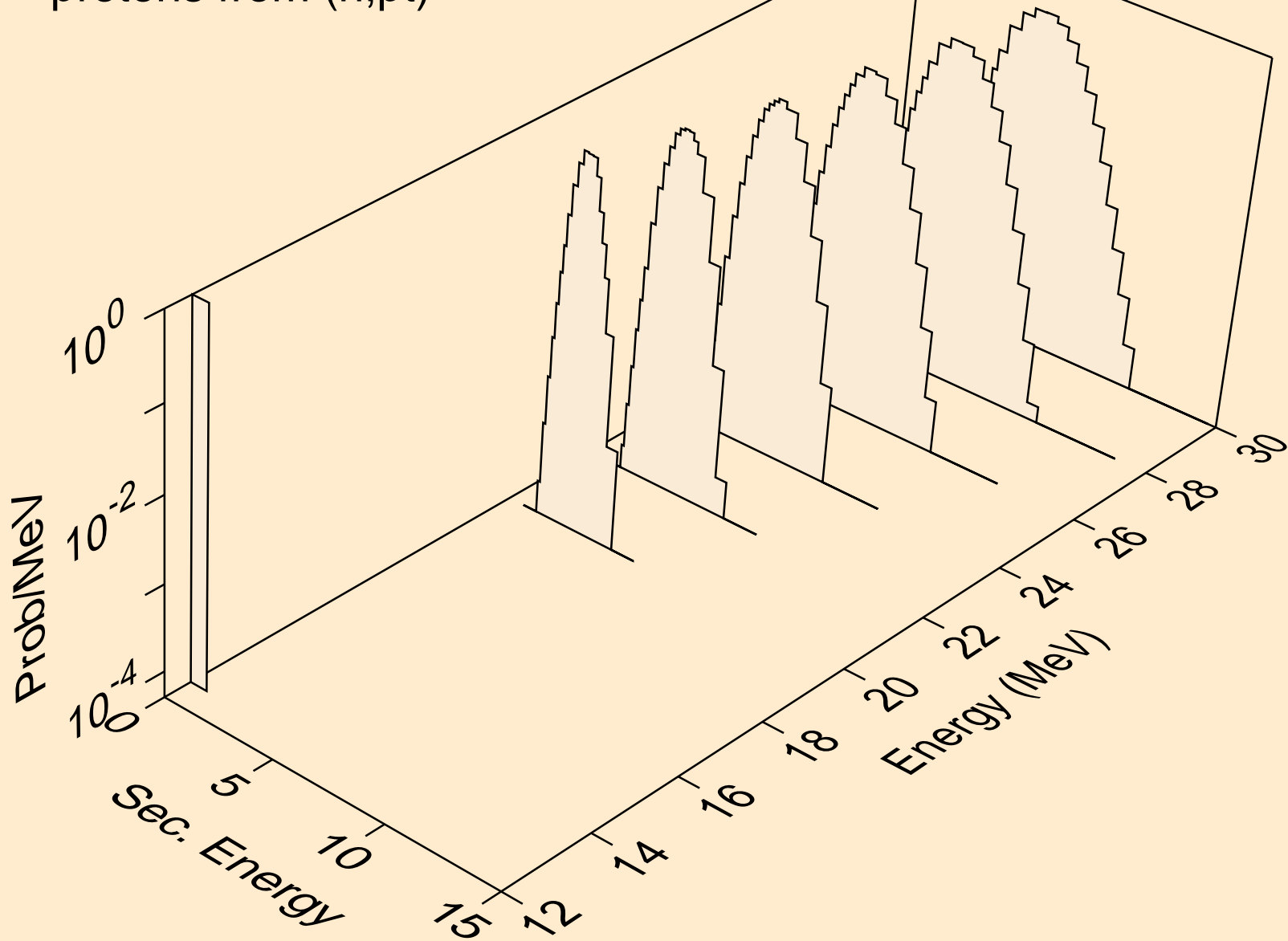

YB172 NEUTRON ACER TENDL-2024 LIBRARY; T=0.K
deuterons from (n,x)

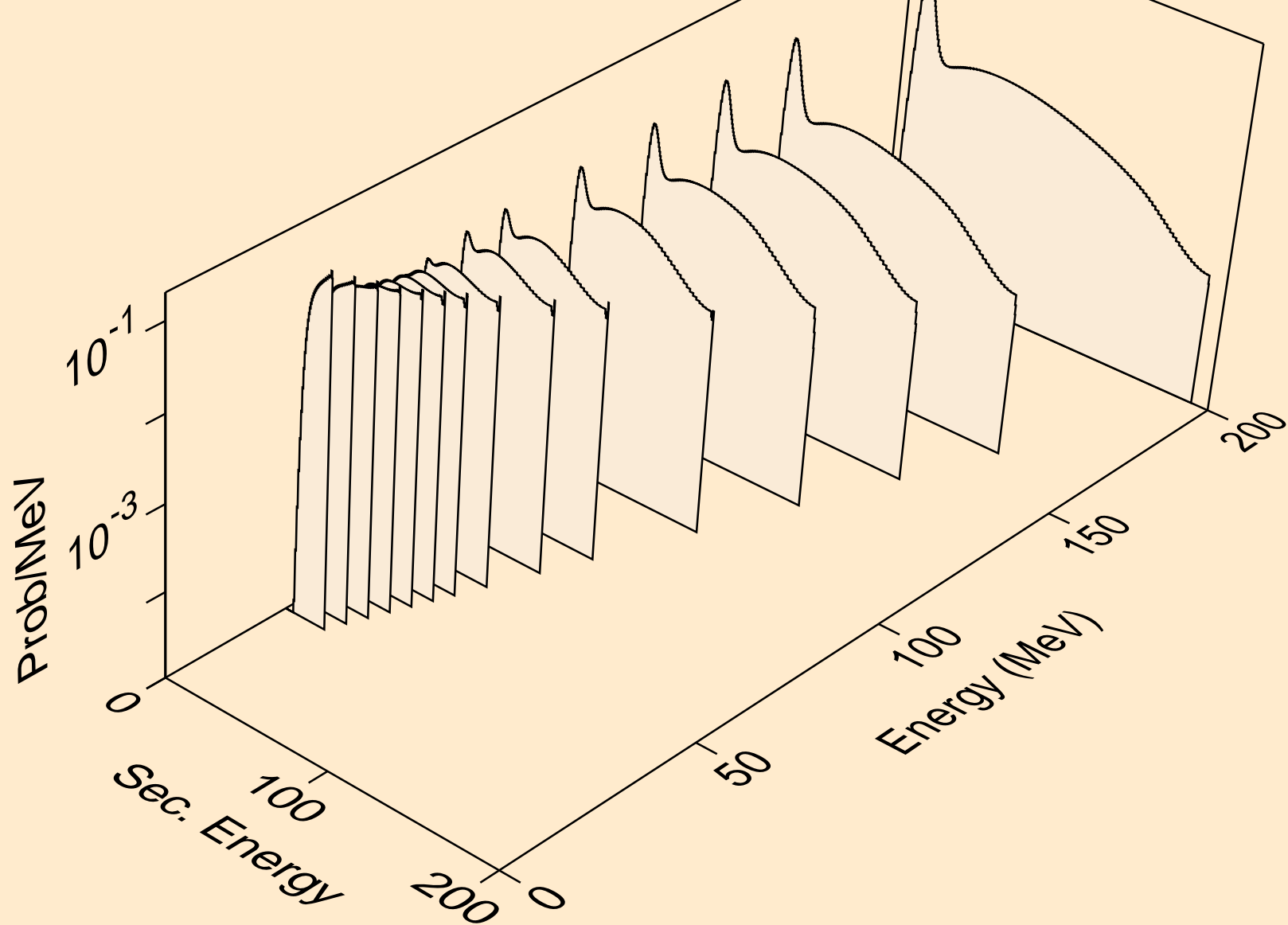

YB172 NEUTRON ACER TENDL-2024 LIBRARY; T=0.K
deuterons from (n,2nd)

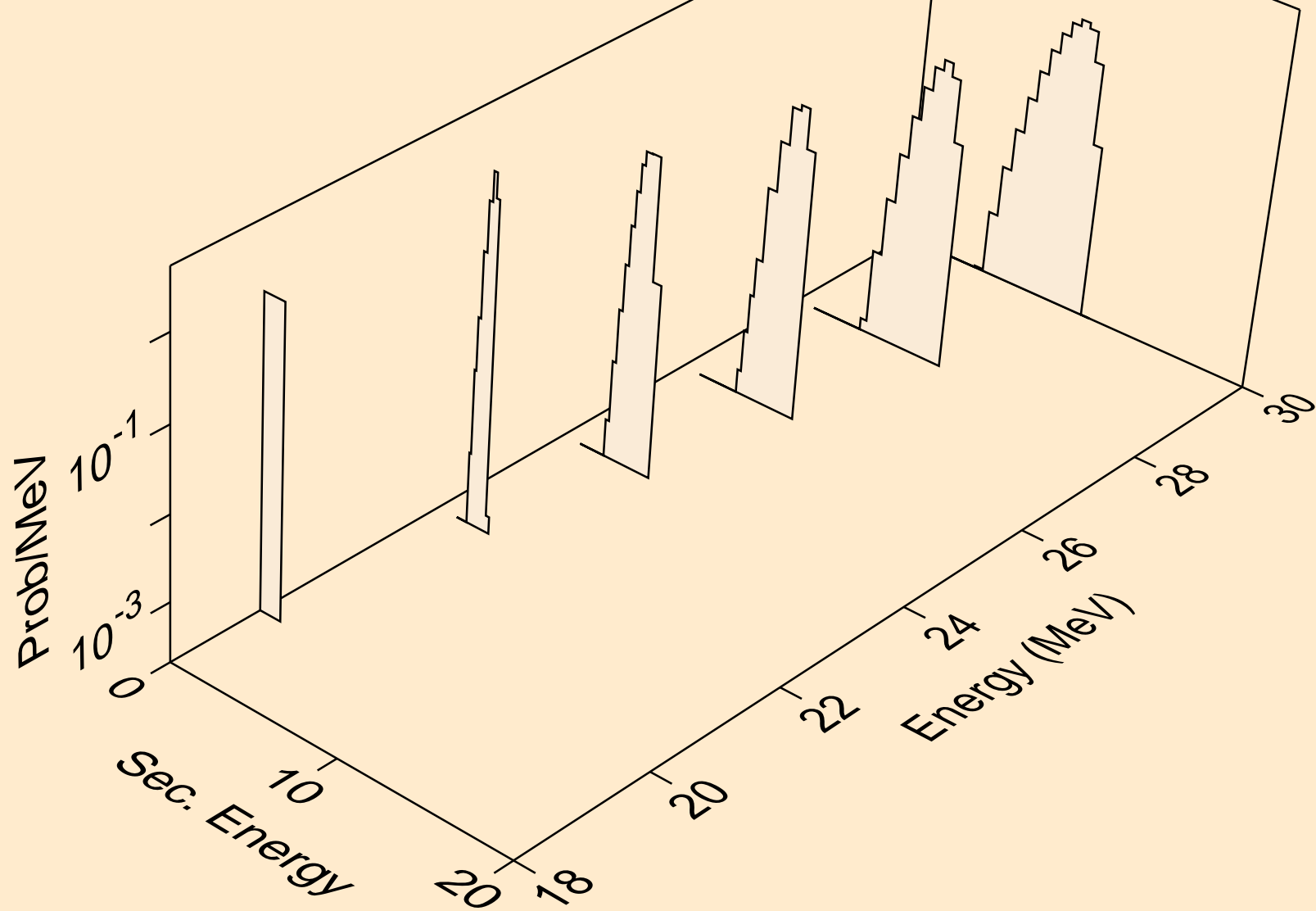

YB172 NEUTRON ACER TENDL-2024 LIBRARY; T=0.K
deuterons from (n,n*)d

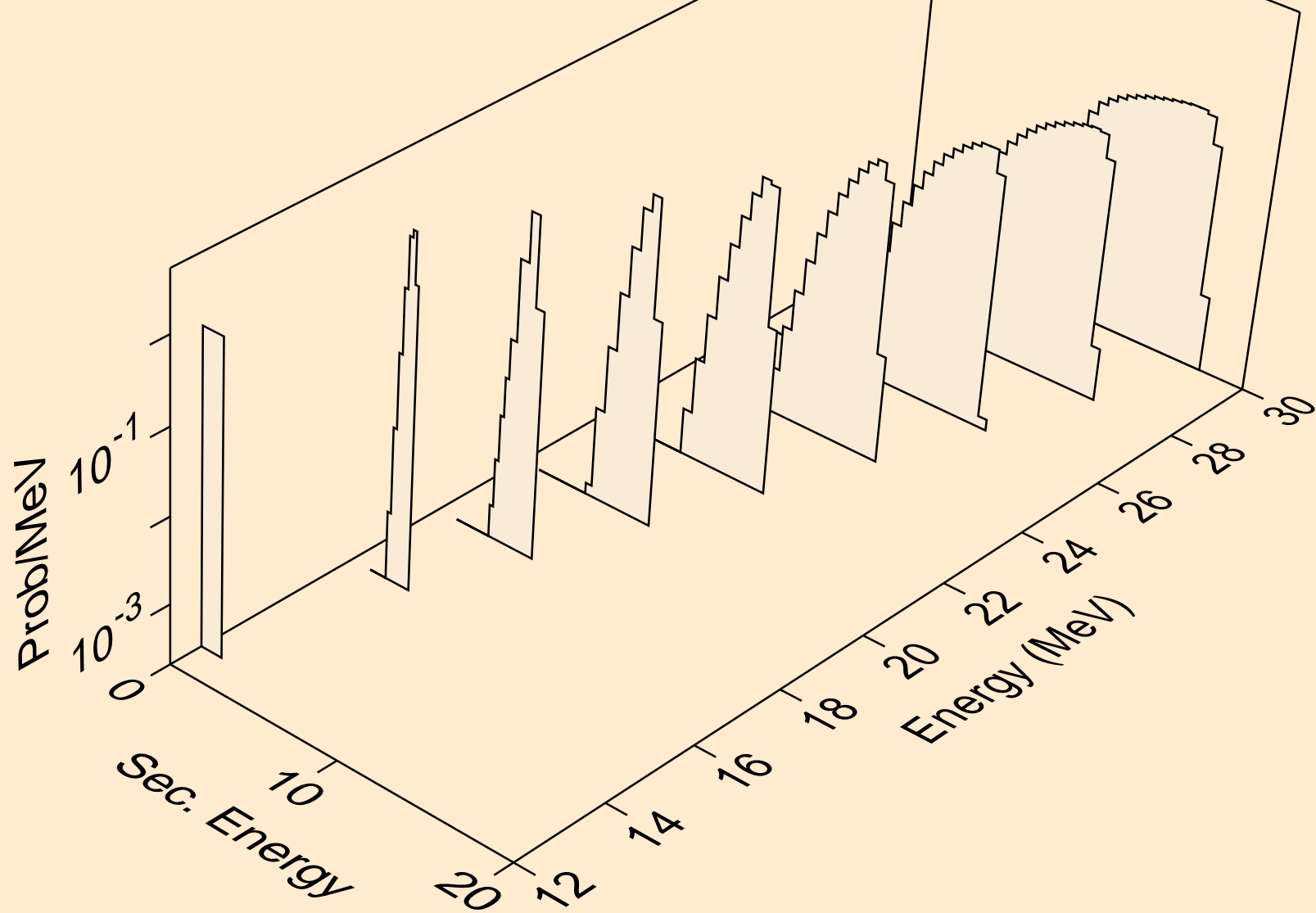

YB172 NEUTRON ACER TENDL-2024 LIBRARY; T=0.K
deuterons from (n,d)

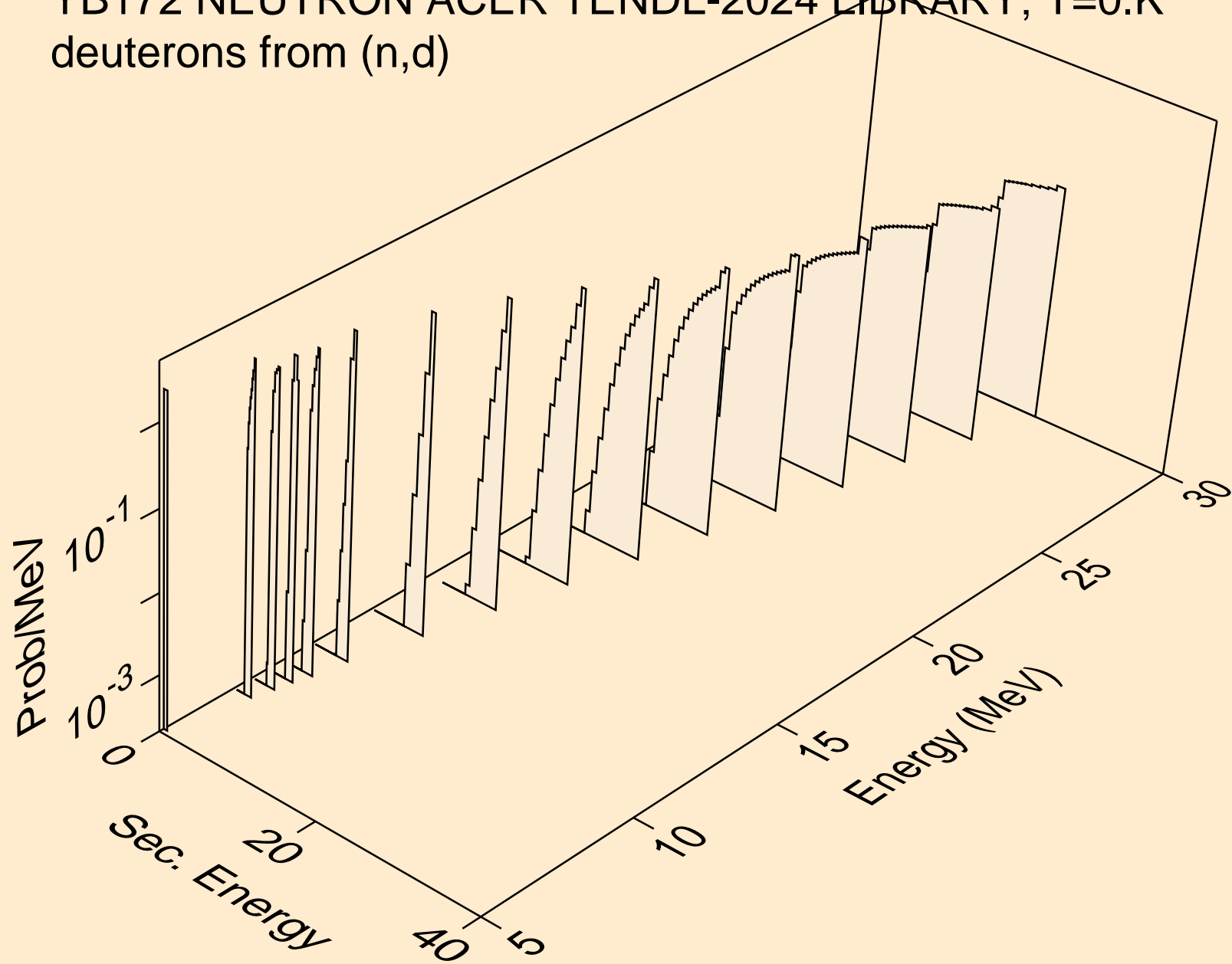

YB172 NEUTRON ACER TENDL-2024 LIBRARY; T=0.K
deuterons from (n,pd)

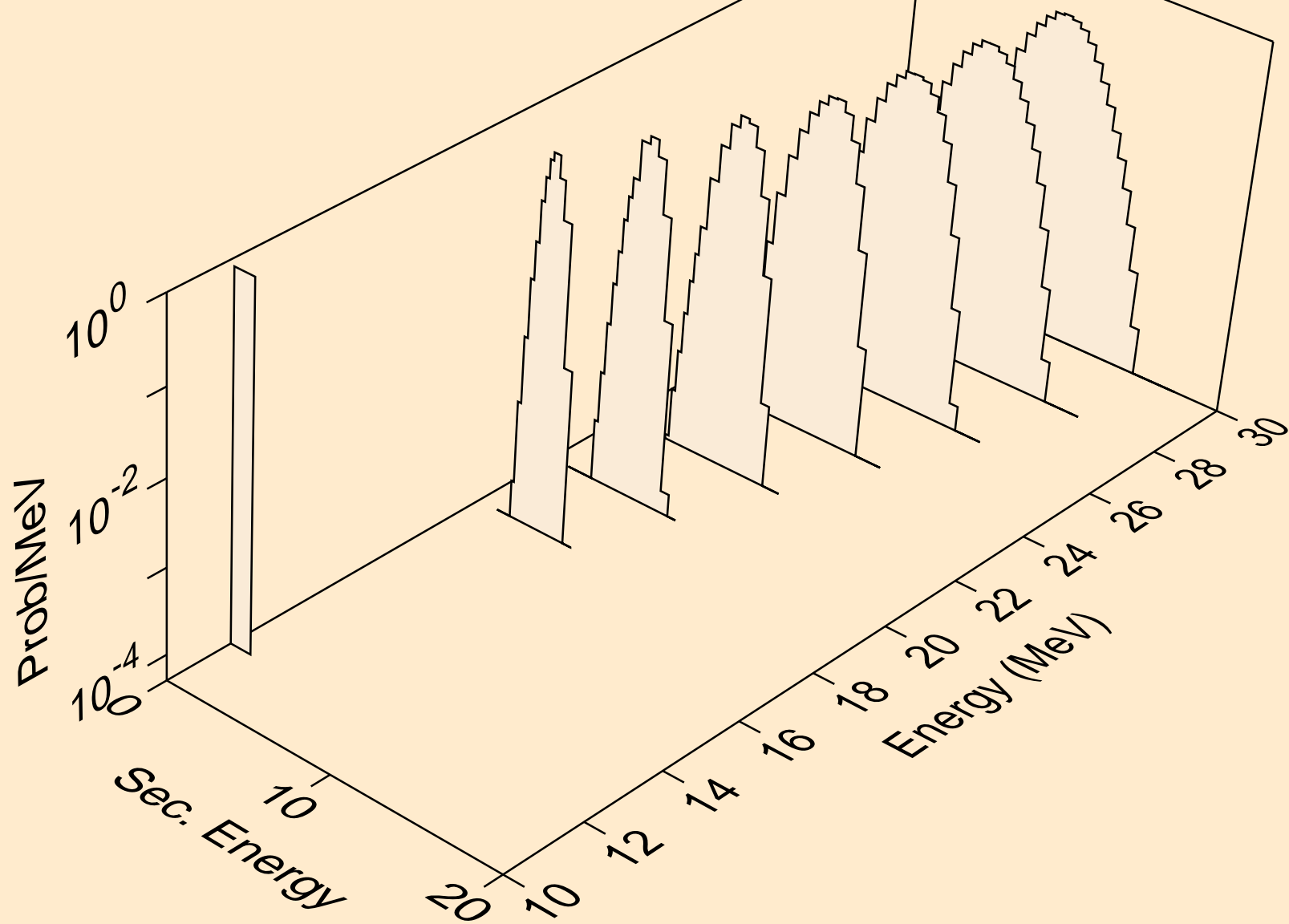

YB172 NEUTRON ACER TENDL-2024 LIBRARY; T=0.K
tritons from (n,x)

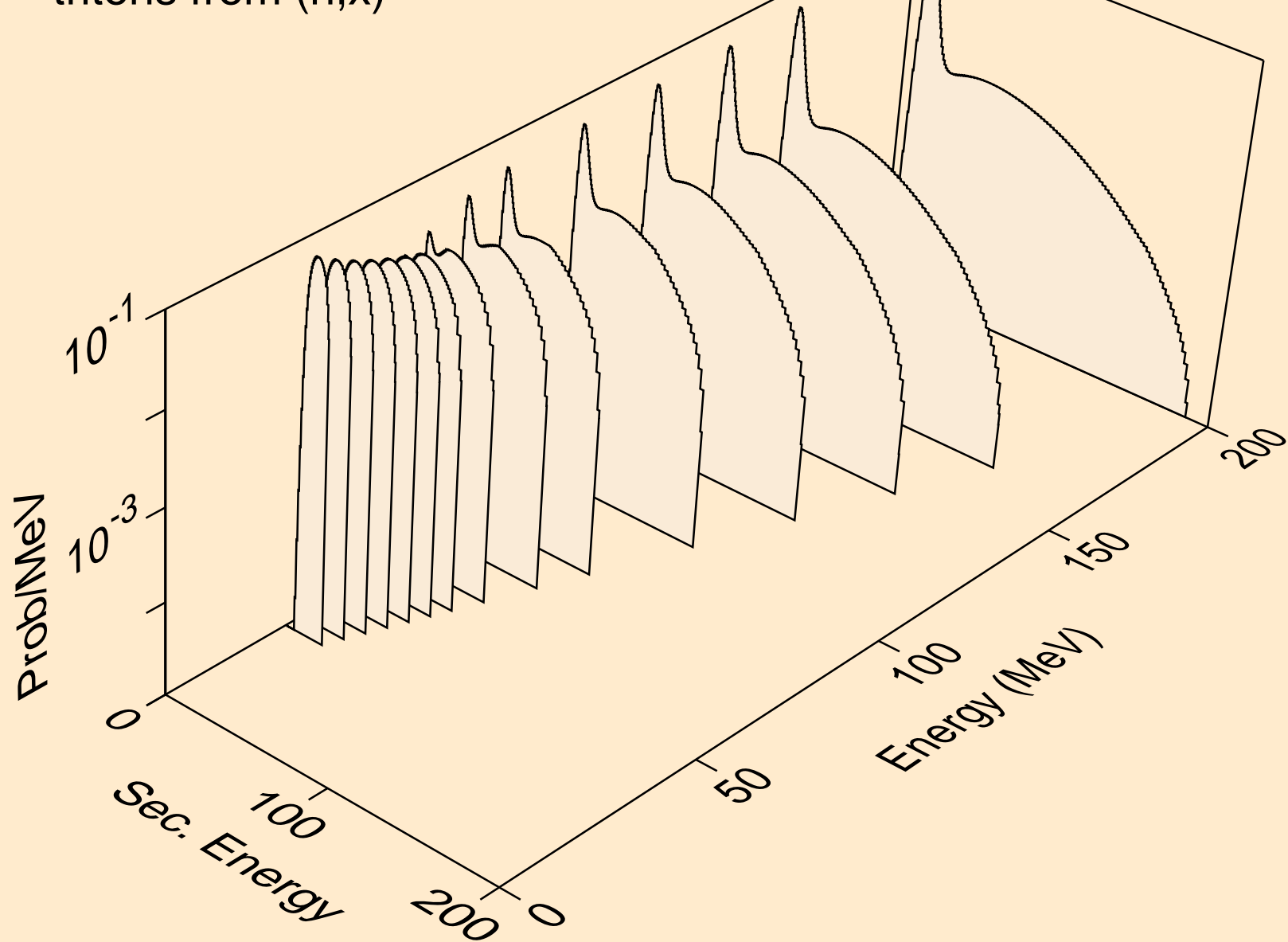

YB172 NEUTRON ACER TENDL-2024 LIBRARY; T=0.K
tritons from (n,n*)t

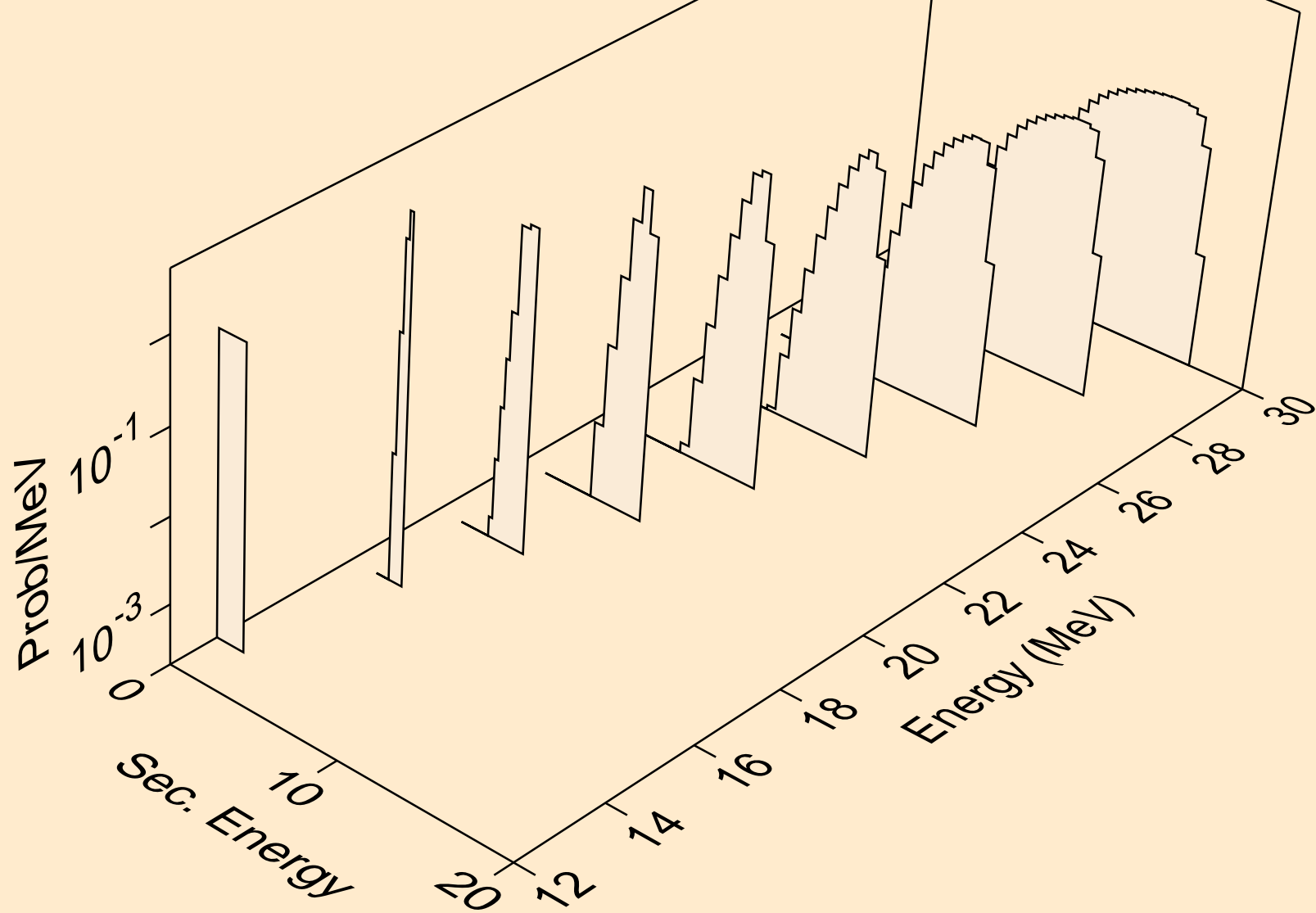

YB172 NEUTRON ACER TENDL-2024 LIBRARY; T=0.K
tritons from (n,t)

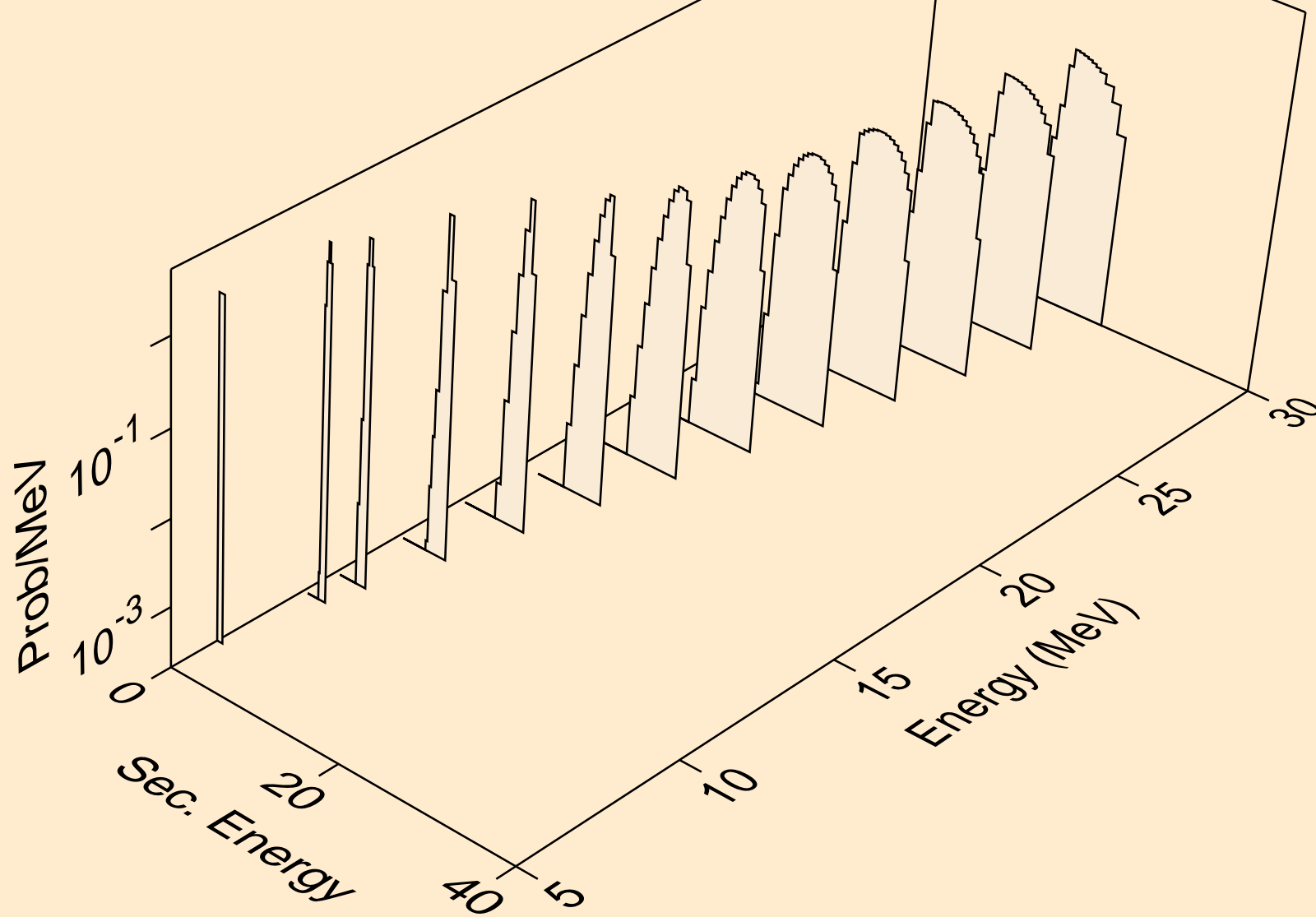

YB172 NEUTRON ACER TENDL-2024 LIBRARY; T=0.K
tritons from (n,pt)

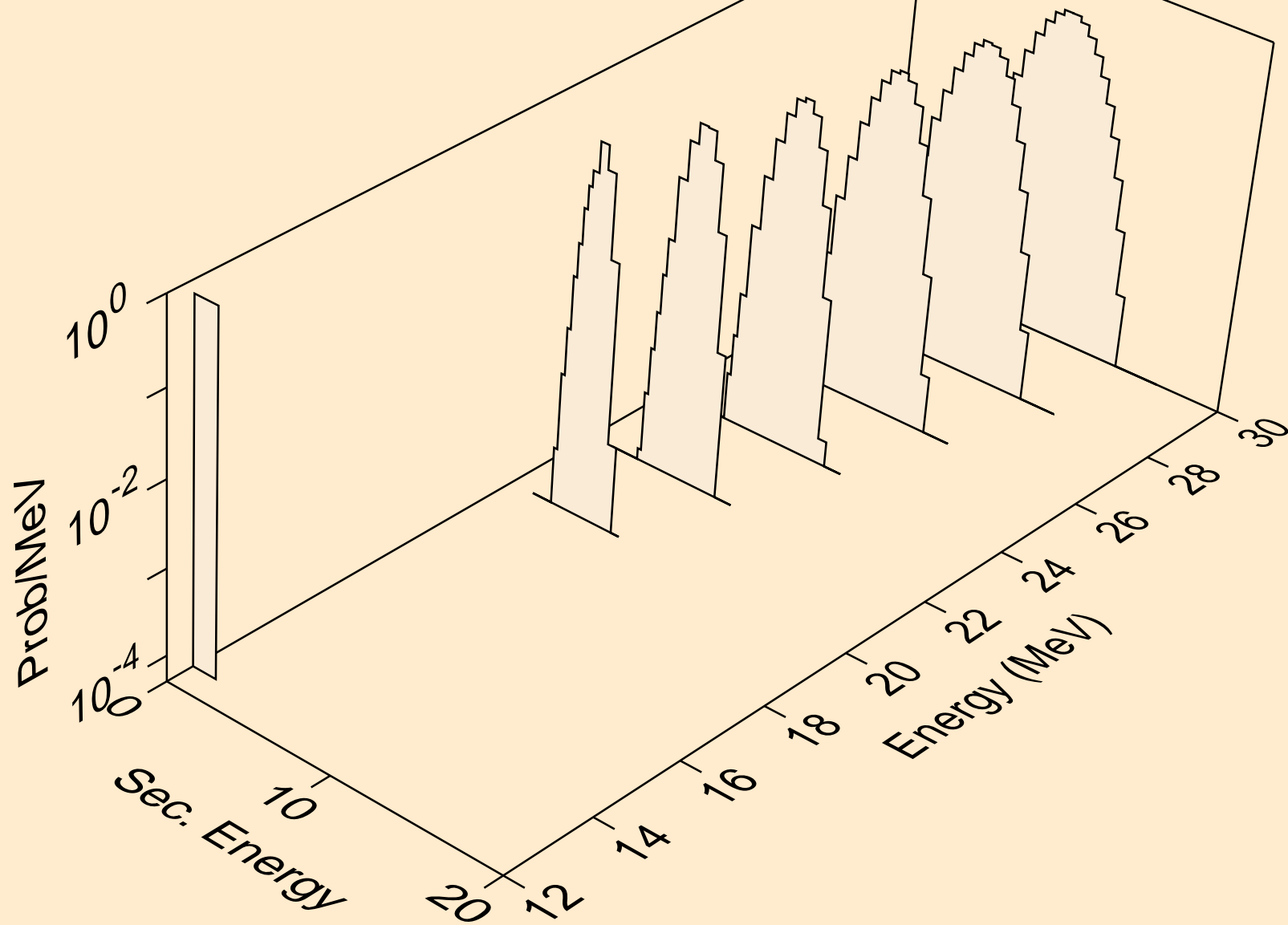

YB172 NEUTRON ACER TENDL-2024 LIBRARY; T=0.K
he3s from (n,x)

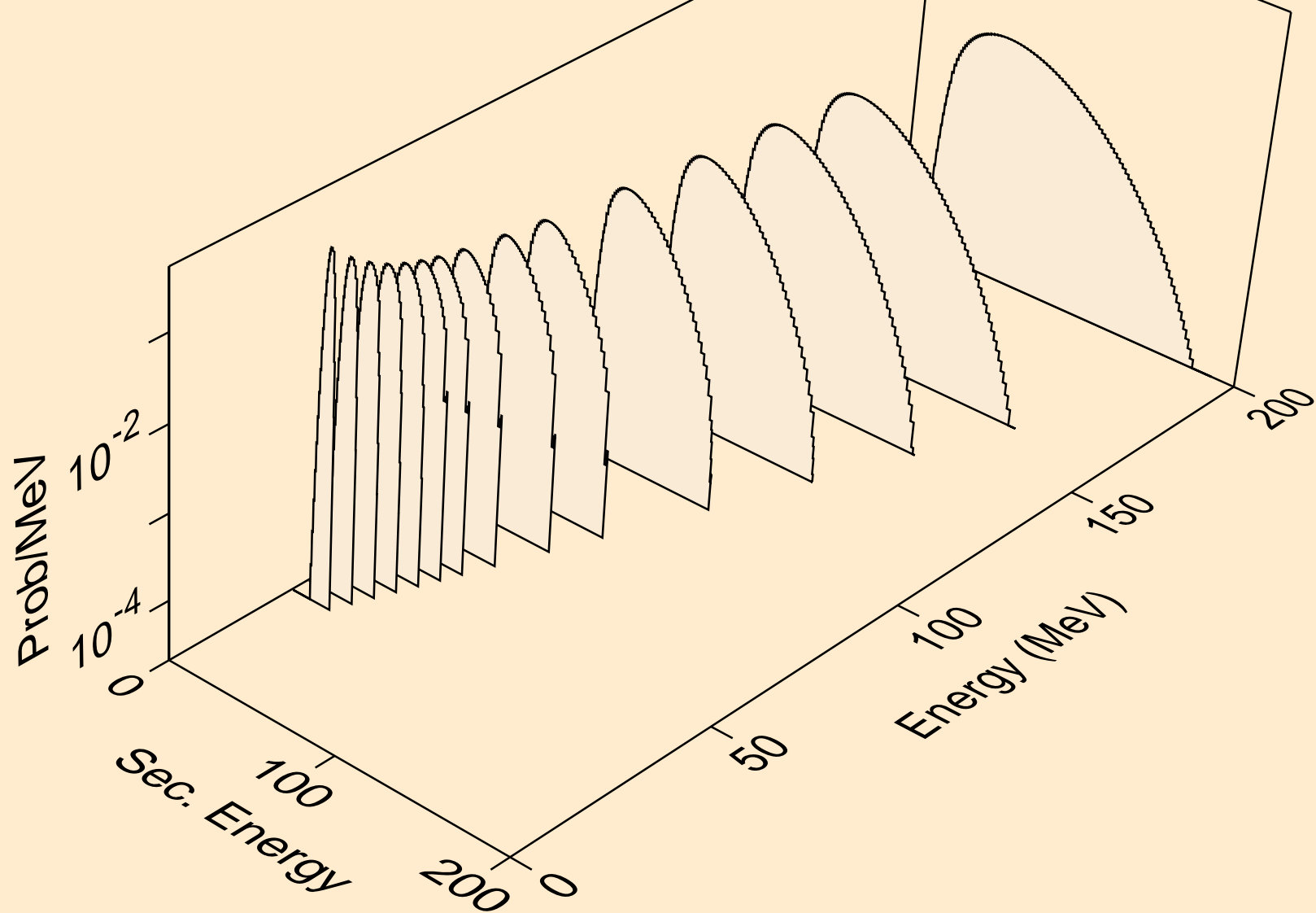

YB172 NEUTRON ACER TENDL-2024 LIBRARY; T=0.K
he3s from (n,n*)he3

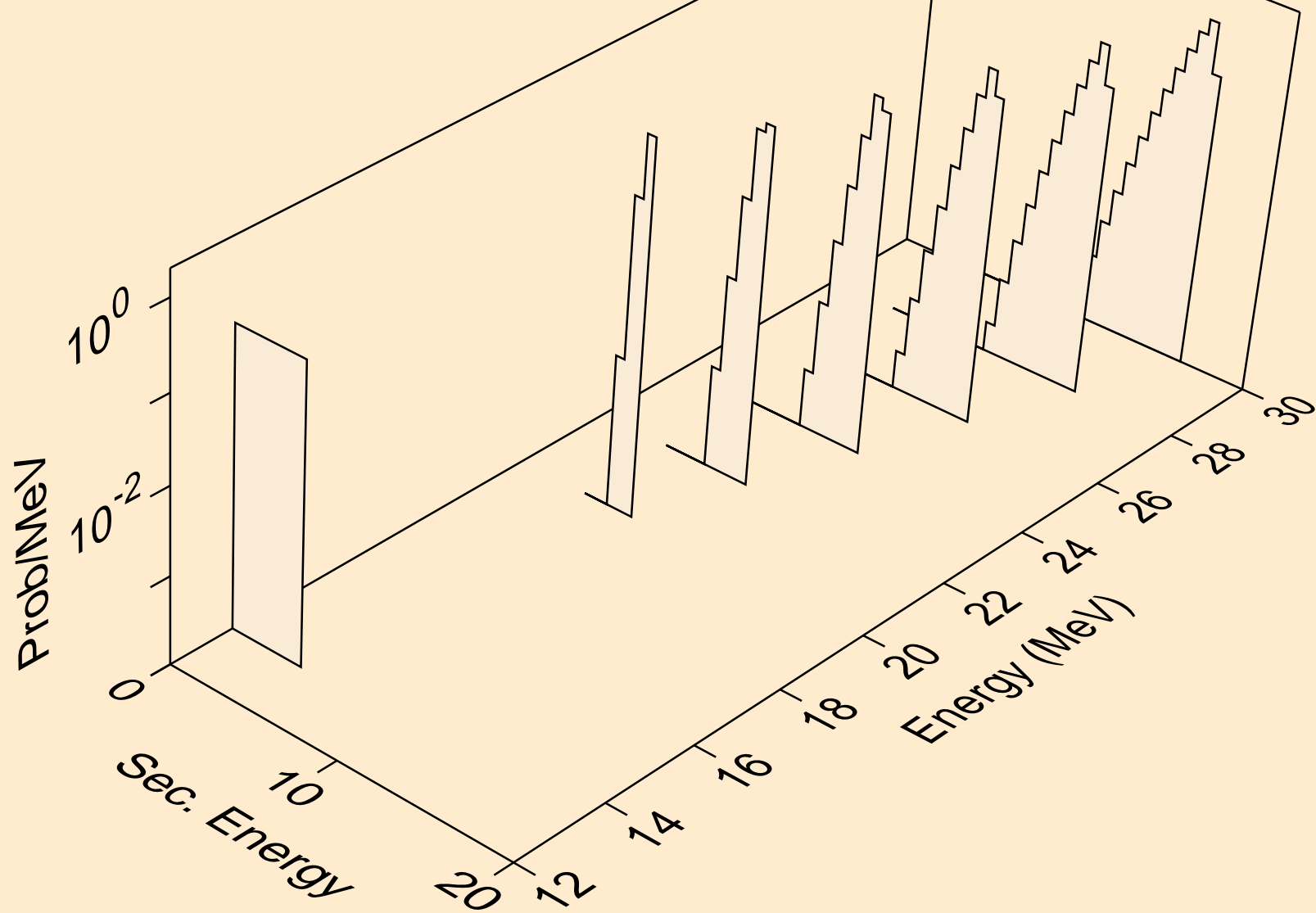

YB172 NEUTRON ACER TENDL-2024 LIBRARY; T=0.K
he3s from (n,he3)

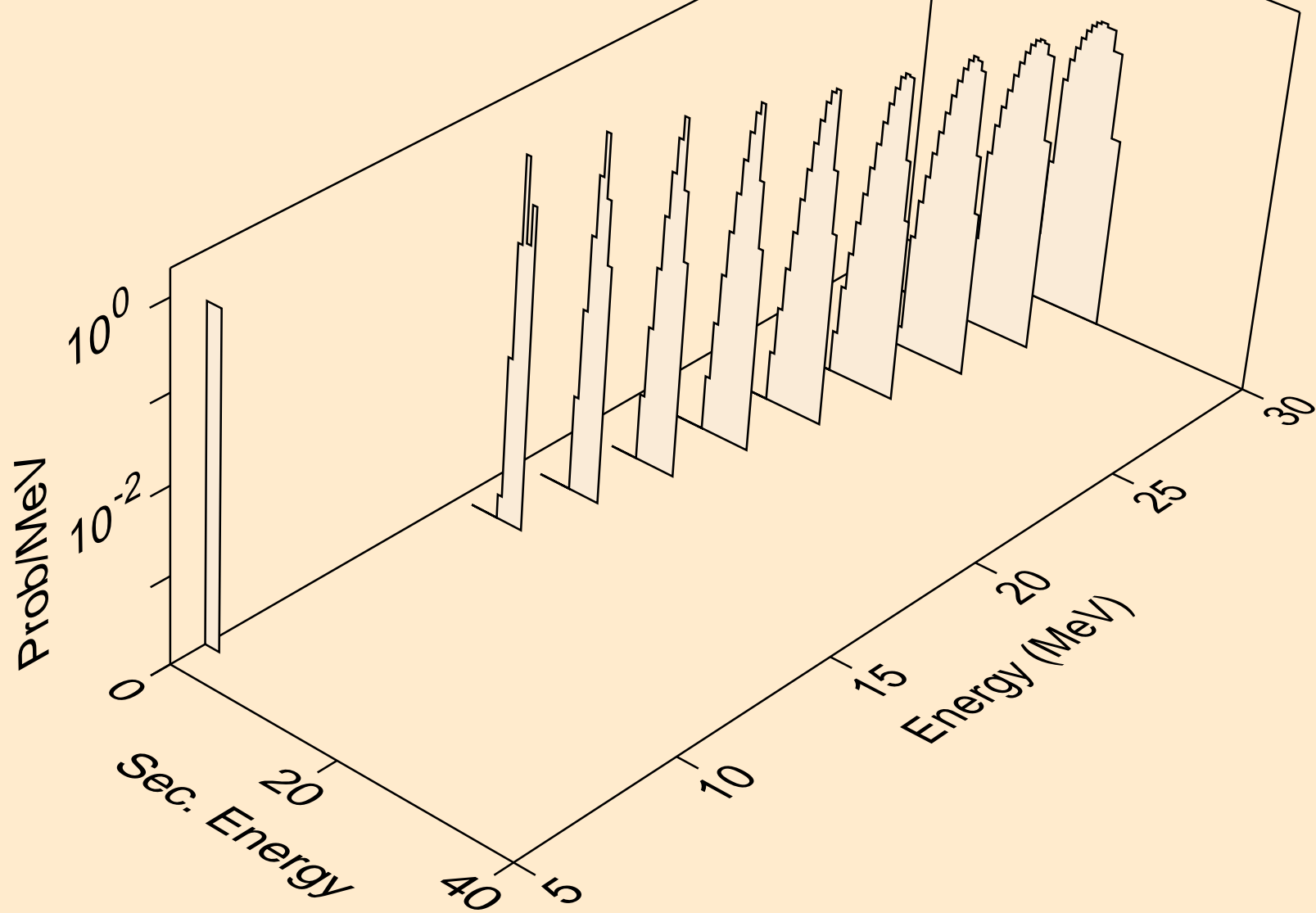

YB172 NEUTRON ACER TENDL-2024 LIBRARY; T=0.K
alphas from (n,x)

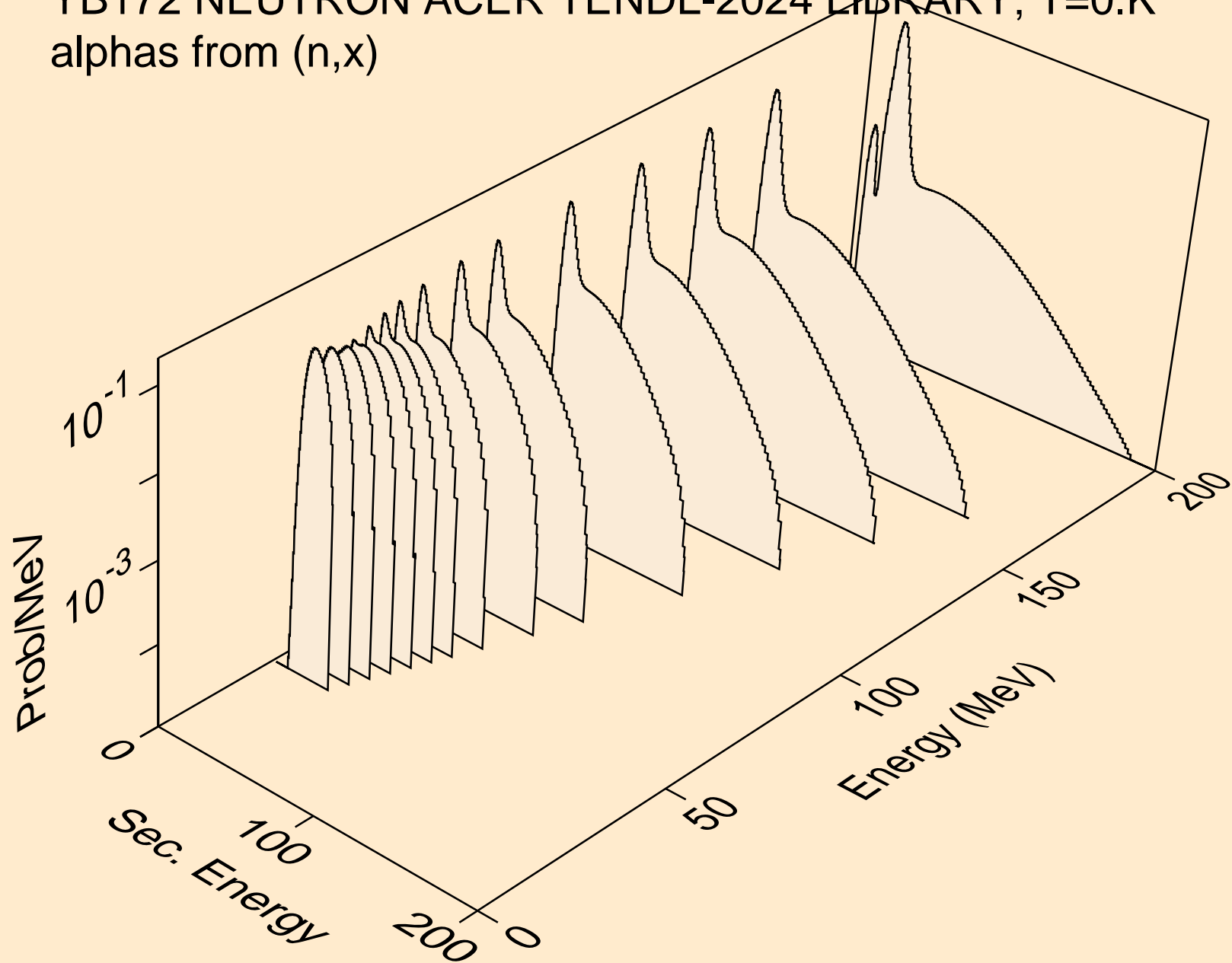

YB172 NEUTRON ACER TENDL-2024 LIBRARY; T=0.K
alphas from (n,n*)a

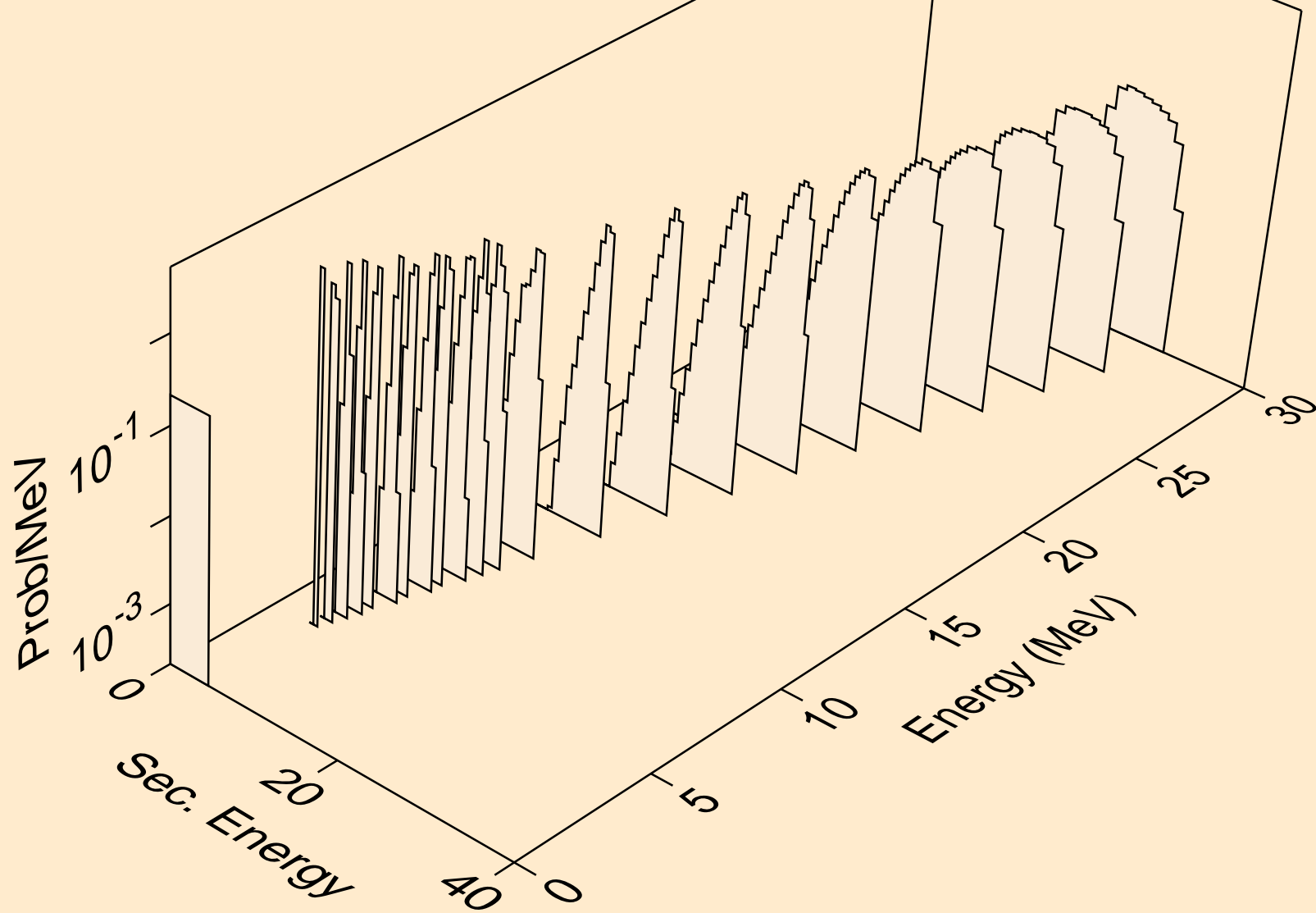

YB172 NEUTRON ACER TENDL-2024 LIBRARY; T=0.K
alphas from (n,2n)a

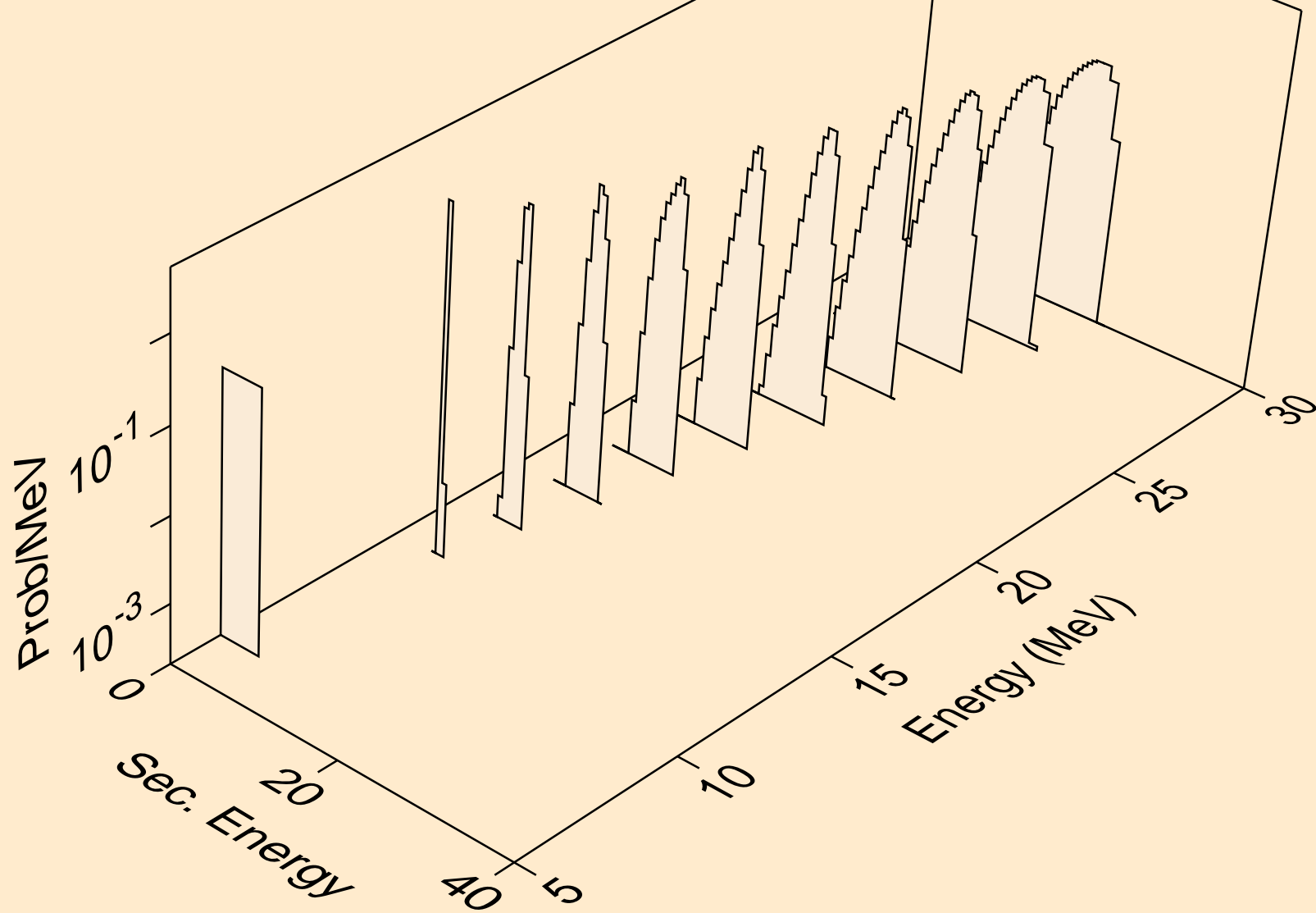

YB172 NEUTRON ACER TENDL-2024 LIBRARY; T=0.K
alphas from (n,3n)a

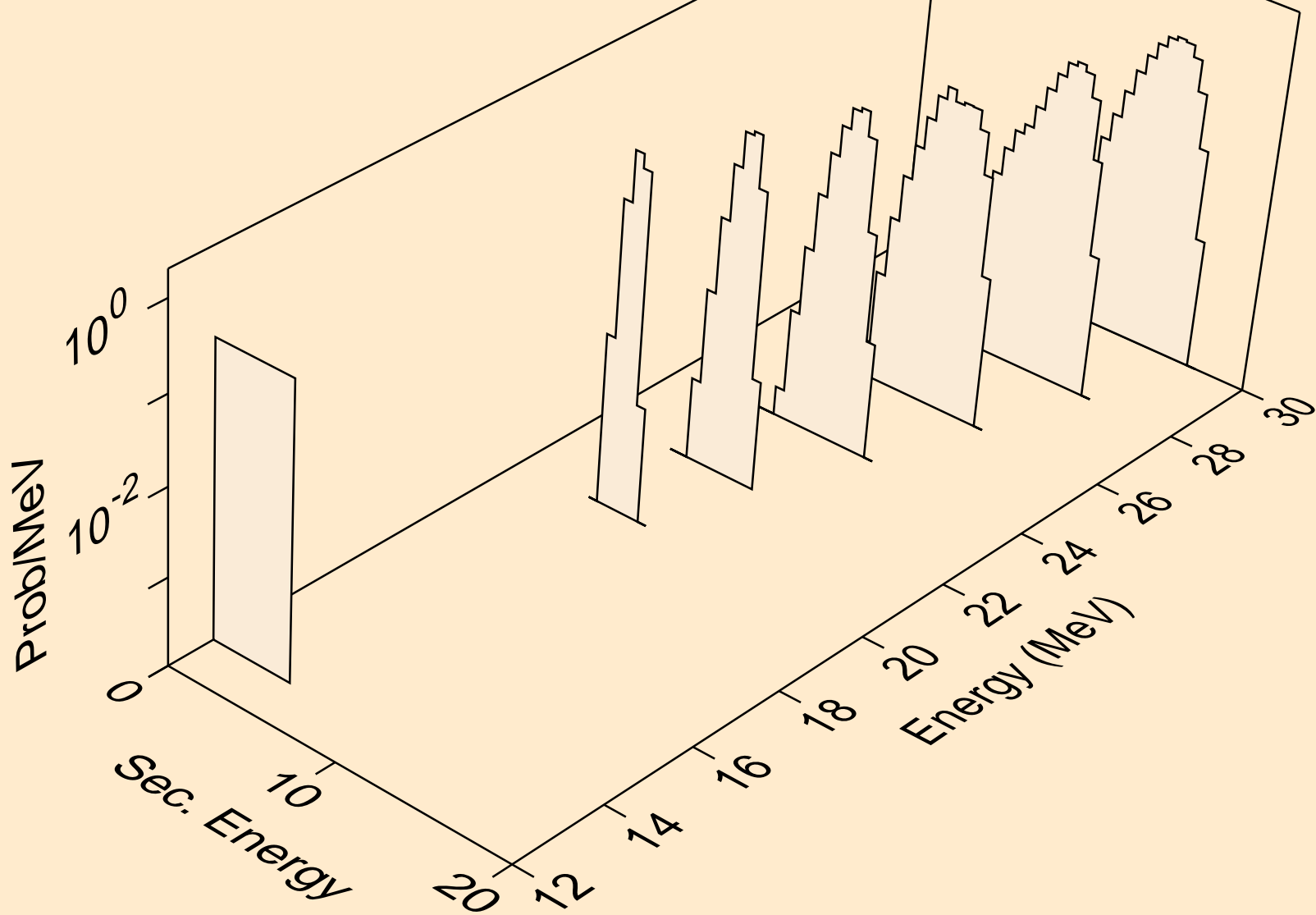

YB172 NEUTRON ACER TENDL-2024 LIBRARY; T=0.K
alphas from (n,n*)2a

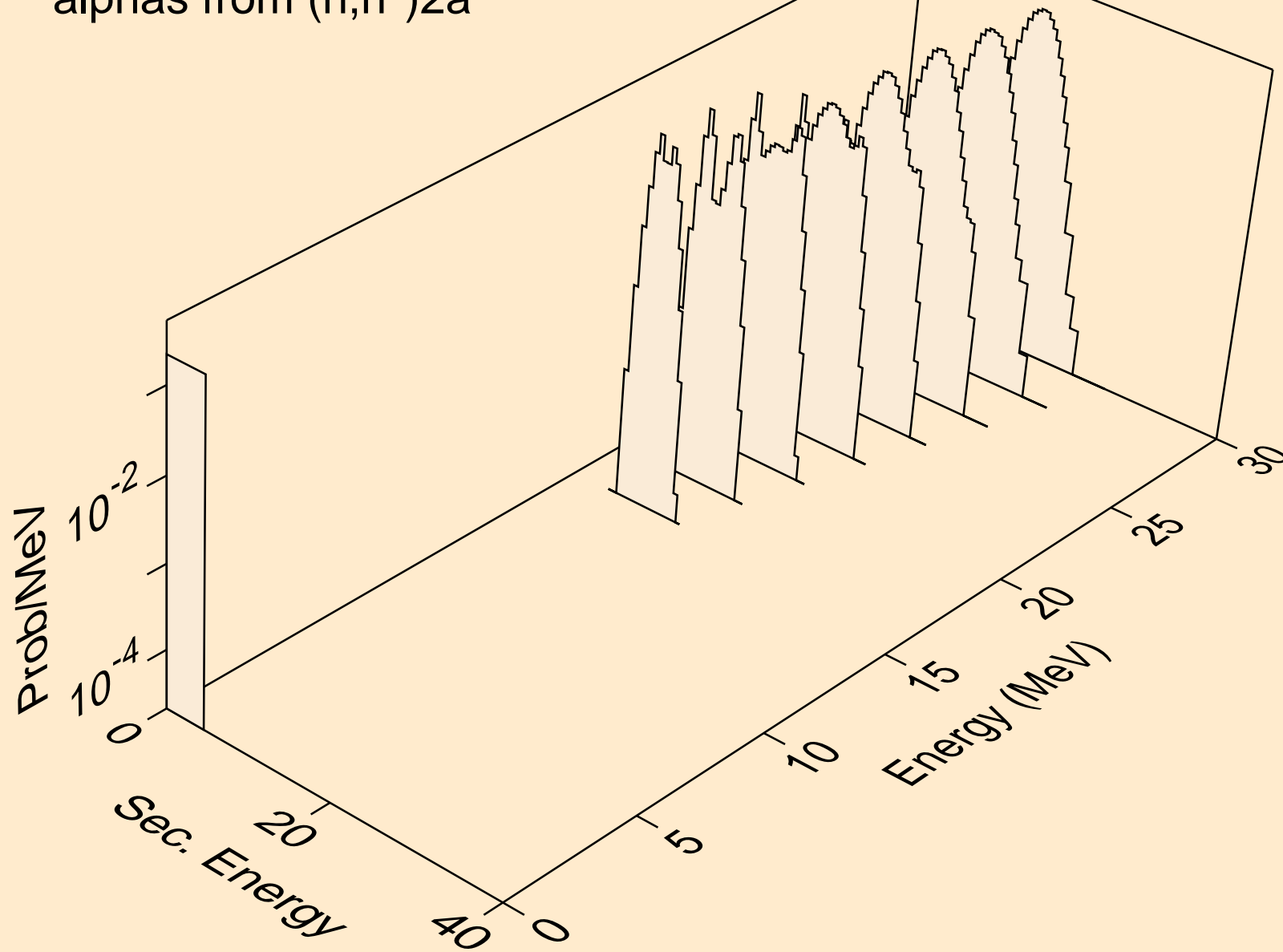

YB172 NEUTRON ACER TENDL-2024 LIBRARY; T=0.K
alphas from (n,npa)

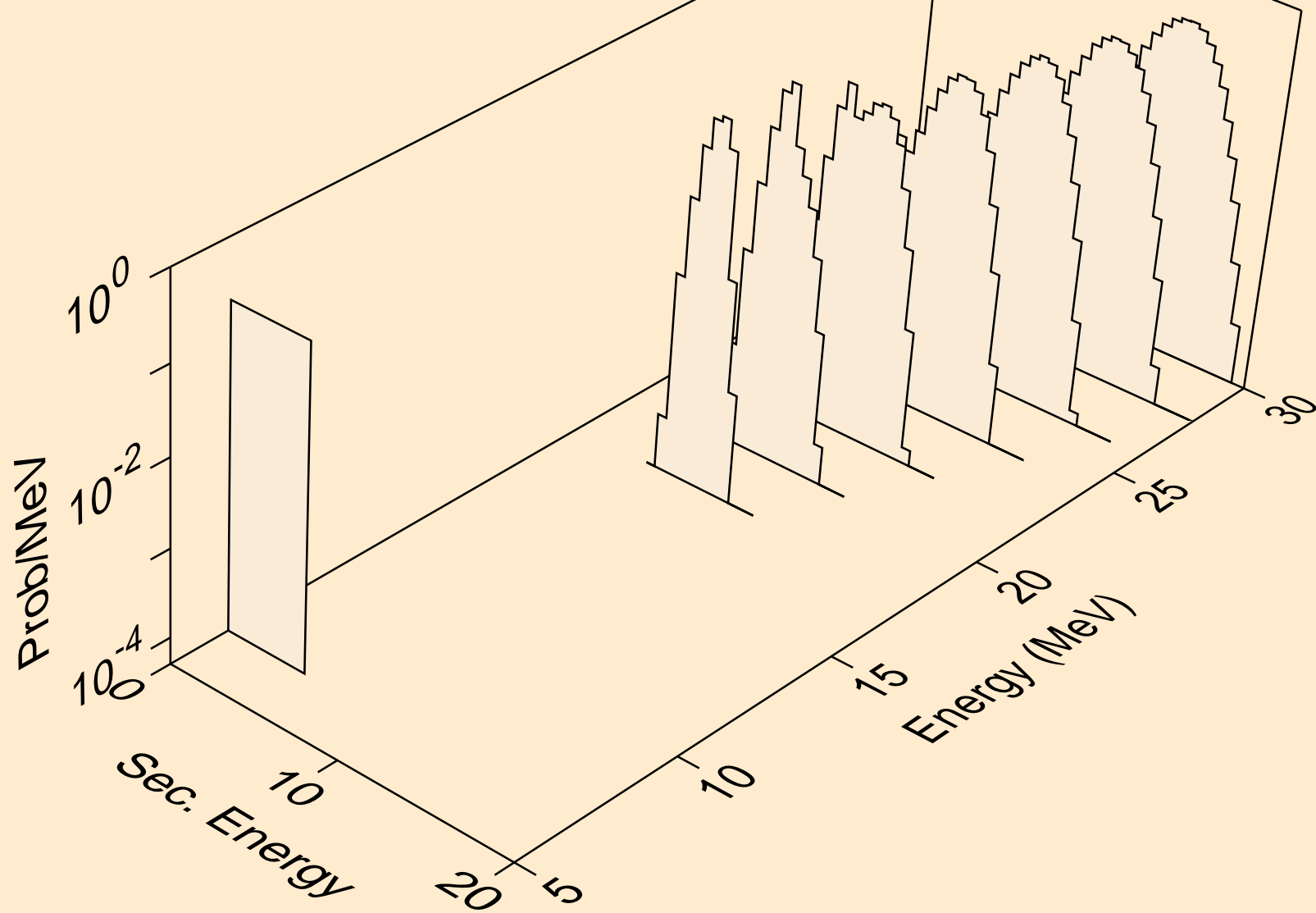

YB172 NEUTRON ACER TENDL-2024 LIBRARY; T=0.K
alphas from (n,a)

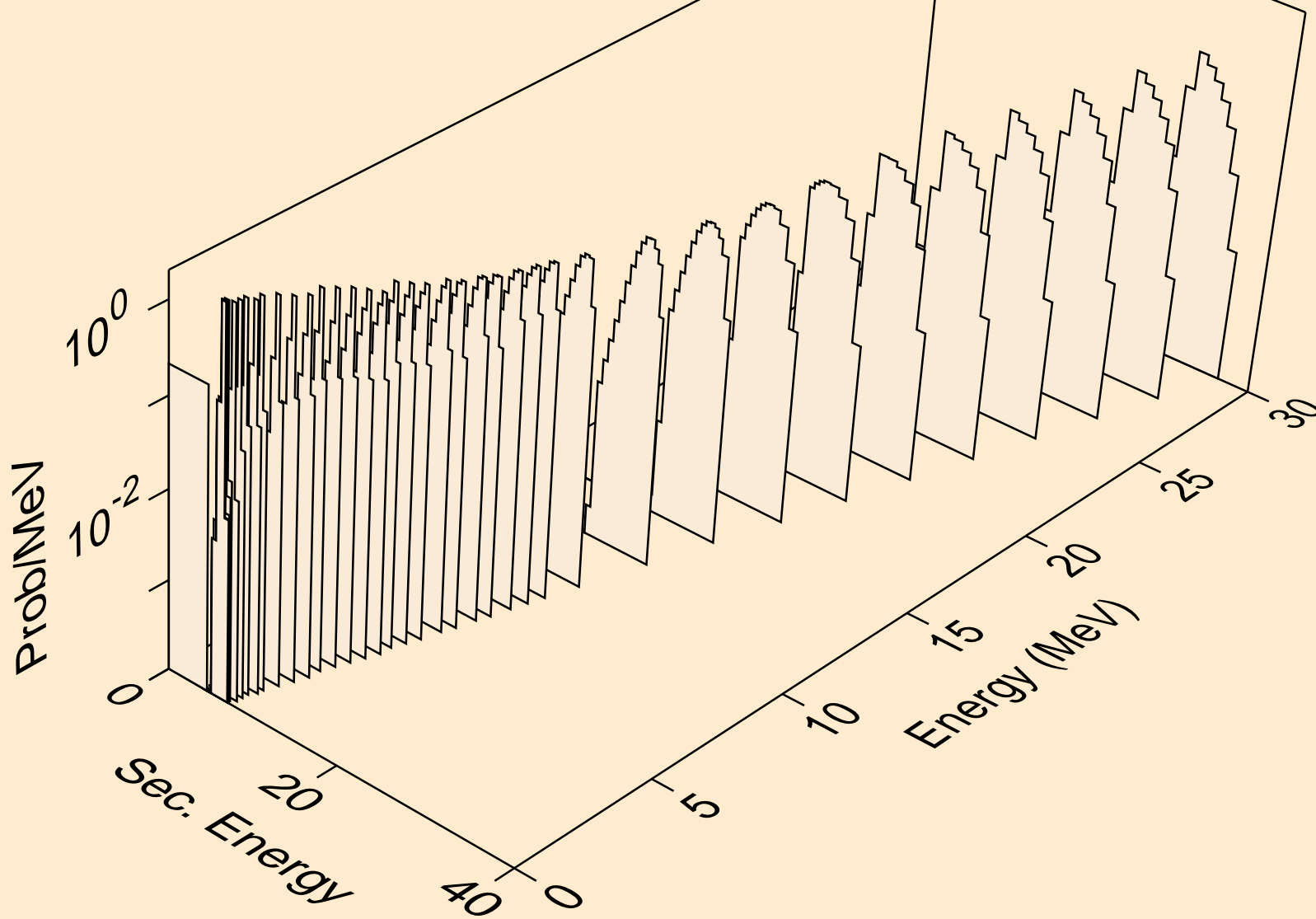

YB172 NEUTRON ACER TENDL-2024 LIBRARY; T=0.K
alphas from (n,2a)

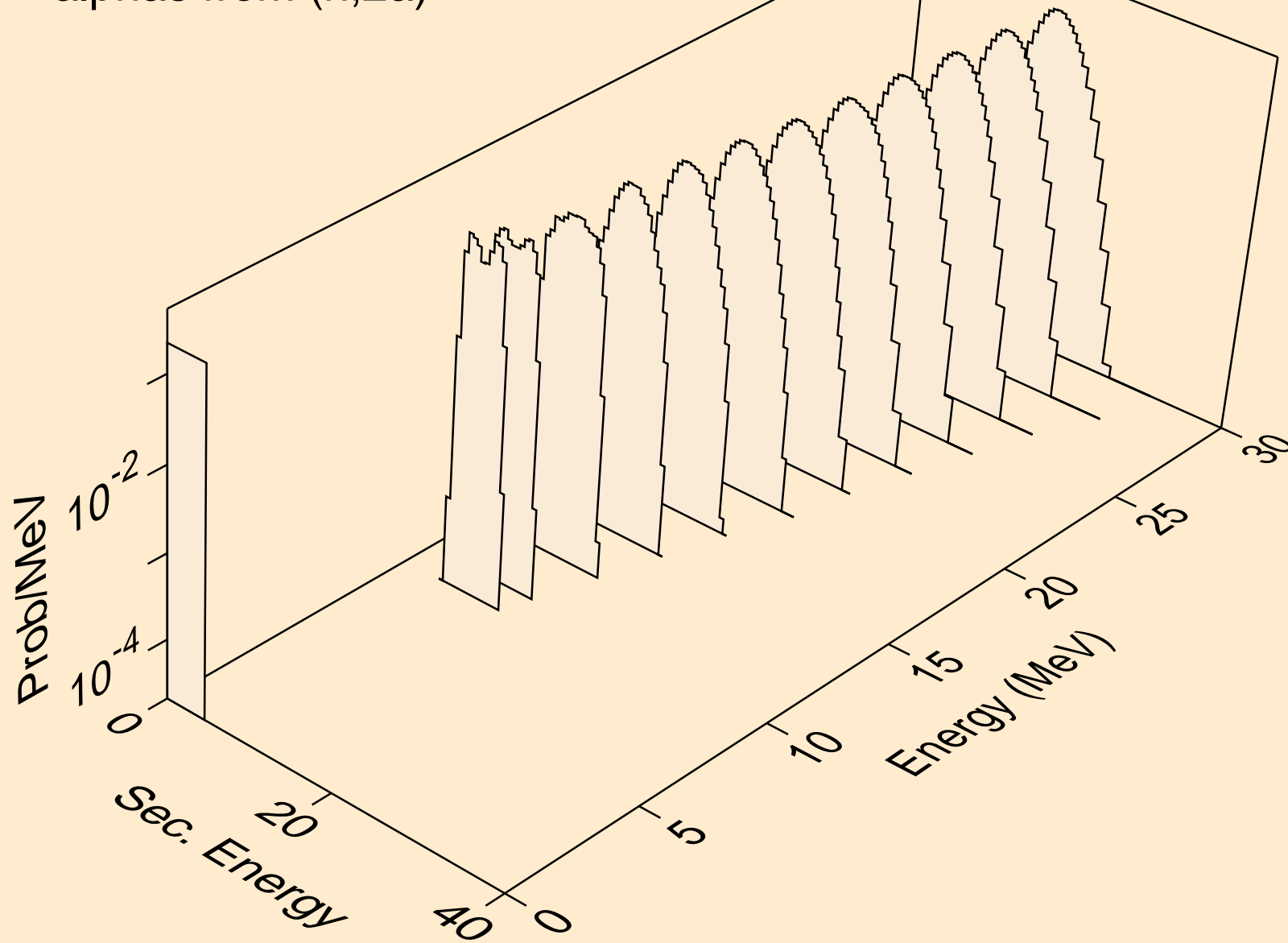

YB172 NEUTRON ACER TENDL-2024 LIBRARY; T=0.K
alphas from (n,pa)

