

# YB185 NEUTRON ACER TENDL-2024 LIBRARY; T=0.K

## Principal cross sections

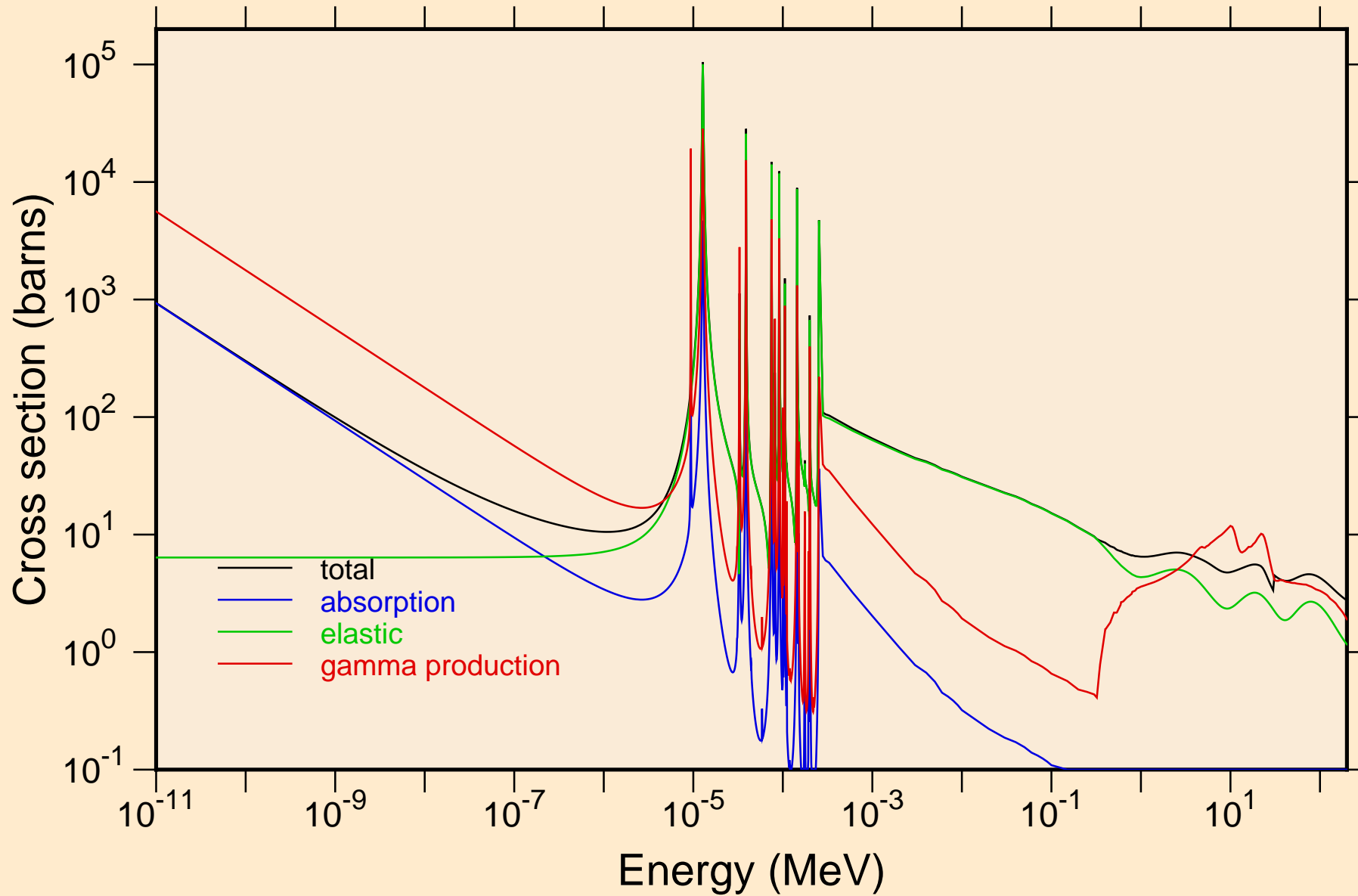

YB185 NEUTRON ACER TENDL-2024 LIBRARY; T=0.K  
resonance total cross section

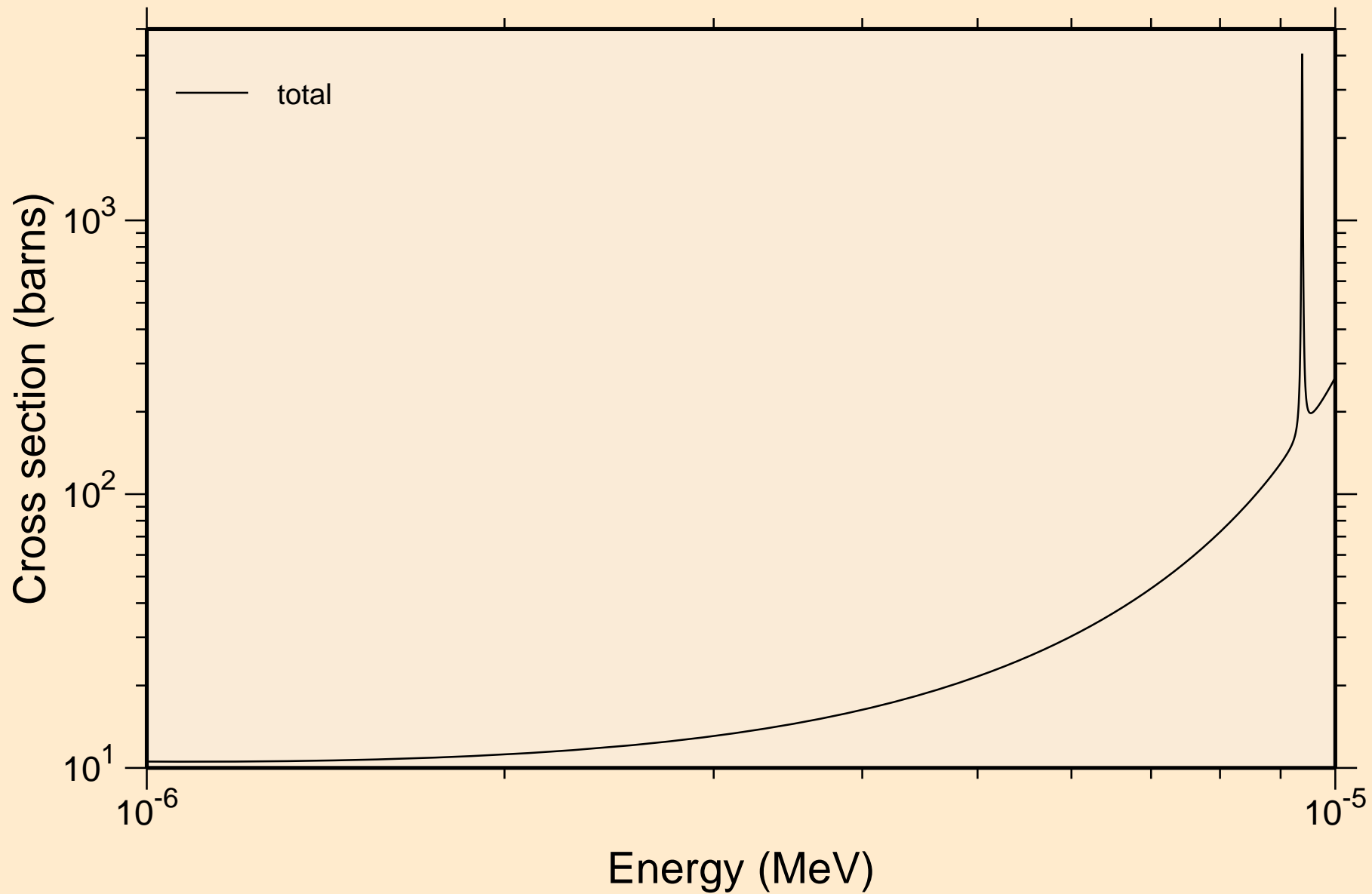

YB185 NEUTRON ACER TENDL-2024 LIBRARY; T=0.K  
resonance total cross section

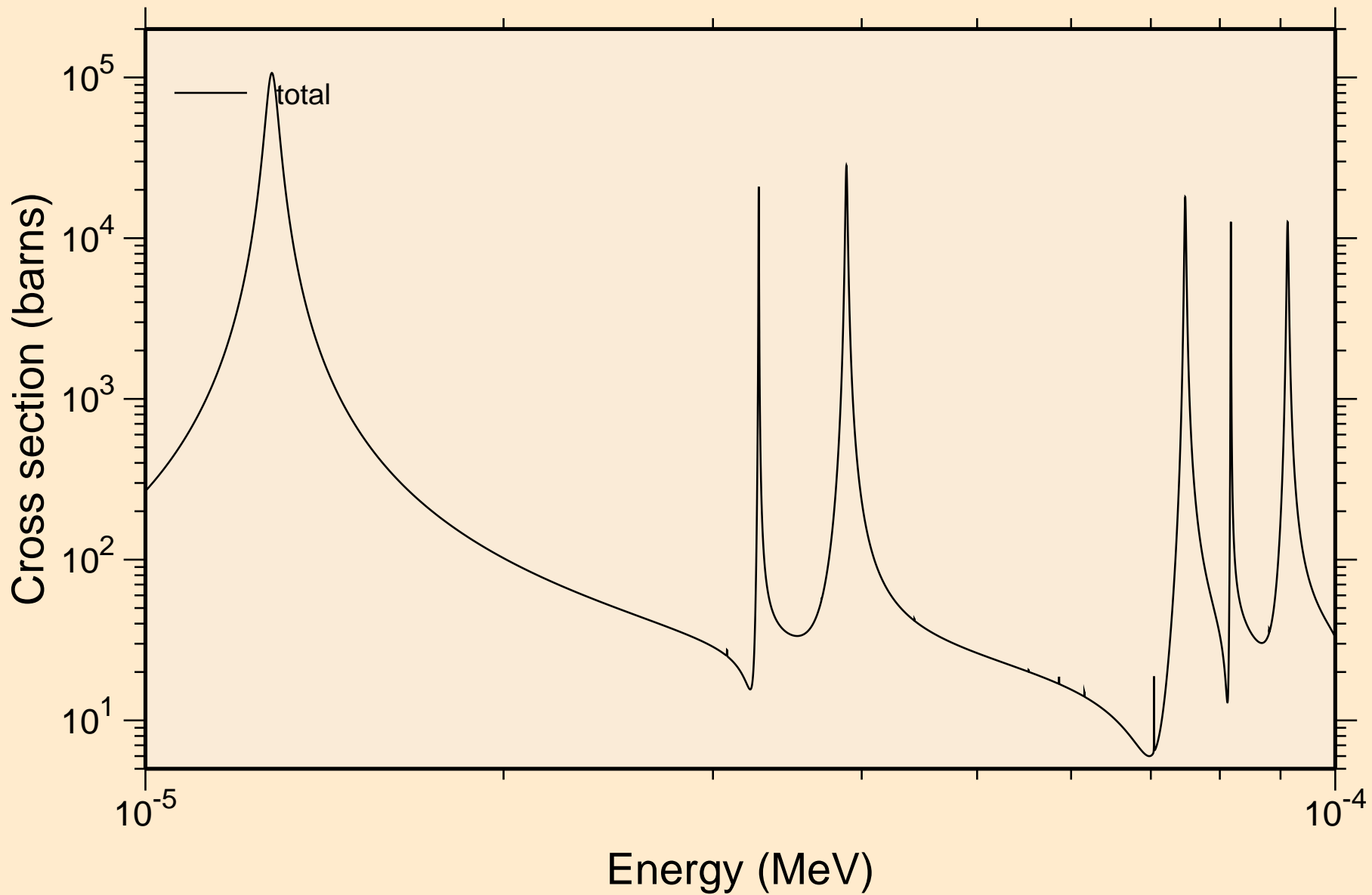

YB185 NEUTRON ACER TENDL-2024 LIBRARY; T=0.K  
resonance total cross section

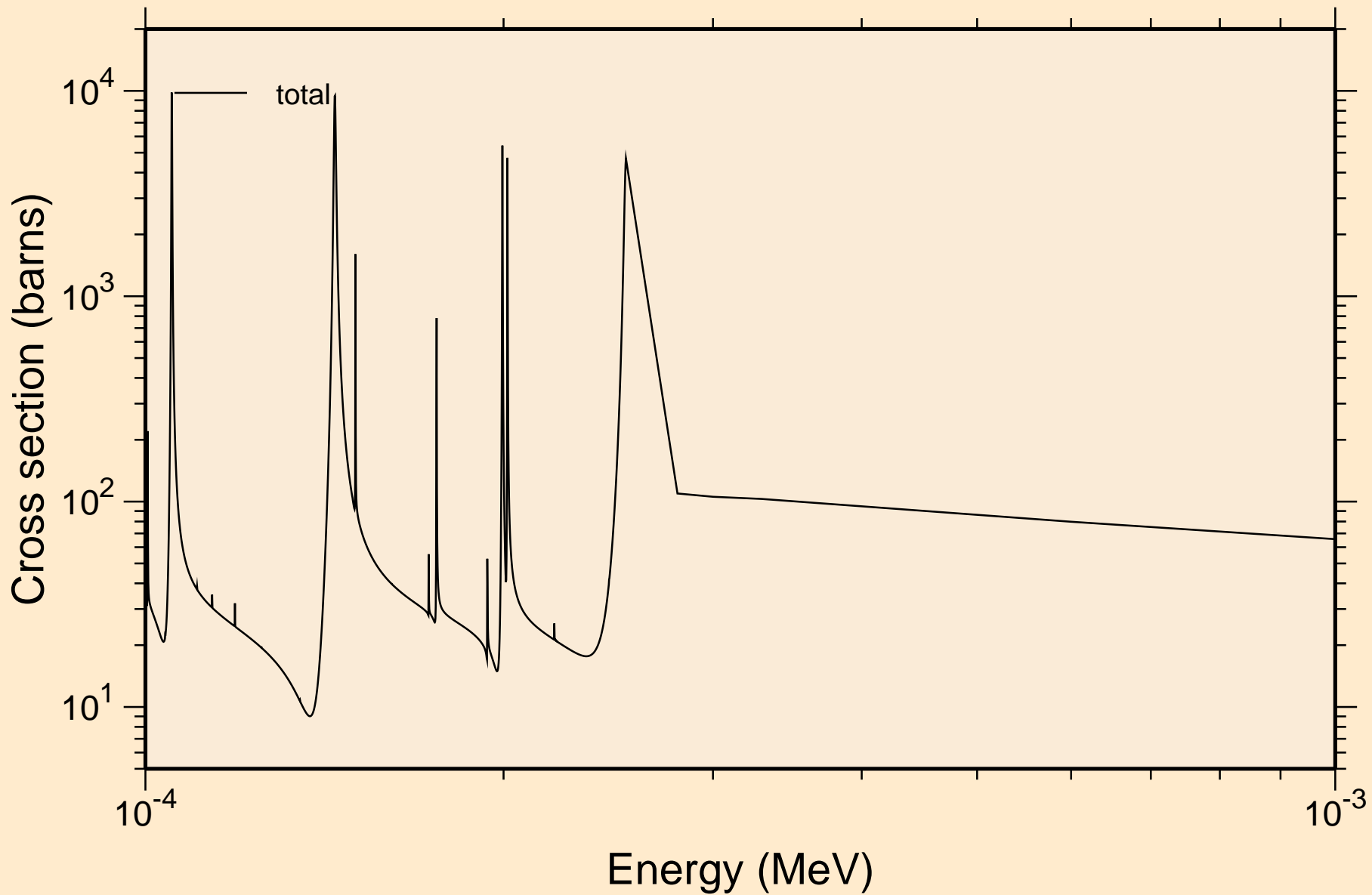

YB185 NEUTRON ACER TENDL-2024 LIBRARY; T=0.K  
resonance total cross section

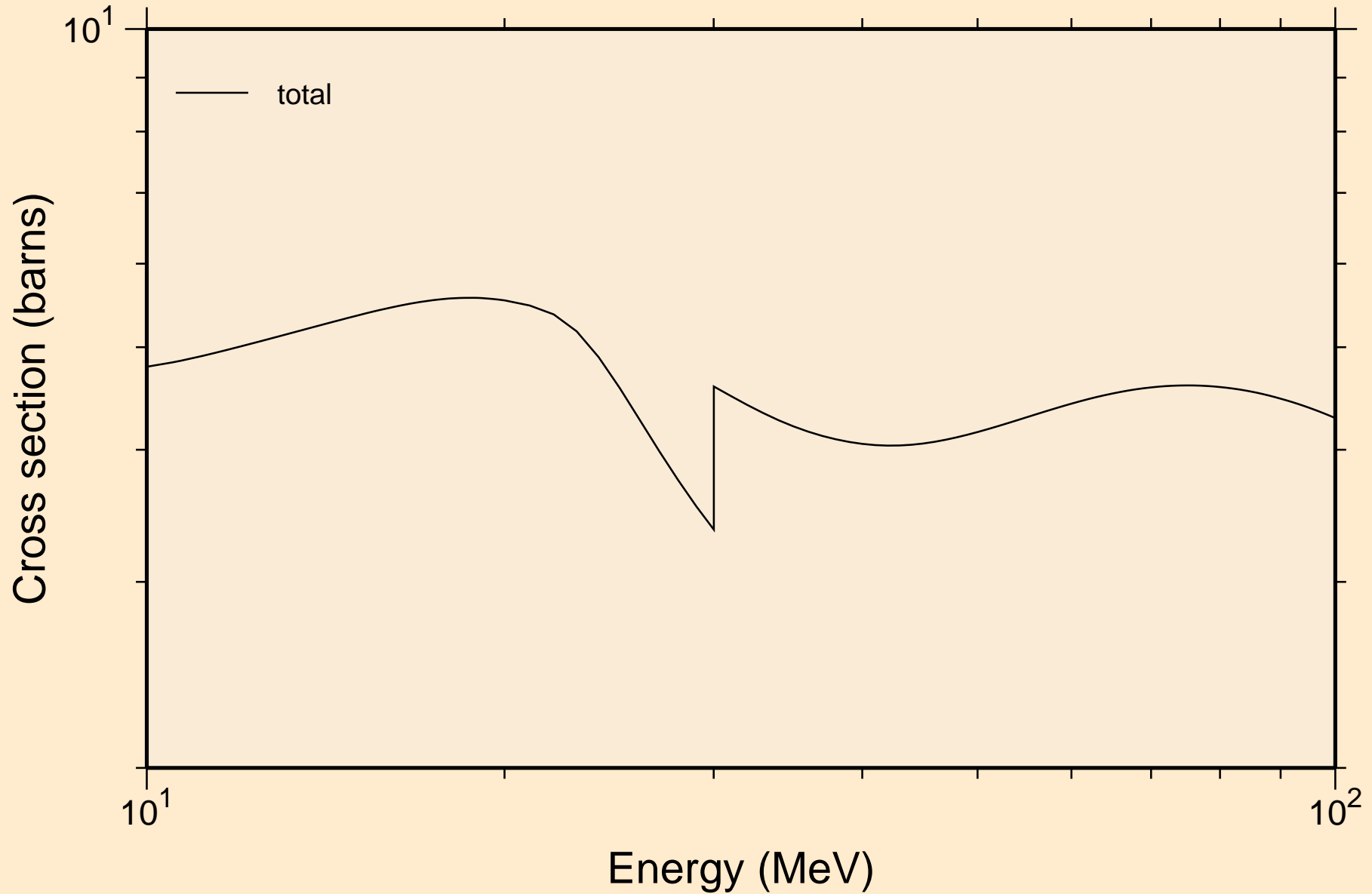

YB185 NEUTRON ACER TENDL-2024 LIBRARY; T=0.K  
resonance absorption cross sections

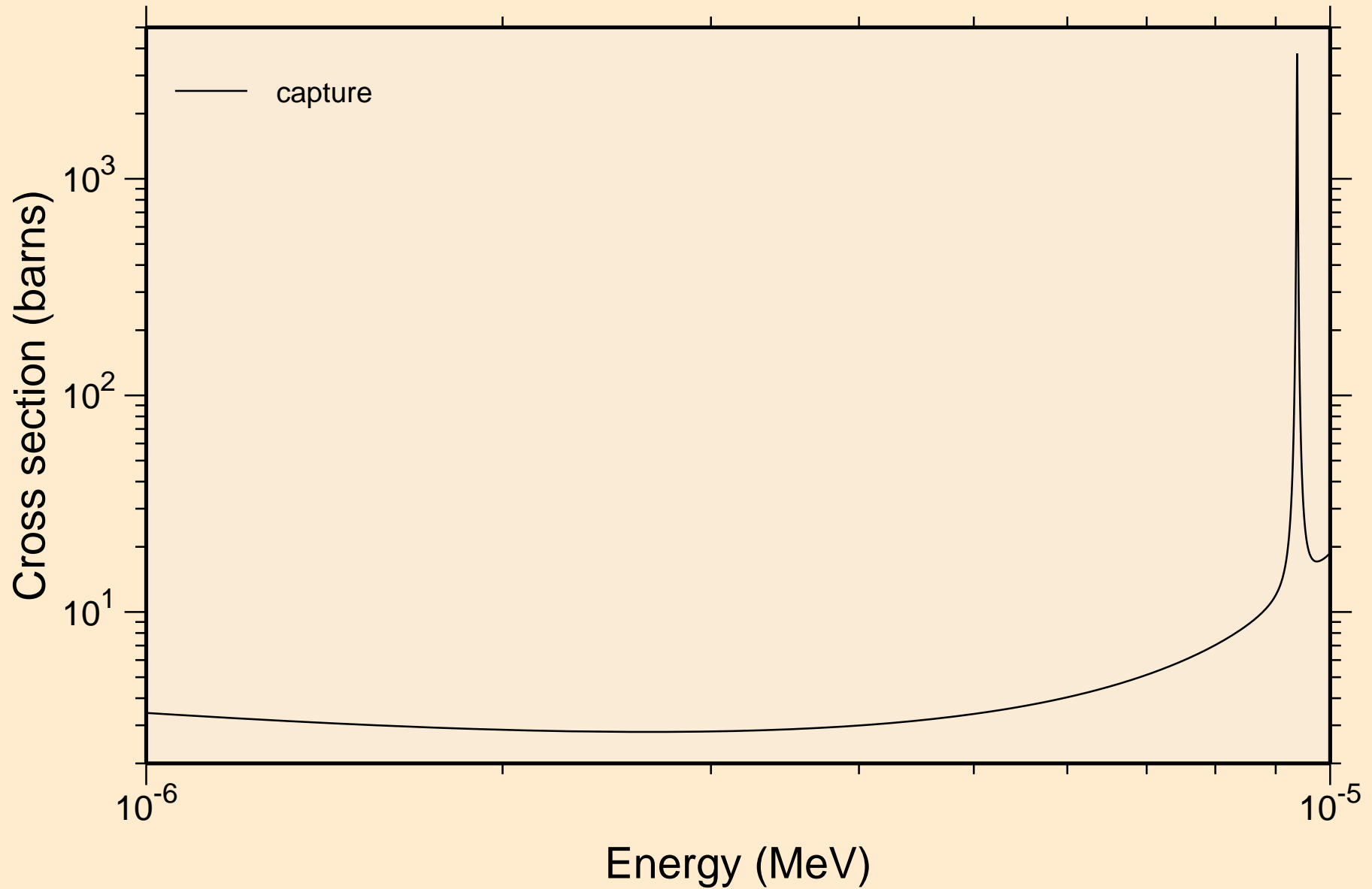

YB185 NEUTRON ACER TENDL-2024 LIBRARY; T=0.K  
resonance absorption cross sections

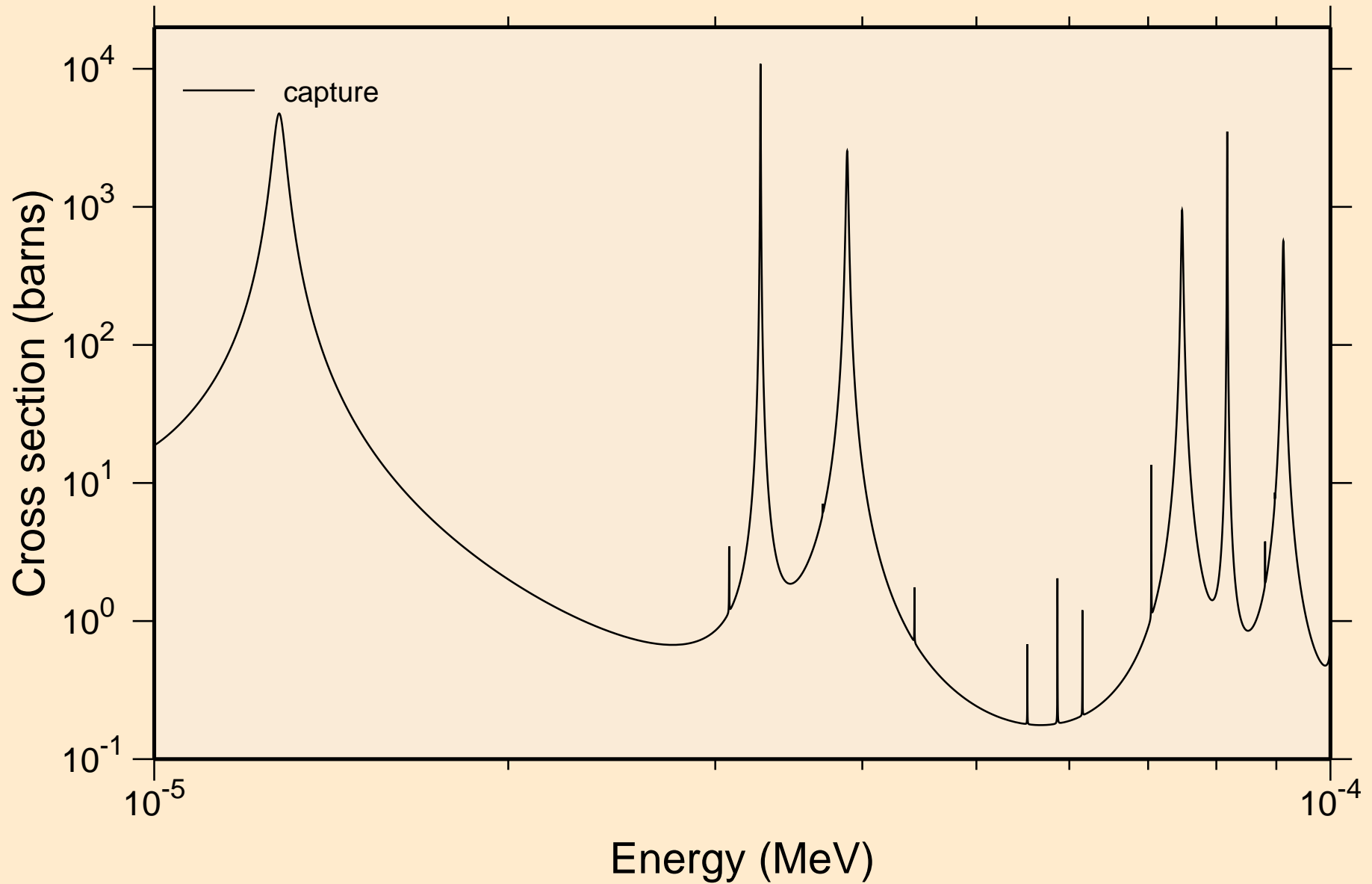

YB185 NEUTRON ACER TENDL-2024 LIBRARY; T=0.K  
resonance absorption cross sections

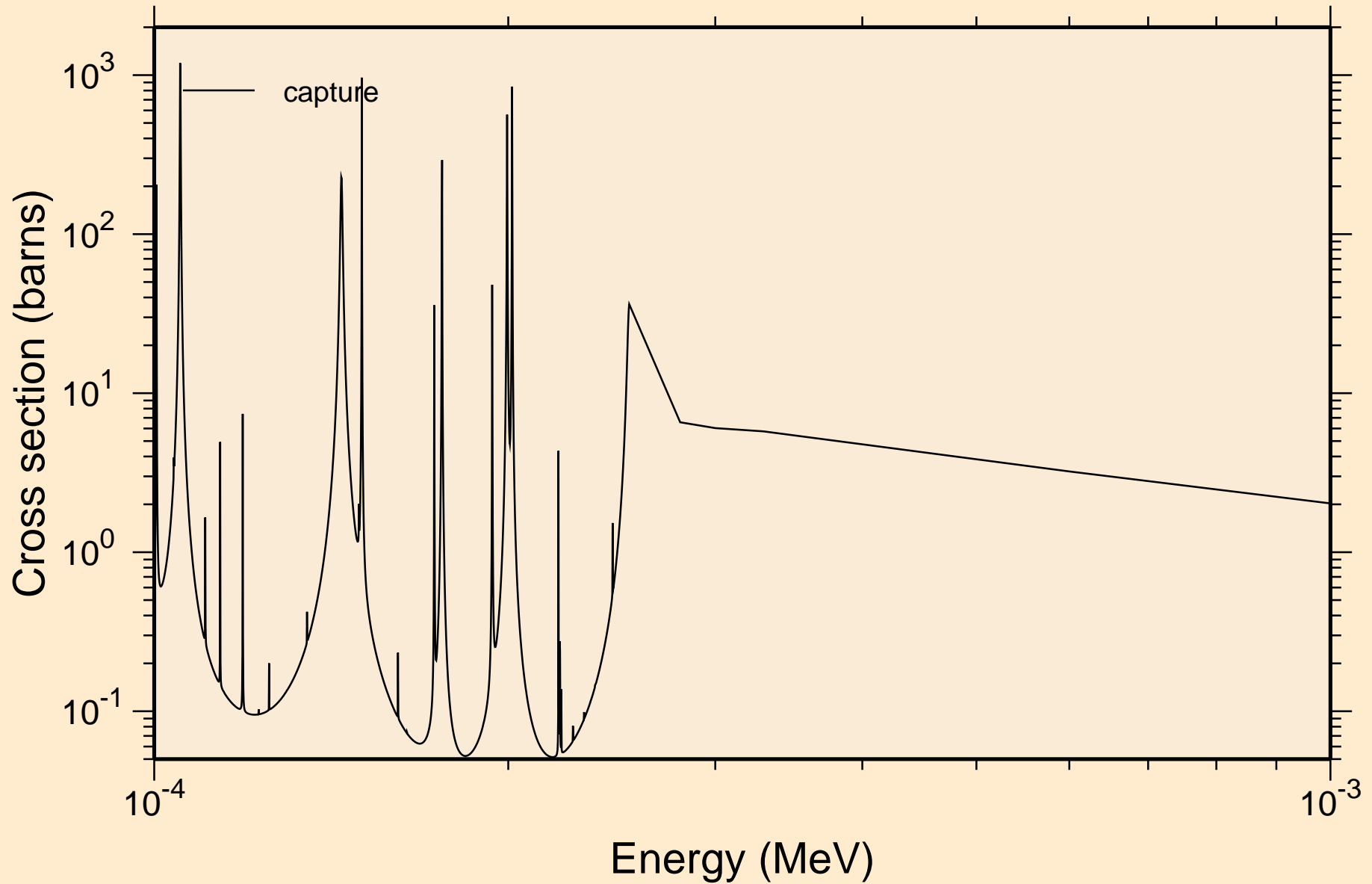



YB185 NEUTRON ACER TENDL-2024 LIBRARY; T=0.K  
resonance absorption cross sections

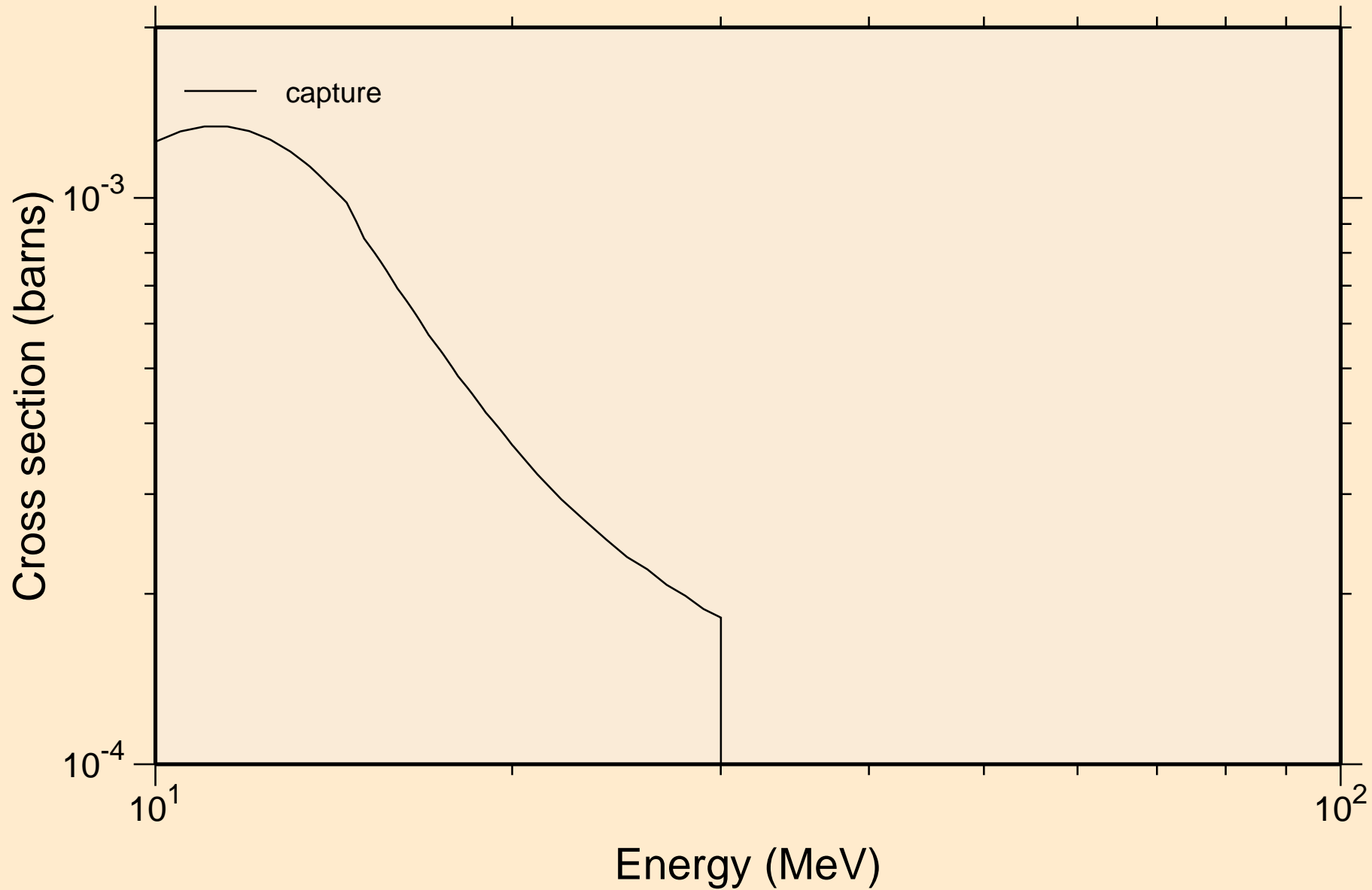

YB185 NEUTRON ACER TENDL-2024 LIBRARY; T=0.K  
Heating

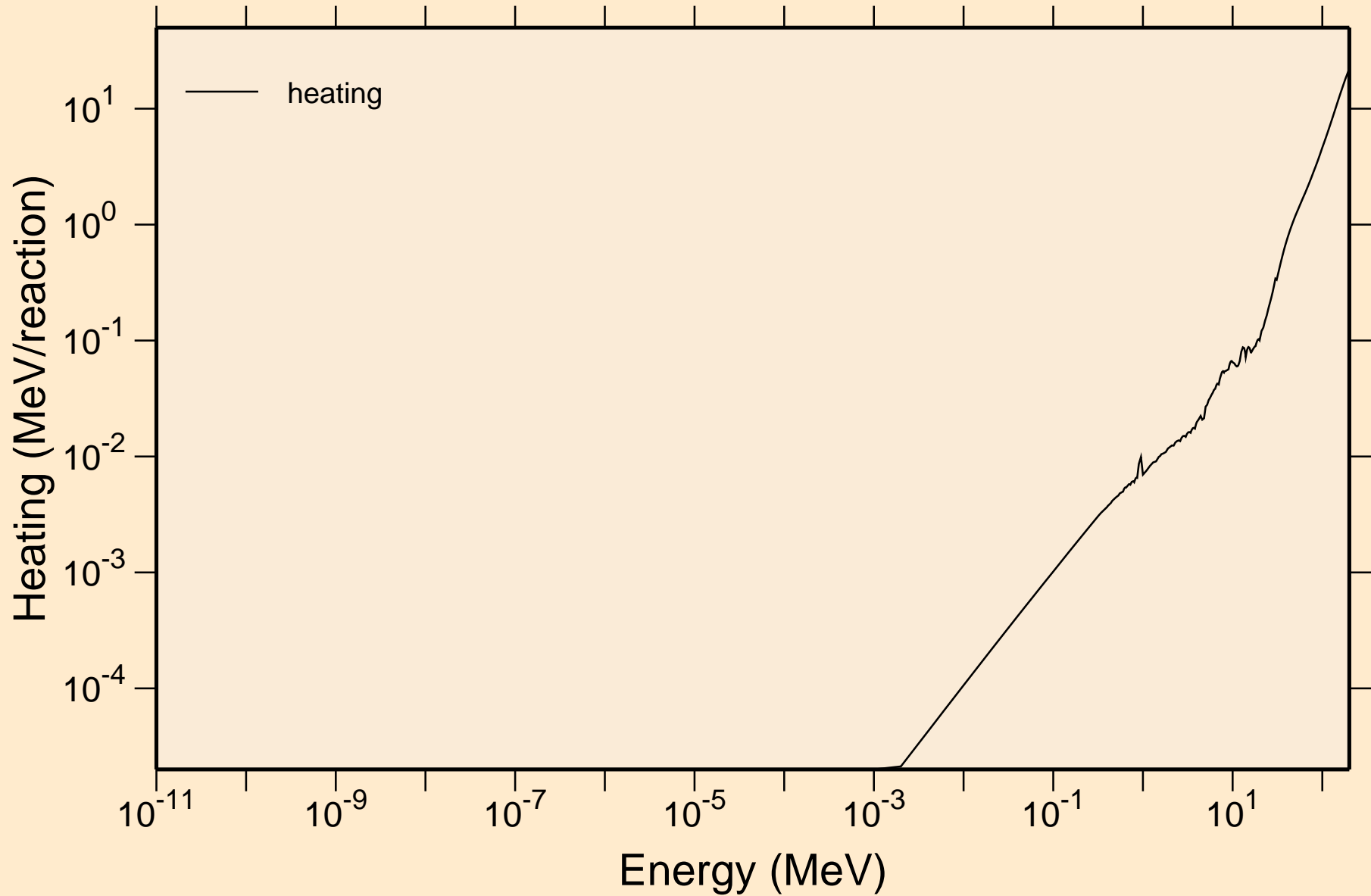

# YB185 NEUTRON ACER TENDL-2024 LIBRARY; T=0.K

## Damage

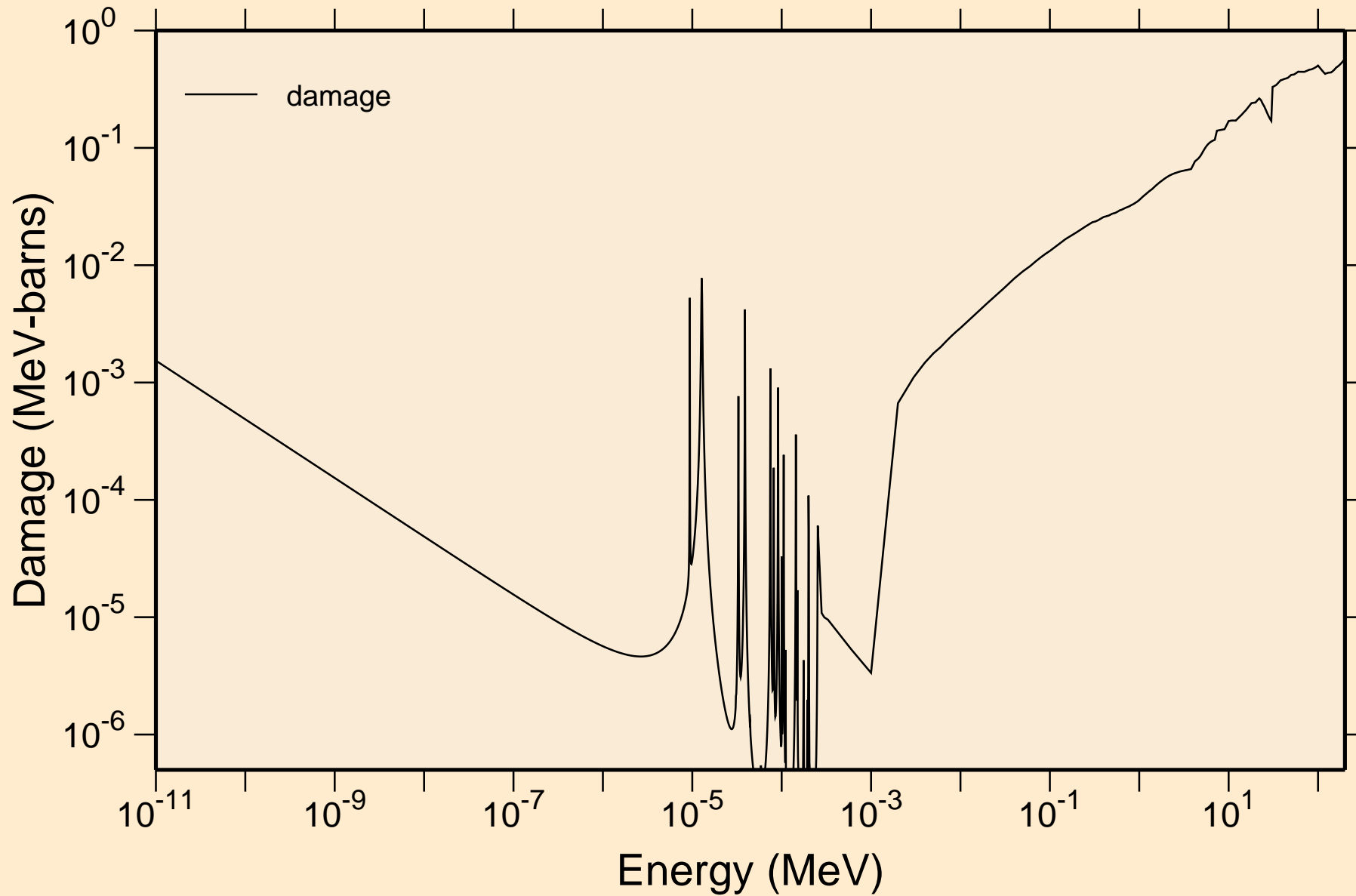

YB185 NEUTRON ACER TENDL-2024 LIBRARY; T=0.K  
Non-threshold reactions

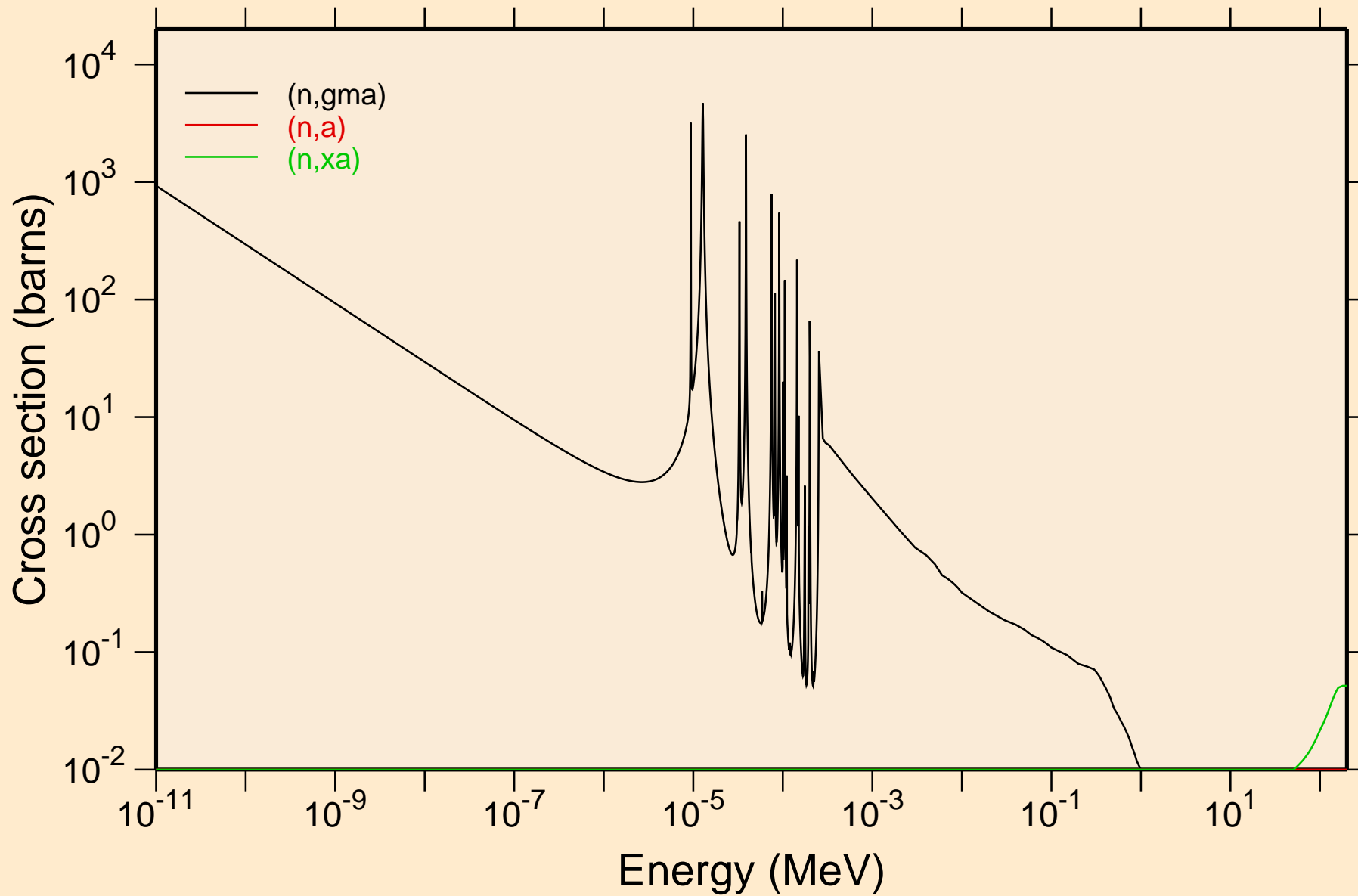

# YB185 NEUTRON ACER TENDL-2024 LIBRARY; T=0.K

## Principal cross sections

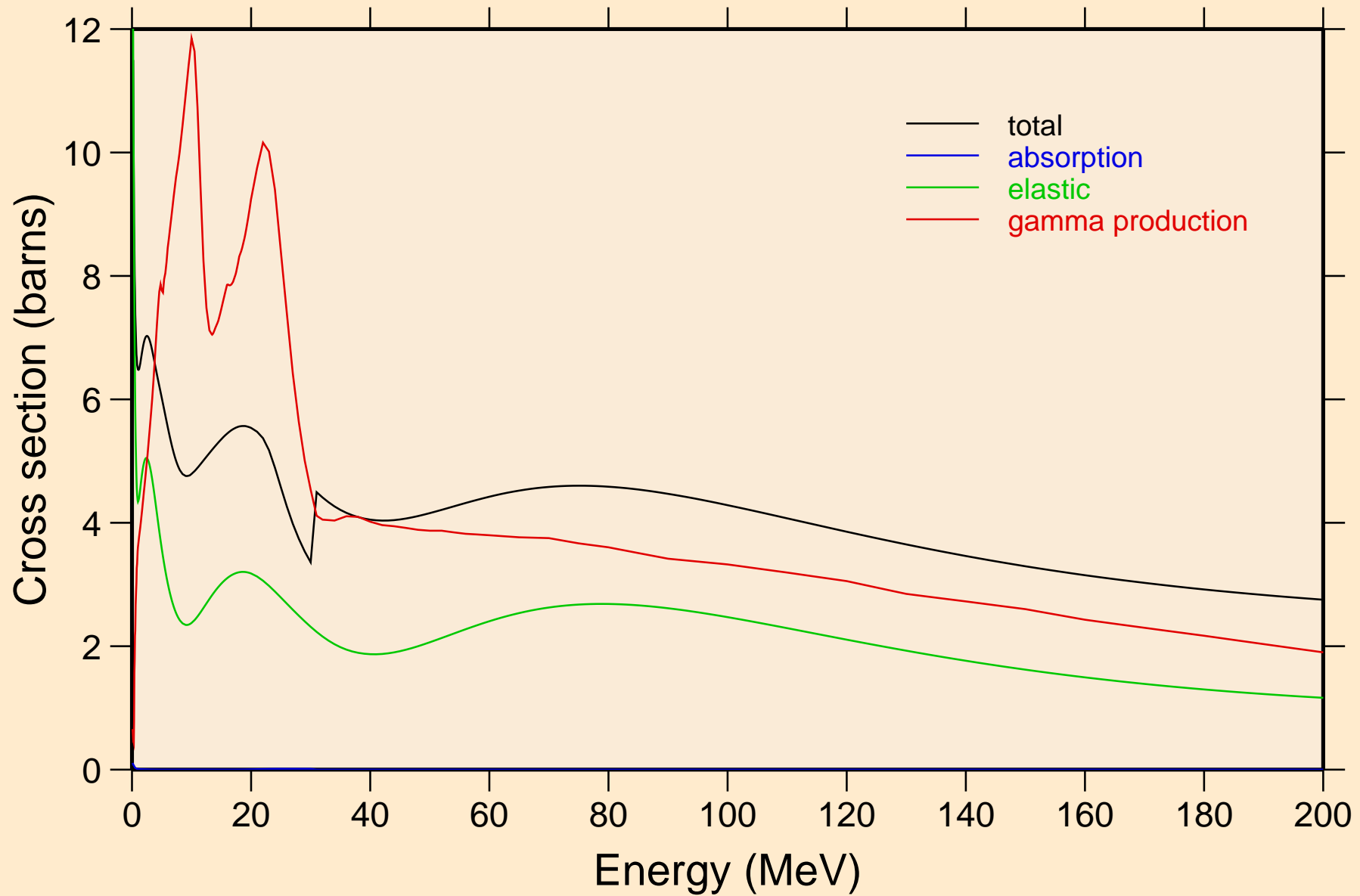

# YB185 NEUTRON ACER TENDL-2024 LIBRARY; T=0.K

## Heating

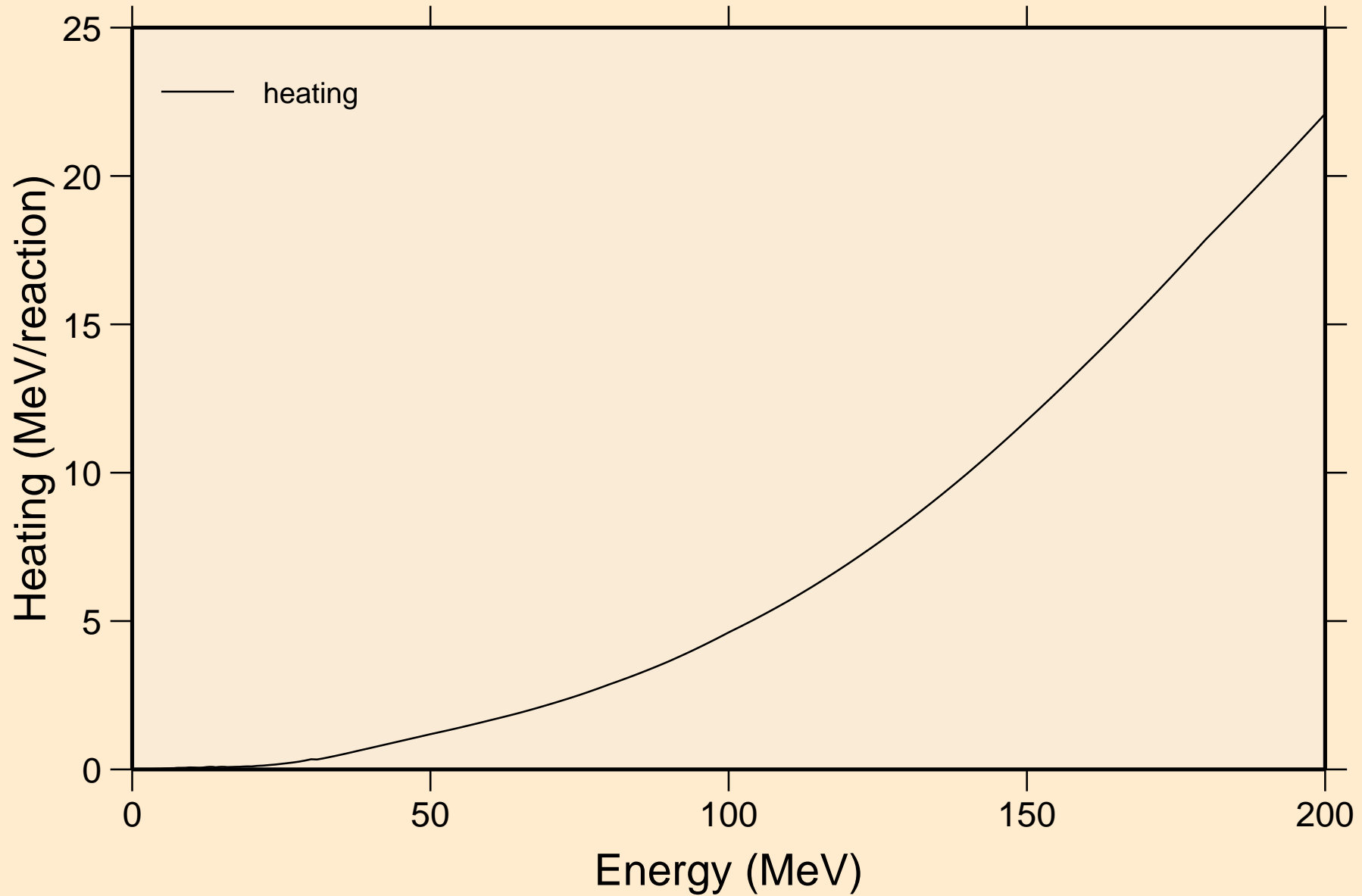

# YB185 NEUTRON ACER TENDL-2024 LIBRARY; T=0.K

## Damage

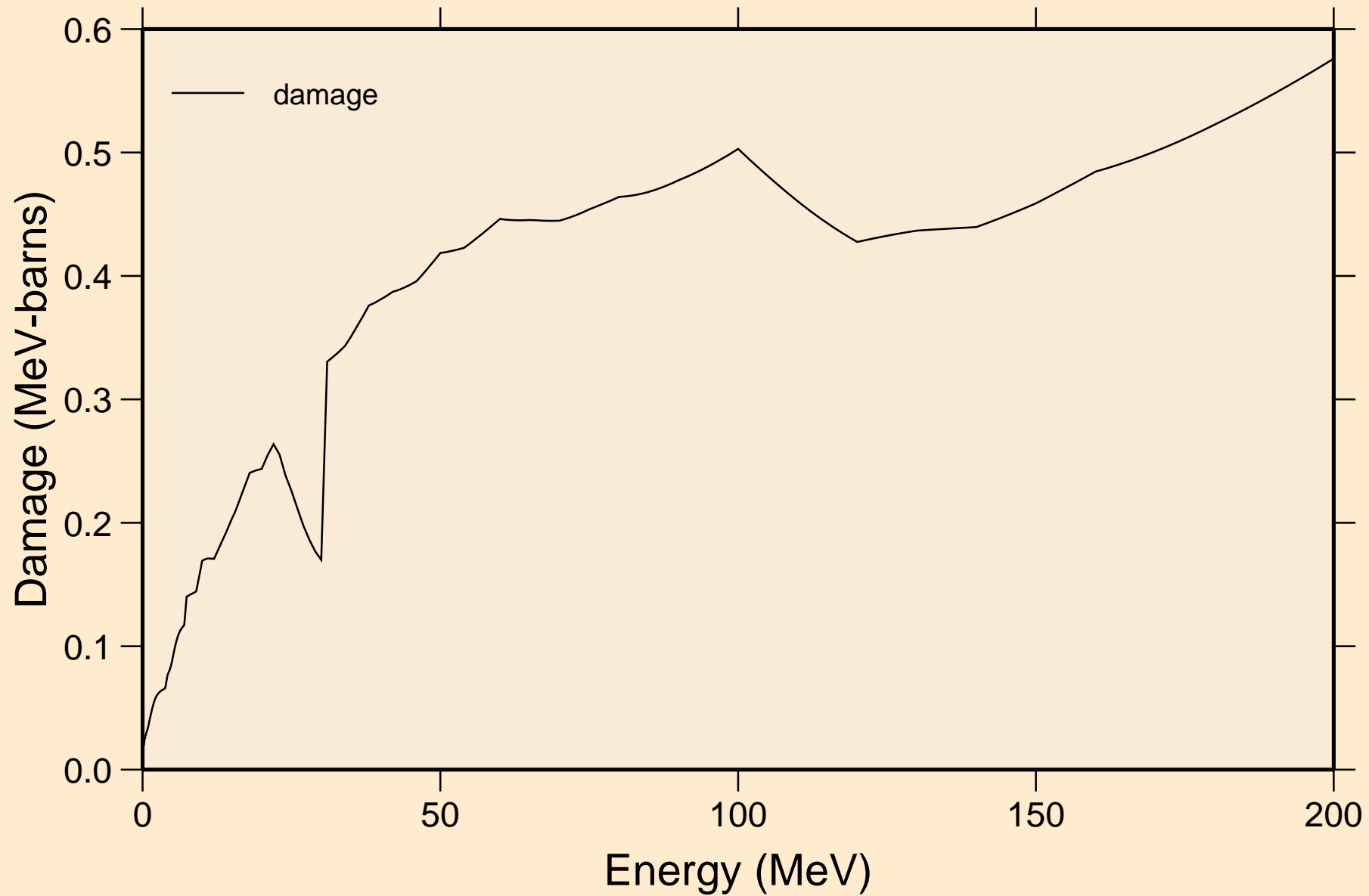

YB185 NEUTRON ACER TENDL-2024 LIBRARY; T=0.K  
Non-threshold reactions

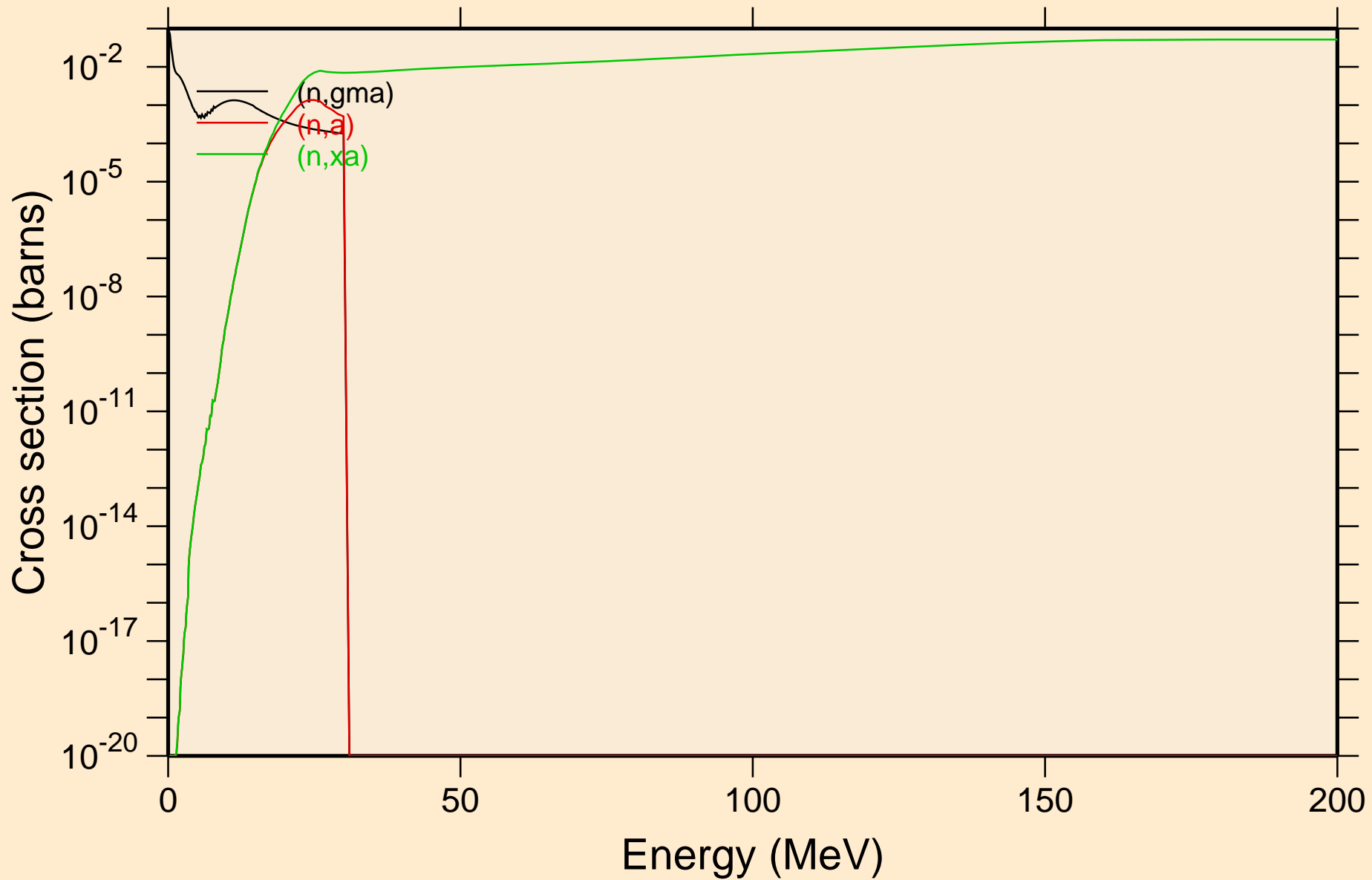



YB185 NEUTRON ACER TENDL-2024 LIBRARY; T=0.K  
Inelastic levels

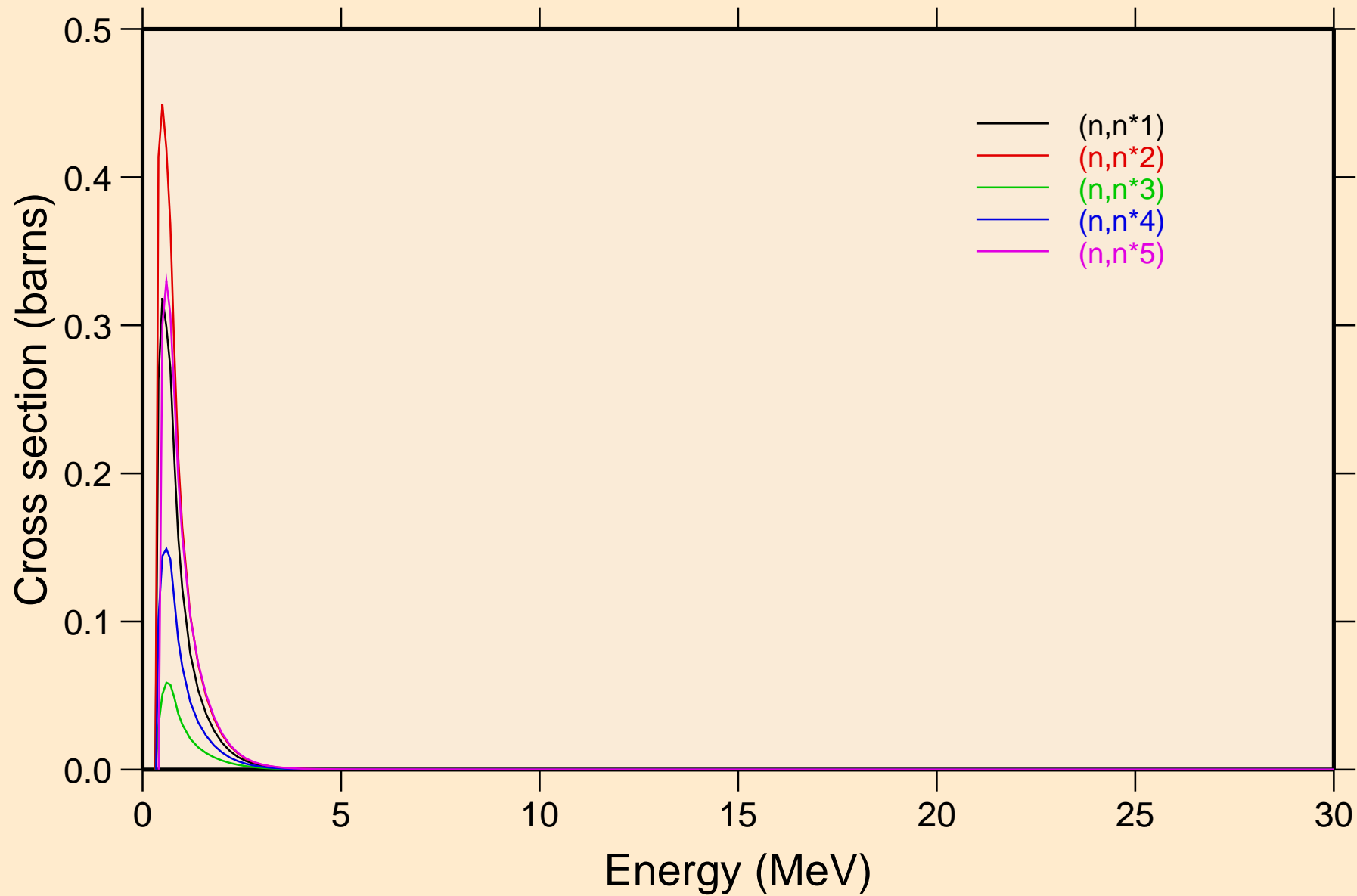

YB185 NEUTRON ACER TENDL-2024 LIBRARY; T=0.K  
Inelastic levels

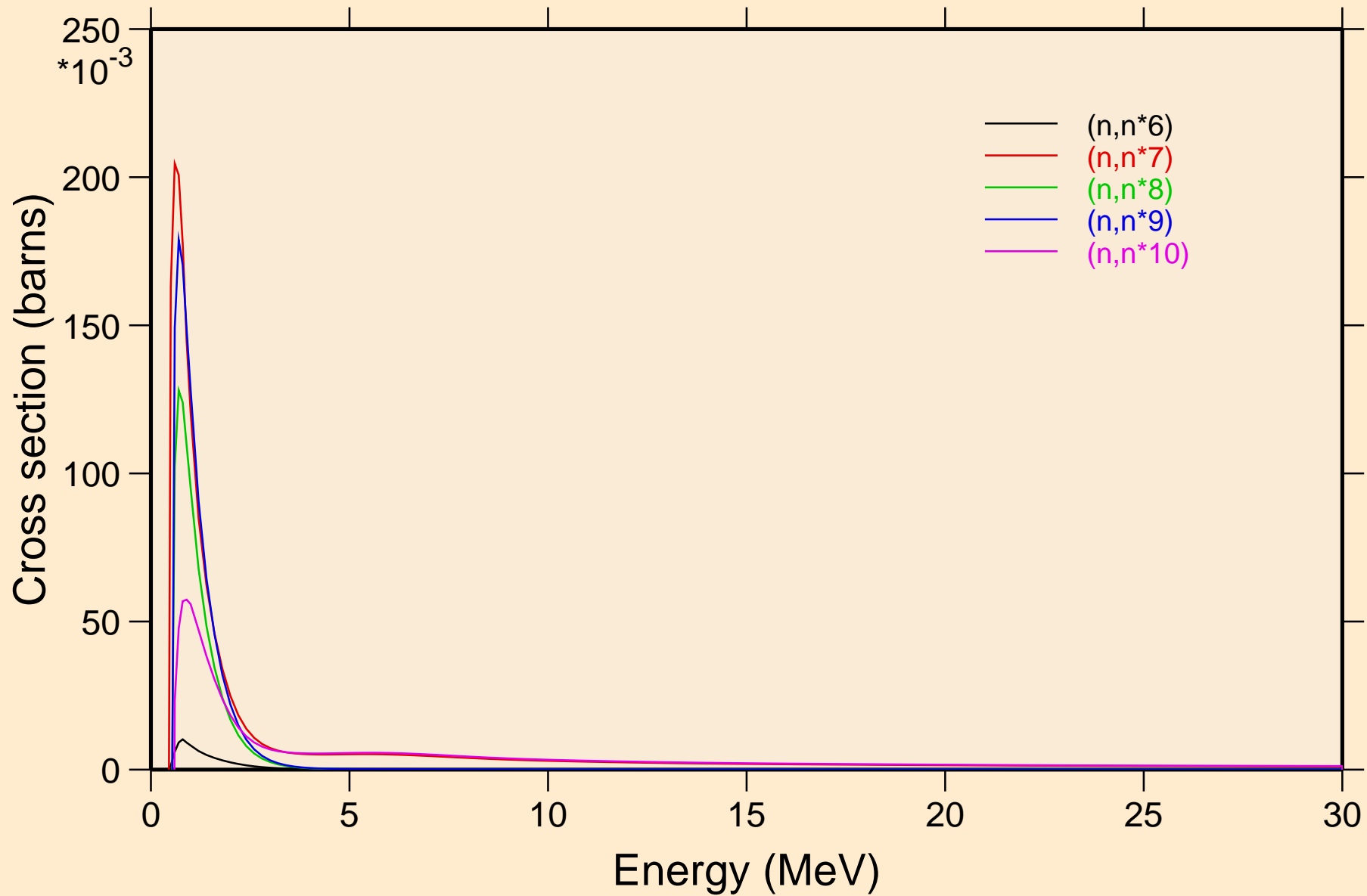

YB185 NEUTRON ACER TENDL-2024 LIBRARY; T=0.K  
Inelastic levels

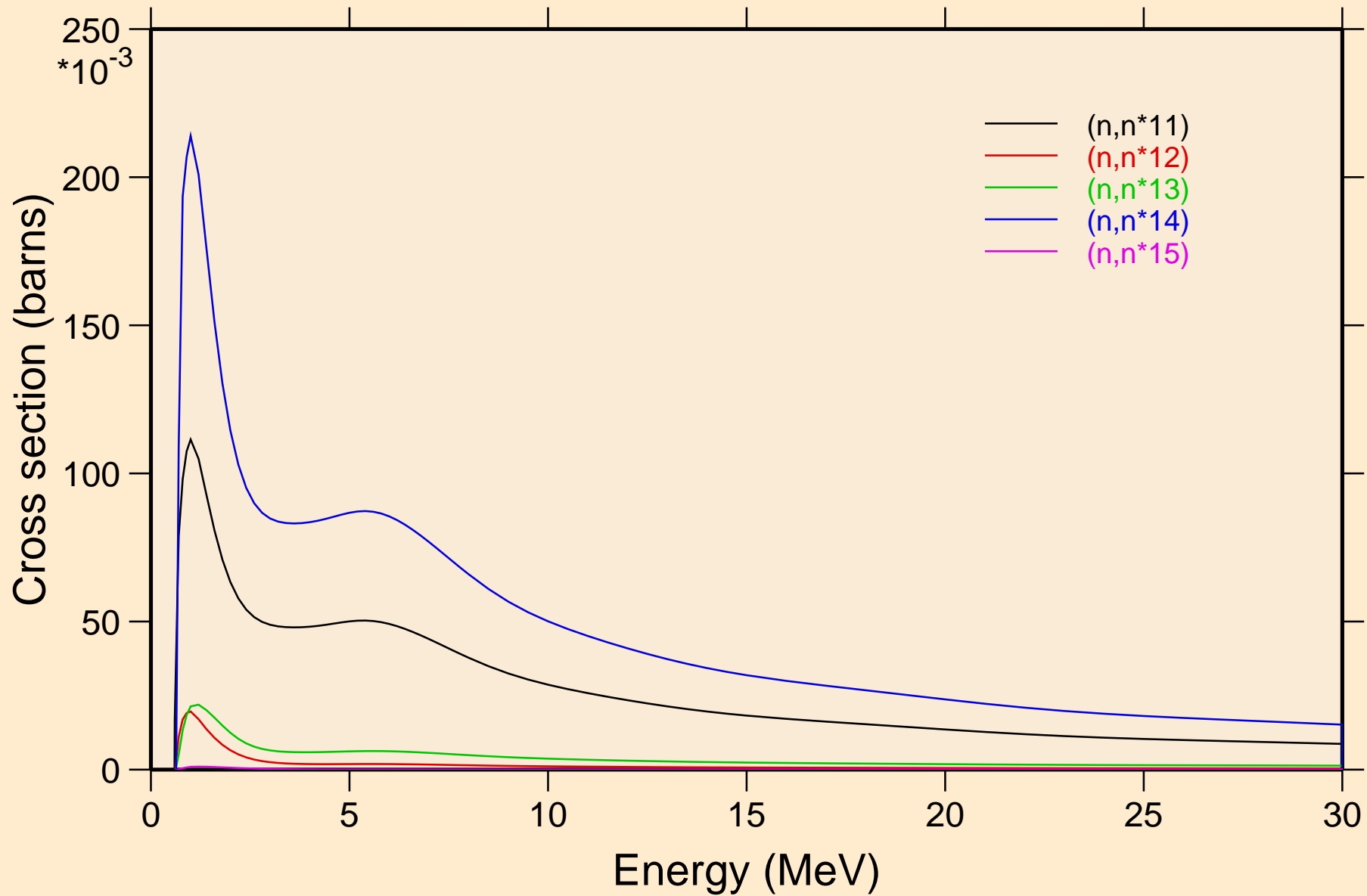

YB185 NEUTRON ACER TENDL-2024 LIBRARY; T=0.K  
Inelastic levels

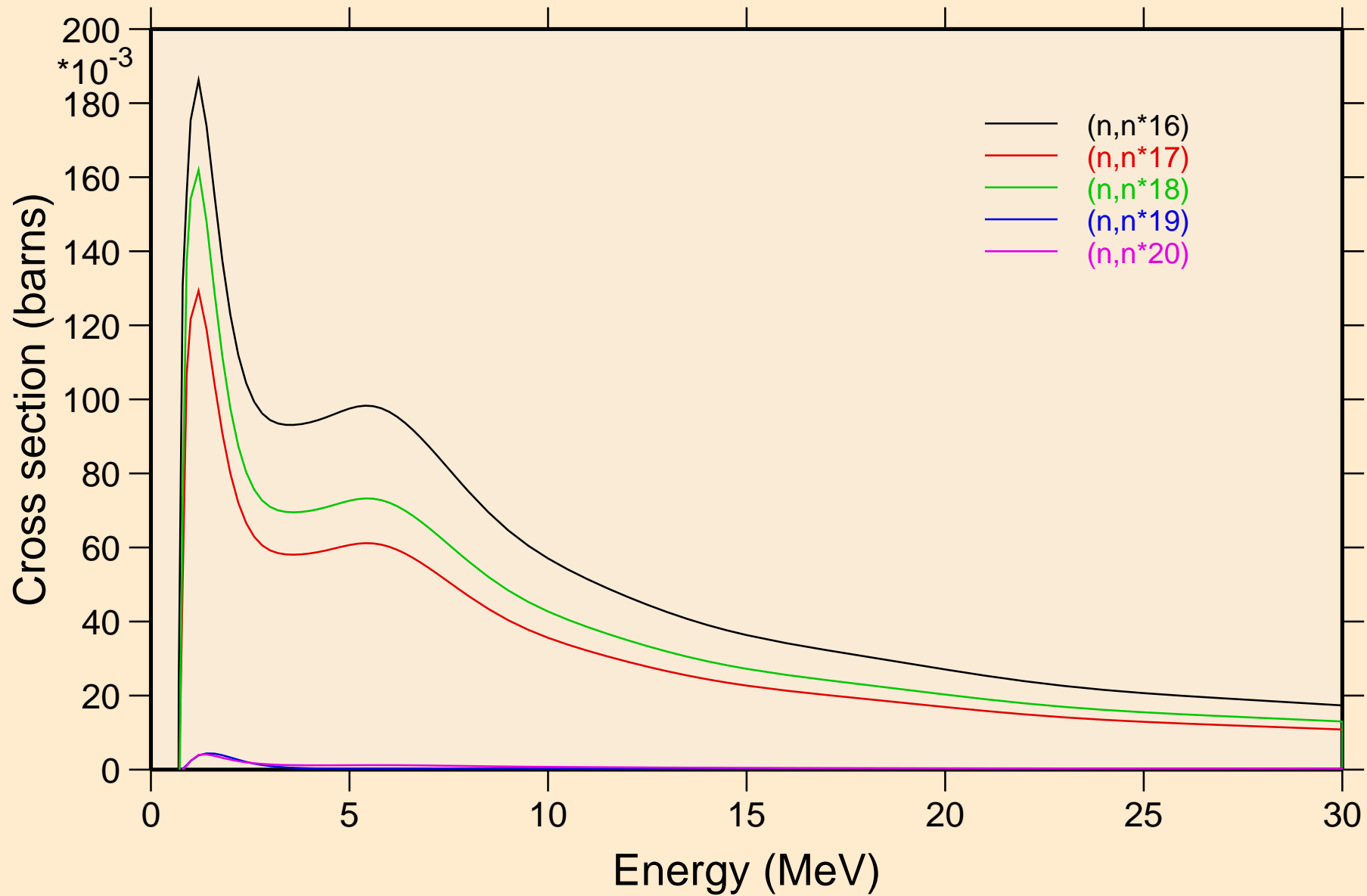

# YB185 NEUTRON ACER TENDL-2024 LIBRARY; T=0.K

## Inelastic levels

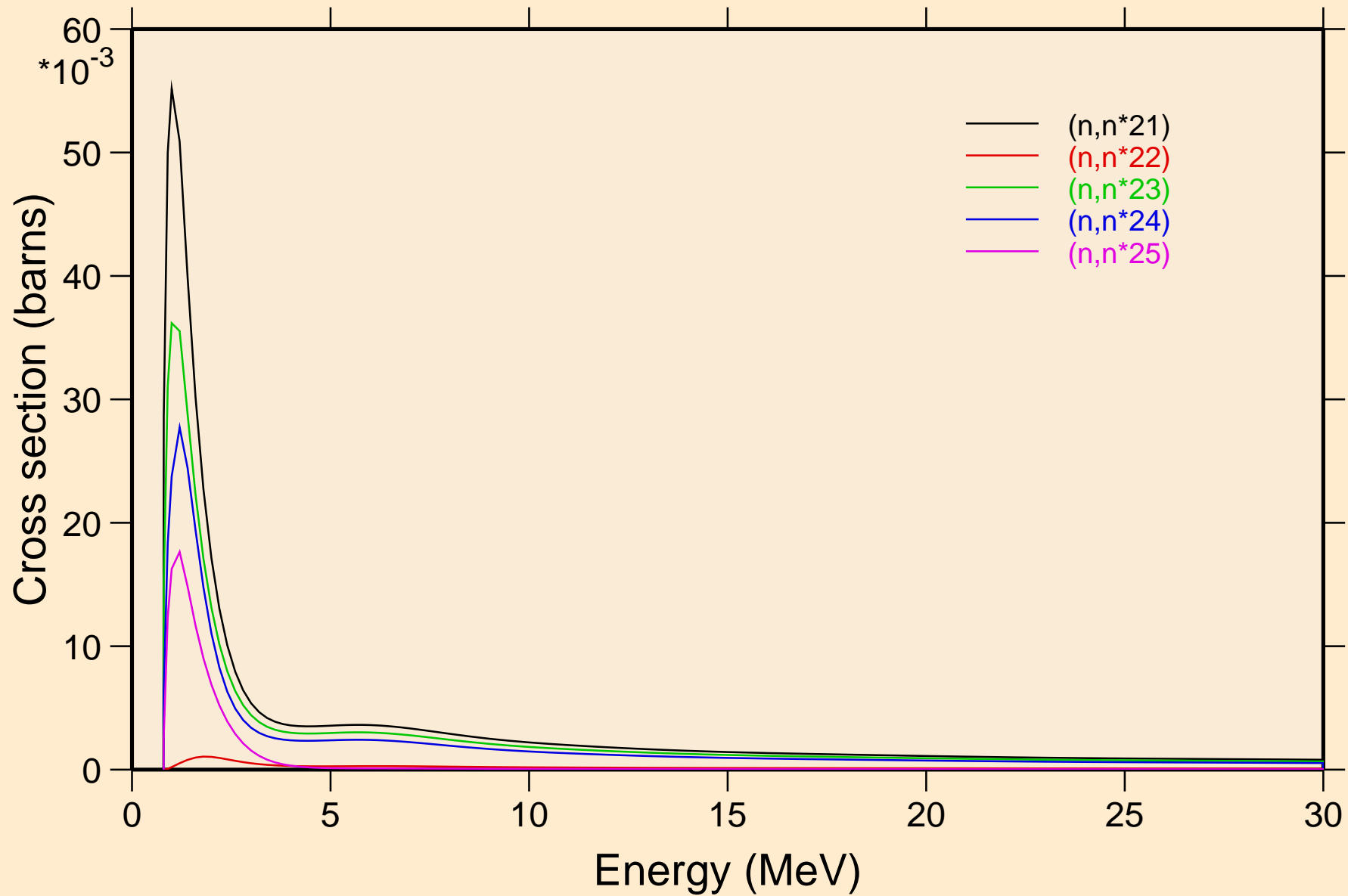

YB185 NEUTRON ACER TENDL-2024 LIBRARY; T=0.K  
Inelastic levels

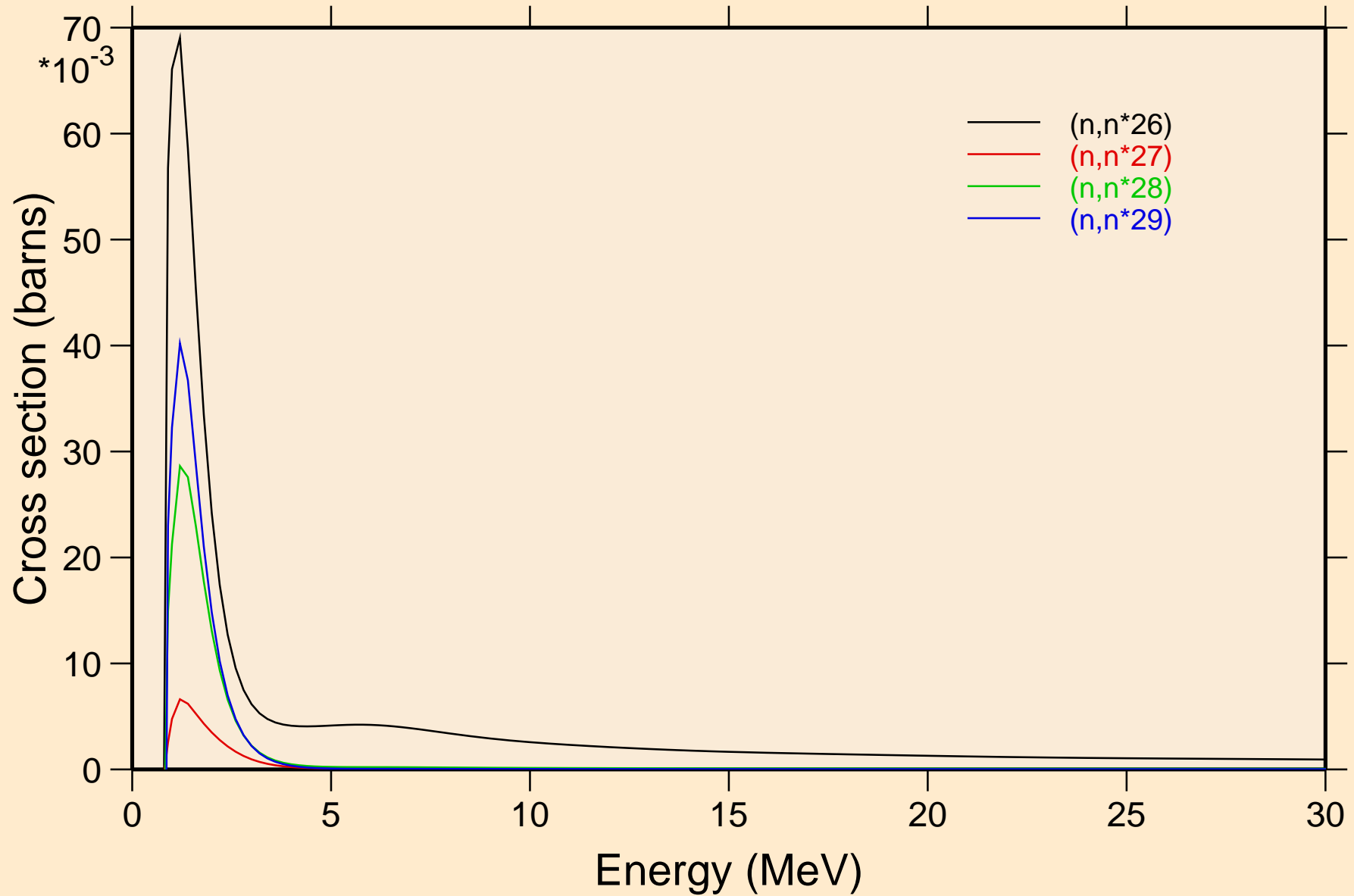

YB185 NEUTRON ACER TENDL-2024 LIBRARY; T=0.K  
Threshold reactions

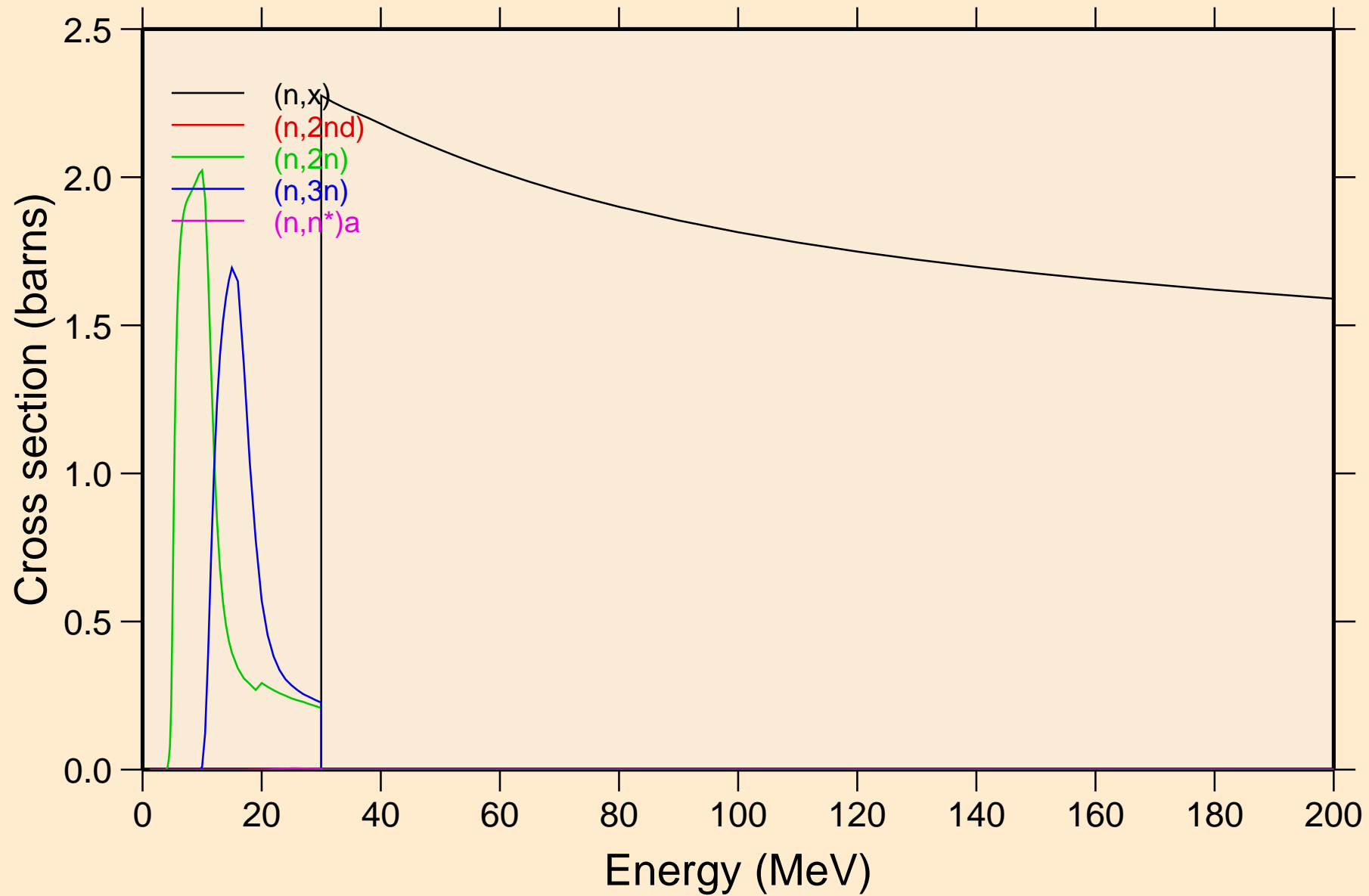

YB185 NEUTRON ACER TENDL-2024 LIBRARY; T=0.K  
Threshold reactions

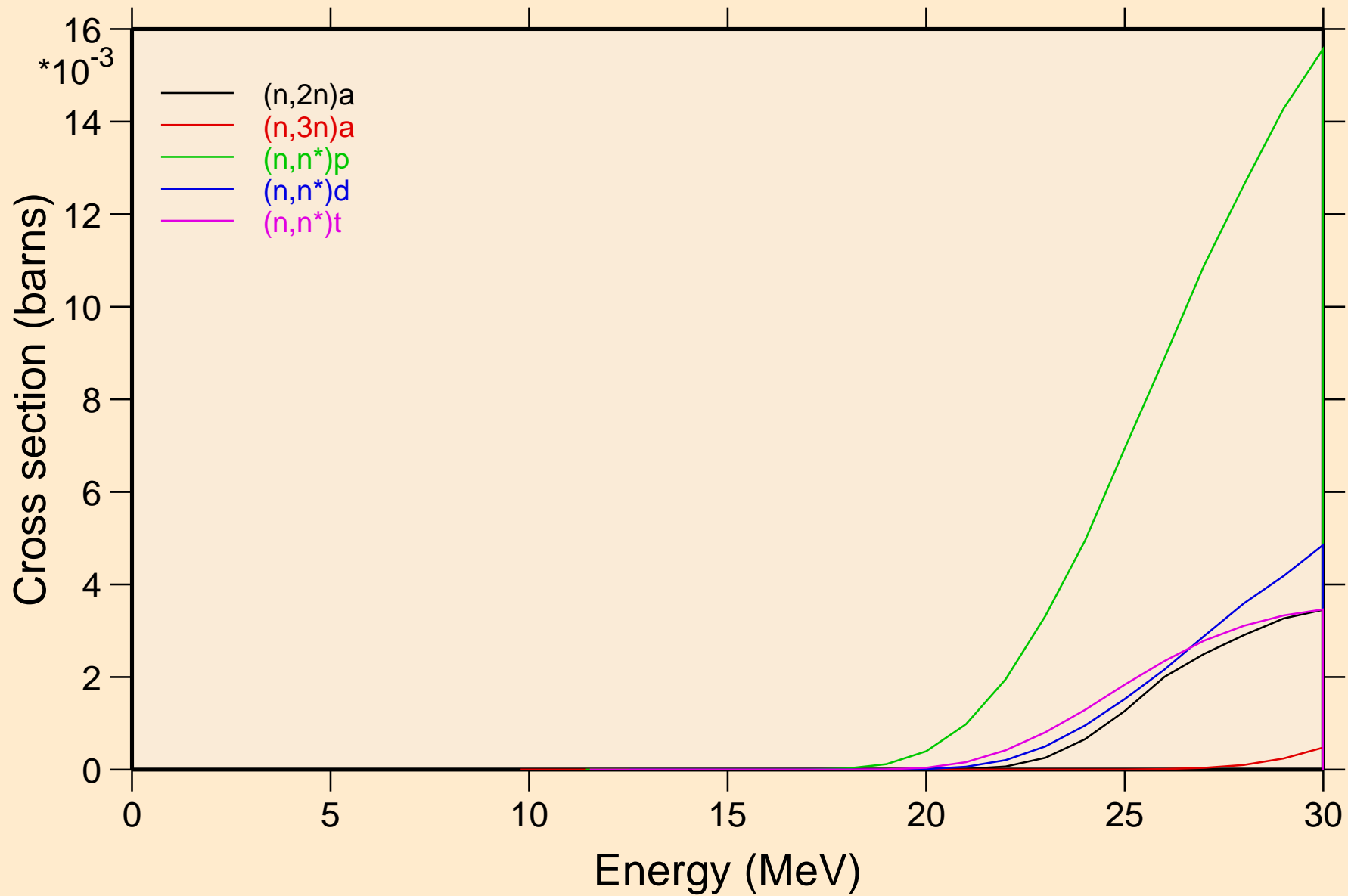



YB185 NEUTRON ACER TENDL-2024 LIBRARY; T=0.K  
Threshold reactions

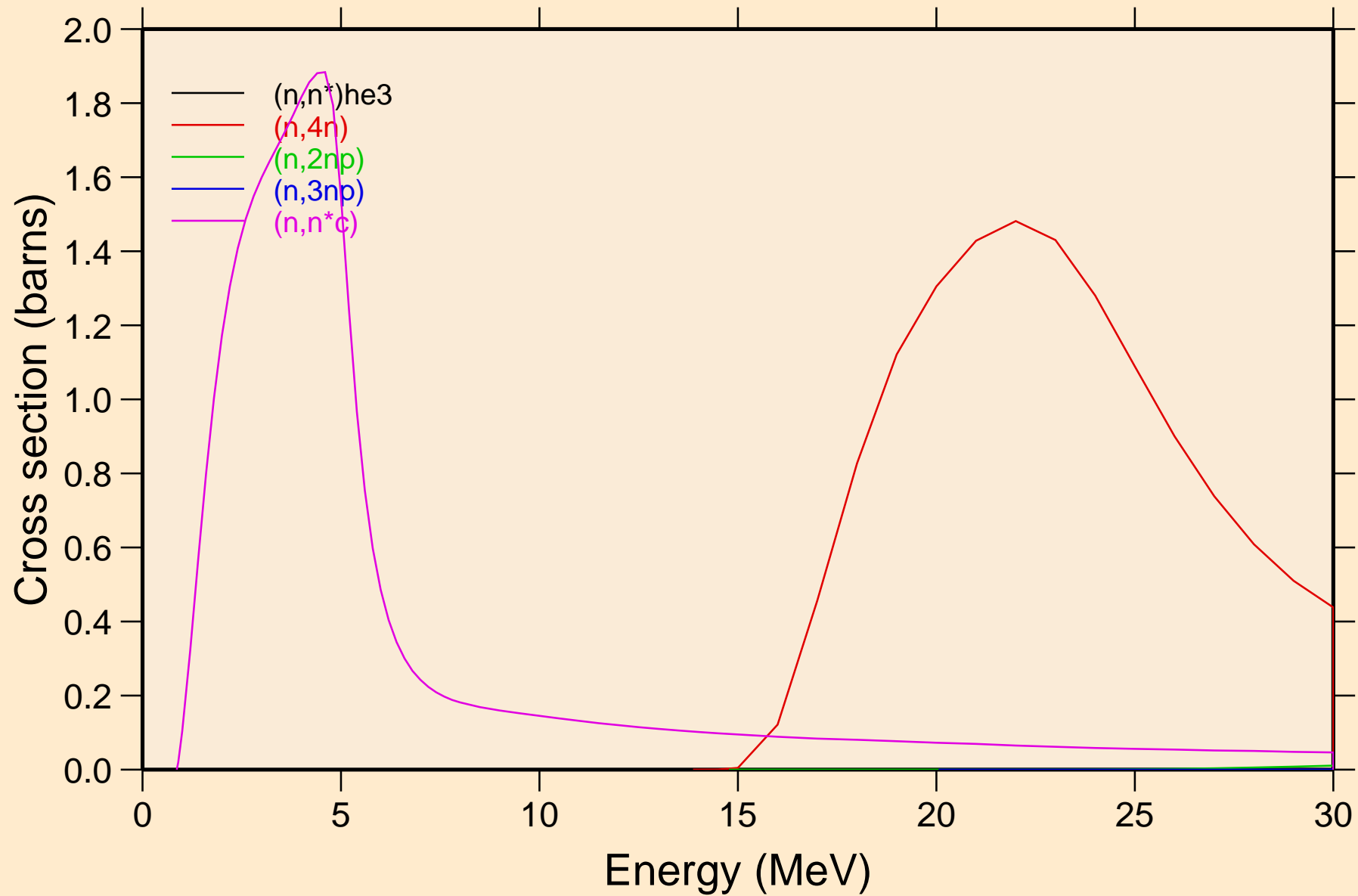

YB185 NEUTRON ACER TENDL-2024 LIBRARY; T=0.K  
Threshold reactions

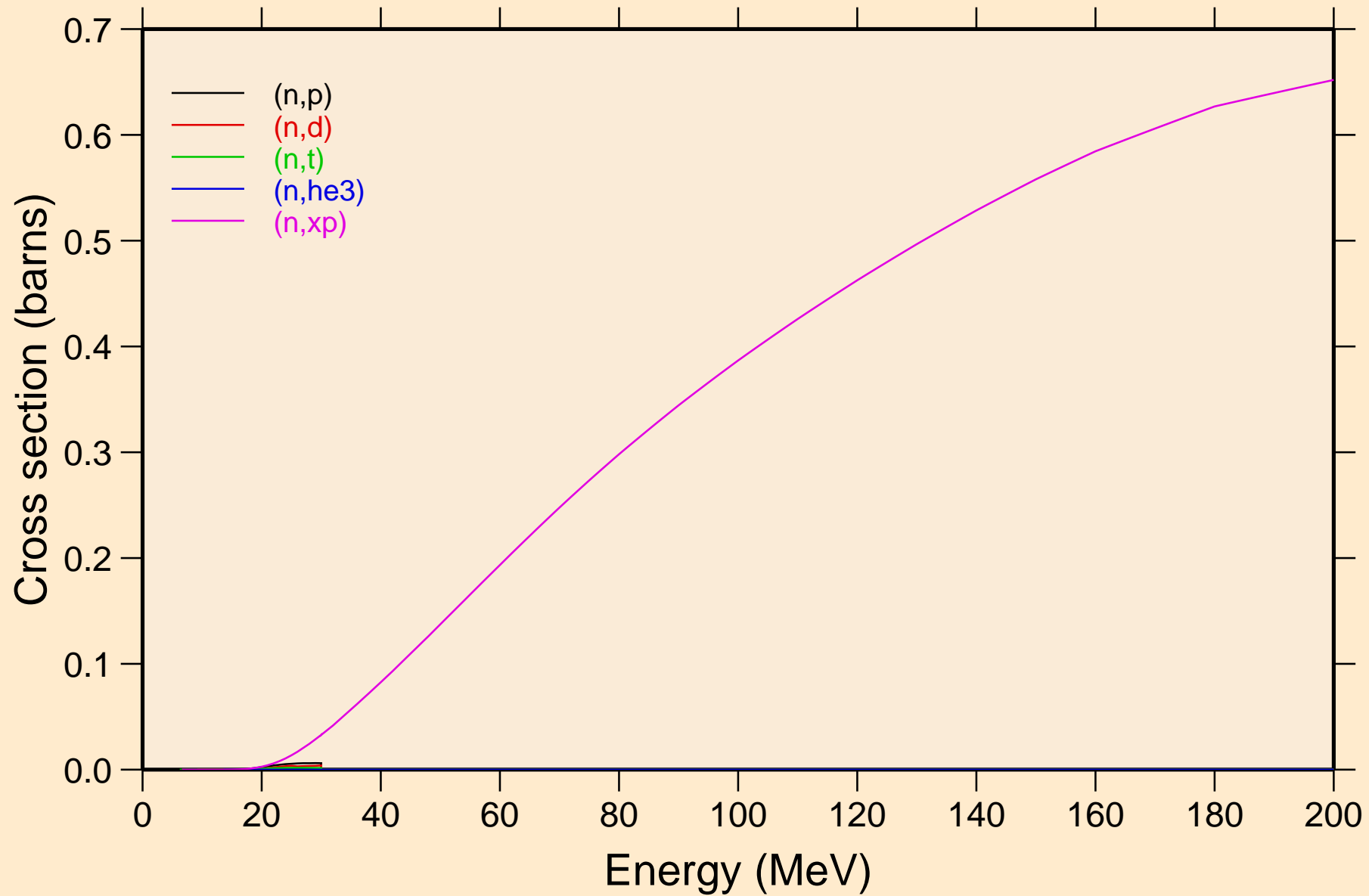

# YB185 NEUTRON ACER TENDL-2024 LIBRARY; T=0.K

## Threshold reactions

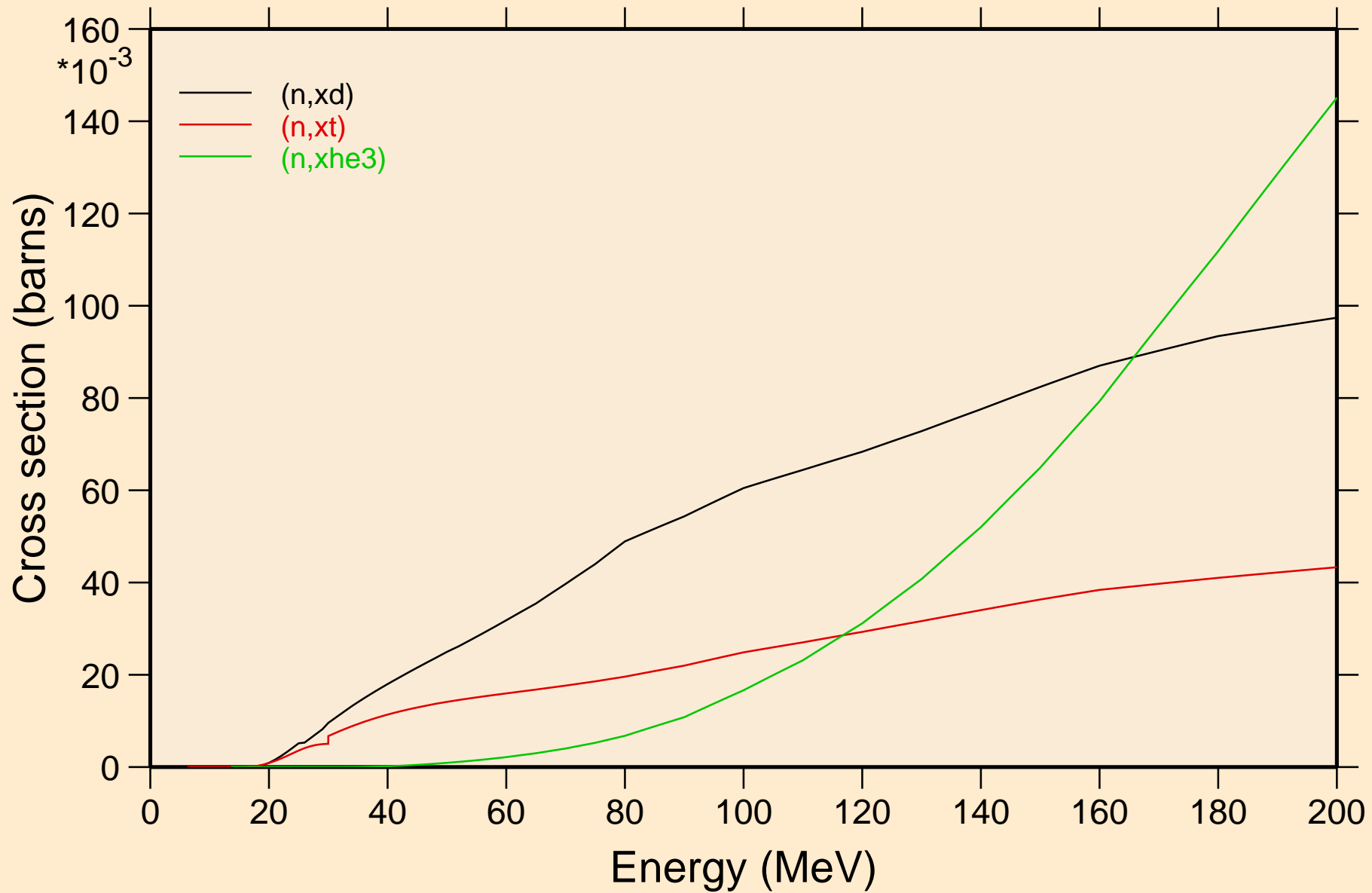

YB185 NEUTRON ACER TENDL-2024 LIBRARY; T=0.K  
angular distribution for elastic

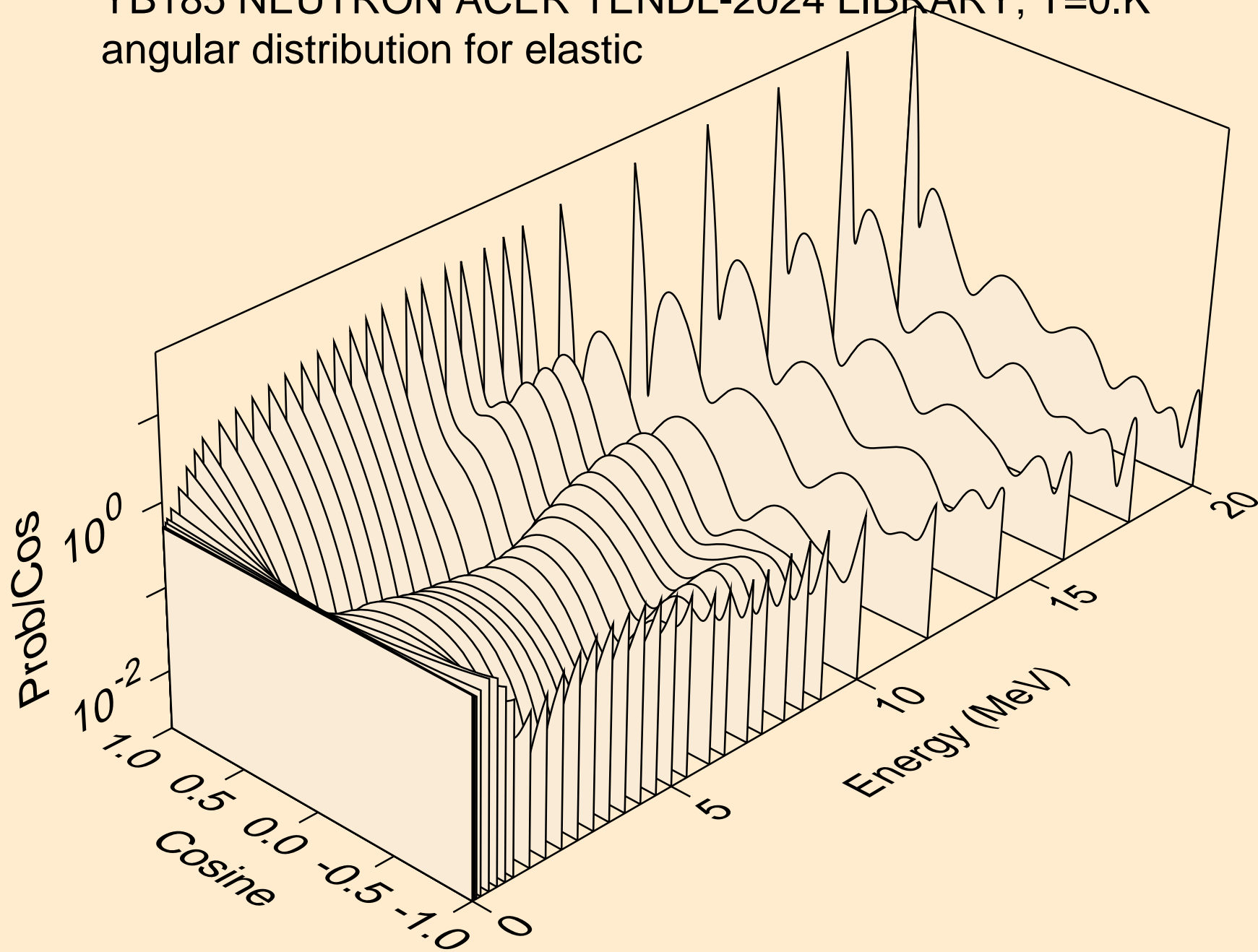

YB185 NEUTRON ACER TENDL-2024 LIBRARY; T=0.K  
angular distribution for elastic

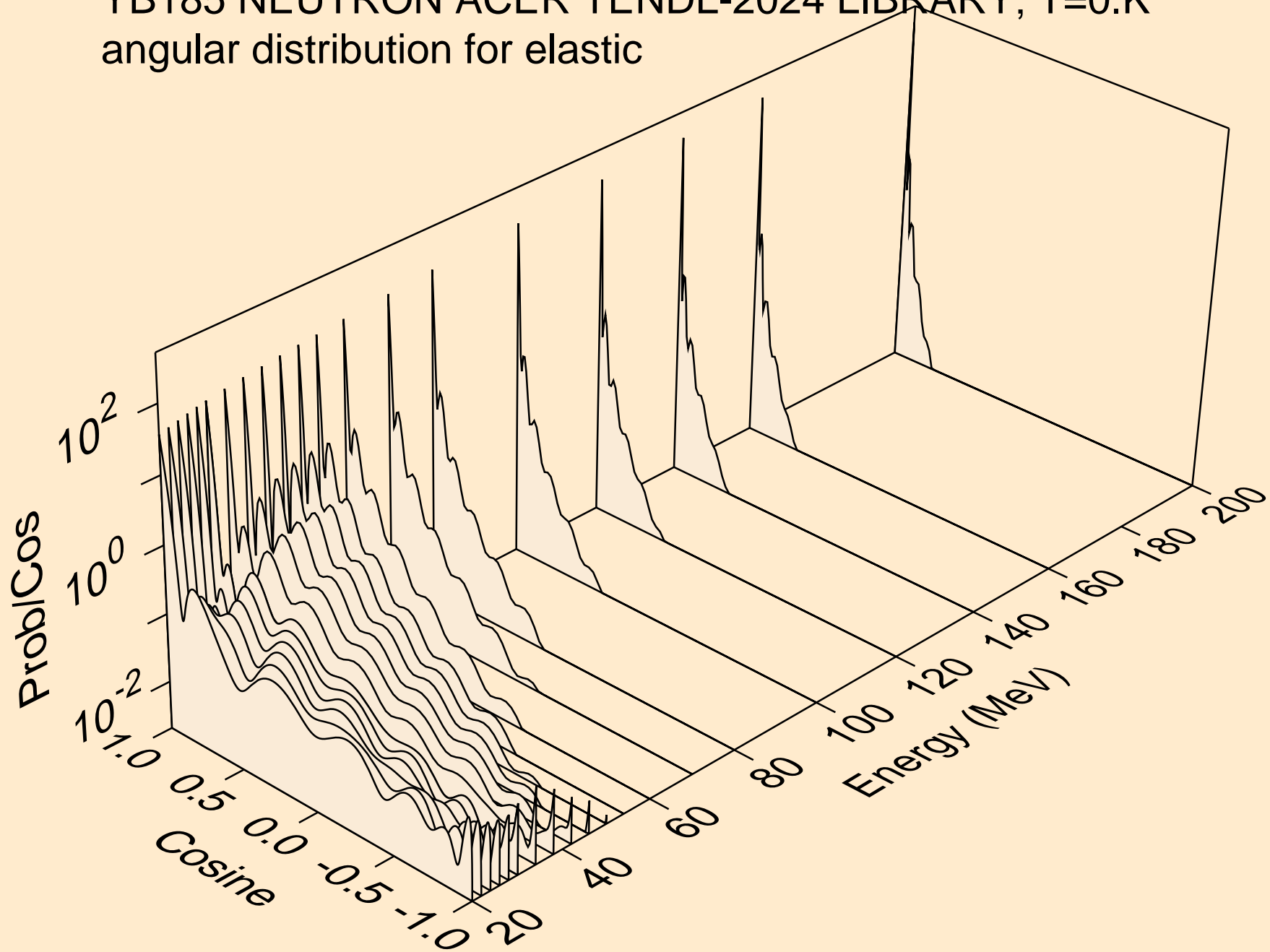

YB185 NEUTRON ACER TENDL-2024 LIBRARY; T=0.K  
angular distribution for (n,n\*1)

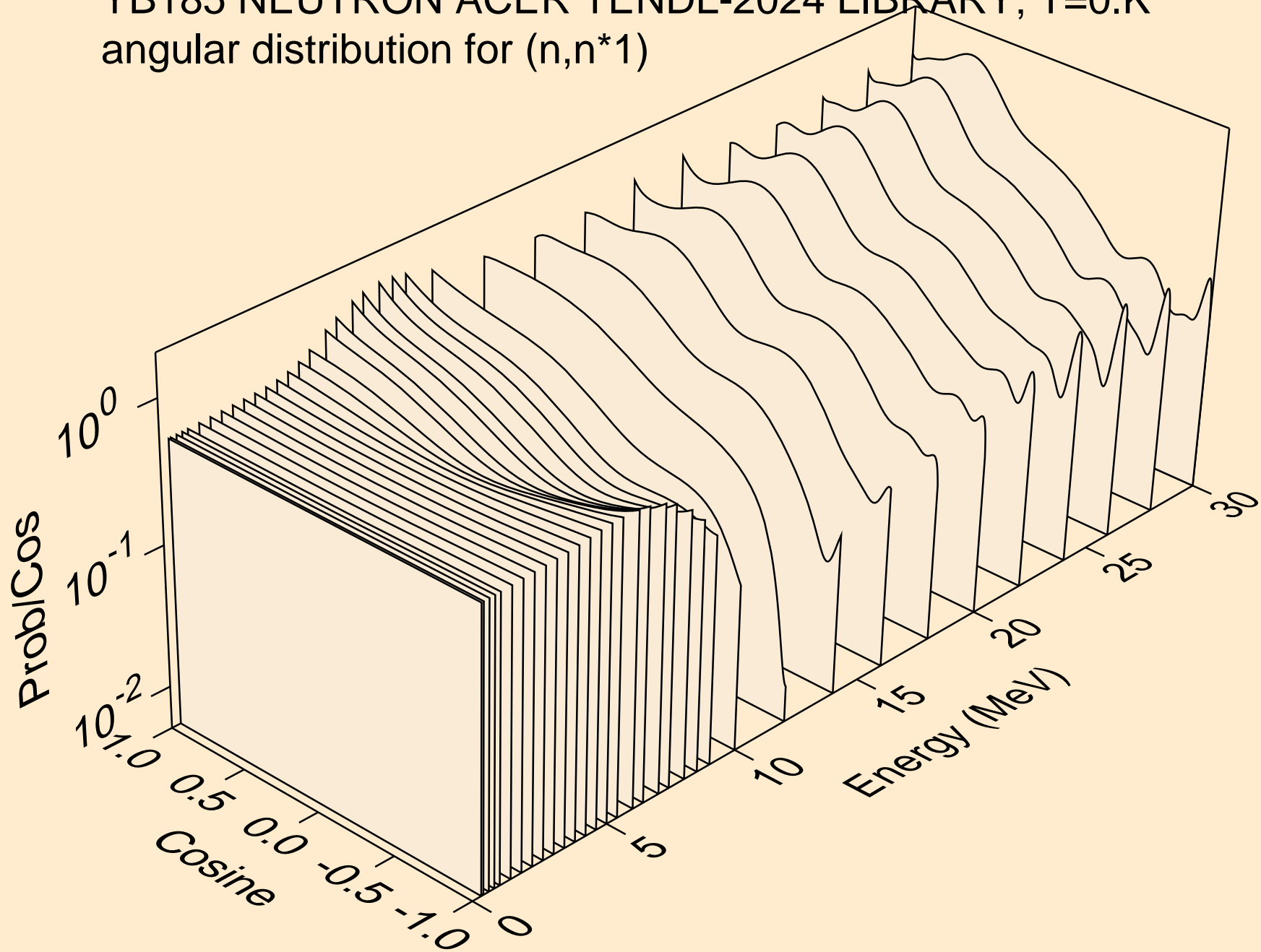

YB185 NEUTRON ACER TENDL-2024 LIBRARY; T=0.K  
angular distribution for (n,n\*2)

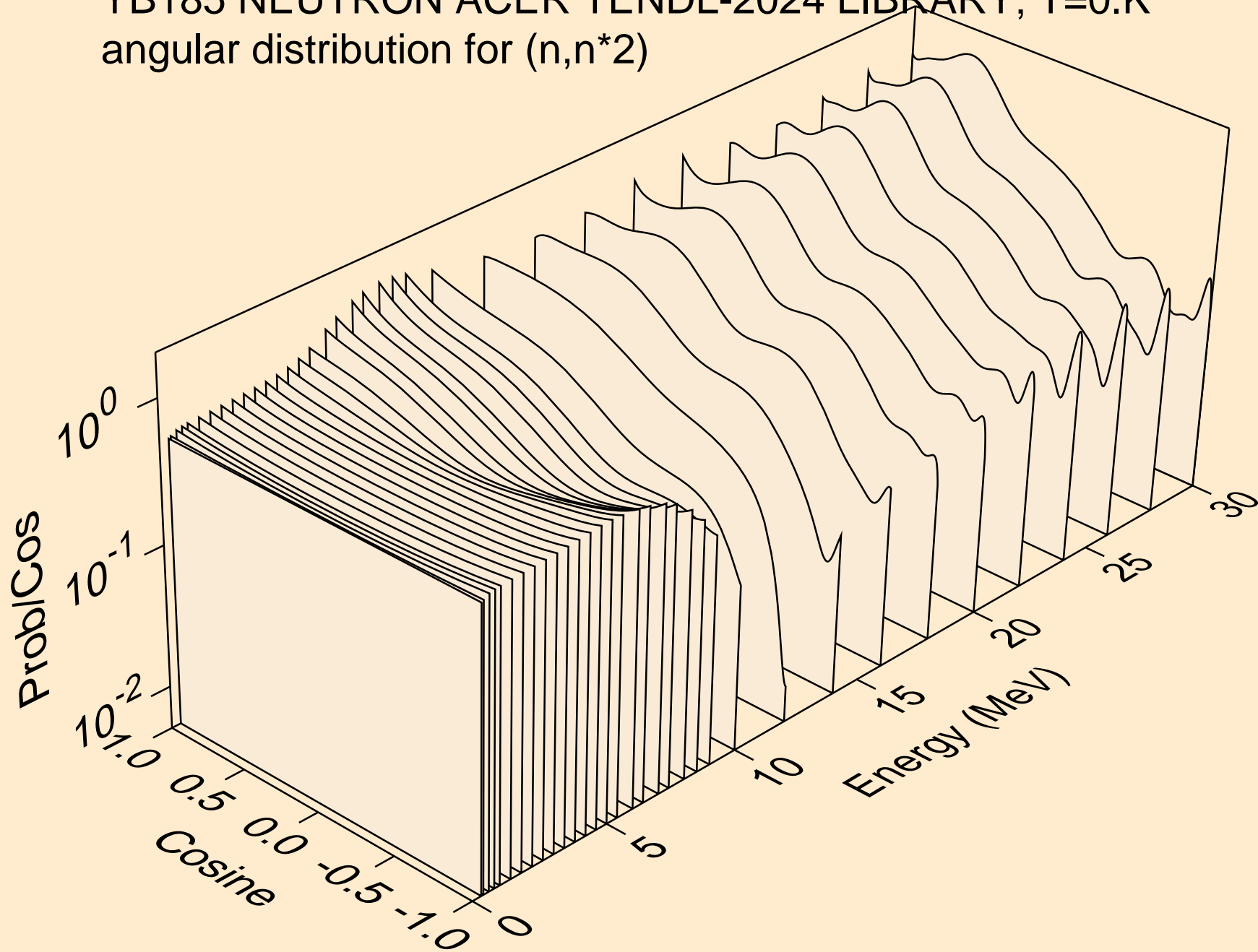

YB185 NEUTRON ACER TENDL-2024 LIBRARY; T=0.K  
angular distribution for (n,n\*3)

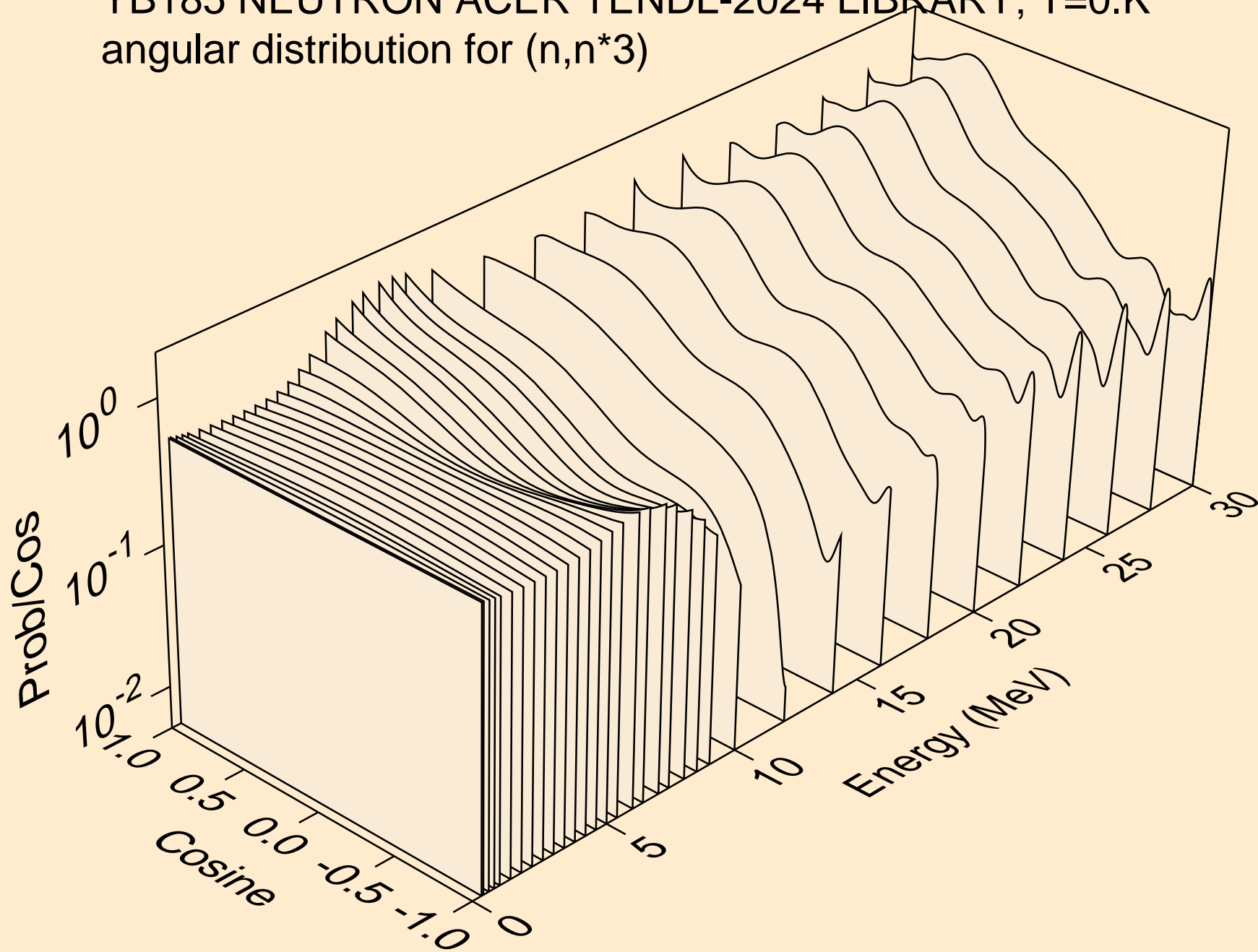



YB185 NEUTRON ACER TENDL-2024 LIBRARY; T=0.K  
angular distribution for (n,n\*4)

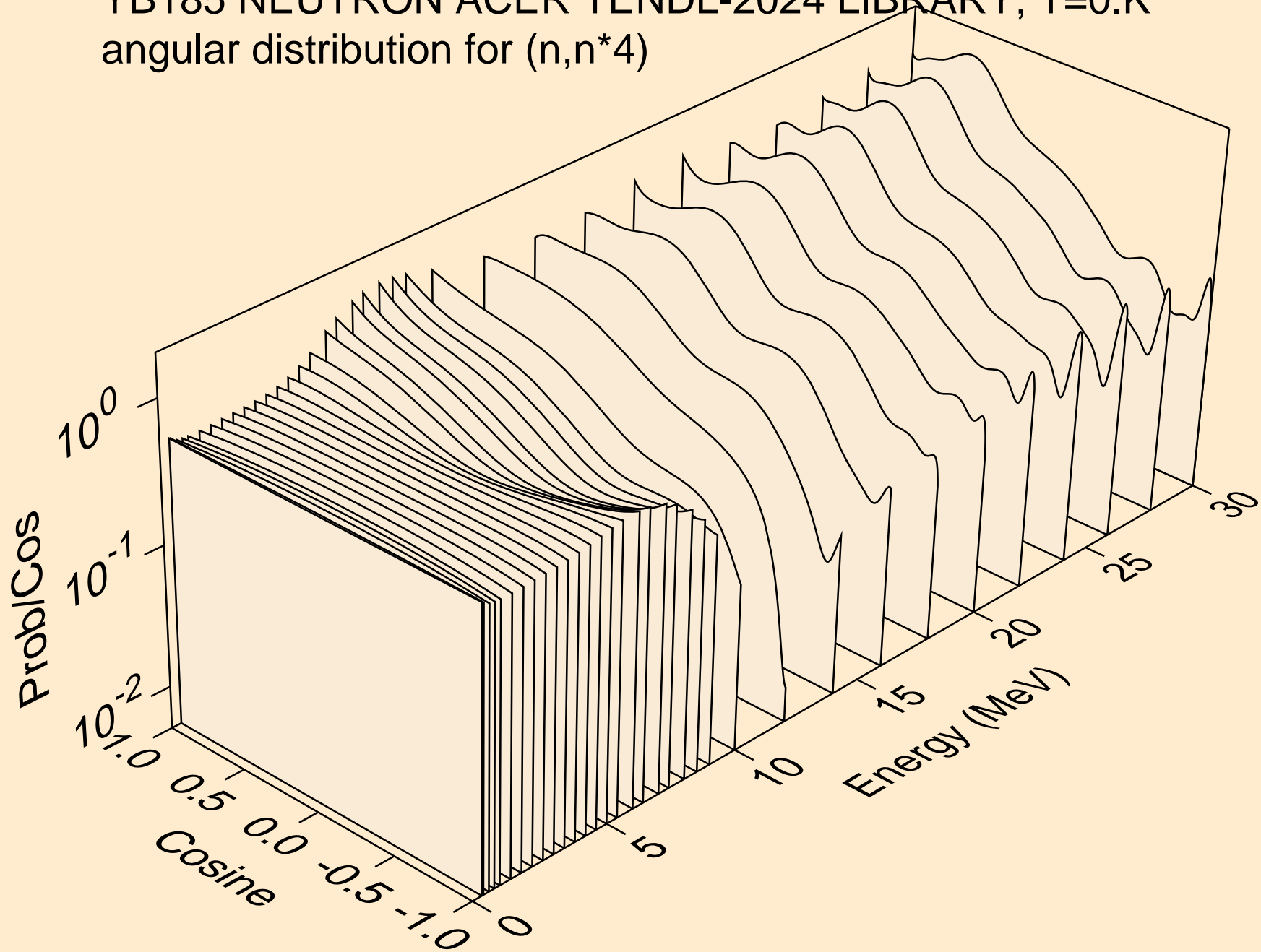

YB185 NEUTRON ACER TENDL-2024 LIBRARY; T=0.K  
angular distribution for (n,n\*5)

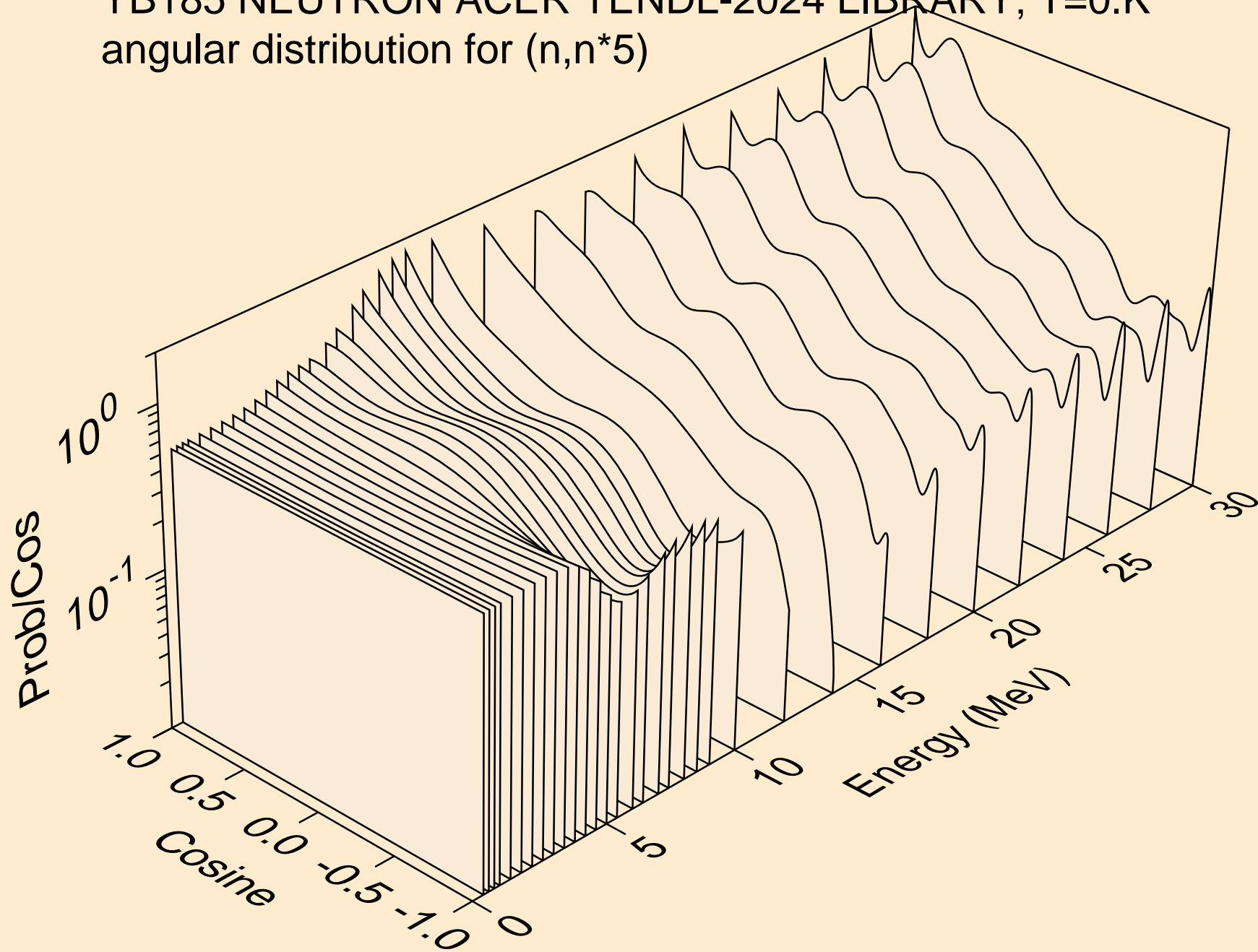

YB185 NEUTRON ACER TENDL-2024 LIBRARY; T=0.K  
angular distribution for (n,n\*6)

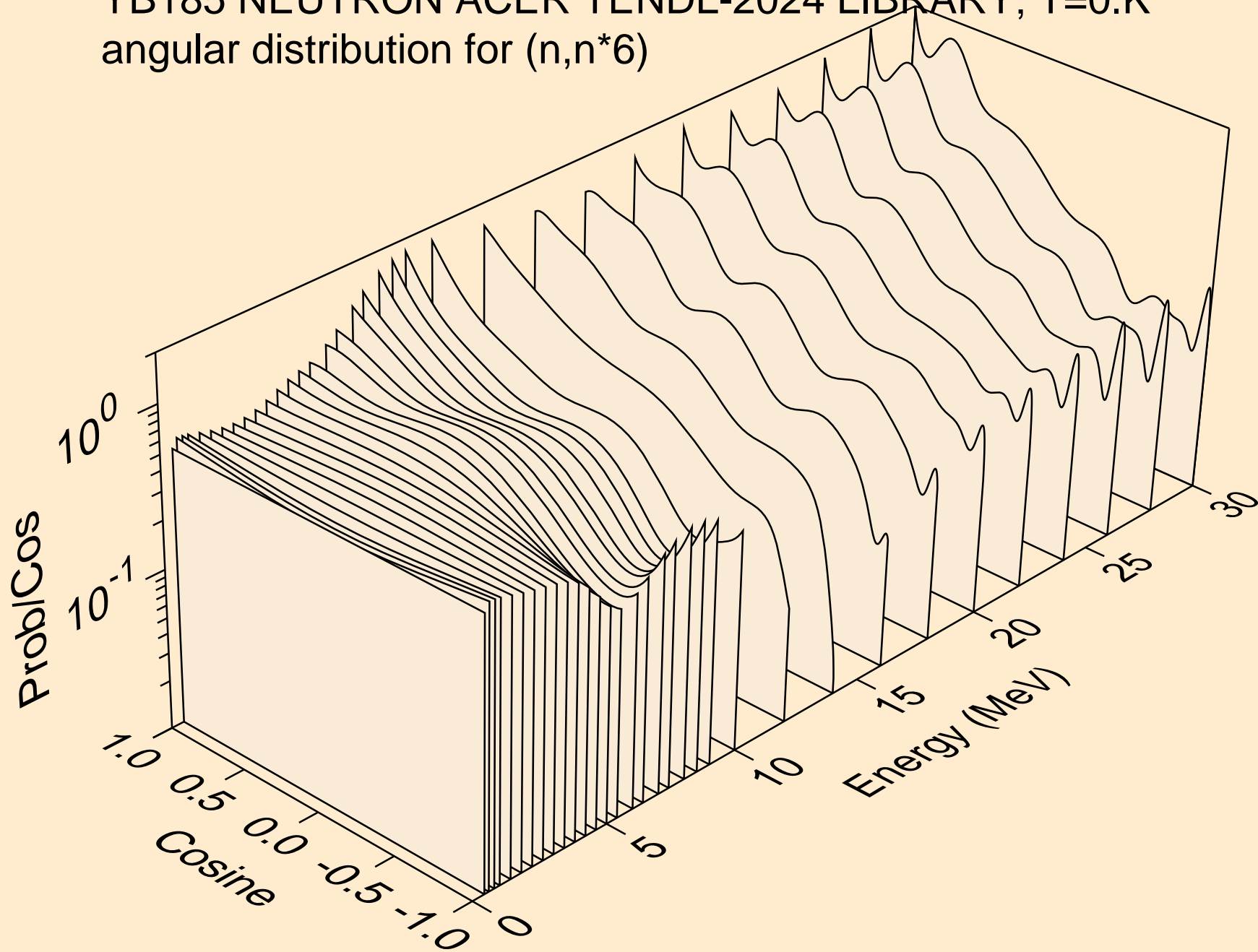

YB185 NEUTRON ACER TENDL-2024 LIBRARY; T=0.K  
angular distribution for (n,n\*7)

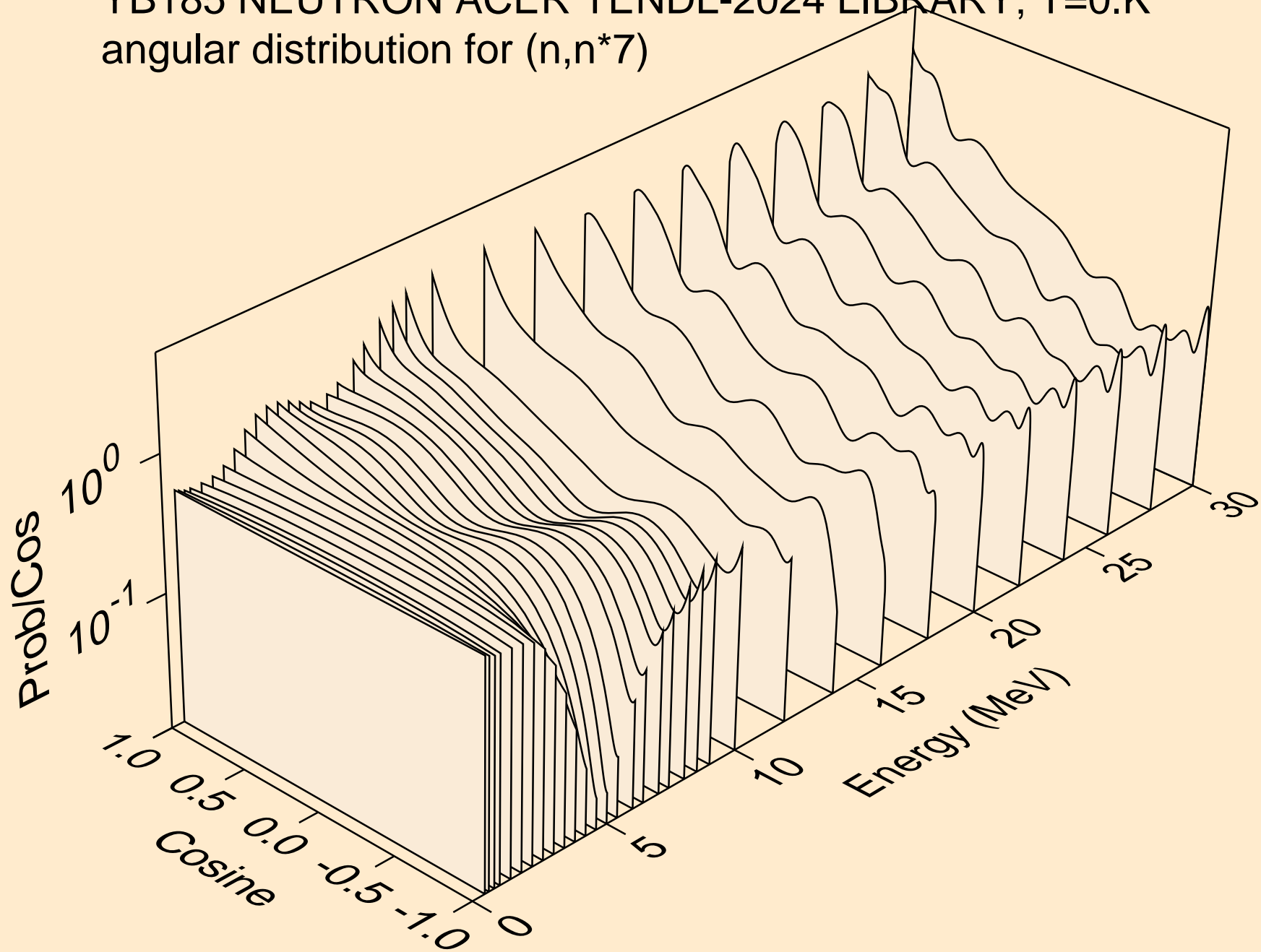

YB185 NEUTRON ACER TENDL-2024 LIBRARY; T=0.K  
angular distribution for (n,n\*8)

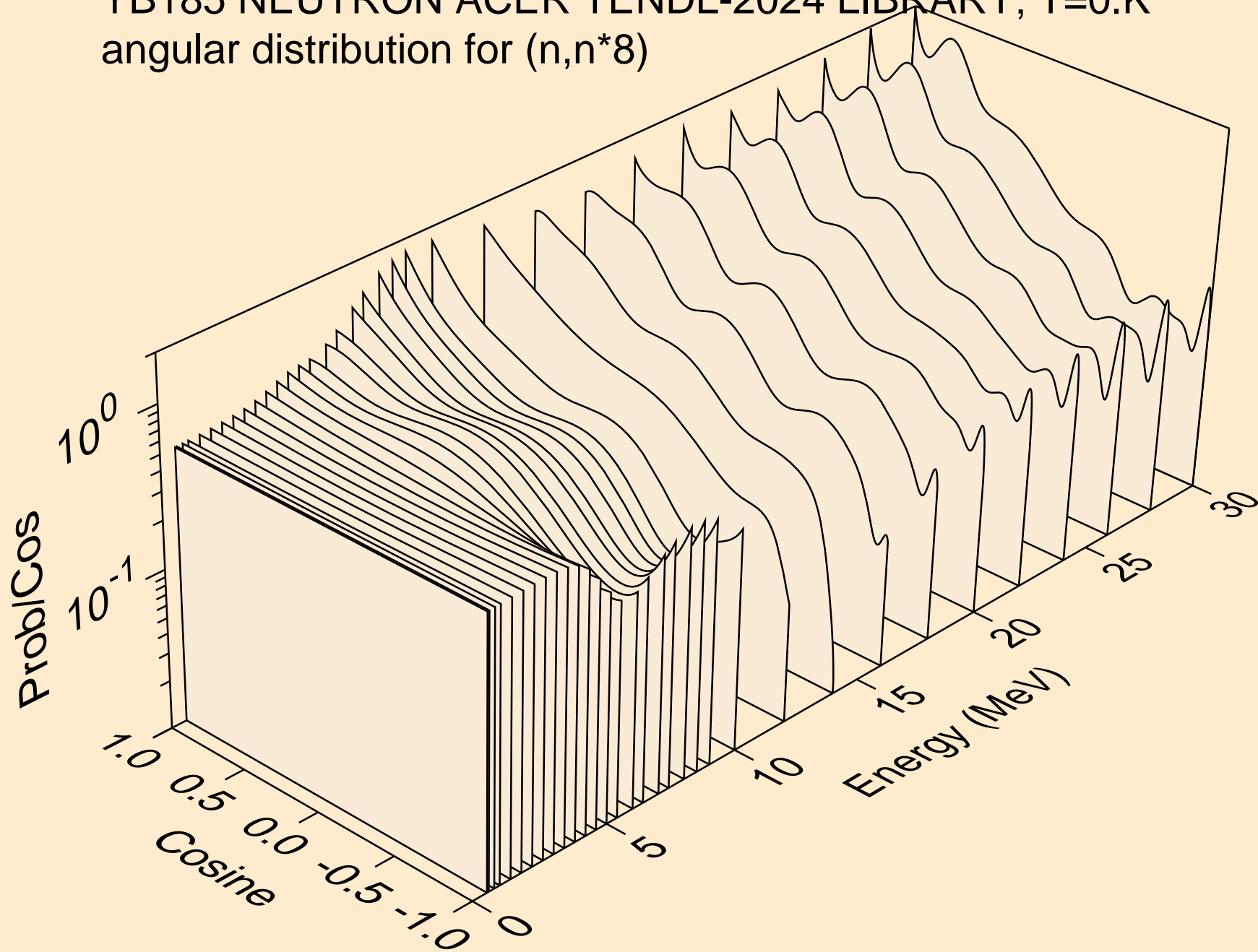

YB185 NEUTRON ACER TENDL-2024 LIBRARY; T=0.K  
angular distribution for (n,n\*9)

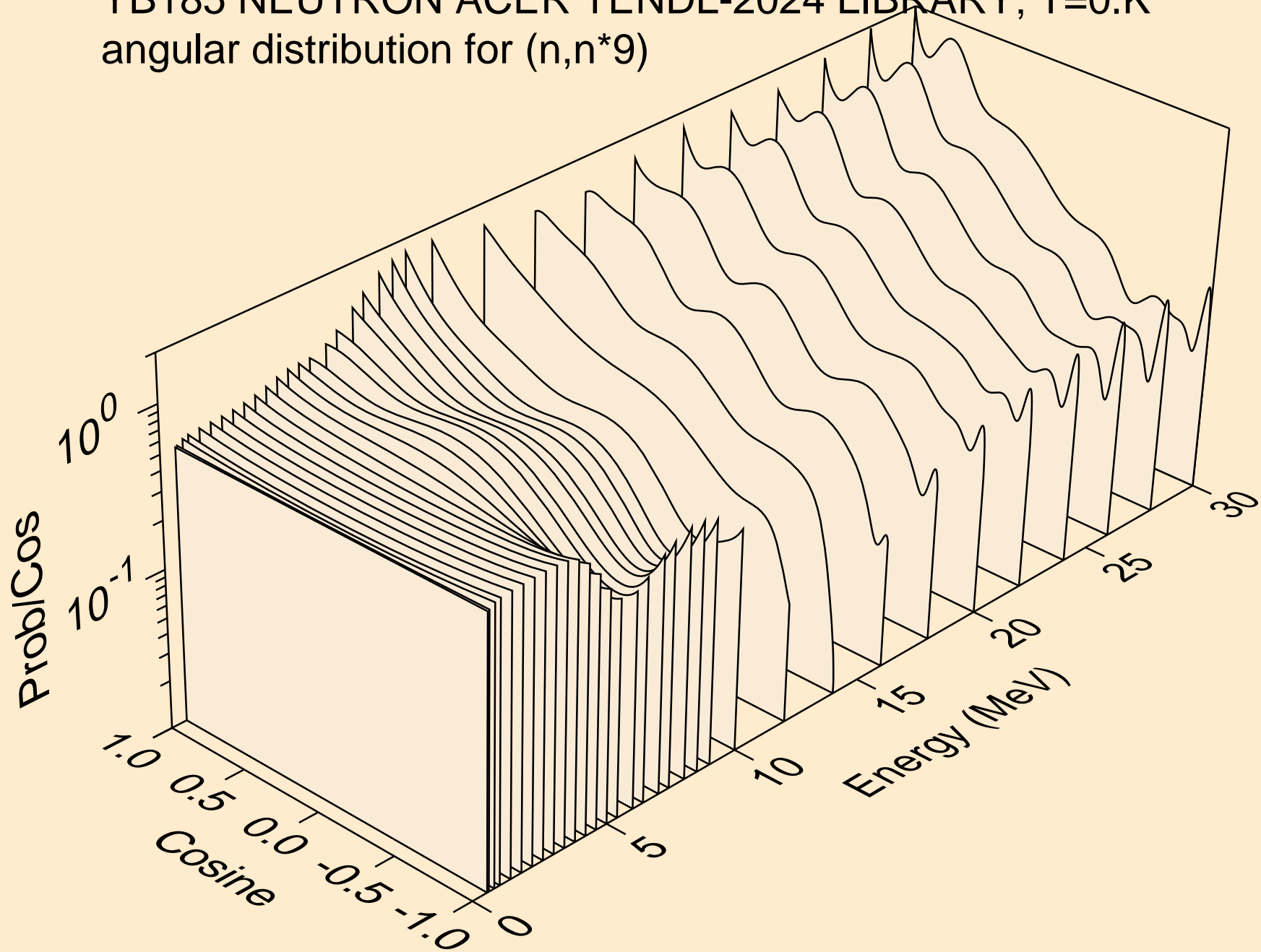

YB185 NEUTRON ACER TENDL-2024 LIBRARY; T=0.K  
angular distribution for (n,n\*10)

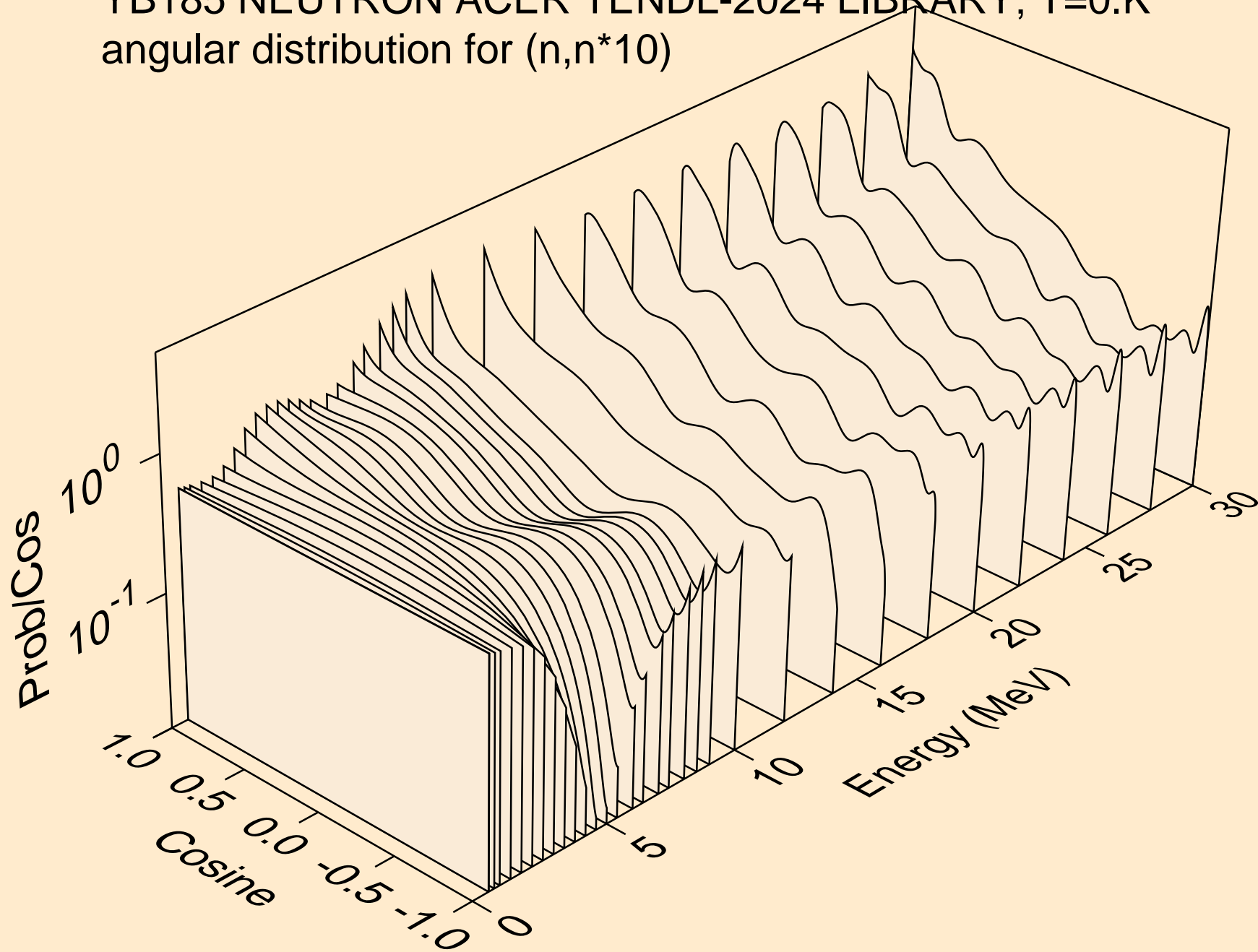



YB185 NEUTRON ACER TENDL-2024 LIBRARY; T=0.K  
angular distribution for (n,n\*11)

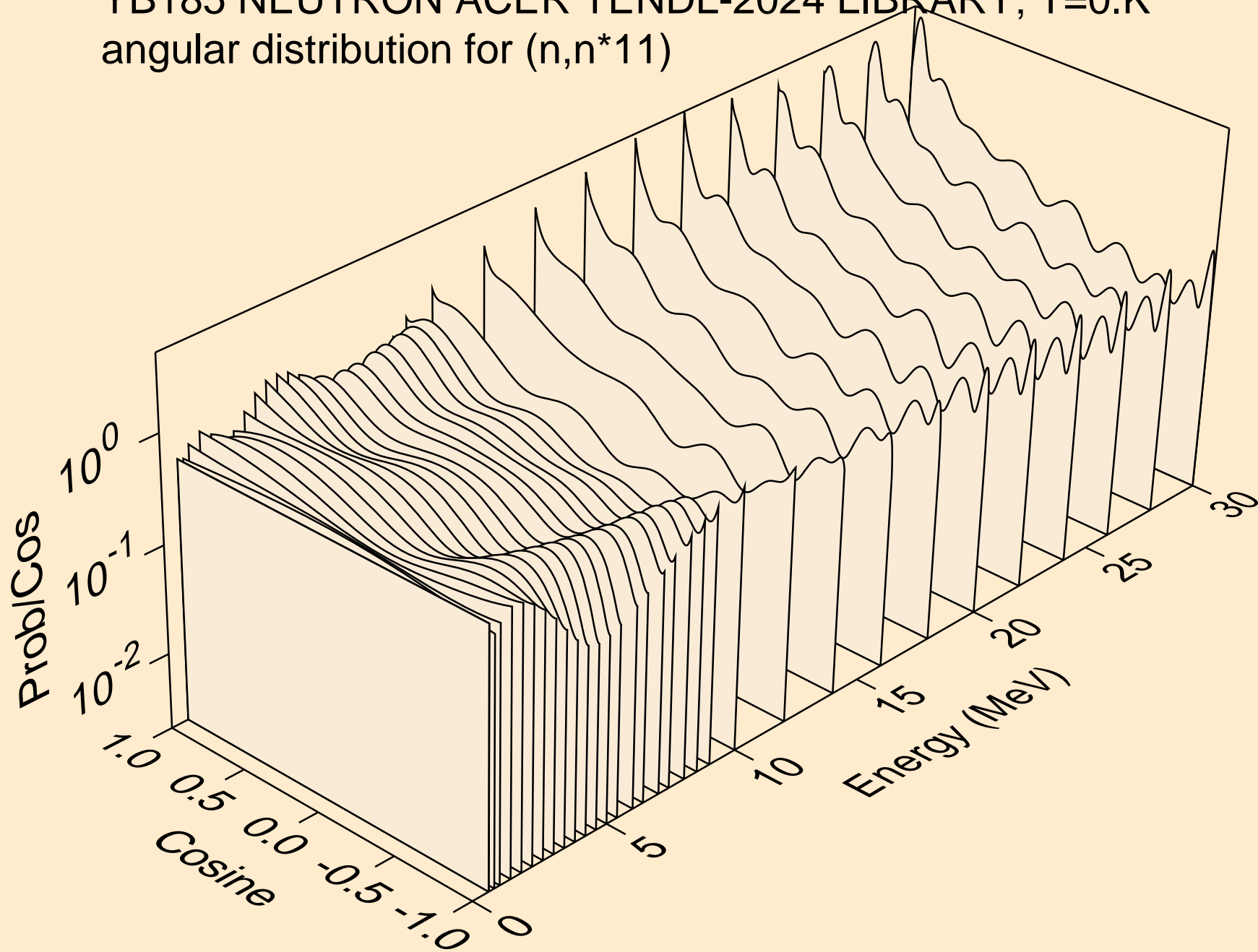



YB185 NEUTRON ACER TENDL-2024 LIBRARY; T=0.K  
angular distribution for (n,n\*12)

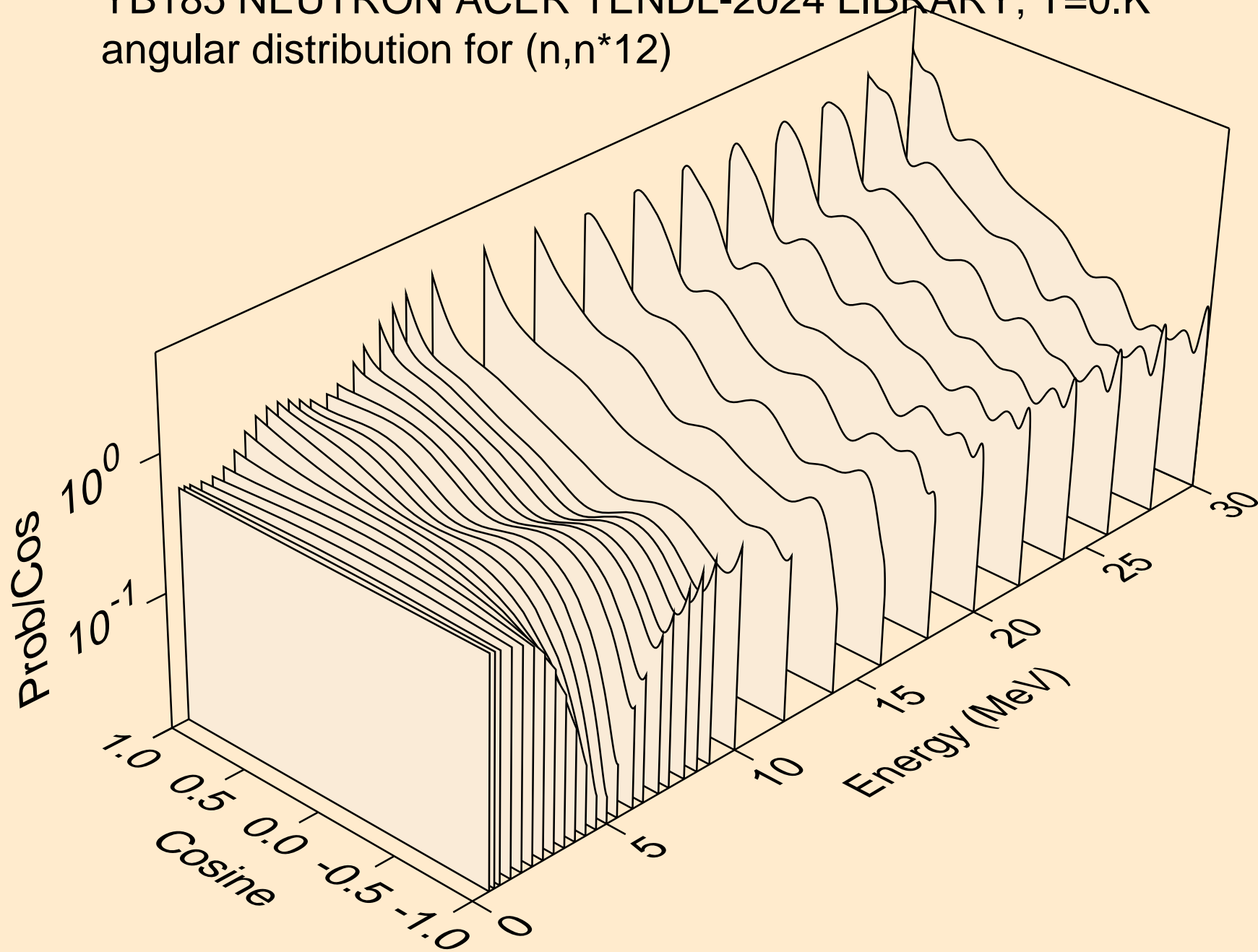

YB185 NEUTRON ACER TENDL-2024 LIBRARY; T=0.K  
angular distribution for (n,n\*13)

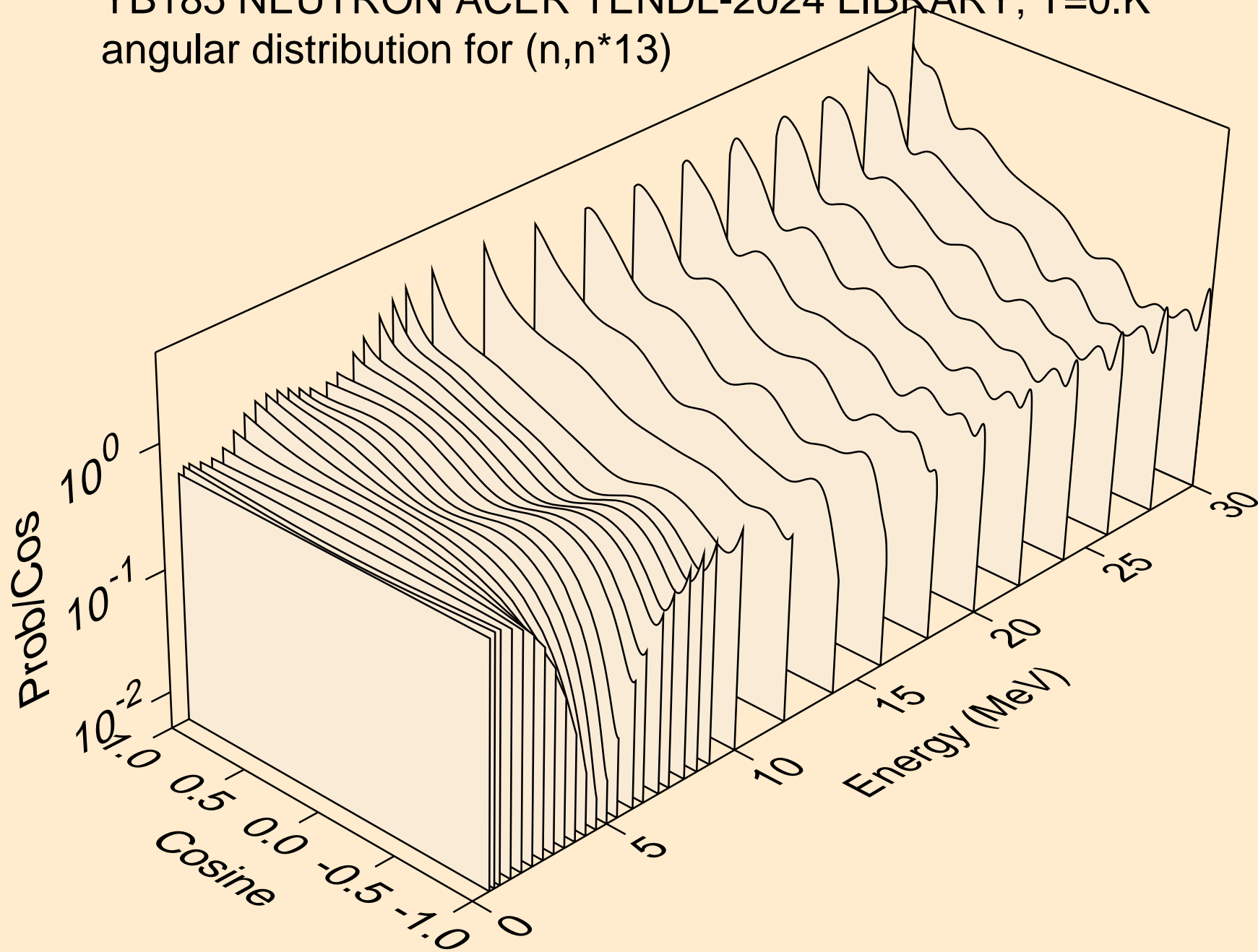

YB185 NEUTRON ACER TENDL-2024 LIBRARY; T=0.K  
angular distribution for (n,n\*14)

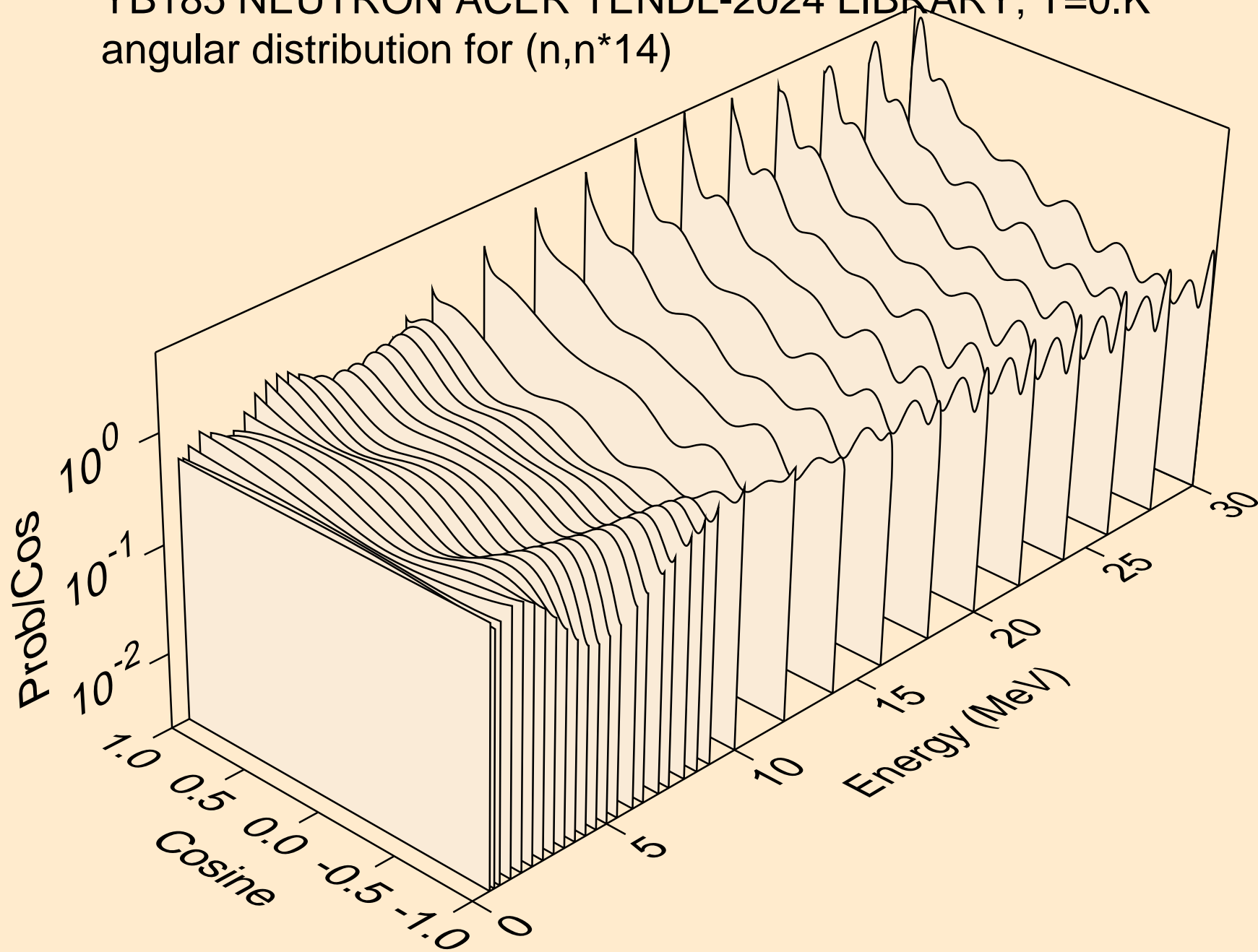

YB185 NEUTRON ACER TENDL-2024 LIBRARY; T=0.K  
angular distribution for (n,n\*15)

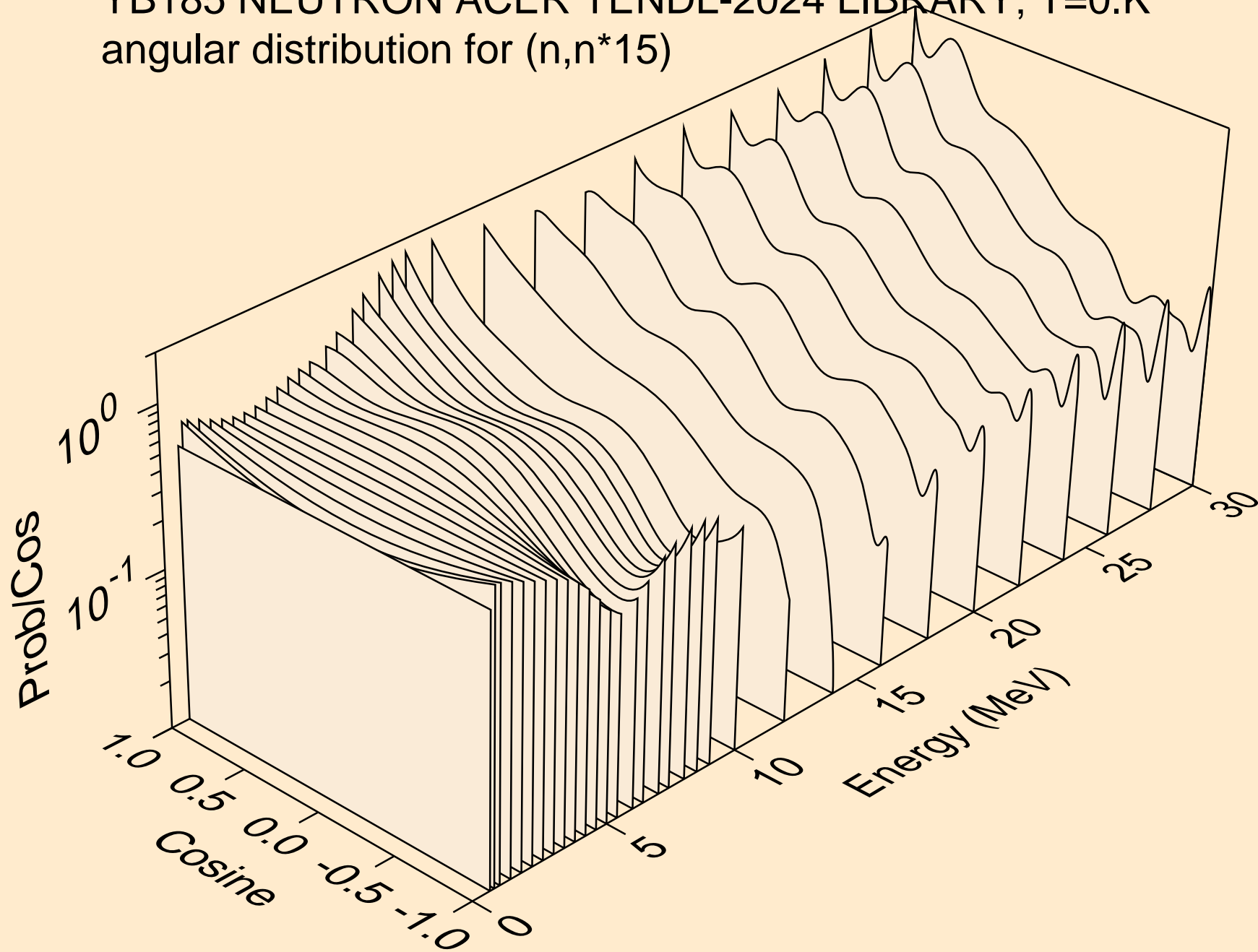

YB185 NEUTRON ACER TENDL-2024 LIBRARY; T=0.K  
angular distribution for (n,n\*16)

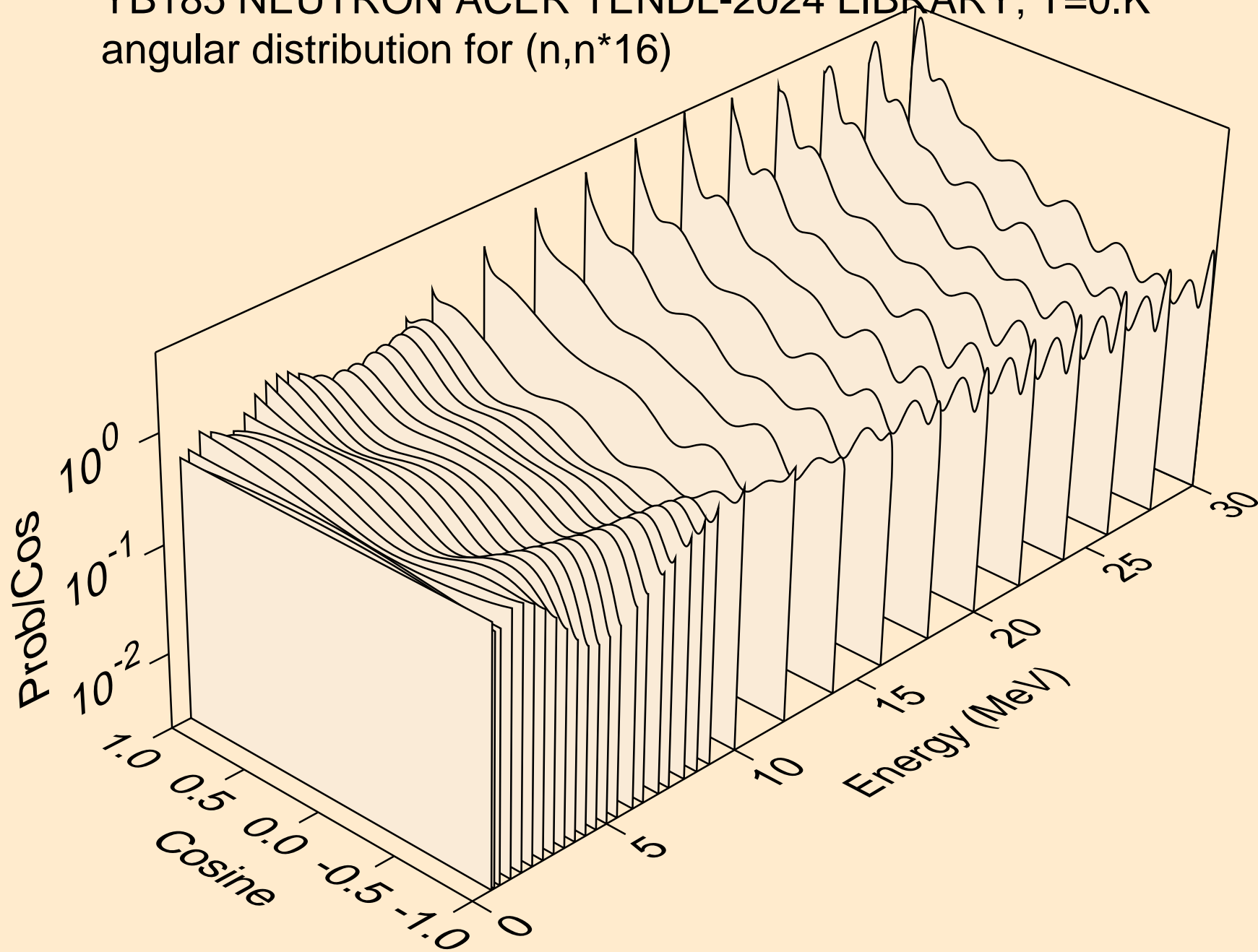

YB185 NEUTRON ACER TENDL-2024 LIBRARY; T=0.K  
angular distribution for (n,n\*17)

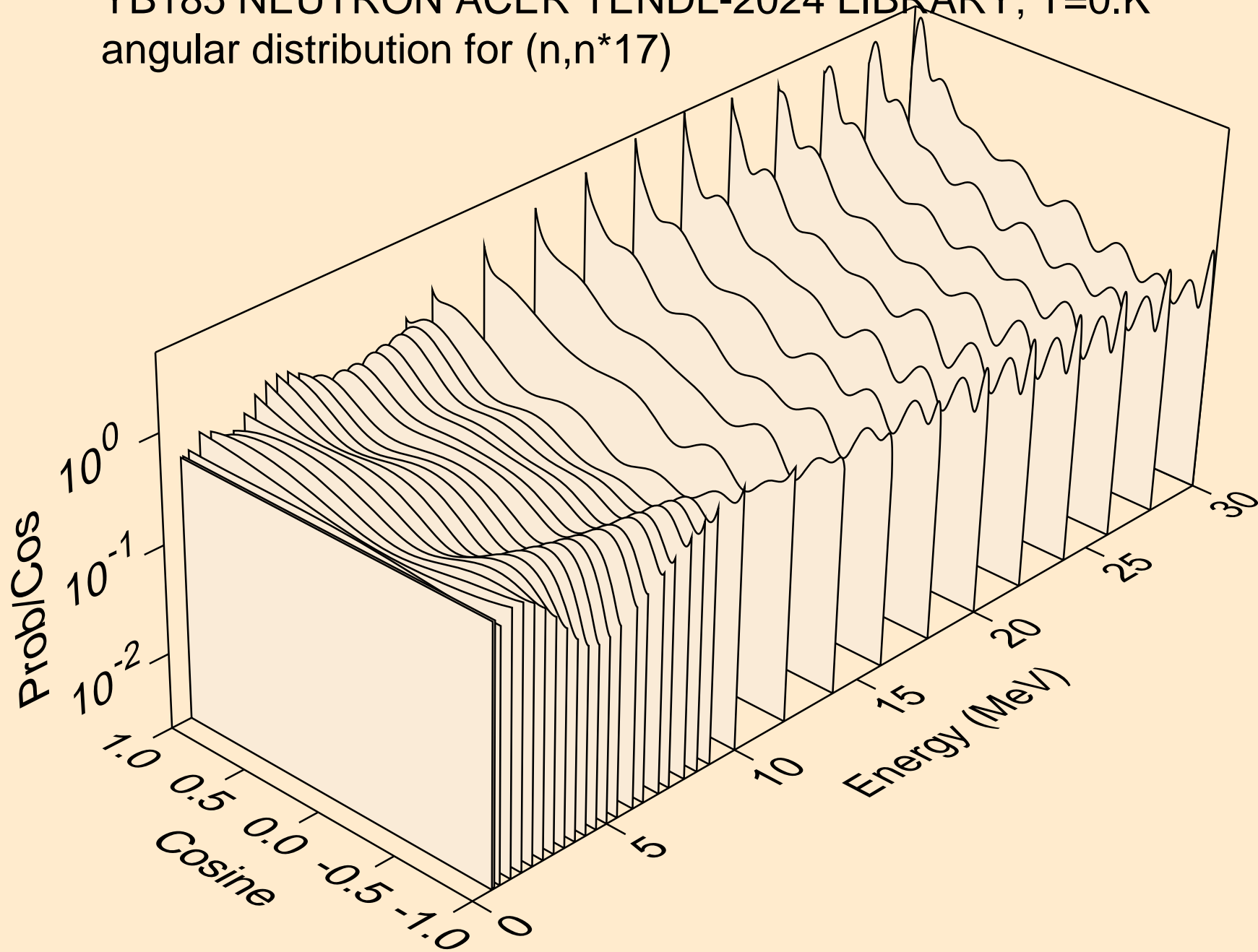

YB185 NEUTRON ACER TENDL-2024 LIBRARY; T=0.K  
angular distribution for (n,n\*18)

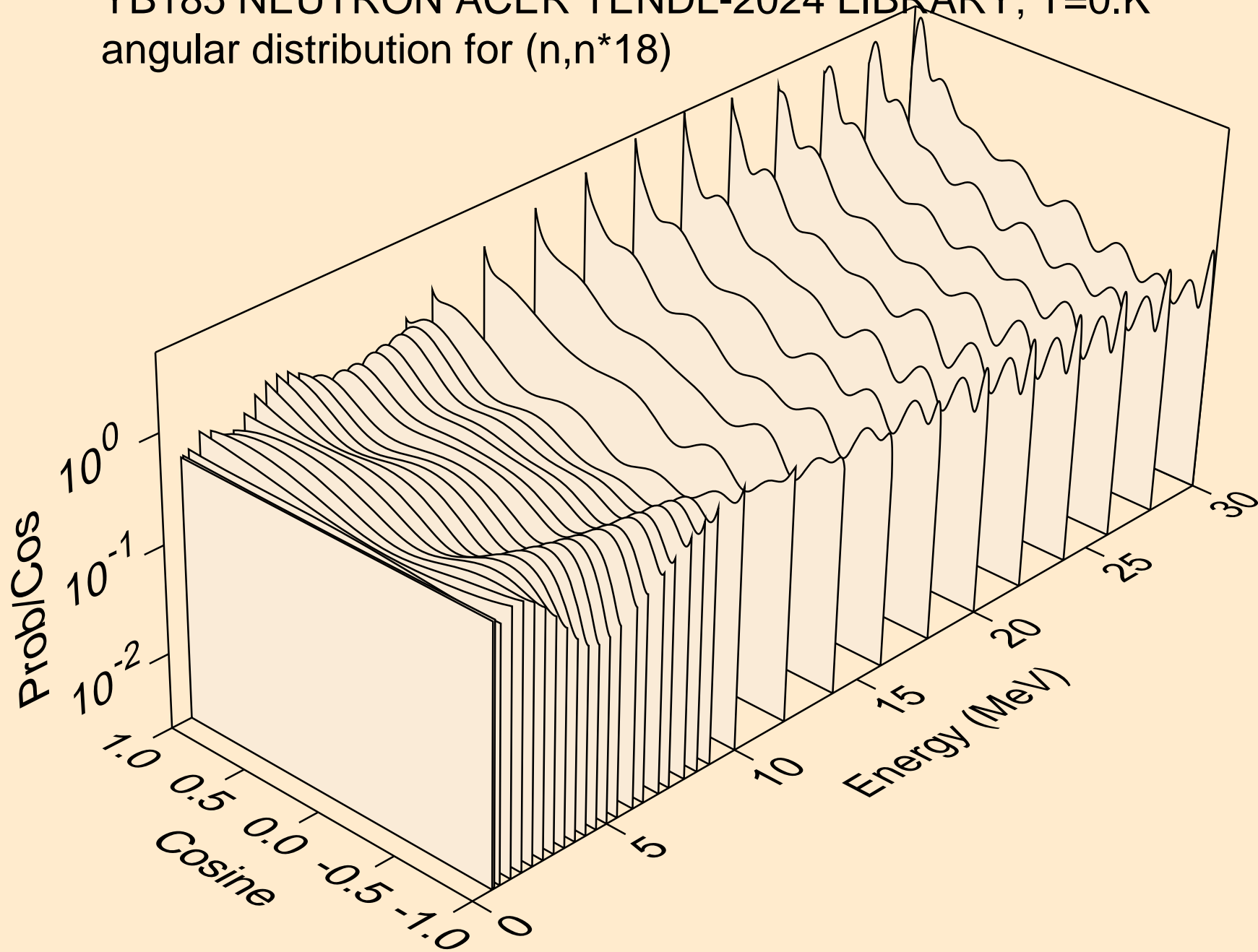



YB185 NEUTRON ACER TENDL-2024 LIBRARY; T=0.K  
angular distribution for (n,n\*19)

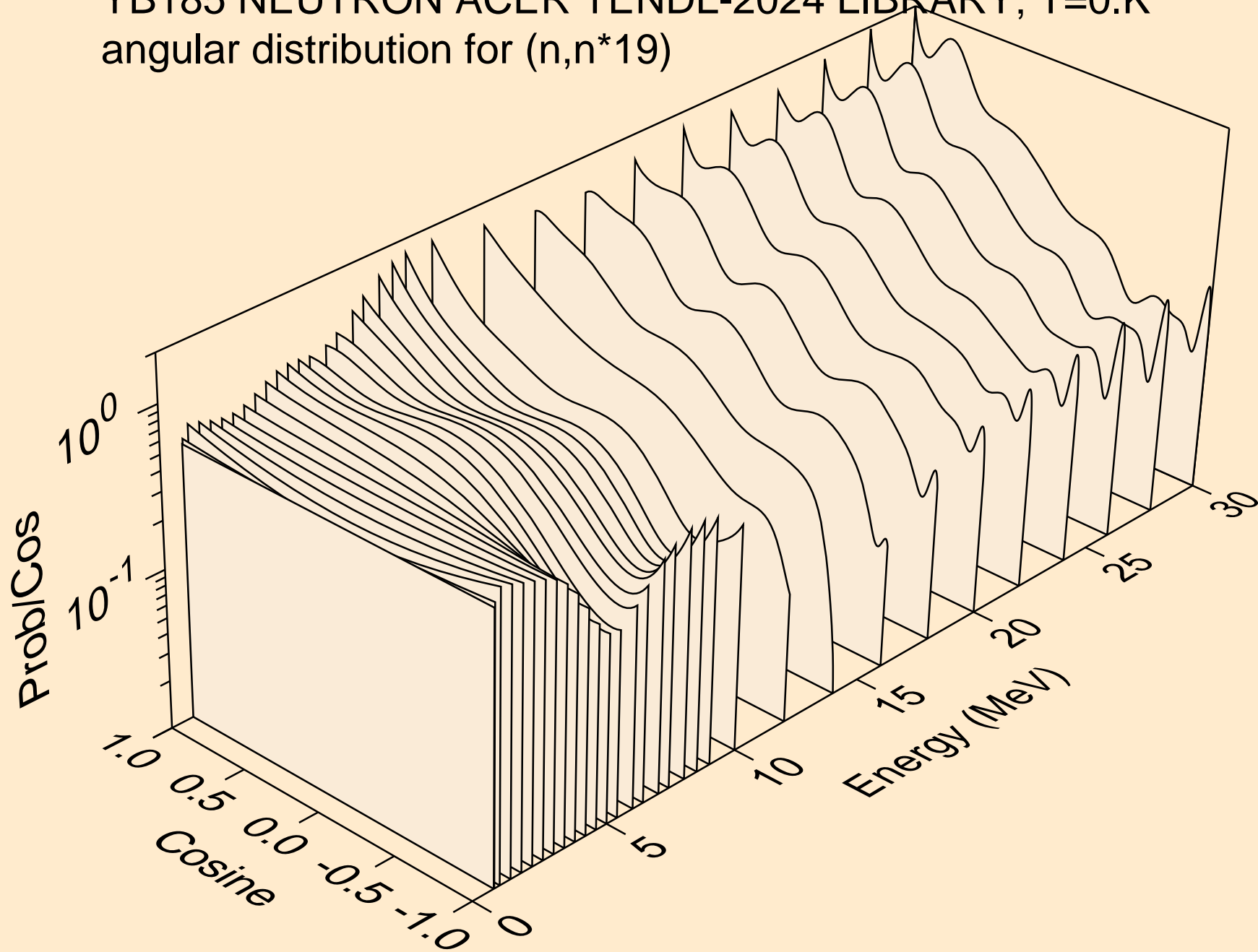



YB185 NEUTRON ACER TENDL-2024 LIBRARY; T=0.K  
angular distribution for (n,n\*20)

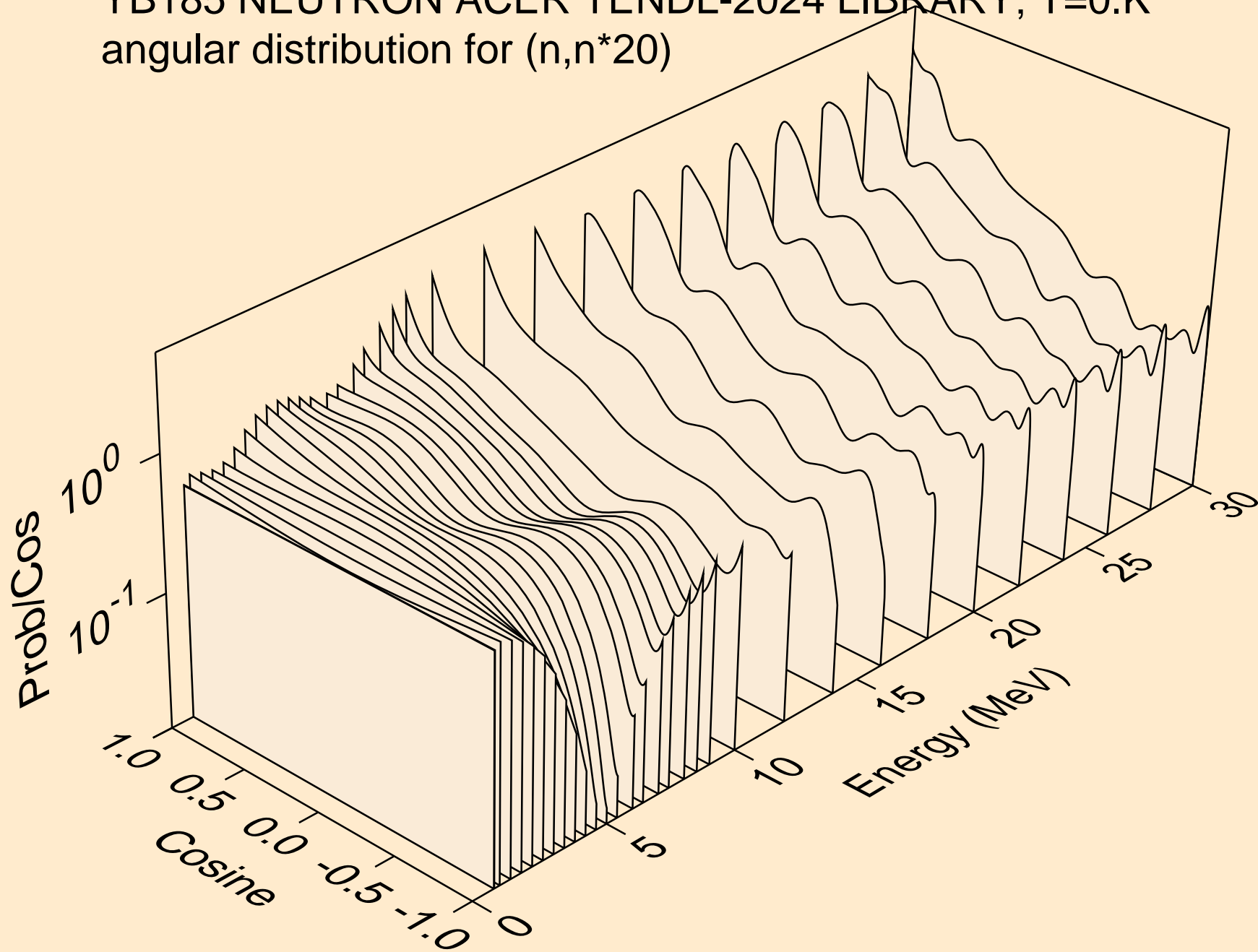

YB185 NEUTRON ACER TENDL-2024 LIBRARY; T=0.K  
angular distribution for (n,n\*21)

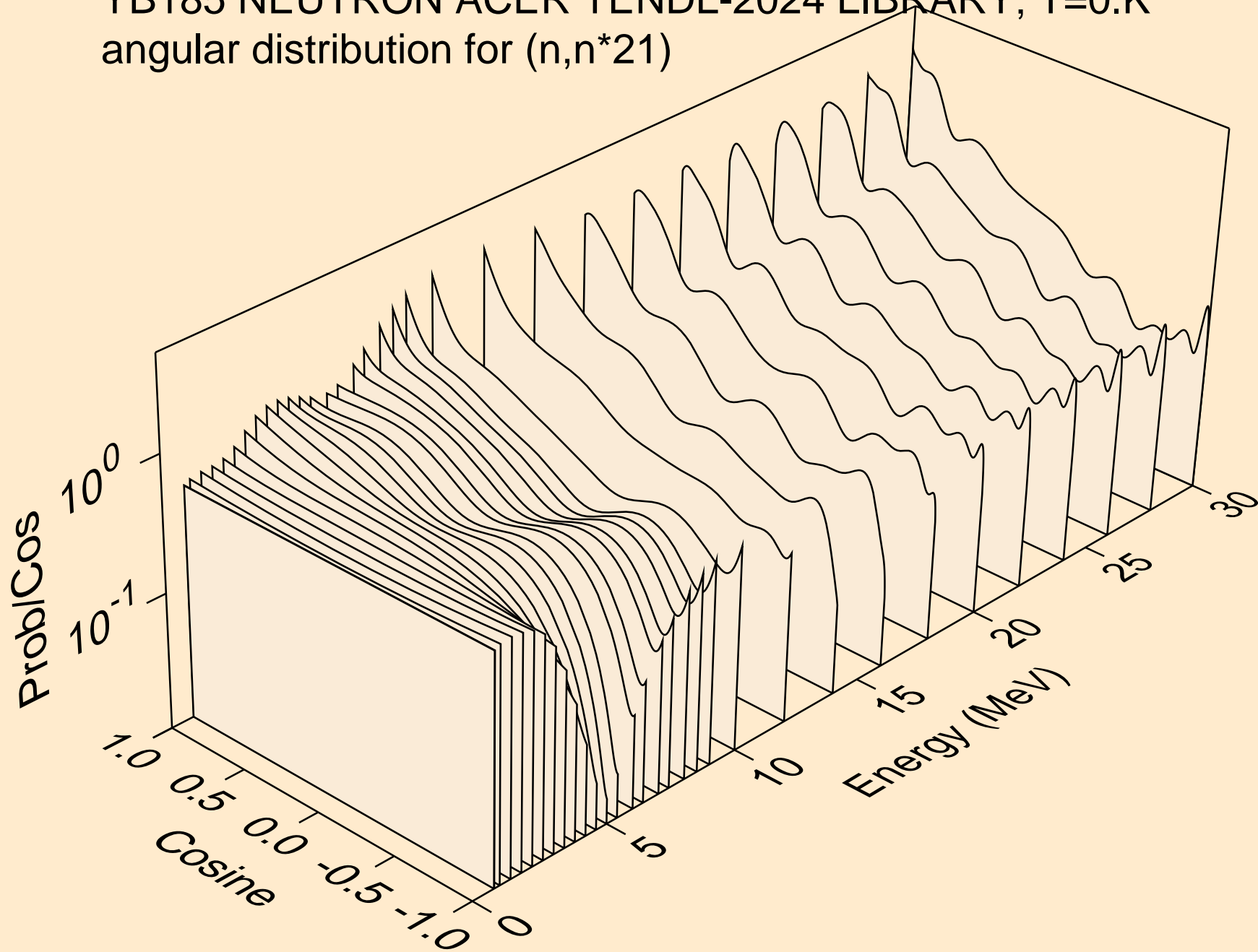

YB185 NEUTRON ACER TENDL-2024 LIBRARY; T=0.K  
angular distribution for (n,n\*22)

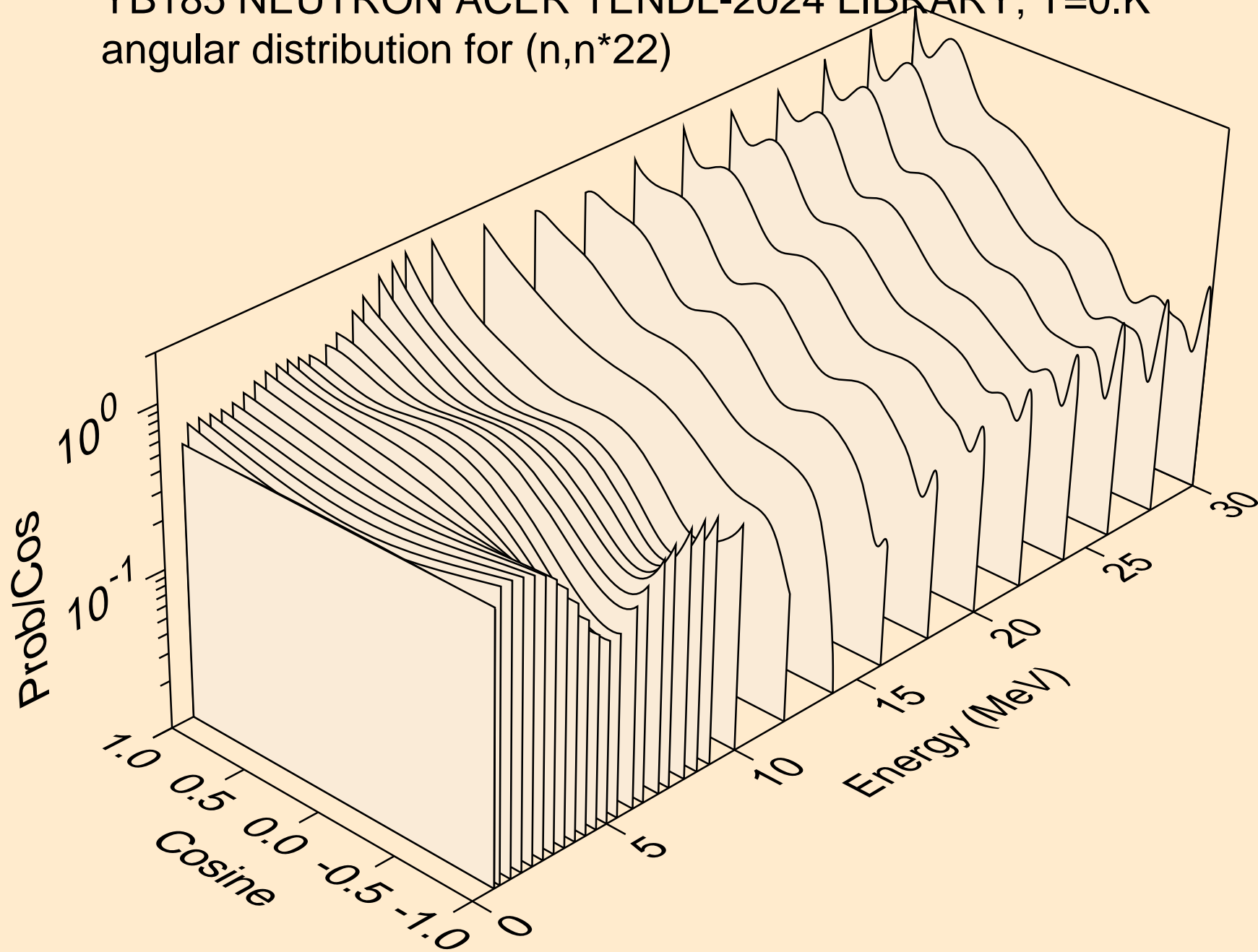

YB185 NEUTRON ACER TENDL-2024 LIBRARY; T=0.K  
angular distribution for (n,n\*23)

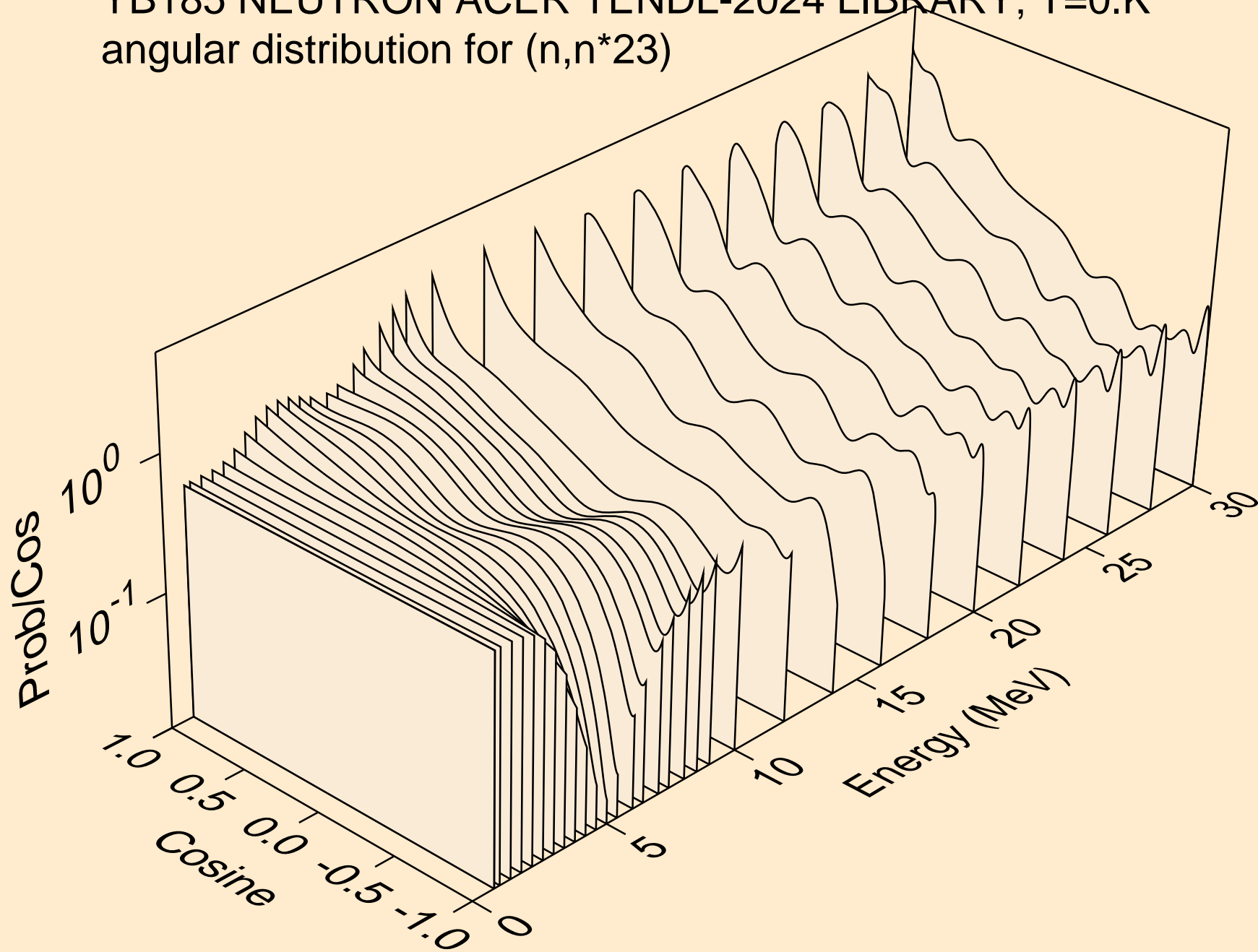

YB185 NEUTRON ACER TENDL-2024 LIBRARY; T=0.K  
angular distribution for (n,n\*24)

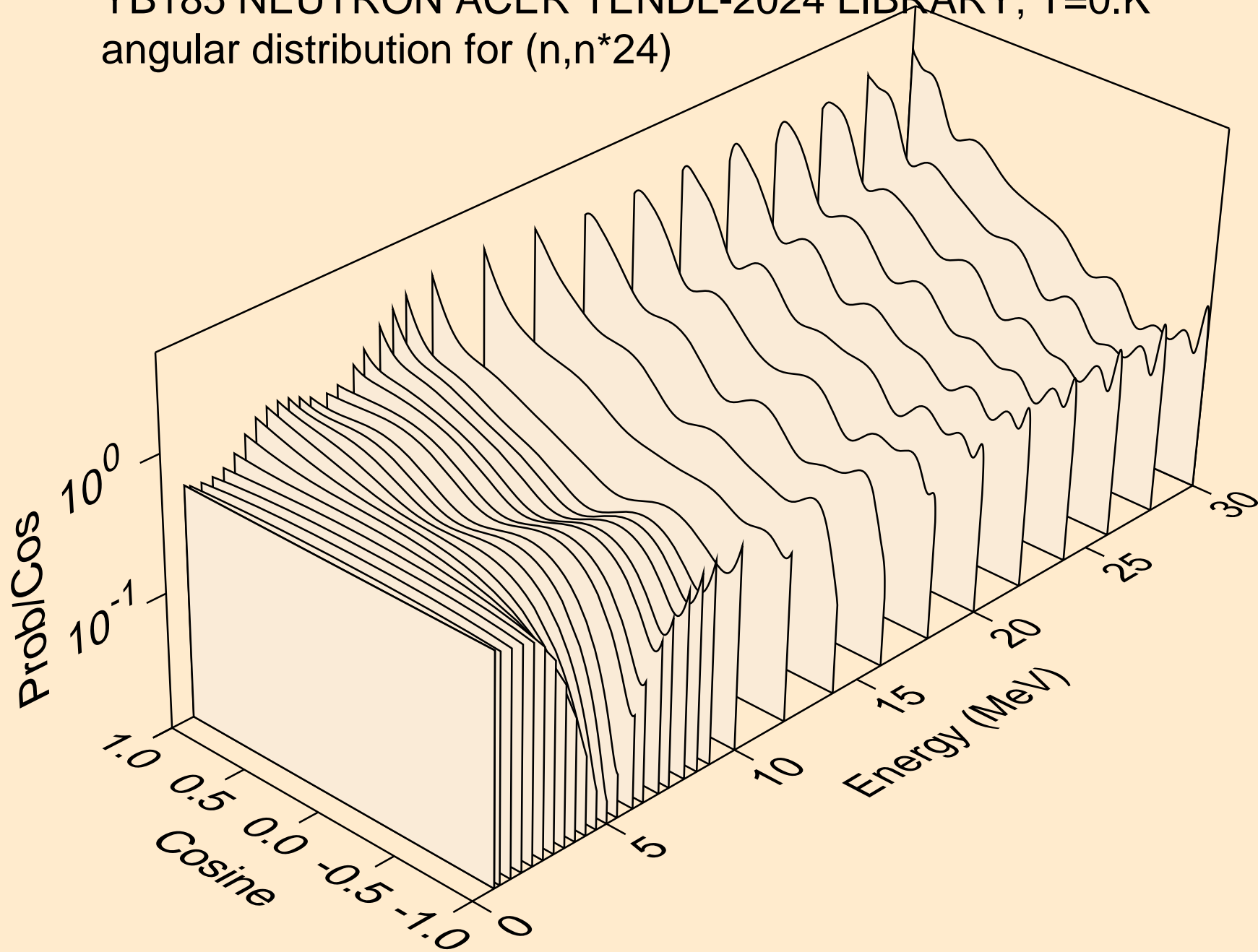

YB185 NEUTRON ACER TENDL-2024 LIBRARY; T=0.K  
angular distribution for (n,n\*25)

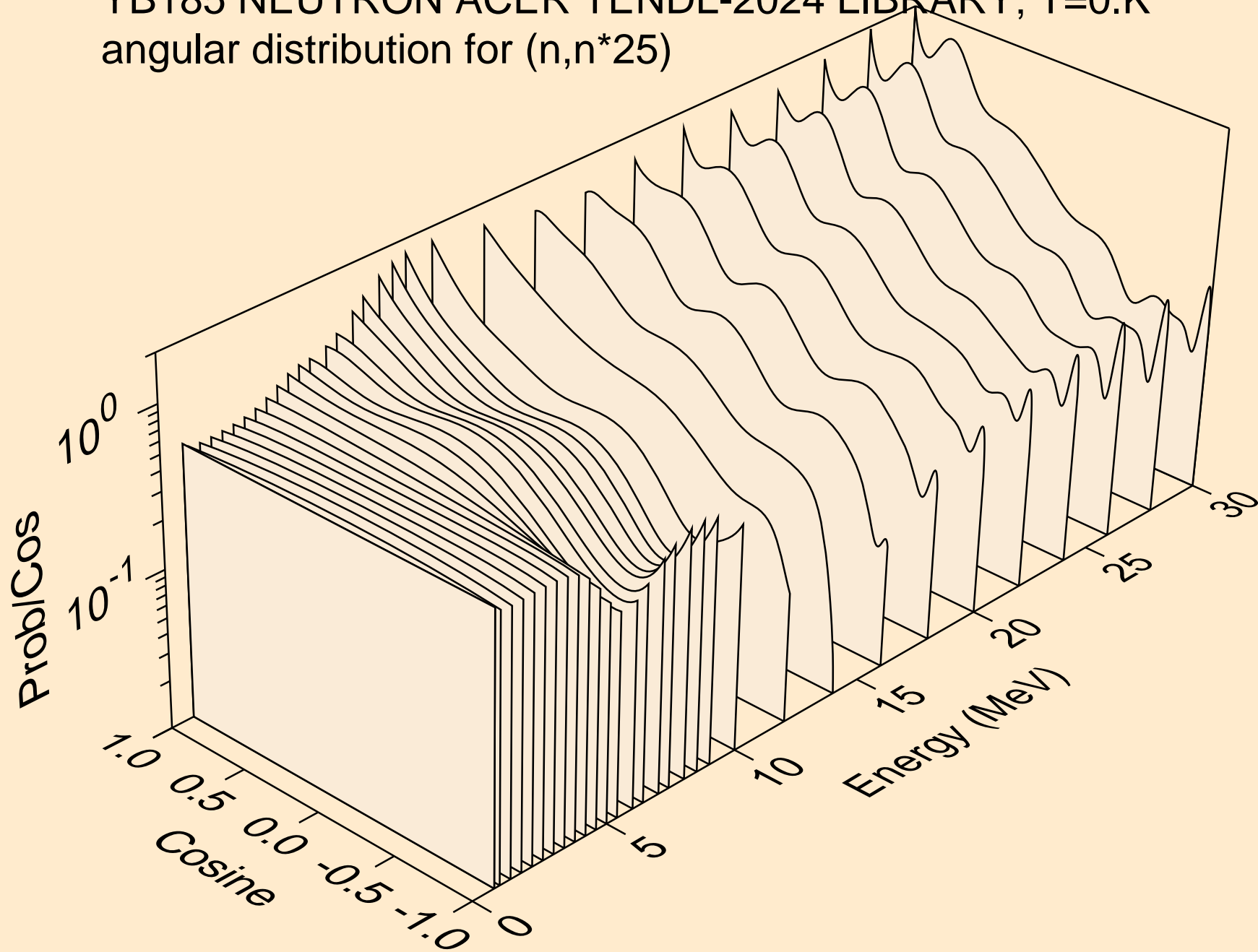

YB185 NEUTRON ACER TENDL-2024 LIBRARY; T=0.K  
angular distribution for (n,n\*26)

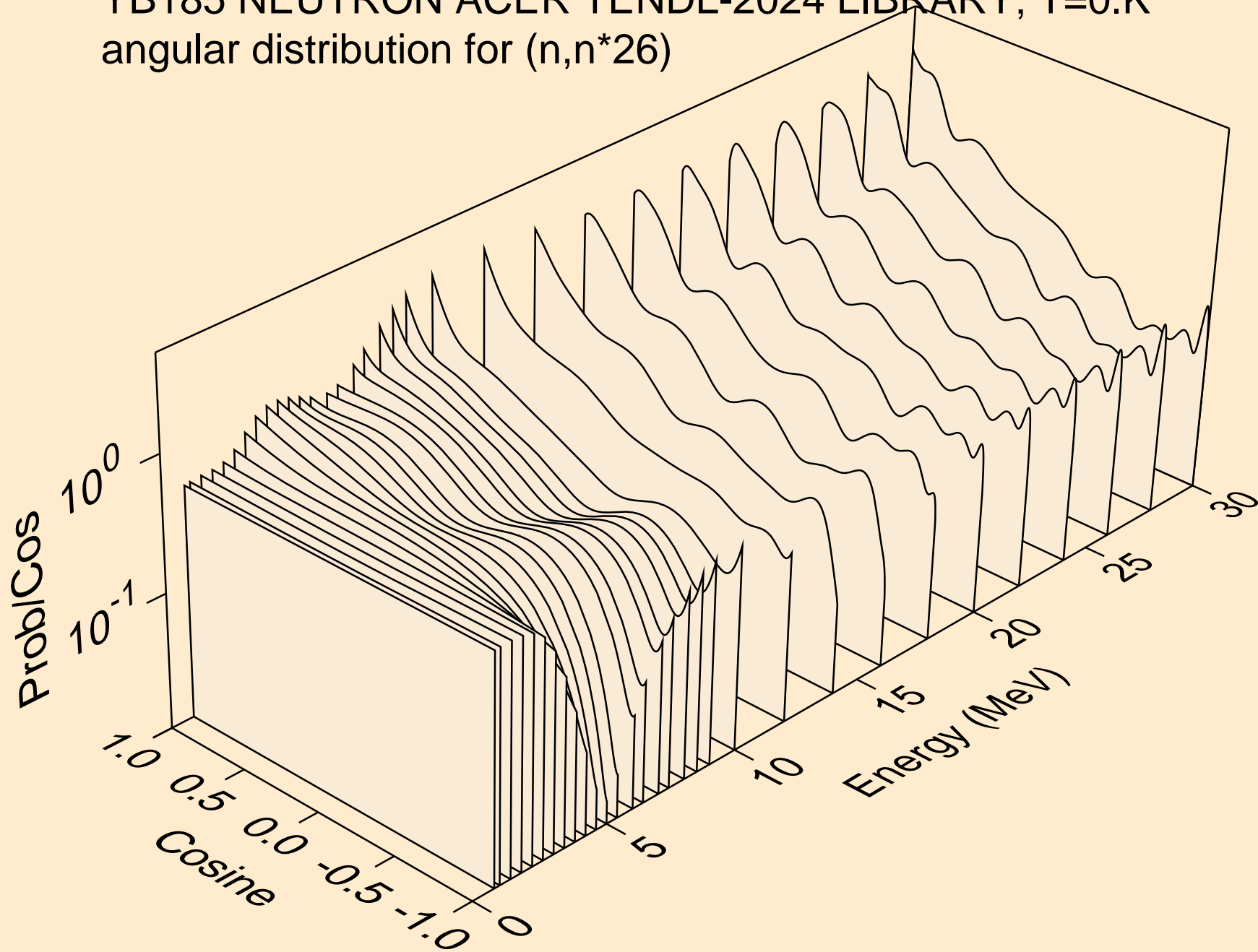

YB185 NEUTRON ACER TENDL-2024 LIBRARY; T=0.K  
angular distribution for (n,n\*27)

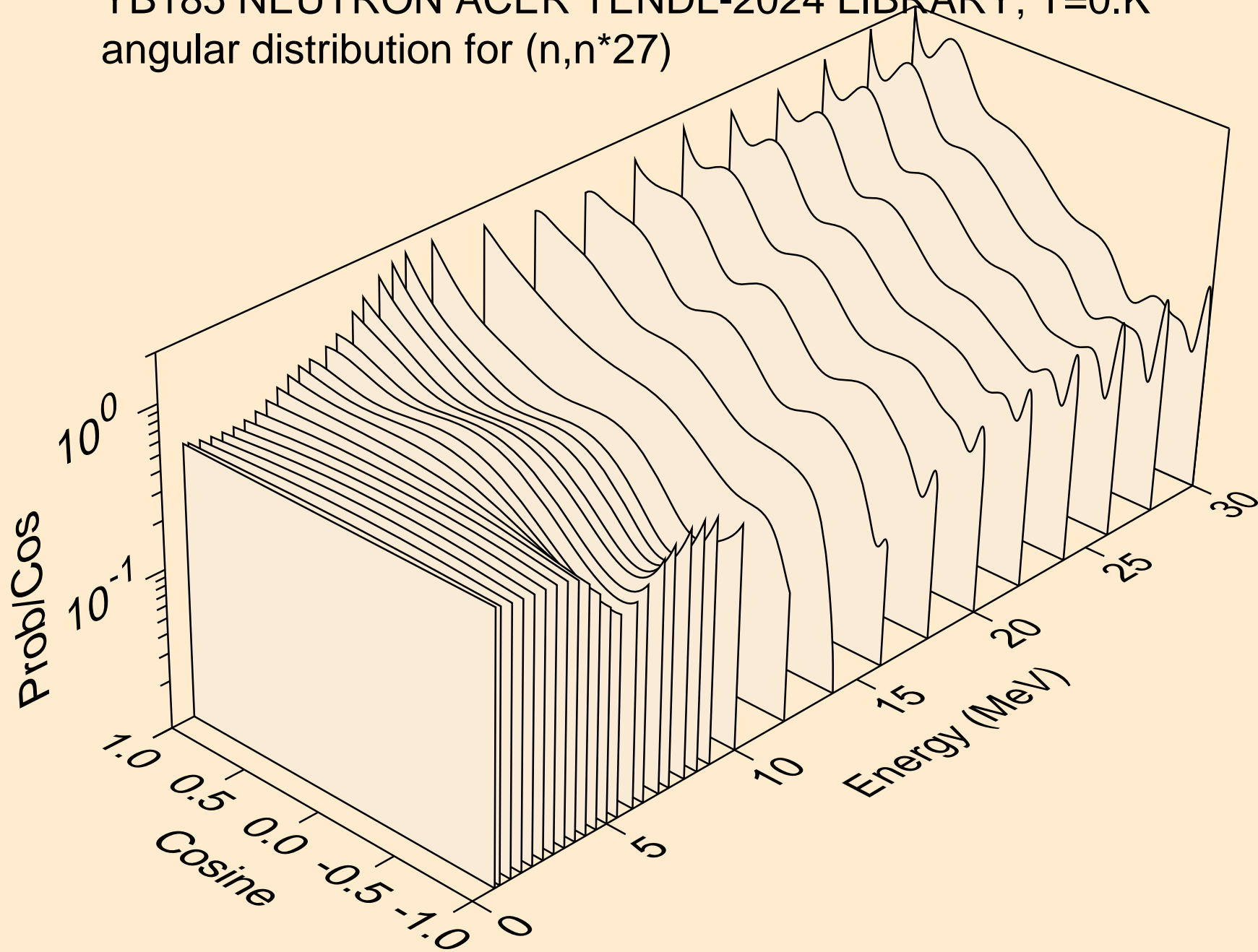



YB185 NEUTRON ACER TENDL-2024 LIBRARY; T=0.K  
angular distribution for (n,n\*28)

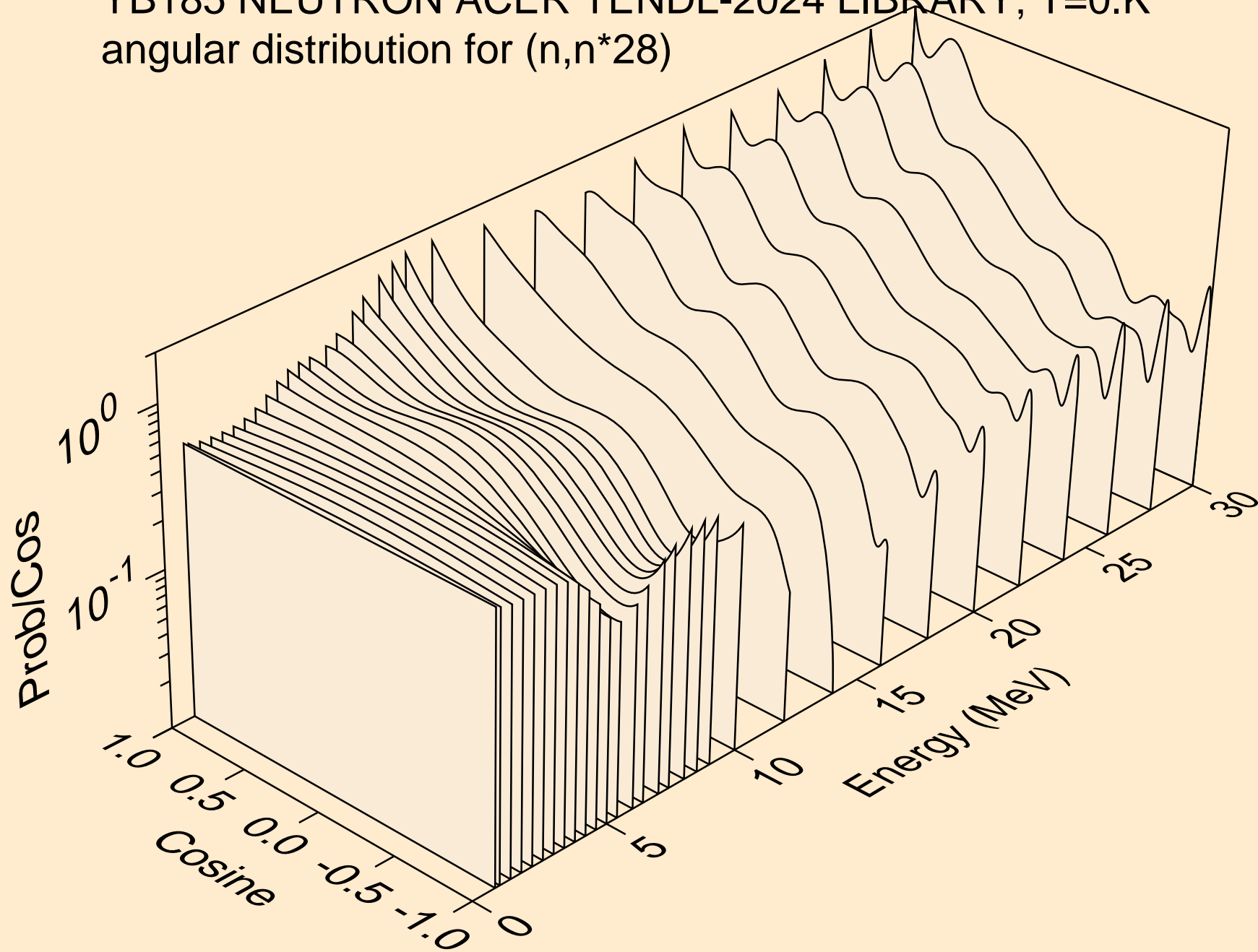

YB185 NEUTRON ACER TENDL-2024 LIBRARY; T=0.K  
angular distribution for (n,n\*29)

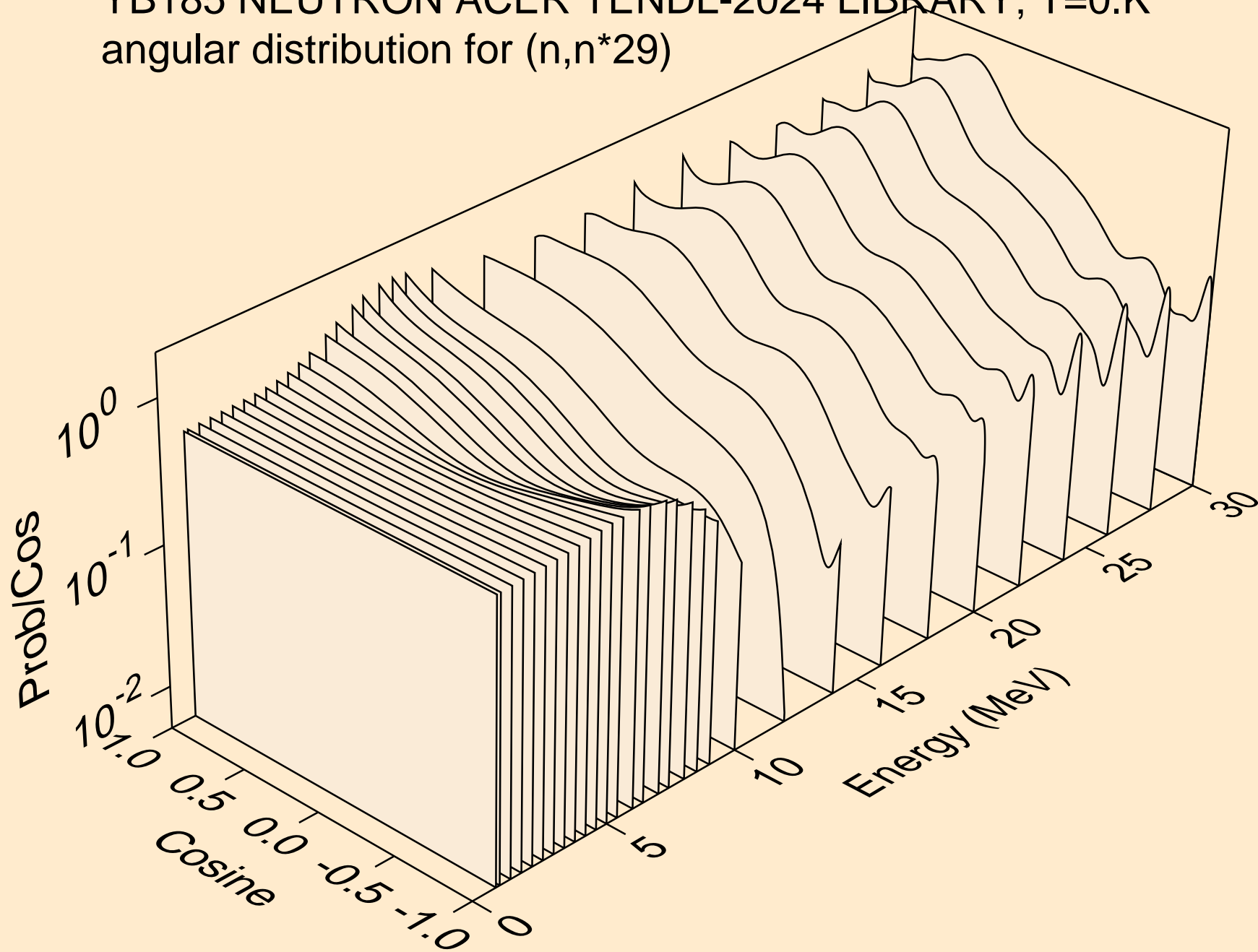

YB185 NEUTRON ACER TENDL-2024 LIBRARY; T=0.K  
Neutron emission for (n,x)

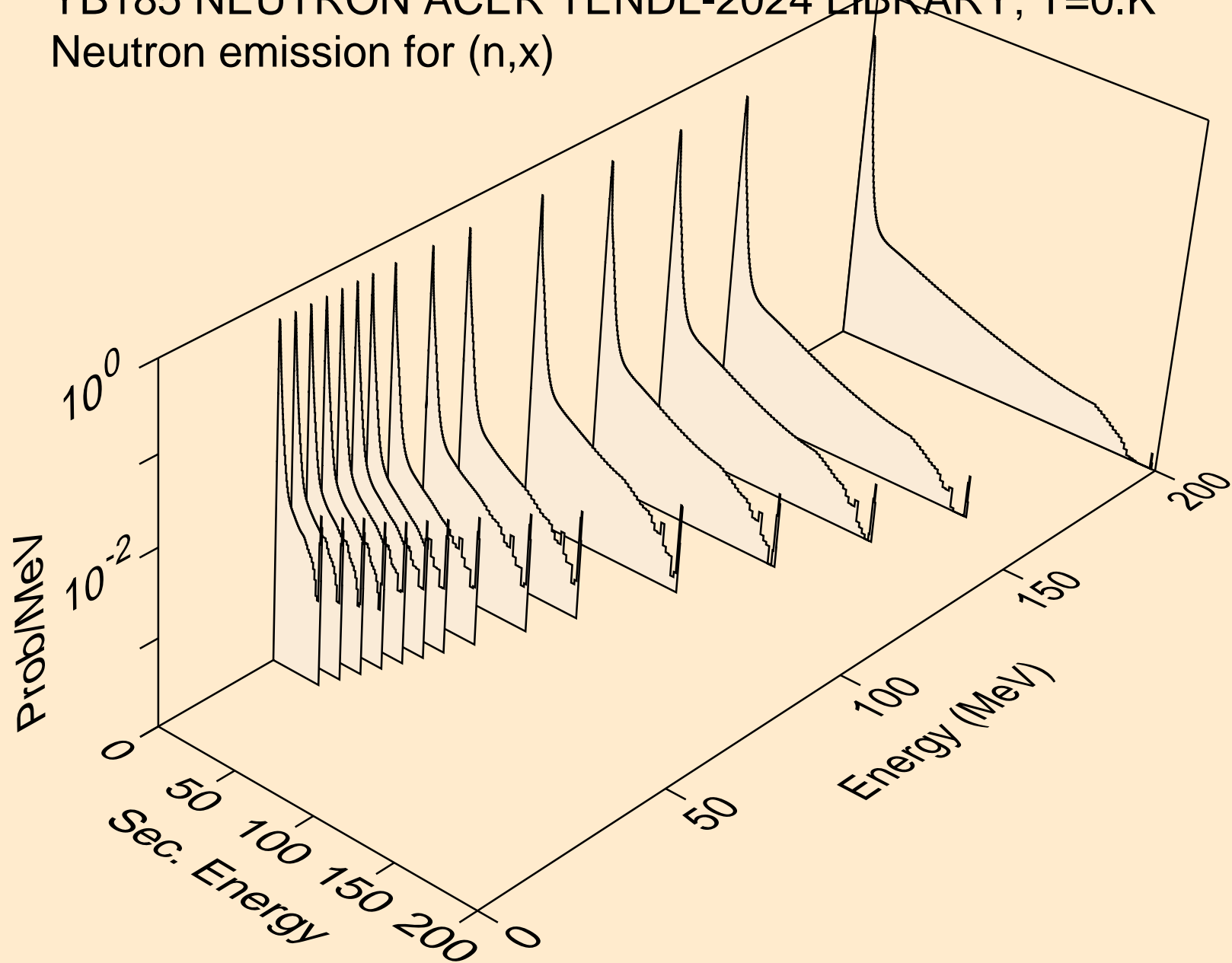

YB185 NEUTRON ACER TENDL-2024 LIBRARY; T=0.K  
Neutron emission for (n,2nd)

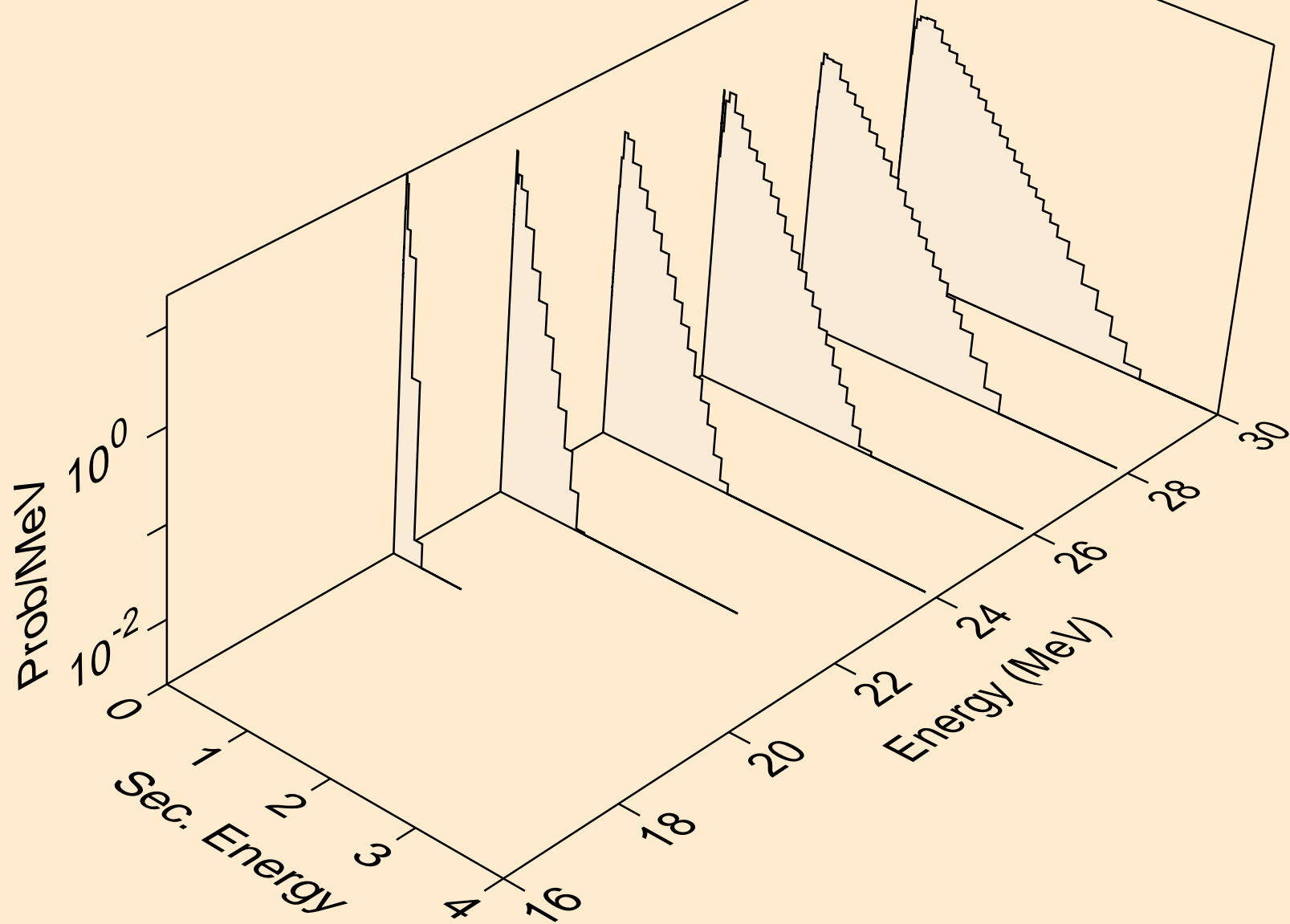

YB185 NEUTRON ACER TENDL-2024 LIBRARY; T=0.K  
Neutron emission for (n,2n)

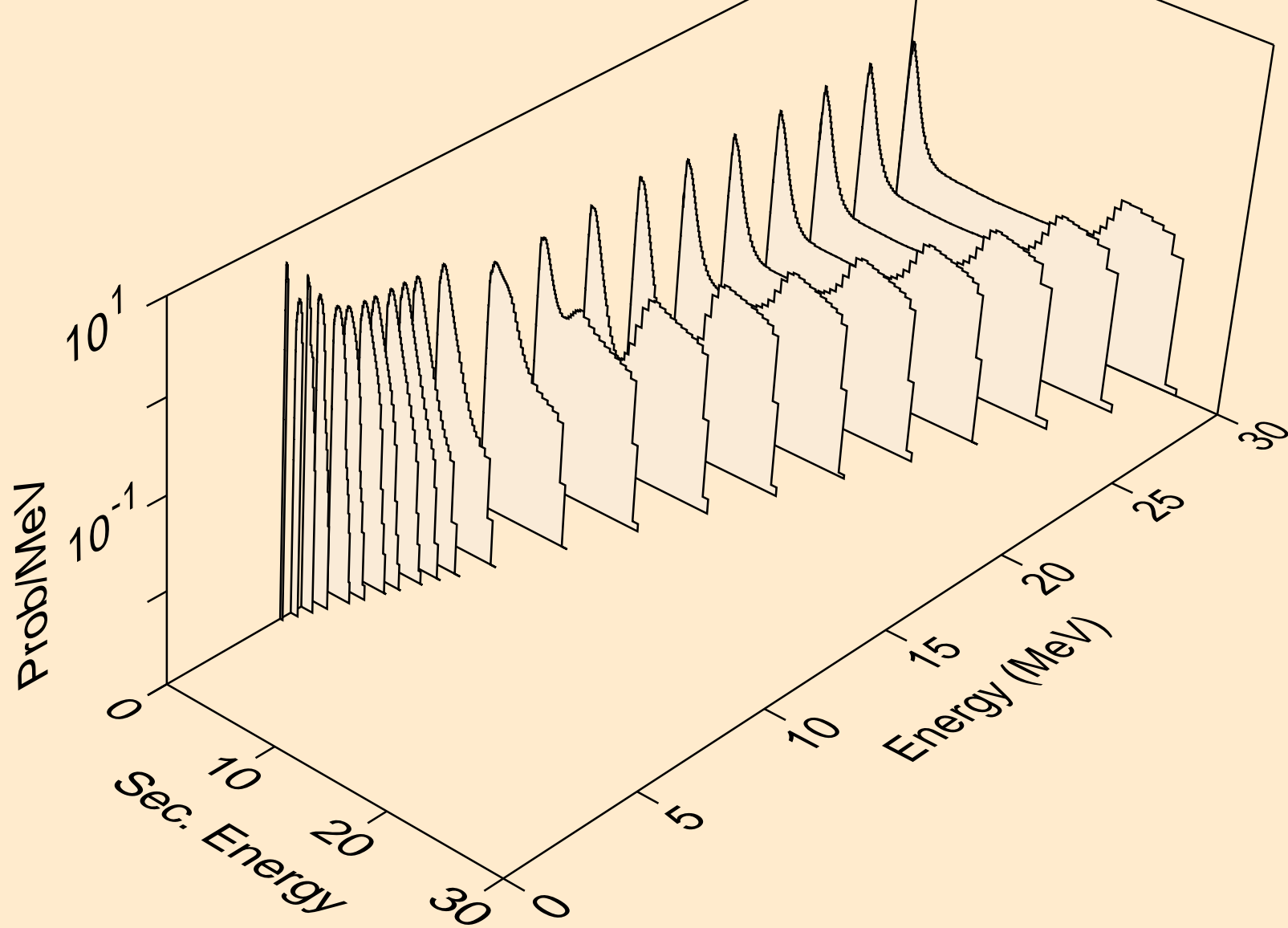

YB185 NEUTRON ACER TENDL-2024 LIBRARY; T=0.K  
Neutron emission for (n,3n)

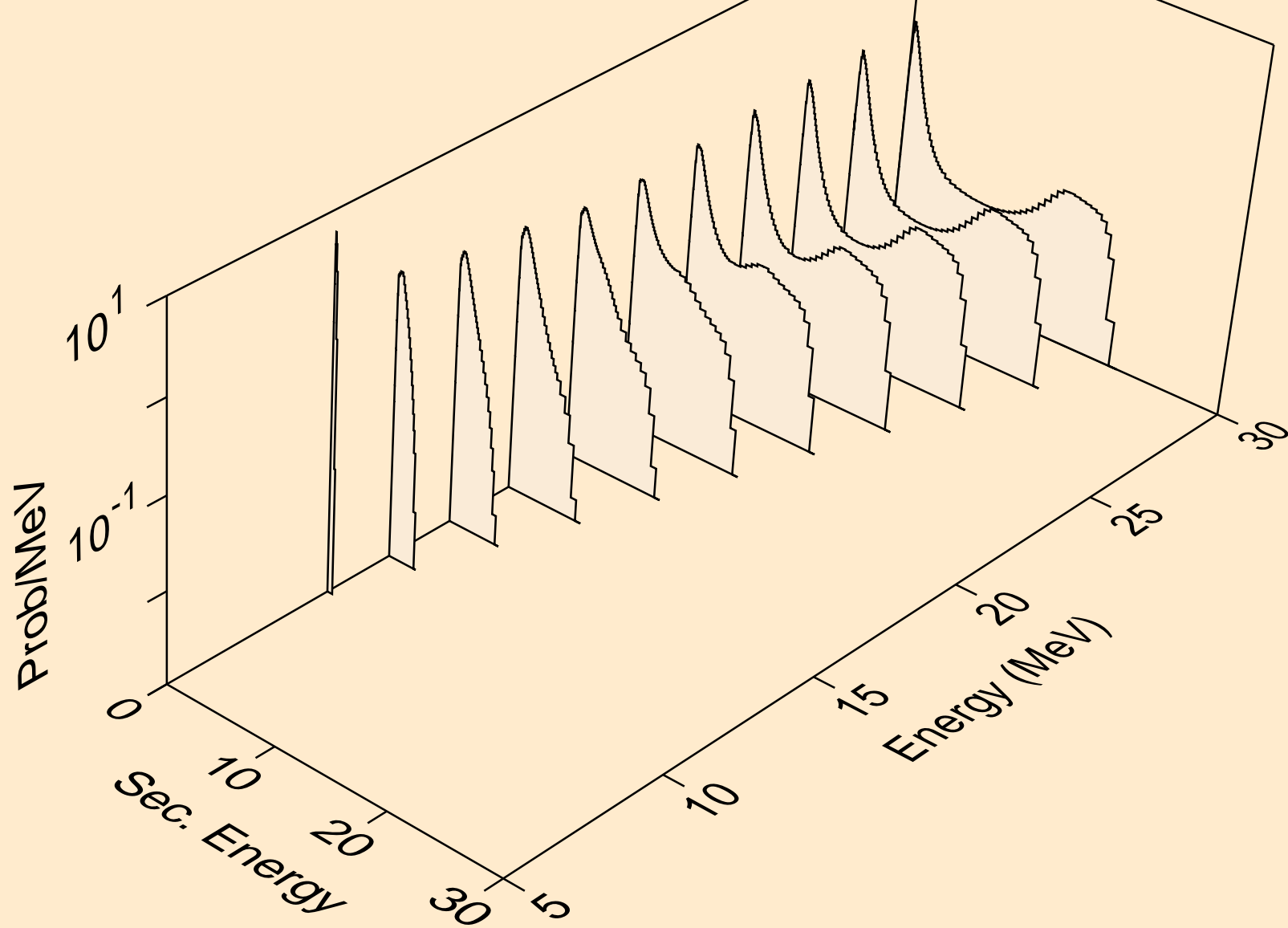

YB185 NEUTRON ACER TENDL-2024 LIBRARY; T=0.K  
Neutron emission for (n,n\*)a

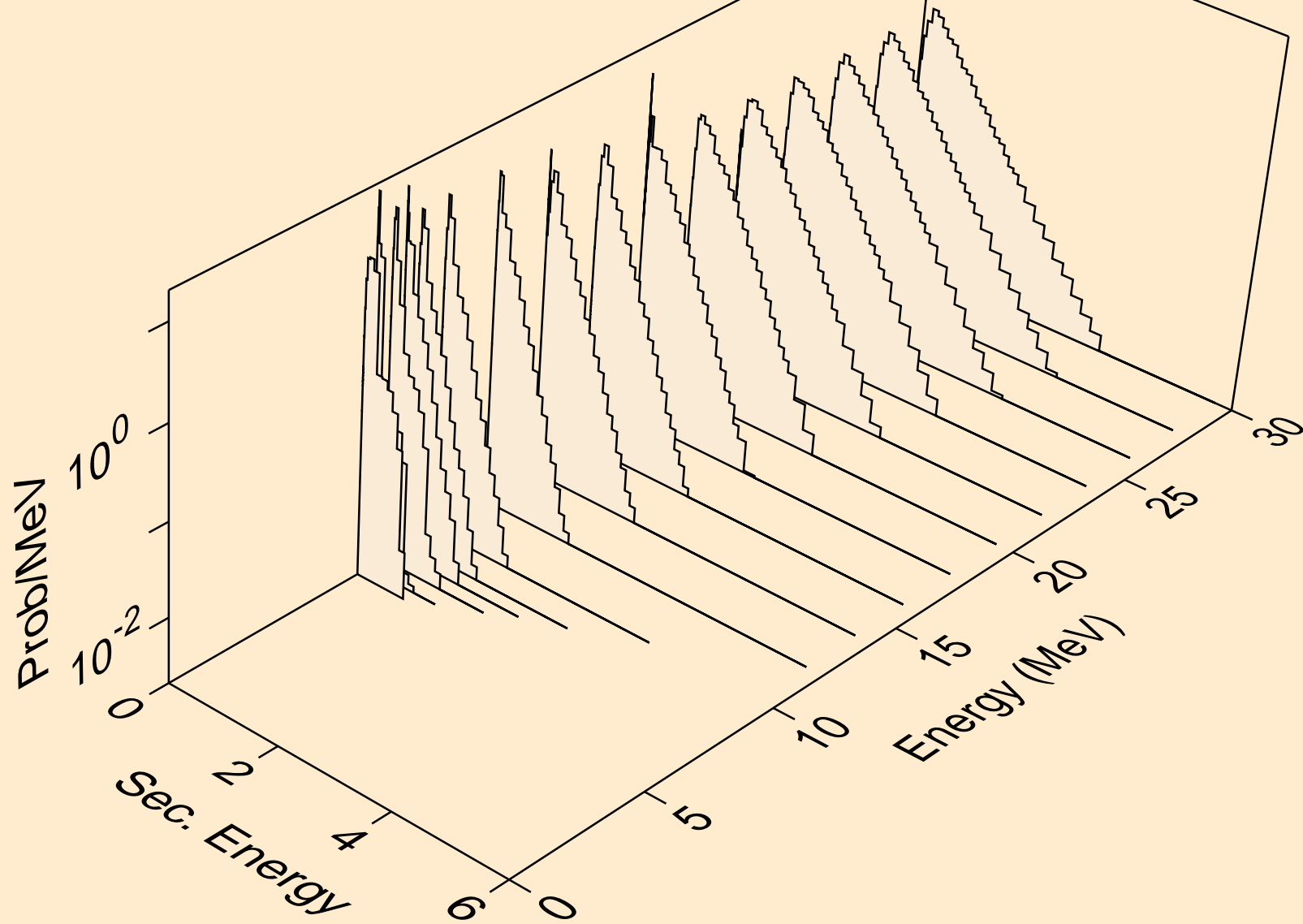

YB185 NEUTRON ACER TENDL-2024 LIBRARY; T=0.K  
Neutron emission for (n,2n)a

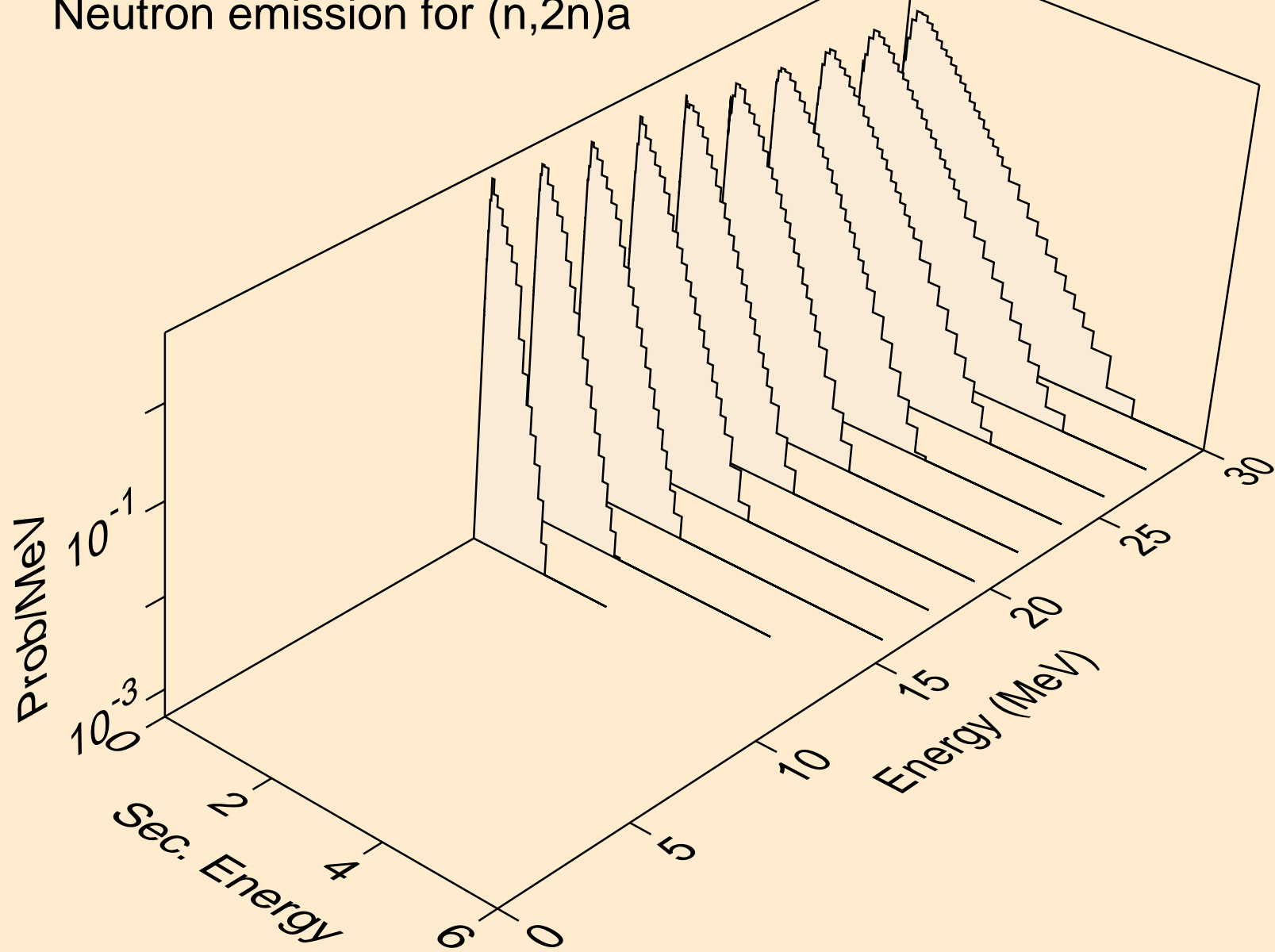



YB185 NEUTRON ACER TENDL-2024 LIBRARY; T=0.K  
Neutron emission for (n,3n)a

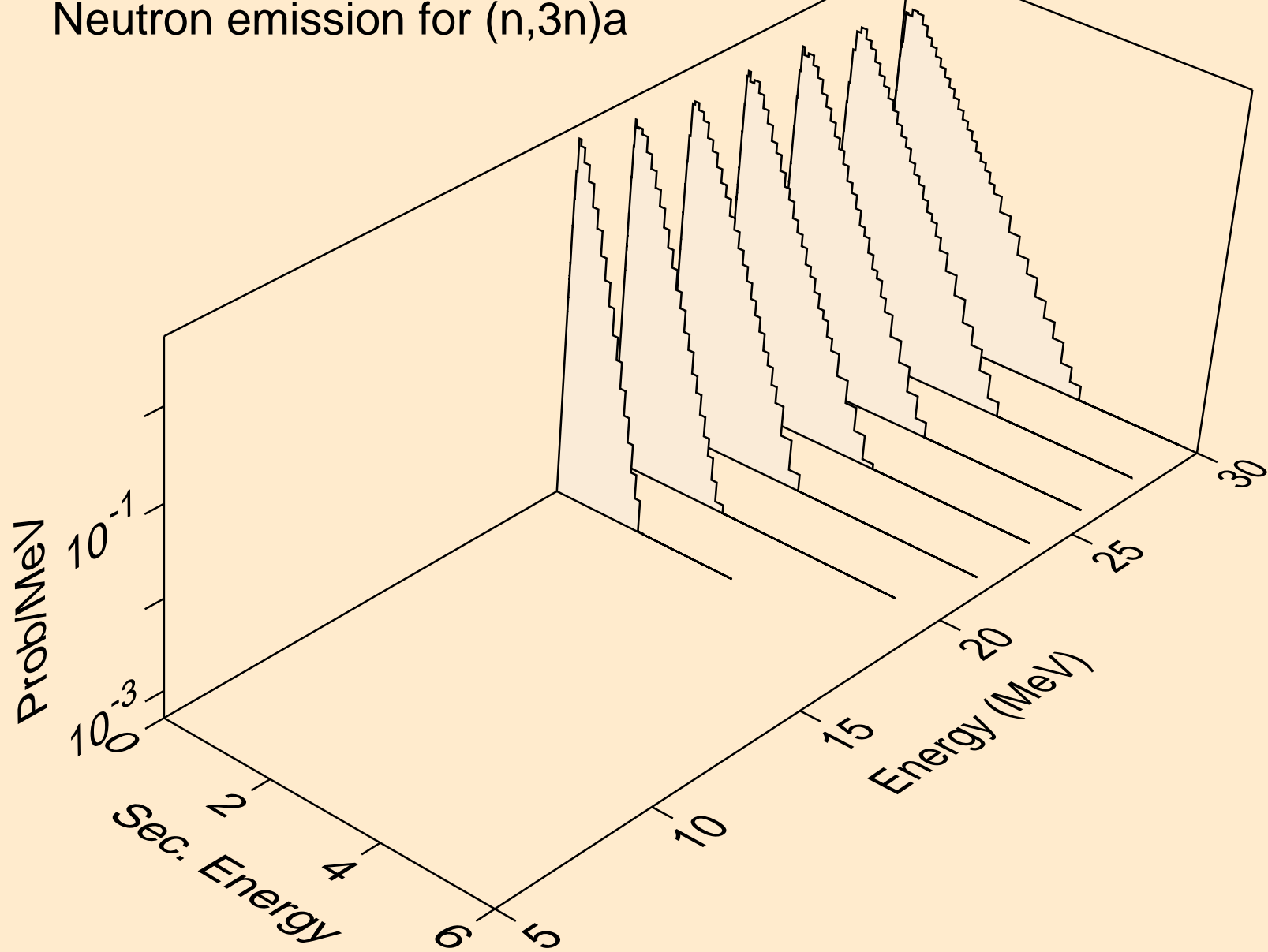

YB185 NEUTRON ACER TENDL-2024 LIBRARY; T=0.K  
Neutron emission for (n,n\*)p

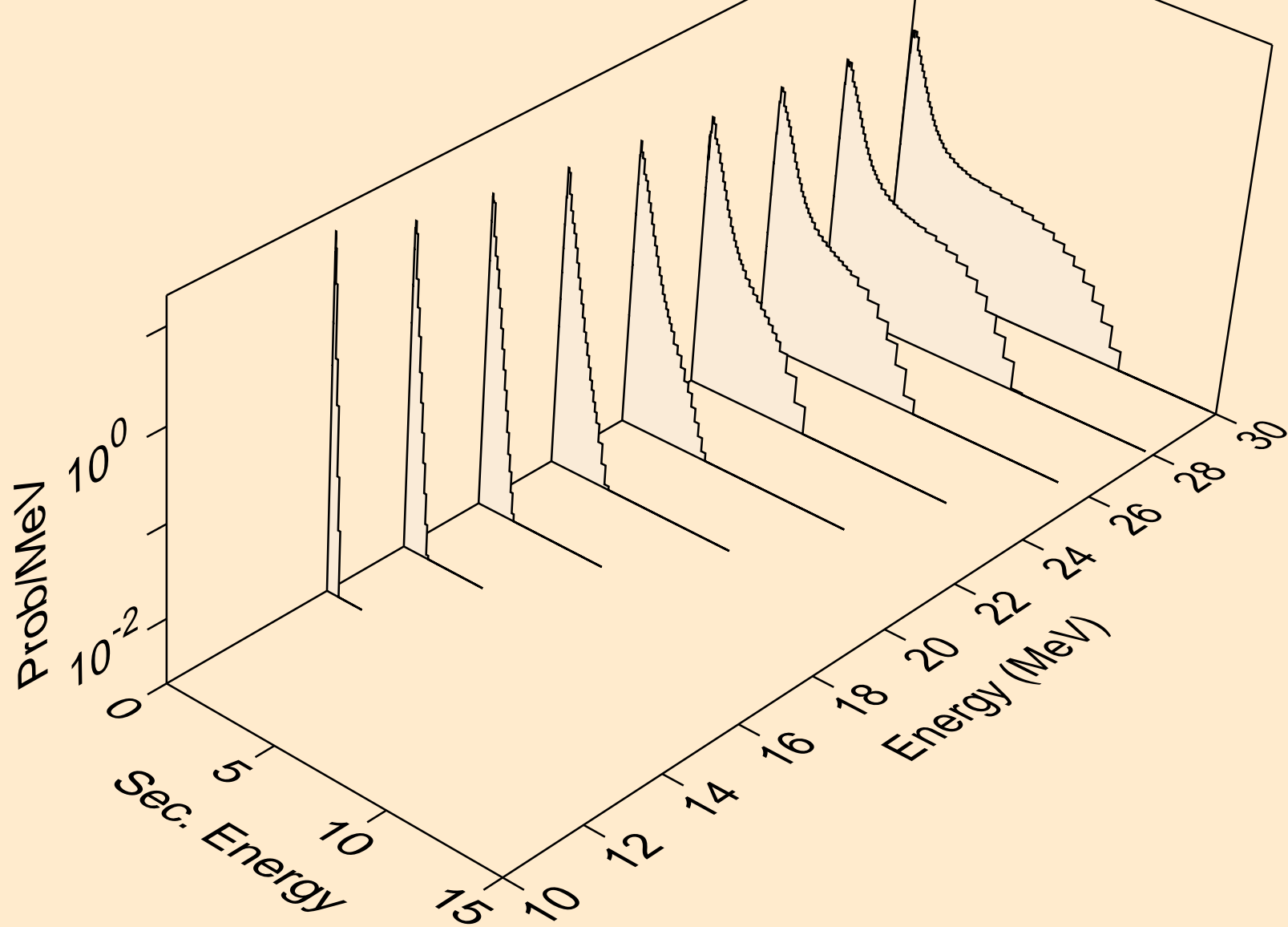

YB185 NEUTRON ACER TENDL-2024 LIBRARY; T=0.K  
Neutron emission for (n,n\*)d

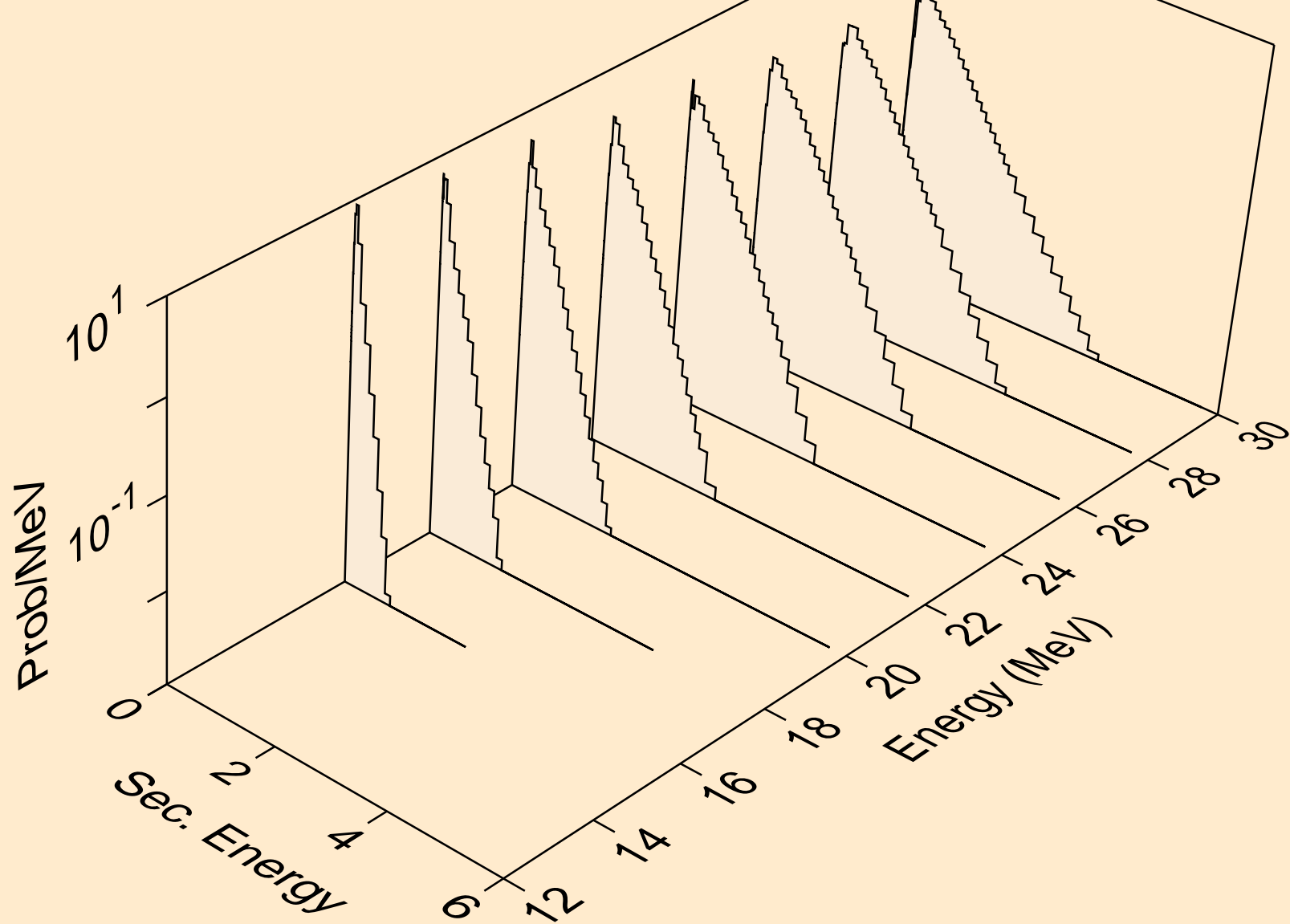

YB185 NEUTRON ACER TENDL-2024 LIBRARY; T=0.K  
Neutron emission for (n,n\*)t

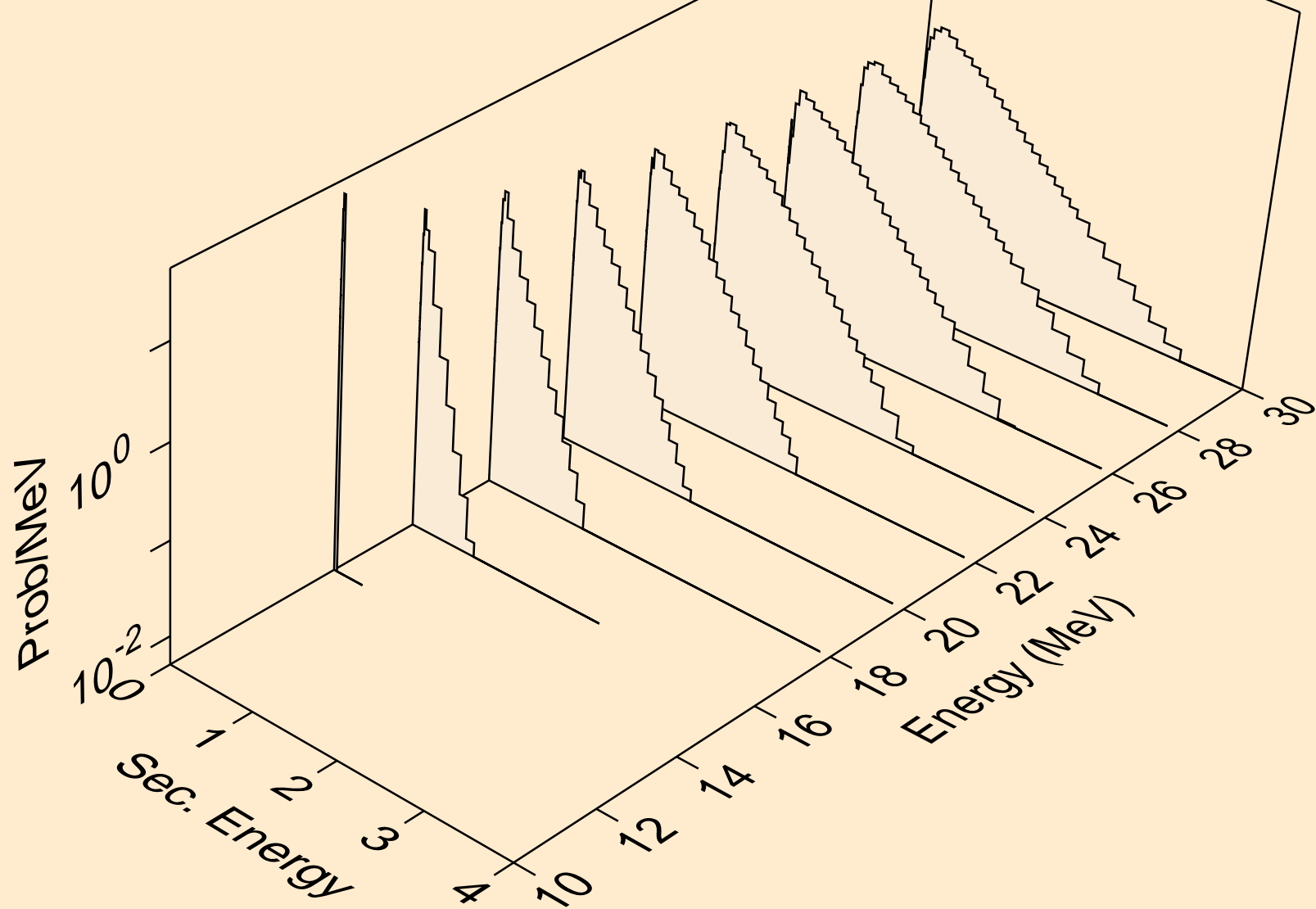

YB185 NEUTRON ACER TENDL-2024 LIBRARY; T=0.K  
Neutron emission for (n,n\*)he3

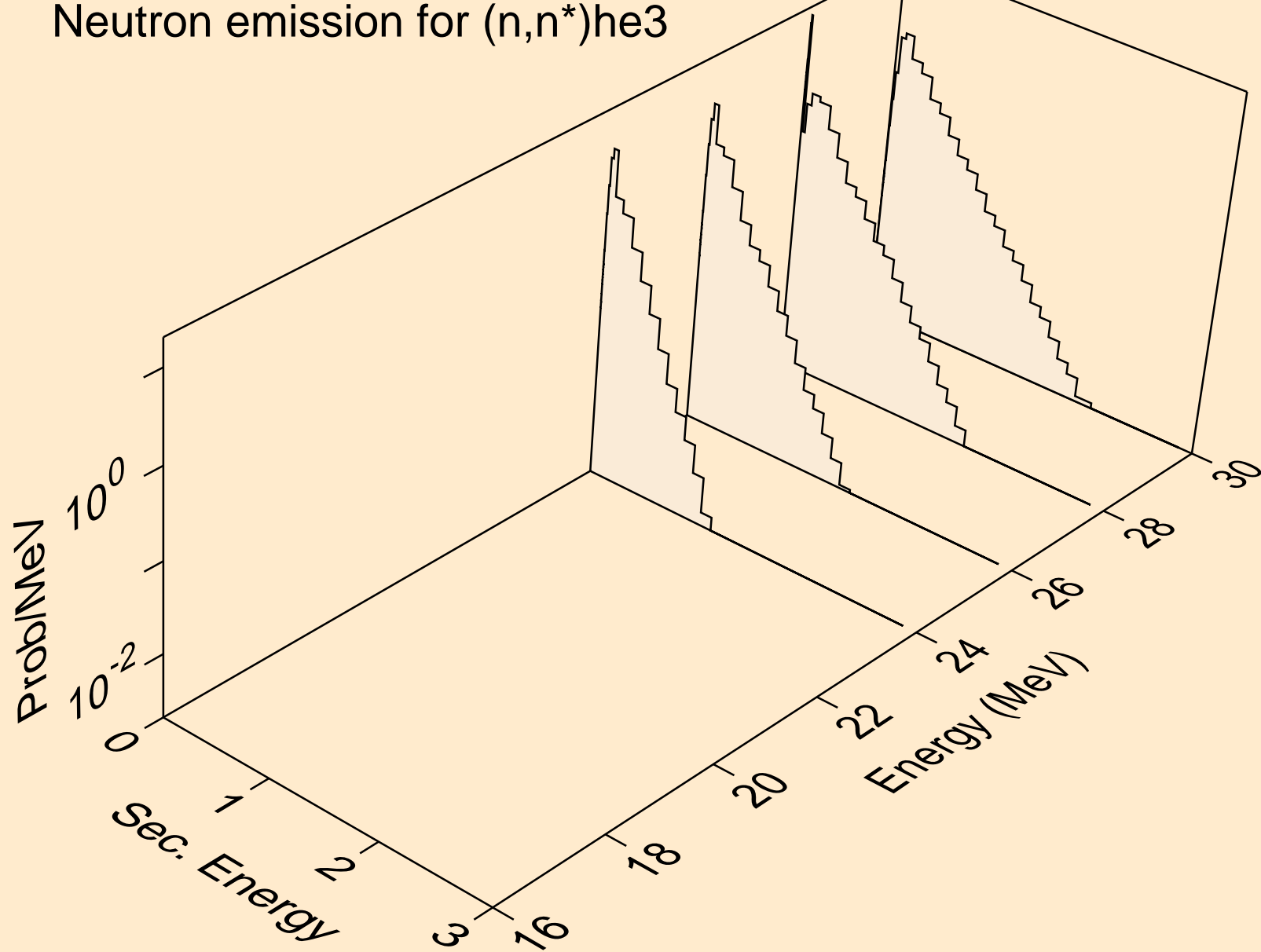

YB185 NEUTRON ACER TENDL-2024 LIBRARY; T=0.K  
Neutron emission for (n,4n)

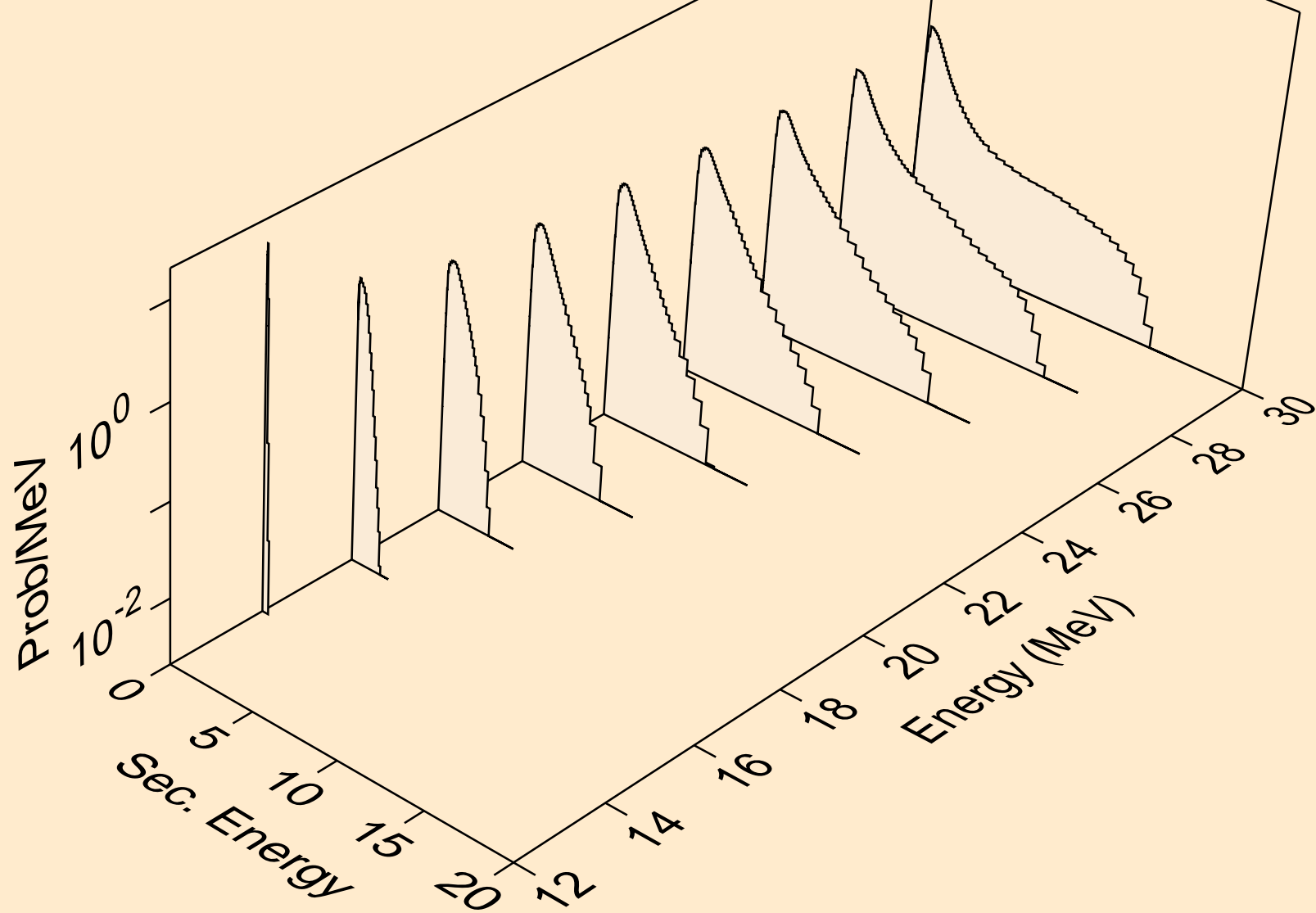

YB185 NEUTRON ACER TENDL-2024 LIBRARY; T=0.K  
Neutron emission for (n,2np)

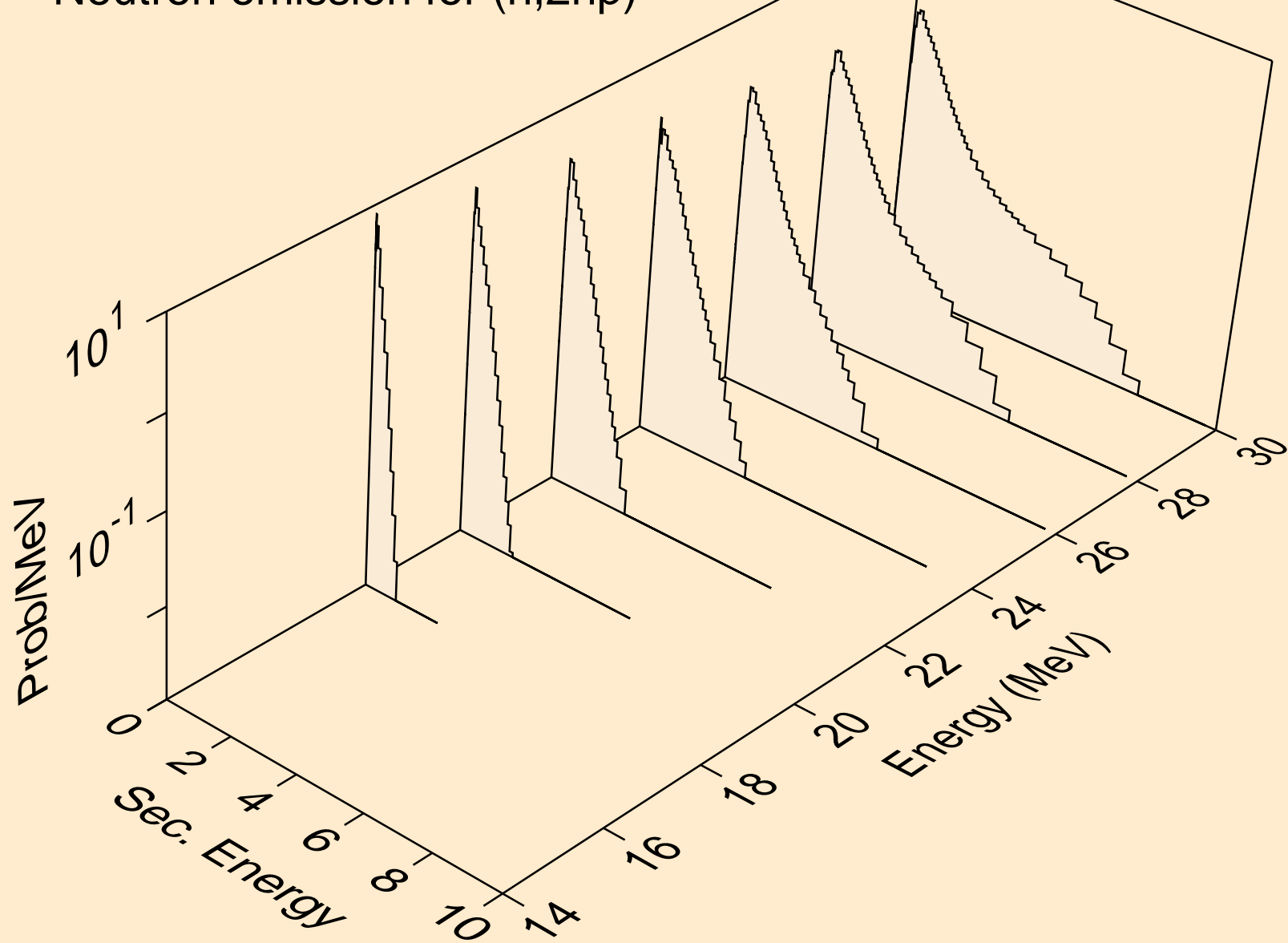

YB185 NEUTRON ACER TENDL-2024 LIBRARY; T=0.K  
Neutron emission for (n,3np)

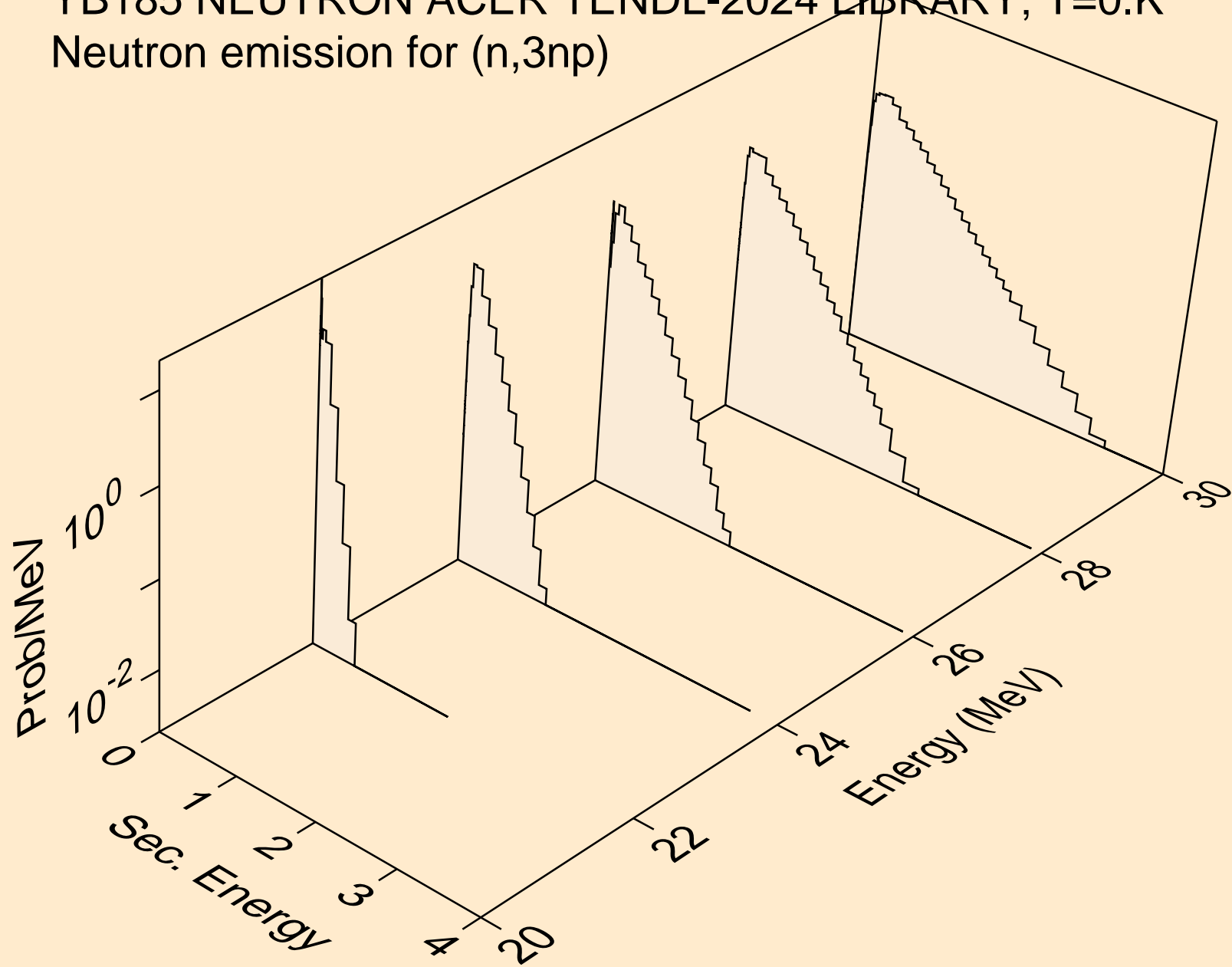



YB185 NEUTRON ACER TENDL-2024 LIBRARY; T=0.K  
Neutron emission for (n,n\*c)

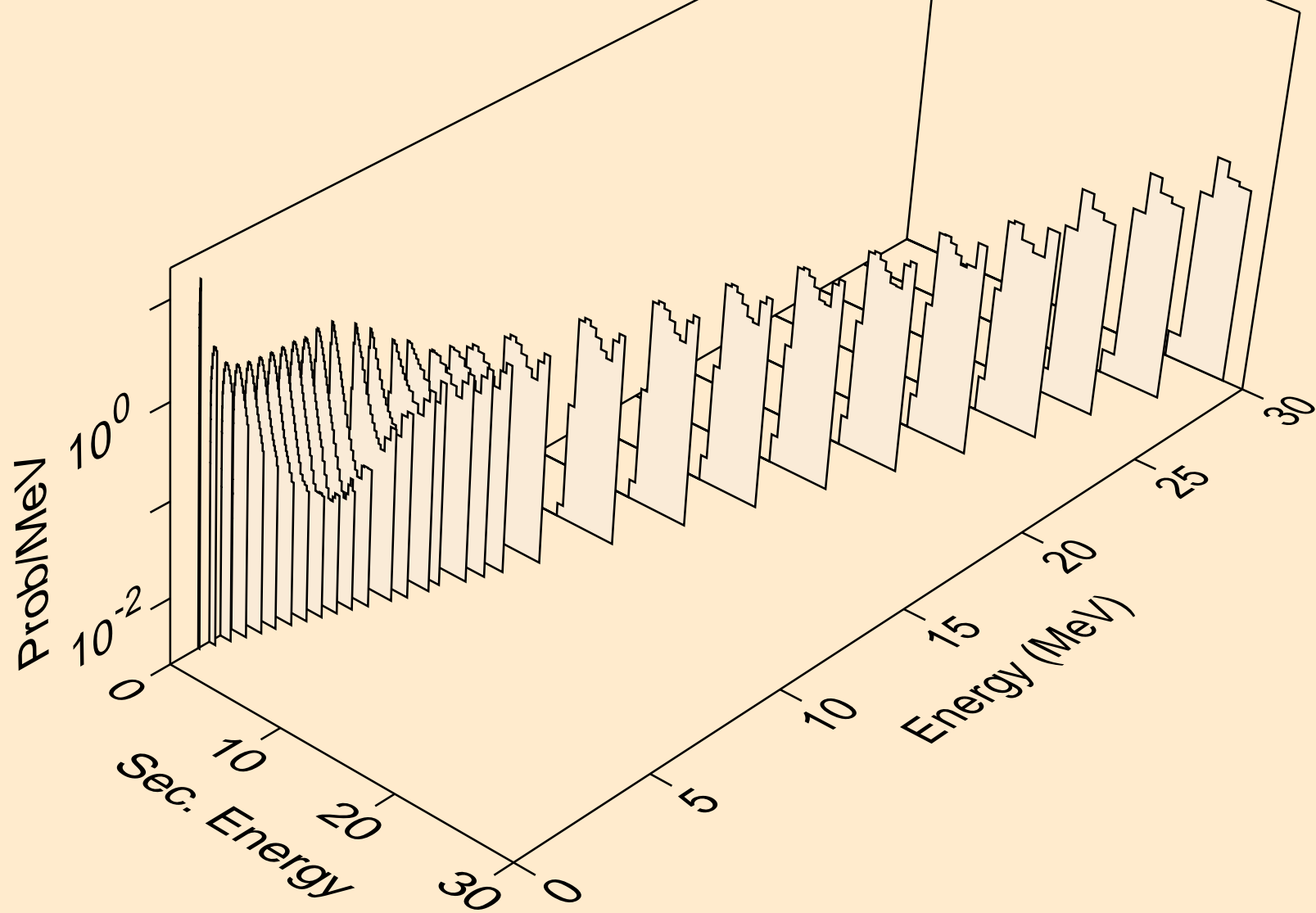

YB185 NEUTRON ACER TENDL-2024 LIBRARY; T=0.K  
Photon emission for (n,x)

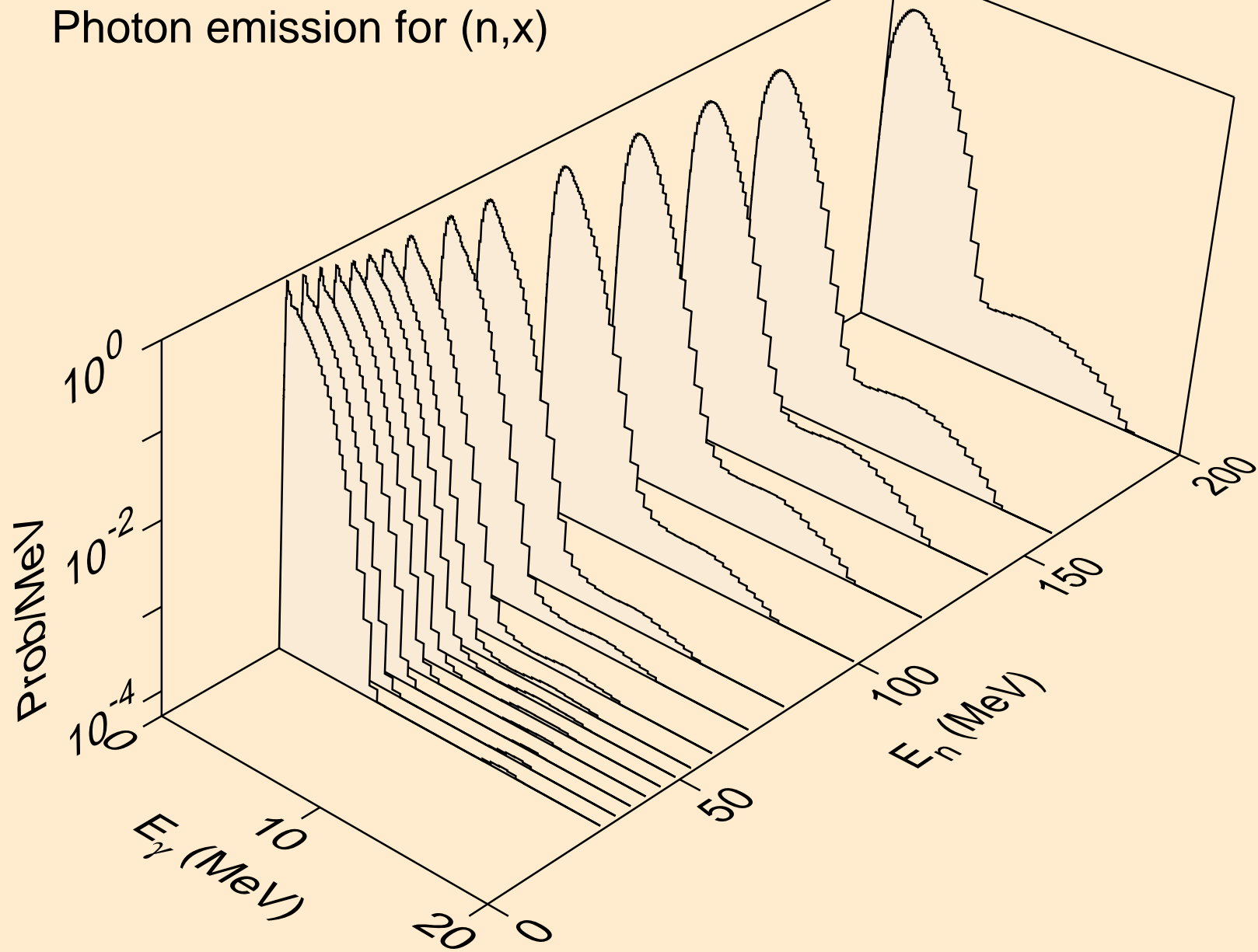

YB185 NEUTRON ACER TENDL-2024 LIBRARY; T=0.K  
Photon emission for (n,2nd)

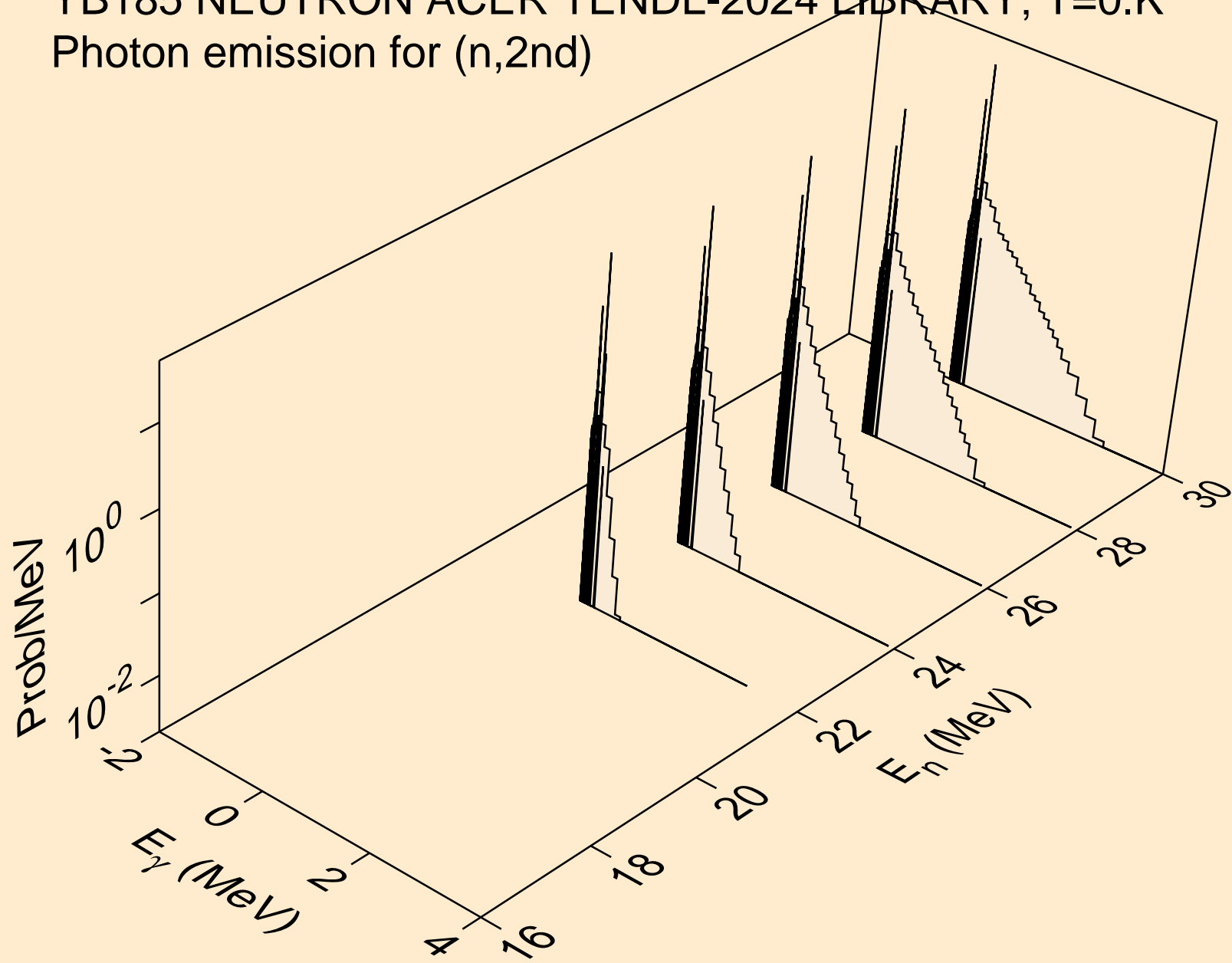

YB185 NEUTRON ACER TENDL-2024 LIBRARY; T=0.K  
Photon emission for (n,2n)

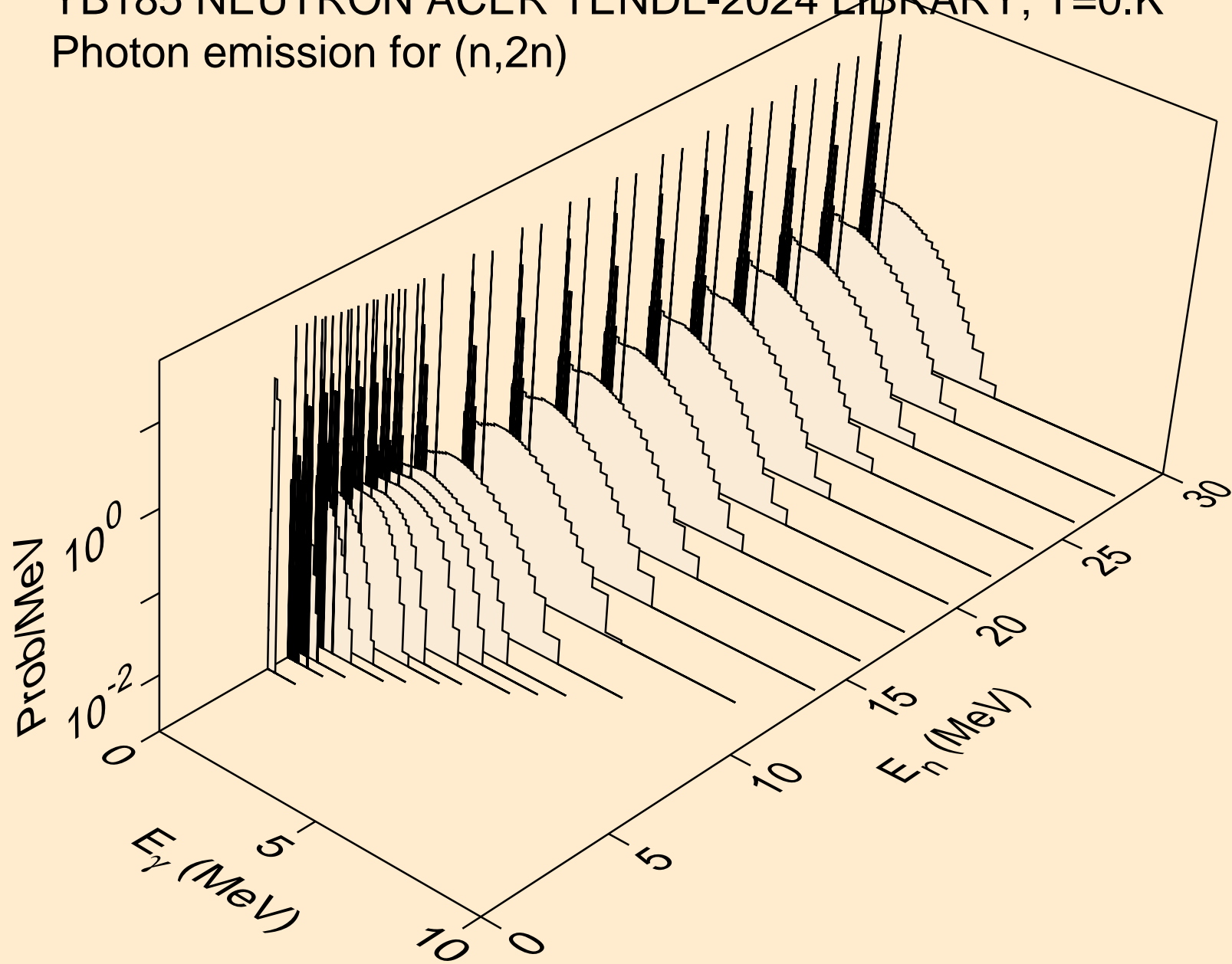

YB185 NEUTRON ACER TENDL-2024 LIBRARY; T=0.K  
Photon emission for (n,3n)

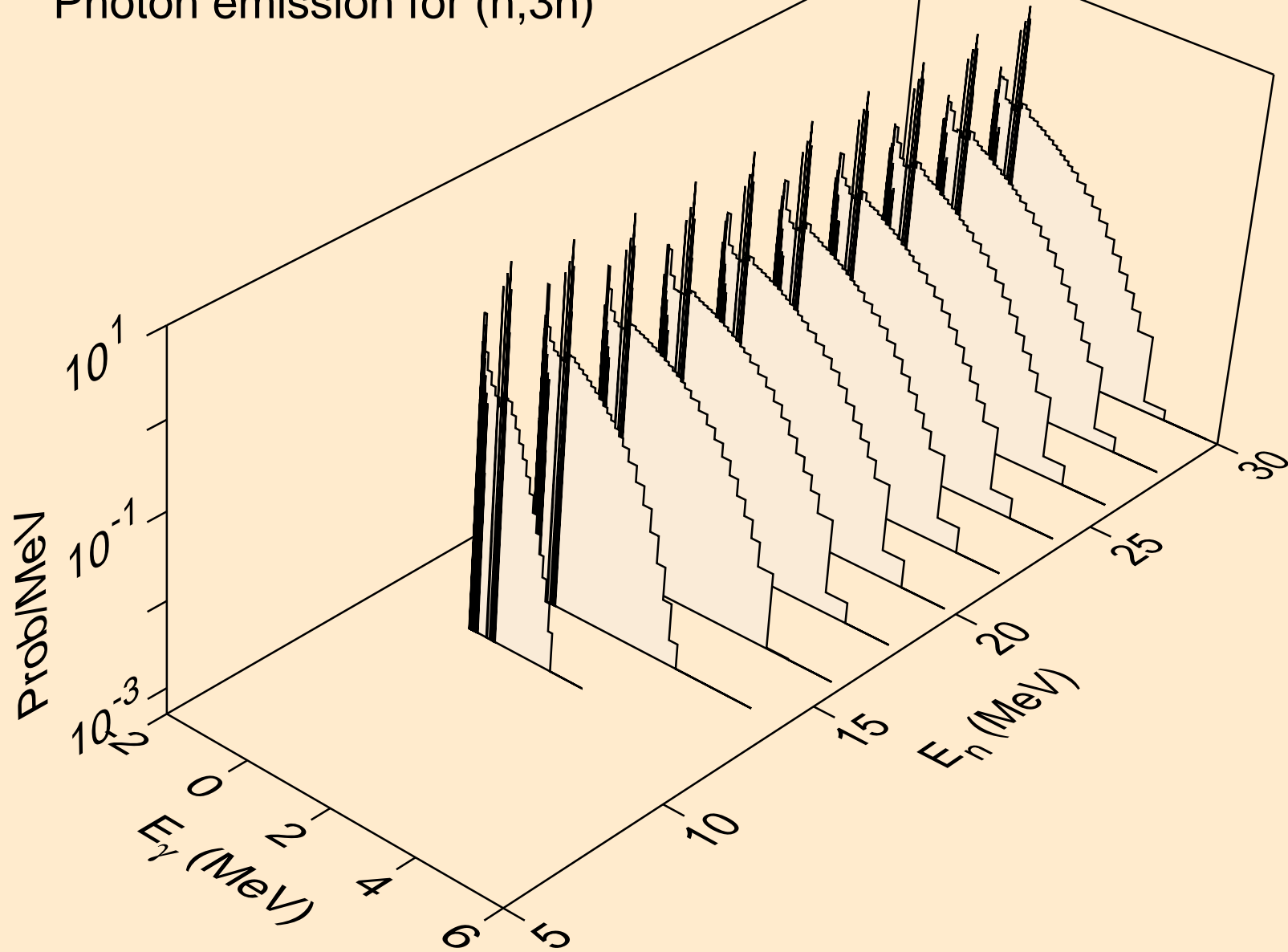

YB185 NEUTRON ACER TENDL-2024 LIBRARY; T=0.K  
Photon emission for (n,n\*)a

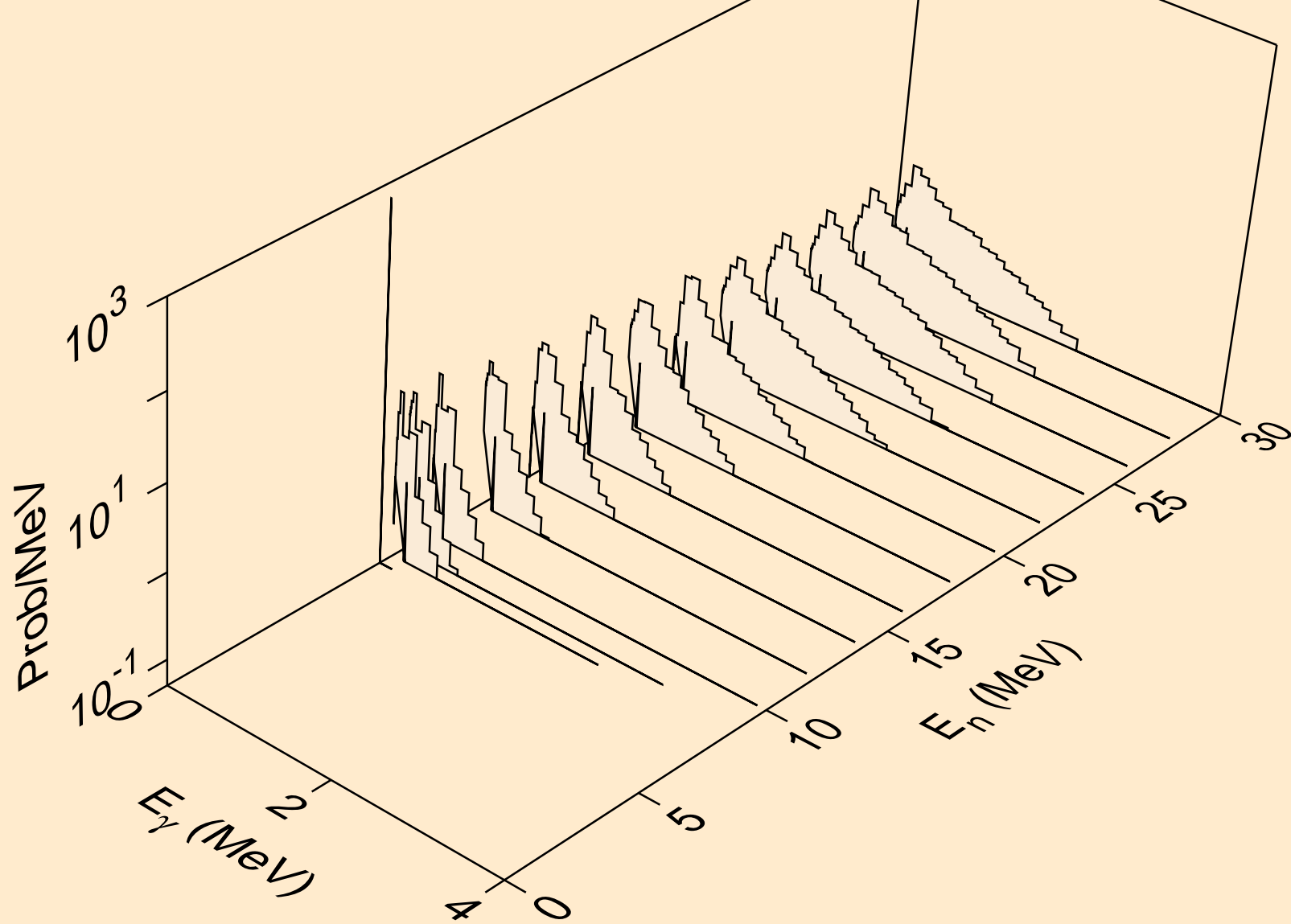

YB185 NEUTRON ACER TENDL-2024 LIBRARY; T=0.K  
Photon emission for (n,2n)a

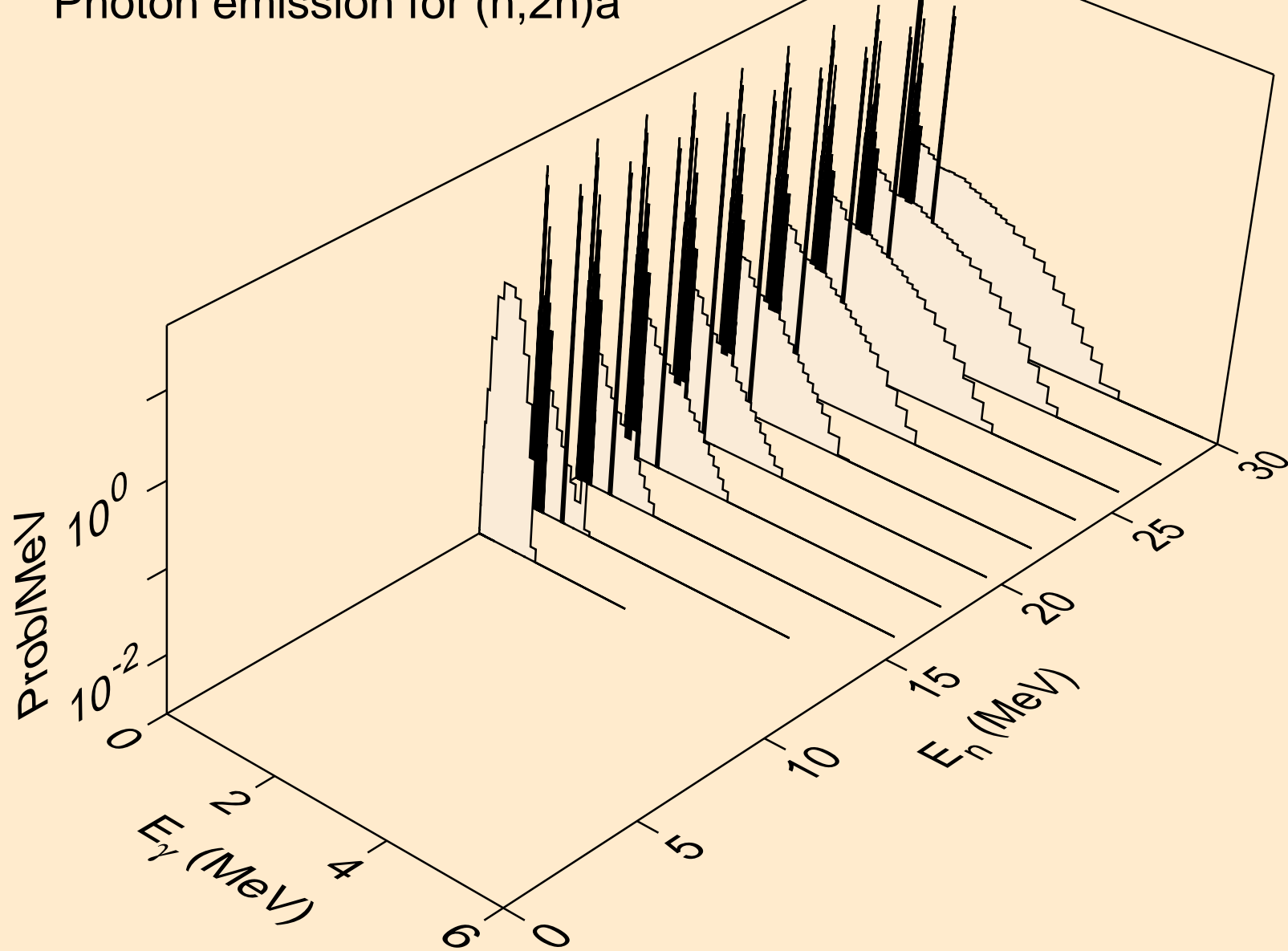

YB185 NEUTRON ACER TENDL-2024 LIBRARY; T=0.K  
Photon emission for (n,3n)a

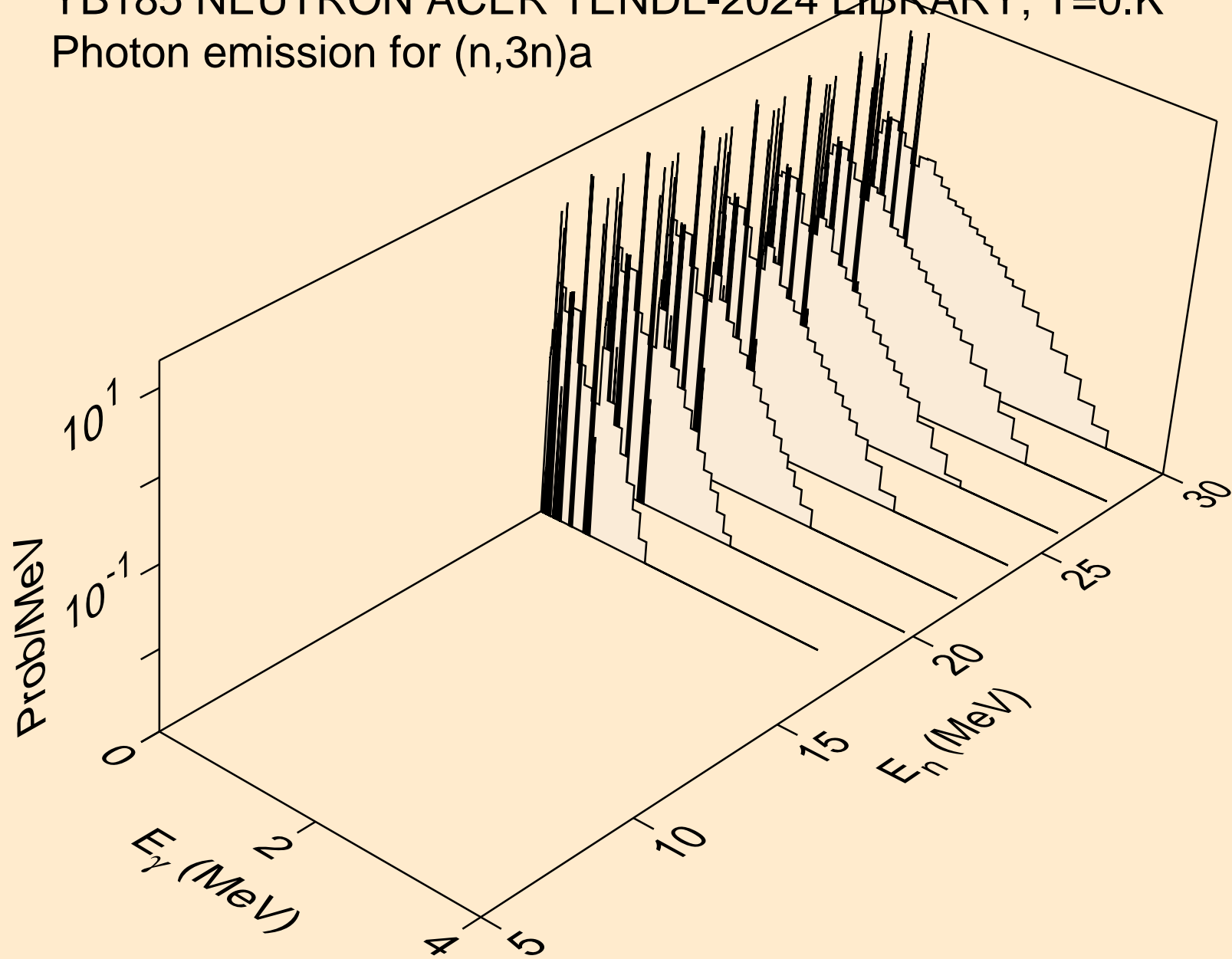



YB185 NEUTRON ACER TENDL-2024 LIBRARY; T=0.K  
Photon emission for (n,n\*)p

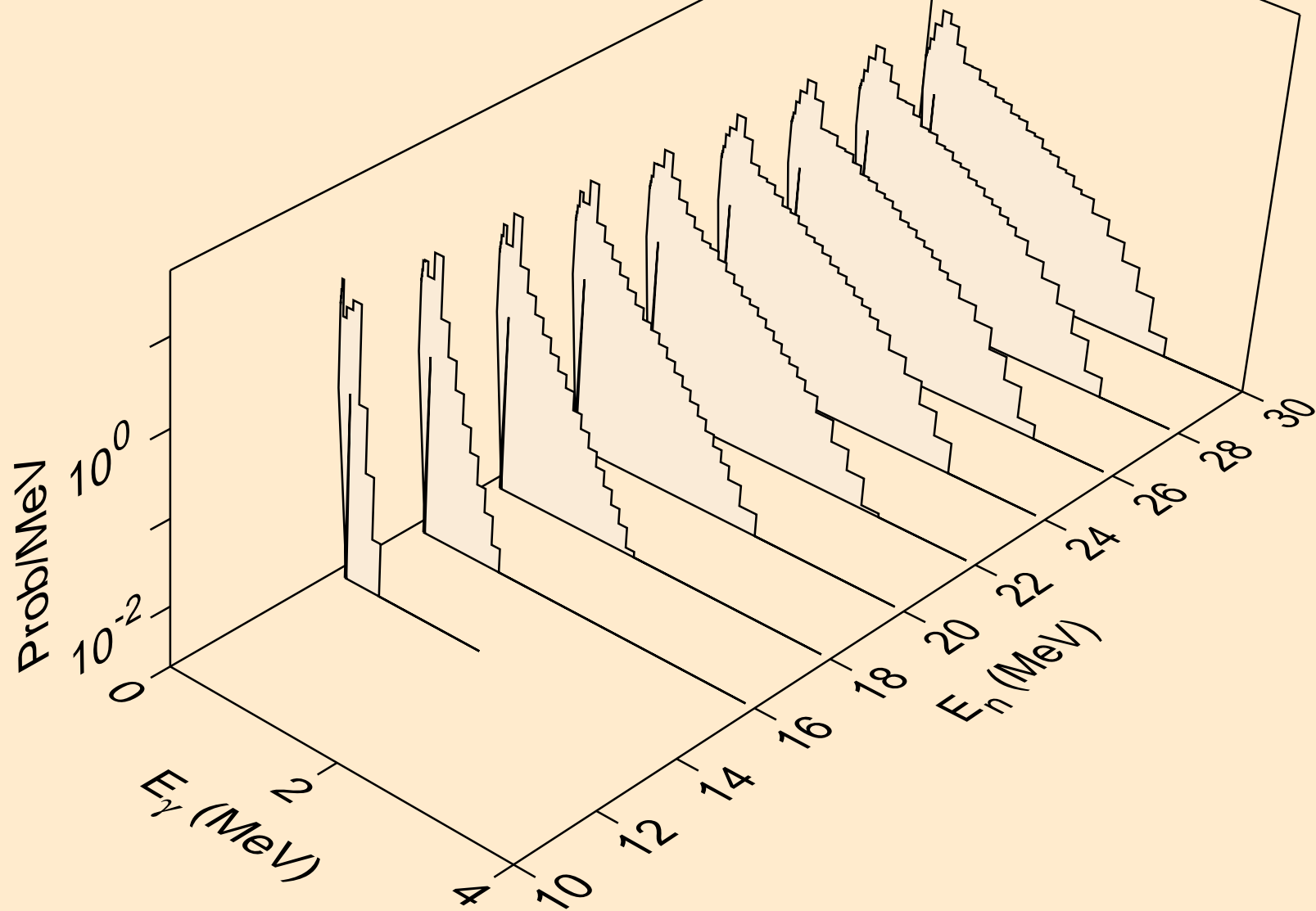

YB185 NEUTRON ACER TENDL-2024 LIBRARY; T=0.K  
Photon emission for (n,n\*)d

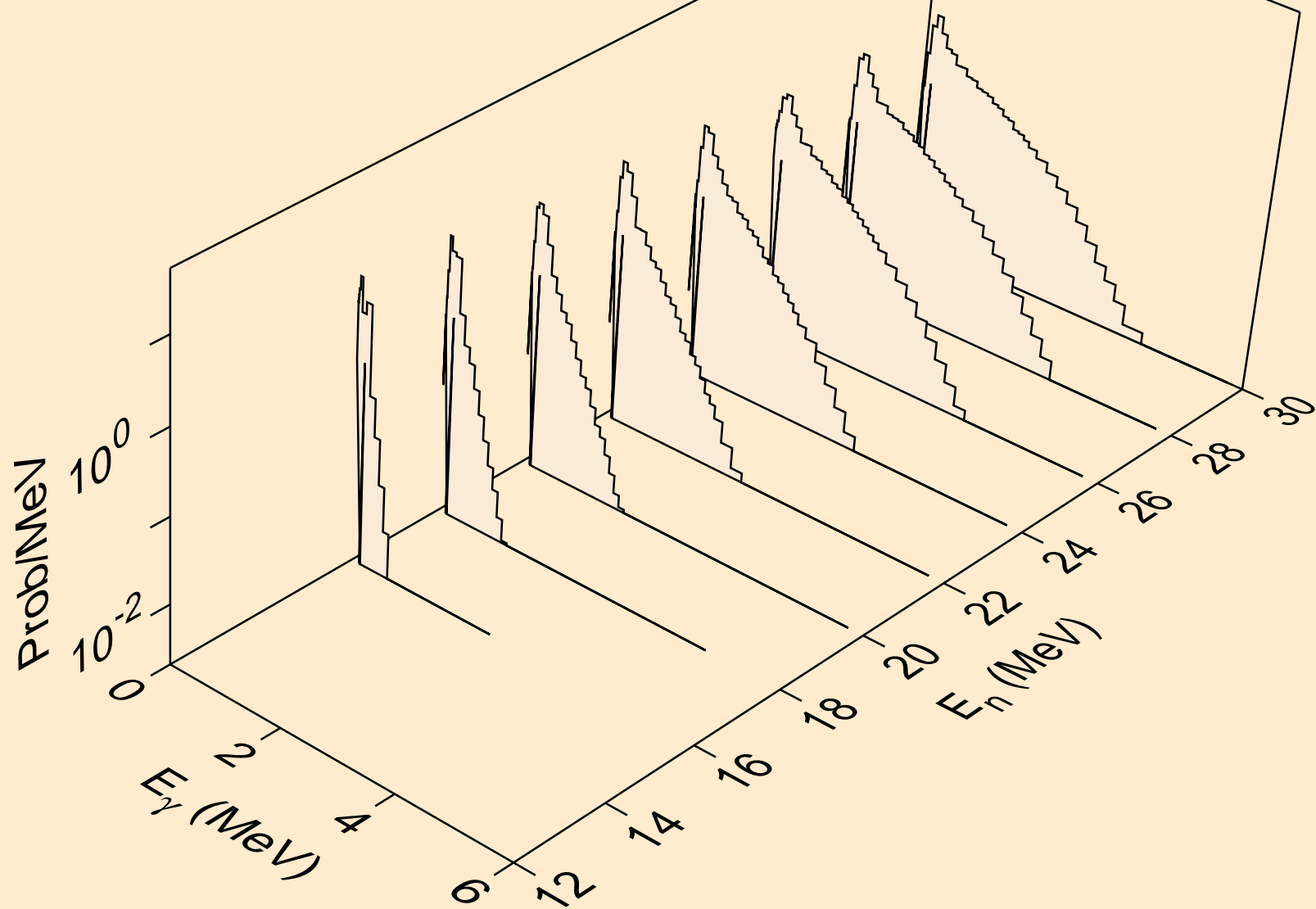

YB185 NEUTRON ACER TENDL-2024 LIBRARY; T=0.K  
Photon emission for (n,n\*)t

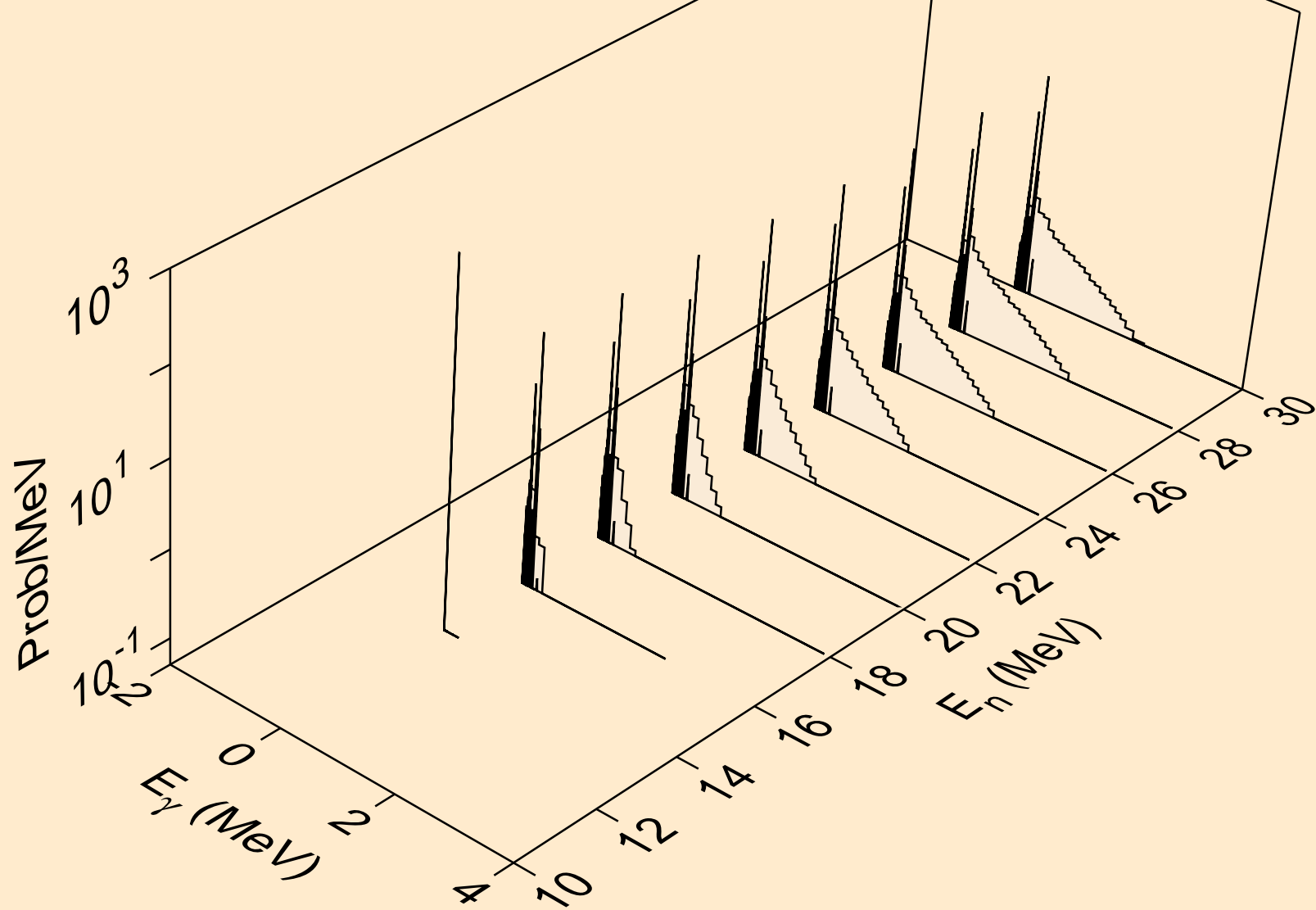

YB185 NEUTRON ACER TENDL-2024 LIBRARY; T=0.K  
Photon emission for (n,n\*)he3

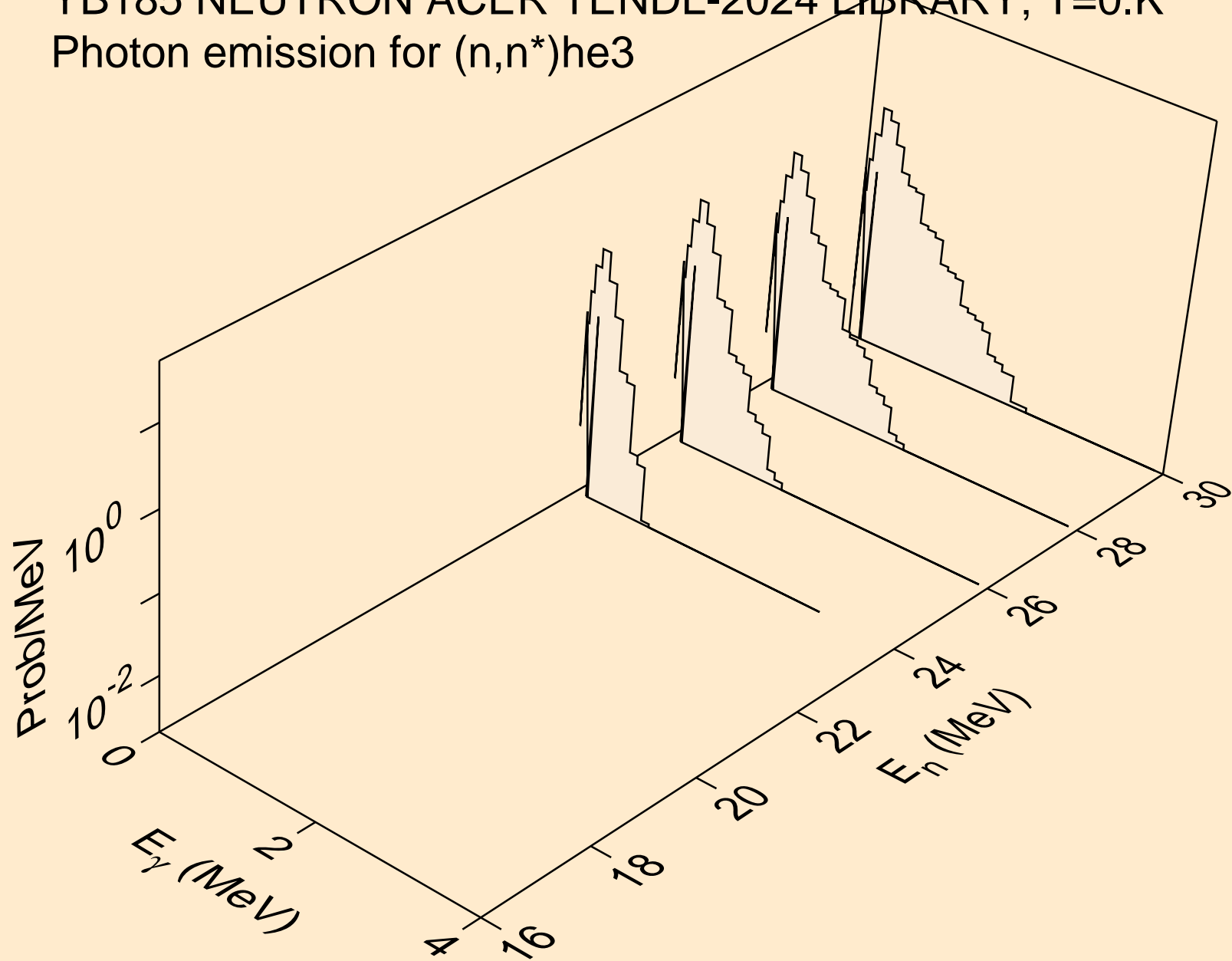

YB185 NEUTRON ACER TENDL-2024 LIBRARY; T=0.K  
Photon emission for (n,4n)

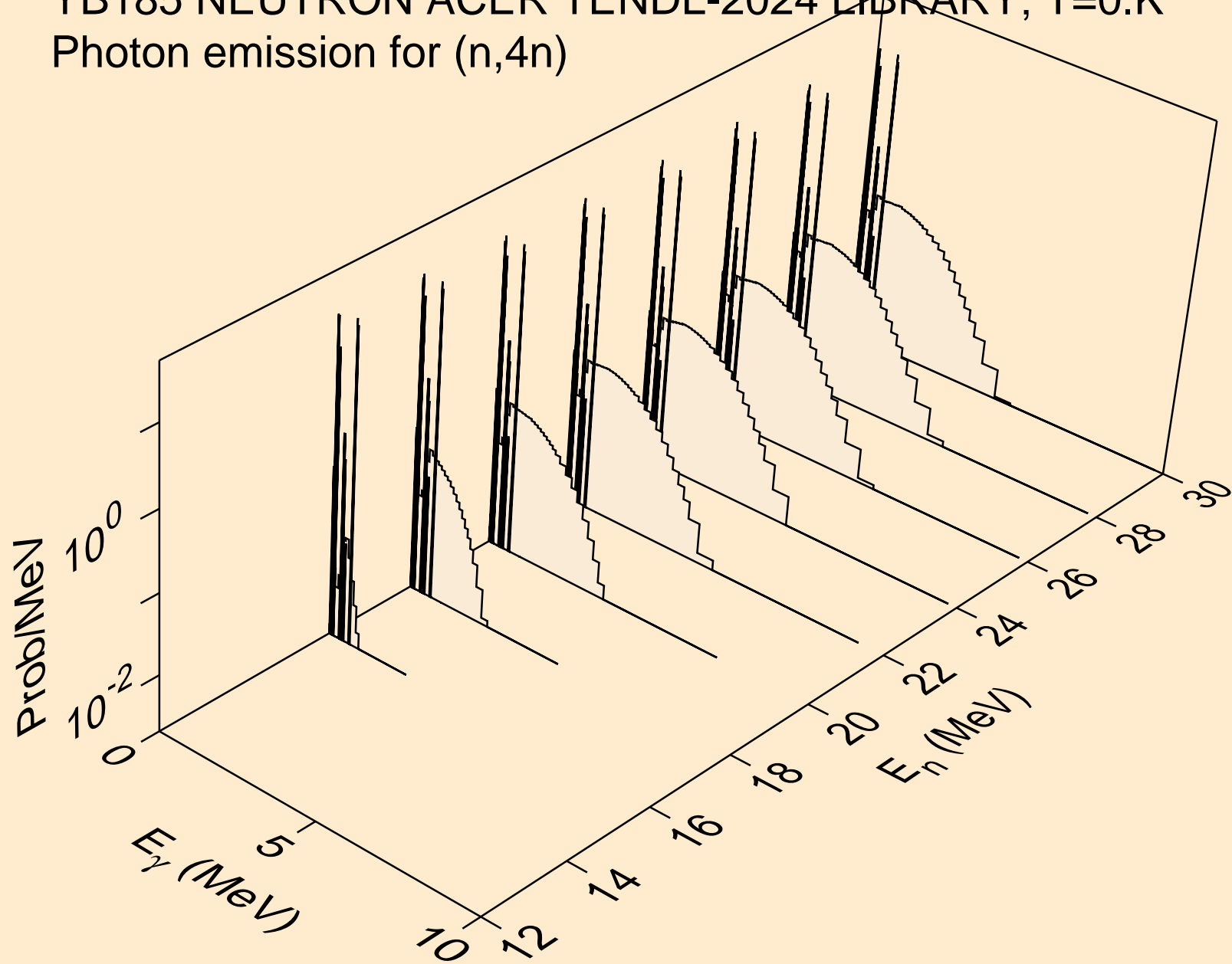

YB185 NEUTRON ACER TENDL-2024 LIBRARY; T=0.K  
Photon emission for (n,2np)

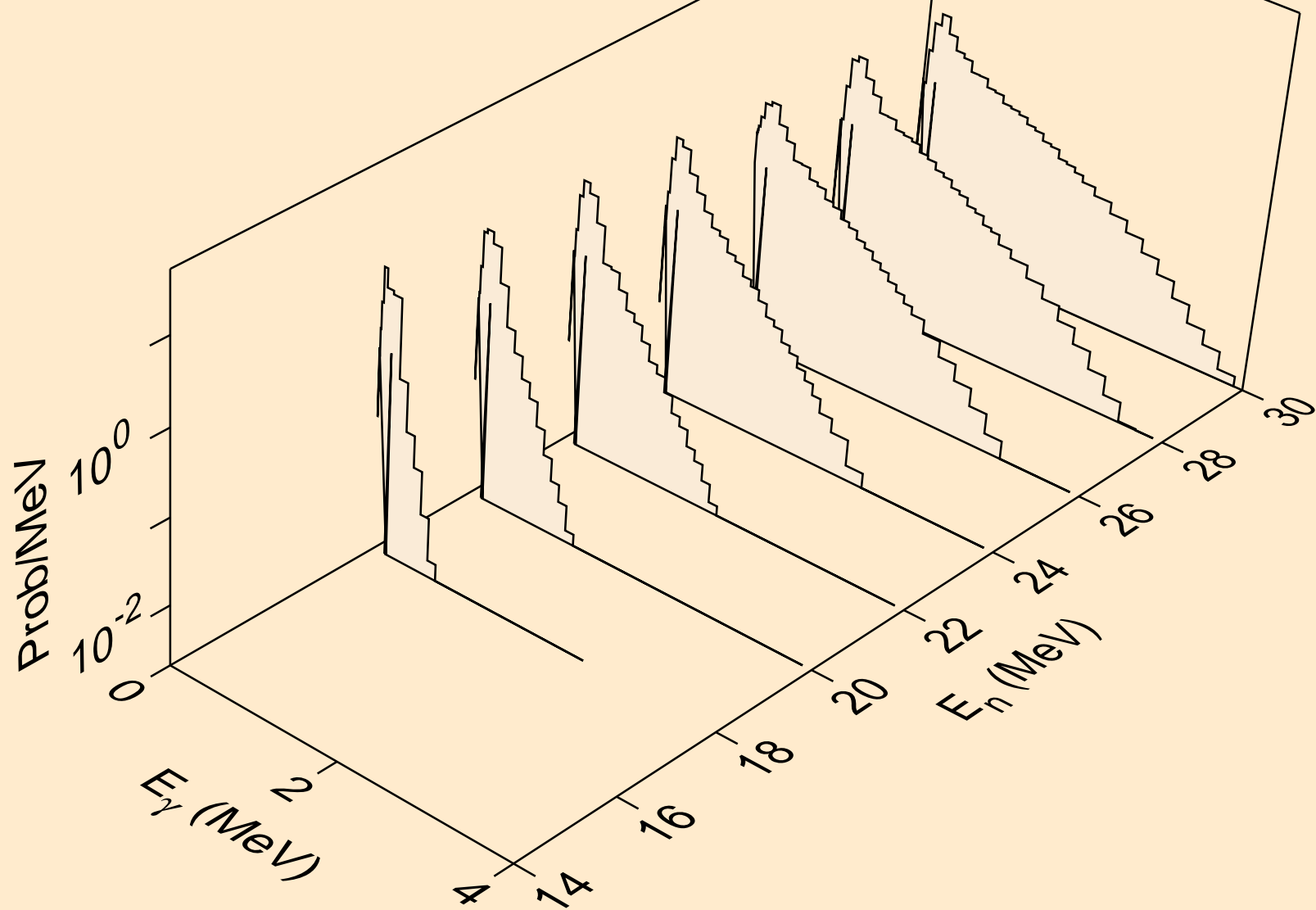

YB185 NEUTRON ACER TENDL-2024 LIBRARY; T=0.K  
Photon emission for (n,3np)

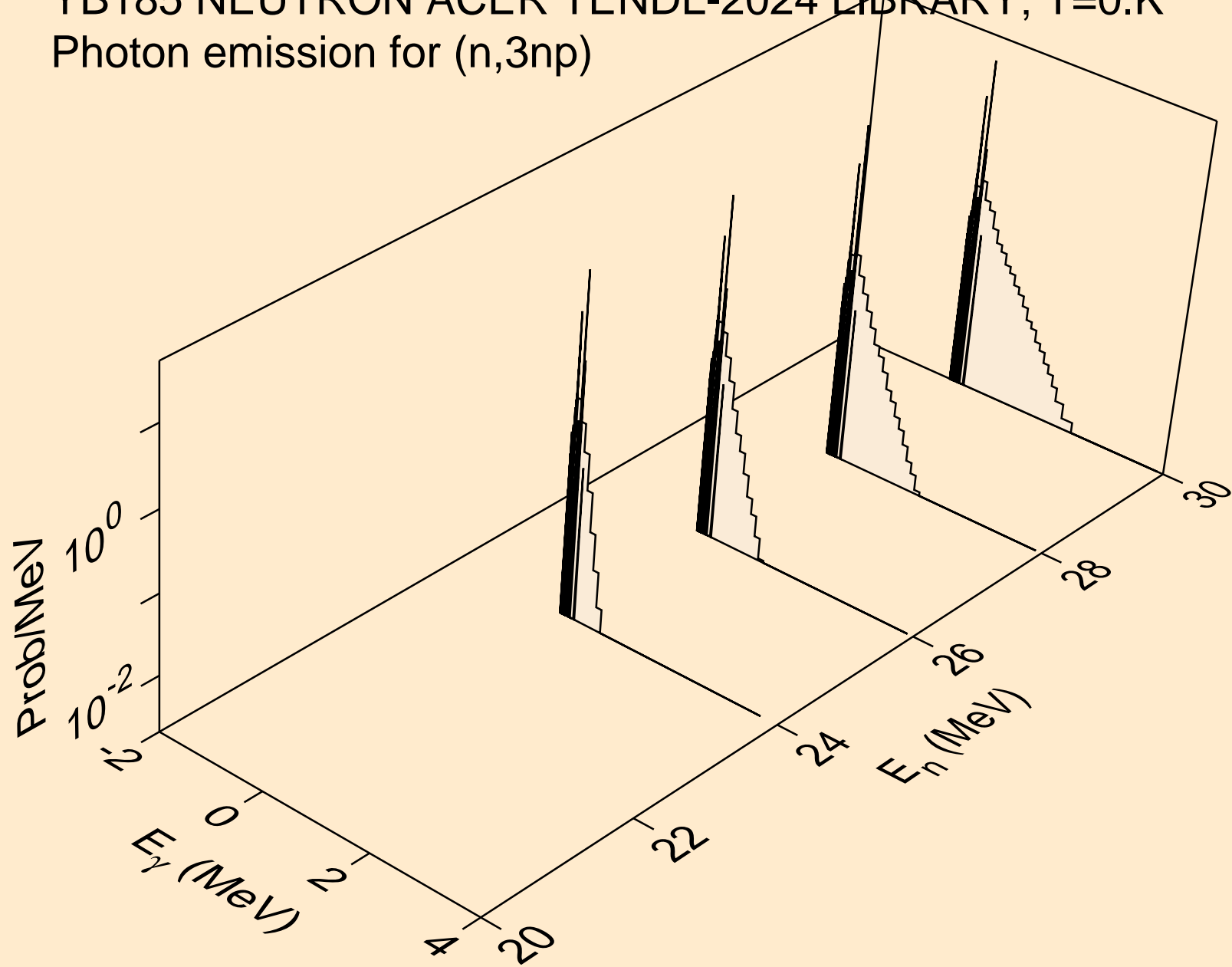

YB185 NEUTRON ACER TENDL-2024 LIBRARY; T=0.K  
Photon emission for (n,n\*c)

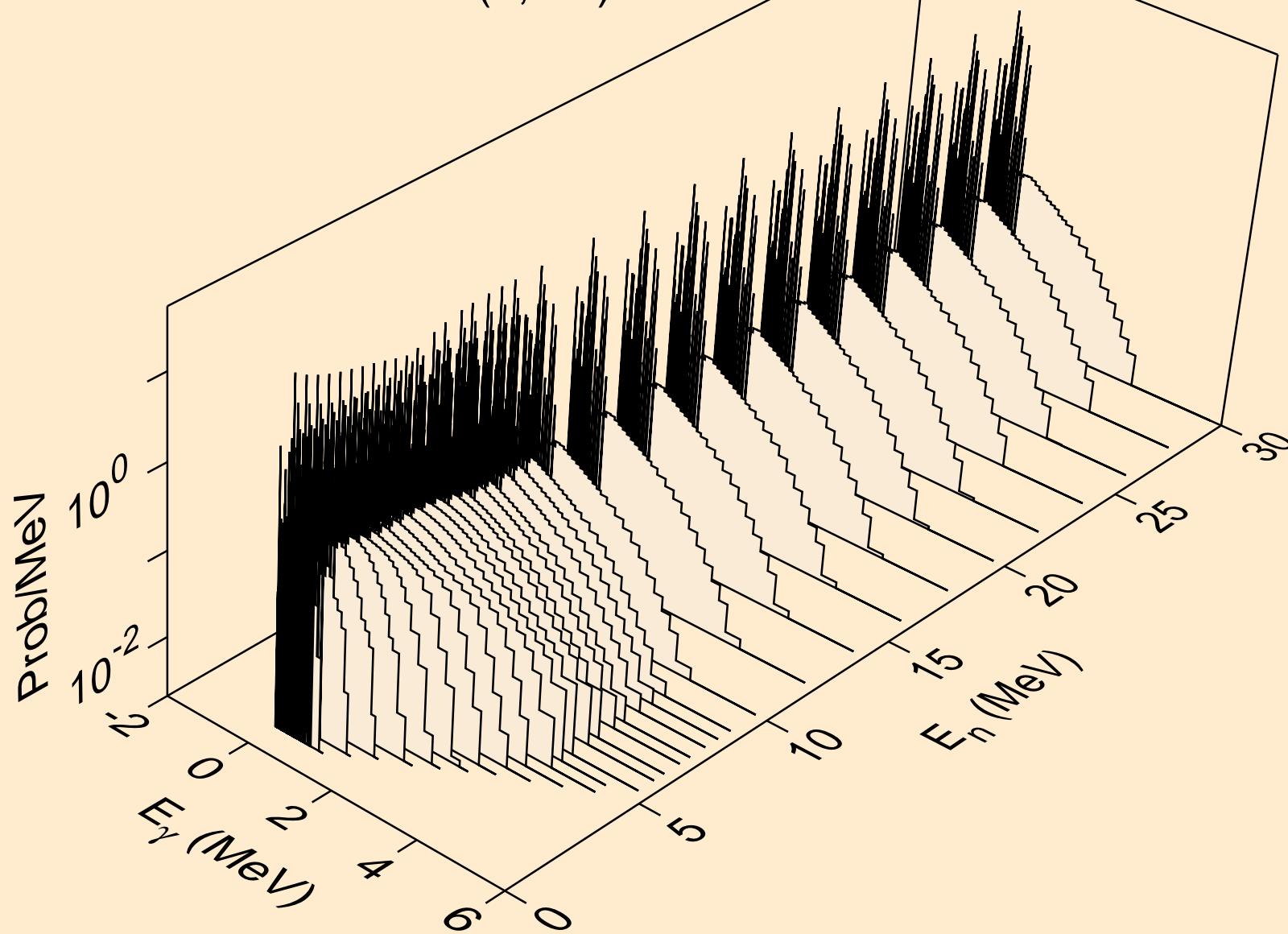



YB185 NEUTRON ACER TENDL-2024 LIBRARY; T=0.K  
Photon emission for (n,gma)

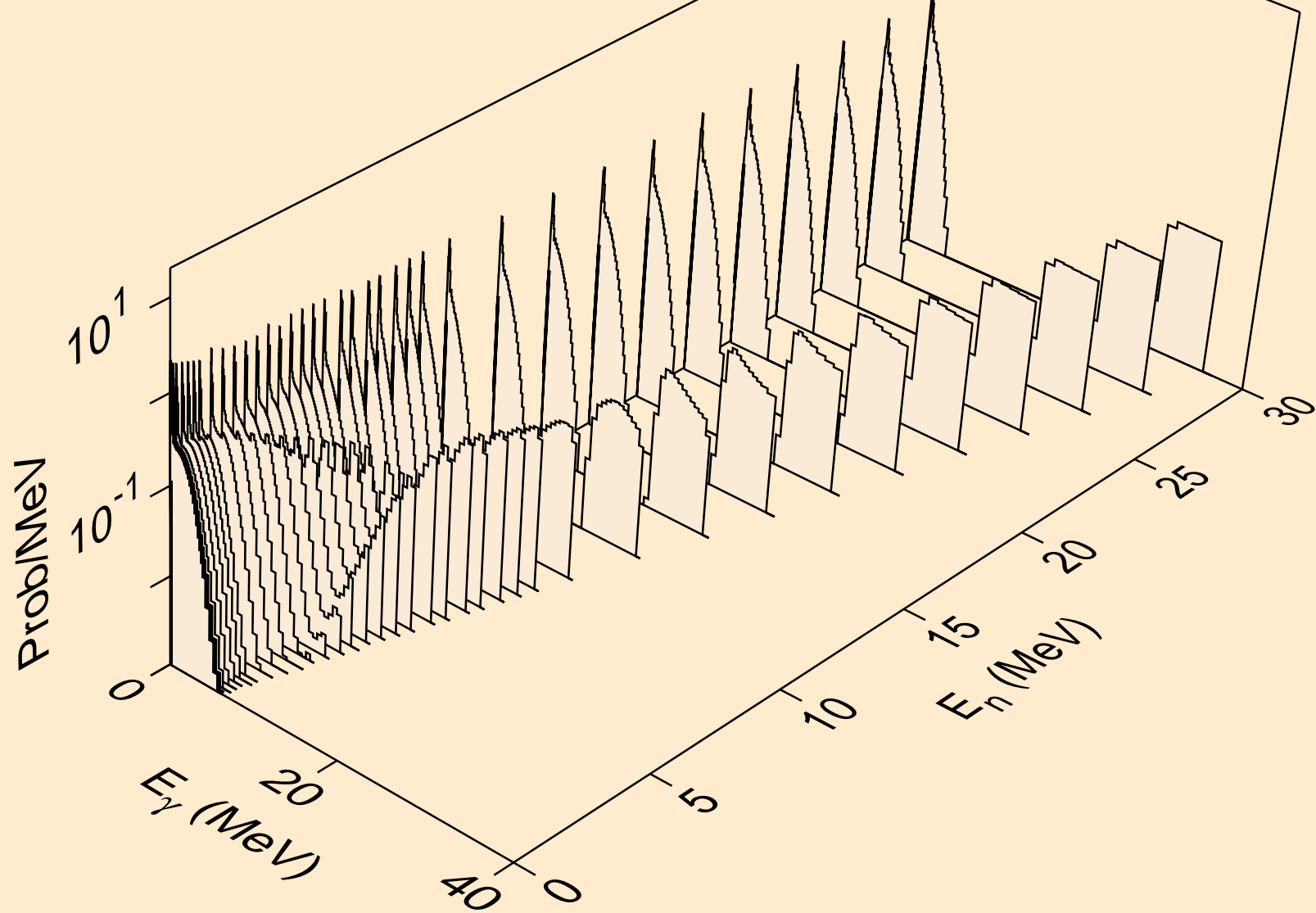

YB185 NEUTRON ACER TENDL-2024 LIBRARY; T=0.K  
Photon emission for (n,p)

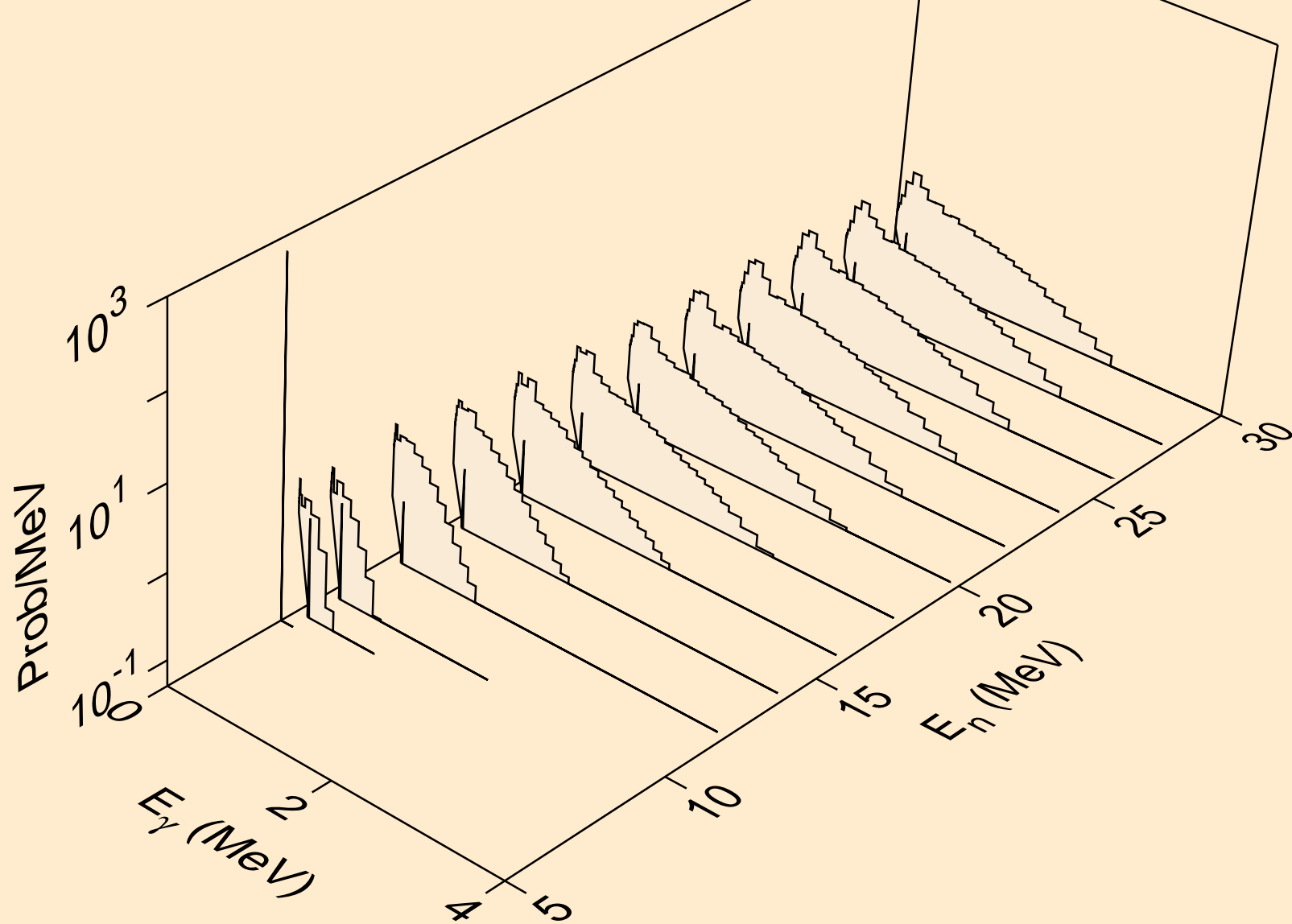

YB185 NEUTRON ACER TENDL-2024 LIBRARY; T=0.K  
Photon emission for (n,d)

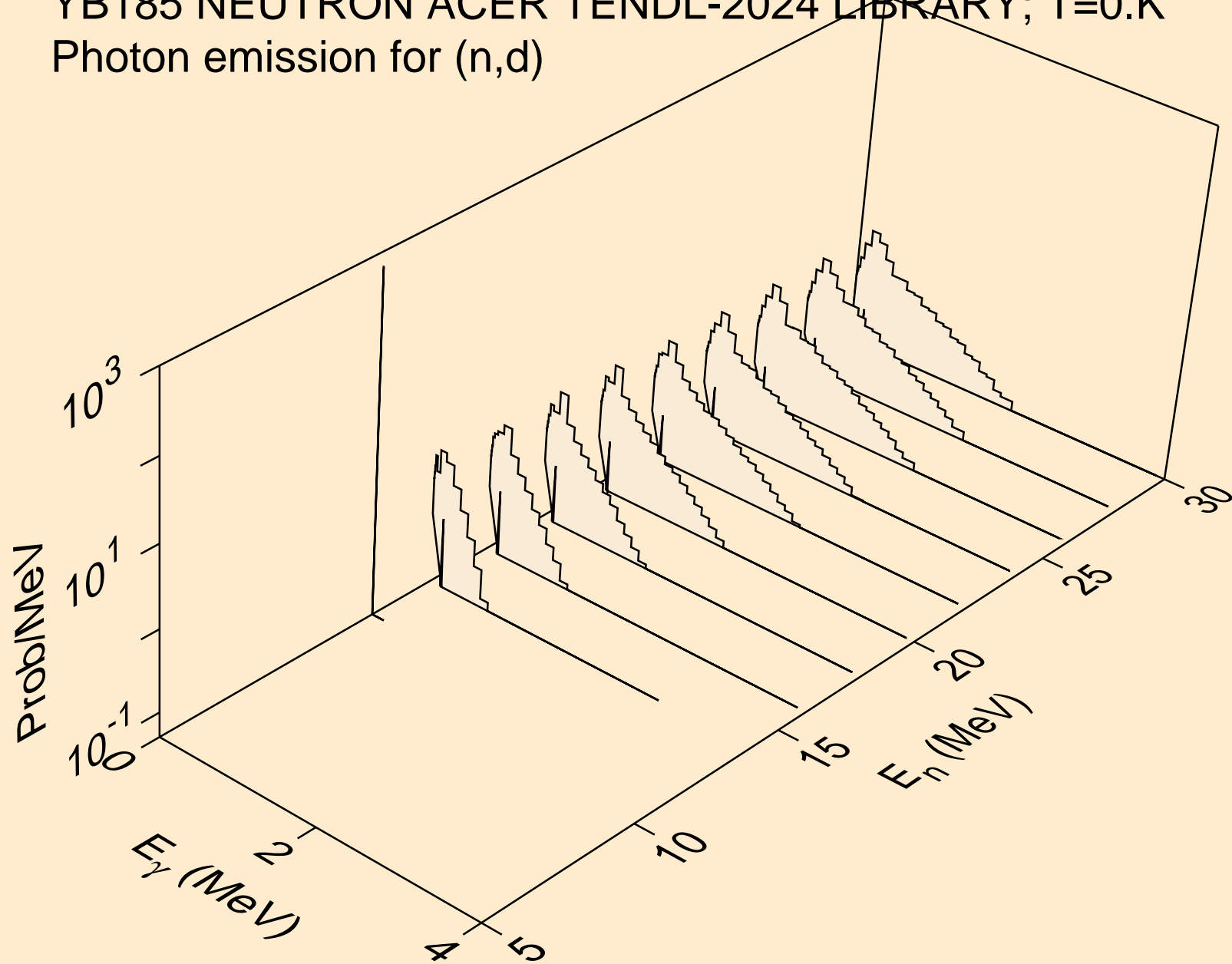

YB185 NEUTRON ACER TENDL-2024 LIBRARY; T=0.K  
Photon emission for (n,t)

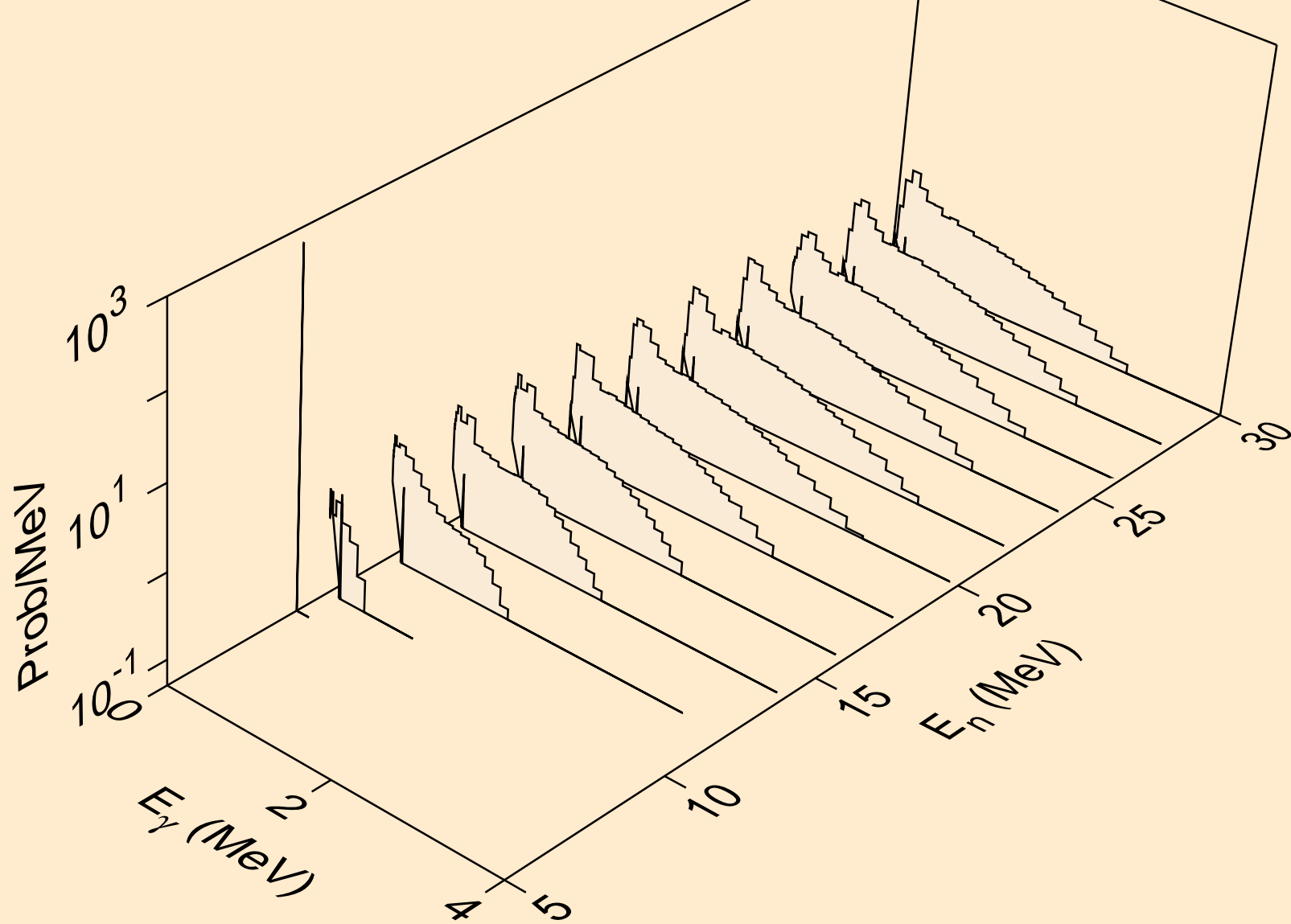

YB185 NEUTRON ACER TENDL-2024 LIBRARY; T=0.K  
Photon emission for (n,he3)

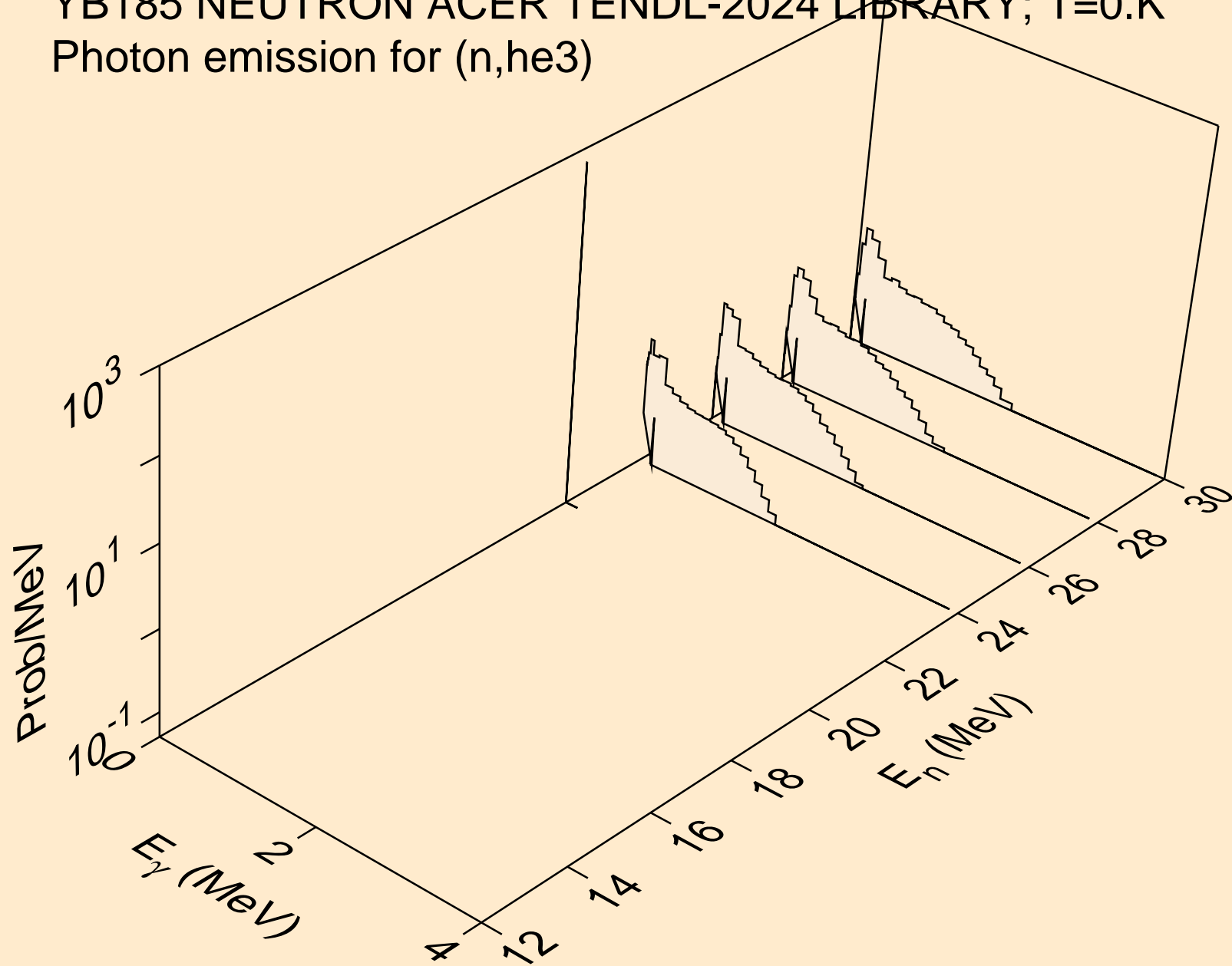

YB185 NEUTRON ACER TENDL-2024 LIBRARY; T=0.K  
Photon emission for (n,a)

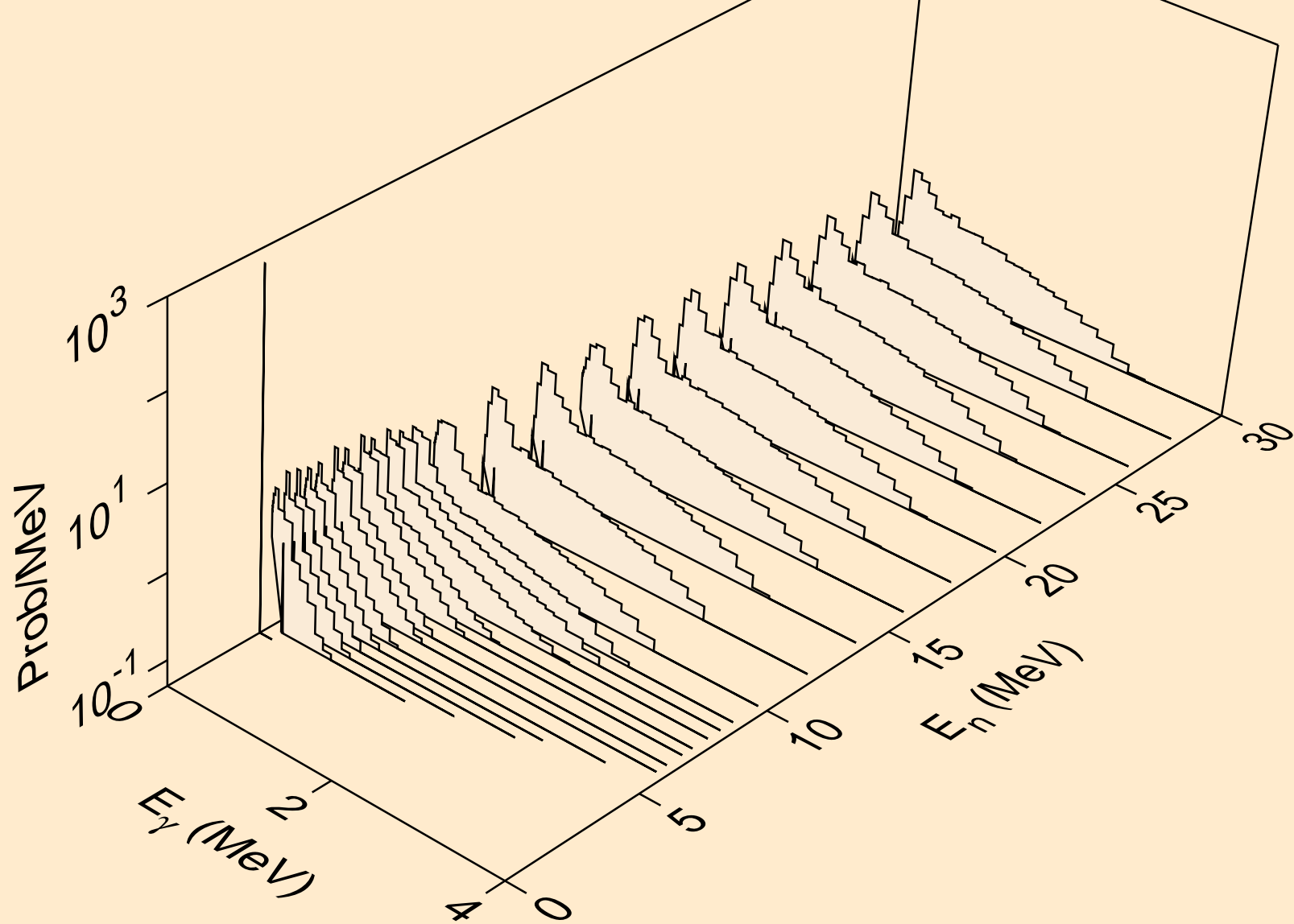

YB185 NEUTRON ACER TENDL-2024 LIBRARY; T=0.K  
thermal capture photon spectrum

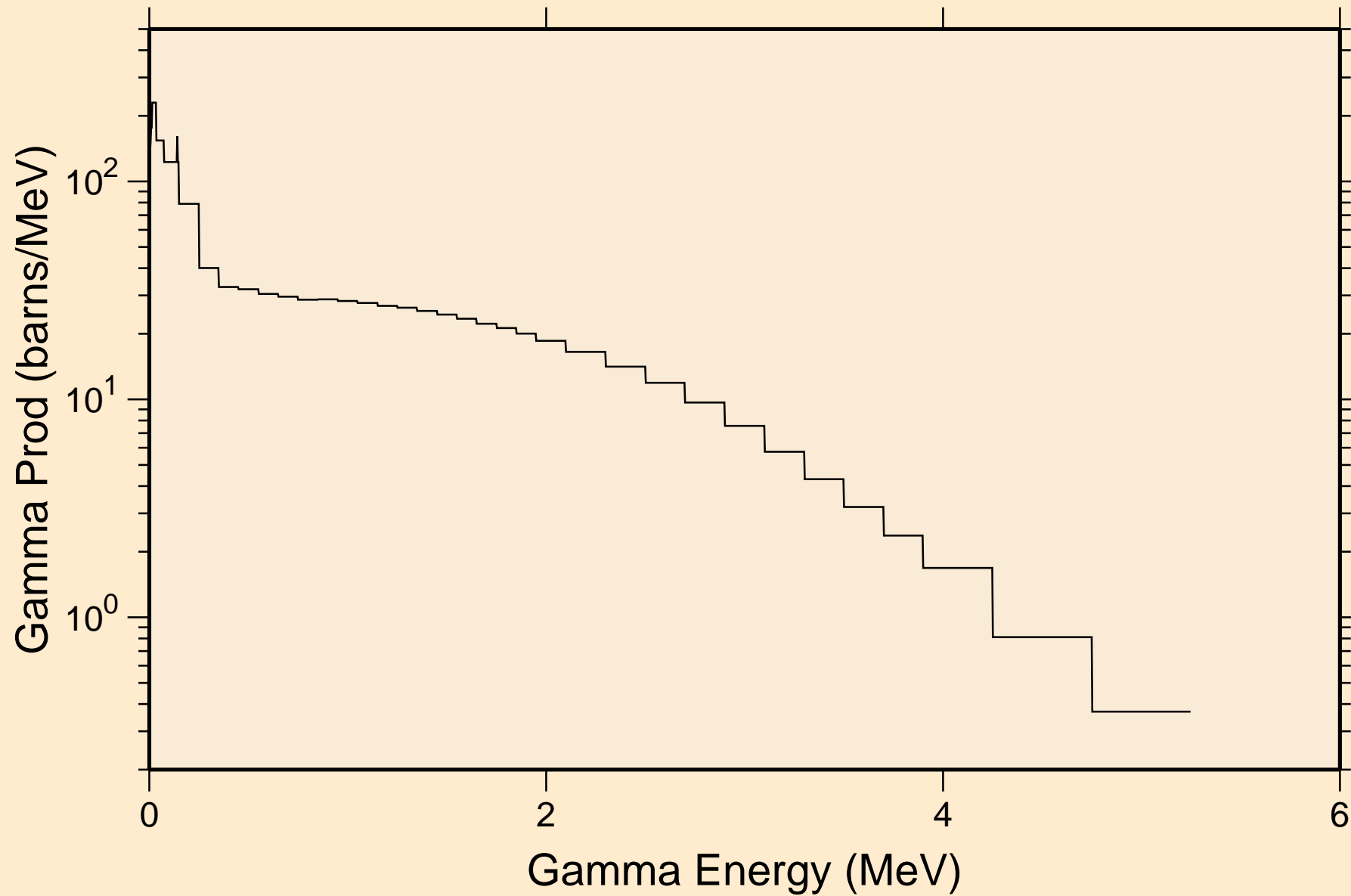

YB185 NEUTRON ACER TENDL-2024 LIBRARY; T=0.K  
14 MeV photon spectrum

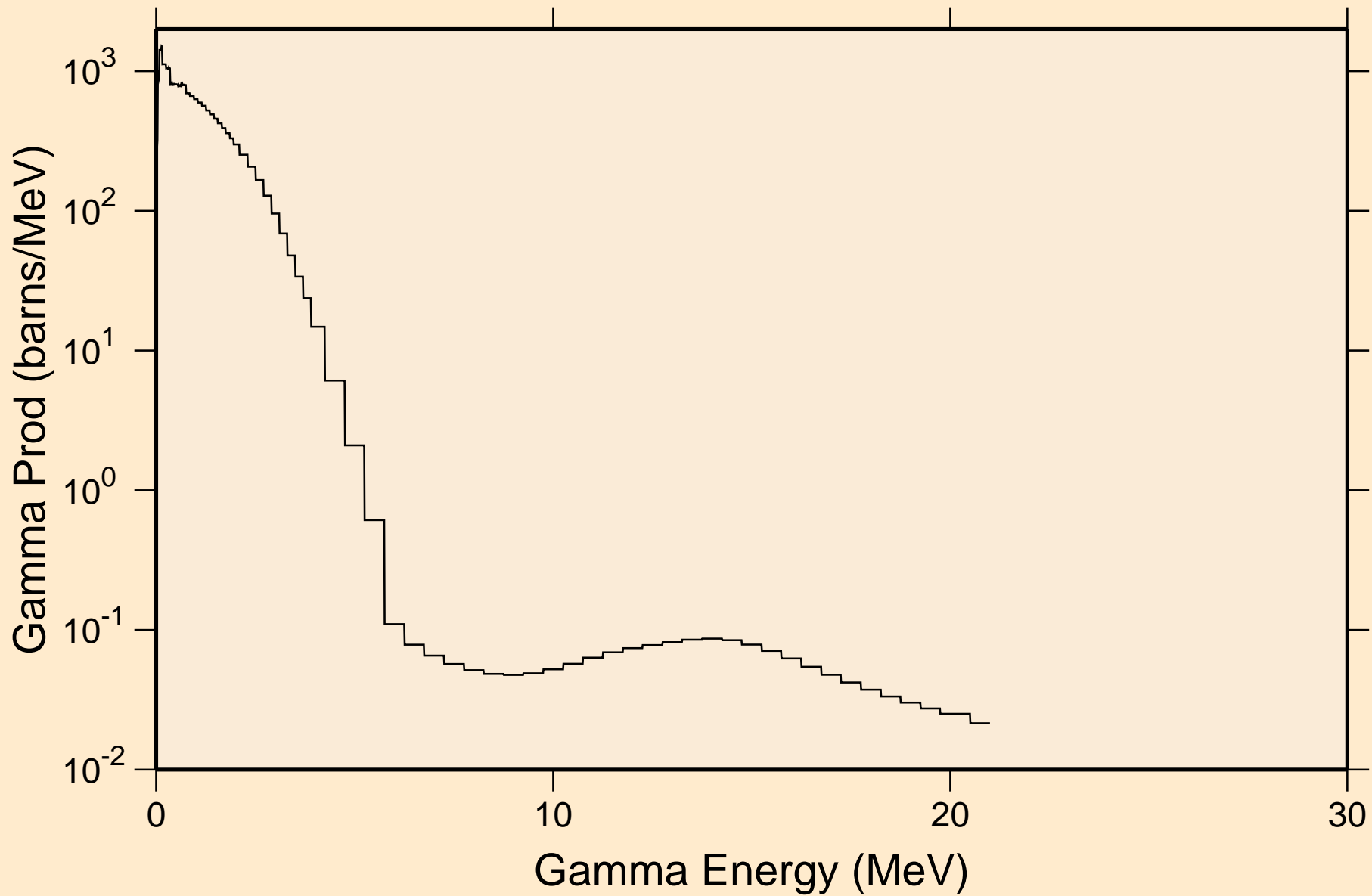



# YB185 NEUTRON ACER TENDL-2024 LIBRARY; T=0.K

## Particle heating contributions

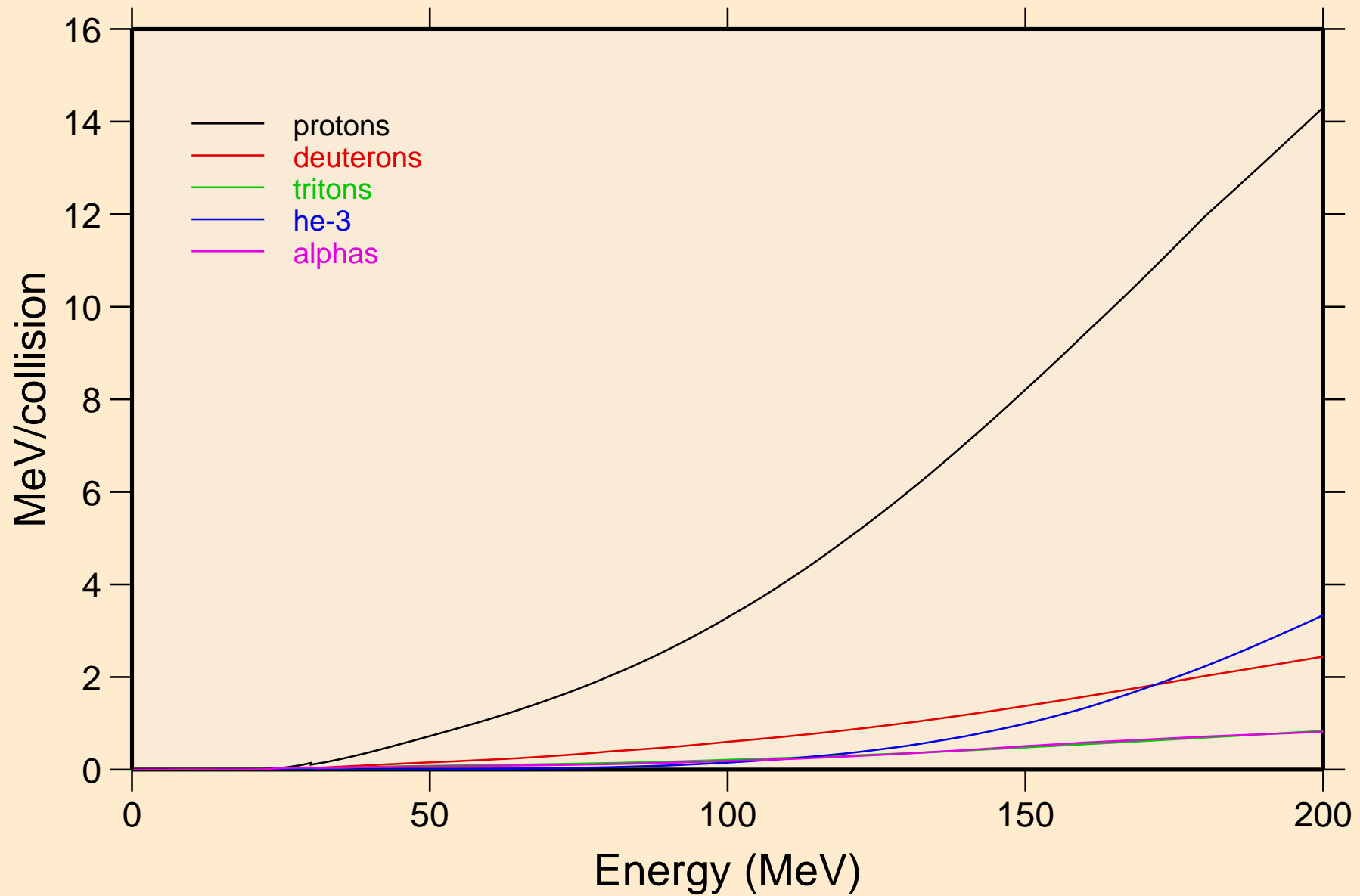

YB185 NEUTRON ACER TENDL-2024 LIBRARY; T=0.K  
Recoil Heating

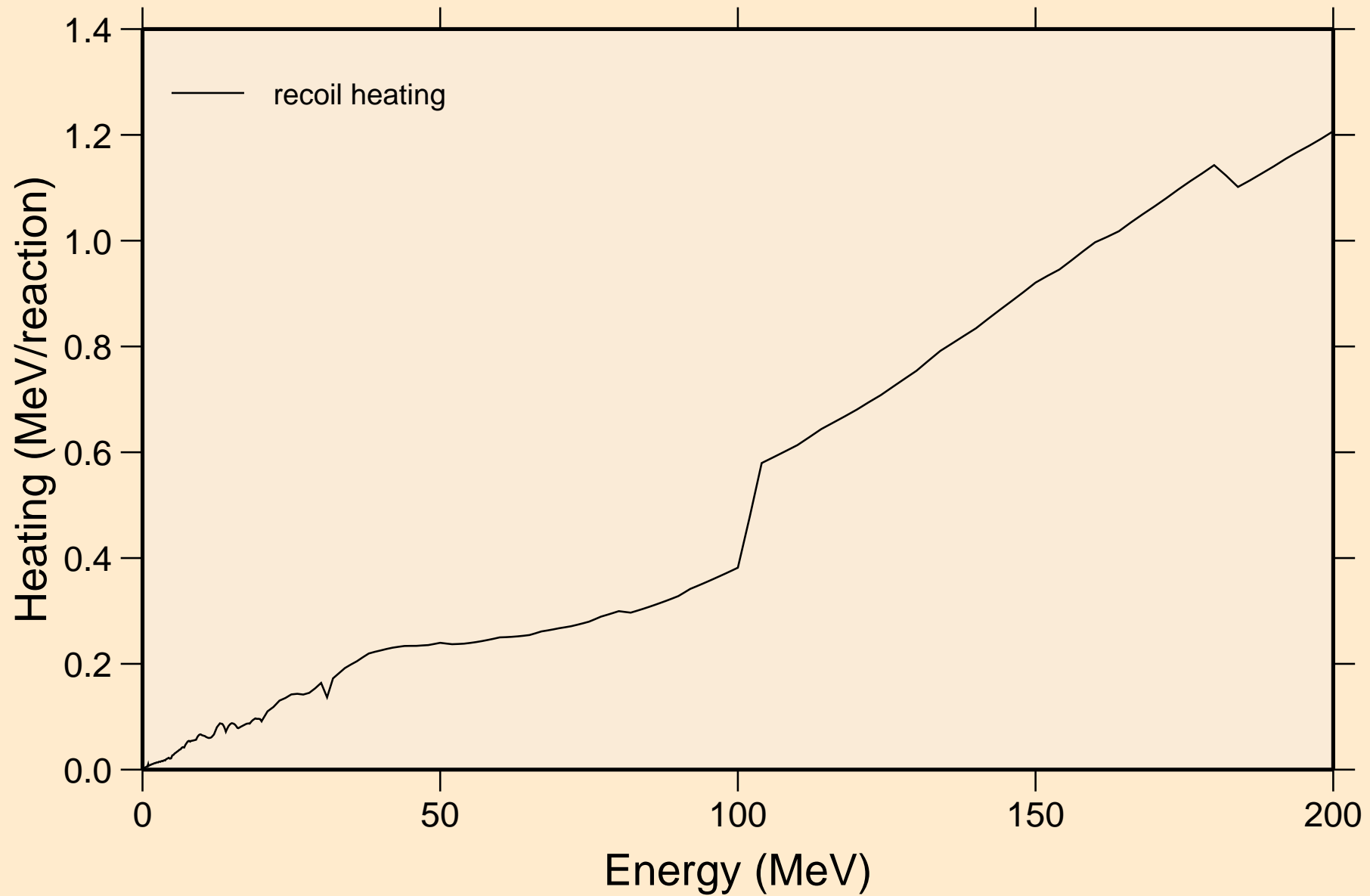

# YB185 NEUTRON ACER TENDL-2024 LIBRARY; T=0.K

## Particle production cross sections

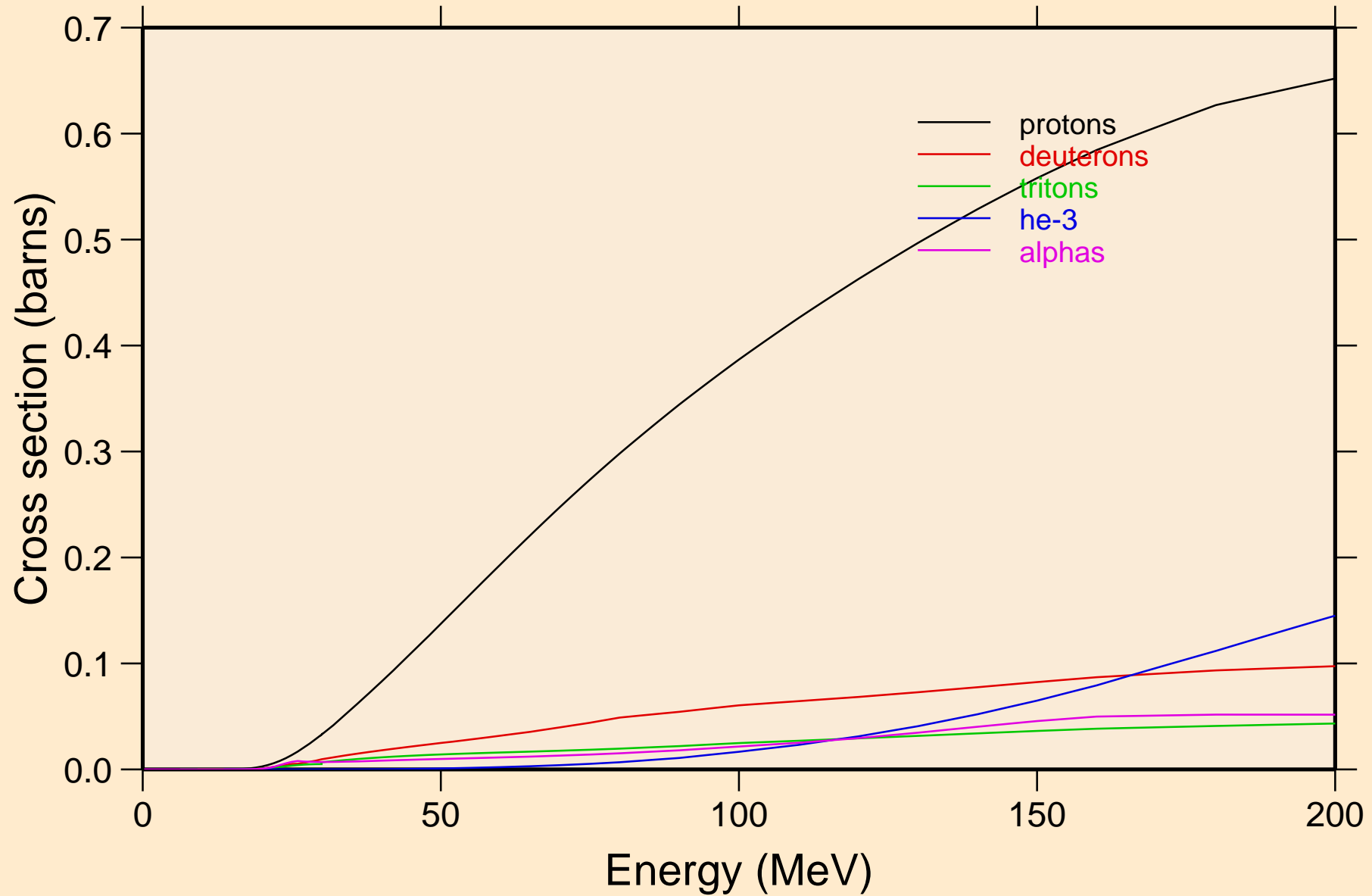

YB185 NEUTRON ACER TENDL-2024 LIBRARY; T=0.K  
protons from (n,x)

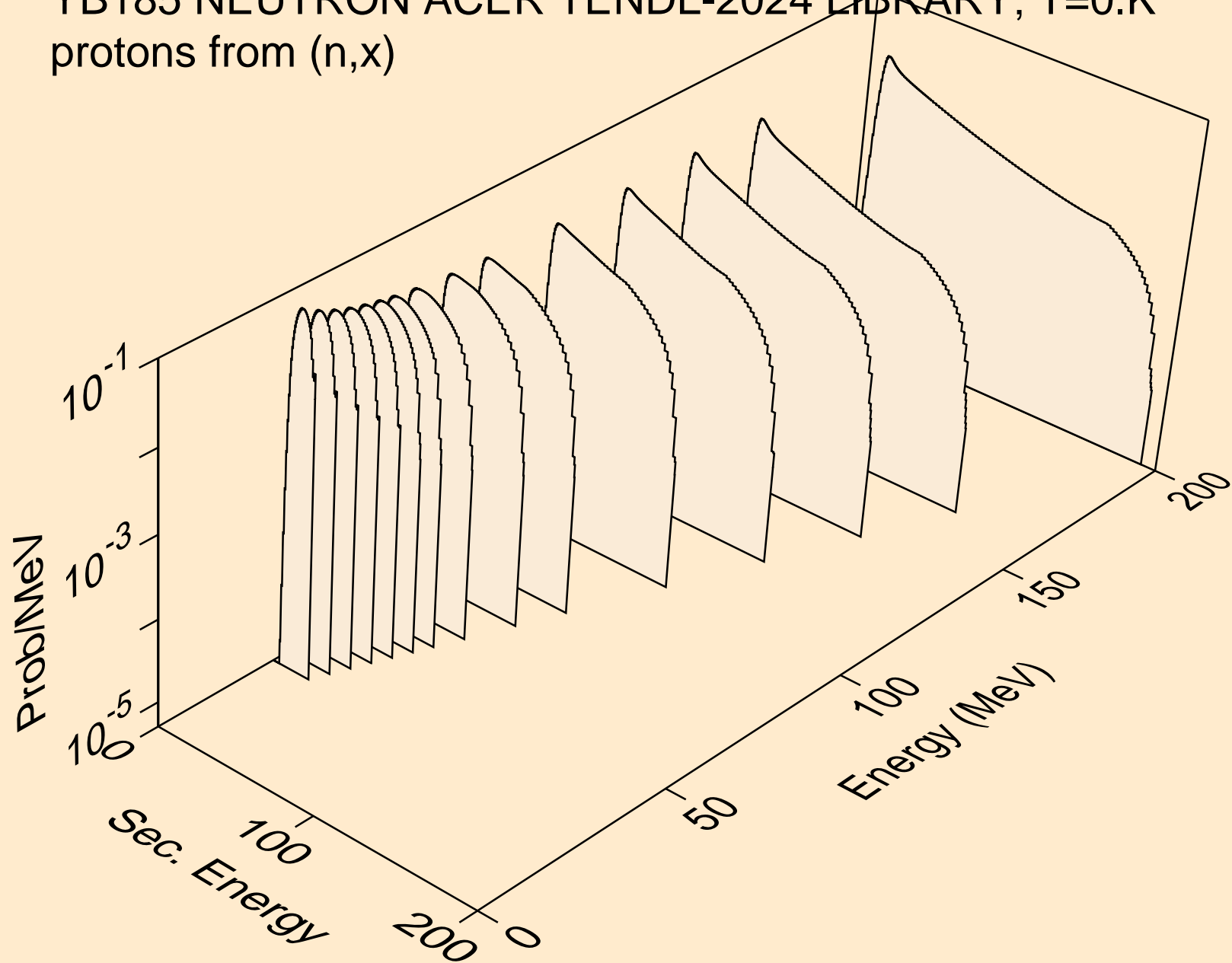

YB185 NEUTRON ACER TENDL-2024 LIBRARY; T=0.K  
protons from (n,n\*)p

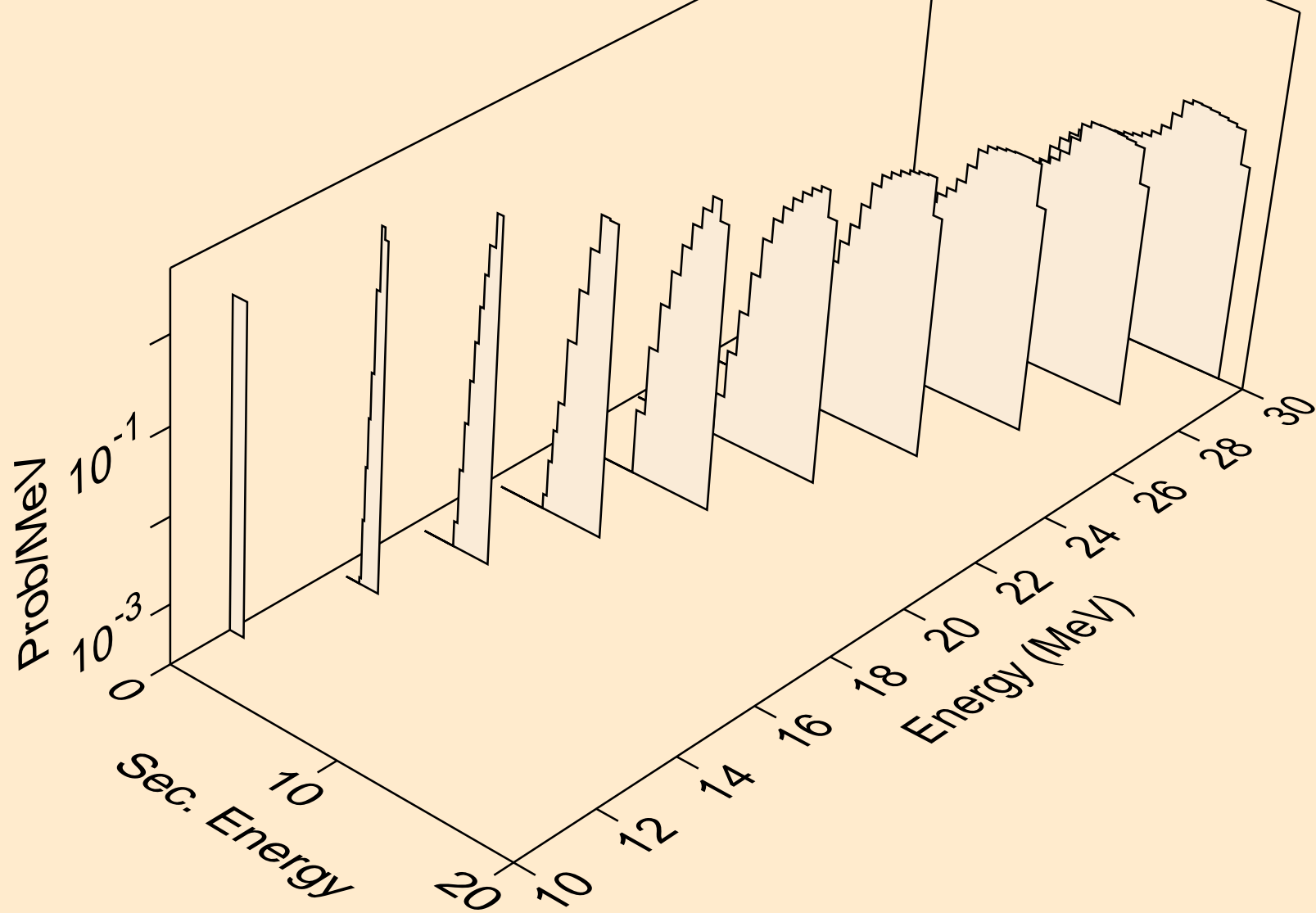

YB185 NEUTRON ACER TENDL-2024 LIBRARY; T=0.K  
protons from (n,2np)

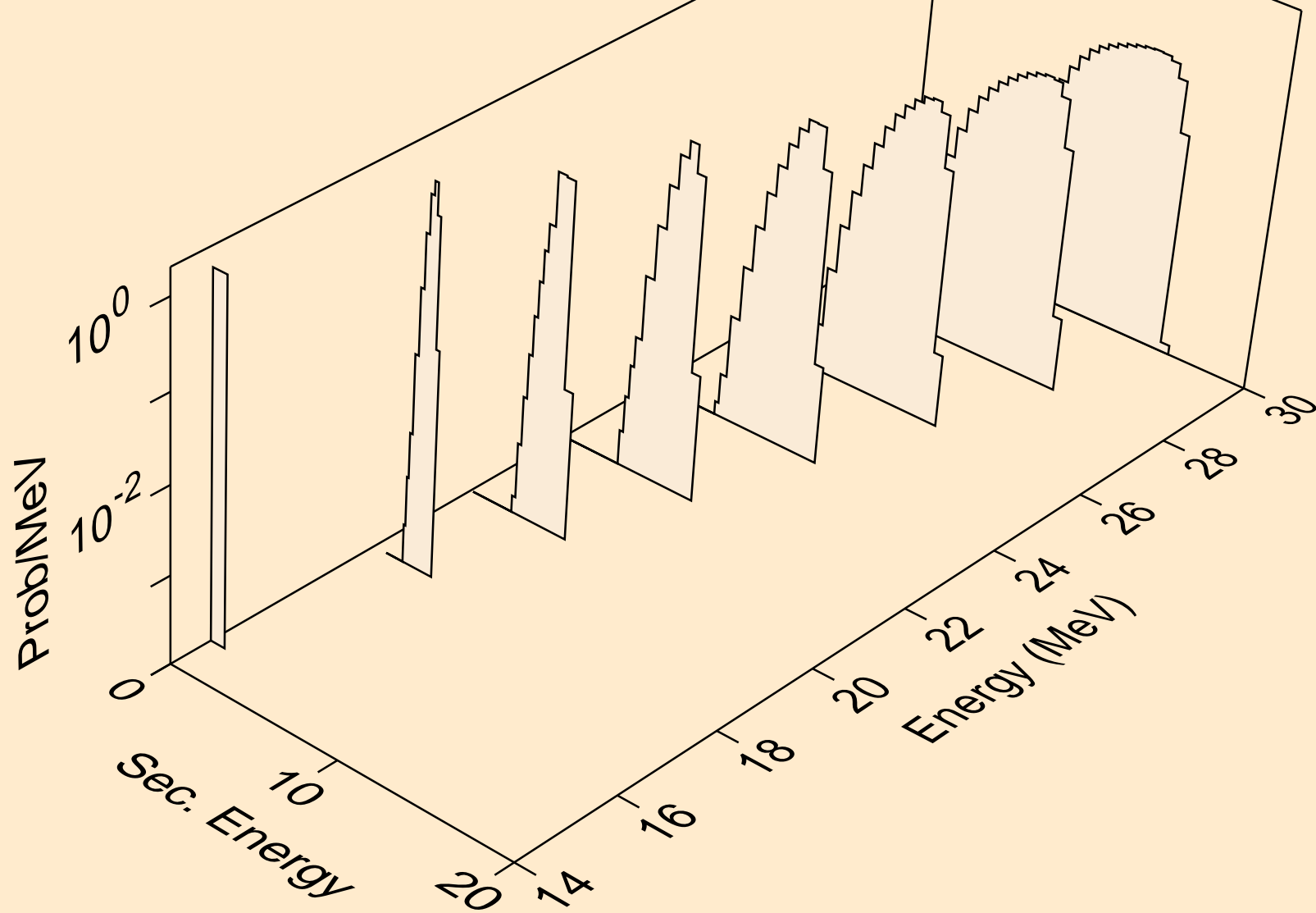

YB185 NEUTRON ACER TENDL-2024 LIBRARY; T=0.K  
protons from (n,3np)

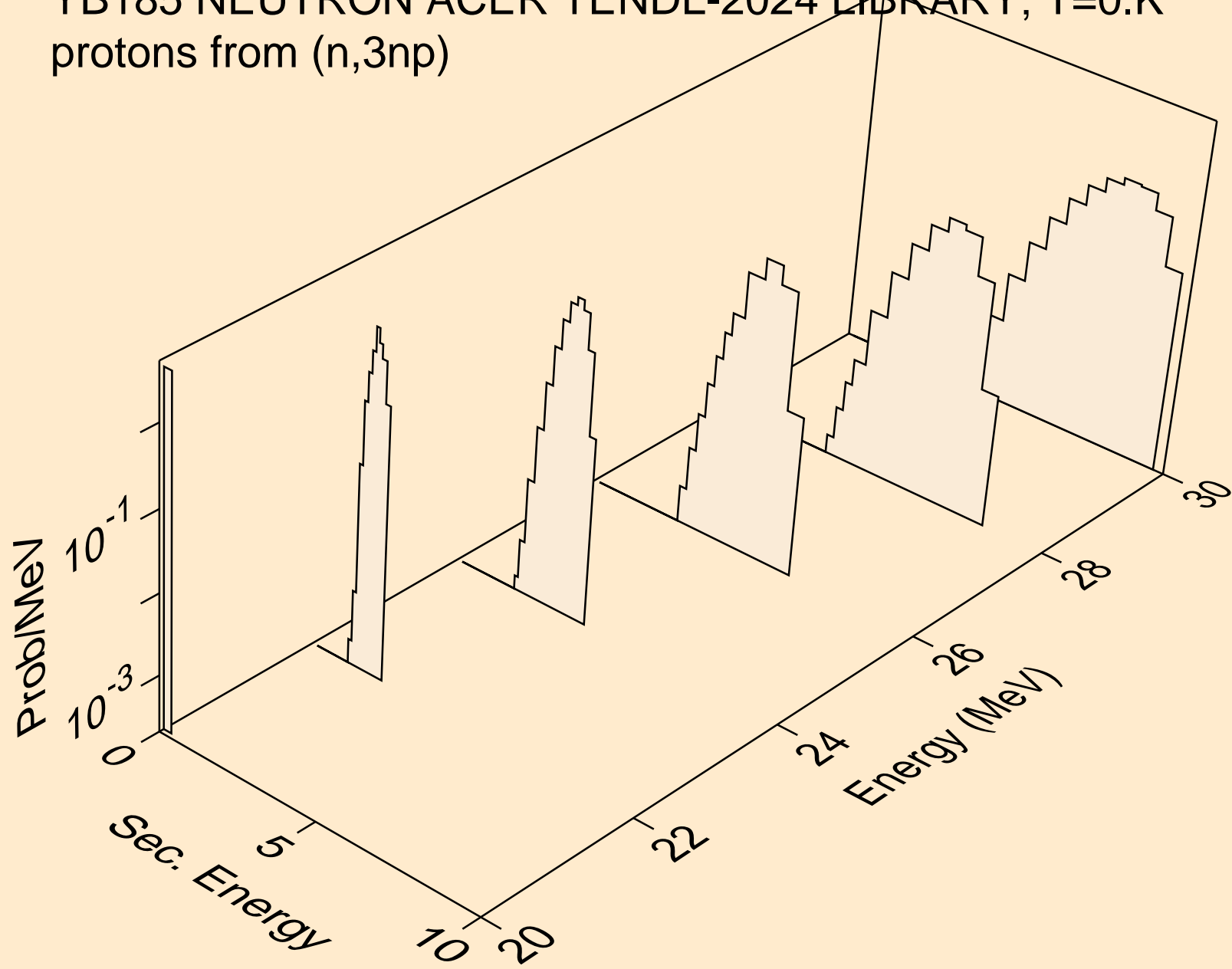

YB185 NEUTRON ACER TENDL-2024 LIBRARY; T=0.K  
protons from (n,p)

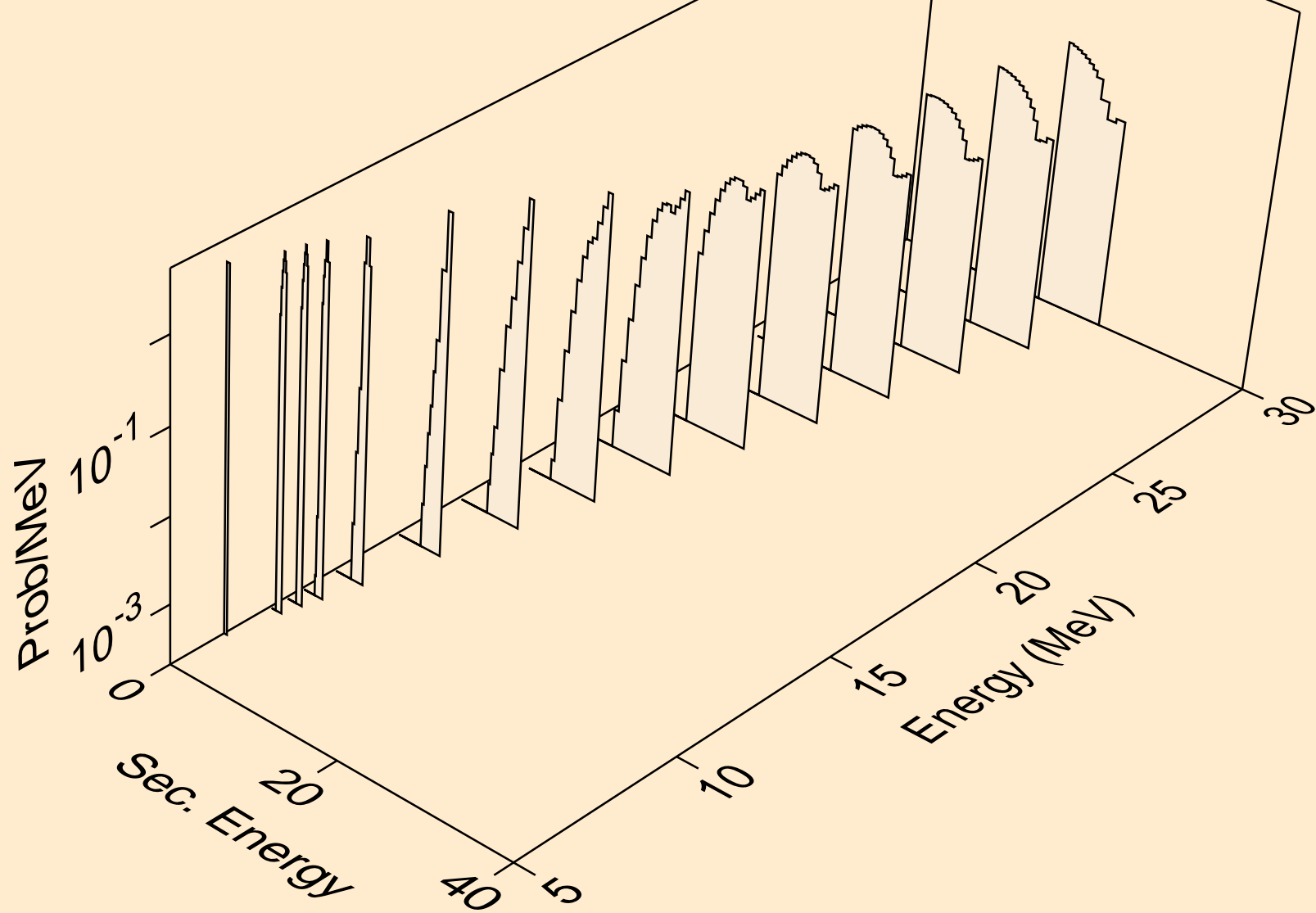



YB185 NEUTRON ACER TENDL-2024 LIBRARY; T=0.K  
deuterons from (n,x)

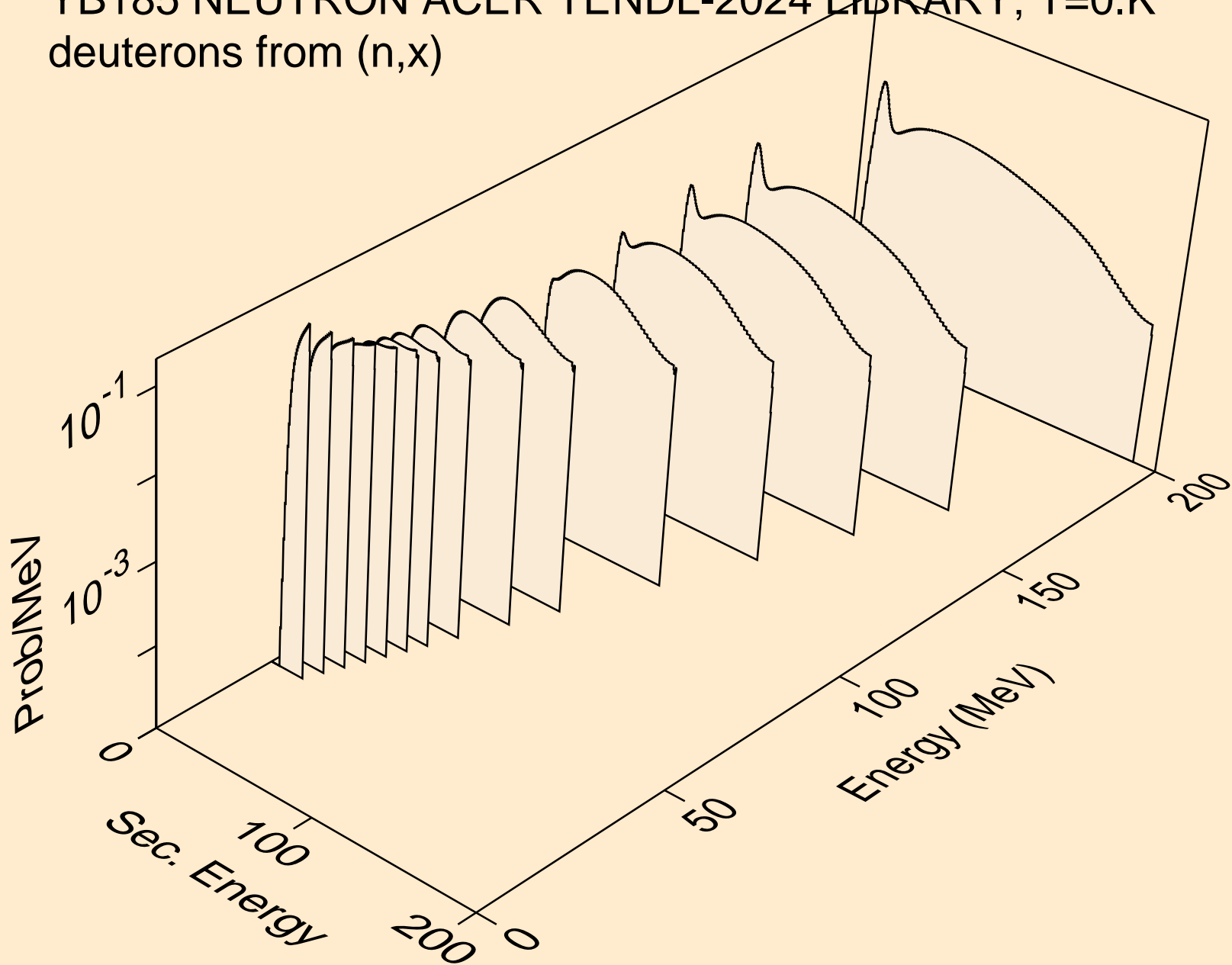

YB185 NEUTRON ACER TENDL-2024 LIBRARY; T=0.K  
deuterons from (n,2nd)

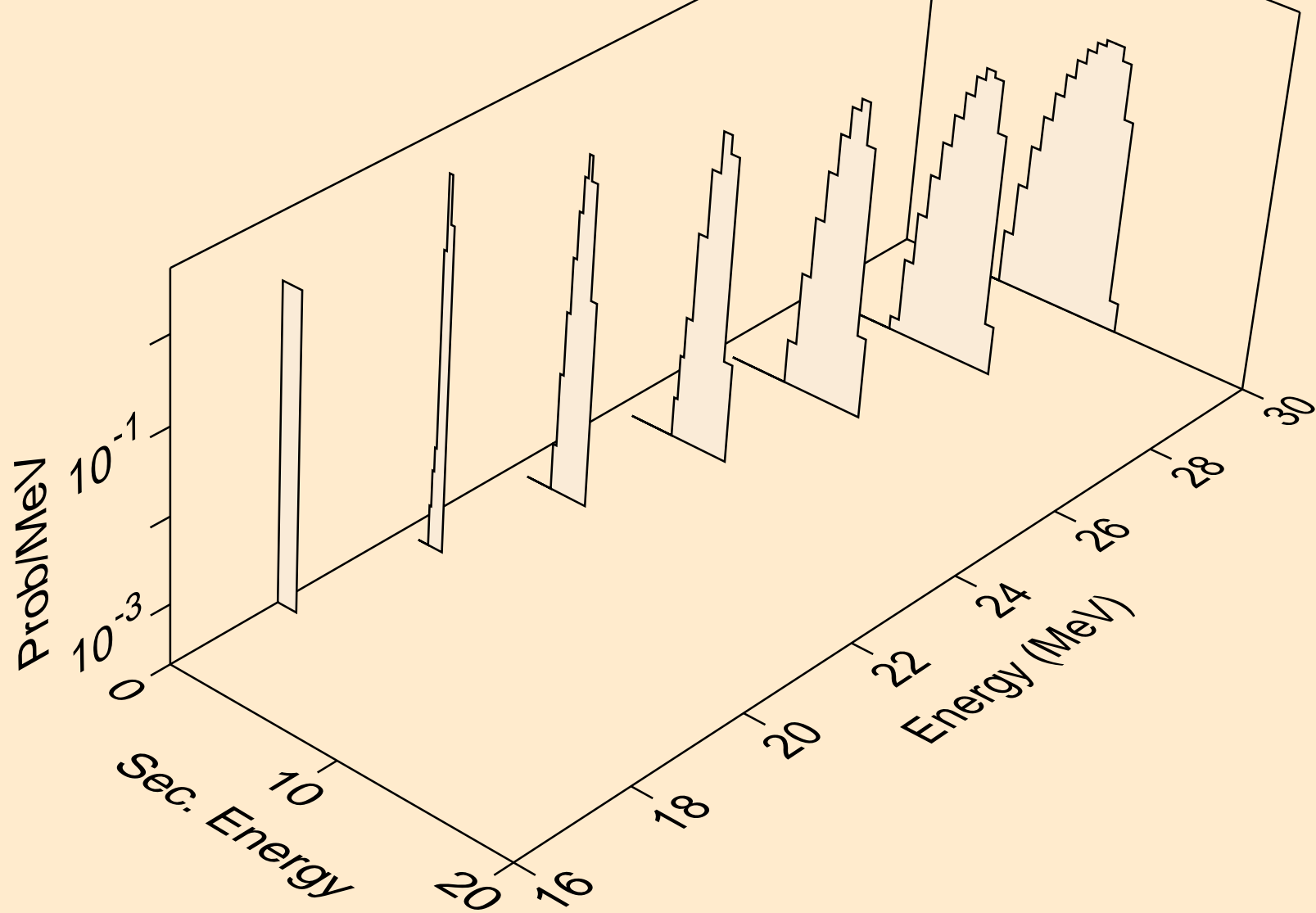

YB185 NEUTRON ACER TENDL-2024 LIBRARY; T=0.K  
deuterons from (n,n\*)d

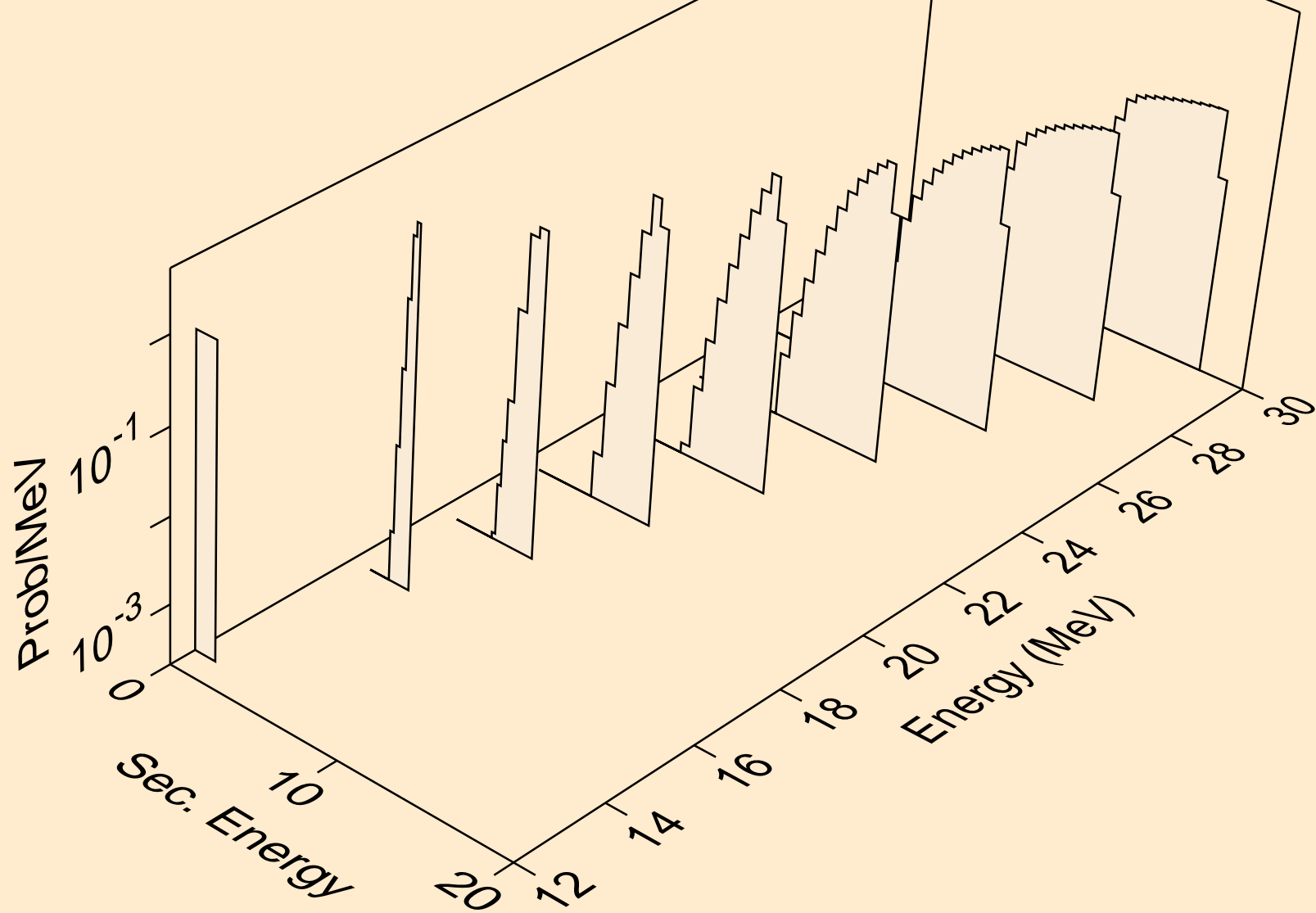

YB185 NEUTRON ACER TENDL-2024 LIBRARY; T=0.K  
deuterons from (n,d)

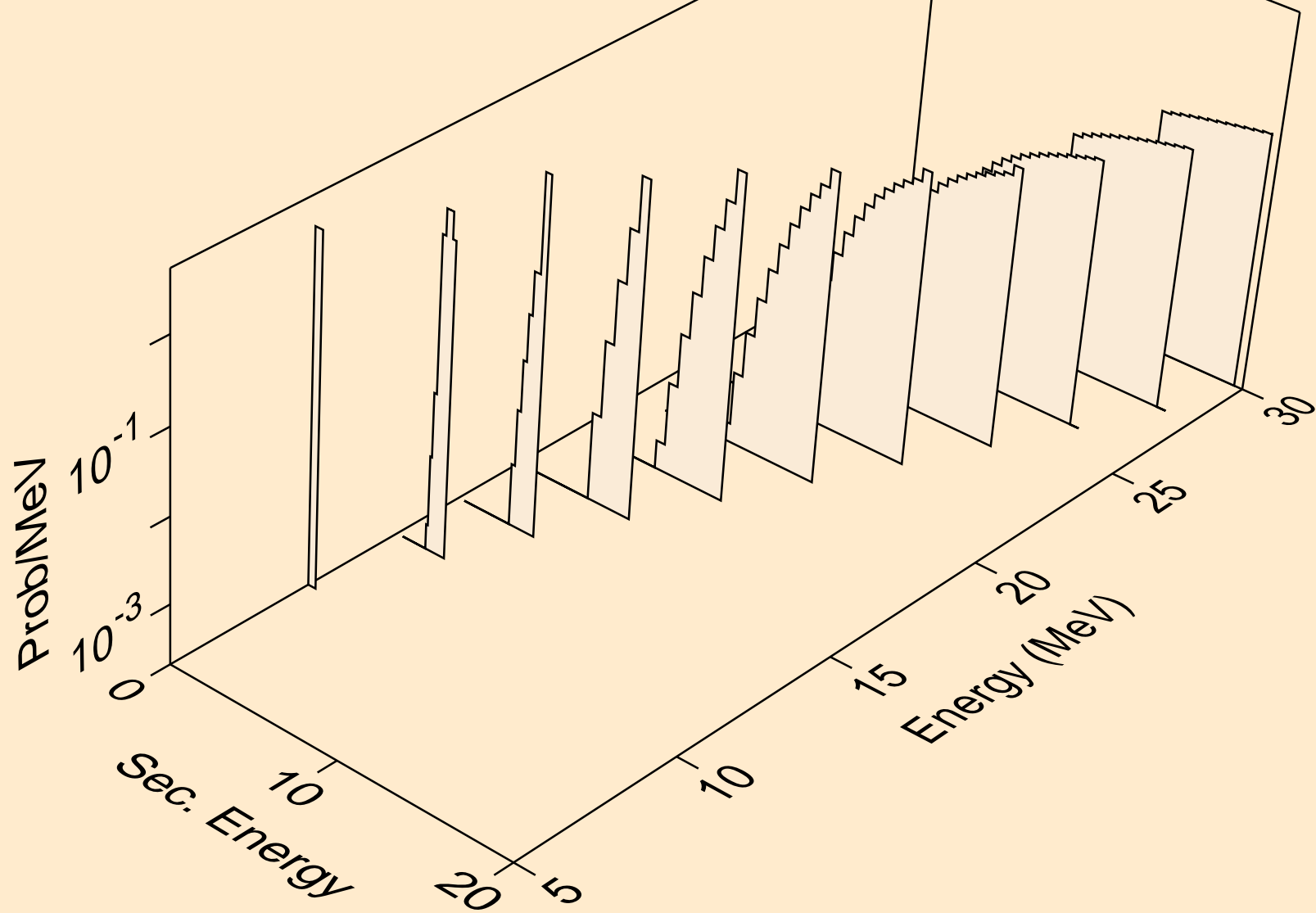

YB185 NEUTRON ACER TENDL-2024 LIBRARY; T=0.K  
tritons from (n,x)

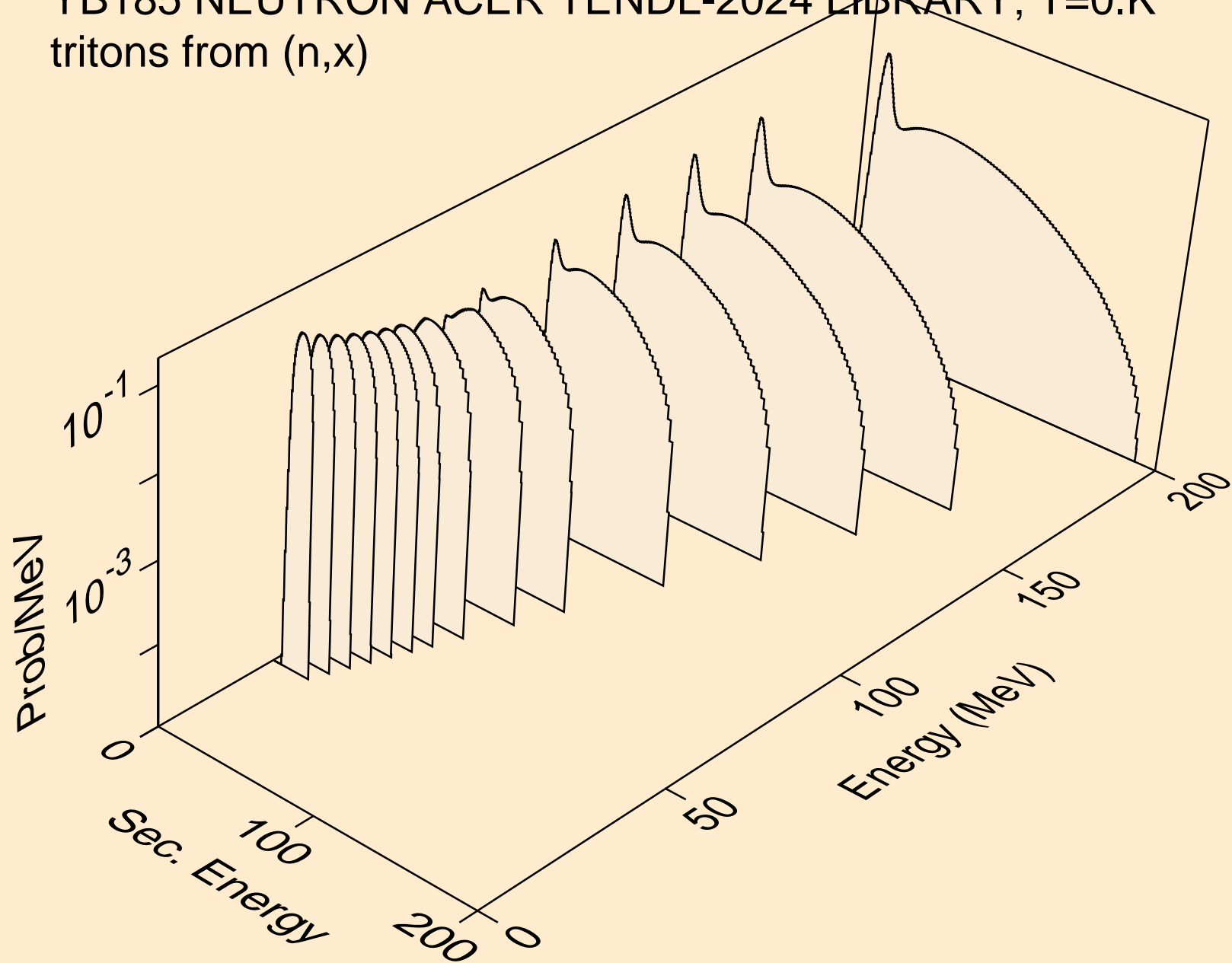

YB185 NEUTRON ACER TENDL-2024 LIBRARY; T=0.K  
tritons from (n,n\*)t

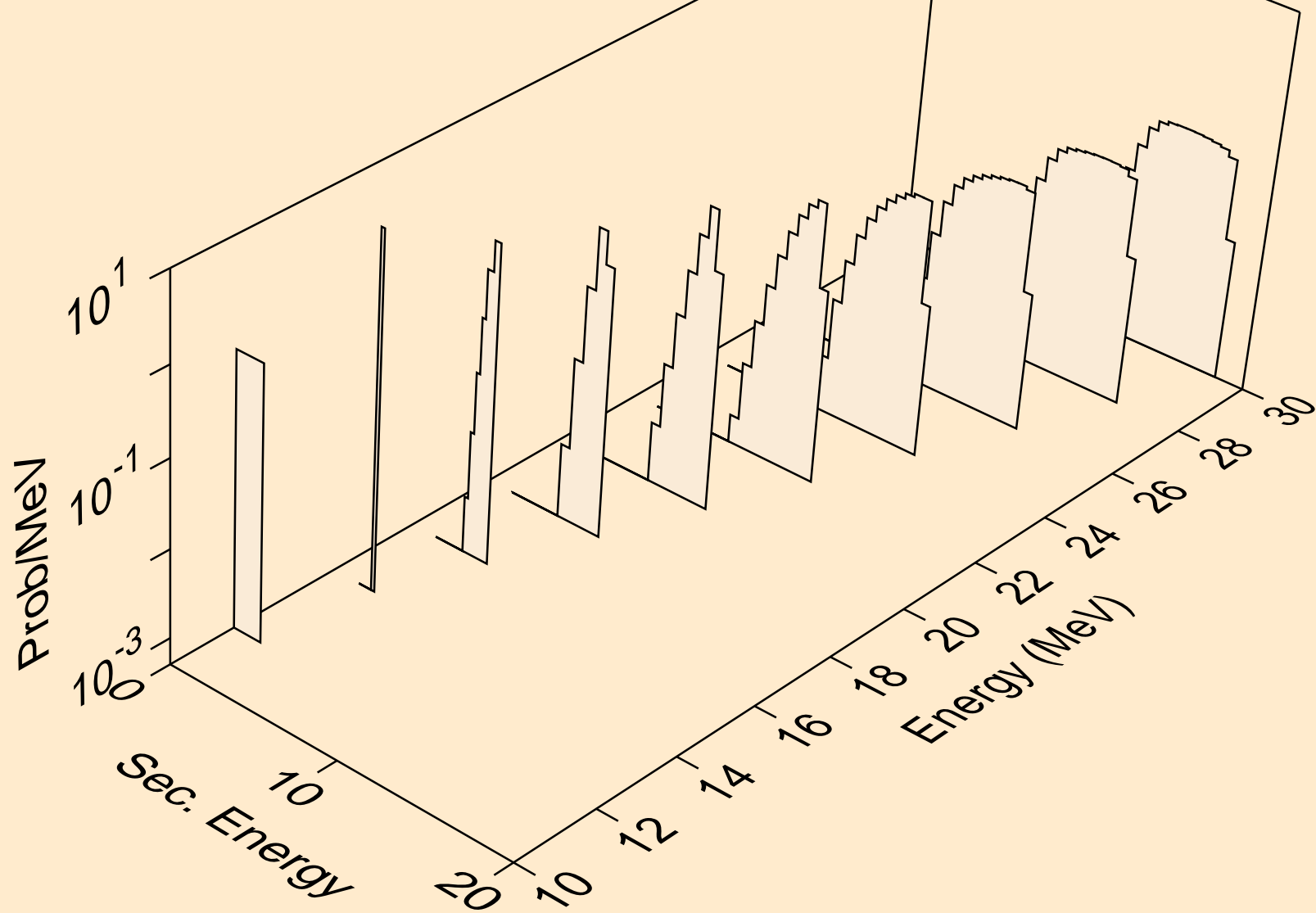

YB185 NEUTRON ACER TENDL-2024 LIBRARY; T=0.K  
tritons from (n,t)

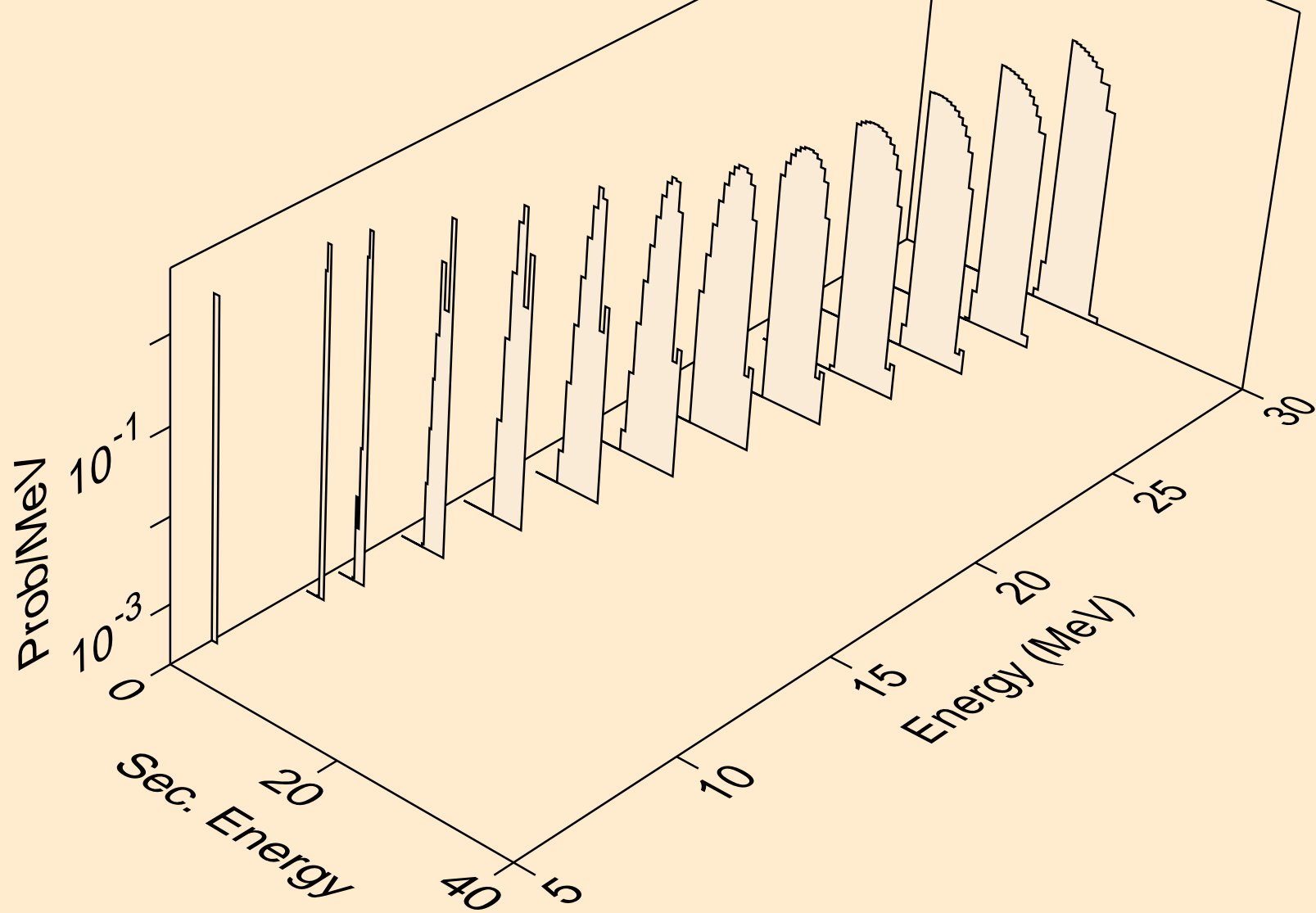

YB185 NEUTRON ACER TENDL-2024 LIBRARY; T=0.K  
he3s from (n,x)

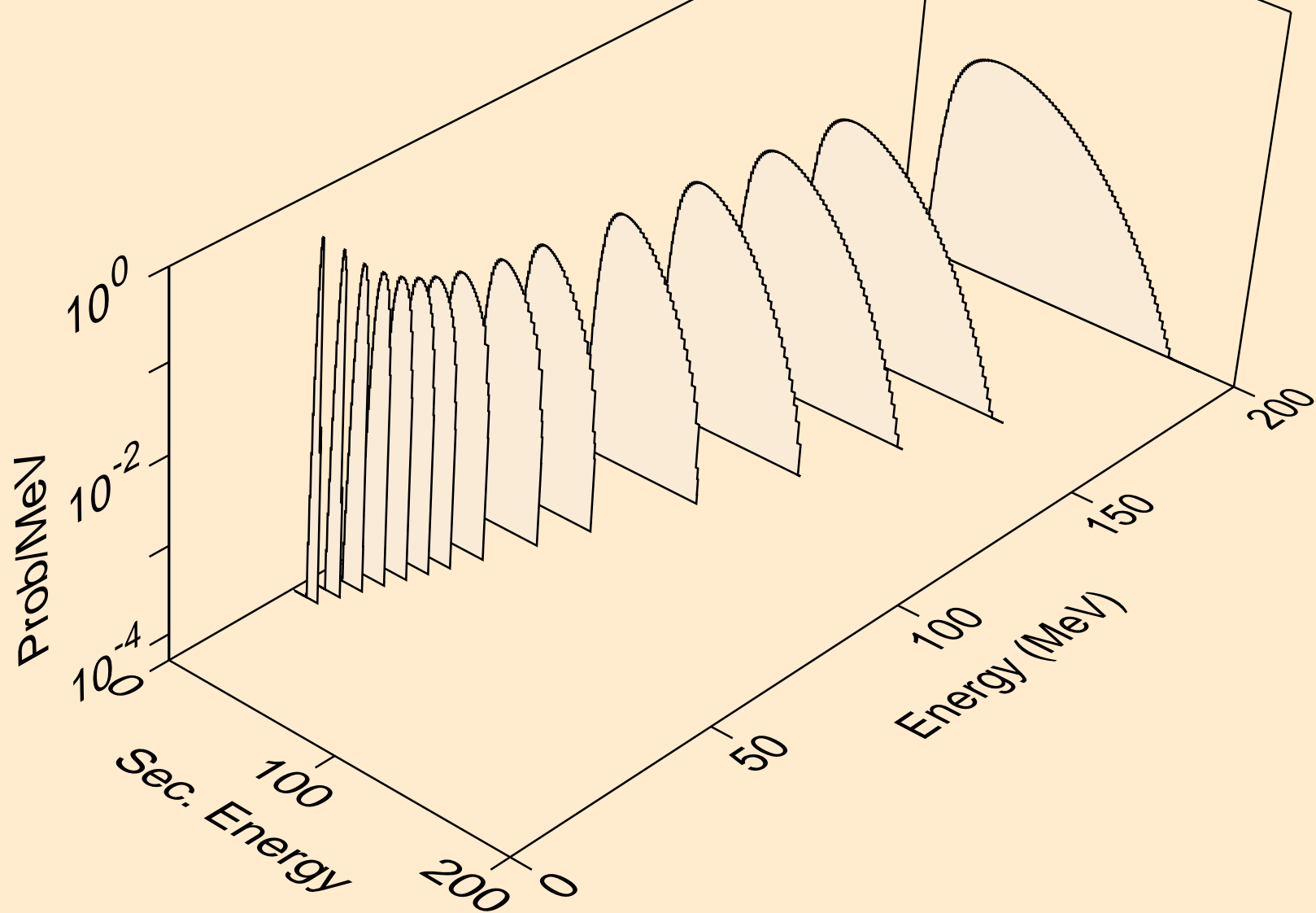



YB185 NEUTRON ACER TENDL-2024 LIBRARY; T=0.K  
he3s from (n,n\*)he3

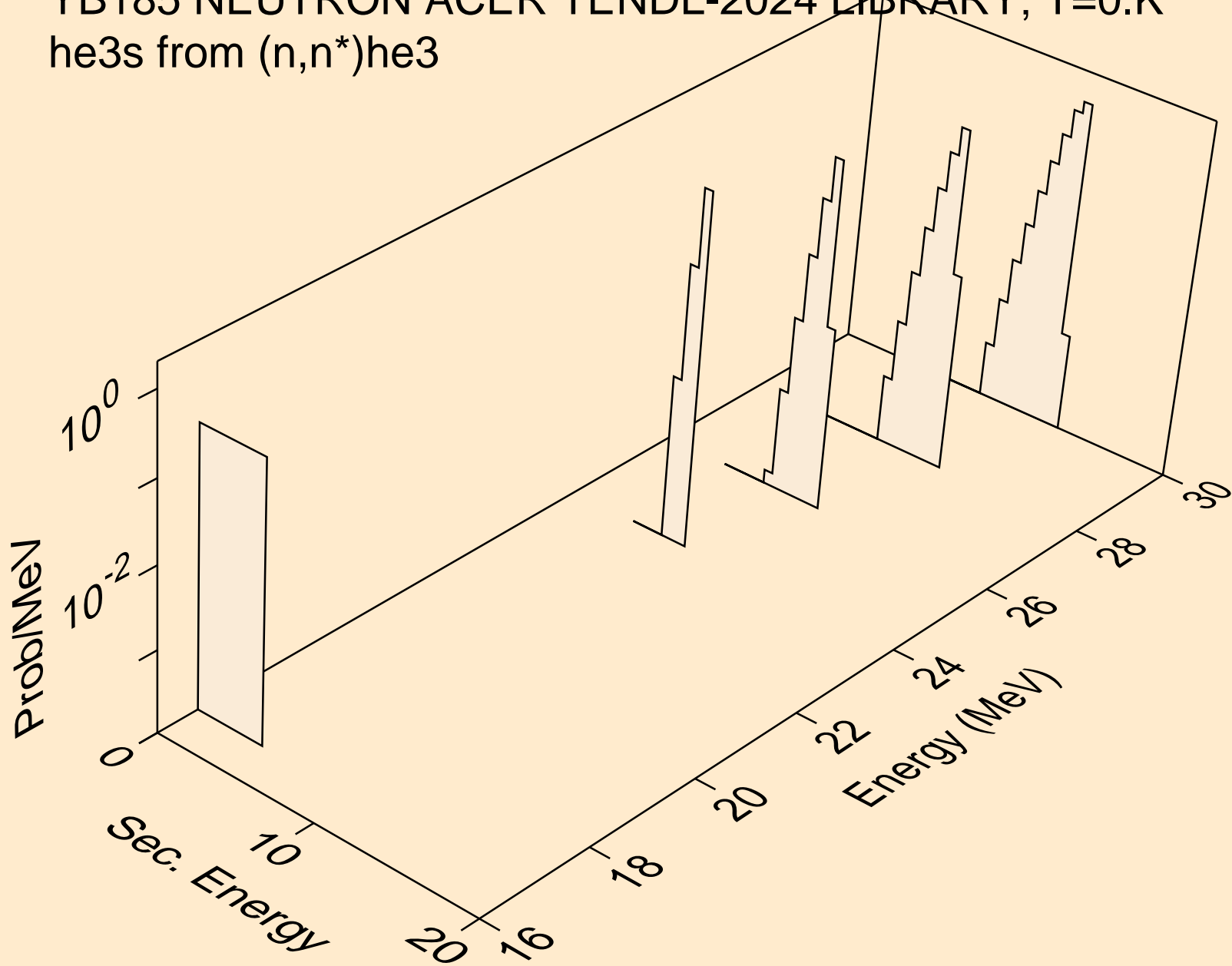

YB185 NEUTRON ACER TENDL-2024 LIBRARY; T=0.K  
he3s from (n,he3)

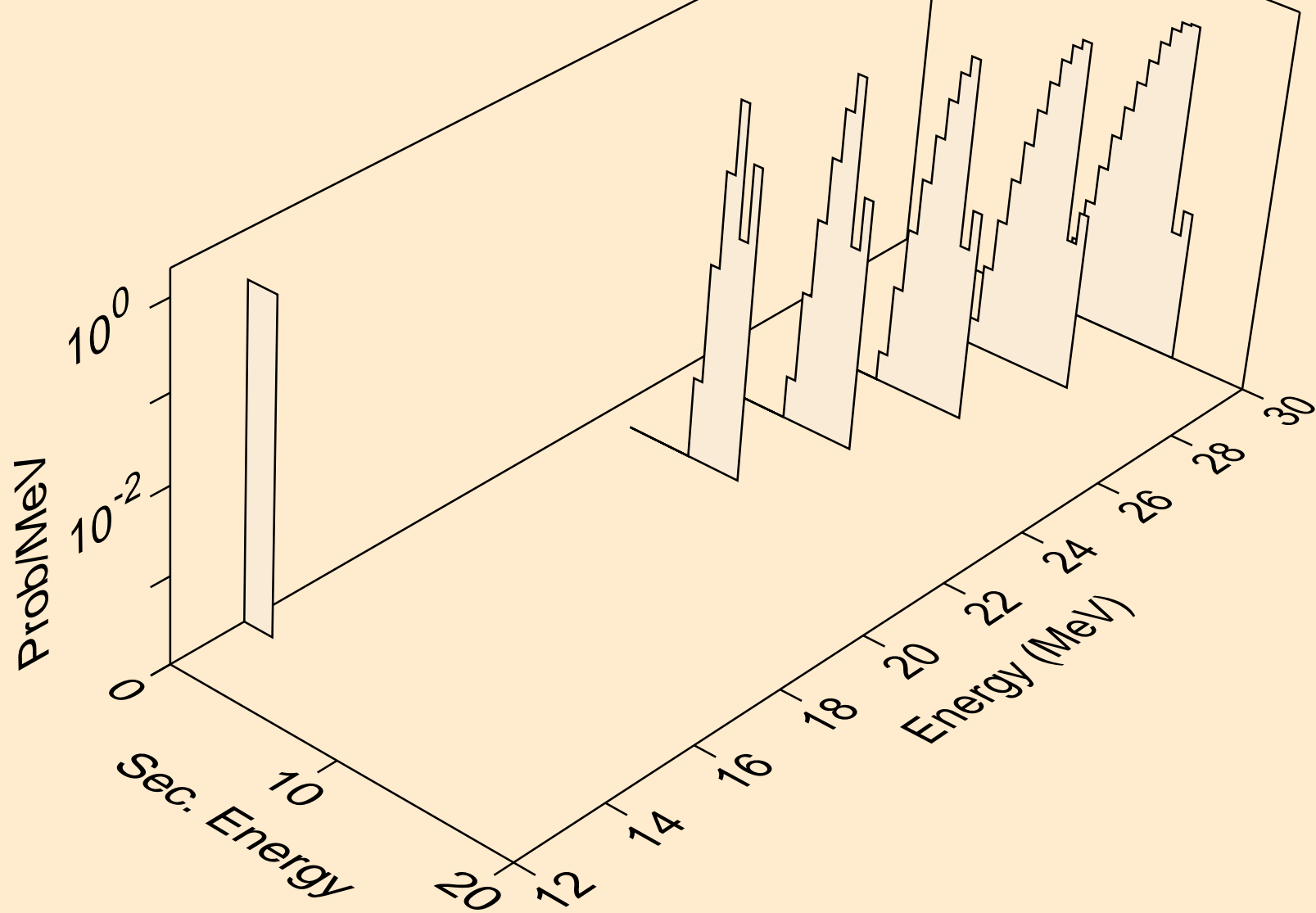

YB185 NEUTRON ACER TENDL-2024 LIBRARY; T=0.K  
alphas from (n,x)

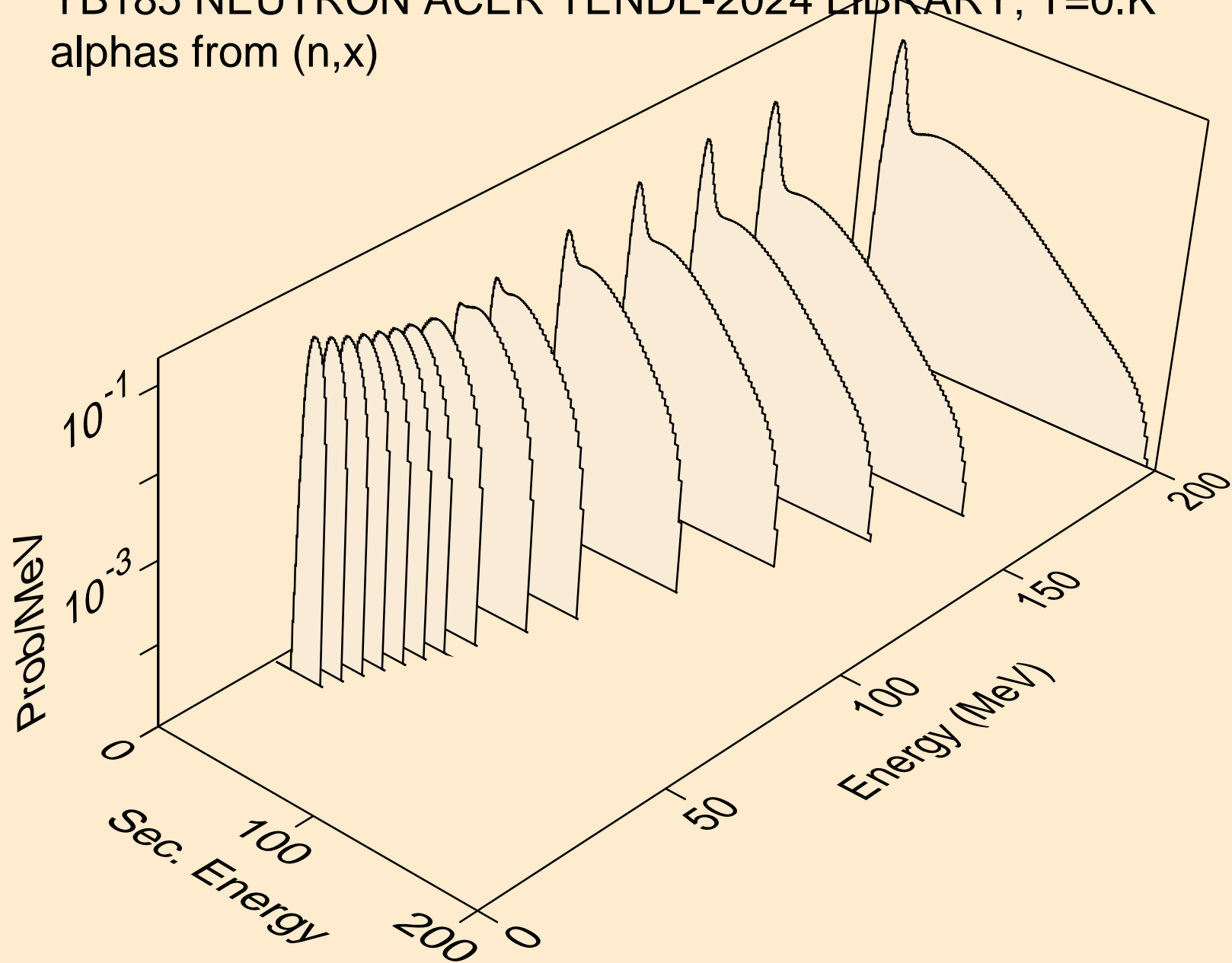

YB185 NEUTRON ACER TENDL-2024 LIBRARY; T=0.K  
alphas from (n,n\*)a

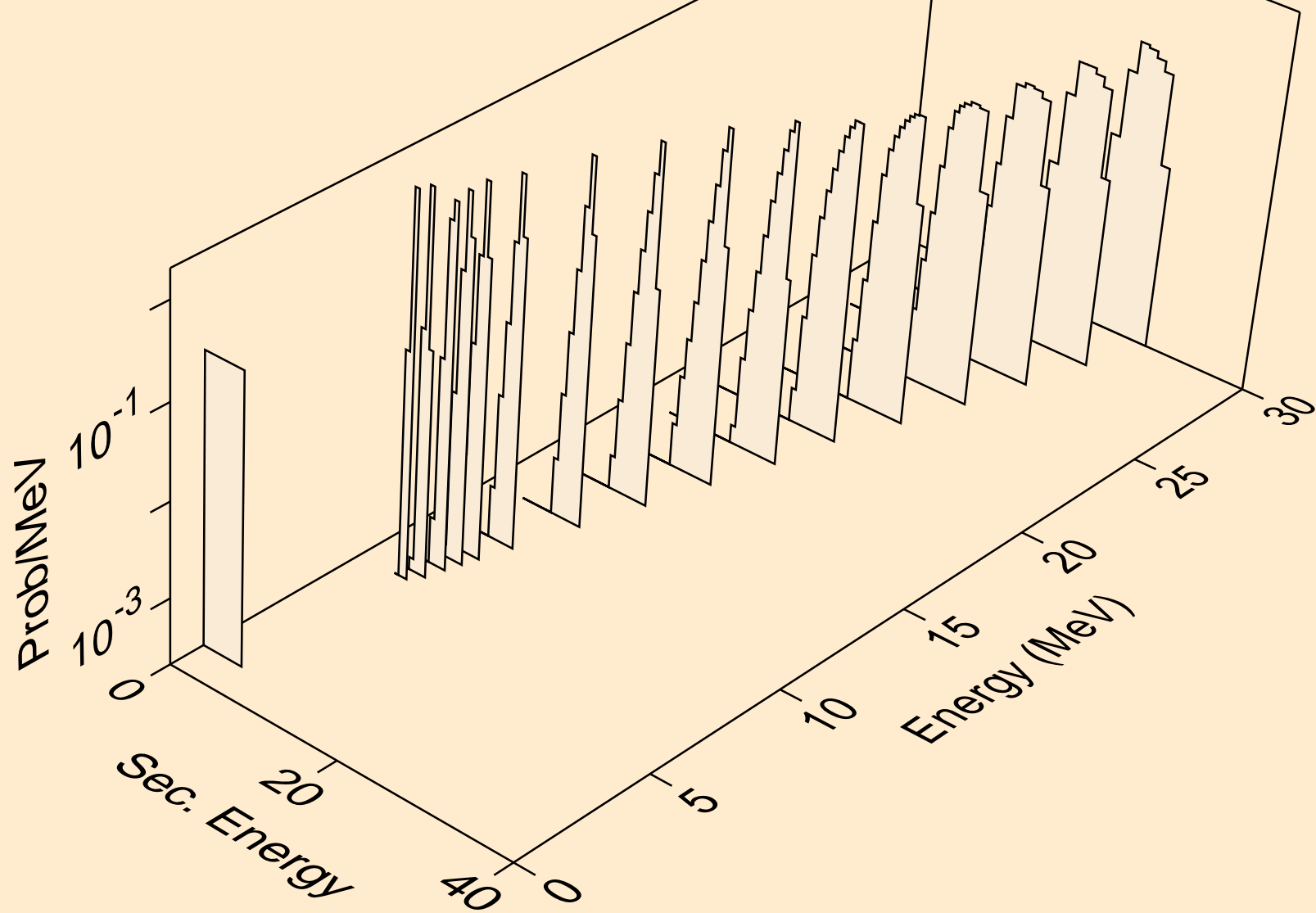

YB185 NEUTRON ACER TENDL-2024 LIBRARY; T=0.K  
alphas from (n,2n)a

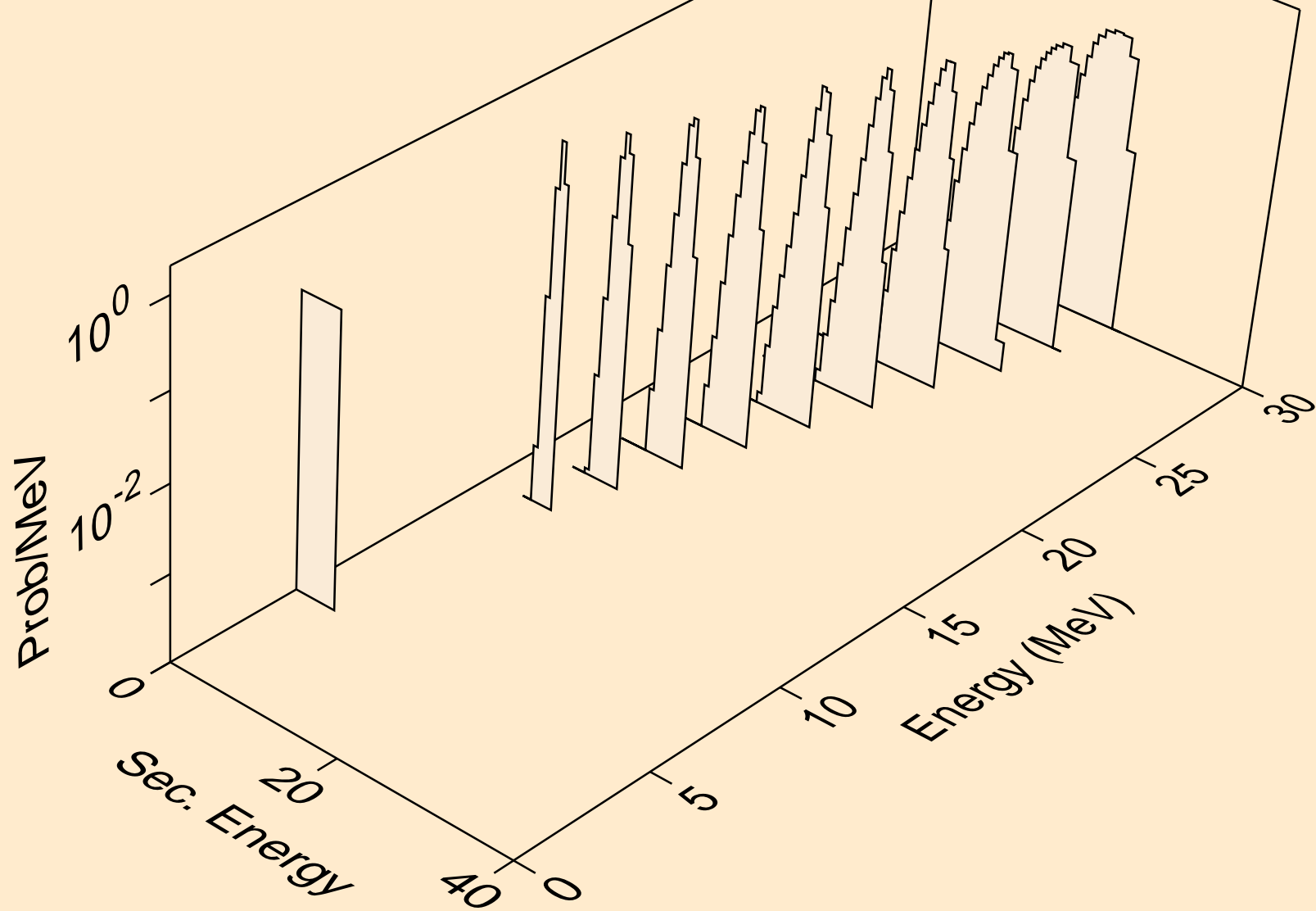

YB185 NEUTRON ACER TENDL-2024 LIBRARY; T=0.K  
alphas from (n,3n)a

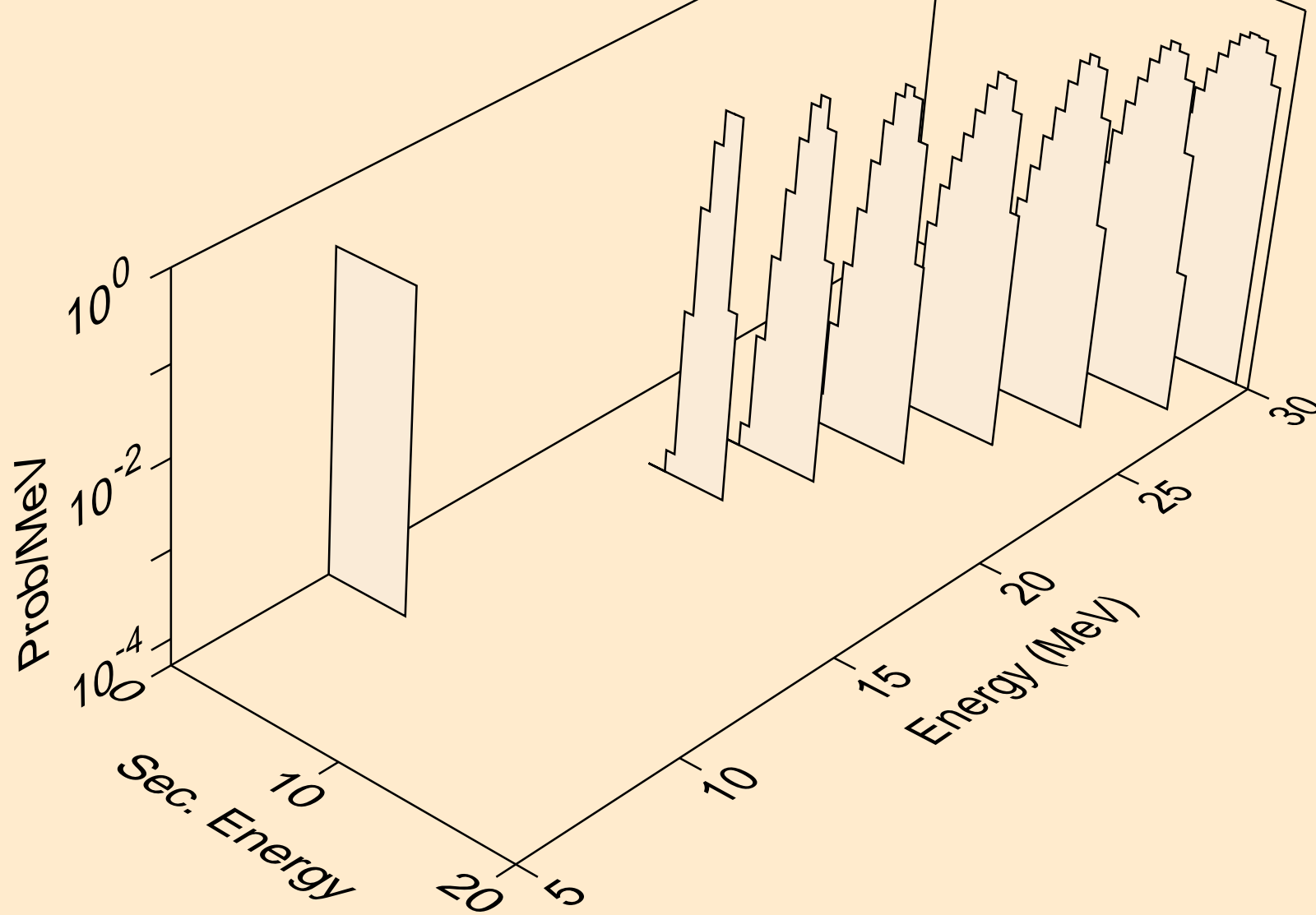

YB185 NEUTRON ACER TENDL-2024 LIBRARY; T=0.K  
alphas from (n,a)

