

ZN071 NEUTRON ACER TENDL-2024 LIBRARY; T=0.K

Principal cross sections

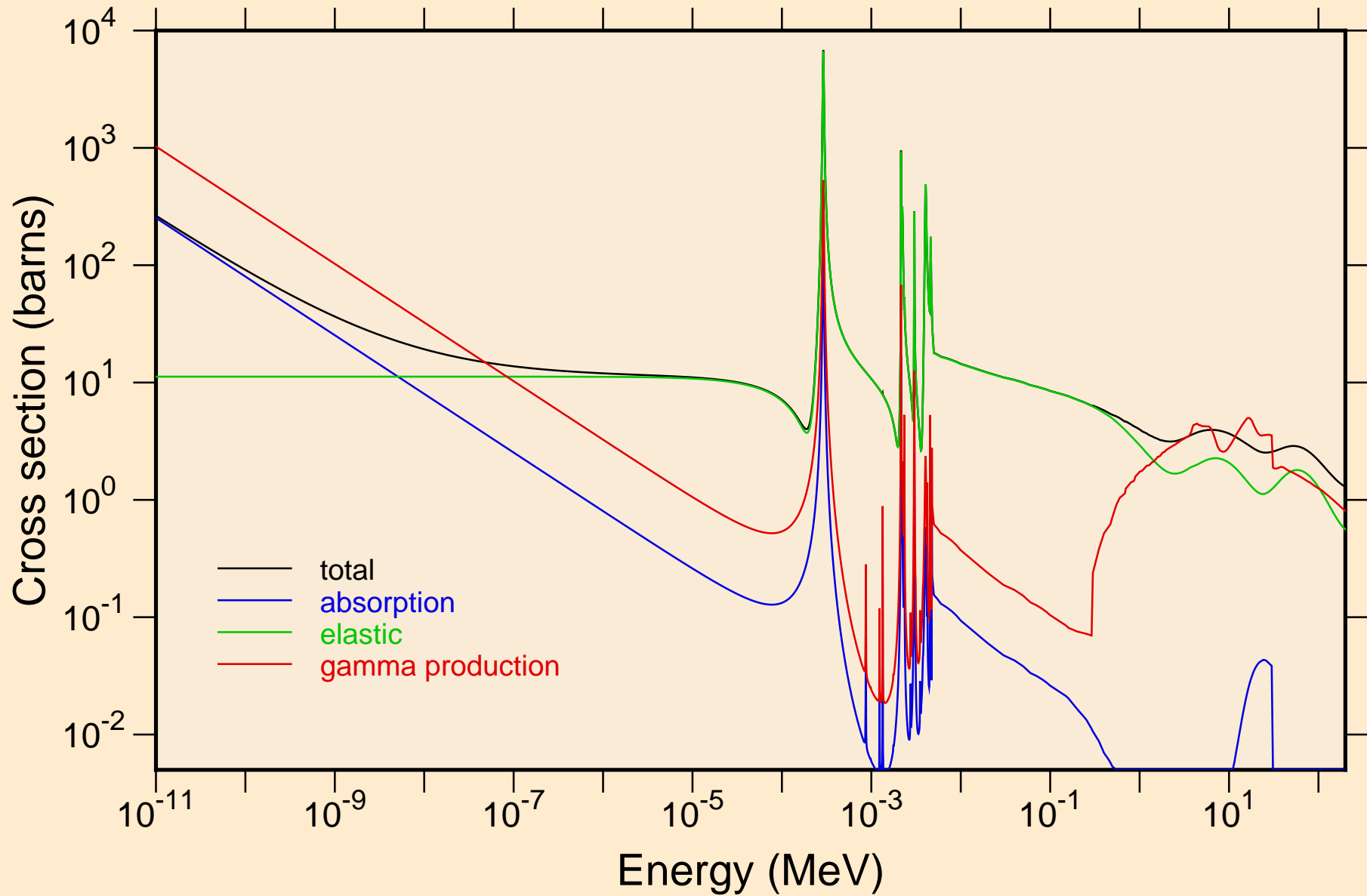

ZN071 NEUTRON ACER TENDL-2024 LIBRARY; T=0.K
resonance total cross section

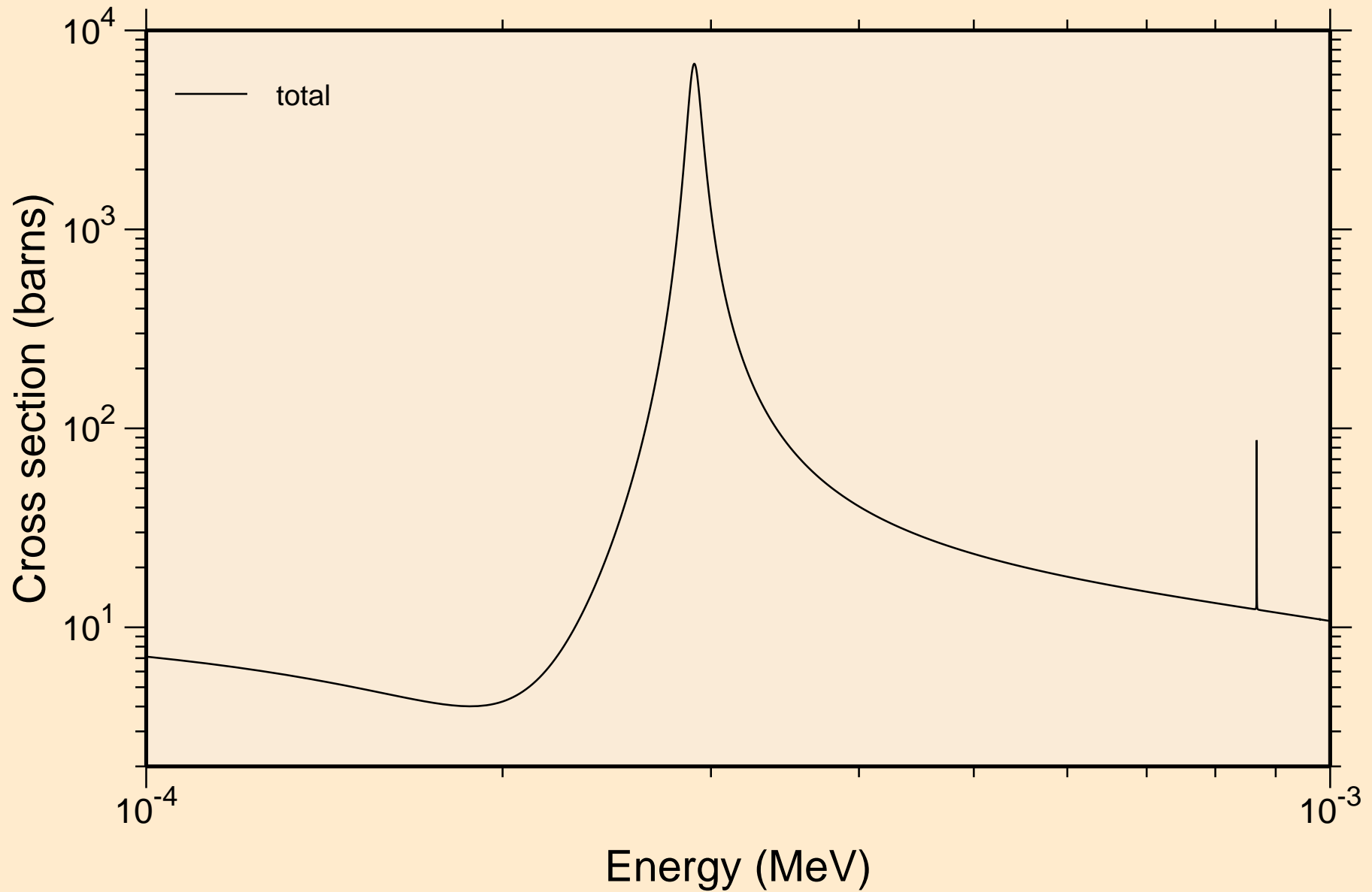

ZN071 NEUTRON ACER TENDL-2024 LIBRARY; T=0.K
resonance total cross section

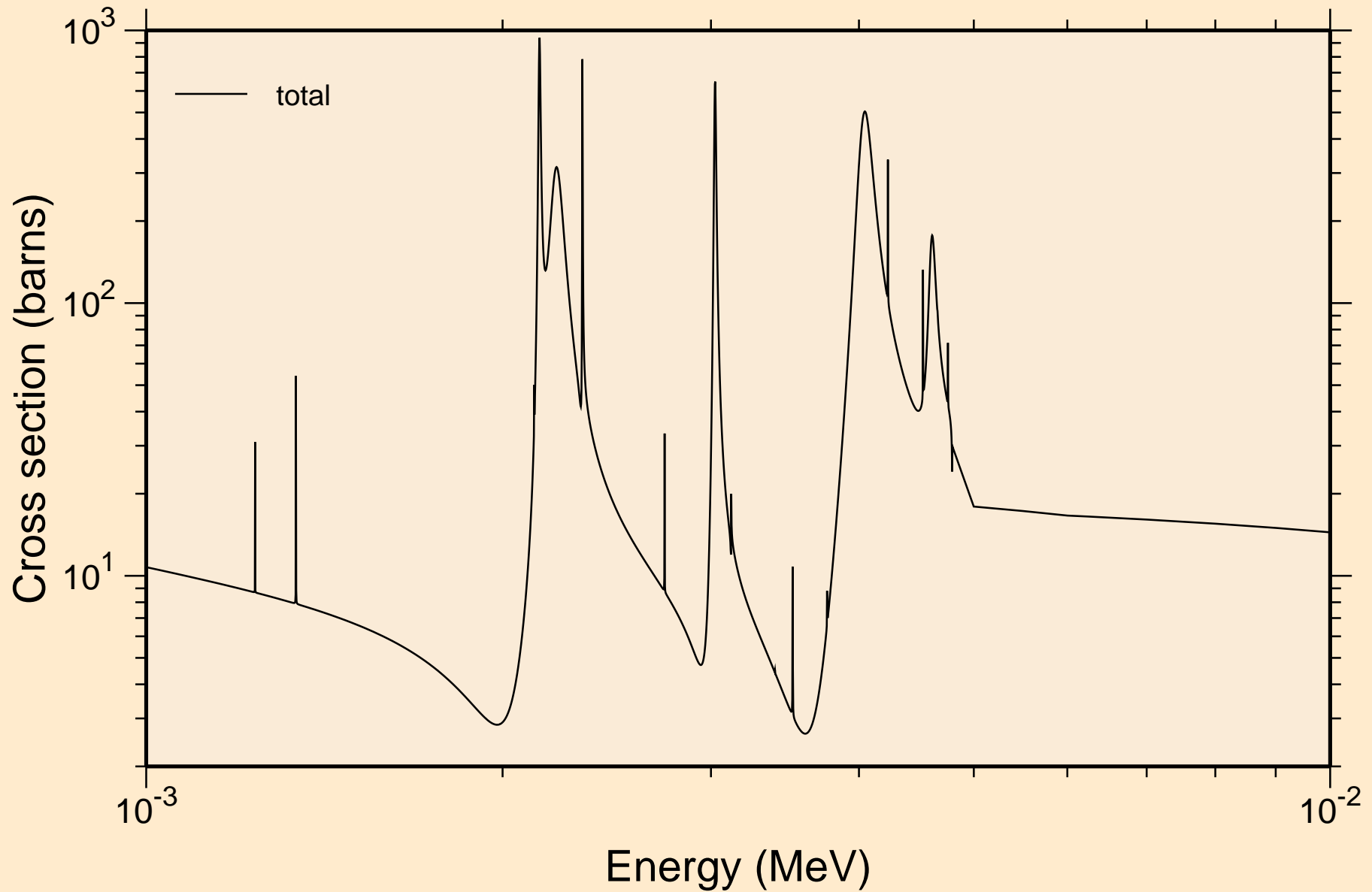

ZN071 NEUTRON ACER TENDL-2024 LIBRARY; T=0.K
resonance total cross section

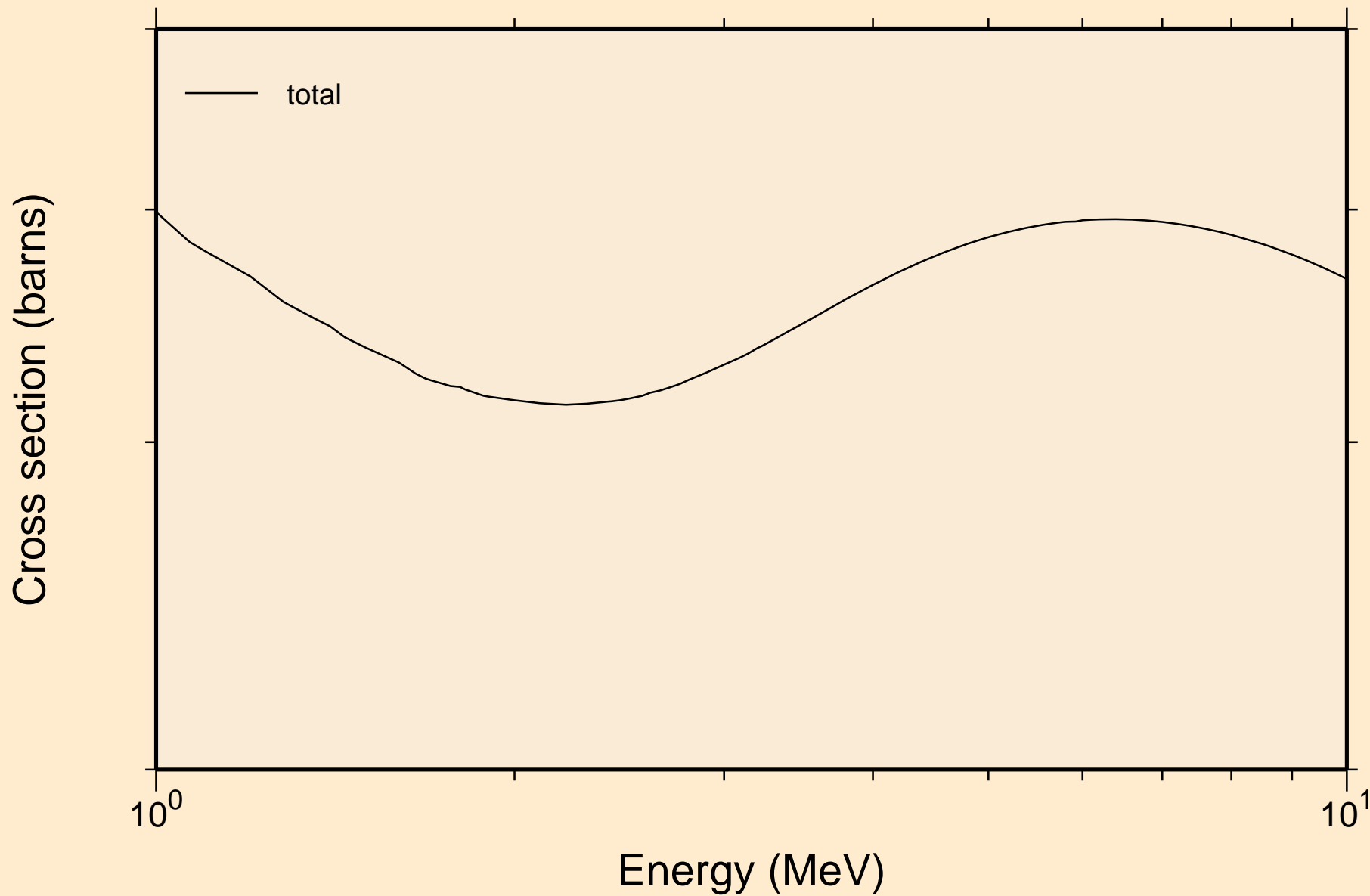

ZN071 NEUTRON ACER TENDL-2024 LIBRARY; T=0.K
resonance absorption cross sections

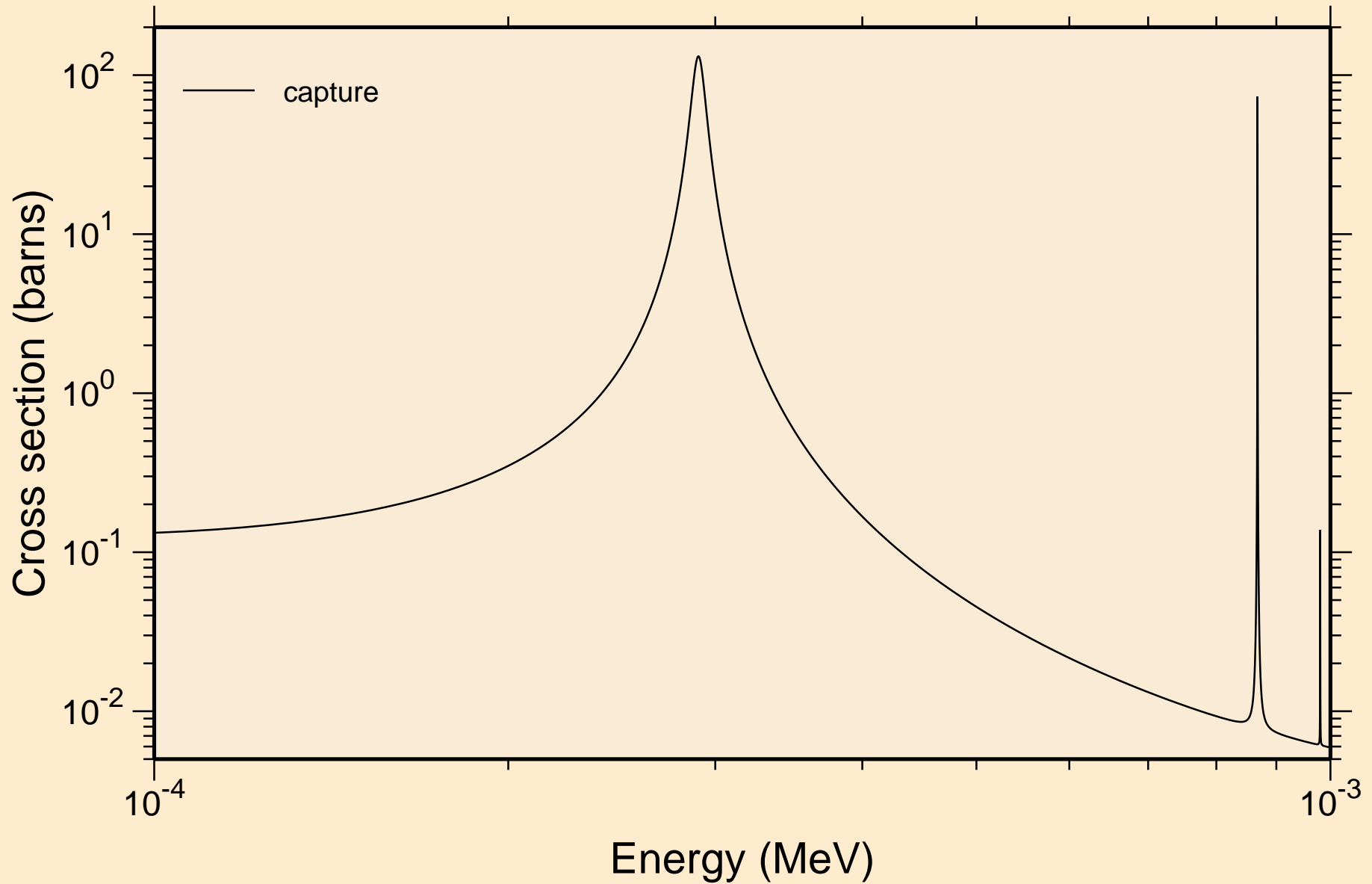

ZN071 NEUTRON ACER TENDL-2024 LIBRARY; T=0.K
resonance absorption cross sections

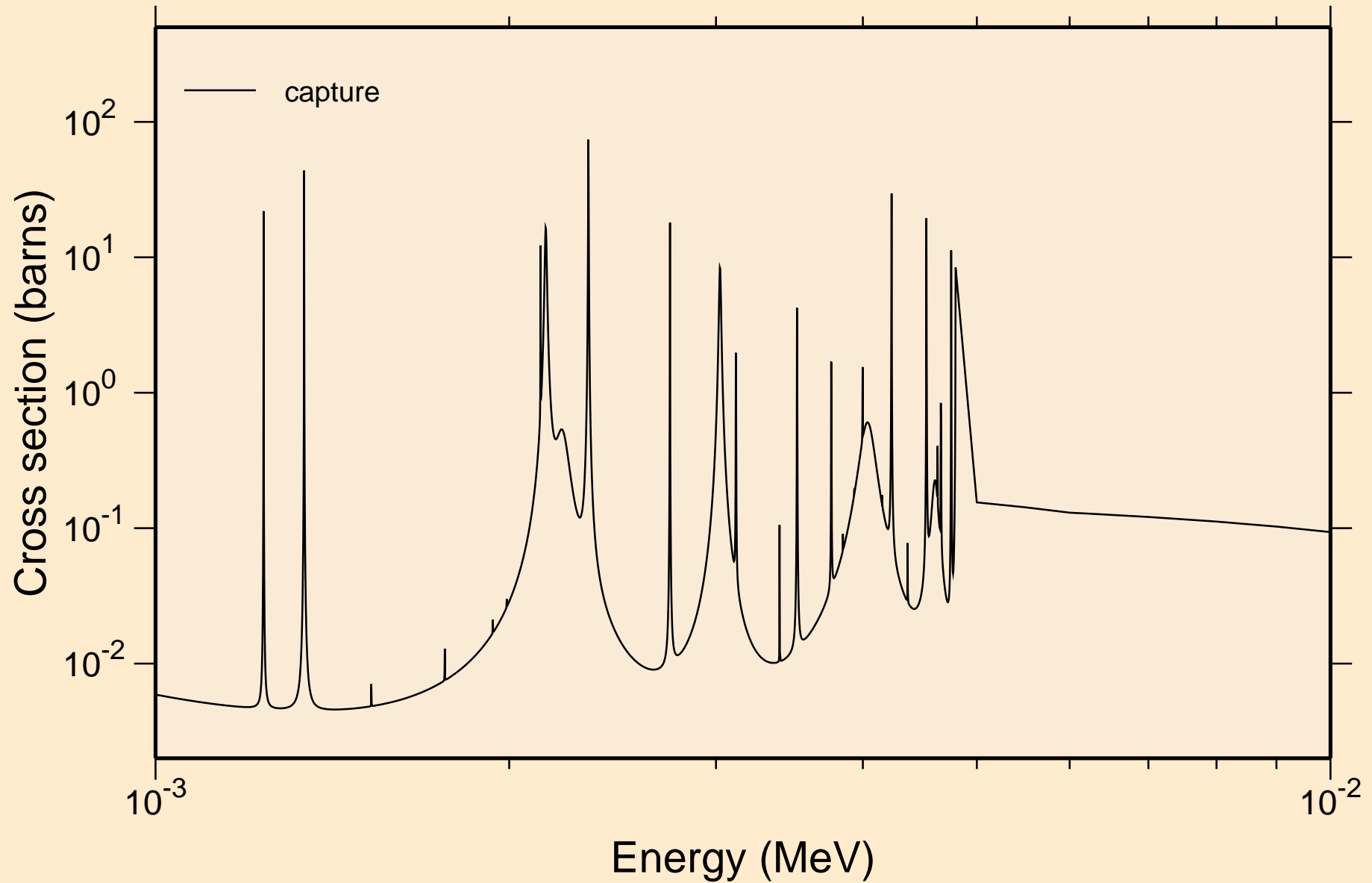

ZN071 NEUTRON ACER TENDL-2024 LIBRARY; T=0.K
resonance absorption cross sections

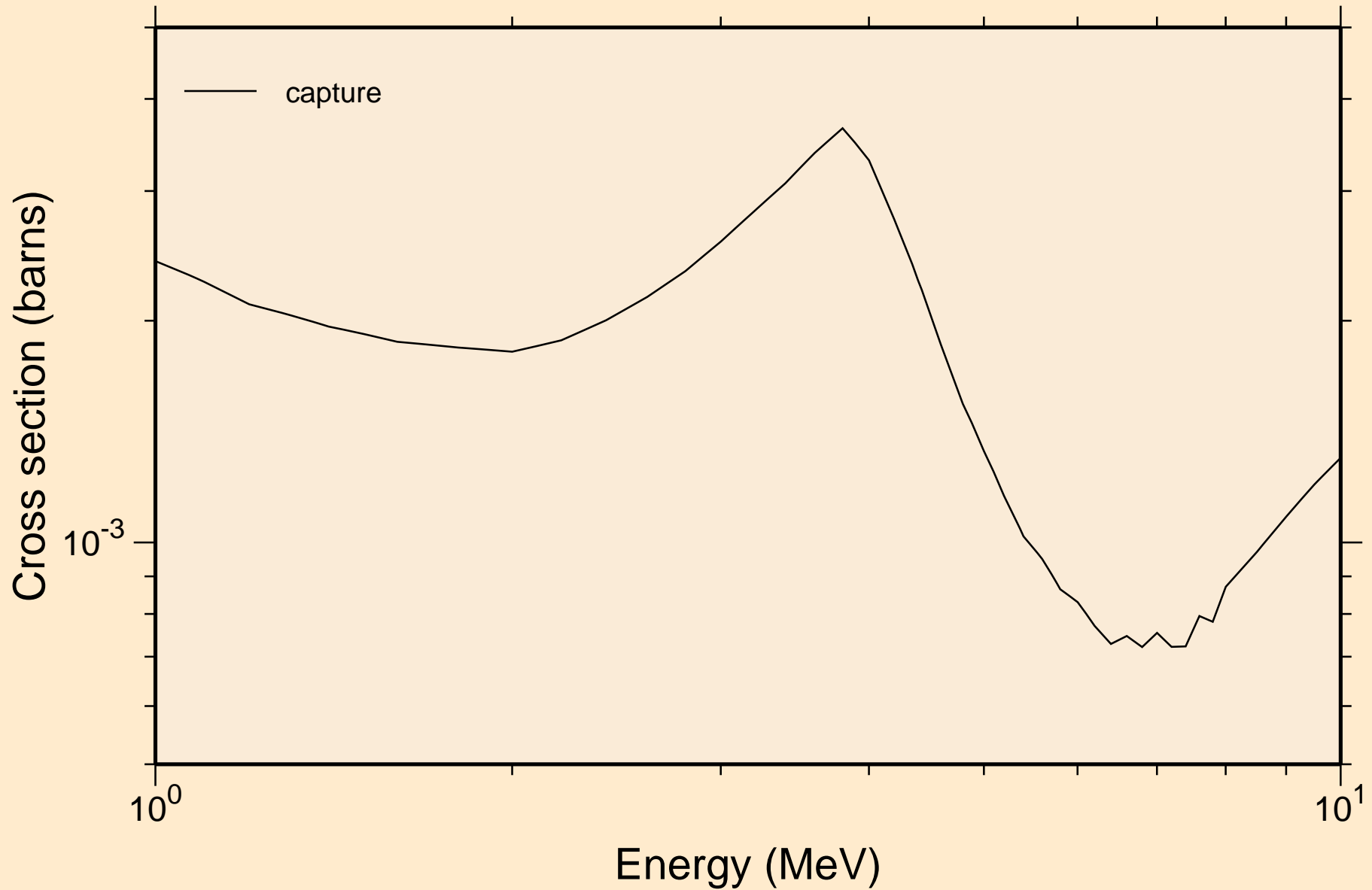

ZN071 NEUTRON ACER TENDL-2024 LIBRARY; T=0.K

Heating

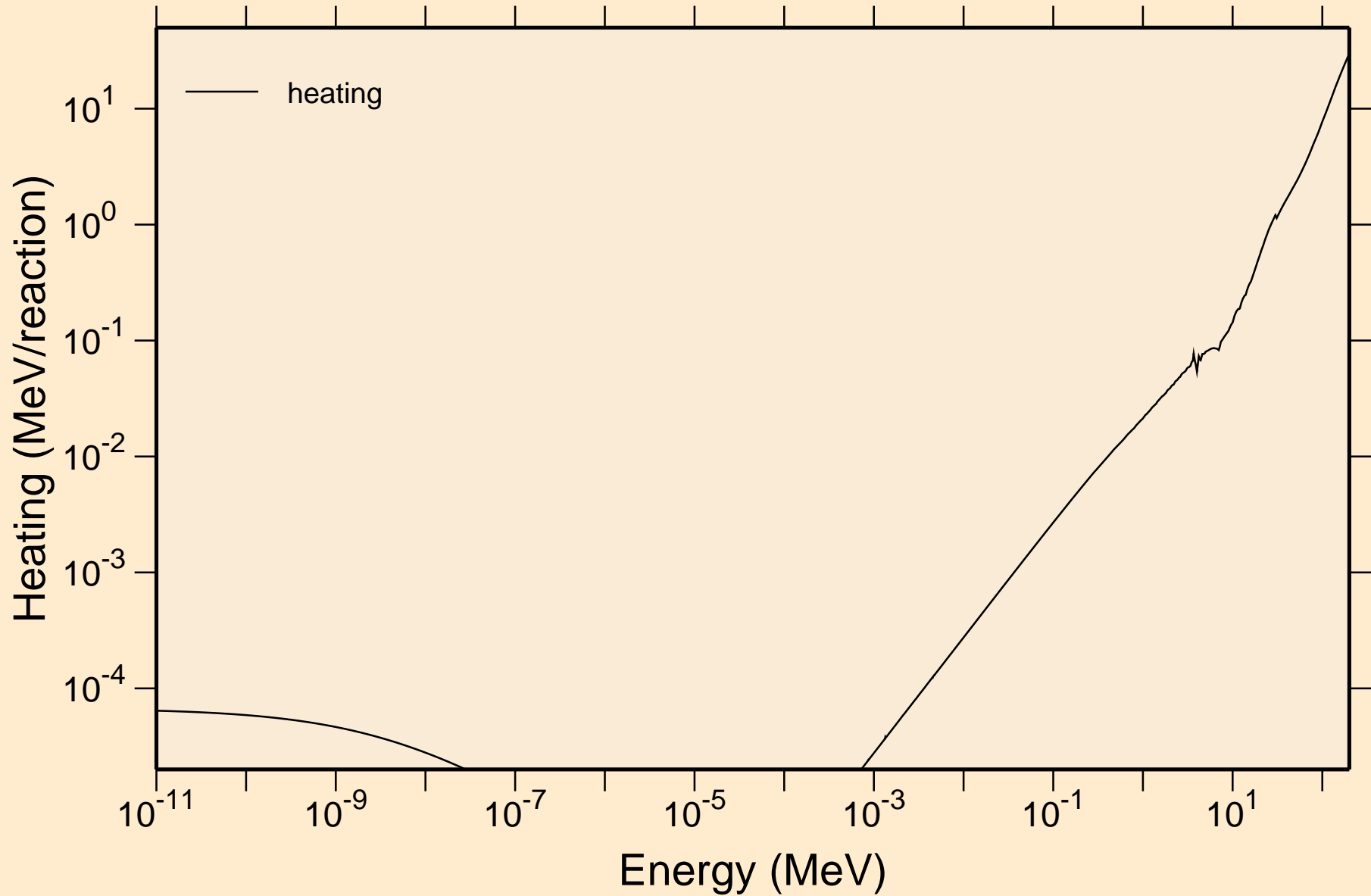

ZN071 NEUTRON ACER TENDL-2024 LIBRARY; T=0.K

Damage

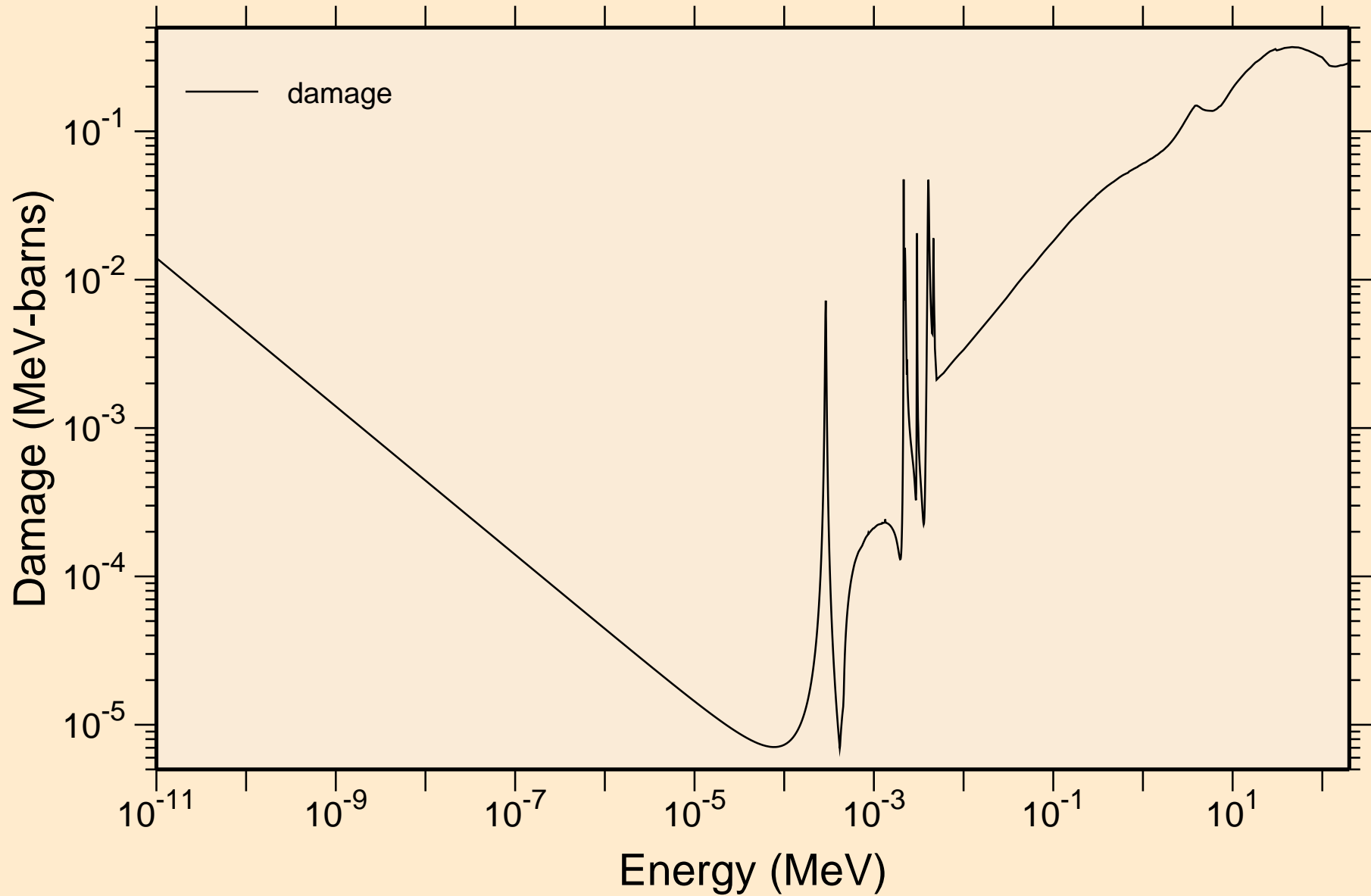

ZN071 NEUTRON ACER TENDL-2024 LIBRARY; T=0.K
Non-threshold reactions

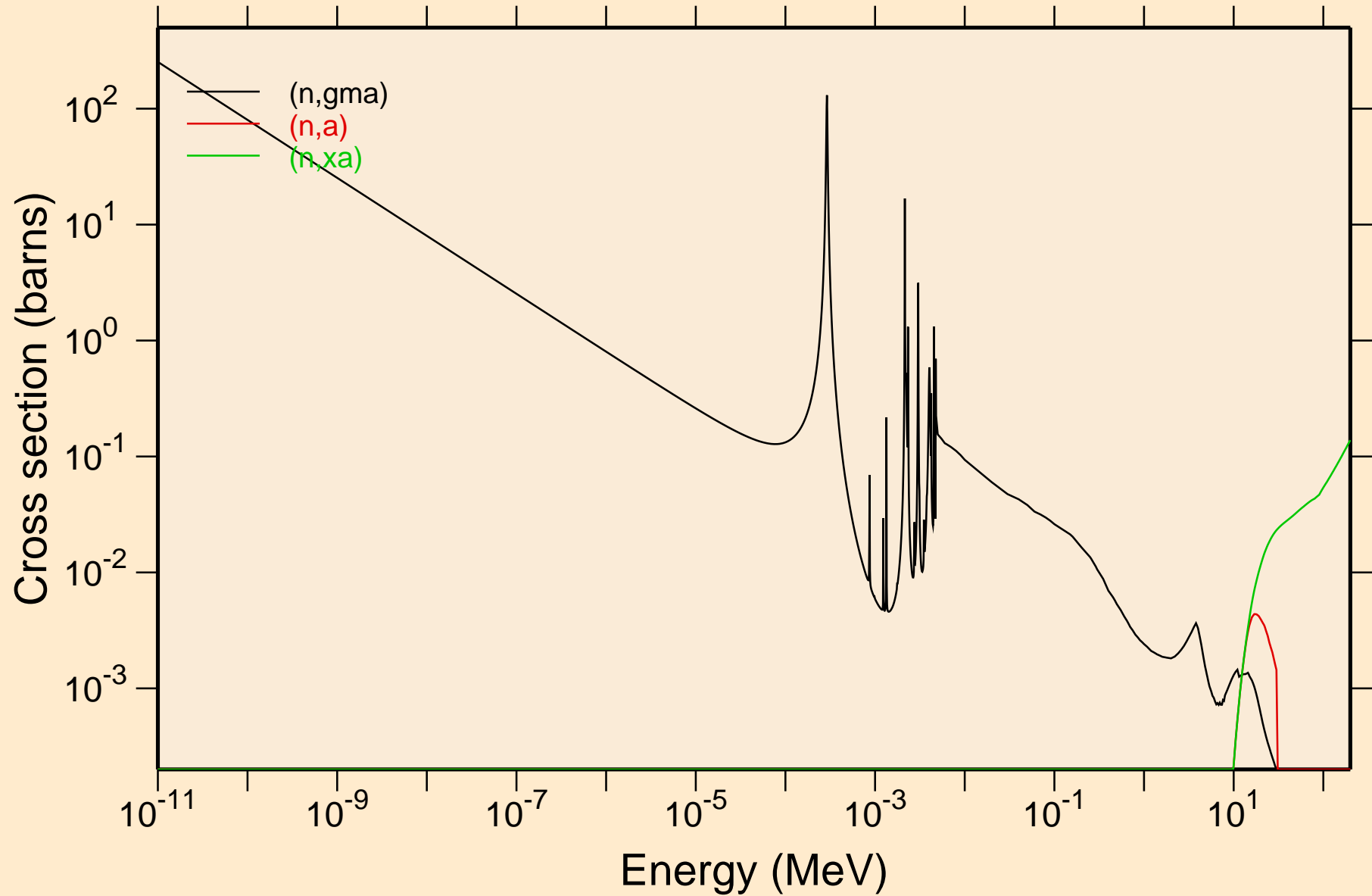

ZN071 NEUTRON ACER TENDL-2024 LIBRARY; T=0.K

Principal cross sections

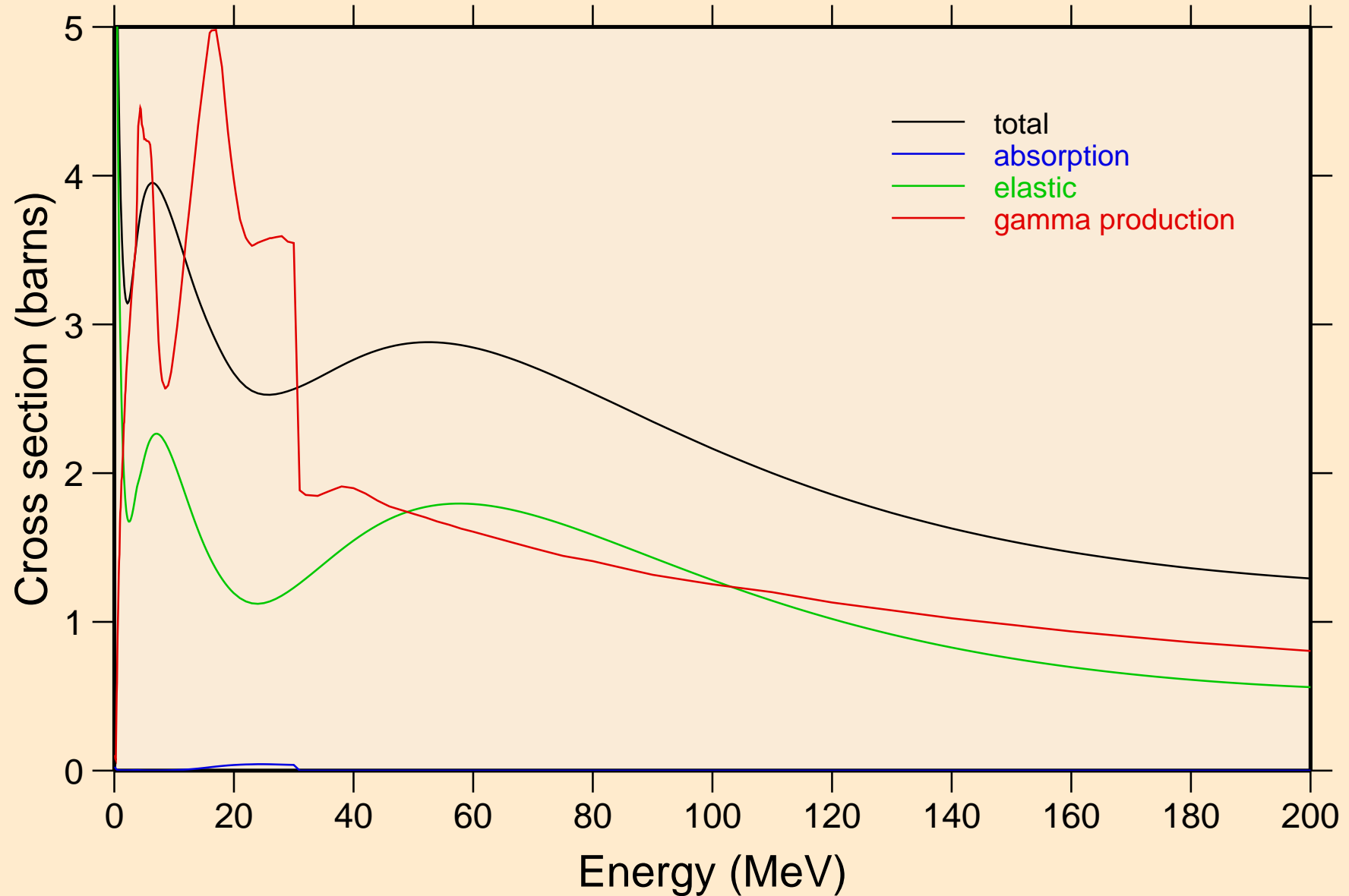

ZN071 NEUTRON ACER TENDL-2024 LIBRARY; T=0.K

Heating

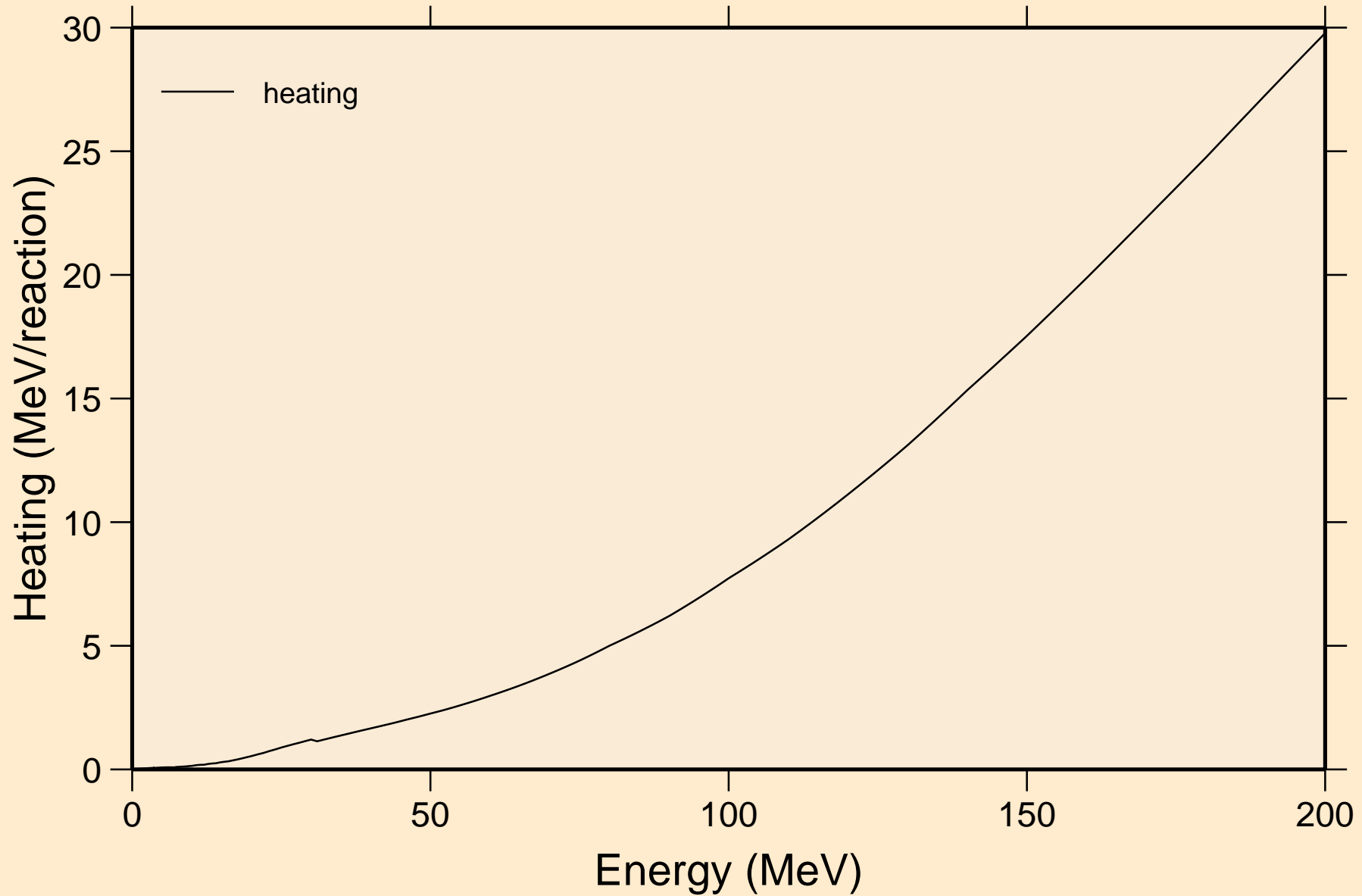

ZN071 NEUTRON ACER TENDL-2024 LIBRARY; T=0.K

Damage

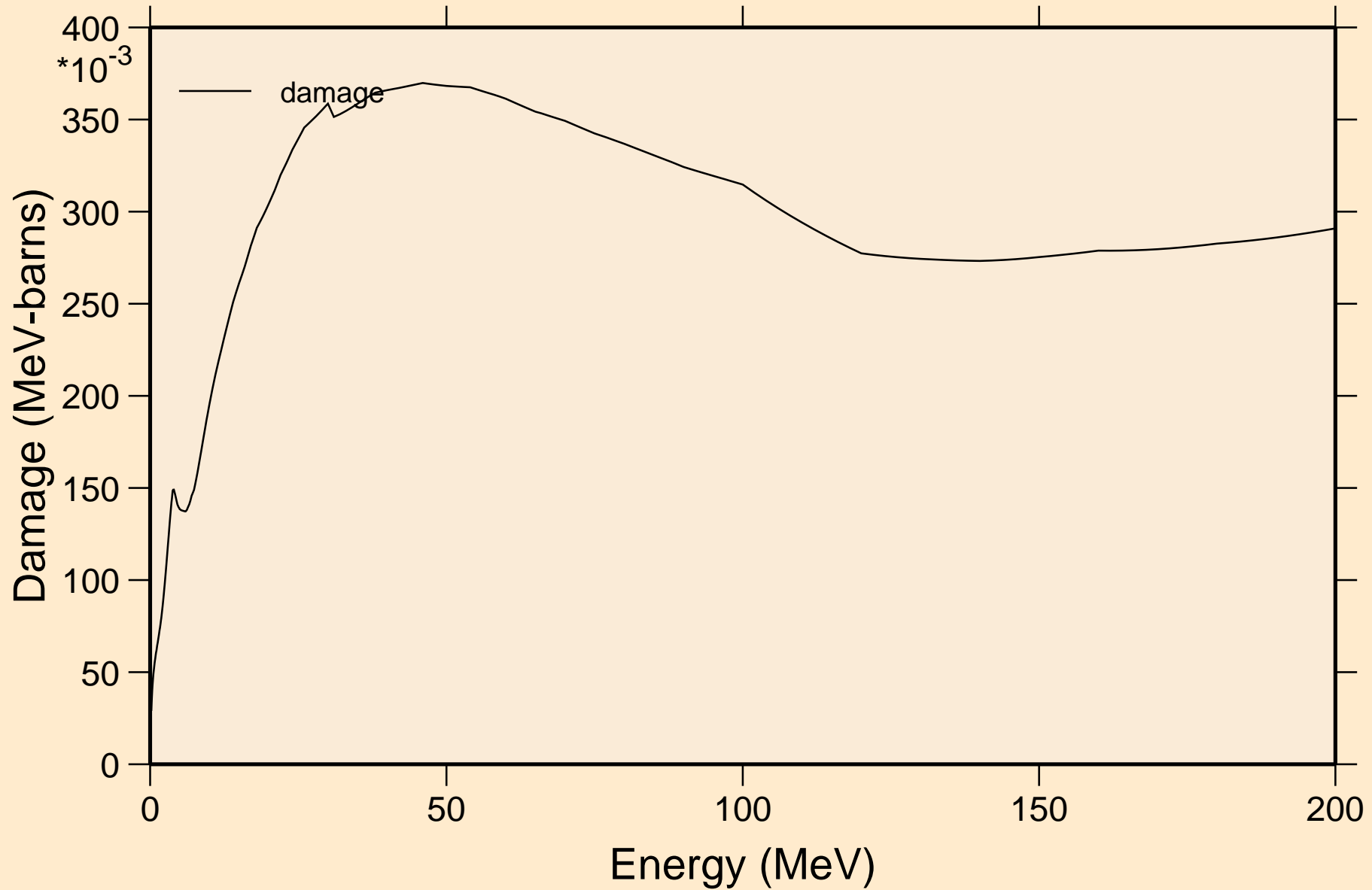

ZN071 NEUTRON ACER TENDL-2024 LIBRARY; T=0.K

Non-threshold reactions

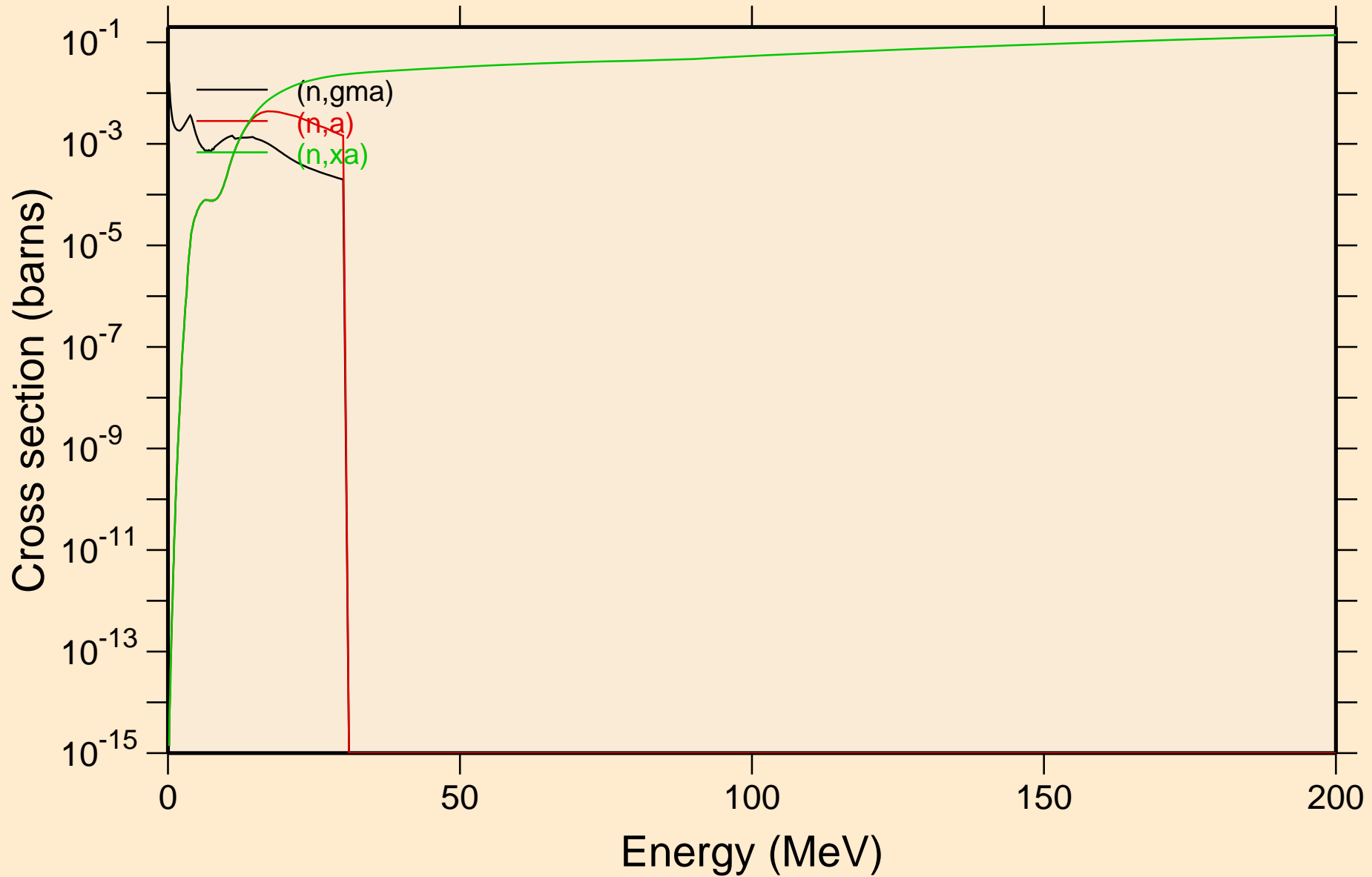

ZN071 NEUTRON ACER TENDL-2024 LIBRARY; T=0.K
Inelastic levels

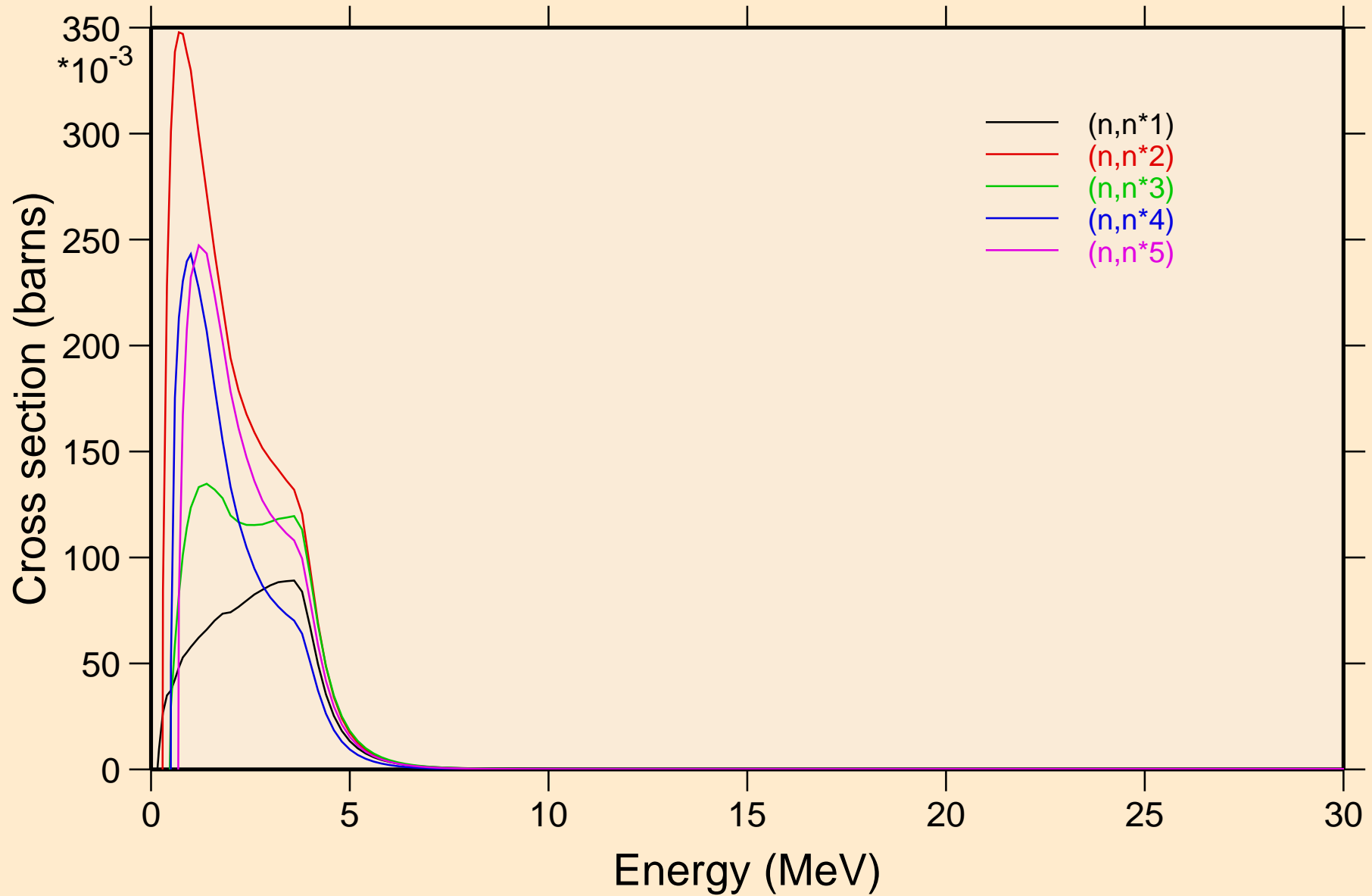

ZN071 NEUTRON ACER TENDL-2024 LIBRARY; T=0.K
Inelastic levels

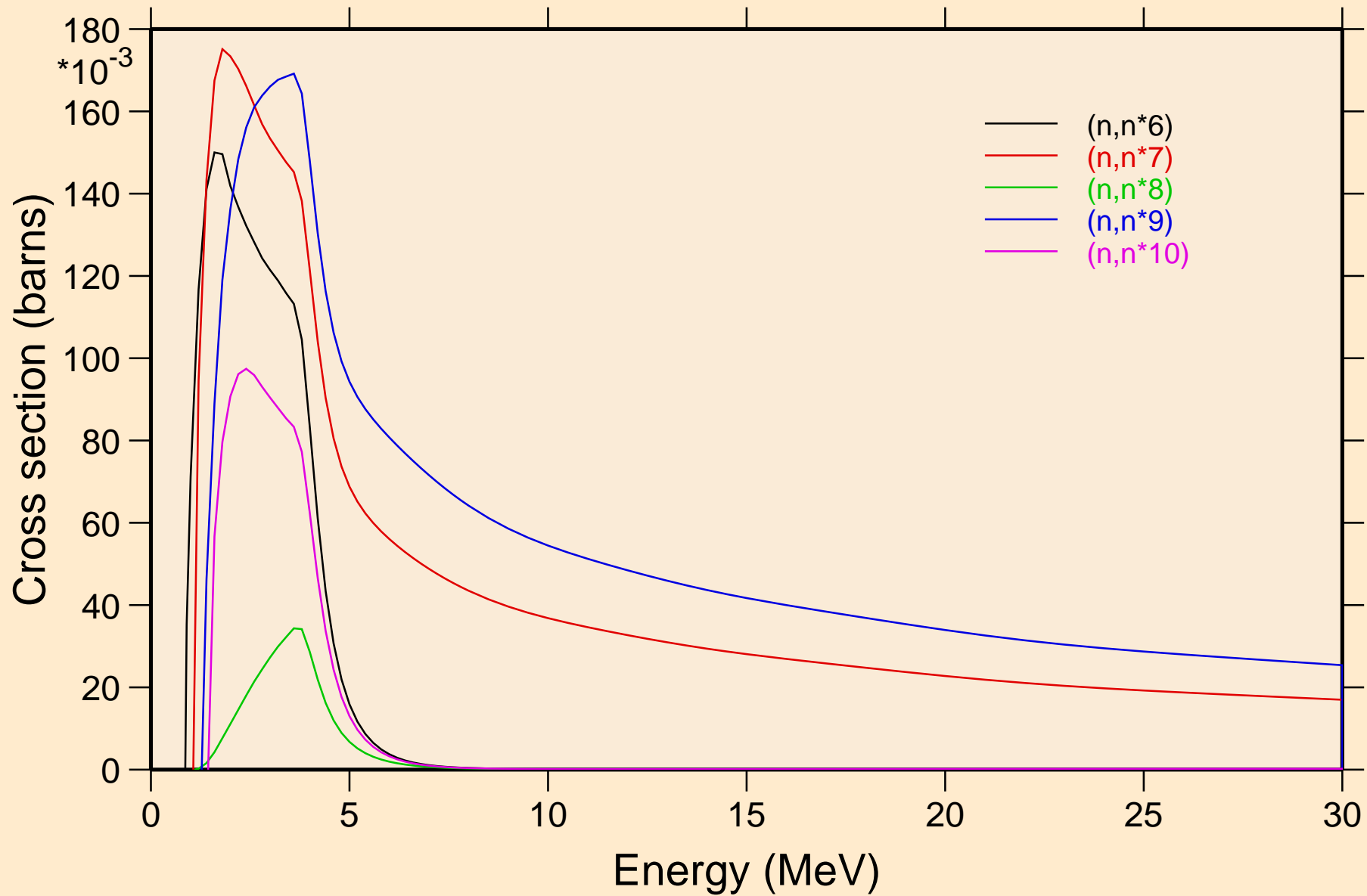

ZN071 NEUTRON ACER TENDL-2024 LIBRARY; T=0.K

Inelastic levels

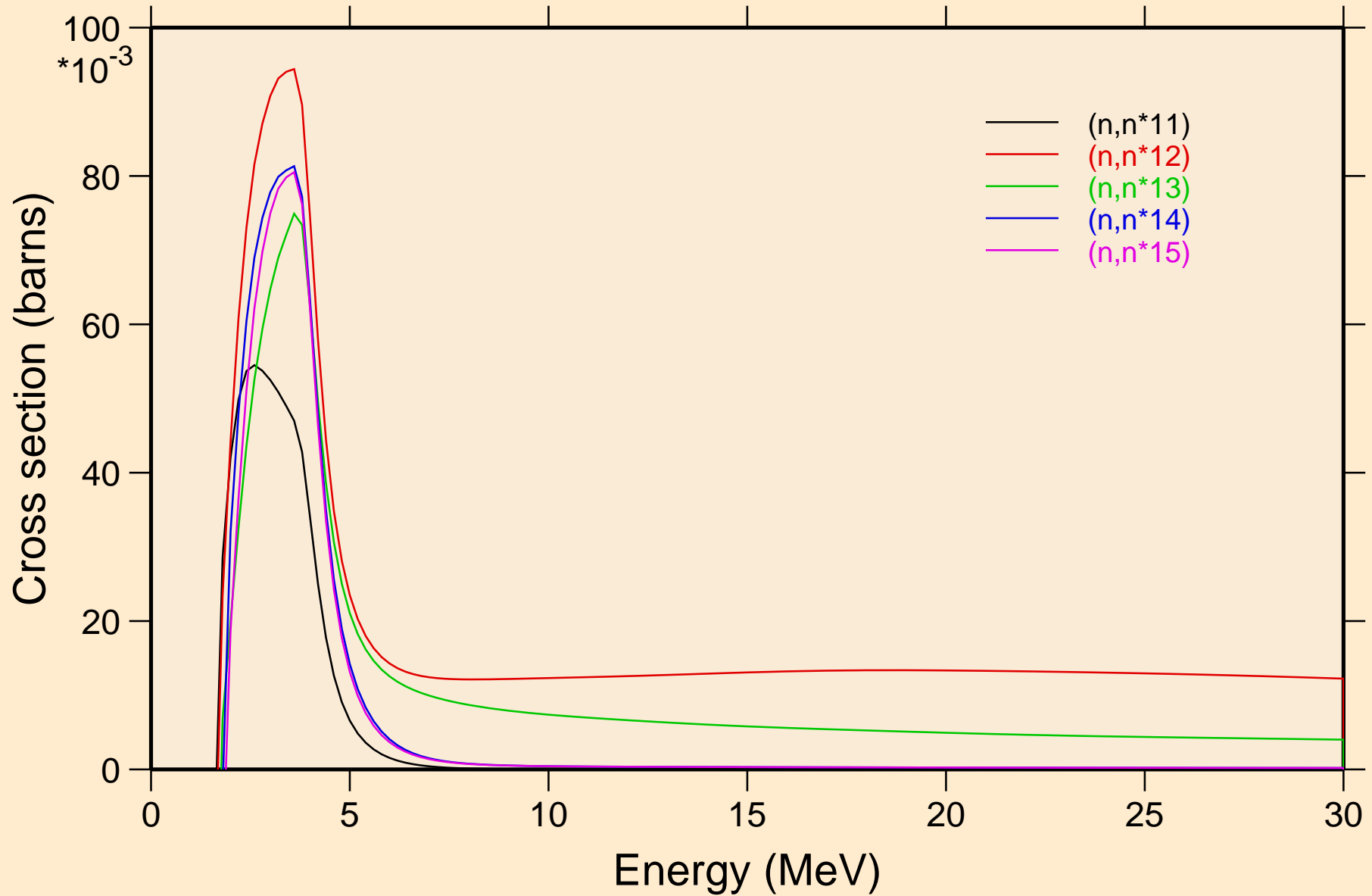

ZN071 NEUTRON ACER TENDL-2024 LIBRARY; T=0.K
Inelastic levels

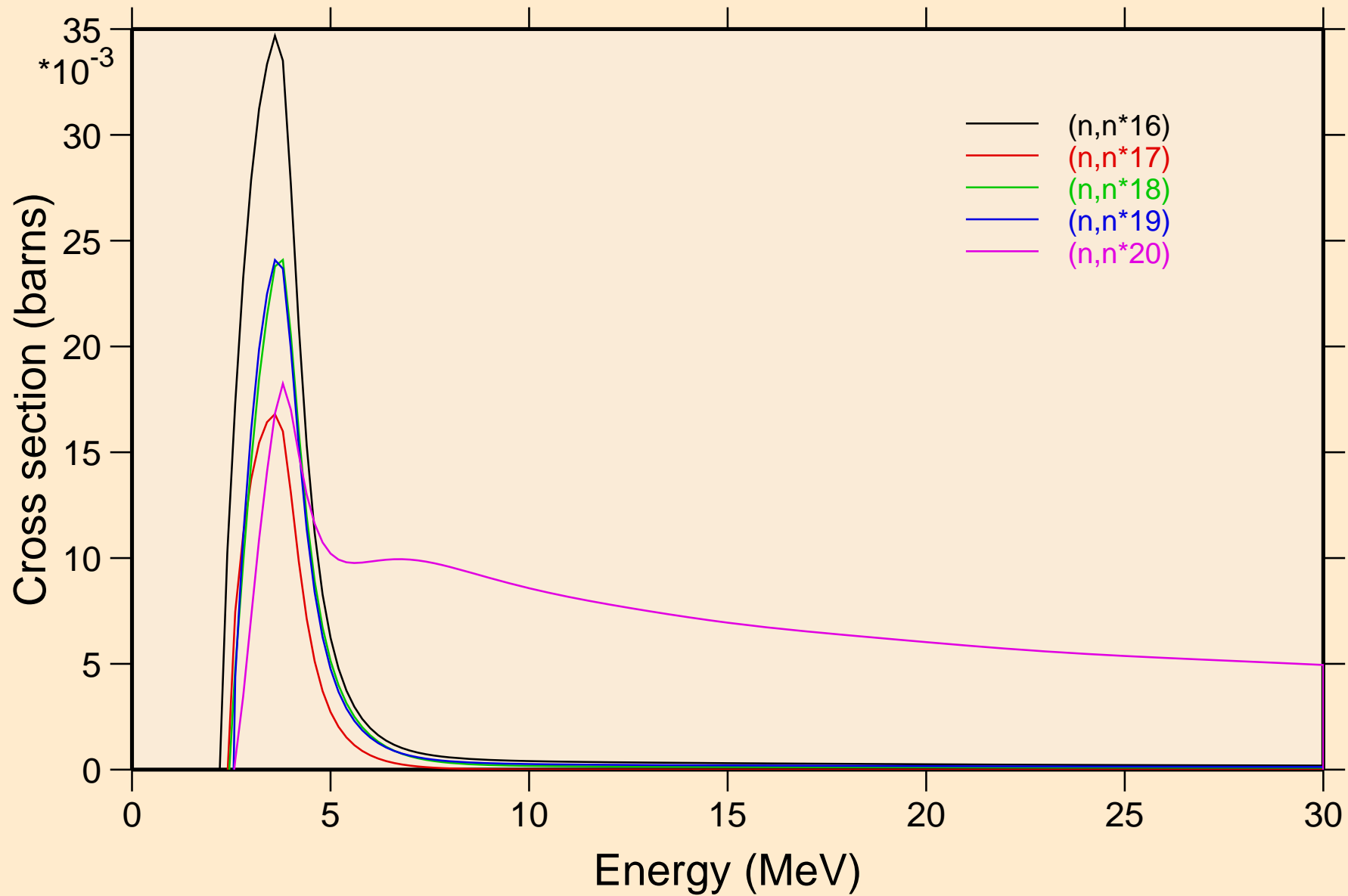

ZN071 NEUTRON ACER TENDL-2024 LIBRARY; T=0.K
Inelastic levels

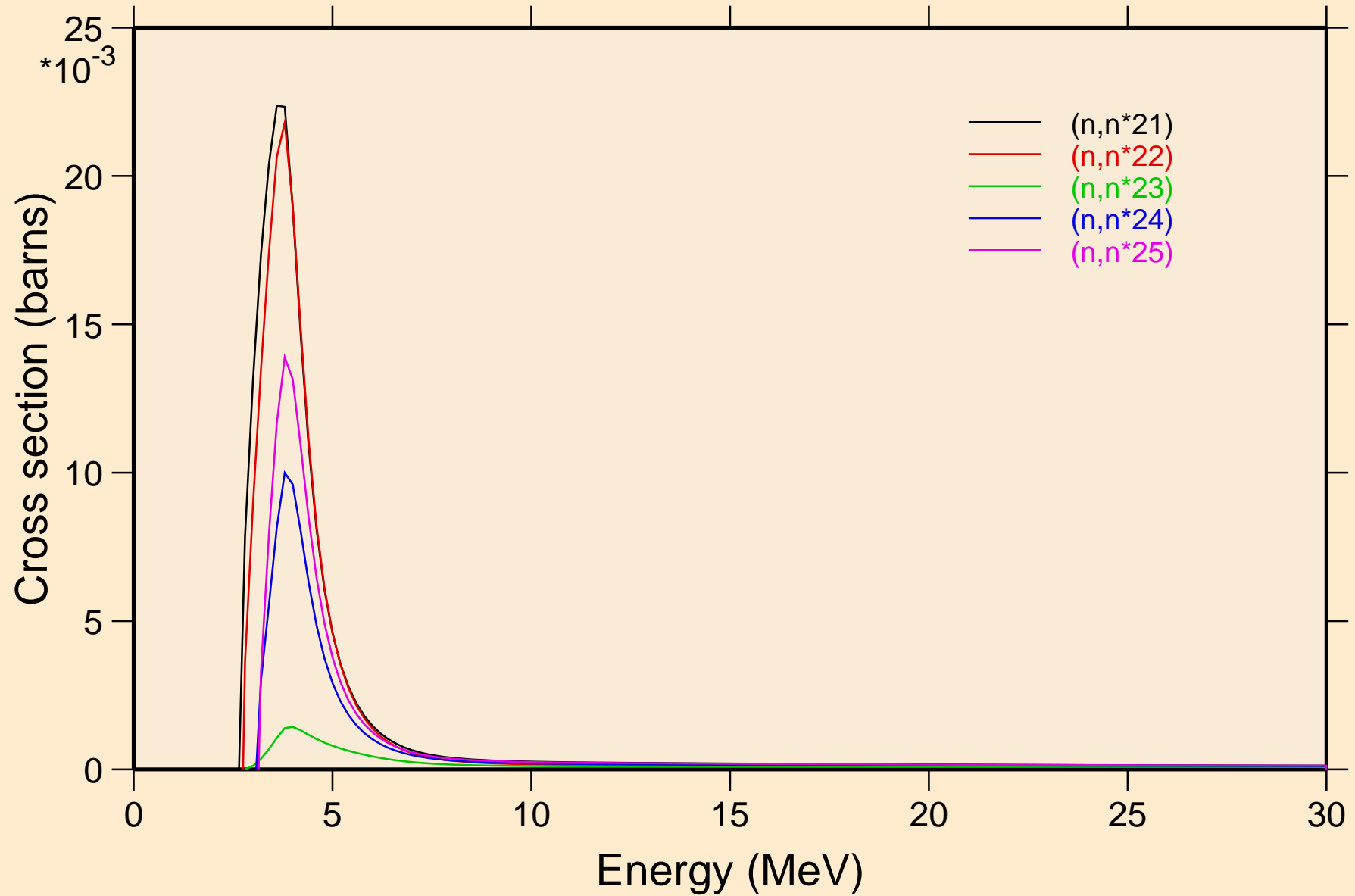

ZN071 NEUTRON ACER TENDL-2024 LIBRARY; T=0.K
Inelastic levels

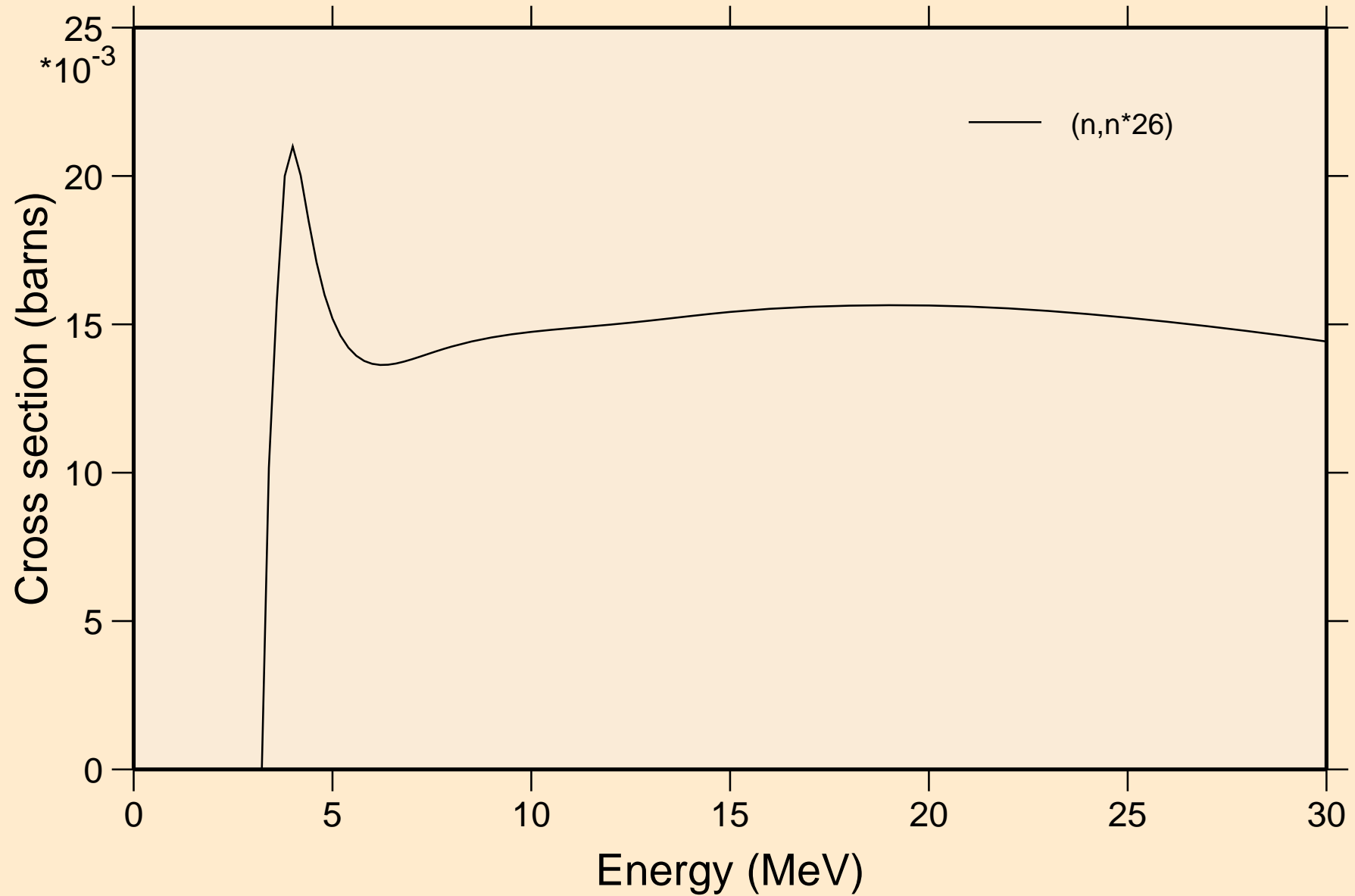

ZN071 NEUTRON ACER TENDL-2024 LIBRARY; T=0.K
Threshold reactions

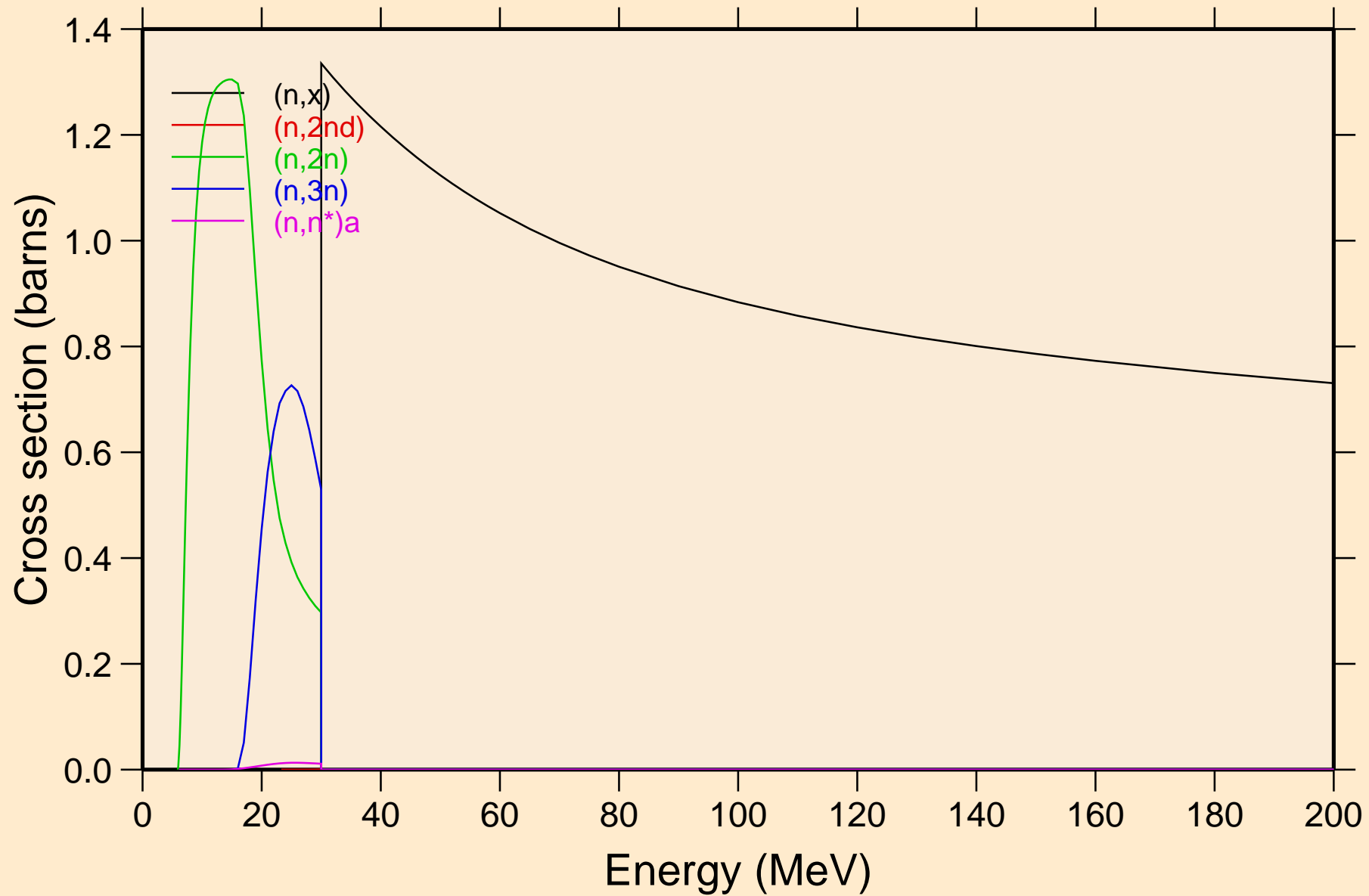

ZN071 NEUTRON ACER TENDL-2024 LIBRARY; T=0.K

Threshold reactions

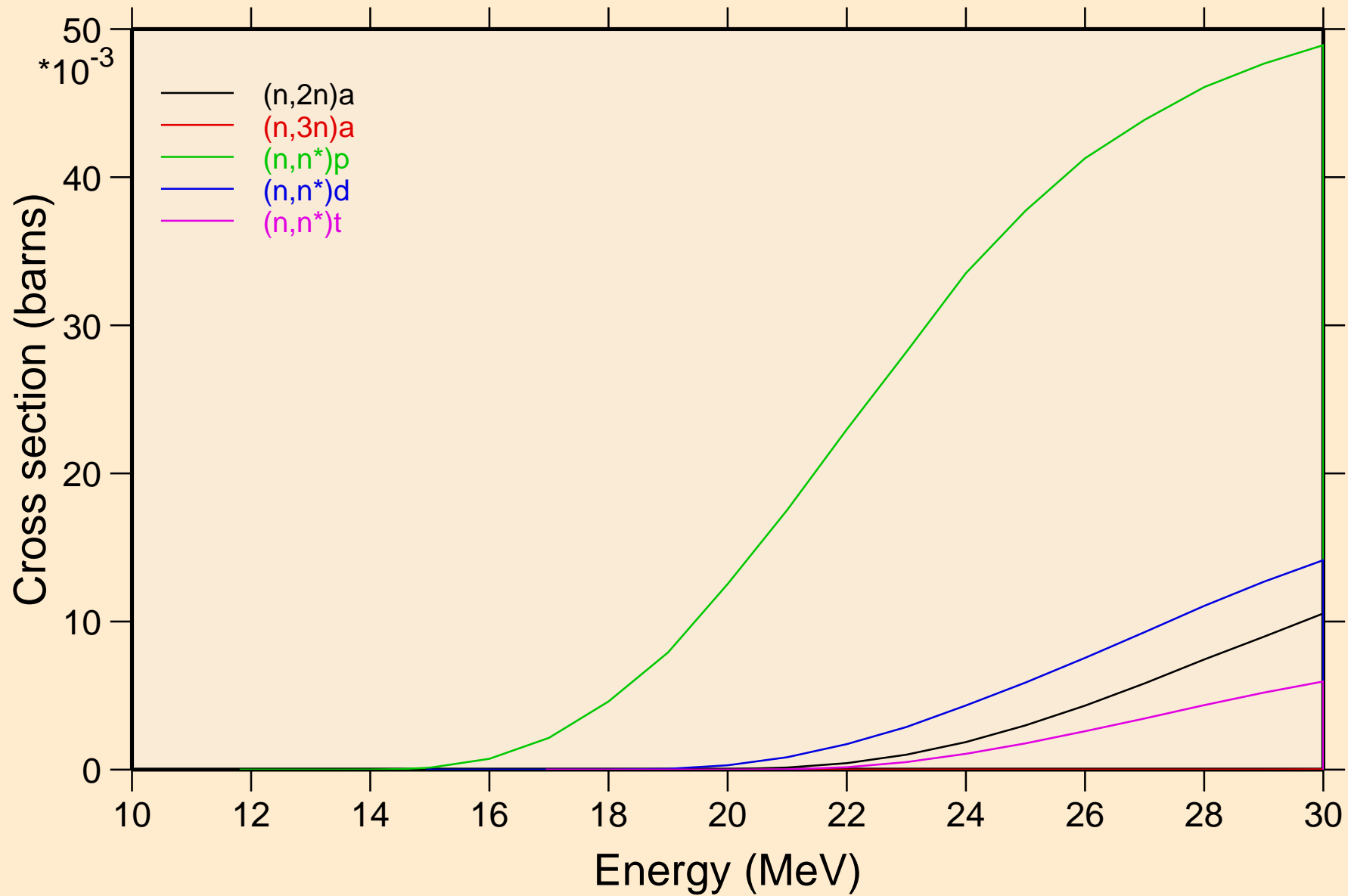

ZN071 NEUTRON ACER TENDL-2024 LIBRARY; T=0.K
Threshold reactions

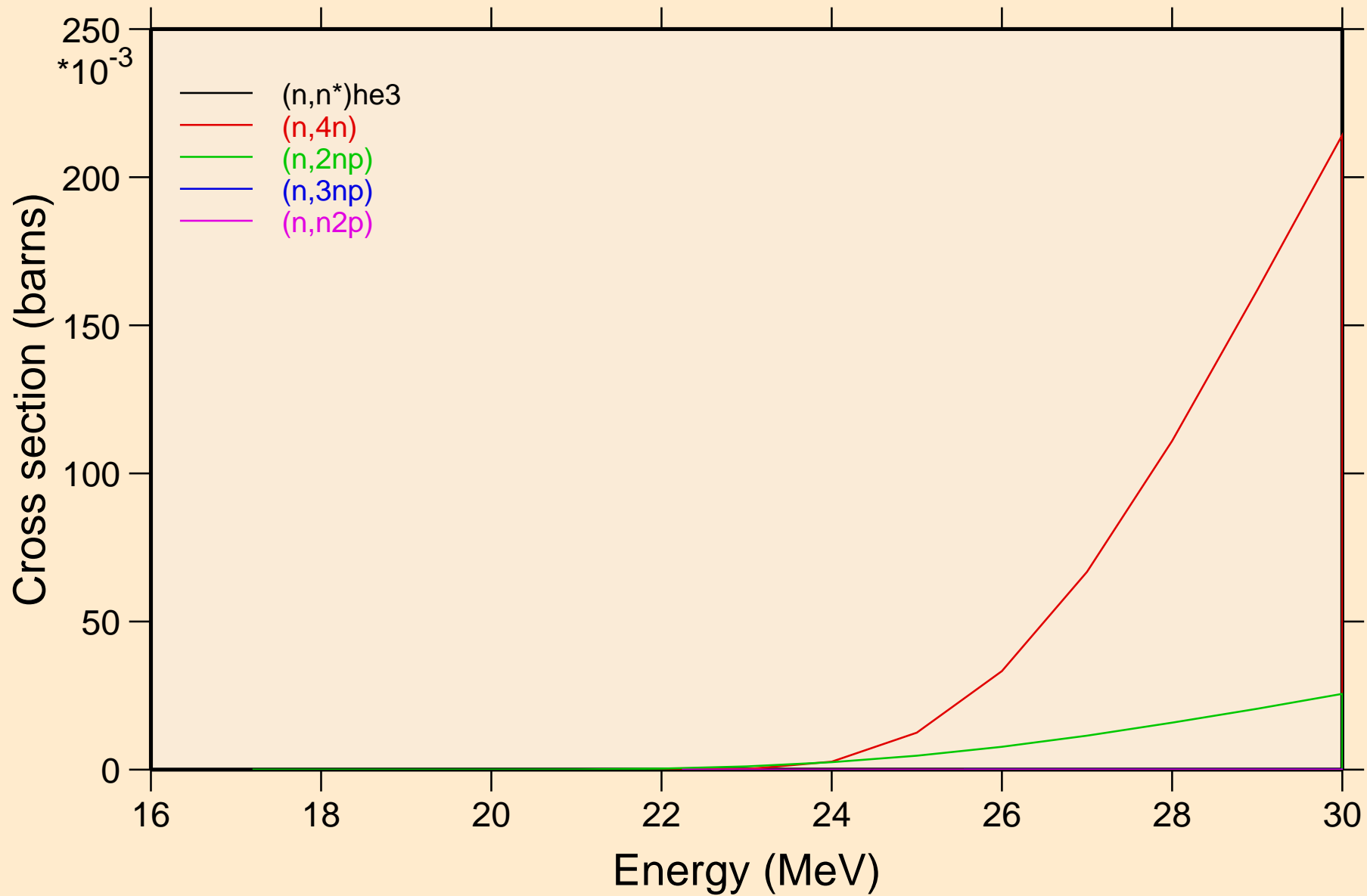

ZN071 NEUTRON ACER TENDL-2024 LIBRARY; T=0.K
Threshold reactions

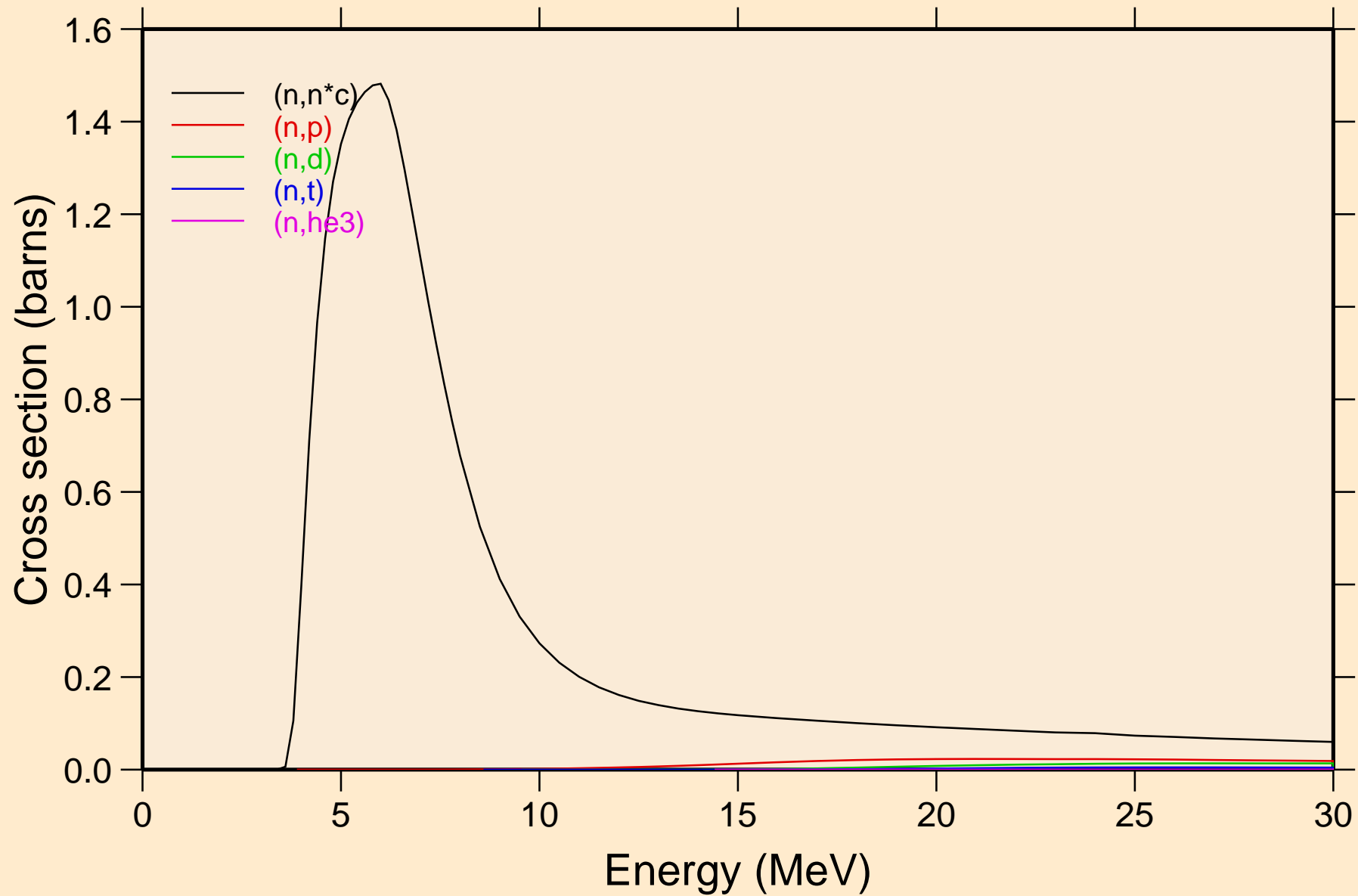

ZN071 NEUTRON ACER TENDL-2024 LIBRARY; T=0.K
Threshold reactions

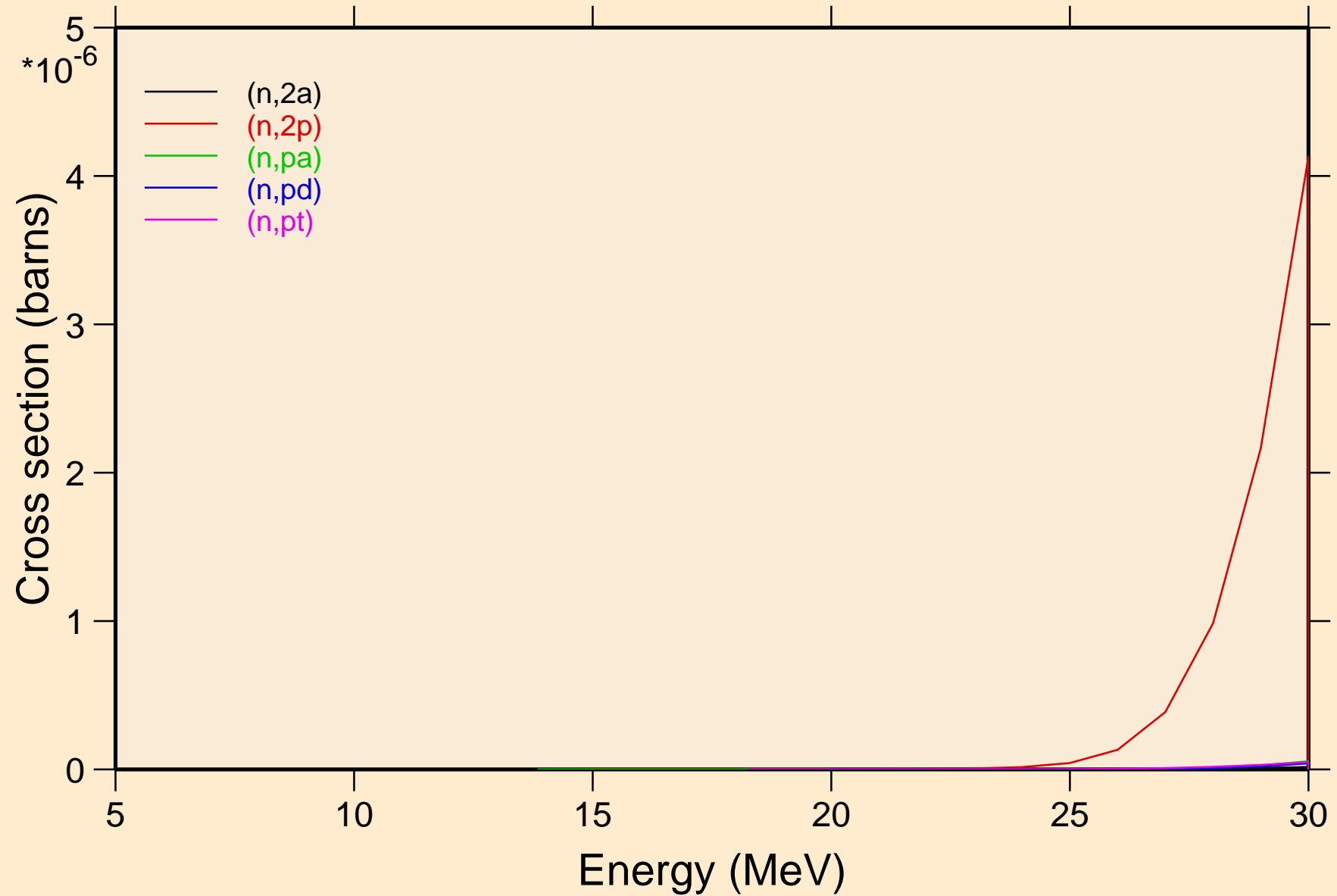

ZN071 NEUTRON ACER TENDL-2024 LIBRARY; T=0.K

Threshold reactions

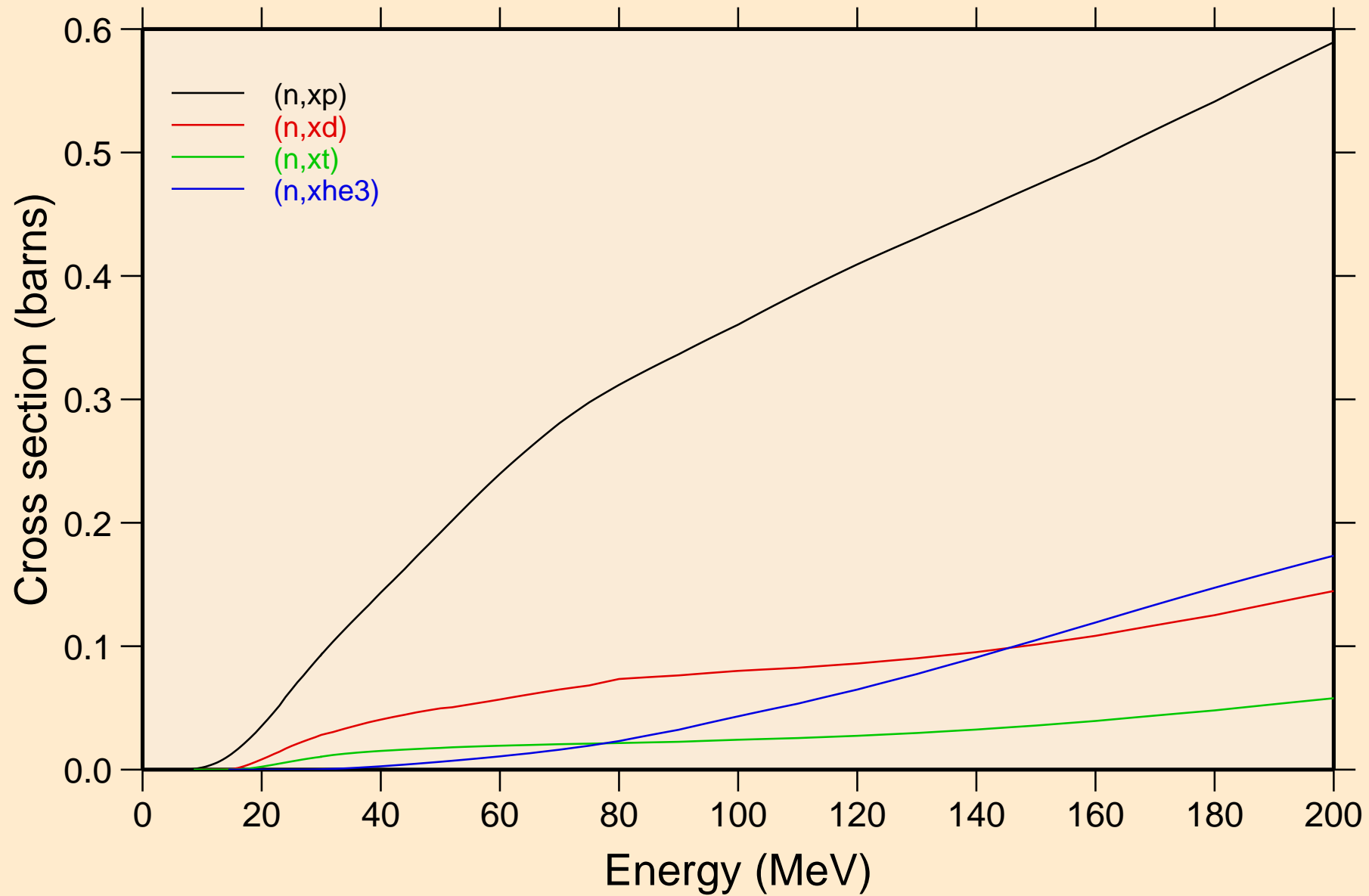

ZN071 NEUTRON ACER TENDL-2024 LIBRARY; T=0.K
angular distribution for elastic

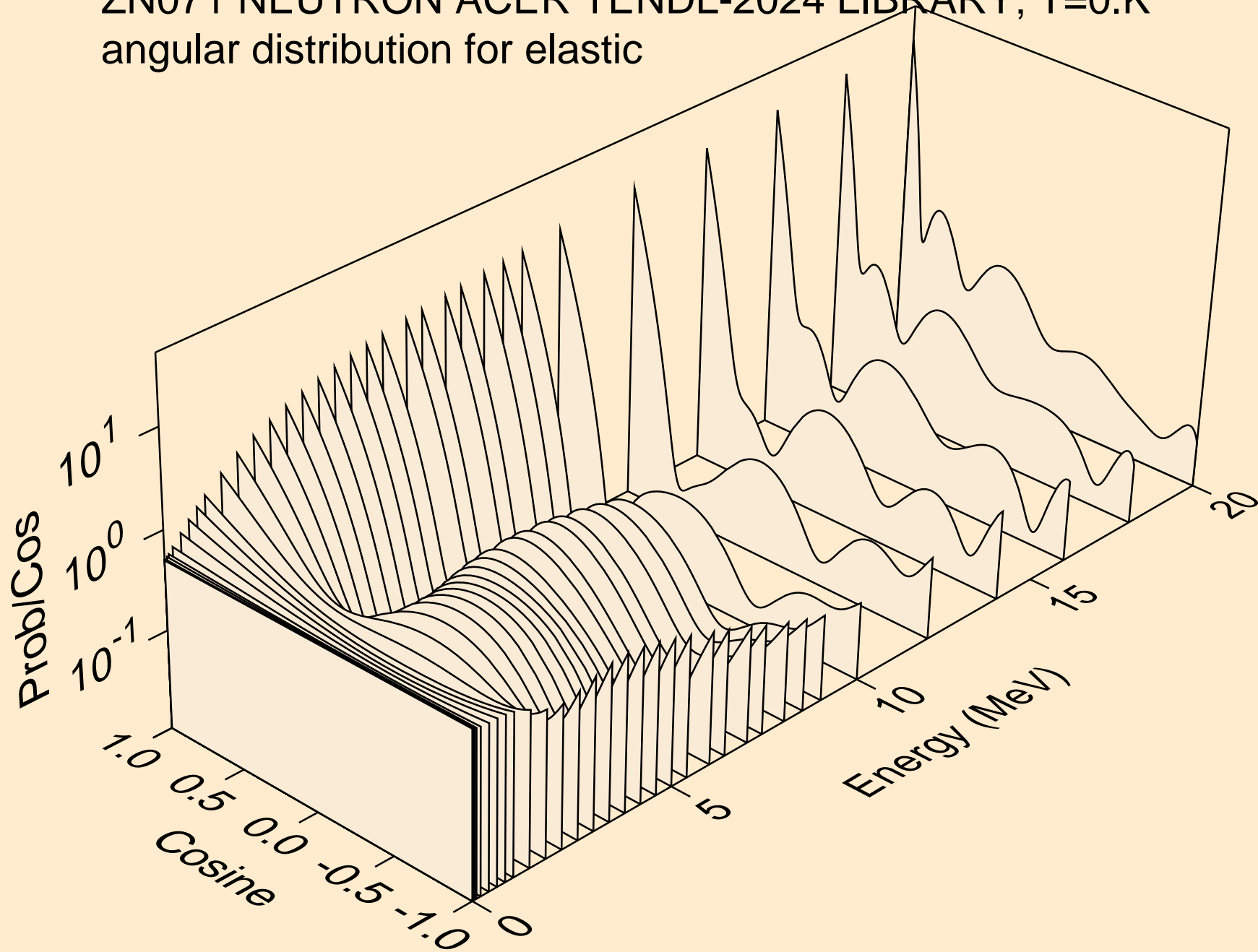

ZN071 NEUTRON ACER TENDL-2024 LIBRARY; T=0.K
angular distribution for elastic

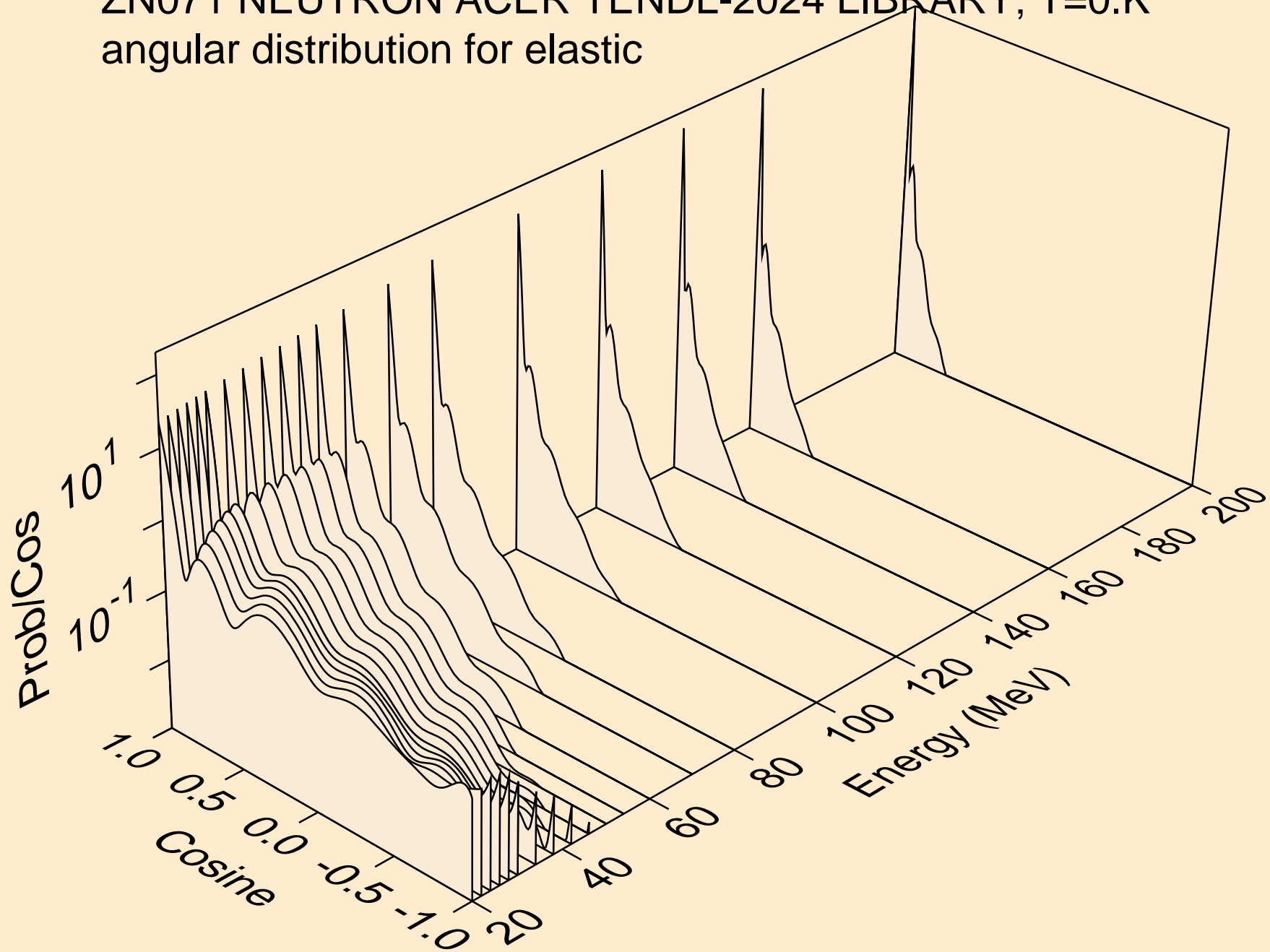

ZN071 NEUTRON ACER TENDL-2024 LIBRARY; T=0.K
angular distribution for (n,n*1)

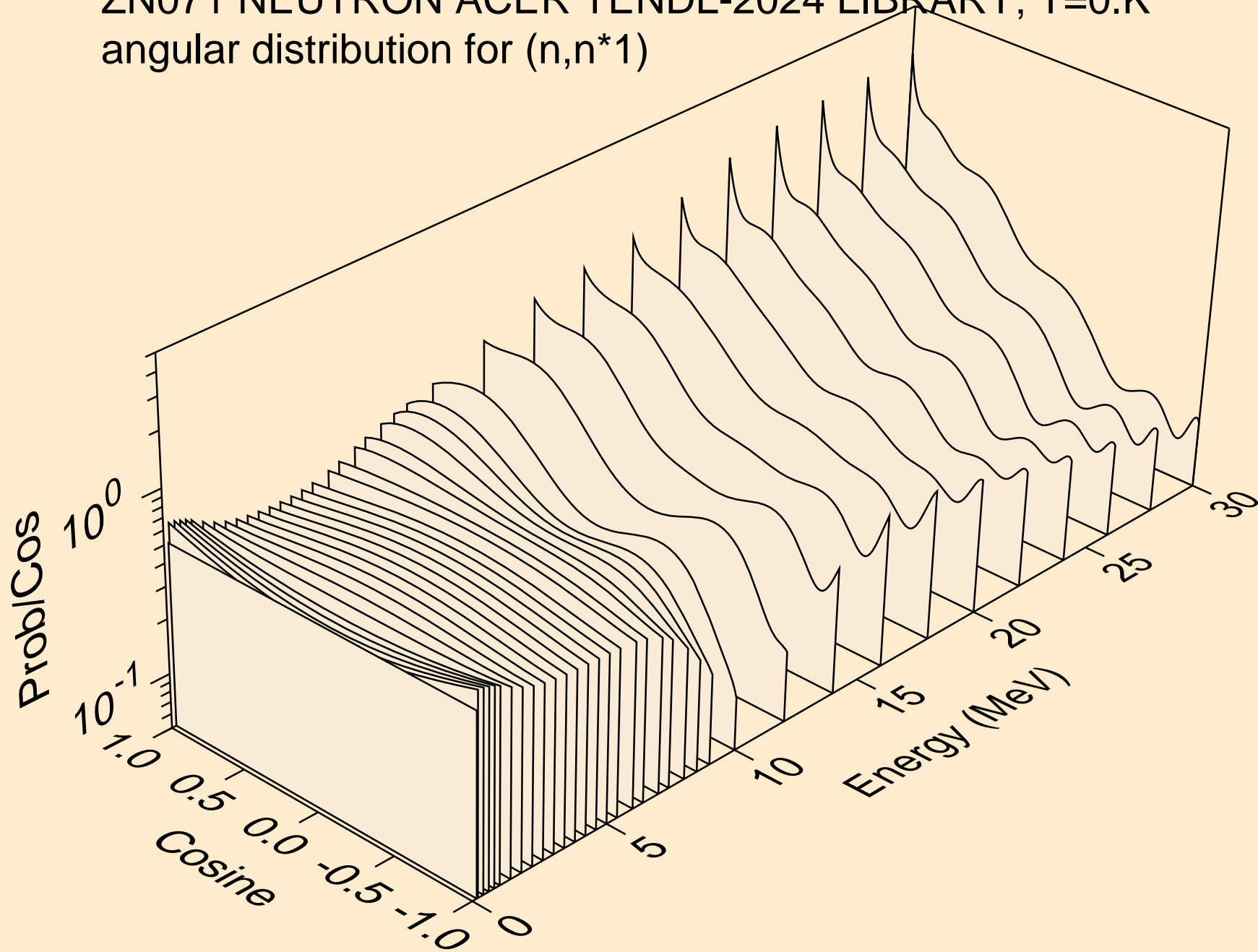

ZN071 NEUTRON ACER TENDL-2024 LIBRARY; T=0.K
angular distribution for (n,n*2)

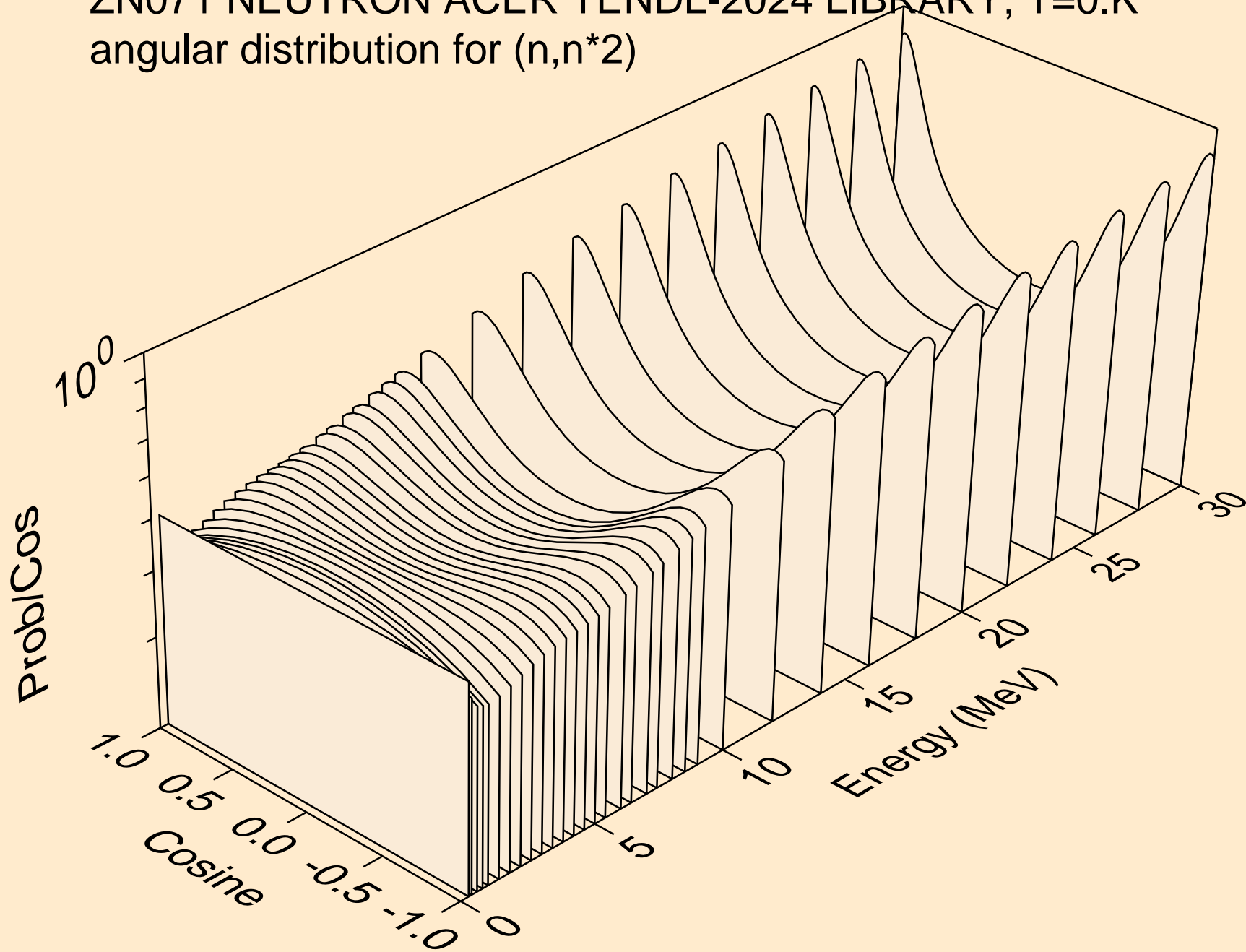

ZN071 NEUTRON ACER TENDL-2024 LIBRARY; T=0.K
angular distribution for (n,n*3)

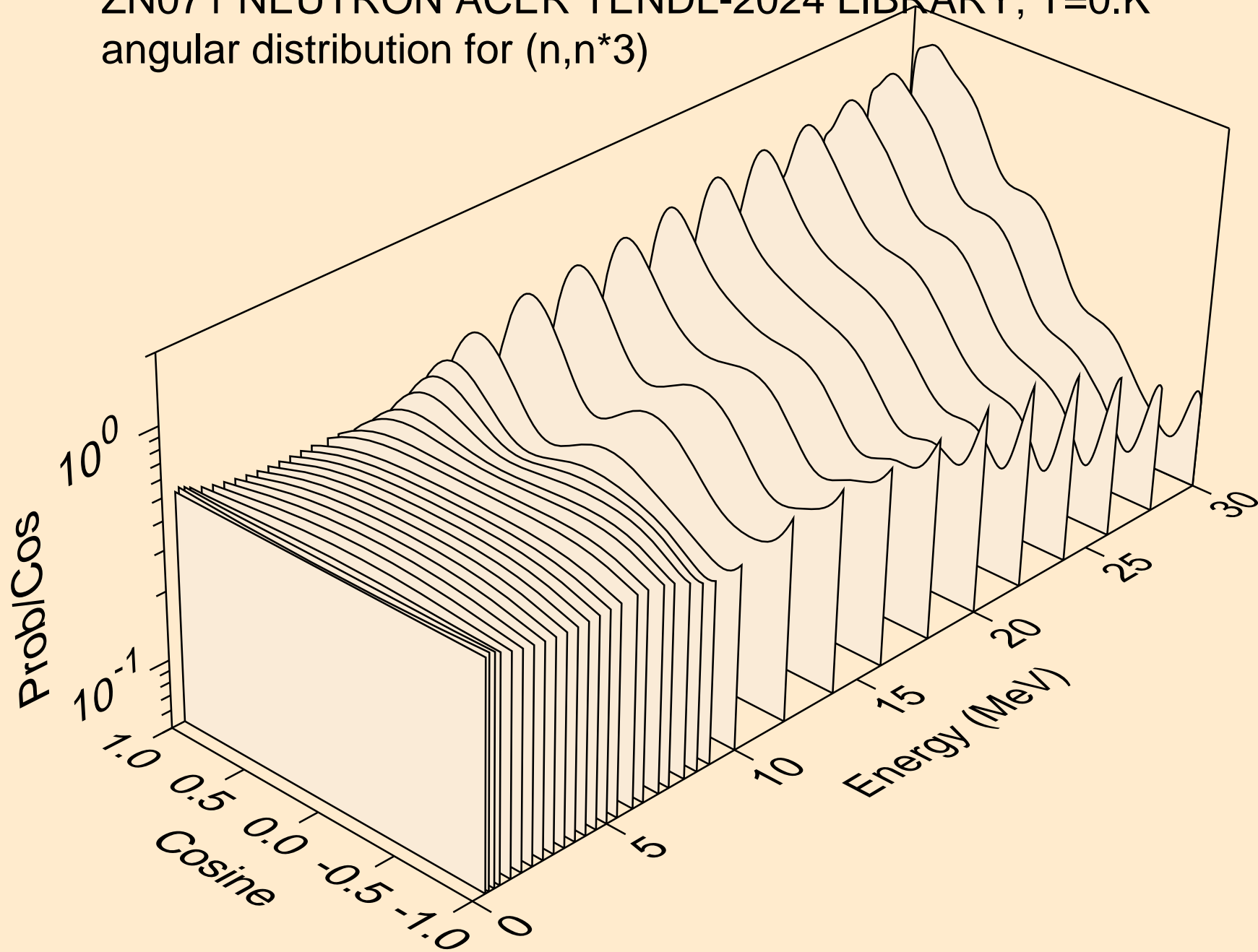

ZN071 NEUTRON ACER TENDL-2024 LIBRARY; T=0.K
angular distribution for (n,n*4)

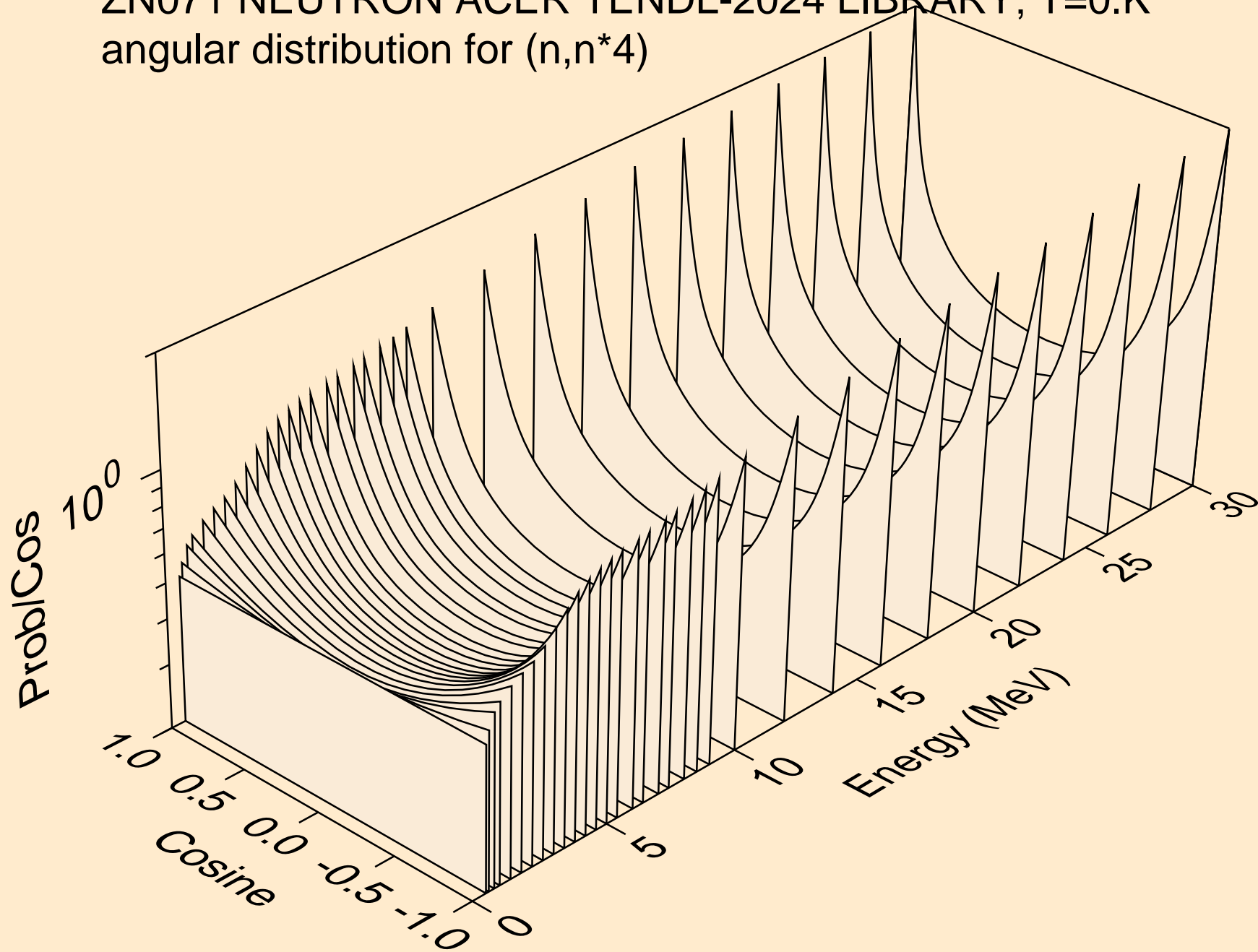

ZN071 NEUTRON ACER TENDL-2024 LIBRARY; T=0.K
angular distribution for (n,n*5)

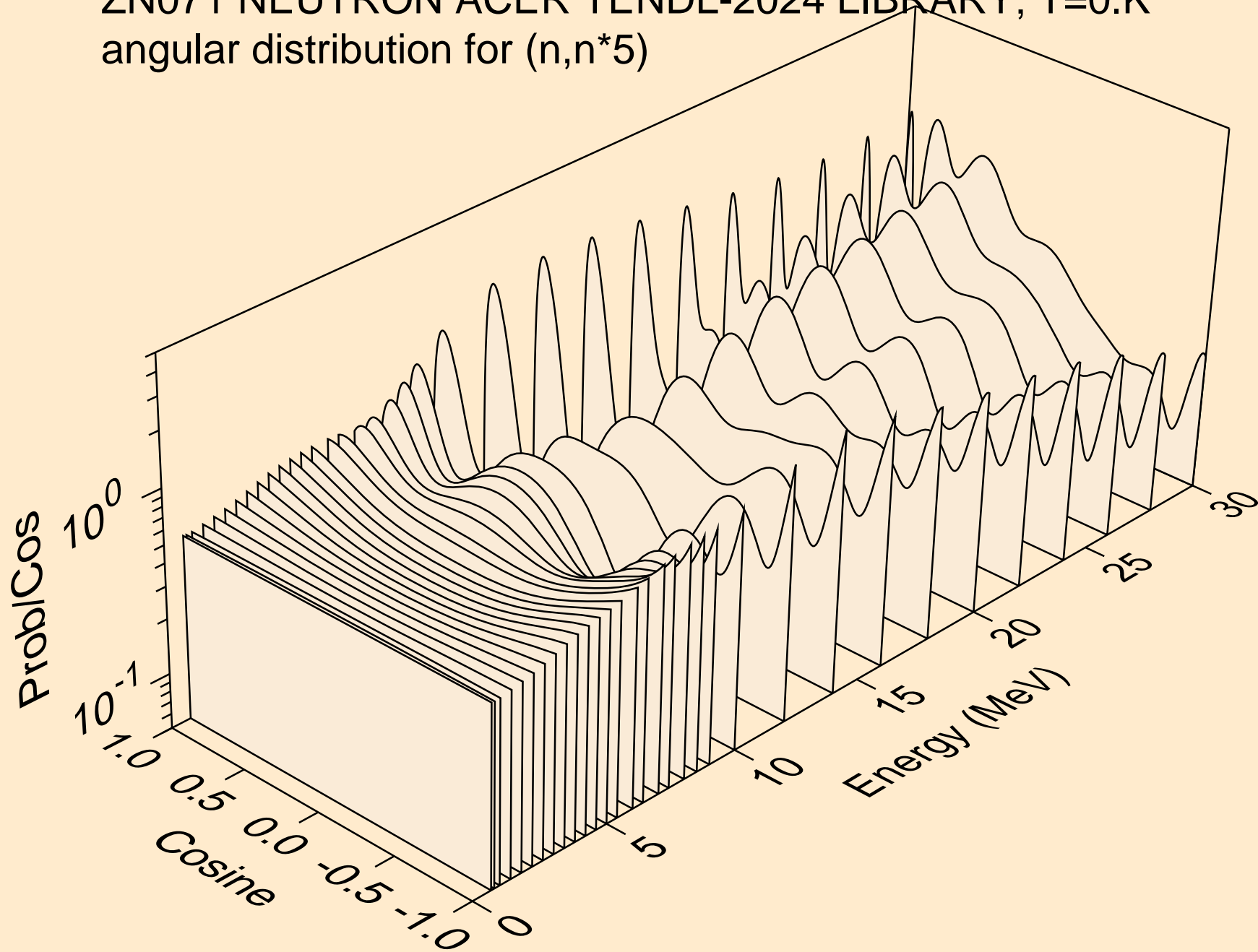

ZN071 NEUTRON ACER TENDL-2024 LIBRARY; T=0.K
angular distribution for (n,n*6)

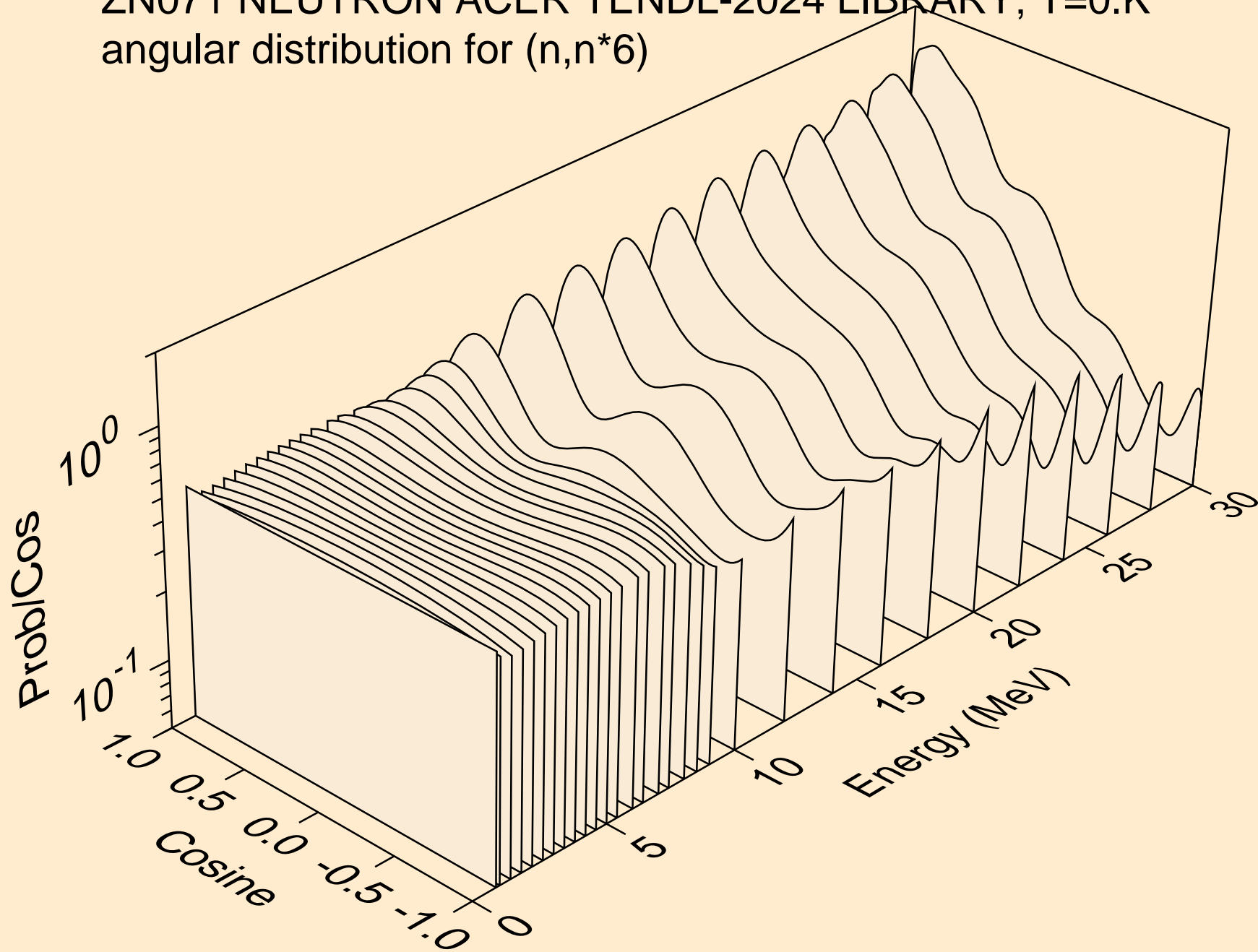

ZN071 NEUTRON ACER TENDL-2024 LIBRARY; T=0.K
angular distribution for (n,n*7)

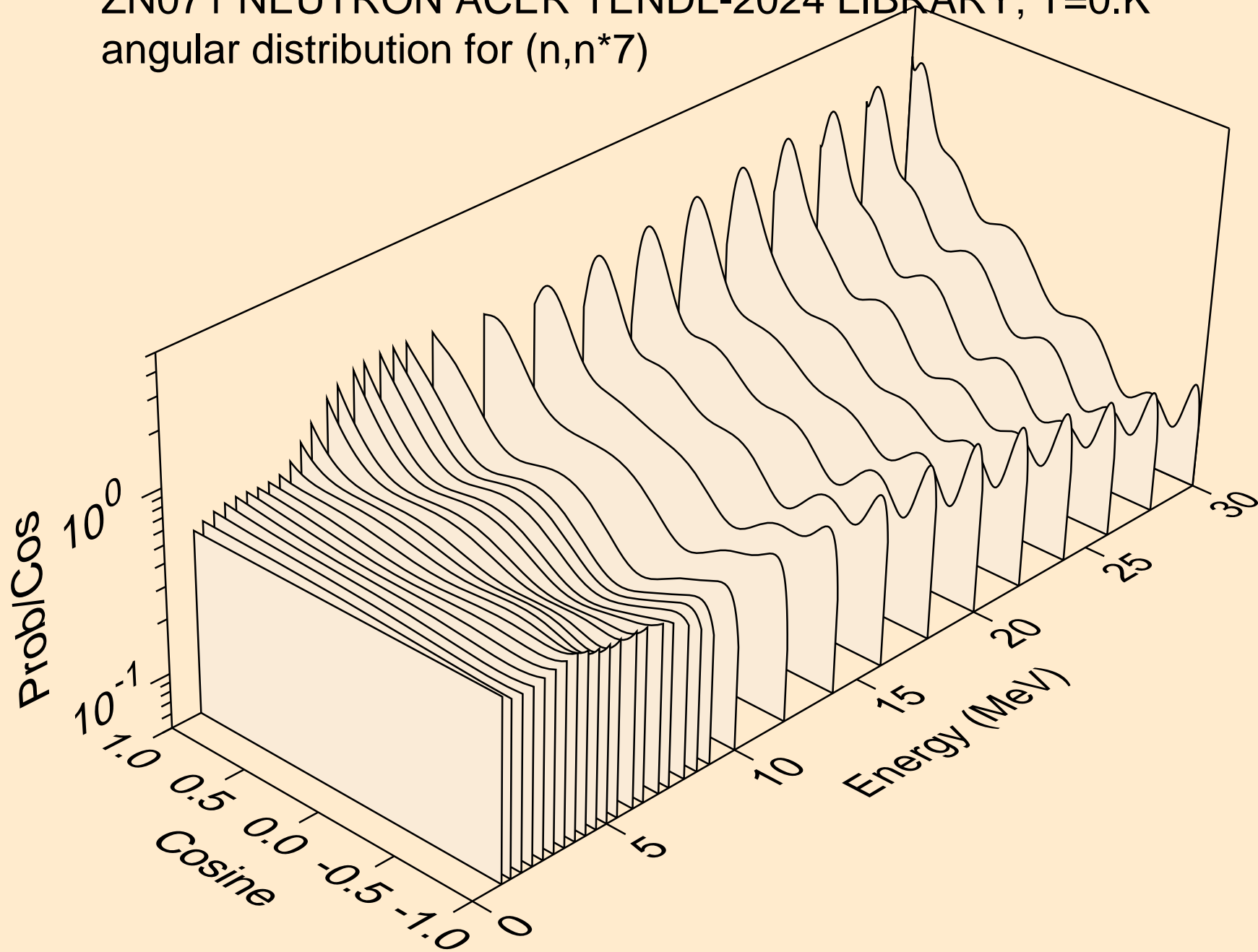

ZN071 NEUTRON ACER TENDL-2024 LIBRARY; T=0.K
angular distribution for (n,n*8)

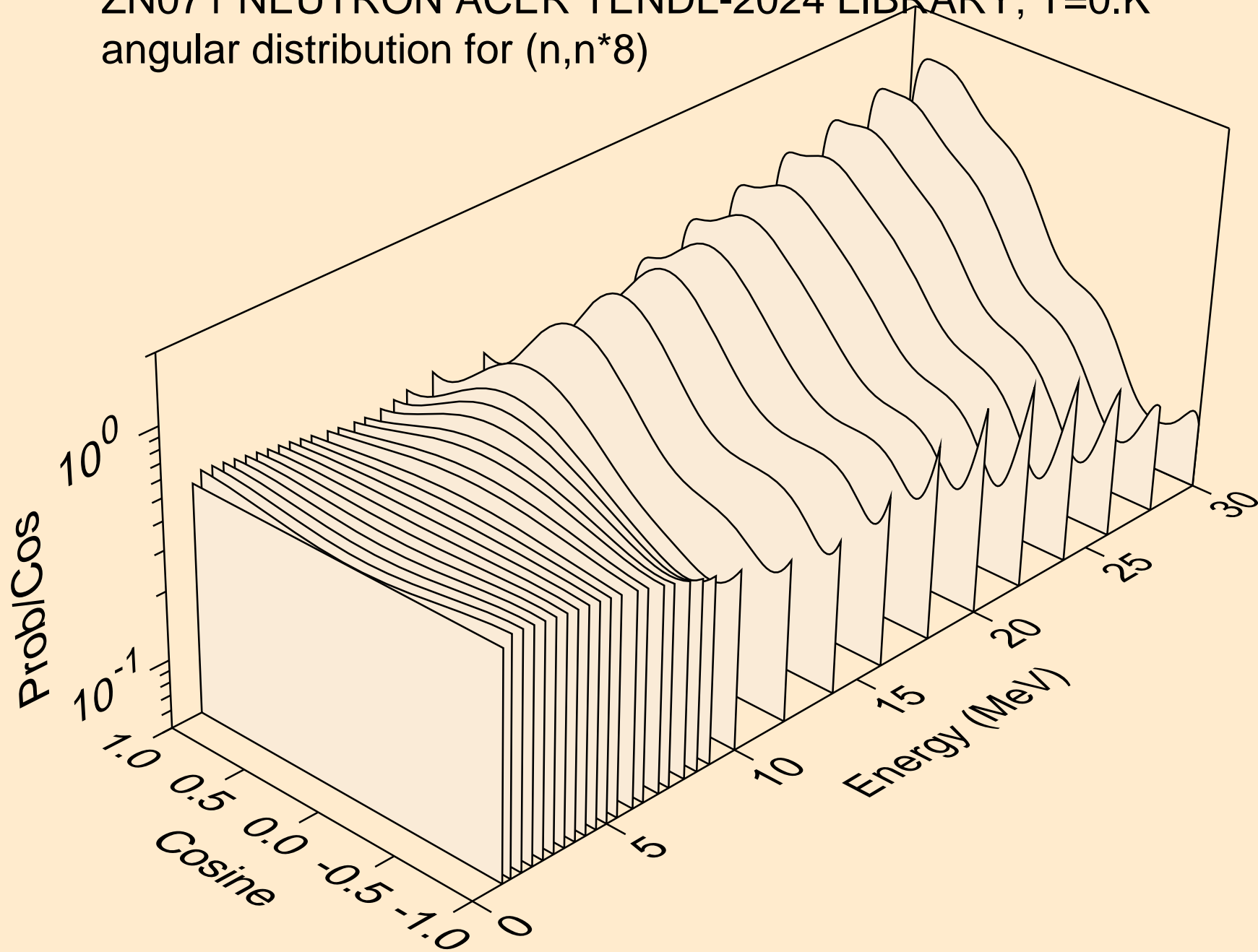

ZN071 NEUTRON ACER TENDL-2024 LIBRARY; T=0.K
angular distribution for (n,n*9)

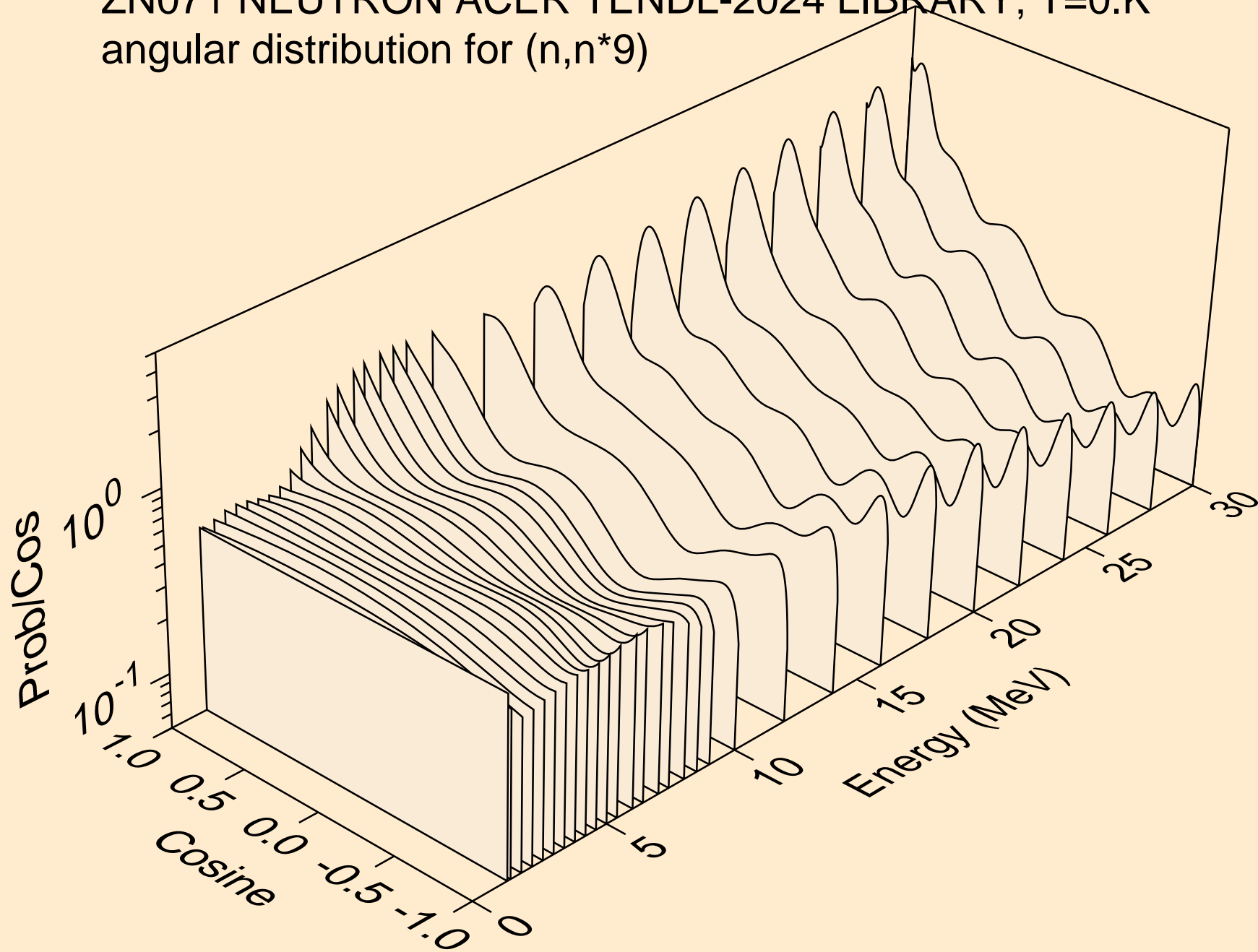

ZN071 NEUTRON ACER TENDL-2024 LIBRARY; T=0.K
angular distribution for (n,n*10)

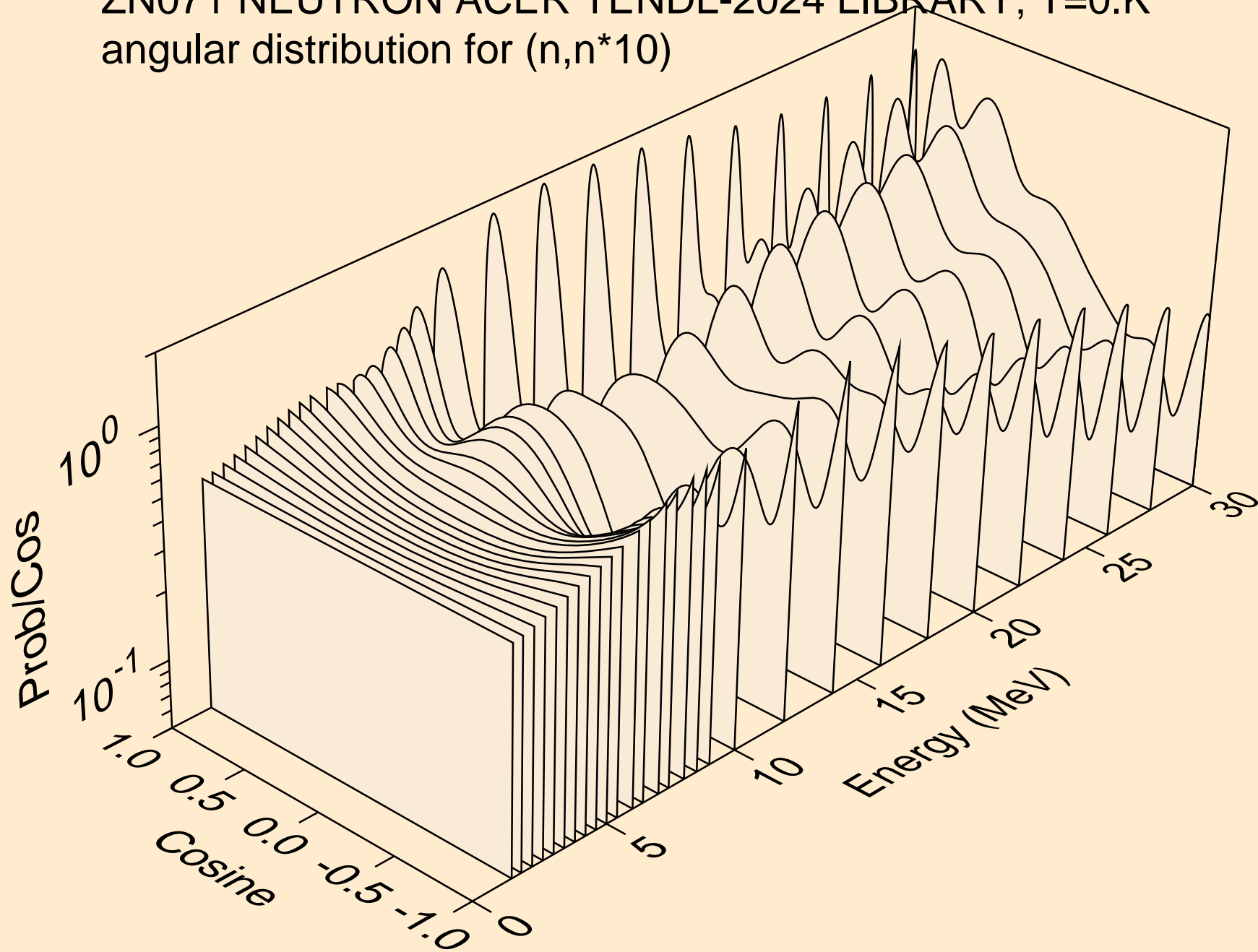

ZN071 NEUTRON ACER TENDL-2024 LIBRARY; T=0.K
angular distribution for (n,n*11)

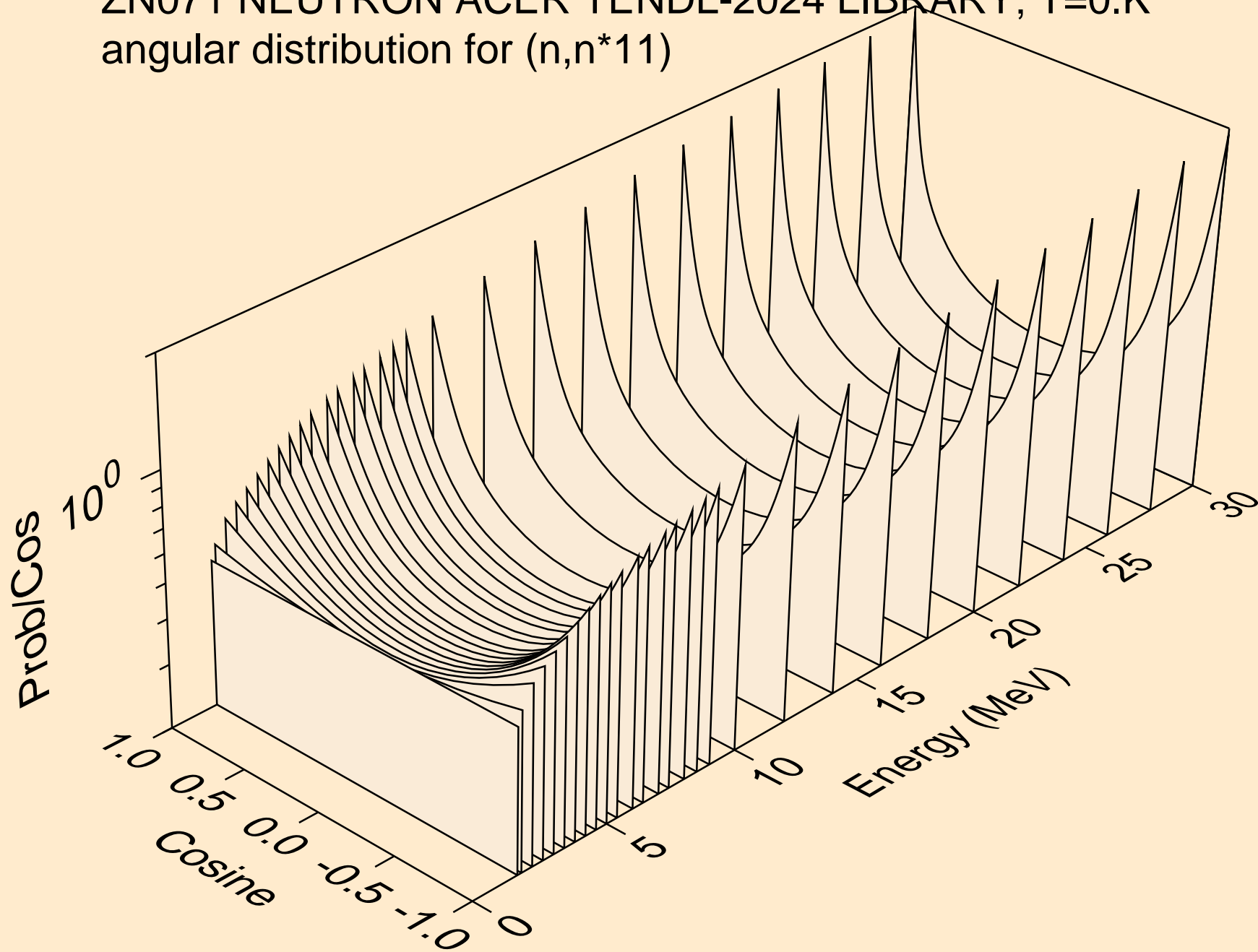

ZN071 NEUTRON ACER TENDL-2024 LIBRARY; T=0.K
angular distribution for (n,n*12)

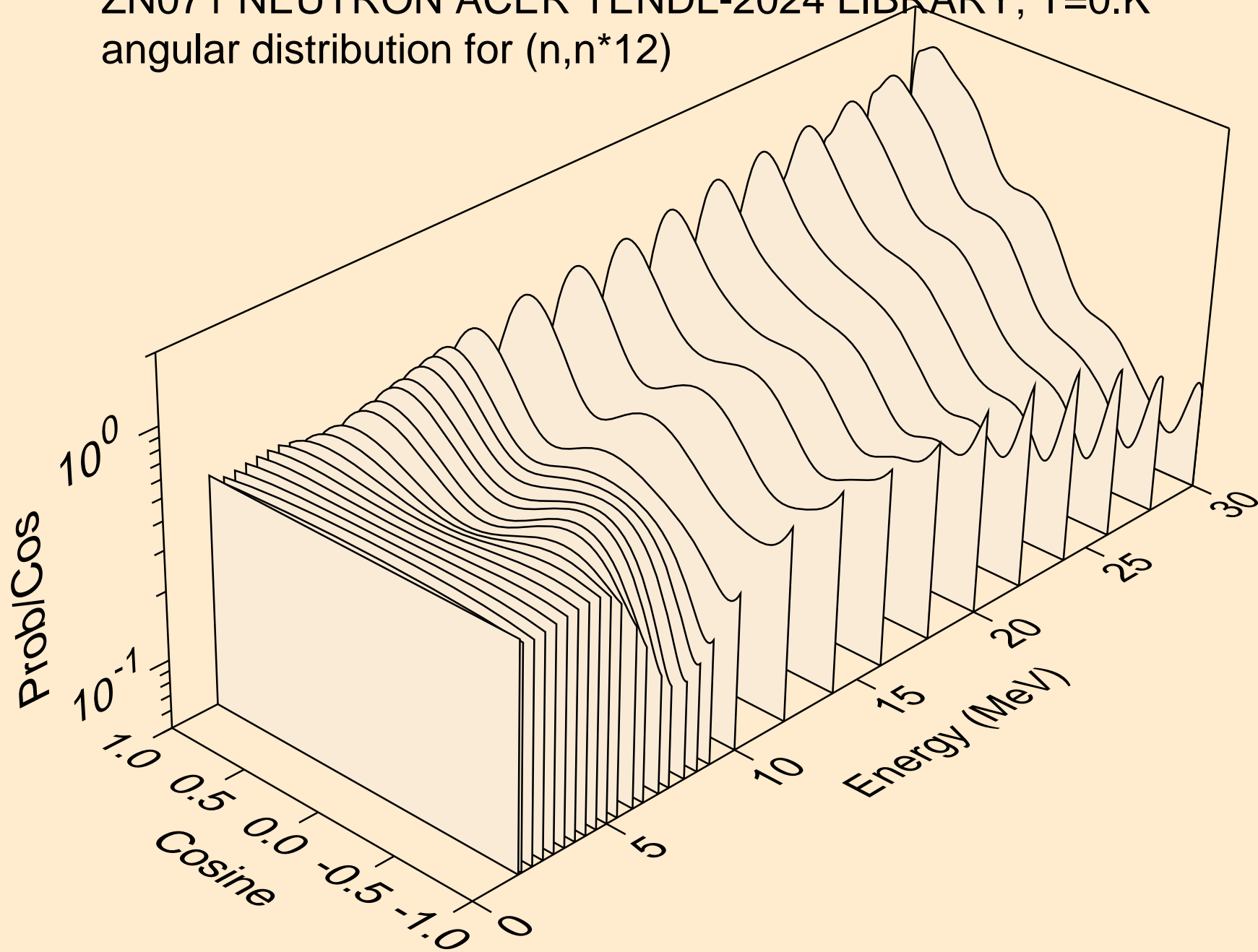

ZN071 NEUTRON ACER TENDL-2024 LIBRARY; T=0.K
angular distribution for (n,n*13)

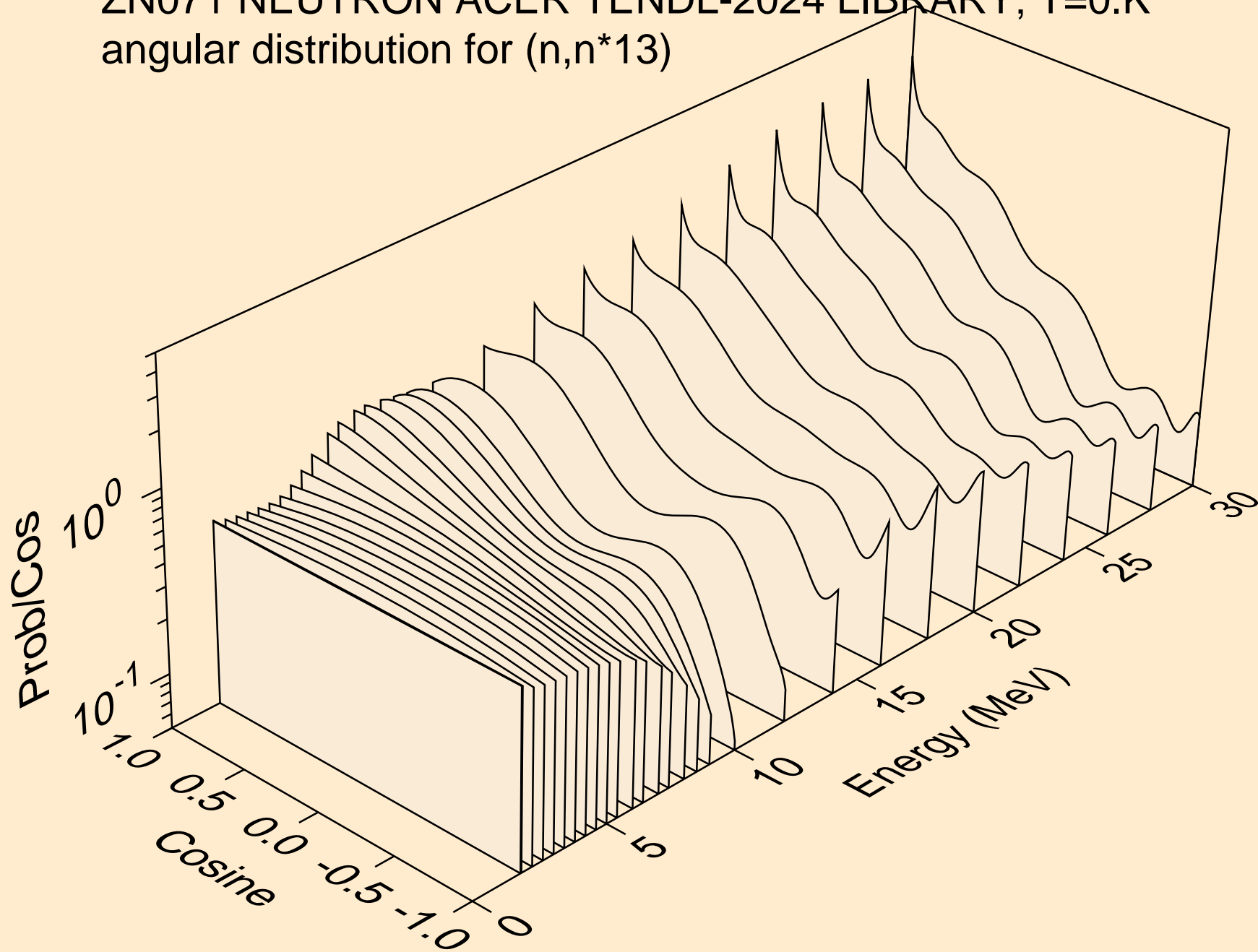

ZN071 NEUTRON ACER TENDL-2024 LIBRARY; T=0.K
angular distribution for (n,n*14)

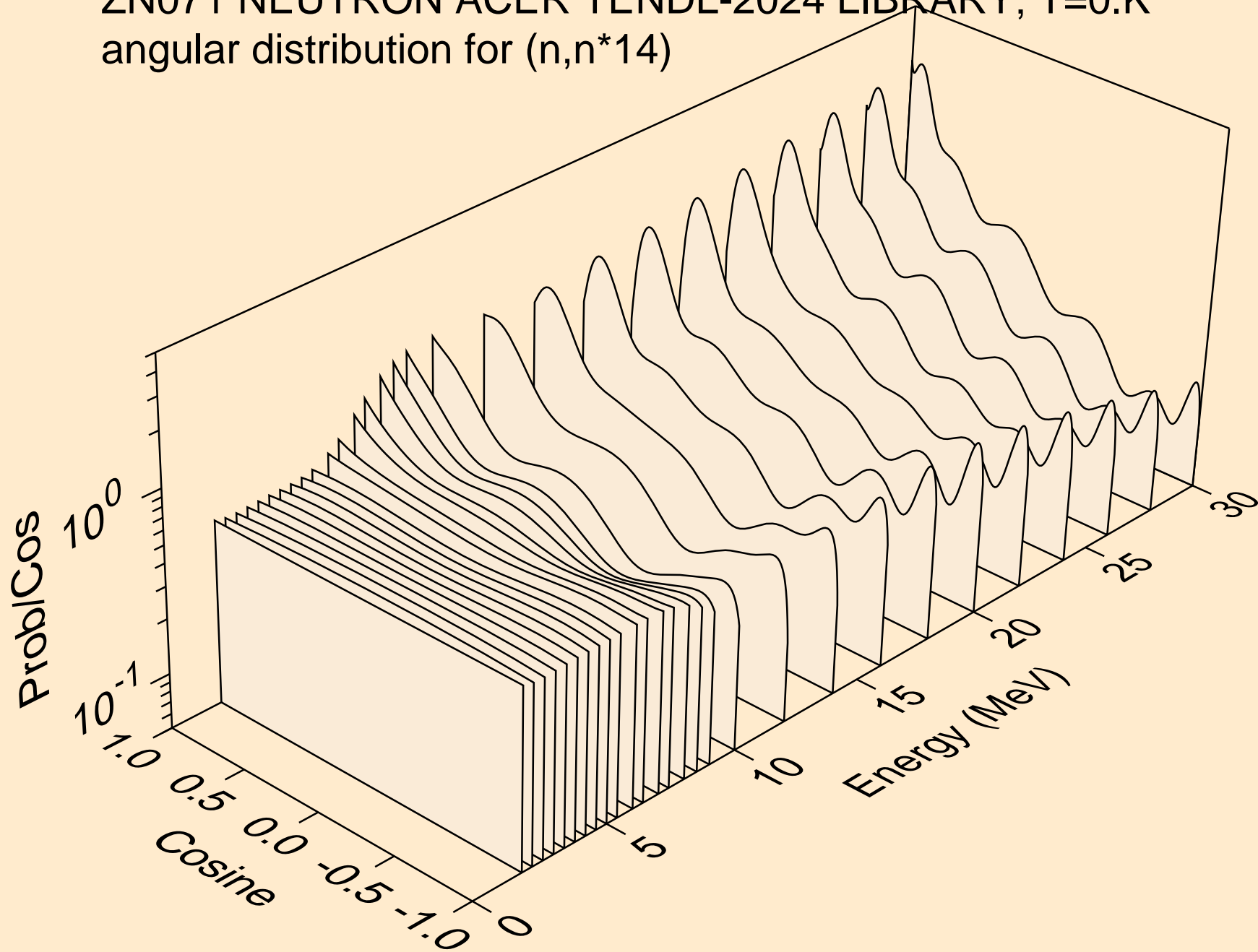

ZN071 NEUTRON ACER TENDL-2024 LIBRARY; T=0.K
angular distribution for (n,n*15)

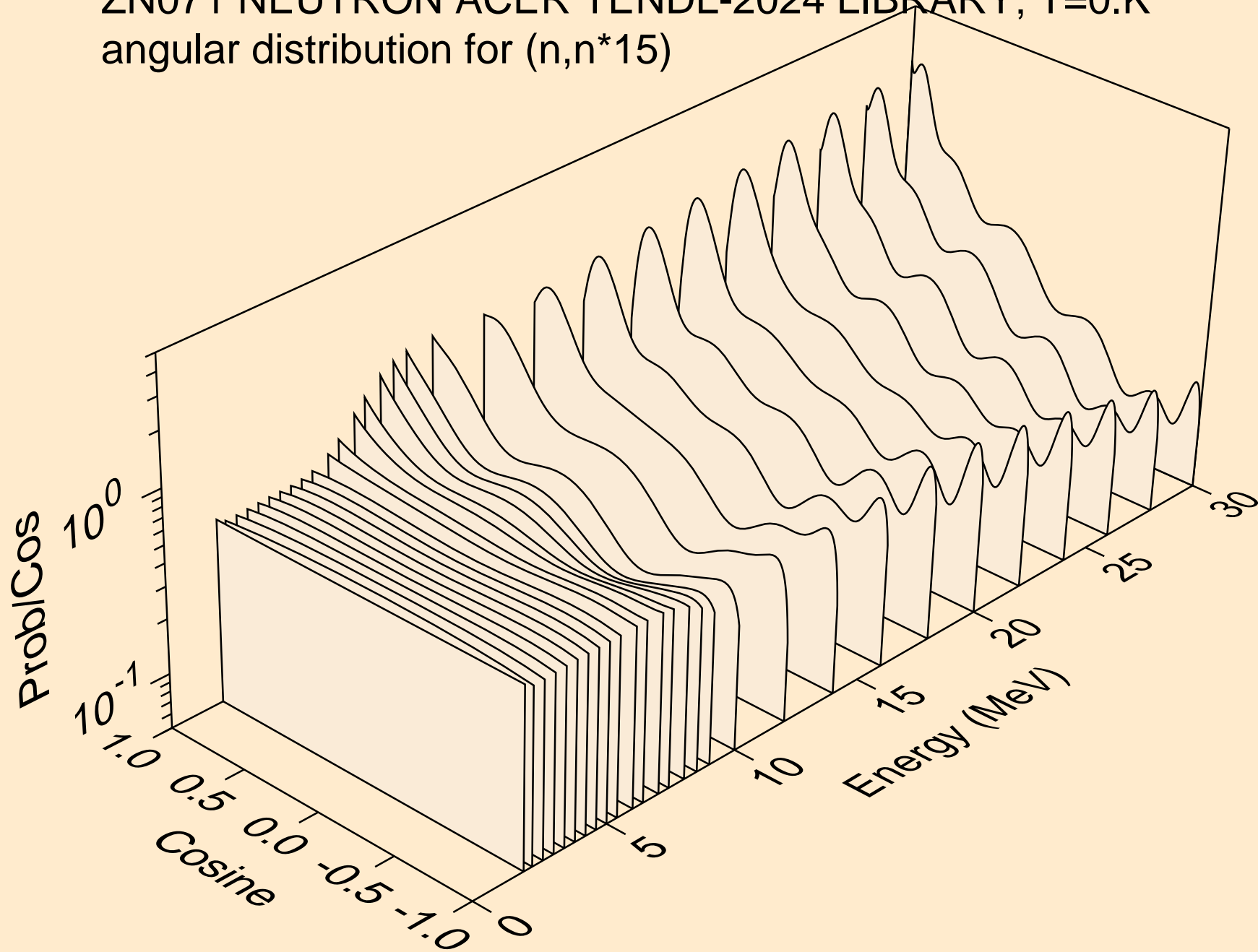

ZN071 NEUTRON ACER TENDL-2024 LIBRARY; T=0.K
angular distribution for (n,n*16)

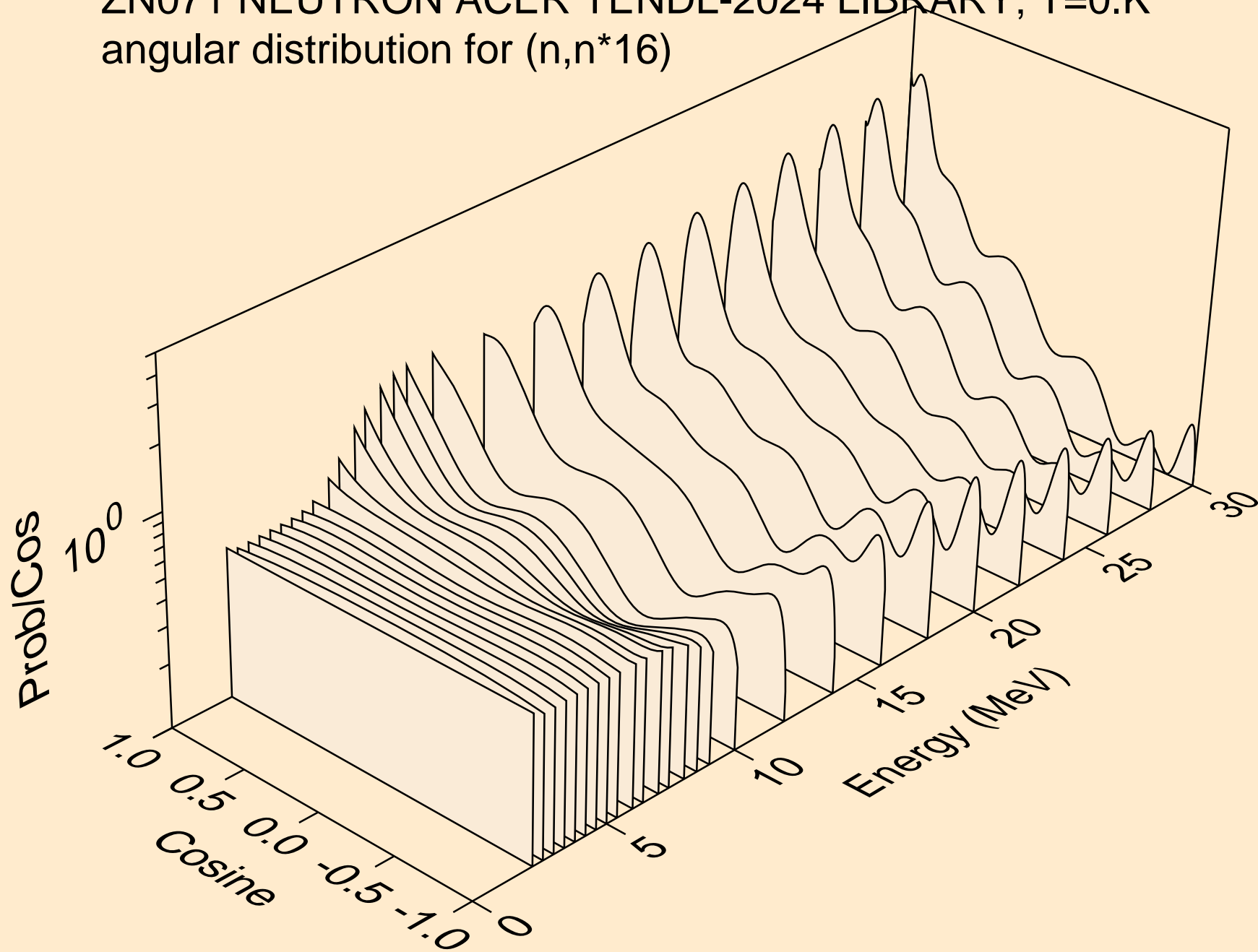

ZN071 NEUTRON ACER TENDL-2024 LIBRARY; T=0.K
angular distribution for (n,n*17)

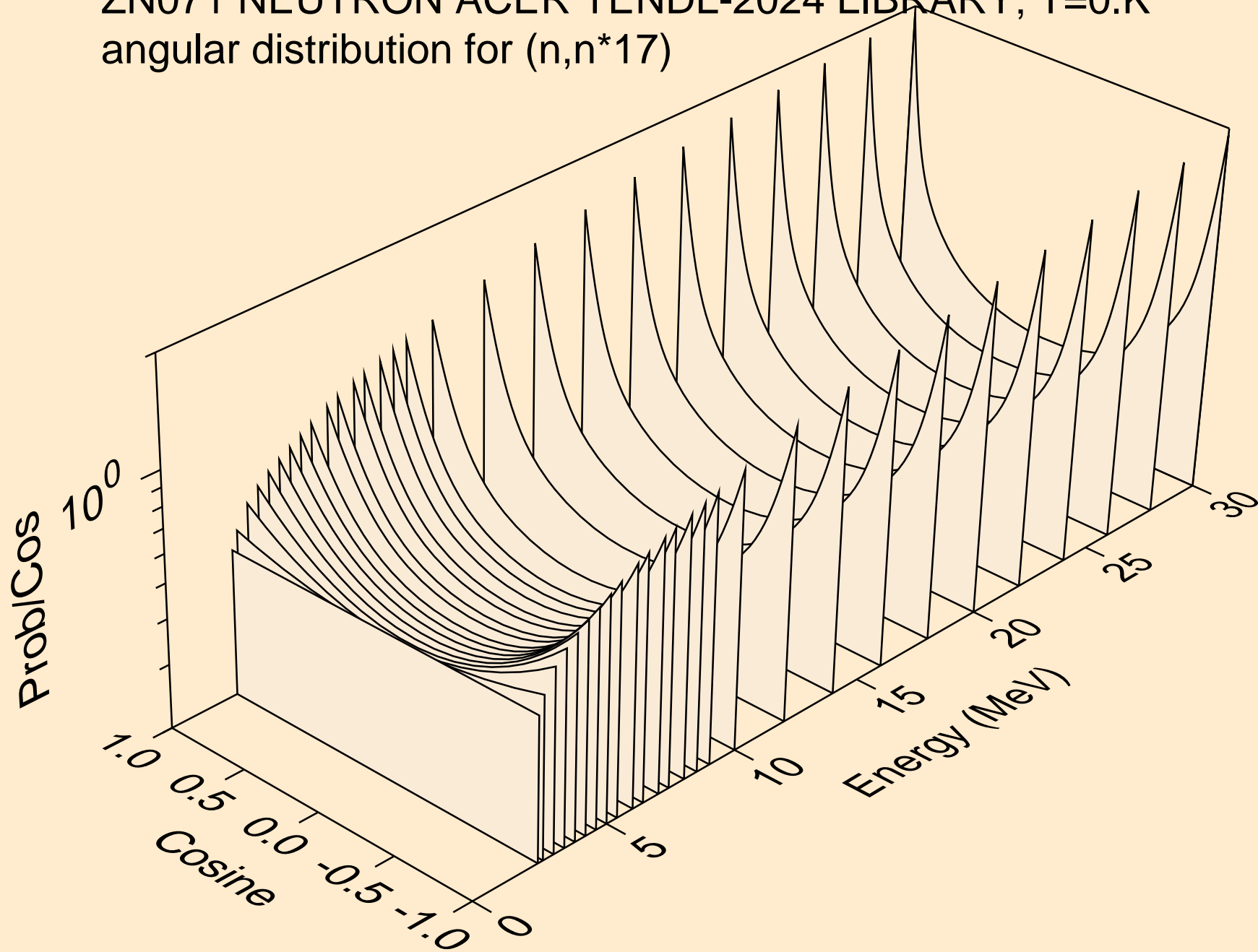

ZN071 NEUTRON ACER TENDL-2024 LIBRARY; T=0.K
angular distribution for (n,n*18)

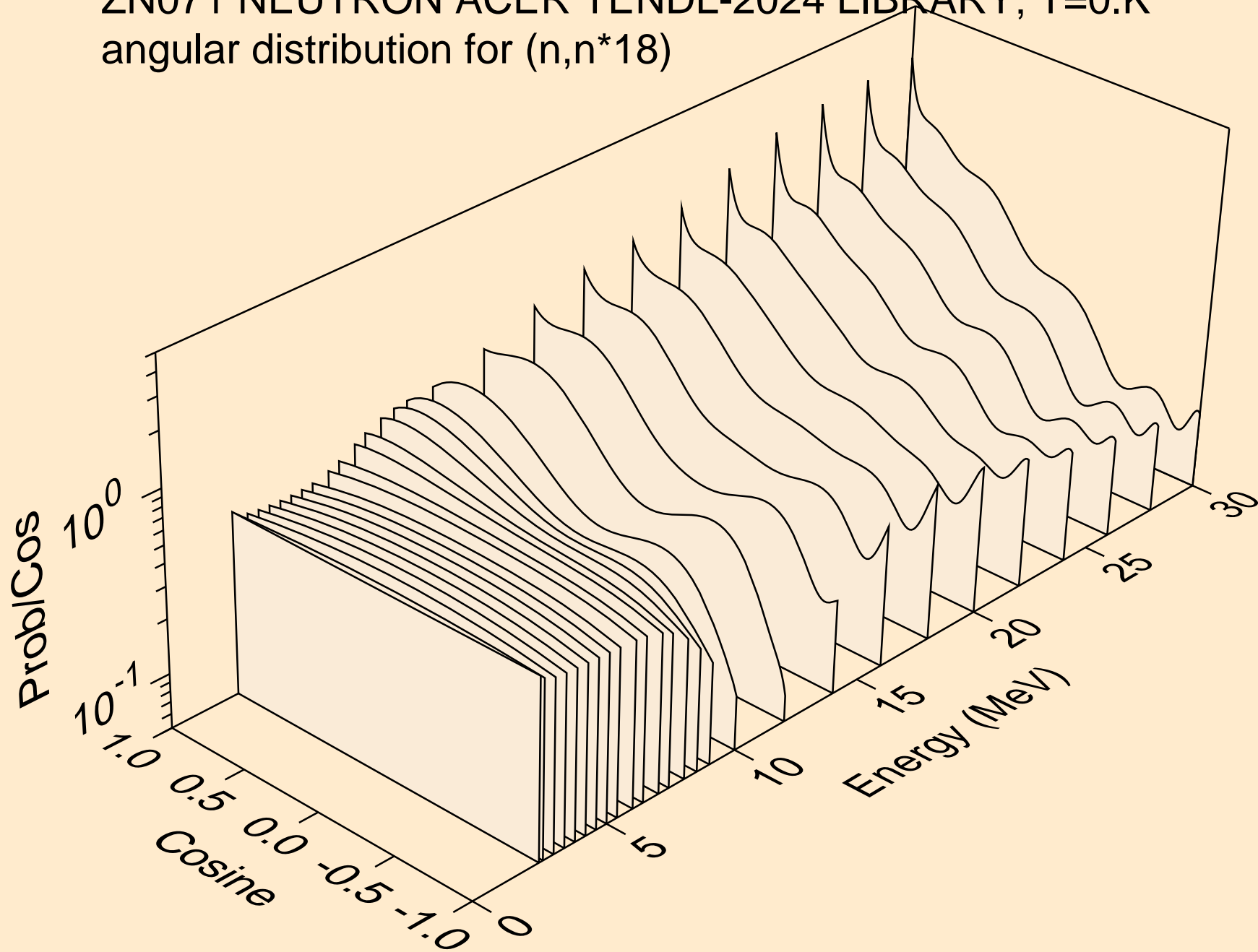

ZN071 NEUTRON ACER TENDL-2024 LIBRARY; T=0.K
angular distribution for (n,n*19)

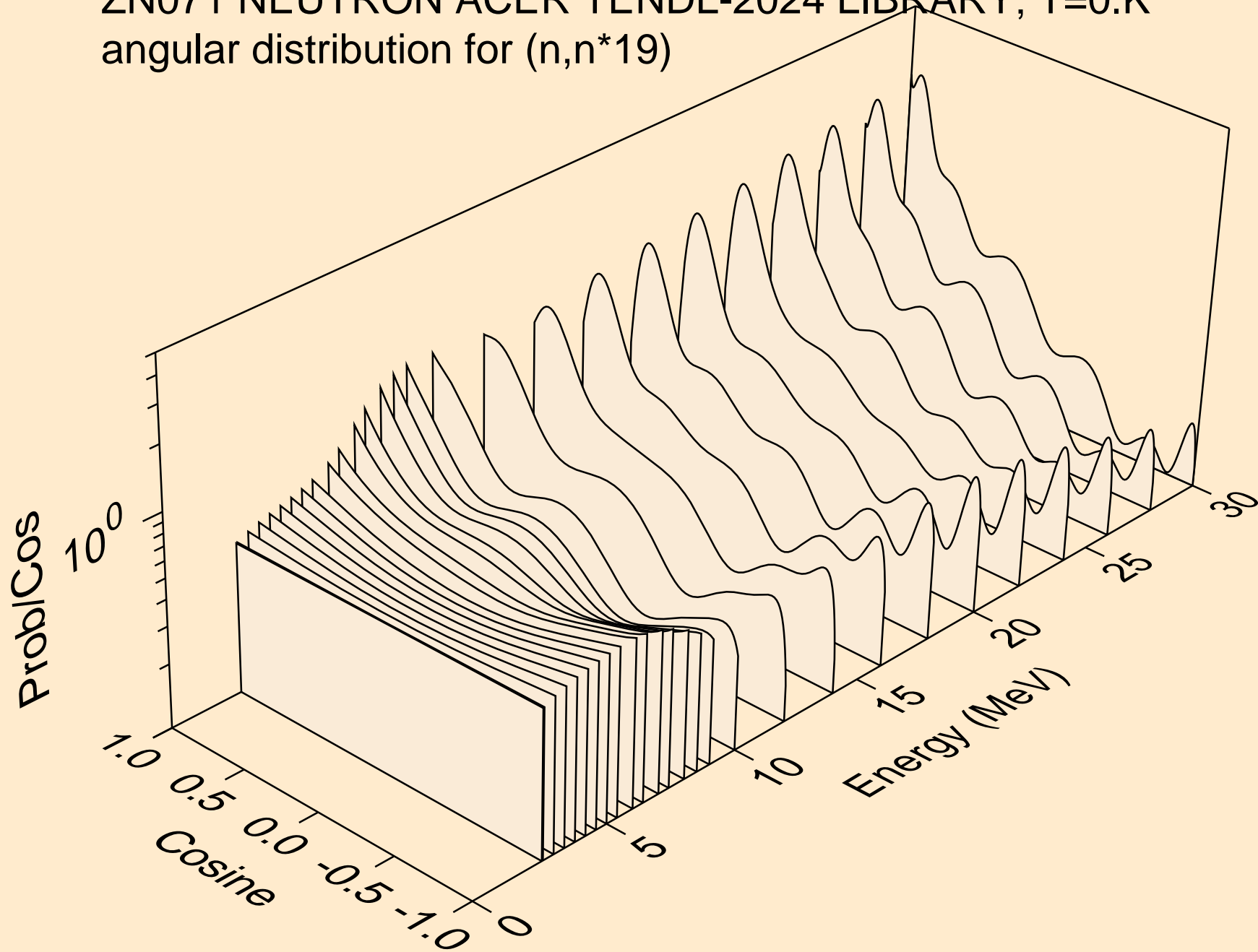

ZN071 NEUTRON ACER TENDL-2024 LIBRARY; T=0.K
angular distribution for (n,n*20)

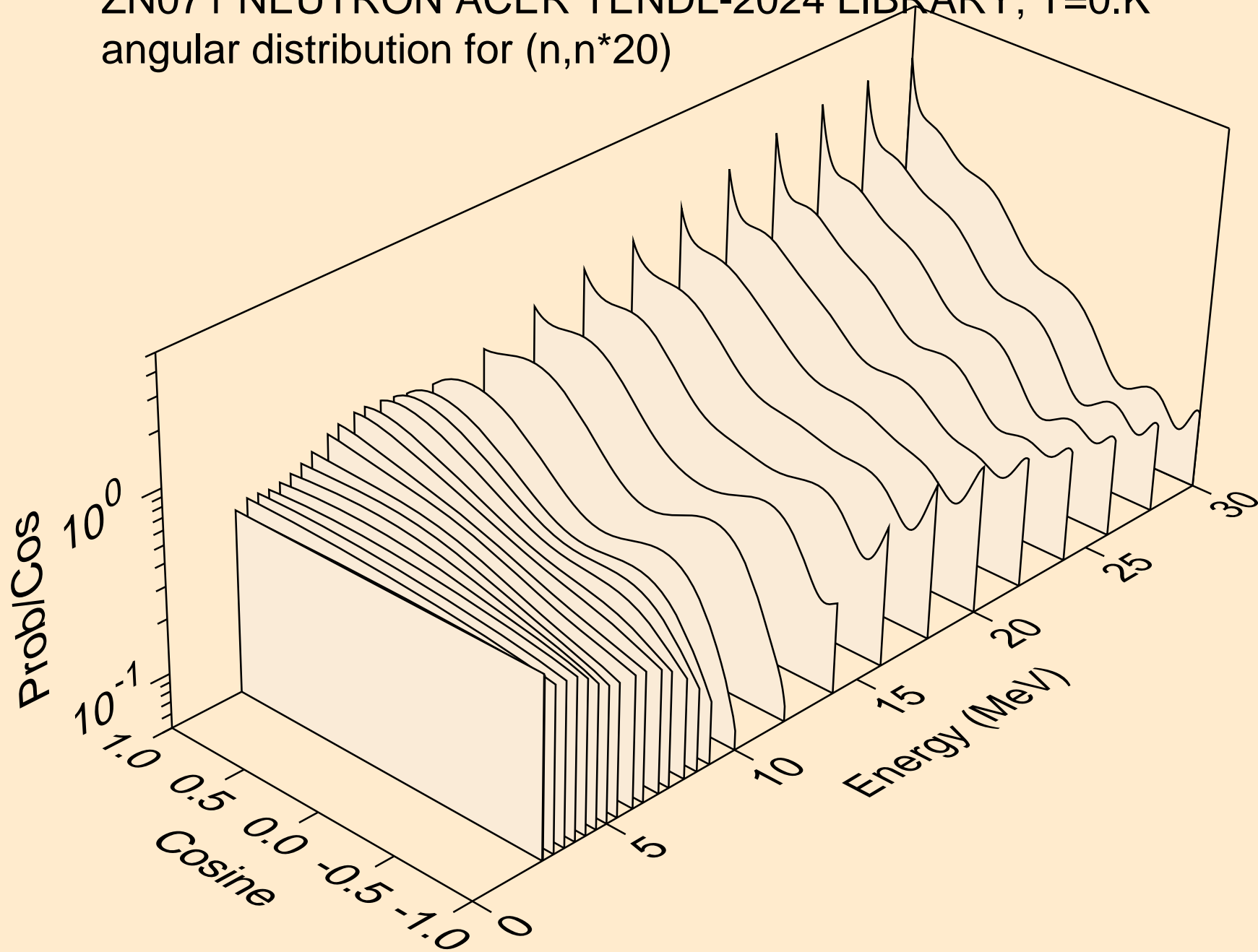

ZN071 NEUTRON ACER TENDL-2024 LIBRARY; T=0.K
angular distribution for (n,n*21)

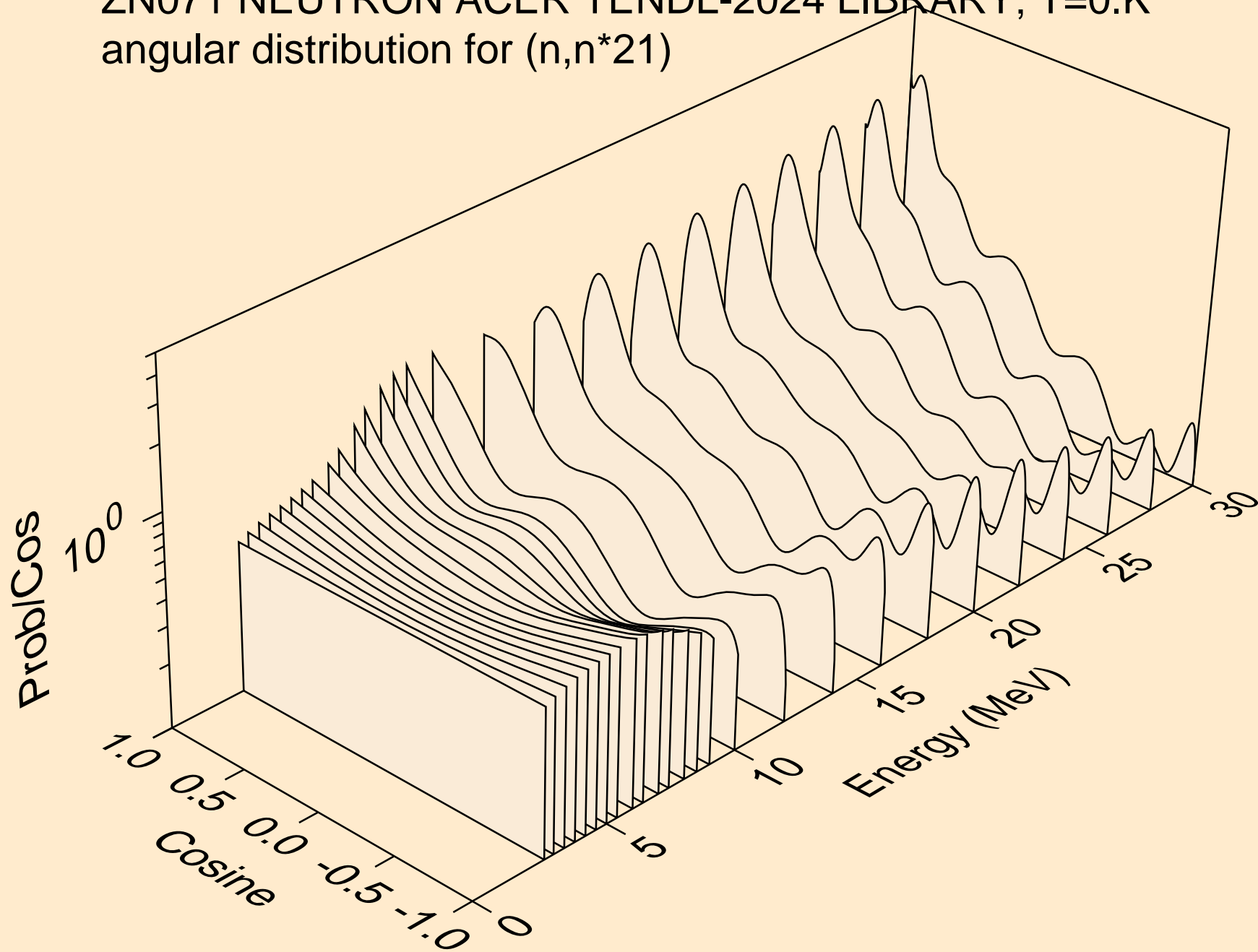

ZN071 NEUTRON ACER TENDL-2024 LIBRARY; T=0.K
angular distribution for (n,n*22)

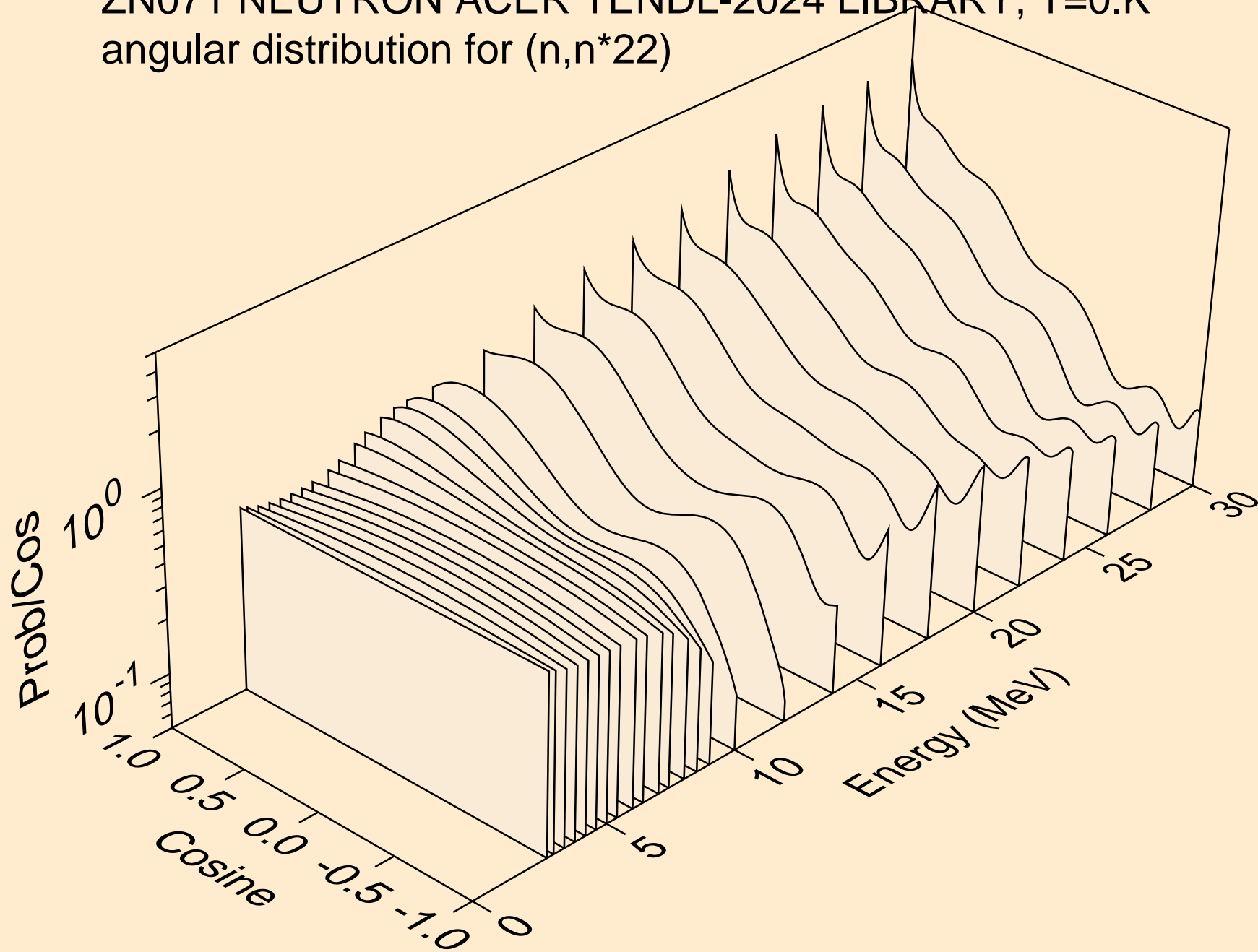

ZN071 NEUTRON ACER TENDL-2024 LIBRARY; T=0.K
angular distribution for (n,n*23)

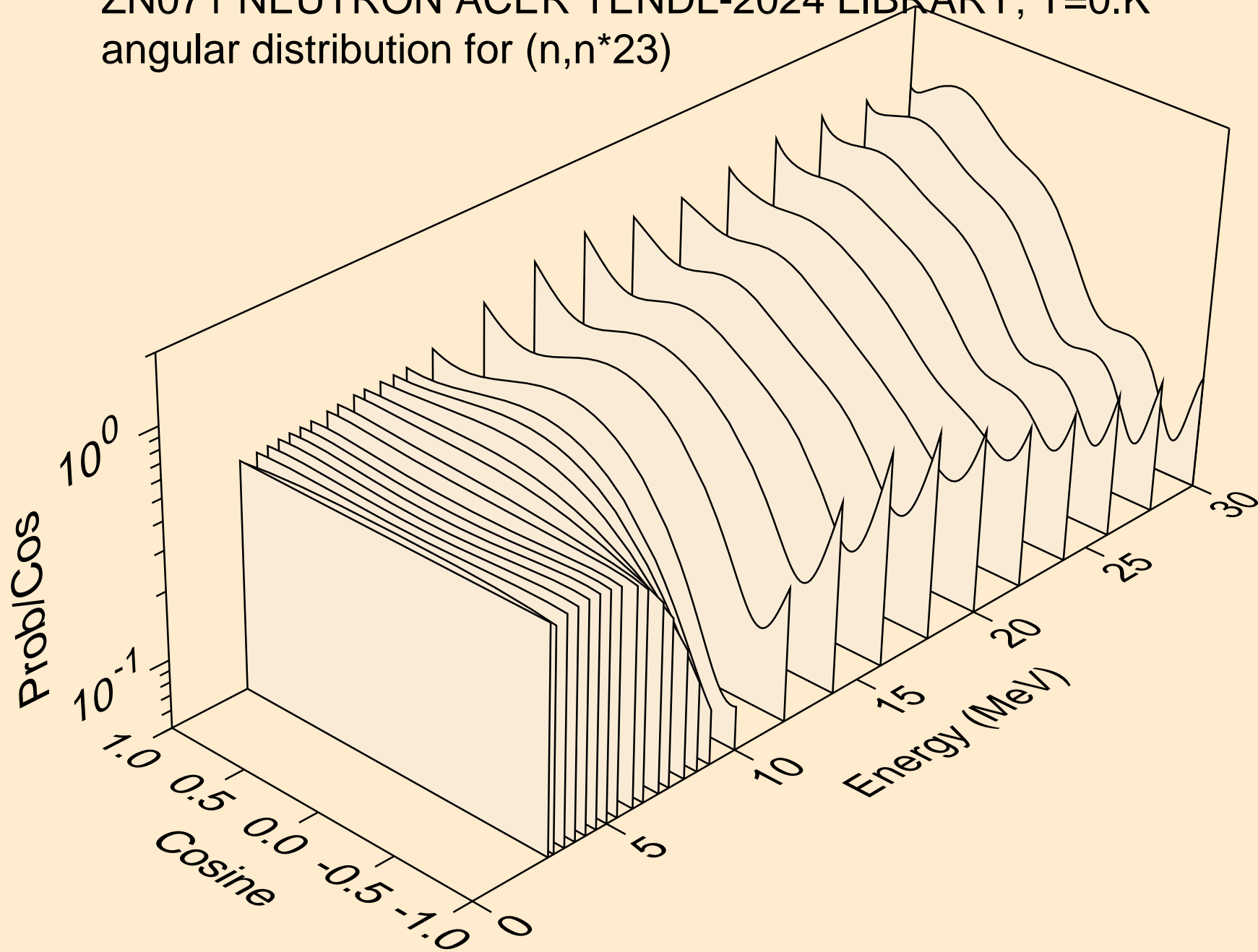

ZN071 NEUTRON ACER TENDL-2024 LIBRARY; T=0.K
angular distribution for (n,n*24)

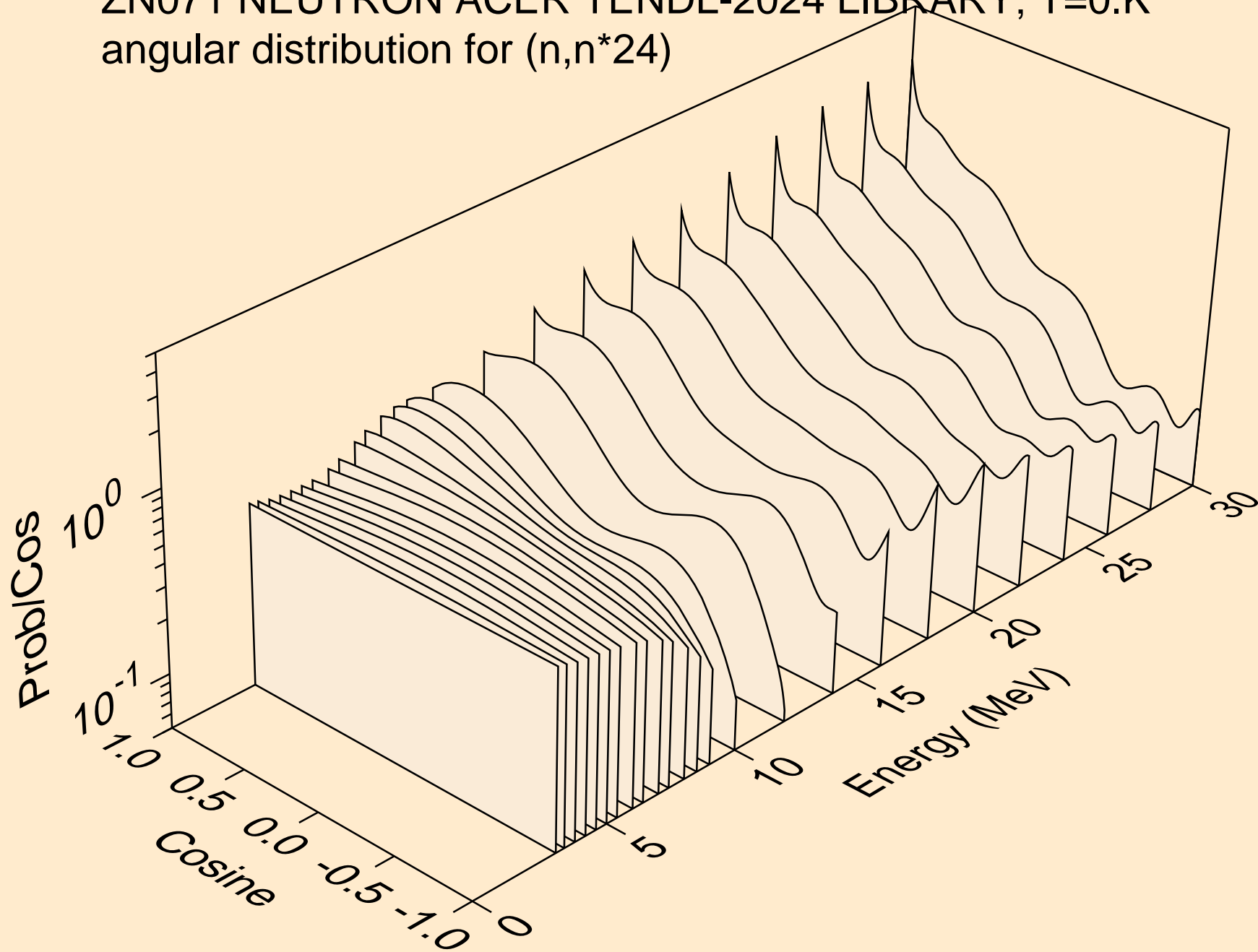

ZN071 NEUTRON ACER TENDL-2024 LIBRARY; T=0.K
angular distribution for (n,n*25)

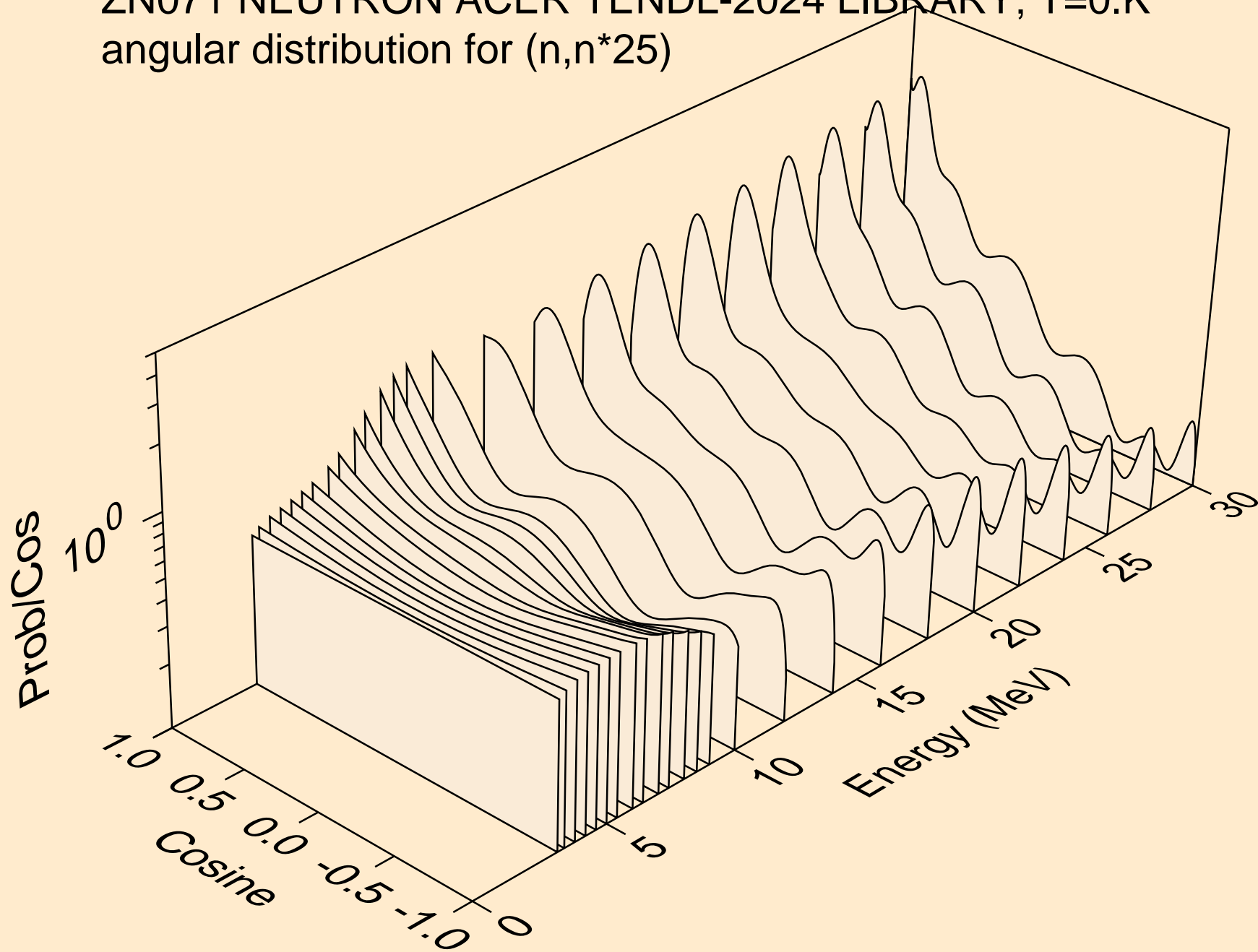

ZN071 NEUTRON ACER TENDL-2024 LIBRARY; T=0.K
angular distribution for (n,n*26)

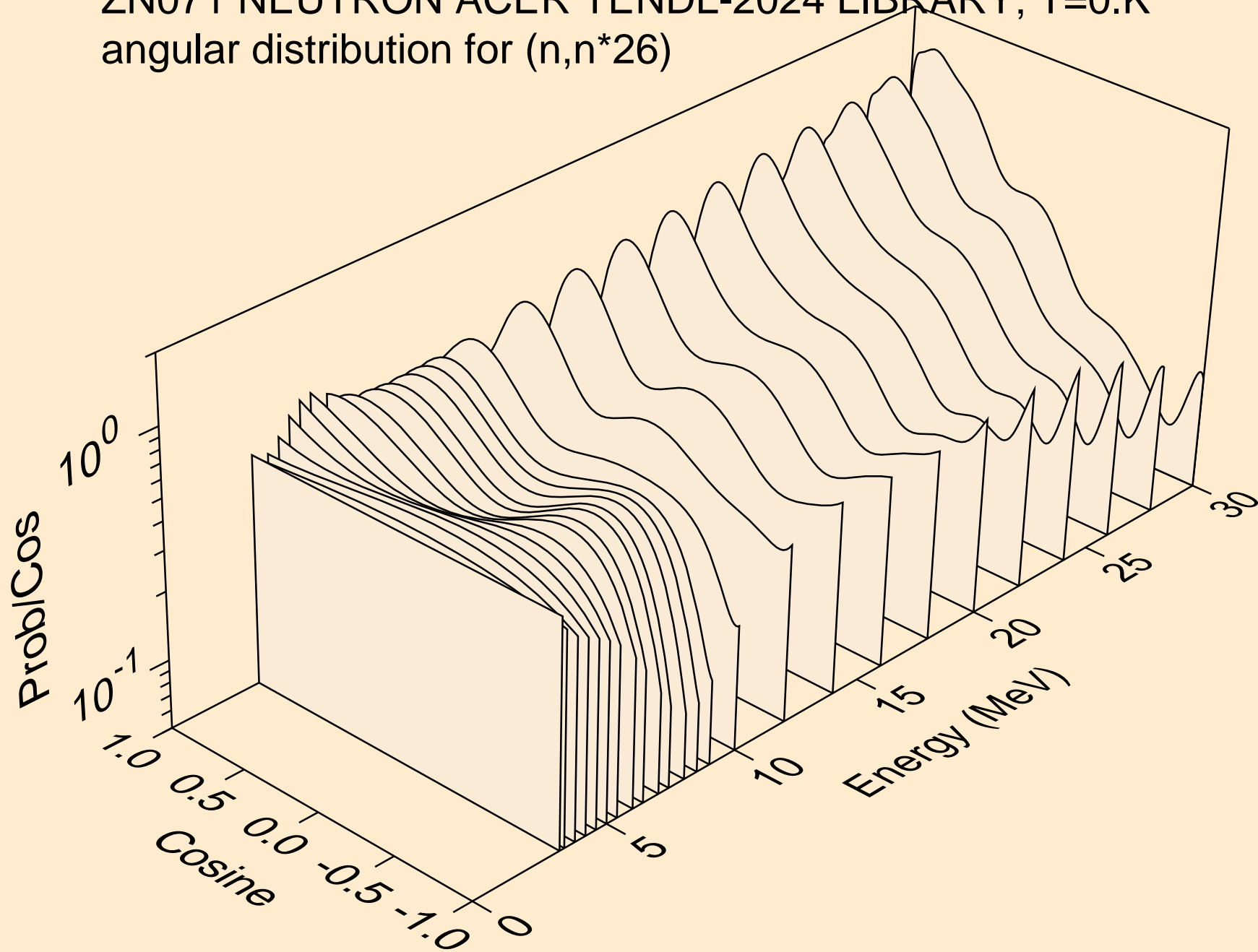

ZN071 NEUTRON ACER TENDL-2024 LIBRARY; T=0.K
Neutron emission for (n,x)

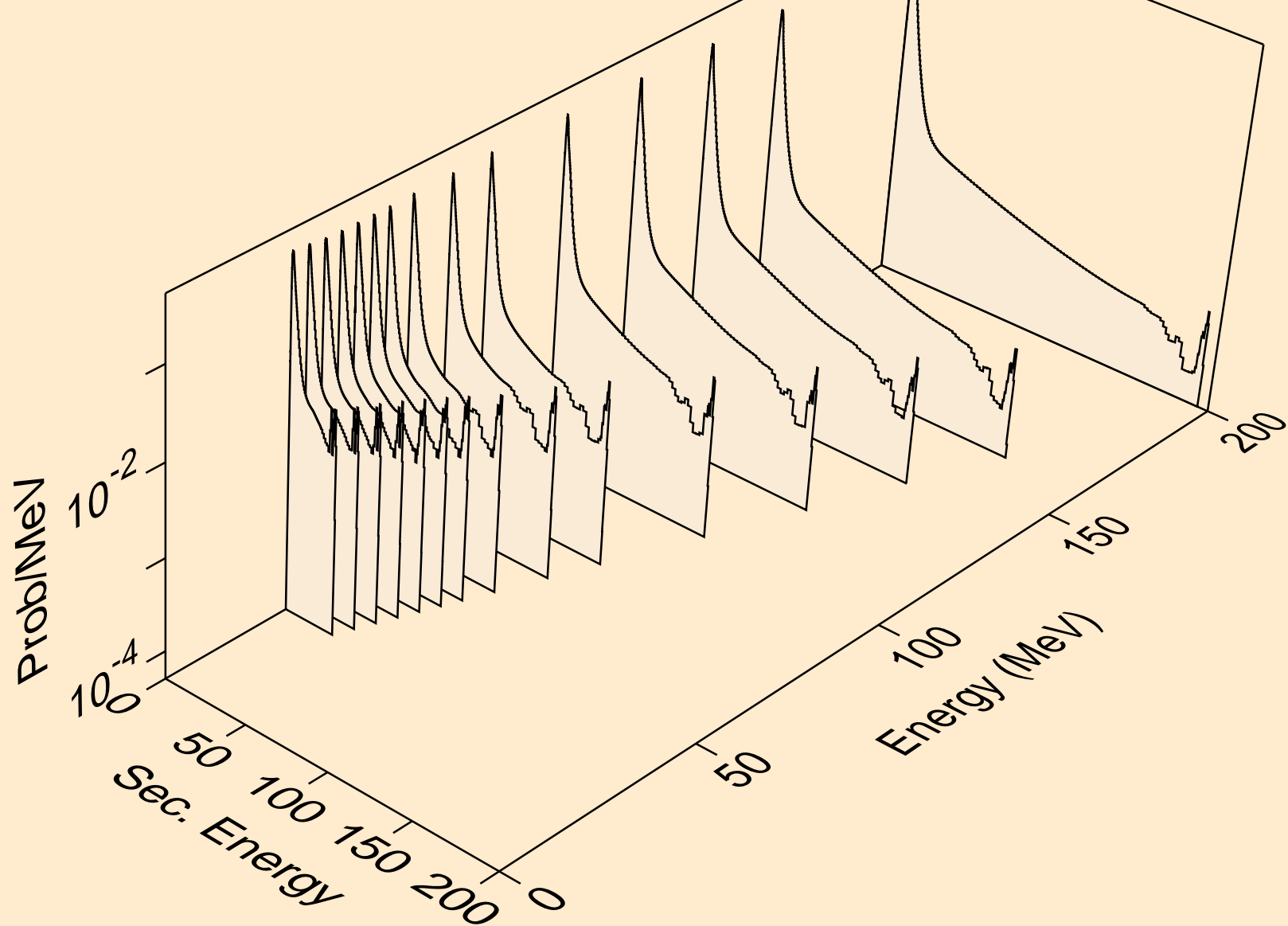

ZN071 NEUTRON ACER TENDL-2024 LIBRARY; T=0.K
Neutron emission for (n,2nd)

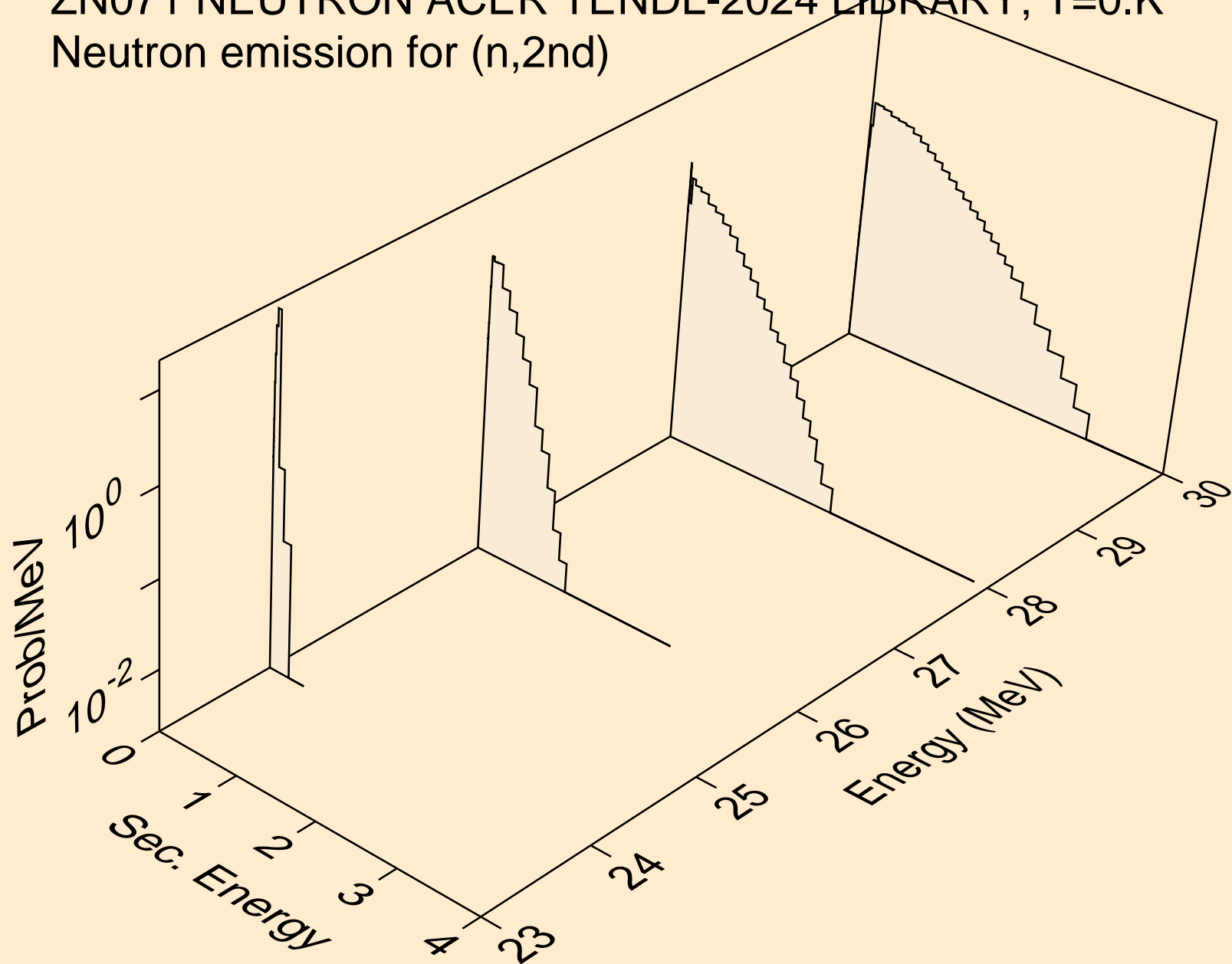

ZN071 NEUTRON ACER TENDL-2024 LIBRARY; T=0.K
Neutron emission for (n,2n)

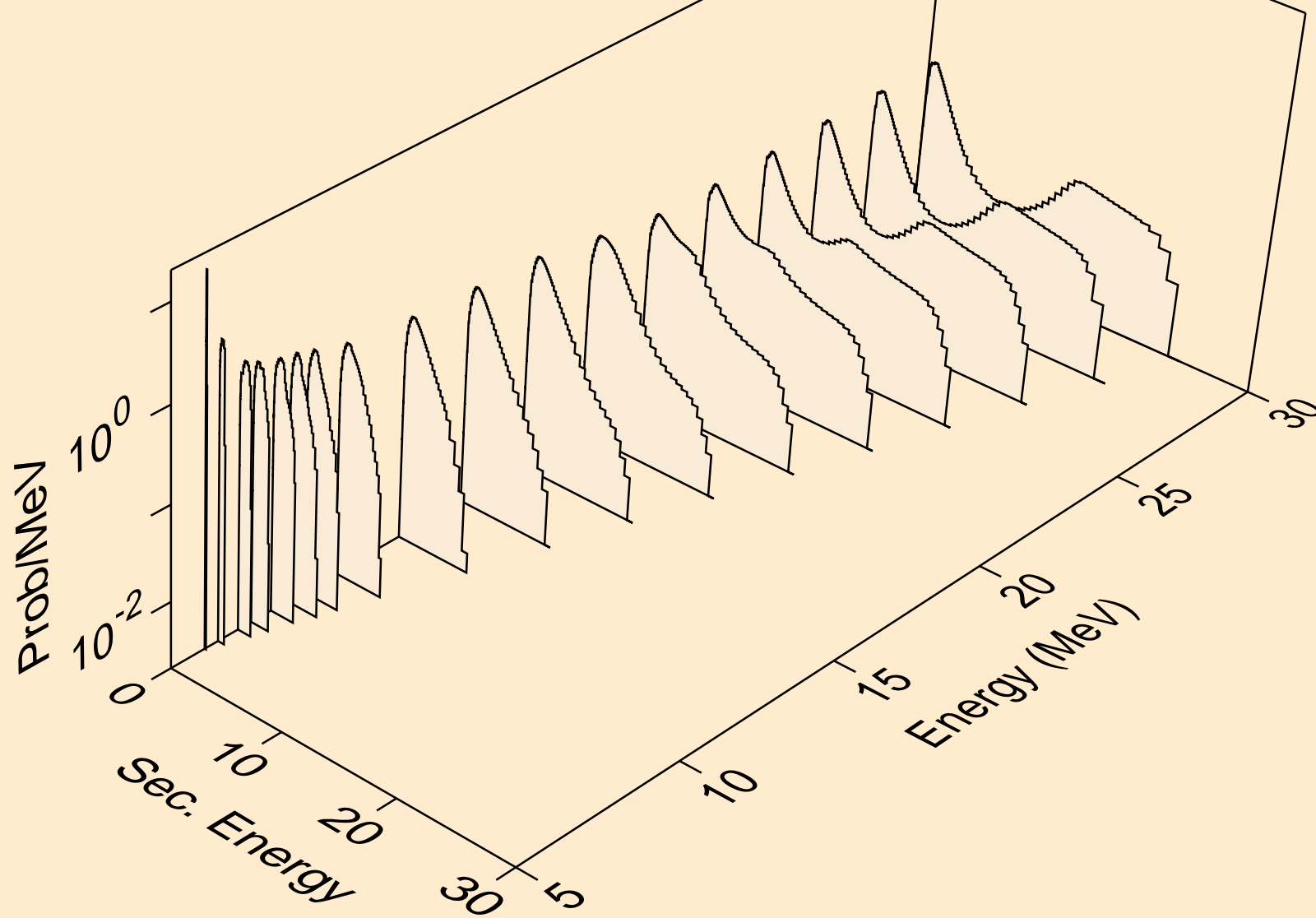

ZN071 NEUTRON ACER TENDL-2024 LIBRARY; T=0.K
Neutron emission for (n,3n)

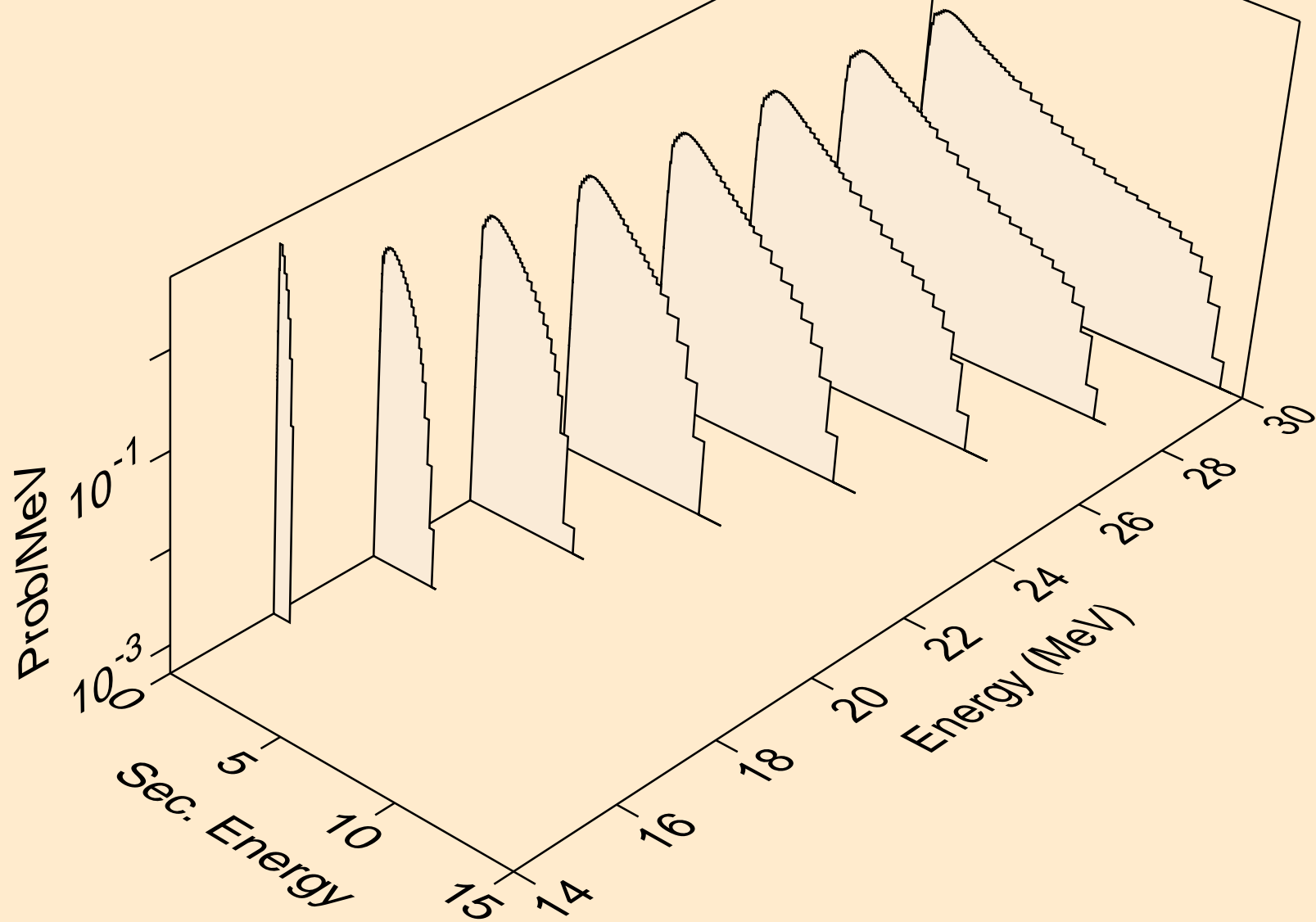

ZN071 NEUTRON ACER TENDL-2024 LIBRARY; T=0.K
Neutron emission for (n,n*)a

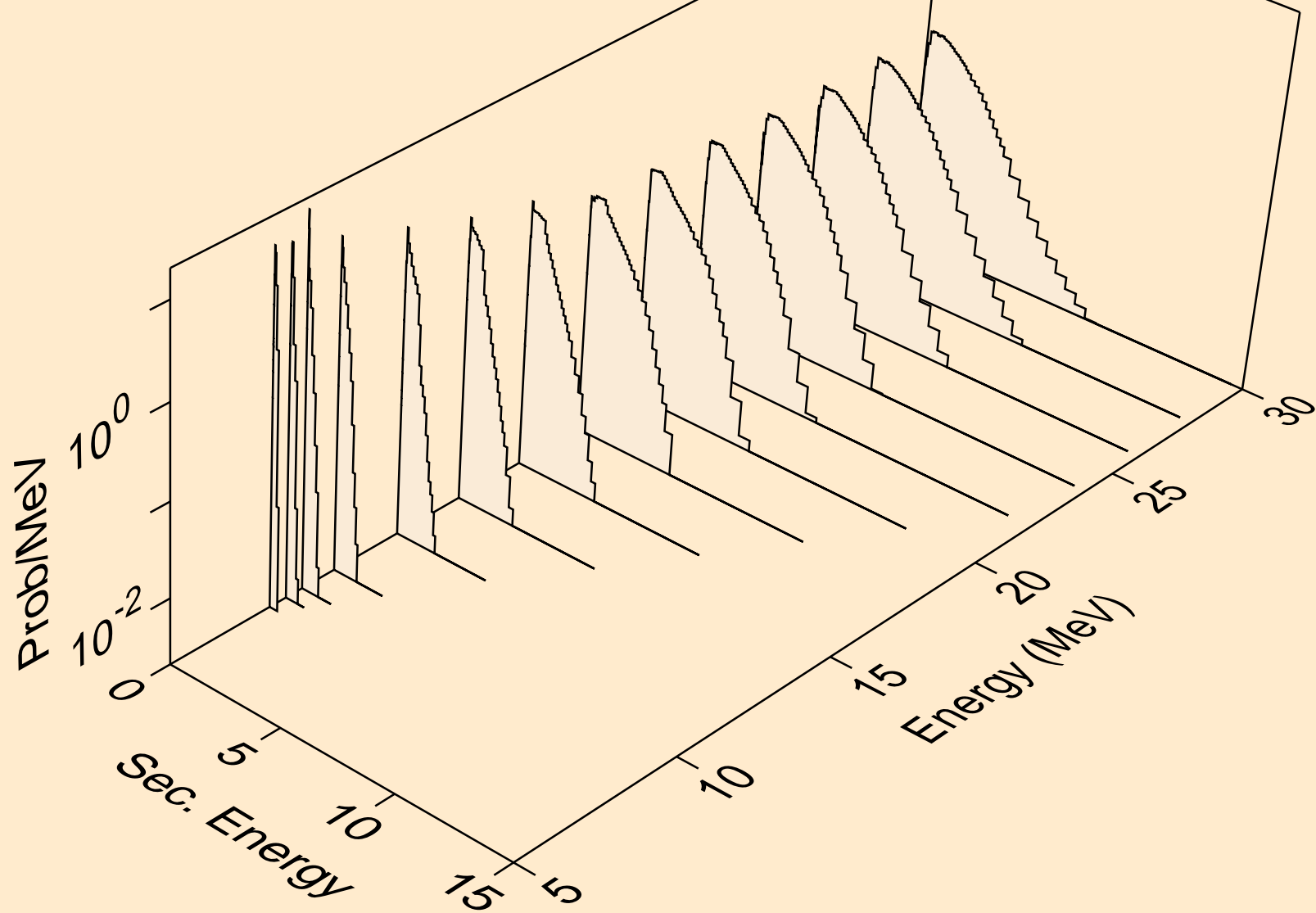

ZN071 NEUTRON ACER TENDL-2024 LIBRARY; T=0.K
Neutron emission for (n,2n)a

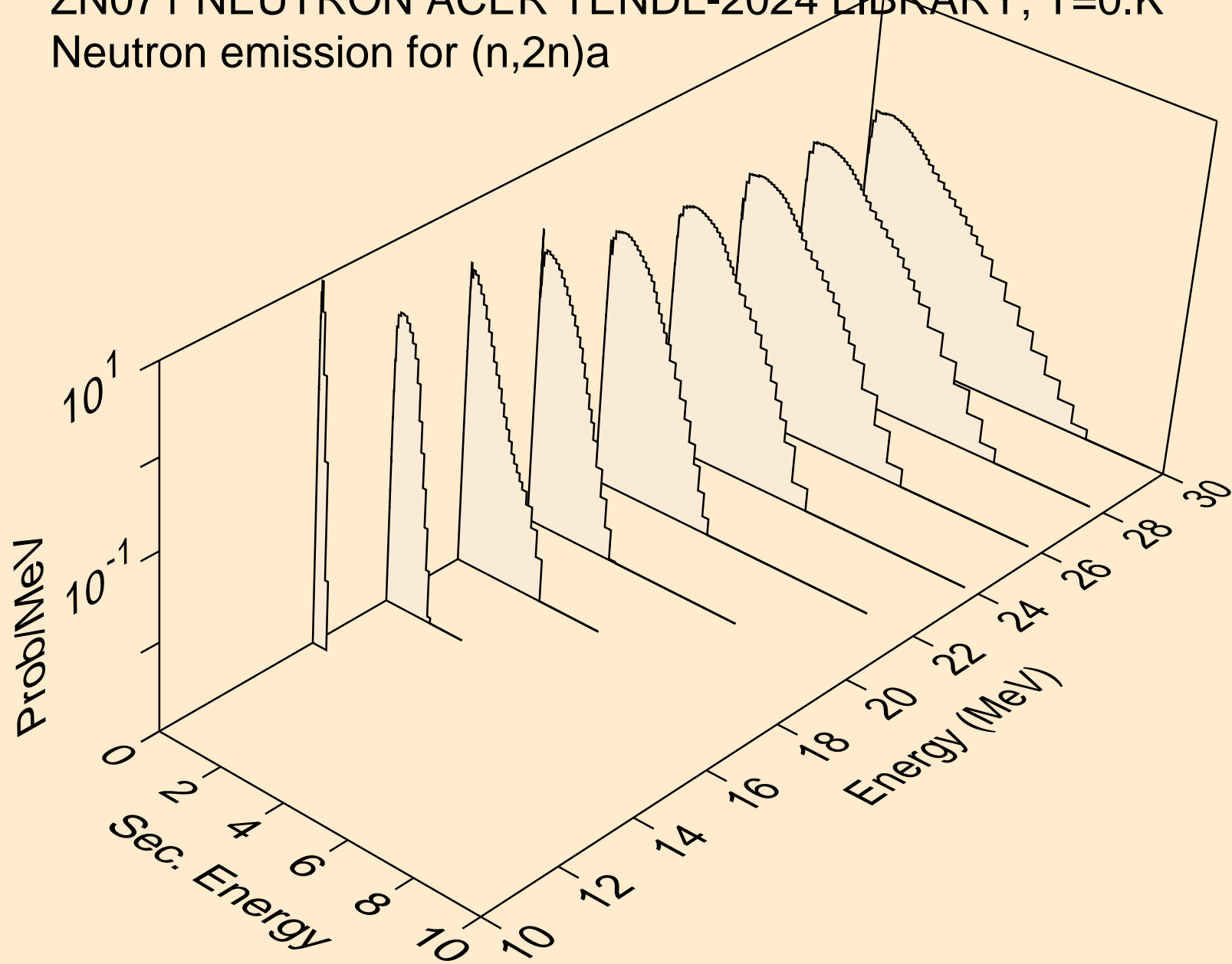

ZN071 NEUTRON ACER TENDL-2024 LIBRARY; T=0.K
Neutron emission for (n,3n)a

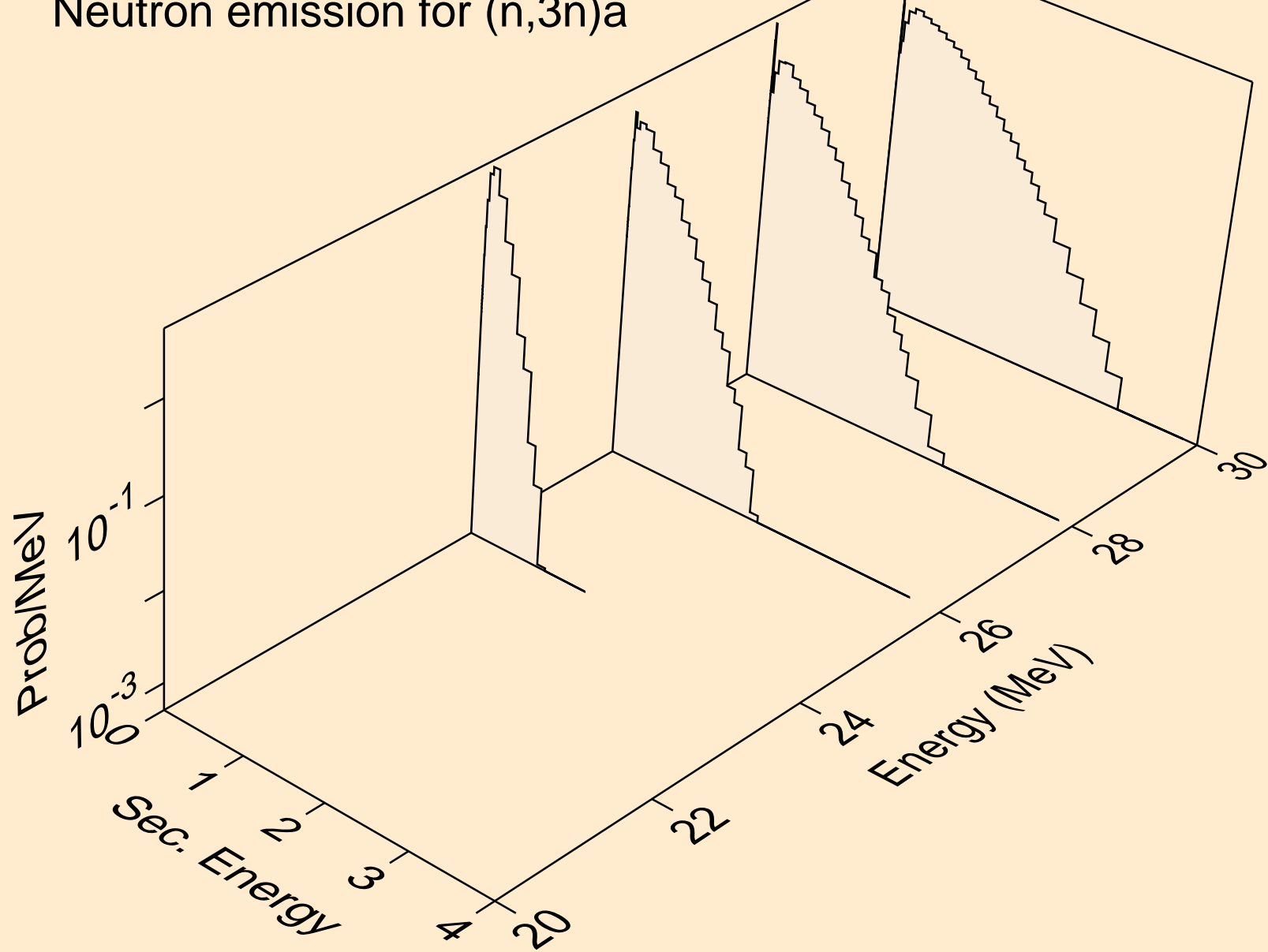

ZN071 NEUTRON ACER TENDL-2024 LIBRARY; T=0.K
Neutron emission for (n,n*)p

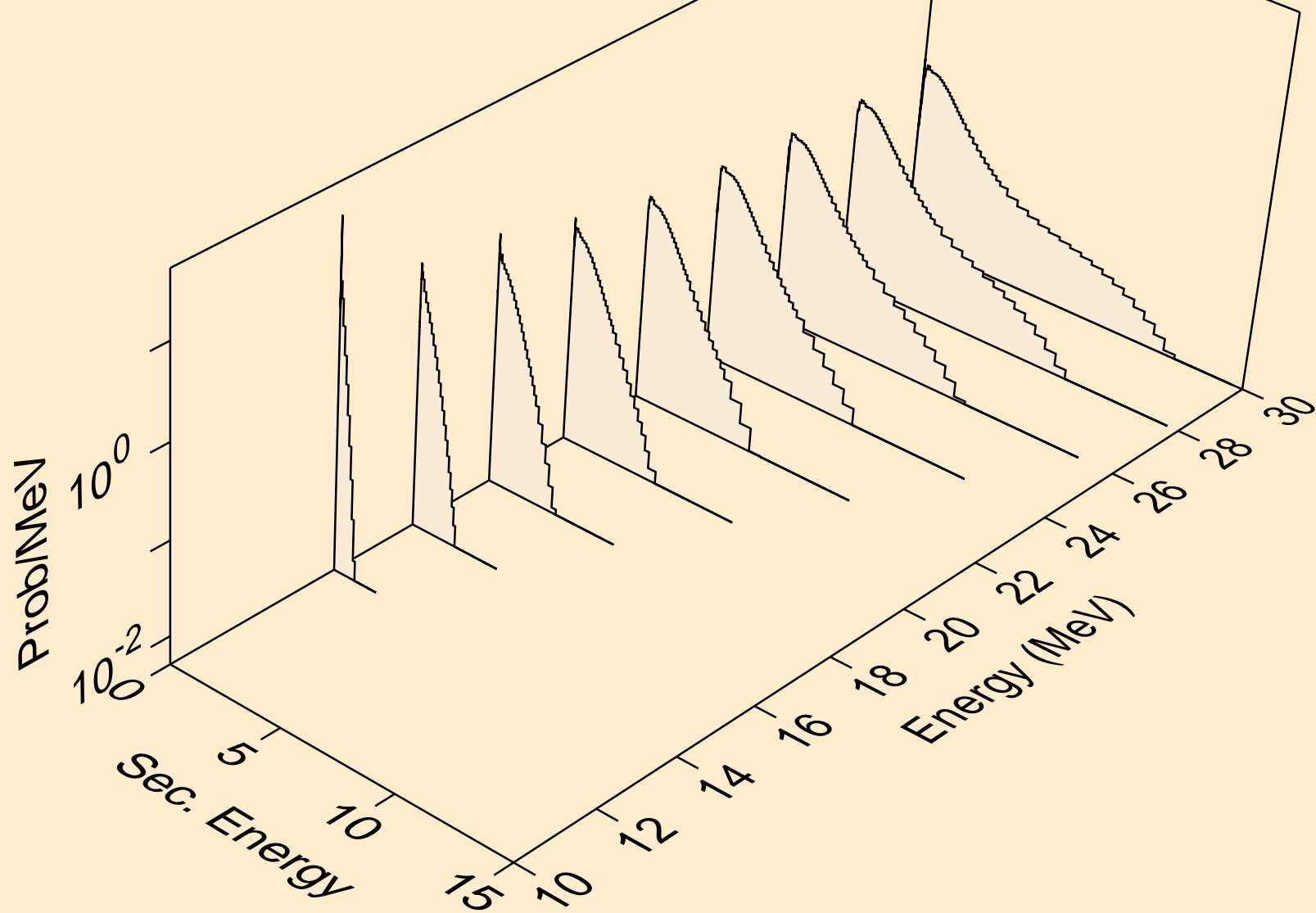

ZN071 NEUTRON ACER TENDL-2024 LIBRARY; T=0.K
Neutron emission for (n,n*)d

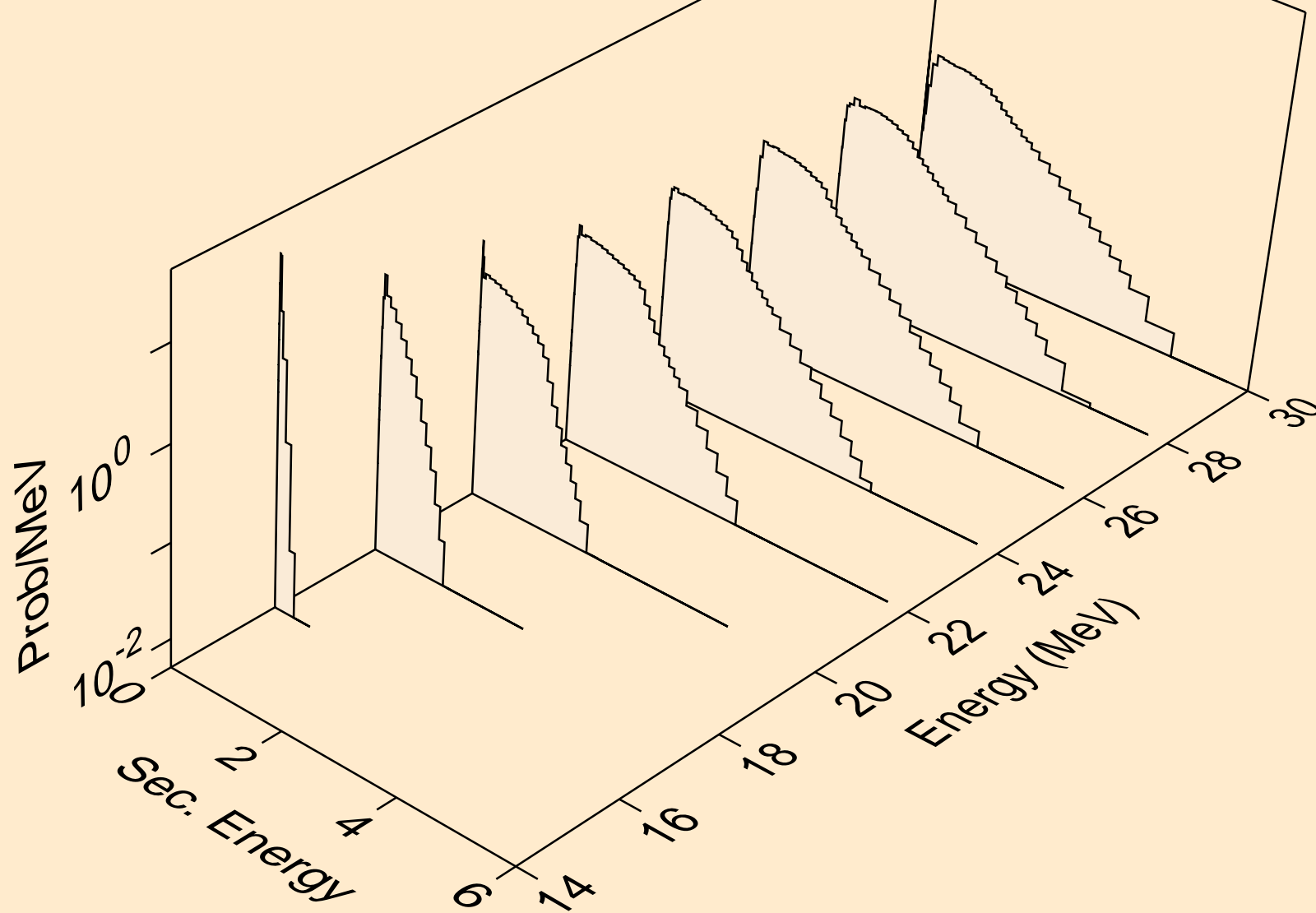

ZN071 NEUTRON ACER TENDL-2024 LIBRARY; T=0.K
Neutron emission for (n,n*)t

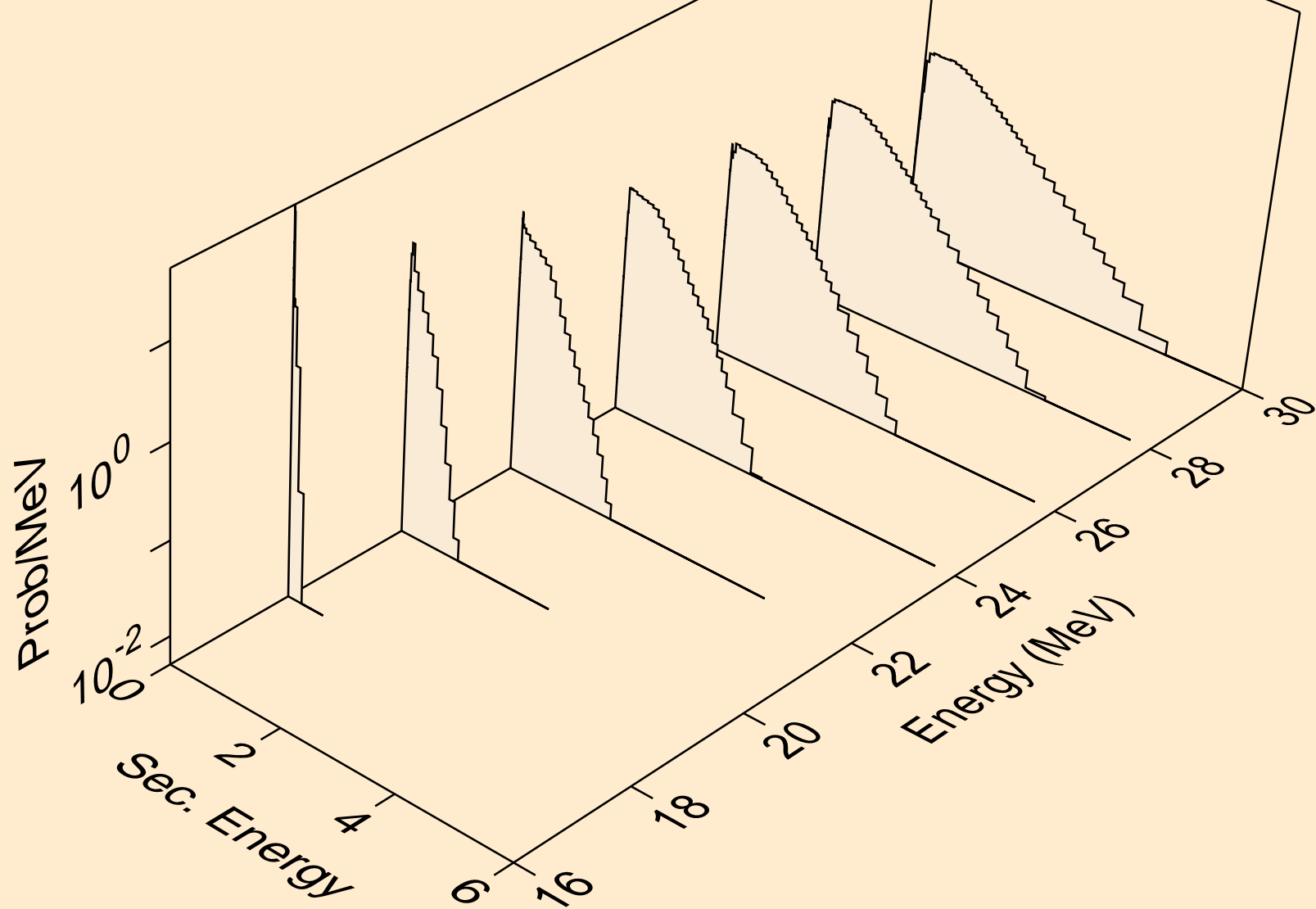

ZN071 NEUTRON ACER TENDL-2024 LIBRARY; T=0.K
Neutron emission for (n,n*)he3

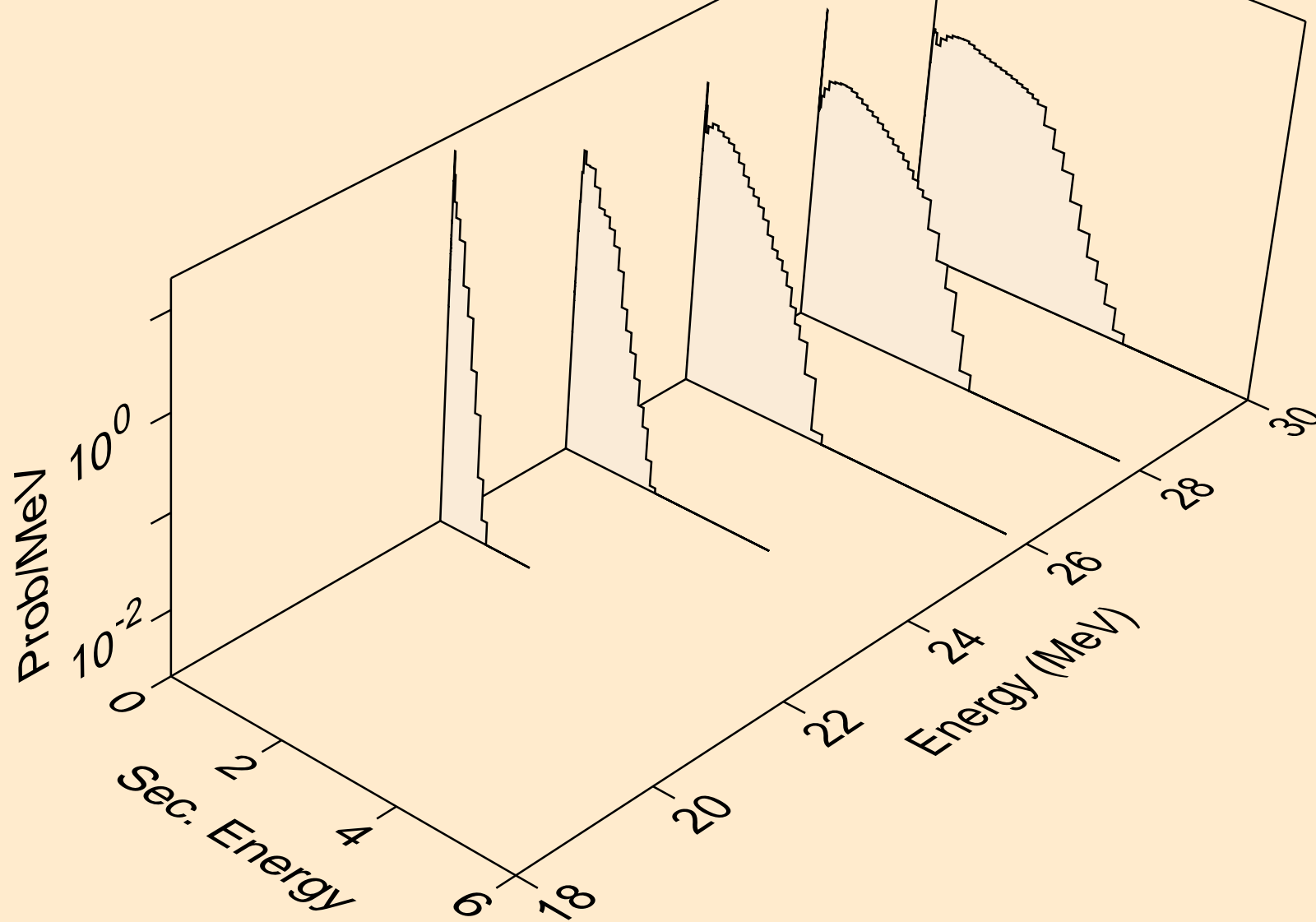

ZN071 NEUTRON ACER TENDL-2024 LIBRARY; T=0.K
Neutron emission for (n,4n)

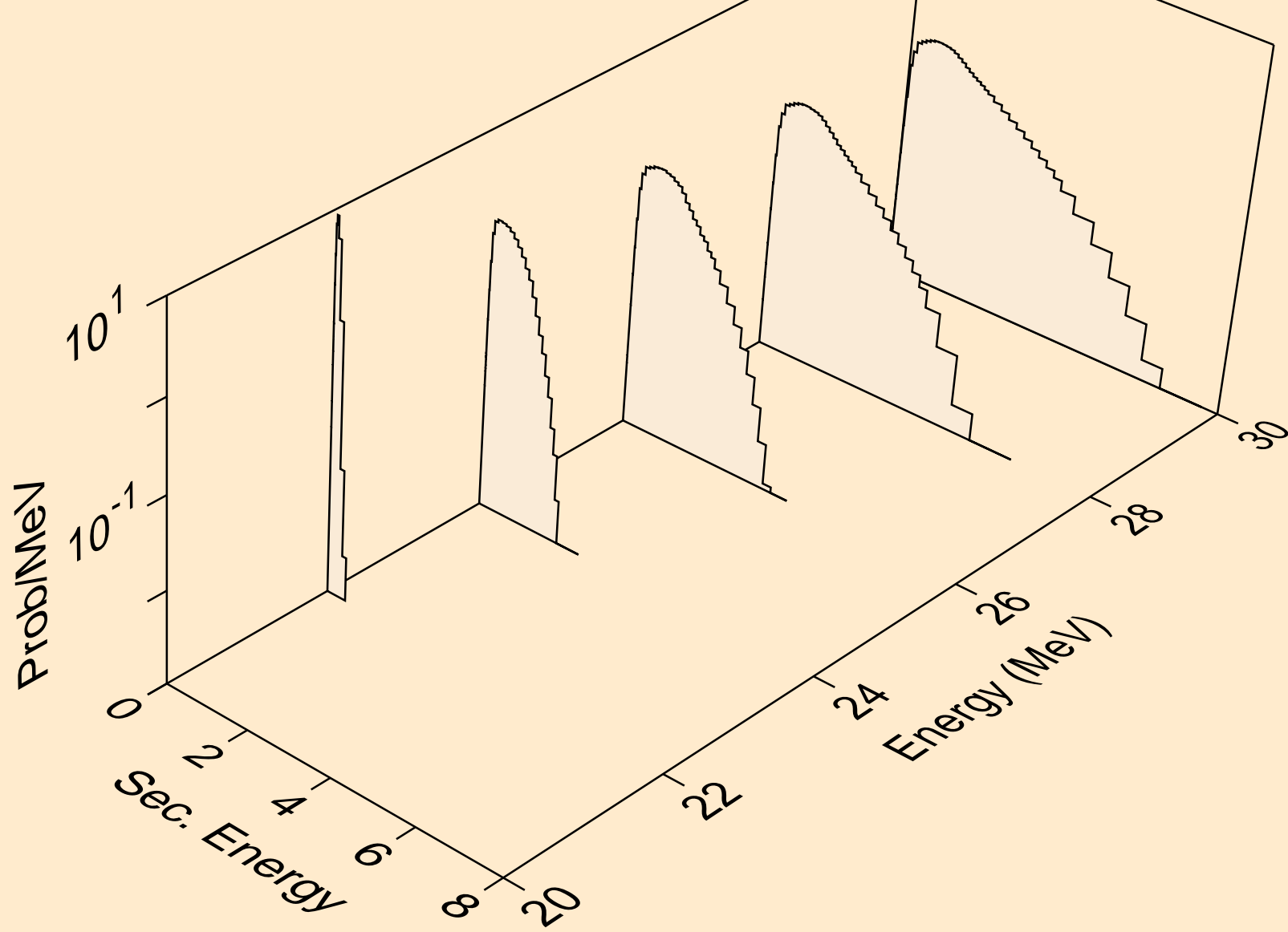

ZN071 NEUTRON ACER TENDL-2024 LIBRARY; T=0.K
Neutron emission for (n,2np)

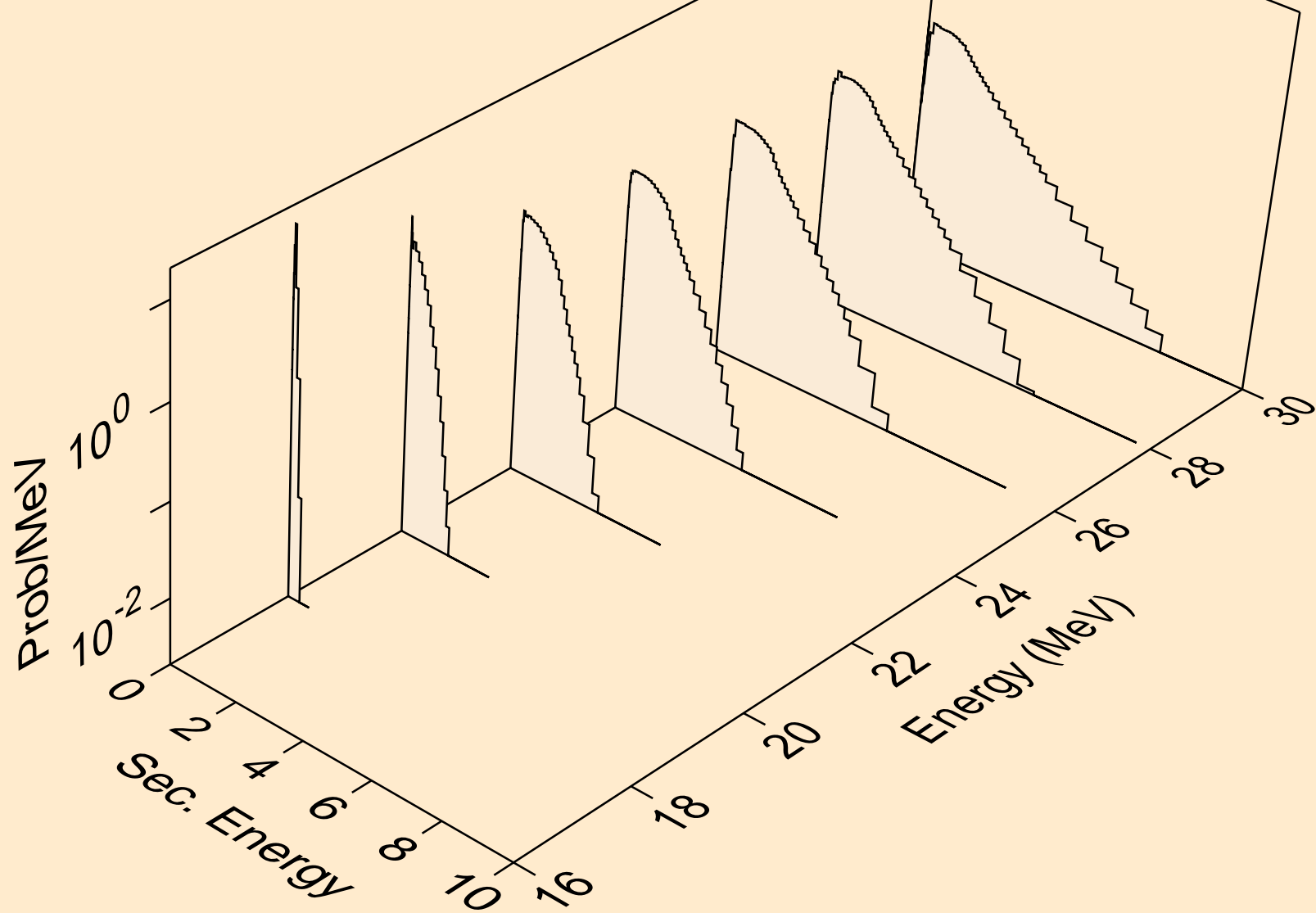

ZN071 NEUTRON ACER TENDL-2024 LIBRARY; T=0.K
Neutron emission for (n,3np)

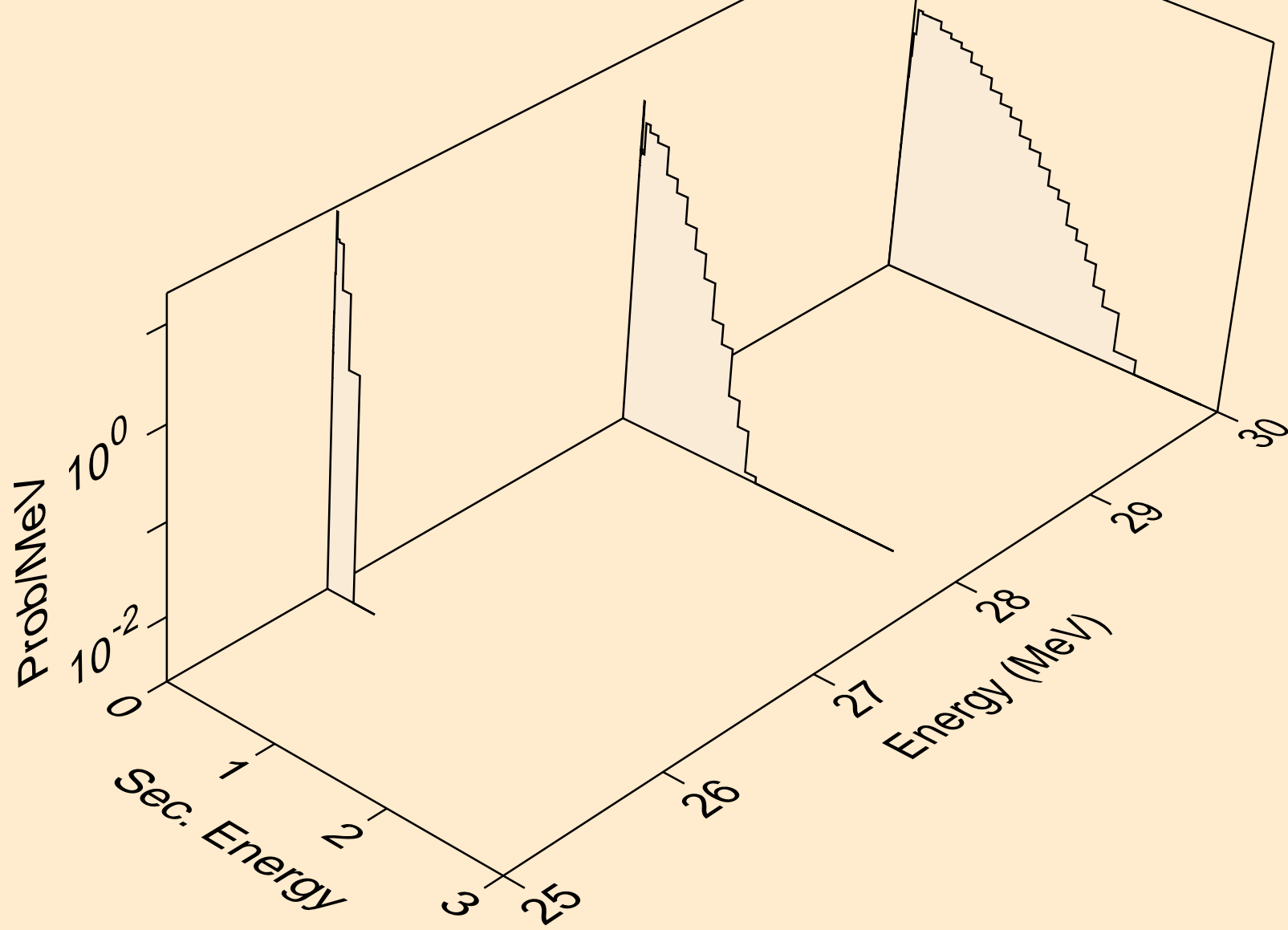

ZN071 NEUTRON ACER TENDL-2024 LIBRARY; T=0.K
Neutron emission for (n,n2p)

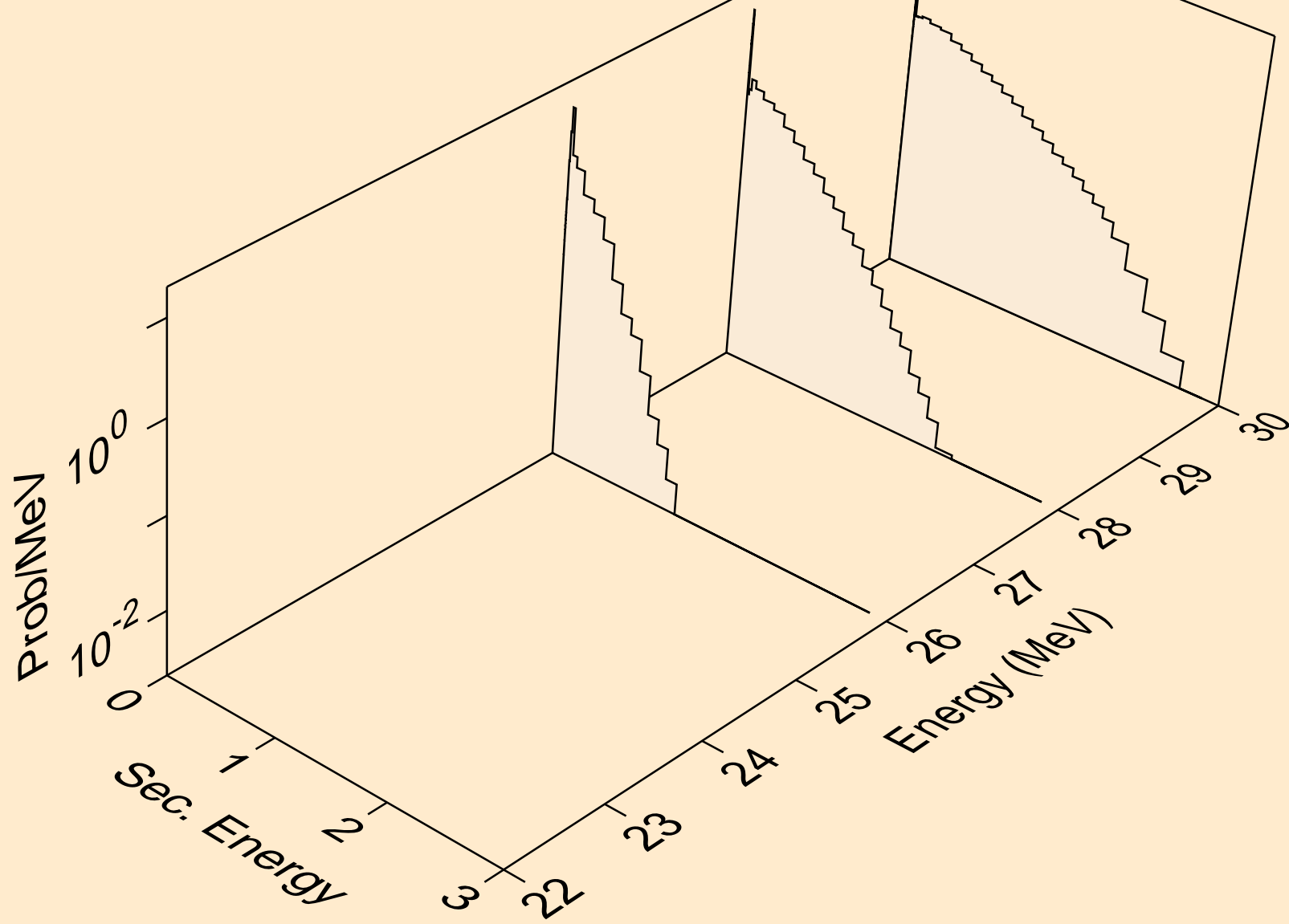

ZN071 NEUTRON ACER TENDL-2024 LIBRARY; T=0.K
Neutron emission for (n,n*c)

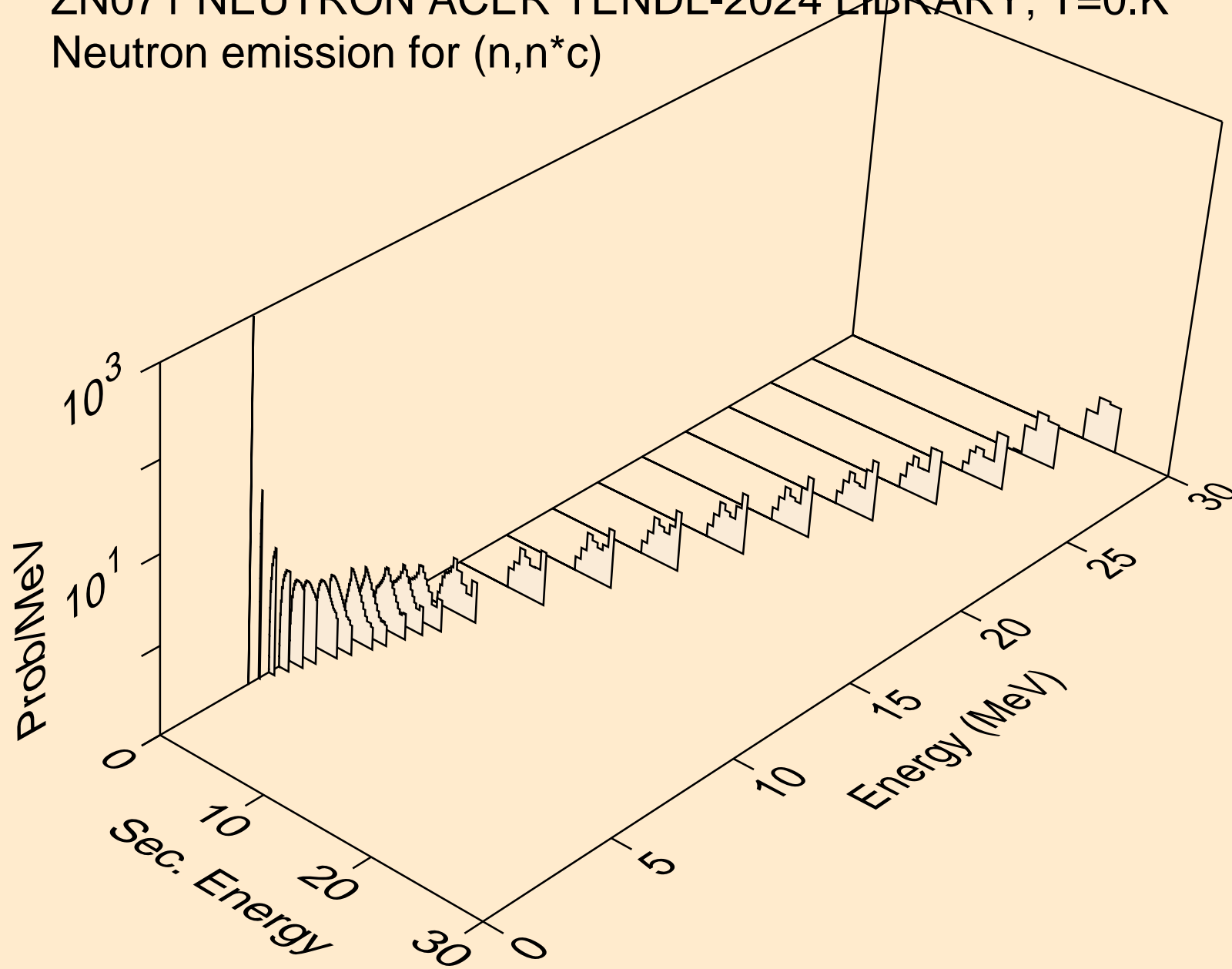

ZN071 NEUTRON ACER TENDL-2024 LIBRARY; T=0.K
Photon emission for (n,x)

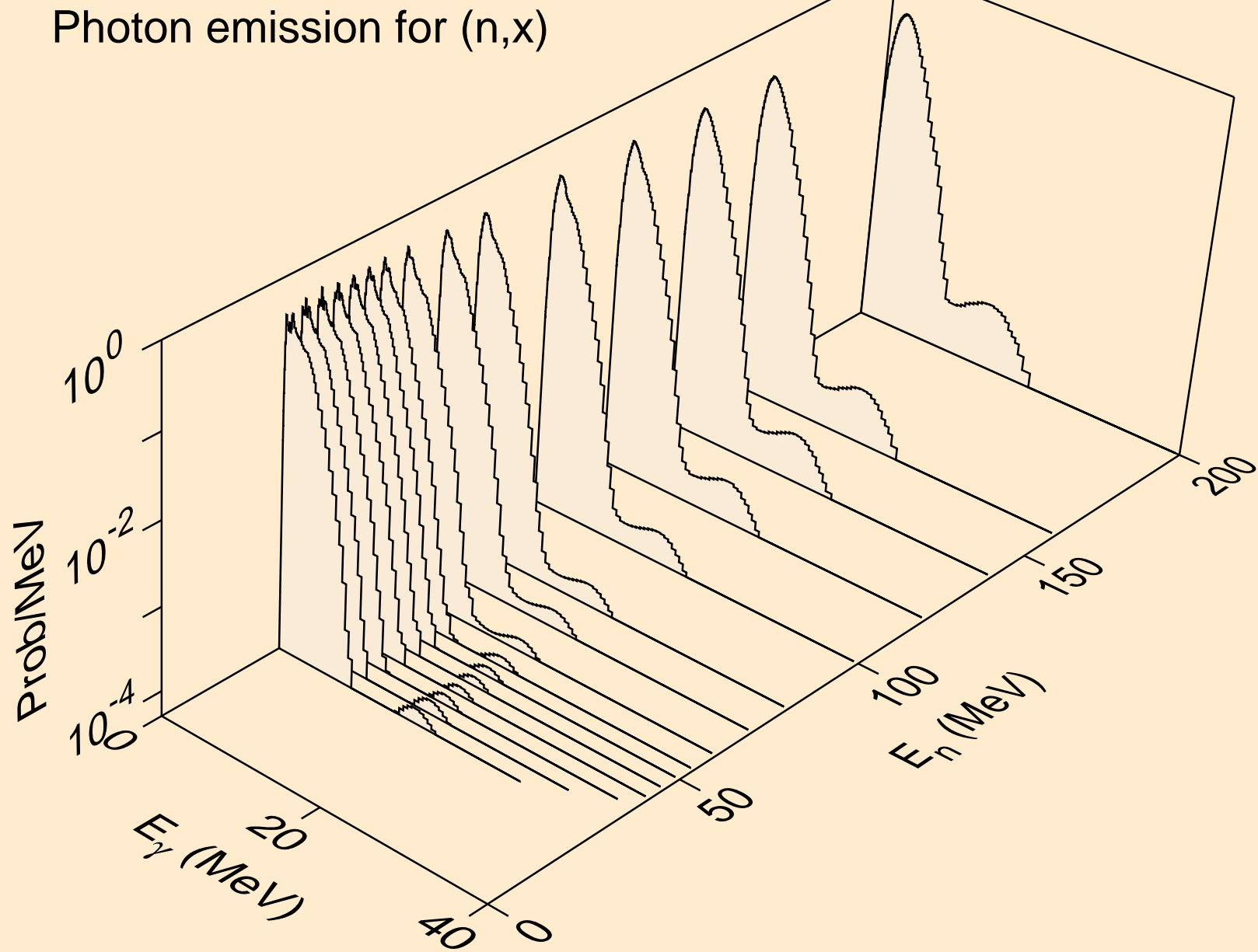

ZN071 NEUTRON ACER TENDL-2024 LIBRARY; T=0.K
Photon emission for (n,2nd)

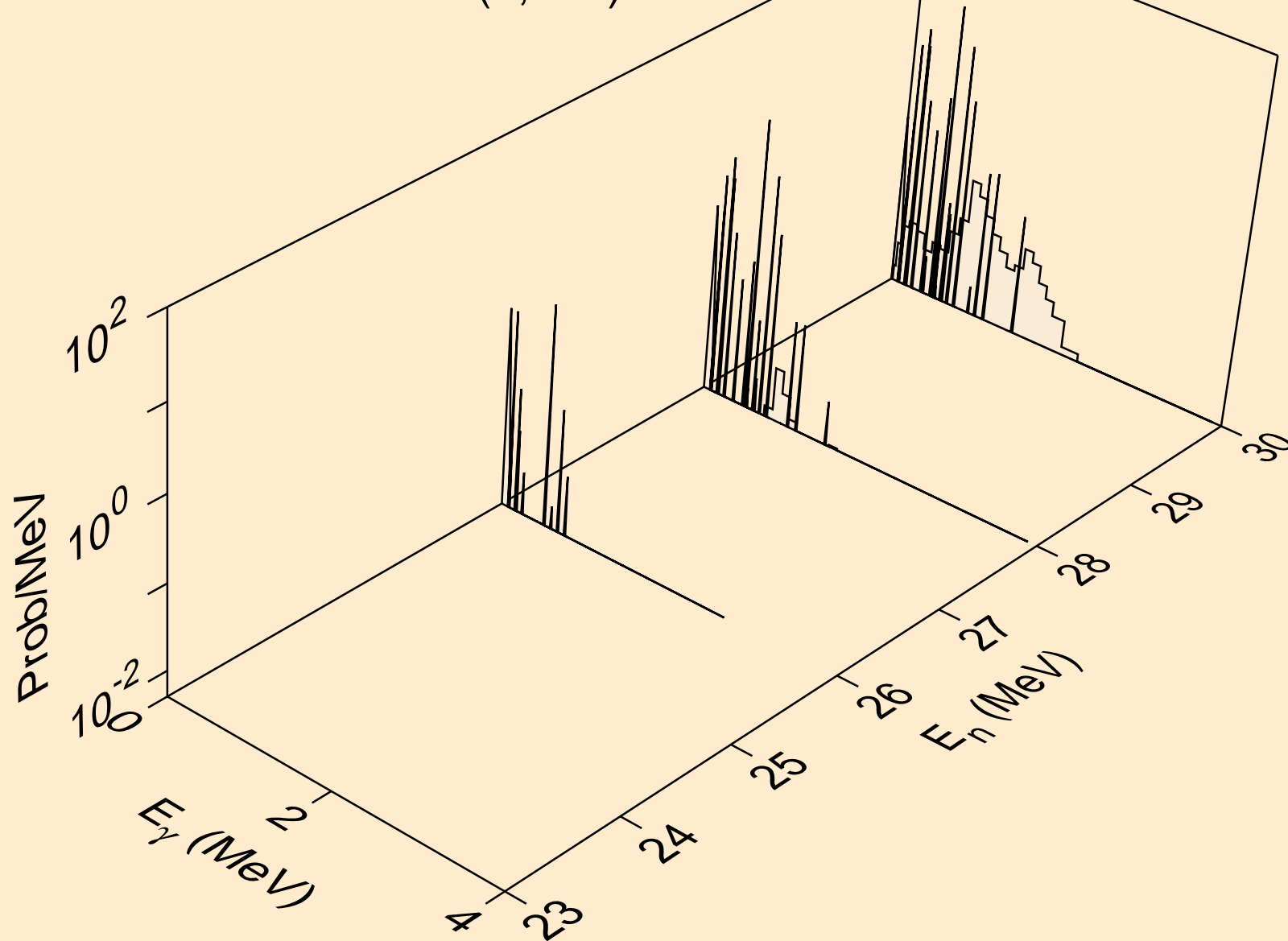

ZN071 NEUTRON ACER TENDL-2024 LIBRARY; T=0.K
Photon emission for (n,2n)

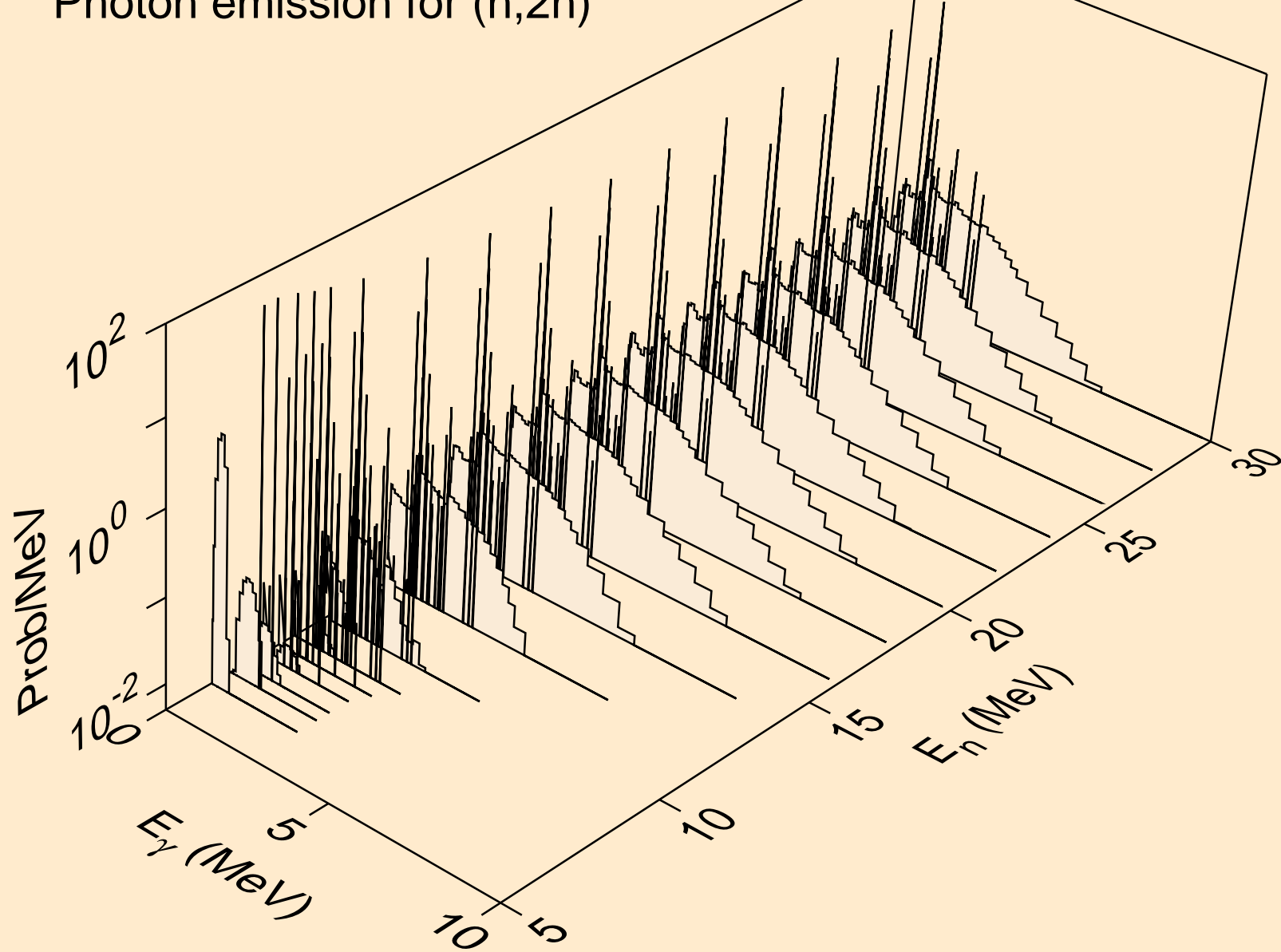

ZN071 NEUTRON ACER TENDL-2024 LIBRARY; T=0.K
Photon emission for (n,3n)

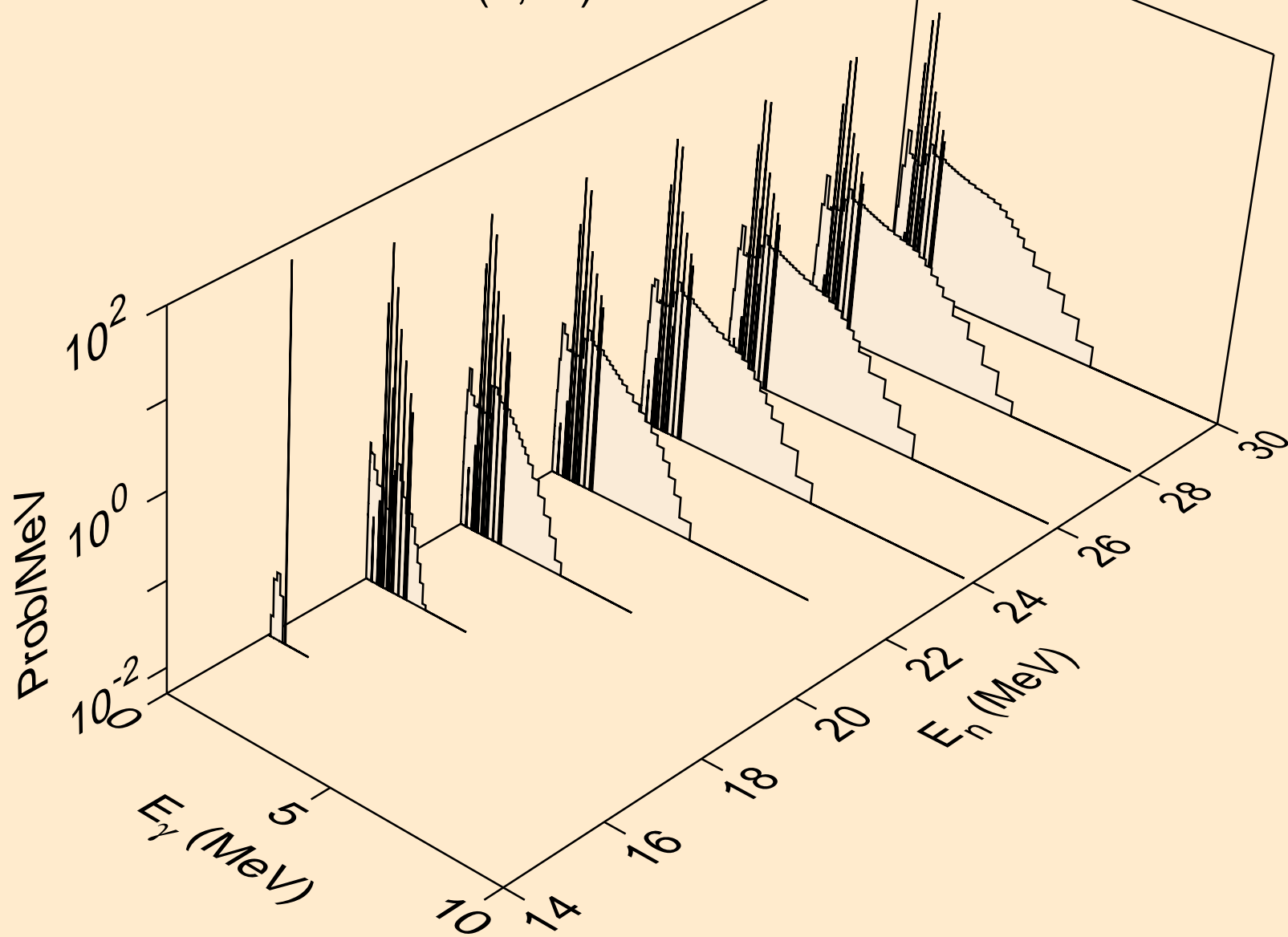

ZN071 NEUTRON ACER TENDL-2024 LIBRARY; T=0.K
Photon emission for (n,n*)a

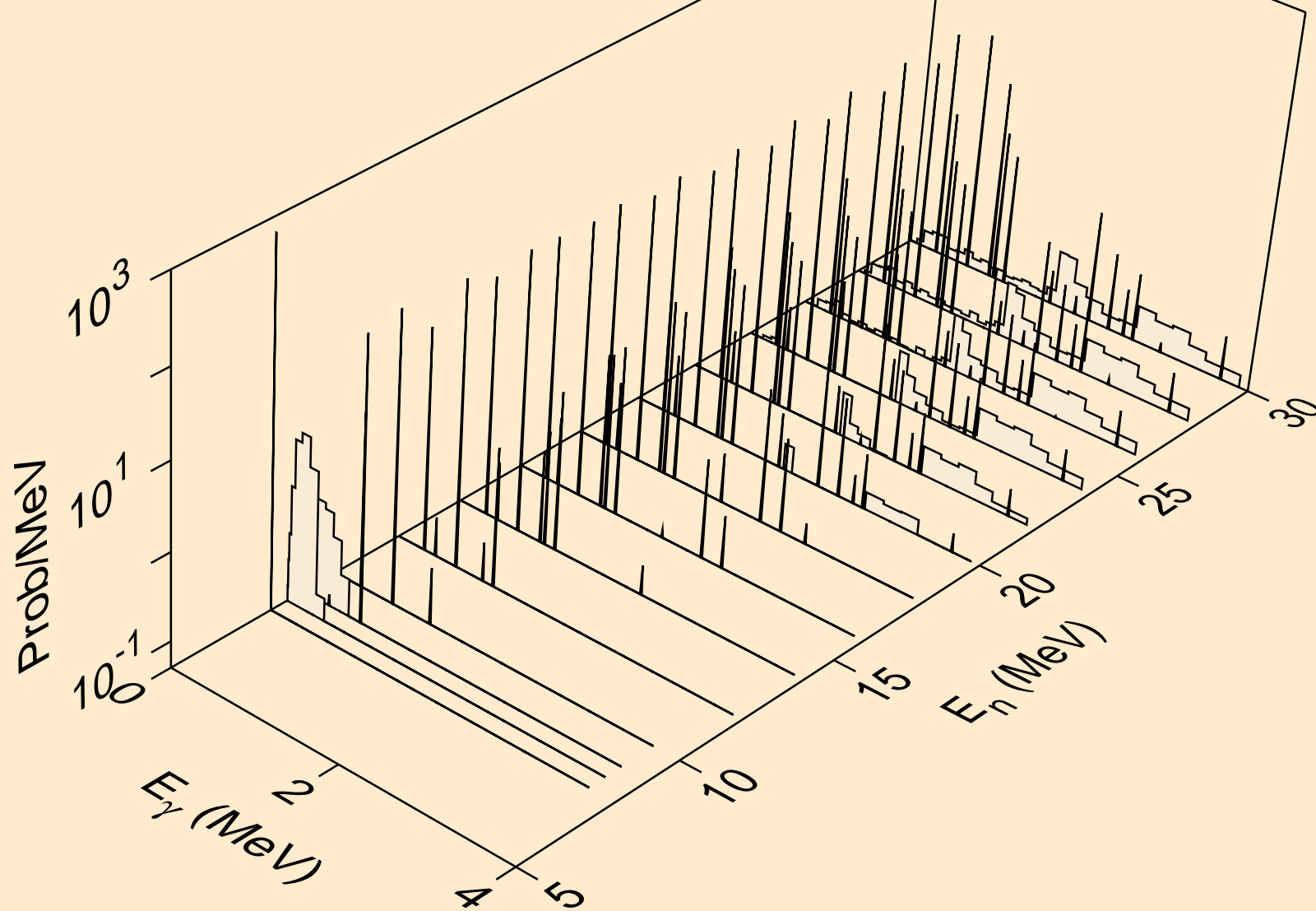

ZN071 NEUTRON ACER TENDL-2024 LIBRARY; T=0.K
Photon emission for (n,2n)a

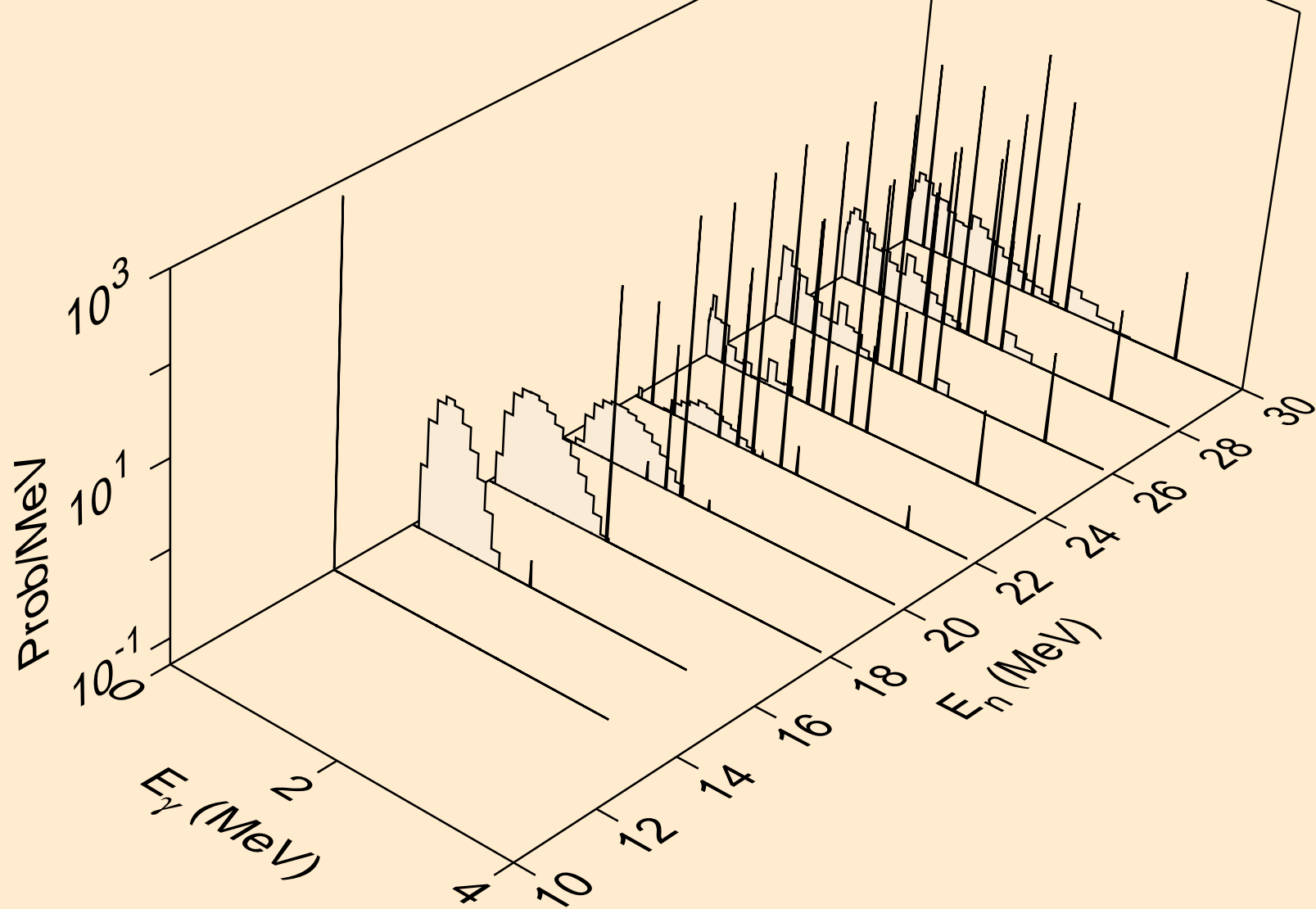

ZN071 NEUTRON ACER TENDL-2024 LIBRARY; T=0.K
Photon emission for (n,3n)a

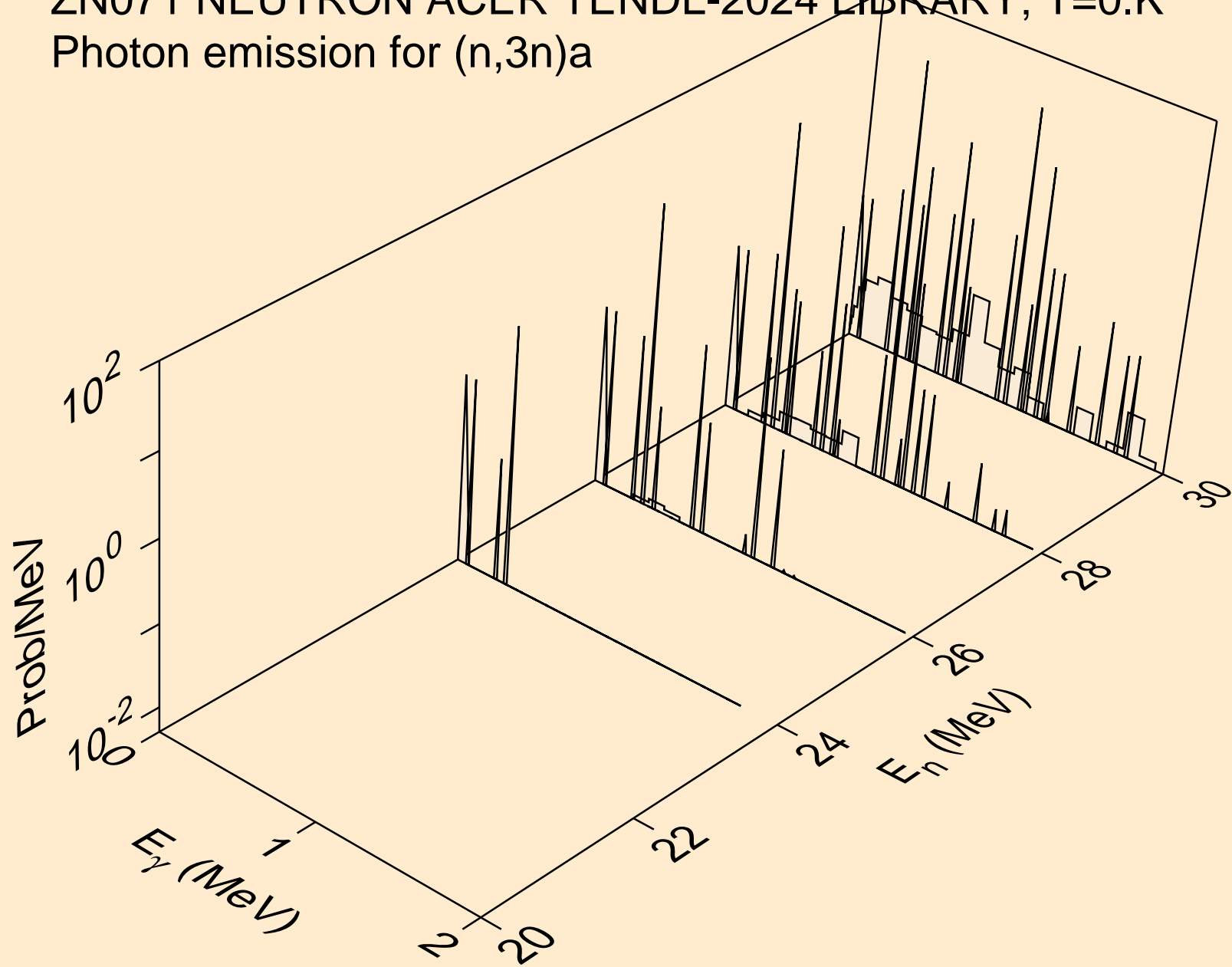

ZN071 NEUTRON ACER TENDL-2024 LIBRARY; T=0.K
Photon emission for (n,n*)p

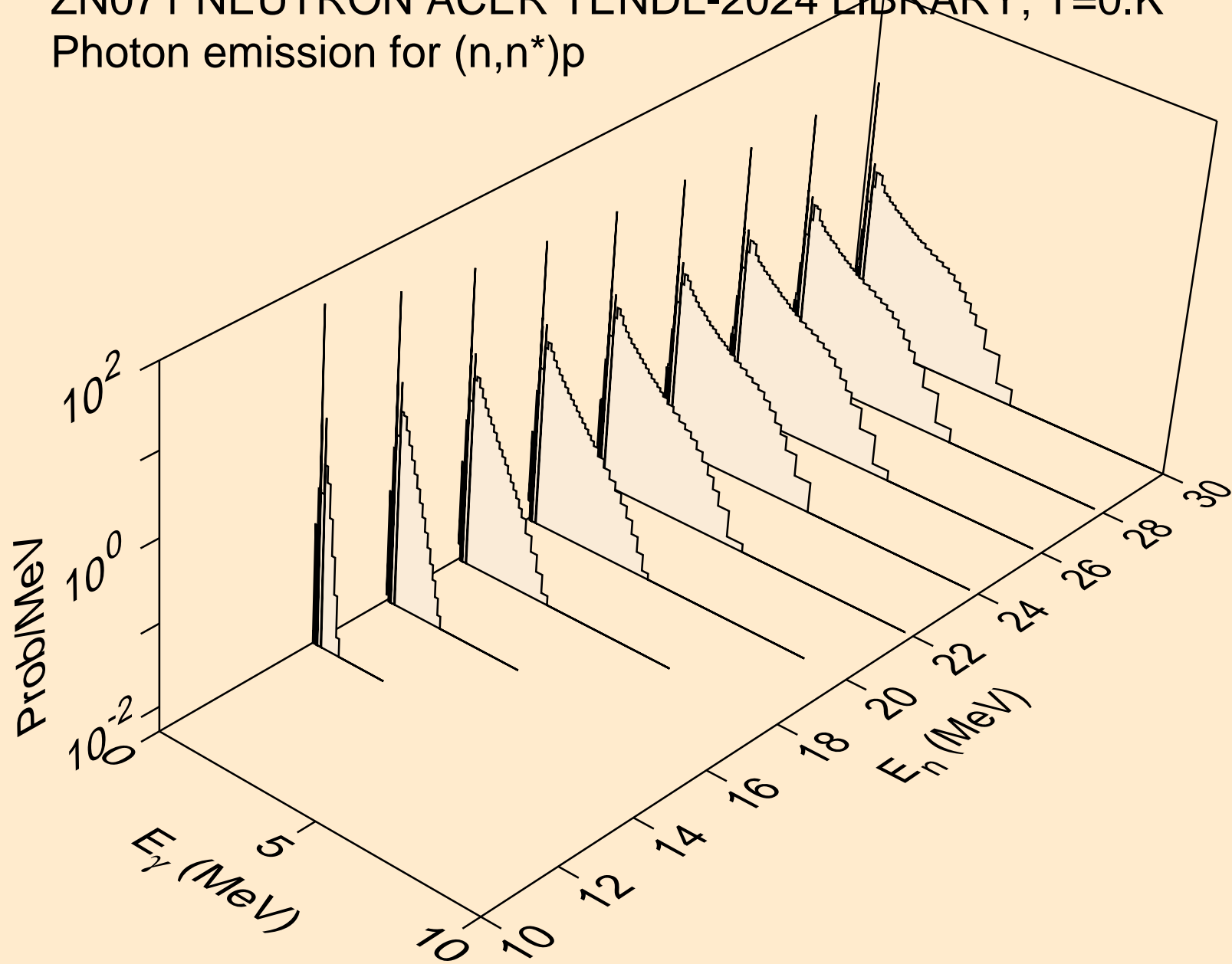

ZN071 NEUTRON ACER TENDL-2024 LIBRARY; T=0.K
Photon emission for (n,n*)d

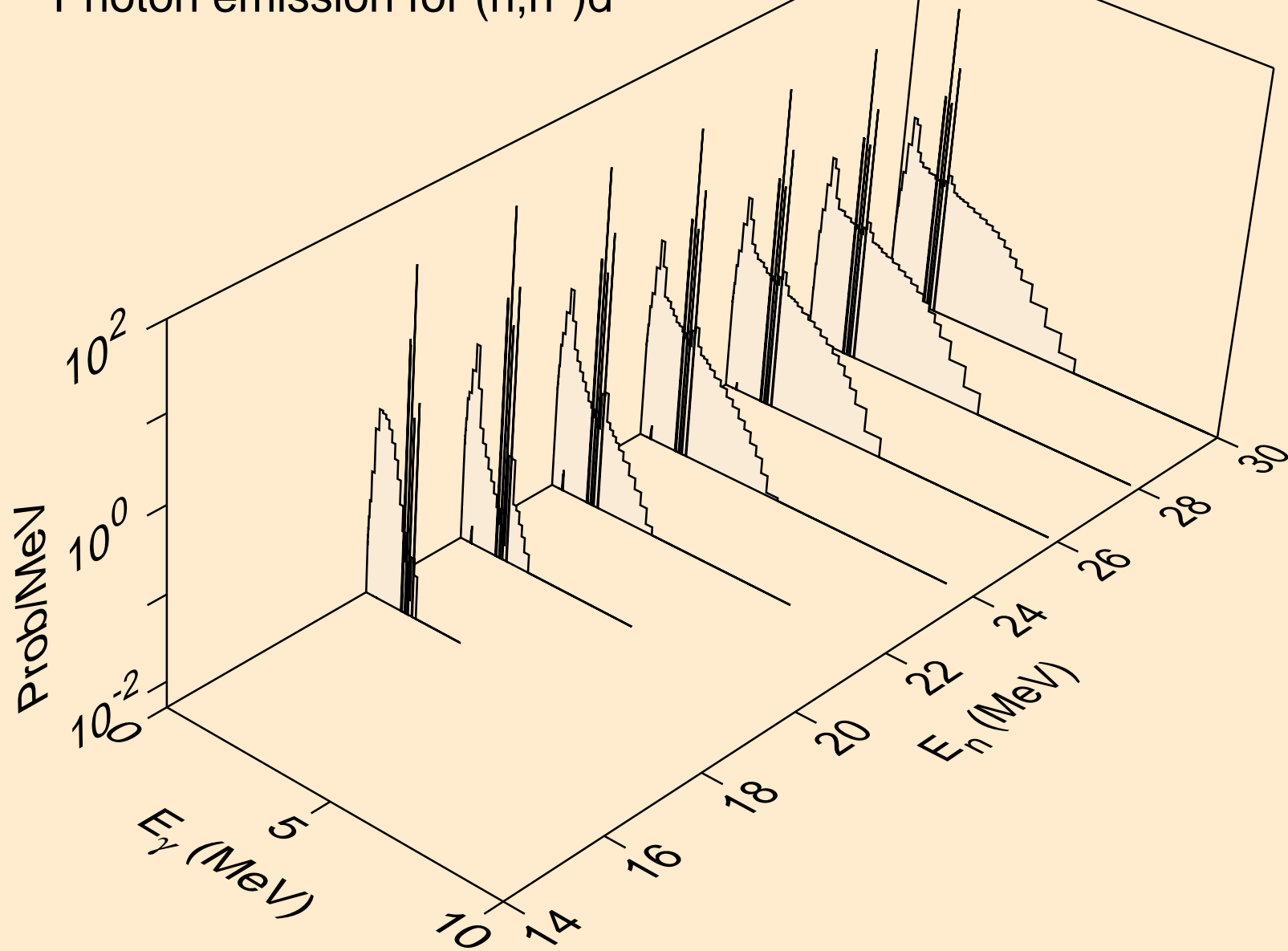

ZN071 NEUTRON ACER TENDL-2024 LIBRARY; T=0.K
Photon emission for (n,n*)t

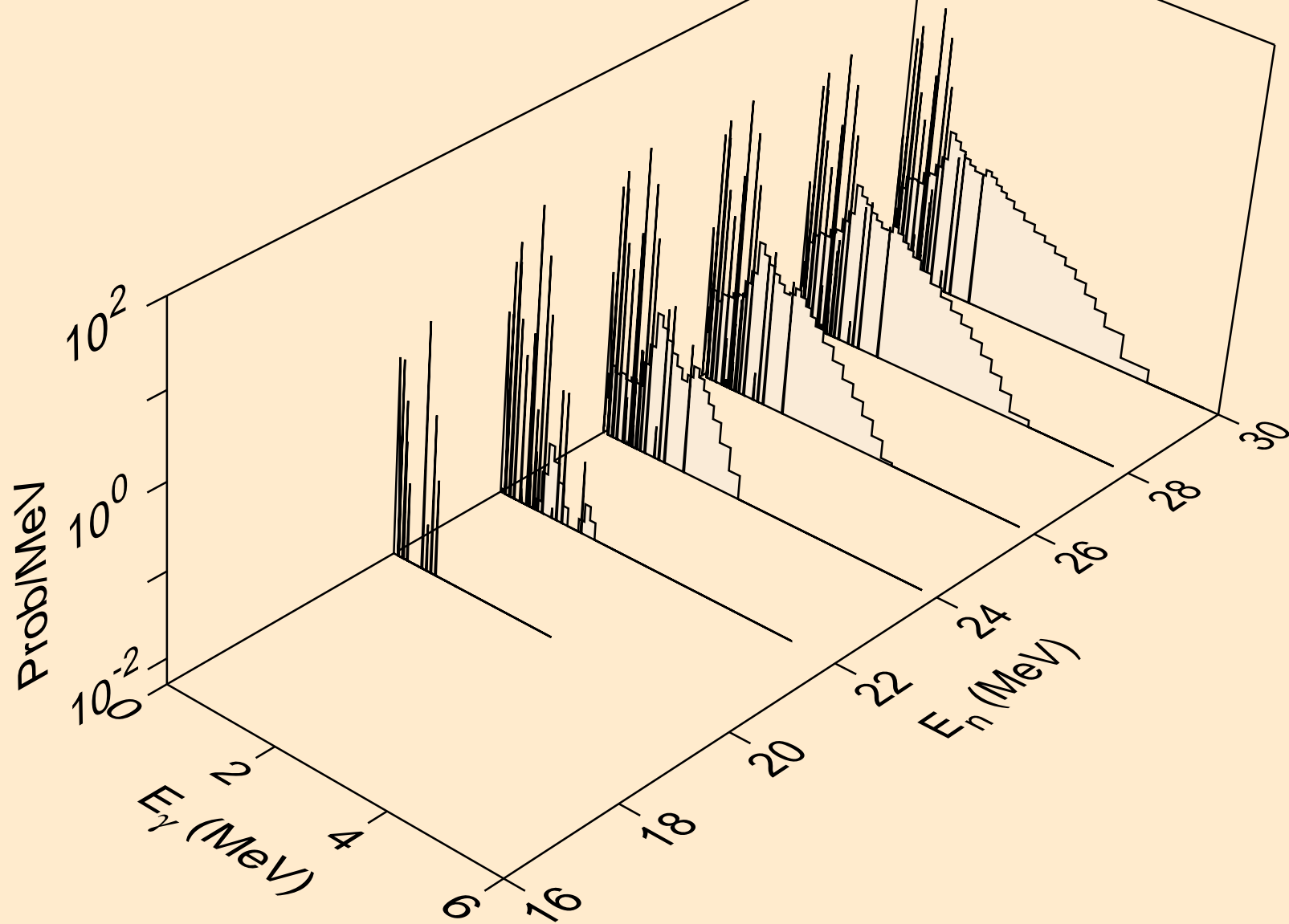

ZN071 NEUTRON ACER TENDL-2024 LIBRARY; T=0.K
Photon emission for (n,n*)he3

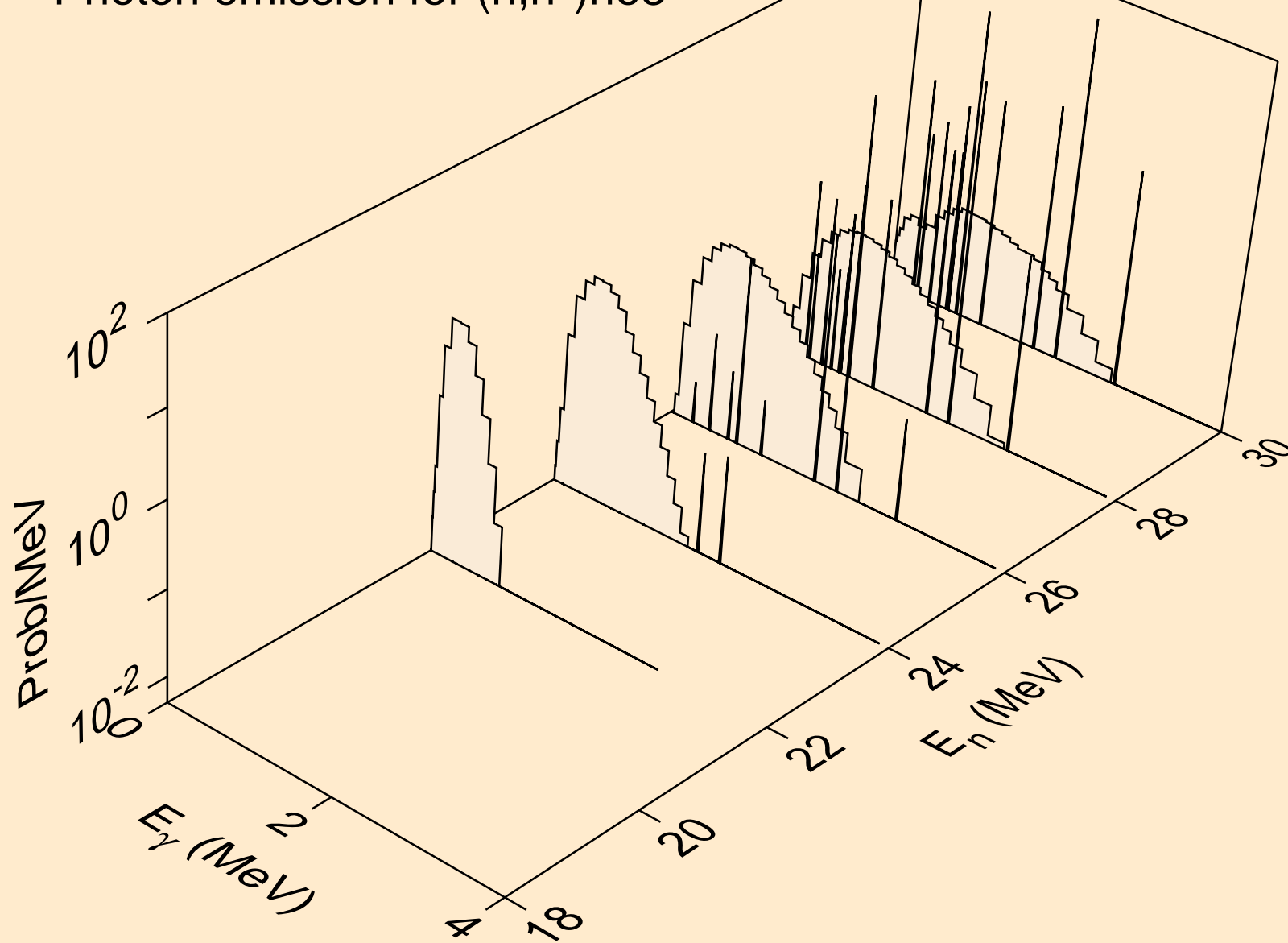

ZN071 NEUTRON ACER TENDL-2024 LIBRARY; T=0.K
Photon emission for (n,4n)

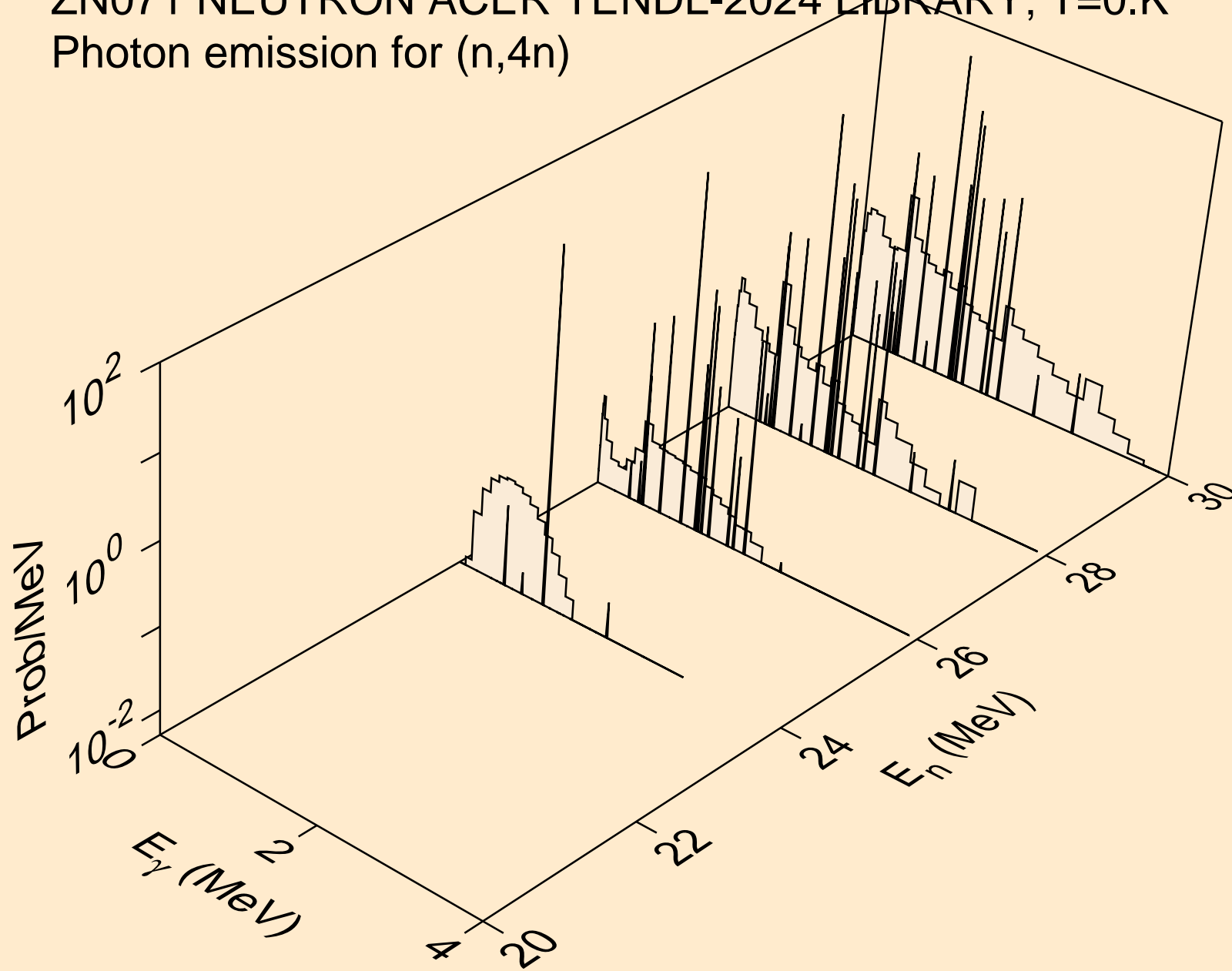

ZN071 NEUTRON ACER TENDL-2024 LIBRARY; T=0.K
Photon emission for (n,2np)

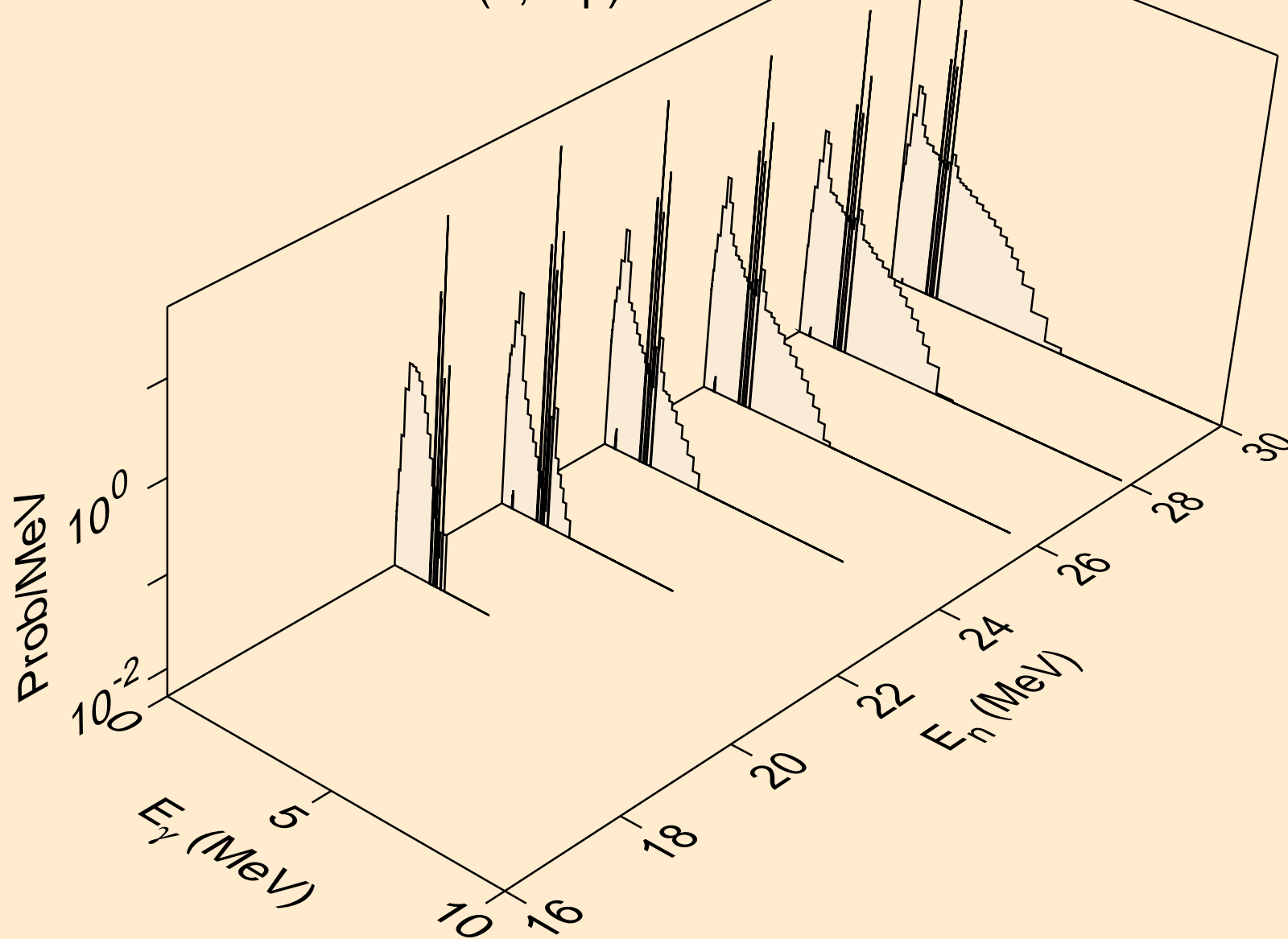

ZN071 NEUTRON ACER TENDL-2024 LIBRARY; T=0.K
Photon emission for (n,3np)

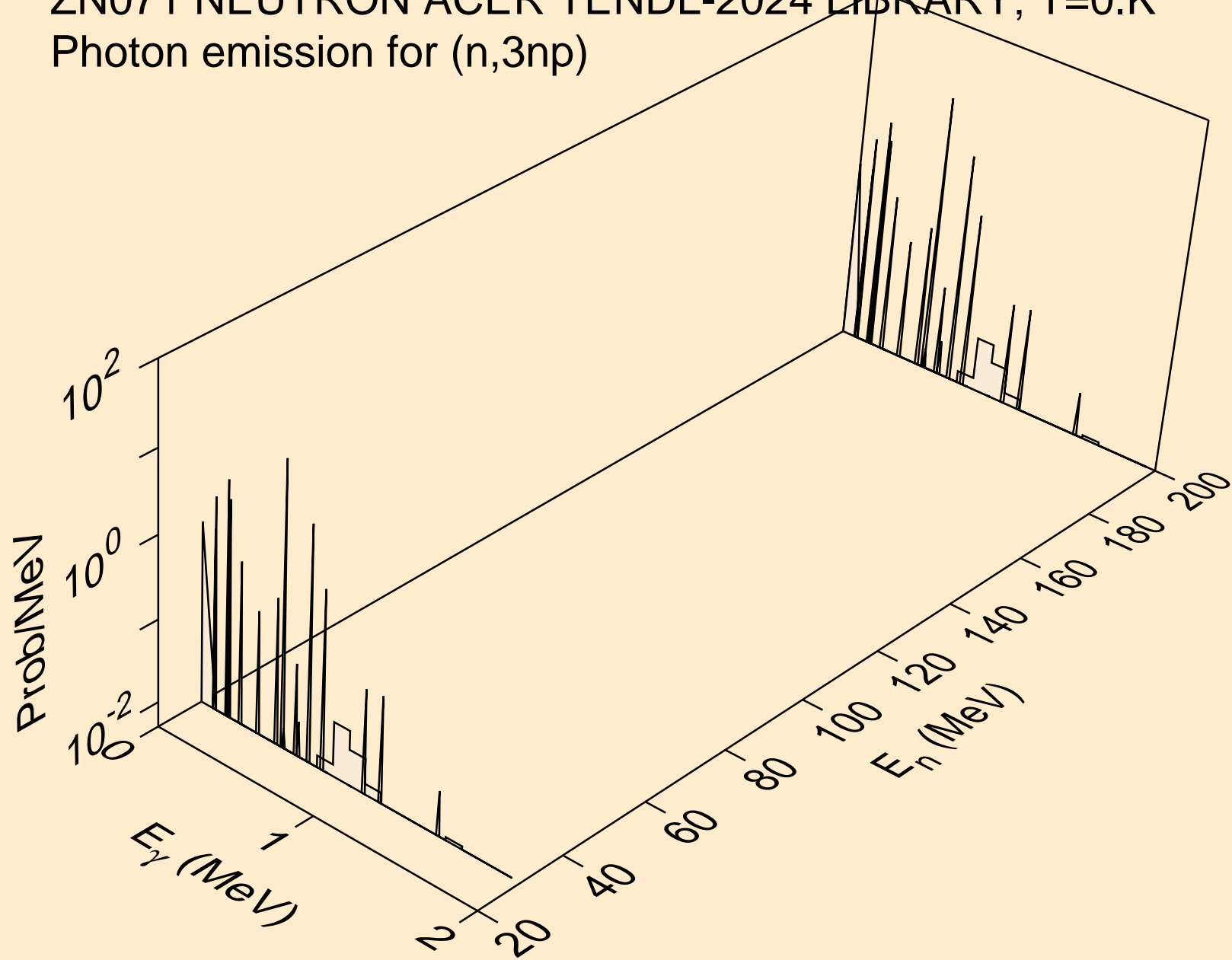

ZN071 NEUTRON ACER TENDL-2024 LIBRARY; T=0.K
Photon emission for (n,n2p)

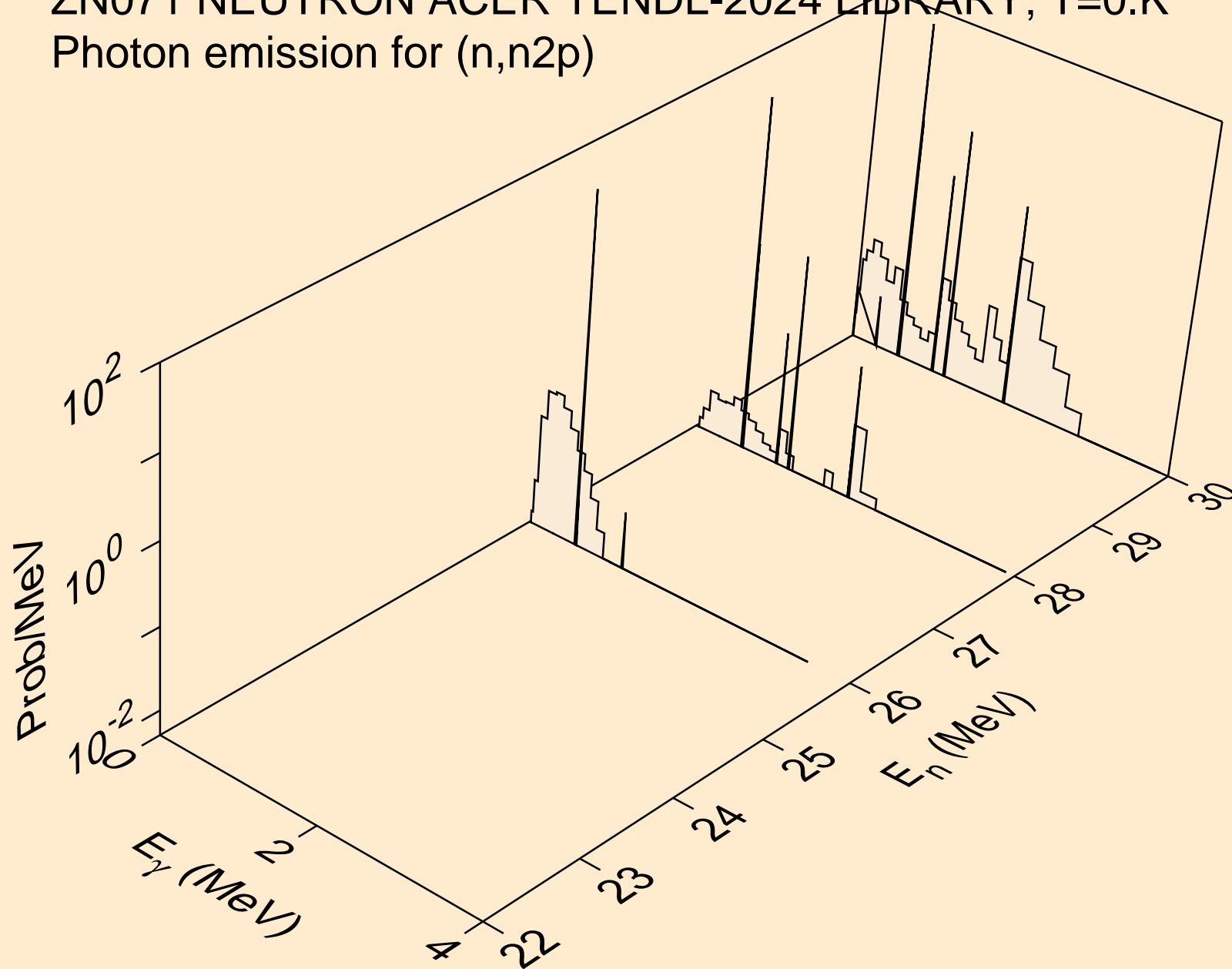

ZN071 NEUTRON ACER TENDL-2024 LIBRARY; T=0.K
Photon emission for (n,n*c)

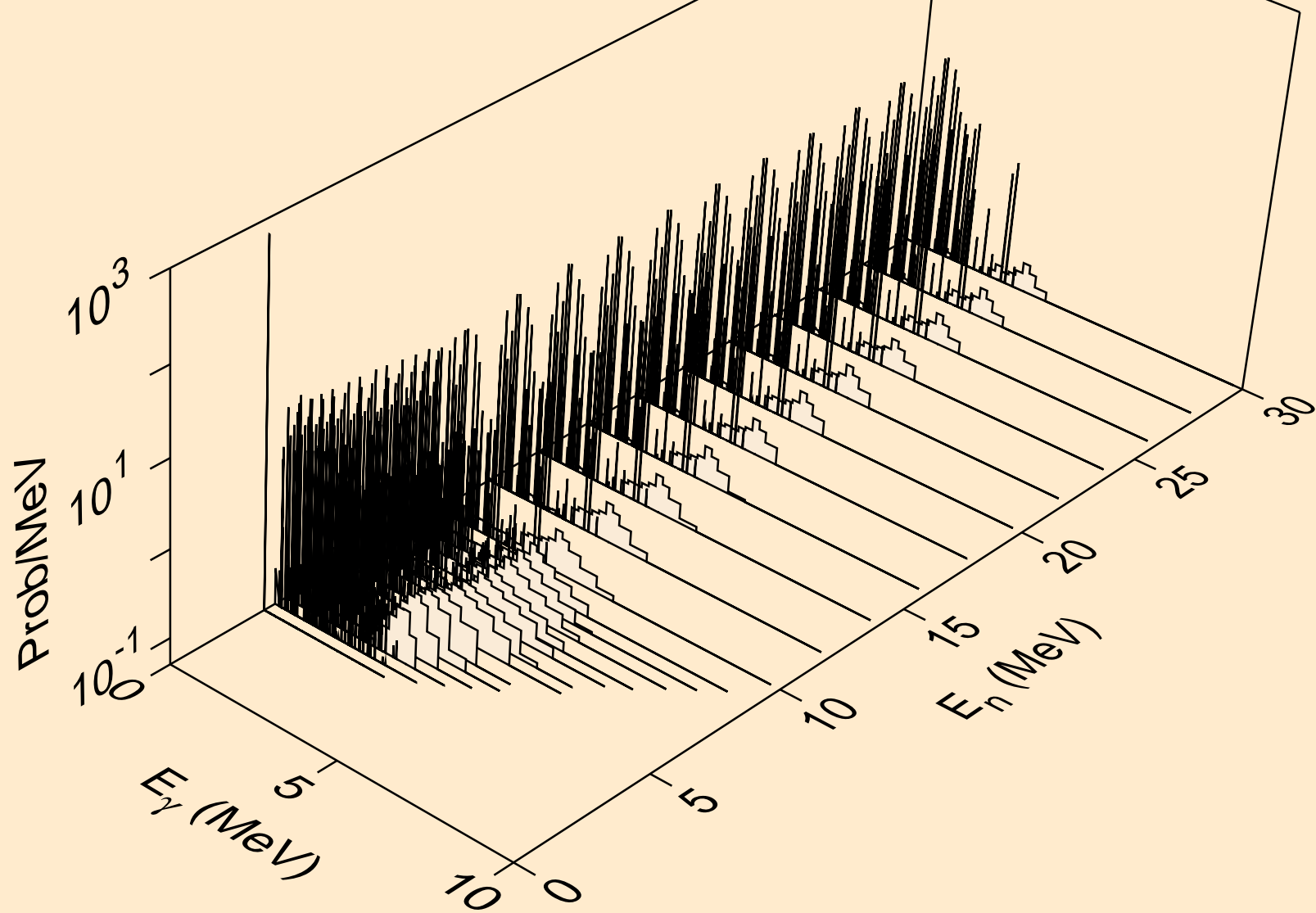

ZN071 NEUTRON ACER TENDL-2024 LIBRARY; T=0.K
Photon emission for (n,gma)

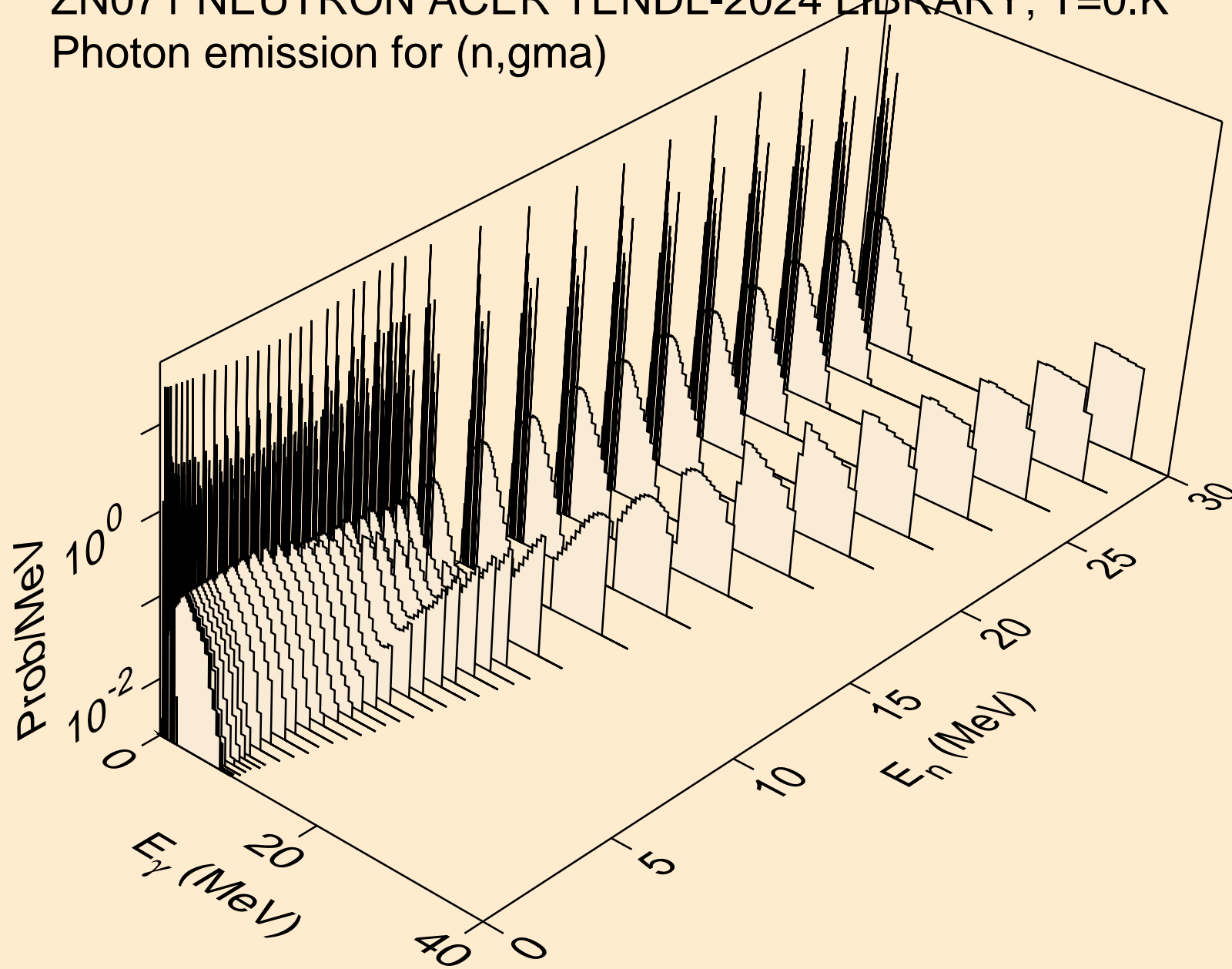

ZN071 NEUTRON ACER TENDL-2024 LIBRARY; T=0.K
Photon emission for (n,p)

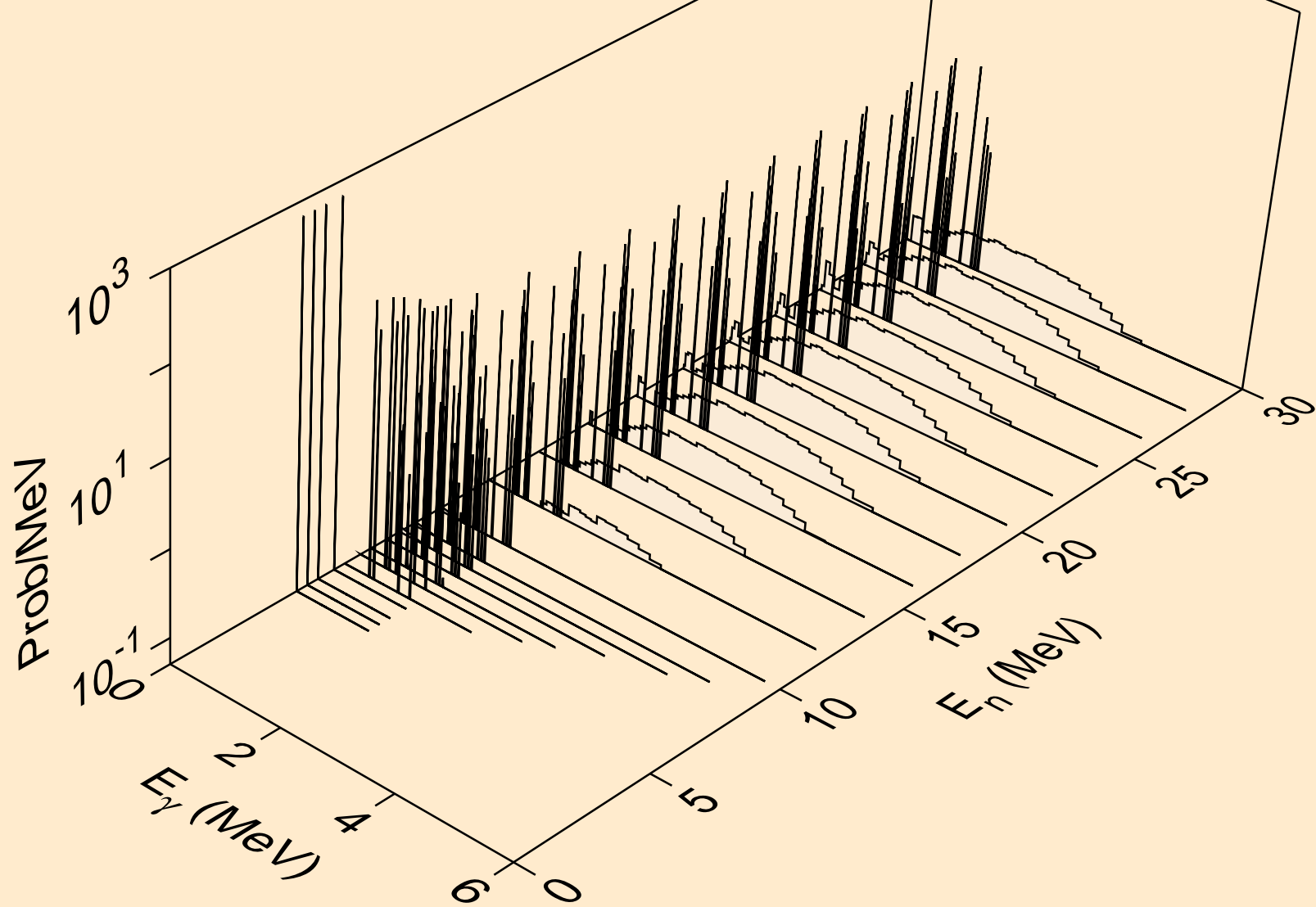

ZN071 NEUTRON ACER TENDL-2024 LIBRARY; T=0.K
Photon emission for (n,d)

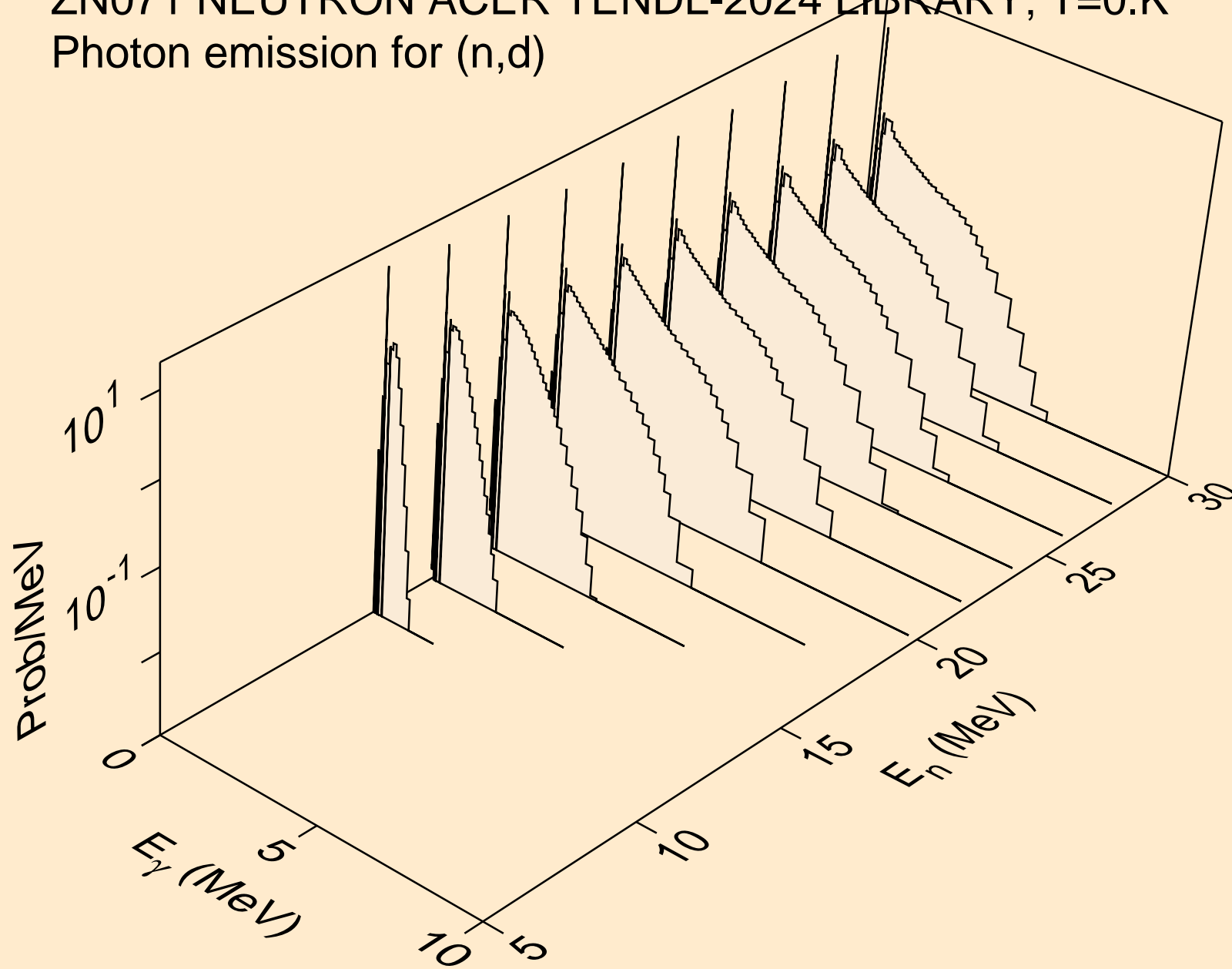

ZN071 NEUTRON ACER TENDL-2024 LIBRARY; T=0.K
Photon emission for (n,t)

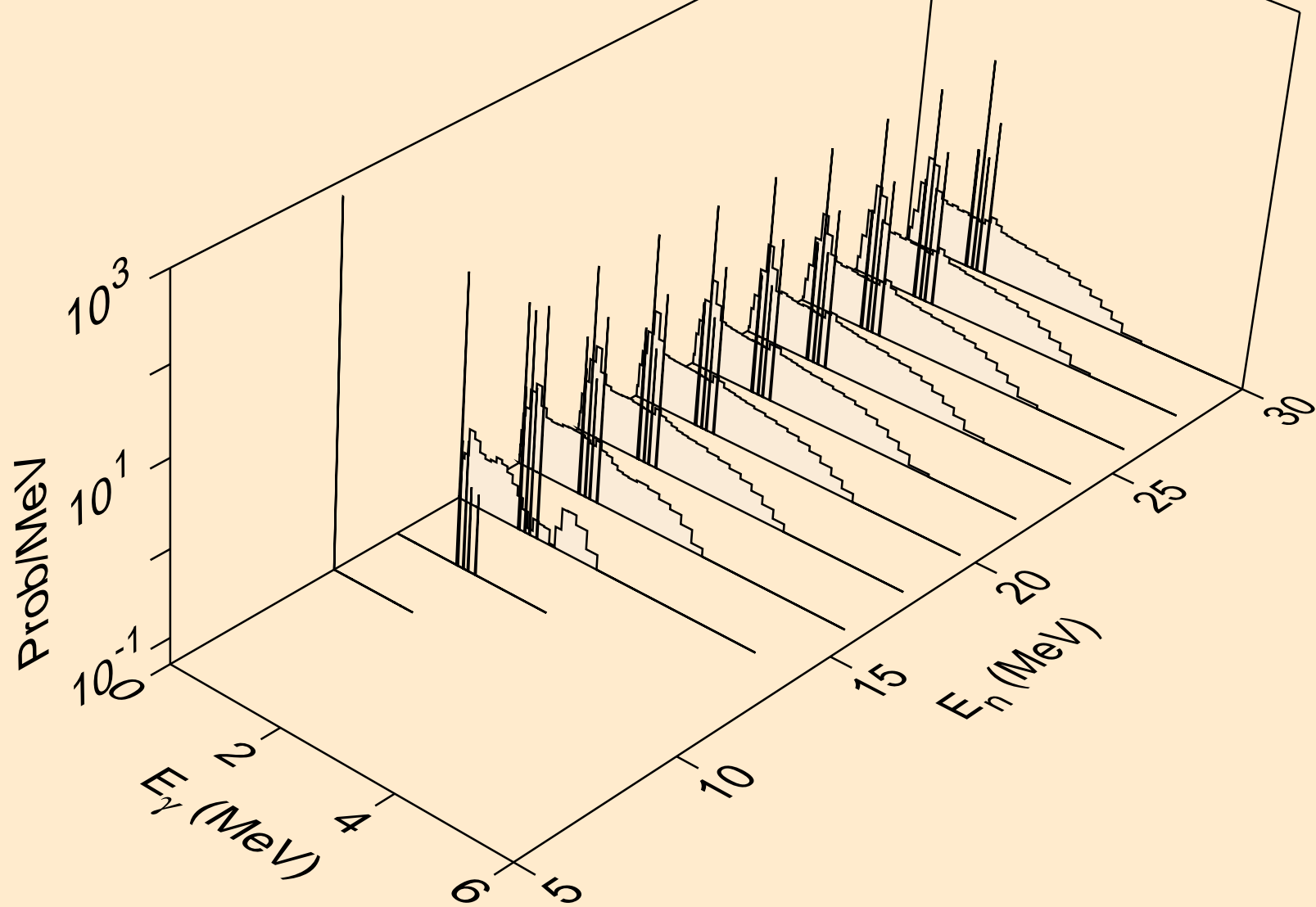

ZN071 NEUTRON ACER TENDL-2024 LIBRARY; T=0.K
Photon emission for (n,he3)

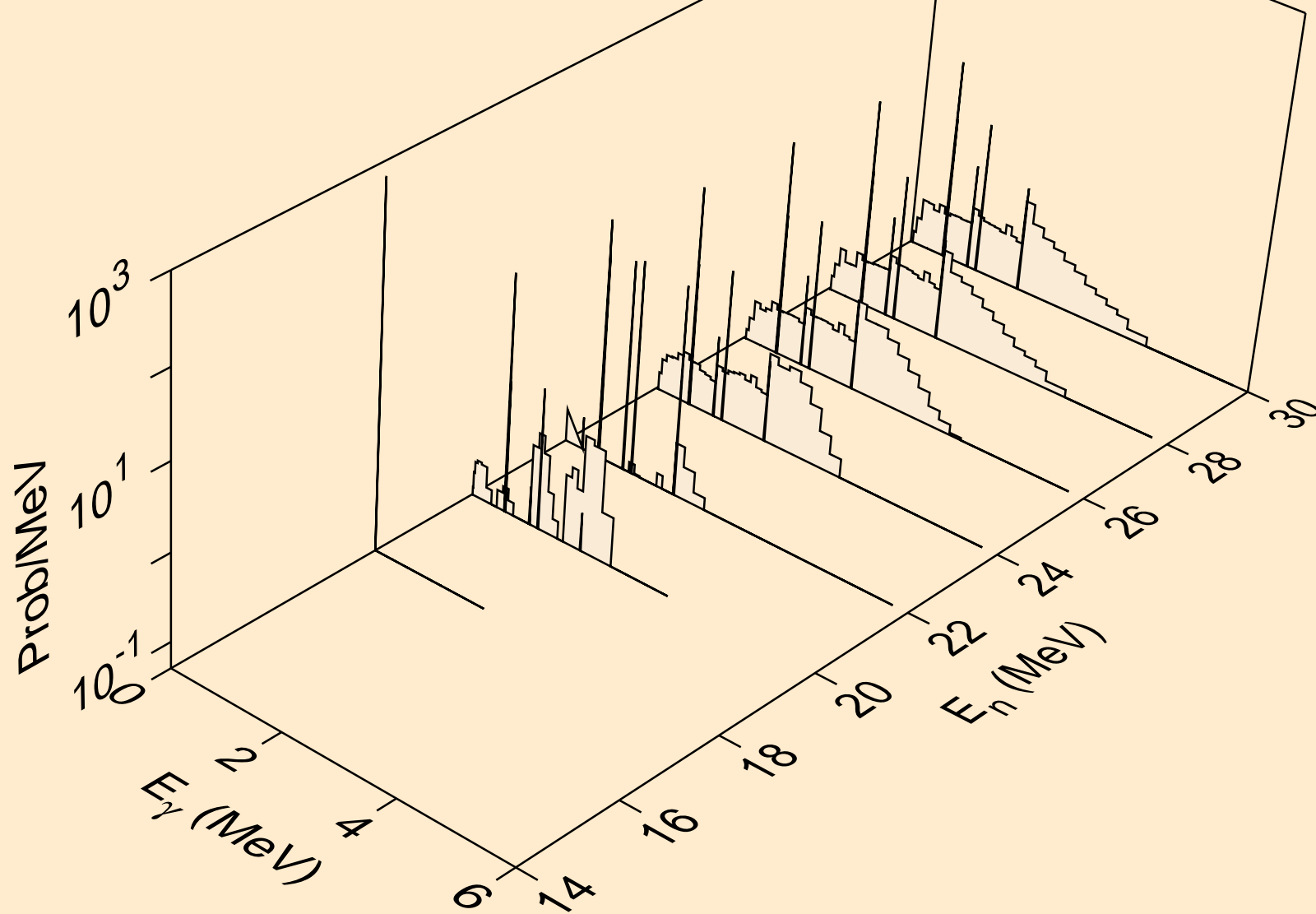

ZN071 NEUTRON ACER TENDL-2024 LIBRARY; T=0.K
Photon emission for (n,a)

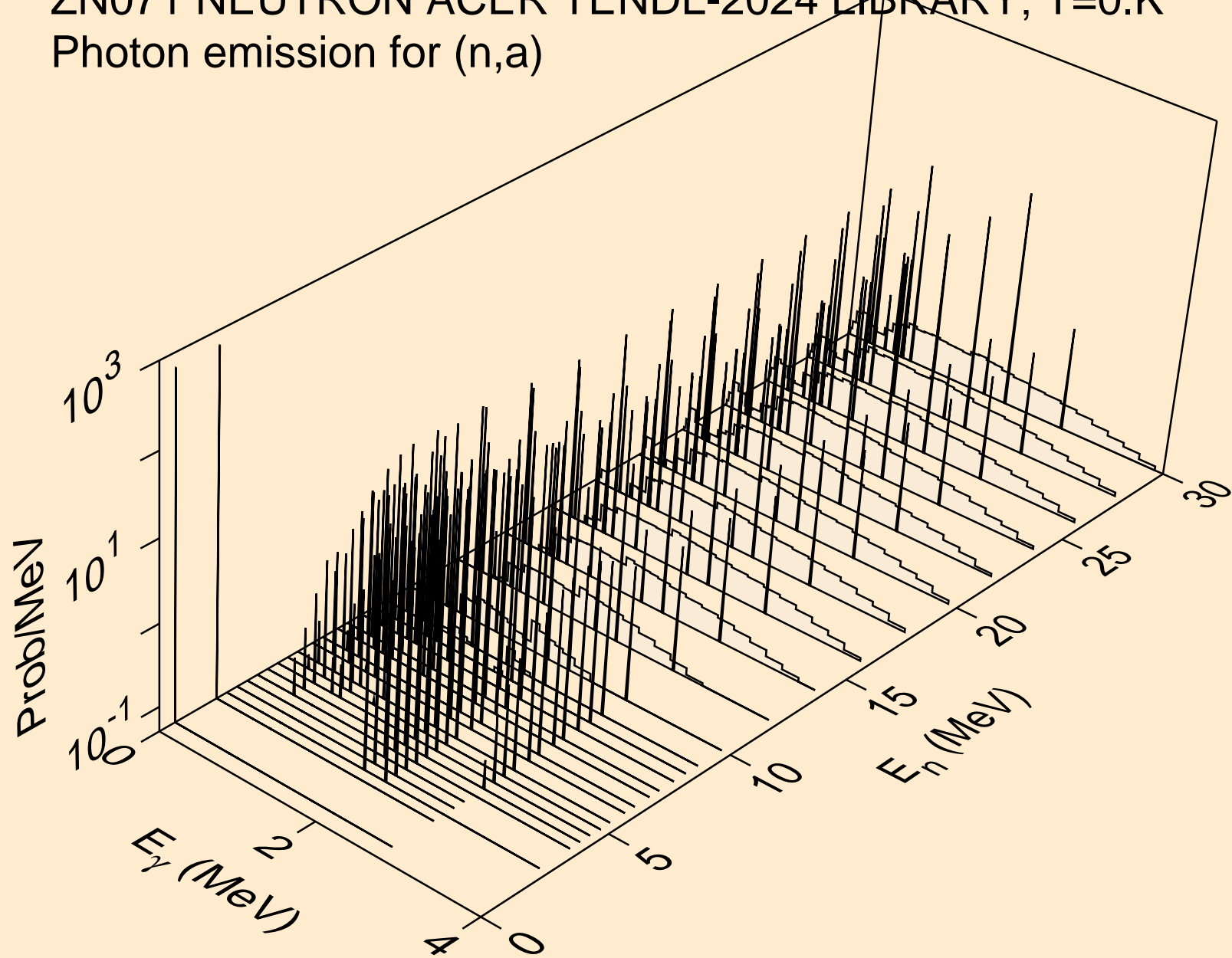

ZN071 NEUTRON ACER TENDL-2024 LIBRARY; T=0.K
Photon emission for (n,2a)

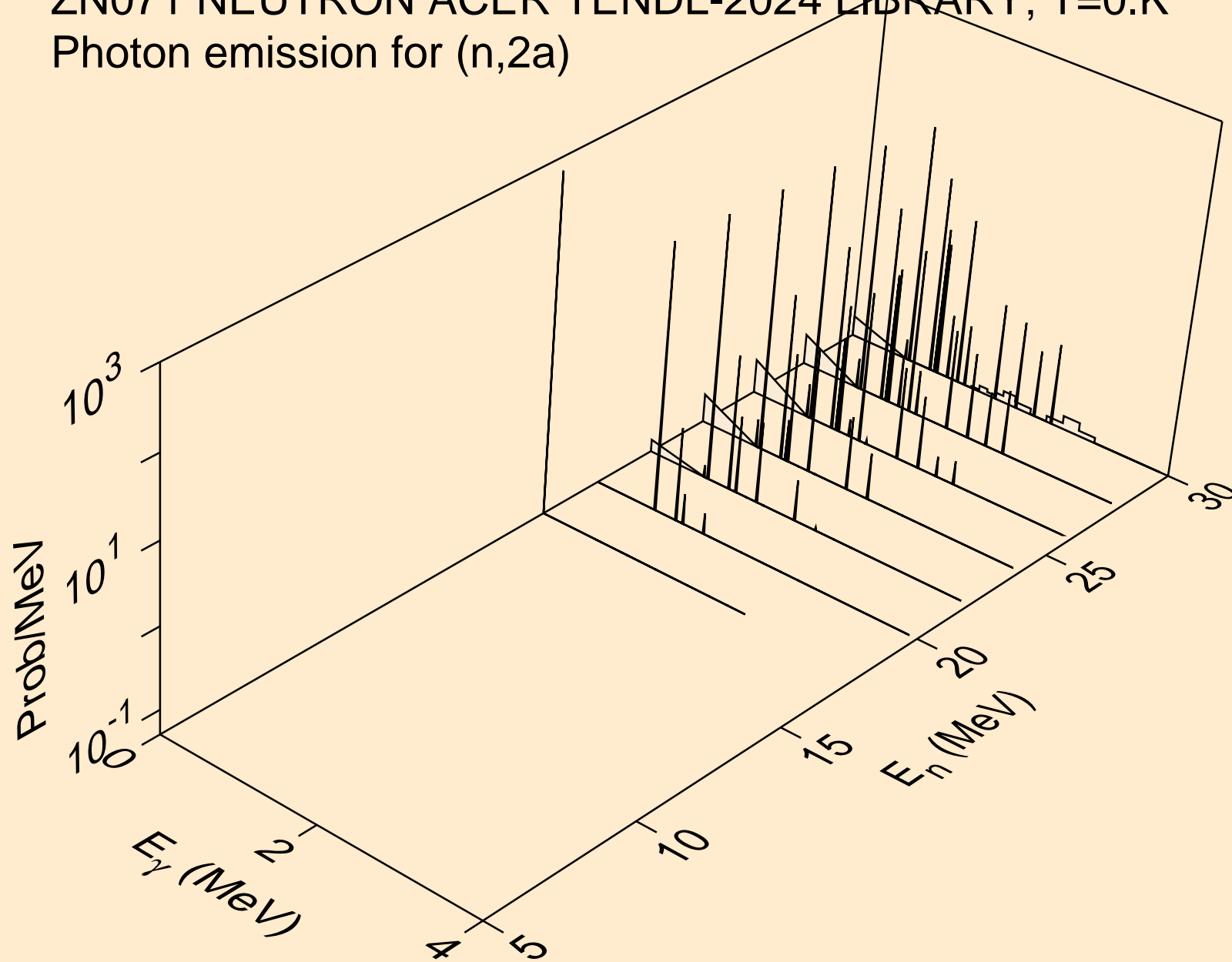

ZN071 NEUTRON ACER TENDL-2024 LIBRARY; T=0.K
Photon emission for (n,2p)

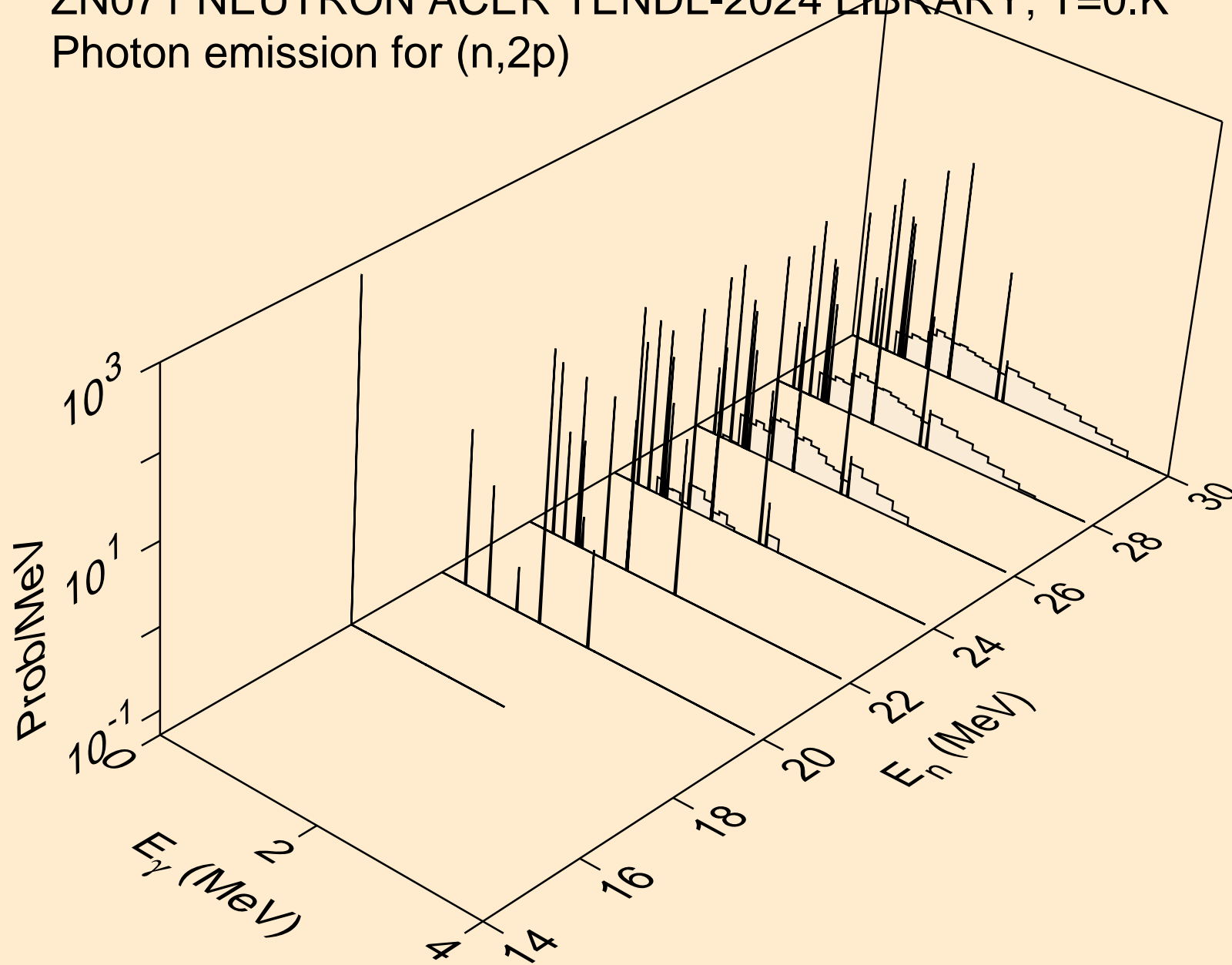

ZN071 NEUTRON ACER TENDL-2024 LIBRARY; T=0.K
Photon emission for (n,p α)

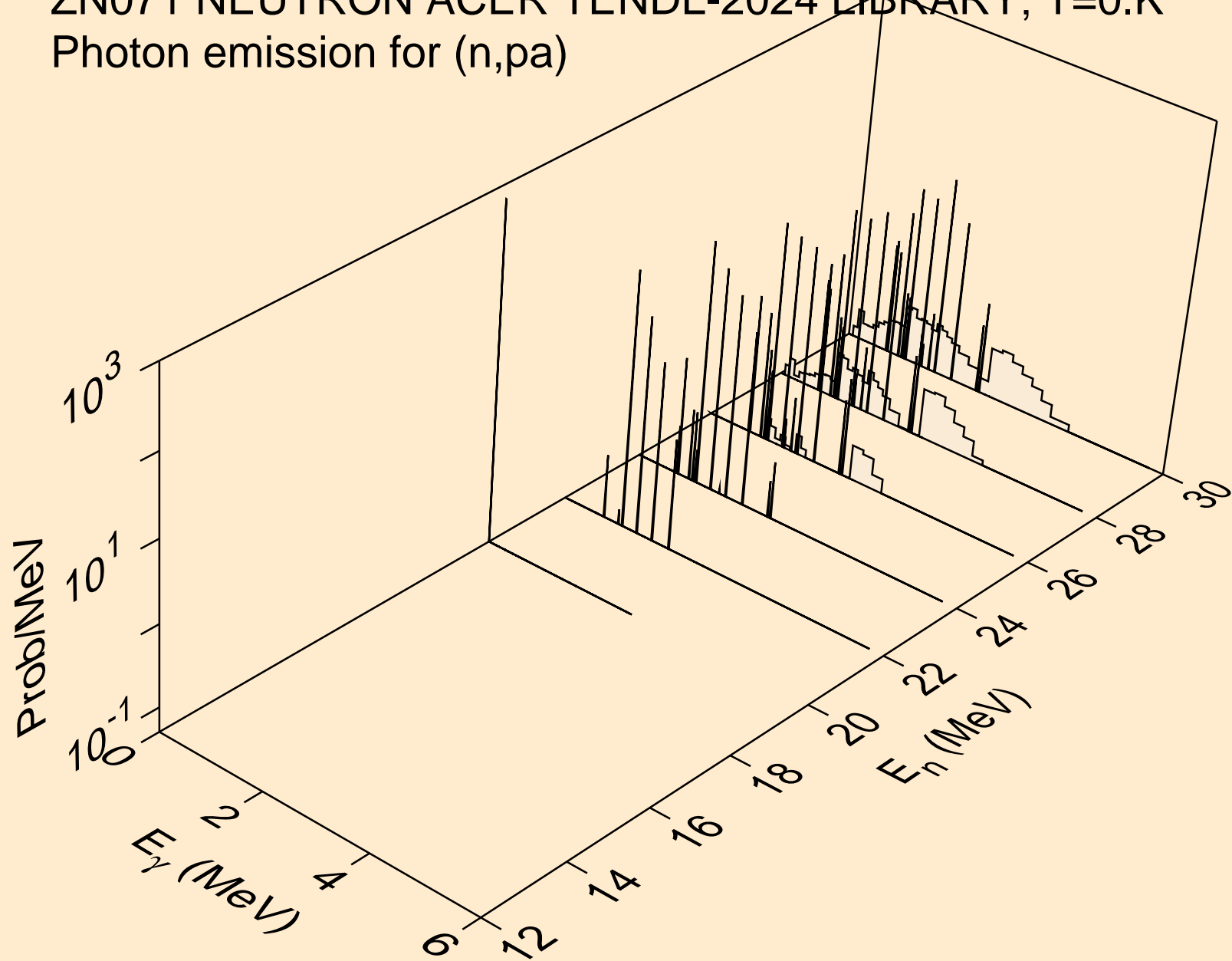

ZN071 NEUTRON ACER TENDL-2024 LIBRARY; T=0.K
Photon emission for (n,pd)

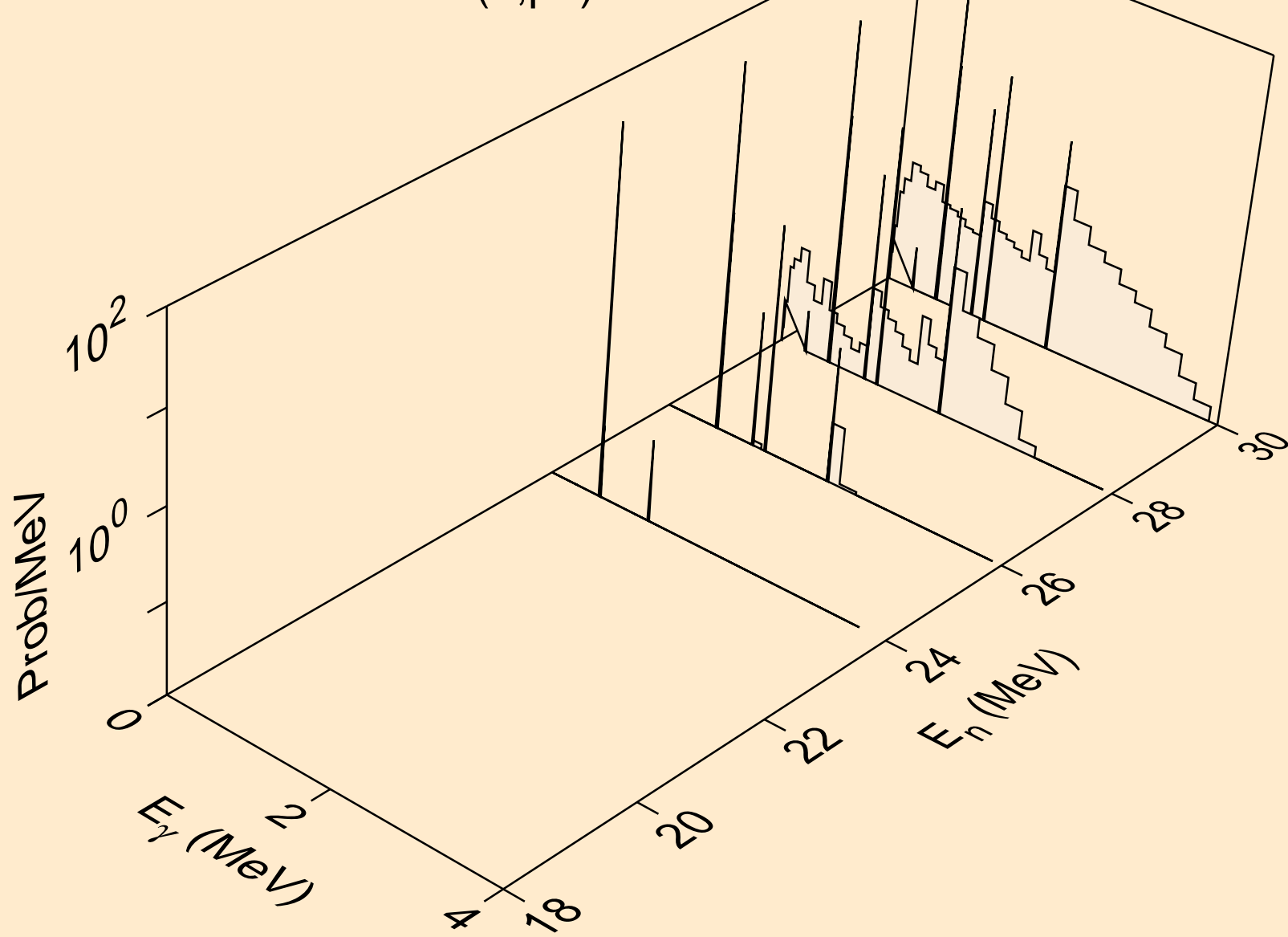

ZN071 NEUTRON ACER TENDL-2024 LIBRARY; T=0.K
Photon emission for (n,pt)

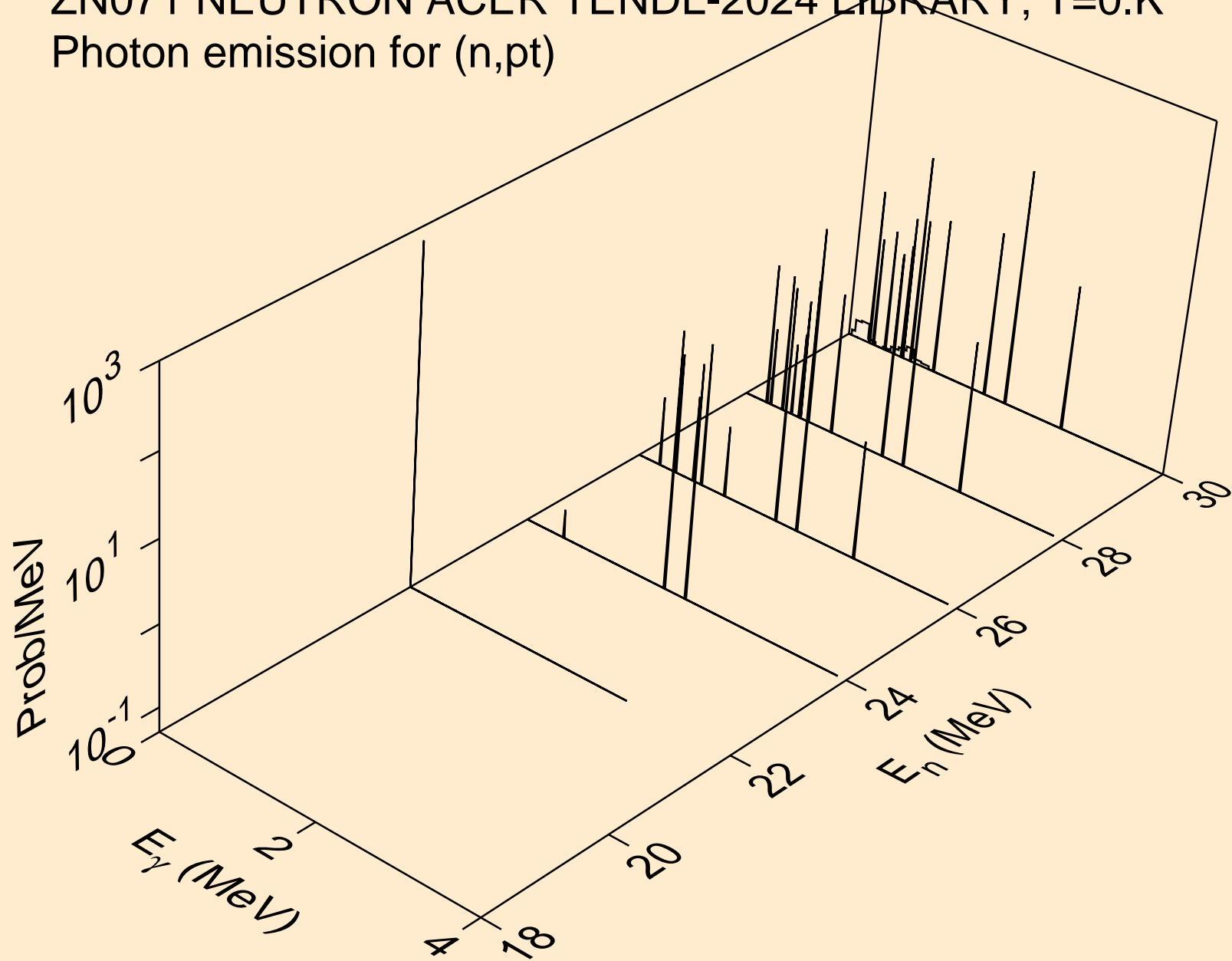

ZN071 NEUTRON ACER TENDL-2024 LIBRARY; T=0.K
thermal capture photon spectrum

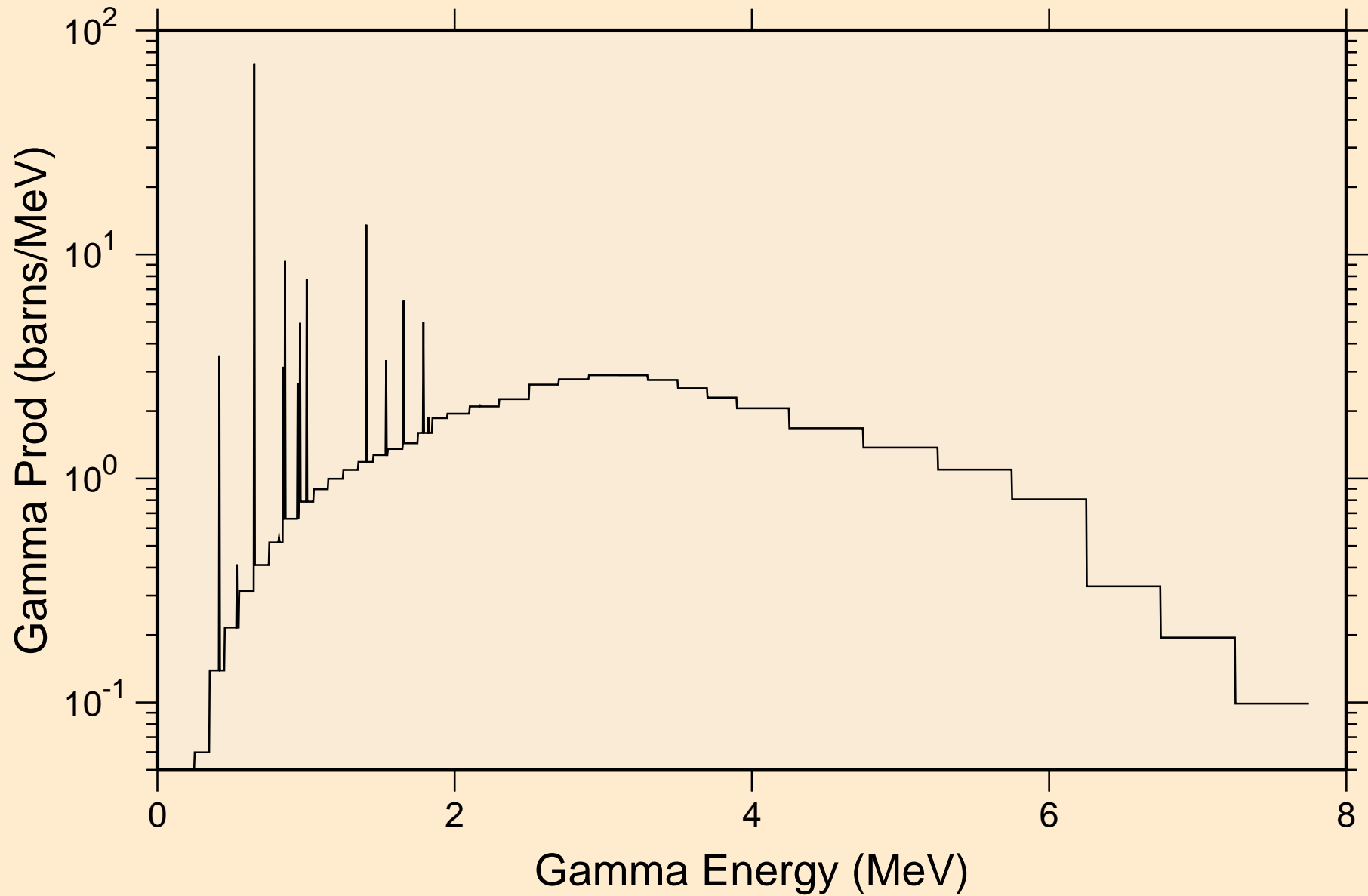

ZN071 NEUTRON ACER TENDL-2024 LIBRARY; T=0.K
14 MeV photon spectrum

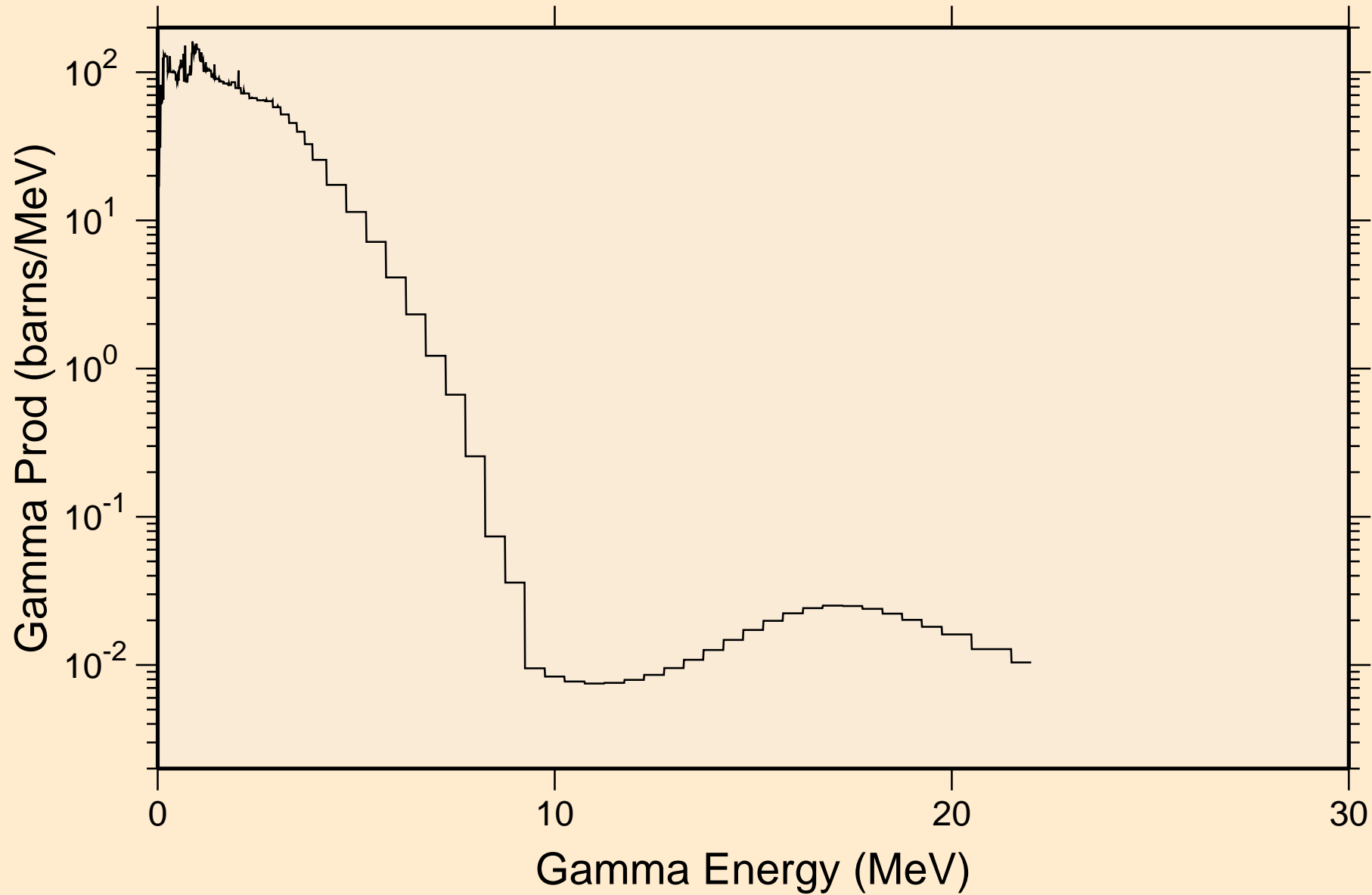

ZN071 NEUTRON ACER TENDL-2024 LIBRARY; T=0.K

Particle heating contributions

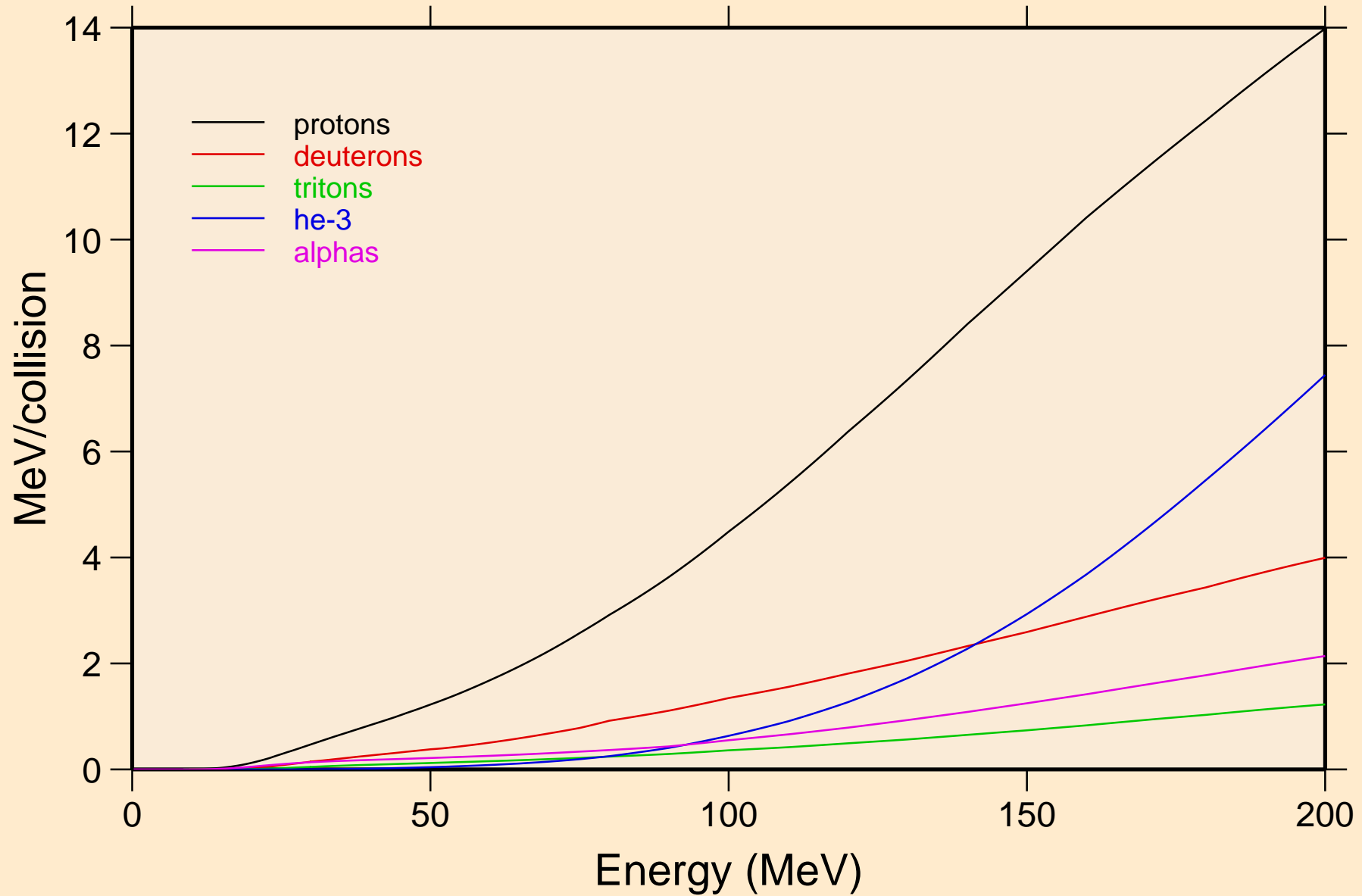

ZN071 NEUTRON ACER TENDL-2024 LIBRARY; T=0.K
Recoil Heating

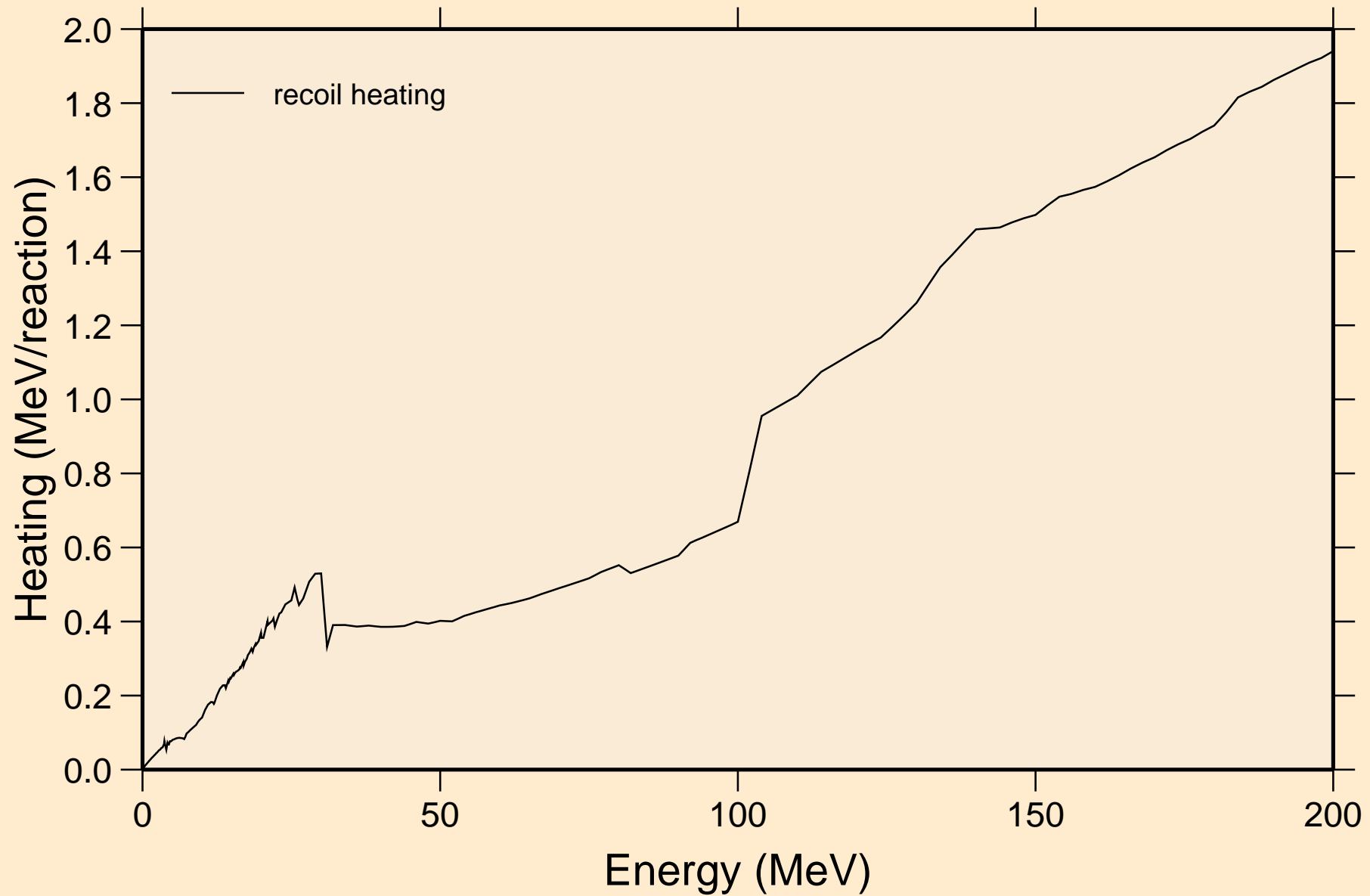

ZN071 NEUTRON ACER TENDL-2024 LIBRARY; T=0.K
Particle production cross sections

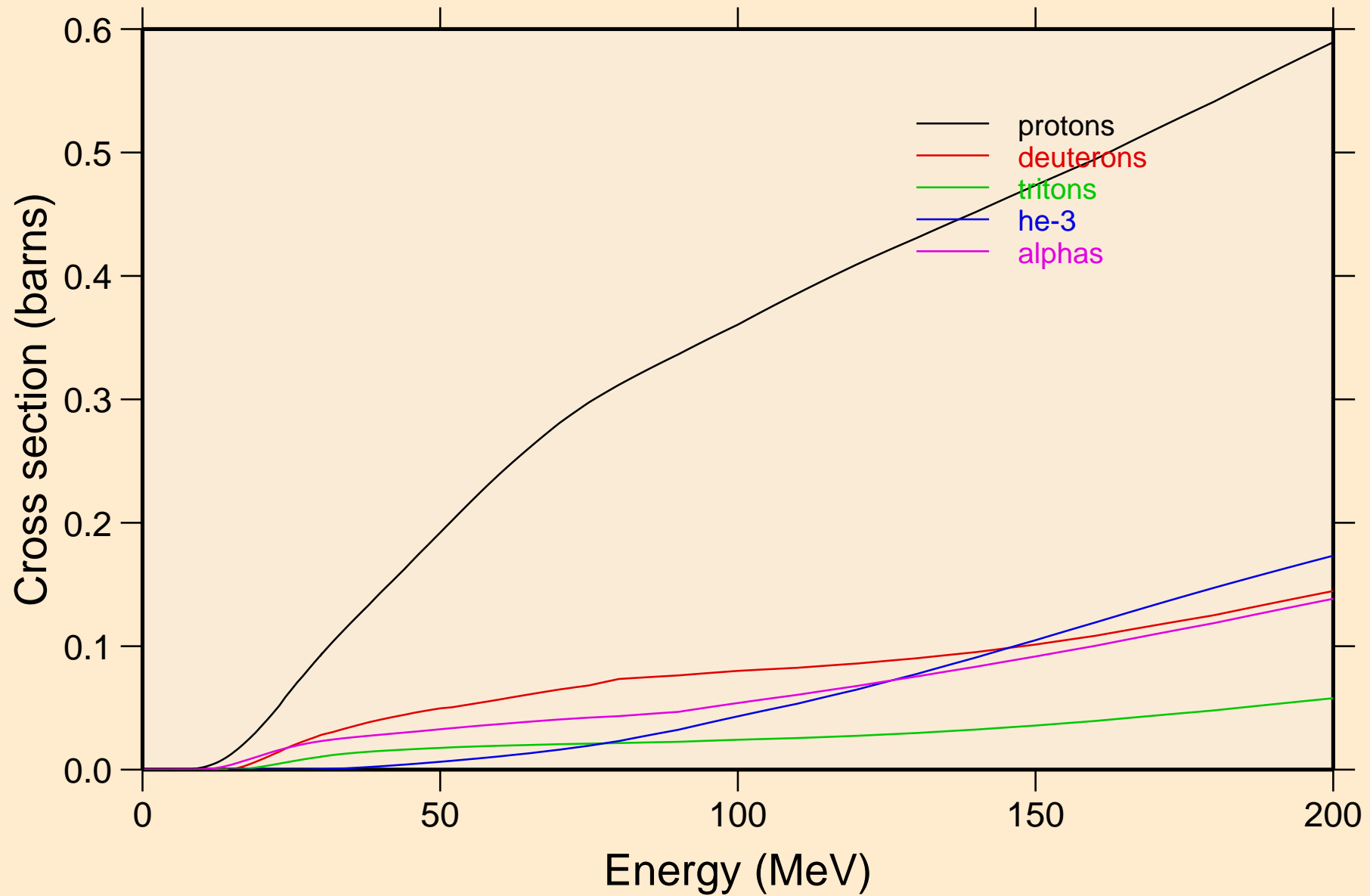

ZN071 NEUTRON ACER TENDL-2024 LIBRARY; T=0.K
protons from (n,x)

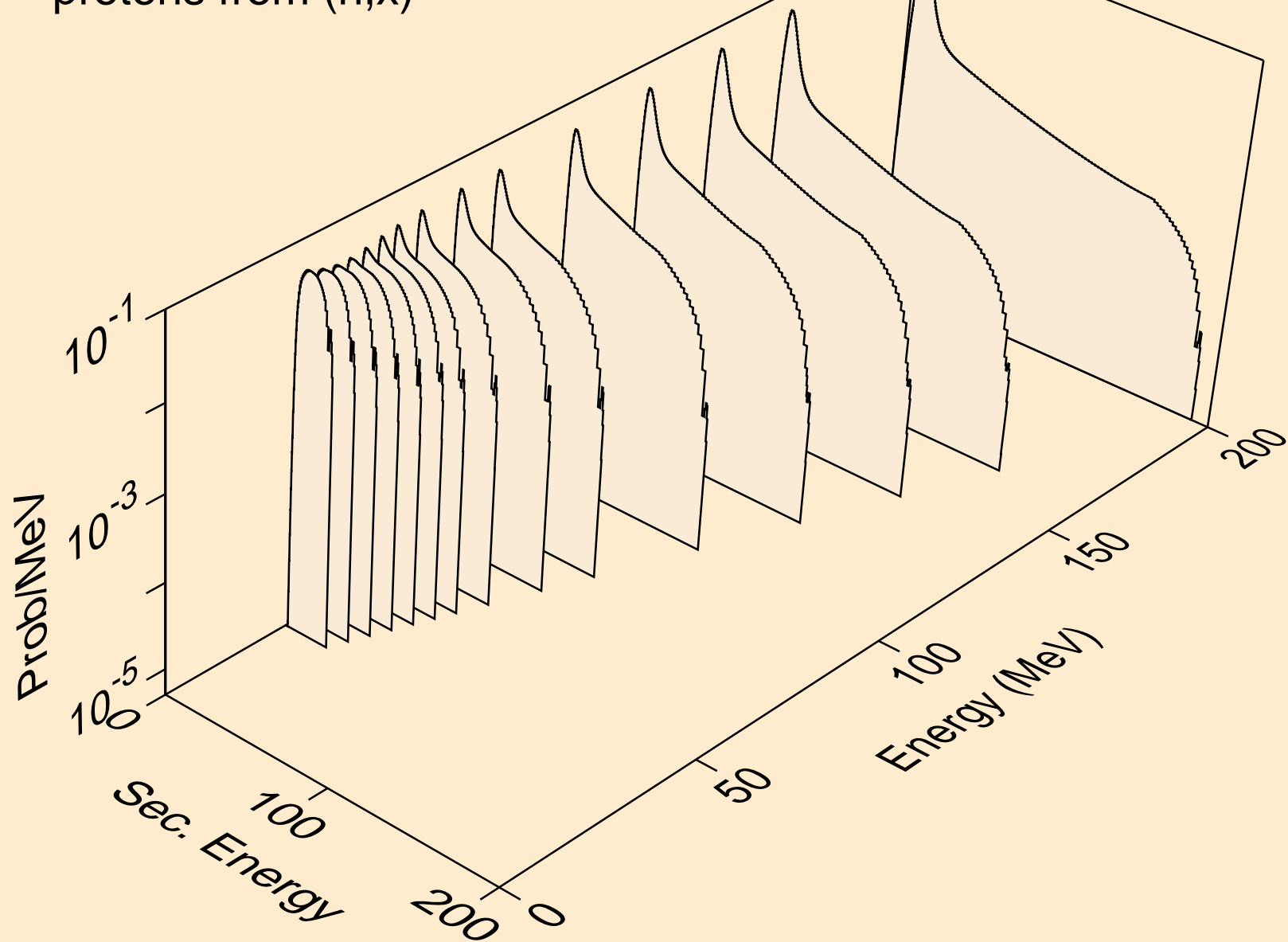

ZN071 NEUTRON ACER TENDL-2024 LIBRARY; T=0.K
protons from (n,n*)p

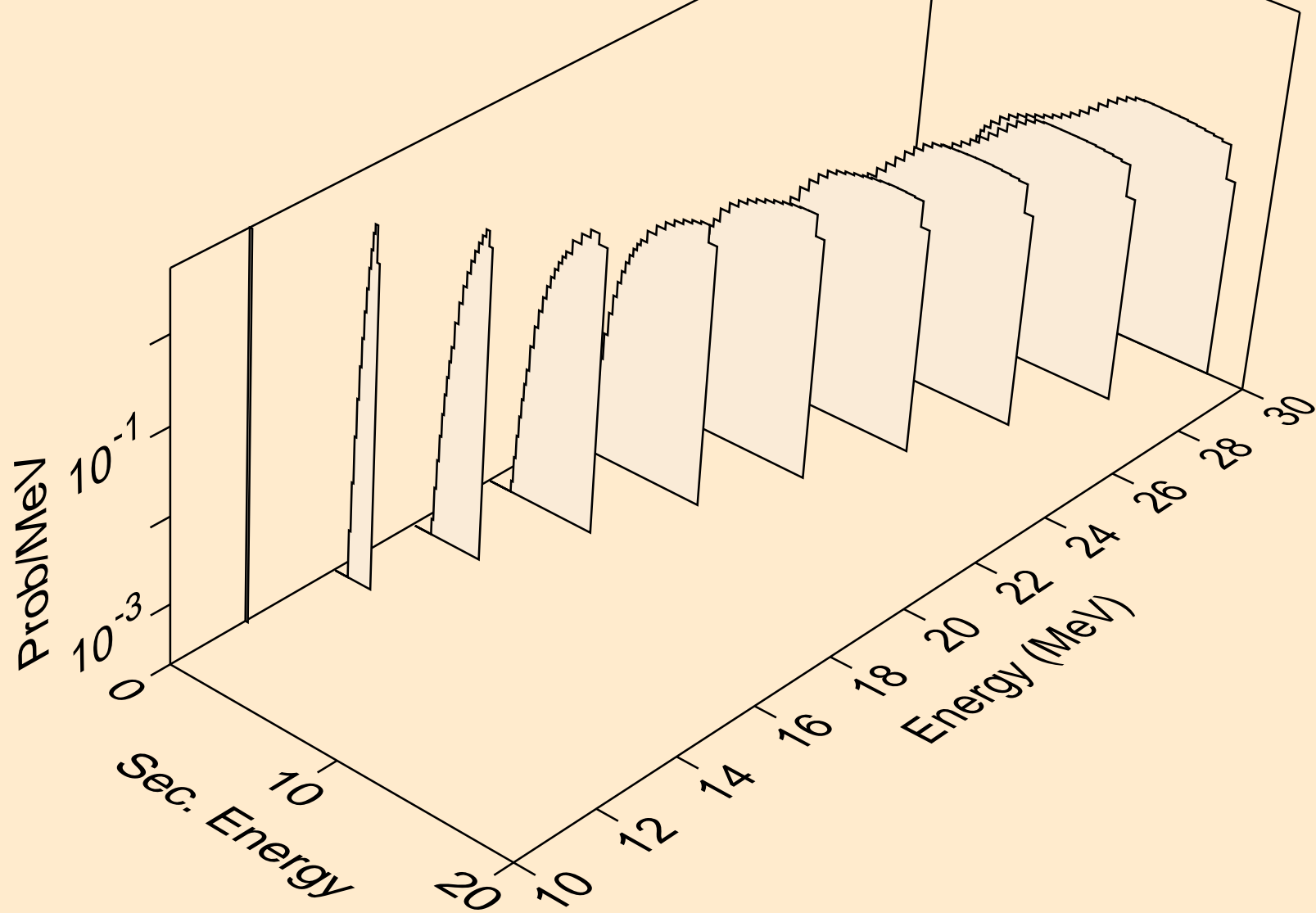

ZN071 NEUTRON ACER TENDL-2024 LIBRARY; T=0.K
protons from (n,2np)

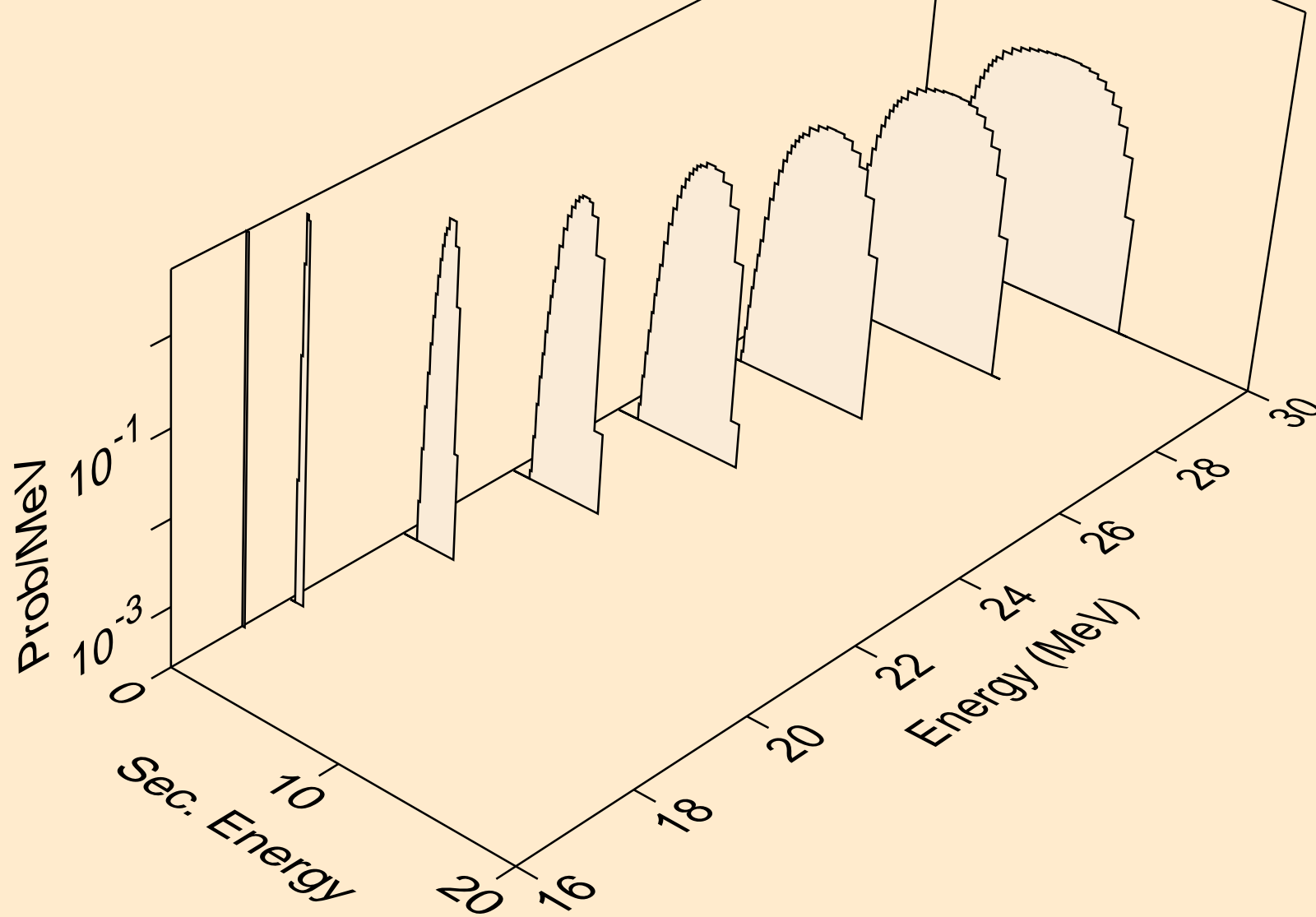

ZN071 NEUTRON ACER TENDL-2024 LIBRARY; T=0.K
protons from (n,3np)

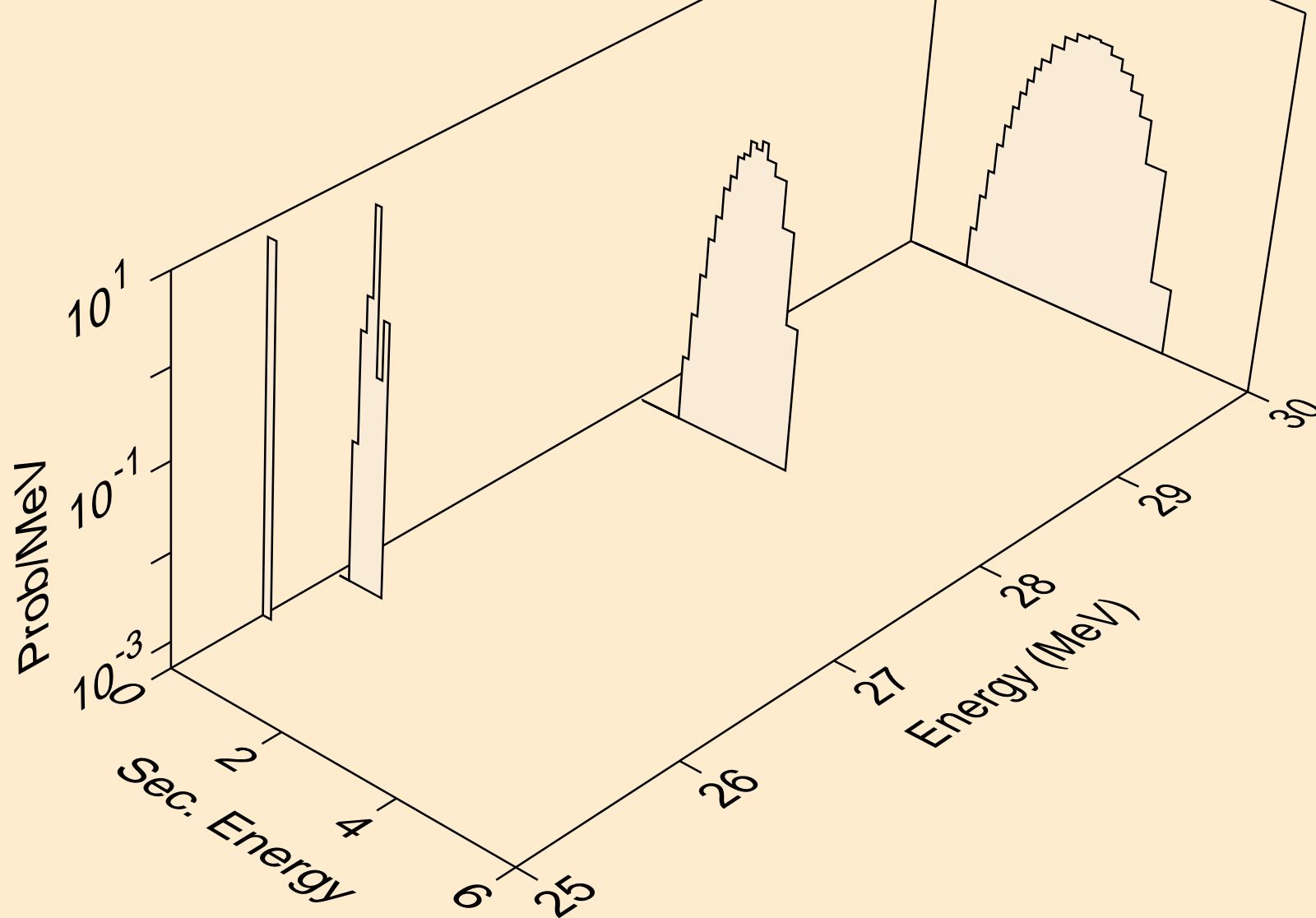

ZN071 NEUTRON ACER TENDL-2024 LIBRARY; T=0.K
protons from (n,n2p)

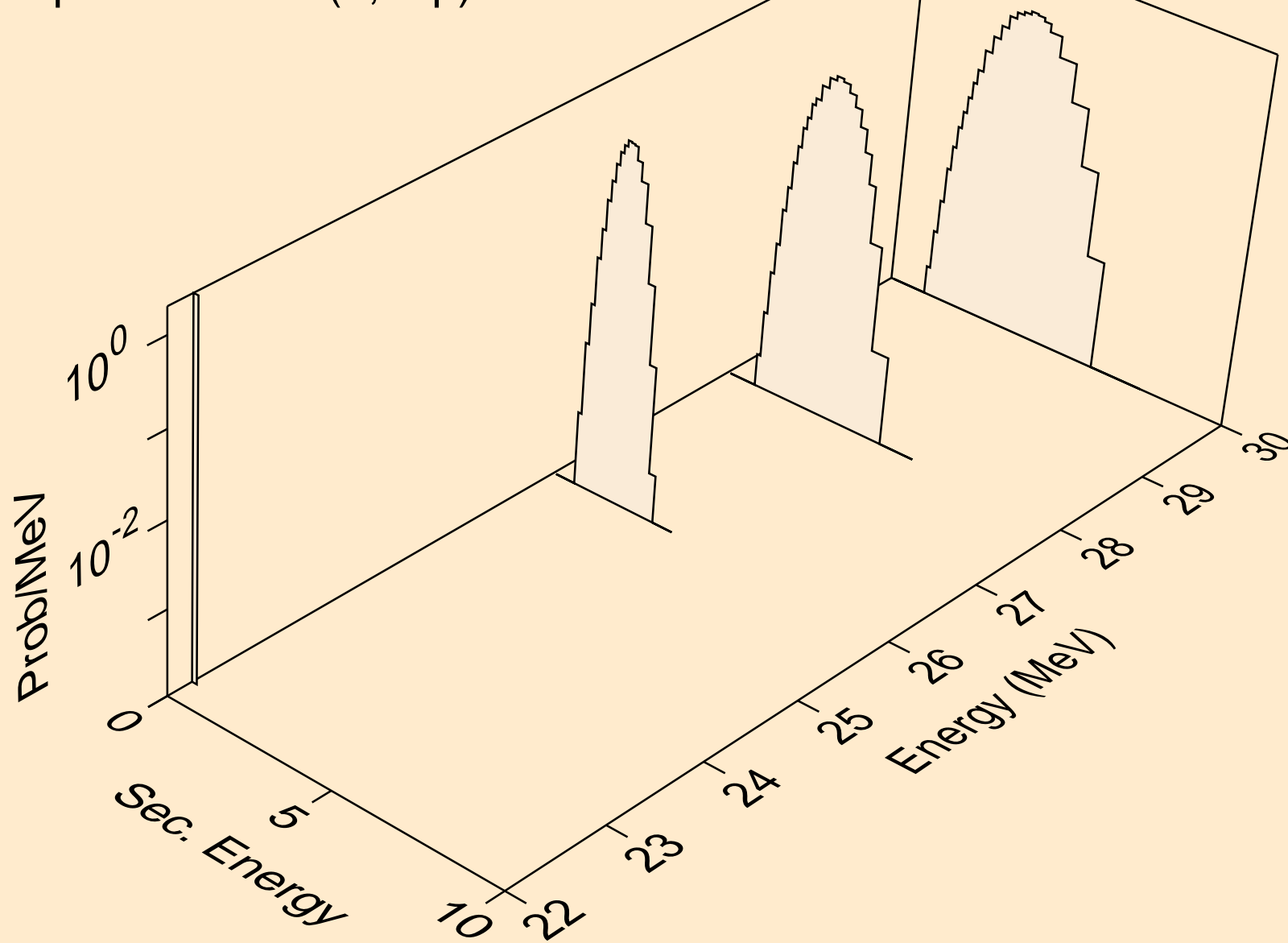

ZN071 NEUTRON ACER TENDL-2024 LIBRARY; T=0.K
protons from (n,p)

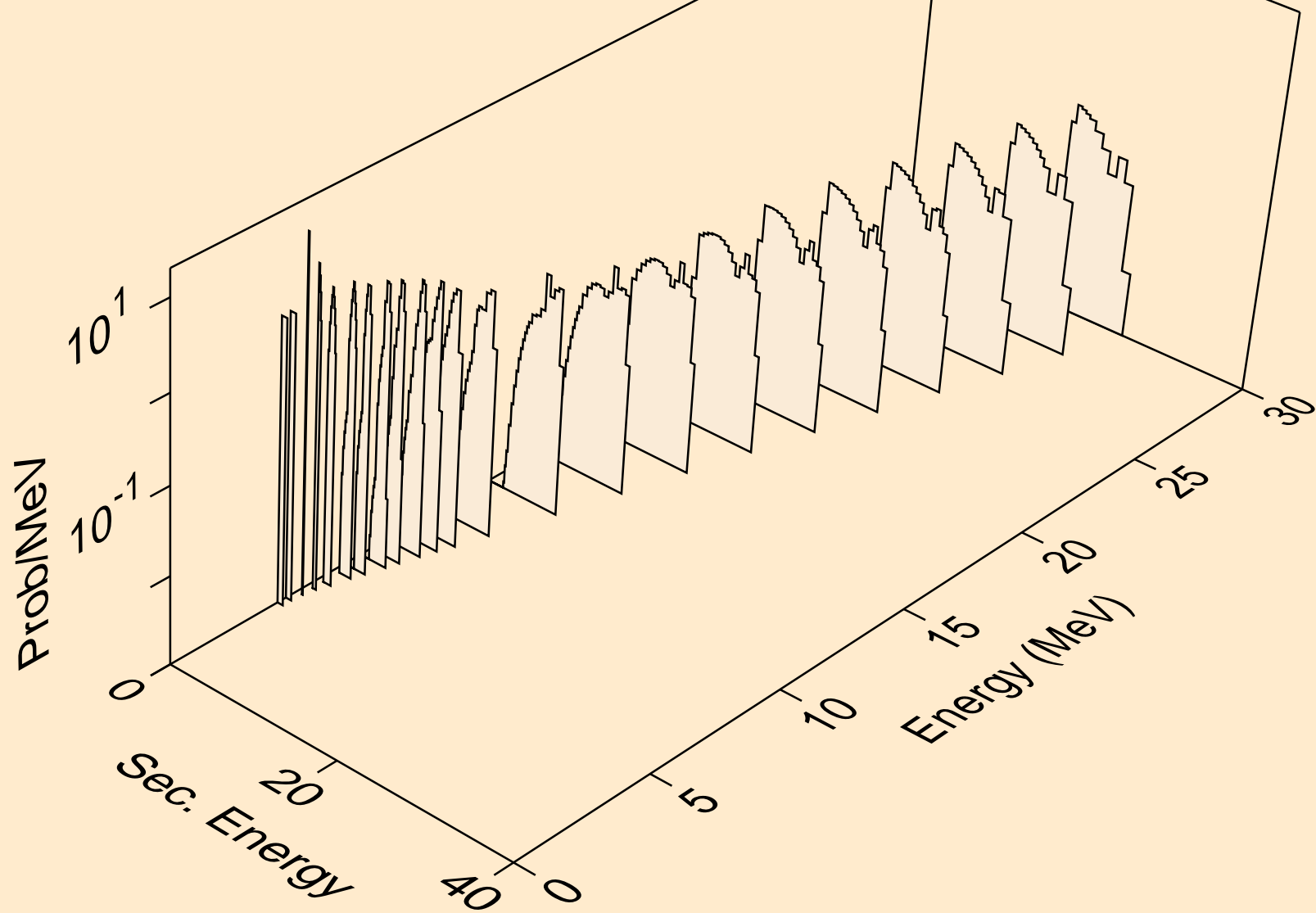

ZN071 NEUTRON ACER TENDL-2024 LIBRARY; T=0.K
protons from (n,2p)

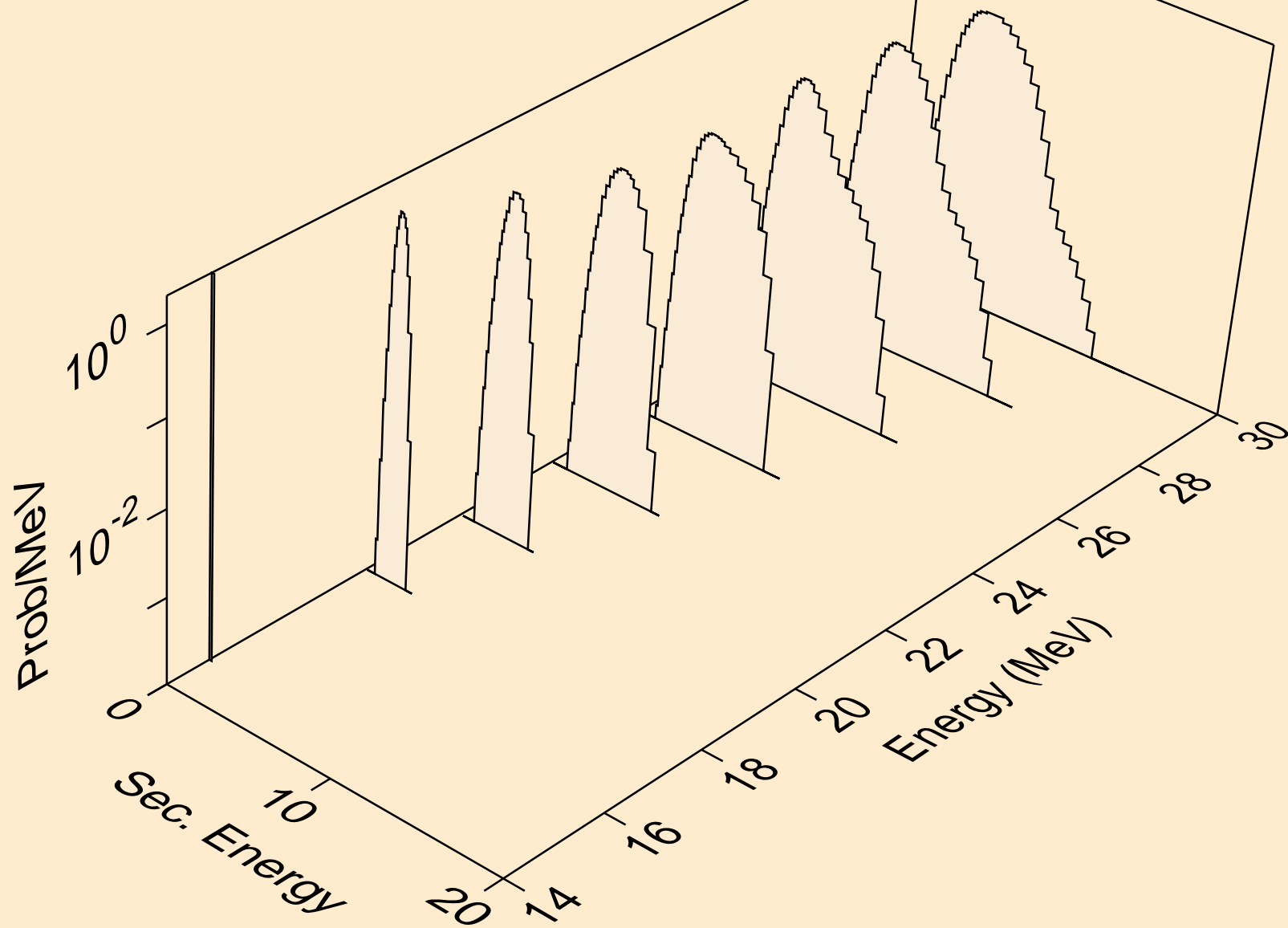

ZN071 NEUTRON ACER TENDL-2024 LIBRARY; T=0.K
protons from (n,p)

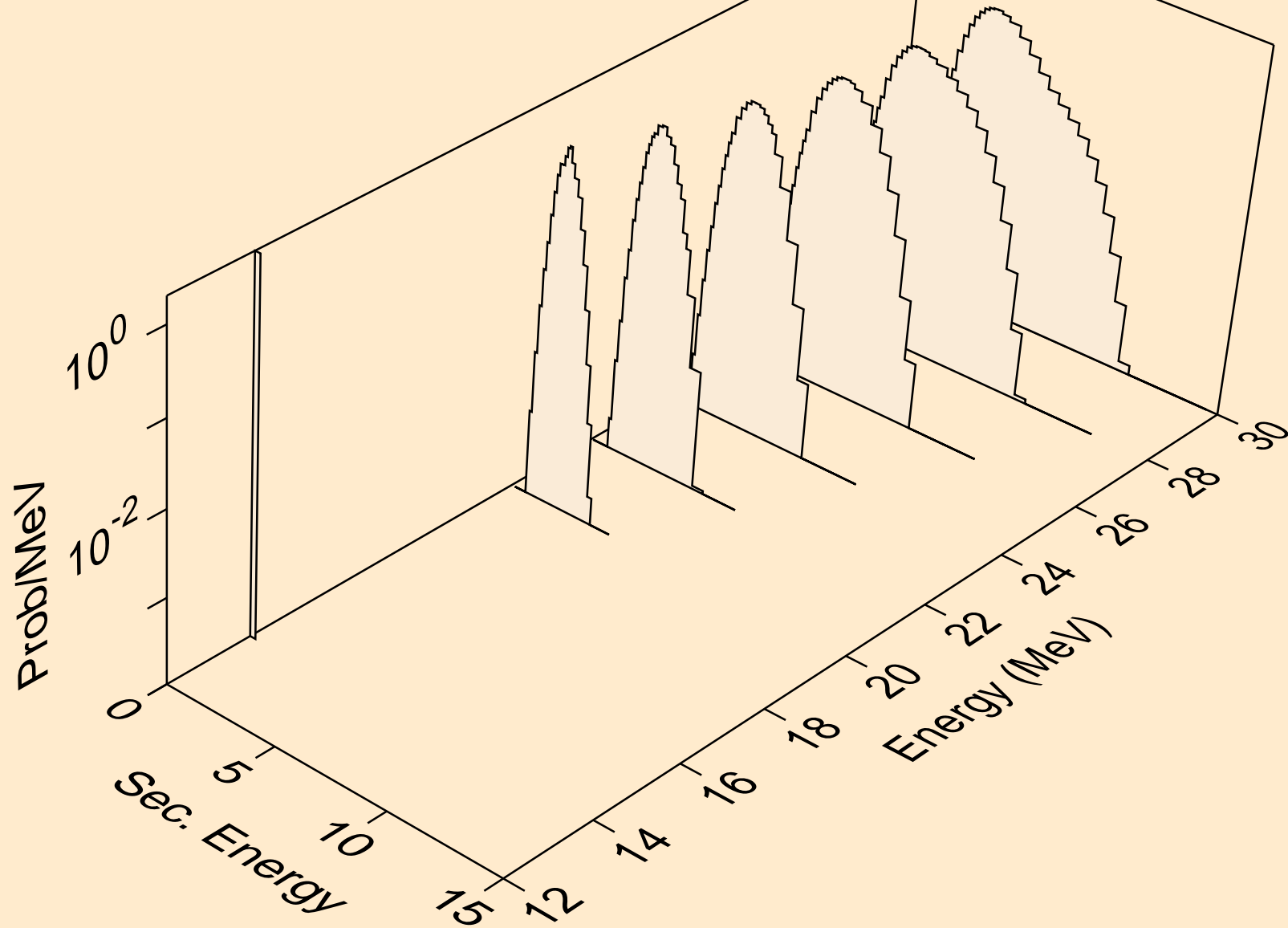

ZN071 NEUTRON ACER TENDL-2024 LIBRARY; T=0.K
protons from (n,pd)

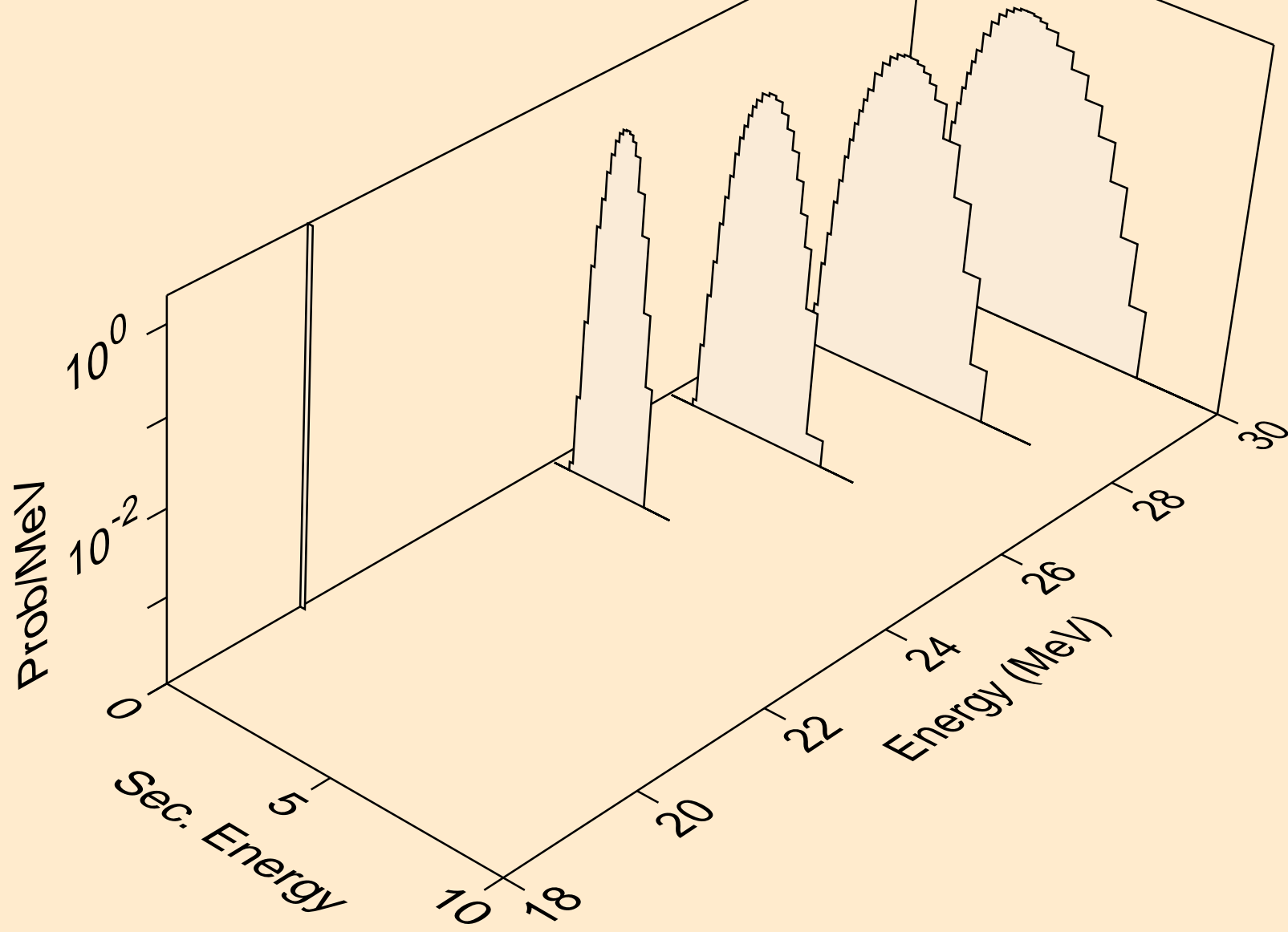

ZN071 NEUTRON ACER TENDL-2024 LIBRARY; T=0.K
protons from (n,pt)

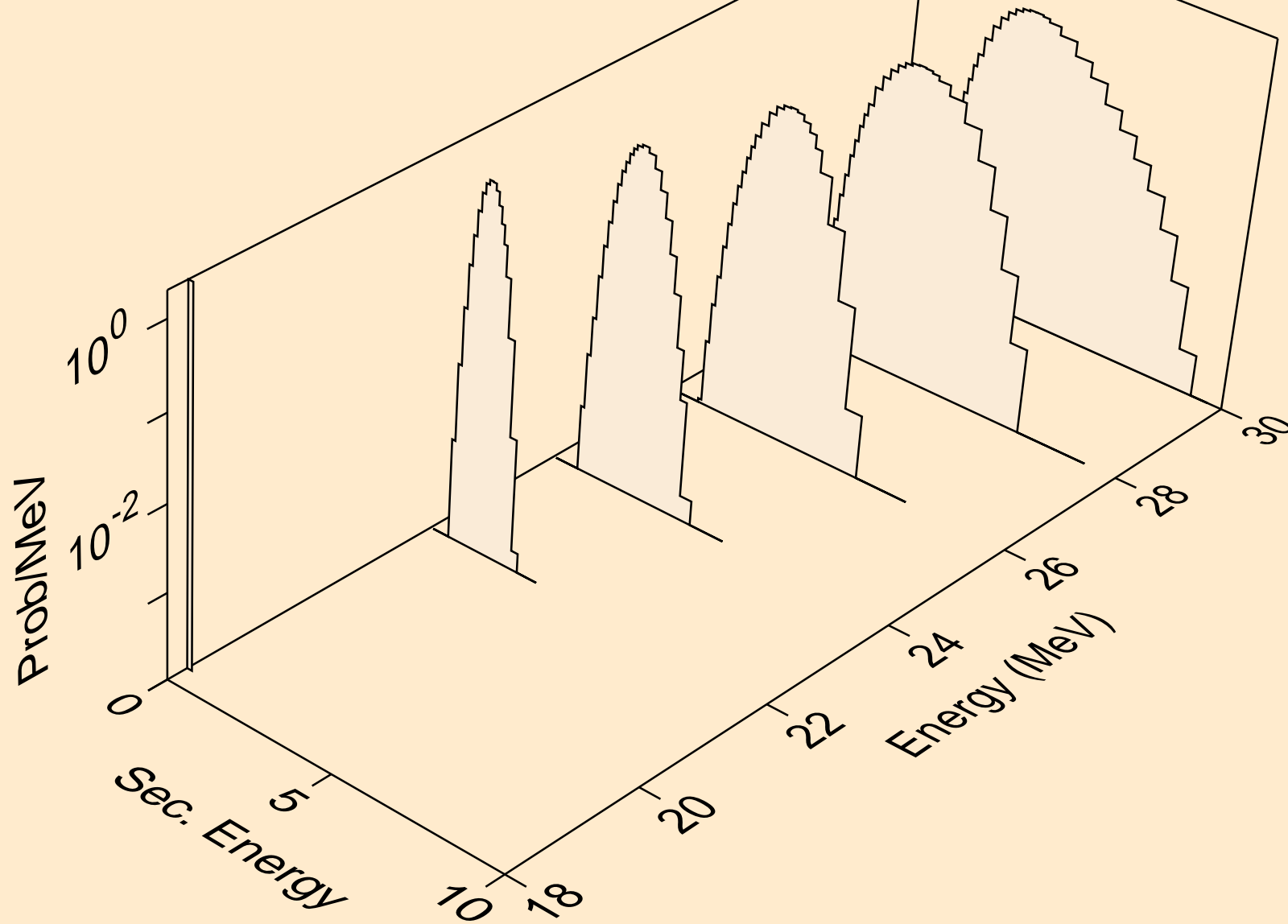

ZN071 NEUTRON ACER TENDL-2024 LIBRARY; T=0.K
deuterons from (n,x)

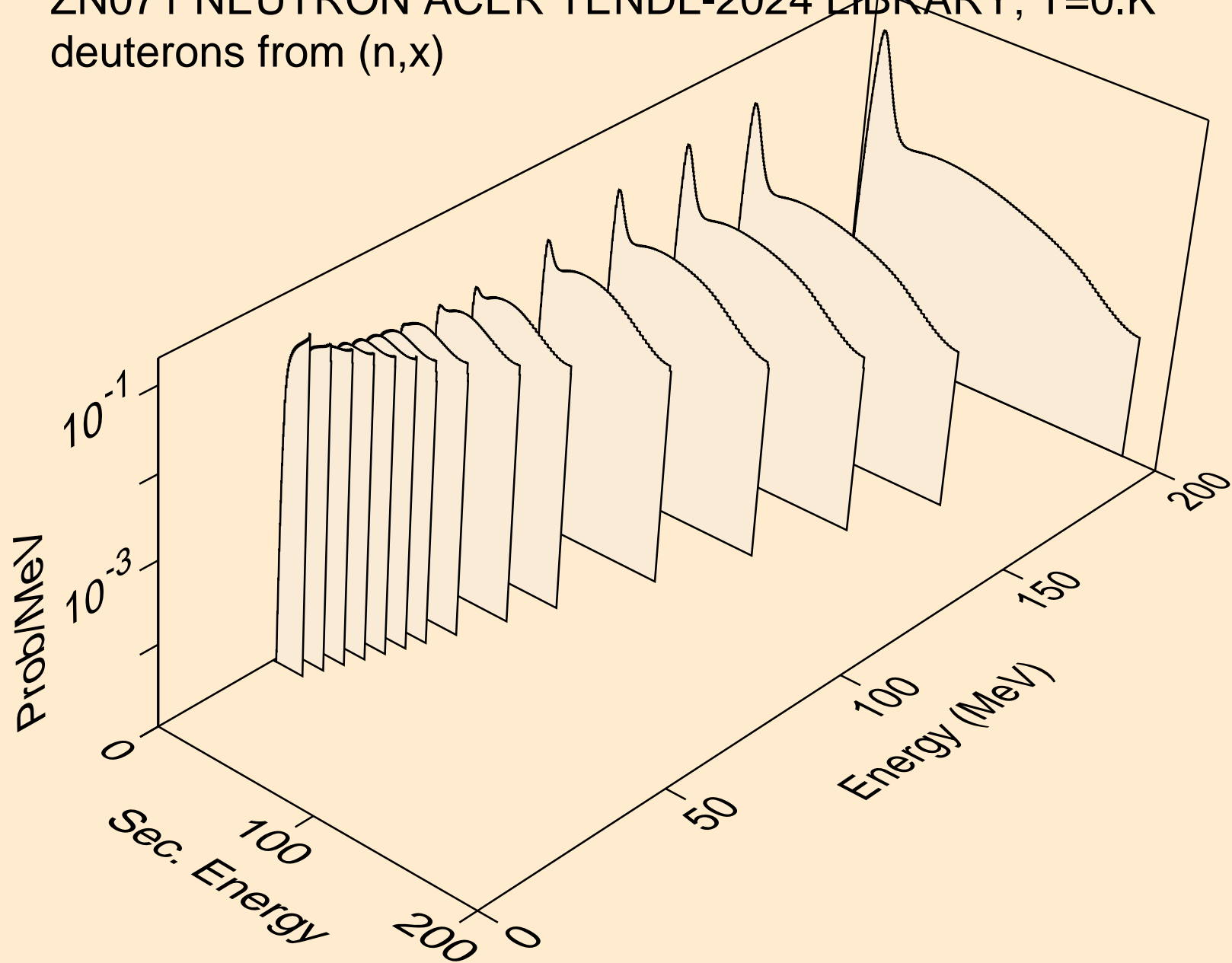

ZN071 NEUTRON ACER TENDL-2024 LIBRARY; T=0.K
deuterons from (n,2nd)

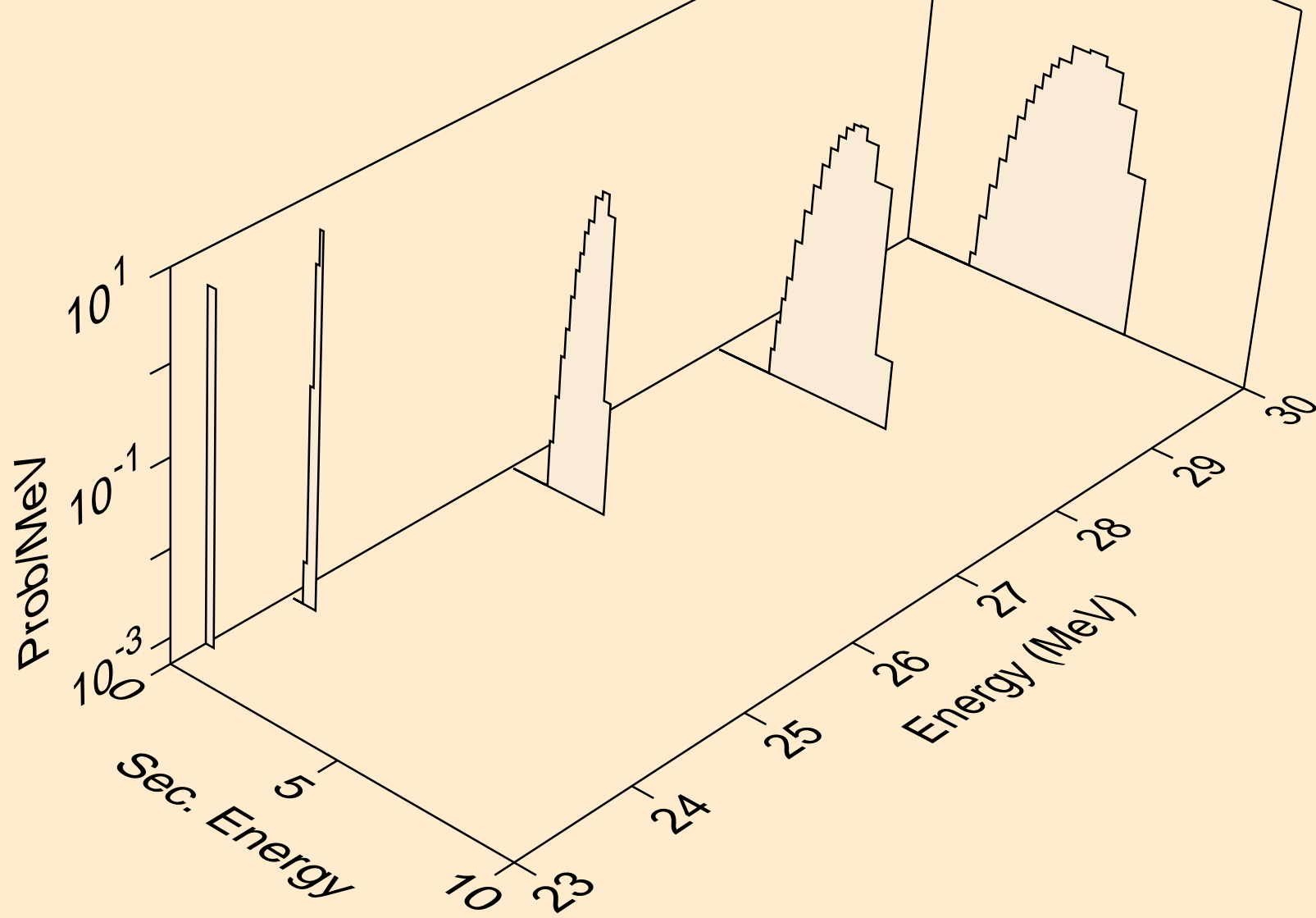

ZN071 NEUTRON ACER TENDL-2024 LIBRARY; T=0.K
deuterons from (n,n*)d

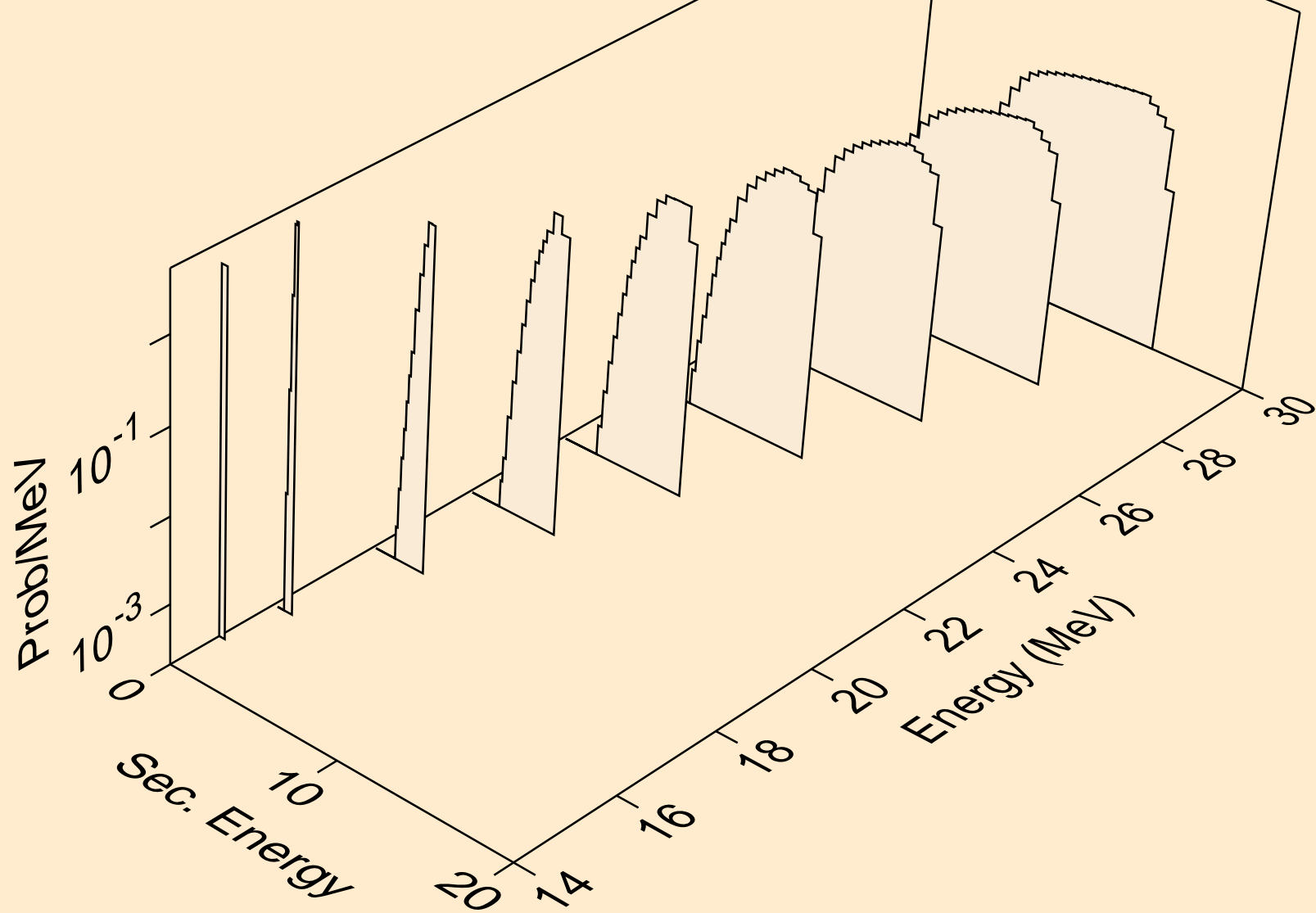

ZN071 NEUTRON ACER TENDL-2024 LIBRARY; T=0.K
deuterons from (n,d)

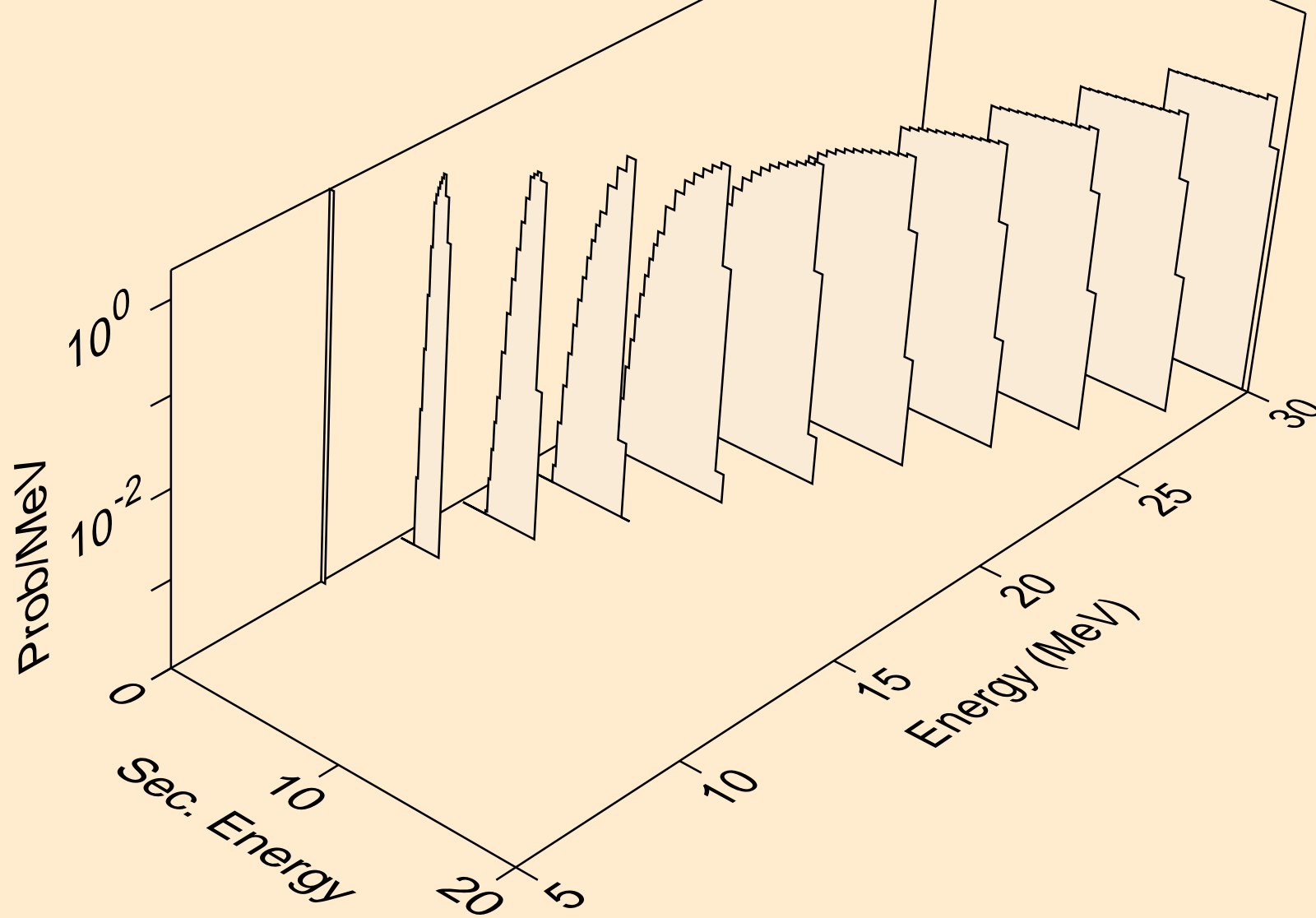

ZN071 NEUTRON ACER TENDL-2024 LIBRARY; T=0.K
deuterons from (n,pd)

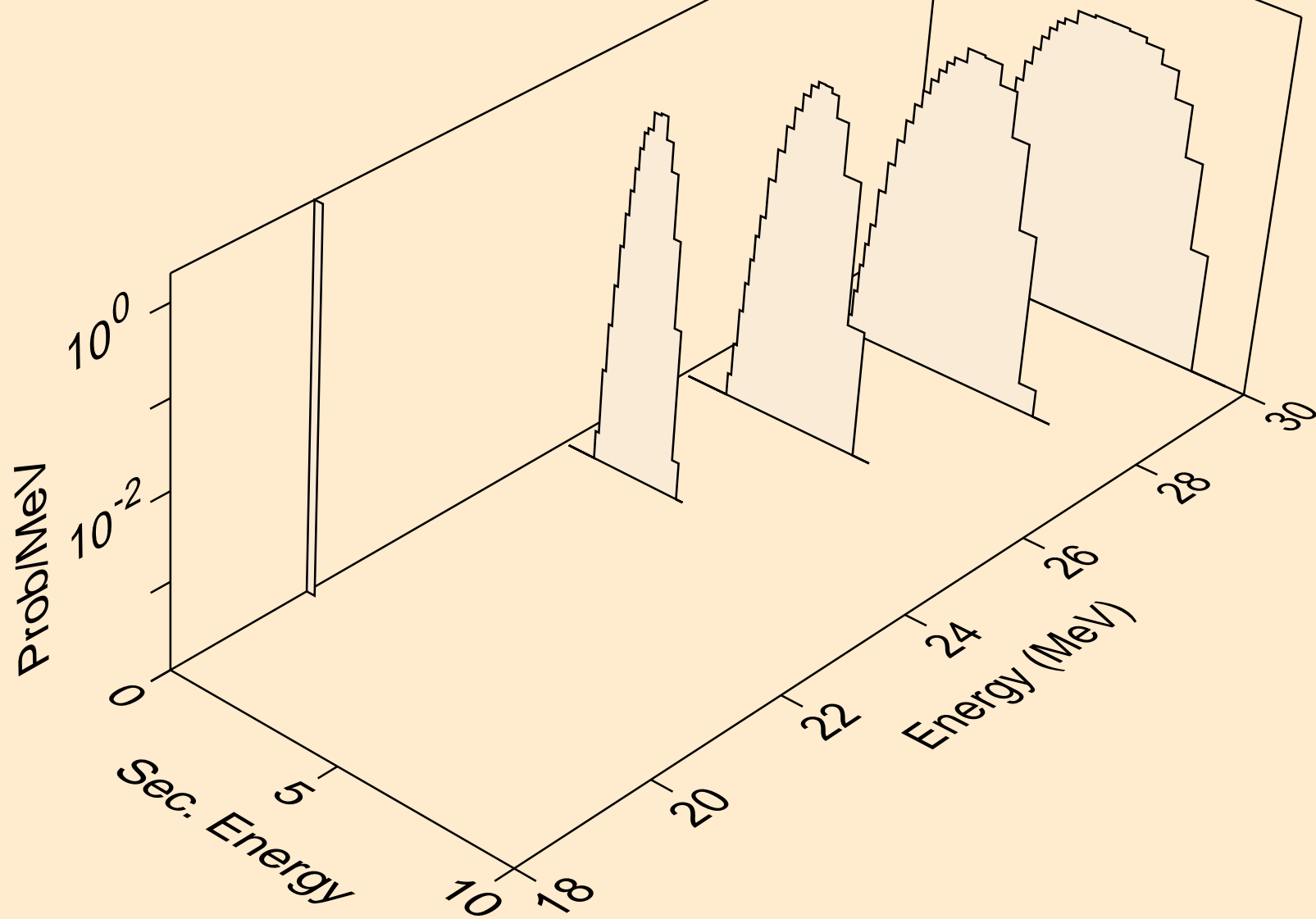

ZN071 NEUTRON ACER TENDL-2024 LIBRARY; T=0.K
tritons from (n,x)

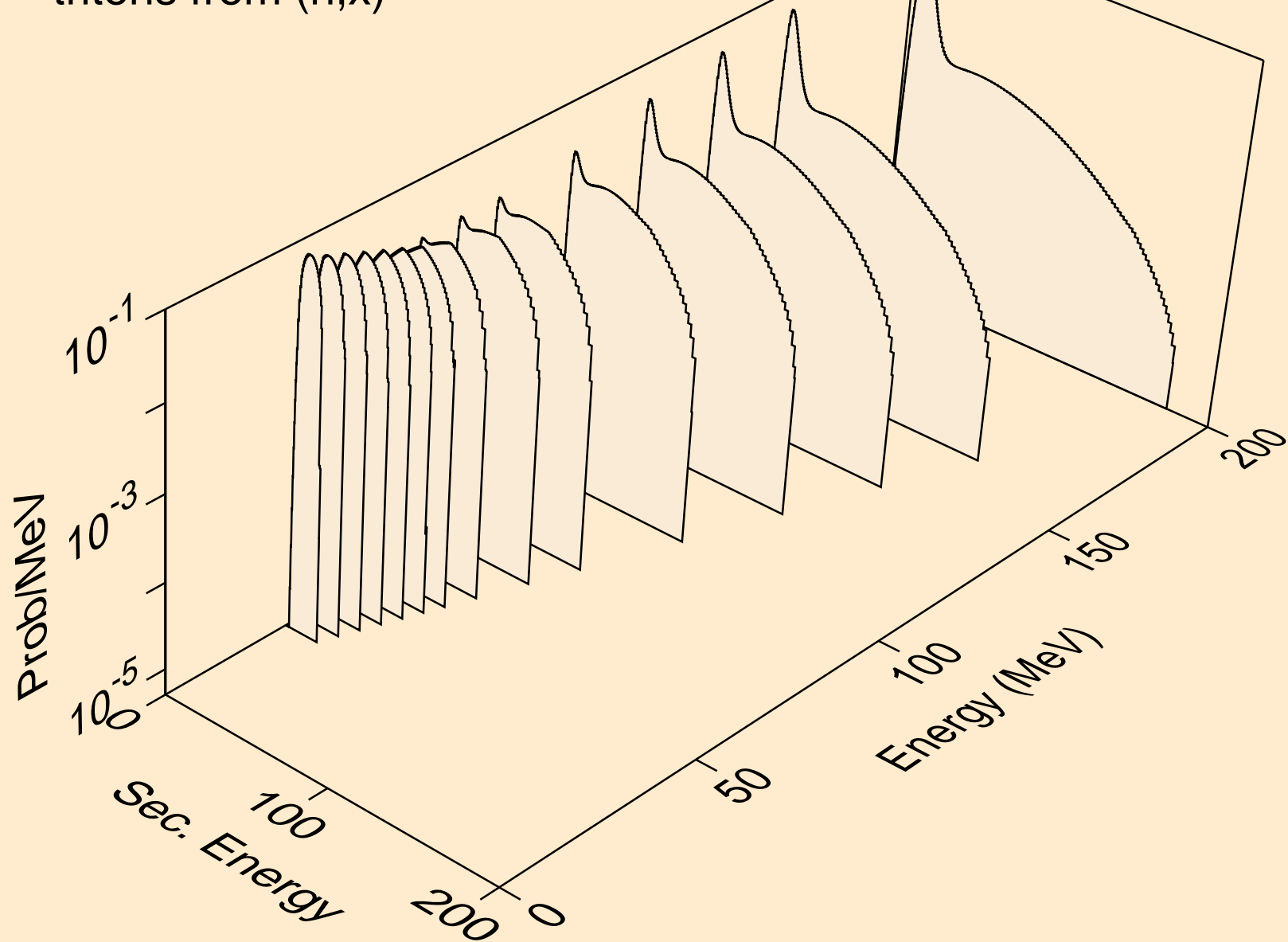

ZN071 NEUTRON ACER TENDL-2024 LIBRARY; T=0.K
tritons from (n,n*)t

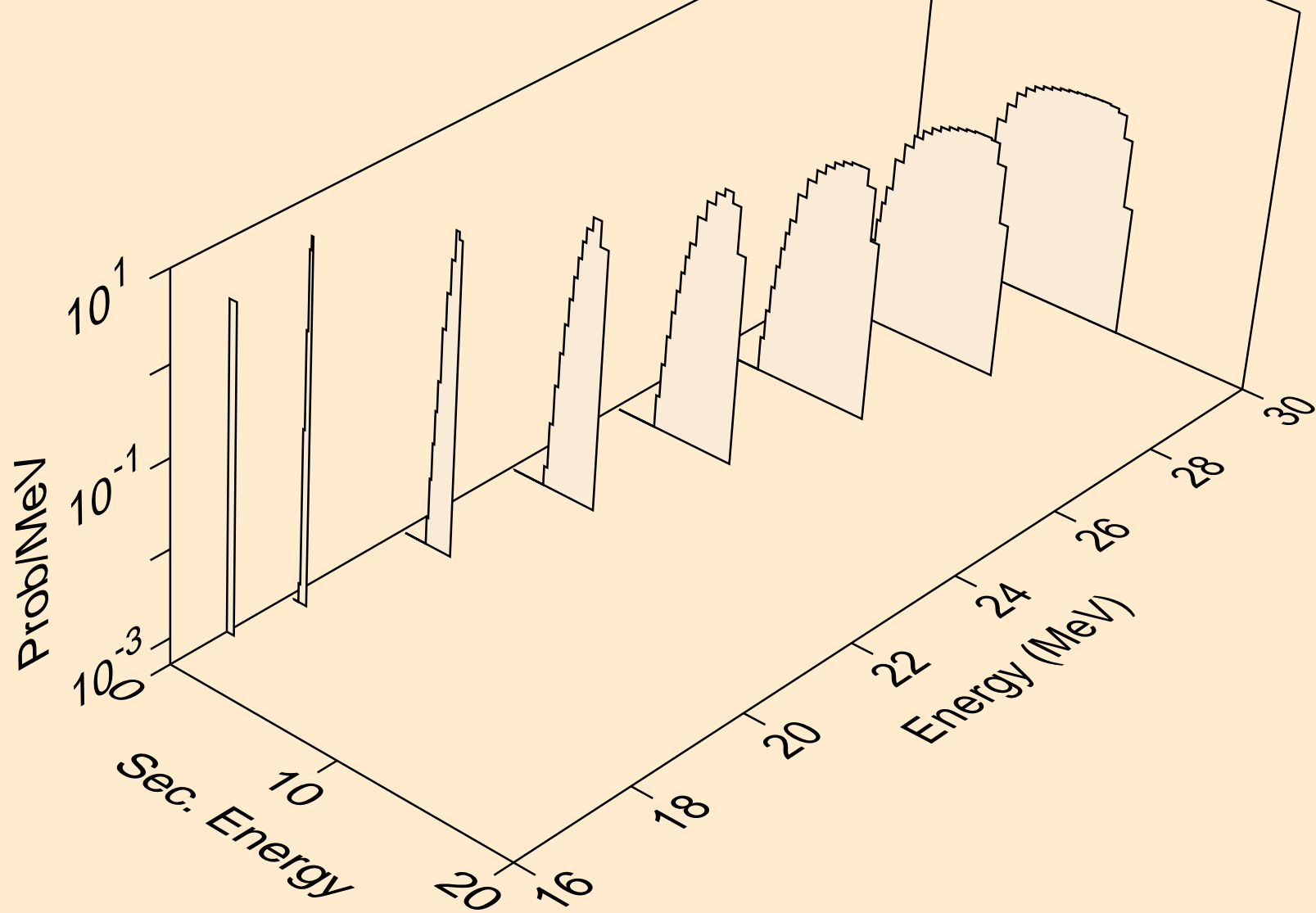

ZN071 NEUTRON ACER TENDL-2024 LIBRARY; T=0.K
tritons from (n,t)

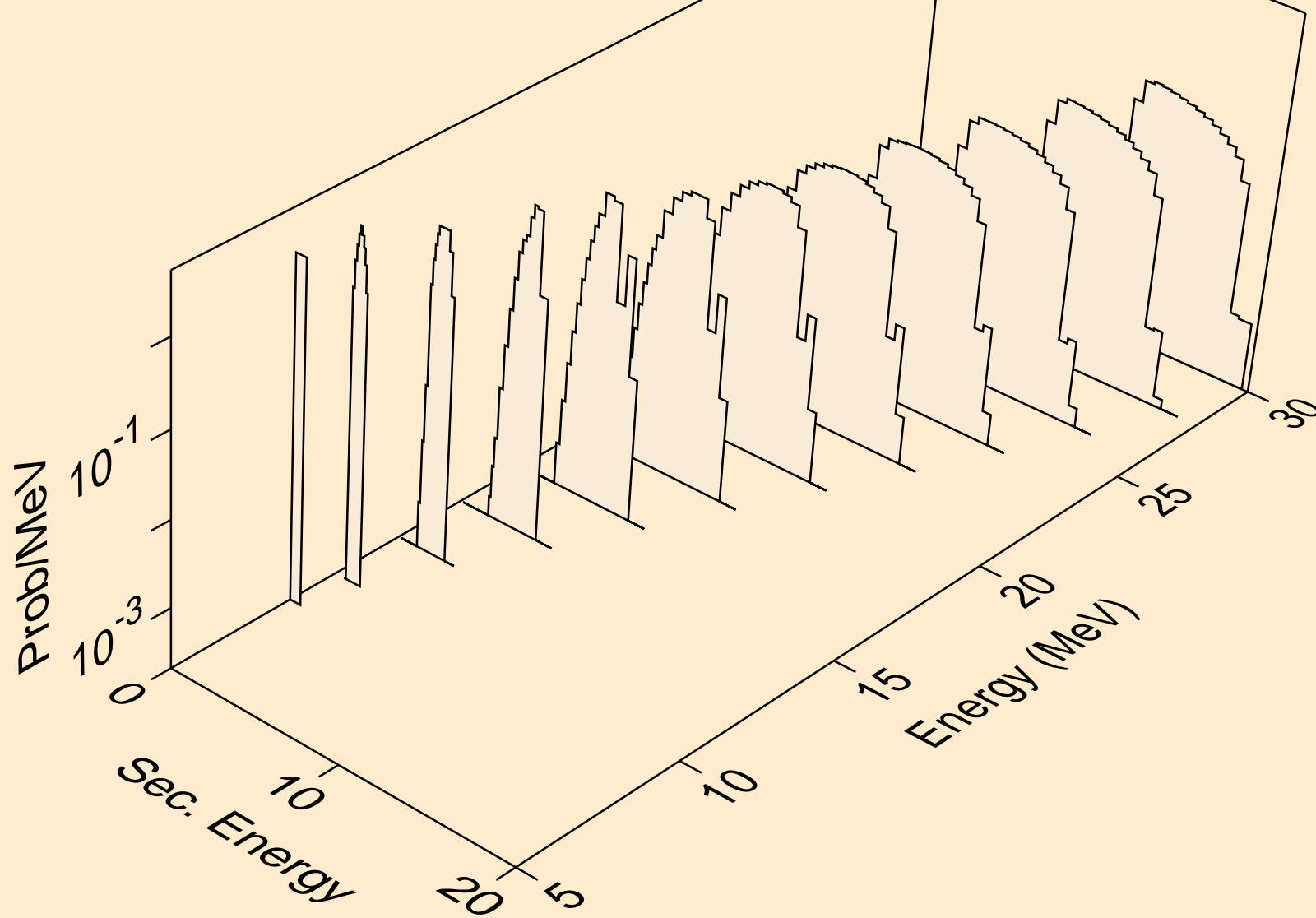

ZN071 NEUTRON ACER TENDL-2024 LIBRARY; T=0.K
tritons from (n,pt)

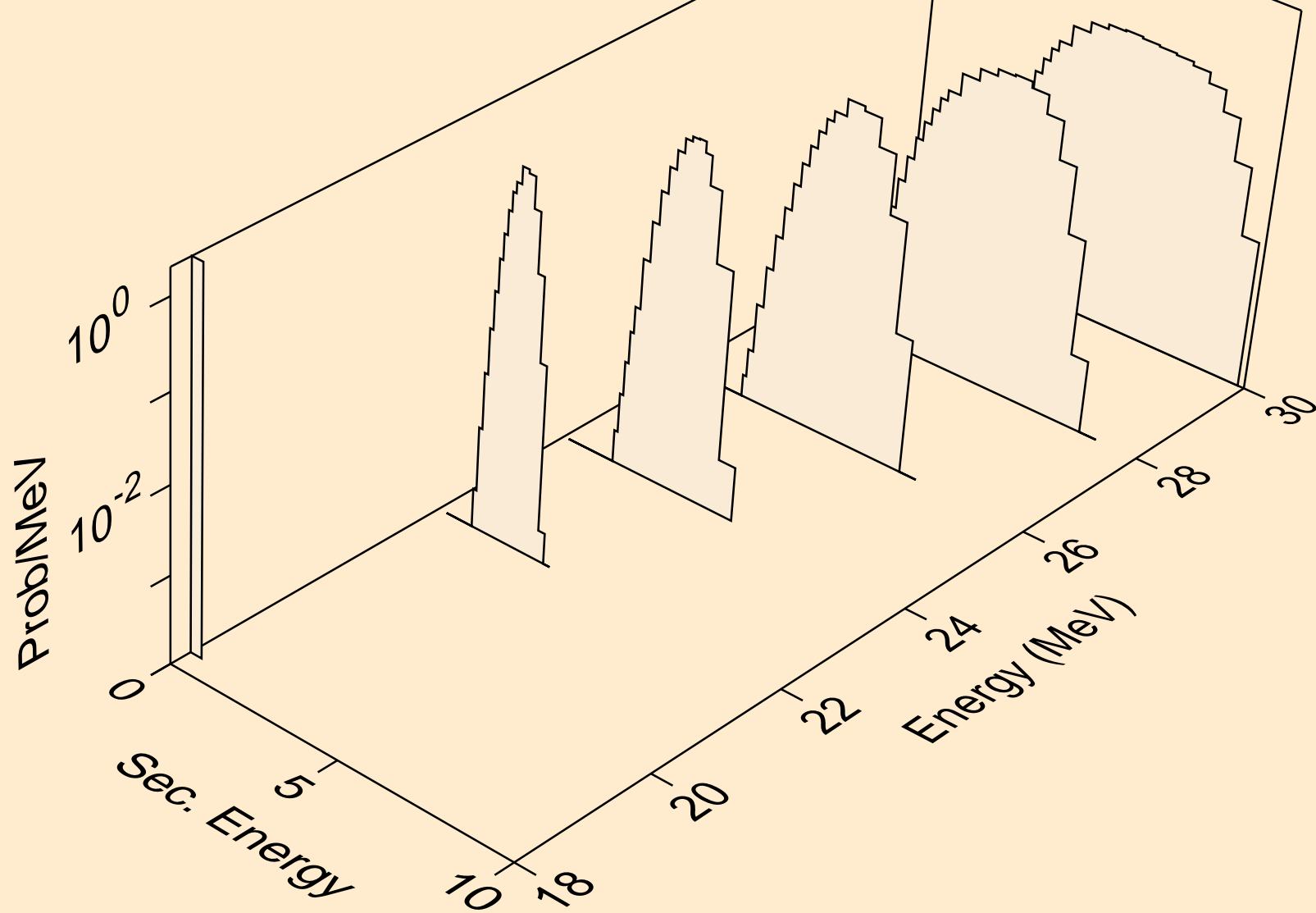

ZN071 NEUTRON ACER TENDL-2024 LIBRARY; T=0.K
he3s from (n,x)

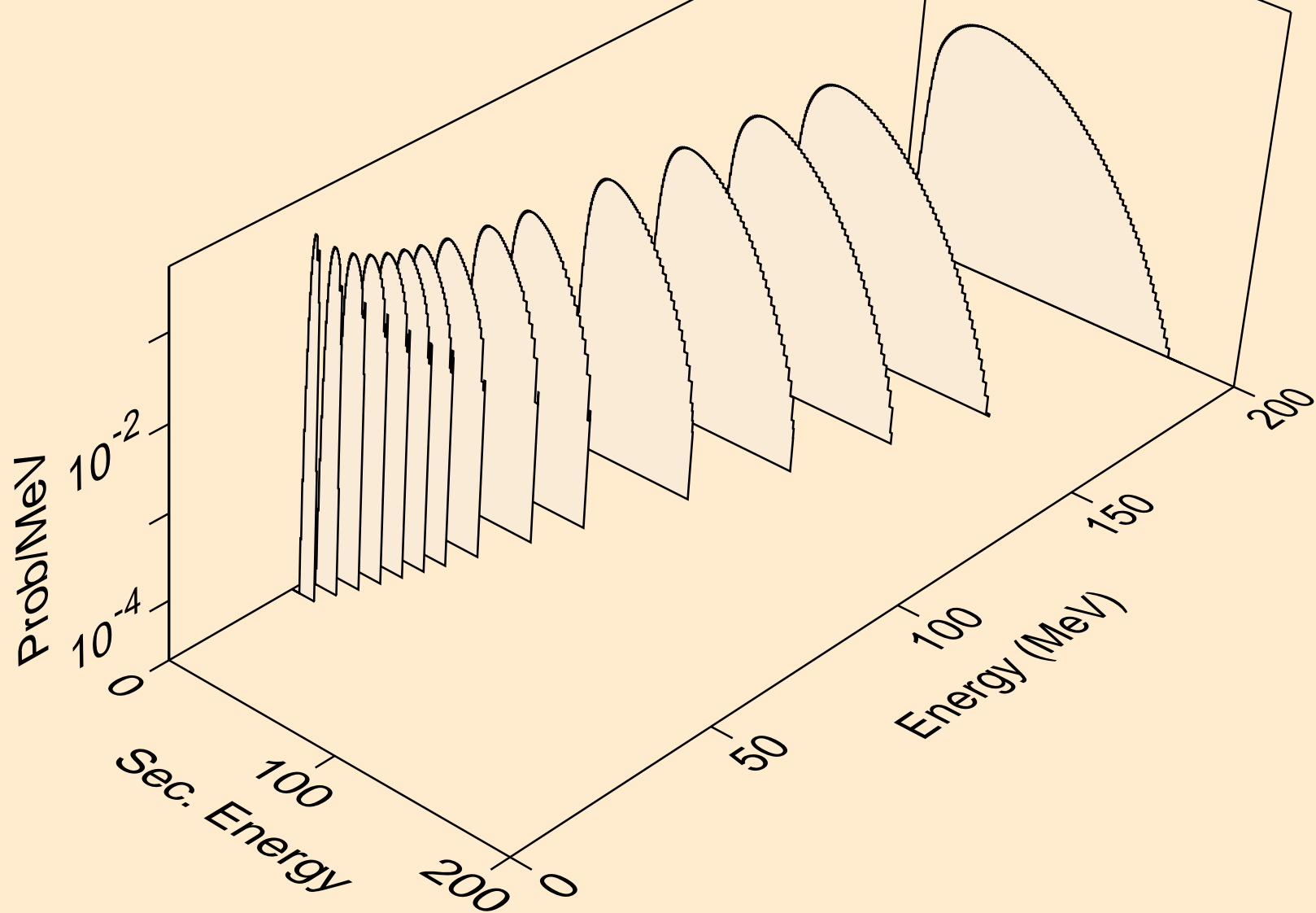

ZN071 NEUTRON ACER TENDL-2024 LIBRARY; T=0.K
he3s from (n,n*)he3

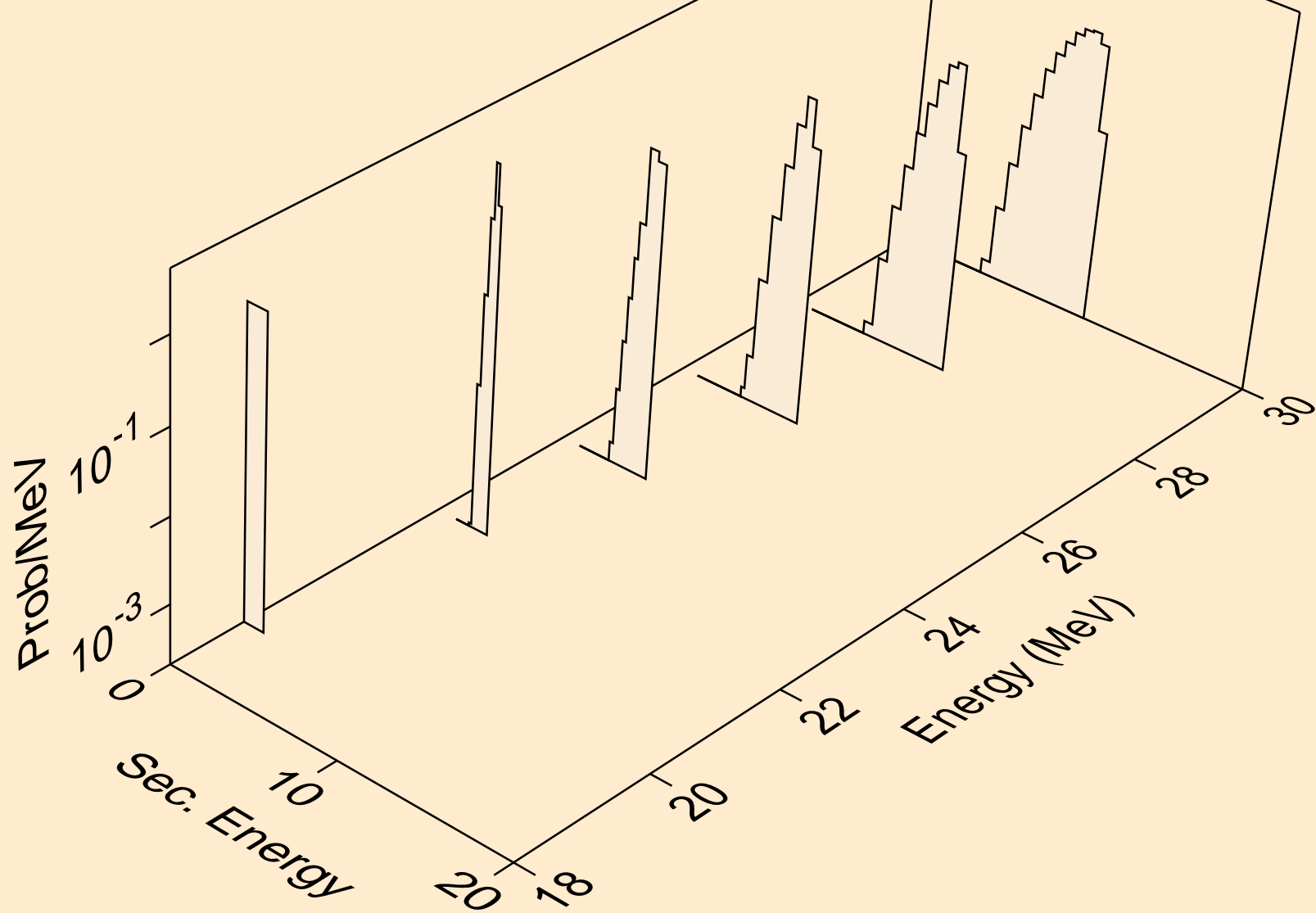

ZN071 NEUTRON ACER TENDL-2024 LIBRARY; T=0.K
he3s from (n,he3)

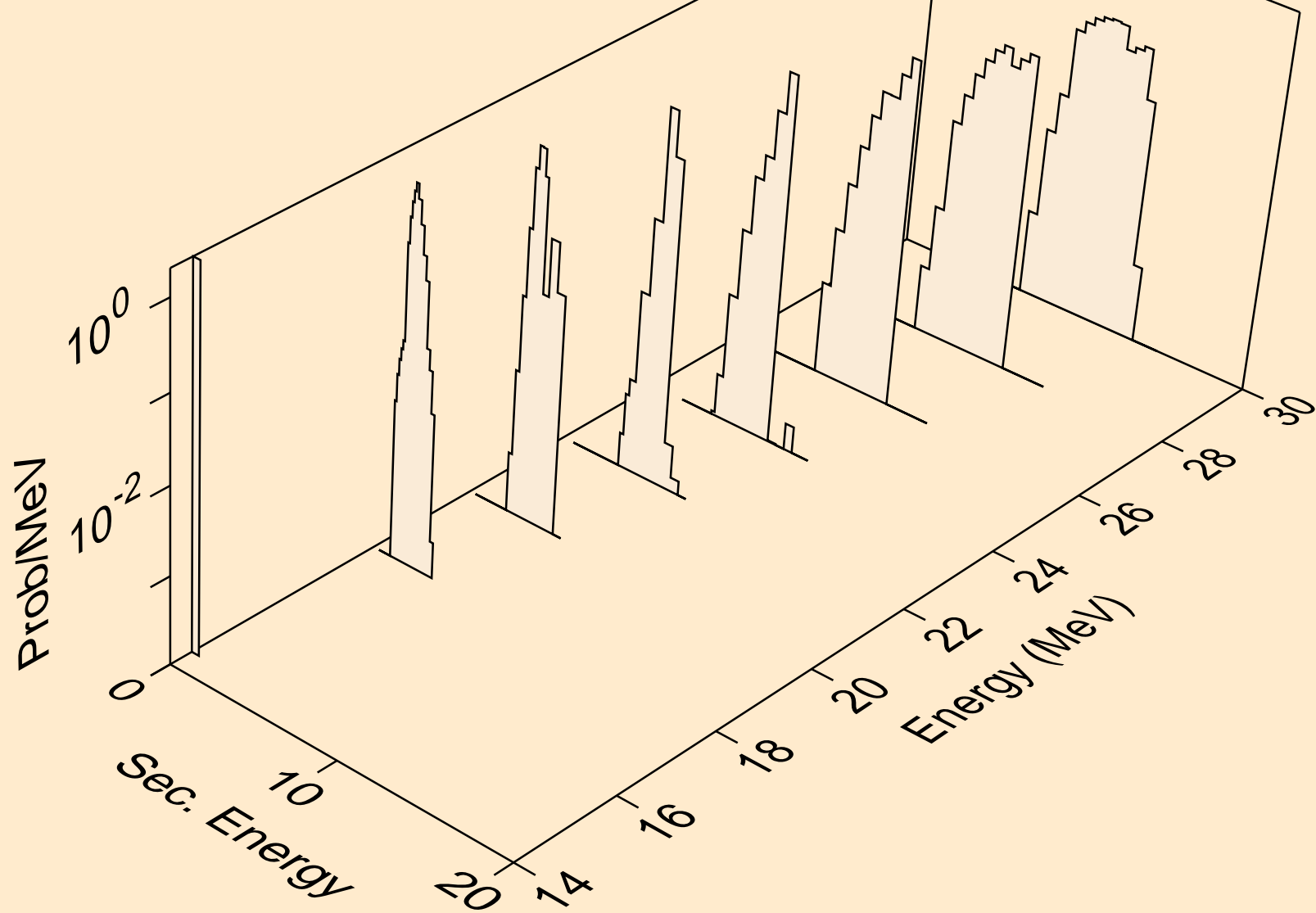

ZN071 NEUTRON ACER TENDL-2024 LIBRARY; T=0.K
alphas from (n,x)

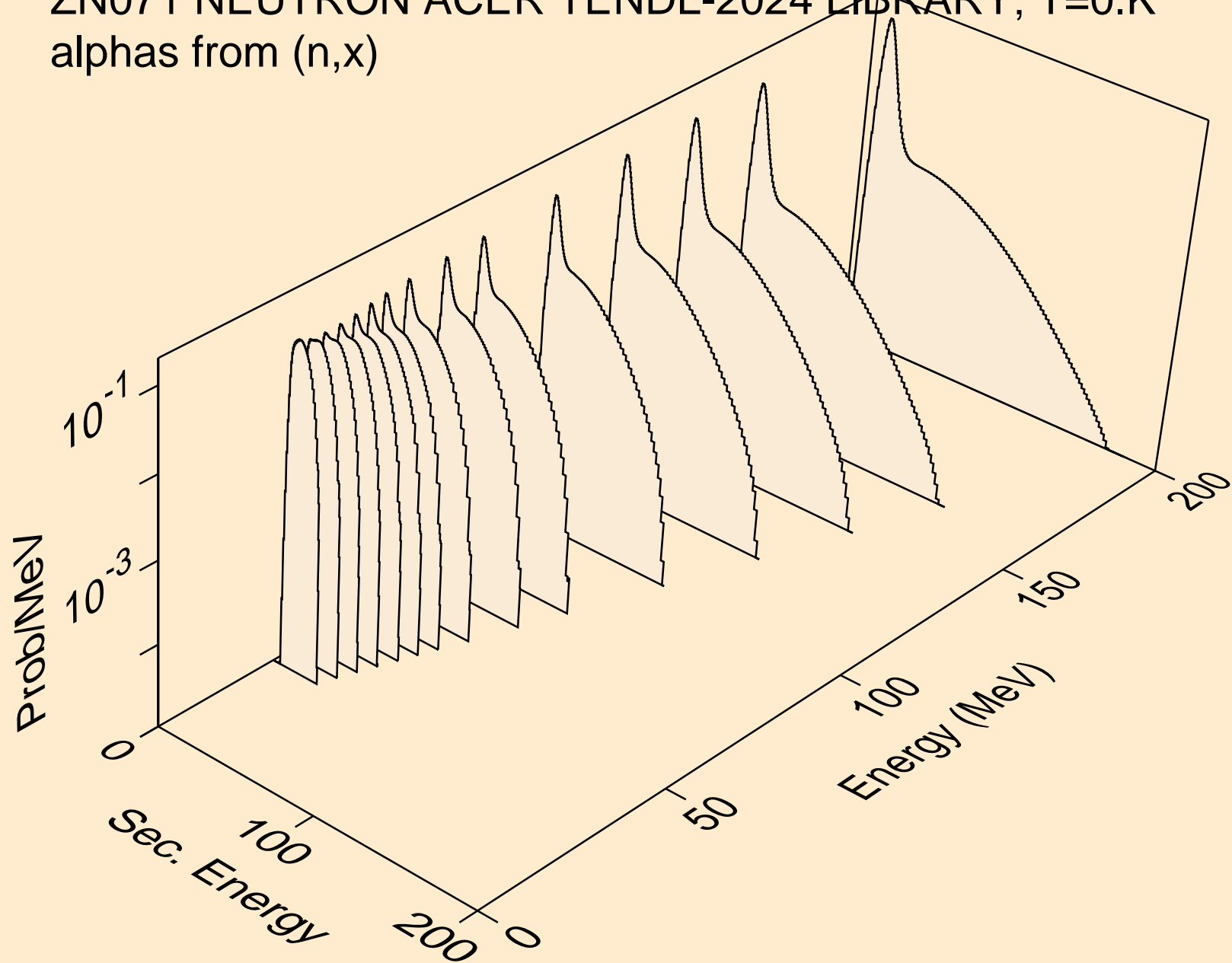

ZN071 NEUTRON ACER TENDL-2024 LIBRARY; T=0.K
alphas from (n,n*)a

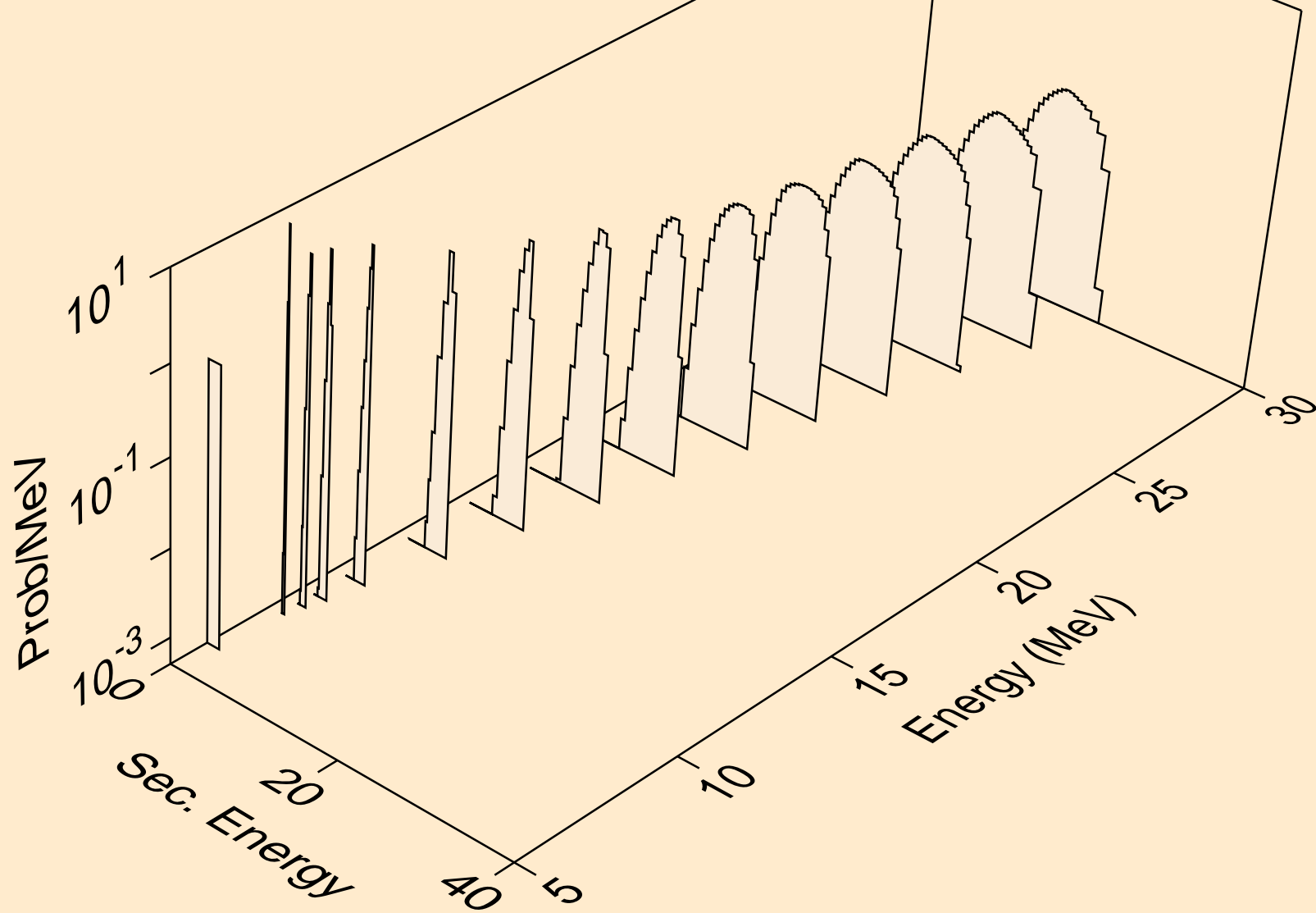

ZN071 NEUTRON ACER TENDL-2024 LIBRARY; T=0.K
alphas from (n,2n)a

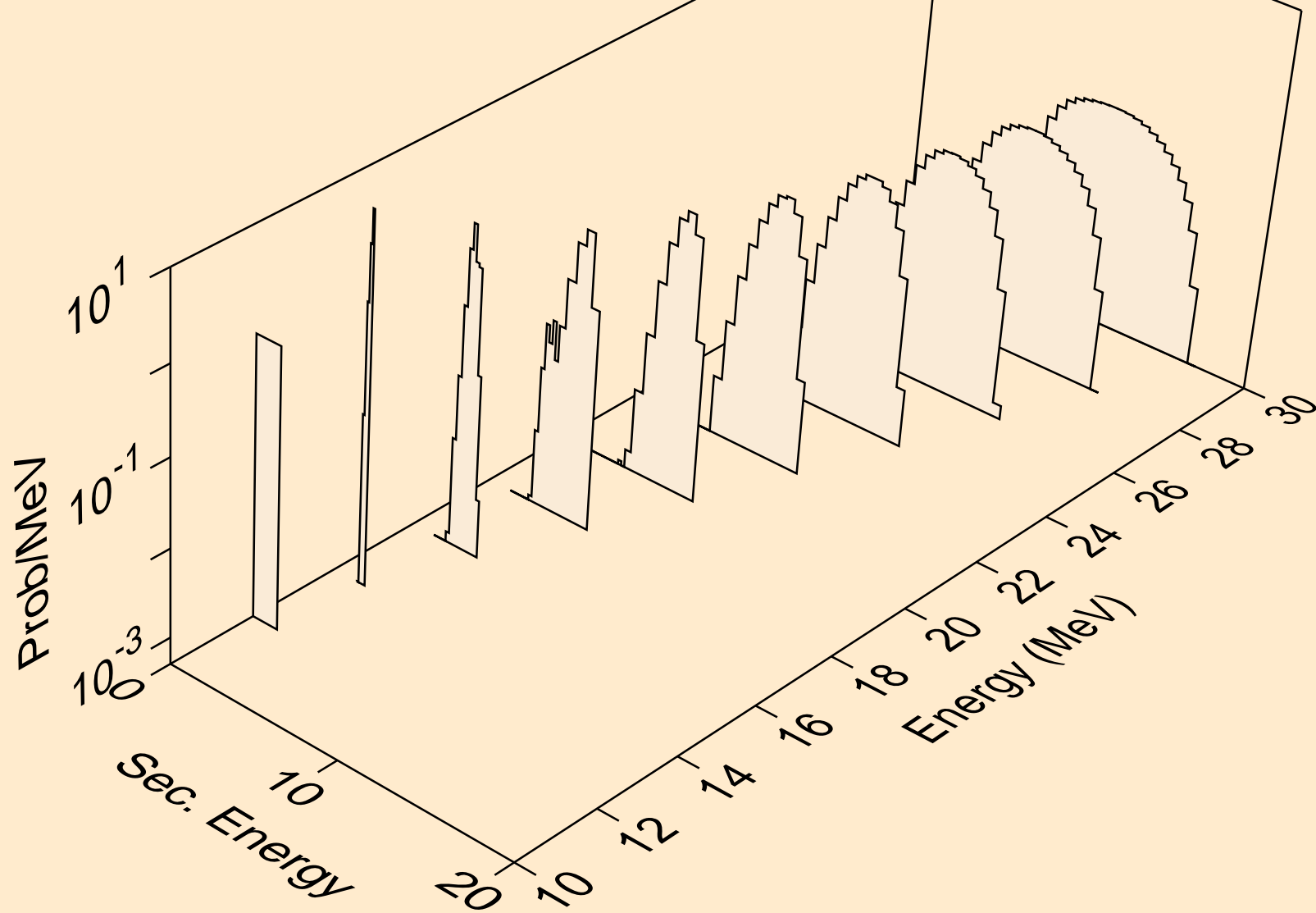

ZN071 NEUTRON ACER TENDL-2024 LIBRARY; T=0.K
alphas from (n,3n)a

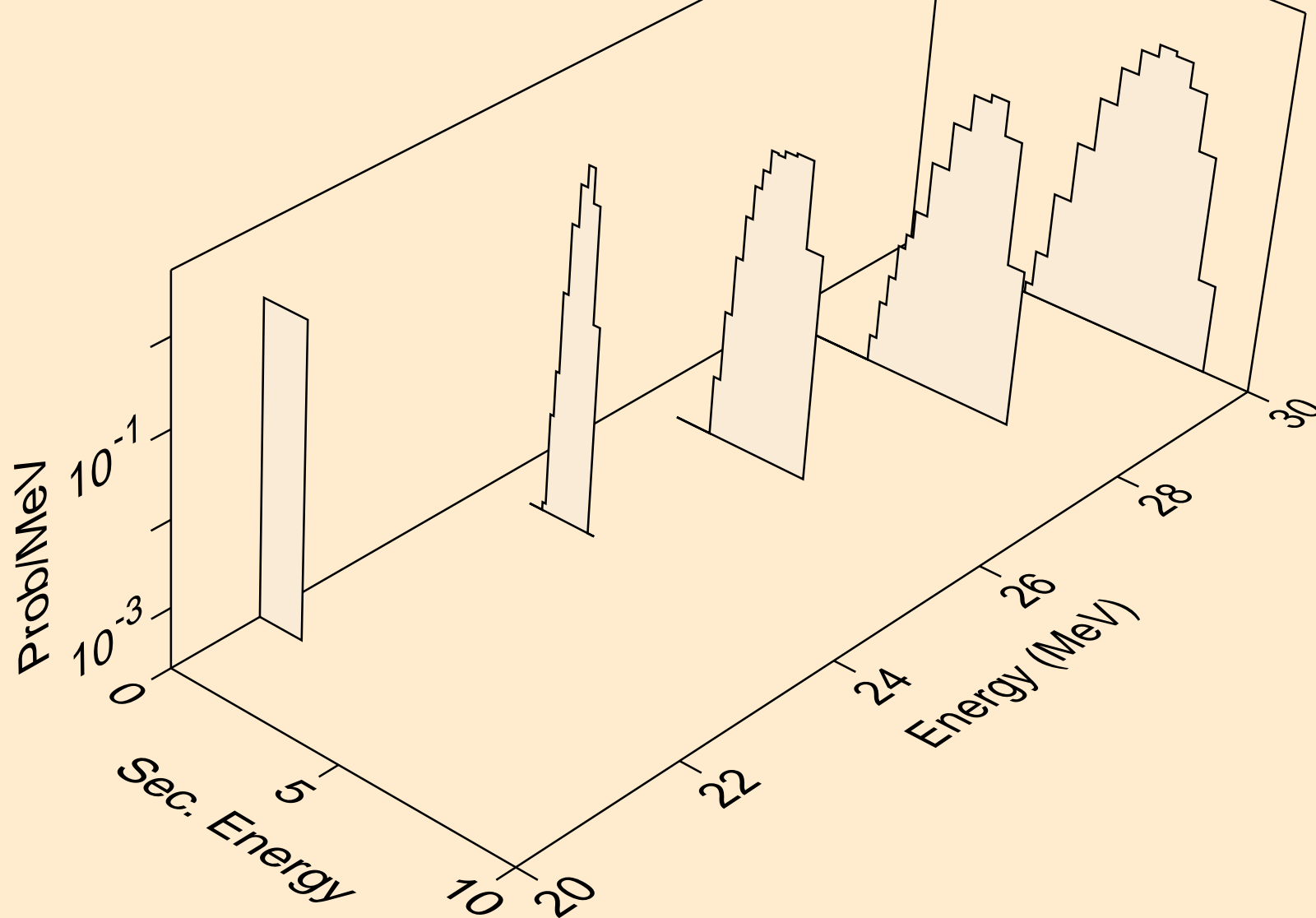

ZN071 NEUTRON ACER TENDL-2024 LIBRARY; T=0.K
alphas from (n,a)

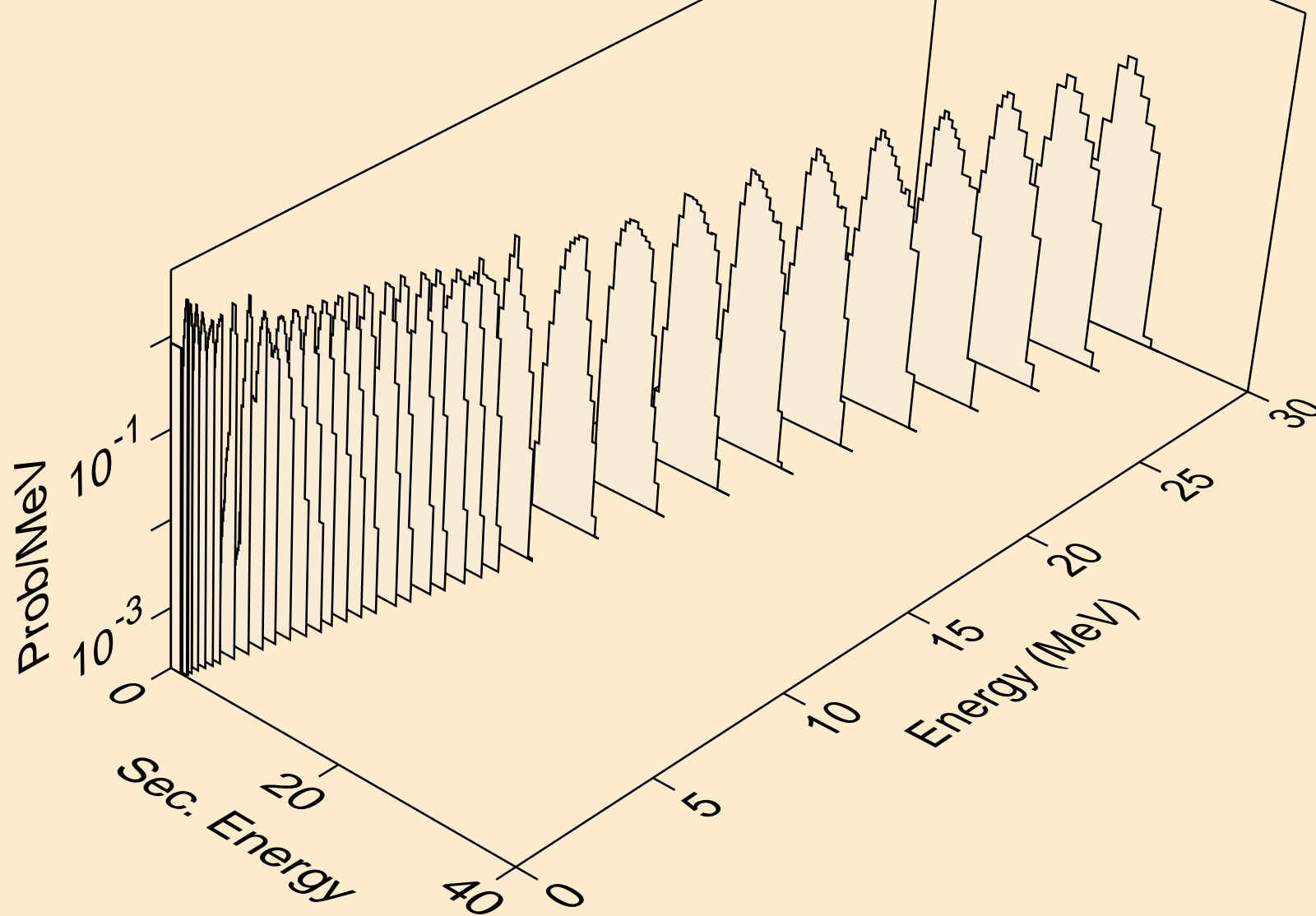

ZN071 NEUTRON ACER TENDL-2024 LIBRARY; T=0.K
alphas from (n,2a)

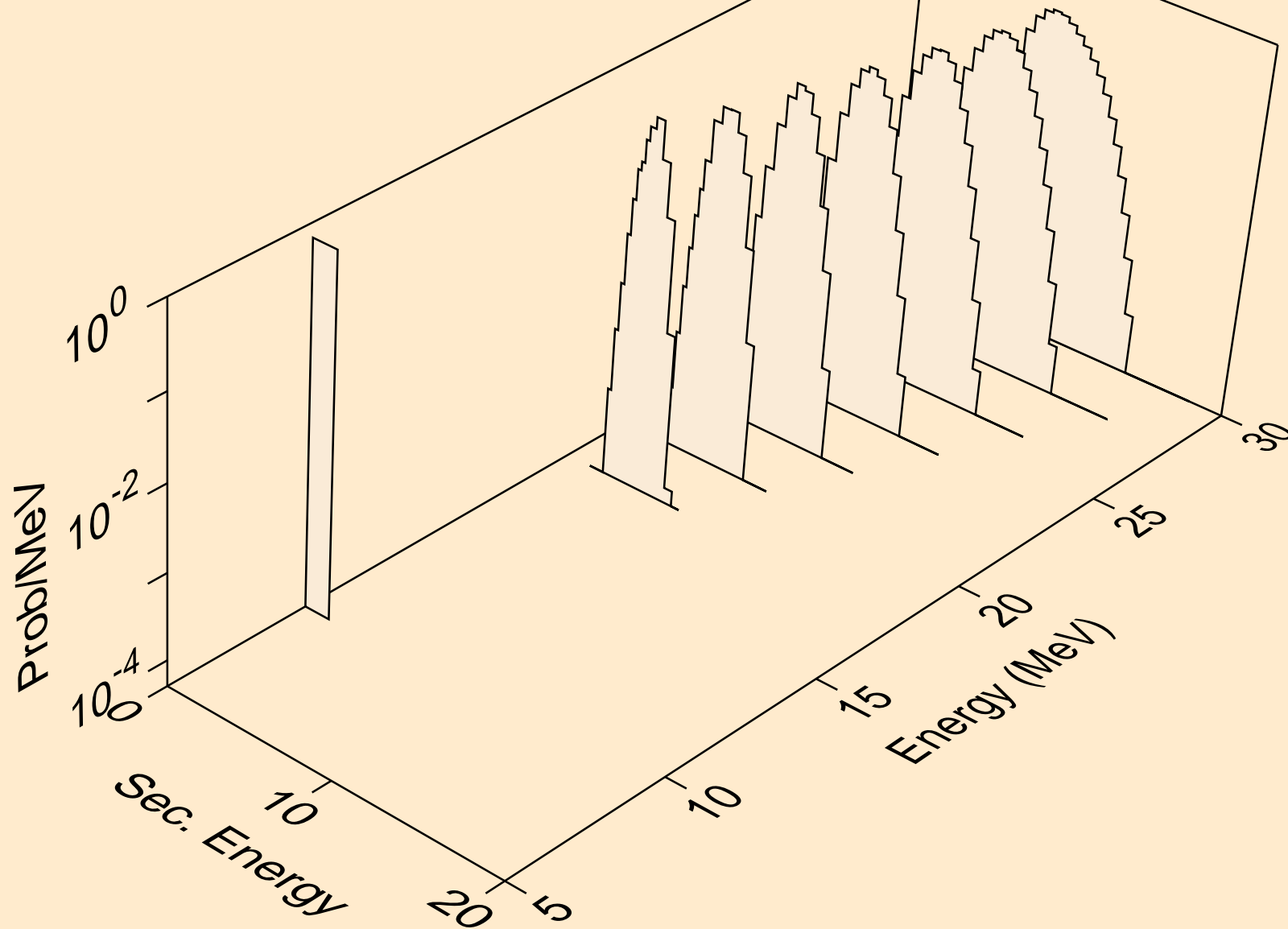

ZN071 NEUTRON ACER TENDL-2024 LIBRARY; T=0.K
alphas from (n,pa)

