

ZR083 NEUTRON ACER TENDL-2024 LIBRARY; T=0.K

Principal cross sections

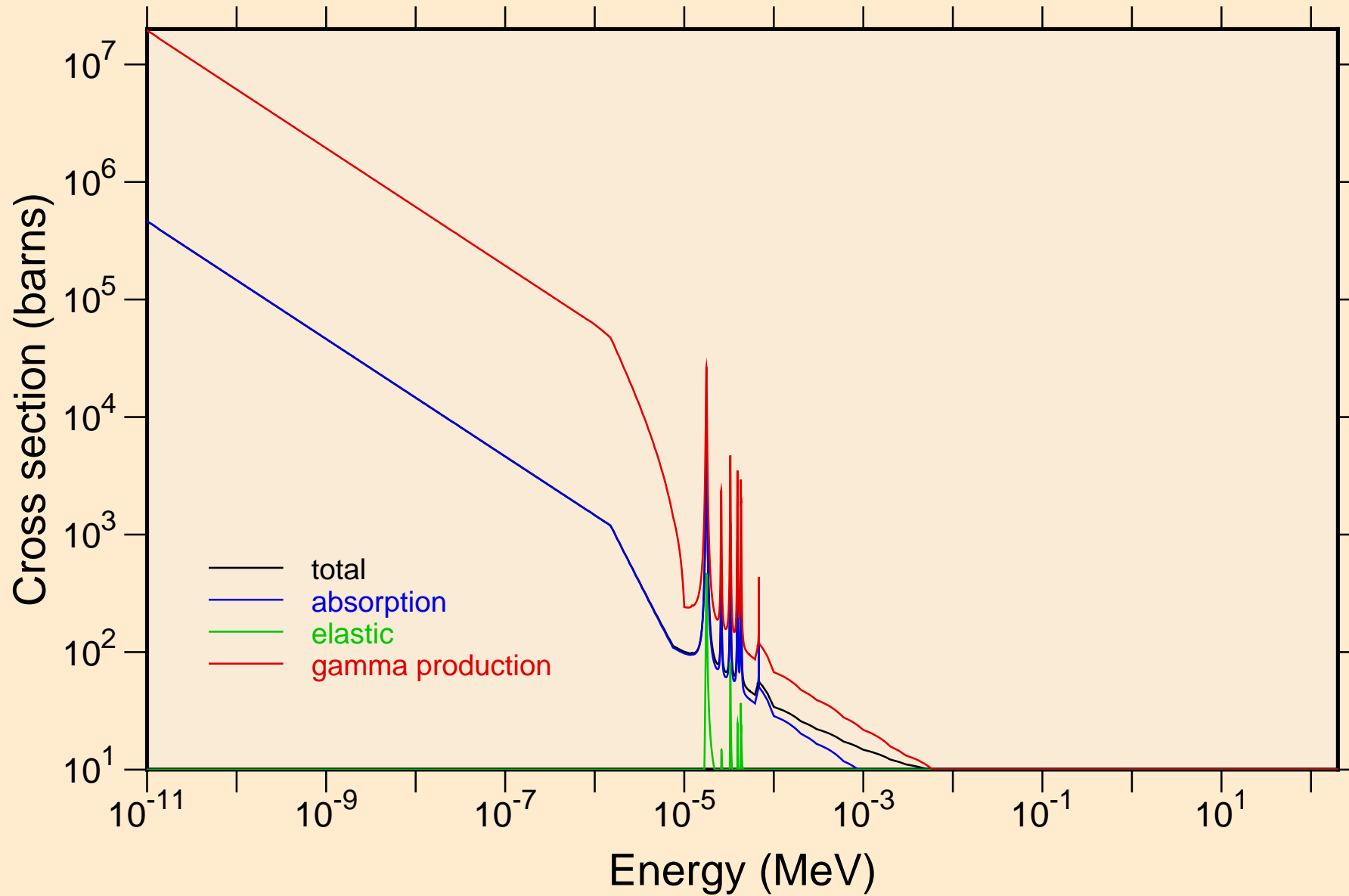

ZR083 NEUTRON ACER TENDL-2024 LIBRARY; T=0.K
resonance total cross section

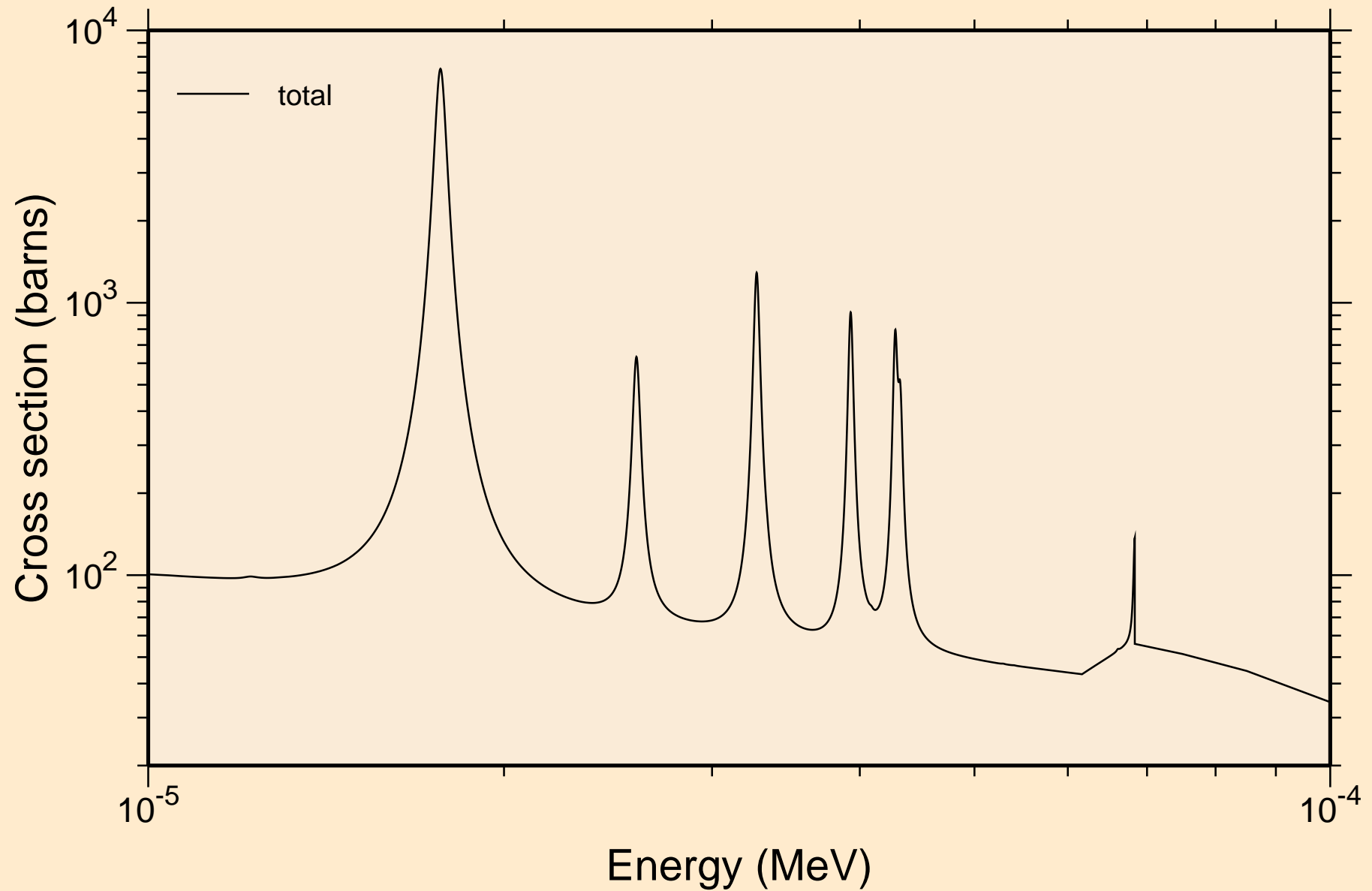

ZR083 NEUTRON ACER TENDL-2024 LIBRARY; T=0.K
resonance total cross section

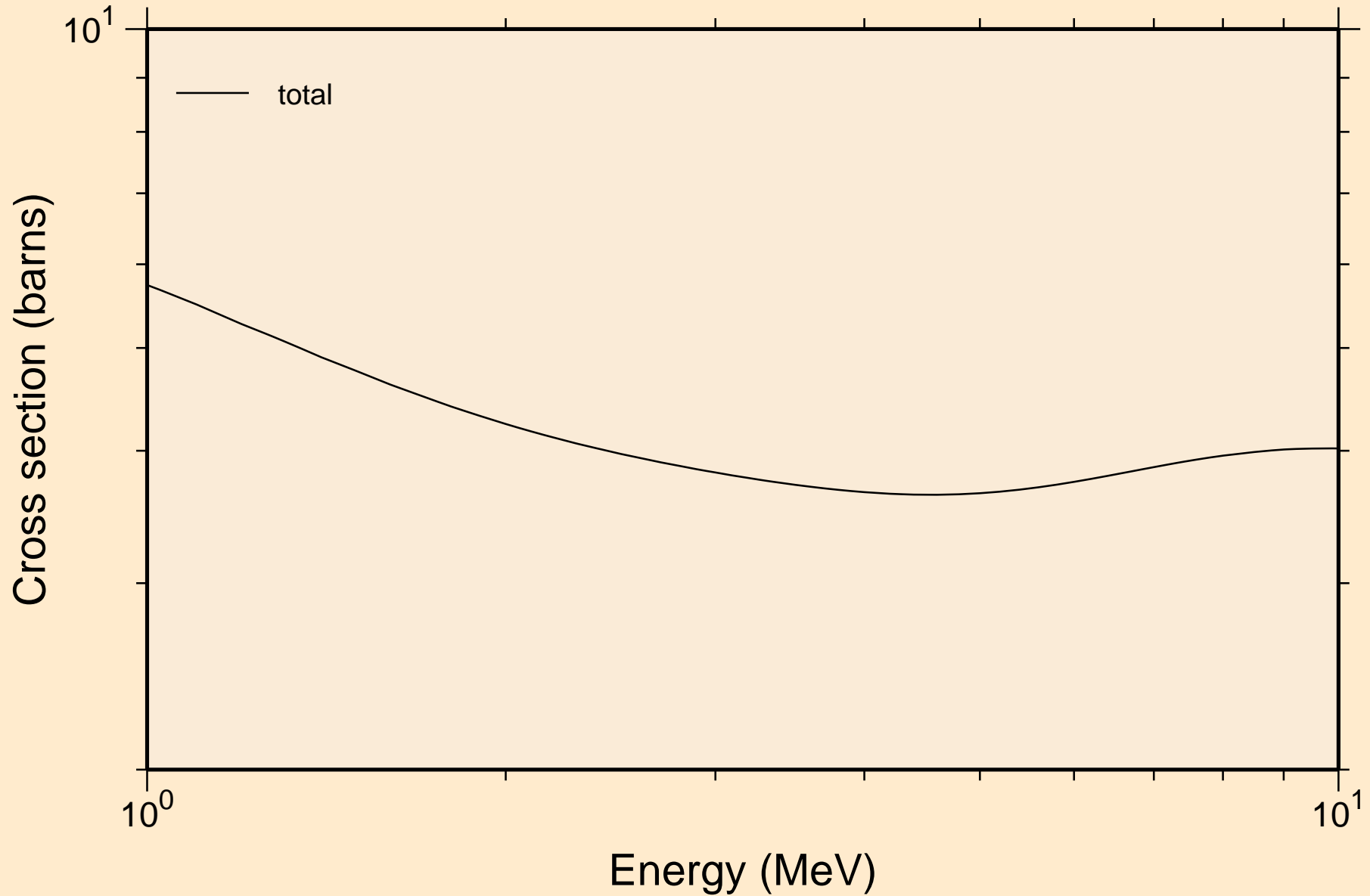

ZR083 NEUTRON ACER TENDL-2024 LIBRARY; T=0.K
resonance absorption cross sections

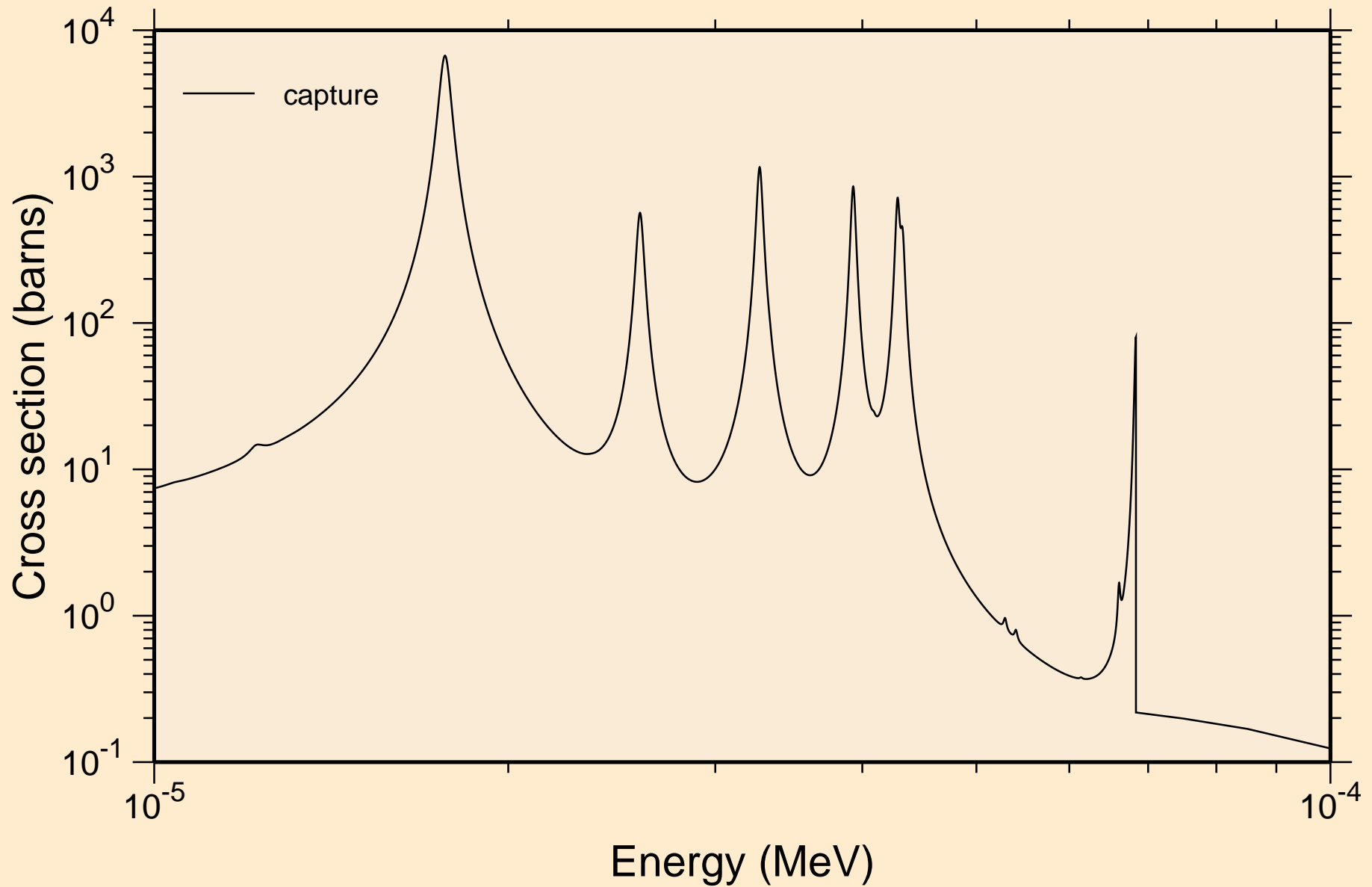

ZR083 NEUTRON ACER TENDL-2024 LIBRARY; T=0.K
resonance absorption cross sections

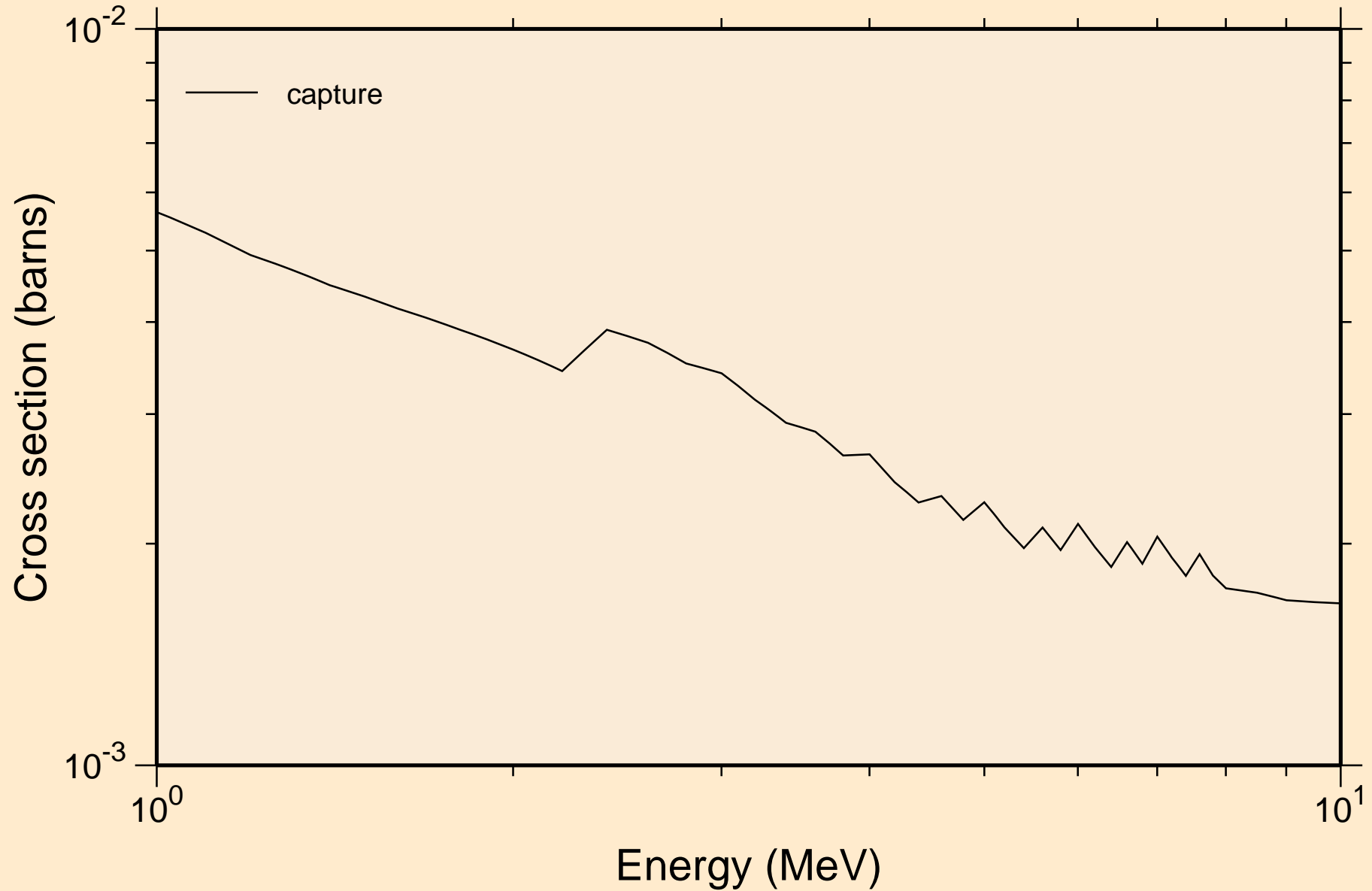

ZR083 NEUTRON ACER TENDL-2024 LIBRARY; T=0.K

Heating

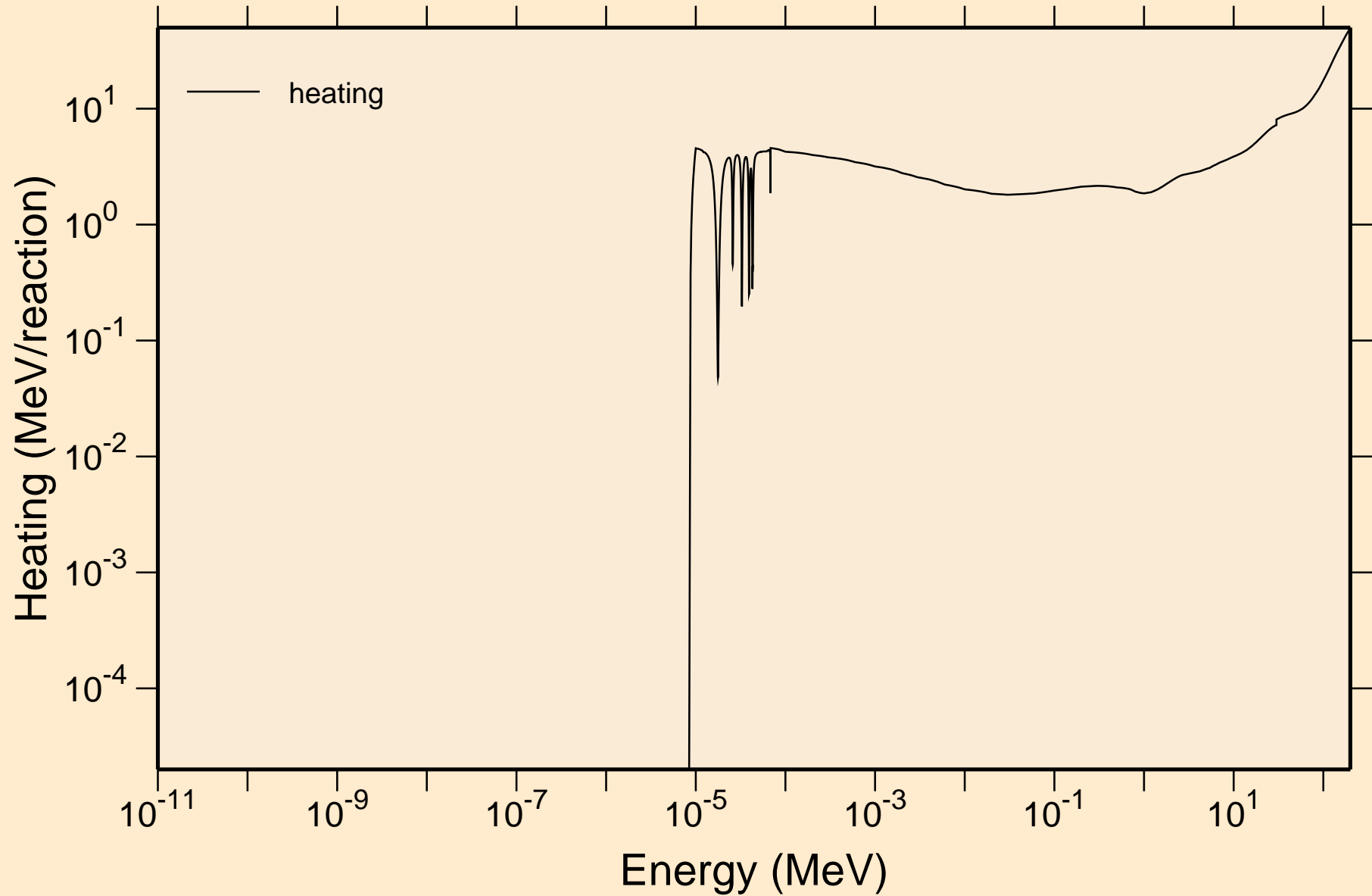

ZR083 NEUTRON ACER TENDL-2024 LIBRARY; T=0.K
Damage

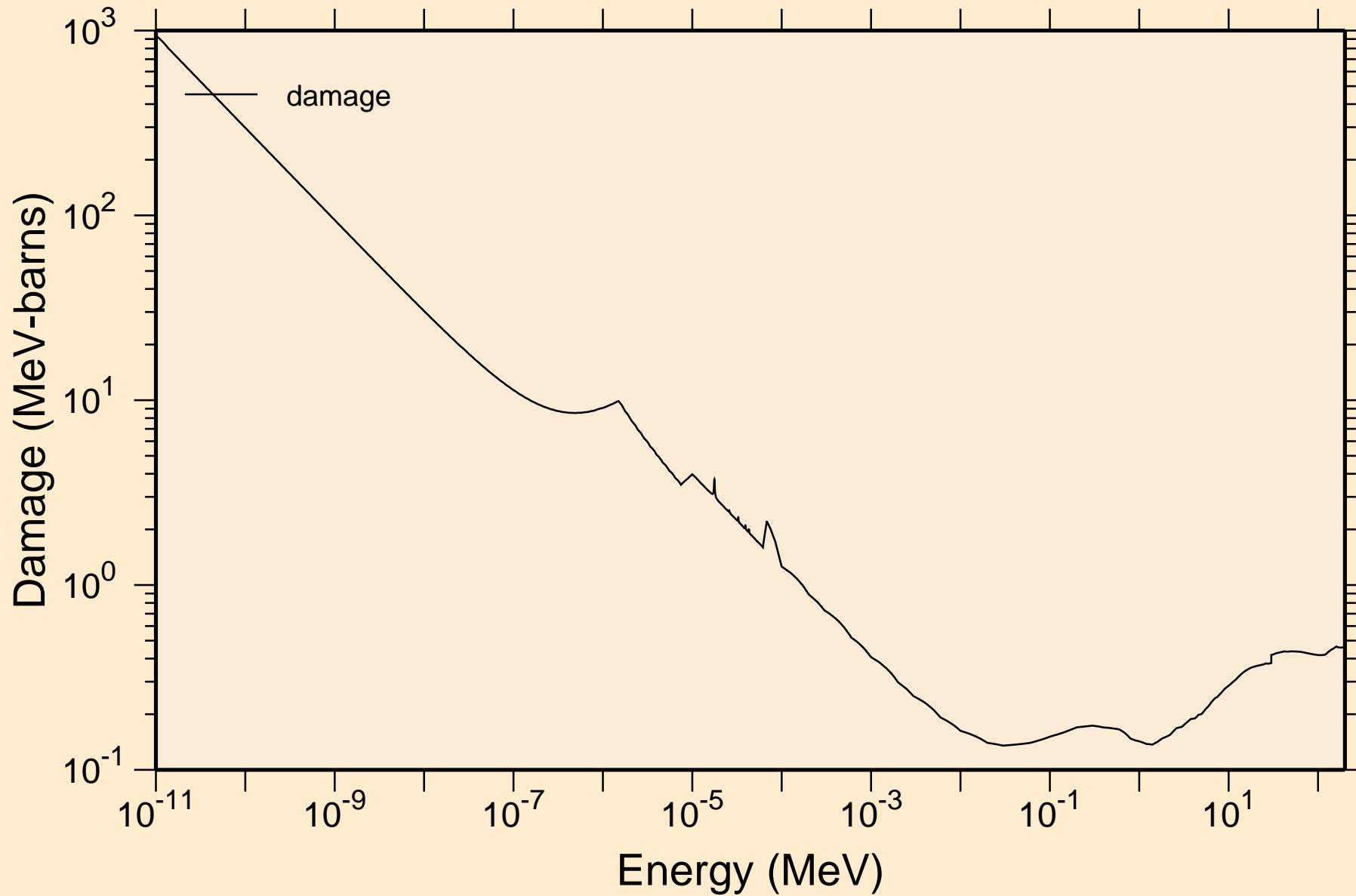

ZR083 NEUTRON ACER TENDL-2024 LIBRARY; T=0.K
Non-threshold reactions

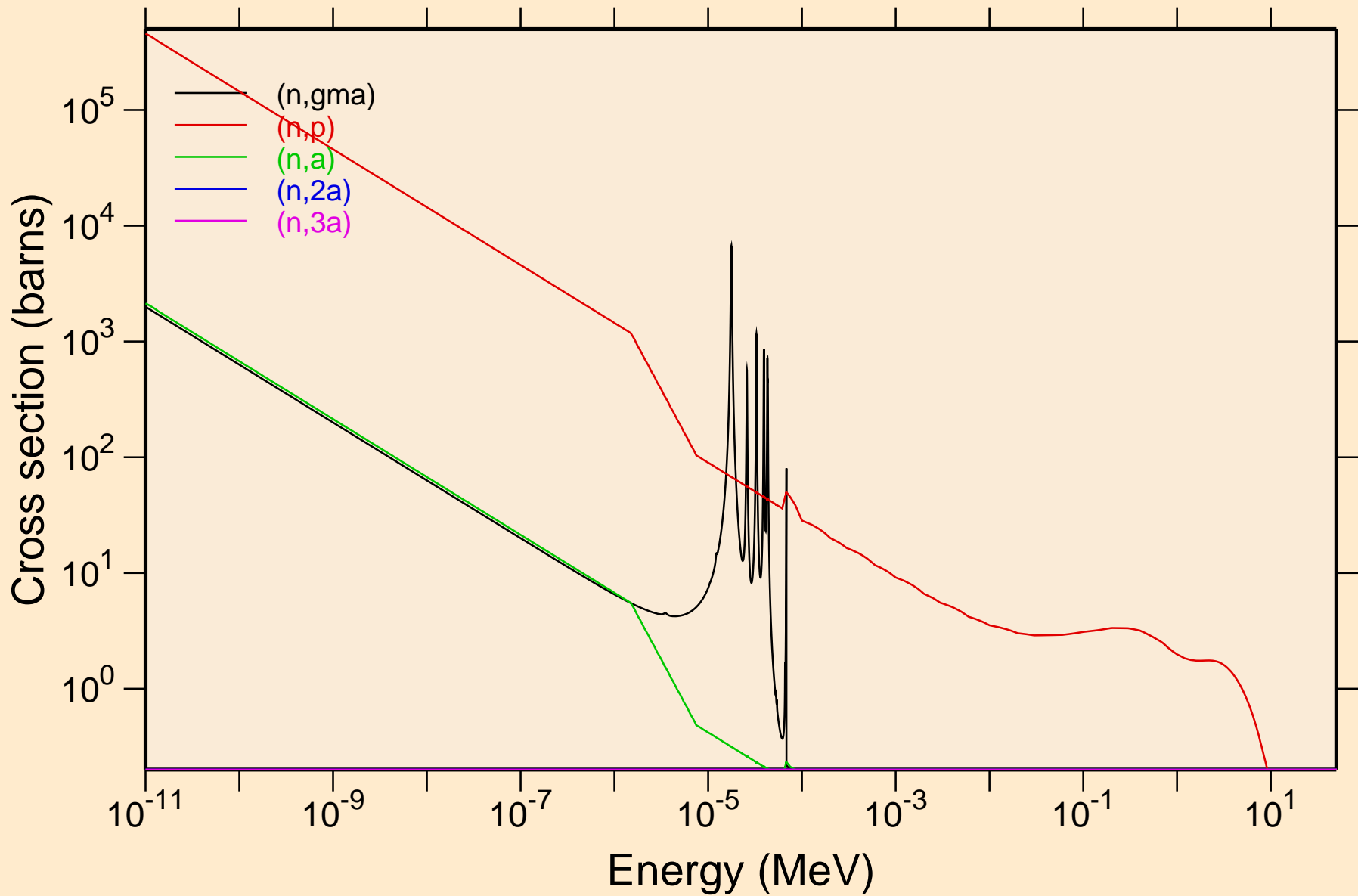

ZR083 NEUTRON ACER TENDL-2024 LIBRARY; T=0.K
Non-threshold reactions

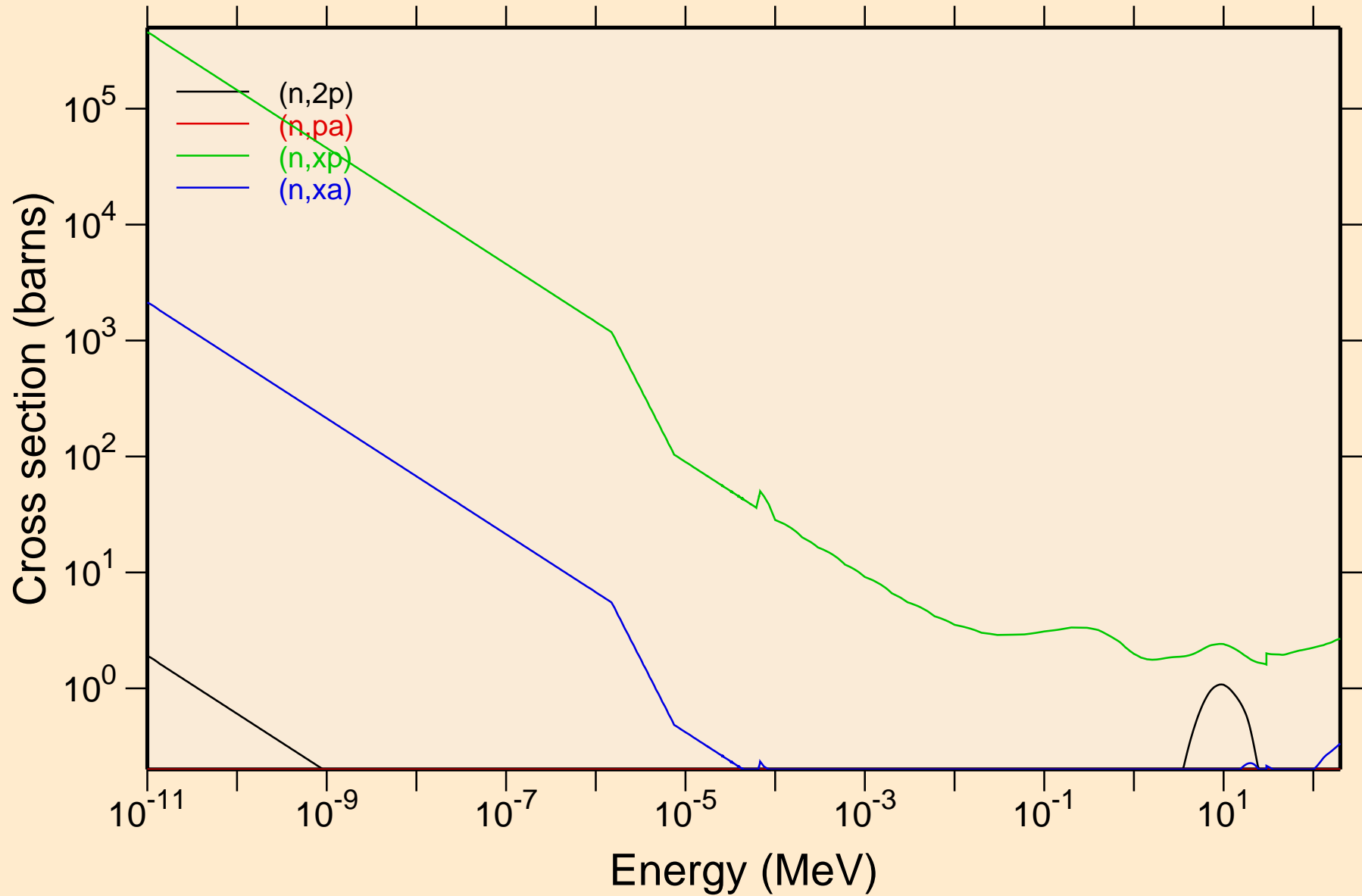

ZR083 NEUTRON ACER TENDL-2024 LIBRARY; T=0.K

Principal cross sections

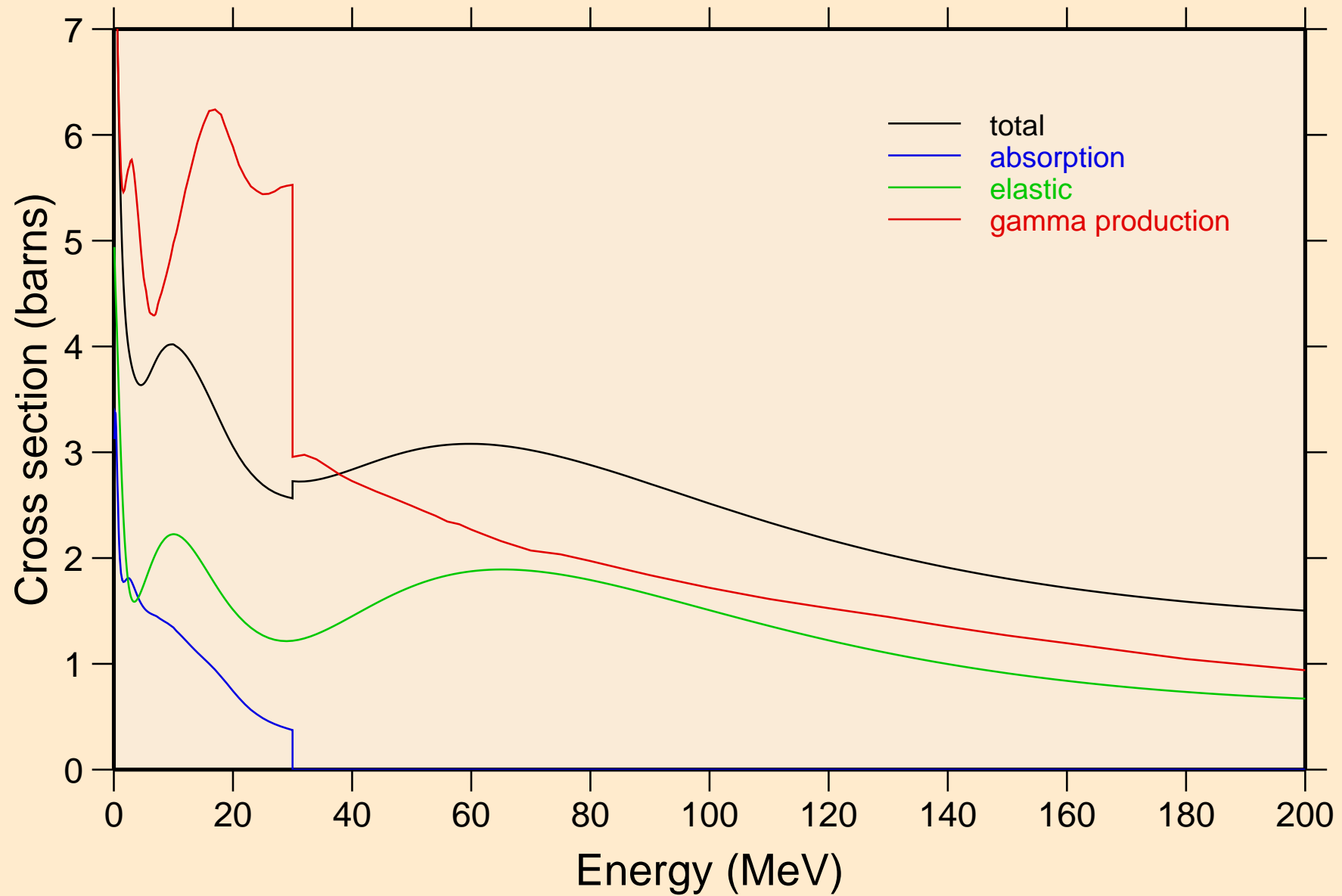

ZR083 NEUTRON ACER TENDL-2024 LIBRARY; T=0.K

Heating

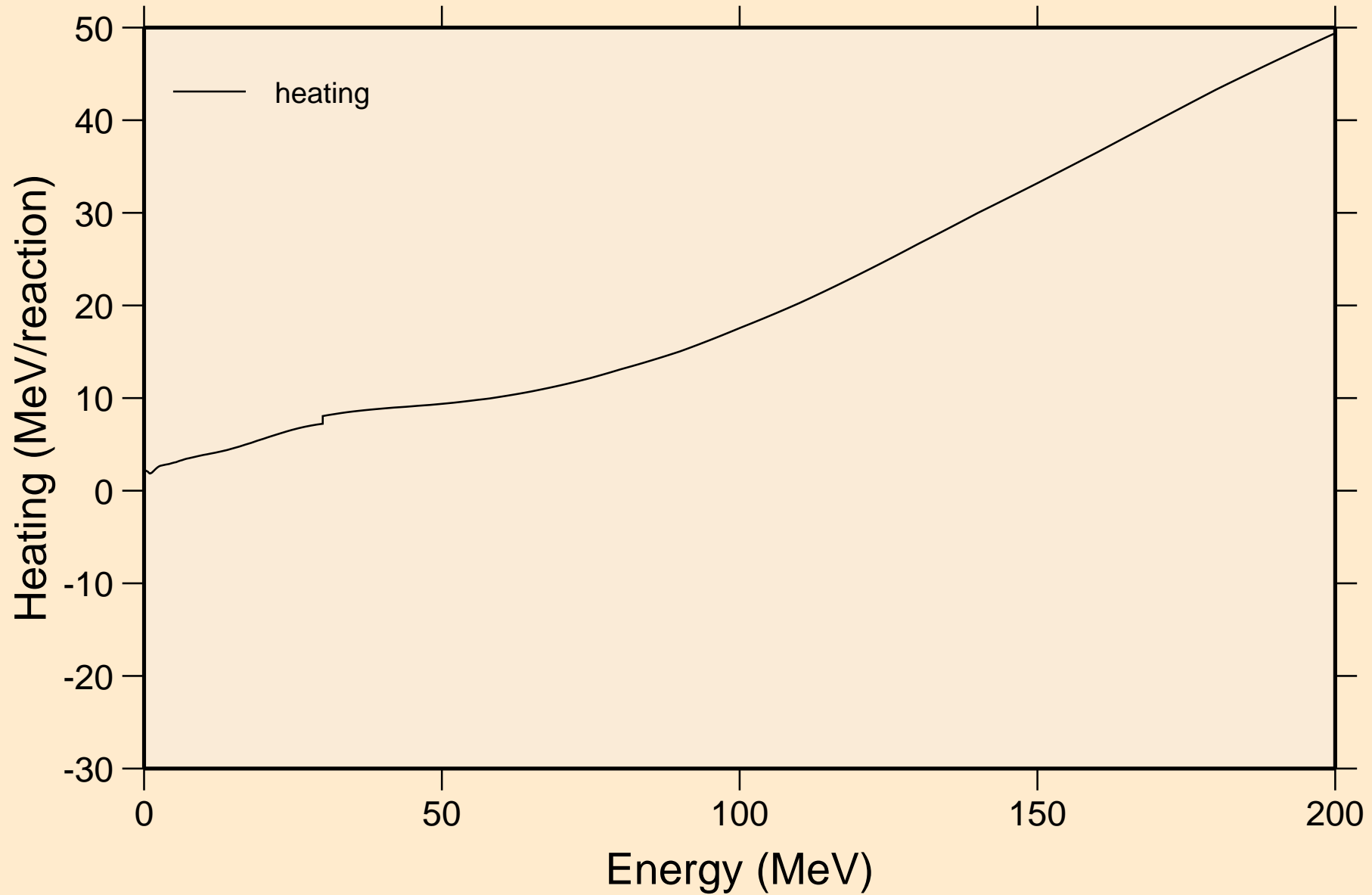

ZR083 NEUTRON ACER TENDL-2024 LIBRARY; T=0.K

Damage

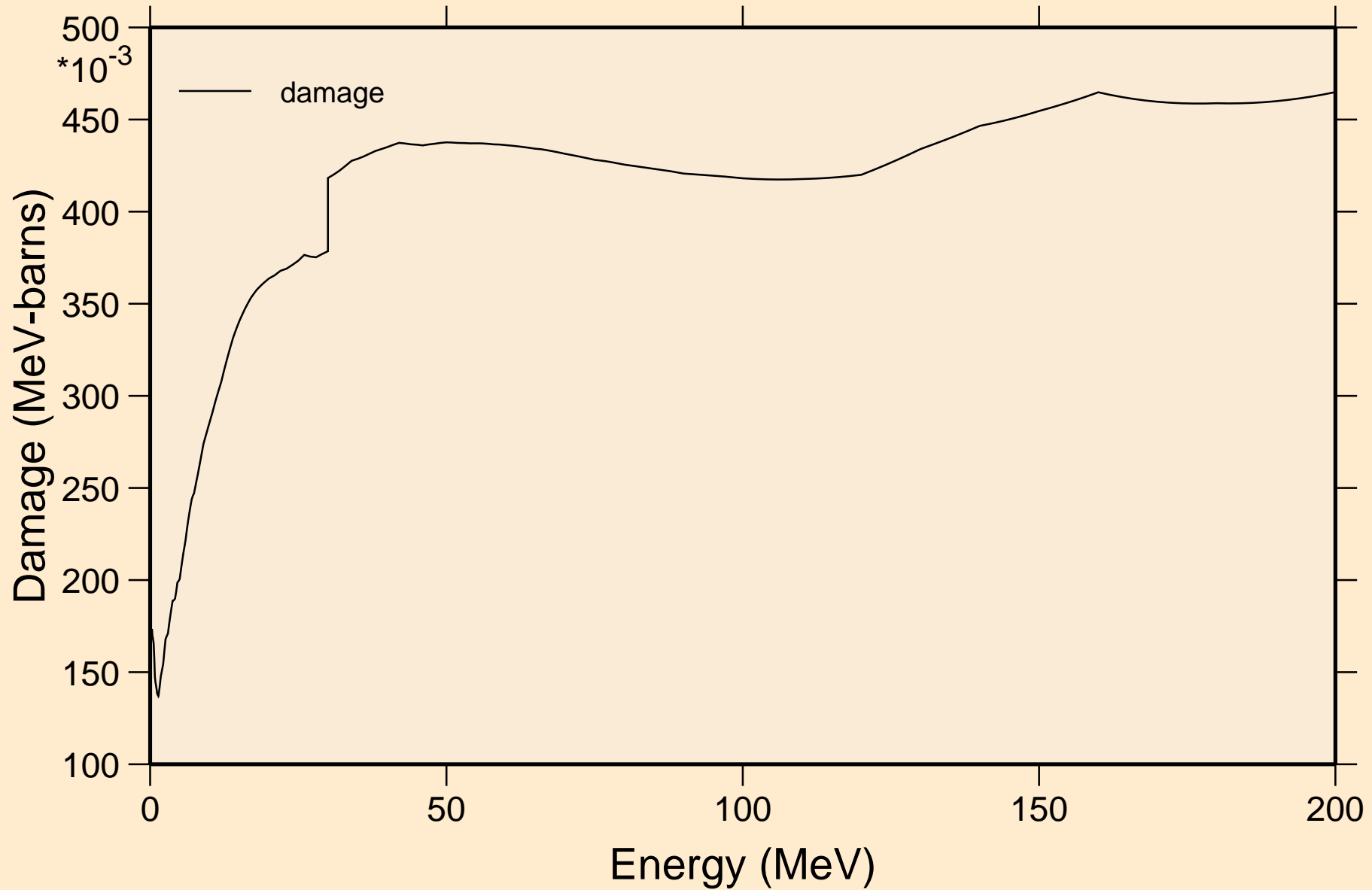

ZR083 NEUTRON ACER TENDL-2024 LIBRARY; T=0.K

Non-threshold reactions

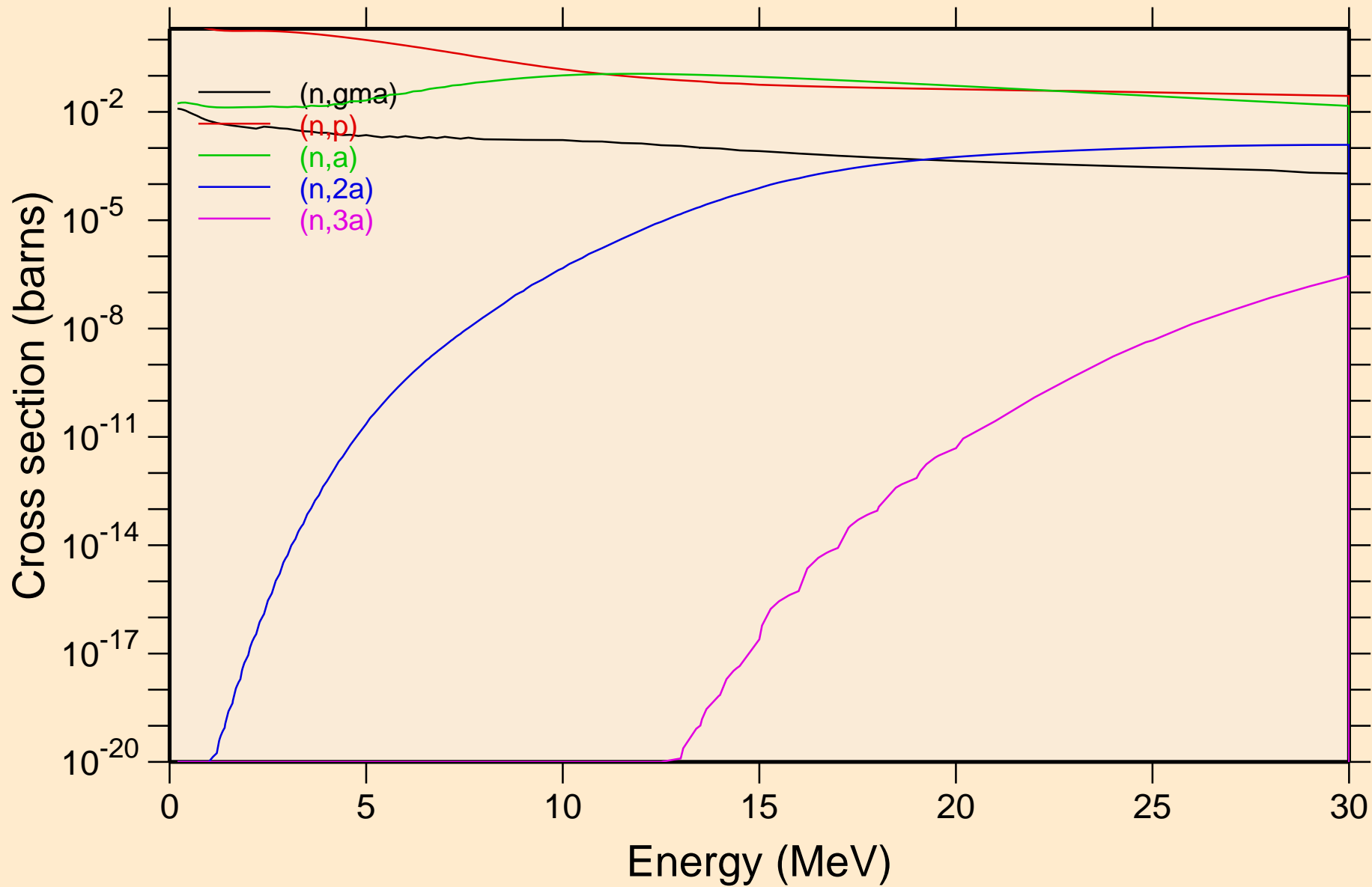

ZR083 NEUTRON ACER TENDL-2024 LIBRARY; T=0.K
Non-threshold reactions

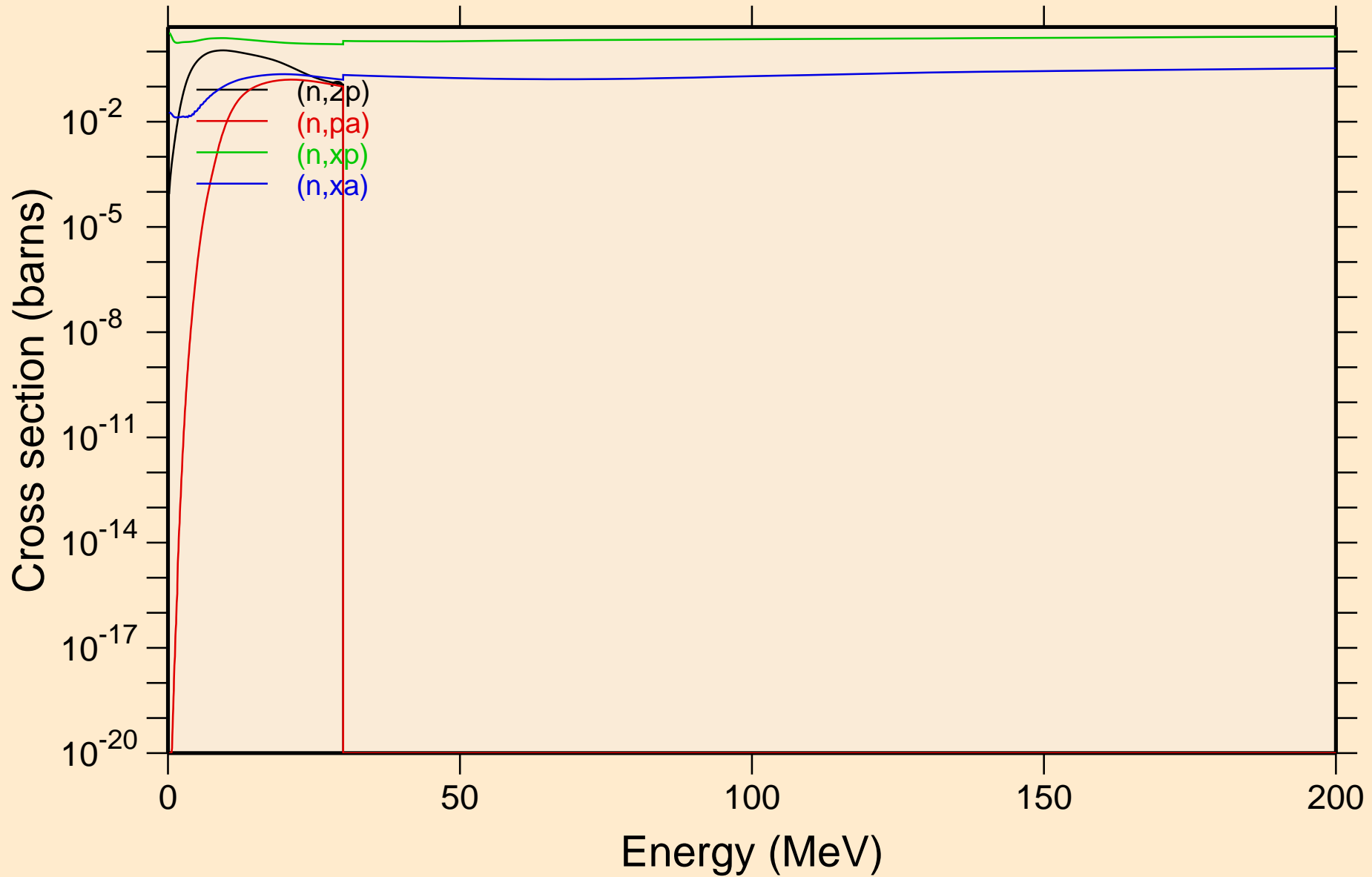

ZR083 NEUTRON ACER TENDL-2024 LIBRARY; T=0.K
Inelastic levels

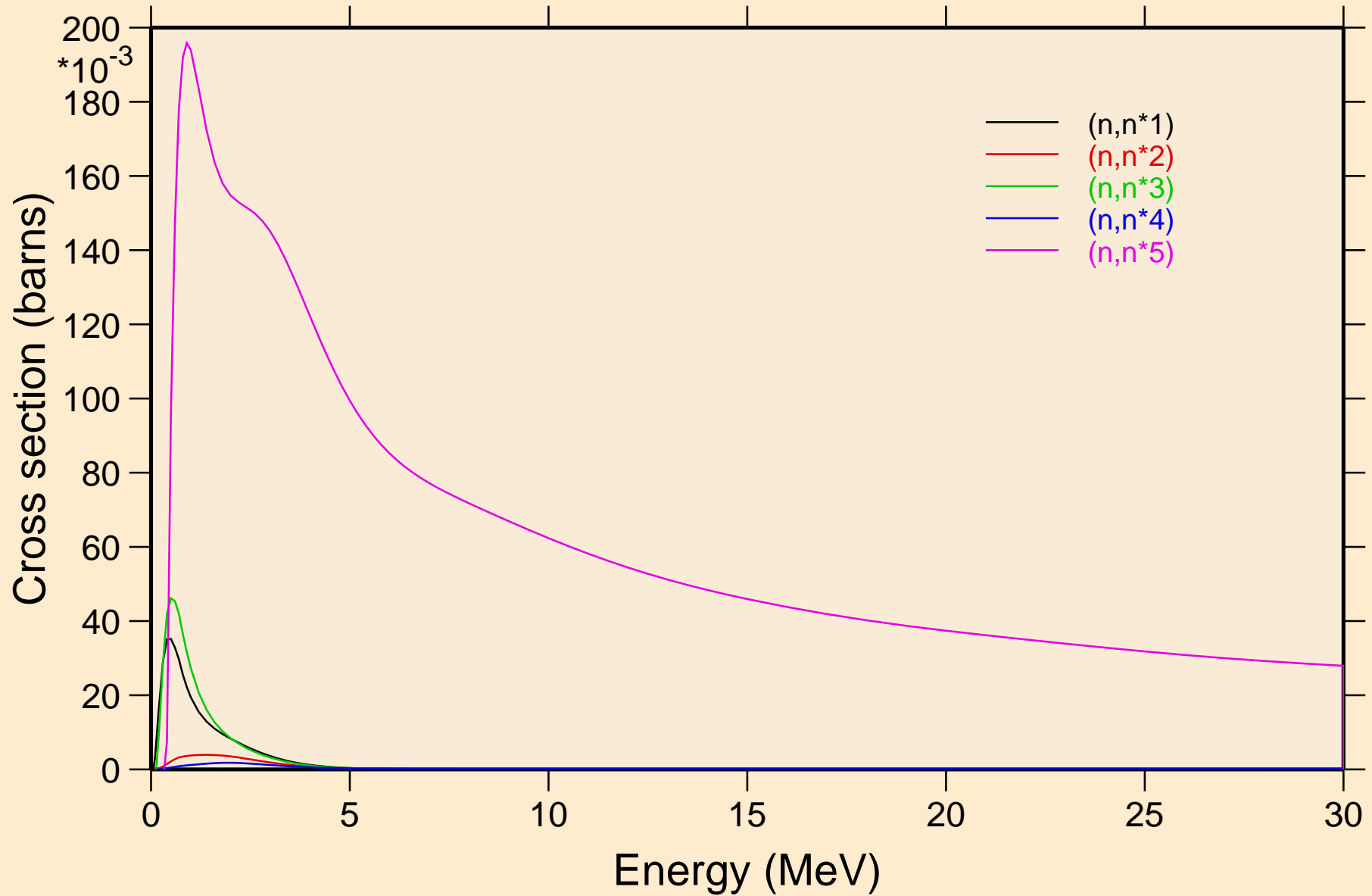

ZR083 NEUTRON ACER TENDL-2024 LIBRARY; T=0.K

Inelastic levels

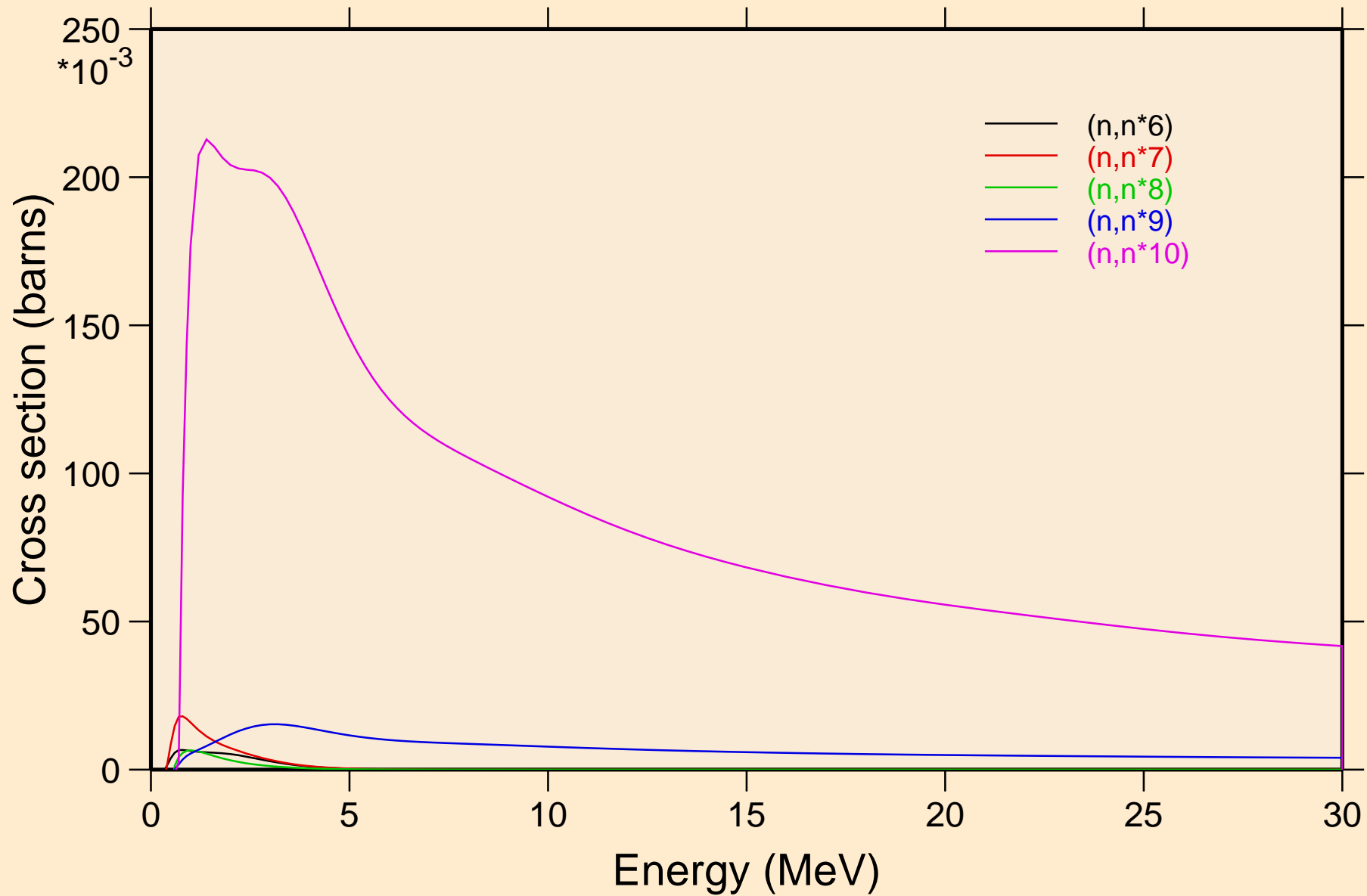

ZR083 NEUTRON ACER TENDL-2024 LIBRARY; T=0.K
Inelastic levels

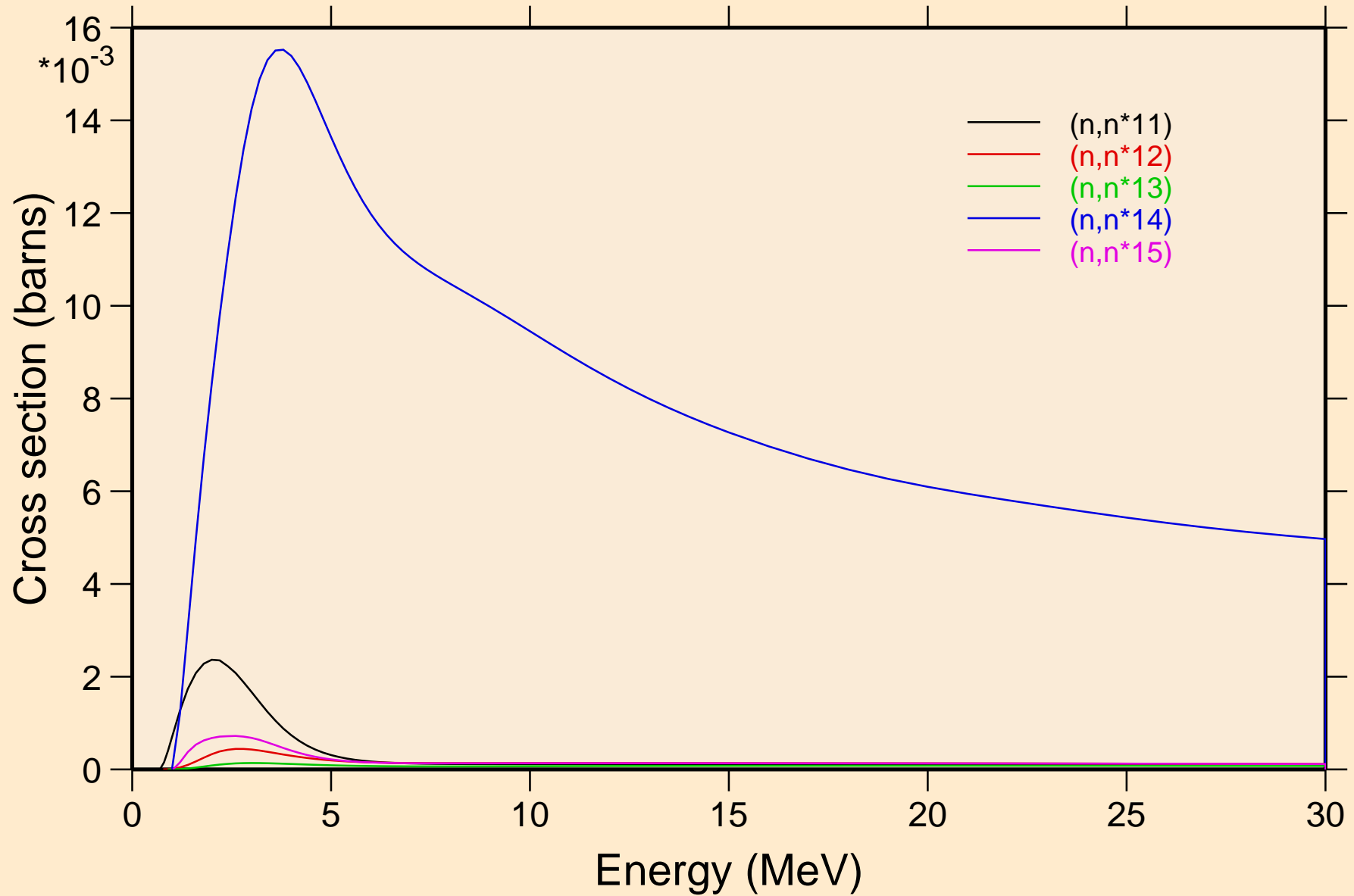

ZR083 NEUTRON ACER TENDL-2024 LIBRARY; T=0.K
Inelastic levels

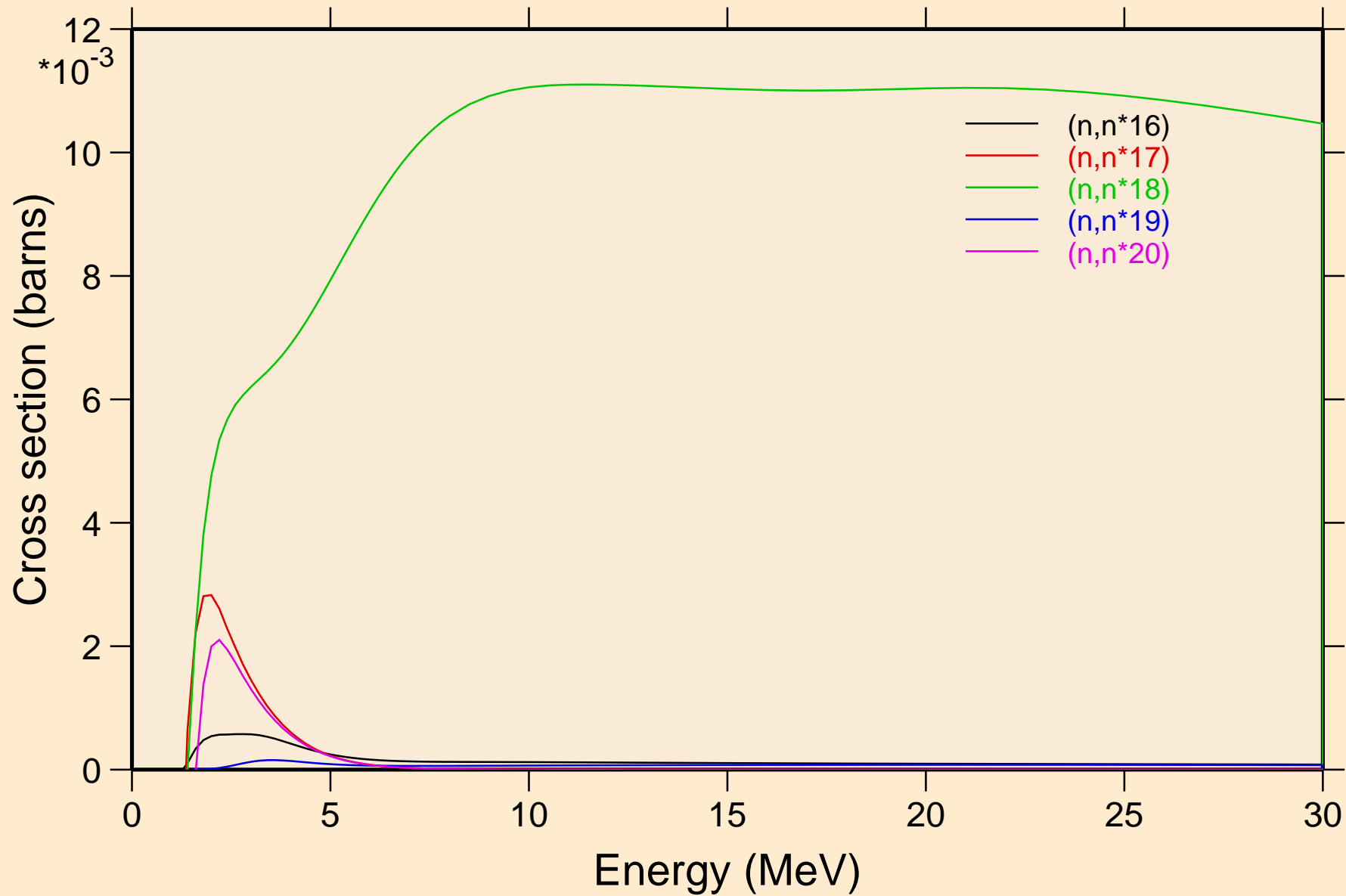

ZR083 NEUTRON ACER TENDL-2024 LIBRARY; T=0.K
Inelastic levels

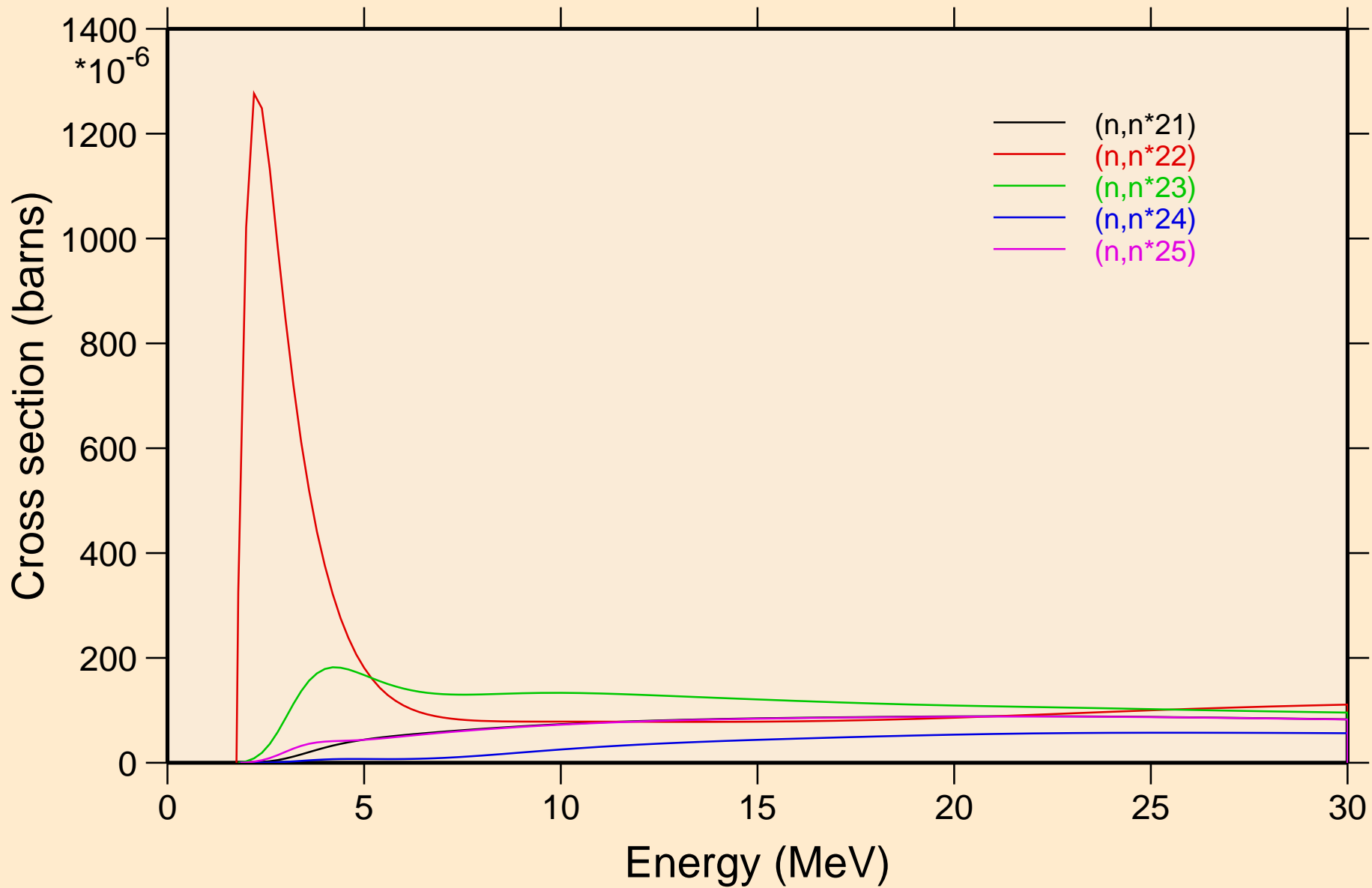

ZR083 NEUTRON ACER TENDL-2024 LIBRARY; T=0.K
Inelastic levels

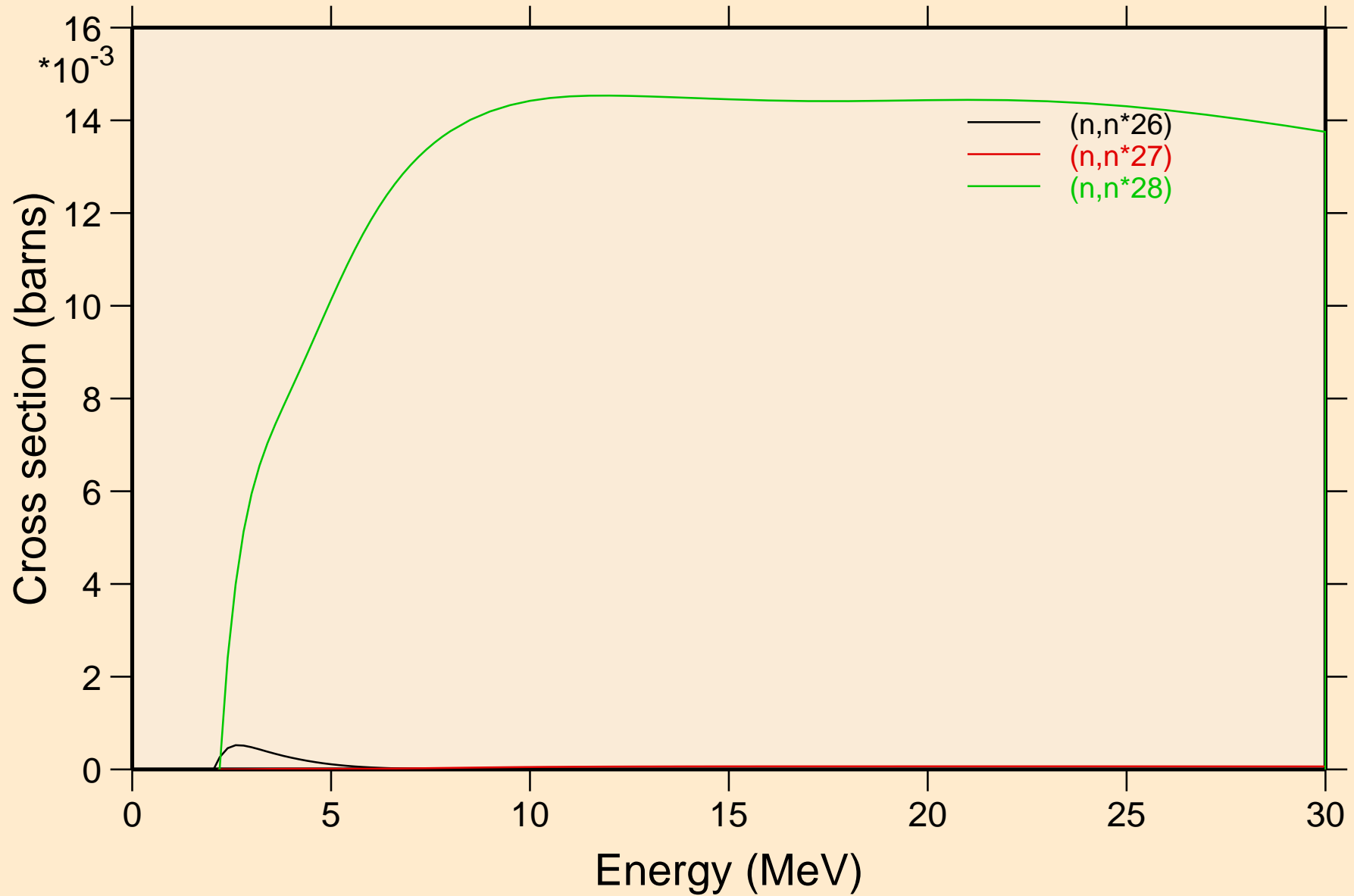

ZR083 NEUTRON ACER TENDL-2024 LIBRARY; T=0.K
Threshold reactions

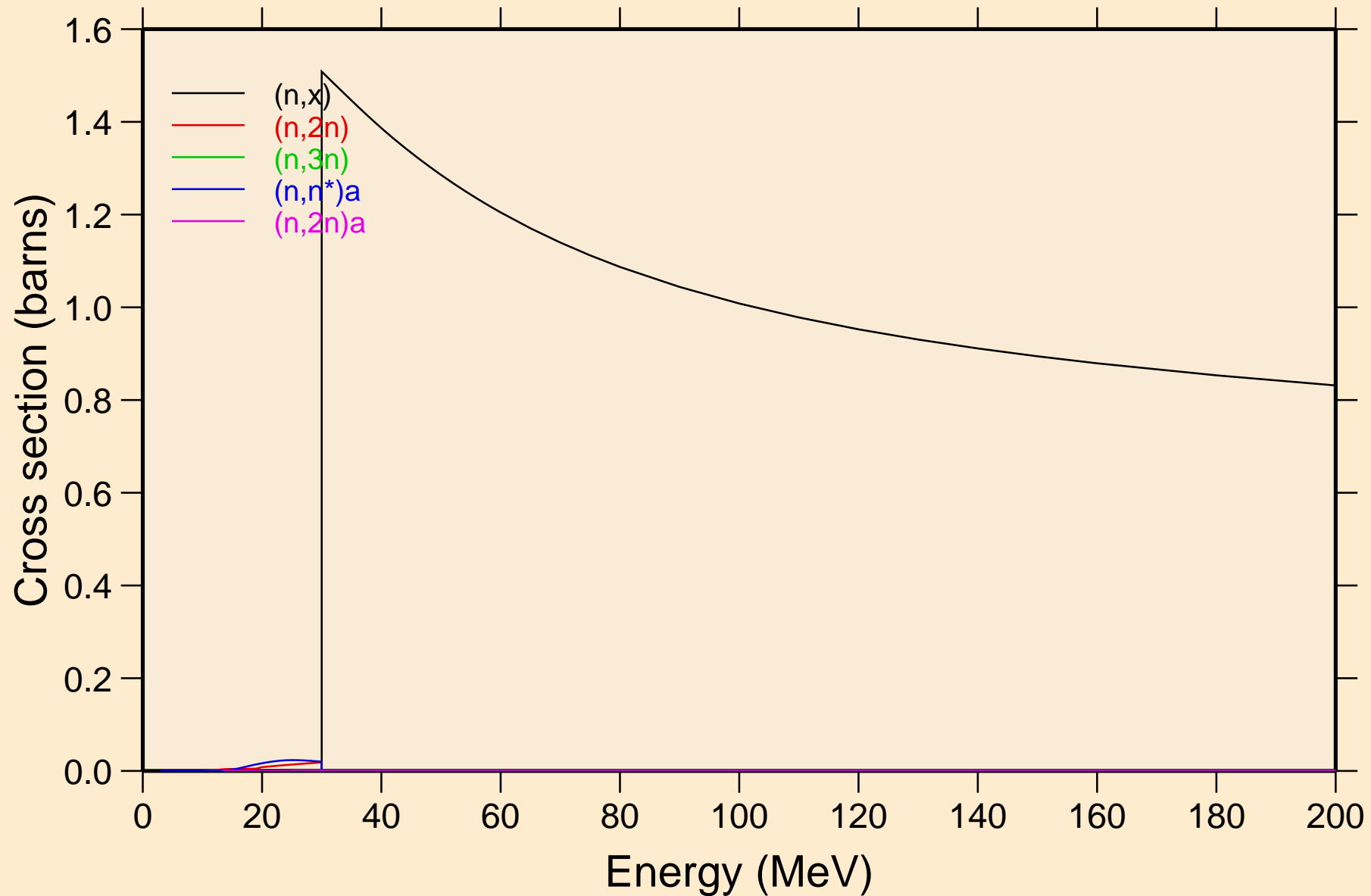

ZR083 NEUTRON ACER TENDL-2024 LIBRARY; T=0.K
Threshold reactions

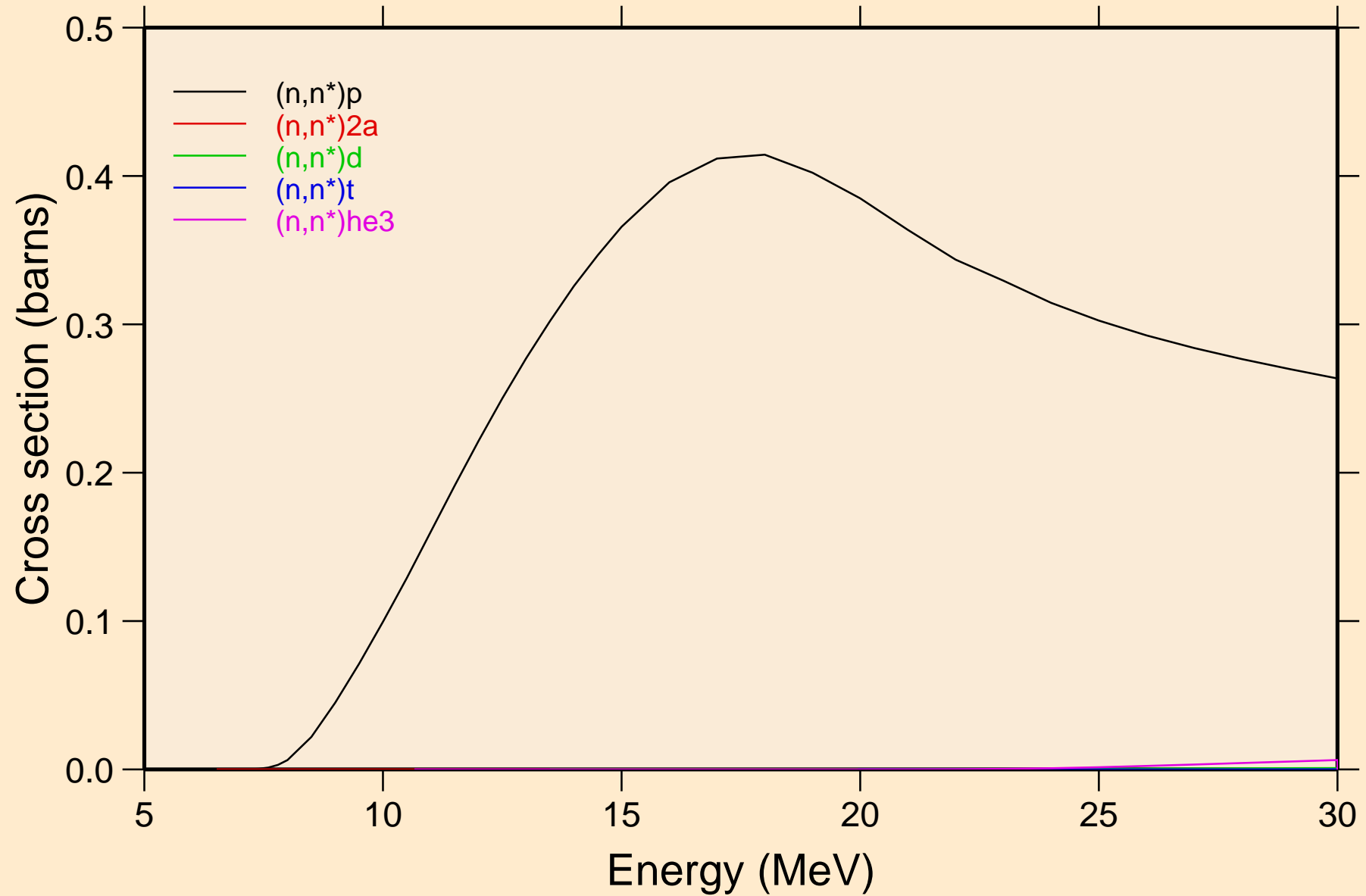

ZR083 NEUTRON ACER TENDL-2024 LIBRARY; T=0.K
Threshold reactions

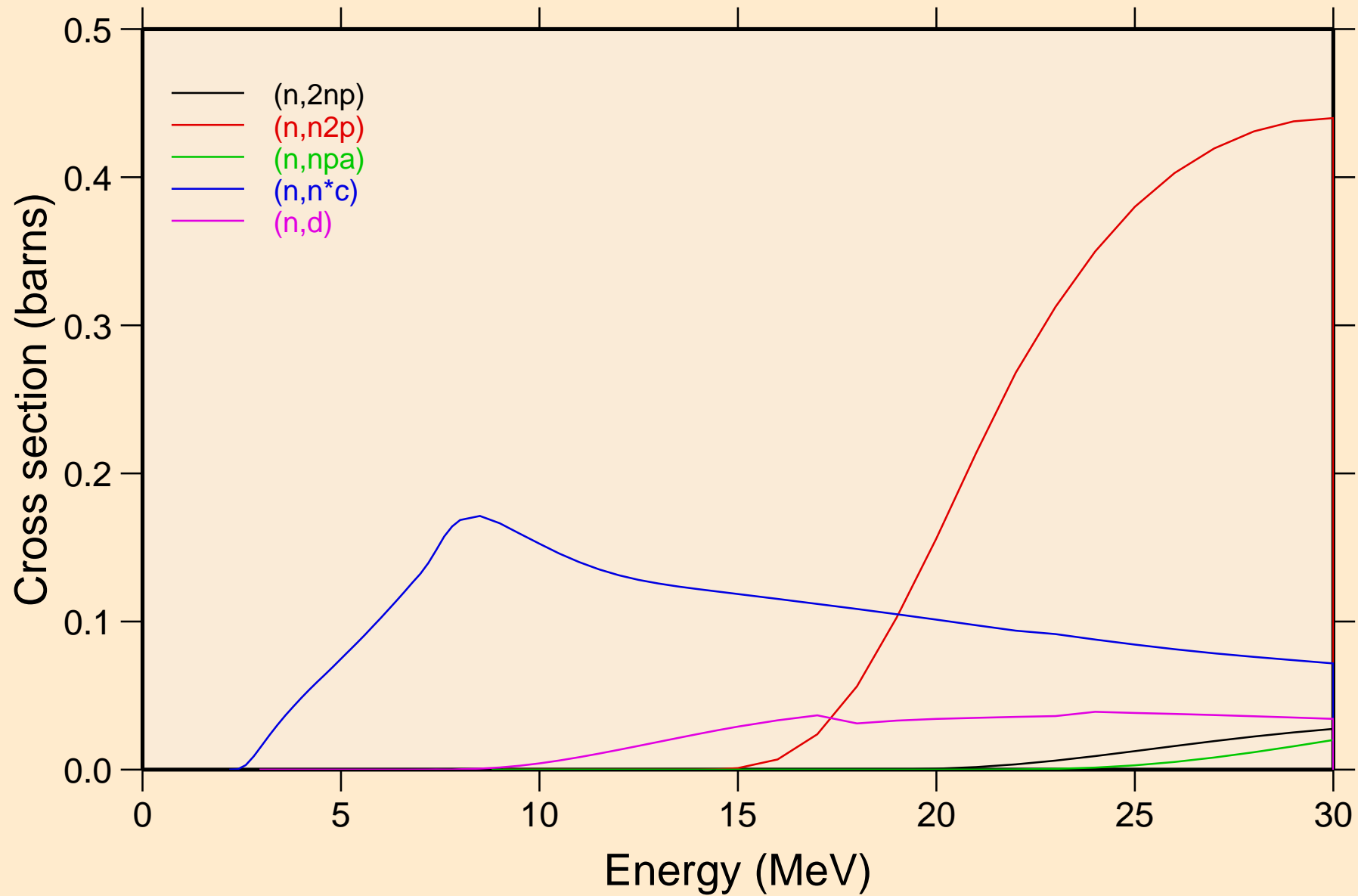

ZR083 NEUTRON ACER TENDL-2024 LIBRARY; T=0.K
Threshold reactions

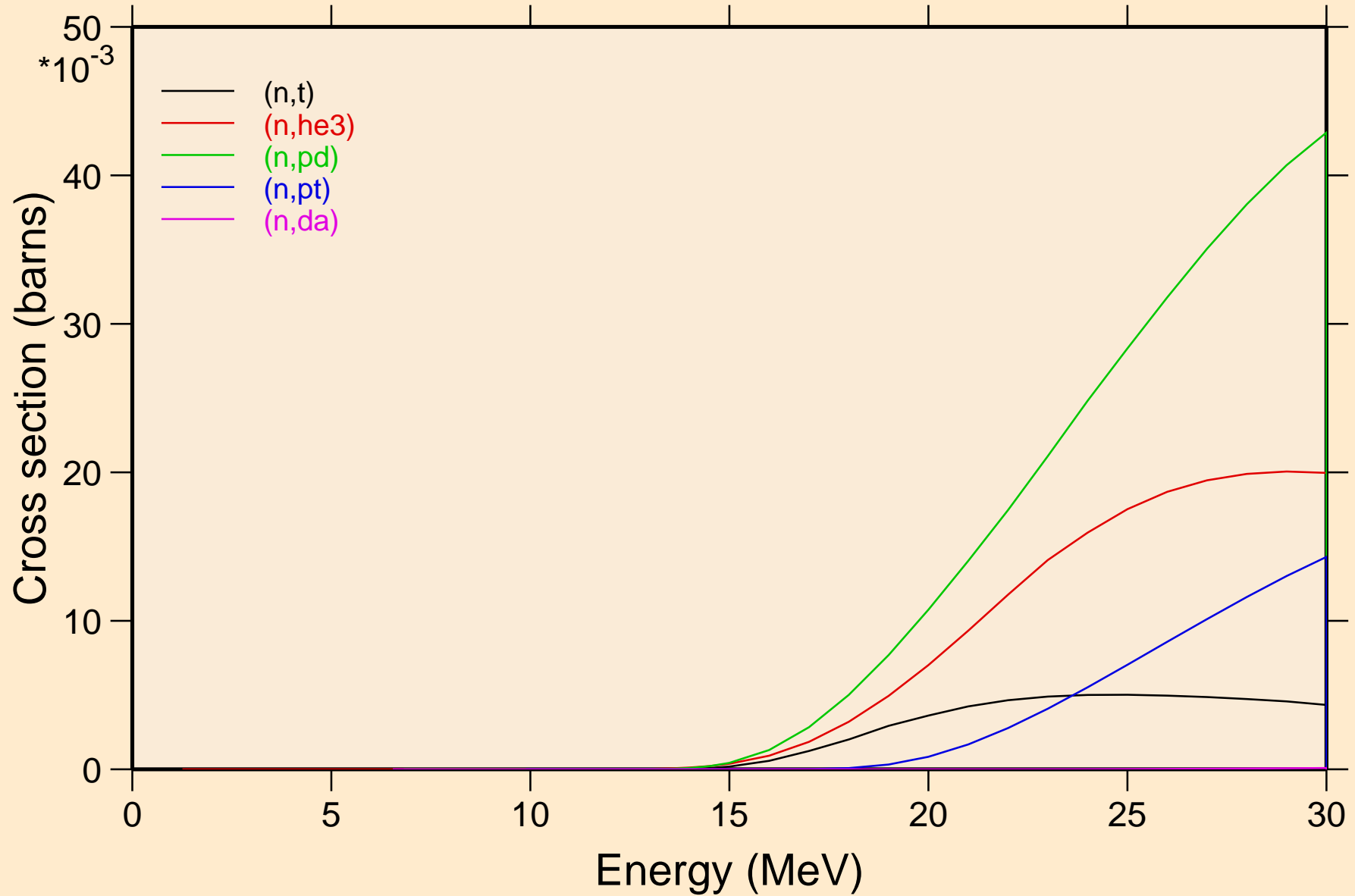

ZR083 NEUTRON ACER TENDL-2024 LIBRARY; T=0.K

Threshold reactions

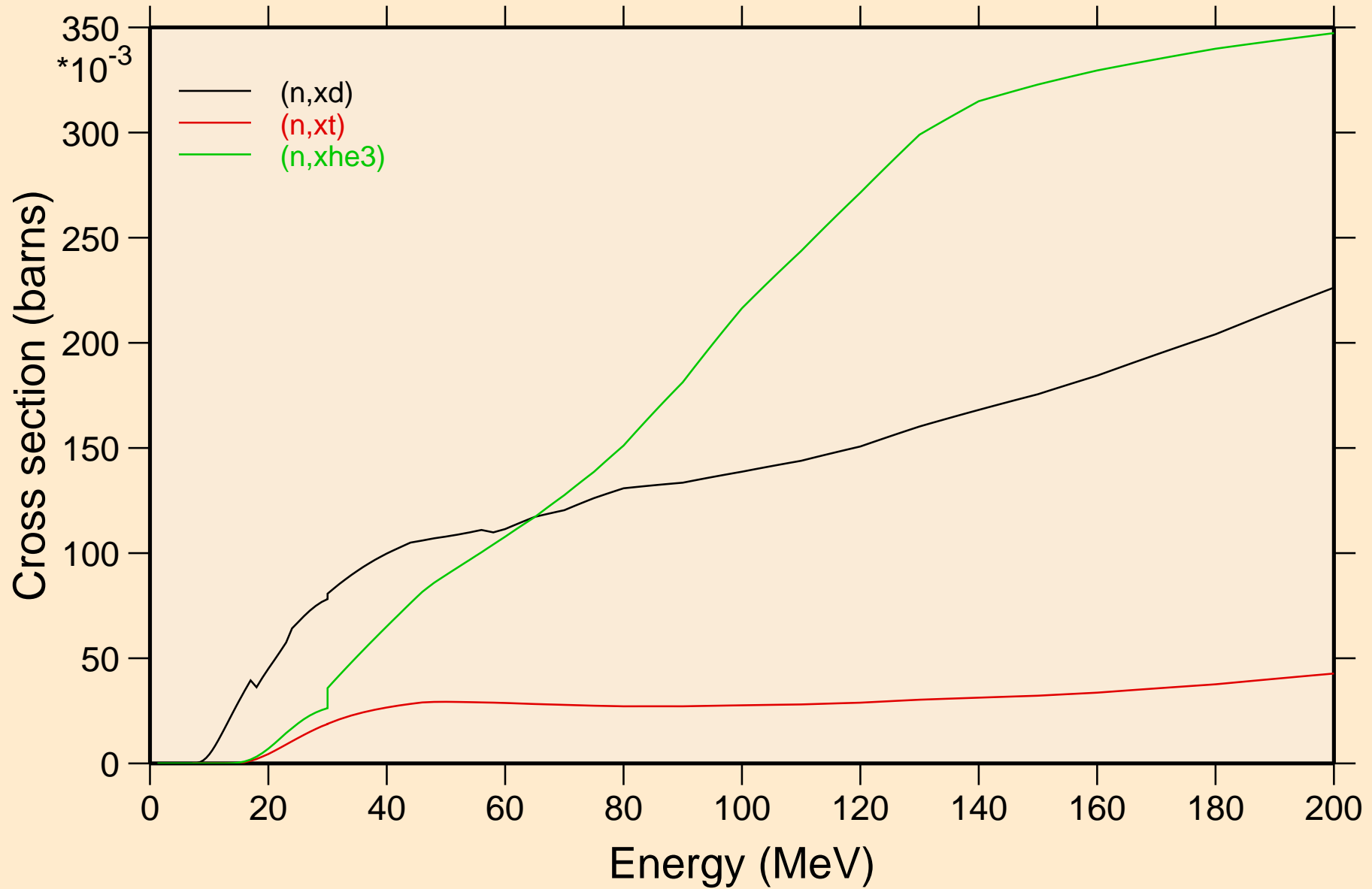

ZR083 NEUTRON ACER TENDL-2024 LIBRARY; T=0.K
angular distribution for elastic

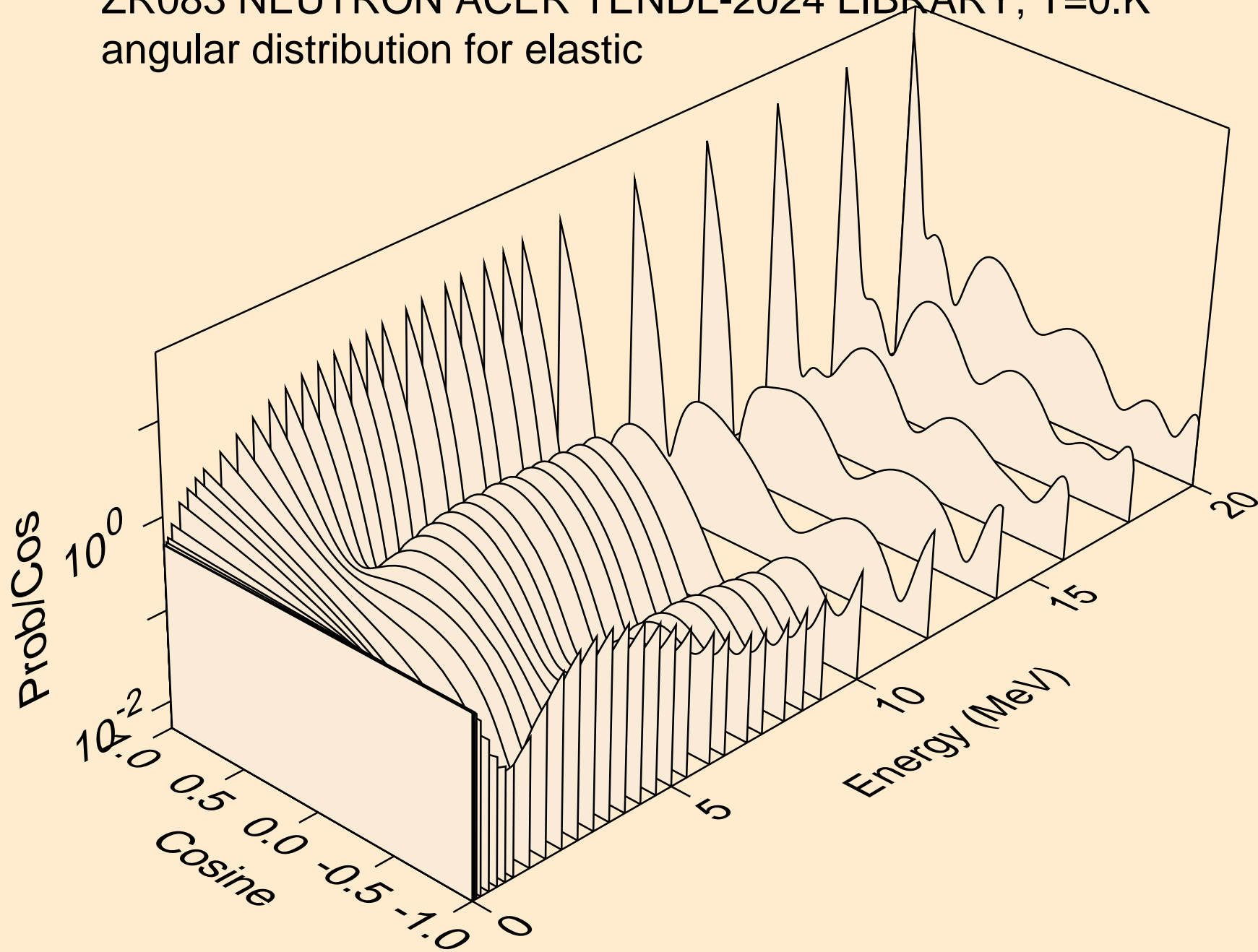

ZR083 NEUTRON ACER TENDL-2024 LIBRARY; T=0.K
angular distribution for elastic

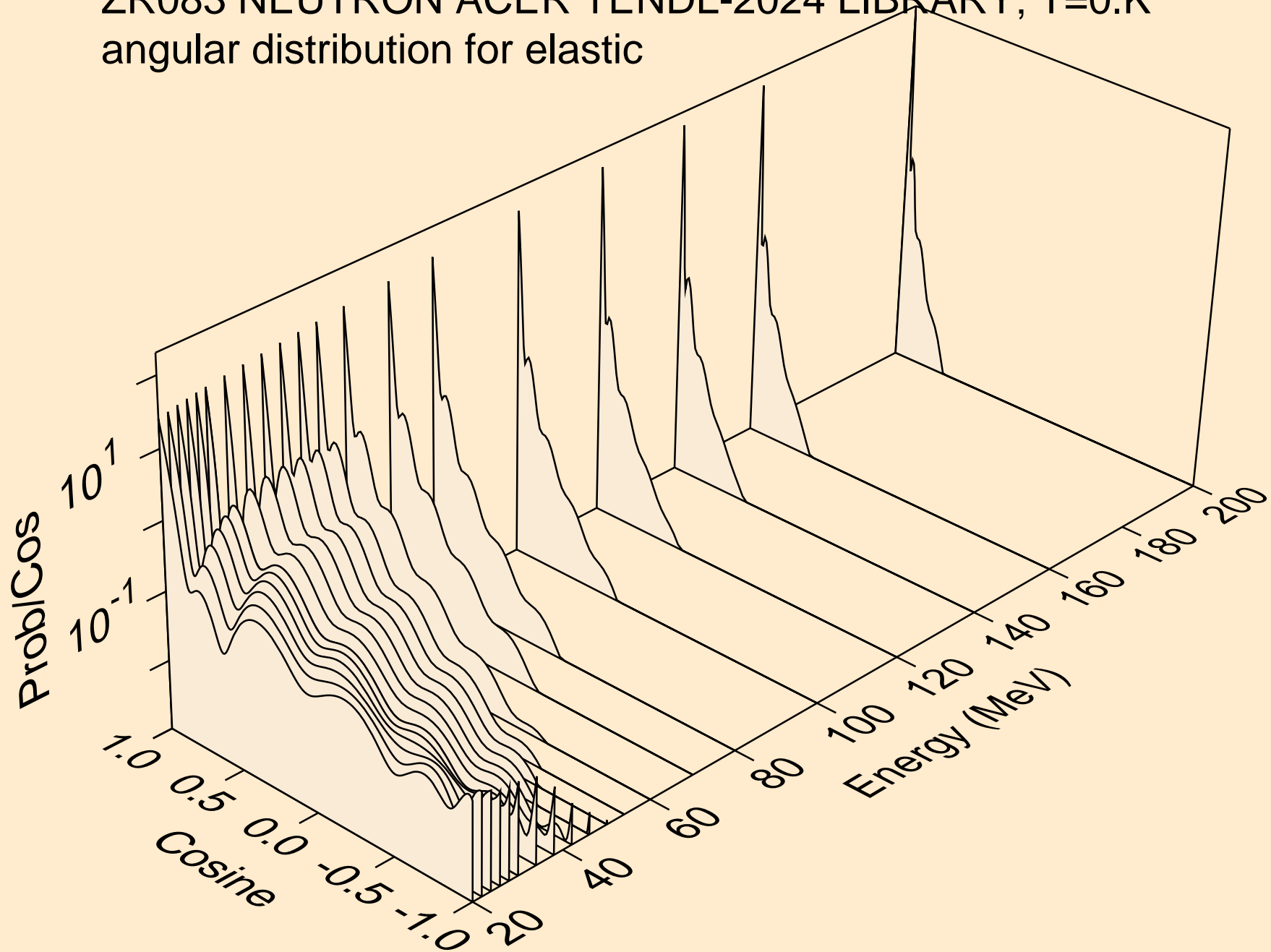

ZR083 NEUTRON ACER TENDL-2024 LIBRARY; T=0.K
angular distribution for (n,n*1)

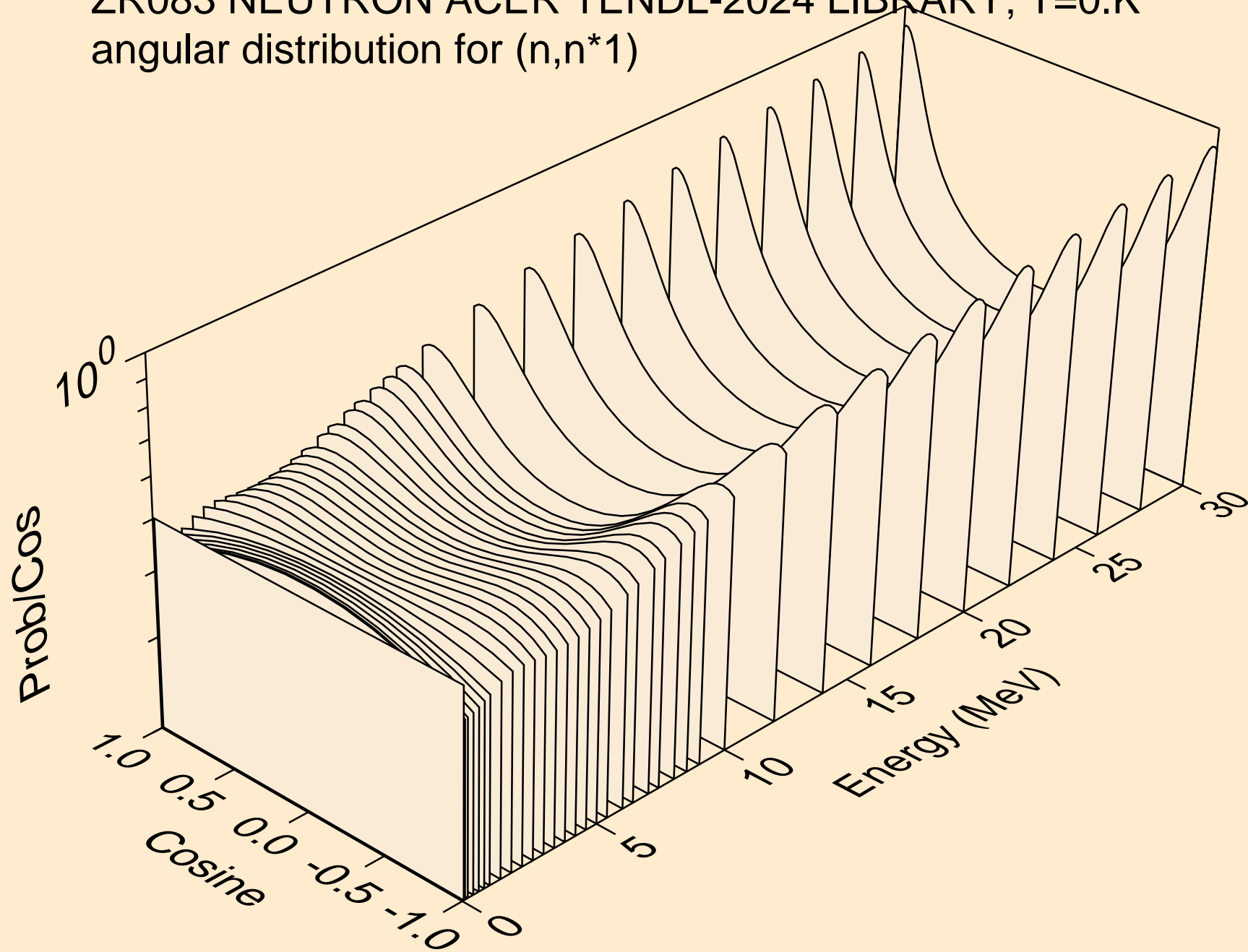

ZR083 NEUTRON ACER TENDL-2024 LIBRARY; T=0.K
angular distribution for (n,n*2)

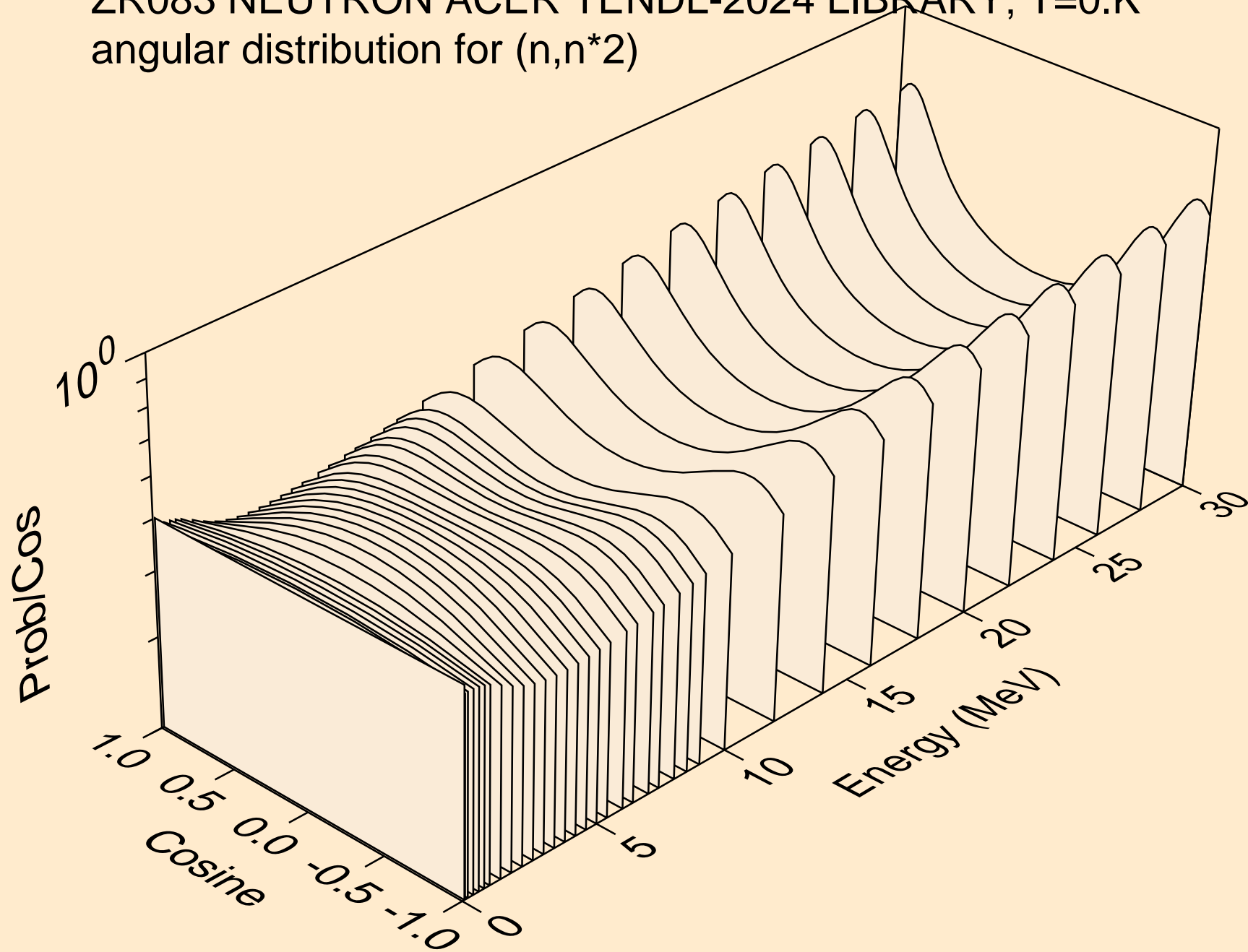

ZR083 NEUTRON ACER TENDL-2024 LIBRARY; T=0.K
angular distribution for (n,n*3)

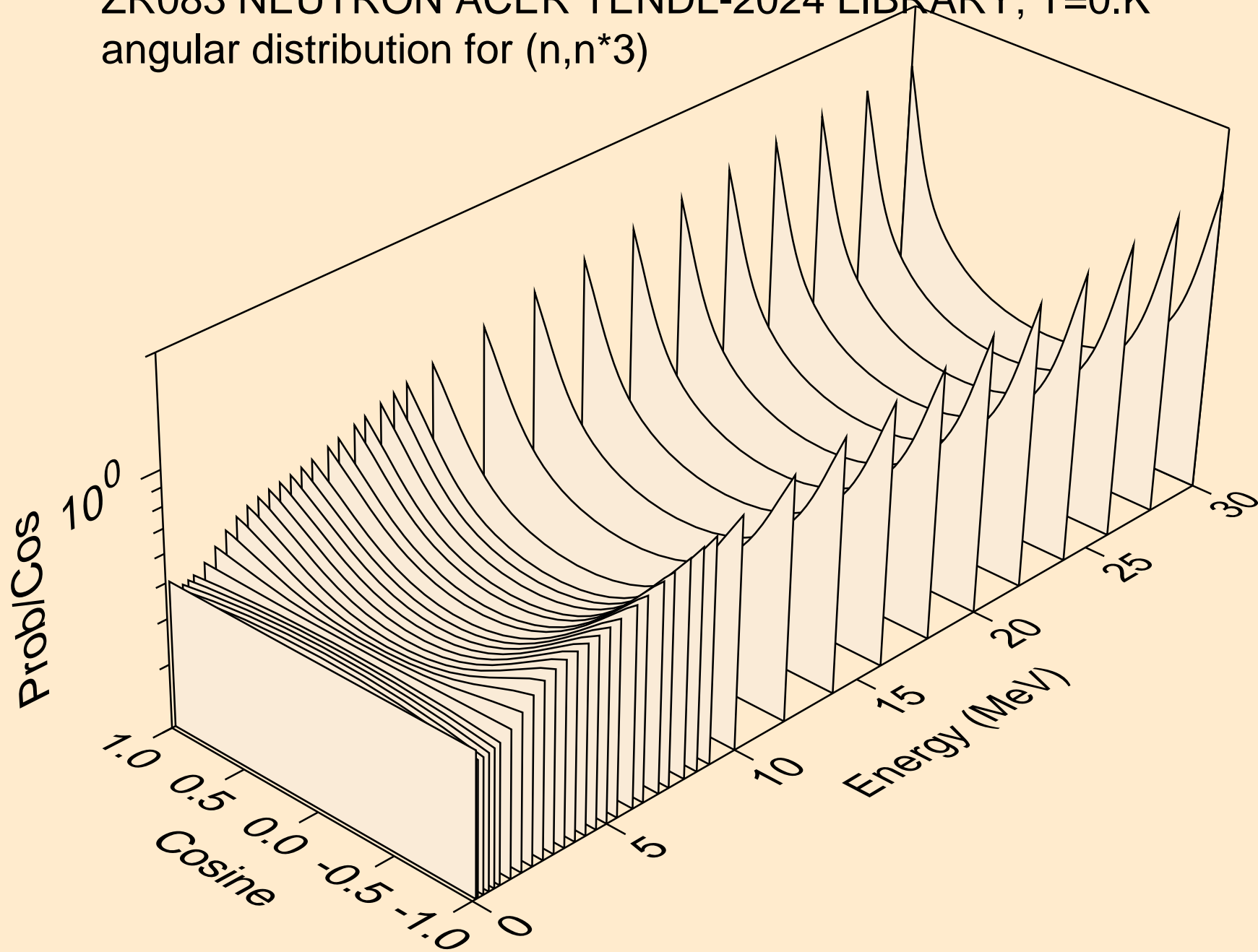

ZR083 NEUTRON ACER TENDL-2024 LIBRARY; T=0.K
angular distribution for (n,n*4)

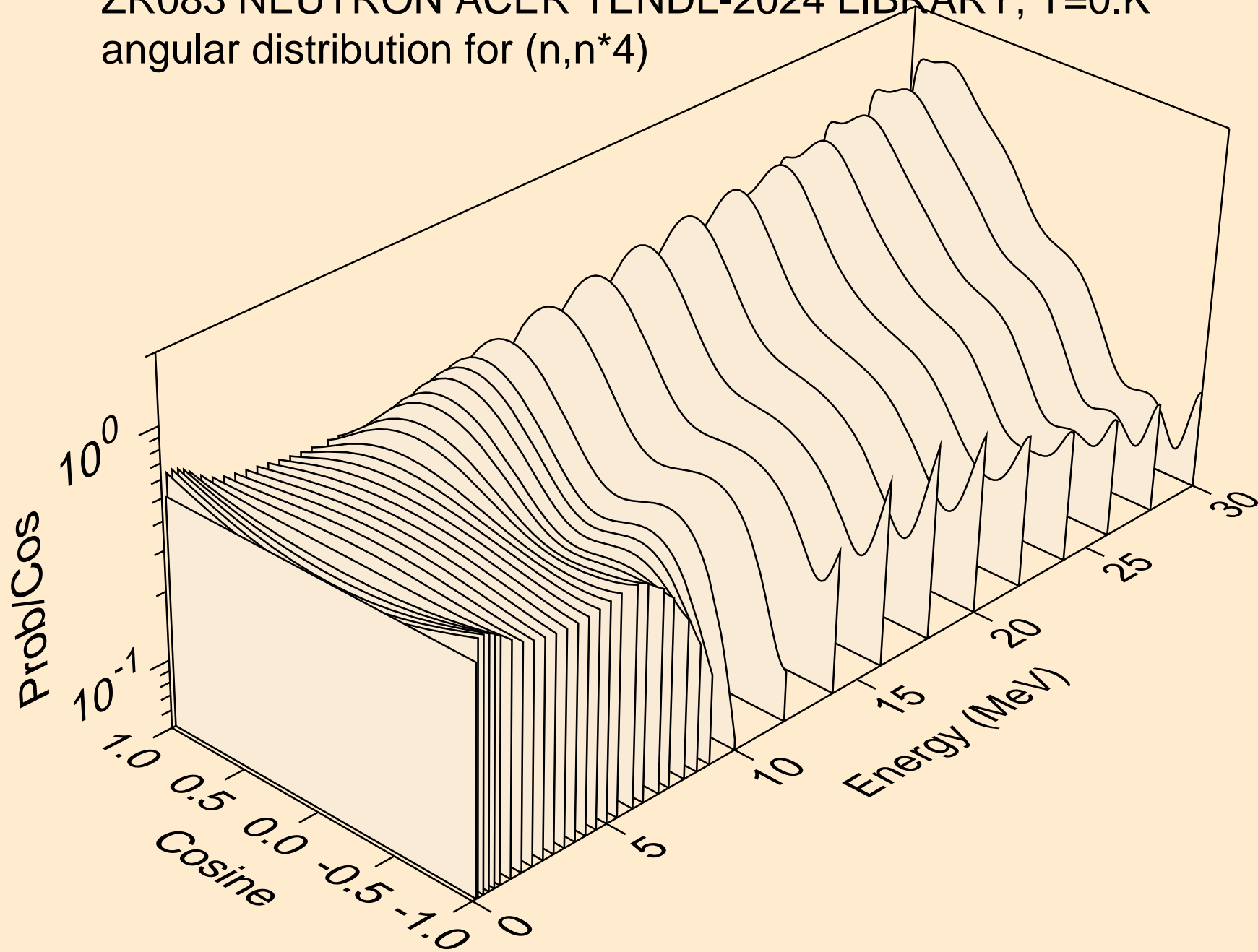

ZR083 NEUTRON ACER TENDL-2024 LIBRARY; T=0.K
angular distribution for (n,n*5)

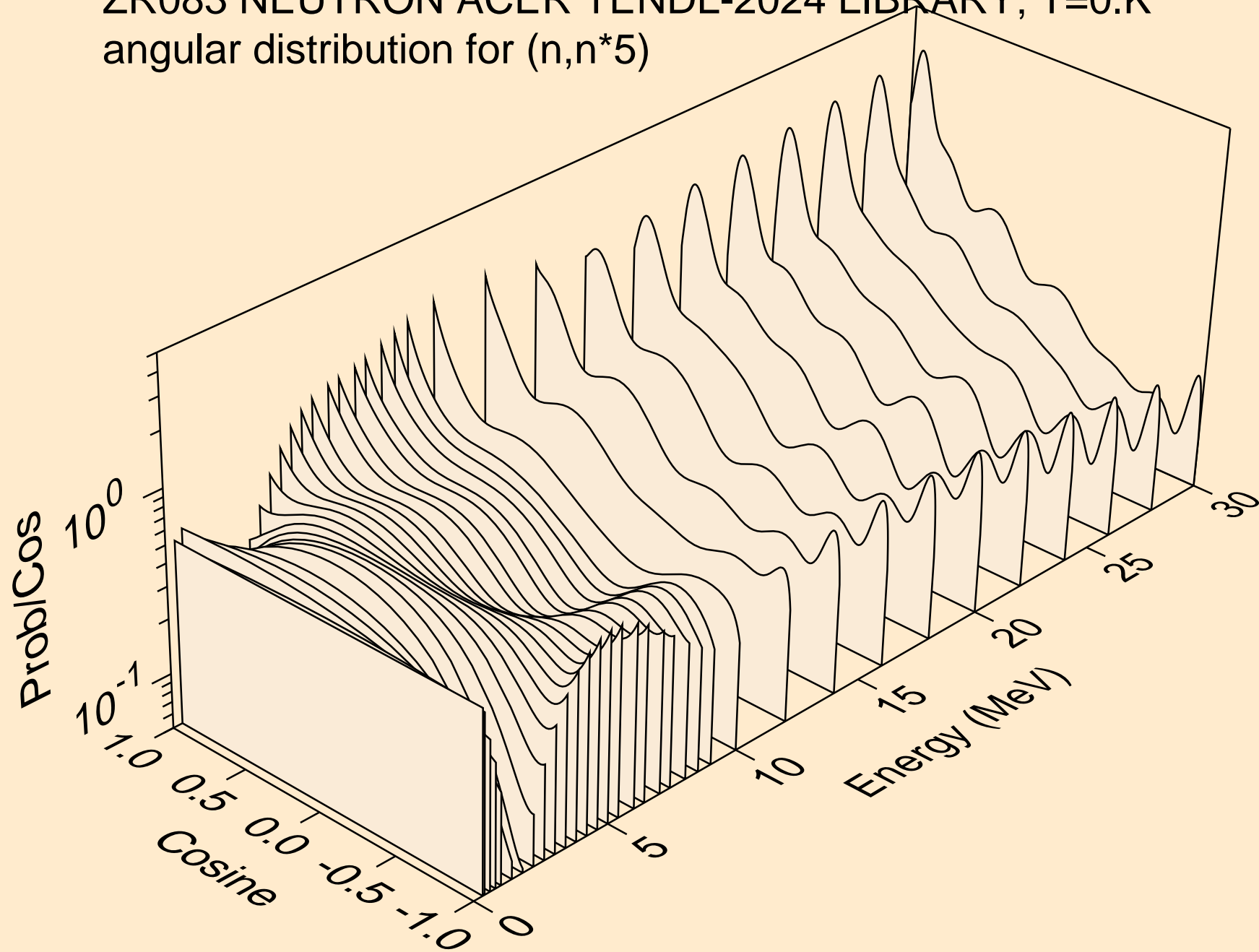

ZR083 NEUTRON ACER TENDL-2024 LIBRARY; T=0.K
angular distribution for (n,n*6)

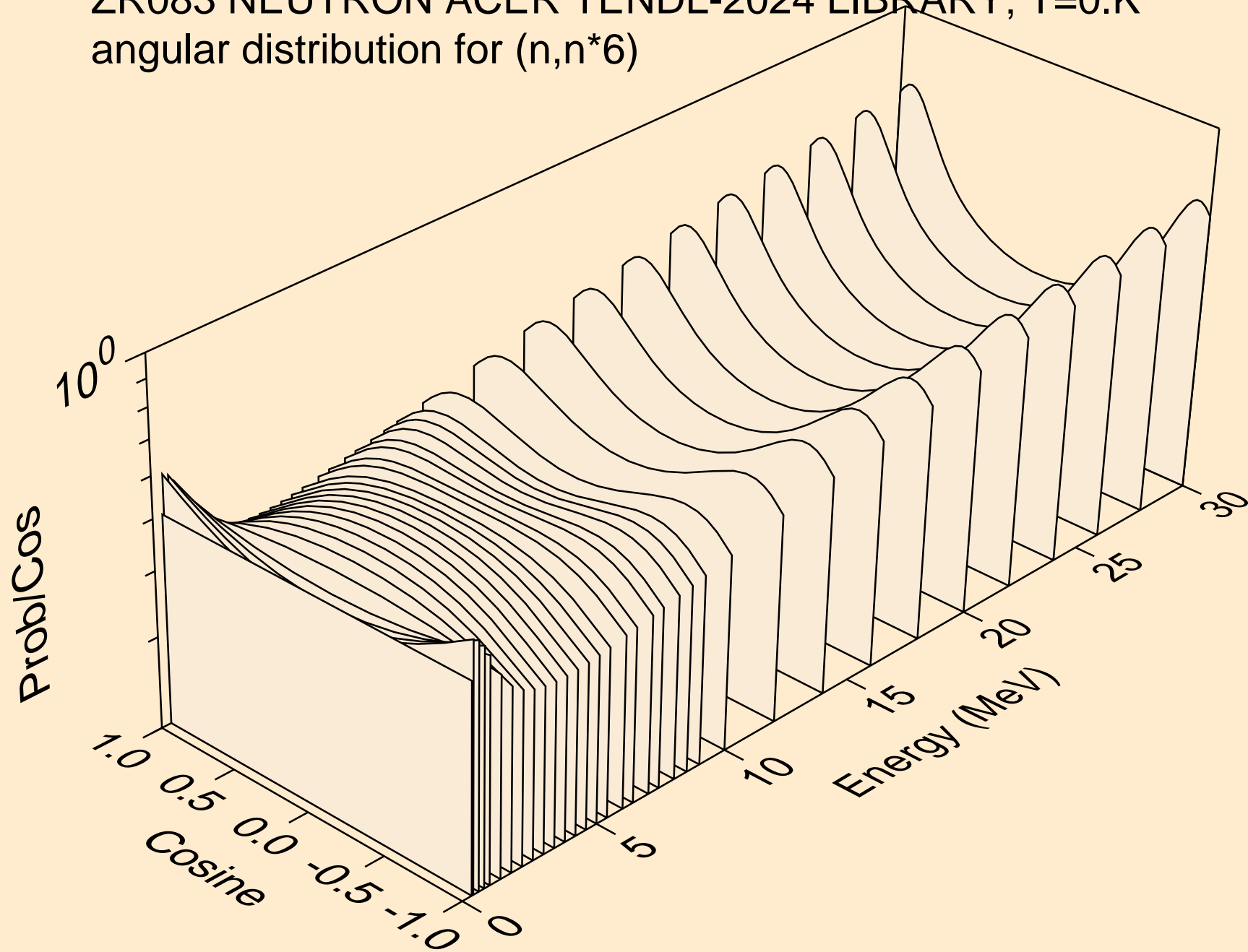

ZR083 NEUTRON ACER TENDL-2024 LIBRARY; T=0.K
angular distribution for (n,n*7)

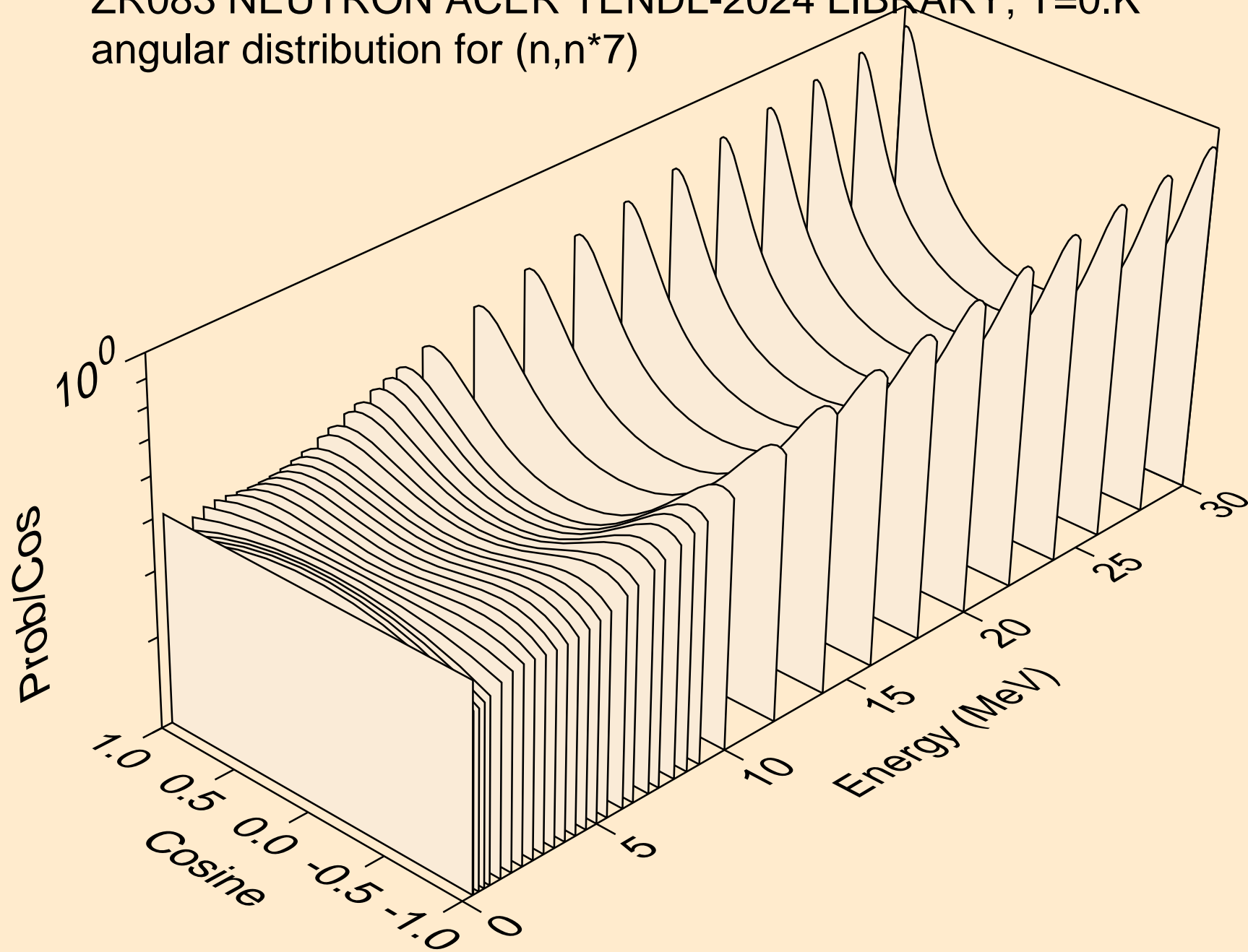

ZR083 NEUTRON ACER TENDL-2024 LIBRARY; T=0.K
angular distribution for (n,n*8)

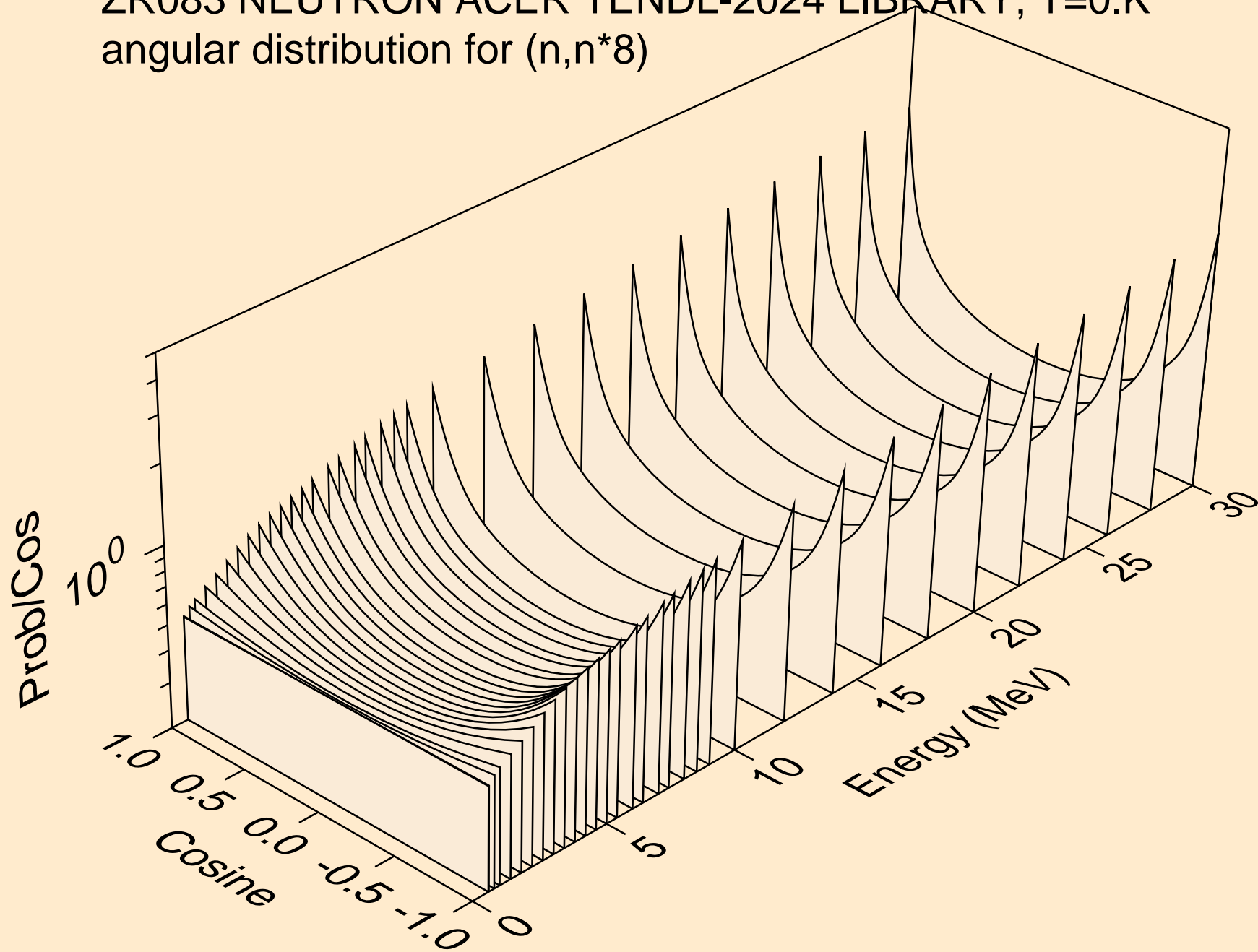

ZR083 NEUTRON ACER TENDL-2024 LIBRARY; T=0.K
angular distribution for (n,n*9)

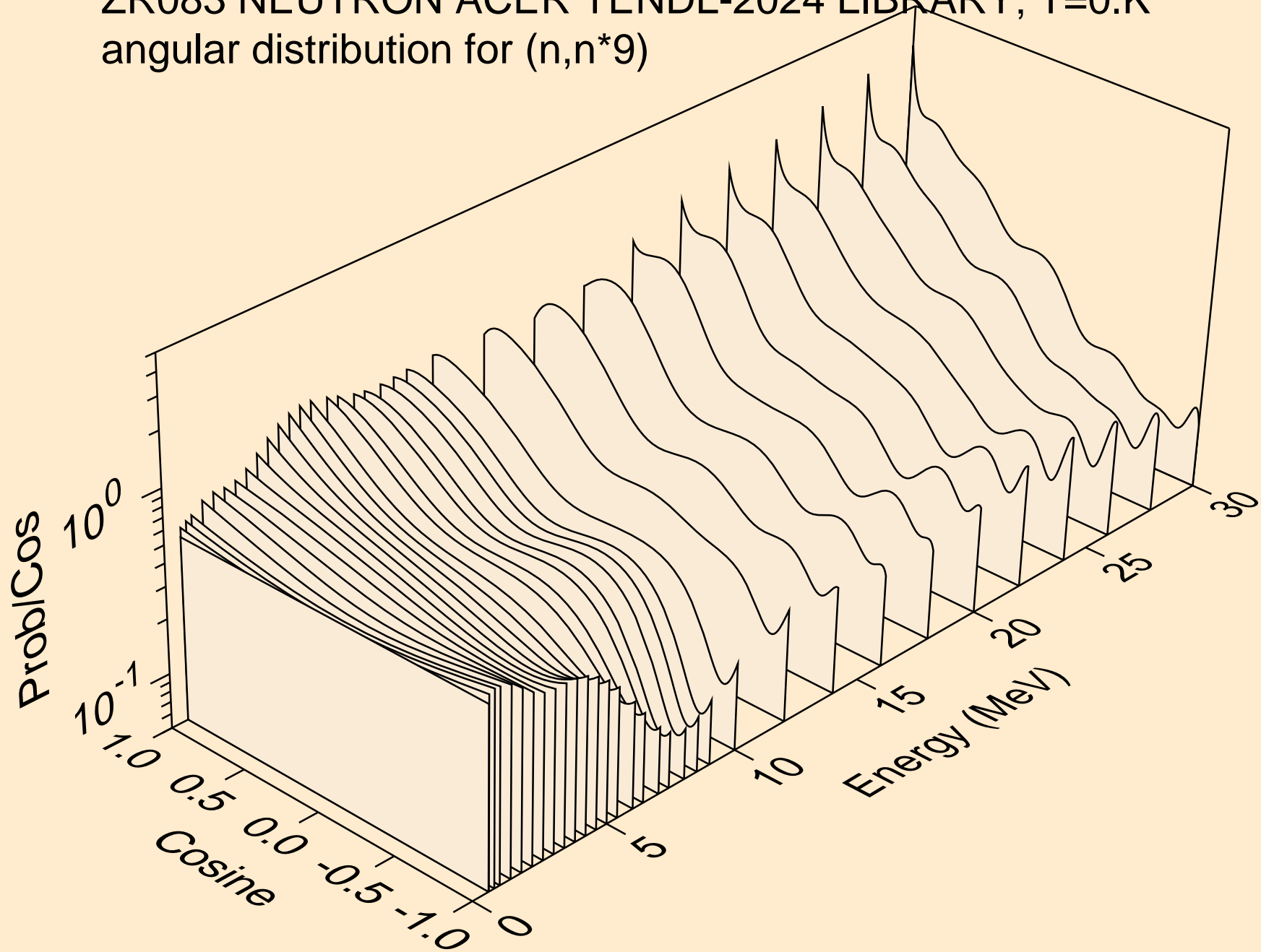

ZR083 NEUTRON ACER TENDL-2024 LIBRARY; T=0.K
angular distribution for (n,n*10)

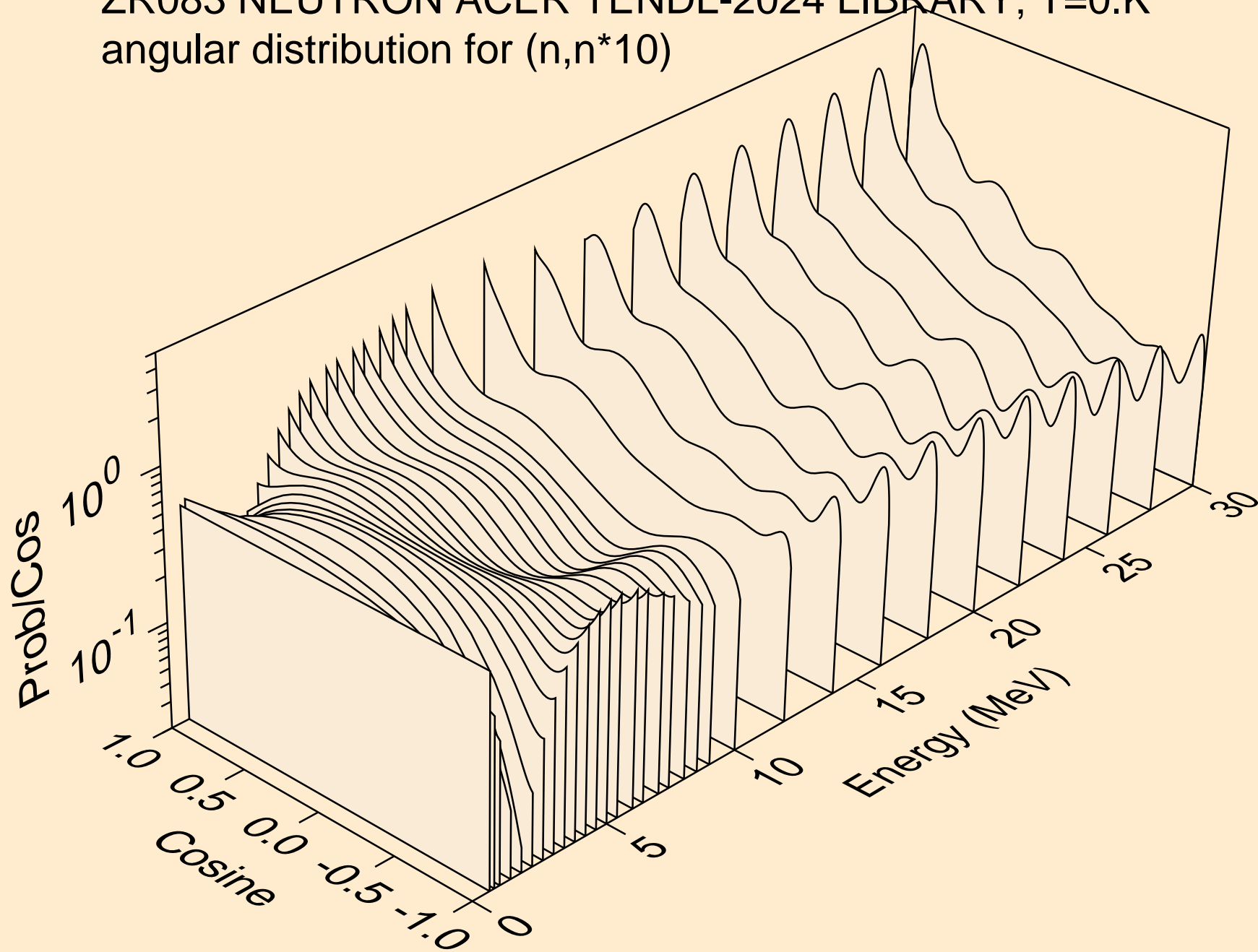

ZR083 NEUTRON ACER TENDL-2024 LIBRARY; T=0.K
angular distribution for (n,n*11)

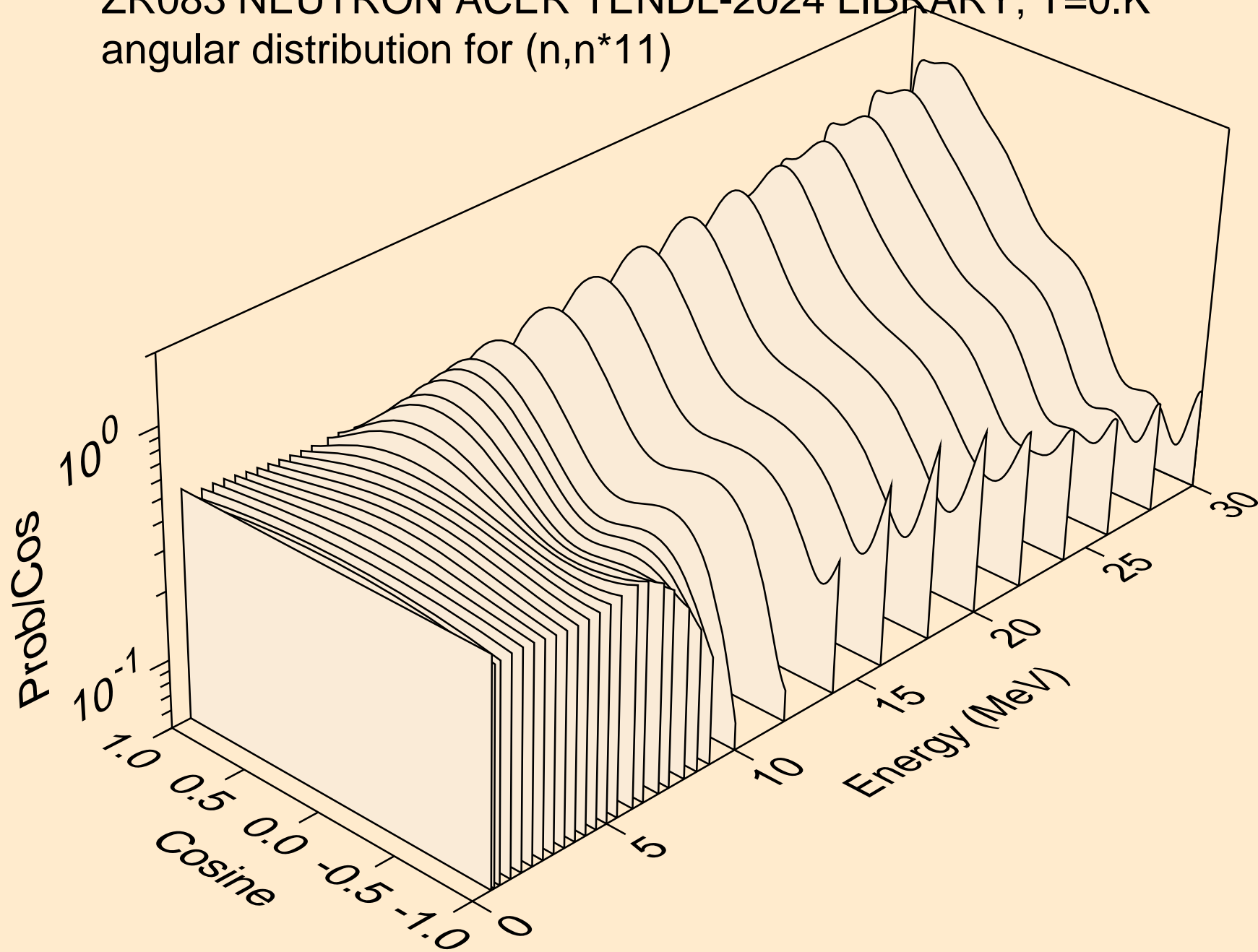

ZR083 NEUTRON ACER TENDL-2024 LIBRARY; T=0.K
angular distribution for (n,n*12)

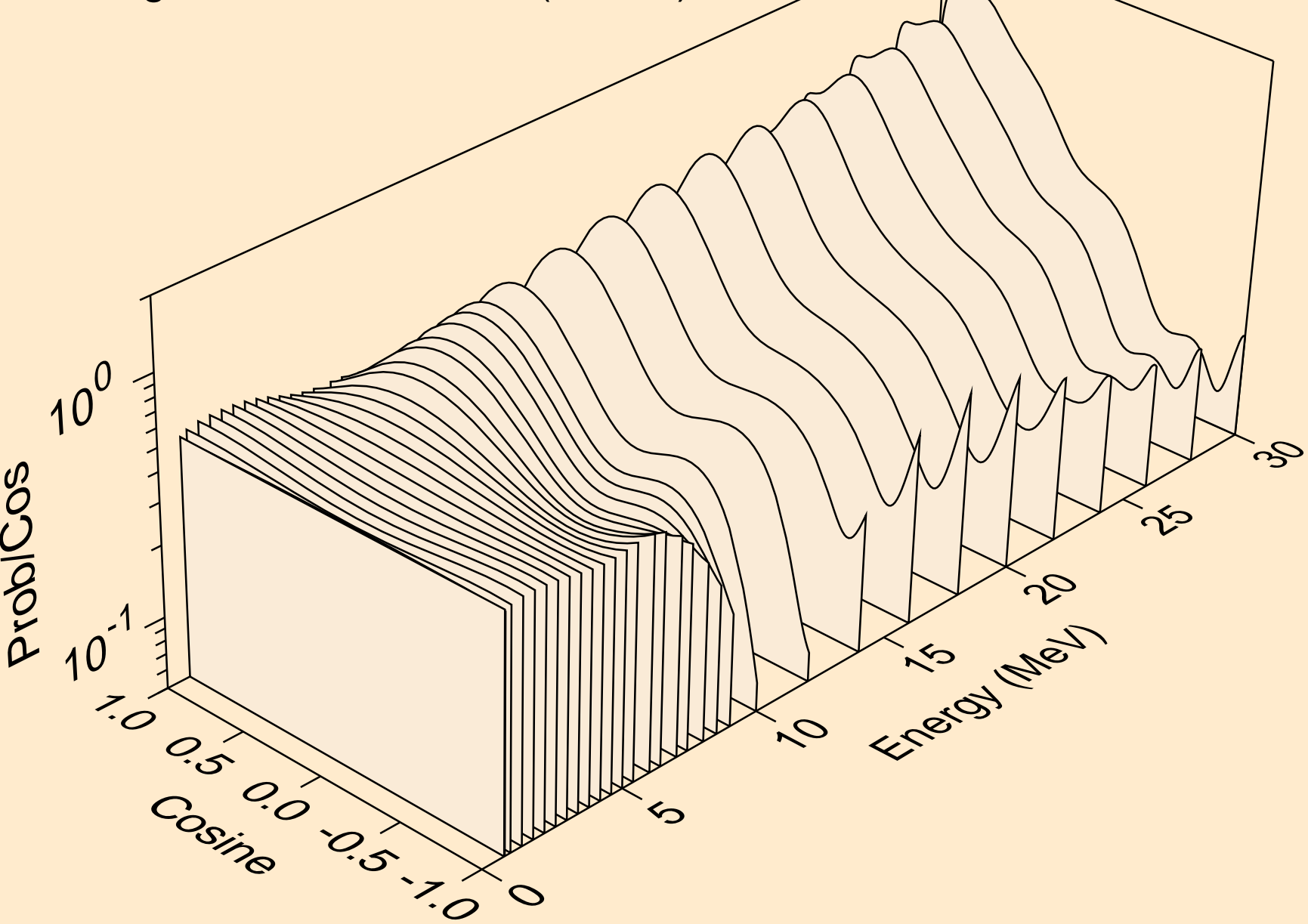

ZR083 NEUTRON ACER TENDL-2024 LIBRARY; T=0.K
angular distribution for (n,n*13)

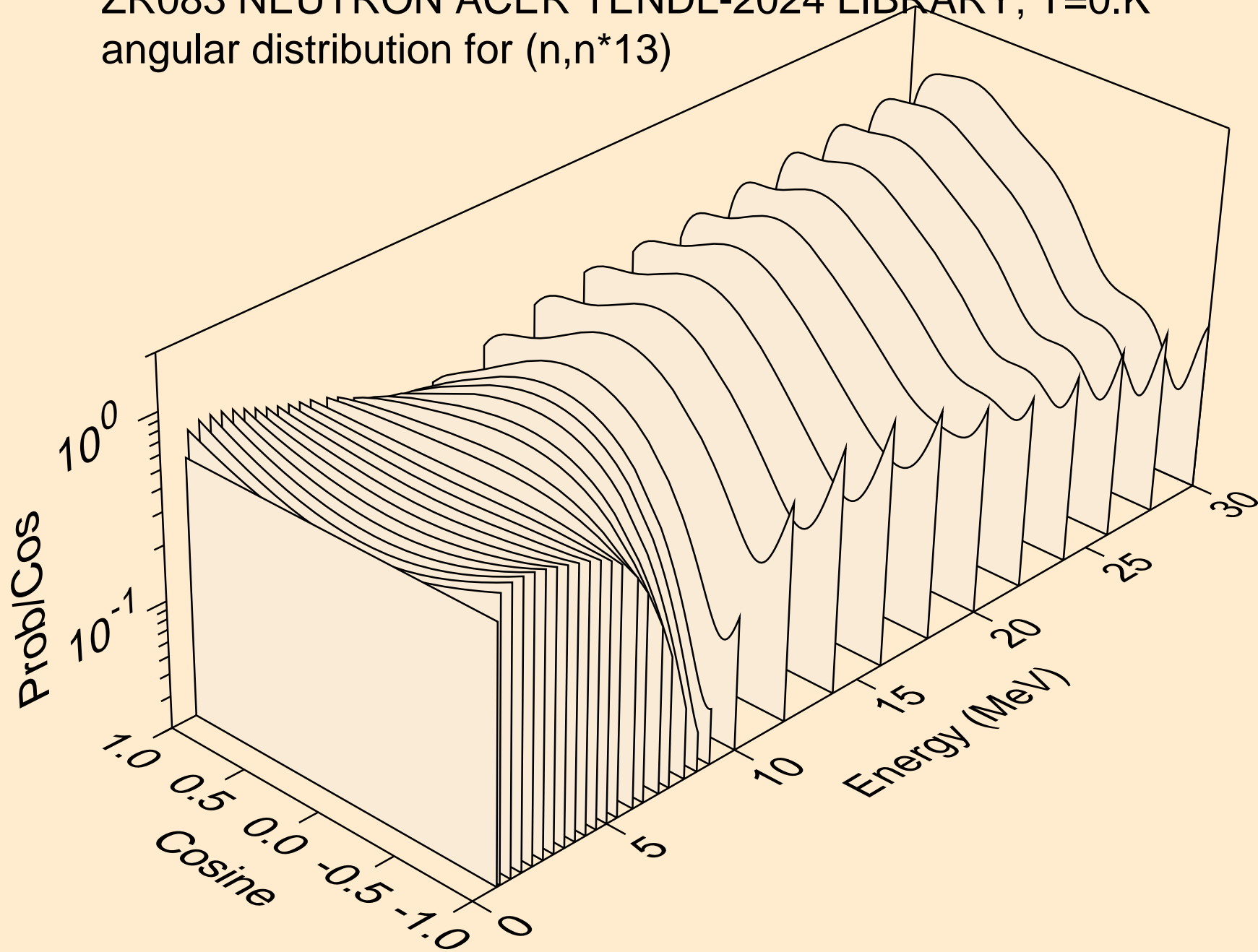

ZR083 NEUTRON ACER TENDL-2024 LIBRARY; T=0.K
angular distribution for (n,n*14)

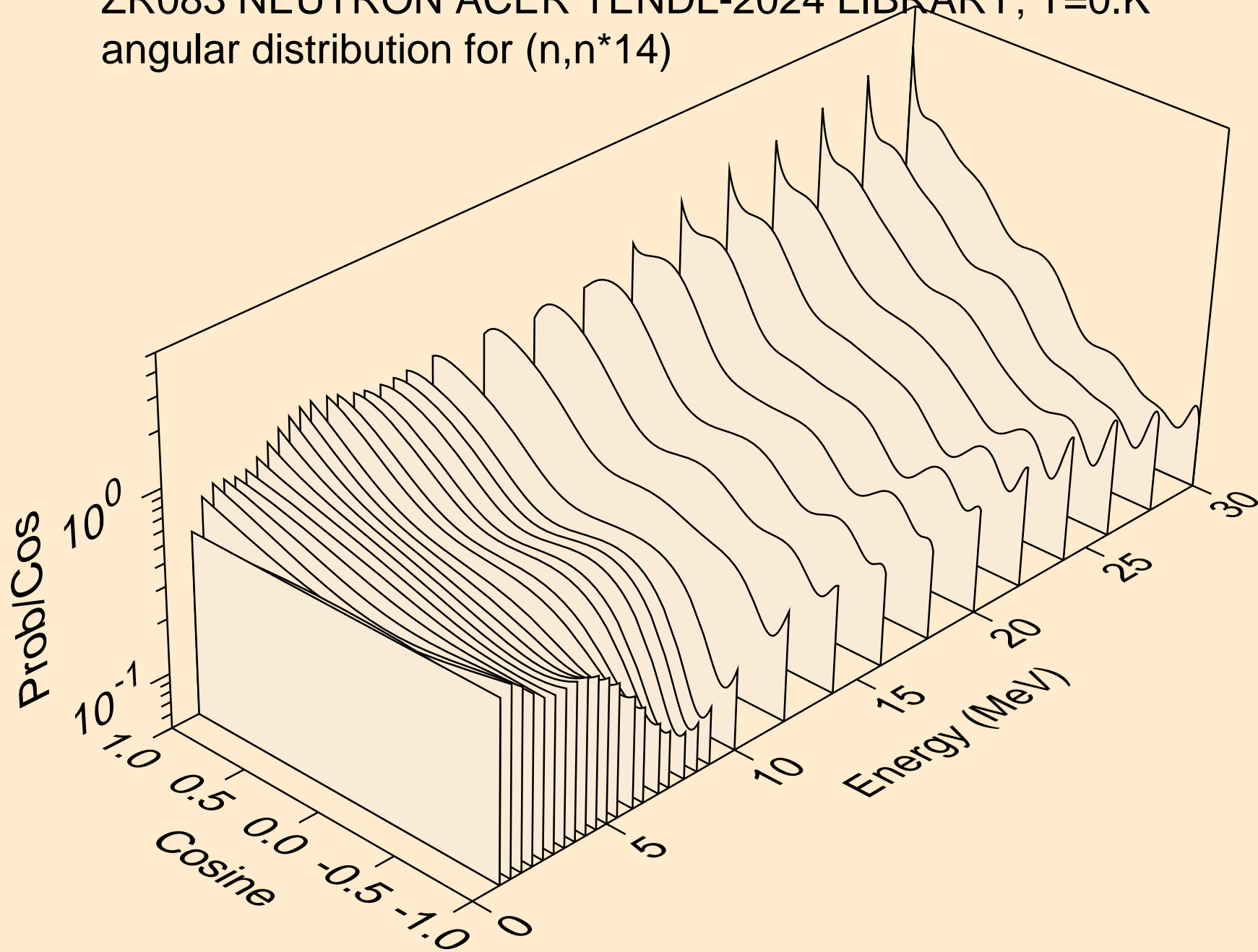

ZR083 NEUTRON ACER TENDL-2024 LIBRARY; T=0.K
angular distribution for (n,n*15)

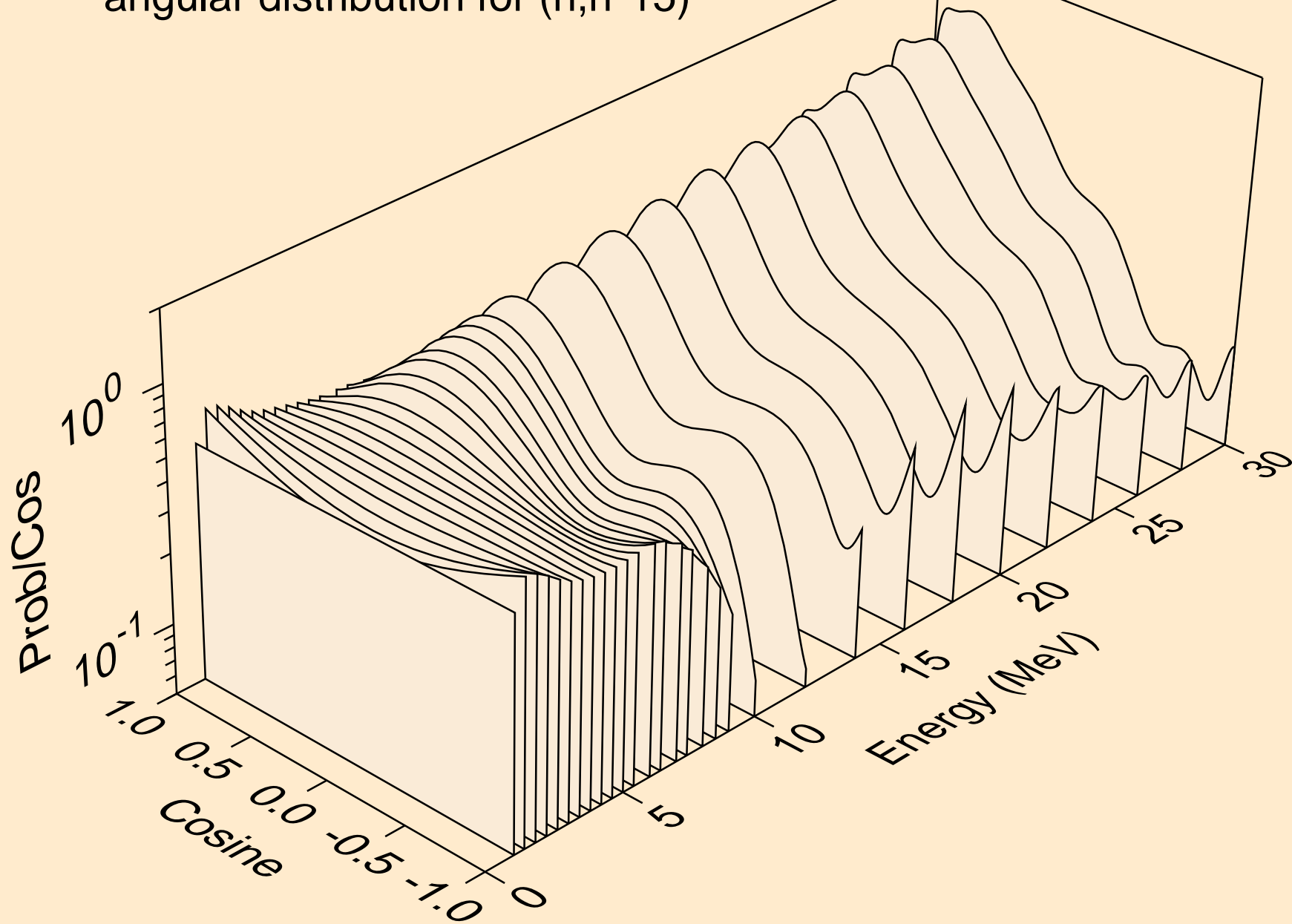

ZR083 NEUTRON ACER TENDL-2024 LIBRARY; T=0.K
angular distribution for (n,n*16)

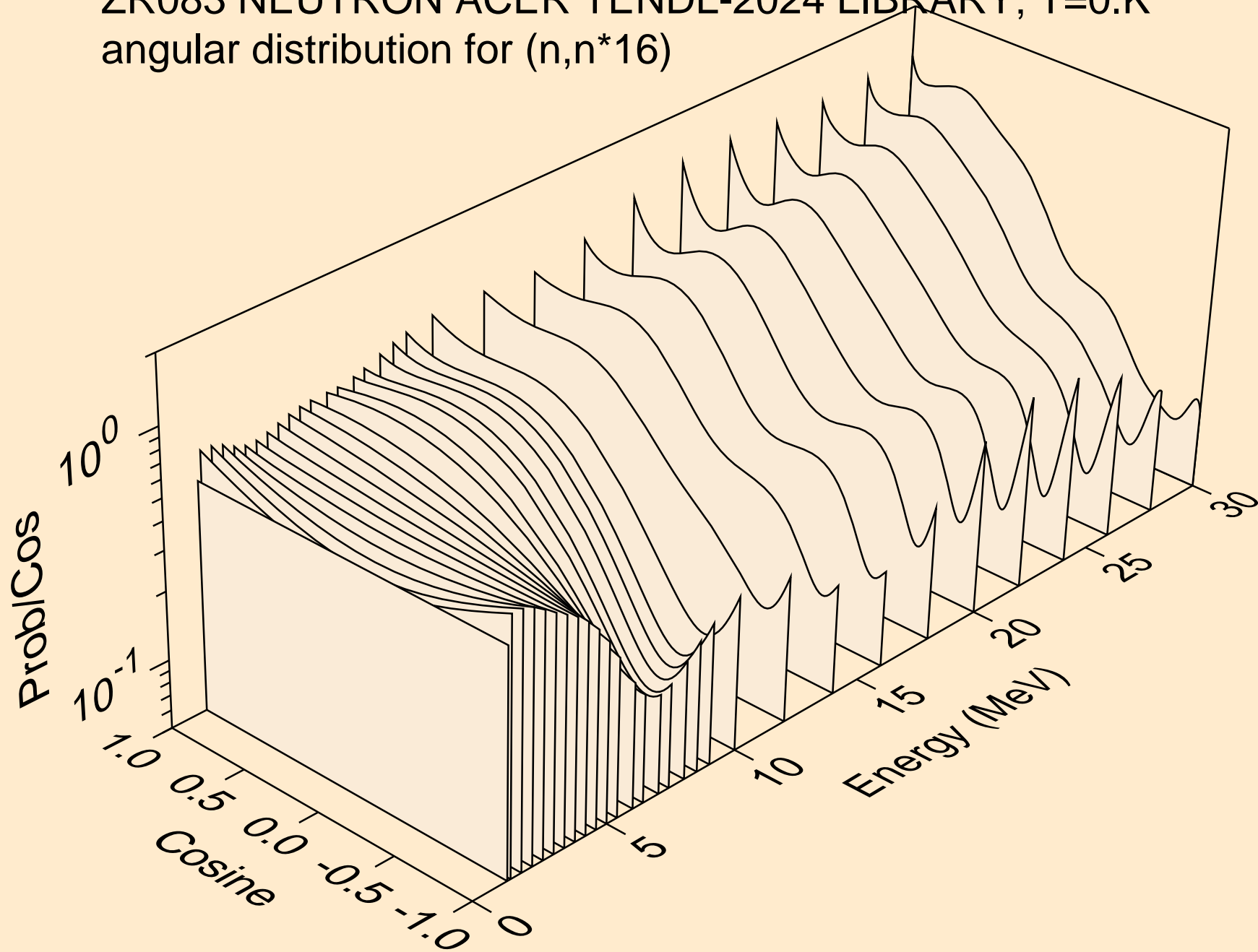

ZR083 NEUTRON ACER TENDL-2024 LIBRARY; T=0.K
angular distribution for (n,n*17)

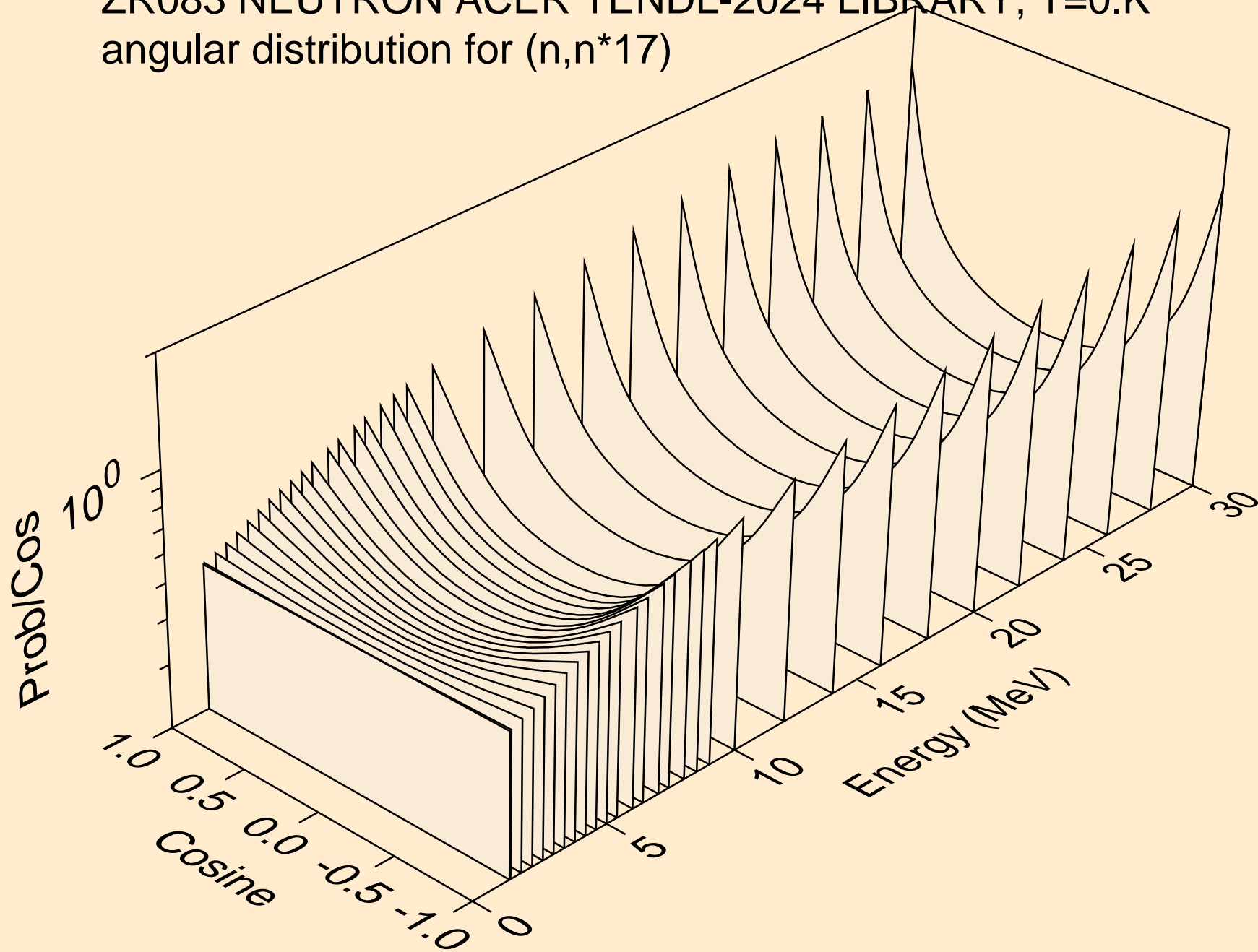

ZR083 NEUTRON ACER TENDL-2024 LIBRARY; T=0.K
angular distribution for (n,n*18)

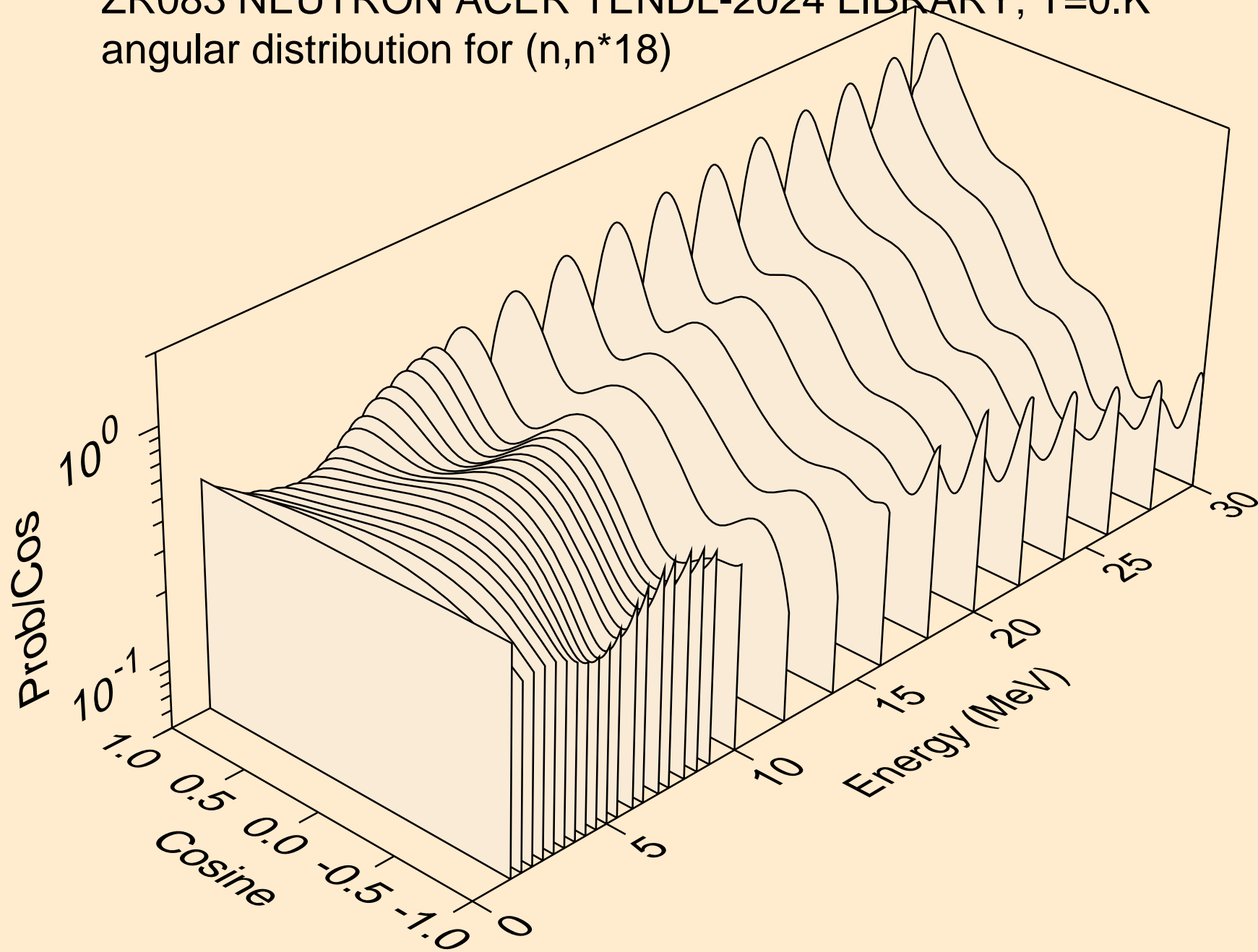

ZR083 NEUTRON ACER TENDL-2024 LIBRARY; T=0.K
angular distribution for (n,n*19)

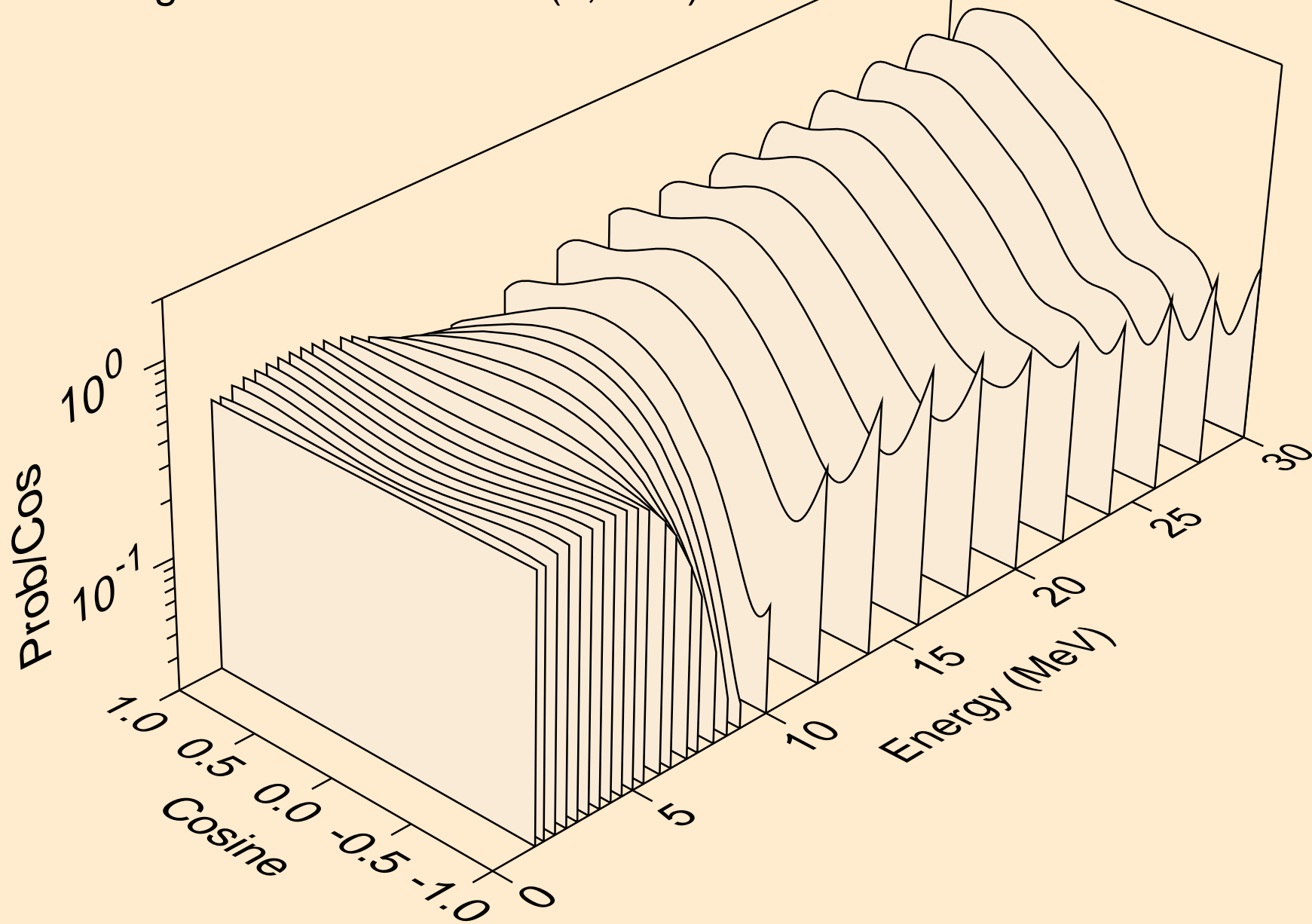

ZR083 NEUTRON ACER TENDL-2024 LIBRARY; T=0.K
angular distribution for (n,n*20)

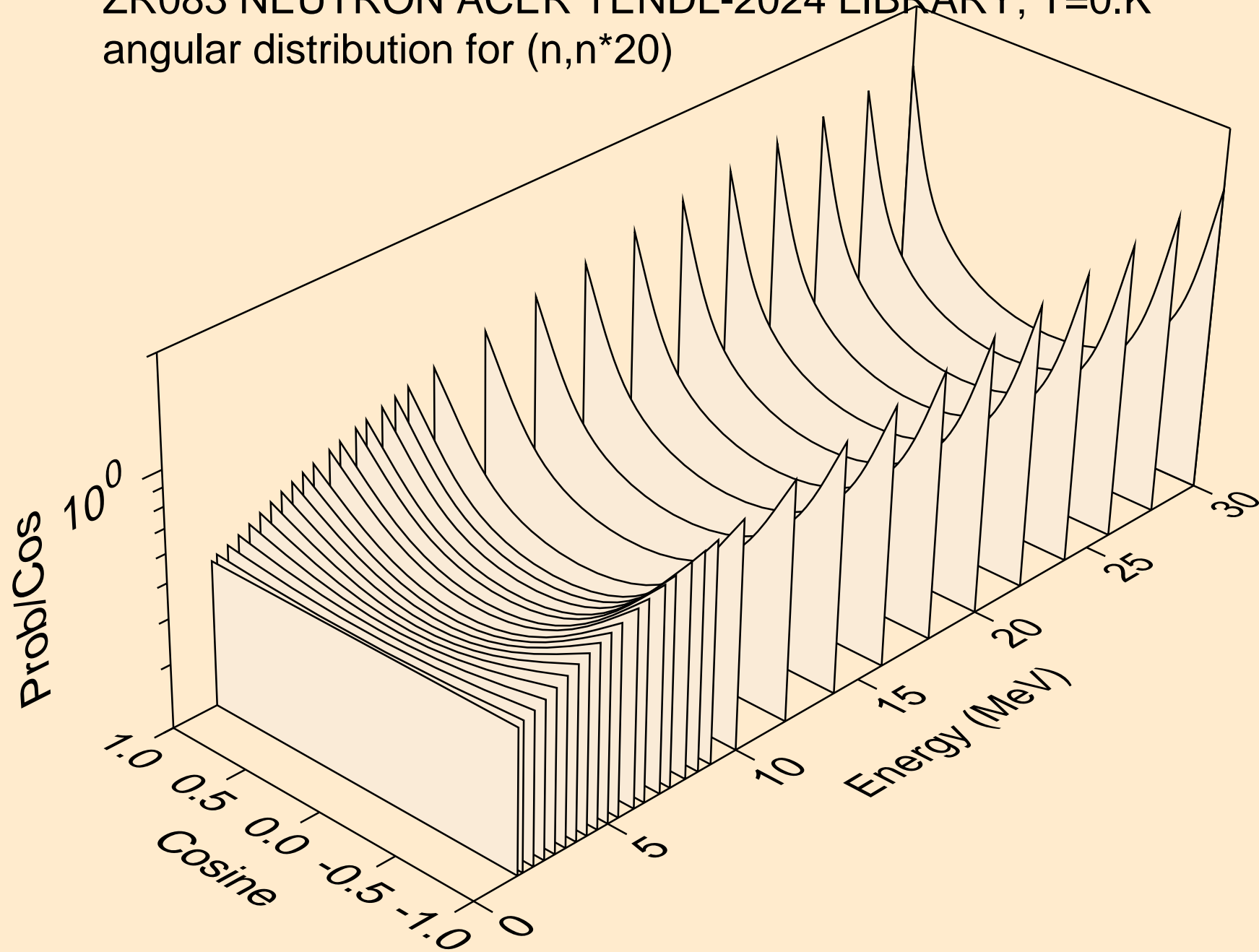

ZR083 NEUTRON ACER TENDL-2024 LIBRARY; T=0.K
angular distribution for (n,n*21)

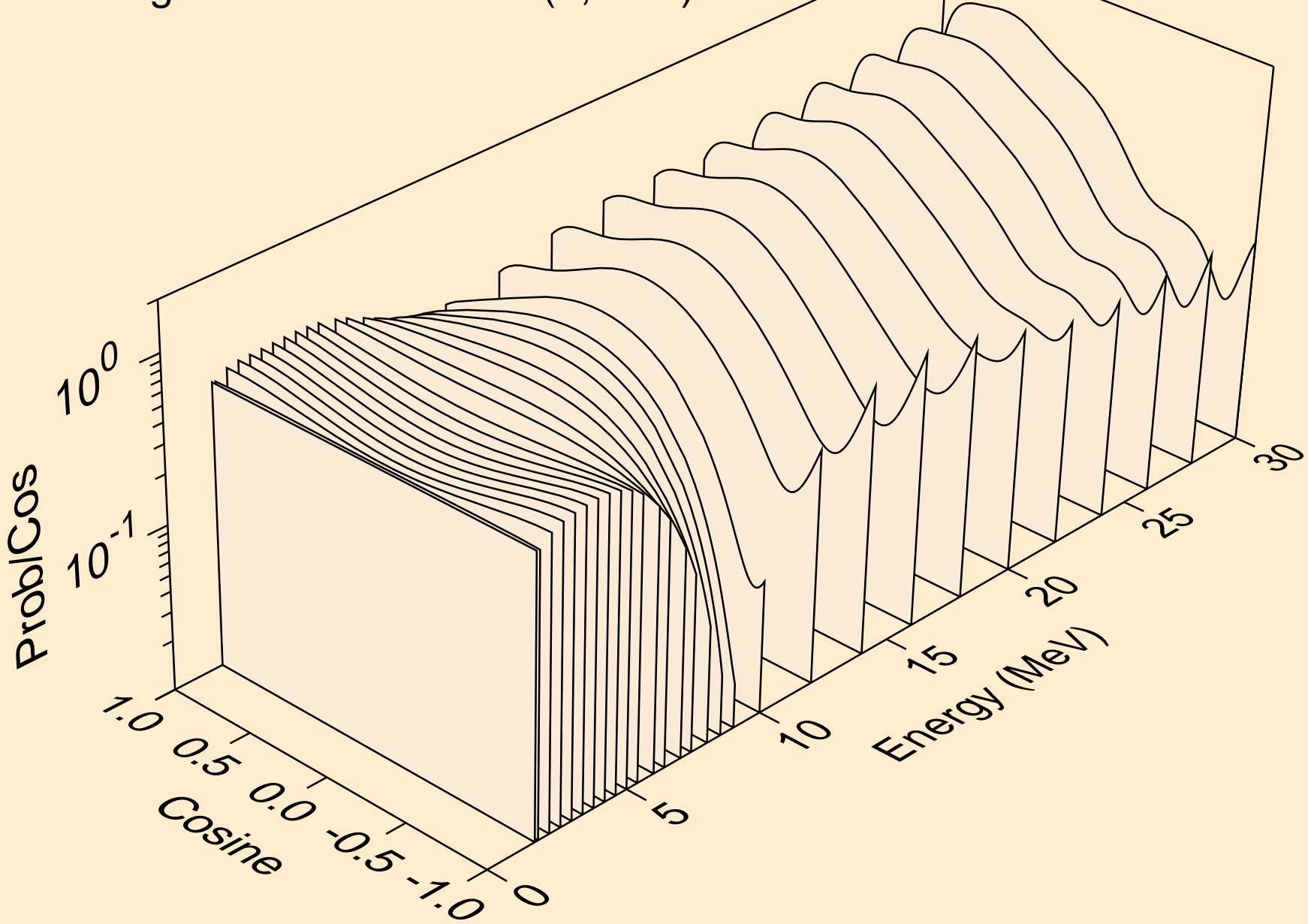

ZR083 NEUTRON ACER TENDL-2024 LIBRARY; T=0.K
angular distribution for (n,n*22)

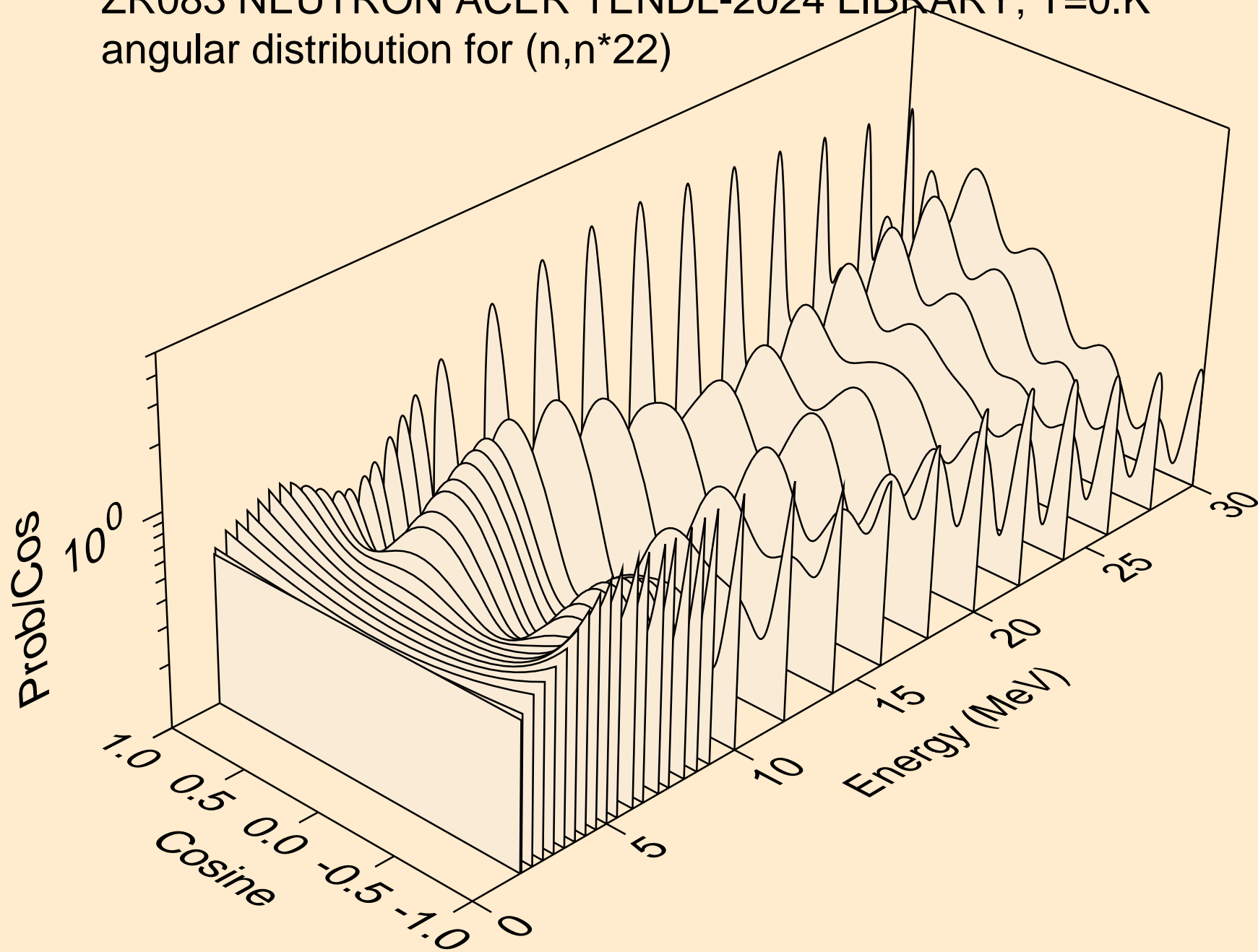

ZR083 NEUTRON ACER TENDL-2024 LIBRARY; T=0.K
angular distribution for (n,n*23)

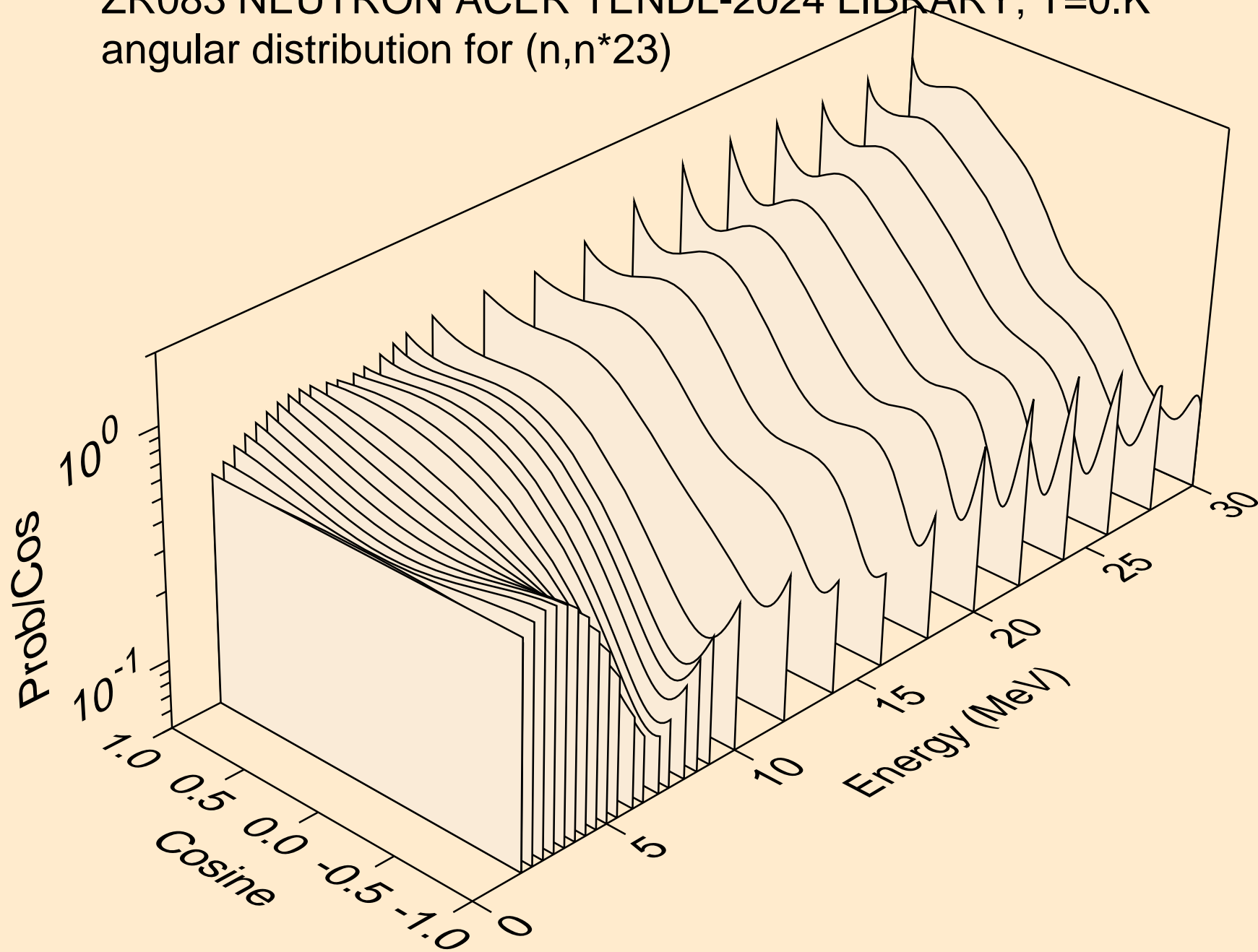

ZR083 NEUTRON ACER TENDL-2024 LIBRARY; T=0.K
angular distribution for (n,n*24)

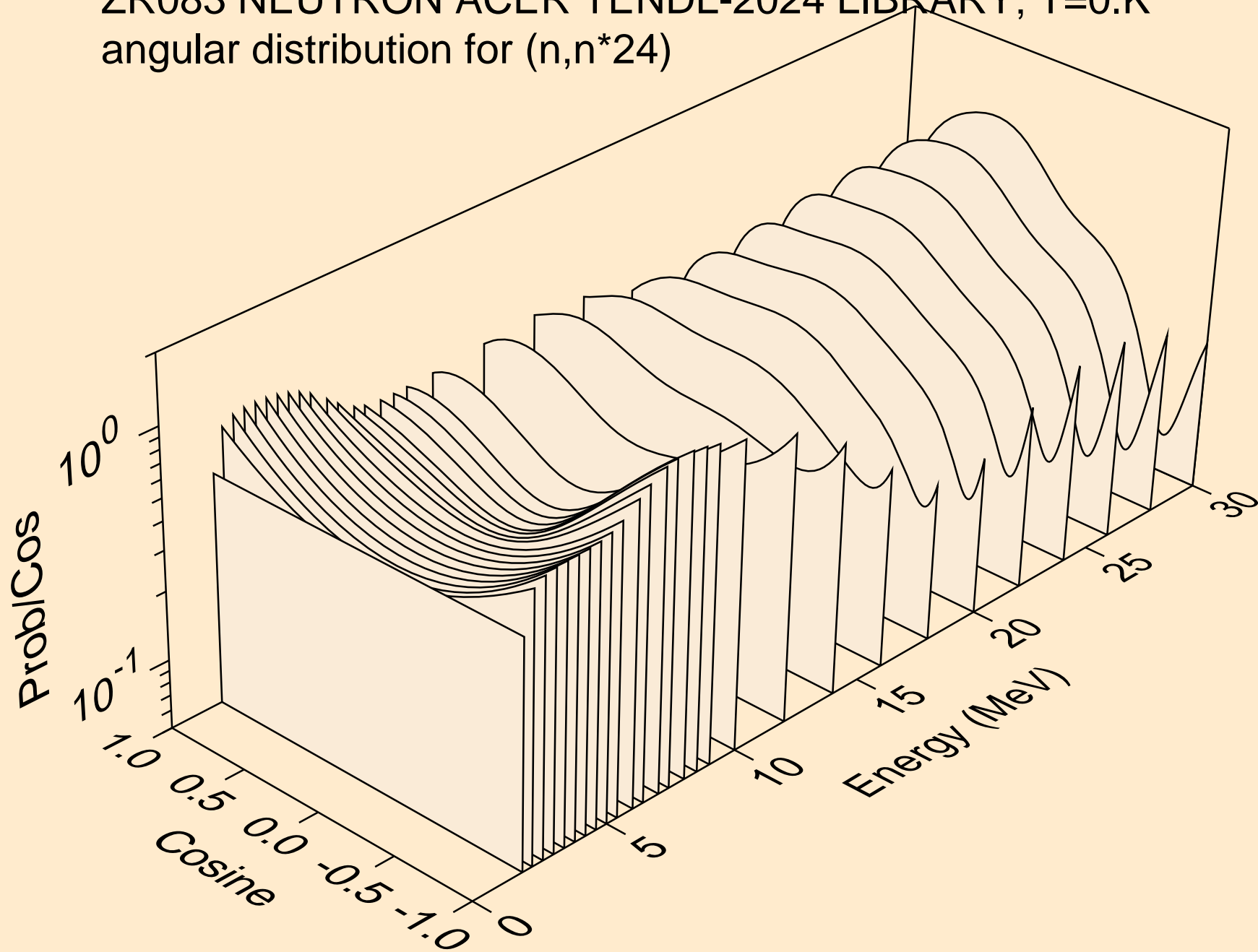

ZR083 NEUTRON ACER TENDL-2024 LIBRARY; T=0.K
angular distribution for (n,n*25)

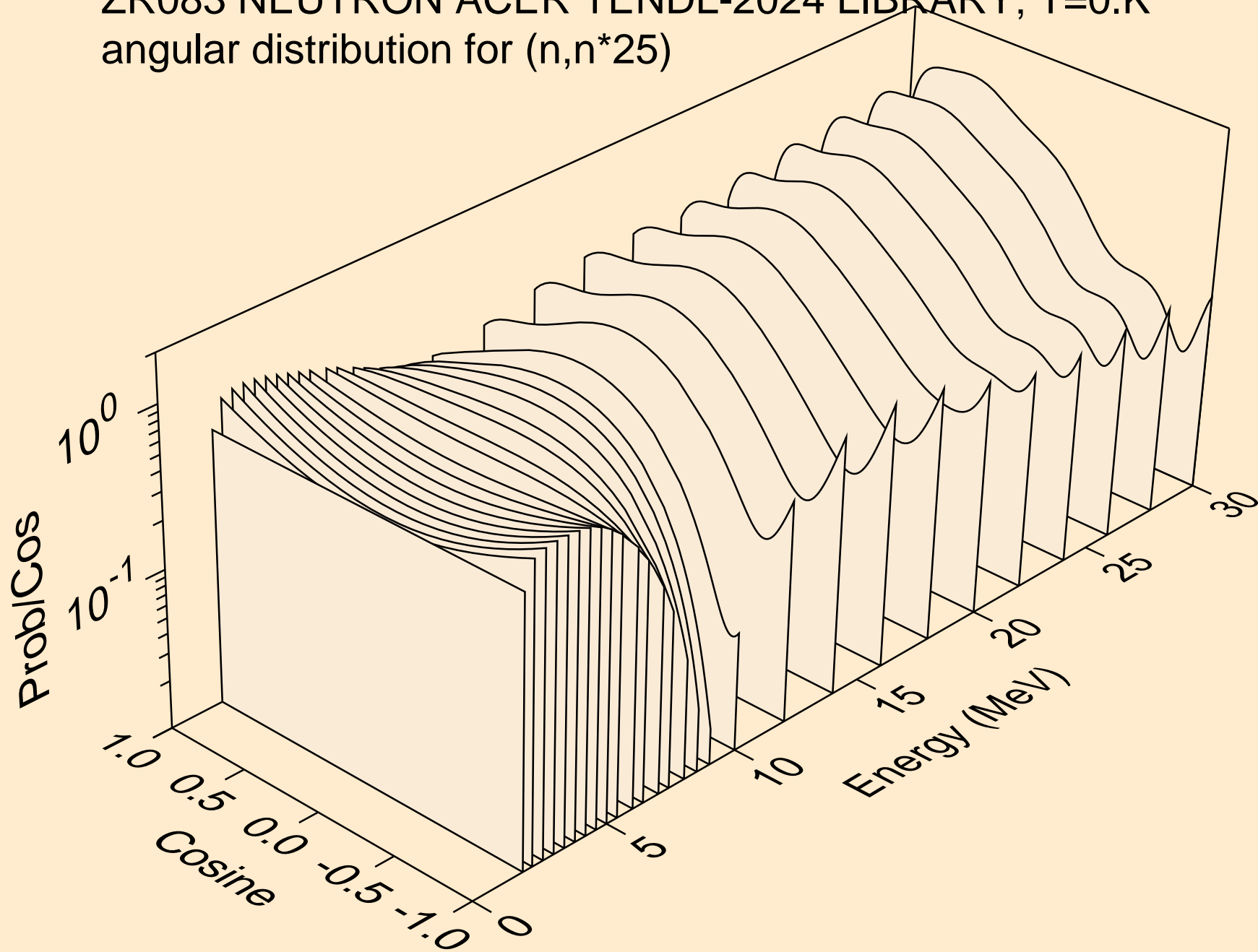

ZR083 NEUTRON ACER TENDL-2024 LIBRARY; T=0.K
angular distribution for (n,n*26)

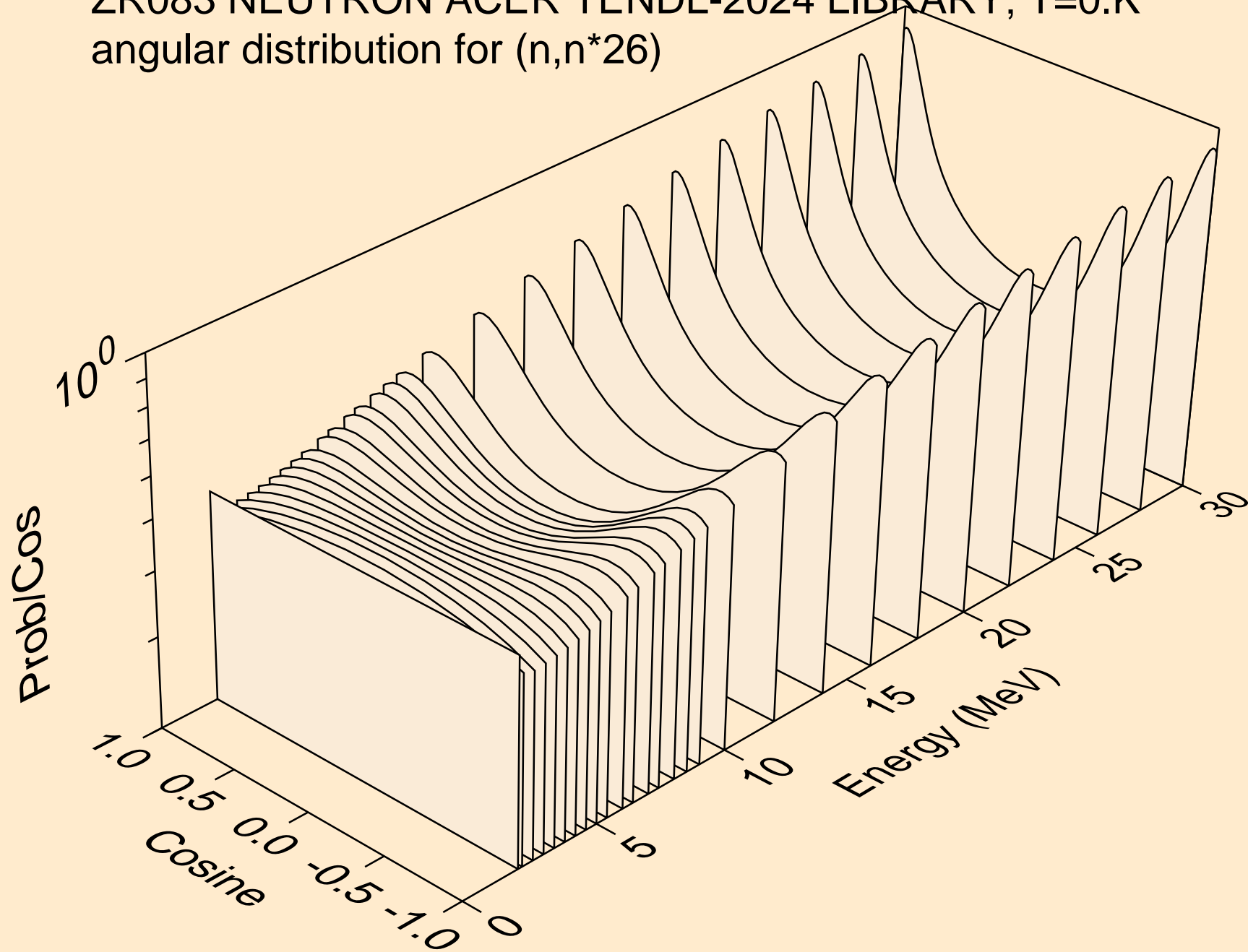

ZR083 NEUTRON ACER TENDL-2024 LIBRARY; T=0.K
angular distribution for (n,n*27)

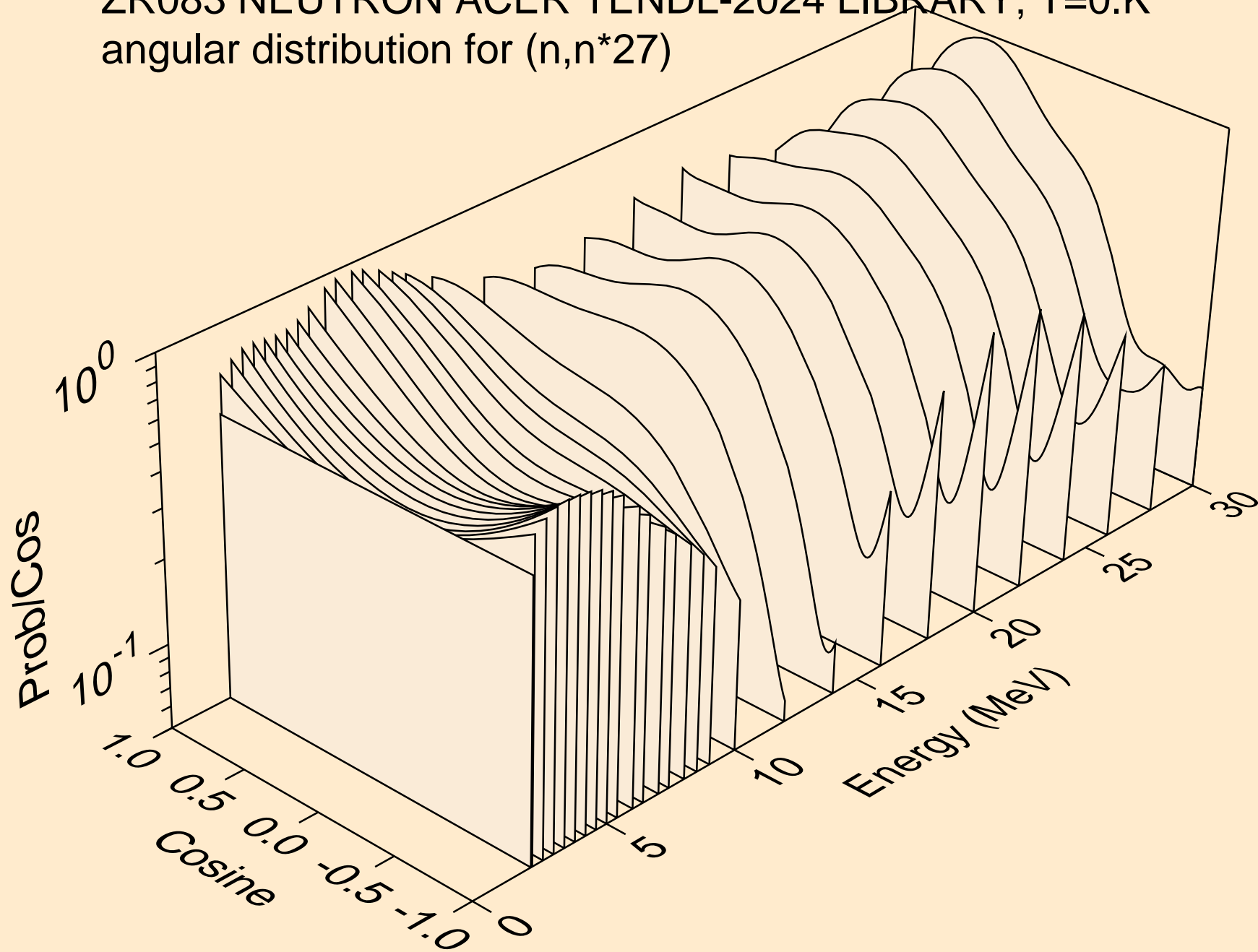

ZR083 NEUTRON ACER TENDL-2024 LIBRARY; T=0.K
angular distribution for (n,n*28)

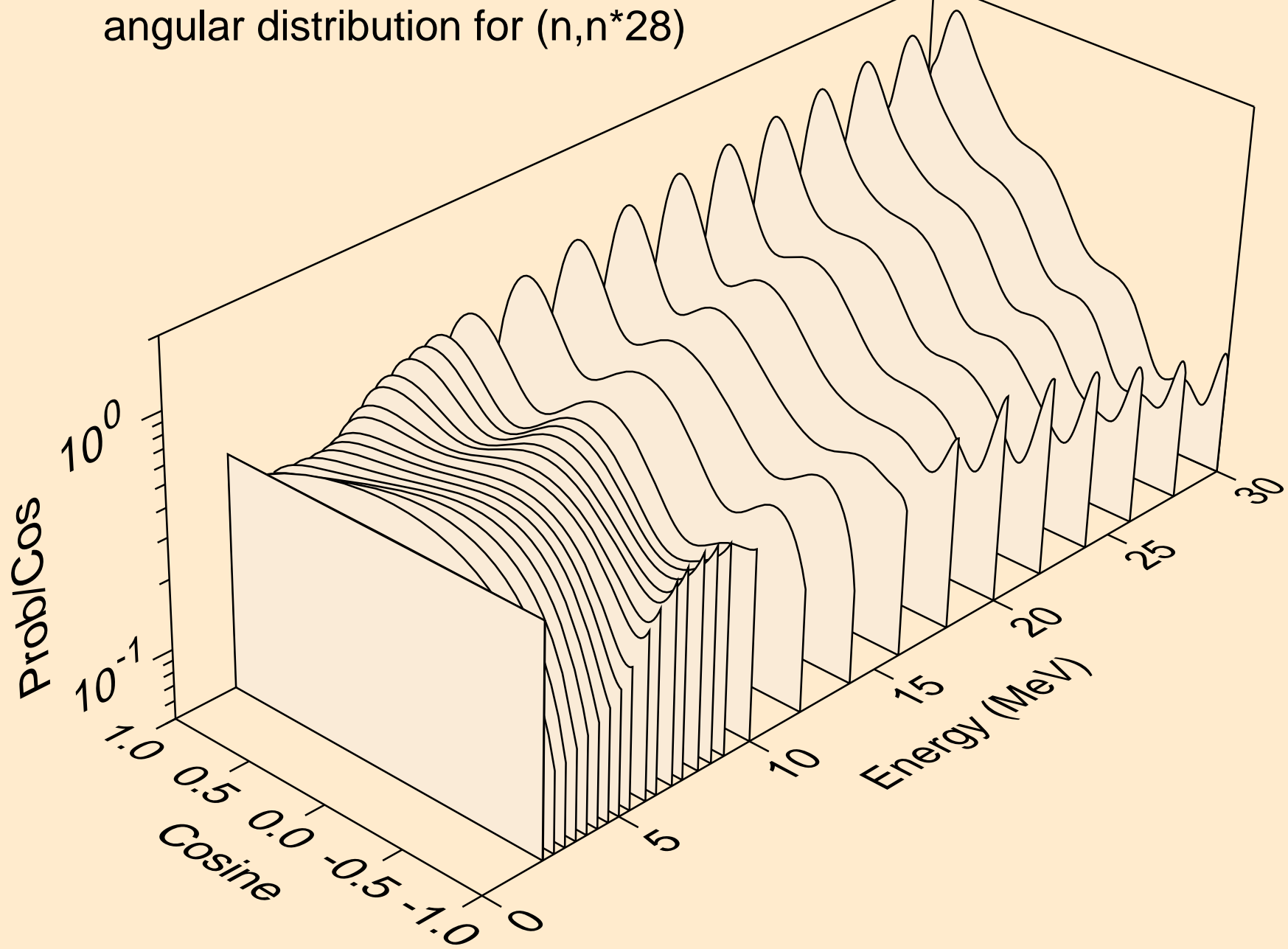

ZR083 NEUTRON ACER TENDL-2024 LIBRARY; T=0.K
Neutron emission for (n,x)

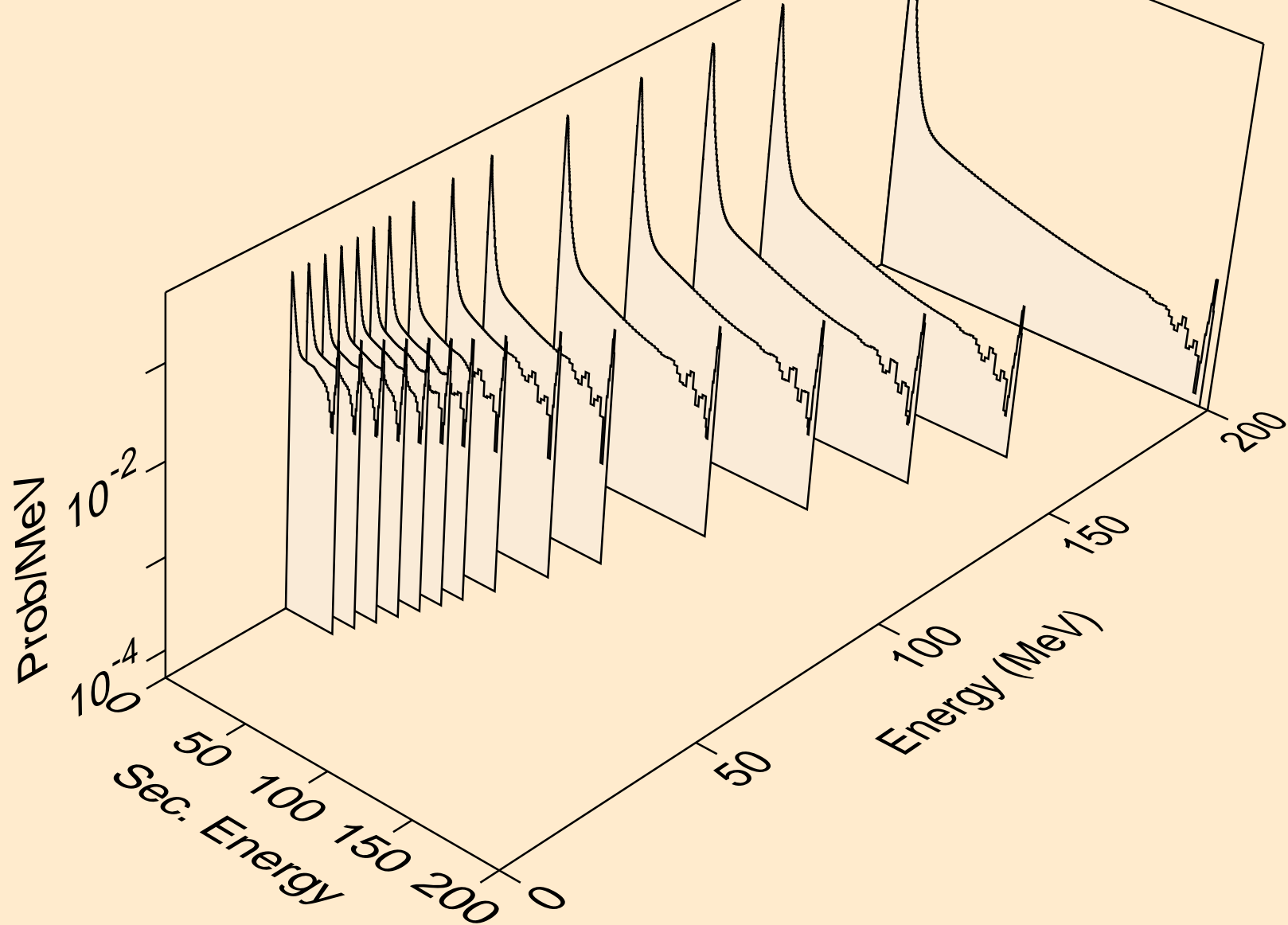

ZR083 NEUTRON ACER TENDL-2024 LIBRARY; T=0.K
Neutron emission for (n,2n)

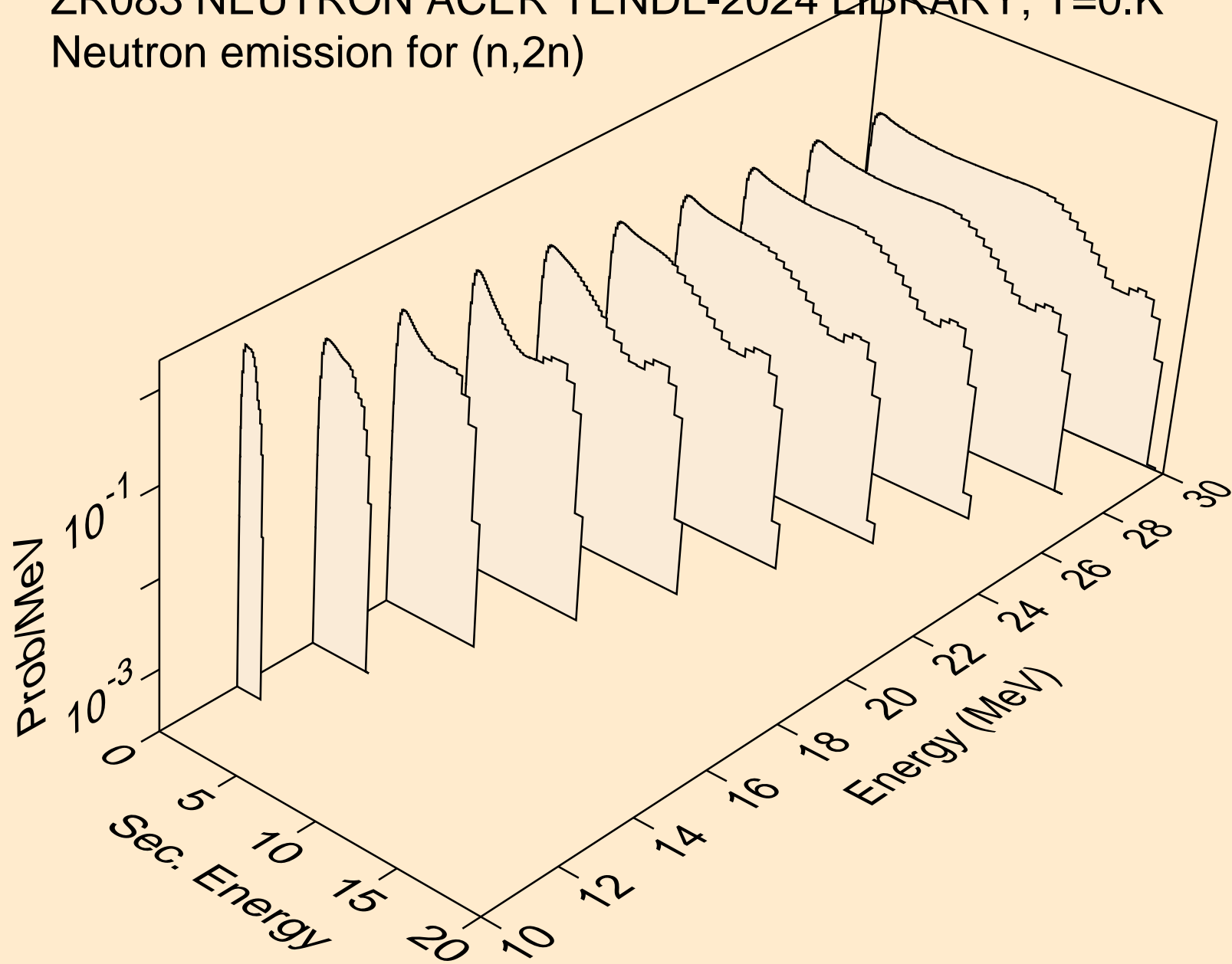

ZR083 NEUTRON ACER TENDL-2024 LIBRARY; T=0.K
Neutron emission for (n,3n)

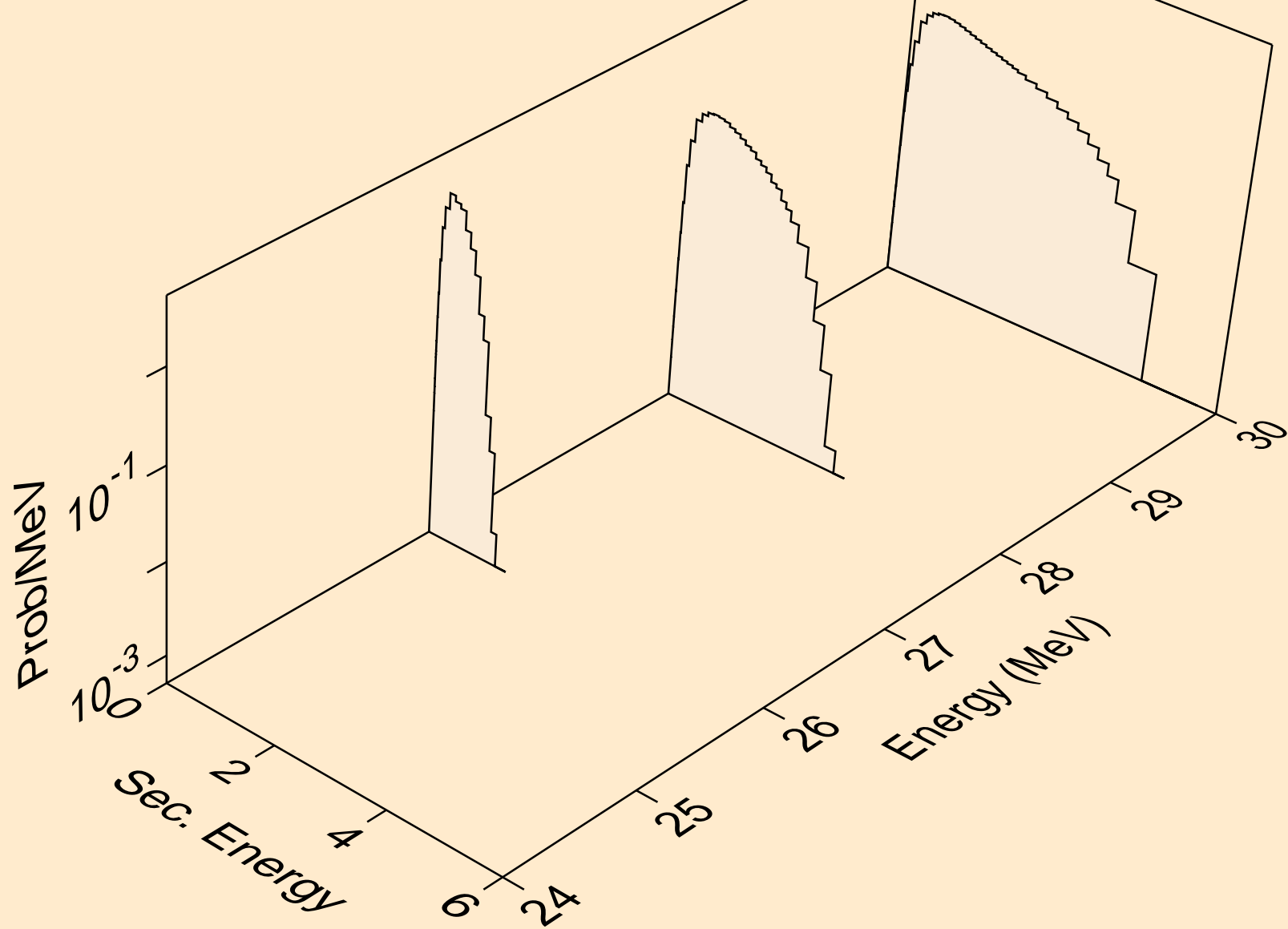

ZR083 NEUTRON ACER TENDL-2024 LIBRARY; T=0.K
Neutron emission for (n,n*)a

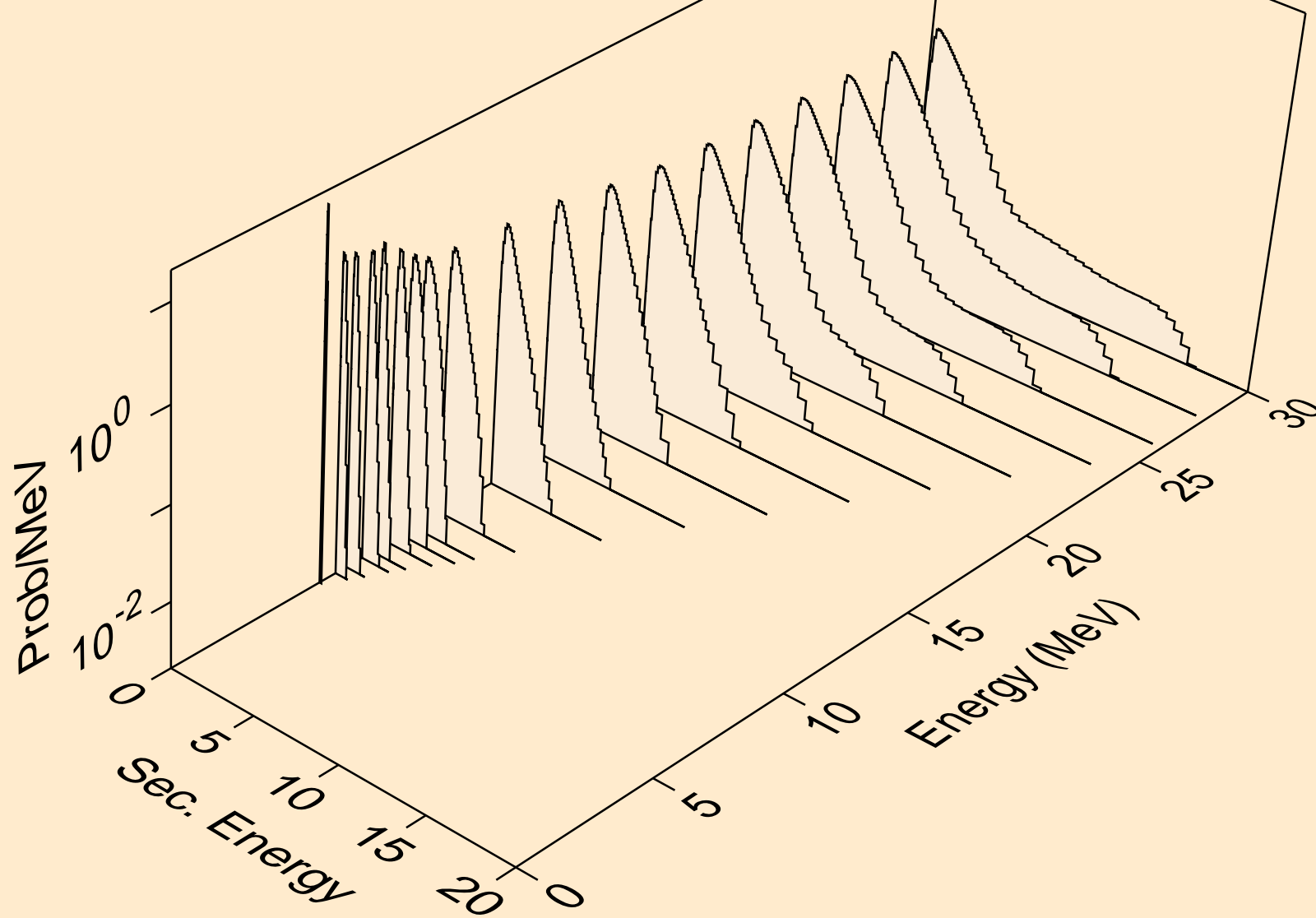

ZR083 NEUTRON ACER TENDL-2024 LIBRARY; T=0.K
Neutron emission for (n,2n)a

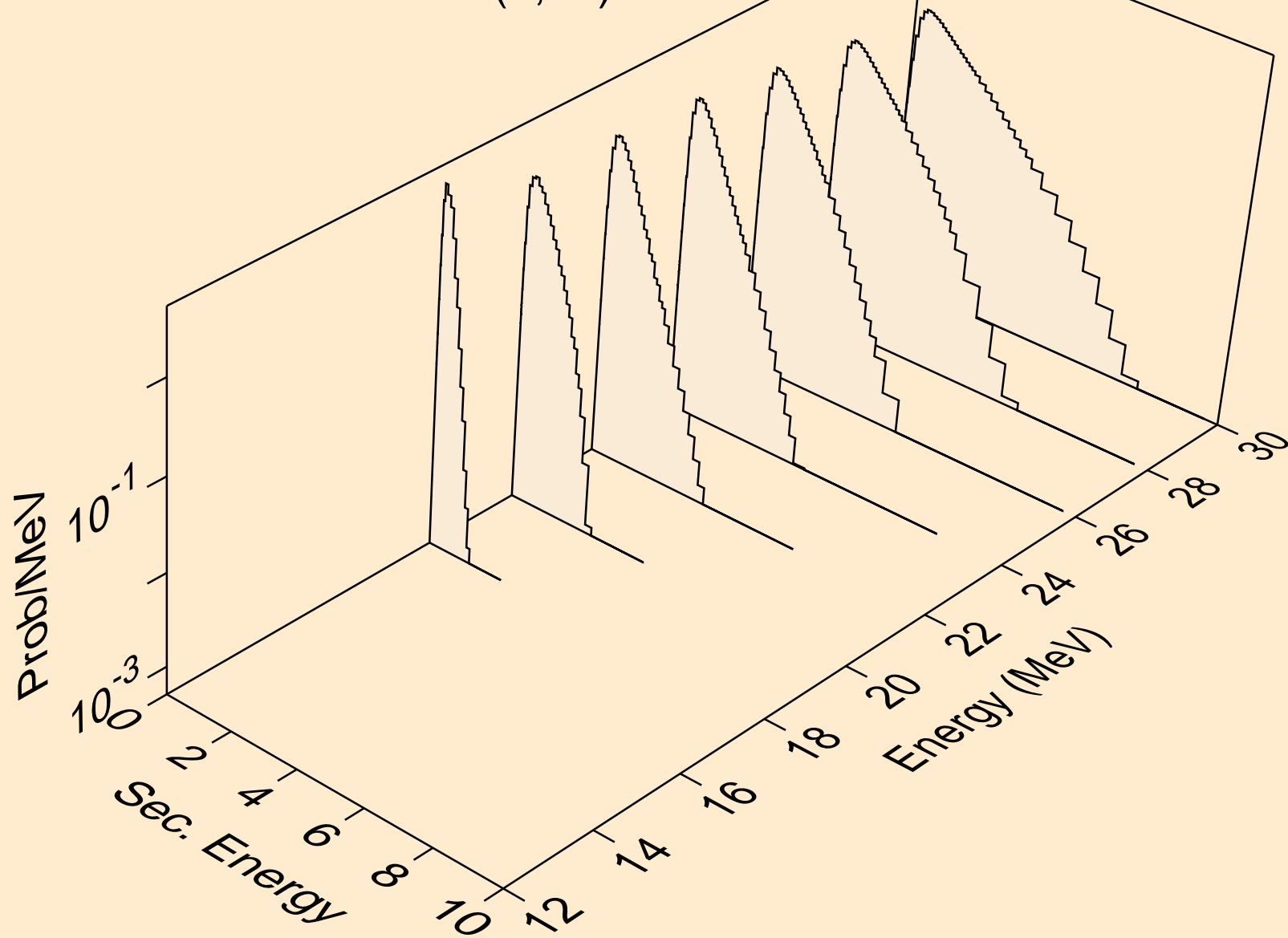

ZR083 NEUTRON ACER TENDL-2024 LIBRARY; T=0.K
Neutron emission for (n,n*)p

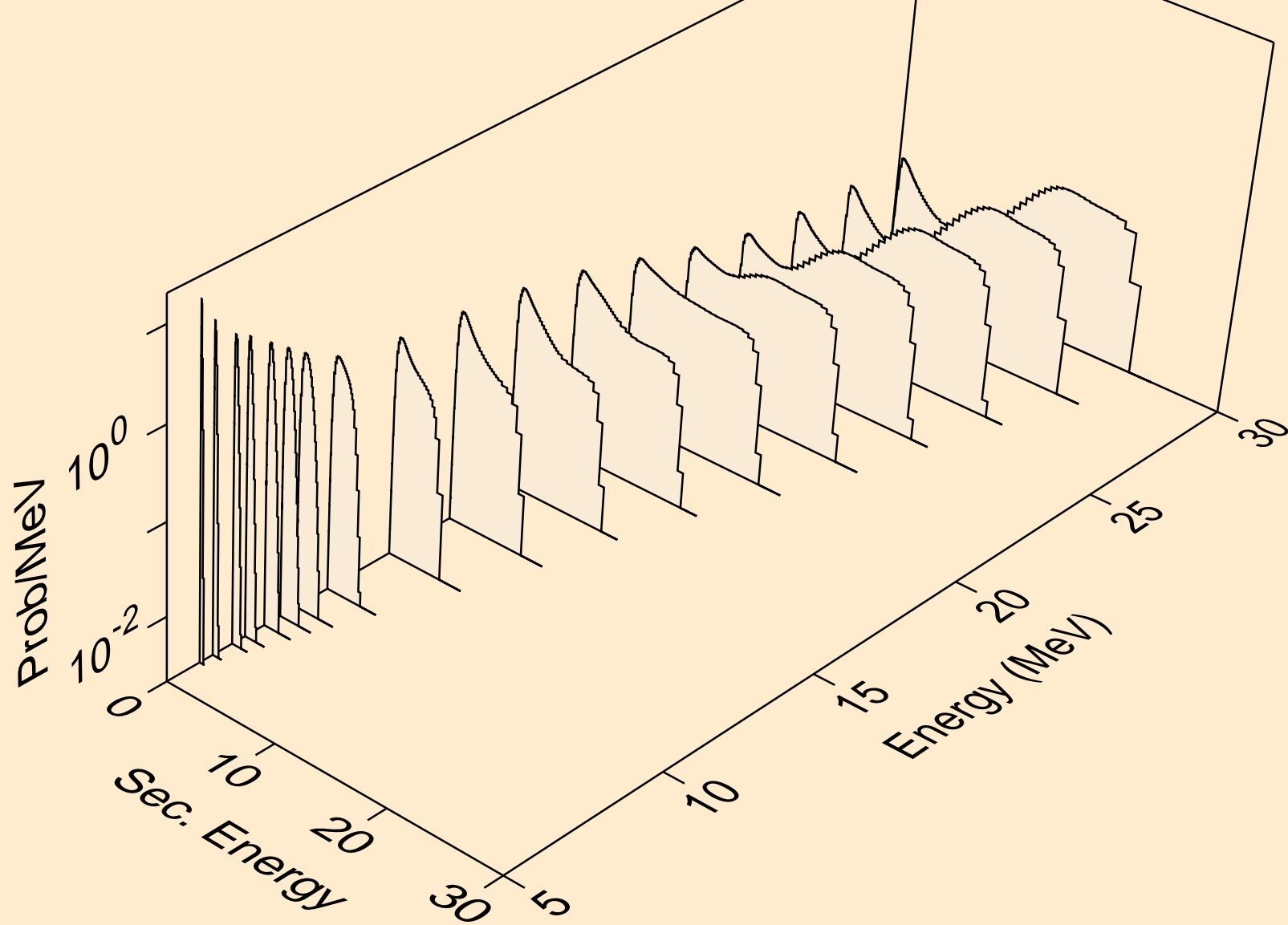

ZR083 NEUTRON ACER TENDL-2024 LIBRARY; T=0.K
Neutron emission for (n,n*)2a

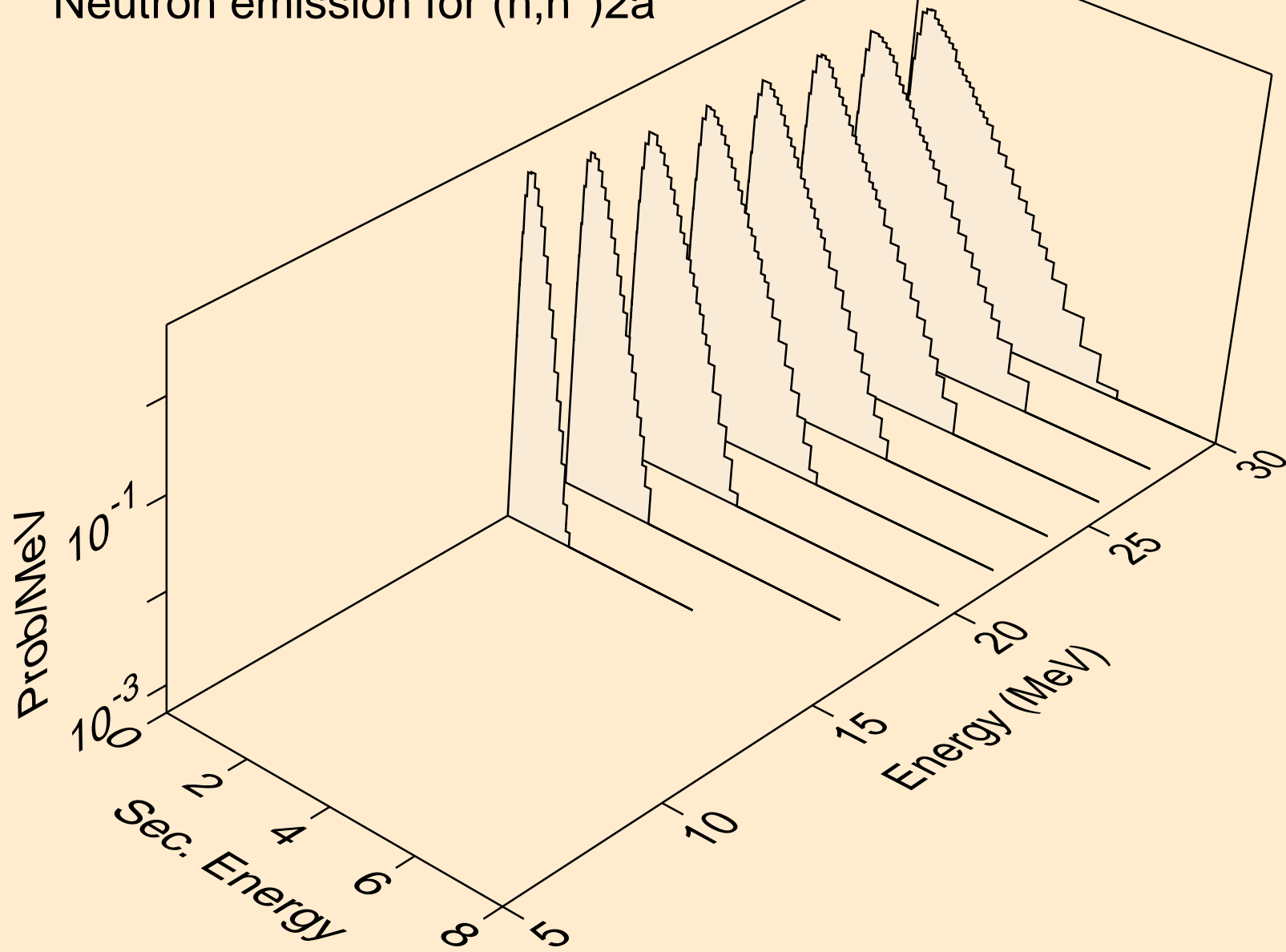

ZR083 NEUTRON ACER TENDL-2024 LIBRARY; T=0.K
Neutron emission for (n,n*)d

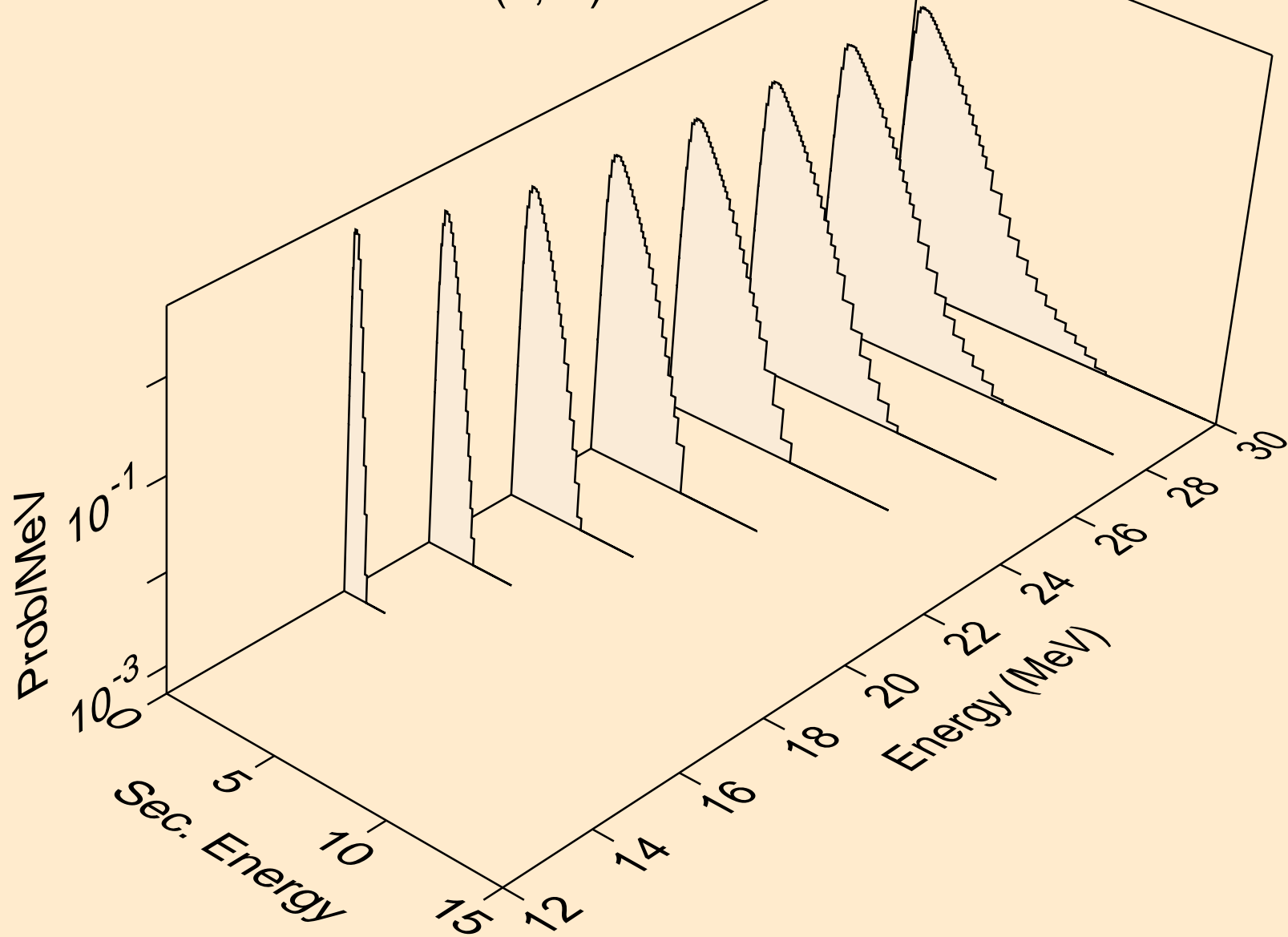

ZR083 NEUTRON ACER TENDL-2024 LIBRARY; T=0.K
Neutron emission for (n,n*)t

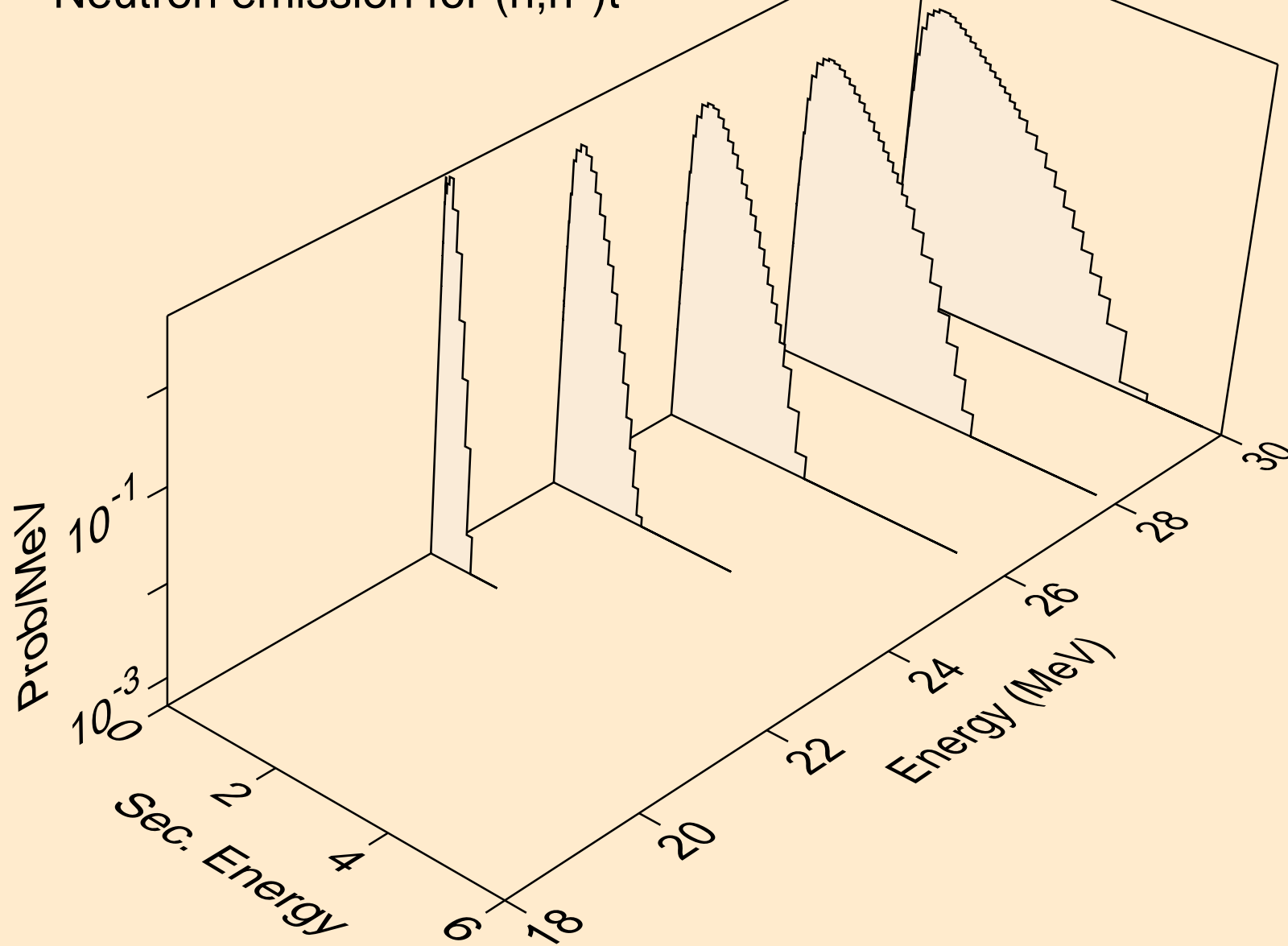

ZR083 NEUTRON ACER TENDL-2024 LIBRARY; T=0.K
Neutron emission for (n,n*)he3

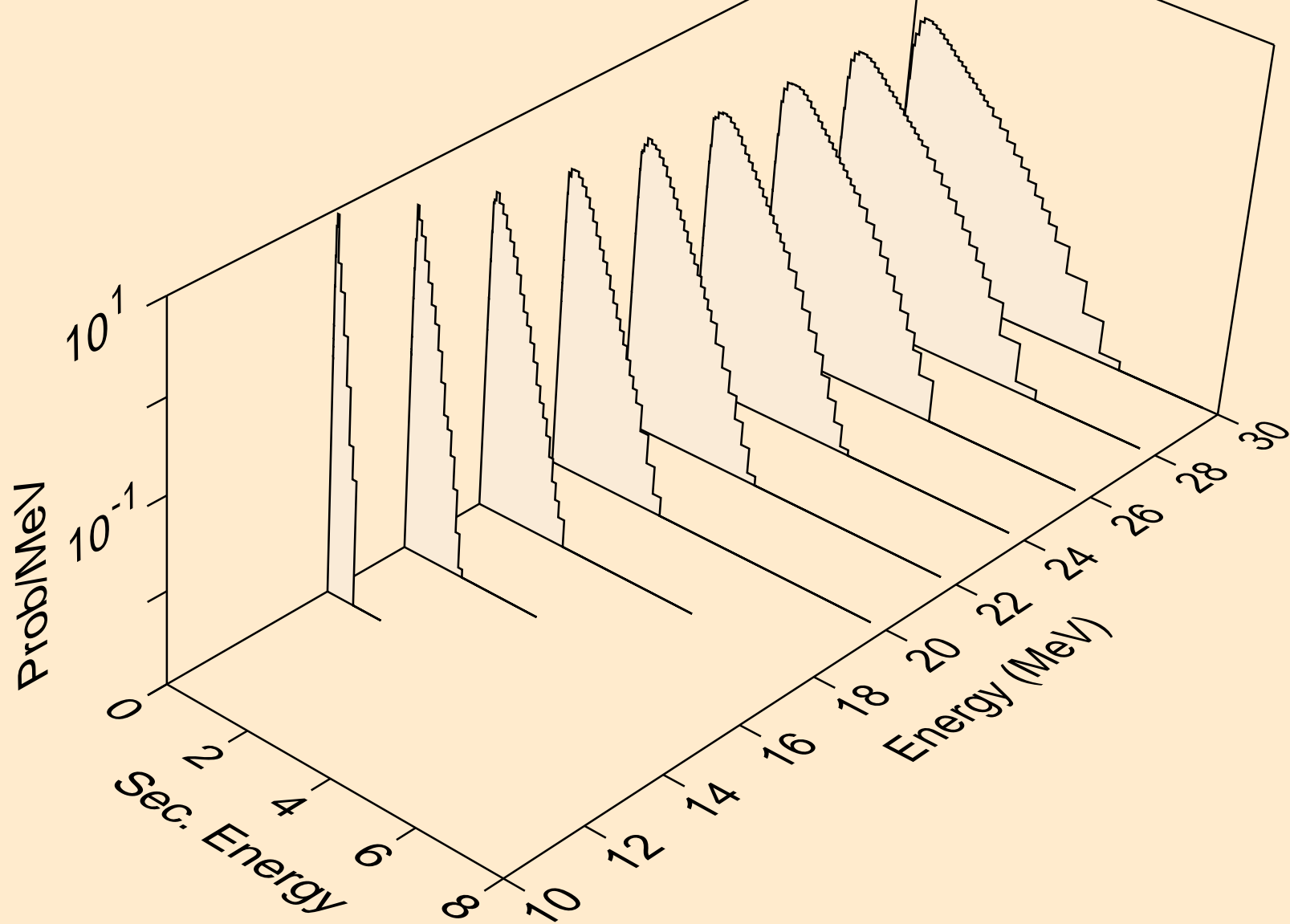

ZR083 NEUTRON ACER TENDL-2024 LIBRARY; T=0.K
Neutron emission for (n,2np)

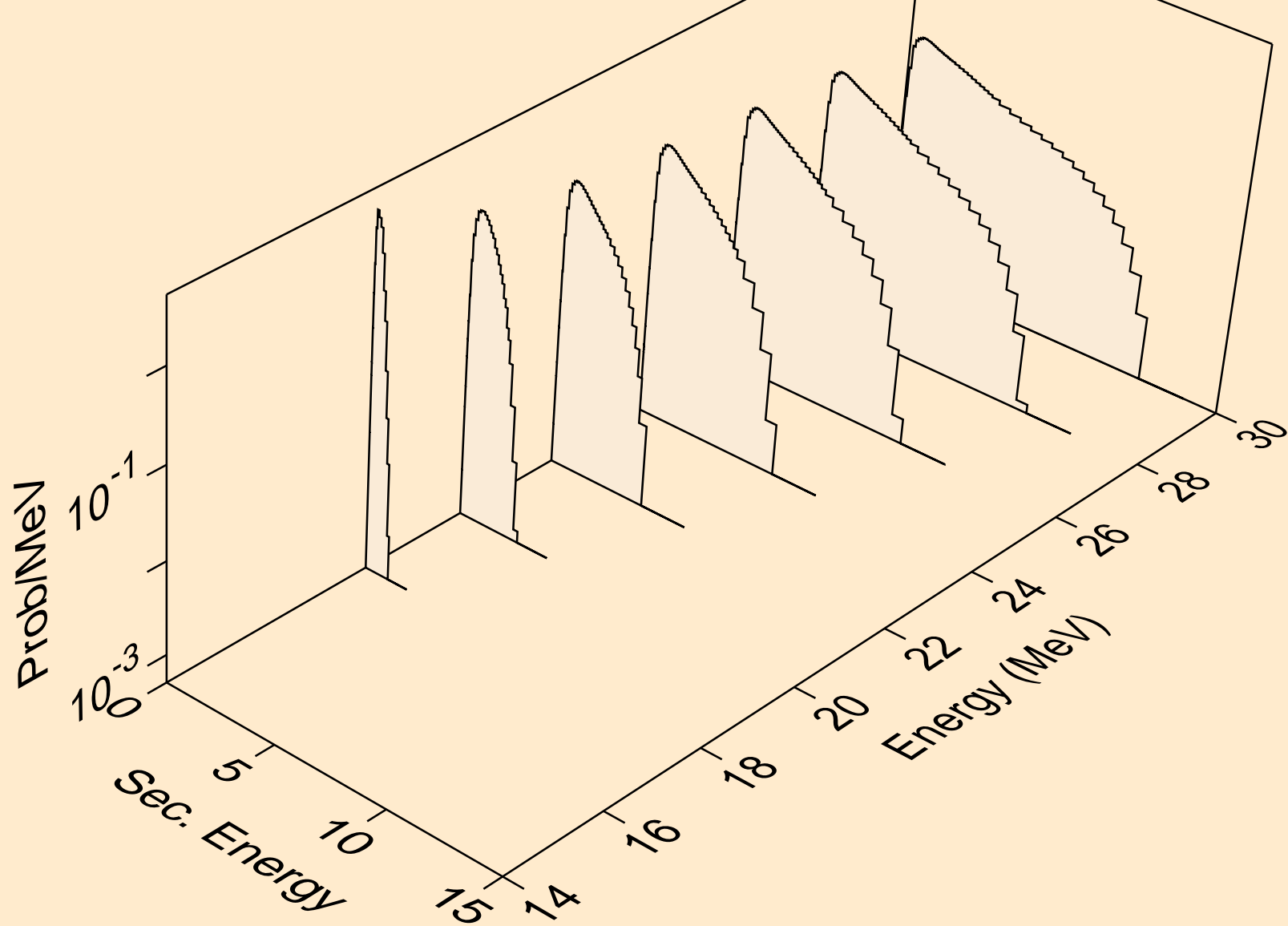

ZR083 NEUTRON ACER TENDL-2024 LIBRARY; T=0.K
Neutron emission for (n,n2p)

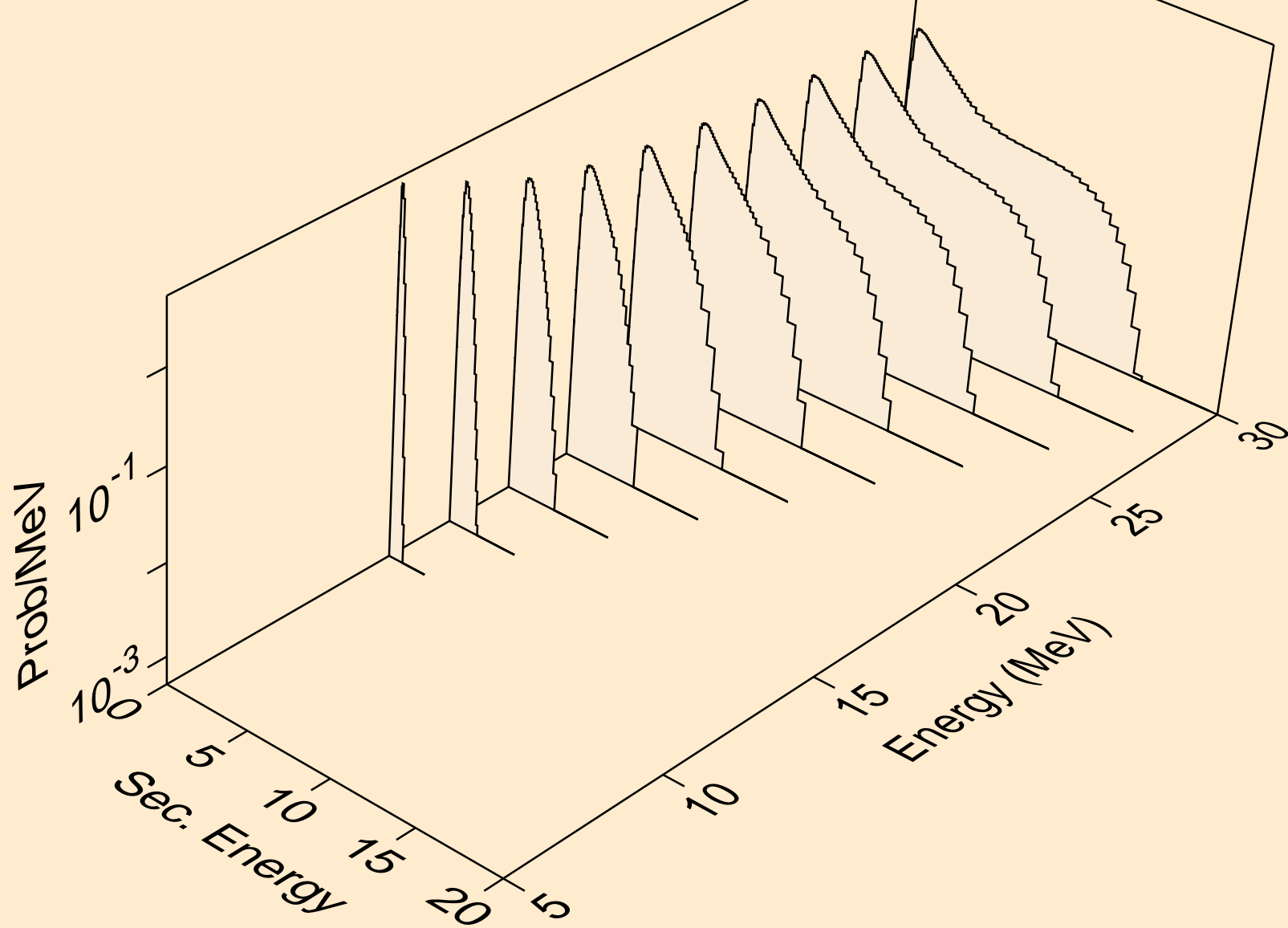

ZR083 NEUTRON ACER TENDL-2024 LIBRARY; T=0.K
Neutron emission for (n,npa)

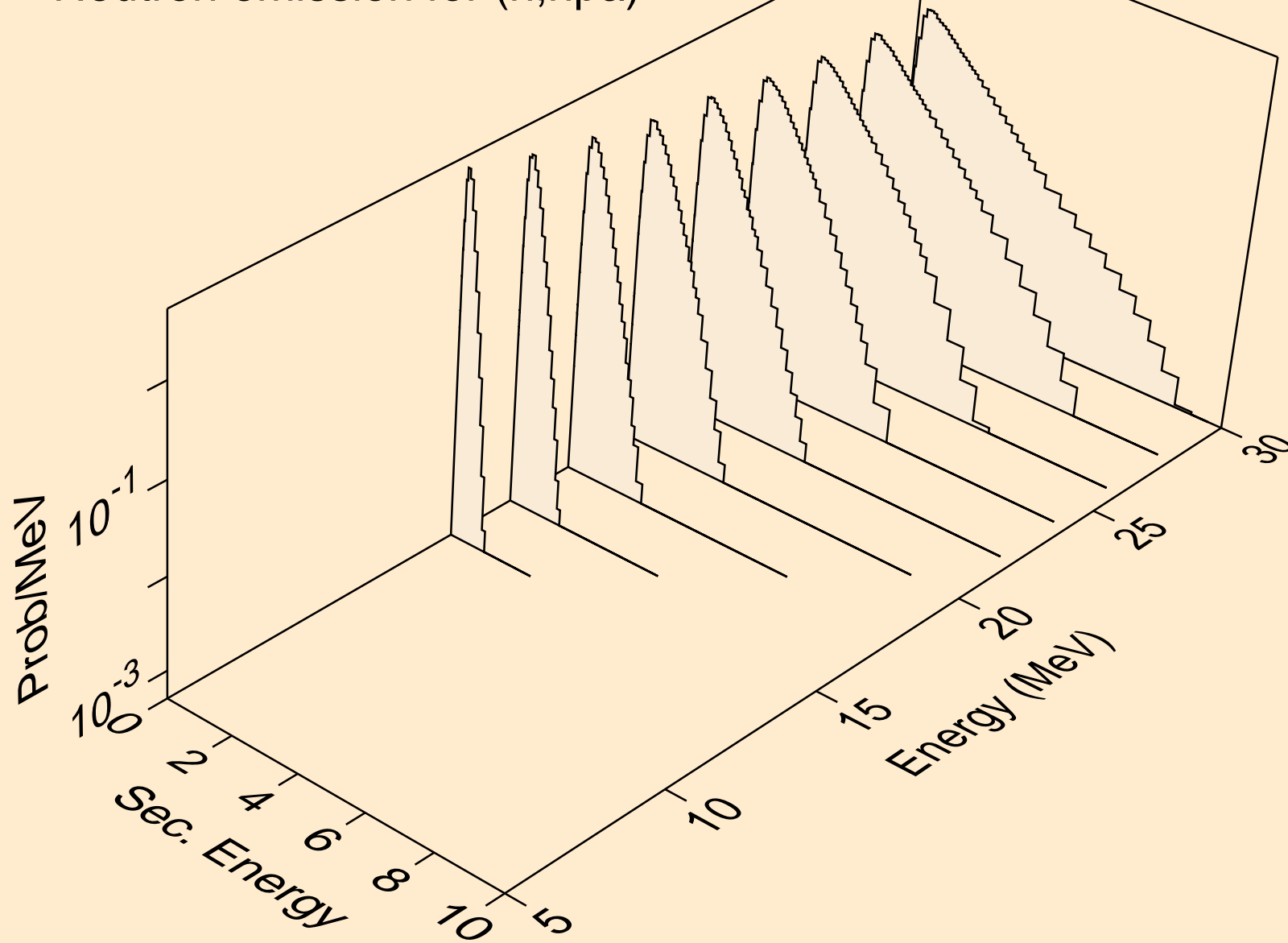

ZR083 NEUTRON ACER TENDL-2024 LIBRARY; T=0.K
Neutron emission for (n,n*c)

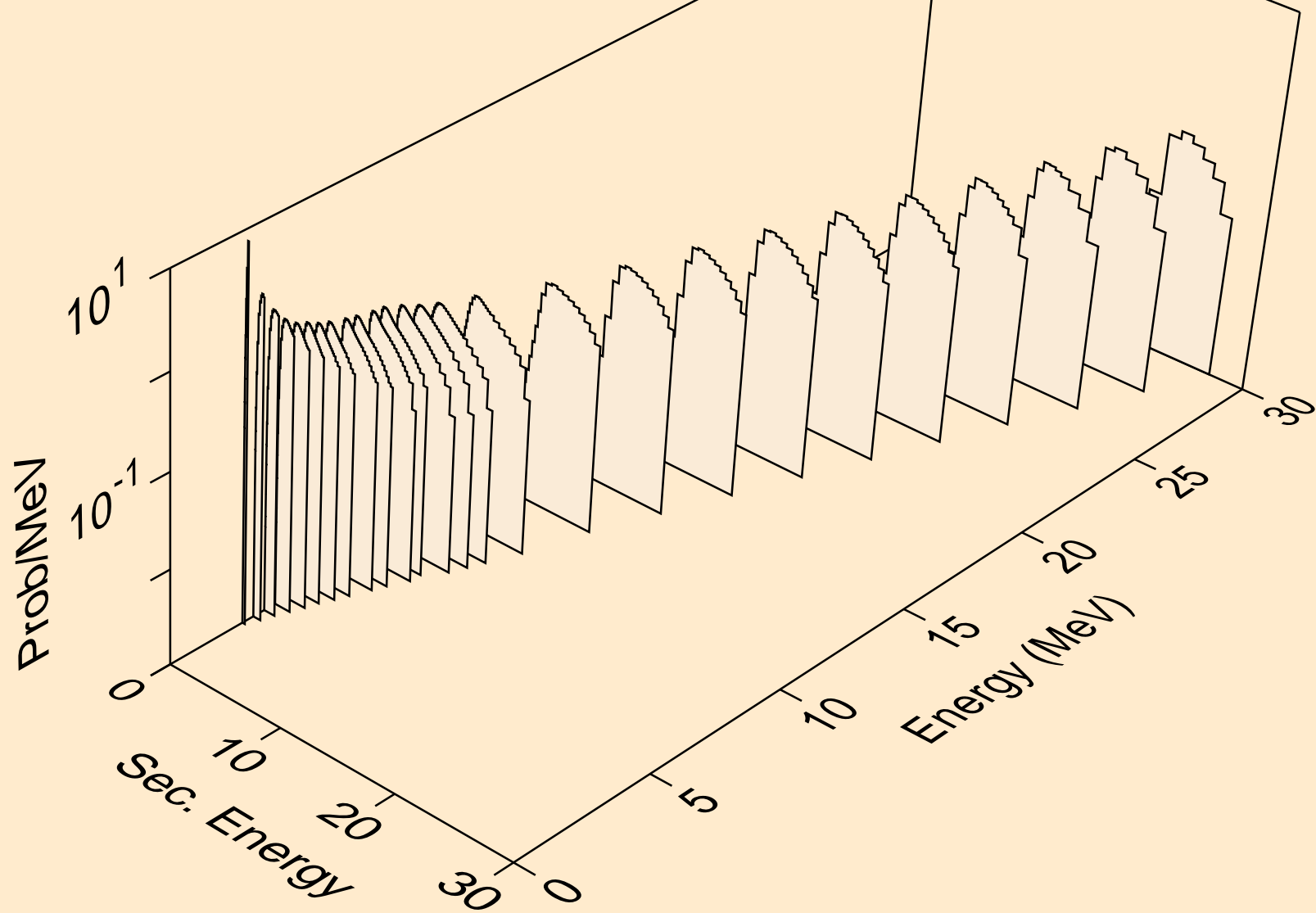

ZR083 NEUTRON ACER TENDL-2024 LIBRARY; T=0.K
Photon emission for (n,x)

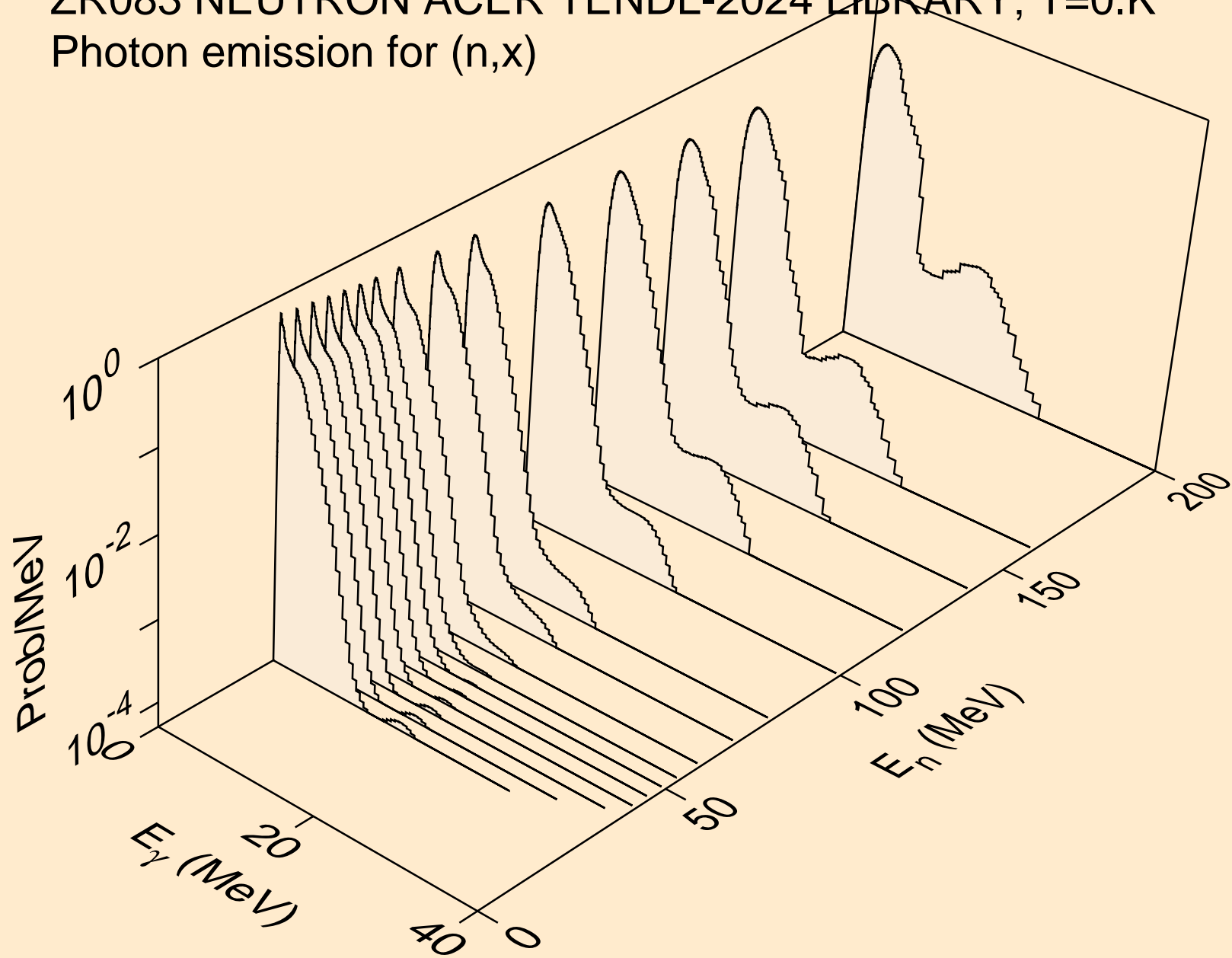

ZR083 NEUTRON ACER TENDL-2024 LIBRARY; T=0.K
Photon emission for (n,2n)

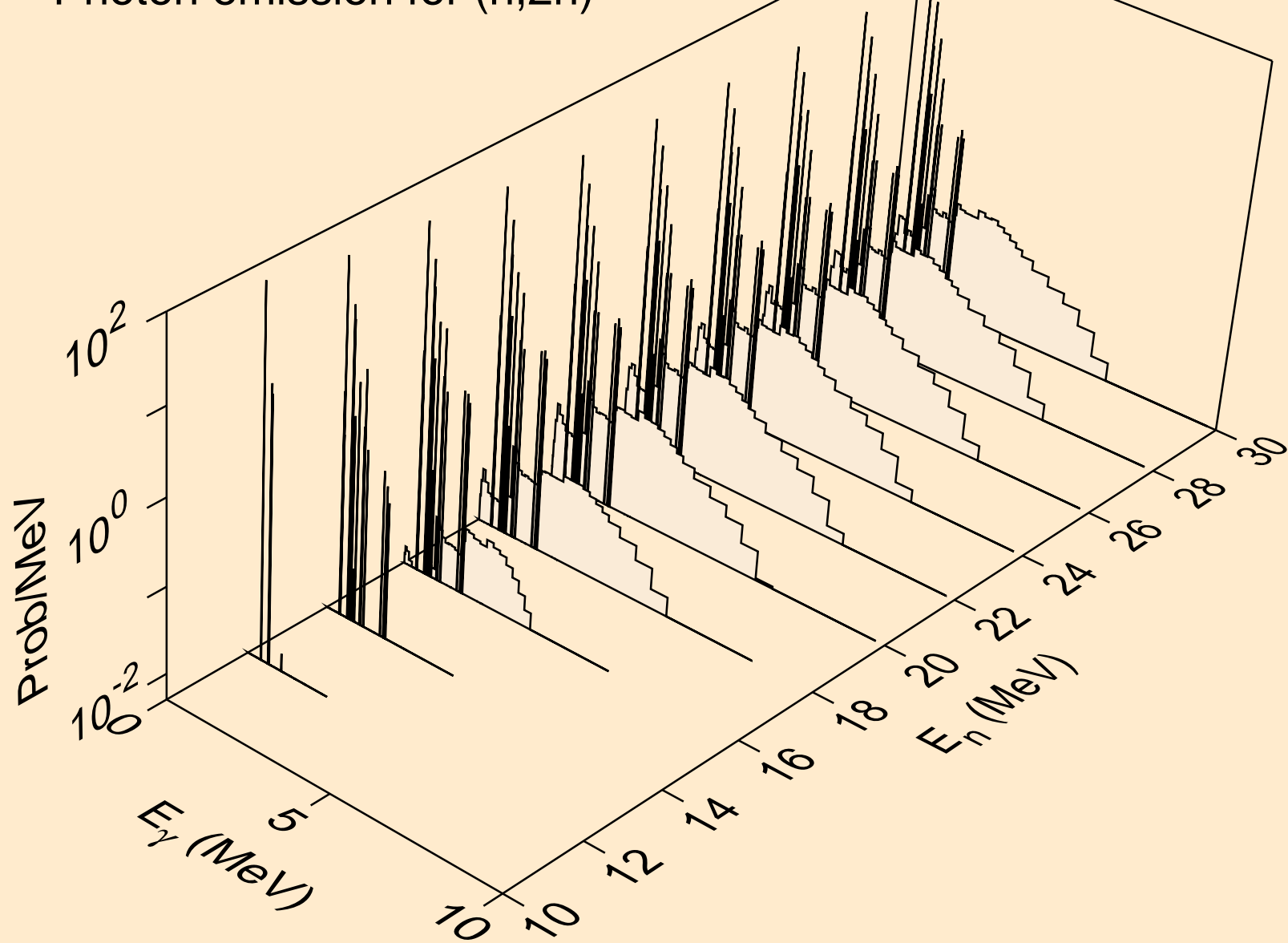

ZR083 NEUTRON ACER TENDL-2024 LIBRARY; T=0.K
Photon emission for (n,3n)

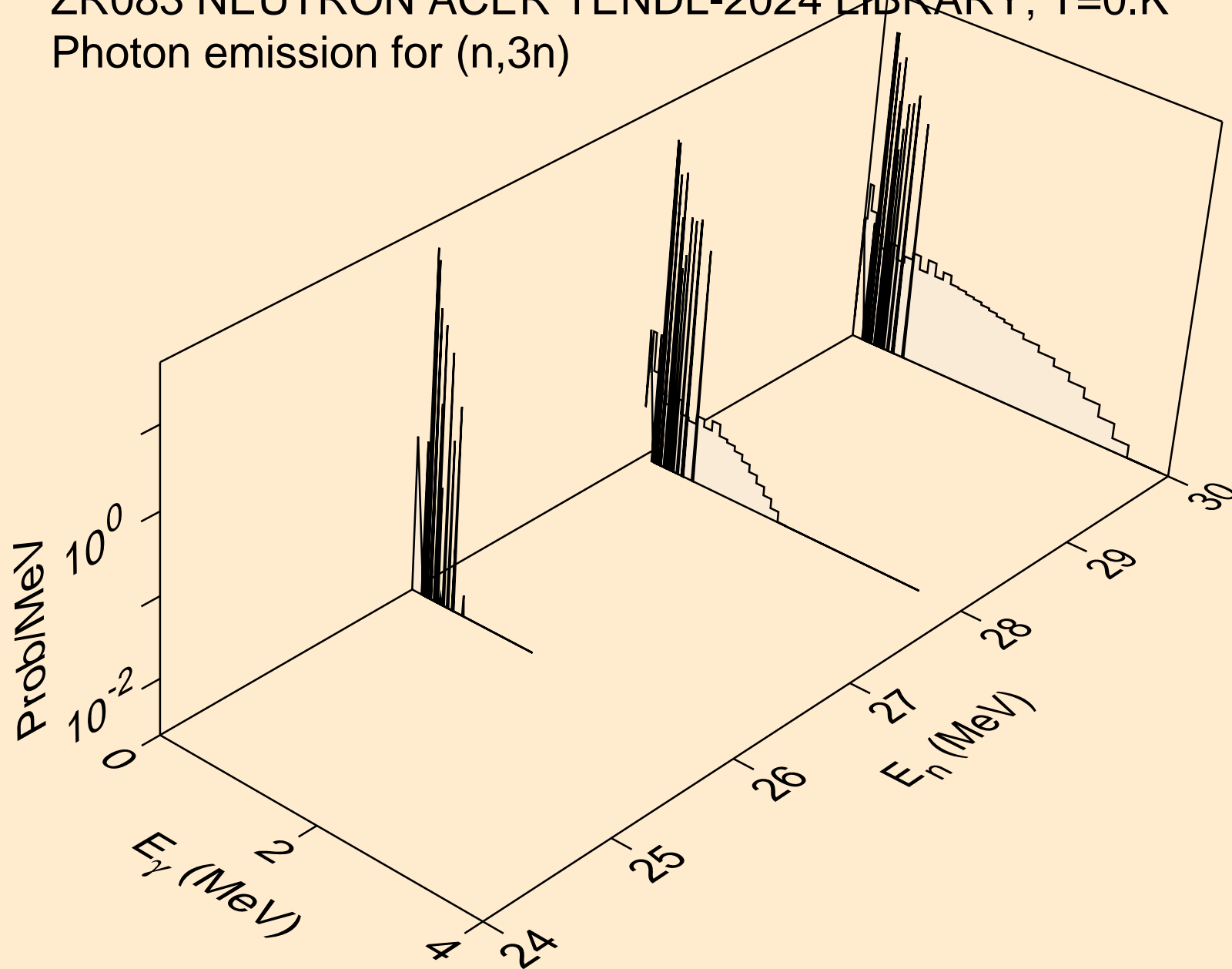

ZR083 NEUTRON ACER TENDL-2024 LIBRARY; T=0.K
Photon emission for (n,n*)a

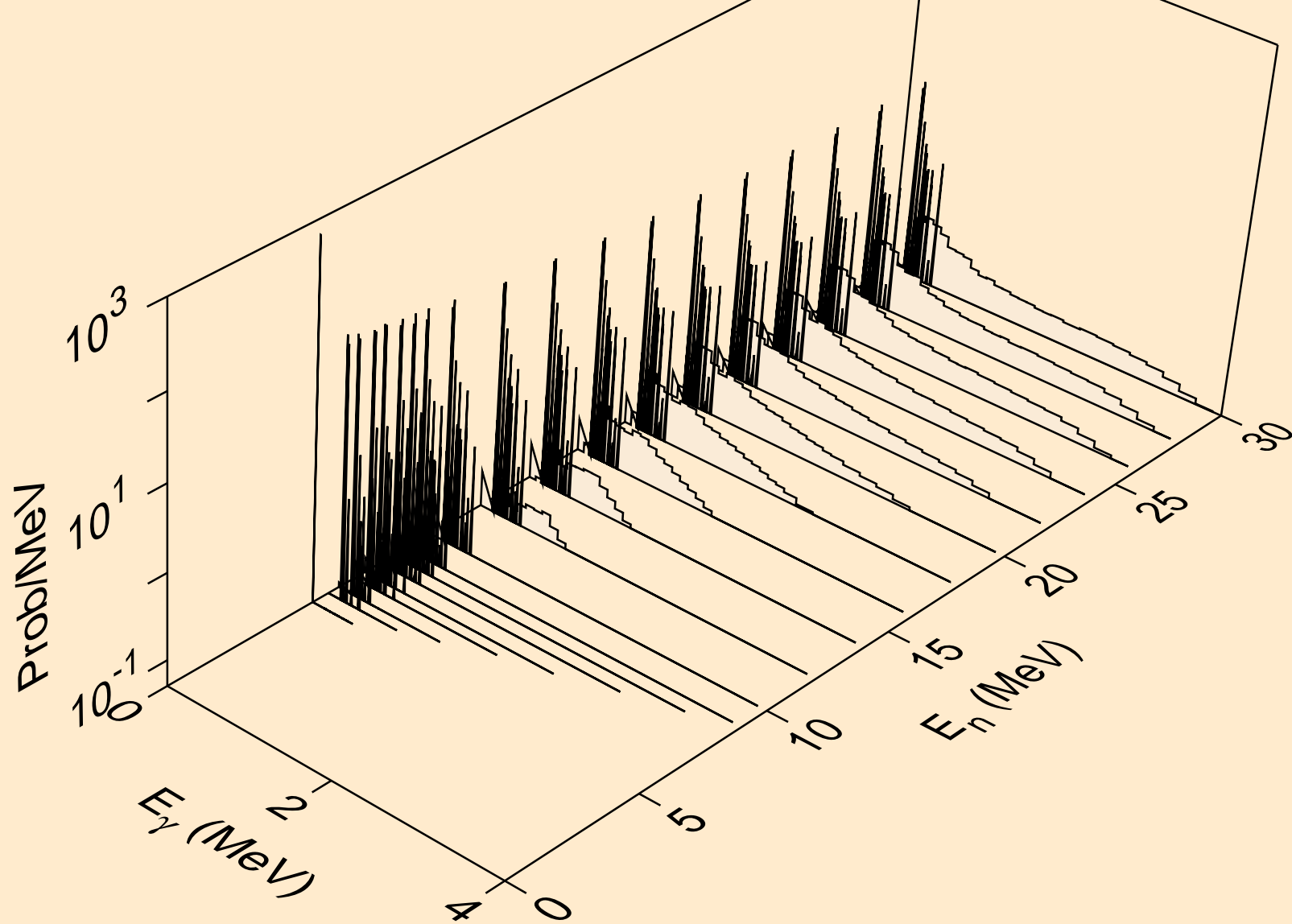

ZR083 NEUTRON ACER TENDL-2024 LIBRARY; T=0.K
Photon emission for (n,2n)a

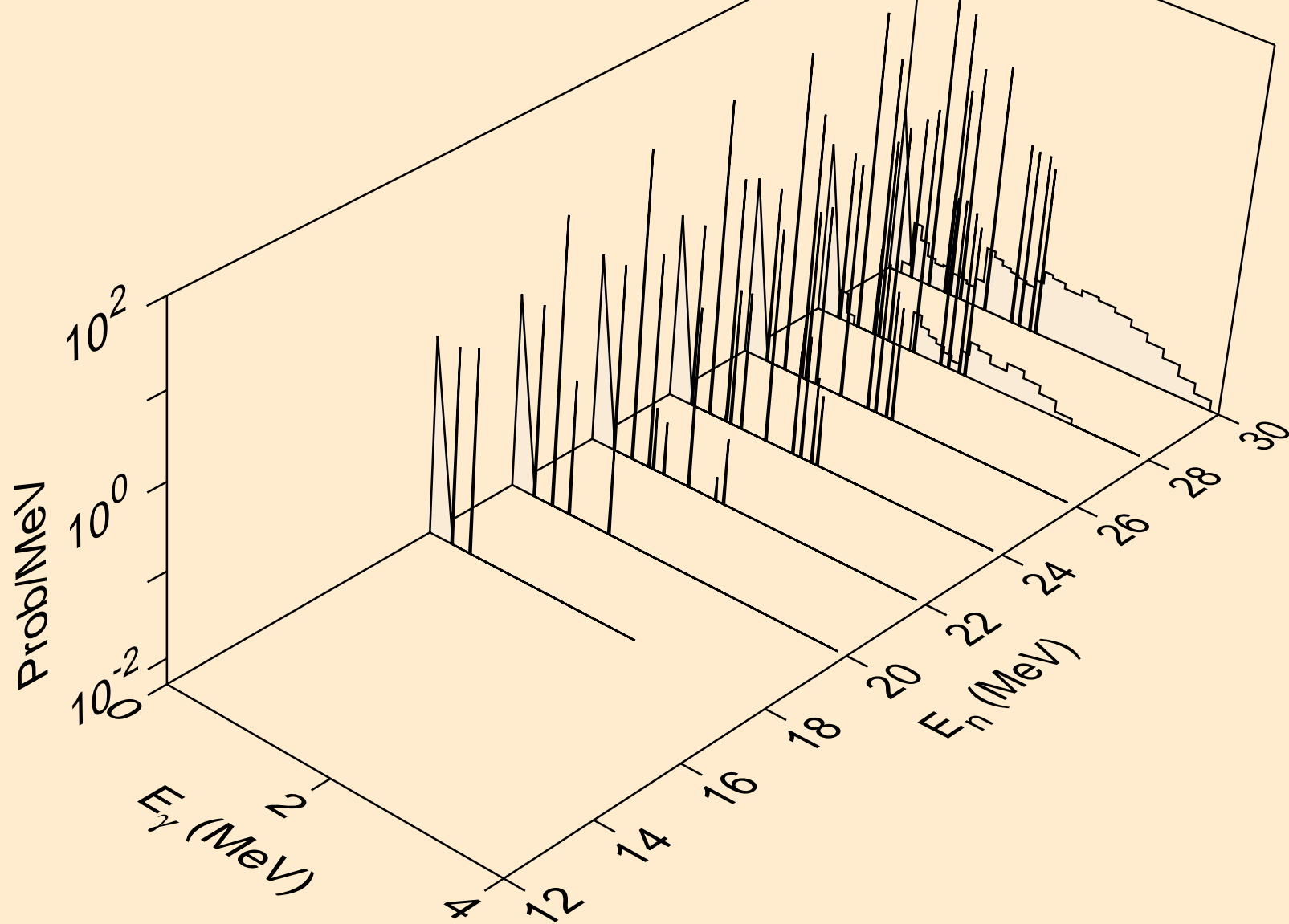

ZR083 NEUTRON ACER TENDL-2024 LIBRARY; T=0.K
Photon emission for (n,n*)p

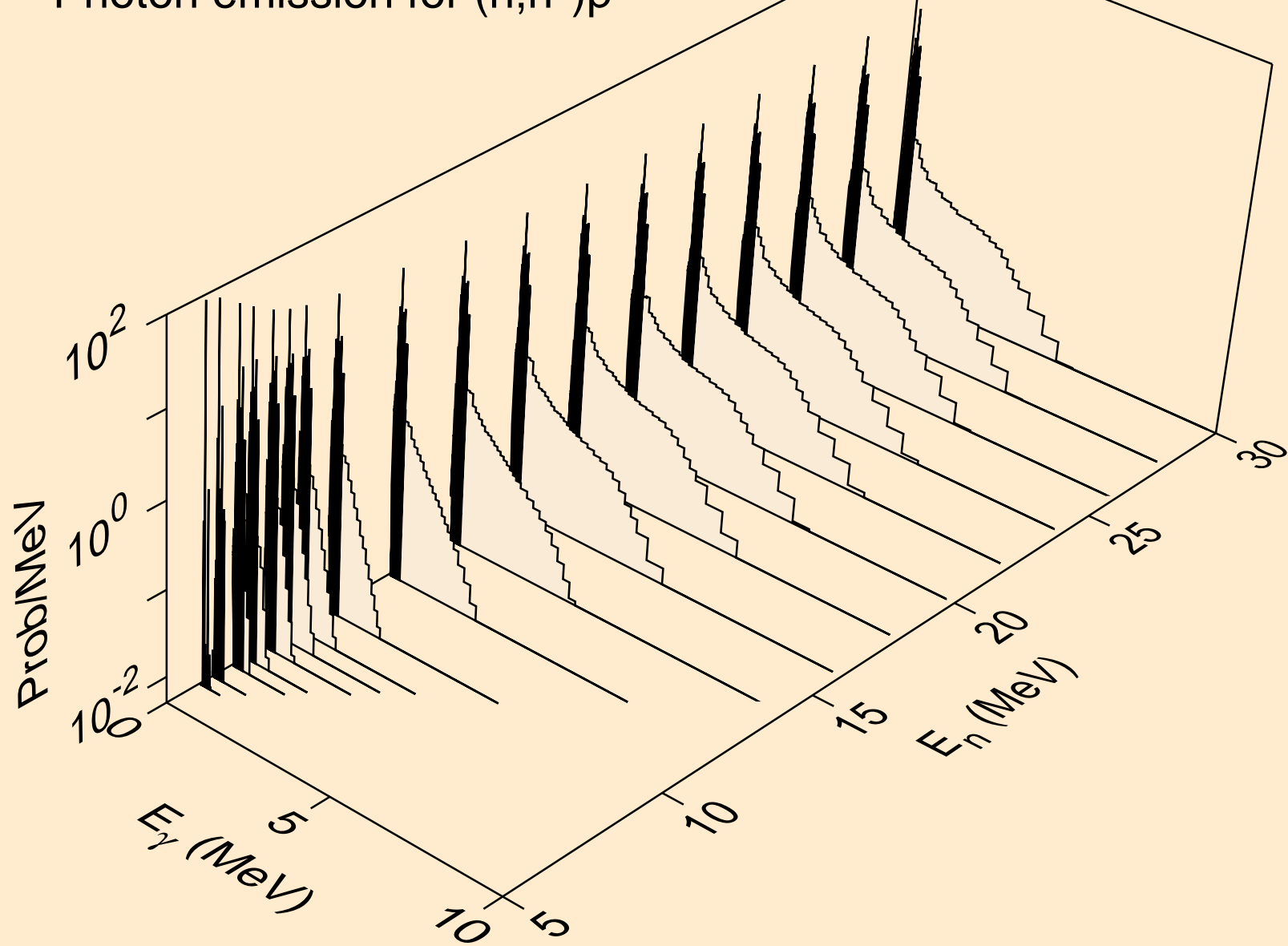

ZR083 NEUTRON ACER TENDL-2024 LIBRARY; T=0.K
Photon emission for (n,n*)2a

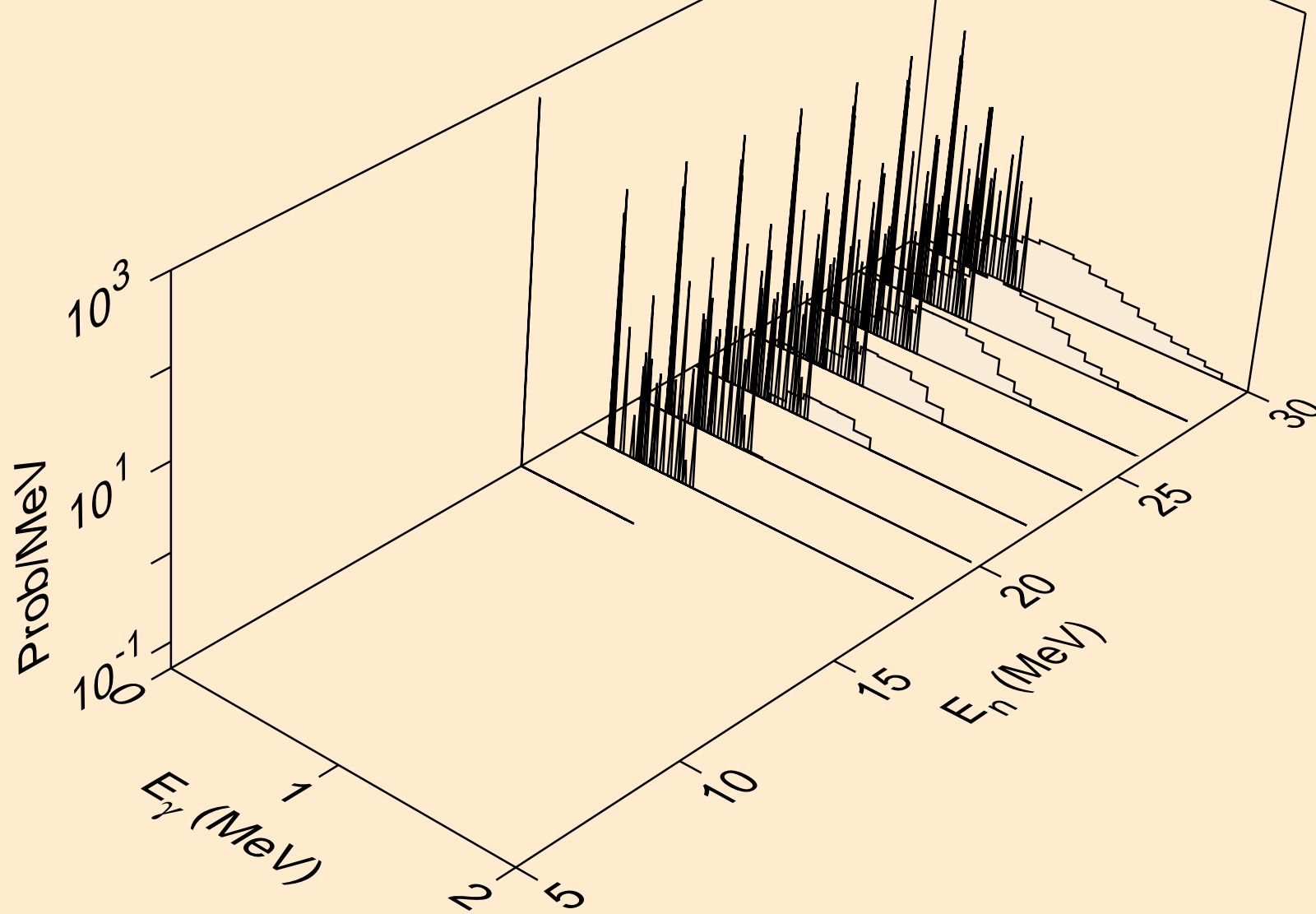

ZR083 NEUTRON ACER TENDL-2024 LIBRARY; T=0.K
Photon emission for (n,n*)d

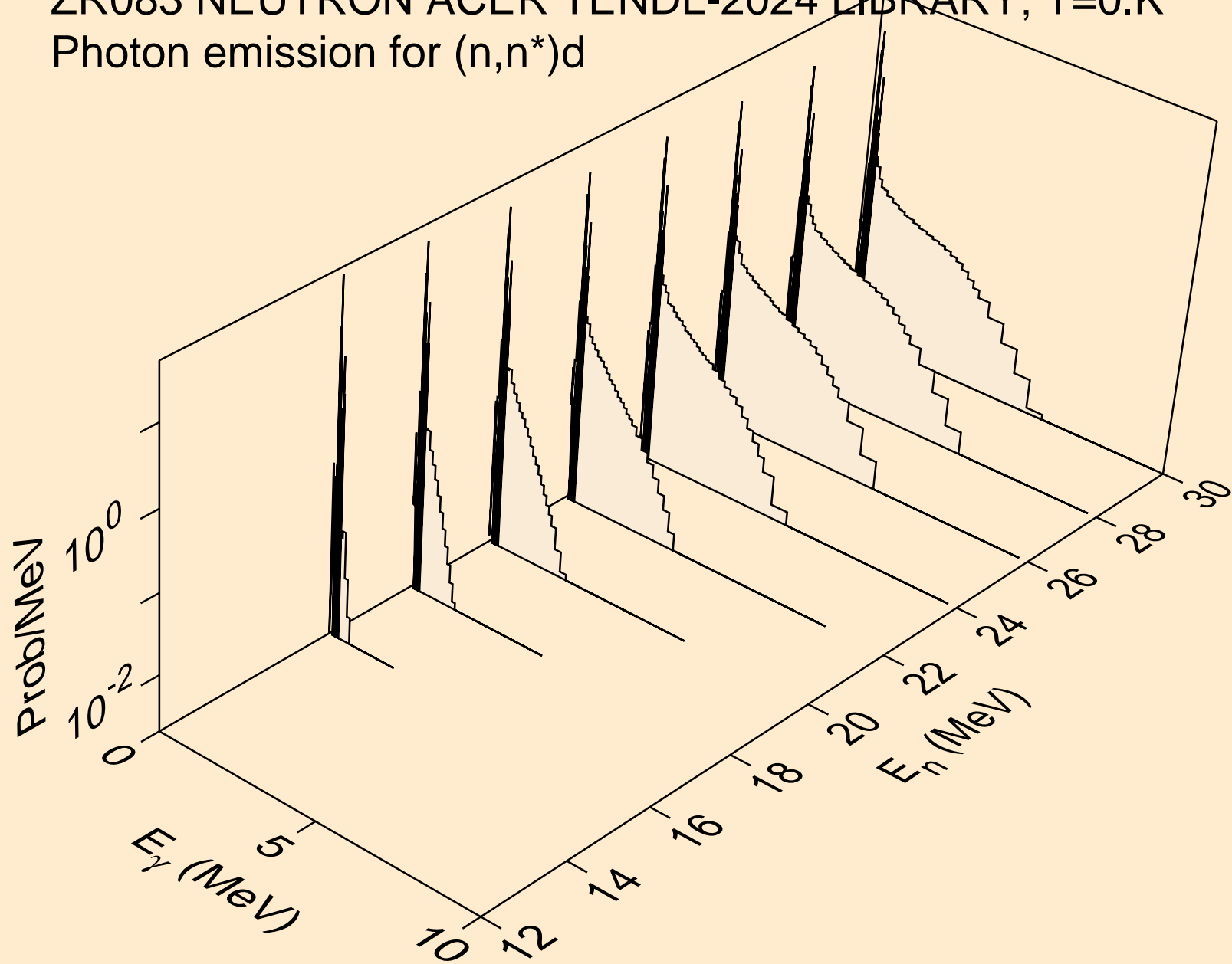

ZR083 NEUTRON ACER TENDL-2024 LIBRARY; T=0.K
Photon emission for (n,n*)t

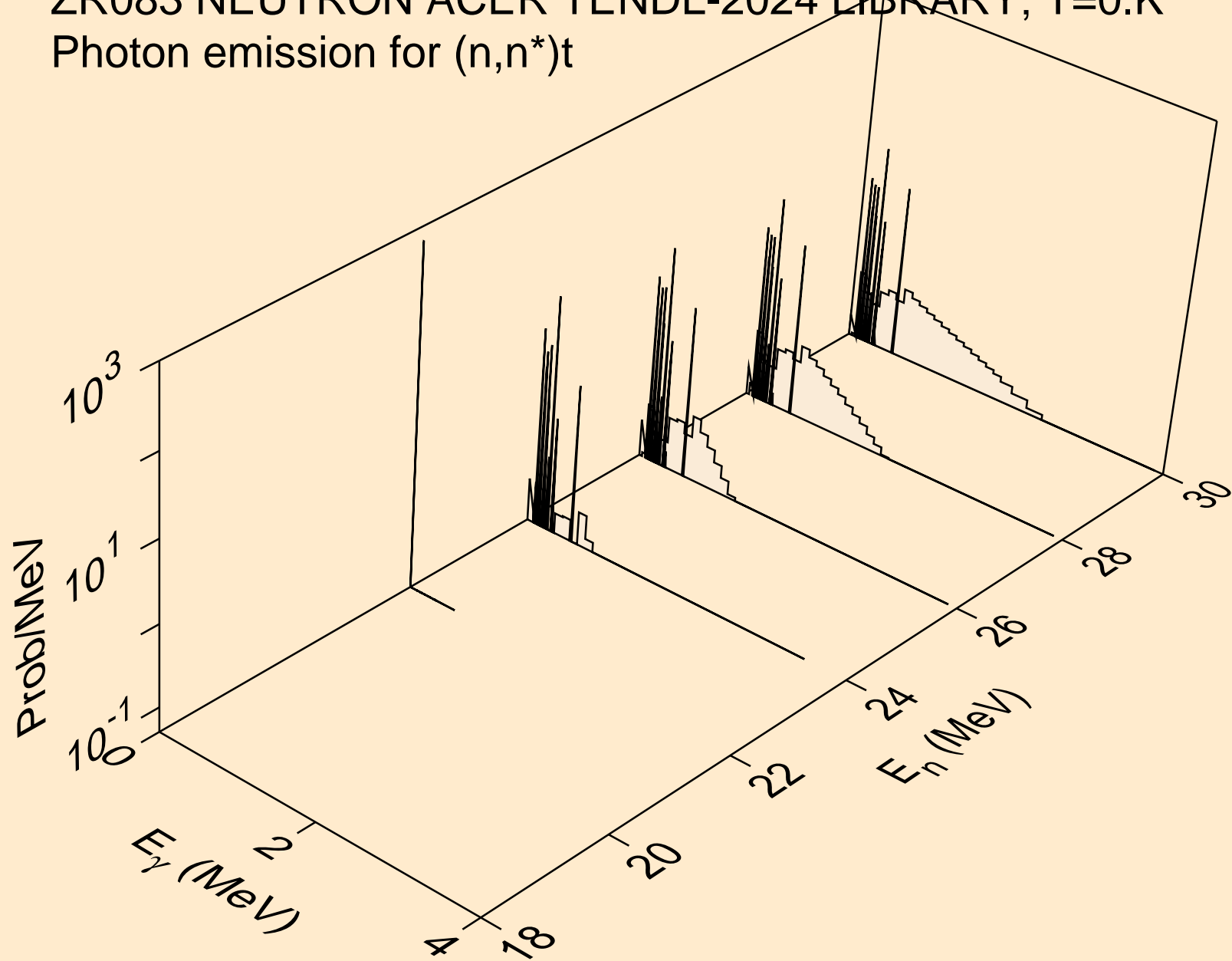

ZR083 NEUTRON ACER TENDL-2024 LIBRARY; T=0.K
Photon emission for (n,n*)he3

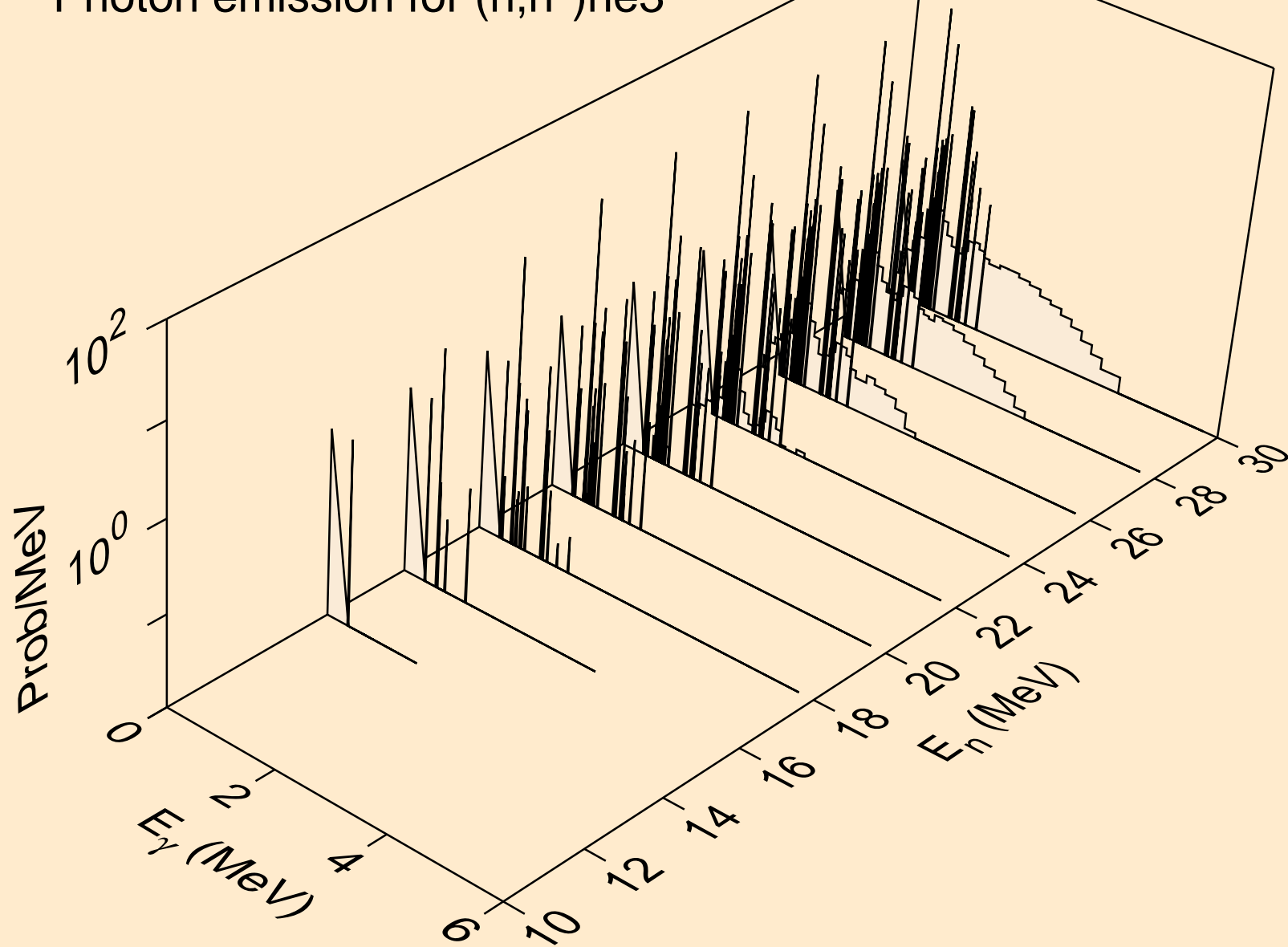

ZR083 NEUTRON ACER TENDL-2024 LIBRARY; T=0.K
Photon emission for (n,2np)

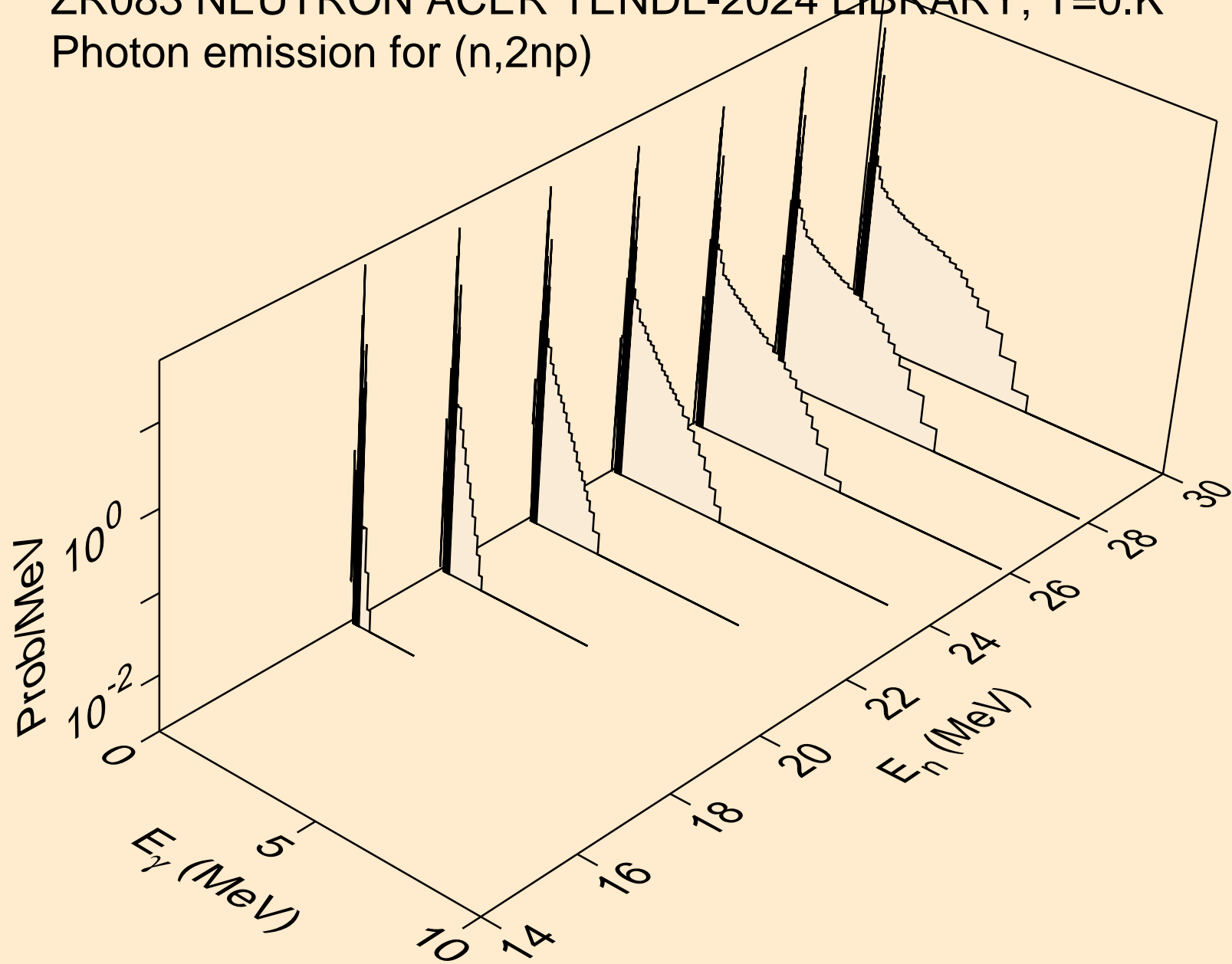

ZR083 NEUTRON ACER TENDL-2024 LIBRARY; T=0.K
Photon emission for (n,n2p)

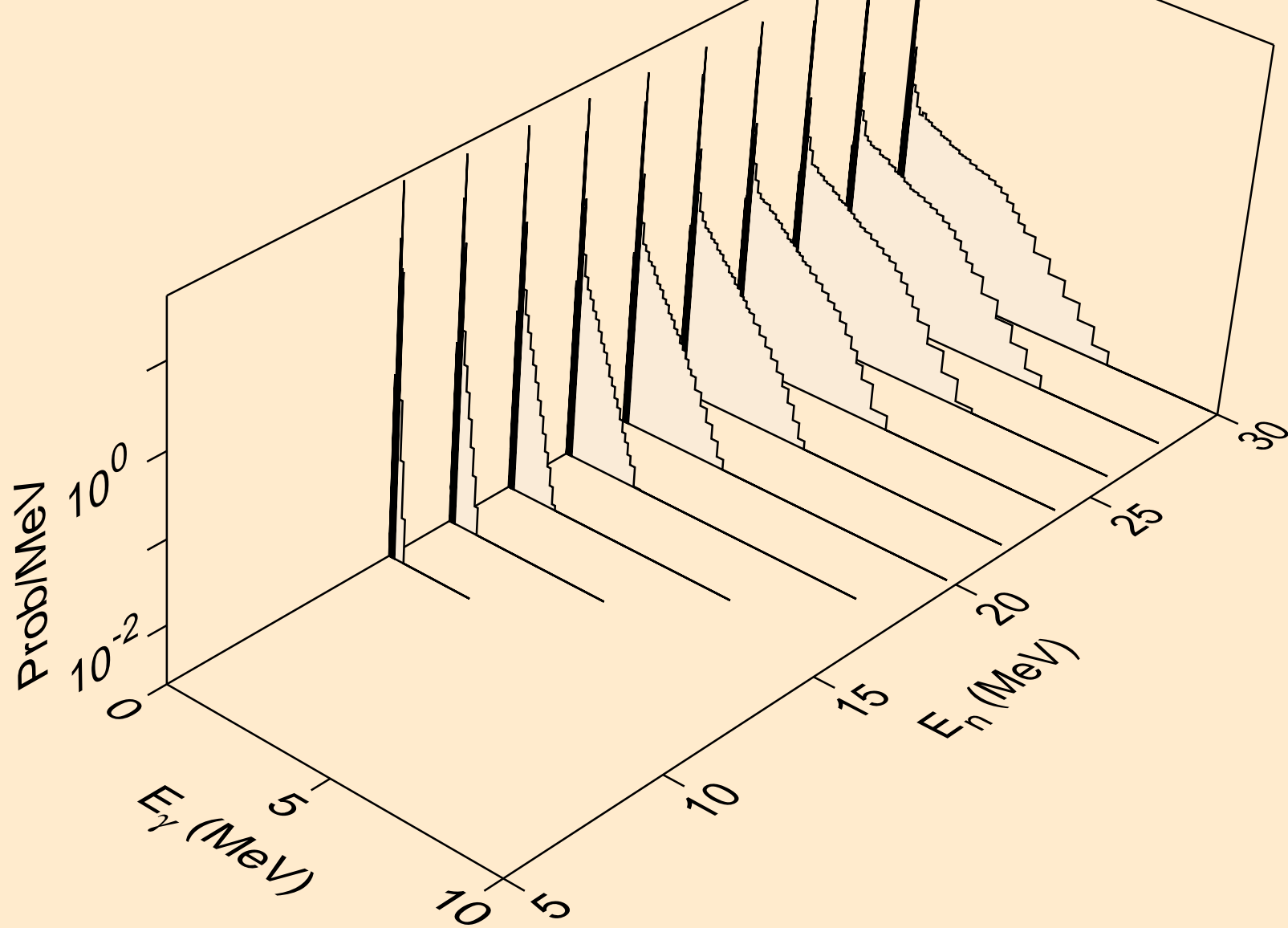

ZR083 NEUTRON ACER TENDL-2024 LIBRARY; T=0.K
Photon emission for (n,npa)

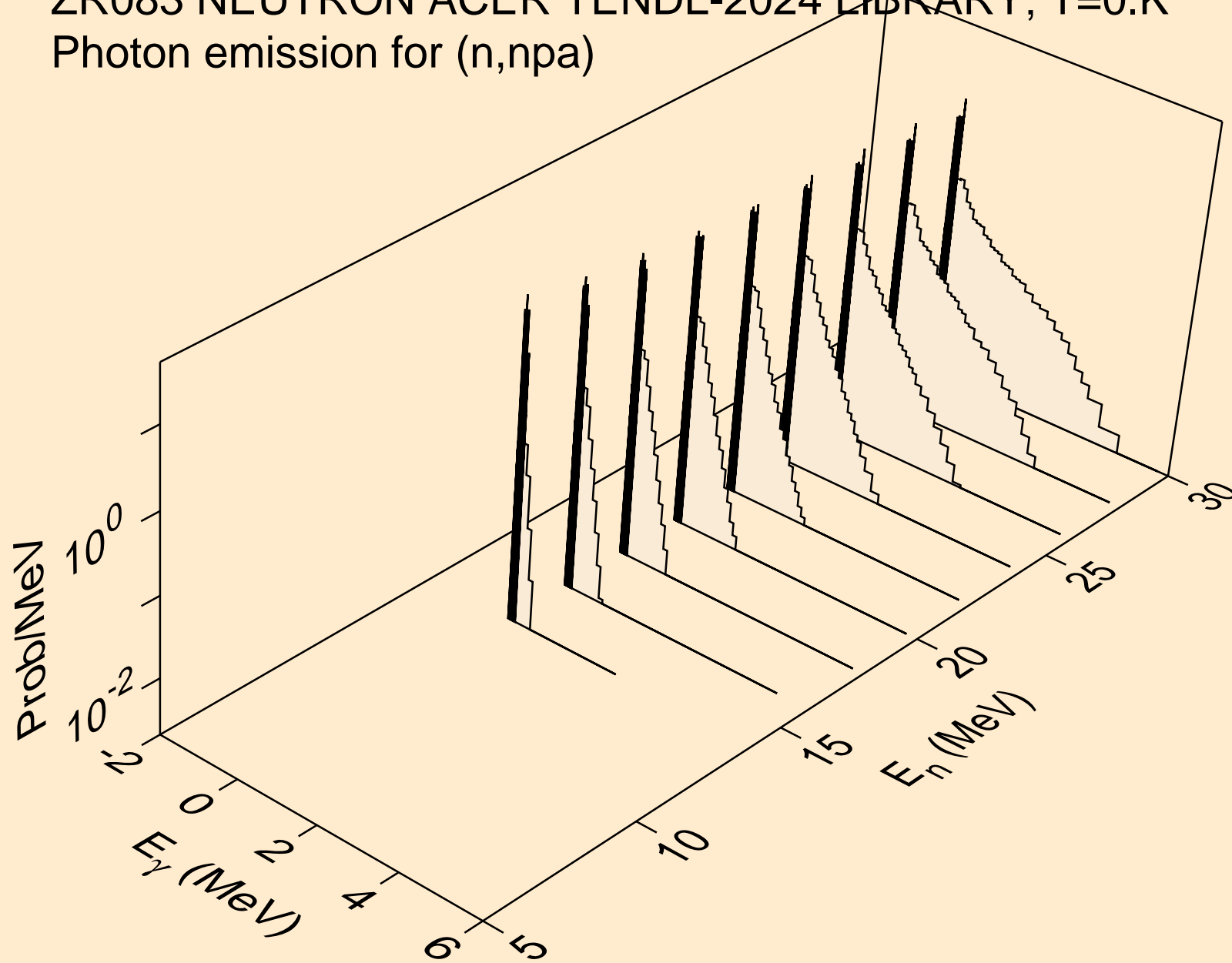

ZR083 NEUTRON ACER TENDL-2024 LIBRARY; T=0.K
Photon emission for (n,n*c)

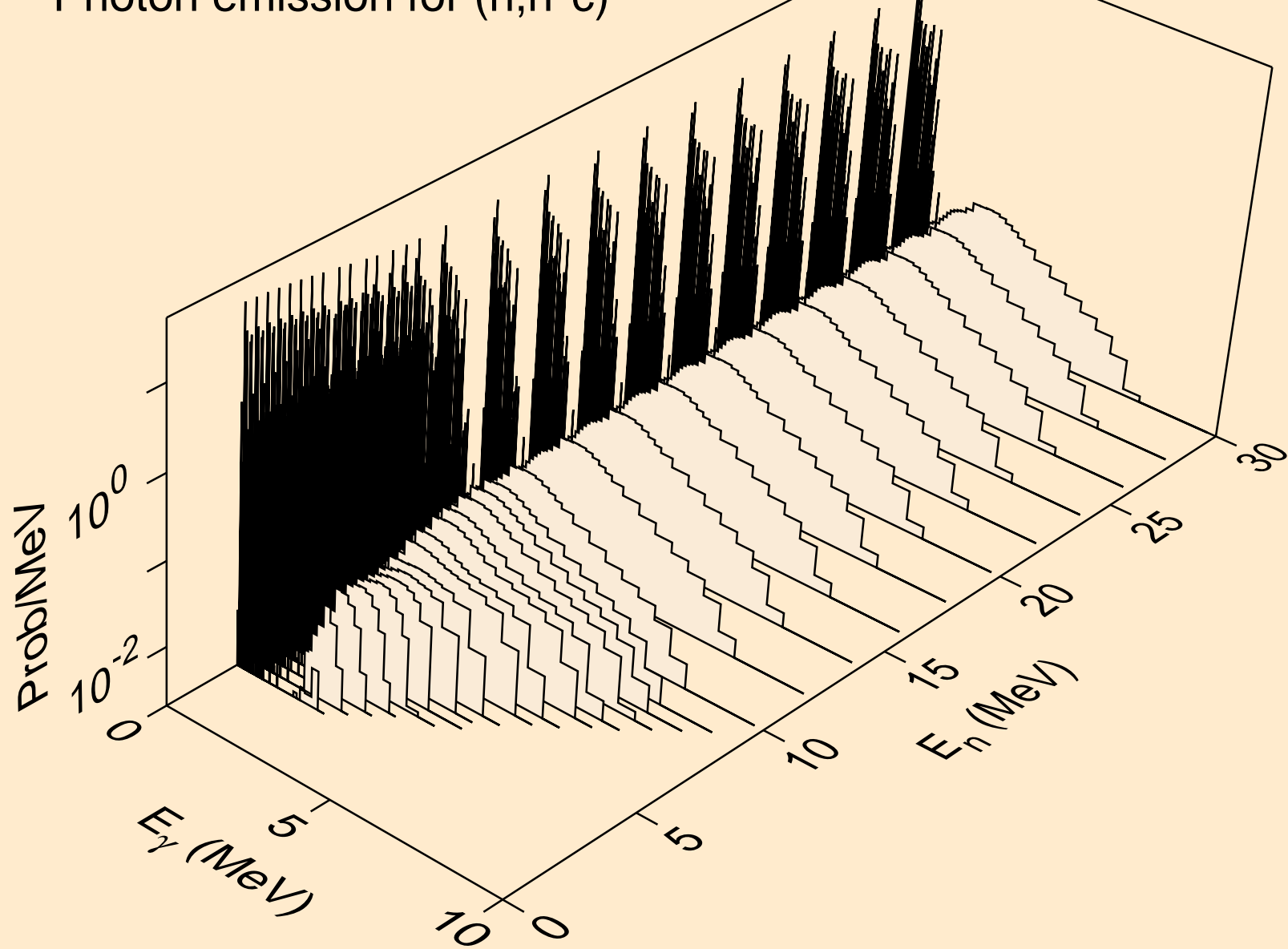

ZR083 NEUTRON ACER TENDL-2024 LIBRARY; T=0.K
Photon emission for (n,gma)

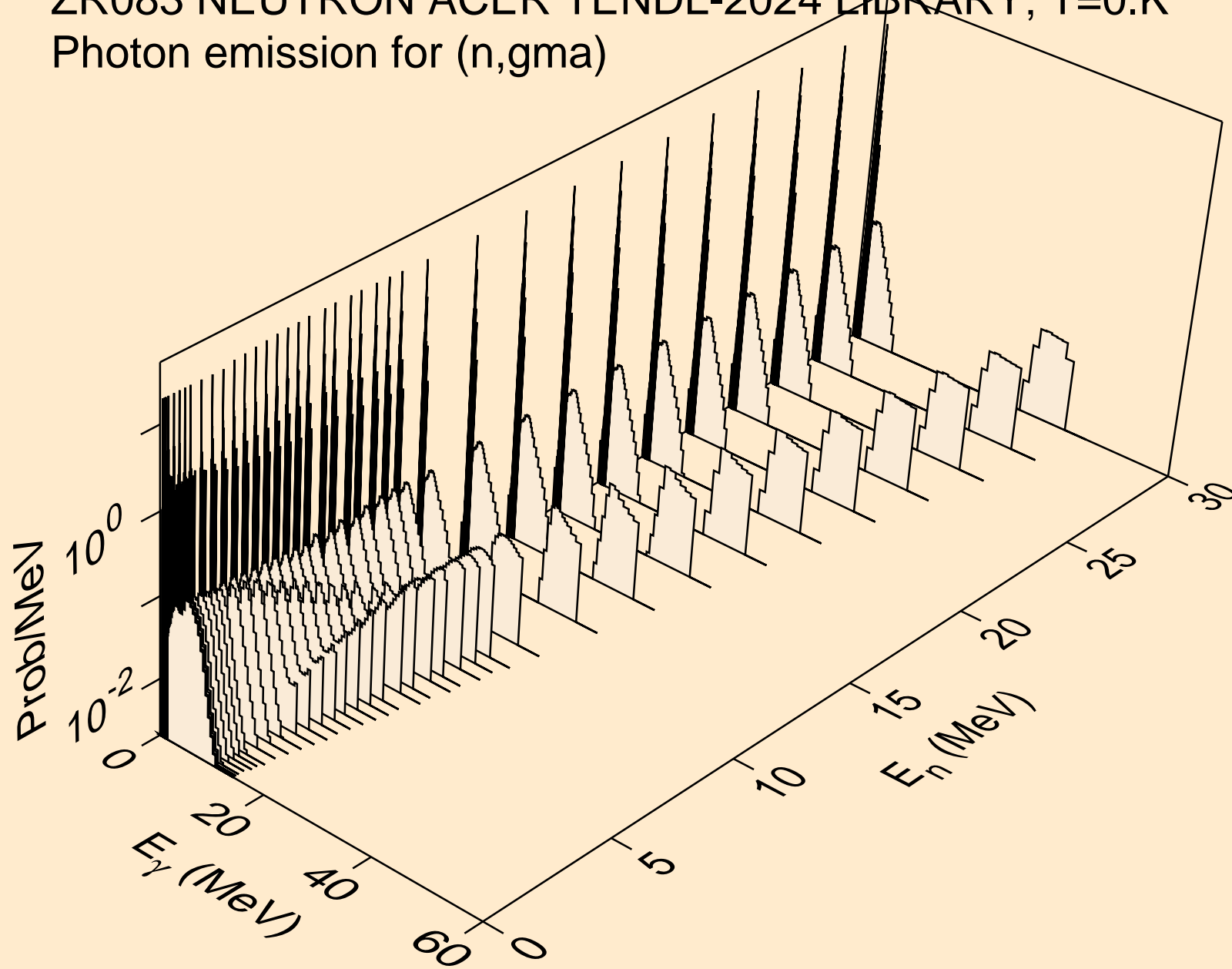

ZR083 NEUTRON ACER TENDL-2024 LIBRARY; T=0.K
Photon emission for (n,p)

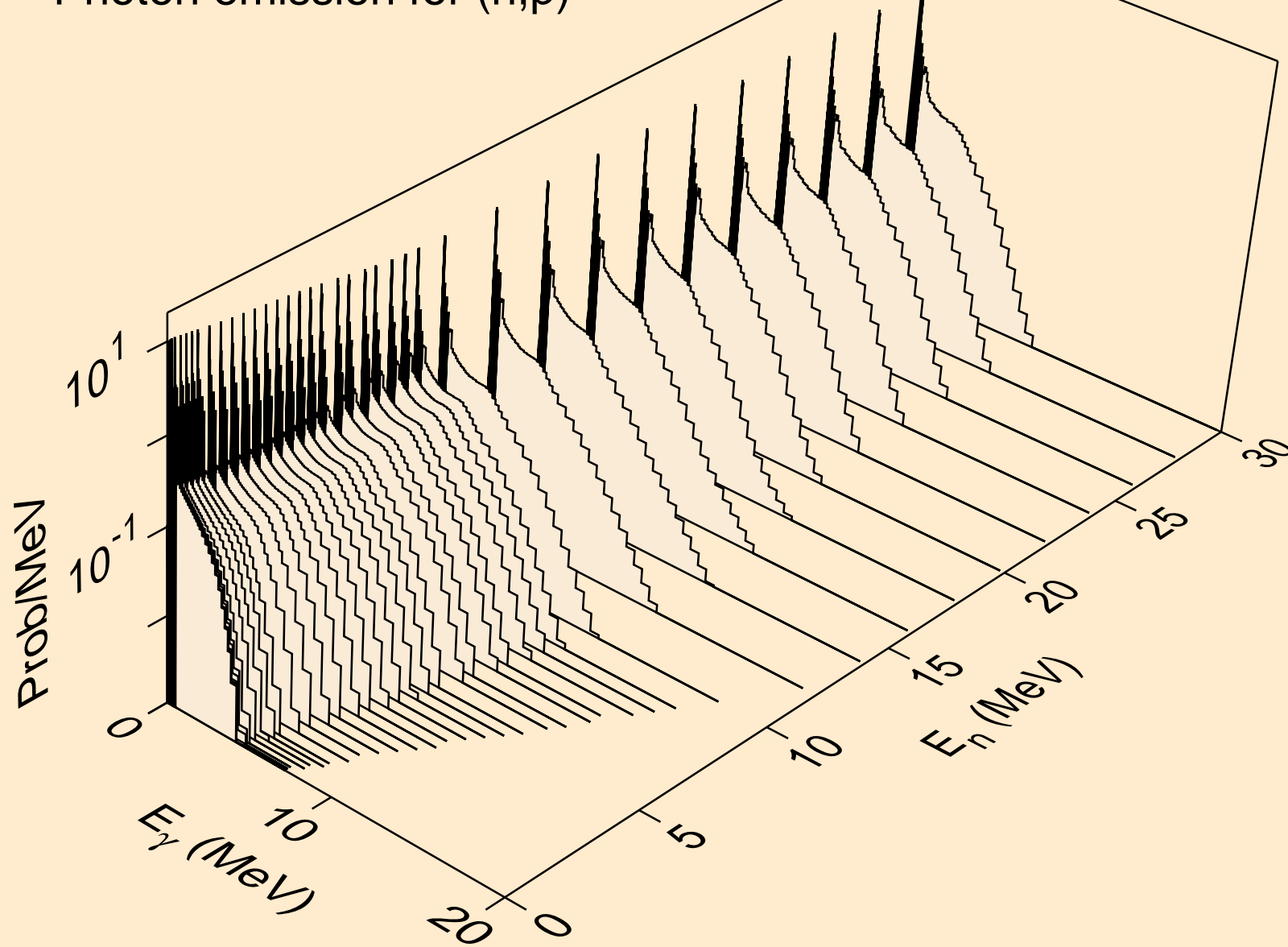

ZR083 NEUTRON ACER TENDL-2024 LIBRARY; T=0.K
Photon emission for (n,d)

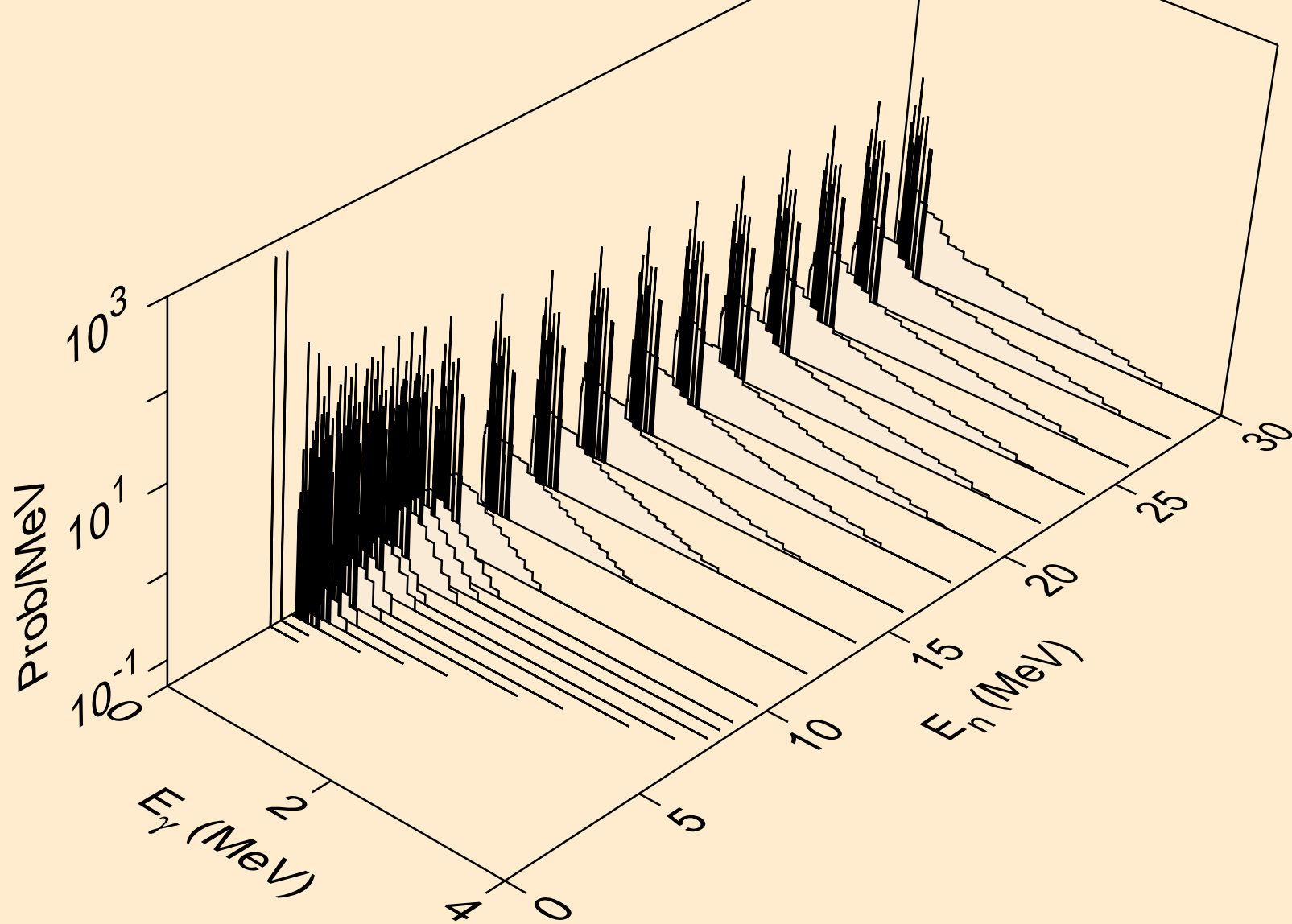

ZR083 NEUTRON ACER TENDL-2024 LIBRARY; T=0.K
Photon emission for (n,t)

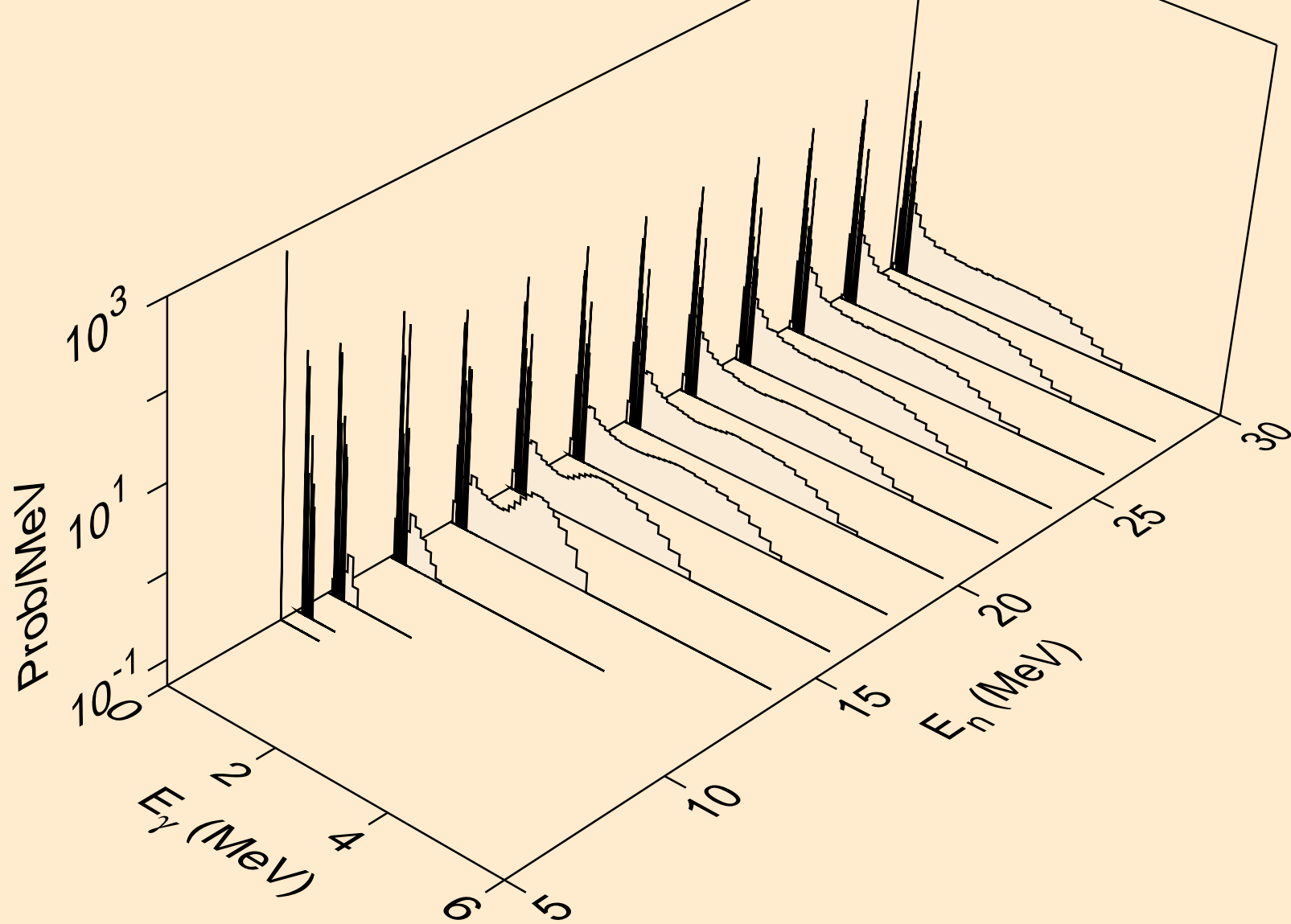

ZR083 NEUTRON ACER TENDL-2024 LIBRARY; T=0.K
Photon emission for (n,he3)

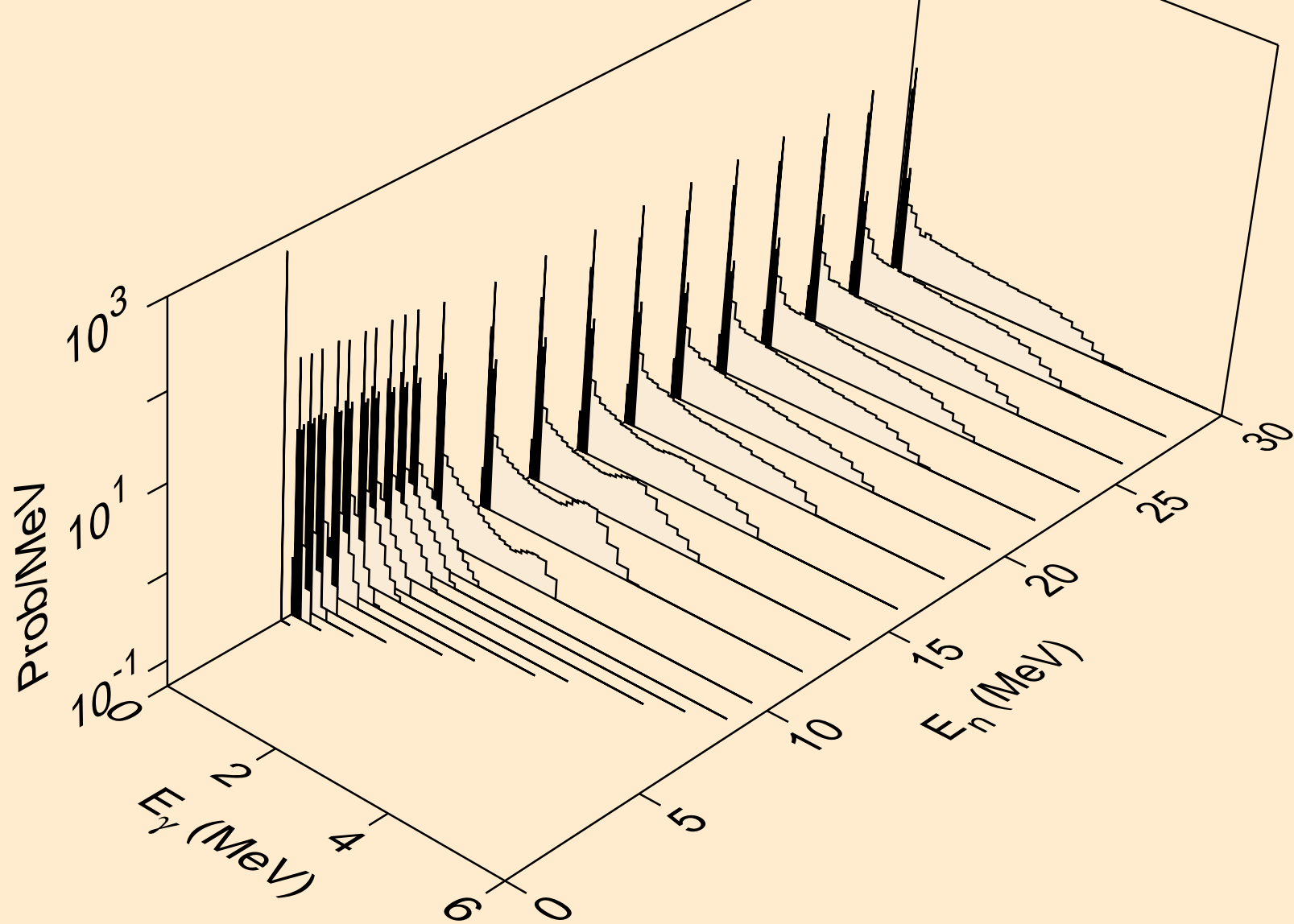

ZR083 NEUTRON ACER TENDL-2024 LIBRARY; T=0.K
Photon emission for (n,a)

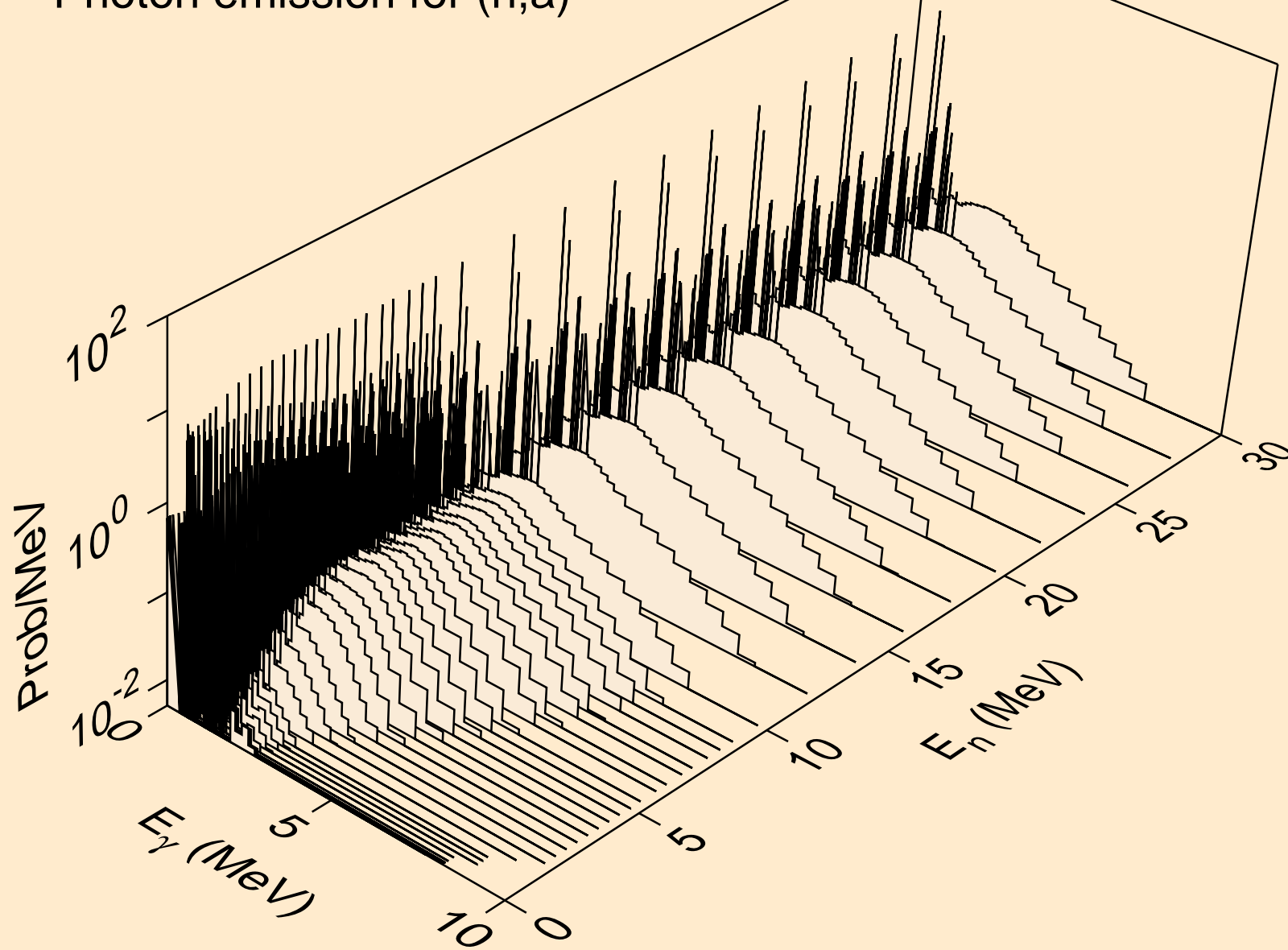

ZR083 NEUTRON ACER TENDL-2024 LIBRARY; T=0.K
Photon emission for (n,2a)

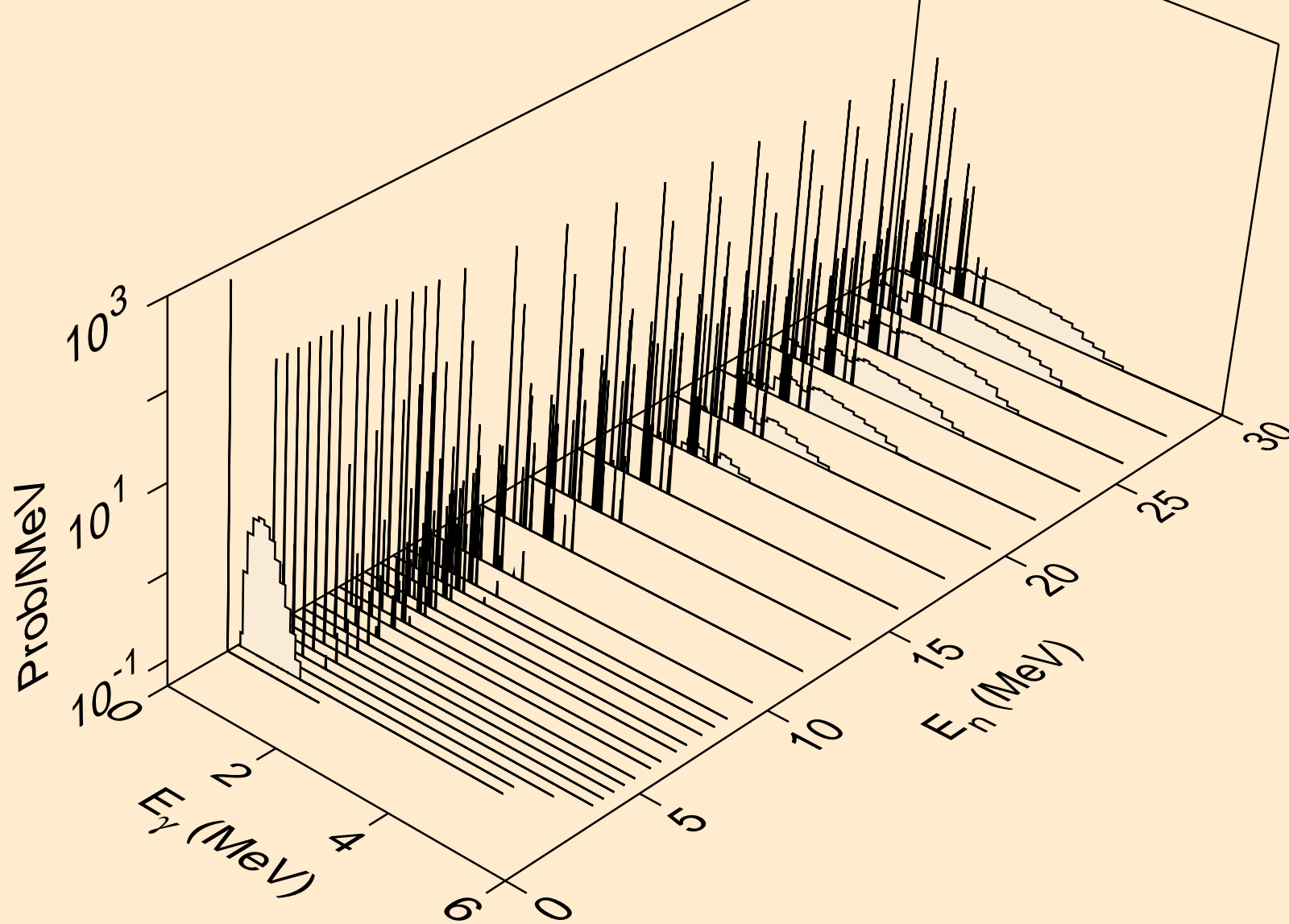

ZR083 NEUTRON ACER TENDL-2024 LIBRARY; T=0.K
Photon emission for (n,3a)

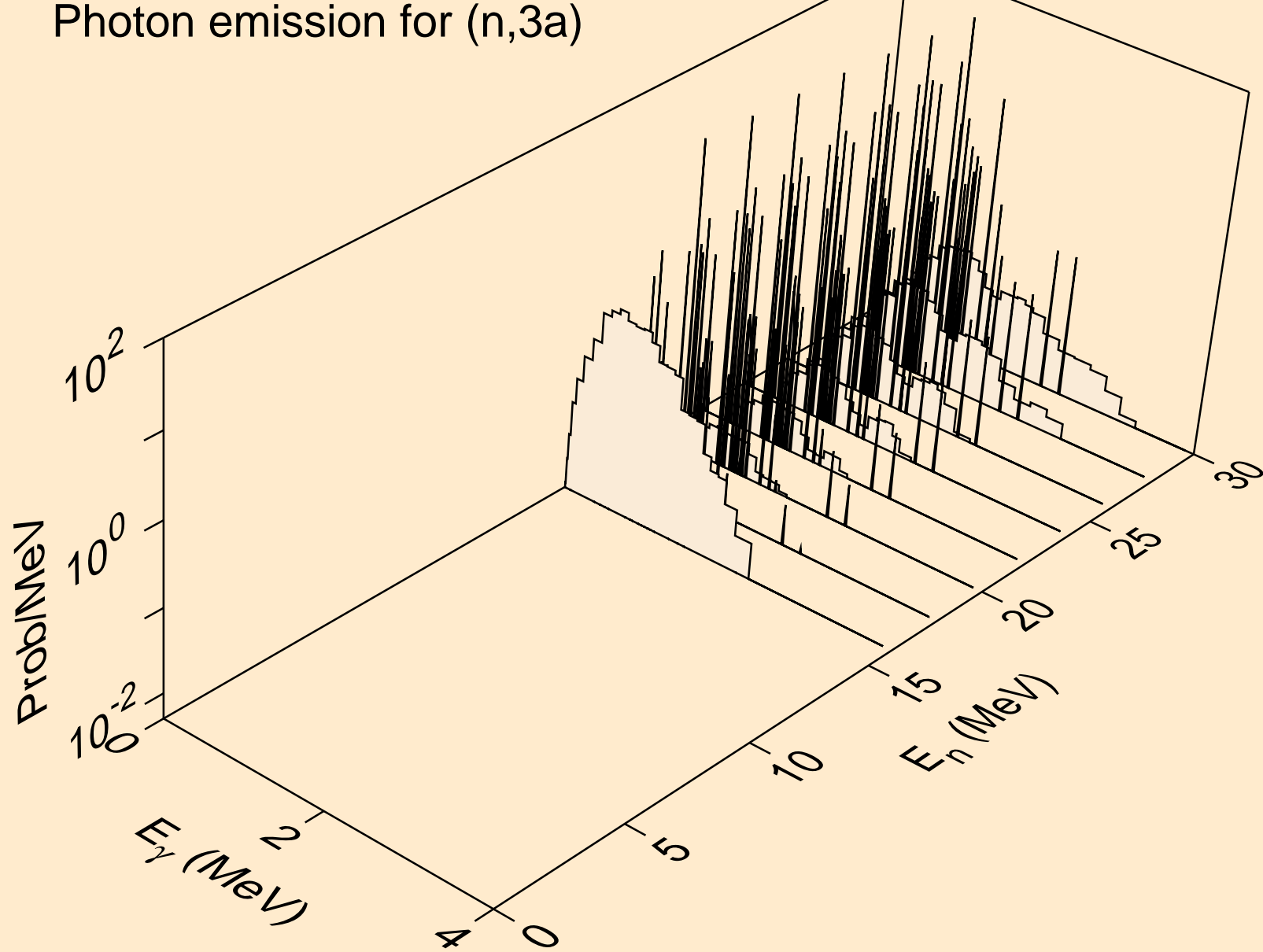

ZR083 NEUTRON ACER TENDL-2024 LIBRARY; T=0.K
Photon emission for (n,2p)

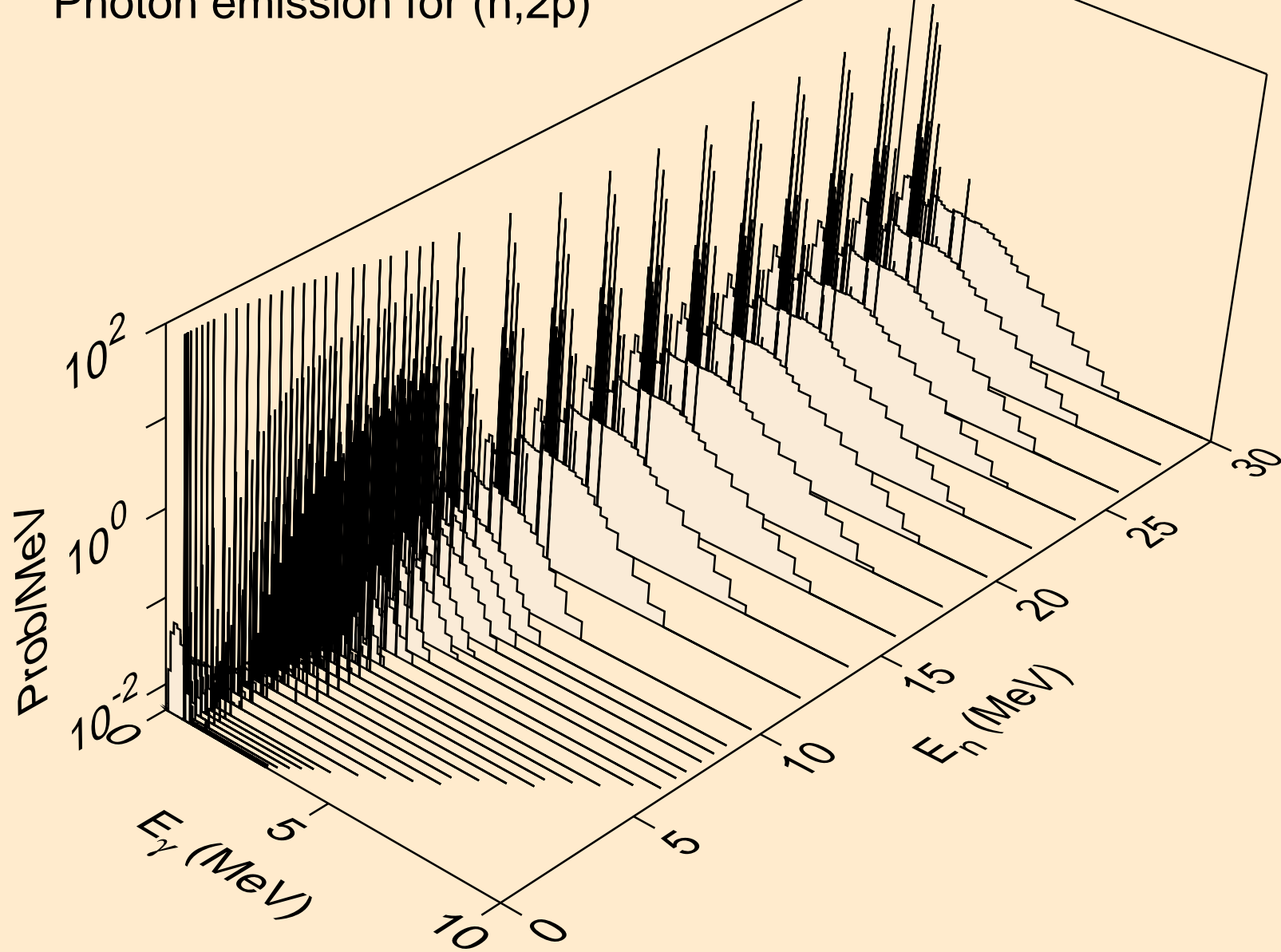

ZR083 NEUTRON ACER TENDL-2024 LIBRARY; T=0.K
Photon emission for (n,p)

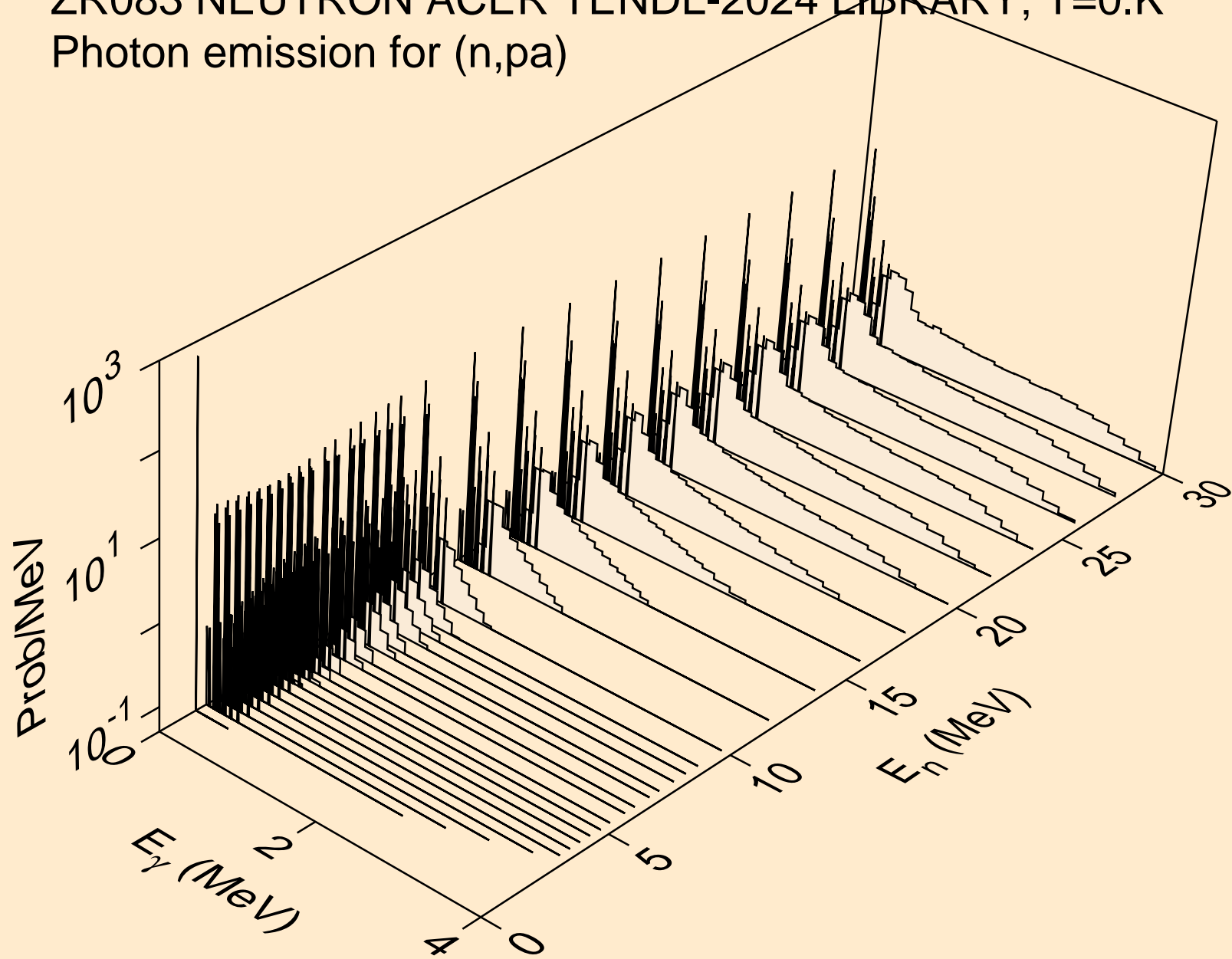

ZR083 NEUTRON ACER TENDL-2024 LIBRARY; T=0.K
Photon emission for (n,pd)

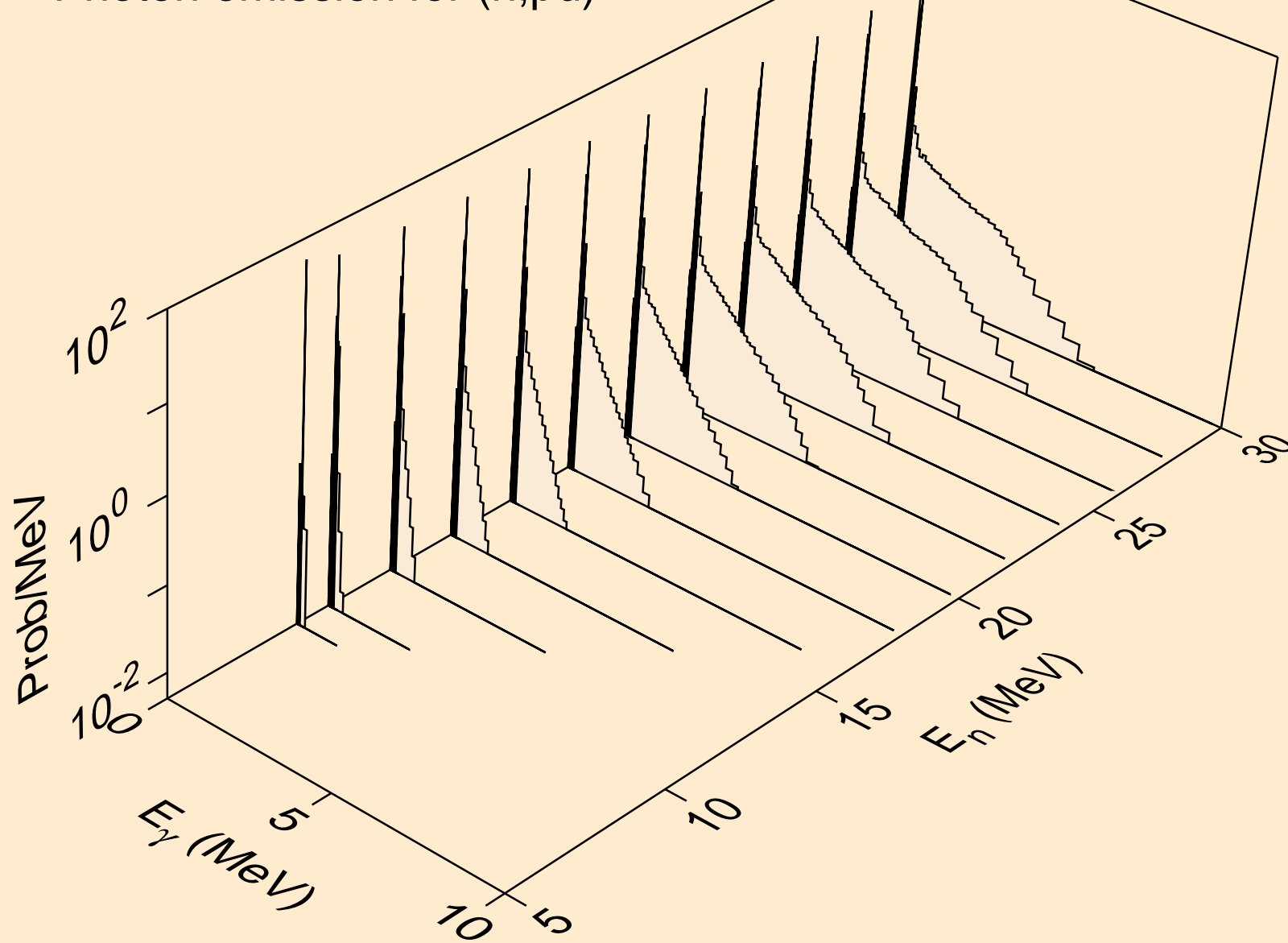

ZR083 NEUTRON ACER TENDL-2024 LIBRARY; T=0.K
Photon emission for (n,pt)

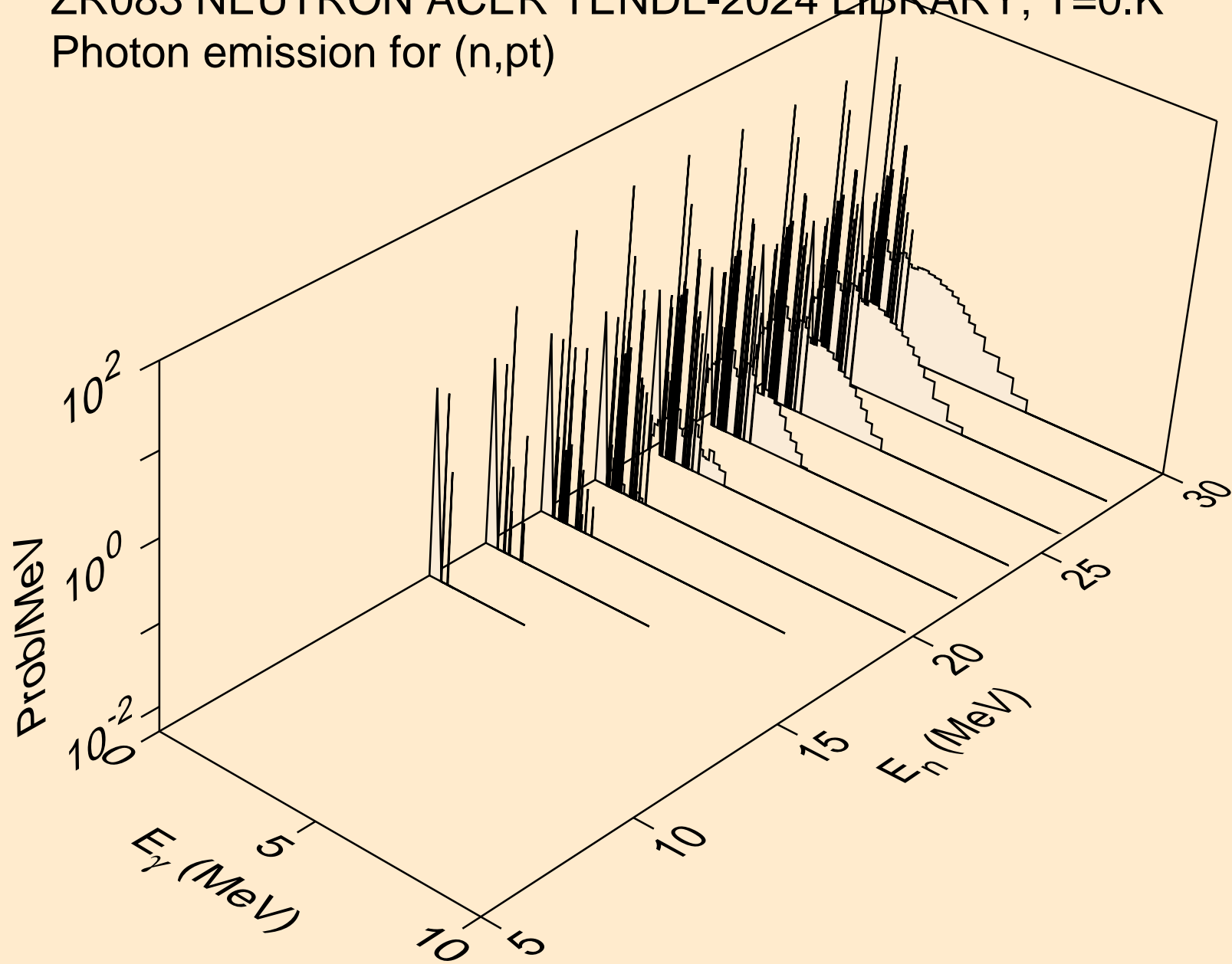

ZR083 NEUTRON ACER TENDL-2024 LIBRARY; T=0.K
Photon emission for (n,da)

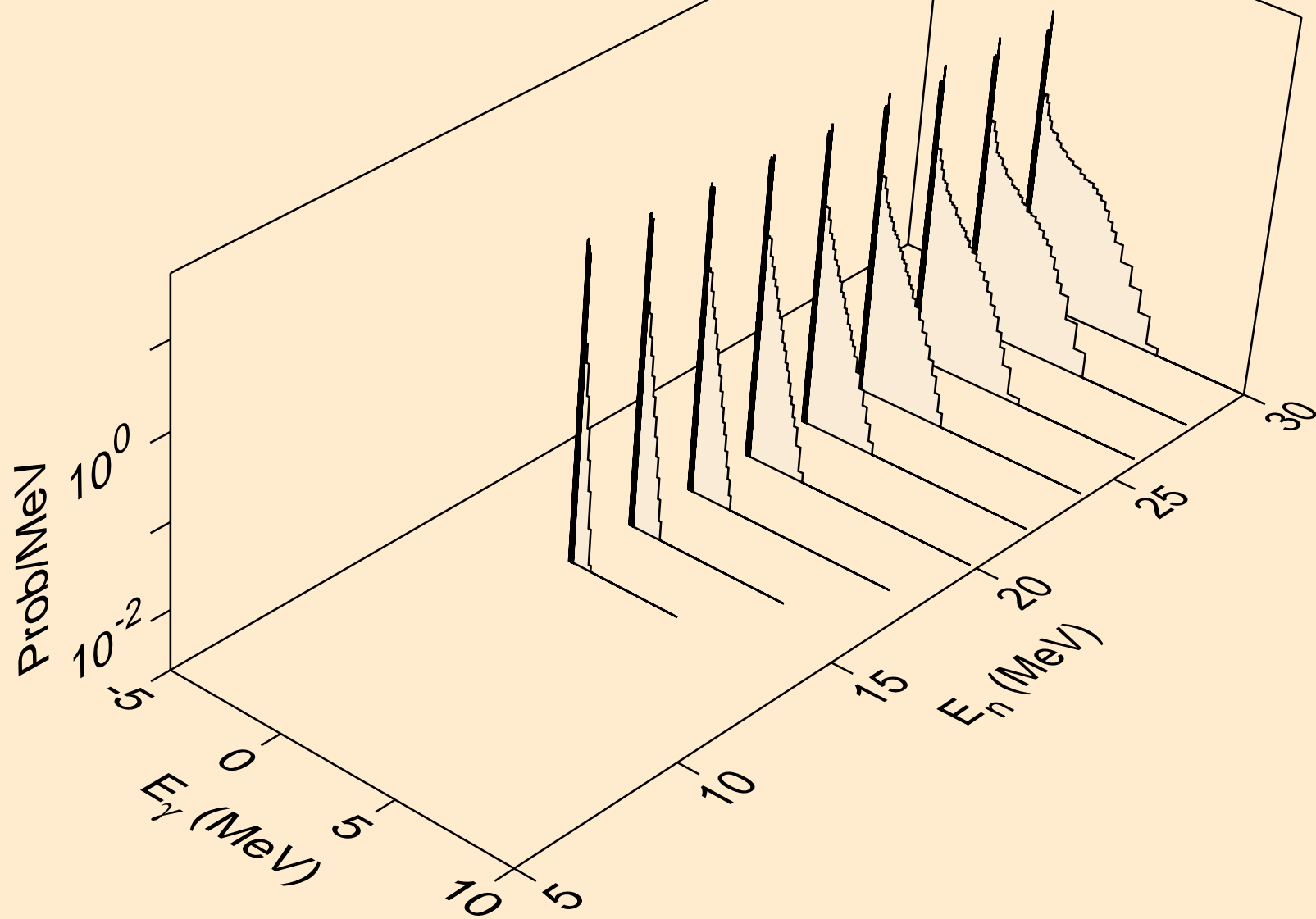

ZR083 NEUTRON ACER TENDL-2024 LIBRARY; T=0.K
14 MeV photon spectrum

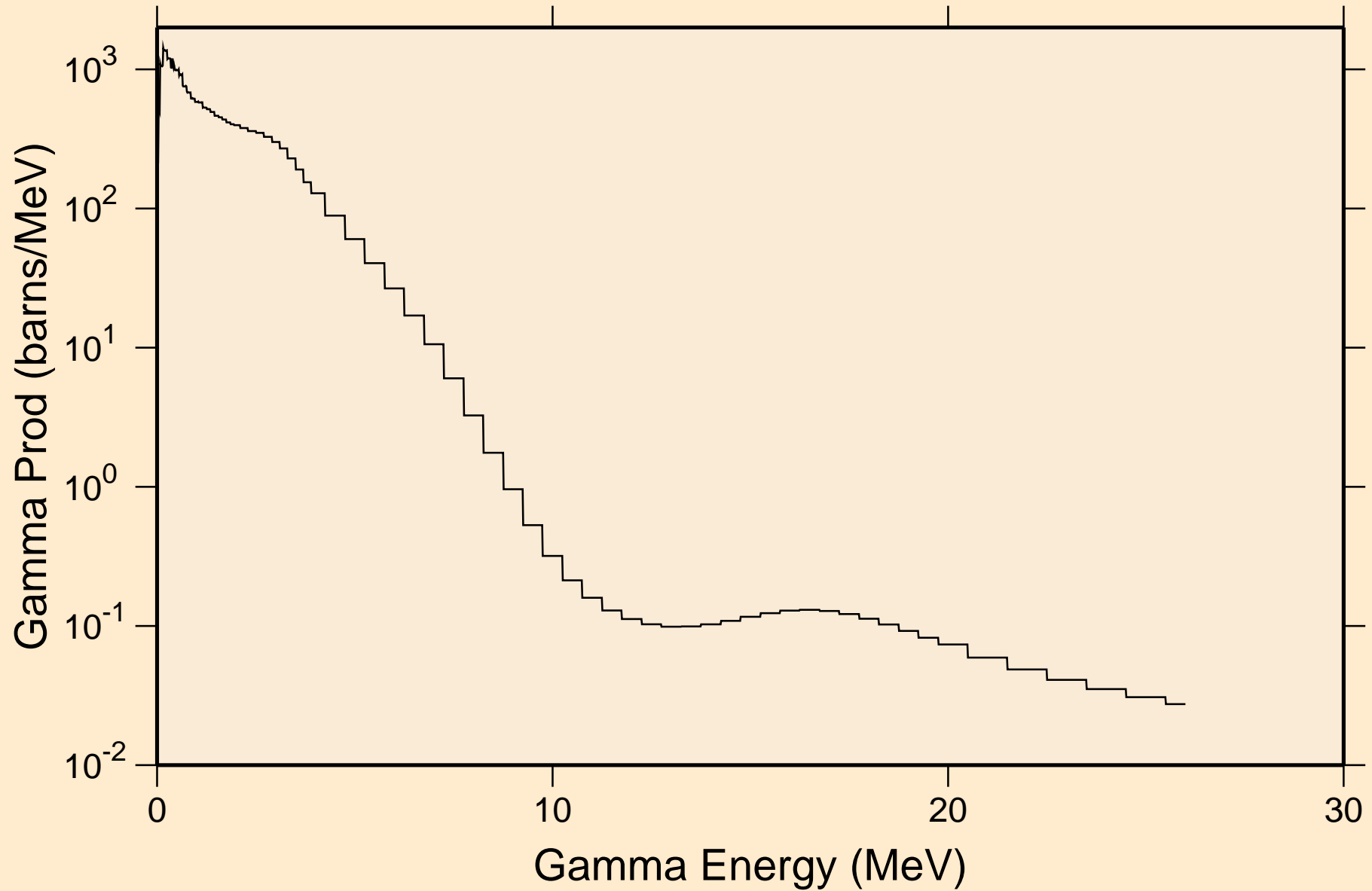

ZR083 NEUTRON ACER TENDL-2024 LIBRARY; T=0.K

Particle heating contributions

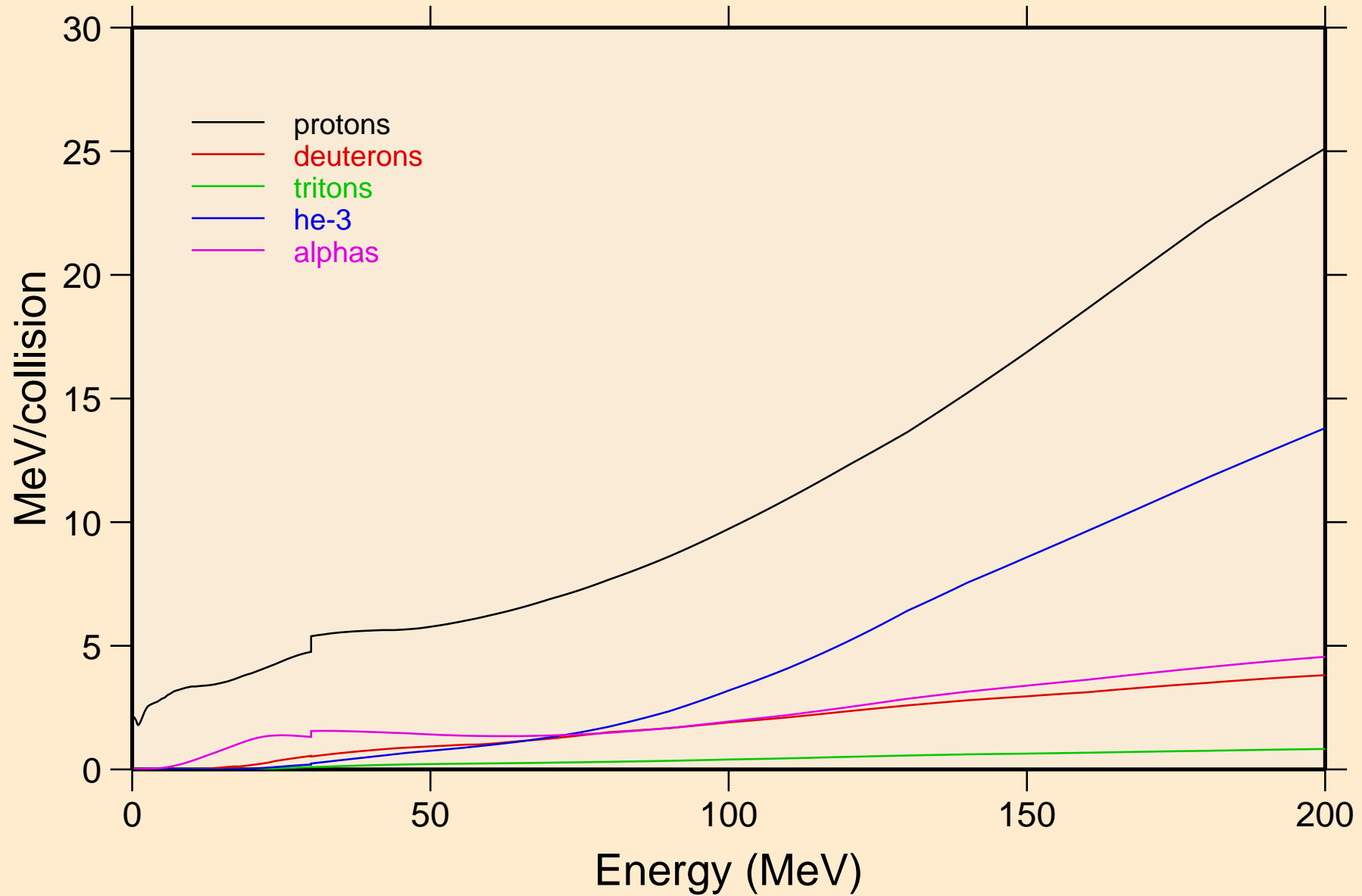

ZR083 NEUTRON ACER TENDL-2024 LIBRARY; T=0.K
Recoil Heating

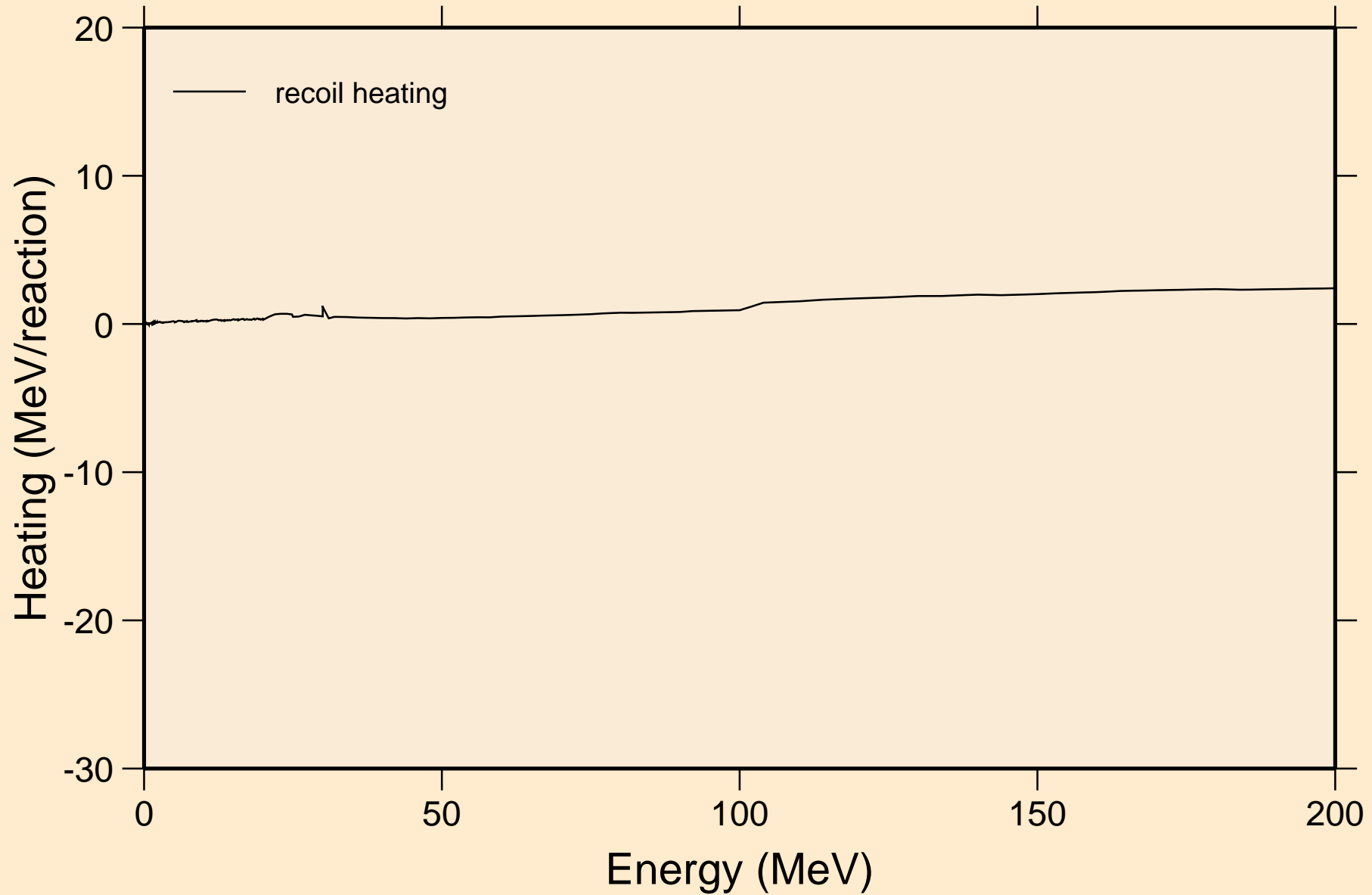

ZR083 NEUTRON ACER TENDL-2024 LIBRARY; T=0.K

Particle production cross sections

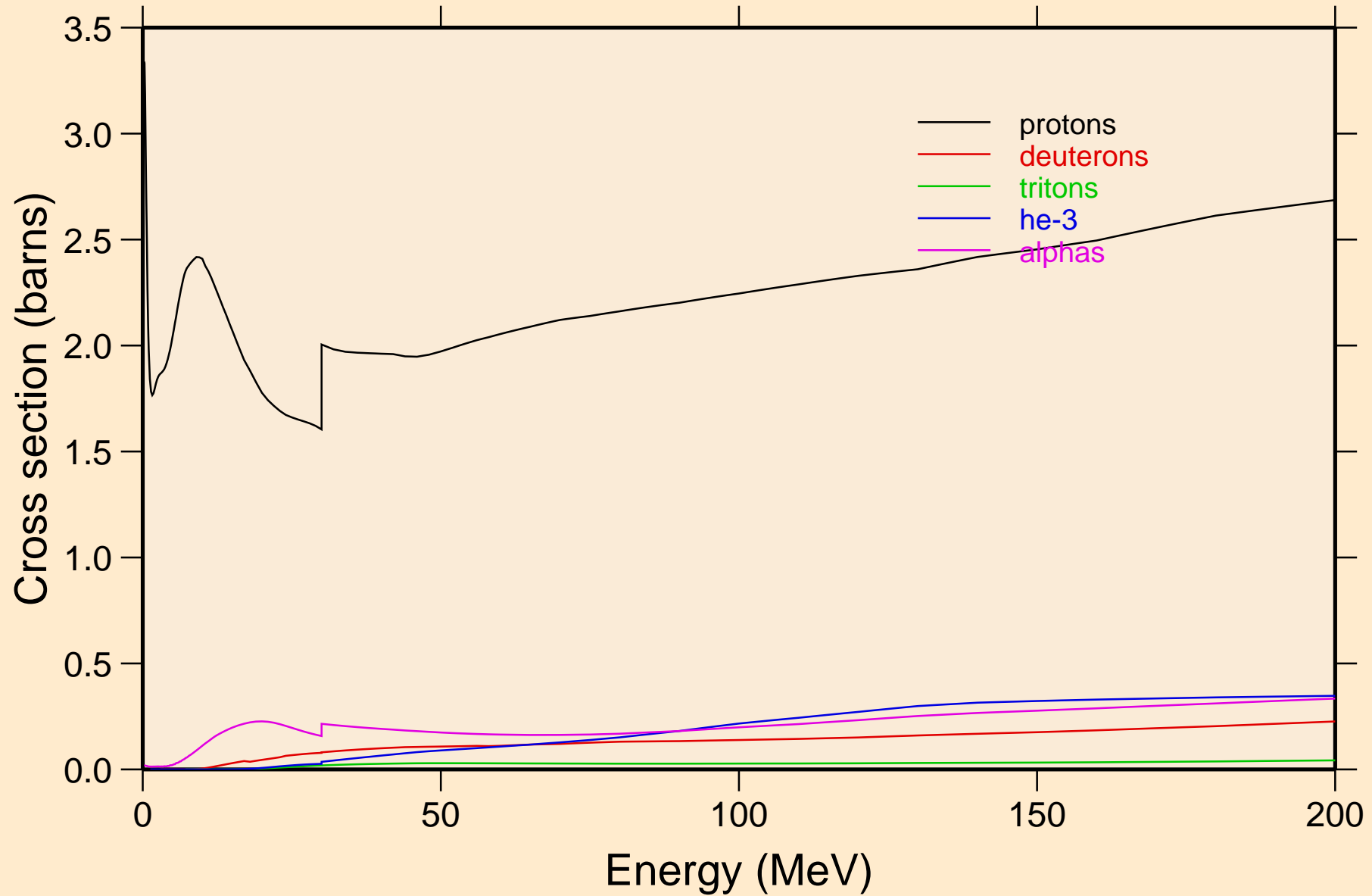

ZR083 NEUTRON ACER TENDL-2024 LIBRARY; T=0.K
protons from (n,x)

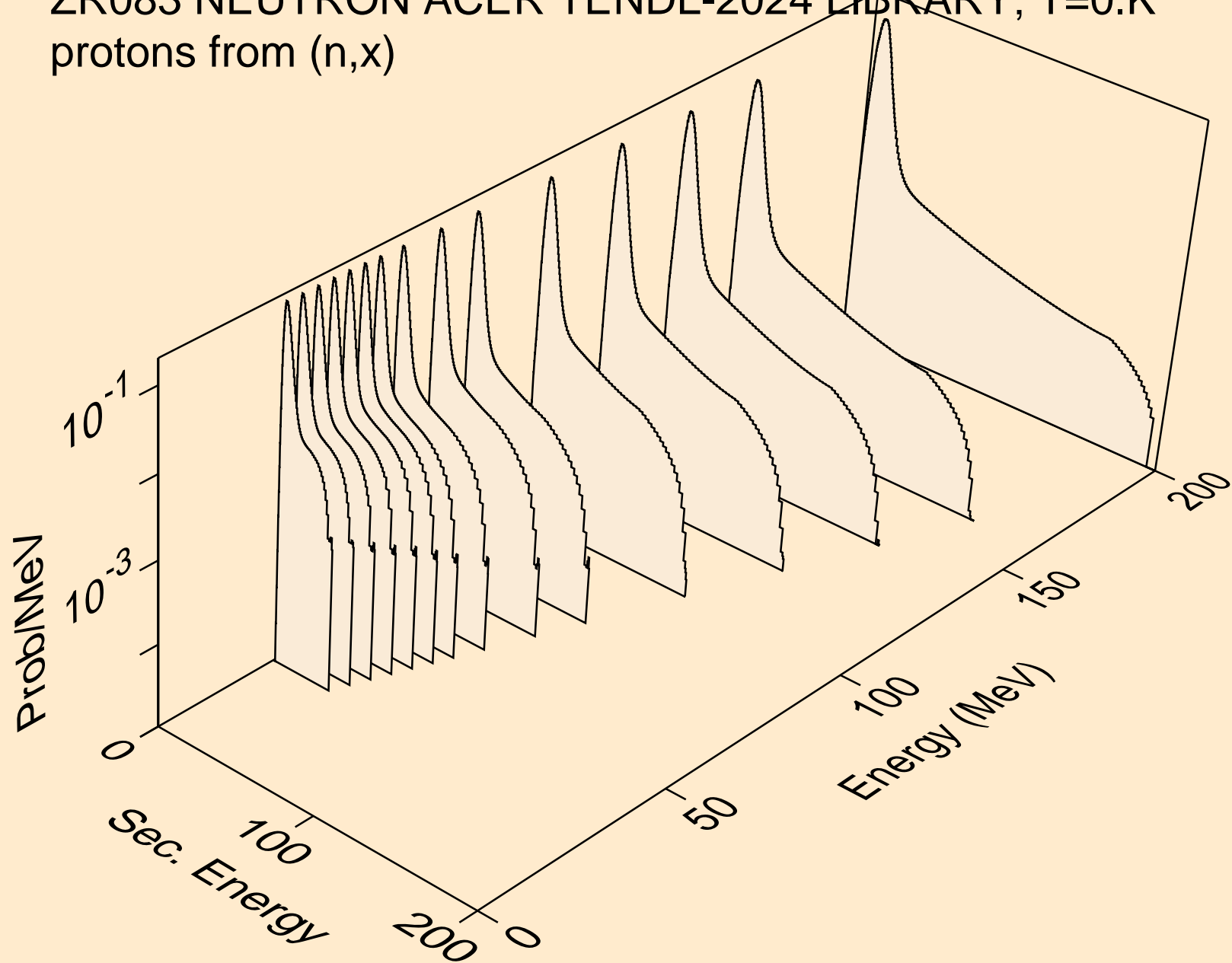

ZR083 NEUTRON ACER TENDL-2024 LIBRARY; T=0.K
protons from (n,n*)p

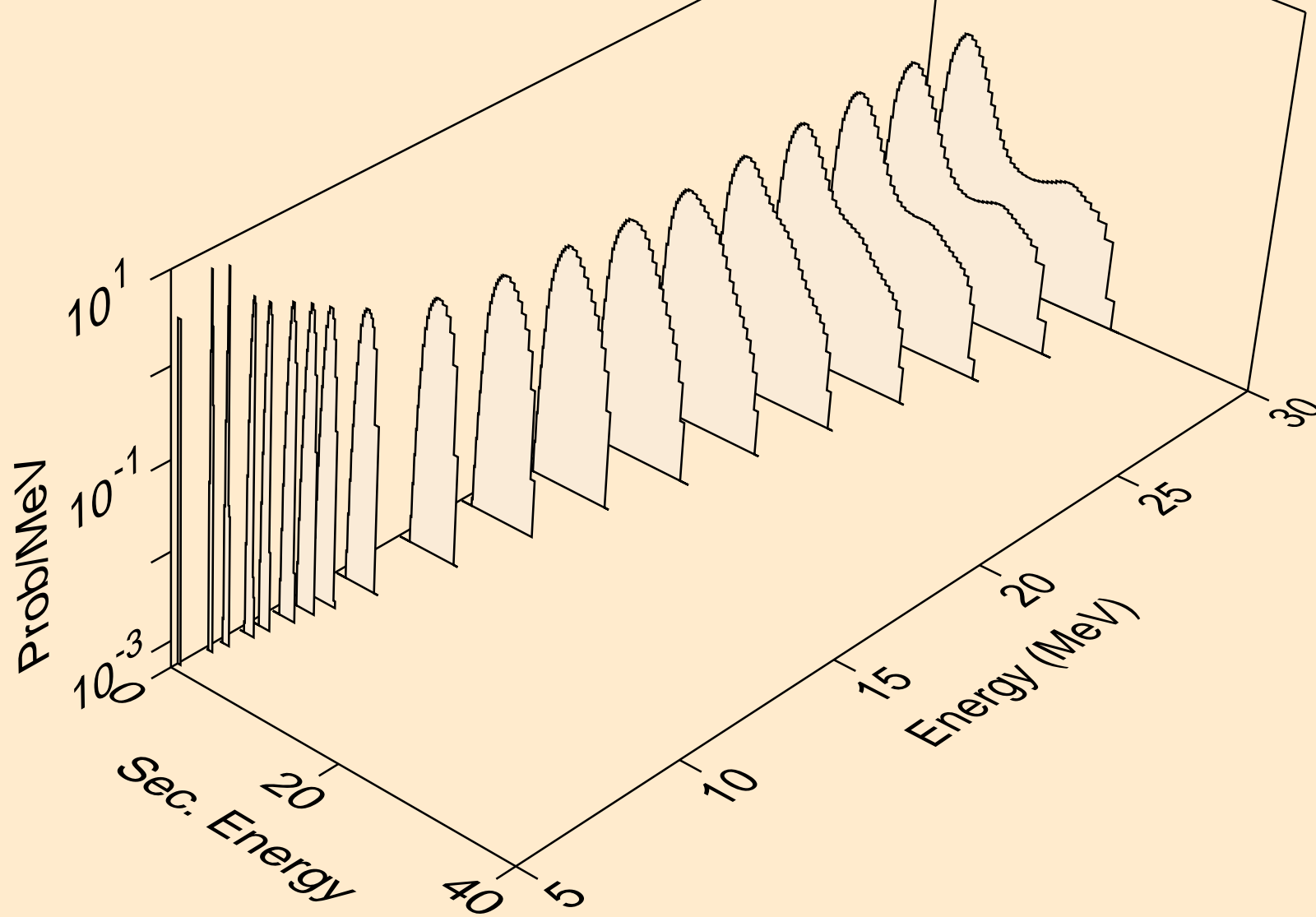

ZR083 NEUTRON ACER TENDL-2024 LIBRARY; T=0.K
protons from (n,2np)

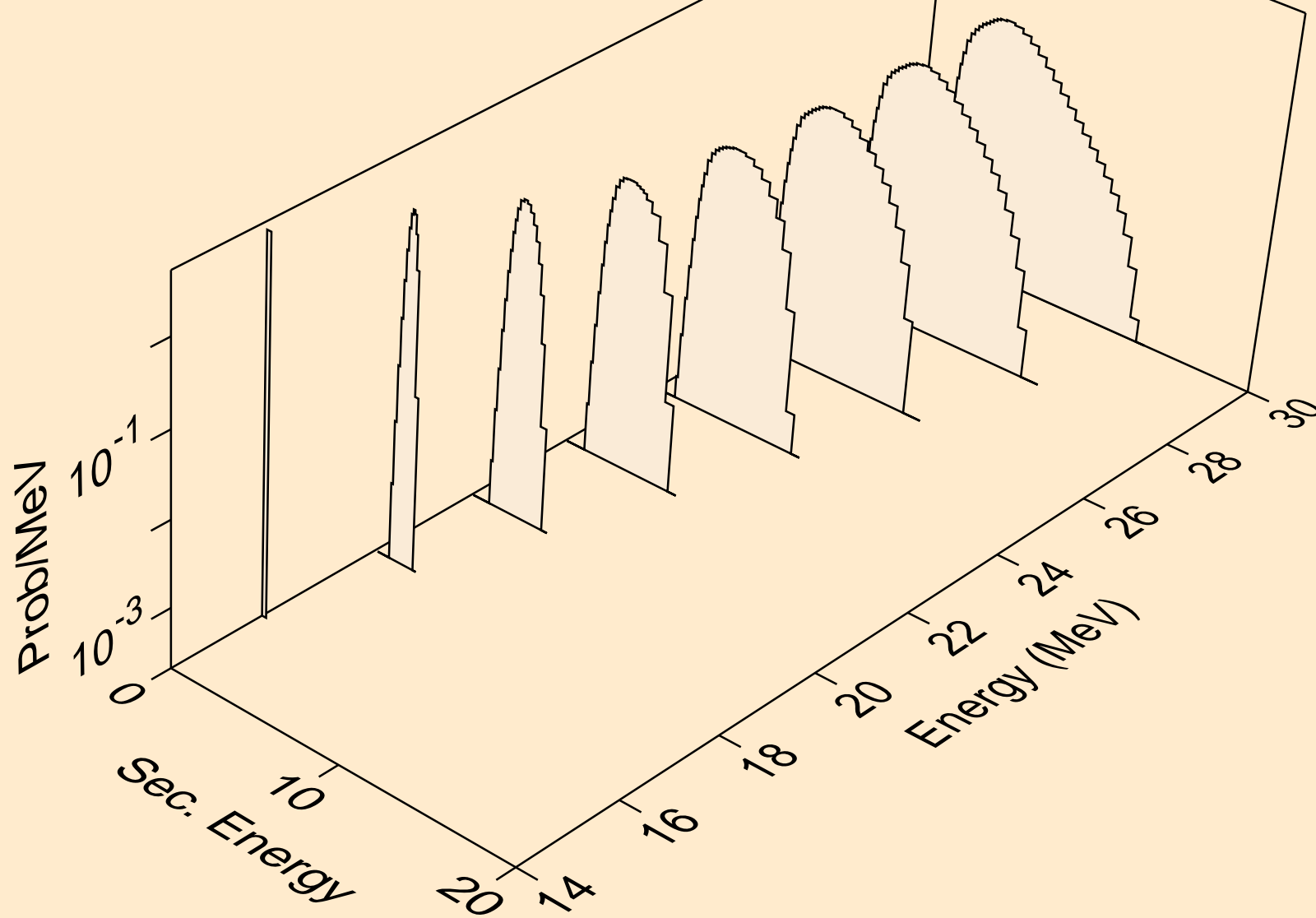

ZR083 NEUTRON ACER TENDL-2024 LIBRARY; T=0.K
protons from (n,n2p)

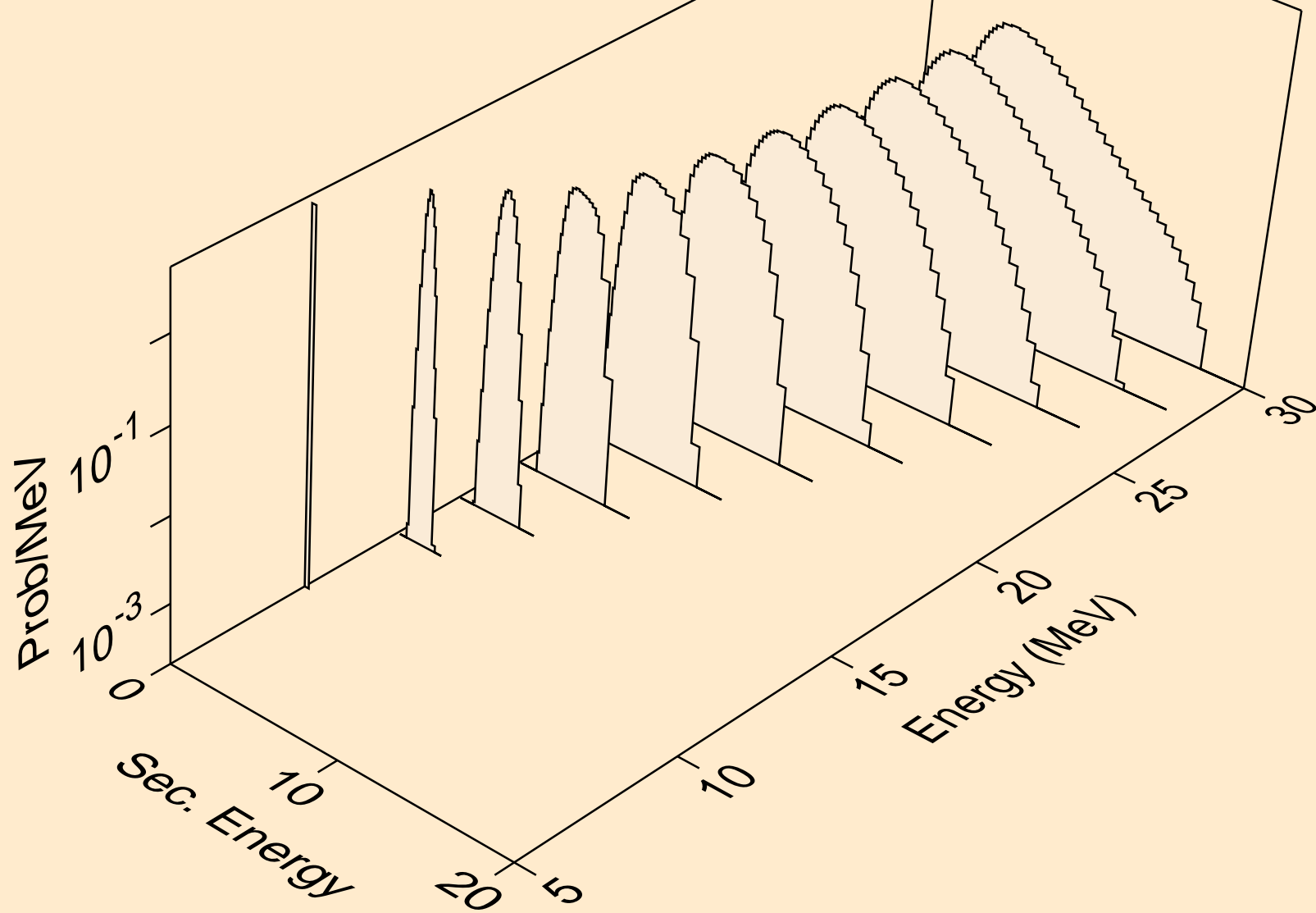

ZR083 NEUTRON ACER TENDL-2024 LIBRARY; T=0.K
protons from (n,npa)

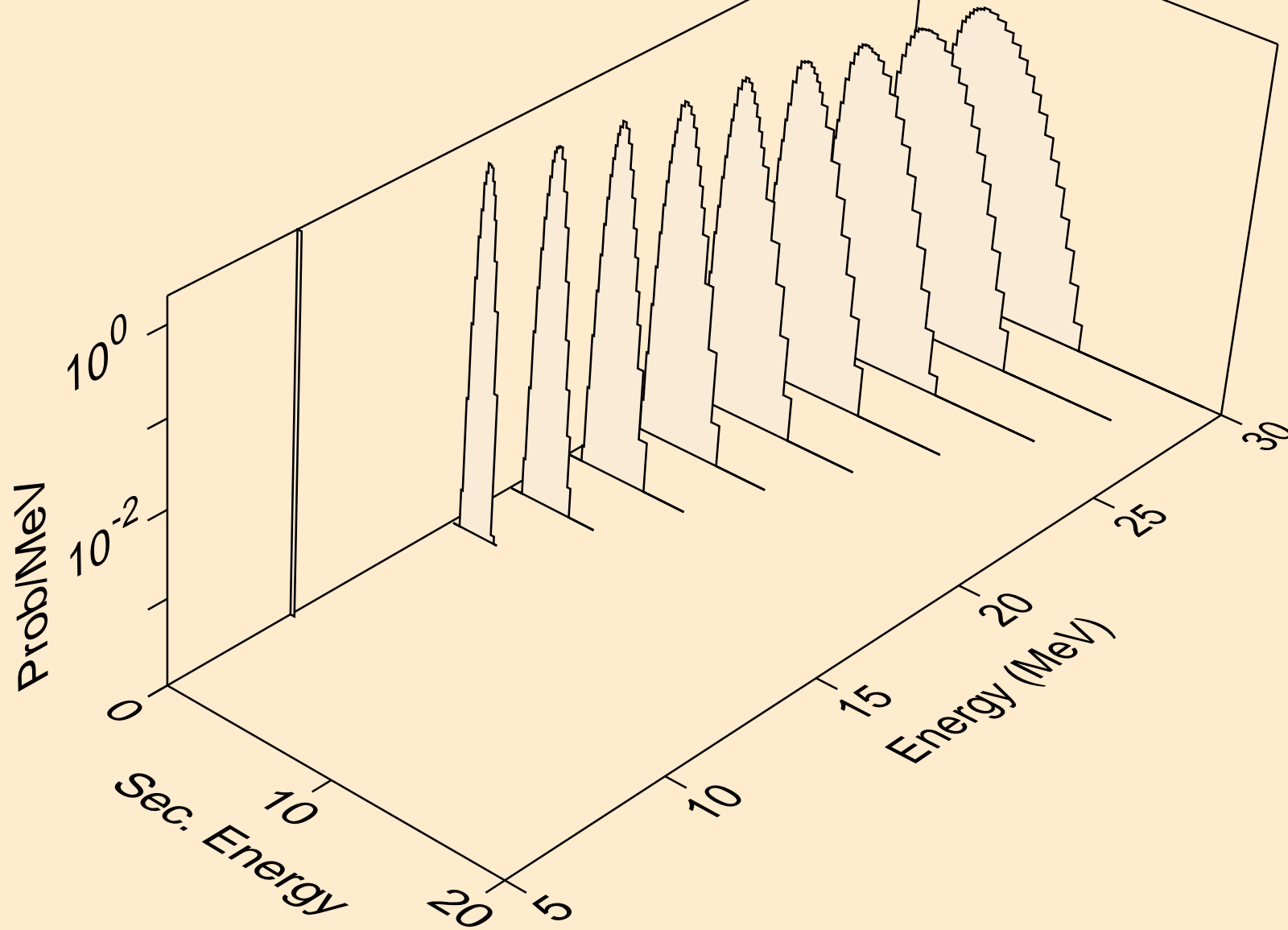

ZR083 NEUTRON ACER TENDL-2024 LIBRARY; T=0.K
protons from (n,p)

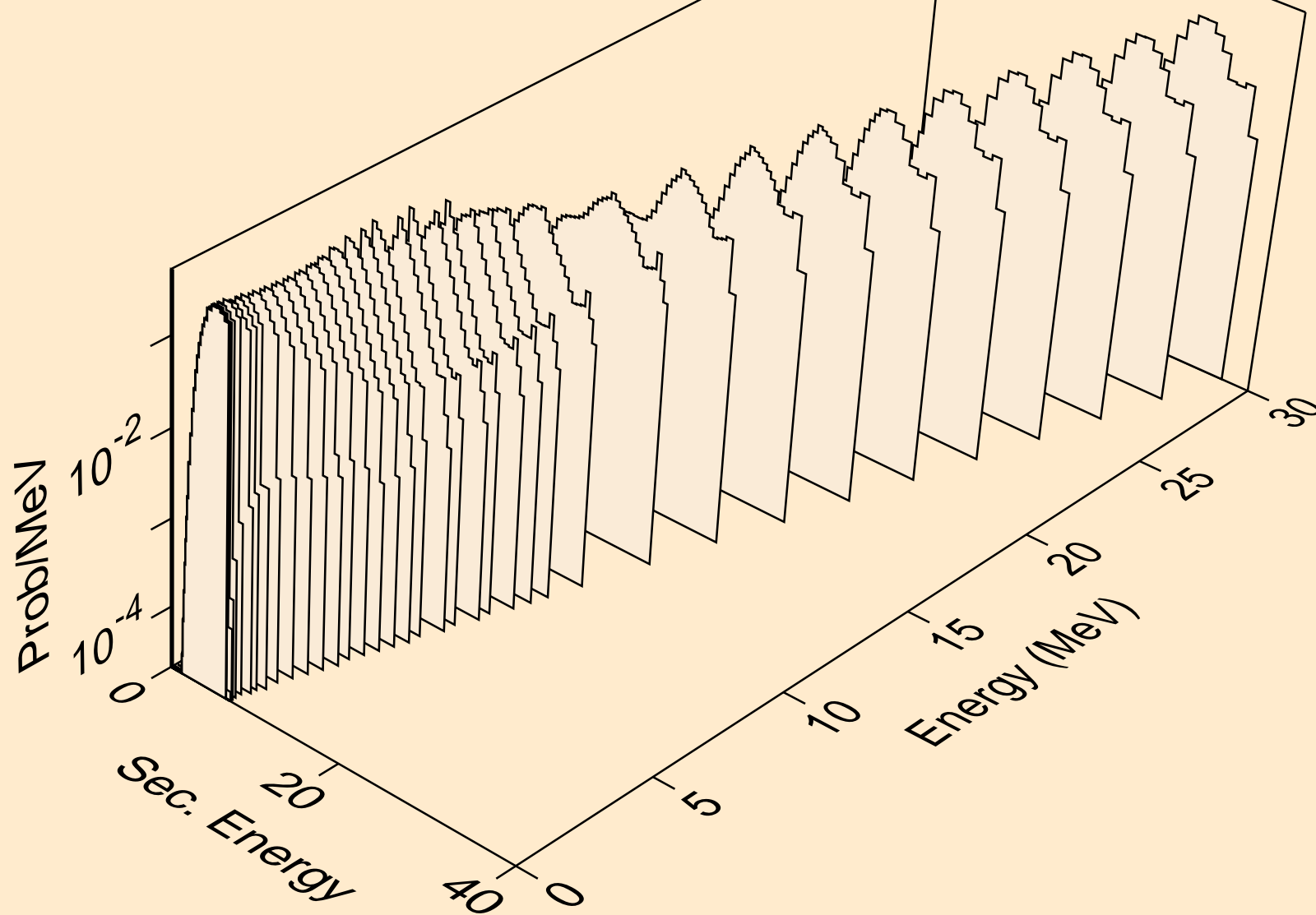

ZR083 NEUTRON ACER TENDL-2024 LIBRARY; T=0.K
protons from (n,2p)

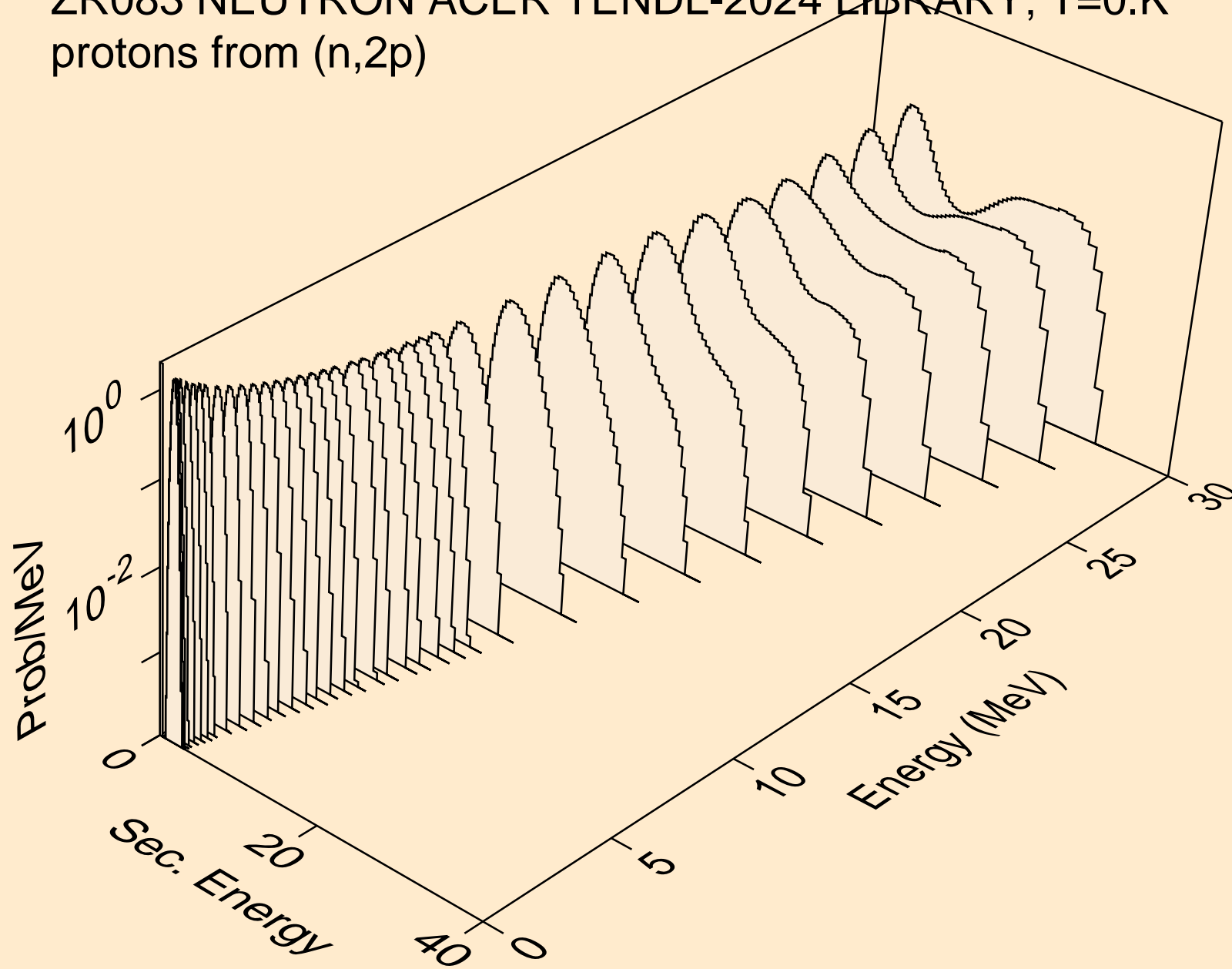

ZR083 NEUTRON ACER TENDL-2024 LIBRARY; T=0.K
protons from (n,p)

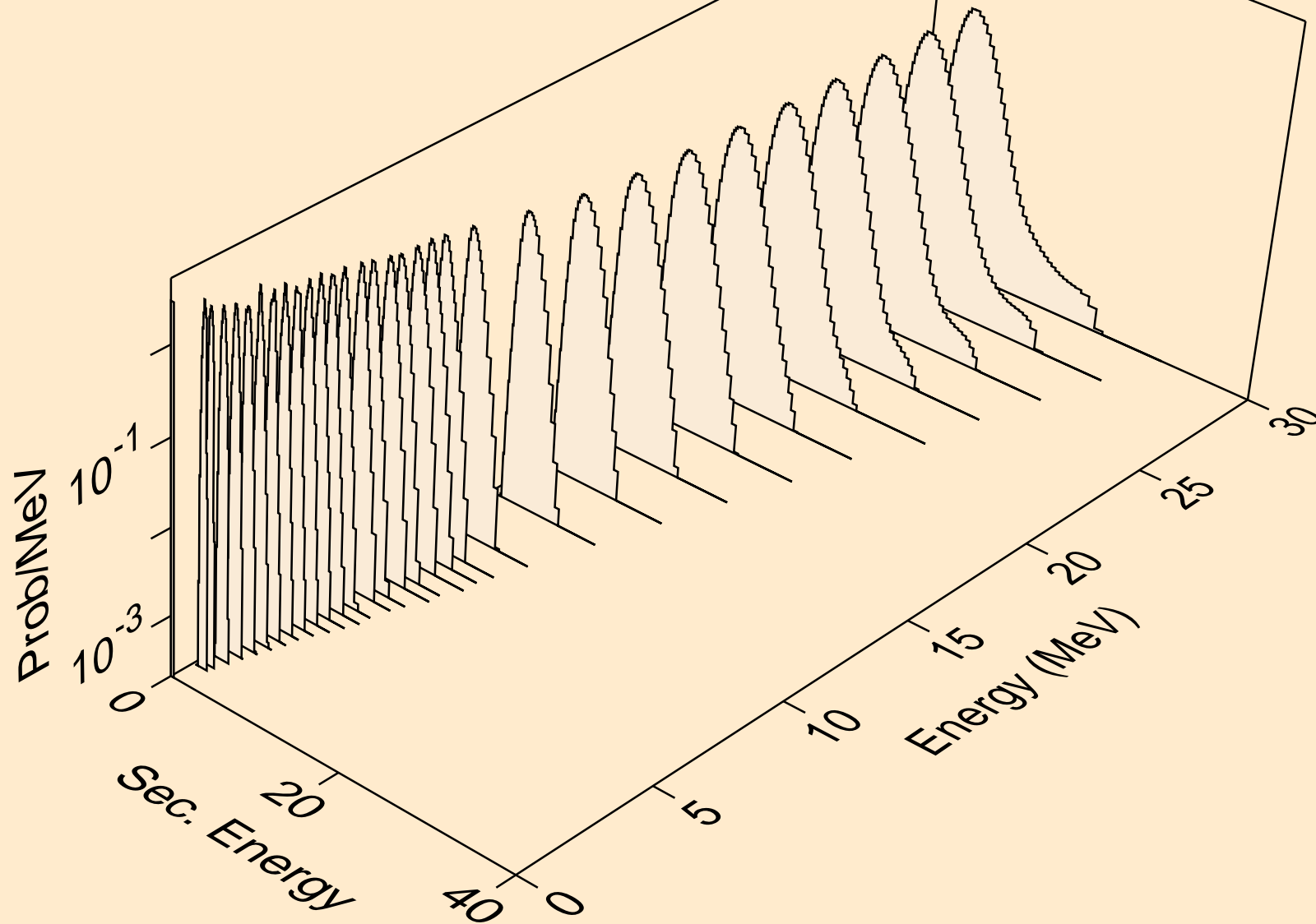

ZR083 NEUTRON ACER TENDL-2024 LIBRARY; T=0.K
protons from (n,pd)

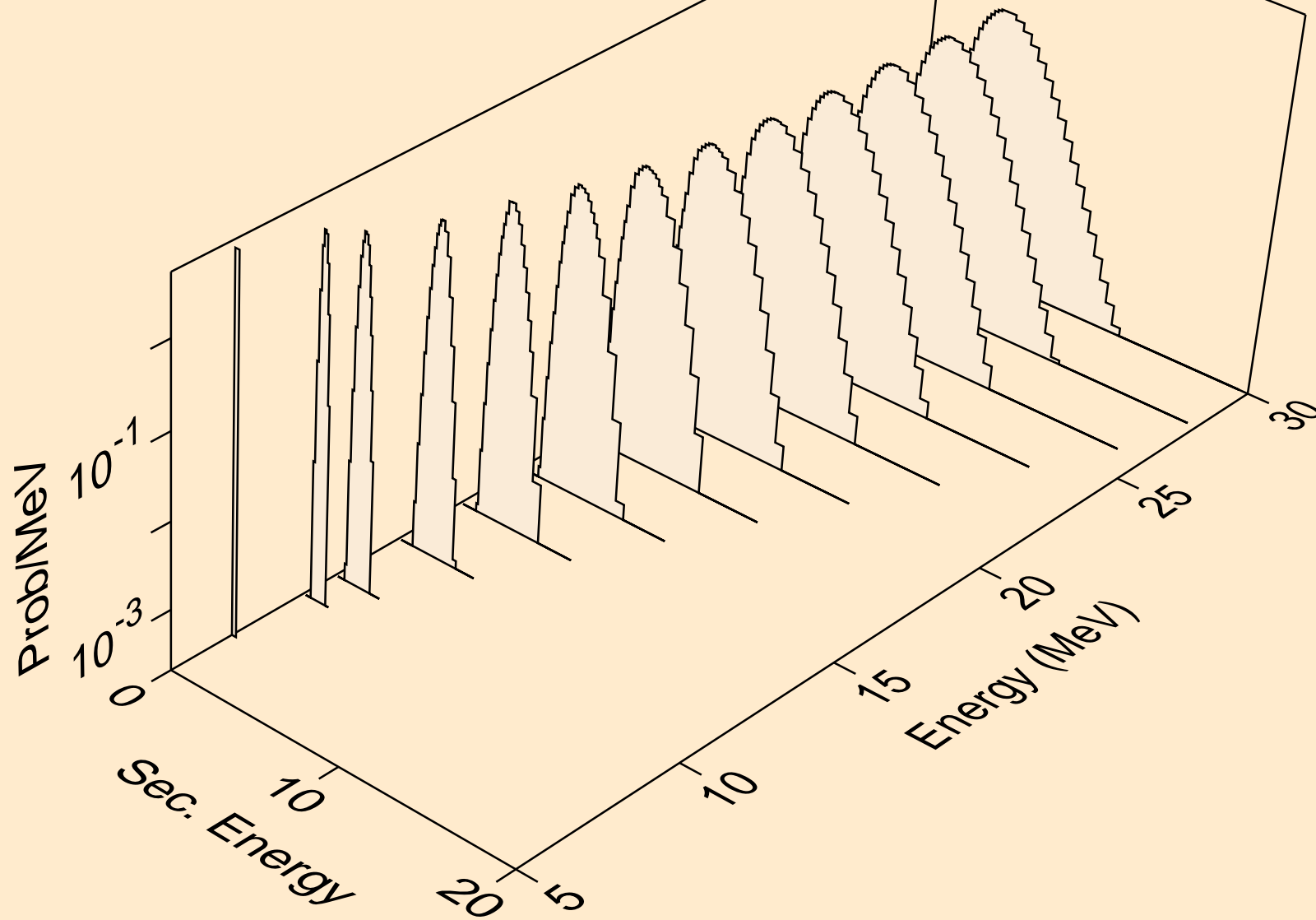

ZR083 NEUTRON ACER TENDL-2024 LIBRARY; T=0.K
protons from (n,pt)

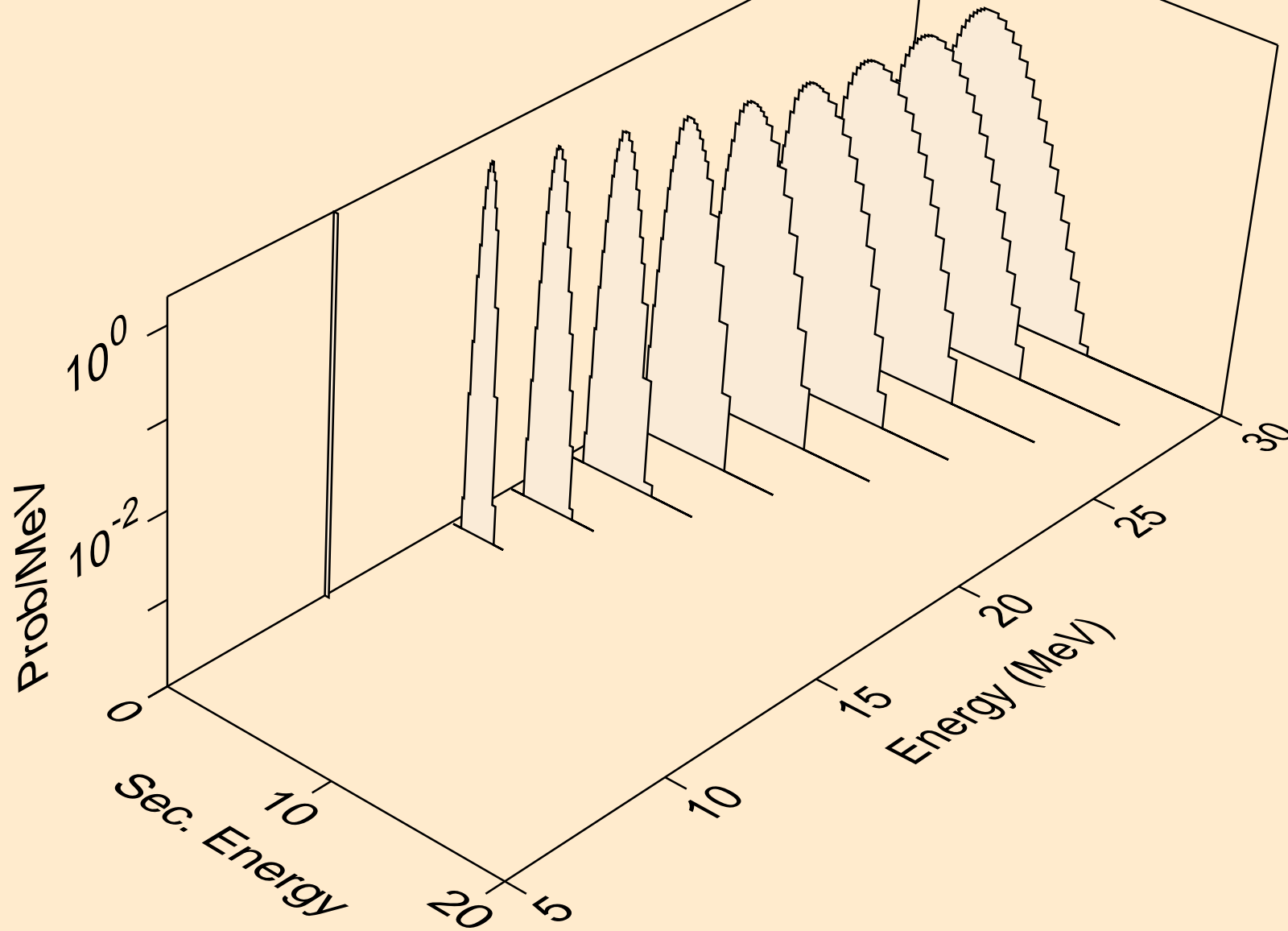

ZR083 NEUTRON ACER TENDL-2024 LIBRARY; T=0.K
deuterons from (n,x)

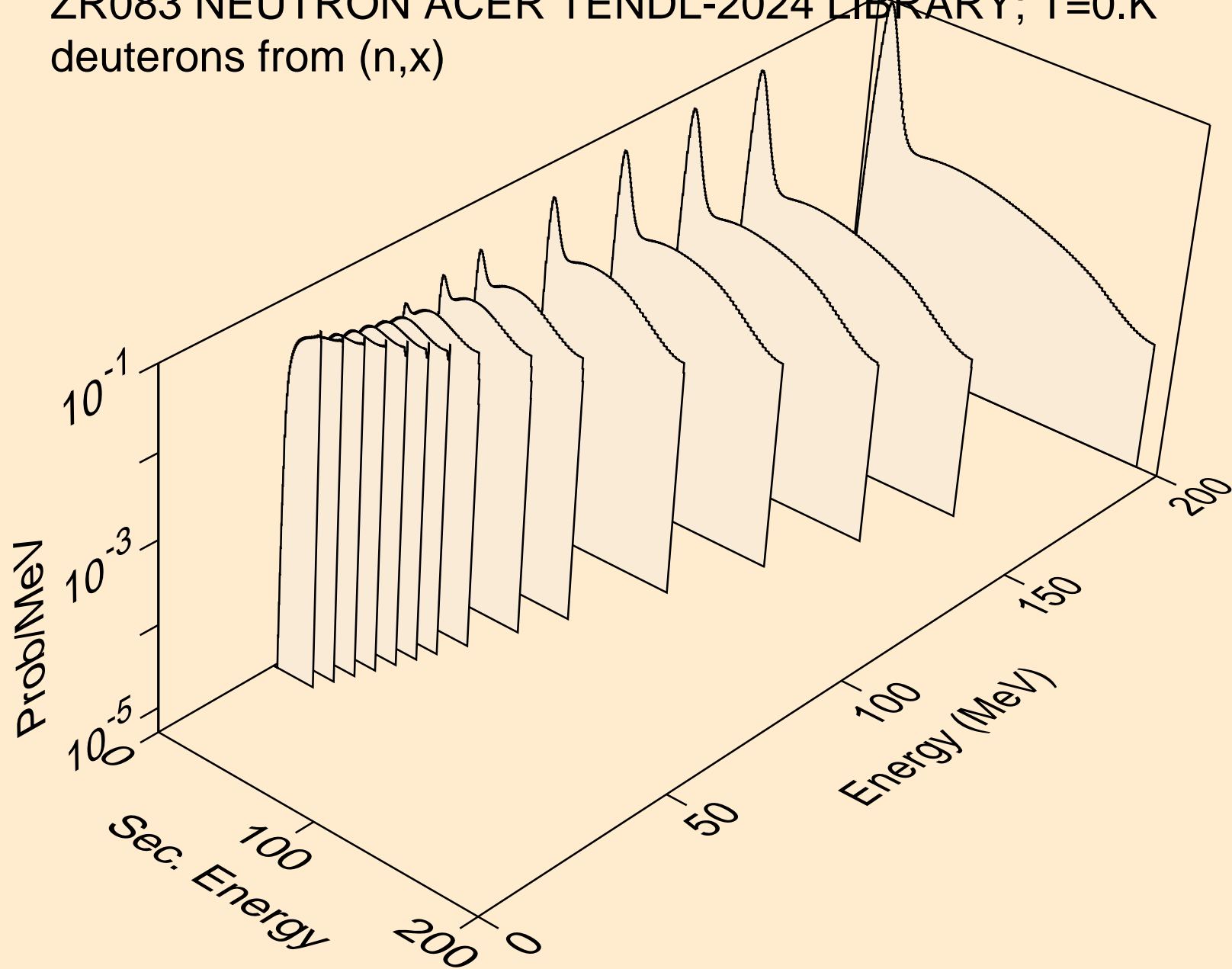

ZR083 NEUTRON ACER TENDL-2024 LIBRARY; T=0.K
deuterons from (n,n*)d

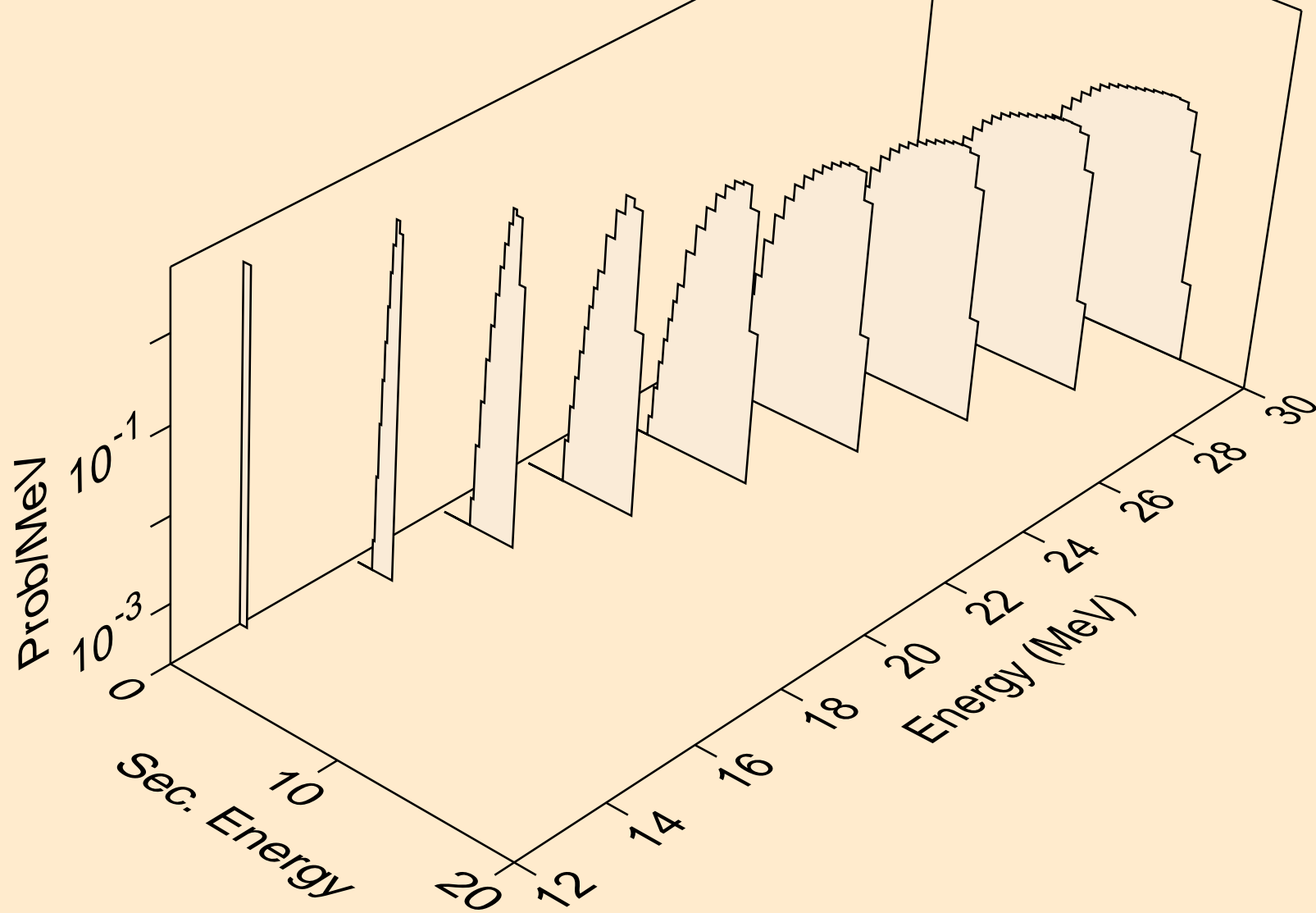

ZR083 NEUTRON ACER TENDL-2024 LIBRARY; T=0.K
deuterons from (n,d)

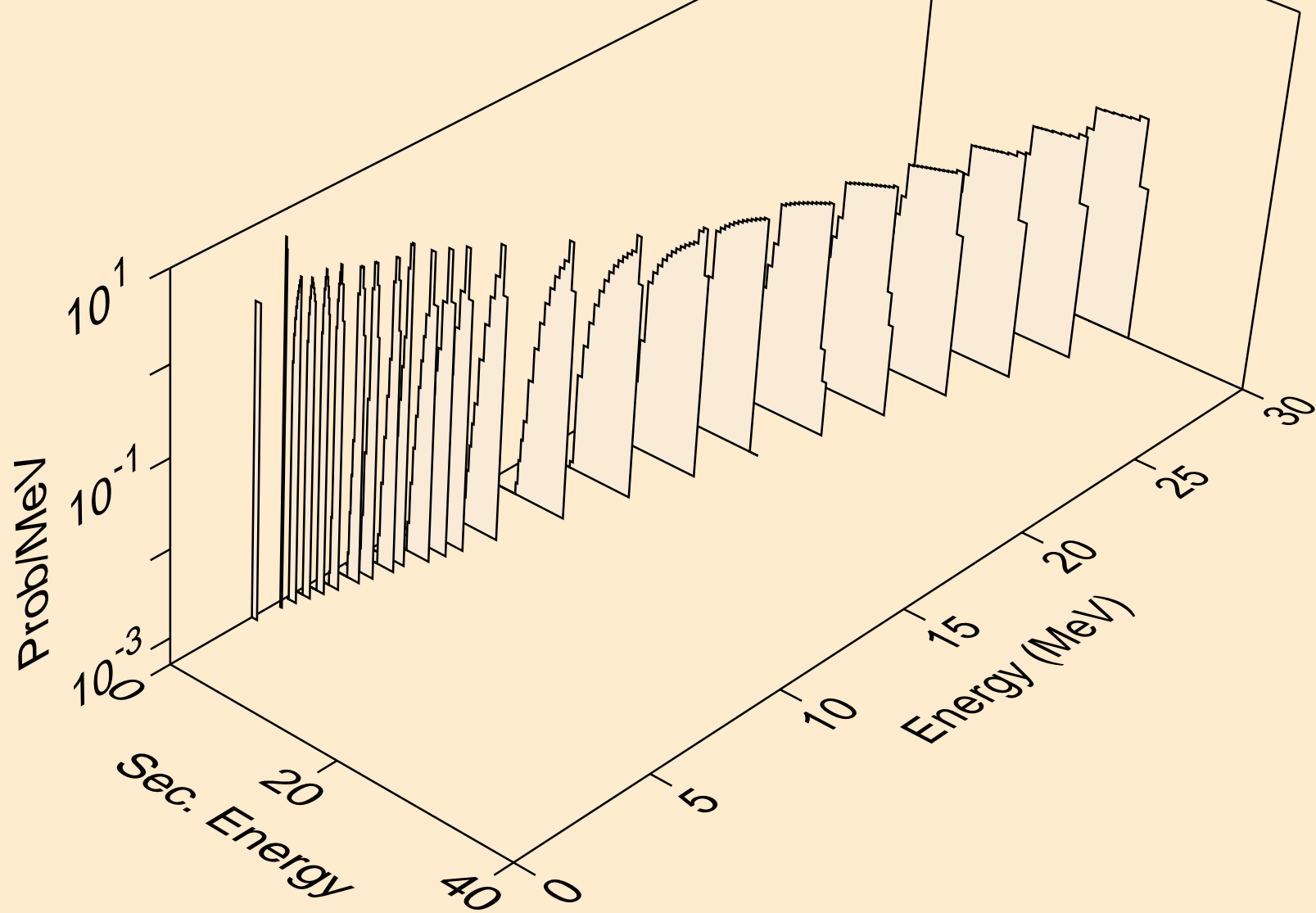

ZR083 NEUTRON ACER TENDL-2024 LIBRARY; T=0.K
deuterons from (n,pd)

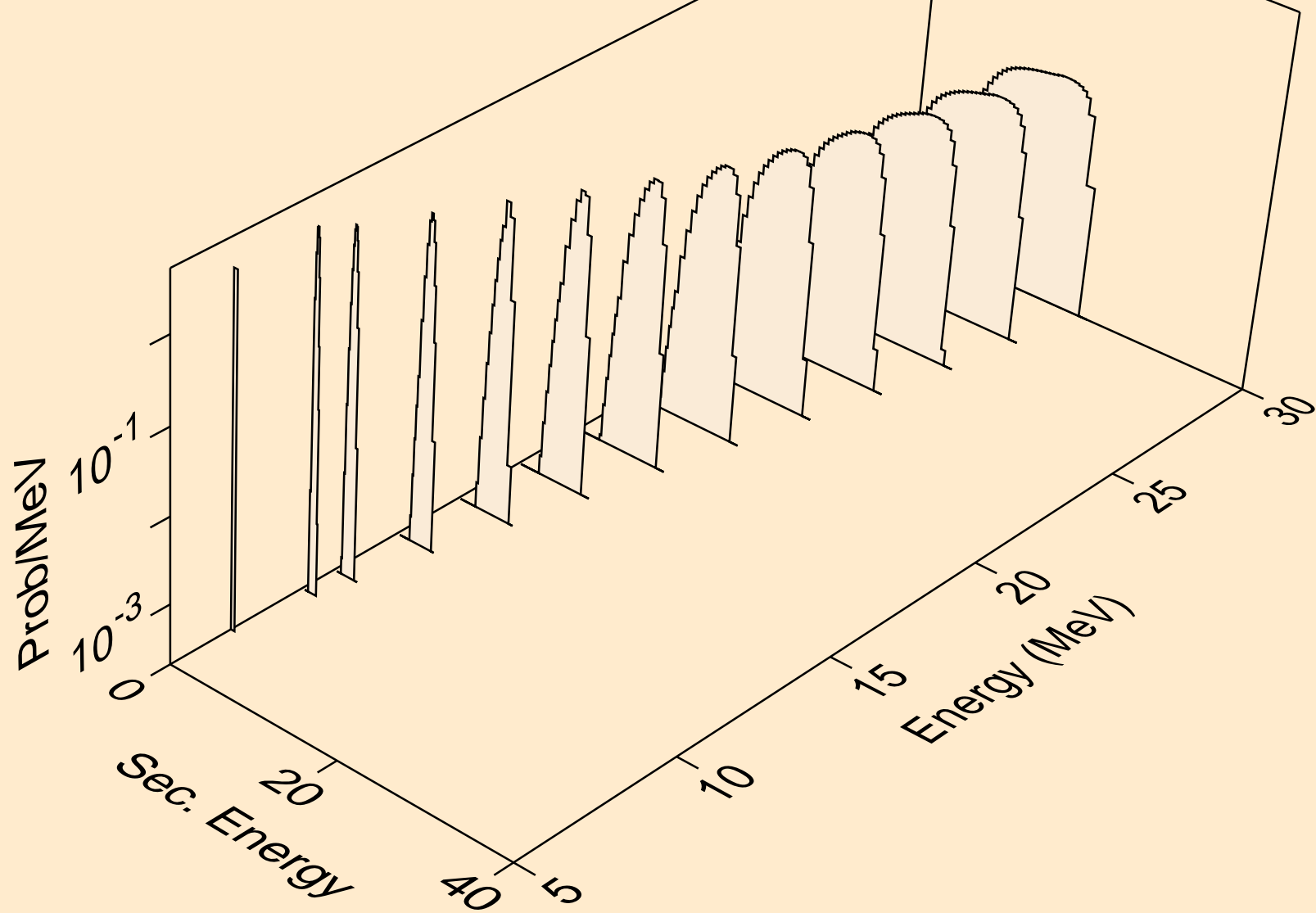

ZR083 NEUTRON ACER TENDL-2024 LIBRARY; T=0.K
deuterons from (n,da)

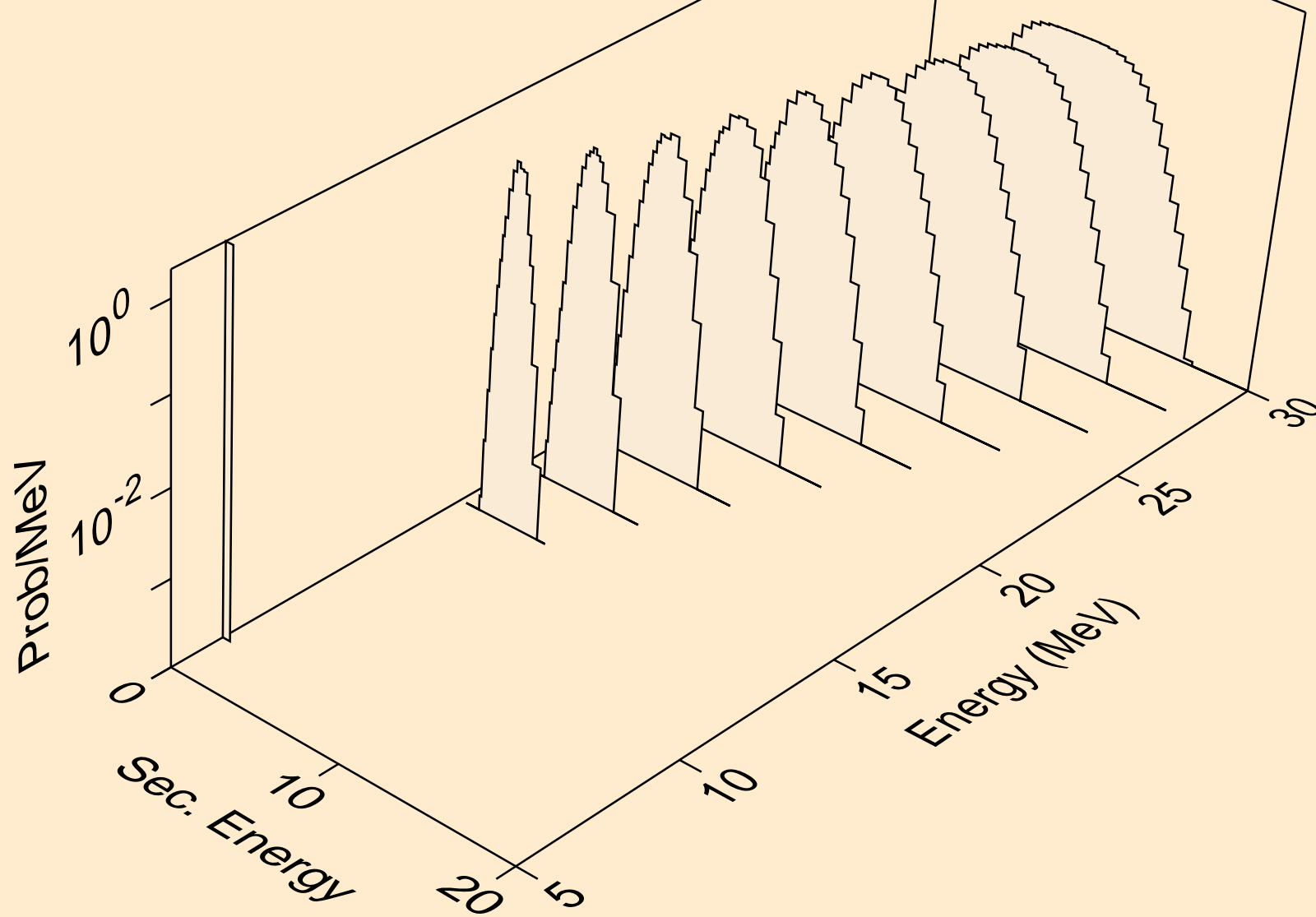

ZR083 NEUTRON ACER TENDL-2024 LIBRARY; T=0.K
tritons from (n,x)

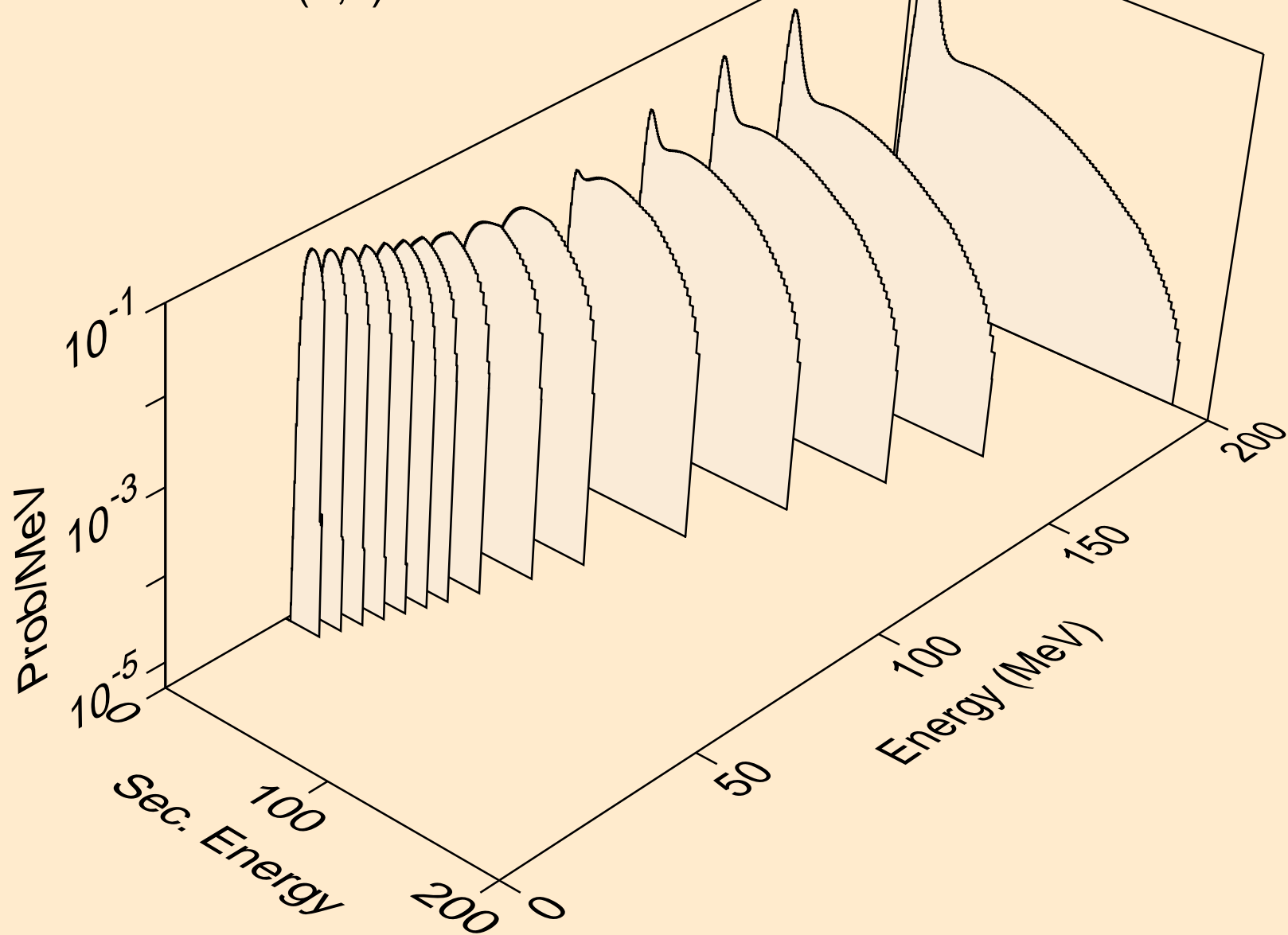

ZR083 NEUTRON ACER TENDL-2024 LIBRARY; T=0.K
tritons from (n,n*)t

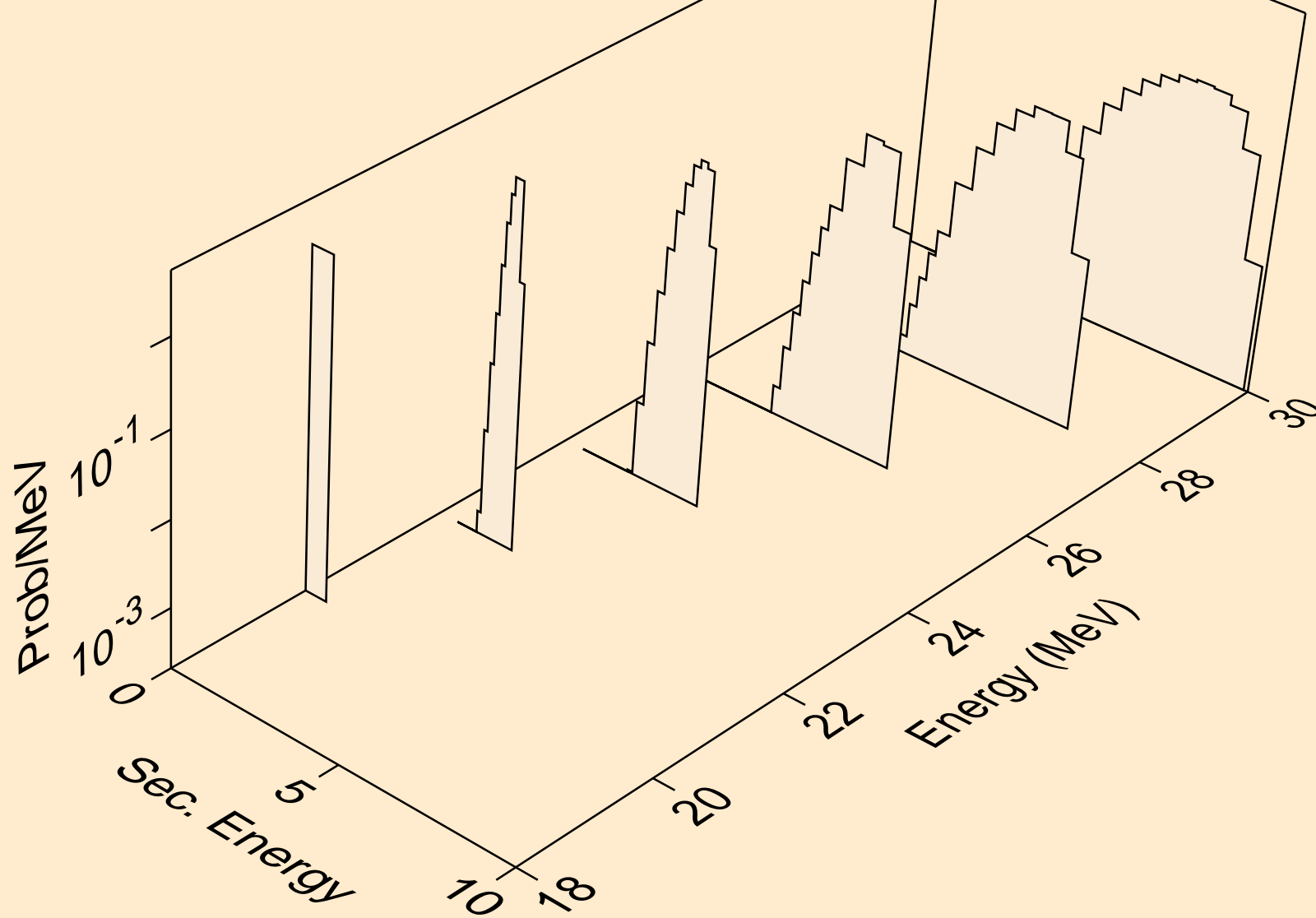

ZR083 NEUTRON ACER TENDL-2024 LIBRARY; T=0.K
tritons from (n,t)

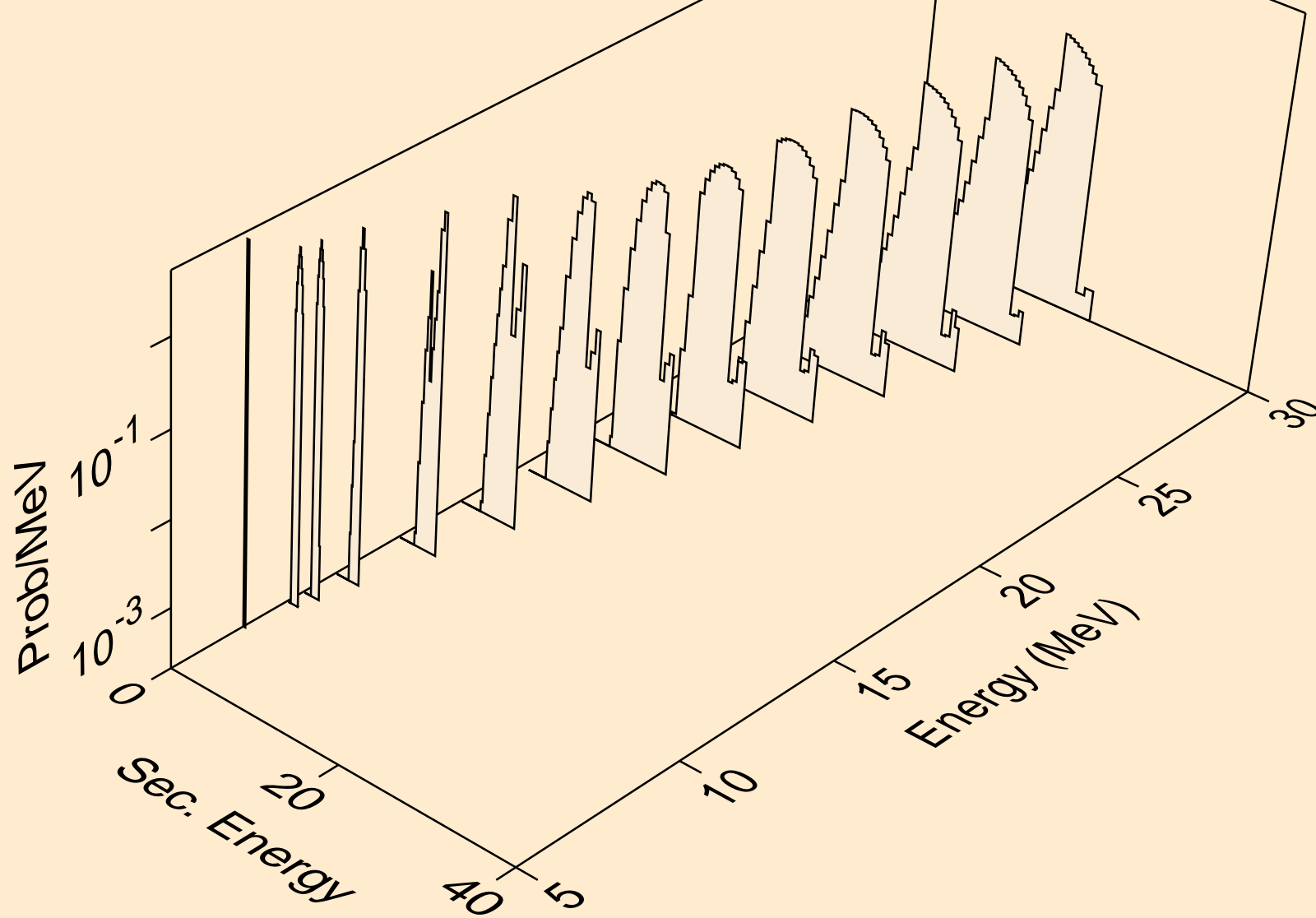

ZR083 NEUTRON ACER TENDL-2024 LIBRARY; T=0.K
tritons from (n,pt)

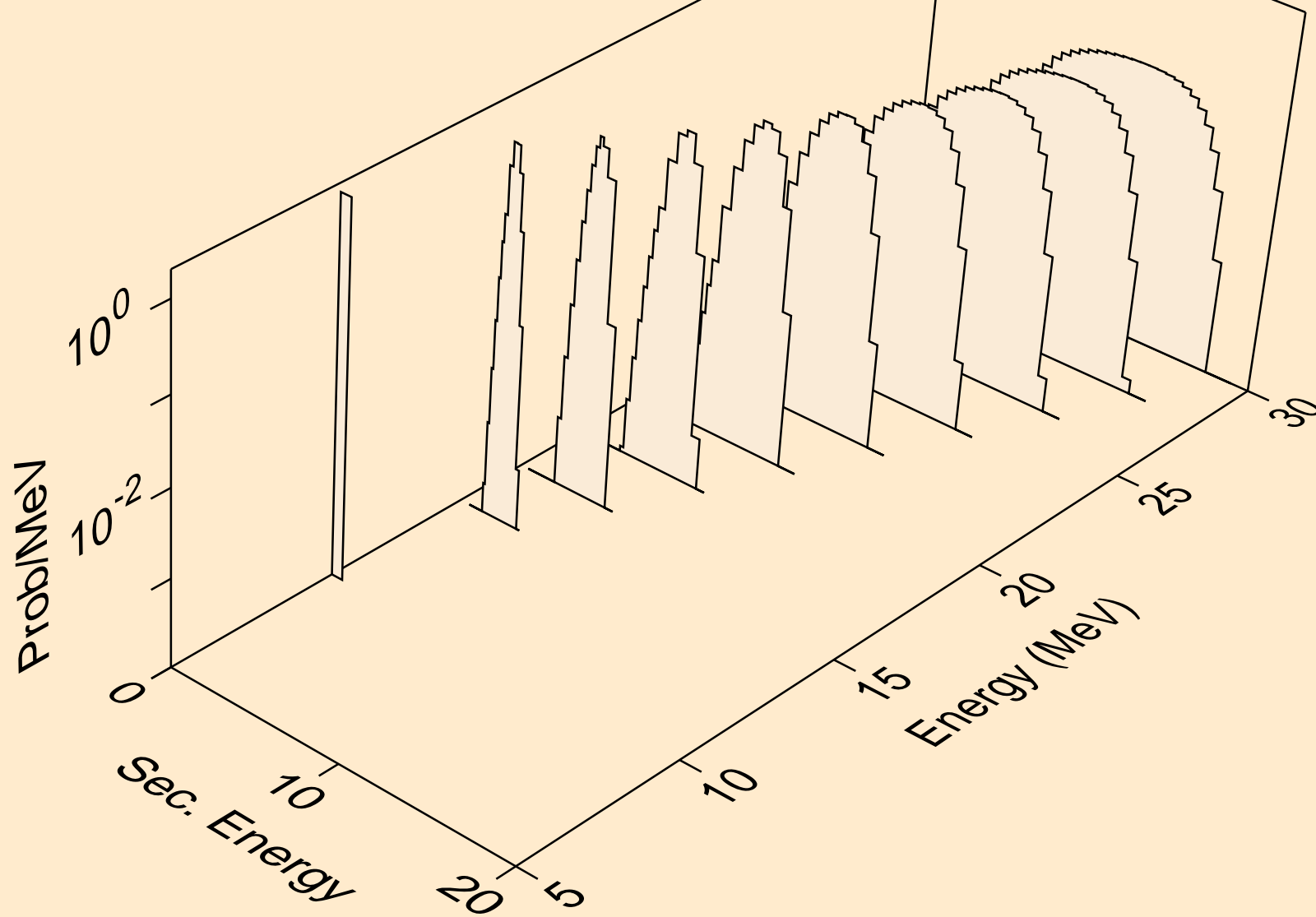

ZR083 NEUTRON ACER TENDL-2024 LIBRARY; T=0.K
he3s from (n,x)

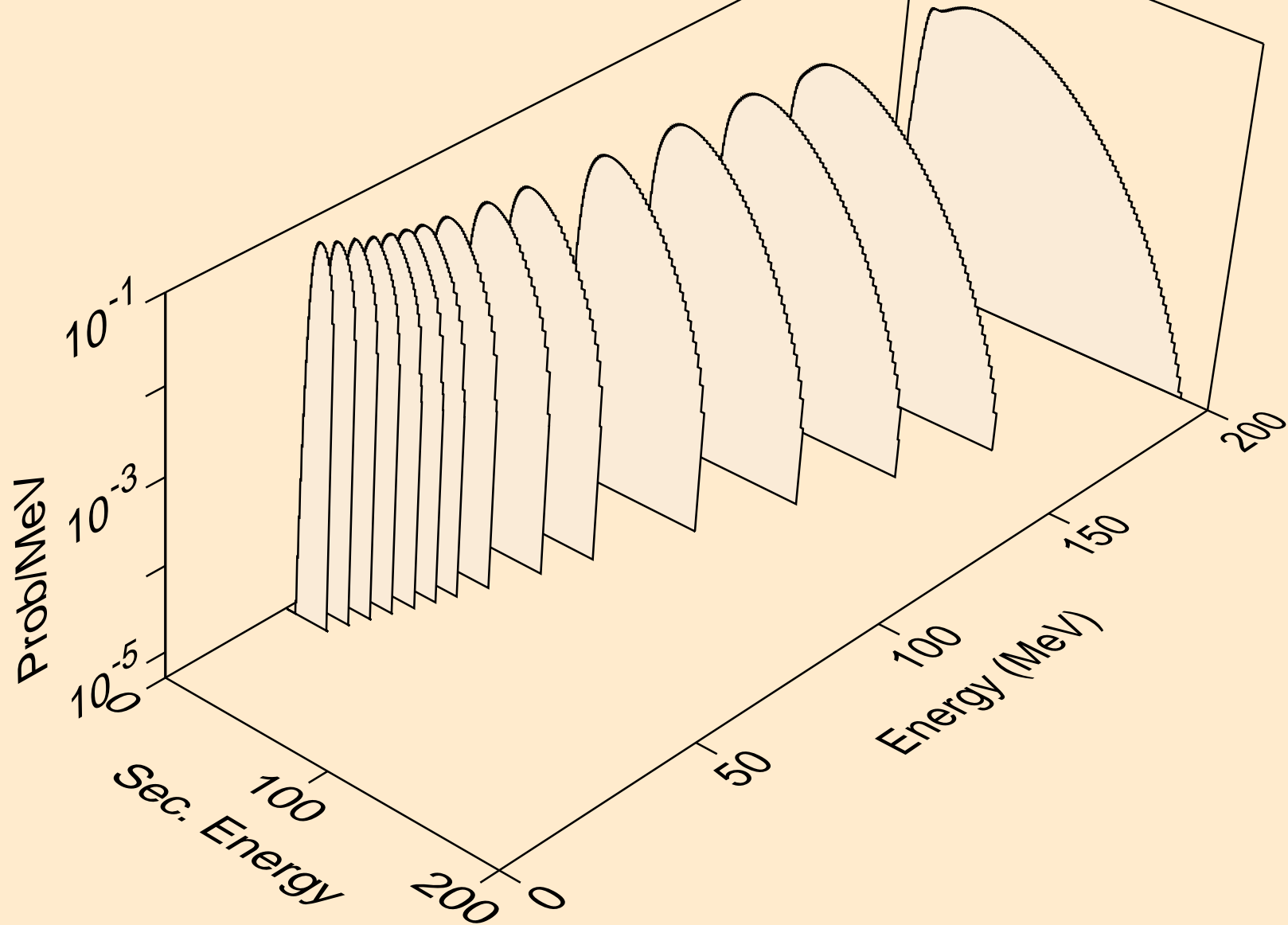

ZR083 NEUTRON ACER TENDL-2024 LIBRARY; T=0.K
he3s from (n,n*)he3

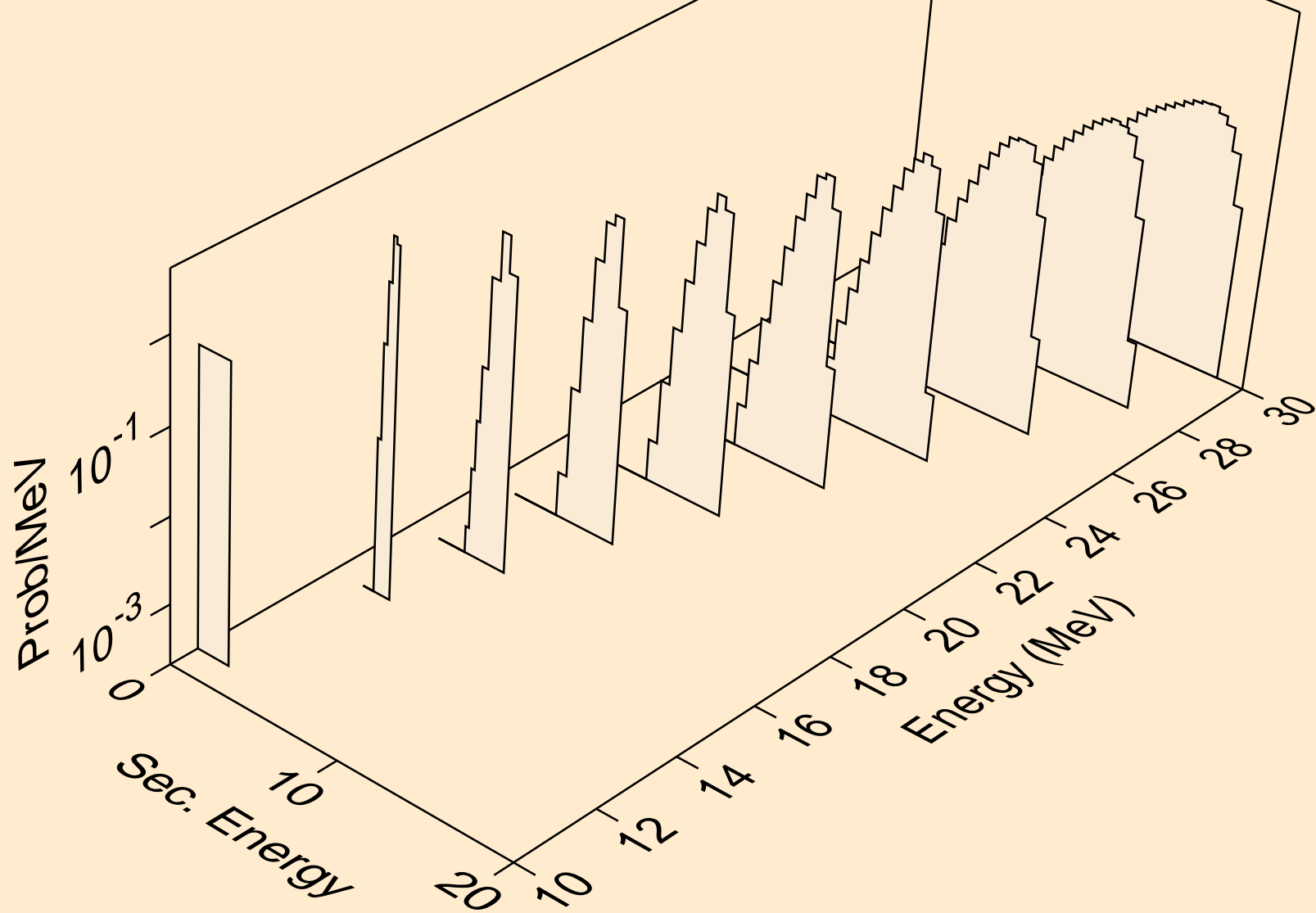

ZR083 NEUTRON ACER TENDL-2024 LIBRARY; T=0.K
he3s from (n,he3)

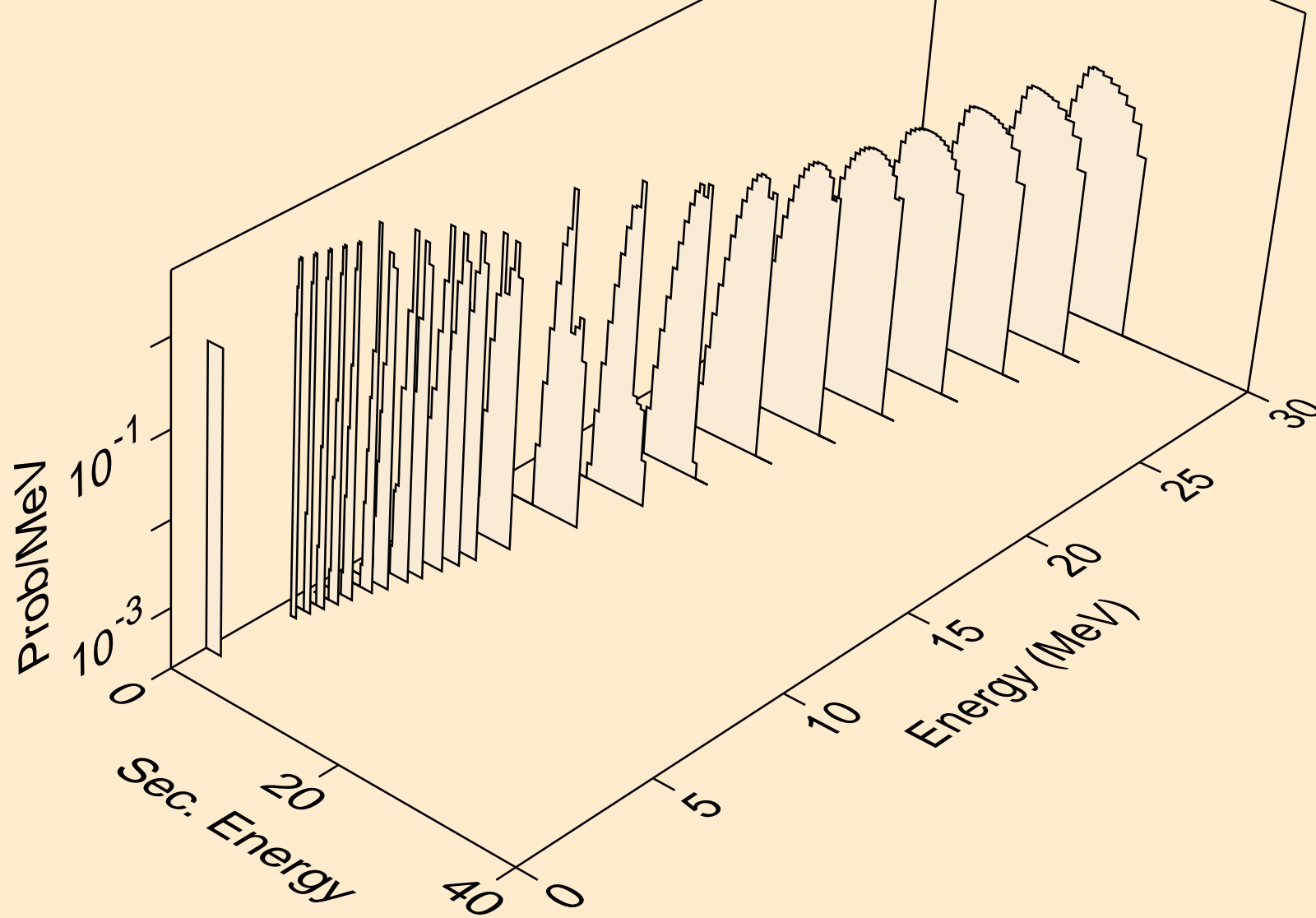

ZR083 NEUTRON ACER TENDL-2024 LIBRARY; T=0.K
alphas from (n,x)

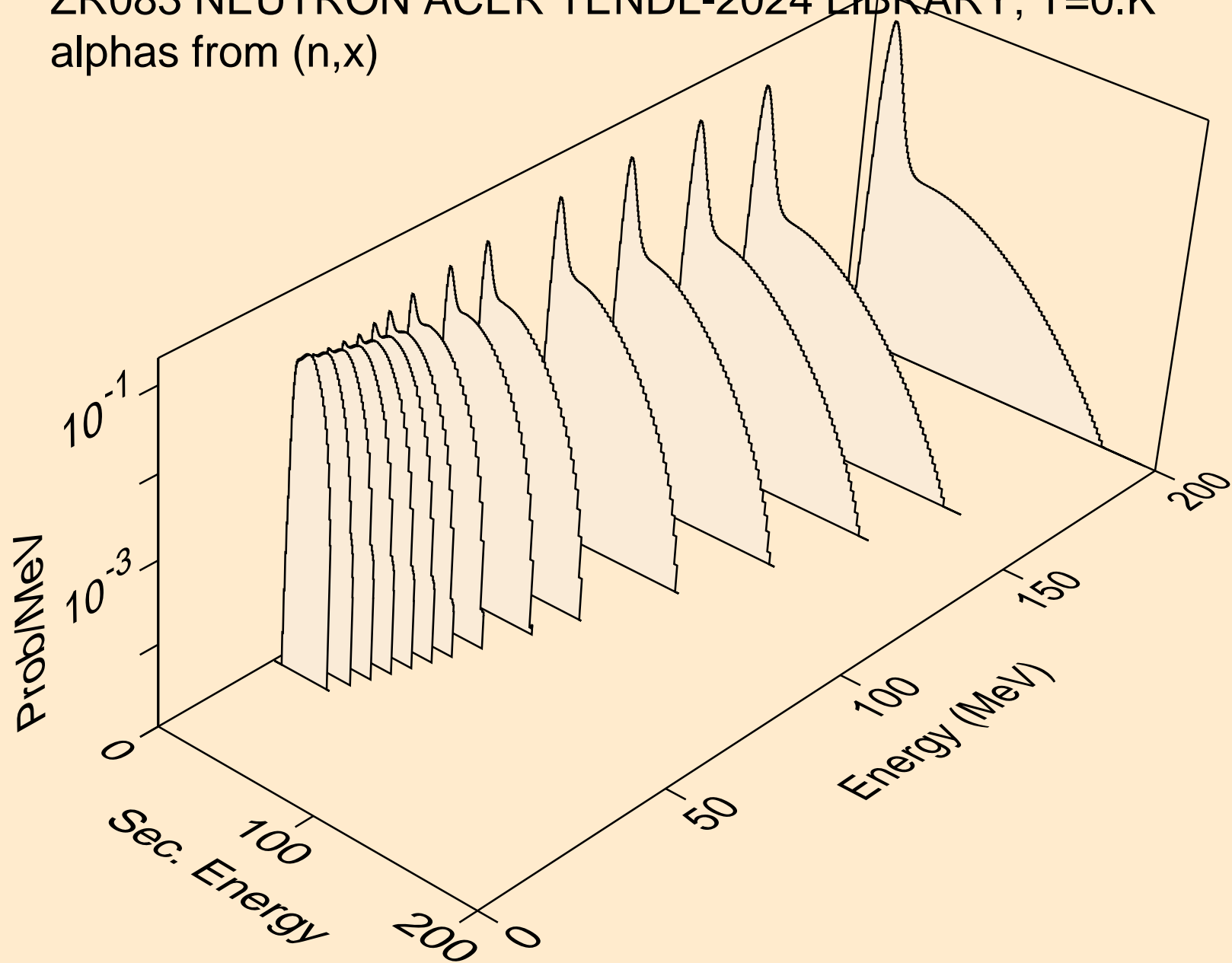

ZR083 NEUTRON ACER TENDL-2024 LIBRARY; T=0.K
alphas from (n,n*)a

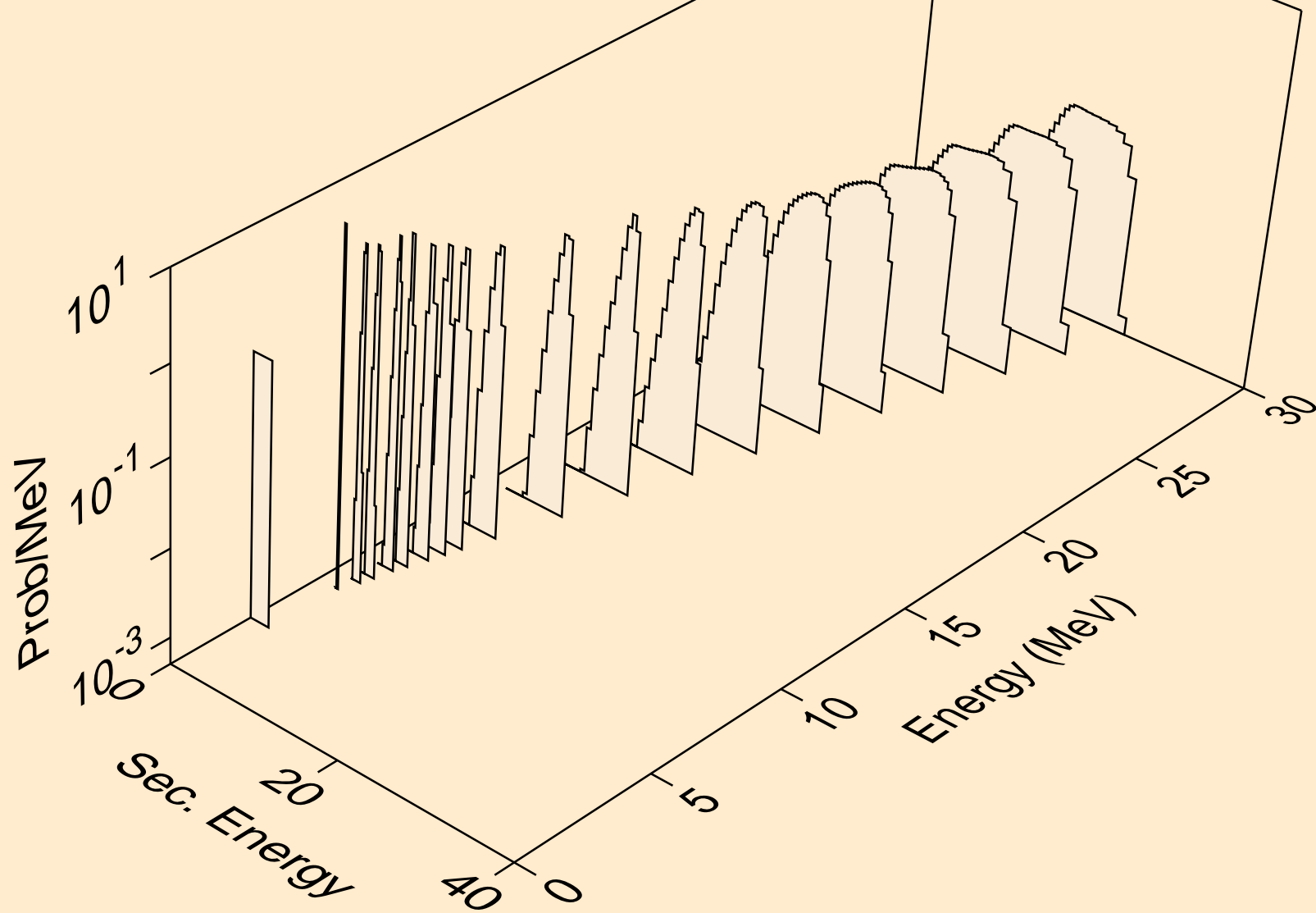

ZR083 NEUTRON ACER TENDL-2024 LIBRARY; T=0.K
alphas from (n,2n)a

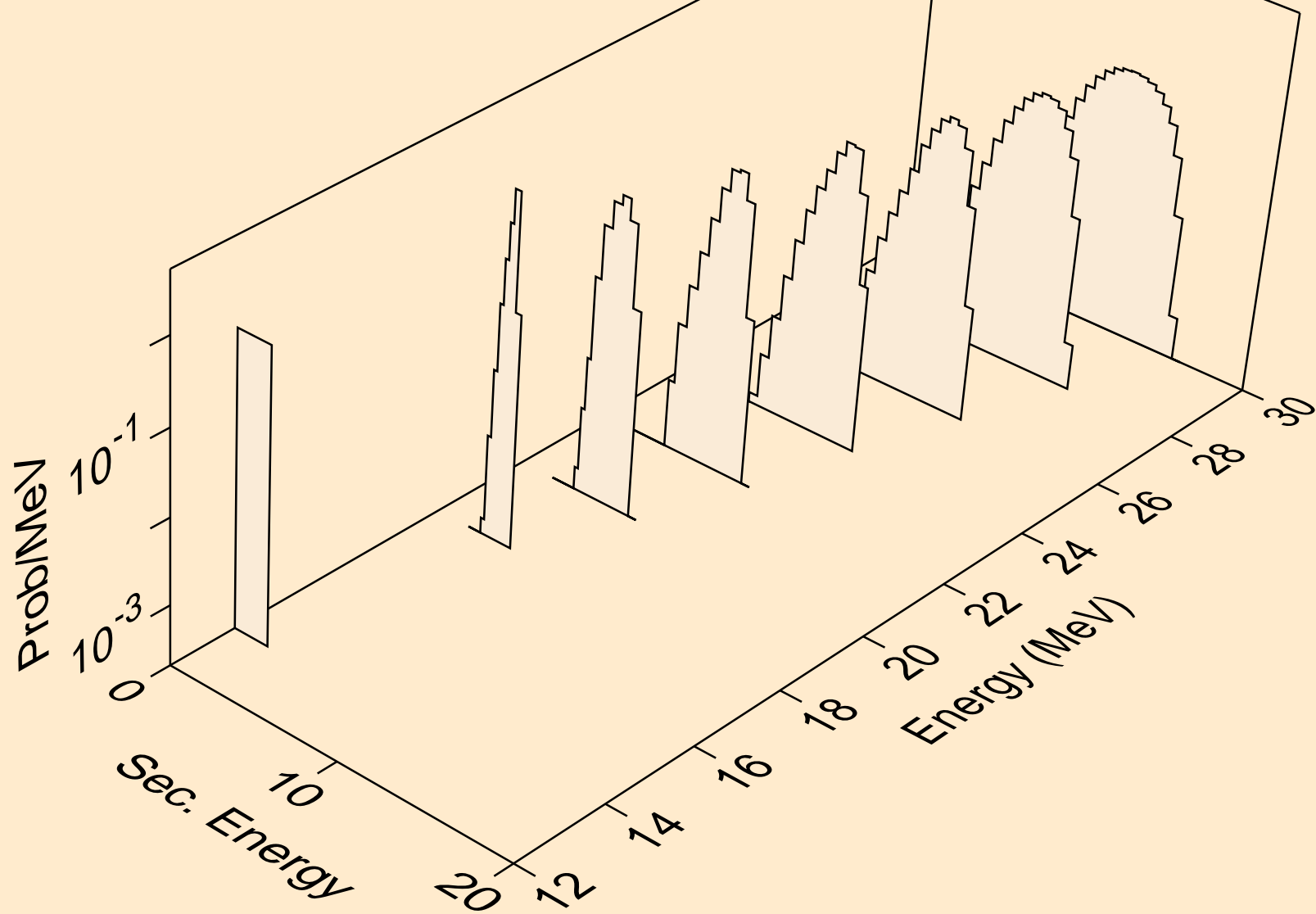

ZR083 NEUTRON ACER TENDL-2024 LIBRARY; T=0.K
alphas from (n,n*)2a

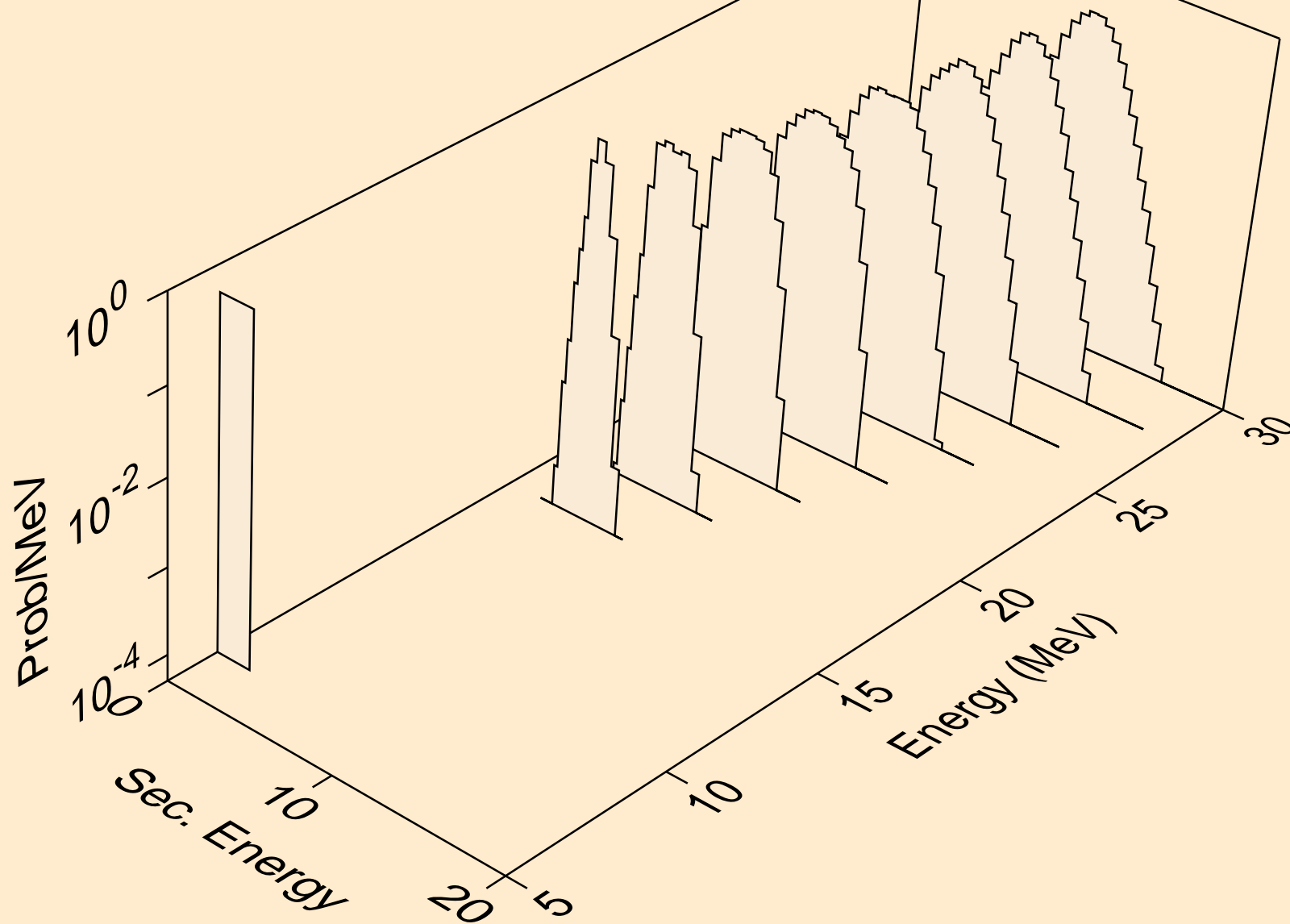

ZR083 NEUTRON ACER TENDL-2024 LIBRARY; T=0.K
alphas from (n,npa)

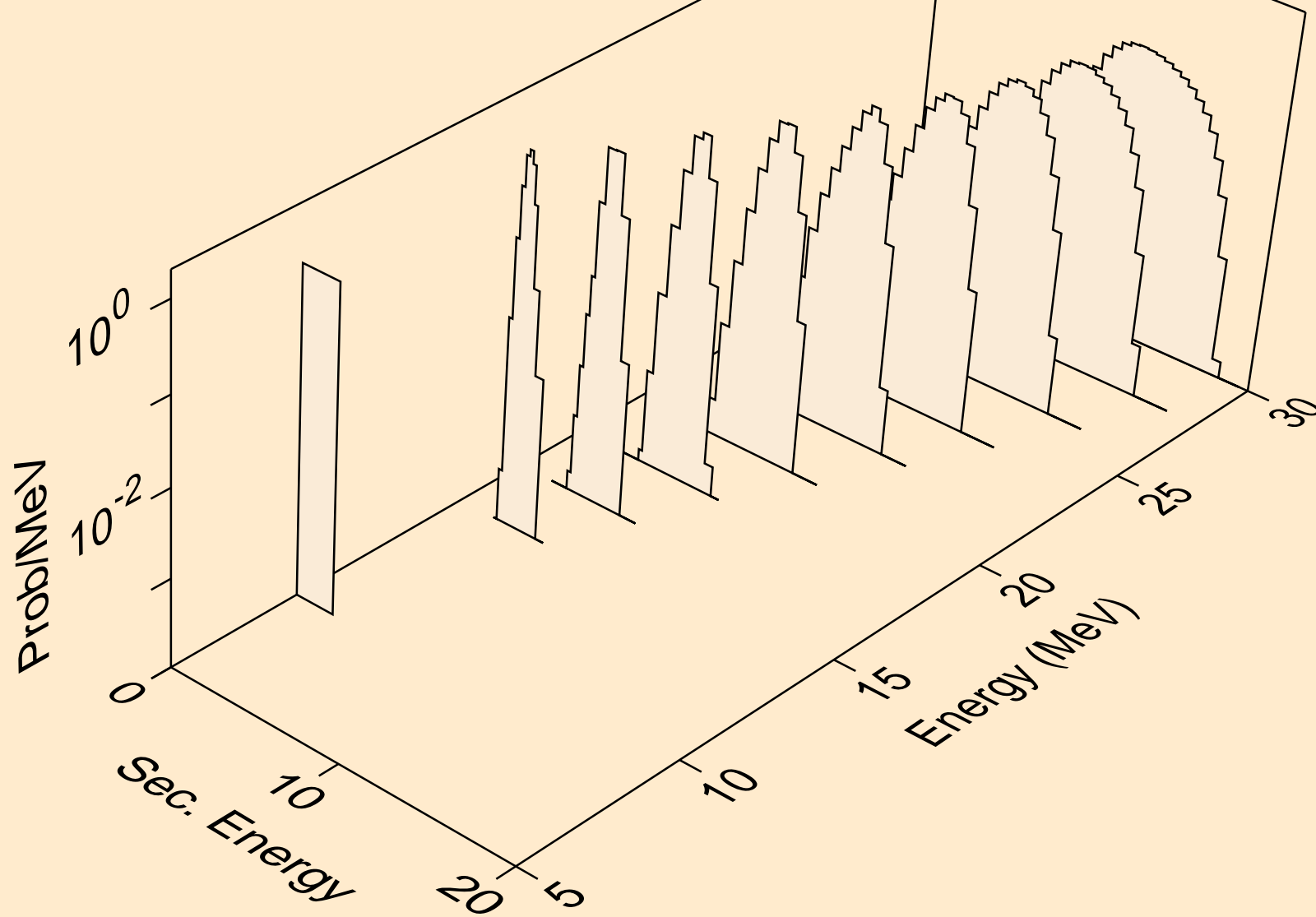

ZR083 NEUTRON ACER TENDL-2024 LIBRARY; T=0.K
alphas from (n,a)

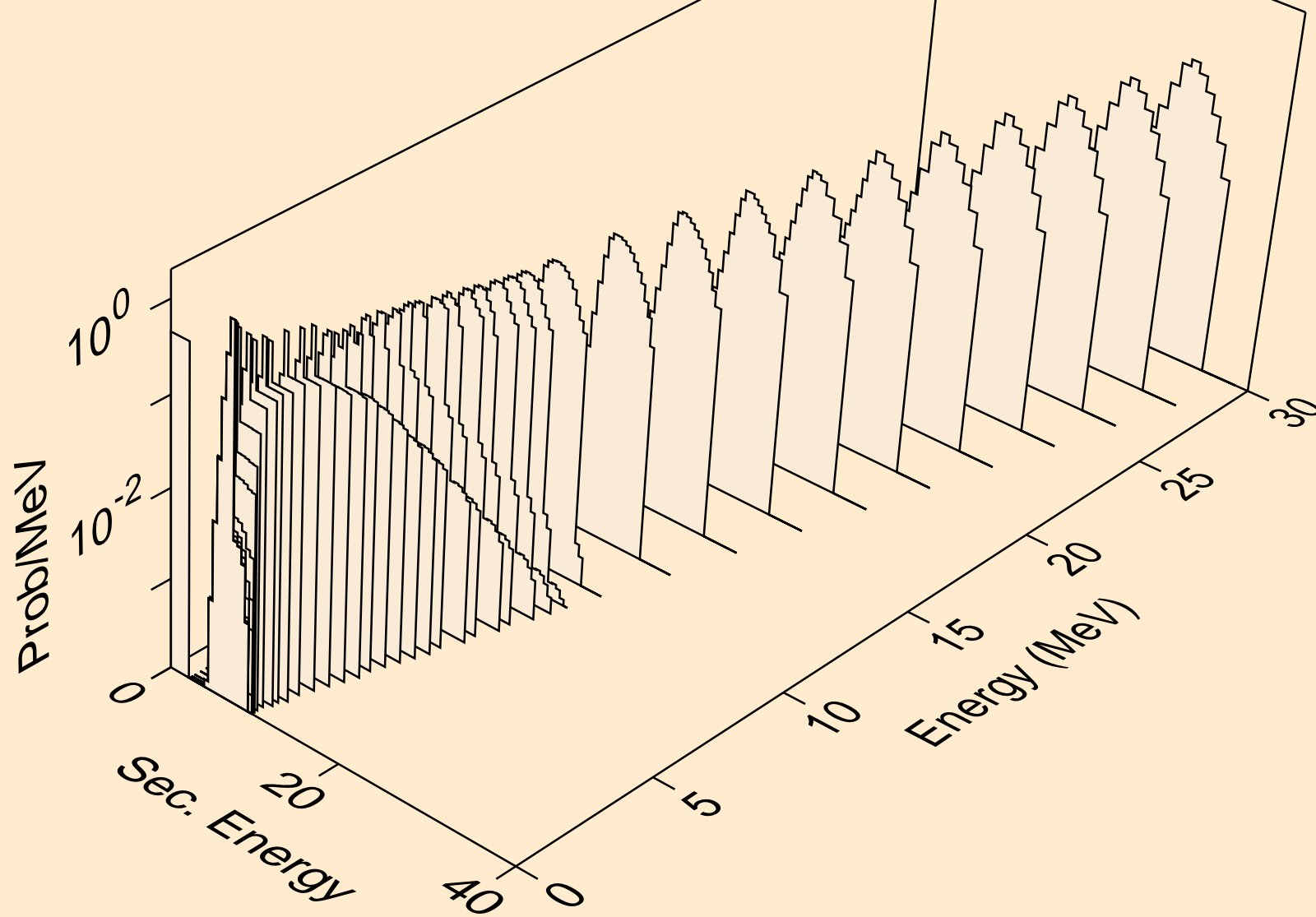

ZR083 NEUTRON ACER TENDL-2024 LIBRARY; T=0.K
alphas from (n,2a)

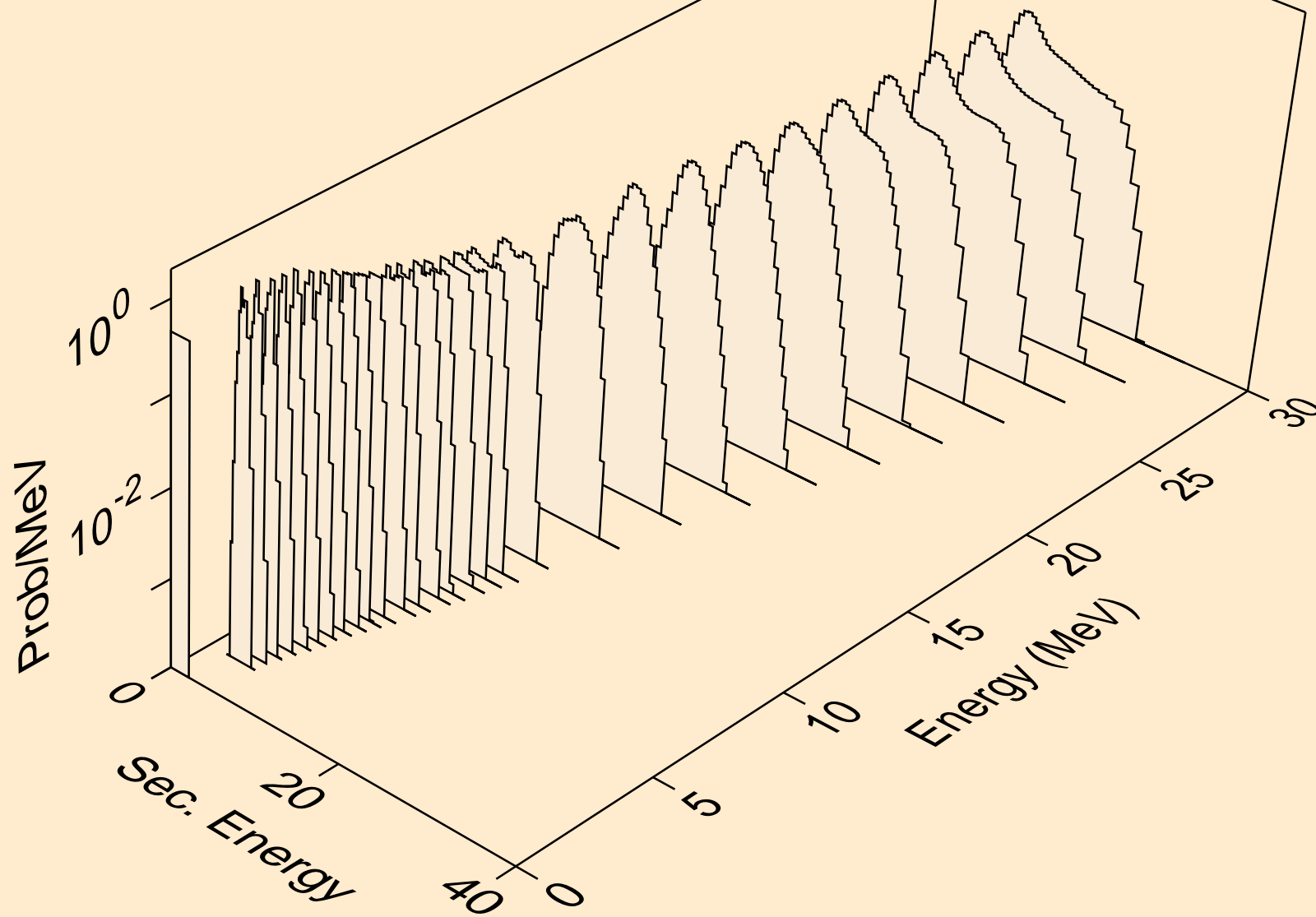

ZR083 NEUTRON ACER TENDL-2024 LIBRARY; T=0.K
alphas from (n,3a)

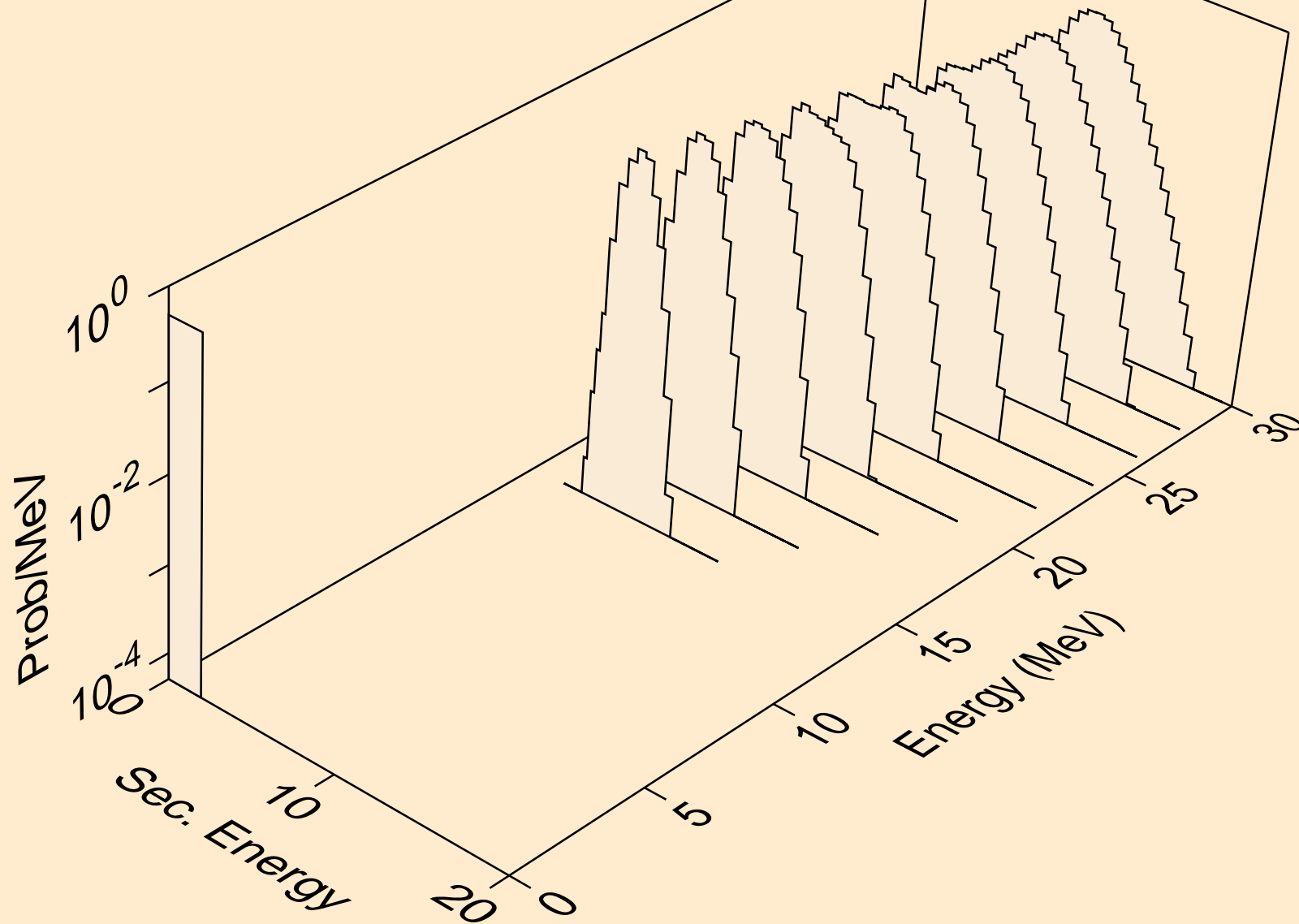

ZR083 NEUTRON ACER TENDL-2024 LIBRARY; T=0.K
alphas from (n,pa)

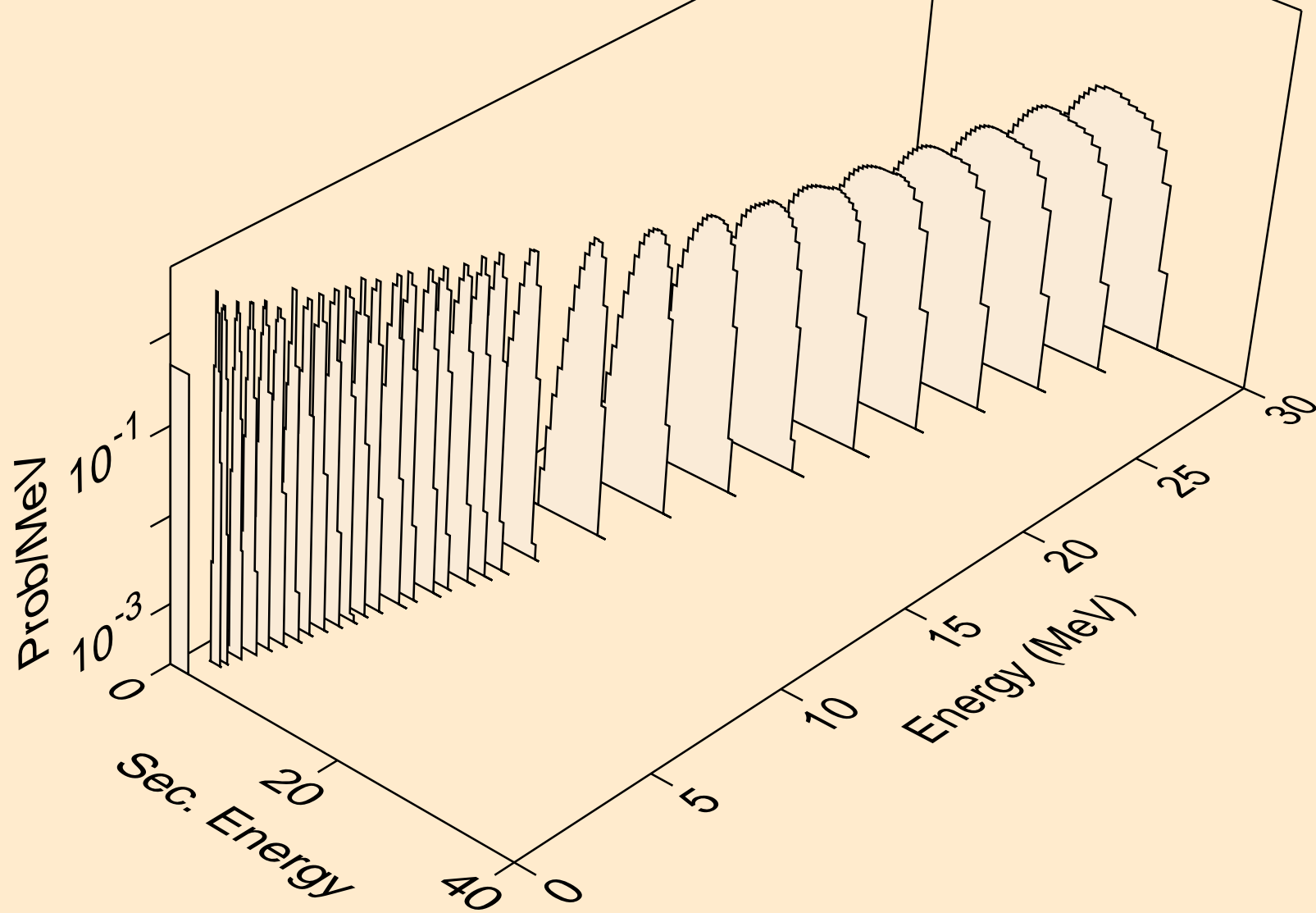

ZR083 NEUTRON ACER TENDL-2024 LIBRARY; T=0.K
alphas from (n,da)

