

BK244 PROTON ACER TENDL-2023 LIBRARY; T=0.K
Principal cross sections

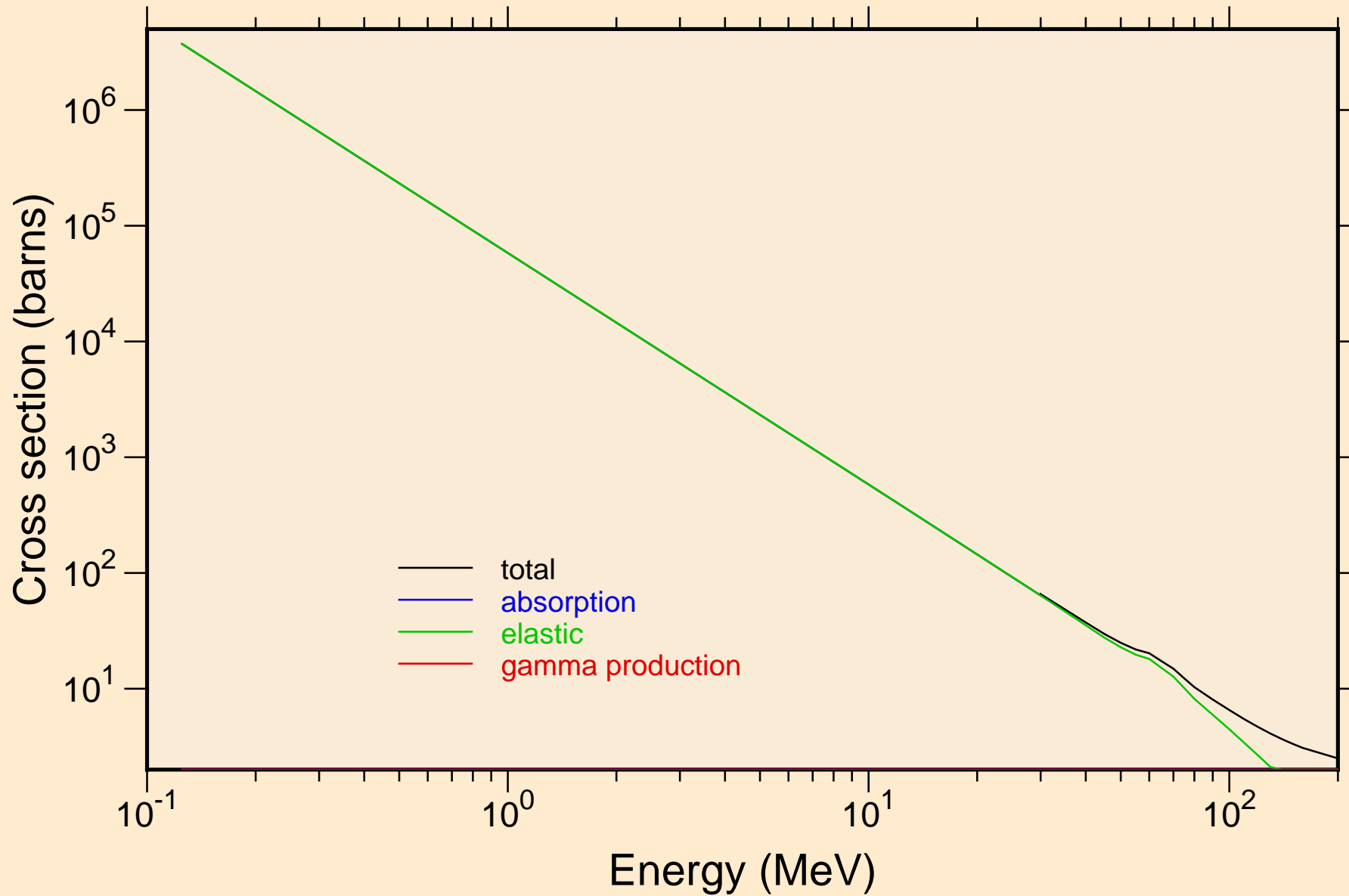

BK244 PROTON ACER TENDL-2023 LIBRARY; T=0.K

Heating

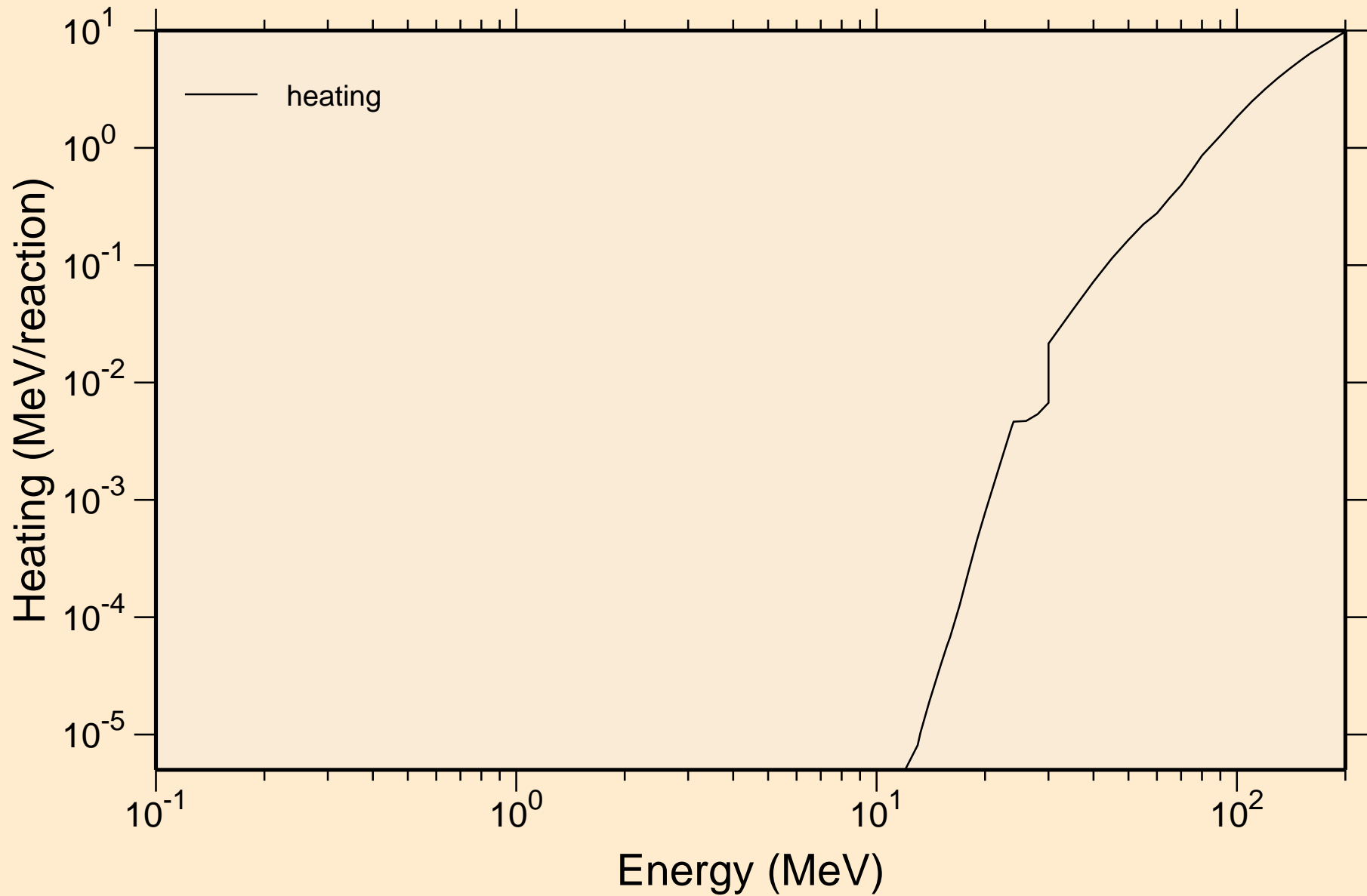

BK244 PROTON ACER TENDL-2023 LIBRARY; T=0.K

Principal cross sections

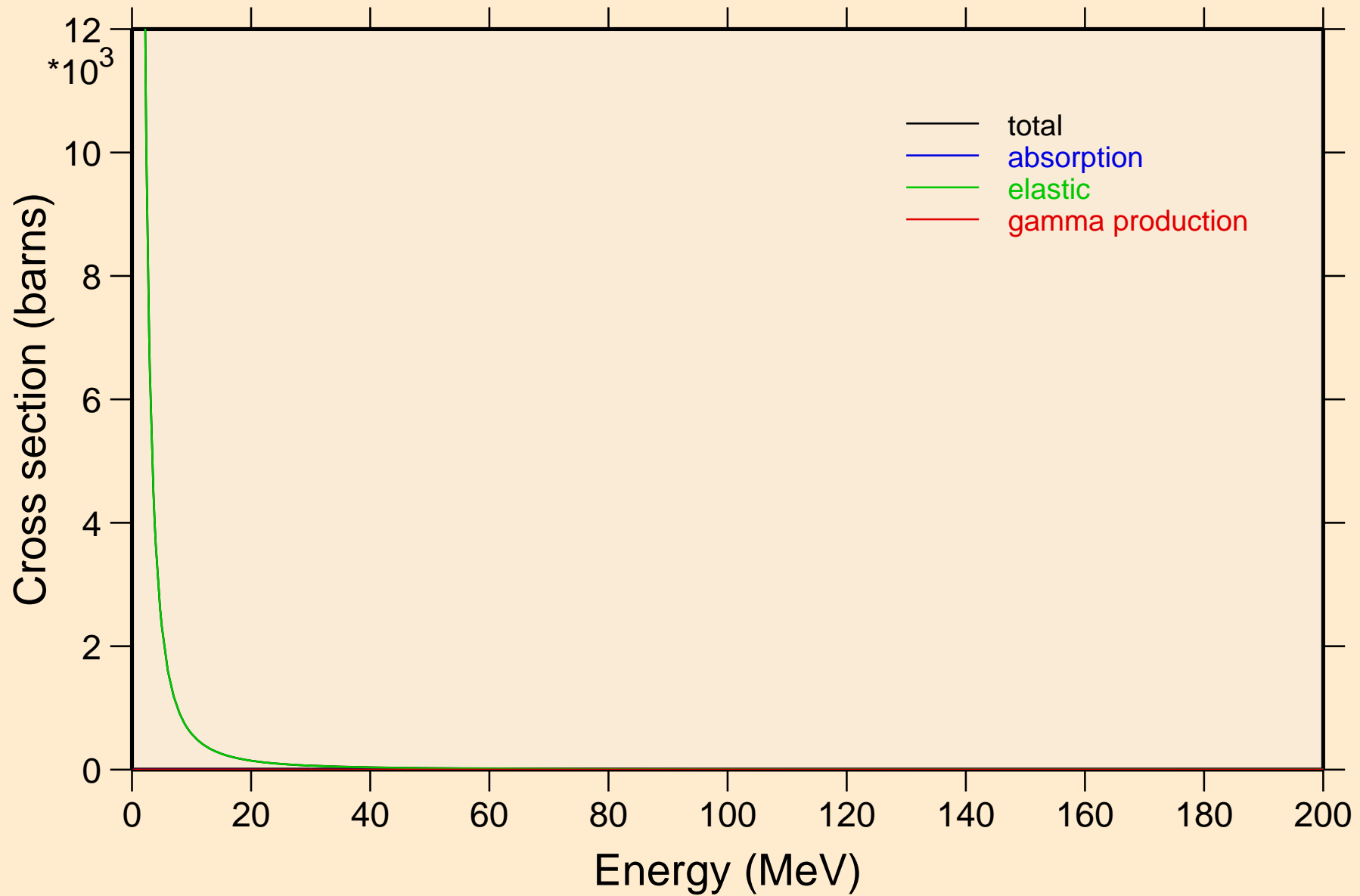

BK244 PROTON ACER TENDL-2023 LIBRARY; T=0.K

Heating

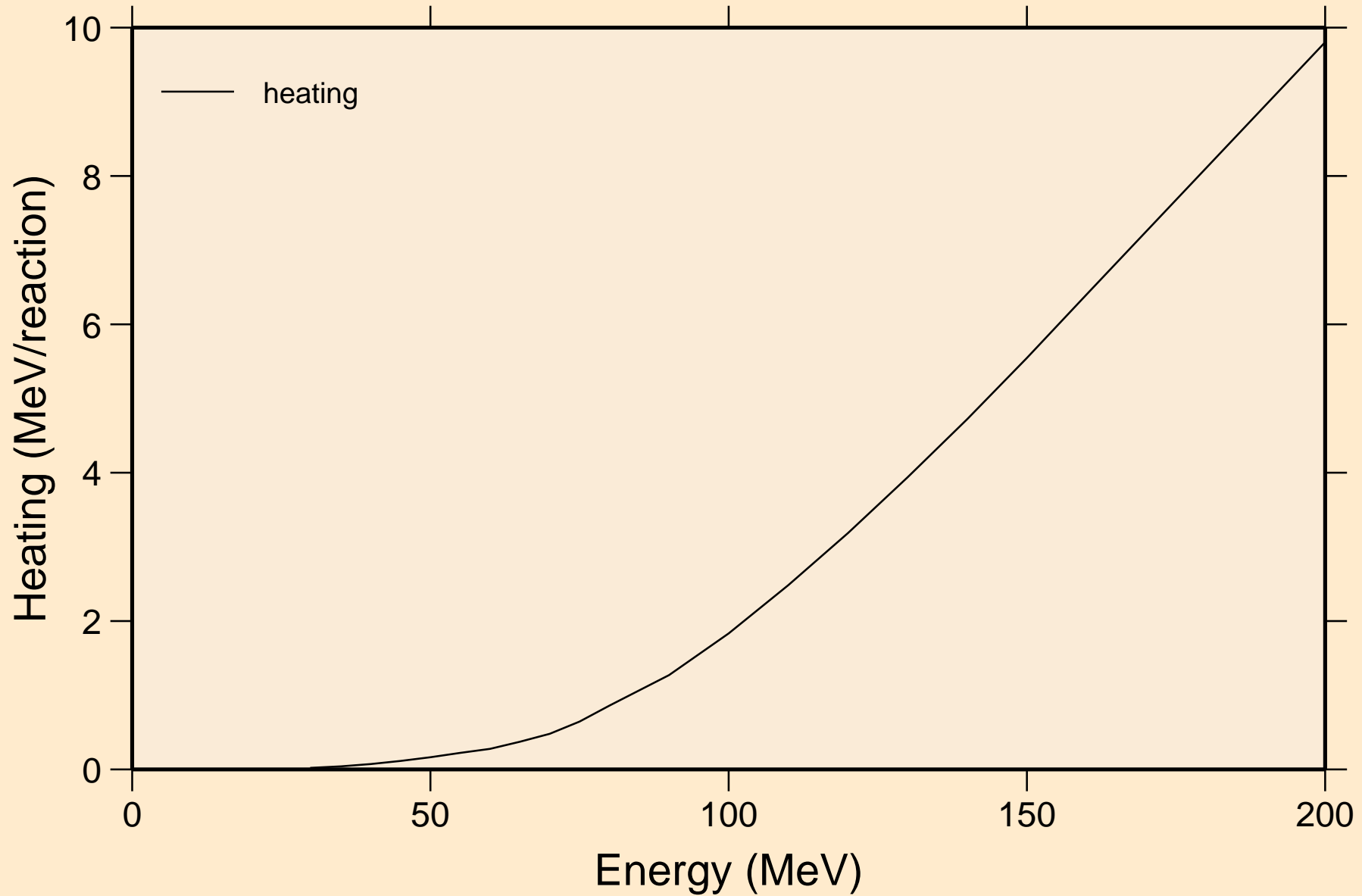

BK244 PROTON ACER TENDL-2023 LIBRARY; T=0.K
Threshold reactions

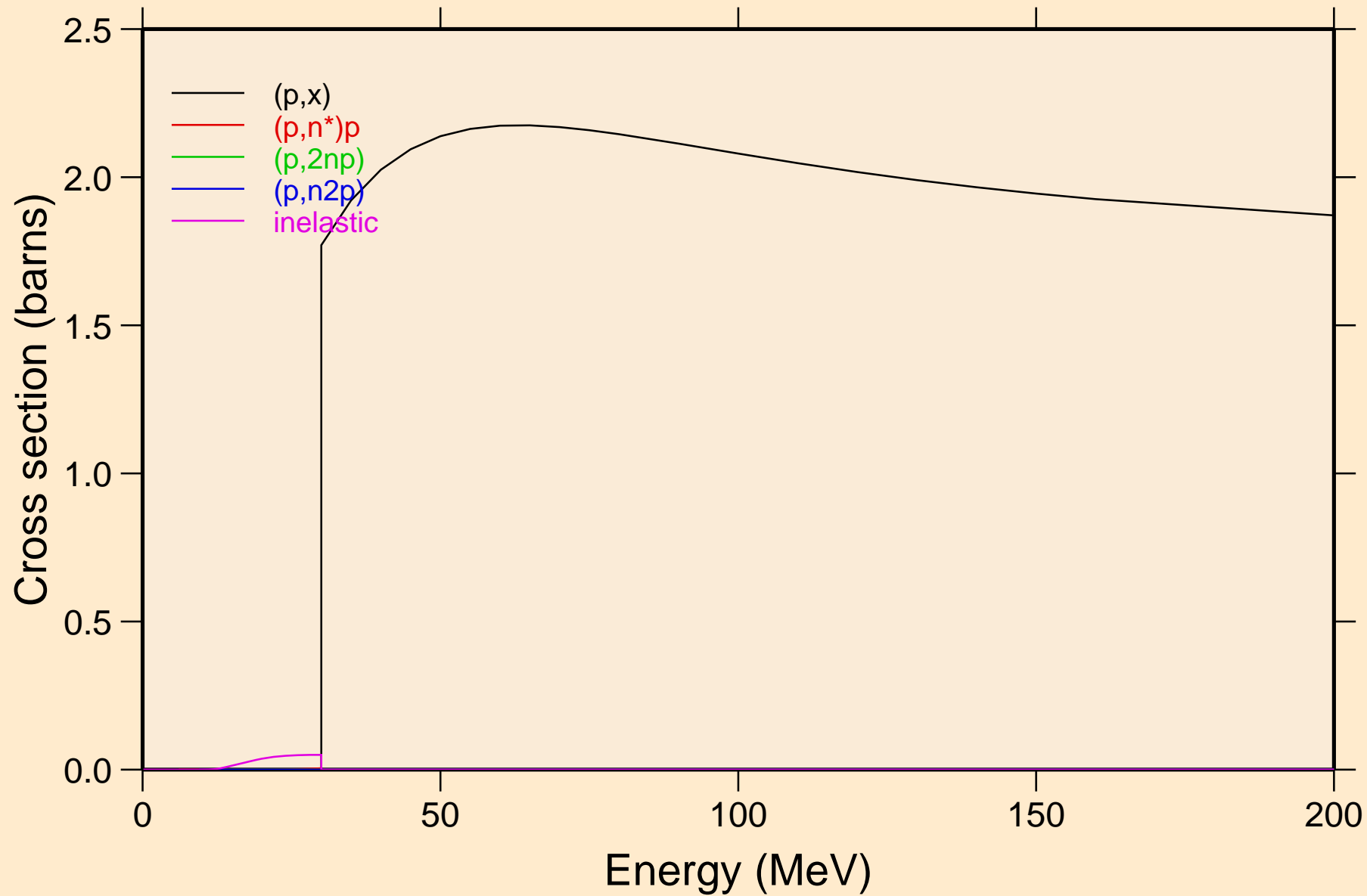

BK244 PROTON ACER TENDL-2023 LIBRARY; T=0.K
Threshold reactions

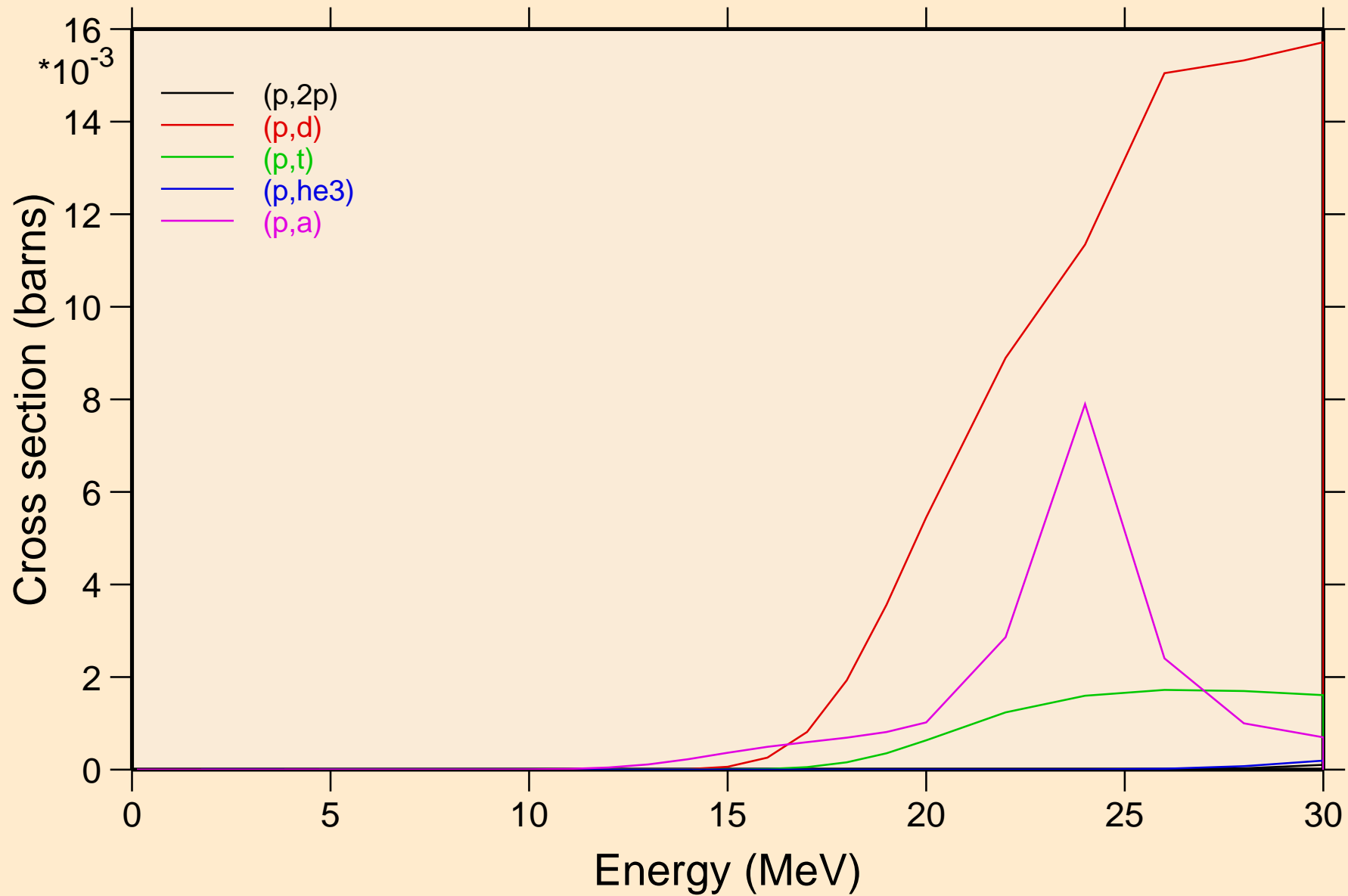

BK244 PROTON ACER TENDL-2023 LIBRARY; T=0.K
Threshold reactions

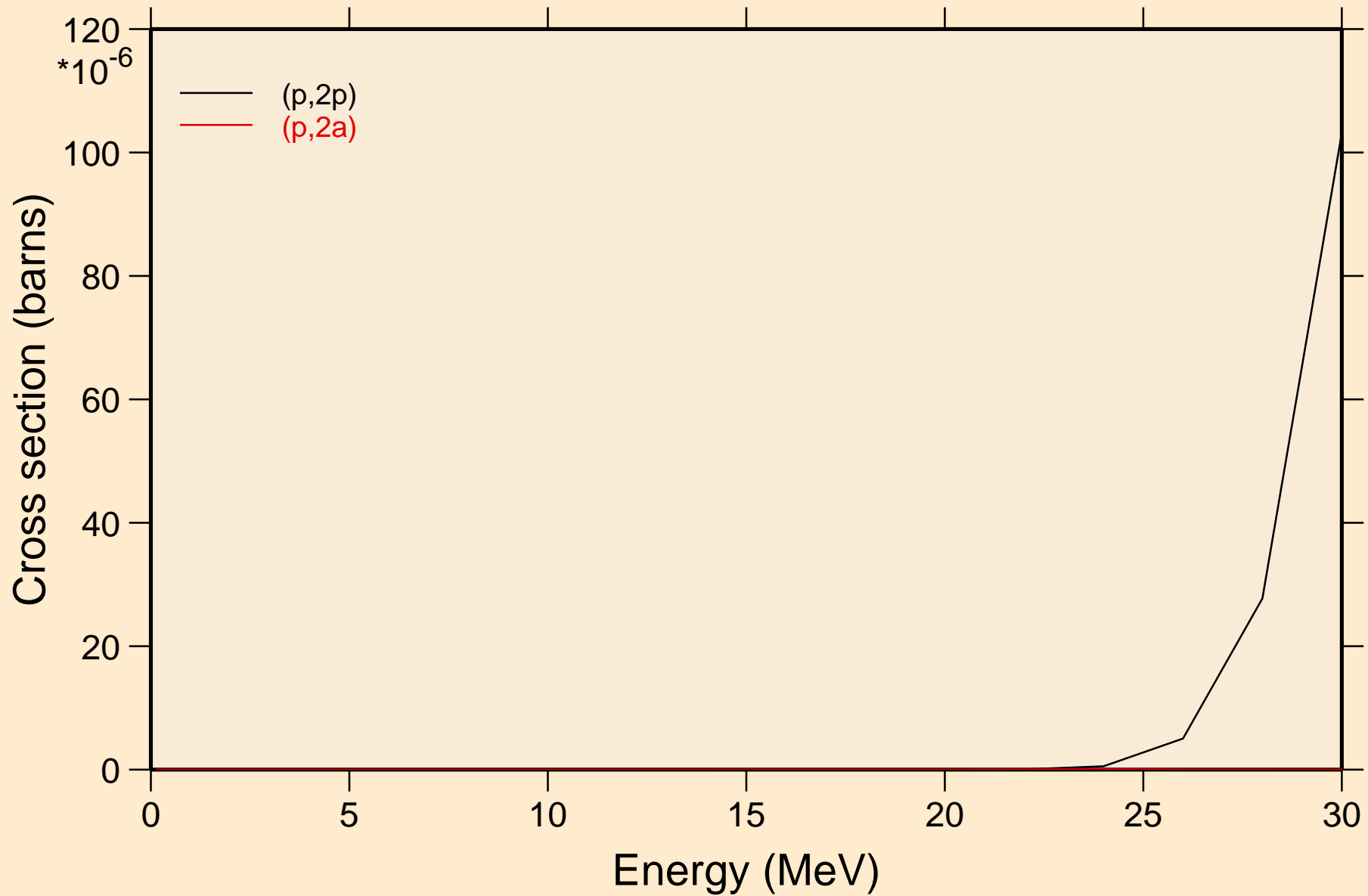

BK244 PROTON ACER TENDL-2023 LIBRARY; T=0.K
Threshold reactions

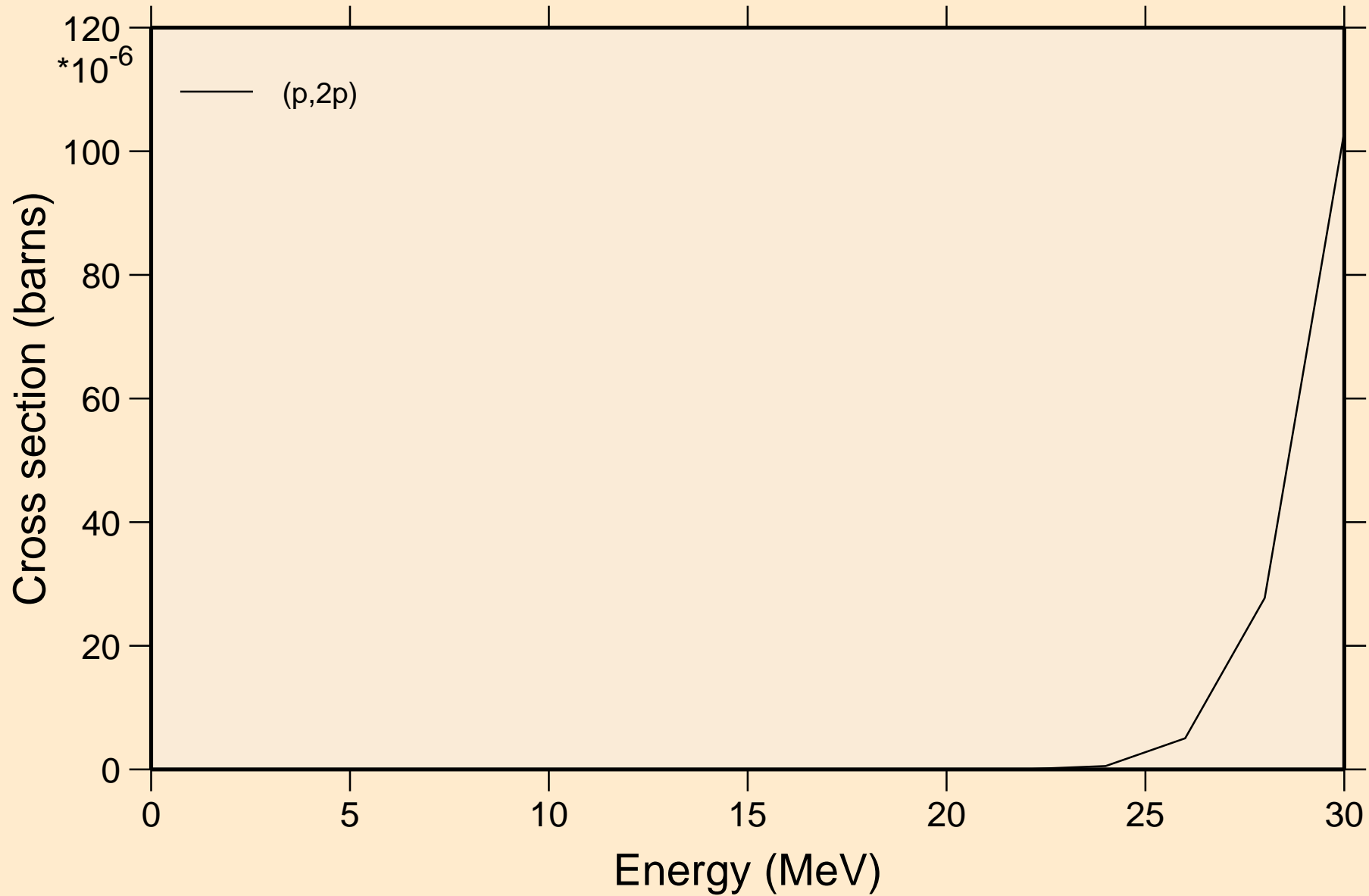

BK244 PROTON ACER TENDL-2023 LIBRARY; T=0.K
angular distribution for elastic

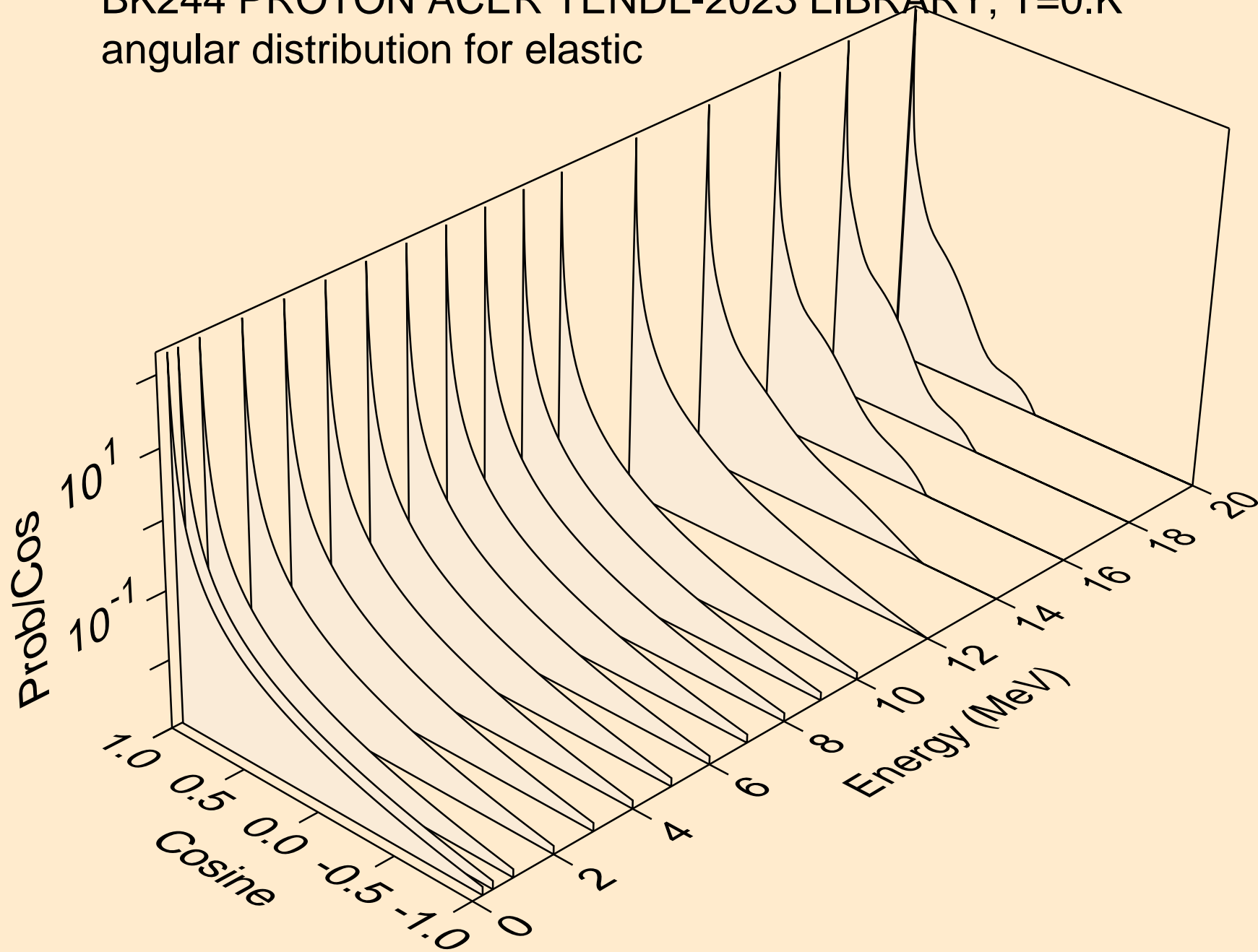

BK244 PROTON ACER TENDL-2023 LIBRARY; T=0.K
angular distribution for elastic

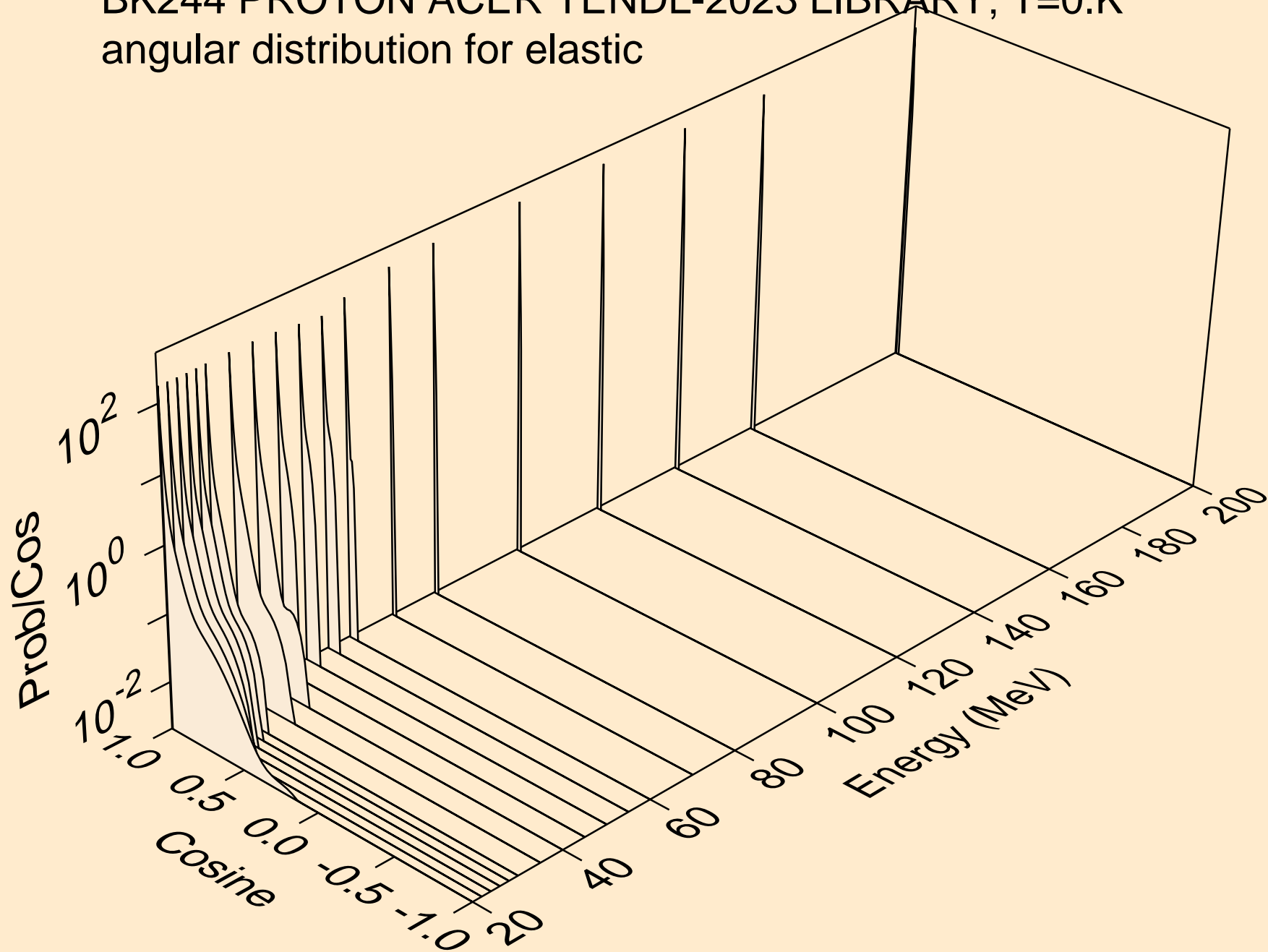

BK244 PROTON ACER TENDL-2023 LIBRARY; T=0.K
Proton emission for (p,x)

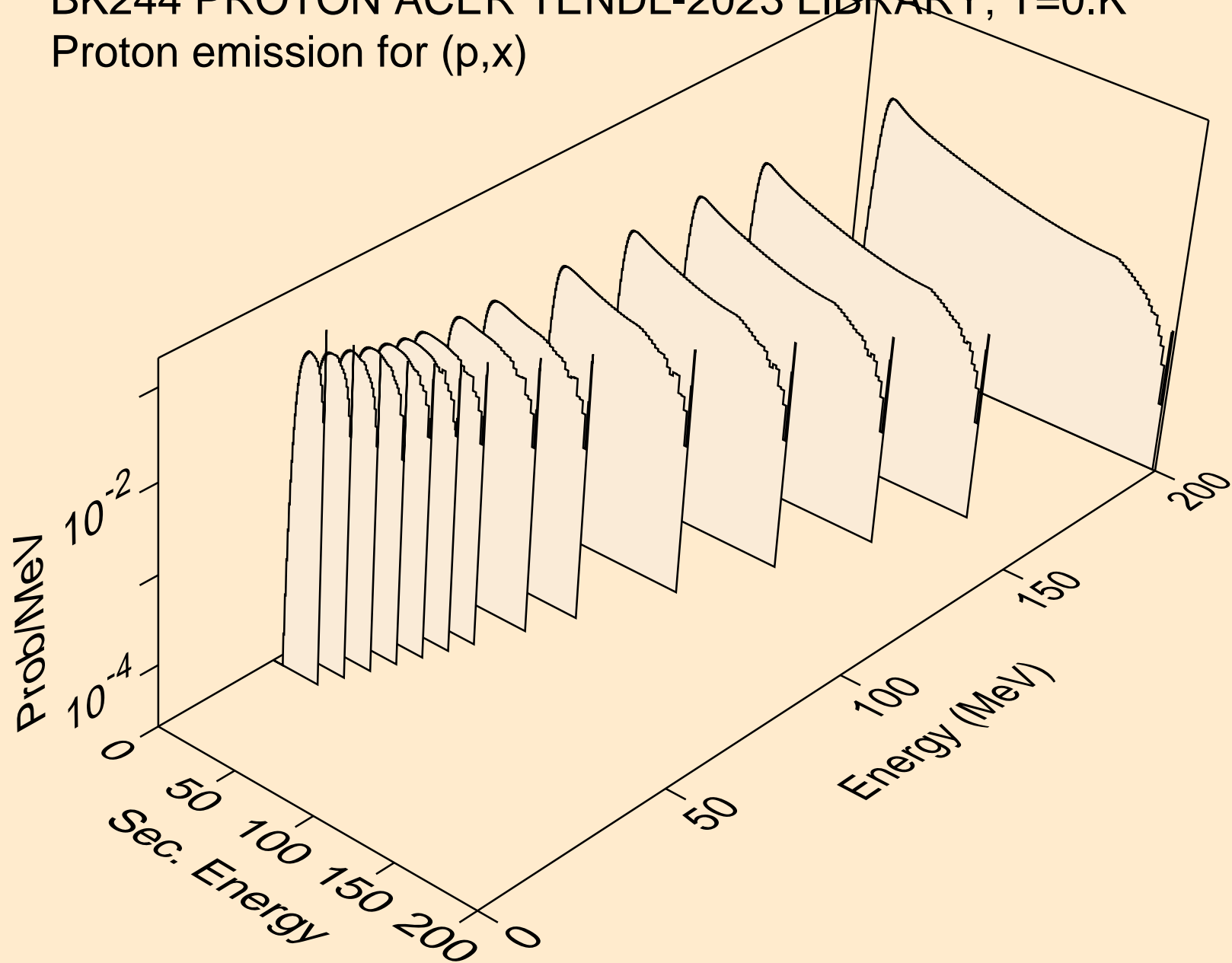

BK244 PROTON ACER TENDL-2023 LIBRARY; T=0.K
Proton emission for (p,n*)p

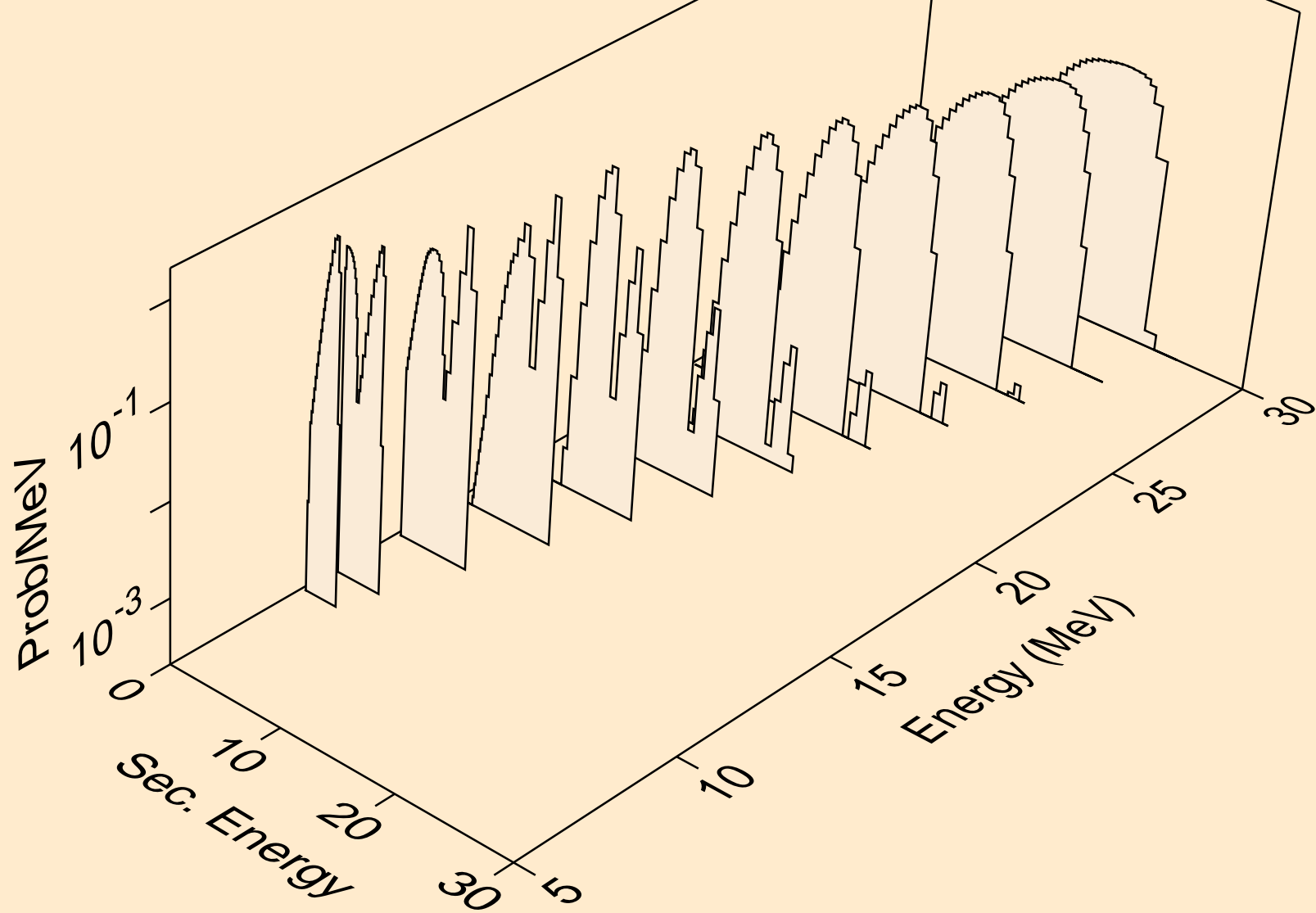

BK244 PROTON ACER TENDL-2023 LIBRARY; T=0.K
Proton emission for (p,2np)

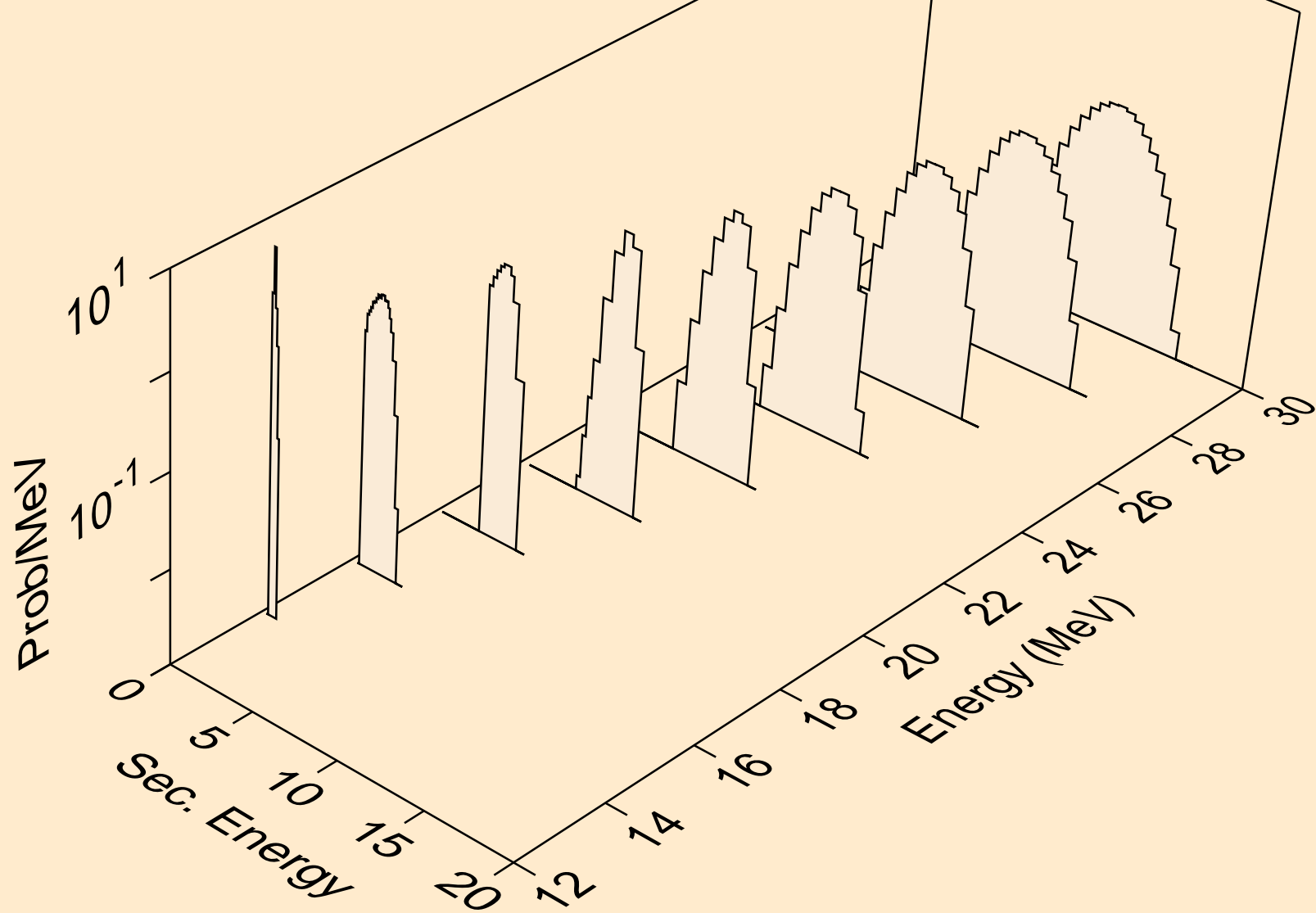

BK244 PROTON ACER TENDL-2023 LIBRARY; T=0.K
Proton emission for (p,n2p)

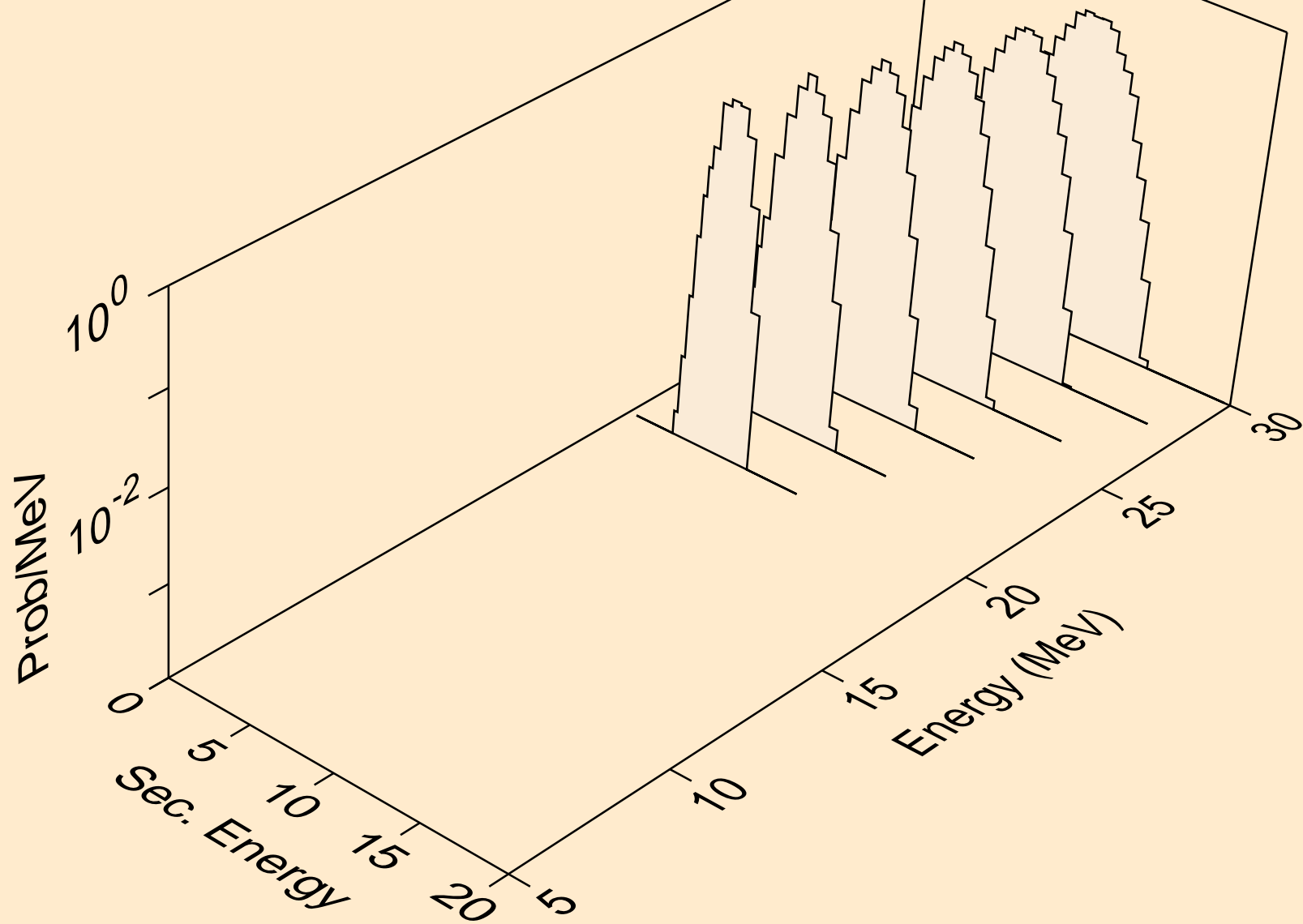

BK244 PROTON ACER TENDL-2023 LIBRARY; T=0.K
Proton emission for inelastic

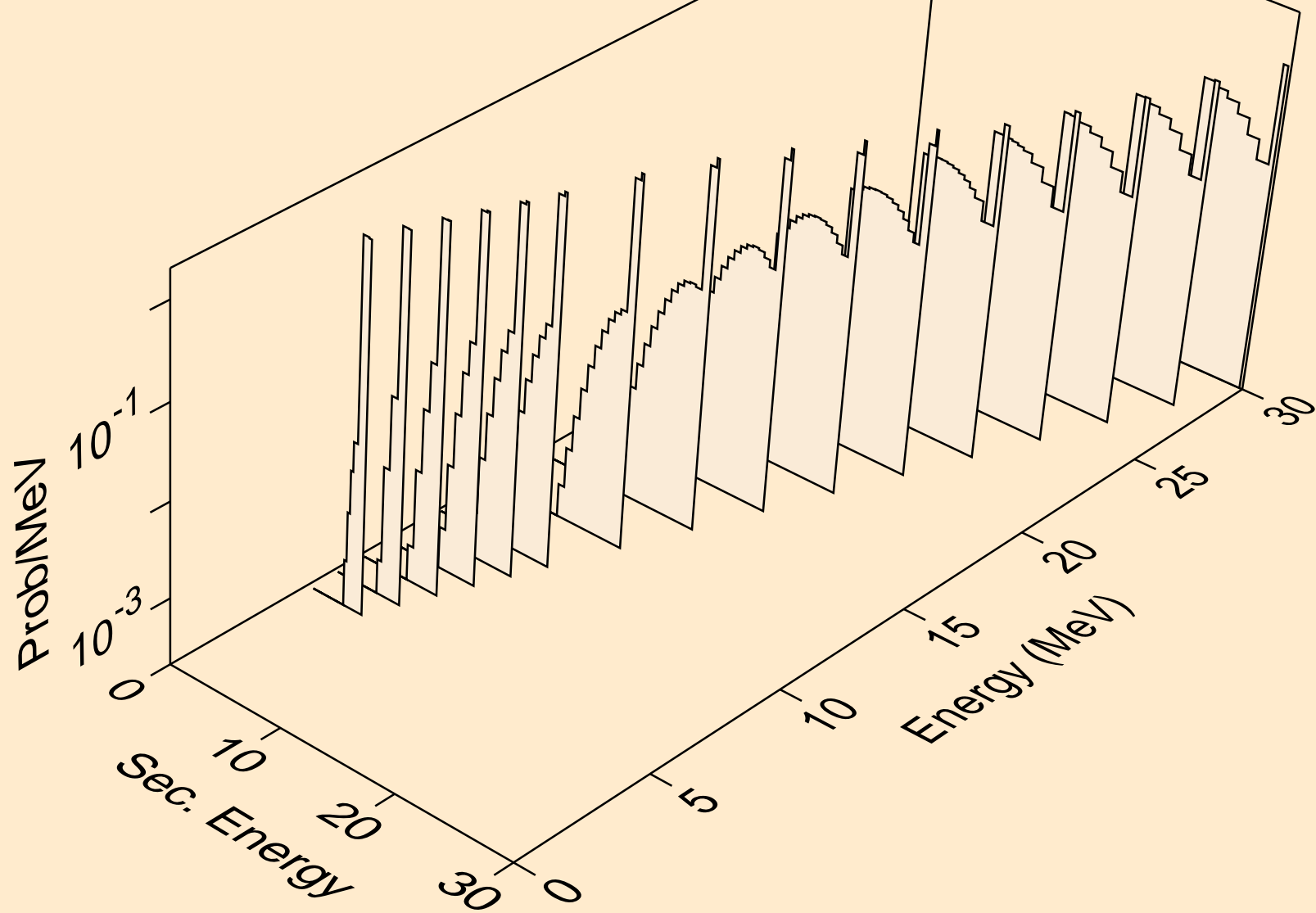

BK244 PROTON ACER TENDL-2023 LIBRARY; T=0.K
Proton emission for (p,2p)

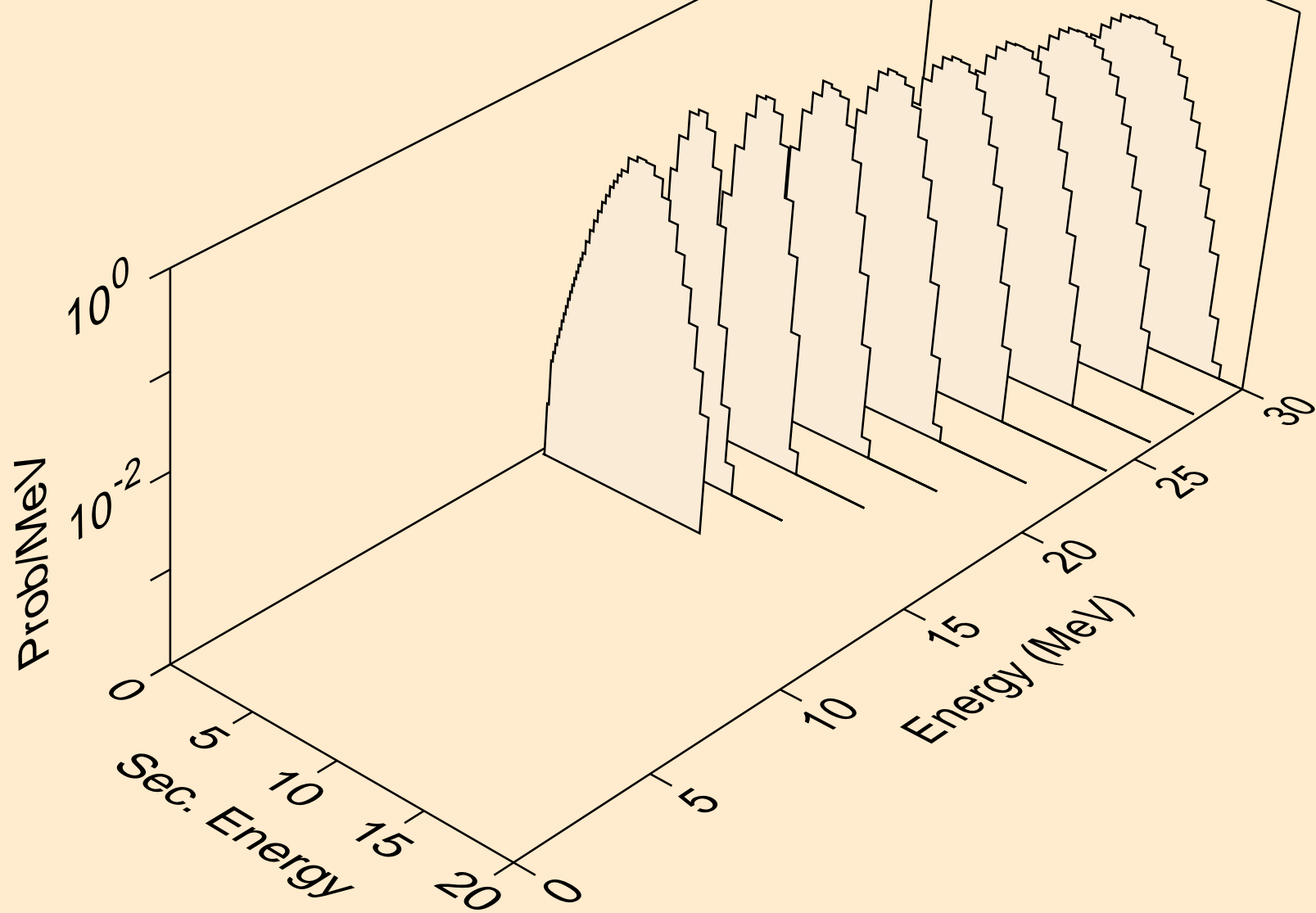

BK244 PROTON ACER TENDL-2023 LIBRARY; T=0.K
Photon emission for (z,n)

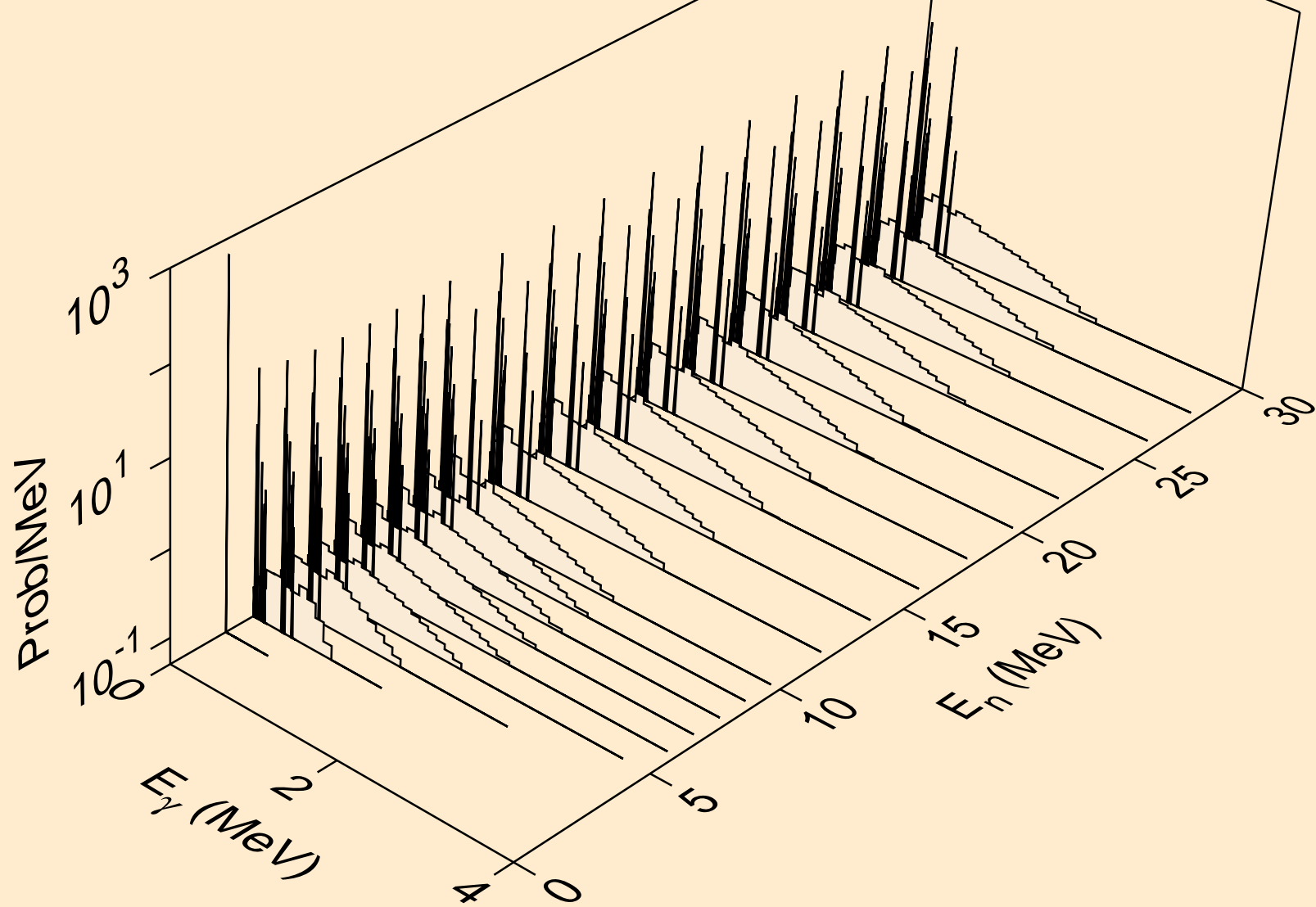

BK244 PROTON ACER TENDL-2023 LIBRARY; T=0.K
Photon emission for (z,x)

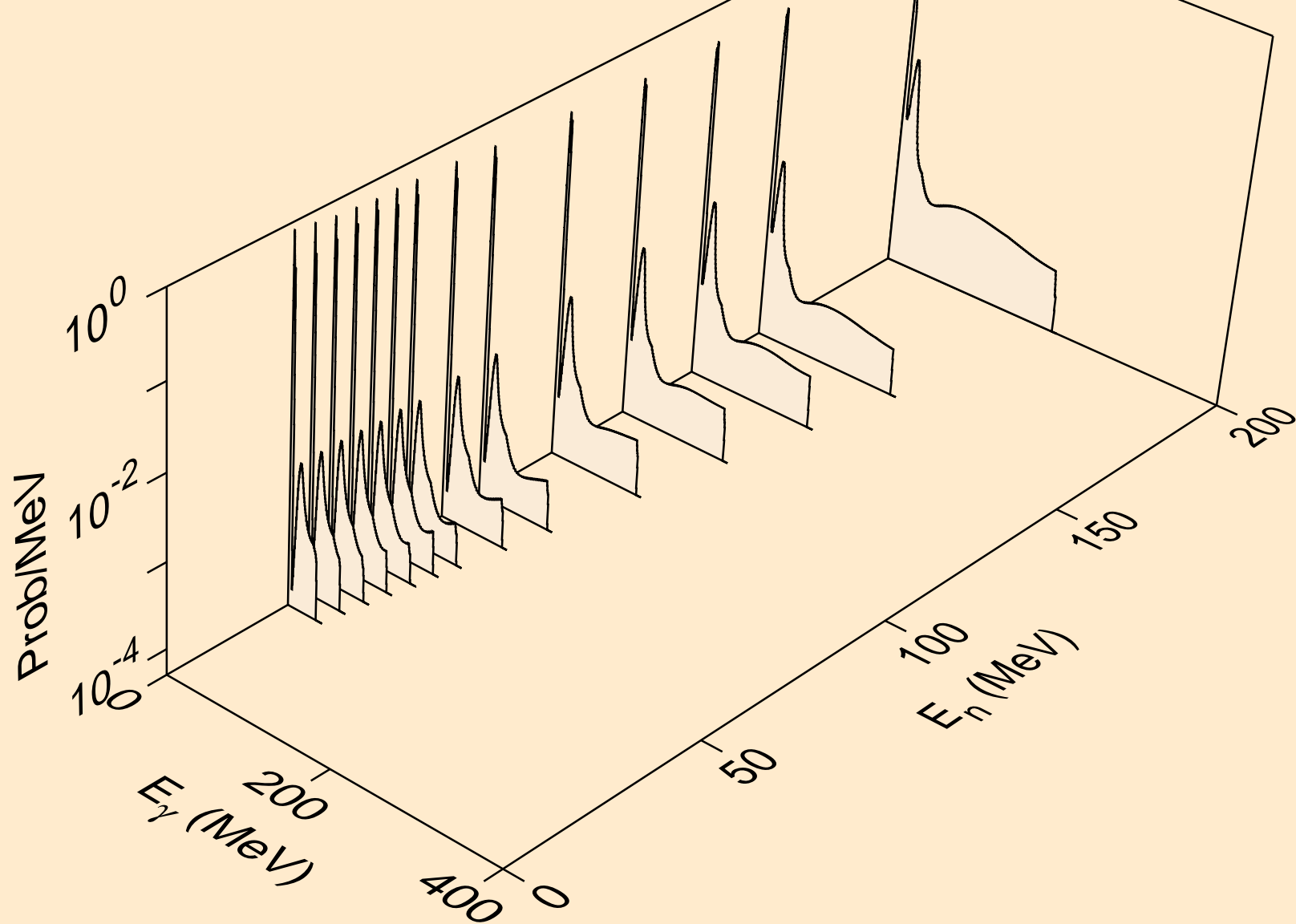

BK244 PROTON ACER TENDL-2023 LIBRARY; T=0.K
Photon emission for (n,2n)

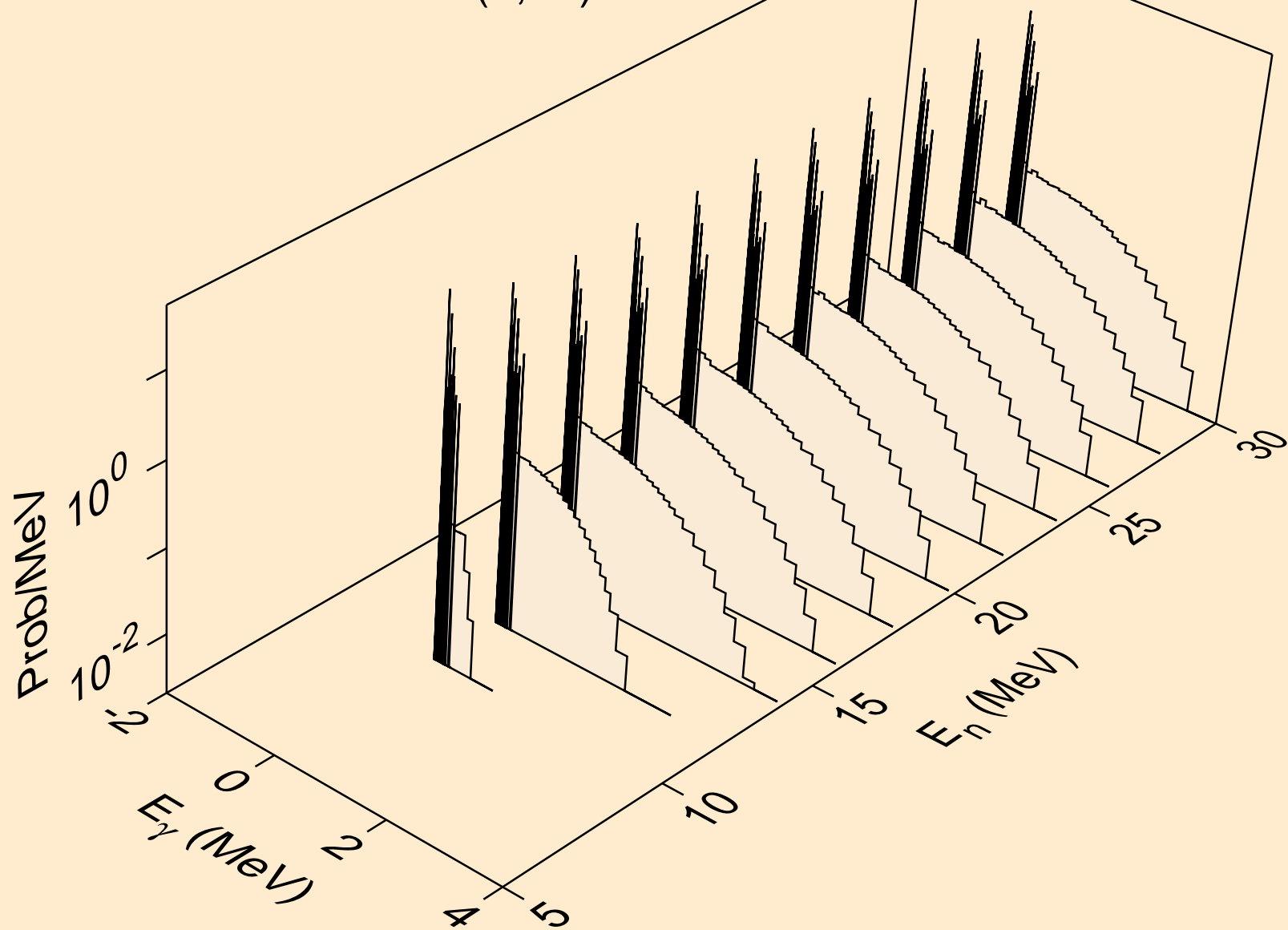

BK244 PROTON ACER TENDL-2023 LIBRARY; T=0.K
Photon emission for (n,3n)

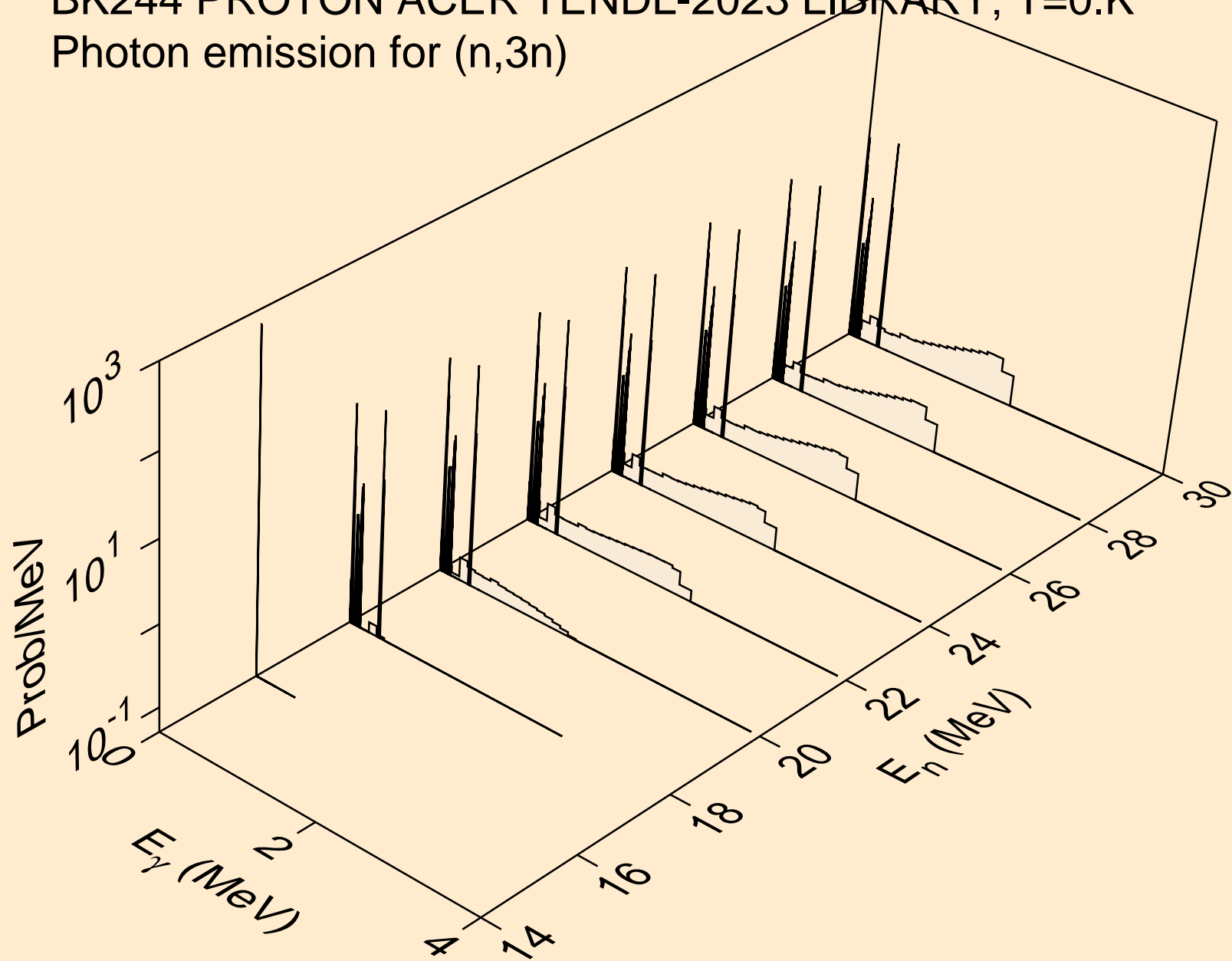

BK244 PROTON ACER TENDL-2023 LIBRARY; T=0.K
Photon emission for (n,n*)a

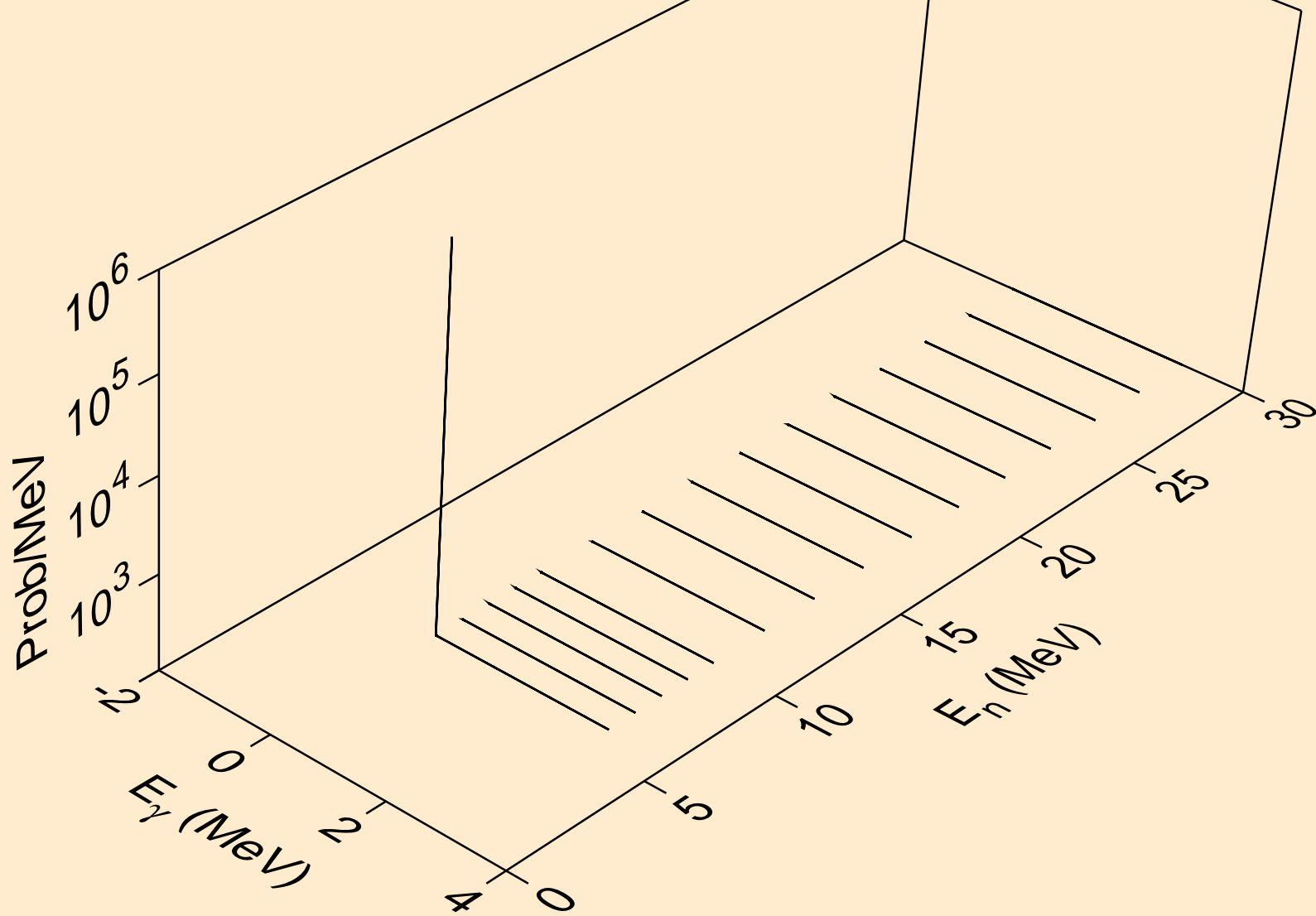

BK244 PROTON ACER TENDL-2023 LIBRARY; T=0.K
Photon emission for (n,2n)a

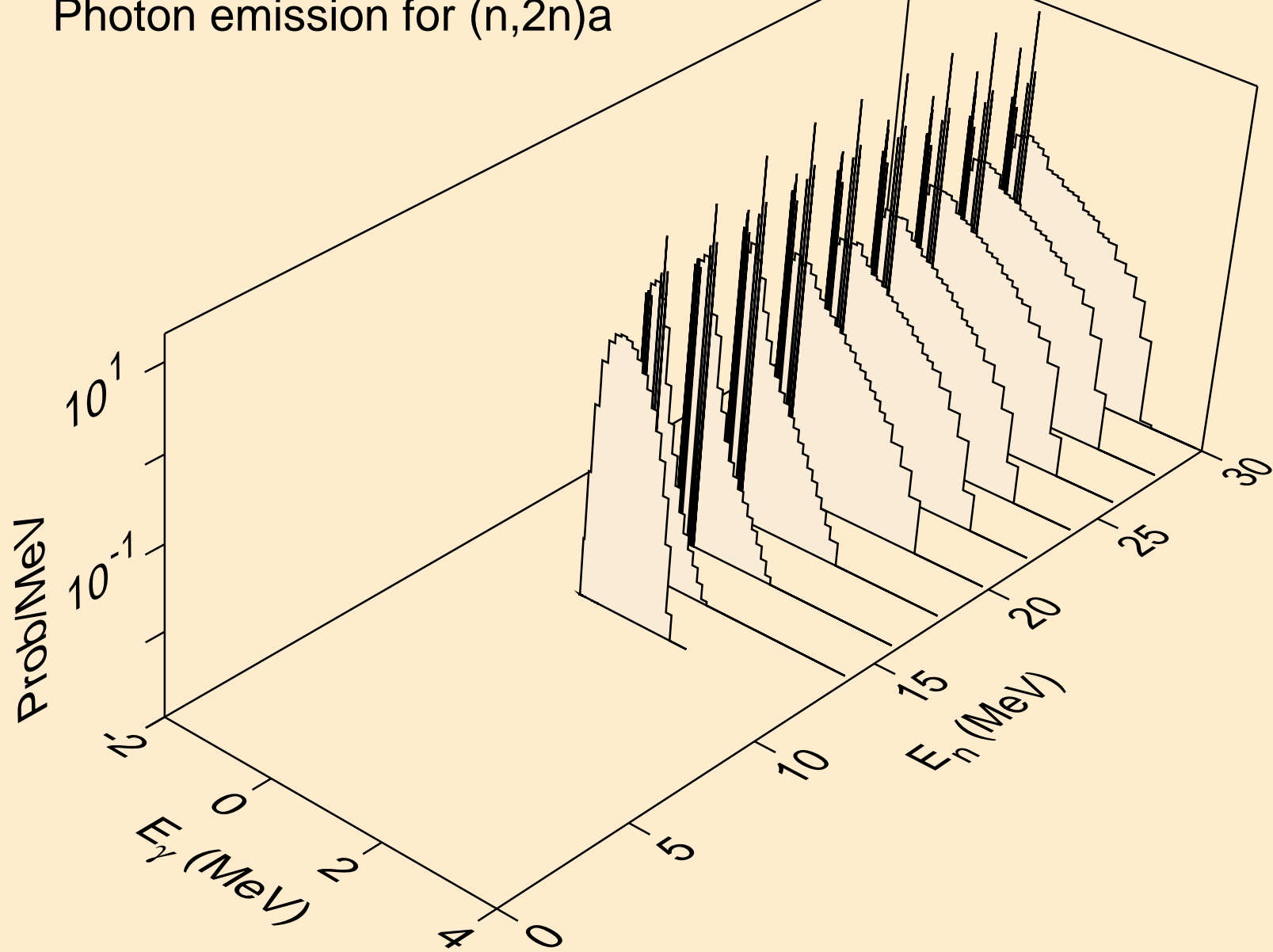

BK244 PROTON ACER TENDL-2023 LIBRARY; T=0.K
Photon emission for (n,n*)p

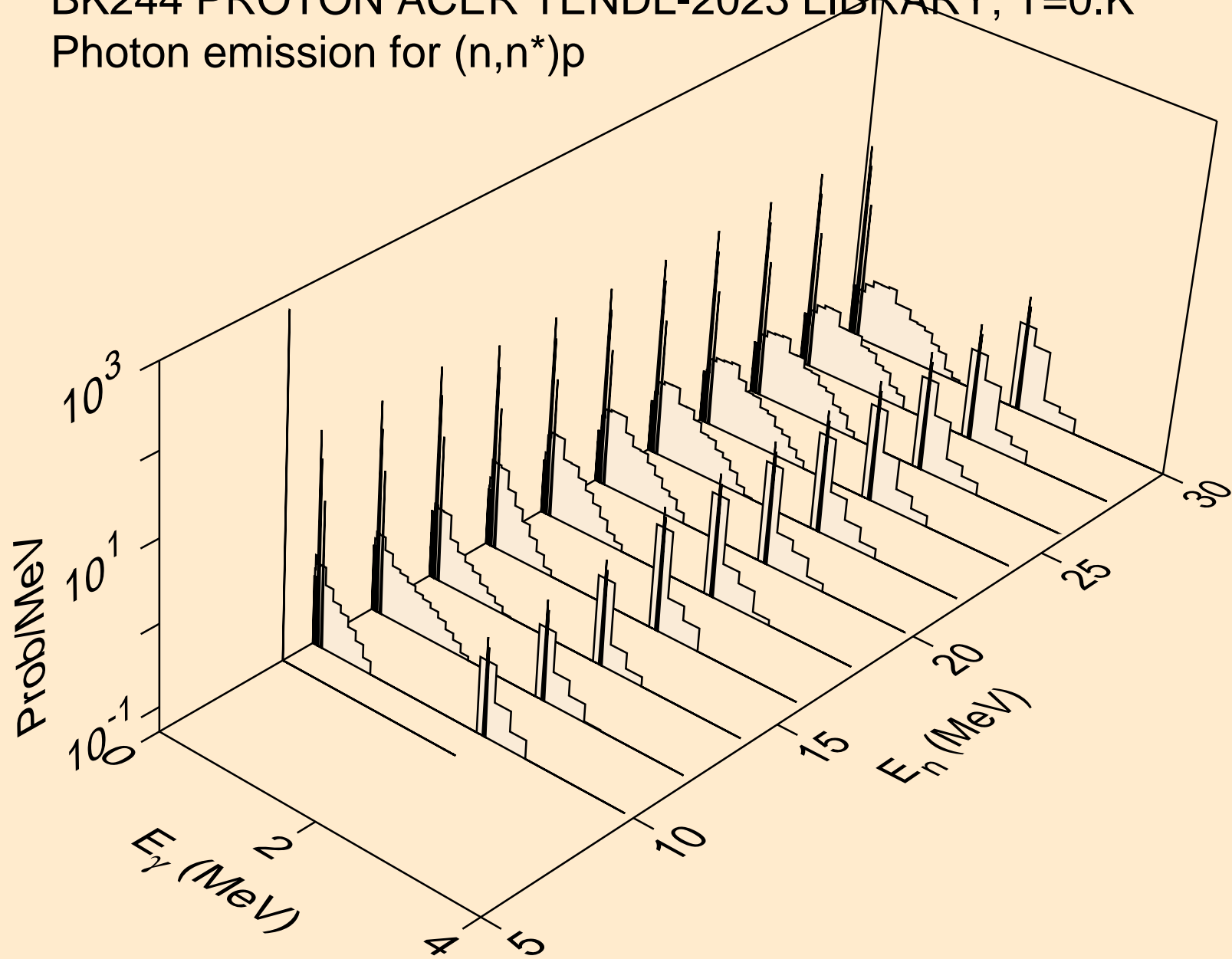

BK244 PROTON ACER TENDL-2023 LIBRARY; T=0.K
Photon emission for (n,n*)d

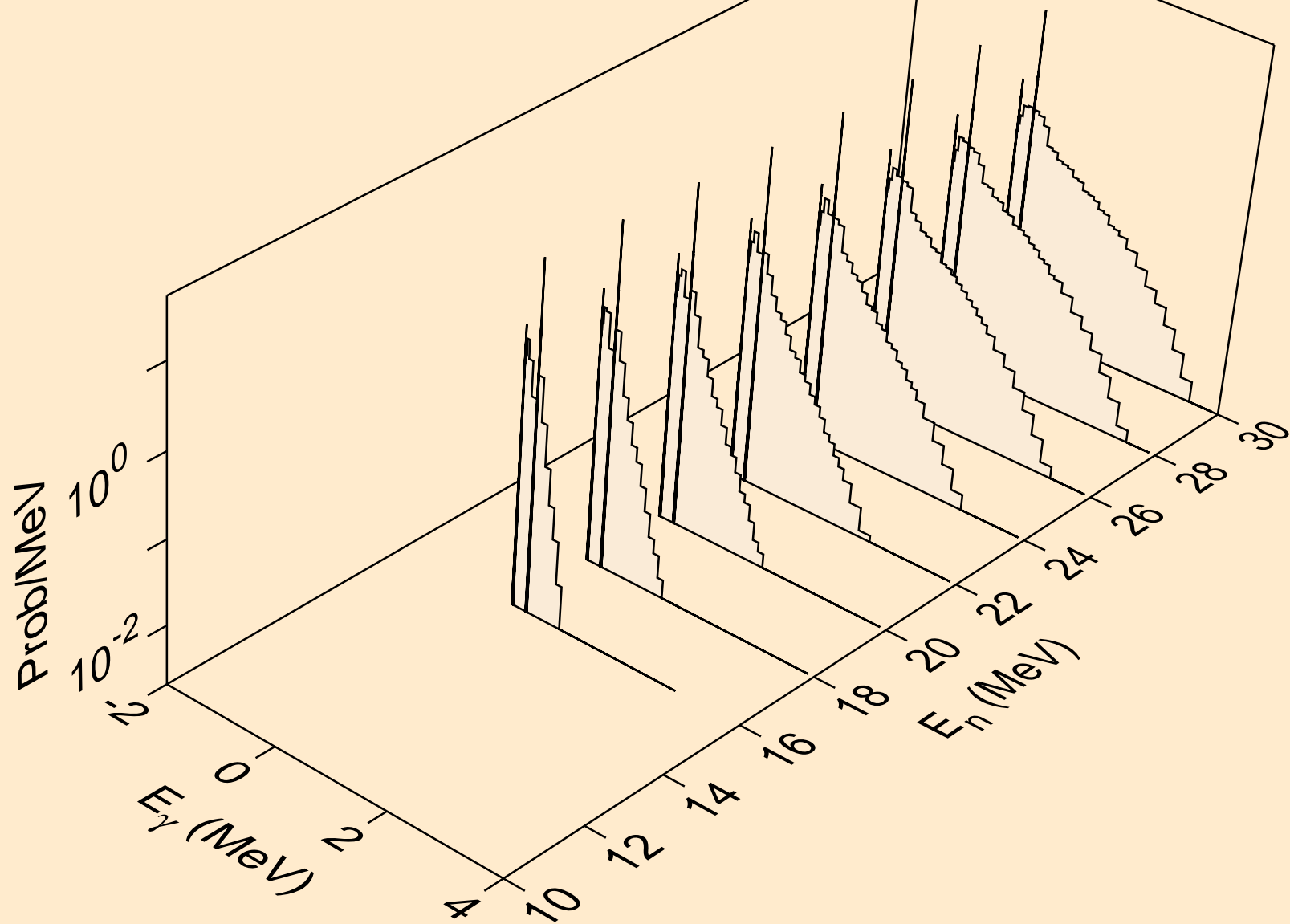

BK244 PROTON ACER TENDL-2023 LIBRARY; T=0.K
Photon emission for (n,n*)t

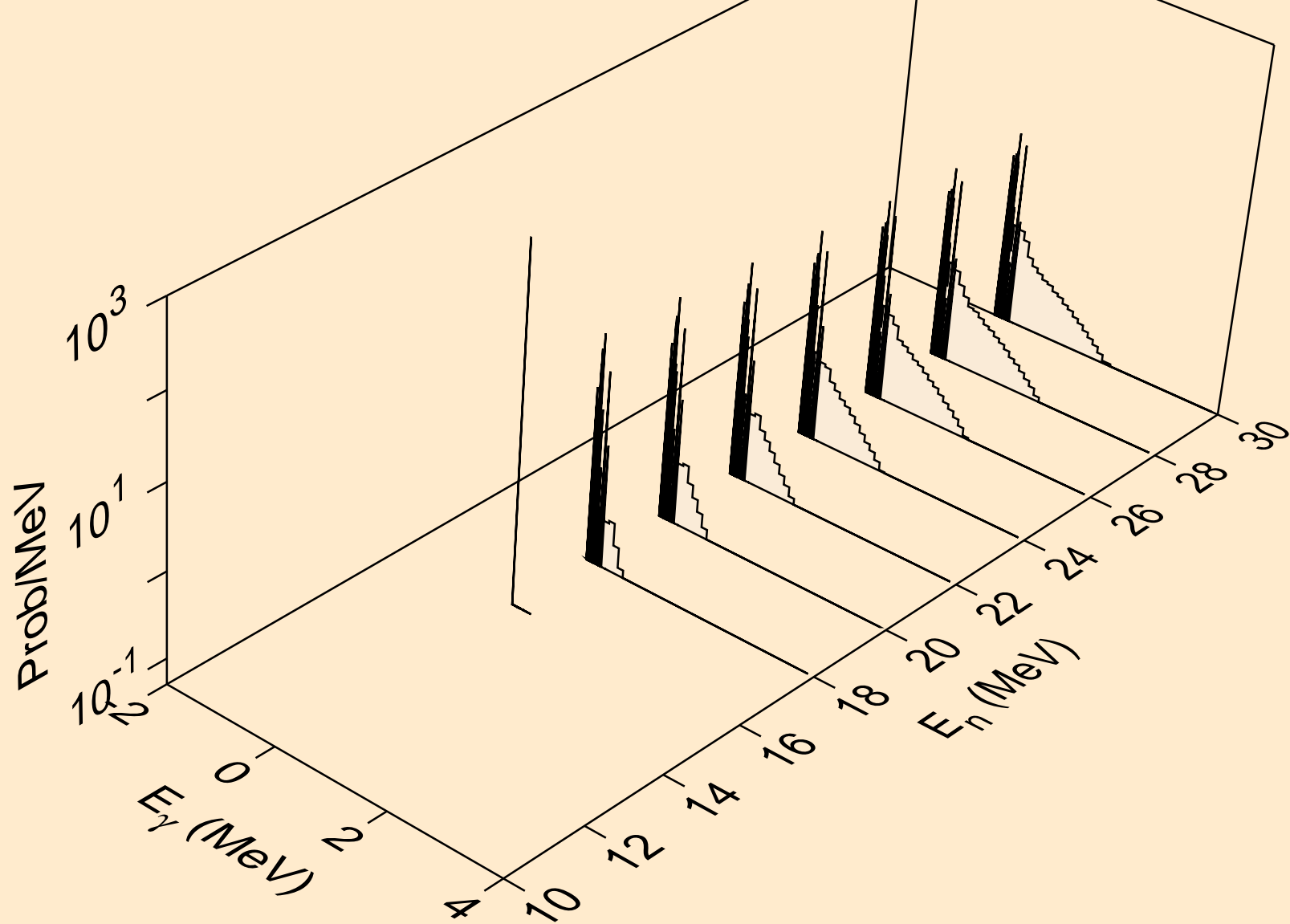

BK244 PROTON ACER TENDL-2023 LIBRARY; T=0.K
Photon emission for (n,n*)he3

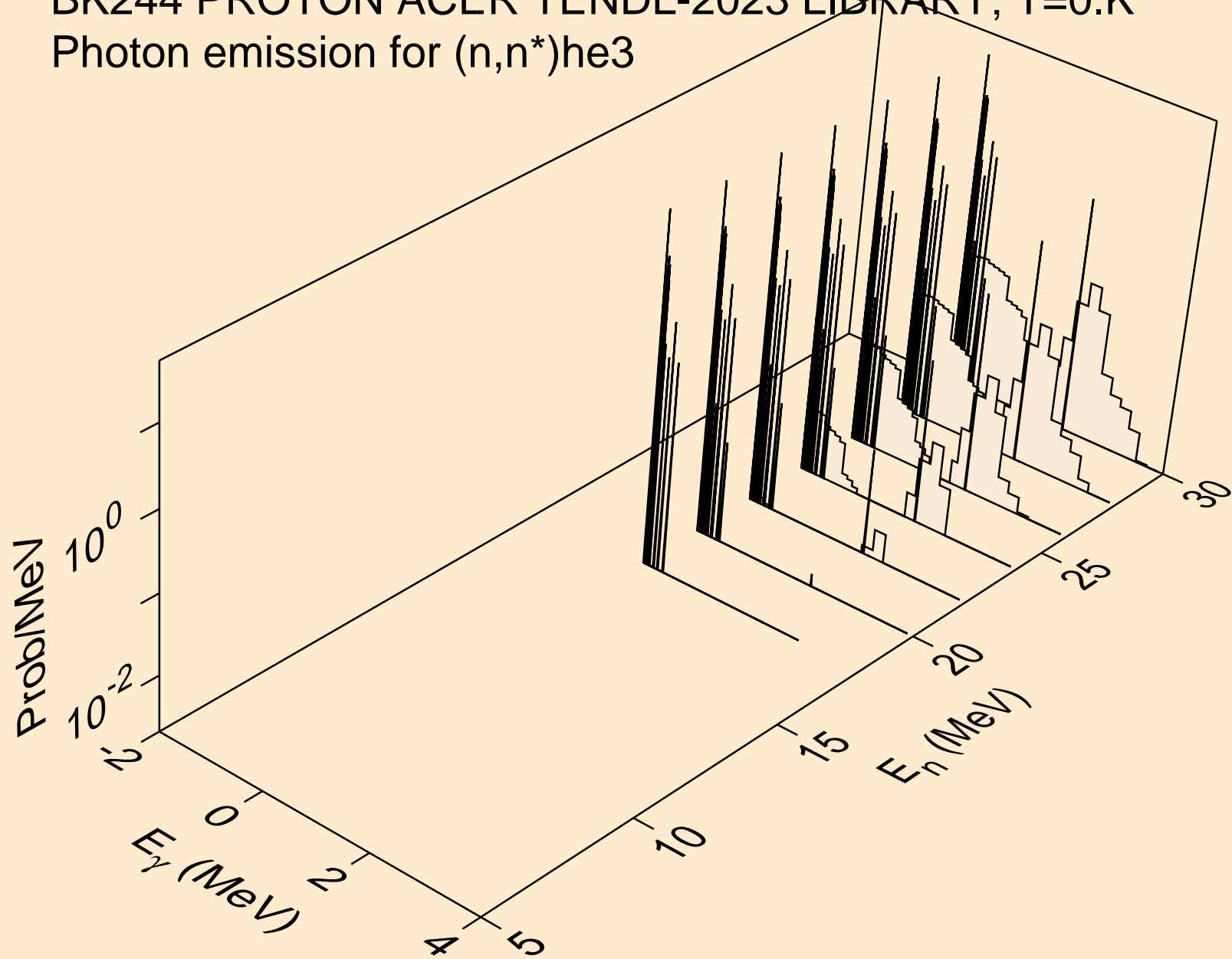

BK244 PROTON ACER TENDL-2023 LIBRARY; T=0.K
Photon emission for (n,4n)

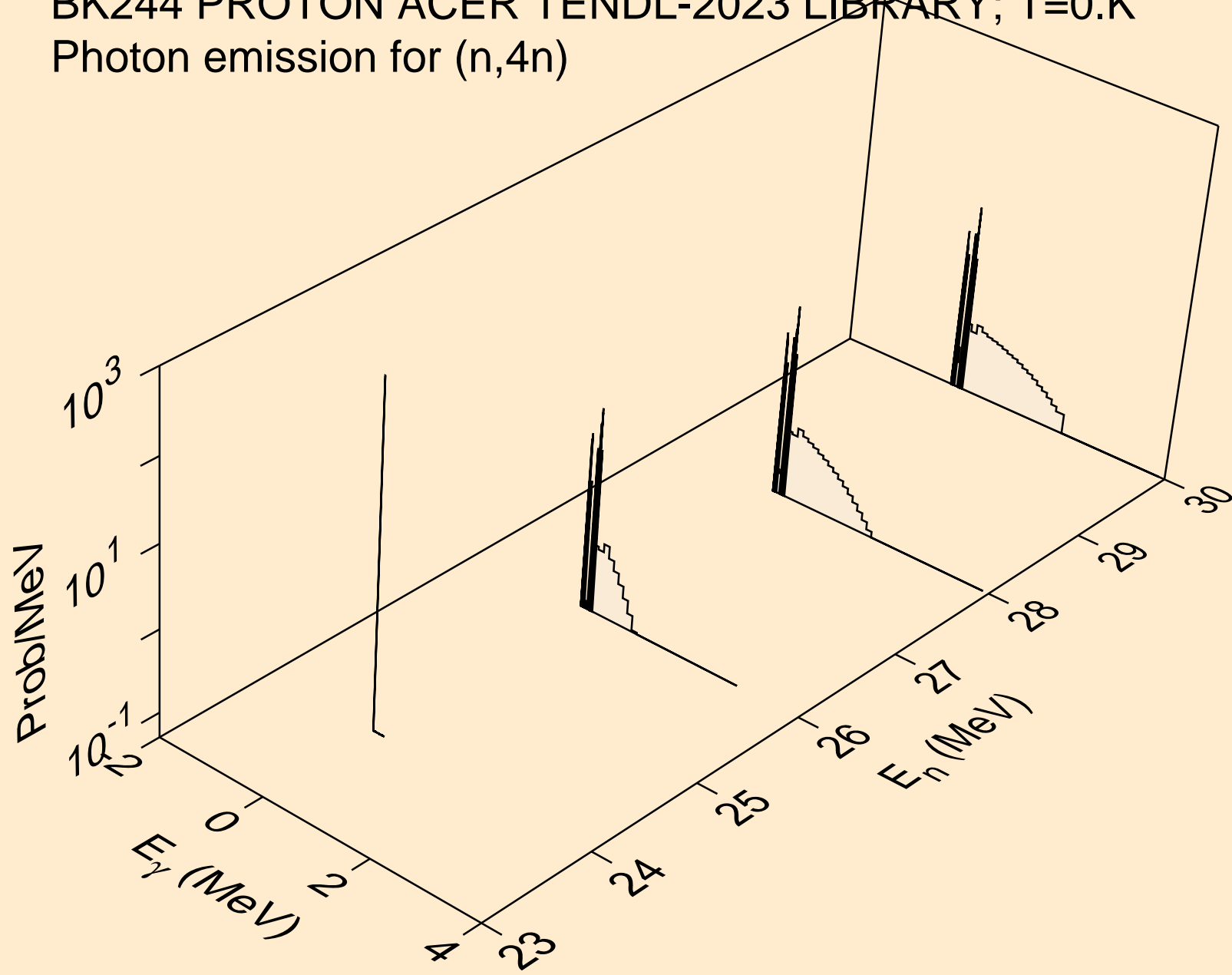

BK244 PROTON ACER TENDL-2023 LIBRARY; T=0.K
Photon emission for (n,2np)

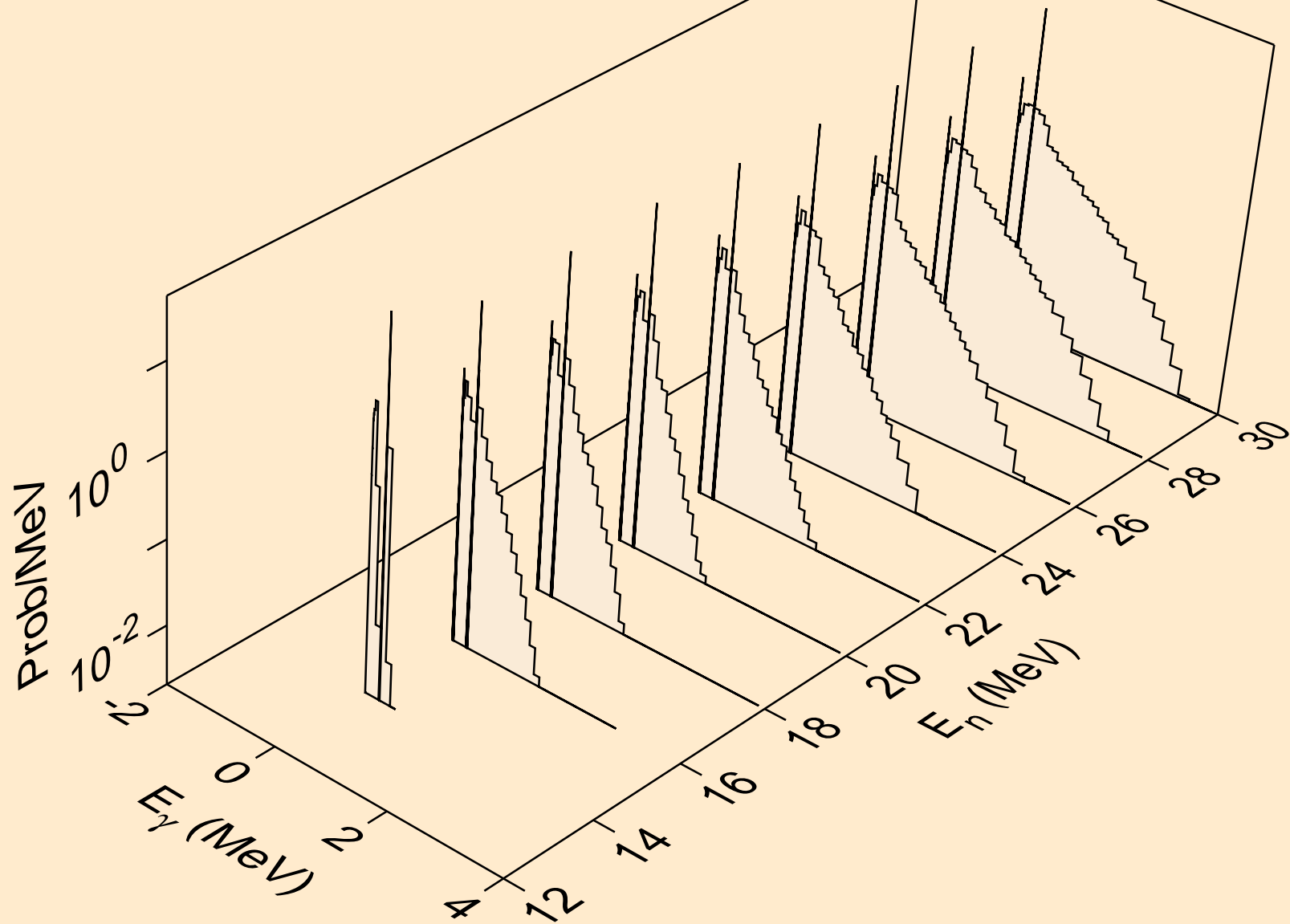

BK244 PROTON ACER TENDL-2023 LIBRARY; T=0.K
Photon emission for (n,n2p)

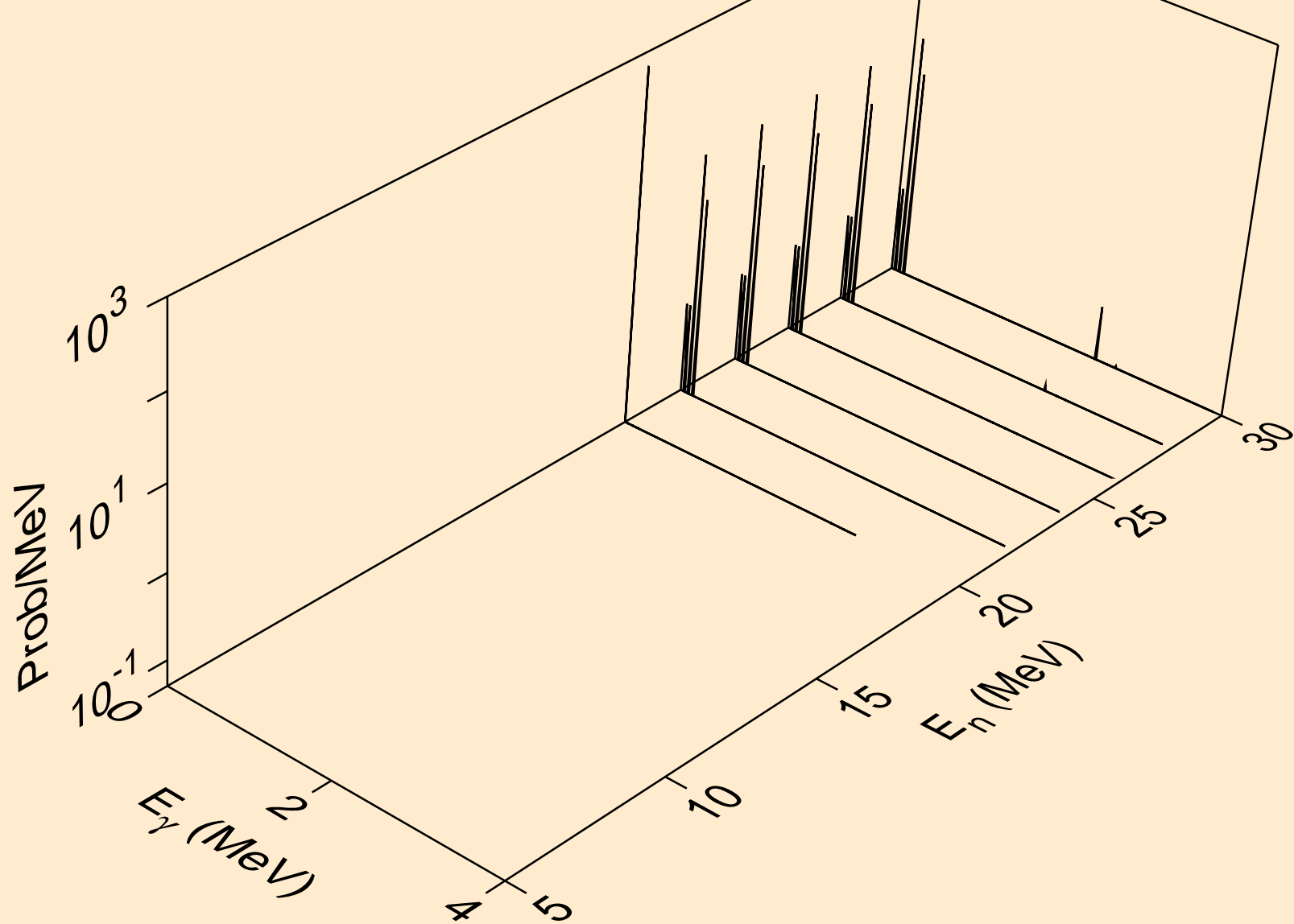

BK244 PROTON ACER TENDL-2023 LIBRARY; T=0.K
Photon emission for (n,gma)

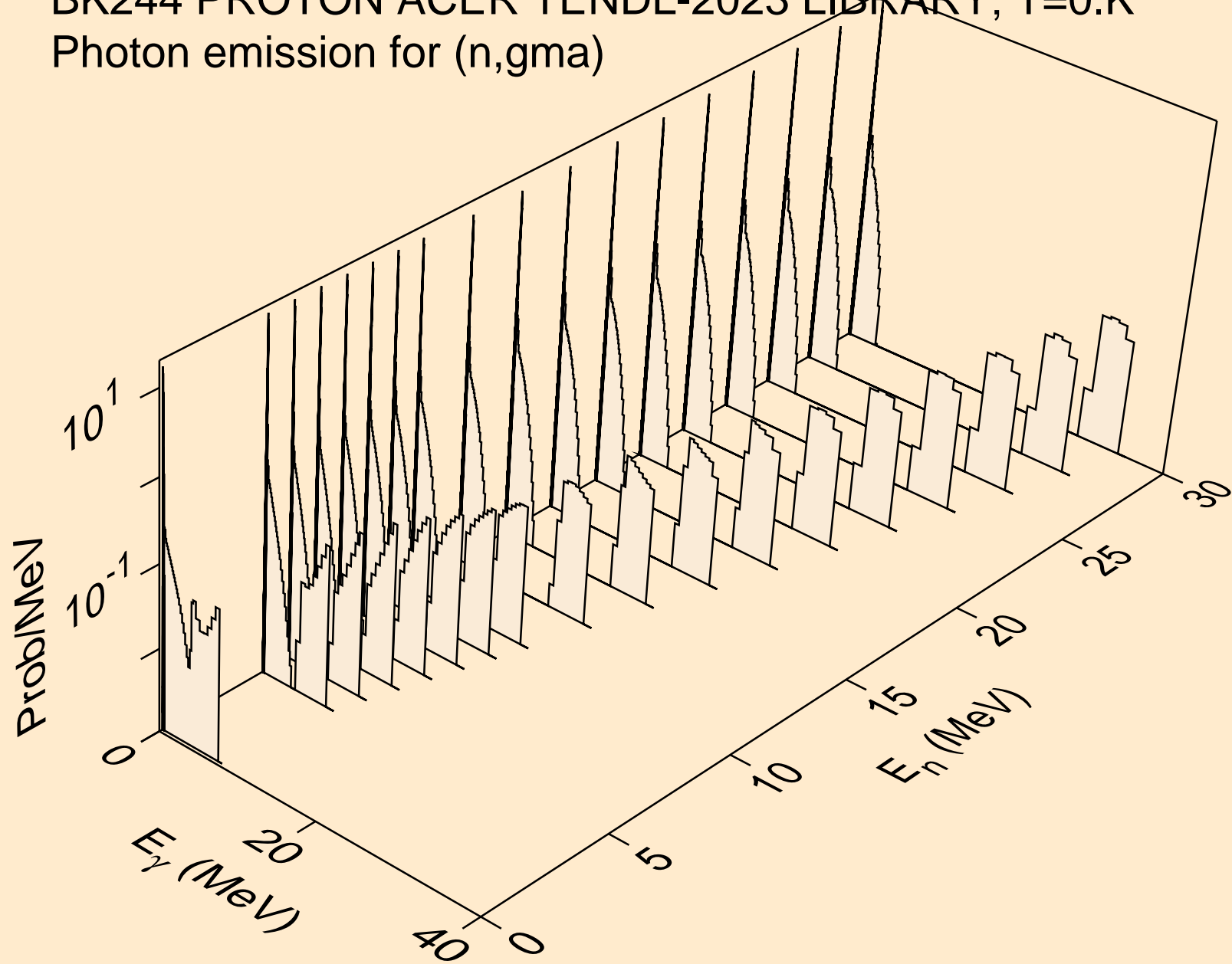

BK244 PROTON ACER TENDL-2023 LIBRARY; T=0.K
Photon emission for inelastic

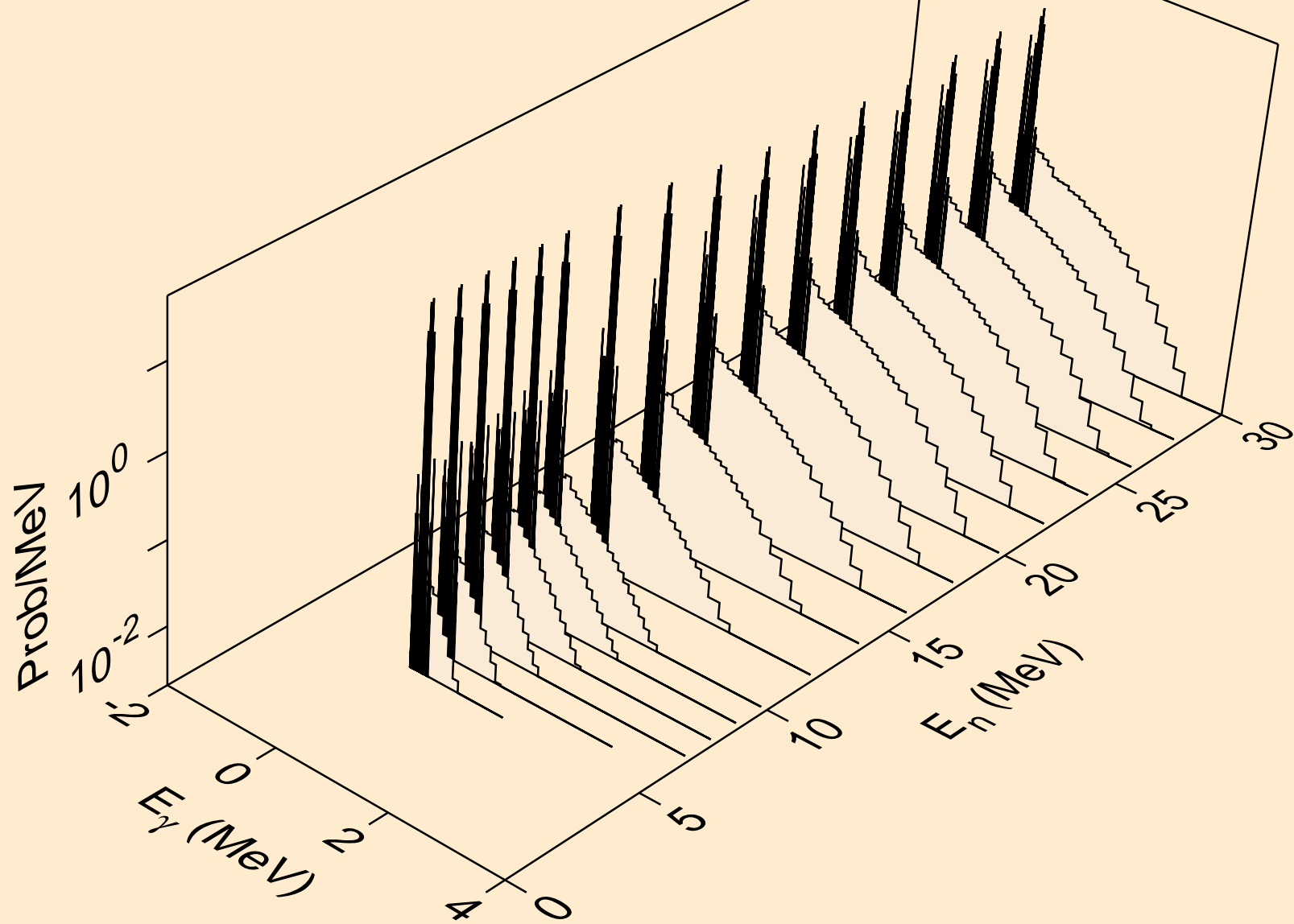

BK244 PROTON ACER TENDL-2023 LIBRARY; T=0.K
Photon emission for (n,d)

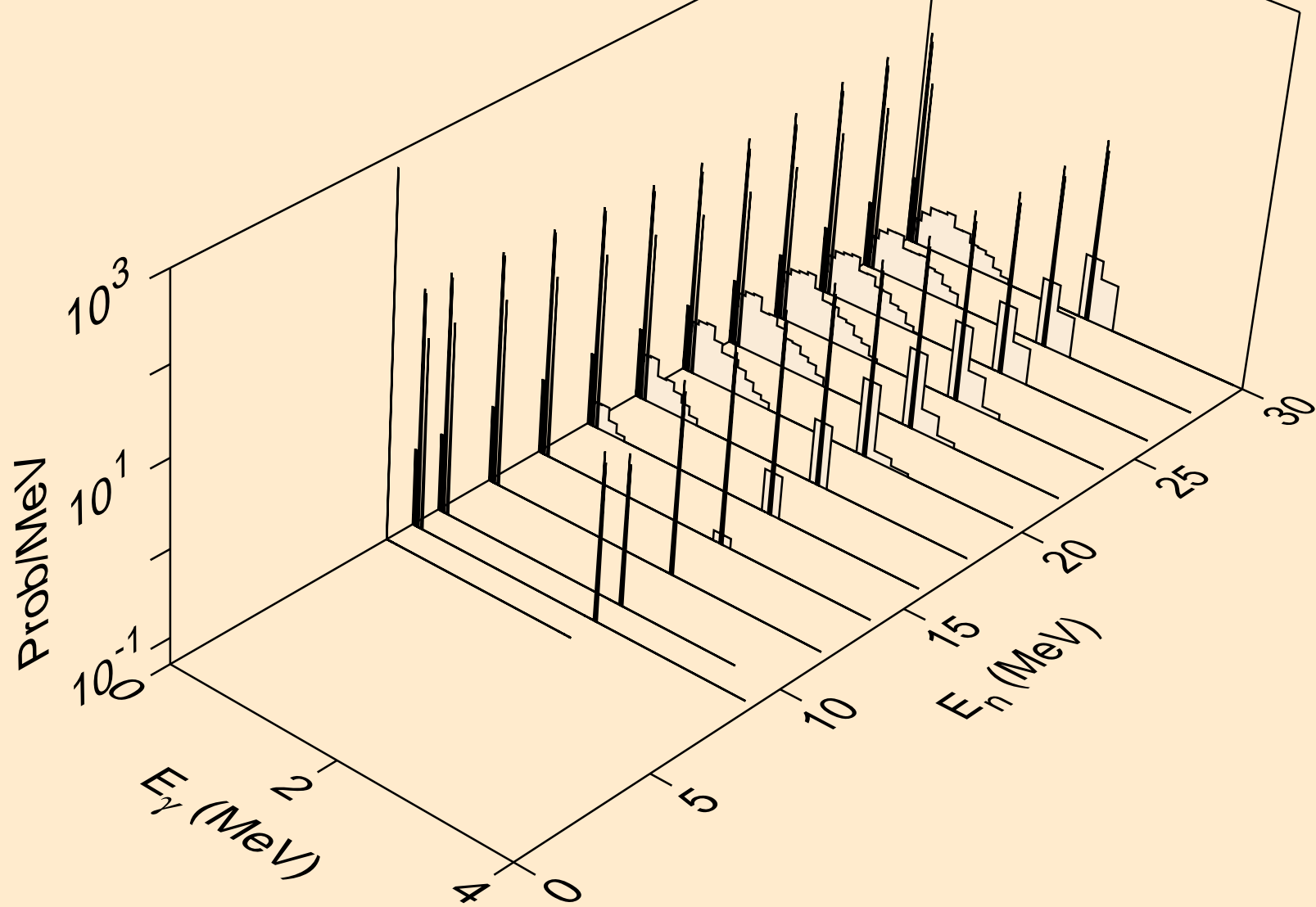

BK244 PROTON ACER TENDL-2023 LIBRARY; T=0.K
Photon emission for (n,t)

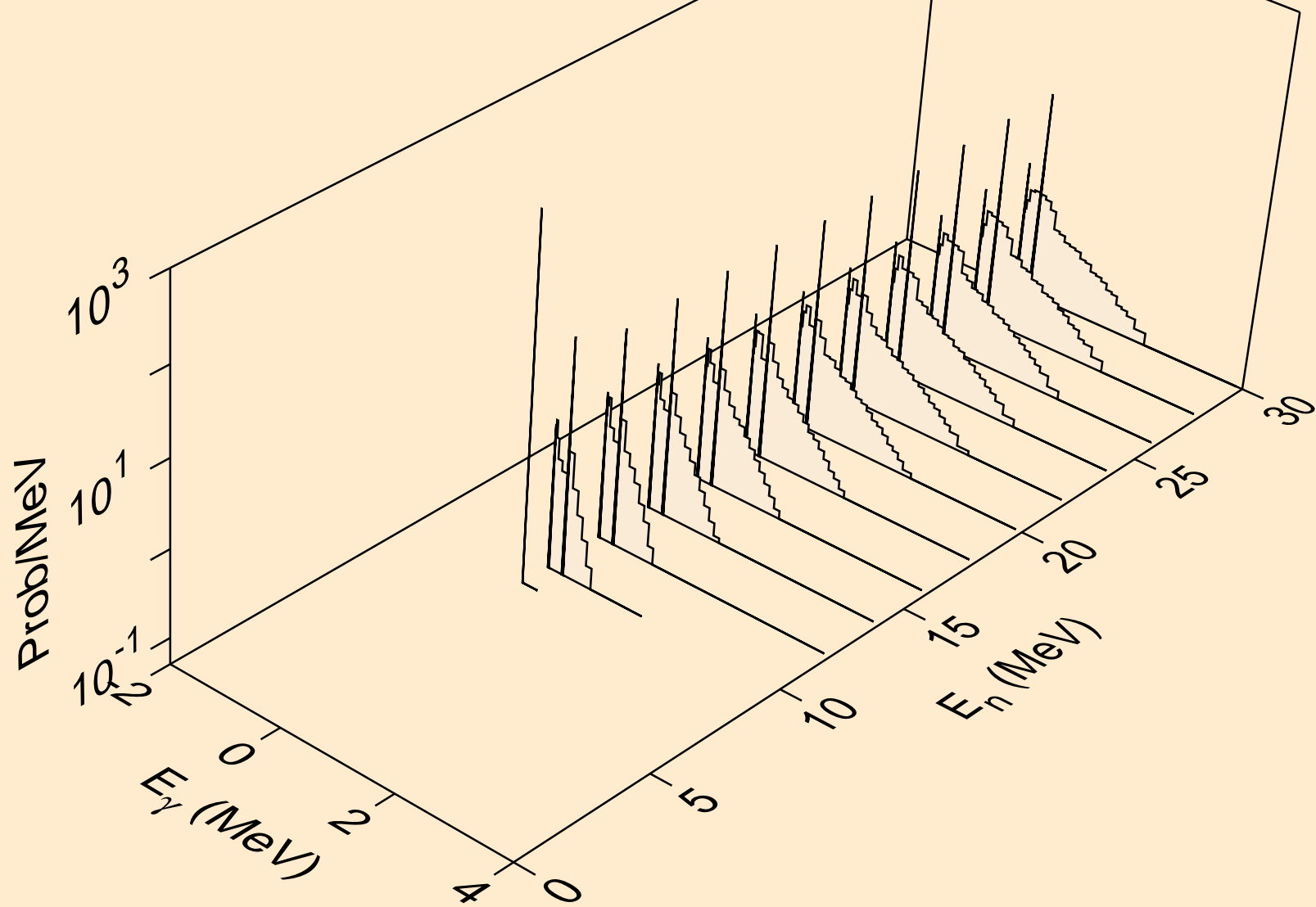

BK244 PROTON ACER TENDL-2023 LIBRARY; T=0.K
Photon emission for (n,he3)

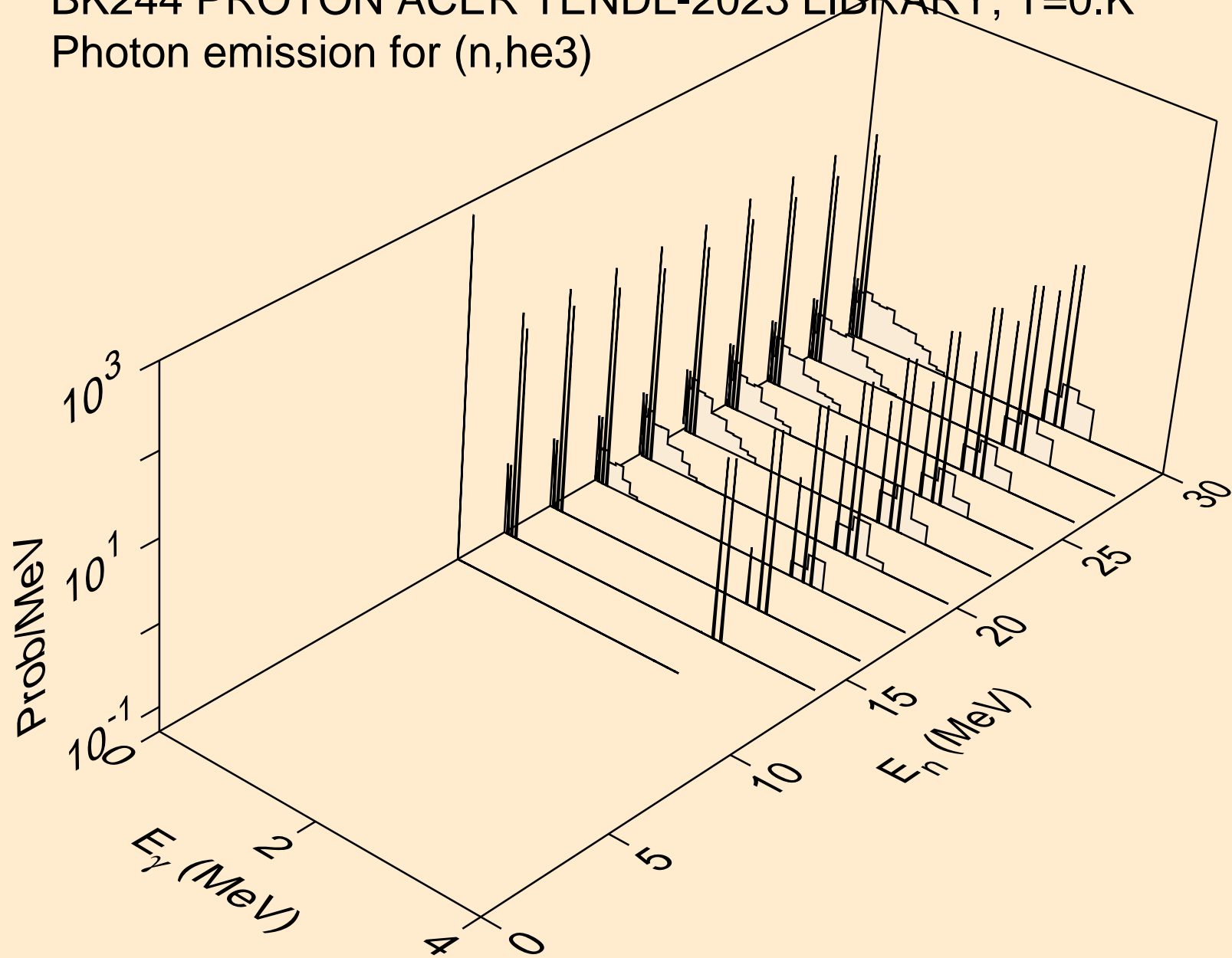

BK244 PROTON ACER TENDL-2023 LIBRARY; T=0.K
Photon emission for (n,a)

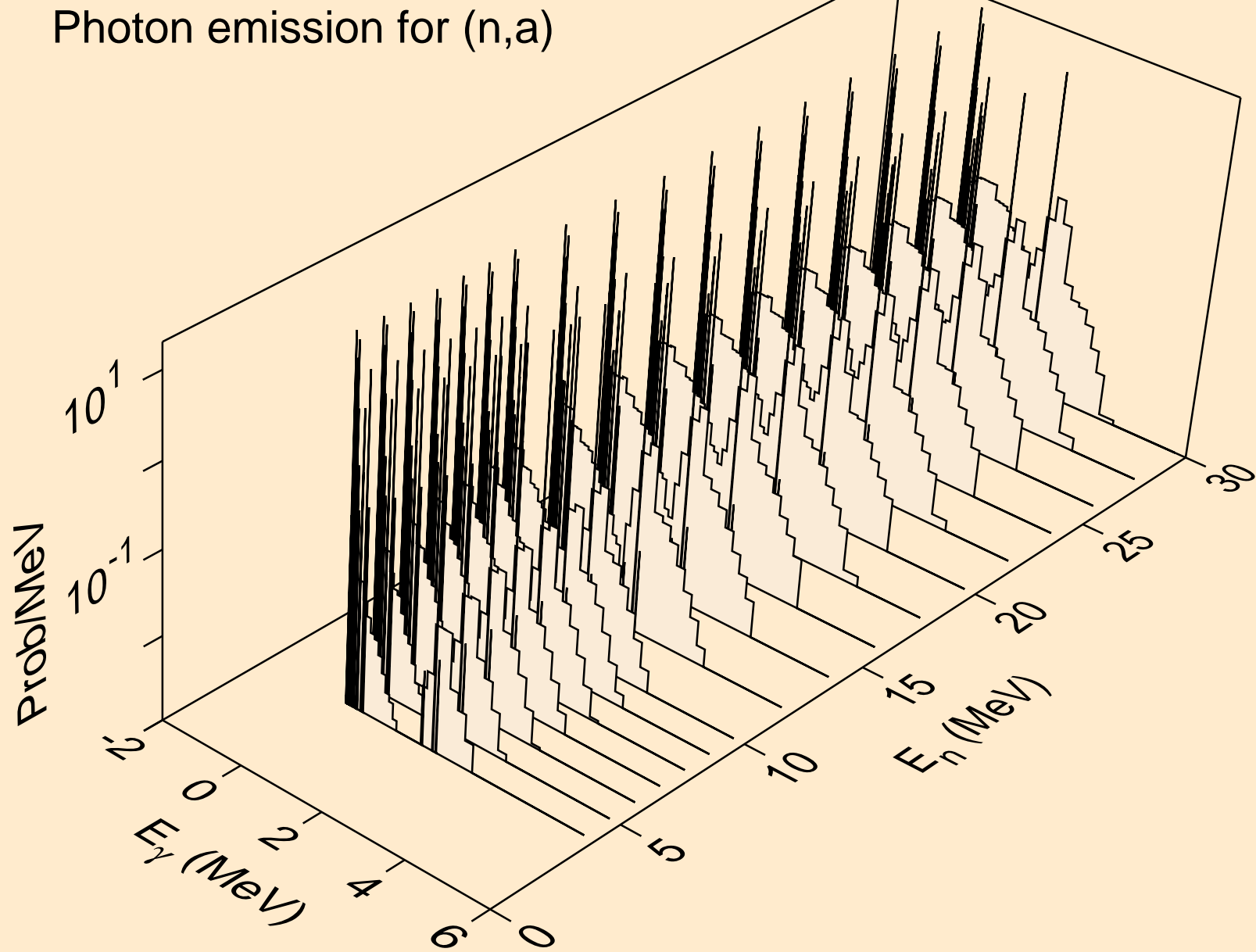

BK244 PROTON ACER TENDL-2023 LIBRARY; T=0.K
Photon emission for (n,2a)

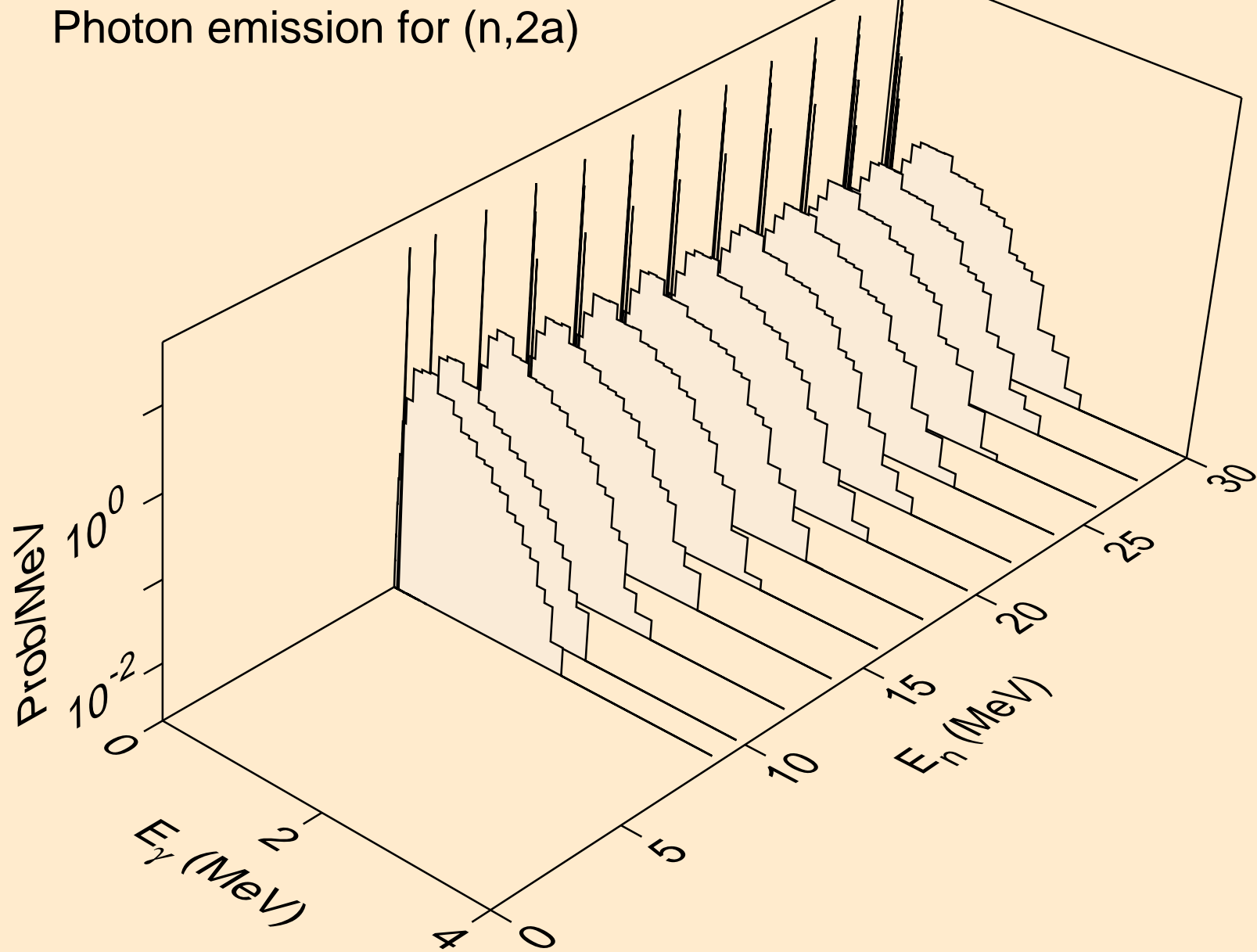

BK244 PROTON ACER TENDL-2023 LIBRARY; T=0.K
Photon emission for (n,2p)

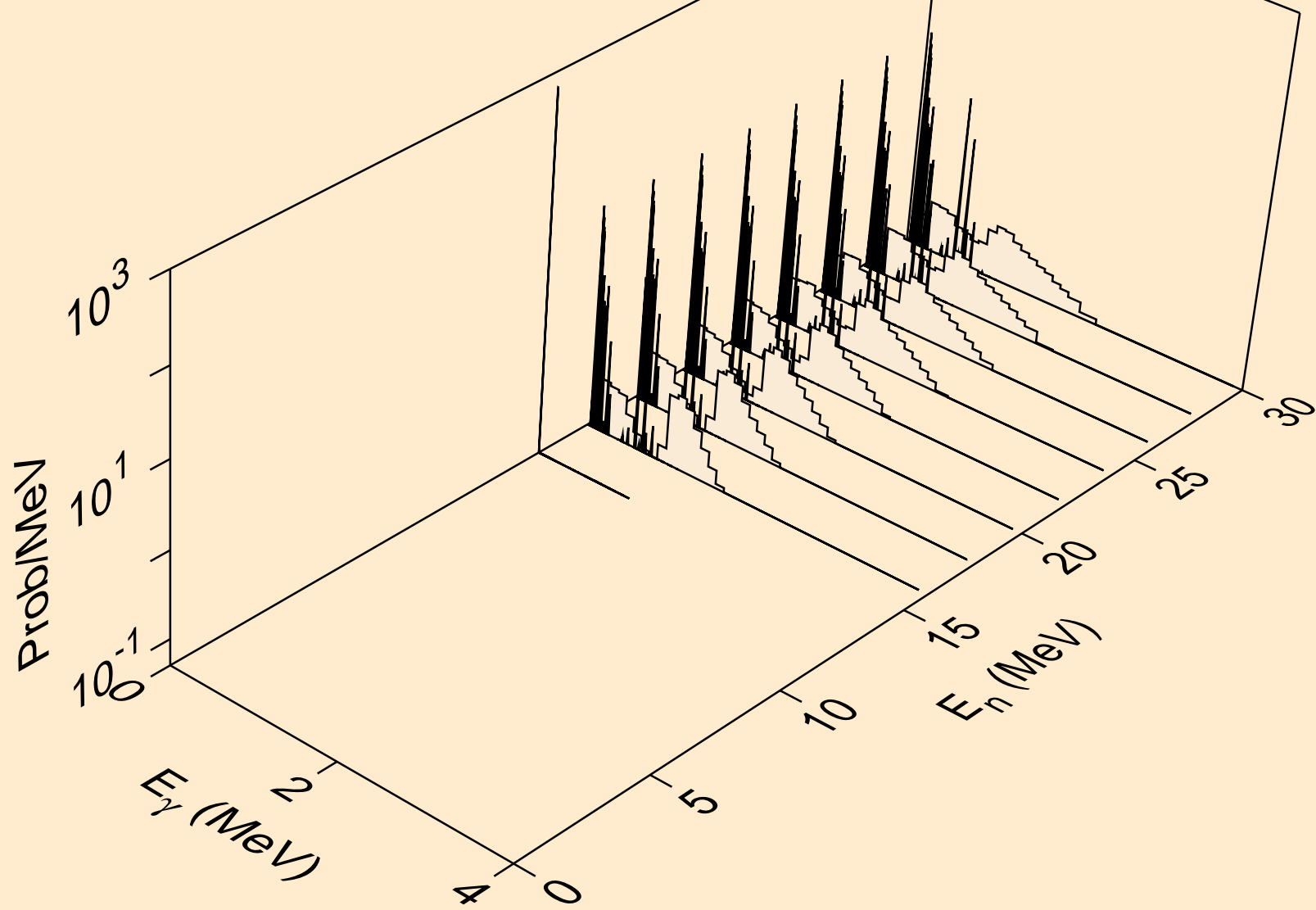

BK244 PROTON ACER TENDL-2023 LIBRARY; T=0.K
Particle heating contributions

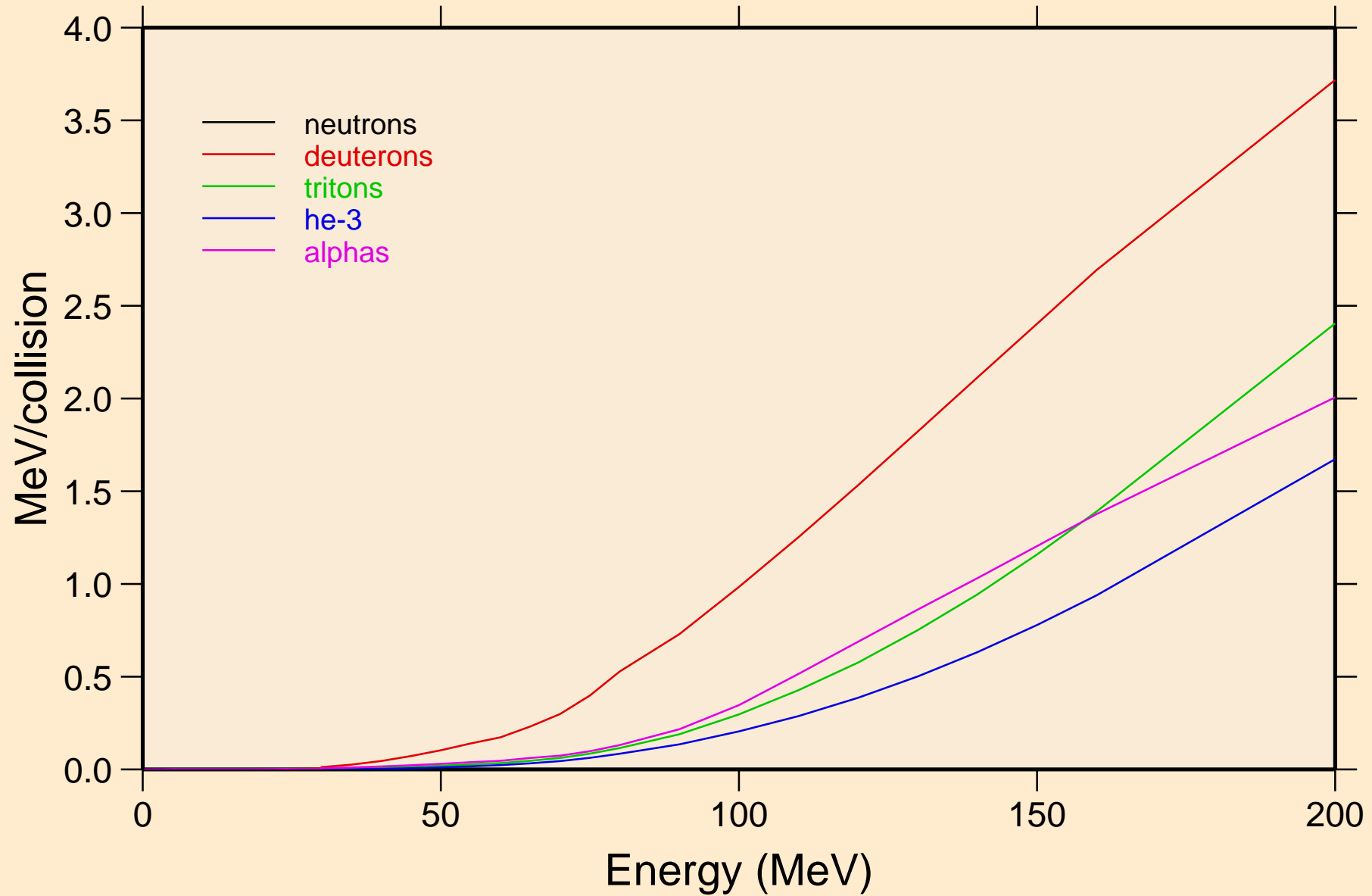

BK244 PROTON ACER TENDL-2023 LIBRARY; T=0.K

Recoil Heating

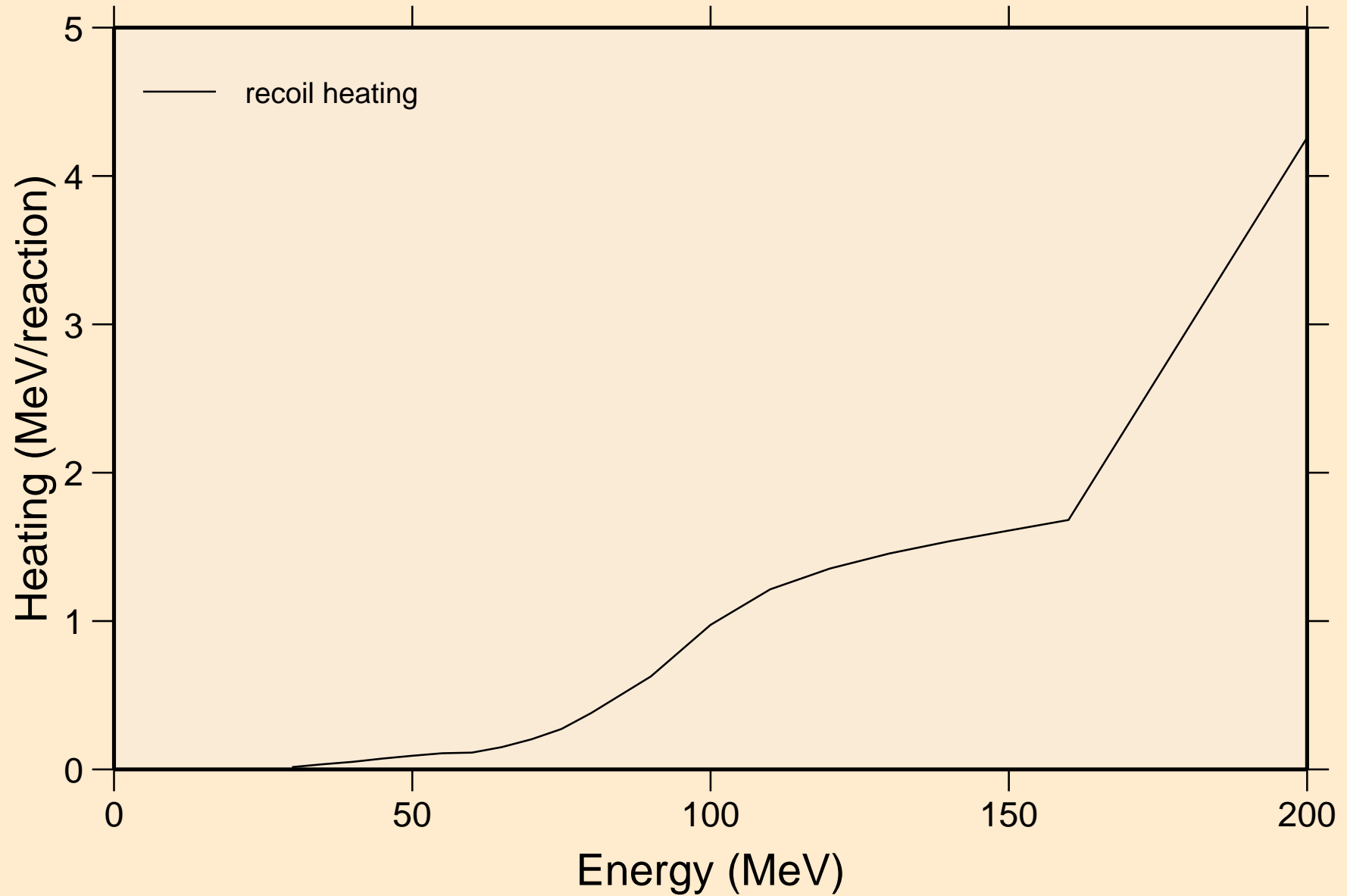

BK244 PROTON ACER TENDL-2023 LIBRARY; T=0.K
Particle production cross sections

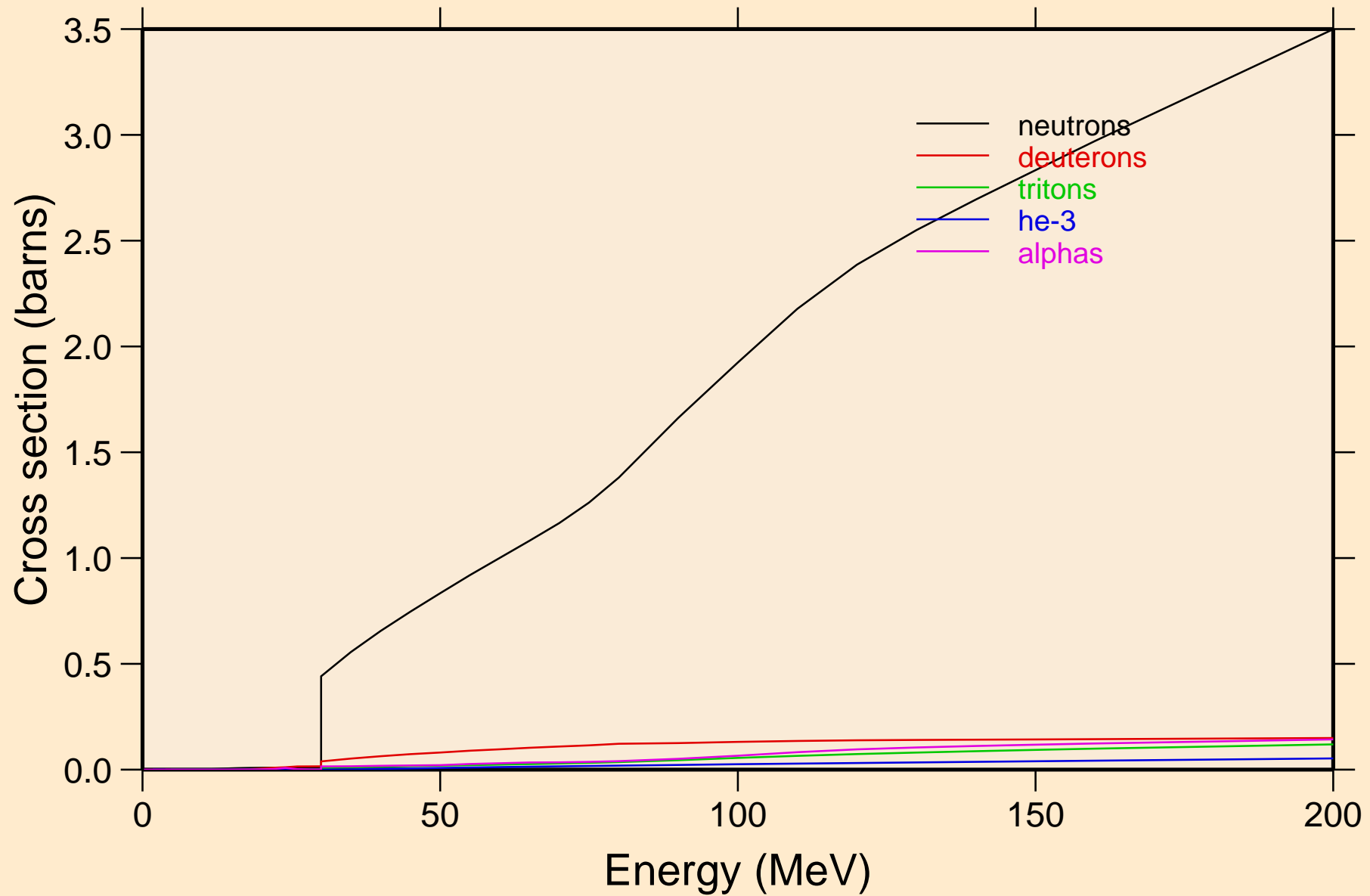

BK244 PROTON ACER TENDL-2023 LIBRARY; T=0.K
neutrons from (p,n)

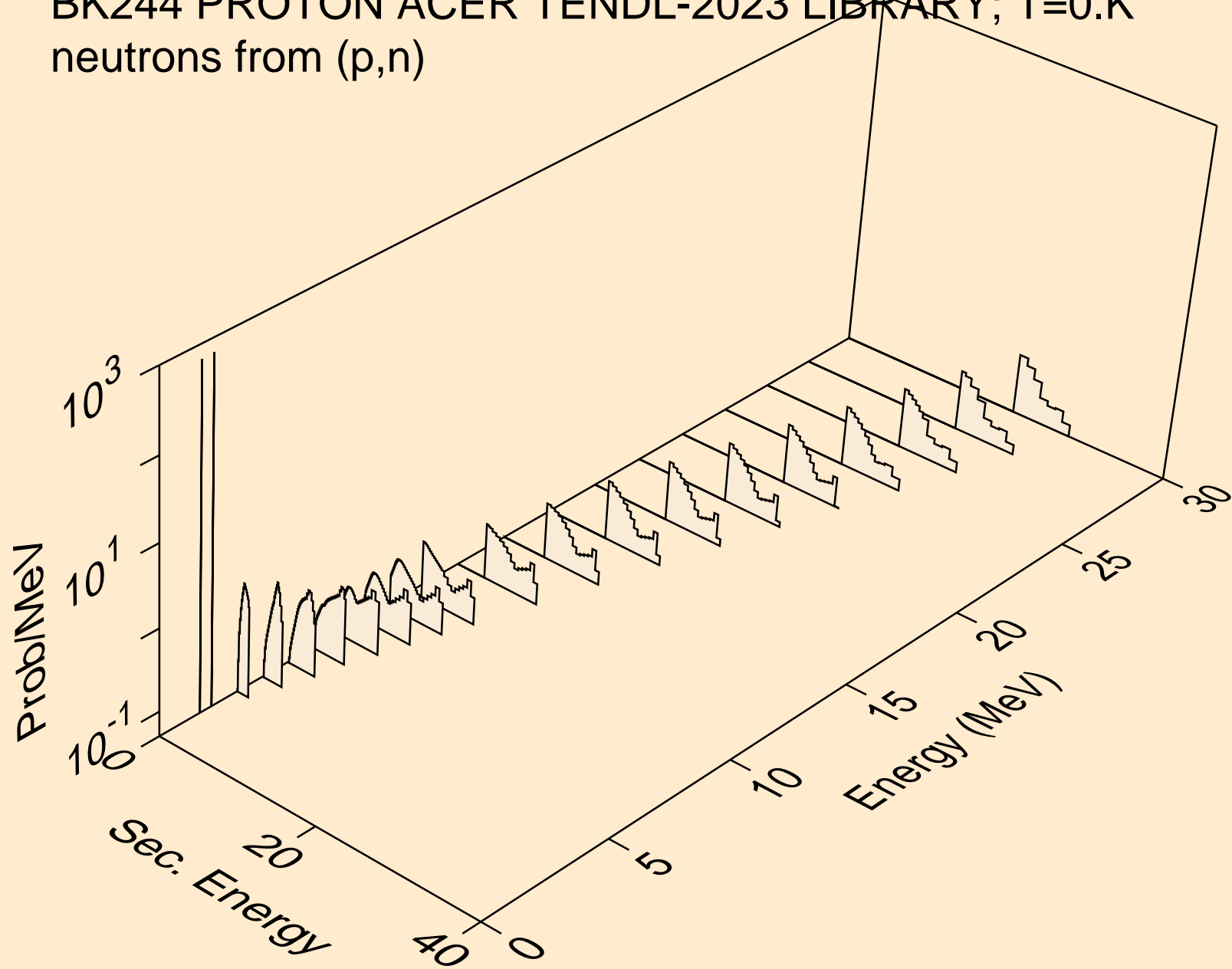

BK244 PROTON ACER TENDL-2023 LIBRARY; T=0.K
neutrons from (p,x)

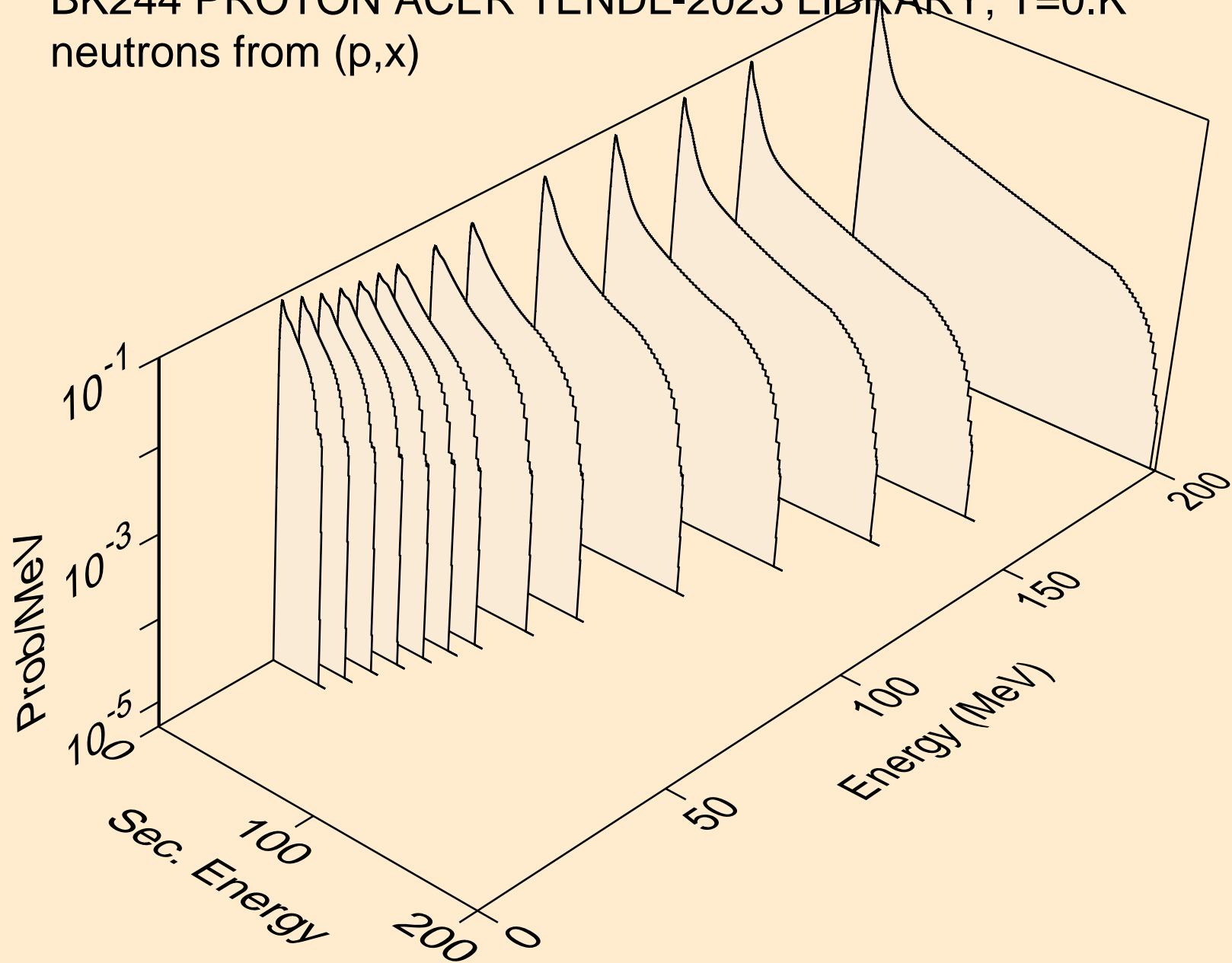

BK244 PROTON ACER TENDL-2023 LIBRARY; T=0.K
neutrons from (p,2n)

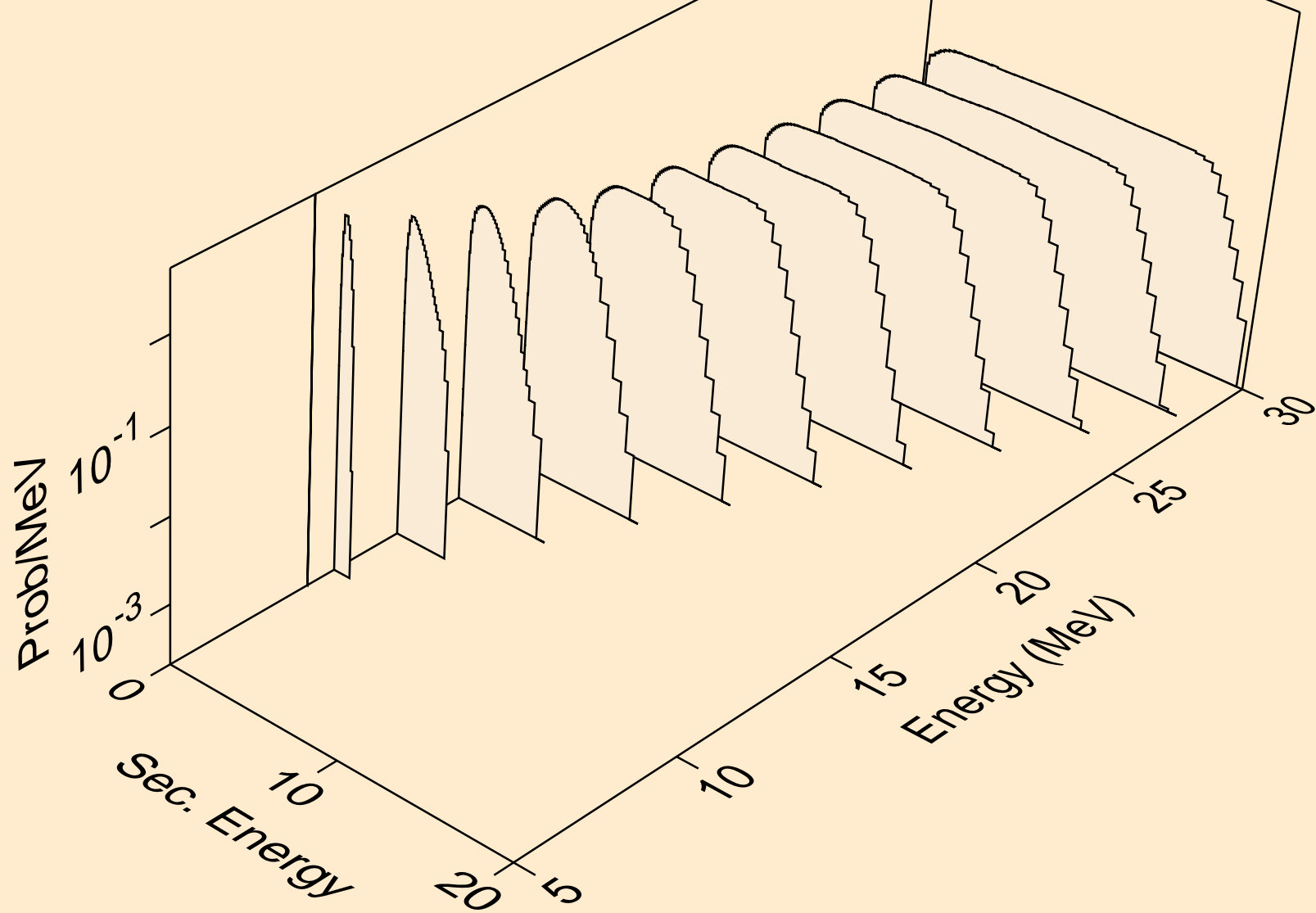

BK244 PROTON ACER TENDL-2023 LIBRARY; T=0.K
neutrons from (p,3n)

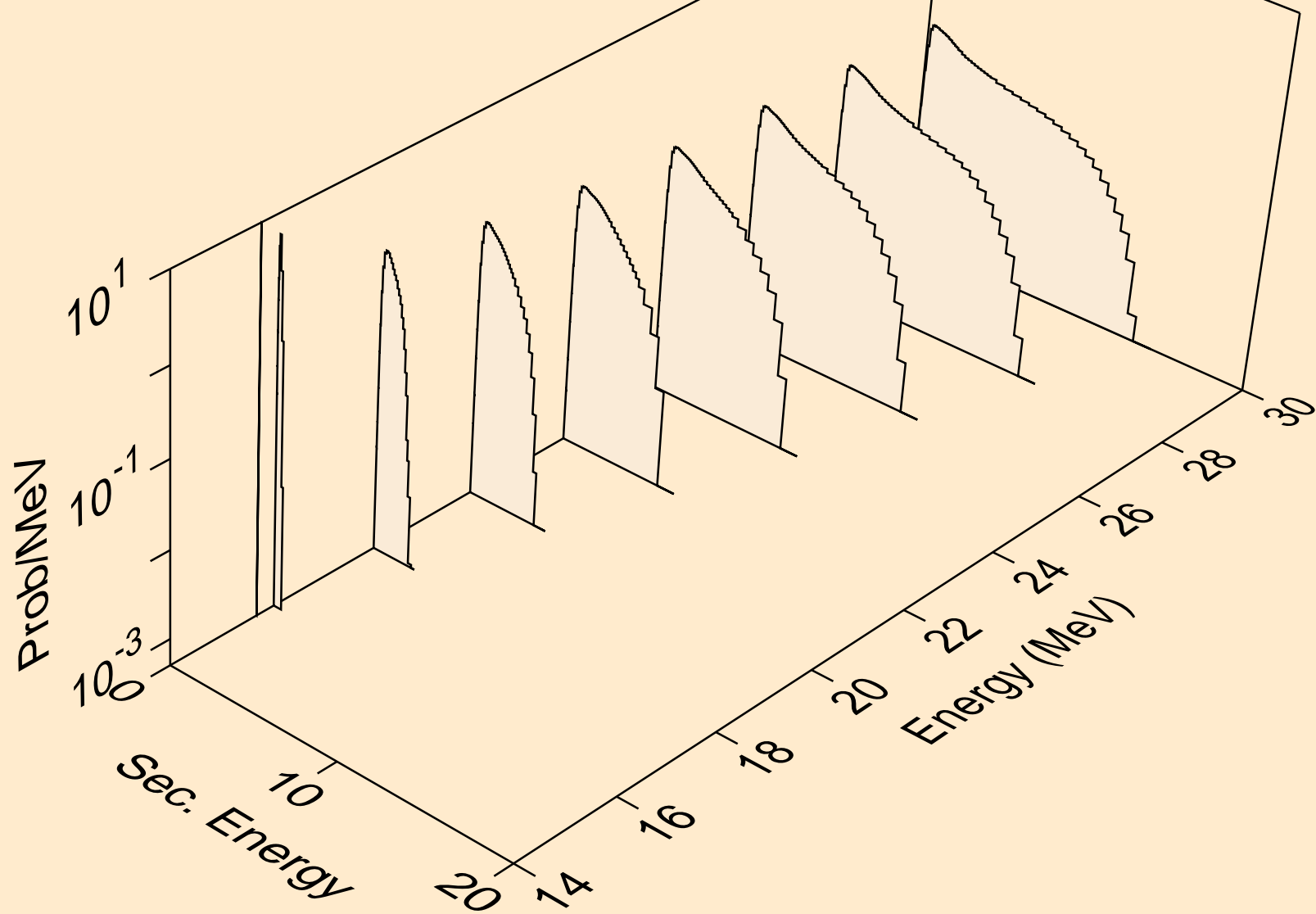

BK244 PROTON ACER TENDL-2023 LIBRARY; T=0.K
neutrons from (p,n*)a

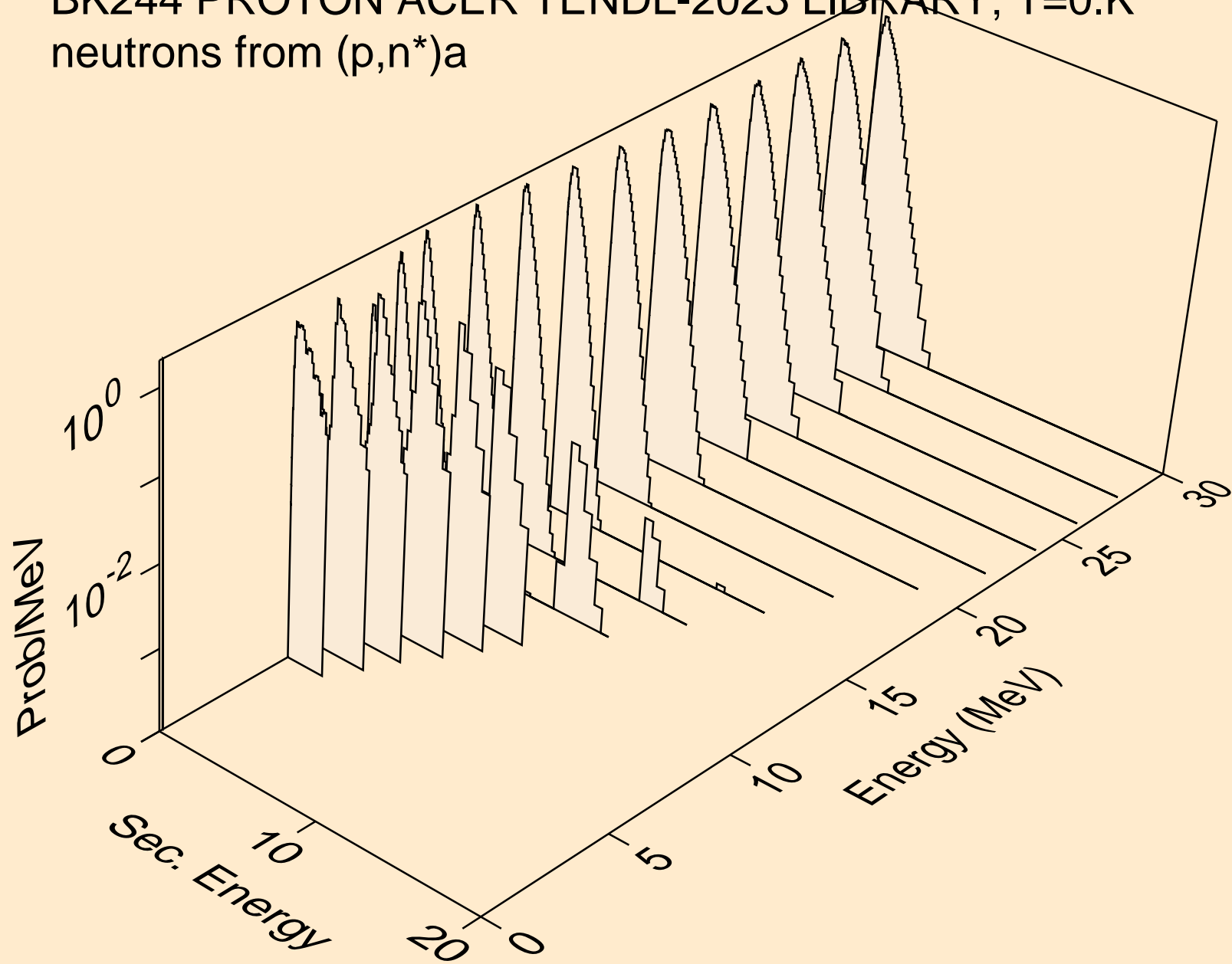

BK244 PROTON ACER TENDL-2023 LIBRARY; T=0.K
neutrons from (p,2n)a

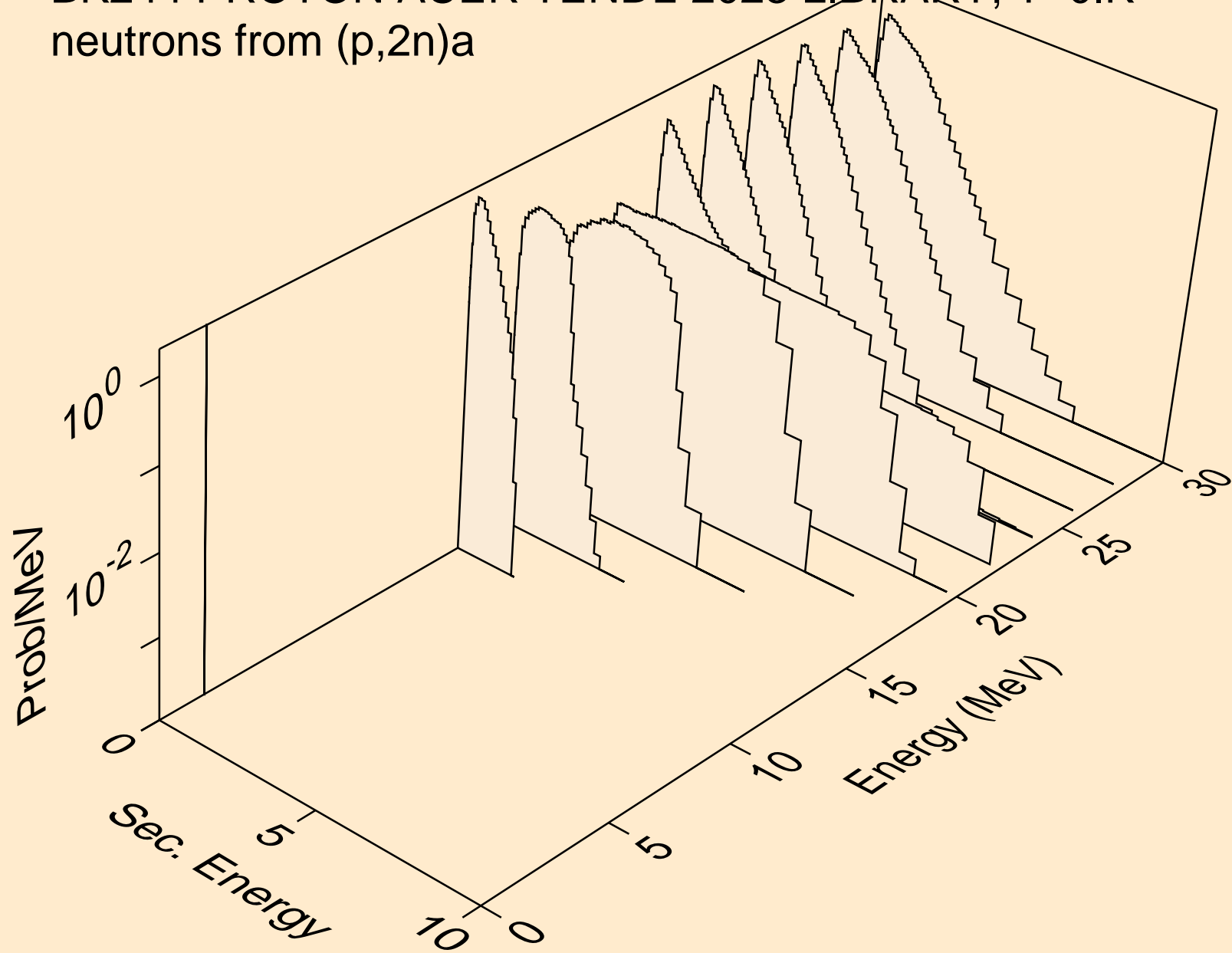

BK244 PROTON ACER TENDL-2023 LIBRARY; T=0.K
neutrons from (p,n*)p

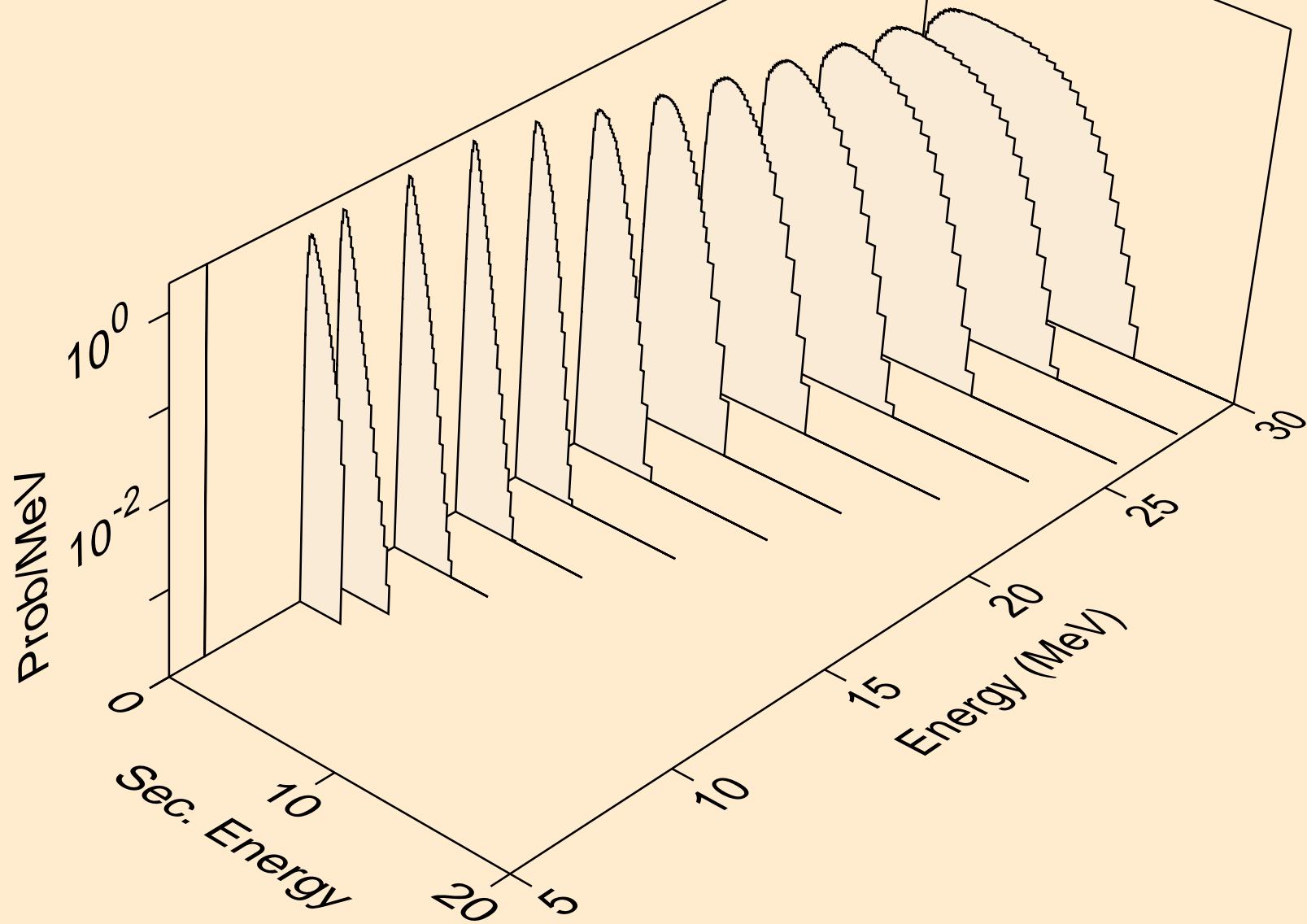

BK244 PROTON ACER TENDL-2023 LIBRARY; T=0.K
neutrons from (p,n*)d

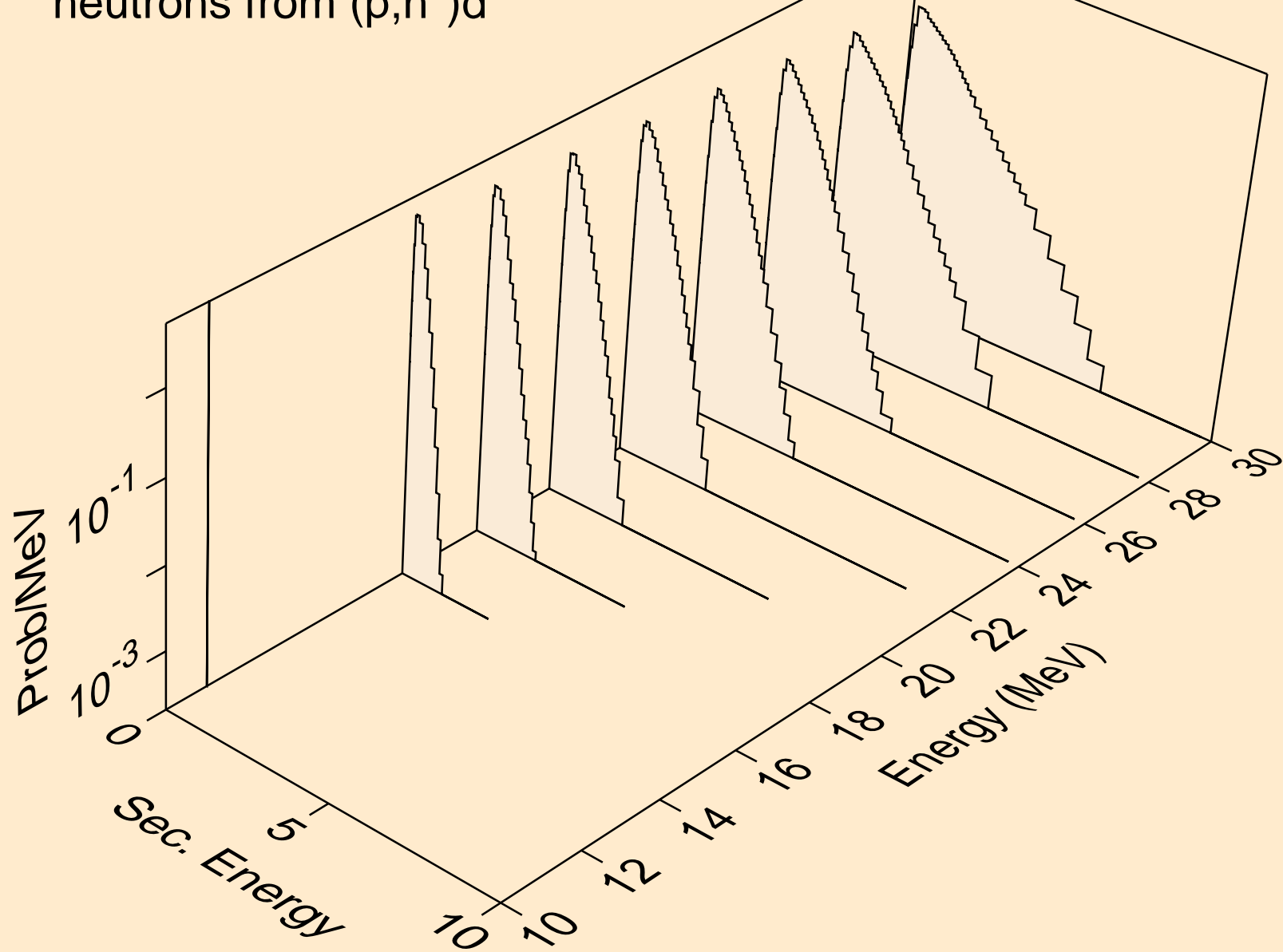

BK244 PROTON ACER TENDL-2023 LIBRARY; T=0.K
neutrons from (p,n*)t

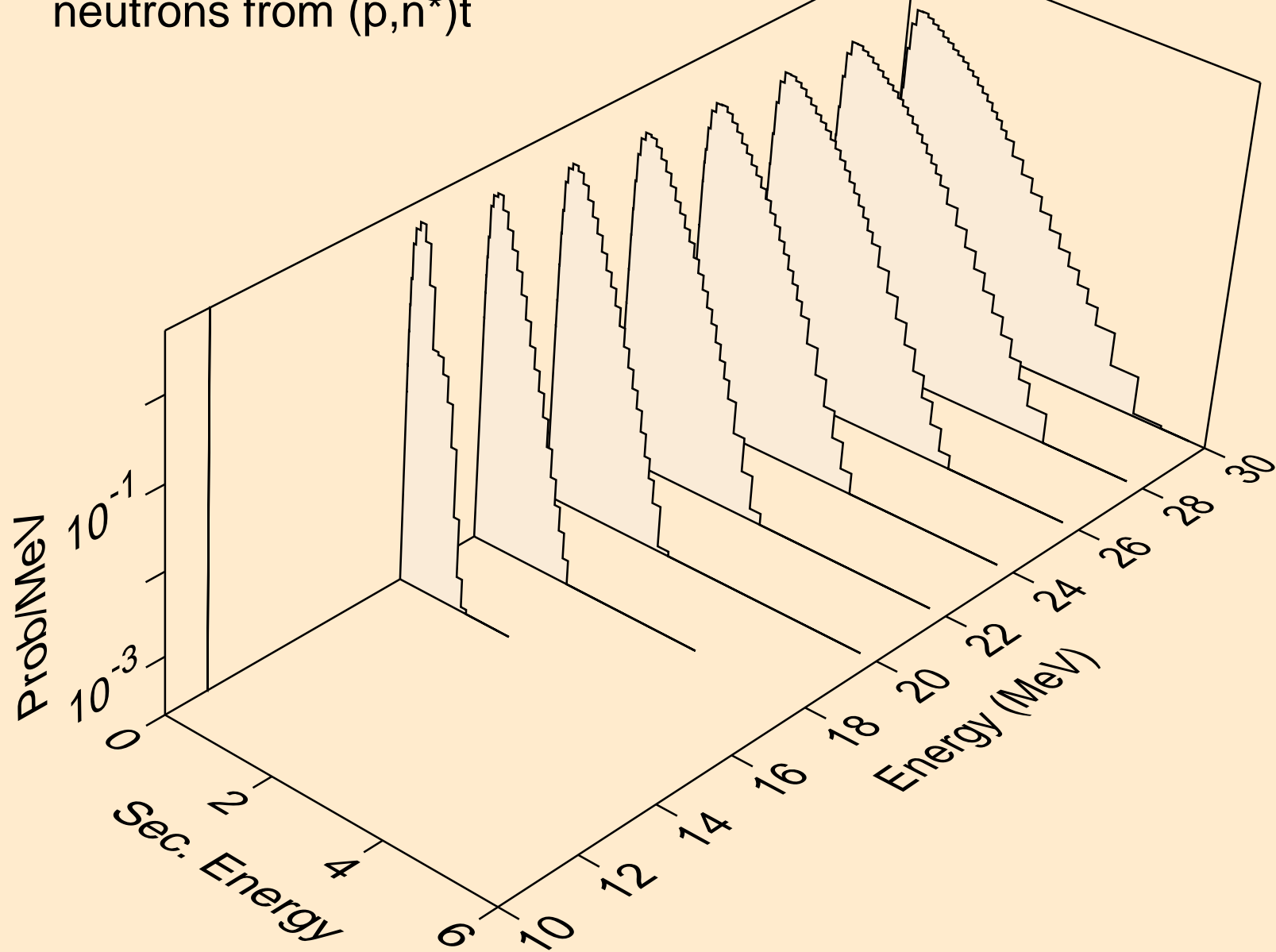

BK244 PROTON ACER TENDL-2023 LIBRARY; T=0.K
neutrons from (p,n*)he3

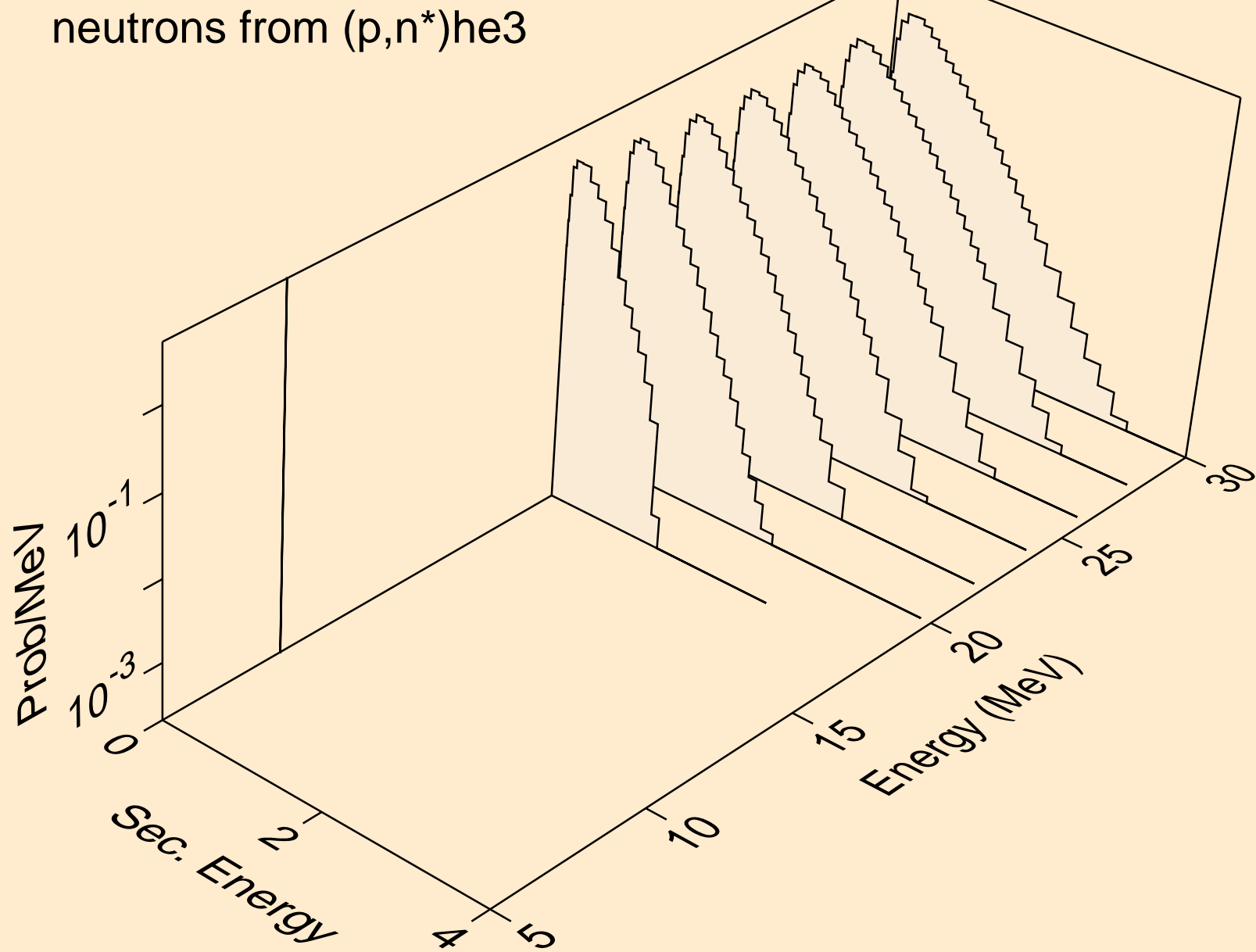

BK244 PROTON ACER TENDL-2023 LIBRARY; T=0.K
neutrons from (p,4n)

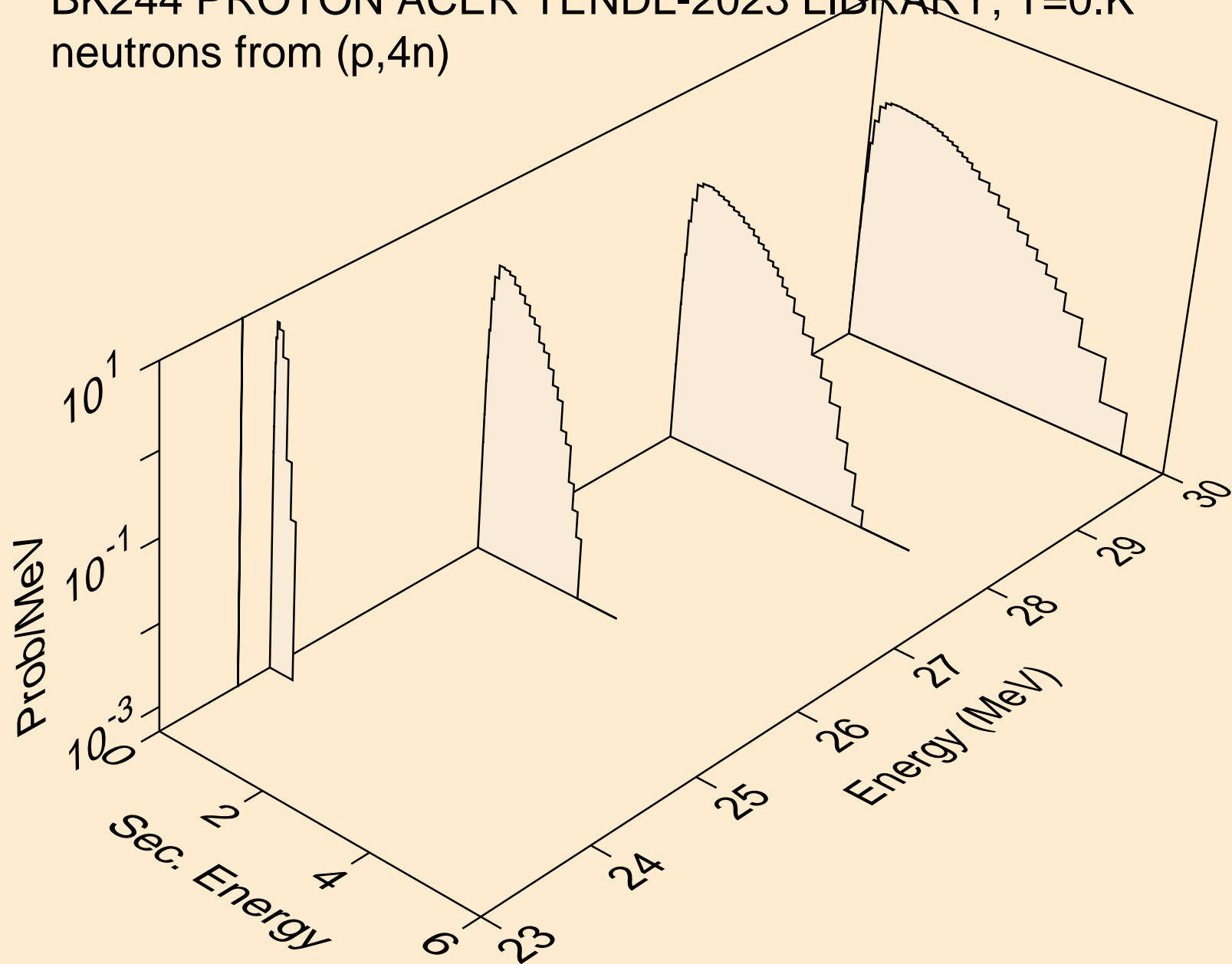

BK244 PROTON ACER TENDL-2023 LIBRARY; T=0.K
neutrons from (p,2np)

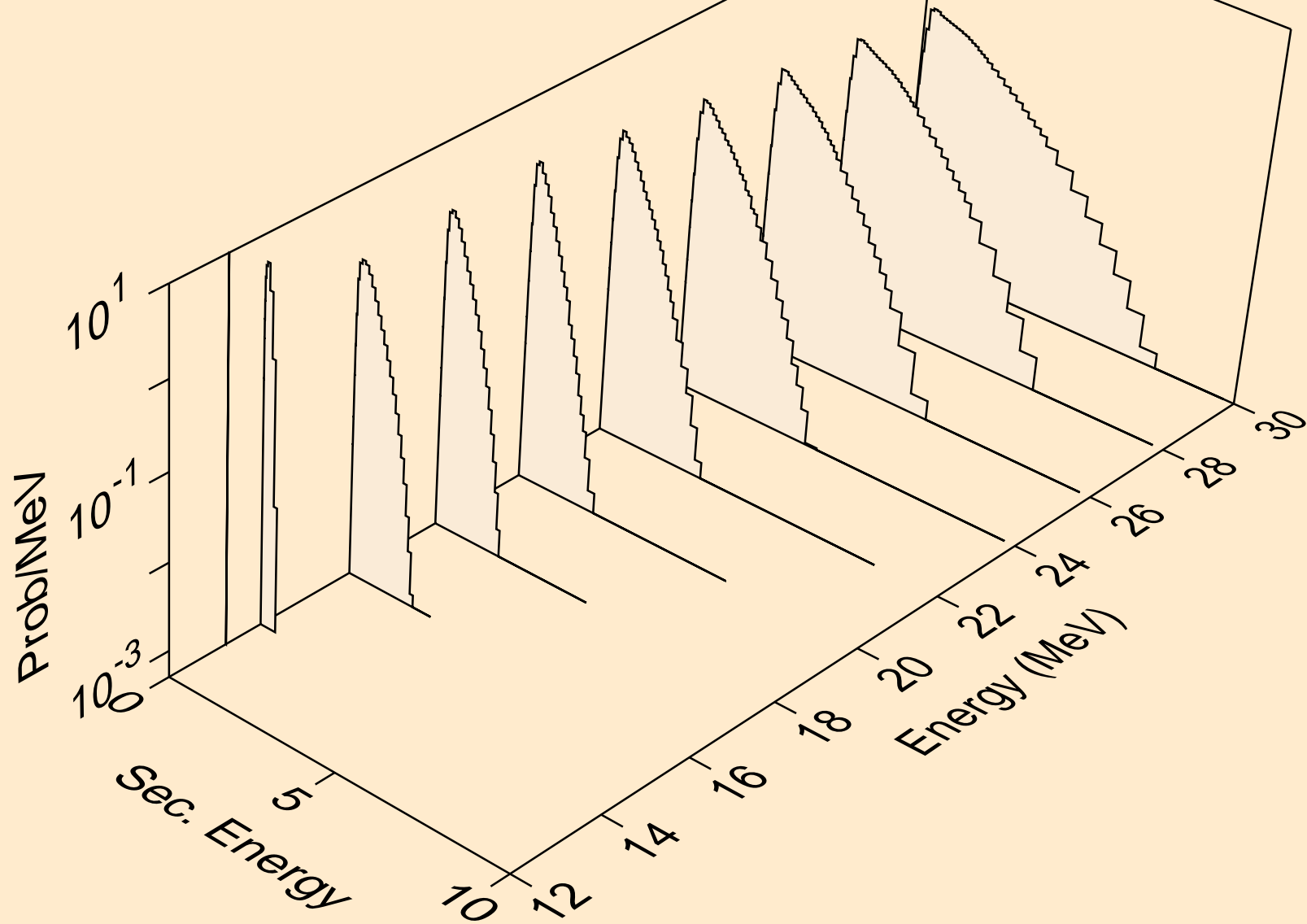

BK244 PROTON ACER TENDL-2023 LIBRARY; T=0.K
neutrons from (p,n2p)

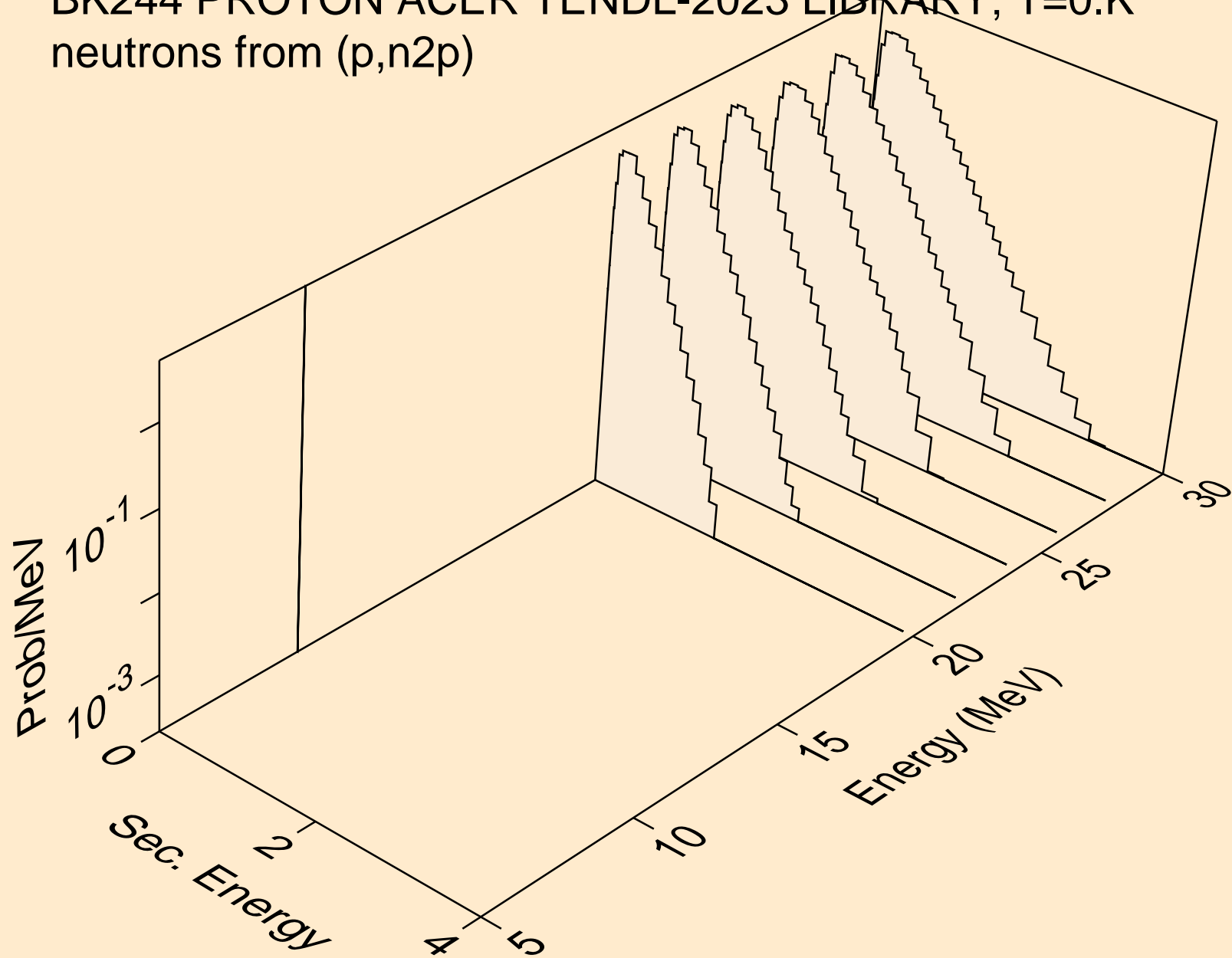

BK244 PROTON ACER TENDL-2023 LIBRARY; T=0.K
deuterons from (p,x)

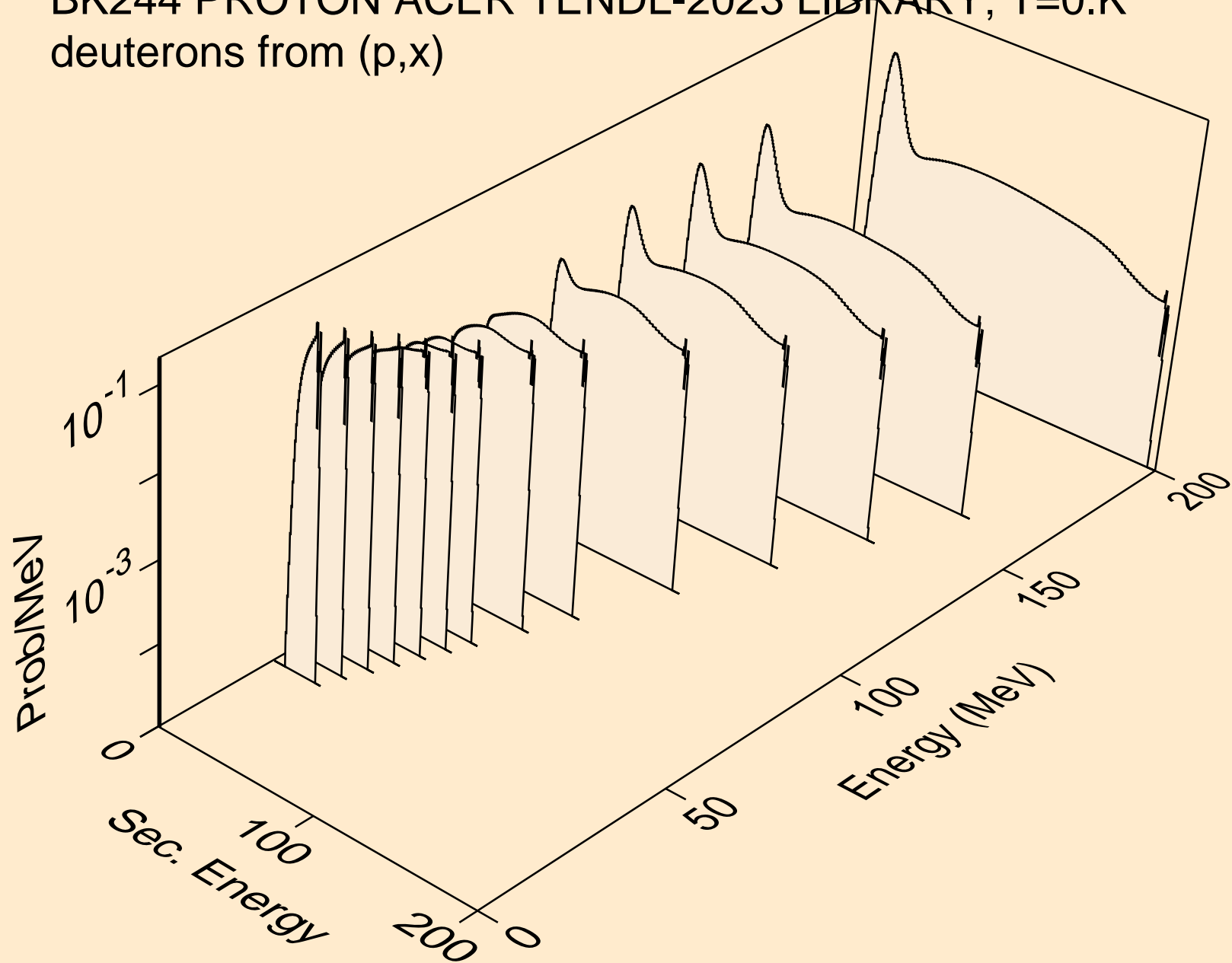

BK244 PROTON ACER TENDL-2023 LIBRARY; T=0.K
deuterons from (p,n*)d

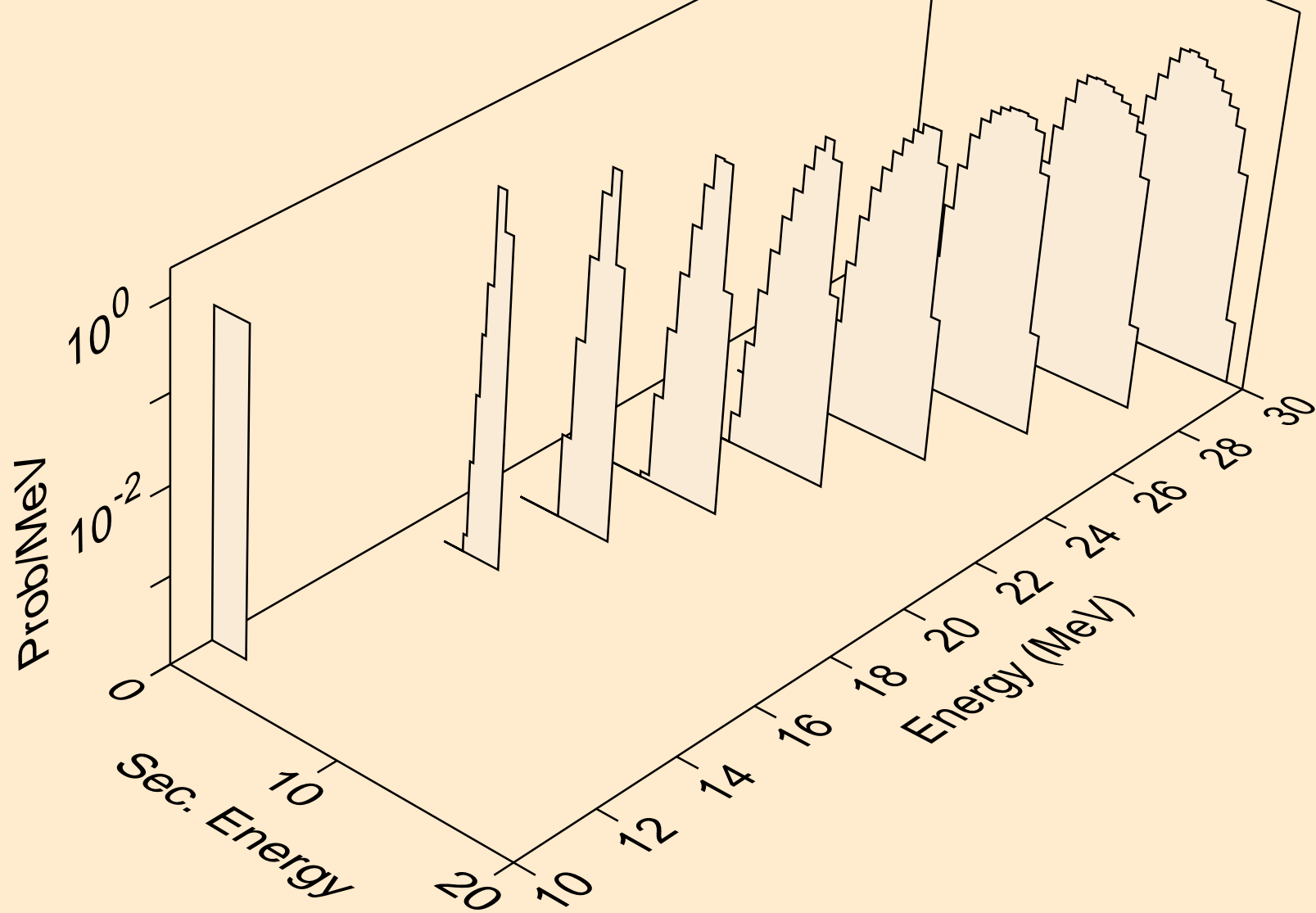

BK244 PROTON ACER TENDL-2023 LIBRARY; T=0.K
deuterons from (p,d)

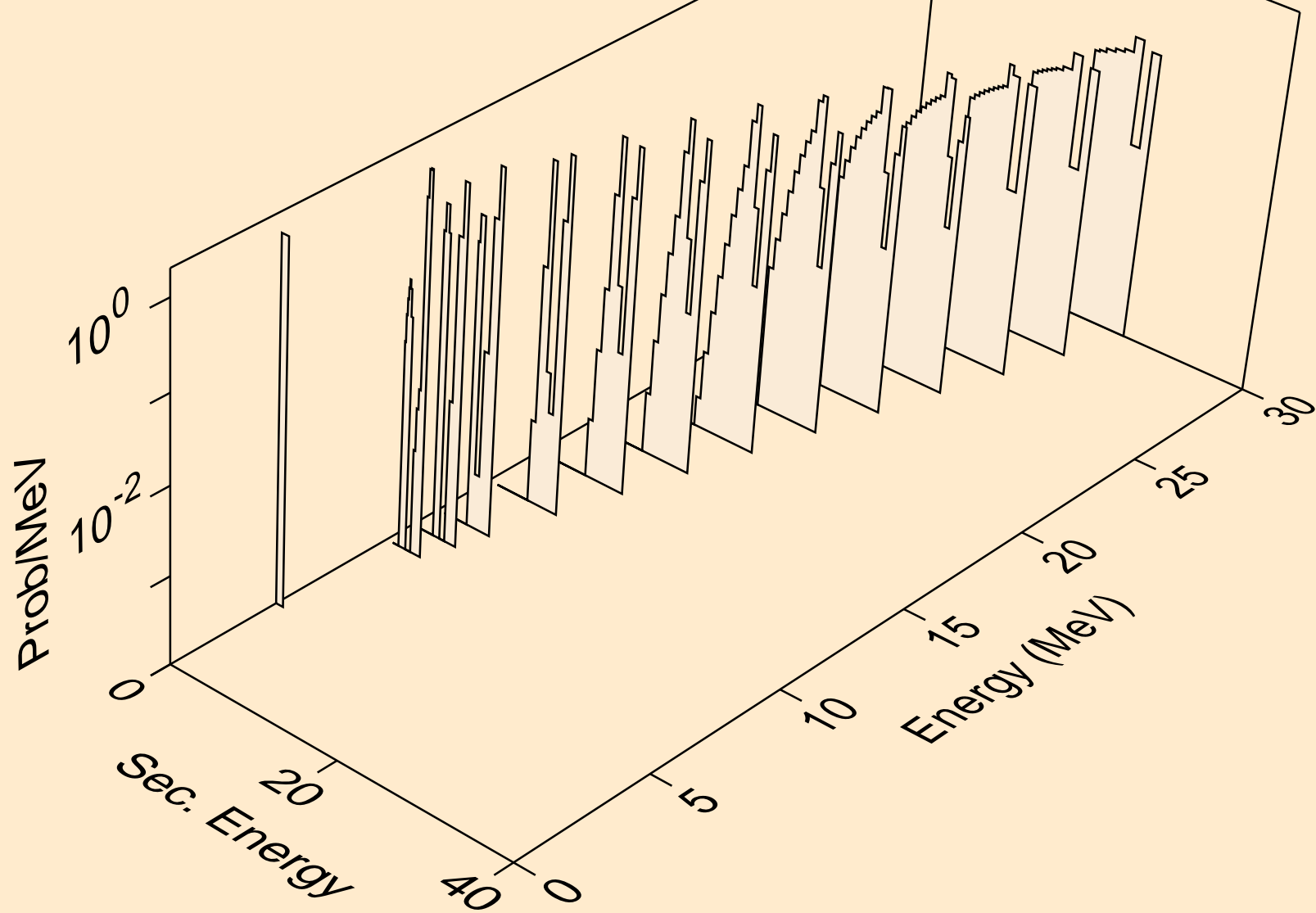

BK244 PROTON ACER TENDL-2023 LIBRARY; T=0.K
tritons from (p,x)

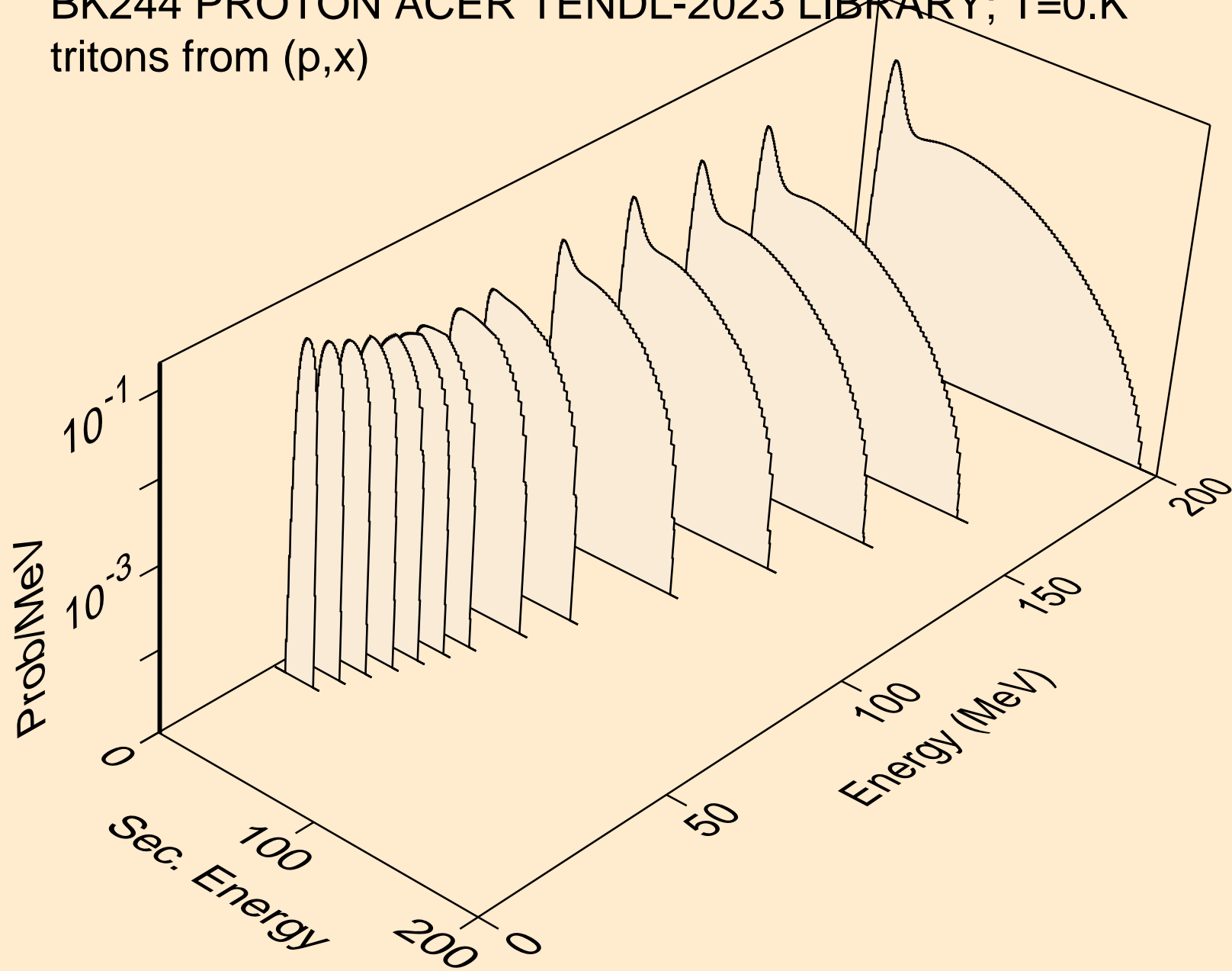

BK244 PROTON ACER TENDL-2023 LIBRARY; T=0.K
tritons from (p,n*)t

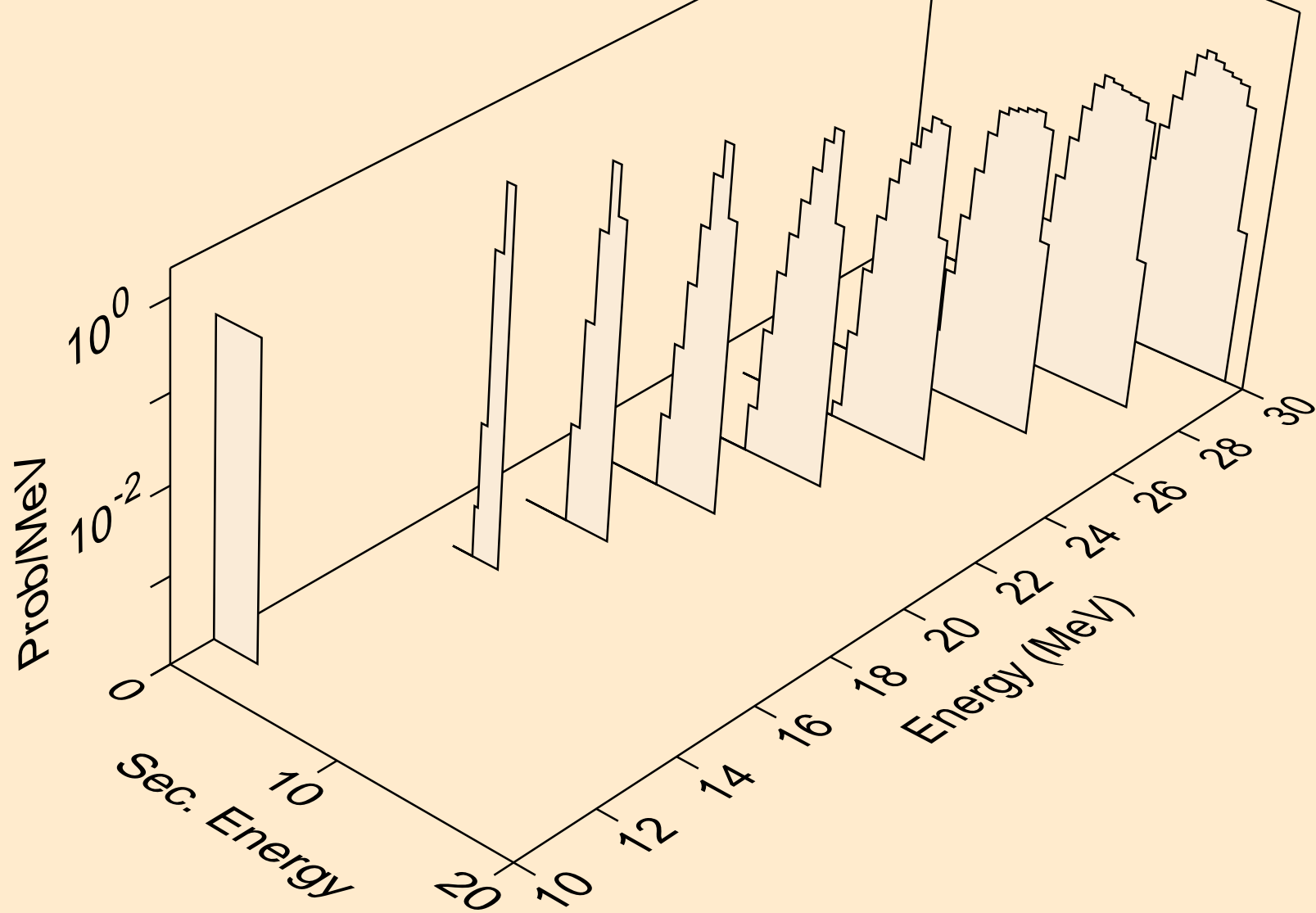

BK244 PROTON ACER TENDL-2023 LIBRARY; T=0.K
tritons from (p,t)

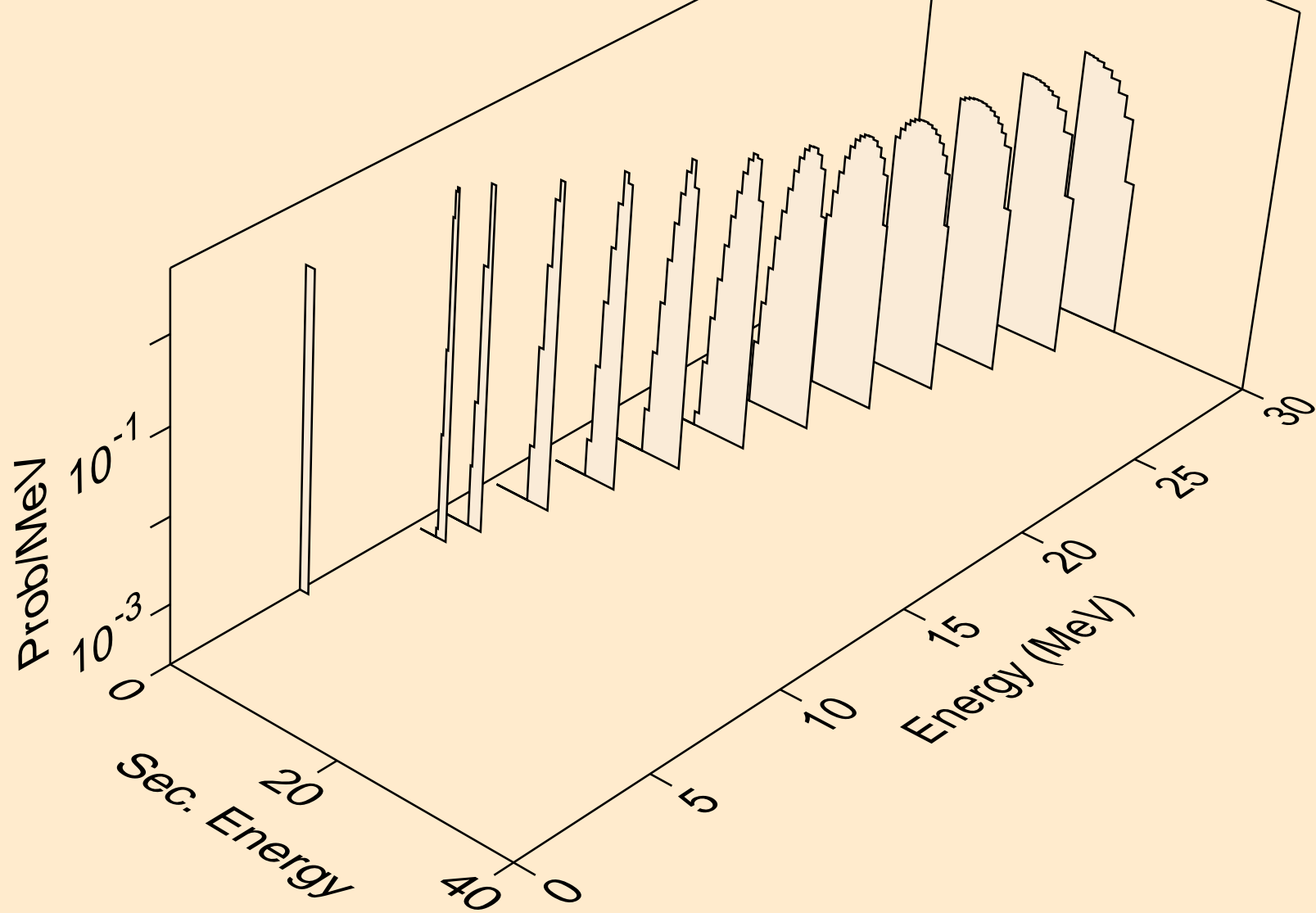

BK244 PROTON ACER TENDL-2023 LIBRARY; T=0.K
he3s from (p,x)

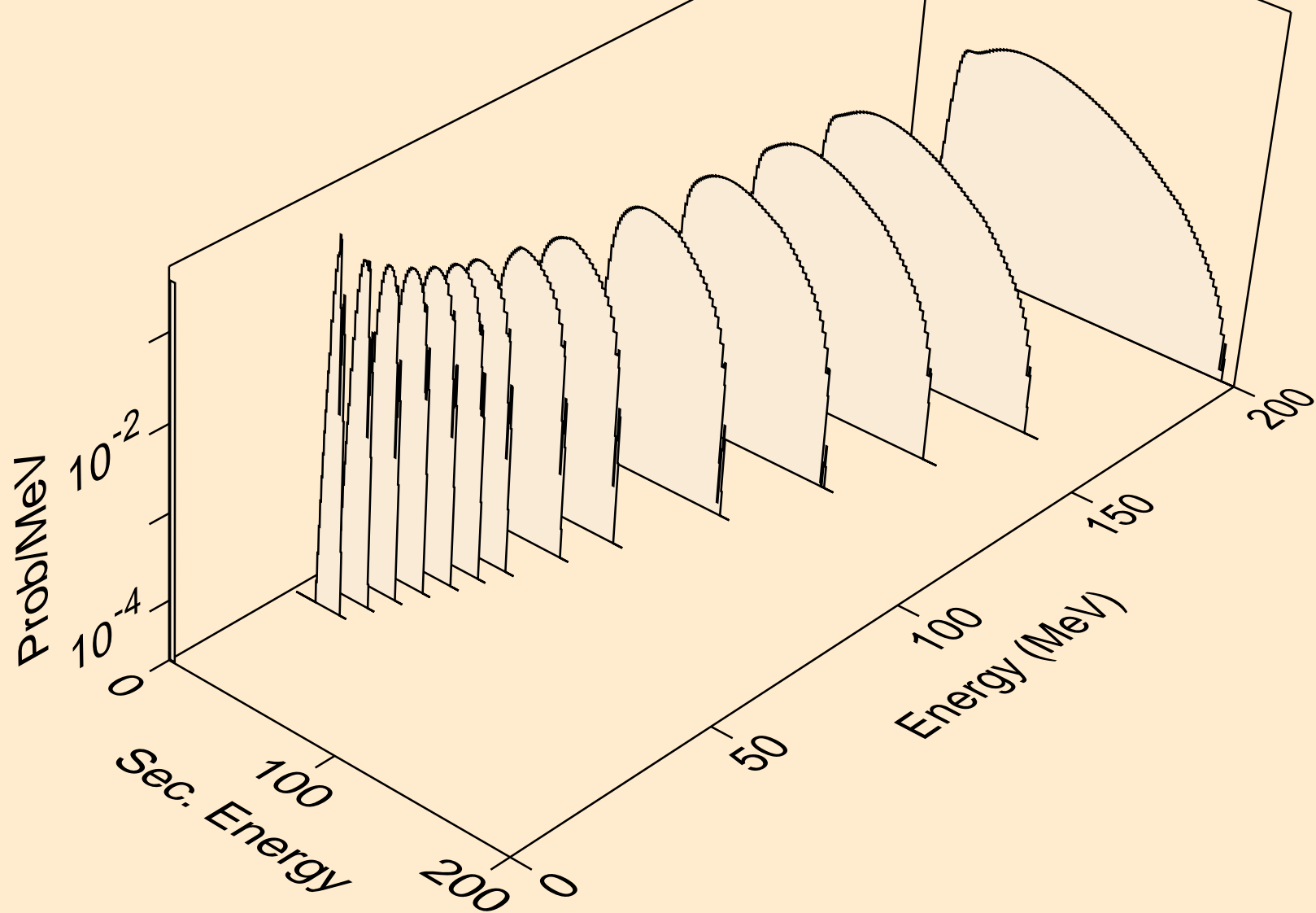

BK244 PROTON ACER TENDL-2023 LIBRARY; T=0.K
he3s from (p,n*)he3

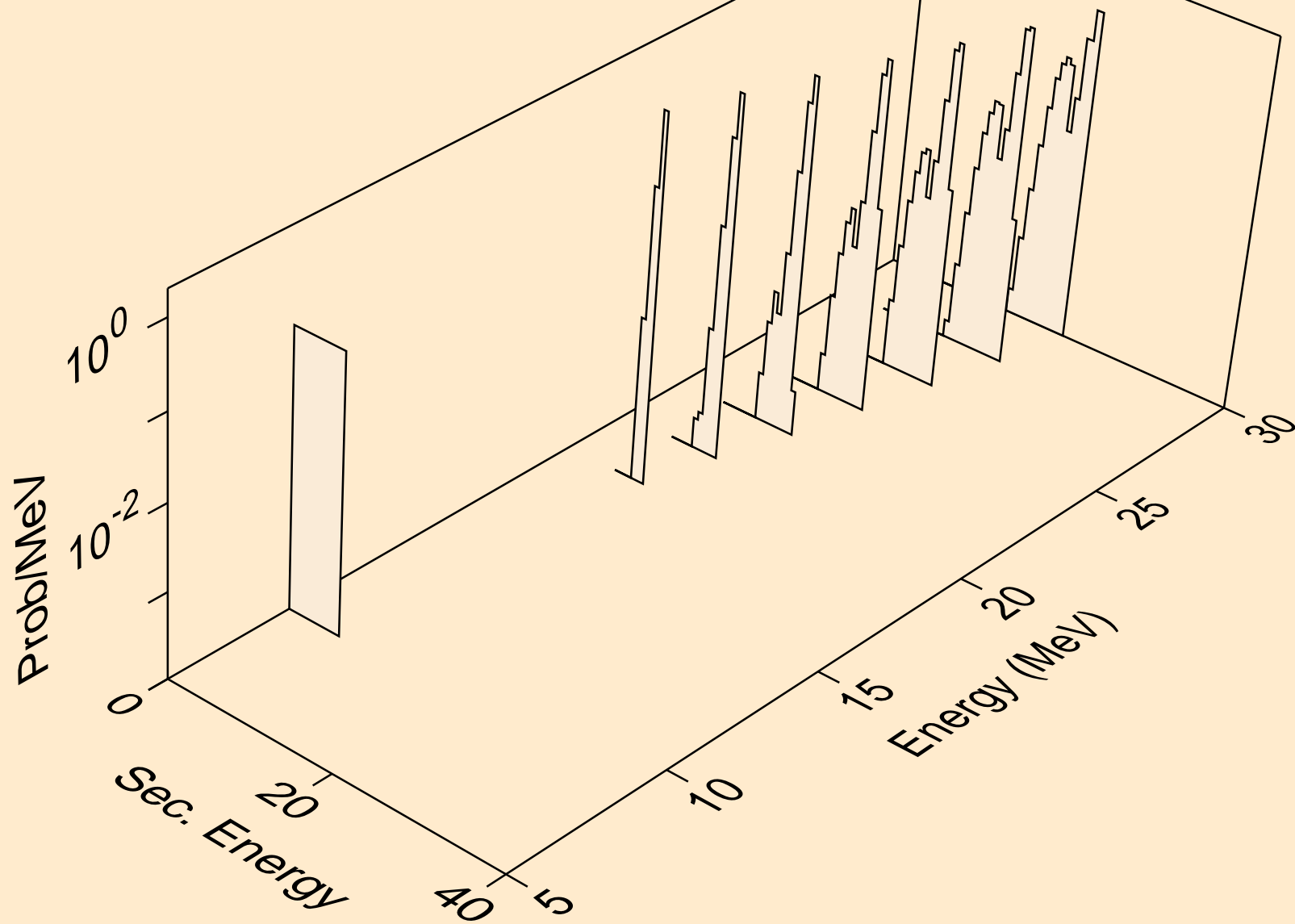

BK244 PROTON ACER TENDL-2023 LIBRARY; T=0.K
he3s from (p,he3)

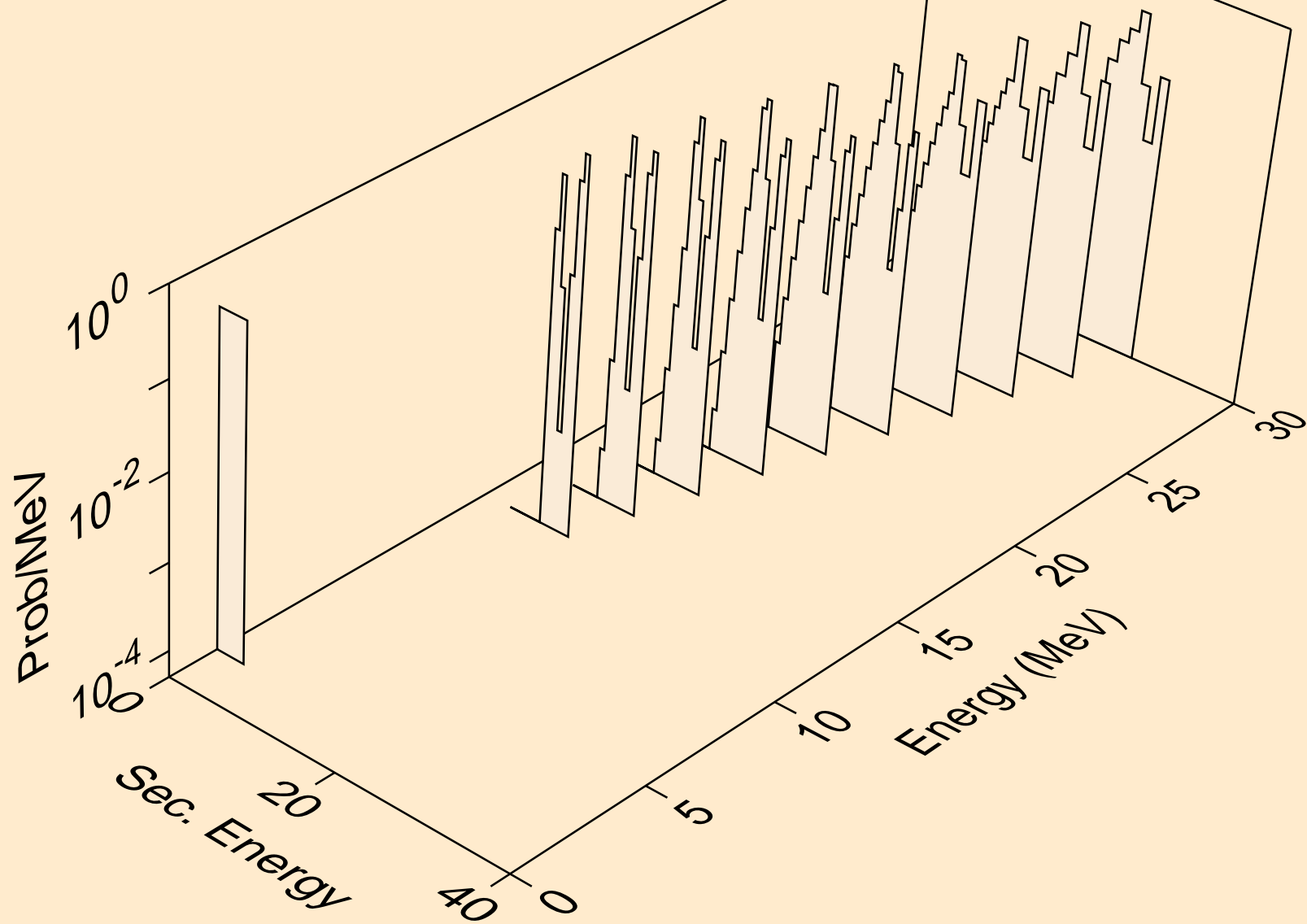

BK244 PROTON ACER TENDL-2023 LIBRARY; T=0.K
alphas from (p,x)

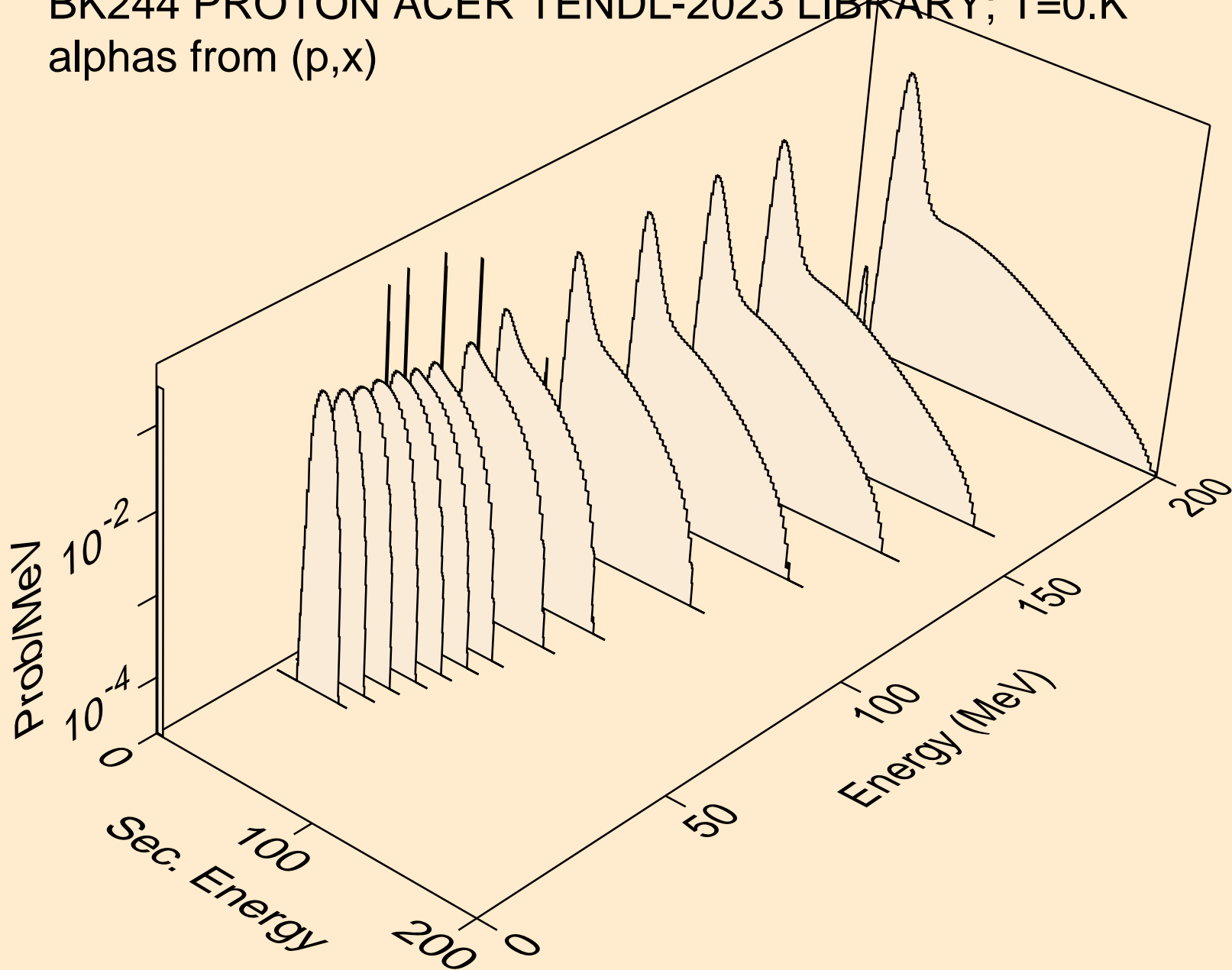

BK244 PROTON ACER TENDL-2023 LIBRARY; T=0.K
alphas from (p,n*)a

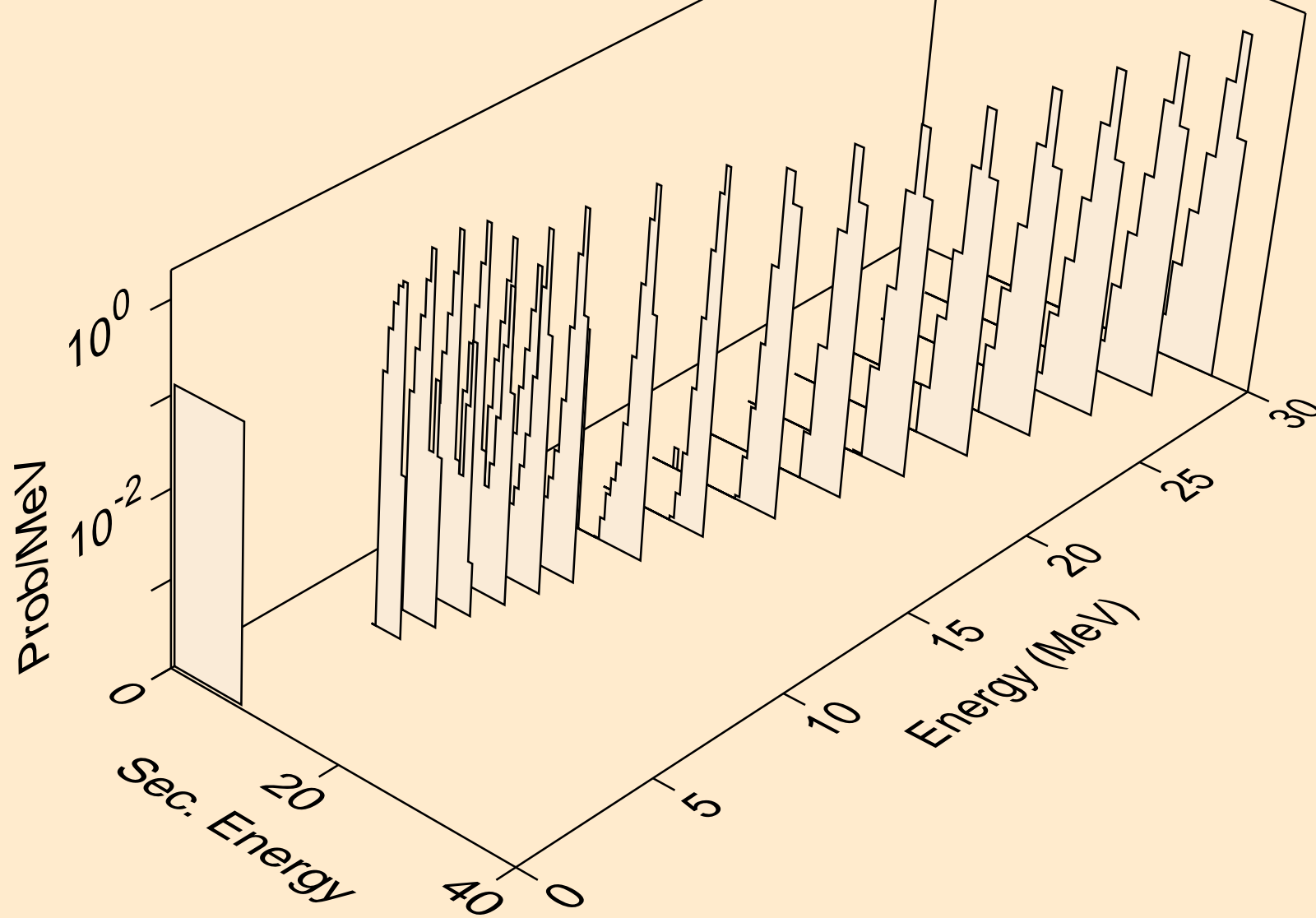

BK244 PROTON ACER TENDL-2023 LIBRARY; T=0.K
alphas from (p,2n)a

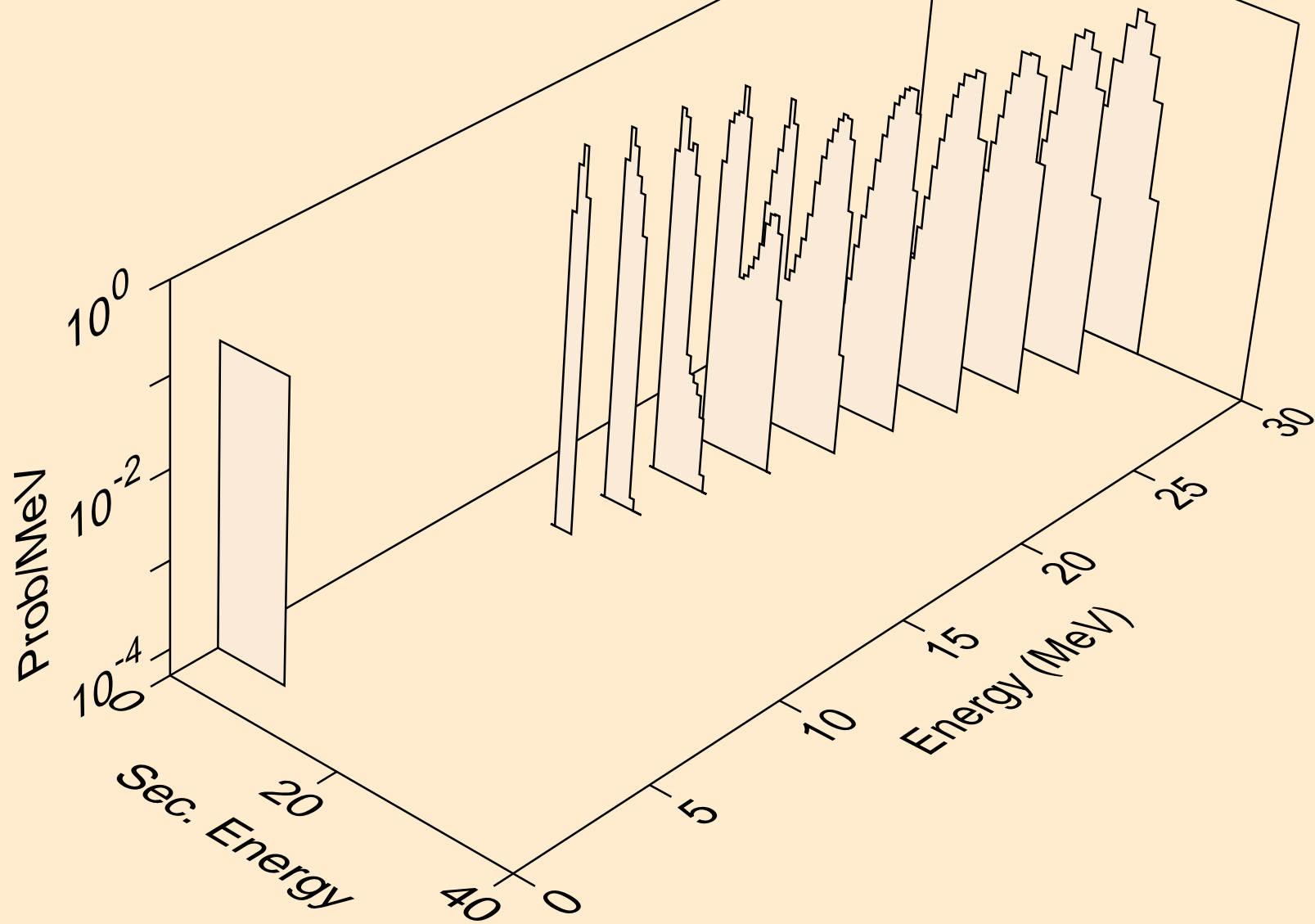

BK244 PROTON ACER TENDL-2023 LIBRARY; T=0.K
alphas from (p,a)

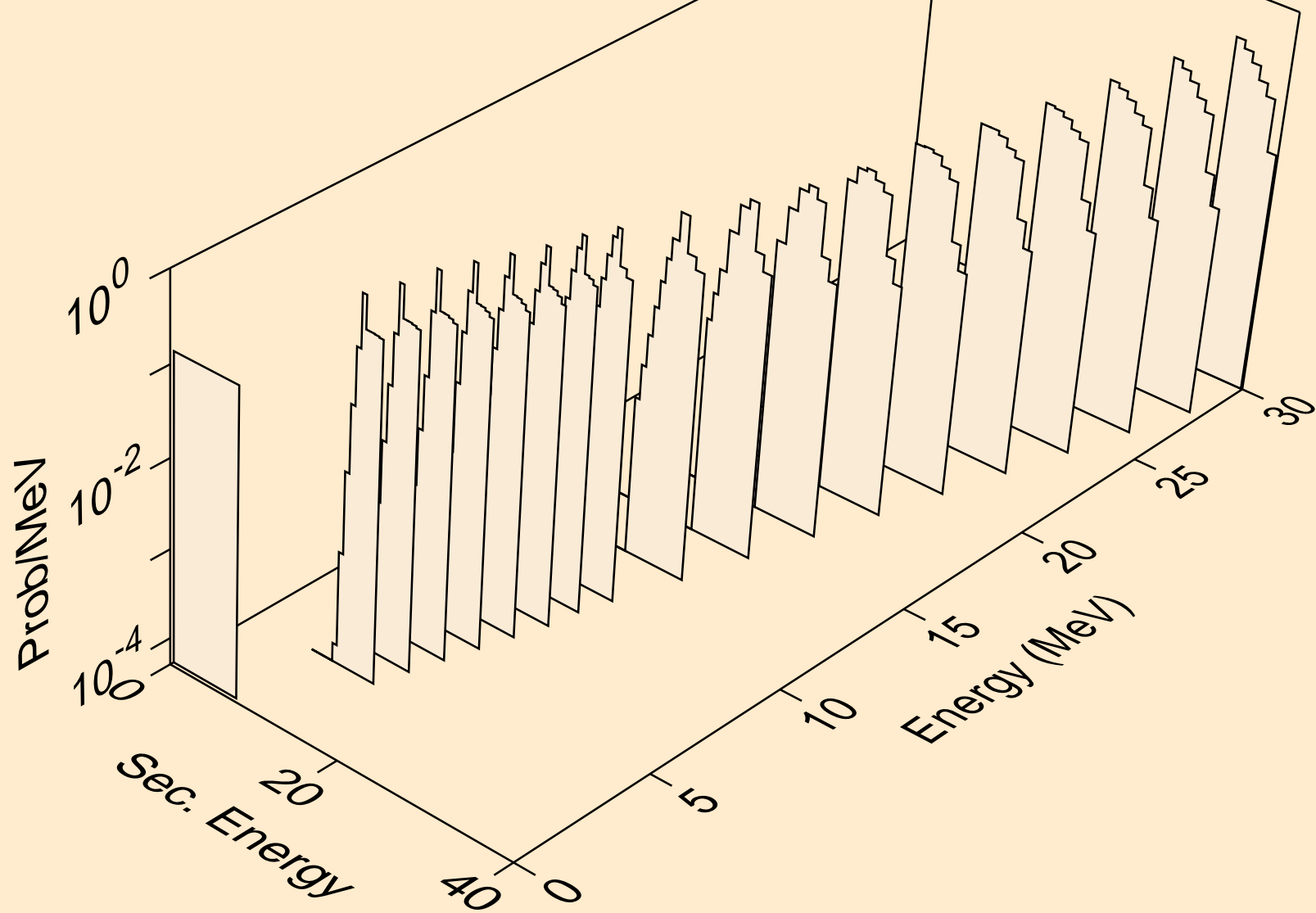

BK244 PROTON ACER TENDL-2023 LIBRARY; T=0.K
alphas from (p,2a)

