

BR081 PROTON ACER TENDL-2023 LIBRARY; T=0.K  
Principal cross sections

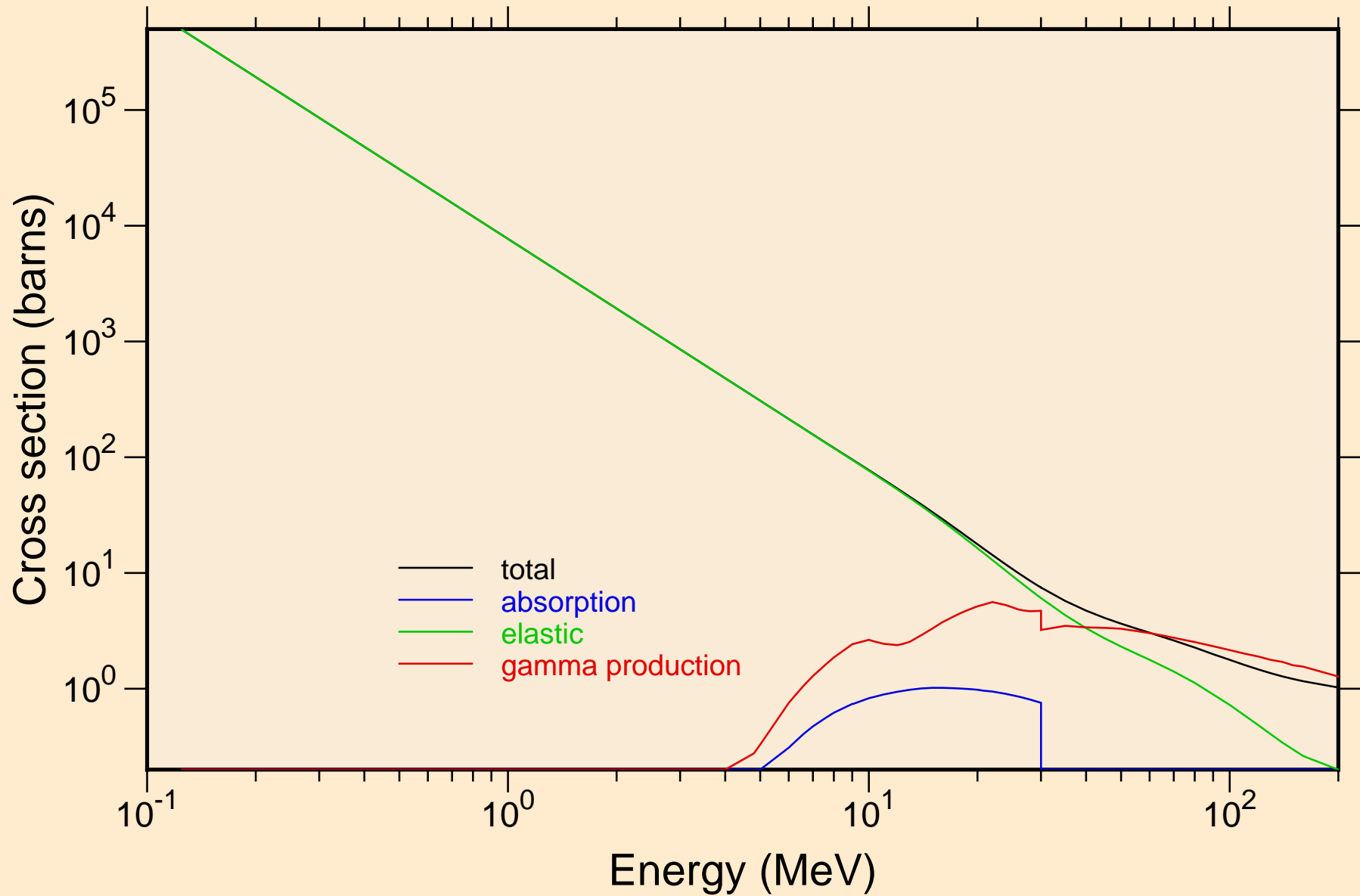

# BR081 PROTON ACER TENDL-2023 LIBRARY; T=0.K

## Heating

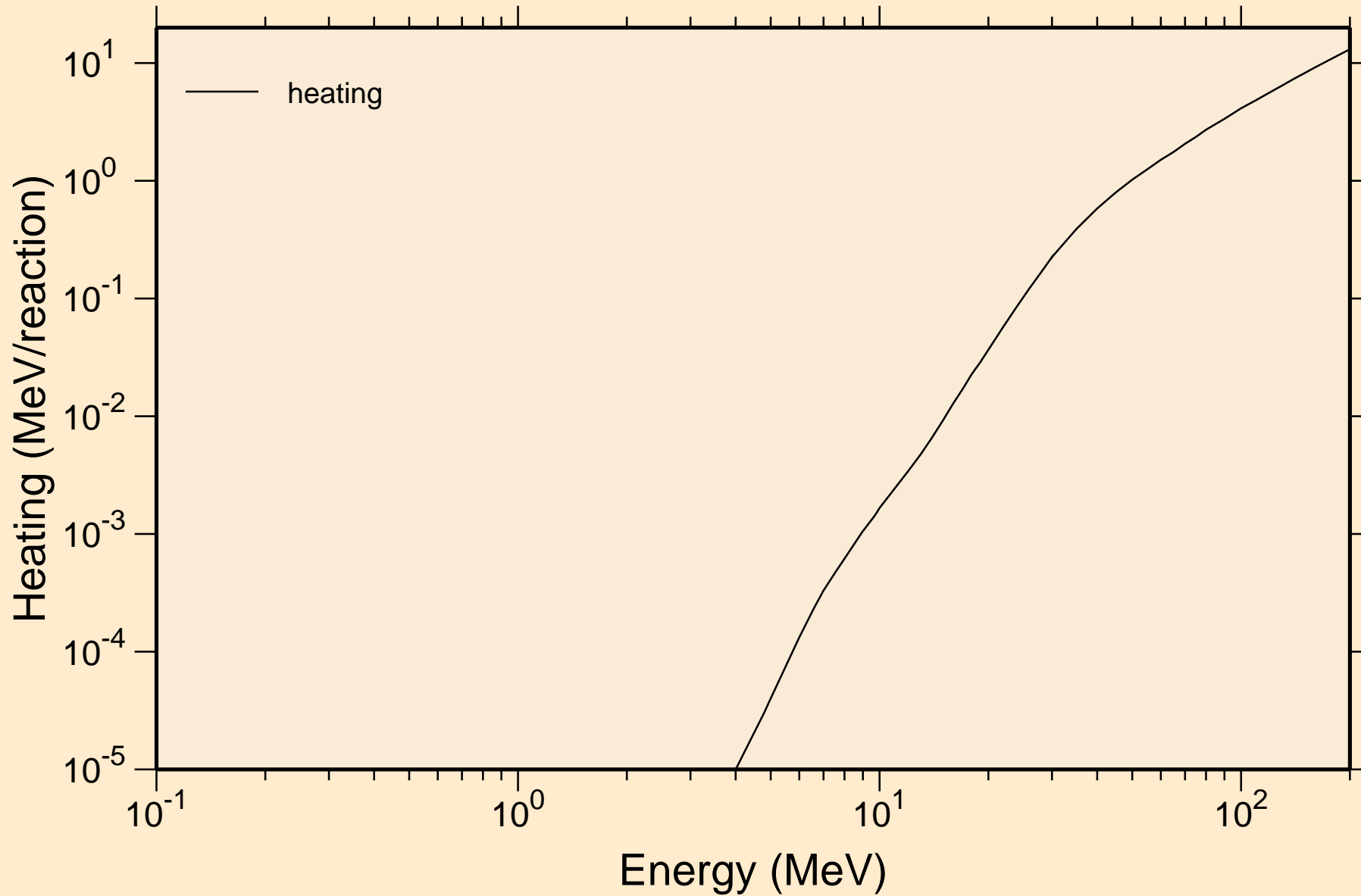

# BR081 PROTON ACER TENDL-2023 LIBRARY; T=0.K

## Principal cross sections

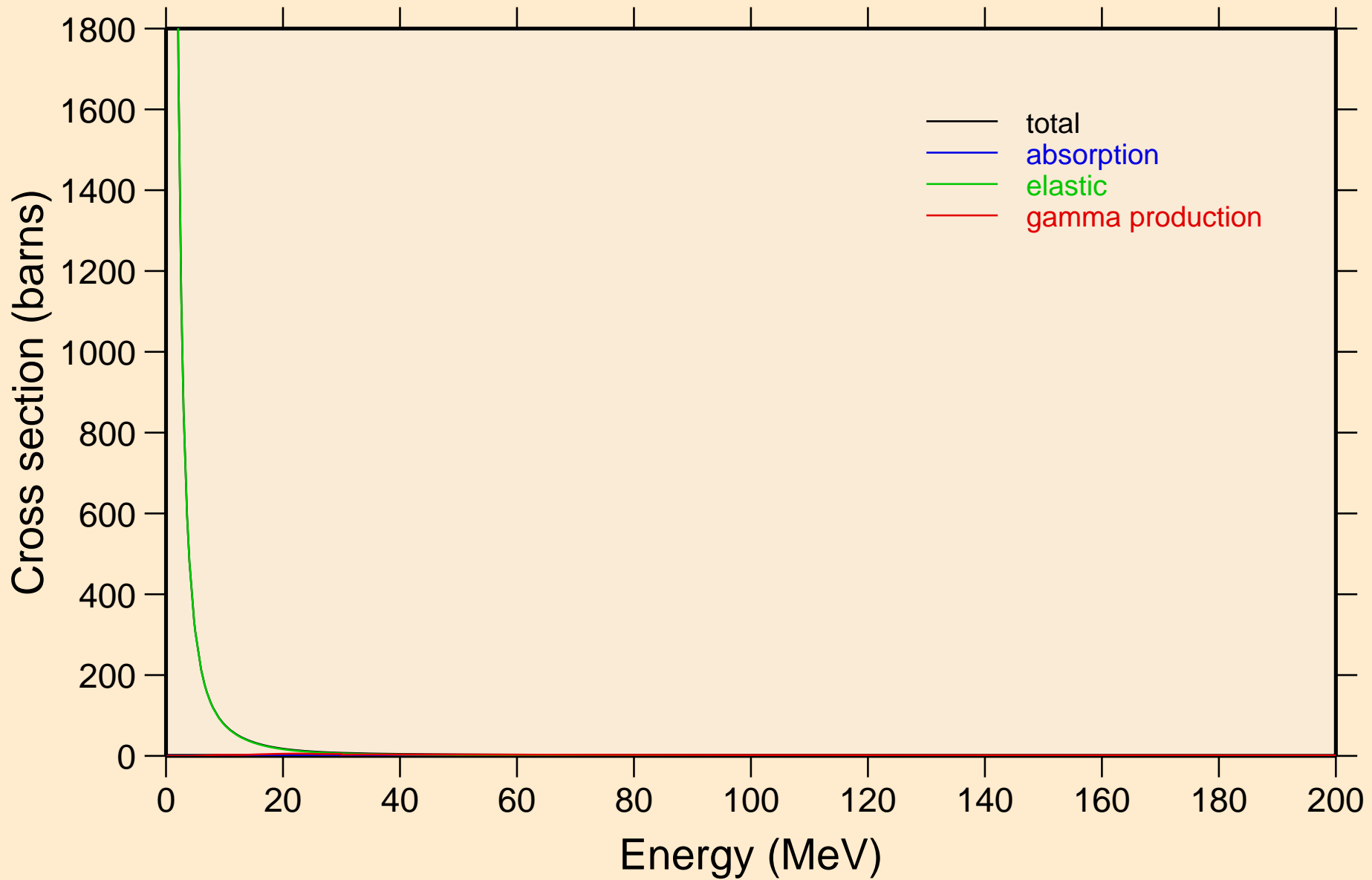

BR081 PROTON ACER TENDL-2023 LIBRARY; T=0.K

Heating

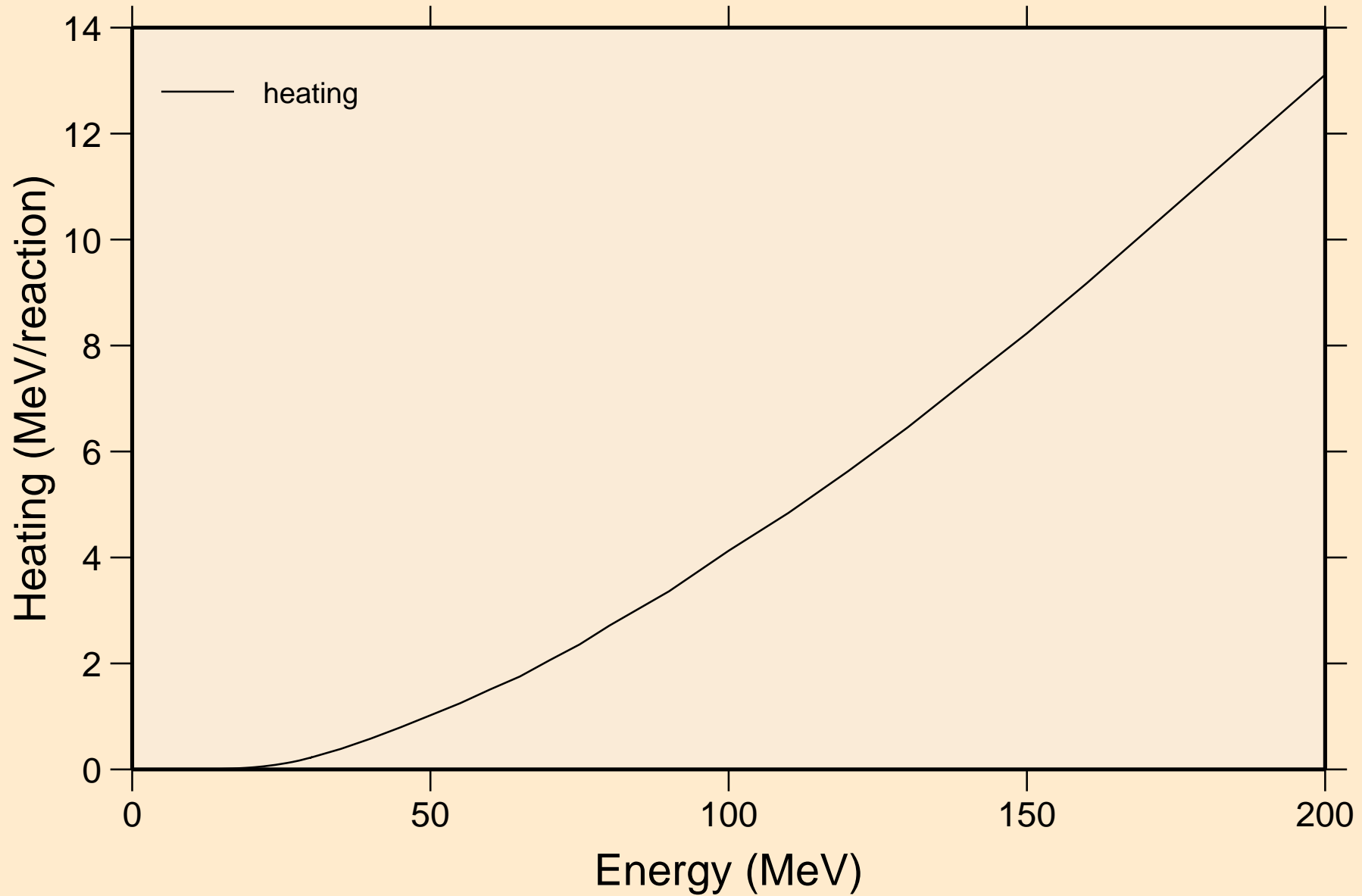

# BR081 PROTON ACER TENDL-2023 LIBRARY; T=0.K

## Threshold reactions

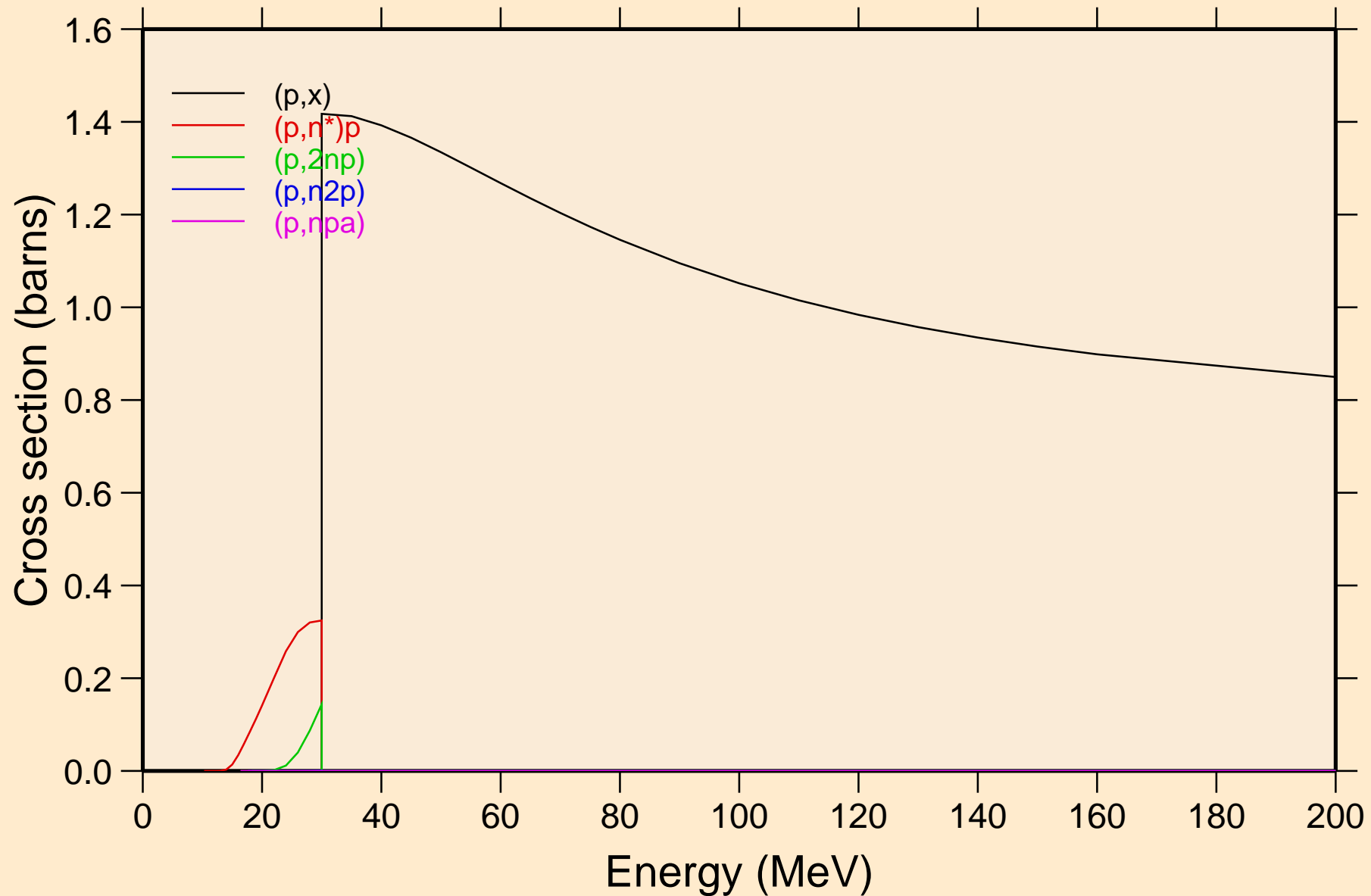

BR081 PROTON ACER TENDL-2023 LIBRARY; T=0.K  
Threshold reactions

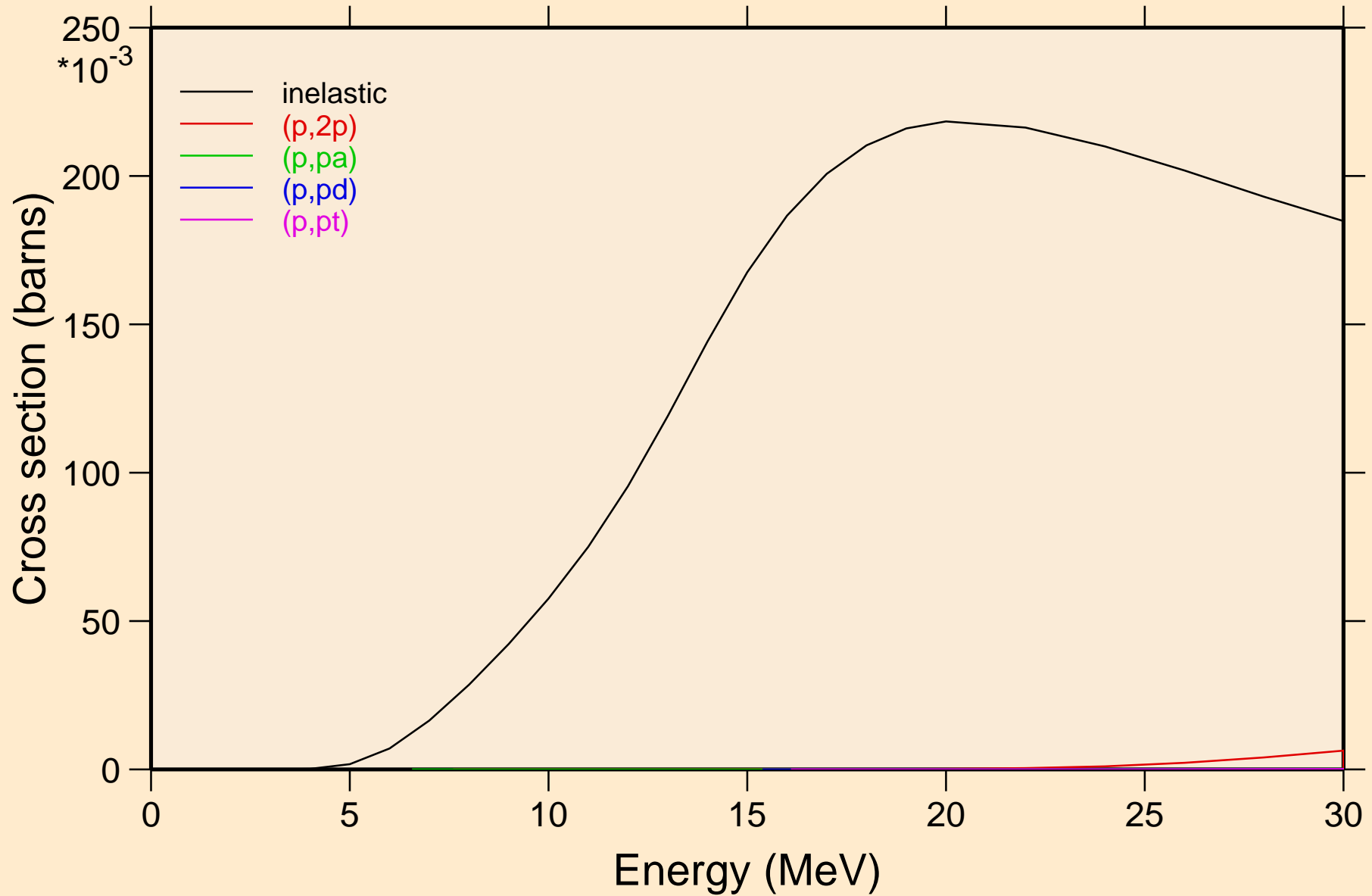

BR081 PROTON ACER TENDL-2023 LIBRARY; T=0.K  
Threshold reactions

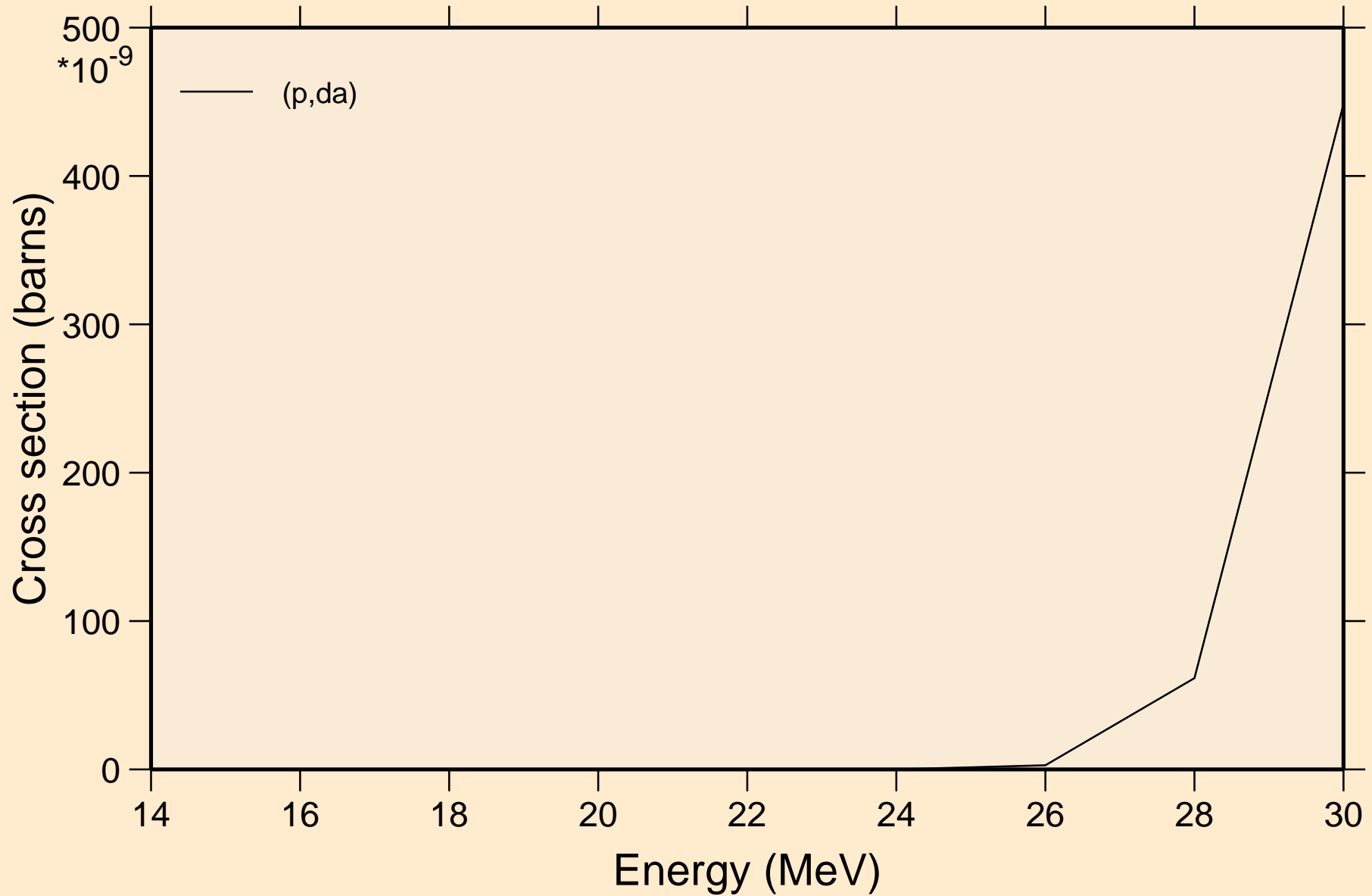

BR081 PROTON ACER TENDL-2023 LIBRARY; T=0.K  
angular distribution for elastic

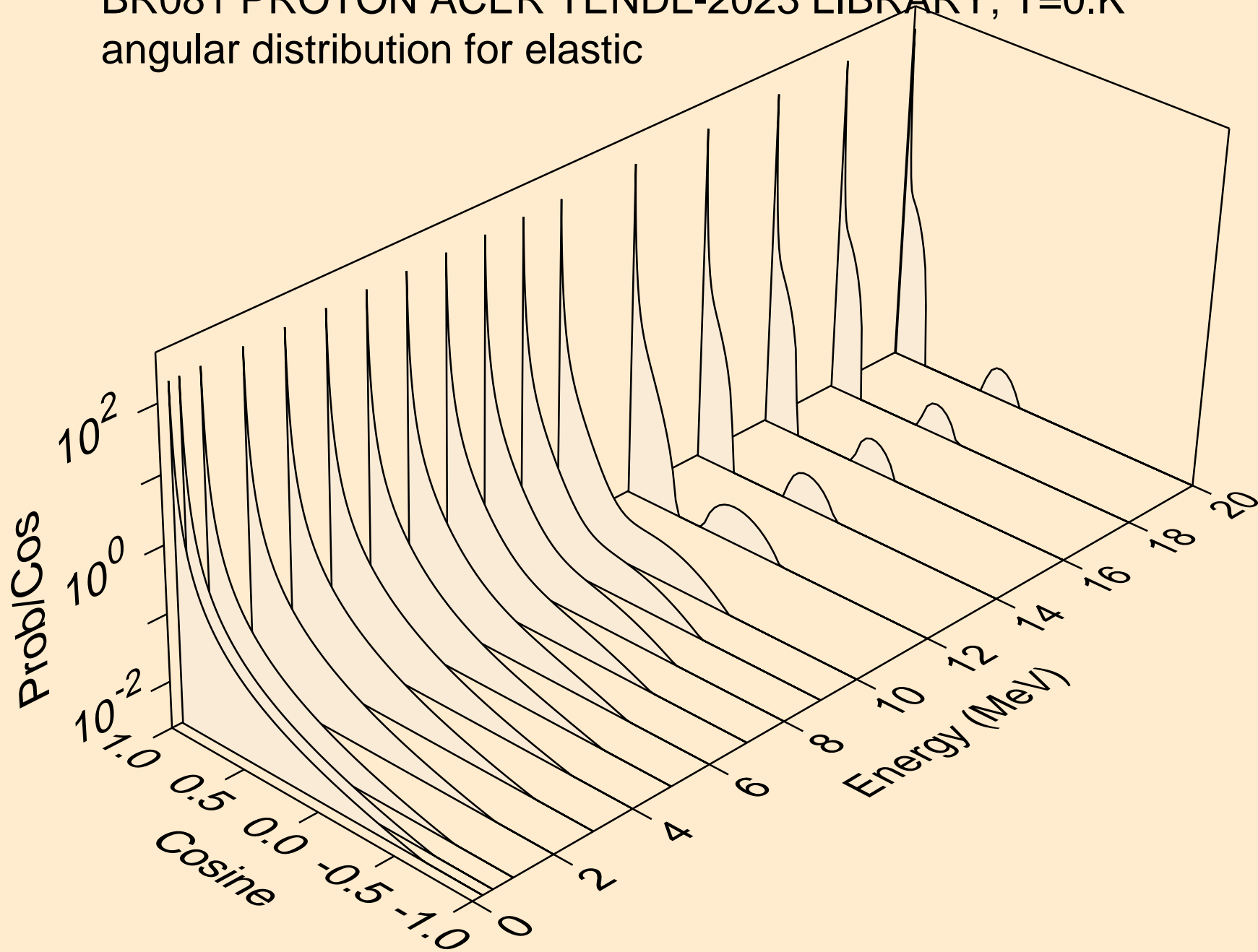



BR081 PROTON ACER TENDL-2023 LIBRARY; T=0.K  
angular distribution for elastic

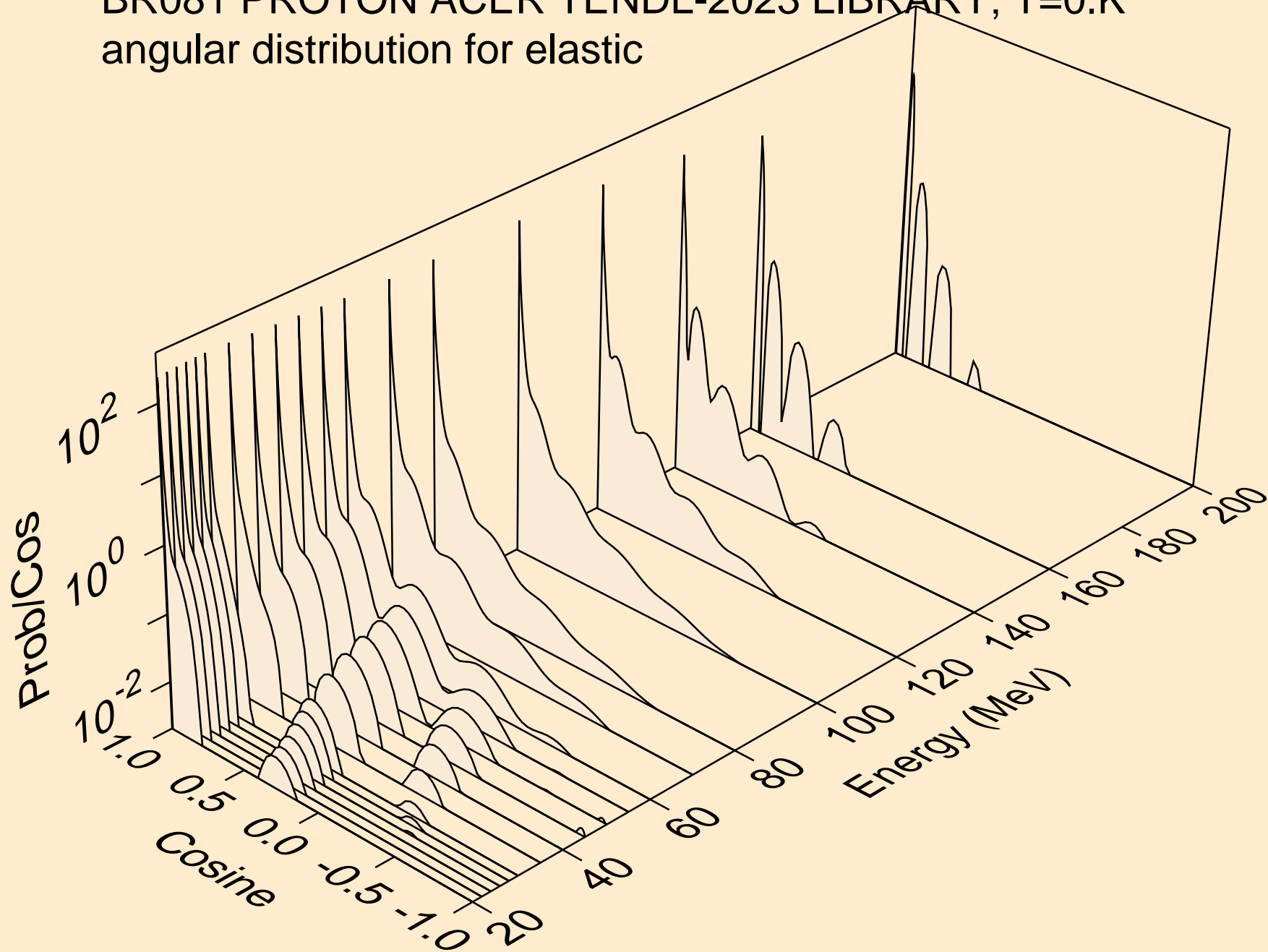

BR081 PROTON ACER TENDL-2023 LIBRARY; T=0.K  
Proton emission for (p,x)

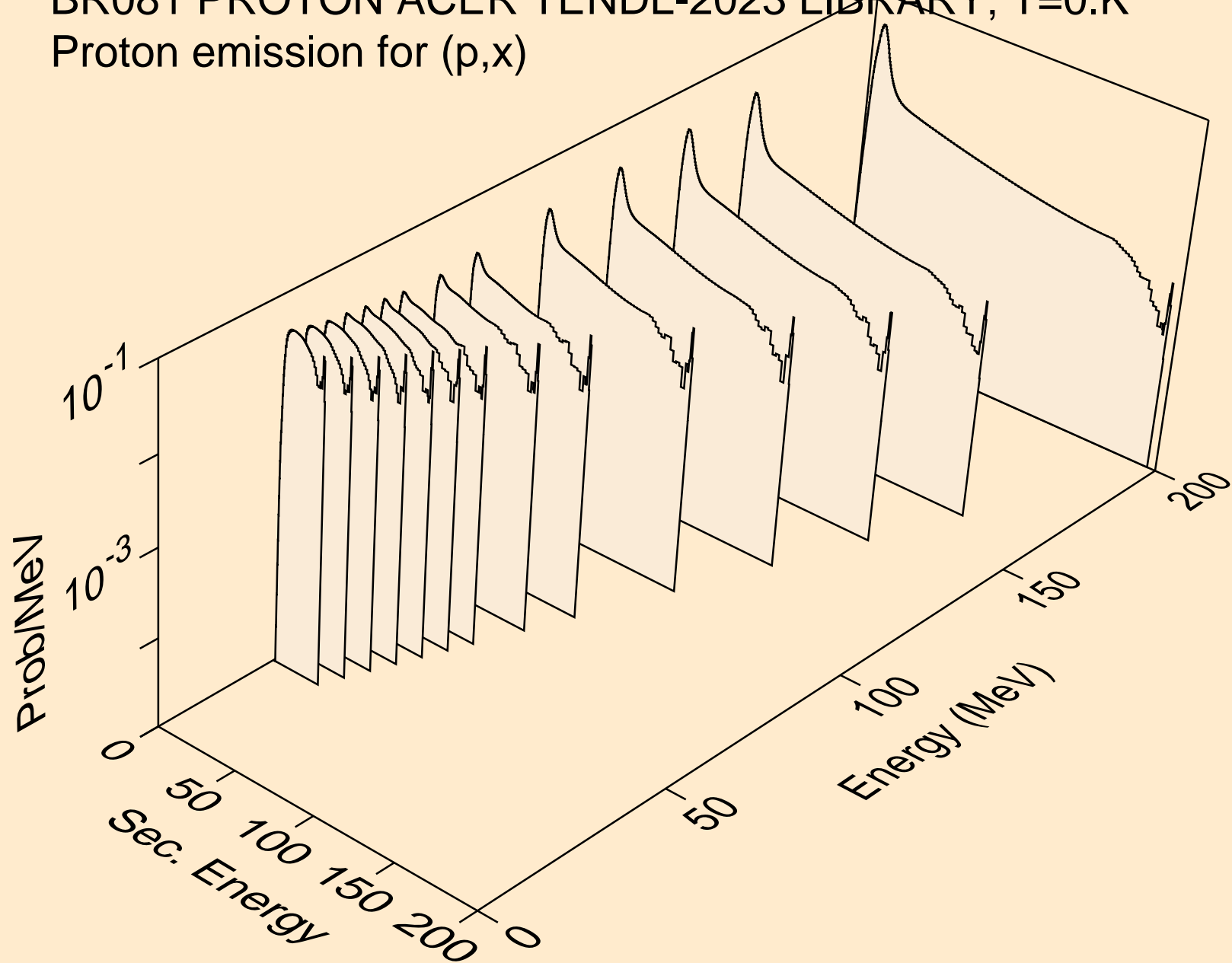

BR081 PROTON ACER TENDL-2023 LIBRARY; T=0.K  
Proton emission for (p,n\*)p

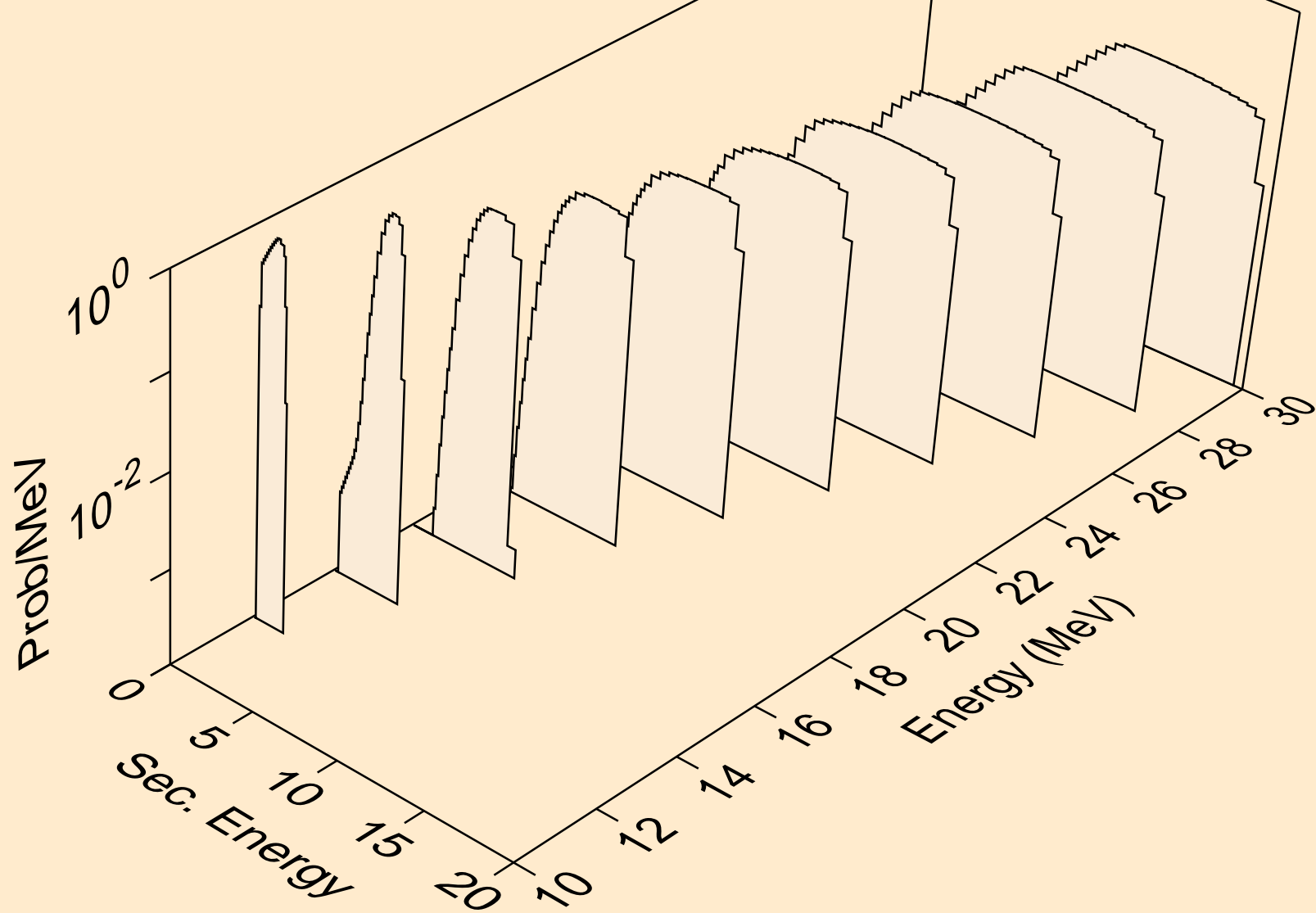

BR081 PROTON ACER TENDL-2023 LIBRARY; T=0.K  
Proton emission for (p,2np)

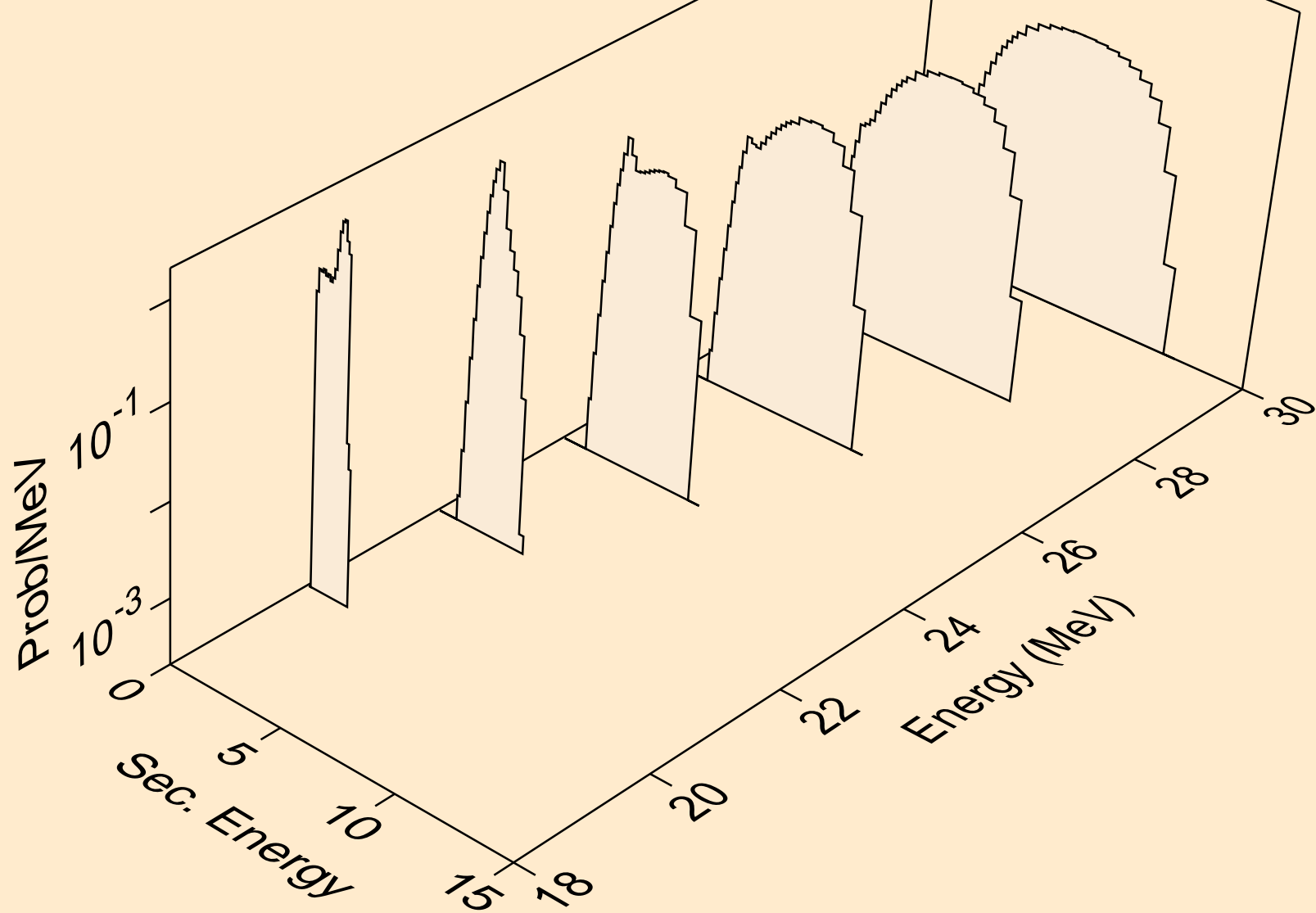

BR081 PROTON ACER TENDL-2023 LIBRARY; T=0.K  
Proton emission for (p,n2p)

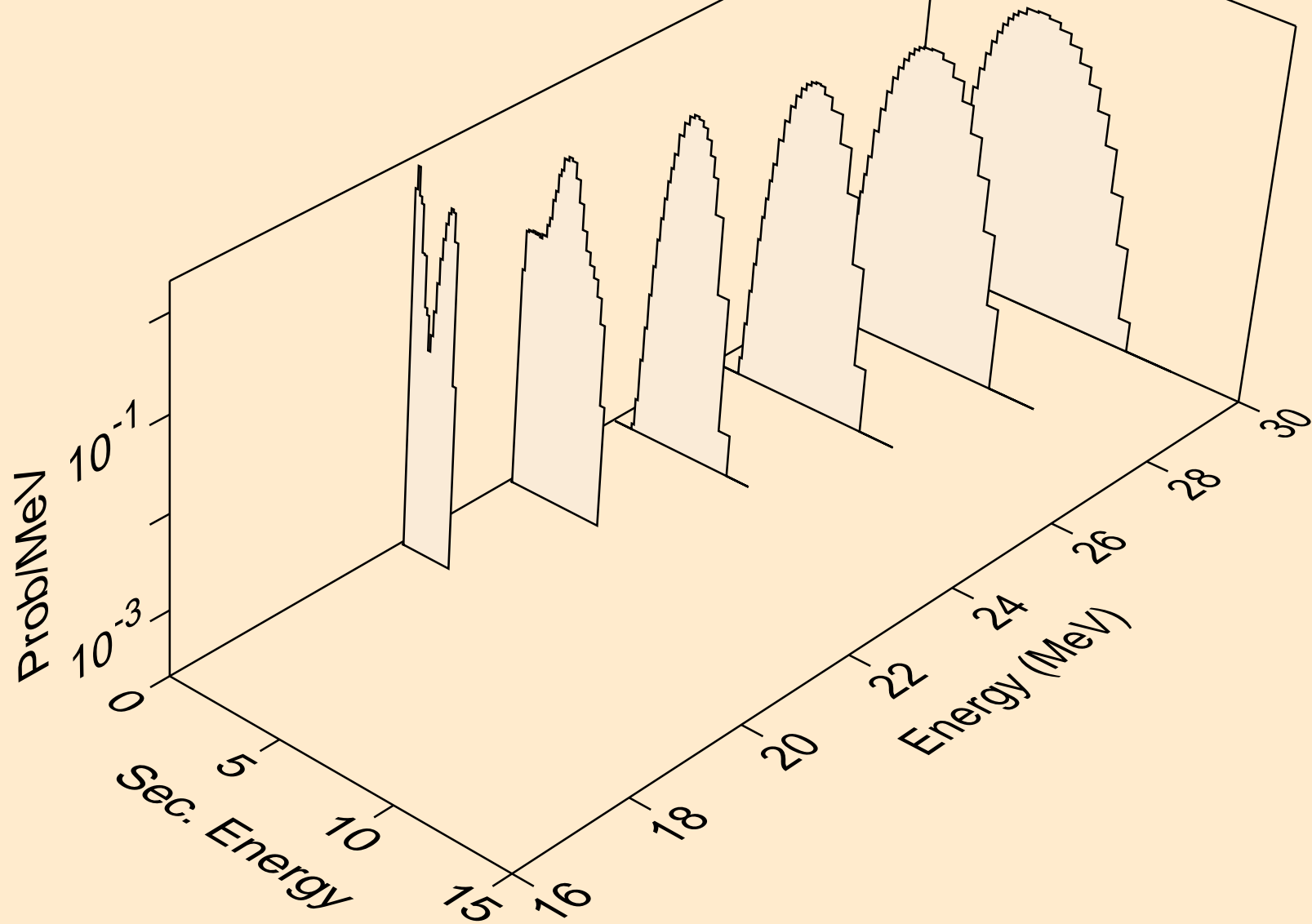

BR081 PROTON ACER TENDL-2023 LIBRARY; T=0.K  
Proton emission for (p,npa)

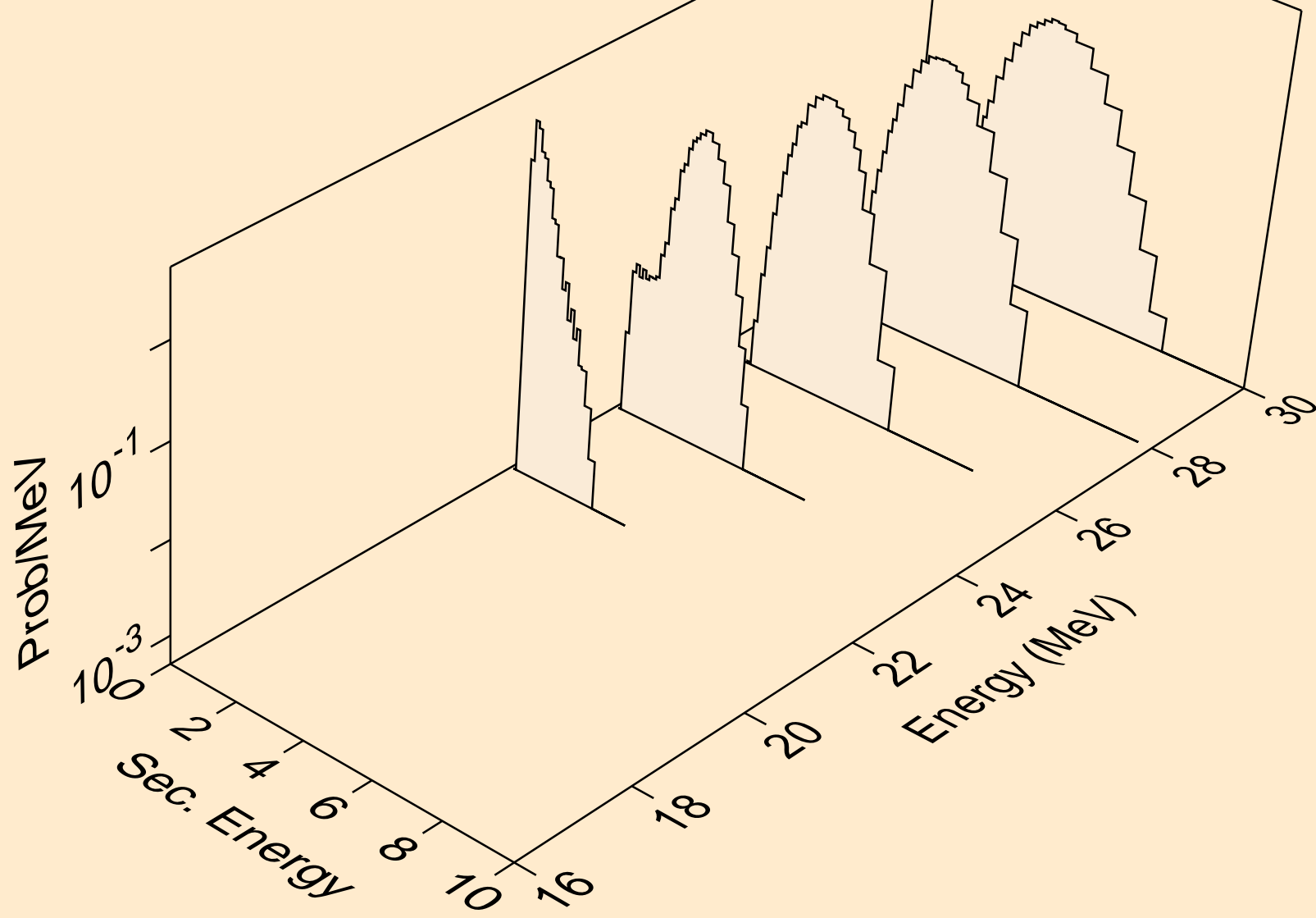

BR081 PROTON ACER TENDL-2023 LIBRARY; T=0.K  
Proton emission for inelastic

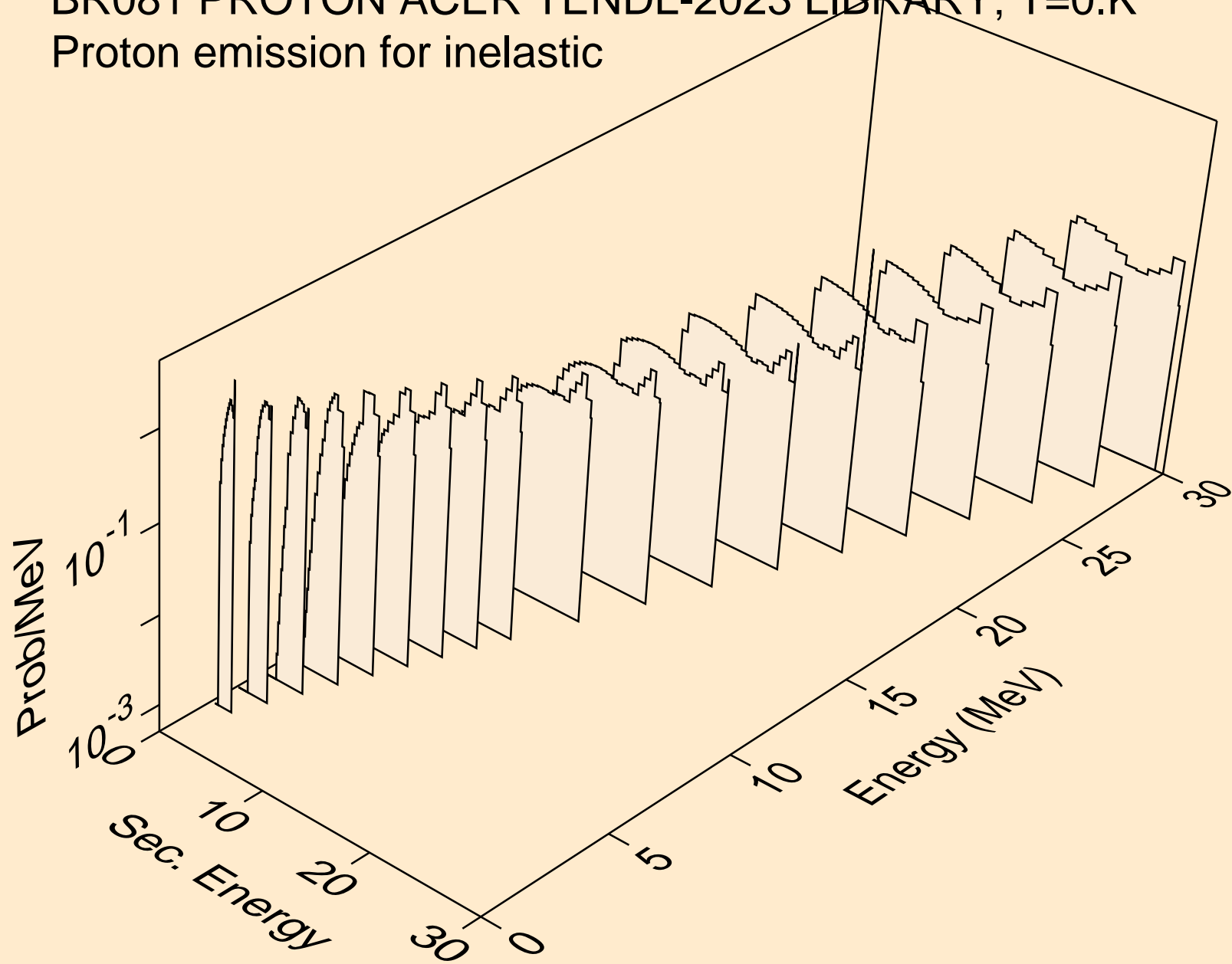

BR081 PROTON ACER TENDL-2023 LIBRARY; T=0.K  
Proton emission for (p,2p)

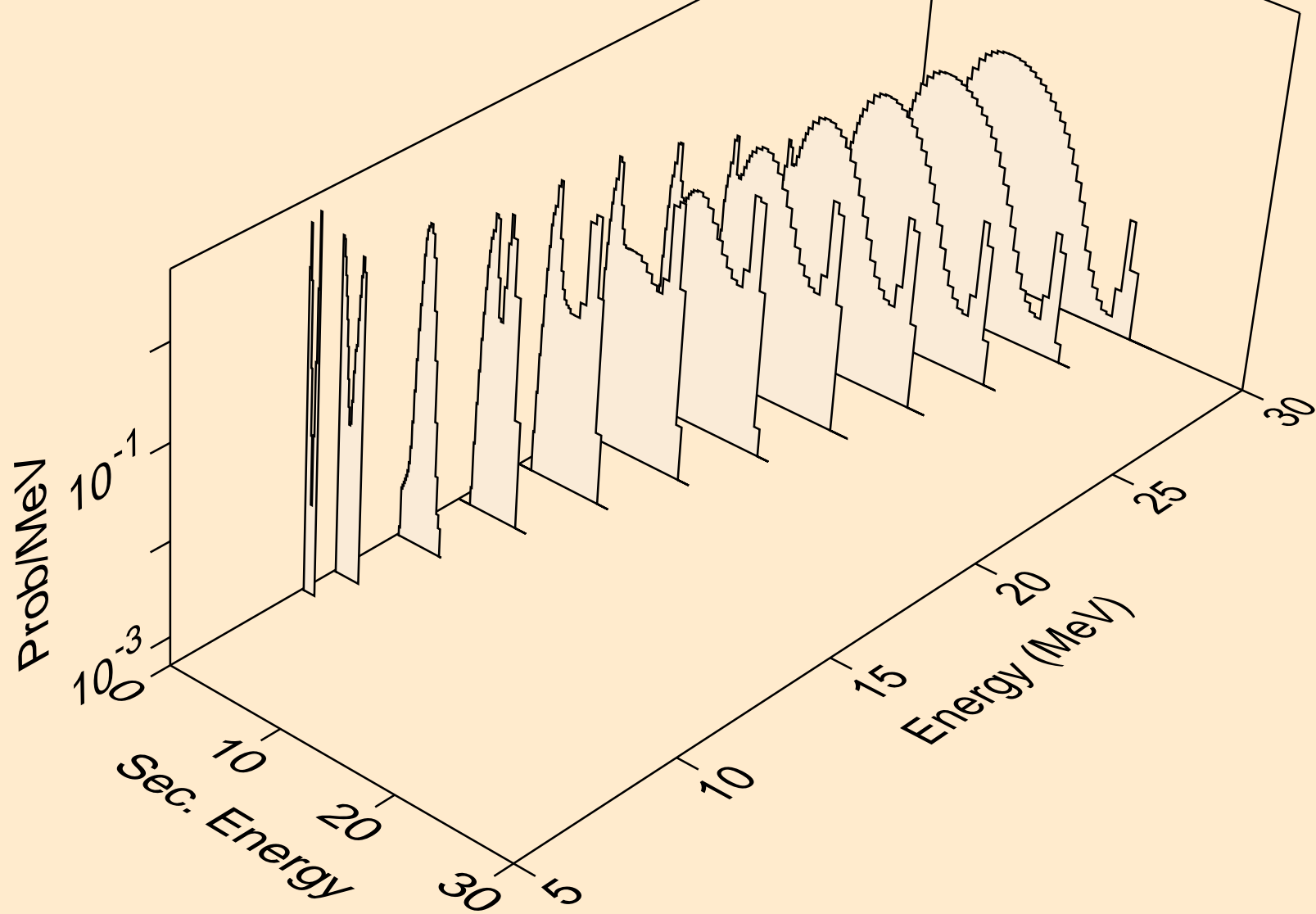



BR081 PROTON ACER TENDL-2023 LIBRARY; T=0.K  
Proton emission for (p,pa)

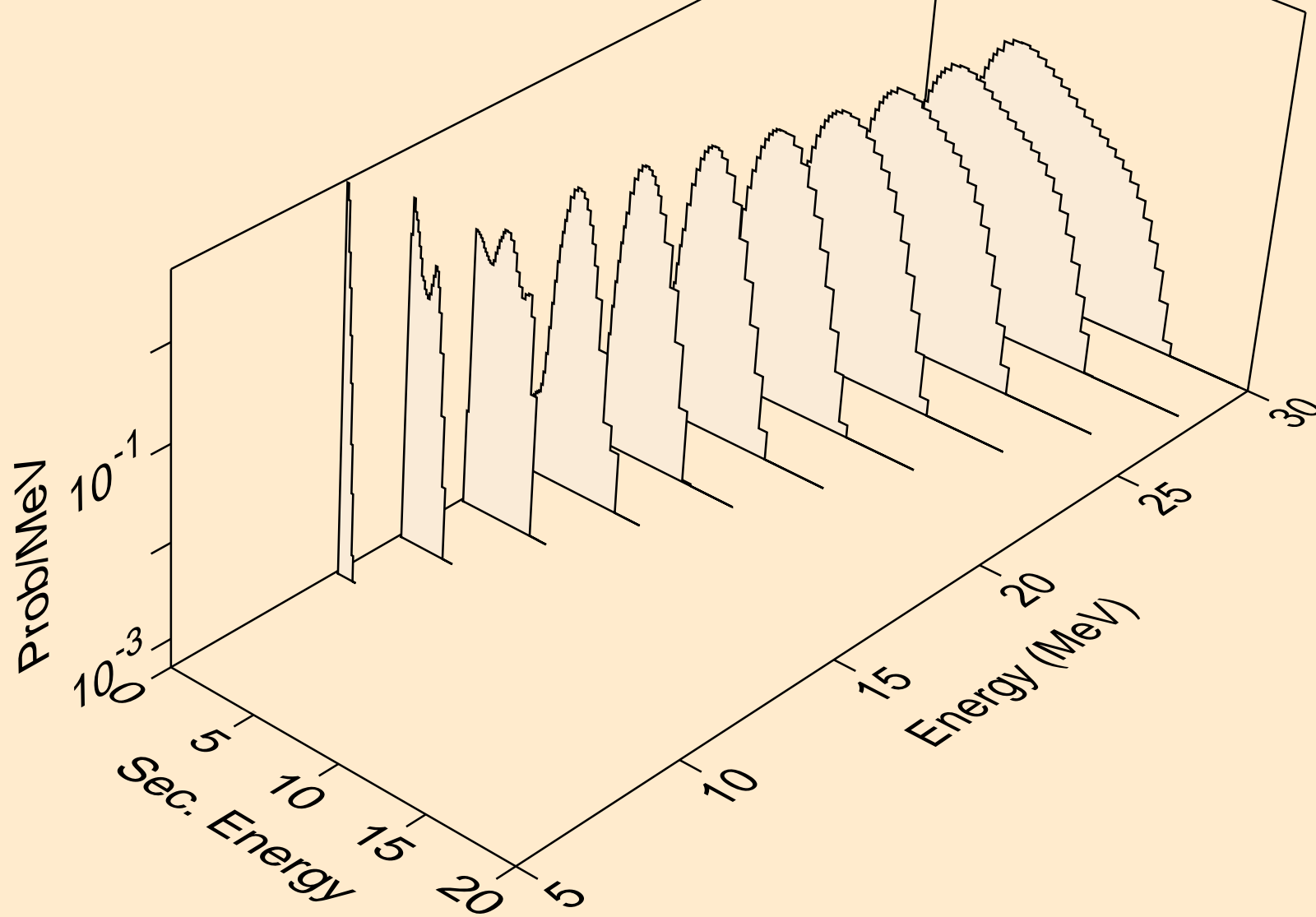

BR081 PROTON ACER TENDL-2023 LIBRARY; T=0.K  
Proton emission for (p,pd)

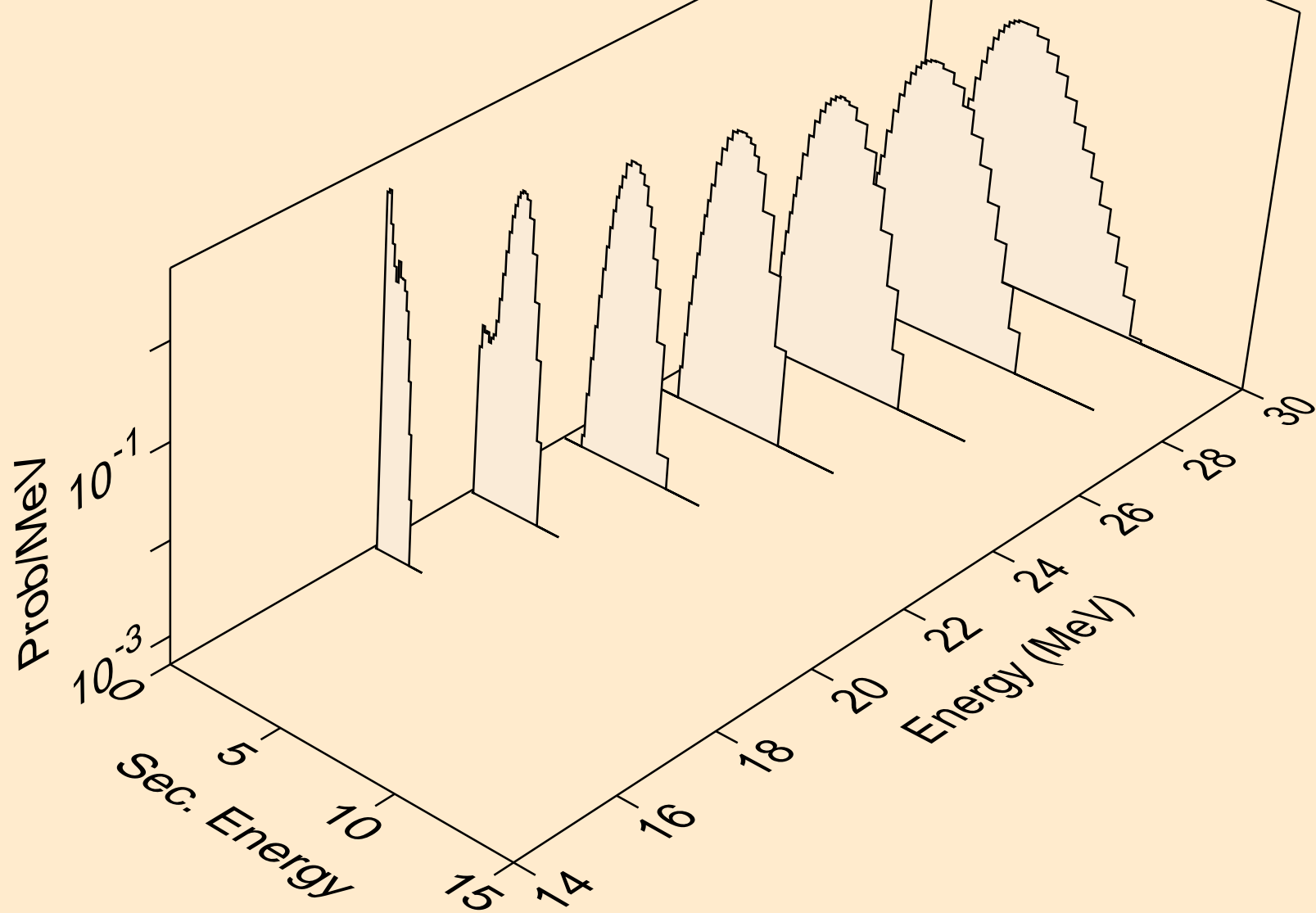

BR081 PROTON ACER TENDL-2023 LIBRARY; T=0.K  
Proton emission for (p,pt)

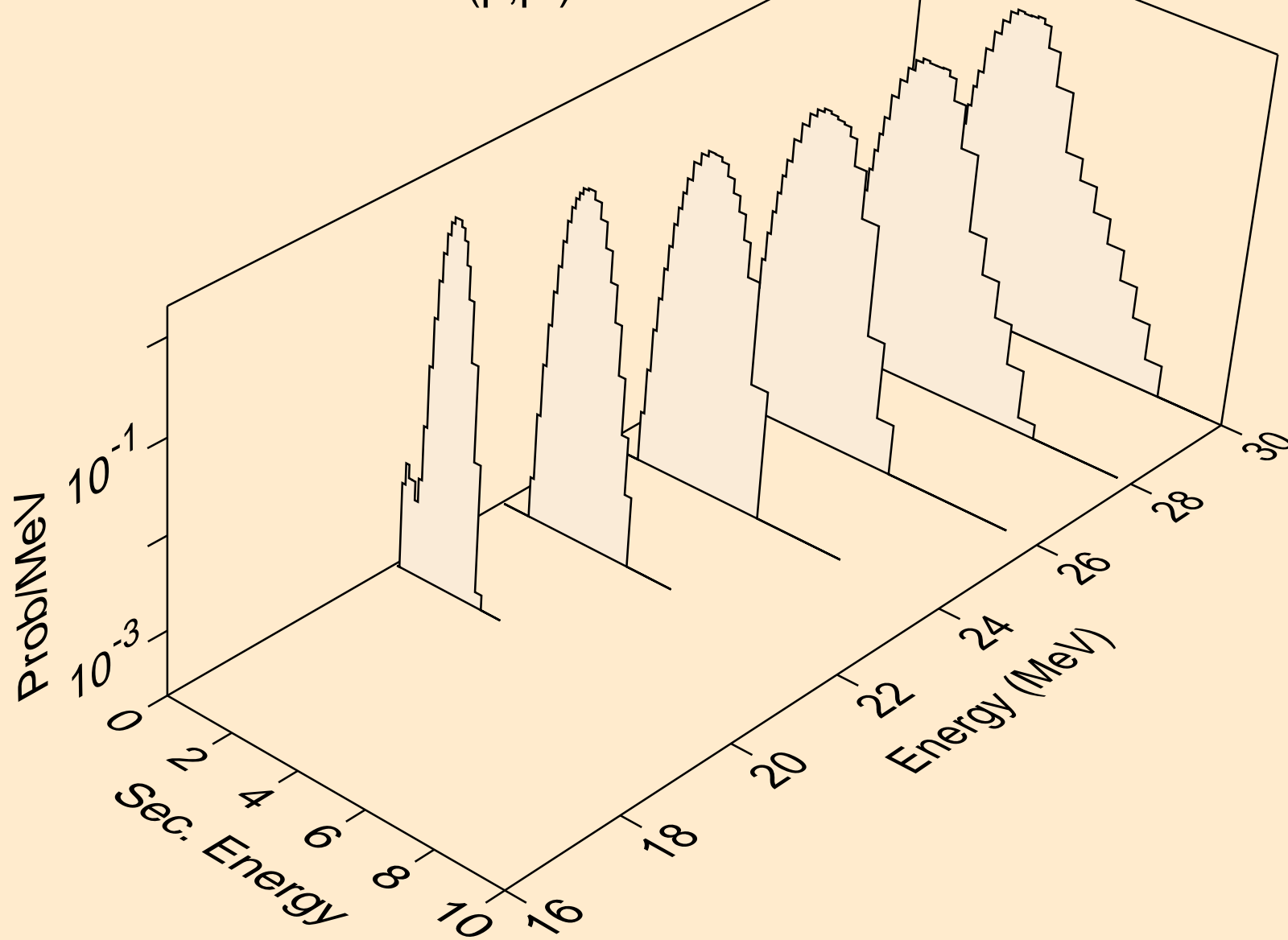

BR081 PROTON ACER TENDL-2023 LIBRARY; T=0.K  
Photon emission for (z,n)

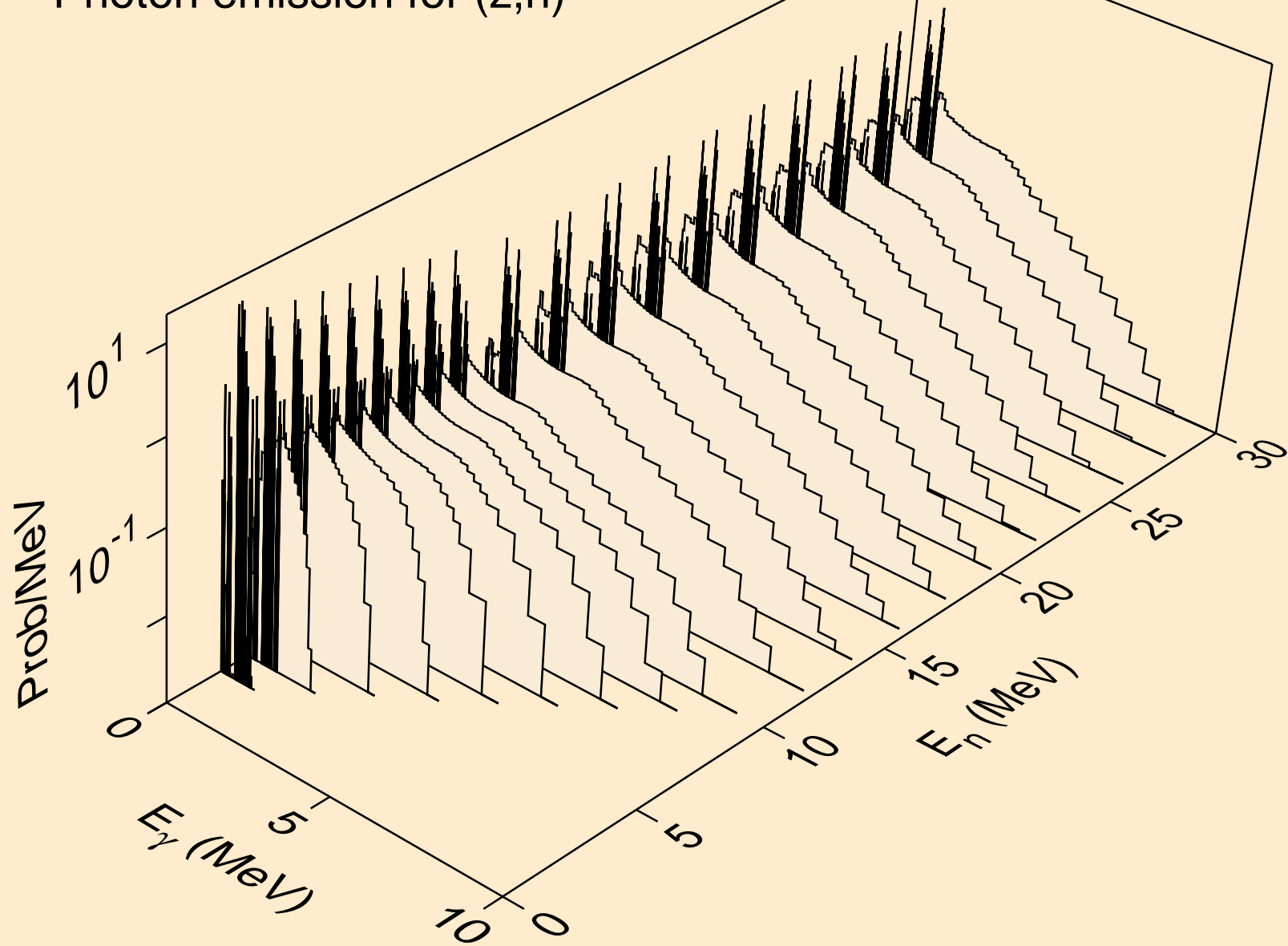

BR081 PROTON ACER TENDL-2023 LIBRARY; T=0.K  
Photon emission for (z,x)

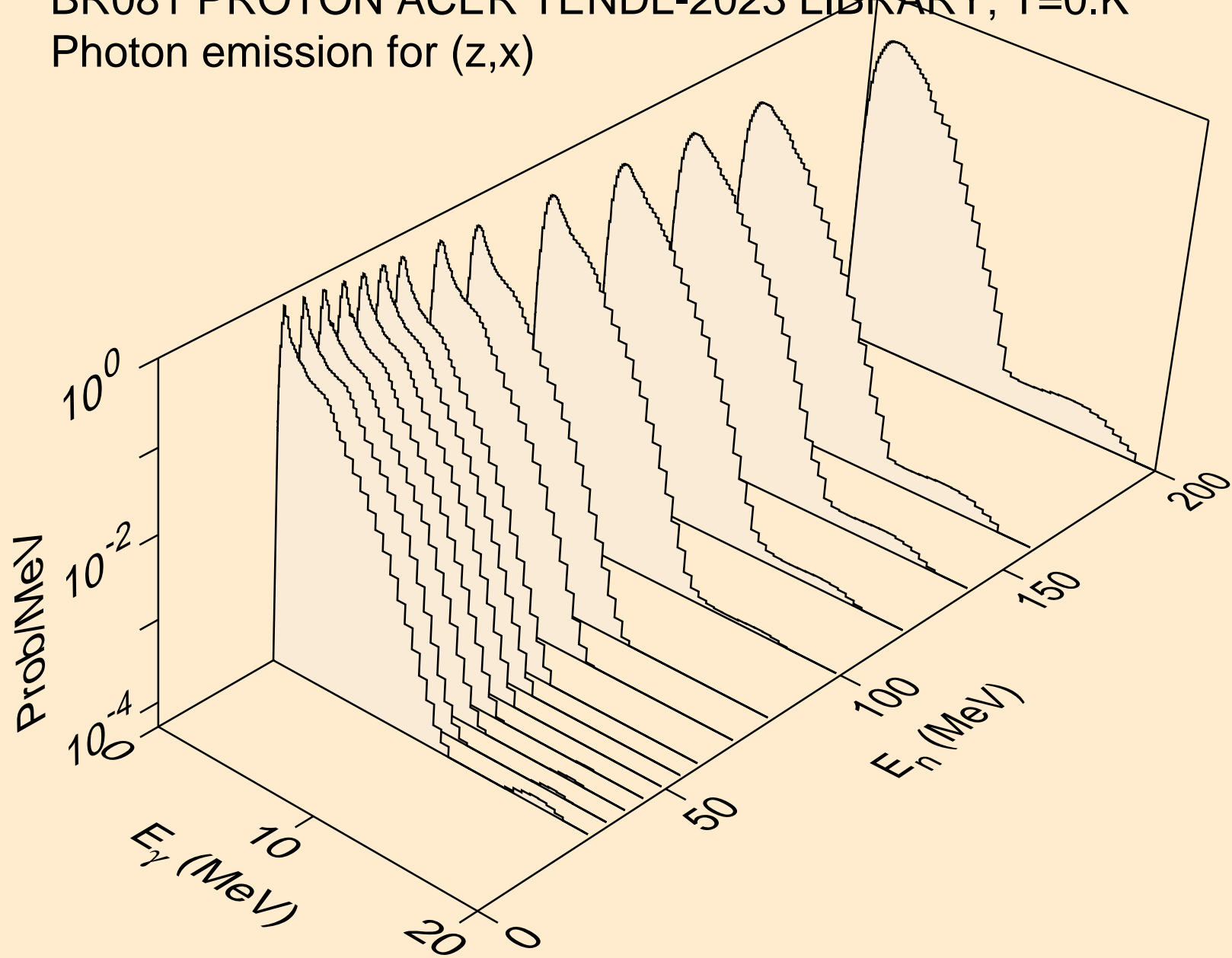

BR081 PROTON ACER TENDL-2023 LIBRARY; T=0.K  
Photon emission for (n,2nd)

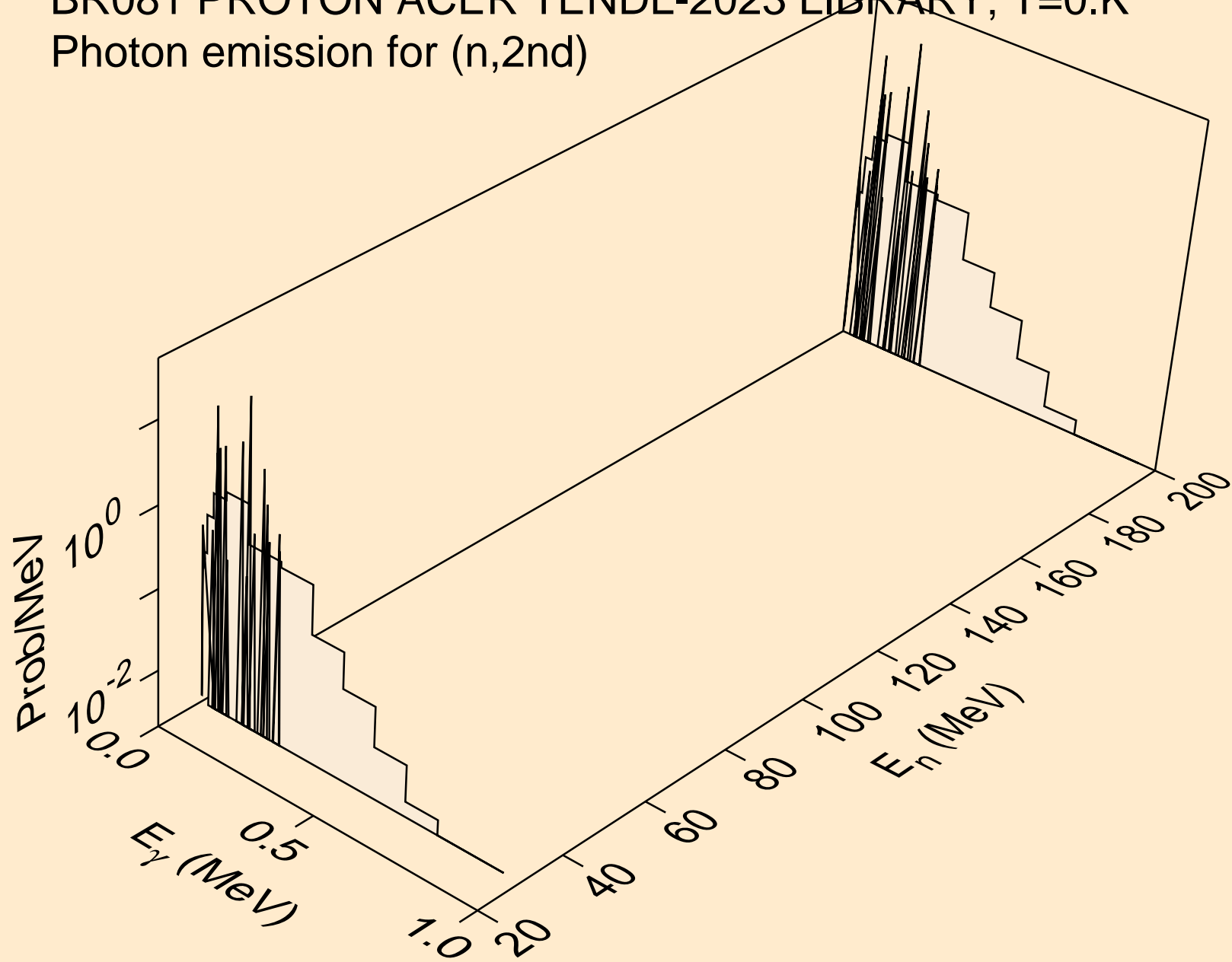

BR081 PROTON ACER TENDL-2023 LIBRARY; T=0.K  
Photon emission for (n,2n)

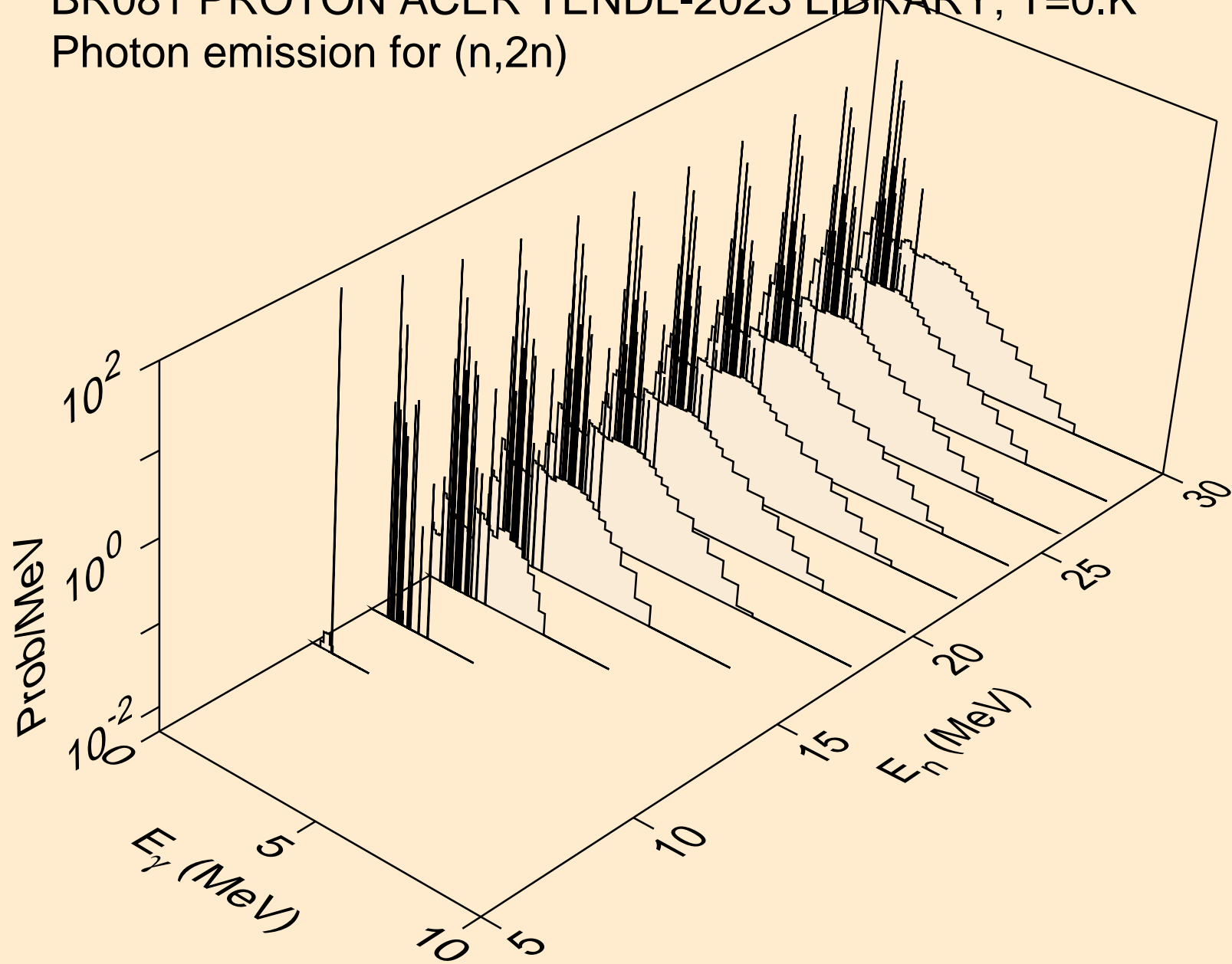

BR081 PROTON ACER TENDL-2023 LIBRARY; T=0.K  
Photon emission for (n,3n)

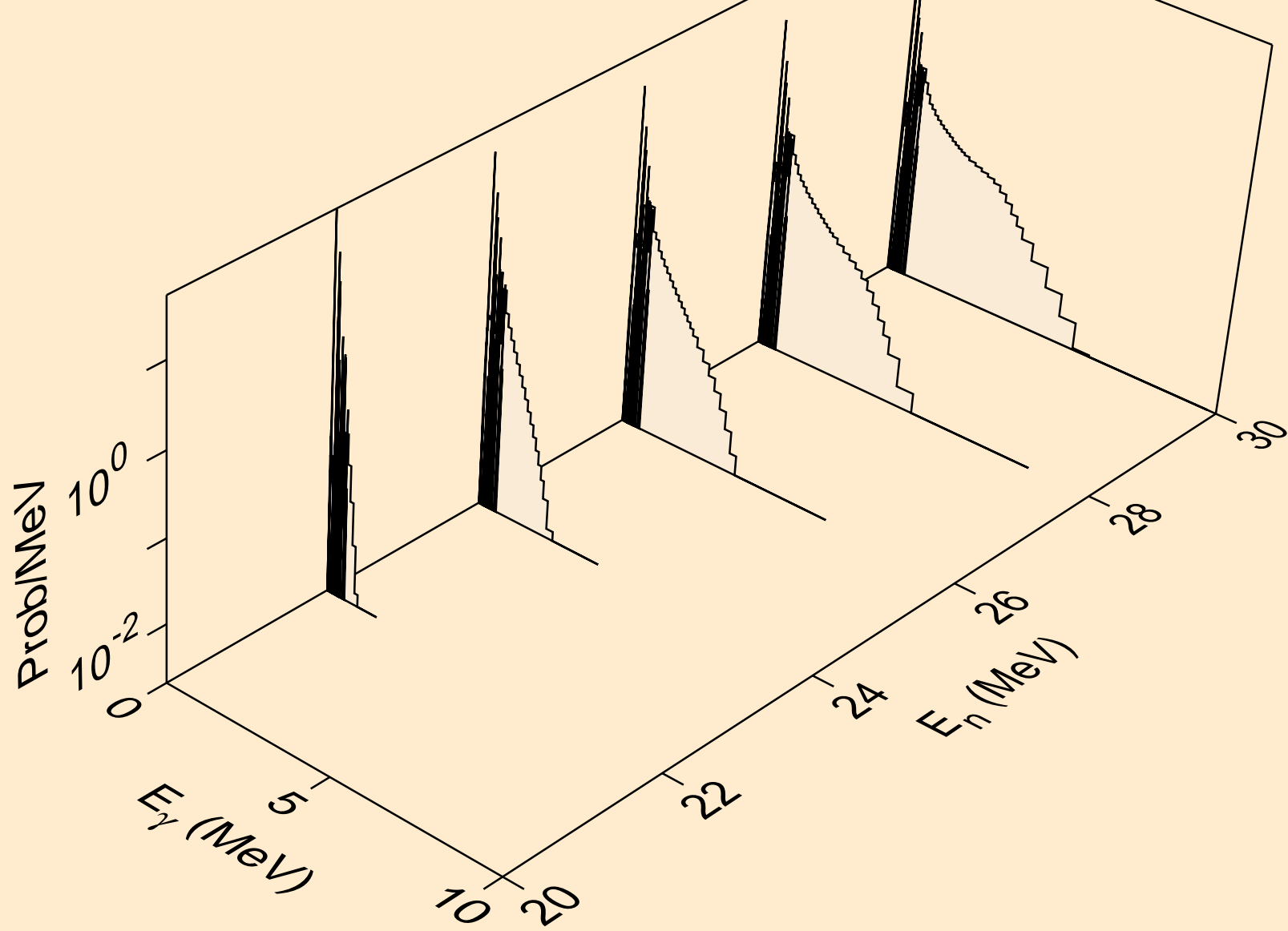



BR081 PROTON ACER TENDL-2023 LIBRARY; T=0.K  
Photon emission for (n,n\*)a

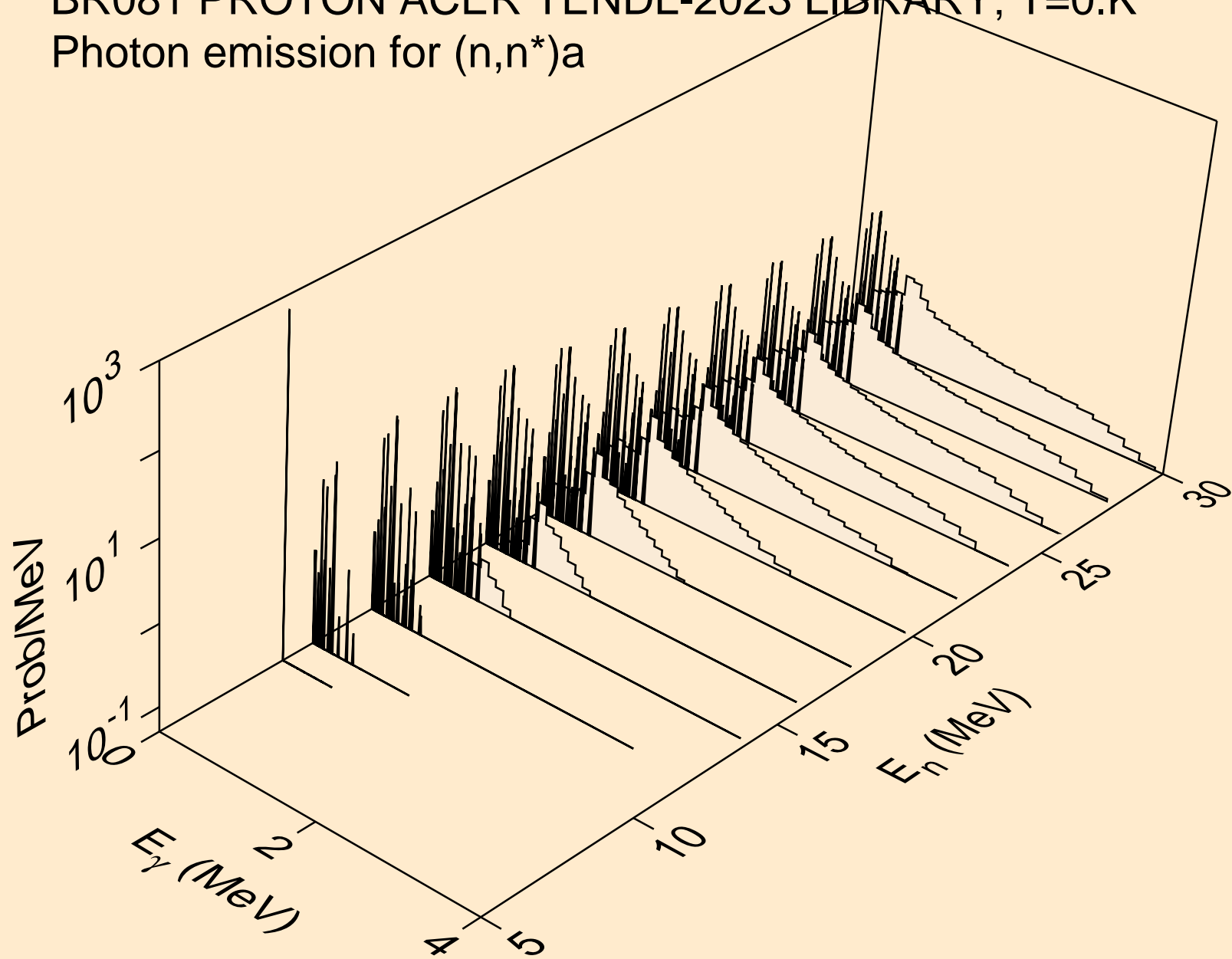

BR081 PROTON ACER TENDL-2023 LIBRARY; T=0.K  
Photon emission for (n,2n)a

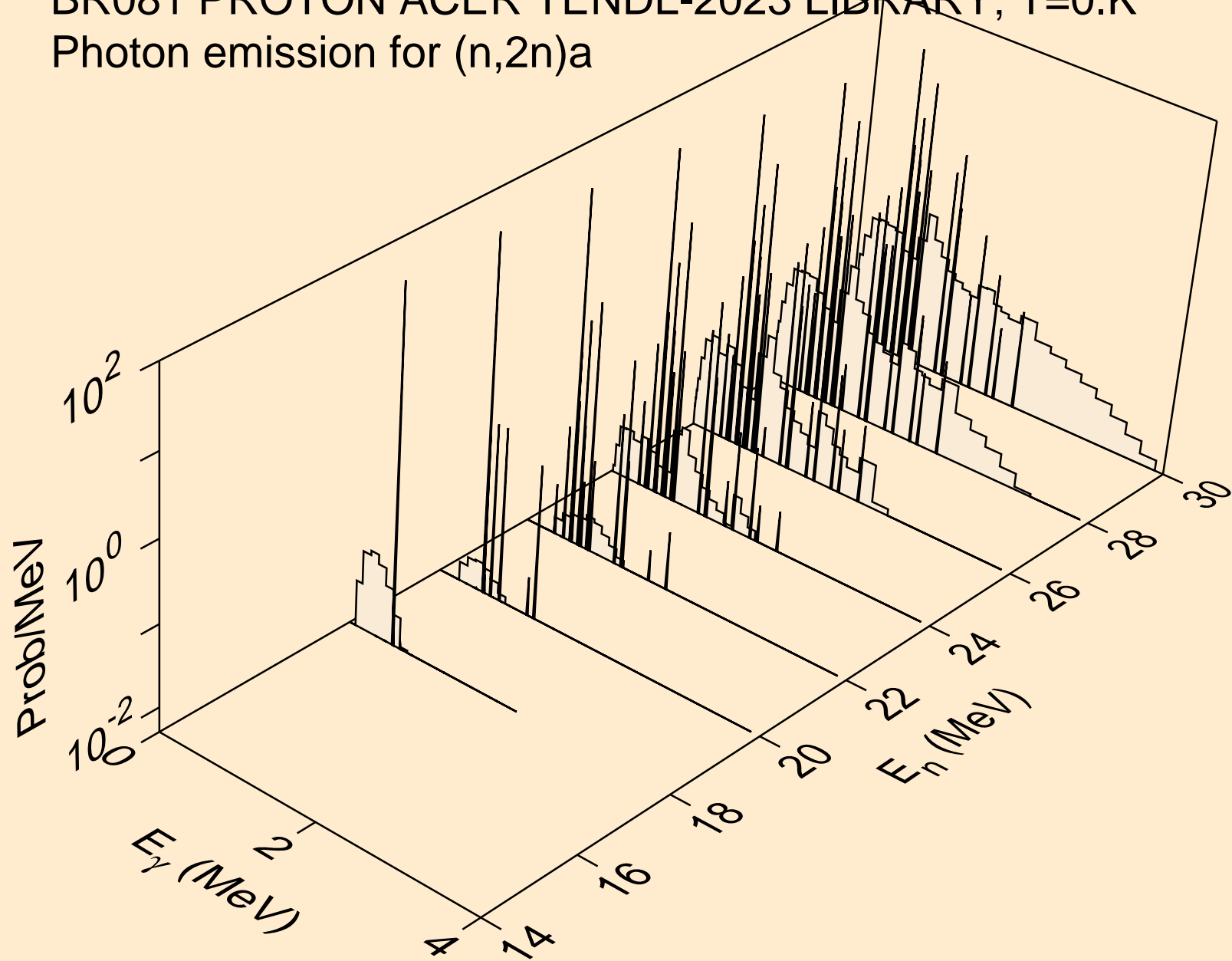

BR081 PROTON ACER TENDL-2023 LIBRARY; T=0.K  
Photon emission for (n,n\*)p

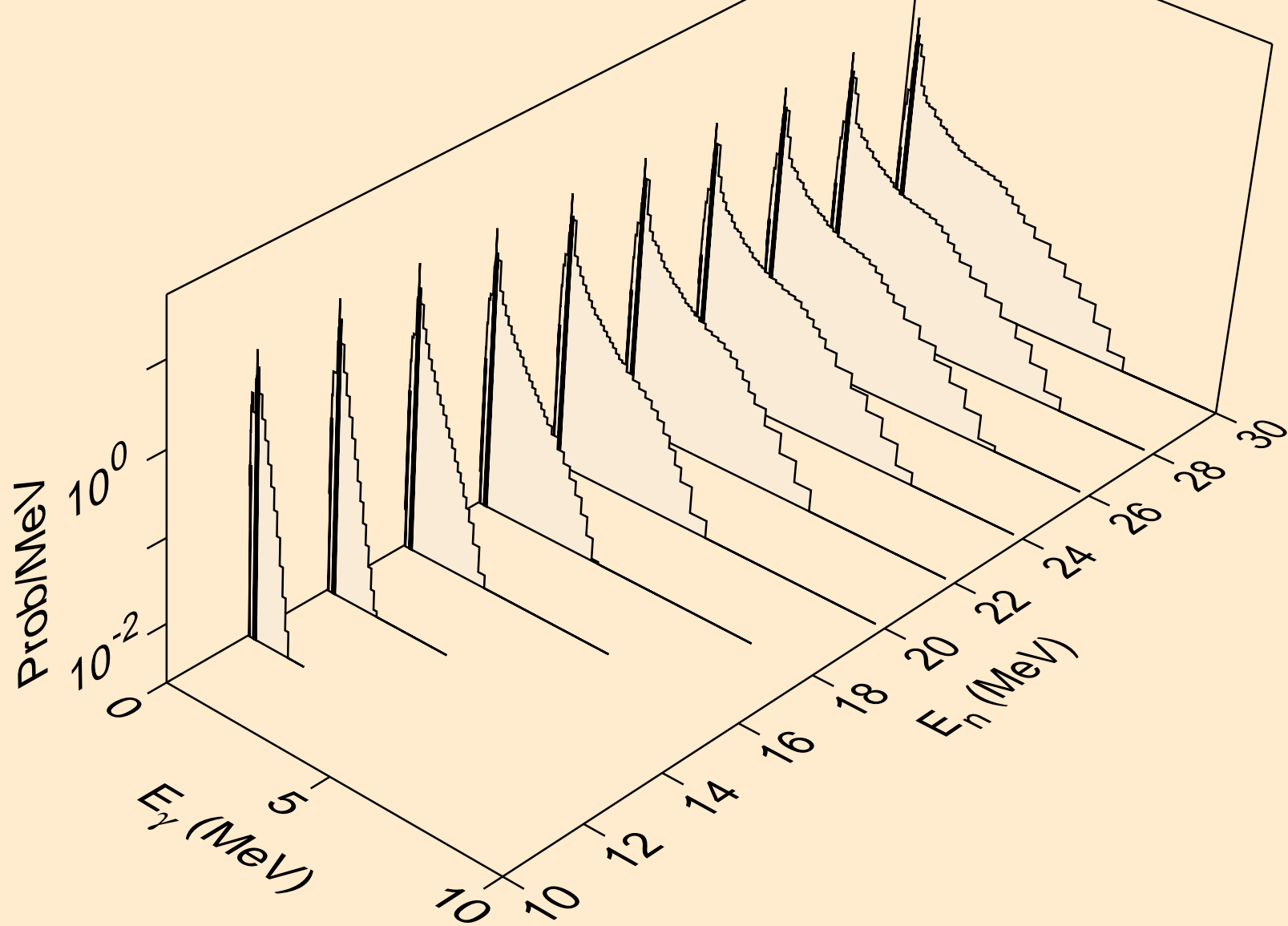

BR081 PROTON ACER TENDL-2023 LIBRARY; T=0.K  
Photon emission for (n,n\*)2a

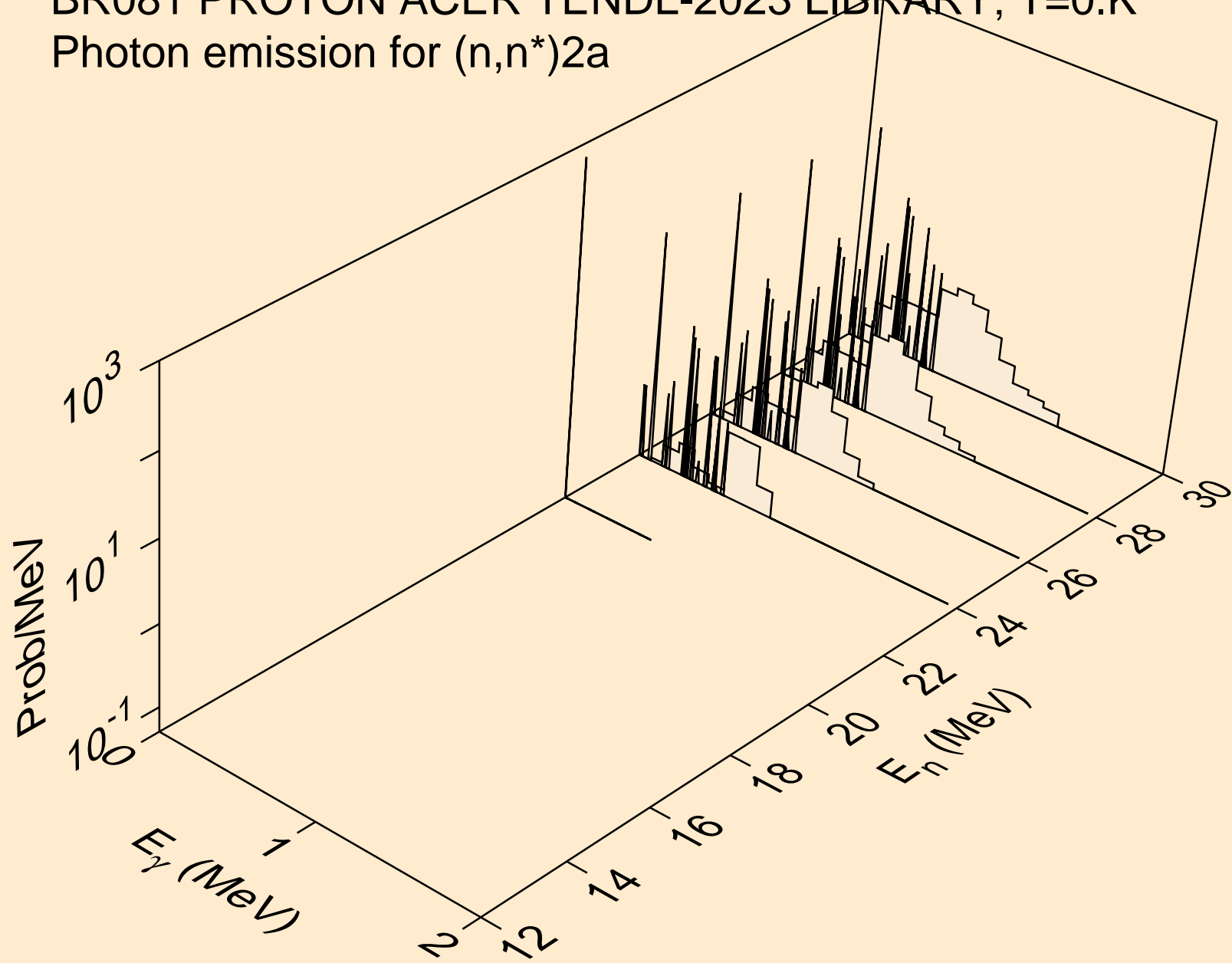

BR081 PROTON ACER TENDL-2023 LIBRARY; T=0.K  
Photon emission for (n,n\*)d

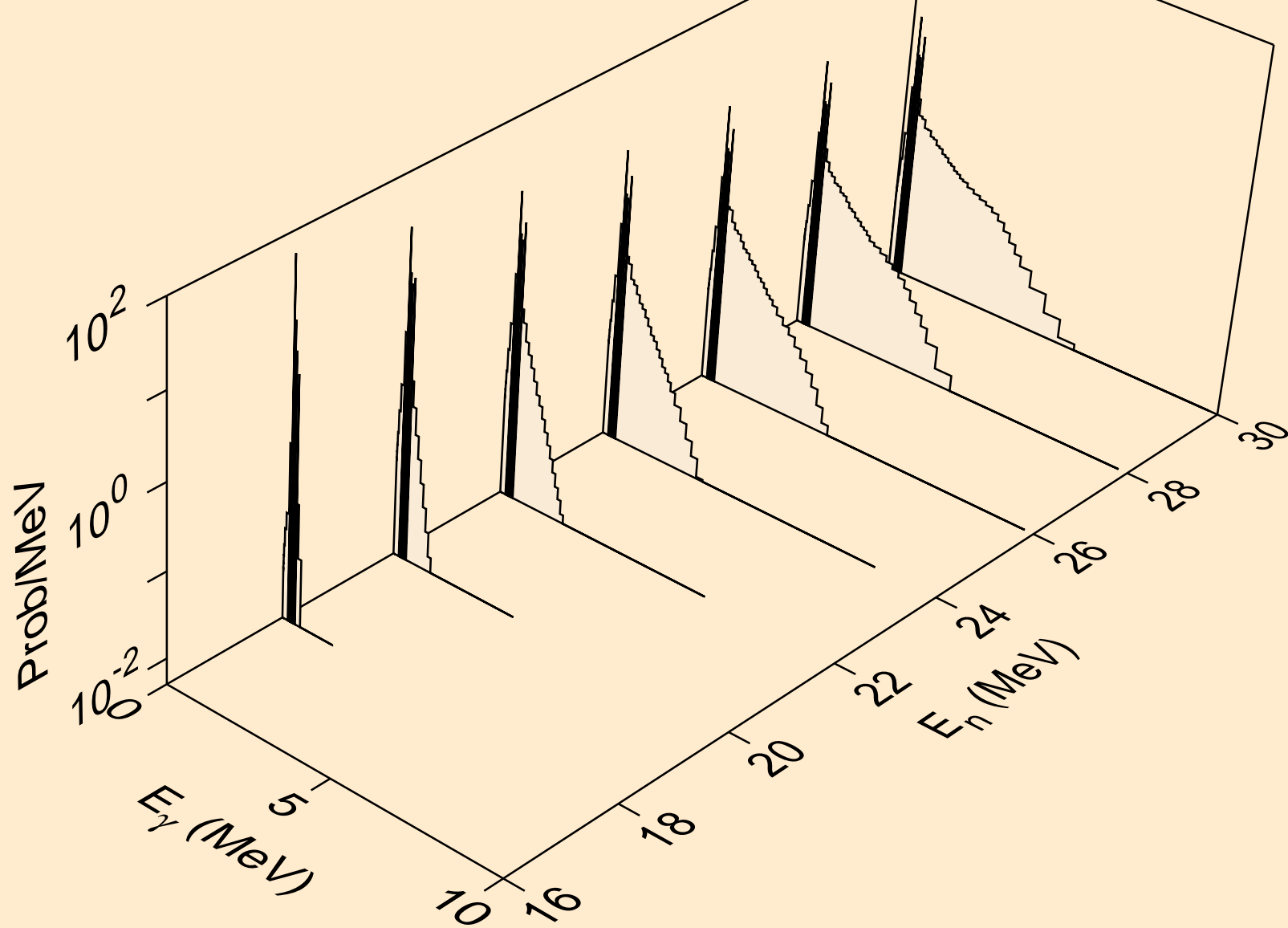

BR081 PROTON ACER TENDL-2023 LIBRARY; T=0.K  
Photon emission for (n,n\*)t

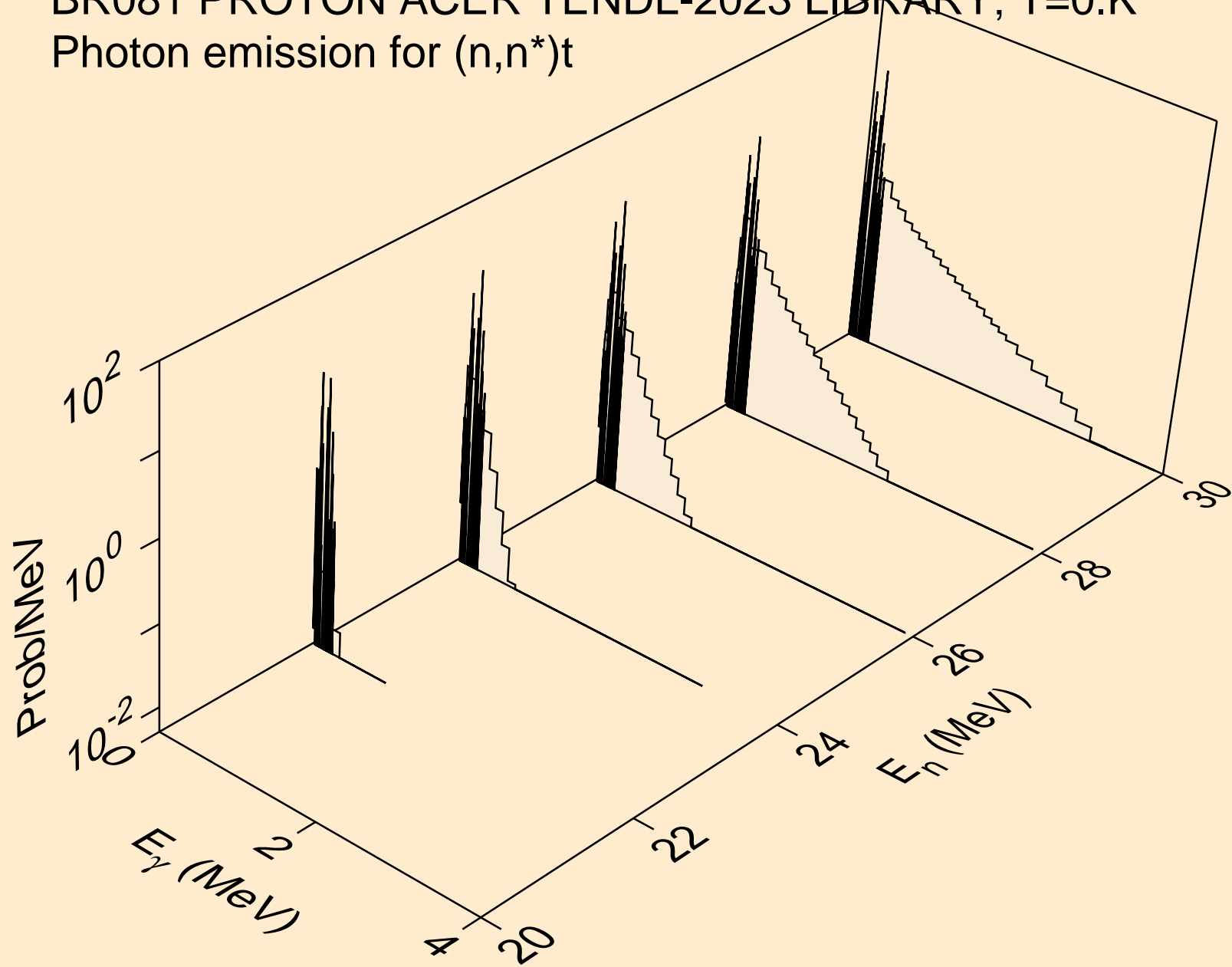

BR081 PROTON ACER TENDL-2023 LIBRARY; T=0.K  
Photon emission for (n,n\*)he3

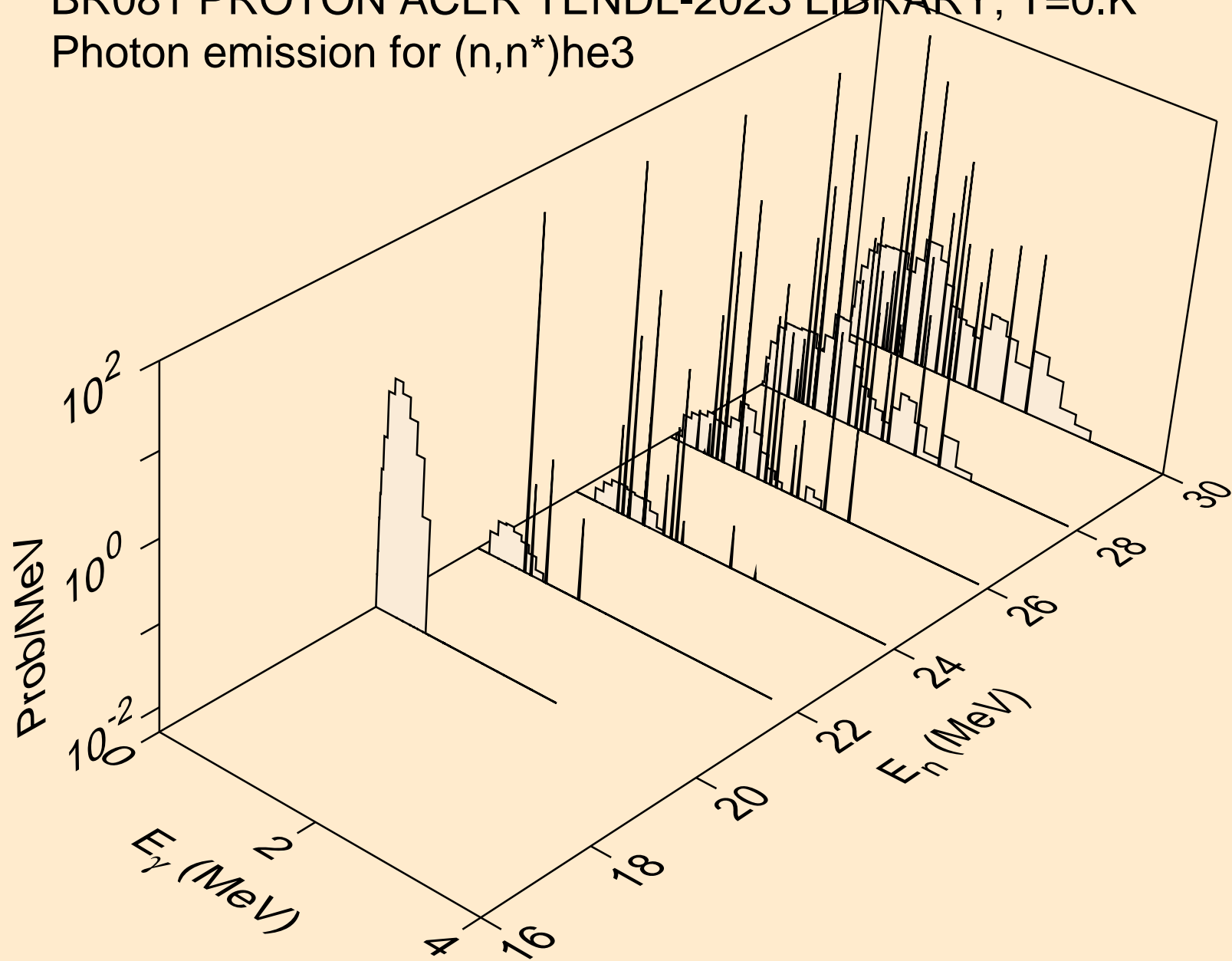

BR081 PROTON ACER TENDL-2023 LIBRARY; T=0.K  
Photon emission for (n,2np)

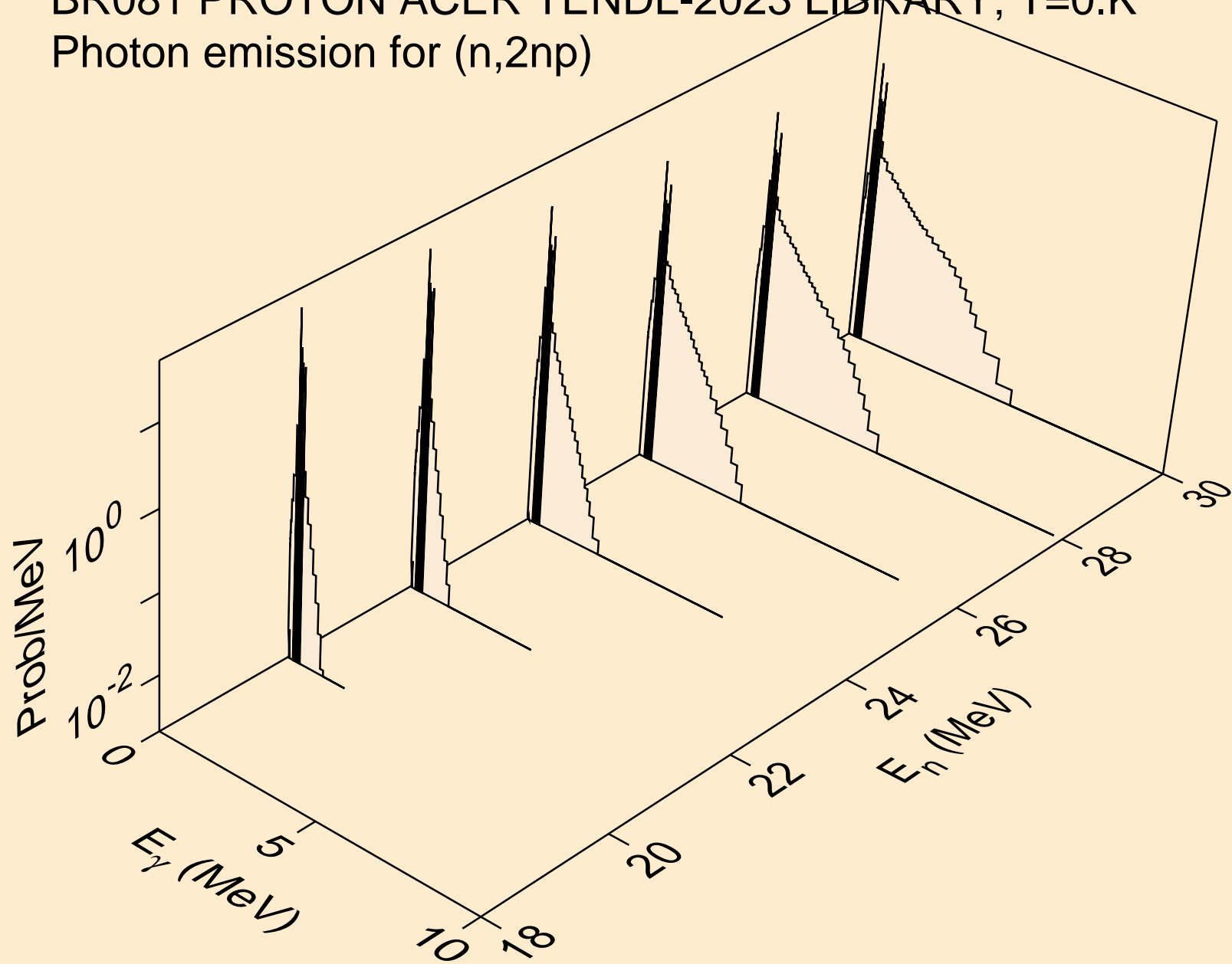



BR081 PROTON ACER TENDL-2023 LIBRARY; T=0.K  
Photon emission for (n,n2p)

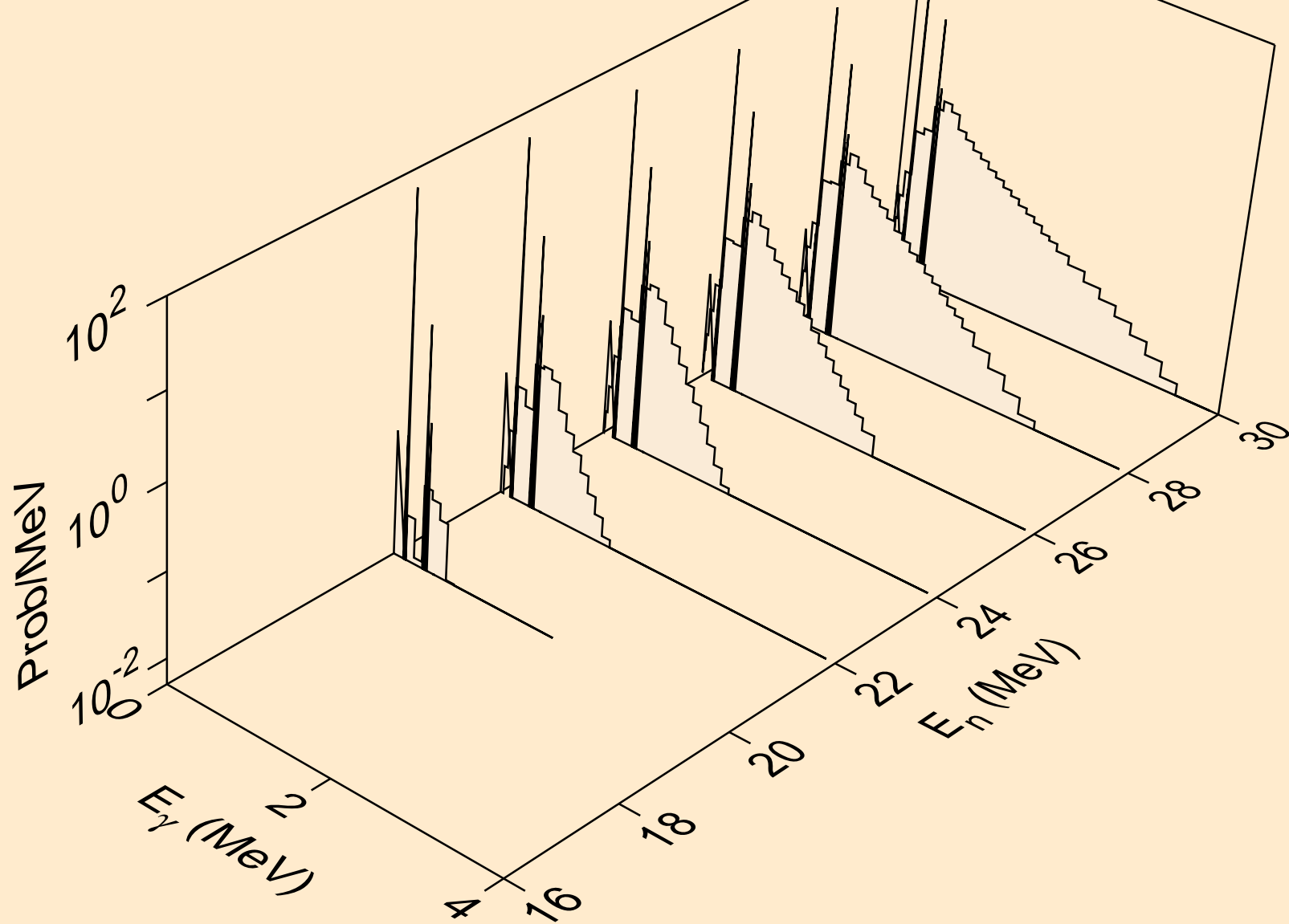

BR081 PROTON ACER TENDL-2023 LIBRARY; T=0.K  
Photon emission for (n,npa)

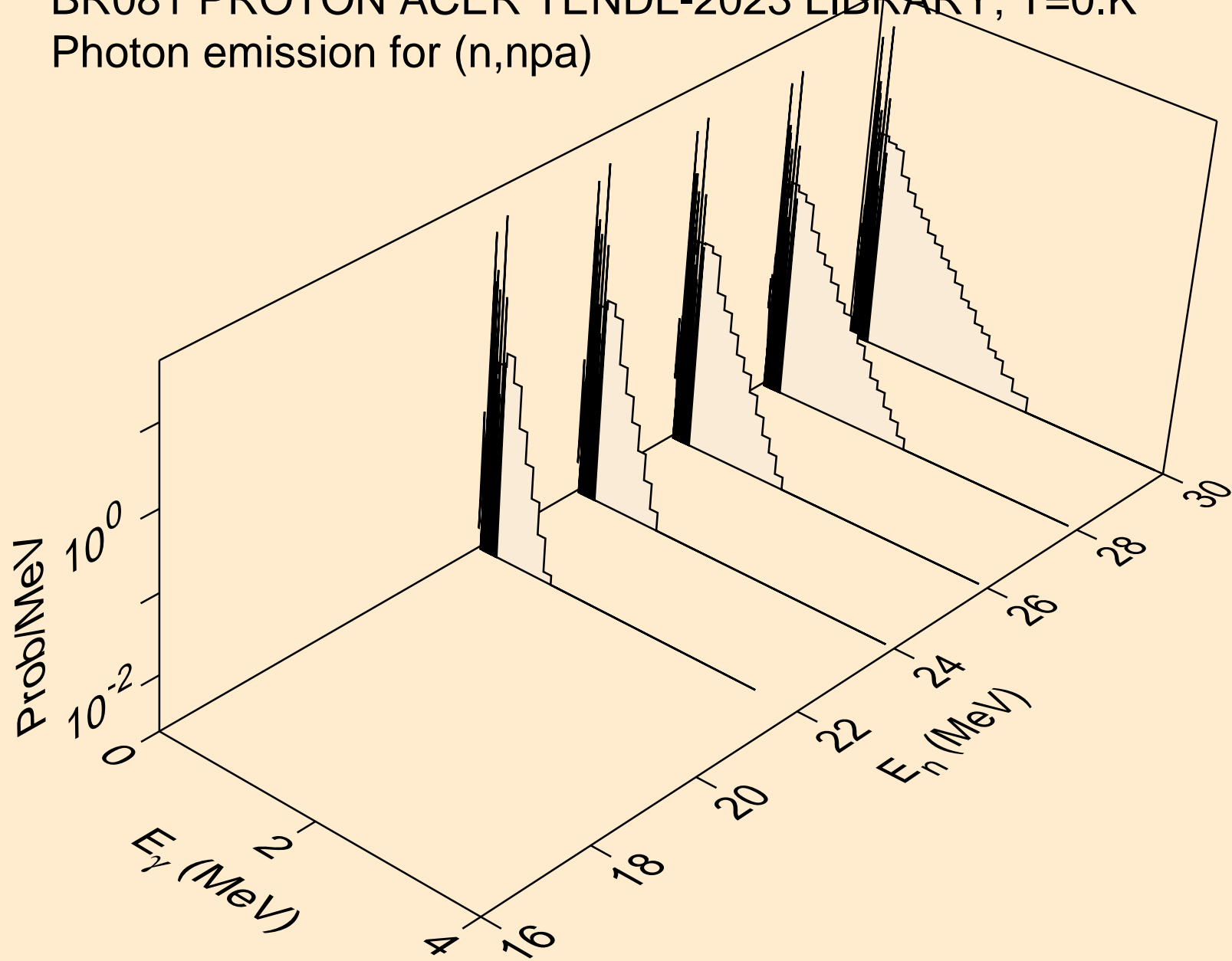

BR081 PROTON ACER TENDL-2023 LIBRARY; T=0.K  
Photon emission for (n,gma)

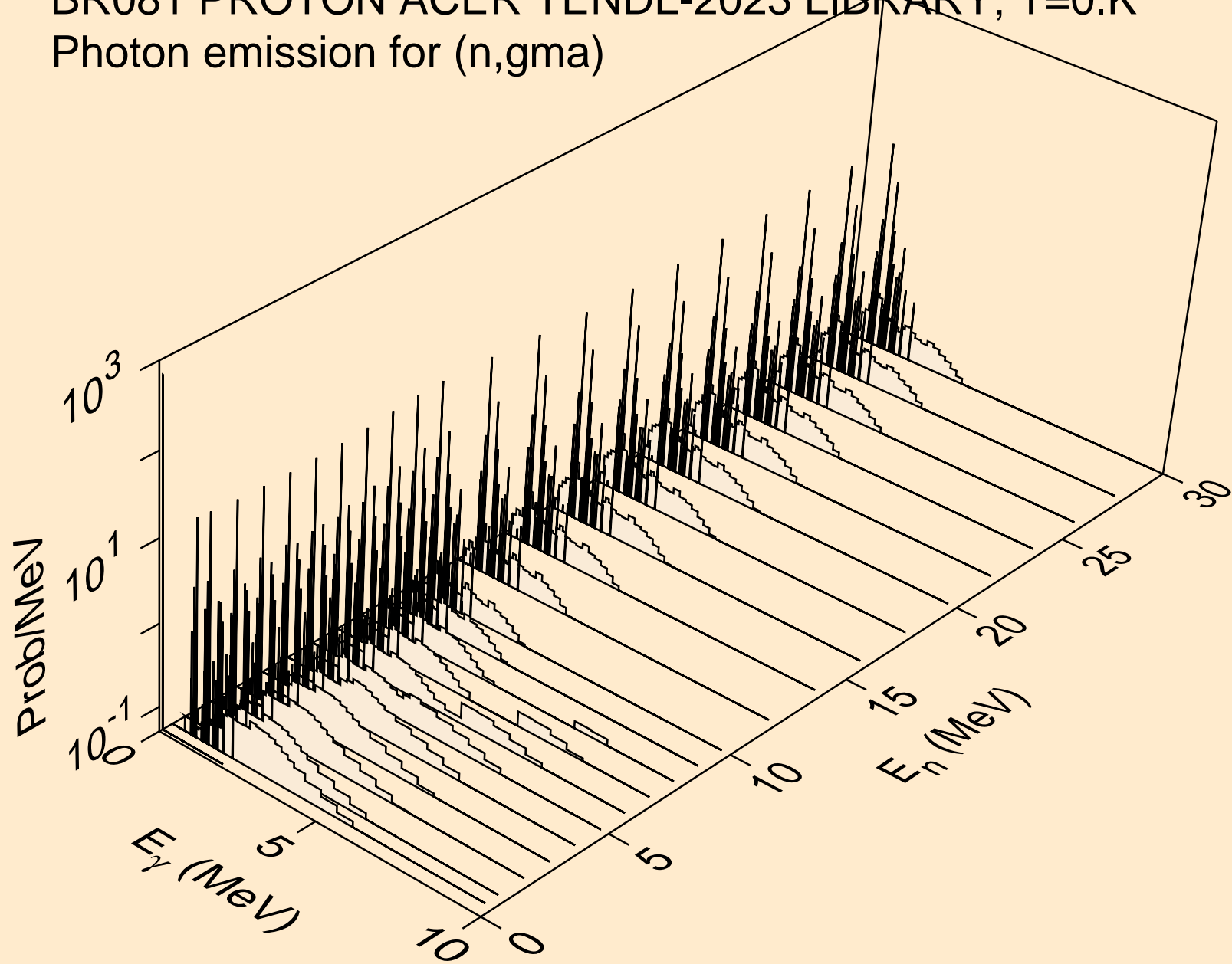

BR081 PROTON ACER TENDL-2023 LIBRARY; T=0.K  
Photon emission for inelastic

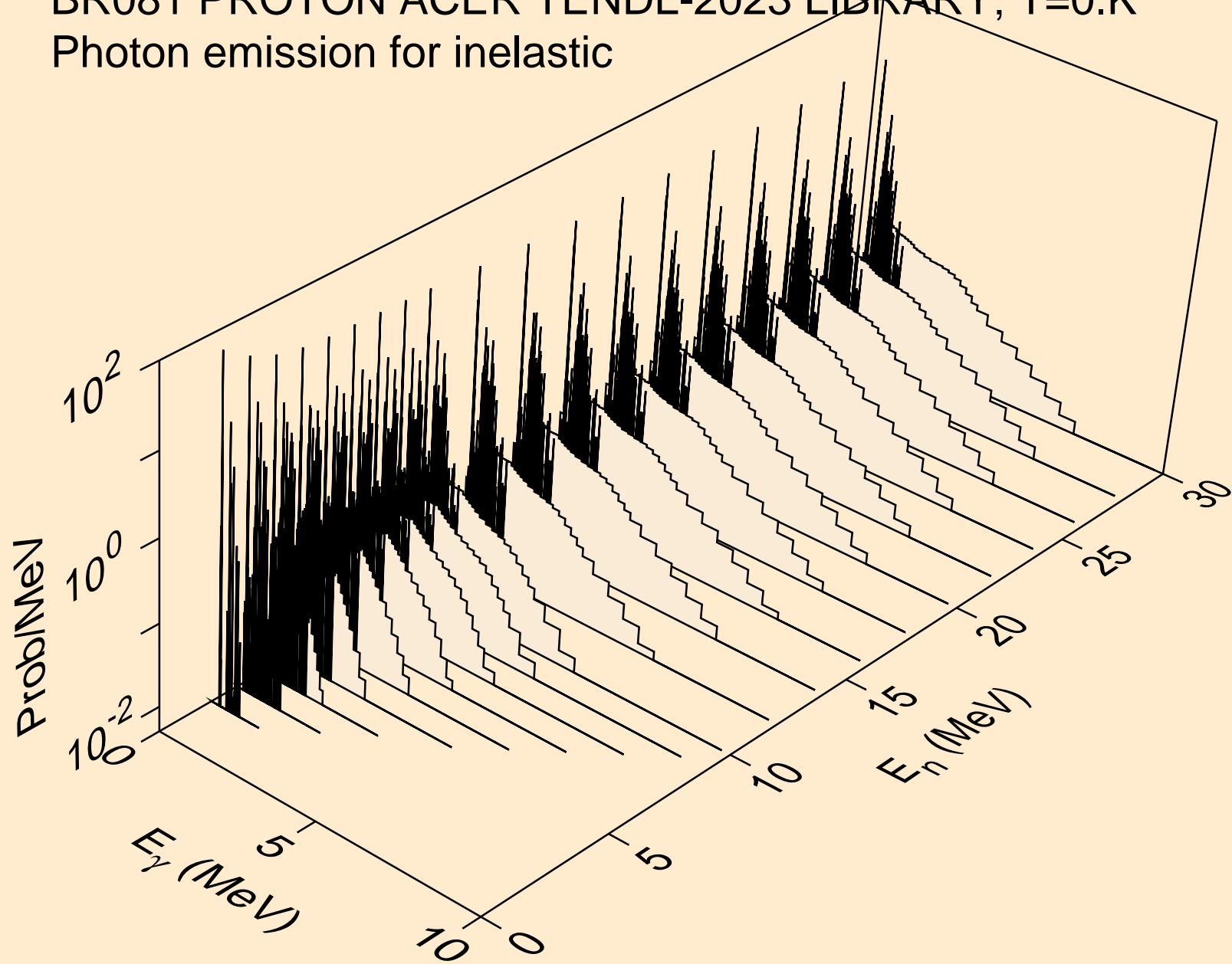

BR081 PROTON ACER TENDL-2023 LIBRARY; T=0.K  
Photon emission for (n,d)

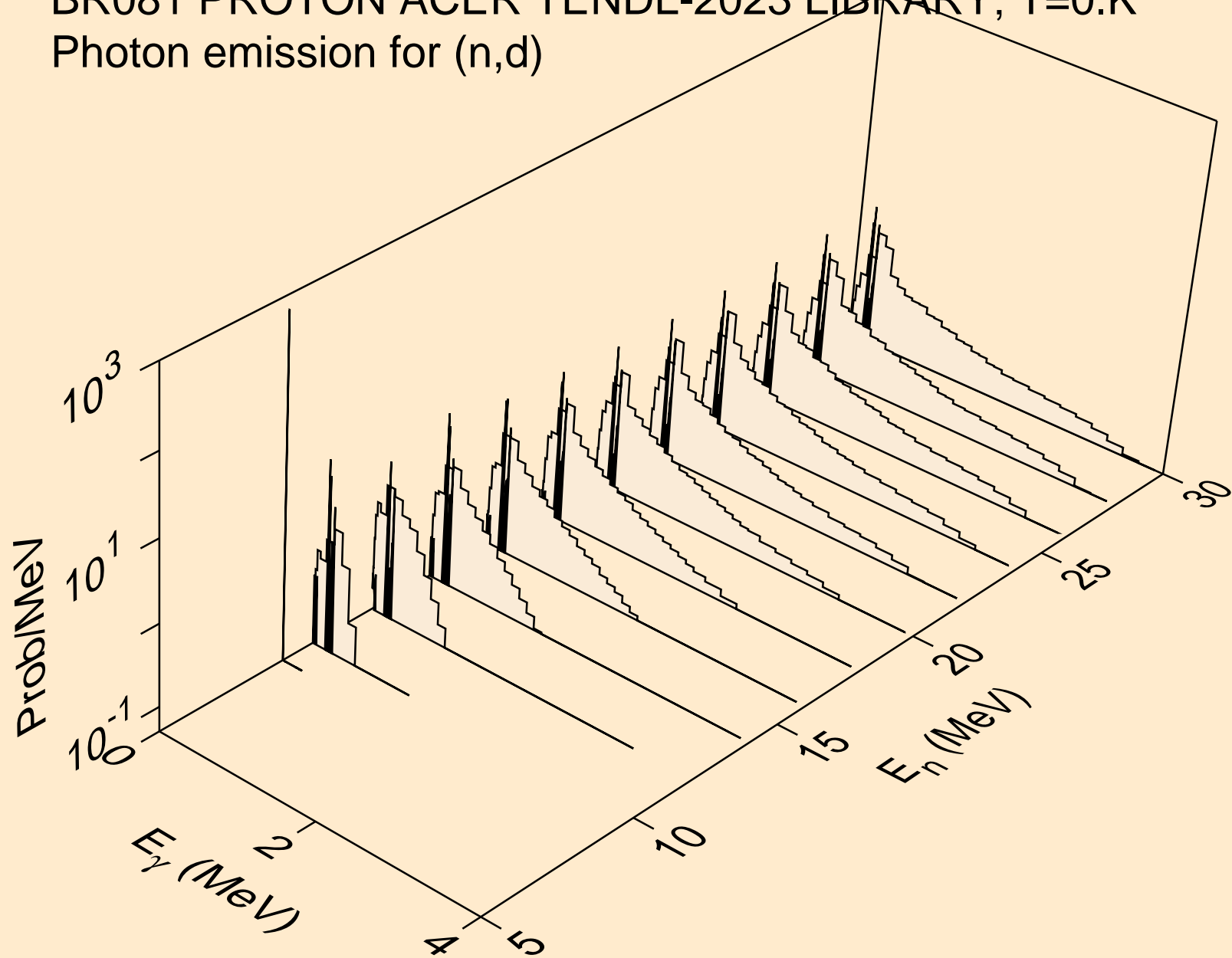

BR081 PROTON ACER TENDL-2023 LIBRARY; T=0.K  
Photon emission for (n,t)

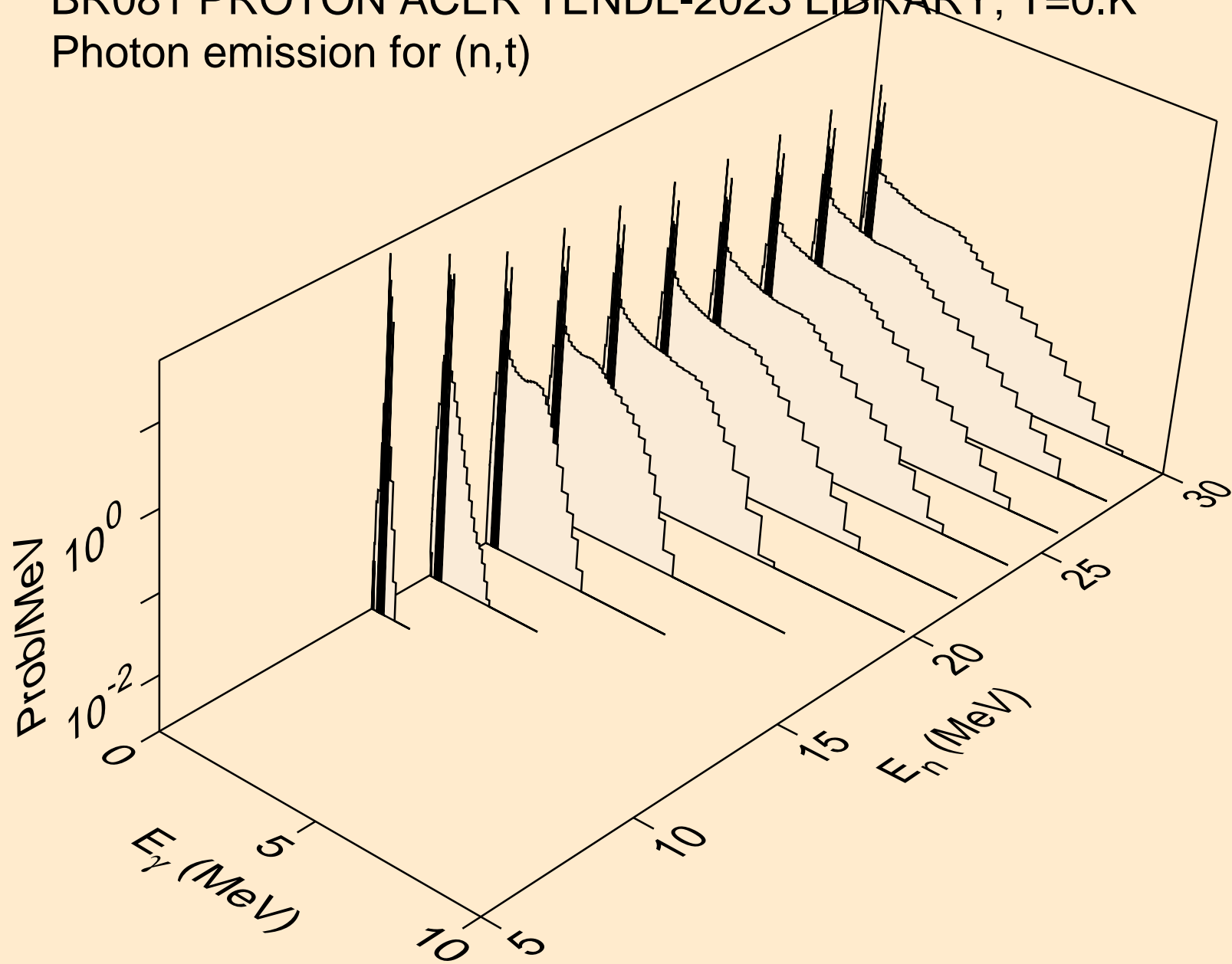

BR081 PROTON ACER TENDL-2023 LIBRARY; T=0.K  
Photon emission for (n,he3)

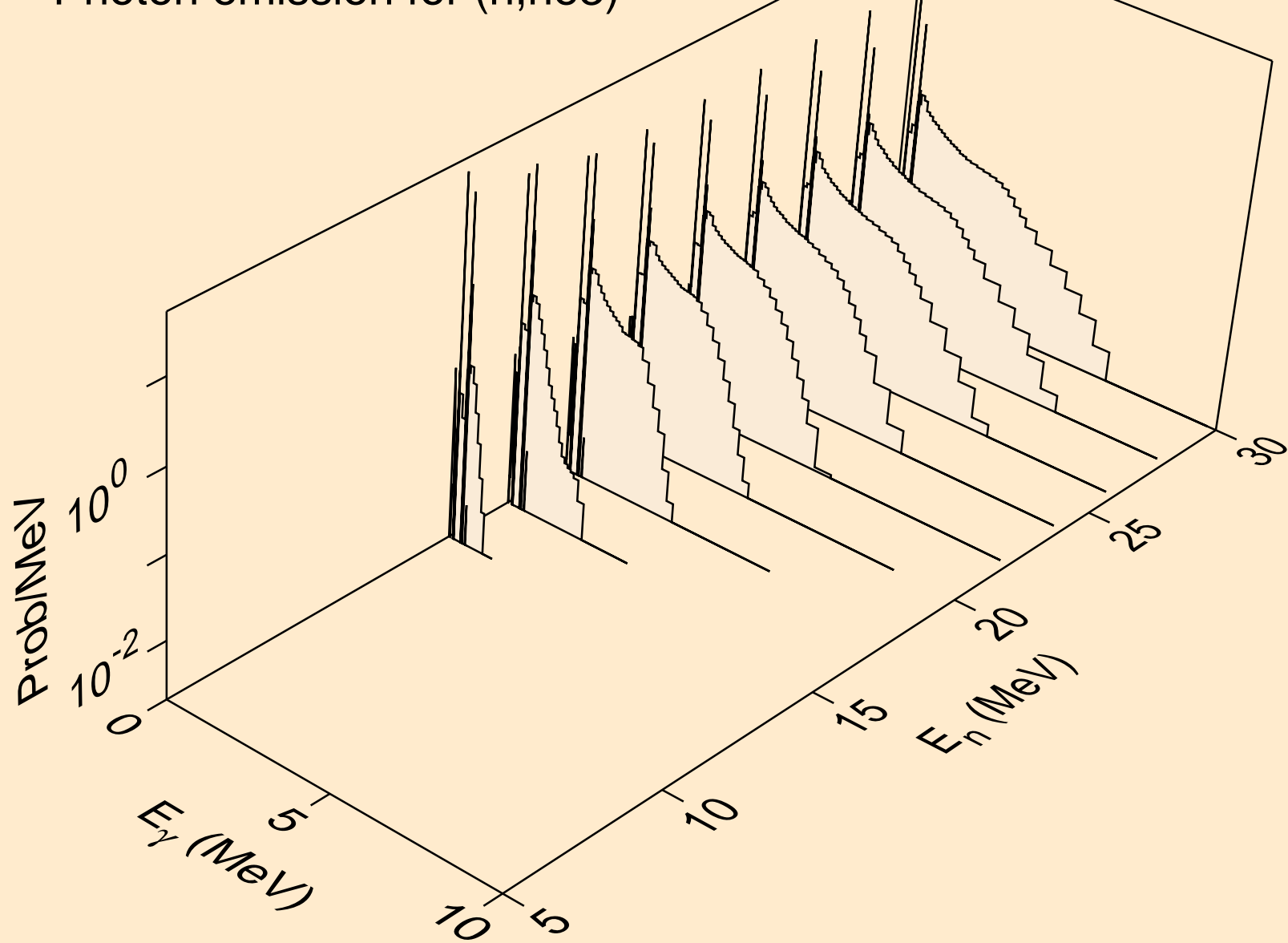

BR081 PROTON ACER TENDL-2023 LIBRARY; T=0.K  
Photon emission for (n,a)

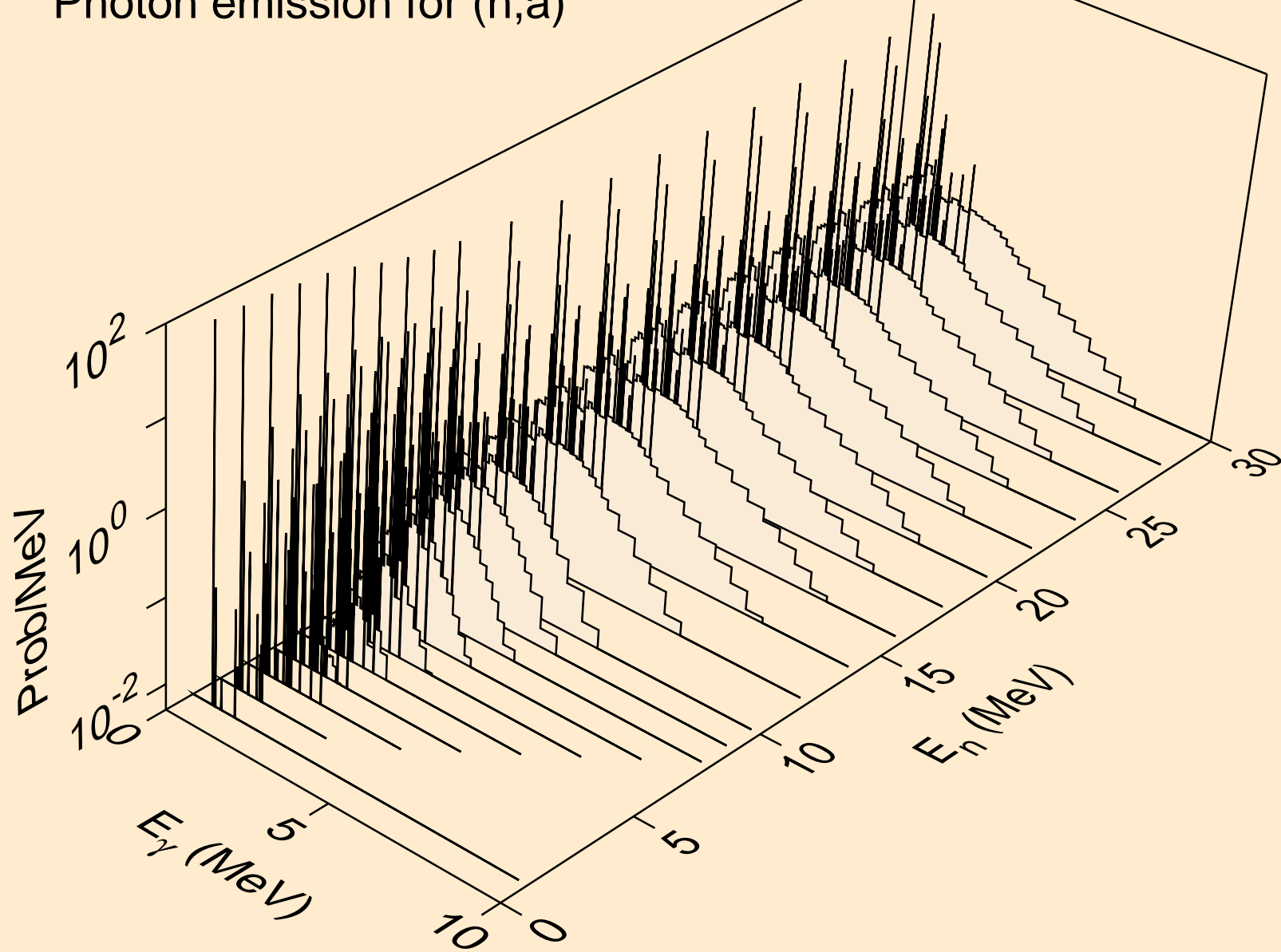



BR081 PROTON ACER TENDL-2023 LIBRARY; T=0.K  
Photon emission for (n,2a)

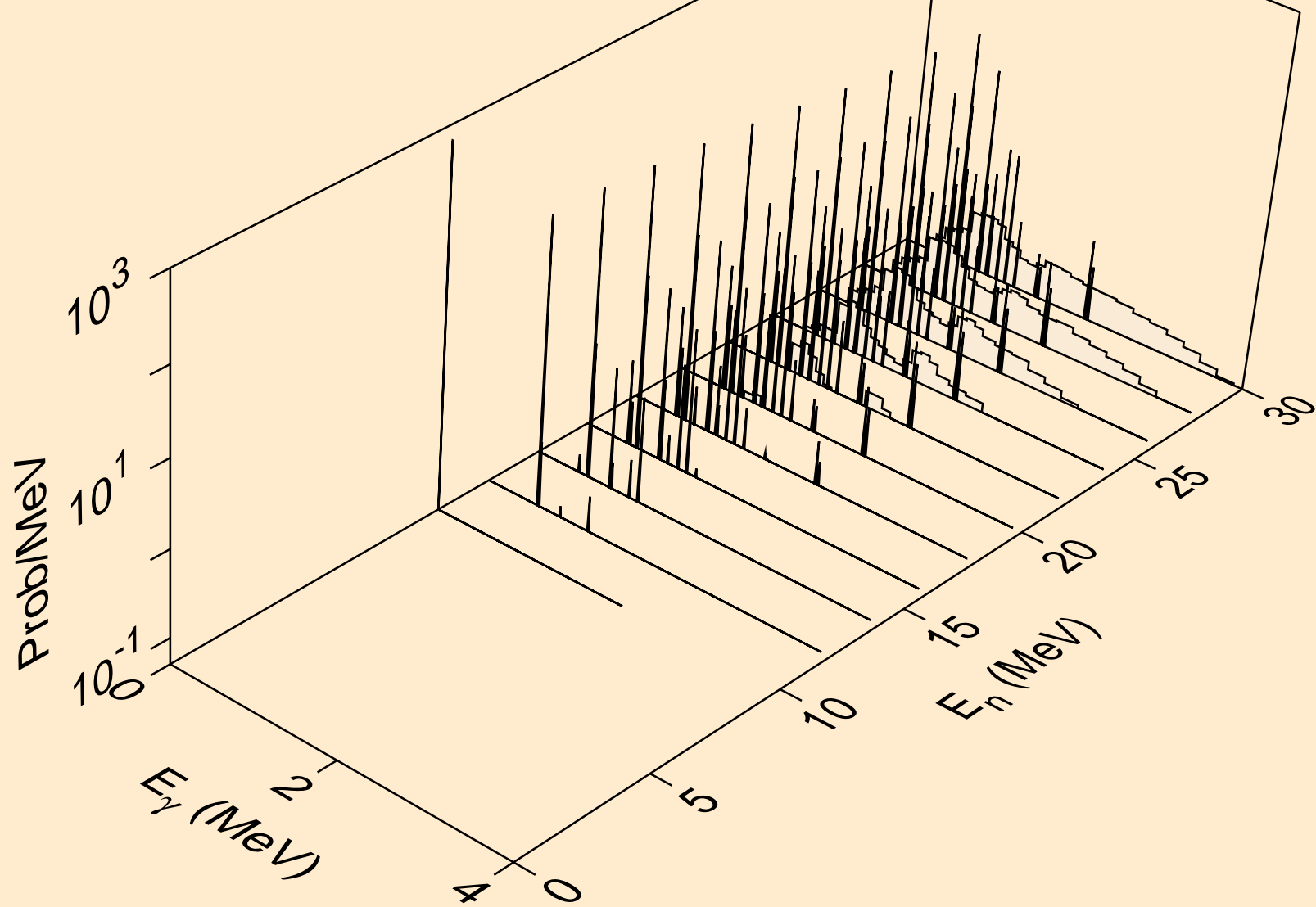

BR081 PROTON ACER TENDL-2023 LIBRARY; T=0.K  
Photon emission for (n,2p)

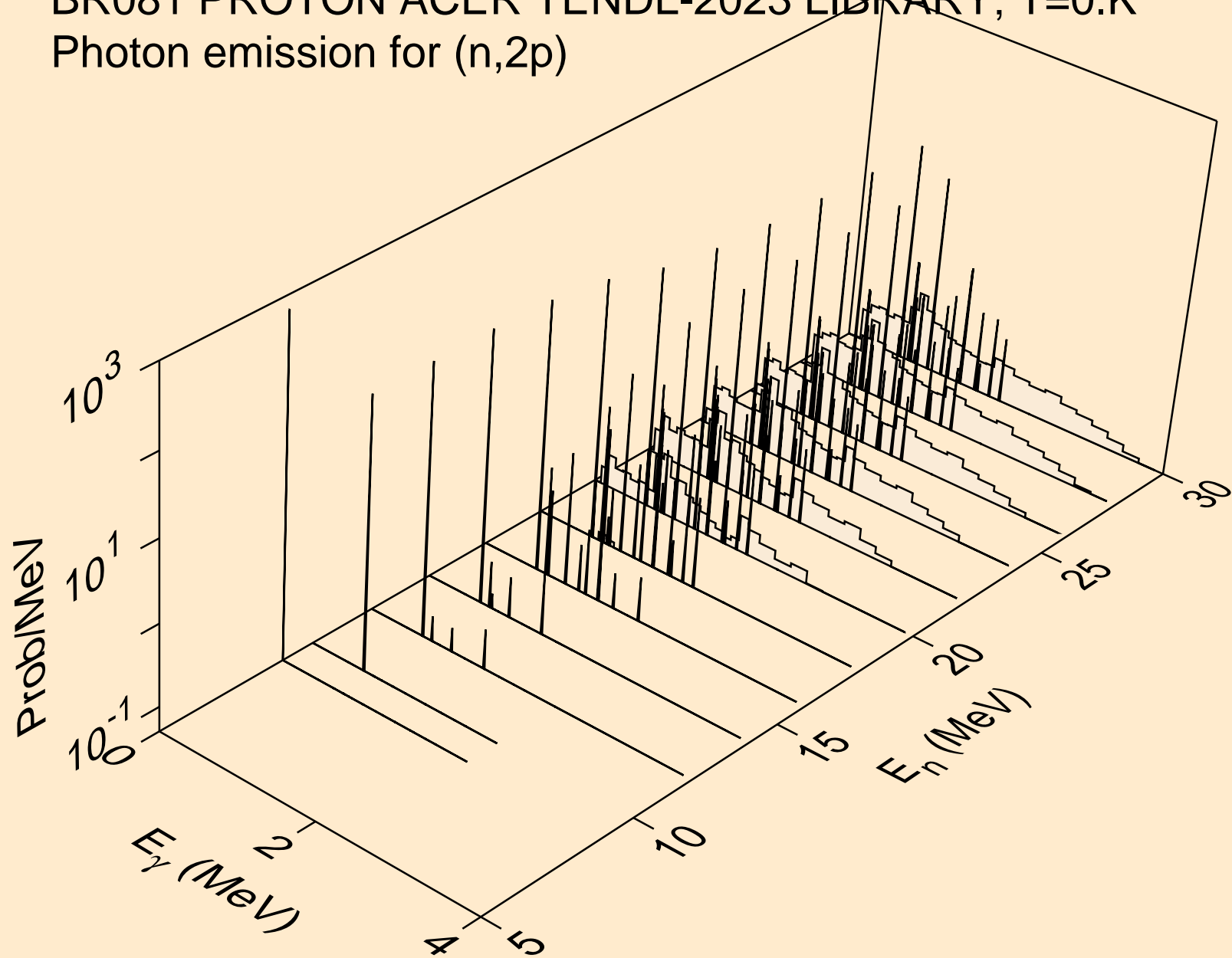

BR081 PROTON ACER TENDL-2023 LIBRARY; T=0.K  
Photon emission for (n,pa)

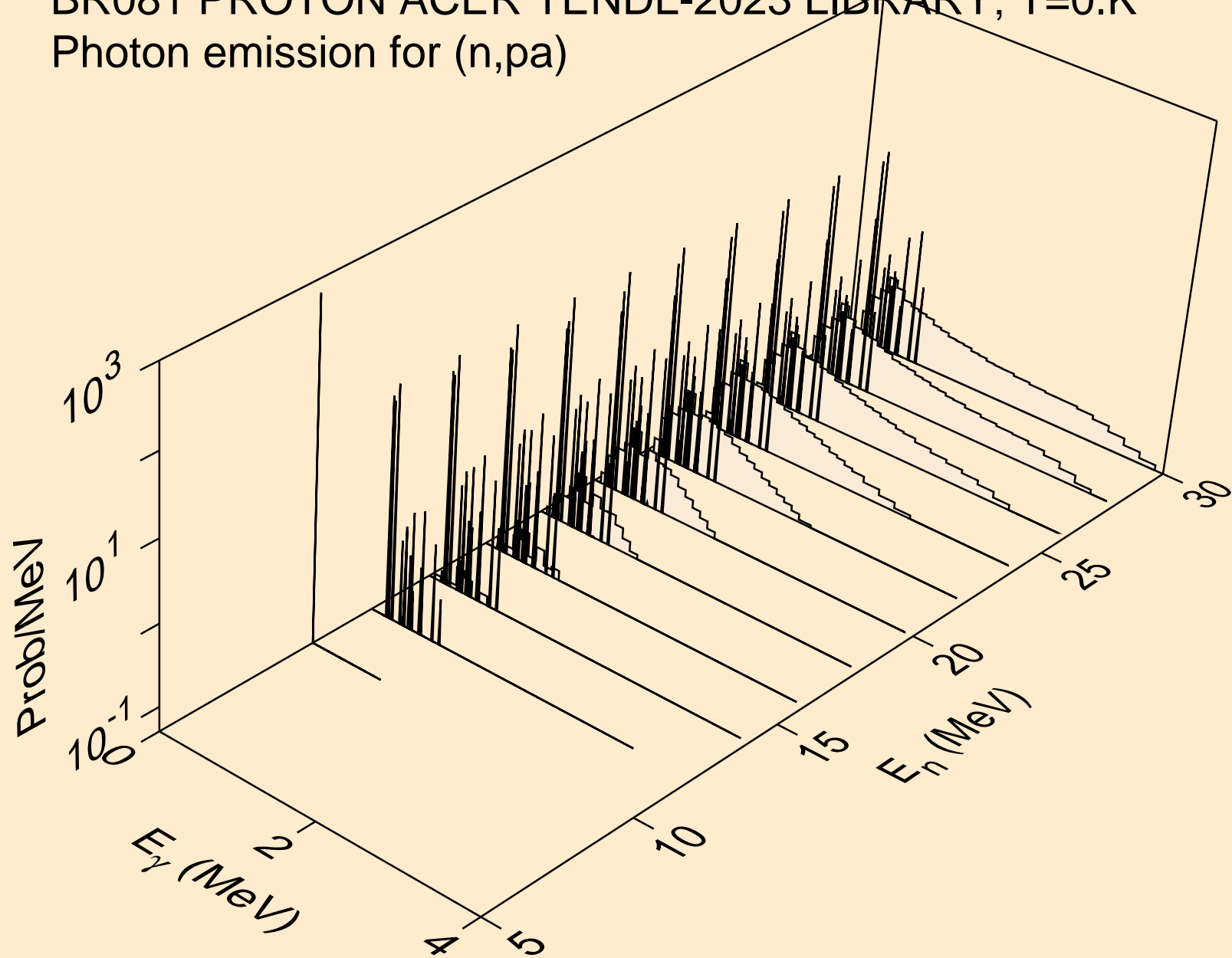

BR081 PROTON ACER TENDL-2023 LIBRARY; T=0.K  
Photon emission for (n,pd)

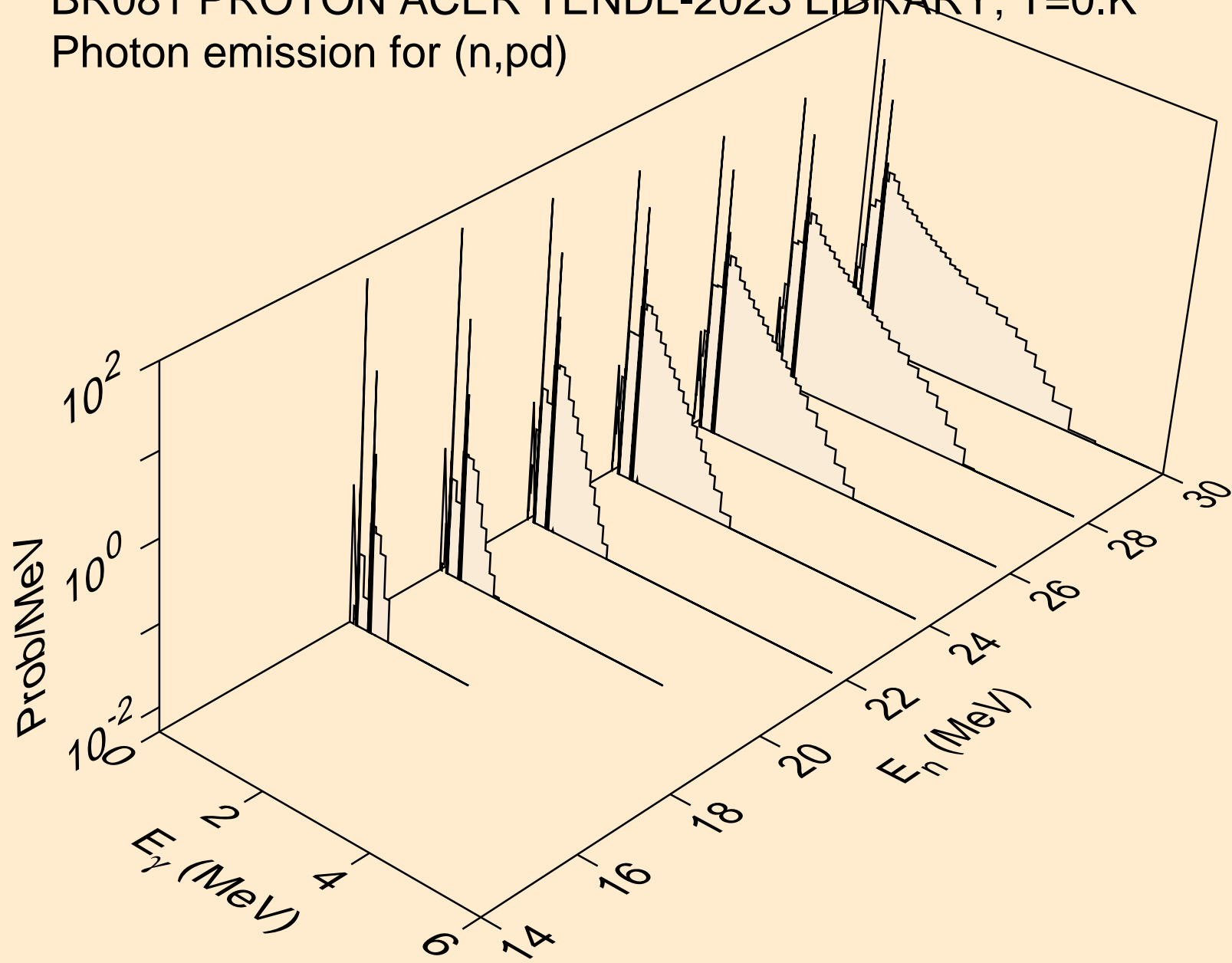

BR081 PROTON ACER TENDL-2023 LIBRARY; T=0.K  
Photon emission for (n,pt)

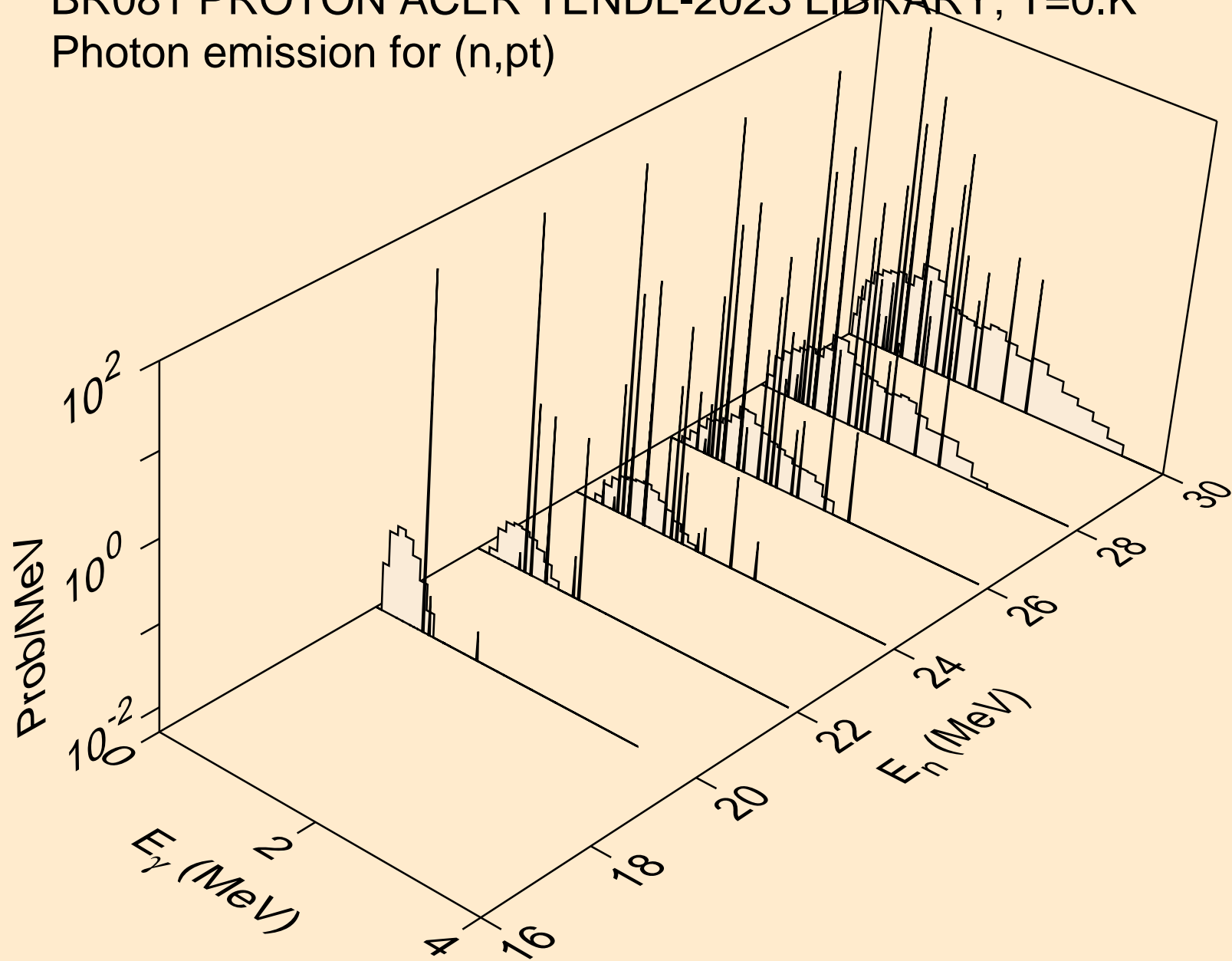

BR081 PROTON ACER TENDL-2023 LIBRARY; T=0.K  
Photon emission for (n,da)

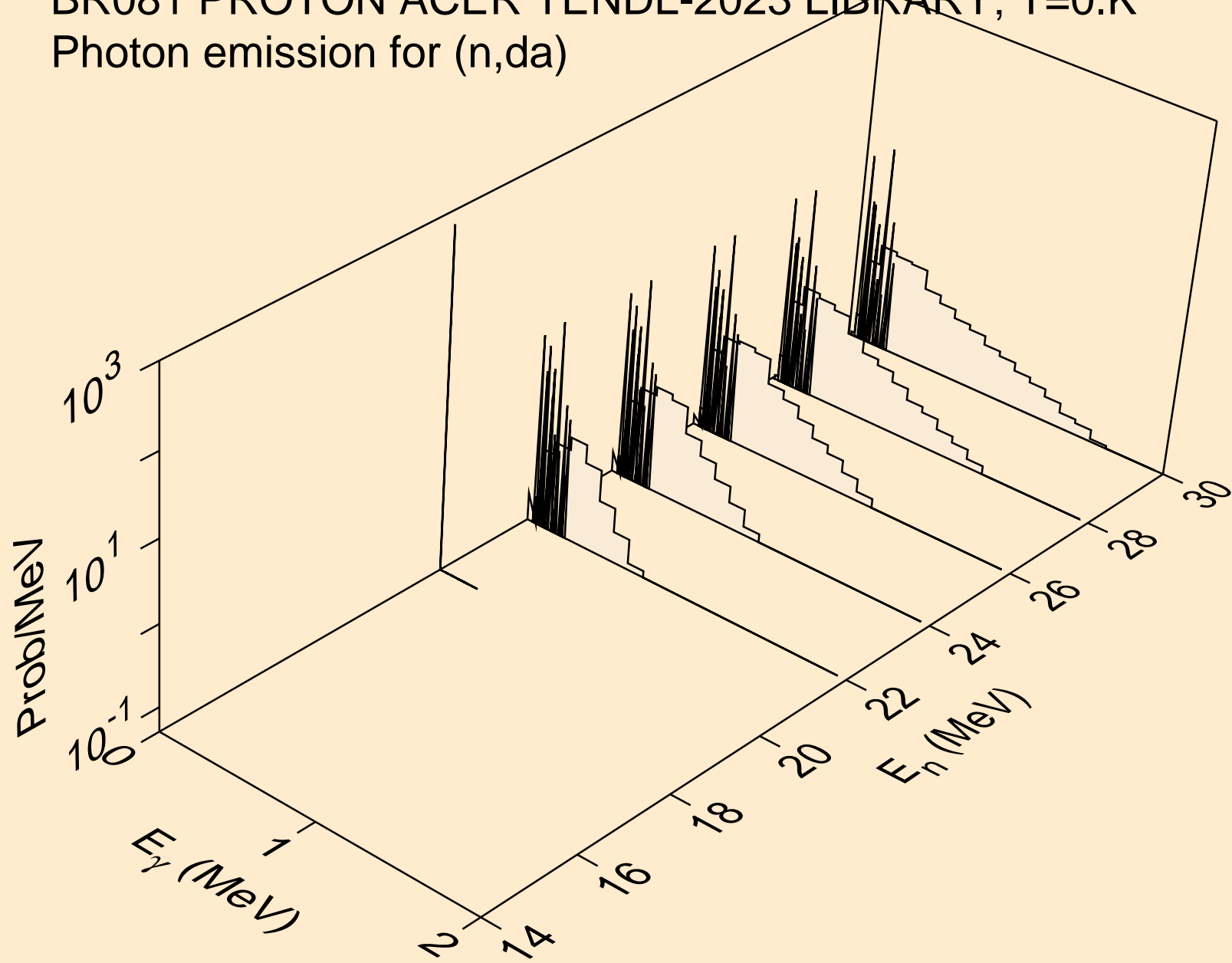

BR081 PROTON ACER TENDL-2023 LIBRARY; T=0.K  
Particle heating contributions

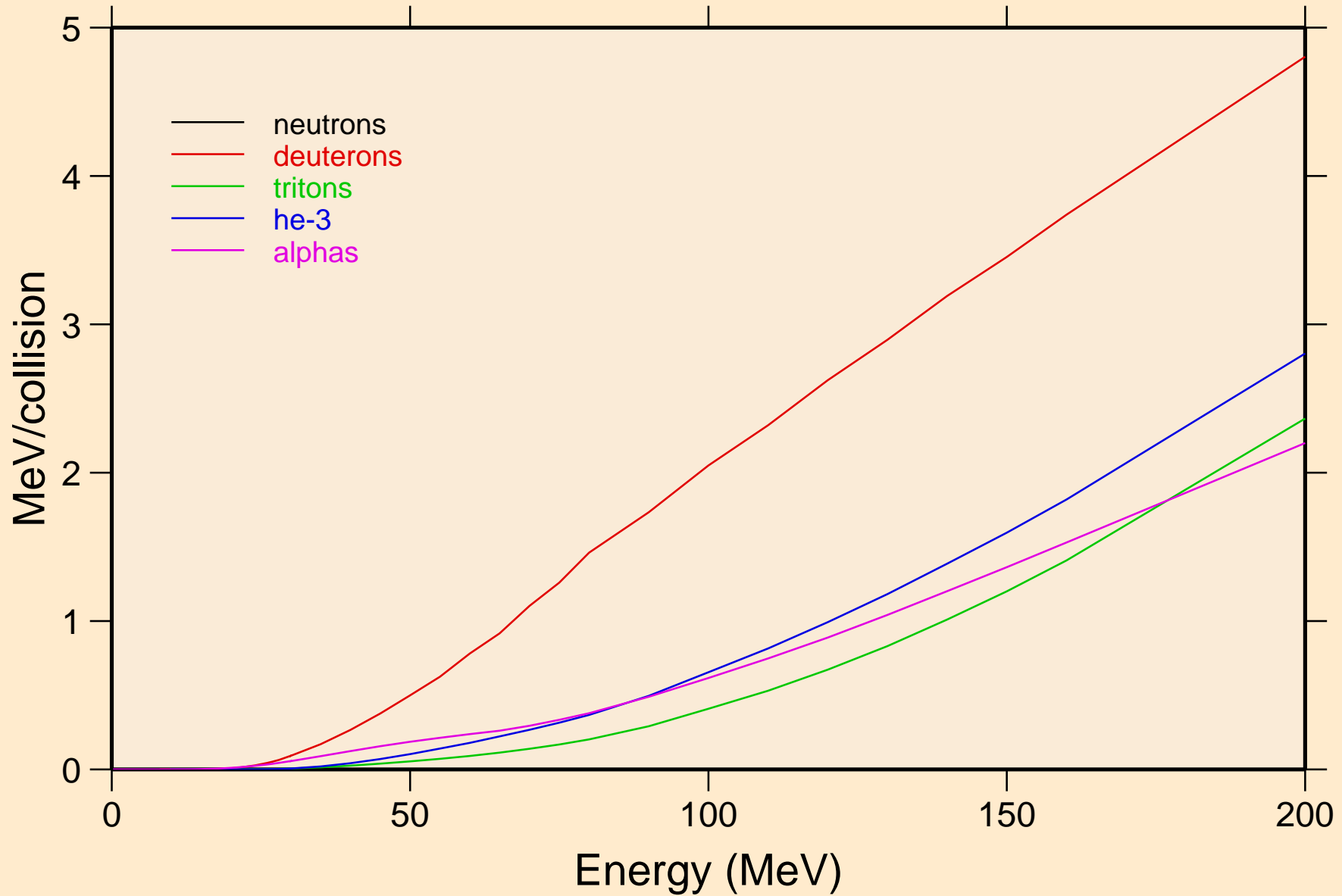

BR081 PROTON ACER TENDL-2023 LIBRARY; T=0.K  
Recoil Heating

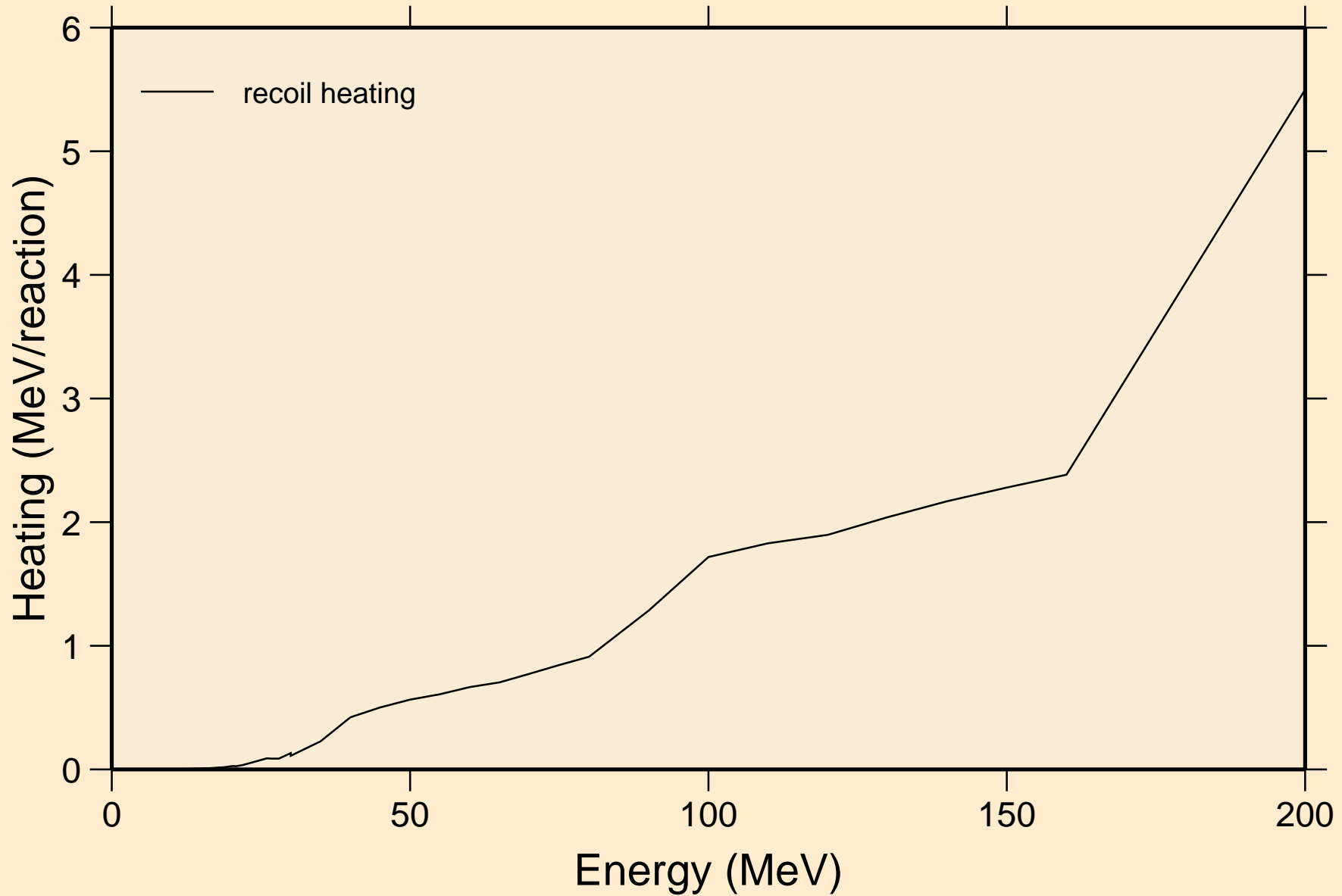



BR081 PROTON ACER TENDL-2023 LIBRARY; T=0.K  
Particle production cross sections

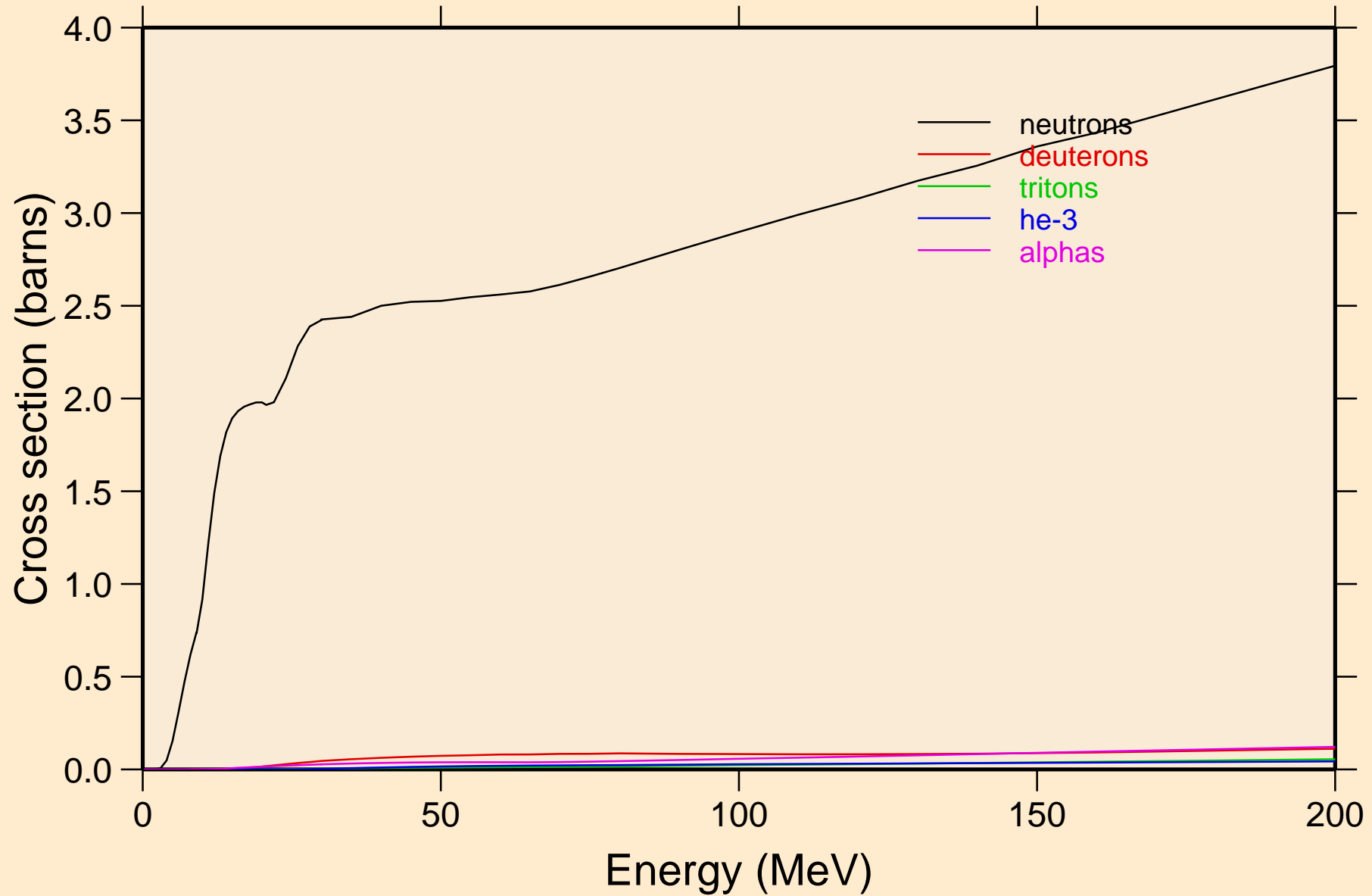

BR081 PROTON ACER TENDL-2023 LIBRARY; T=0.K  
neutrons from (p,n)

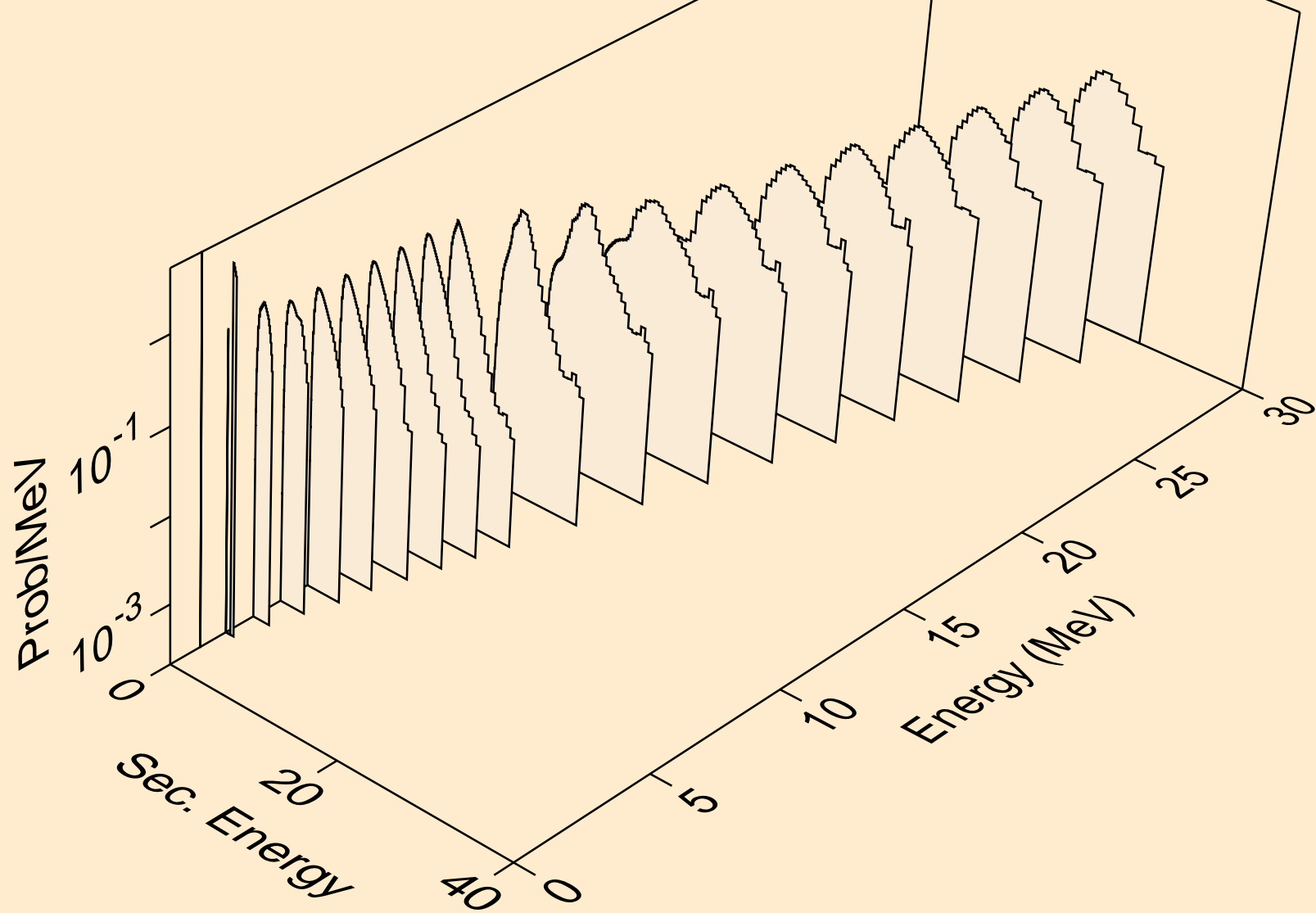

BR081 PROTON ACER TENDL-2023 LIBRARY; T=0.K  
neutrons from (p,x)

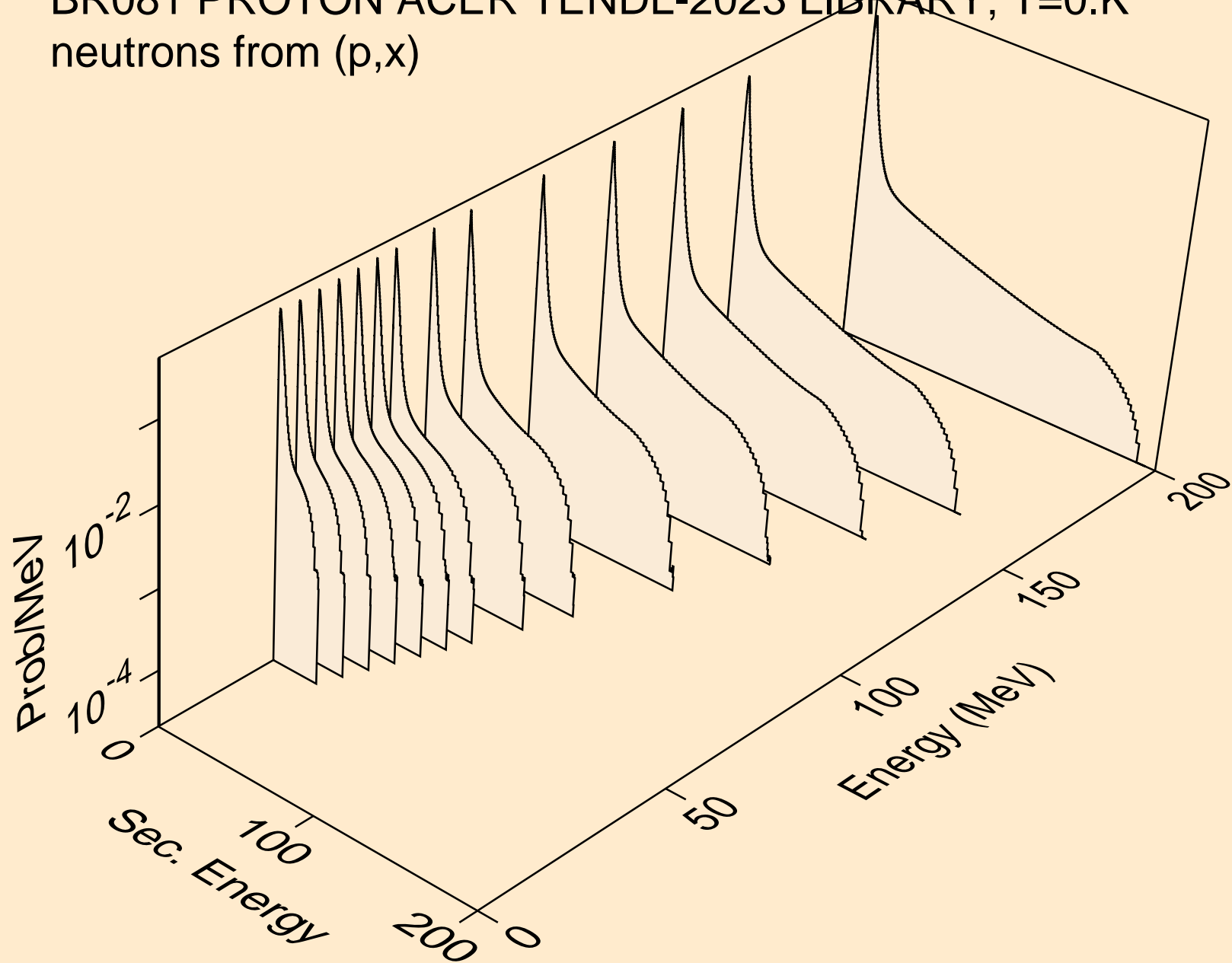

BR081 PROTON ACER TENDL-2023 LIBRARY; T=0.K  
neutrons from (p,2nd)

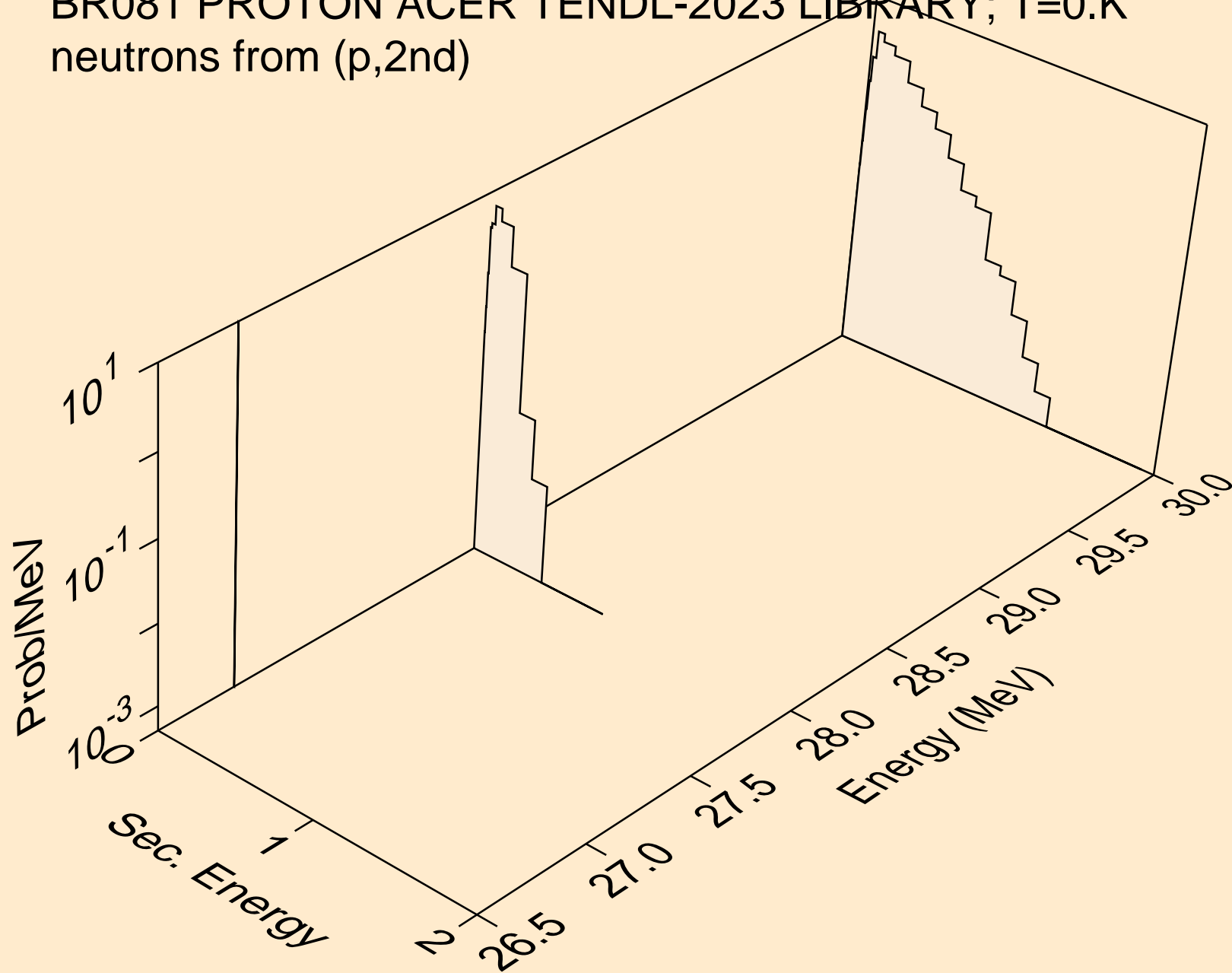

BR081 PROTON ACER TENDL-2023 LIBRARY; T=0.K  
neutrons from (p,2n)

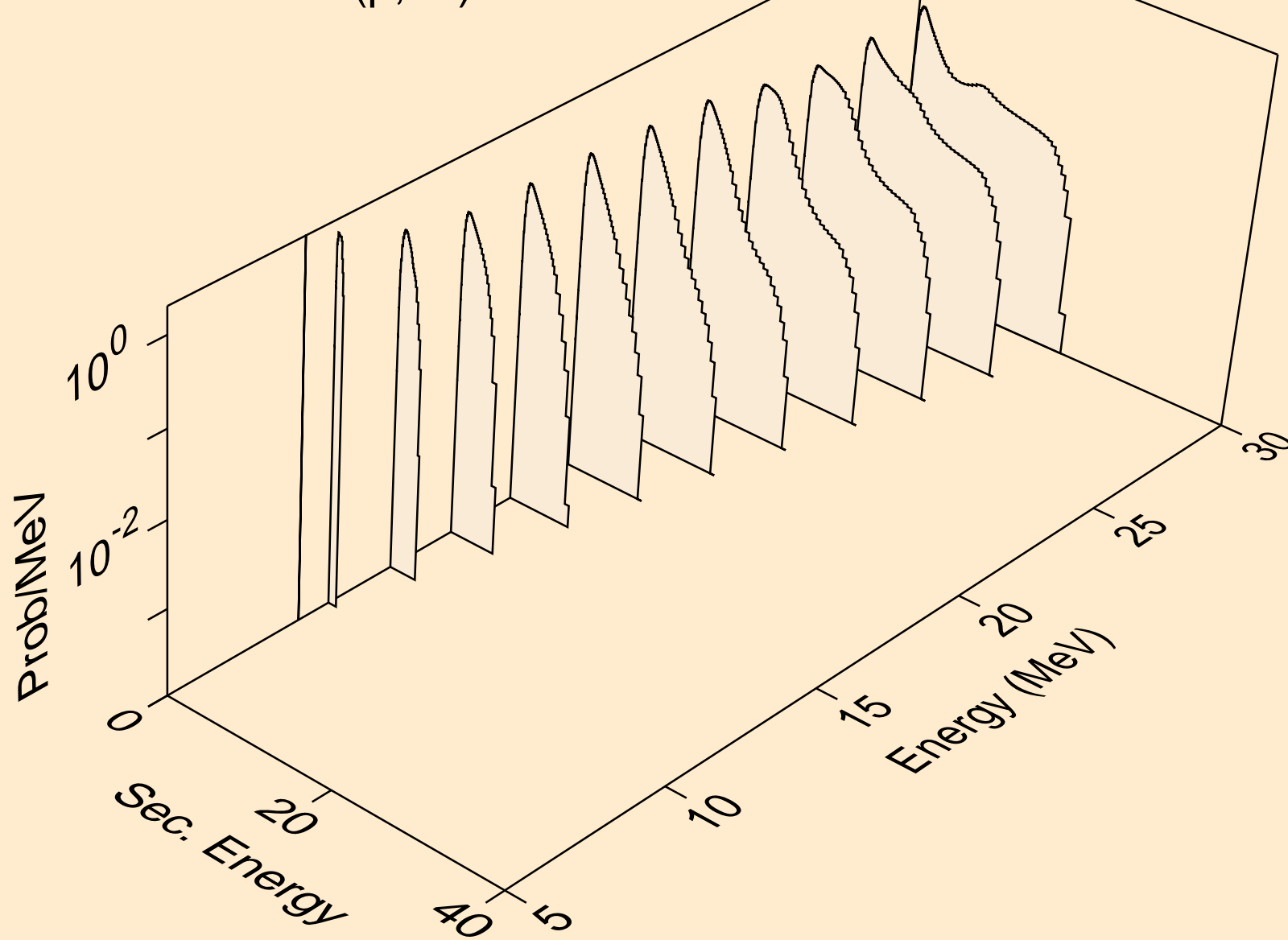

BR081 PROTON ACER TENDL-2023 LIBRARY; T=0.K  
neutrons from (p,3n)

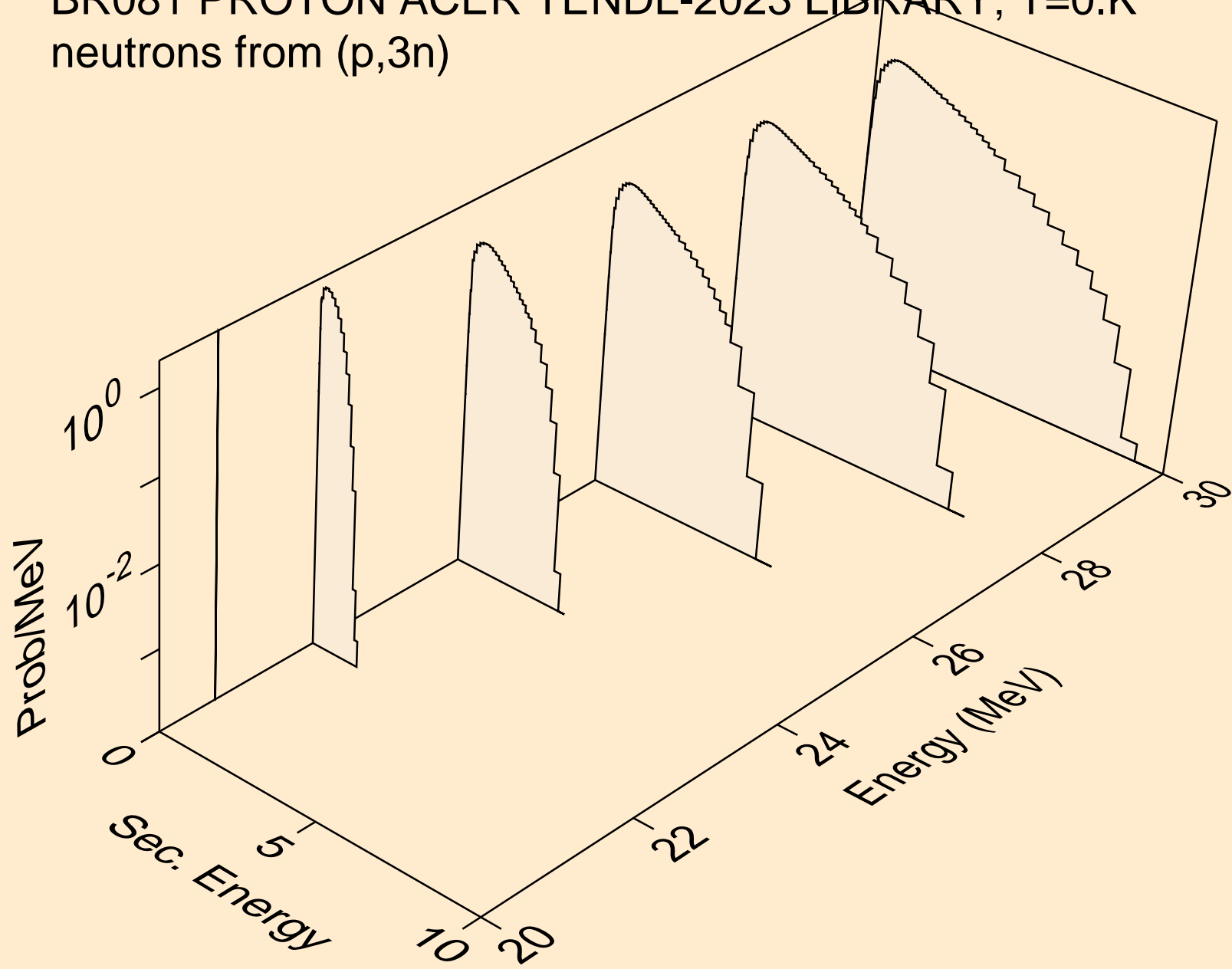

BR081 PROTON ACER TENDL-2023 LIBRARY; T=0.K  
neutrons from (p,n\*)a

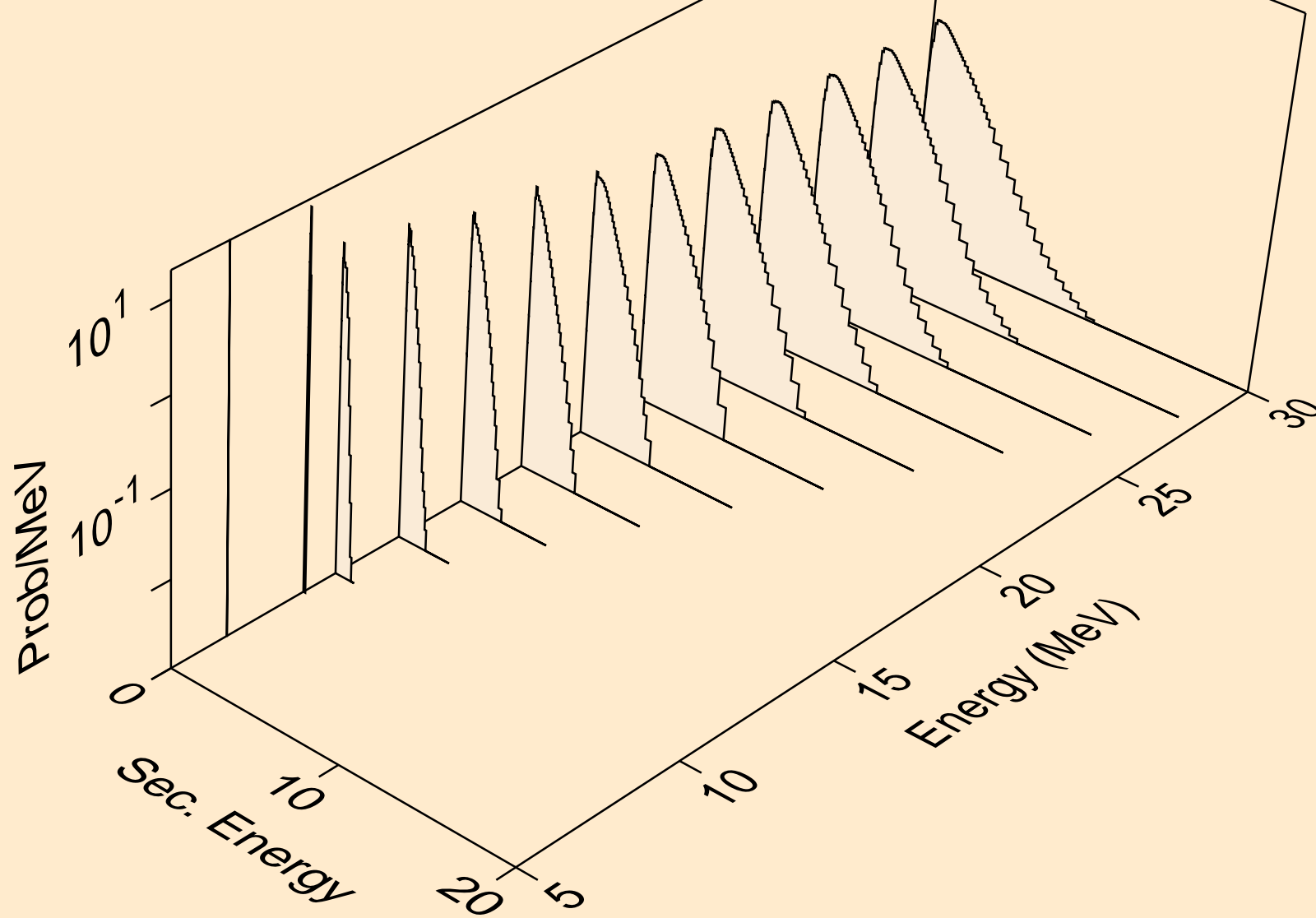

BR081 PROTON ACER TENDL-2023 LIBRARY; T=0.K  
neutrons from (p,2n)a

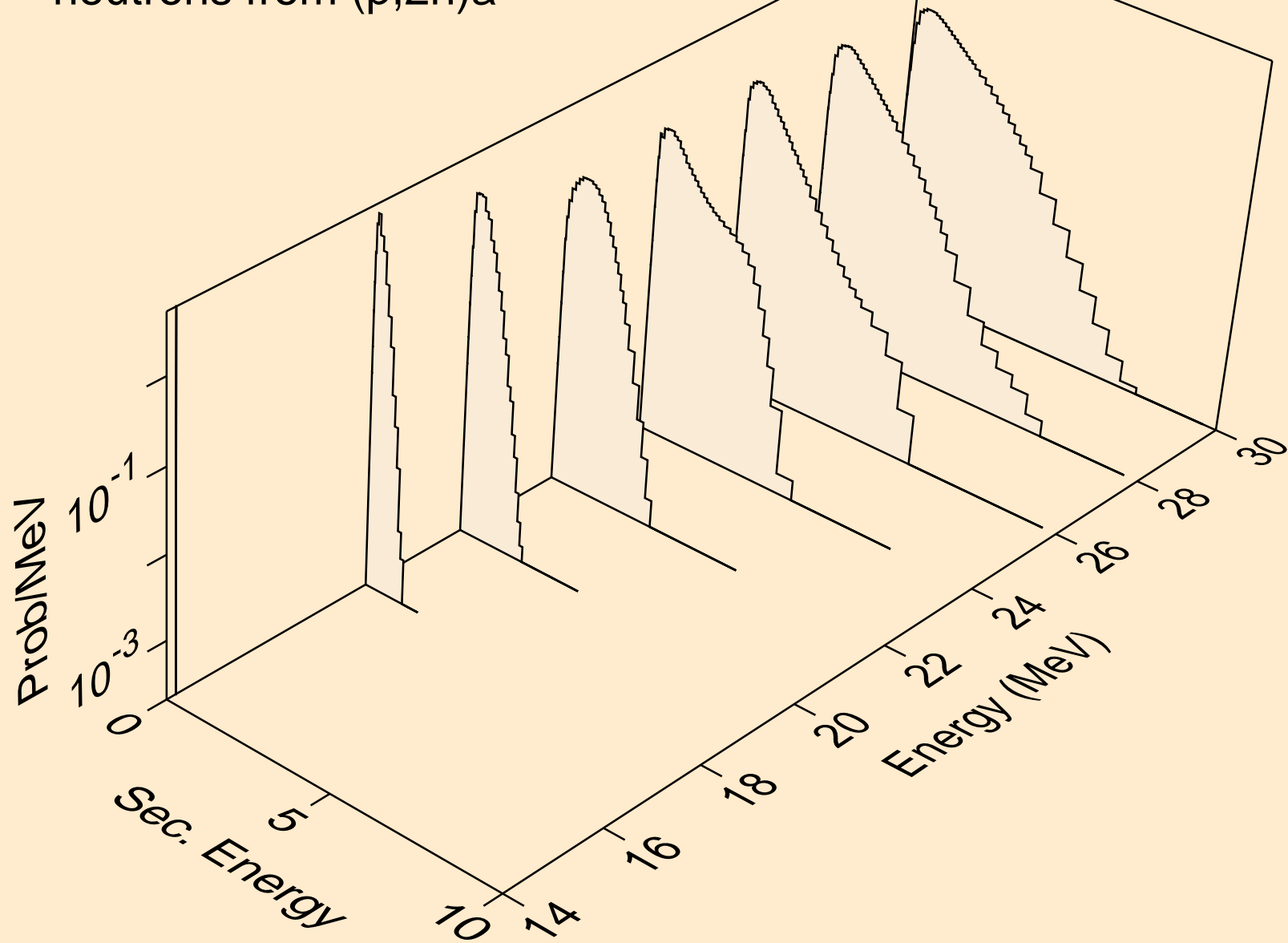



BR081 PROTON ACER TENDL-2023 LIBRARY; T=0.K  
neutrons from (p,n\*)p

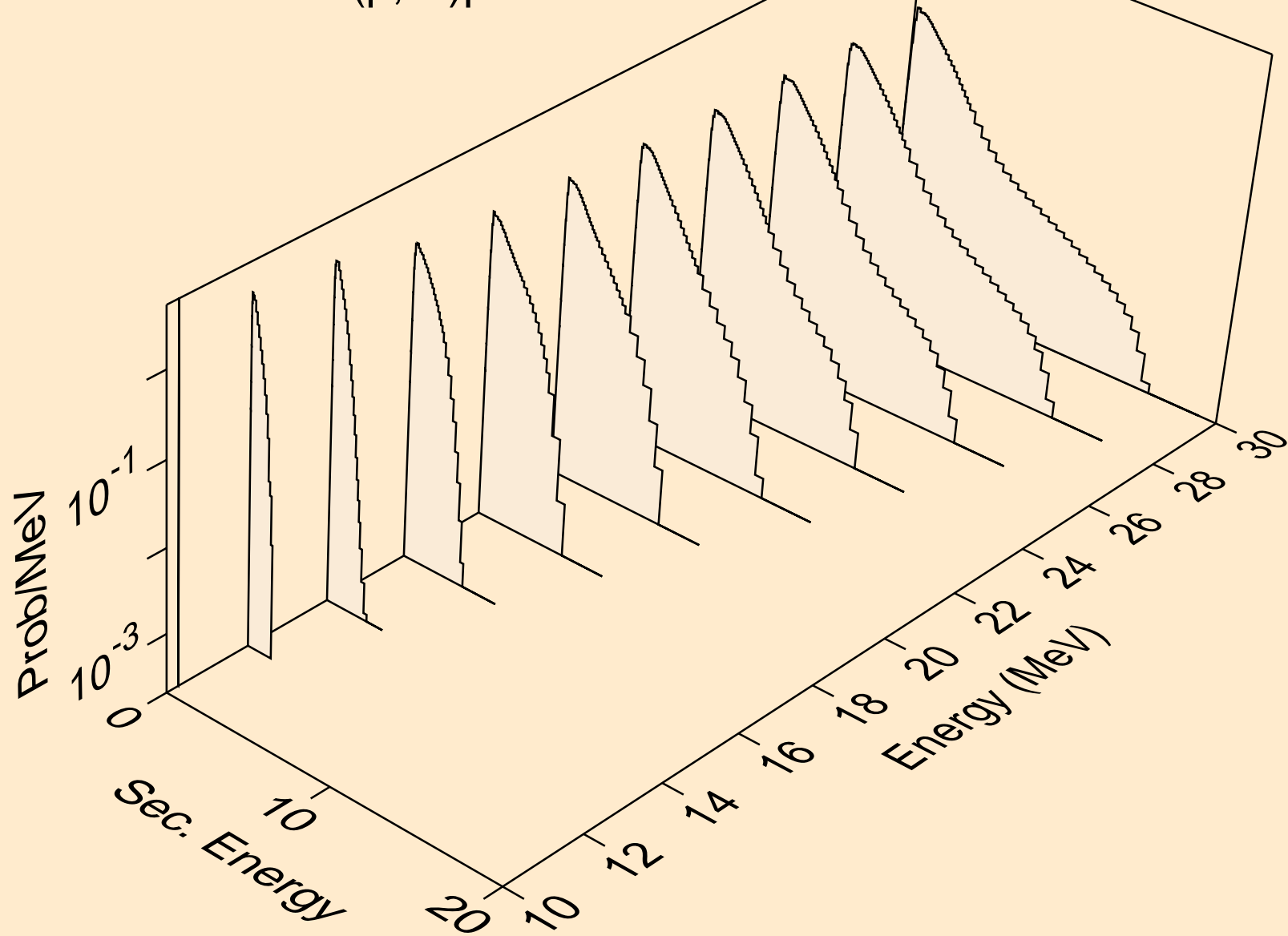

BR081 PROTON ACER TENDL-2023 LIBRARY; T=0.K  
neutrons from (p,n\*)2a

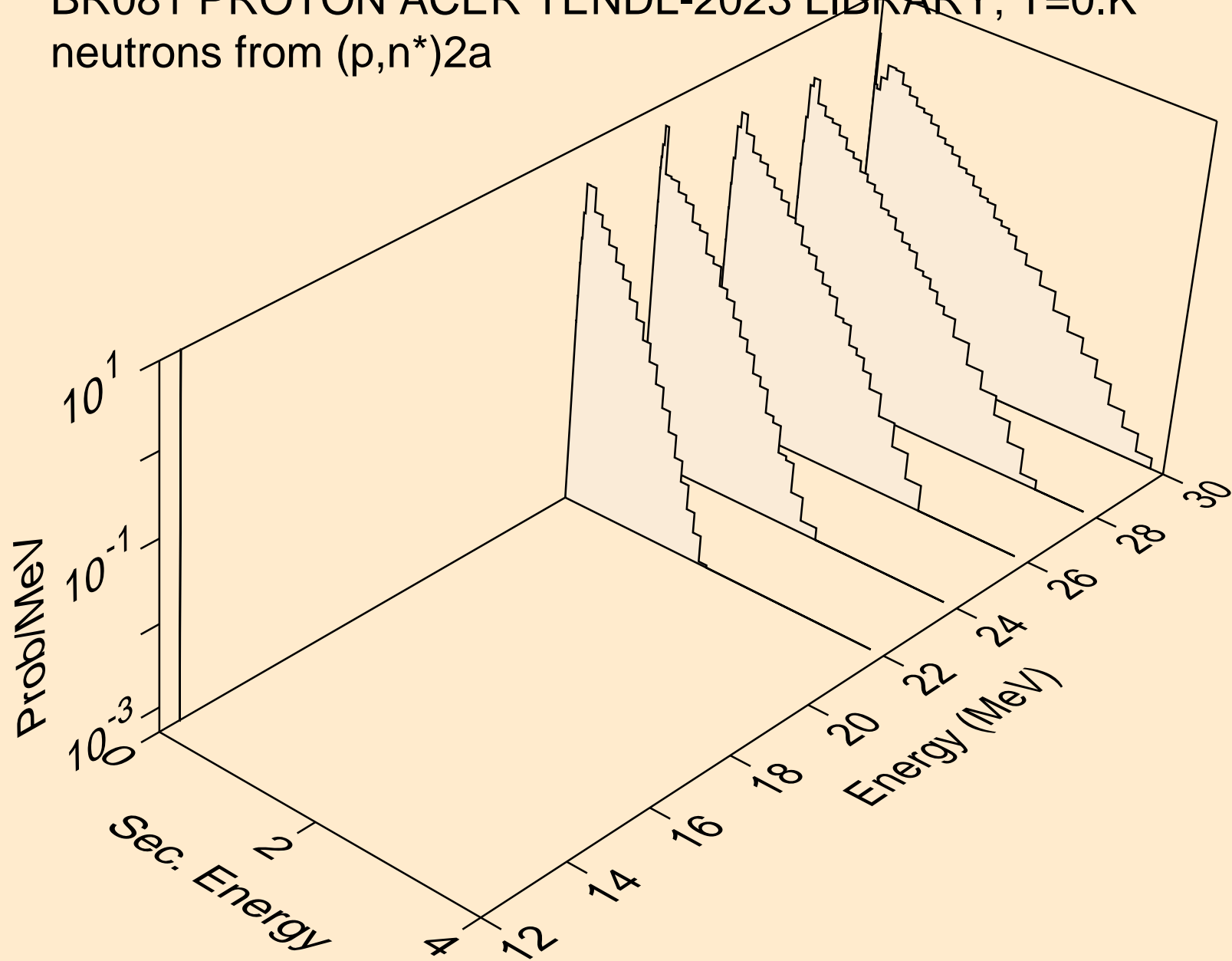

BR081 PROTON ACER TENDL-2023 LIBRARY; T=0.K  
neutrons from (p,n\*)d

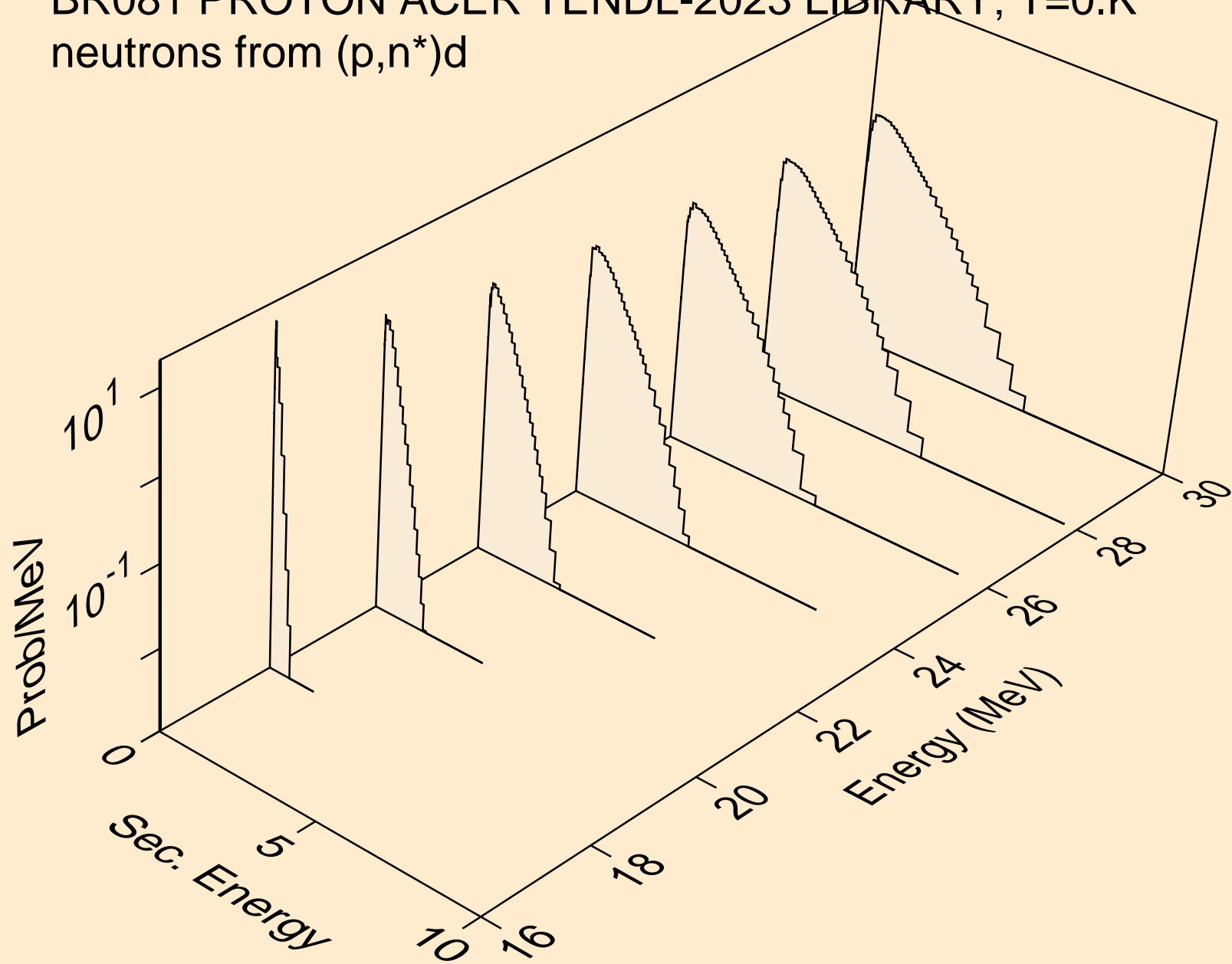

BR081 PROTON ACER TENDL-2023 LIBRARY; T=0.K  
neutrons from (p,n\*)t

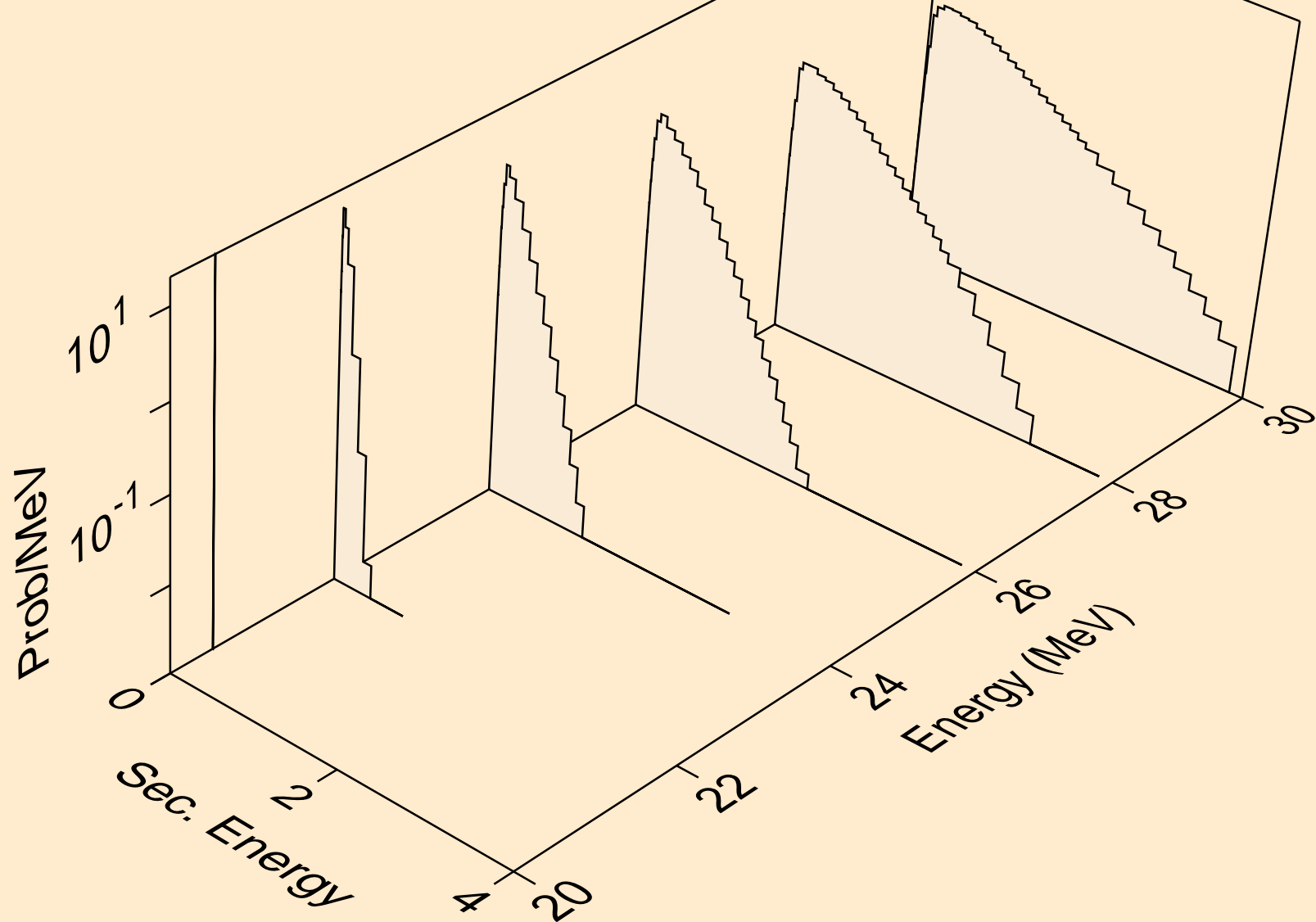

BR081 PROTON ACER TENDL-2023 LIBRARY; T=0.K  
neutrons from (p,n\*)he3

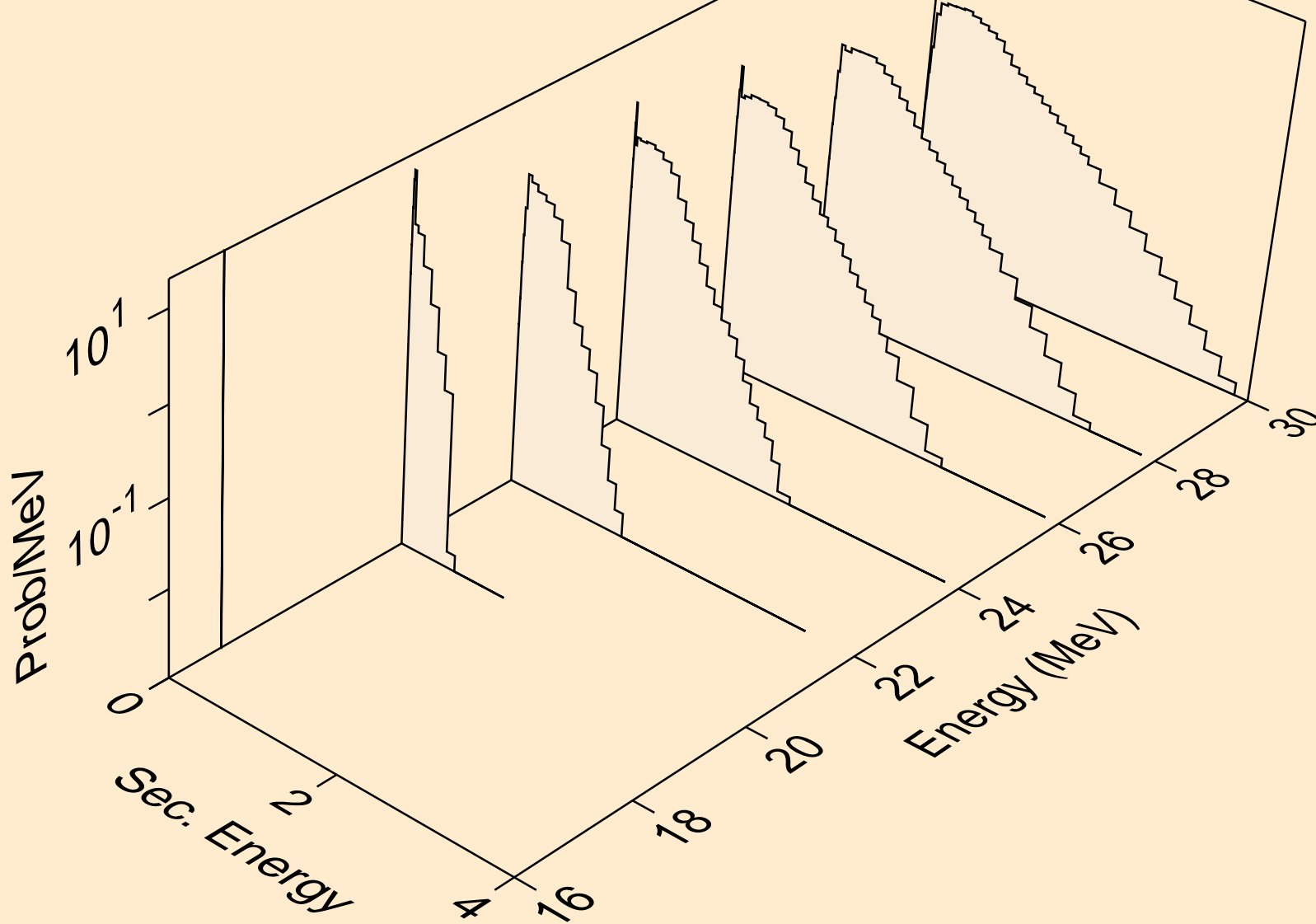

BR081 PROTON ACER TENDL-2023 LIBRARY; T=0.K  
neutrons from (p,2np)

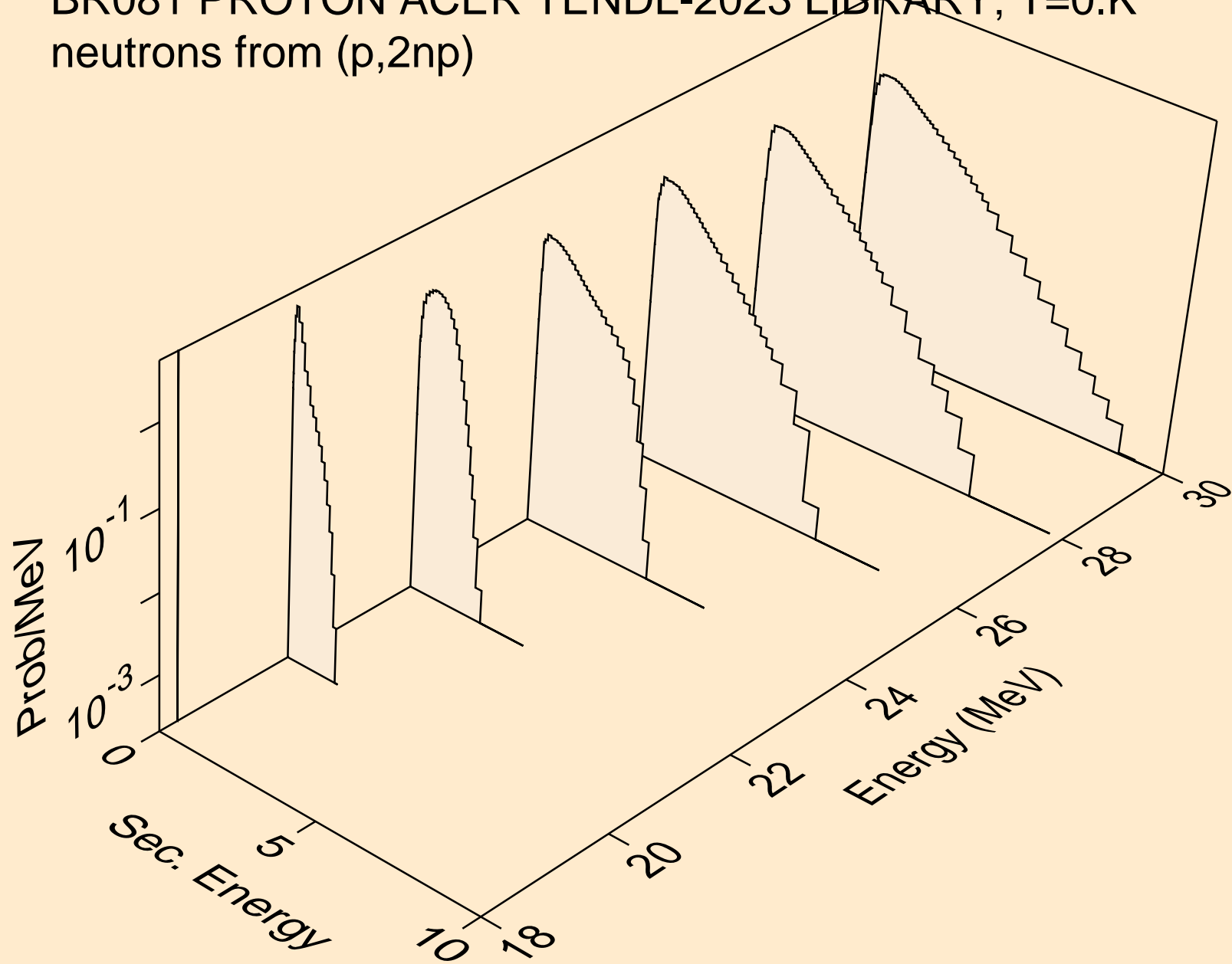

BR081 PROTON ACER TENDL-2023 LIBRARY; T=0.K  
neutrons from (p,n2p)

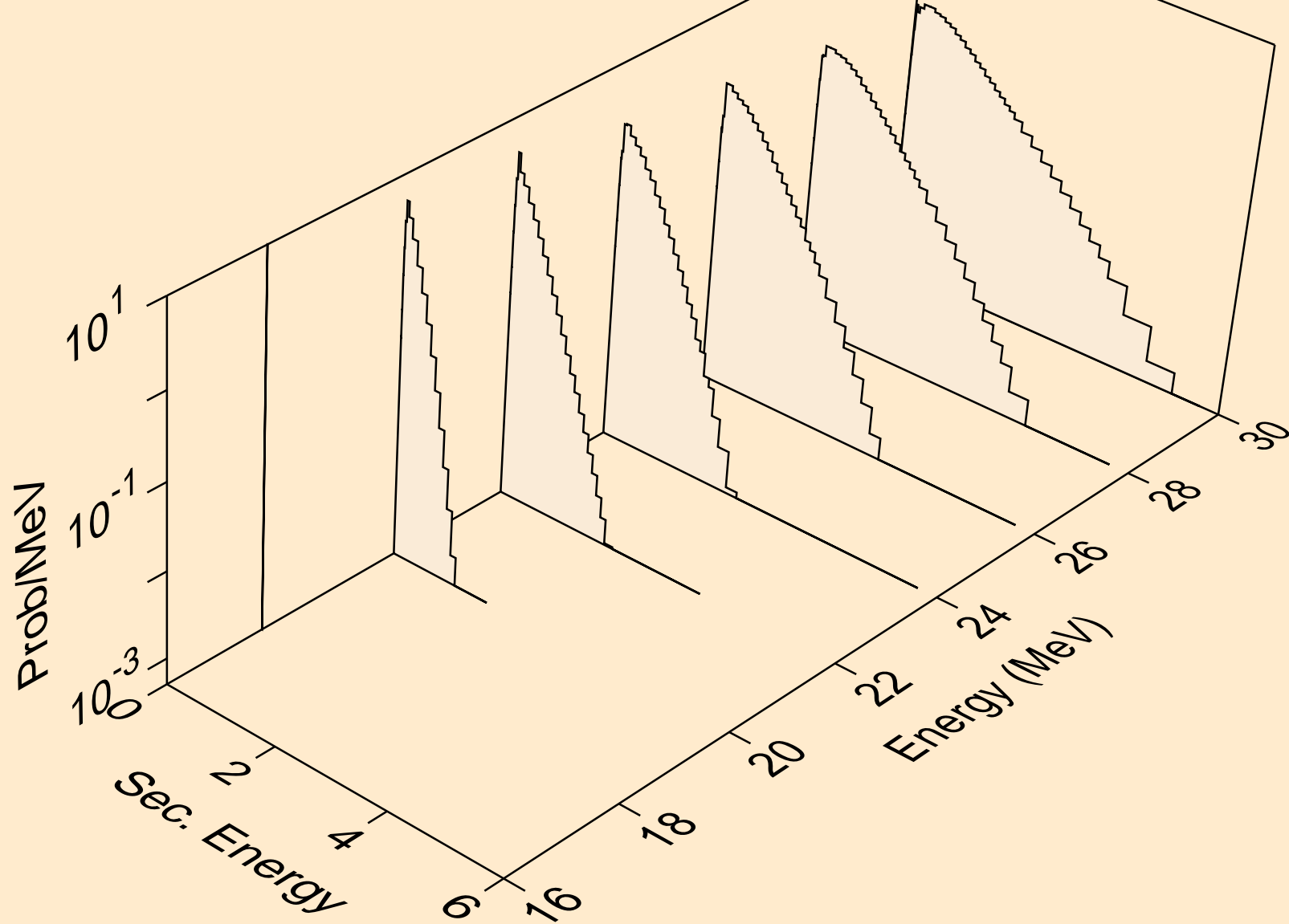

BR081 PROTON ACER TENDL-2023 LIBRARY; T=0.K  
neutrons from (p,npa)

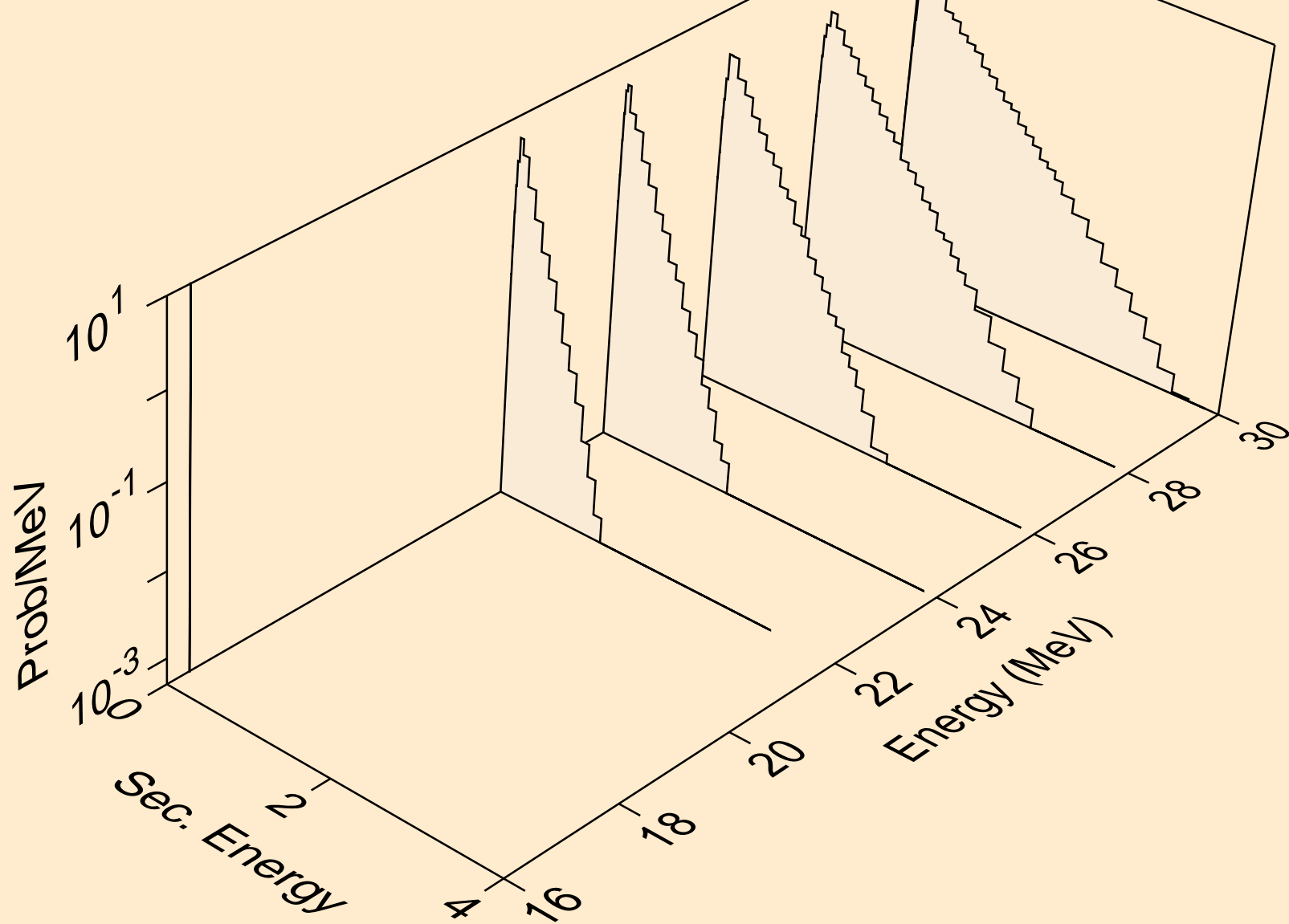



BR081 PROTON ACER TENDL-2023 LIBRARY; T=0.K  
deuterons from (p,x)

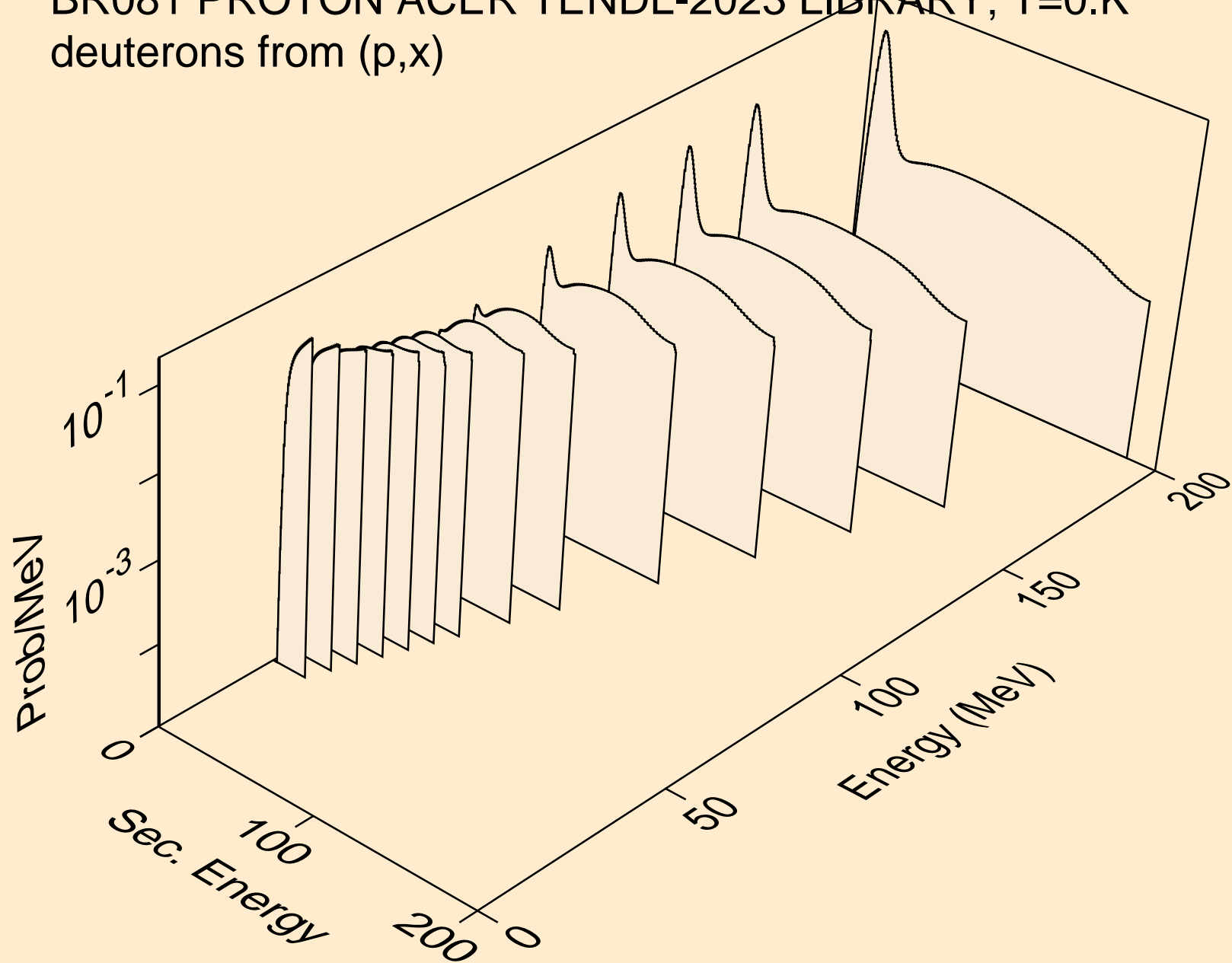

BR081 PROTON ACER TENDL-2023 LIBRARY; T=0.K  
deuterons from (p,2nd)

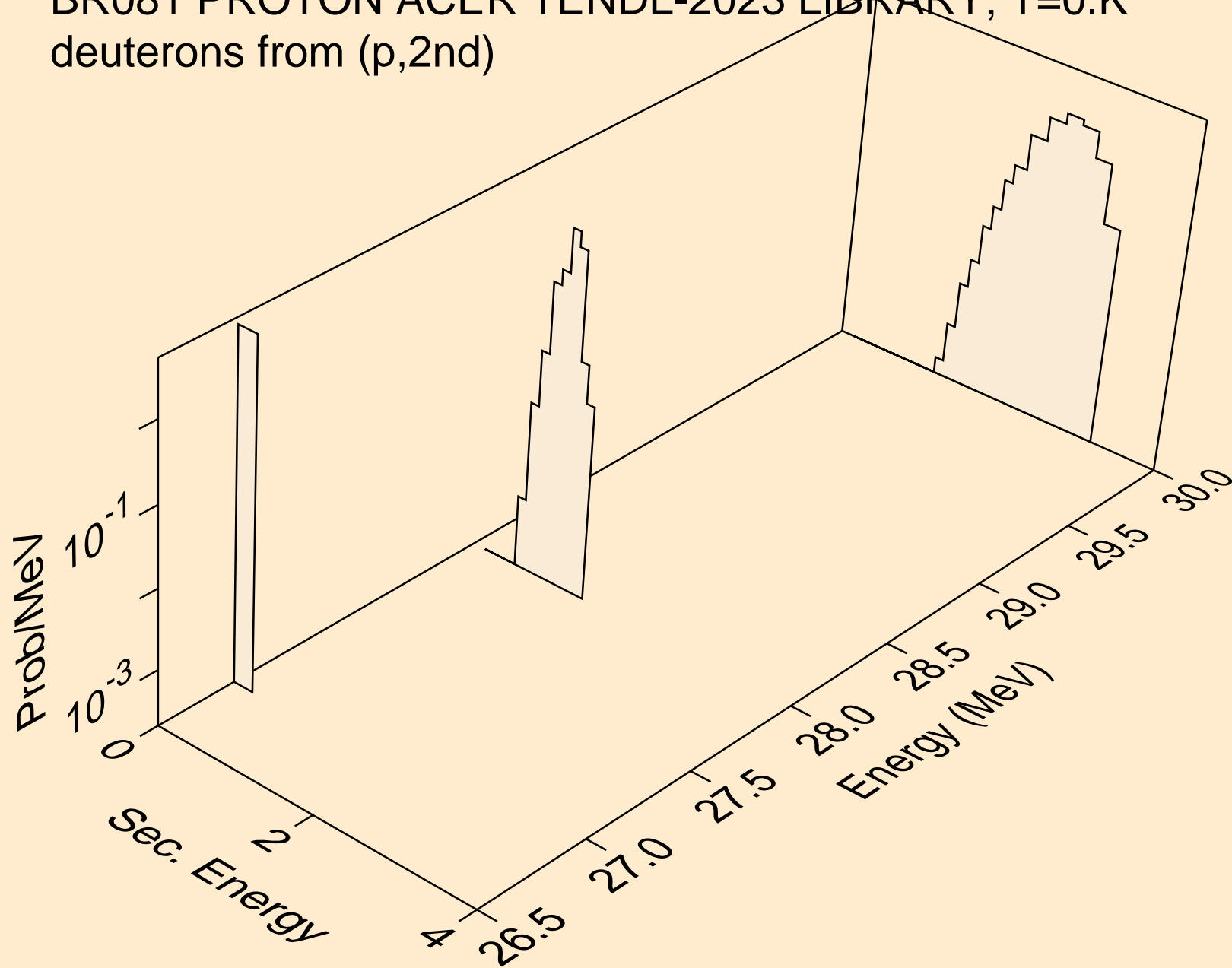

BR081 PROTON ACER TENDL-2023 LIBRARY; T=0.K  
deuterons from (p,n\*)d

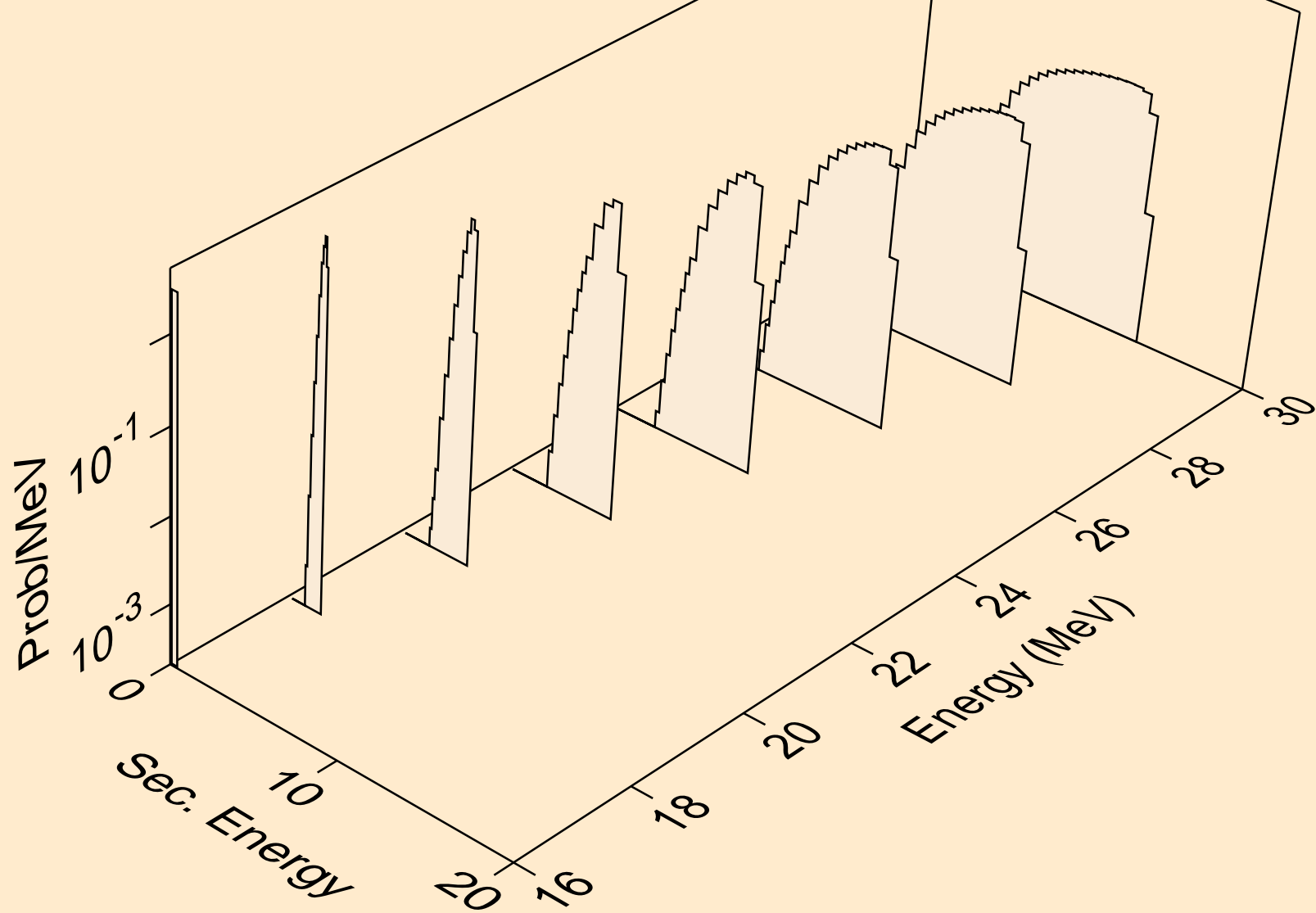

BR081 PROTON ACER TENDL-2023 LIBRARY; T=0.K  
deuterons from (p,d)

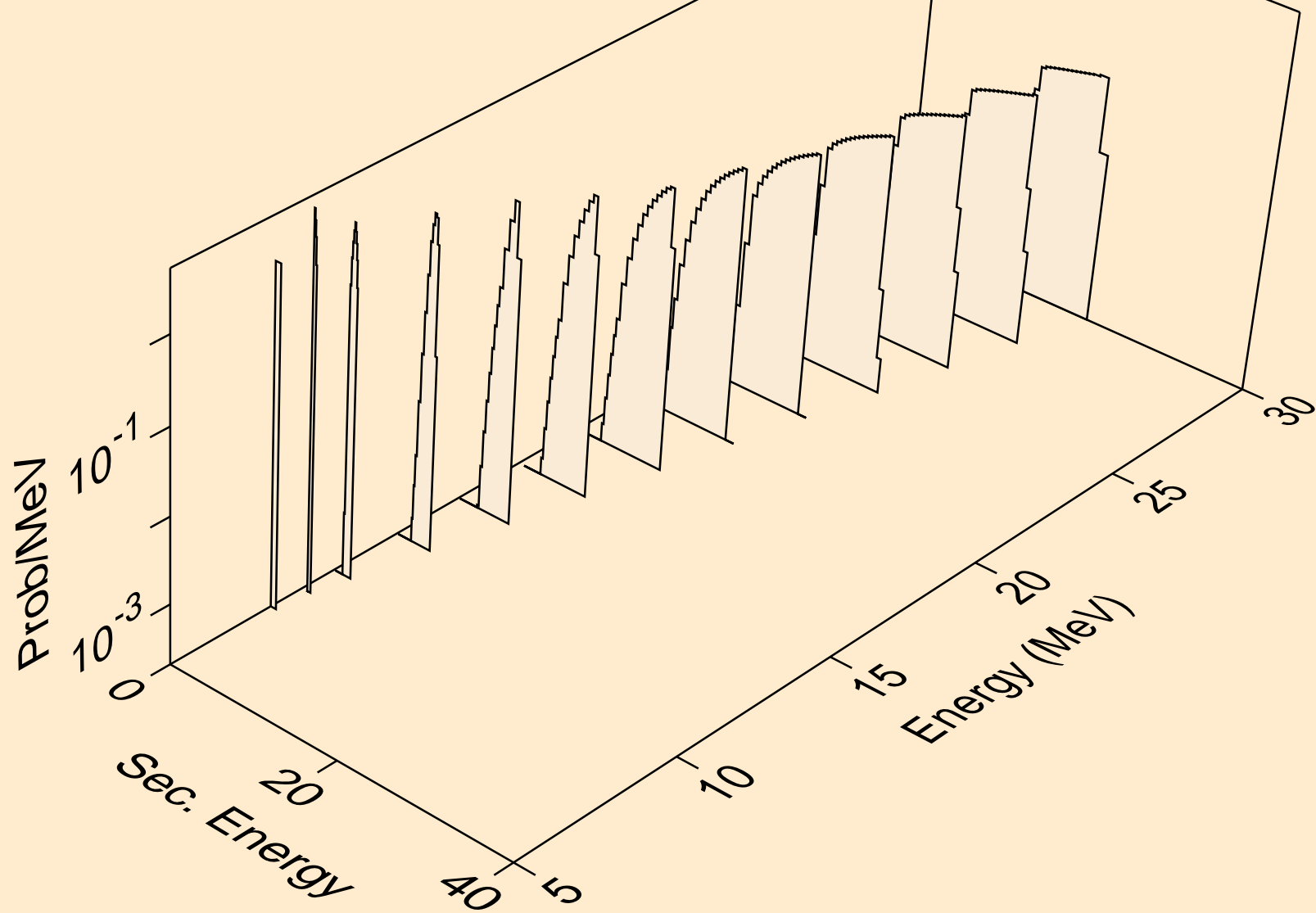

BR081 PROTON ACER TENDL-2023 LIBRARY; T=0.K  
deuterons from (p,pd)

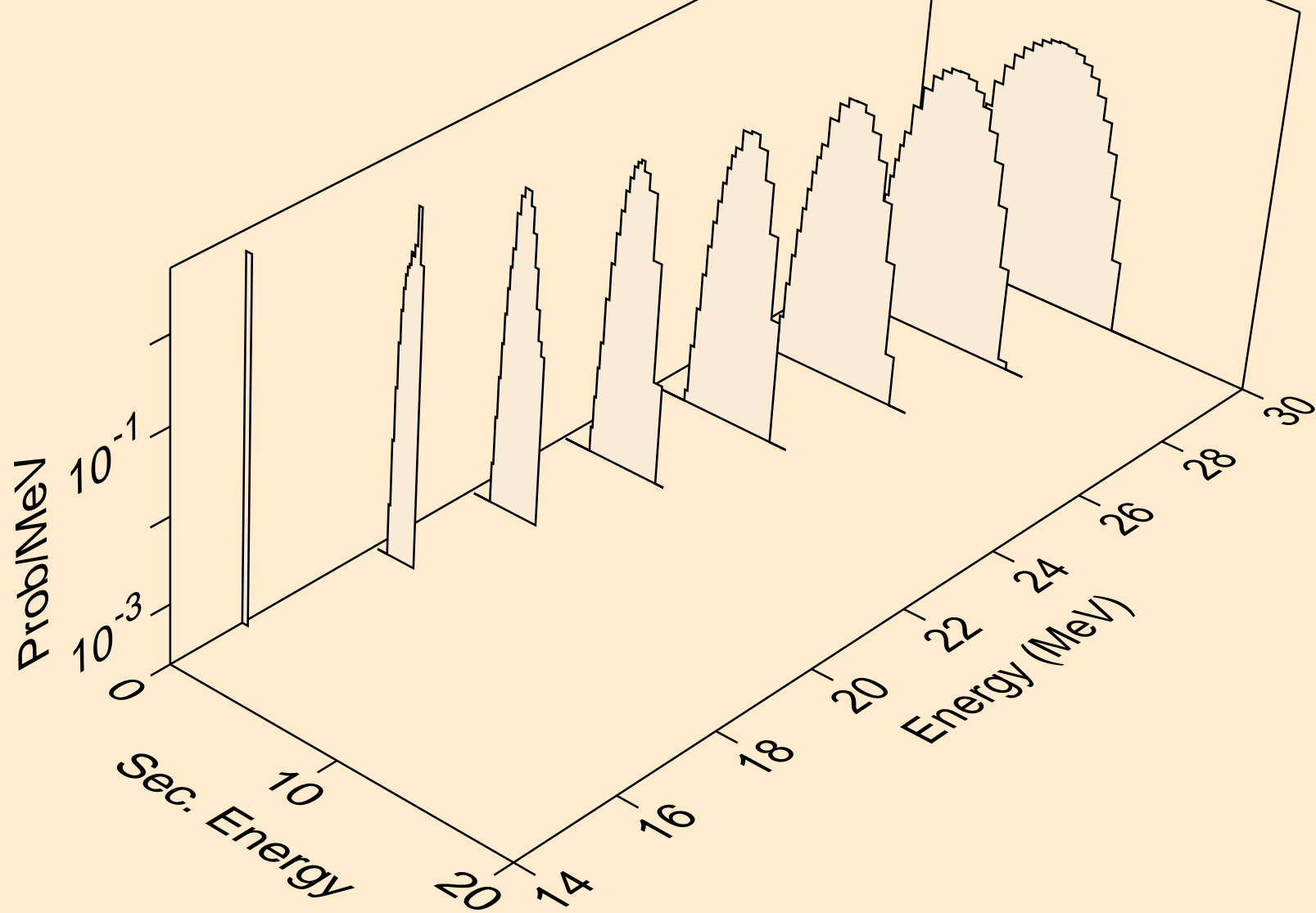

BR081 PROTON ACER TENDL-2023 LIBRARY; T=0.K  
deuterons from (p,da)

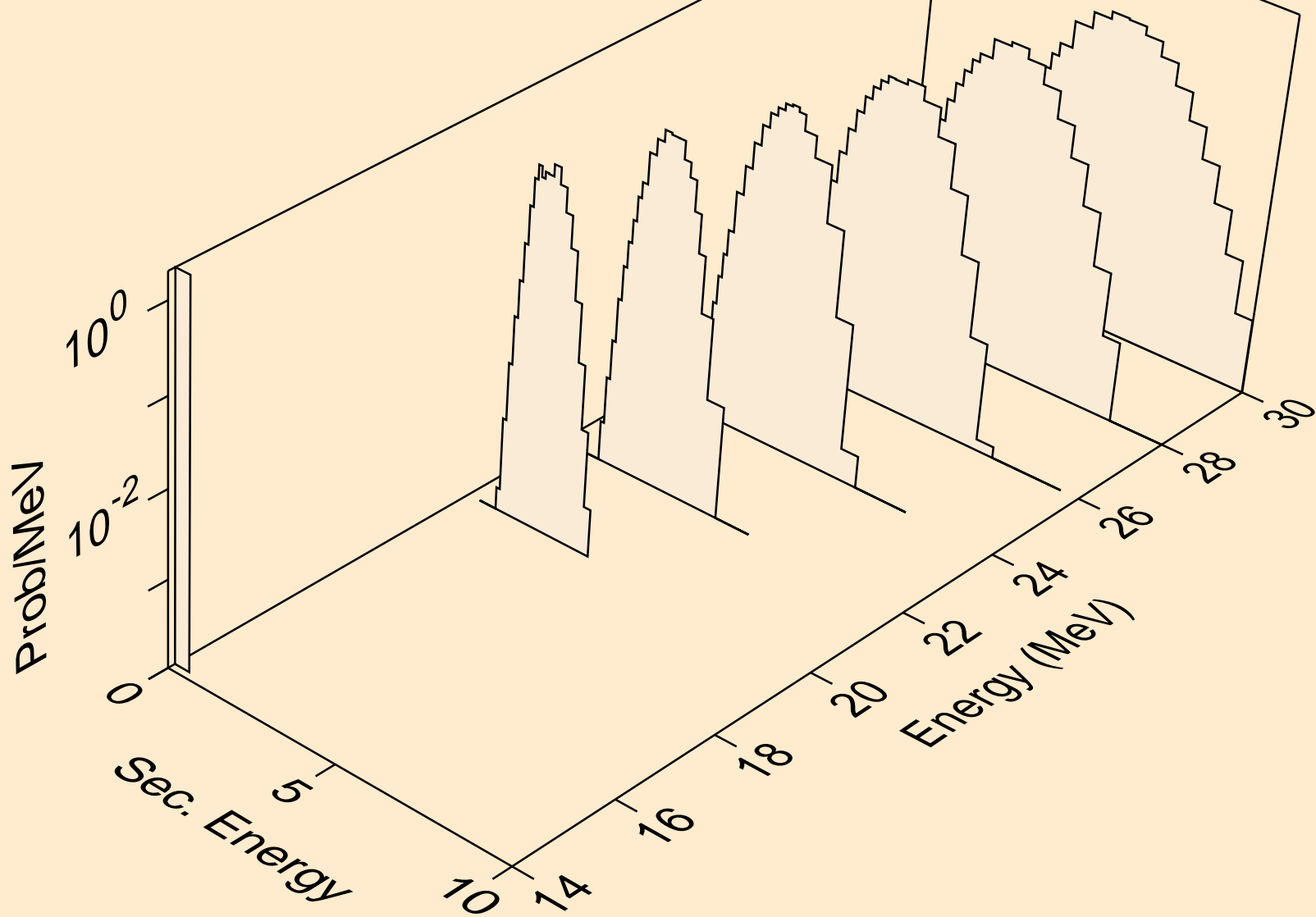

BR081 PROTON ACER TENDL-2023 LIBRARY; T=0.K  
tritons from (p,x)

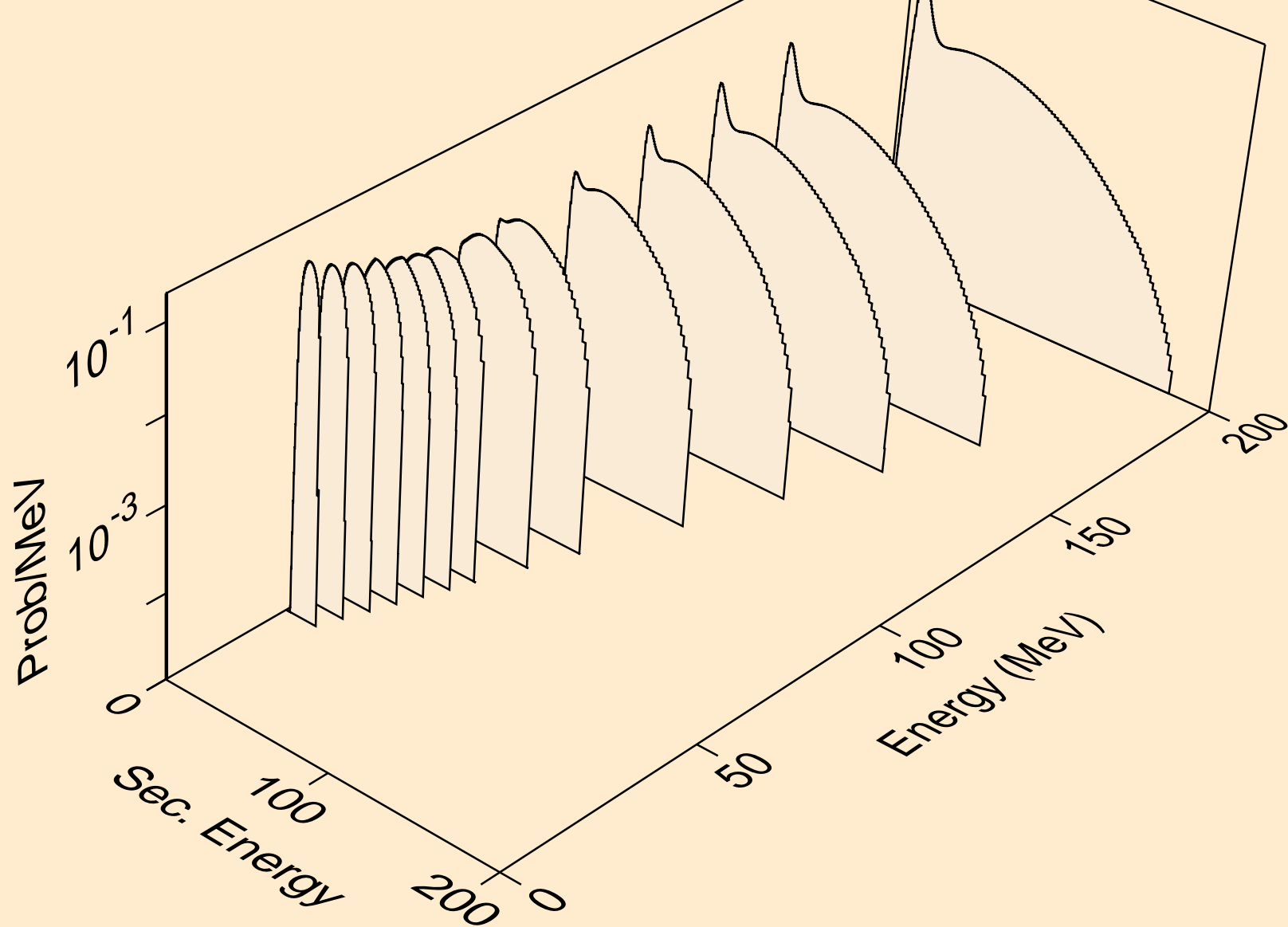

BR081 PROTON ACER TENDL-2023 LIBRARY; T=0.K  
tritons from (p,n\*)t

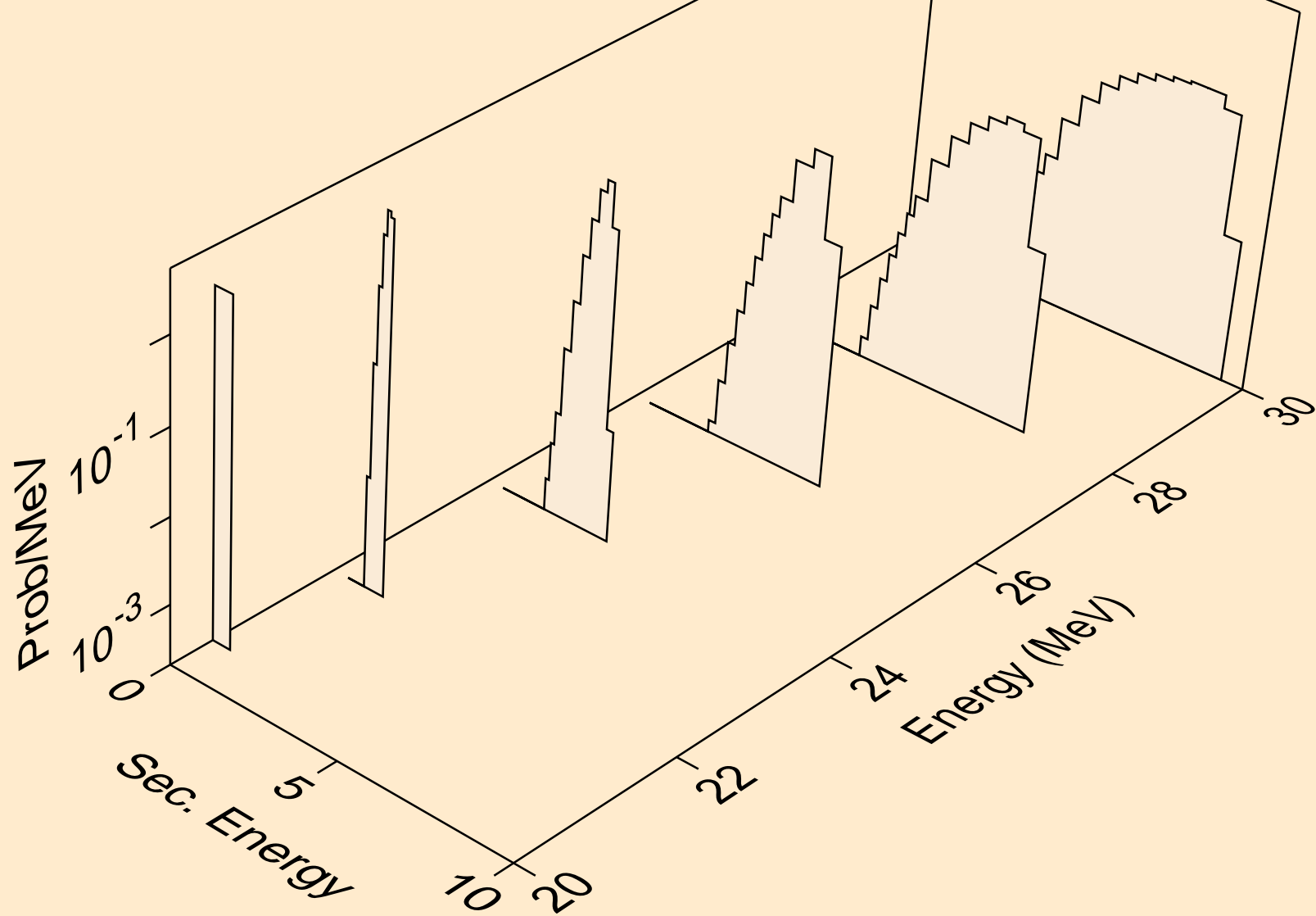



BR081 PROTON ACER TENDL-2023 LIBRARY; T=0.K  
tritons from (p,t)

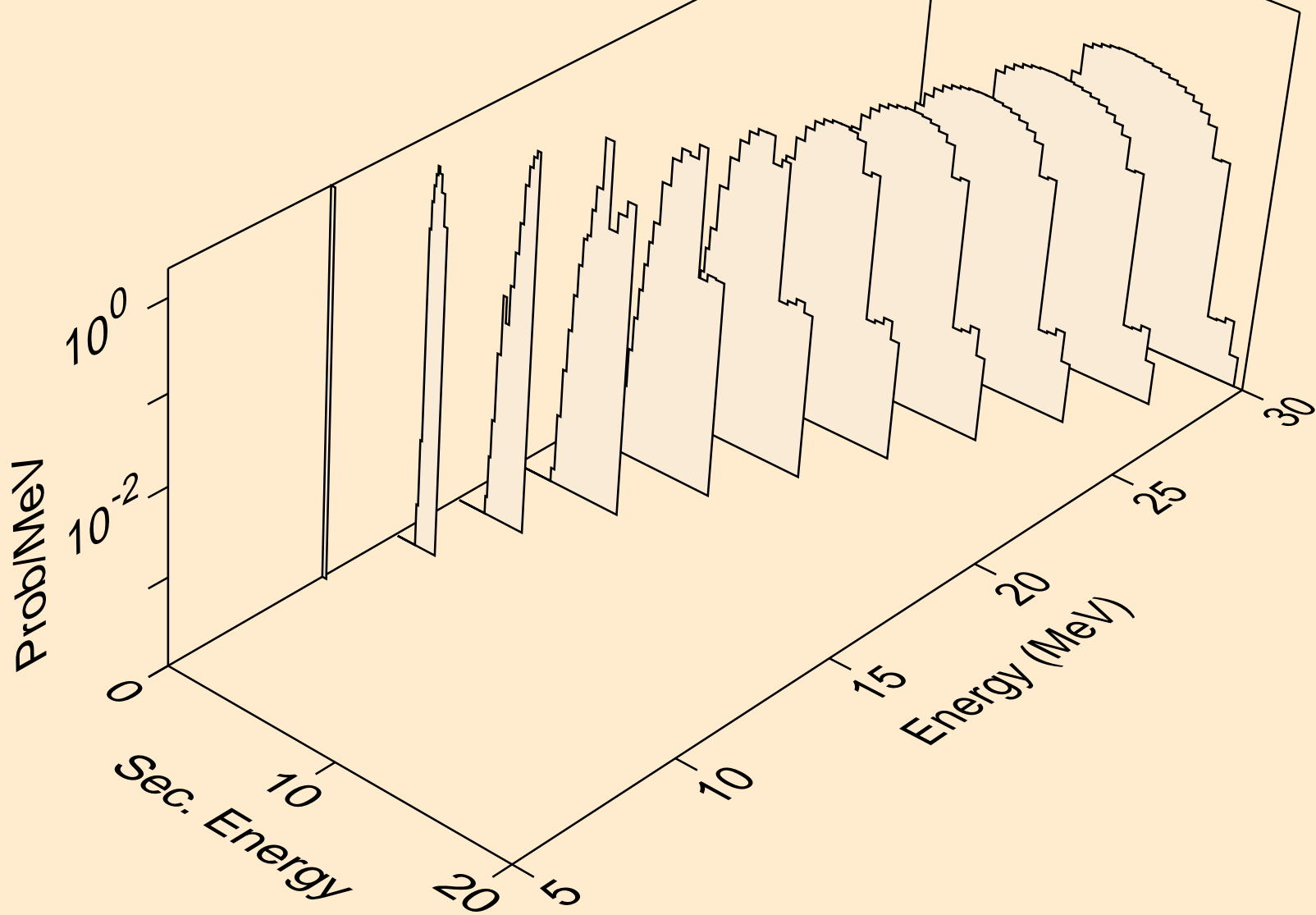

BR081 PROTON ACER TENDL-2023 LIBRARY; T=0.K  
tritons from (p,pt)

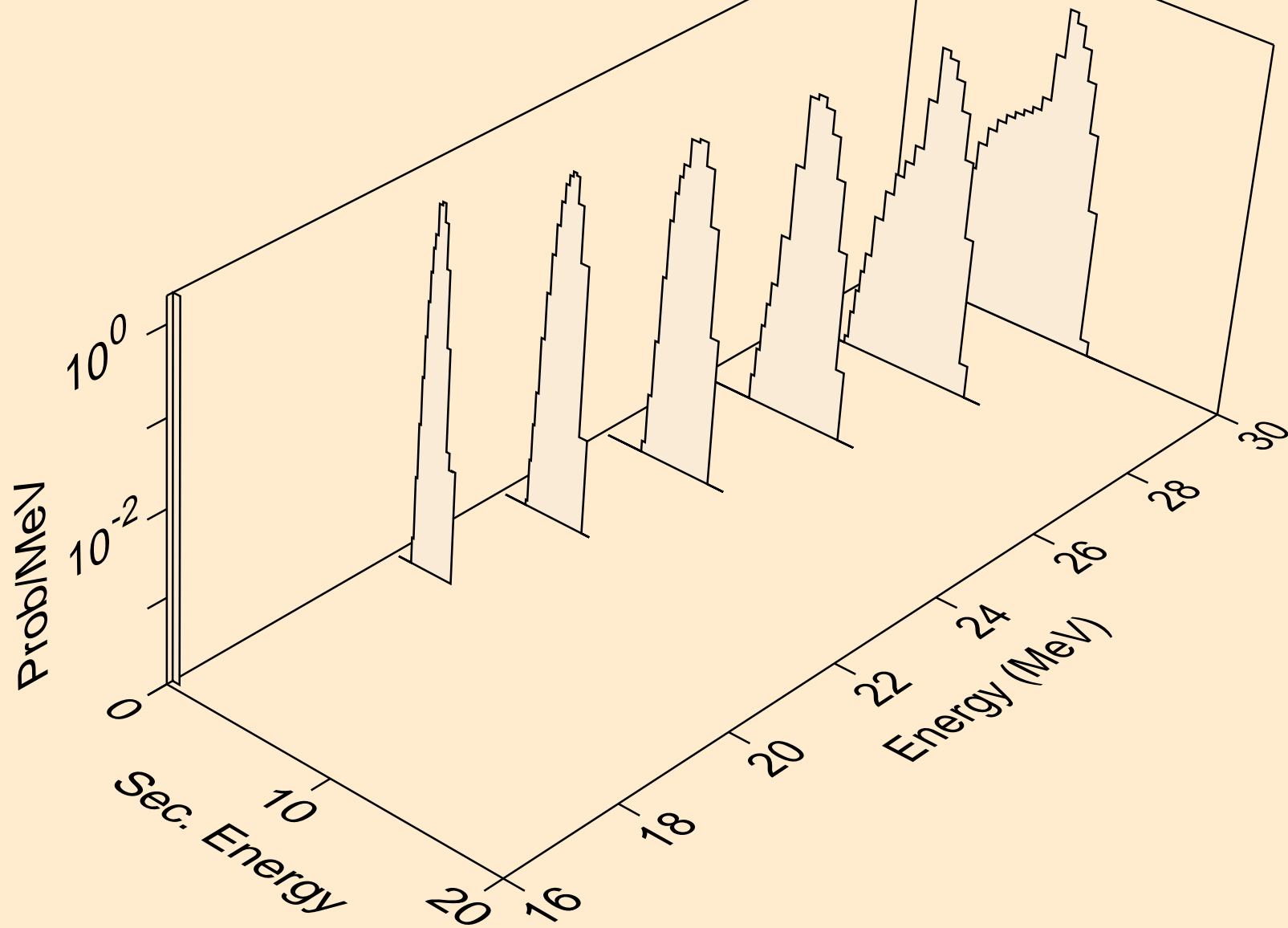

BR081 PROTON ACER TENDL-2023 LIBRARY; T=0.K  
he3s from (p,x)

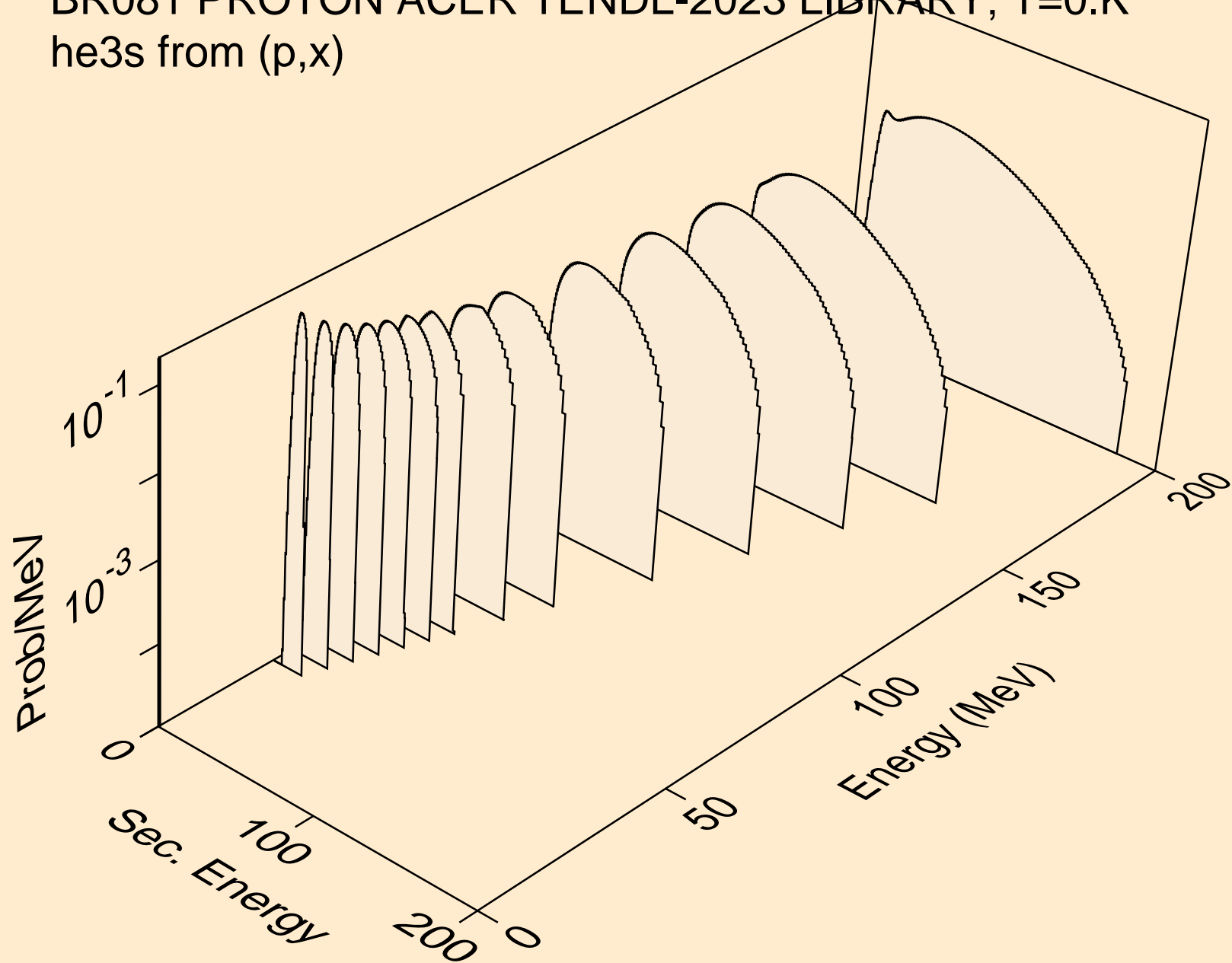

BR081 PROTON ACER TENDL-2023 LIBRARY; T=0.K  
he3s from (p,n\*)he3

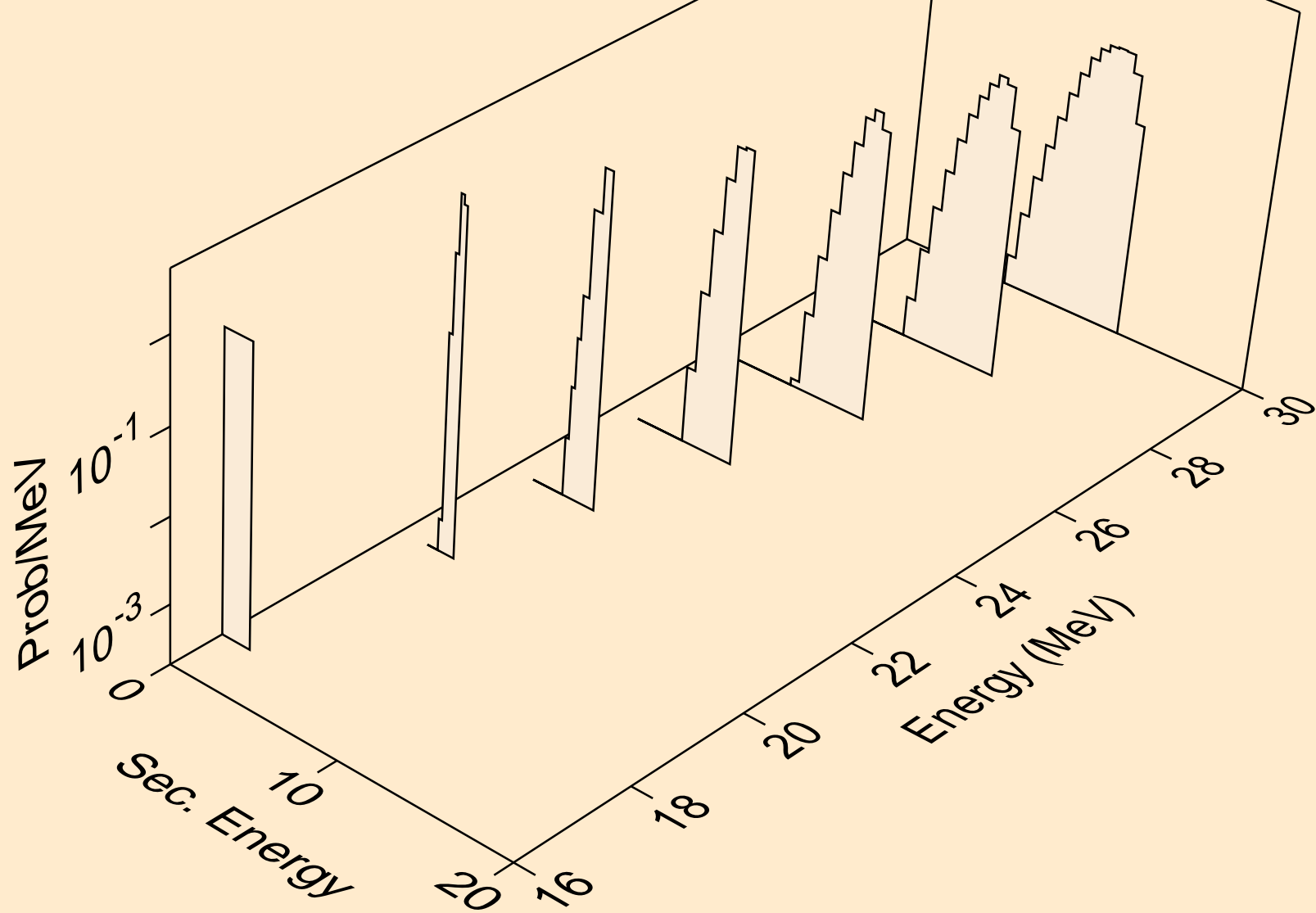

BR081 PROTON ACER TENDL-2023 LIBRARY; T=0.K  
he3s from (p,he3)

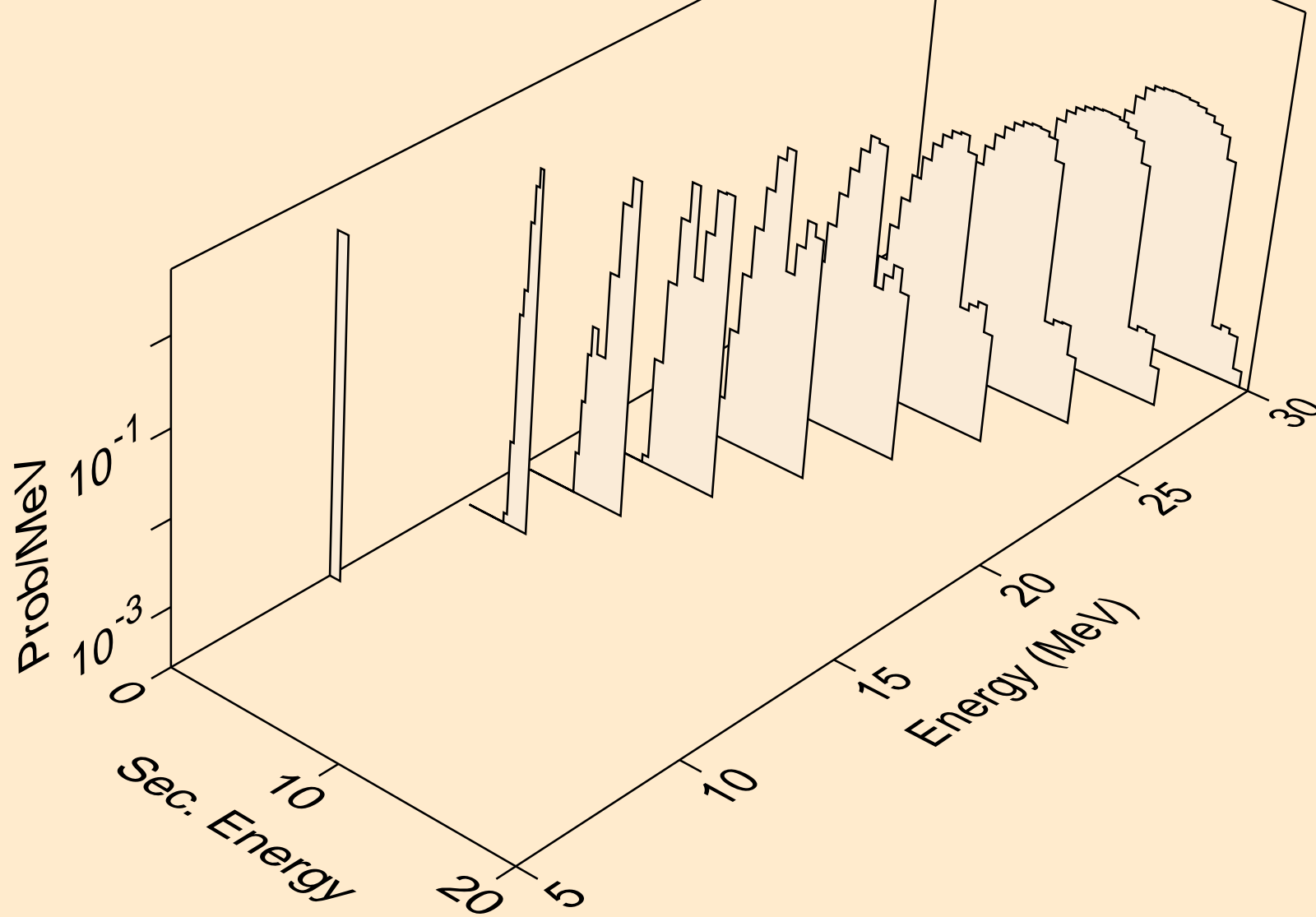

BR081 PROTON ACER TENDL-2023 LIBRARY; T=0.K  
alphas from (p,x)

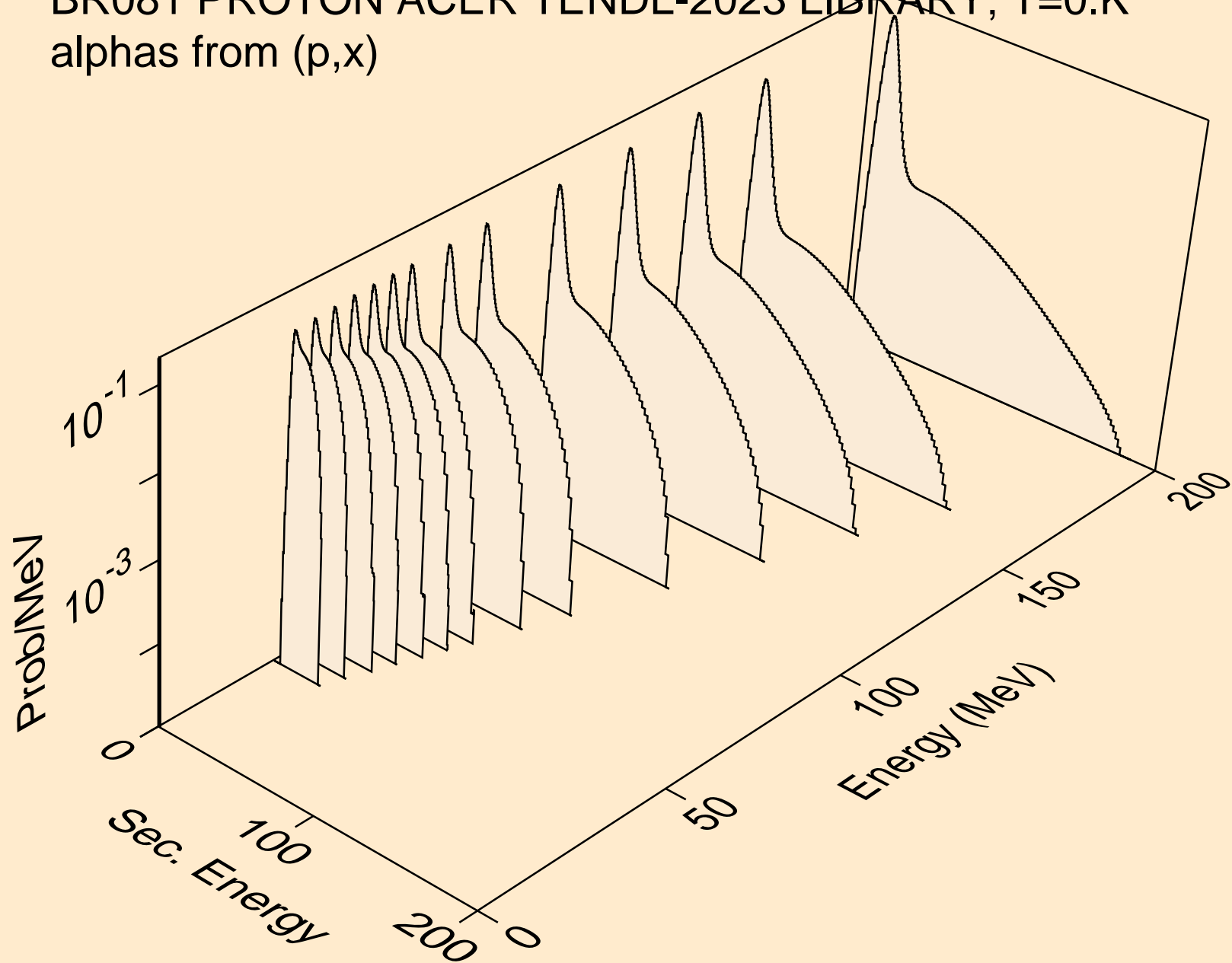

BR081 PROTON ACER TENDL-2023 LIBRARY; T=0.K  
alphas from (p,n\*)a

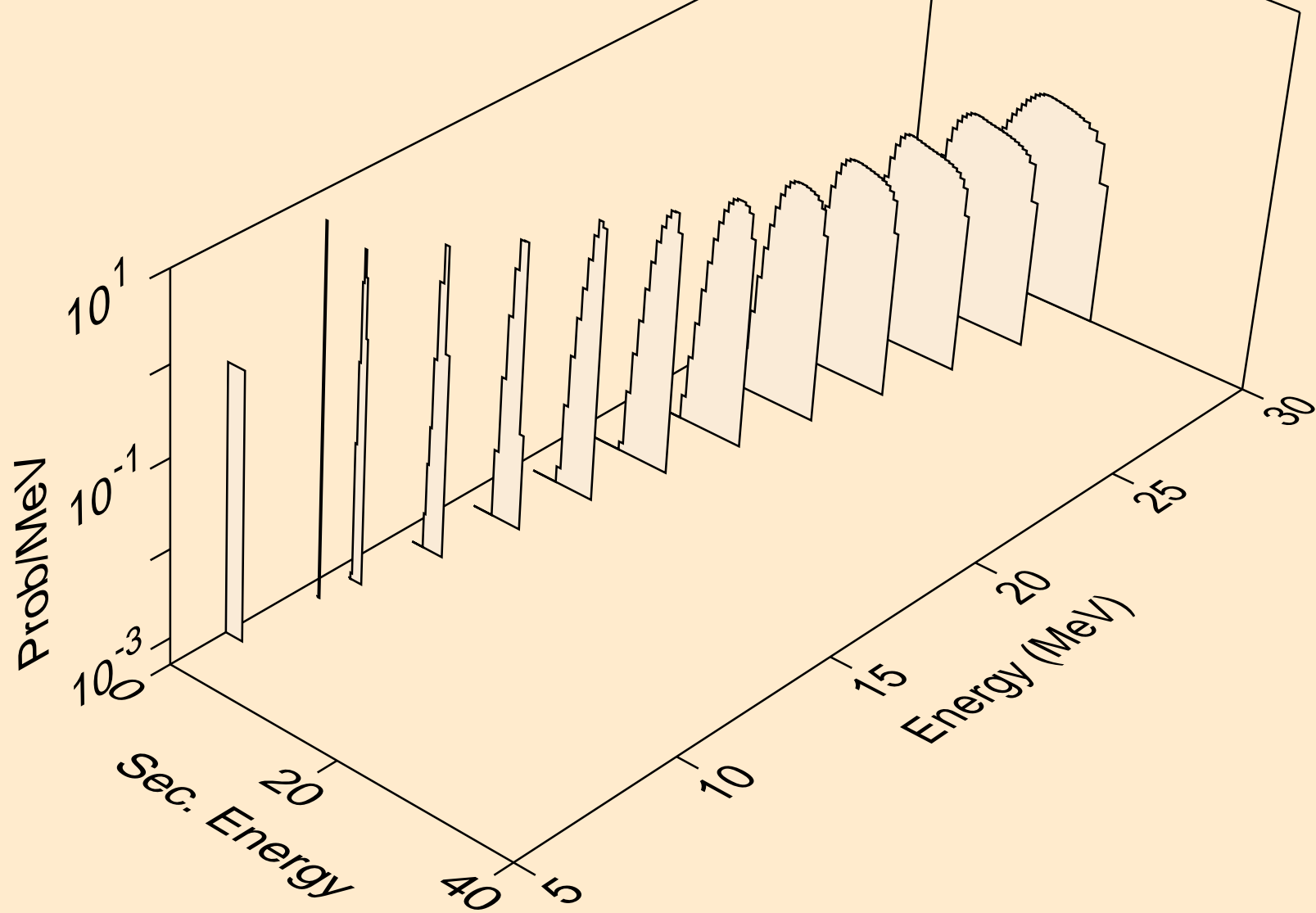

BR081 PROTON ACER TENDL-2023 LIBRARY; T=0.K  
alphas from (p,2n)a

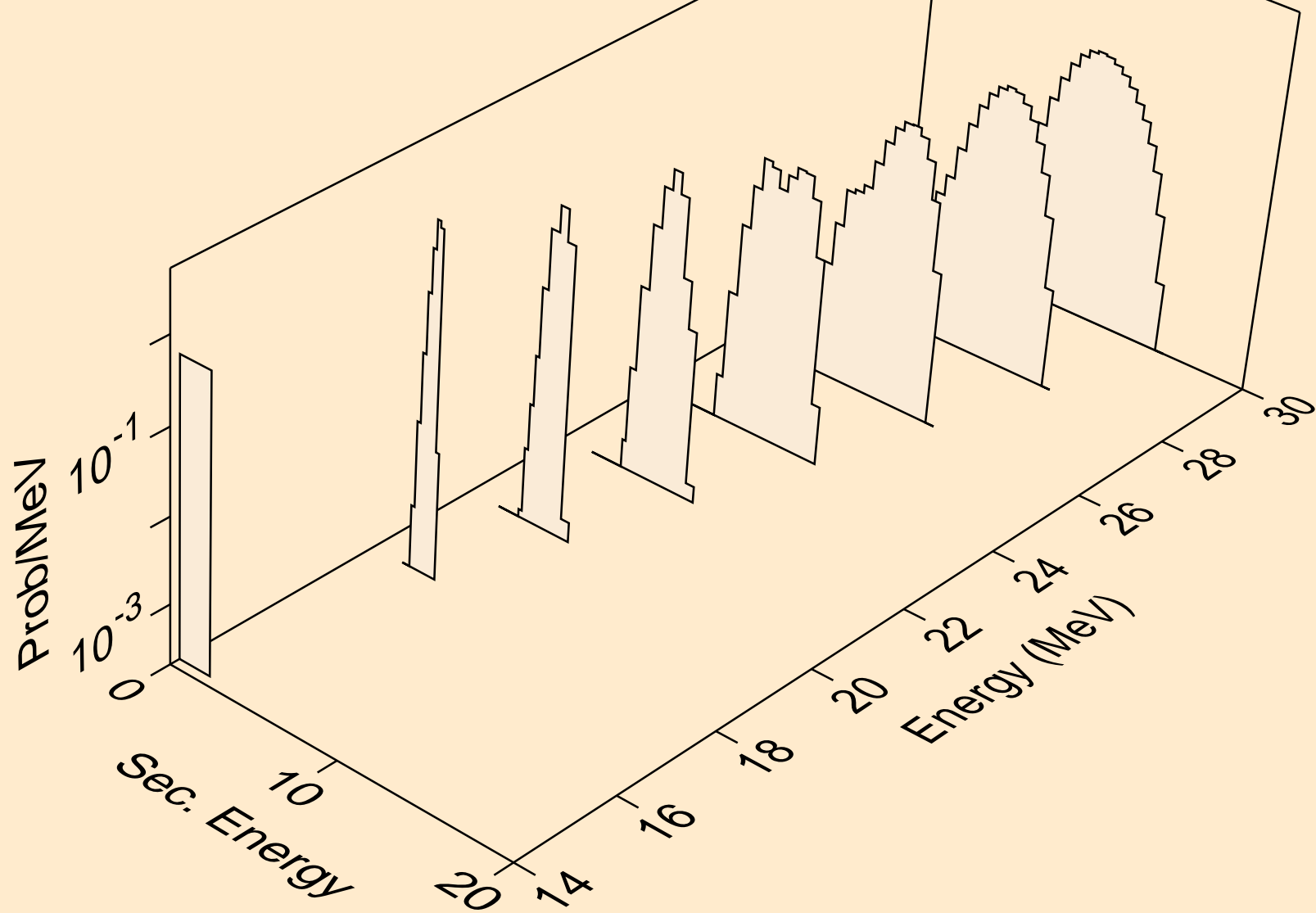



BR081 PROTON ACER TENDL-2023 LIBRARY; T=0.K  
alphas from (p,n\*)2a

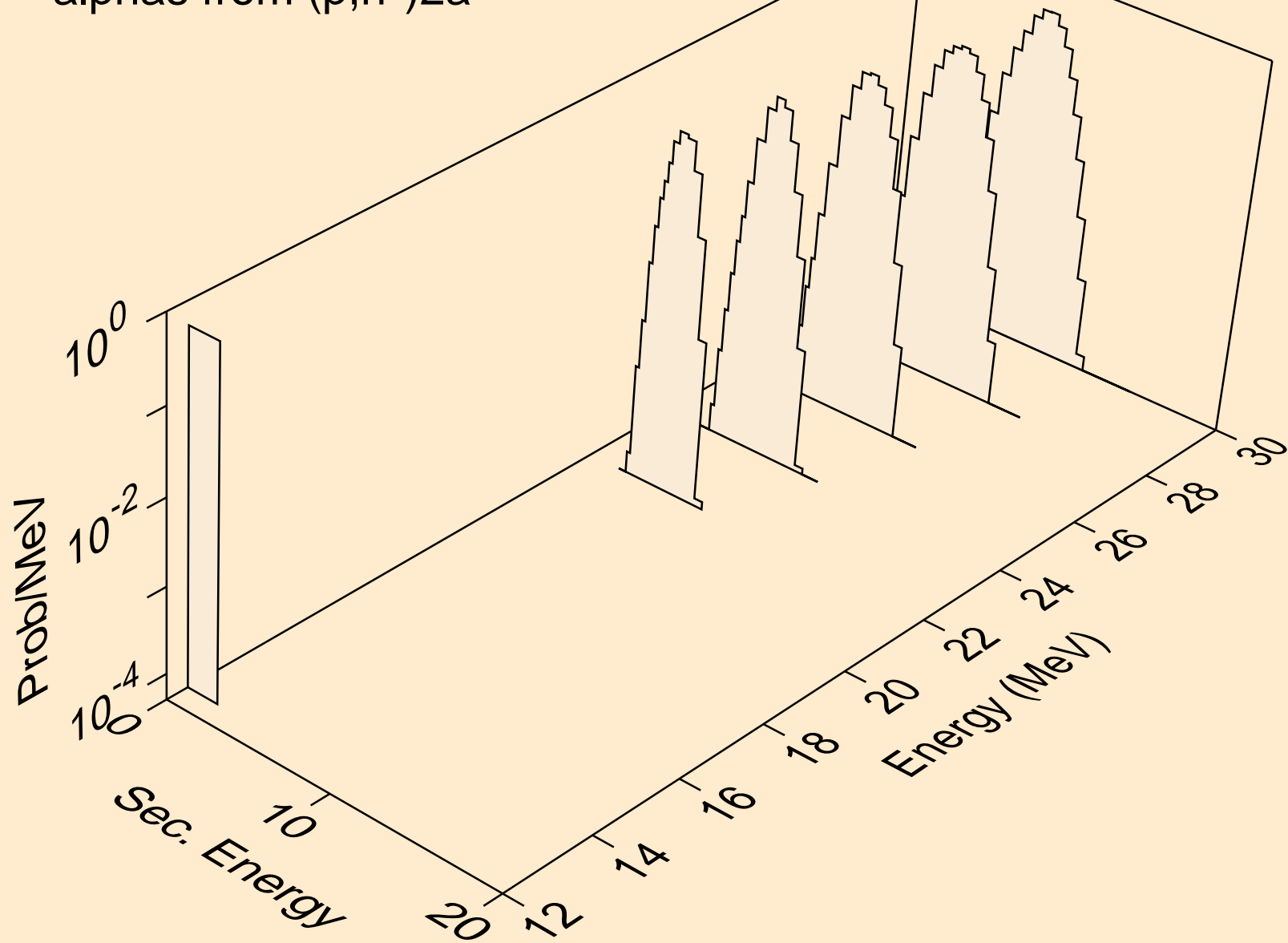

BR081 PROTON ACER TENDL-2023 LIBRARY; T=0.K  
alphas from (p,npa)

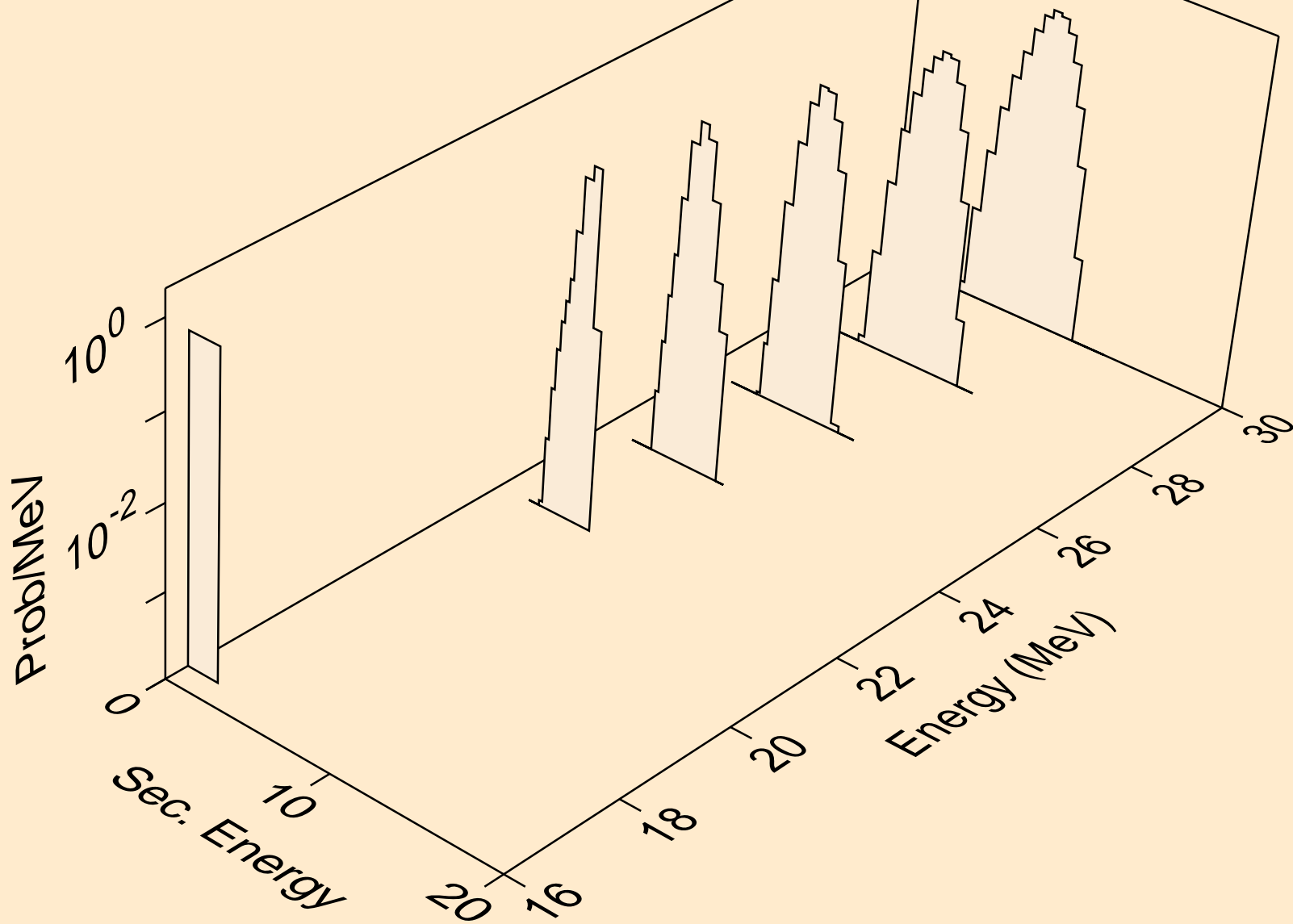

BR081 PROTON ACER TENDL-2023 LIBRARY; T=0.K  
alphas from (p,a)

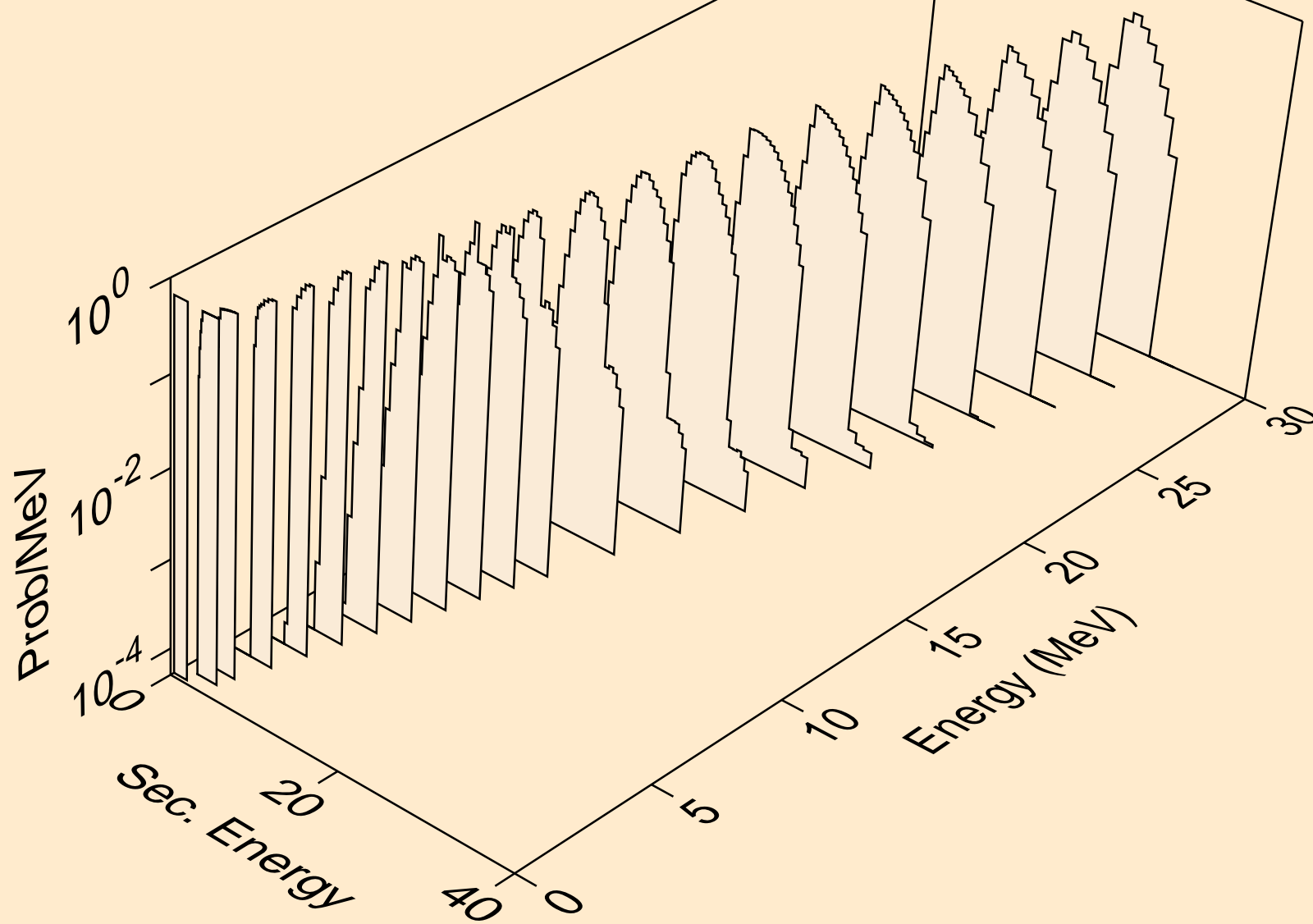

BR081 PROTON ACER TENDL-2023 LIBRARY; T=0.K  
alphas from (p,2a)

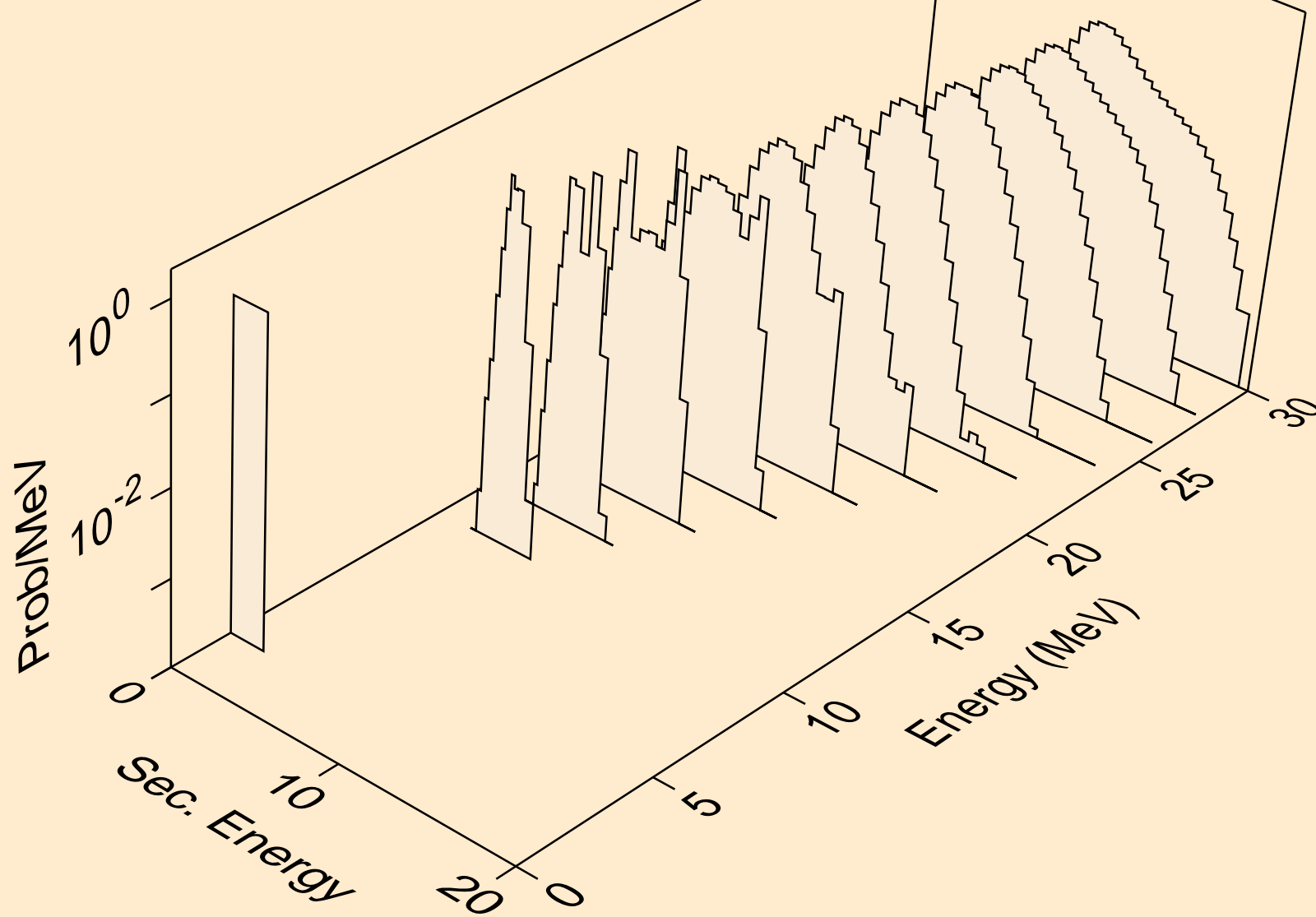

BR081 PROTON ACER TENDL-2023 LIBRARY; T=0.K  
alphas from (p,pa)

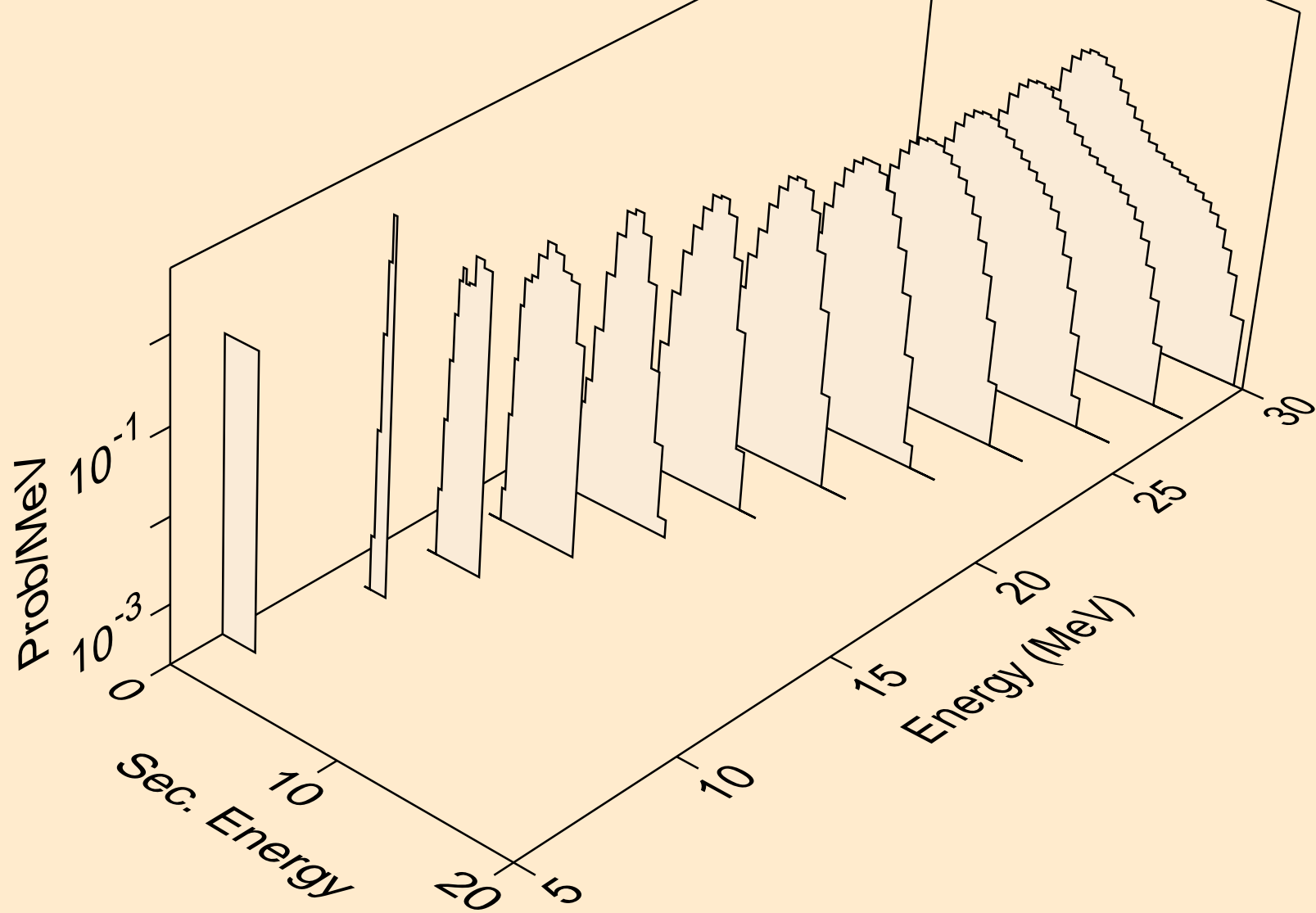

BR081 PROTON ACER TENDL-2023 LIBRARY; T=0.K  
alphas from (p,da)

