

# CD102 PROTON ACER TENDL-2023 LIBRARY; T=0.K

## Principal cross sections

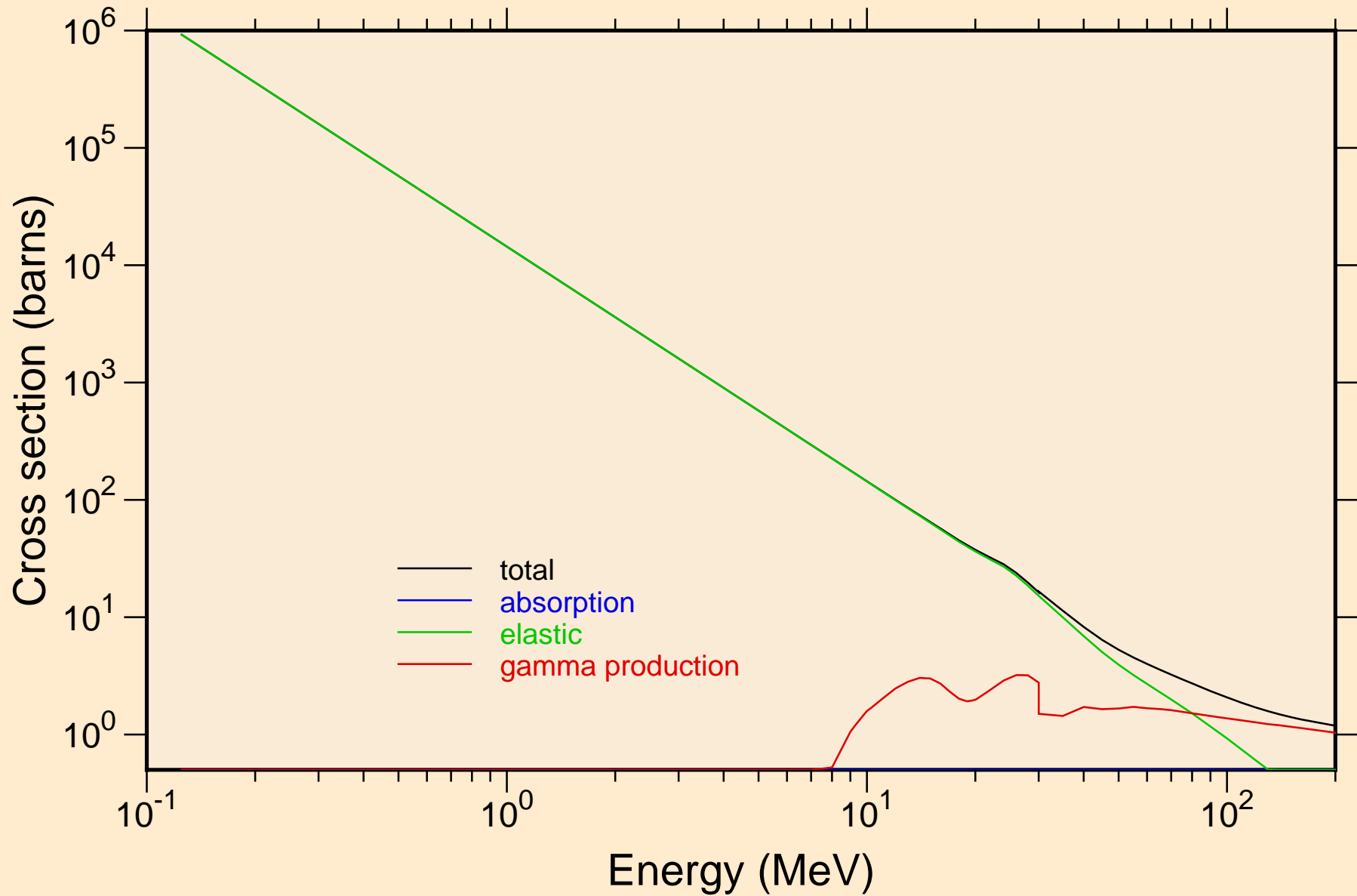

# CD102 PROTON ACER TENDL-2023 LIBRARY; T=0.K

## Heating

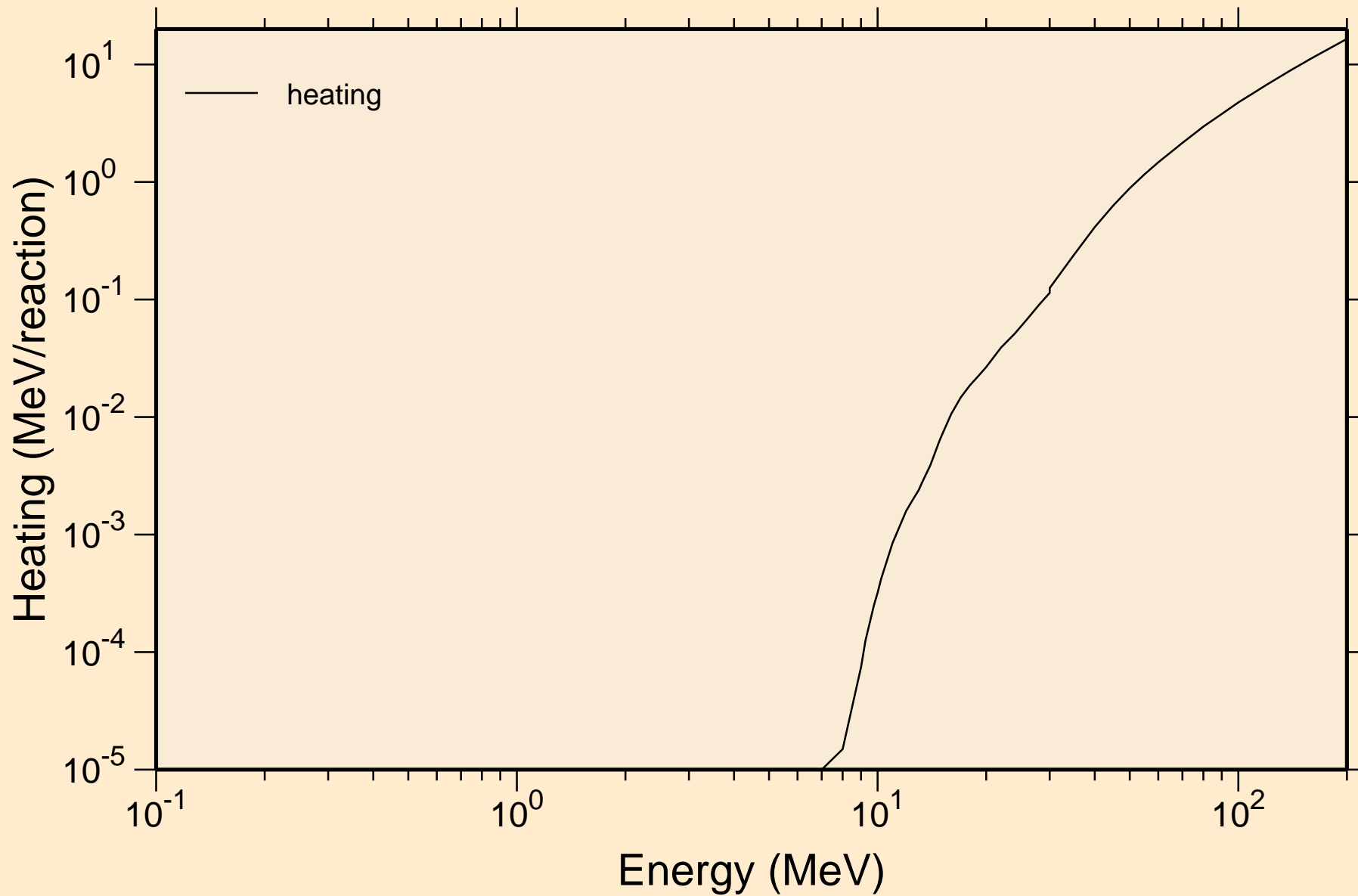

# CD102 PROTON ACER TENDL-2023 LIBRARY; T=0.K

## Principal cross sections

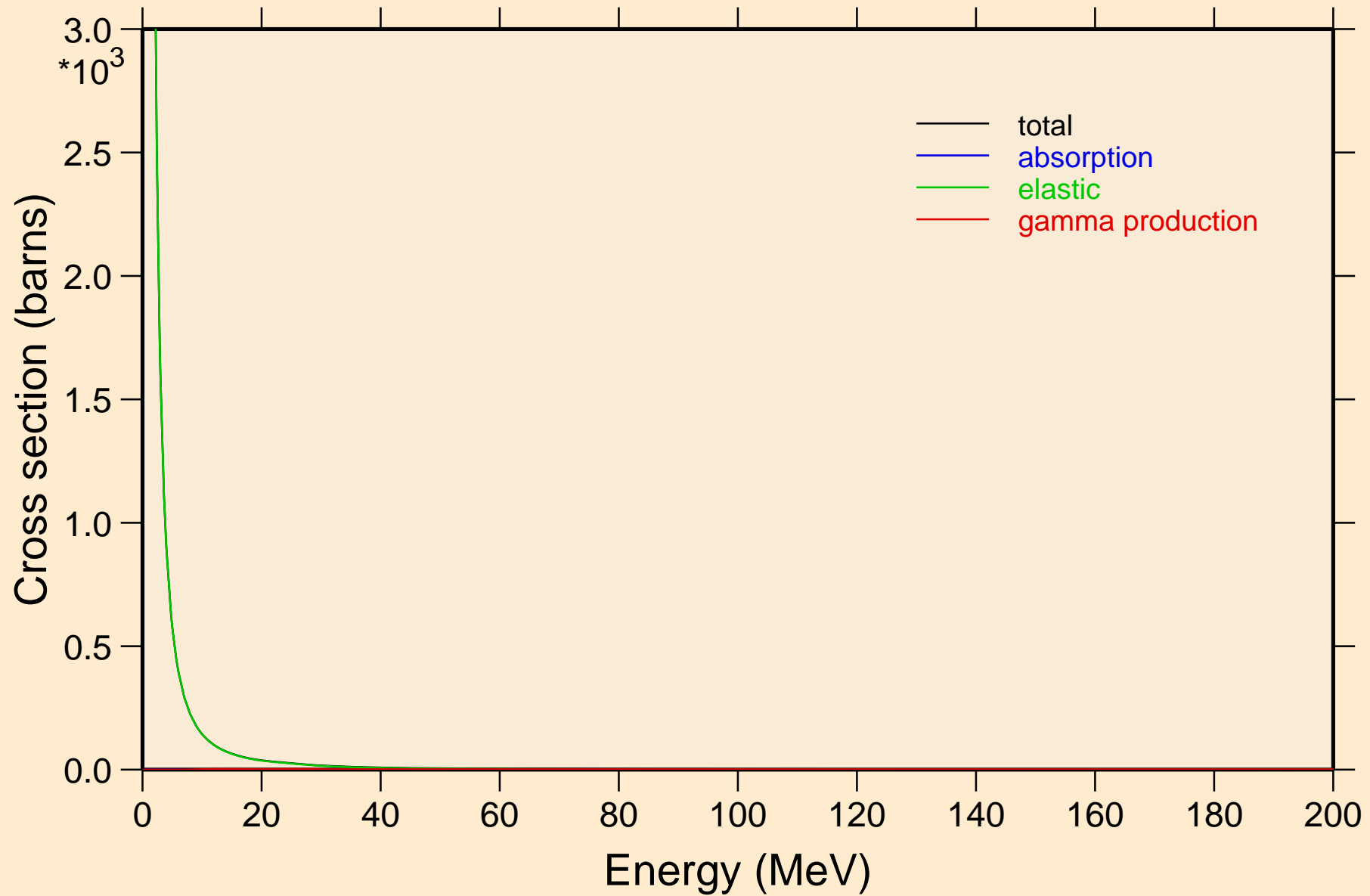

# CD102 PROTON ACER TENDL-2023 LIBRARY; T=0.K

## Heating

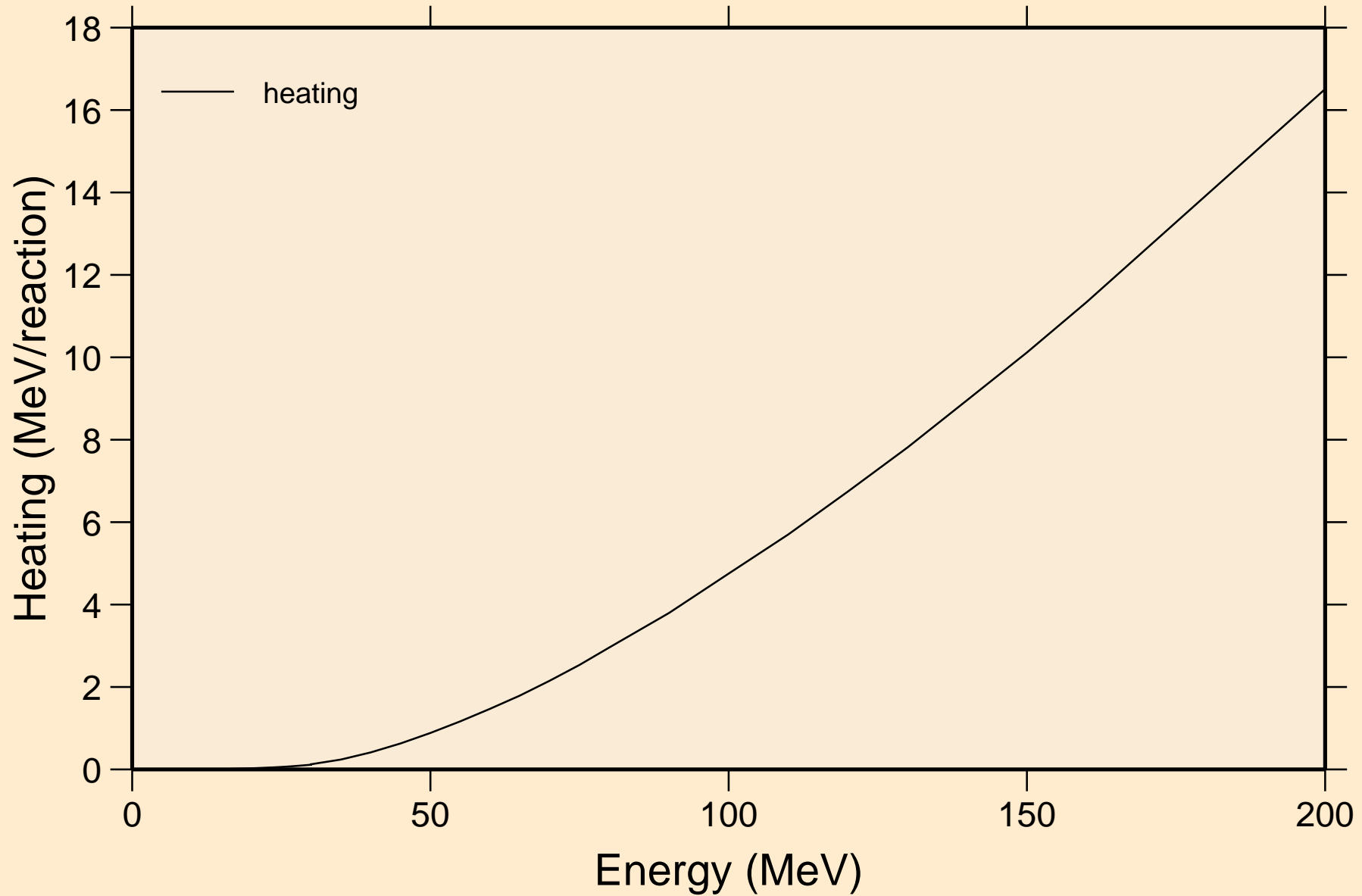

# CD102 PROTON ACER TENDL-2023 LIBRARY; T=0.K

## Threshold reactions

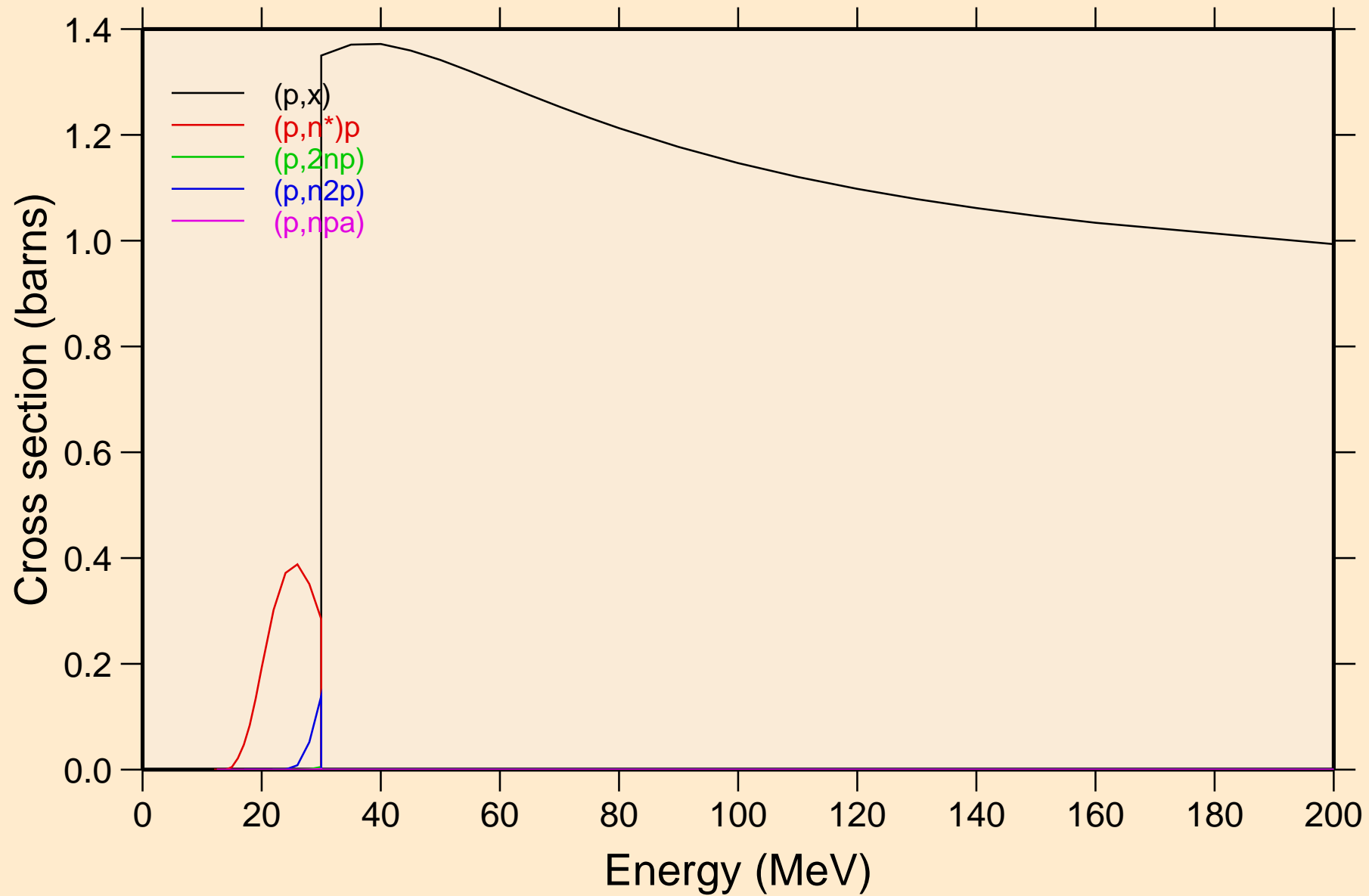

# CD102 PROTON ACER TENDL-2023 LIBRARY; T=0.K

## Threshold reactions

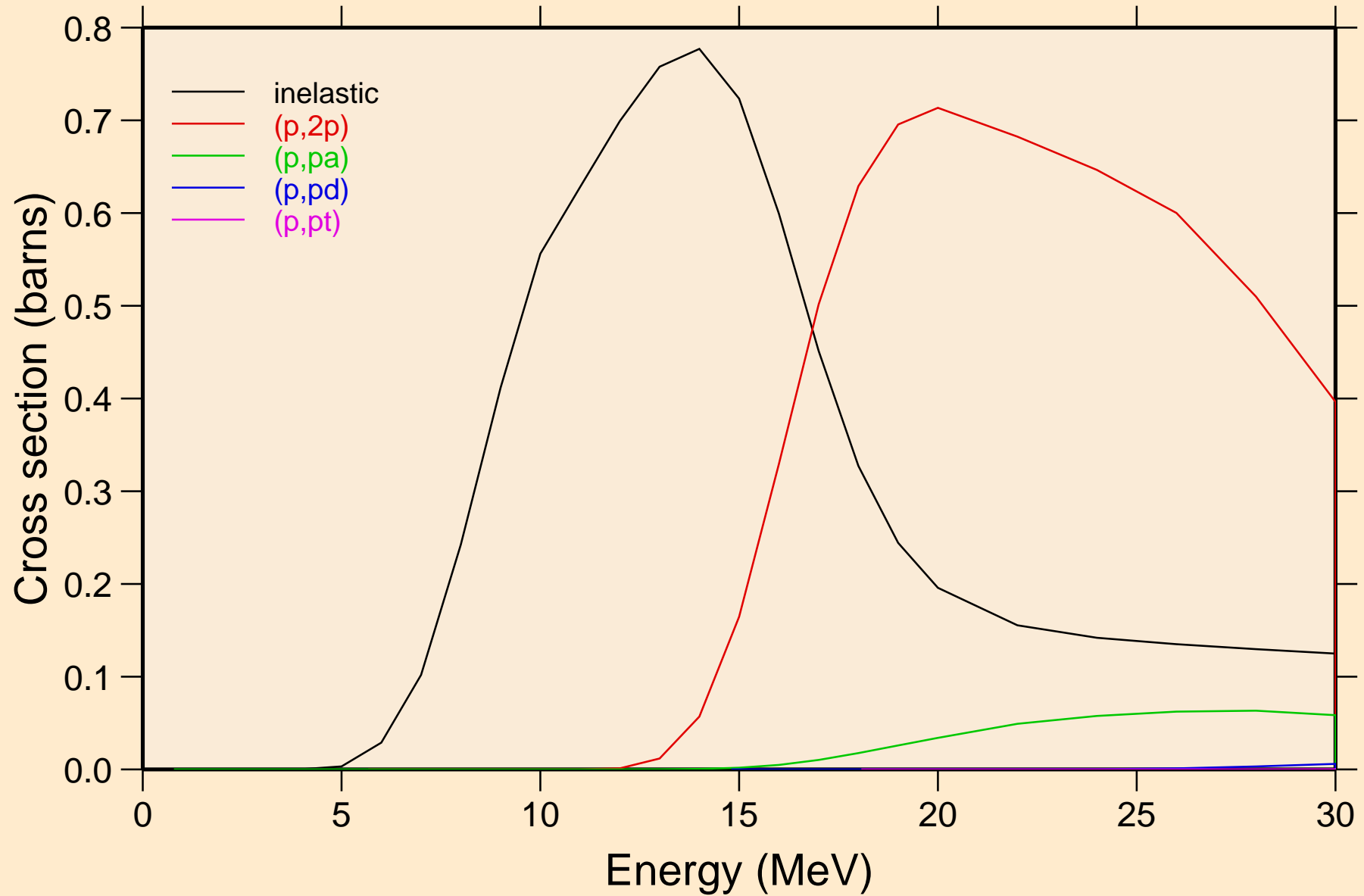

CD102 PROTON ACER TENDL-2023 LIBRARY; T=0.K  
Threshold reactions

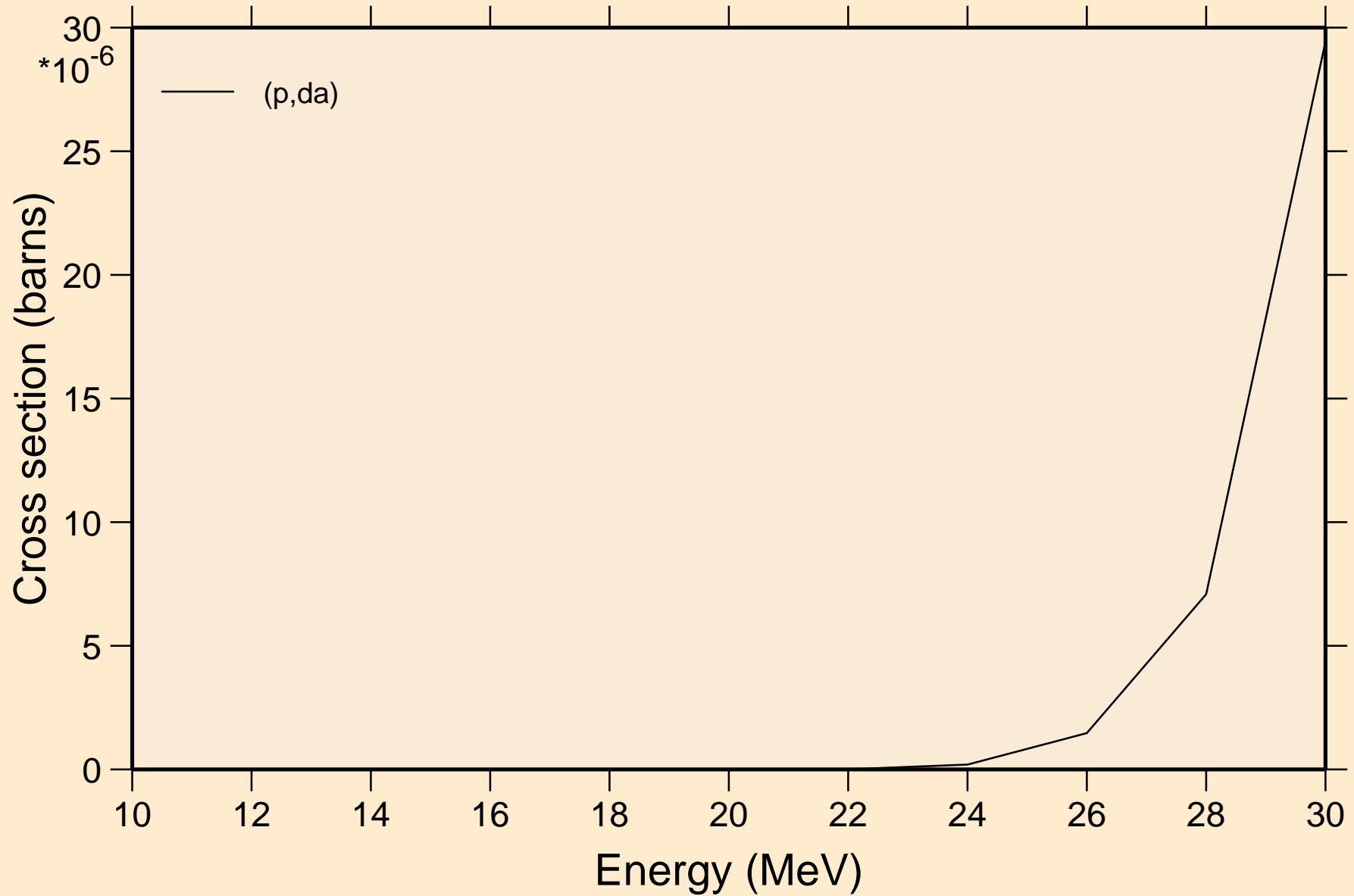

CD102 PROTON ACER TENDL-2023 LIBRARY; T=0.K  
angular distribution for elastic

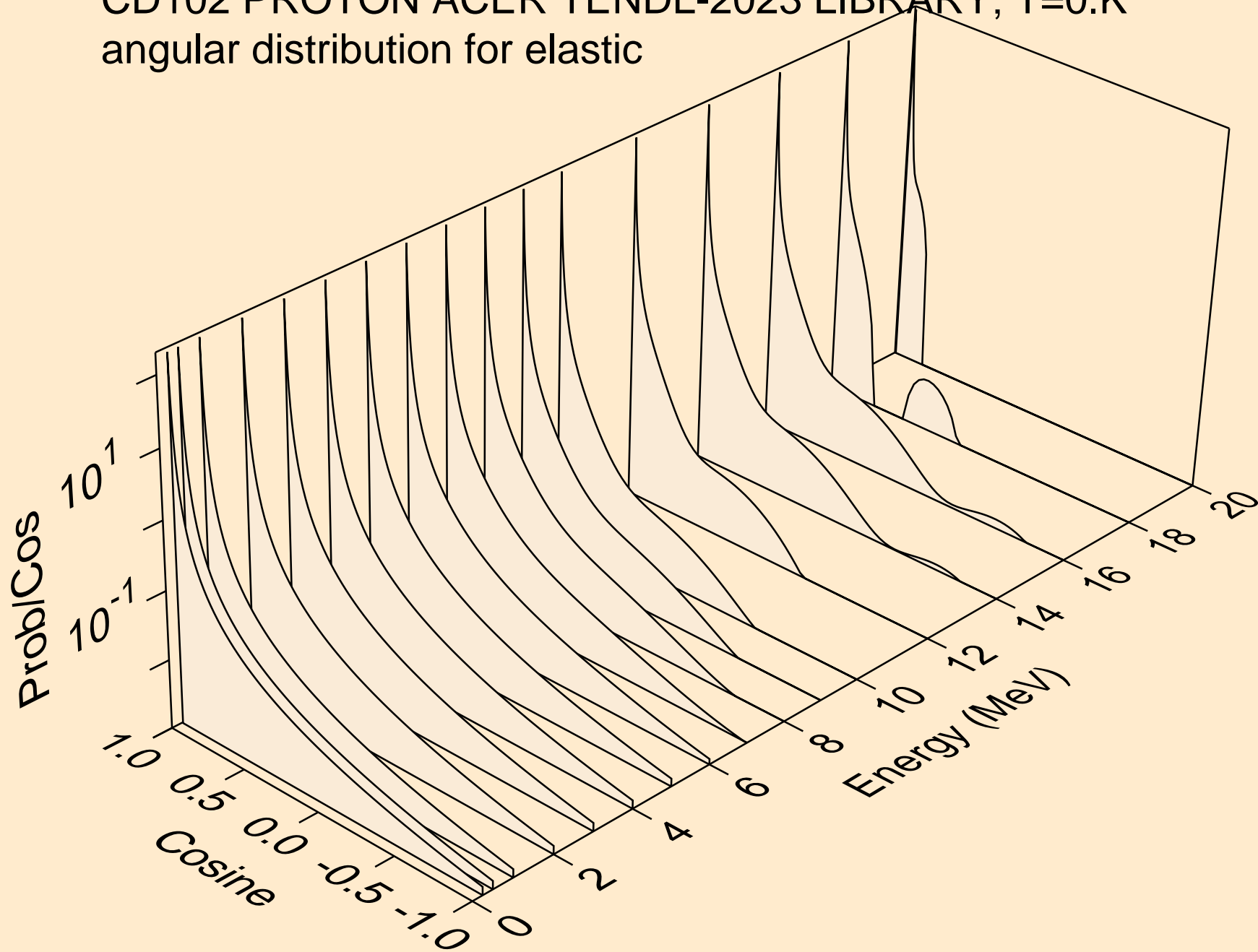



CD102 PROTON ACER TENDL-2023 LIBRARY; T=0.K  
angular distribution for elastic

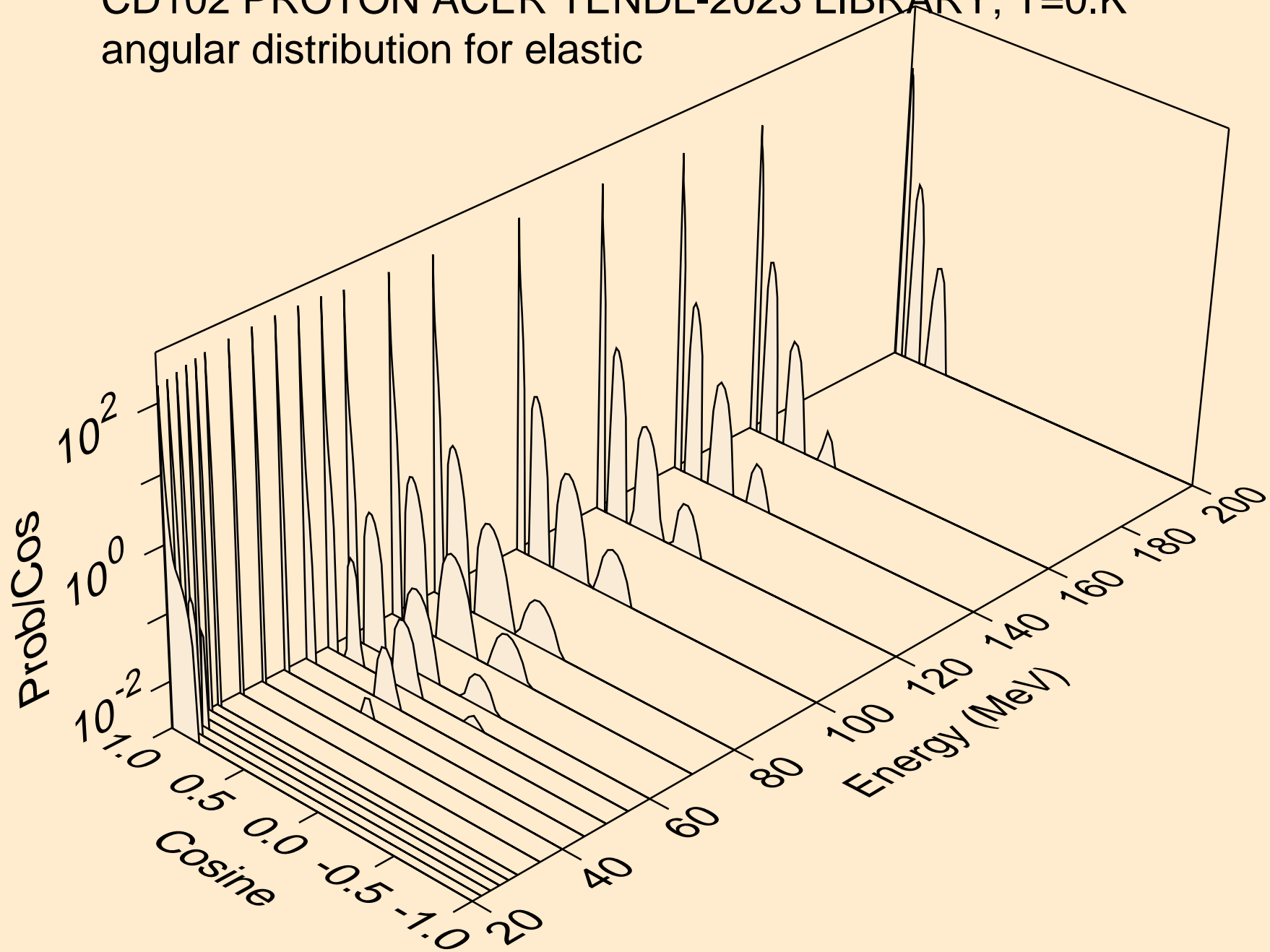

CD102 PROTON ACER TENDL-2023 LIBRARY; T=0.K  
Proton emission for (p,x)

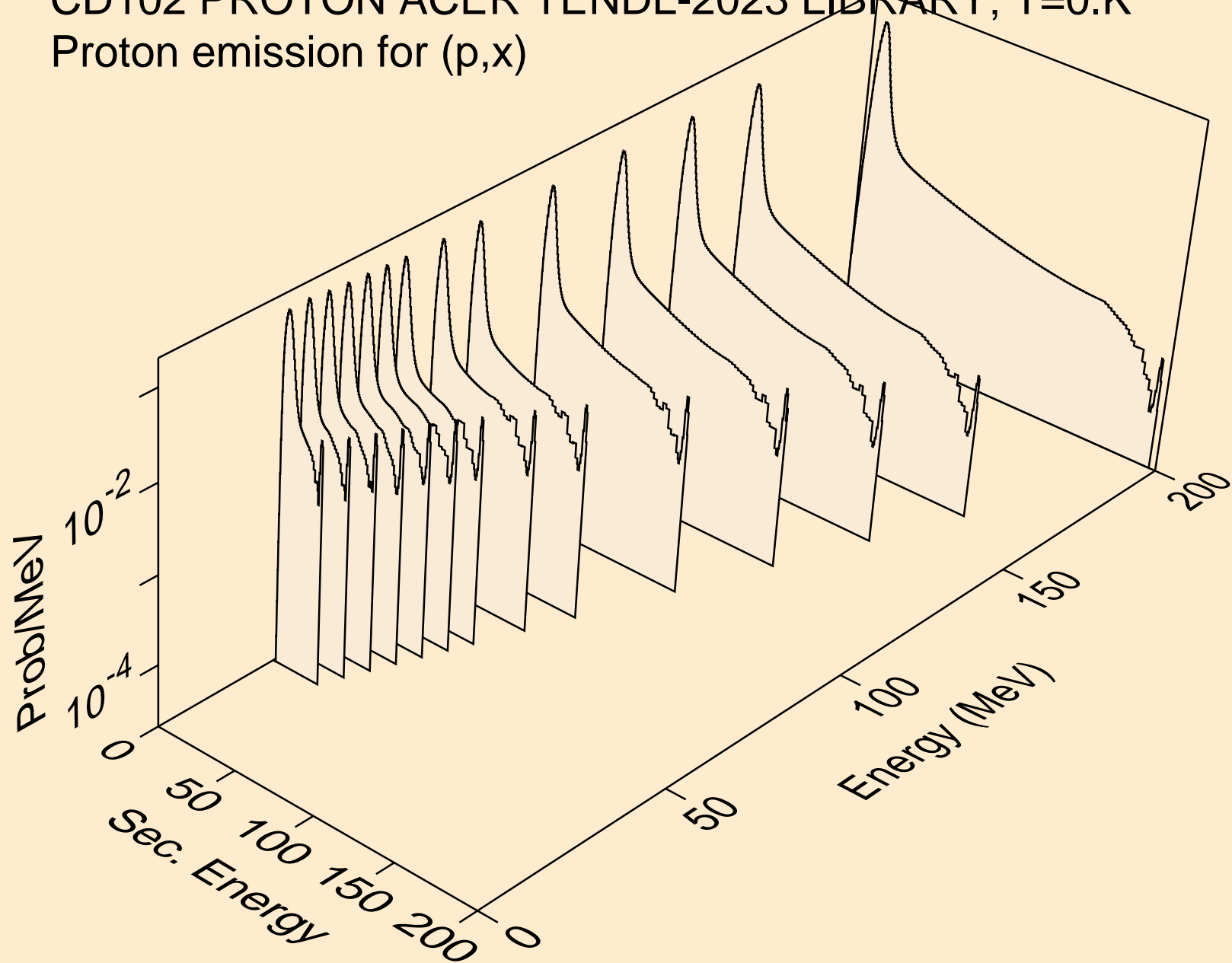

CD102 PROTON ACER TENDL-2023 LIBRARY; T=0.K  
Proton emission for (p,n\*)p

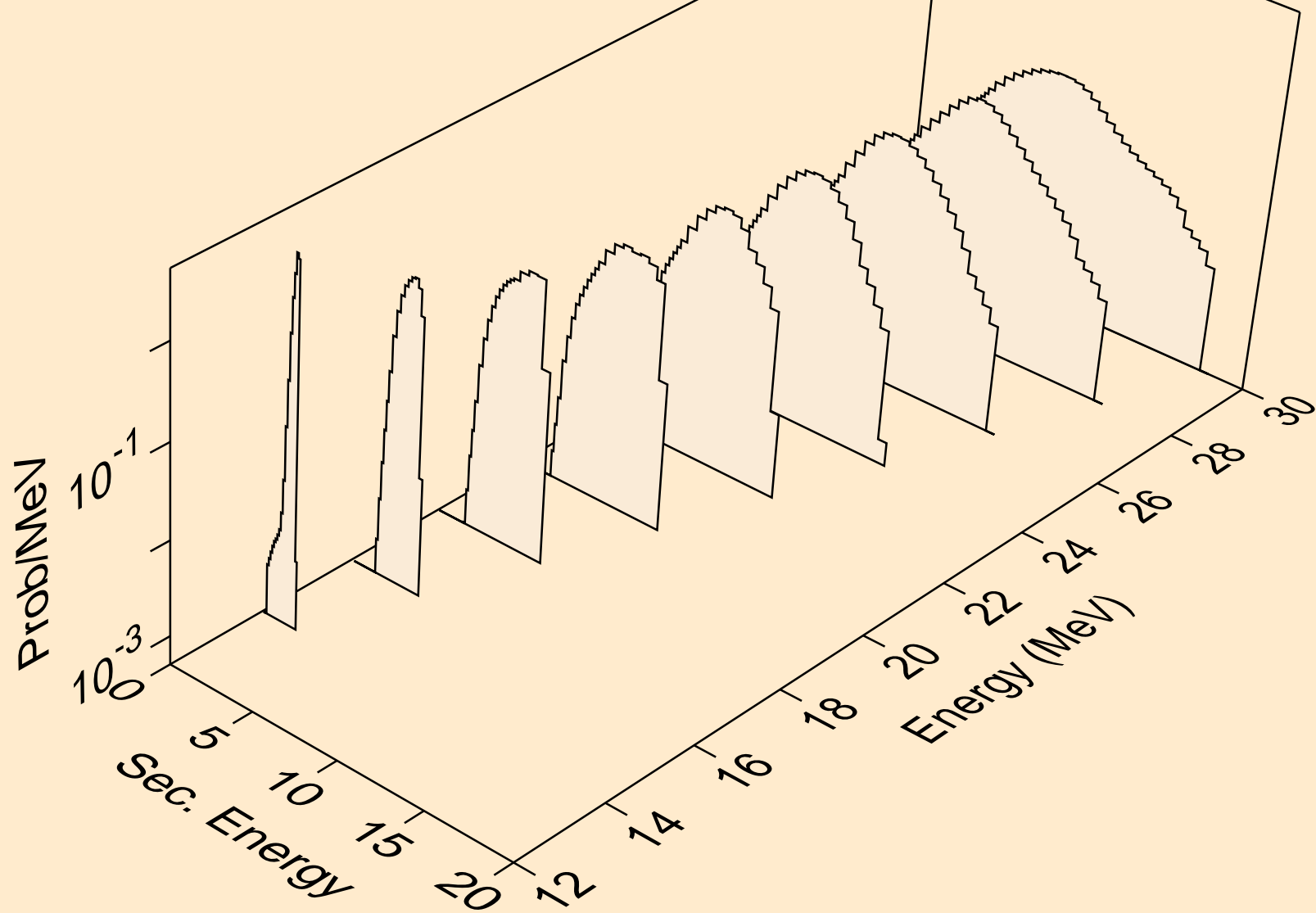

CD102 PROTON ACER TENDL-2023 LIBRARY; T=0.K  
Proton emission for (p,2np)

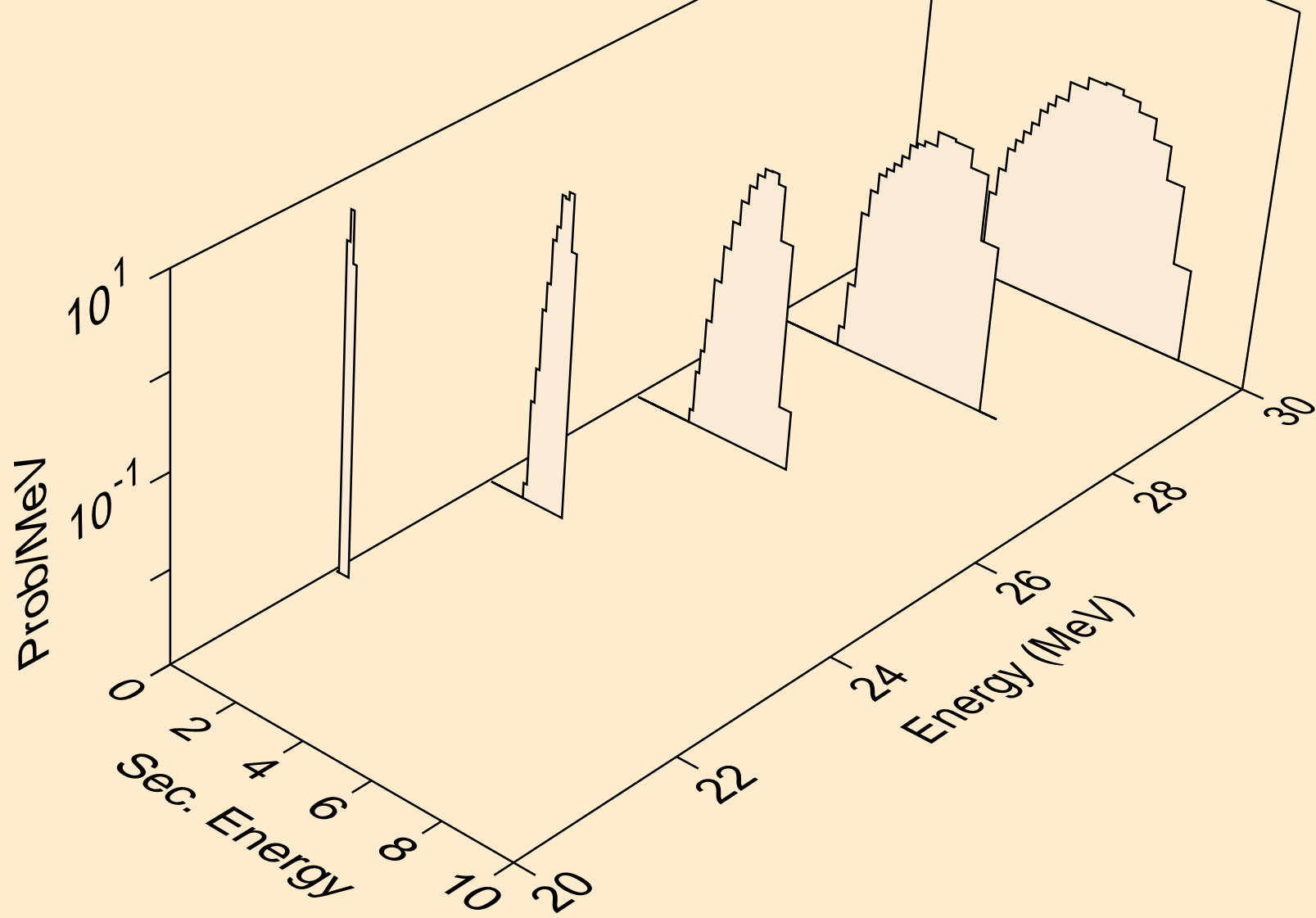

CD102 PROTON ACER TENDL-2023 LIBRARY; T=0.K  
Proton emission for (p,n2p)

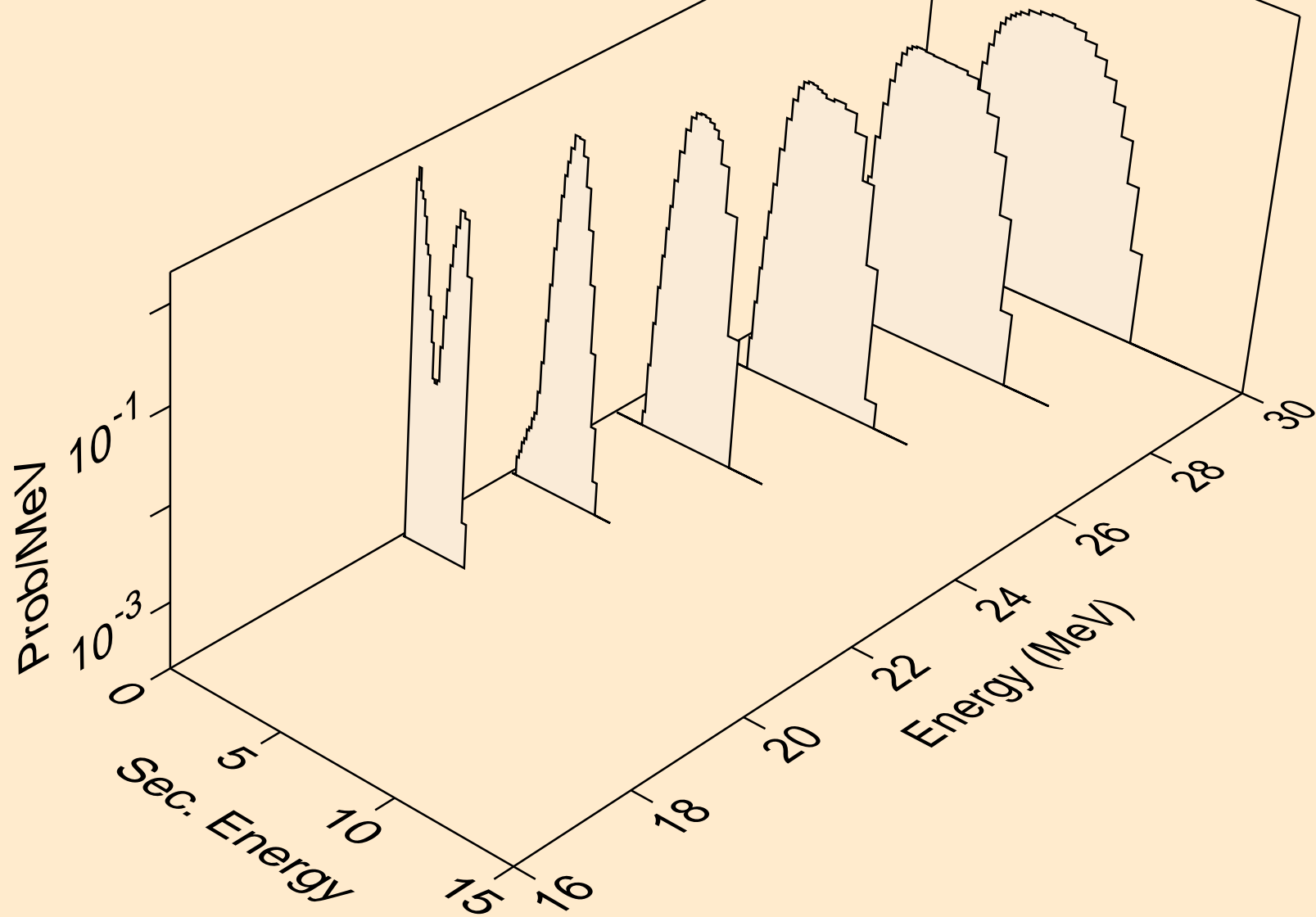

CD102 PROTON ACER TENDL-2023 LIBRARY; T=0.K  
Proton emission for (p,npa)

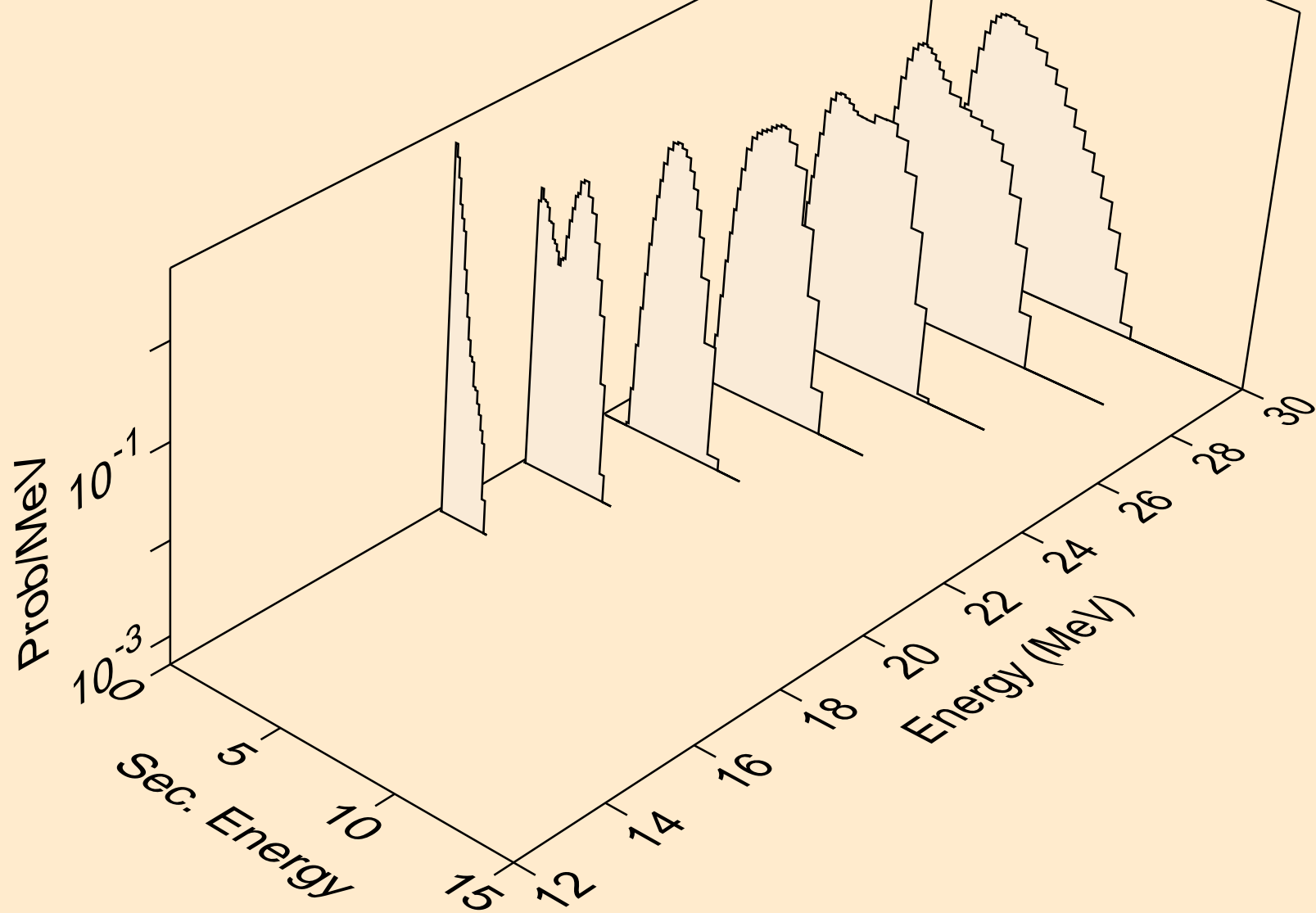

CD102 PROTON ACER TENDL-2023 LIBRARY; T=0.K  
Proton emission for inelastic

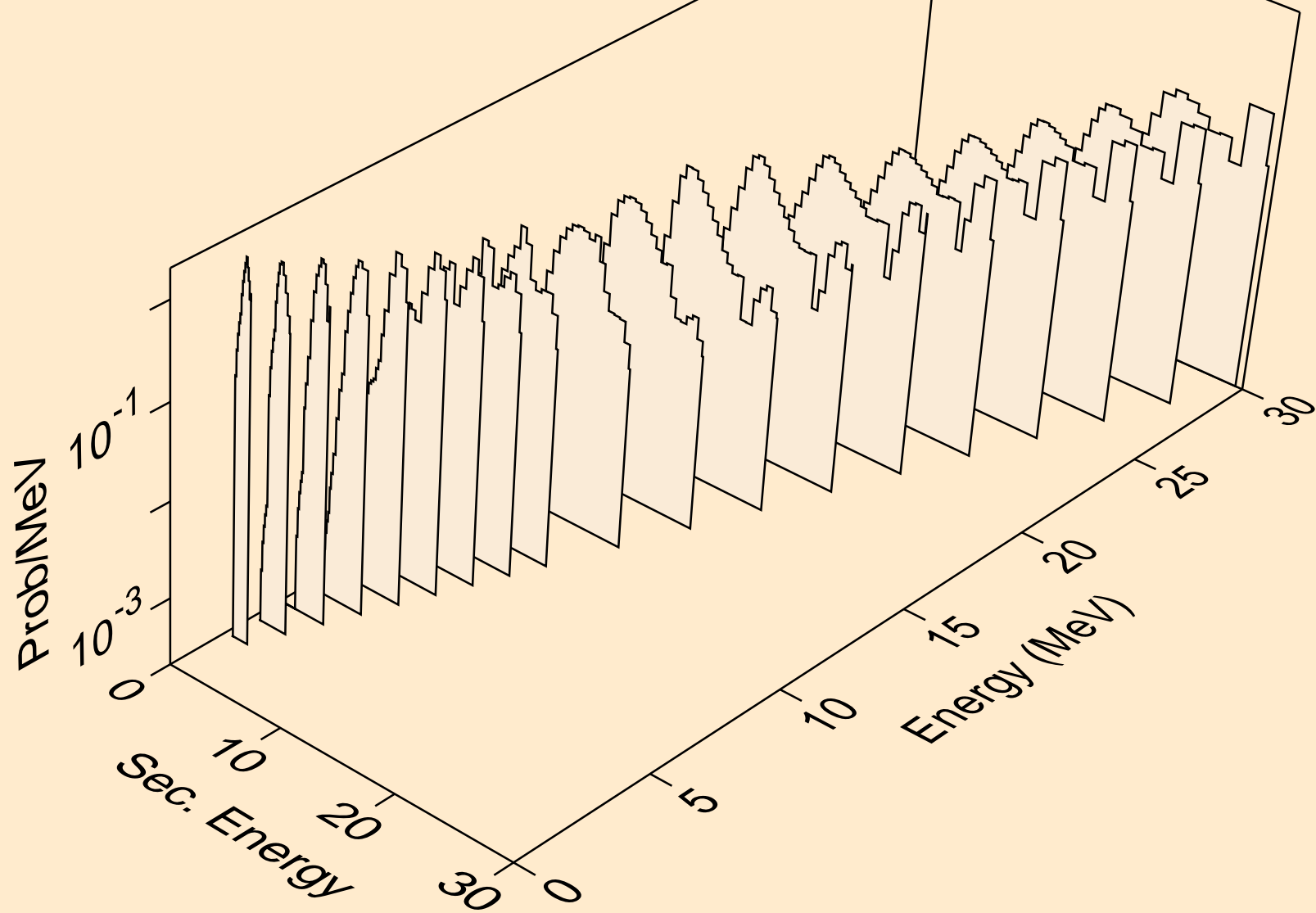

CD102 PROTON ACER TENDL-2023 LIBRARY; T=0.K  
Proton emission for (p,2p)

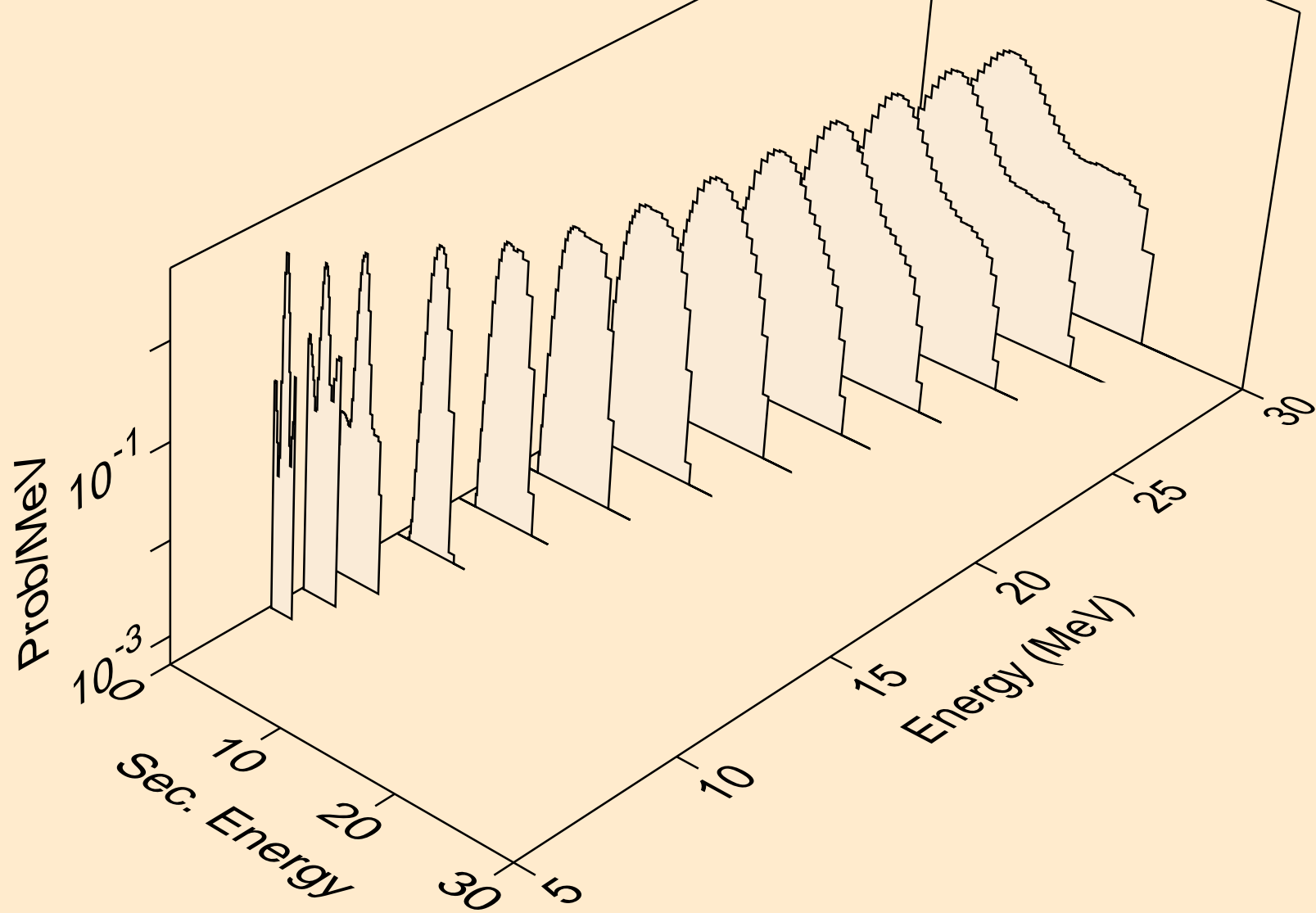



CD102 PROTON ACER TENDL-2023 LIBRARY; T=0.K  
Proton emission for (p,pa)

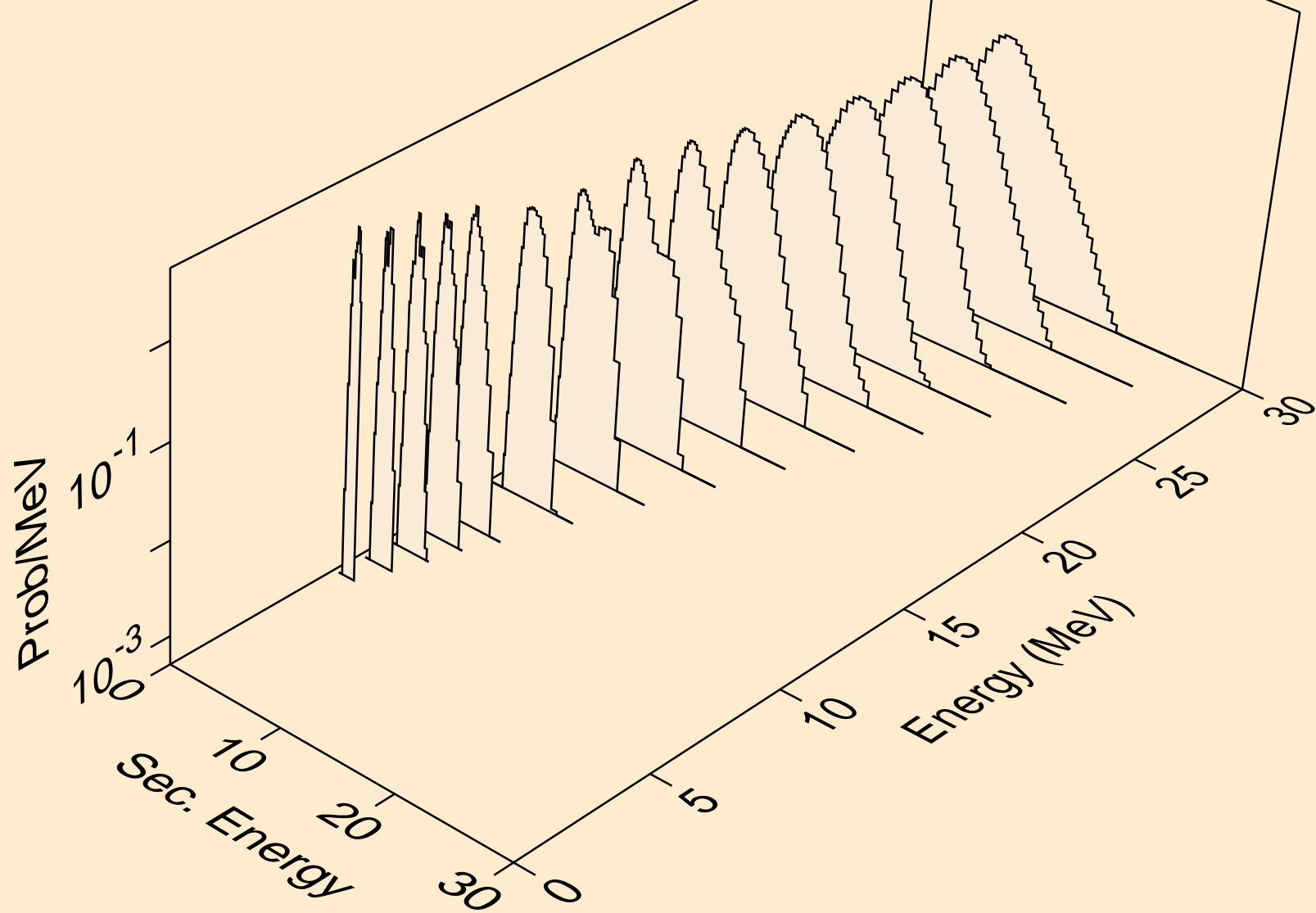

CD102 PROTON ACER TENDL-2023 LIBRARY; T=0.K  
Proton emission for (p,pd)

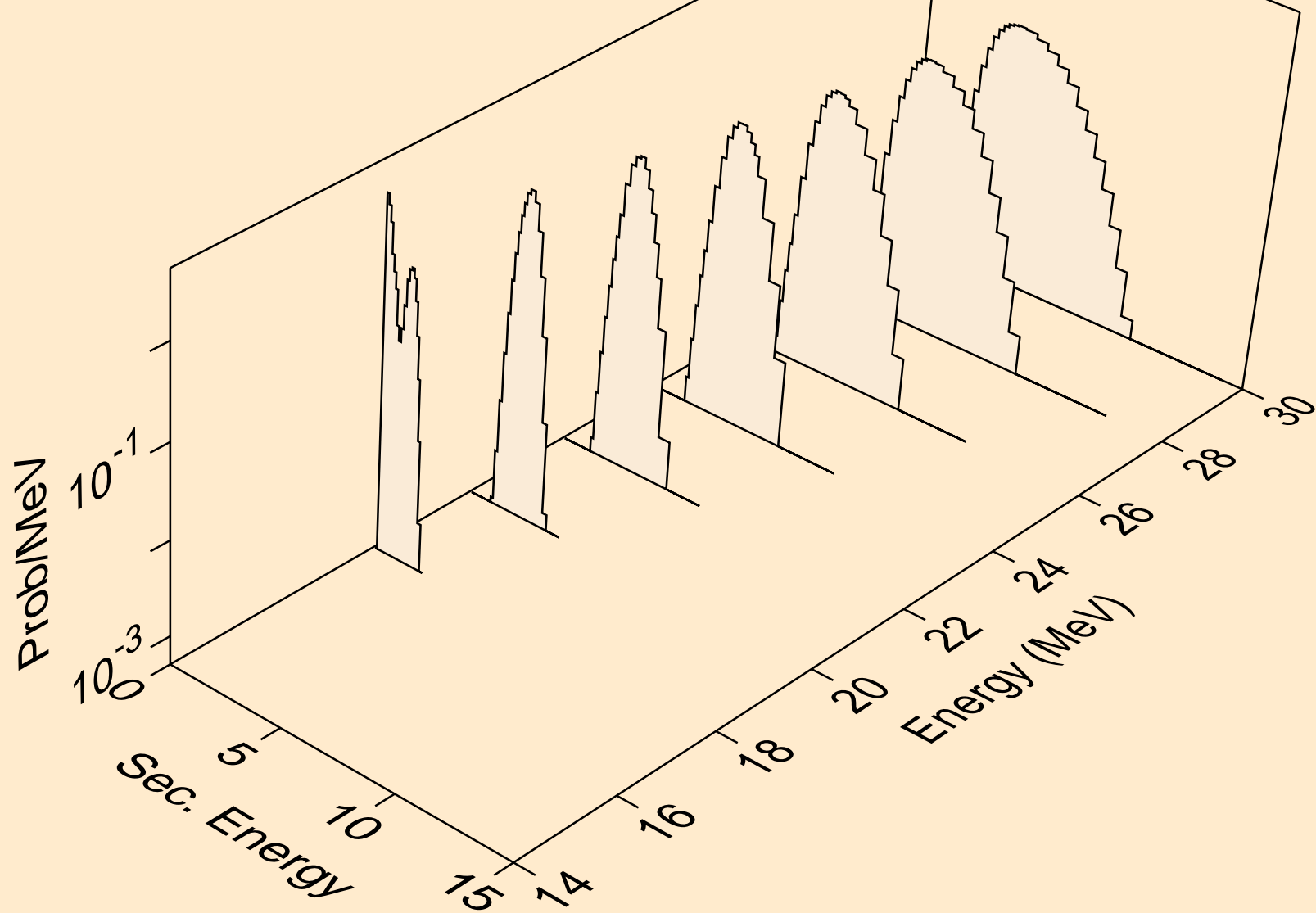

CD102 PROTON ACER TENDL-2023 LIBRARY; T=0.K  
Proton emission for (p,pt)

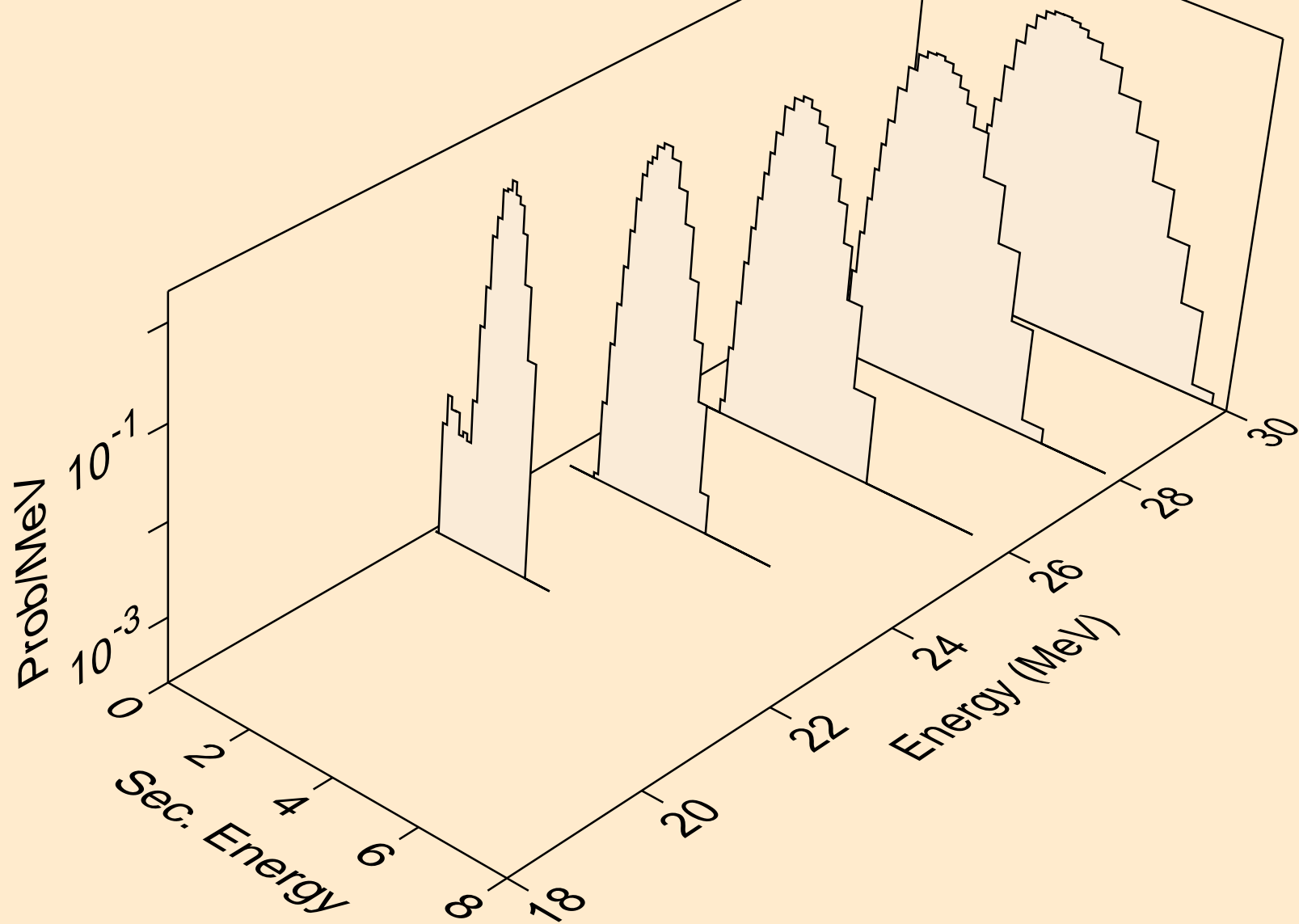

CD102 PROTON ACER TENDL-2023 LIBRARY; T=0.K  
Photon emission for (z,n)

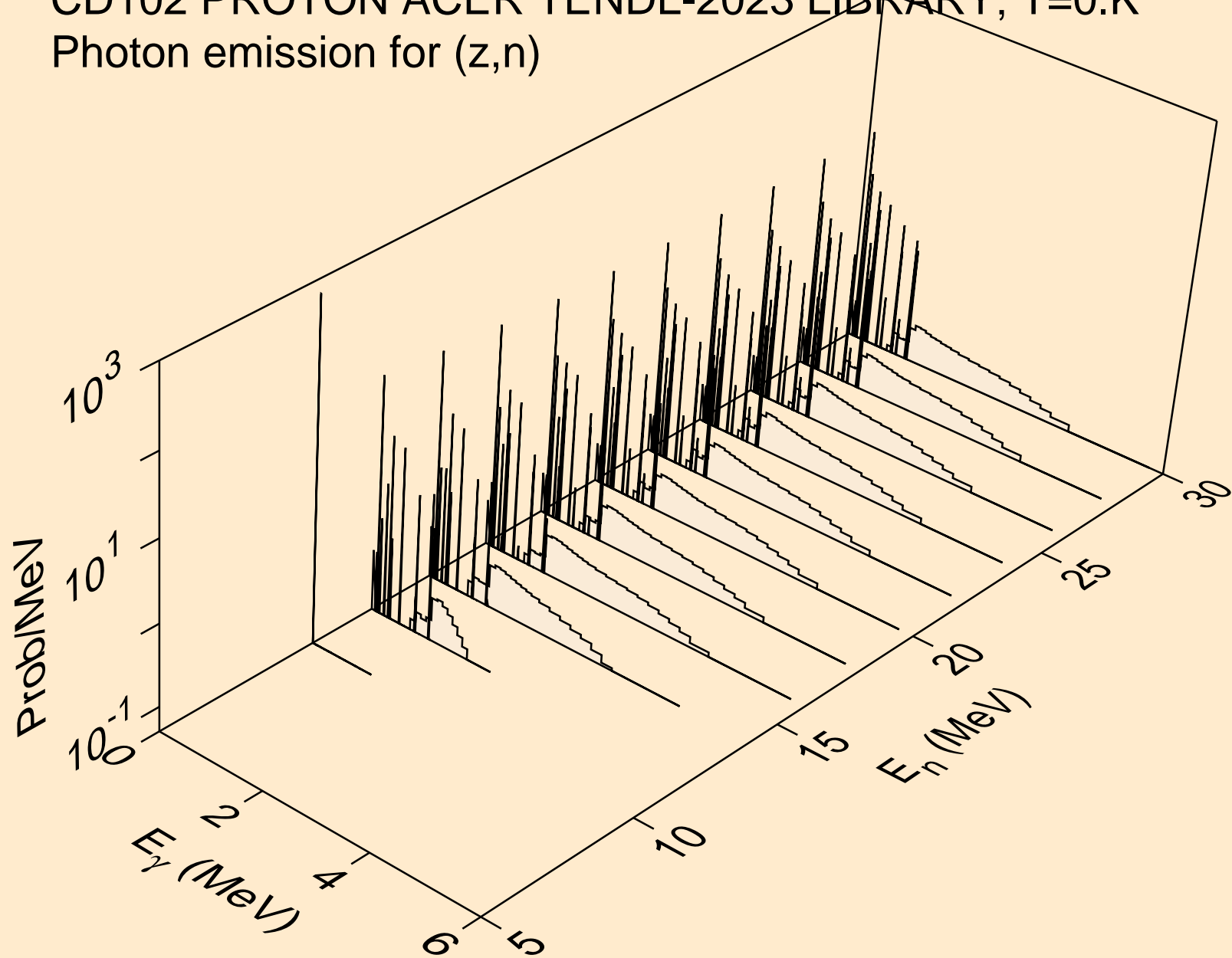

CD102 PROTON ACER TENDL-2023 LIBRARY; T=0.K  
Photon emission for (z,x)

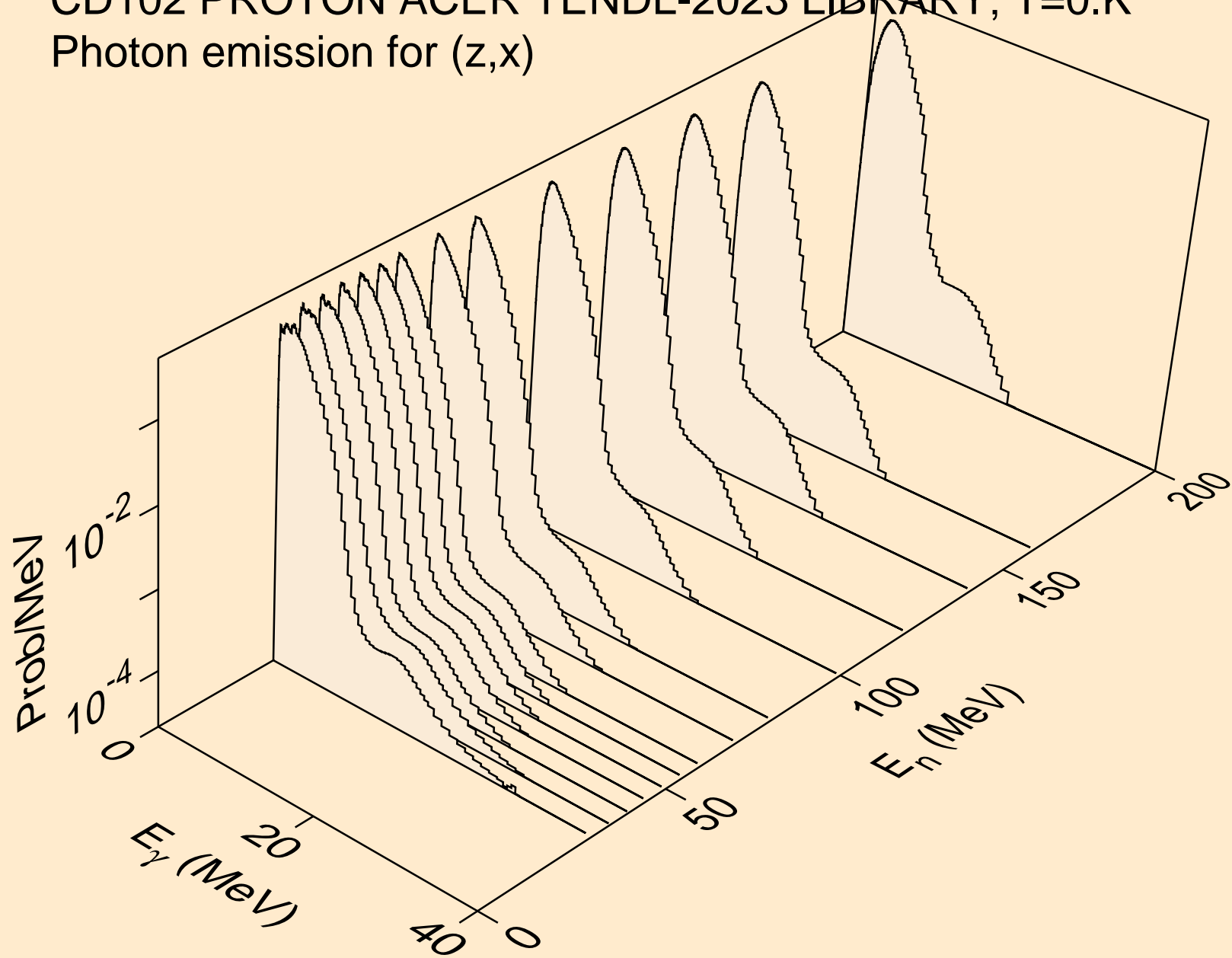

CD102 PROTON ACER TENDL-2023 LIBRARY; T=0.K  
Photon emission for (n,2n)

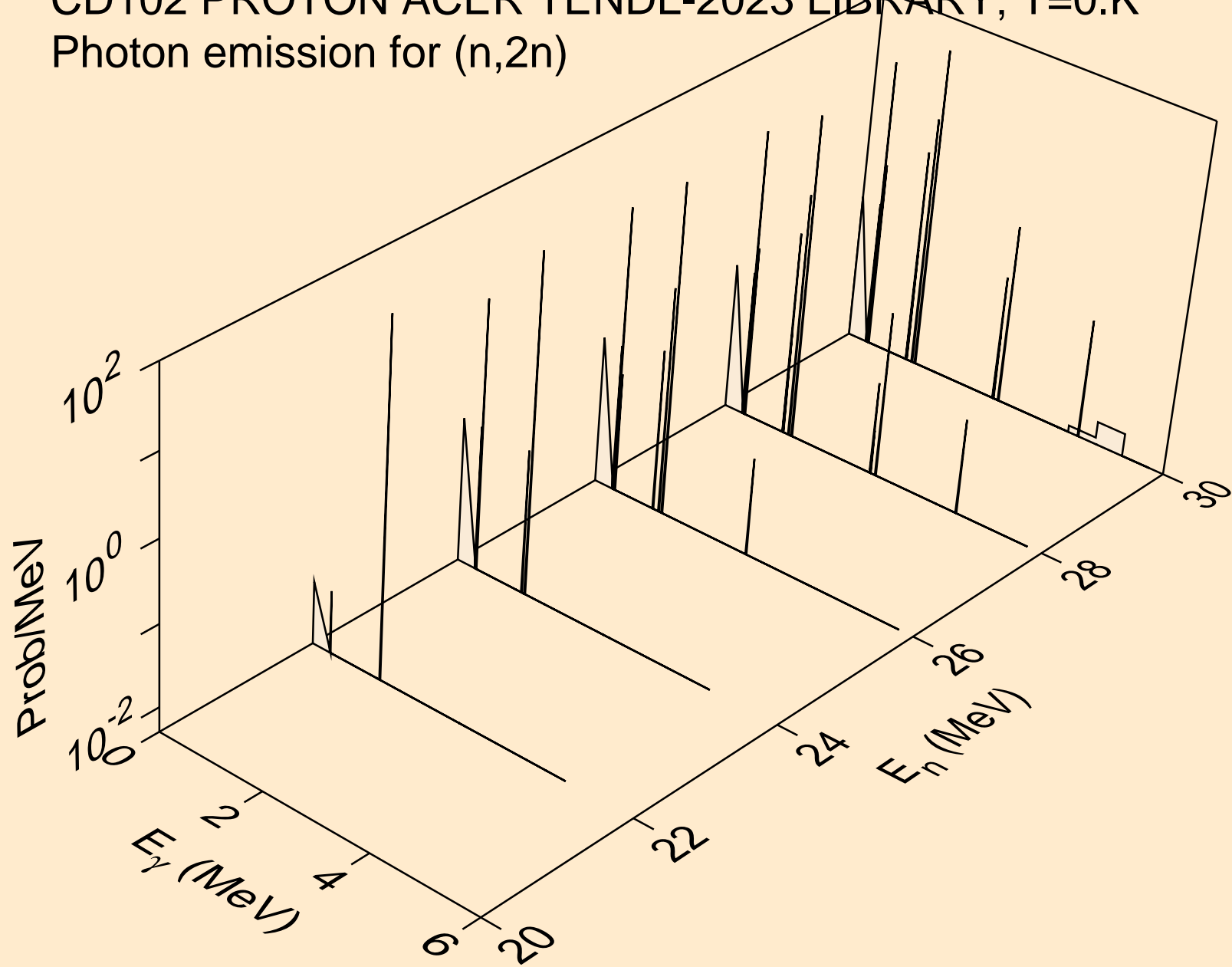

CD102 PROTON ACER TENDL-2023 LIBRARY; T=0.K  
Photon emission for (n,n\*)a

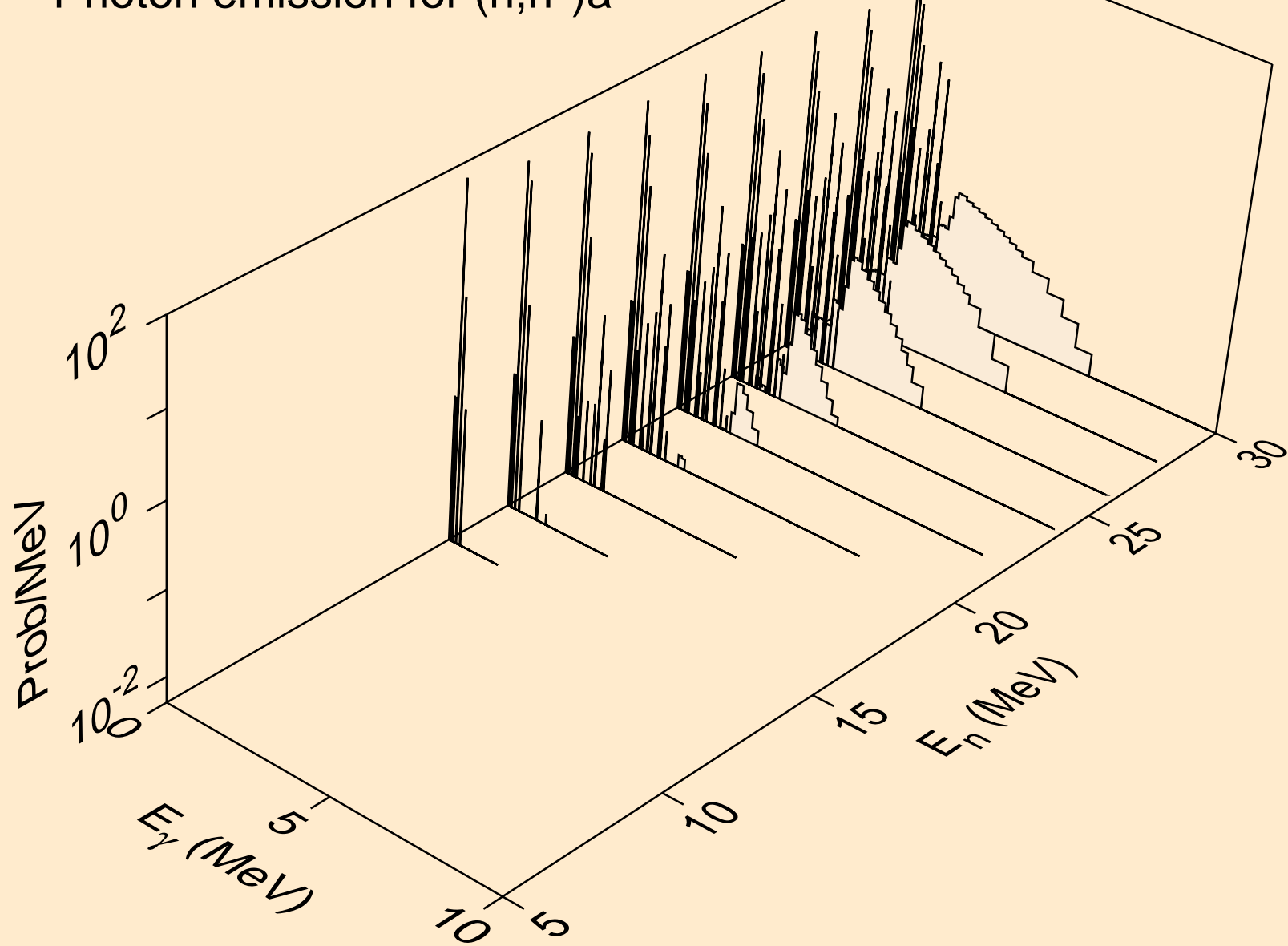

CD102 PROTON ACER TENDL-2023 LIBRARY; T=0.K  
Photon emission for (n,2n)a

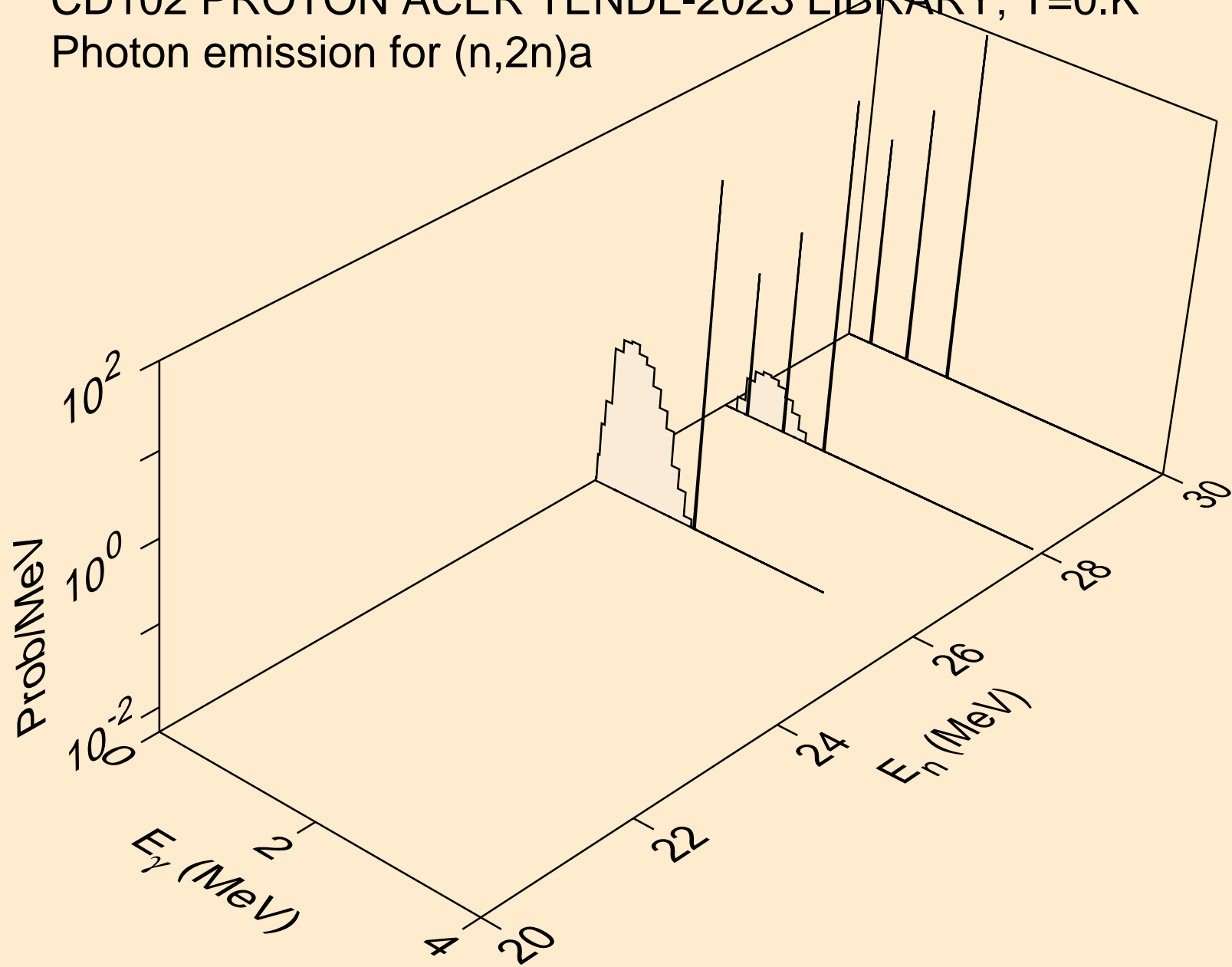



CD102 PROTON ACER TENDL-2023 LIBRARY; T=0.K  
Photon emission for (n,n\*)p

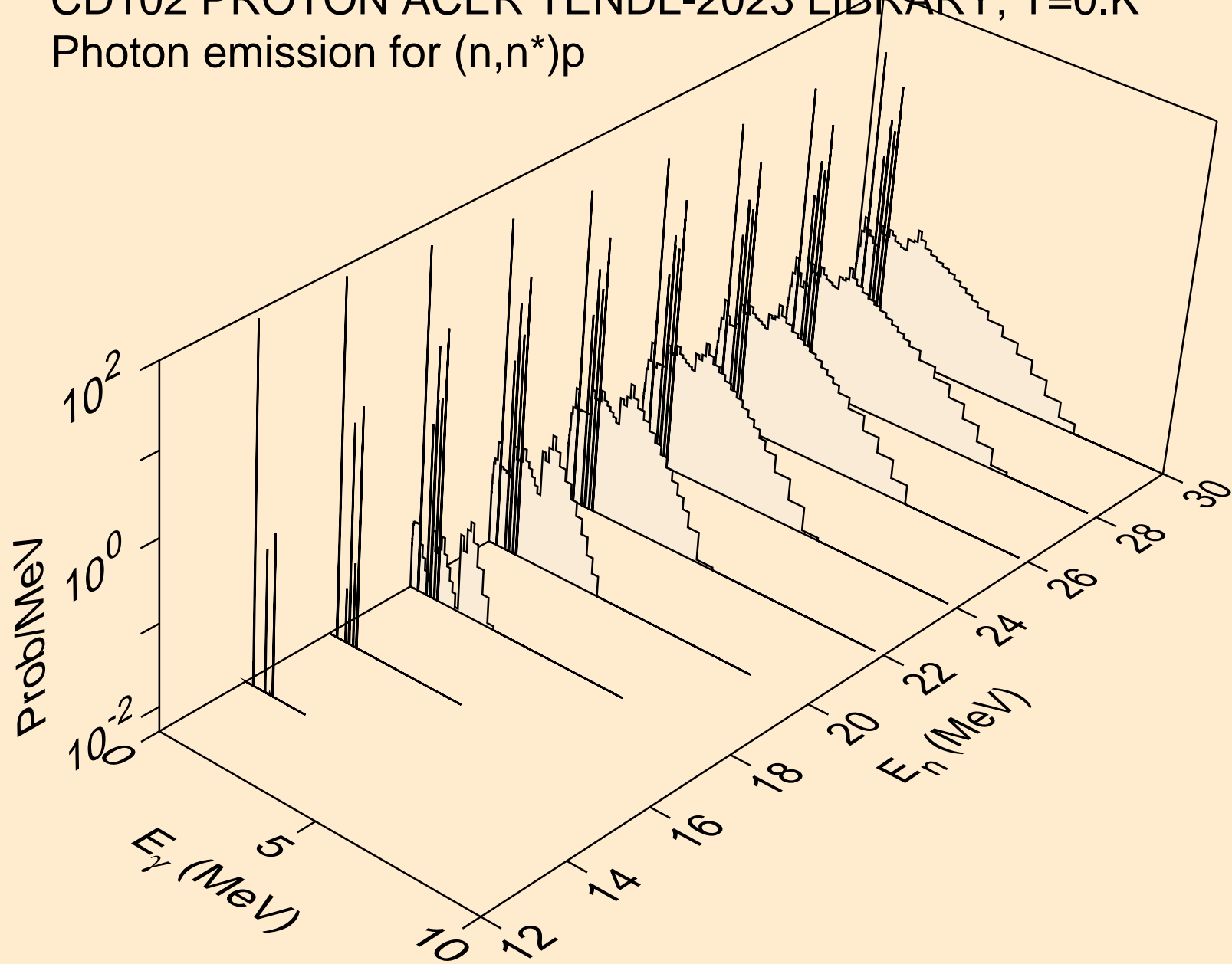

CD102 PROTON ACER TENDL-2023 LIBRARY; T=0.K  
Photon emission for (n,n\*)d

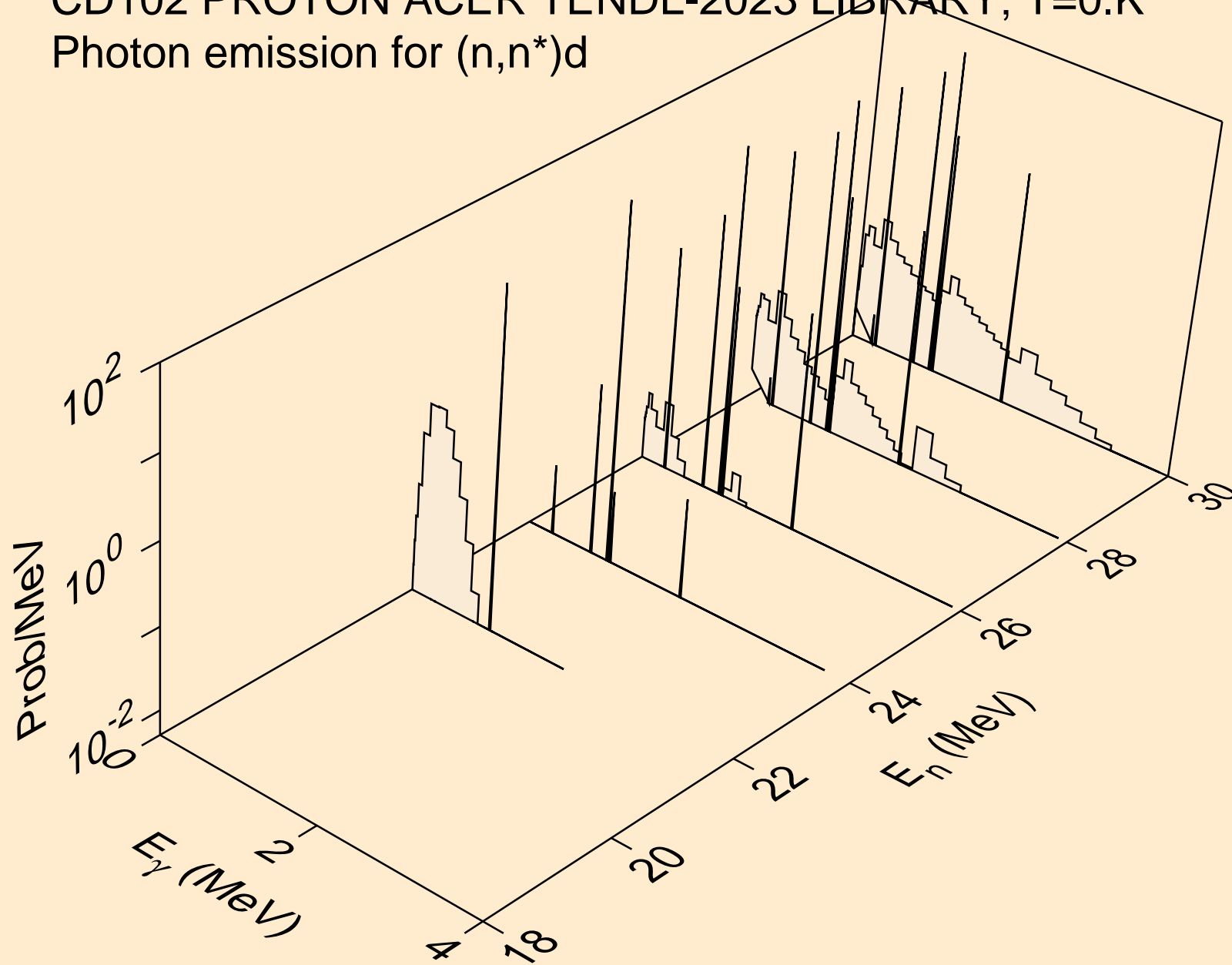

CD102 PROTON ACER TENDL-2023 LIBRARY; T=0.K  
Photon emission for (n,n\*)t

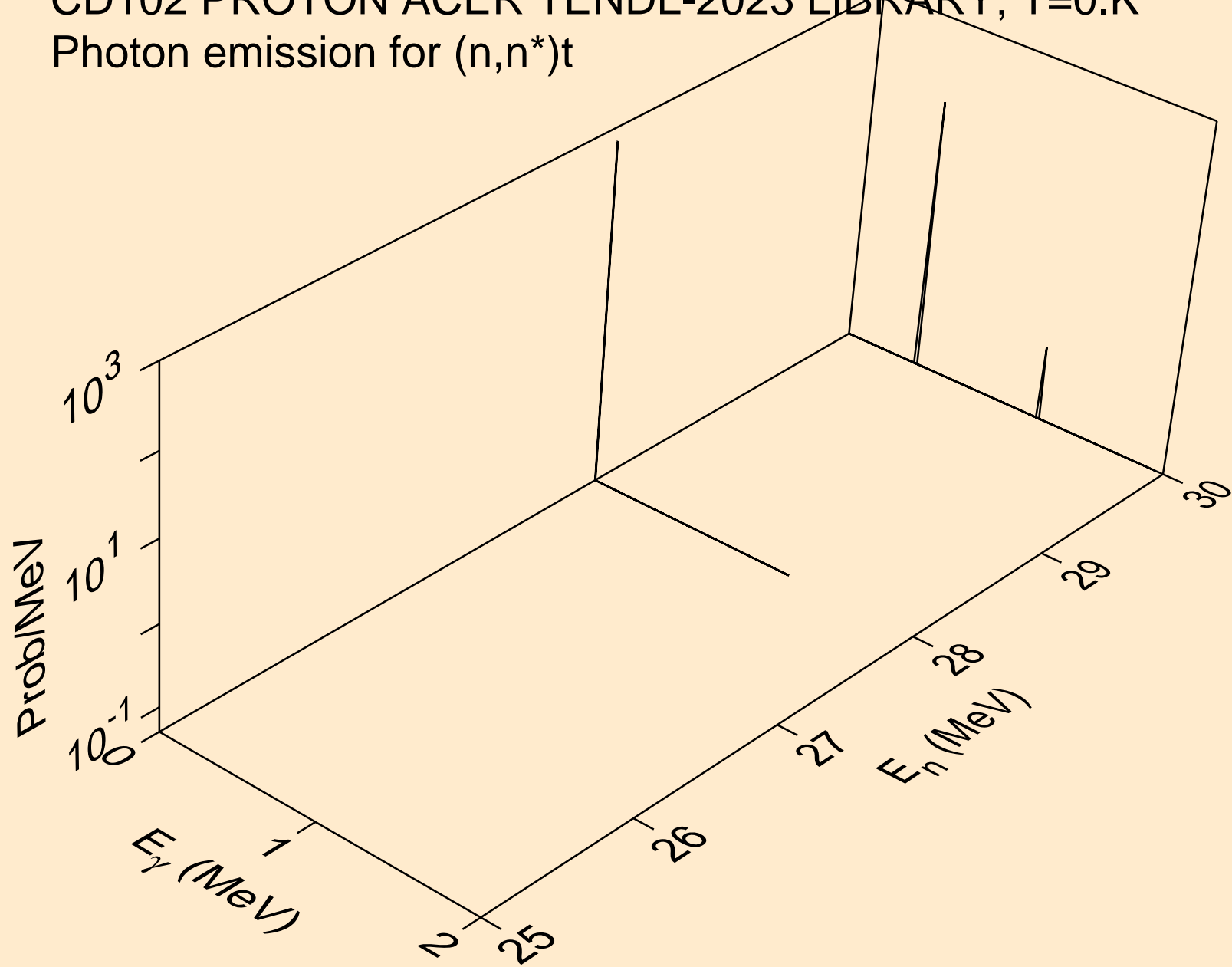

CD102 PROTON ACER TENDL-2023 LIBRARY; T=0.K  
Photon emission for (n,n\*)he3

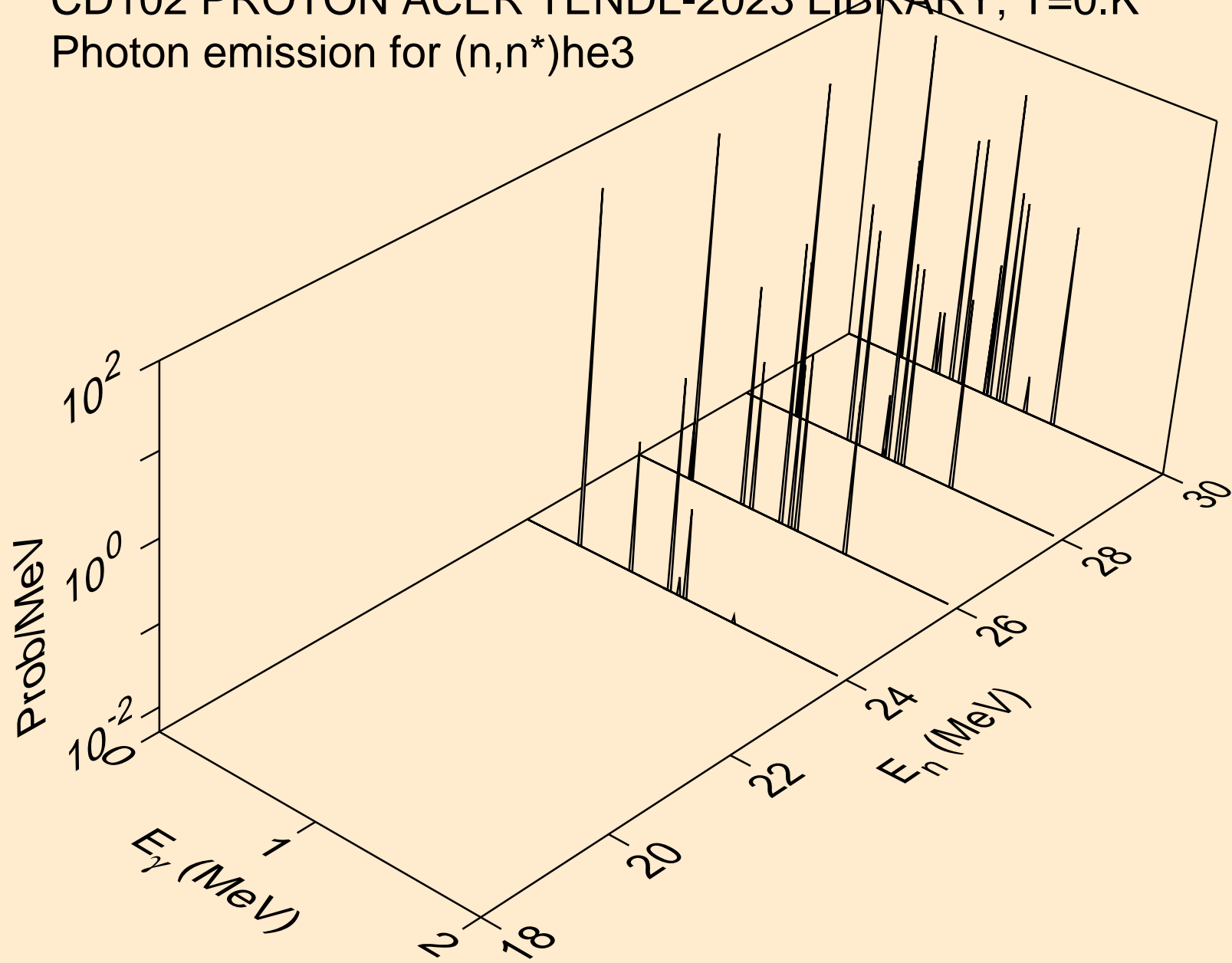

CD102 PROTON ACER TENDL-2023 LIBRARY; T=0.K  
Photon emission for (n,2np)

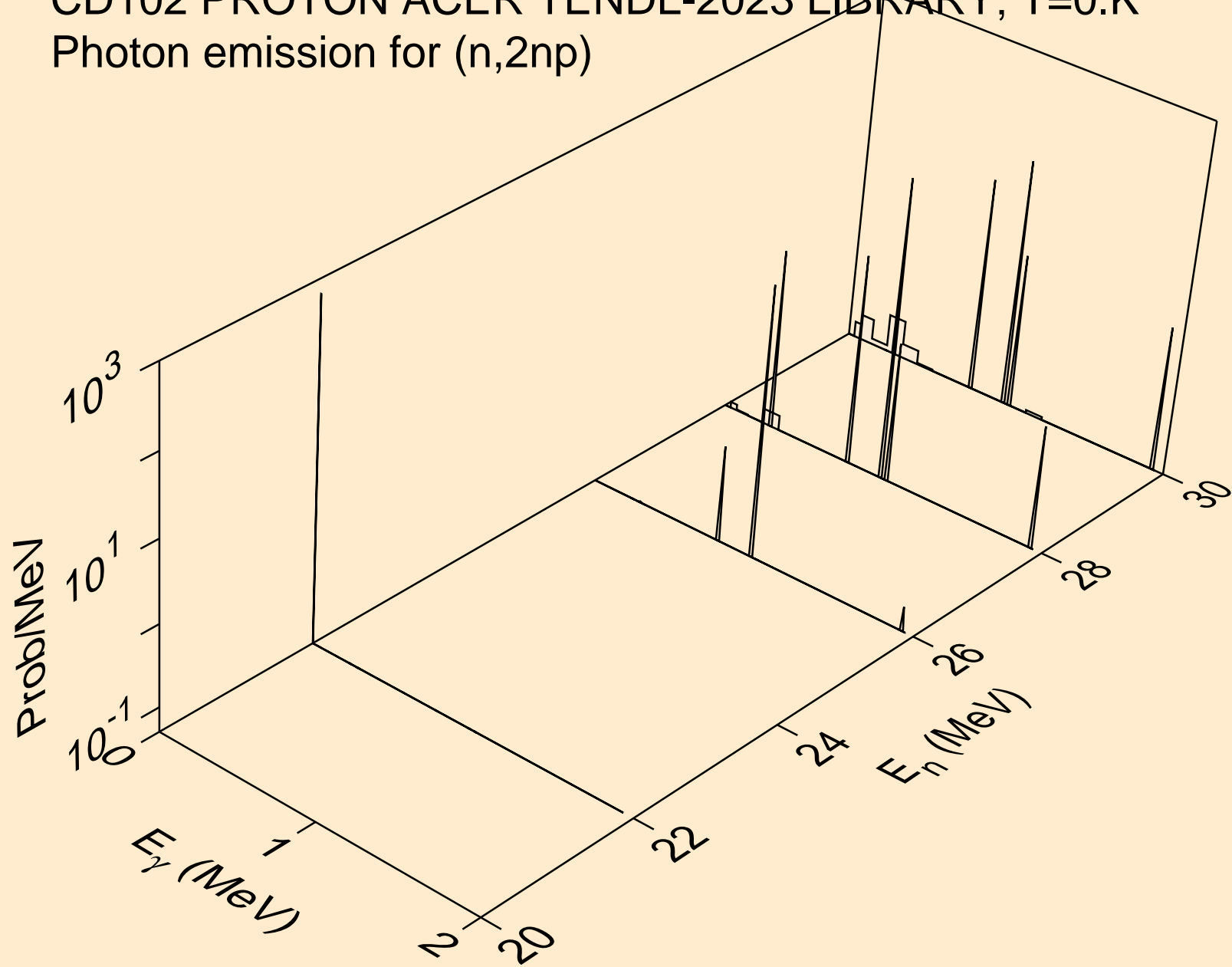

CD102 PROTON ACER TENDL-2023 LIBRARY; T=0.K  
Photon emission for (n,n2p)

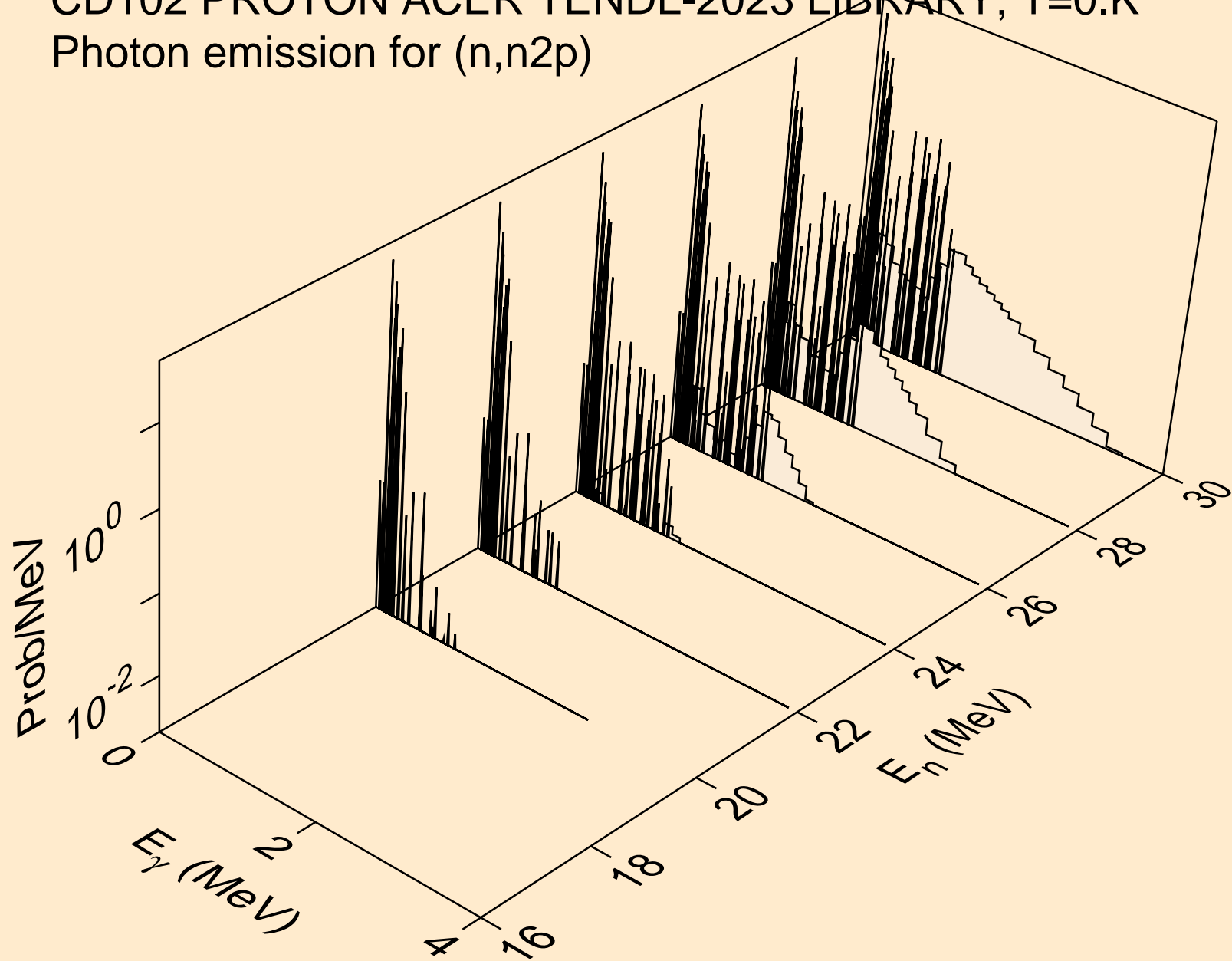

CD102 PROTON ACER TENDL-2023 LIBRARY; T=0.K  
Photon emission for (n,npa)

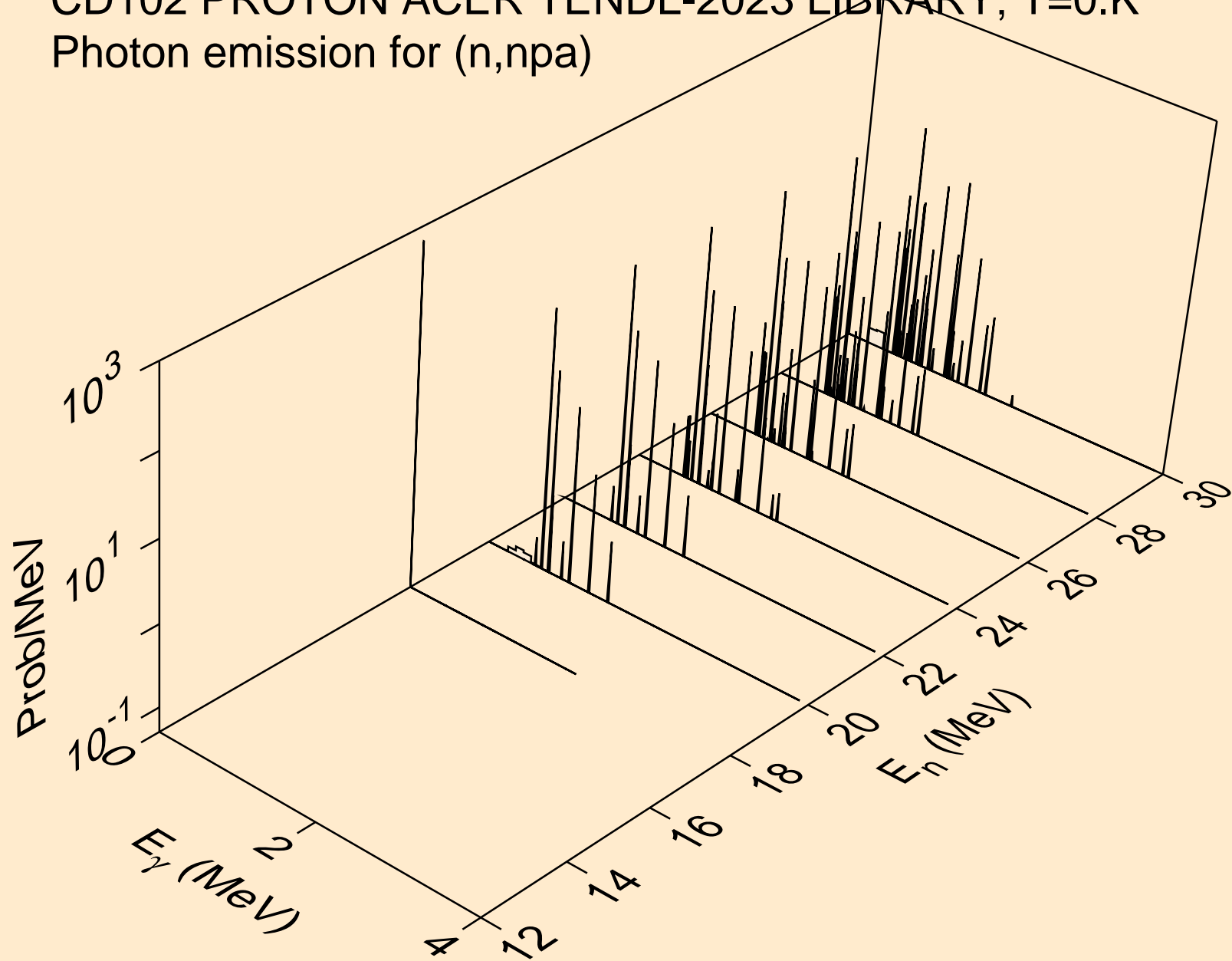

CD102 PROTON ACER TENDL-2023 LIBRARY; T=0.K  
Photon emission for (n,gma)

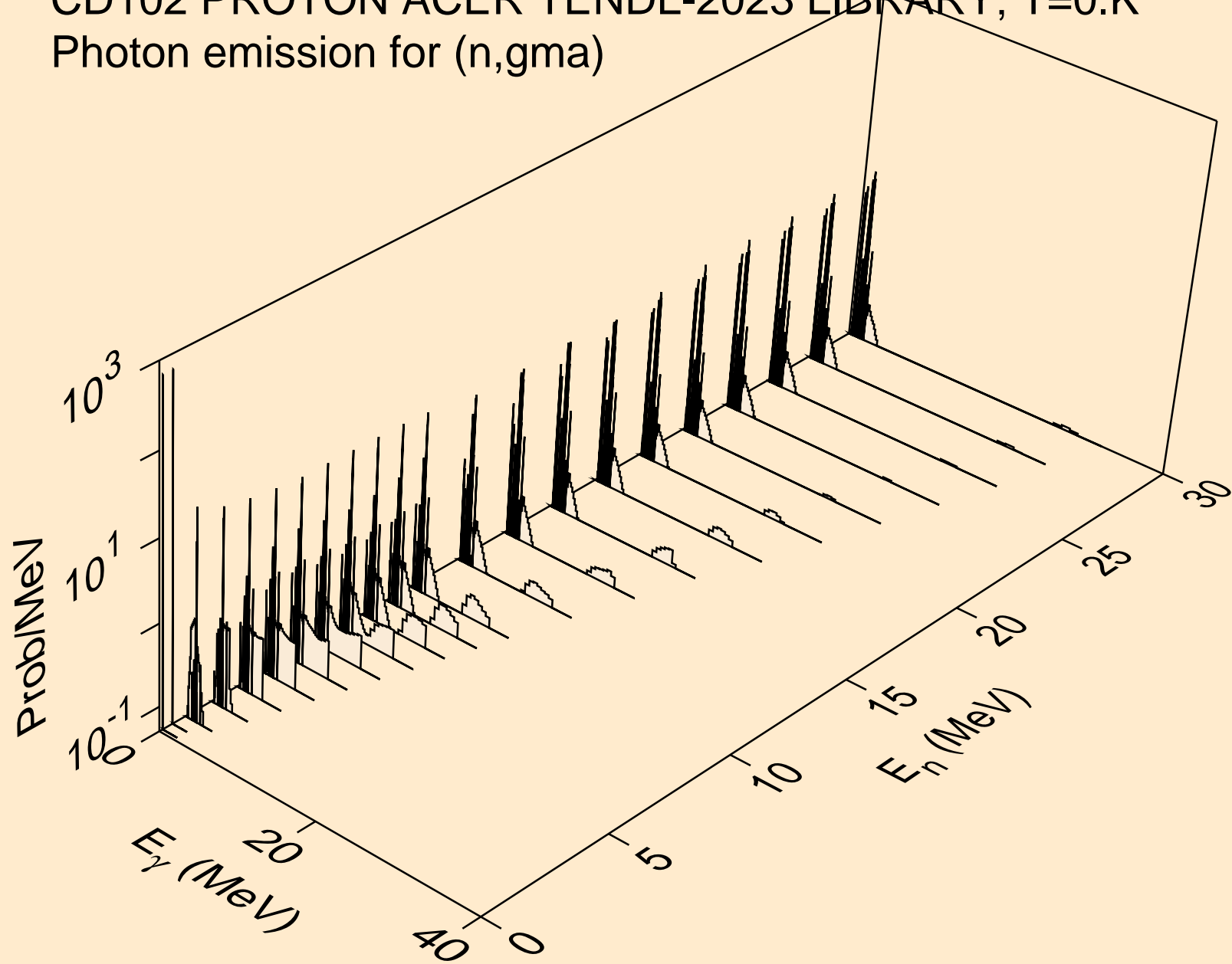



CD102 PROTON ACER TENDL-2023 LIBRARY; T=0.K  
Photon emission for inelastic

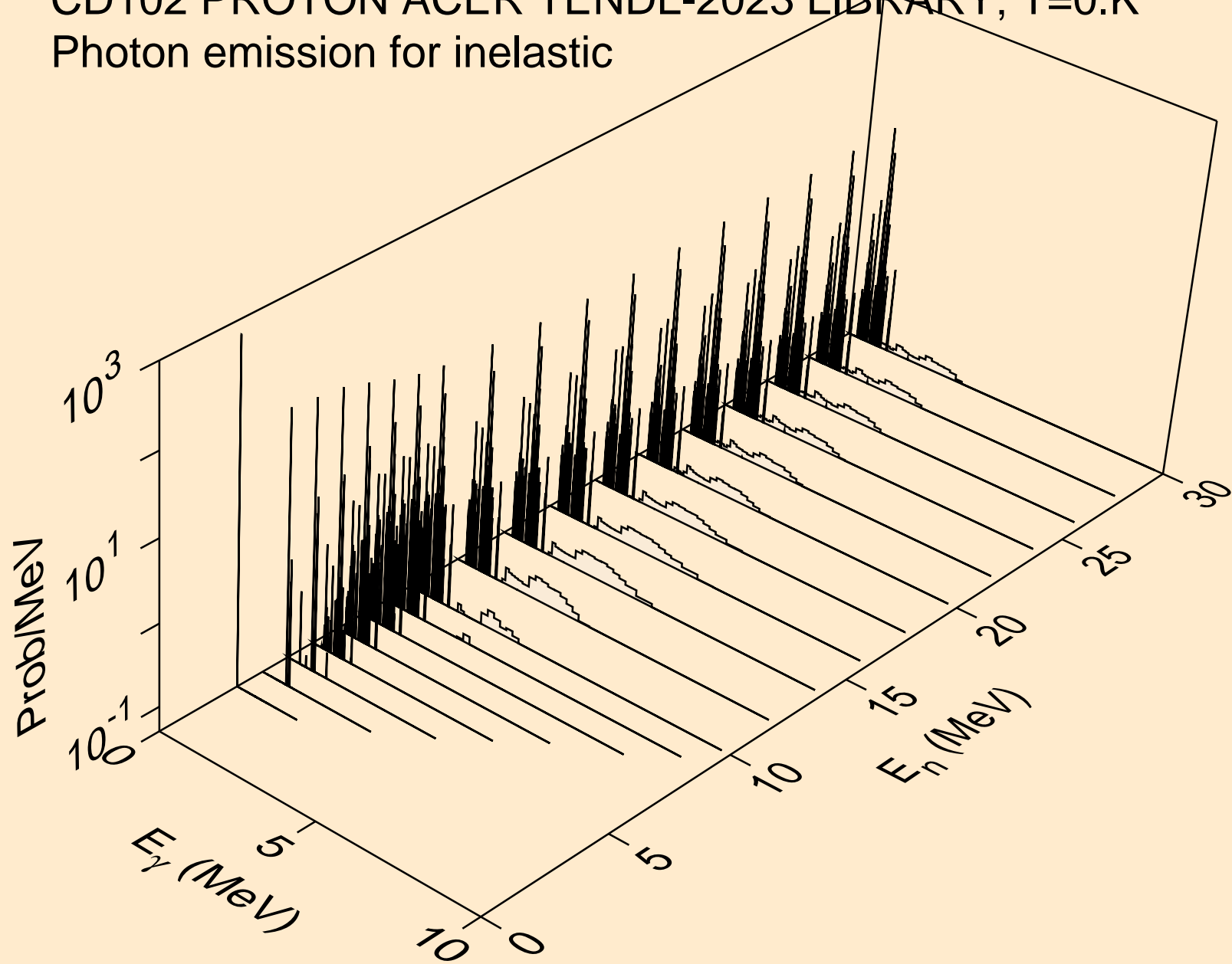

CD102 PROTON ACER TENDL-2023 LIBRARY; T=0.K  
Photon emission for (n,d)

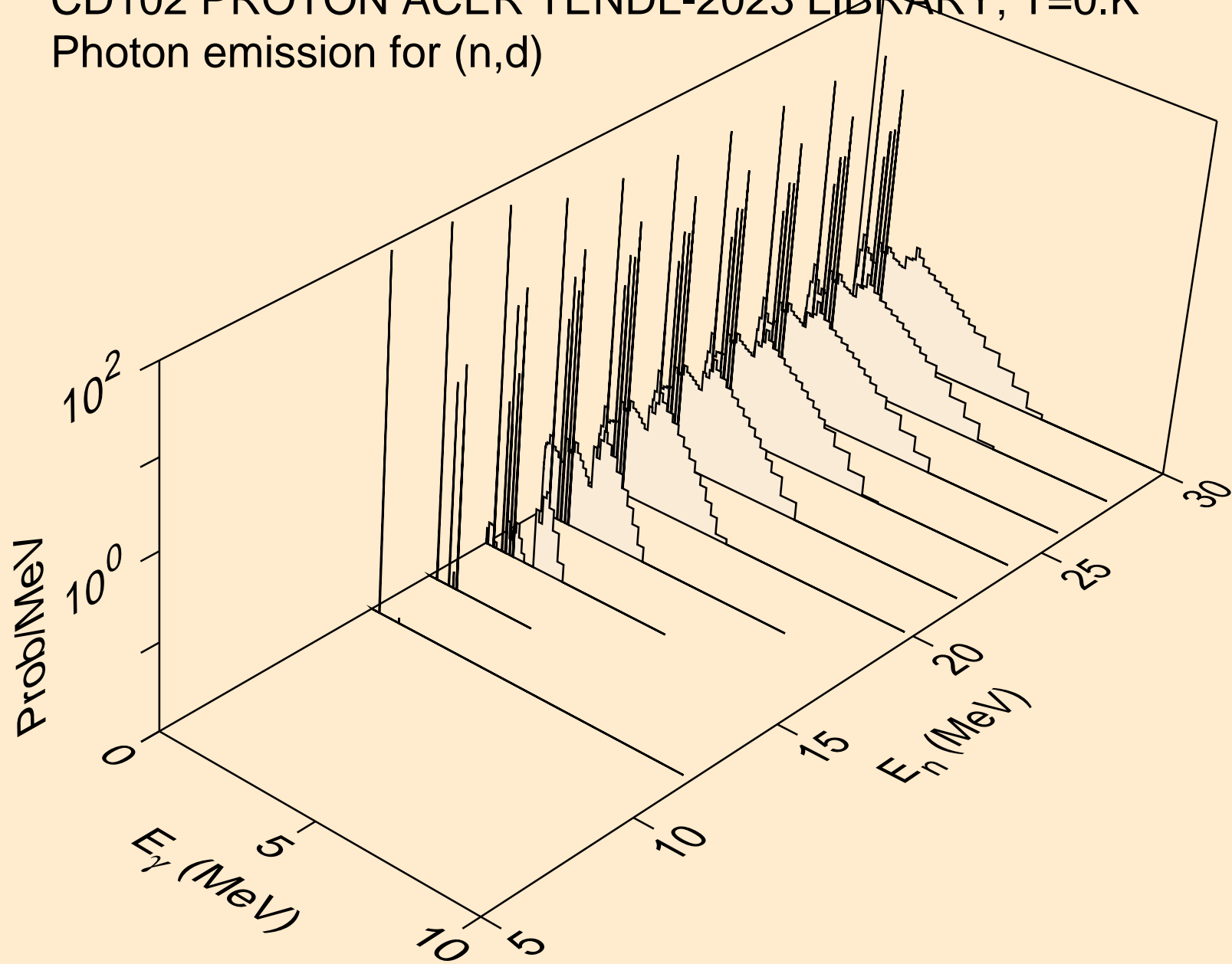

CD102 PROTON ACER TENDL-2023 LIBRARY; T=0.K  
Photon emission for (n,t)

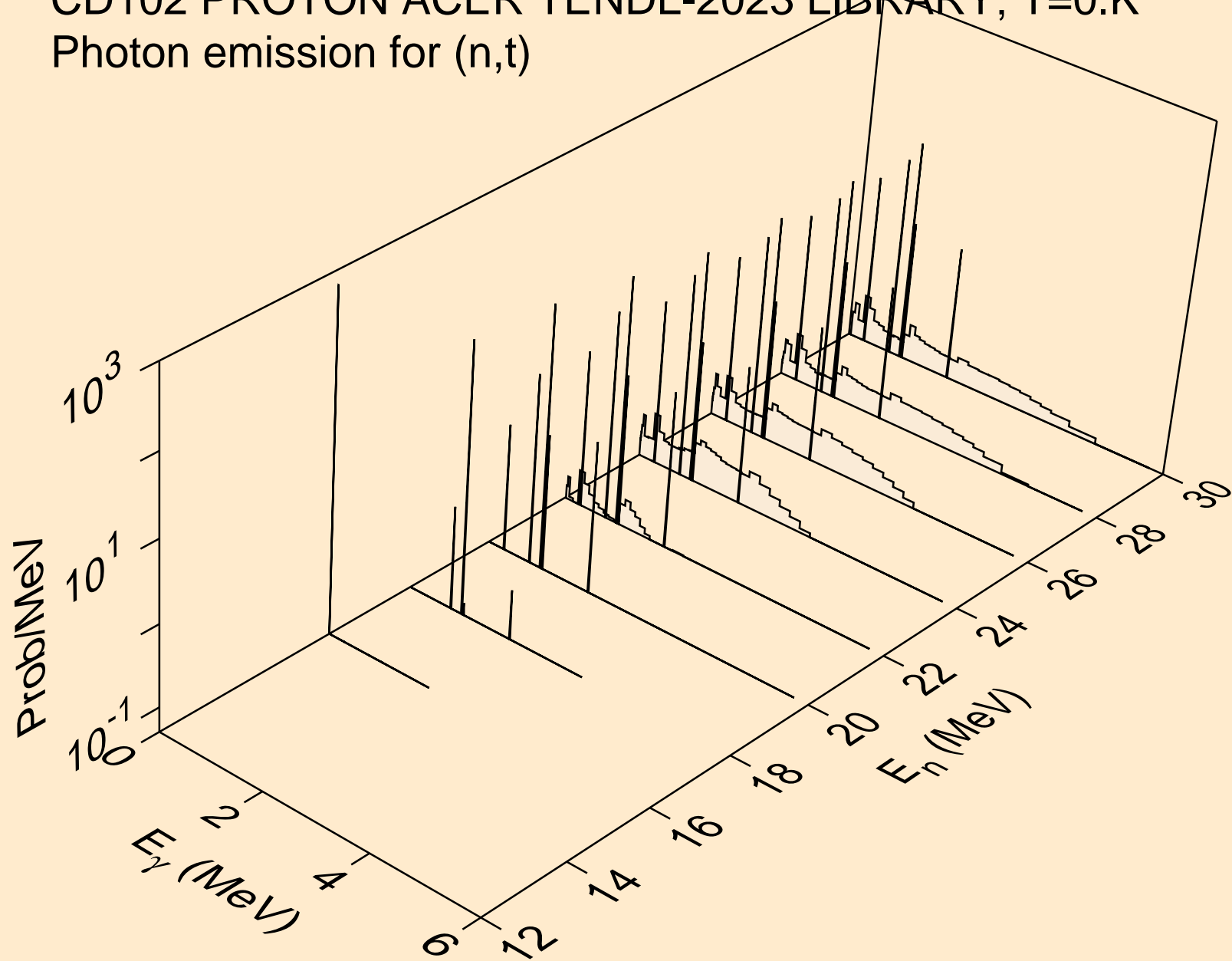

CD102 PROTON ACER TENDL-2023 LIBRARY; T=0.K  
Photon emission for (n,he3)

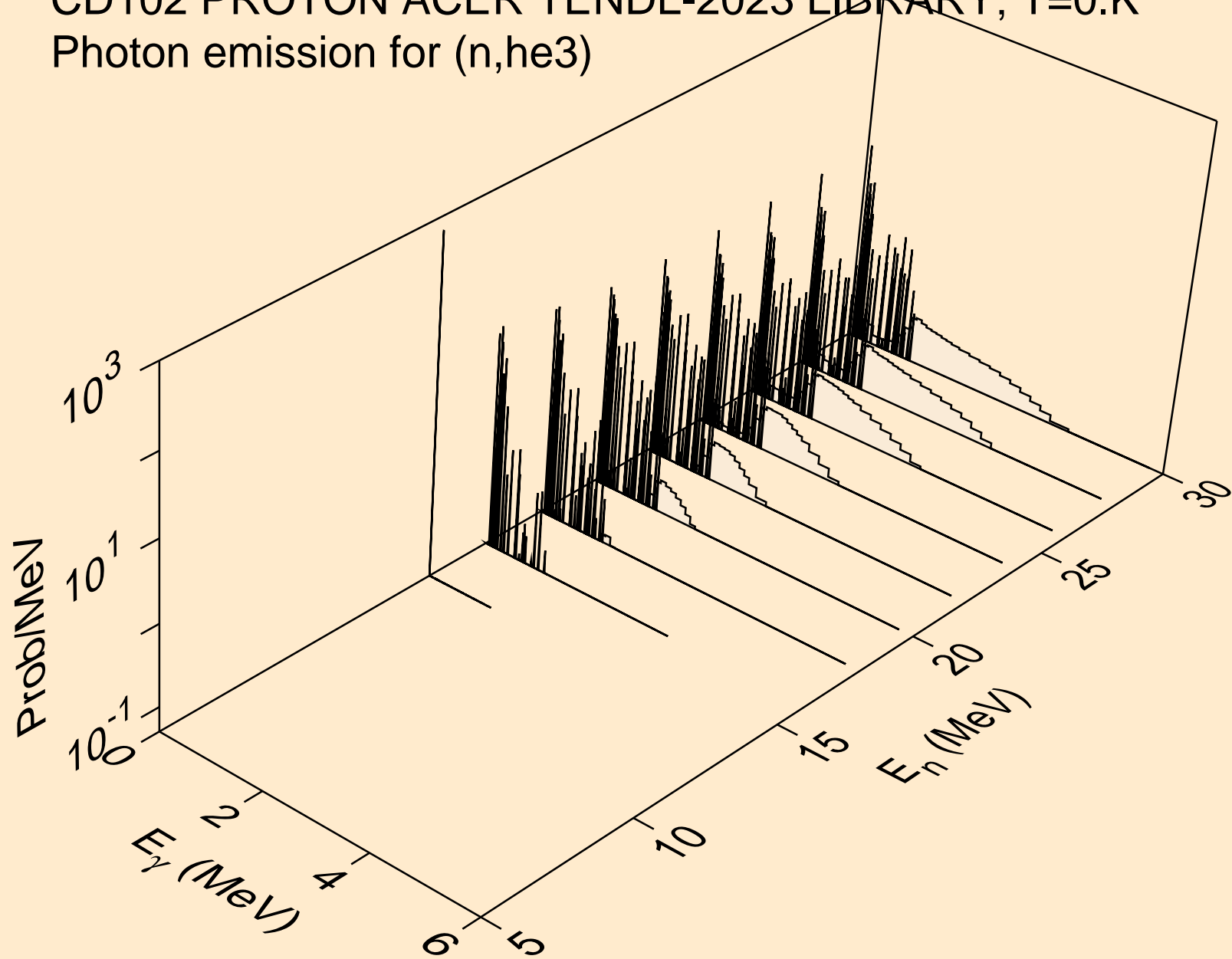

CD102 PROTON ACER TENDL-2023 LIBRARY; T=0.K  
Photon emission for (n,a)

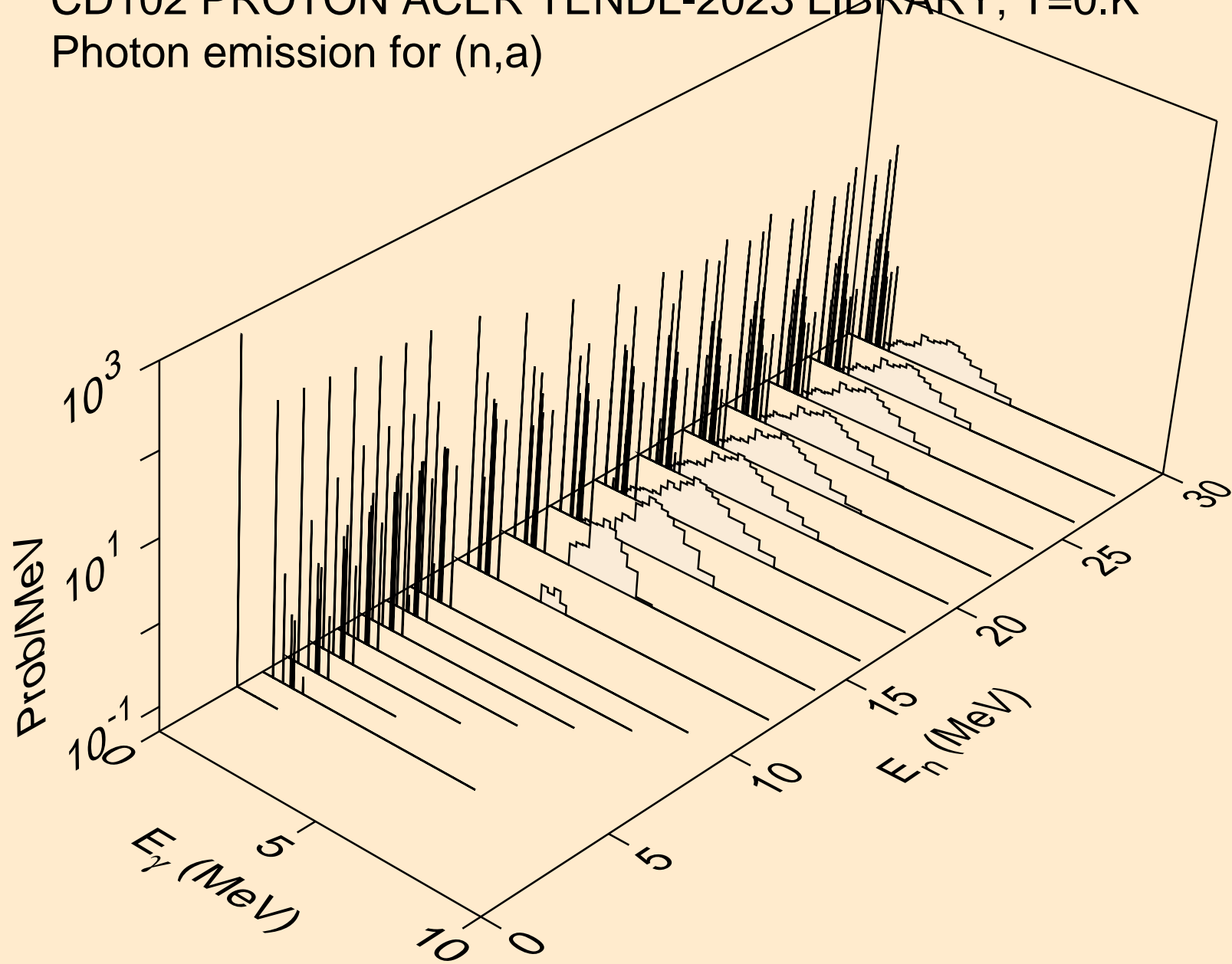

CD102 PROTON ACER TENDL-2023 LIBRARY; T=0.K  
Photon emission for (n,2a)

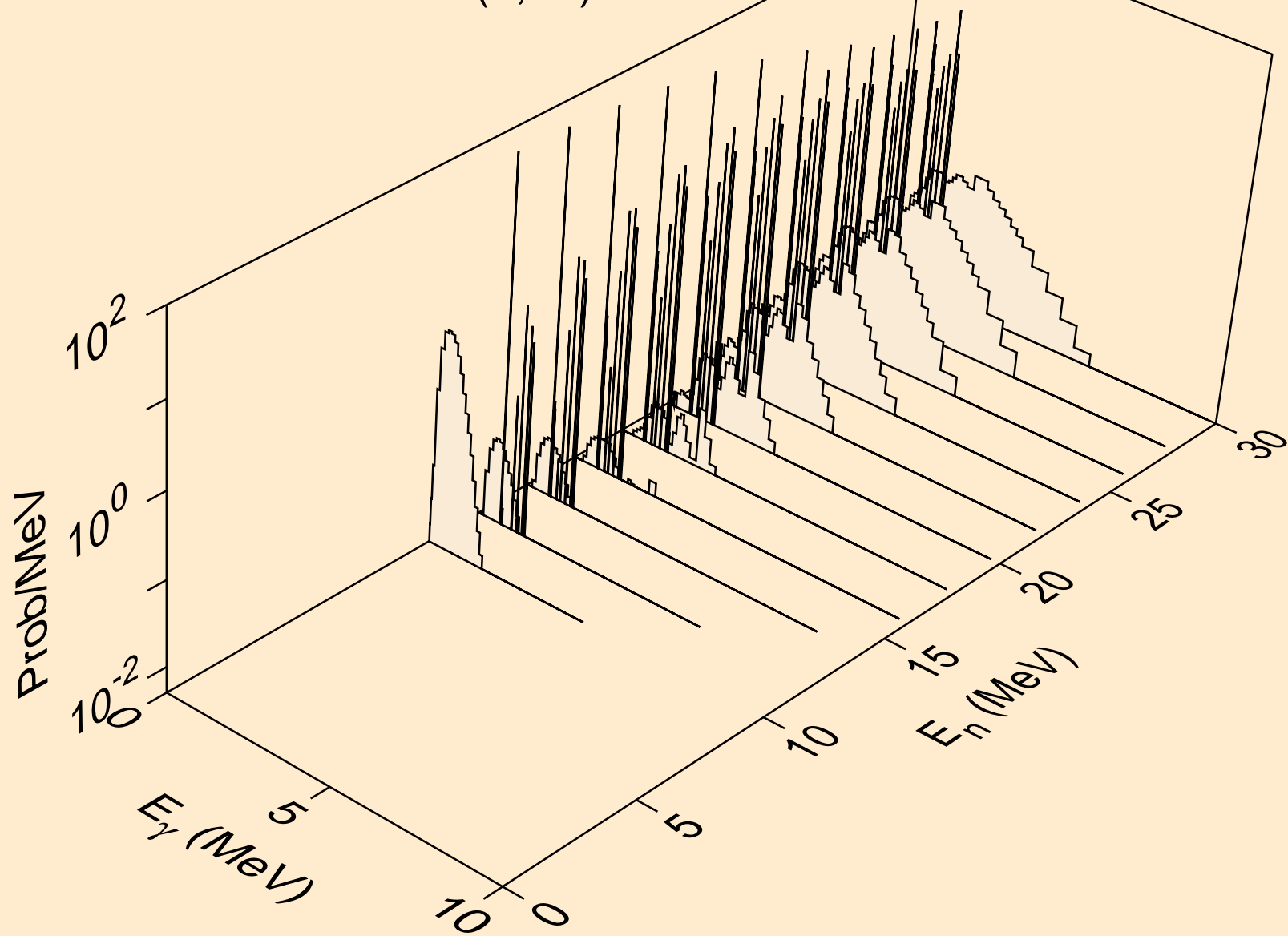

CD102 PROTON ACER TENDL-2023 LIBRARY; T=0.K  
Photon emission for (n,2p)

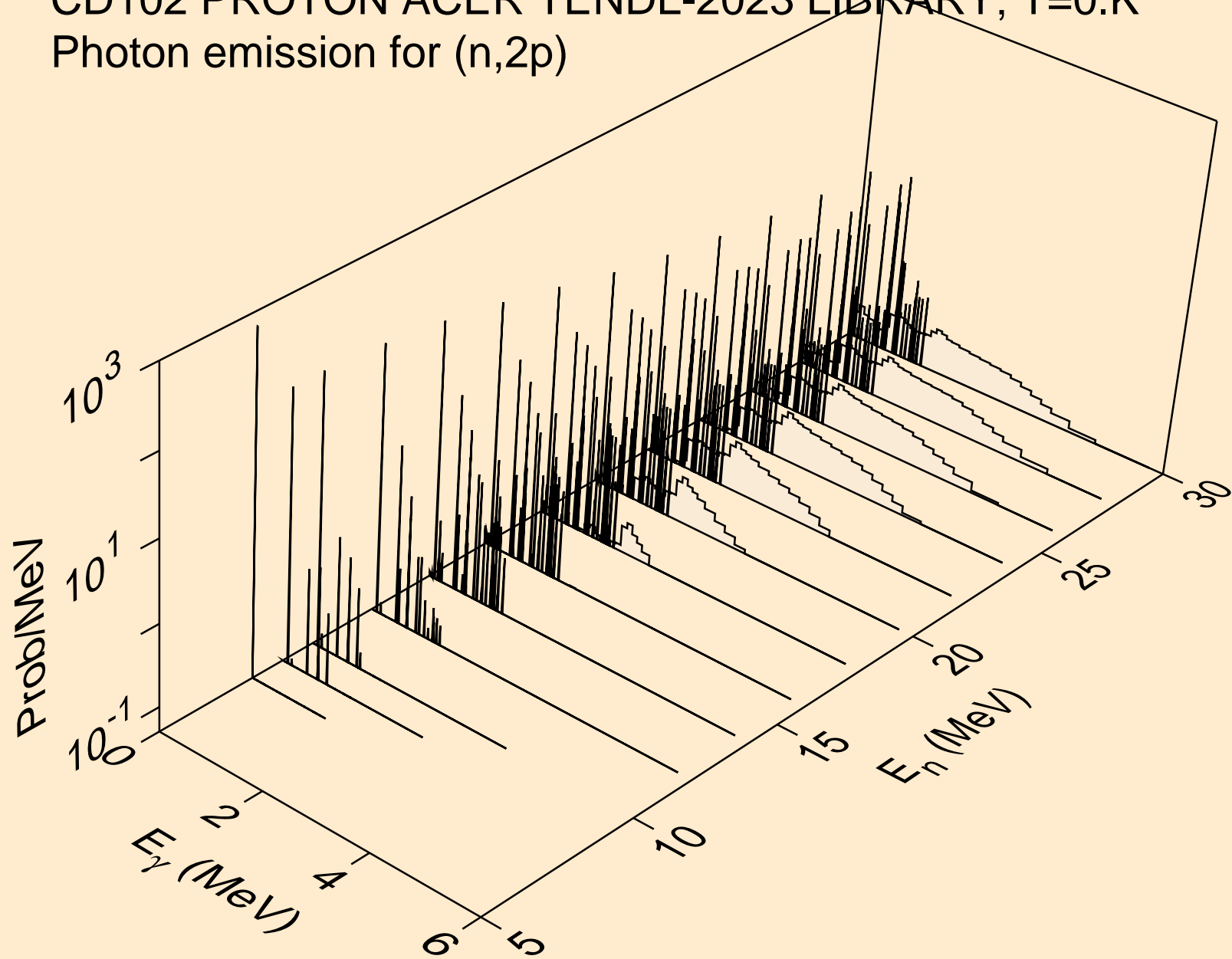

CD102 PROTON ACER TENDL-2023 LIBRARY; T=0.K  
Photon emission for (n,pa)

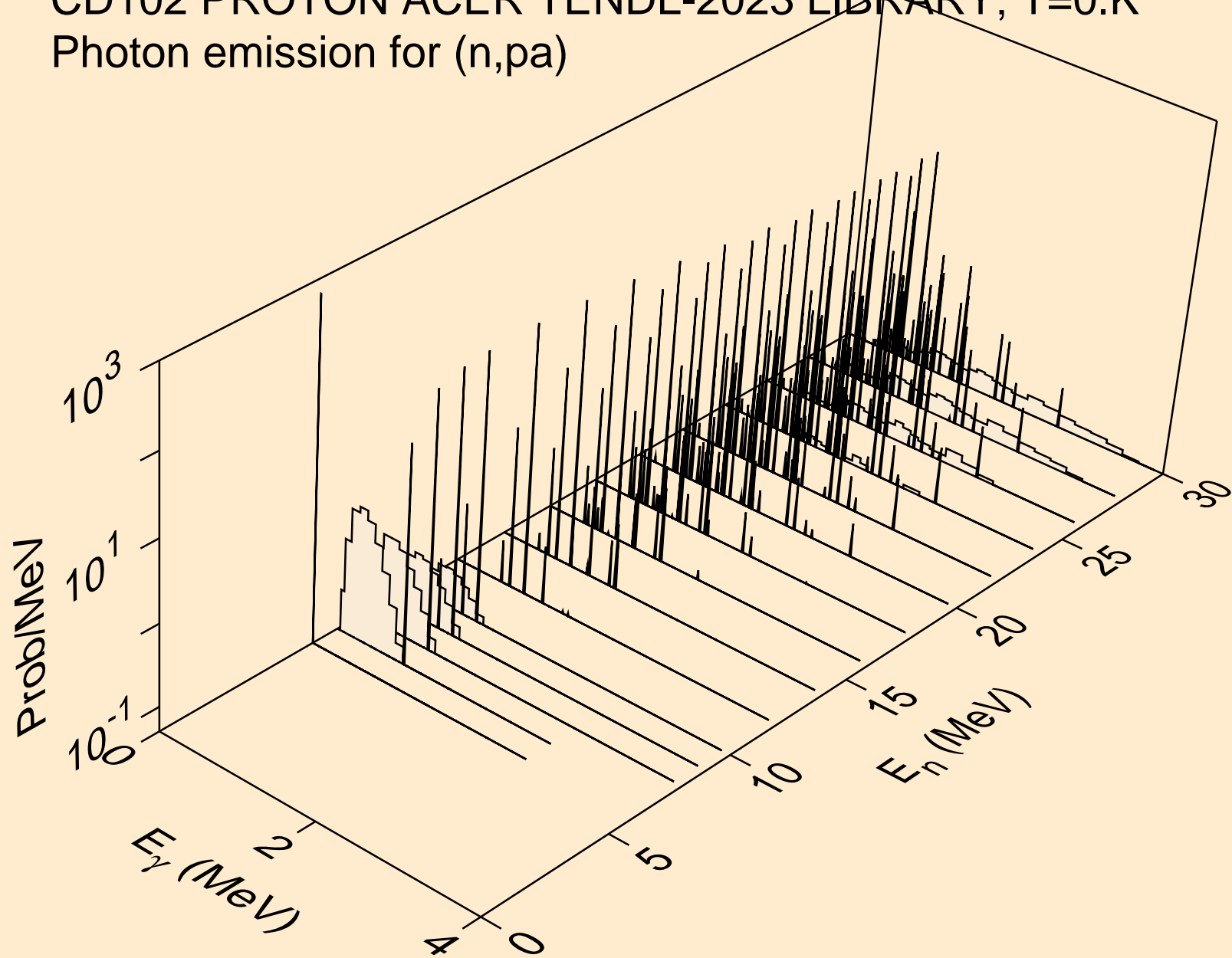



CD102 PROTON ACER TENDL-2023 LIBRARY; T=0.K  
Photon emission for (n,pd)

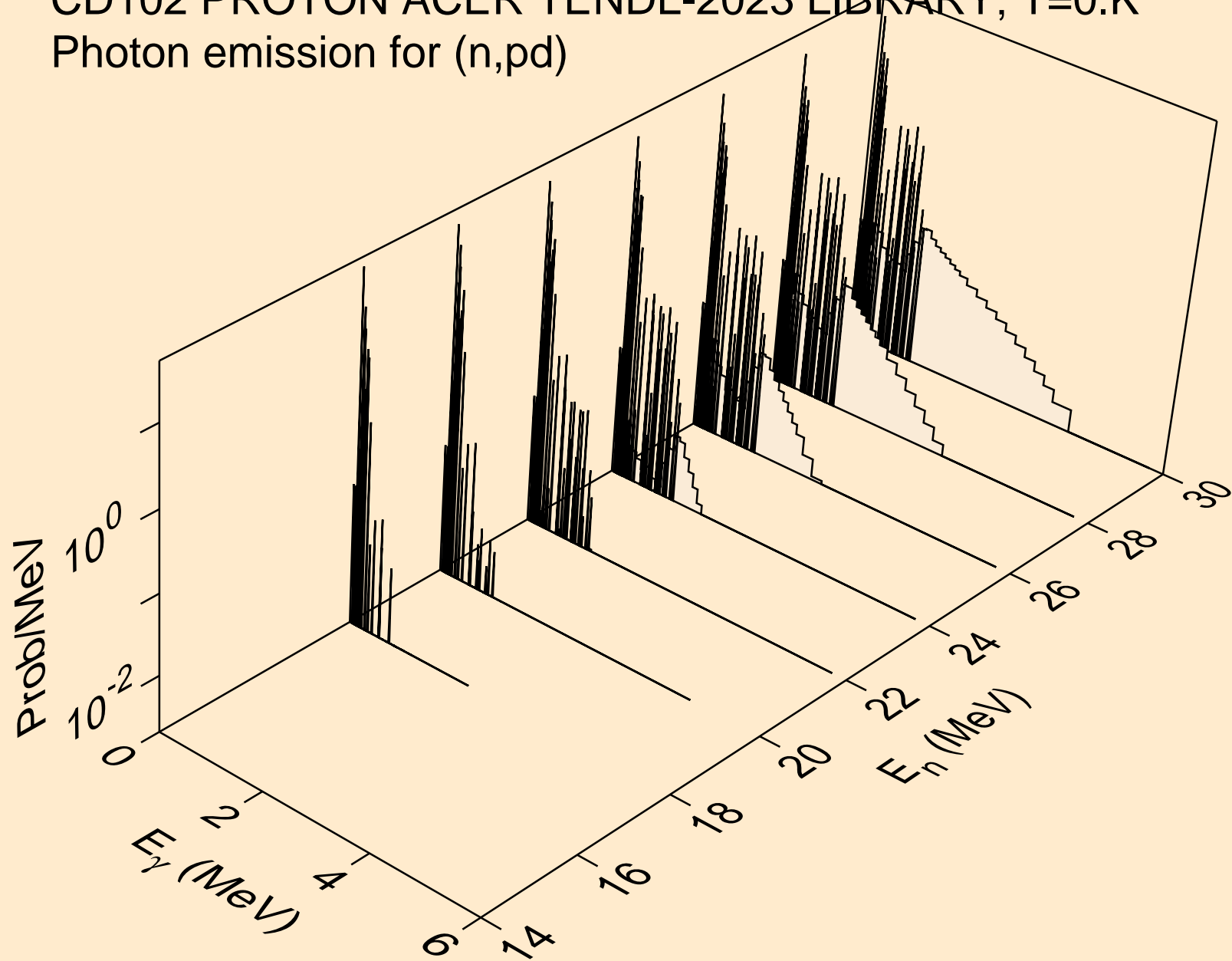

CD102 PROTON ACER TENDL-2023 LIBRARY; T=0.K  
Photon emission for (n,pt)

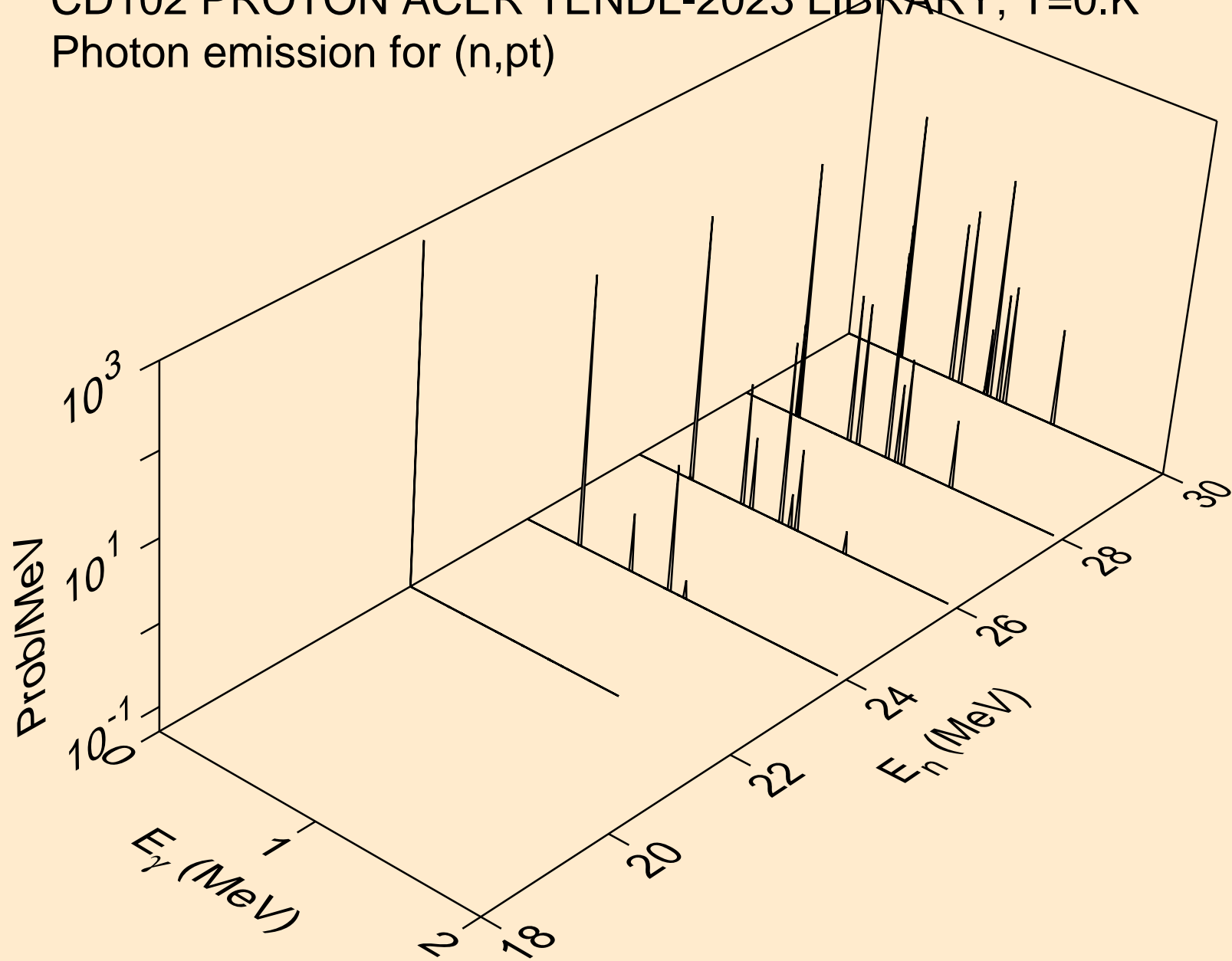

CD102 PROTON ACER TENDL-2023 LIBRARY; T=0.K  
Photon emission for (n,da)

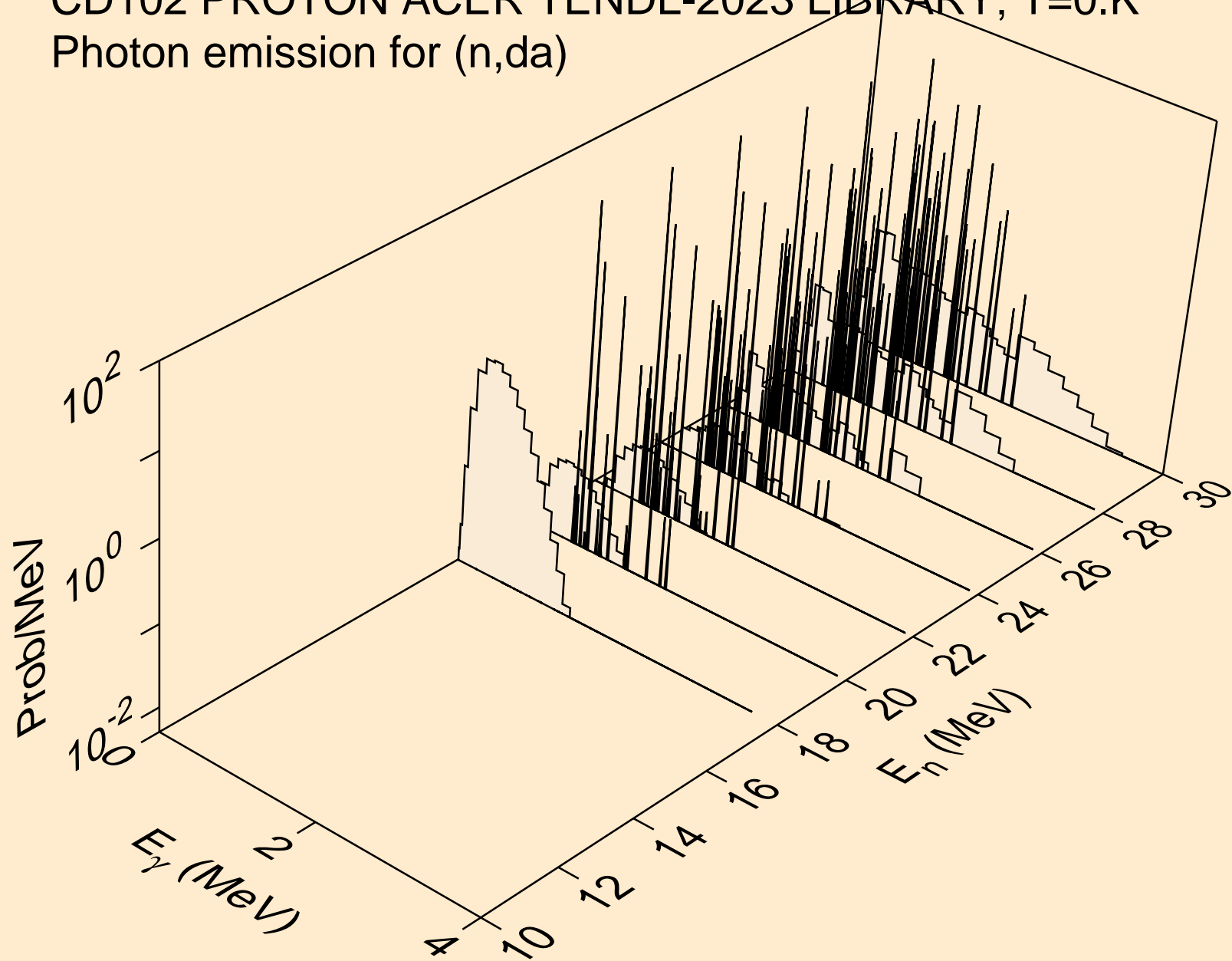

CD102 PROTON ACER TENDL-2023 LIBRARY; T=0.K  
Particle heating contributions

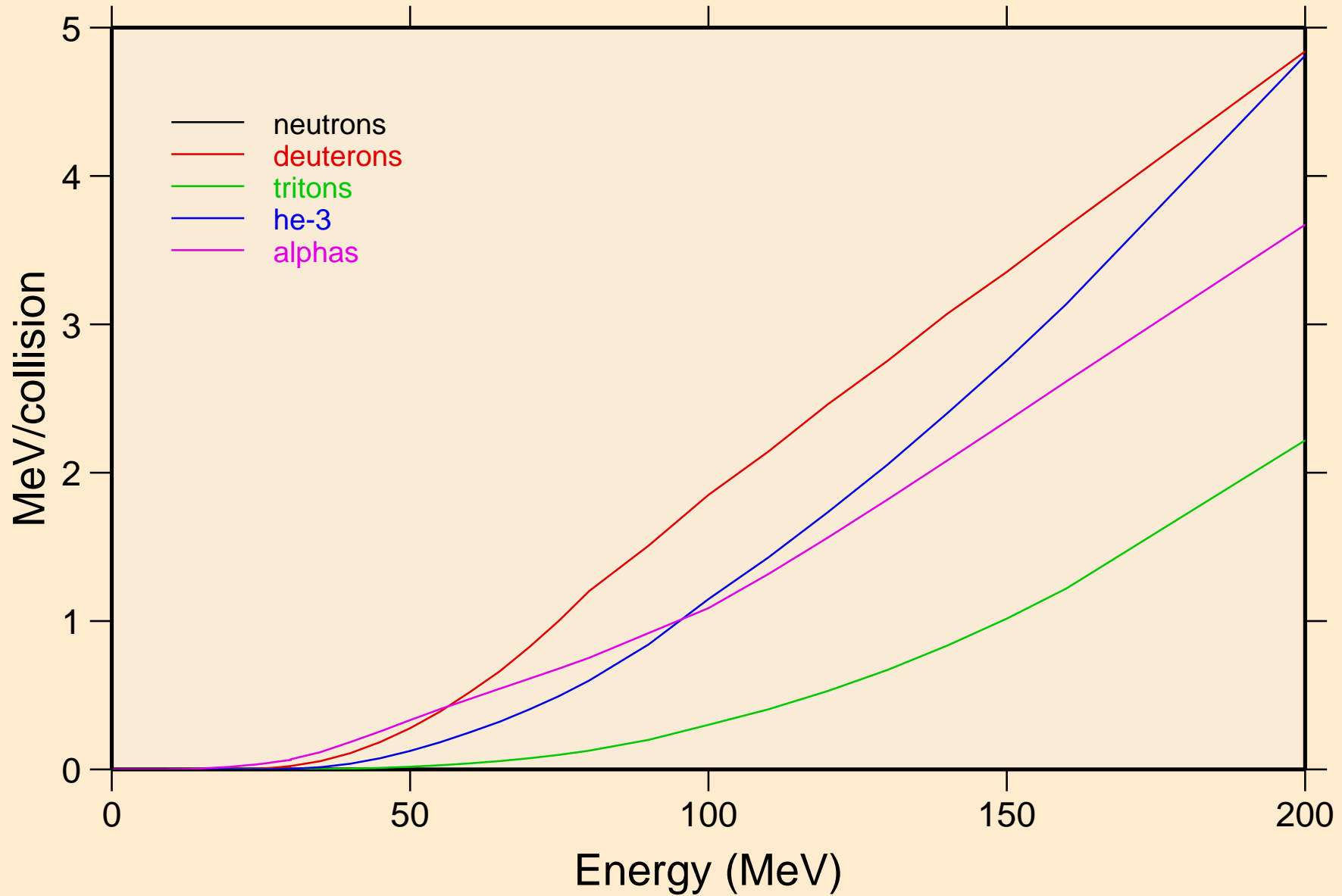

CD102 PROTON ACER TENDL-2023 LIBRARY; T=0.K  
Recoil Heating

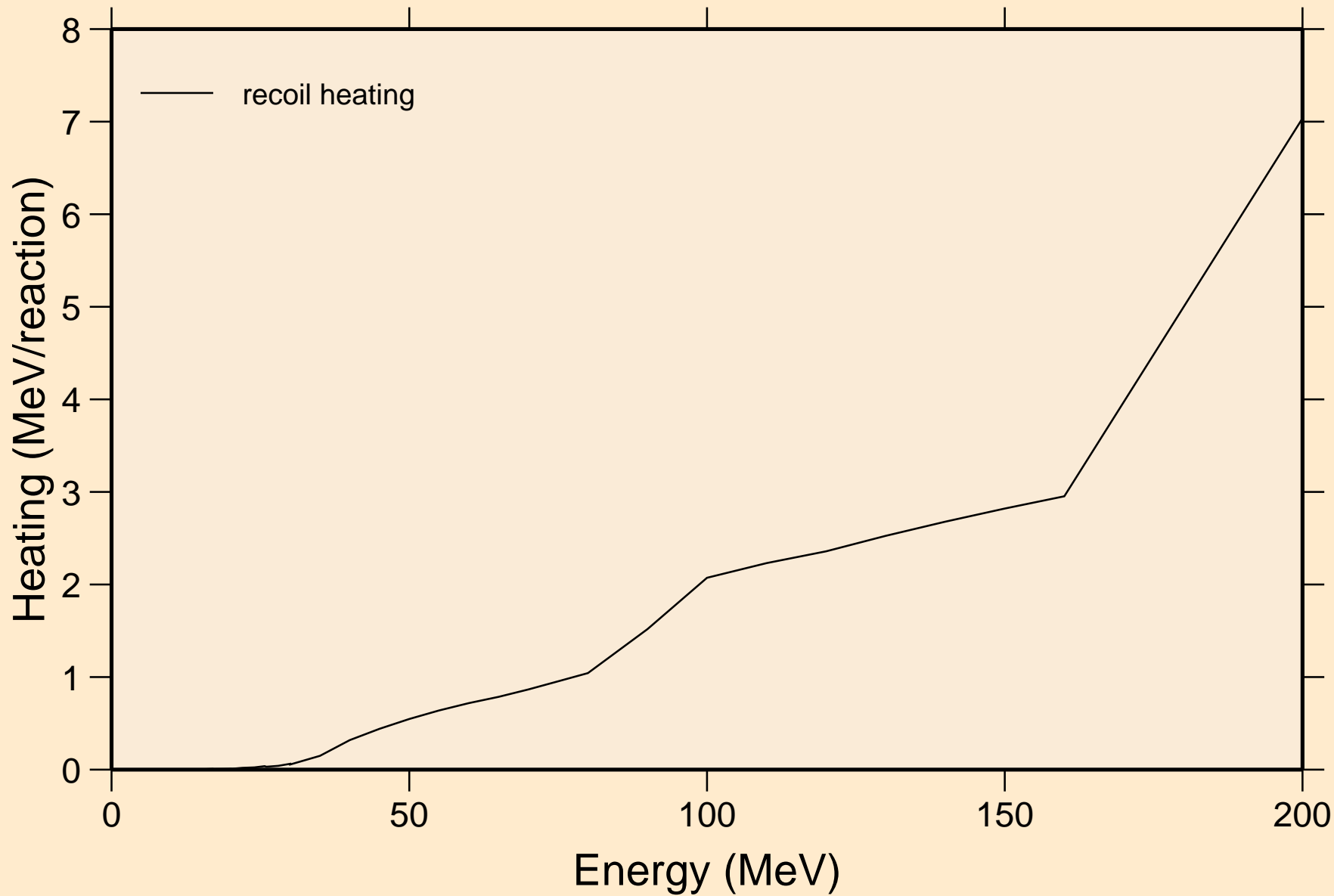

# CD102 PROTON ACER TENDL-2023 LIBRARY; T=0.K

## Particle production cross sections

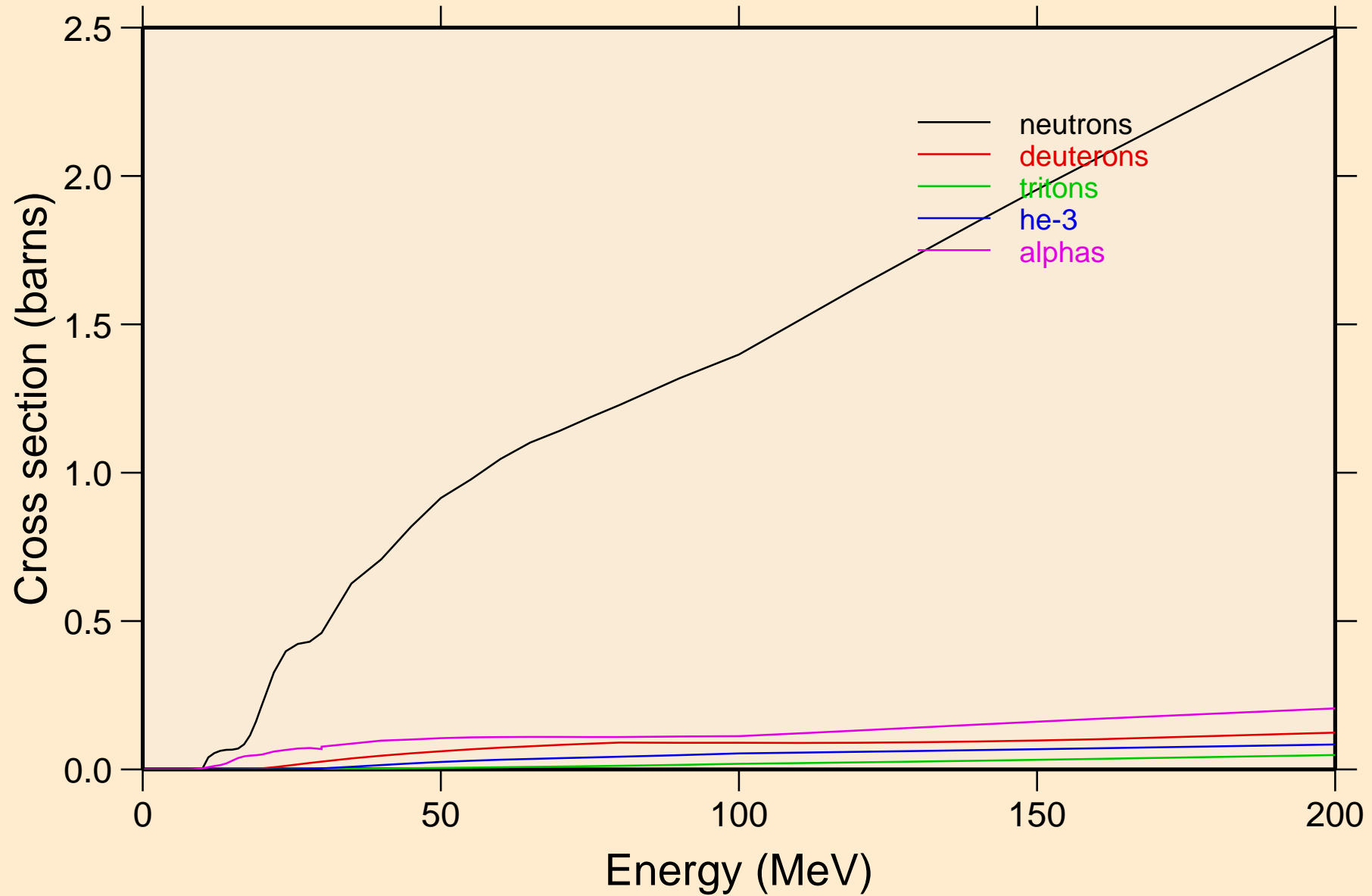

CD102 PROTON ACER TENDL-2023 LIBRARY; T=0.K  
neutrons from (p,n)

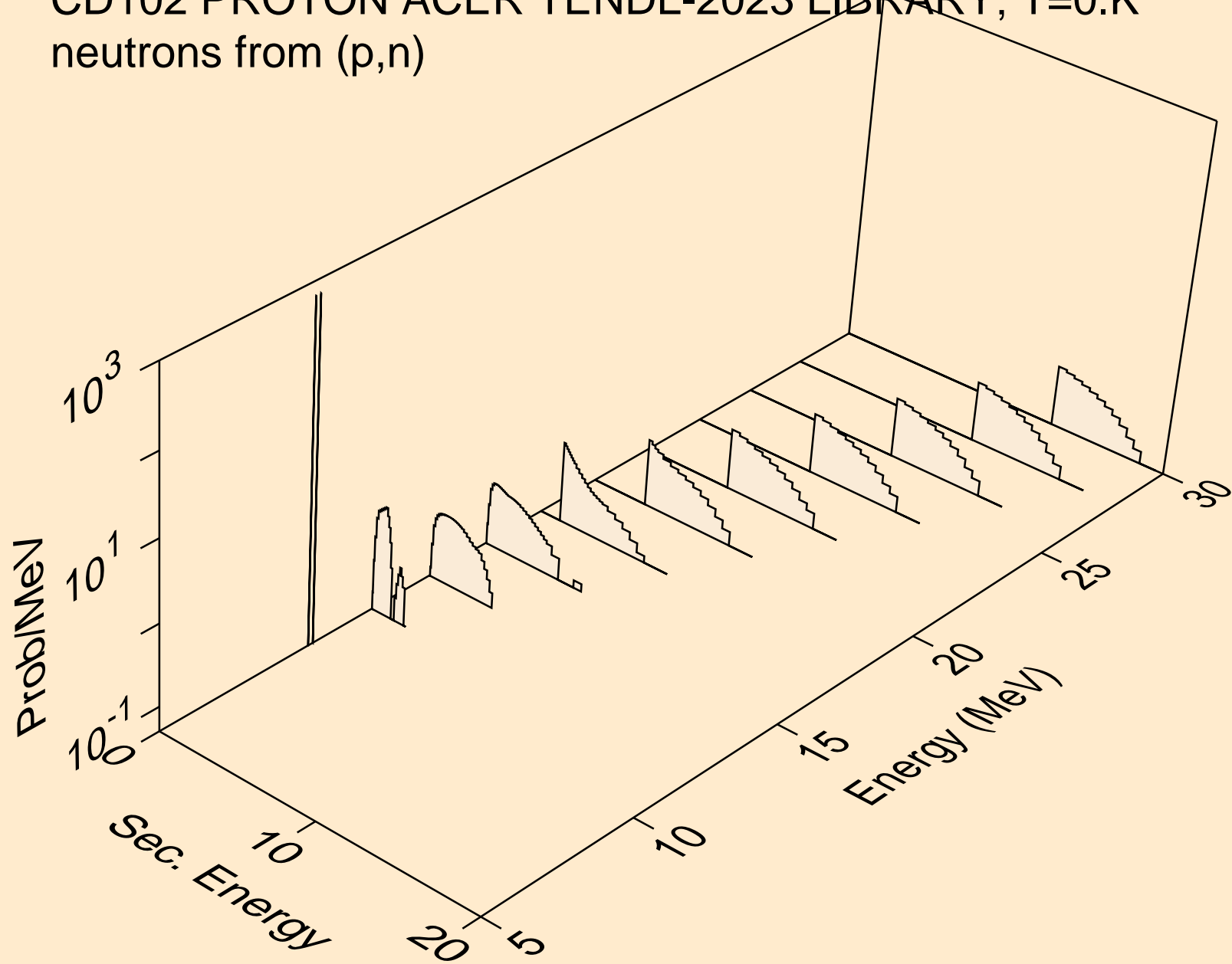

CD102 PROTON ACER TENDL-2023 LIBRARY; T=0.K  
neutrons from (p,x)

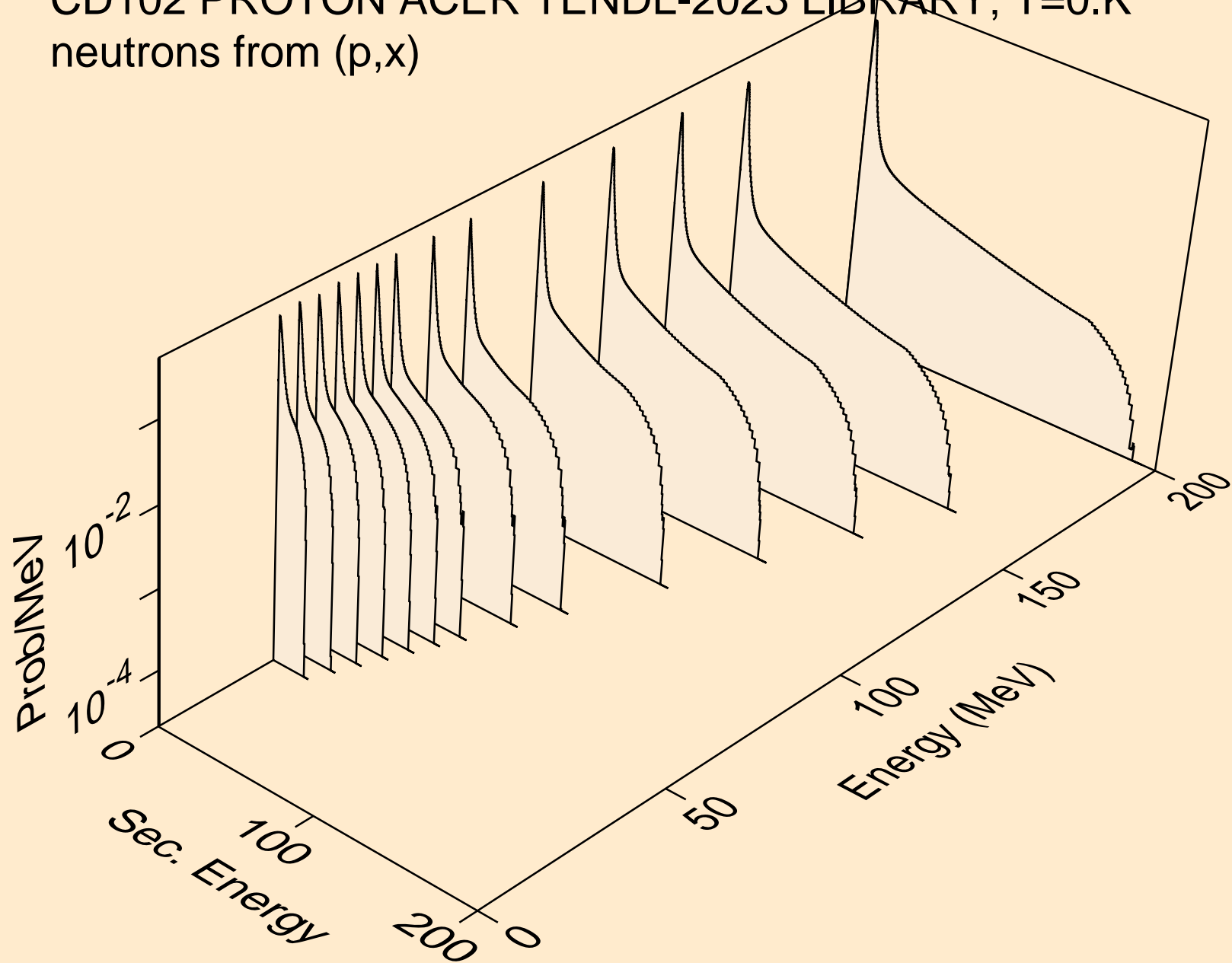



CD102 PROTON ACER TENDL-2023 LIBRARY; T=0.K  
neutrons from (p,2n)

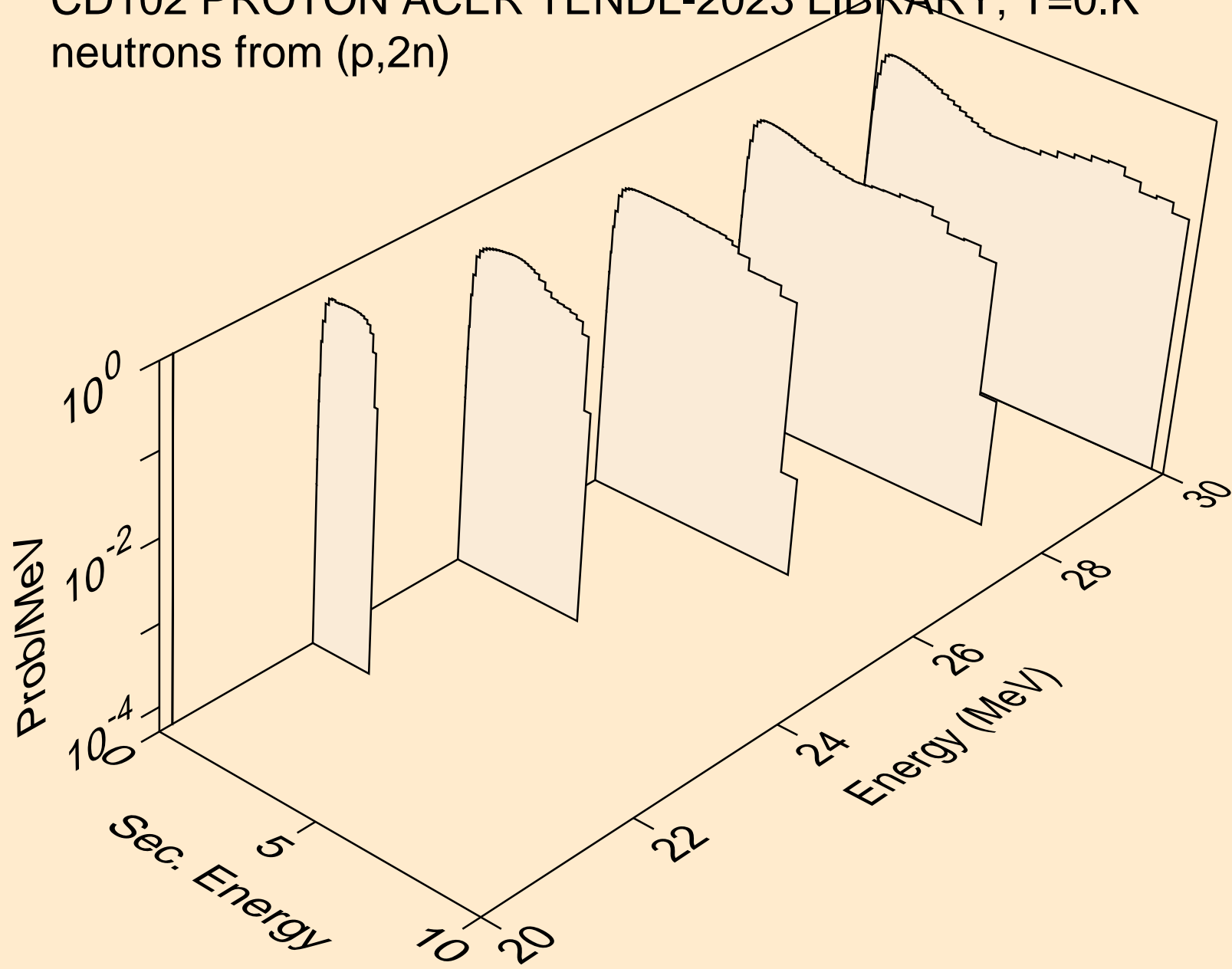

CD102 PROTON ACER TENDL-2023 LIBRARY; T=0.K  
neutrons from (p,n\*)a

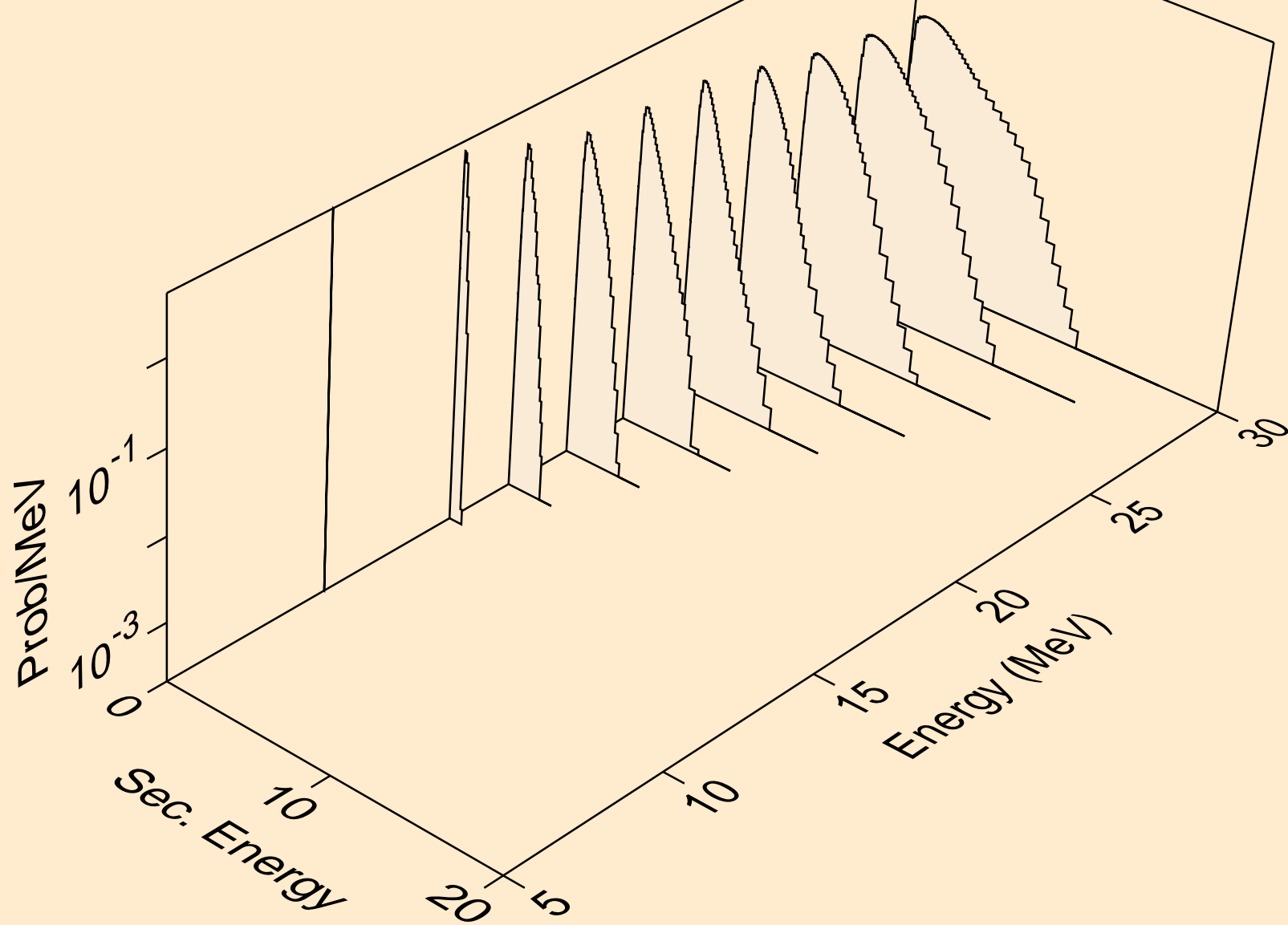

CD102 PROTON ACER TENDL-2023 LIBRARY; T=0.K  
neutrons from (p,2n)a

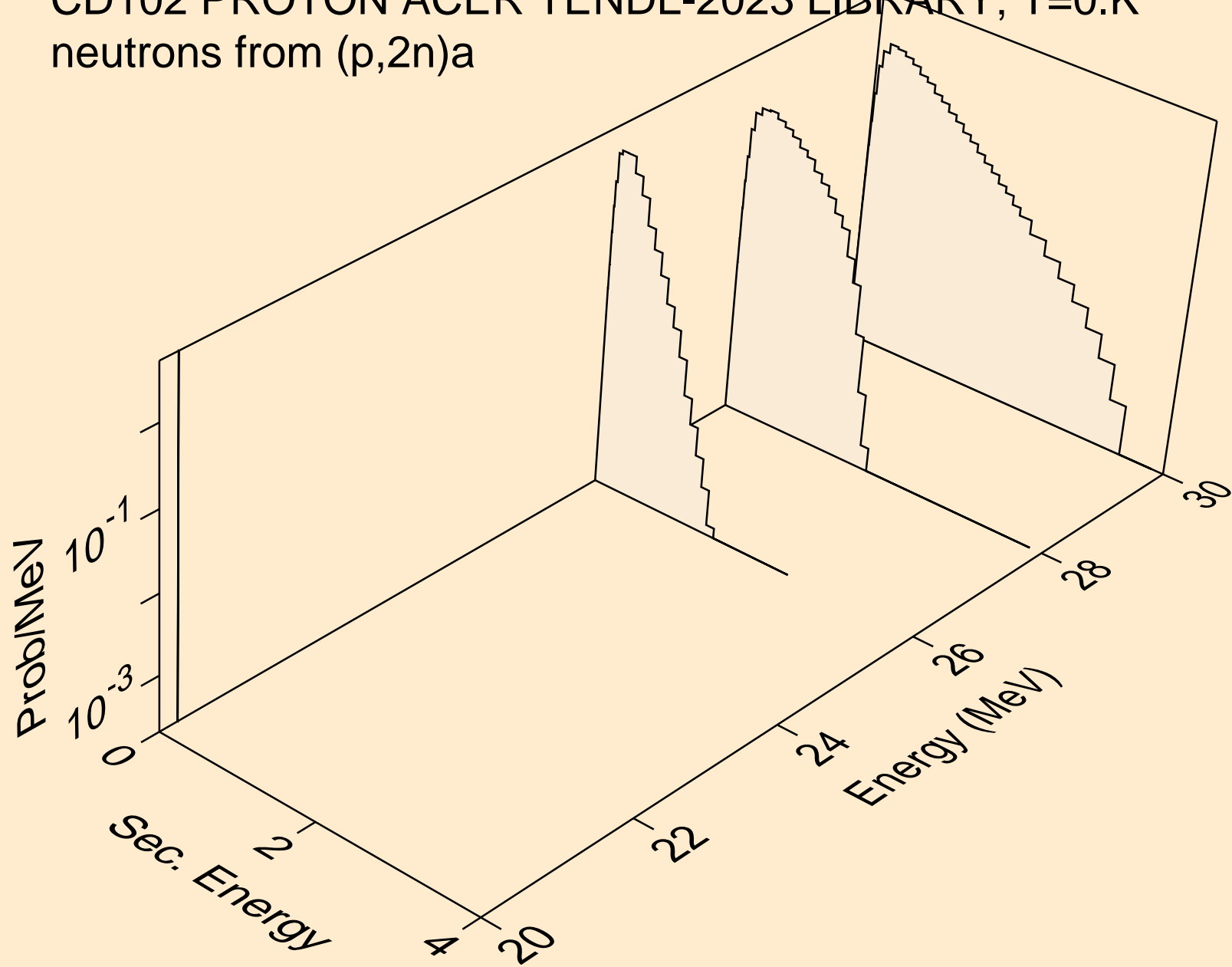

CD102 PROTON ACER TENDL-2023 LIBRARY; T=0.K  
neutrons from (p,n\*)p

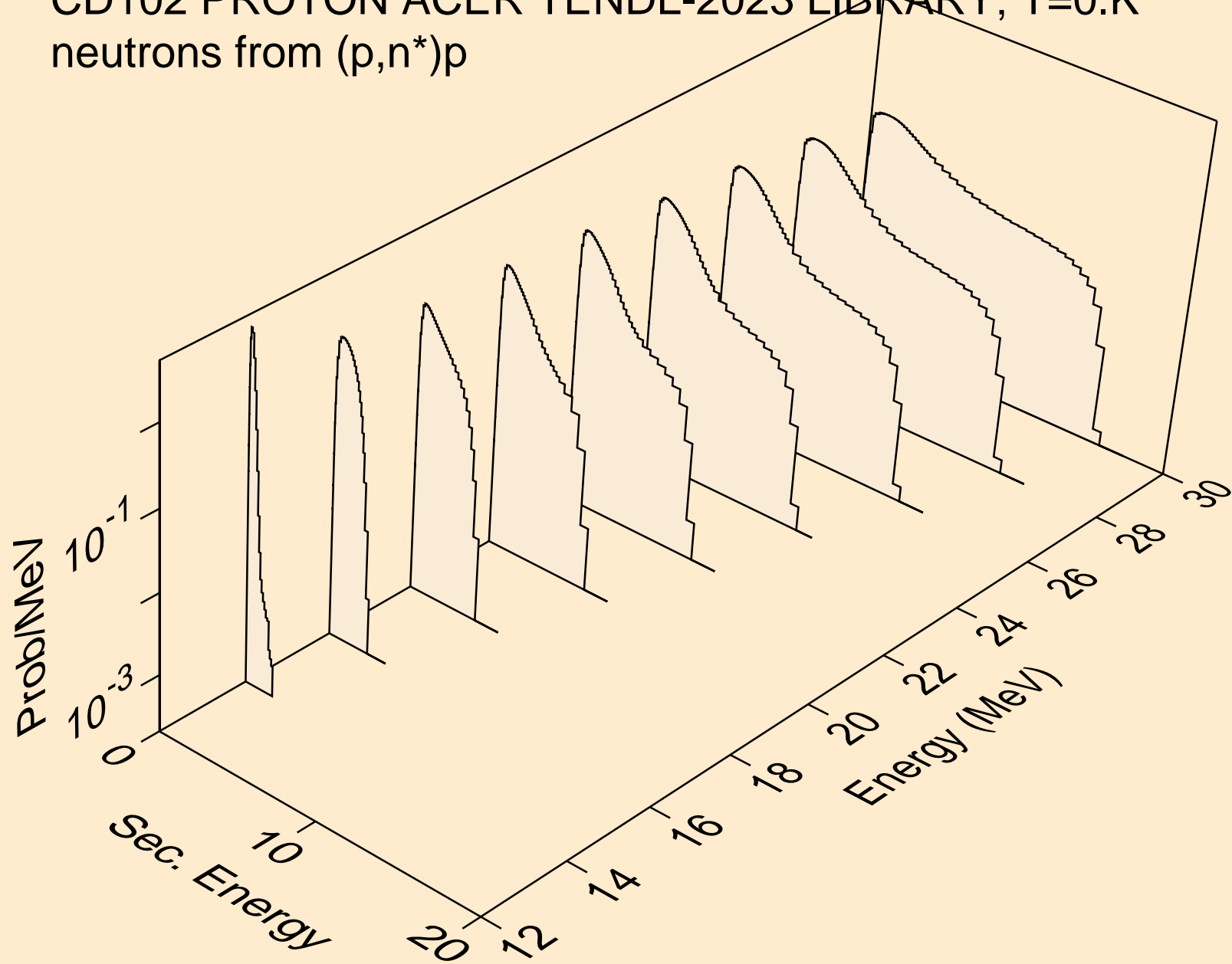

CD102 PROTON ACER TENDL-2023 LIBRARY; T=0.K  
neutrons from (p,n\*)d

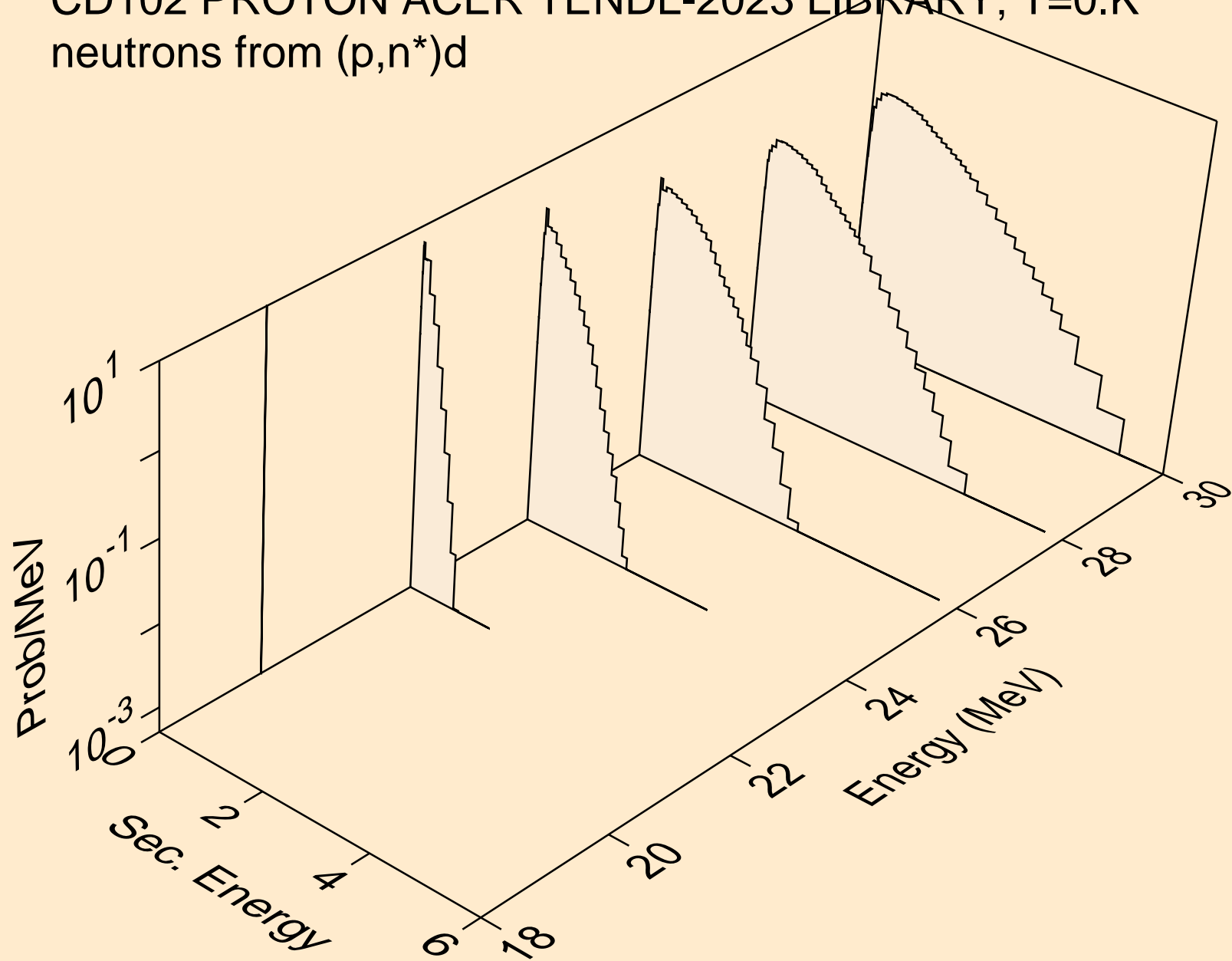

CD102 PROTON ACER TENDL-2023 LIBRARY; T=0.K  
neutrons from (p,n\*)t

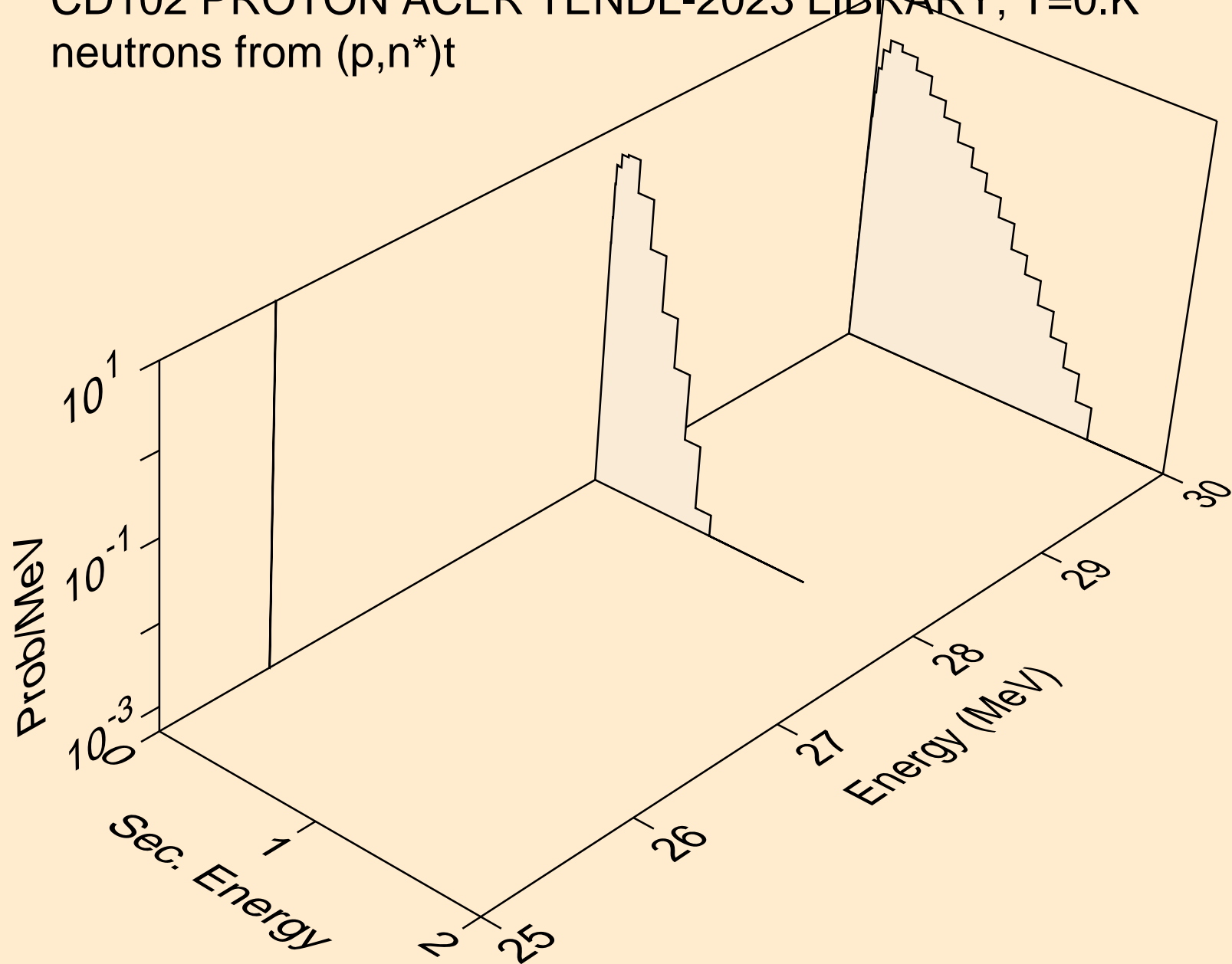

CD102 PROTON ACER TENDL-2023 LIBRARY; T=0.K  
neutrons from (p,n\*)he3

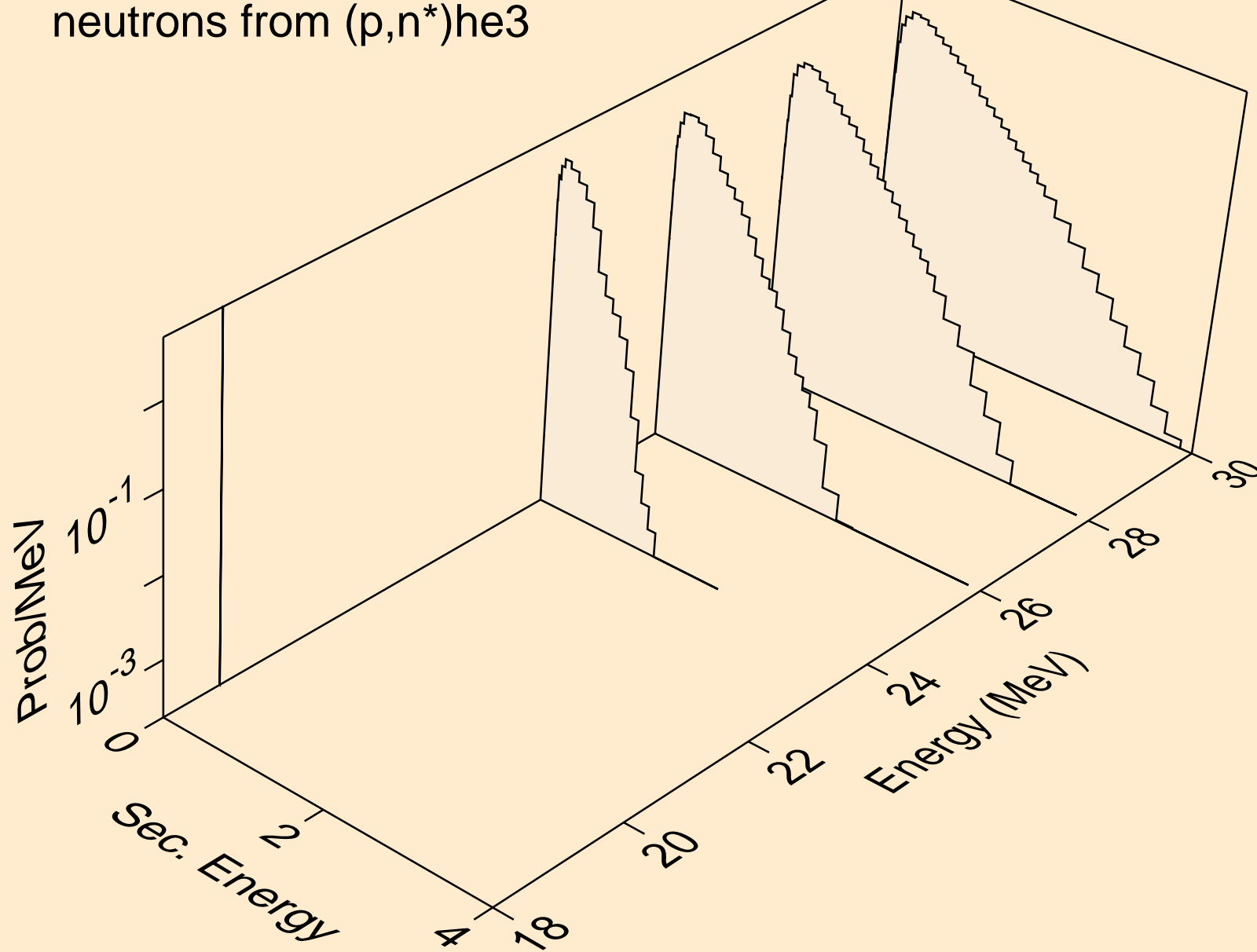

CD102 PROTON ACER TENDL-2023 LIBRARY; T=0.K  
neutrons from (p,2np)

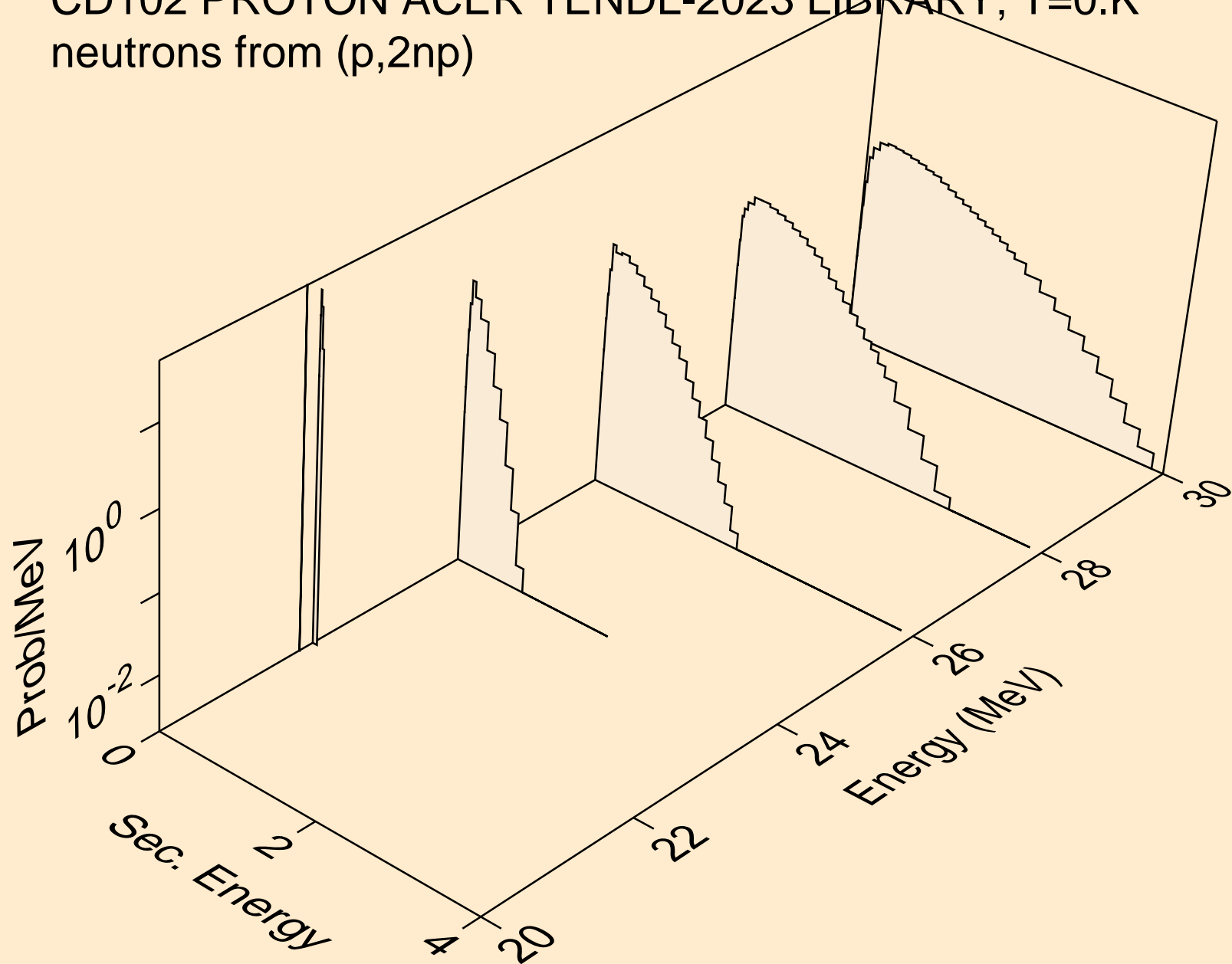



CD102 PROTON ACER TENDL-2023 LIBRARY; T=0.K  
neutrons from (p,n2p)

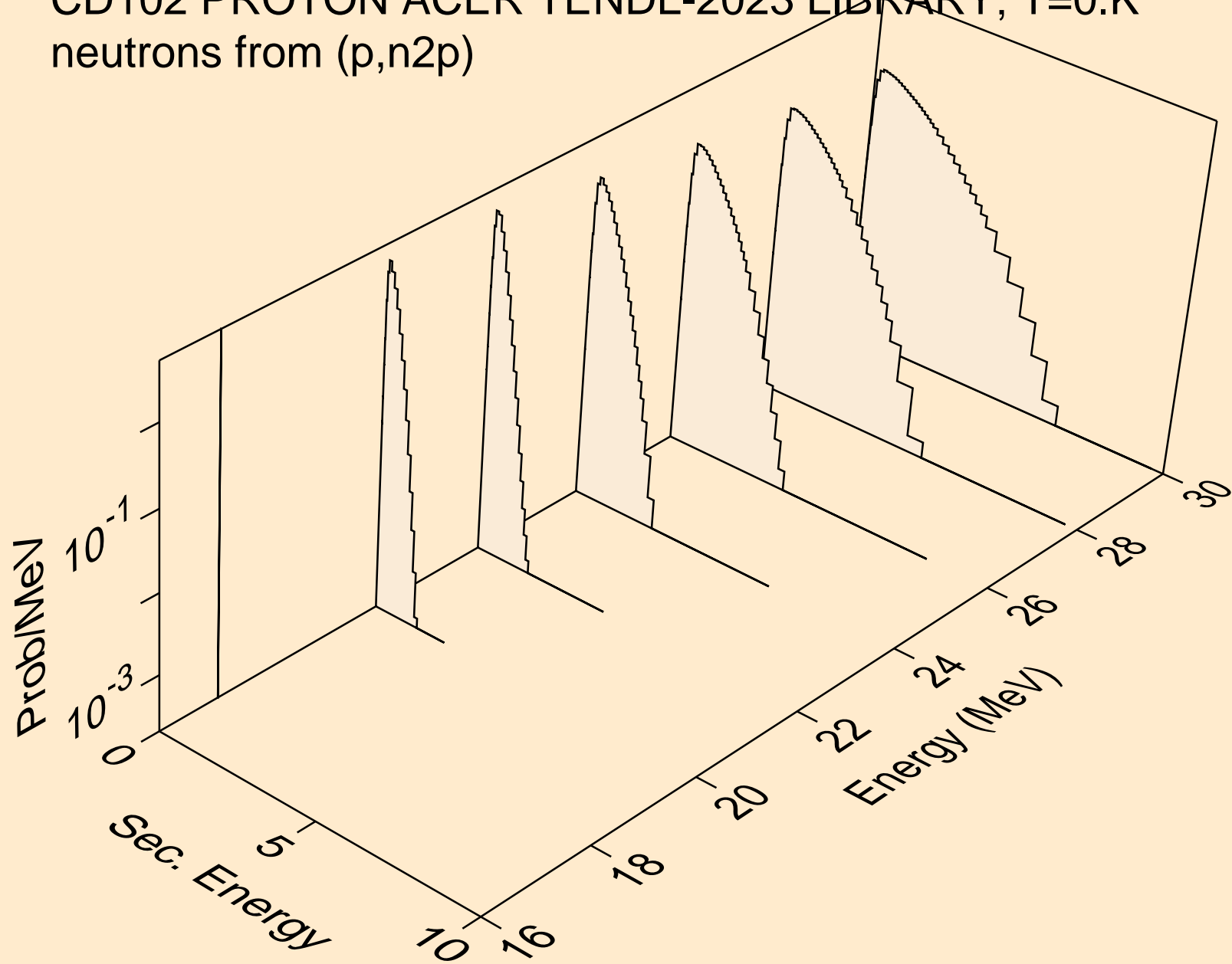

CD102 PROTON ACER TENDL-2023 LIBRARY; T=0.K  
neutrons from (p,npa)

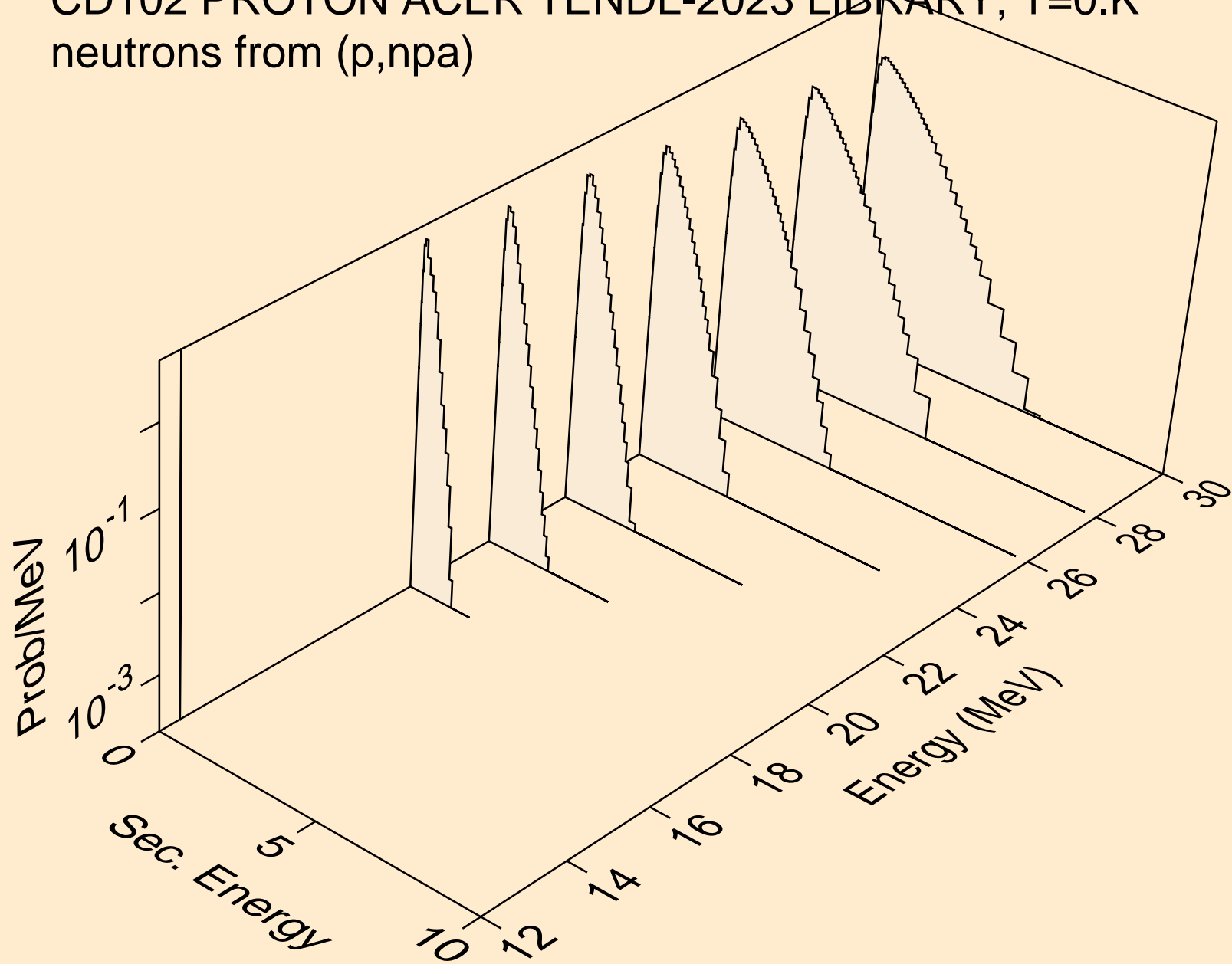

CD102 PROTON ACER TENDL-2023 LIBRARY; T=0.K  
deuterons from (p,x)

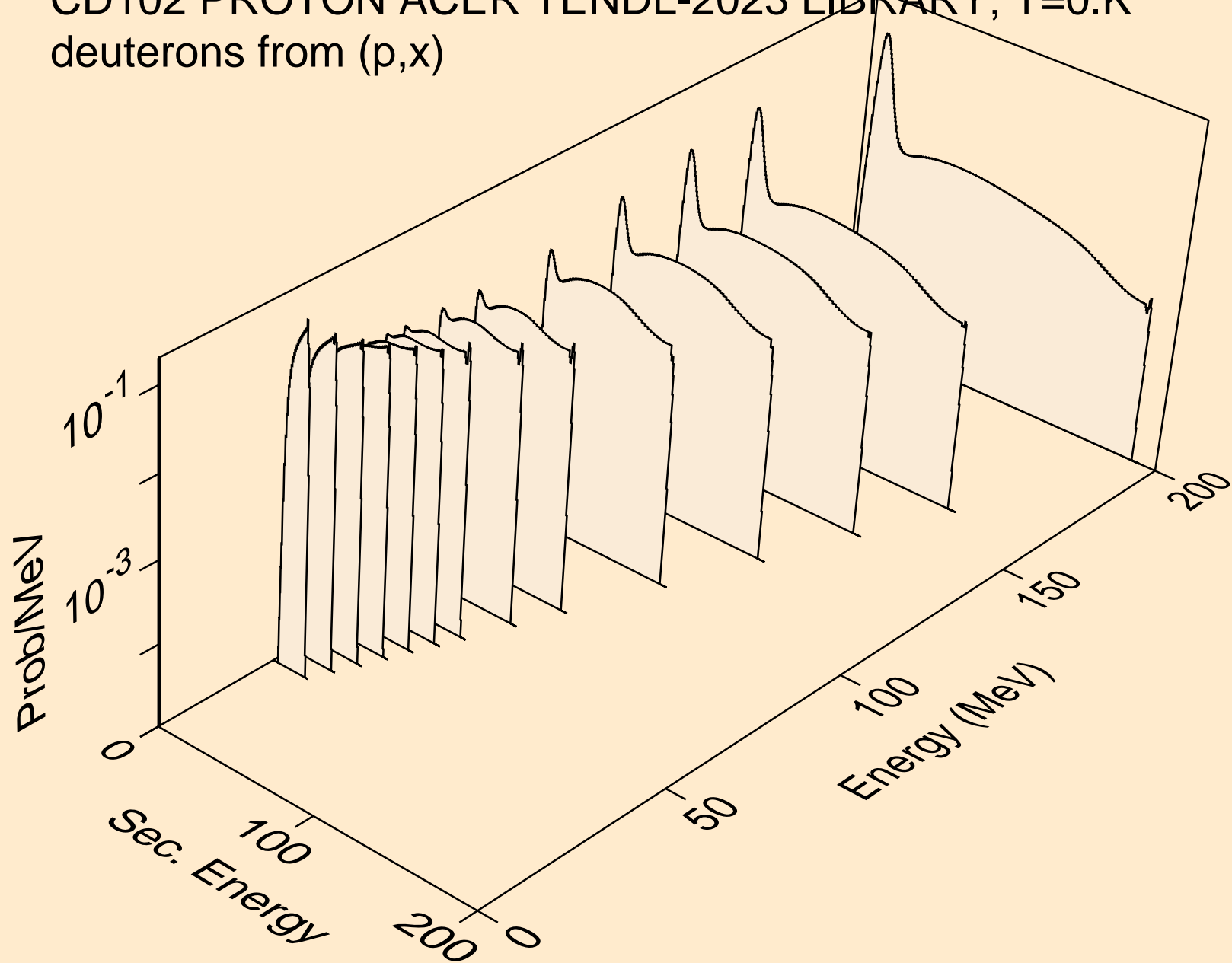

CD102 PROTON ACER TENDL-2023 LIBRARY; T=0.K  
deuterons from (p,n\*)d

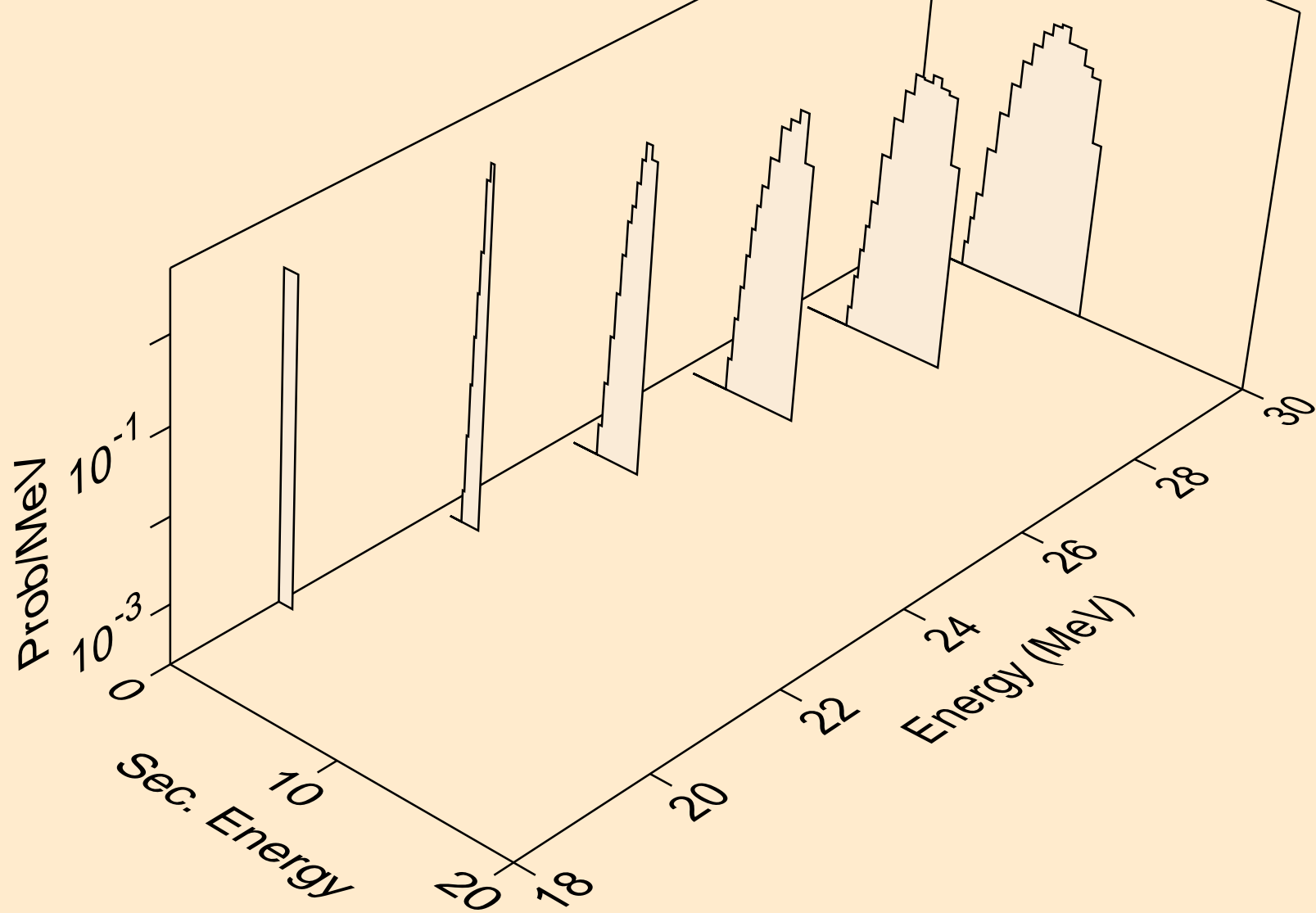

CD102 PROTON ACER TENDL-2023 LIBRARY; T=0.K  
deuterons from (p,d)

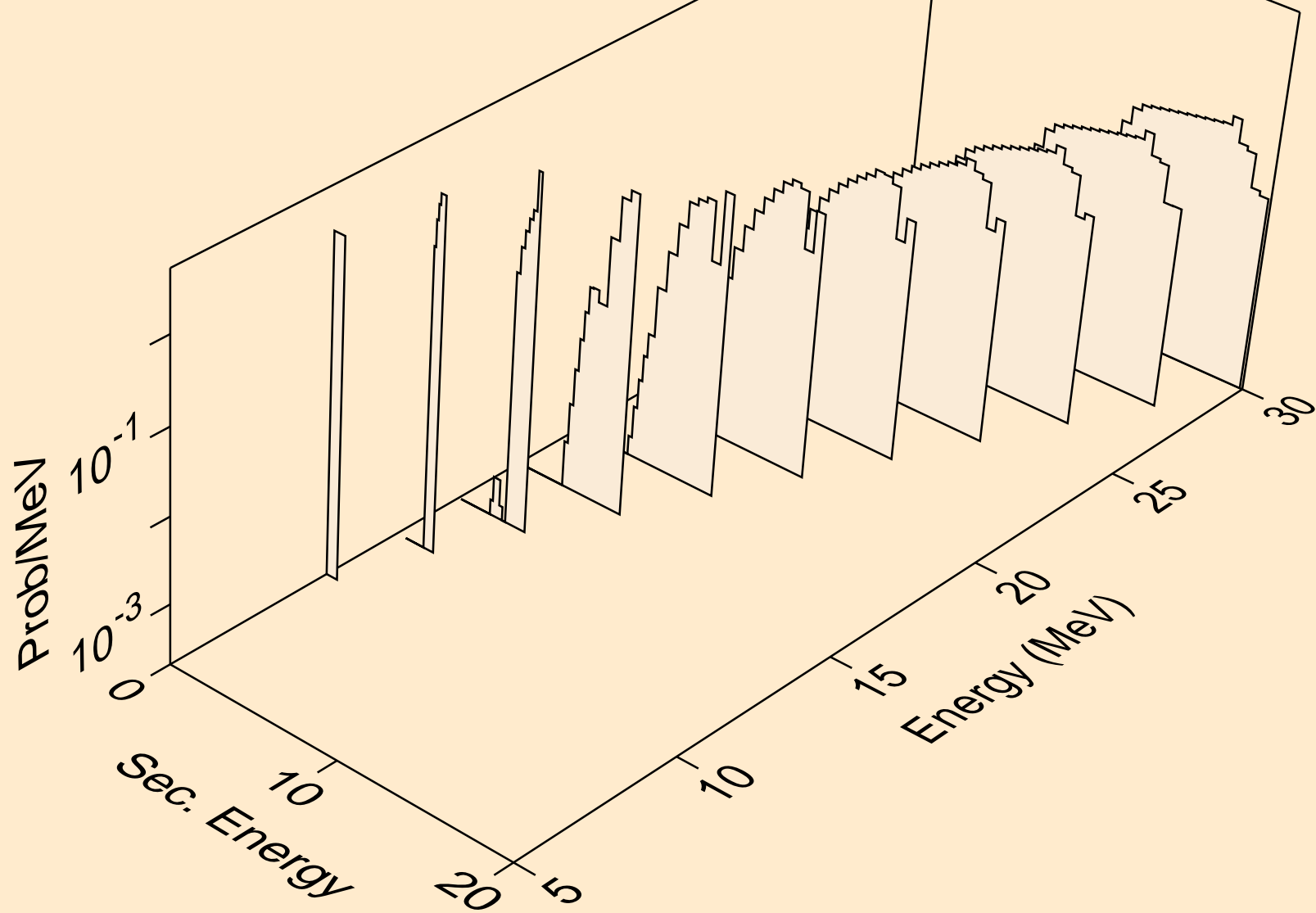

CD102 PROTON ACER TENDL-2023 LIBRARY; T=0.K  
deuterons from (p,pd)

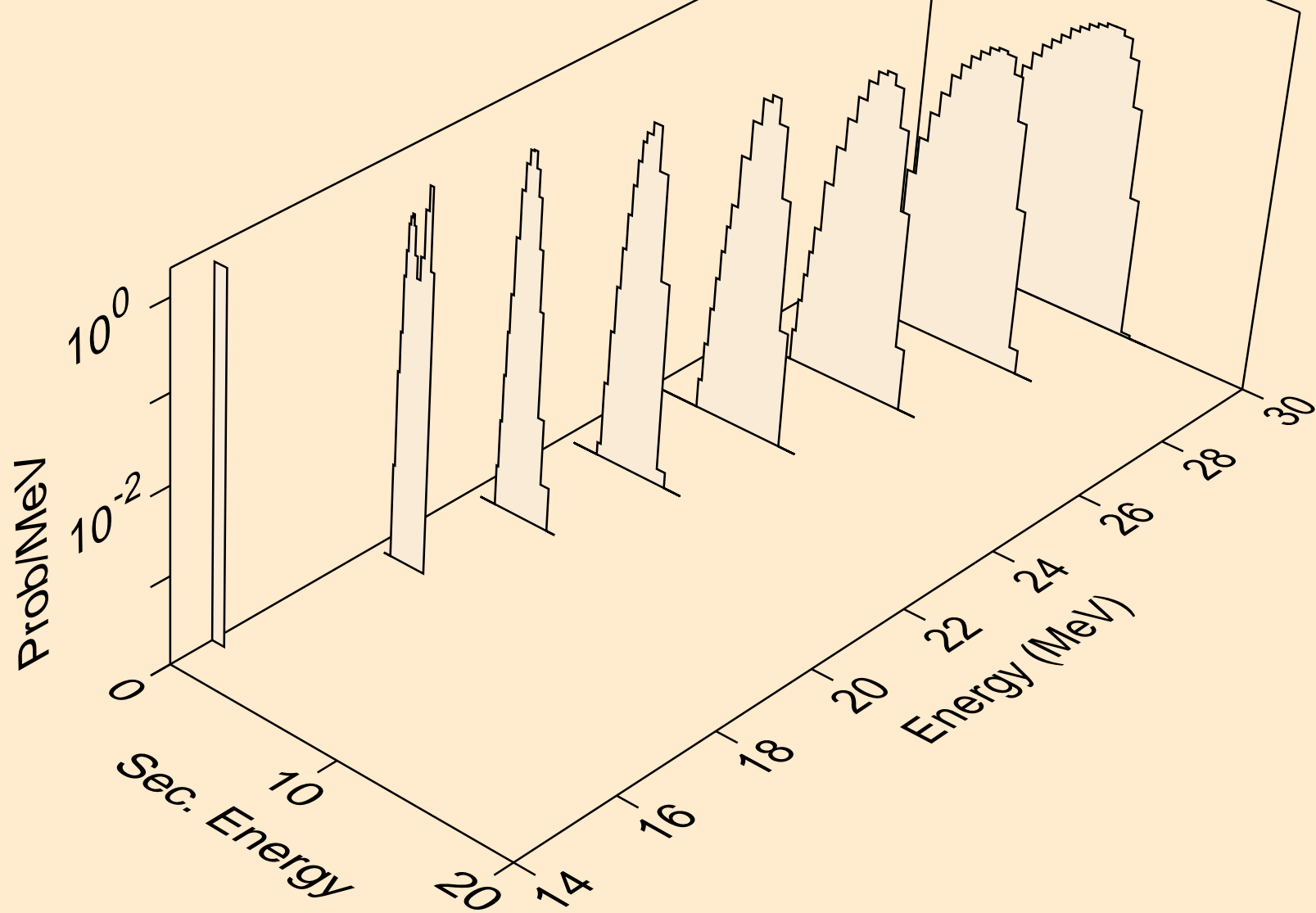

CD102 PROTON ACER TENDL-2023 LIBRARY; T=0.K  
deuterons from (p,da)

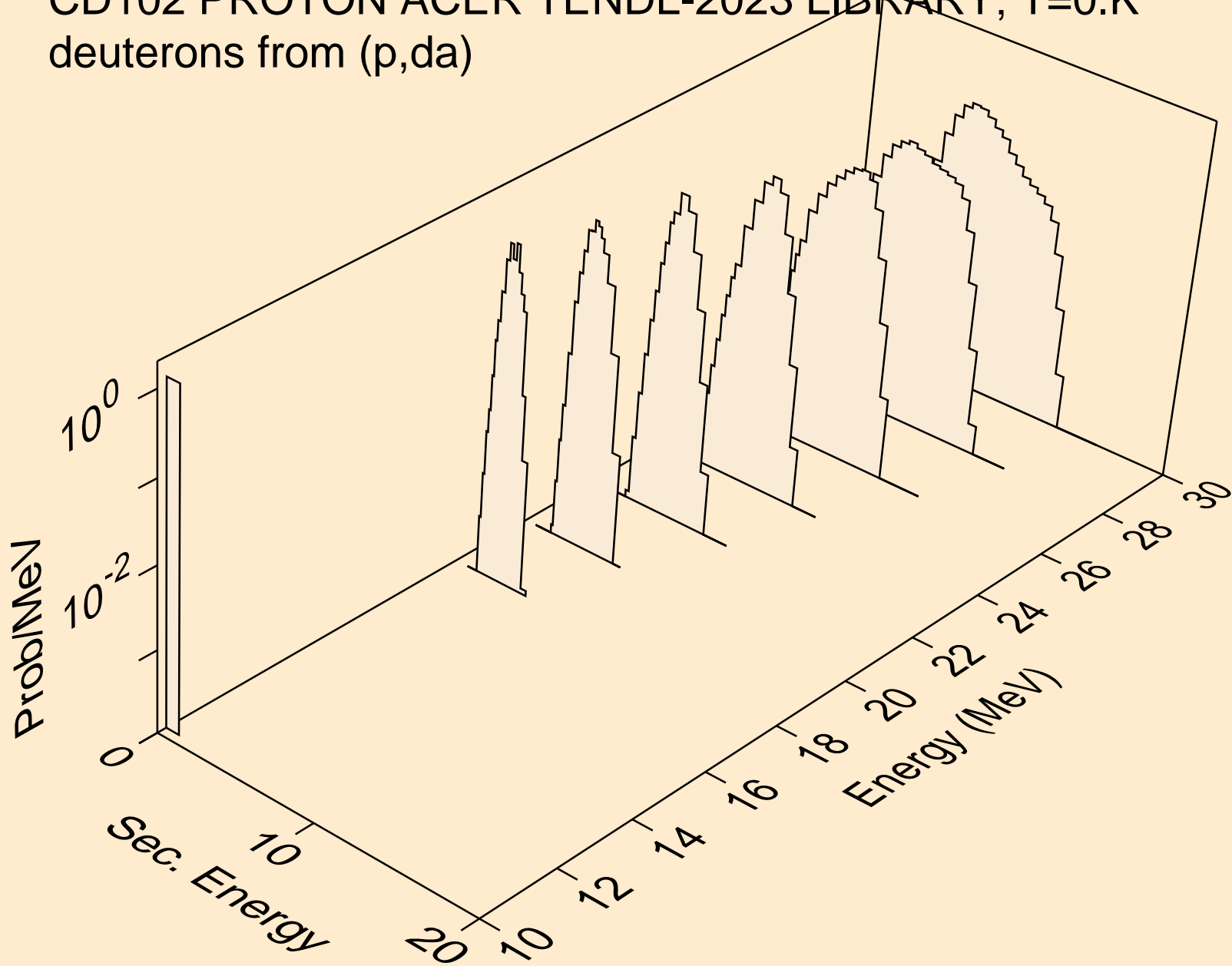

CD102 PROTON ACER TENDL-2023 LIBRARY; T=0.K  
tritons from (p,x)

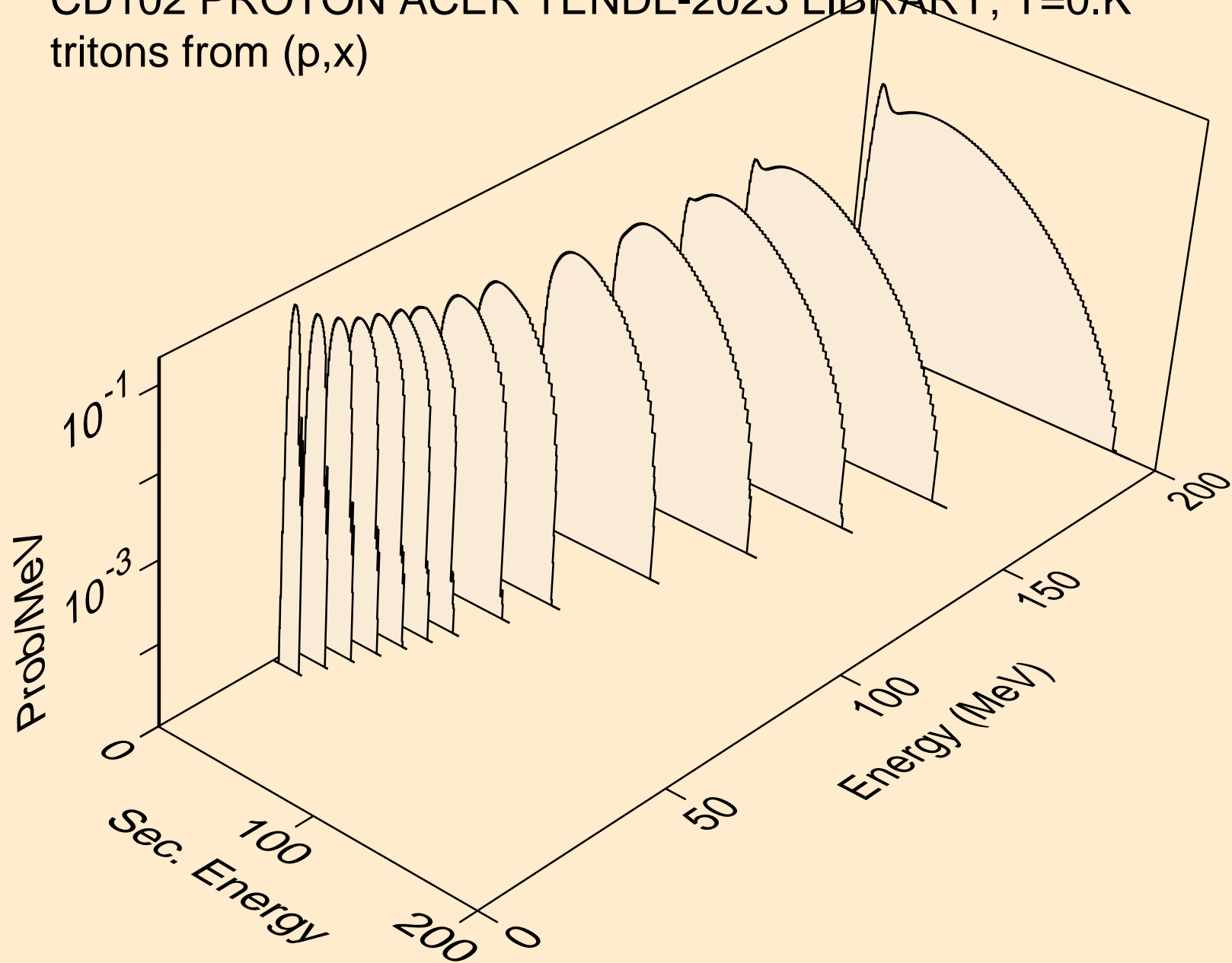



CD102 PROTON ACER TENDL-2023 LIBRARY; T=0.K  
tritons from (p,n\*)t

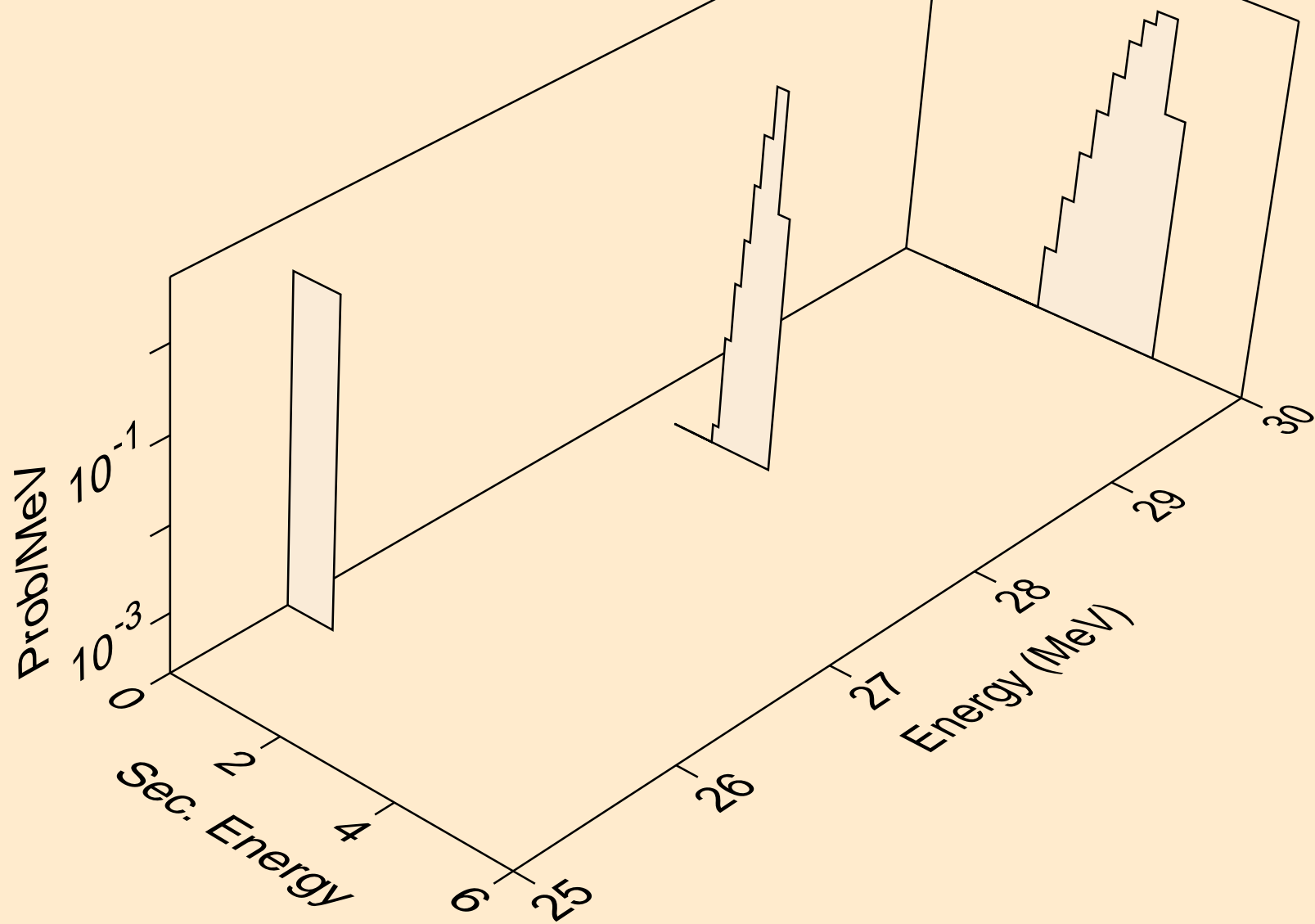

CD102 PROTON ACER TENDL-2023 LIBRARY; T=0.K  
tritons from (p,t)

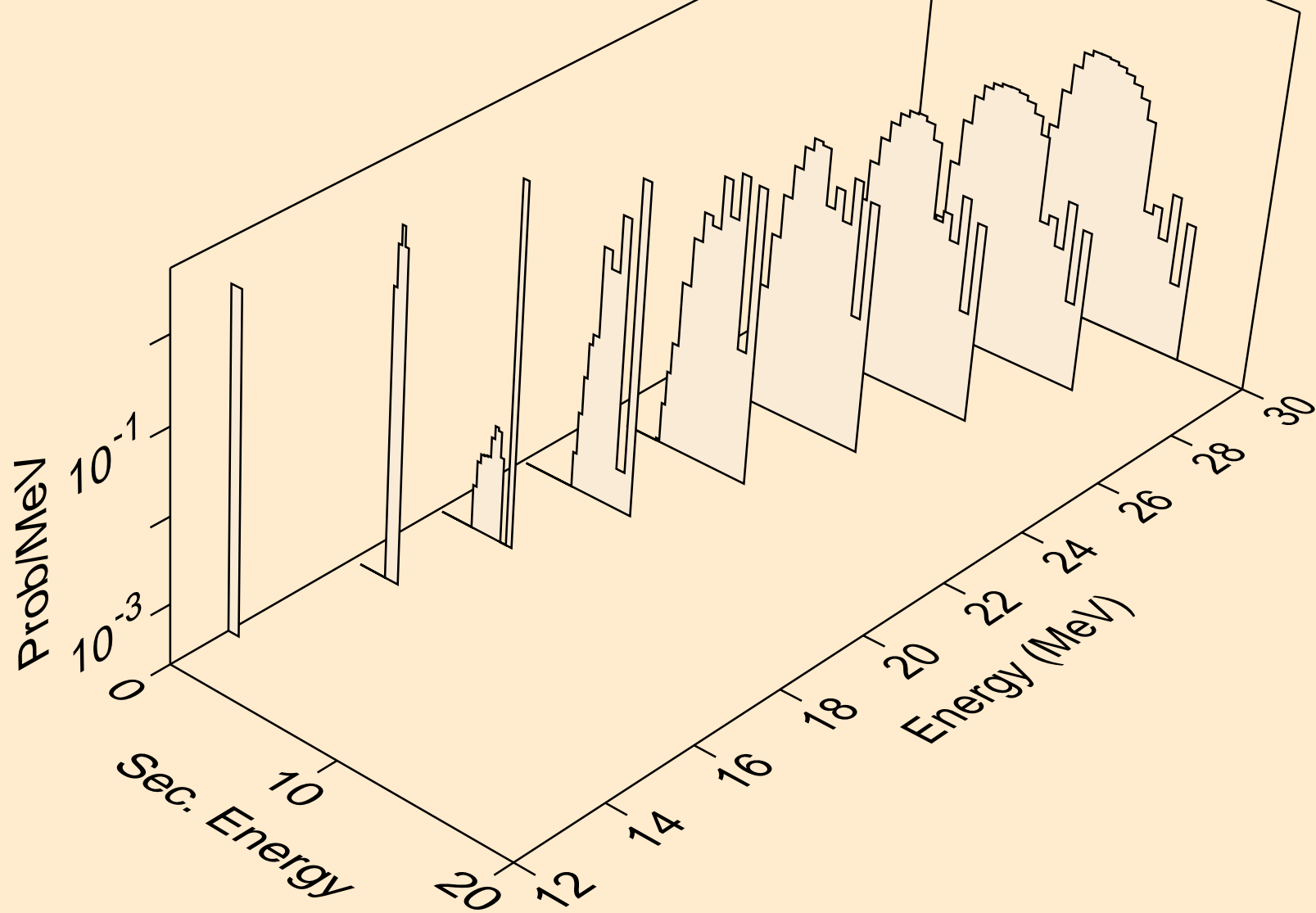

CD102 PROTON ACER TENDL-2023 LIBRARY; T=0.K  
tritons from (p,pt)

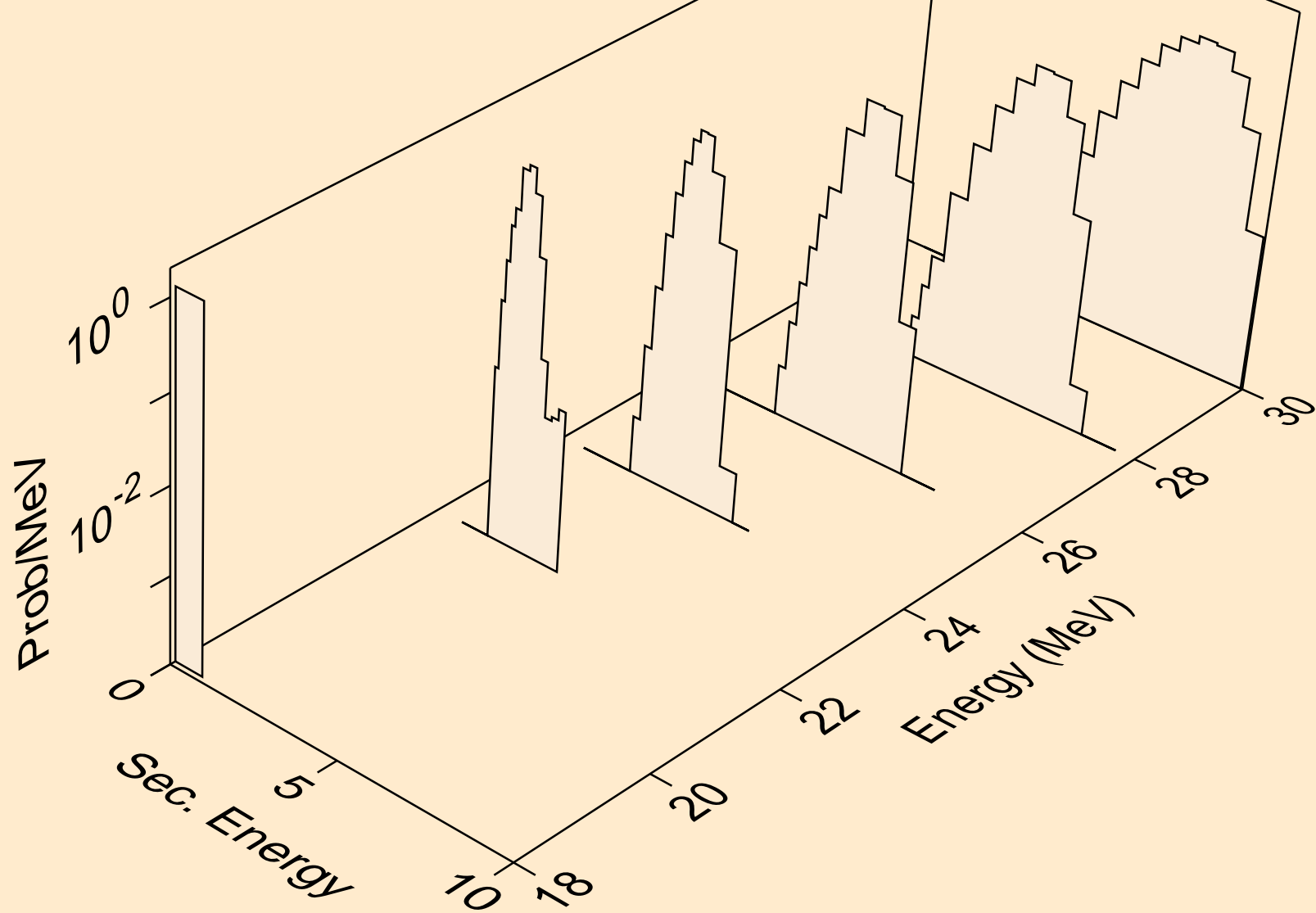

CD102 PROTON ACER TENDL-2023 LIBRARY; T=0.K  
he3s from (p,x)

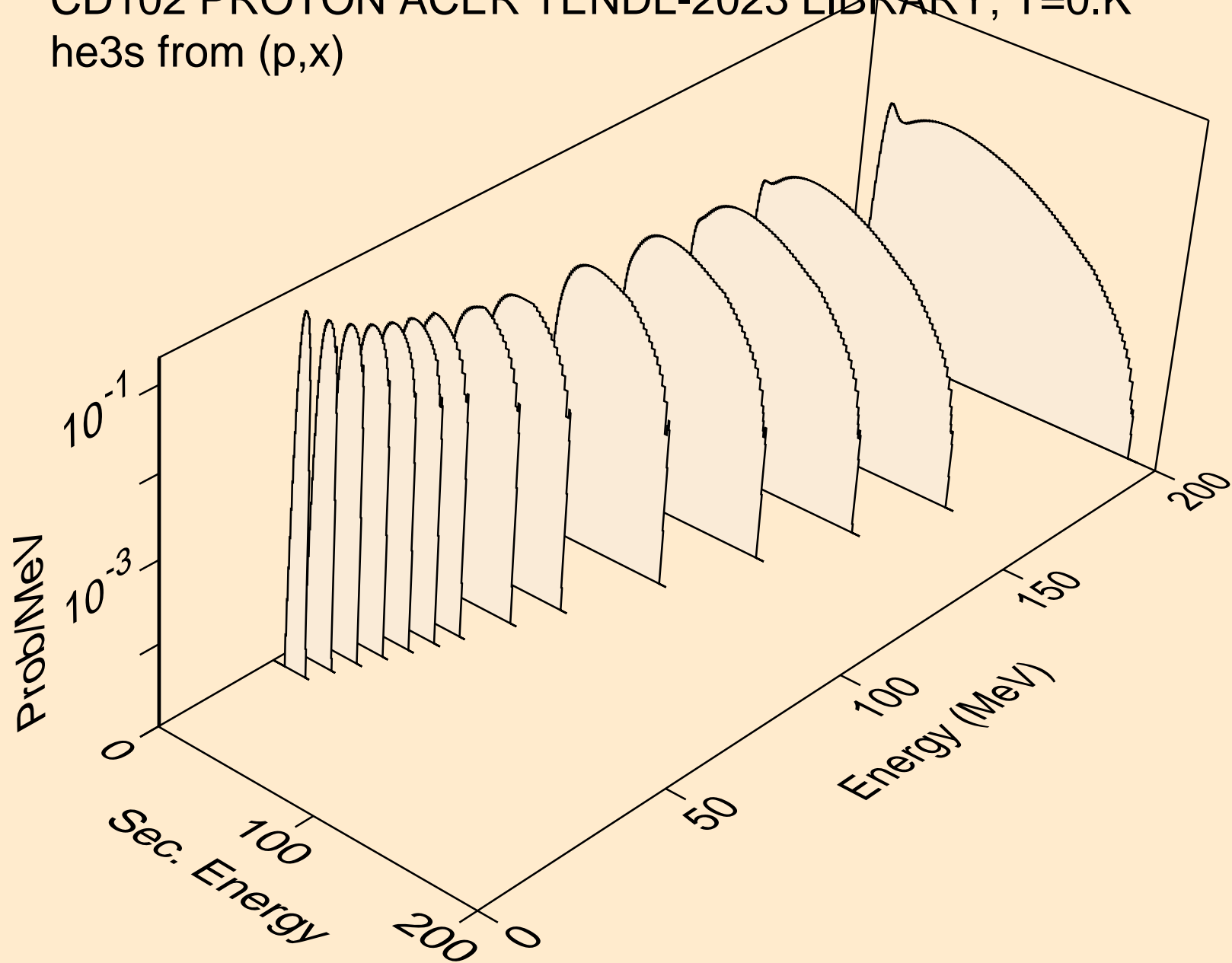

CD102 PROTON ACER TENDL-2023 LIBRARY; T=0.K  
he3s from (p,n\*)he3

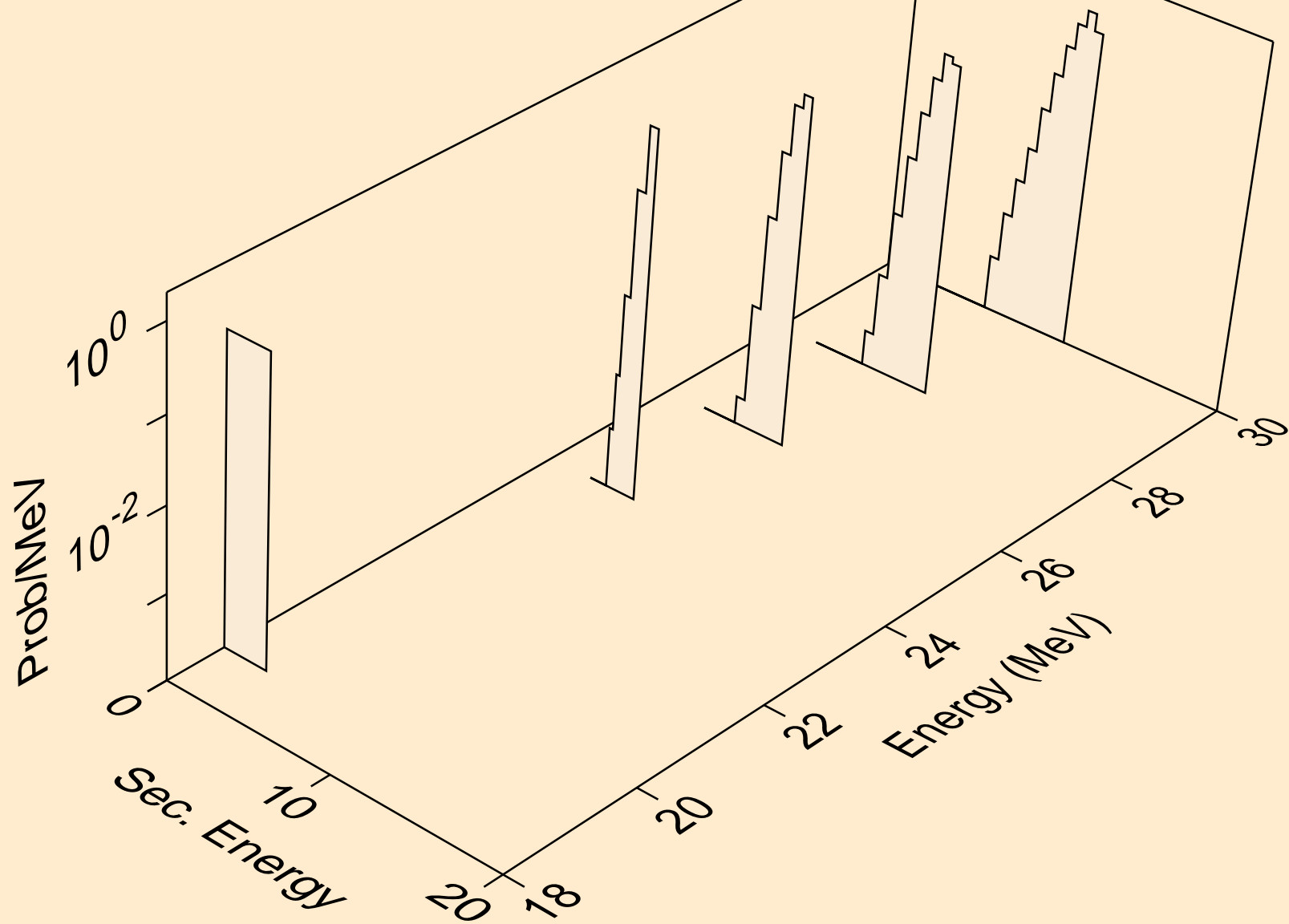

CD102 PROTON ACER TENDL-2023 LIBRARY; T=0.K  
he3s from (p,he3)

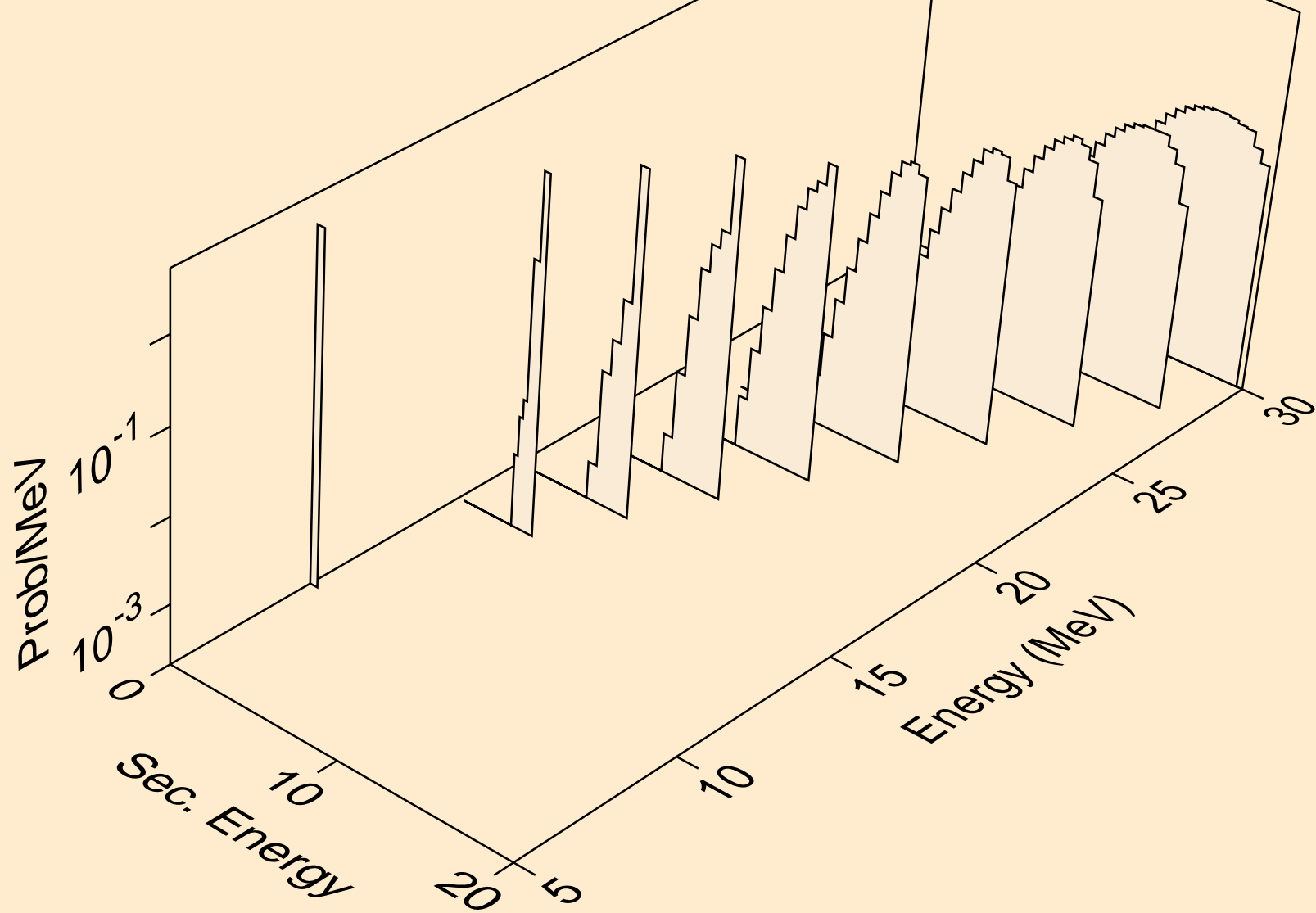

CD102 PROTON ACER TENDL-2023 LIBRARY; T=0.K  
alphas from (p,x)

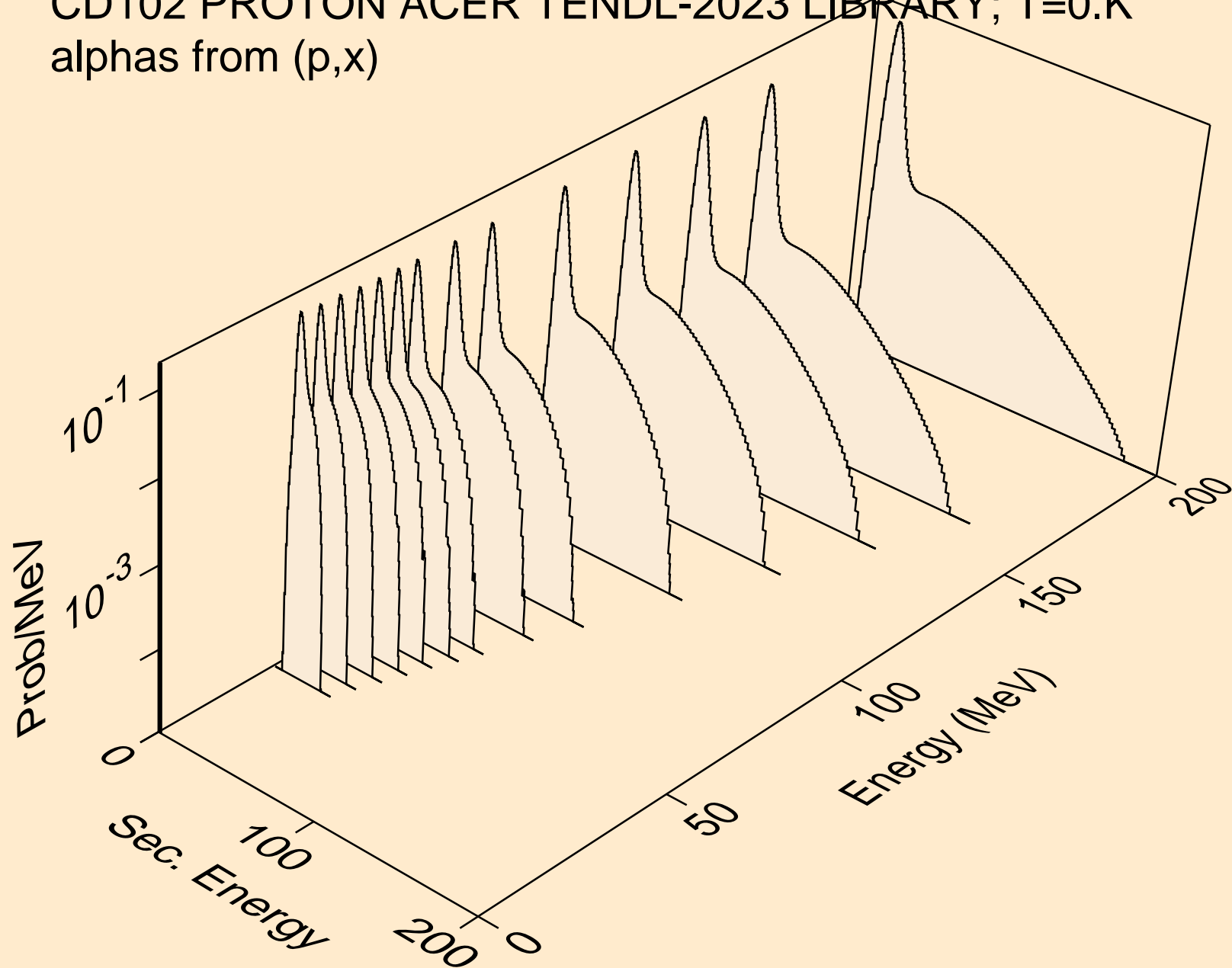

CD102 PROTON ACER TENDL-2023 LIBRARY; T=0.K  
alphas from (p,n\*)a

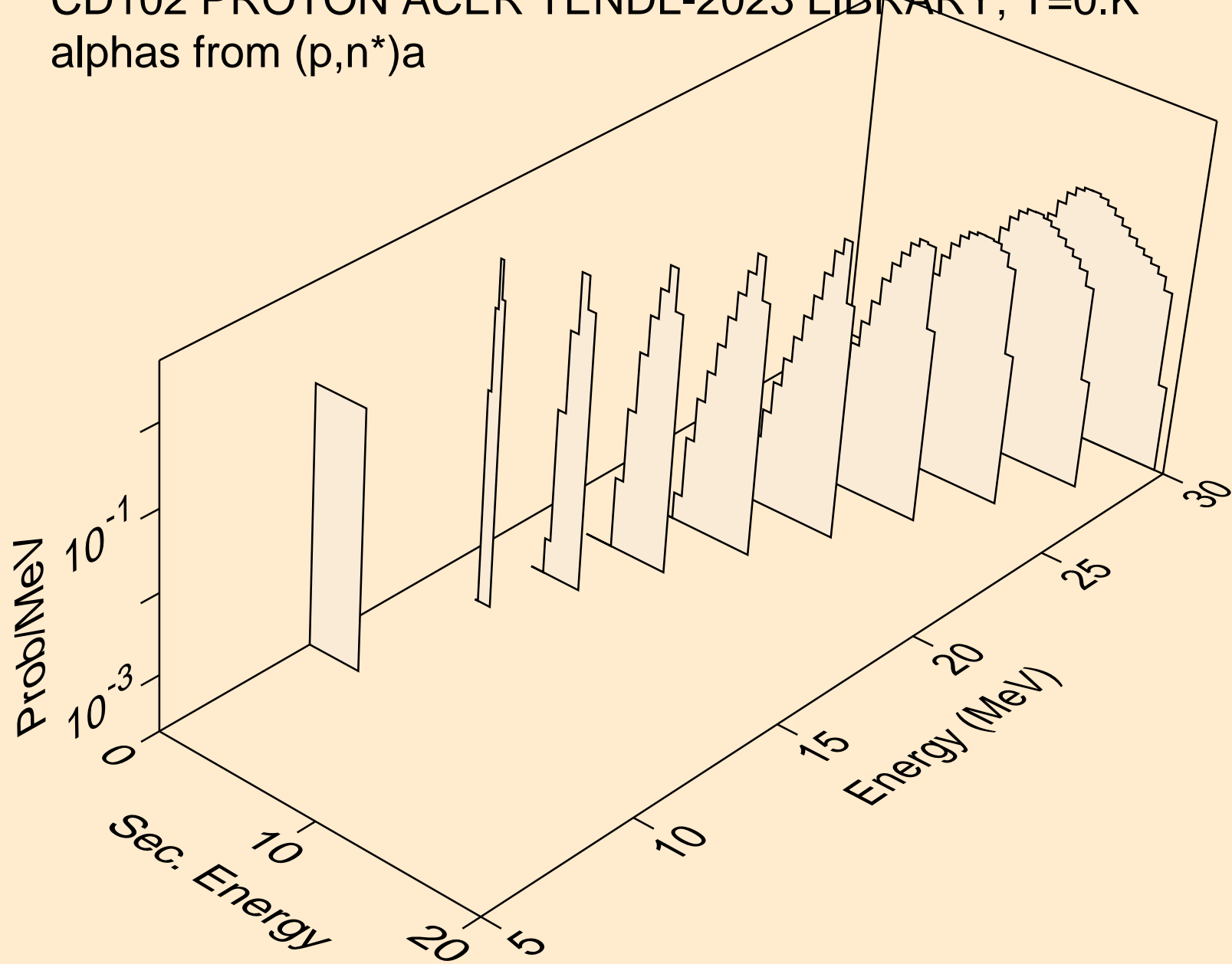



CD102 PROTON ACER TENDL-2023 LIBRARY; T=0.K  
alphas from (p,2n)a

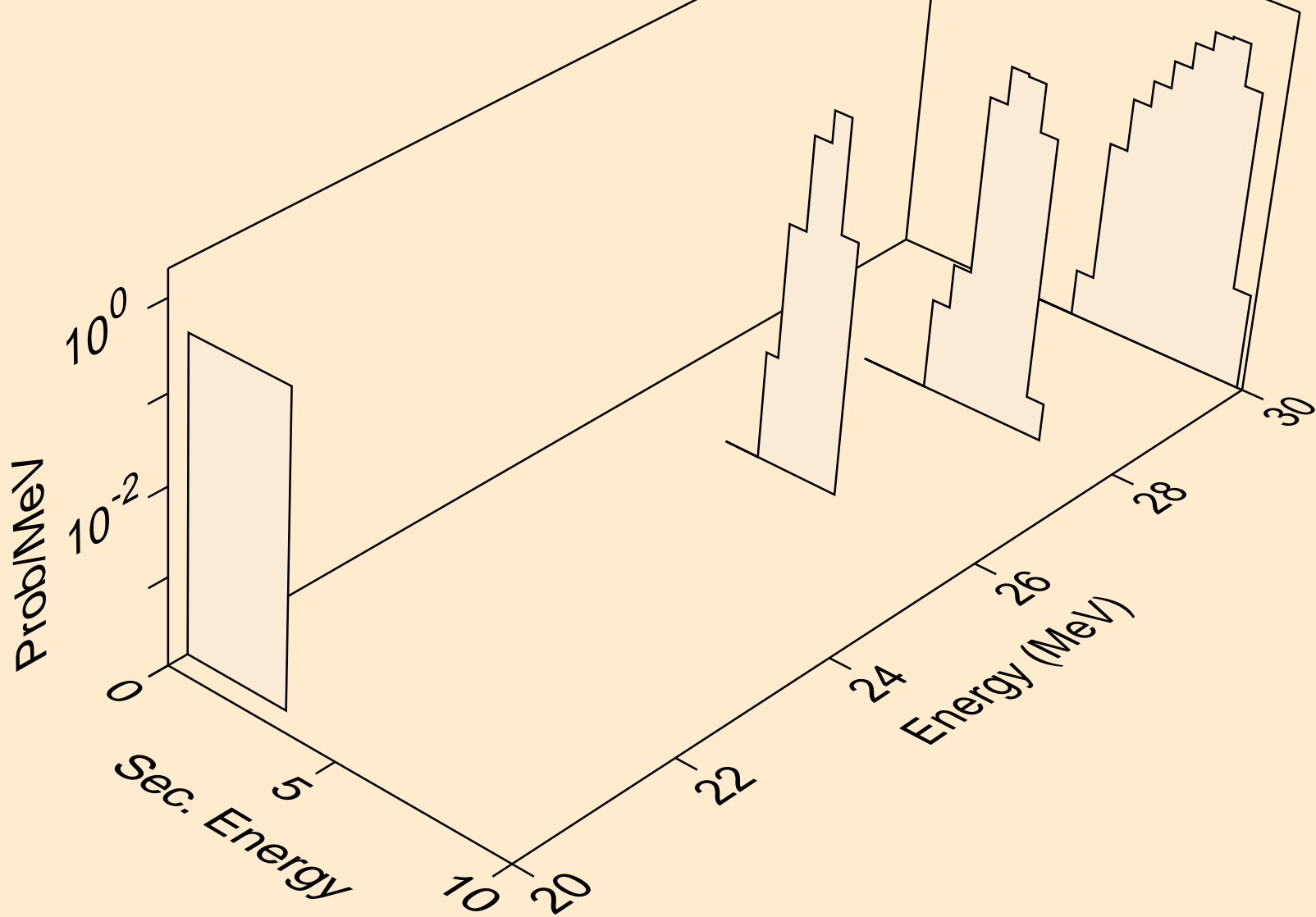

CD102 PROTON ACER TENDL-2023 LIBRARY; T=0.K  
alphas from (p,npa)

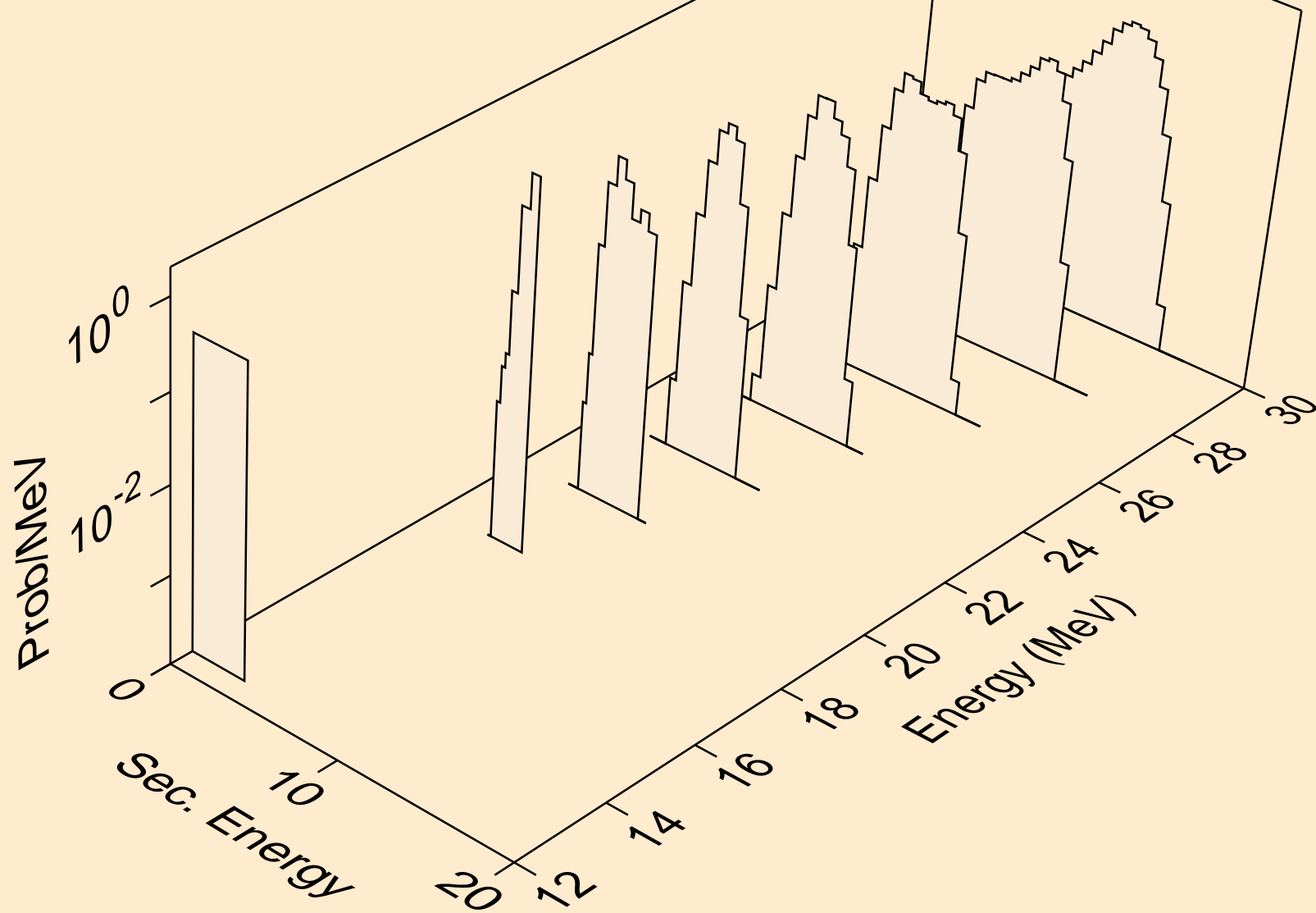

CD102 PROTON ACER TENDL-2023 LIBRARY; T=0.K  
alphas from (p,a)

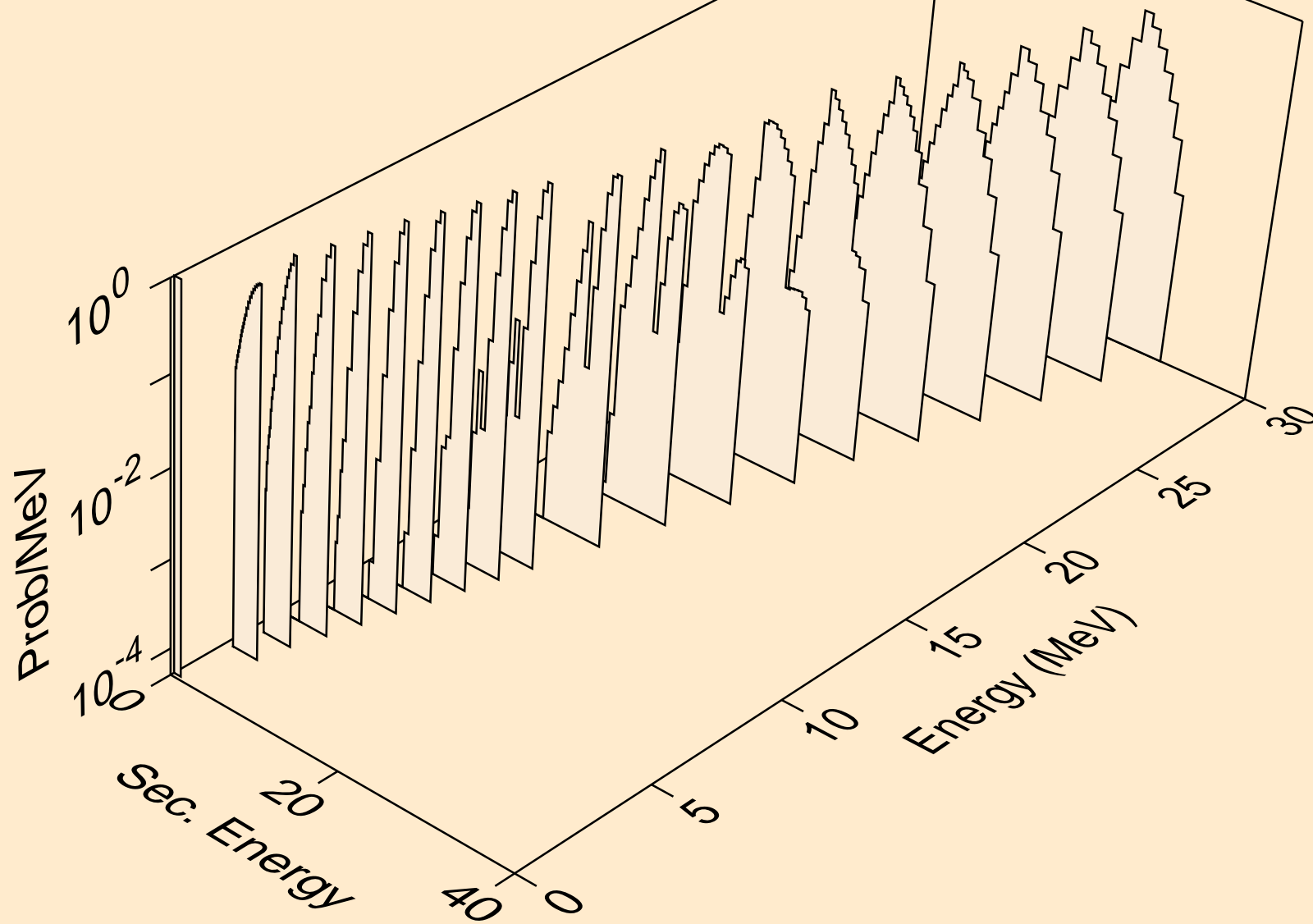

CD102 PROTON ACER TENDL-2023 LIBRARY; T=0.K  
alphas from (p,2a)

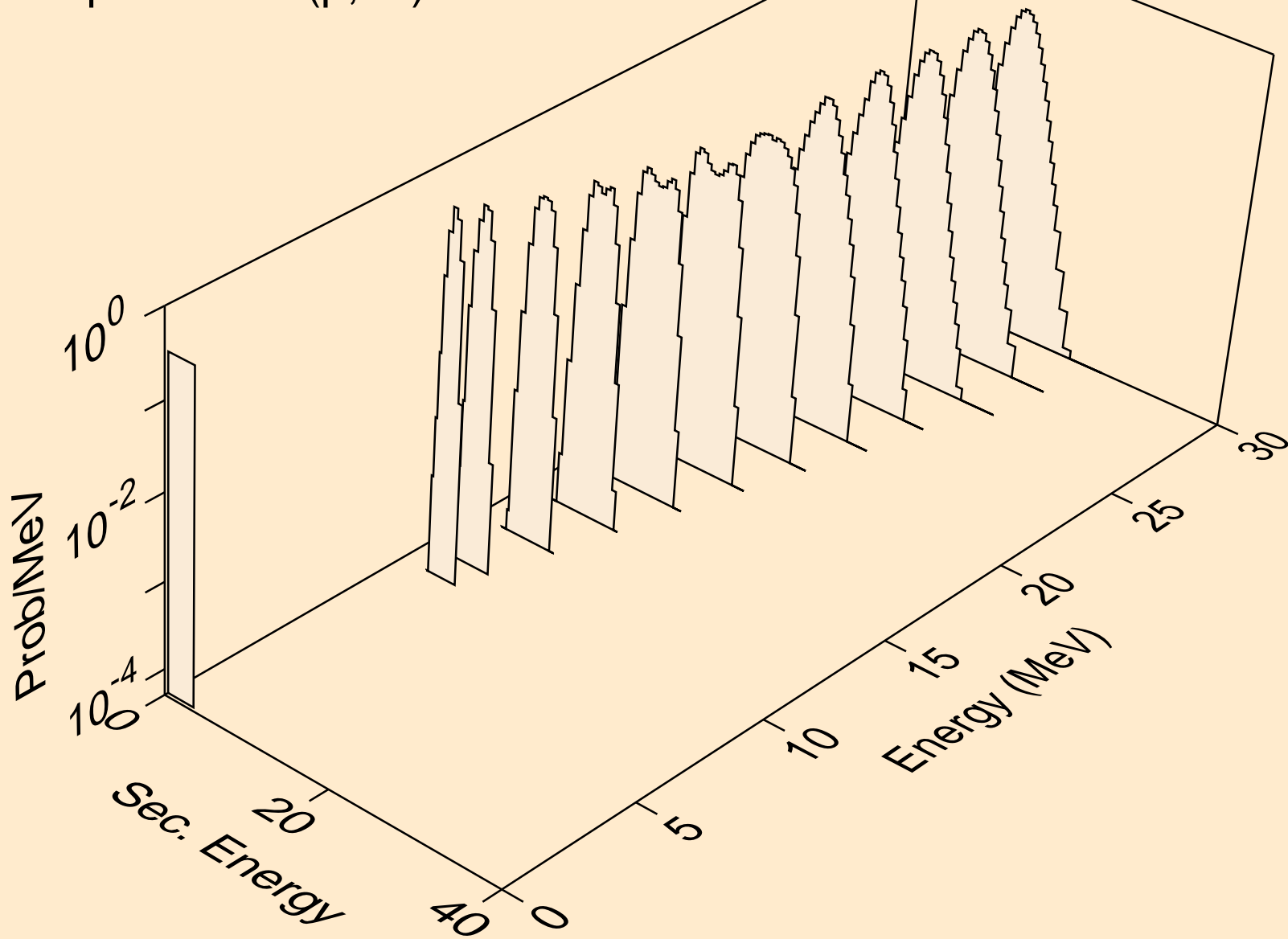

CD102 PROTON ACER TENDL-2023 LIBRARY; T=0.K  
alphas from (p,pa)

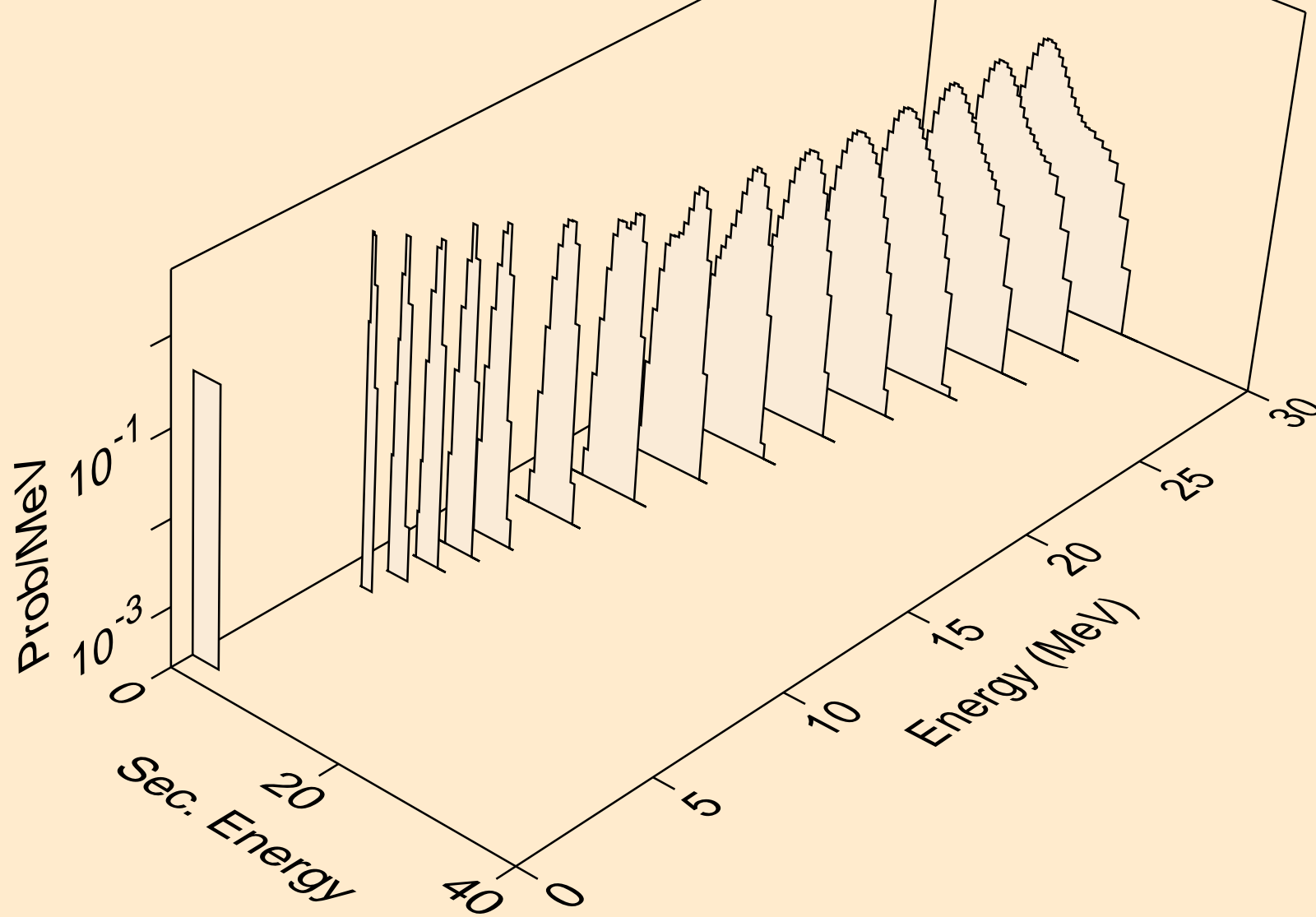

CD102 PROTON ACER TENDL-2023 LIBRARY; T=0.K  
alphas from (p,da)

