

# CE135 PROTON ACER TENDL-2023 LIBRARY; T=0.K

## Principal cross sections

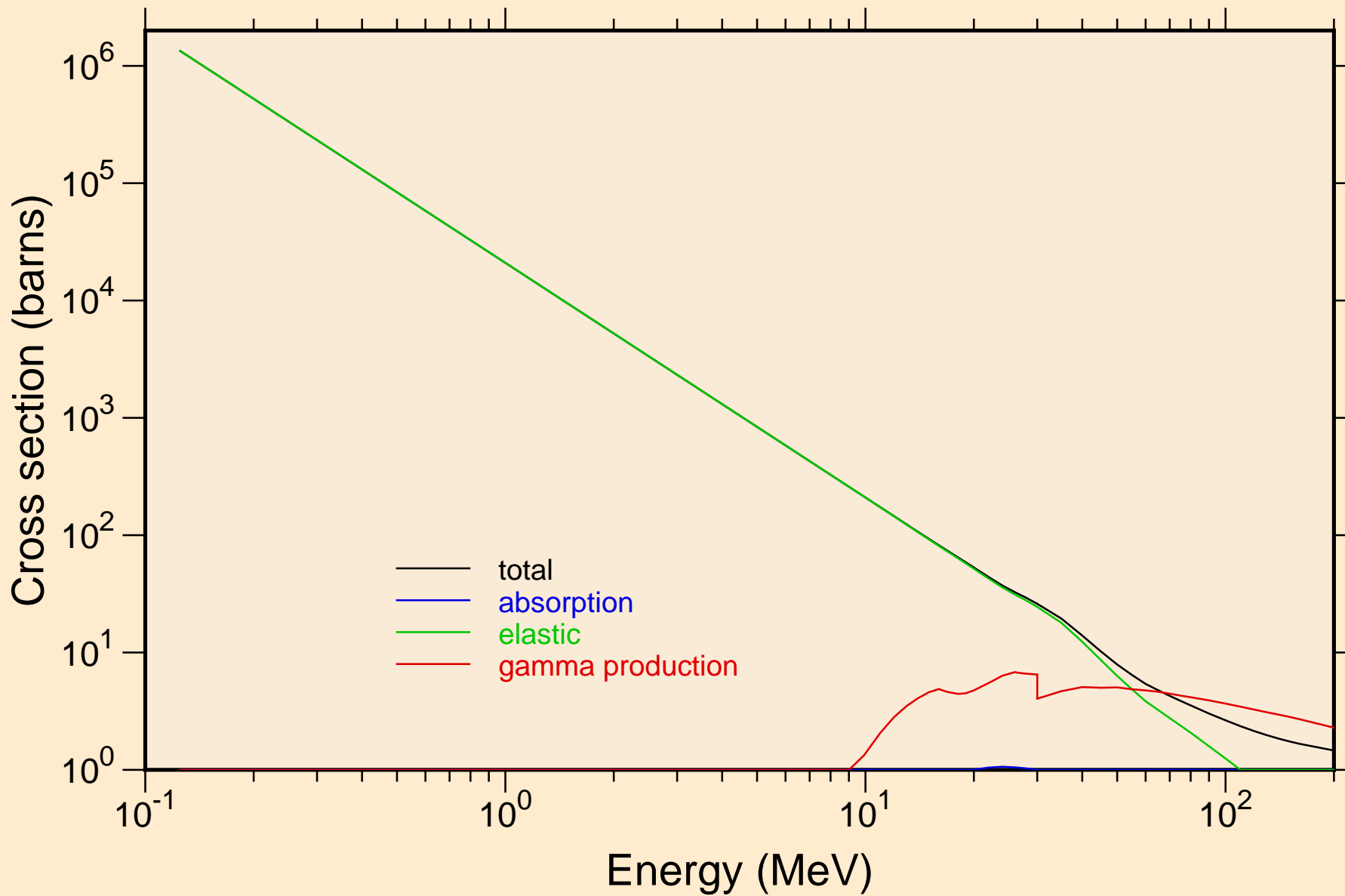

CE135 PROTON ACER TENDL-2023 LIBRARY; T=0.K  
Heating

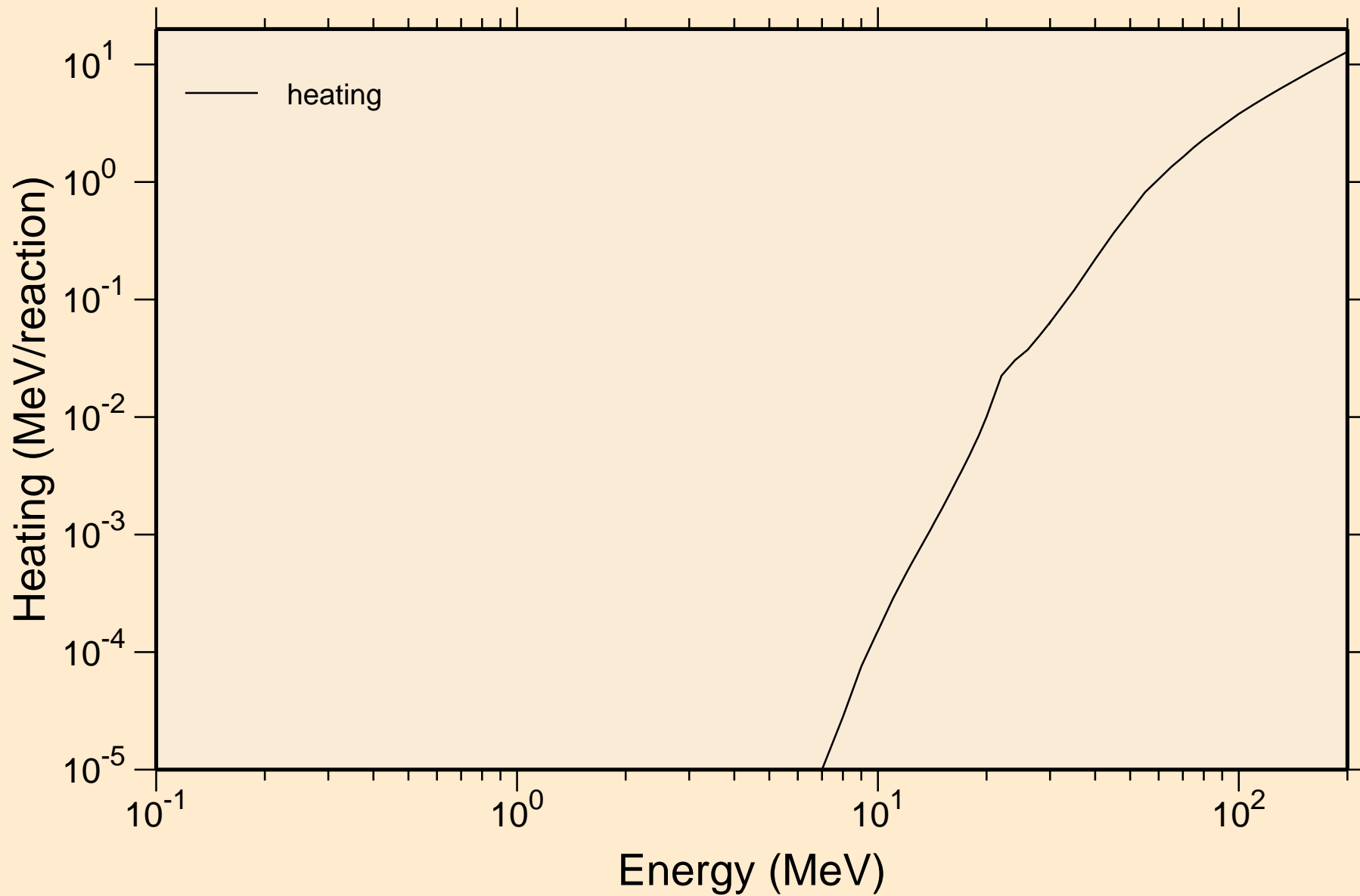

# CE135 PROTON ACER TENDL-2023 LIBRARY; T=0.K

## Principal cross sections

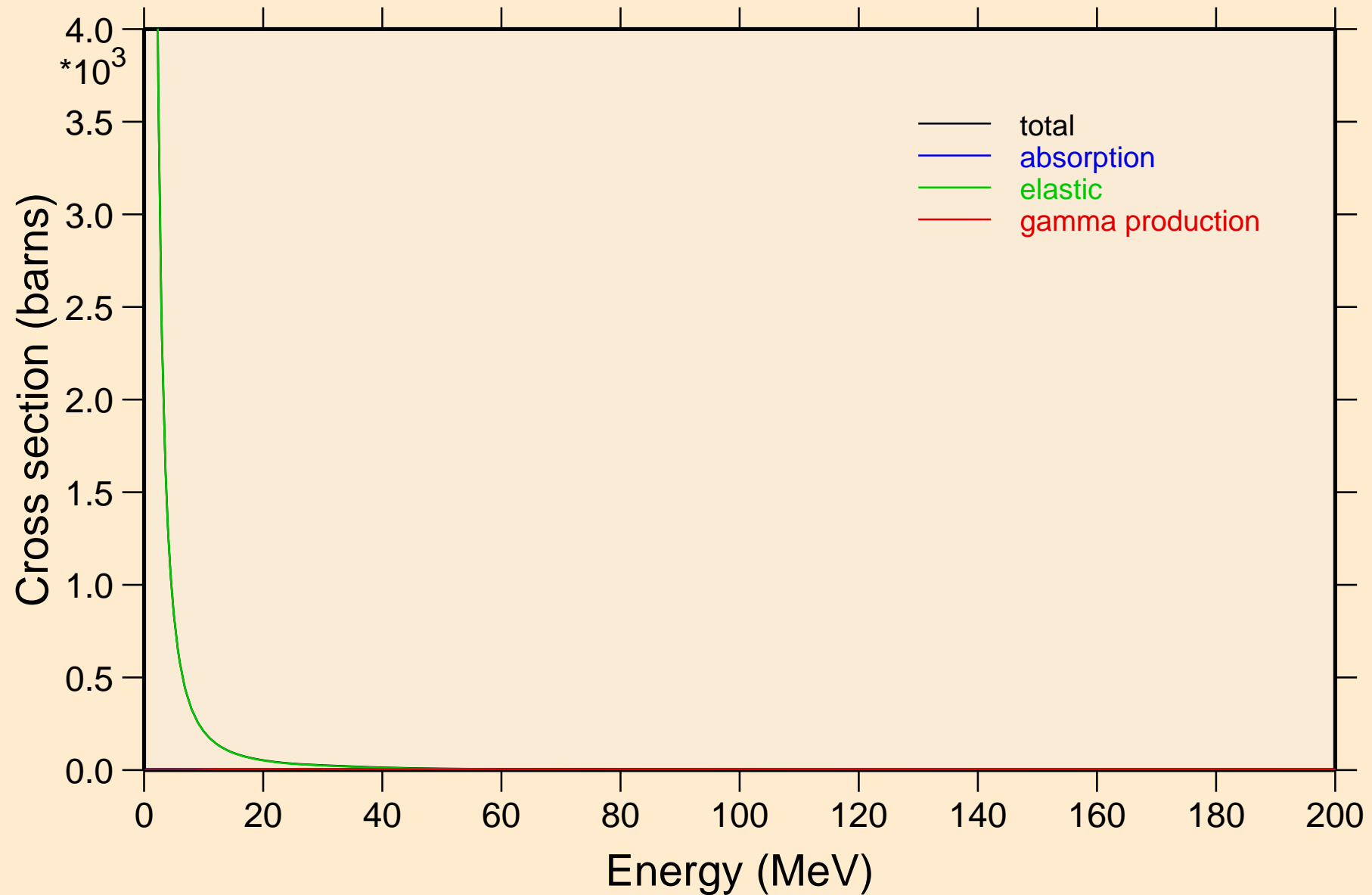

# CE135 PROTON ACER TENDL-2023 LIBRARY; T=0.K

## Heating

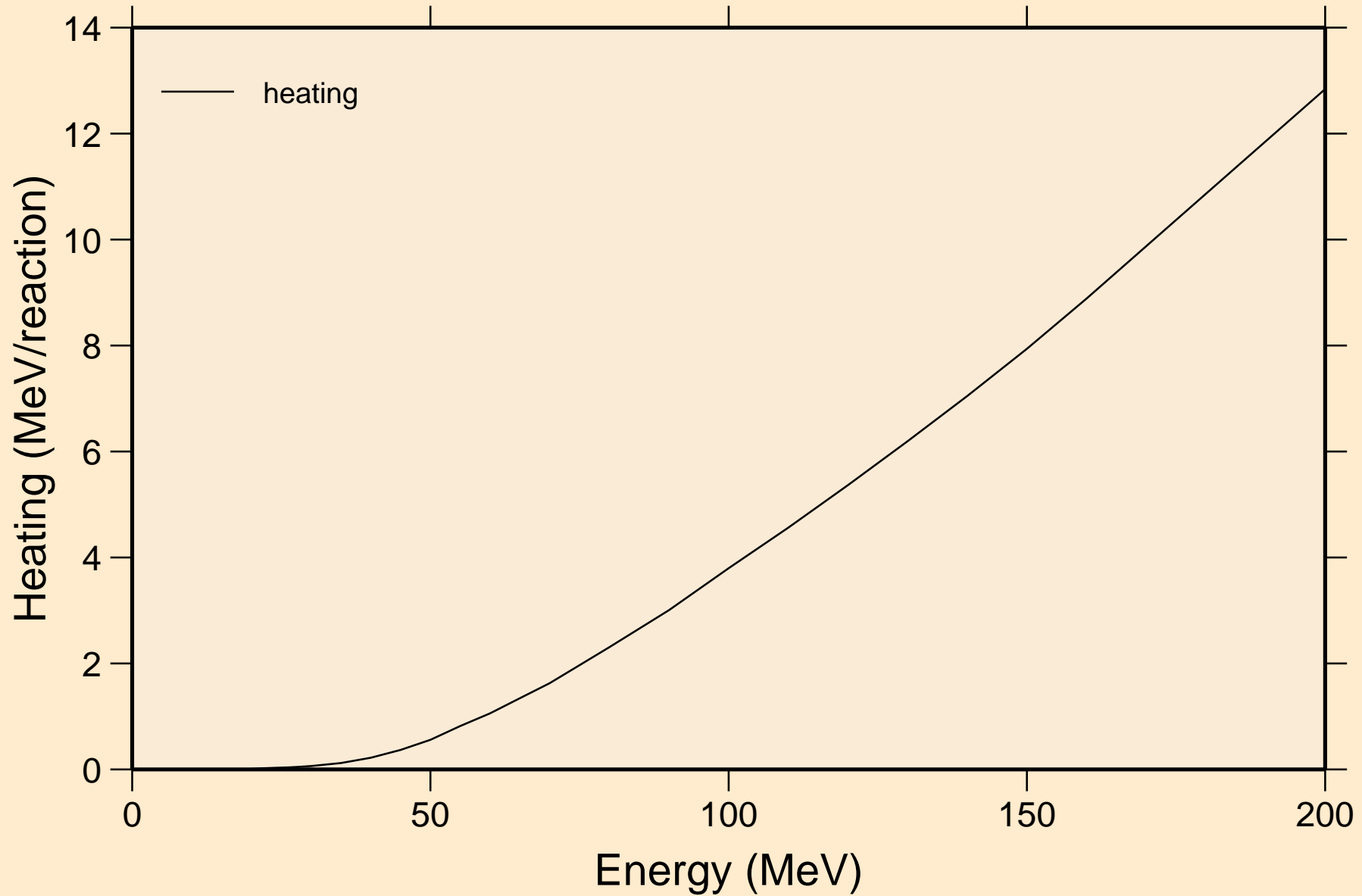

# CE135 PROTON ACER TENDL-2023 LIBRARY; T=0.K

## Threshold reactions

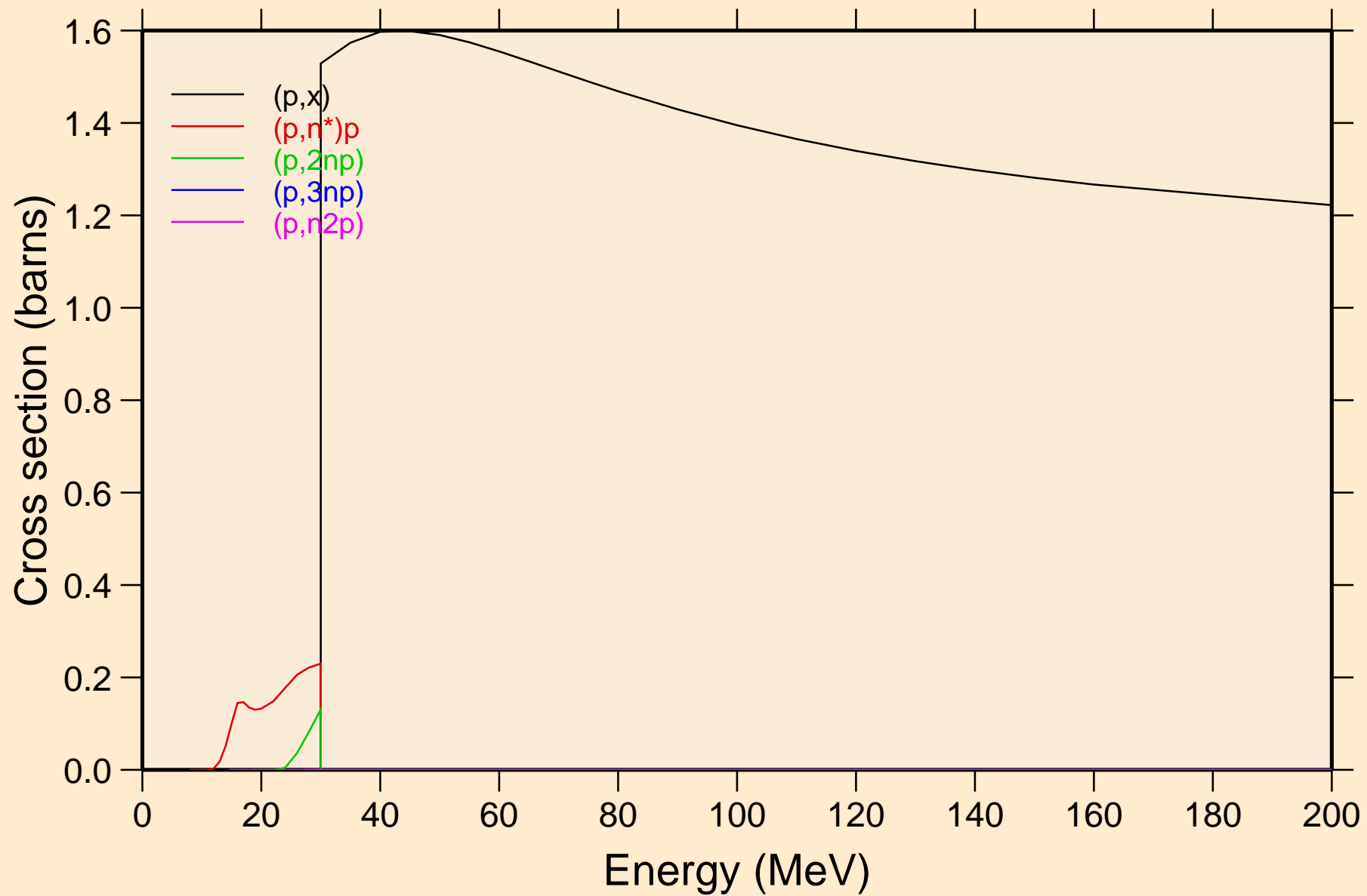

# CE135 PROTON ACER TENDL-2023 LIBRARY; T=0.K

## Threshold reactions

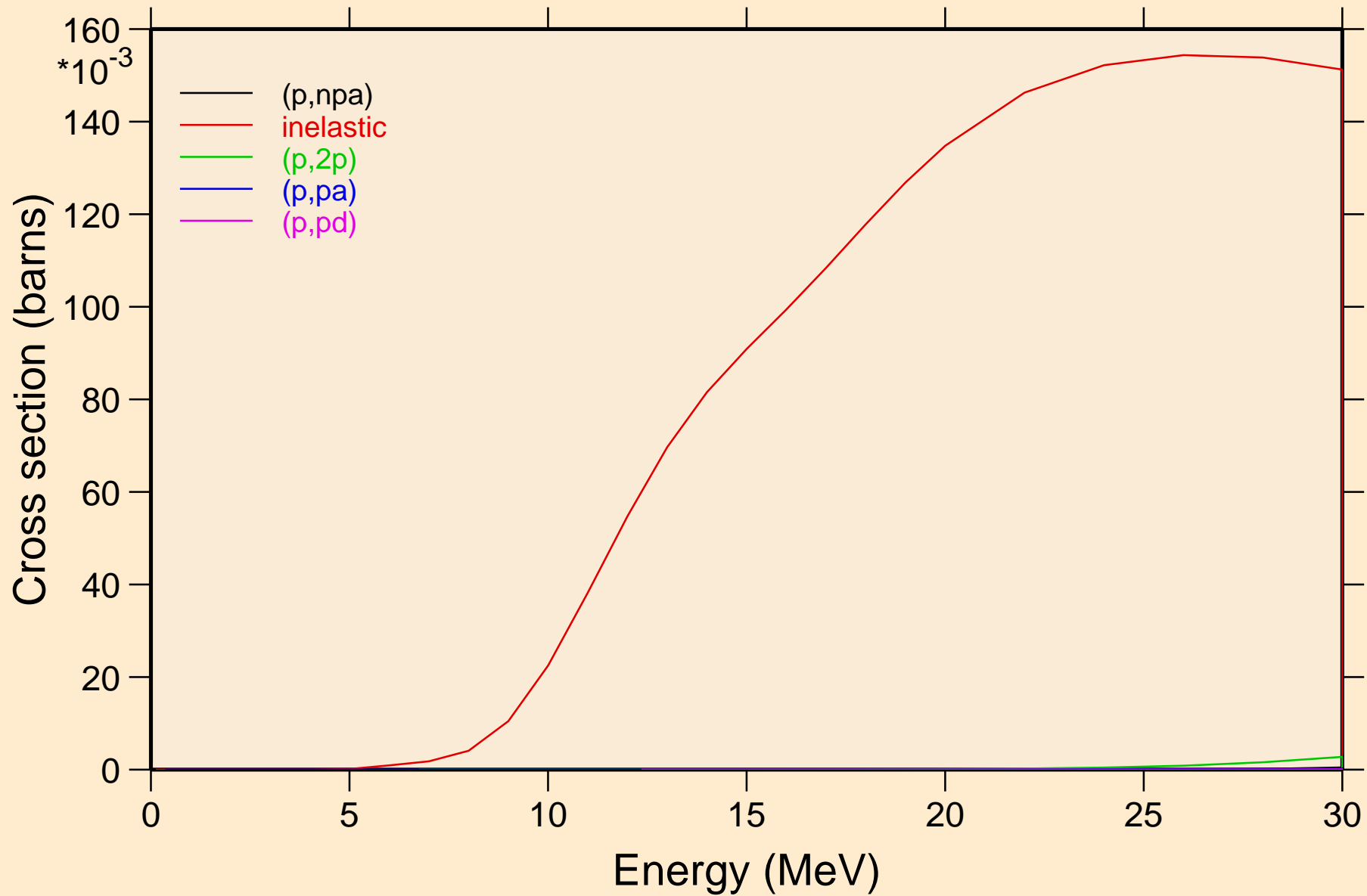

# CE135 PROTON ACER TENDL-2023 LIBRARY; T=0.K

## Threshold reactions

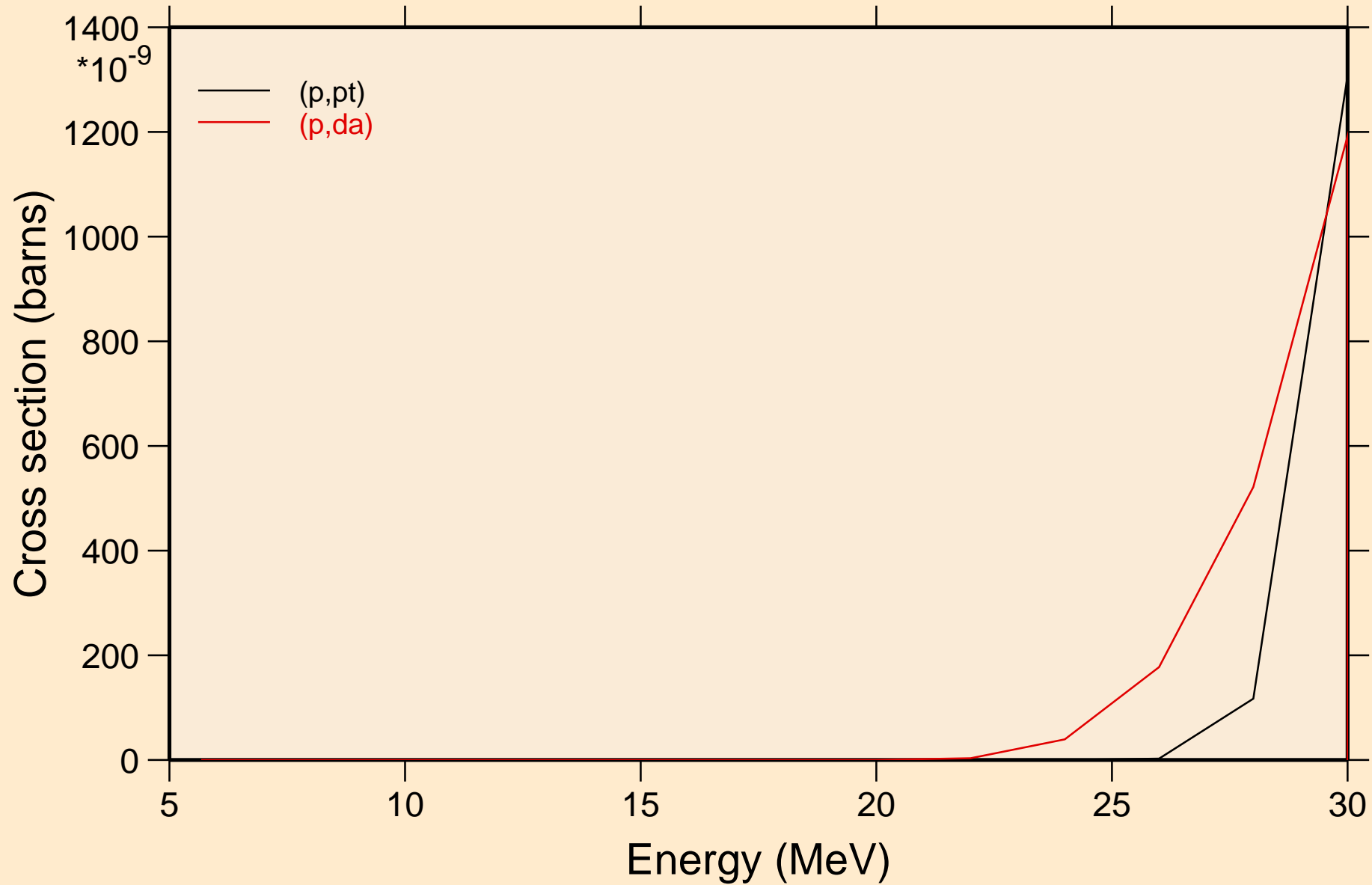

CE135 PROTON ACER TENDL-2023 LIBRARY; T=0.K  
angular distribution for elastic

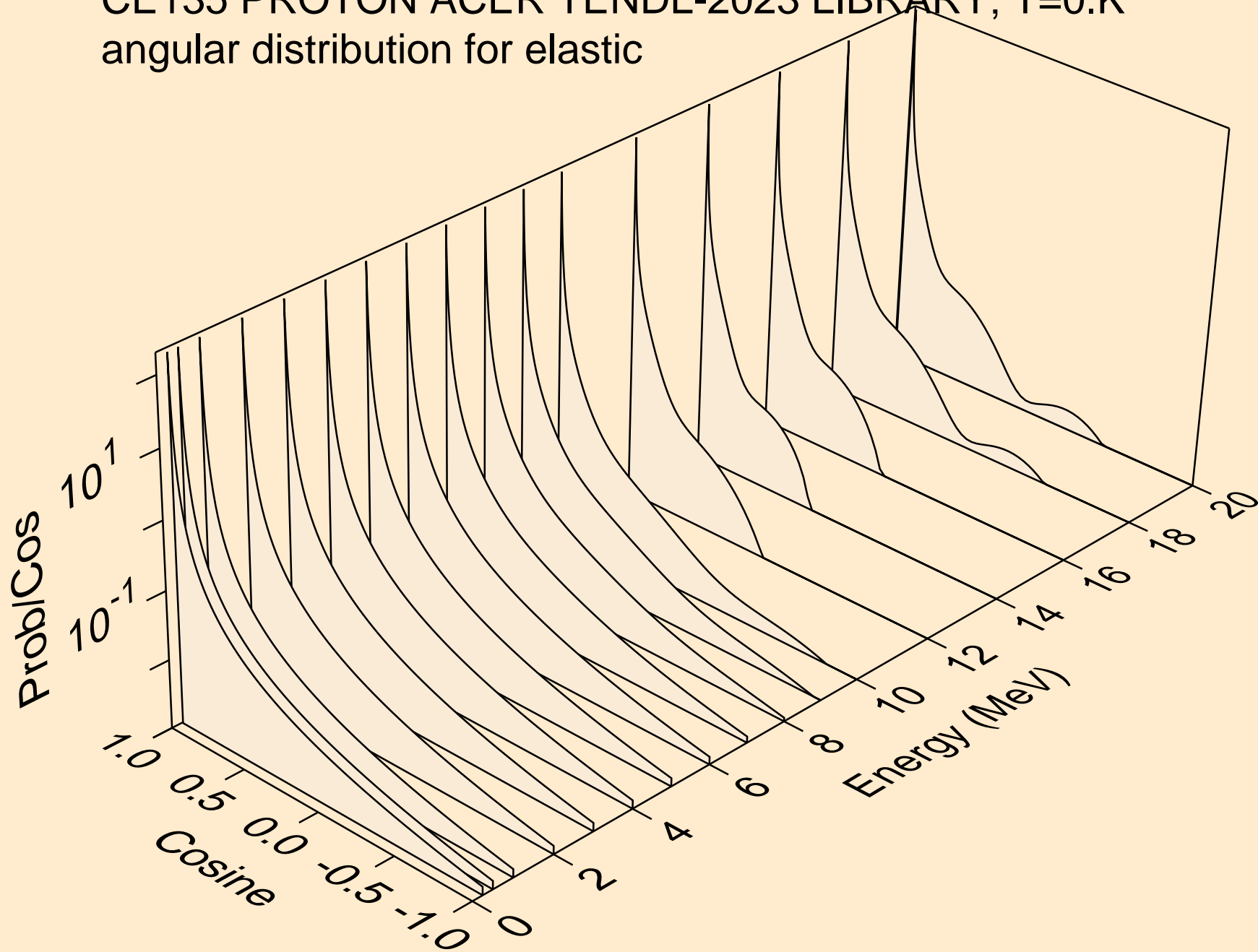



CE135 PROTON ACER TENDL-2023 LIBRARY; T=0.K  
angular distribution for elastic

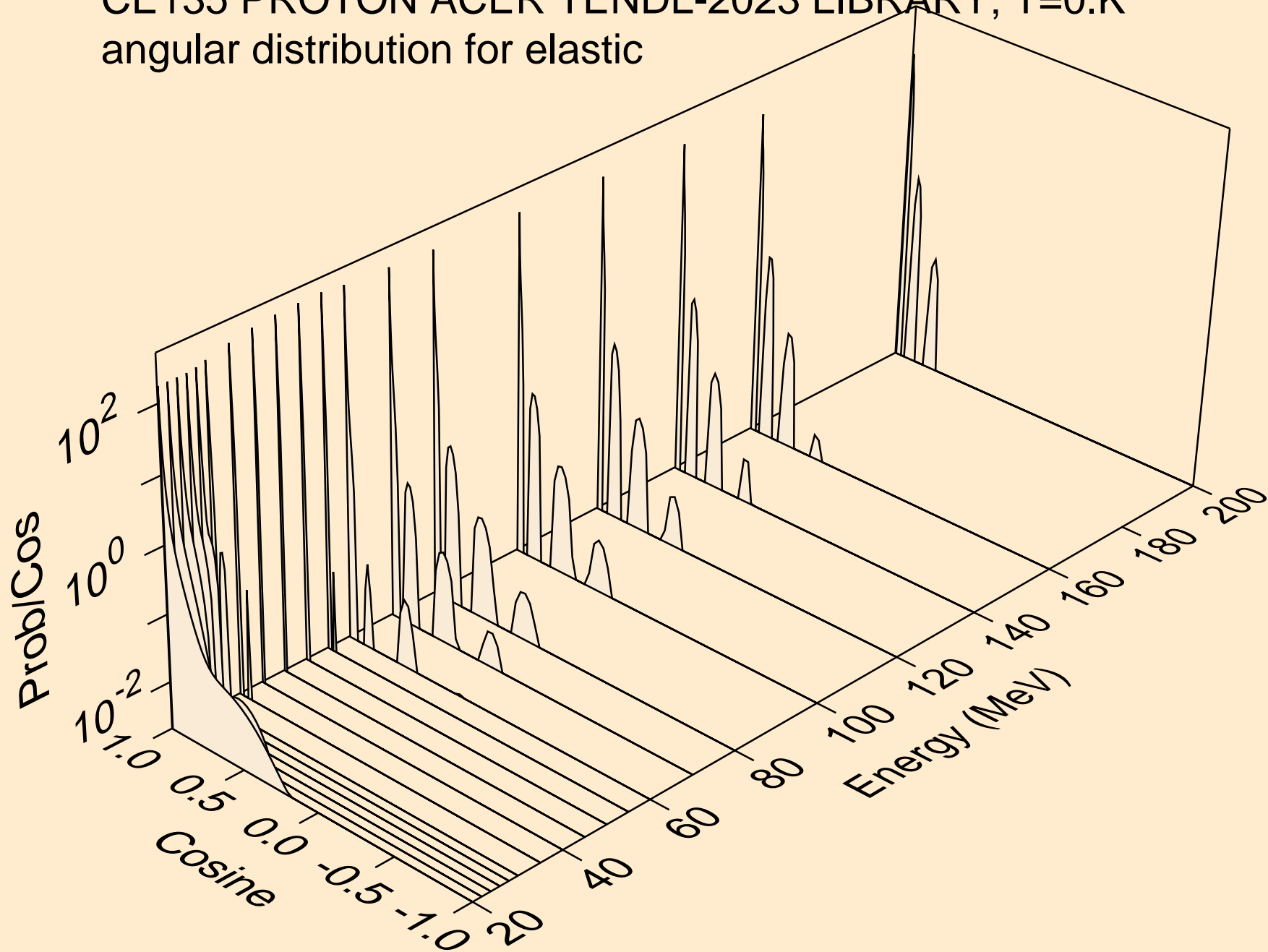

CE135 PROTON ACER TENDL-2023 LIBRARY; T=0.K  
Proton emission for (p,x)

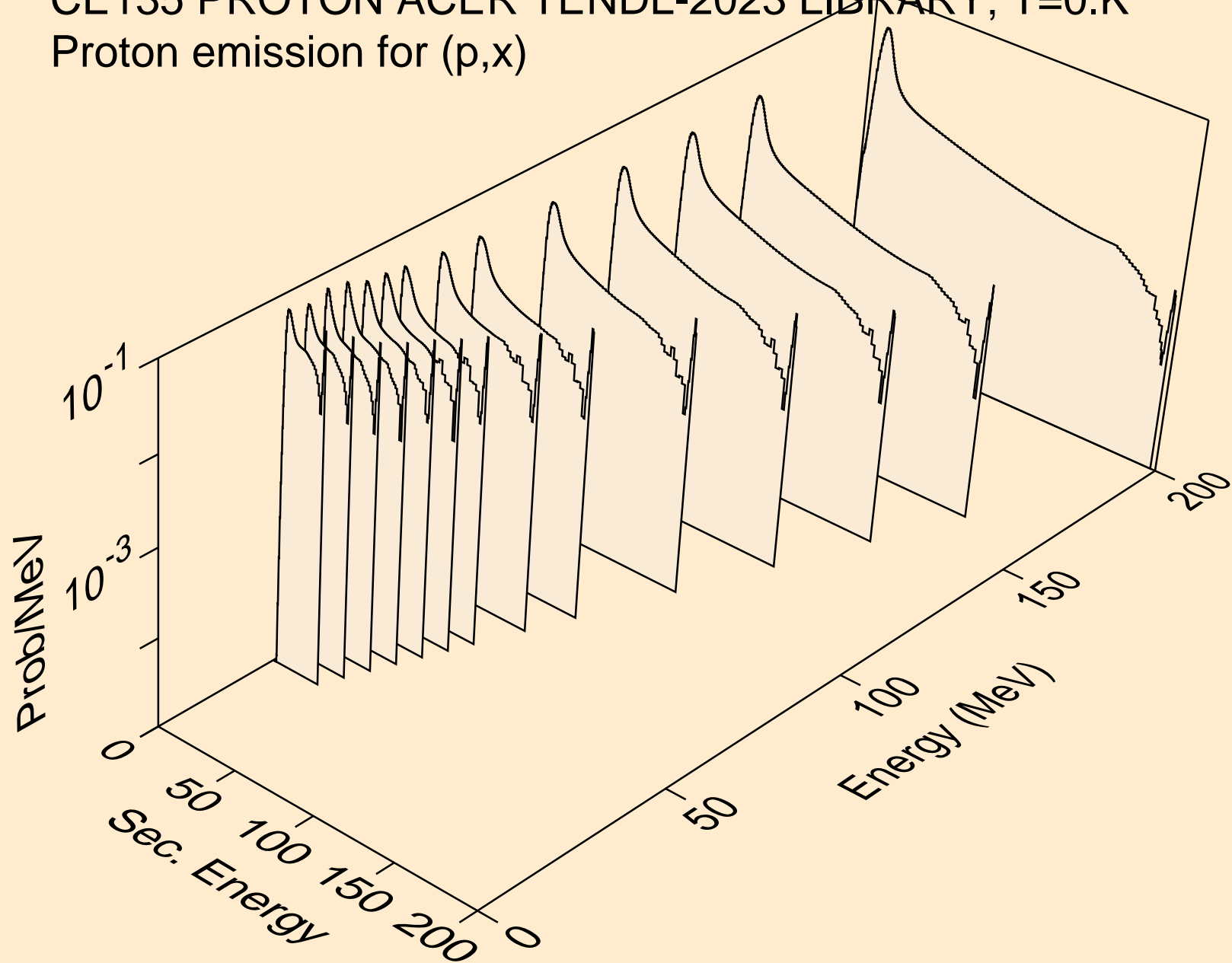

CE135 PROTON ACER TENDL-2023 LIBRARY; T=0.K  
Proton emission for (p,n\*)p

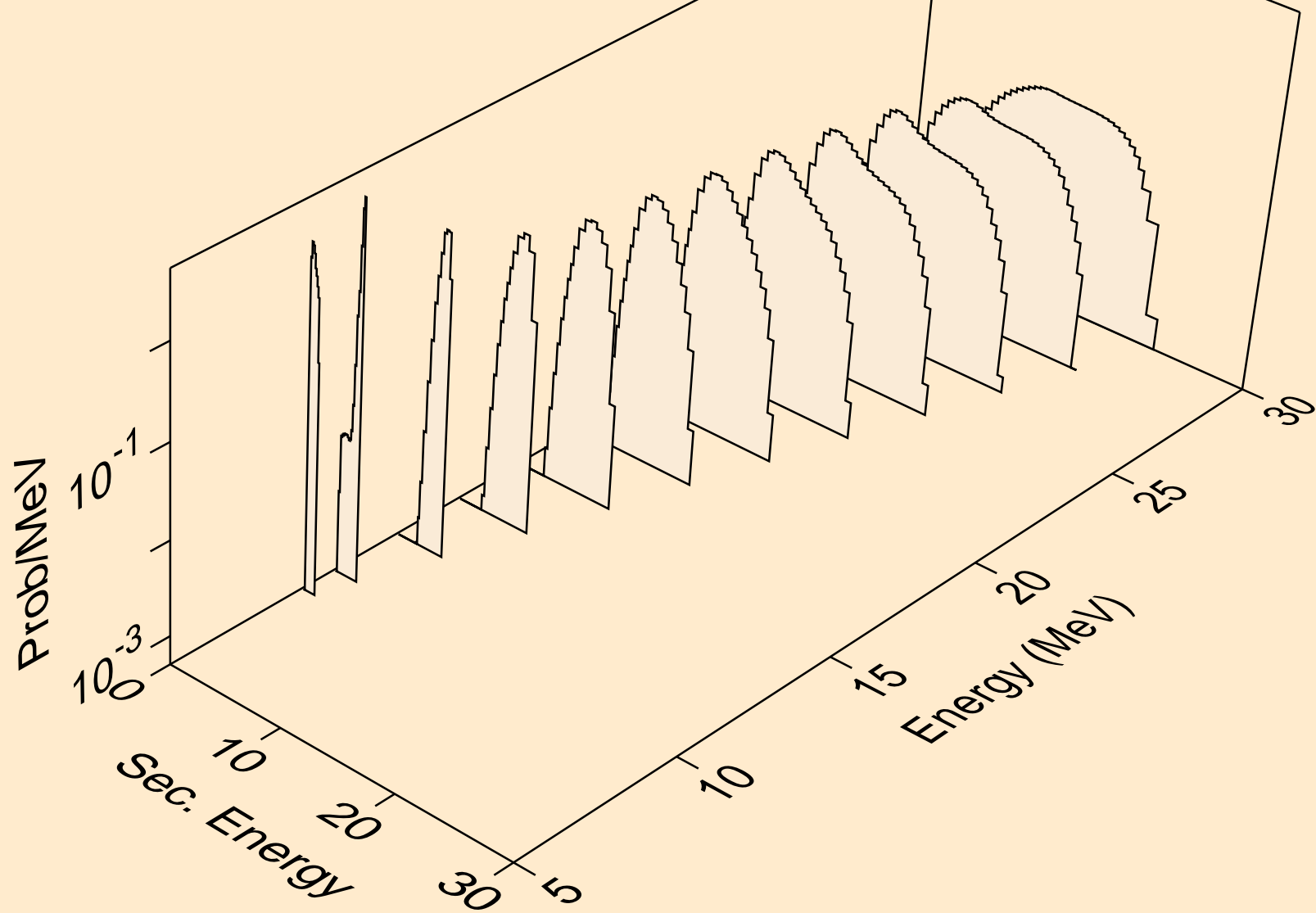

CE135 PROTON ACER TENDL-2023 LIBRARY; T=0.K  
Proton emission for (p,2np)

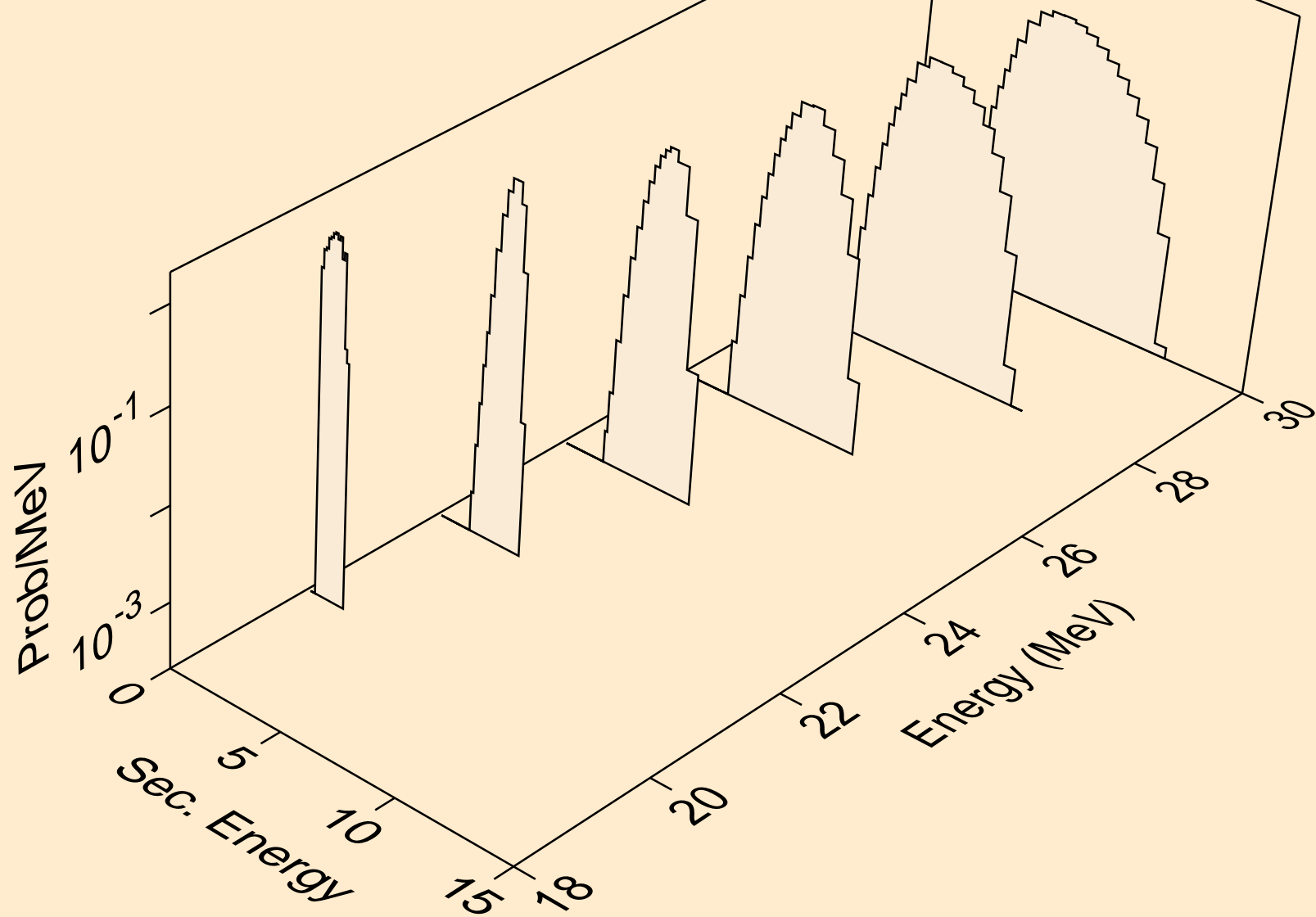

CE135 PROTON ACER TENDL-2023 LIBRARY; T=0.K  
Proton emission for (p,3np)

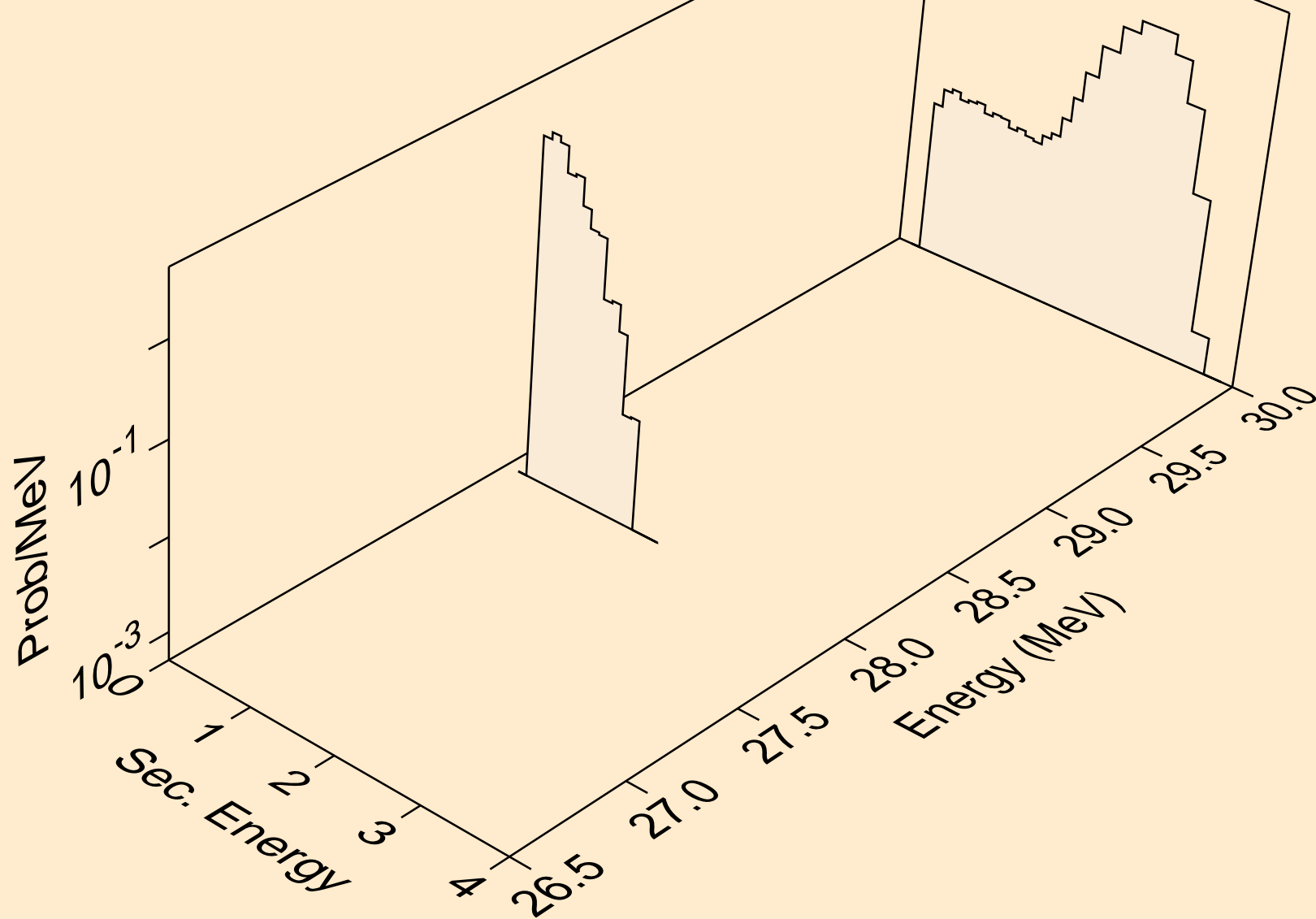

CE135 PROTON ACER TENDL-2023 LIBRARY; T=0.K  
Proton emission for (p,n2p)

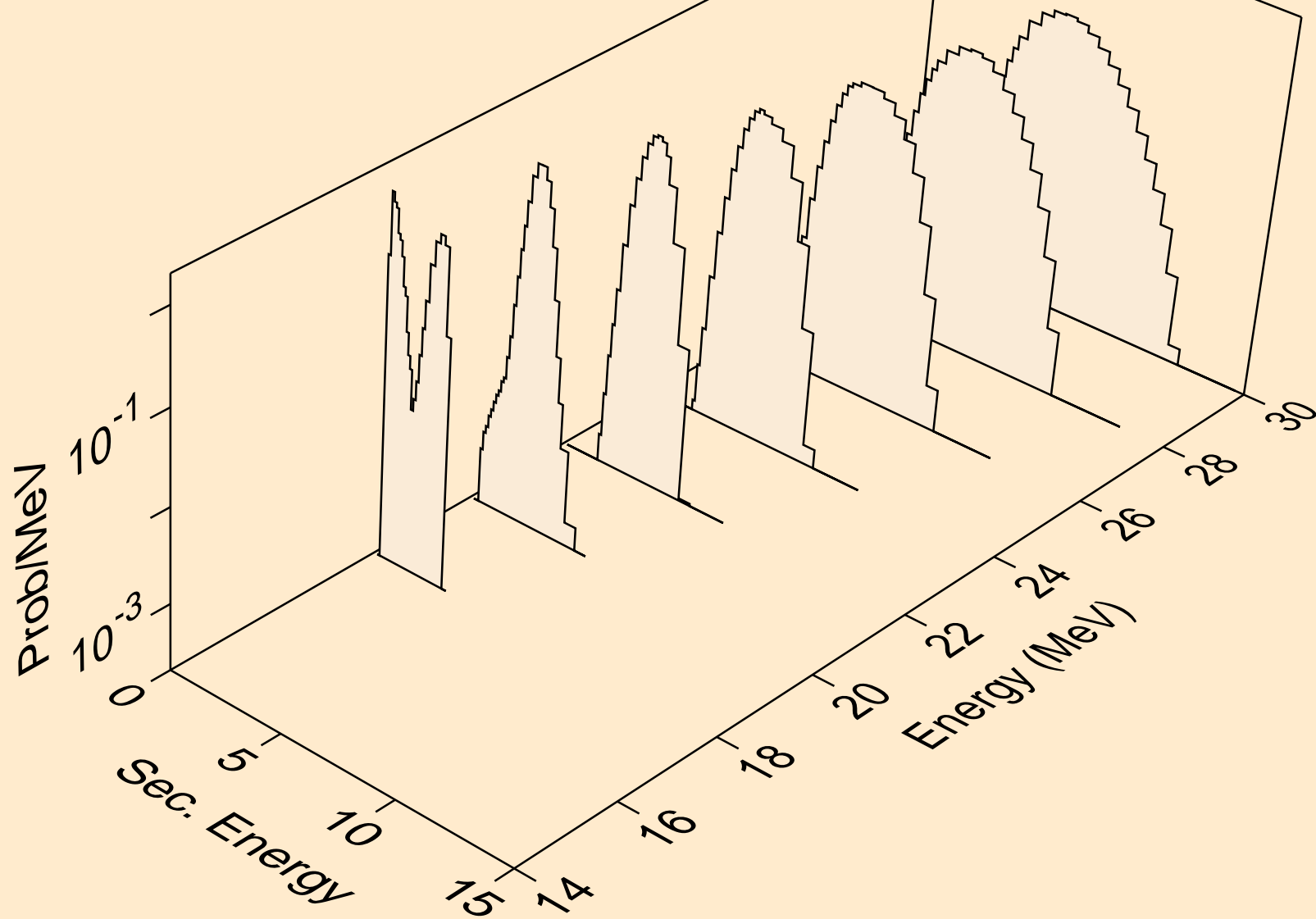

CE135 PROTON ACER TENDL-2023 LIBRARY; T=0.K  
Proton emission for (p,npa)

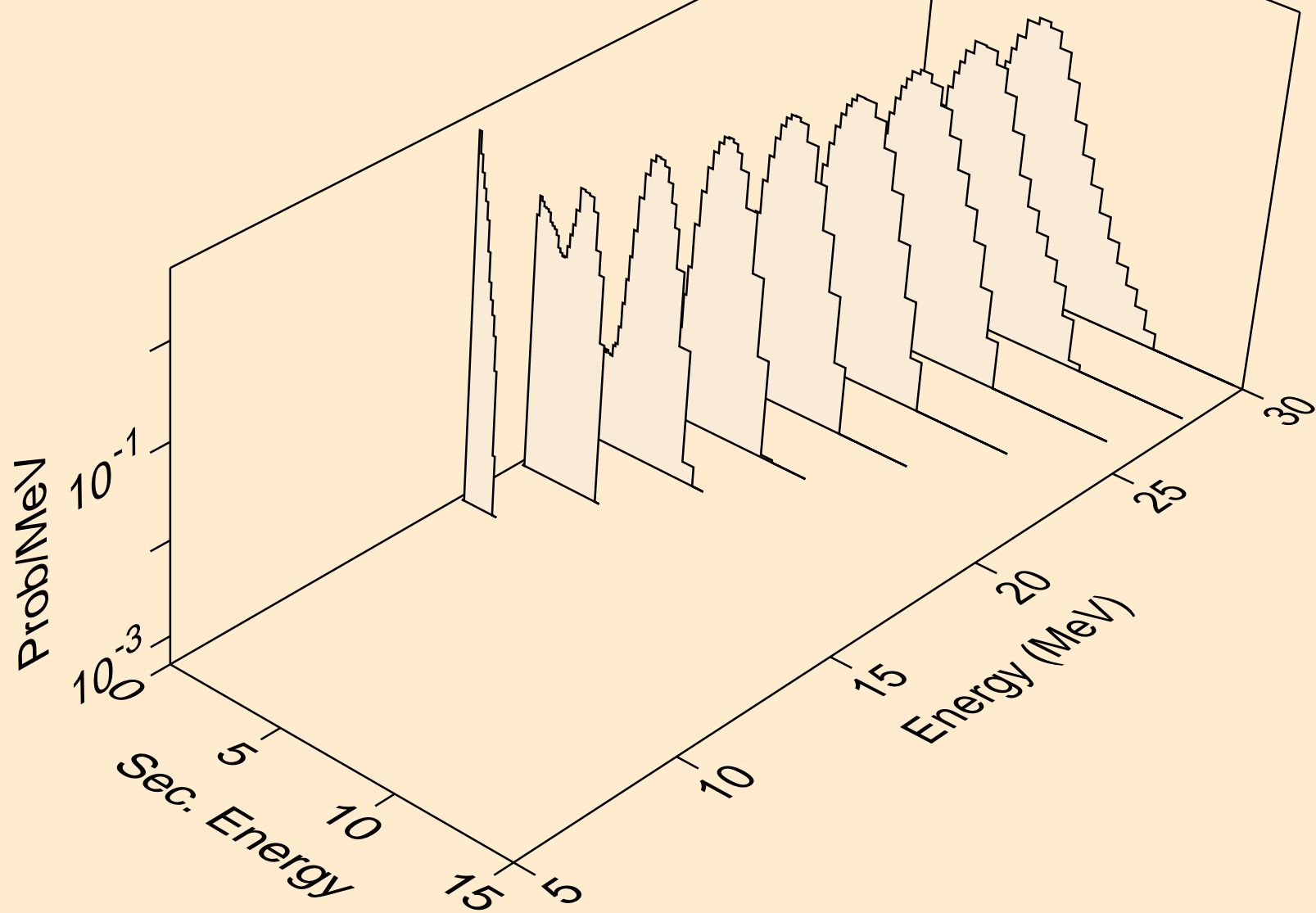

CE135 PROTON ACER TENDL-2023 LIBRARY; T=0.K  
Proton emission for inelastic

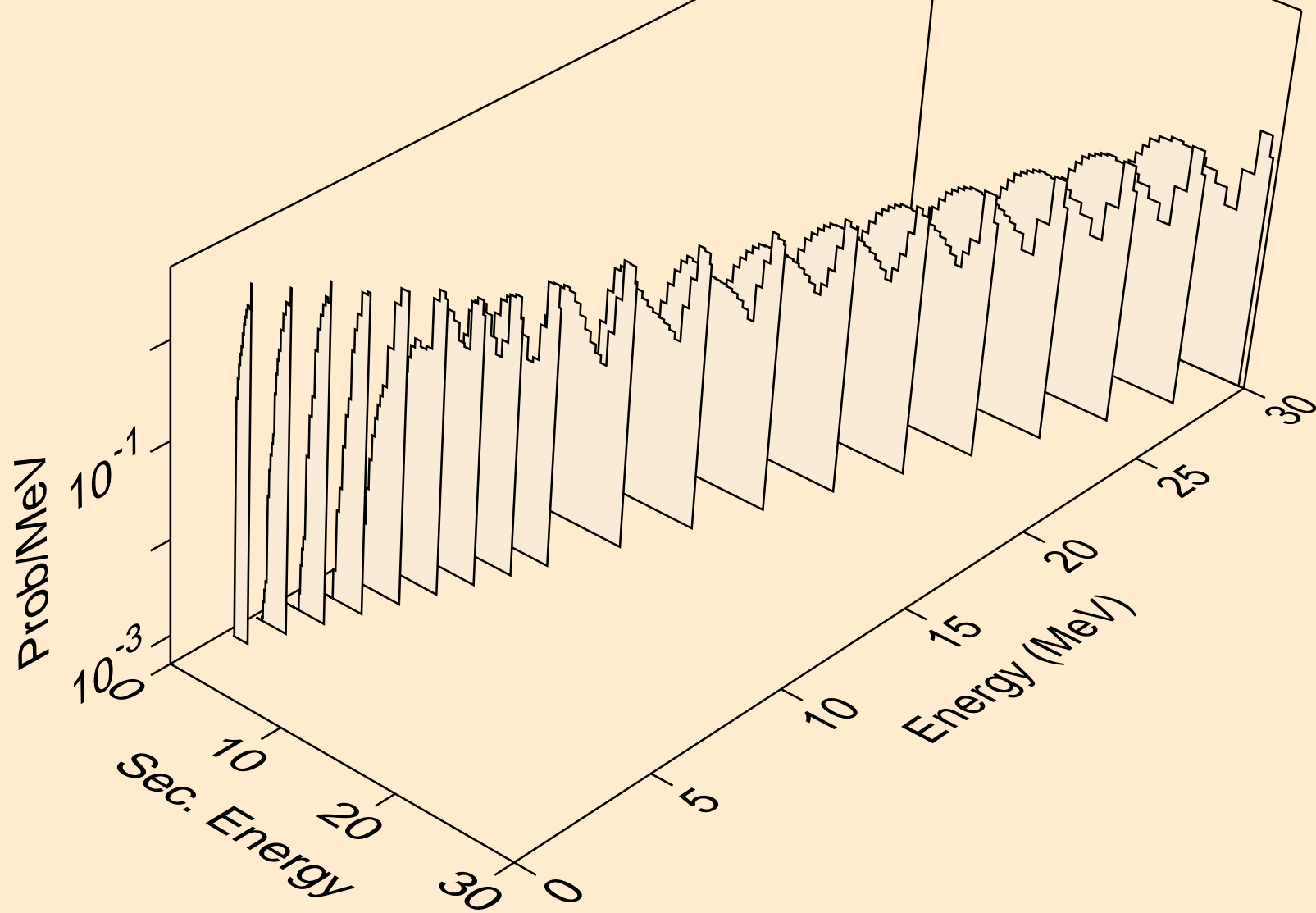



CE135 PROTON ACER TENDL-2023 LIBRARY; T=0.K  
Proton emission for (p,2p)

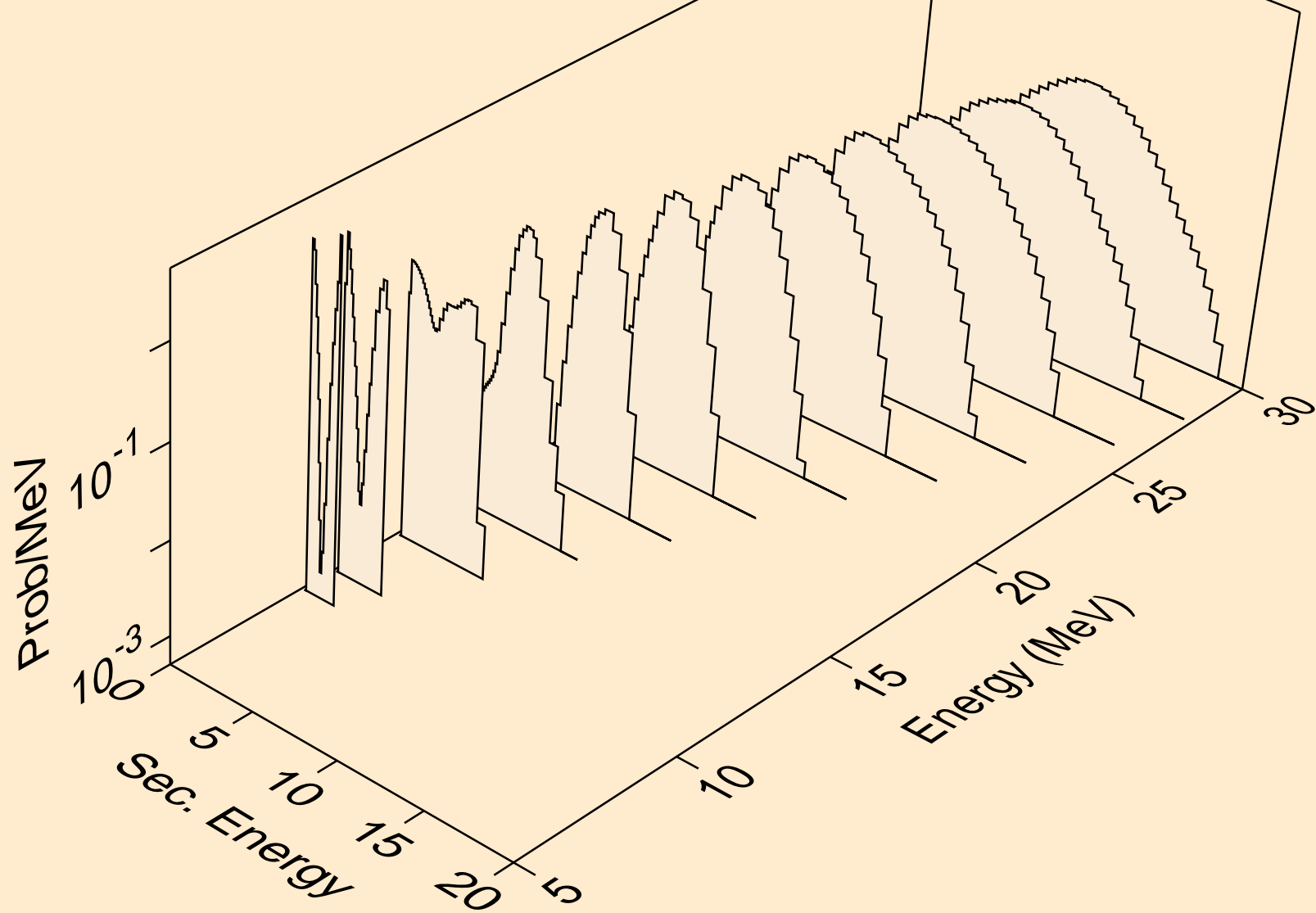

CE135 PROTON ACER TENDL-2023 LIBRARY; T=0.K  
Proton emission for (p,pa)

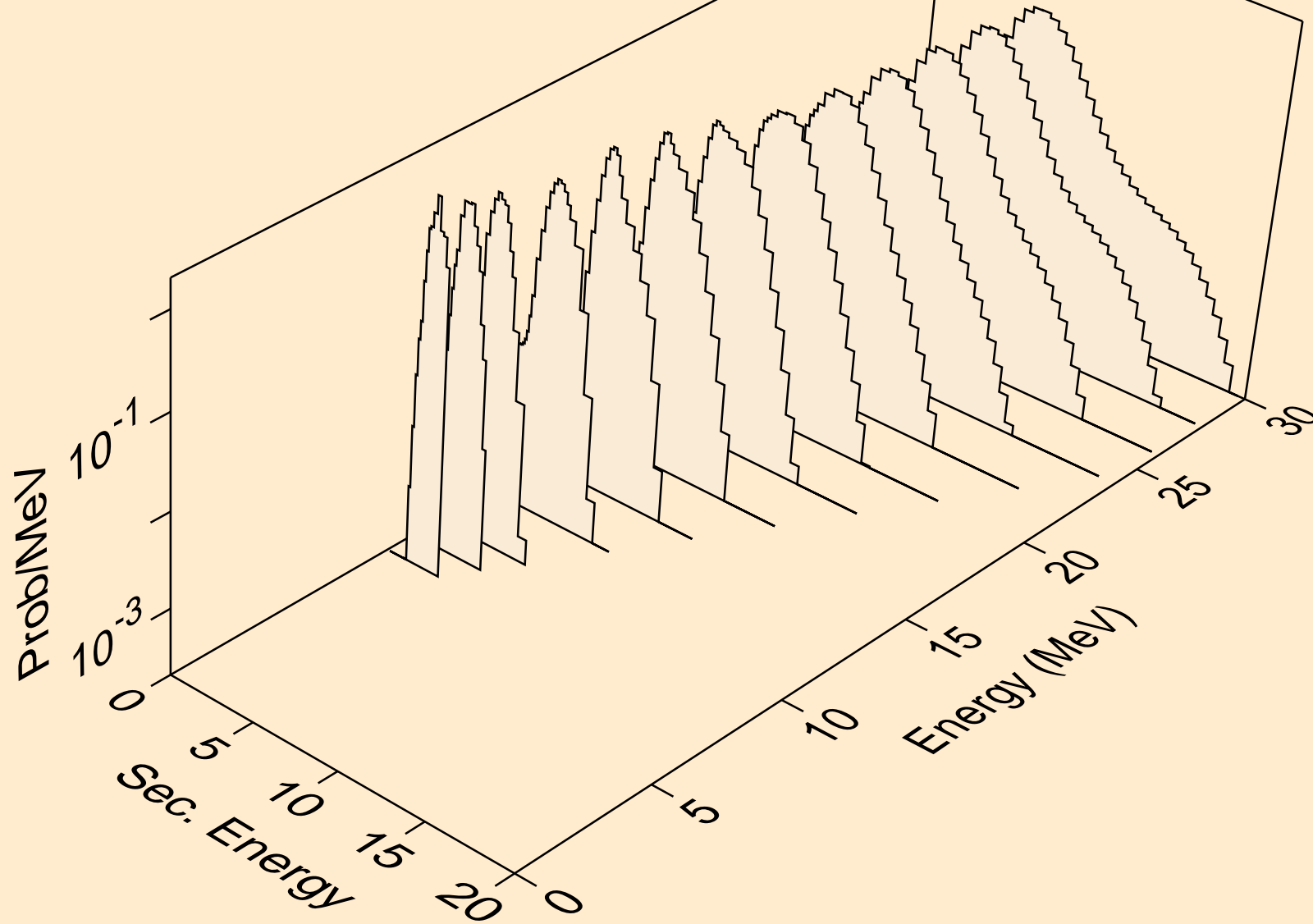

CE135 PROTON ACER TENDL-2023 LIBRARY; T=0.K  
Proton emission for (p,pd)

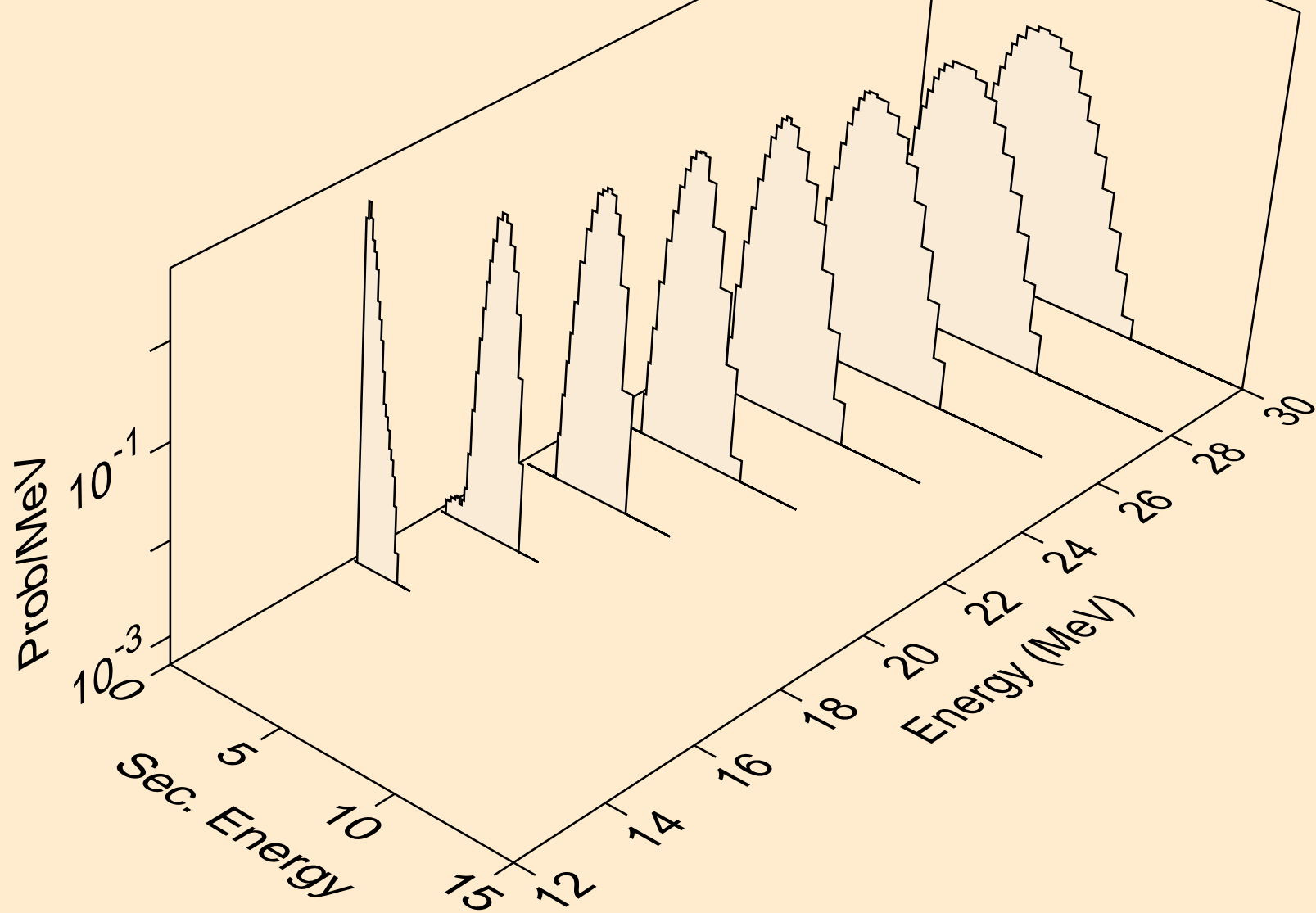

# CE135 PROTON ACER TENDL-2023 LIBRARY; T=0.K

Proton emission for (p,pt)

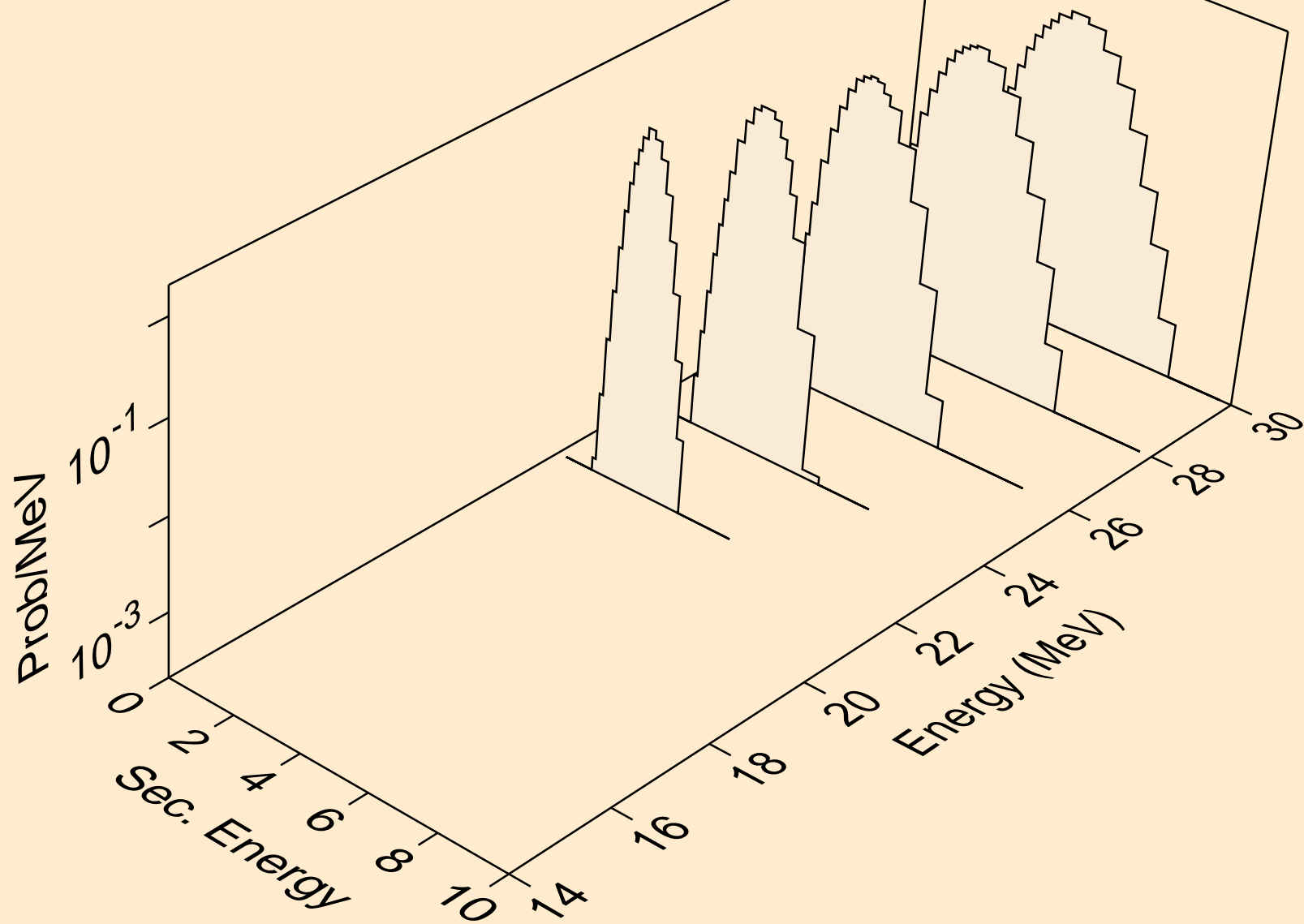

CE135 PROTON ACER TENDL-2023 LIBRARY; T=0.K  
Photon emission for (z,n)

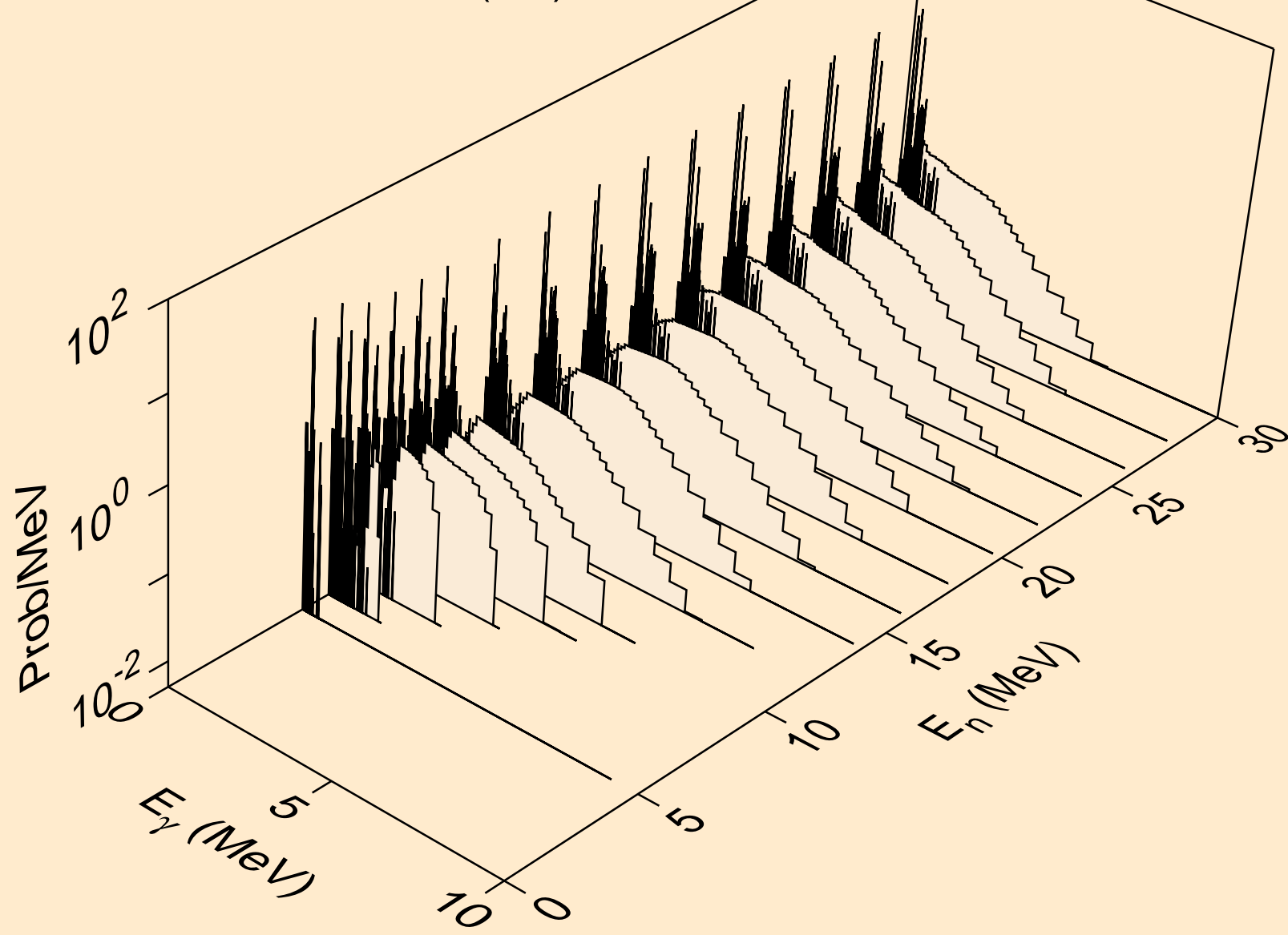

CE135 PROTON ACER TENDL-2023 LIBRARY; T=0.K  
Photon emission for (z,x)

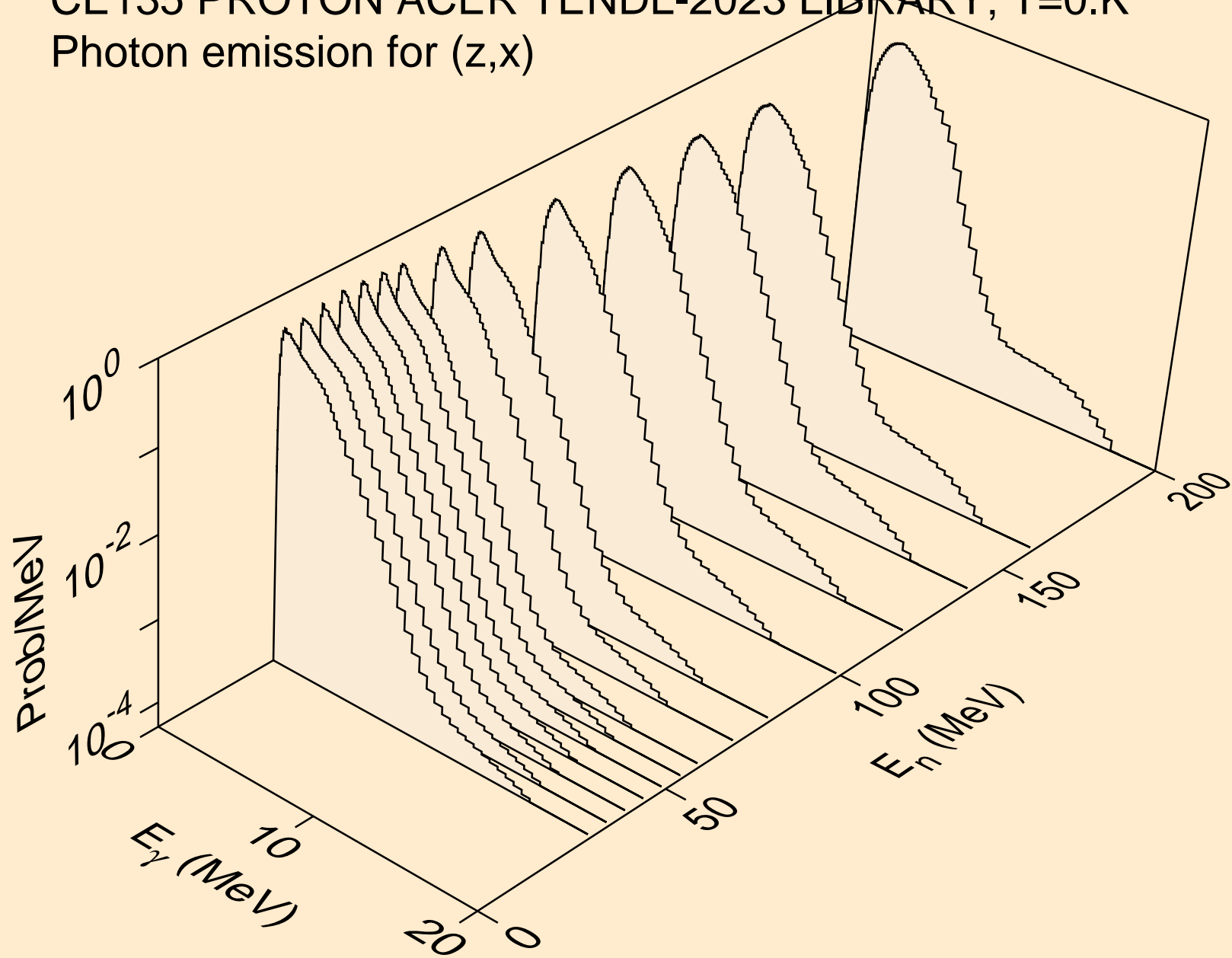

CE135 PROTON ACER TENDL-2023 LIBRARY; T=0.K  
Photon emission for (n,2nd)

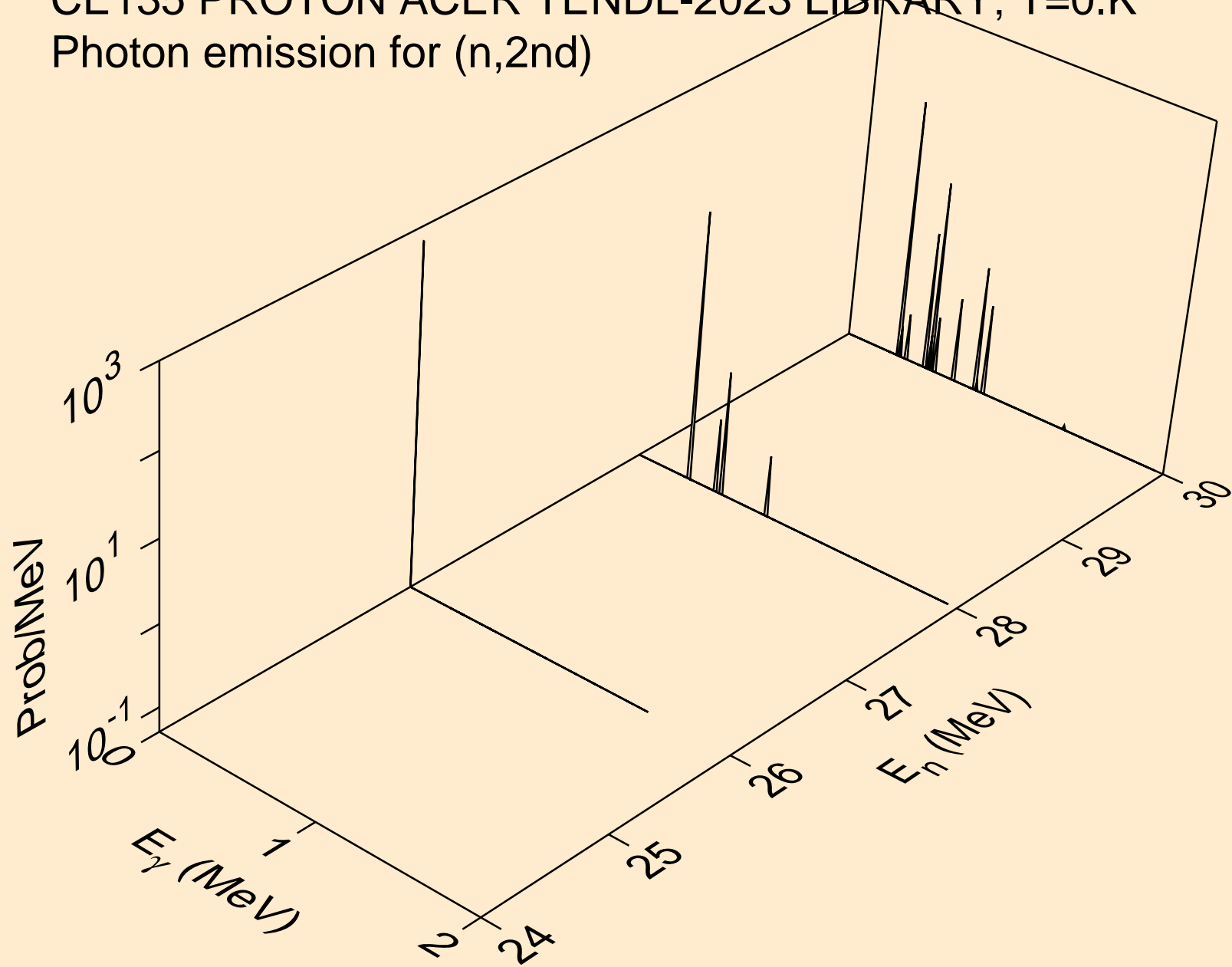

CE135 PROTON ACER TENDL-2023 LIBRARY; T=0.K  
Photon emission for (n,2n)

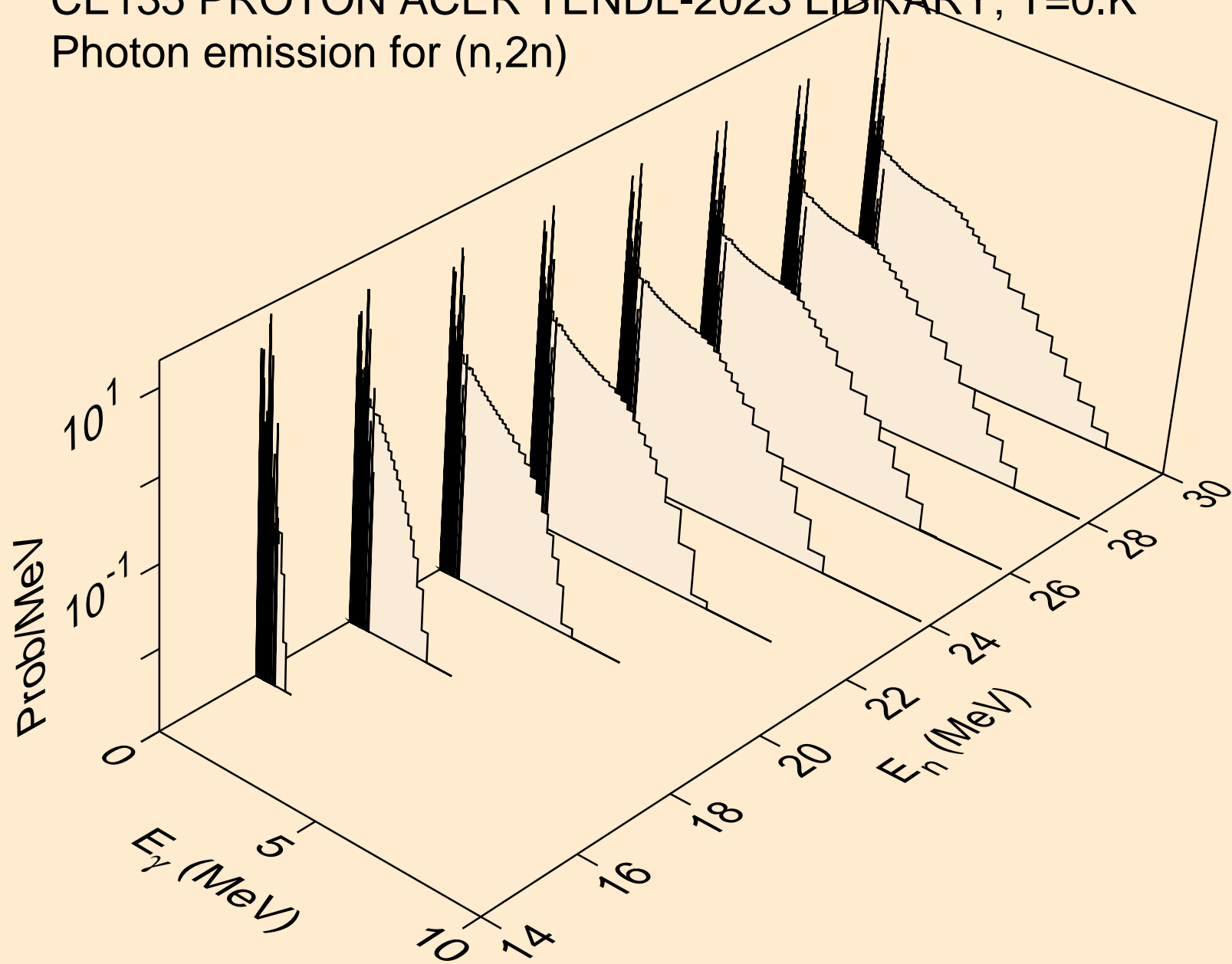



CE135 PROTON ACER TENDL-2023 LIBRARY; T=0.K  
Photon emission for (n,3n)

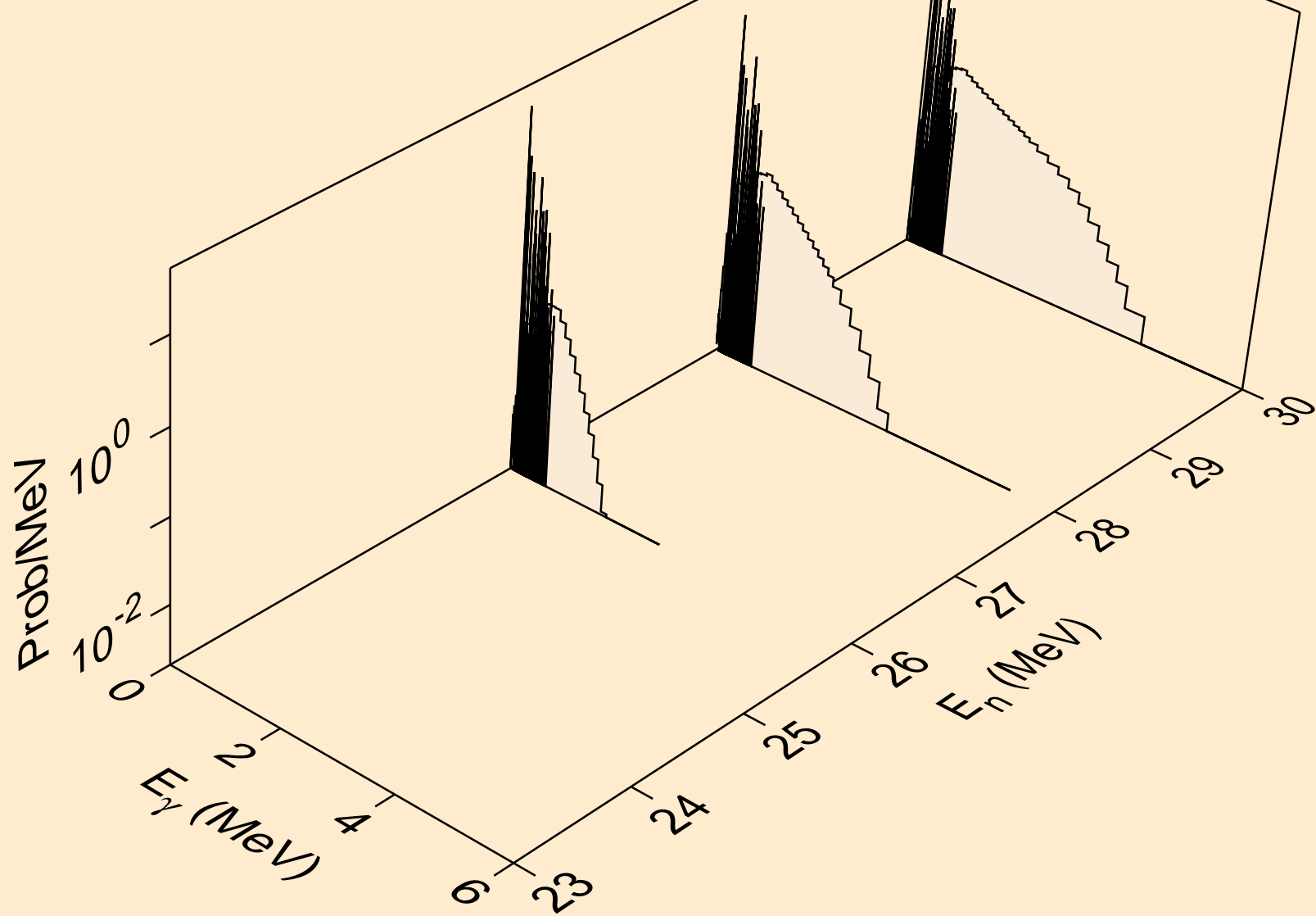

CE135 PROTON ACER TENDL-2023 LIBRARY; T=0.K  
Photon emission for (n,n\*)a

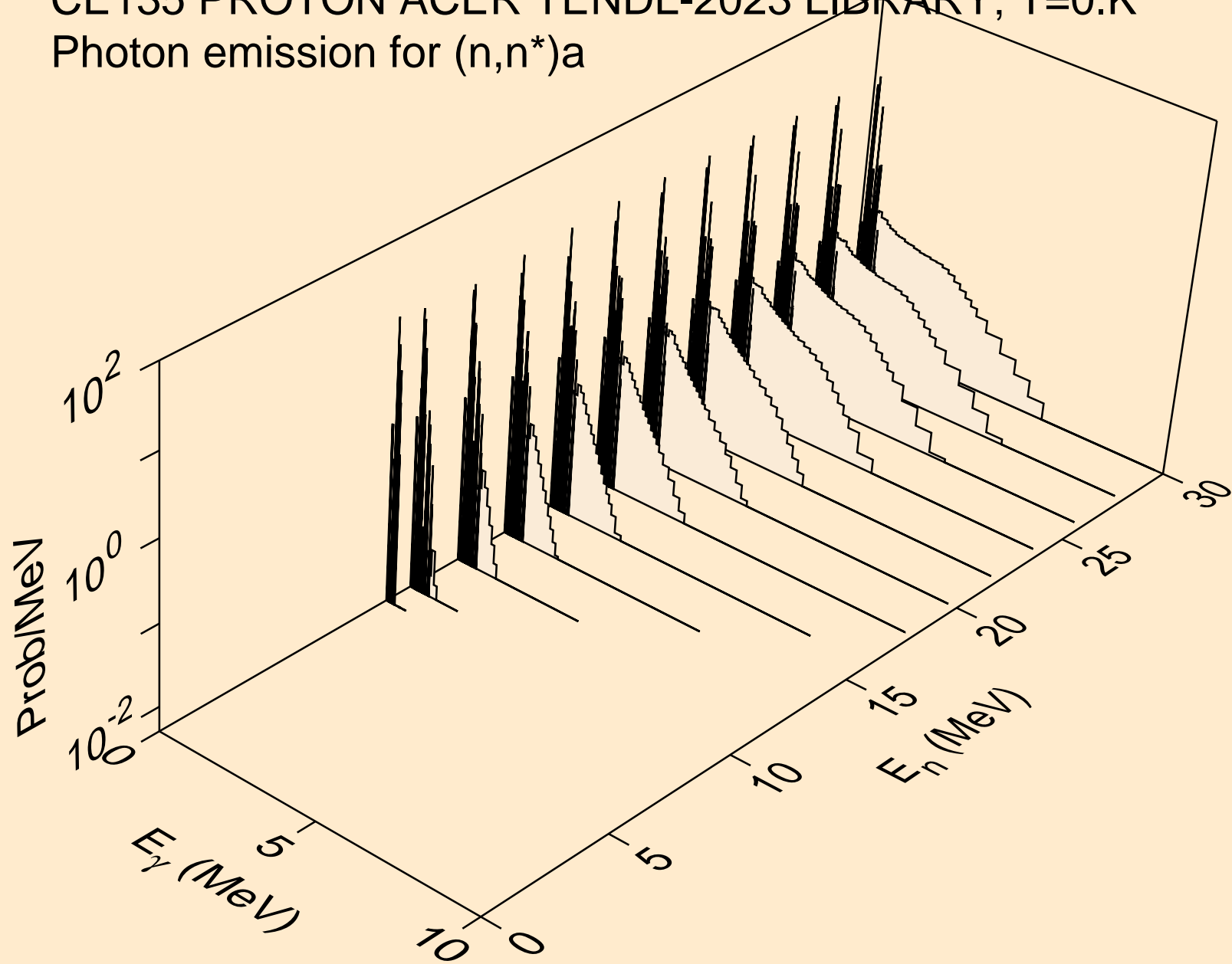

CE135 PROTON ACER TENDL-2023 LIBRARY; T=0.K  
Photon emission for (n,2n)a

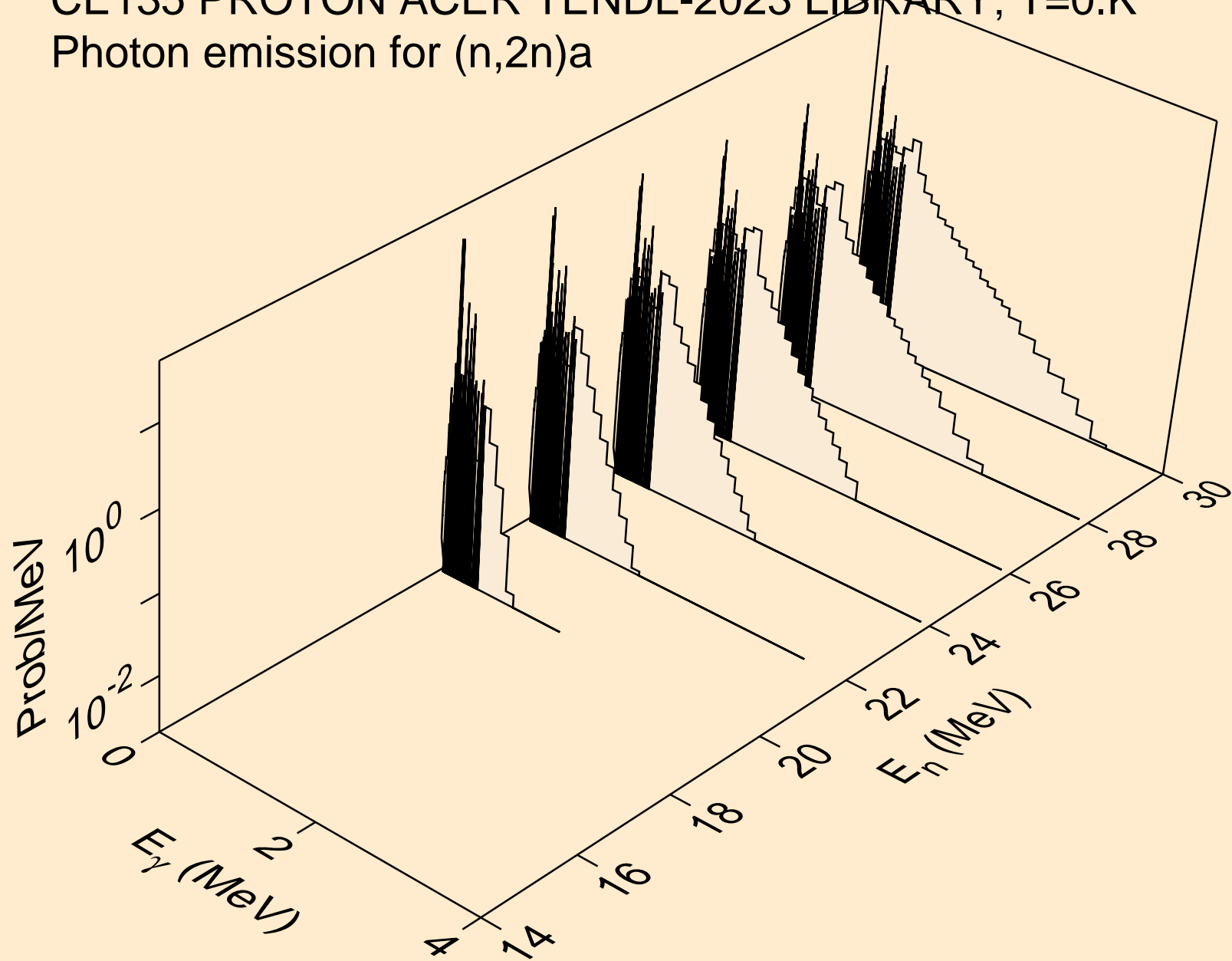

CE135 PROTON ACER TENDL-2023 LIBRARY; T=0.K  
Photon emission for (n,n\*)p

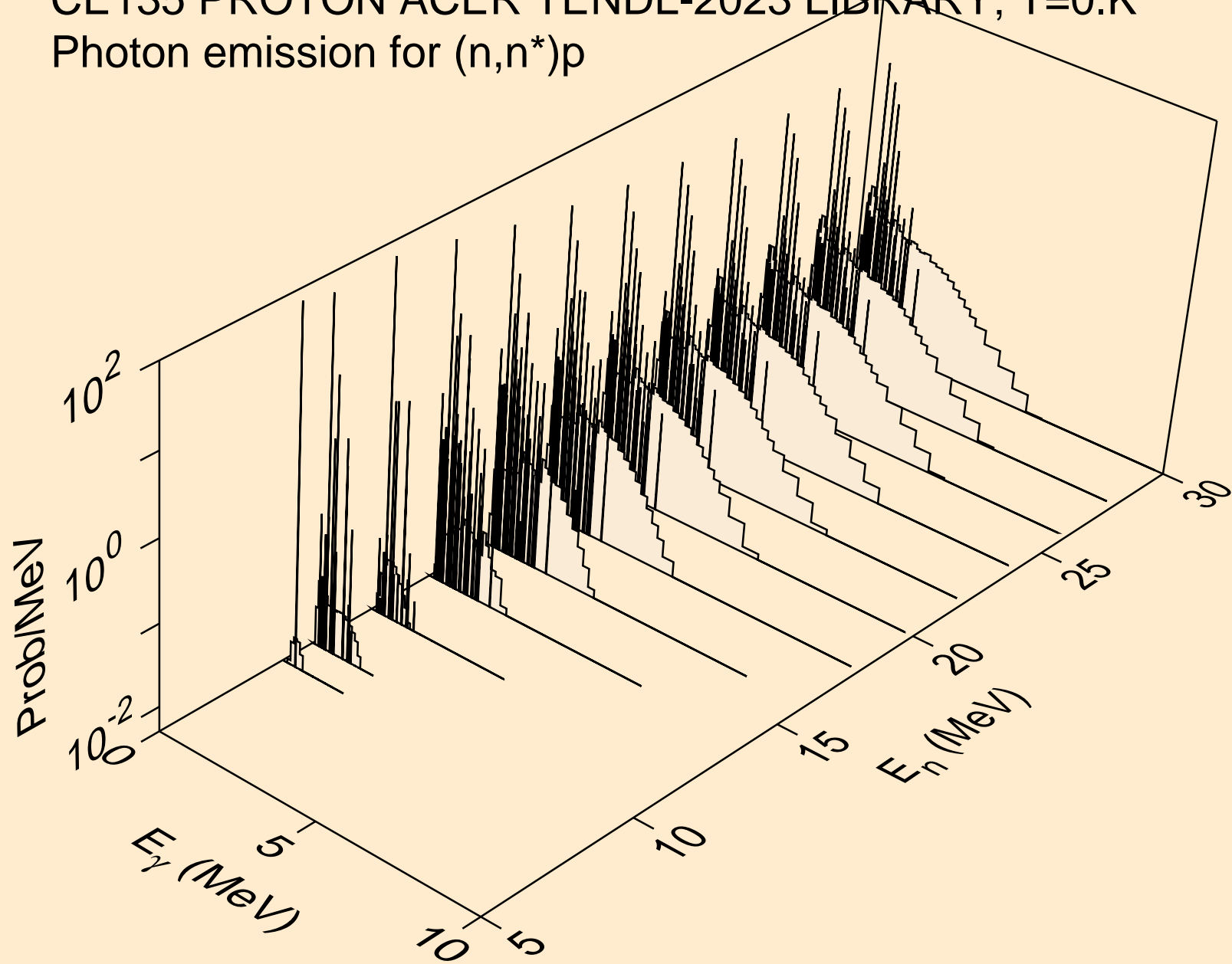

CE135 PROTON ACER TENDL-2023 LIBRARY; T=0.K  
Photon emission for (n,n\*)2a

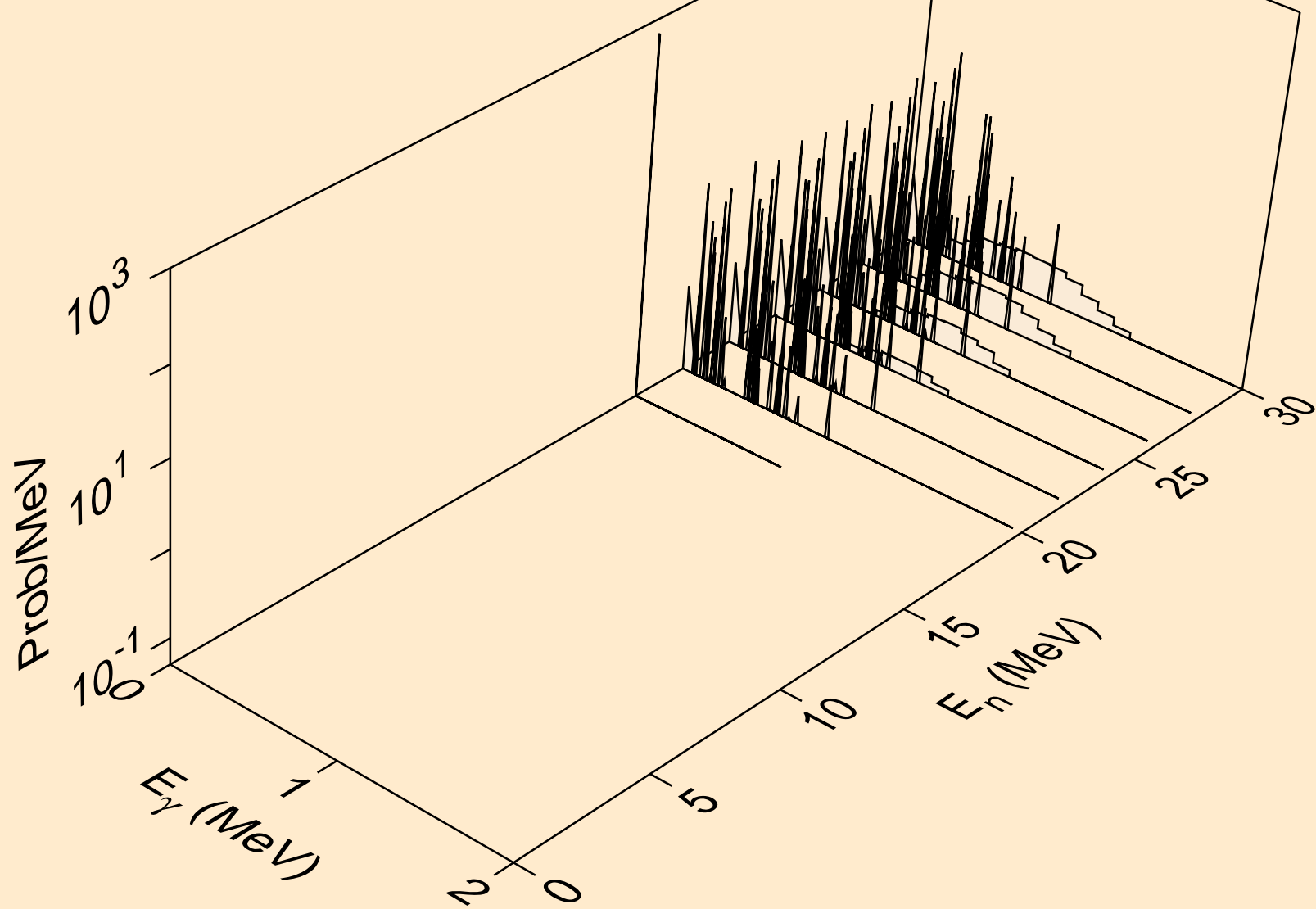

CE135 PROTON ACER TENDL-2023 LIBRARY; T=0.K  
Photon emission for (n,n\*)d

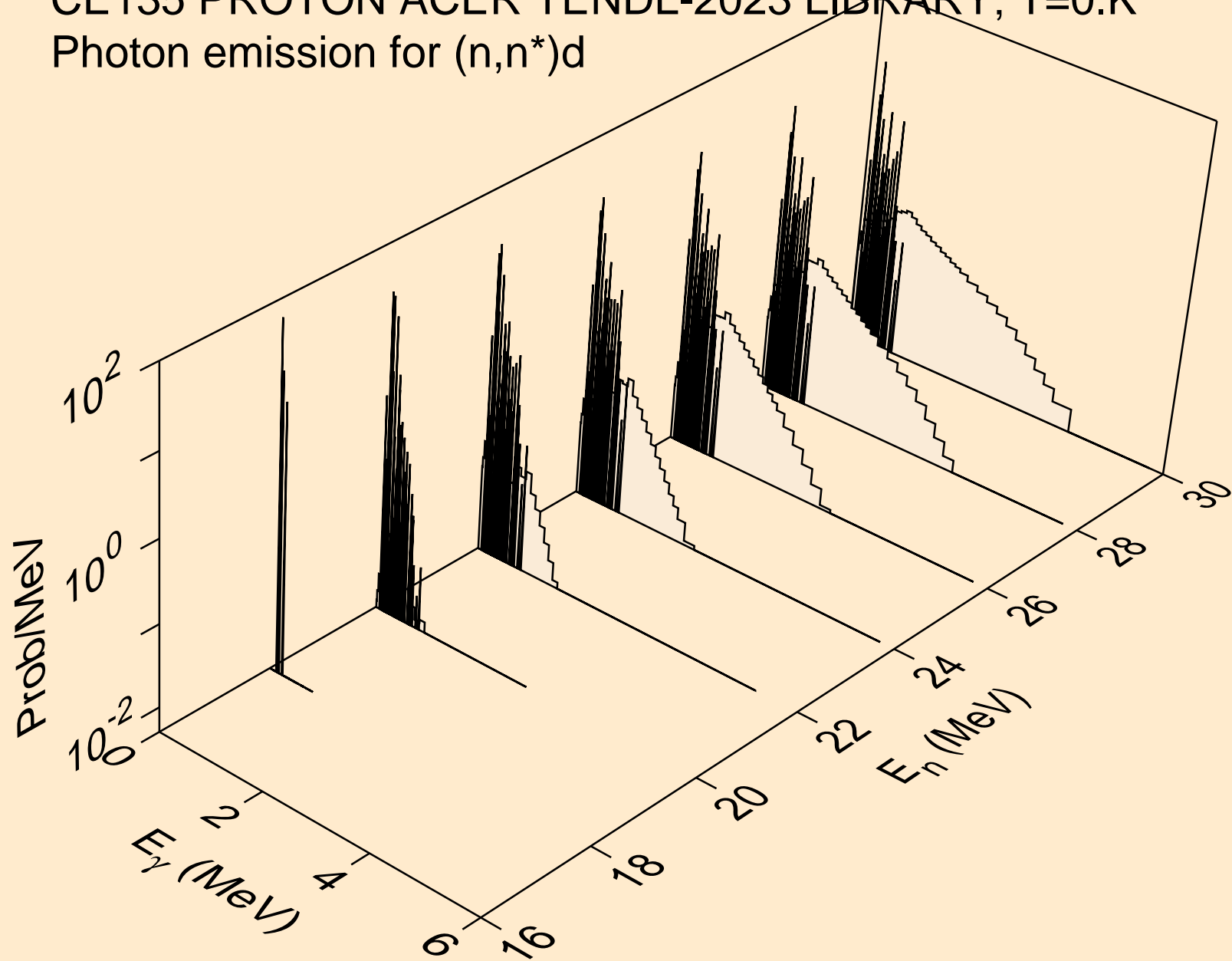

CE135 PROTON ACER TENDL-2023 LIBRARY; T=0.K  
Photon emission for (n,n\*)t

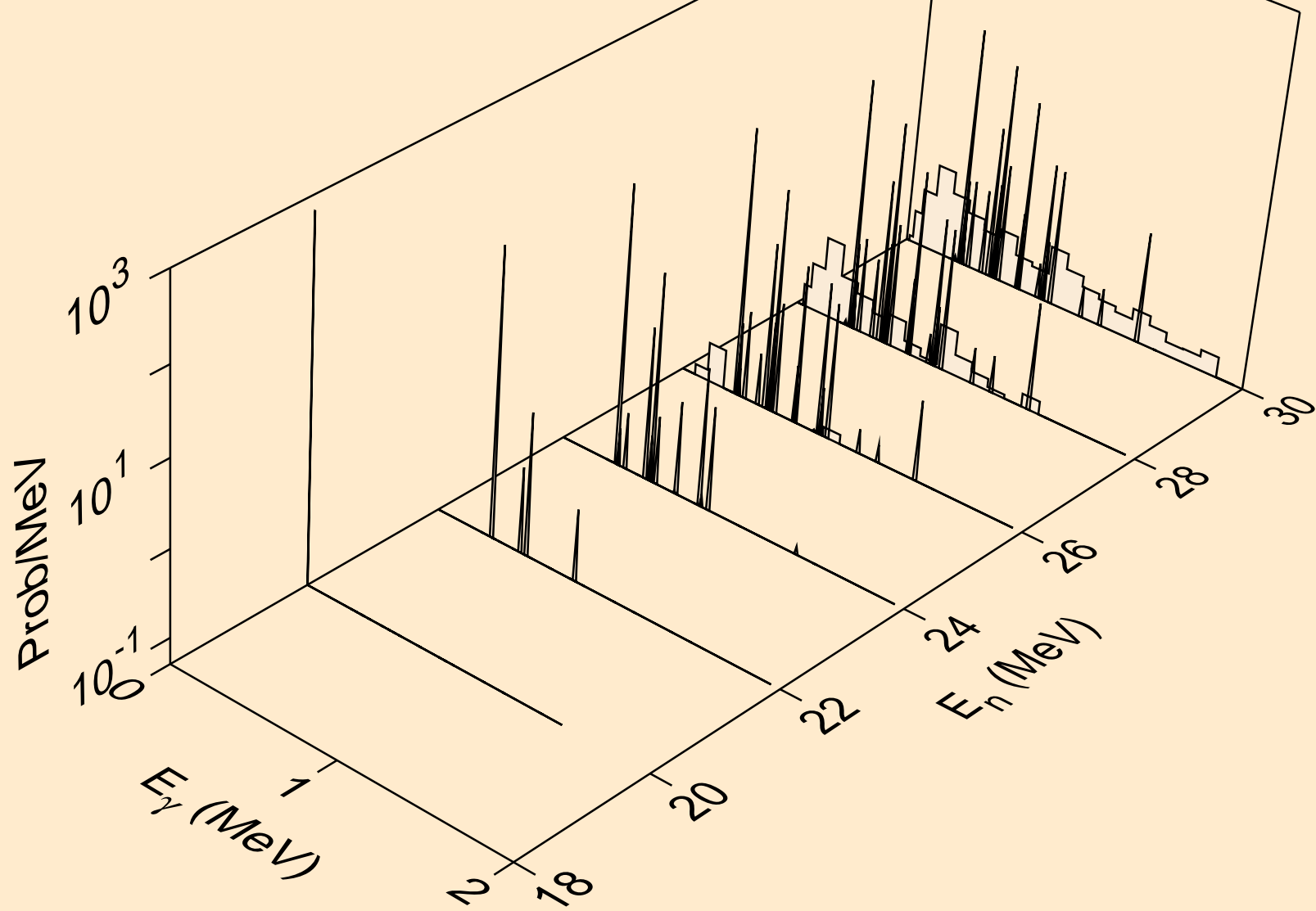

CE135 PROTON ACER TENDL-2023 LIBRARY; T=0.K  
Photon emission for (n,n\*)he3

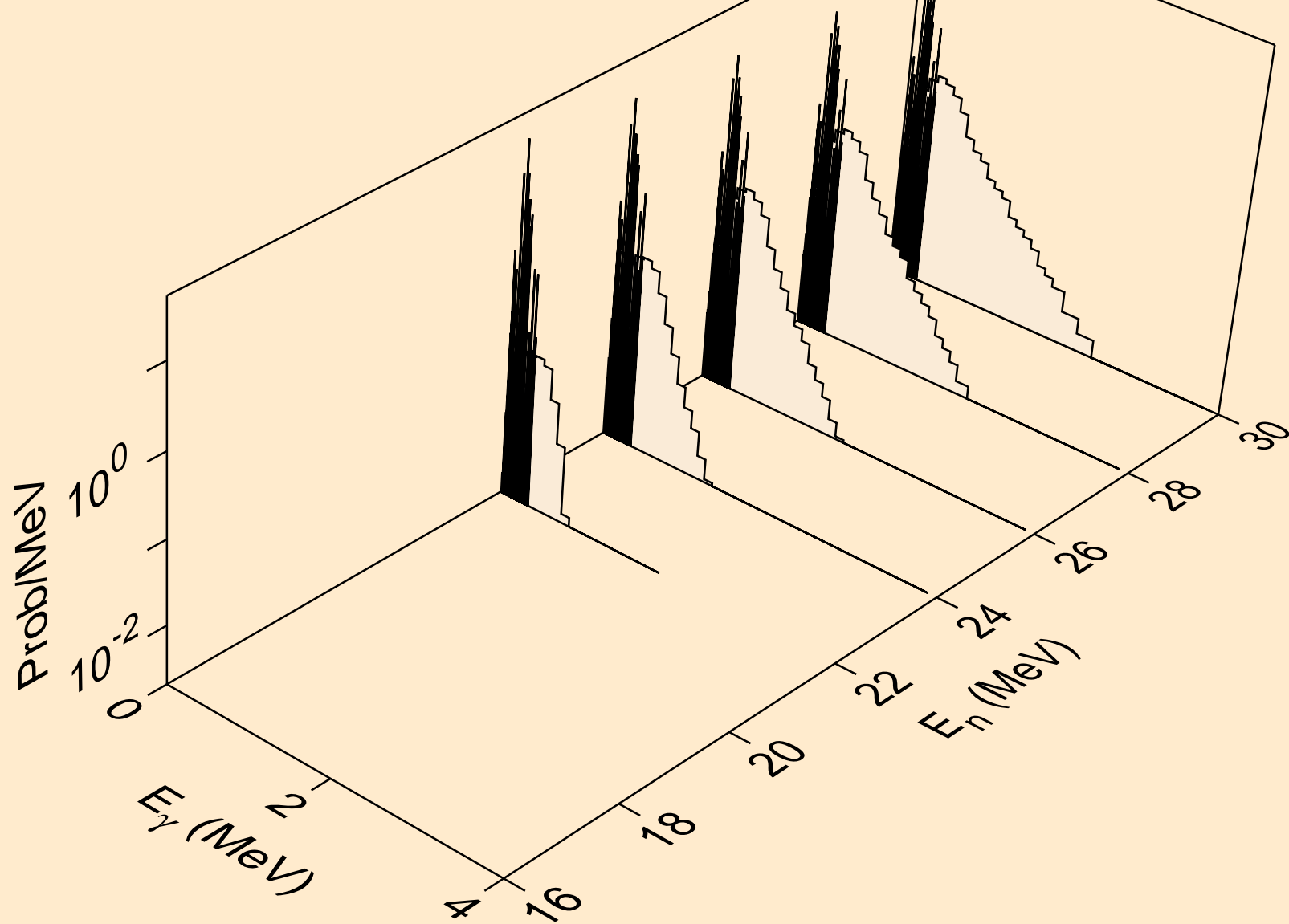



CE135 PROTON ACER TENDL-2023 LIBRARY; T=0.K  
Photon emission for (n,2np)

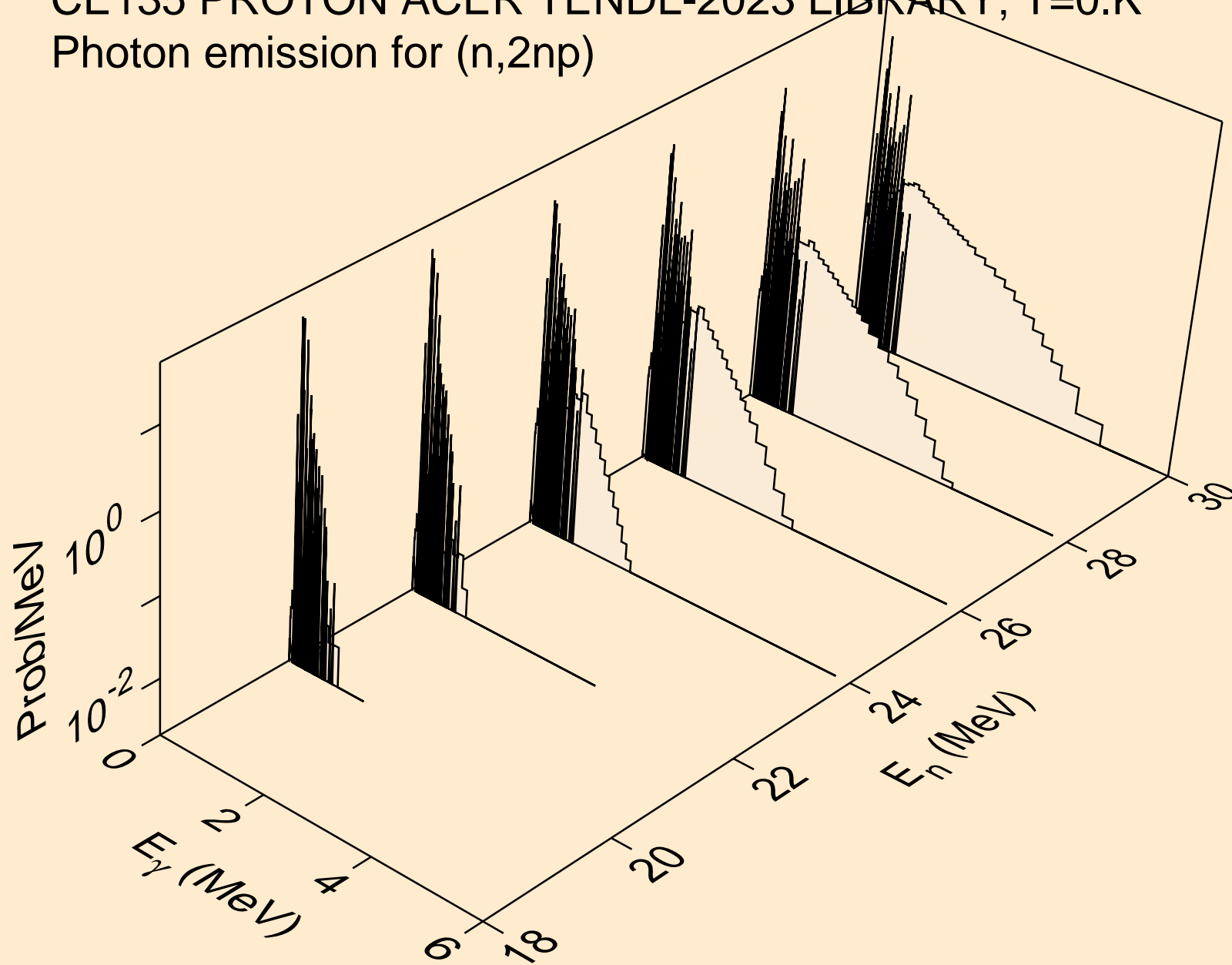

CE135 PROTON ACER TENDL-2023 LIBRARY; T=0.K  
Photon emission for (n,3np)

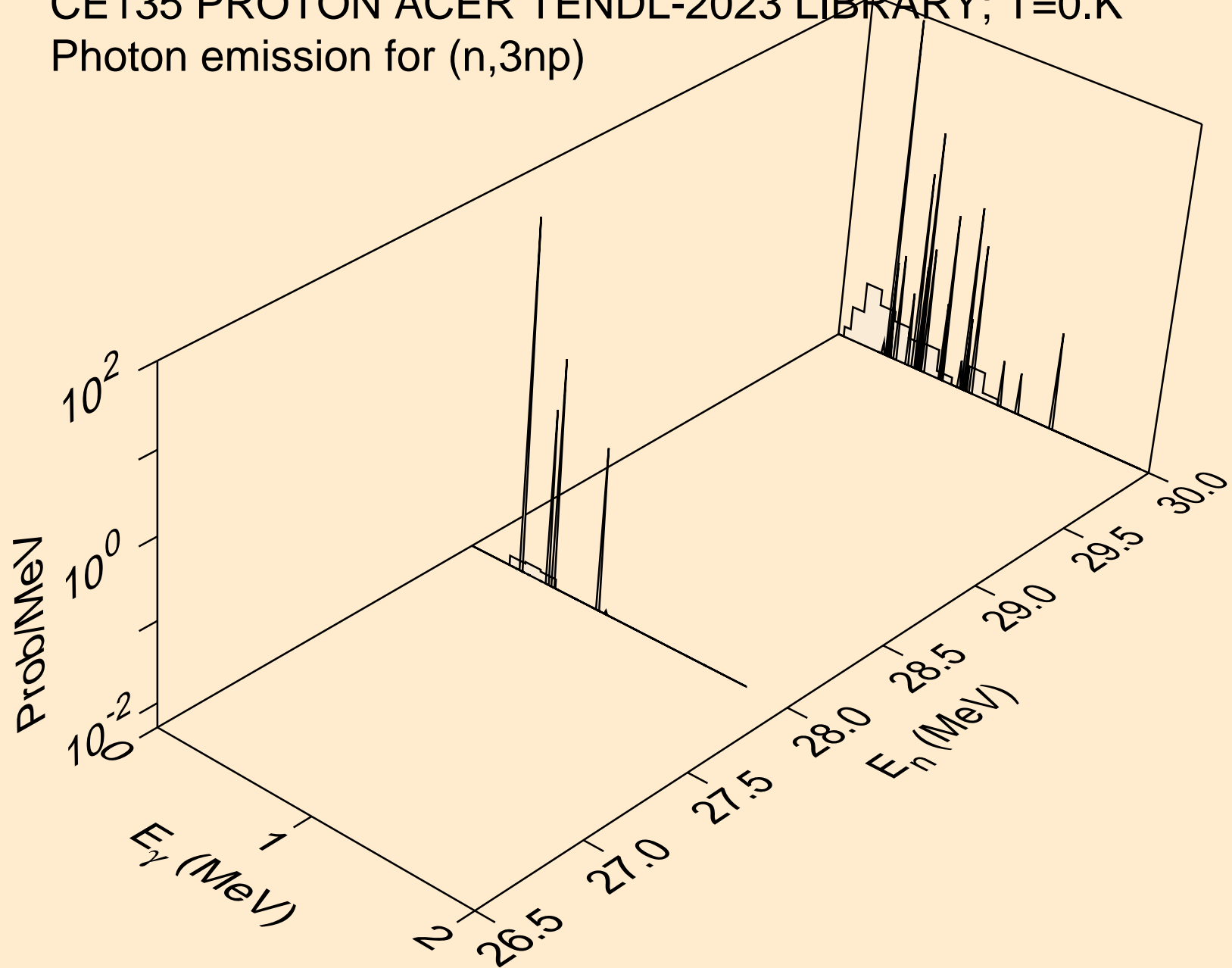

CE135 PROTON ACER TENDL-2023 LIBRARY; T=0.K  
Photon emission for (n,n2p)

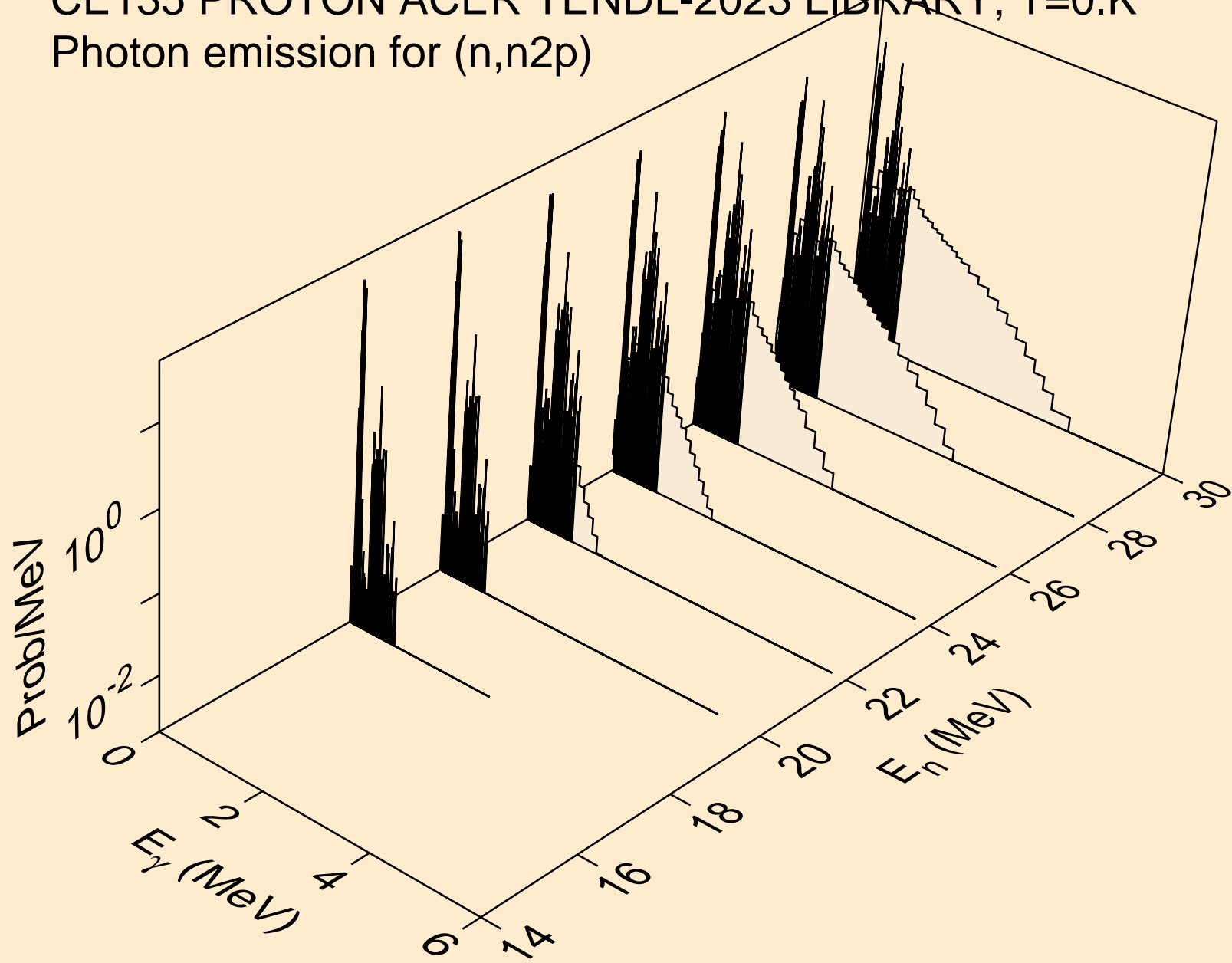

CE135 PROTON ACER TENDL-2023 LIBRARY; T=0.K  
Photon emission for (n,npa)

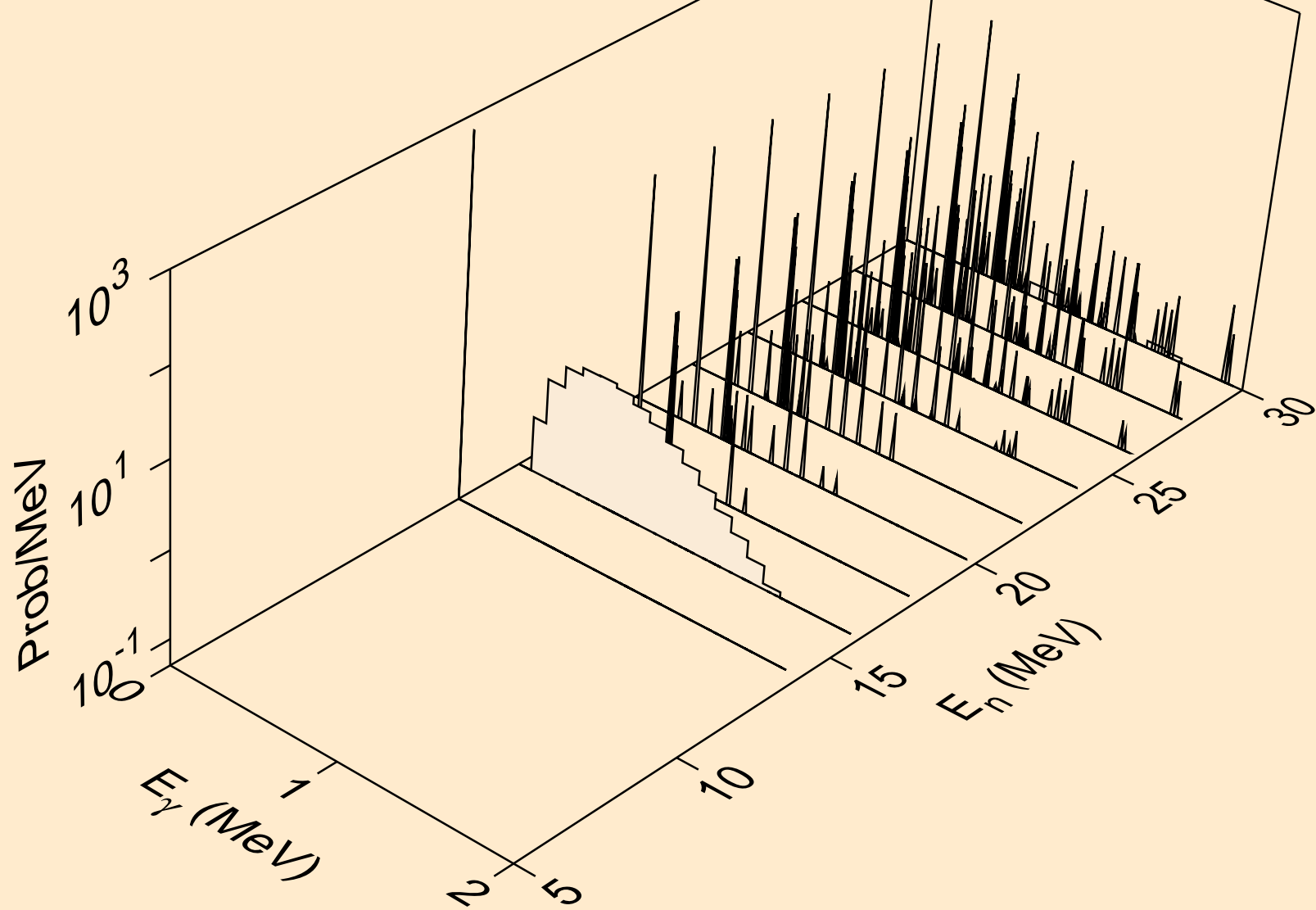

CE135 PROTON ACER TENDL-2023 LIBRARY; T=0.K  
Photon emission for (n,gma)

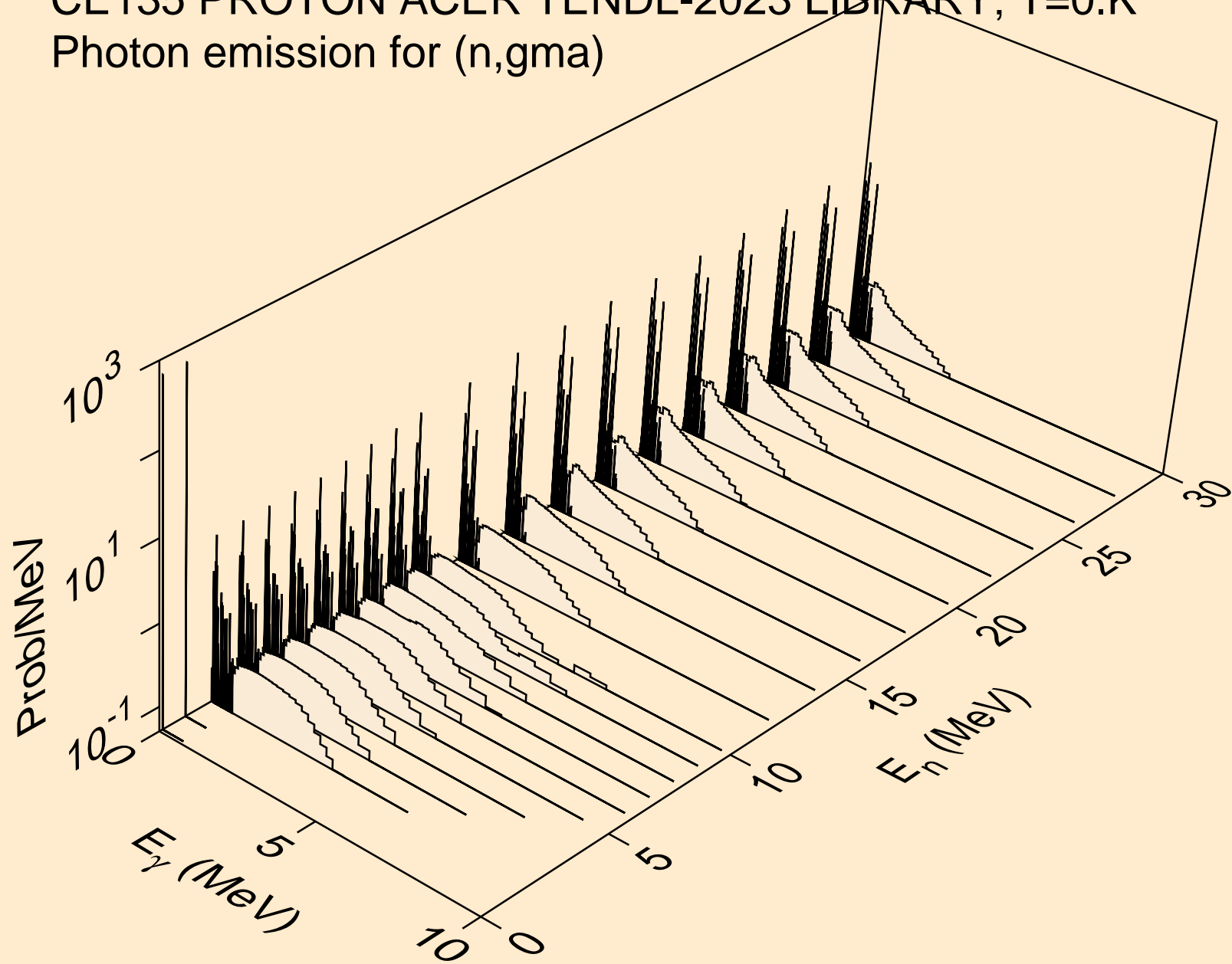

CE135 PROTON ACER TENDL-2023 LIBRARY; T=0.K  
Photon emission for inelastic

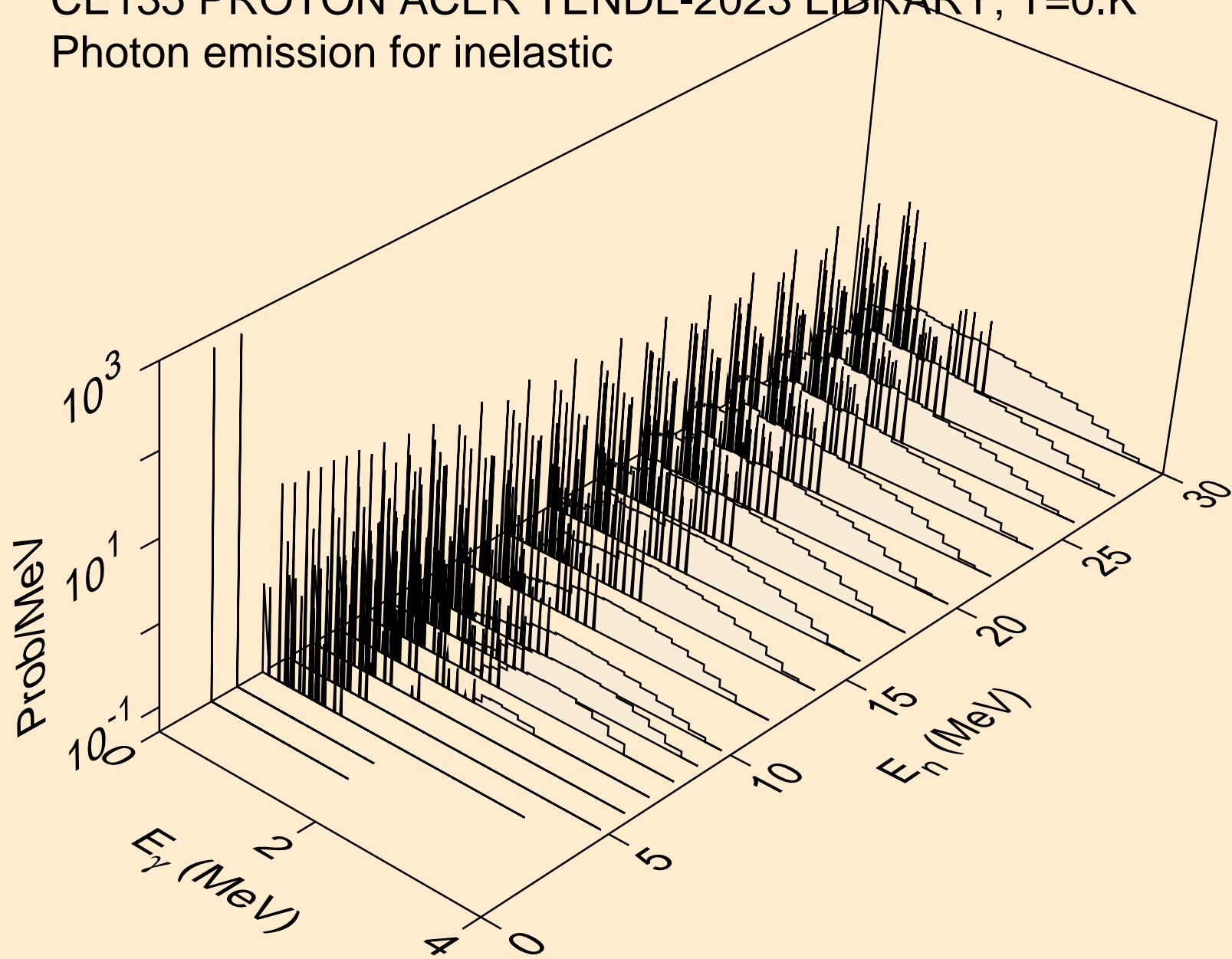

CE135 PROTON ACER TENDL-2023 LIBRARY; T=0.K  
Photon emission for (n,d)

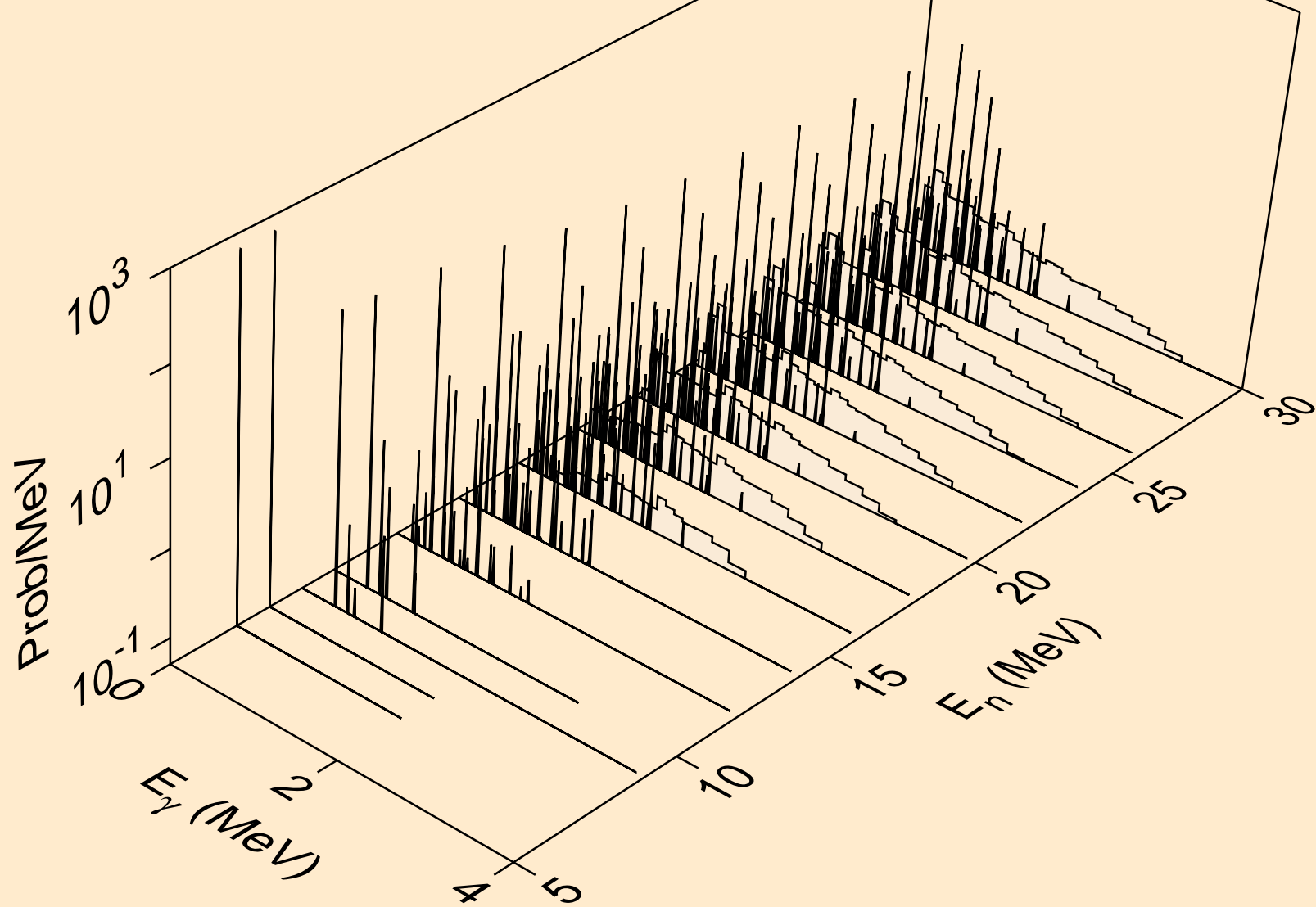

CE135 PROTON ACER TENDL-2023 LIBRARY; T=0.K  
Photon emission for (n,t)

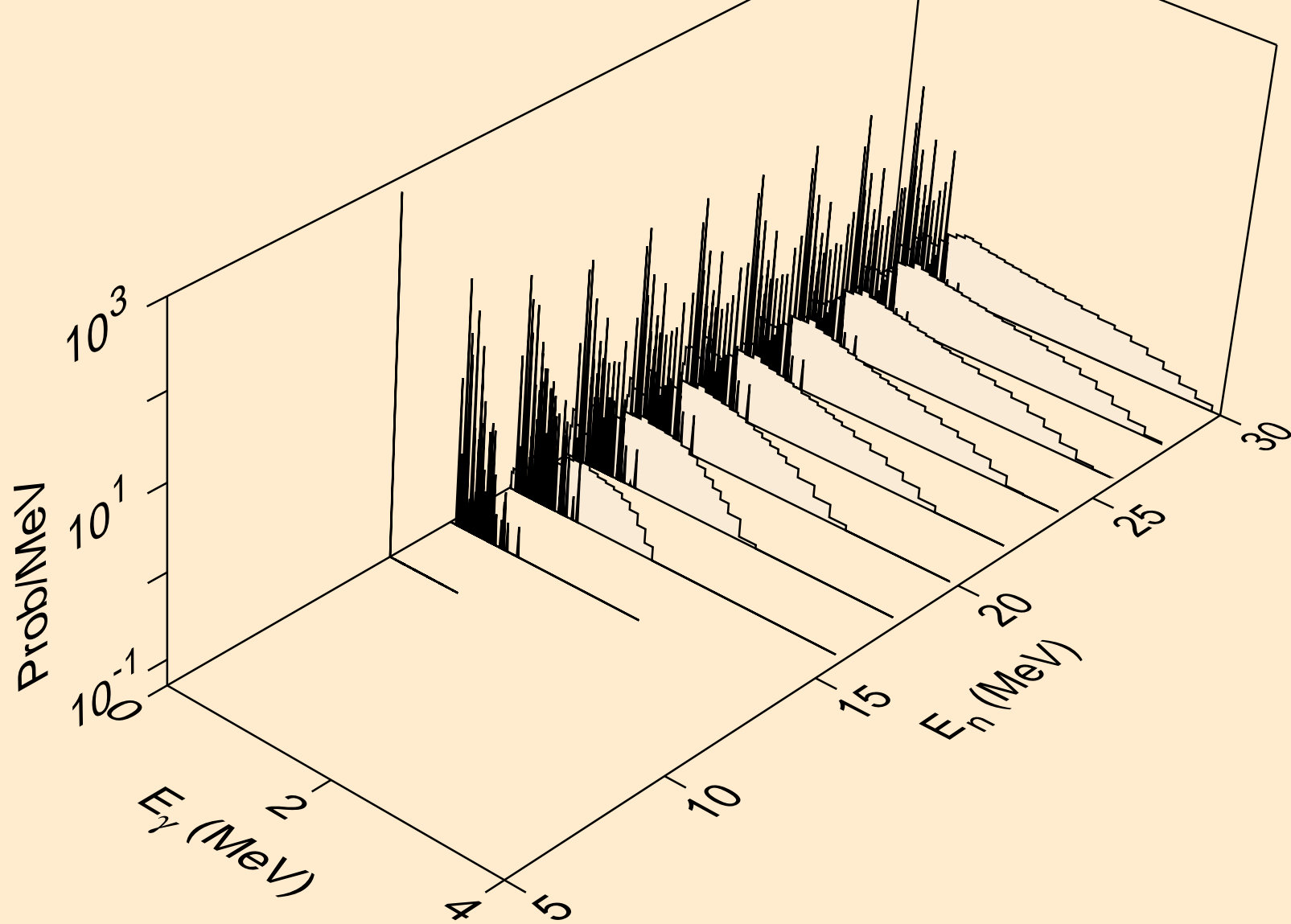



CE135 PROTON ACER TENDL-2023 LIBRARY; T=0.K  
Photon emission for (n,he3)

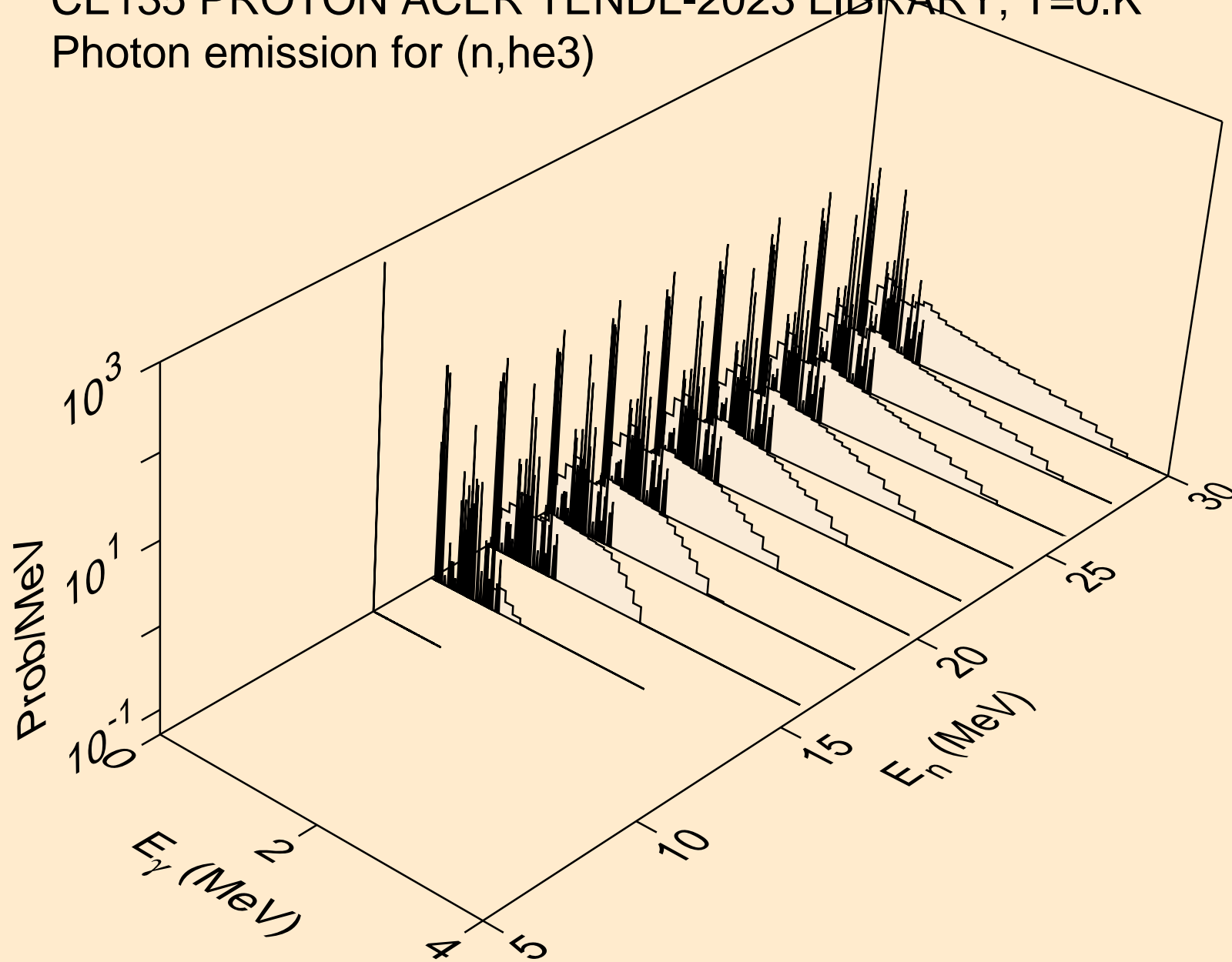

CE135 PROTON ACER TENDL-2023 LIBRARY; T=0.K  
Photon emission for (n,a)

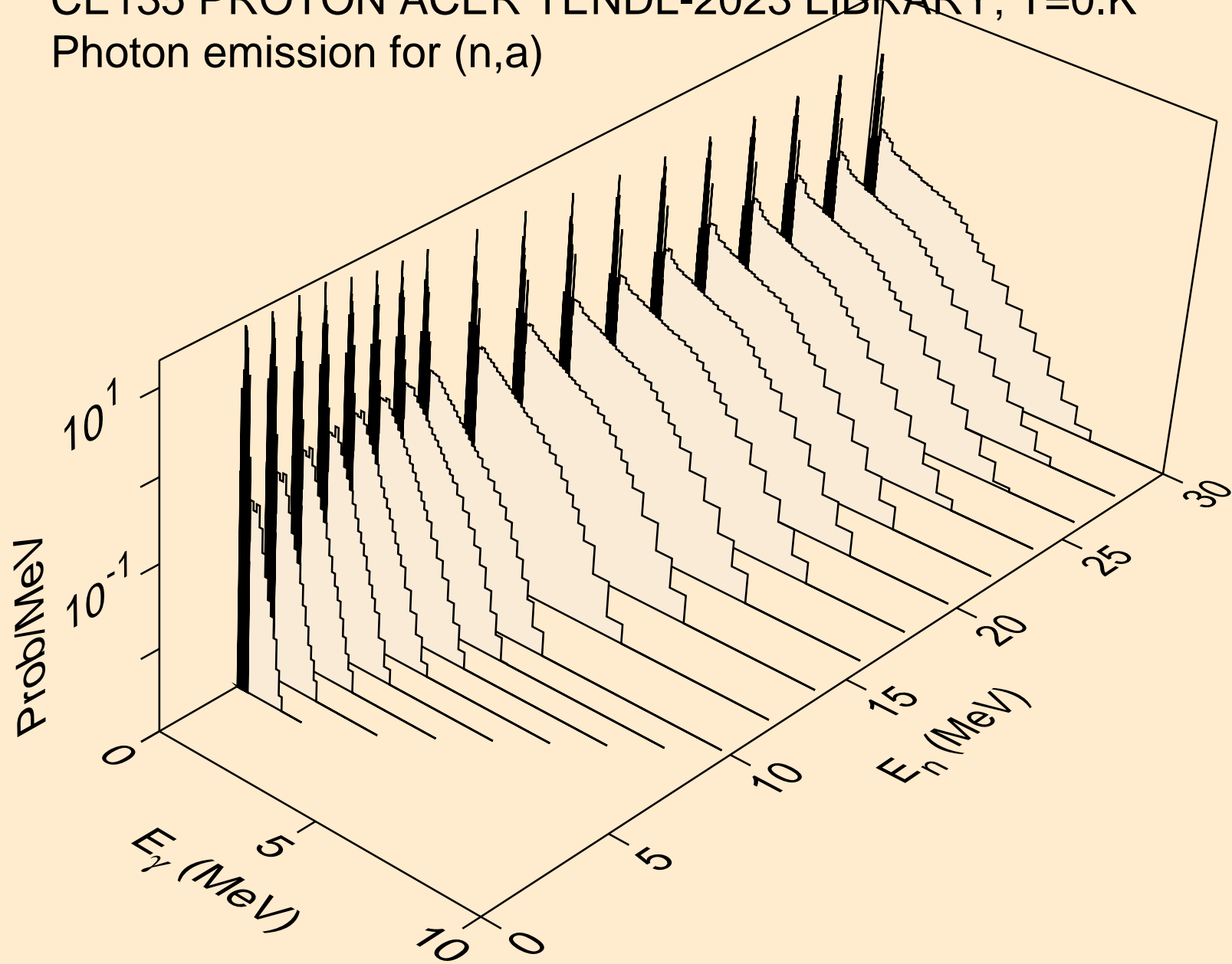

CE135 PROTON ACER TENDL-2023 LIBRARY; T=0.K  
Photon emission for (n,2a)

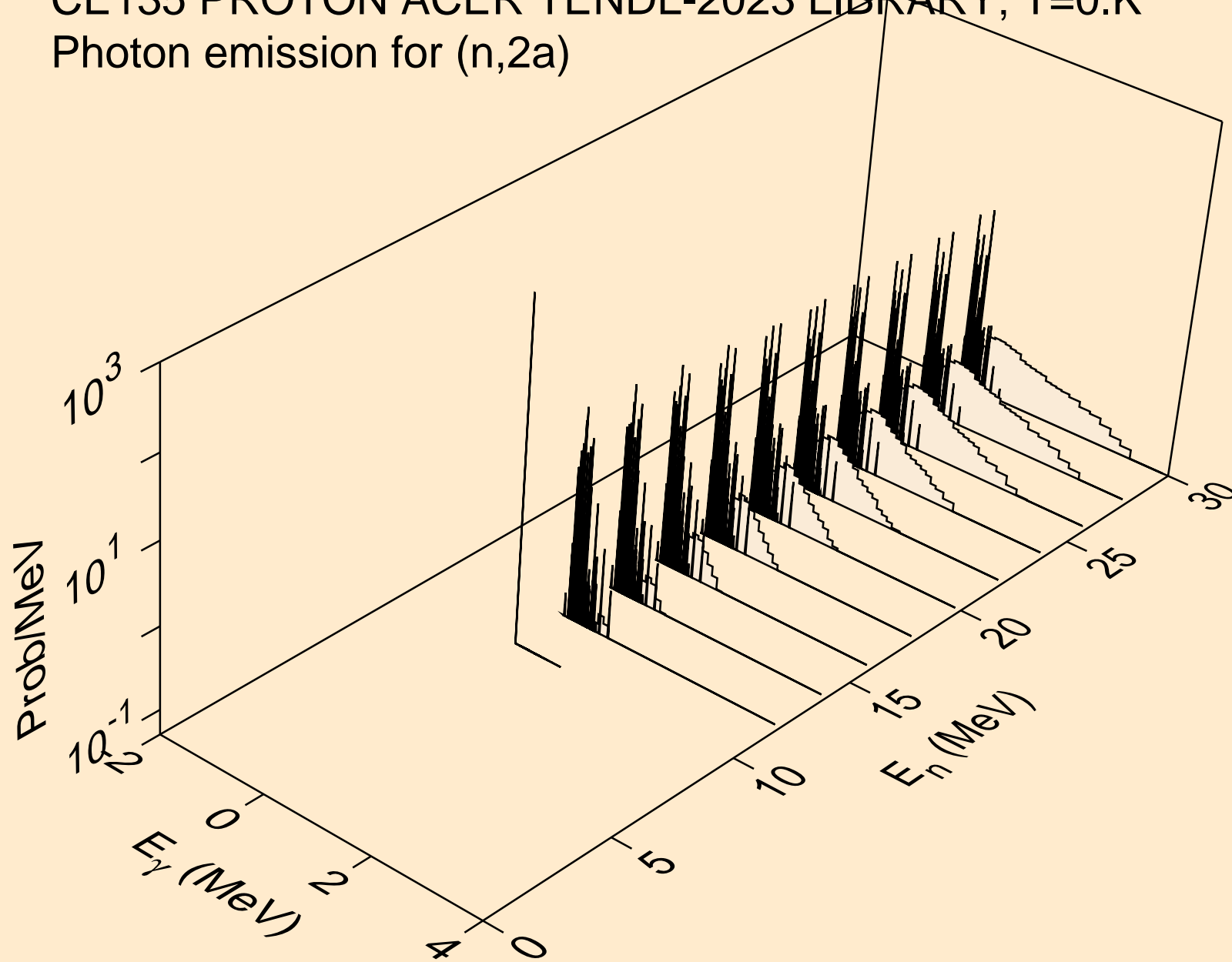

CE135 PROTON ACER TENDL-2023 LIBRARY; T=0.K  
Photon emission for (n,2p)

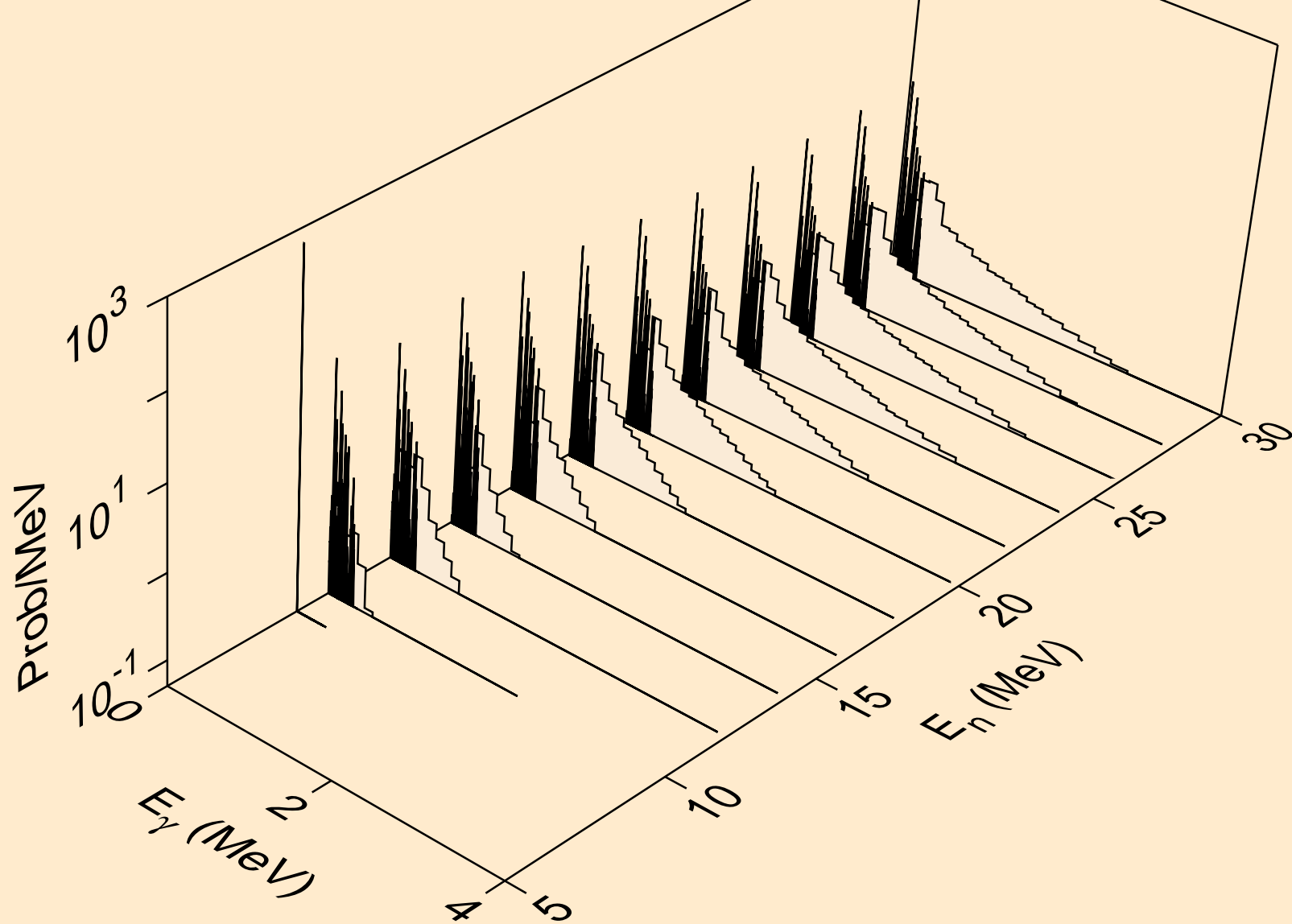

CE135 PROTON ACER TENDL-2023 LIBRARY; T=0.K  
Photon emission for (n,pa)

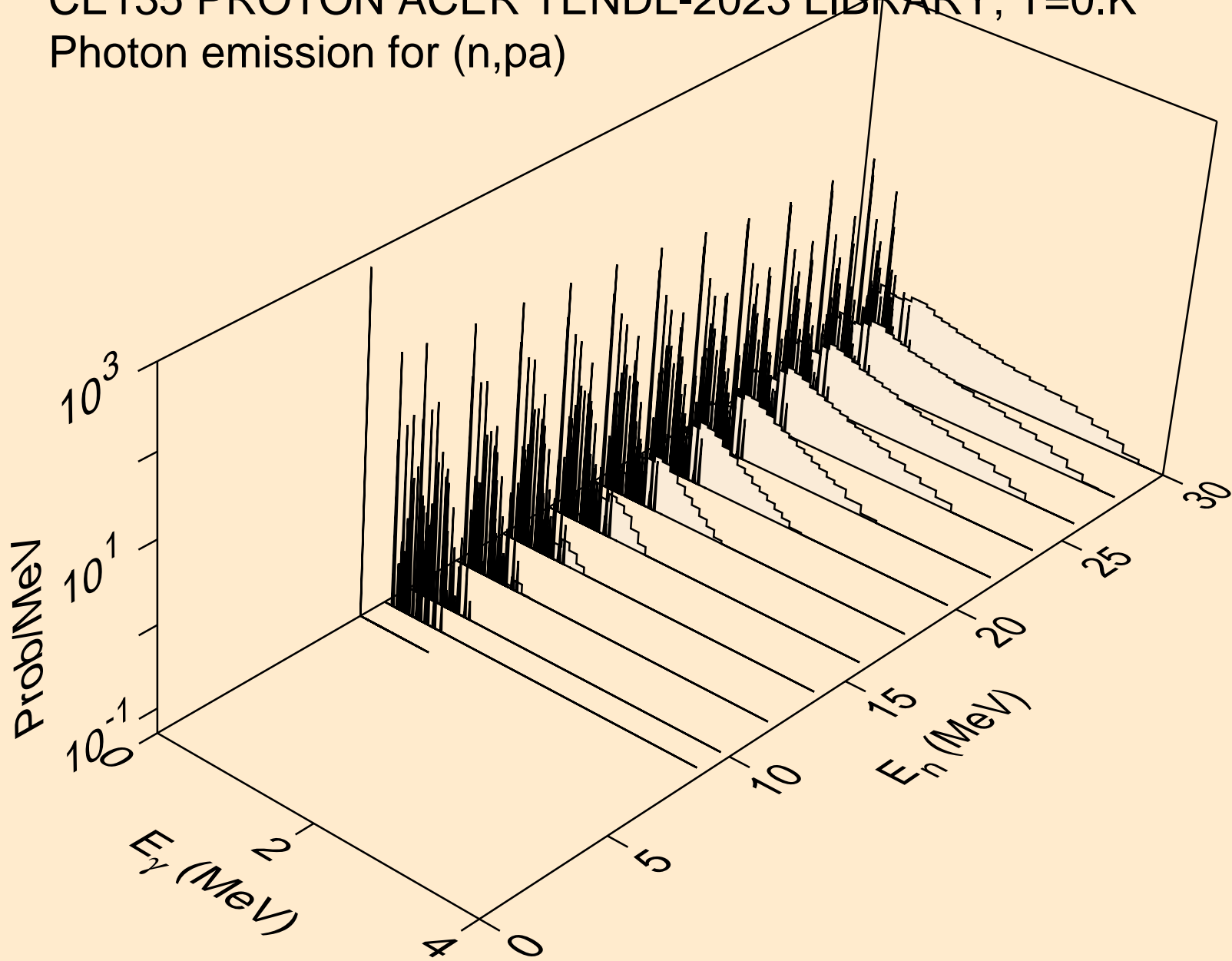

CE135 PROTON ACER TENDL-2023 LIBRARY; T=0.K  
Photon emission for (n,pd)

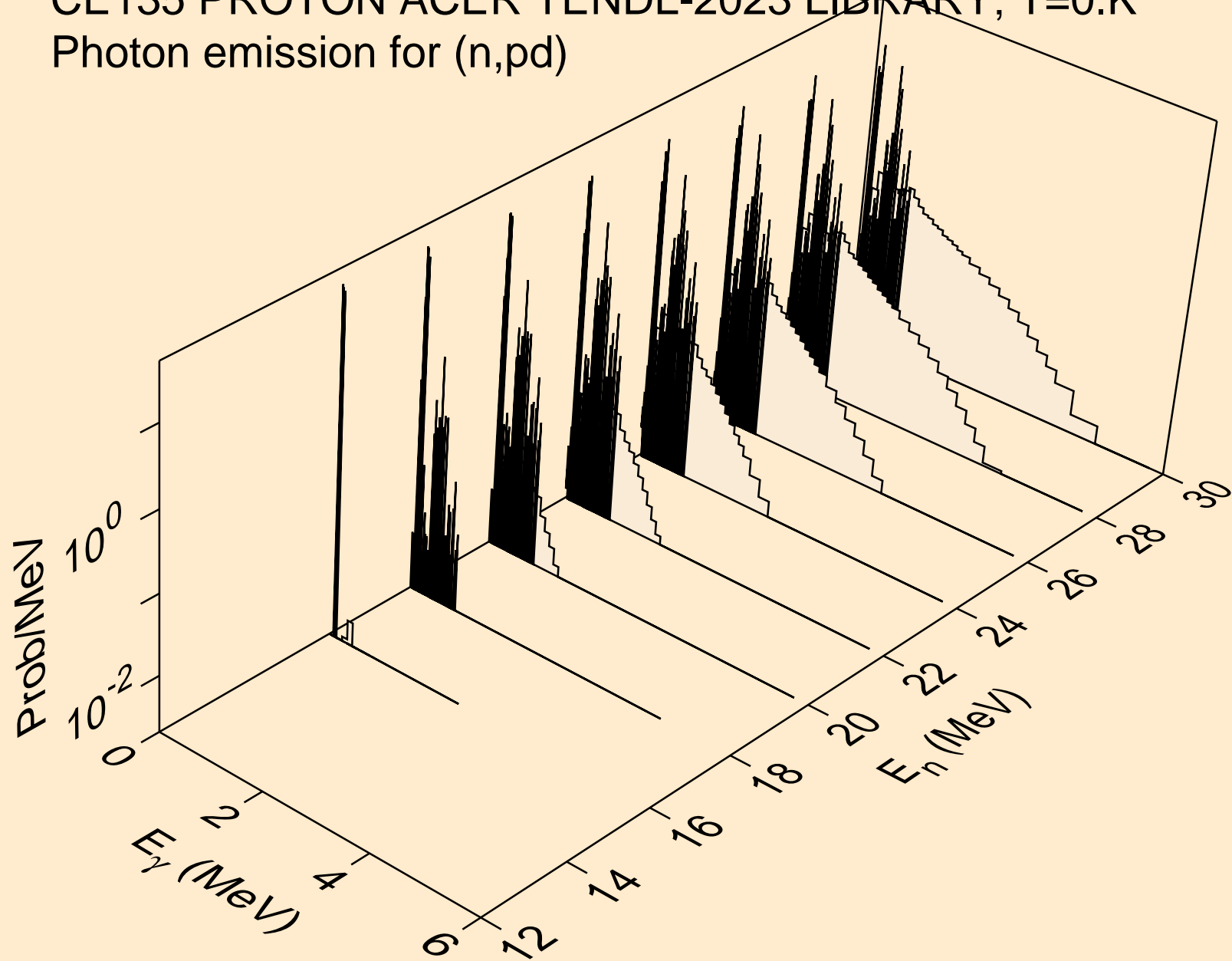

CE135 PROTON ACER TENDL-2023 LIBRARY; T=0.K

Photon emission for (n,pt)

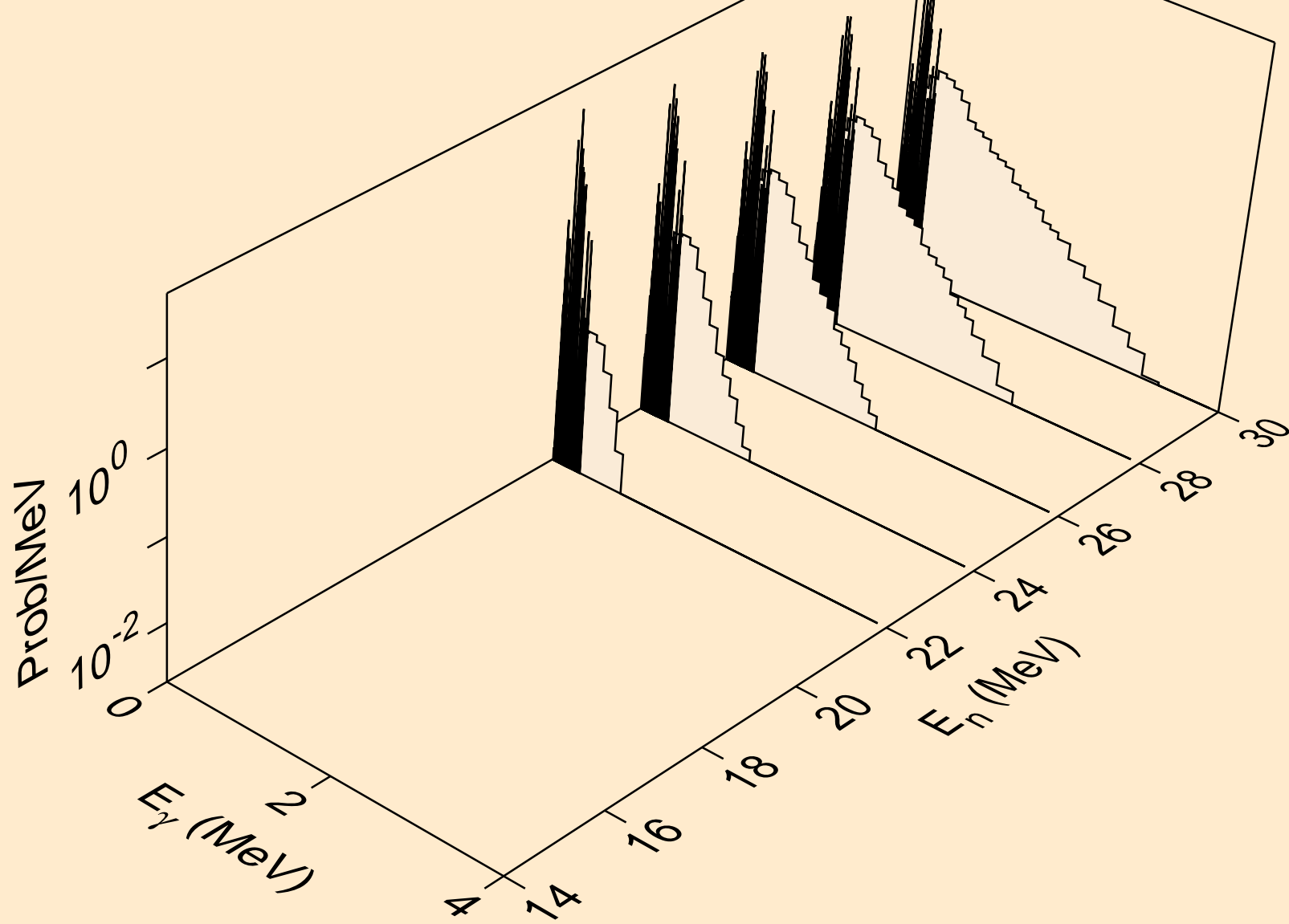

CE135 PROTON ACER TENDL-2023 LIBRARY; T=0.K  
Photon emission for (n,da)

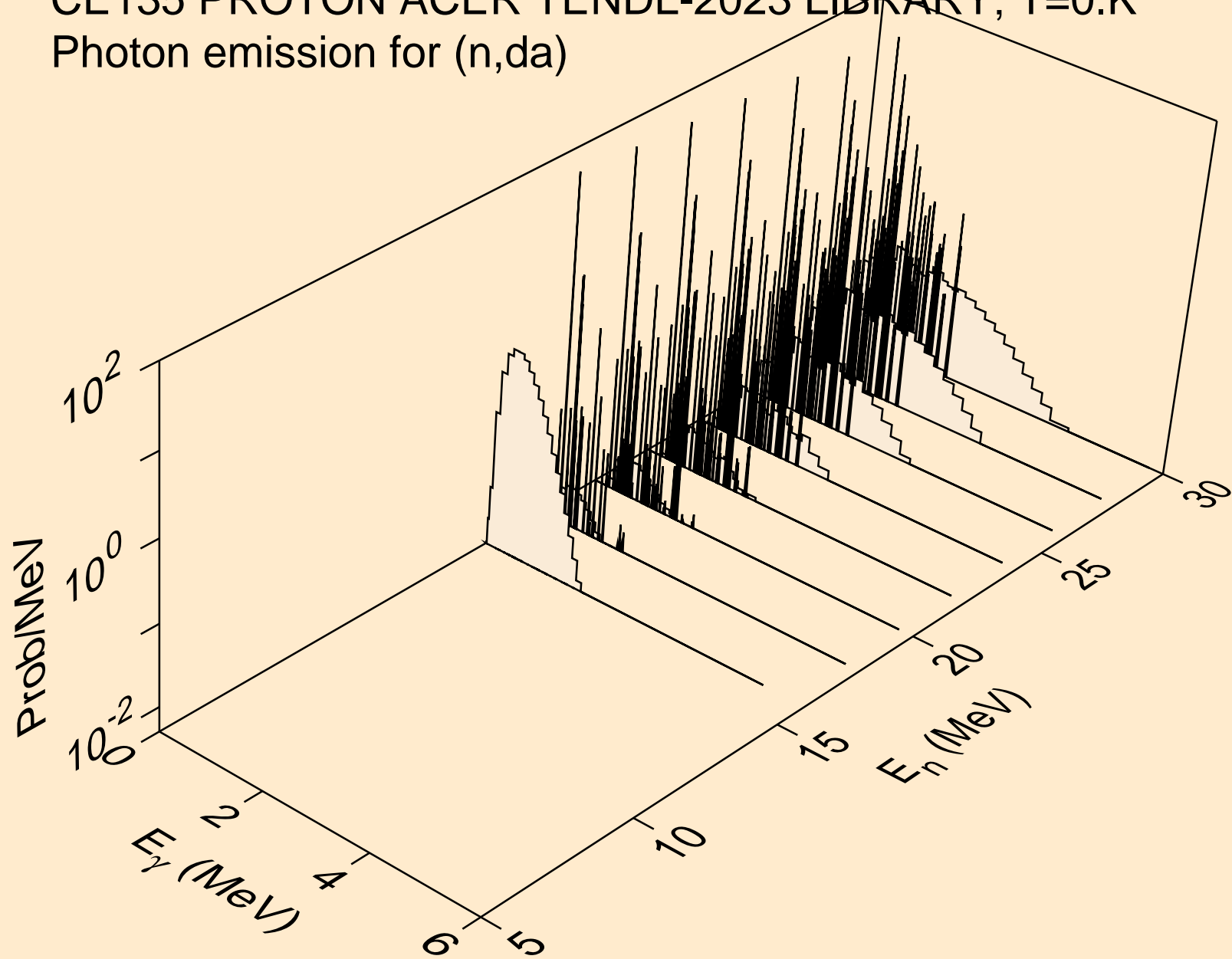



CE135 PROTON ACER TENDL-2023 LIBRARY; T=0.K  
Particle heating contributions

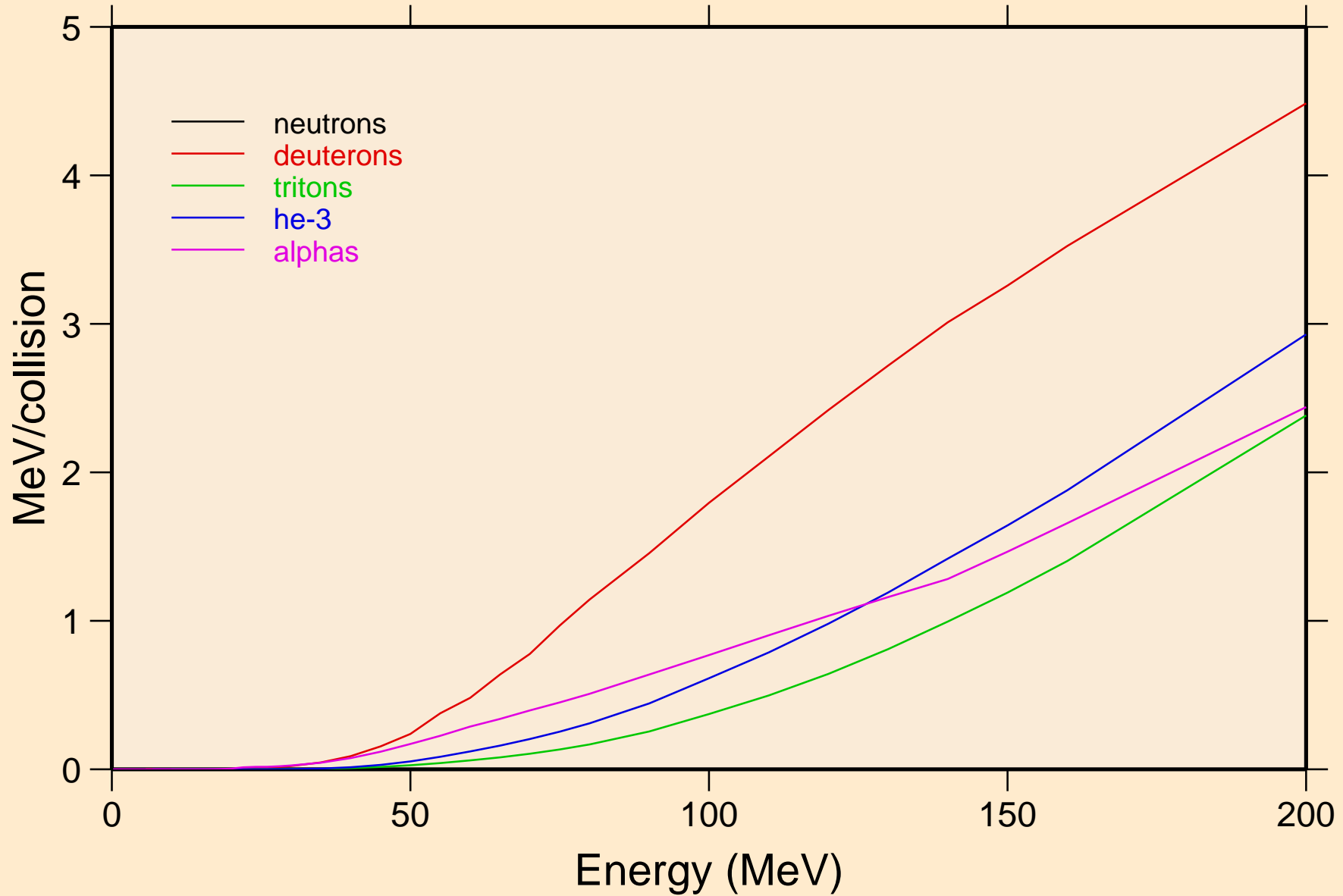

# CE135 PROTON ACER TENDL-2023 LIBRARY; T=0.K

## Recoil Heating

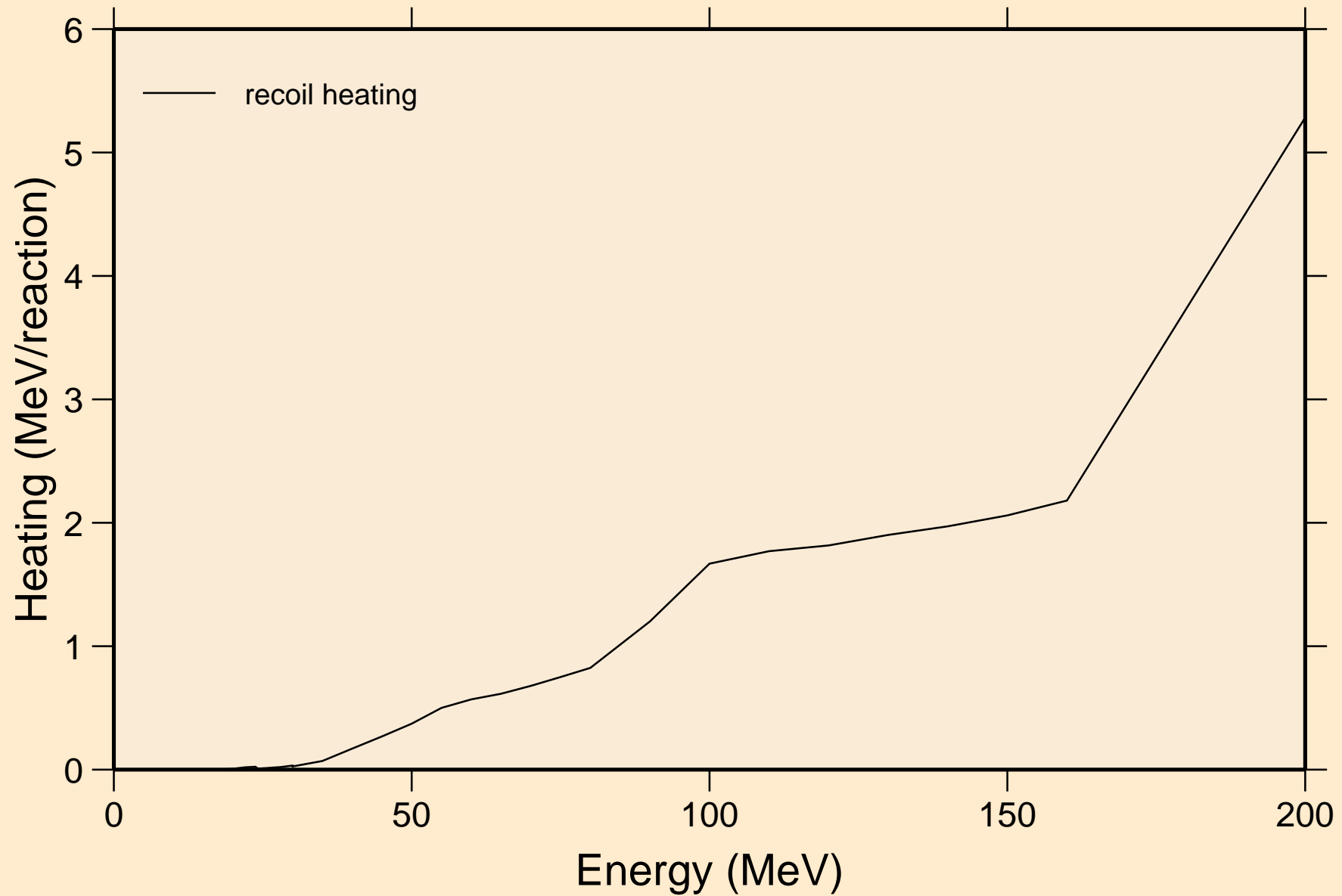

CE135 PROTON ACER TENDL-2023 LIBRARY; T=0.K  
Particle production cross sections

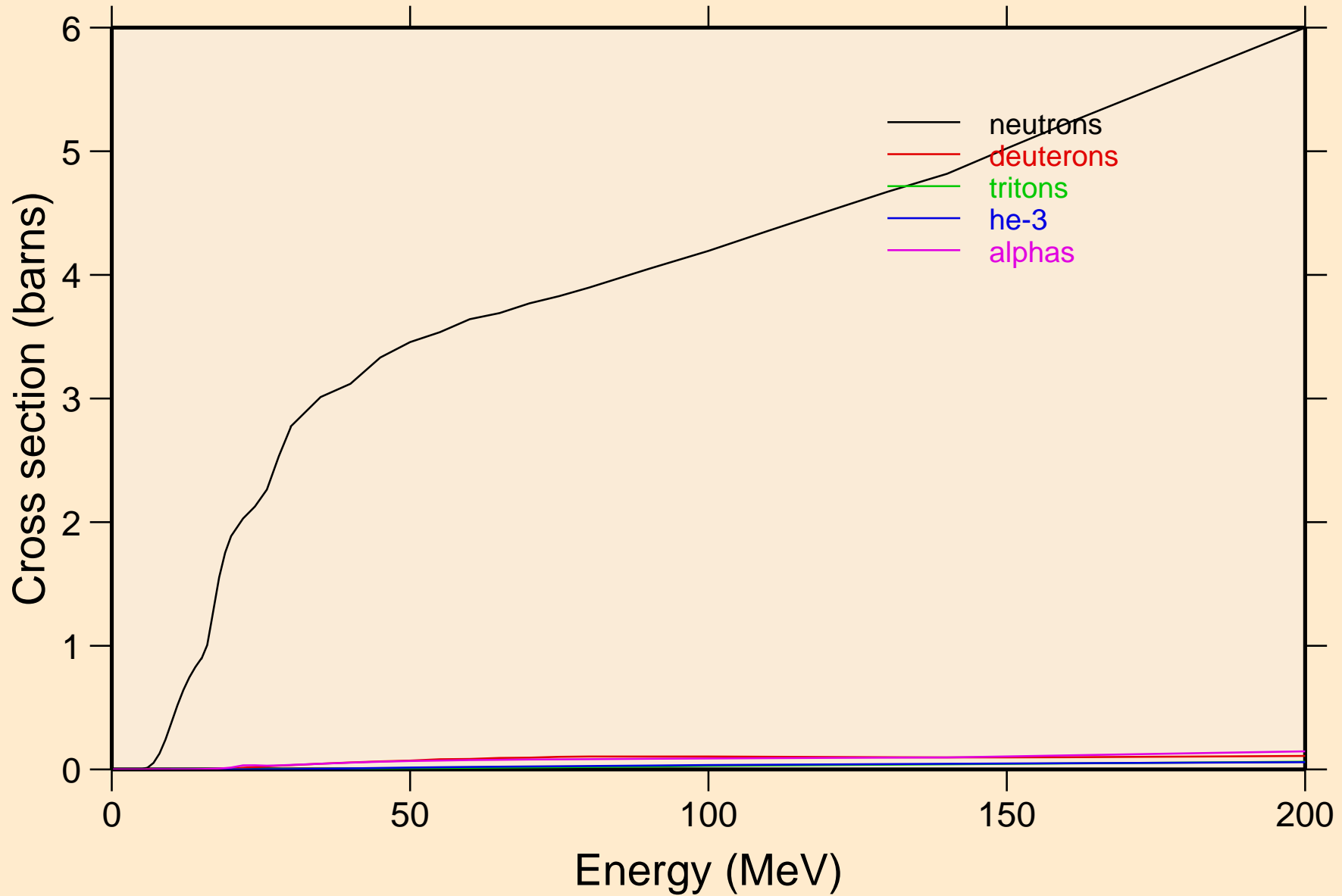

CE135 PROTON ACER TENDL-2023 LIBRARY; T=0.K  
neutrons from (p,n)

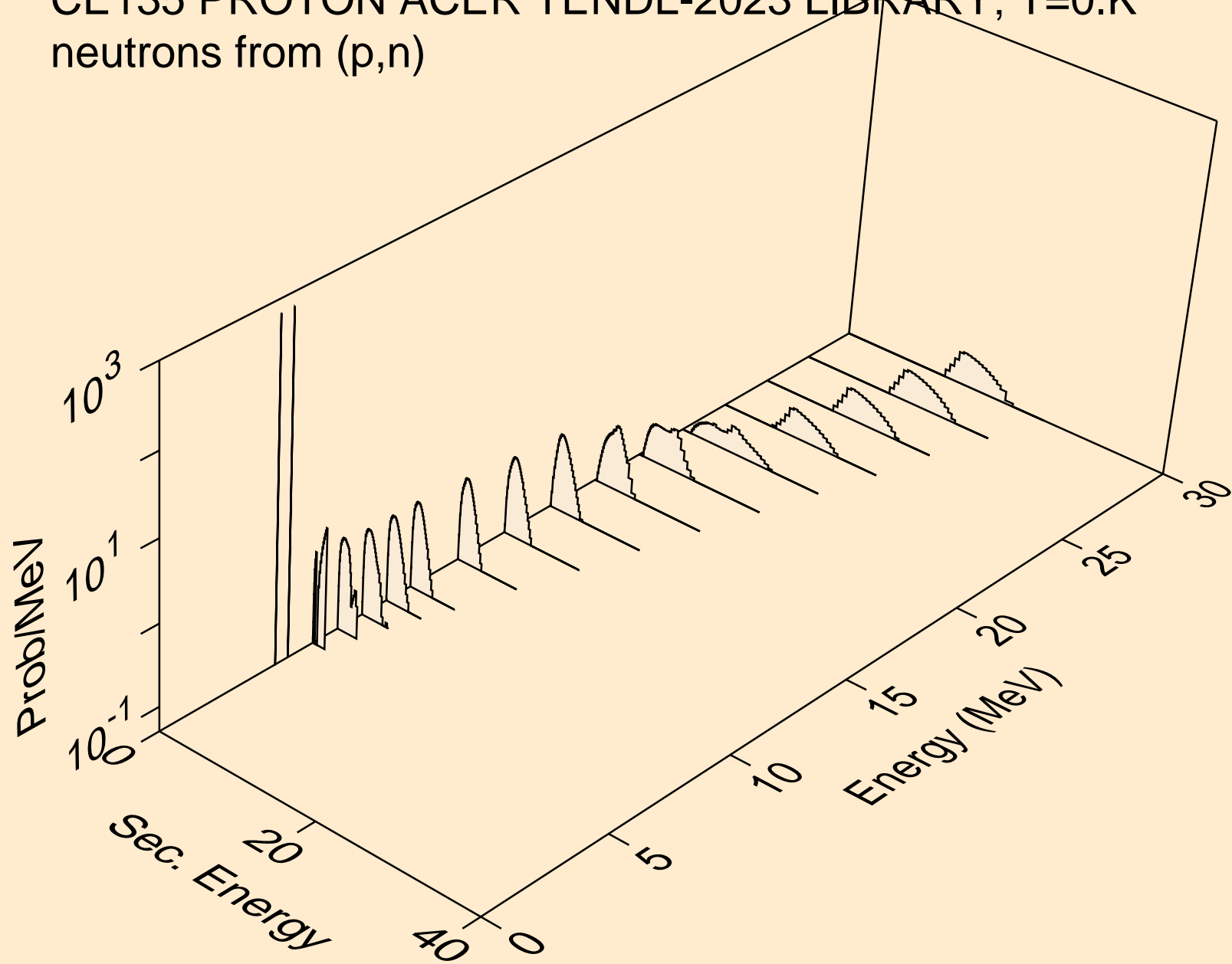

CE135 PROTON ACER TENDL-2023 LIBRARY; T=0.K  
neutrons from (p,x)

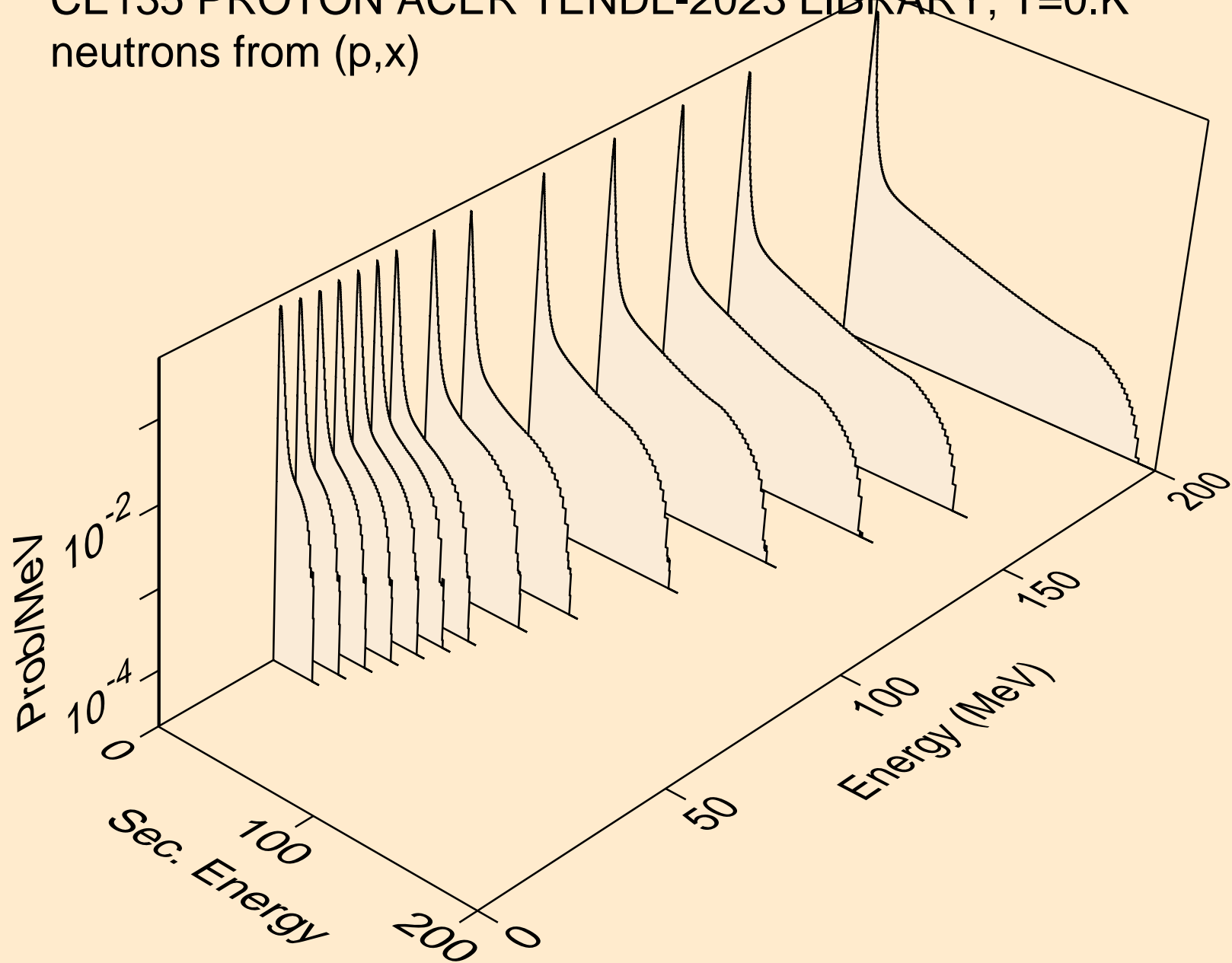

CE135 PROTON ACER TENDL-2023 LIBRARY; T=0.K  
neutrons from (p,2nd)

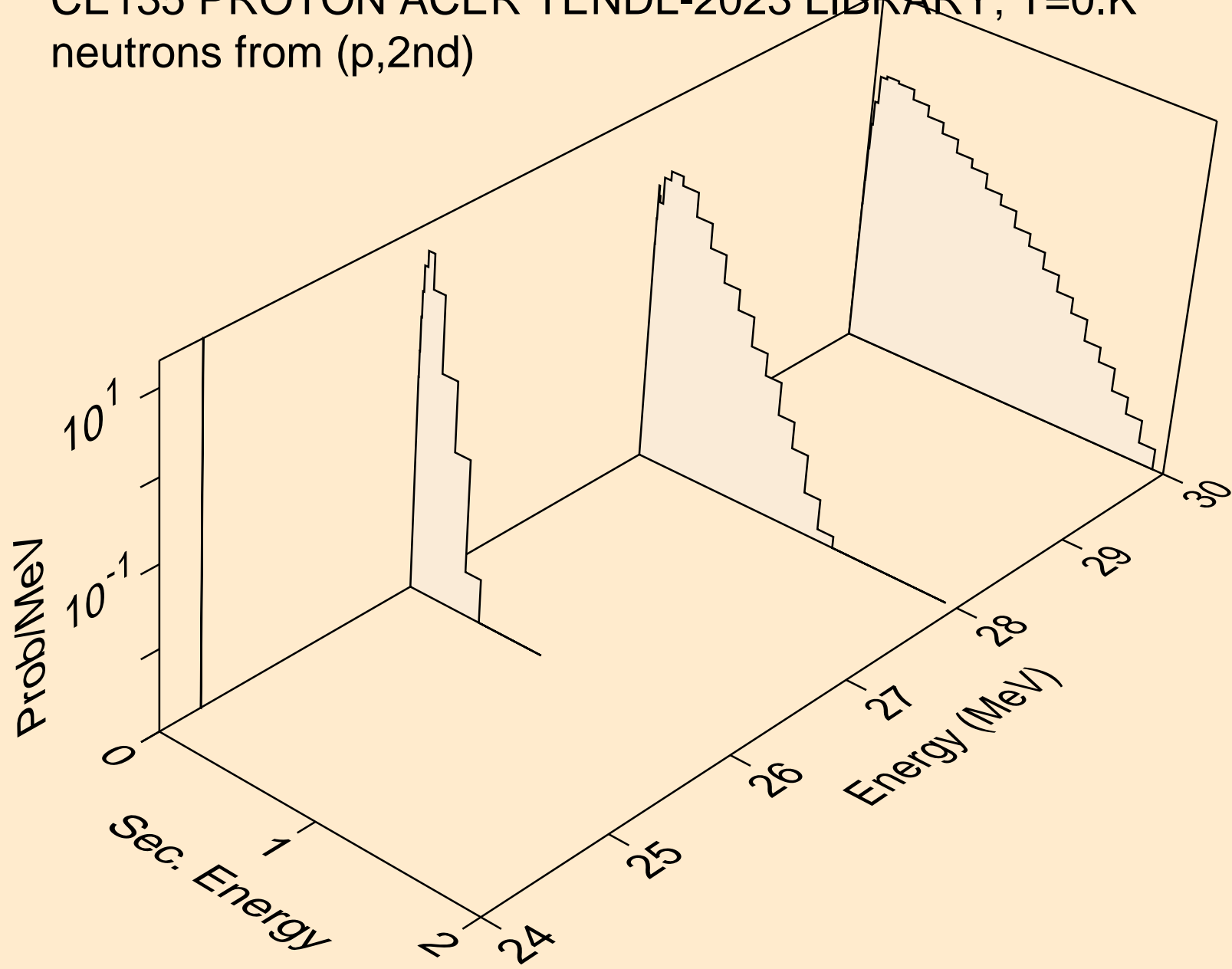

CE135 PROTON ACER TENDL-2023 LIBRARY; T=0.K  
neutrons from (p,2n)

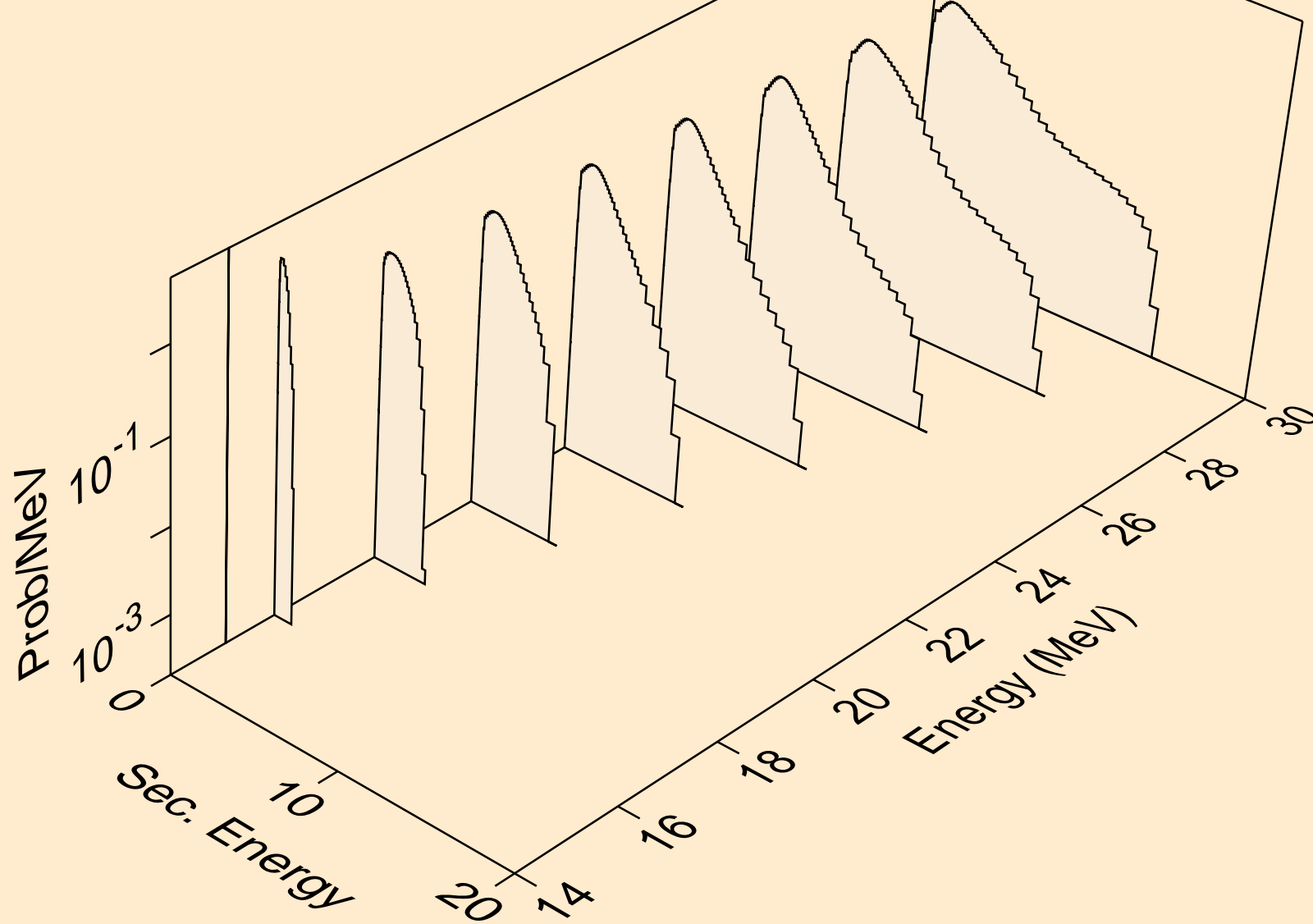

CE135 PROTON ACER TENDL-2023 LIBRARY; T=0.K  
neutrons from (p,3n)

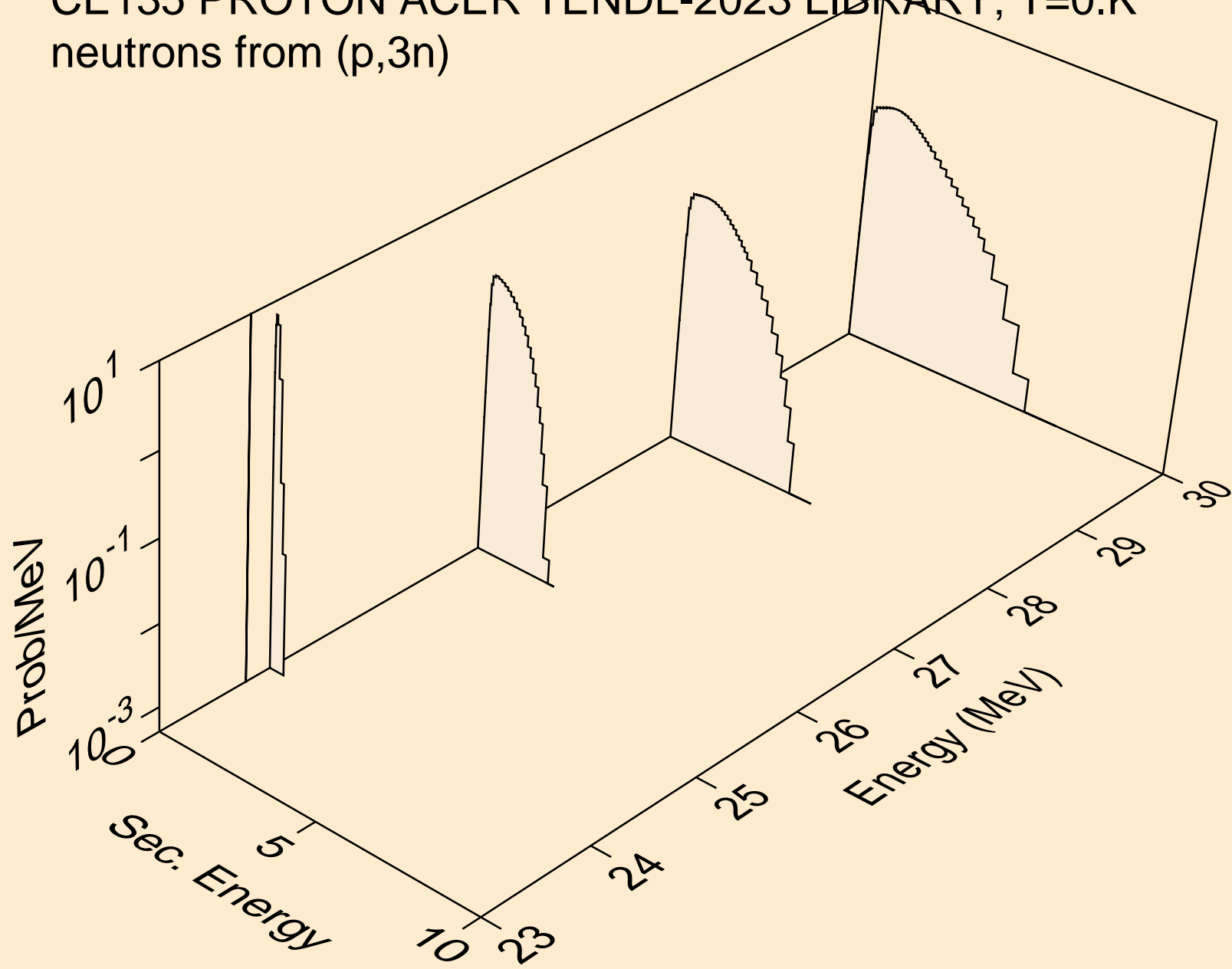



CE135 PROTON ACER TENDL-2023 LIBRARY; T=0.K  
neutrons from (p,n\*)a

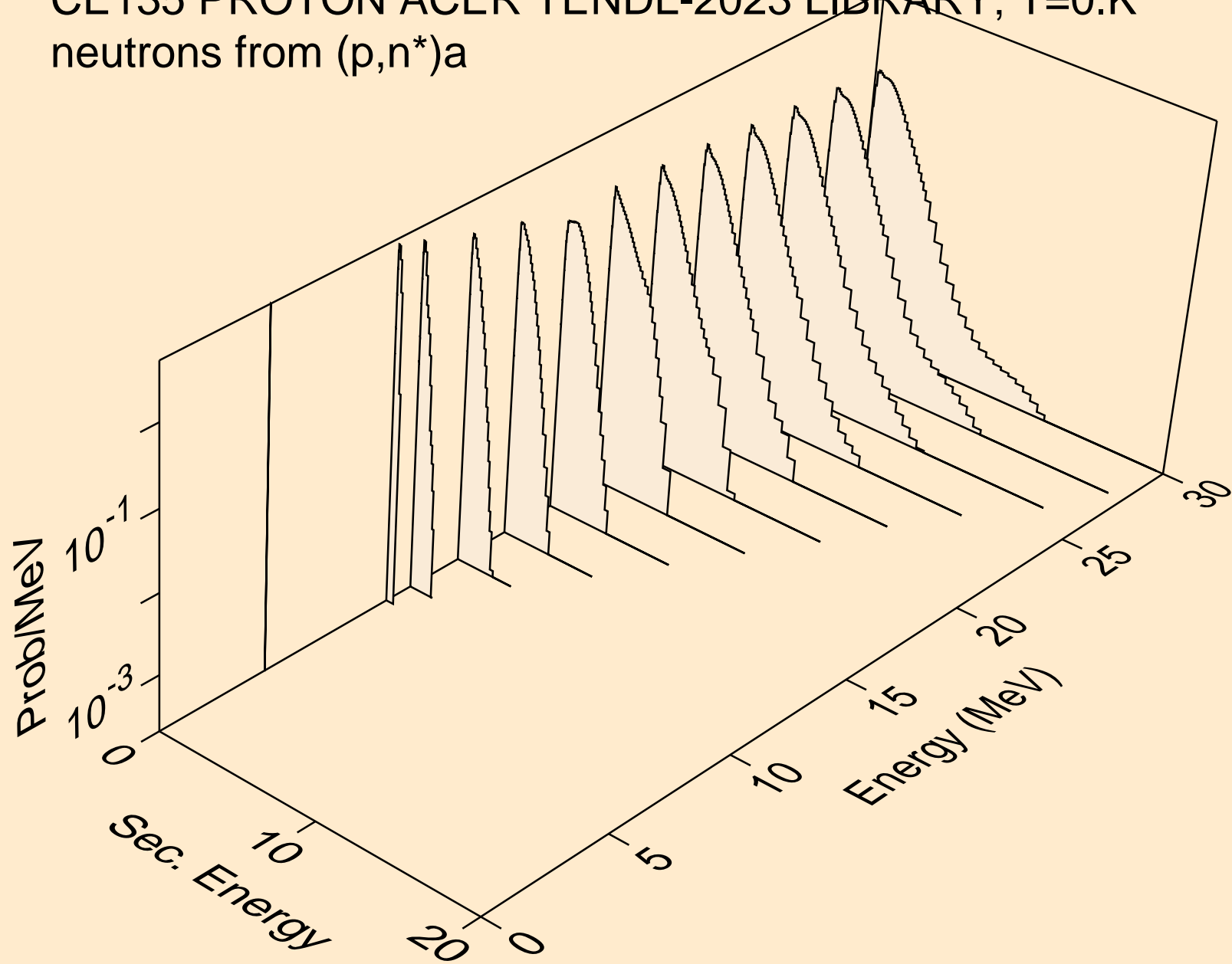

CE135 PROTON ACER TENDL-2023 LIBRARY; T=0.K  
neutrons from (p,2n)a

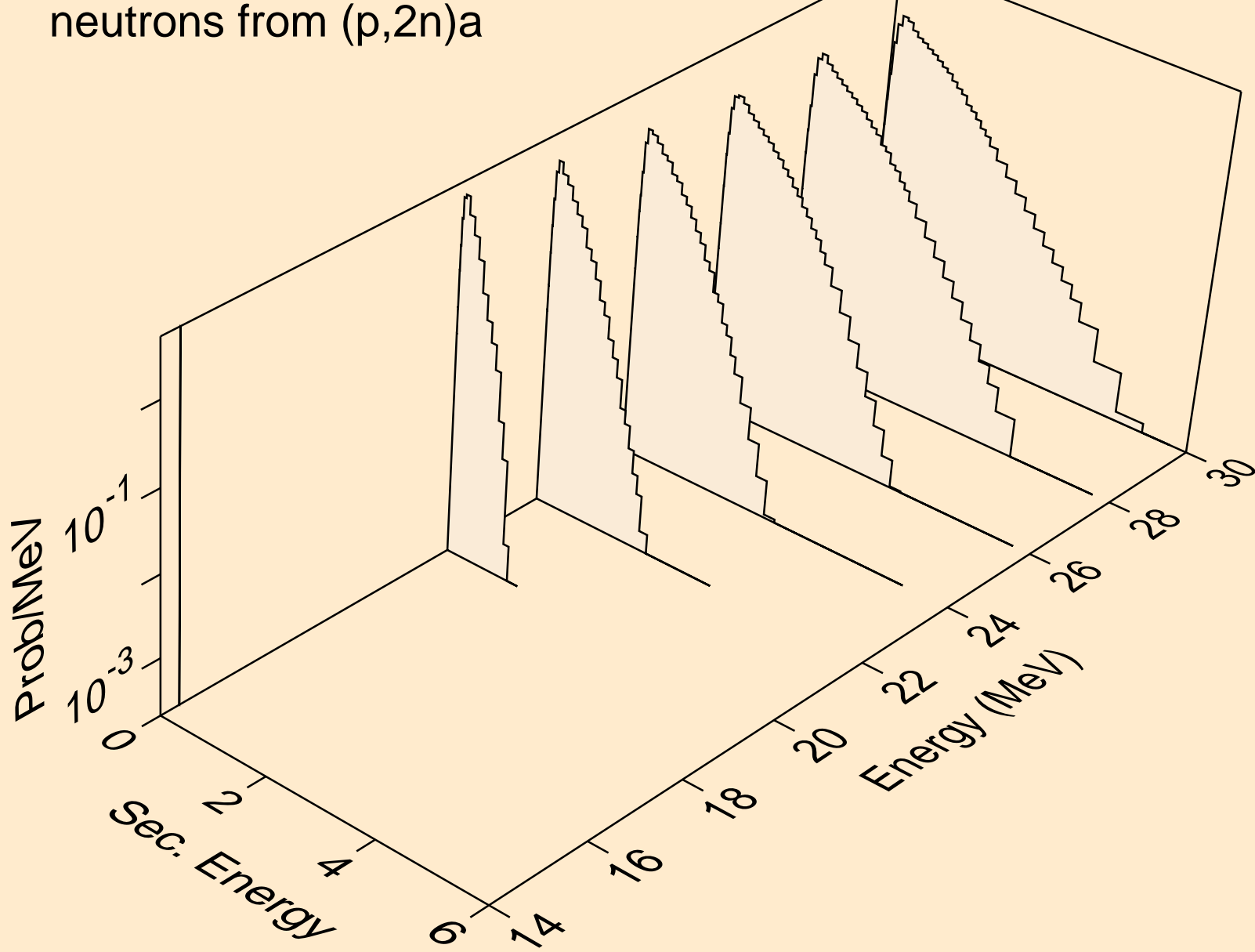

CE135 PROTON ACER TENDL-2023 LIBRARY; T=0.K  
neutrons from (p,n\*)p

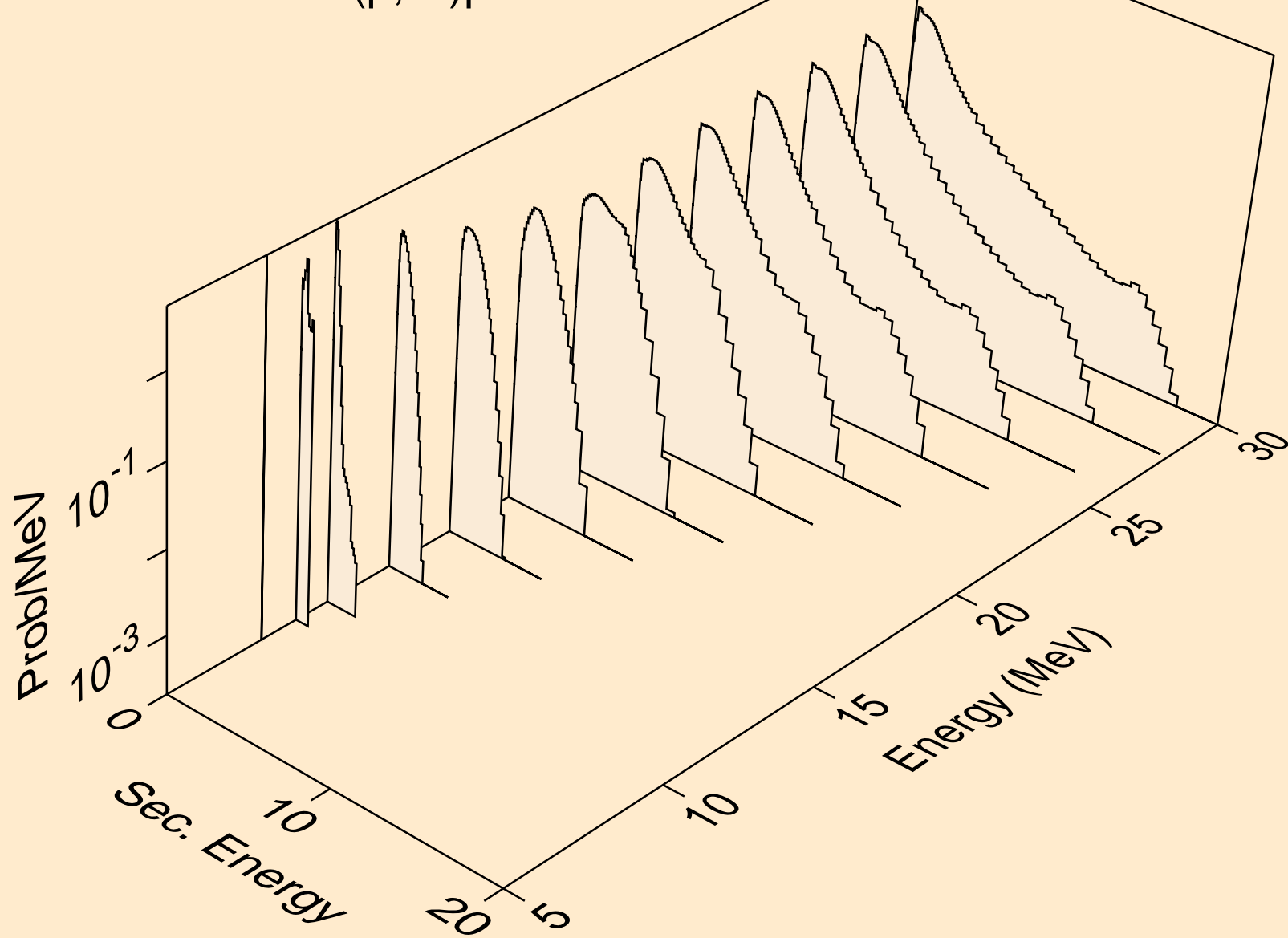

CE135 PROTON ACER TENDL-2023 LIBRARY; T=0.K  
neutrons from (p,n\*)2a

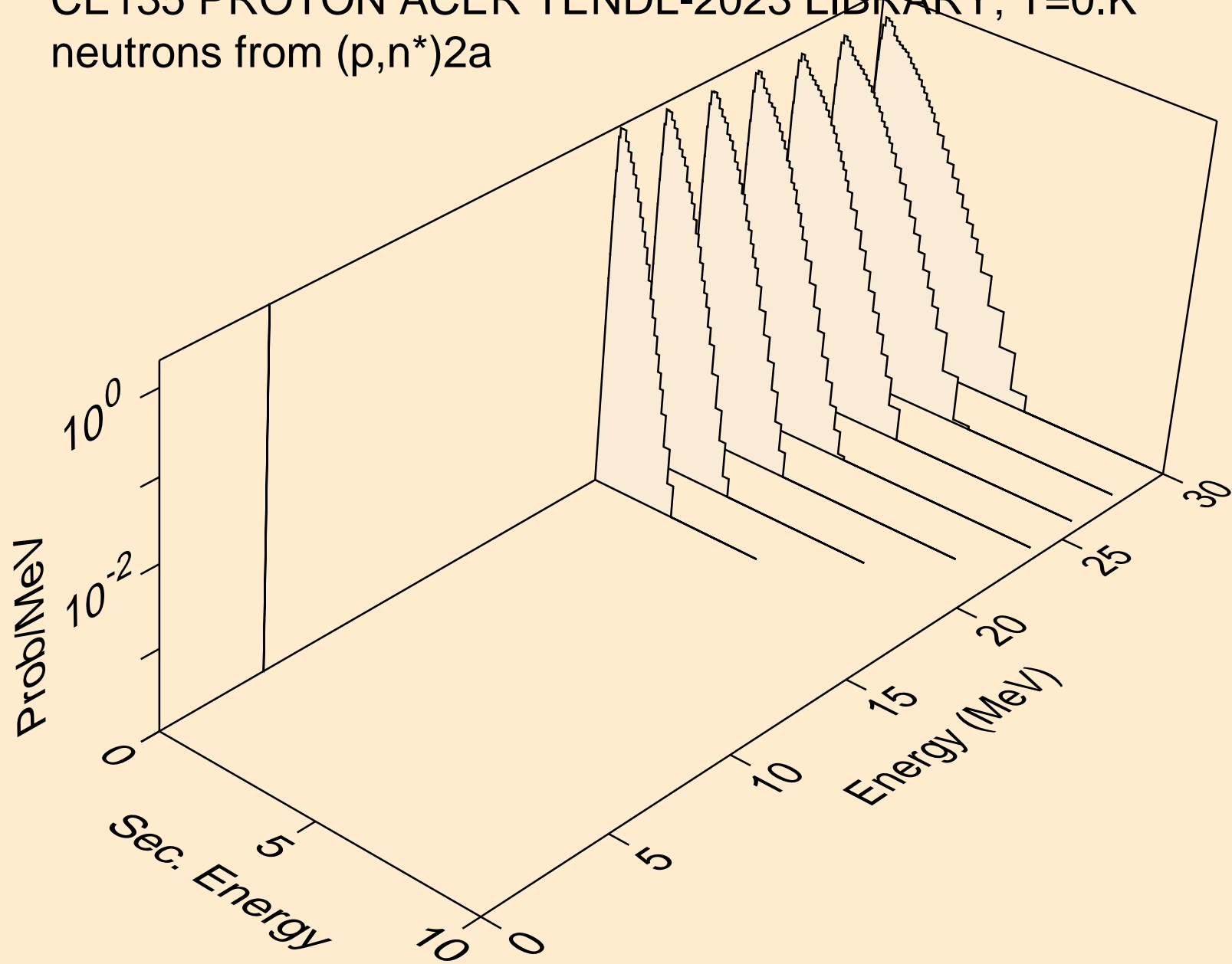

CE135 PROTON ACER TENDL-2023 LIBRARY; T=0.K  
neutrons from (p,n\*)d

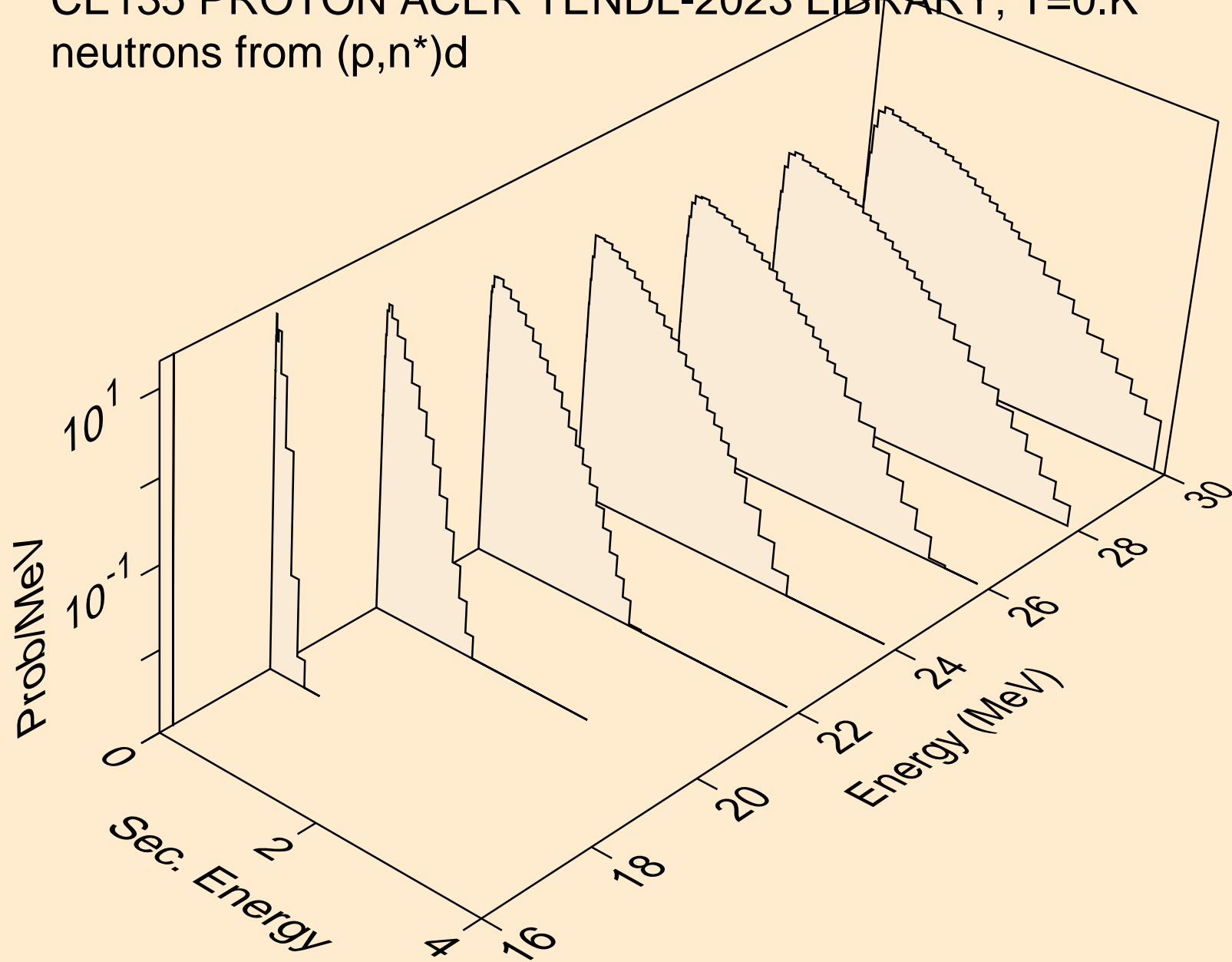

CE135 PROTON ACER TENDL-2023 LIBRARY; T=0.K  
neutrons from (p,n\*)t

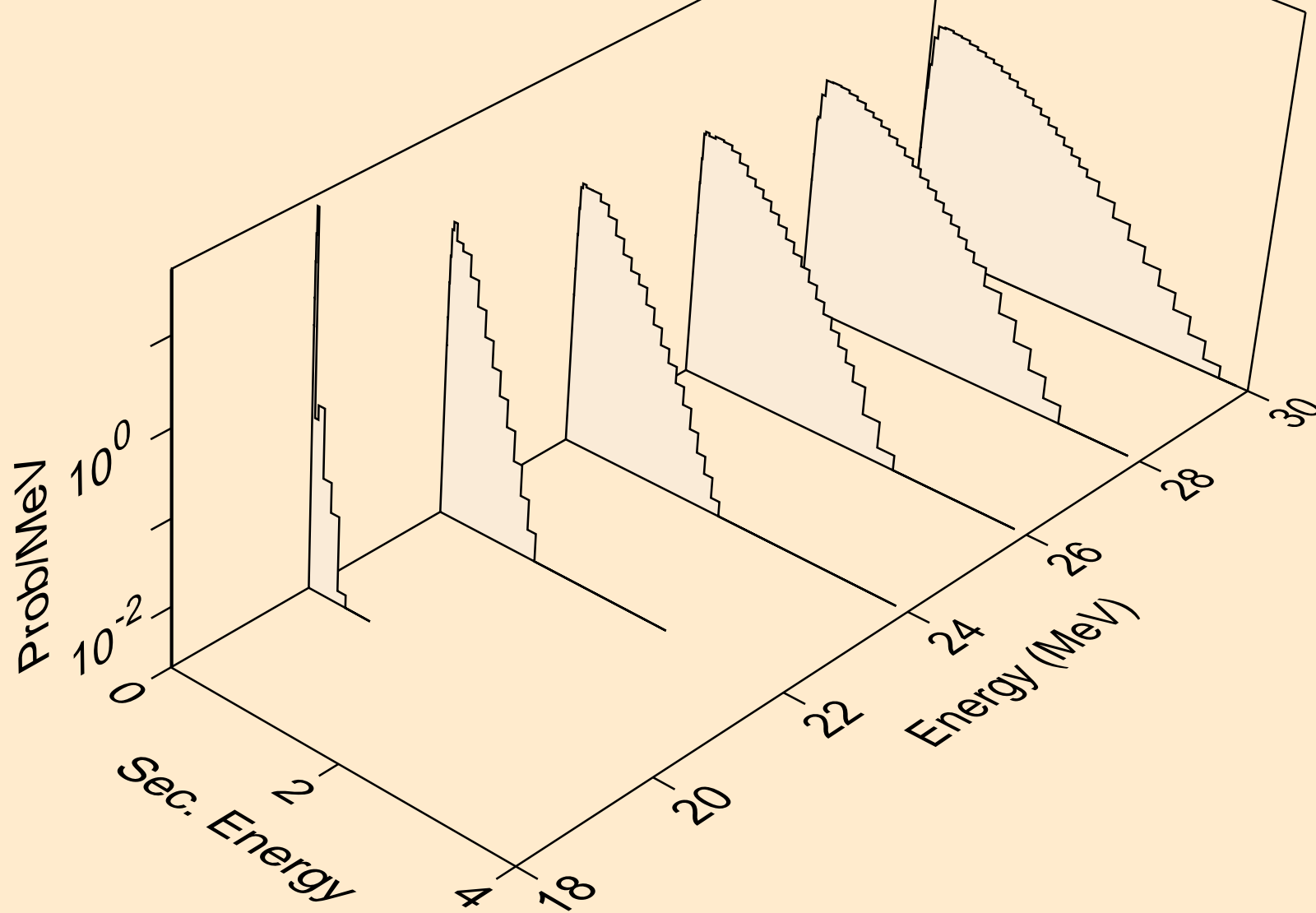

CE135 PROTON ACER TENDL-2023 LIBRARY; T=0.K  
neutrons from (p,n\*)he3

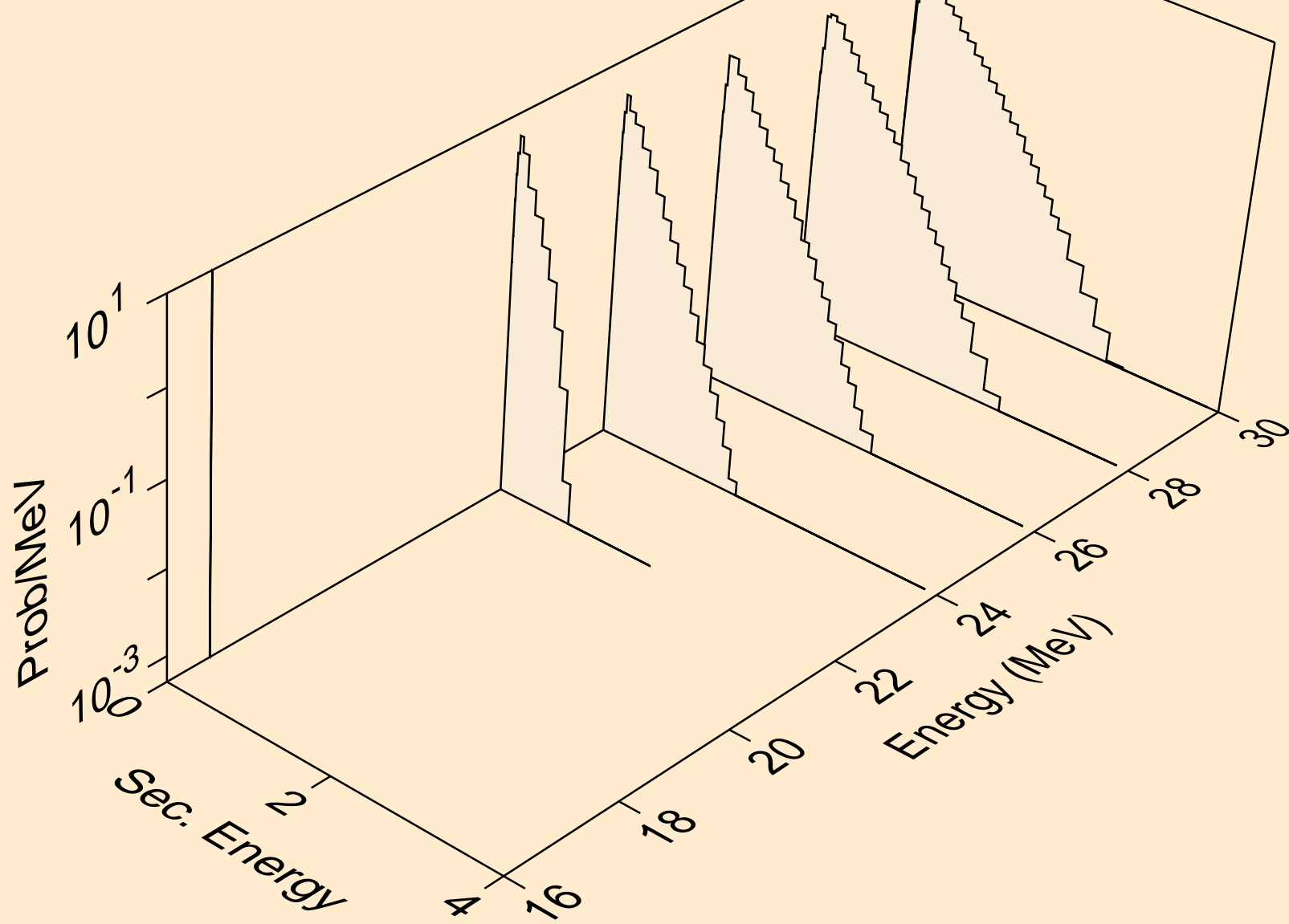

CE135 PROTON ACER TENDL-2023 LIBRARY; T=0.K  
neutrons from (p,2np)

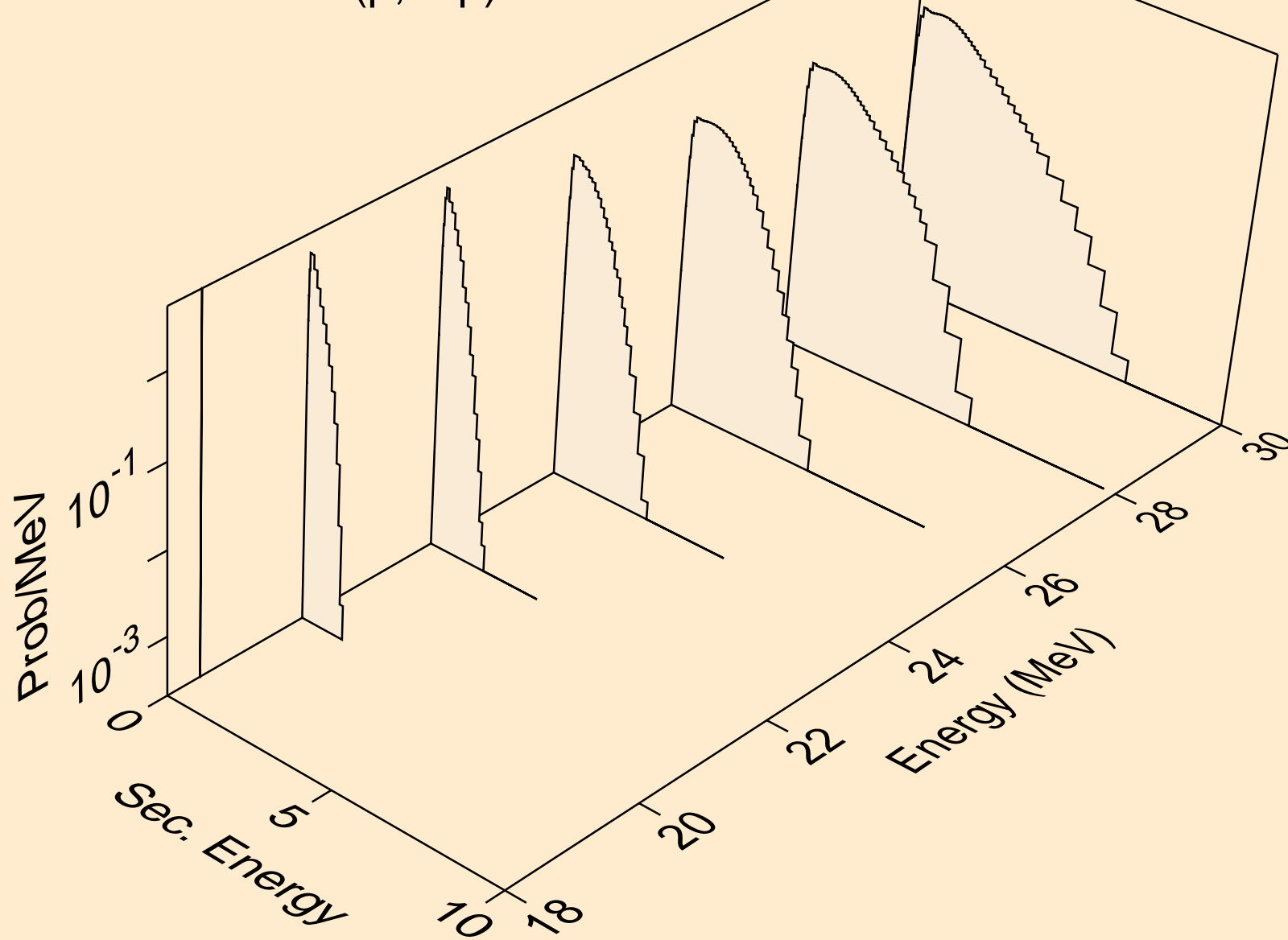



CE135 PROTON ACER TENDL-2023 LIBRARY; T=0.K  
neutrons from (p,3np)

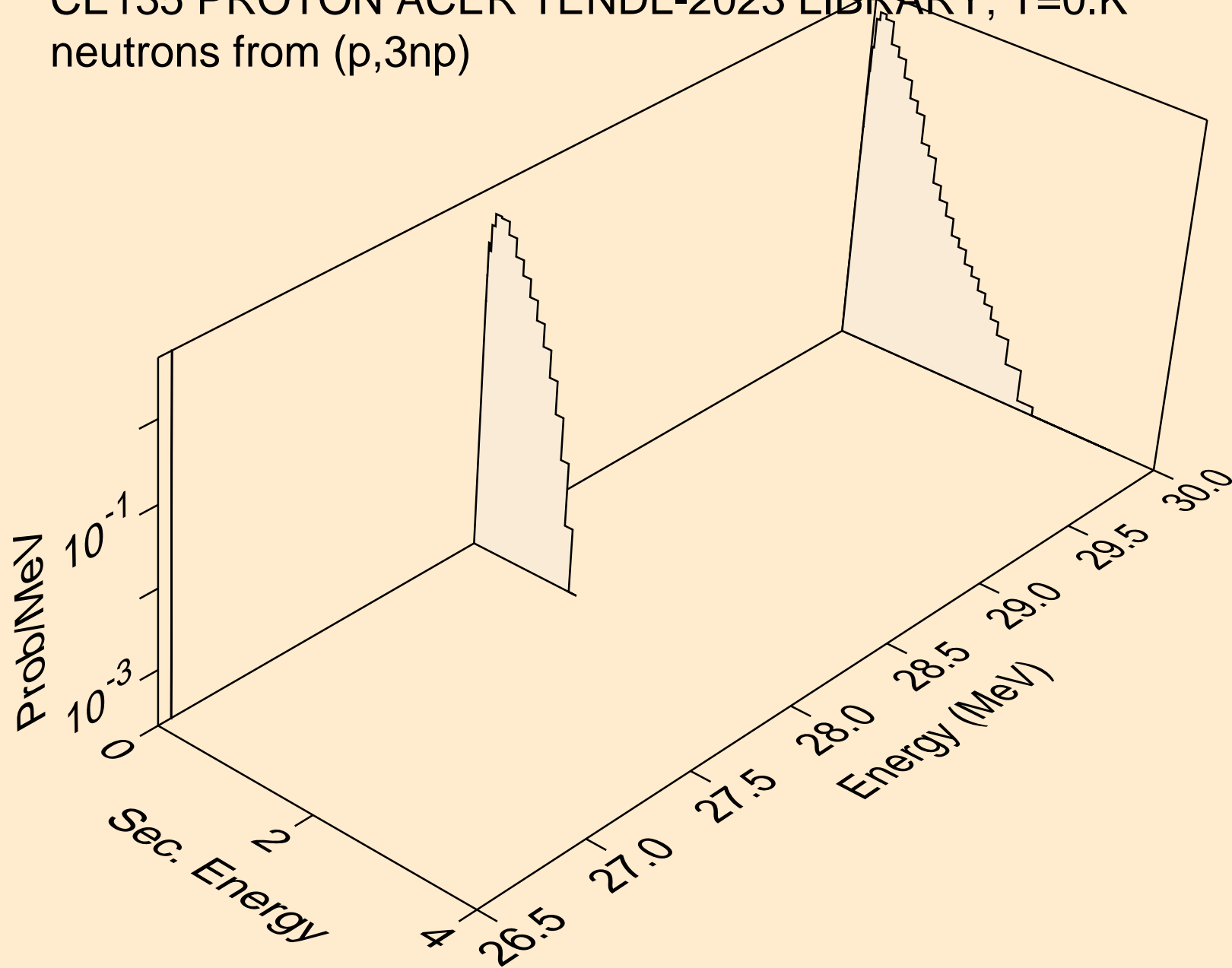

CE135 PROTON ACER TENDL-2023 LIBRARY; T=0.K  
neutrons from (p,n2p)

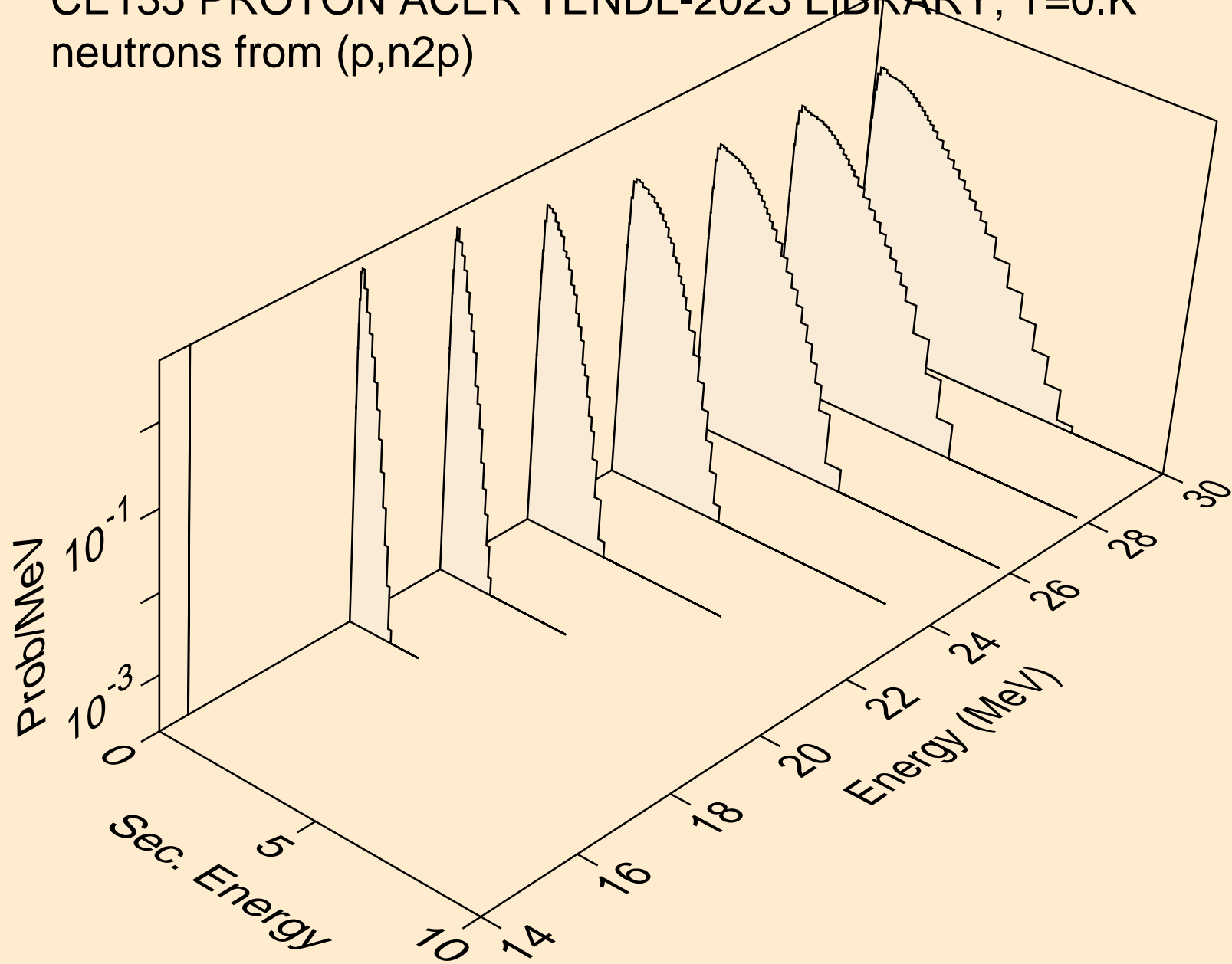

CE135 PROTON ACER TENDL-2023 LIBRARY; T=0.K  
neutrons from (p,npa)

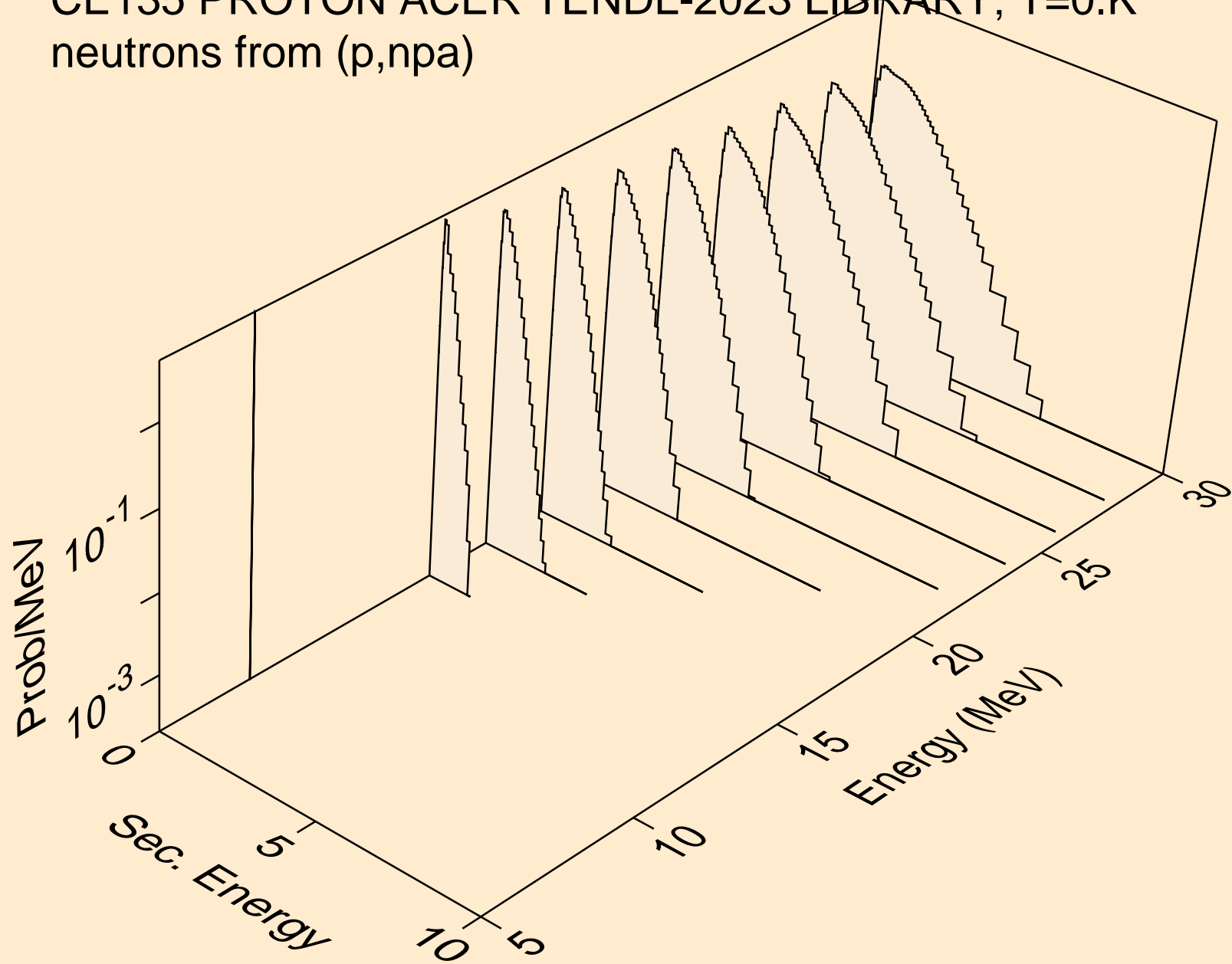

CE135 PROTON ACER TENDL-2023 LIBRARY; T=0.K  
deuterons from (p,x)

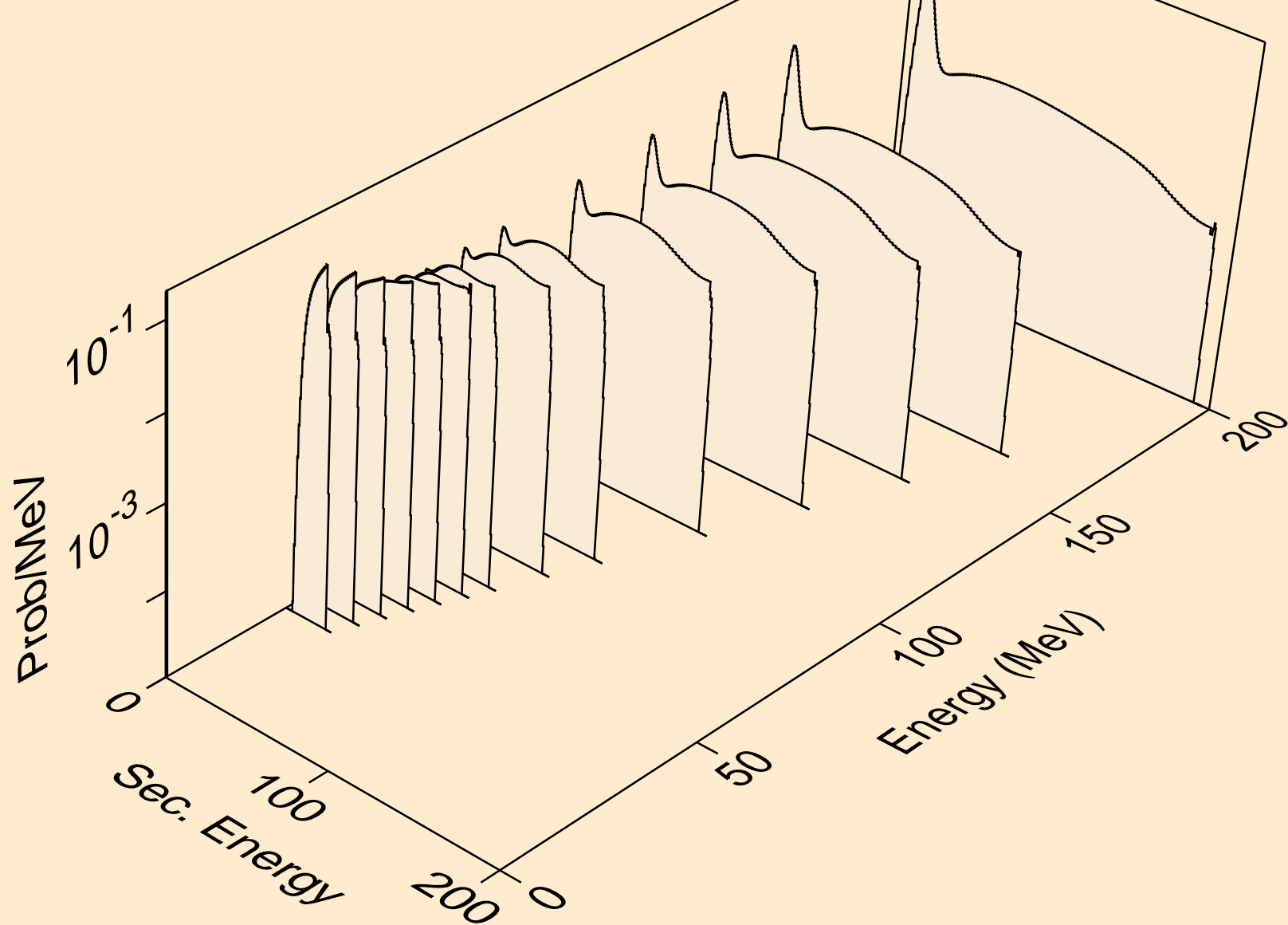

CE135 PROTON ACER TENDL-2023 LIBRARY; T=0.K  
deuterons from (p,2nd)

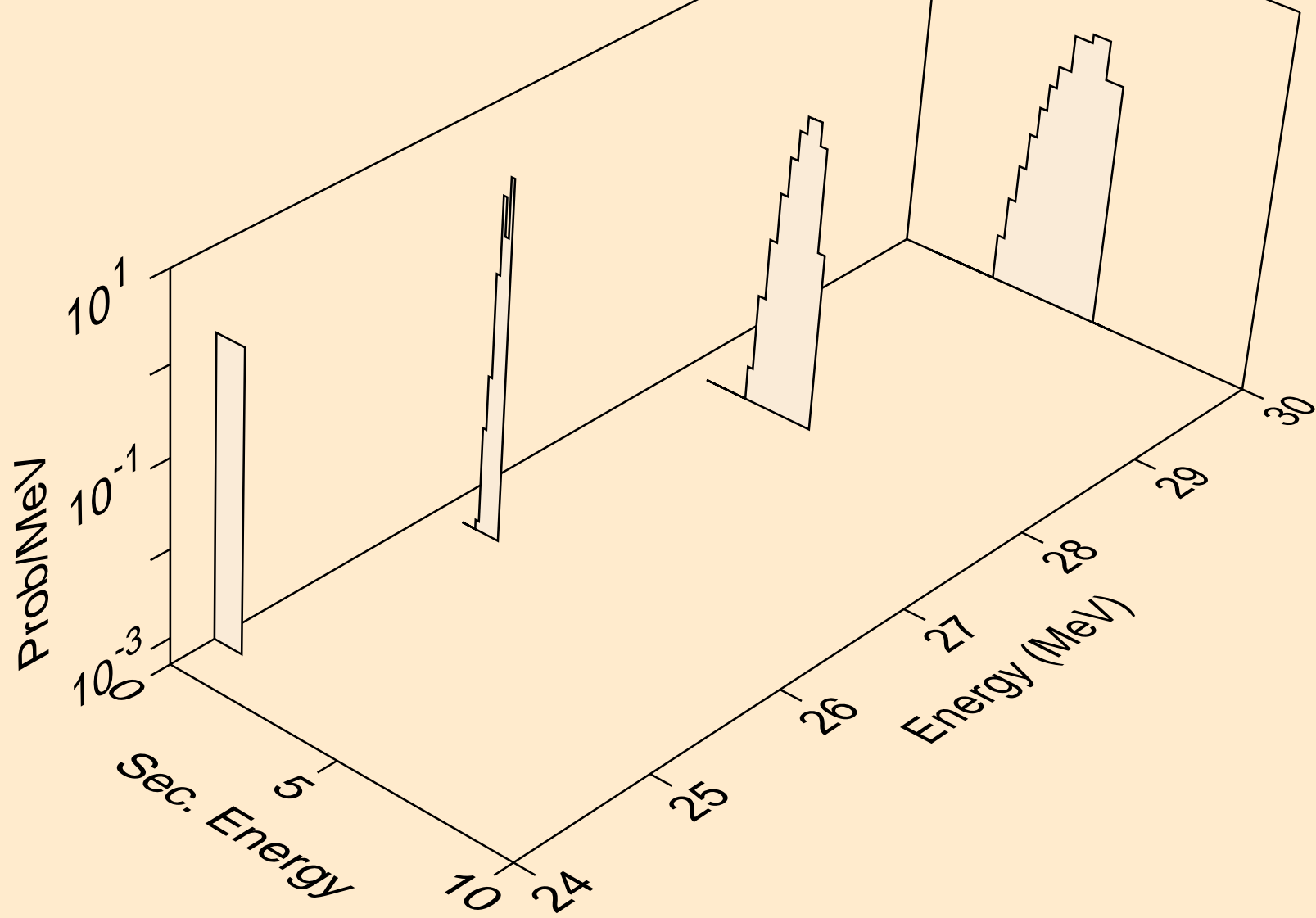

CE135 PROTON ACER TENDL-2023 LIBRARY; T=0.K  
deuterons from (p,n\*)d

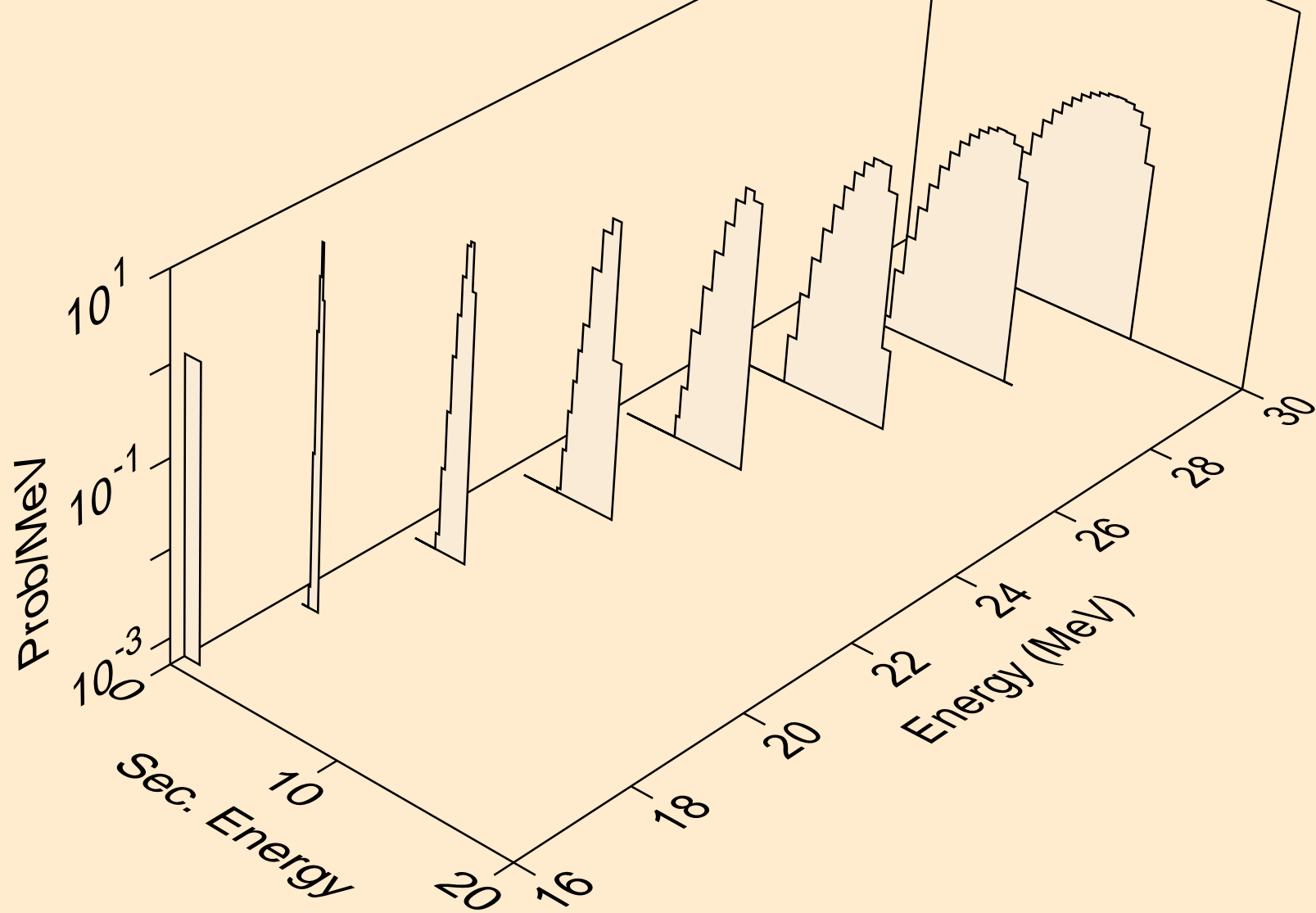

CE135 PROTON ACER TENDL-2023 LIBRARY; T=0.K  
deuterons from (p,d)

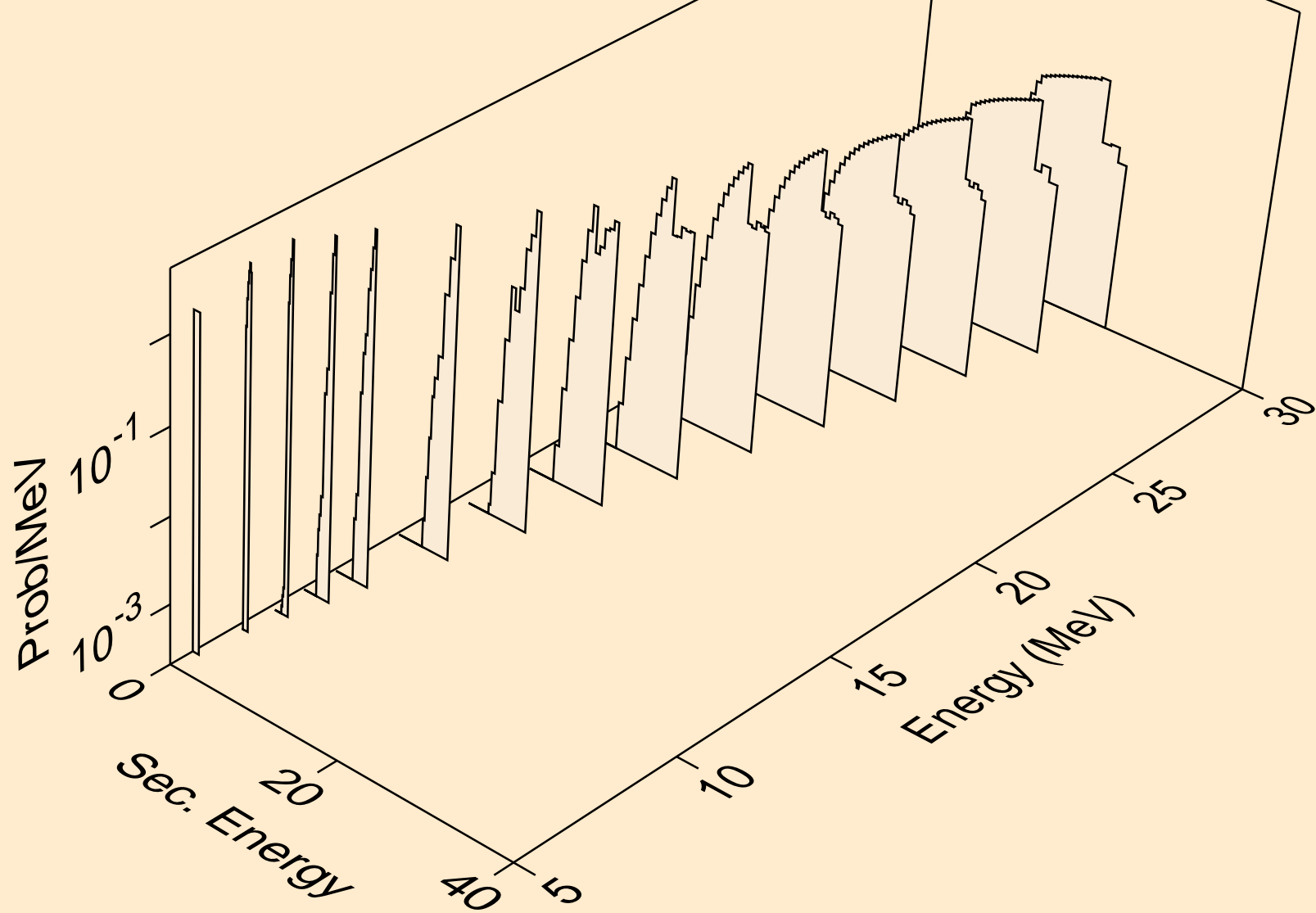

CE135 PROTON ACER TENDL-2023 LIBRARY; T=0.K  
deuterons from (p,pd)

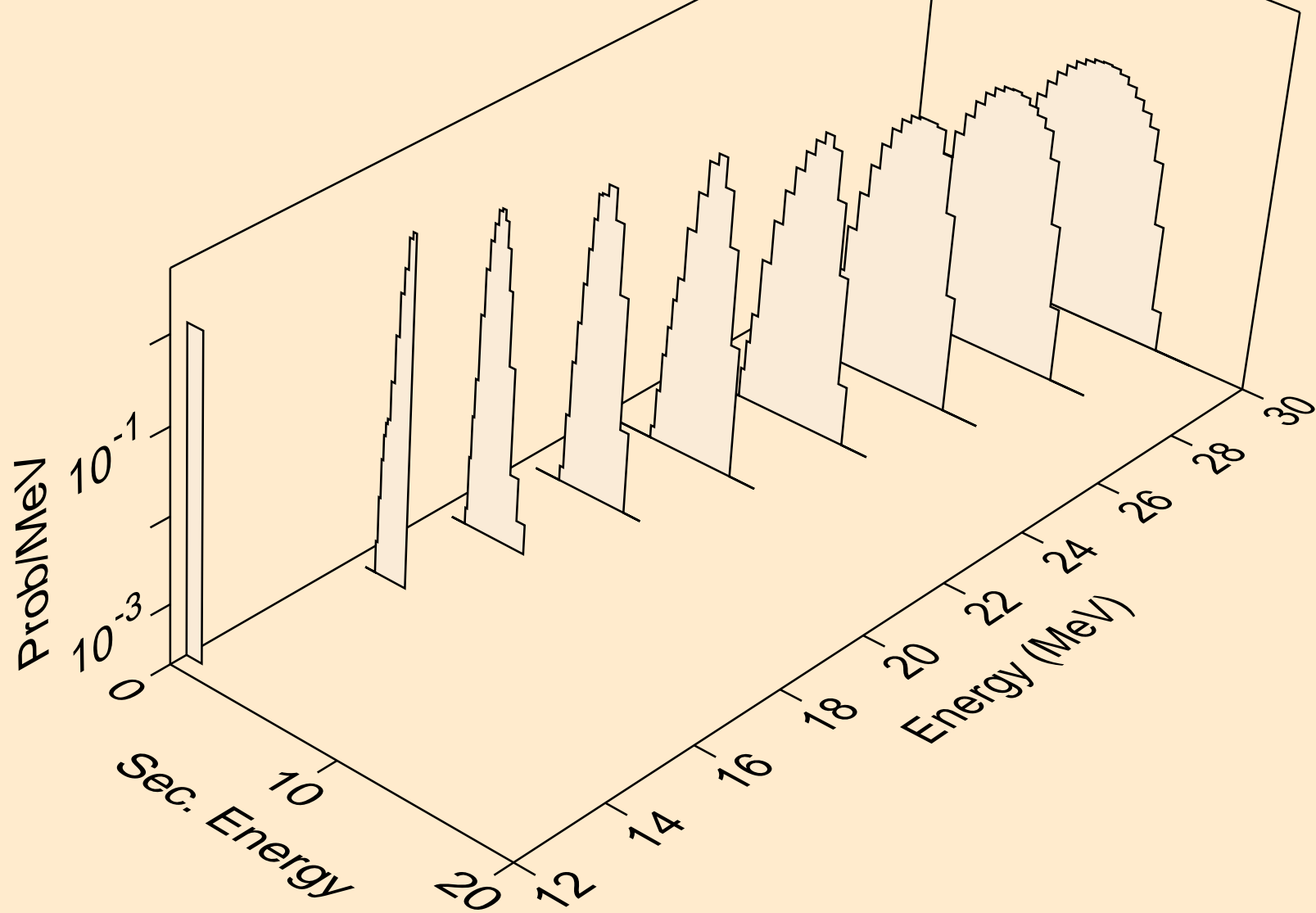



CE135 PROTON ACER TENDL-2023 LIBRARY; T=0.K  
deuterons from (p,da)

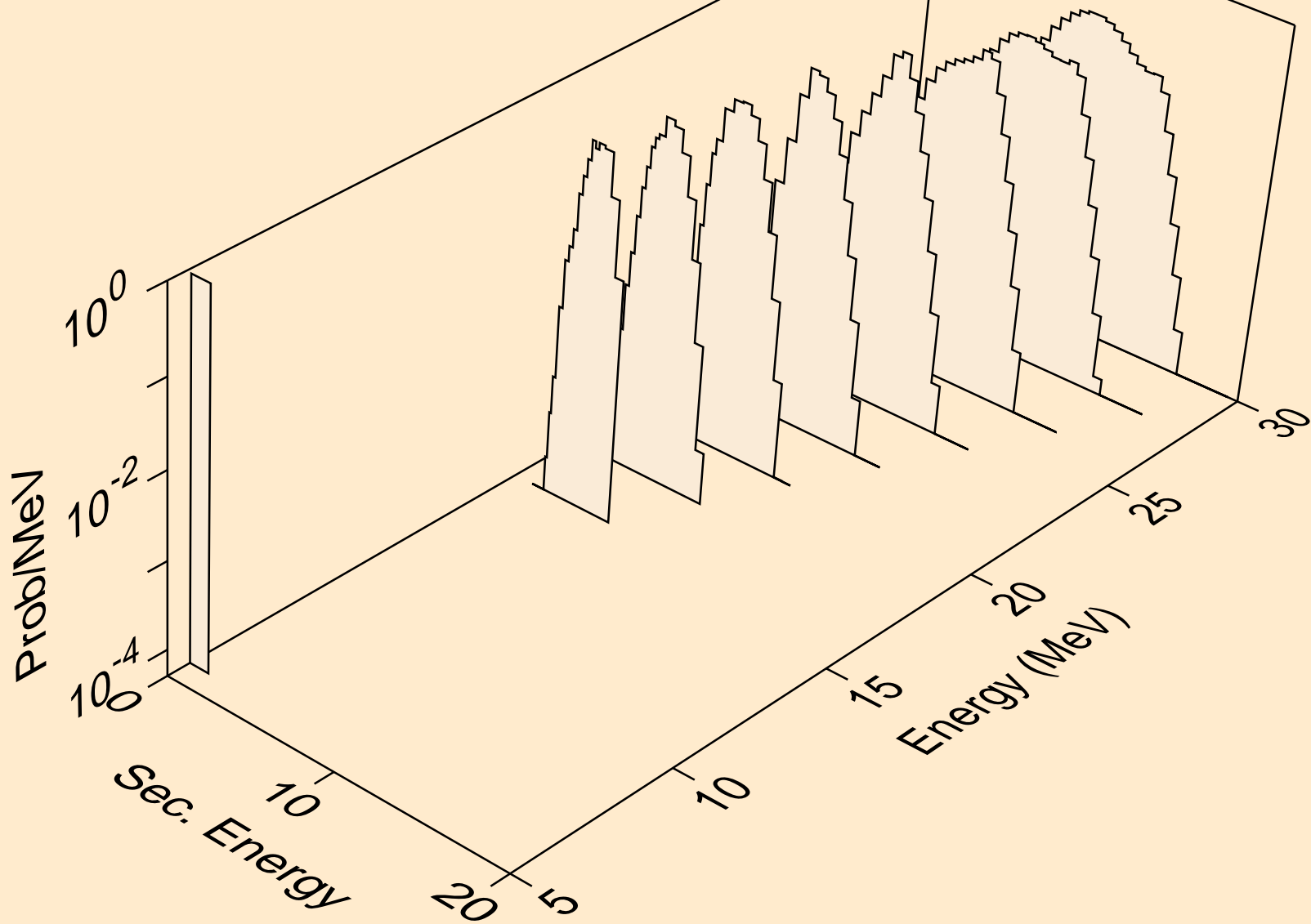

CE135 PROTON ACER TENDL-2023 LIBRARY; T=0.K  
tritons from (p,x)

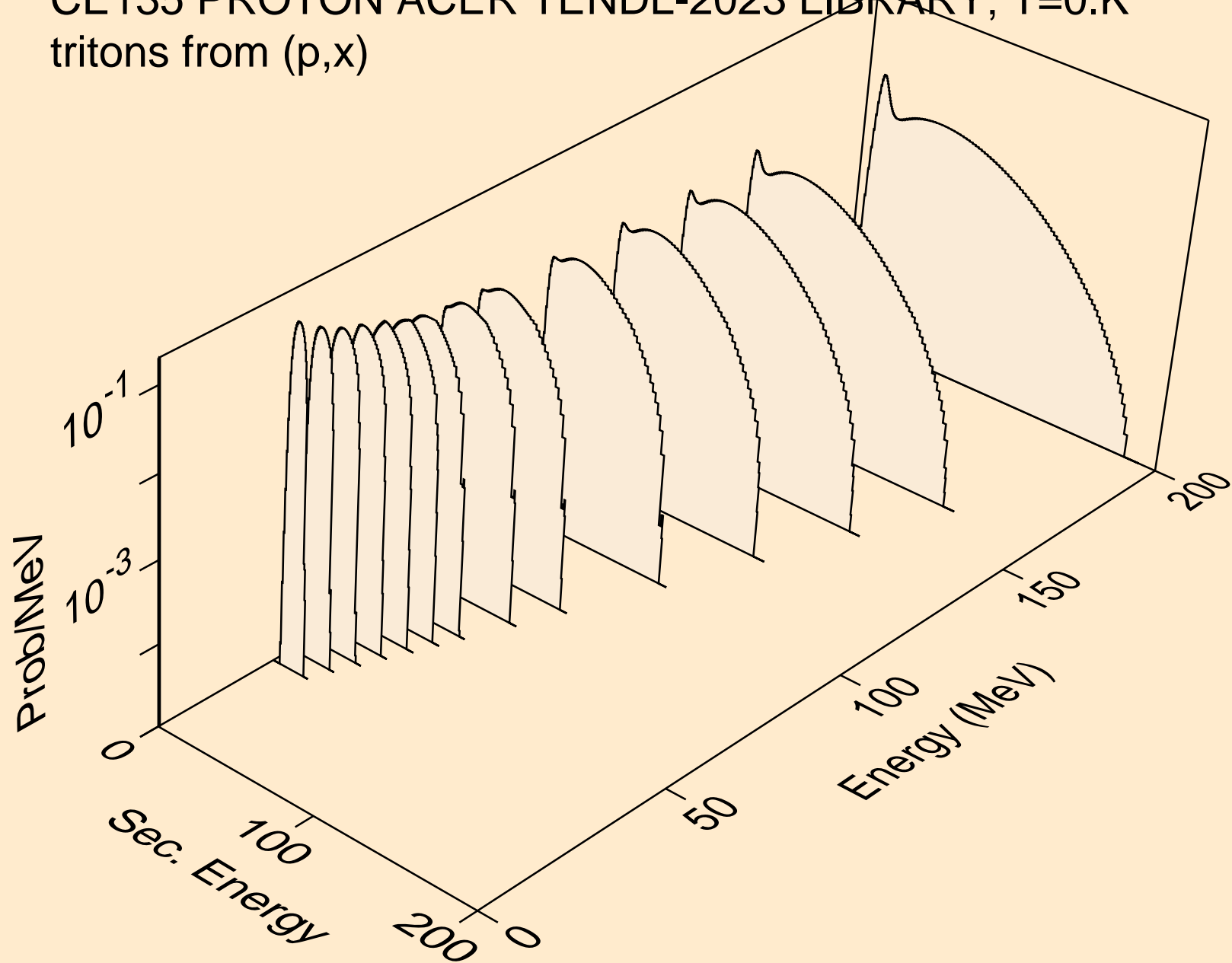

CE135 PROTON ACER TENDL-2023 LIBRARY; T=0.K  
tritons from (p,n\*)t

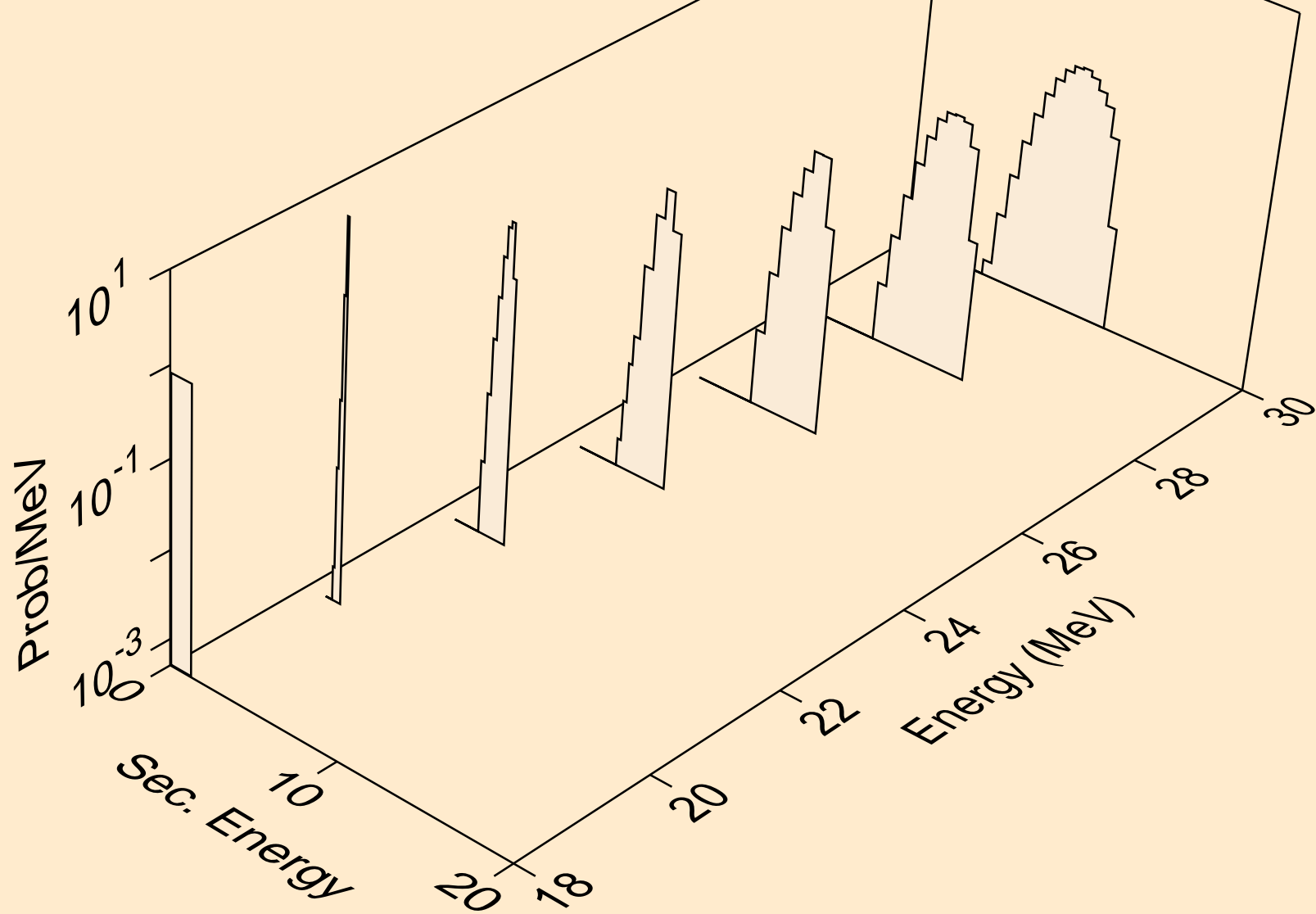

CE135 PROTON ACER TENDL-2023 LIBRARY; T=0.K  
tritons from (p,t)

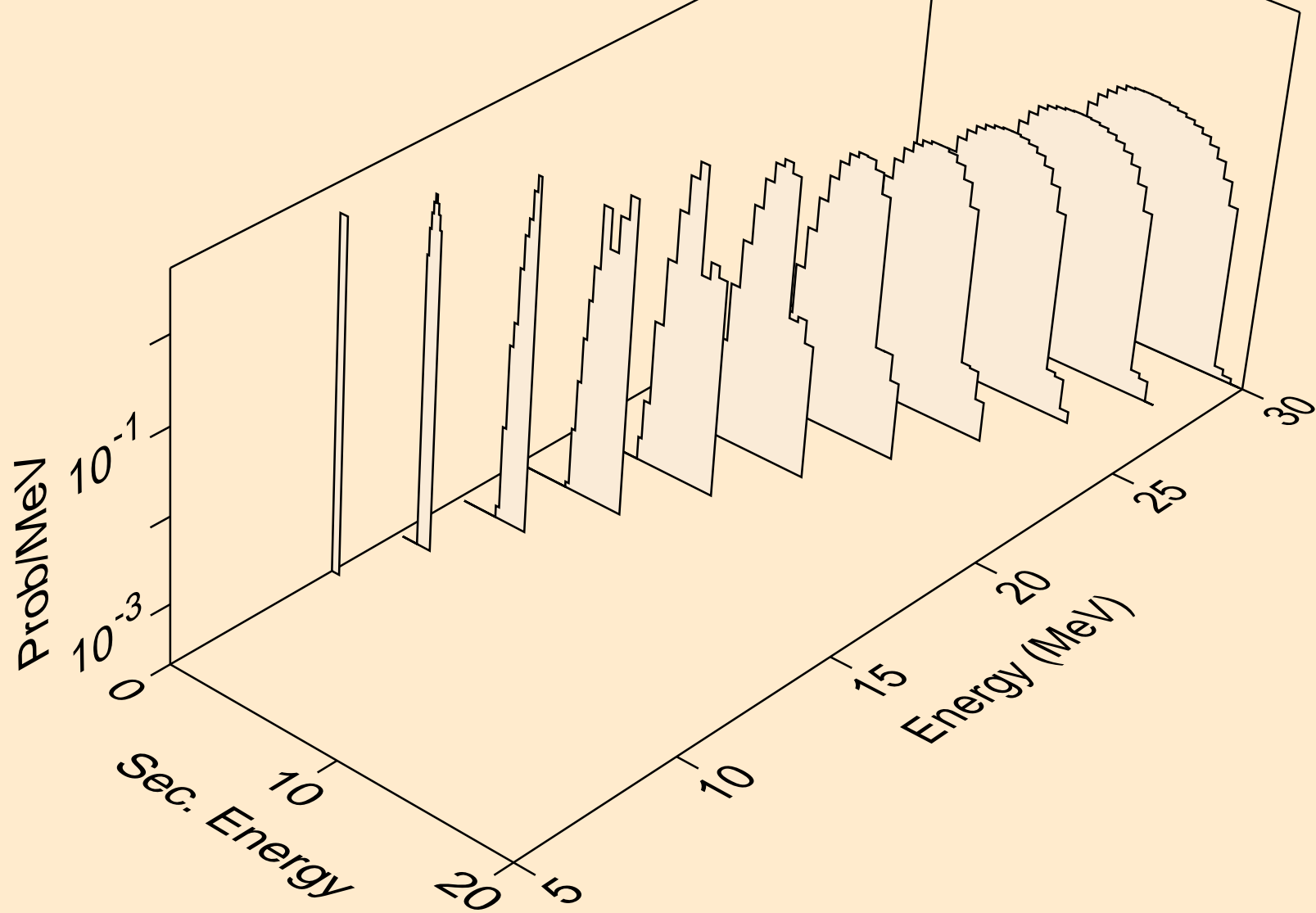

CE135 PROTON ACER TENDL-2023 LIBRARY; T=0.K  
tritons from (p,pt)

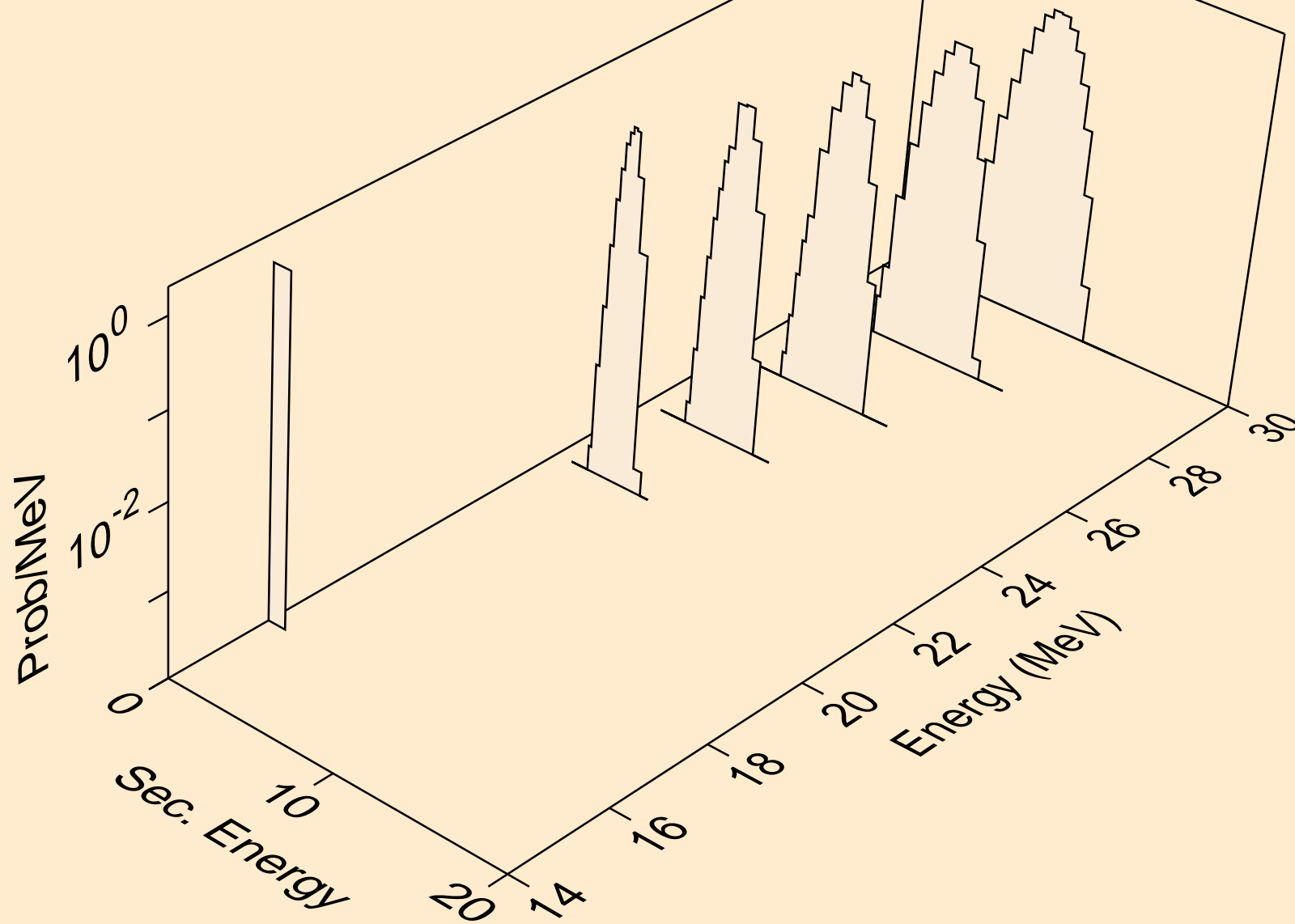

CE135 PROTON ACER TENDL-2023 LIBRARY; T=0.K  
he3s from (p,x)

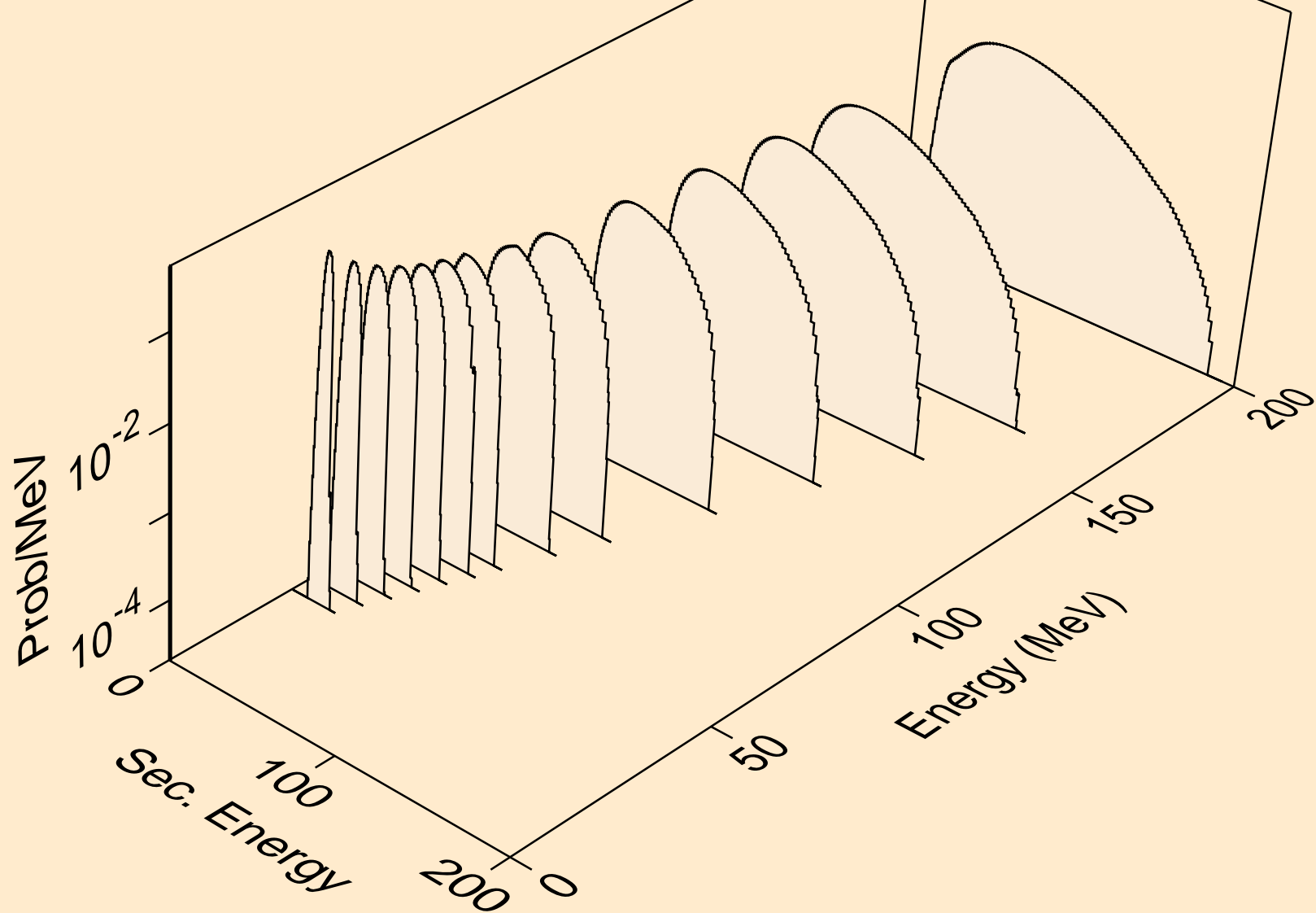

CE135 PROTON ACER TENDL-2023 LIBRARY; T=0.K  
he3s from (p,n\*)he3

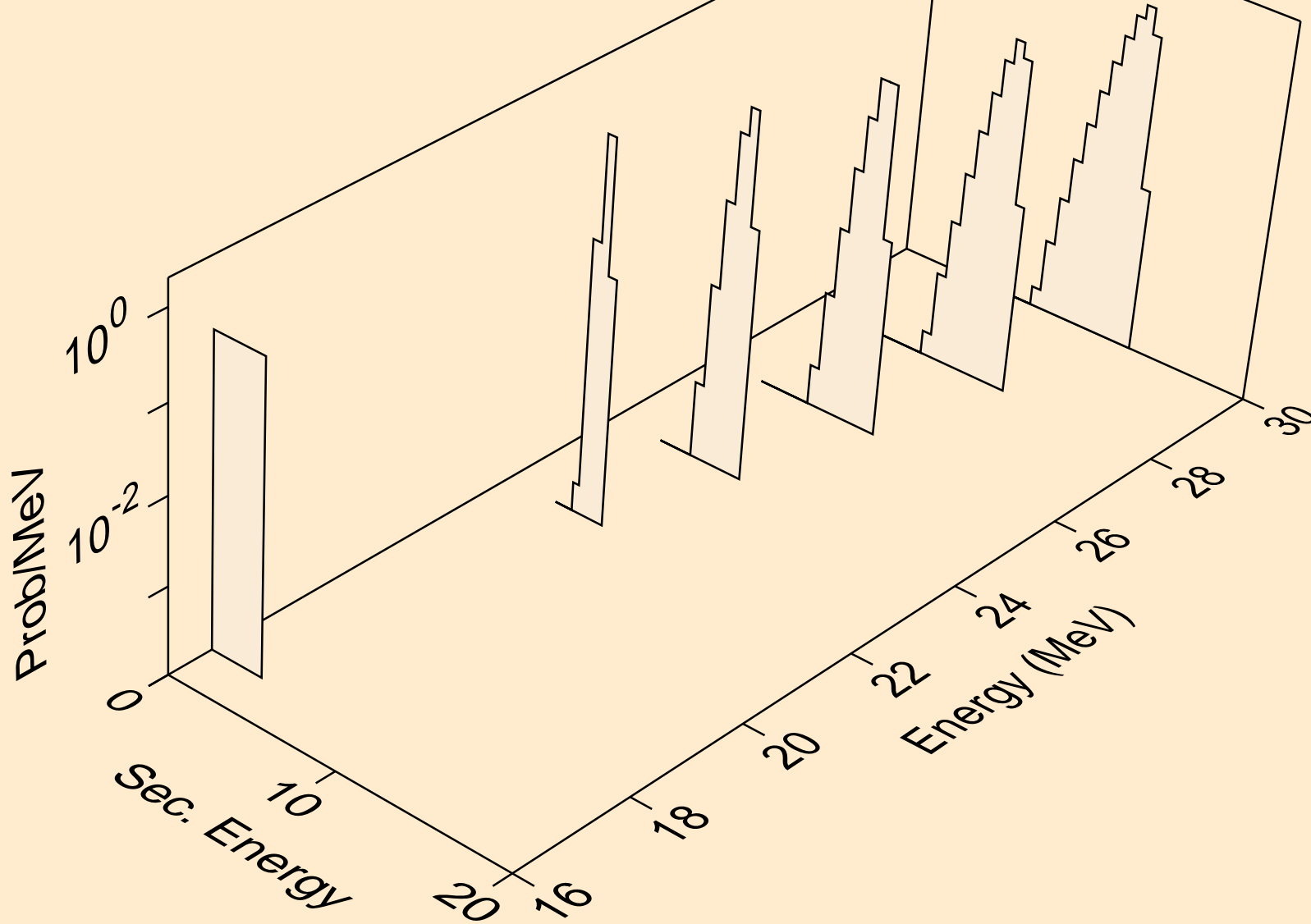

CE135 PROTON ACER TENDL-2023 LIBRARY; T=0.K  
he3s from (p,he3)

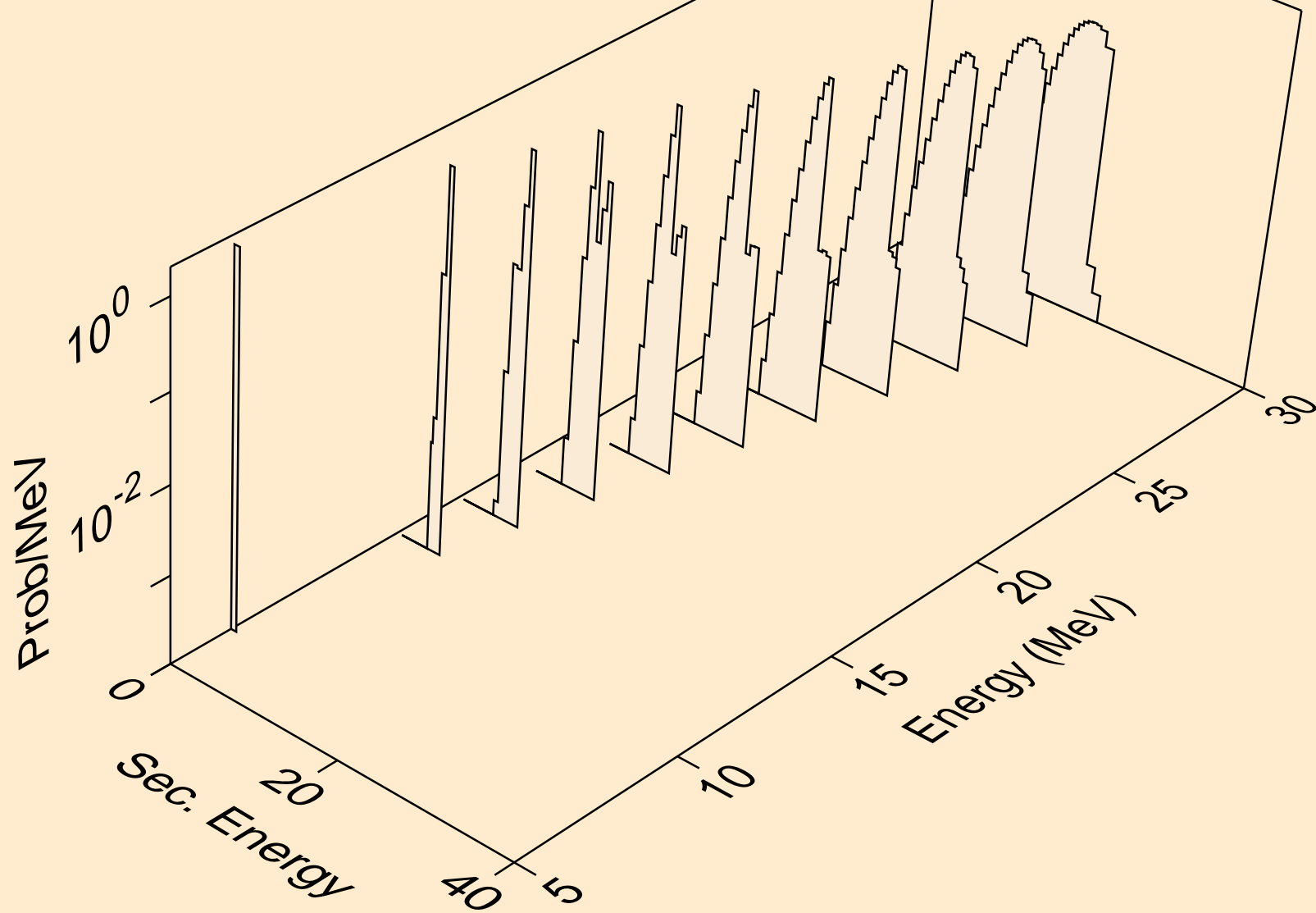



CE135 PROTON ACER TENDL-2023 LIBRARY; T=0.K  
alphas from (p,x)

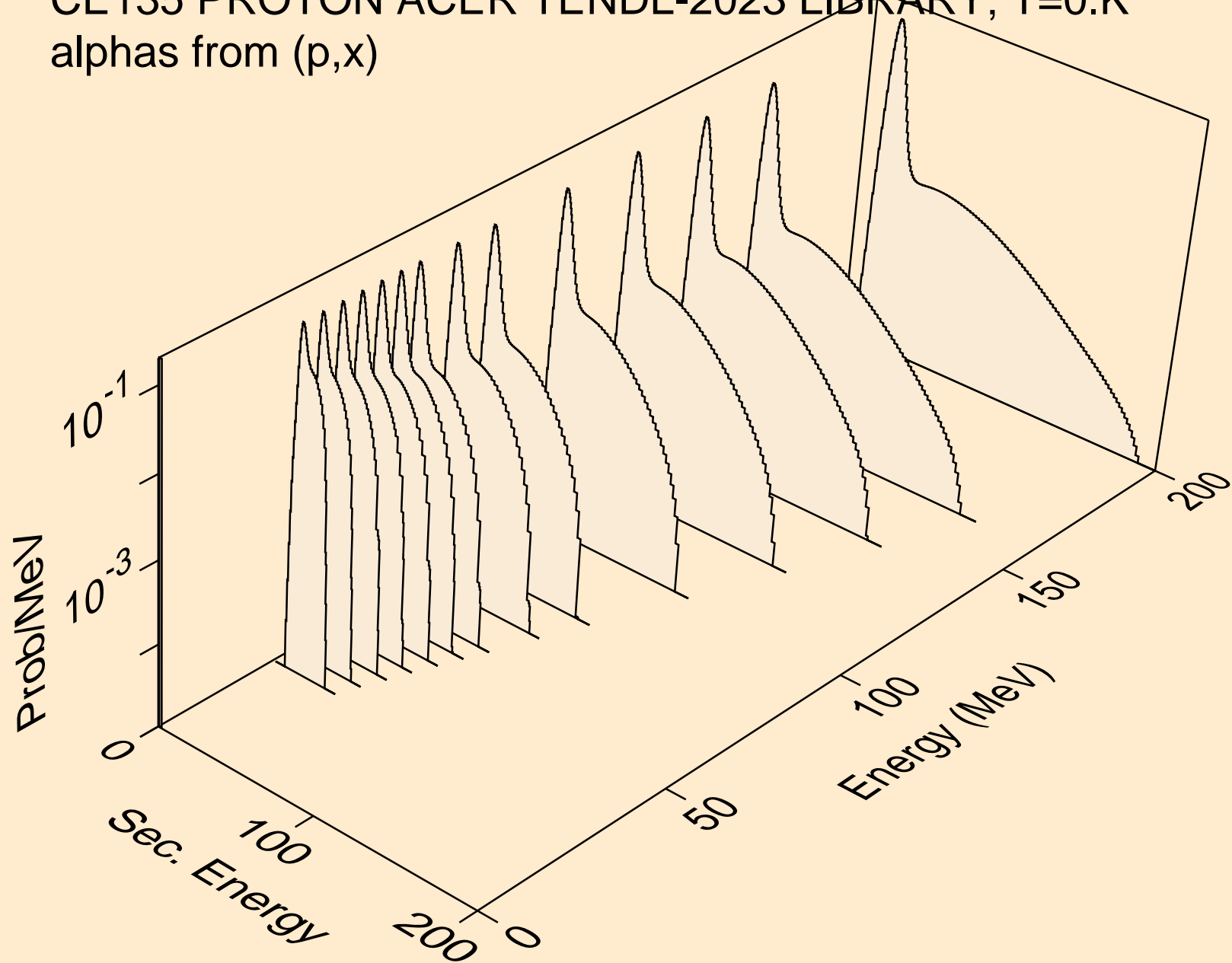

CE135 PROTON ACER TENDL-2023 LIBRARY; T=0.K  
alphas from (p,n\*)a

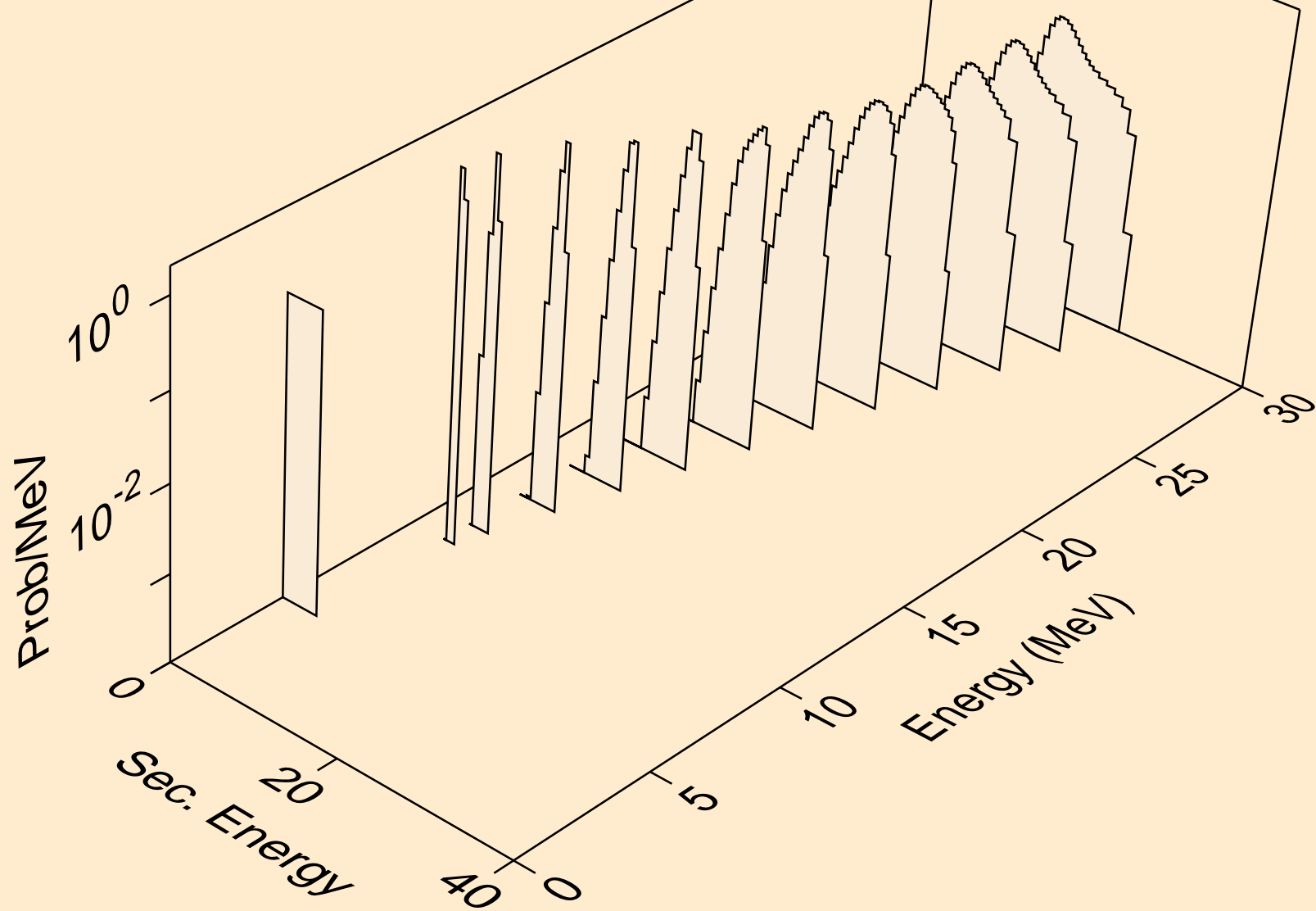

CE135 PROTON ACER TENDL-2023 LIBRARY; T=0.K  
alphas from (p,2n)a

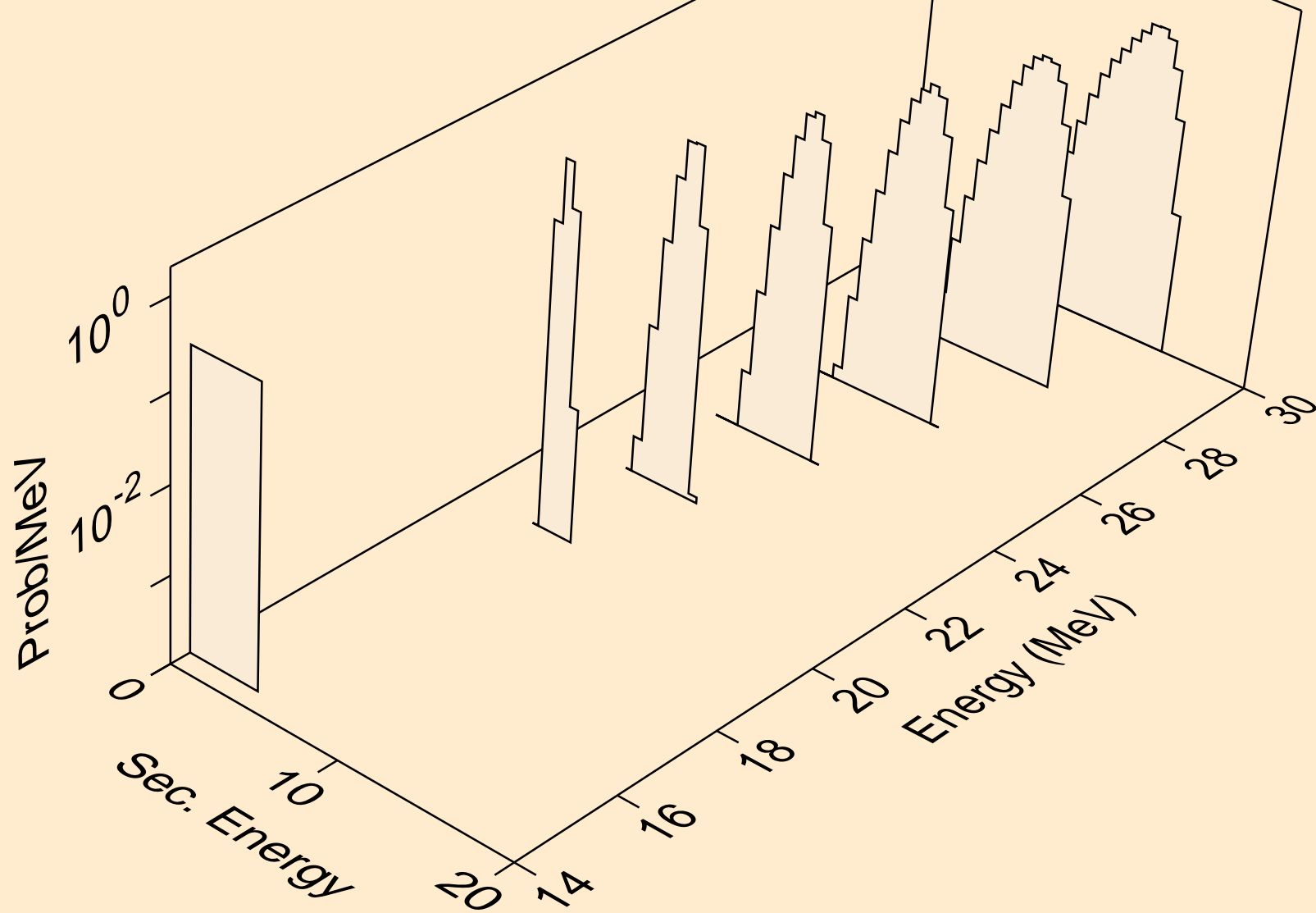

CE135 PROTON ACER TENDL-2023 LIBRARY; T=0.K  
alphas from (p,n\*)2a

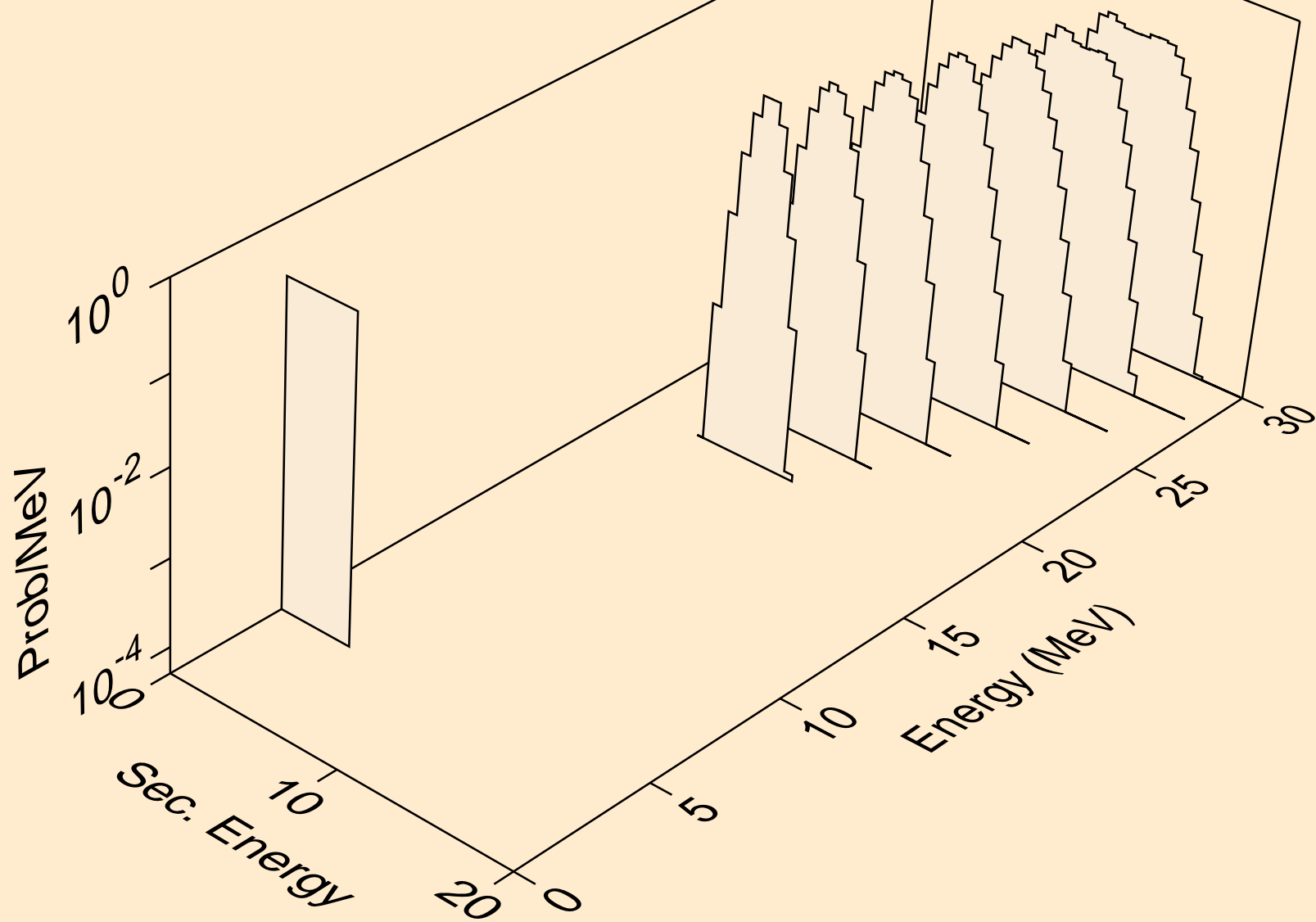

CE135 PROTON ACER TENDL-2023 LIBRARY; T=0.K  
alphas from (p,npa)

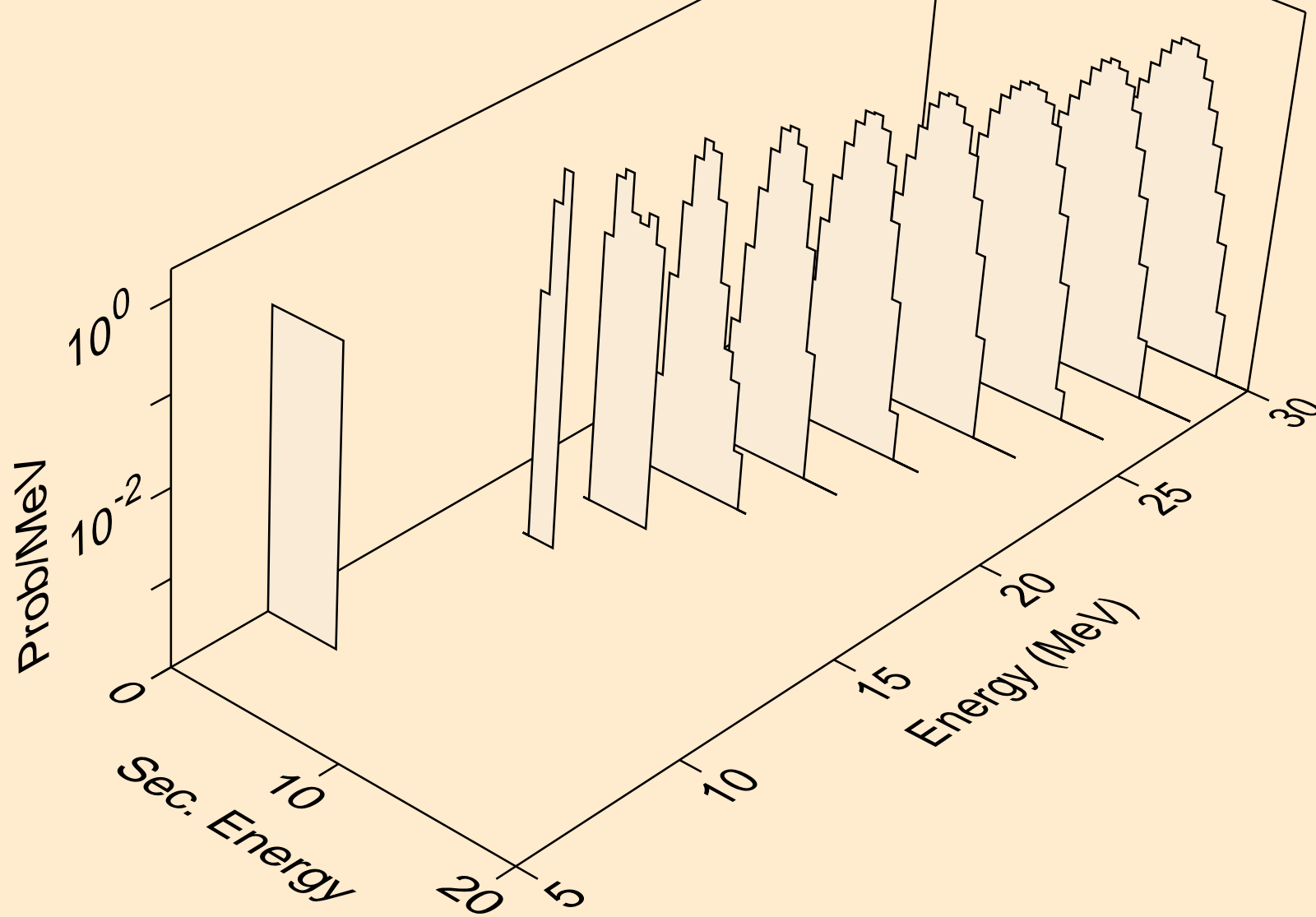

CE135 PROTON ACER TENDL-2023 LIBRARY; T=0.K  
alphas from (p,a)

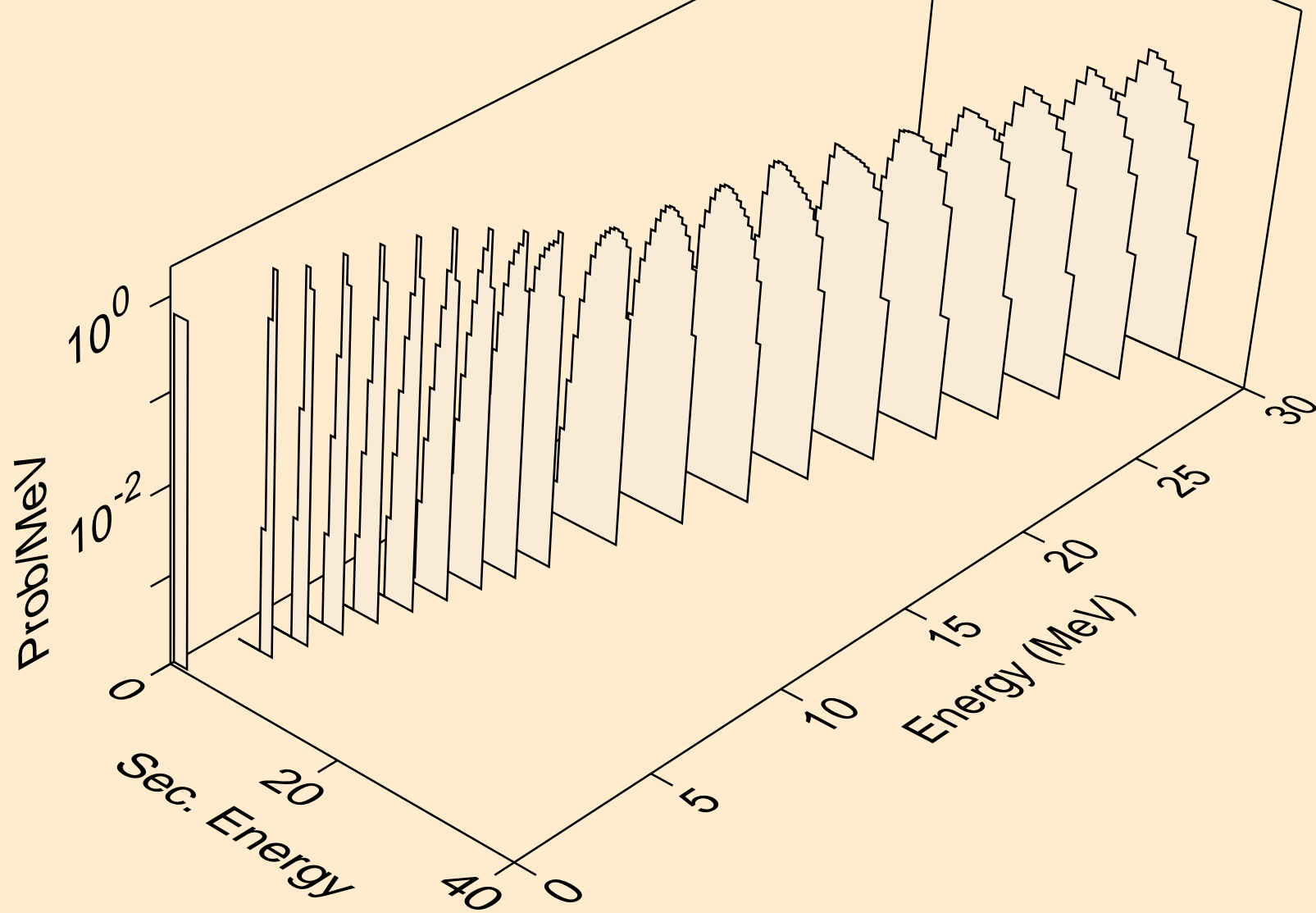

CE135 PROTON ACER TENDL-2023 LIBRARY; T=0.K  
alphas from (p,2a)

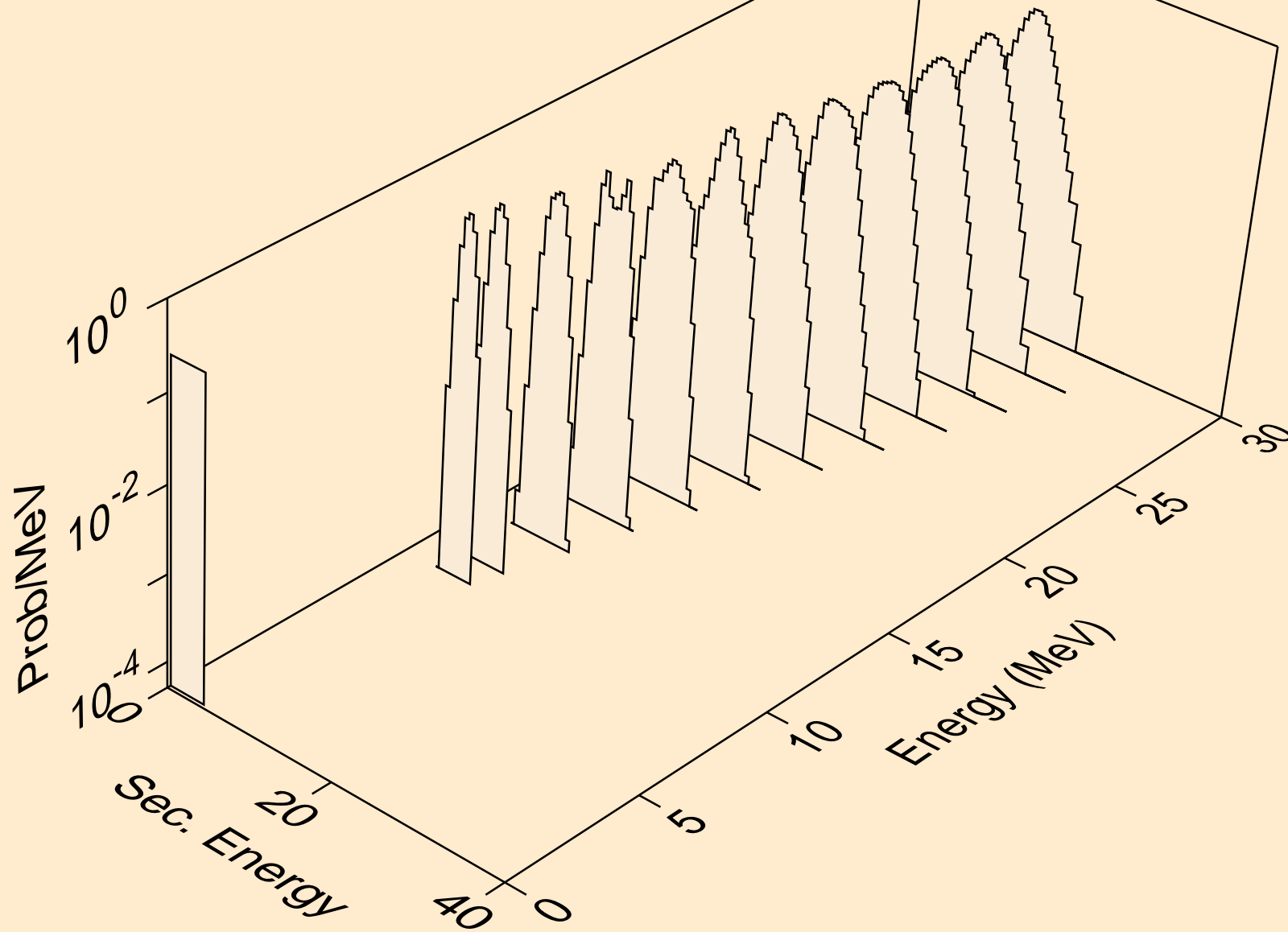

CE135 PROTON ACER TENDL-2023 LIBRARY; T=0.K  
alphas from (p,pa)

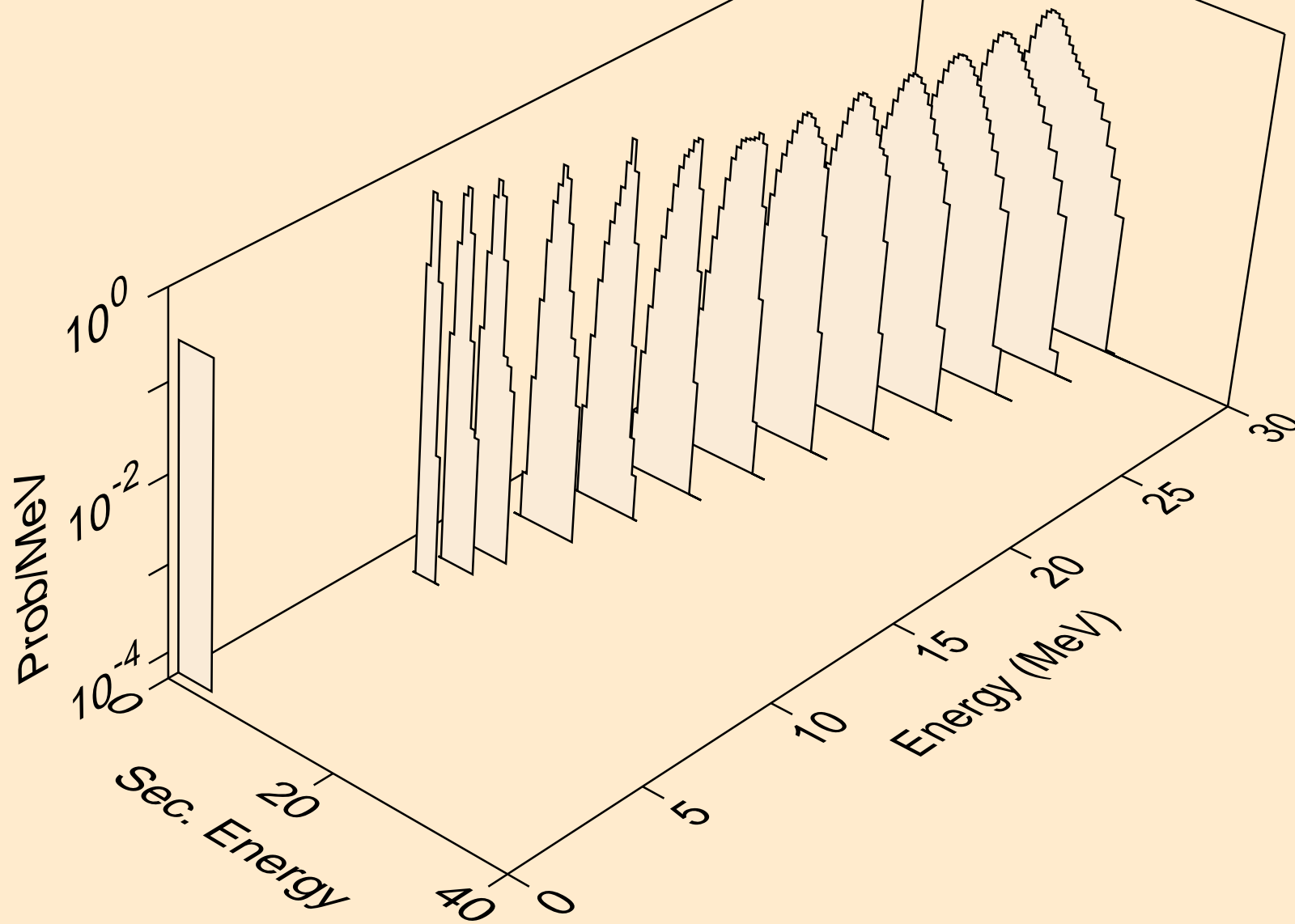



CE135 PROTON ACER TENDL-2023 LIBRARY; T=0.K  
alphas from (p,da)

