

CF253 PROTON ACER TENDL-2023 LIBRARY; T=0.K

Principal cross sections

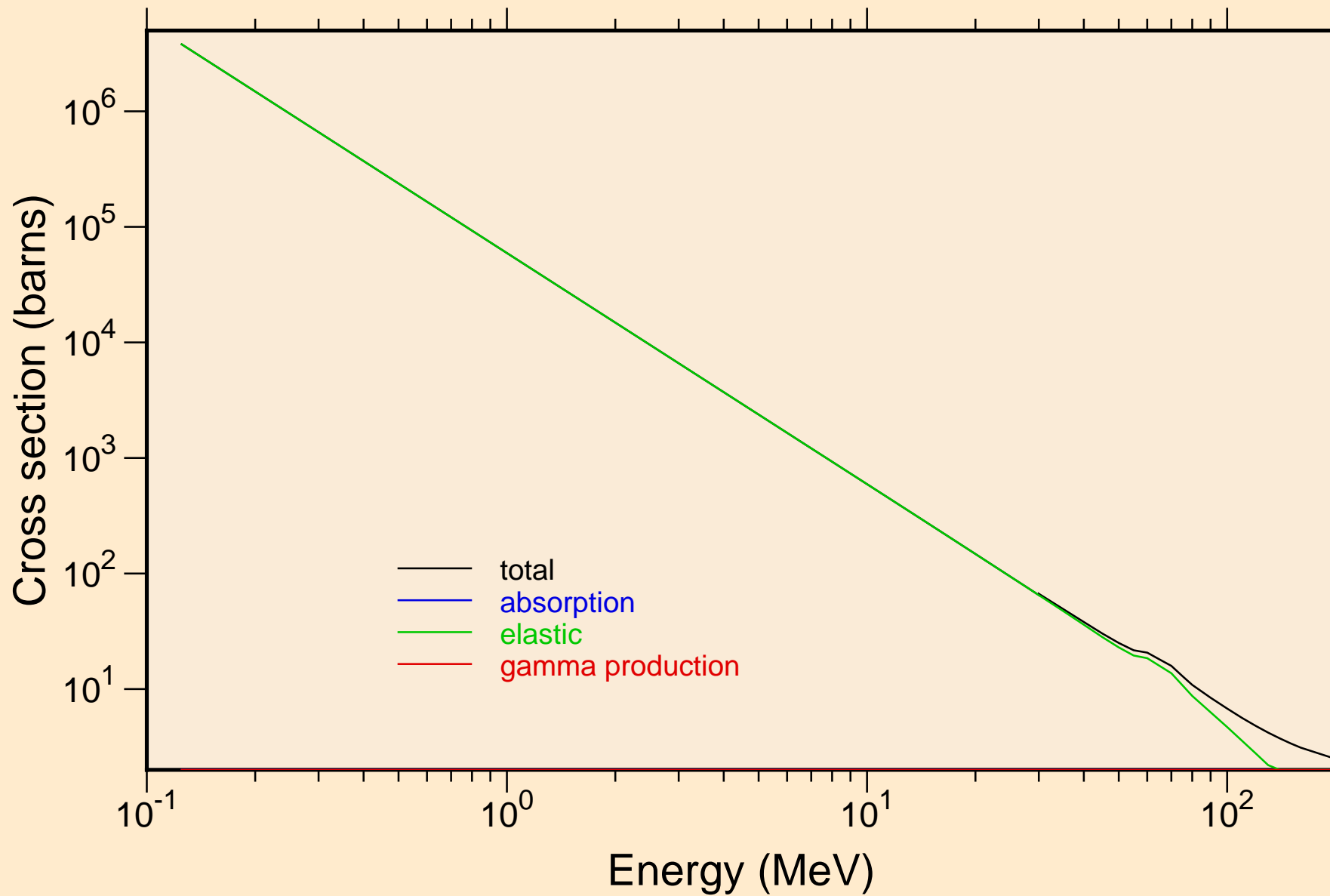

CF253 PROTON ACER TENDL-2023 LIBRARY; T=0.K

Heating

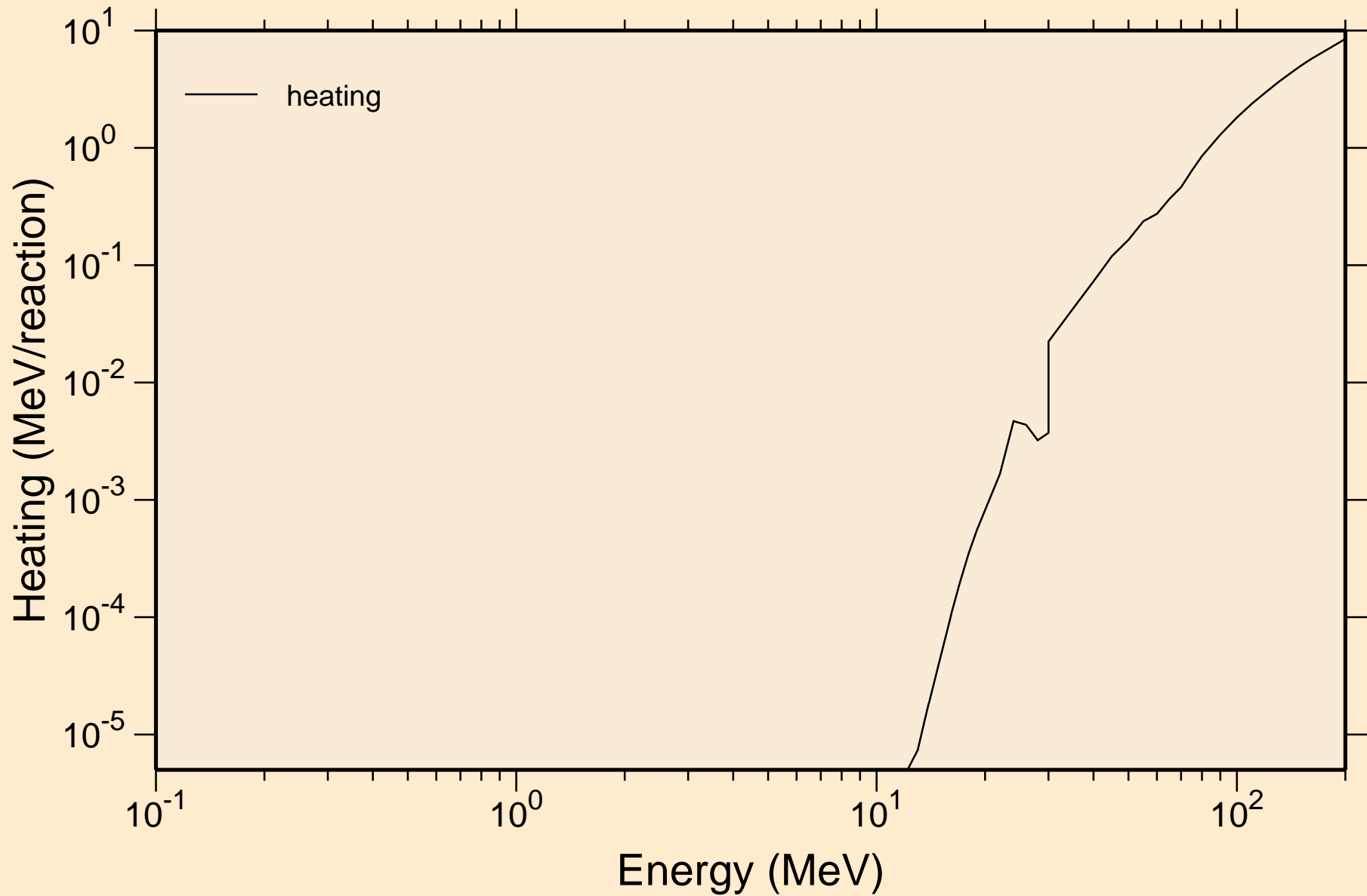

CF253 PROTON ACER TENDL-2023 LIBRARY; T=0.K

Principal cross sections

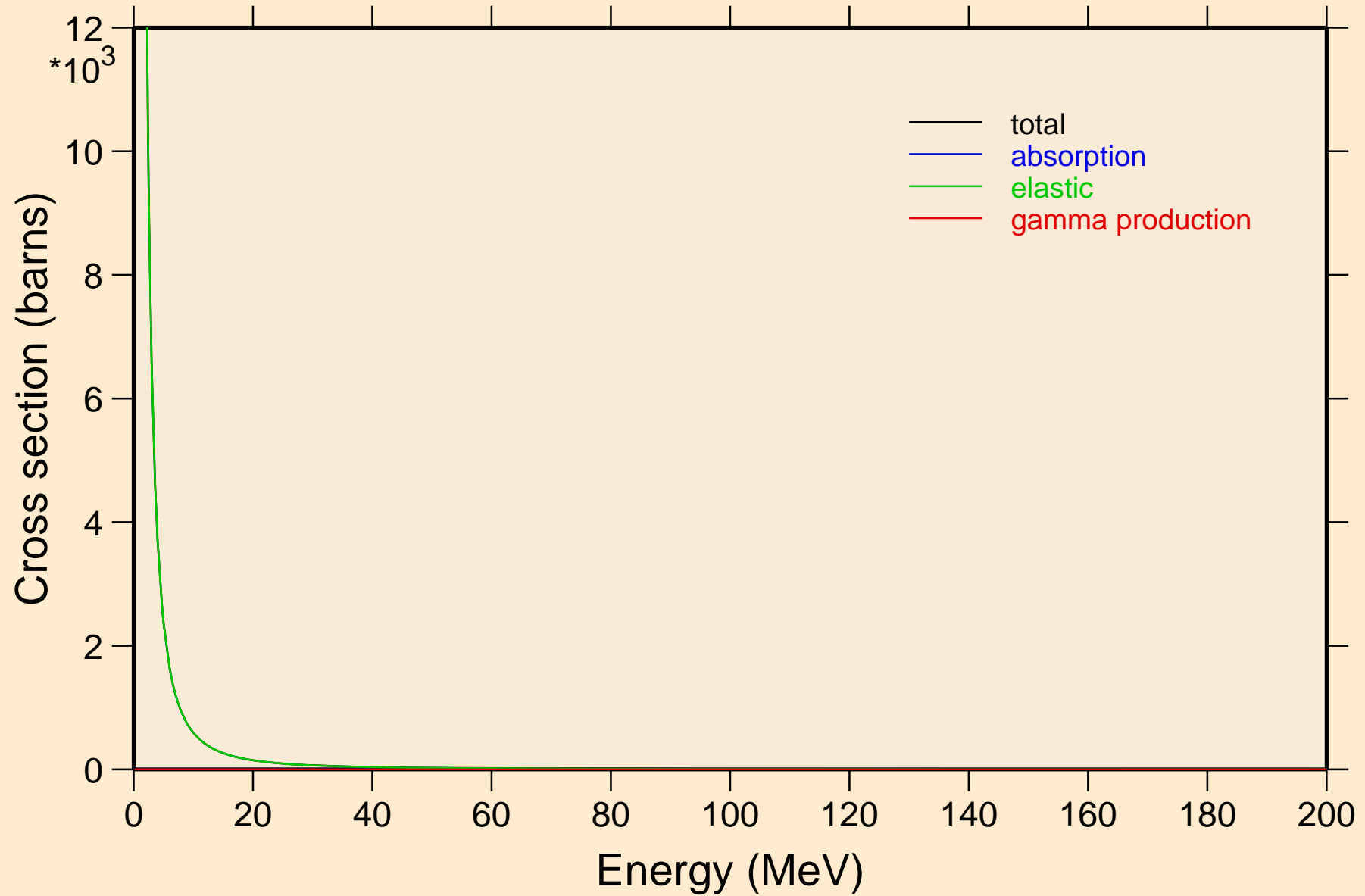

CF253 PROTON ACER TENDL-2023 LIBRARY; T=0.K

Heating

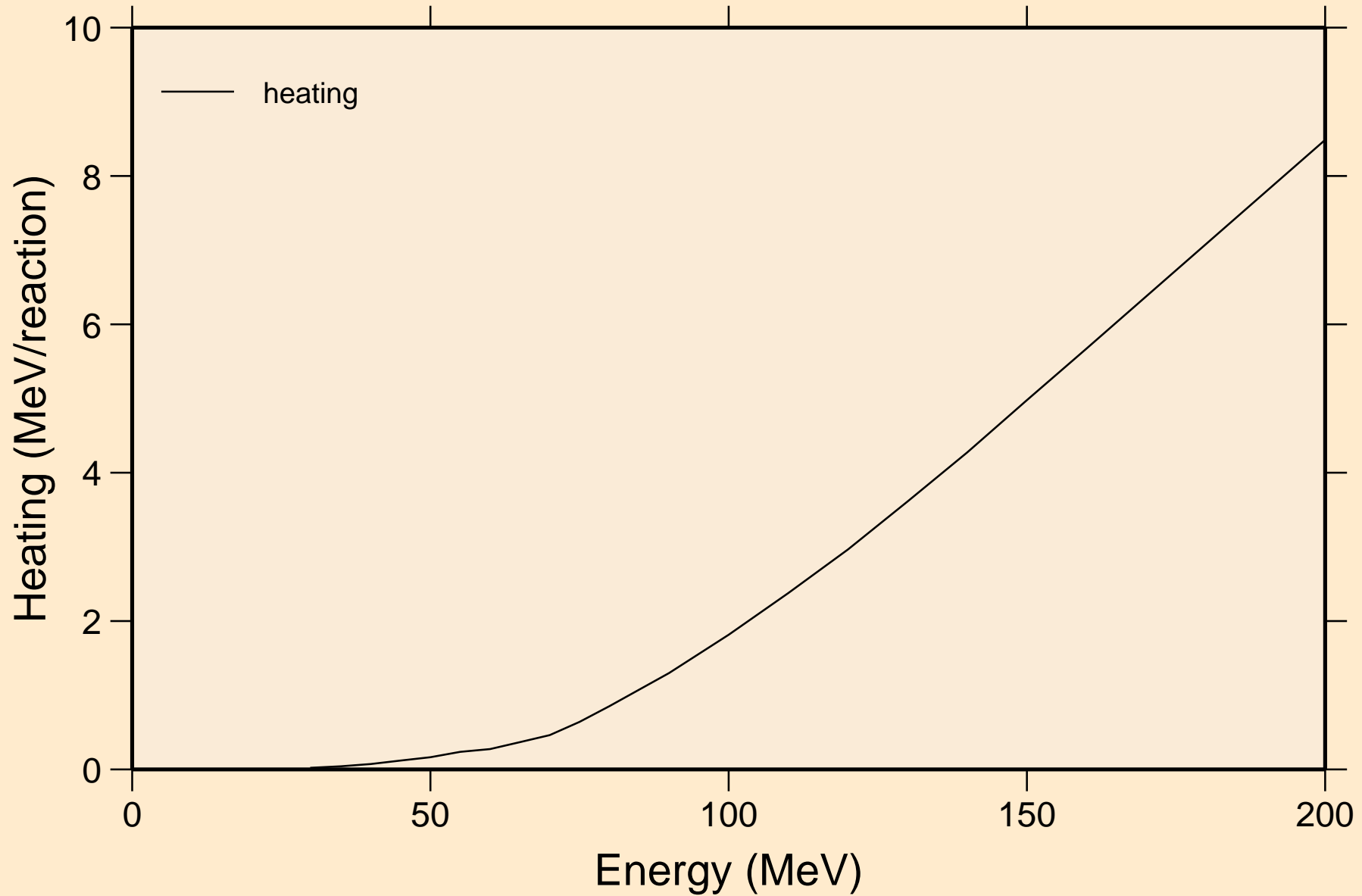

CF253 PROTON ACER TENDL-2023 LIBRARY; T=0.K

Threshold reactions

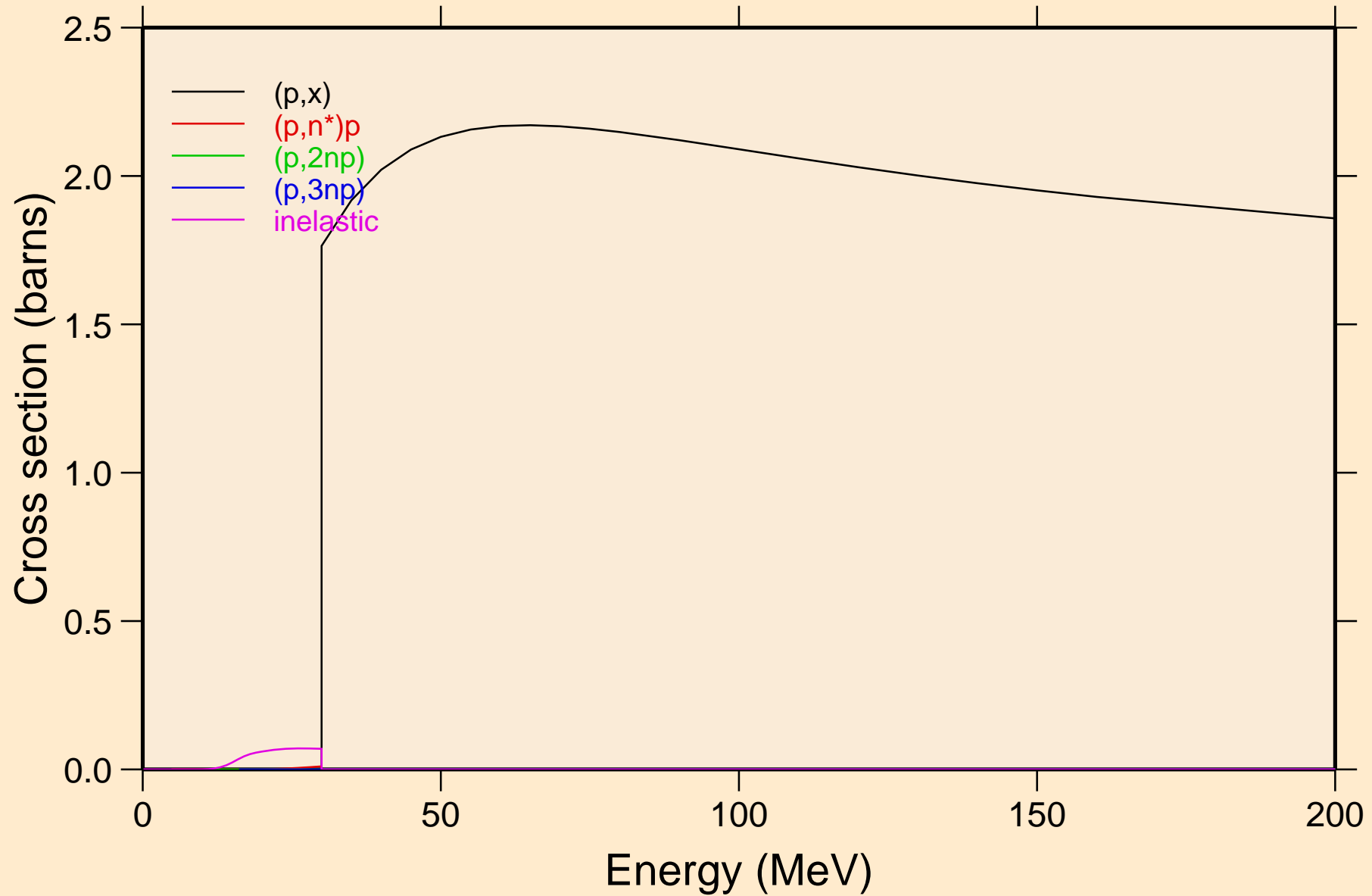

CF253 PROTON ACER TENDL-2023 LIBRARY; T=0.K
Threshold reactions

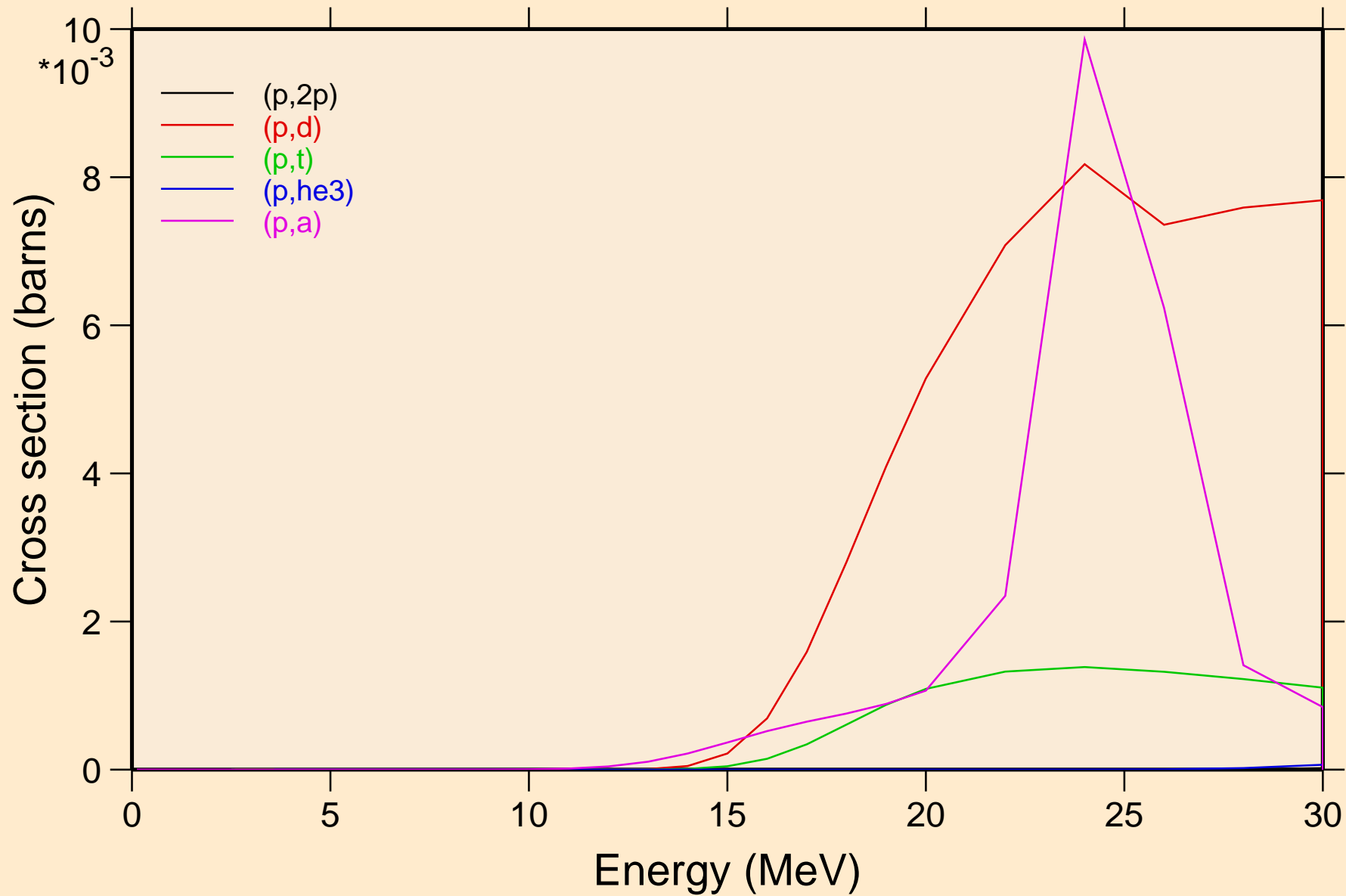

CF253 PROTON ACER TENDL-2023 LIBRARY; T=0.K
Threshold reactions

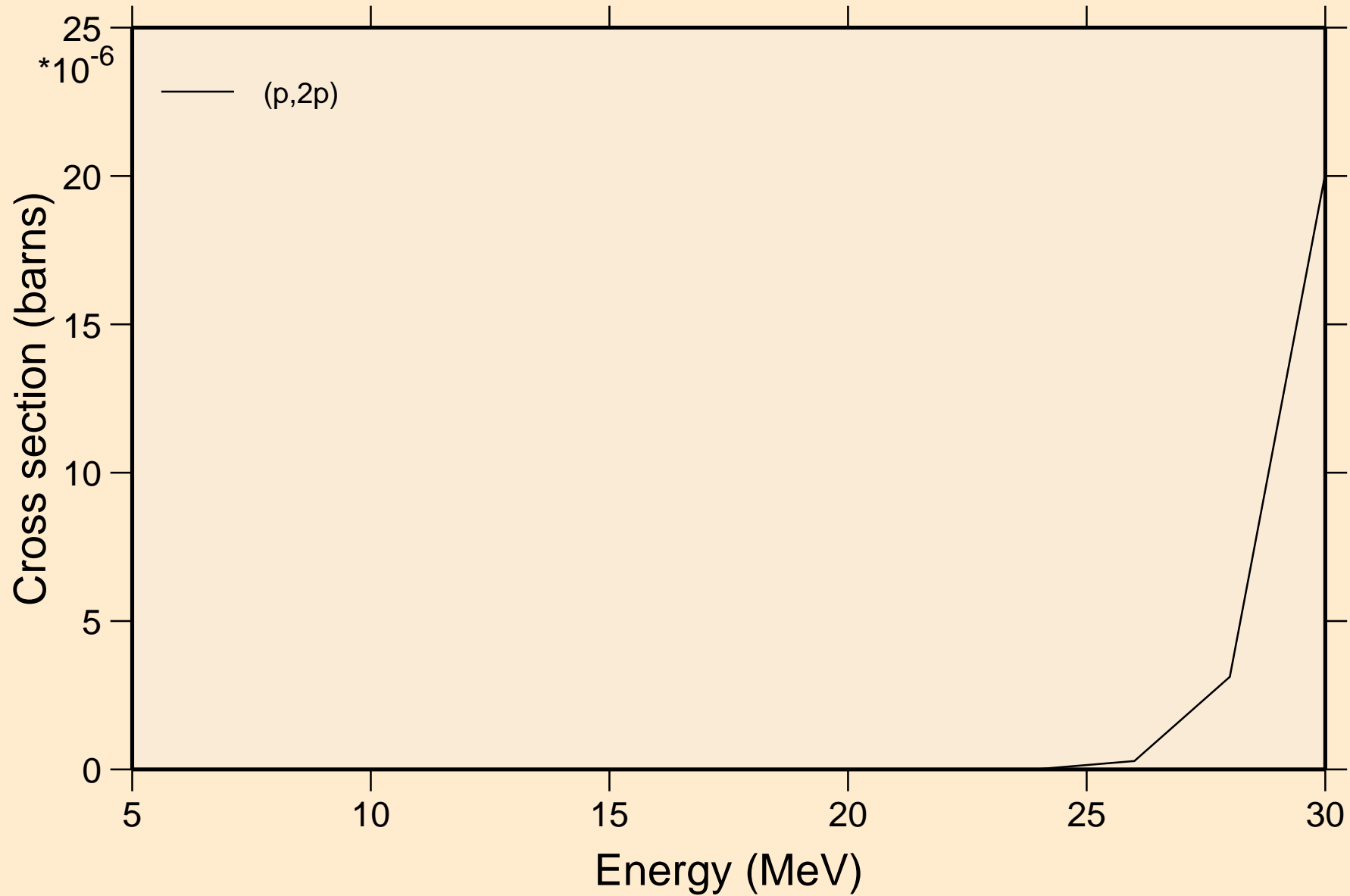

CF253 PROTON ACER TENDL-2023 LIBRARY; T=0.K
angular distribution for elastic

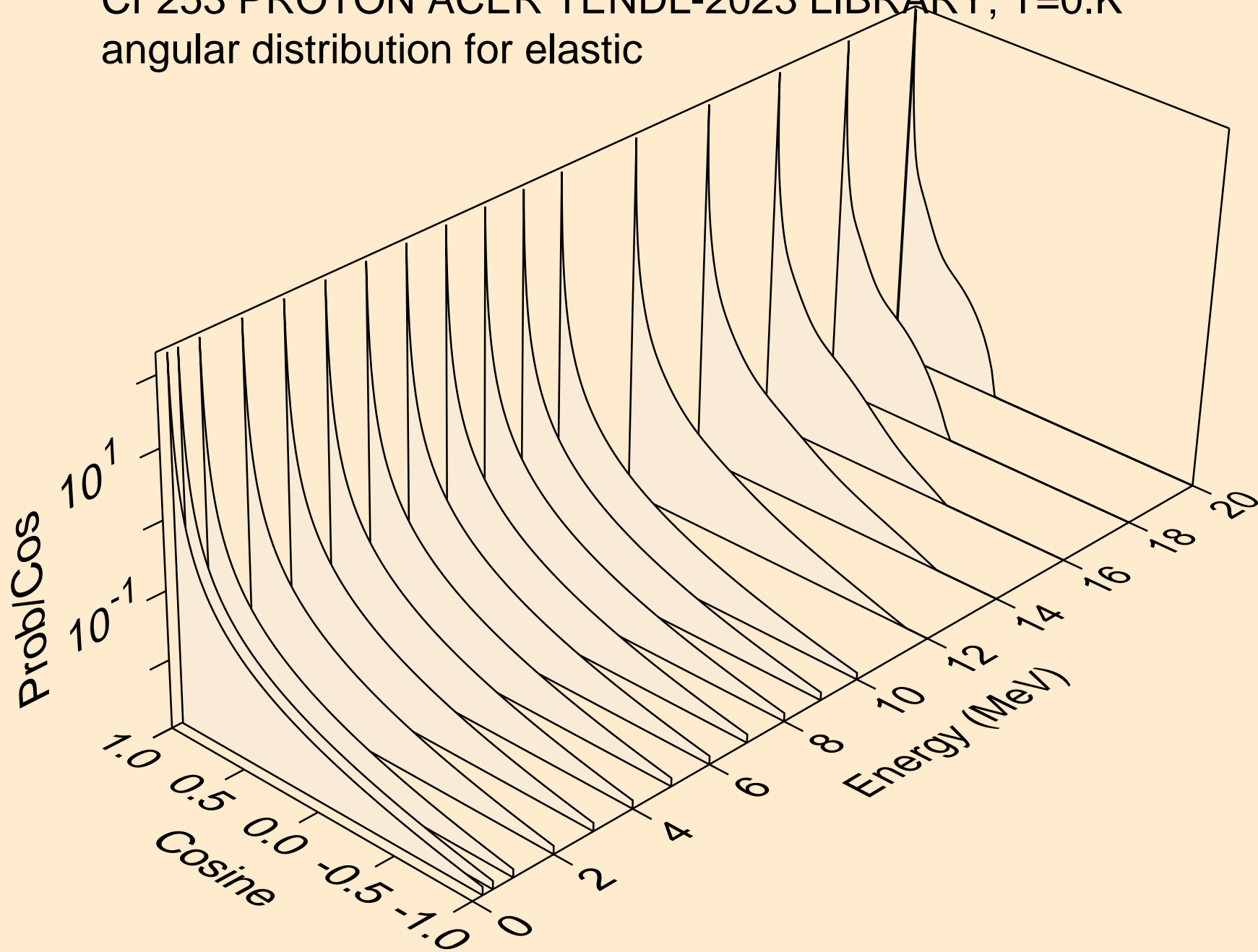

CF253 PROTON ACER TENDL-2023 LIBRARY; T=0.K
angular distribution for elastic

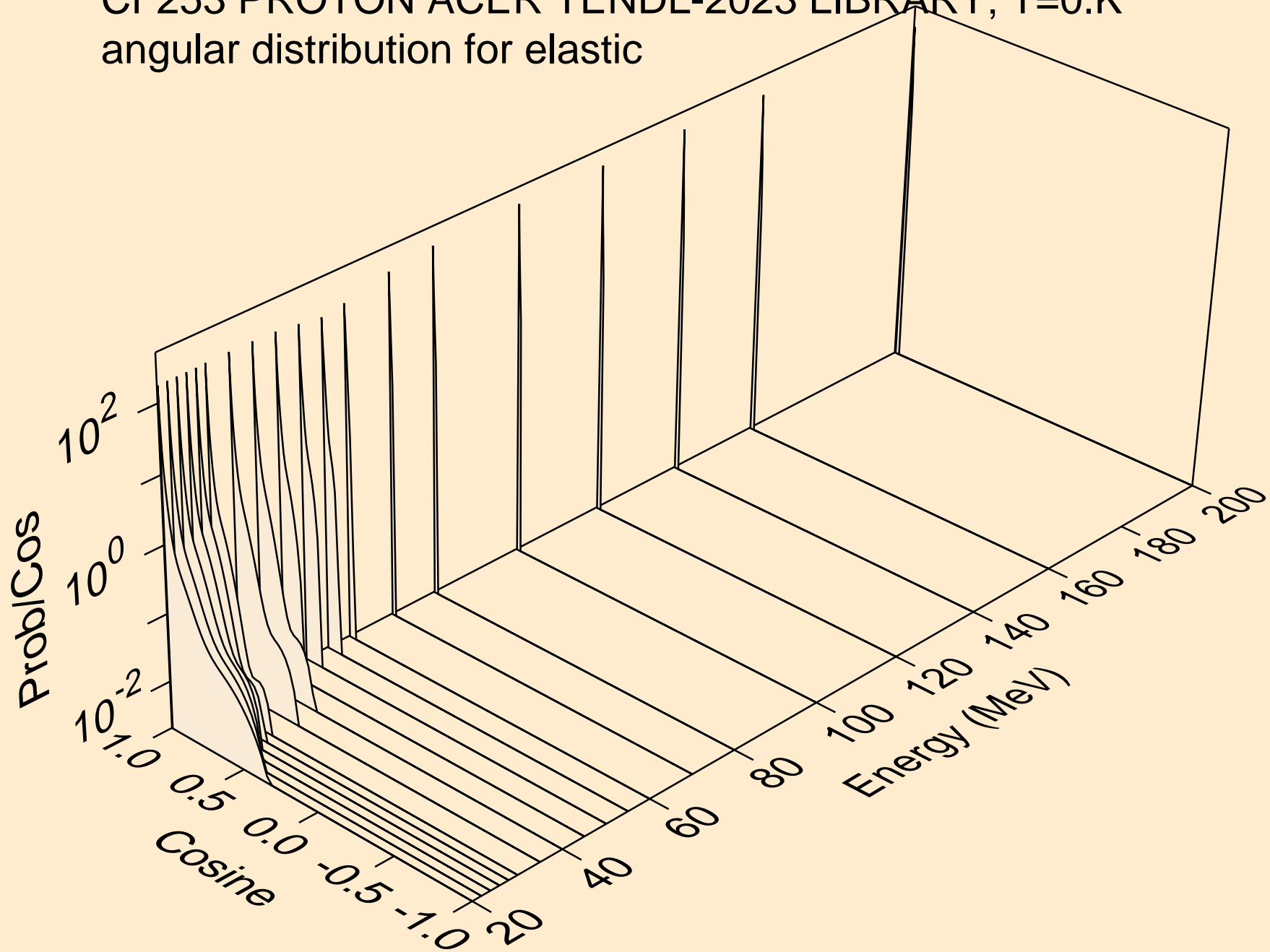

CF253 PROTON ACER TENDL-2023 LIBRARY; T=0.K
Proton emission for (p,x)

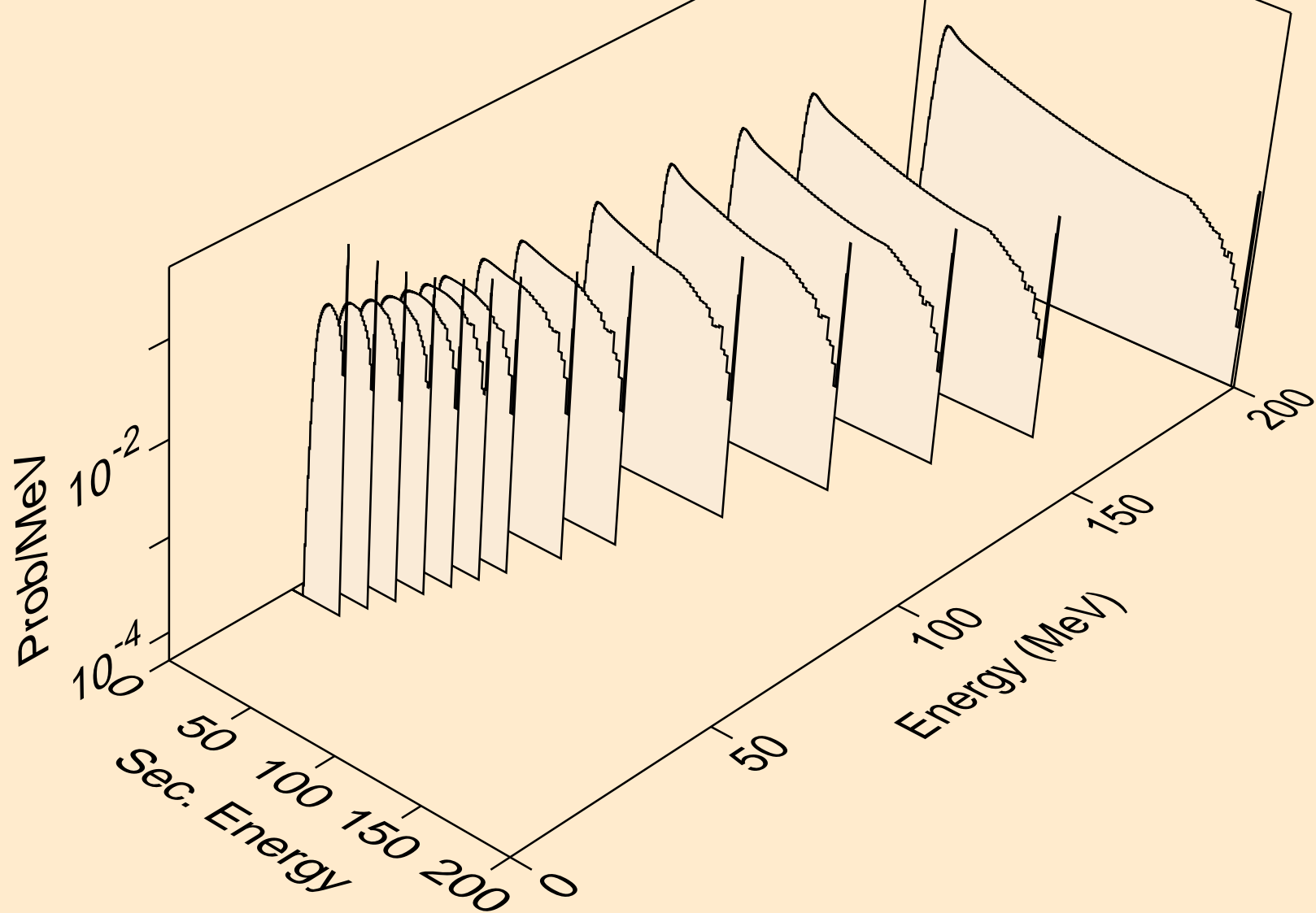

CF253 PROTON ACER TENDL-2023 LIBRARY; T=0.K
Proton emission for (p,n*)p

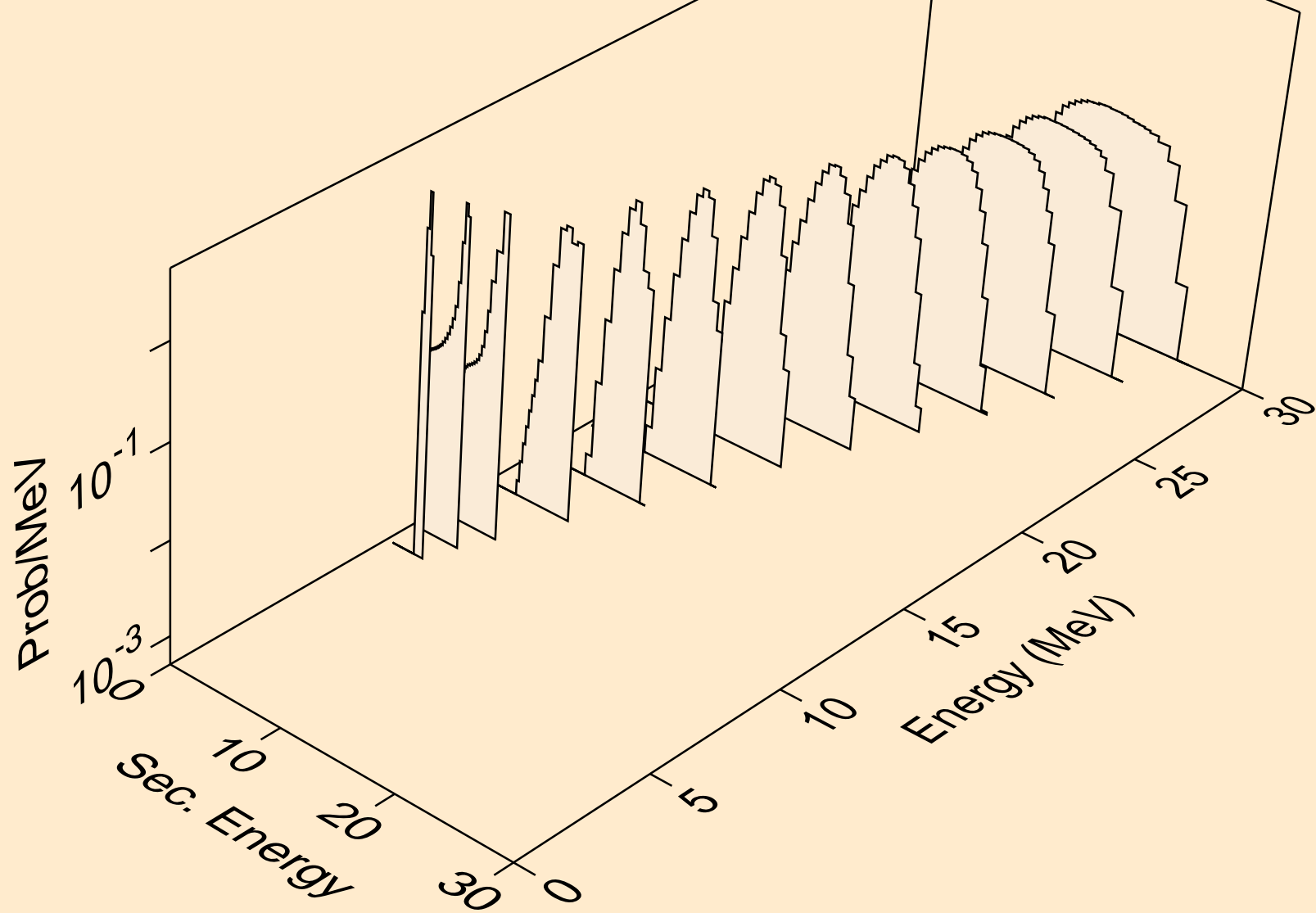

CF253 PROTON ACER TENDL-2023 LIBRARY; T=0.K
Proton emission for (p,2np)

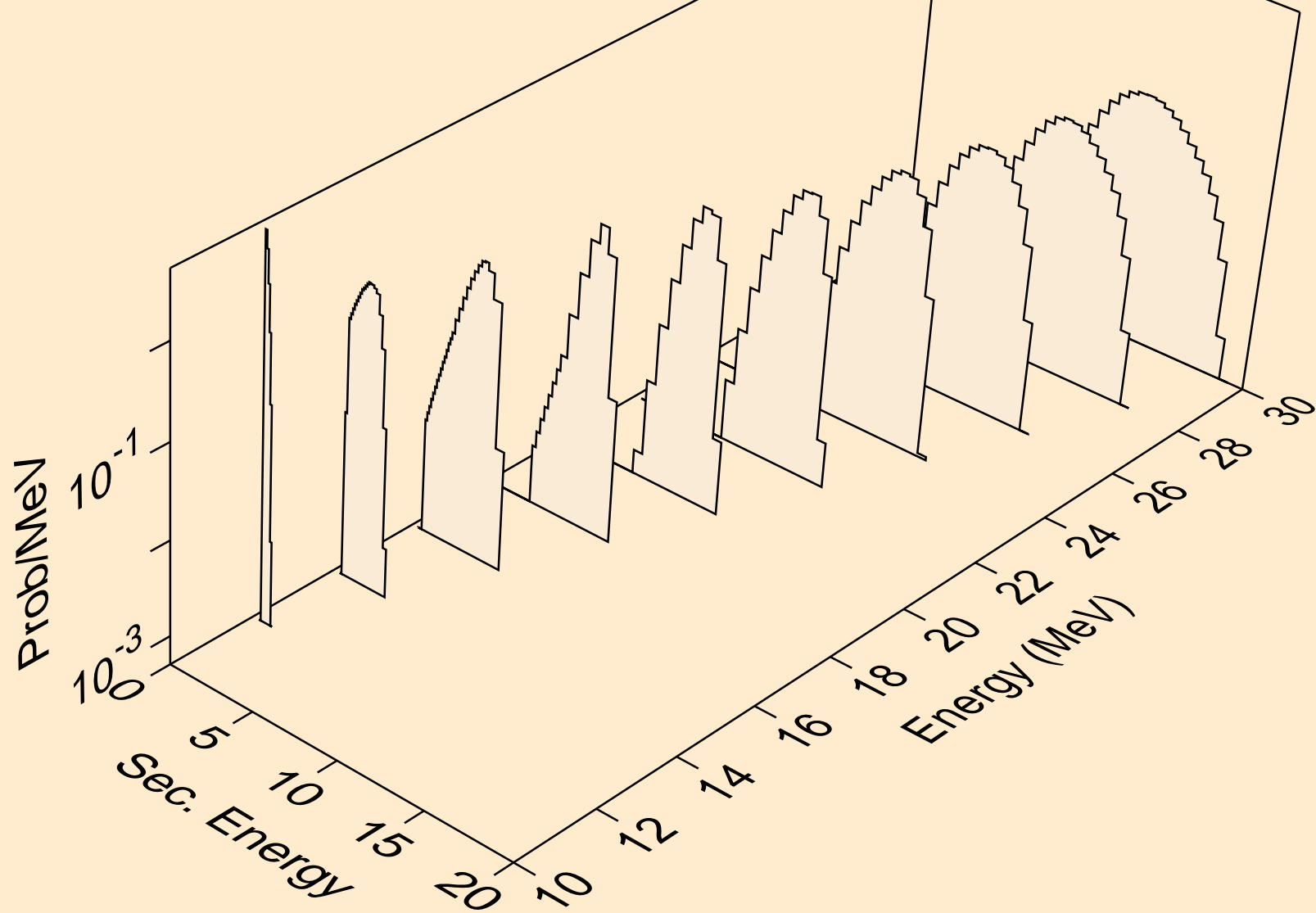

CF253 PROTON ACER TENDL-2023 LIBRARY; T=0.K
Proton emission for (p,3np)

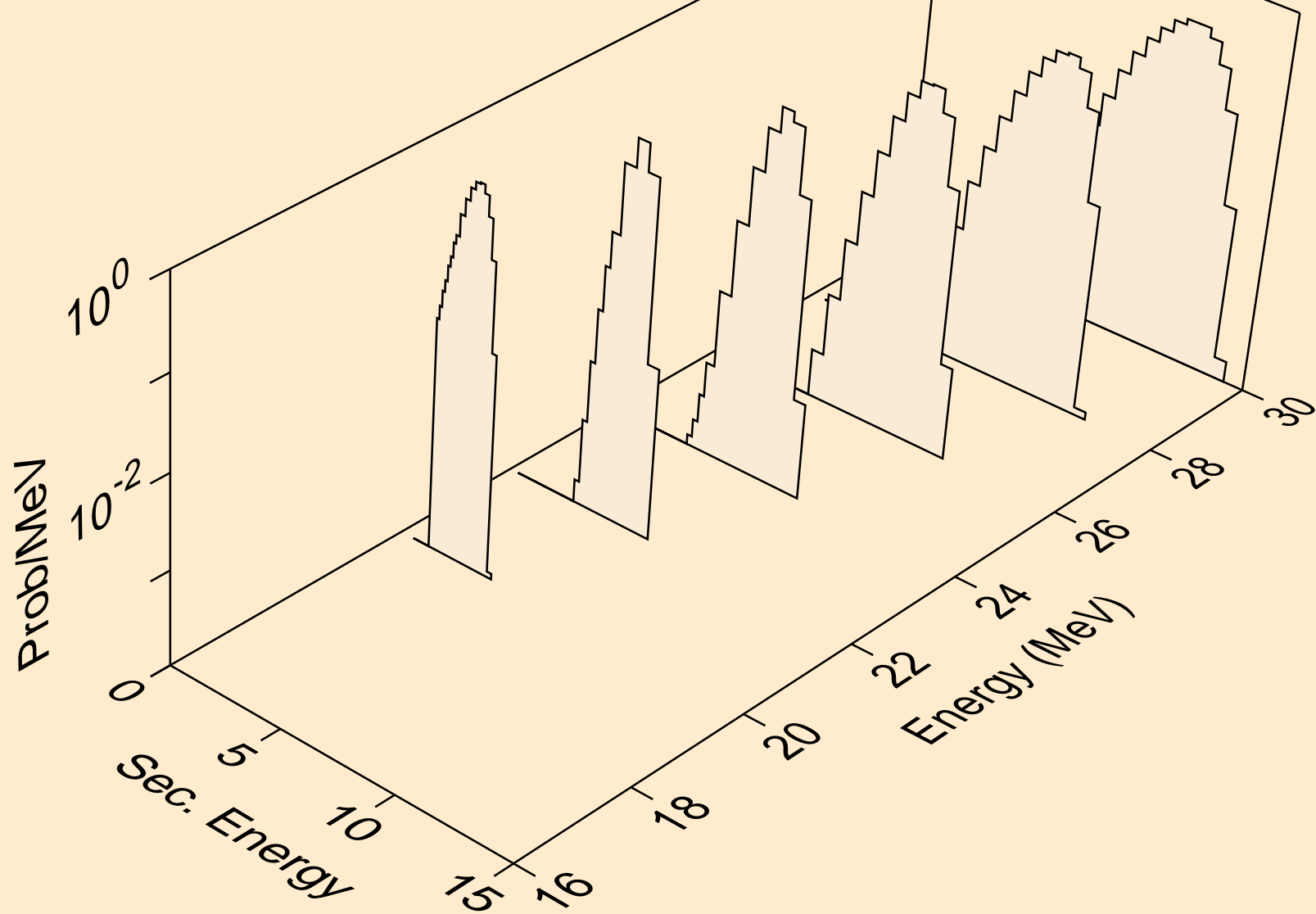

CF253 PROTON ACER TENDL-2023 LIBRARY; T=0.K
Proton emission for inelastic

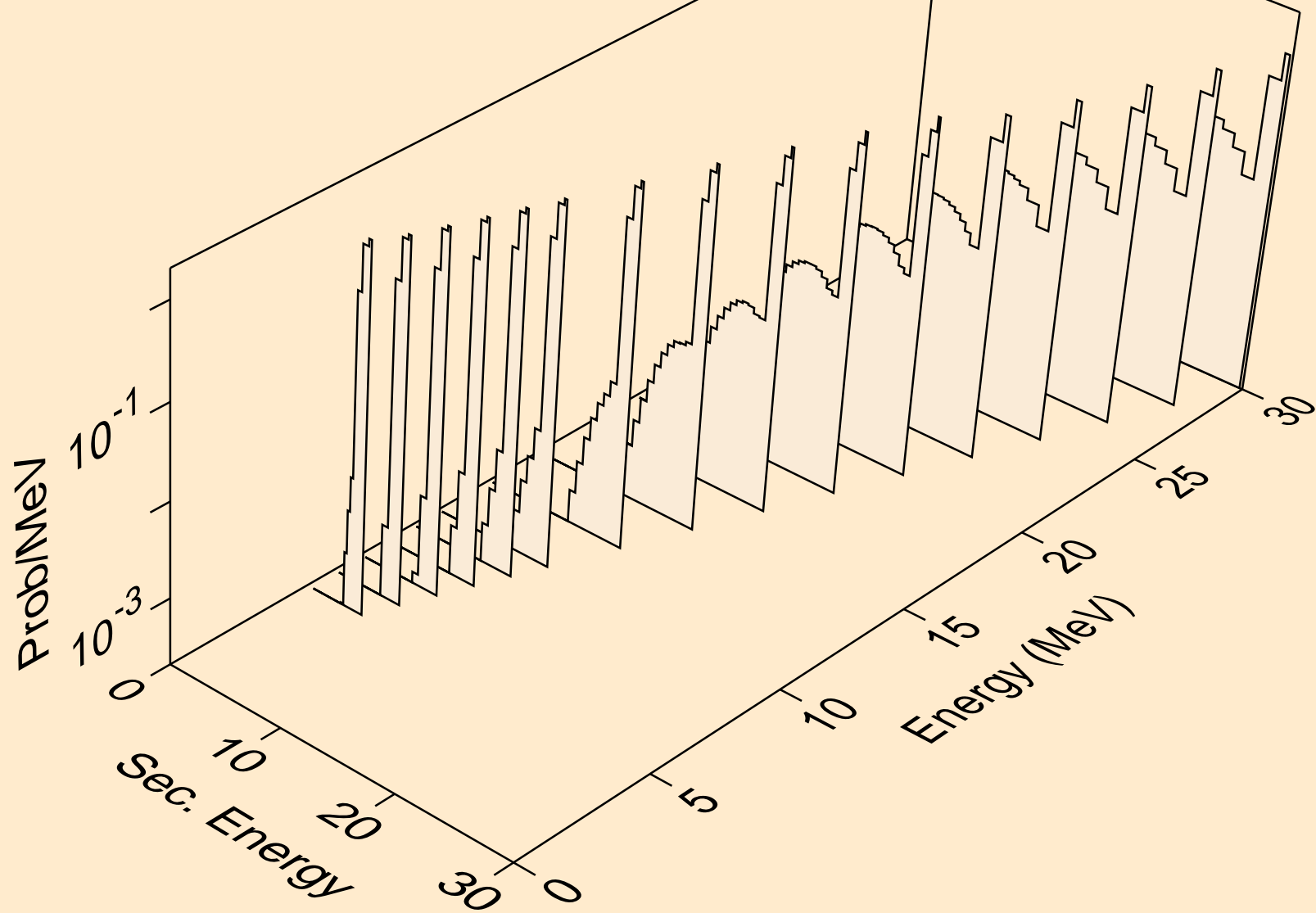

CF253 PROTON ACER TENDL-2023 LIBRARY; T=0.K
Proton emission for (p,2p)

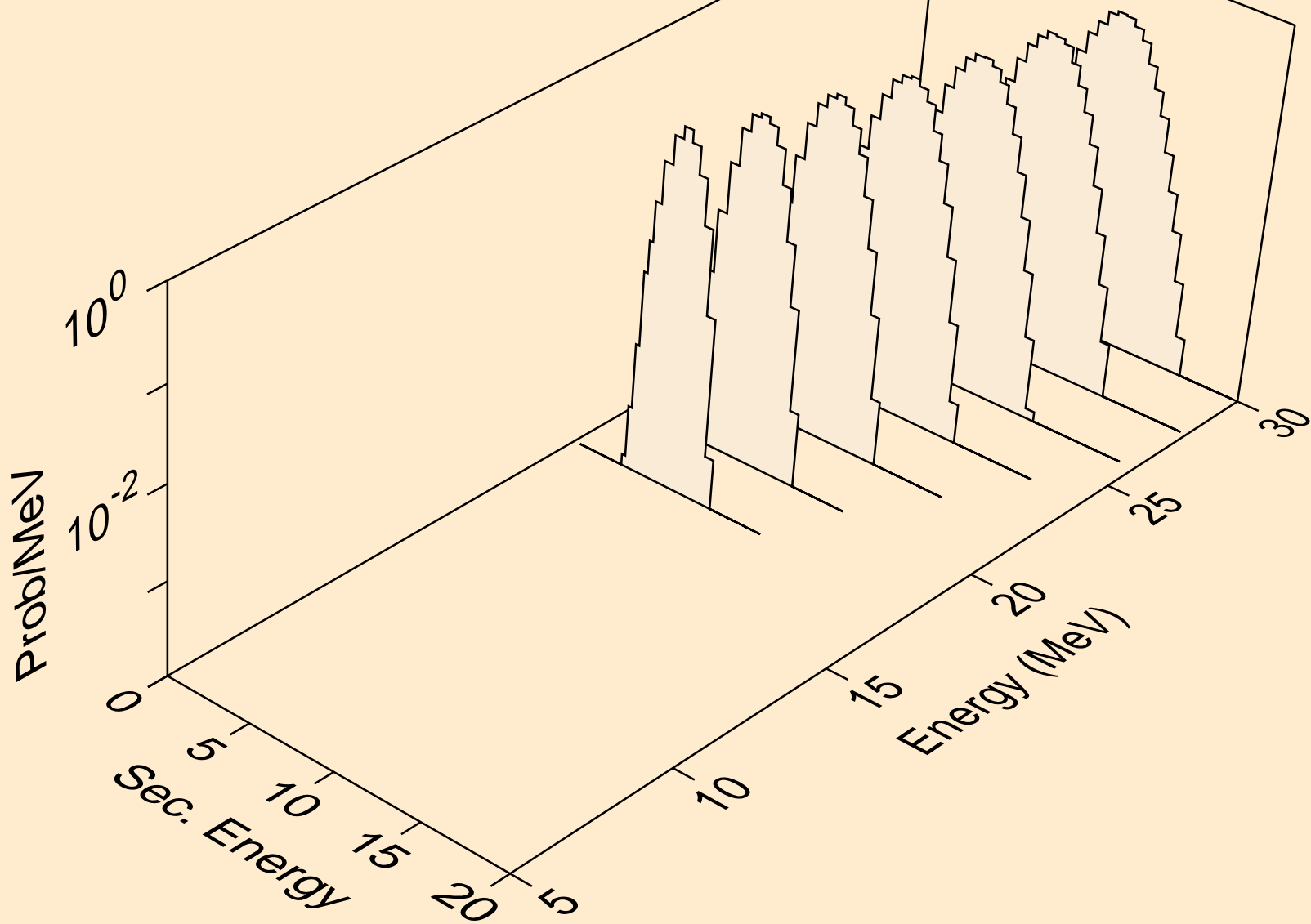

CF253 PROTON ACER TENDL-2023 LIBRARY; T=0.K
Photon emission for (z,n)

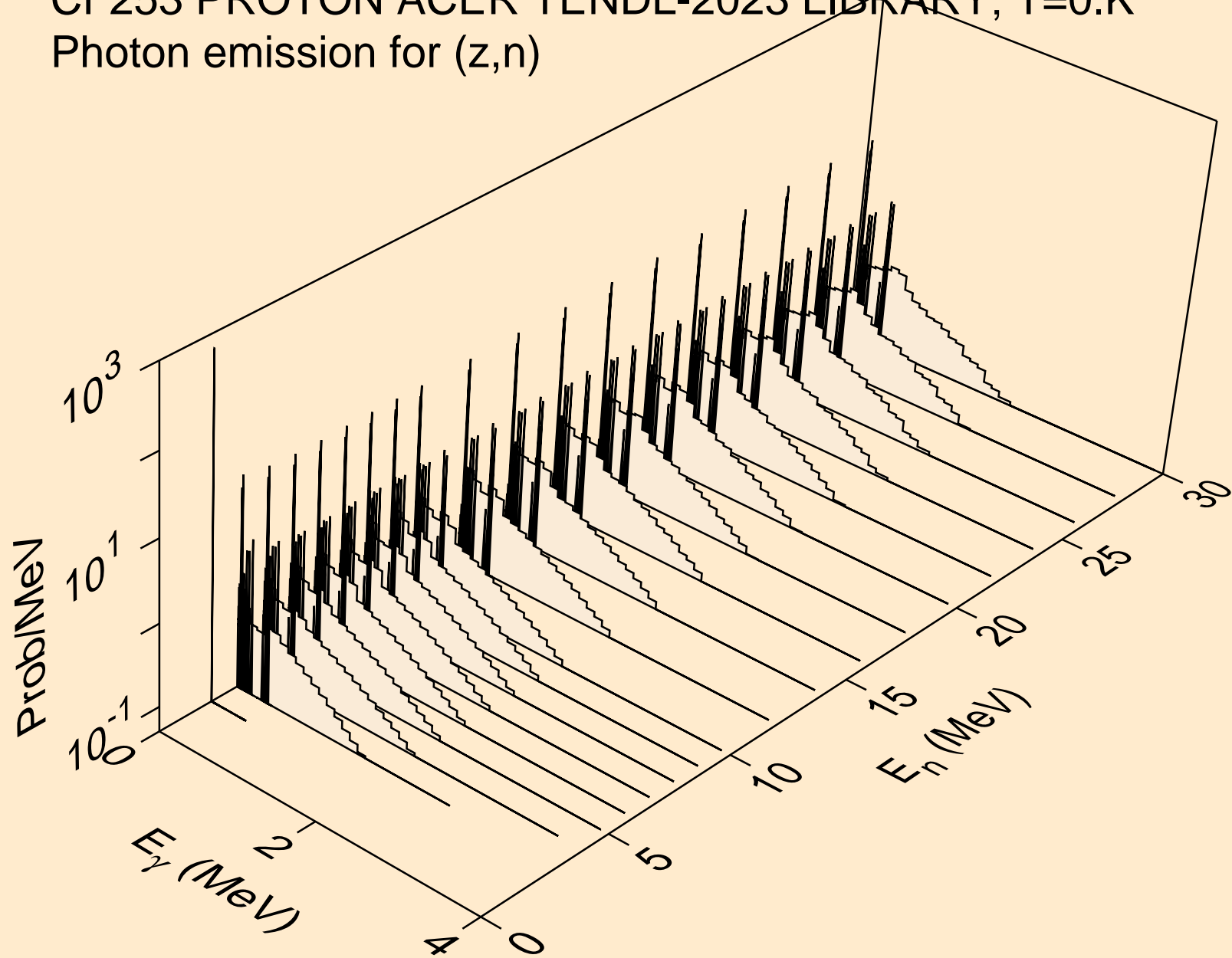

CF253 PROTON ACER TENDL-2023 LIBRARY; T=0.K
Photon emission for (z,x)

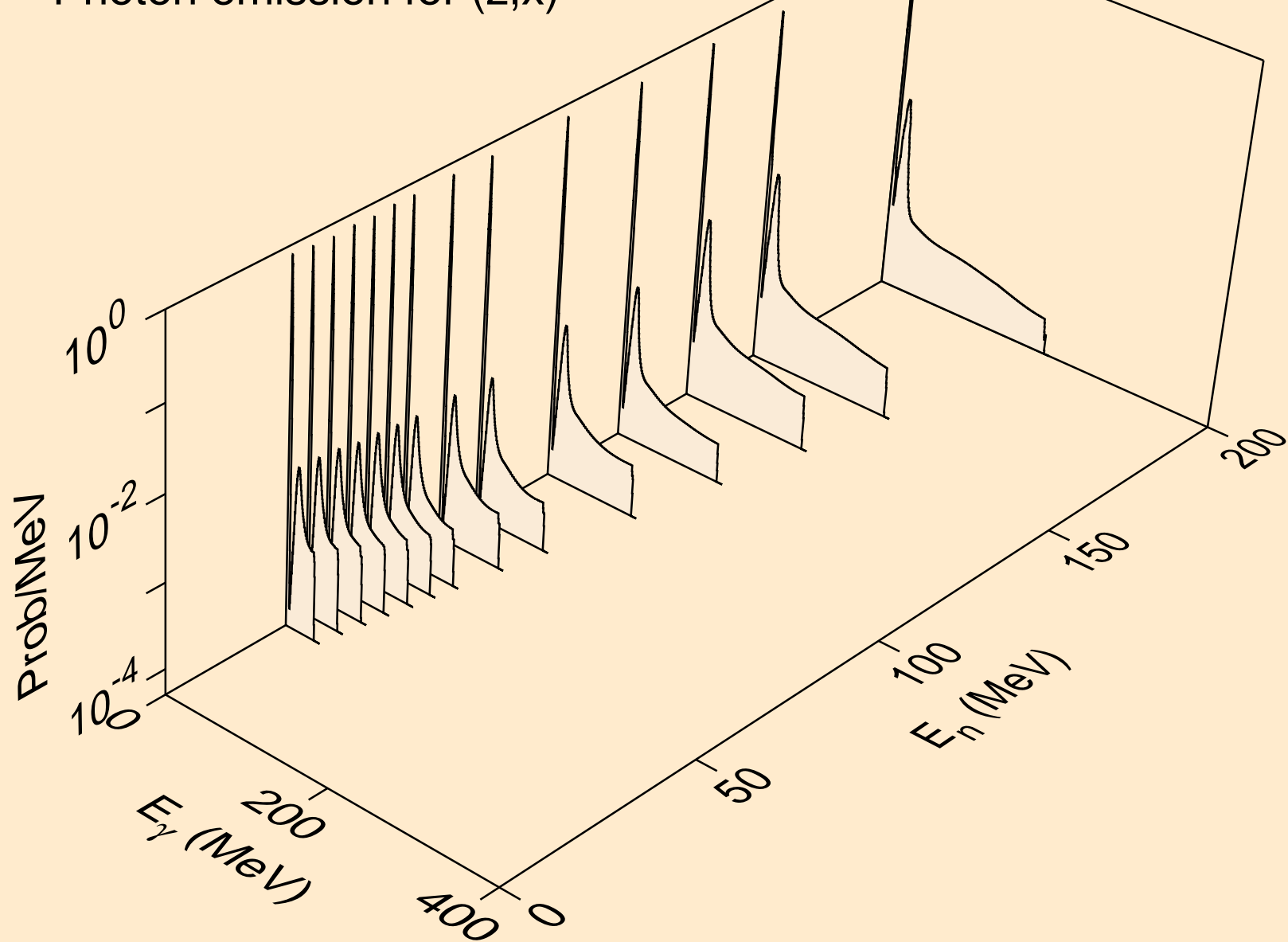

CF253 PROTON ACER TENDL-2023 LIBRARY; T=0.K
Photon emission for (n,2nd)

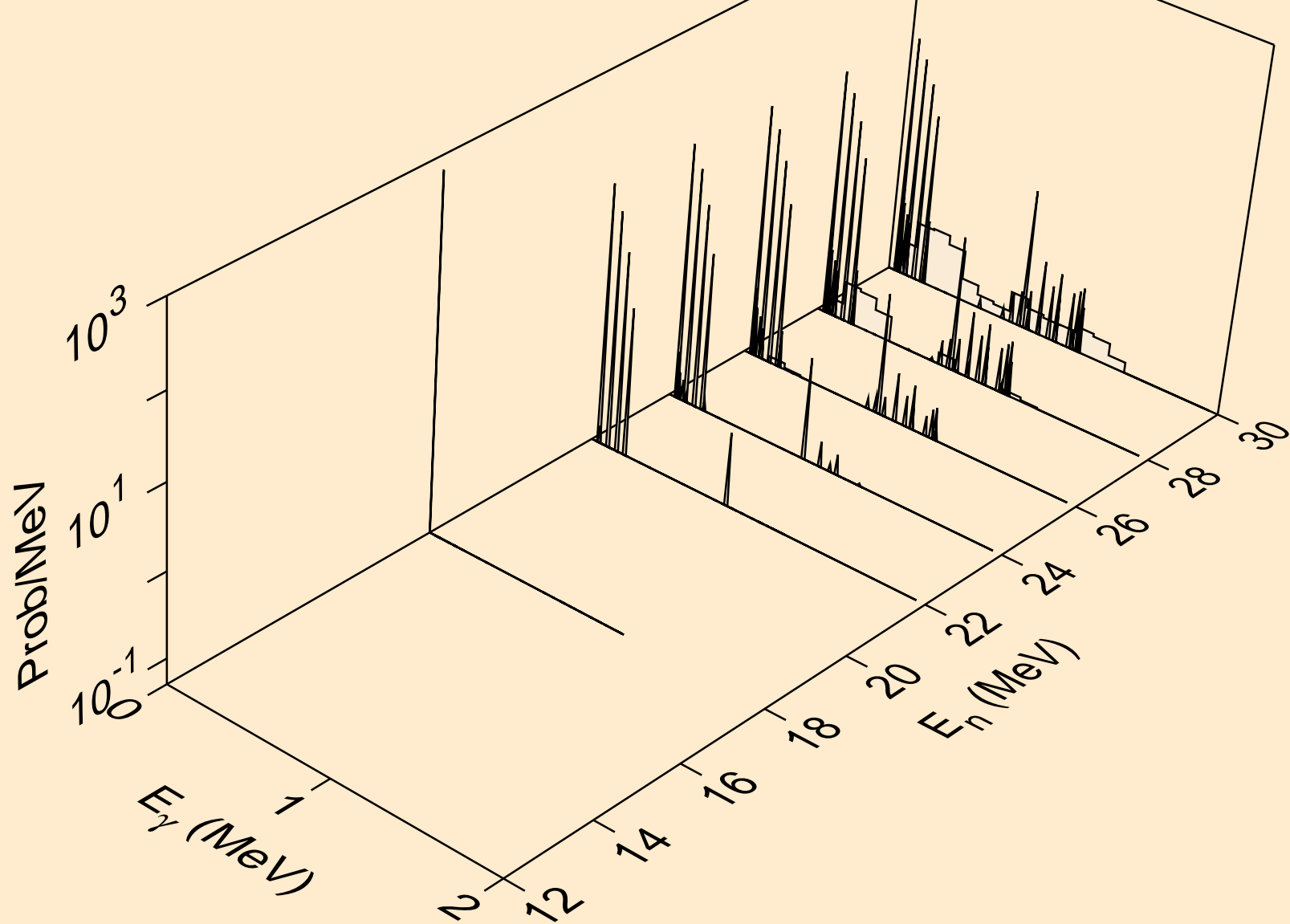

CF253 PROTON ACER TENDL-2023 LIBRARY; T=0.K
Photon emission for (n,2n)

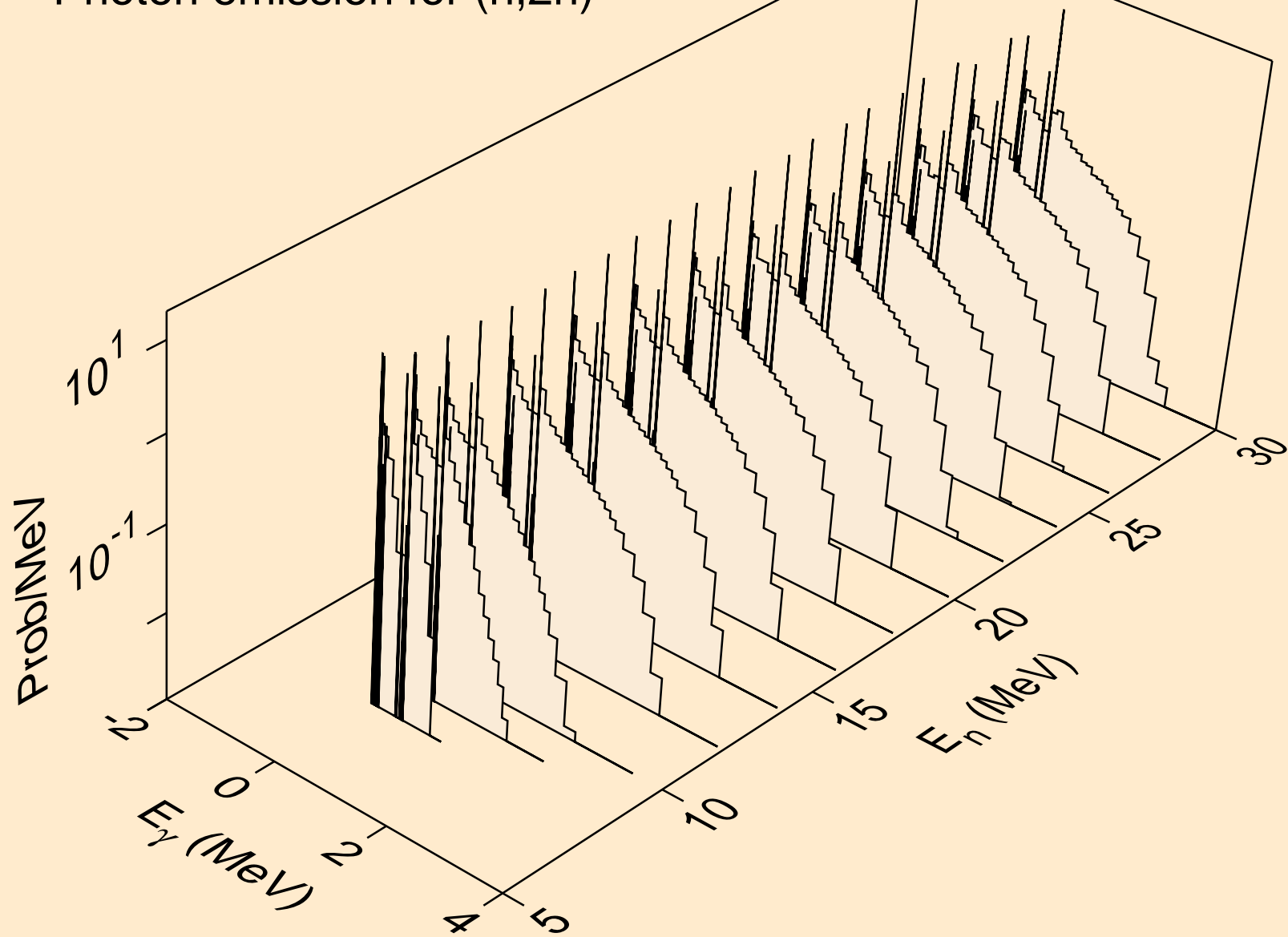

CF253 PROTON ACER TENDL-2023 LIBRARY; T=0.K
Photon emission for (n,3n)

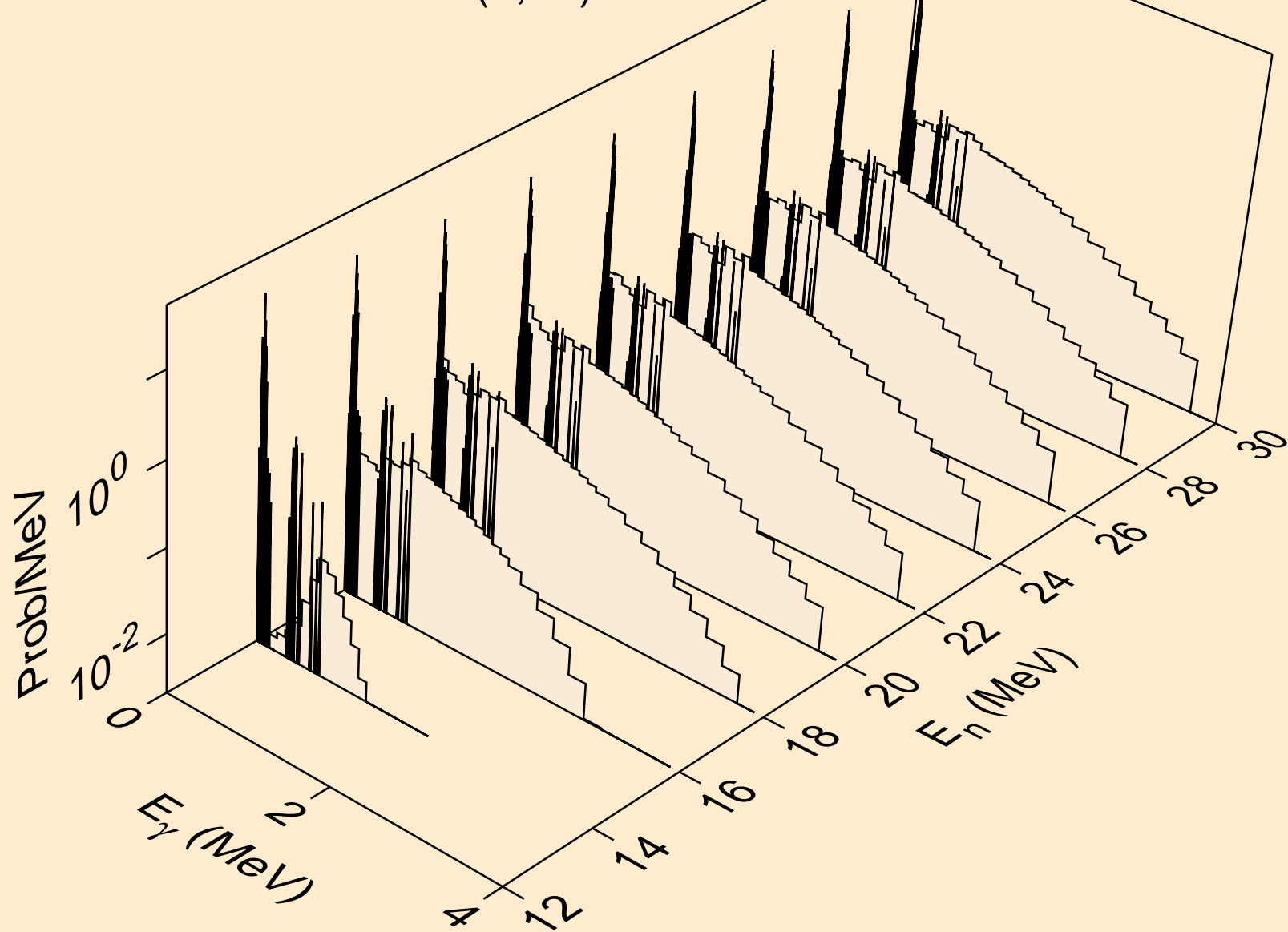

CF253 PROTON ACER TENDL-2023 LIBRARY; T=0.K
Photon emission for (n,n*)a

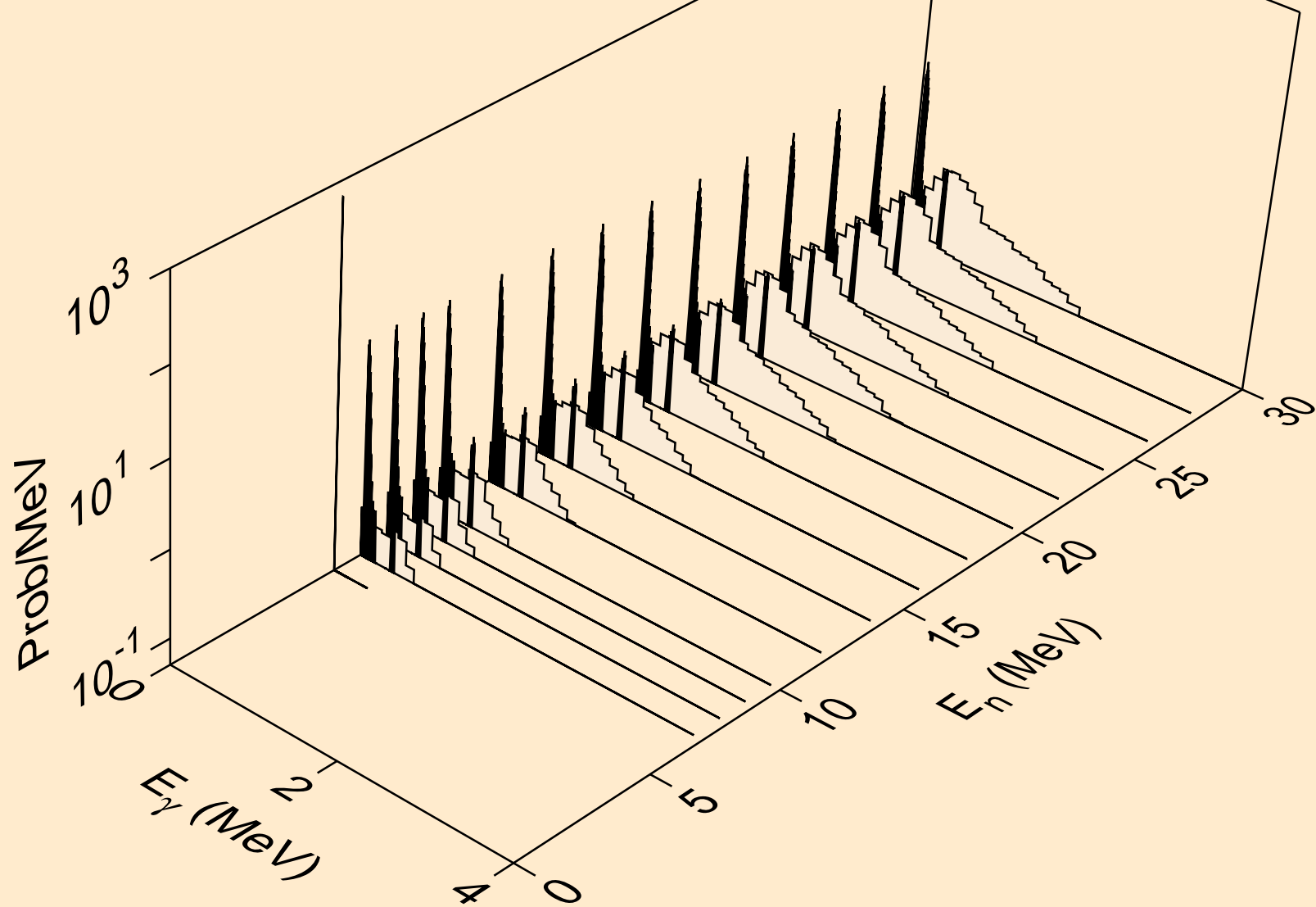

CF253 PROTON ACER TENDL-2023 LIBRARY; T=0.K
Photon emission for (n,2n)a

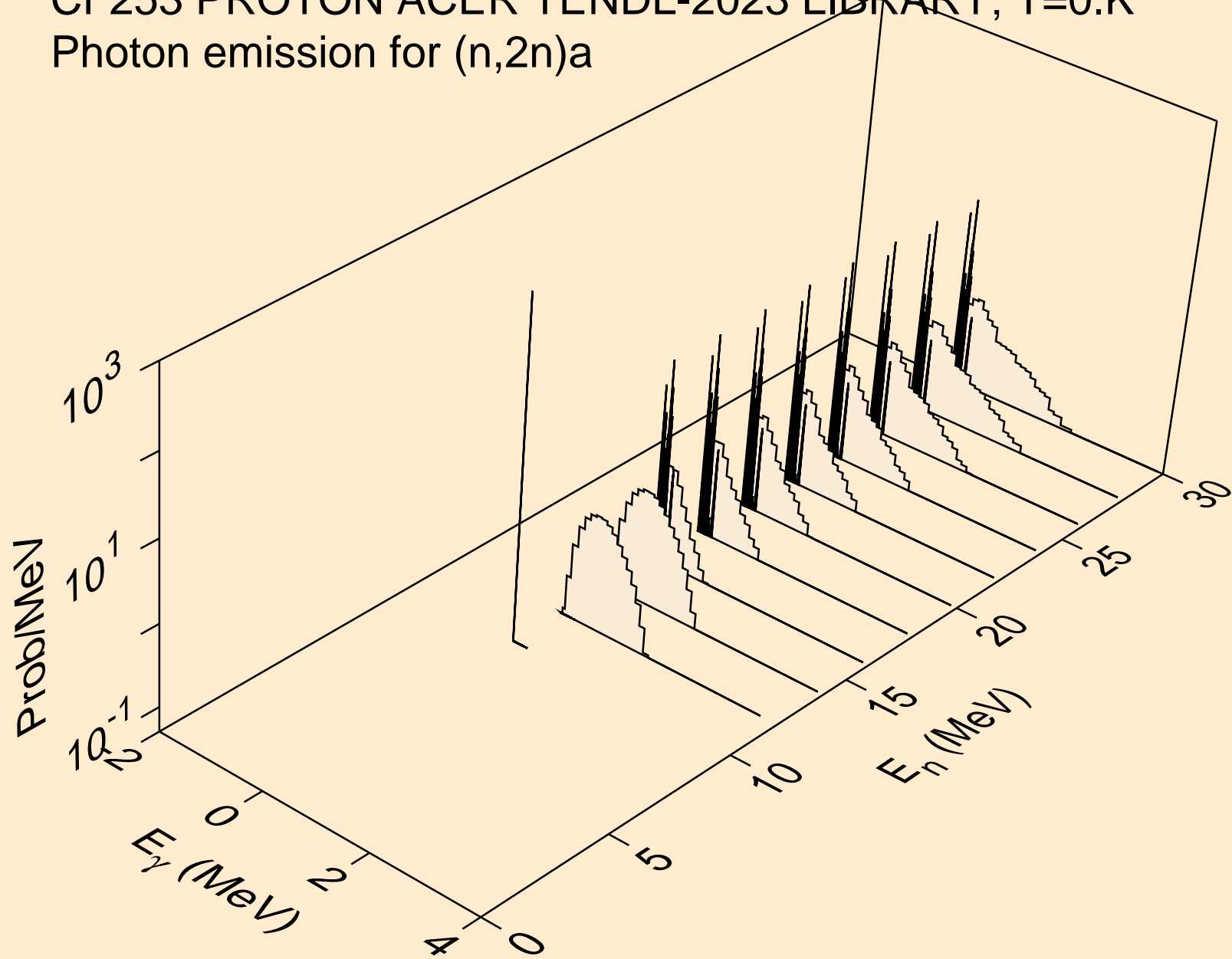

CF253 PROTON ACER TENDL-2023 LIBRARY; T=0.K
Photon emission for (n,n*)p

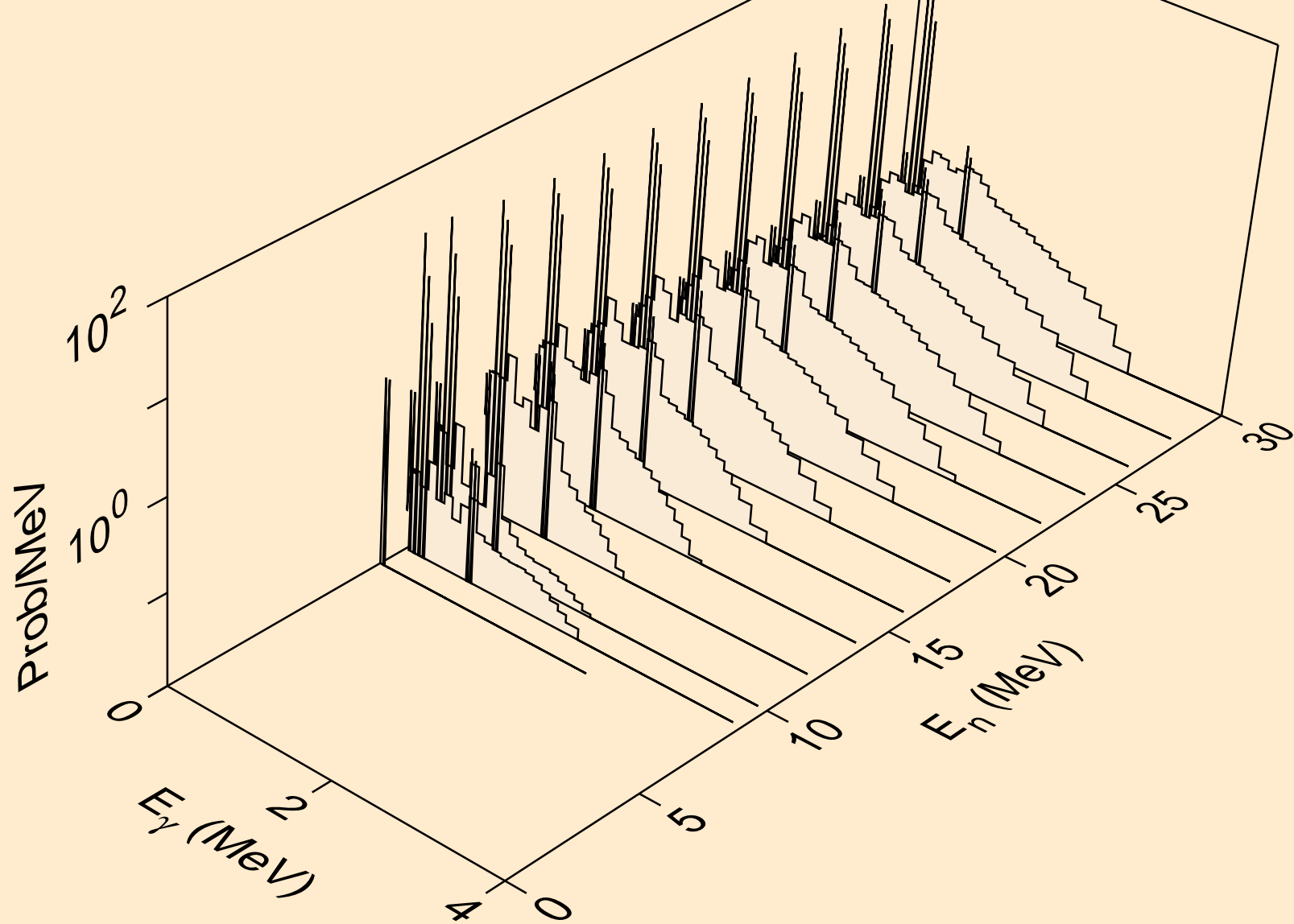

CF253 PROTON ACER TENDL-2023 LIBRARY; T=0.K
Photon emission for (n,n*)d

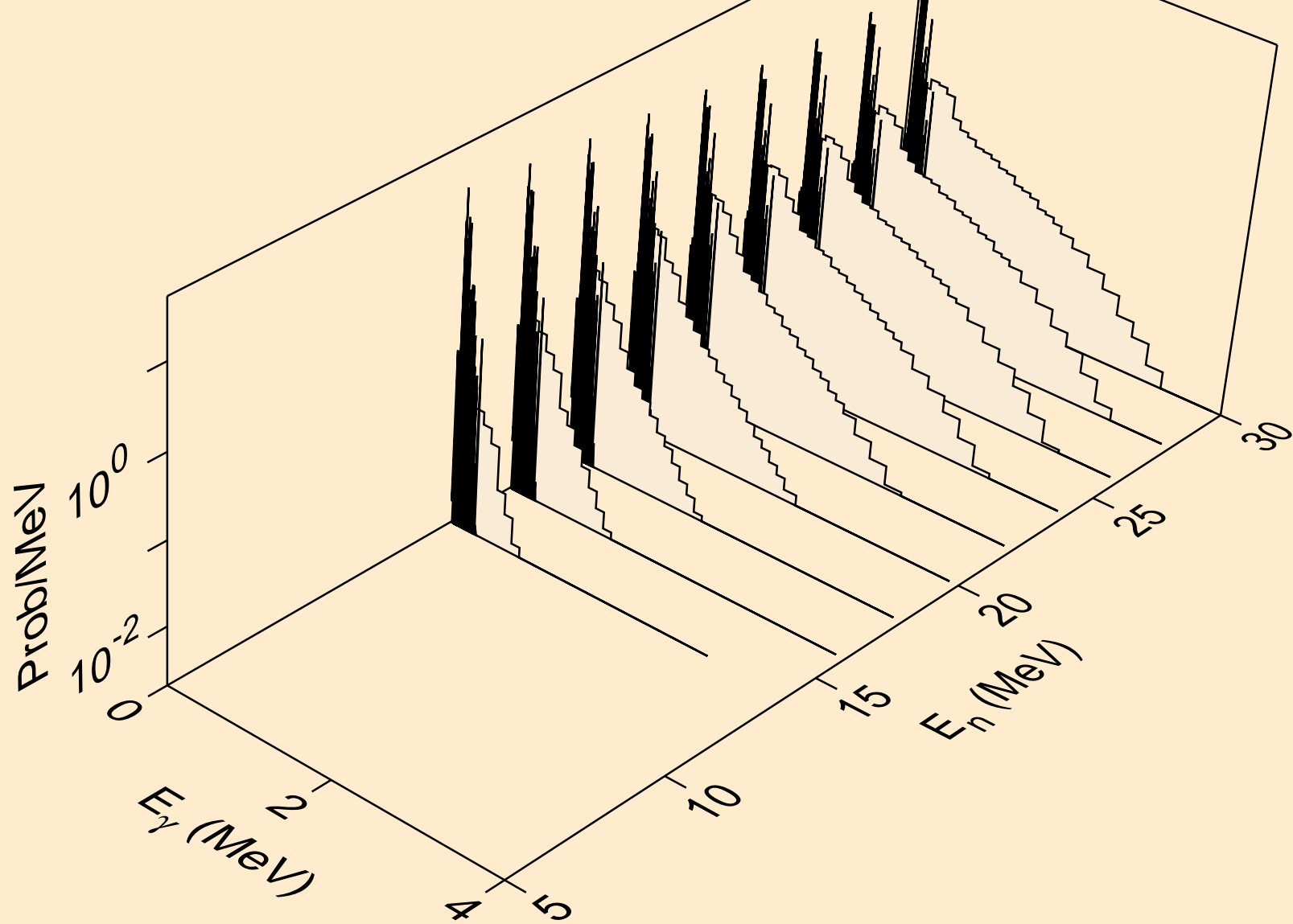

CF253 PROTON ACER TENDL-2023 LIBRARY; T=0.K
Photon emission for (n,n*)t

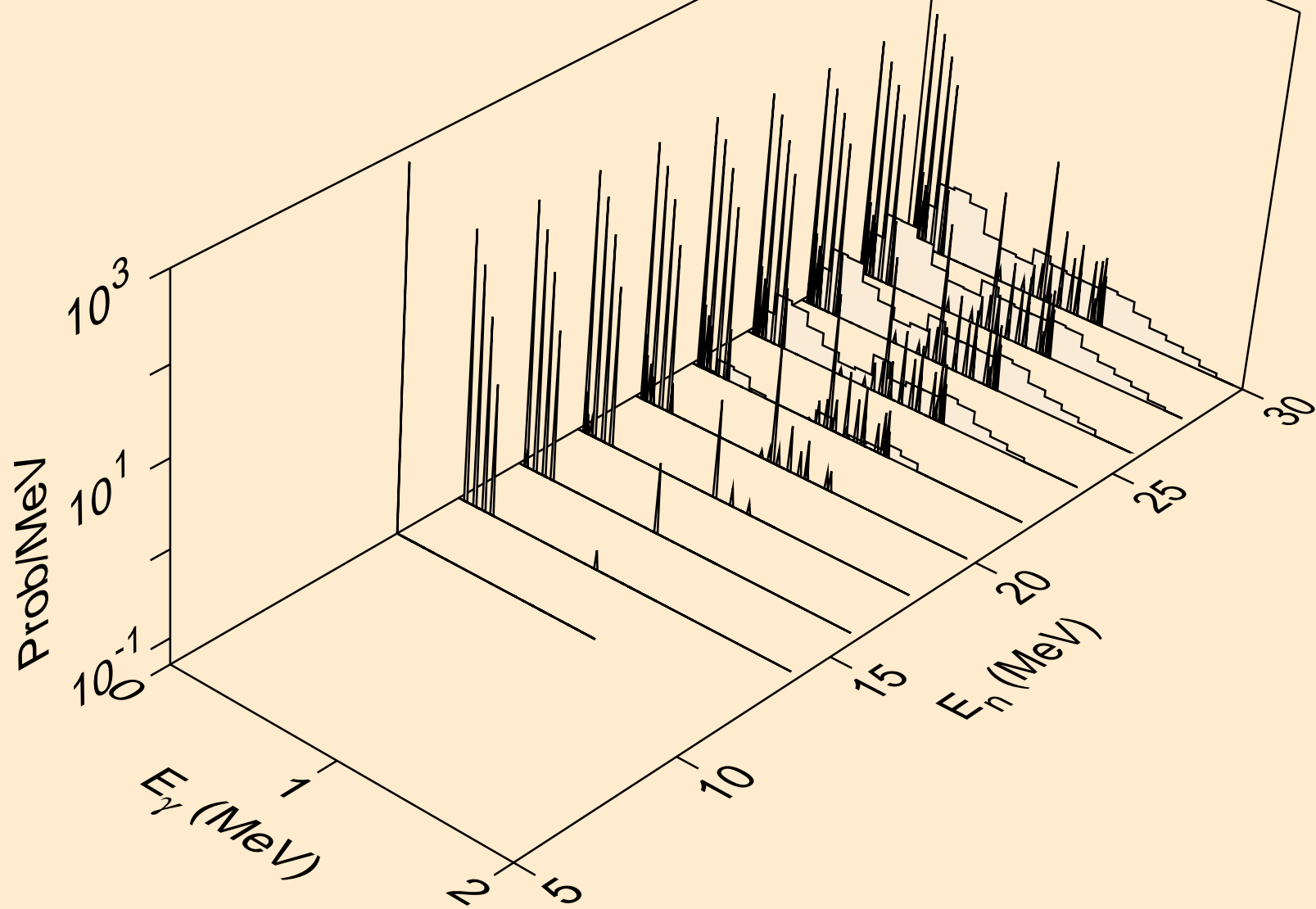

CF253 PROTON ACER TENDL-2023 LIBRARY; T=0.K
Photon emission for (n,n*)he3

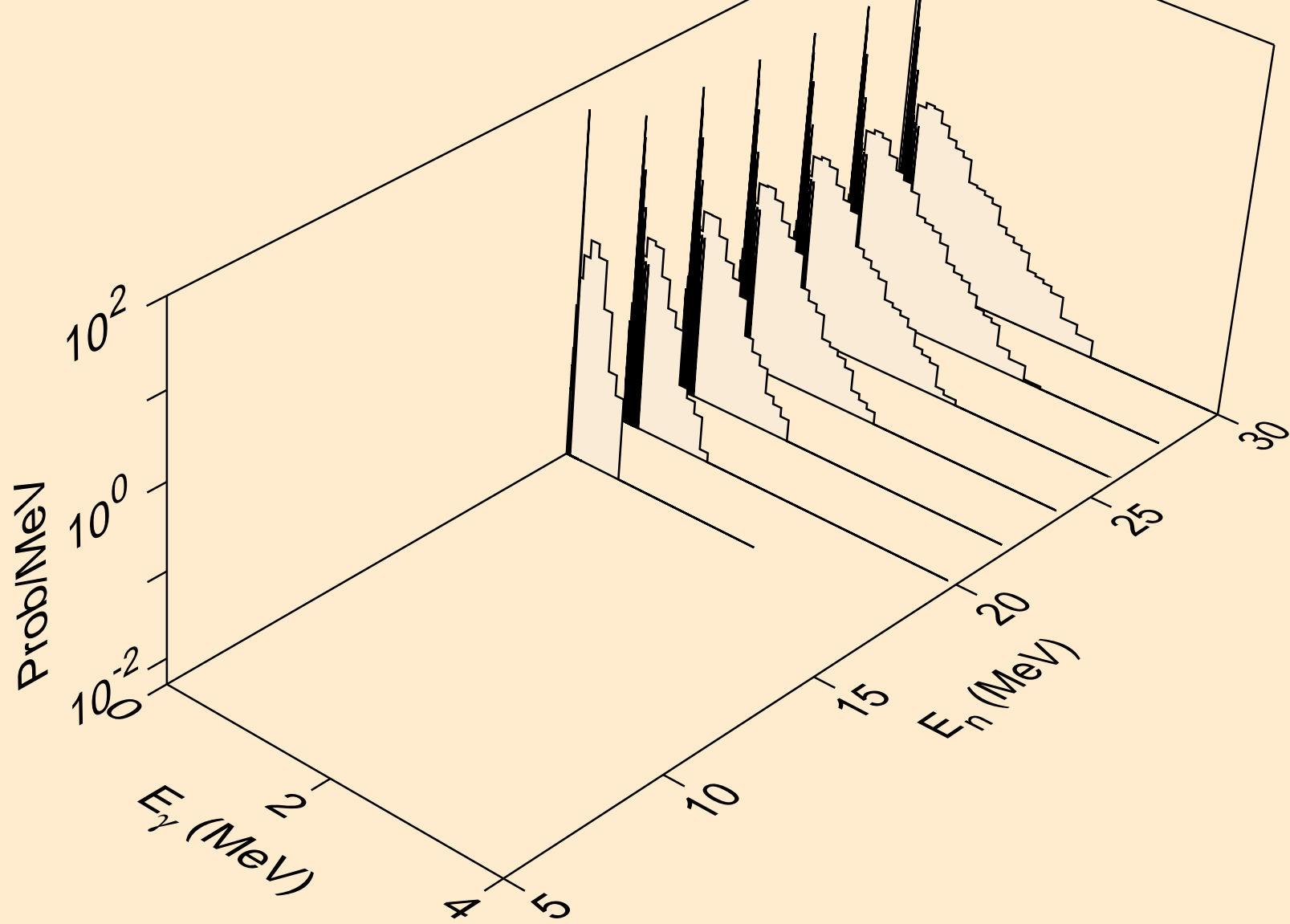

CF253 PROTON ACER TENDL-2023 LIBRARY; T=0.K
Photon emission for (n,4n)

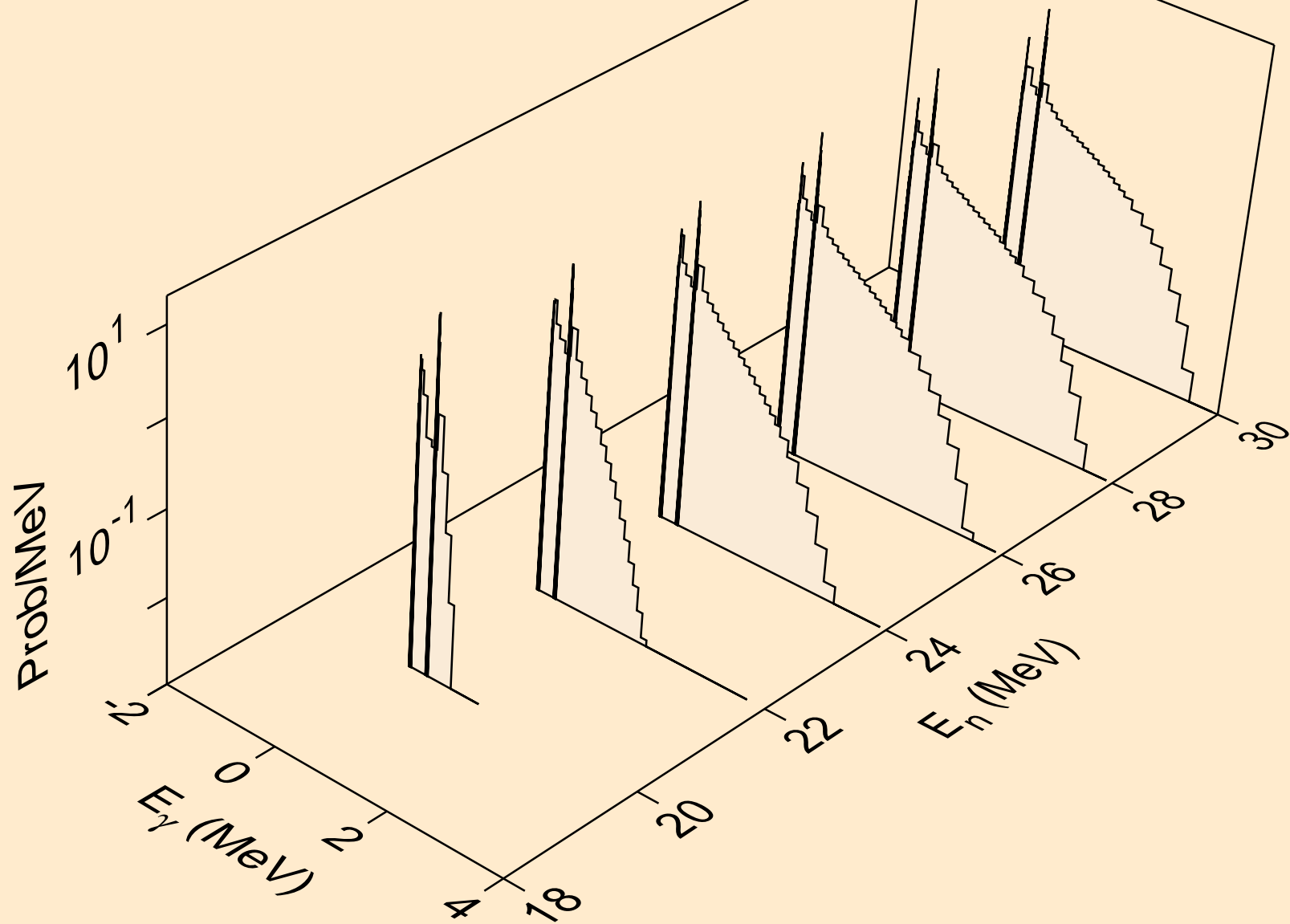

CF253 PROTON ACER TENDL-2023 LIBRARY; T=0.K
Photon emission for (n,2np)

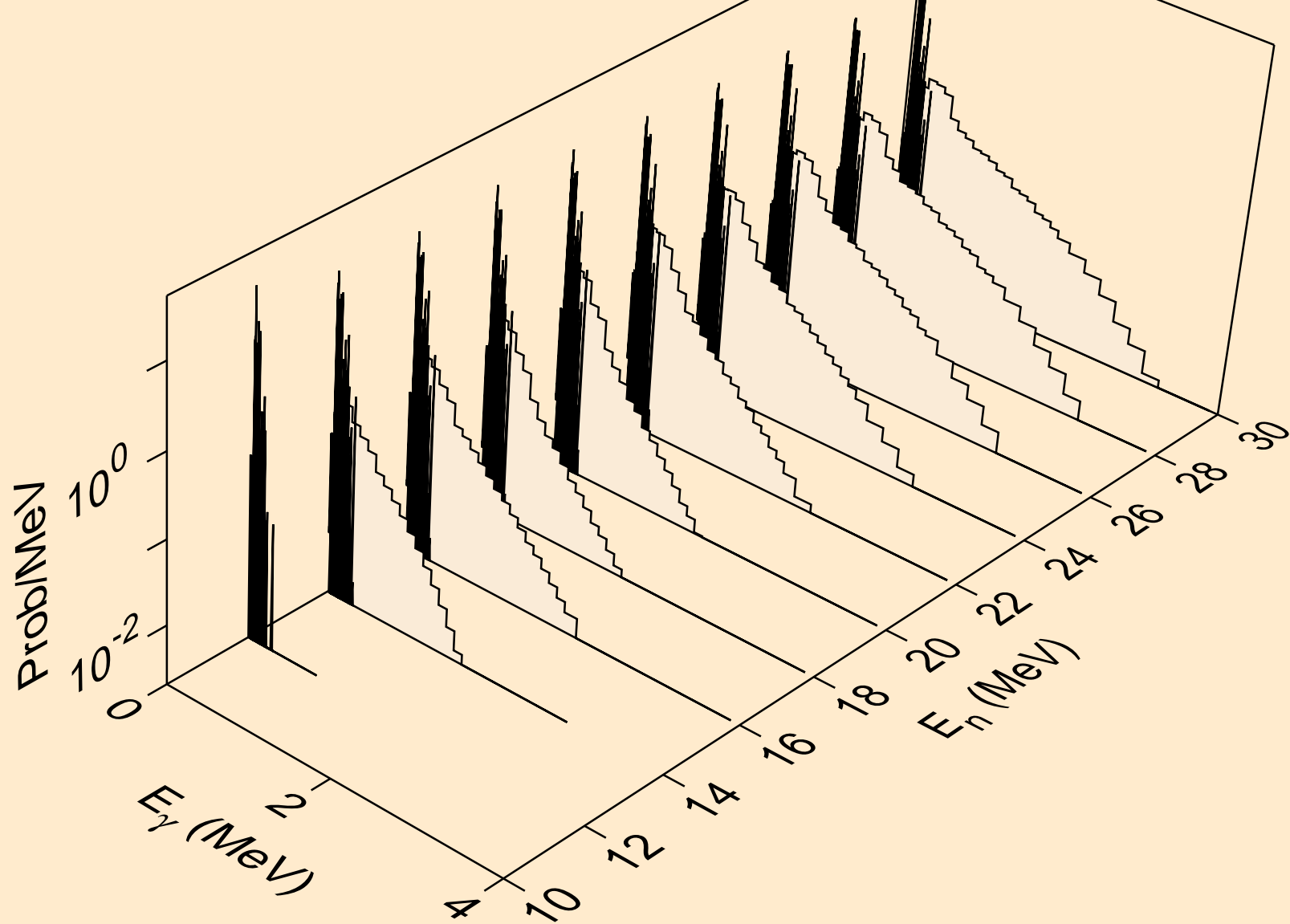

CF253 PROTON ACER TENDL-2023 LIBRARY; T=0.K
Photon emission for (n,3np)

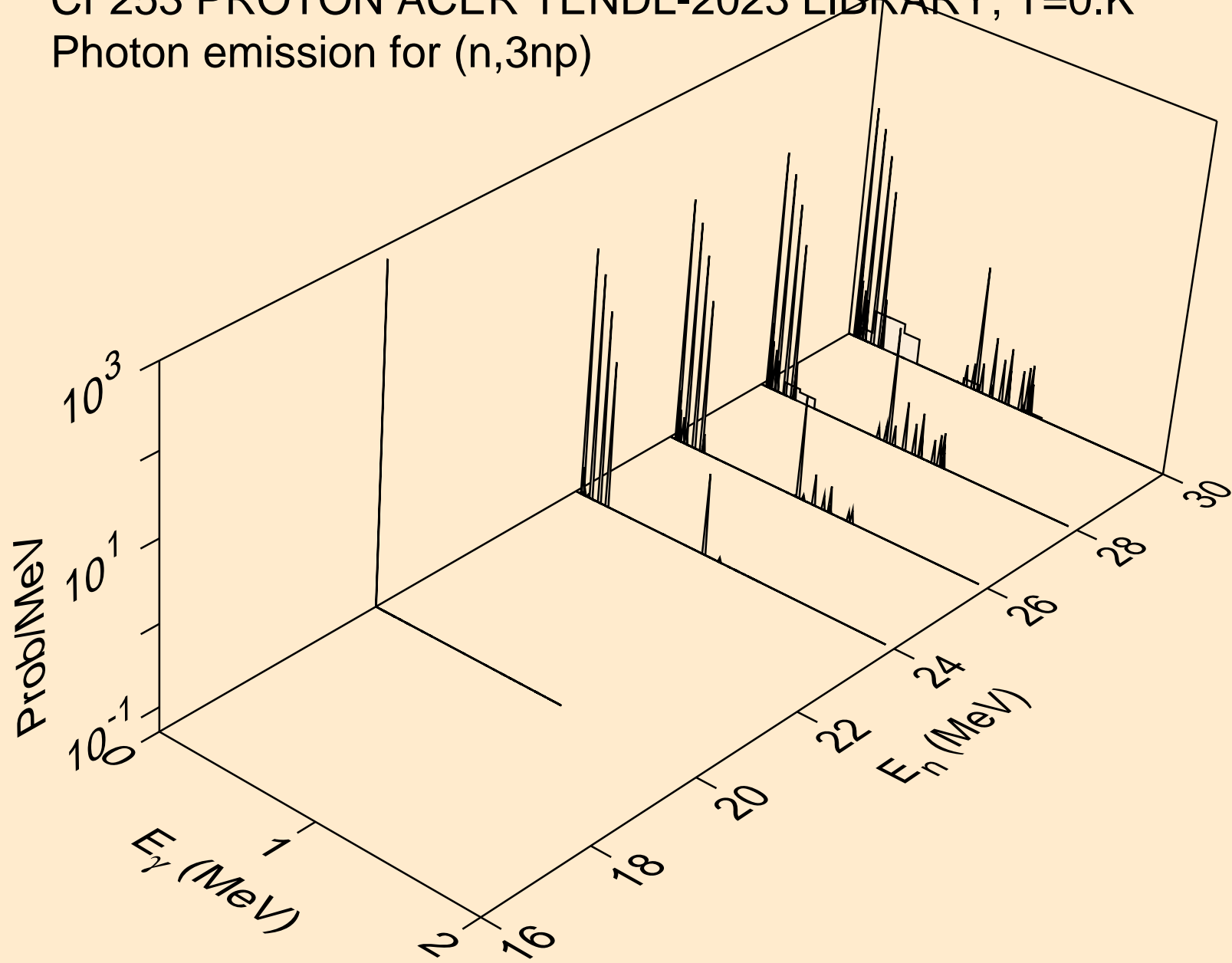

CF253 PROTON ACER TENDL-2023 LIBRARY; T=0.K
Photon emission for (n,gma)

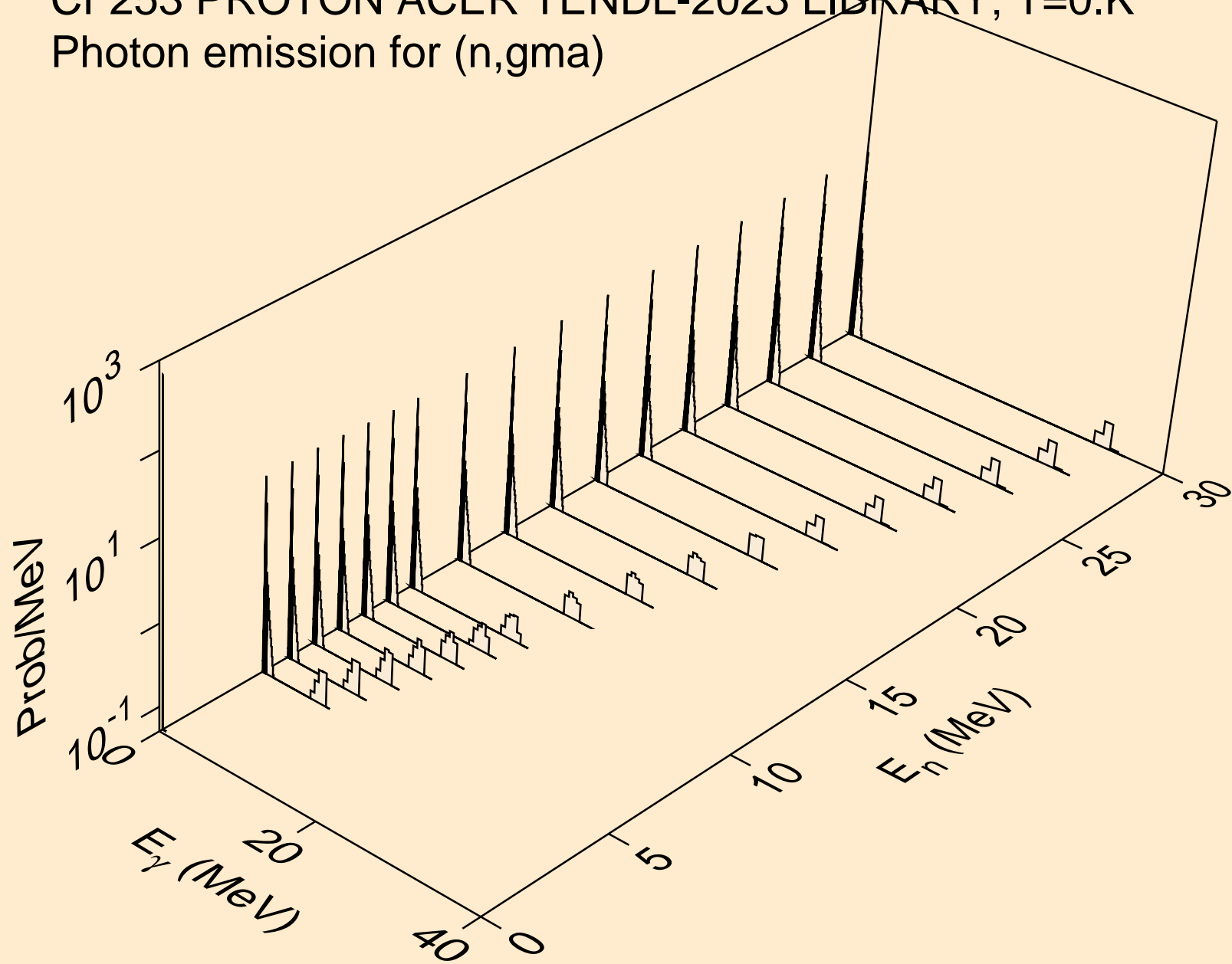

CF253 PROTON ACER TENDL-2023 LIBRARY; T=0.K
Photon emission for inelastic

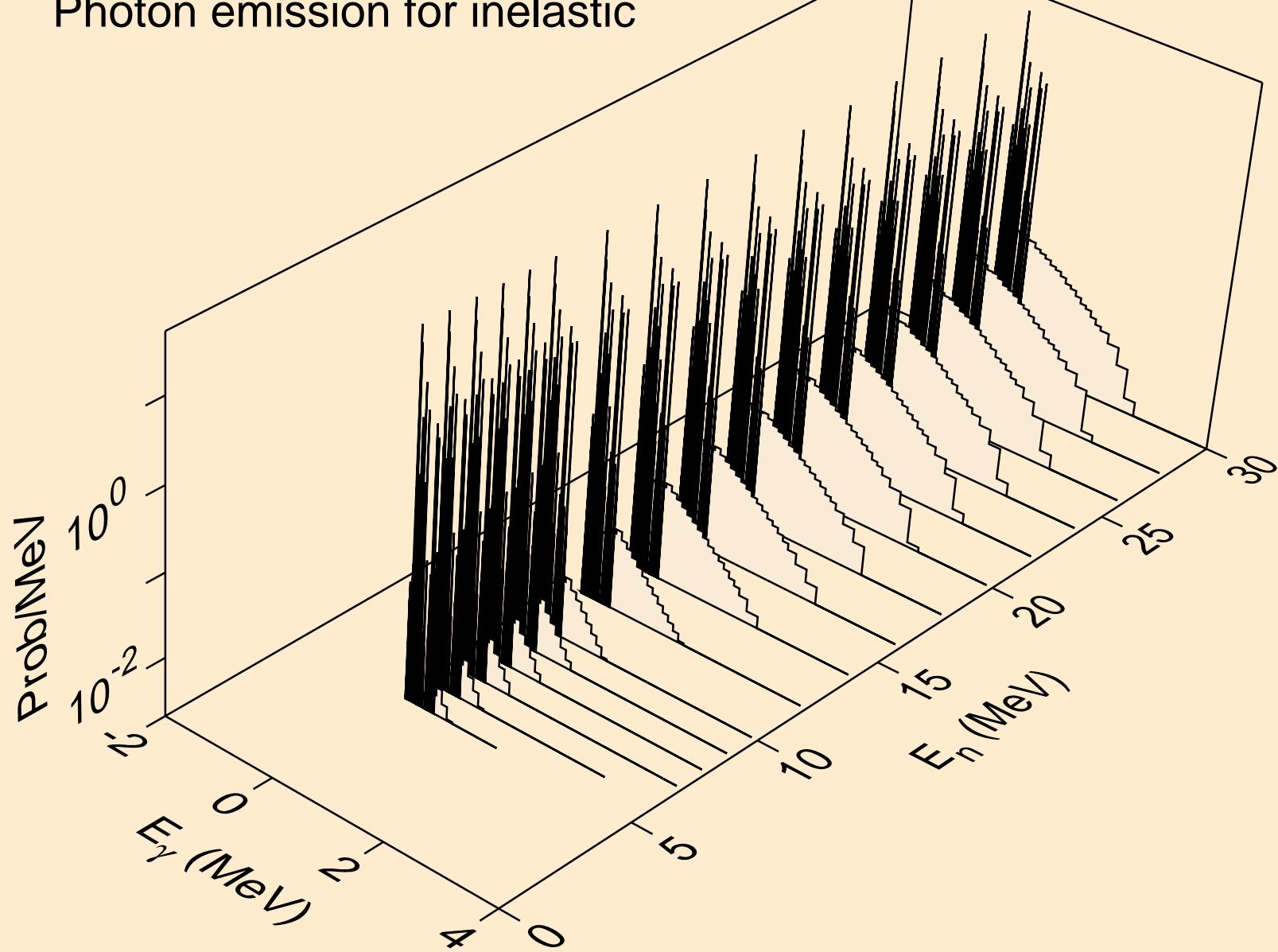

CF253 PROTON ACER TENDL-2023 LIBRARY; T=0.K
Photon emission for (n,d)

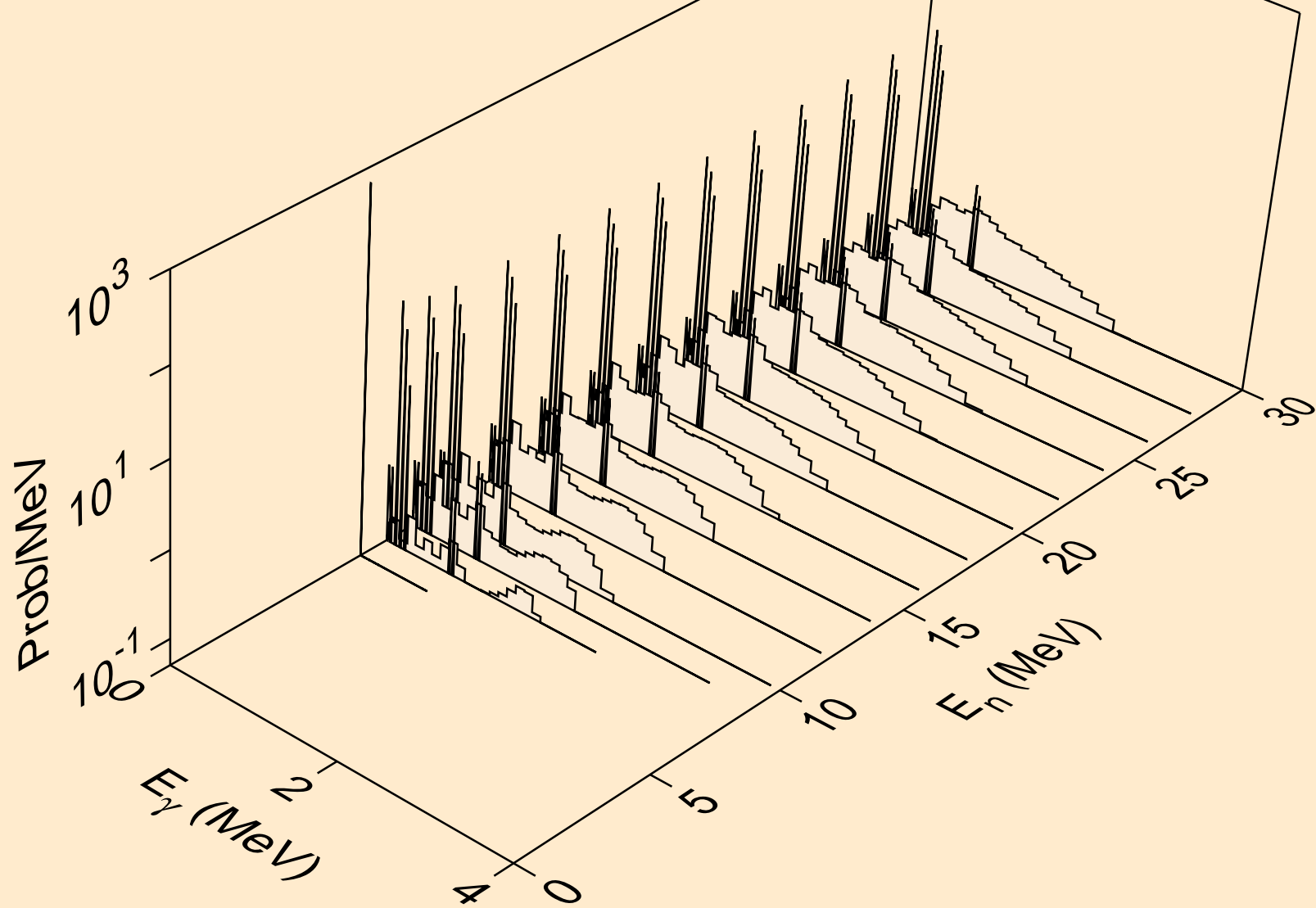

CF253 PROTON ACER TENDL-2023 LIBRARY; T=0.K
Photon emission for (n,t)

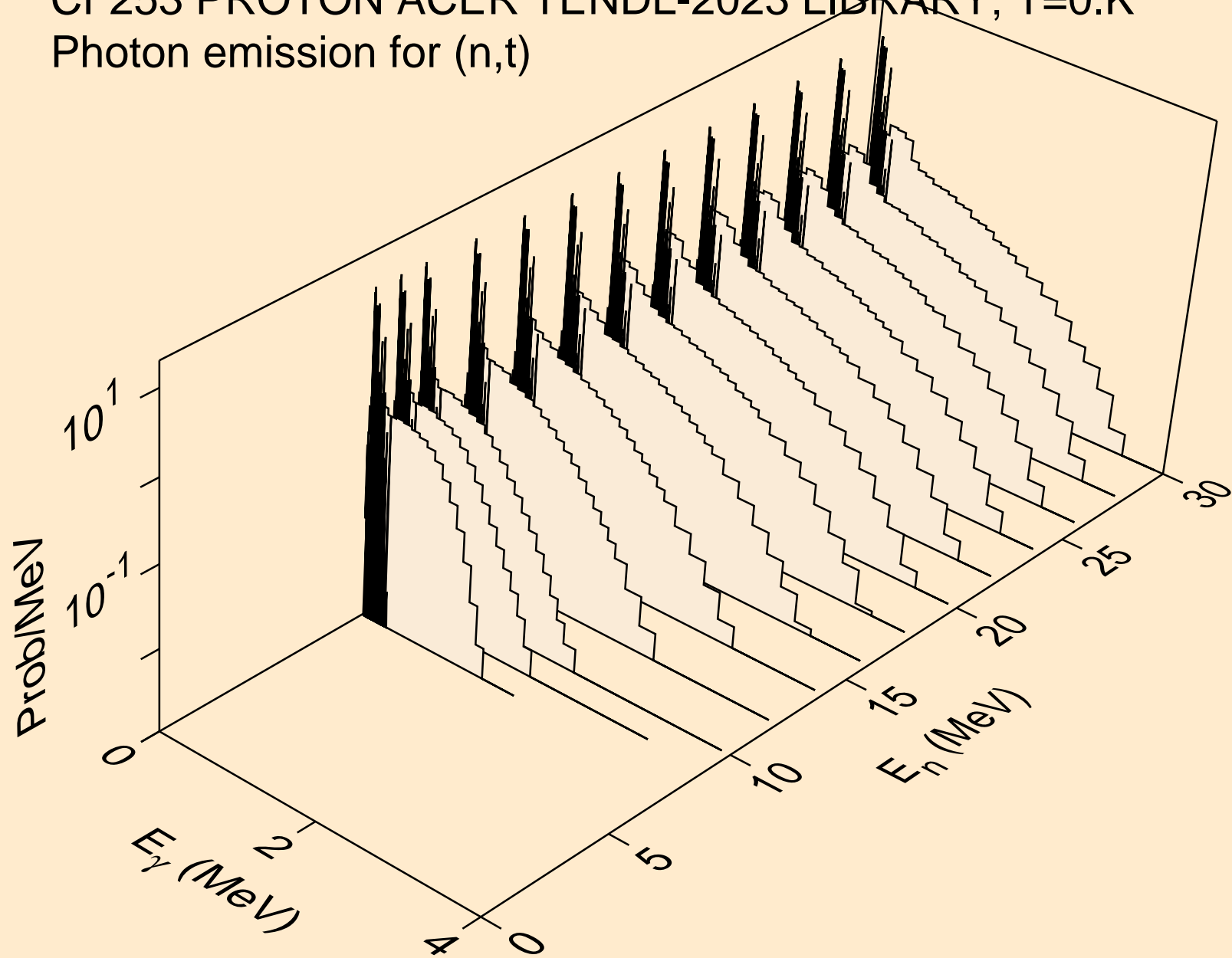

CF253 PROTON ACER TENDL-2023 LIBRARY; T=0.K
Photon emission for (n,he3)

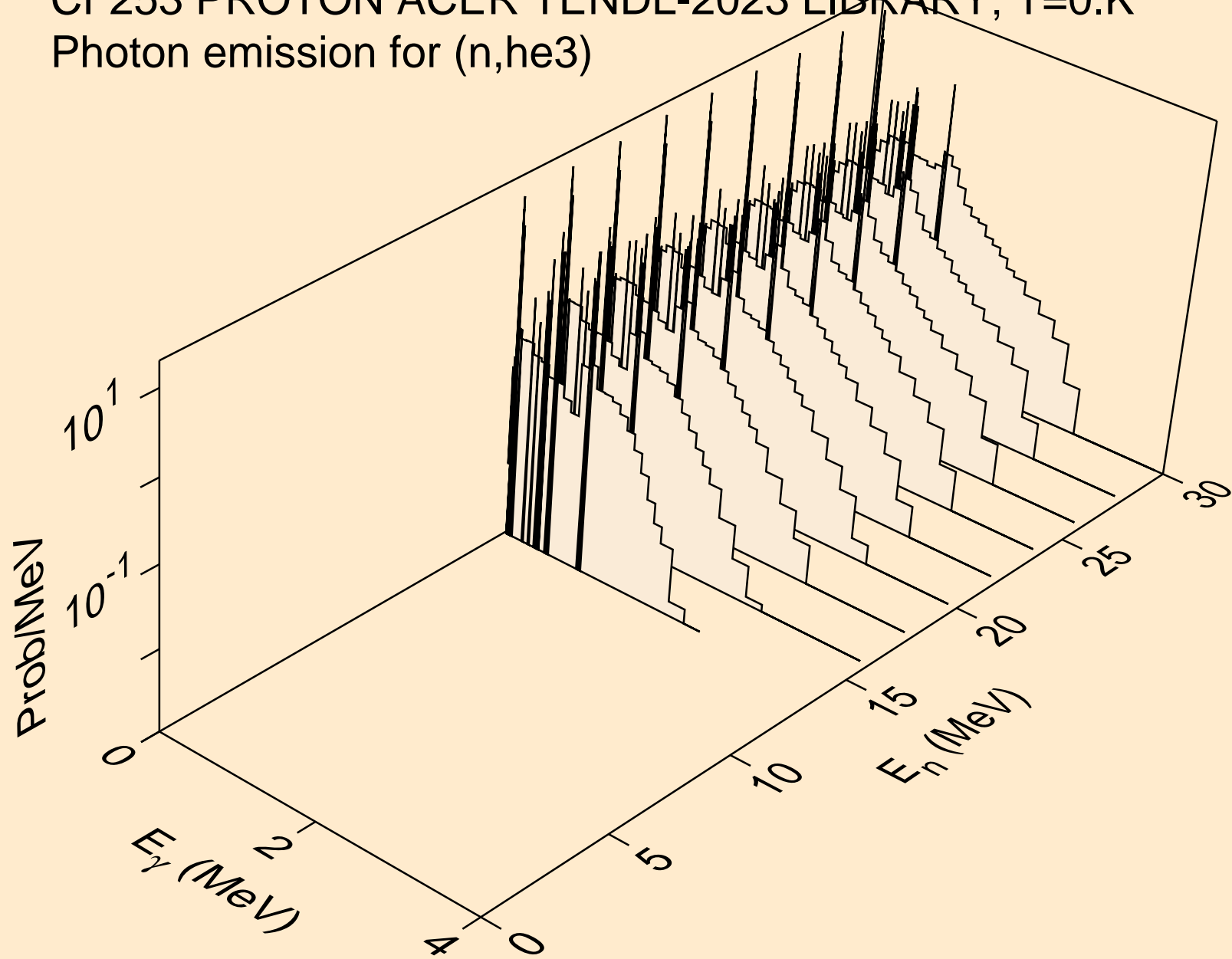

CF253 PROTON ACER TENDL-2023 LIBRARY; T=0.K
Photon emission for (n,a)

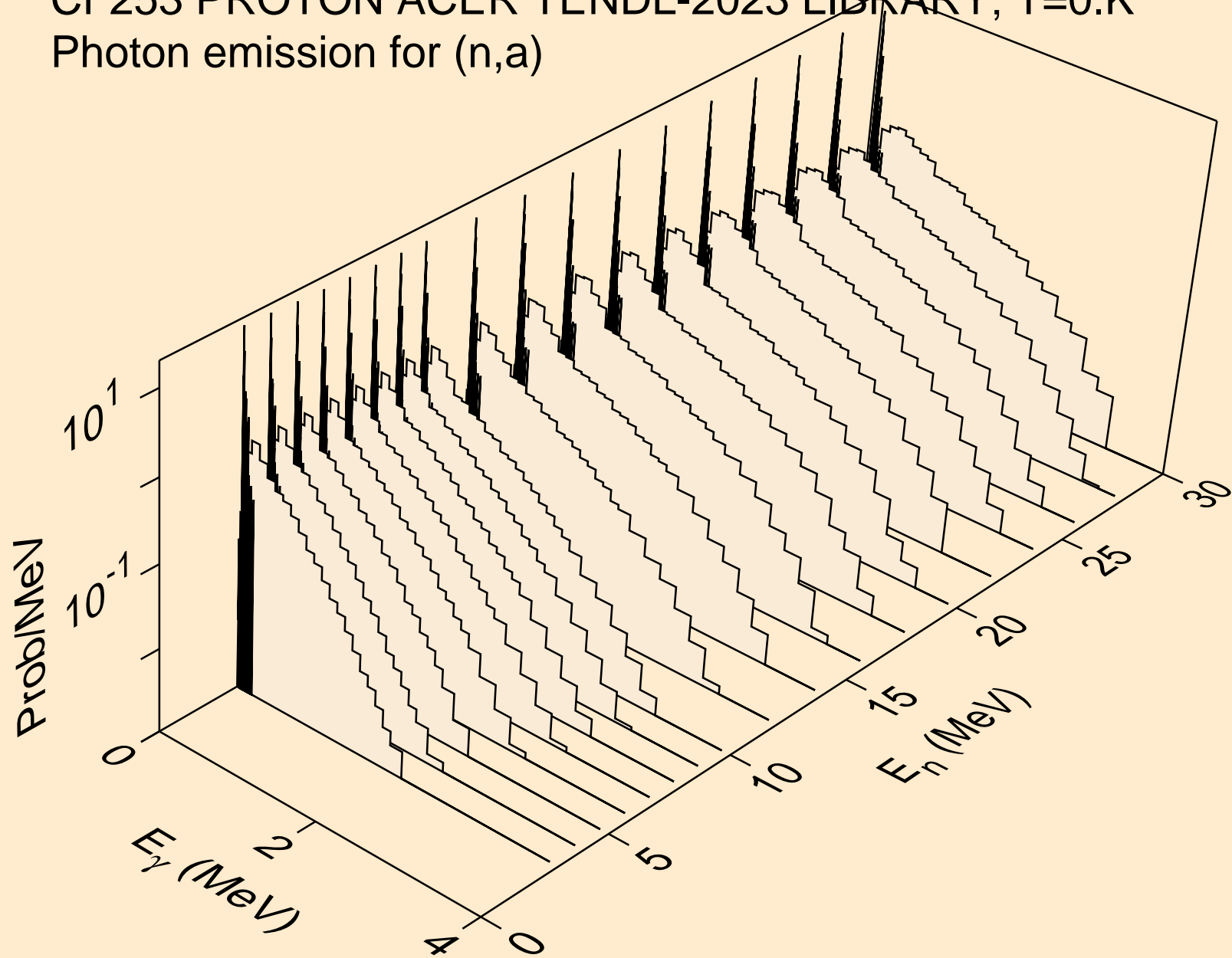

CF253 PROTON ACER TENDL-2023 LIBRARY; T=0.K
Photon emission for (n,2p)

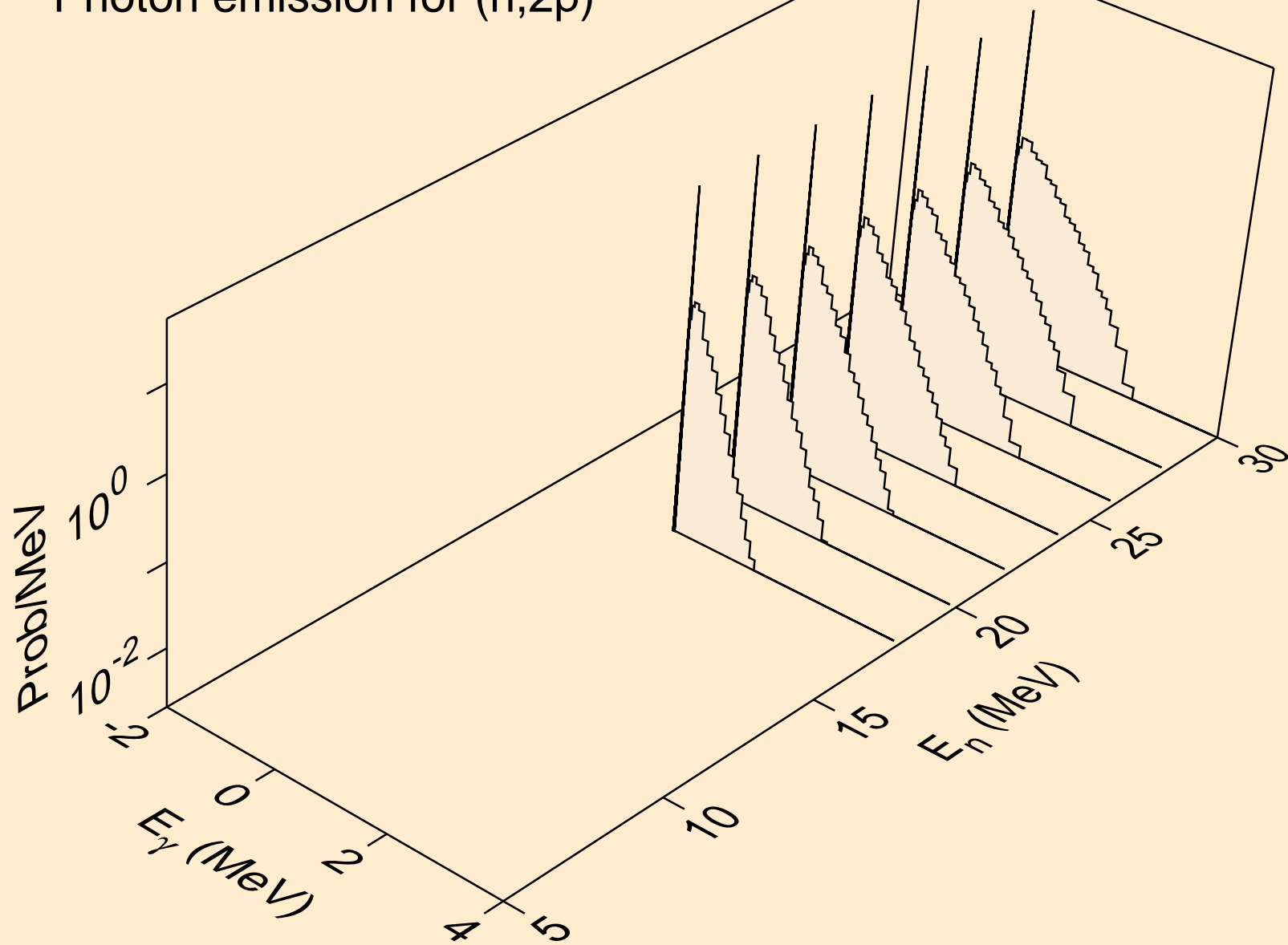

CF253 PROTON ACER TENDL-2023 LIBRARY; T=0.K

Particle heating contributions

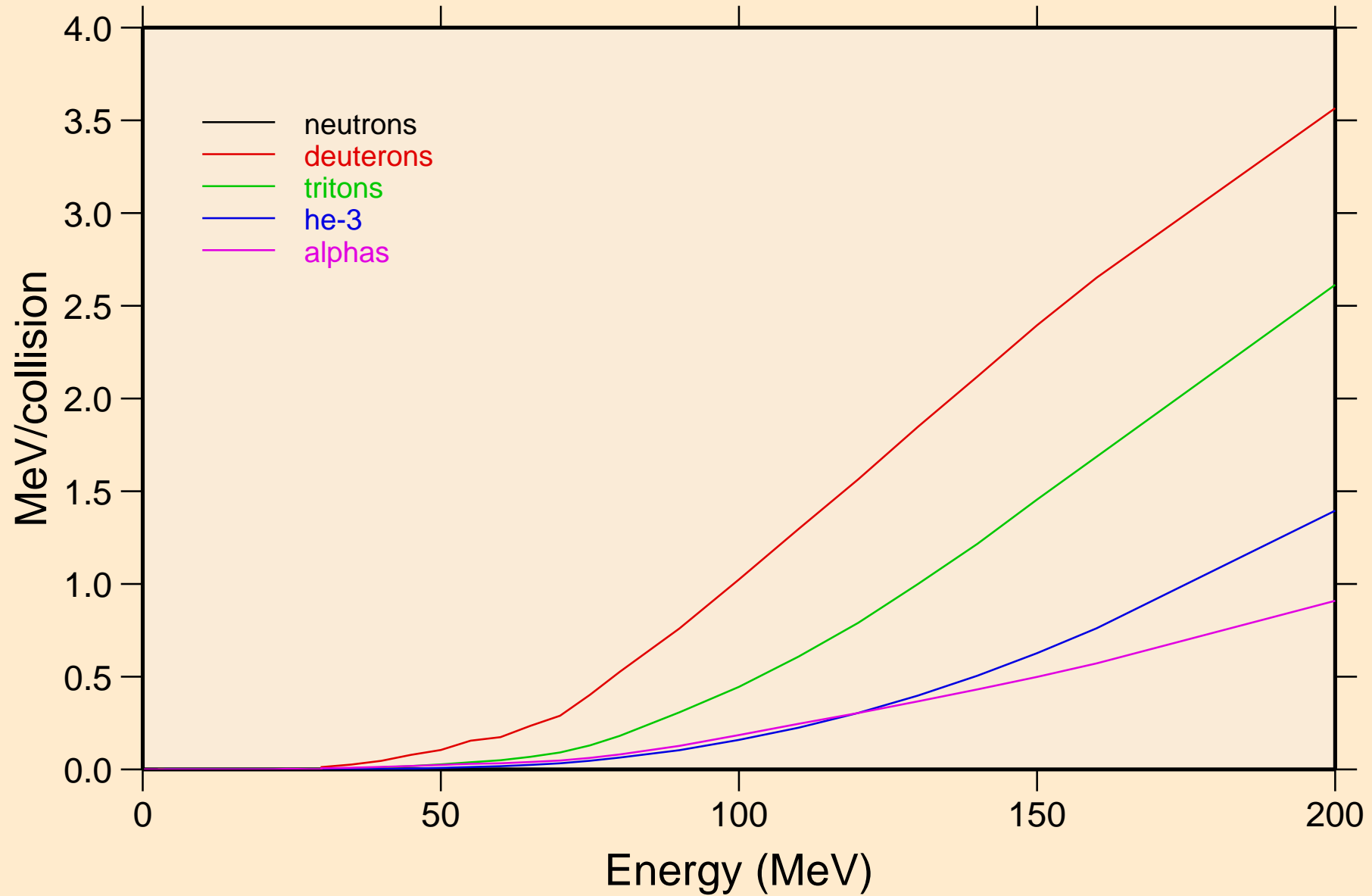

CF253 PROTON ACER TENDL-2023 LIBRARY; T=0.K
Recoil Heating

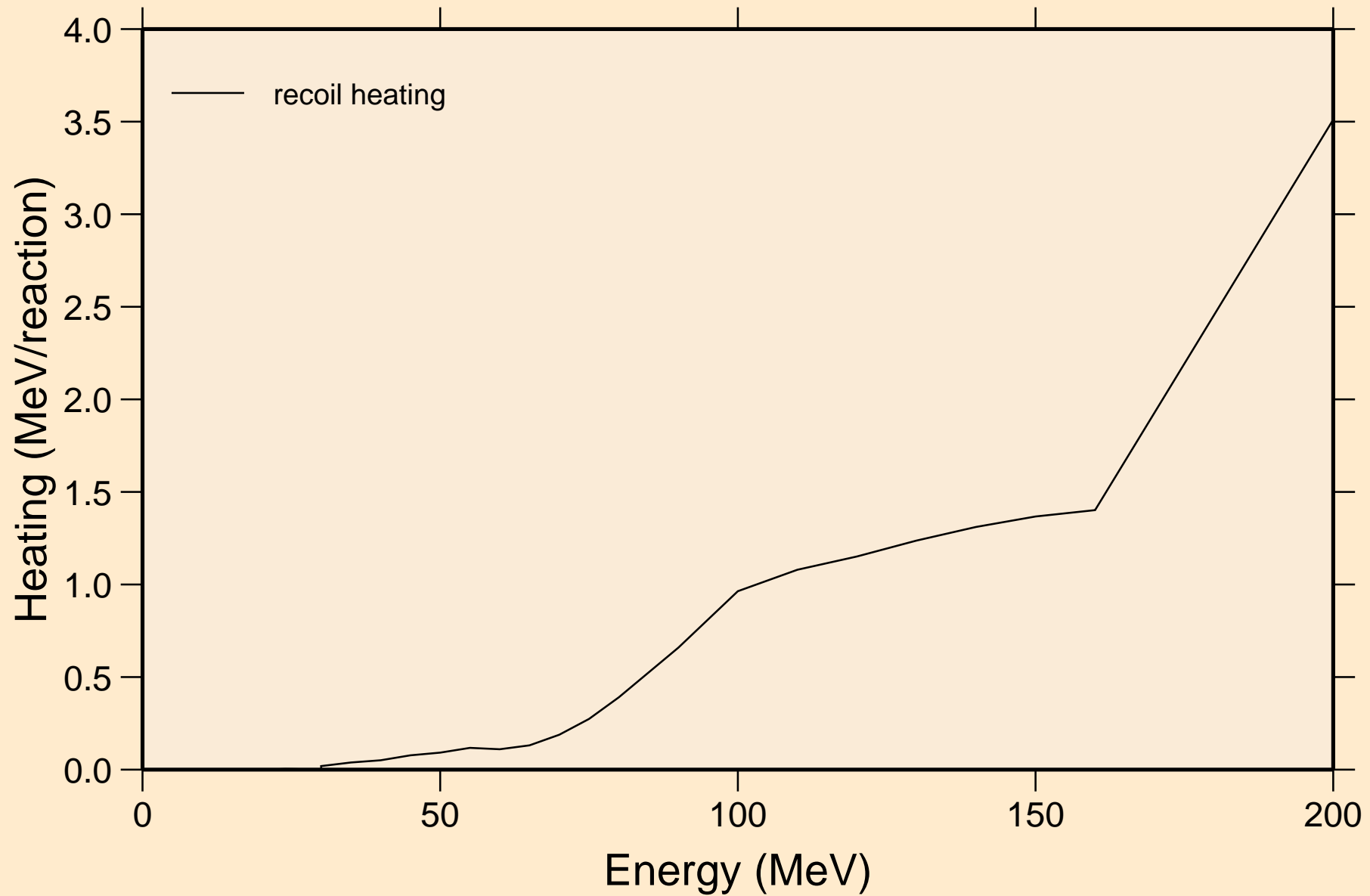

CF253 PROTON ACER TENDL-2023 LIBRARY; T=0.K
Particle production cross sections

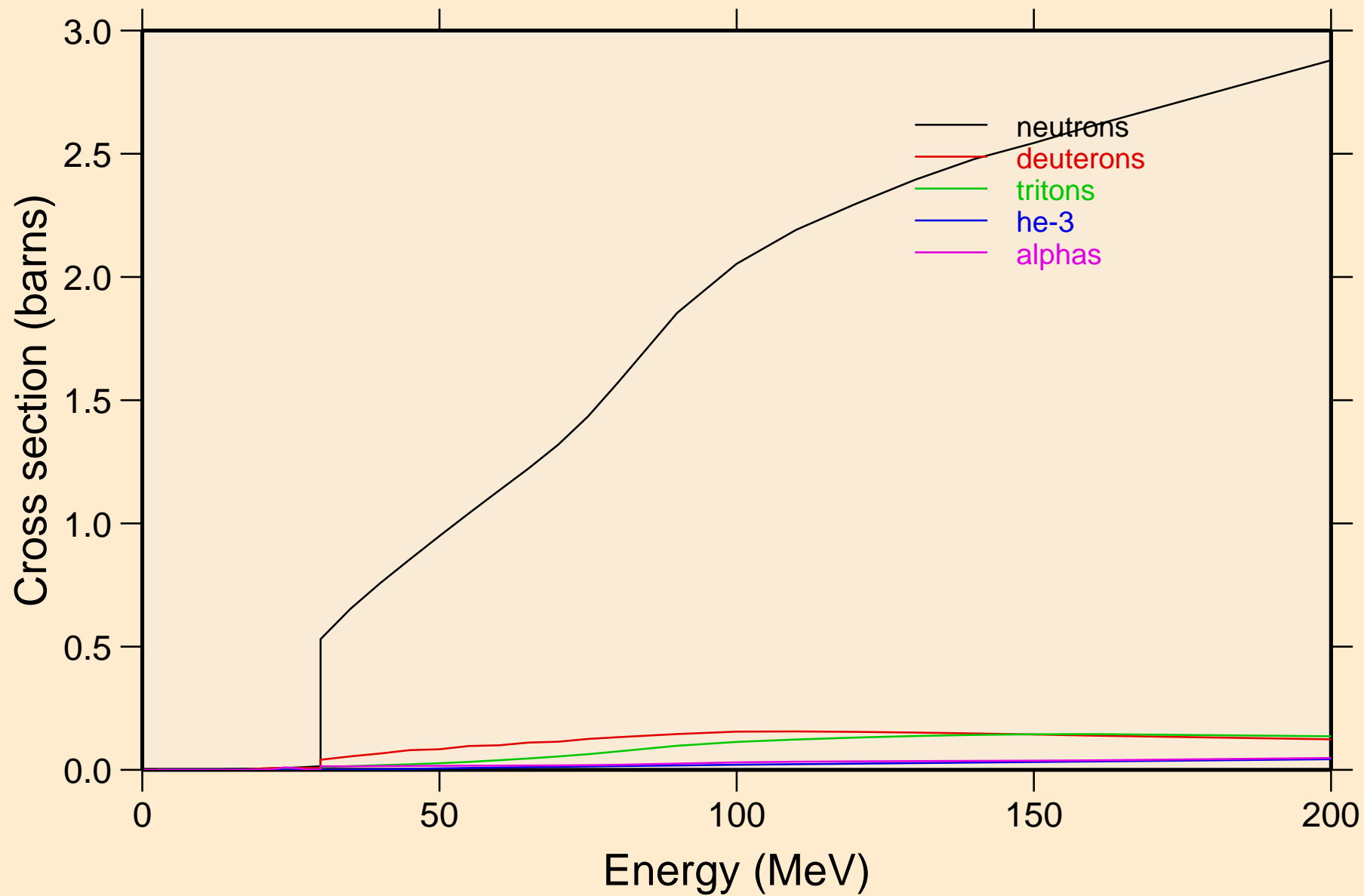

CF253 PROTON ACER TENDL-2023 LIBRARY; T=0.K
neutrons from (p,n)

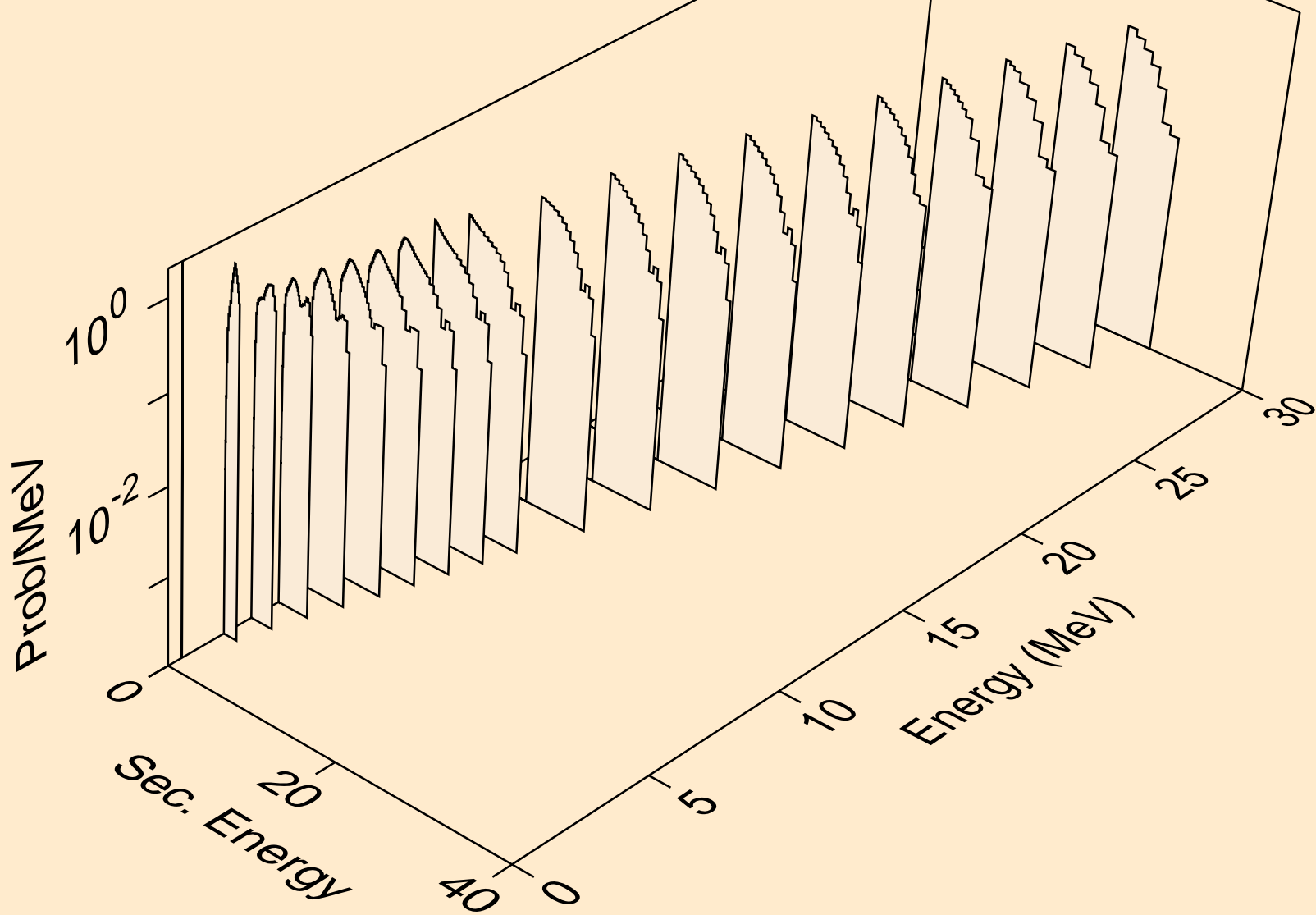

CF253 PROTON ACER TENDL-2023 LIBRARY; T=0.K
neutrons from (p,x)

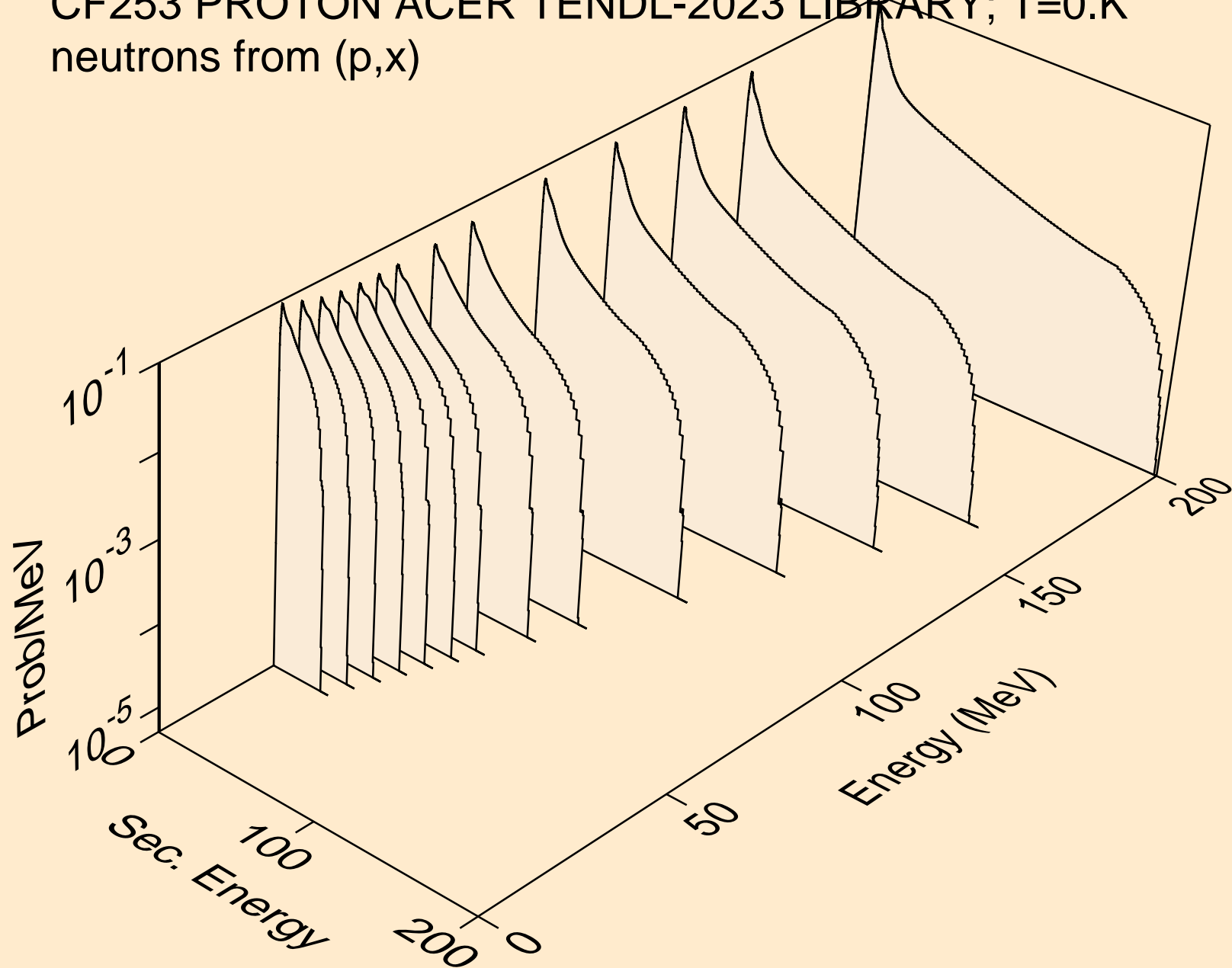

CF253 PROTON ACER TENDL-2023 LIBRARY; T=0.K
neutrons from (p,2nd)

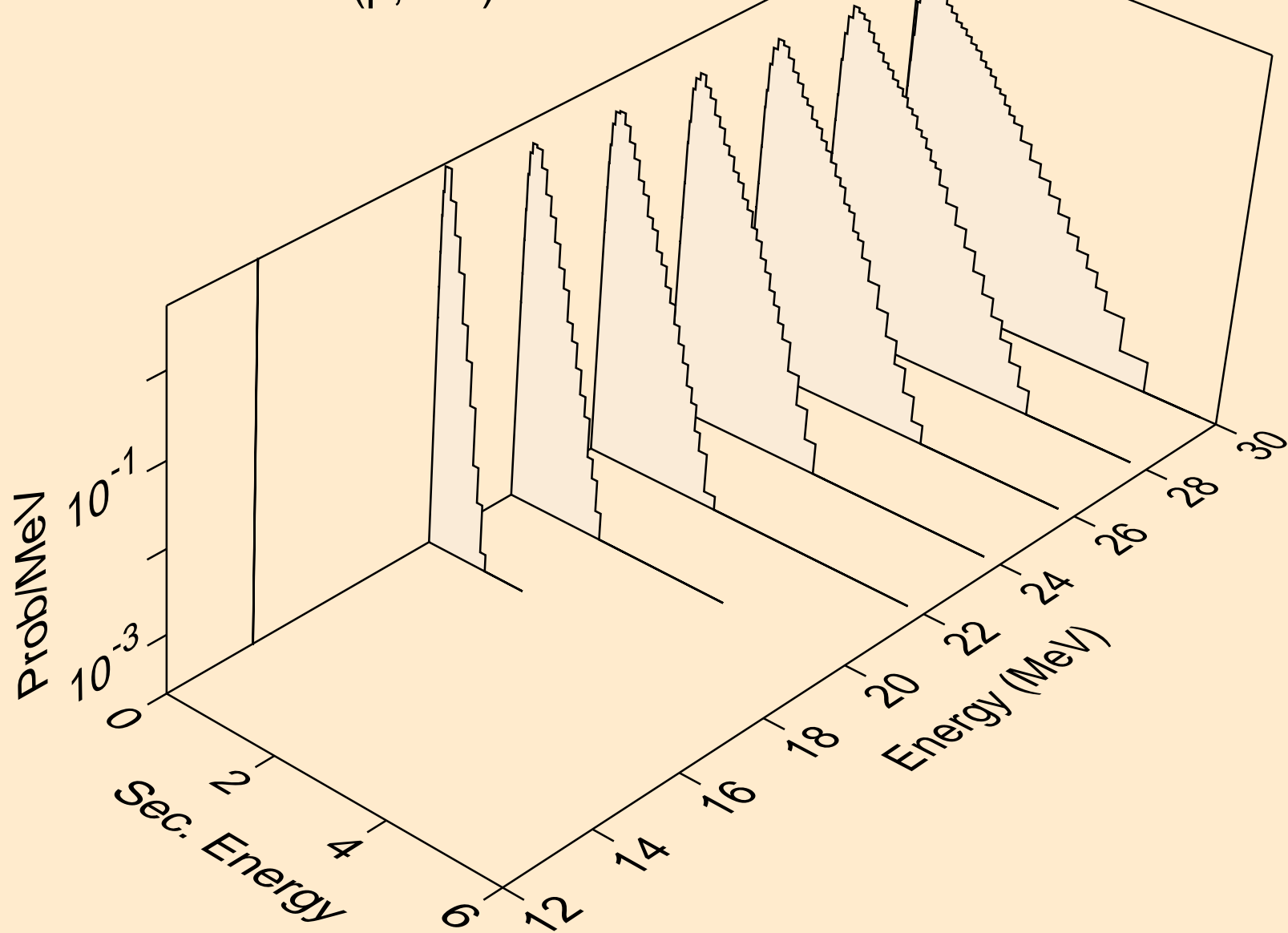

CF253 PROTON ACER TENDL-2023 LIBRARY; T=0.K
neutrons from (p,2n)

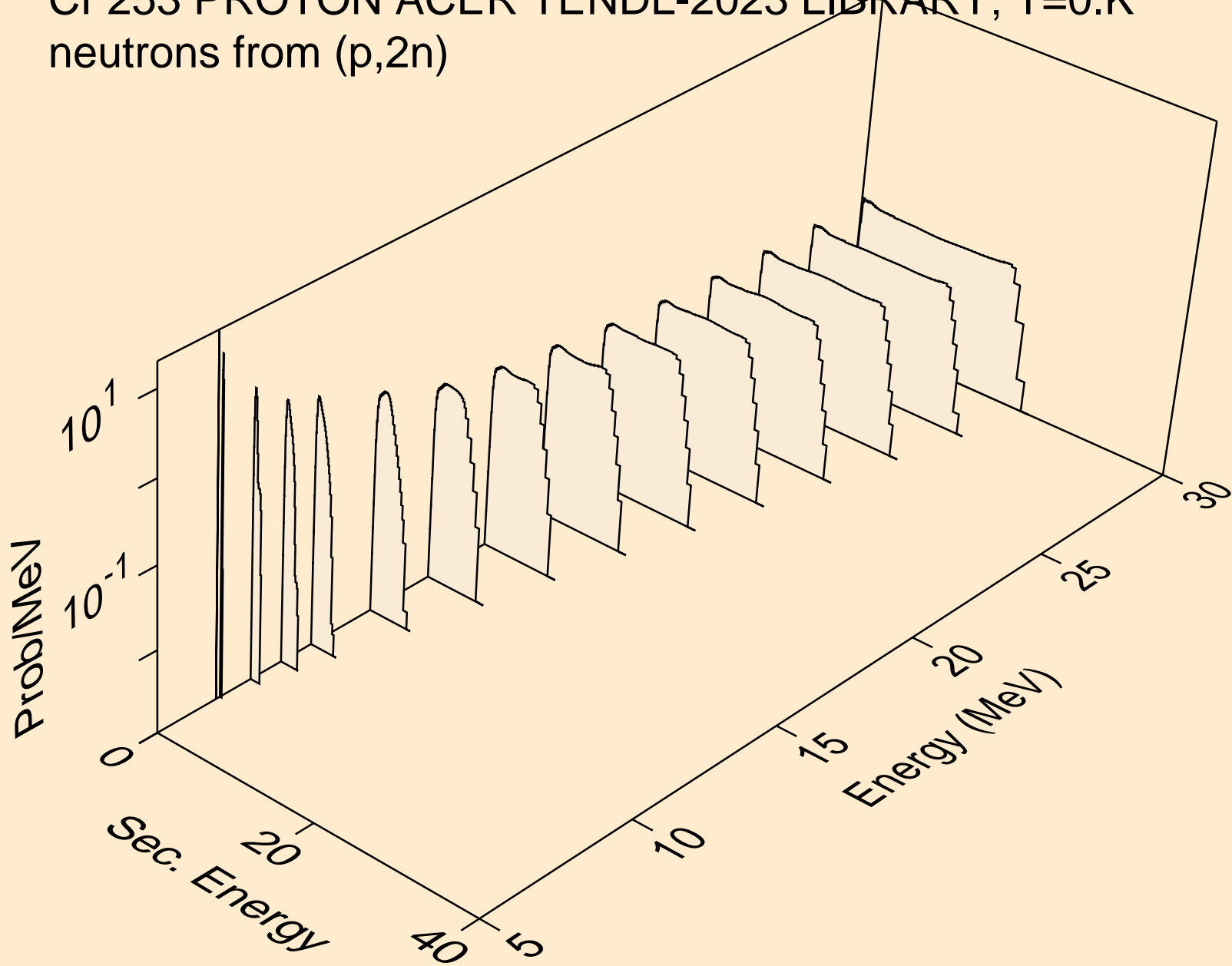

CF253 PROTON ACER TENDL-2023 LIBRARY; T=0.K
neutrons from (p,3n)

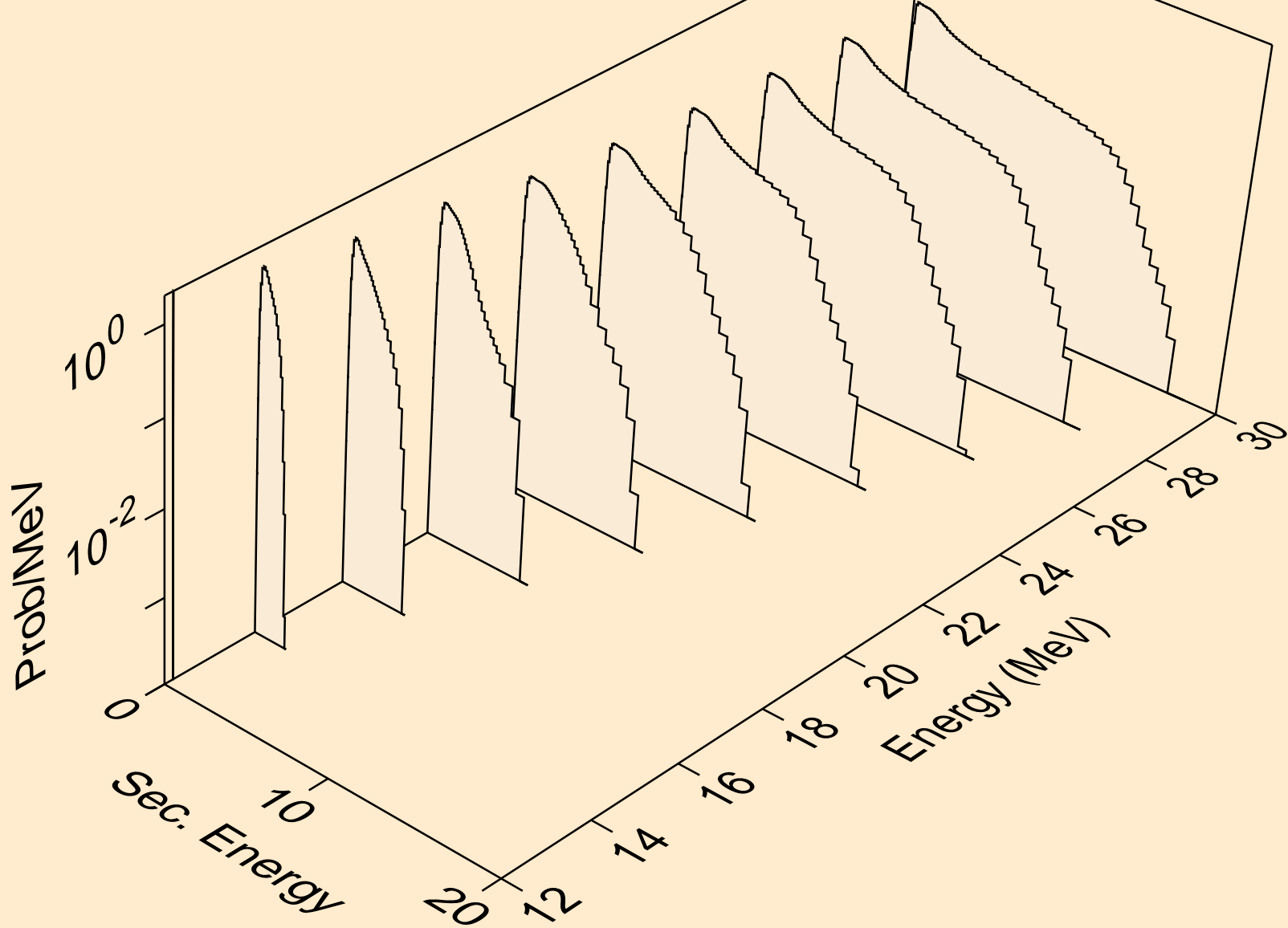

CF253 PROTON ACER TENDL-2023 LIBRARY; T=0.K
neutrons from (p,n*)a

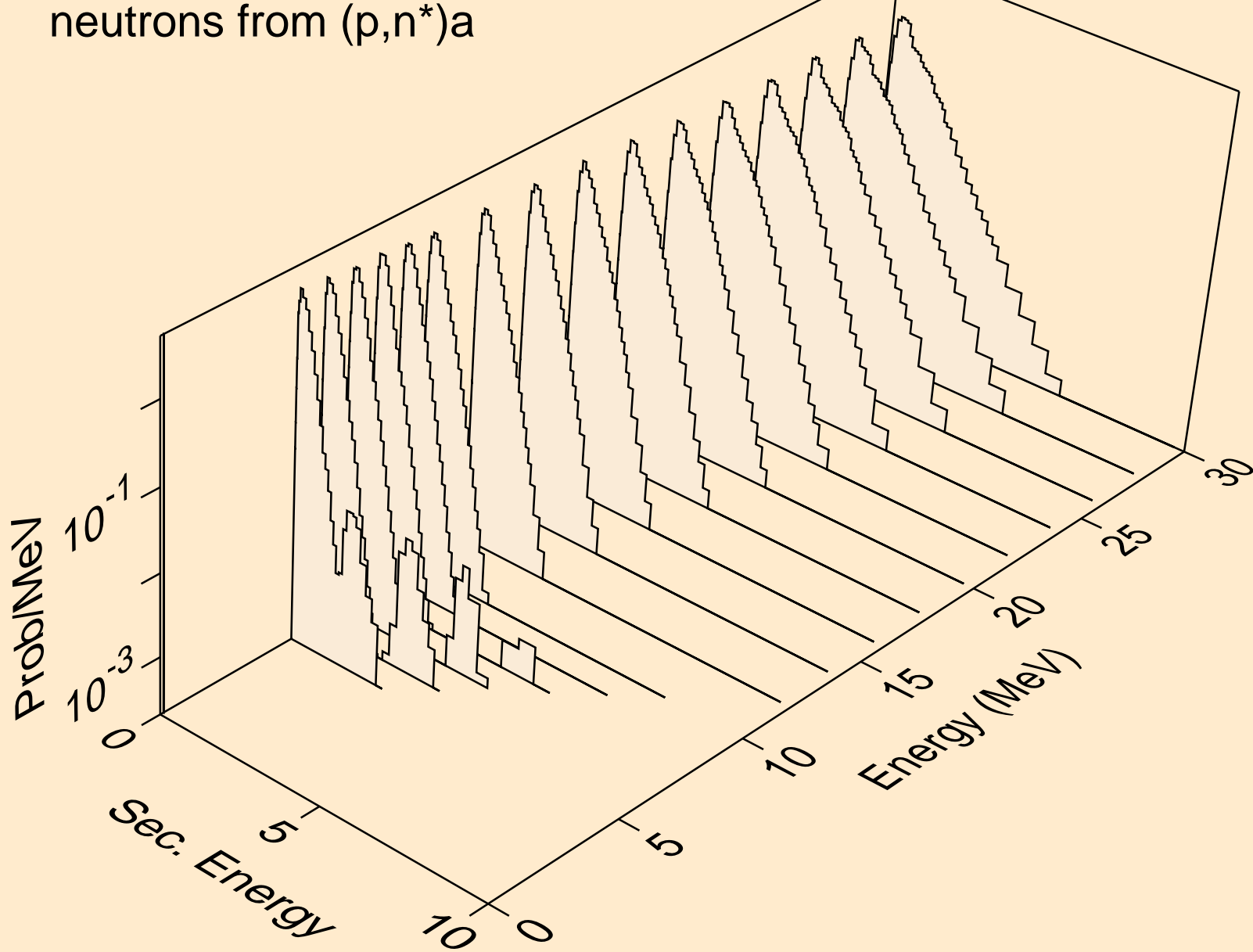

CF253 PROTON ACER TENDL-2023 LIBRARY; T=0.K
neutrons from (p,2n)a

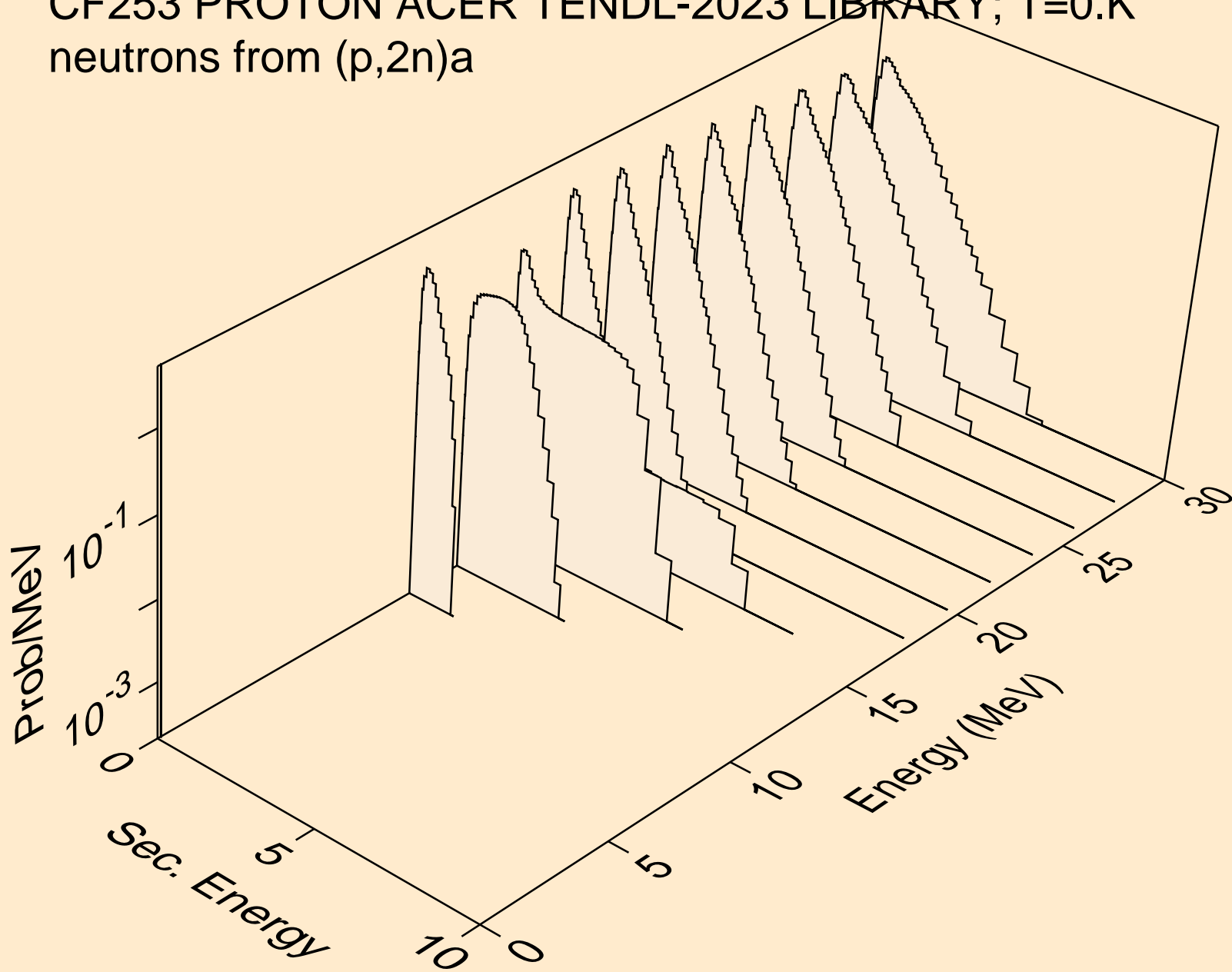

CF253 PROTON ACER TENDL-2023 LIBRARY; T=0.K
neutrons from (p,n*)p

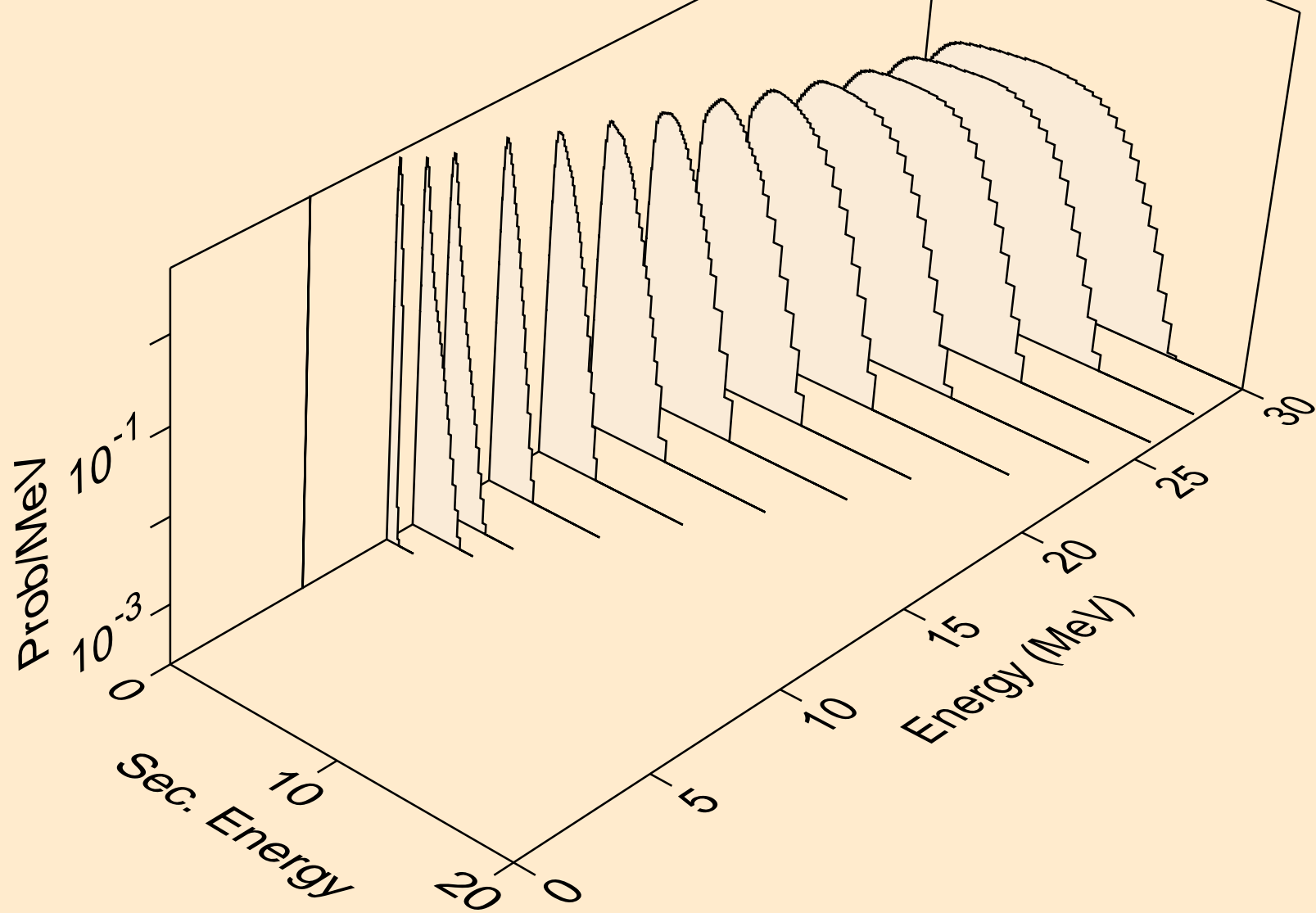

CF253 PROTON ACER TENDL-2023 LIBRARY; T=0.K
neutrons from (p,n*)d

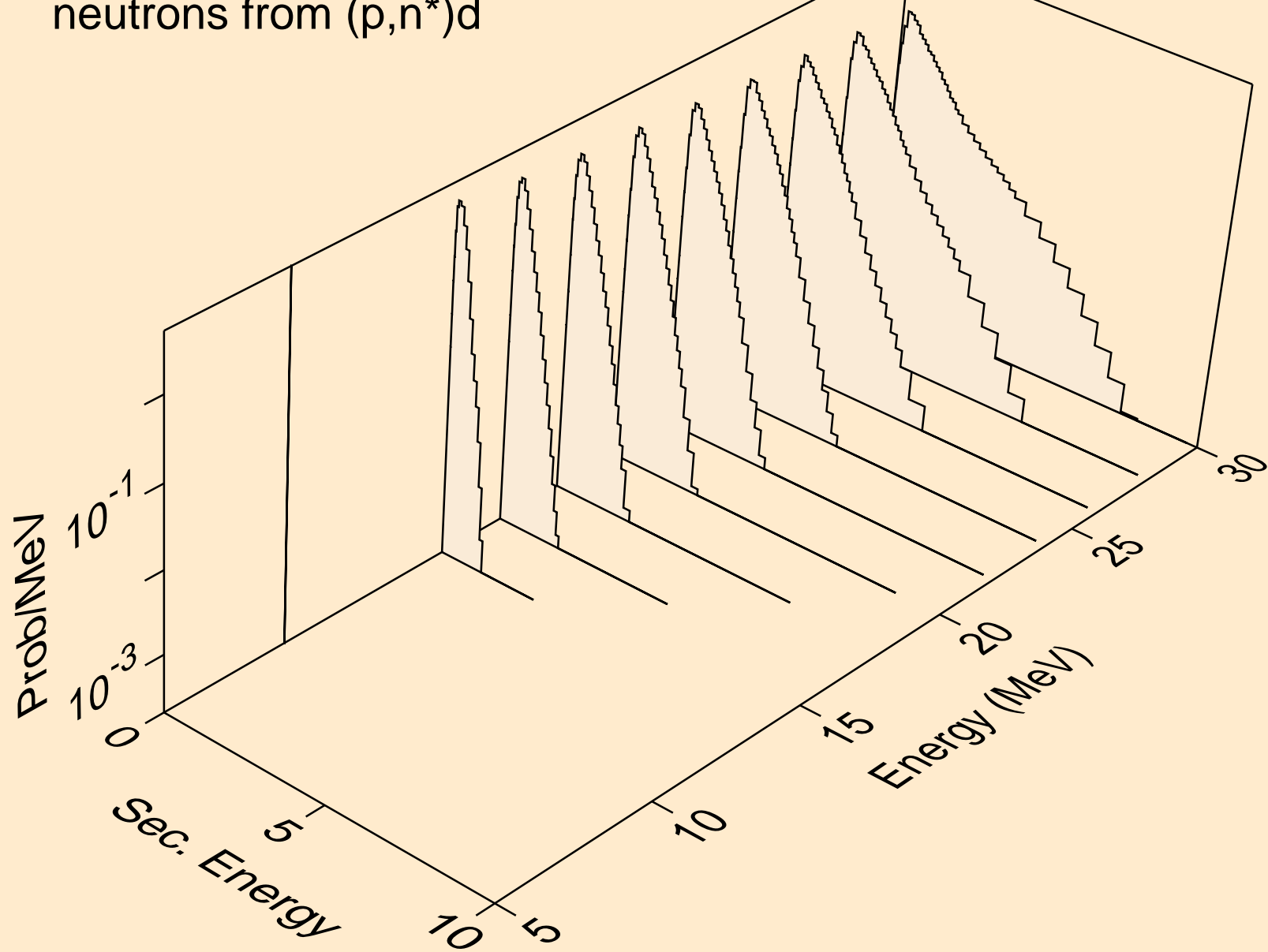

CF253 PROTON ACER TENDL-2023 LIBRARY; T=0.K
neutrons from (p,n*)t

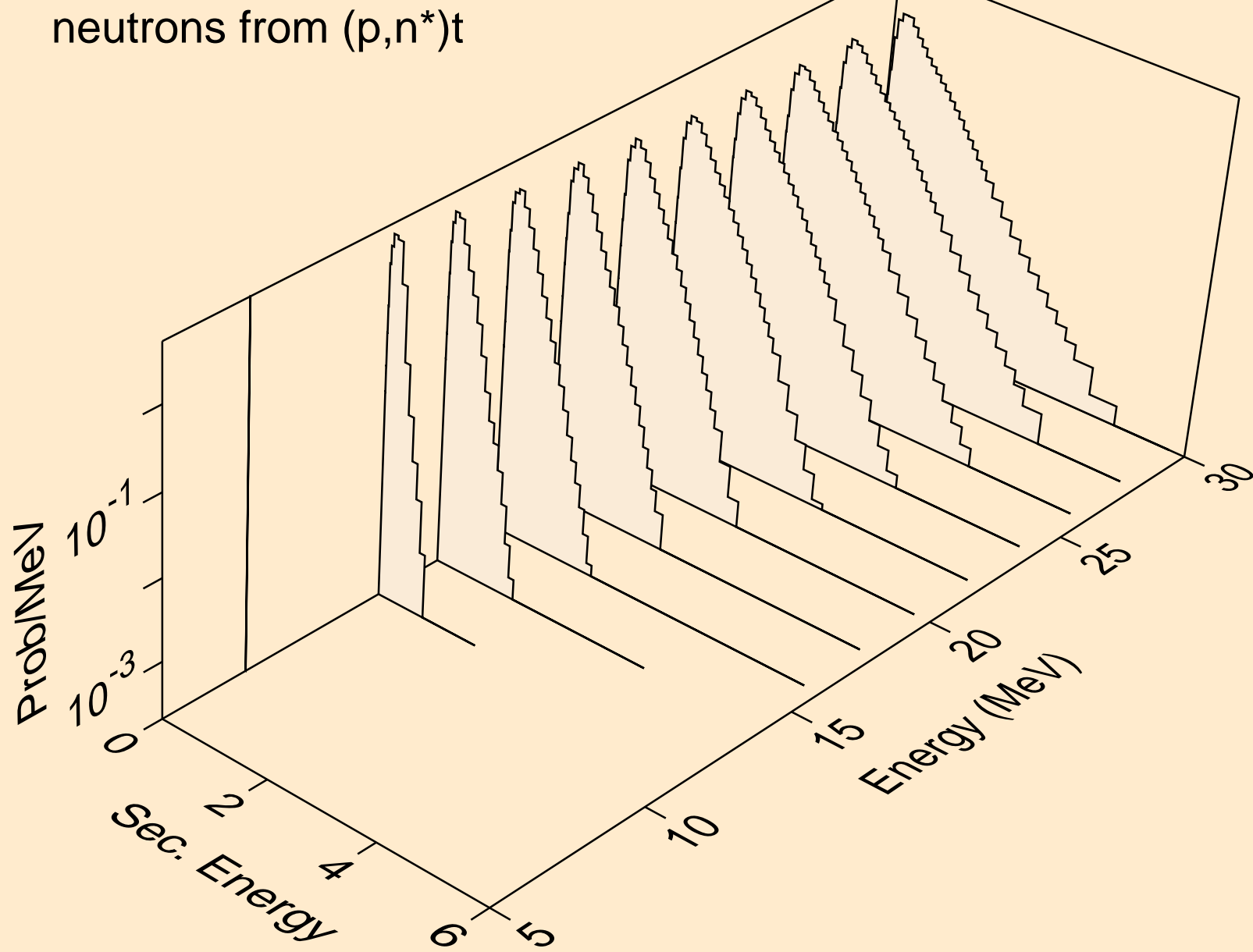

CF253 PROTON ACER TENDL-2023 LIBRARY; T=0.K
neutrons from (p,n*)he3

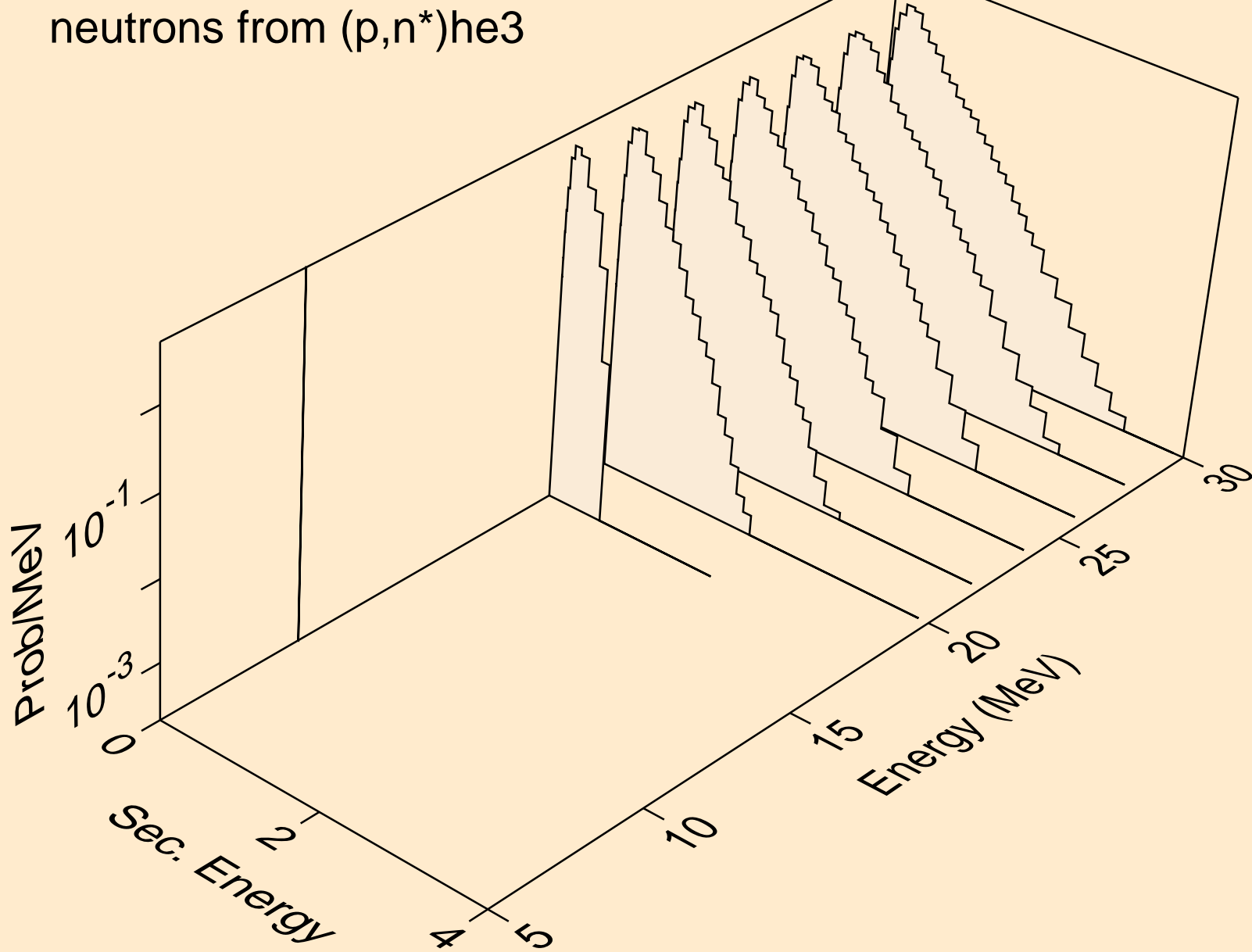

CF253 PROTON ACER TENDL-2023 LIBRARY; T=0.K
neutrons from (p,4n)

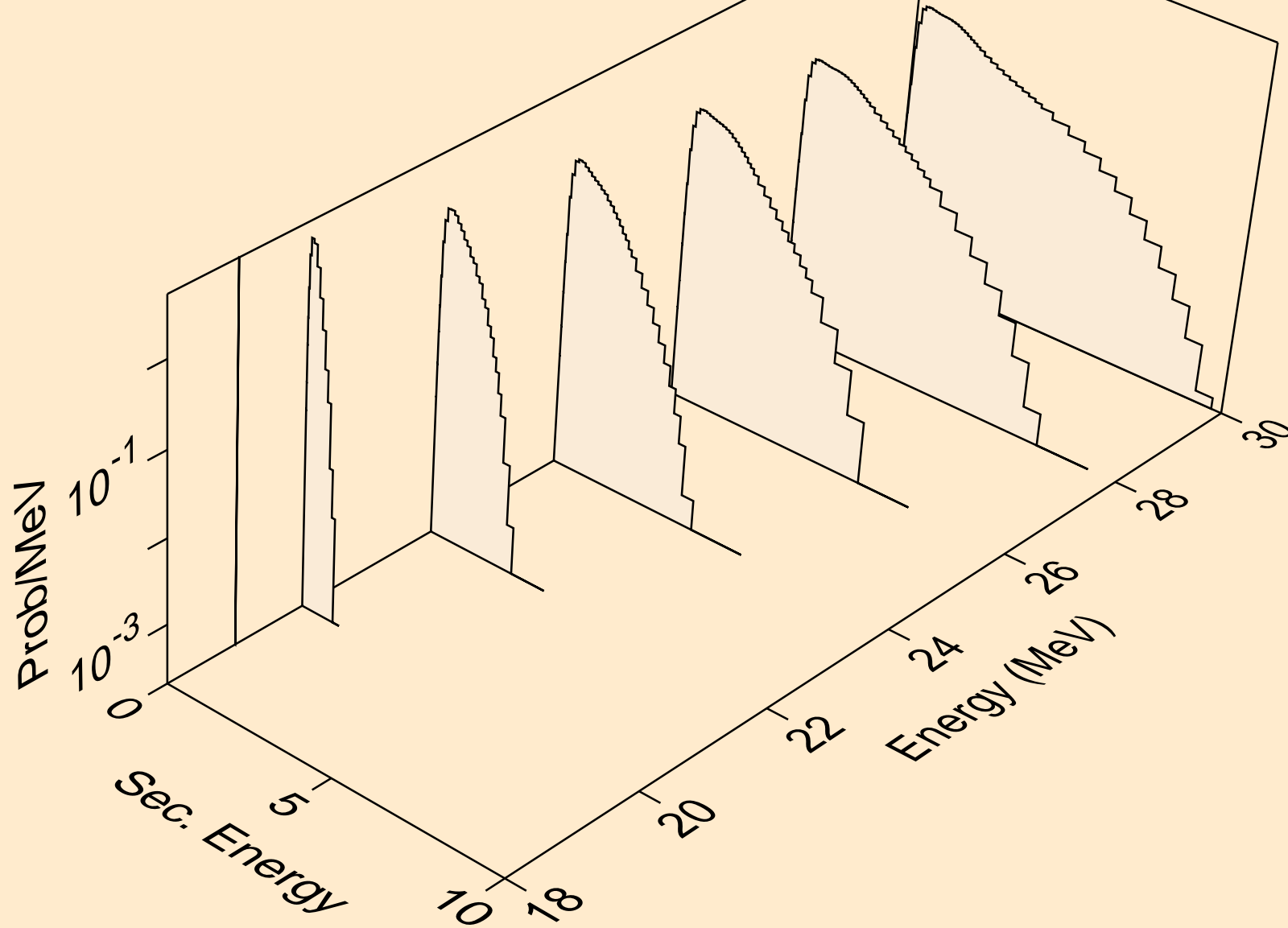

CF253 PROTON ACER TENDL-2023 LIBRARY; T=0.K
neutrons from (p,2np)

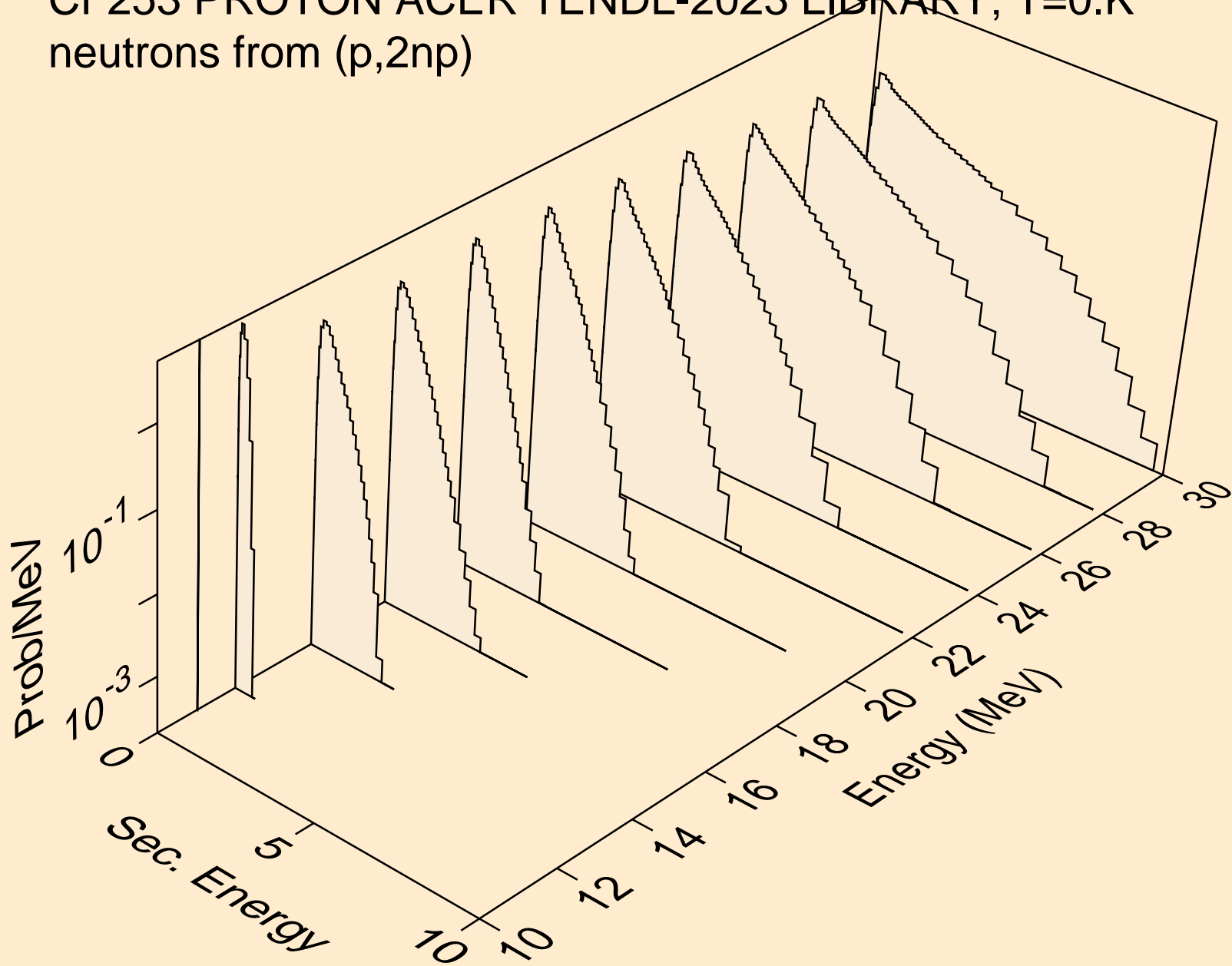

CF253 PROTON ACER TENDL-2023 LIBRARY; T=0.K
neutrons from (p,3np)

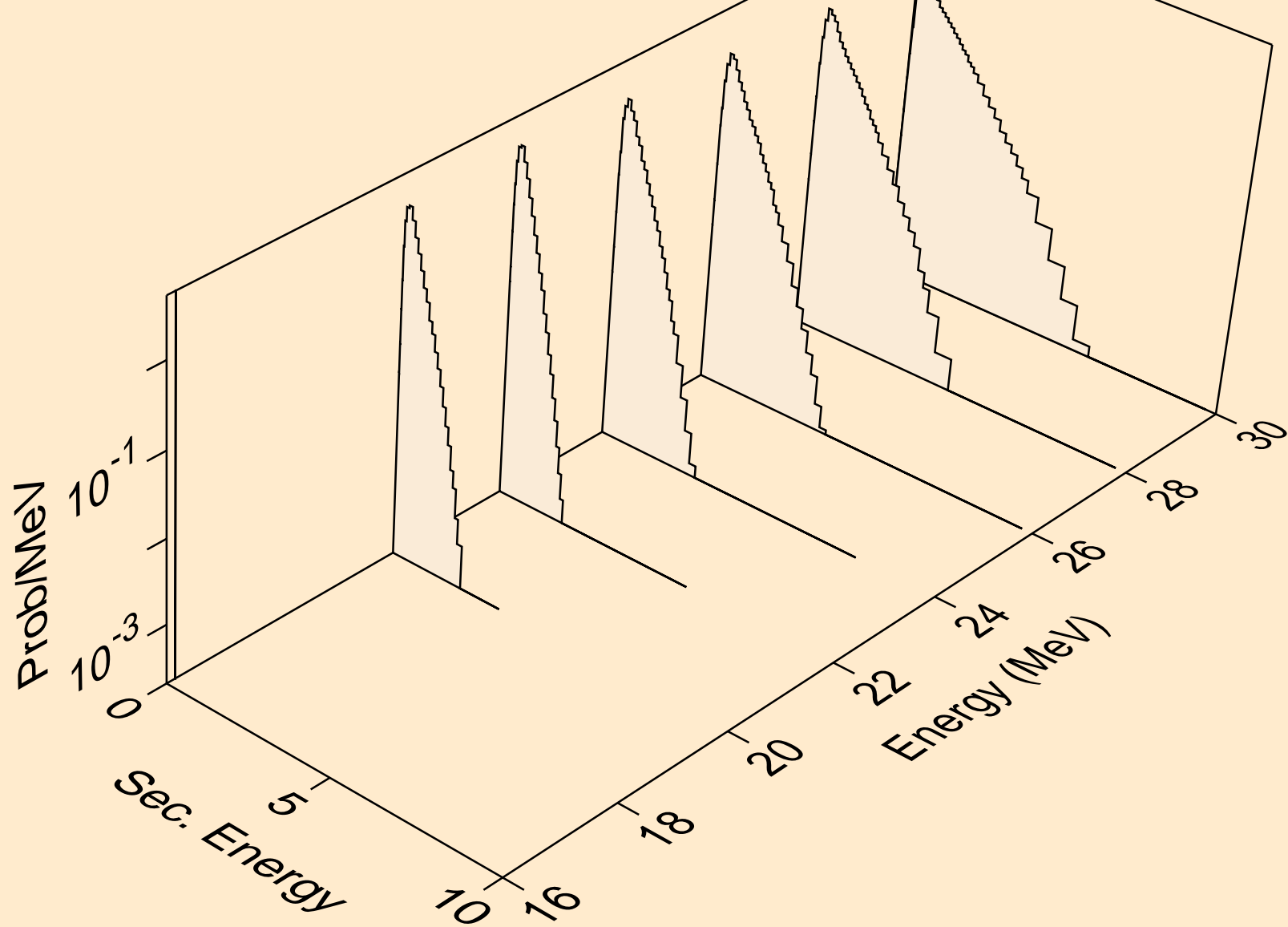

CF253 PROTON ACER TENDL-2023 LIBRARY; T=0.K
deuterons from (p,x)

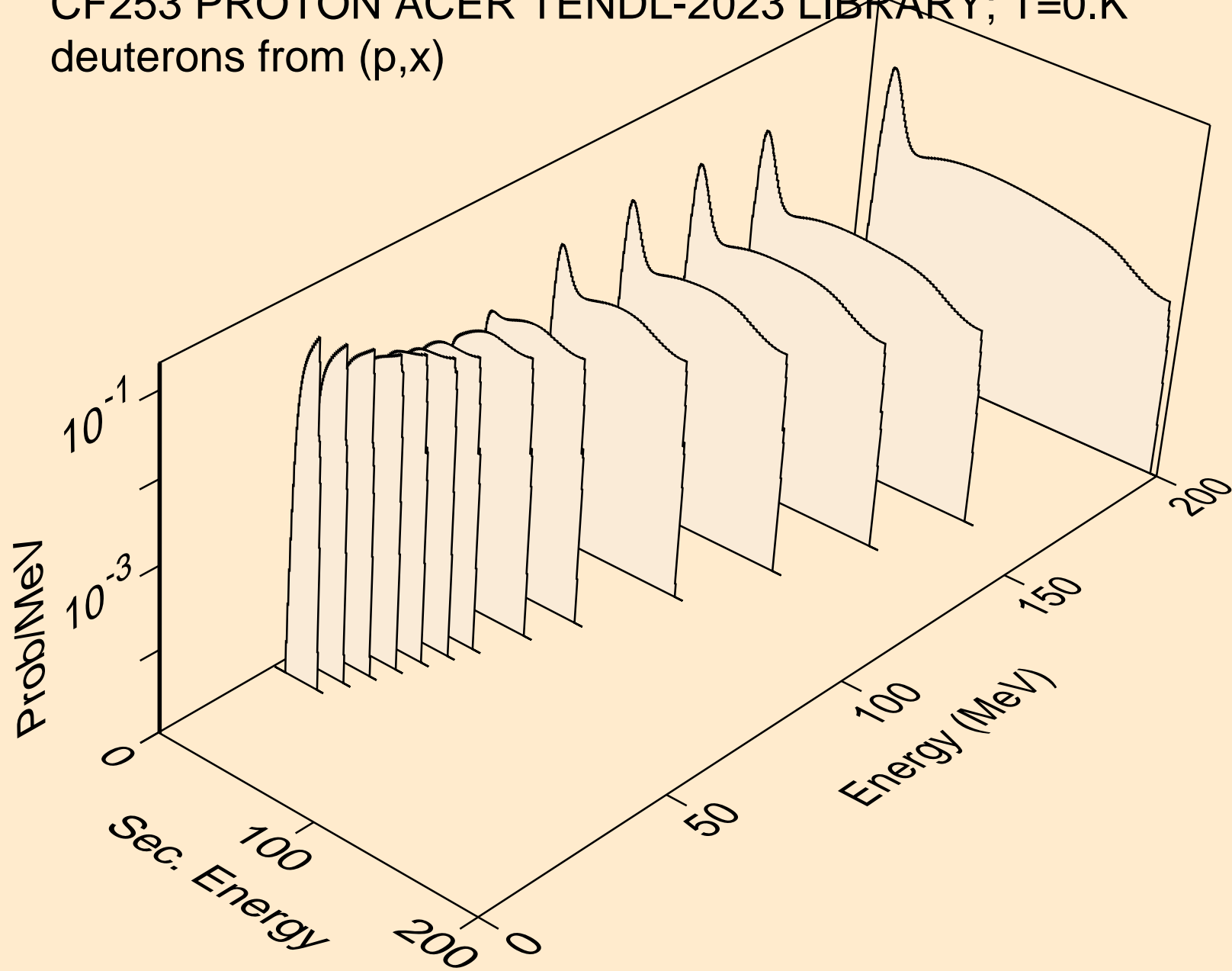

CF253 PROTON ACER TENDL-2023 LIBRARY; T=0.K
deuterons from (p,2nd)

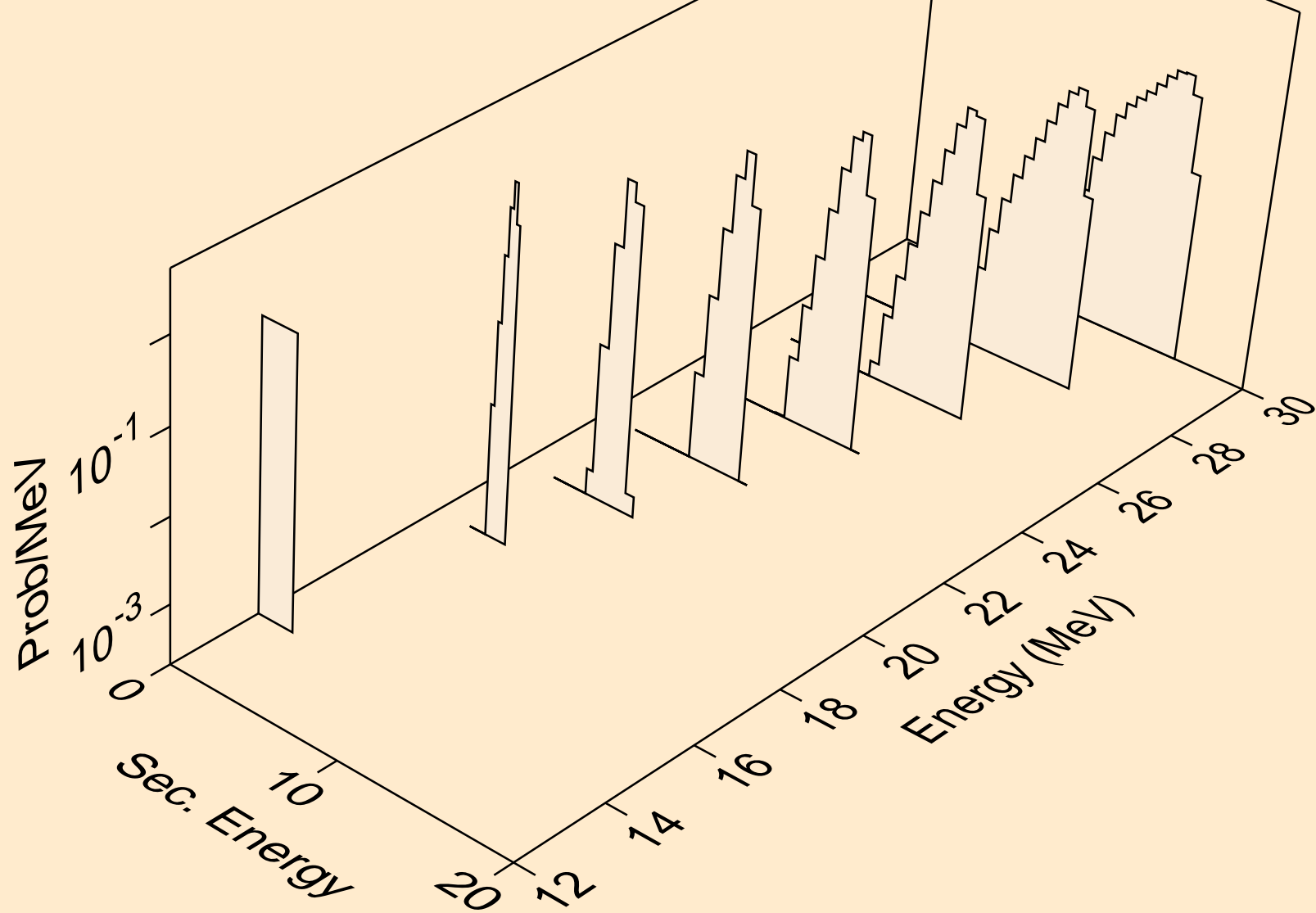

CF253 PROTON ACER TENDL-2023 LIBRARY; T=0.K
deuterons from (p,n*)d

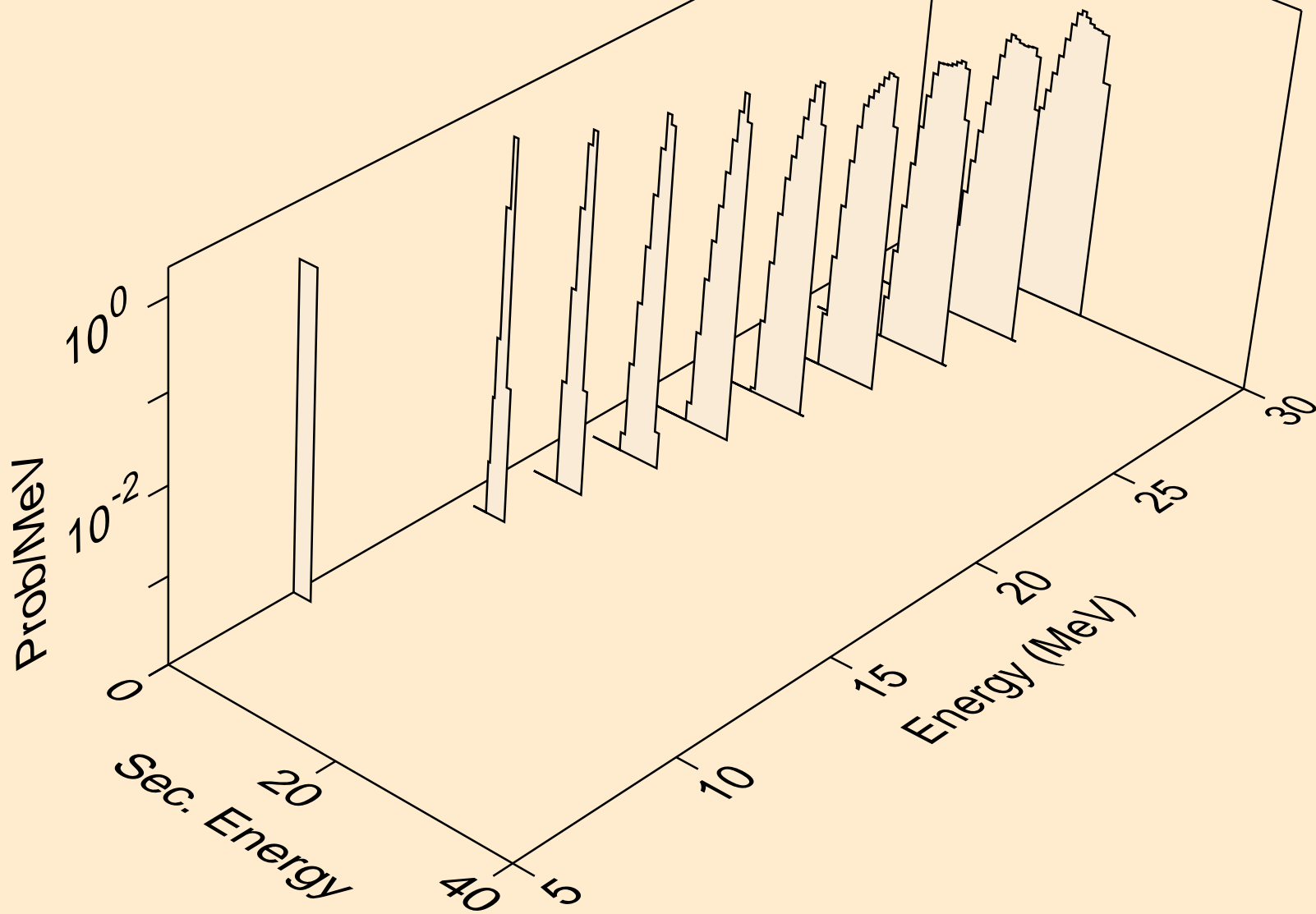

CF253 PROTON ACER TENDL-2023 LIBRARY; T=0.K
deuterons from (p,d)

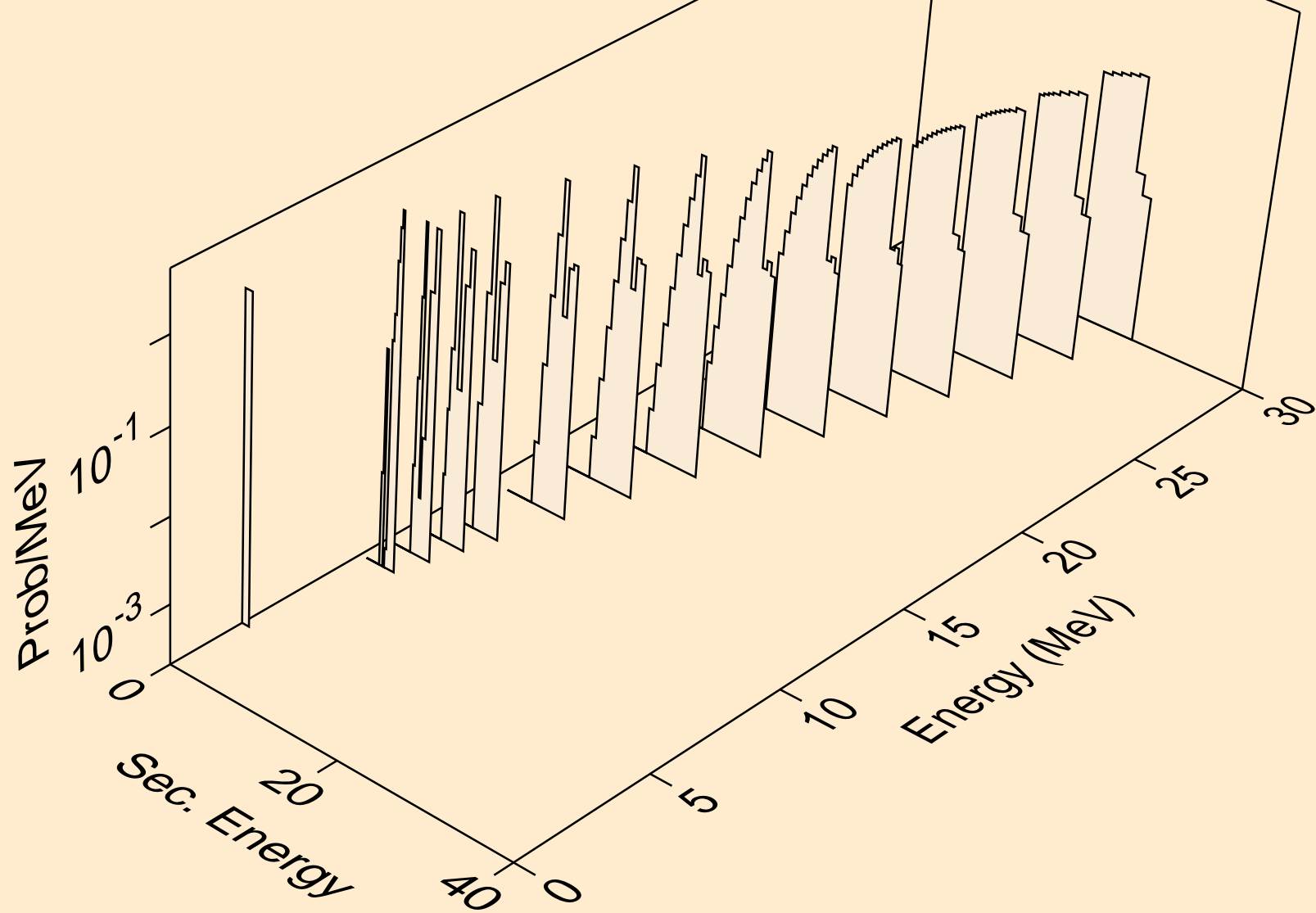

CF253 PROTON ACER TENDL-2023 LIBRARY; T=0.K
tritons from (p,x)

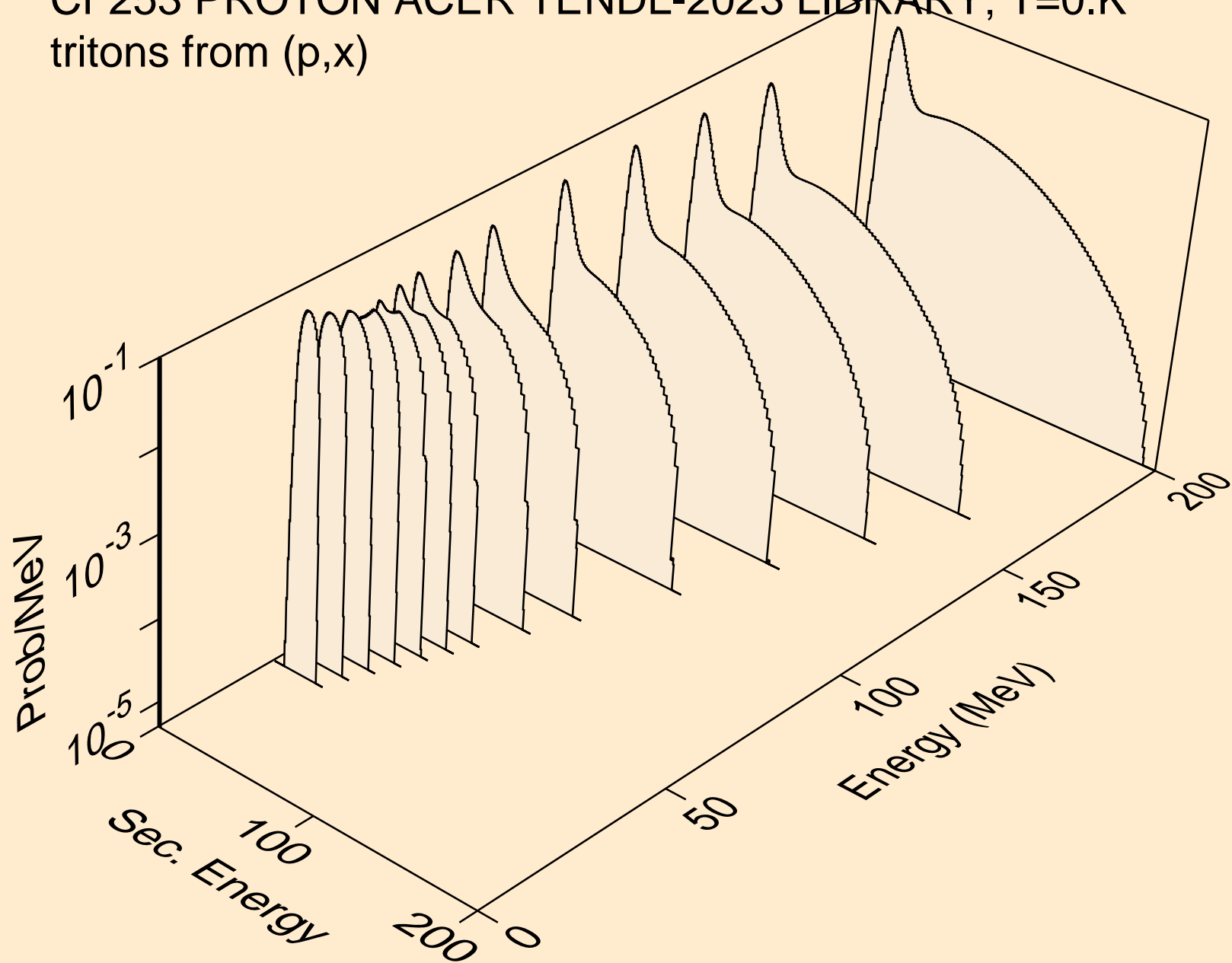

CF253 PROTON ACER TENDL-2023 LIBRARY; T=0.K
tritons from (p,n*)t

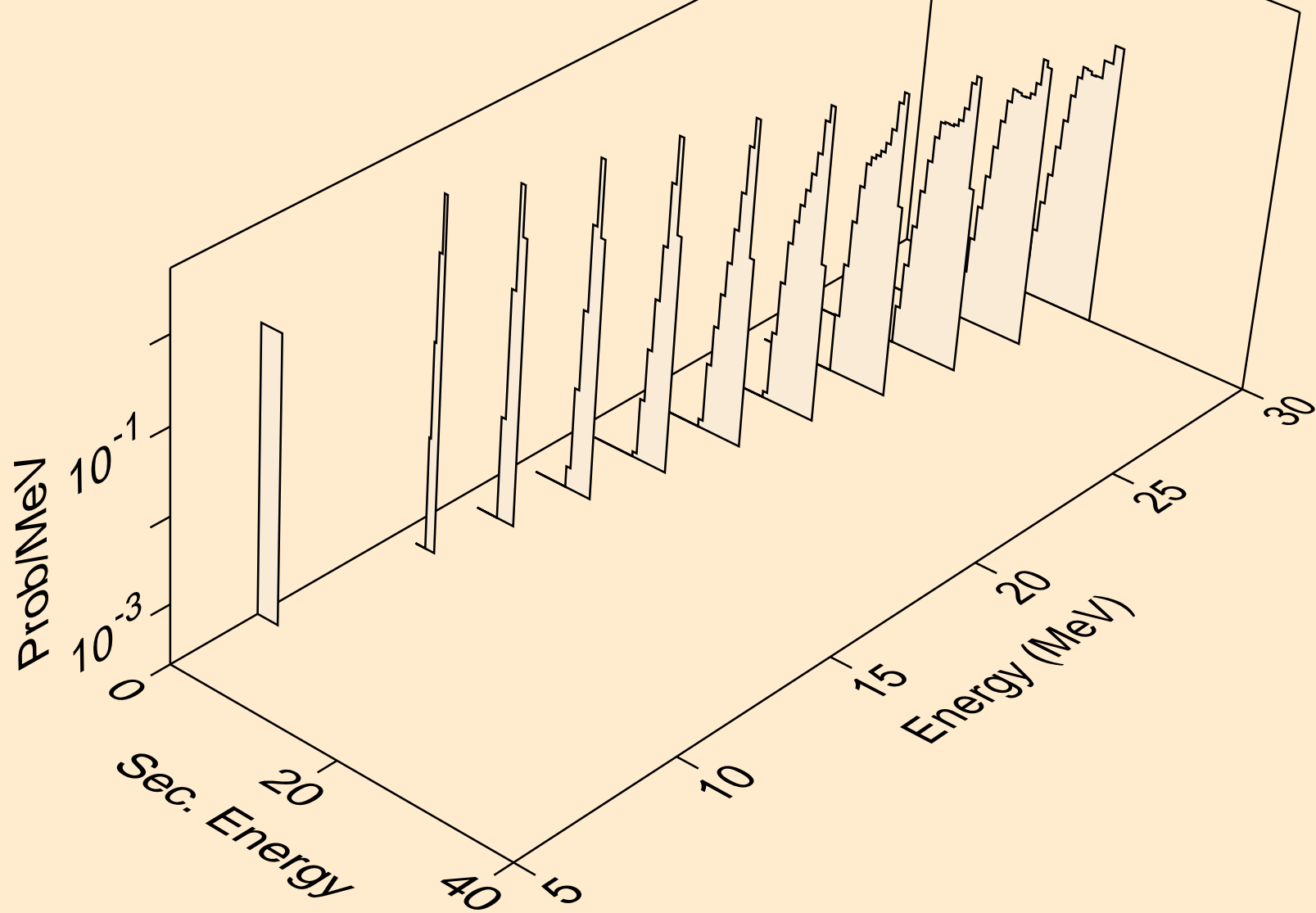

CF253 PROTON ACER TENDL-2023 LIBRARY; T=0.K
tritons from (p,t)

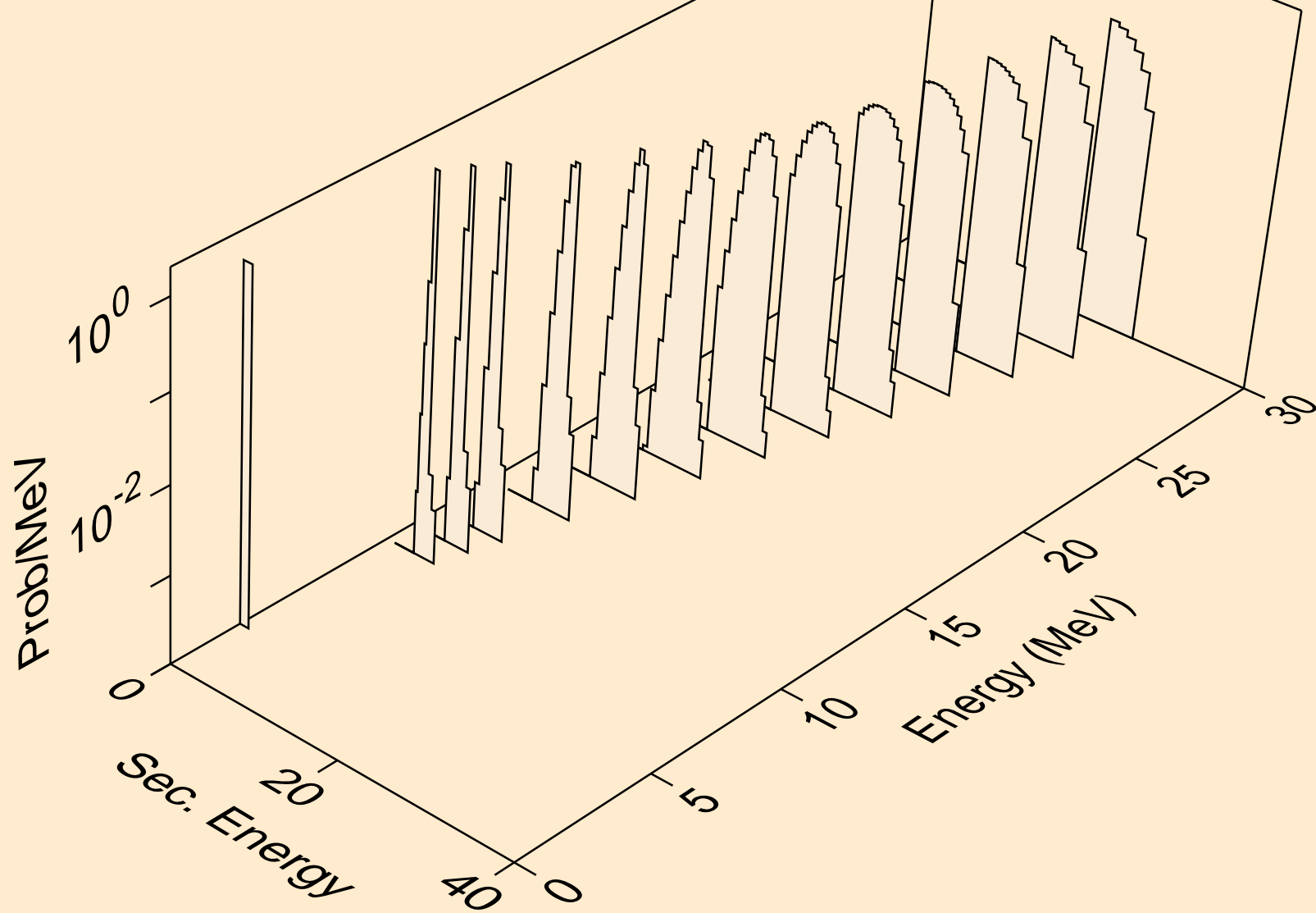

CF253 PROTON ACER TENDL-2023 LIBRARY; T=0.K
he3s from (p,x)

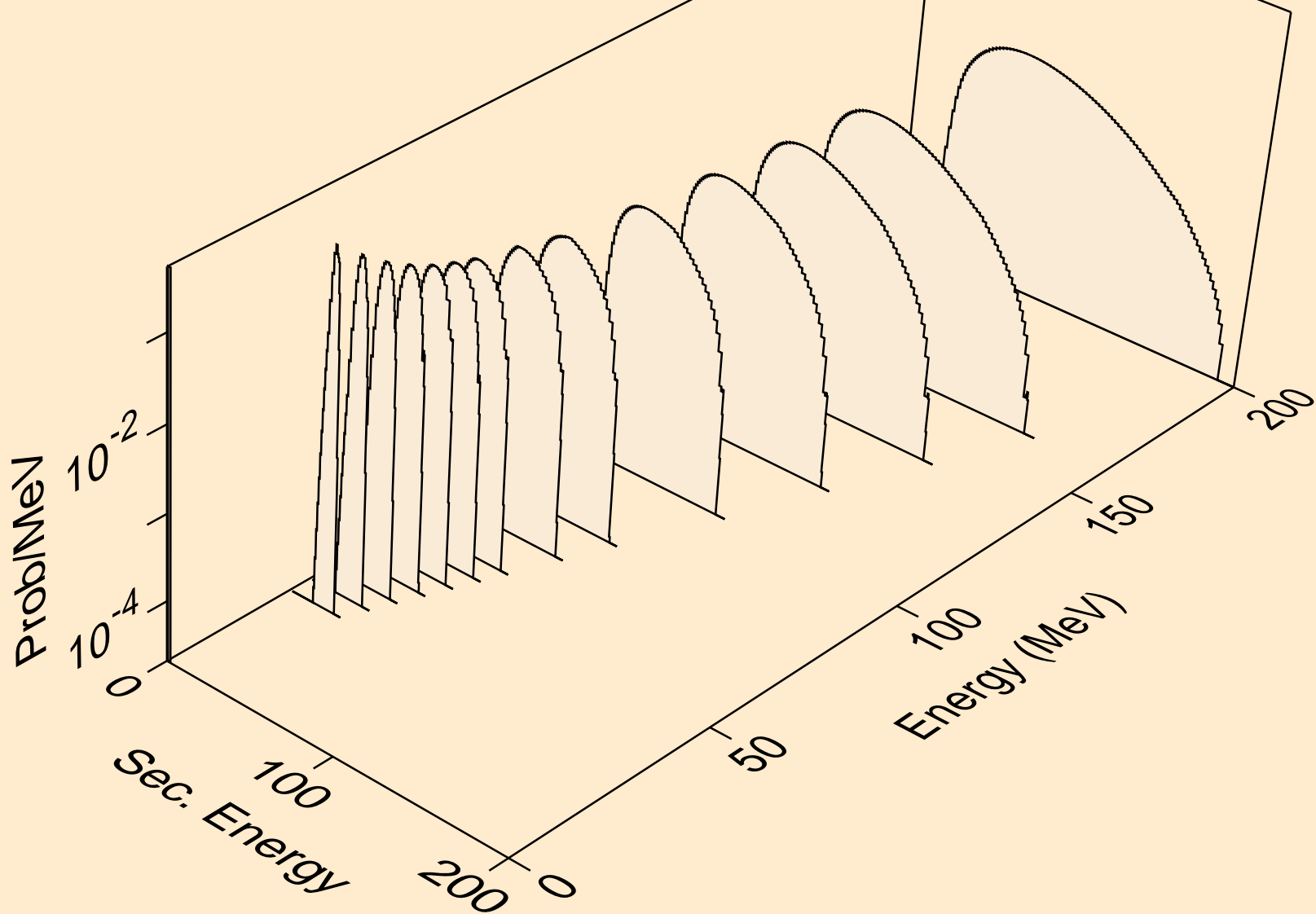

CF253 PROTON ACER TENDL-2023 LIBRARY; T=0.K
he3s from (p,n*)he3

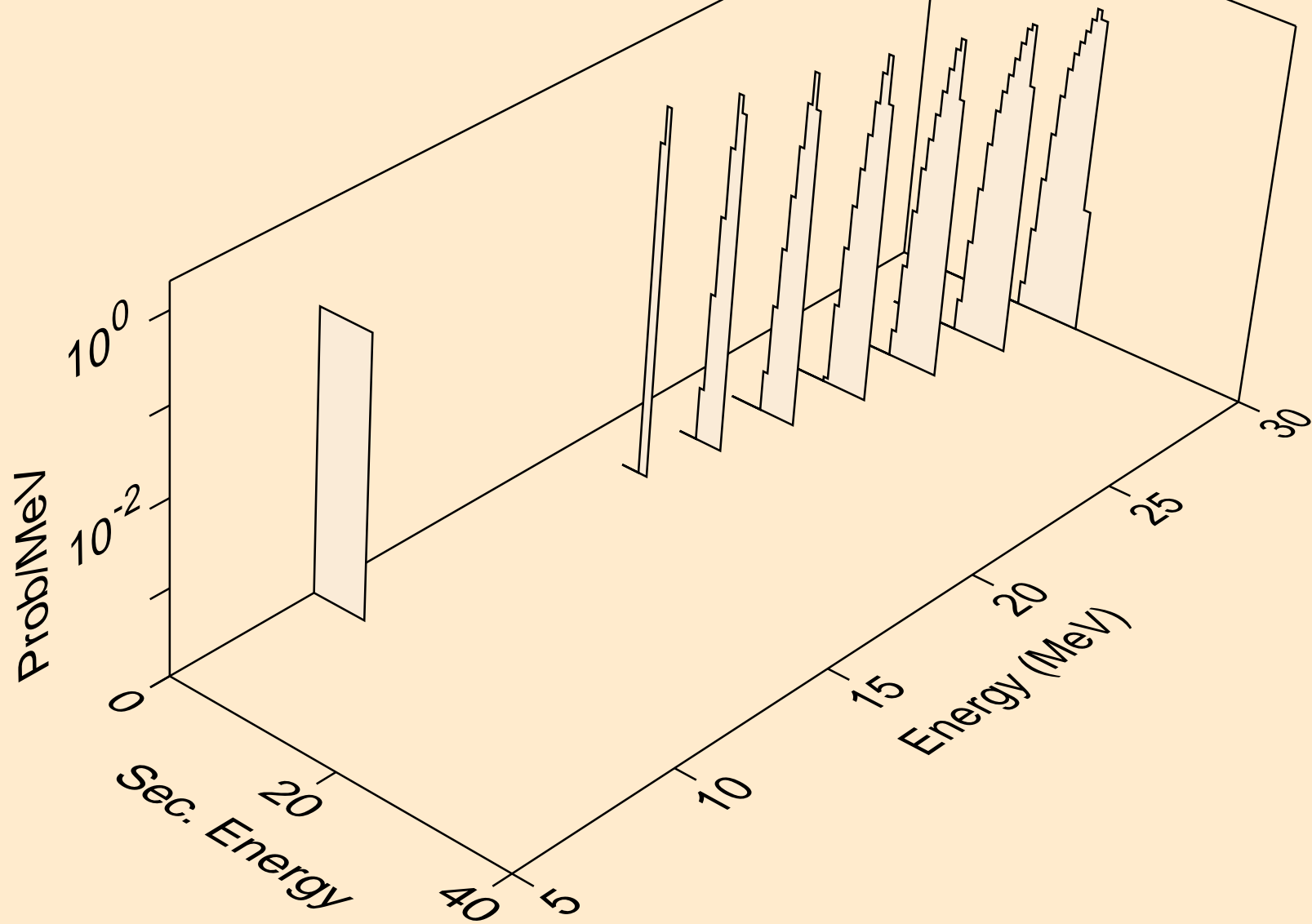

CF253 PROTON ACER TENDL-2023 LIBRARY; T=0.K
he3s from (p,he3)

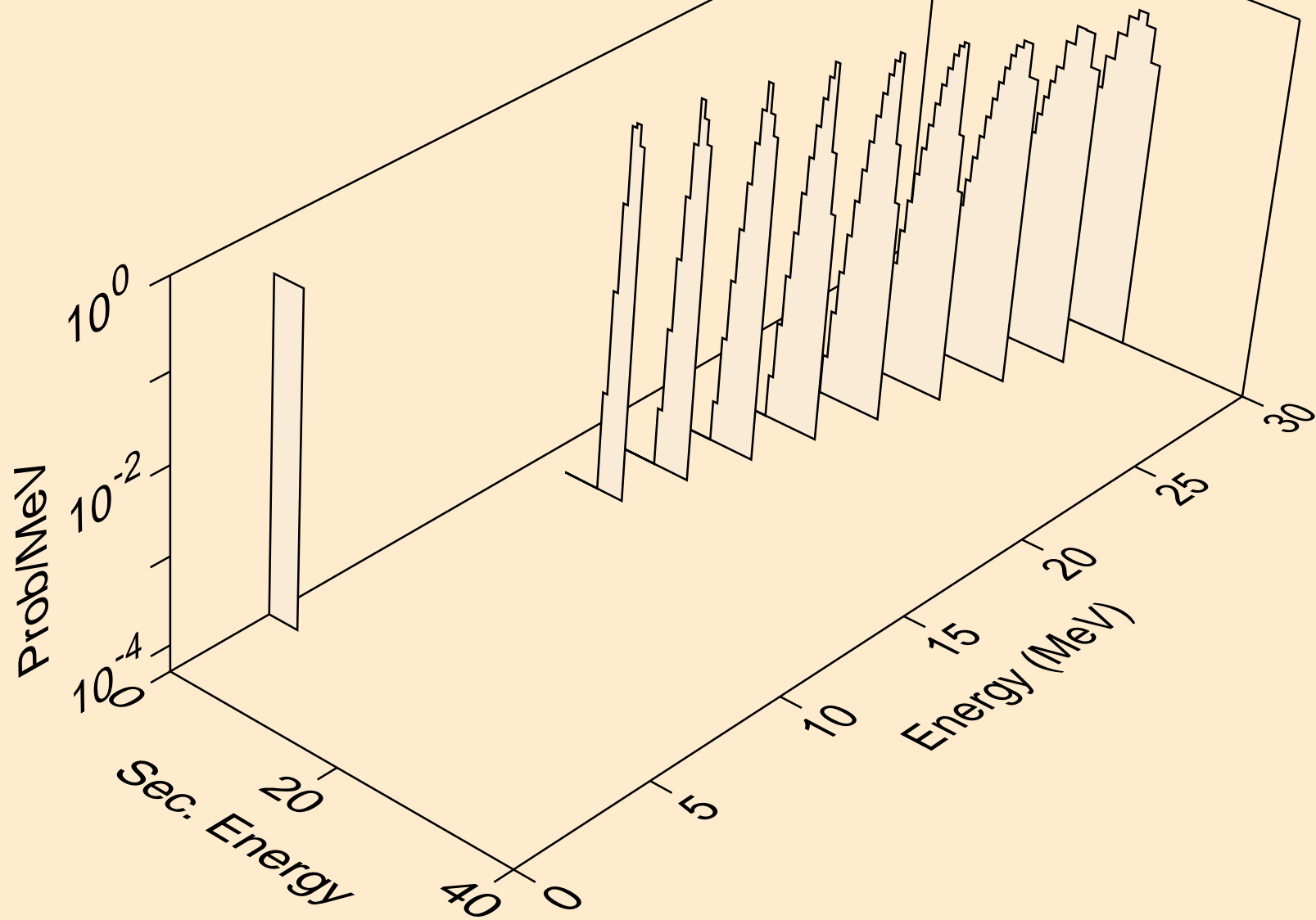

CF253 PROTON ACER TENDL-2023 LIBRARY; T=0.K
alphas from (p,x)

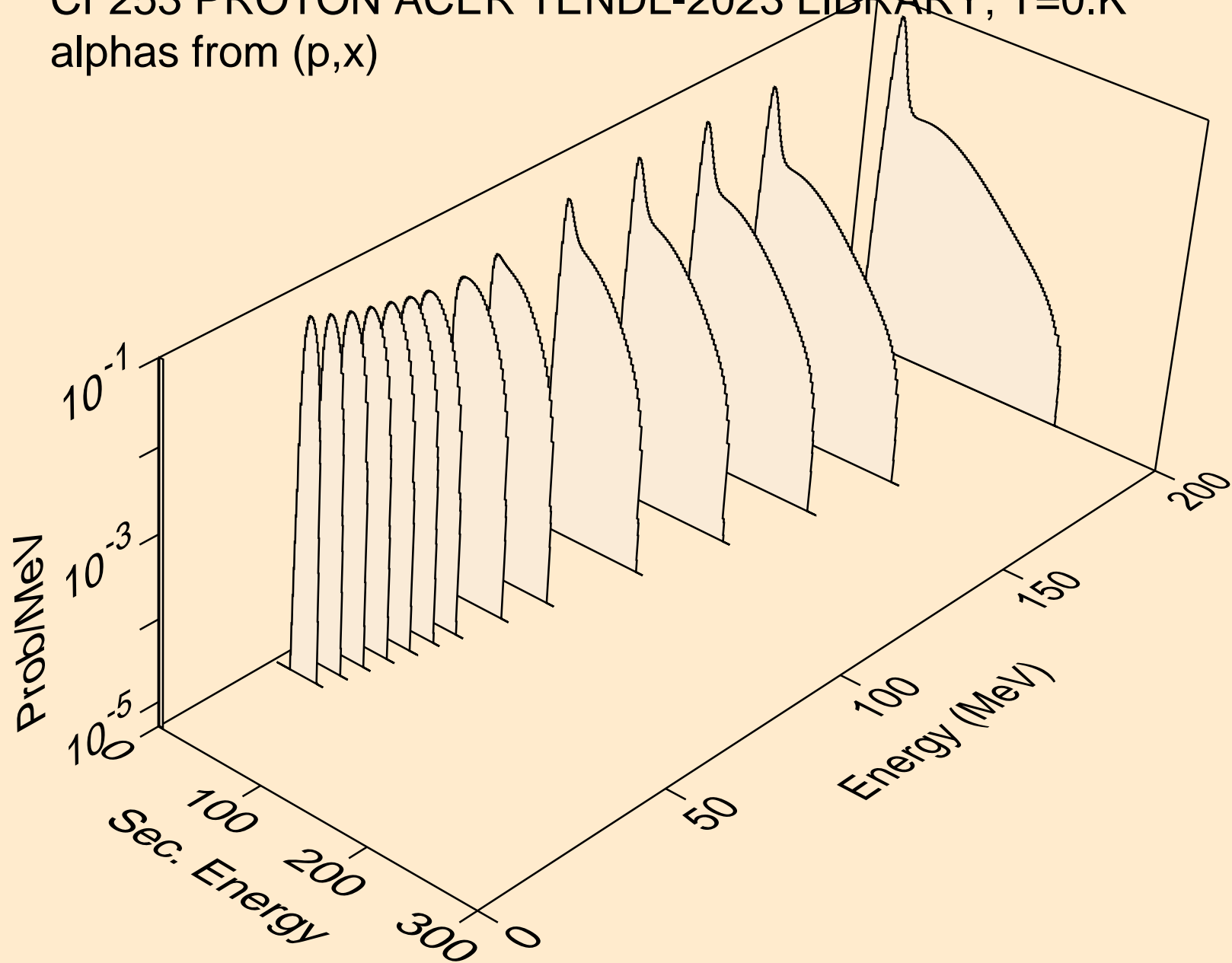

CF253 PROTON ACER TENDL-2023 LIBRARY; T=0.K
alphas from (p,n*)a

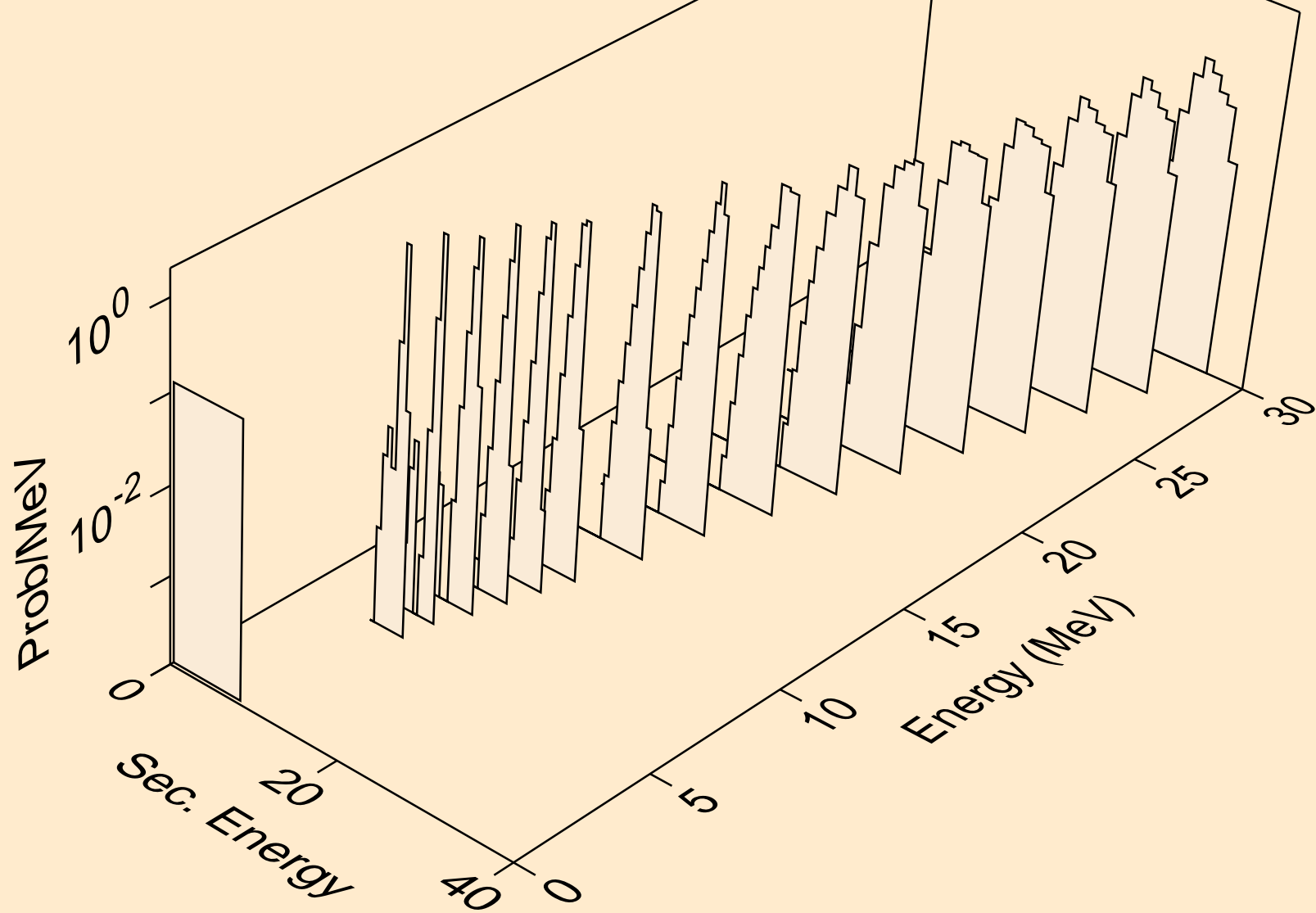

CF253 PROTON ACER TENDL-2023 LIBRARY; T=0.K
alphas from (p,2n)a

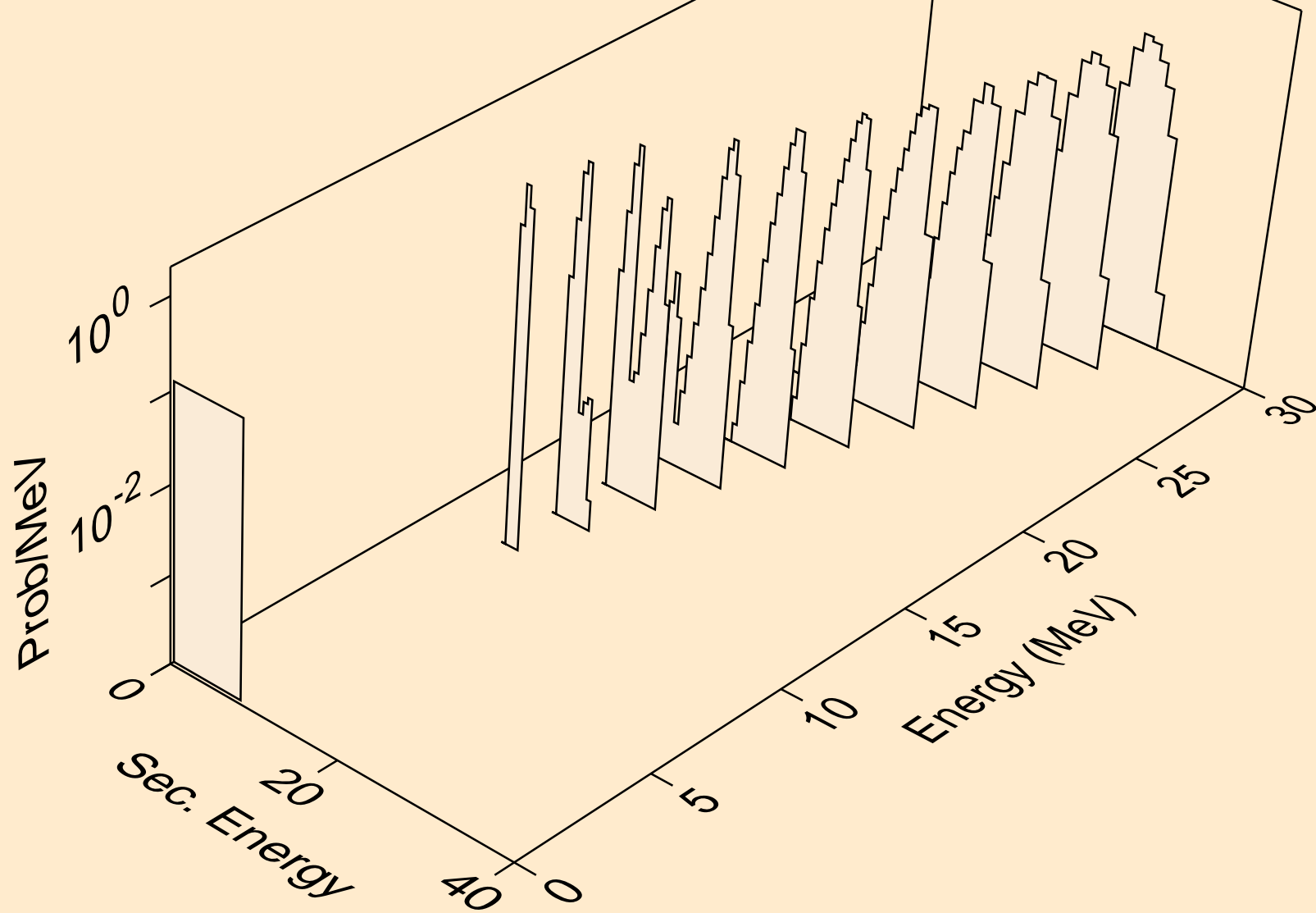

CF253 PROTON ACER TENDL-2023 LIBRARY; T=0.K
alphas from (p,a)

