

# ER167 PROTON ACER TENDL-2023 LIBRARY; T=0.K

## Principal cross sections

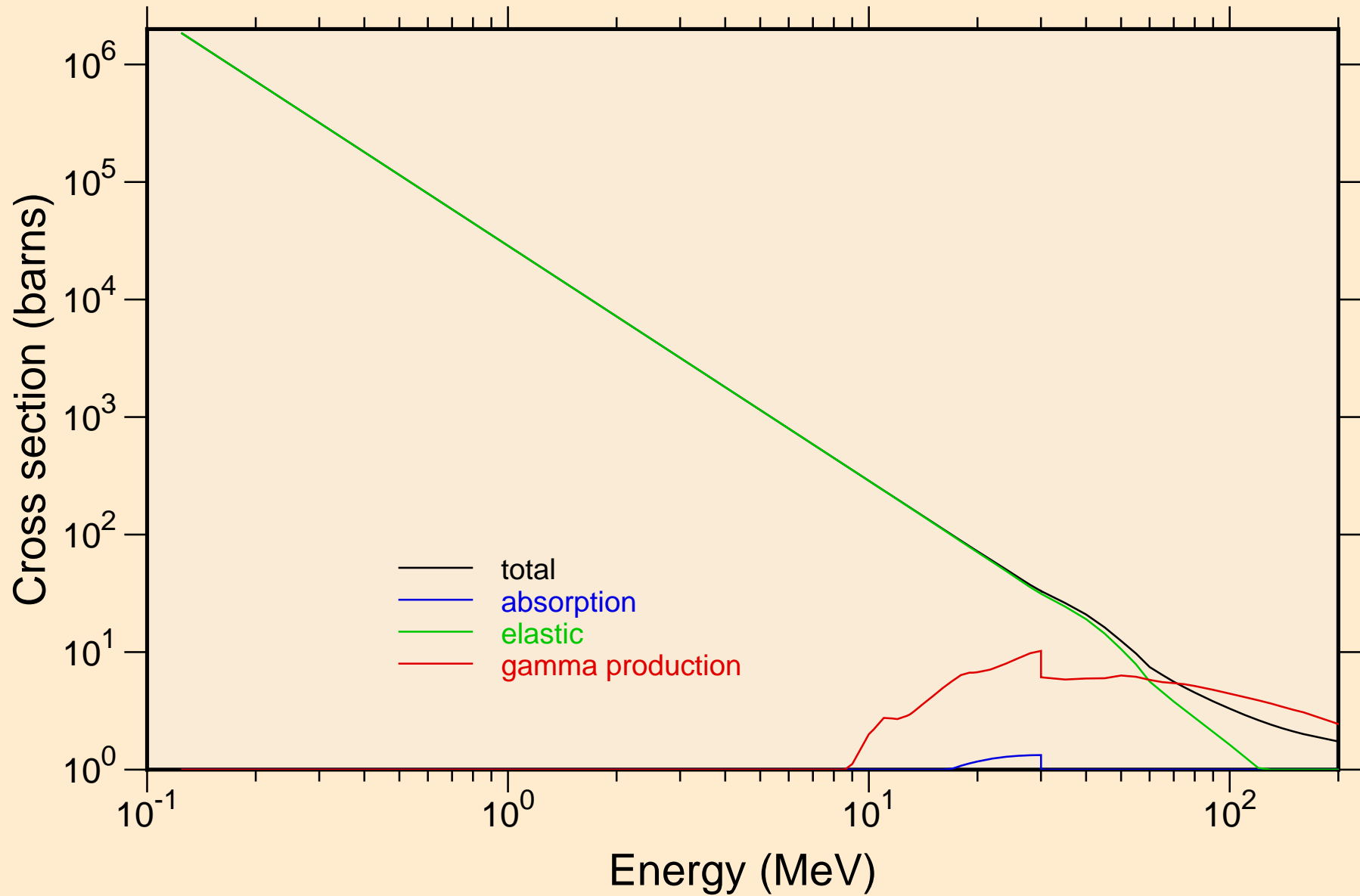

# ER167 PROTON ACER TENDL-2023 LIBRARY; T=0.K

## Heating

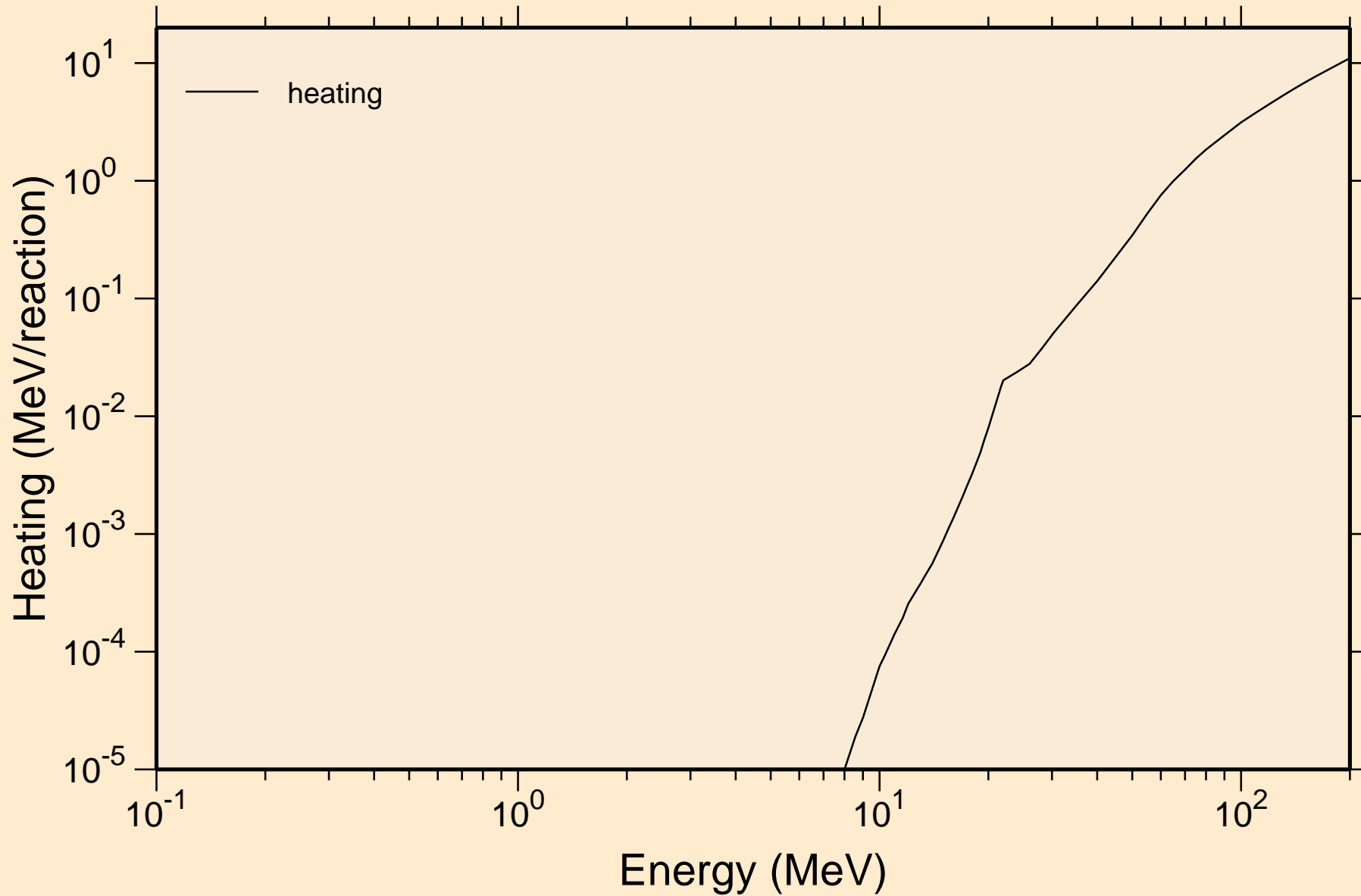

# ER167 PROTON ACER TENDL-2023 LIBRARY; T=0.K

## Principal cross sections

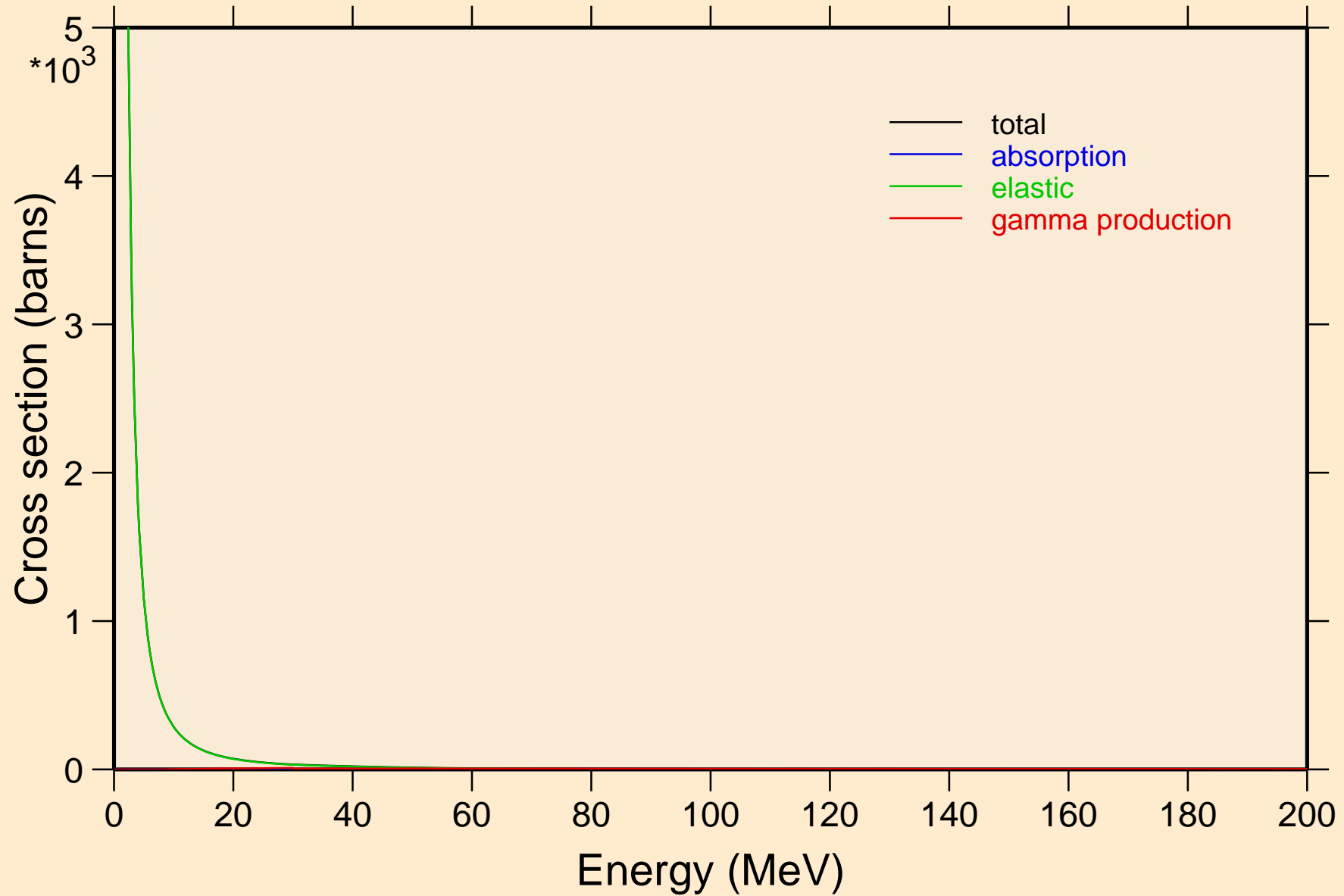

ER167 PROTON ACER TENDL-2023 LIBRARY; T=0.K

Heating

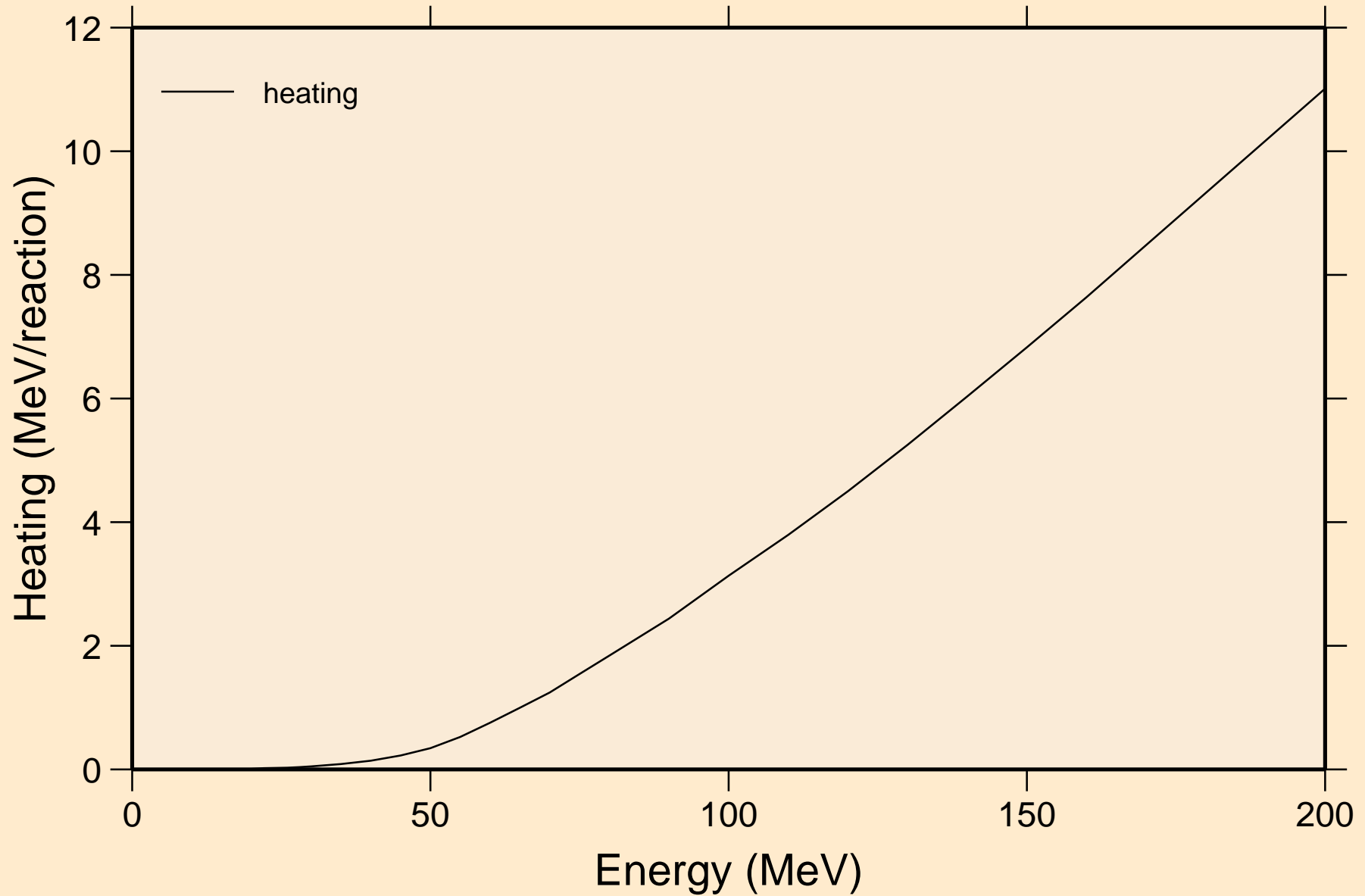

# ER167 PROTON ACER TENDL-2023 LIBRARY; T=0.K

## Threshold reactions

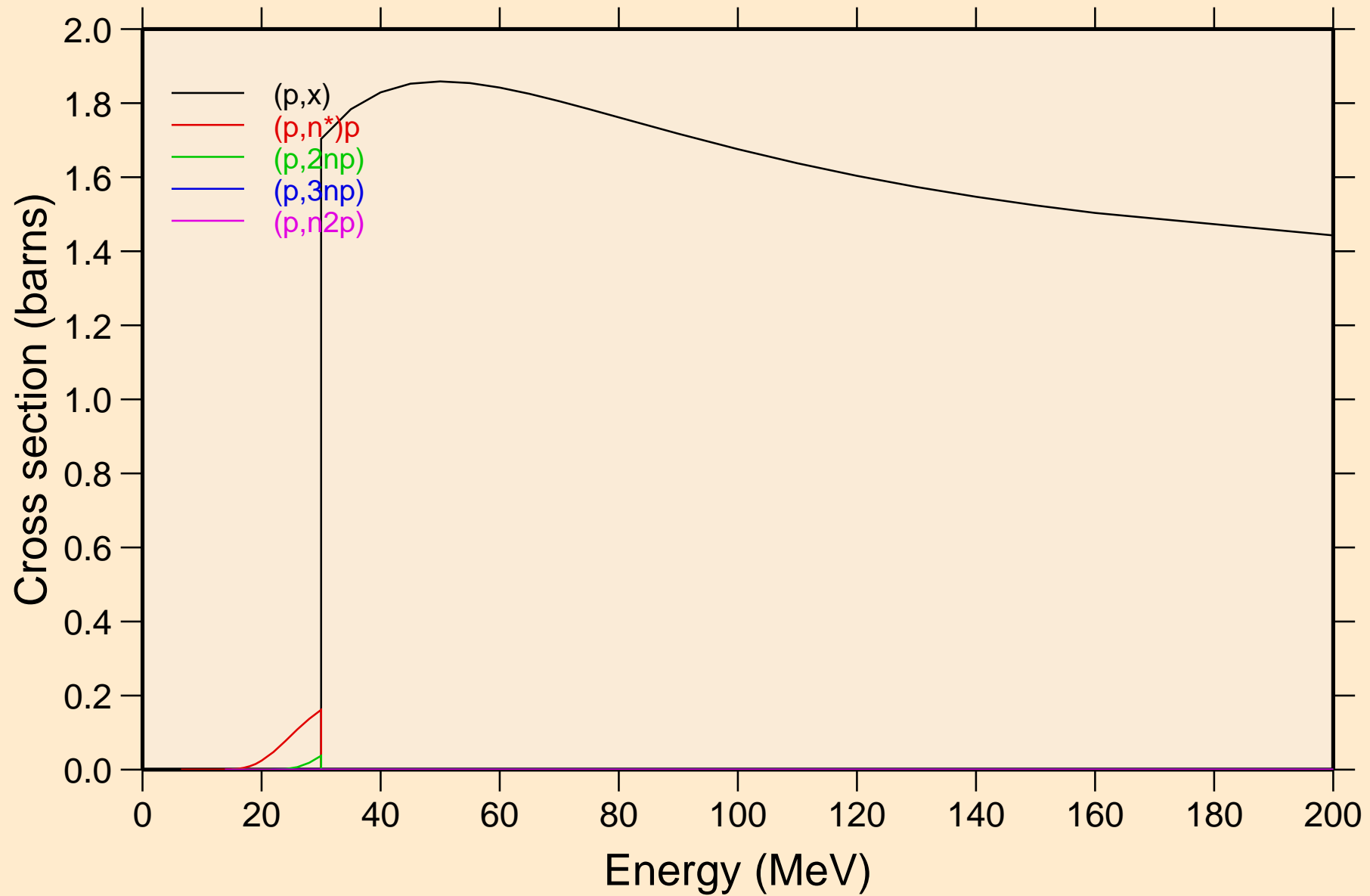

ER167 PROTON ACER TENDL-2023 LIBRARY; T=0.K  
Threshold reactions

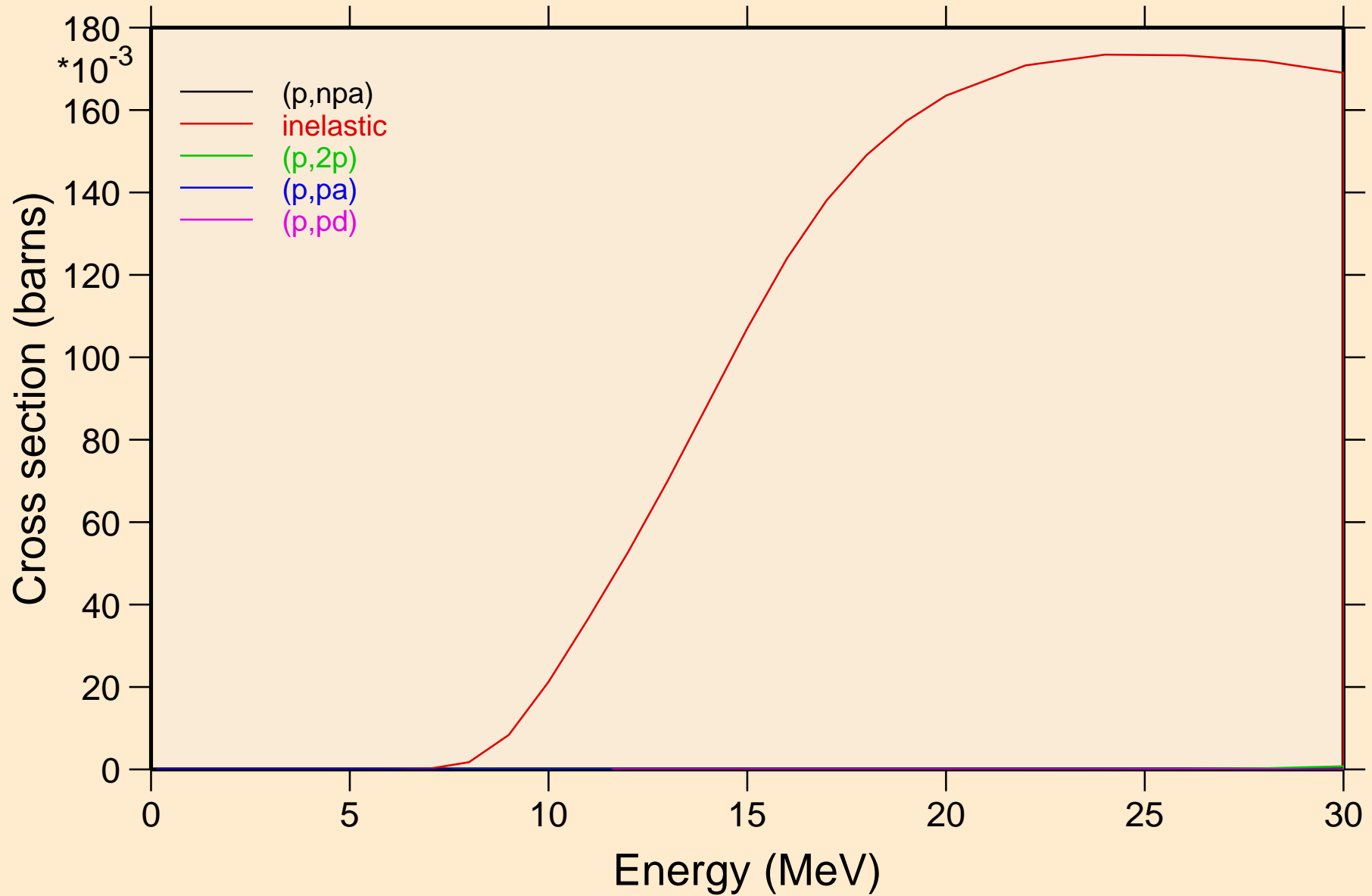

ER167 PROTON ACER TENDL-2023 LIBRARY; T=0.K  
Threshold reactions

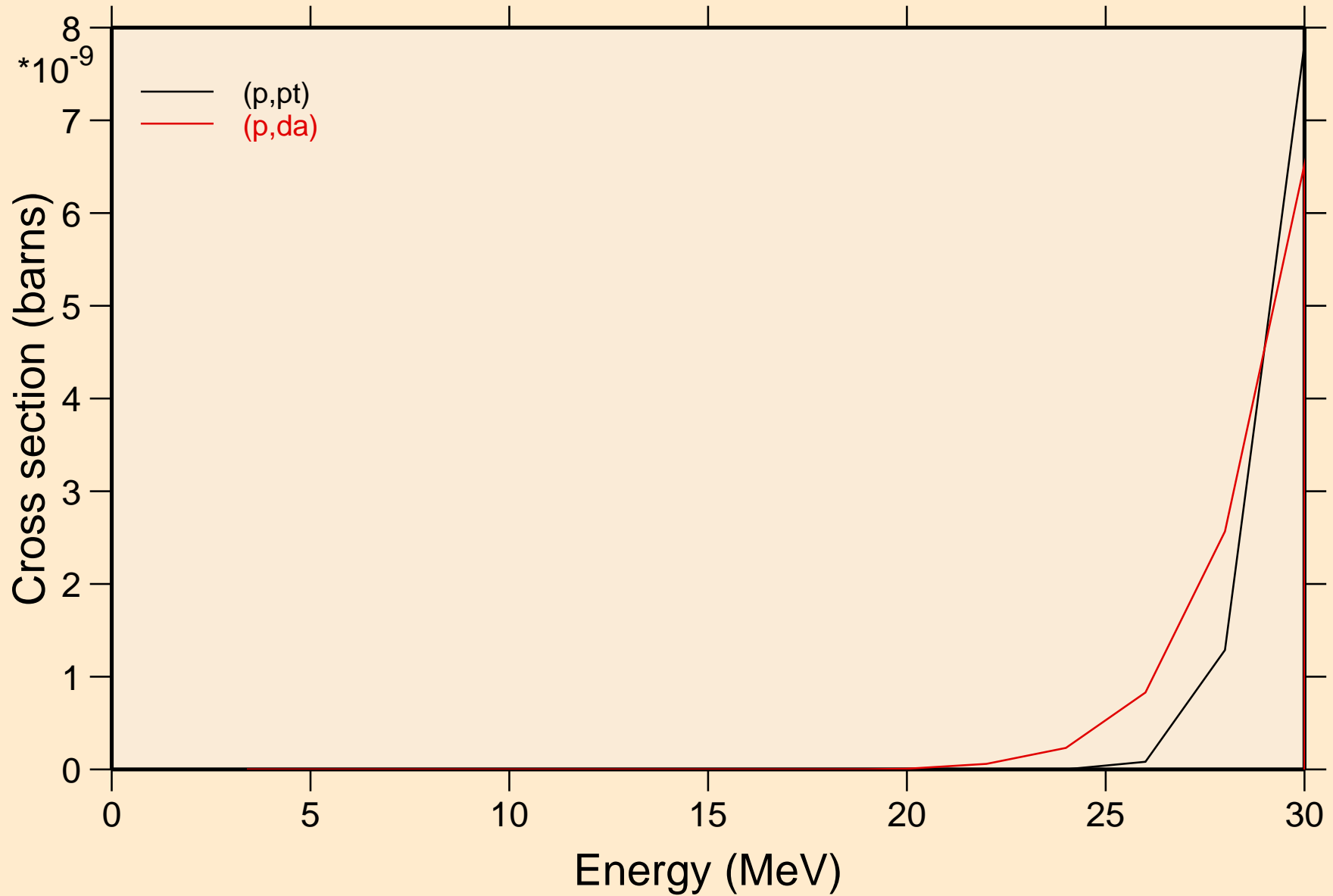

ER167 PROTON ACER TENDL-2023 LIBRARY; T=0.K  
angular distribution for elastic

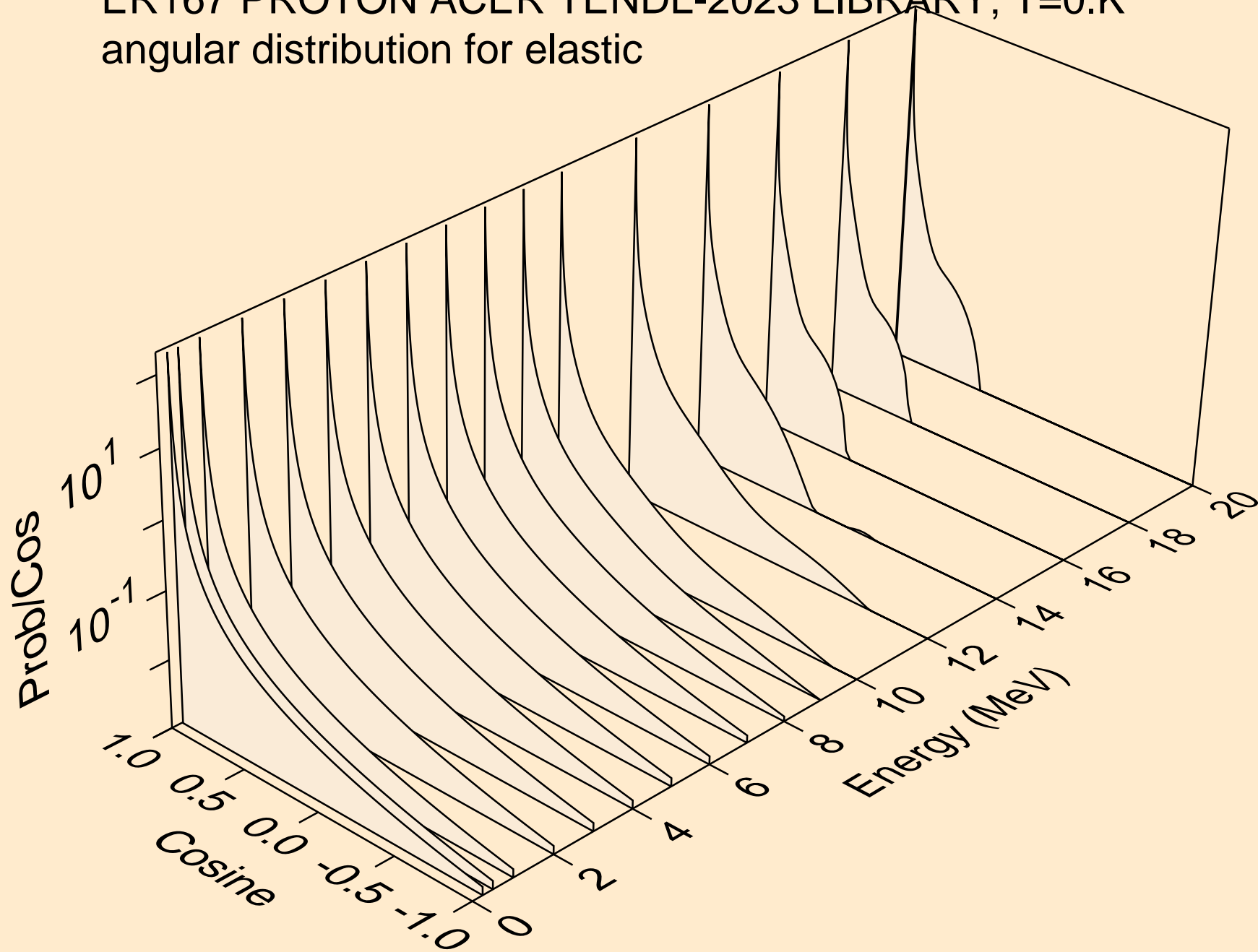



ER167 PROTON ACER TENDL-2023 LIBRARY; T=0.K  
angular distribution for elastic

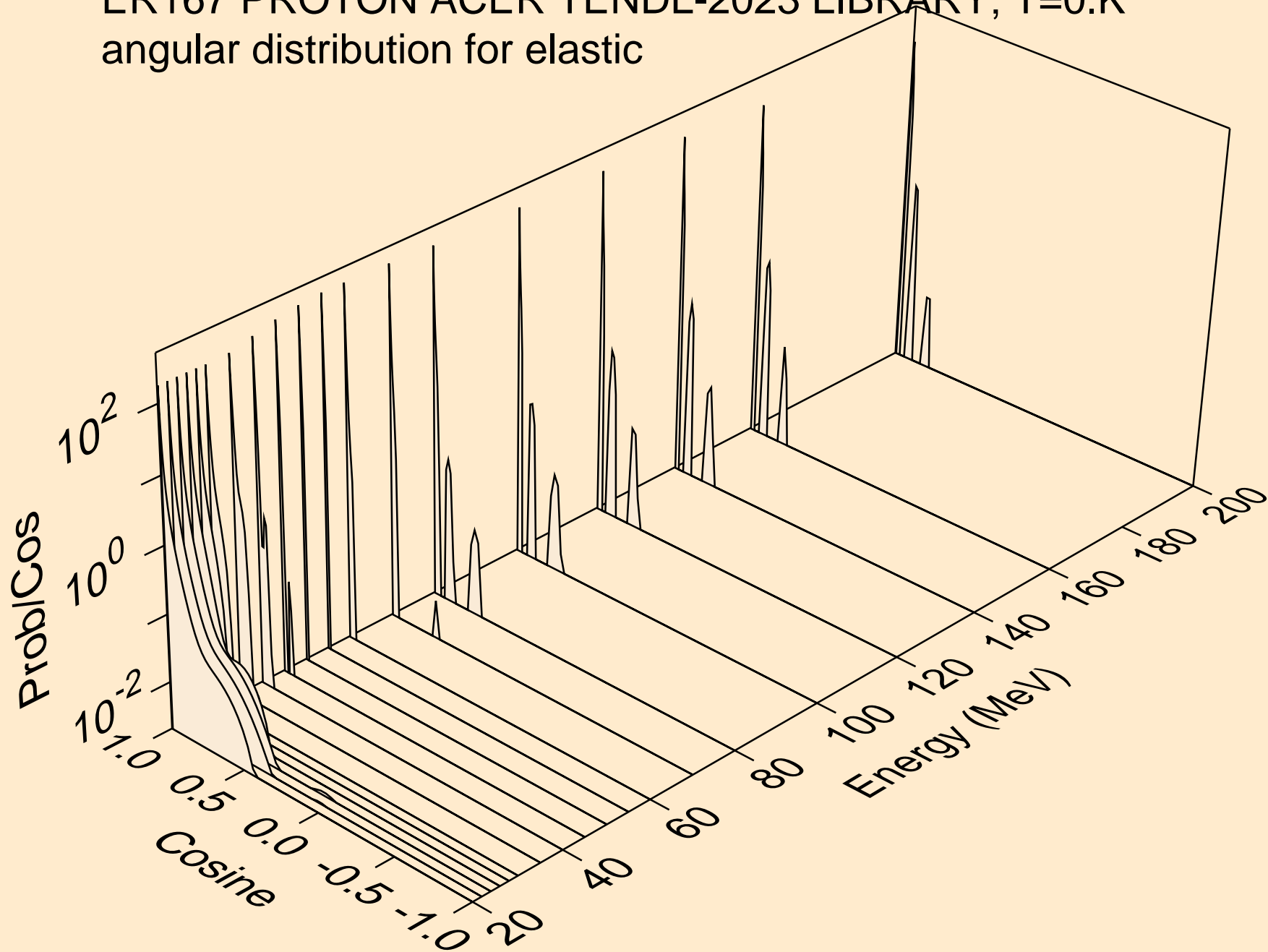

ER167 PROTON ACER TENDL-2023 LIBRARY; T=0.K  
Proton emission for (p,x)

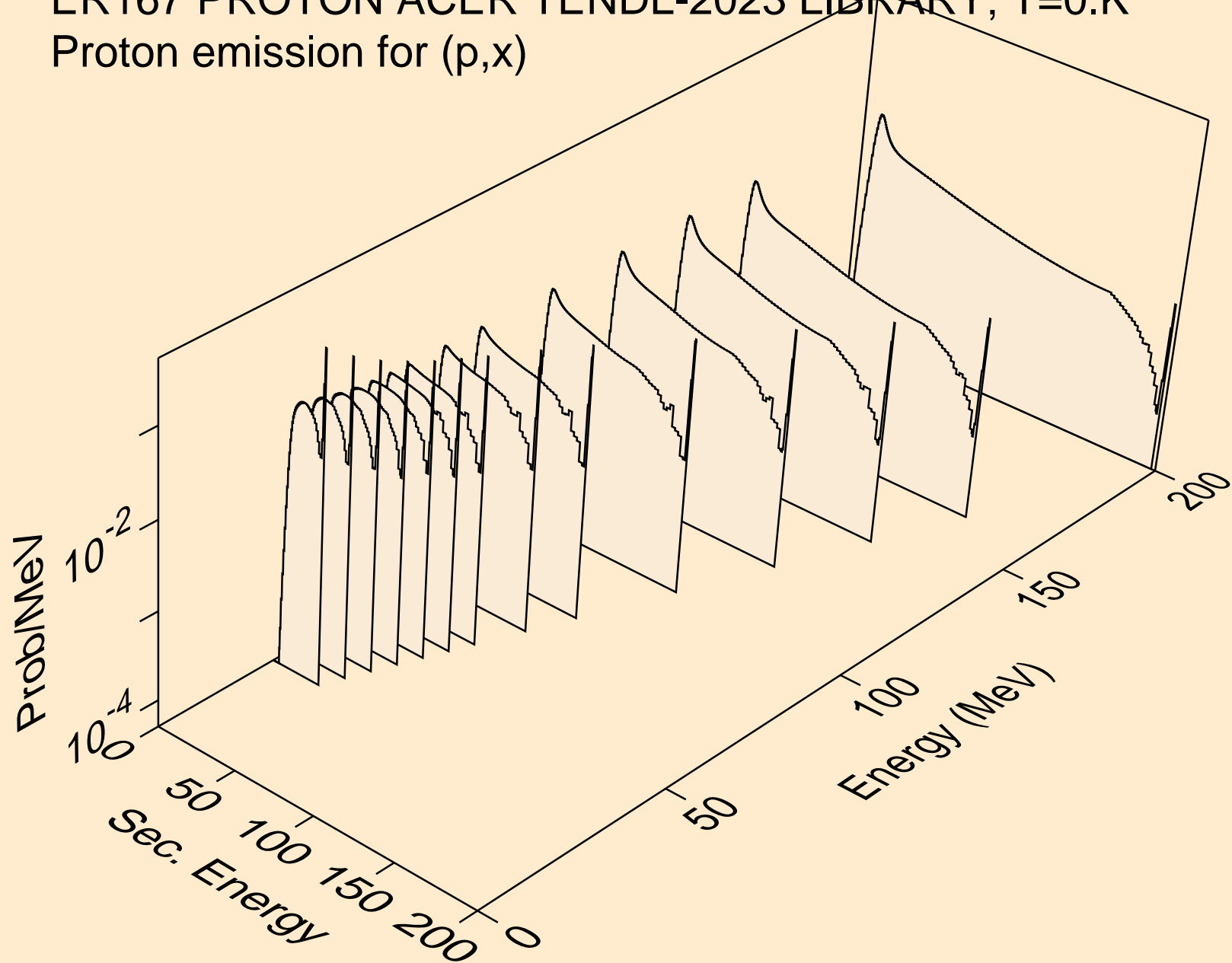

ER167 PROTON ACER TENDL-2023 LIBRARY; T=0.K  
Proton emission for (p,n\*)p

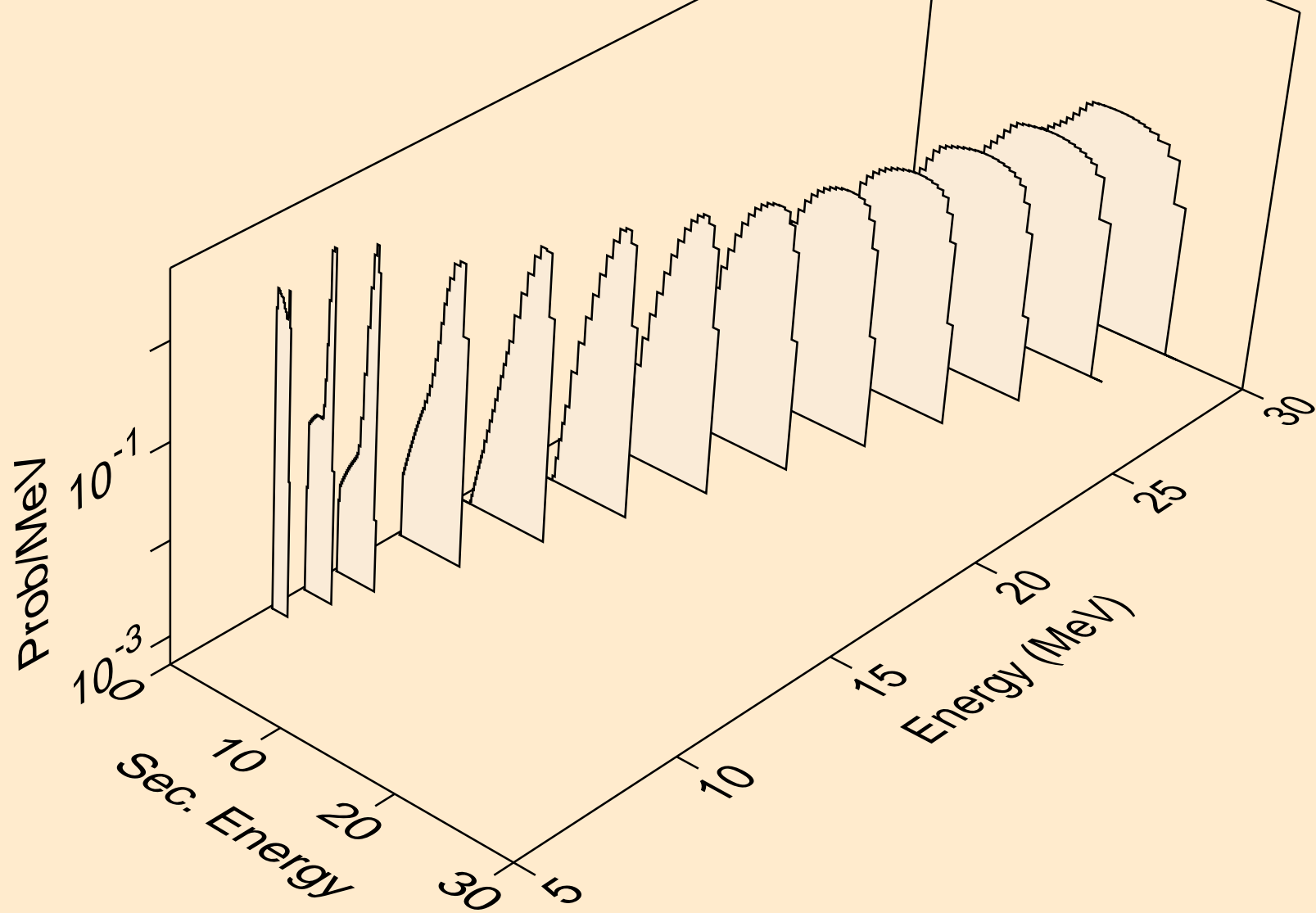

ER167 PROTON ACER TENDL-2023 LIBRARY; T=0.K  
Proton emission for (p,2np)

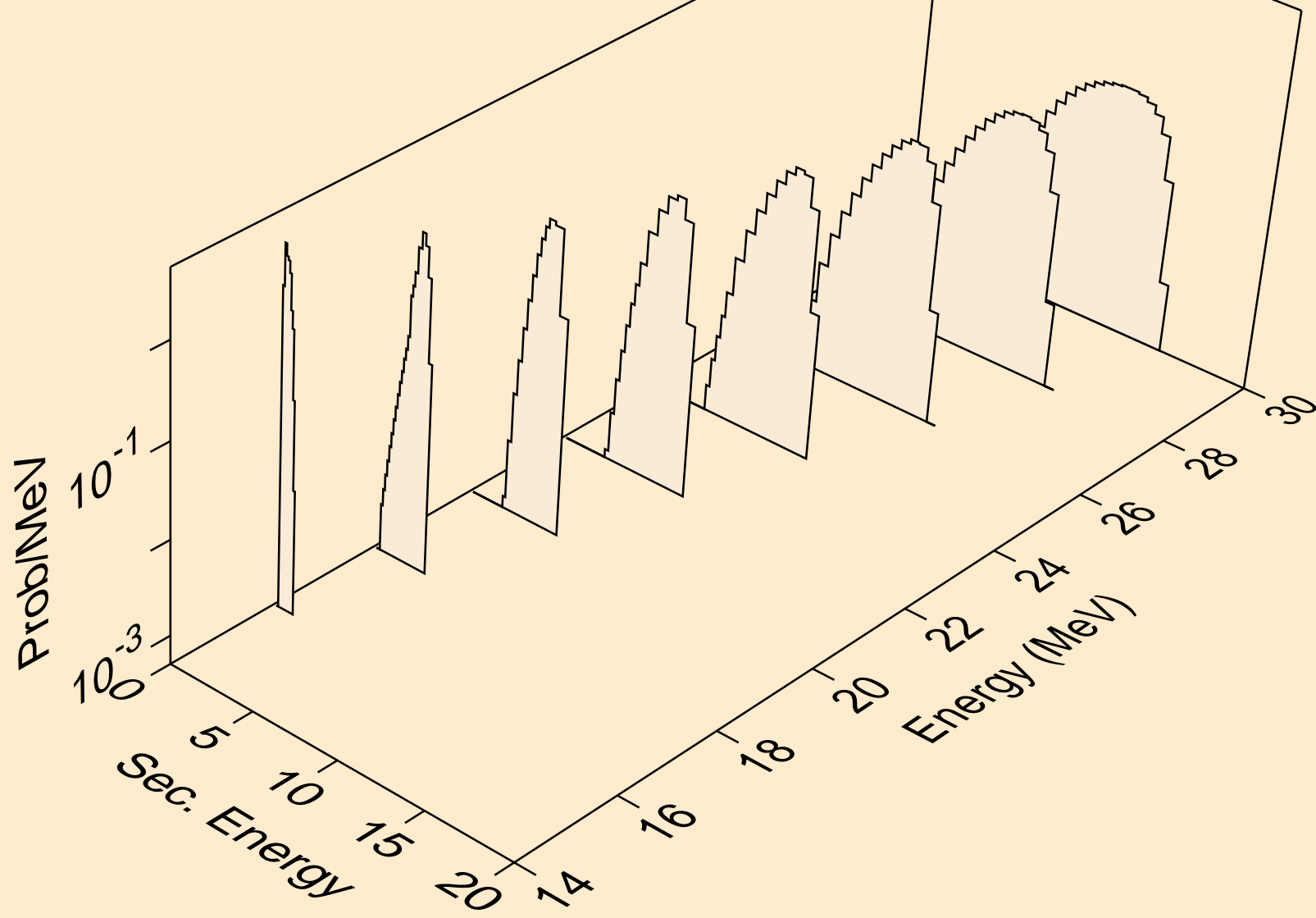

ER167 PROTON ACER TENDL-2023 LIBRARY; T=0.K  
Proton emission for (p,3np)

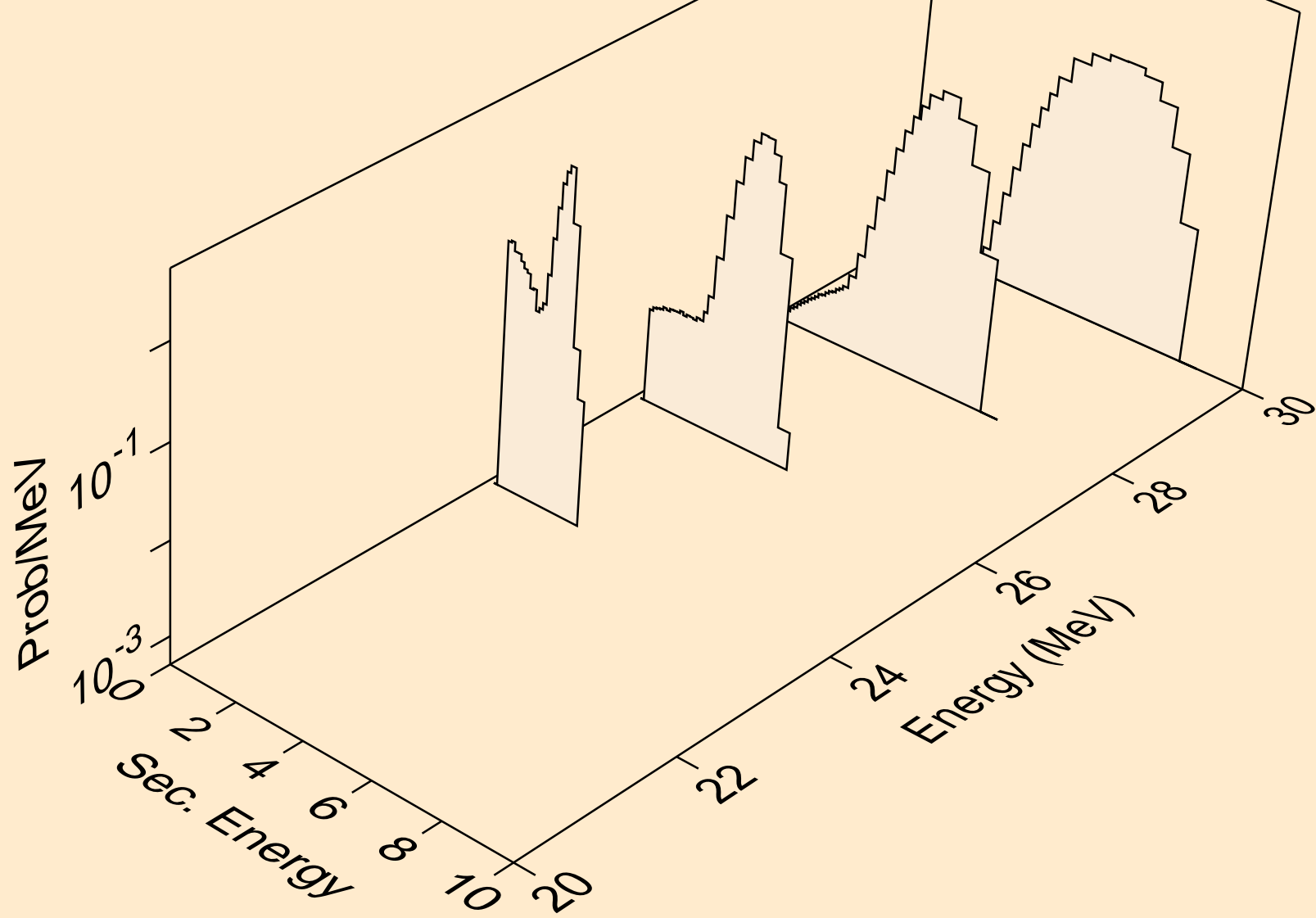

ER167 PROTON ACER TENDL-2023 LIBRARY; T=0.K  
Proton emission for (p,n2p)

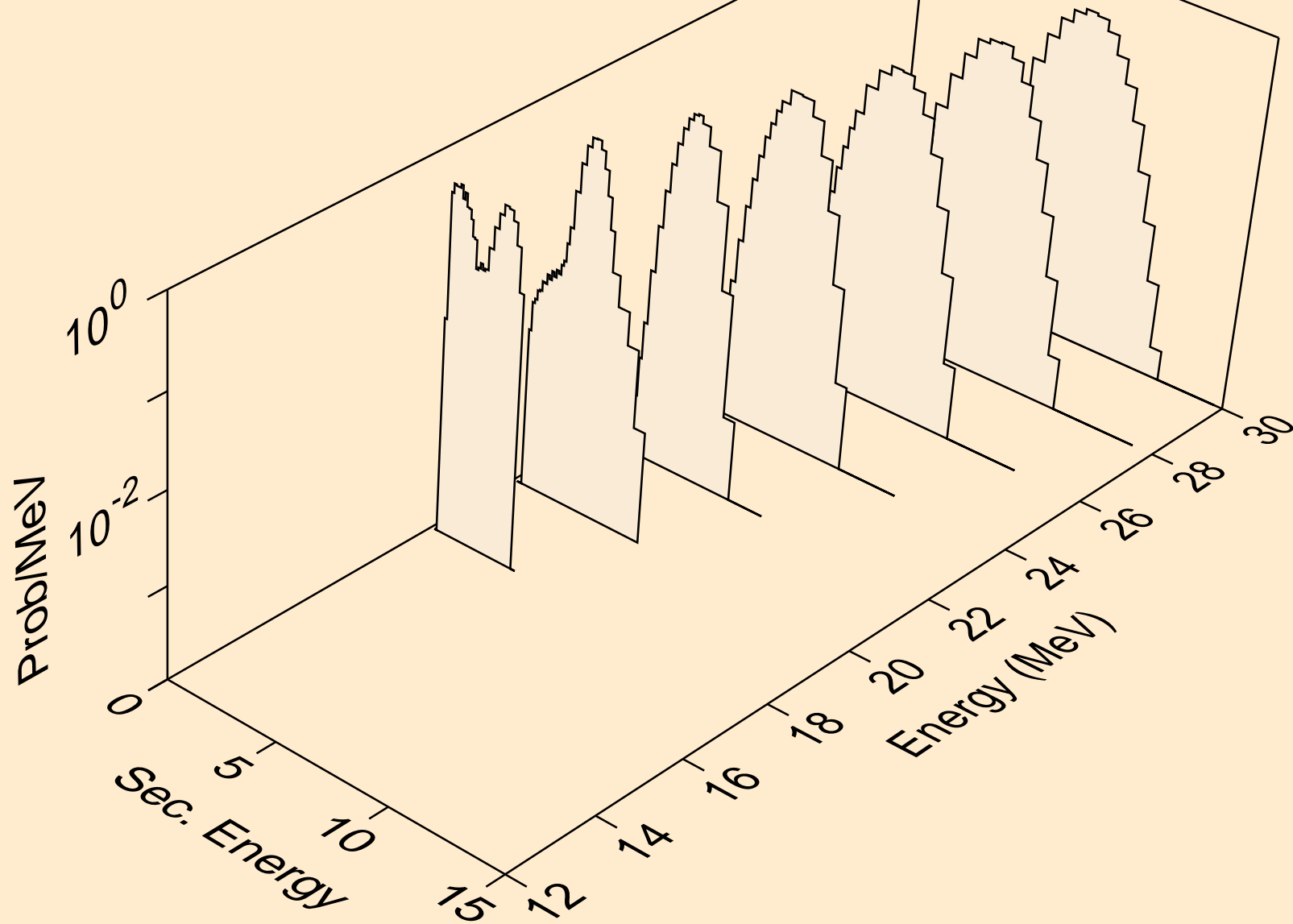

ER167 PROTON ACER TENDL-2023 LIBRARY; T=0.K  
Proton emission for (p,npa)

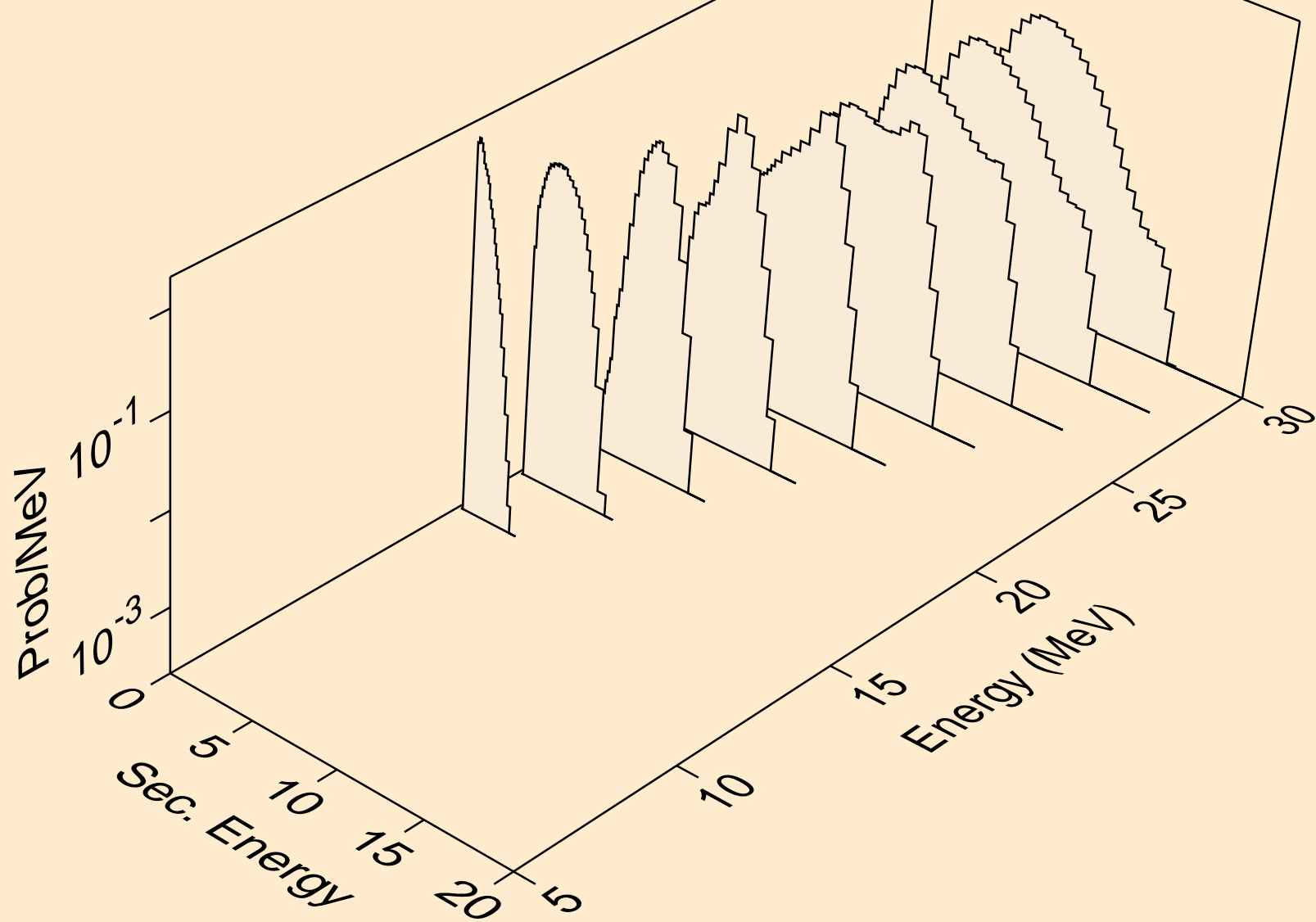

ER167 PROTON ACER TENDL-2023 LIBRARY; T=0.K  
Proton emission for inelastic

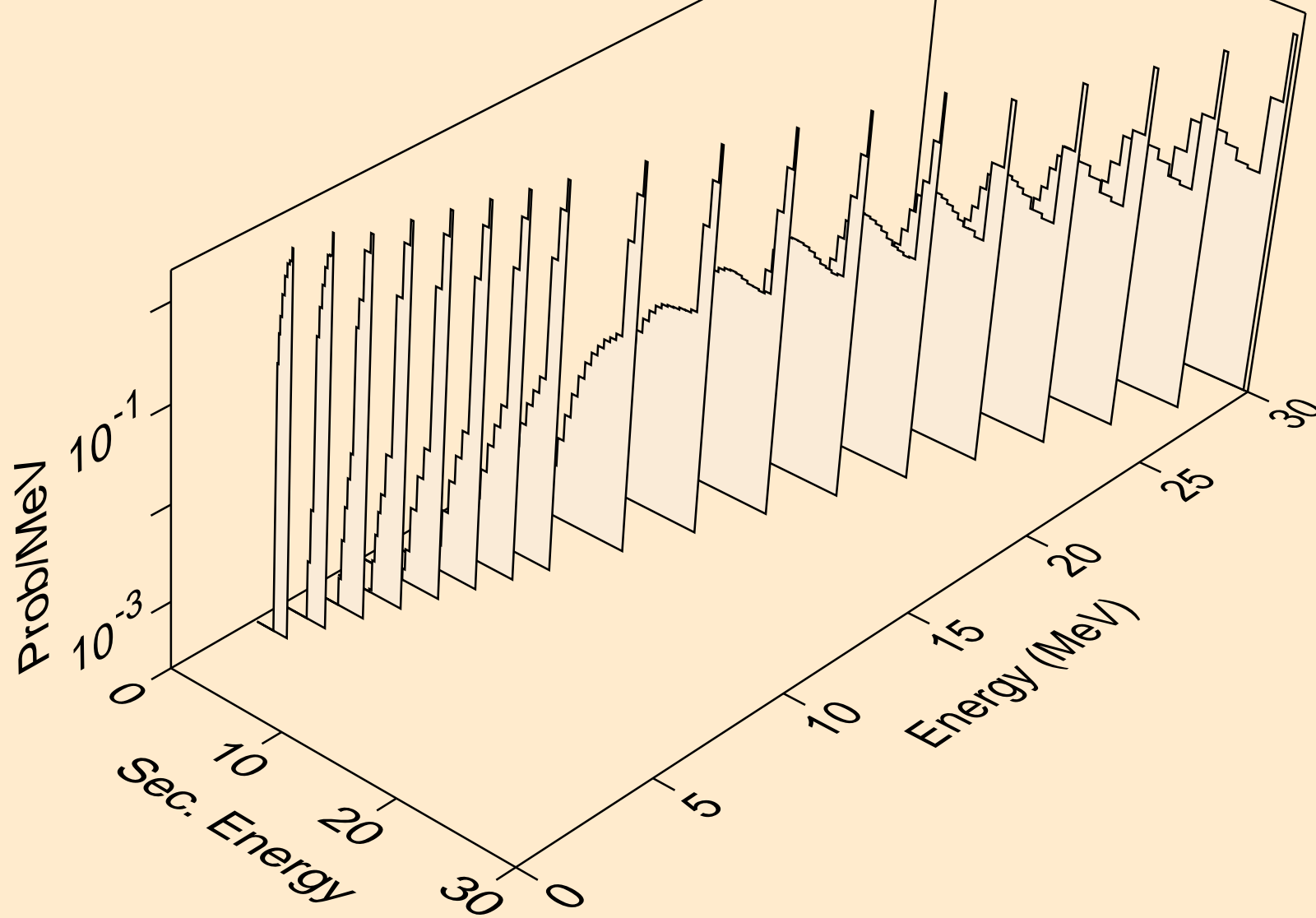



ER167 PROTON ACER TENDL-2023 LIBRARY; T=0.K  
Proton emission for (p,2p)

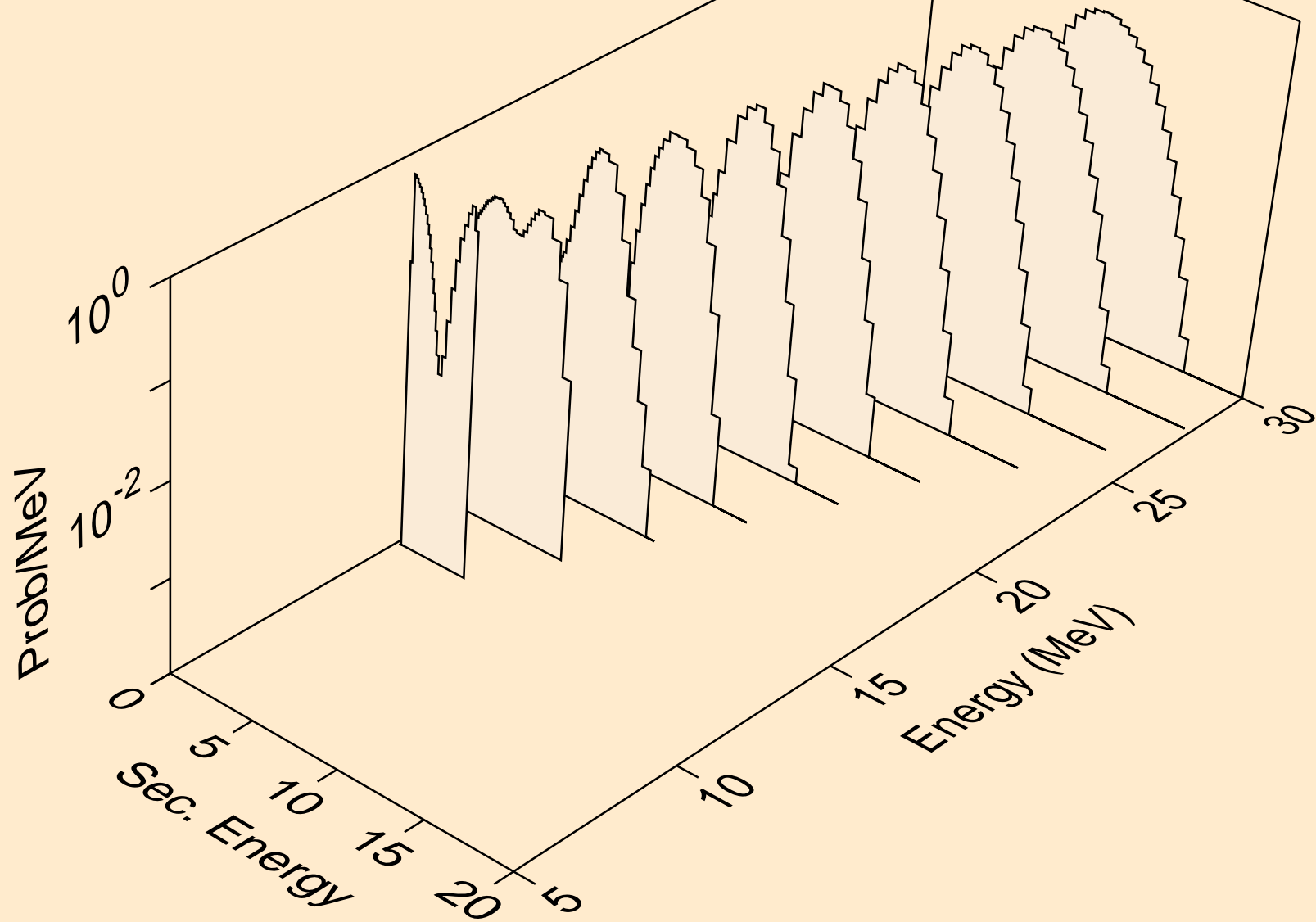

ER167 PROTON ACER TENDL-2023 LIBRARY; T=0.K  
Proton emission for (p,pa)

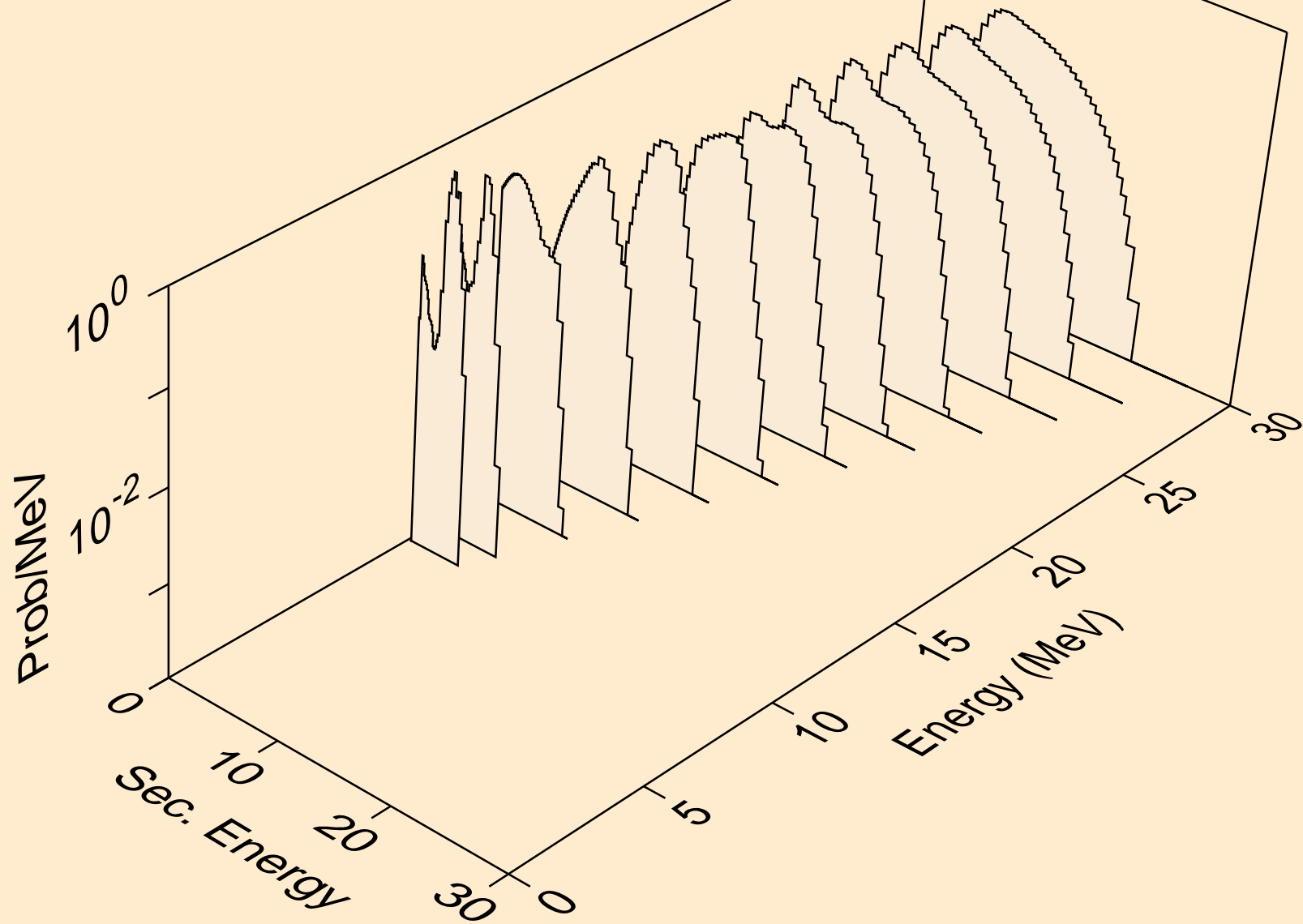

ER167 PROTON ACER TENDL-2023 LIBRARY; T=0.K  
Proton emission for (p,pd)

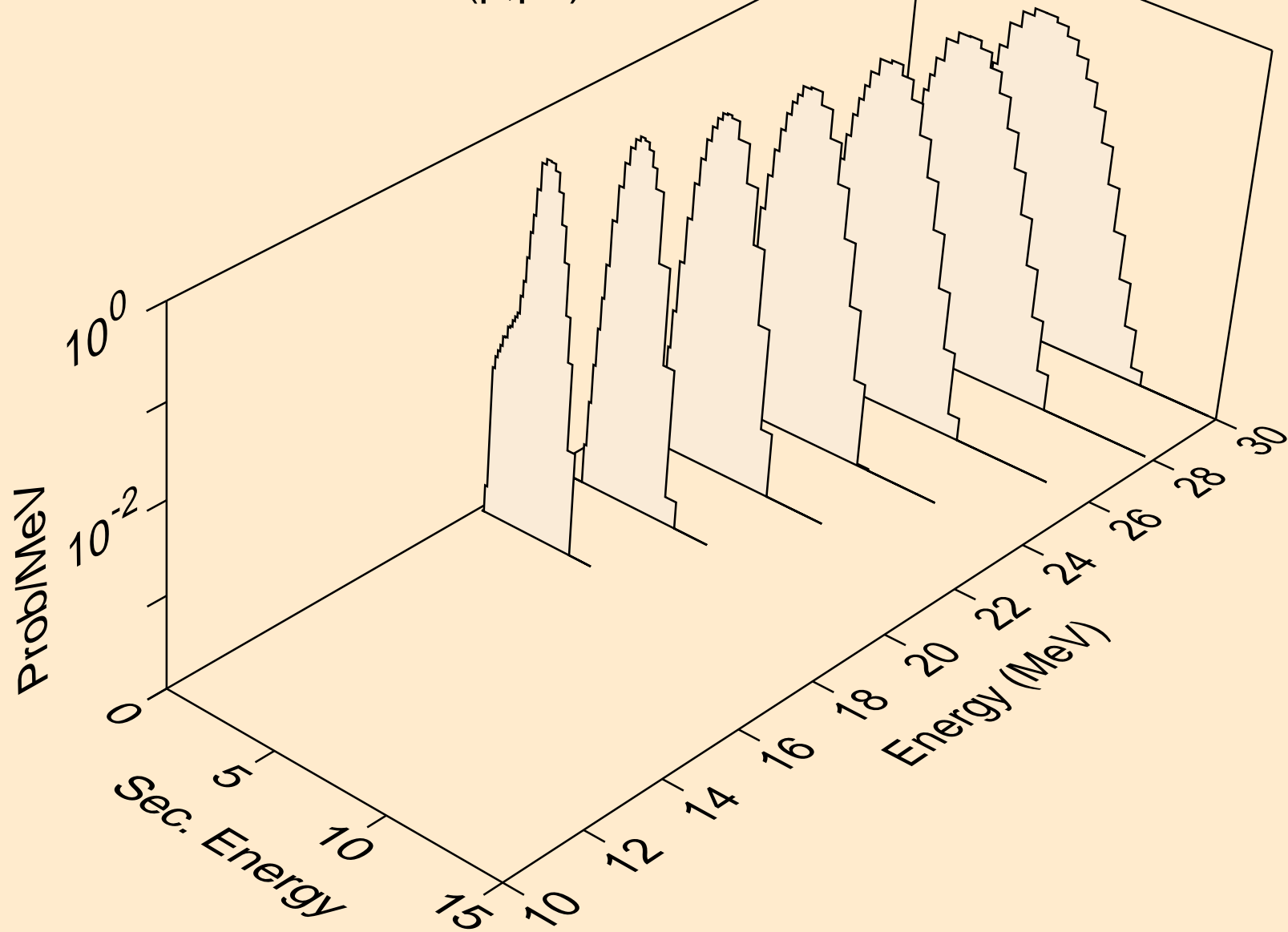

ER167 PROTON ACER TENDL-2023 LIBRARY; T=0.K  
Proton emission for (p,pt)

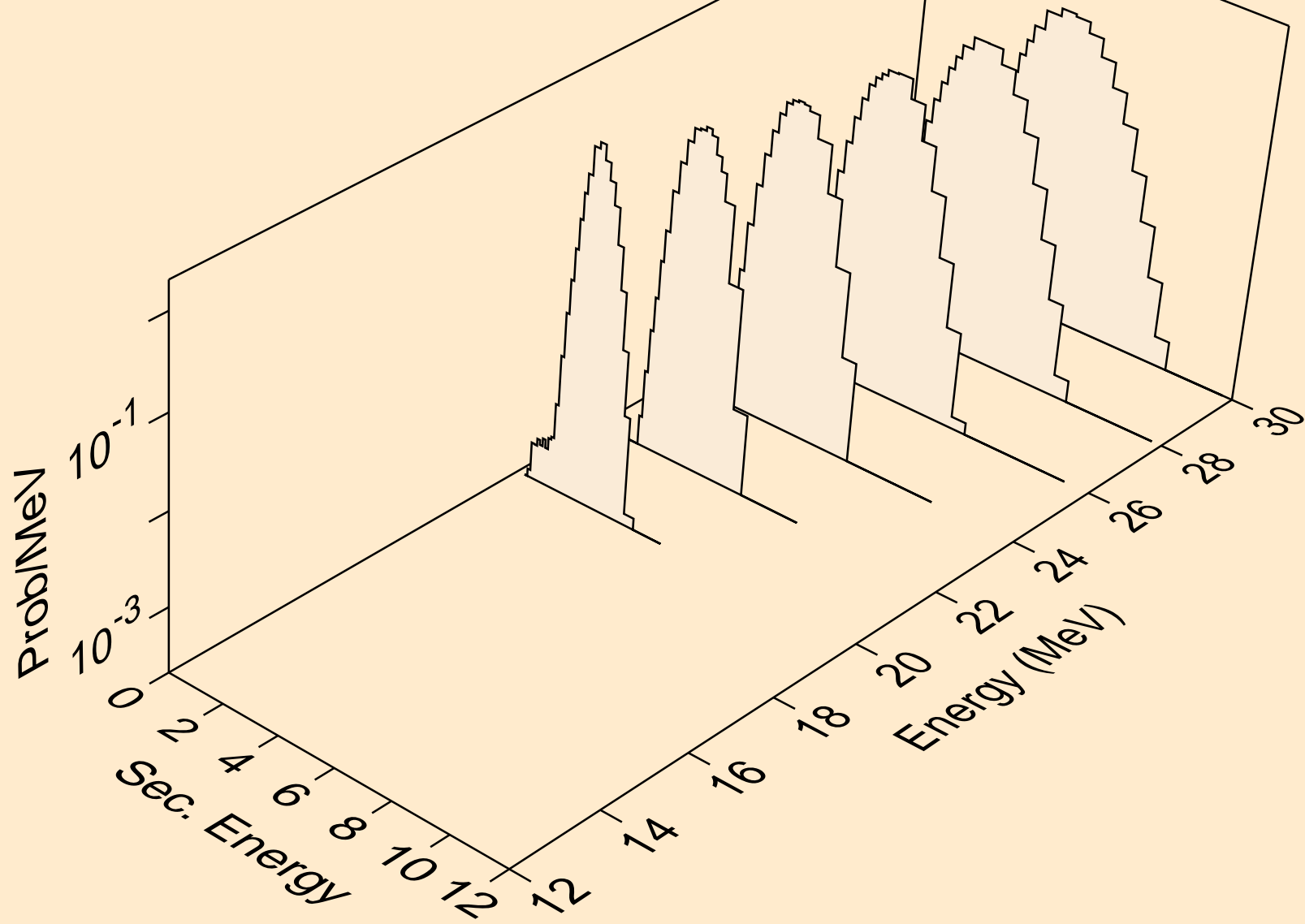

ER167 PROTON ACER TENDL-2023 LIBRARY; T=0.K  
Photon emission for (z,n)

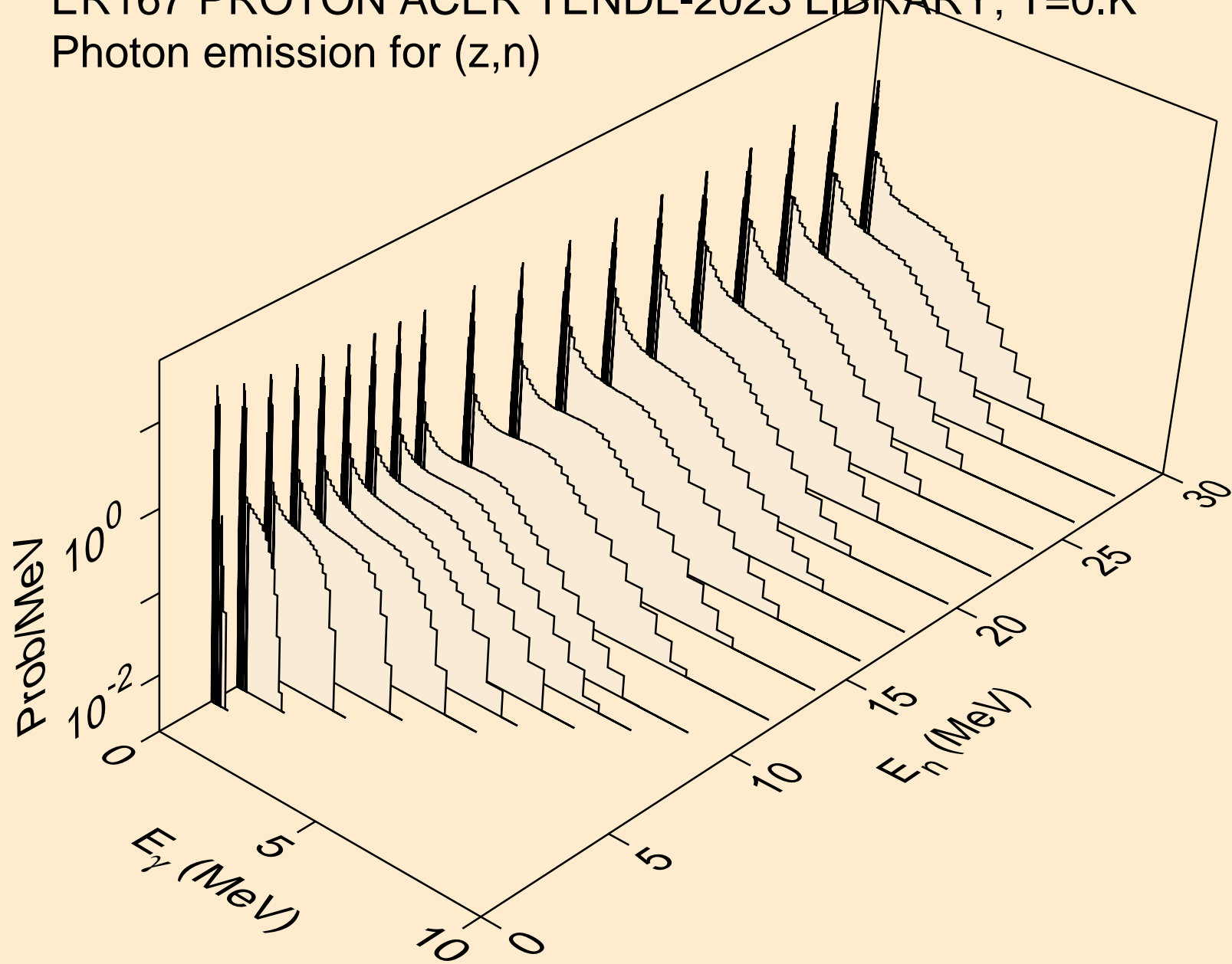

ER167 PROTON ACER TENDL-2023 LIBRARY; T=0.K  
Photon emission for (z,x)

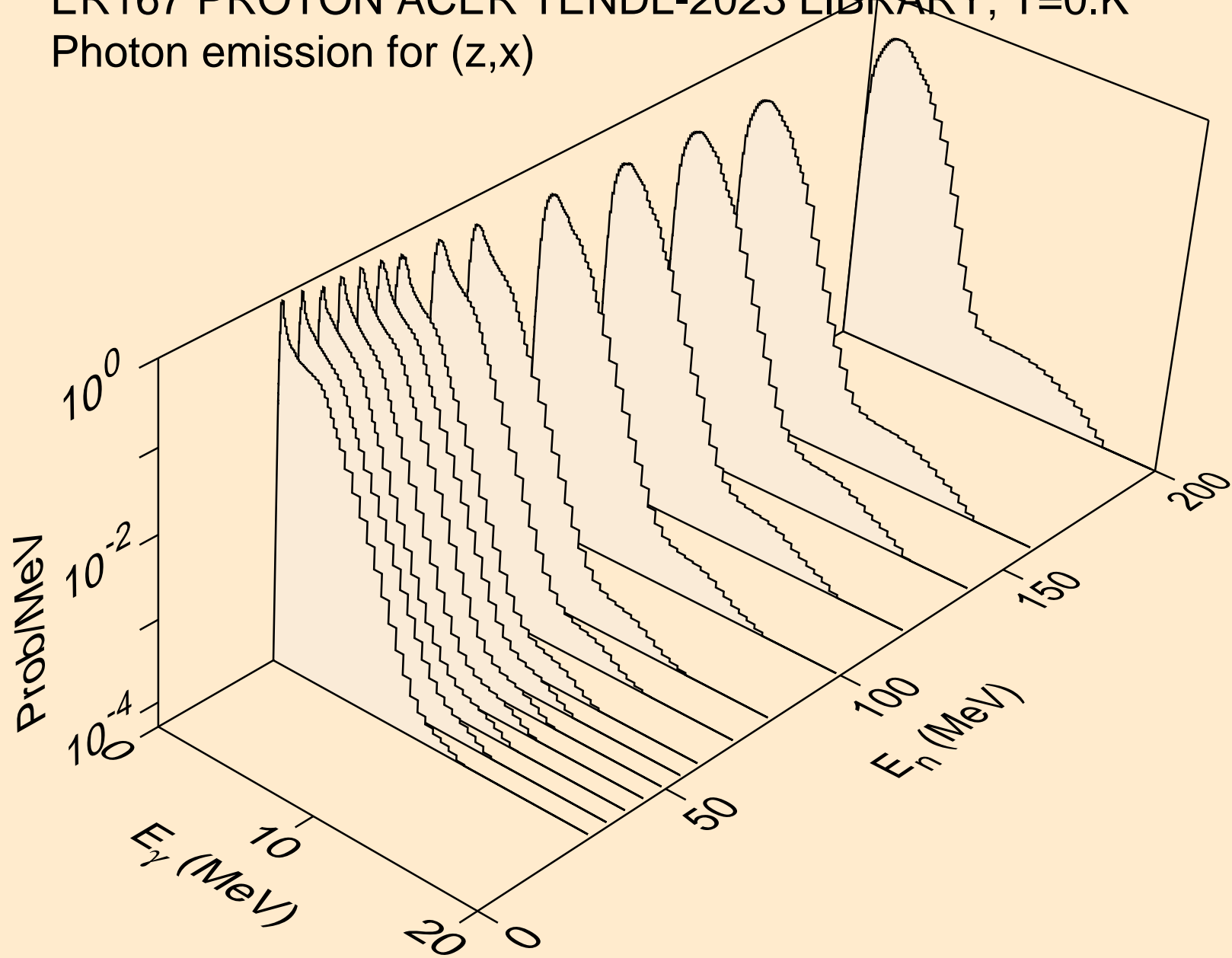

ER167 PROTON ACER TENDL-2023 LIBRARY; T=0.K  
Photon emission for (n,2nd)

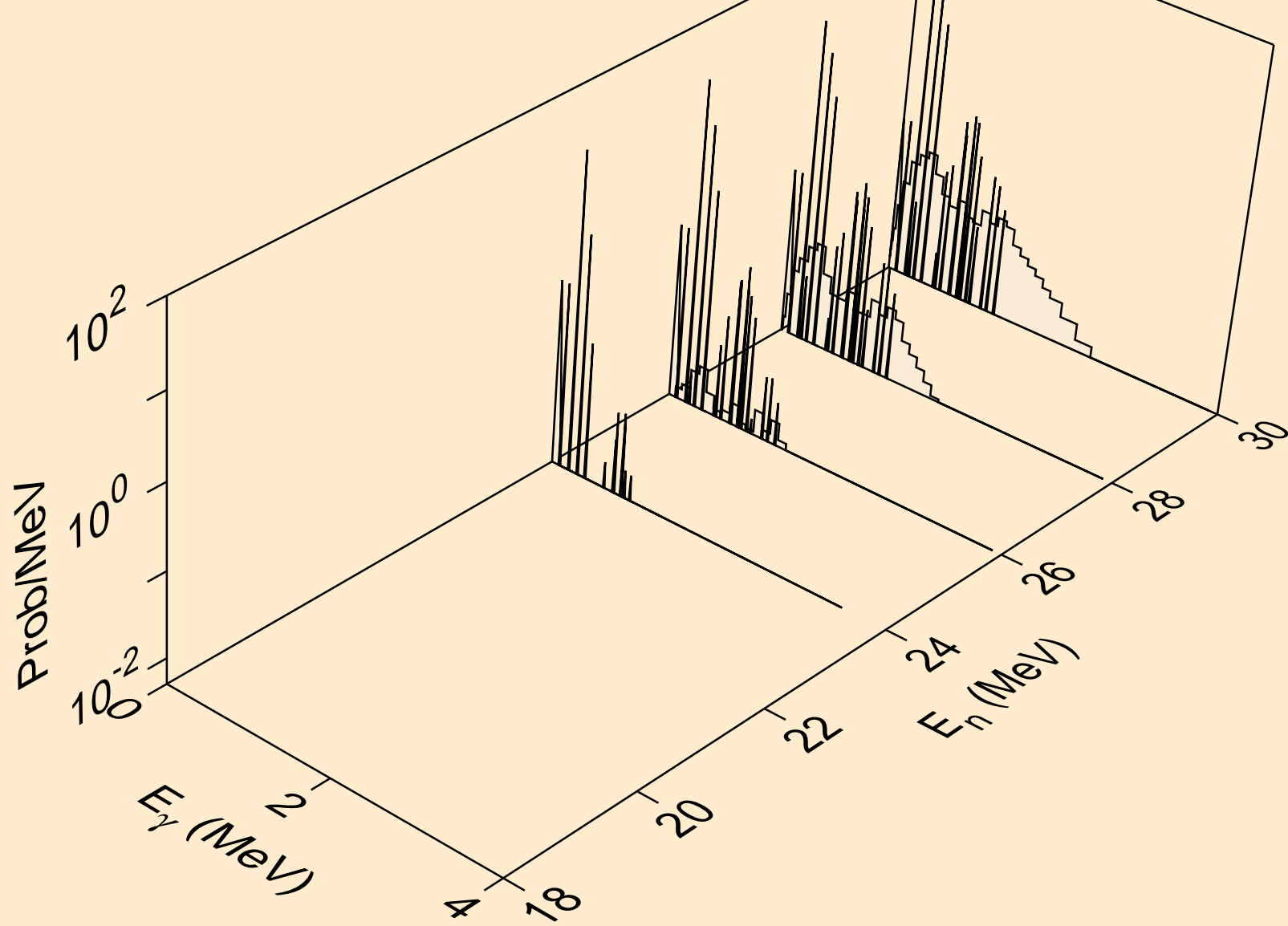

ER167 PROTON ACER TENDL-2023 LIBRARY; T=0.K  
Photon emission for (n,2n)

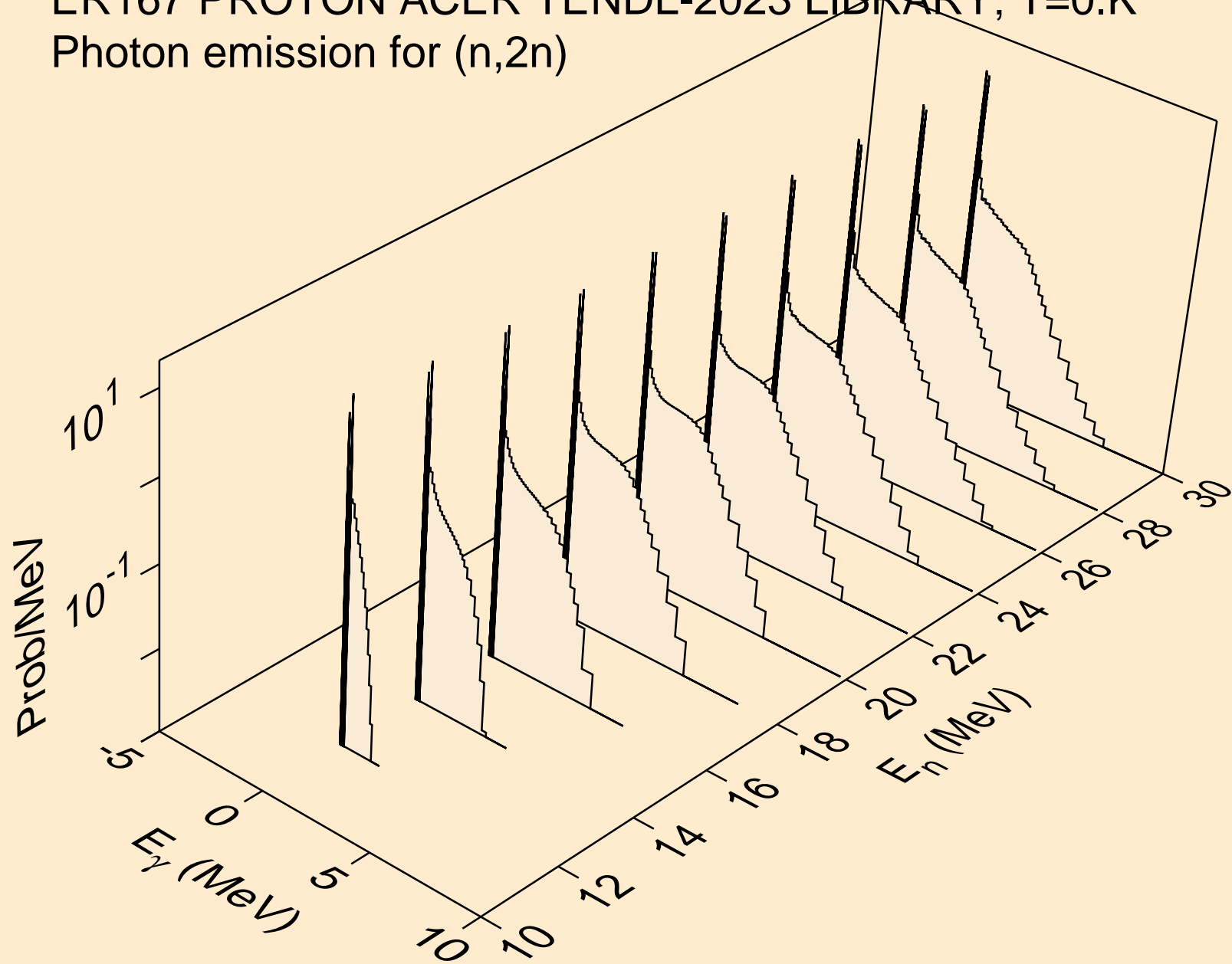



ER167 PROTON ACER TENDL-2023 LIBRARY; T=0.K  
Photon emission for (n,3n)

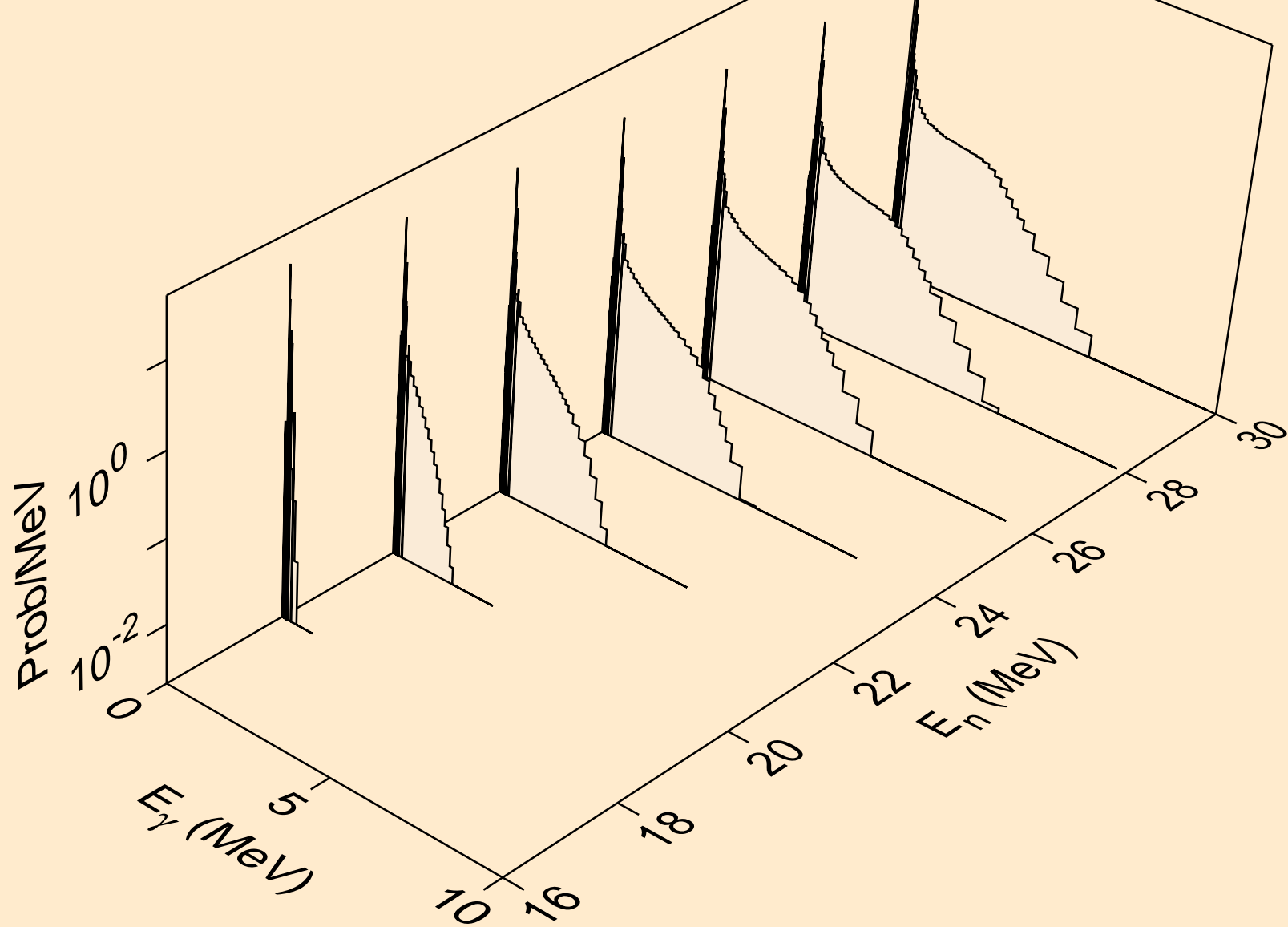

ER167 PROTON ACER TENDL-2023 LIBRARY; T=0.K  
Photon emission for (n,n\*)a

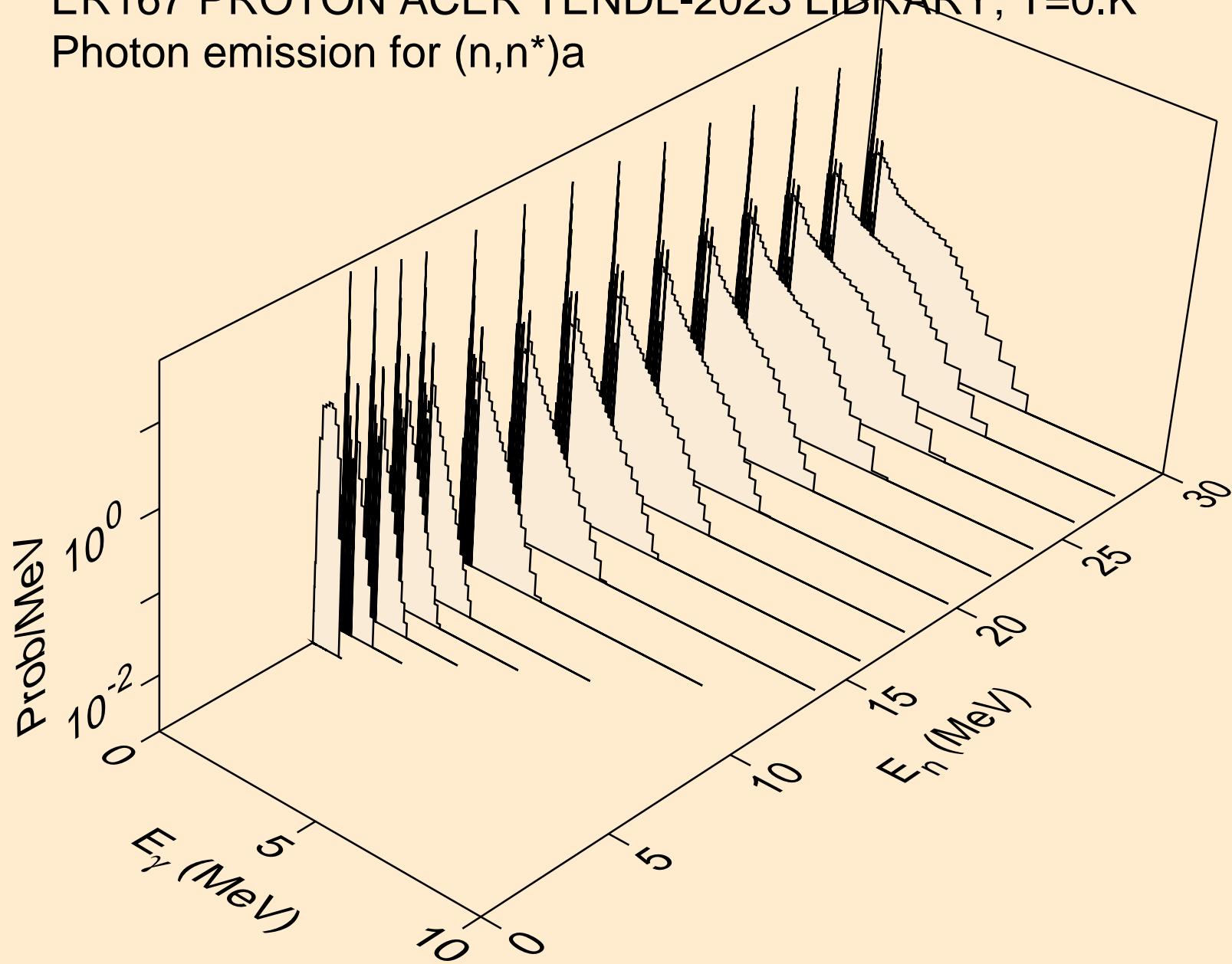

ER167 PROTON ACER TENDL-2023 LIBRARY; T=0.K  
Photon emission for (n,2n)a

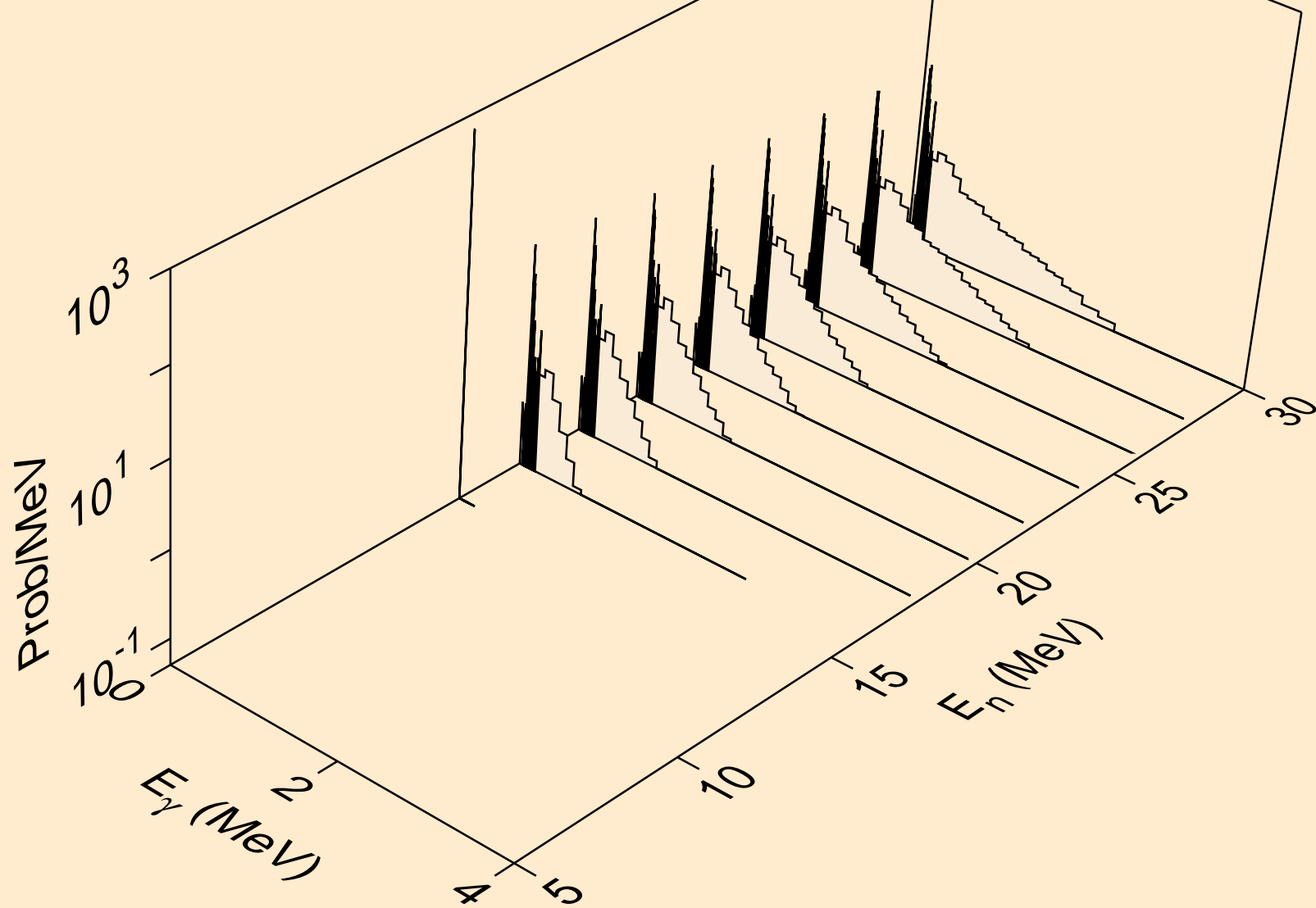

ER167 PROTON ACER TENDL-2023 LIBRARY; T=0.K  
Photon emission for (n,3n)a

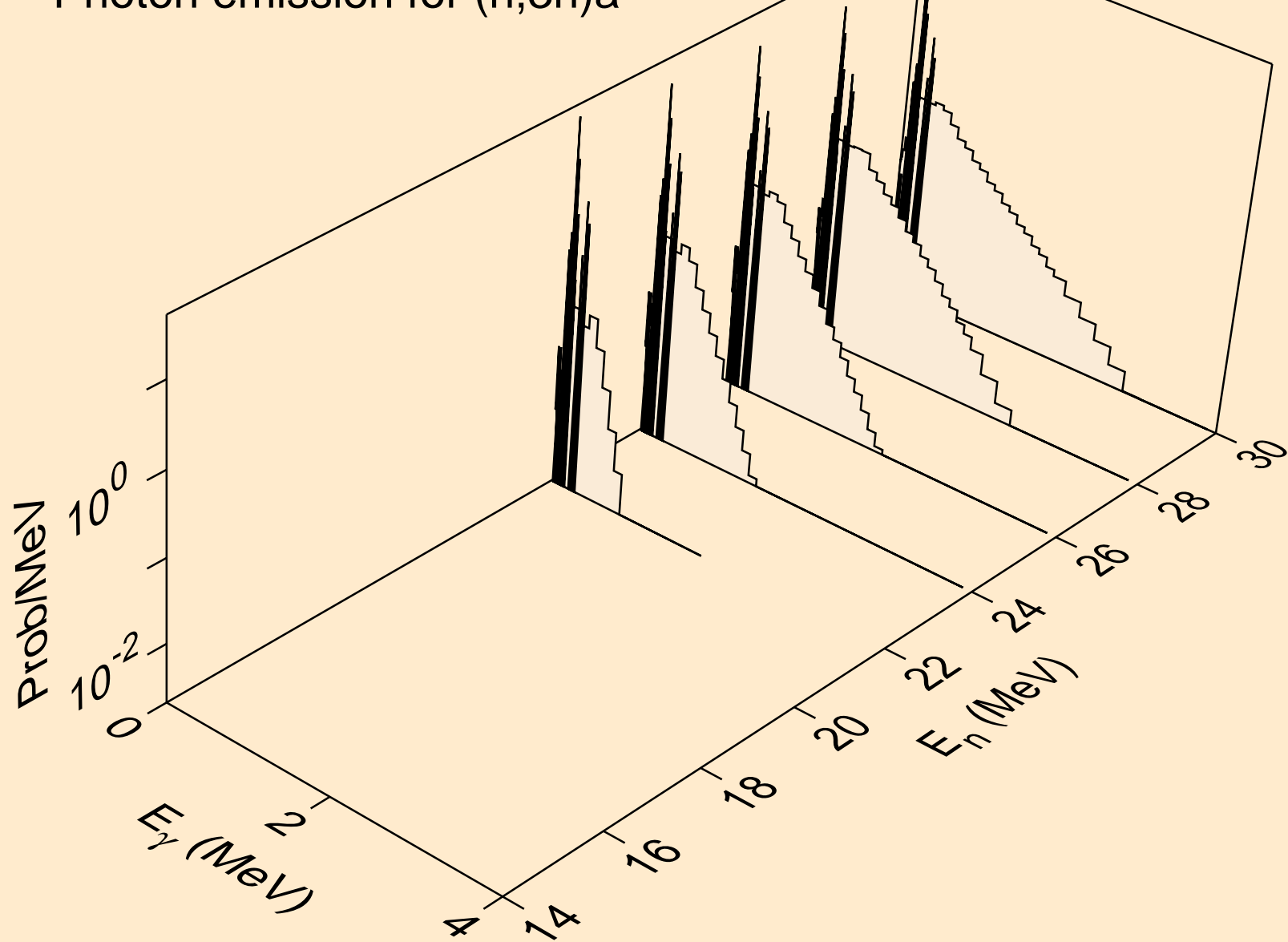

ER167 PROTON ACER TENDL-2023 LIBRARY; T=0.K  
Photon emission for (n,n\*)p

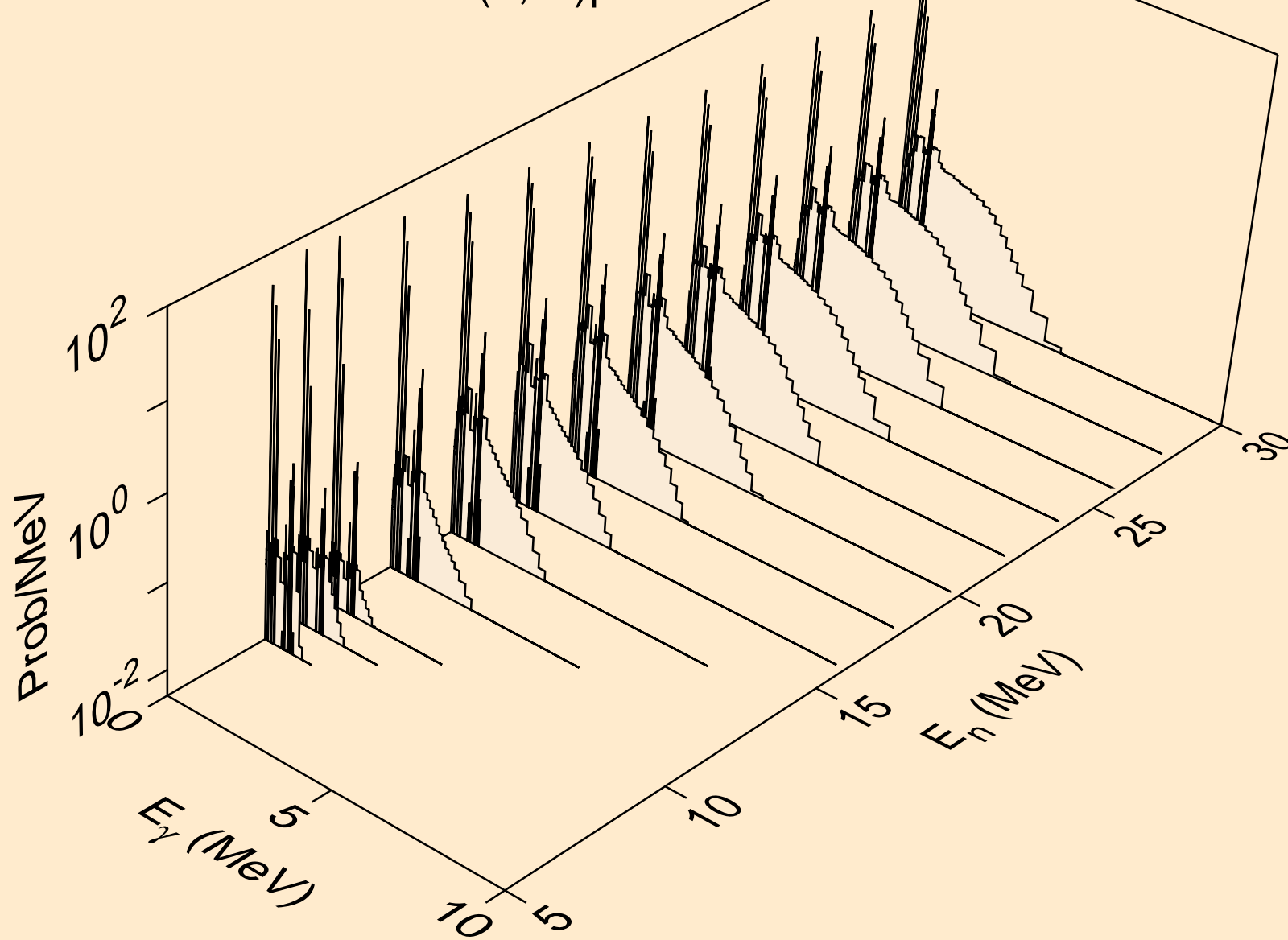

ER167 PROTON ACER TENDL-2023 LIBRARY; T=0.K  
Photon emission for (n,n\*)2a

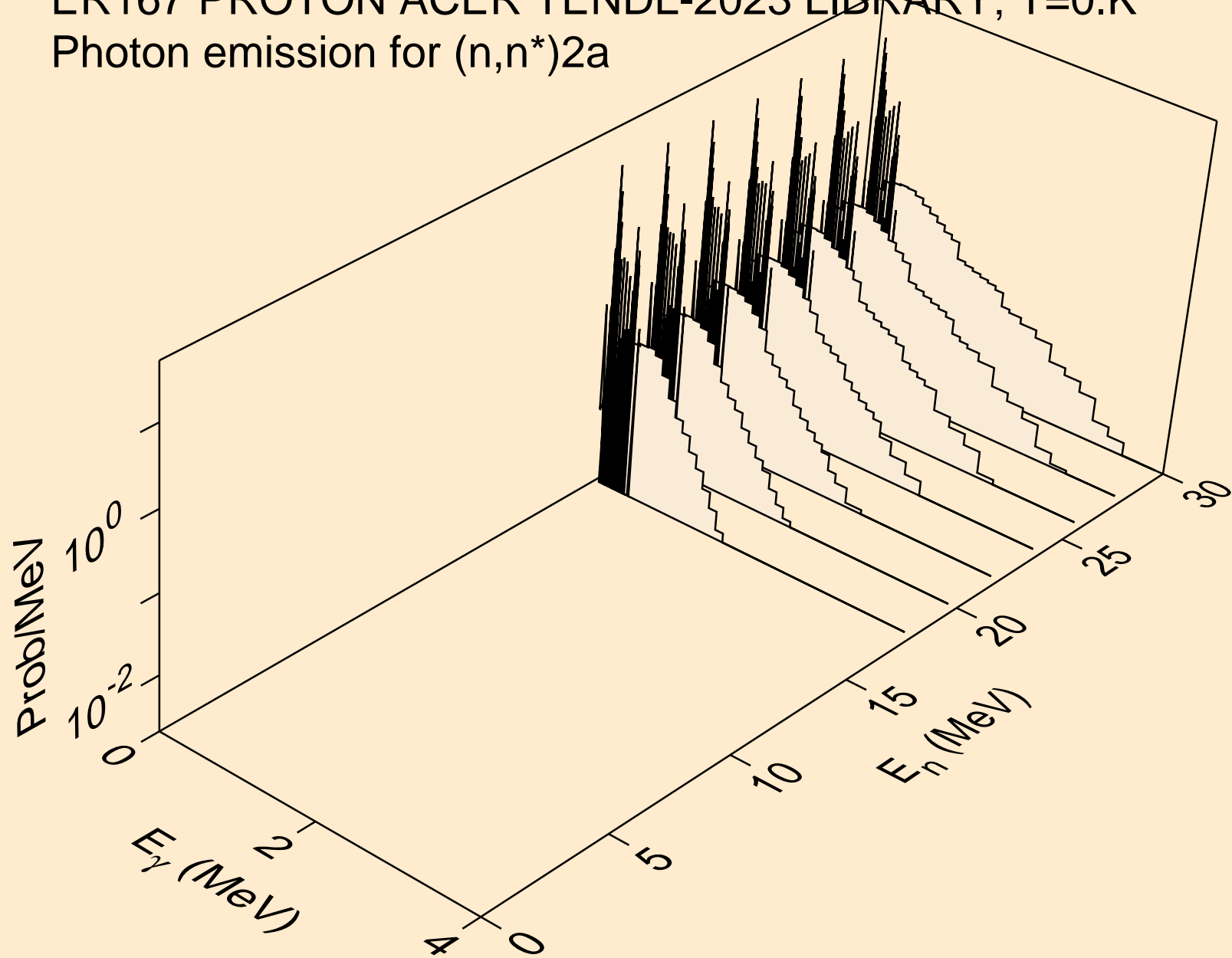

ER167 PROTON ACER TENDL-2023 LIBRARY; T=0.K  
Photon emission for (n,n\*)d

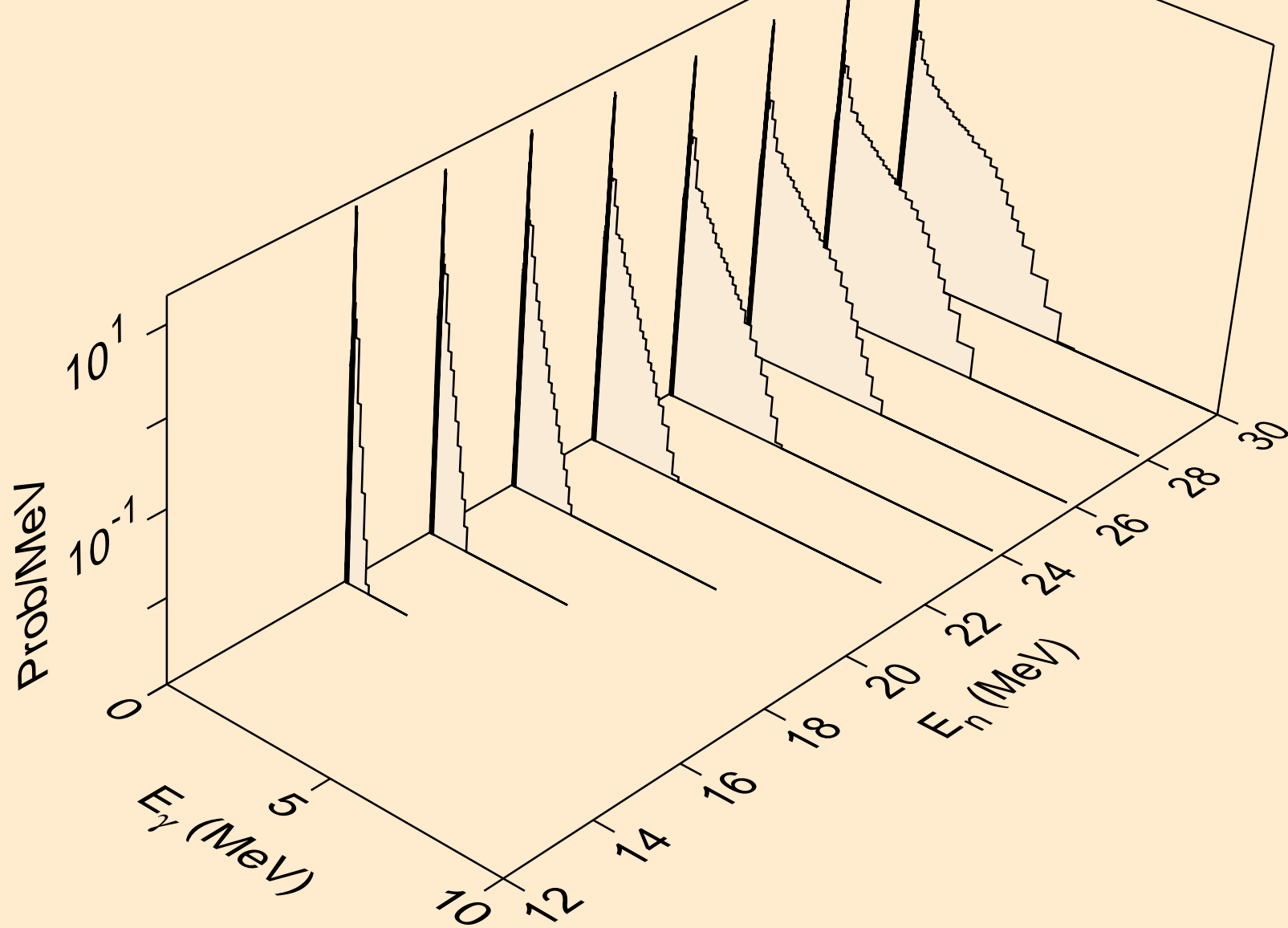

ER167 PROTON ACER TENDL-2023 LIBRARY; T=0.K  
Photon emission for (n,n\*)t

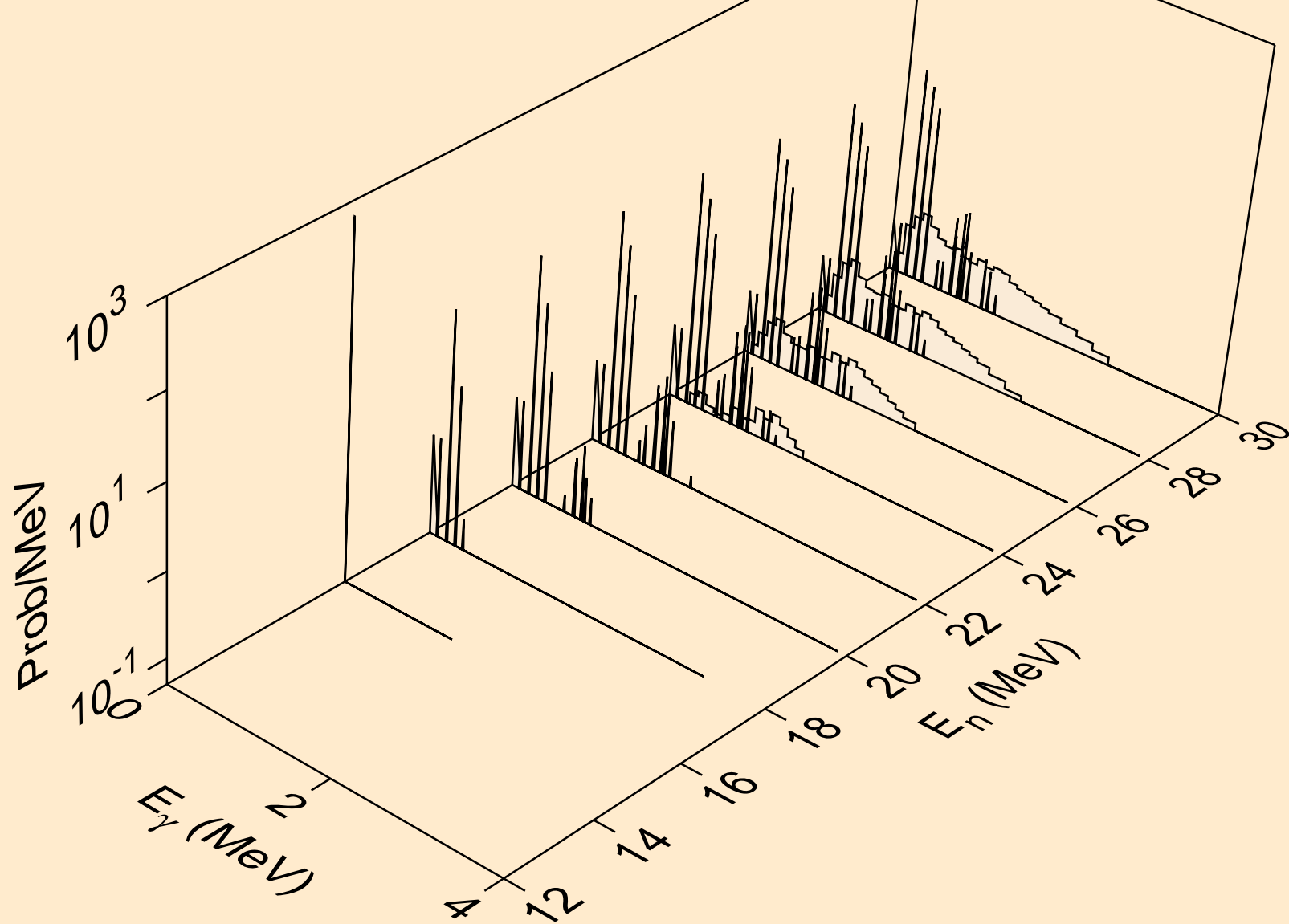



ER167 PROTON ACER TENDL-2023 LIBRARY; T=0.K  
Photon emission for (n,n\*)he3

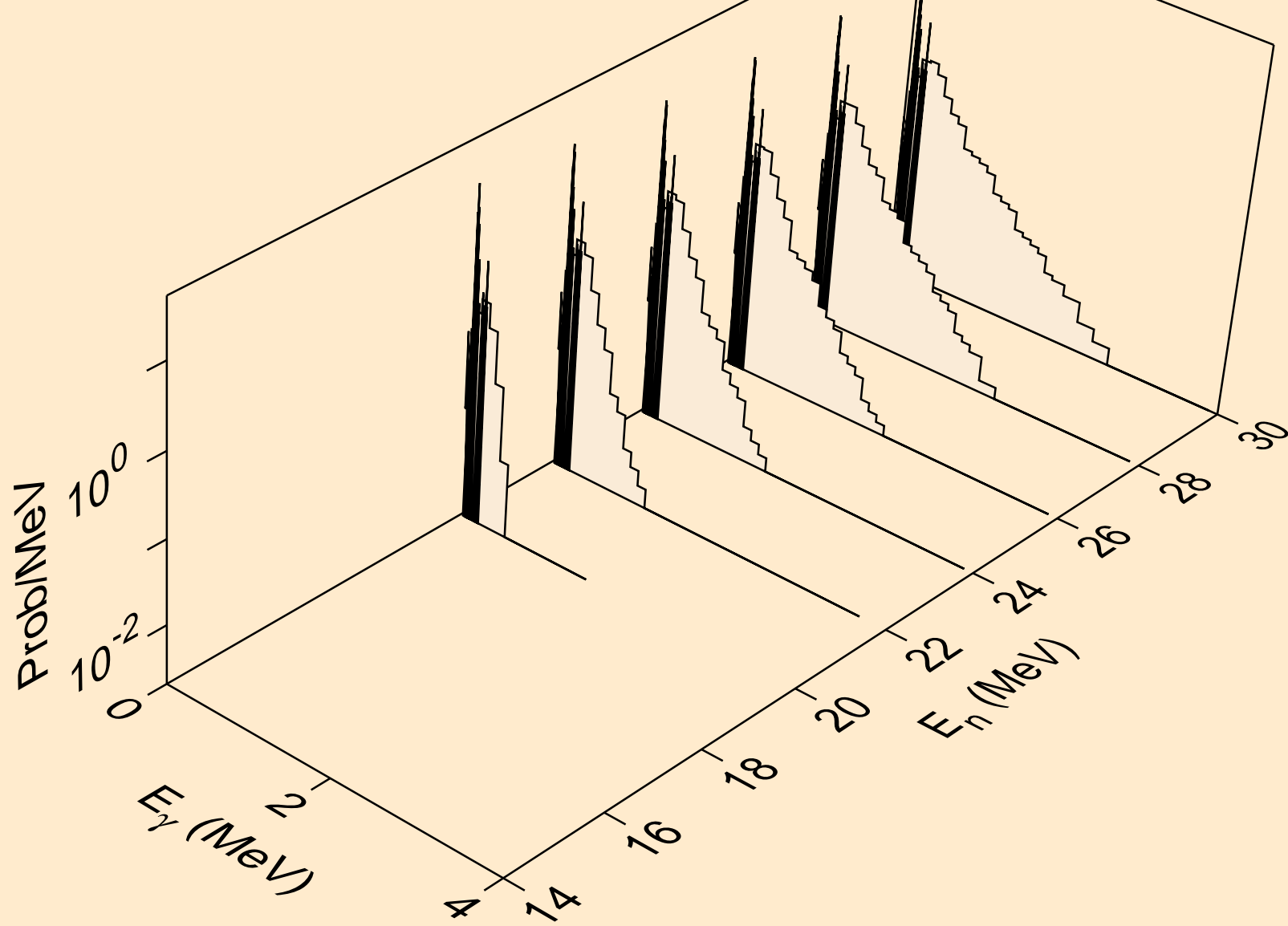

ER167 PROTON ACER TENDL-2023 LIBRARY; T=0.K  
Photon emission for (n,4n)

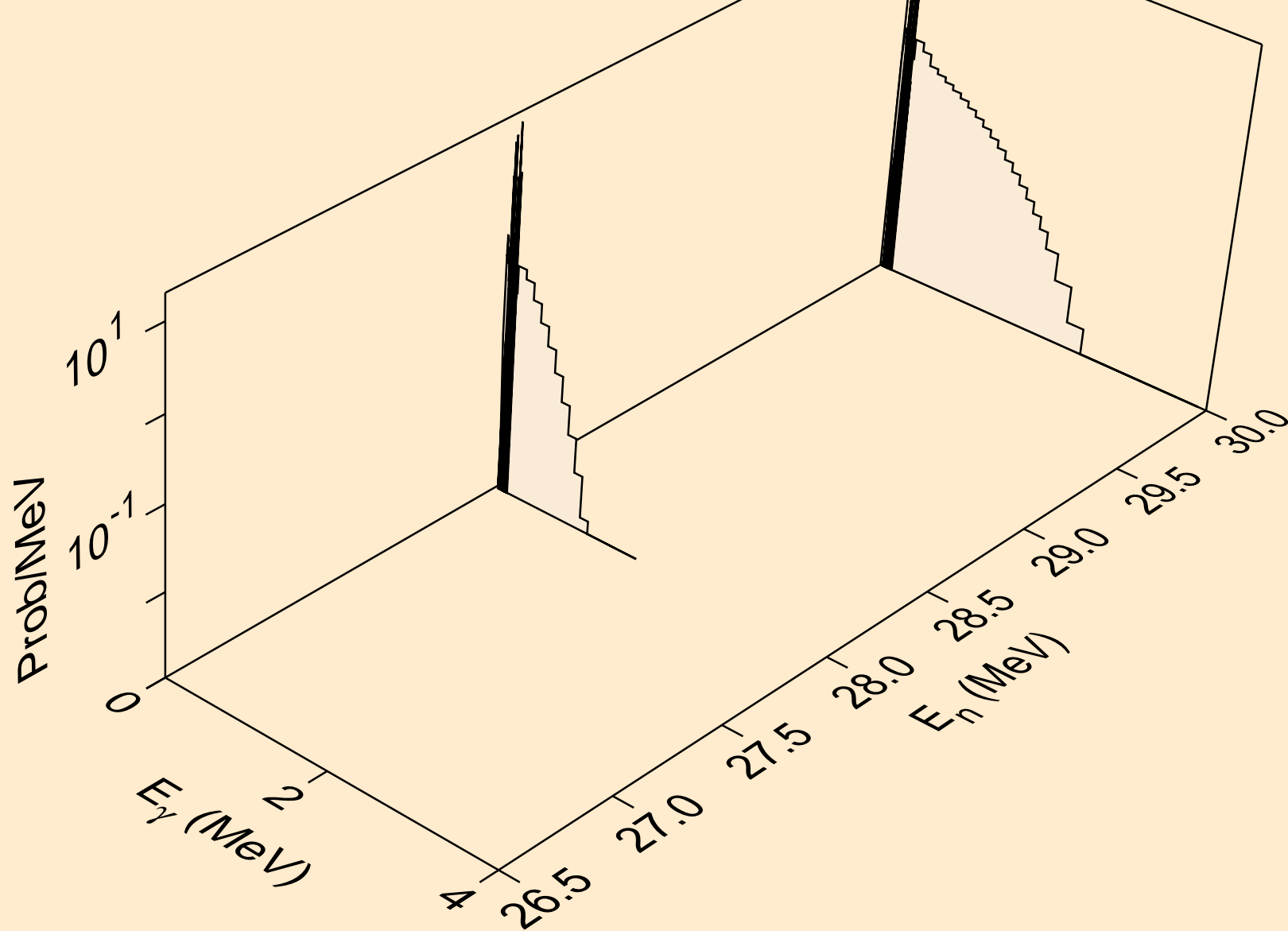

ER167 PROTON ACER TENDL-2023 LIBRARY; T=0.K  
Photon emission for (n,2np)

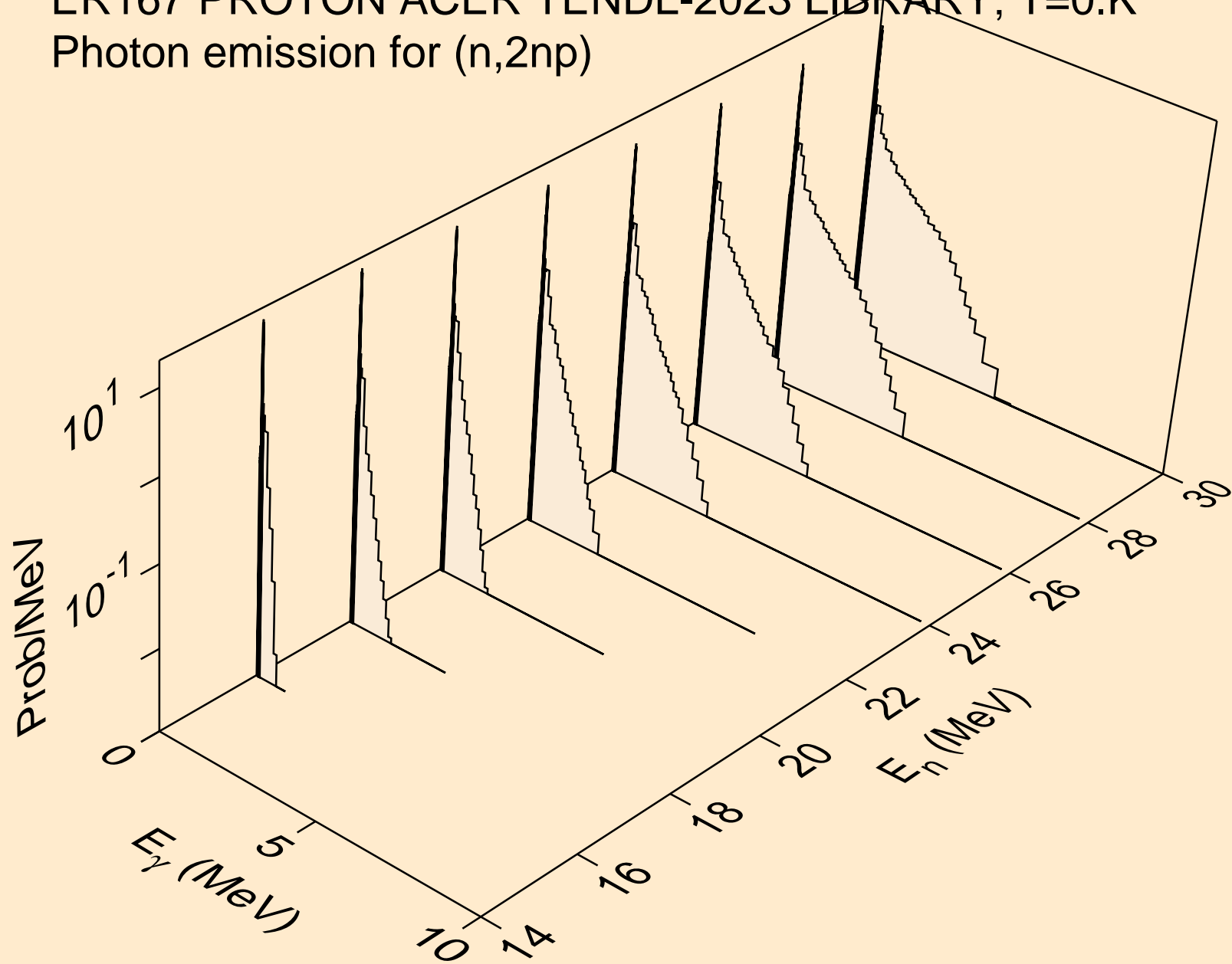

ER167 PROTON ACER TENDL-2023 LIBRARY; T=0.K  
Photon emission for (n,3np)

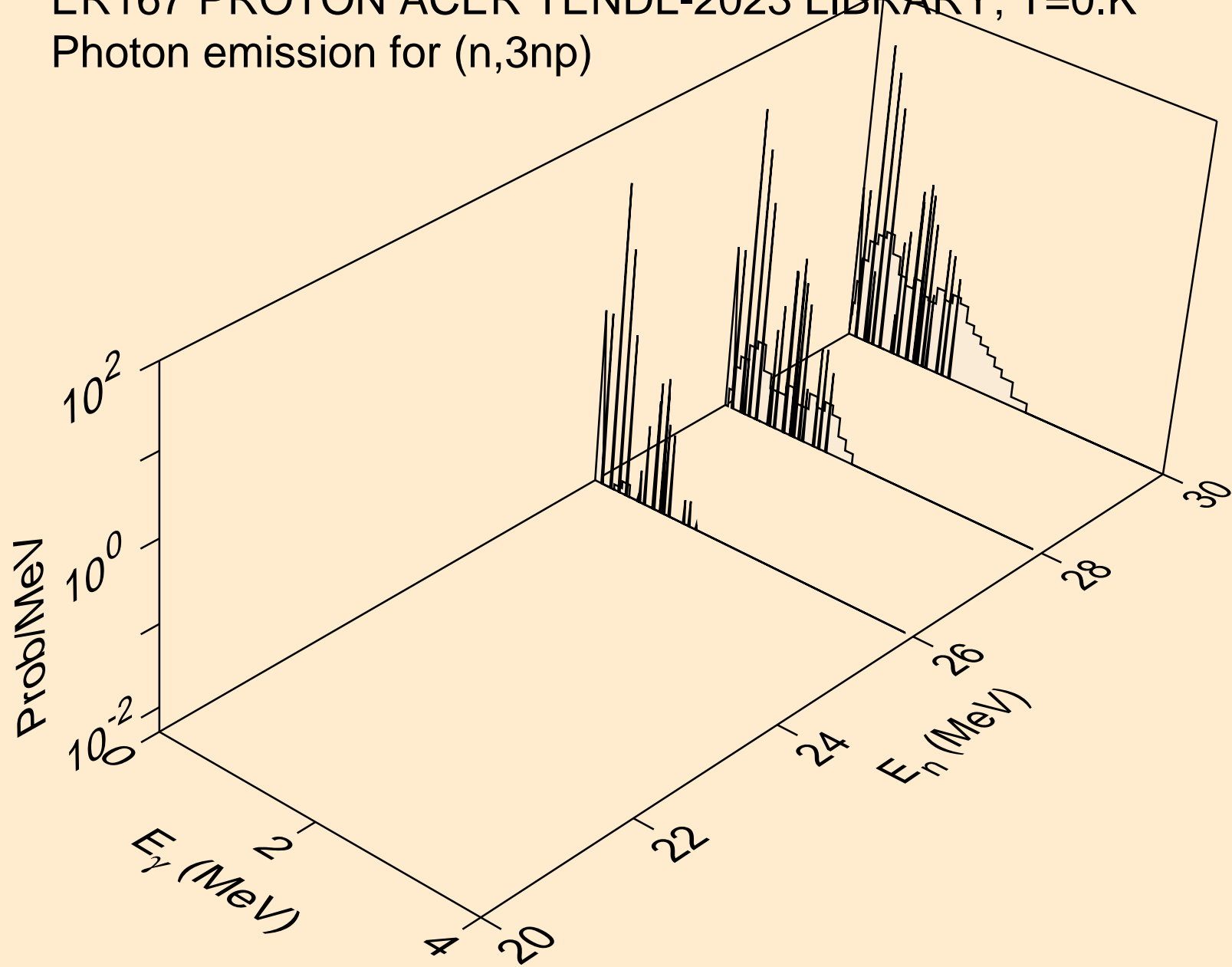

ER167 PROTON ACER TENDL-2023 LIBRARY; T=0.K  
Photon emission for (n,n2p)

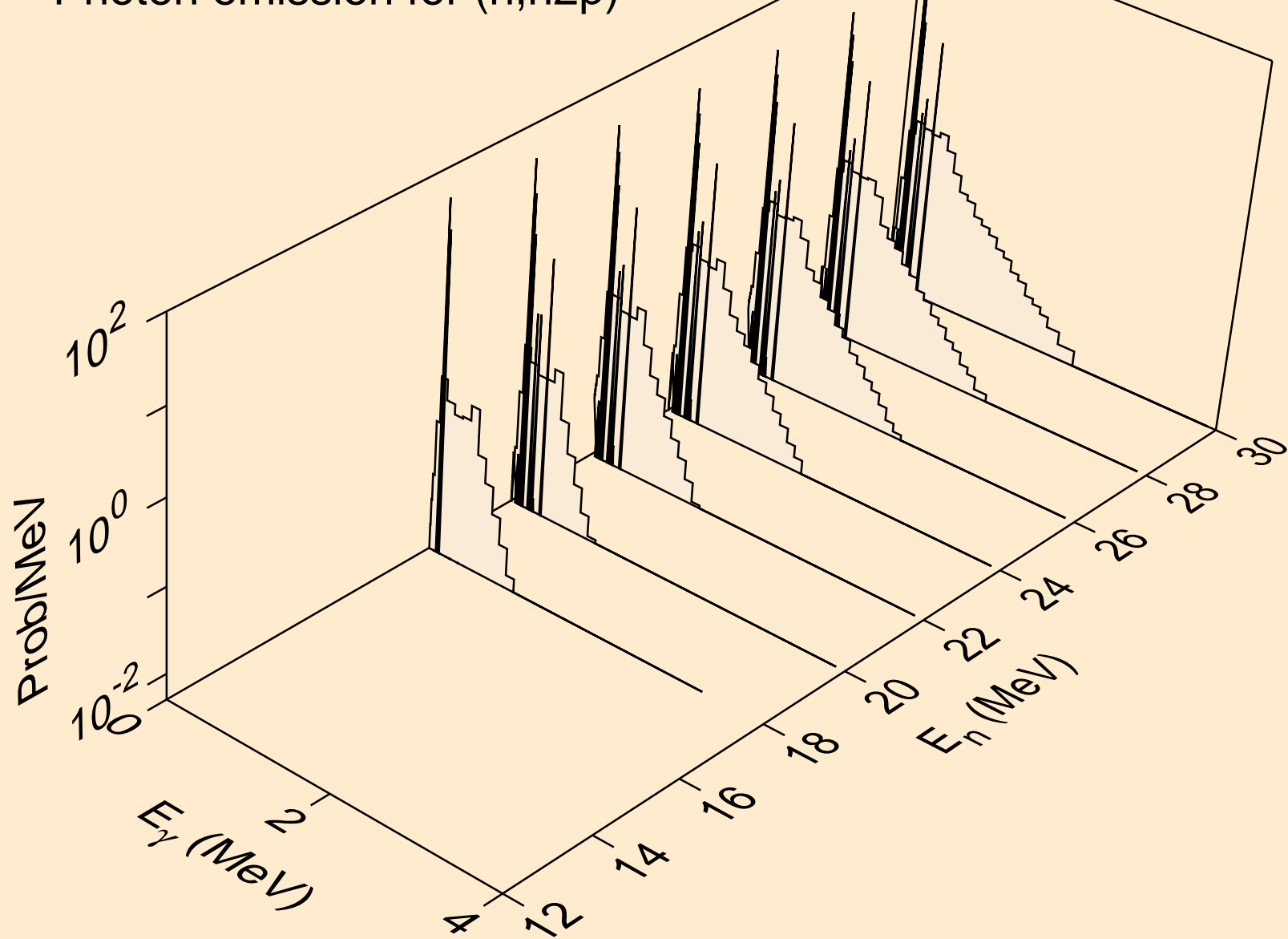

ER167 PROTON ACER TENDL-2023 LIBRARY; T=0.K  
Photon emission for (n,npa)

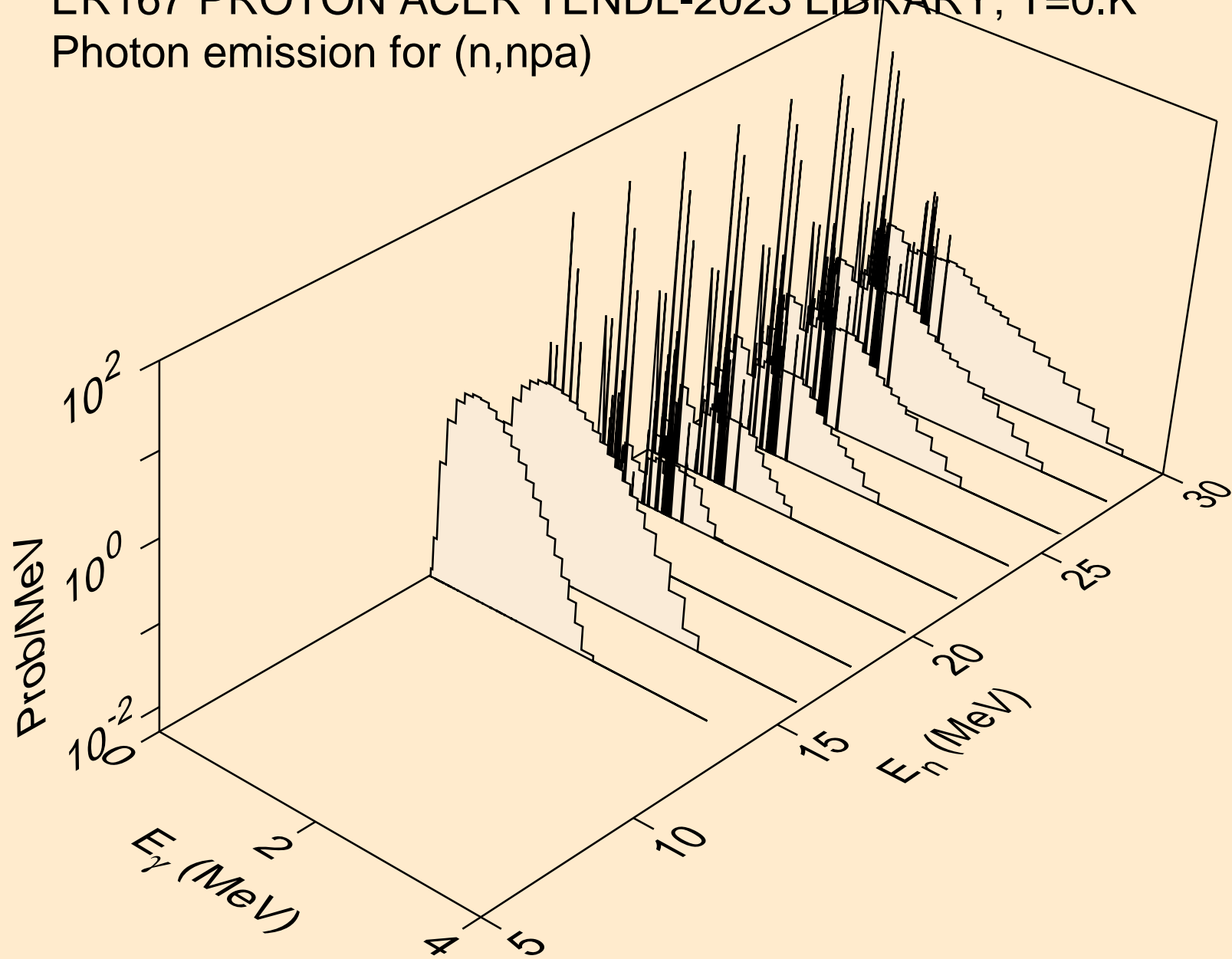

ER167 PROTON ACER TENDL-2023 LIBRARY; T=0.K  
Photon emission for (n,gma)

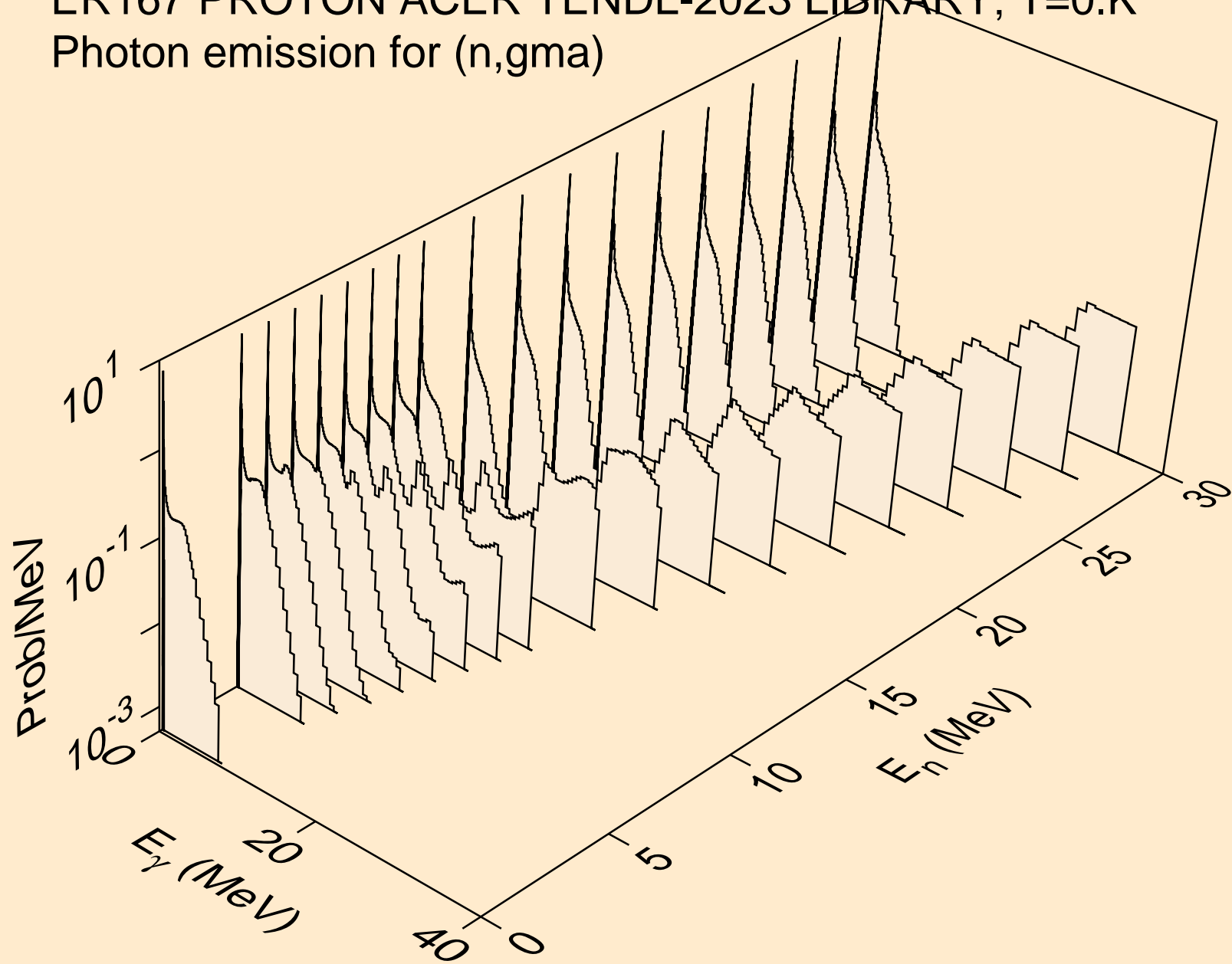

ER167 PROTON ACER TENDL-2023 LIBRARY; T=0.K  
Photon emission for inelastic

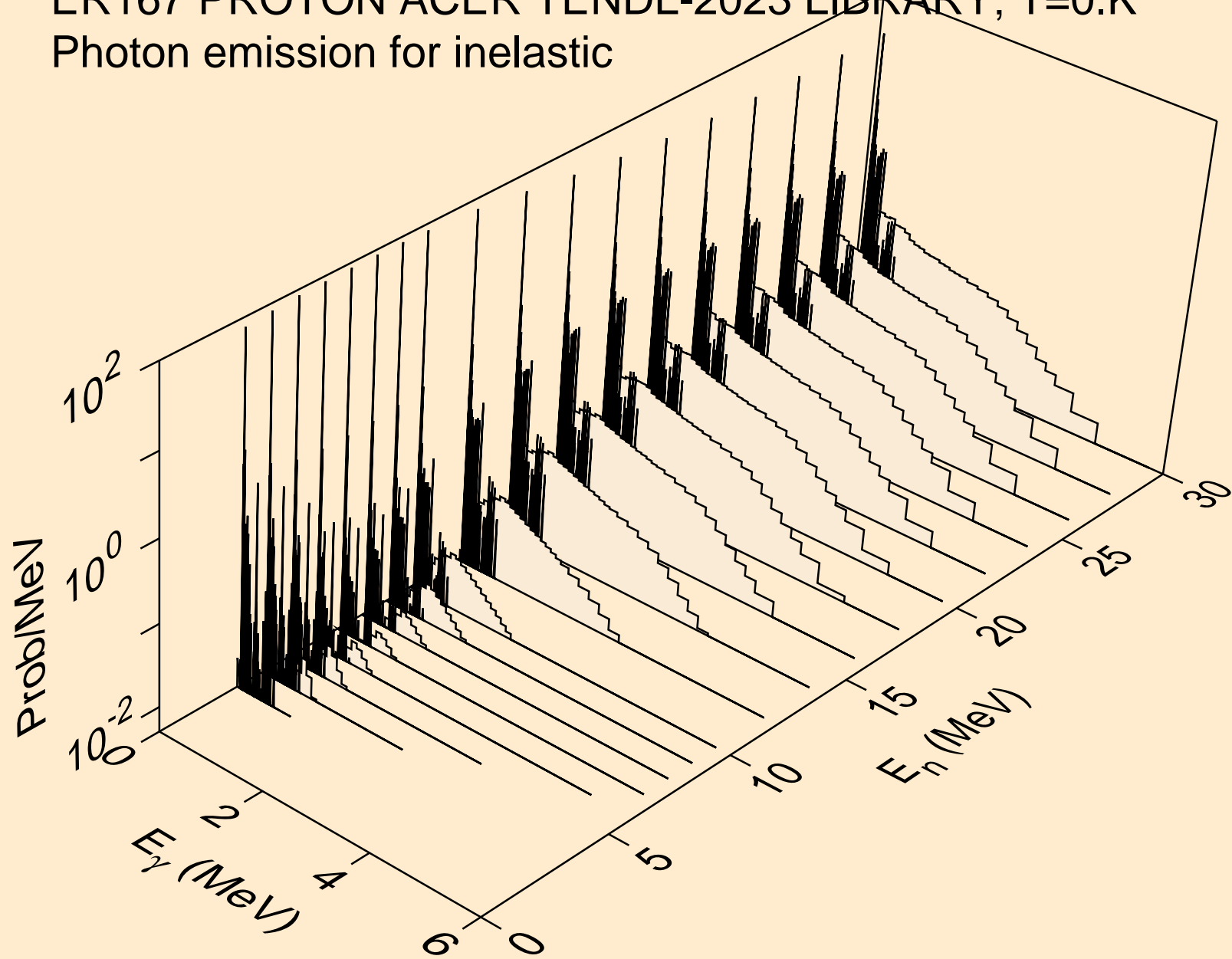



ER167 PROTON ACER TENDL-2023 LIBRARY; T=0.K  
Photon emission for (n,d)

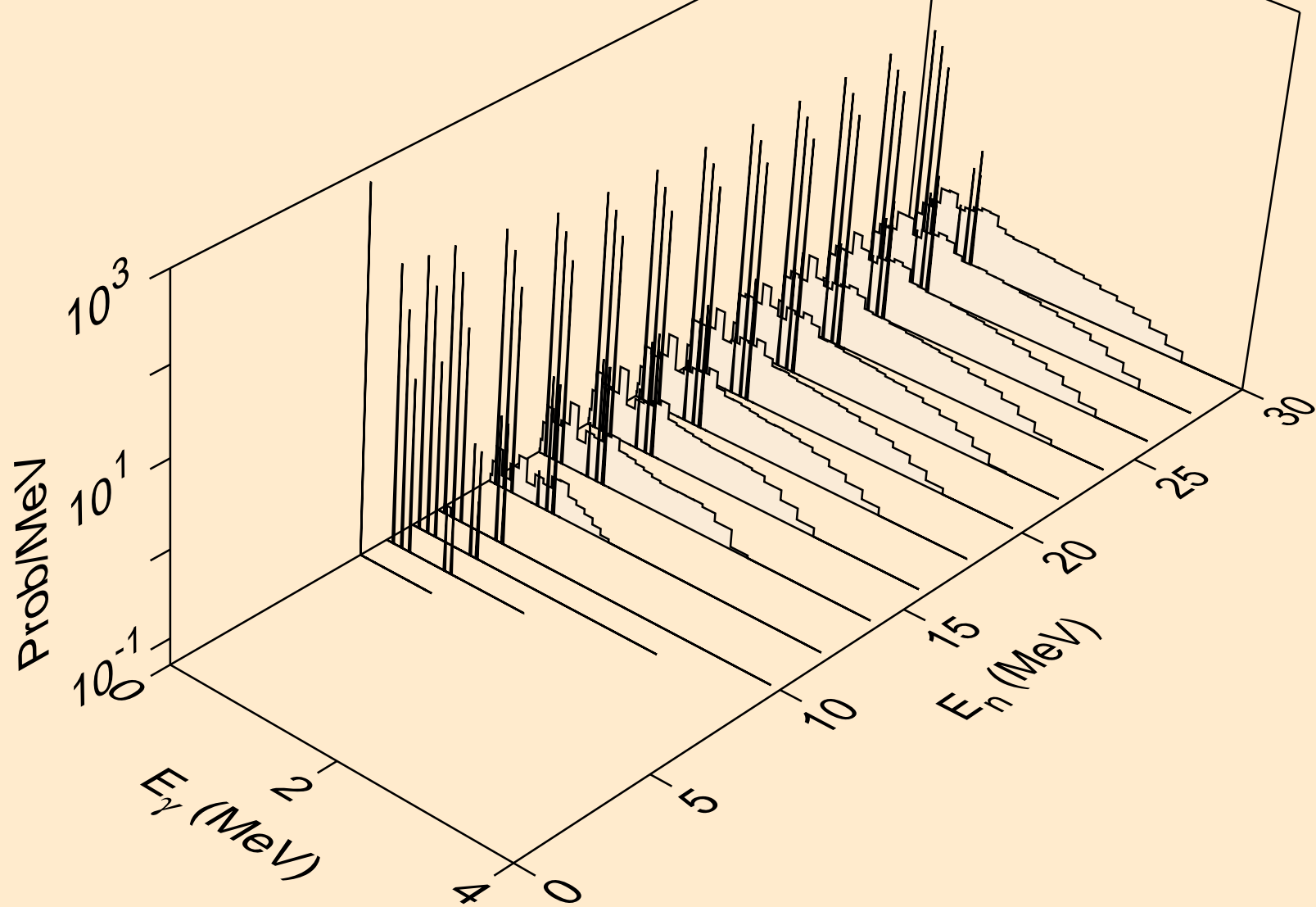

ER167 PROTON ACER TENDL-2023 LIBRARY; T=0.K  
Photon emission for (n,t)

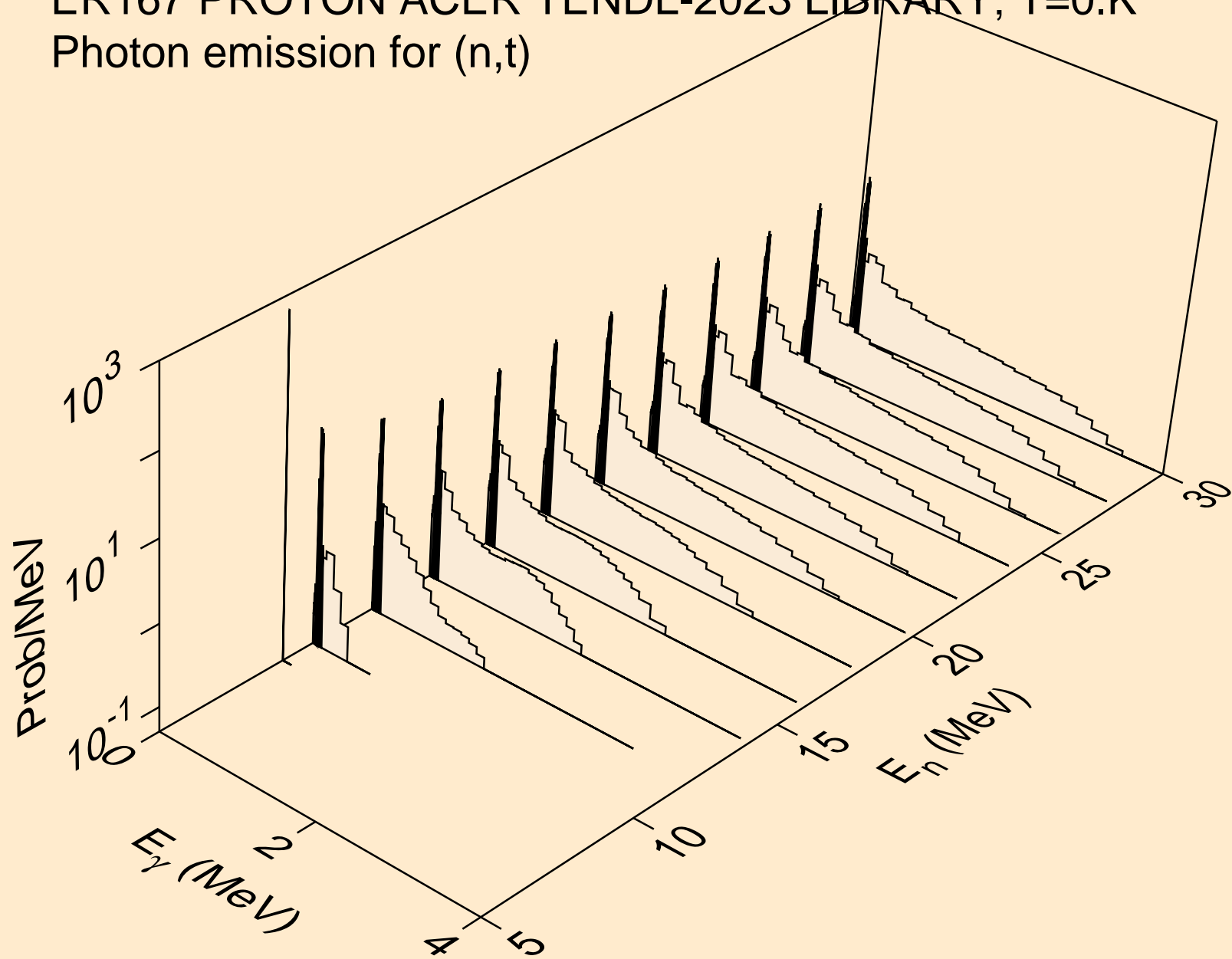

ER167 PROTON ACER TENDL-2023 LIBRARY; T=0.K  
Photon emission for (n,he3)

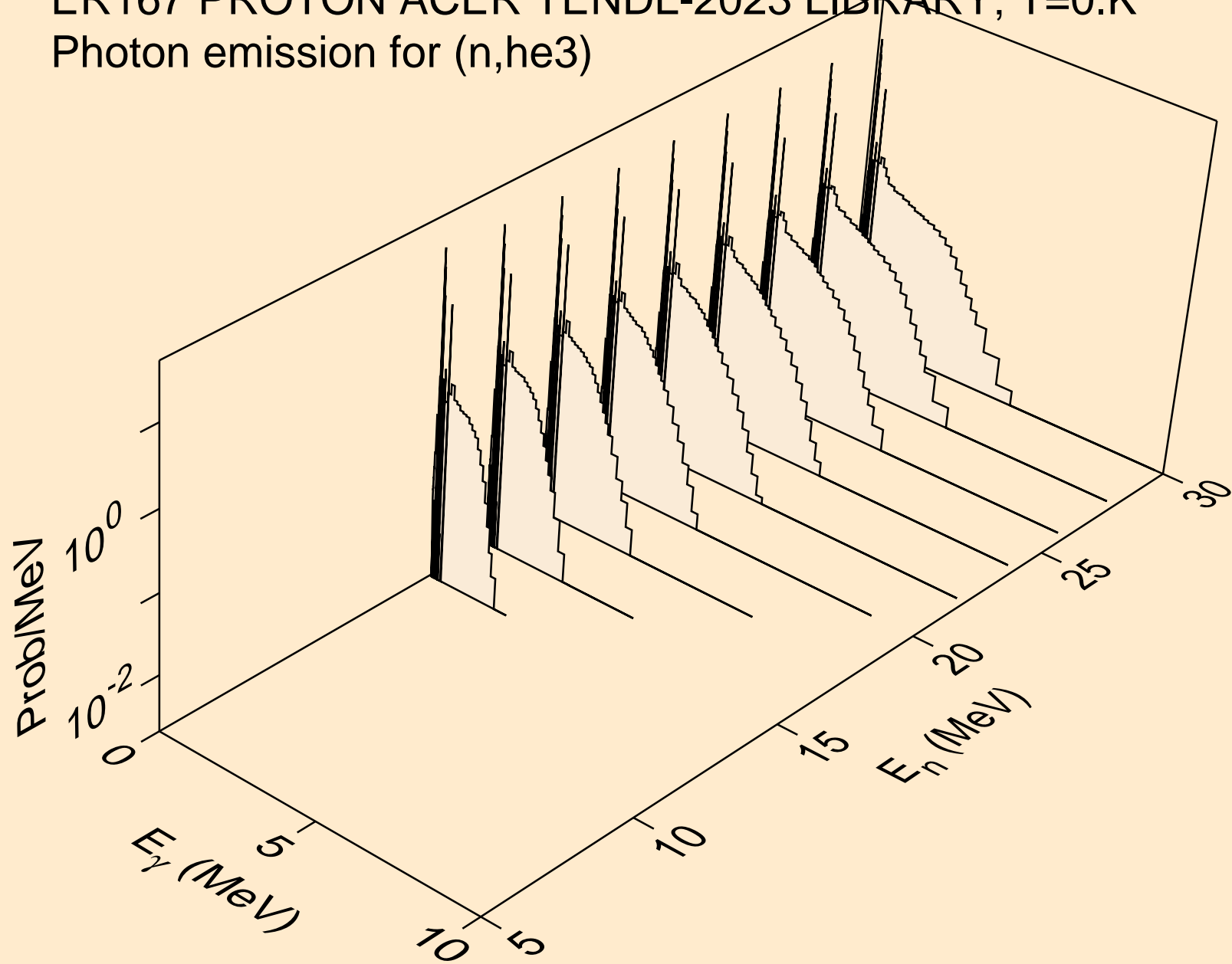

ER167 PROTON ACER TENDL-2023 LIBRARY; T=0.K  
Photon emission for (n,a)

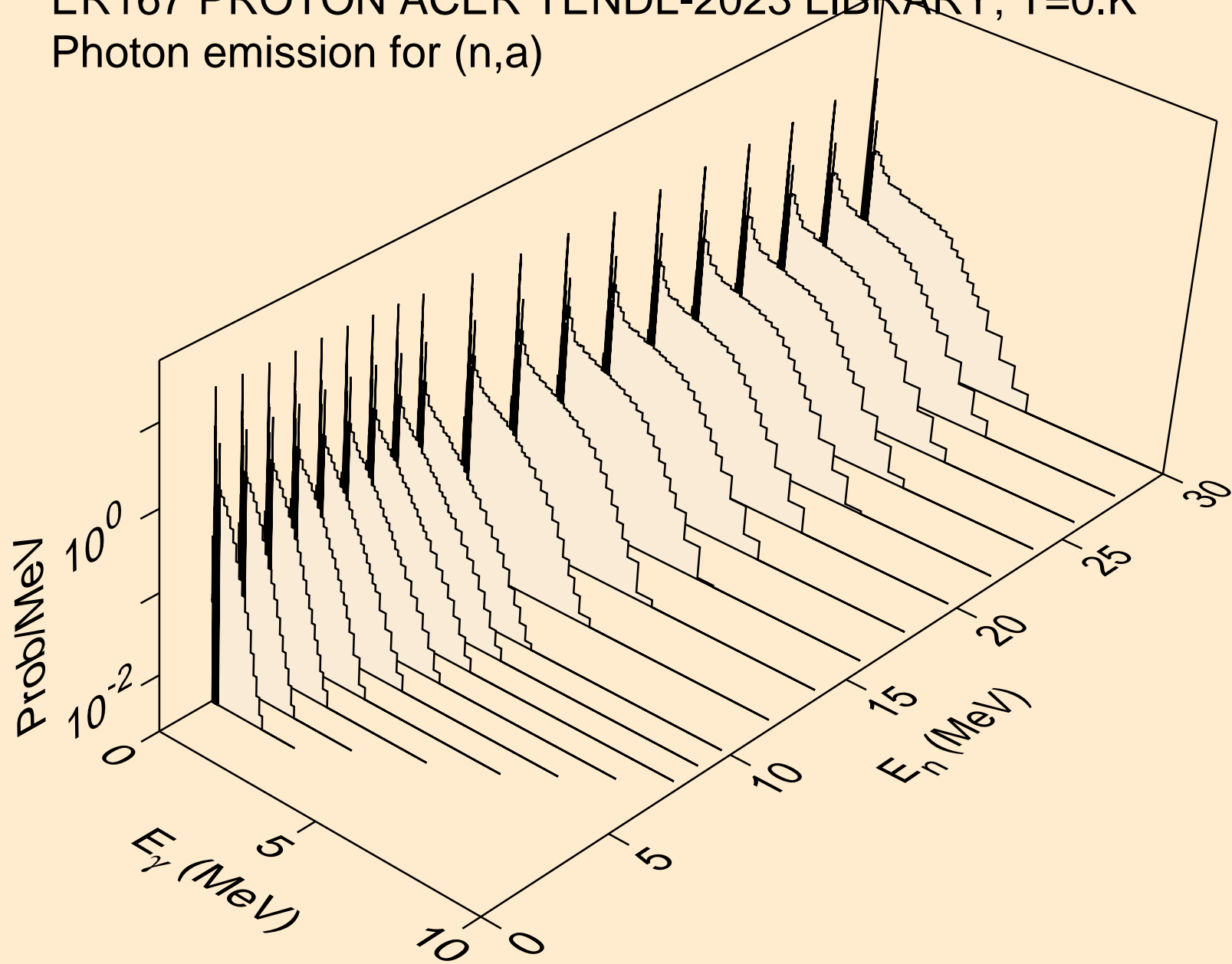

ER167 PROTON ACER TENDL-2023 LIBRARY; T=0.K  
Photon emission for (n,2a)

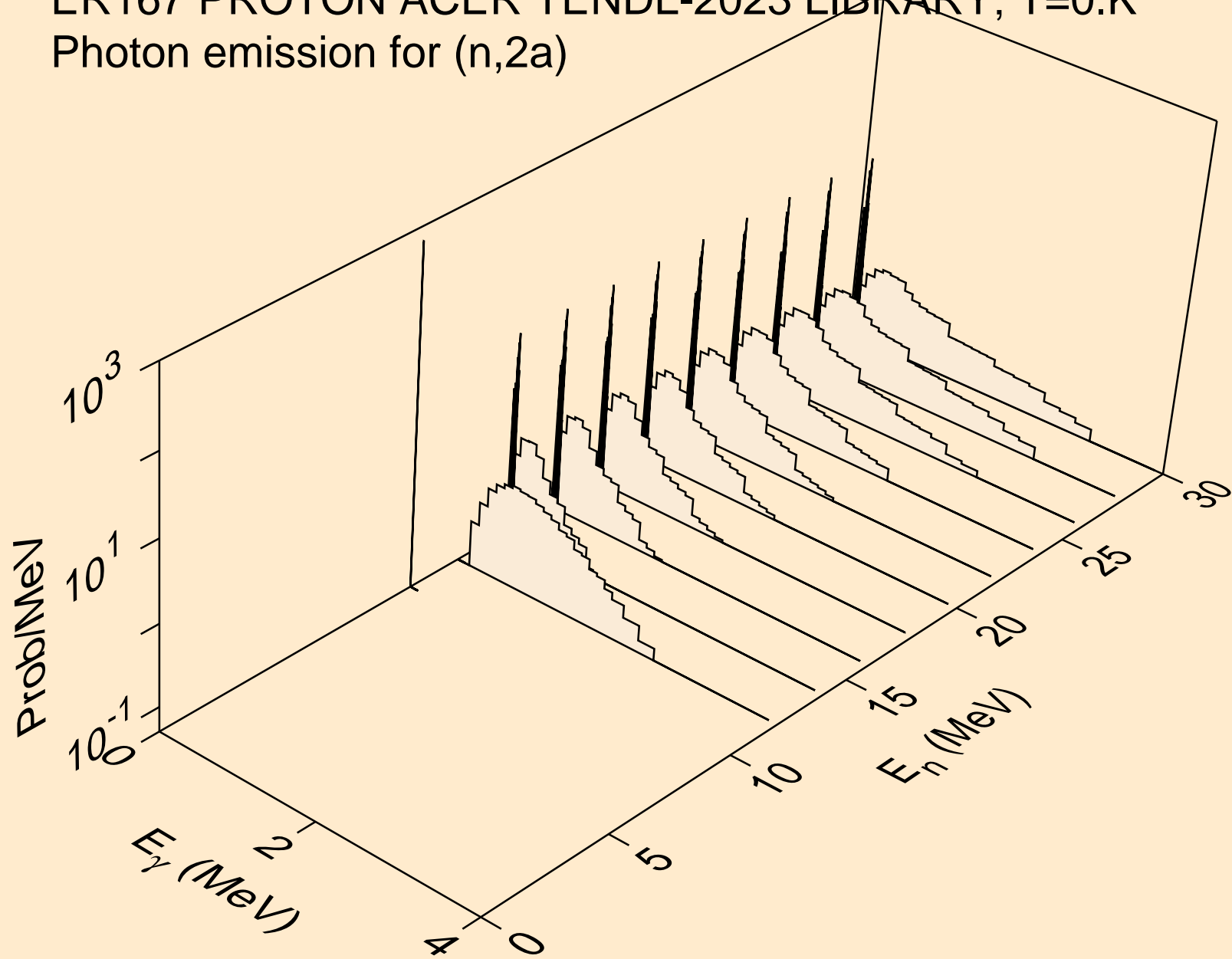

ER167 PROTON ACER TENDL-2023 LIBRARY; T=0.K  
Photon emission for (n,2p)

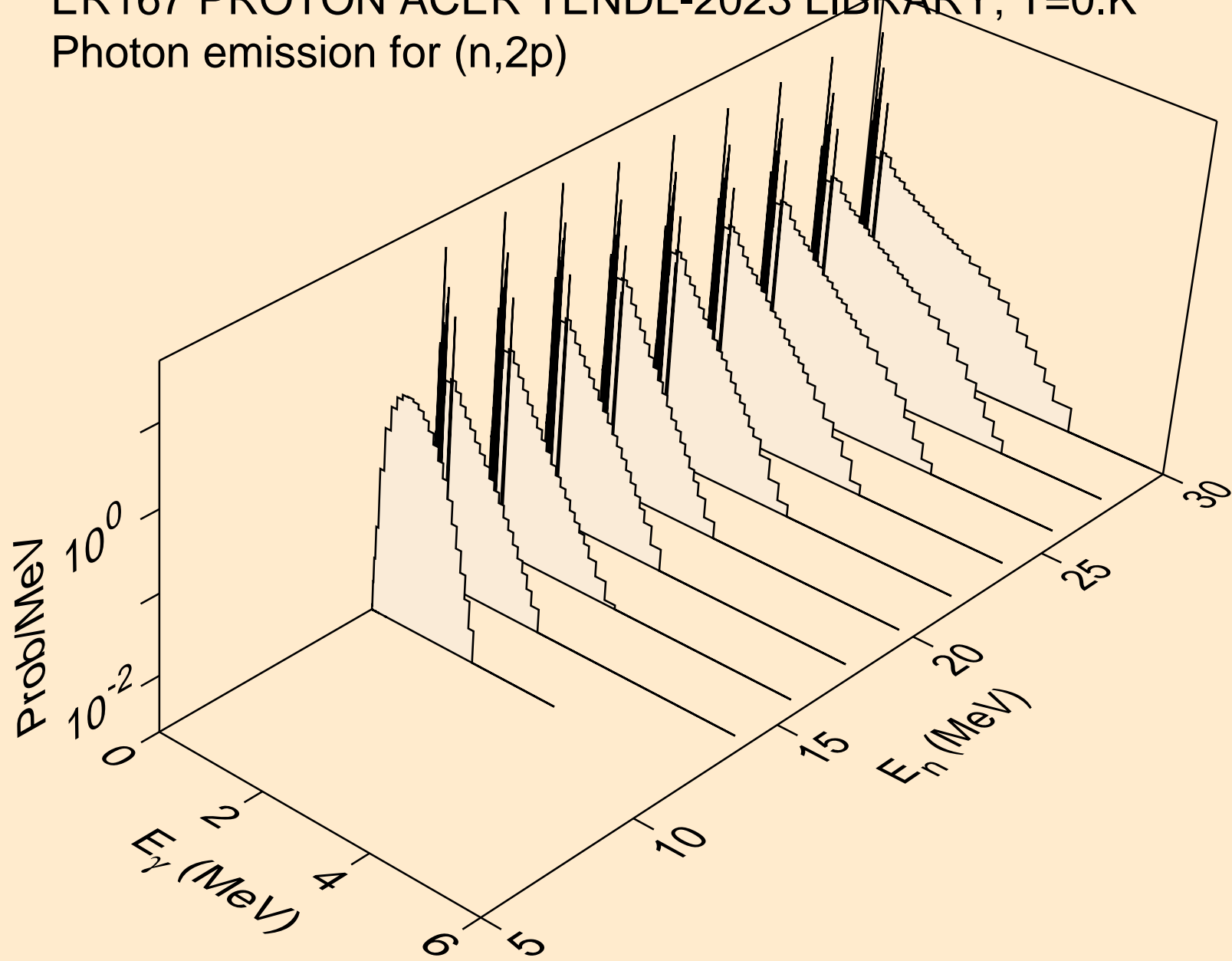

ER167 PROTON ACER TENDL-2023 LIBRARY; T=0.K  
Photon emission for (n,pa)

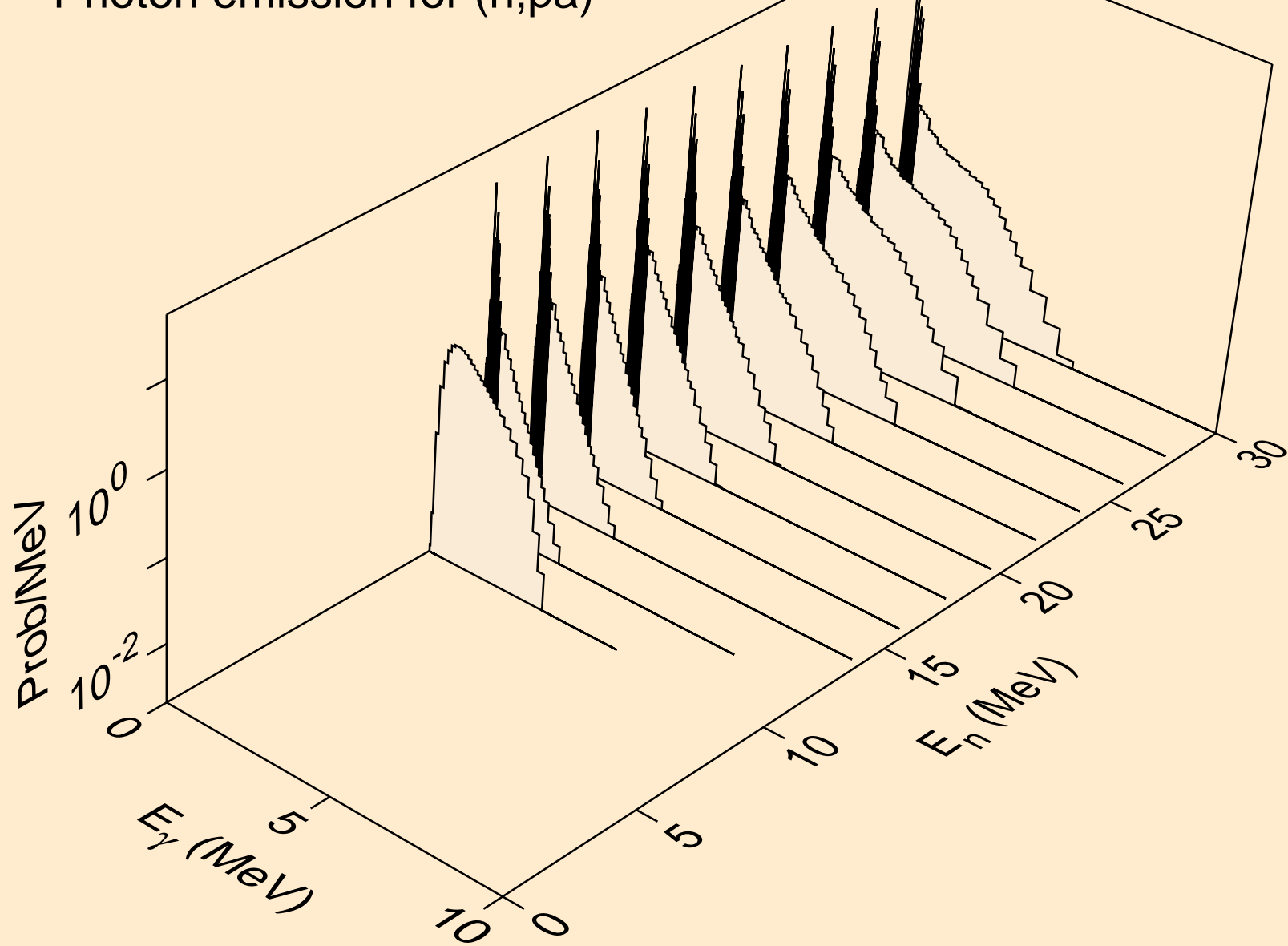

ER167 PROTON ACER TENDL-2023 LIBRARY; T=0.K  
Photon emission for (n,pd)

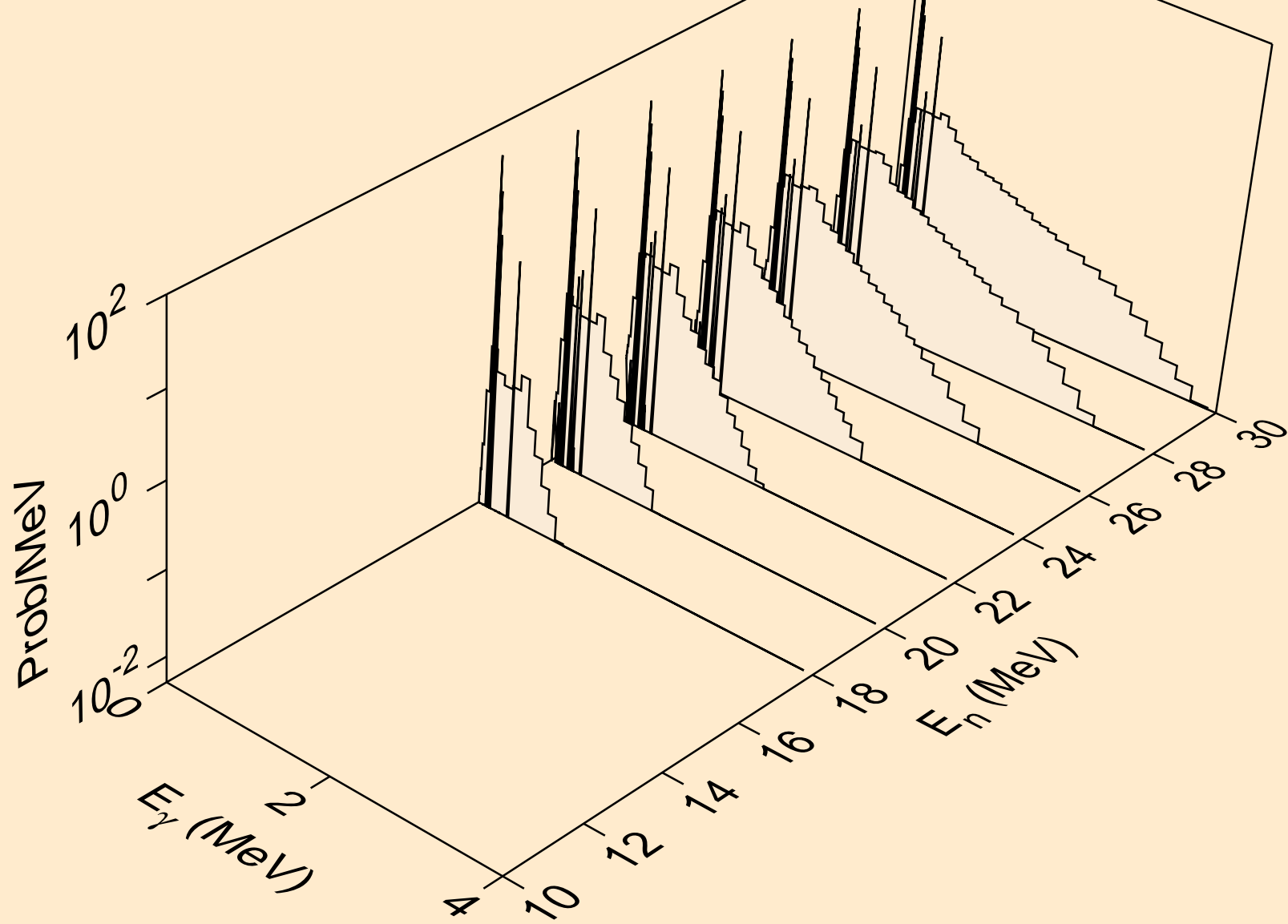



ER167 PROTON ACER TENDL-2023 LIBRARY; T=0.K  
Photon emission for (n,pt)

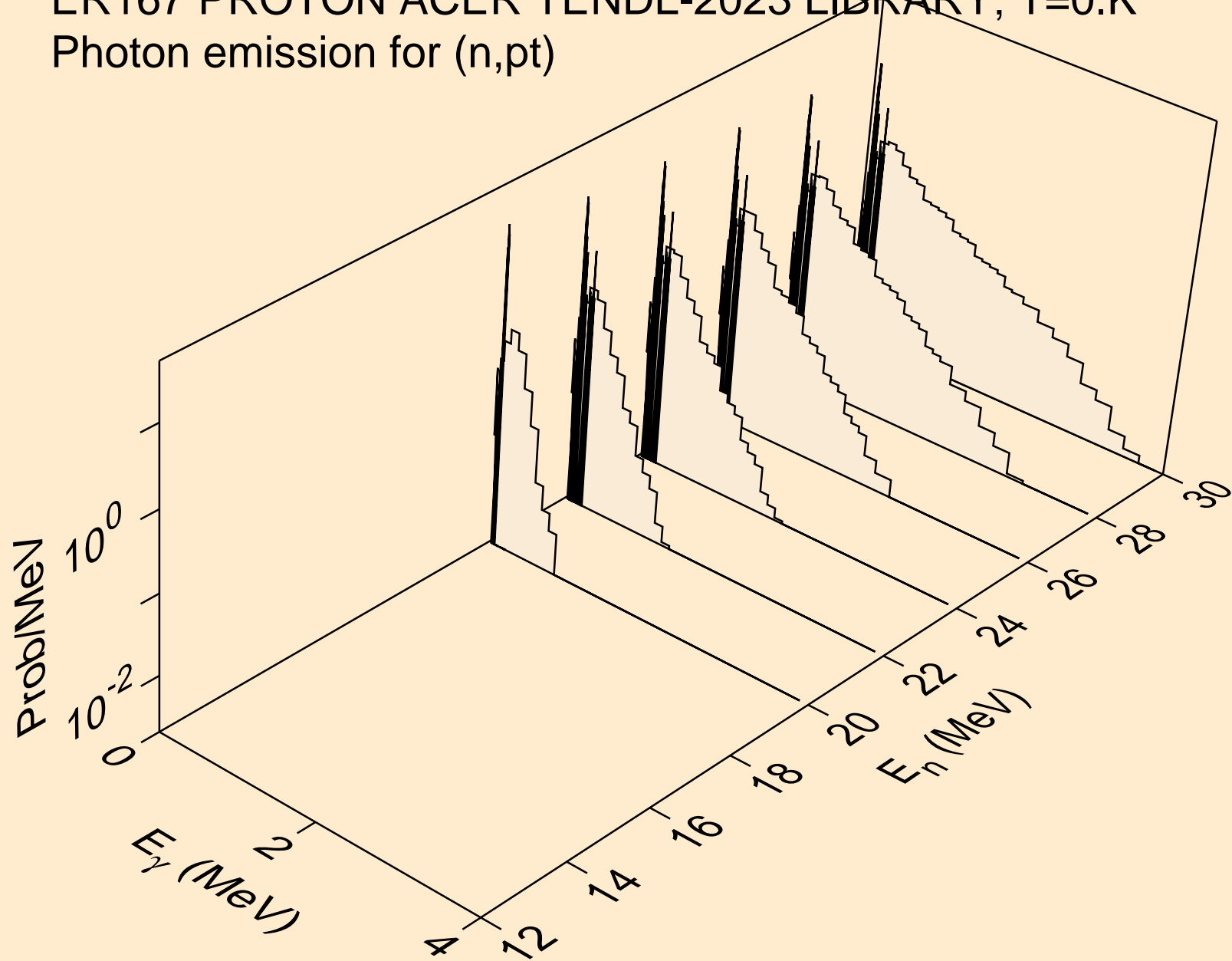

ER167 PROTON ACER TENDL-2023 LIBRARY; T=0.K  
Photon emission for (n,da)

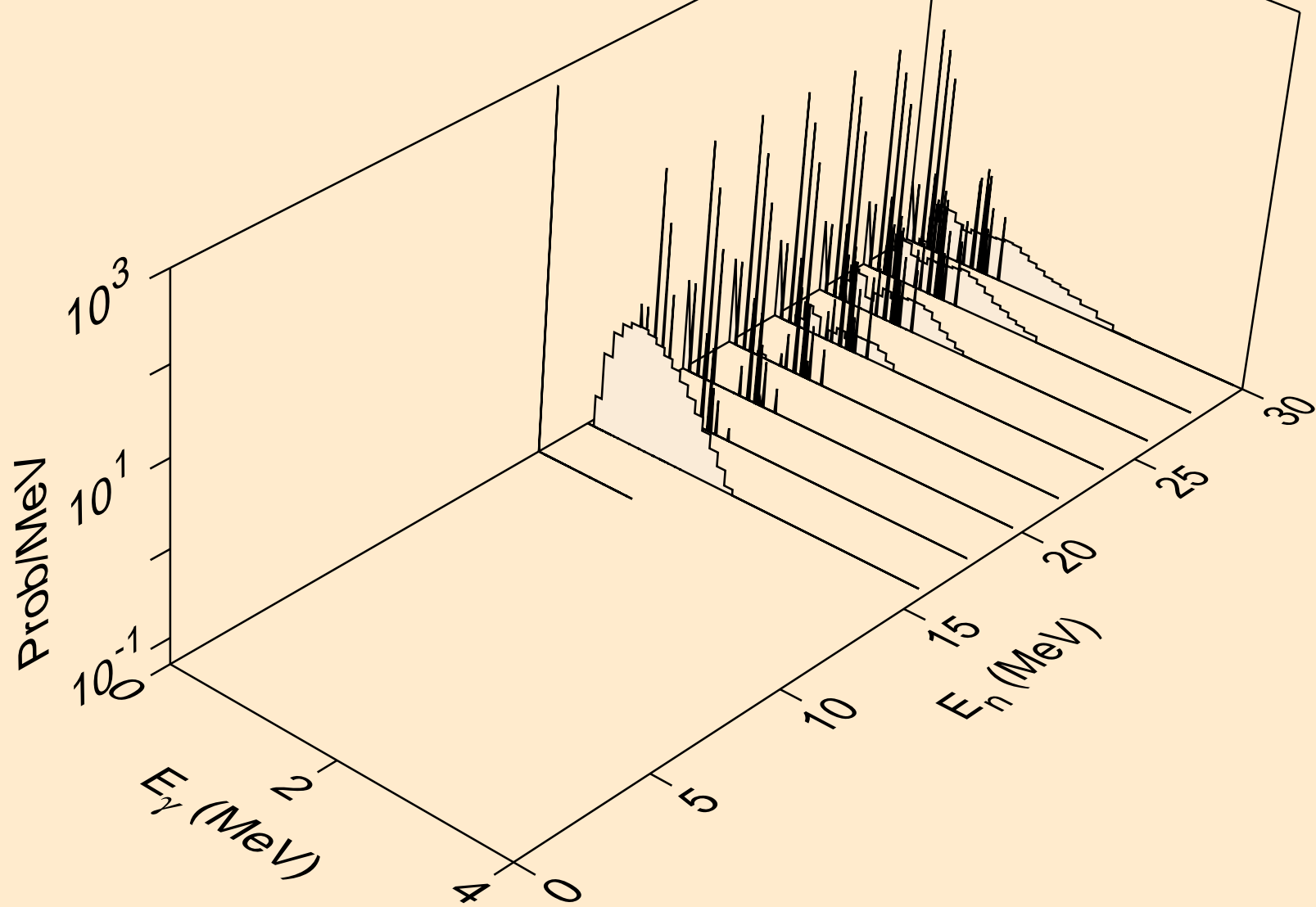

ER167 PROTON ACER TENDL-2023 LIBRARY; T=0.K  
Particle heating contributions

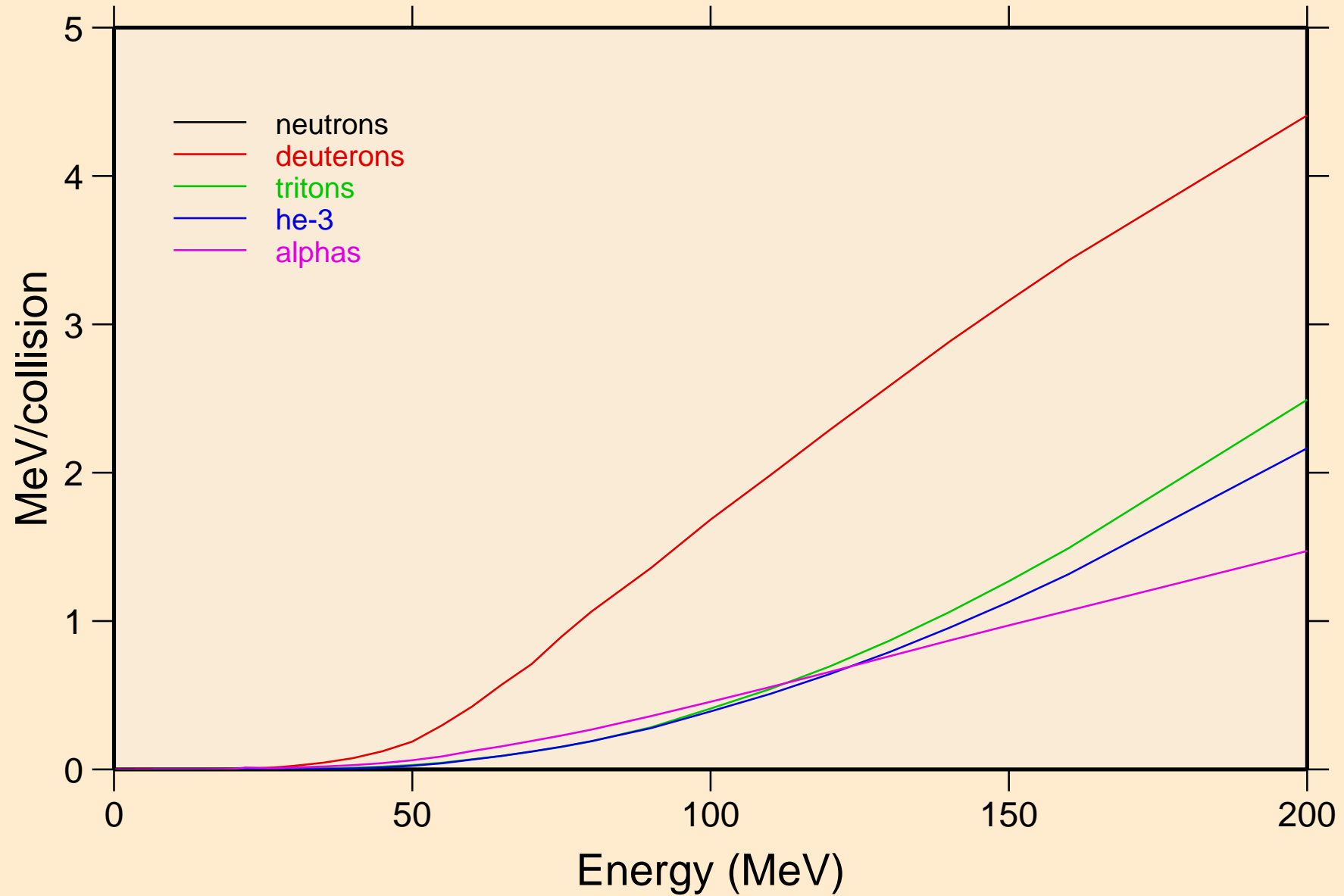

# ER167 PROTON ACER TENDL-2023 LIBRARY; T=0.K

## Recoil Heating

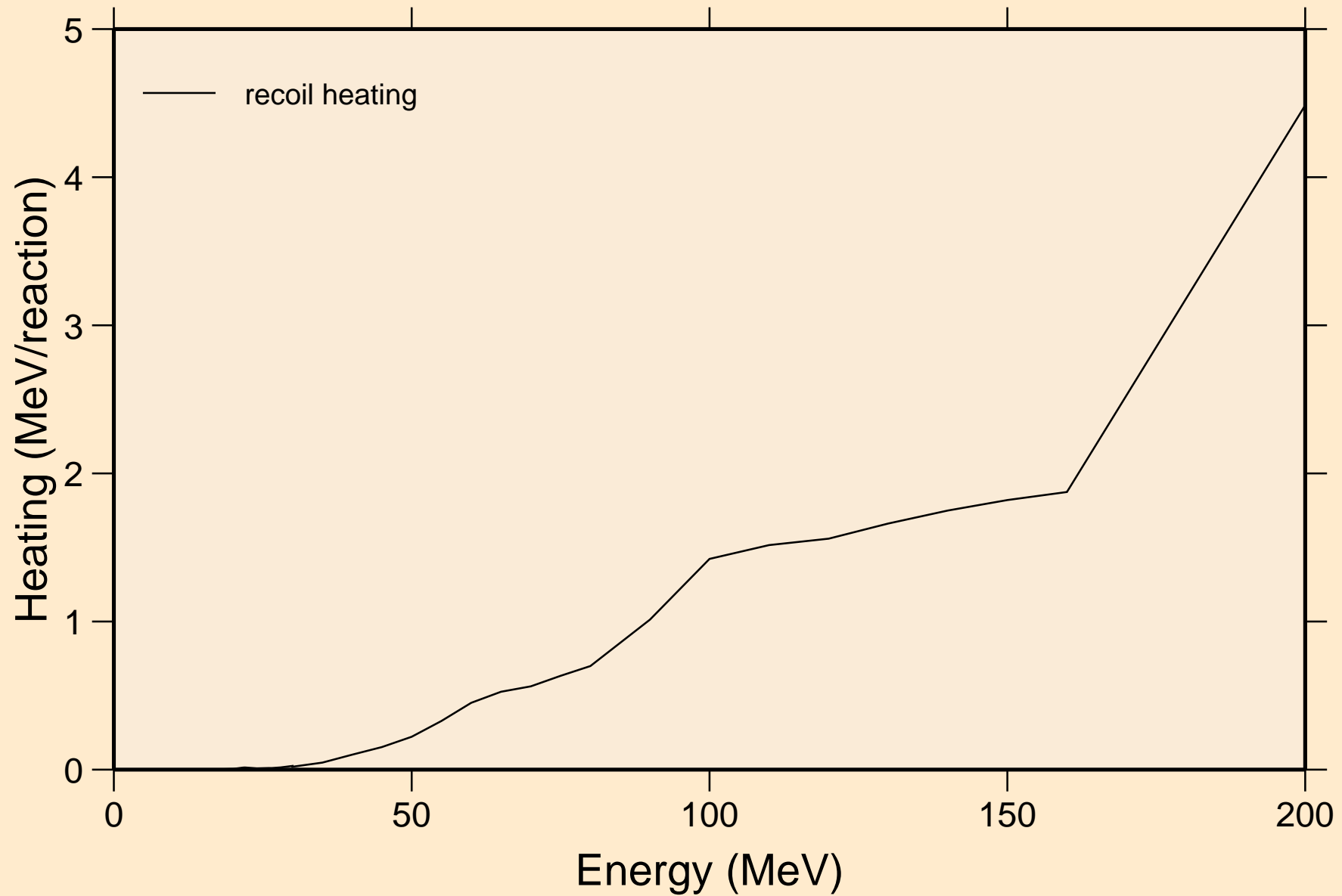

ER167 PROTON ACER TENDL-2023 LIBRARY; T=0.K  
Particle production cross sections

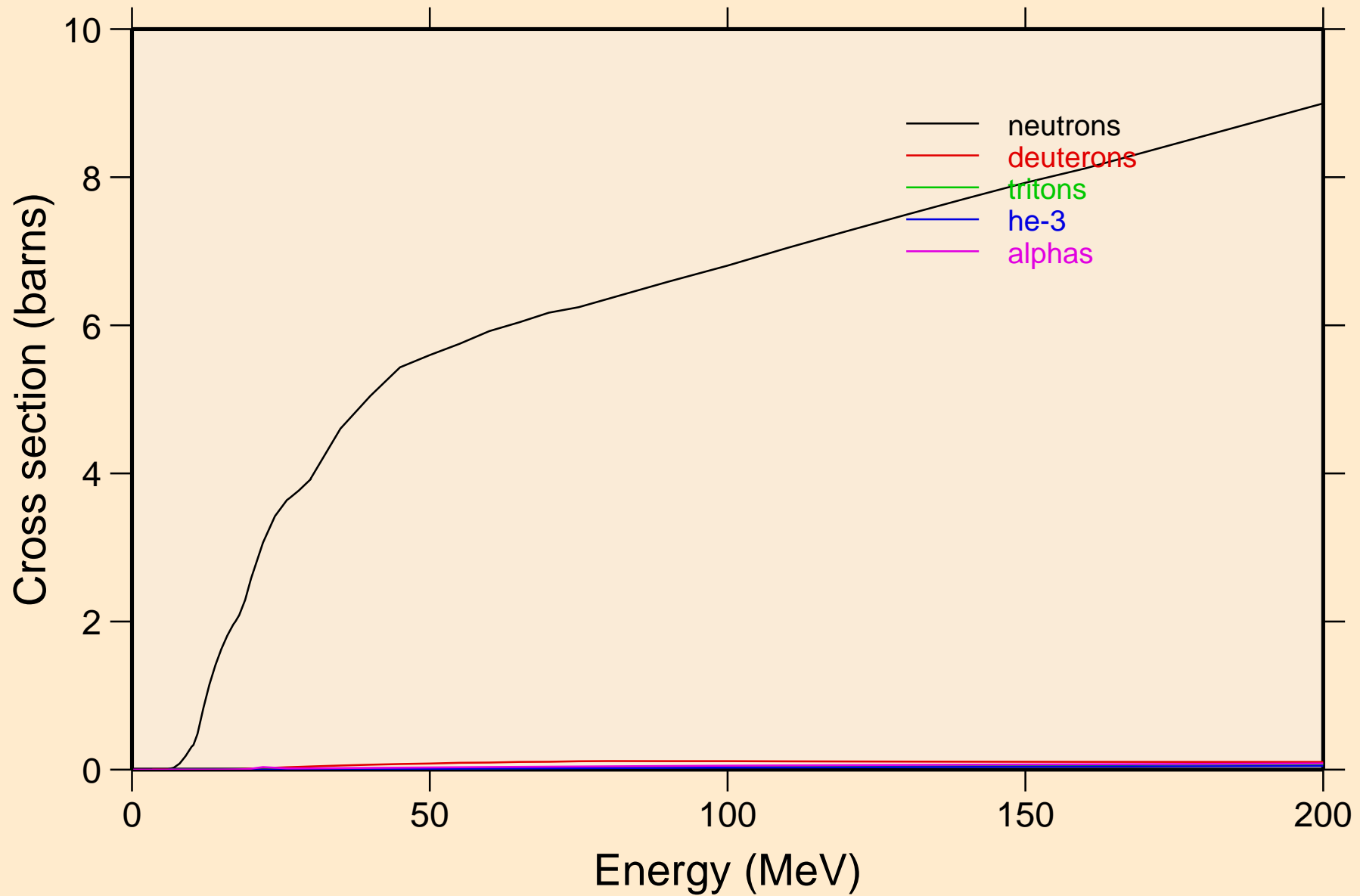

ER167 PROTON ACER TENDL-2023 LIBRARY; T=0.K  
neutrons from (p,n)

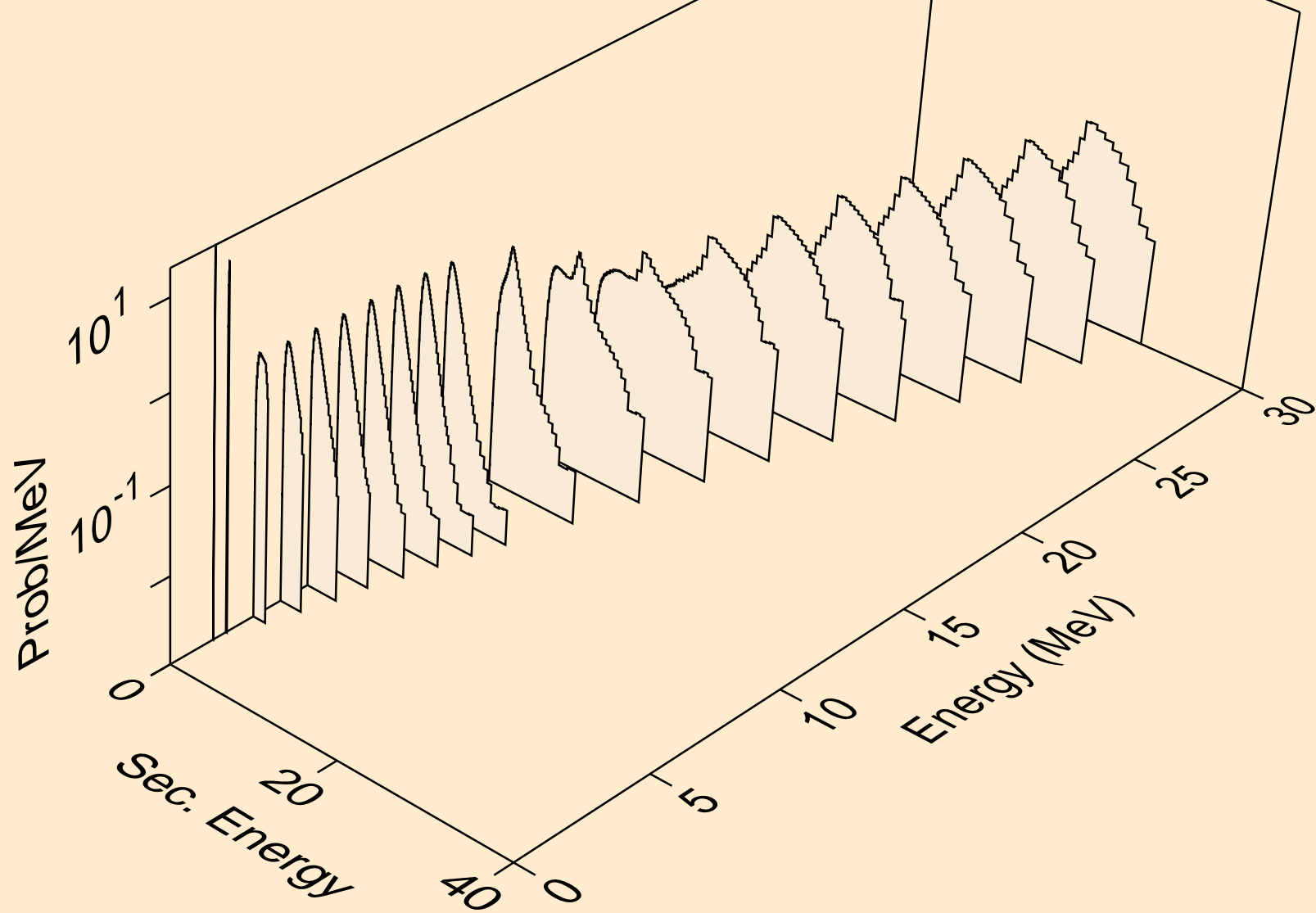

ER167 PROTON ACER TENDL-2023 LIBRARY; T=0.K  
neutrons from (p,x)

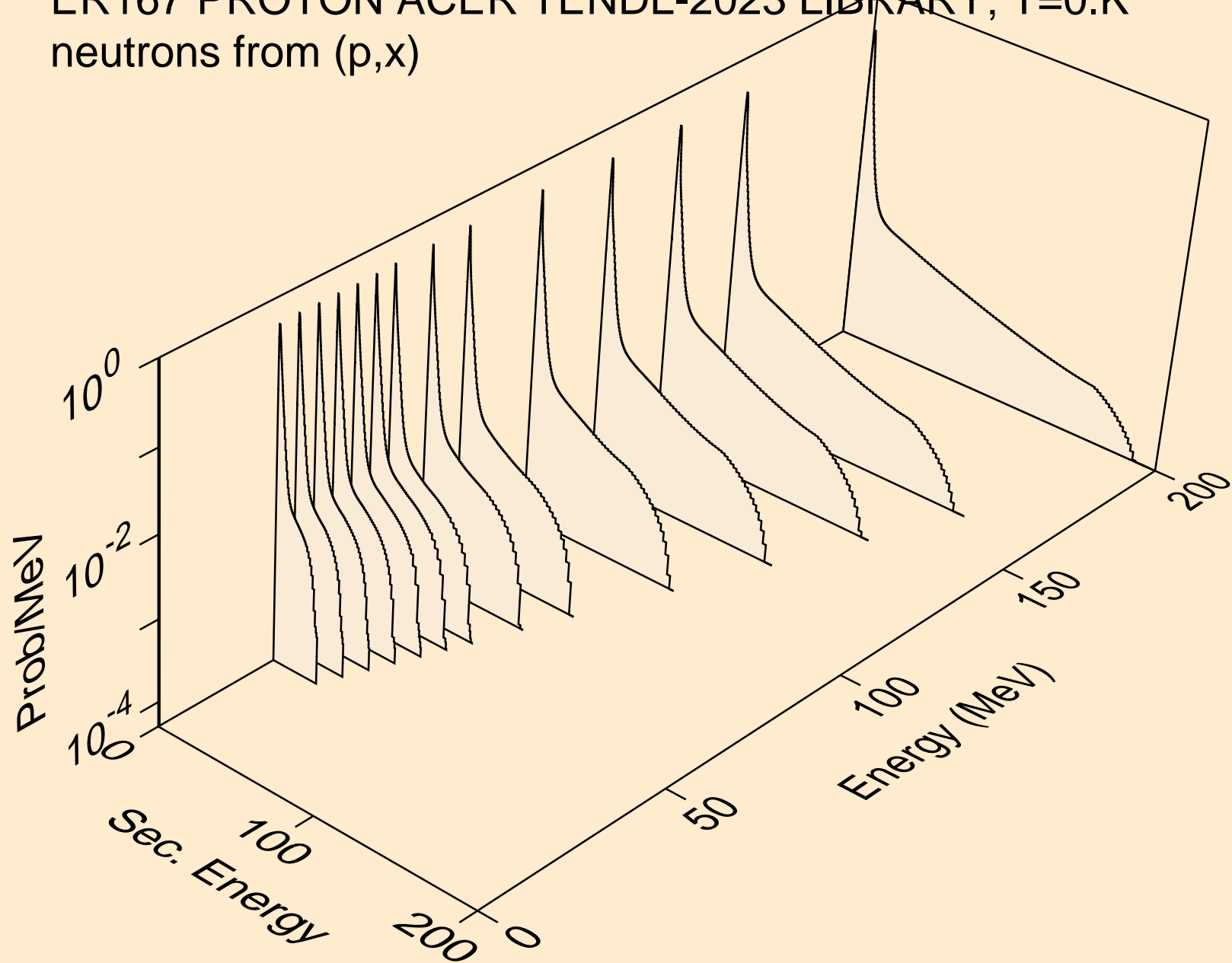

ER167 PROTON ACER TENDL-2023 LIBRARY; T=0.K  
neutrons from (p,2nd)

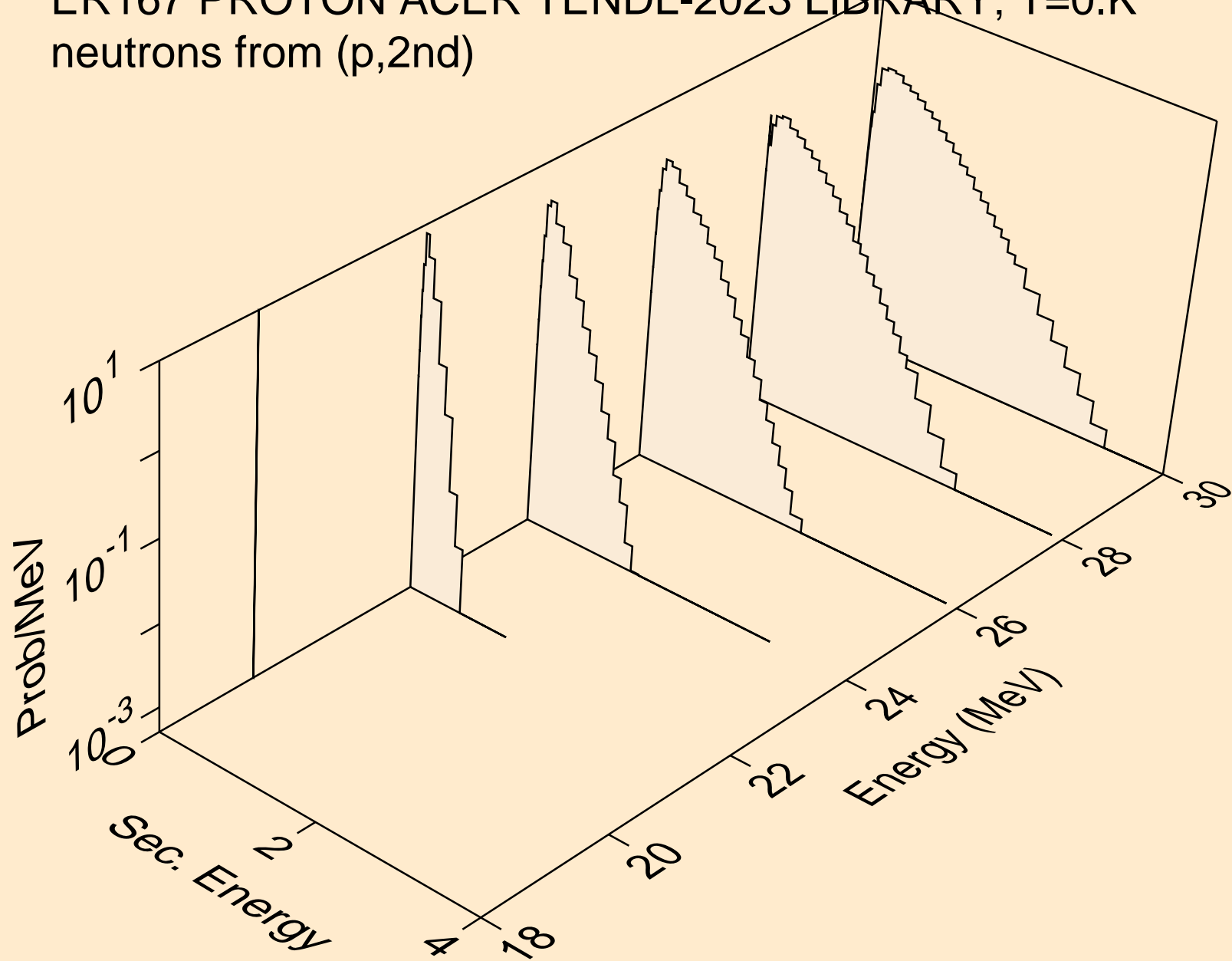



ER167 PROTON ACER TENDL-2023 LIBRARY; T=0.K  
neutrons from (p,2n)

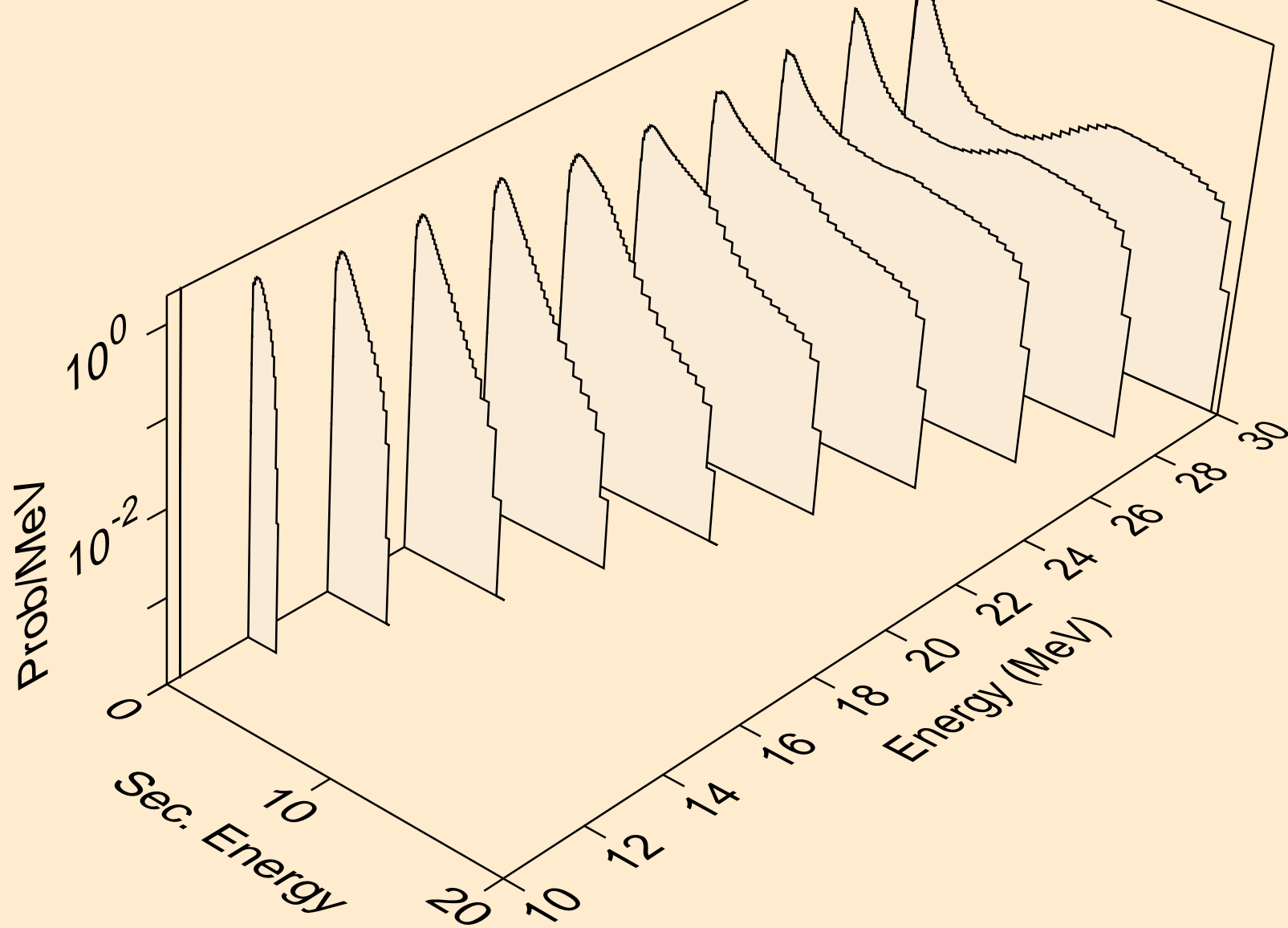

ER167 PROTON ACER TENDL-2023 LIBRARY; T=0.K  
neutrons from (p,3n)

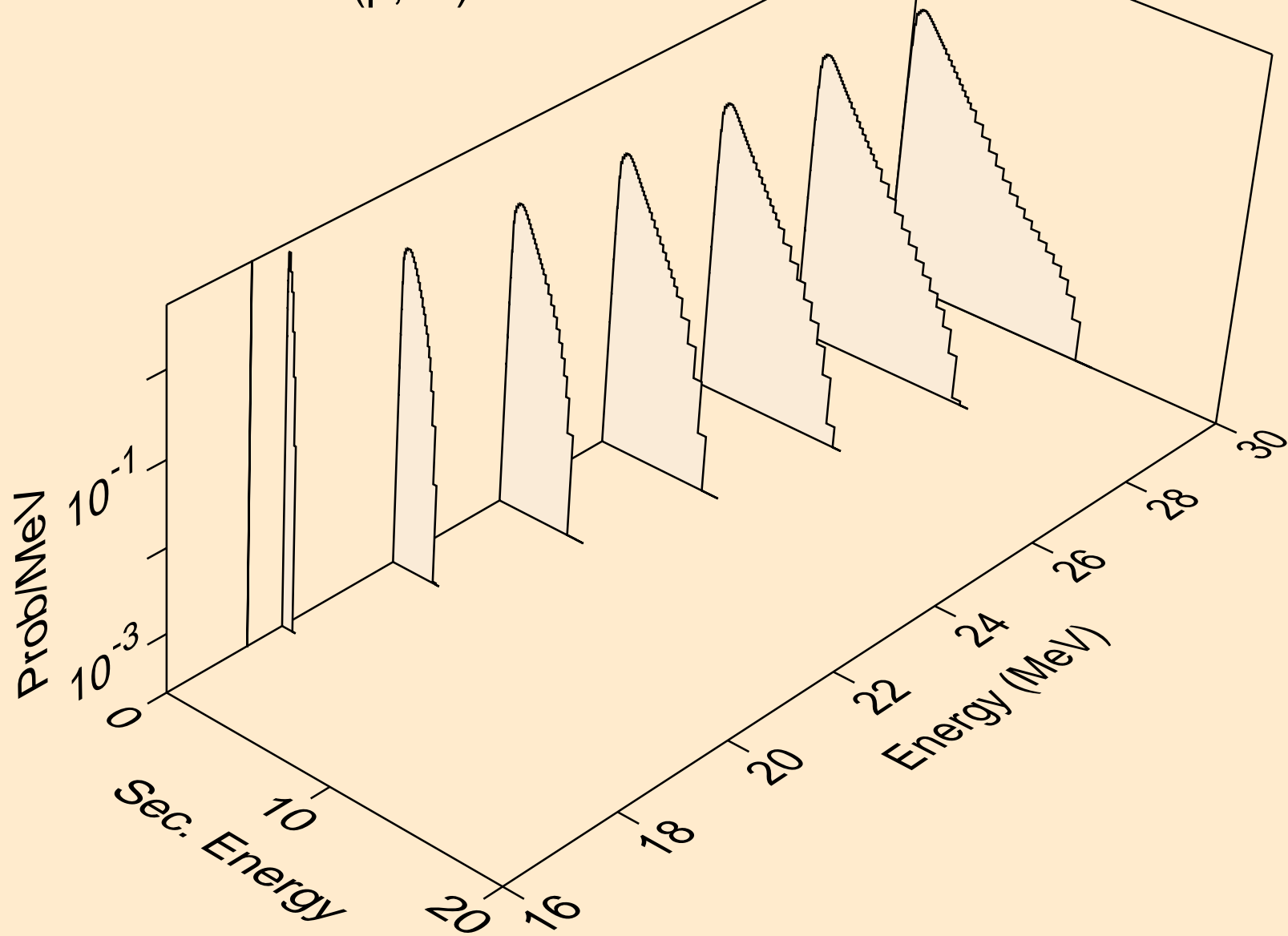

ER167 PROTON ACER TENDL-2023 LIBRARY; T=0.K  
neutrons from (p,n\*)a

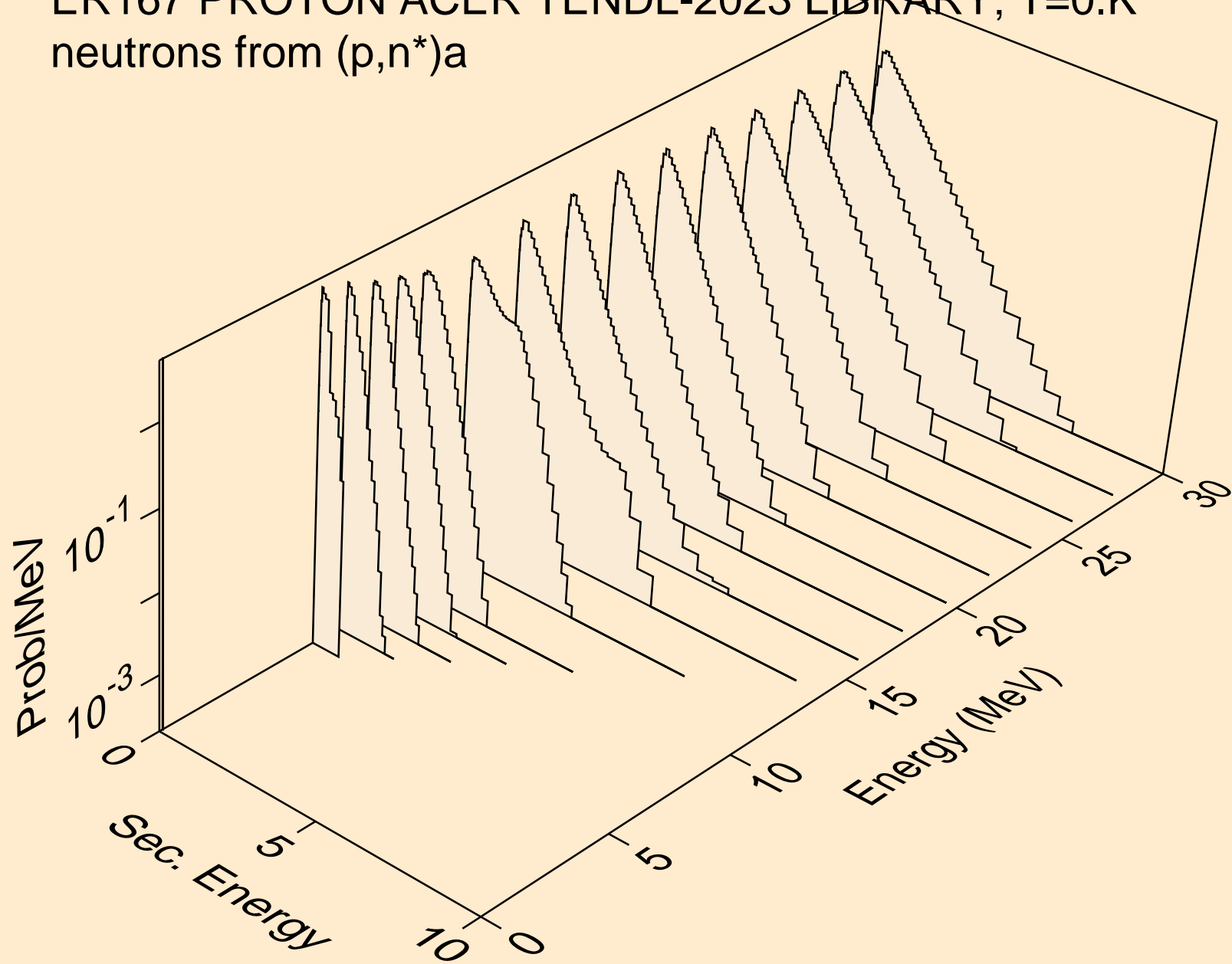

ER167 PROTON ACER TENDL-2023 LIBRARY; T=0.K  
neutrons from (p,2n)a

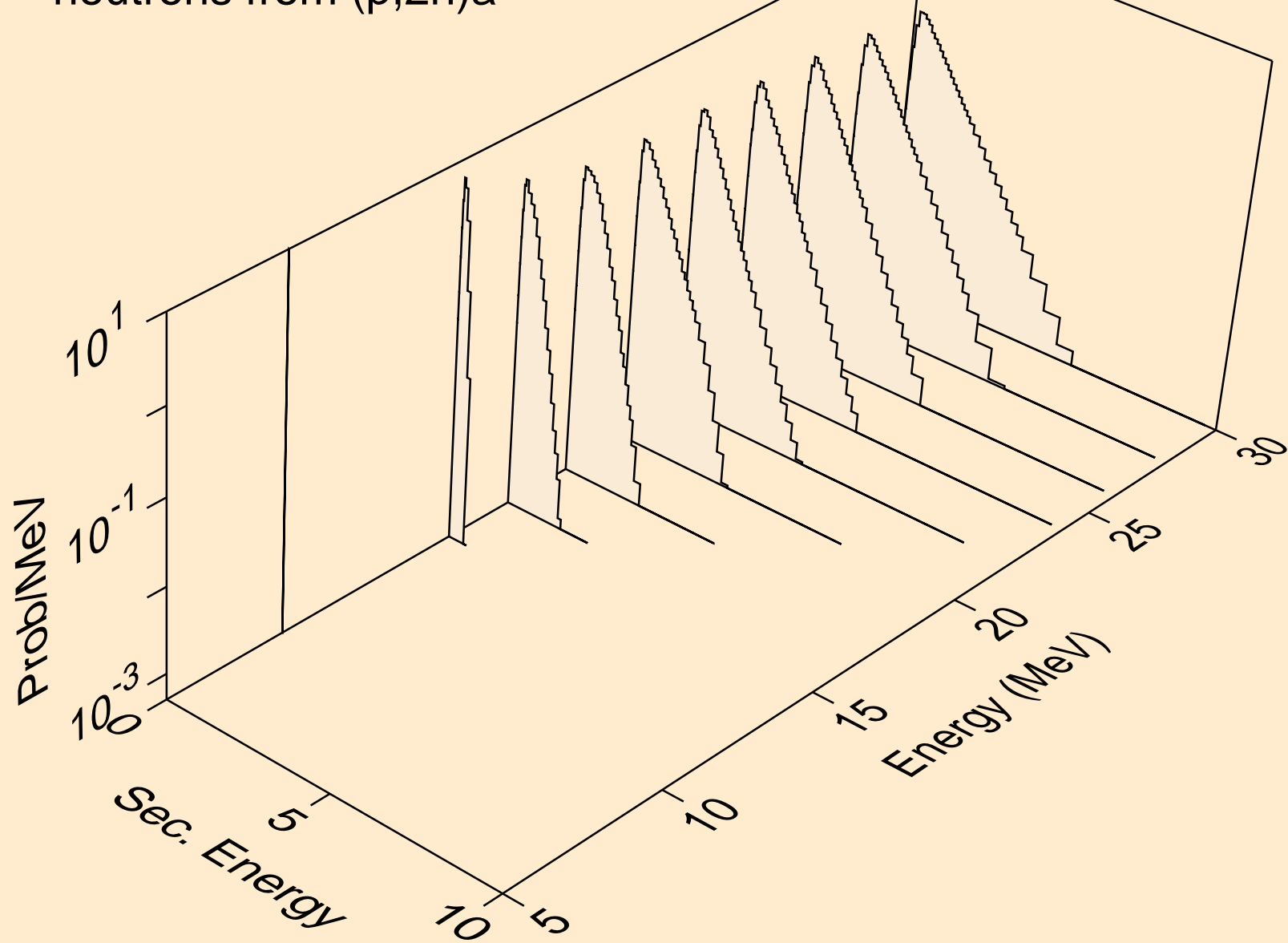

ER167 PROTON ACER TENDL-2023 LIBRARY; T=0.K  
neutrons from (p,3n)a

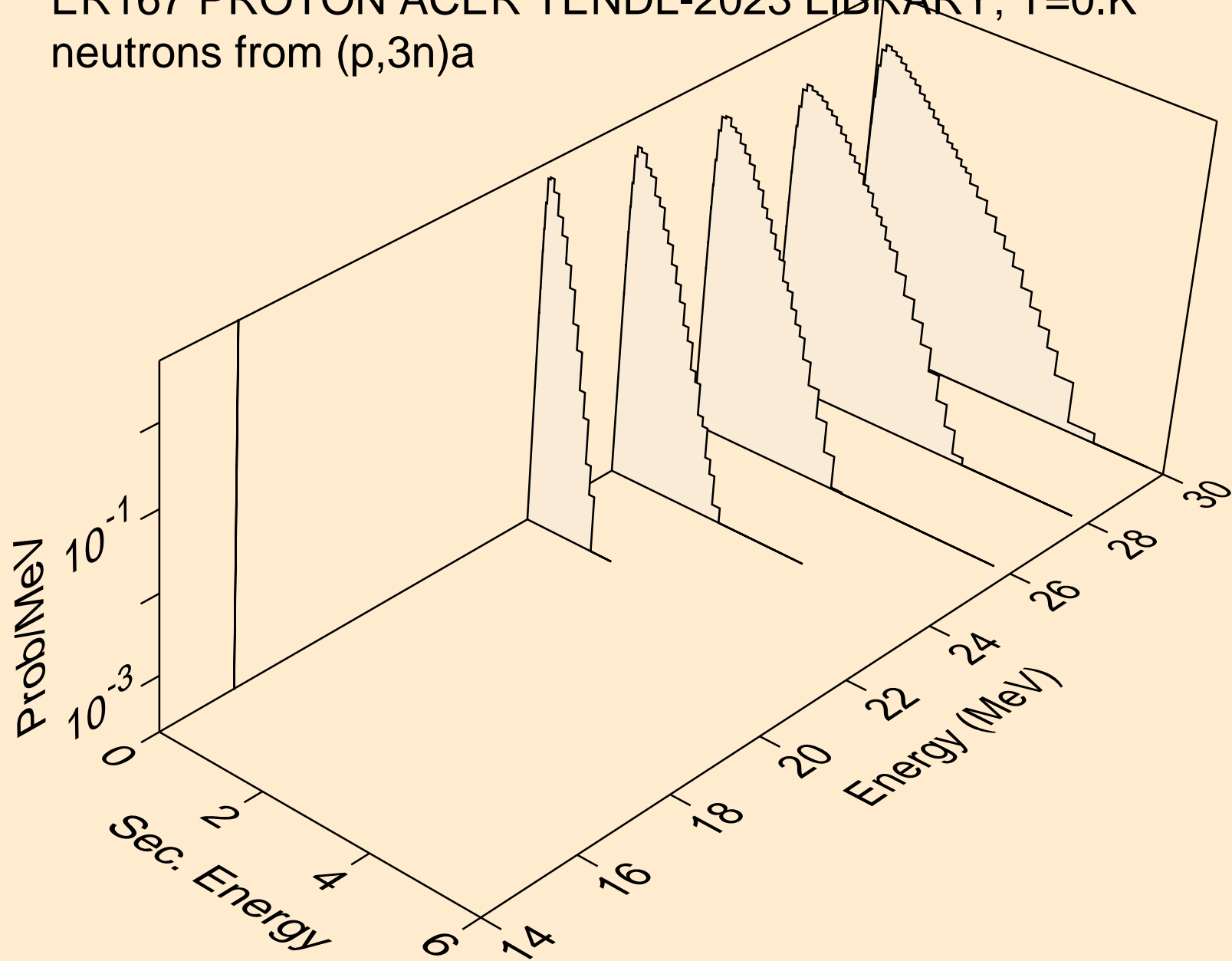

ER167 PROTON ACER TENDL-2023 LIBRARY; T=0.K  
neutrons from (p,n\*)p

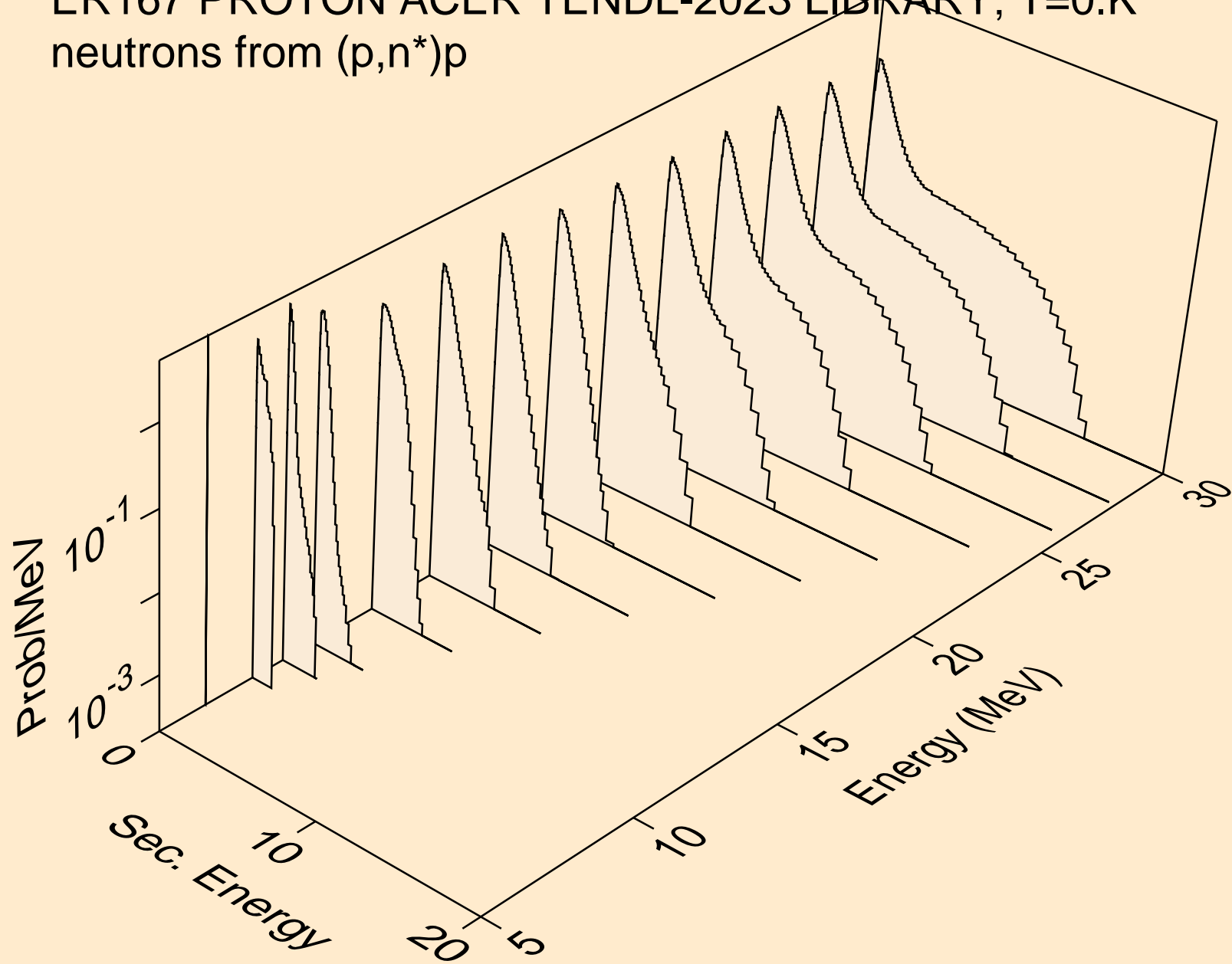

ER167 PROTON ACER TENDL-2023 LIBRARY; T=0.K  
neutrons from (p,n\*)2a

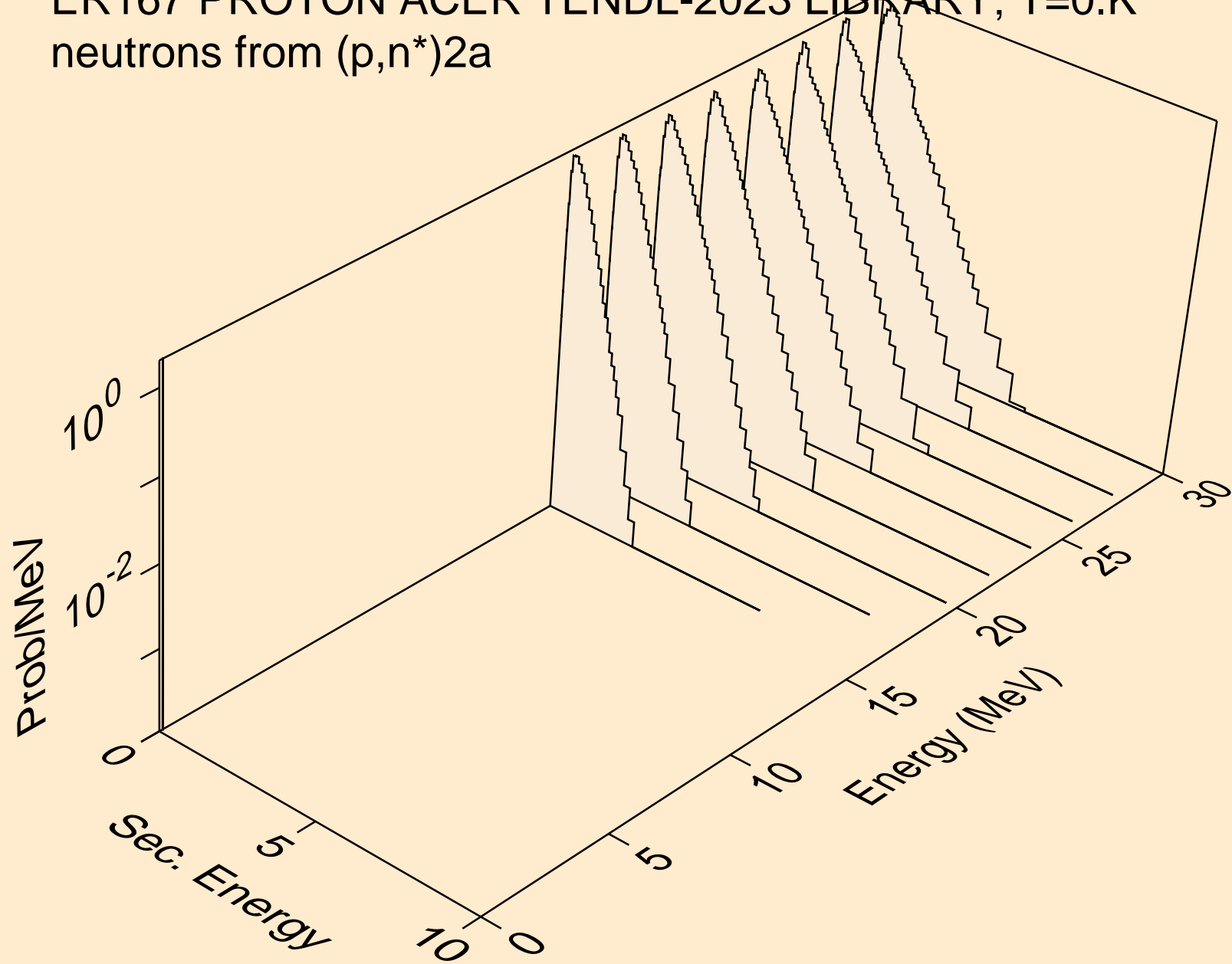

ER167 PROTON ACER TENDL-2023 LIBRARY; T=0.K  
neutrons from (p,n\*)d

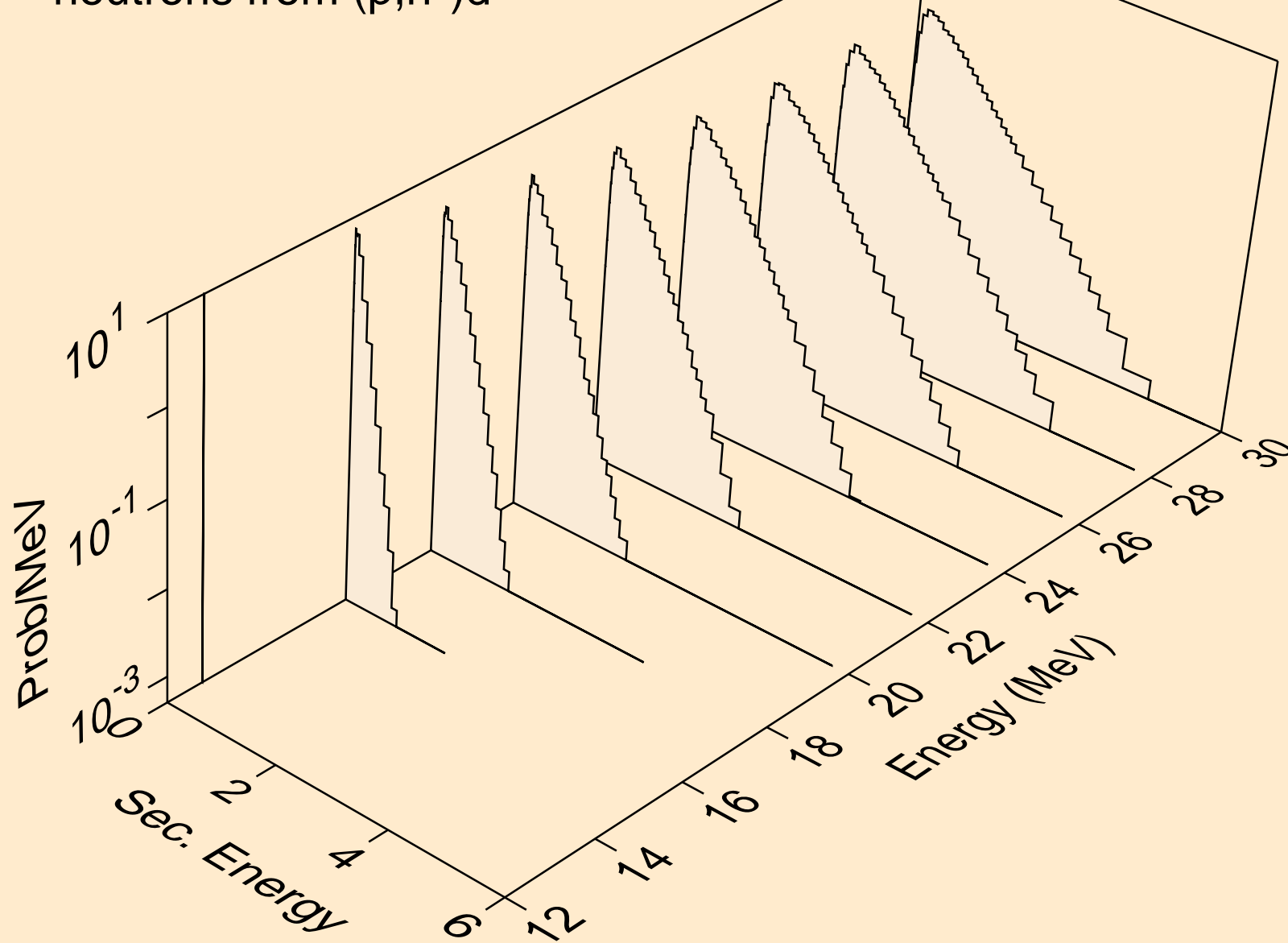



ER167 PROTON ACER TENDL-2023 LIBRARY; T=0.K  
neutrons from (p,n\*)t

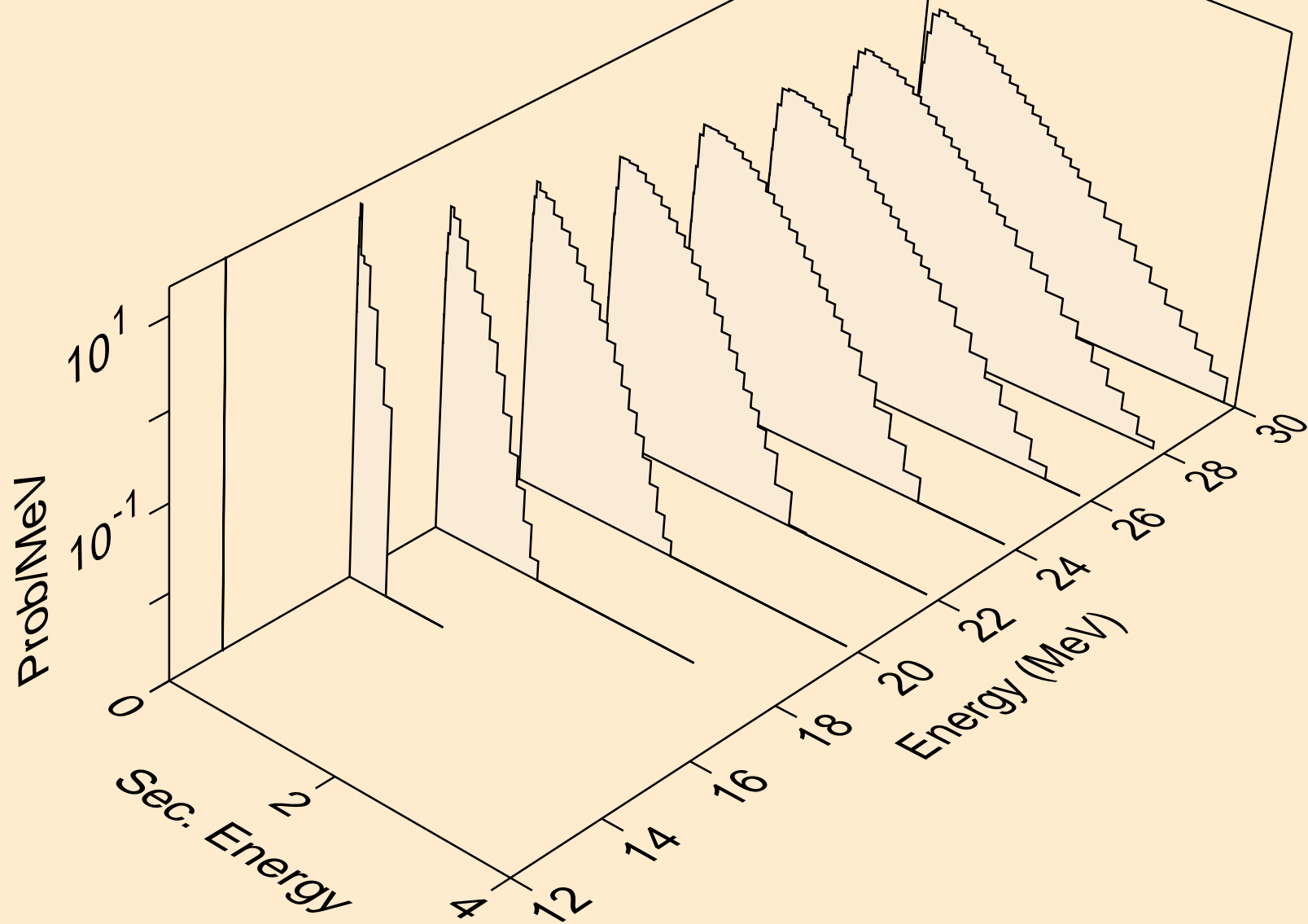

ER167 PROTON ACER TENDL-2023 LIBRARY; T=0.K  
neutrons from (p,n\*)he3

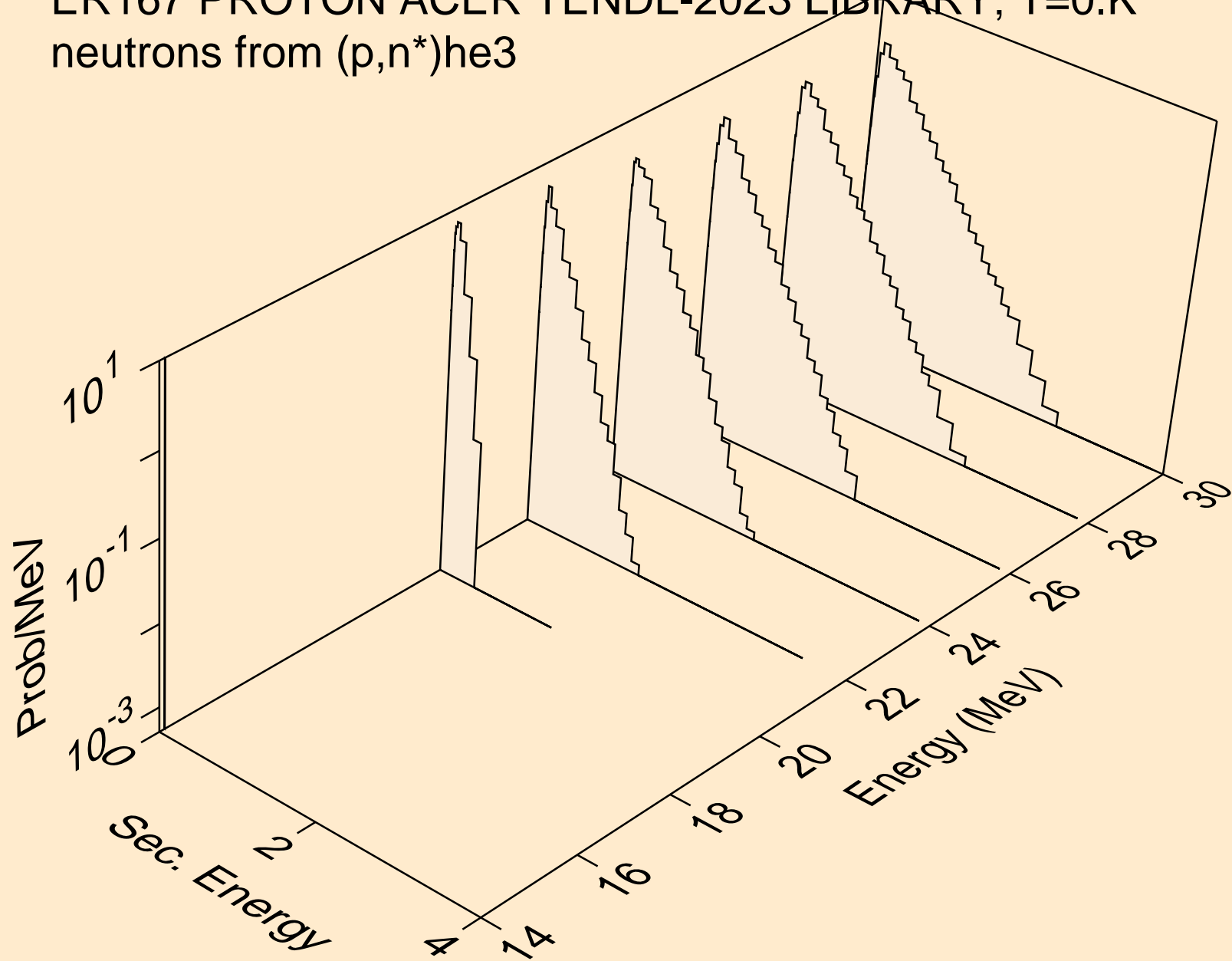

ER167 PROTON ACER TENDL-2023 LIBRARY; T=0.K  
neutrons from (p,4n)

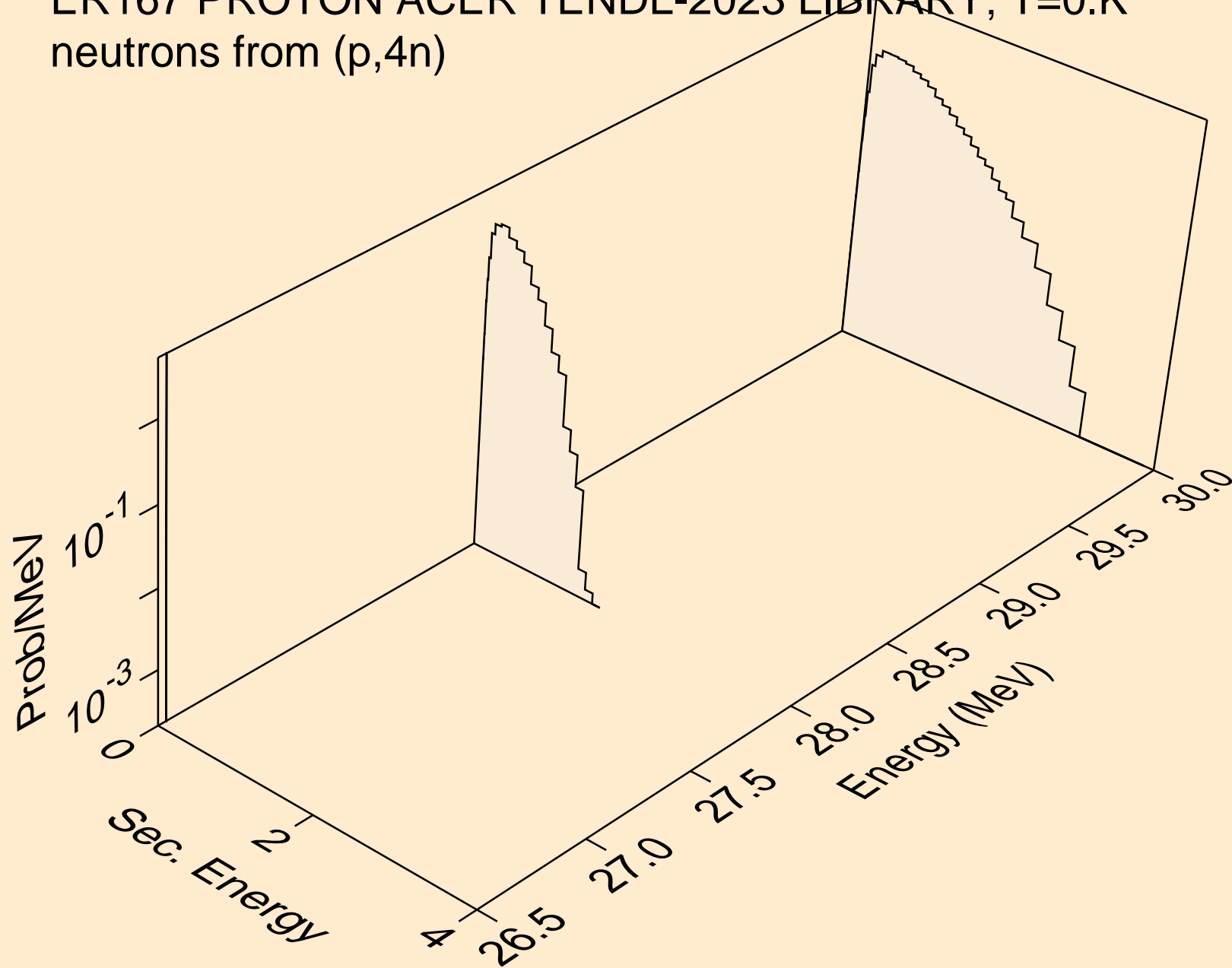

ER167 PROTON ACER TENDL-2023 LIBRARY; T=0.K  
neutrons from (p,2np)

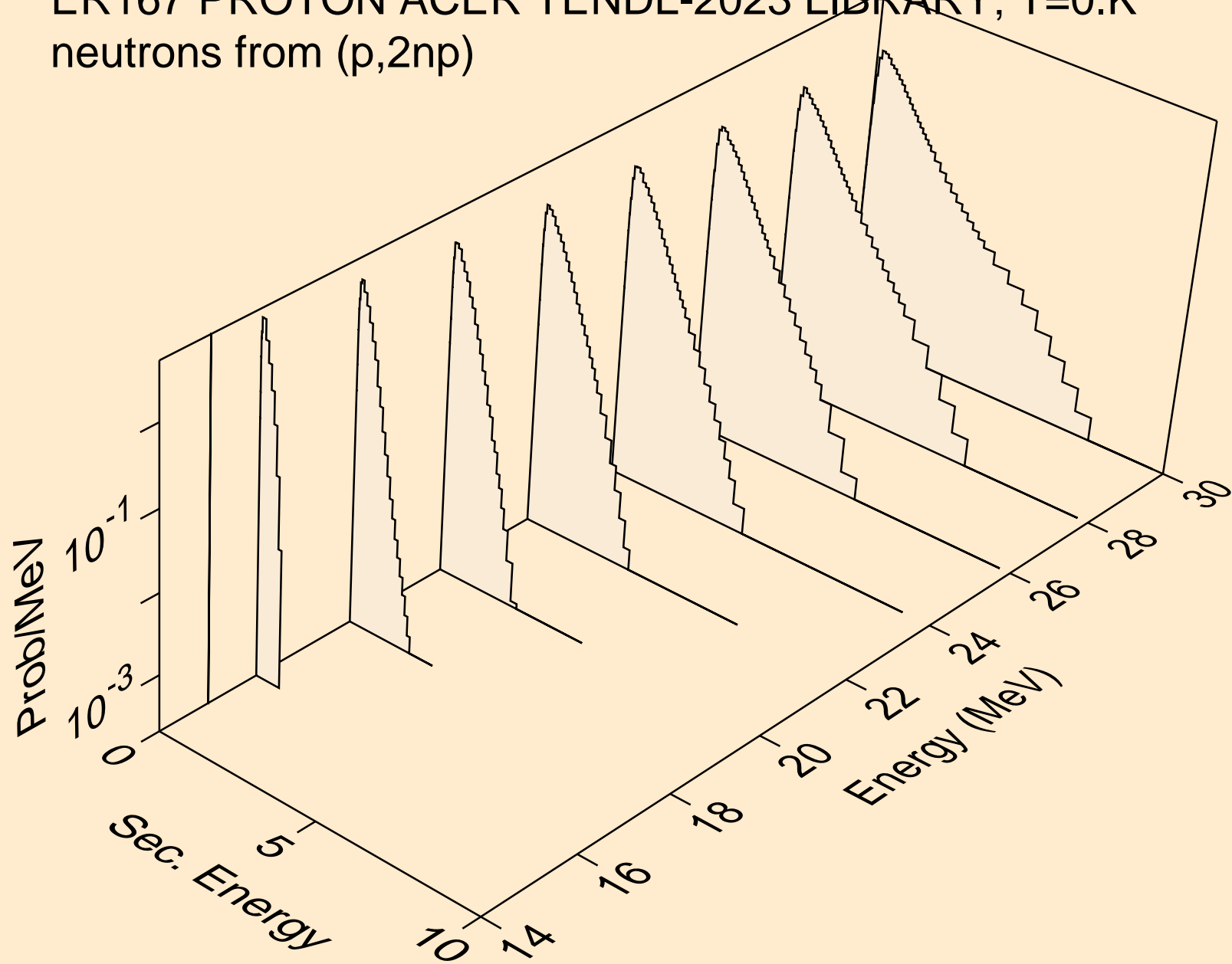

ER167 PROTON ACER TENDL-2023 LIBRARY; T=0.K  
neutrons from (p,3np)

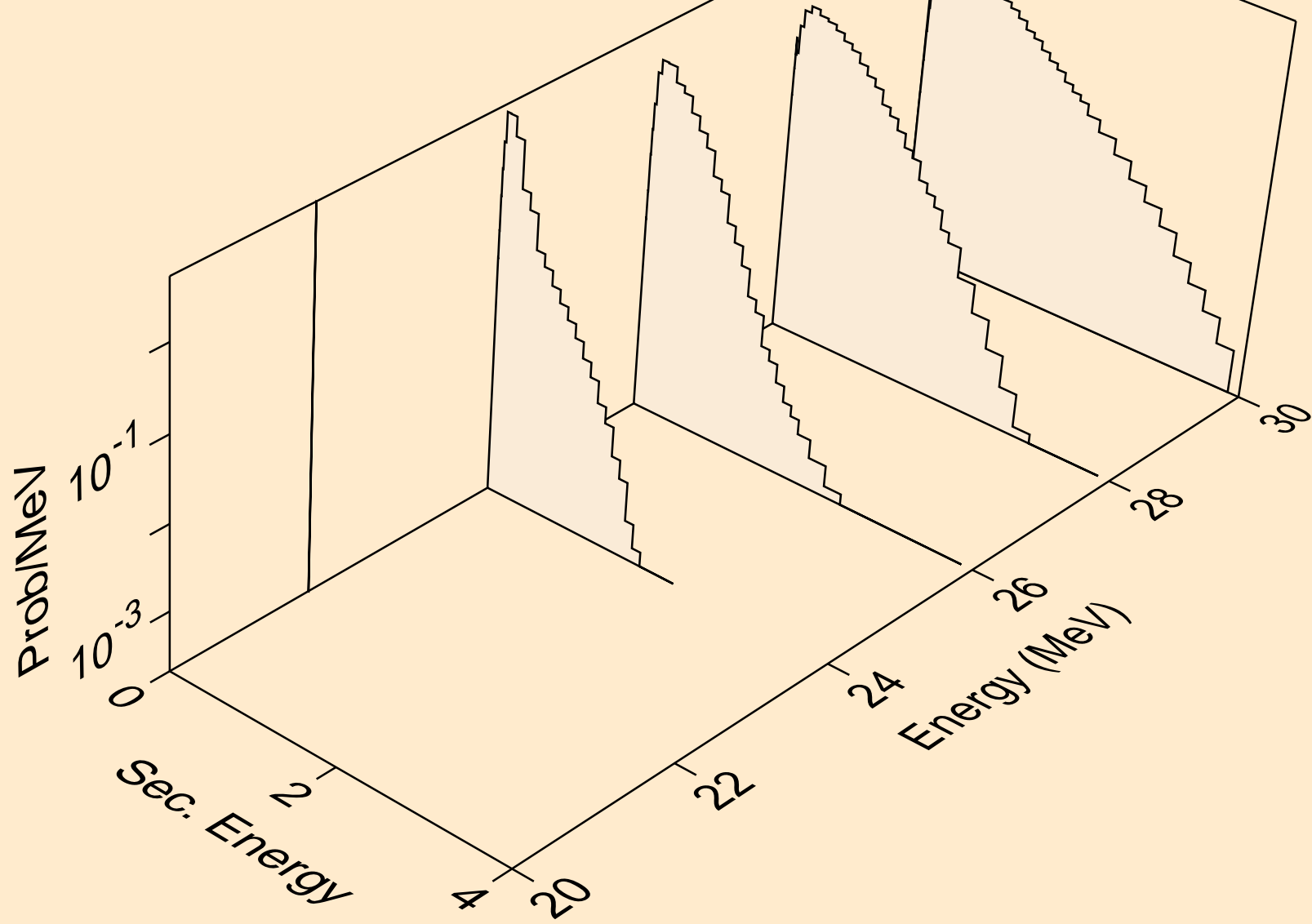

ER167 PROTON ACER TENDL-2023 LIBRARY; T=0.K  
neutrons from (p,n2p)

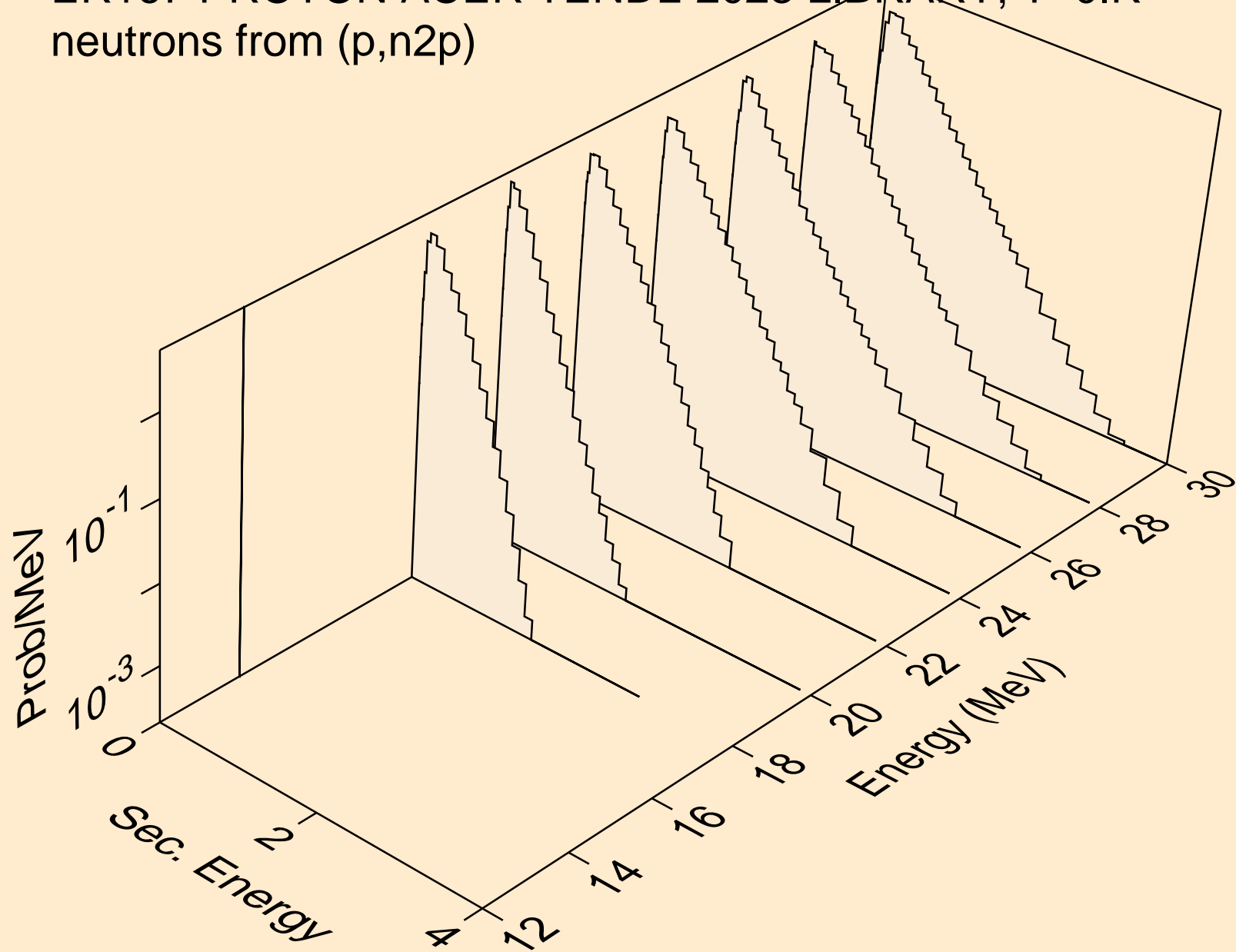

ER167 PROTON ACER TENDL-2023 LIBRARY; T=0.K  
neutrons from (p,npa)

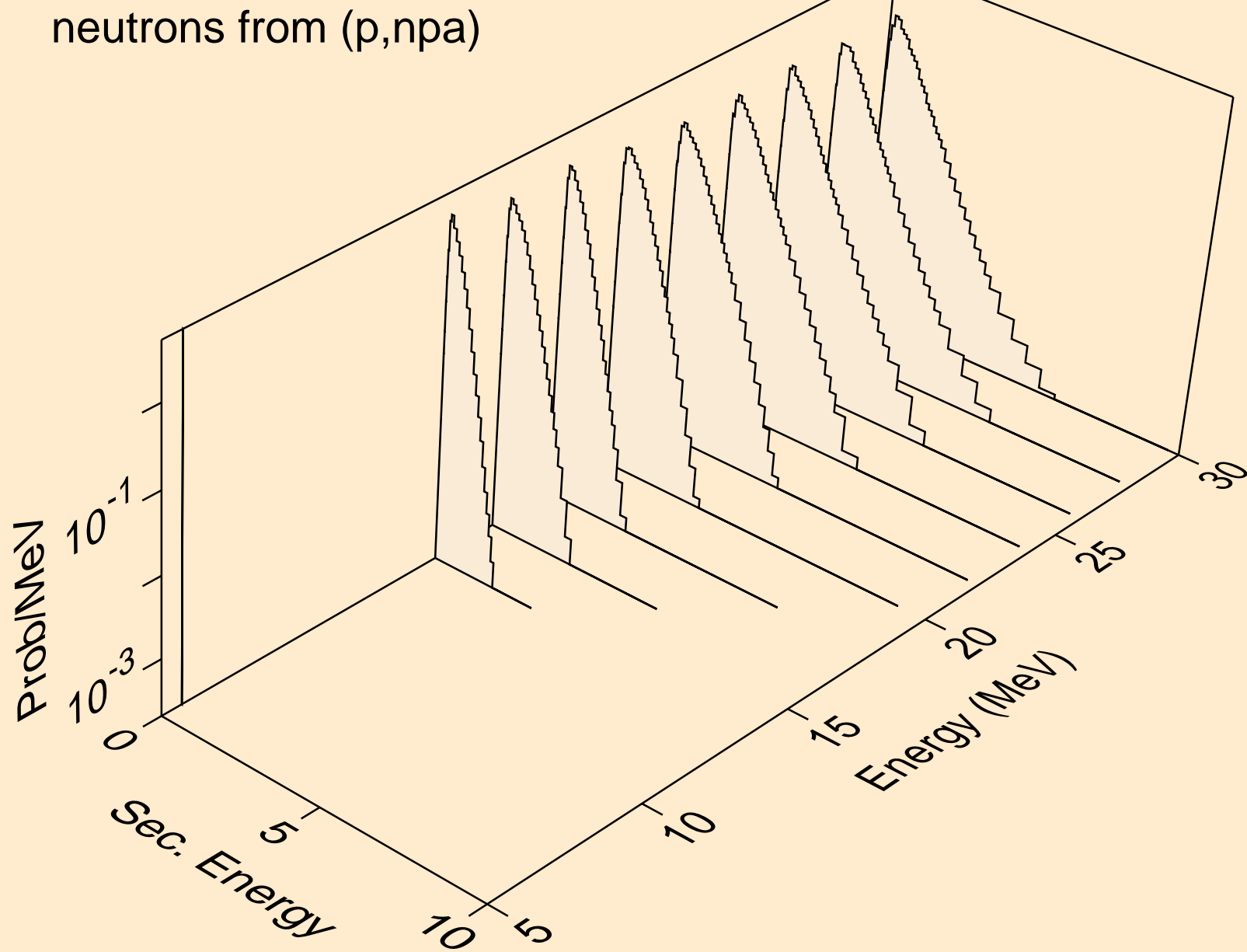

ER167 PROTON ACER TENDL-2023 LIBRARY; T=0.K  
deuterons from (p,x)

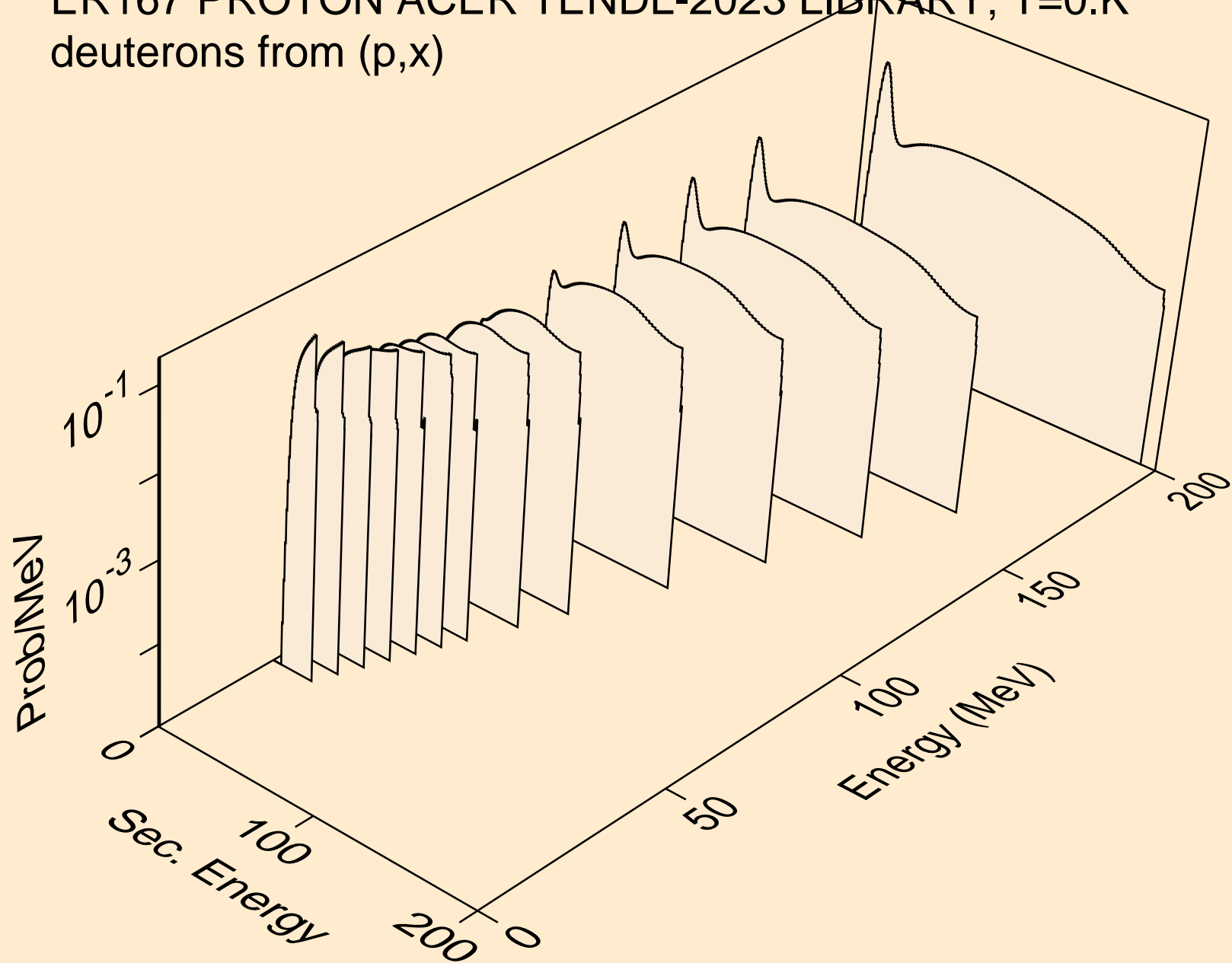



ER167 PROTON ACER TENDL-2023 LIBRARY; T=0.K  
deuterons from (p,2nd)

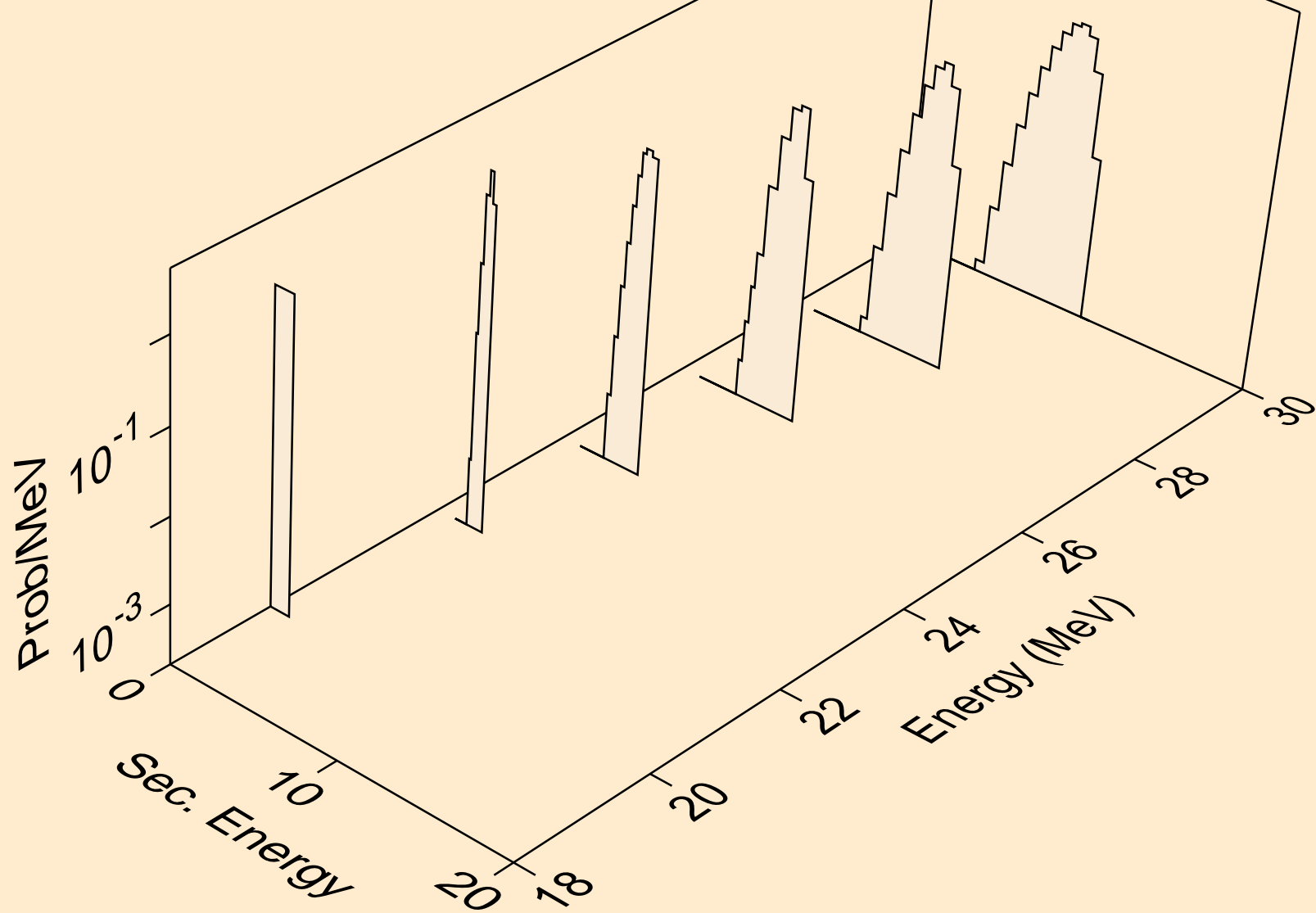

ER167 PROTON ACER TENDL-2023 LIBRARY; T=0.K  
deuterons from (p,n\*)d

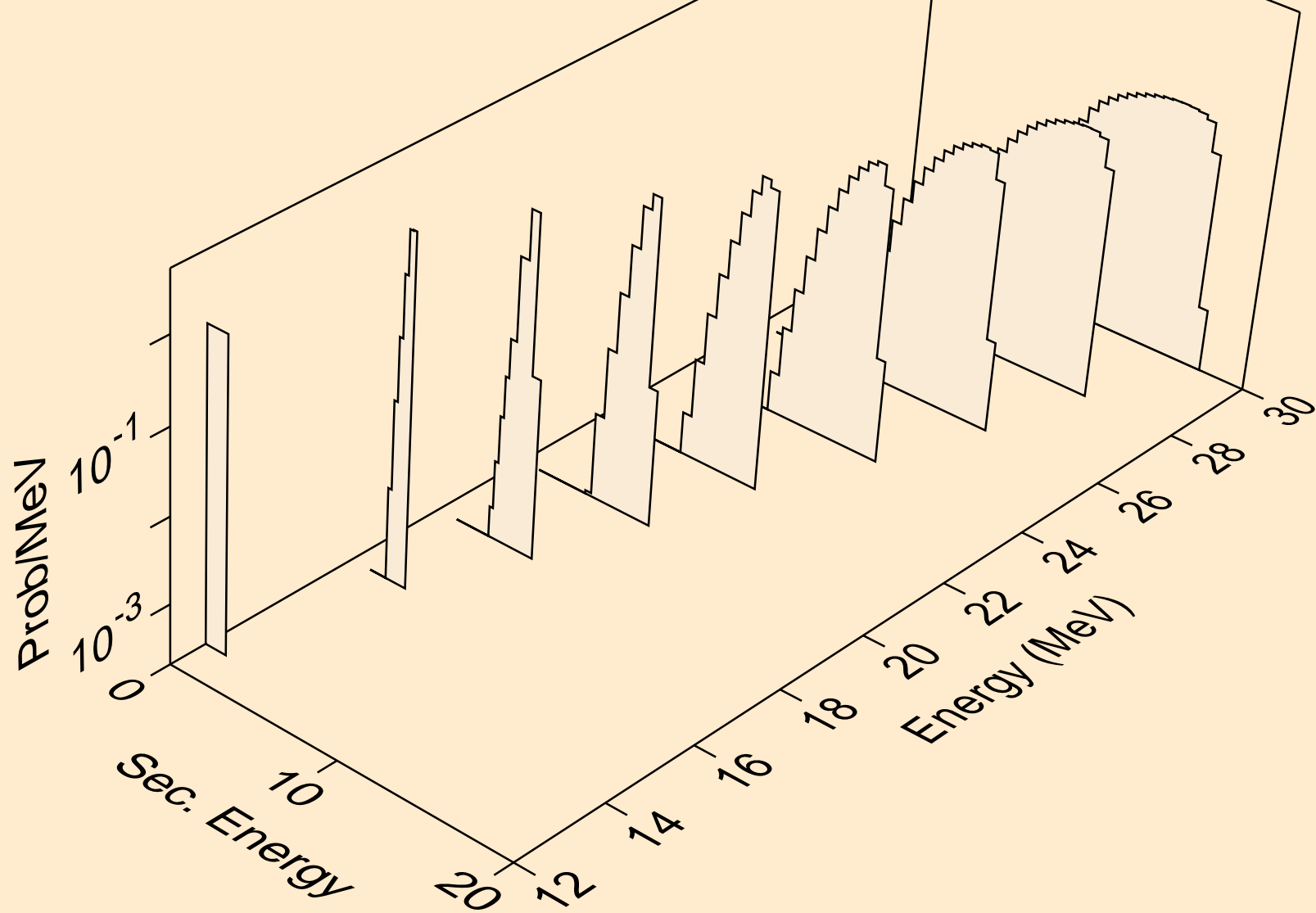

ER167 PROTON ACER TENDL-2023 LIBRARY; T=0.K  
deuterons from (p,d)

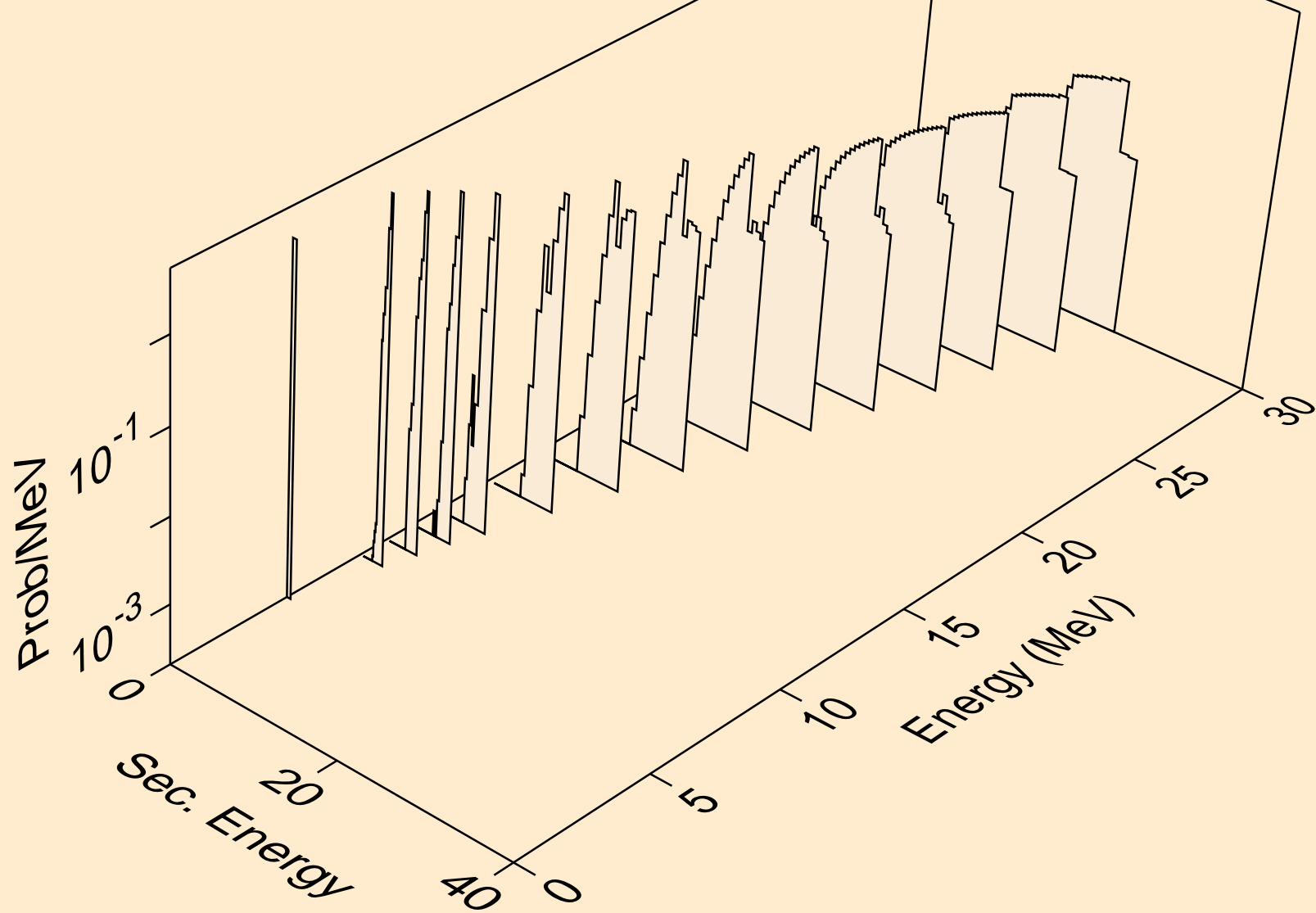

ER167 PROTON ACER TENDL-2023 LIBRARY; T=0.K  
deuterons from (p,pd)

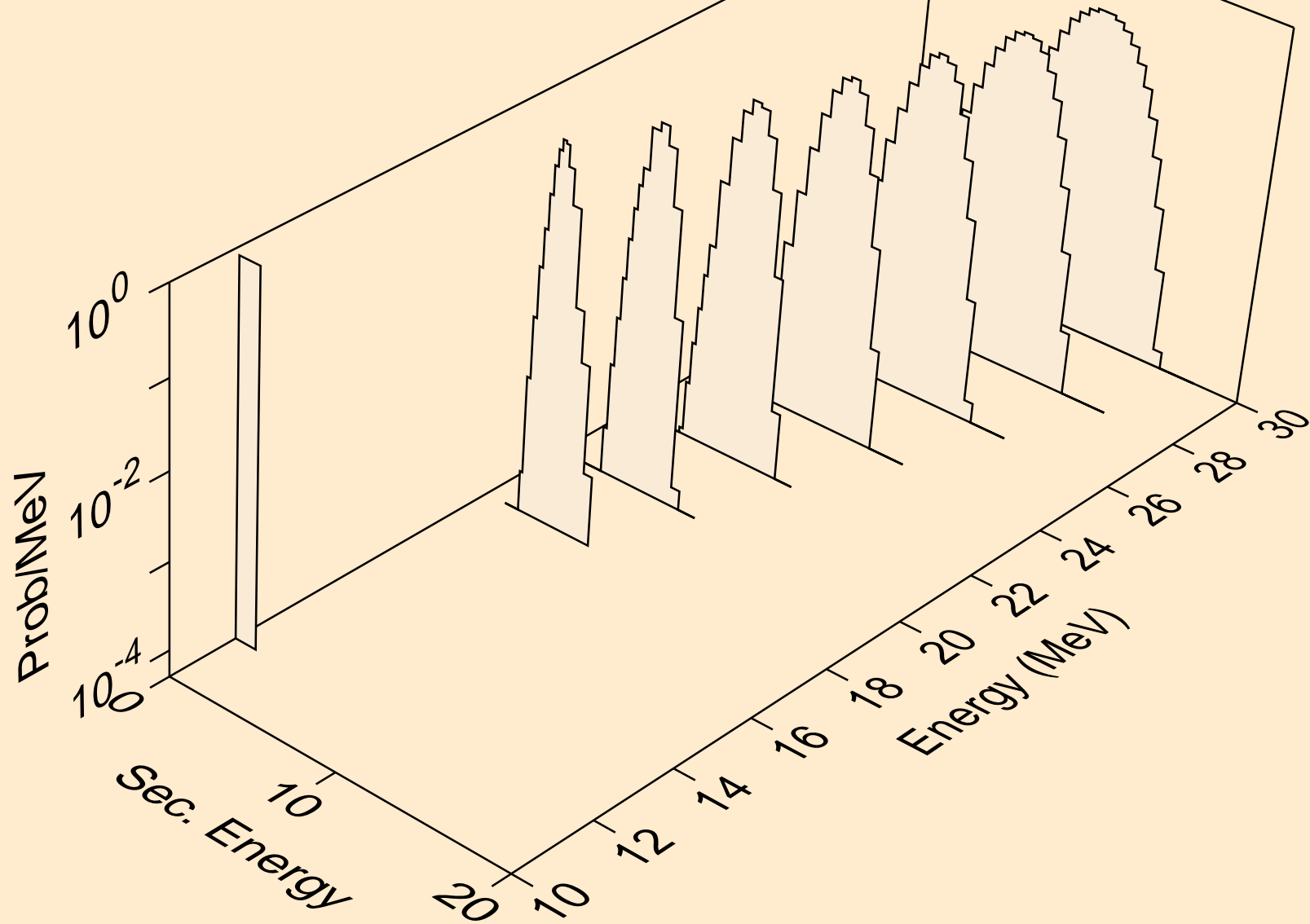

ER167 PROTON ACER TENDL-2023 LIBRARY; T=0.K  
deuterons from (p,da)

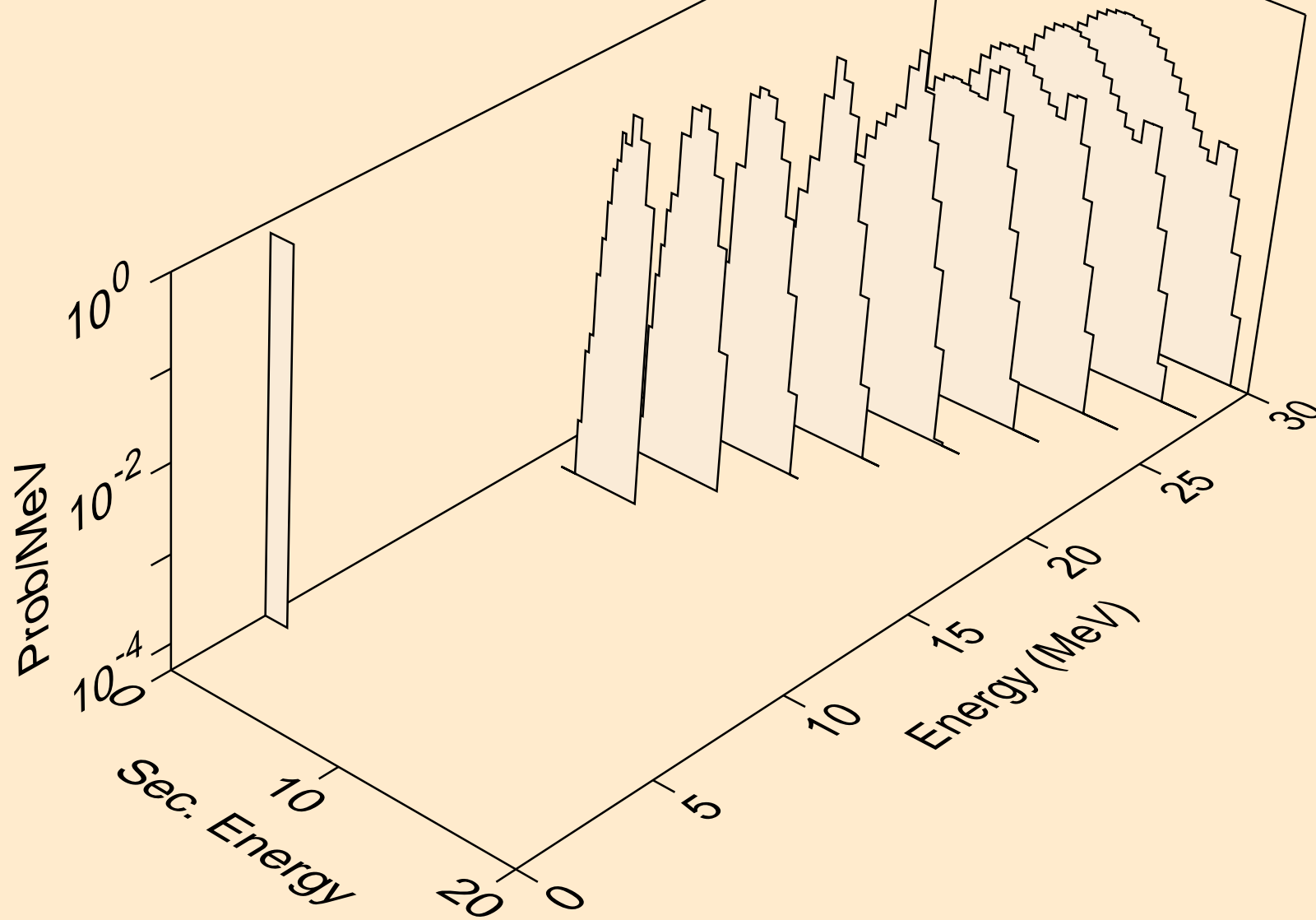

ER167 PROTON ACER TENDL-2023 LIBRARY; T=0.K  
tritons from (p,x)

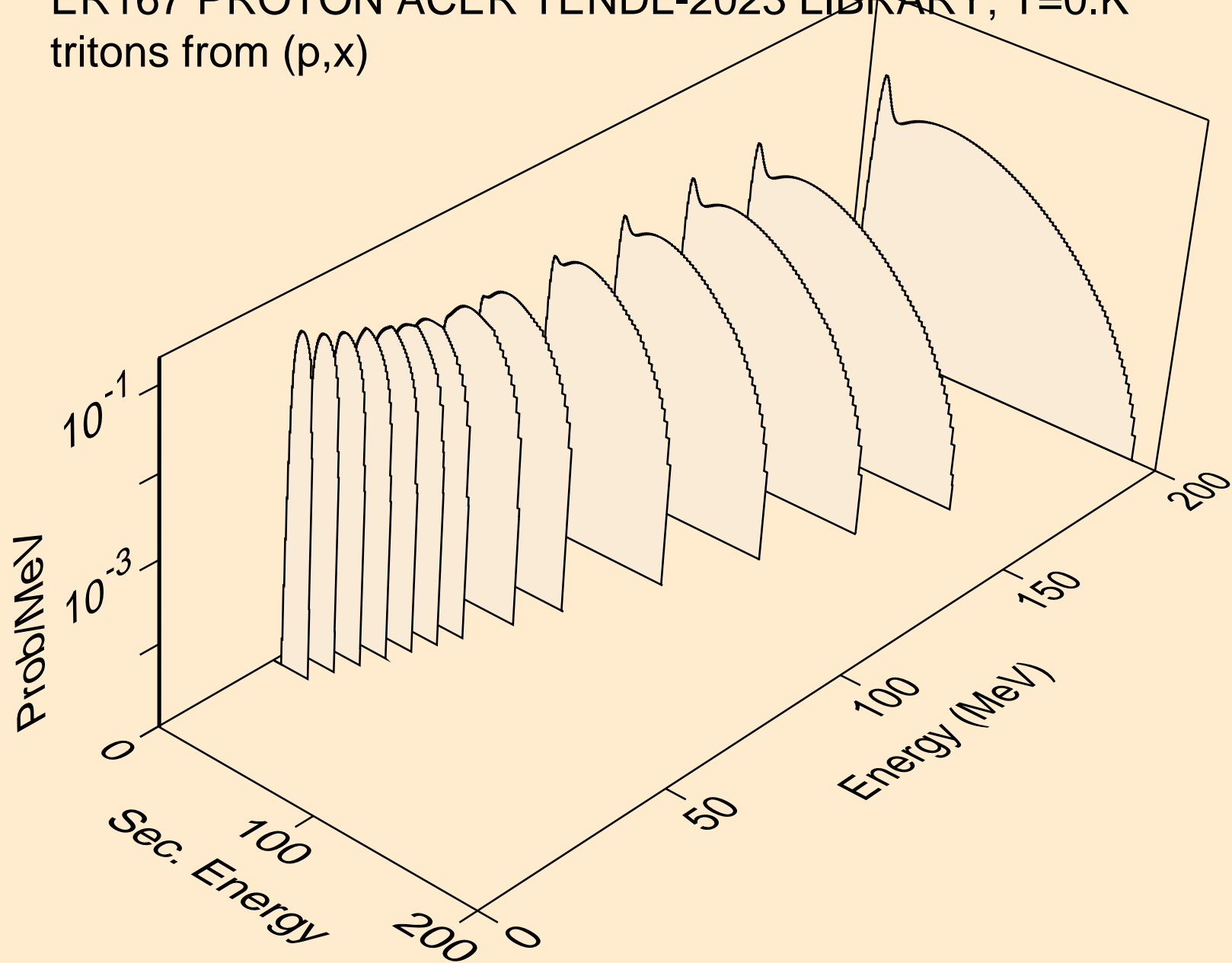

ER167 PROTON ACER TENDL-2023 LIBRARY; T=0.K  
tritons from (p,n\*)t

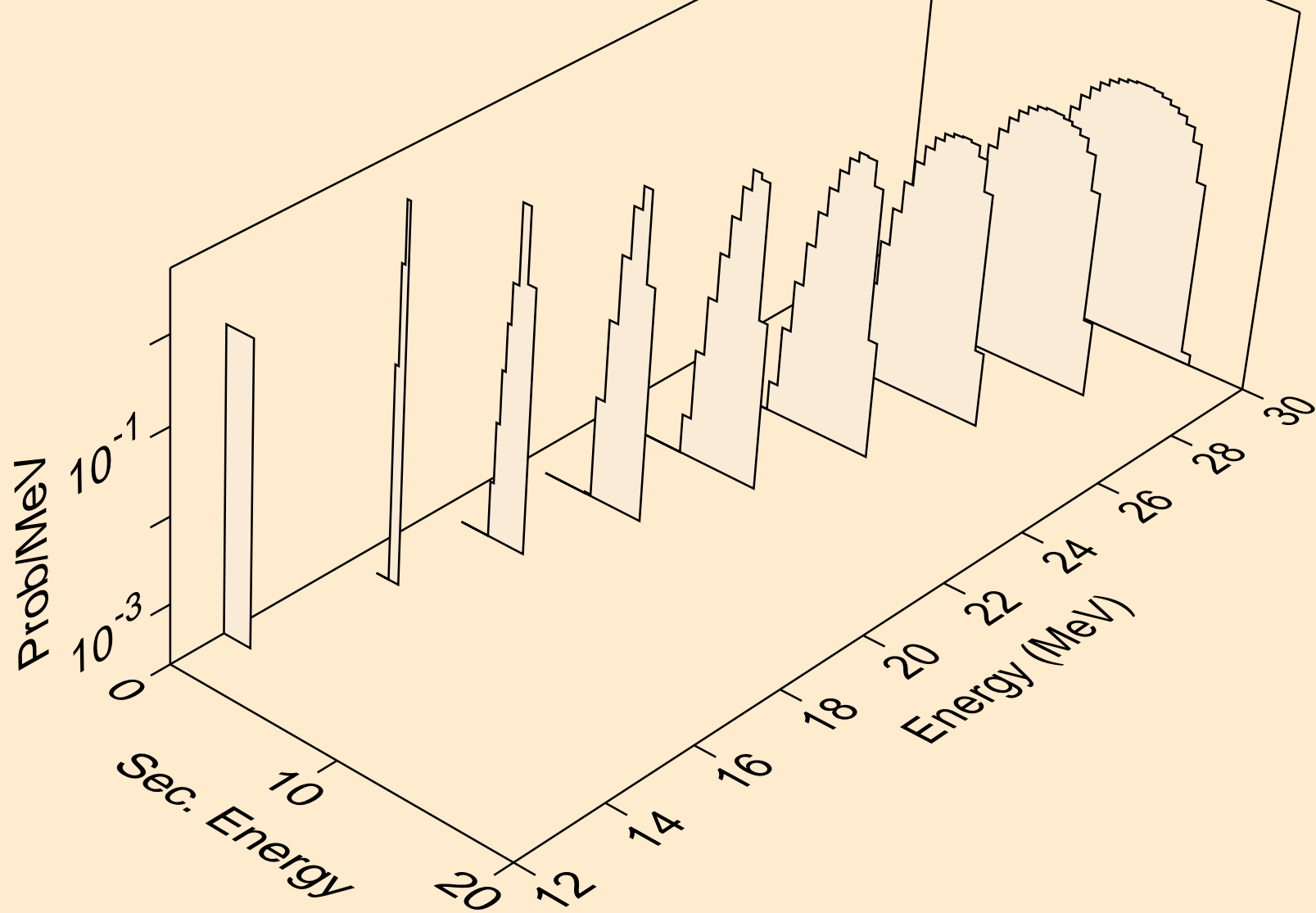

ER167 PROTON ACER TENDL-2023 LIBRARY; T=0.K  
tritons from (p,t)

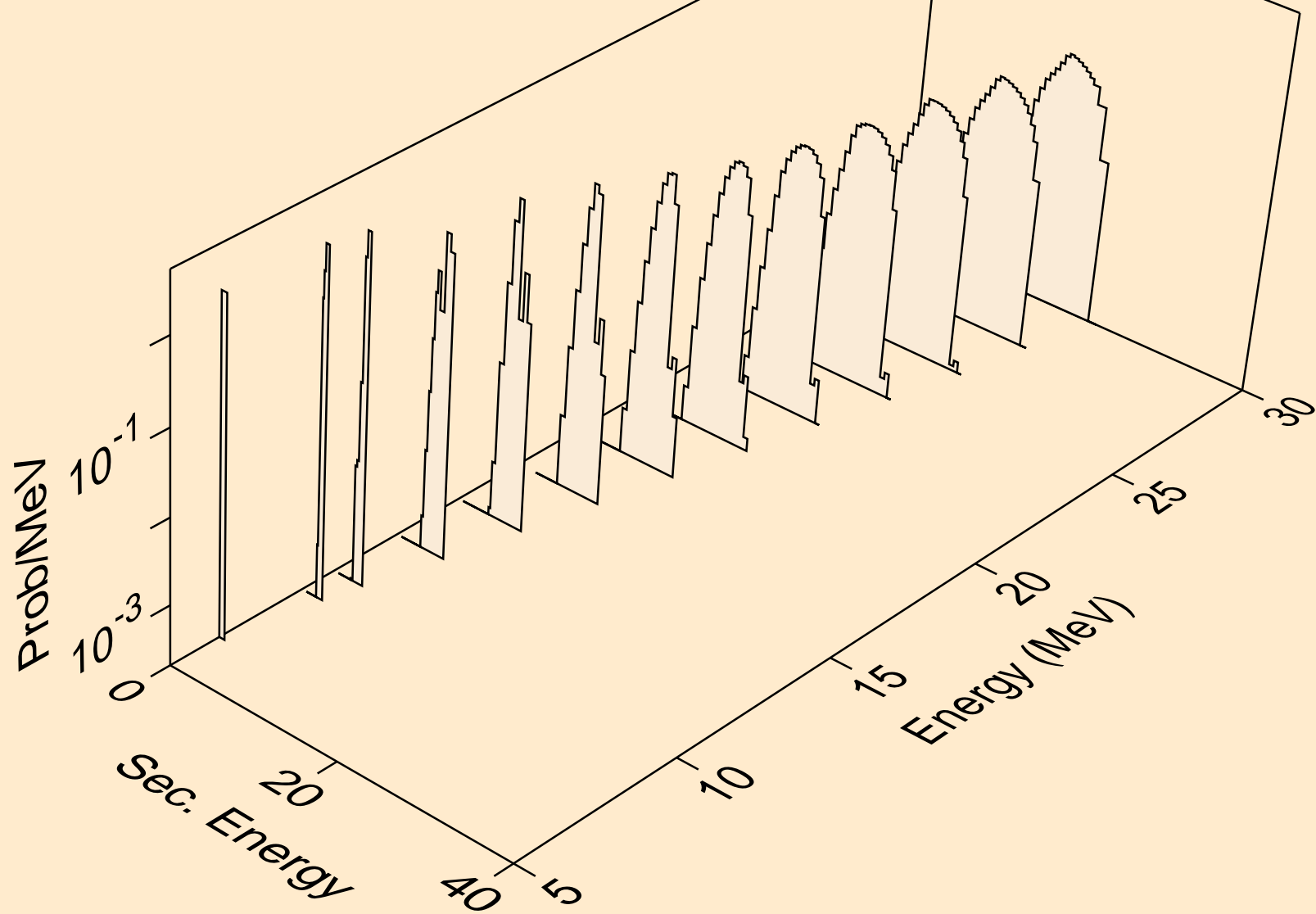



ER167 PROTON ACER TENDL-2023 LIBRARY; T=0.K  
tritons from (p,pt)

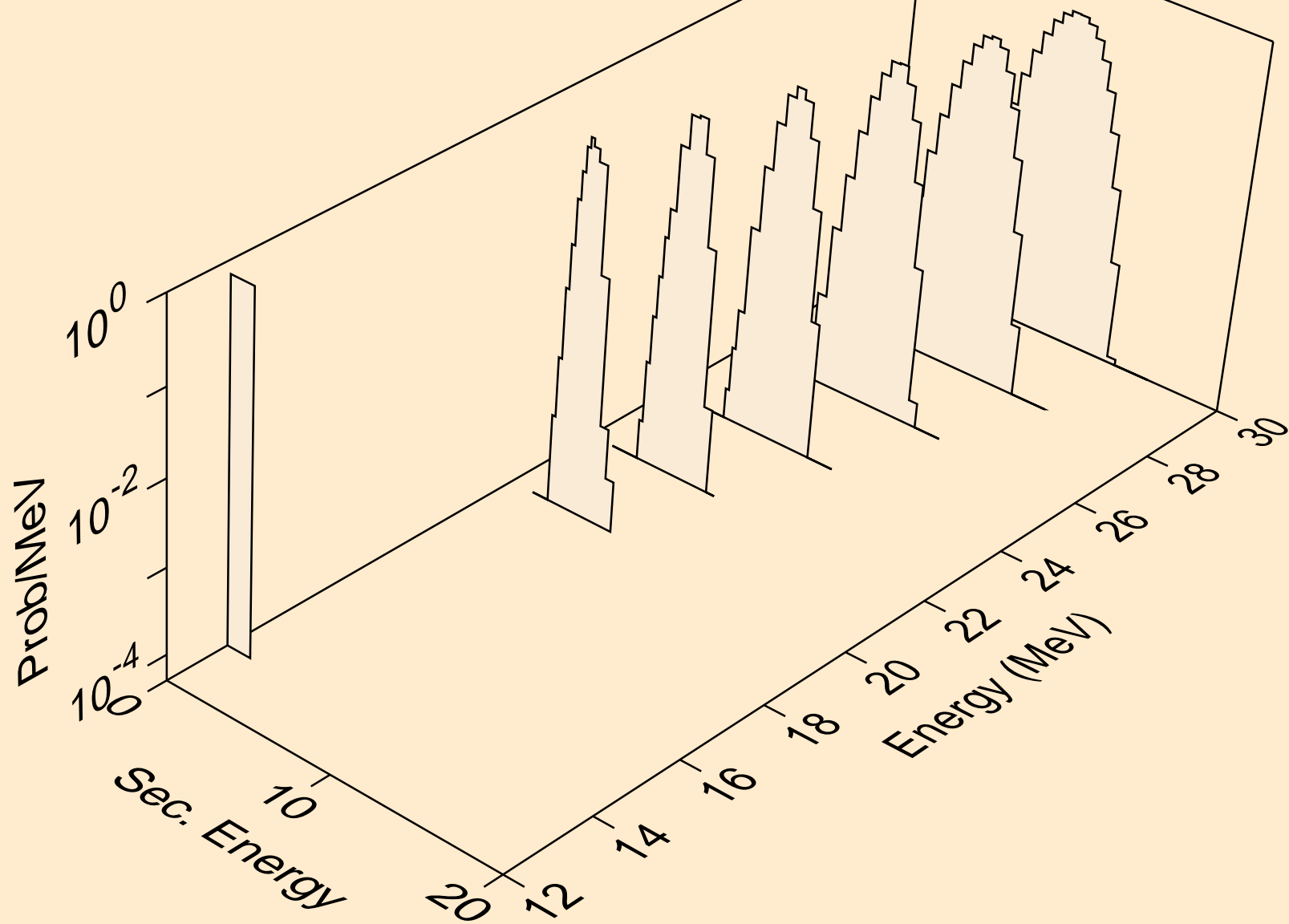

ER167 PROTON ACER TENDL-2023 LIBRARY; T=0.K  
he3s from (p,x)

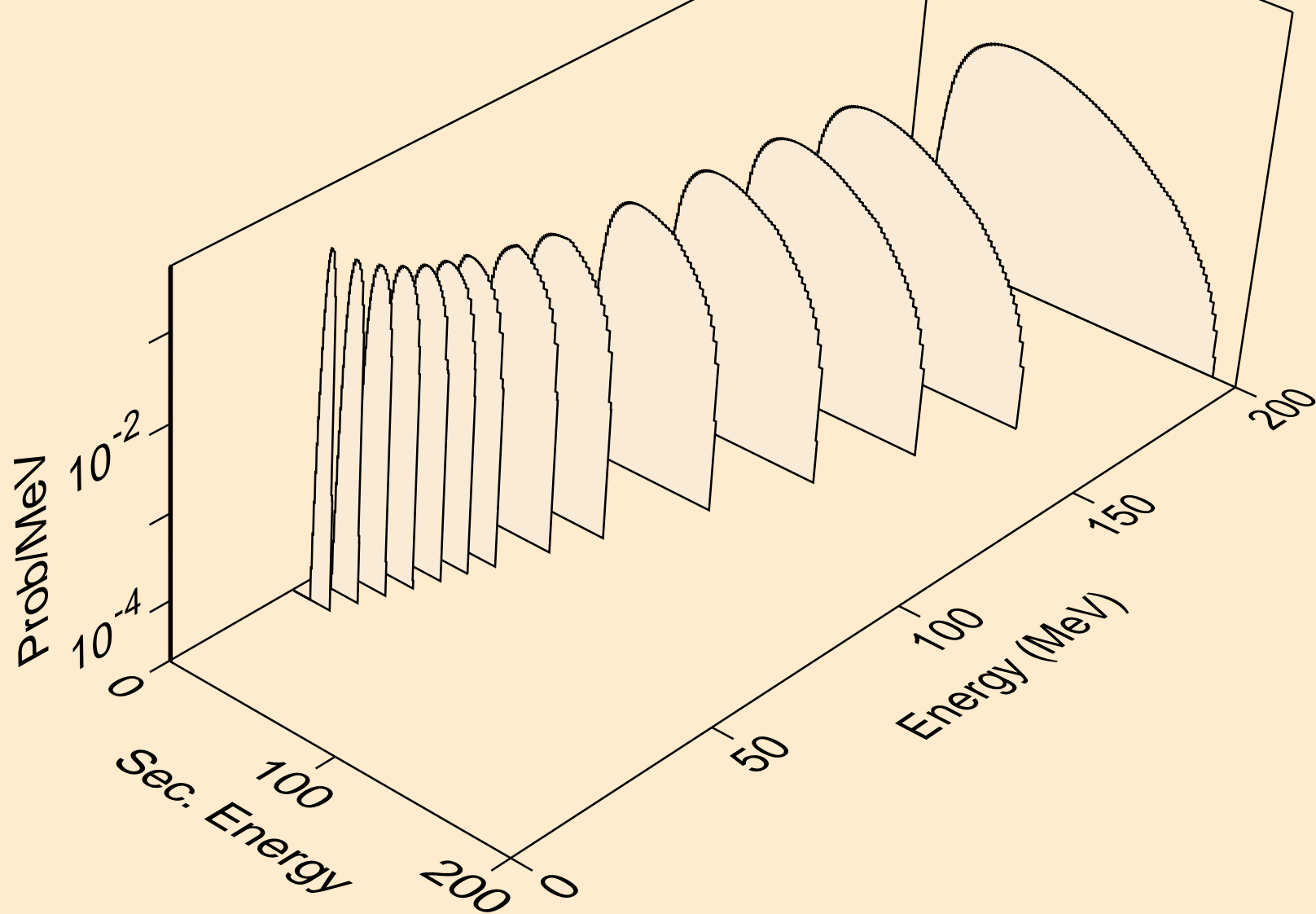

ER167 PROTON ACER TENDL-2023 LIBRARY; T=0.K  
he3s from (p,n\*)he3

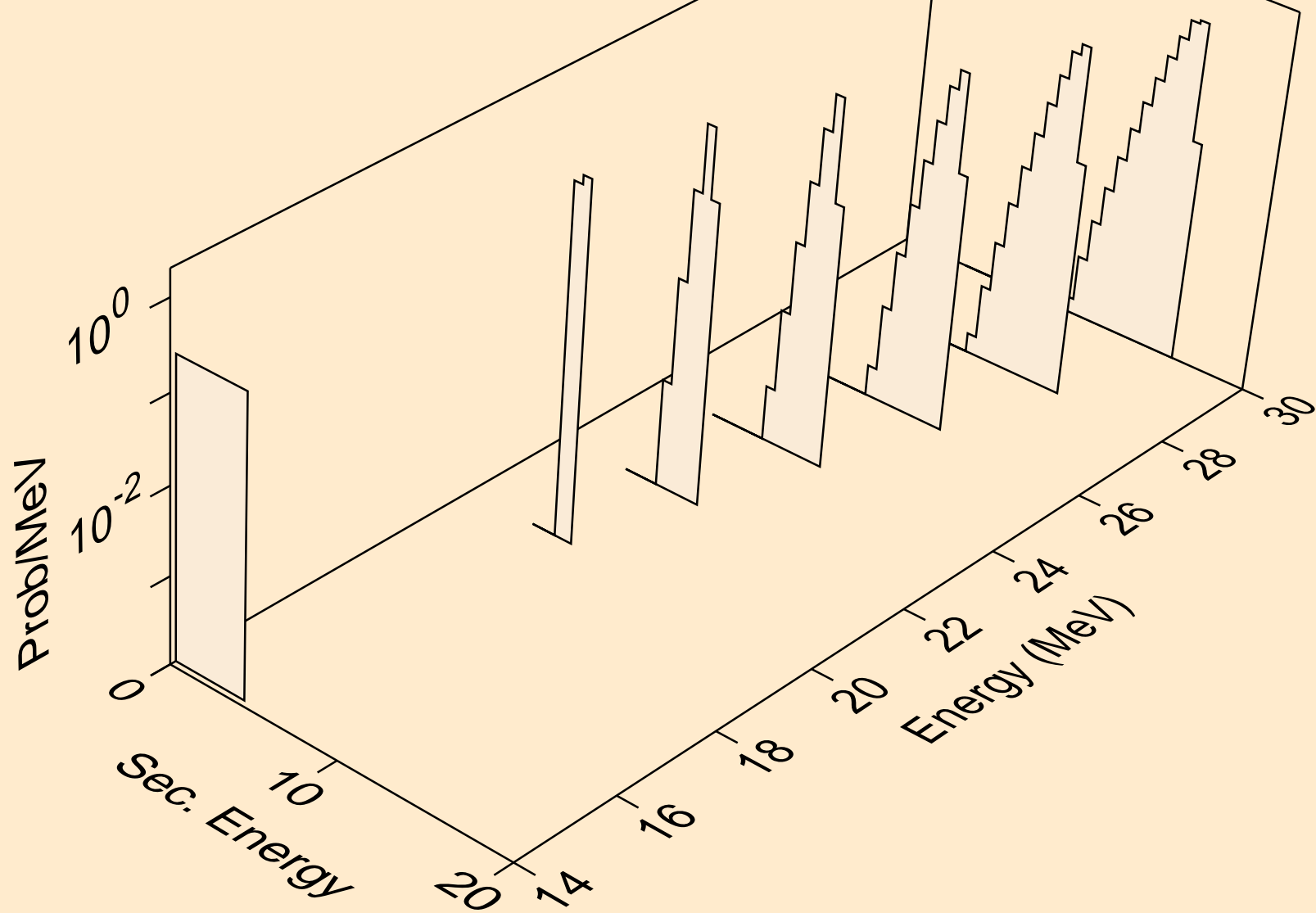

ER167 PROTON ACER TENDL-2023 LIBRARY; T=0.K  
he3s from (p,he3)

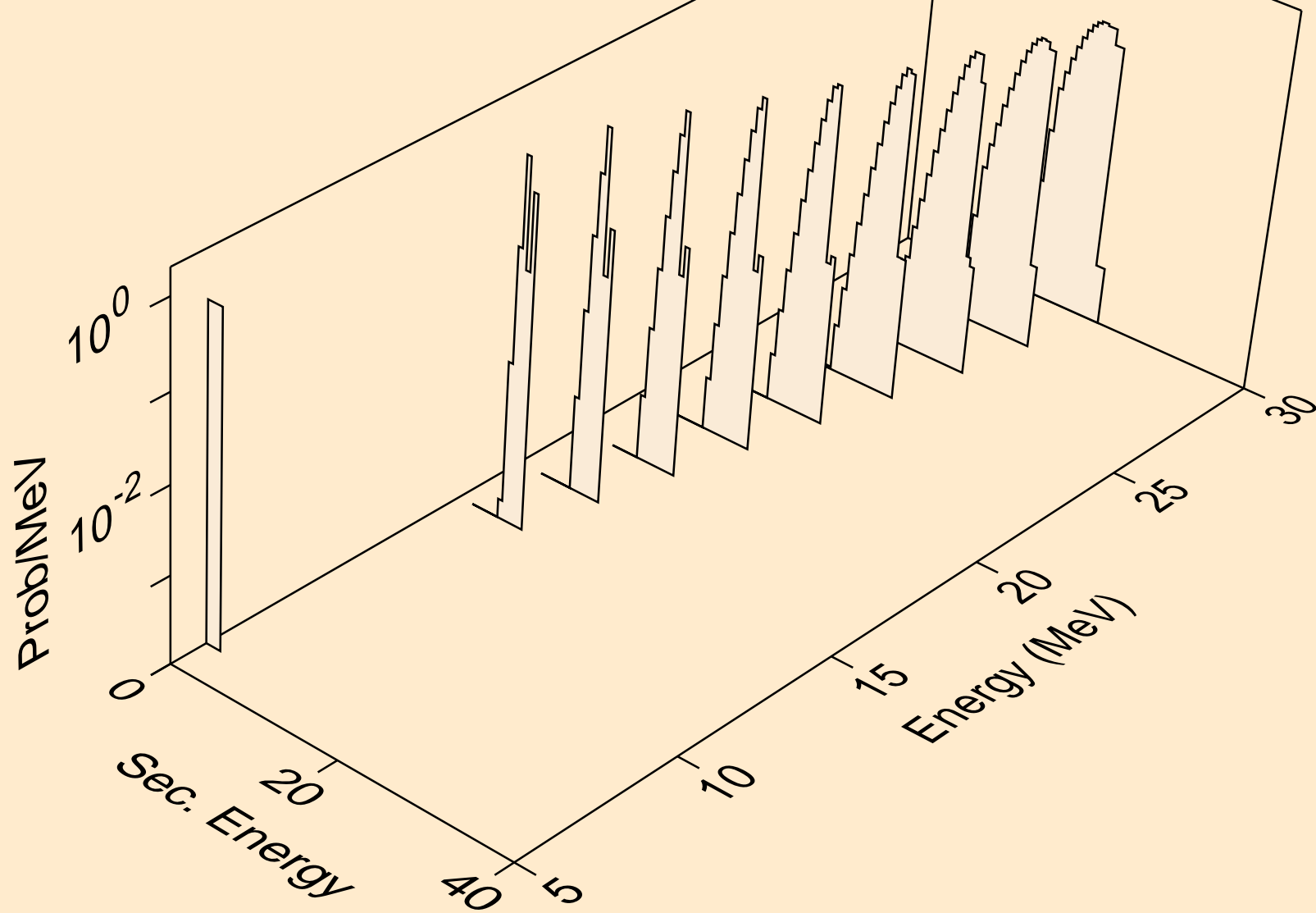

ER167 PROTON ACER TENDL-2023 LIBRARY; T=0.K  
alphas from (p,x)

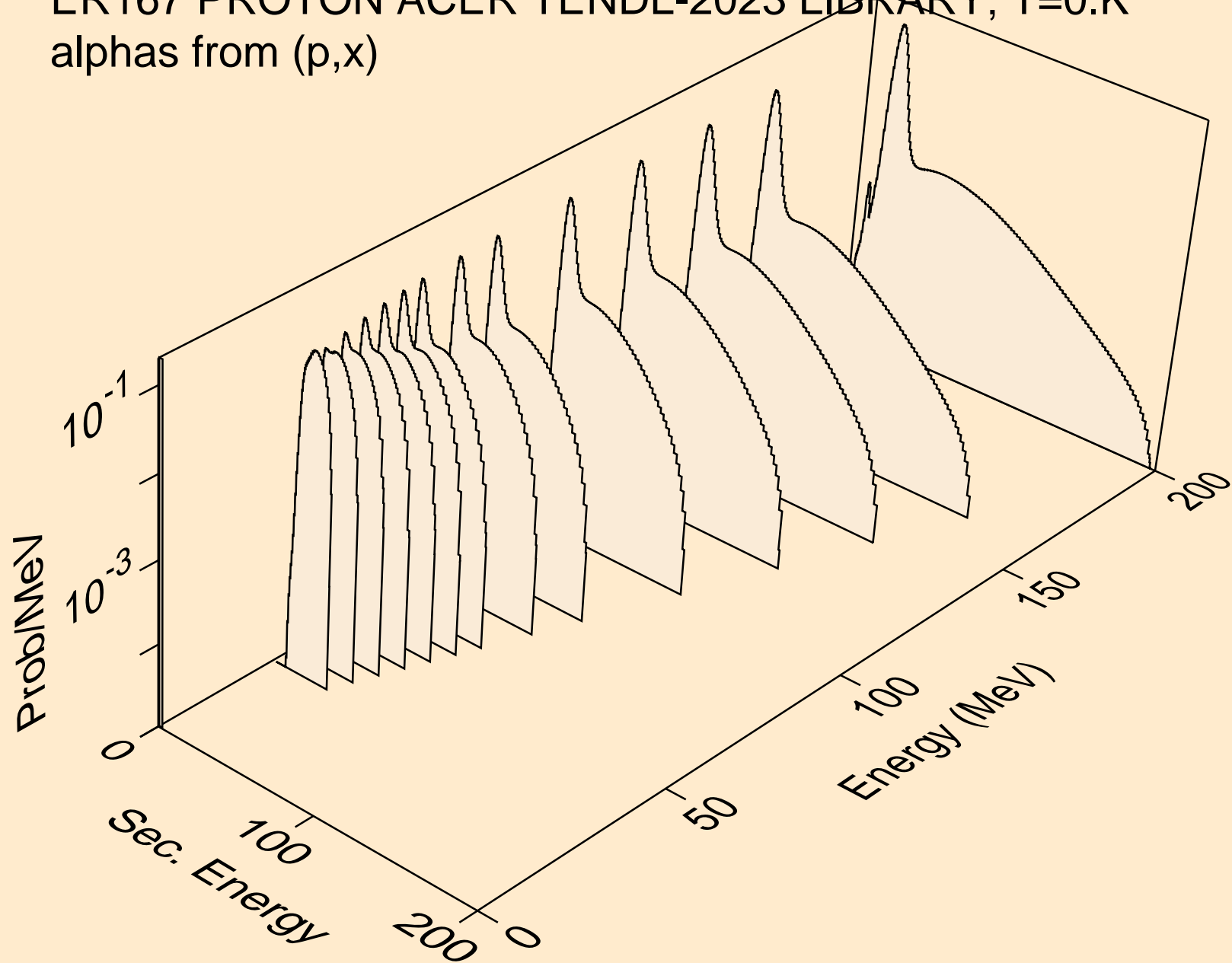

ER167 PROTON ACER TENDL-2023 LIBRARY; T=0.K  
alphas from (p,n\*)a

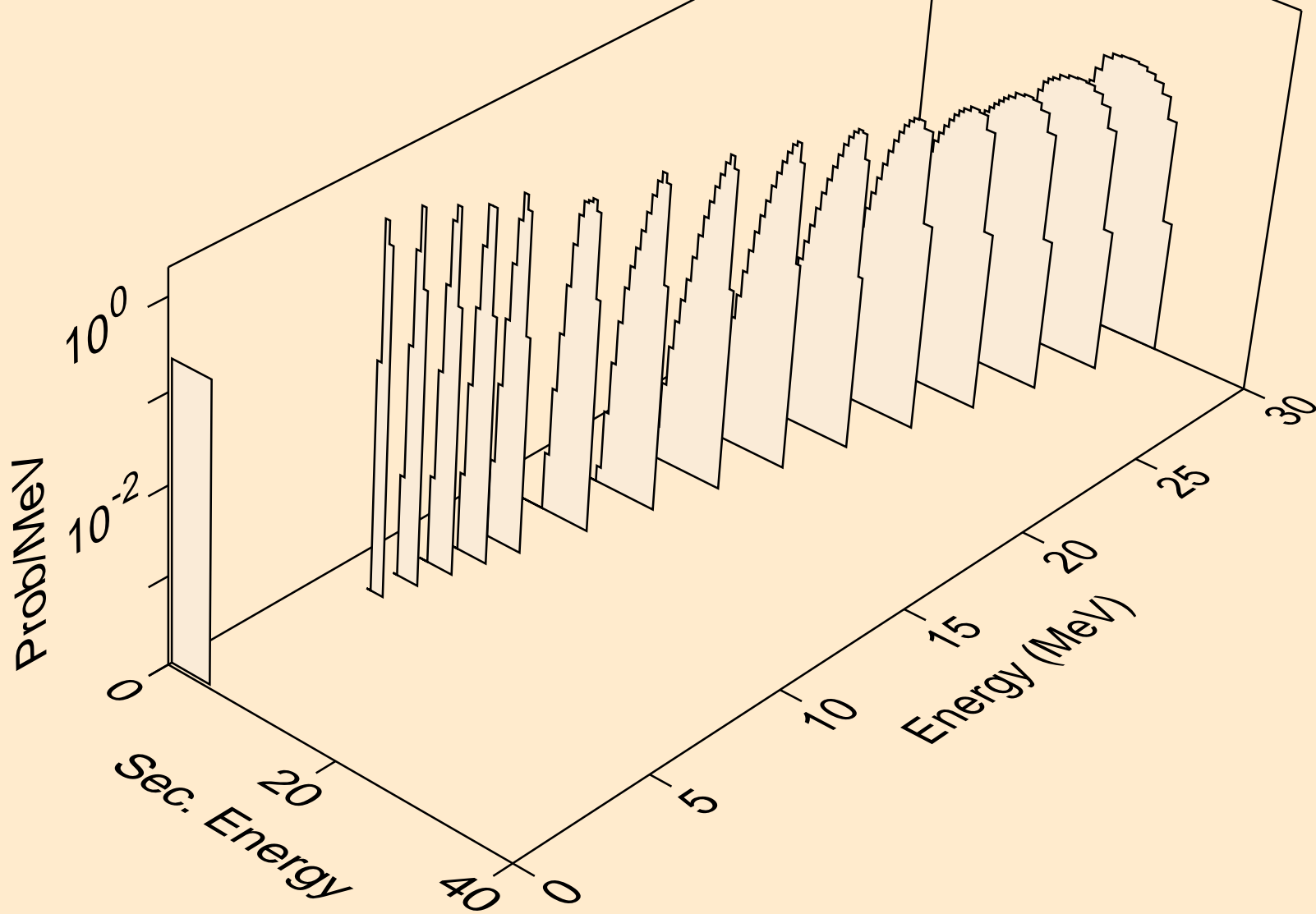

ER167 PROTON ACER TENDL-2023 LIBRARY; T=0.K  
alphas from (p,2n)a

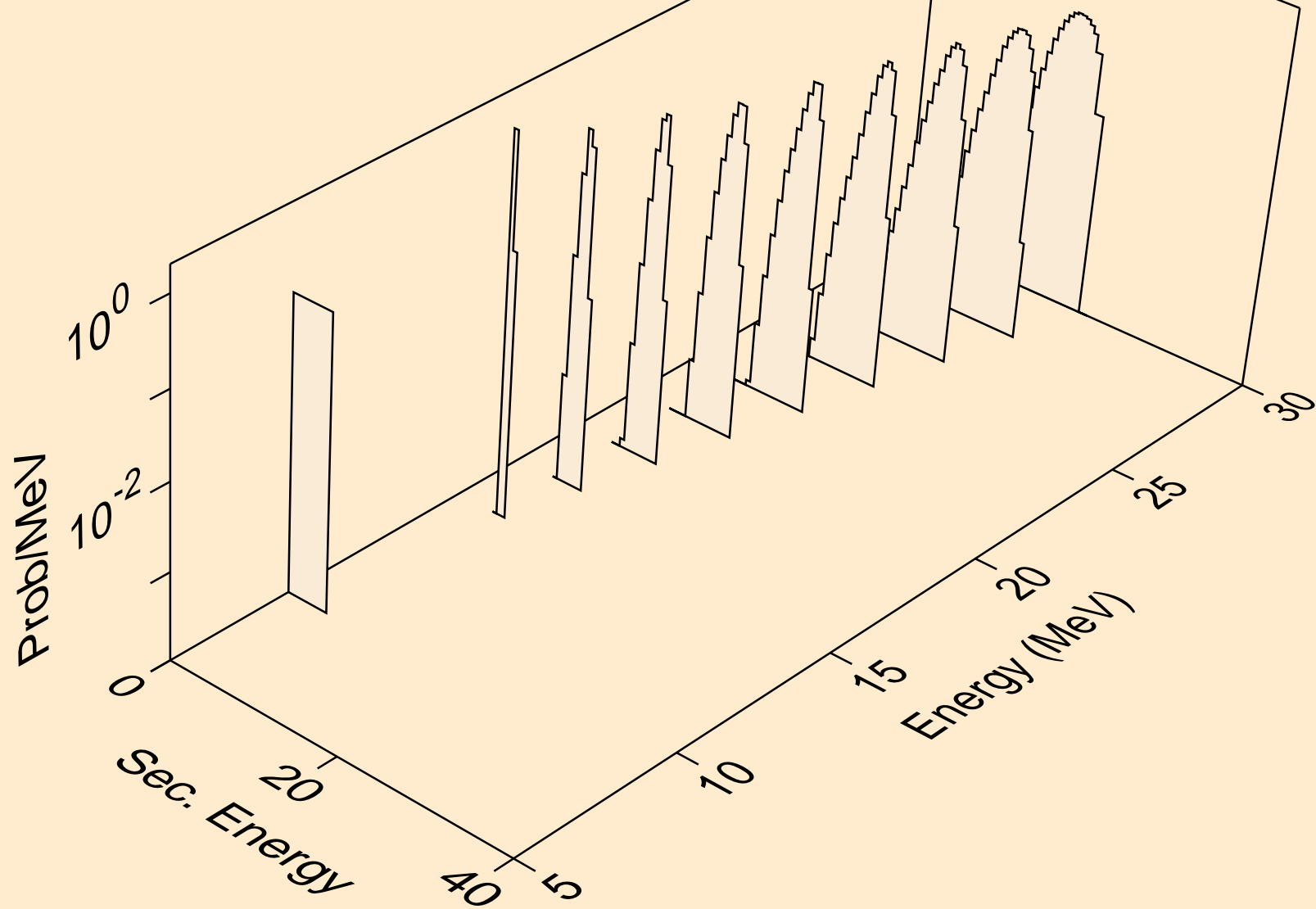

ER167 PROTON ACER TENDL-2023 LIBRARY; T=0.K  
alphas from (p,3n)a

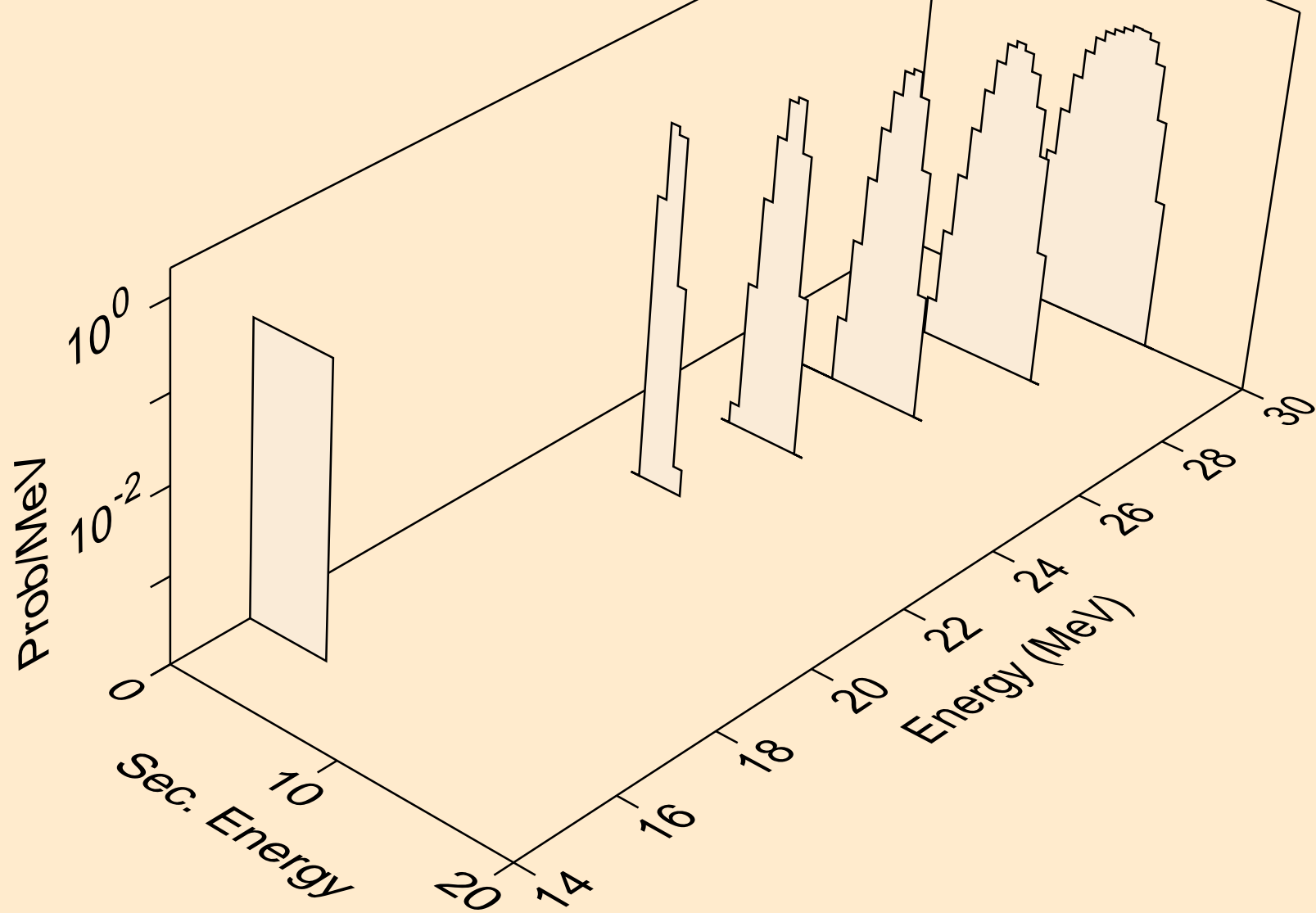



ER167 PROTON ACER TENDL-2023 LIBRARY; T=0.K  
alphas from (p,n\*)2a

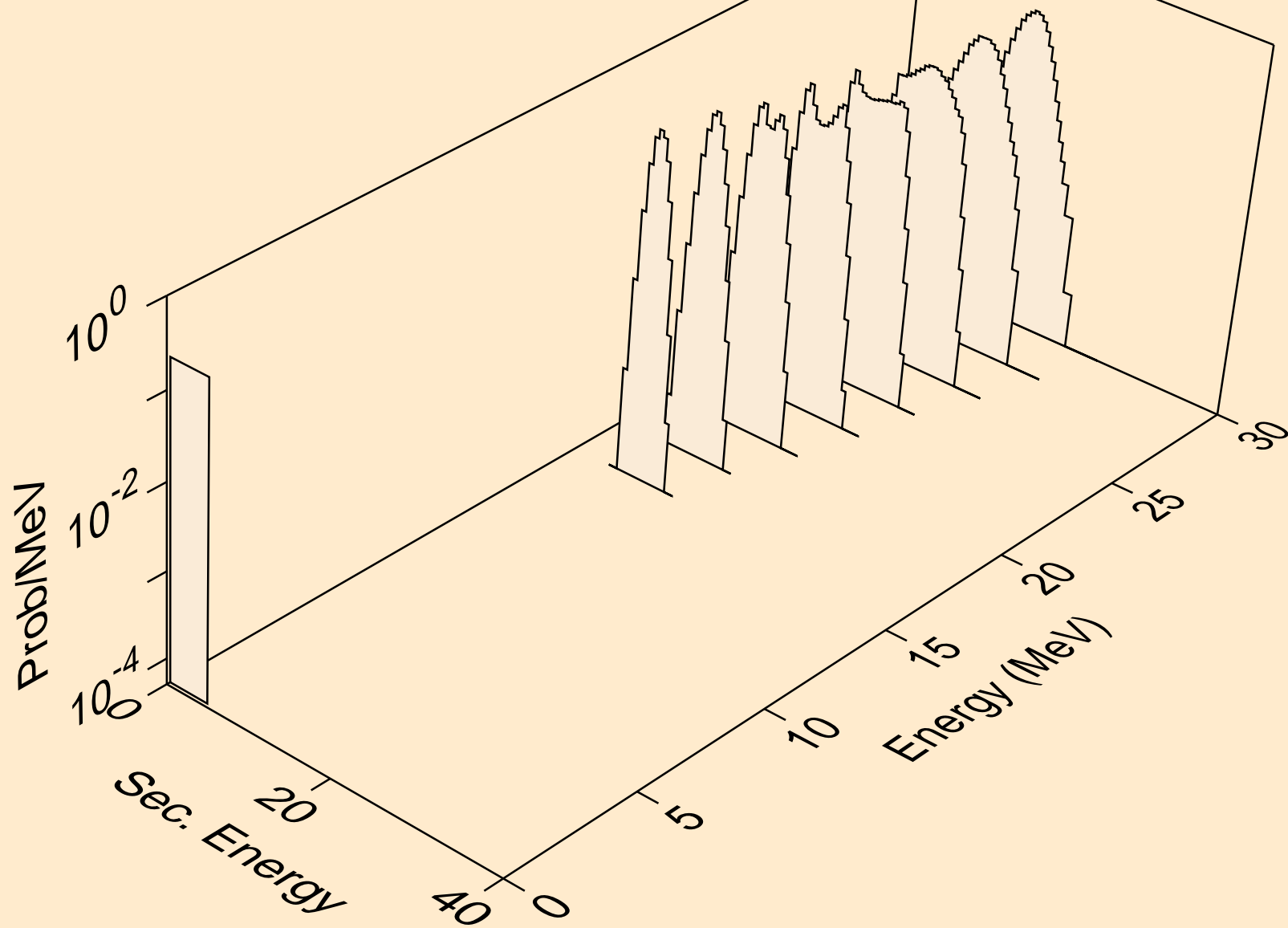

ER167 PROTON ACER TENDL-2023 LIBRARY; T=0.K  
alphas from (p,npa)

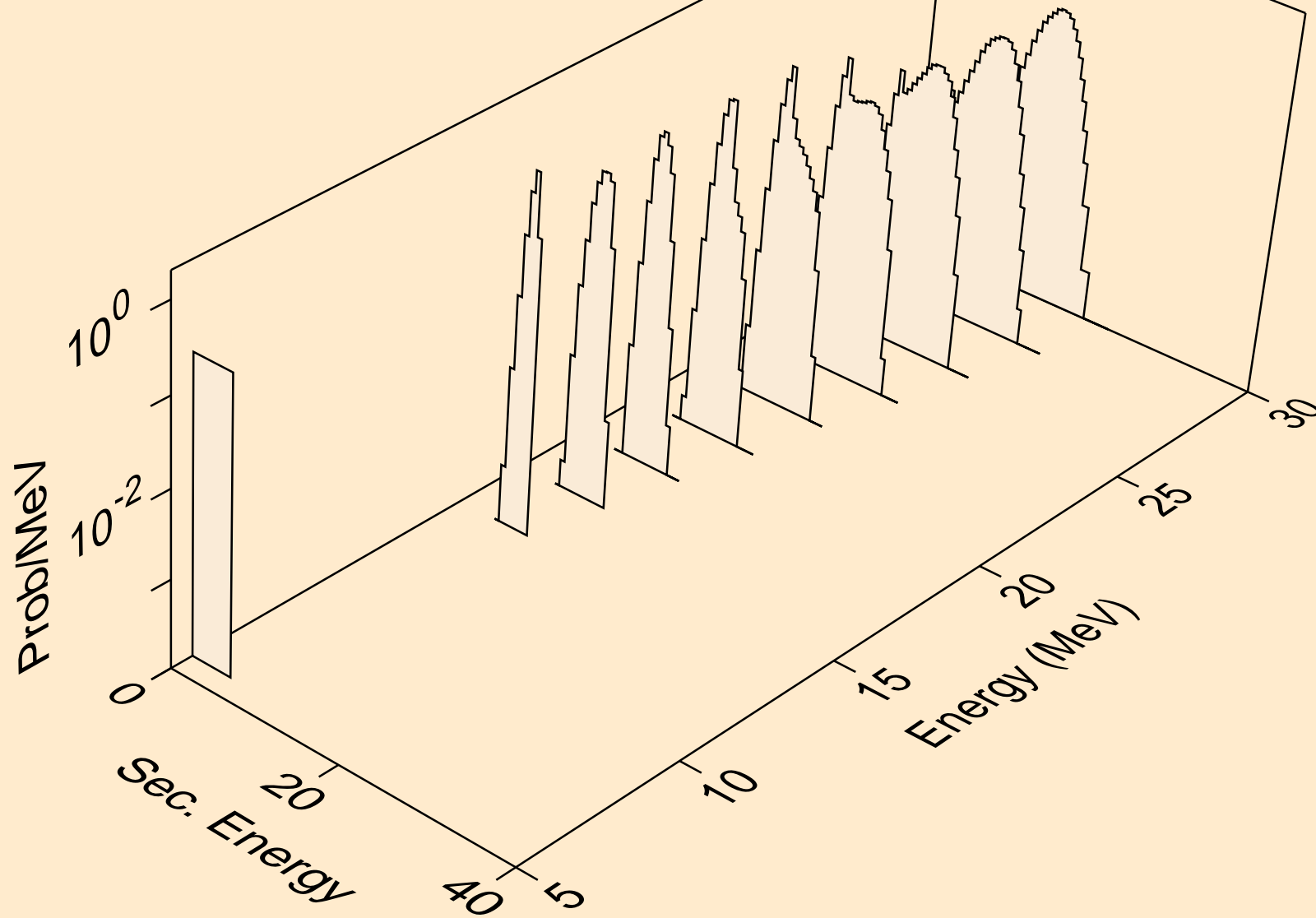

ER167 PROTON ACER TENDL-2023 LIBRARY; T=0.K  
alphas from (p,a)

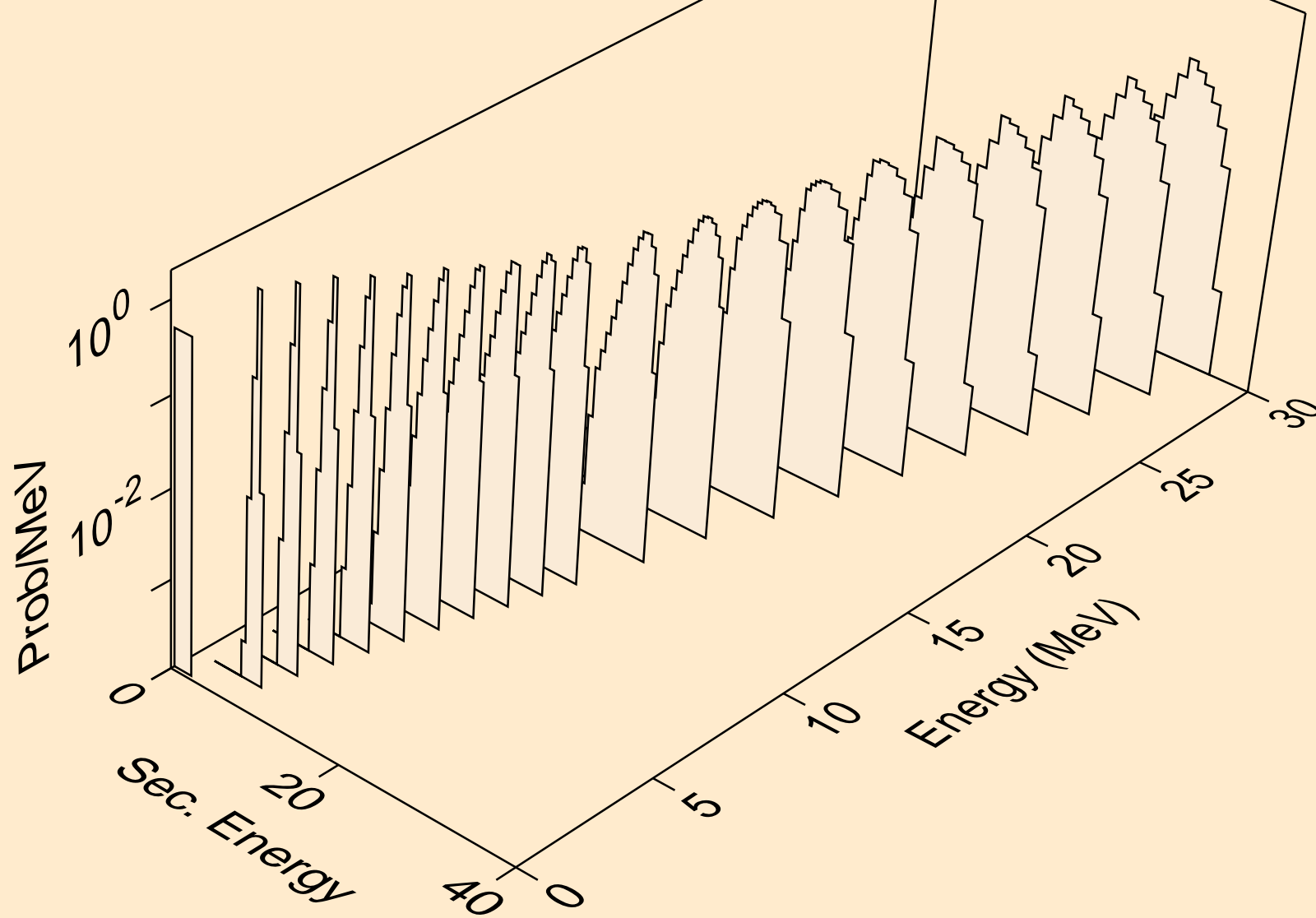

ER167 PROTON ACER TENDL-2023 LIBRARY; T=0.K  
alphas from (p,2a)

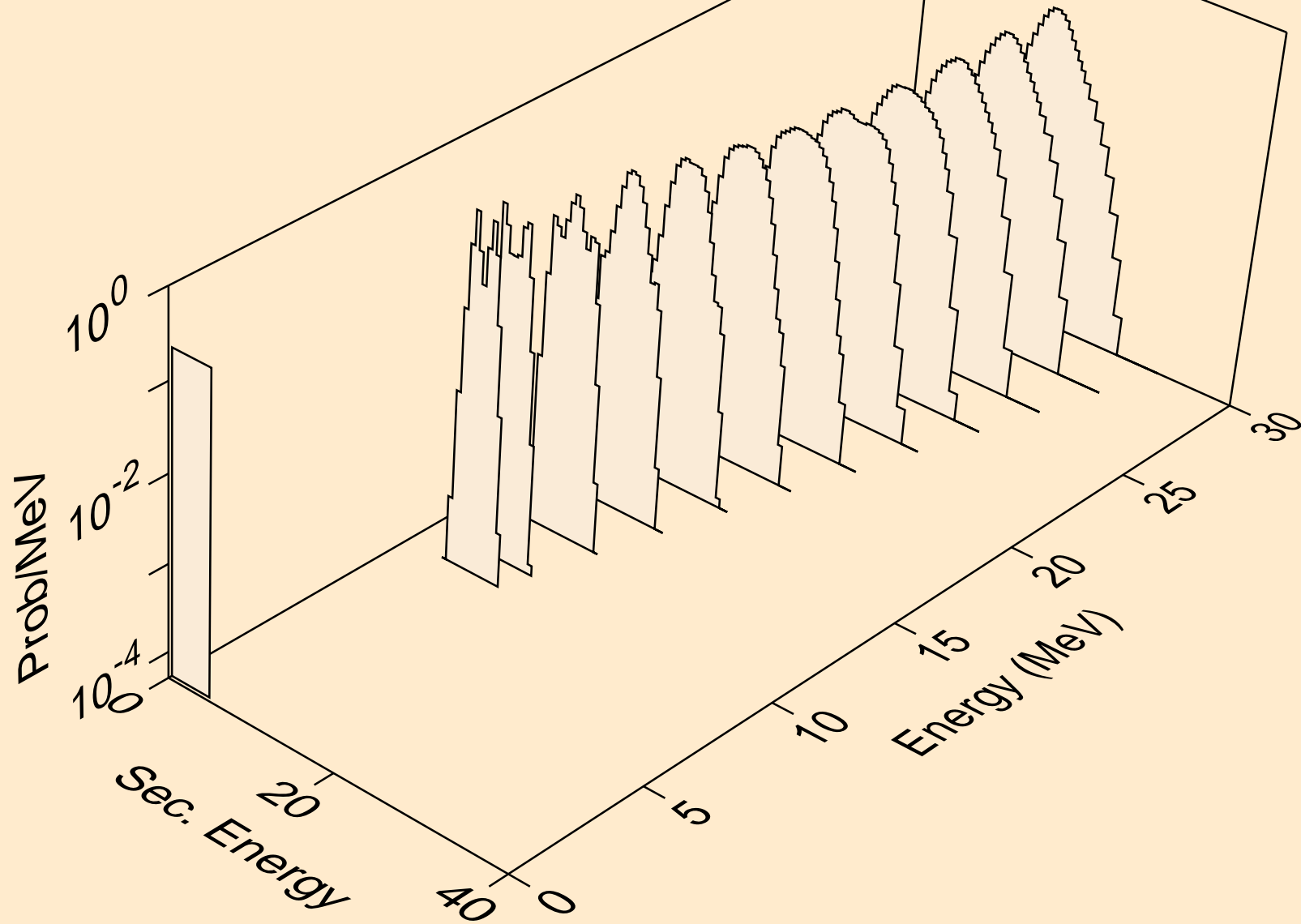

ER167 PROTON ACER TENDL-2023 LIBRARY; T=0.K  
alphas from (p,pa)

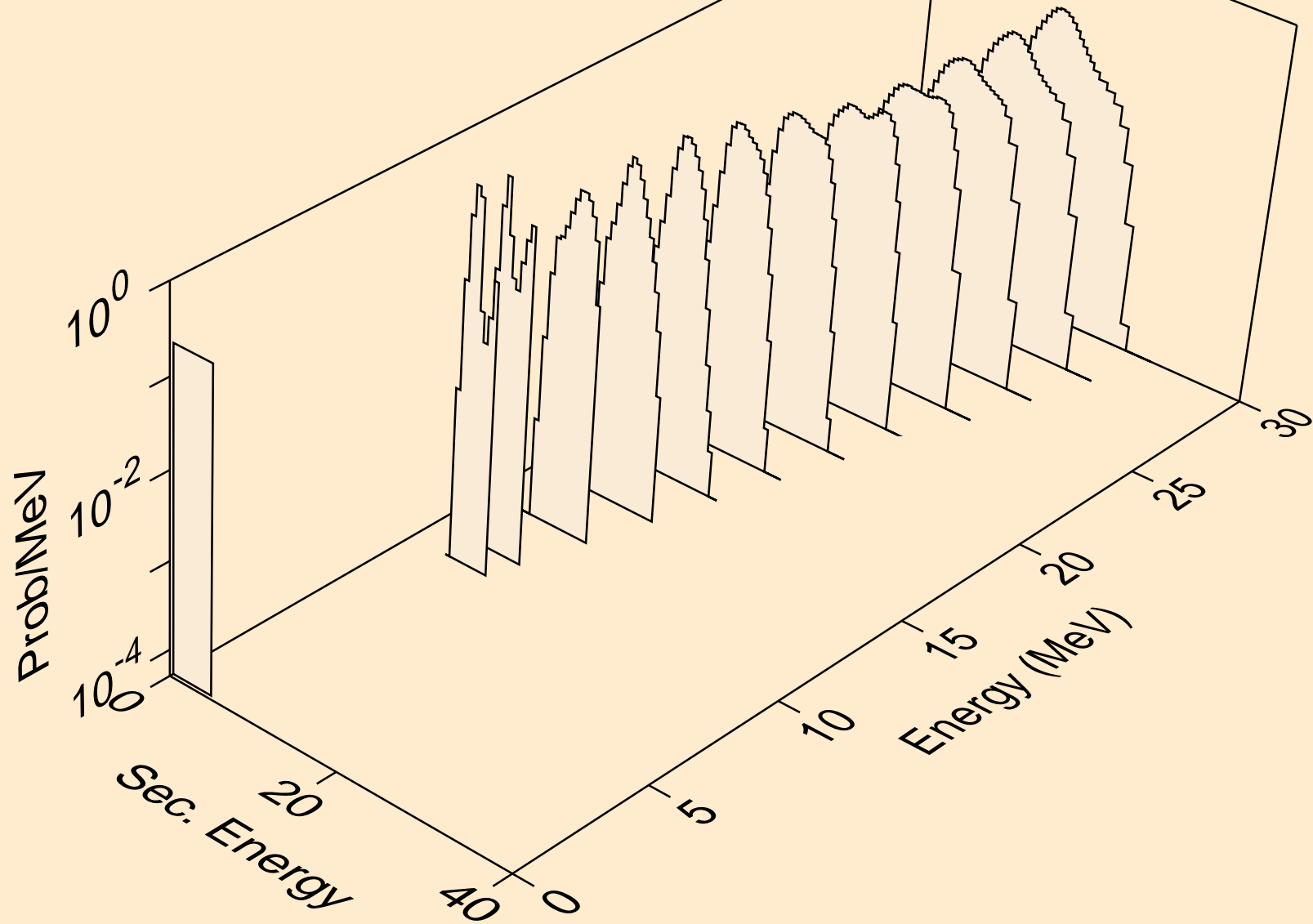

ER167 PROTON ACER TENDL-2023 LIBRARY; T=0.K  
alphas from (p,da)

