

# ES256 PROTON ACER TENDL-2023 LIBRARY; T=0.K

## Principal cross sections

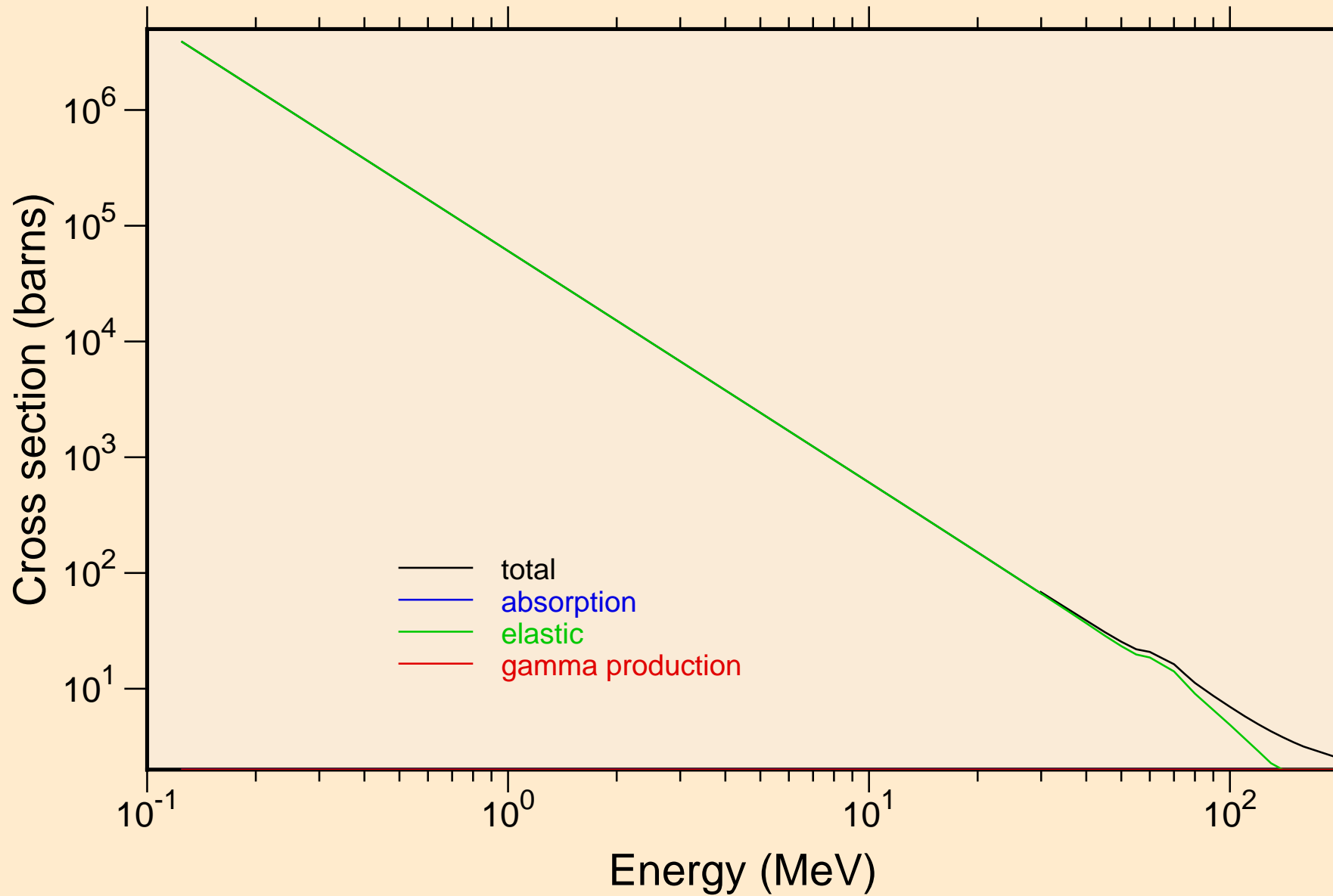

# ES256 PROTON ACER TENDL-2023 LIBRARY; T=0.K

## Heating

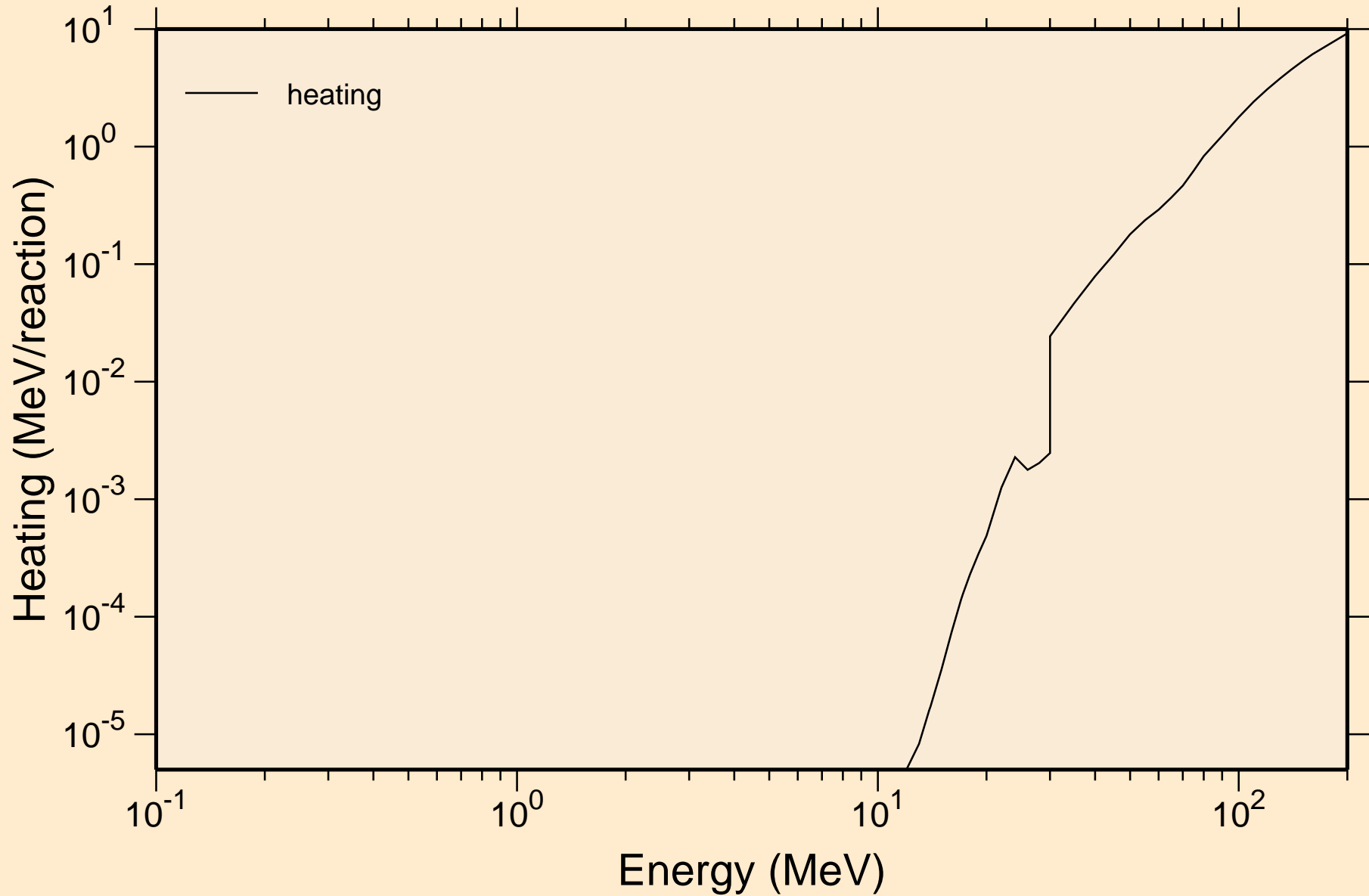

# ES256 PROTON ACER TENDL-2023 LIBRARY; T=0.K

## Principal cross sections

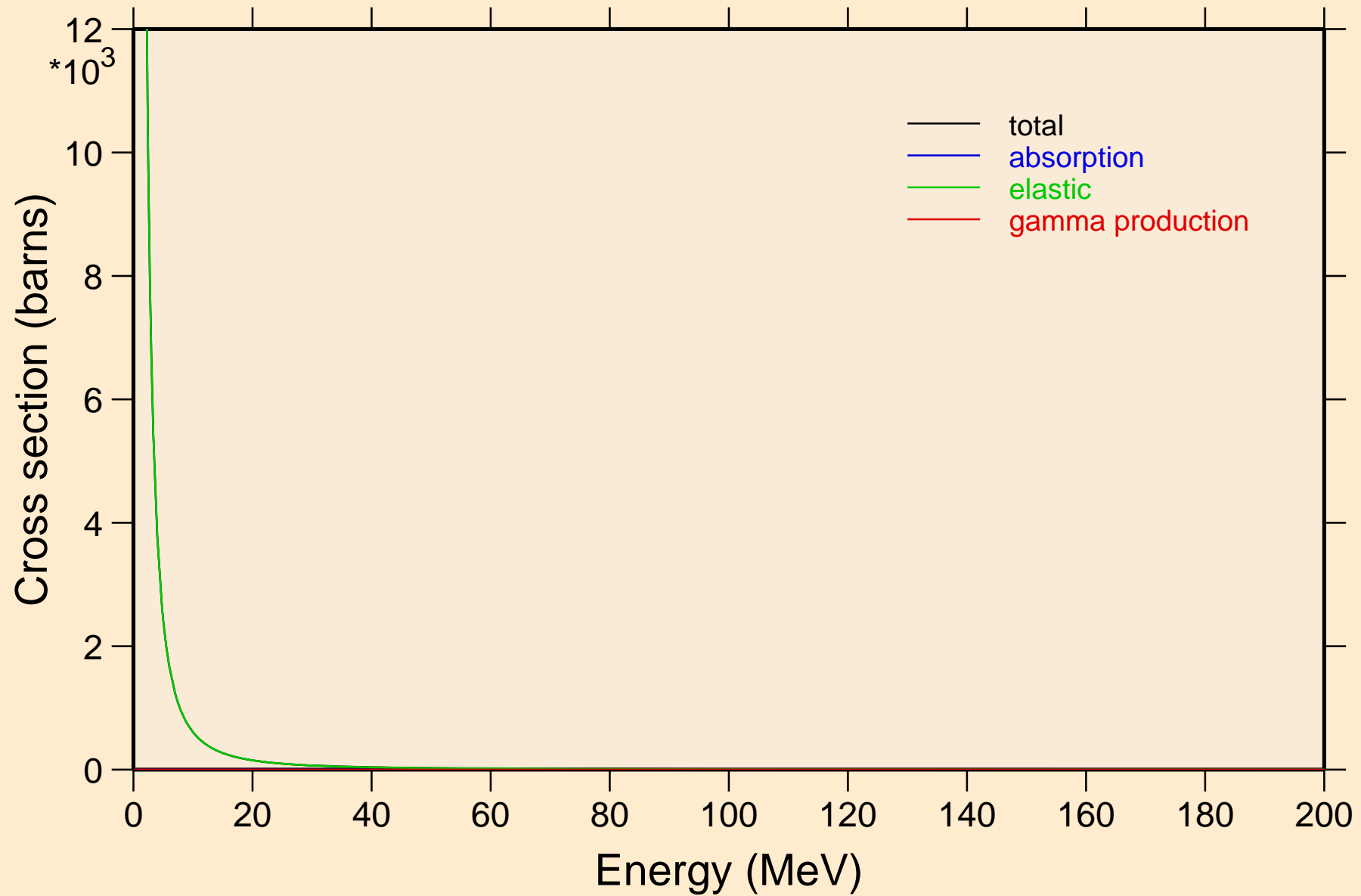

# ES256 PROTON ACER TENDL-2023 LIBRARY; T=0.K

## Heating

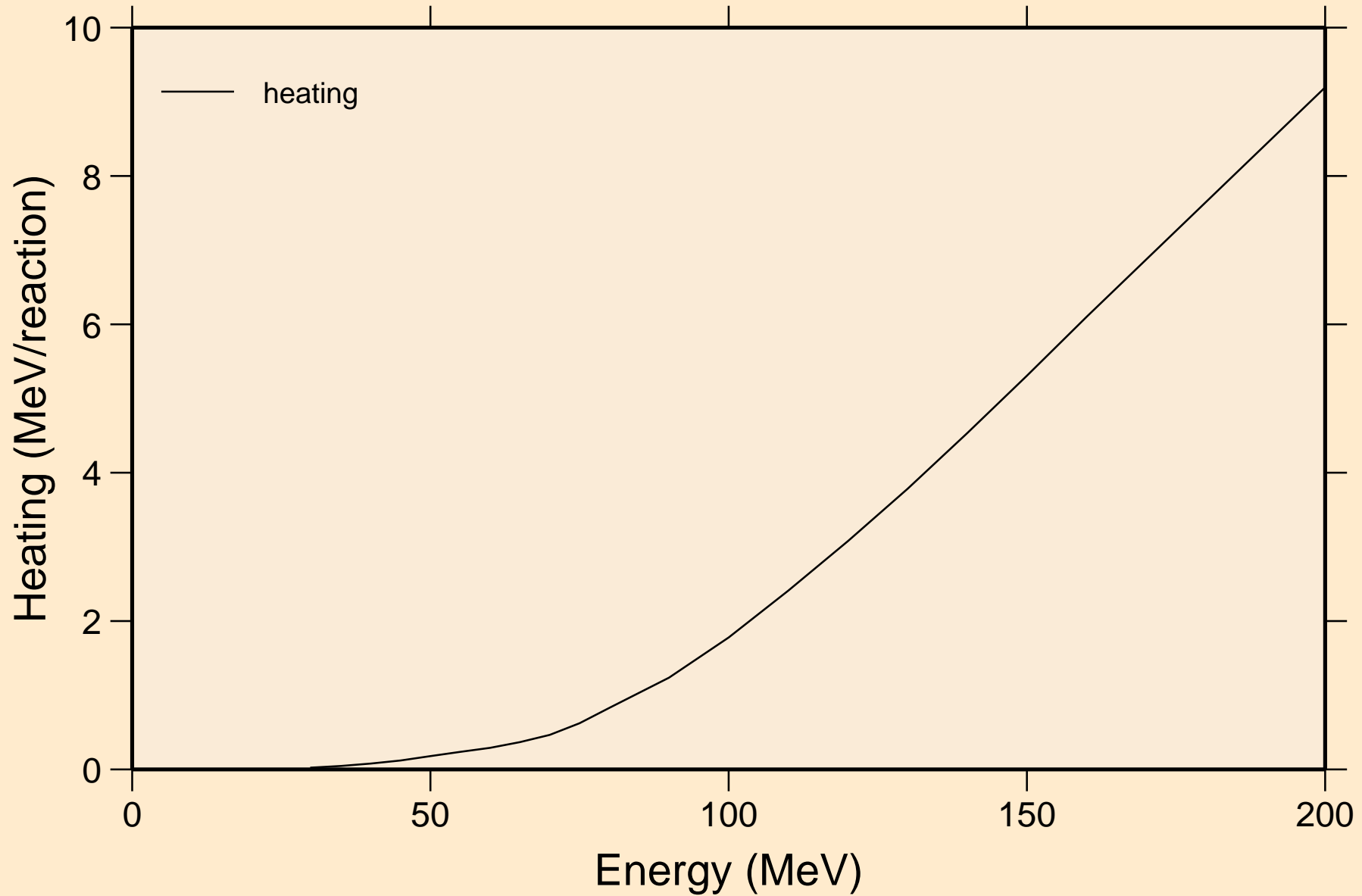

# ES256 PROTON ACER TENDL-2023 LIBRARY; T=0.K

## Threshold reactions

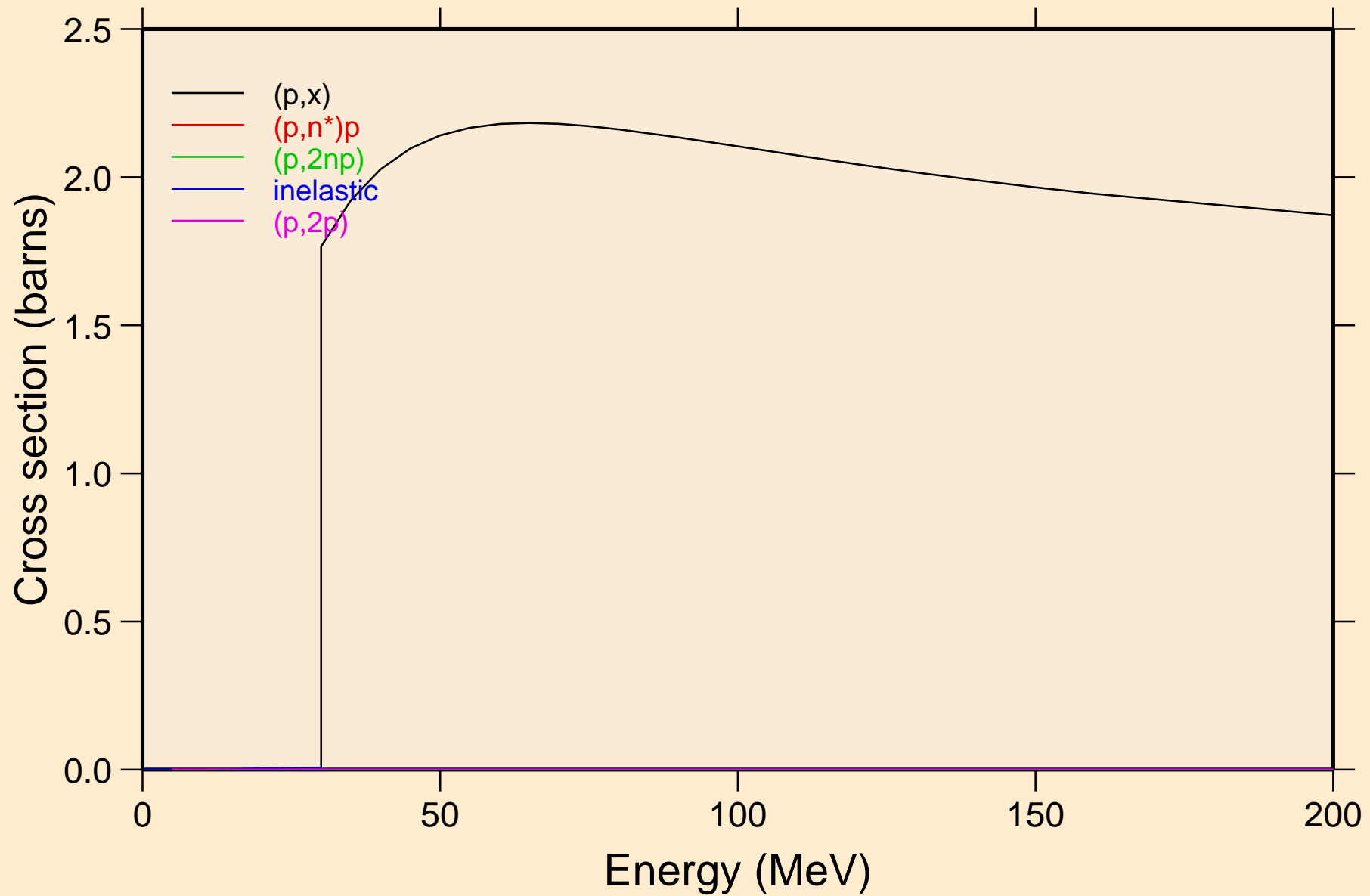

ES256 PROTON ACER TENDL-2023 LIBRARY; T=0.K  
Threshold reactions

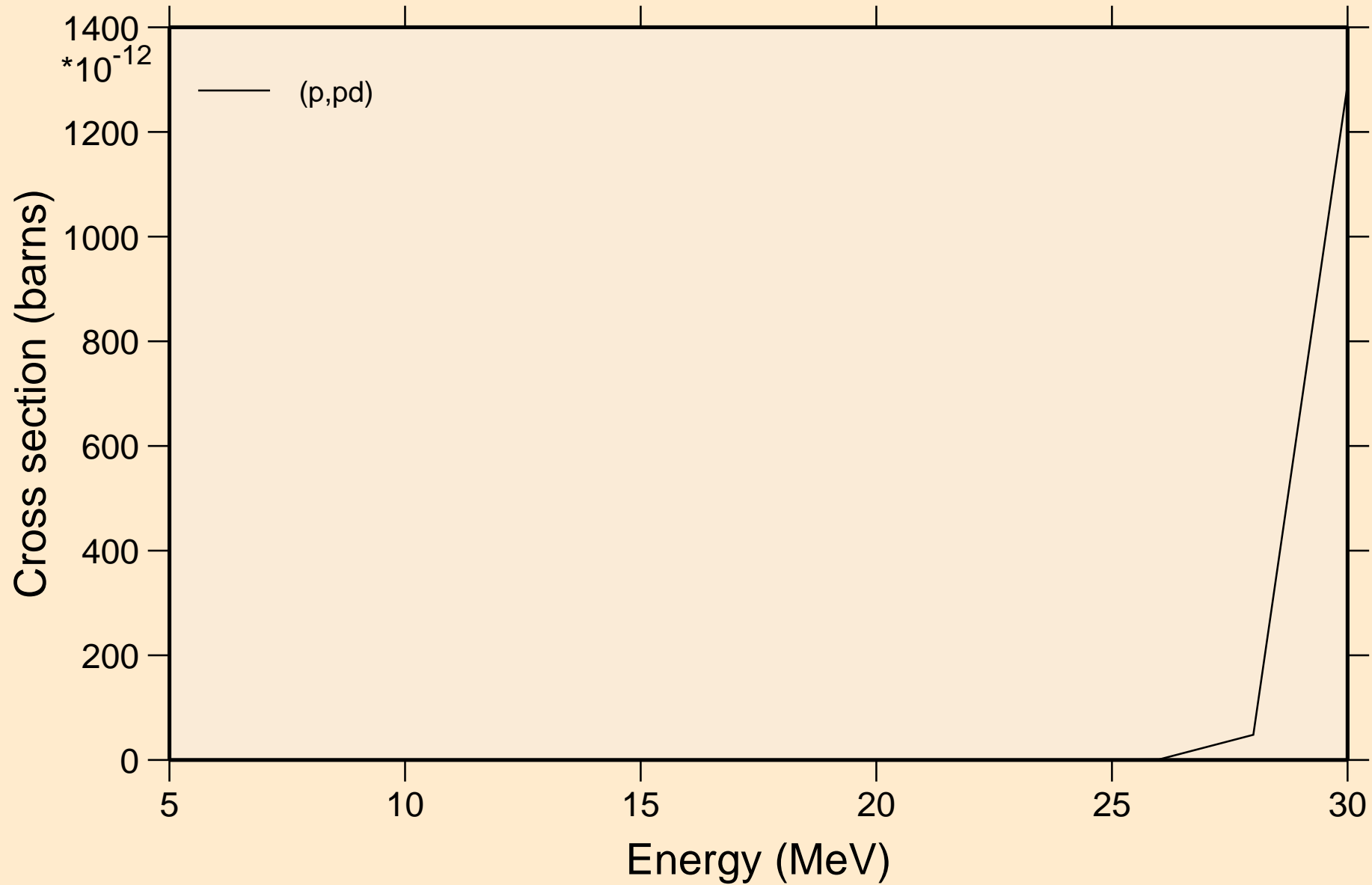

ES256 PROTON ACER TENDL-2023 LIBRARY; T=0.K  
angular distribution for elastic

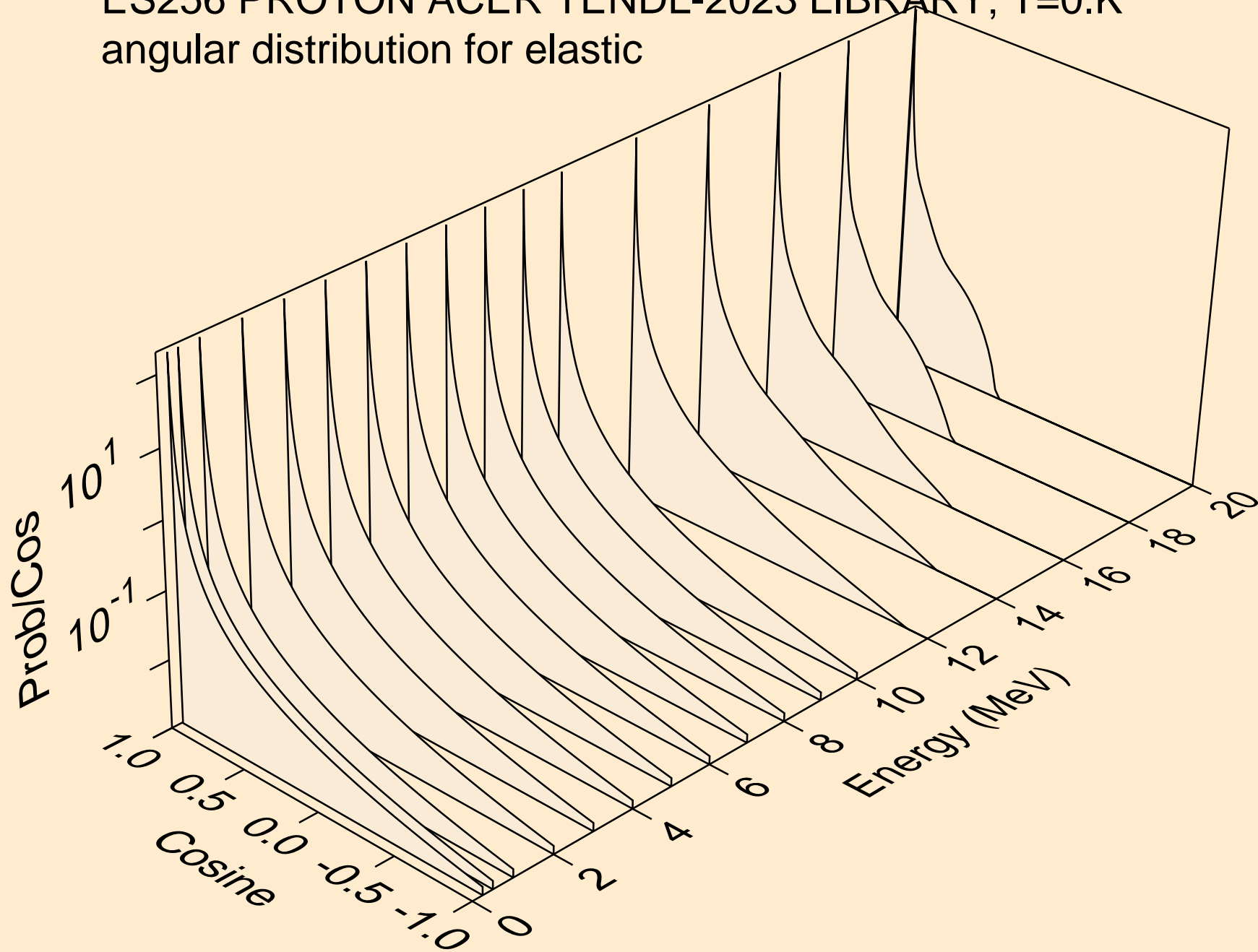

ES256 PROTON ACER TENDL-2023 LIBRARY; T=0.K  
angular distribution for elastic

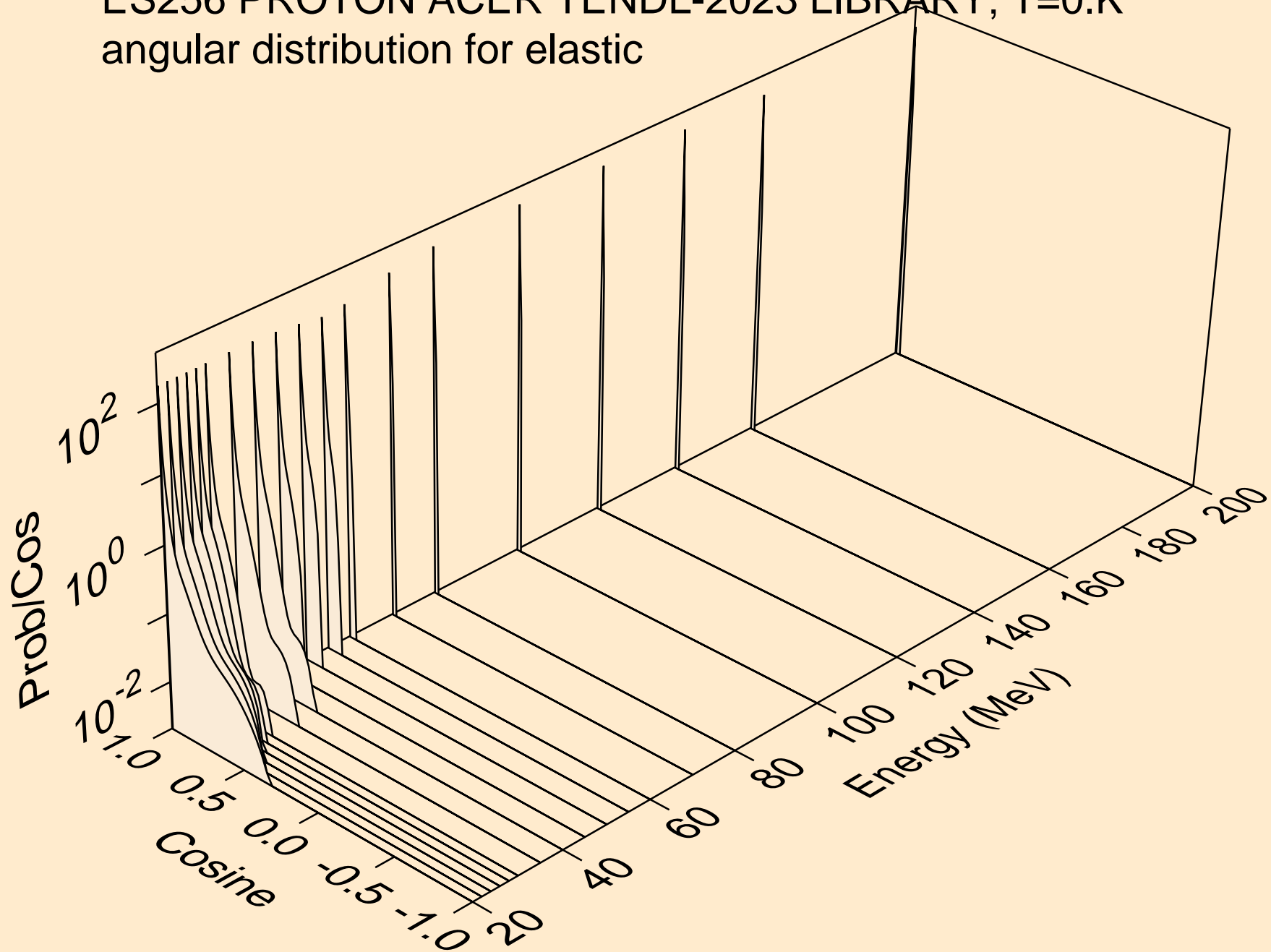



ES256 PROTON ACER TENDL-2023 LIBRARY; T=0.K  
Proton emission for (p,x)

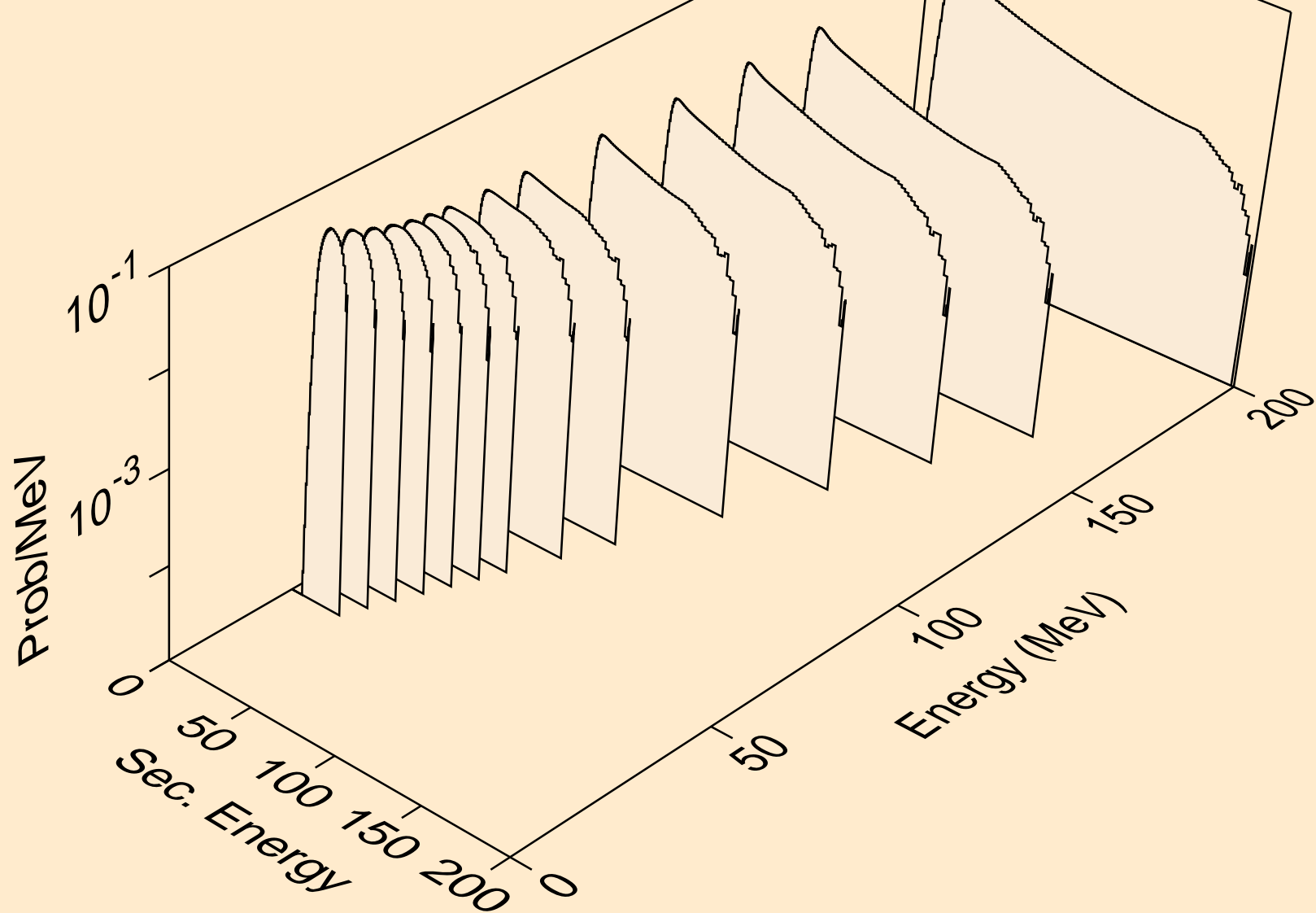

ES256 PROTON ACER TENDL-2023 LIBRARY; T=0.K  
Proton emission for (p,n\*)p

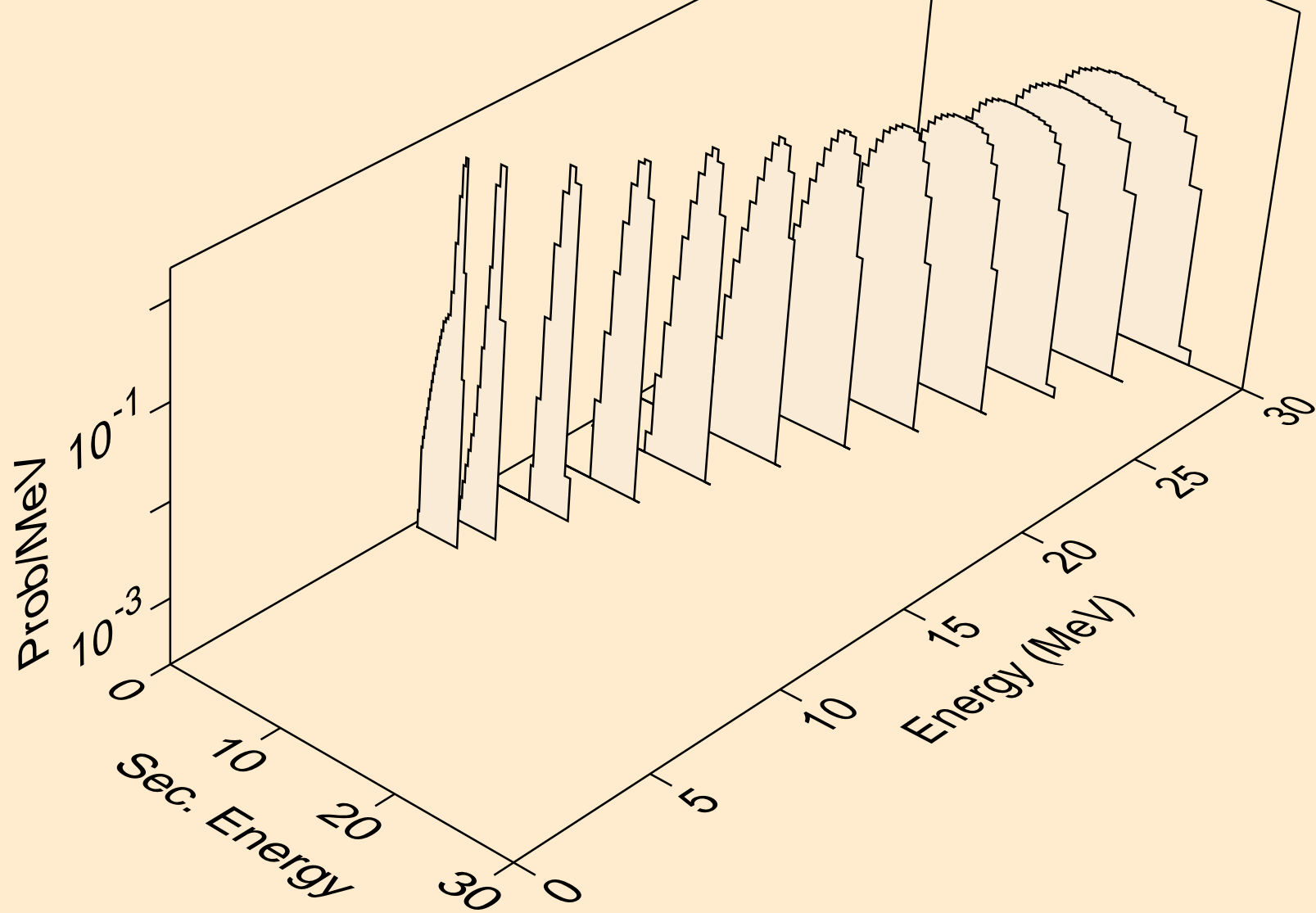

ES256 PROTON ACER TENDL-2023 LIBRARY; T=0.K  
Proton emission for (p,2np)

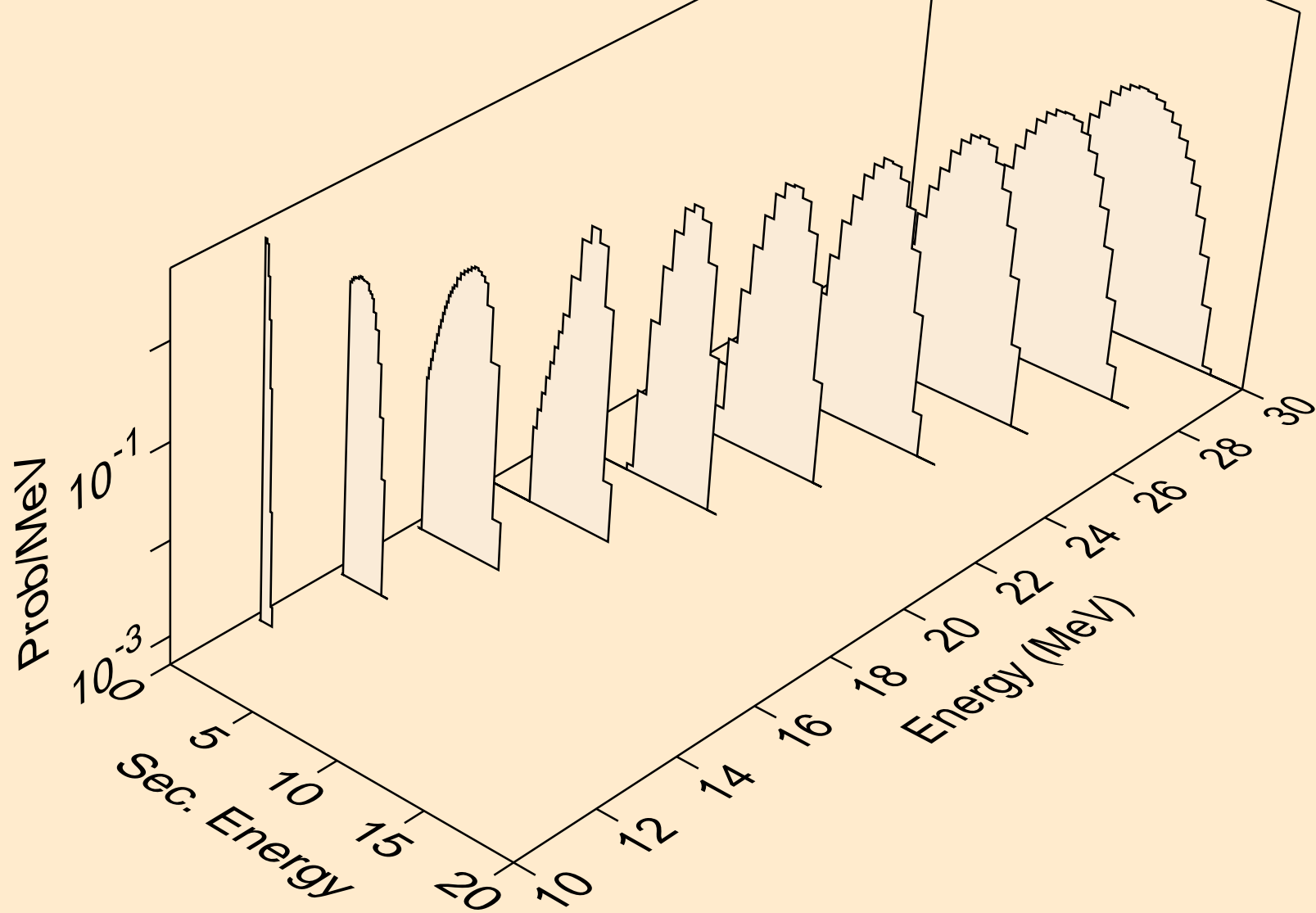

ES256 PROTON ACER TENDL-2023 LIBRARY; T=0.K  
Proton emission for inelastic

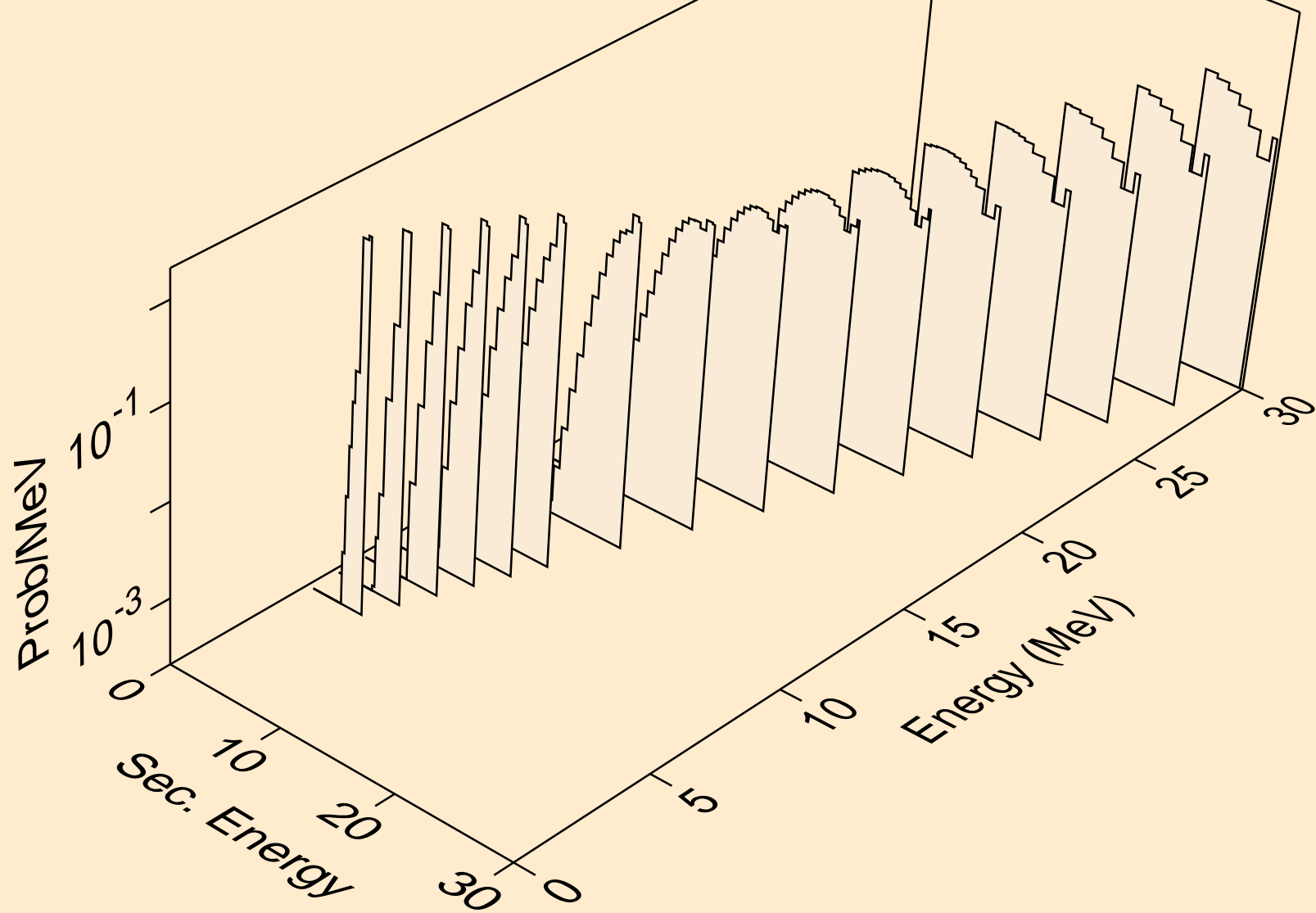

ES256 PROTON ACER TENDL-2023 LIBRARY; T=0.K  
Proton emission for (p,2p)

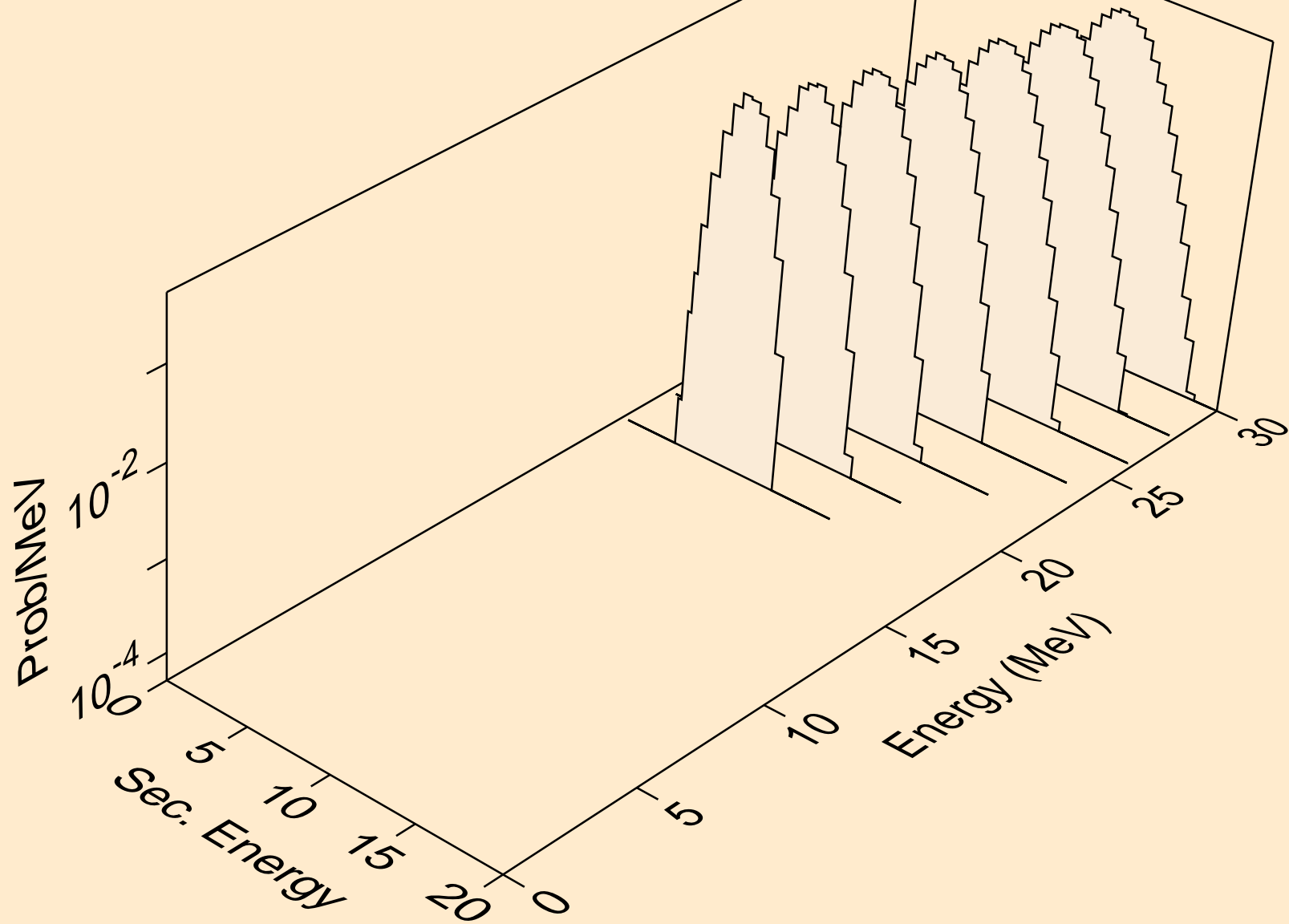

ES256 PROTON ACER TENDL-2023 LIBRARY; T=0.K  
Proton emission for (p,pd)

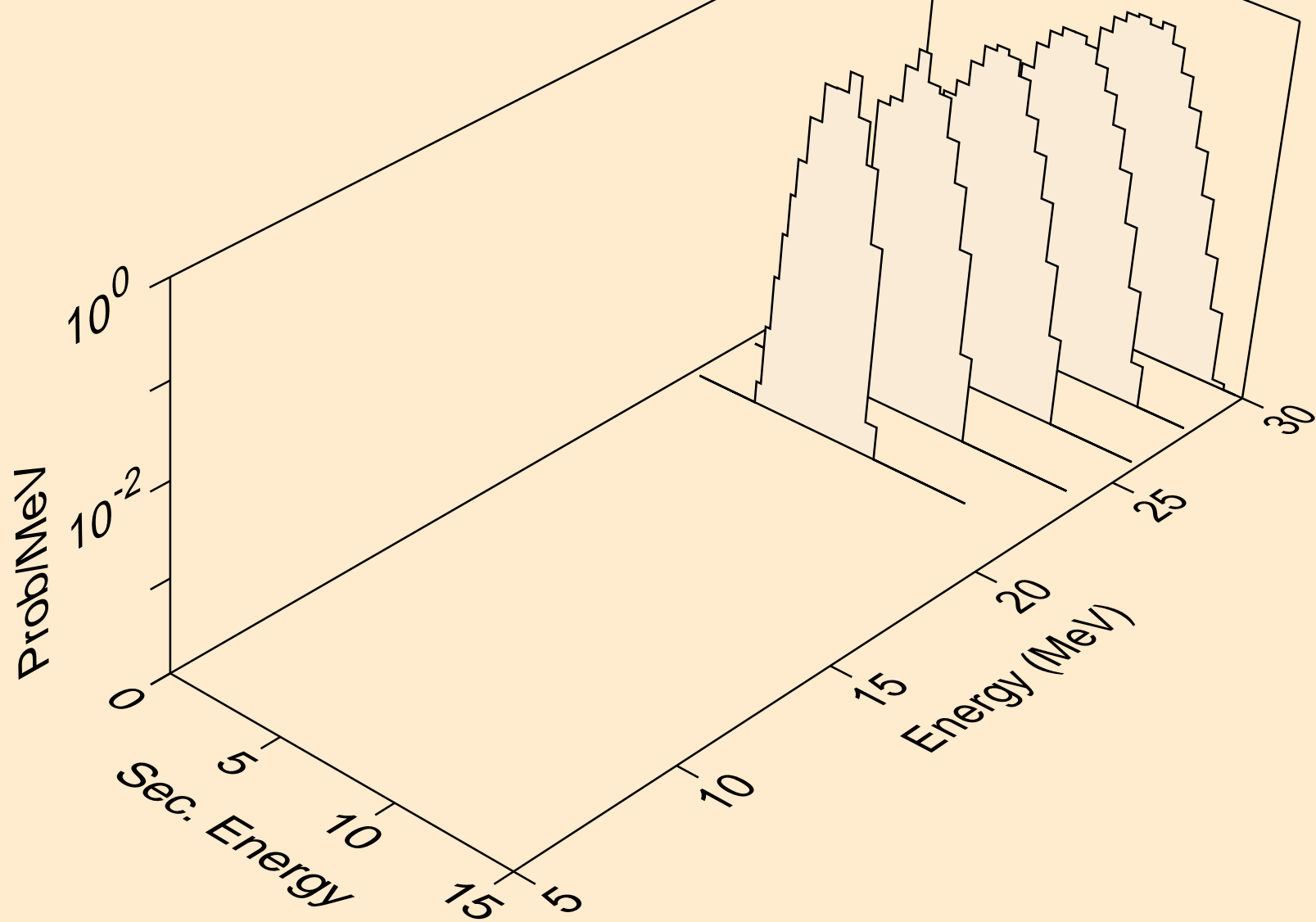

ES256 PROTON ACER TENDL-2023 LIBRARY; T=0.K  
Photon emission for (z,n)

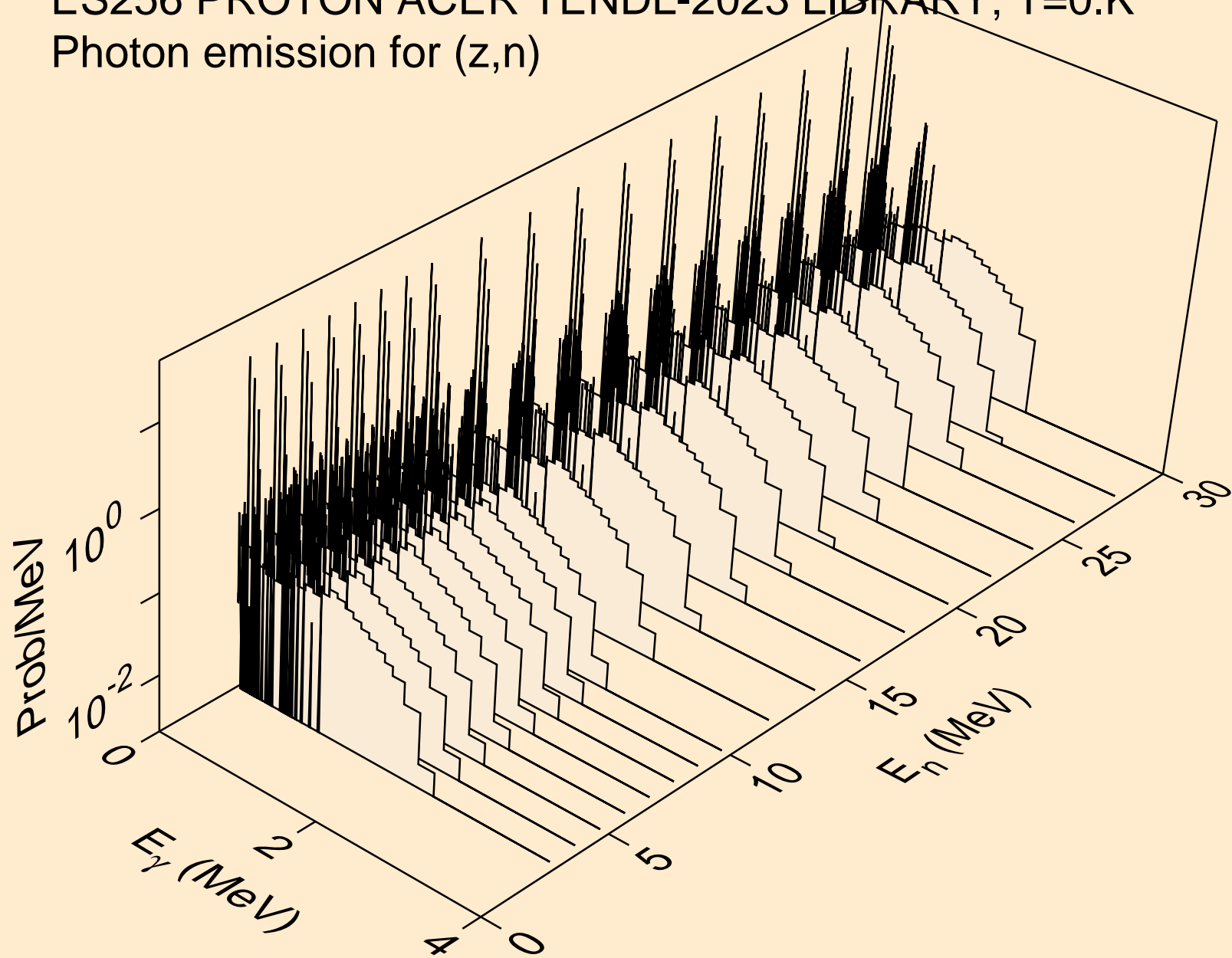

ES256 PROTON ACER TENDL-2023 LIBRARY; T=0.K  
Photon emission for (z,x)

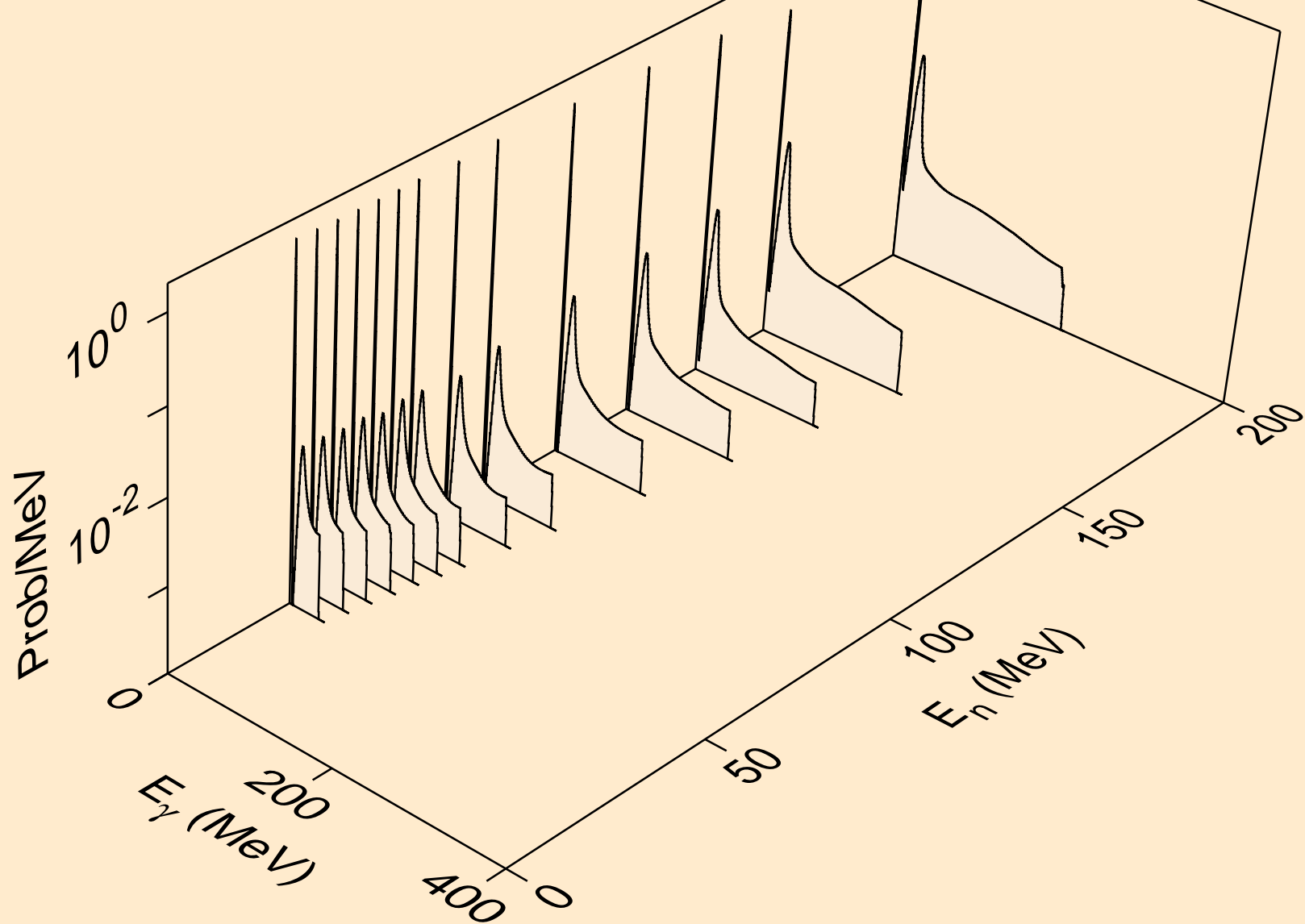



ES256 PROTON ACER TENDL-2023 LIBRARY; T=0.K  
Photon emission for (n,2nd)

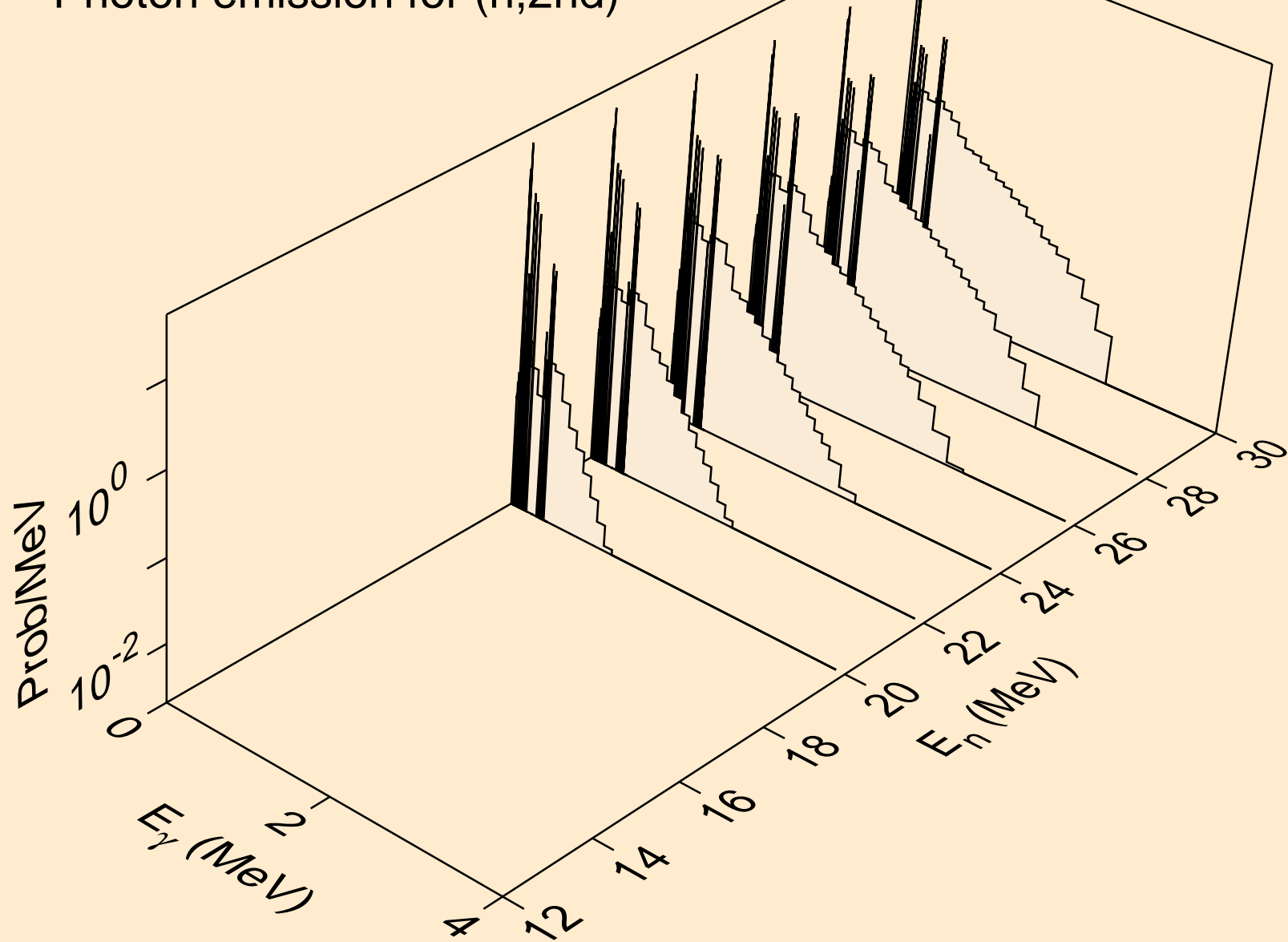

ES256 PROTON ACER TENDL-2023 LIBRARY; T=0.K  
Photon emission for (n,2n)

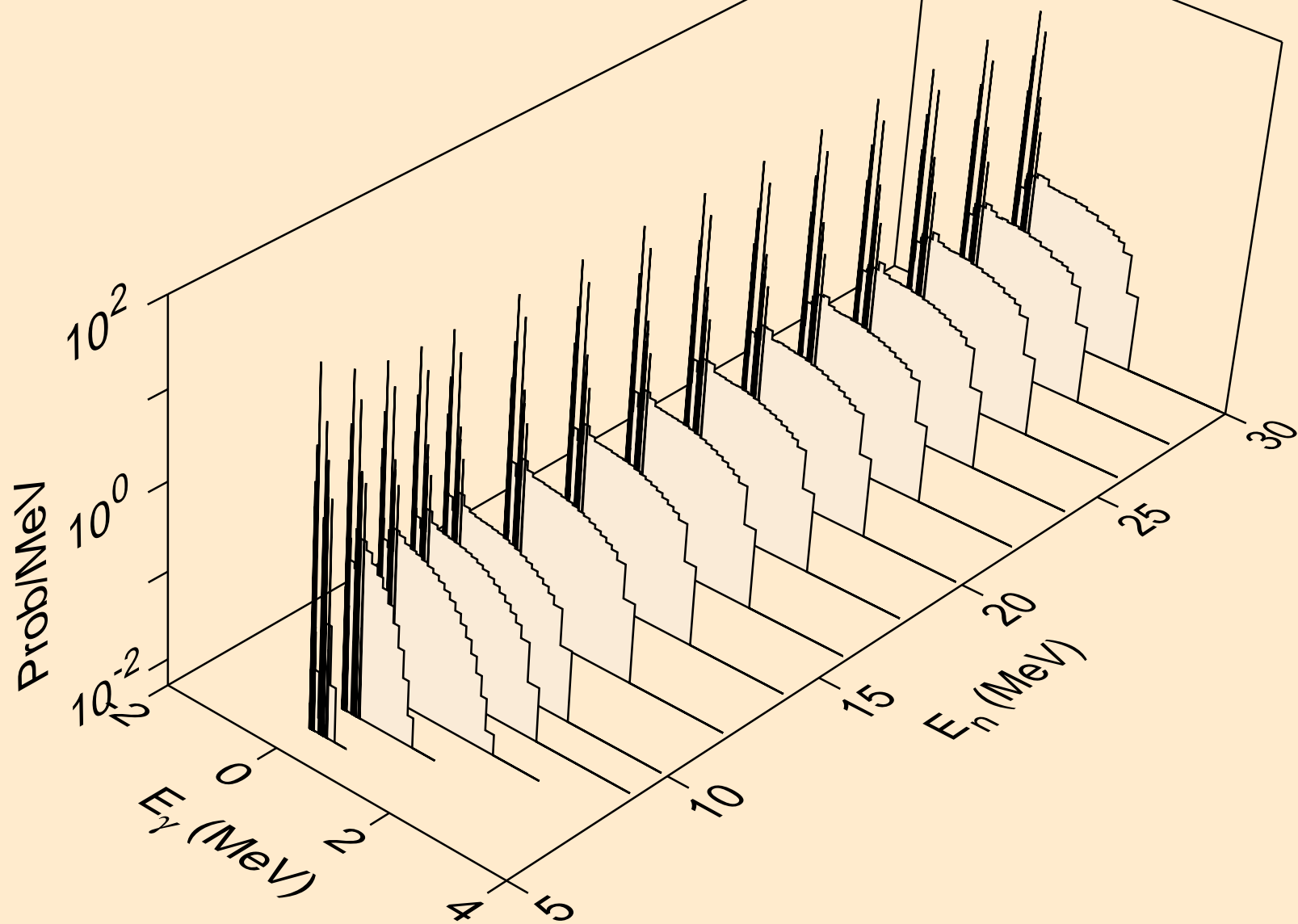

ES256 PROTON ACER TENDL-2023 LIBRARY; T=0.K  
Photon emission for (n,3n)

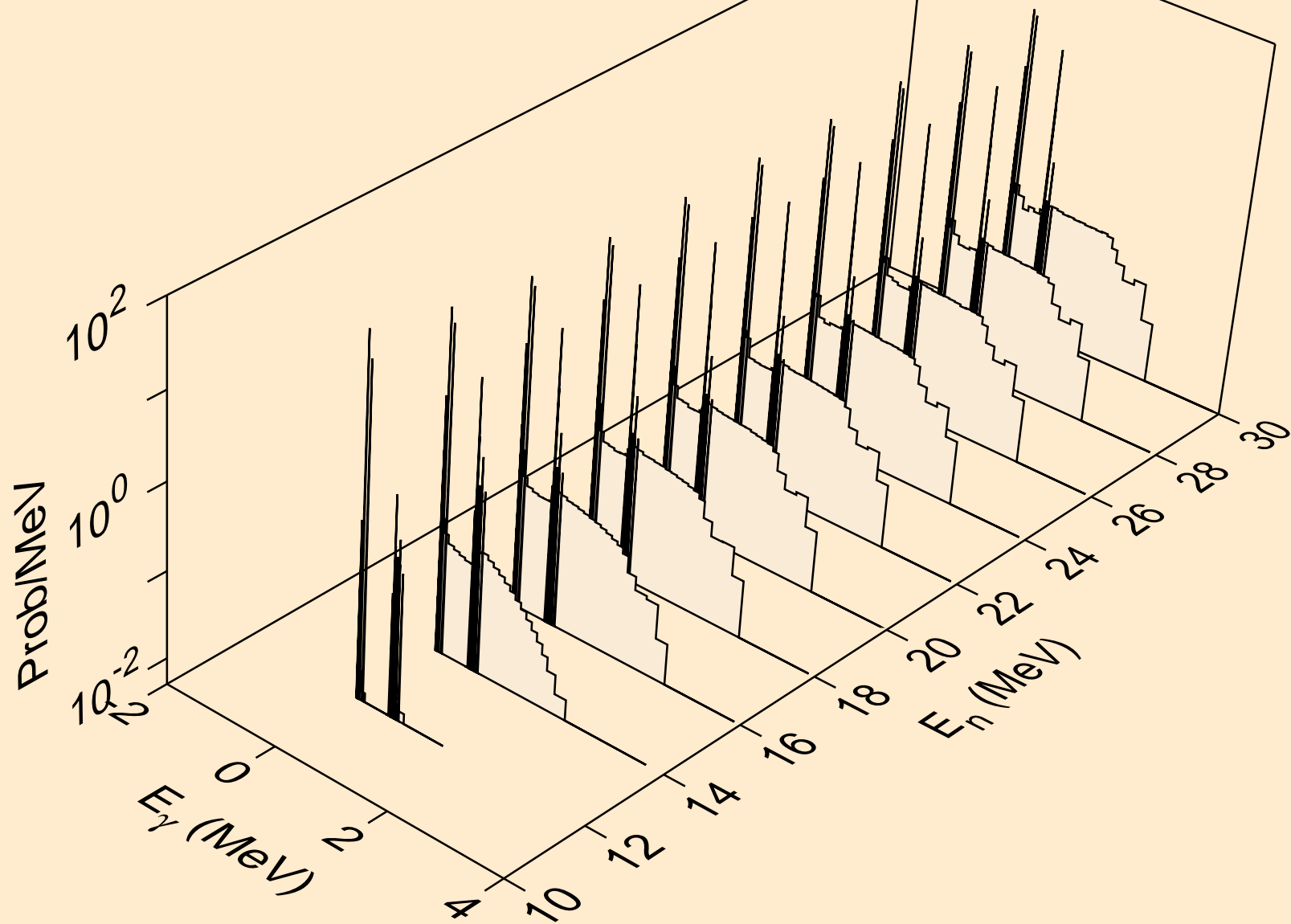

ES256 PROTON ACER TENDL-2023 LIBRARY; T=0.K  
Photon emission for (n,n\*)a

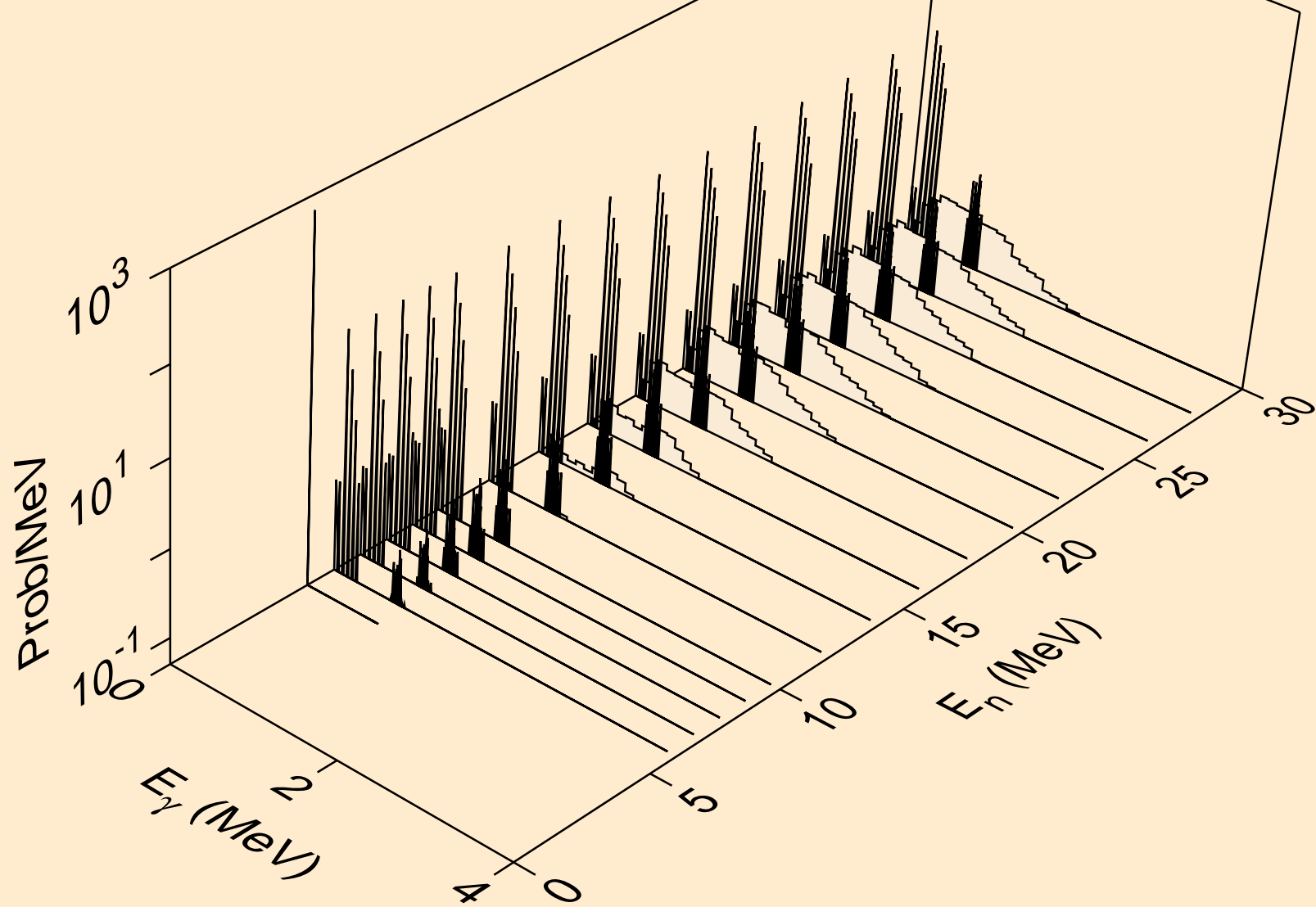

ES256 PROTON ACER TENDL-2023 LIBRARY; T=0.K  
Photon emission for (n,2n)a

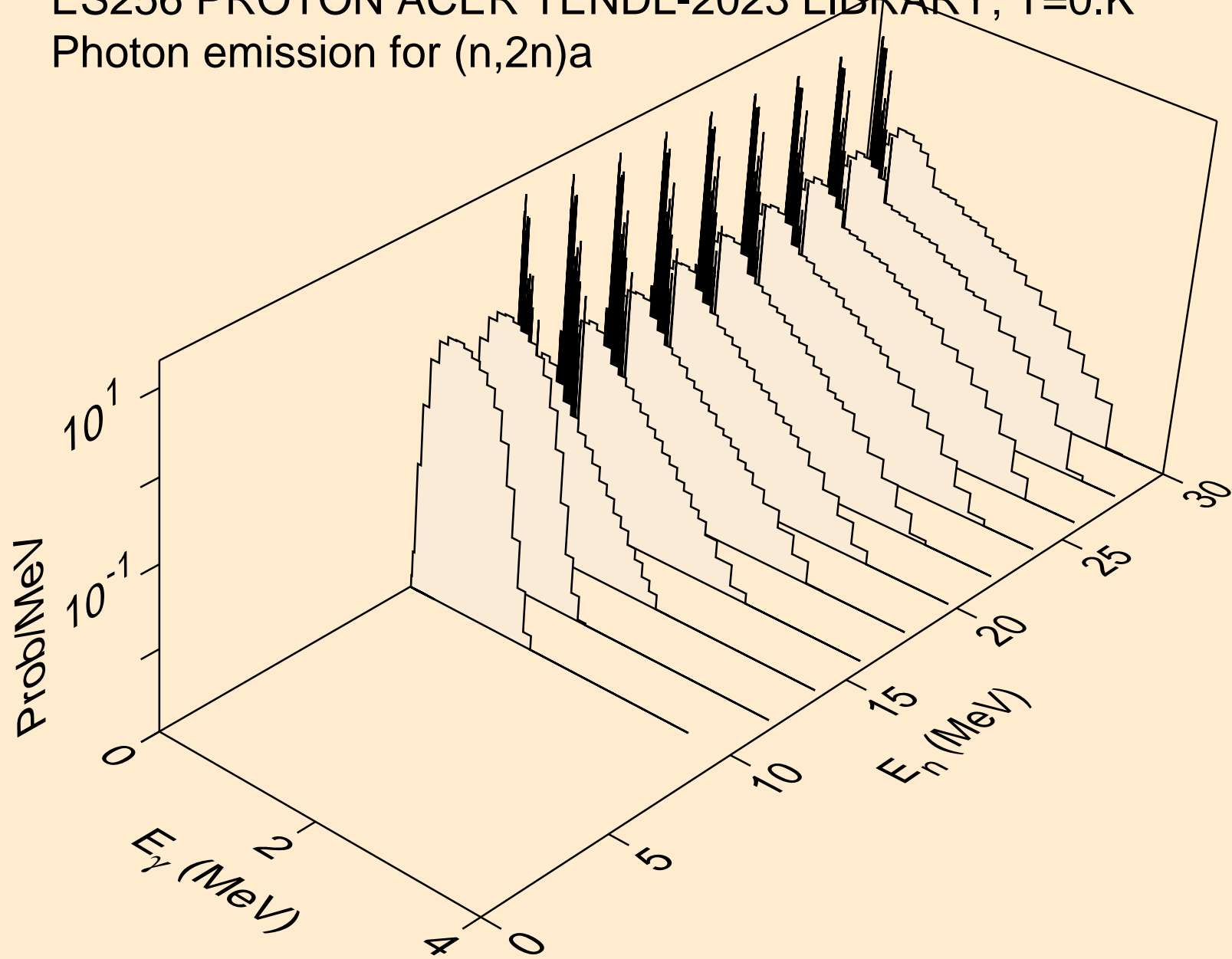

ES256 PROTON ACER TENDL-2023 LIBRARY; T=0.K  
Photon emission for (n,3n)a

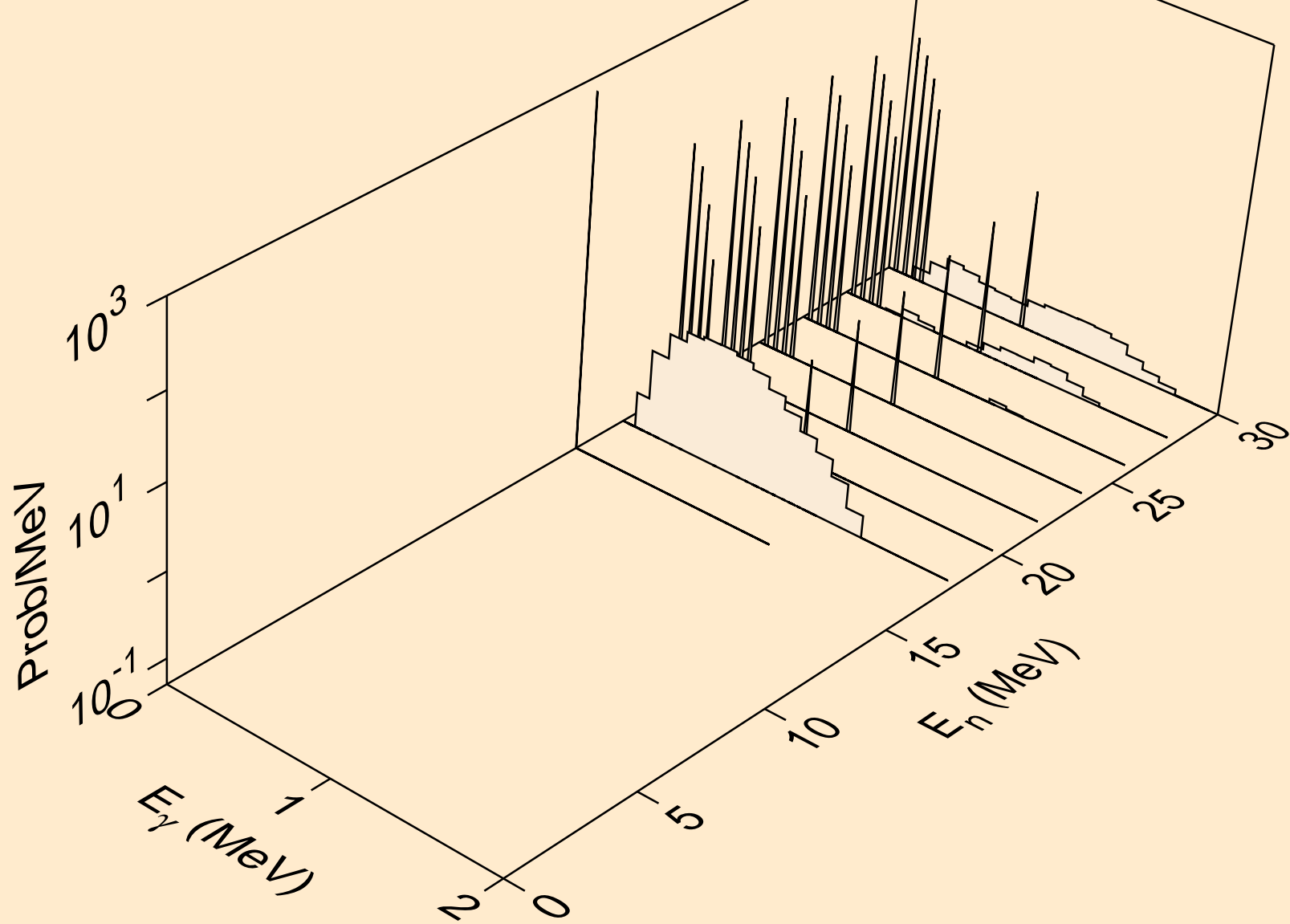

ES256 PROTON ACER TENDL-2023 LIBRARY; T=0.K  
Photon emission for (n,n\*)p

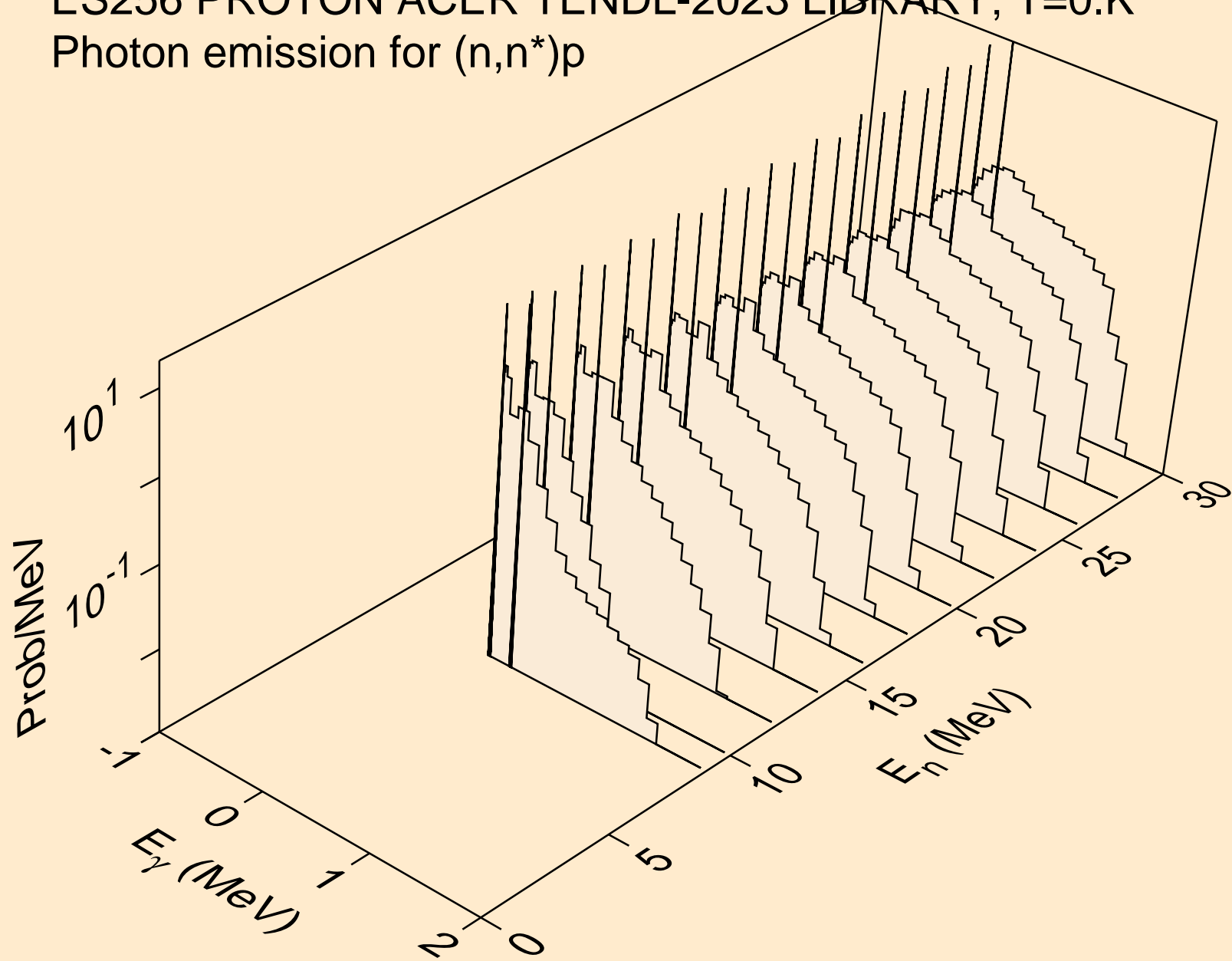

ES256 PROTON ACER TENDL-2023 LIBRARY; T=0.K  
Photon emission for (n,n\*)d

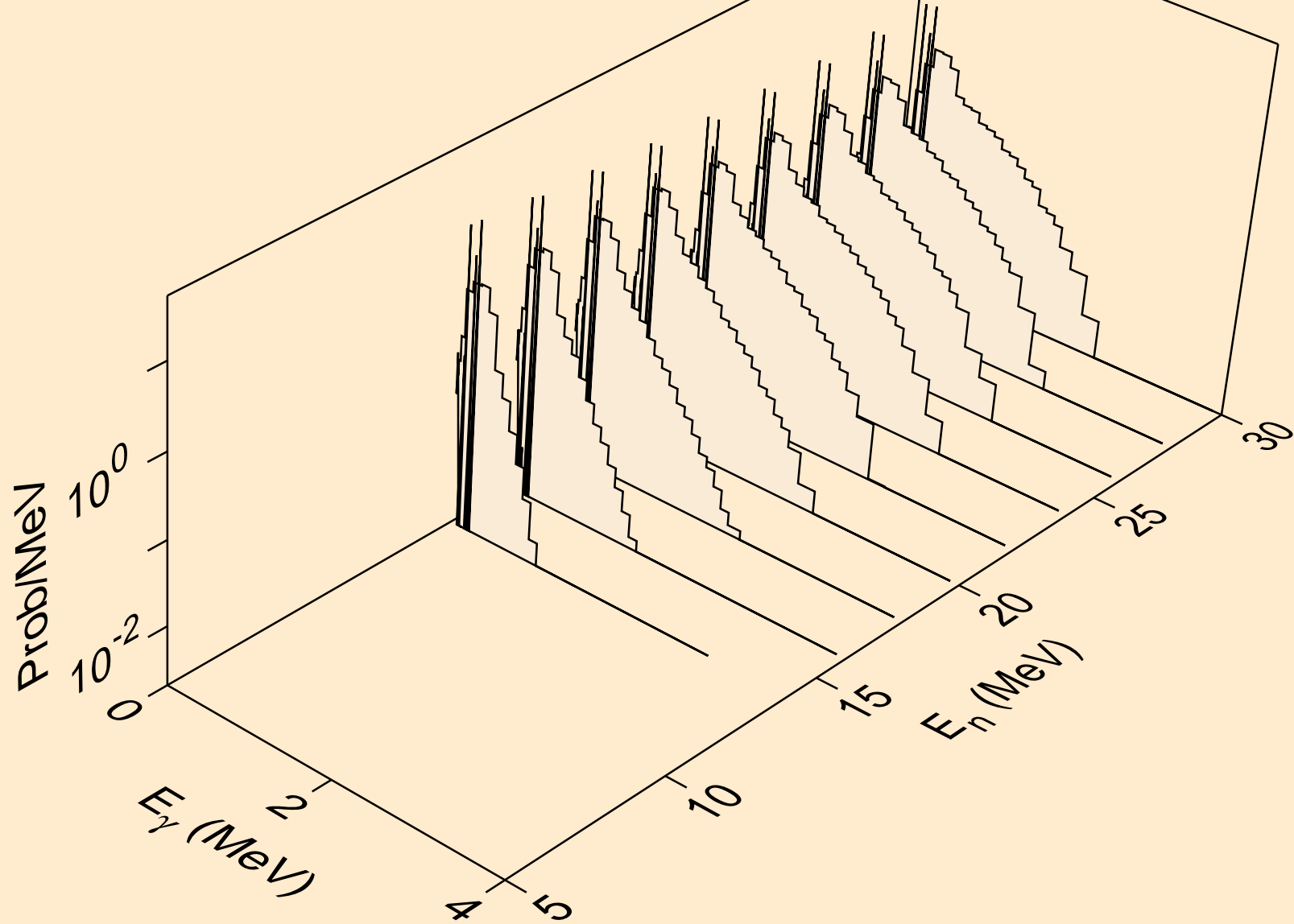



ES256 PROTON ACER TENDL-2023 LIBRARY; T=0.K  
Photon emission for (n,n\*)t

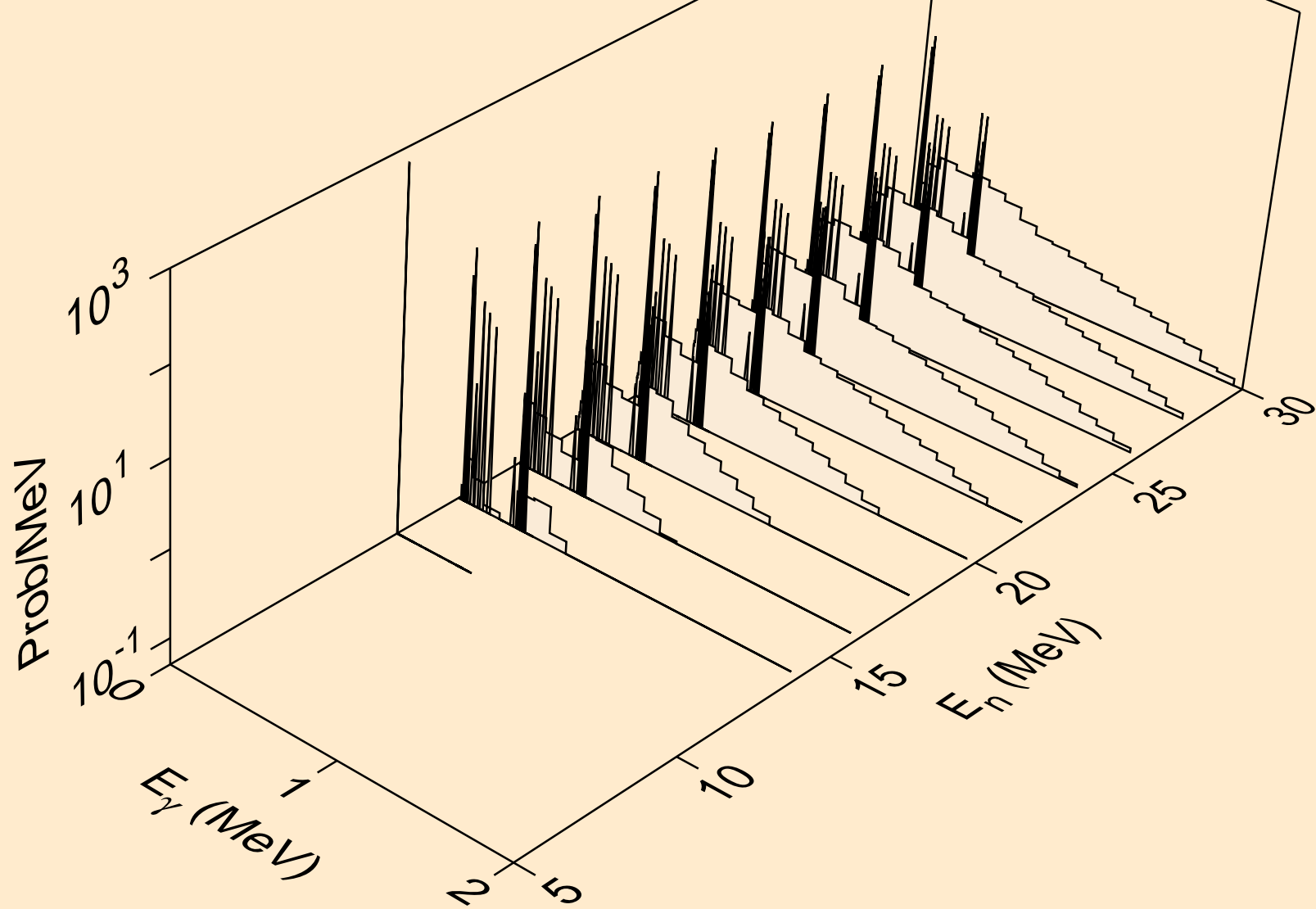

ES256 PROTON ACER TENDL-2023 LIBRARY; T=0.K  
Photon emission for (n,n\*)he3

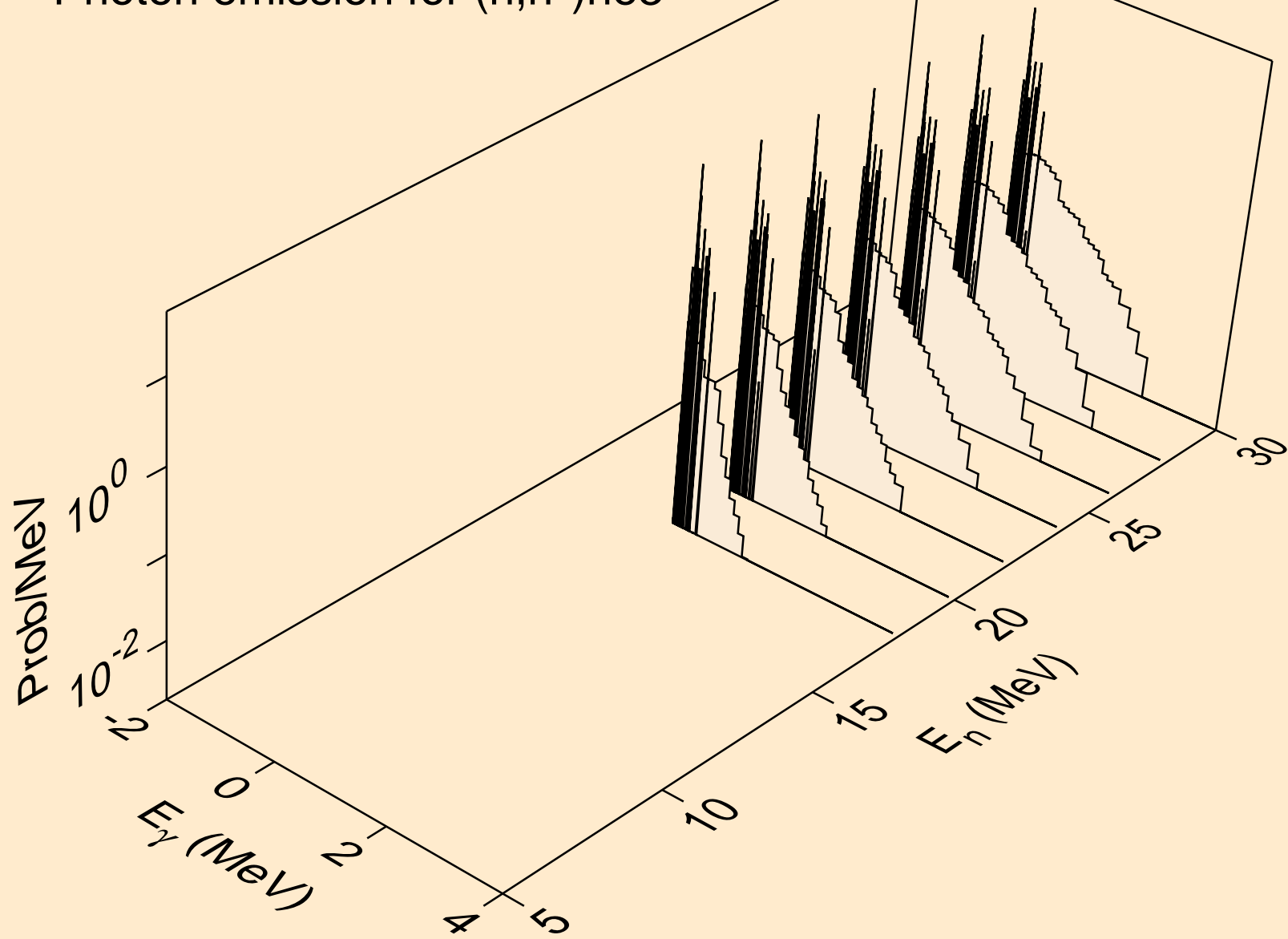

ES256 PROTON ACER TENDL-2023 LIBRARY; T=0.K  
Photon emission for (n,4n)

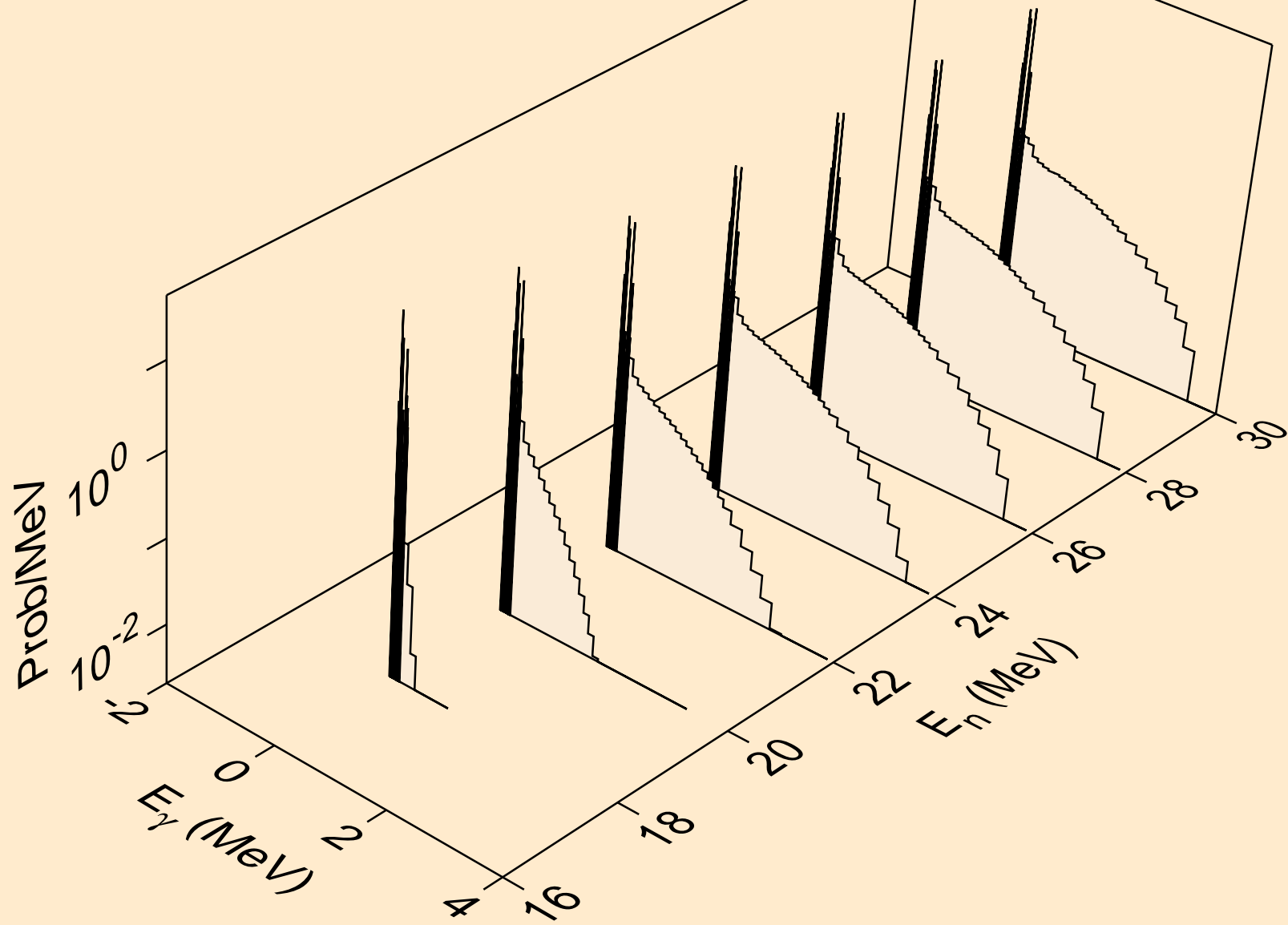

ES256 PROTON ACER TENDL-2023 LIBRARY; T=0.K  
Photon emission for (n,2np)

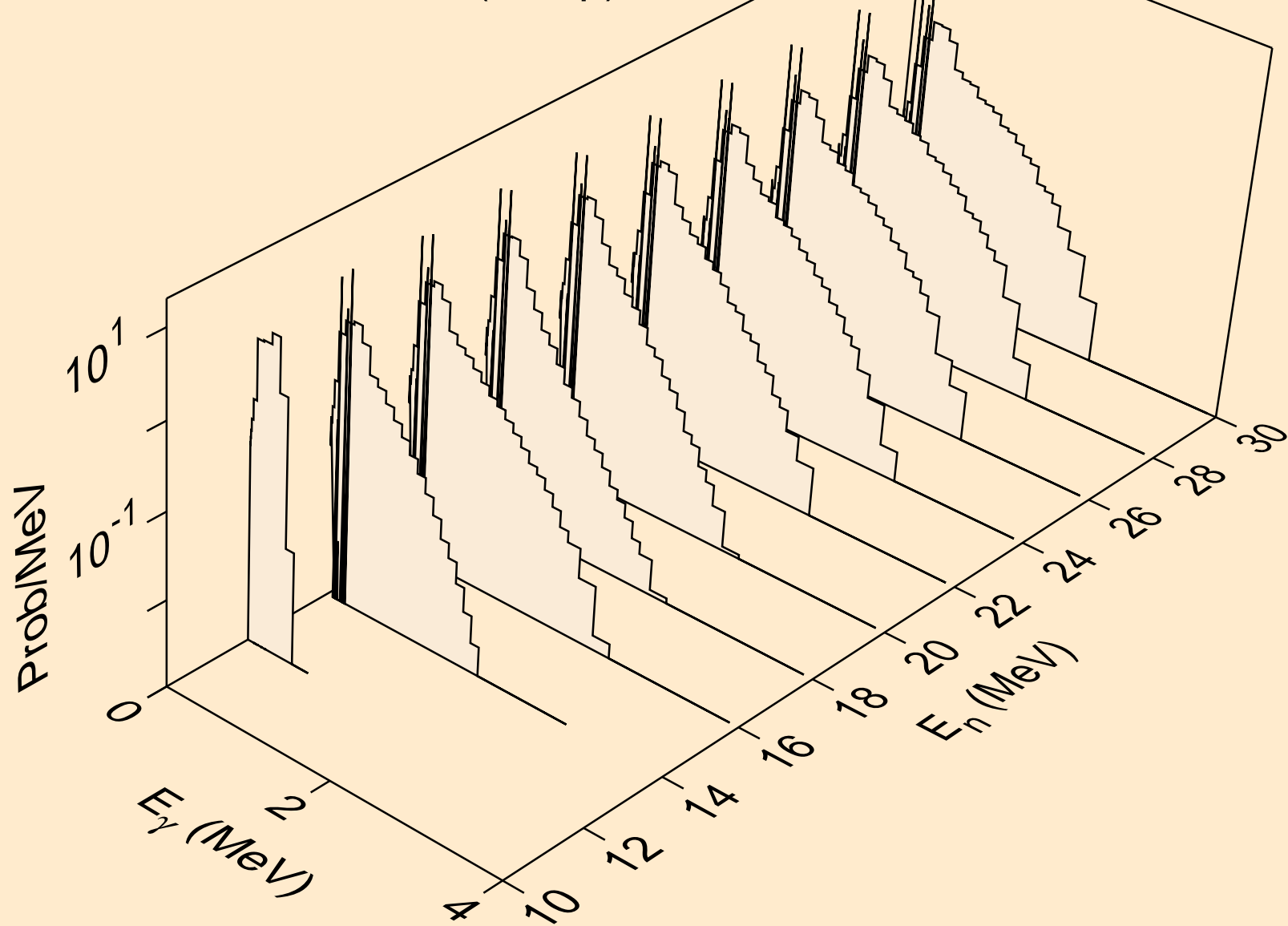

ES256 PROTON ACER TENDL-2023 LIBRARY; T=0.K  
Photon emission for (n,gma)

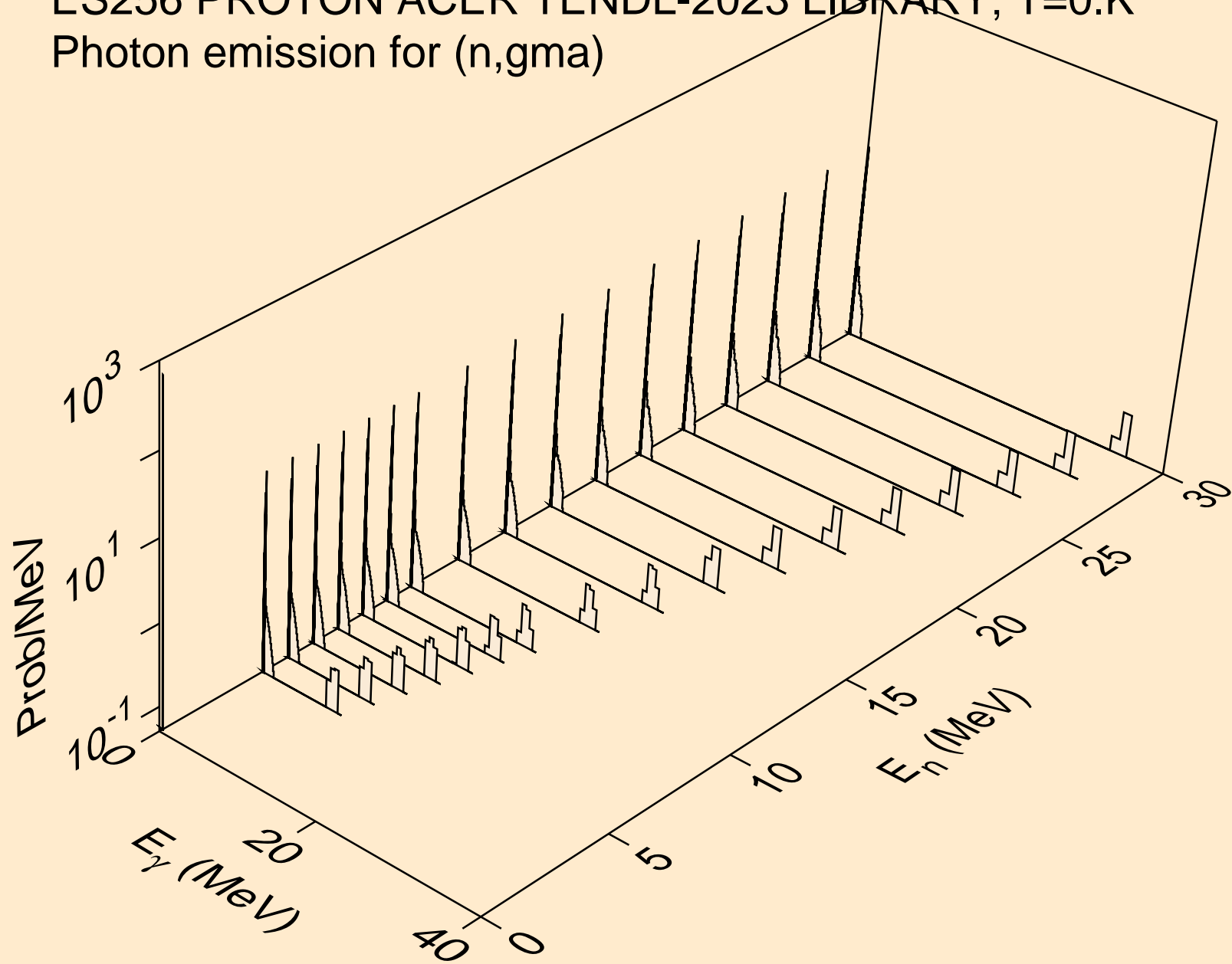

ES256 PROTON ACER TENDL-2023 LIBRARY; T=0.K  
Photon emission for inelastic

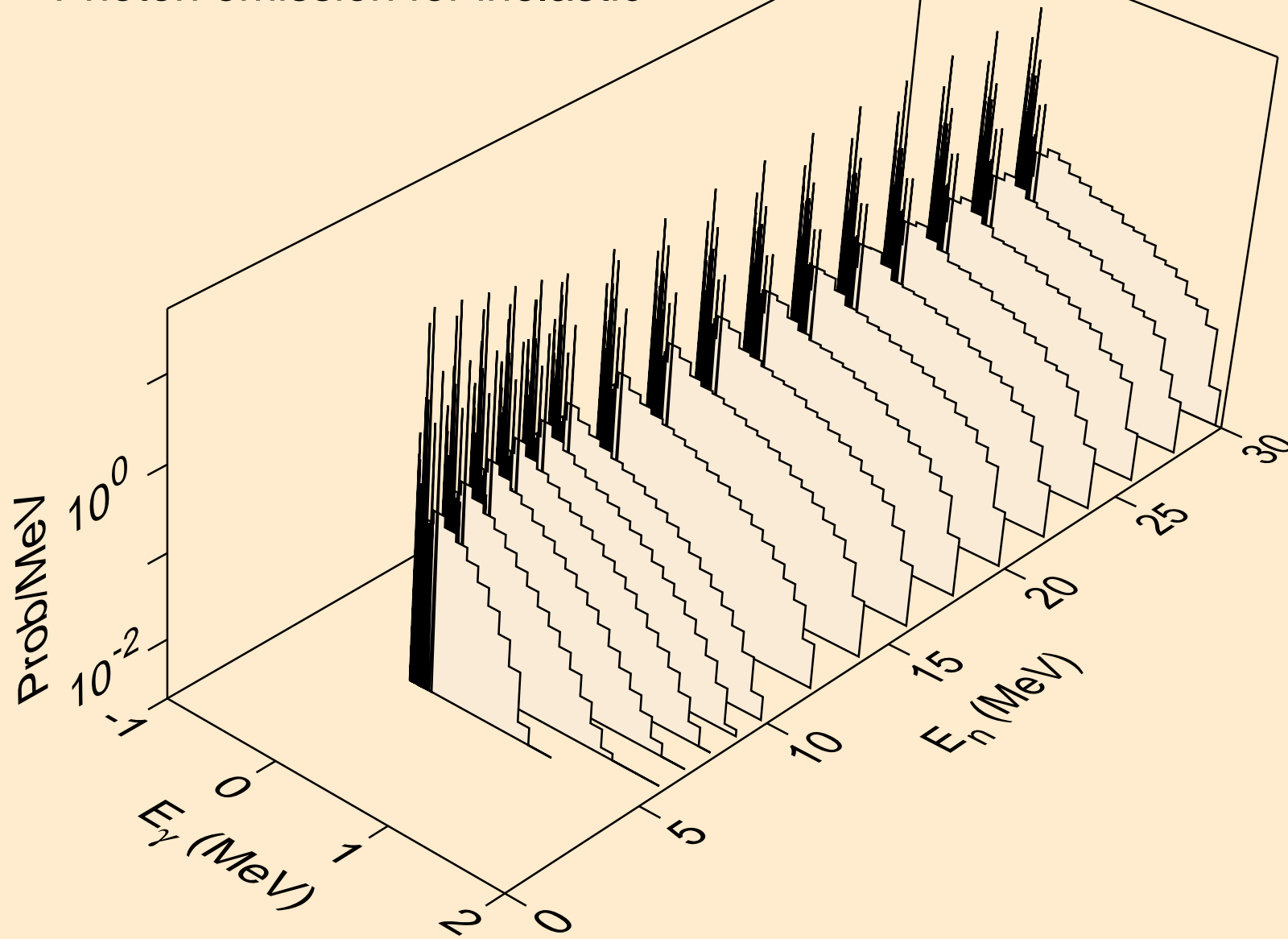

ES256 PROTON ACER TENDL-2023 LIBRARY; T=0.K  
Photon emission for (n,d)

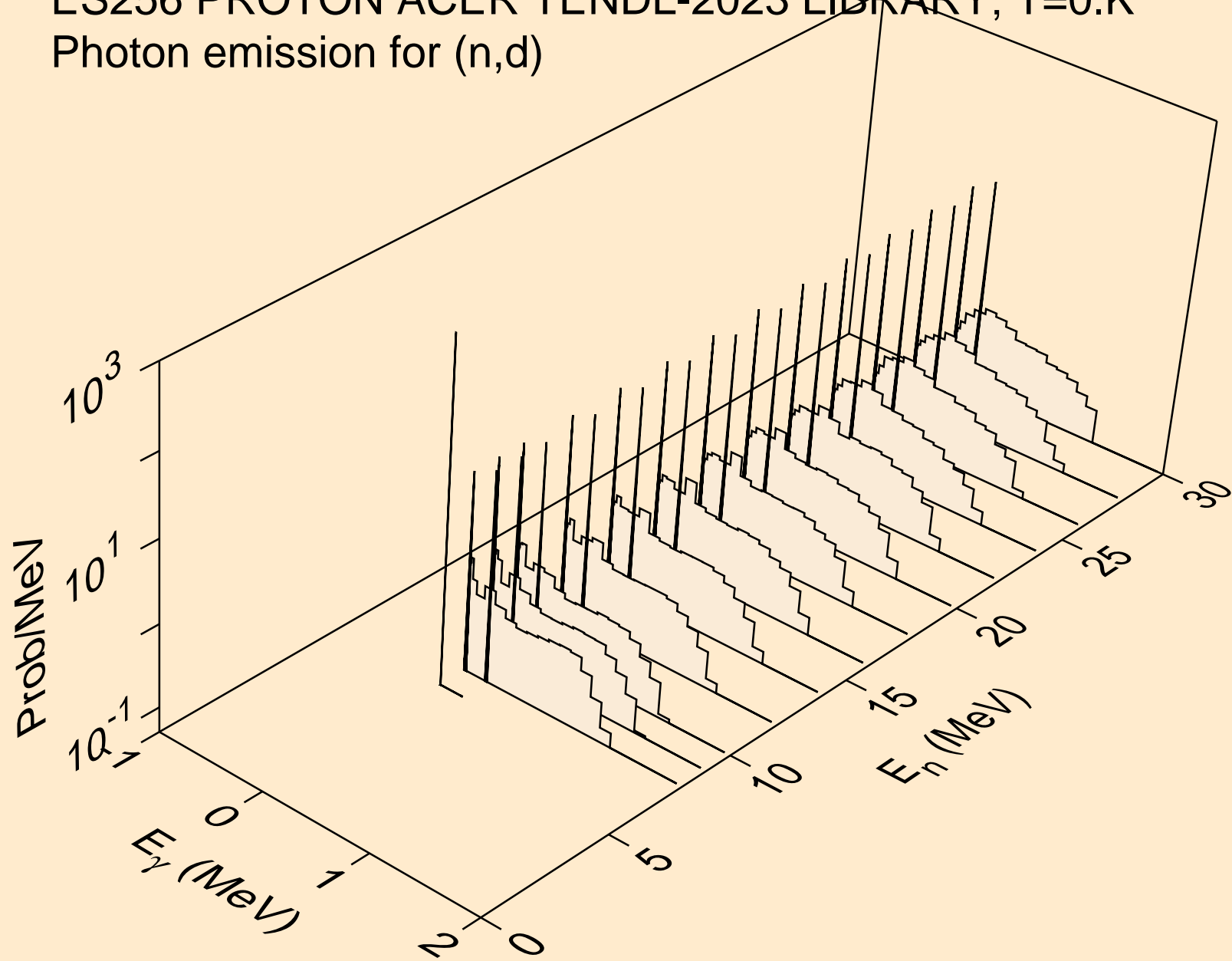

ES256 PROTON ACER TENDL-2023 LIBRARY; T=0.K  
Photon emission for (n,t)

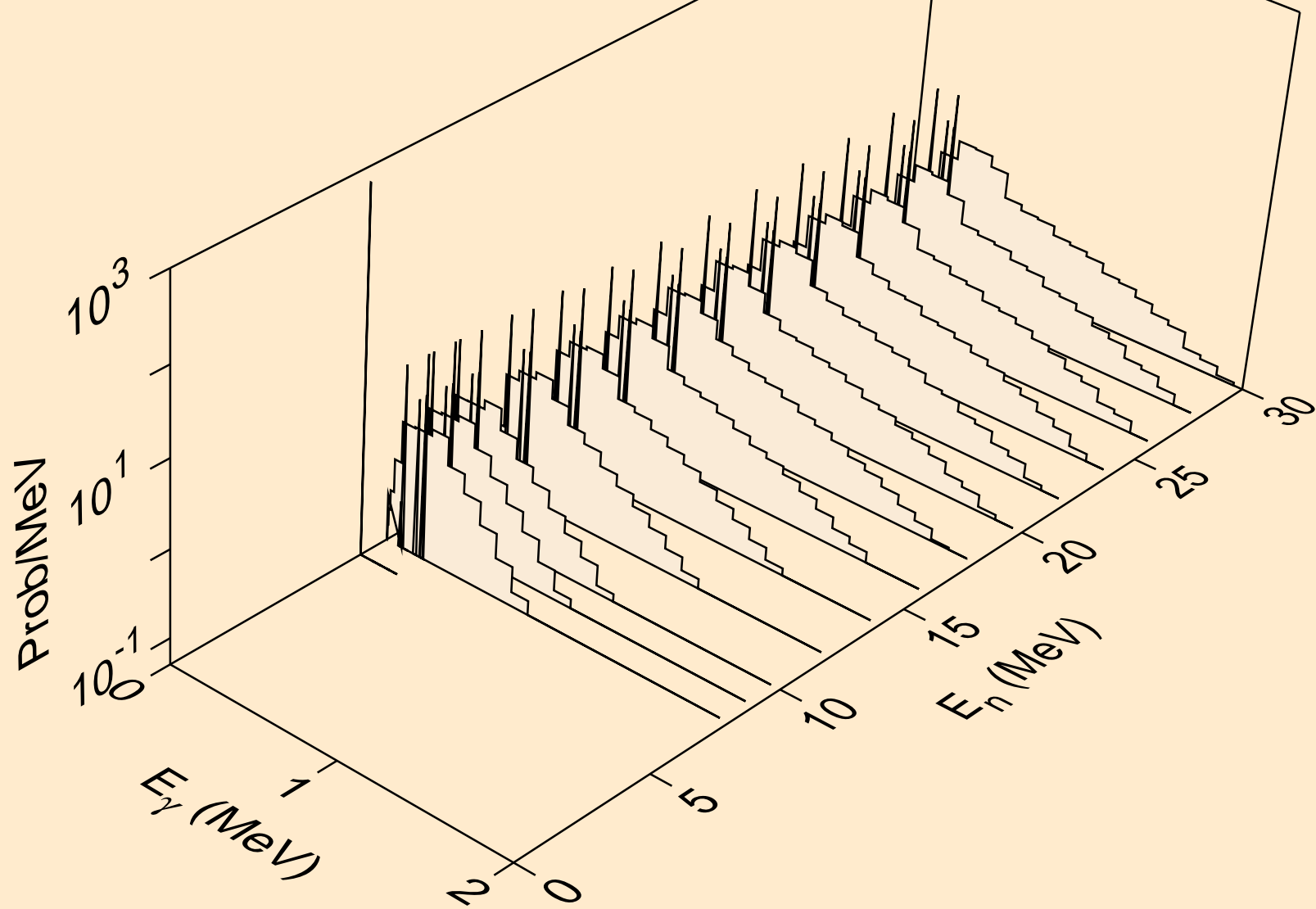



ES256 PROTON ACER TENDL-2023 LIBRARY; T=0.K  
Photon emission for (n,he3)

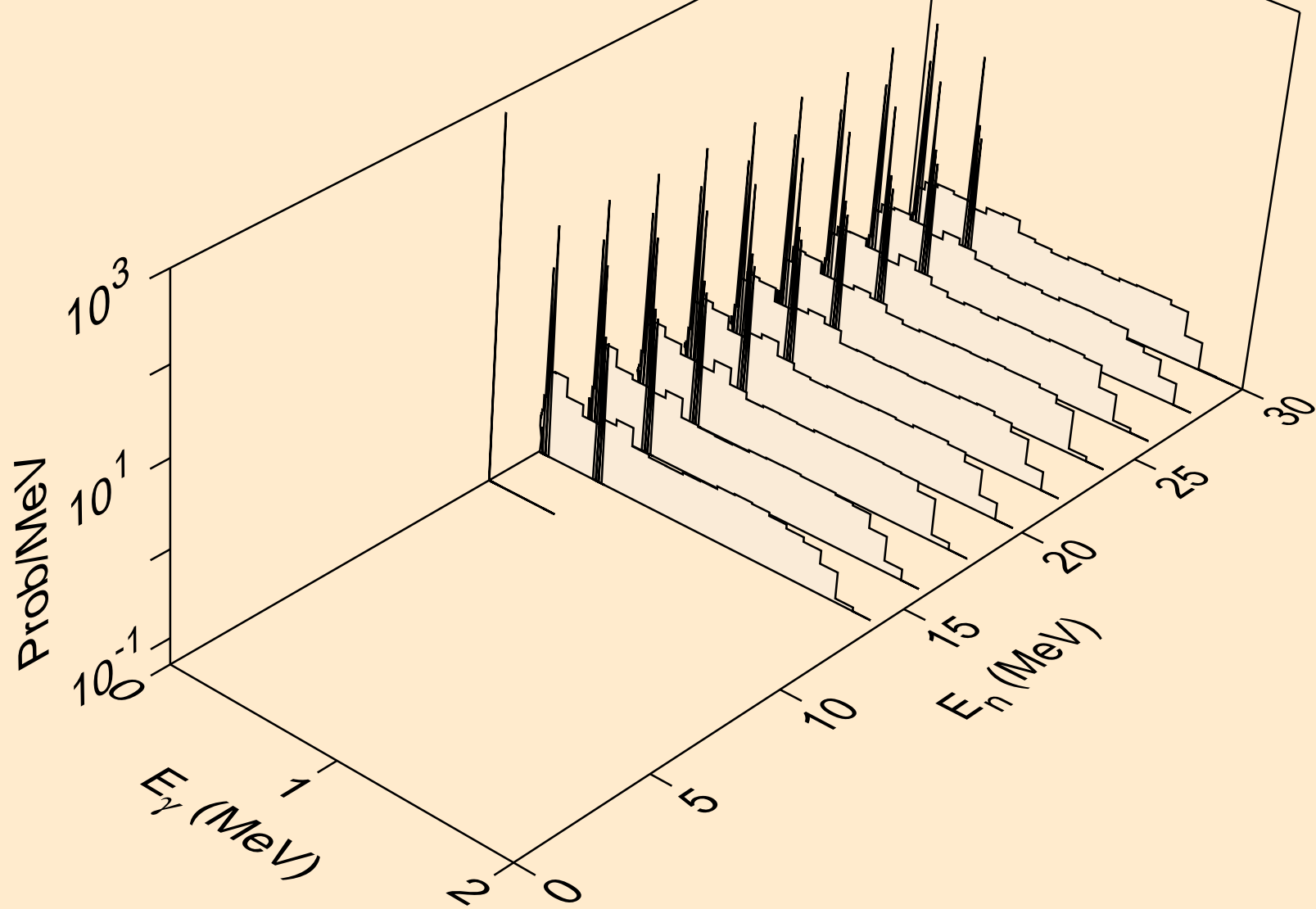

ES256 PROTON ACER TENDL-2023 LIBRARY; T=0.K  
Photon emission for (n,a)

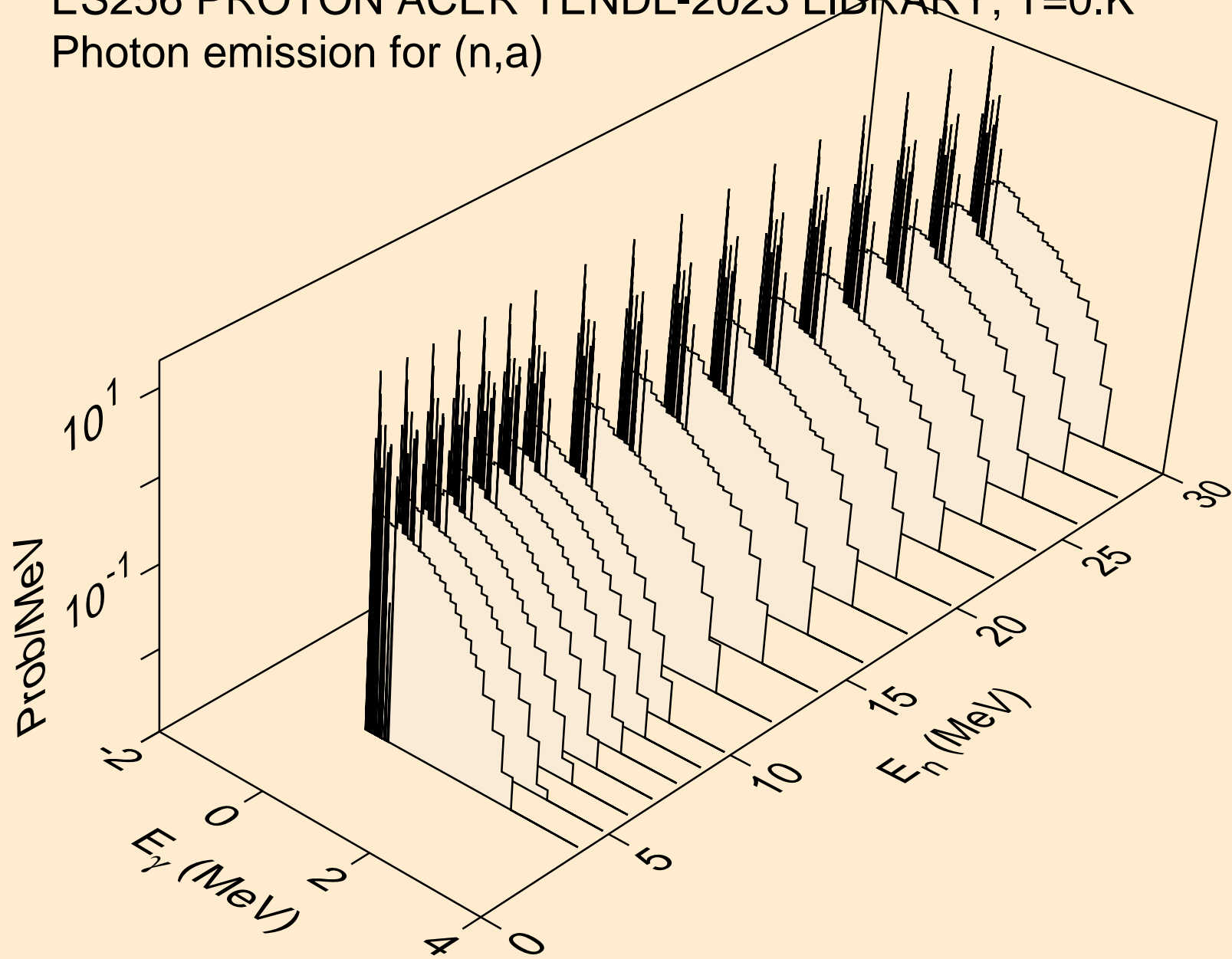

ES256 PROTON ACER TENDL-2023 LIBRARY; T=0.K  
Photon emission for (n,2p)

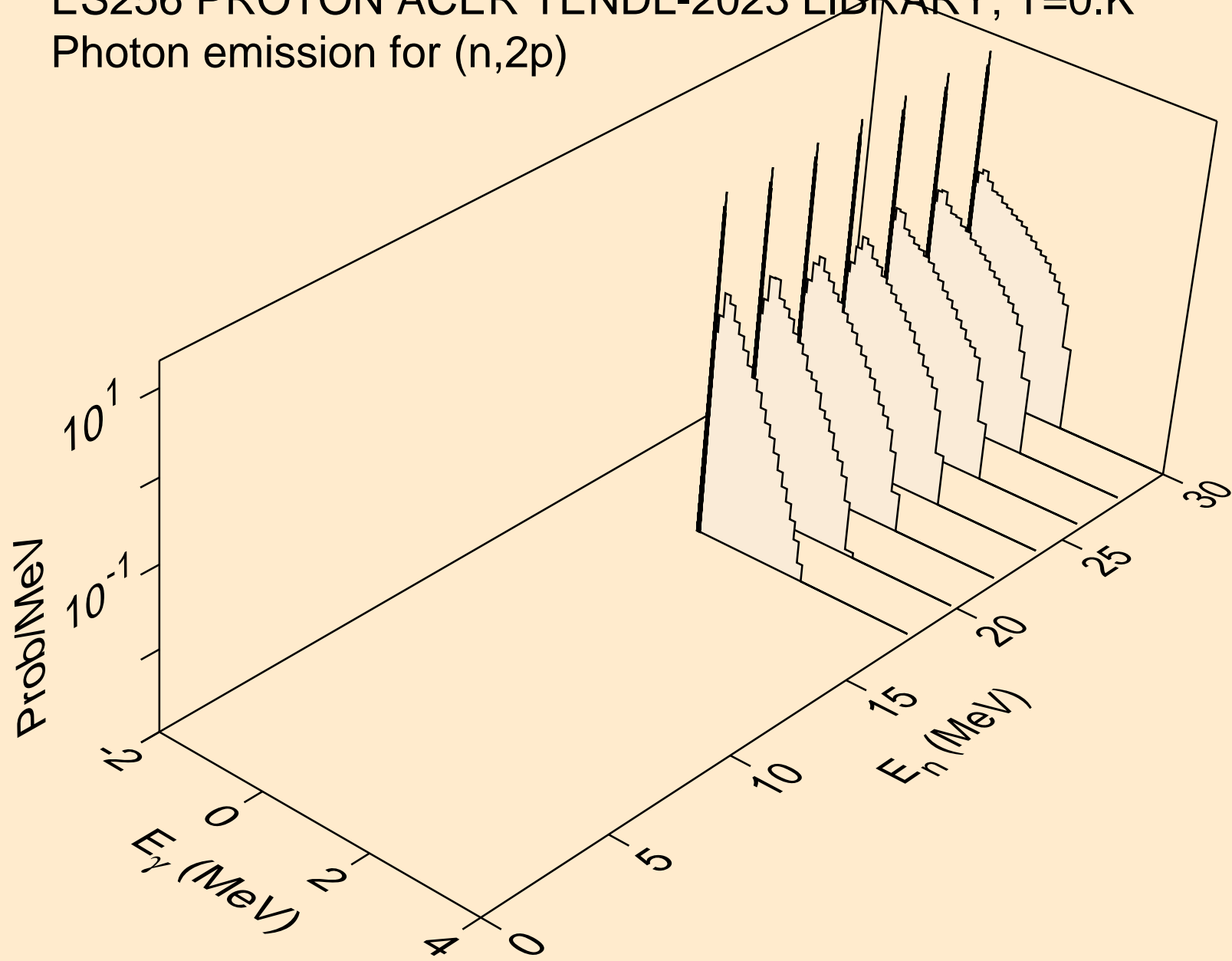

ES256 PROTON ACER TENDL-2023 LIBRARY; T=0.K  
Photon emission for (n,pd)

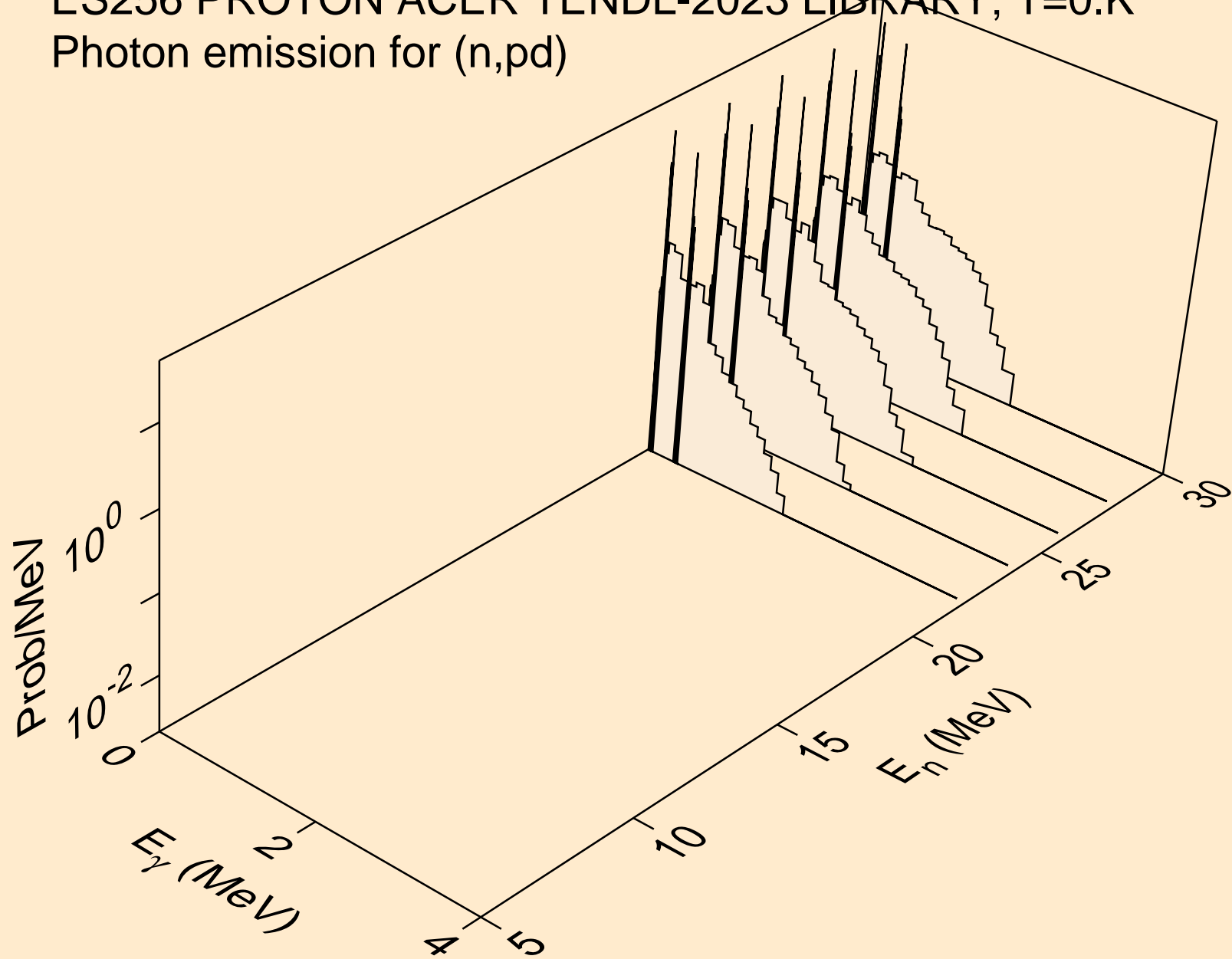

# ES256 PROTON ACER TENDL-2023 LIBRARY; T=0.K

## Particle heating contributions

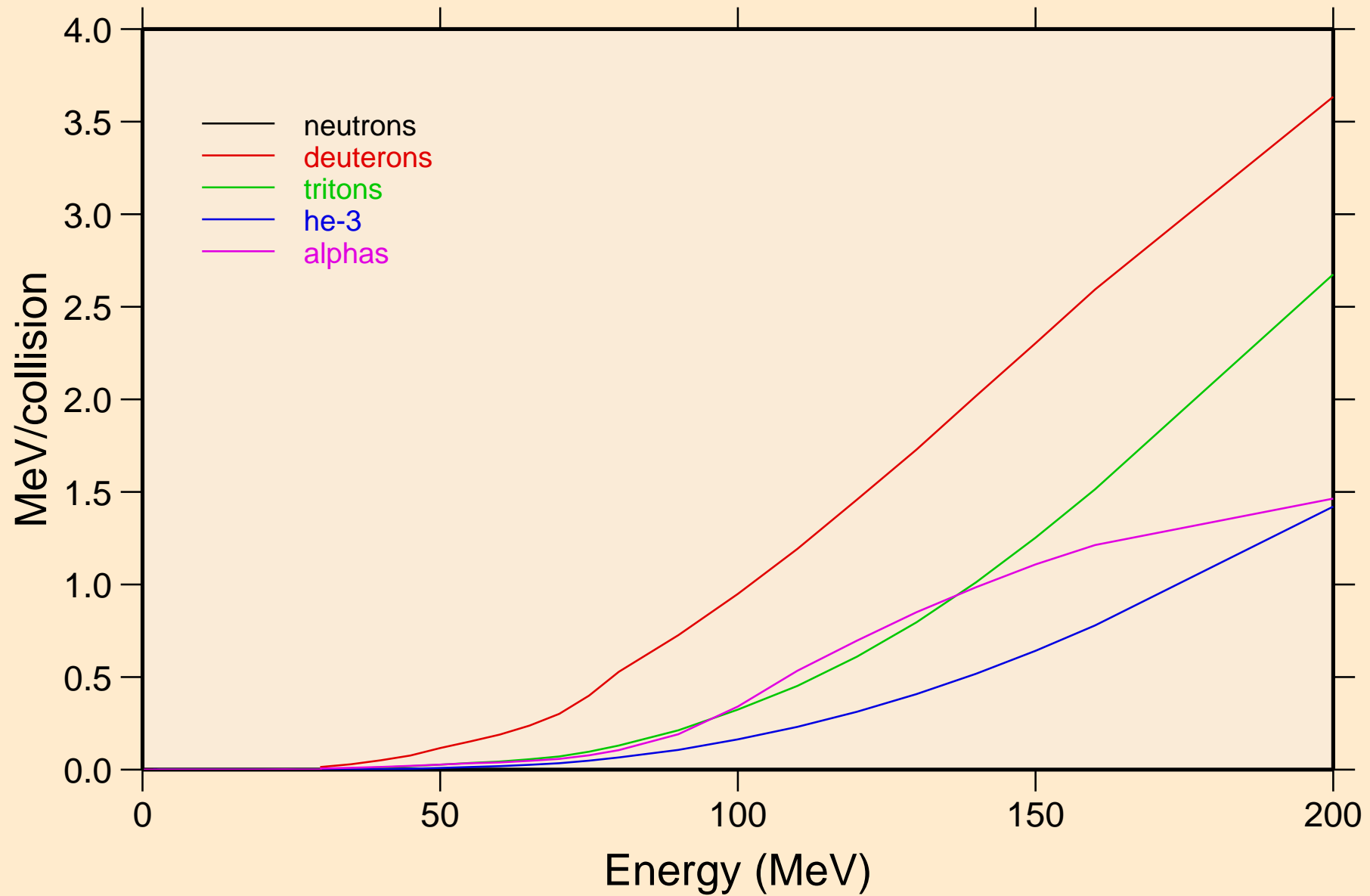

ES256 PROTON ACER TENDL-2023 LIBRARY; T=0.K  
Recoil Heating

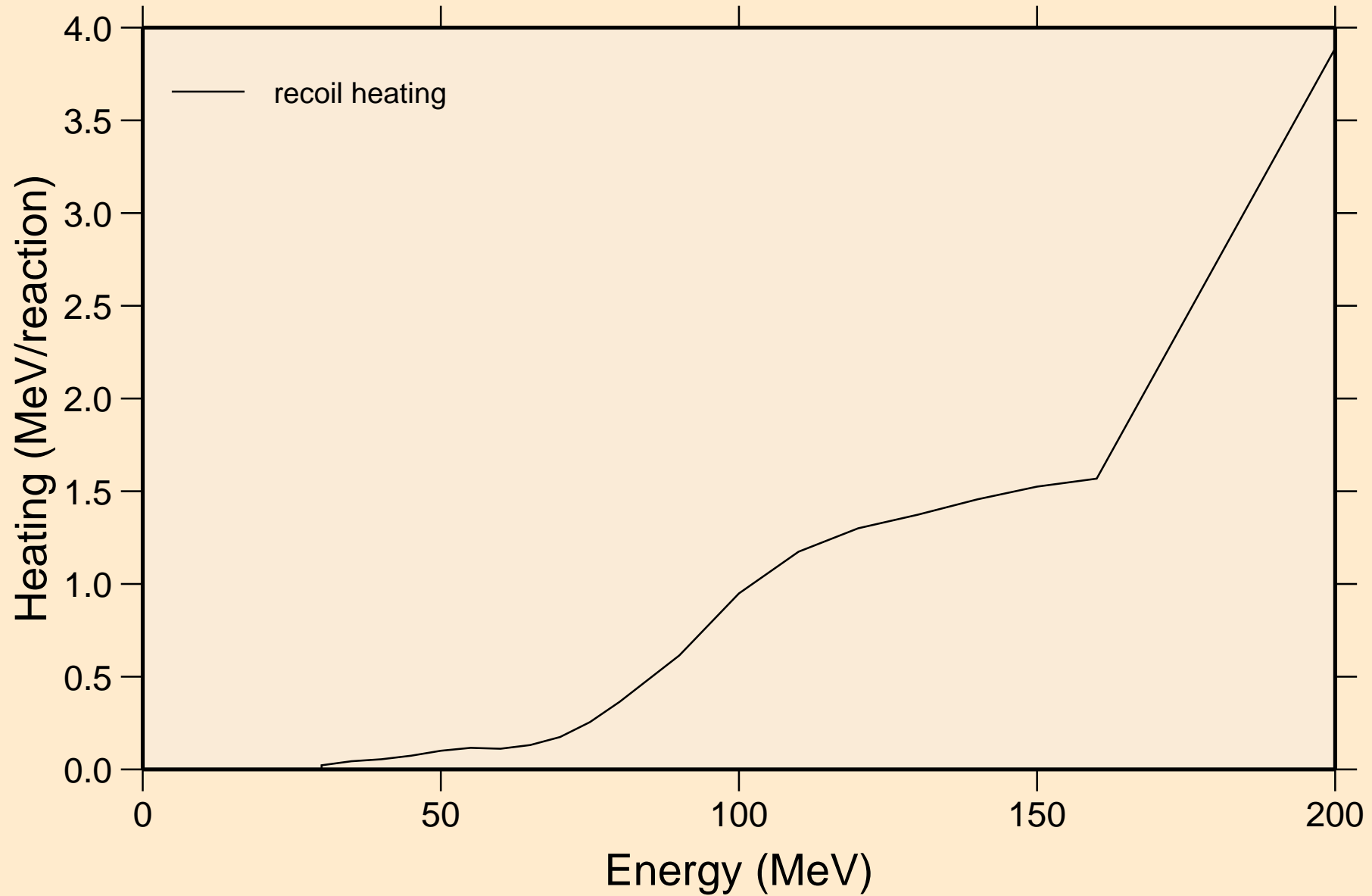

ES256 PROTON ACER TENDL-2023 LIBRARY; T=0.K  
Particle production cross sections

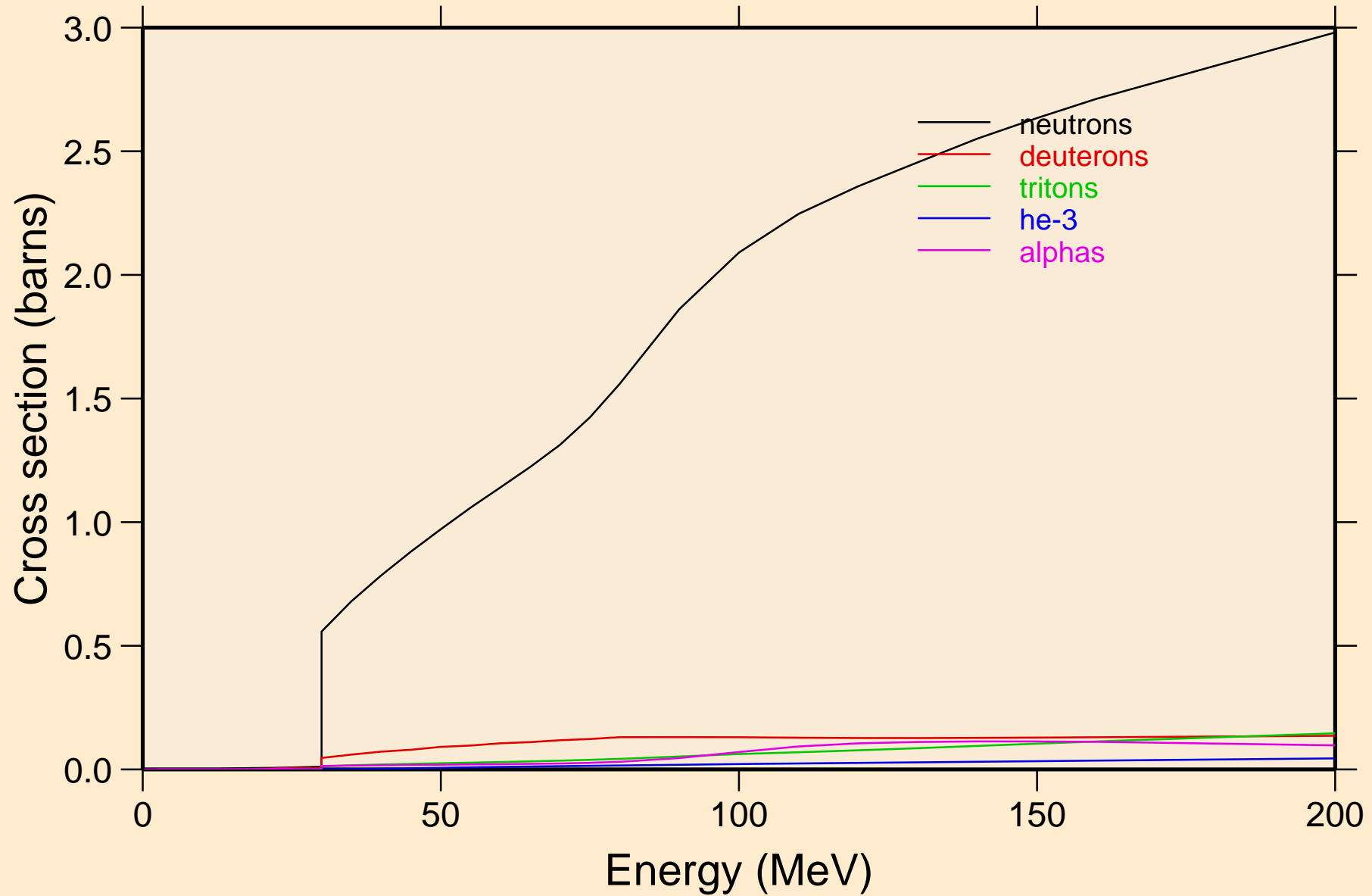

ES256 PROTON ACER TENDL-2023 LIBRARY; T=0.K  
neutrons from (p,n)

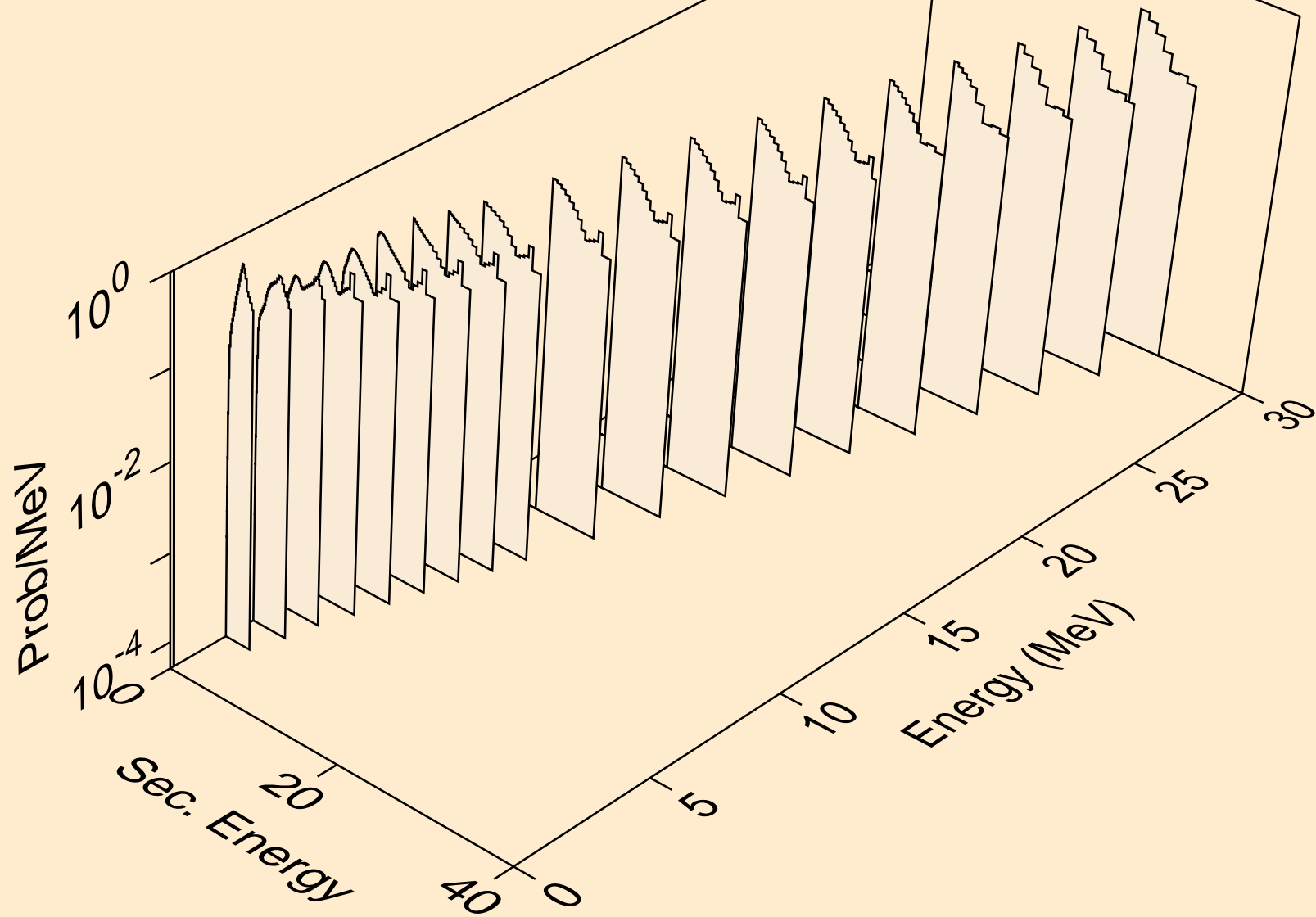



ES256 PROTON ACER TENDL-2023 LIBRARY; T=0.K  
neutrons from (p,x)

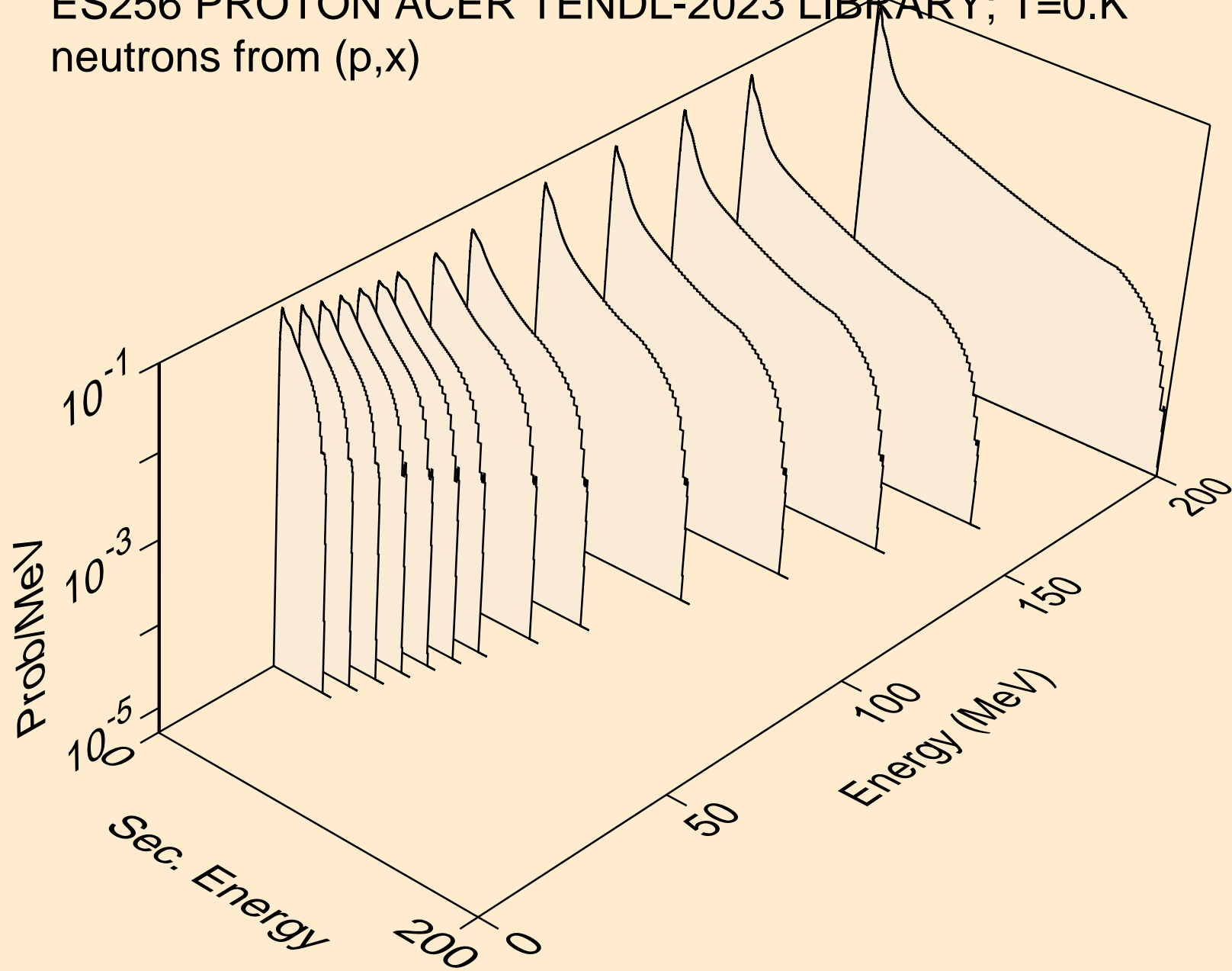

ES256 PROTON ACER TENDL-2023 LIBRARY; T=0.K  
neutrons from (p,2nd)

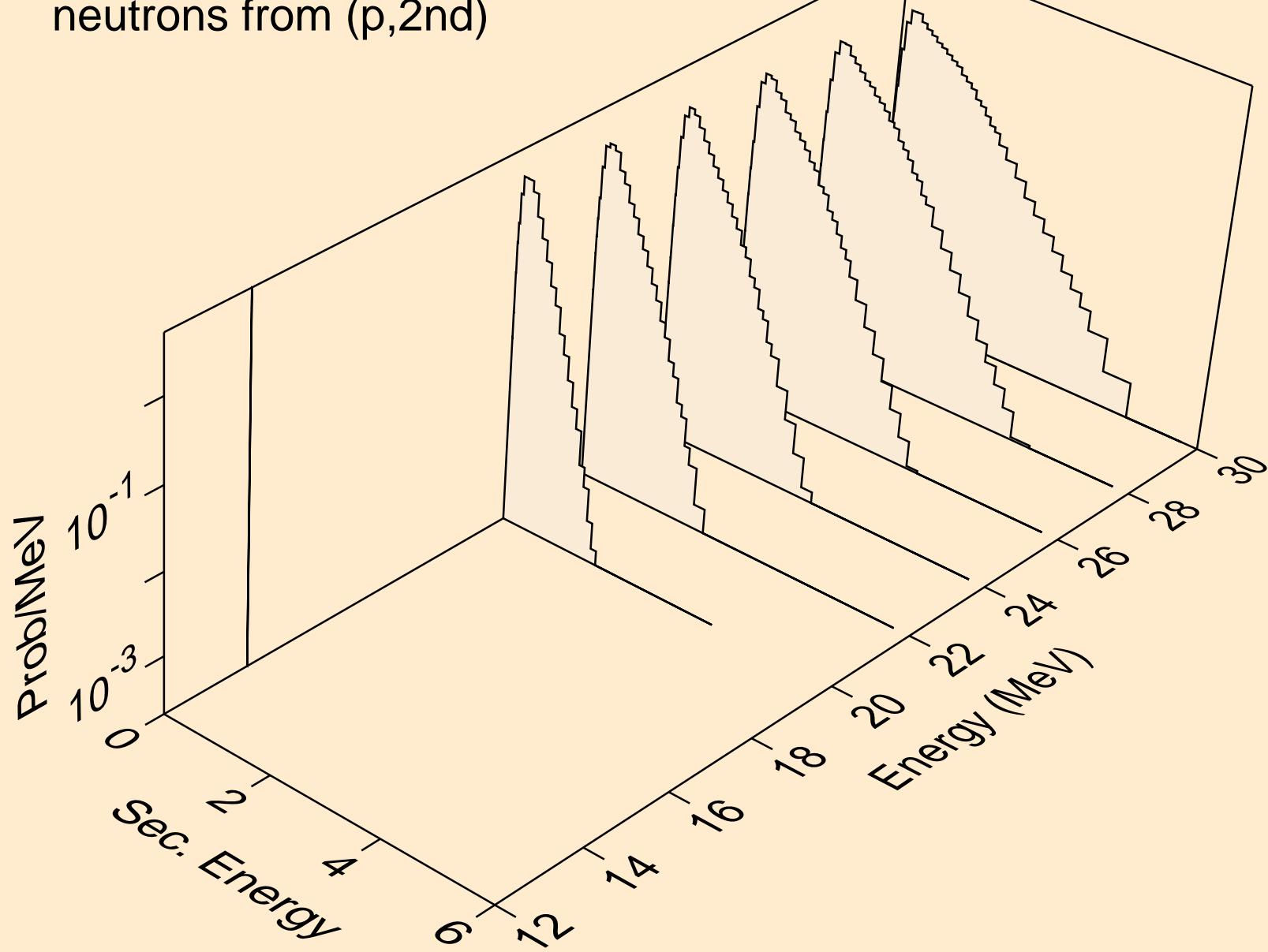

ES256 PROTON ACER TENDL-2023 LIBRARY; T=0.K  
neutrons from (p,2n)

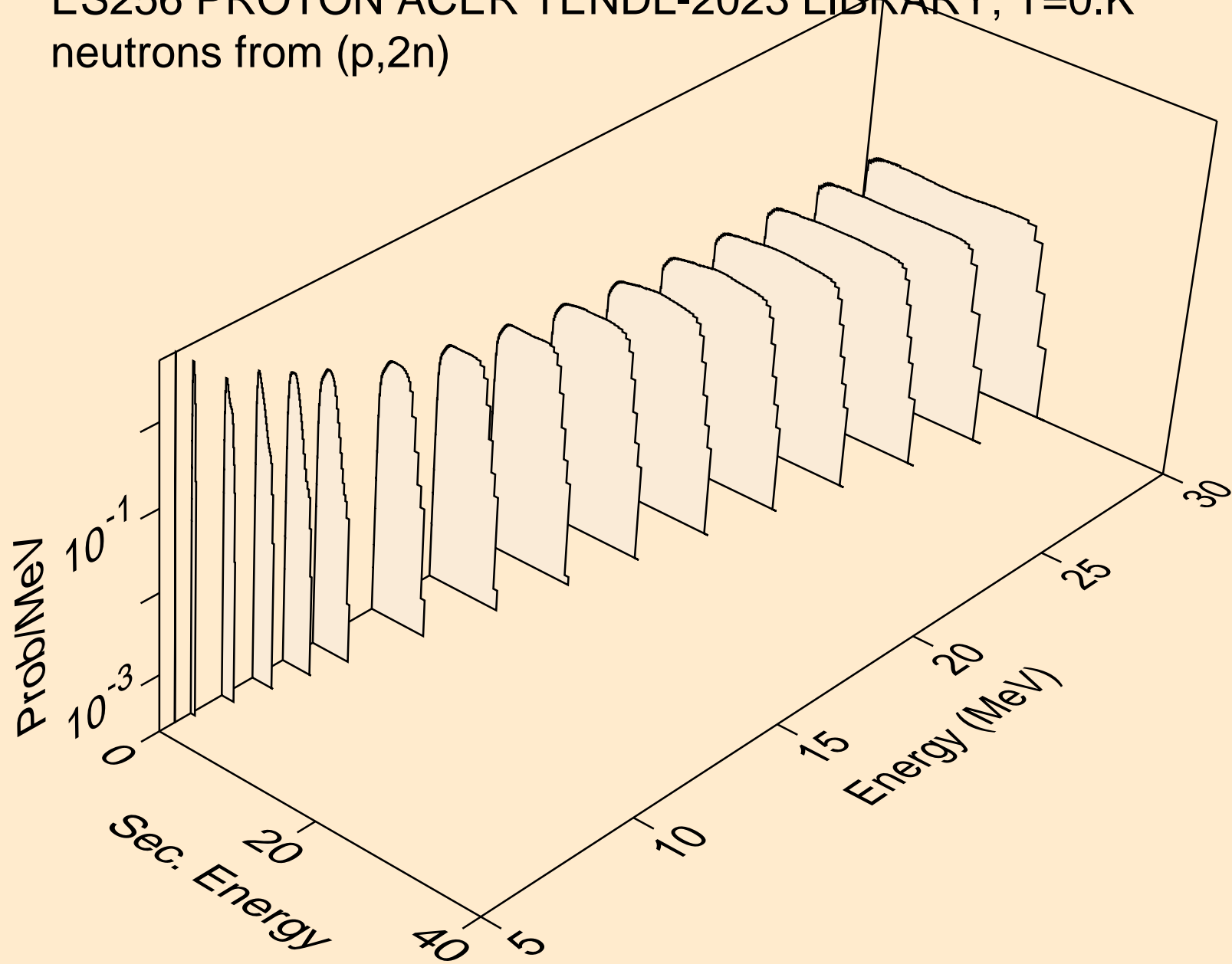

ES256 PROTON ACER TENDL-2023 LIBRARY; T=0.K  
neutrons from (p,3n)

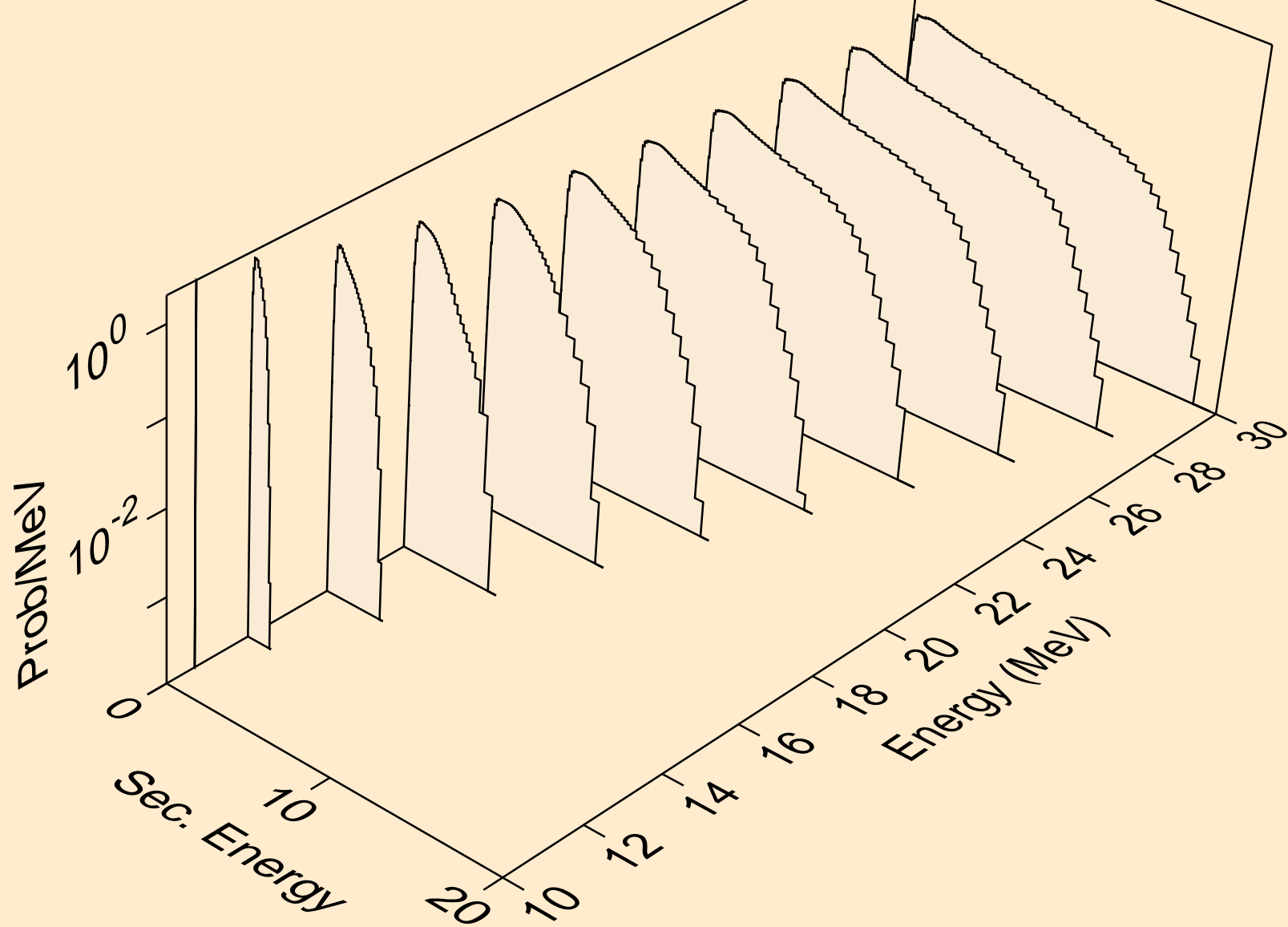

ES256 PROTON ACER TENDL-2023 LIBRARY; T=0.K  
neutrons from (p,n\*)a

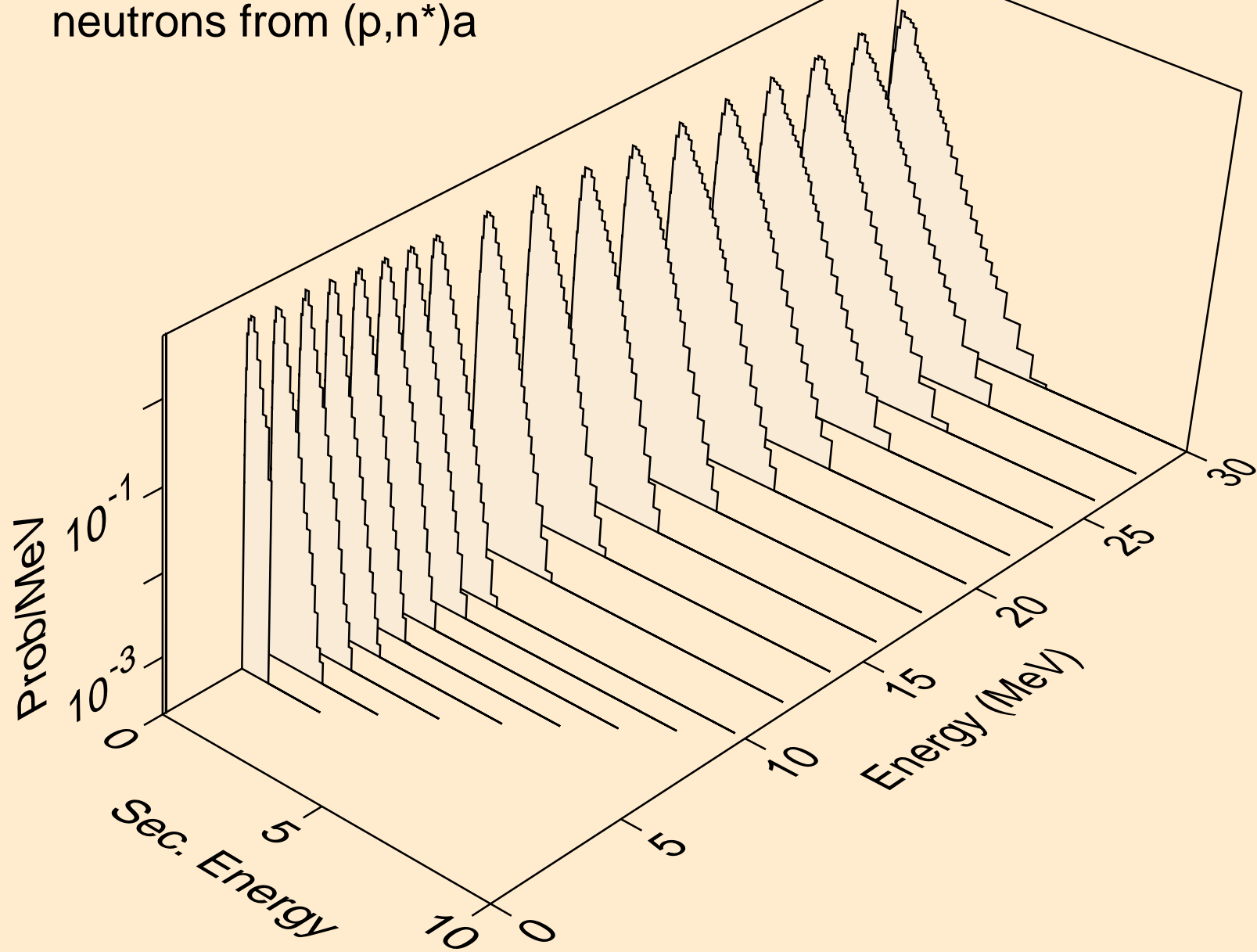

ES256 PROTON ACER TENDL-2023 LIBRARY; T=0.K  
neutrons from (p,2n)a

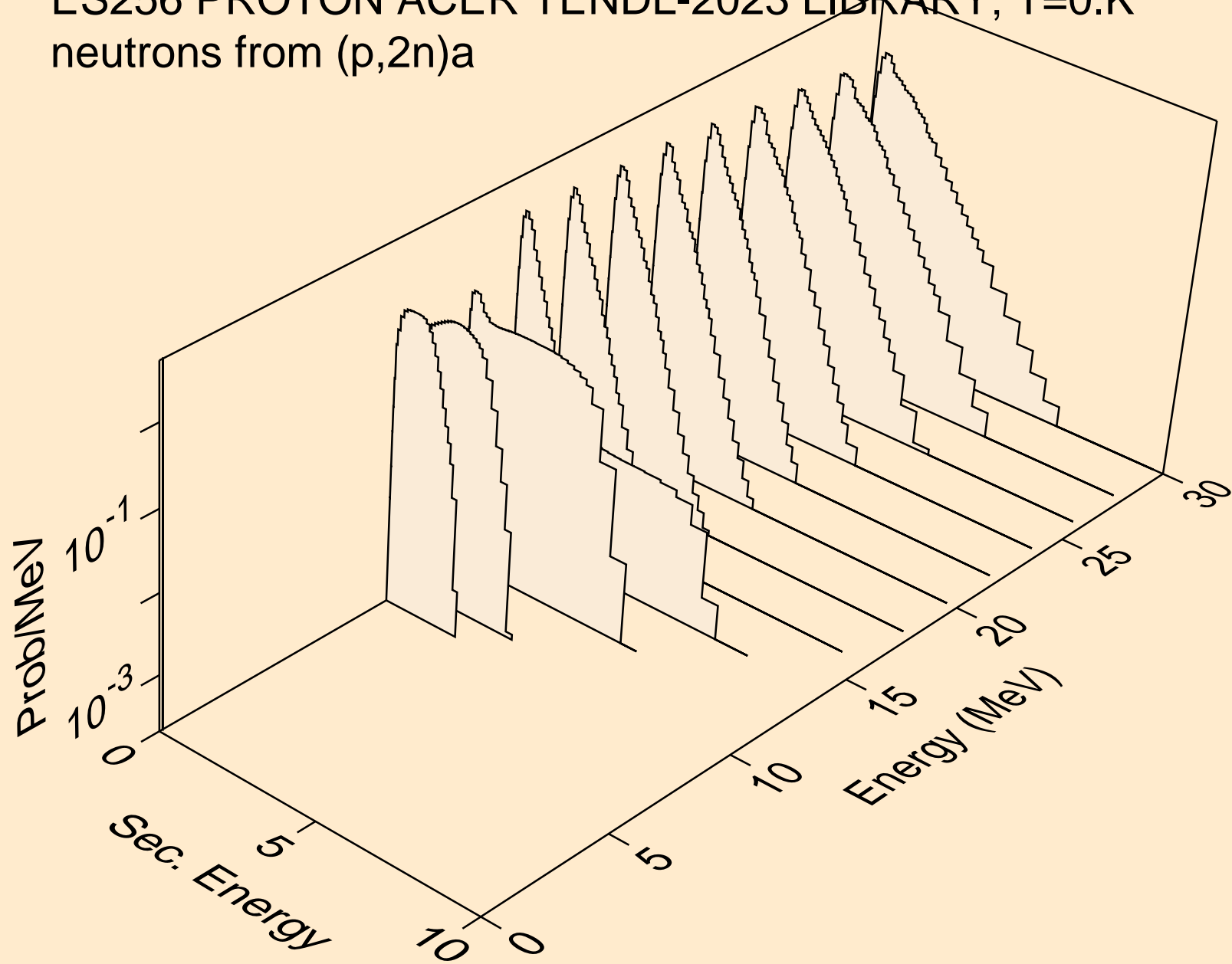

ES256 PROTON ACER TENDL-2023 LIBRARY; T=0.K  
neutrons from (p,3n)a

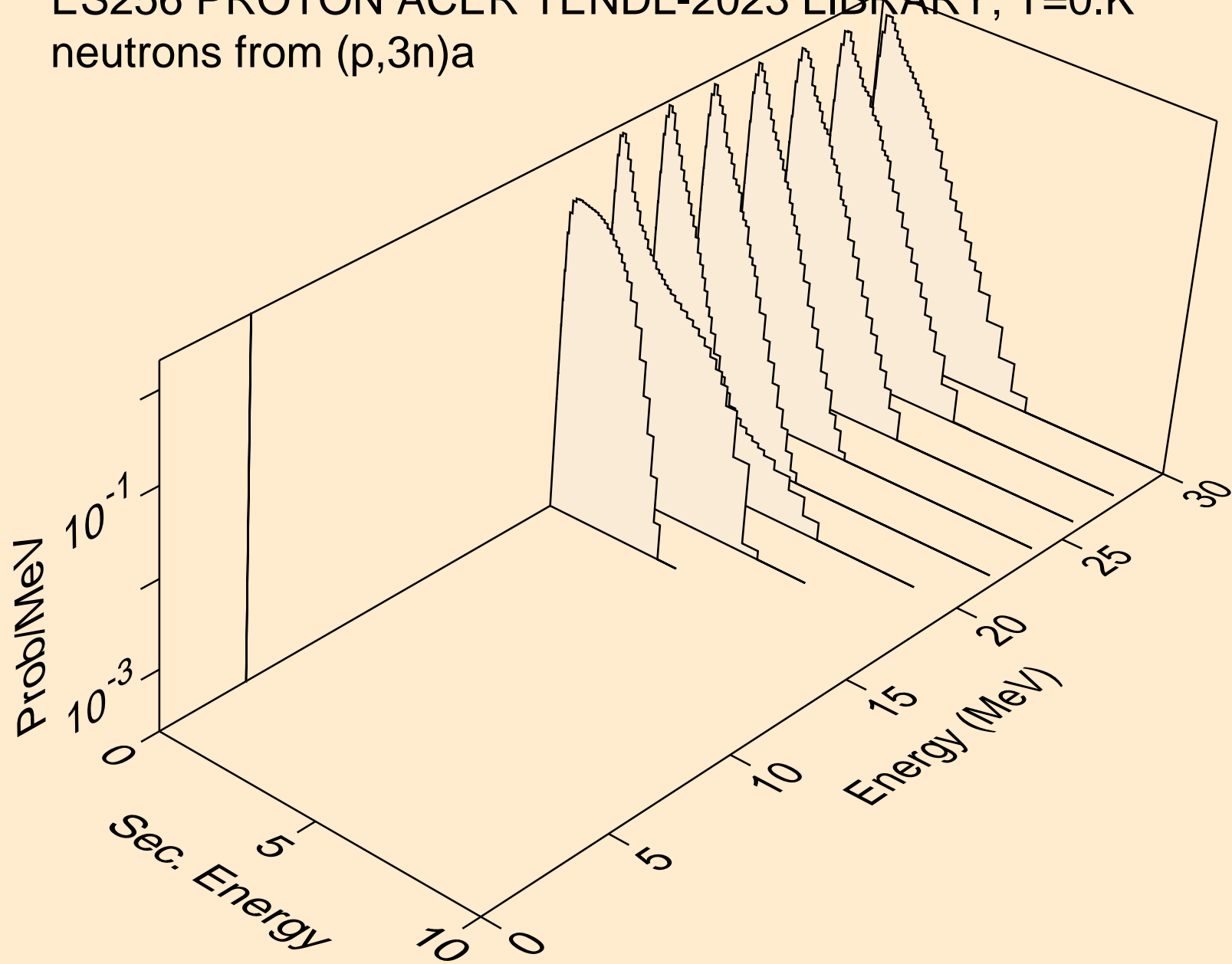

ES256 PROTON ACER TENDL-2023 LIBRARY; T=0.K  
neutrons from (p,n\*)p

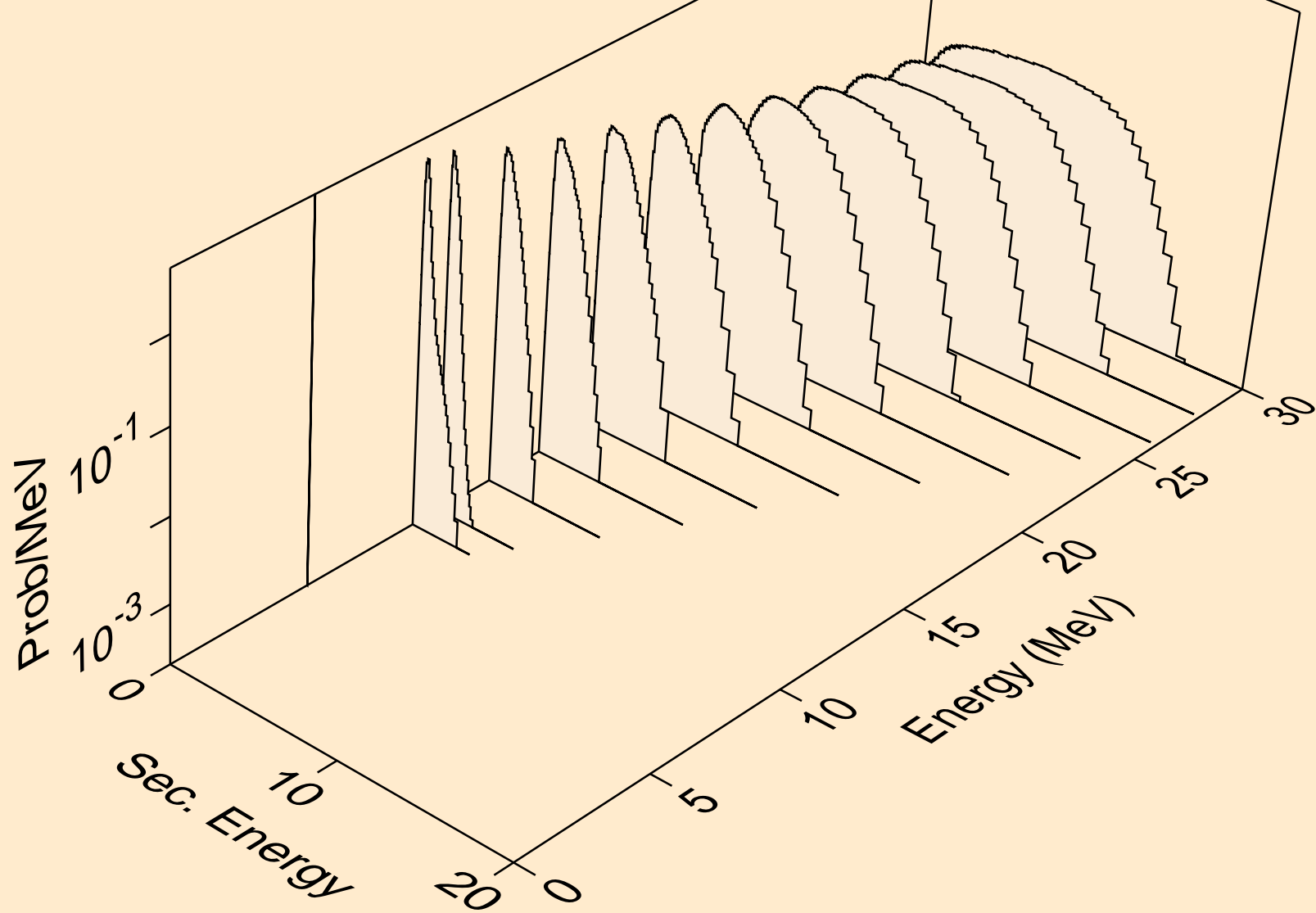



ES256 PROTON ACER TENDL-2023 LIBRARY; T=0.K  
neutrons from (p,n\*)d

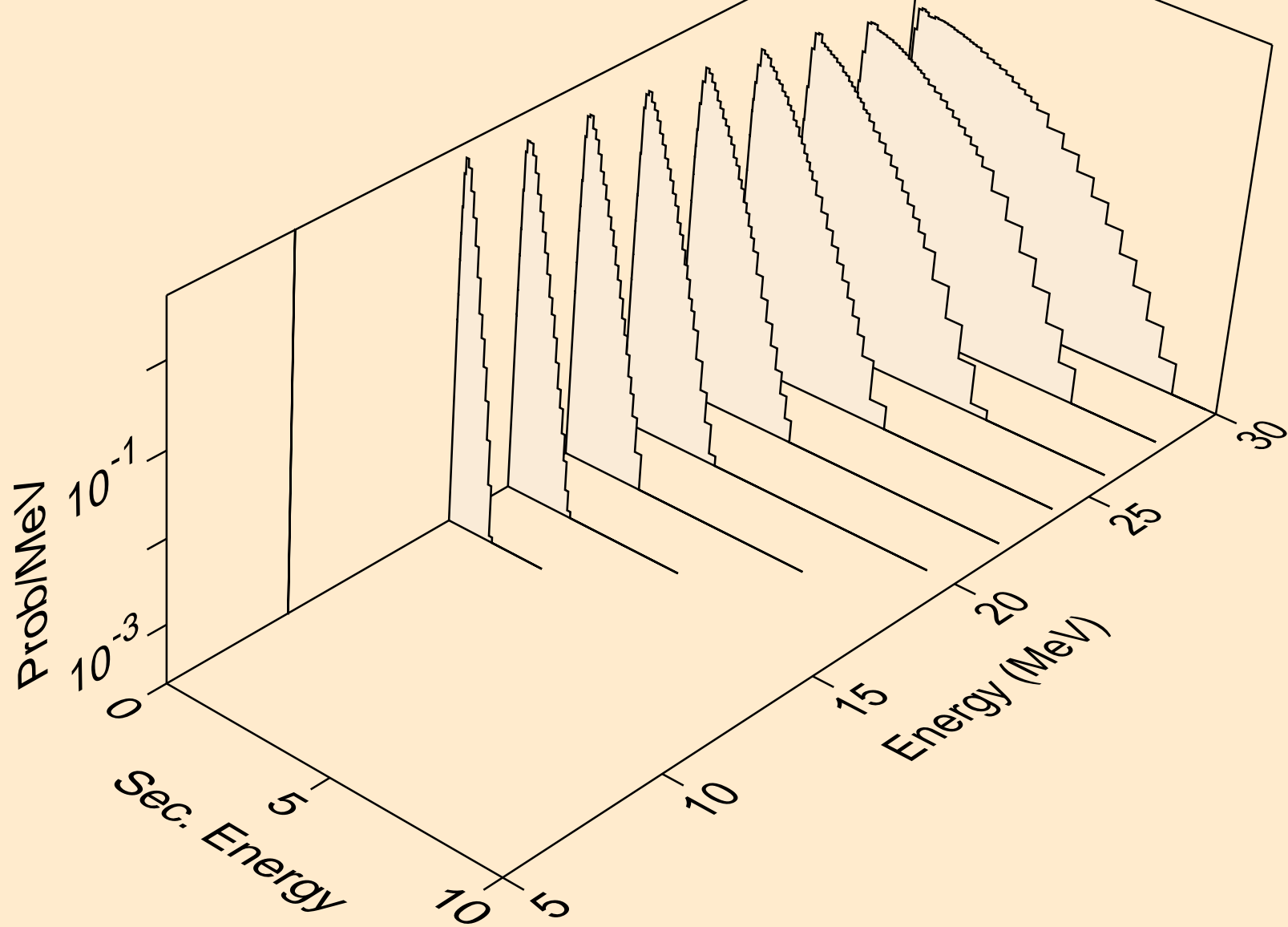

ES256 PROTON ACER TENDL-2023 LIBRARY; T=0.K  
neutrons from (p,n\*)t

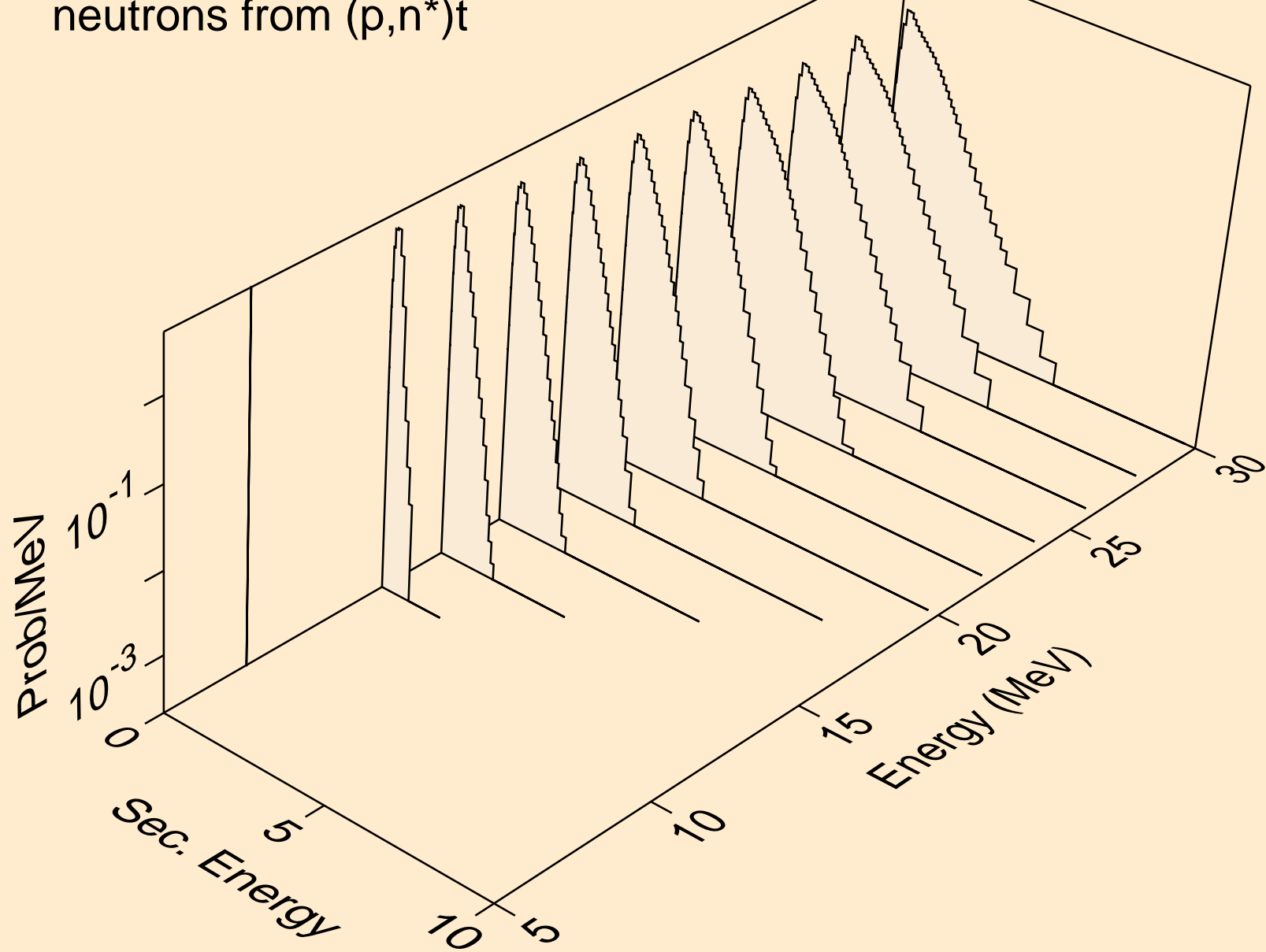

ES256 PROTON ACER TENDL-2023 LIBRARY; T=0.K  
neutrons from (p,n\*)he3

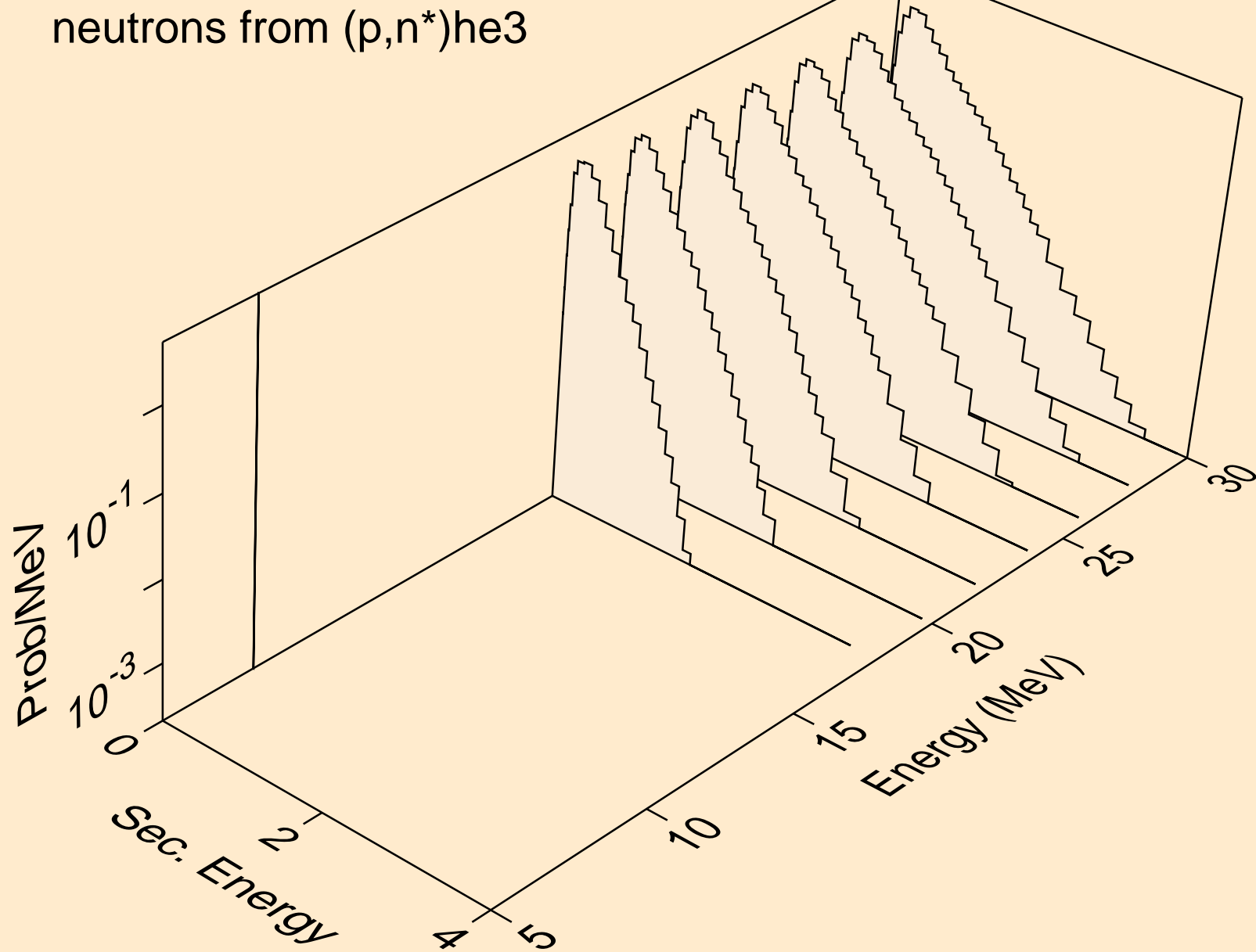

ES256 PROTON ACER TENDL-2023 LIBRARY; T=0.K  
neutrons from (p,4n)

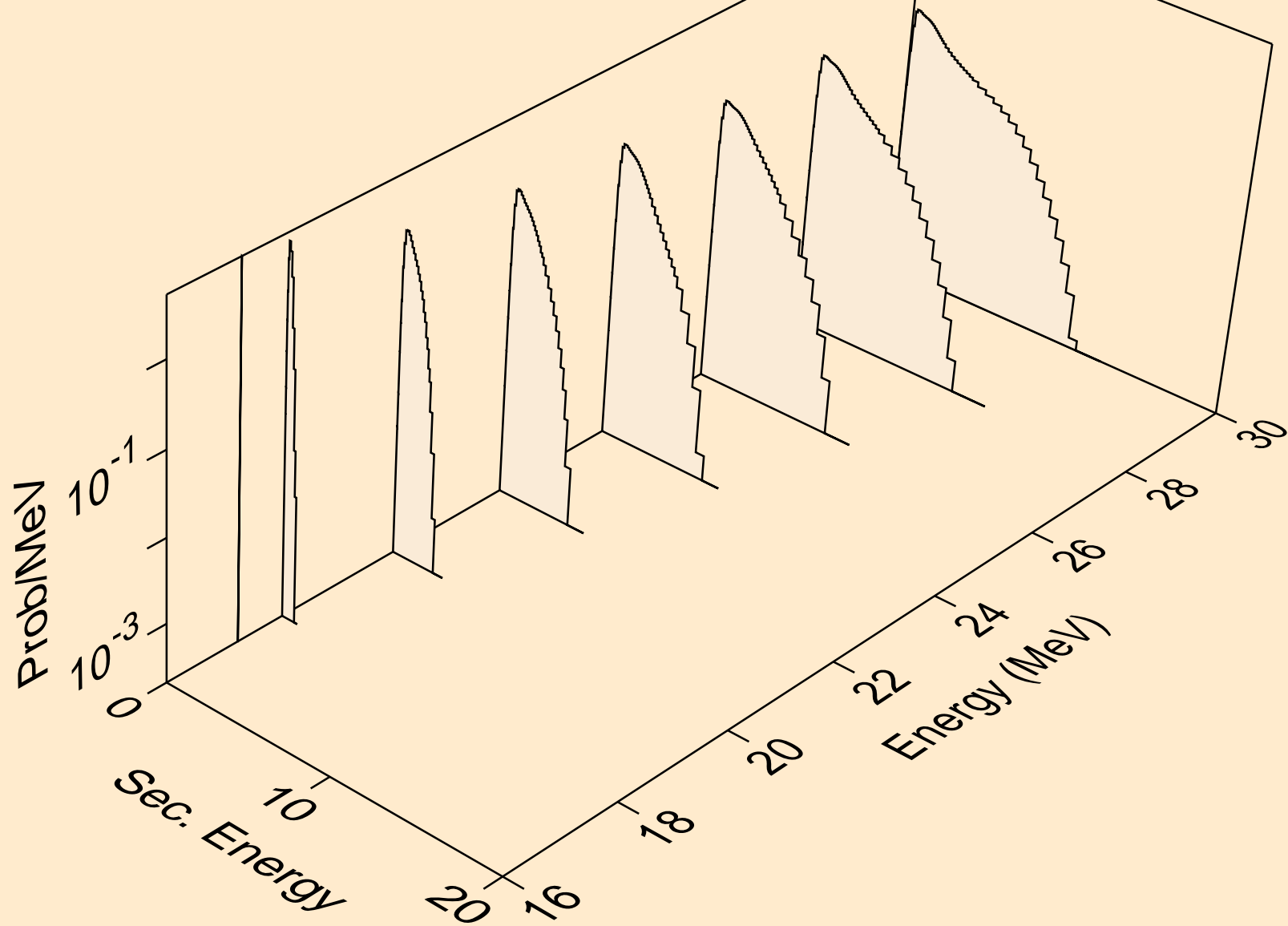

ES256 PROTON ACER TENDL-2023 LIBRARY; T=0.K  
neutrons from (p,2np)

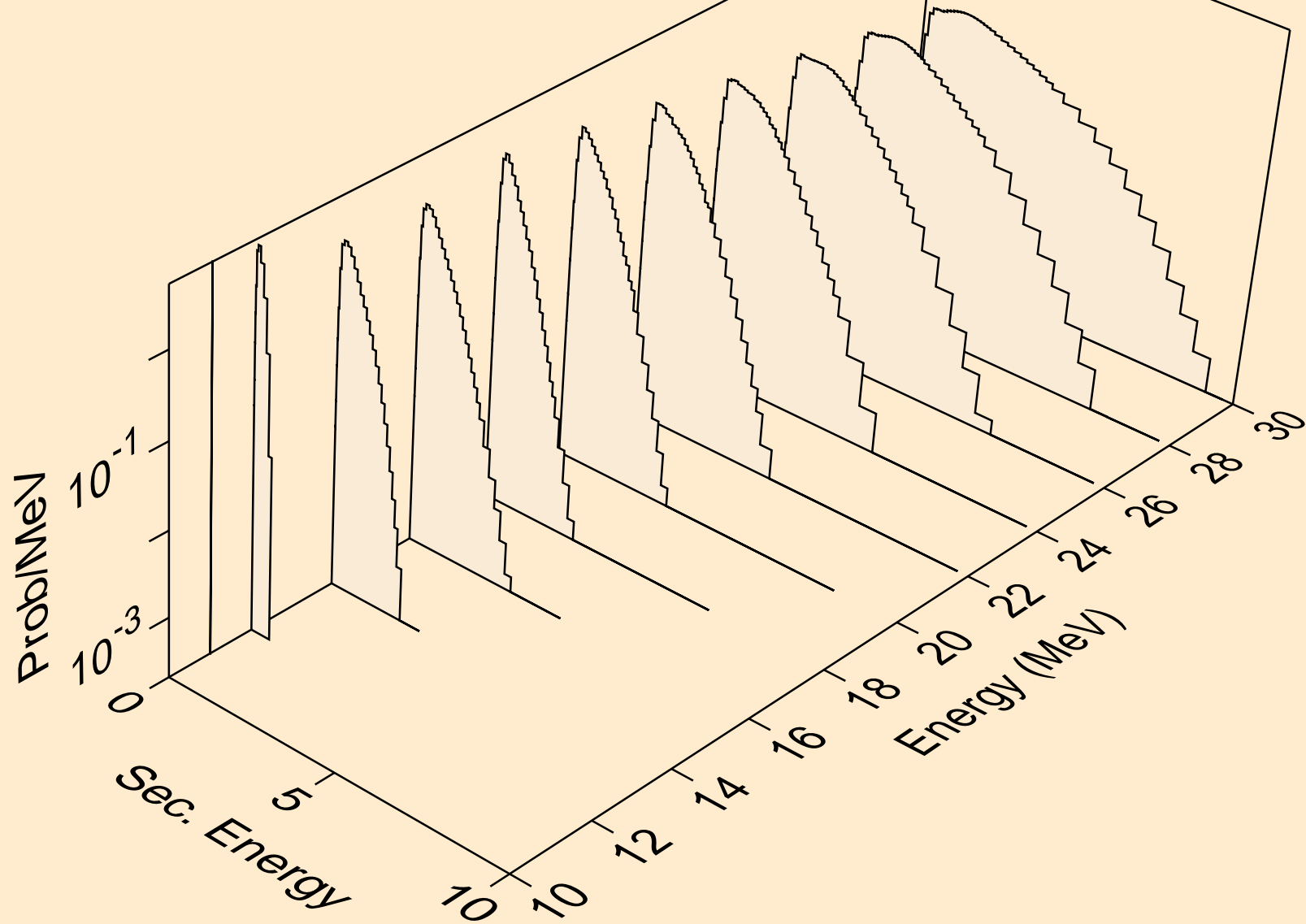

ES256 PROTON ACER TENDL-2023 LIBRARY; T=0.K  
deuterons from (p,x)

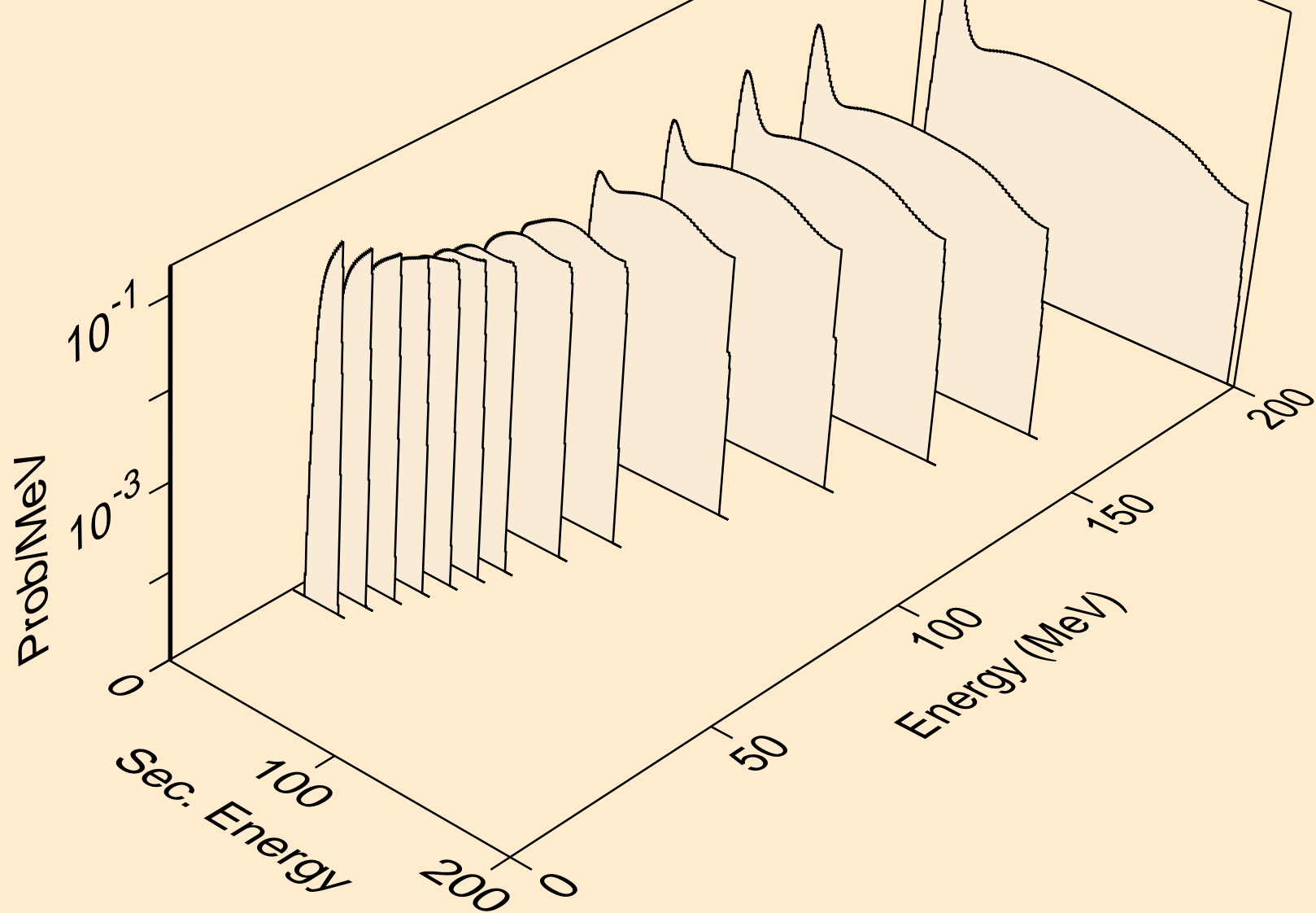

ES256 PROTON ACER TENDL-2023 LIBRARY; T=0.K  
deuterons from (p,2nd)

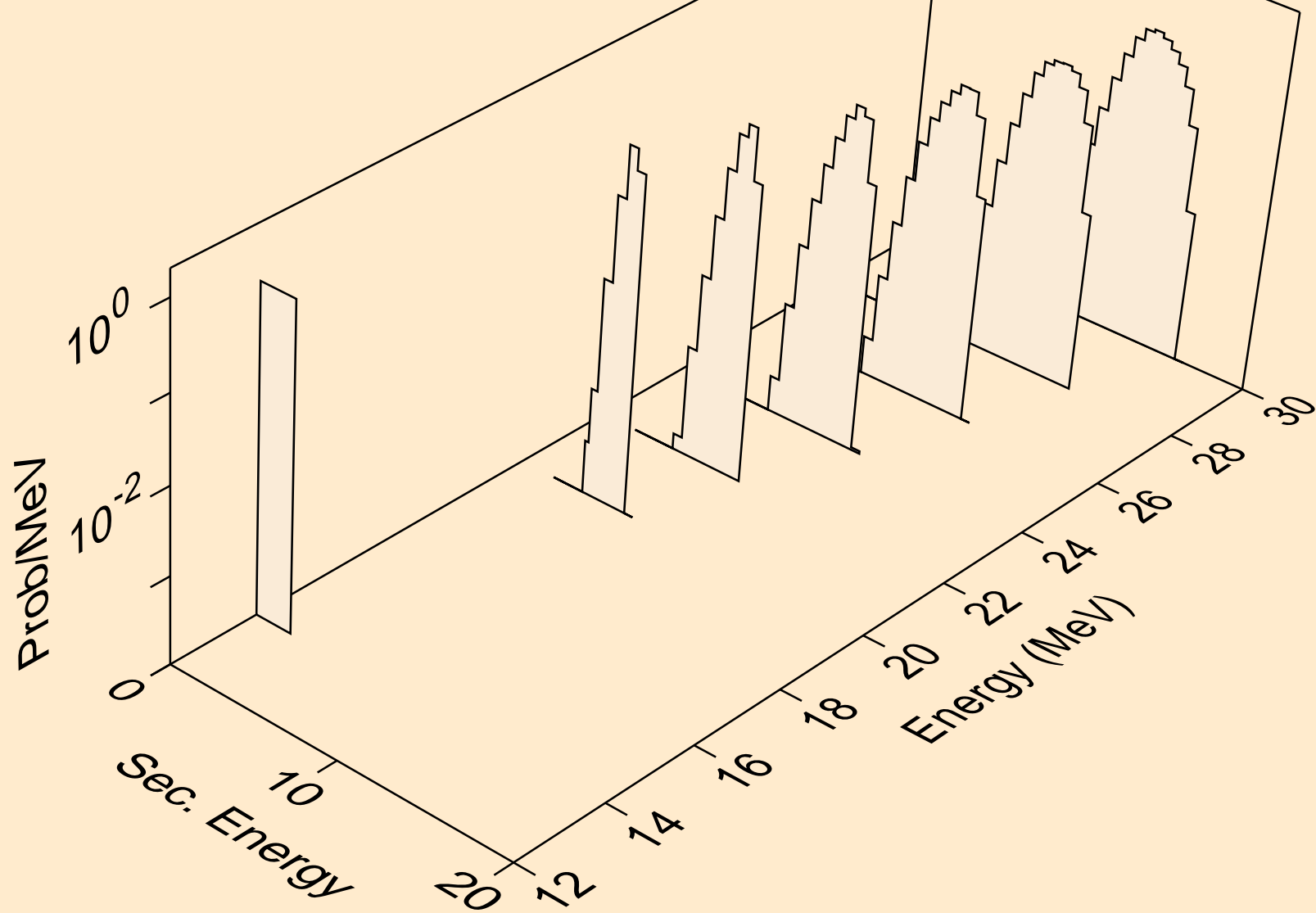

ES256 PROTON ACER TENDL-2023 LIBRARY; T=0.K  
deuterons from (p,n\*)d

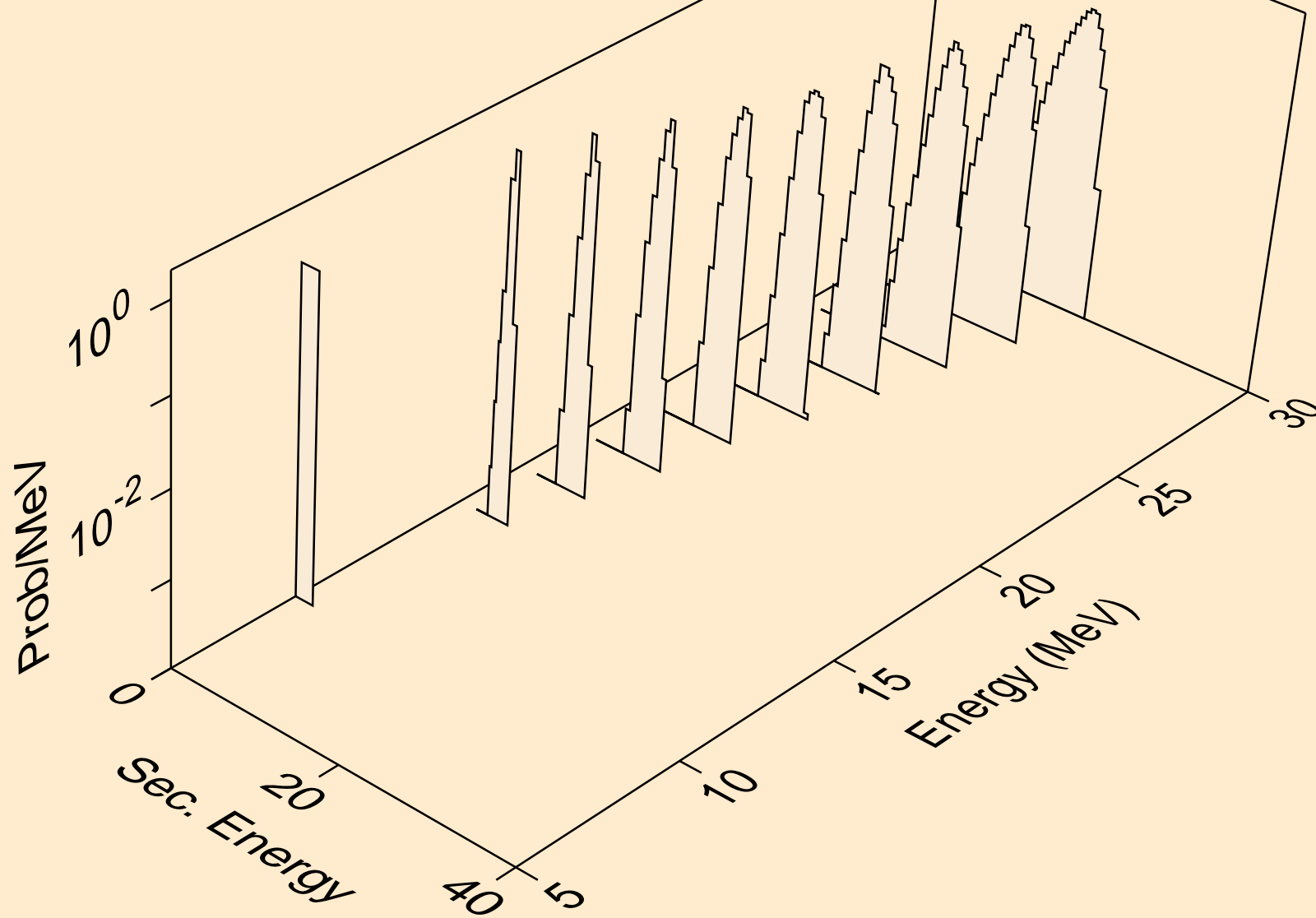



ES256 PROTON ACER TENDL-2023 LIBRARY; T=0.K  
deuterons from (p,d)

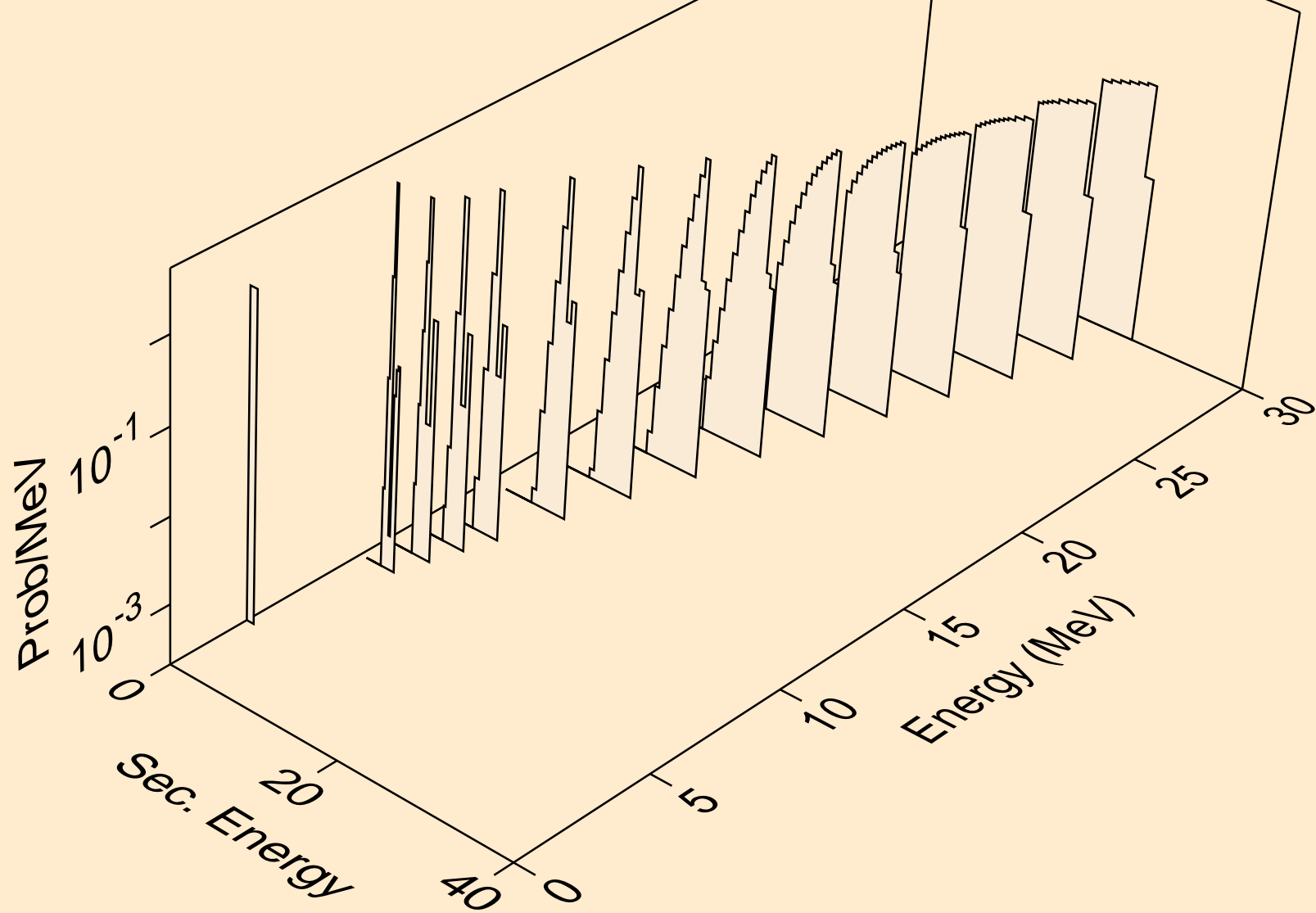

ES256 PROTON ACER TENDL-2023 LIBRARY; T=0.K  
deuterons from (p,pd)

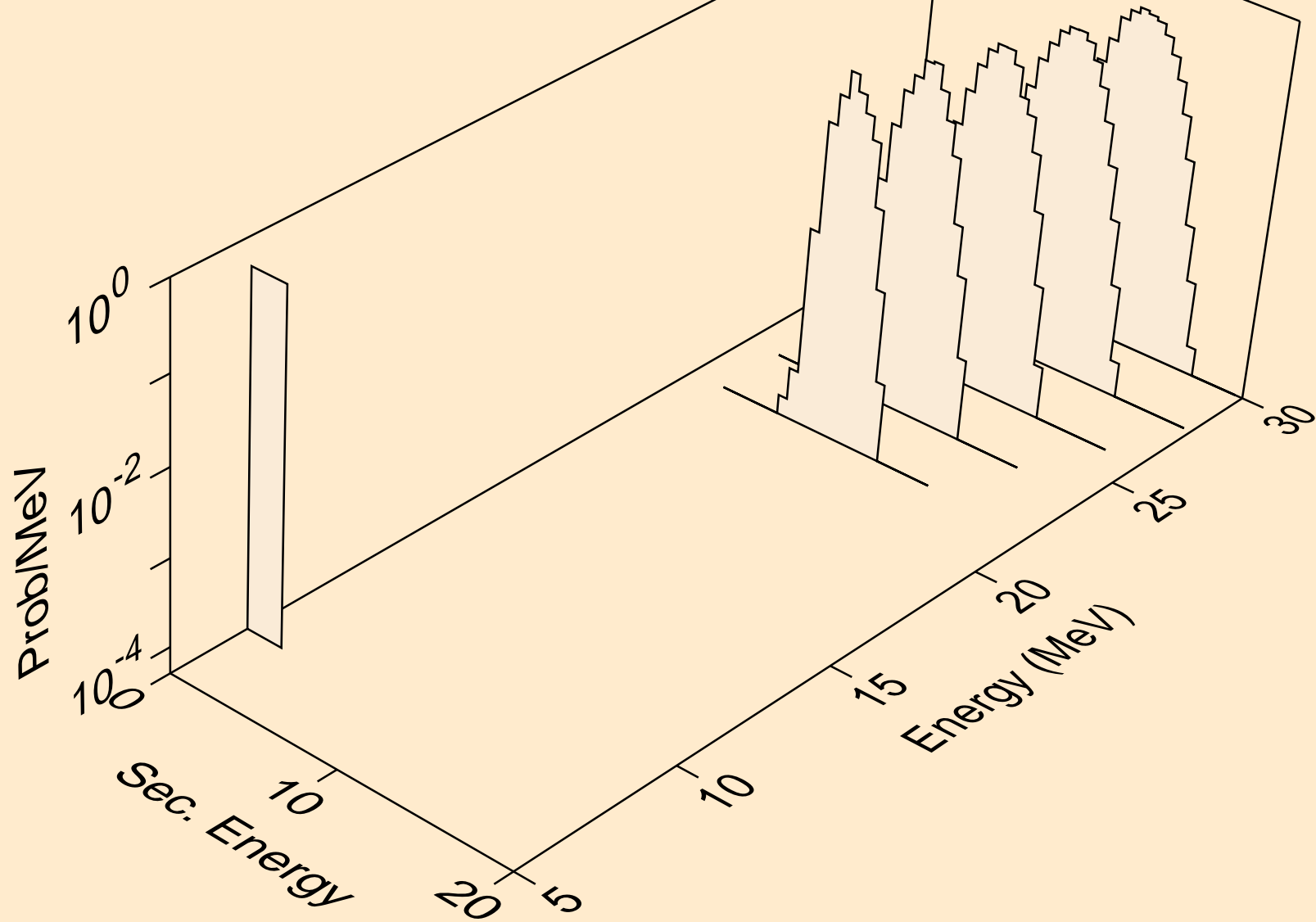

ES256 PROTON ACER TENDL-2023 LIBRARY; T=0.K  
tritons from (p,x)

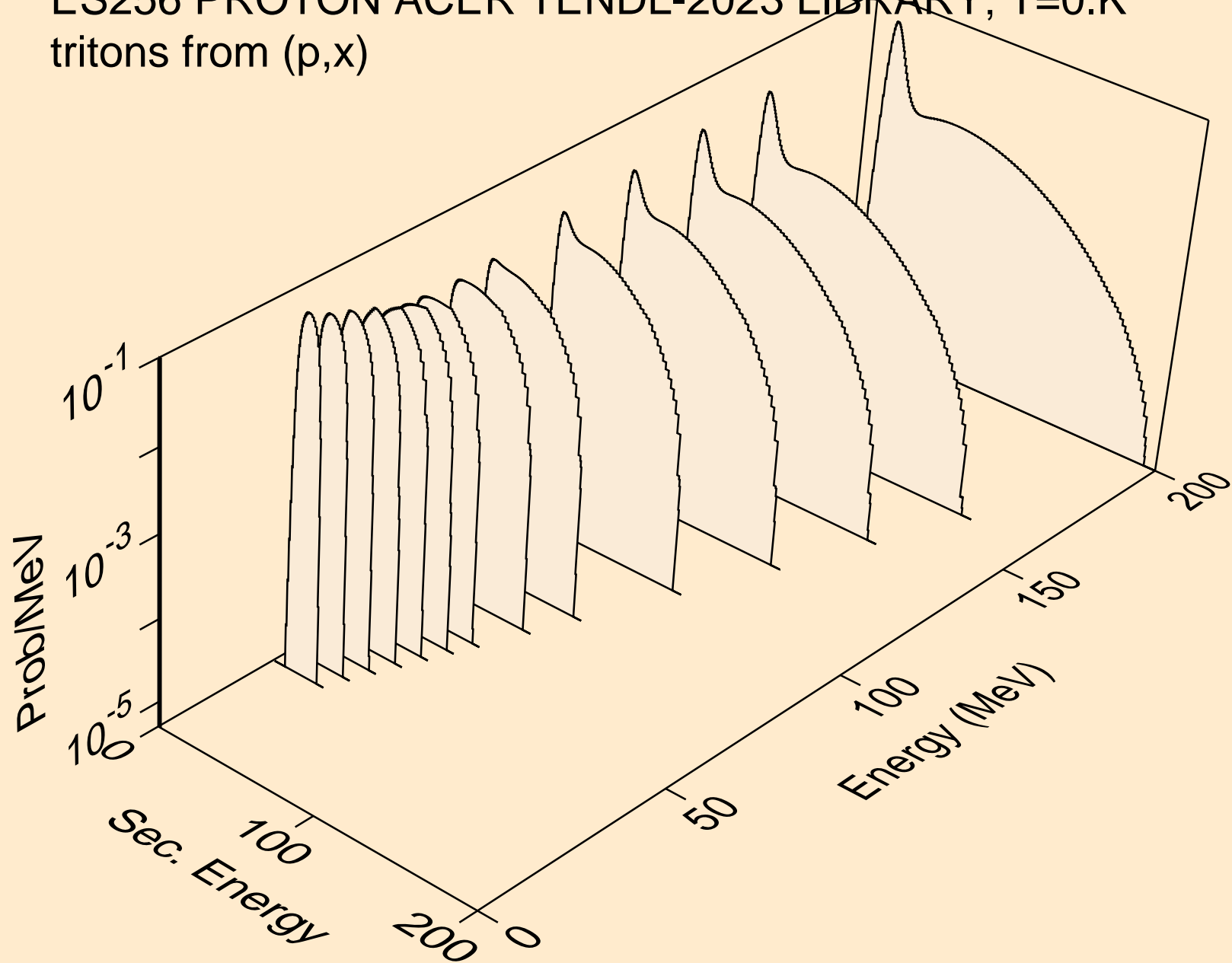

ES256 PROTON ACER TENDL-2023 LIBRARY; T=0.K  
tritons from (p,n\*)t

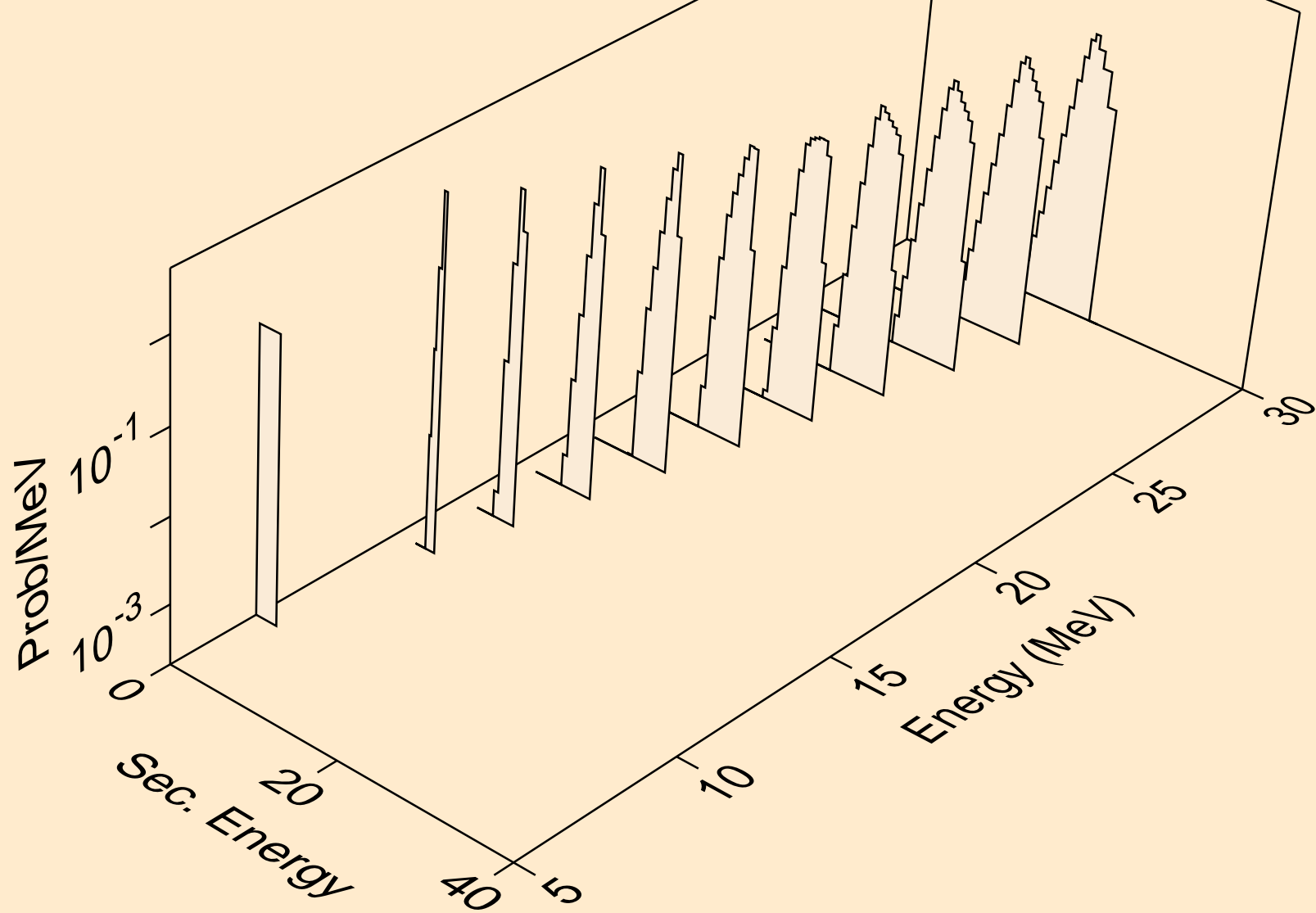

ES256 PROTON ACER TENDL-2023 LIBRARY; T=0.K  
tritons from (p,t)

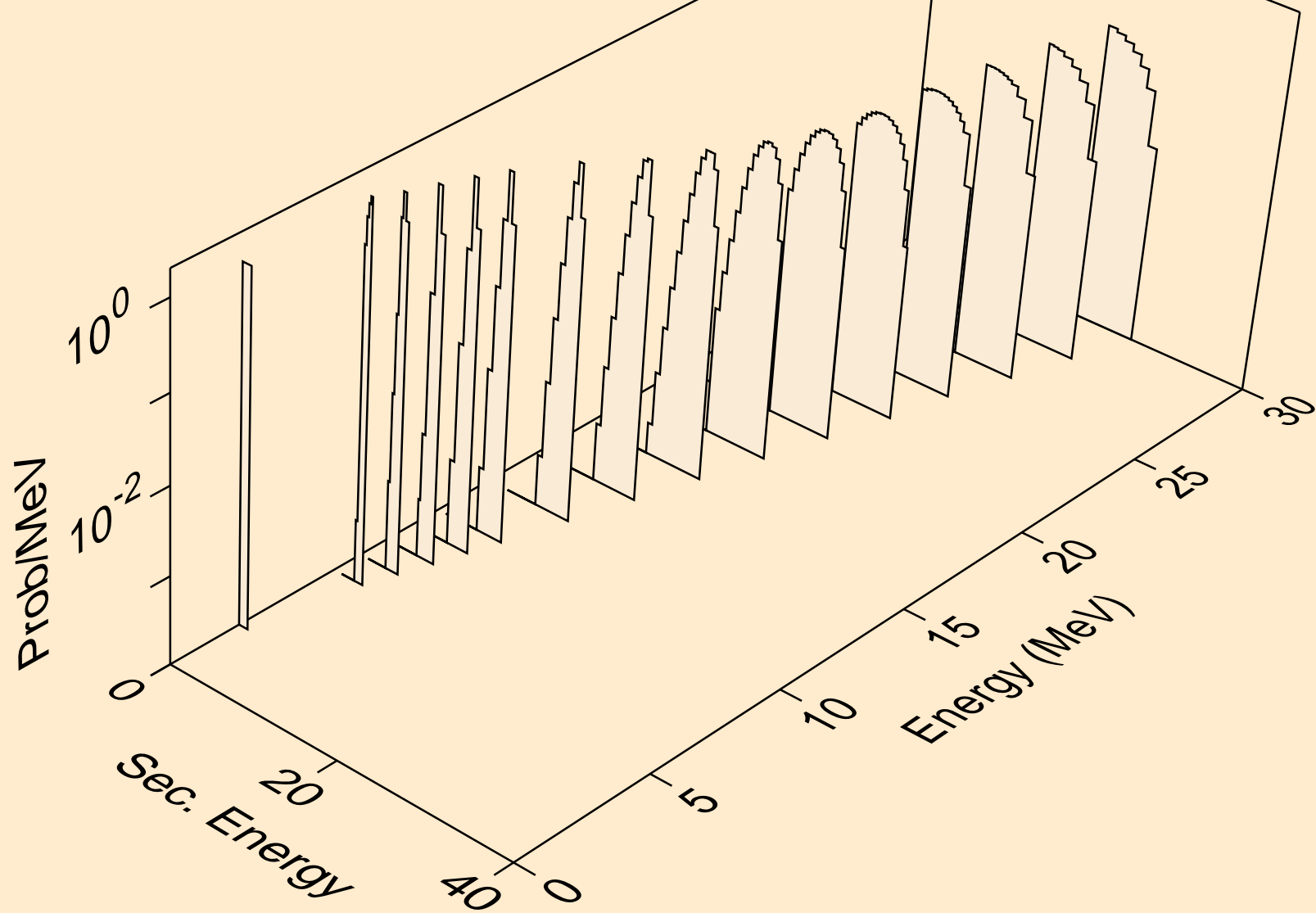

ES256 PROTON ACER TENDL-2023 LIBRARY; T=0.K  
he3s from (p,x)

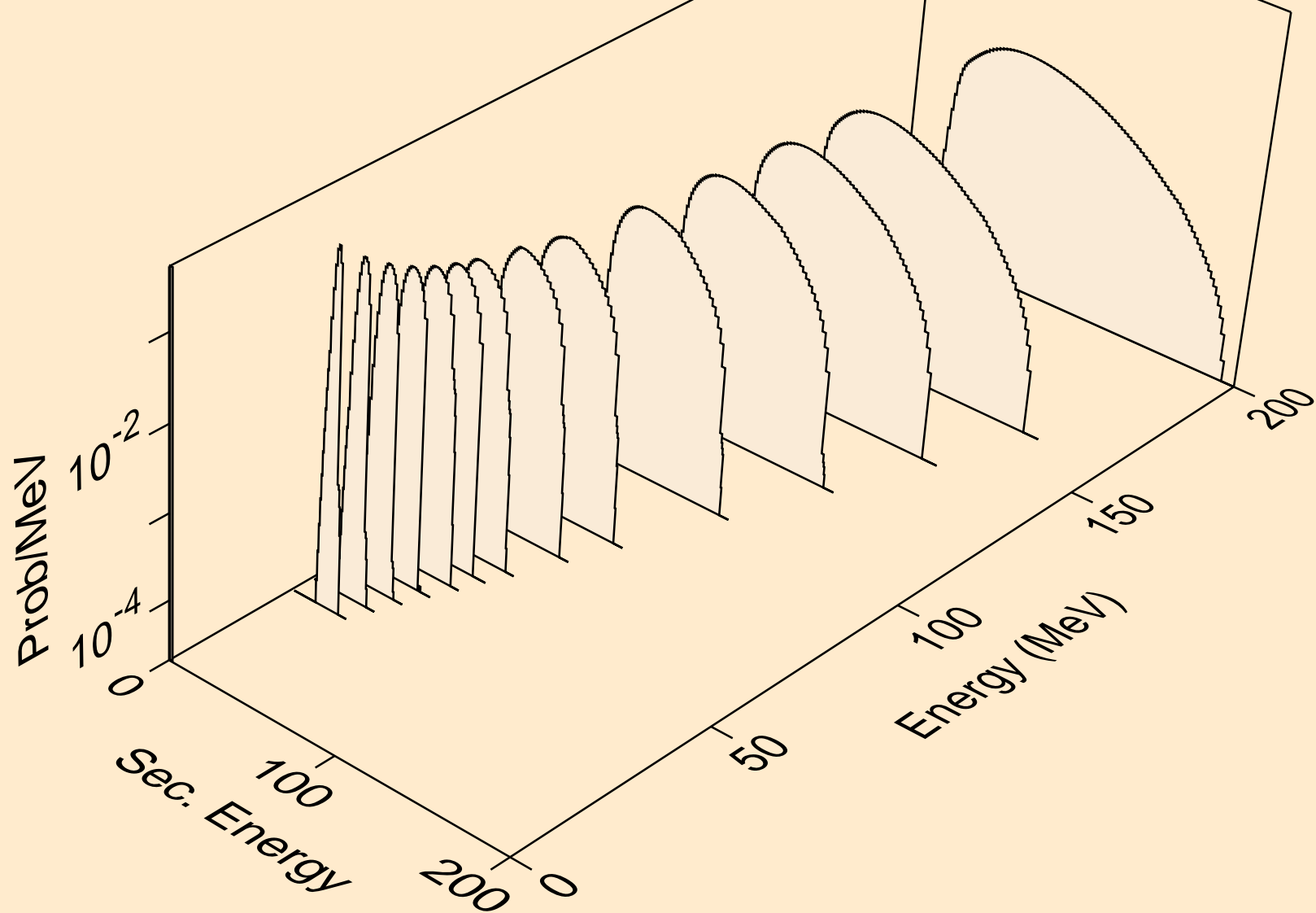

ES256 PROTON ACER TENDL-2023 LIBRARY; T=0.K  
he3s from (p,n\*)he3

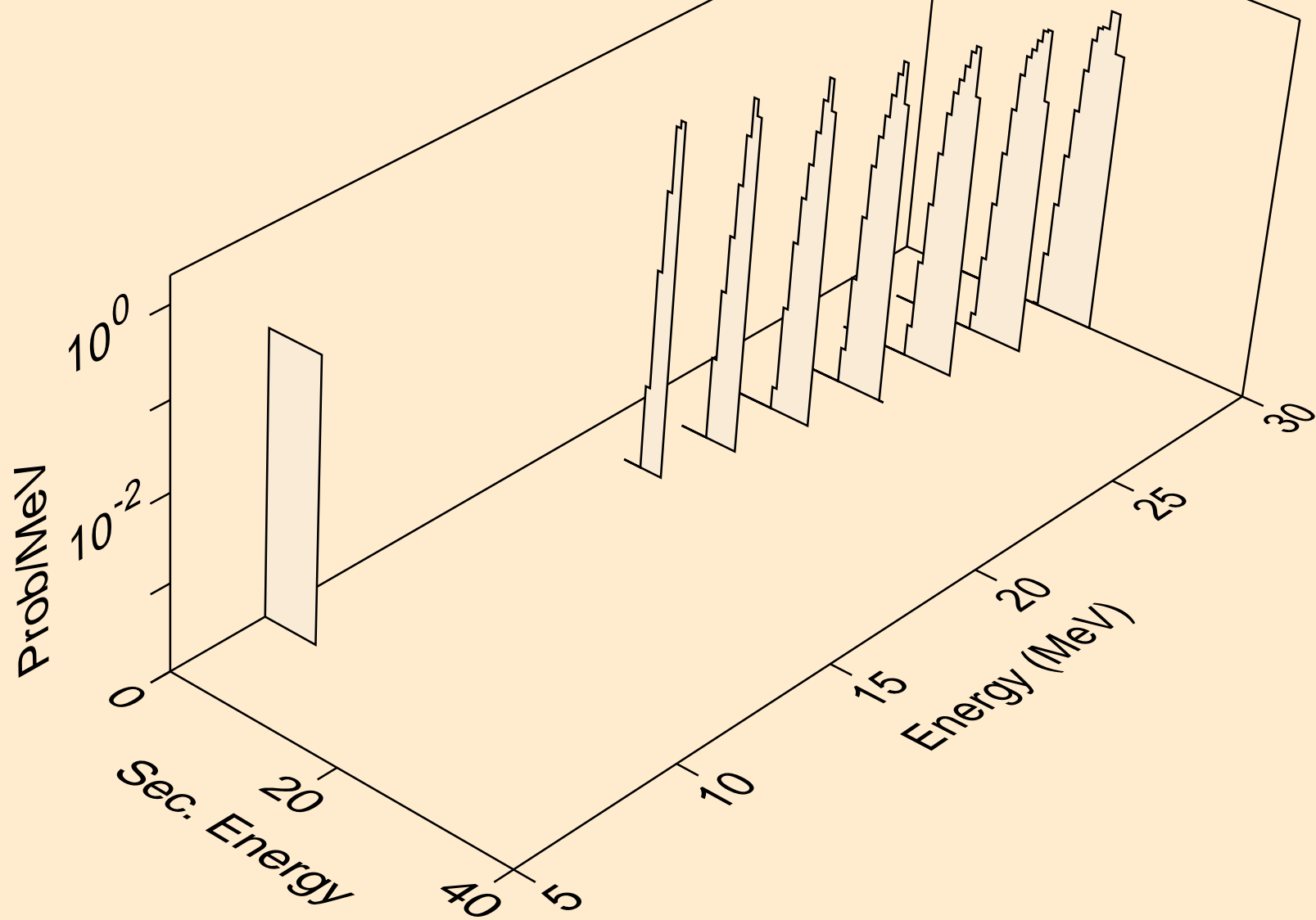

ES256 PROTON ACER TENDL-2023 LIBRARY; T=0.K  
he3s from (p,he3)

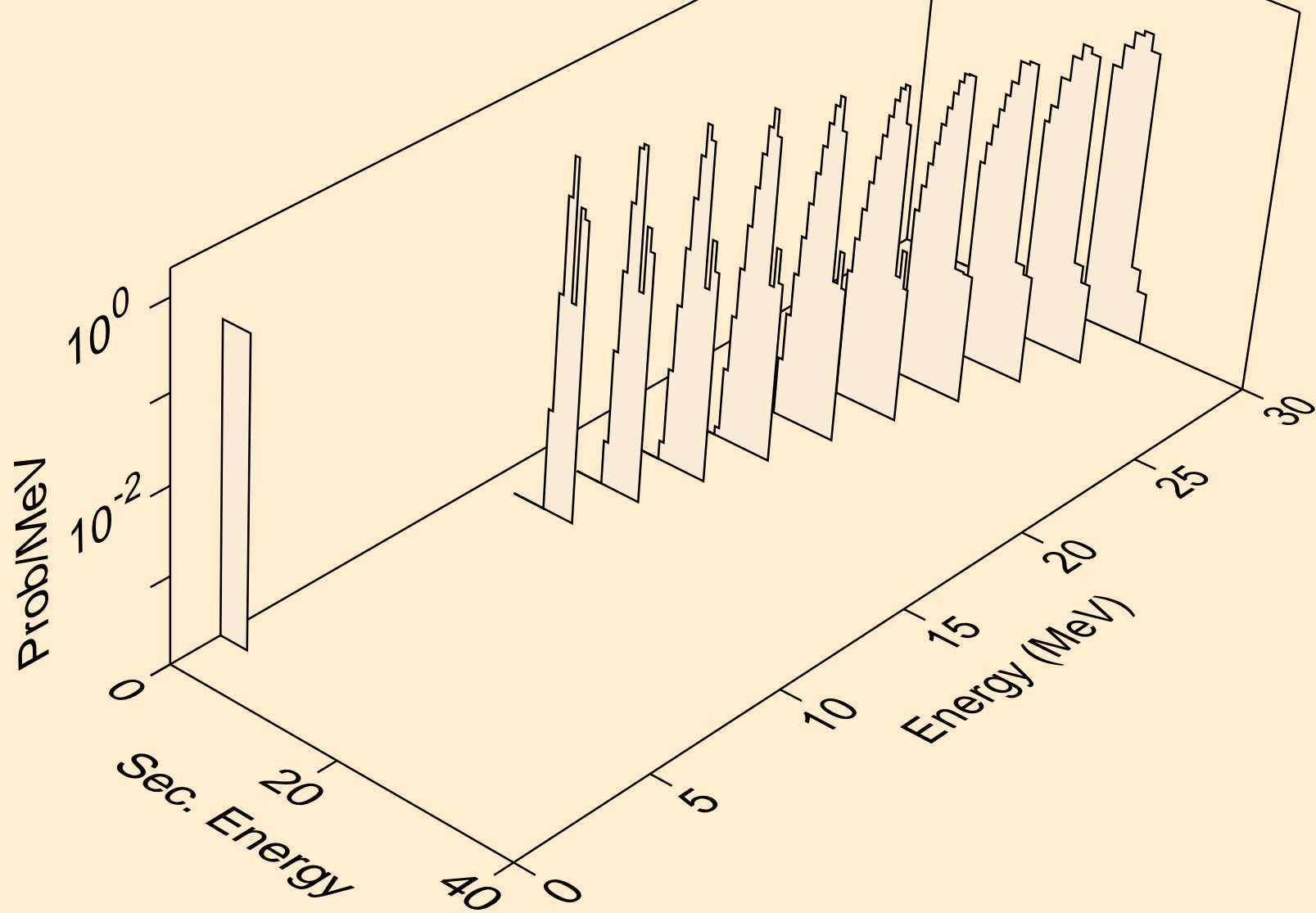



ES256 PROTON ACER TENDL-2023 LIBRARY; T=0.K  
alphas from (p,x)

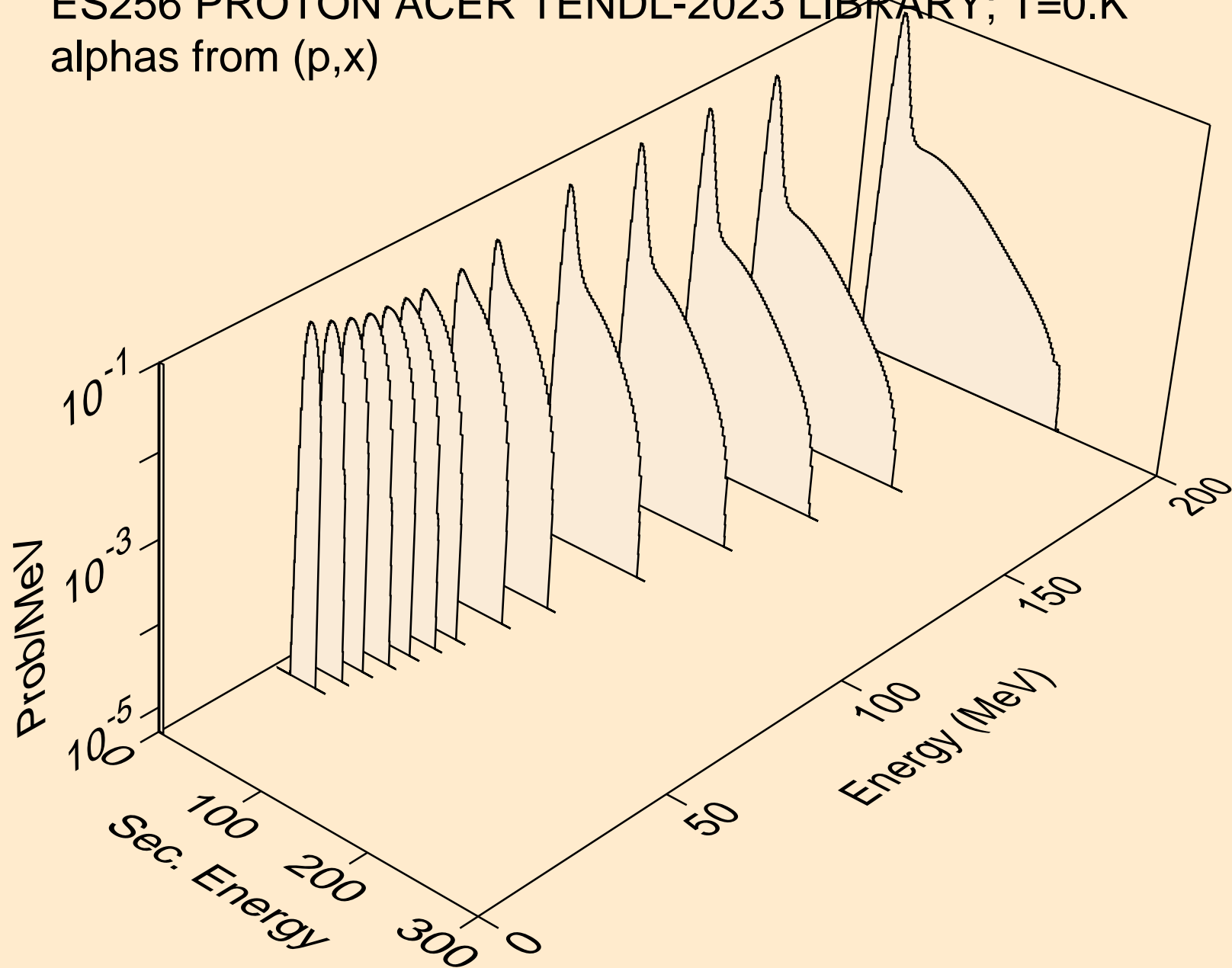

ES256 PROTON ACER TENDL-2023 LIBRARY; T=0.K  
alphas from (p,n\*)a

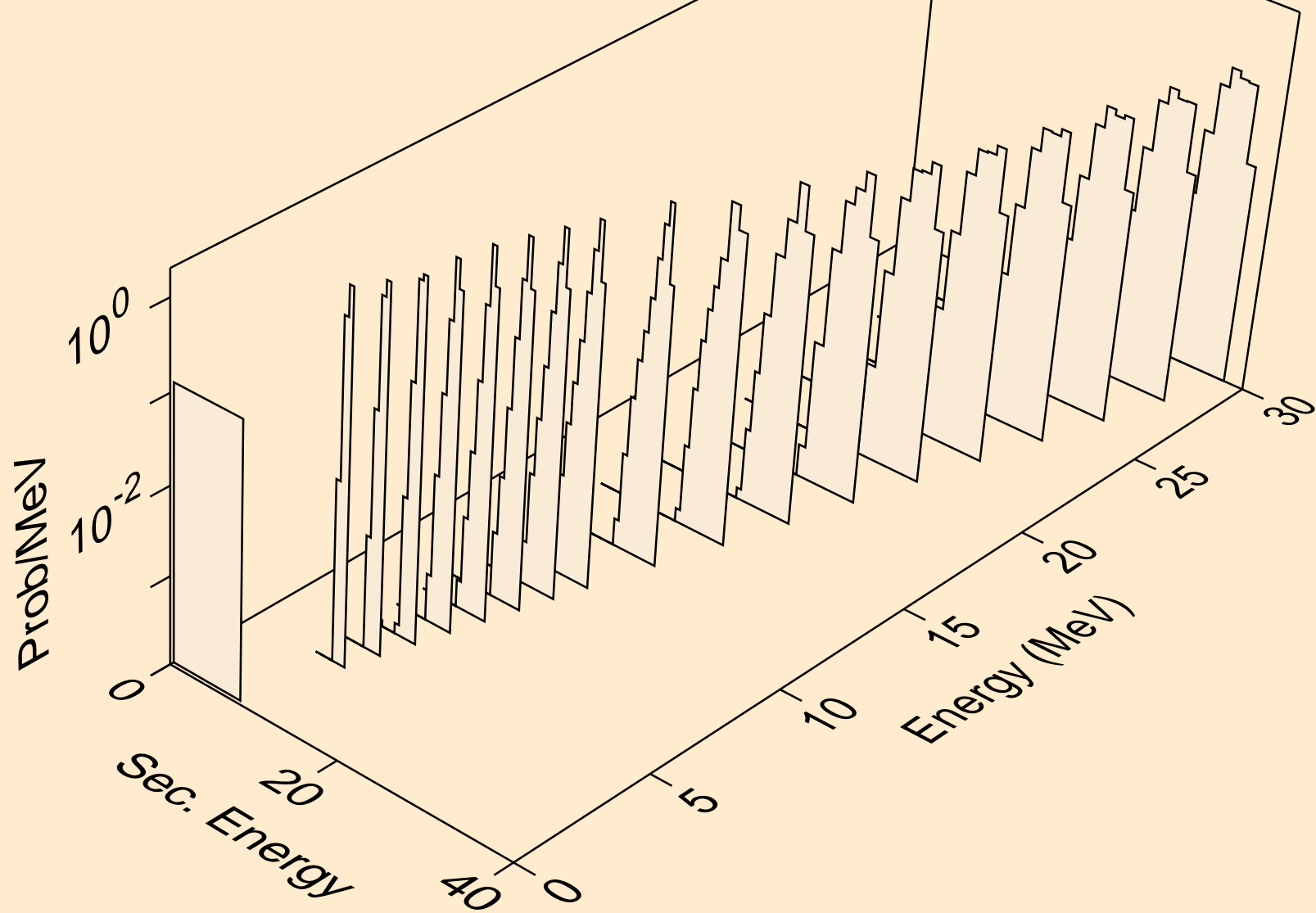

ES256 PROTON ACER TENDL-2023 LIBRARY; T=0.K  
alphas from (p,2n)a

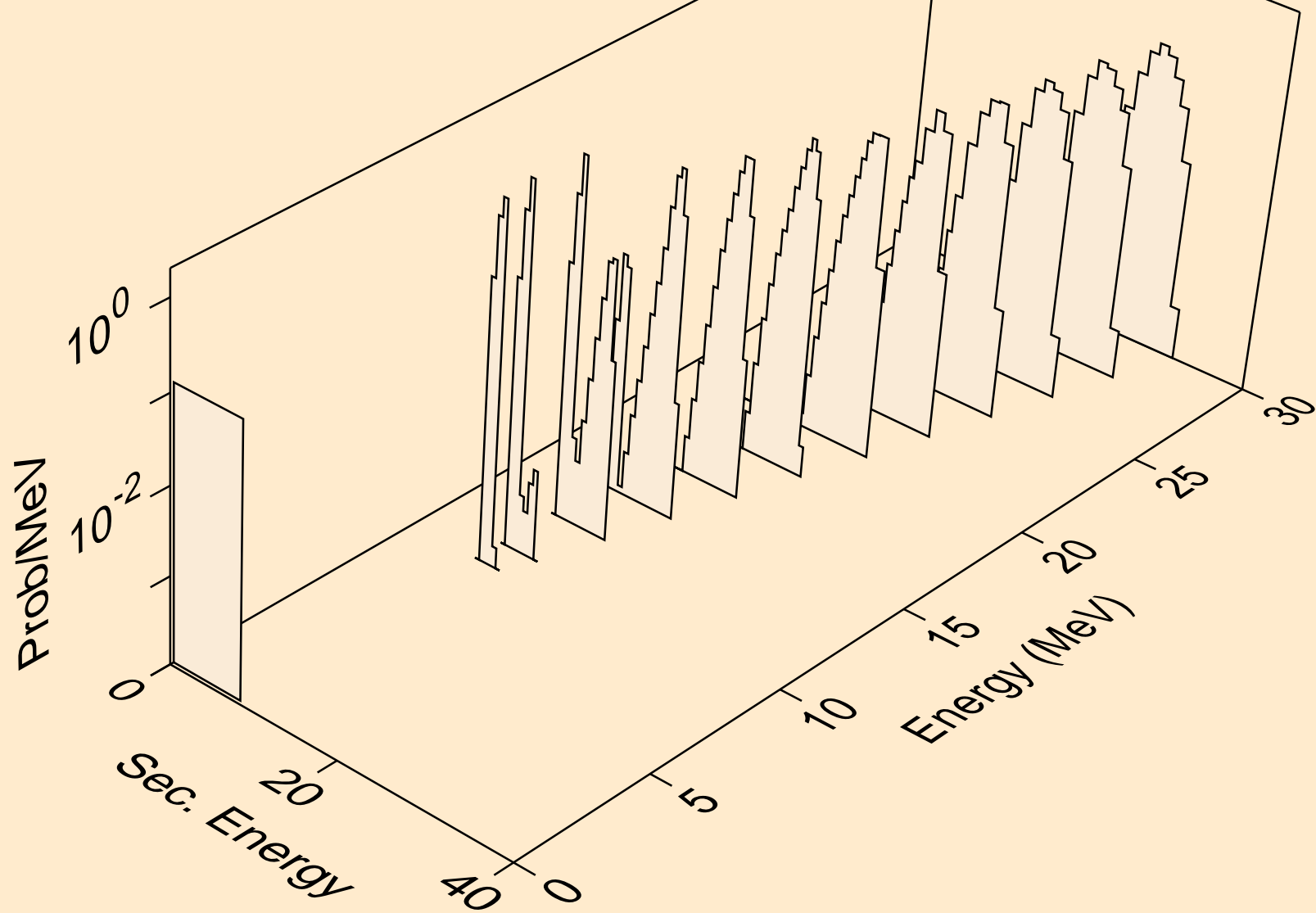

ES256 PROTON ACER TENDL-2023 LIBRARY; T=0.K  
alphas from (p,3n)a

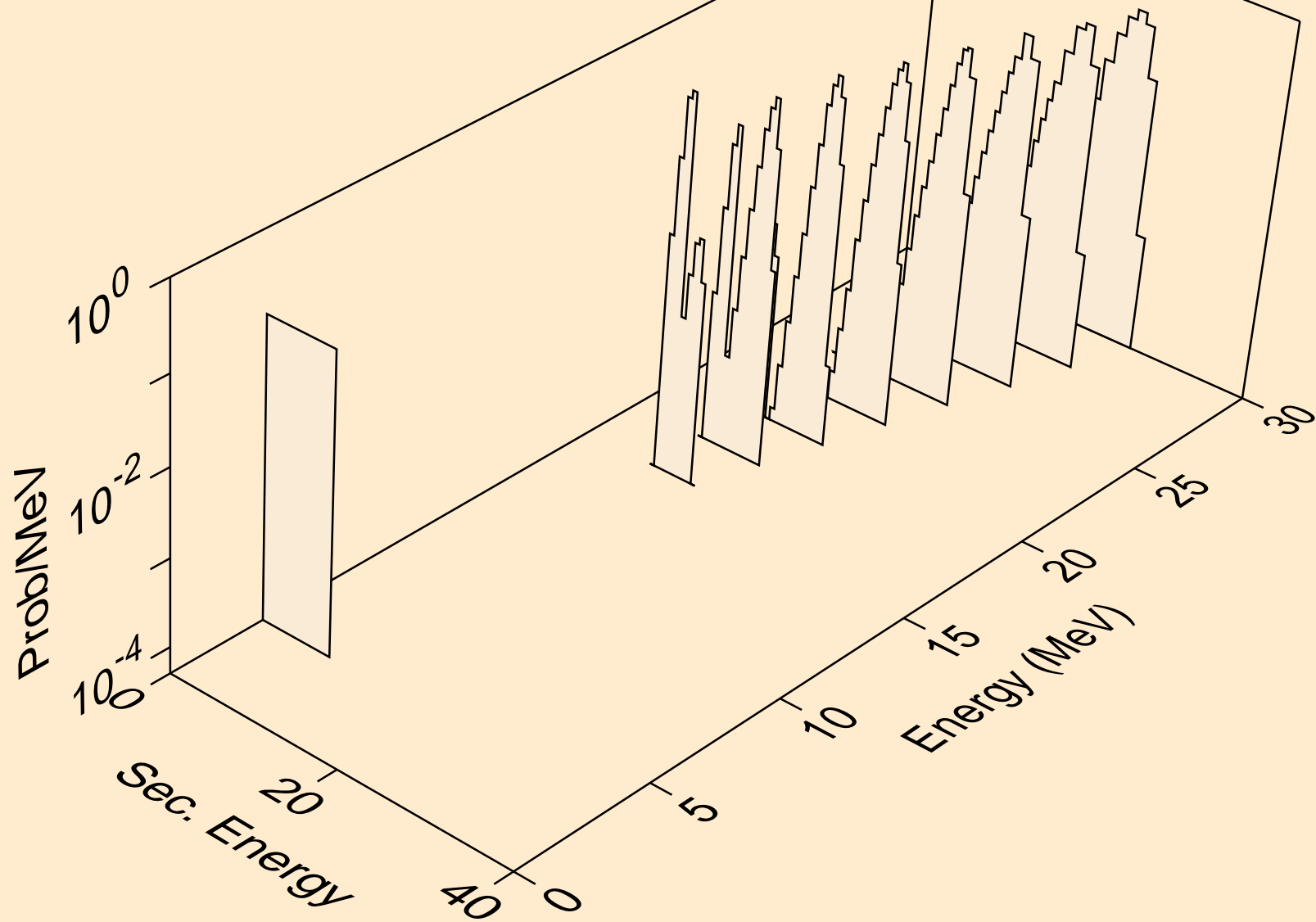

ES256 PROTON ACER TENDL-2023 LIBRARY; T=0.K  
alphas from (p,a)

