

# HF172 PROTON ACER TENDL-2023 LIBRARY; T=0.K

## Principal cross sections

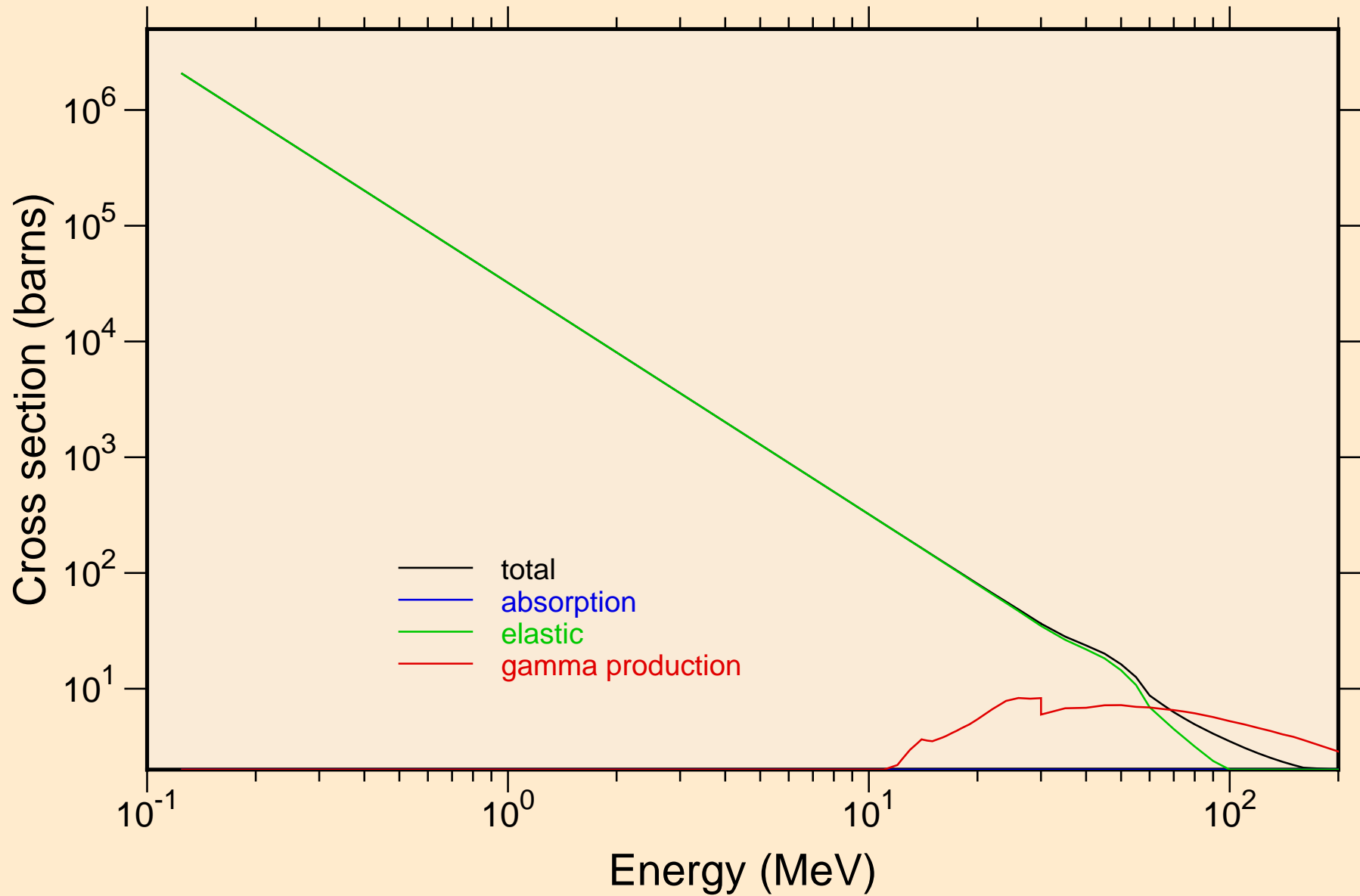

# HF172 PROTON ACER TENDL-2023 LIBRARY; T=0.K

## Heating

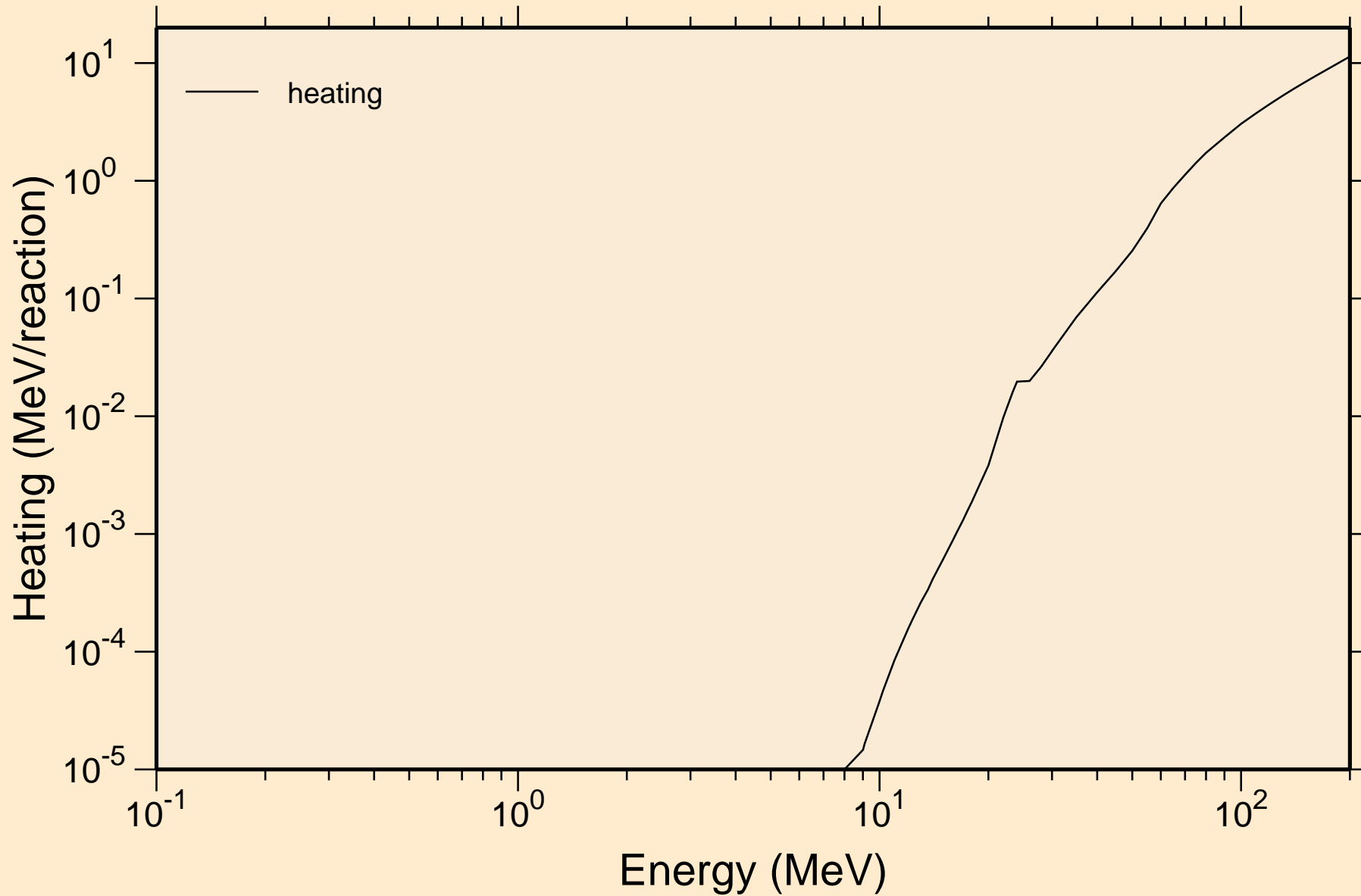

# HF172 PROTON ACER TENDL-2023 LIBRARY; T=0.K

## Principal cross sections

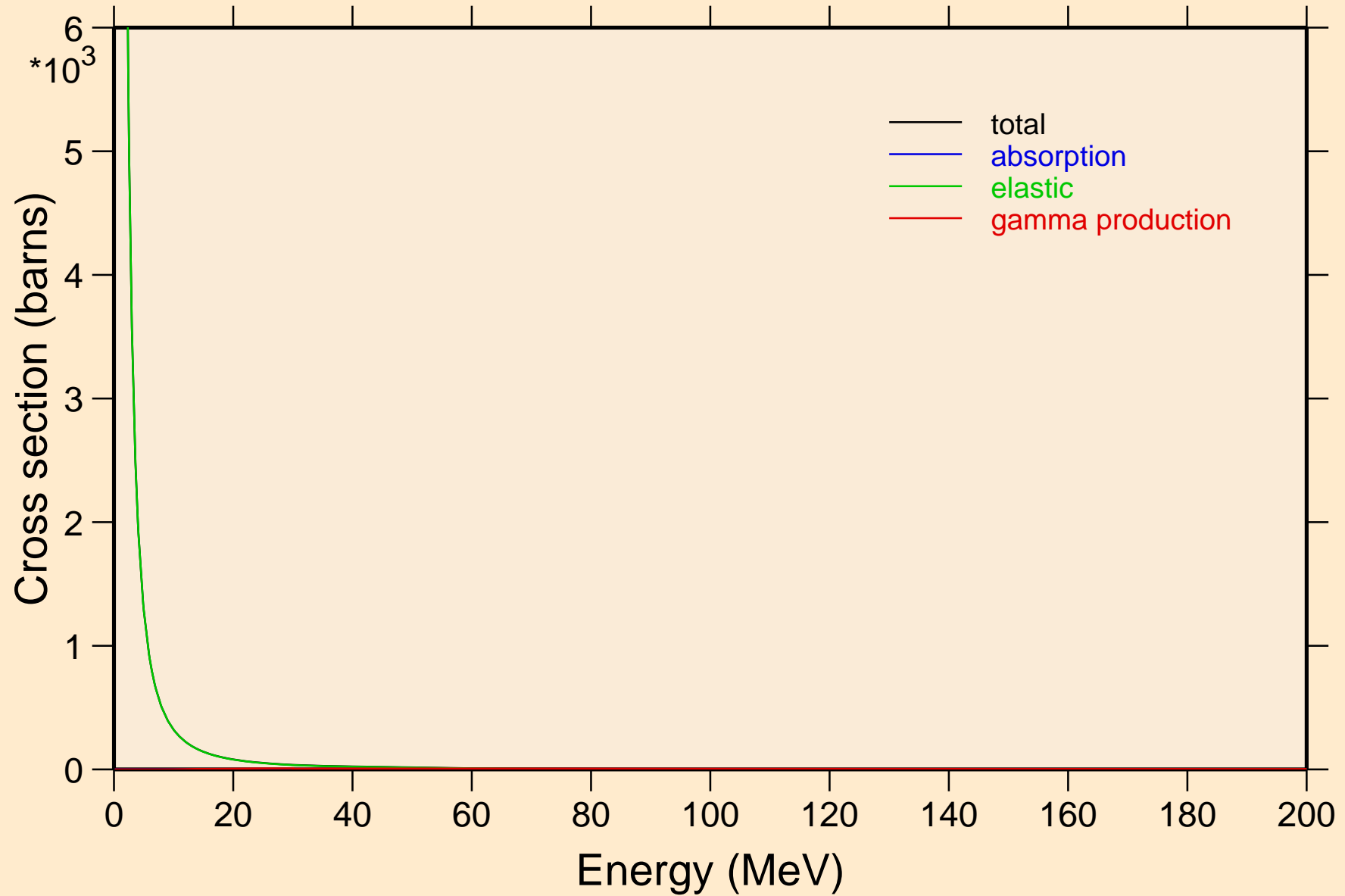

# HF172 PROTON ACER TENDL-2023 LIBRARY; T=0.K

## Heating

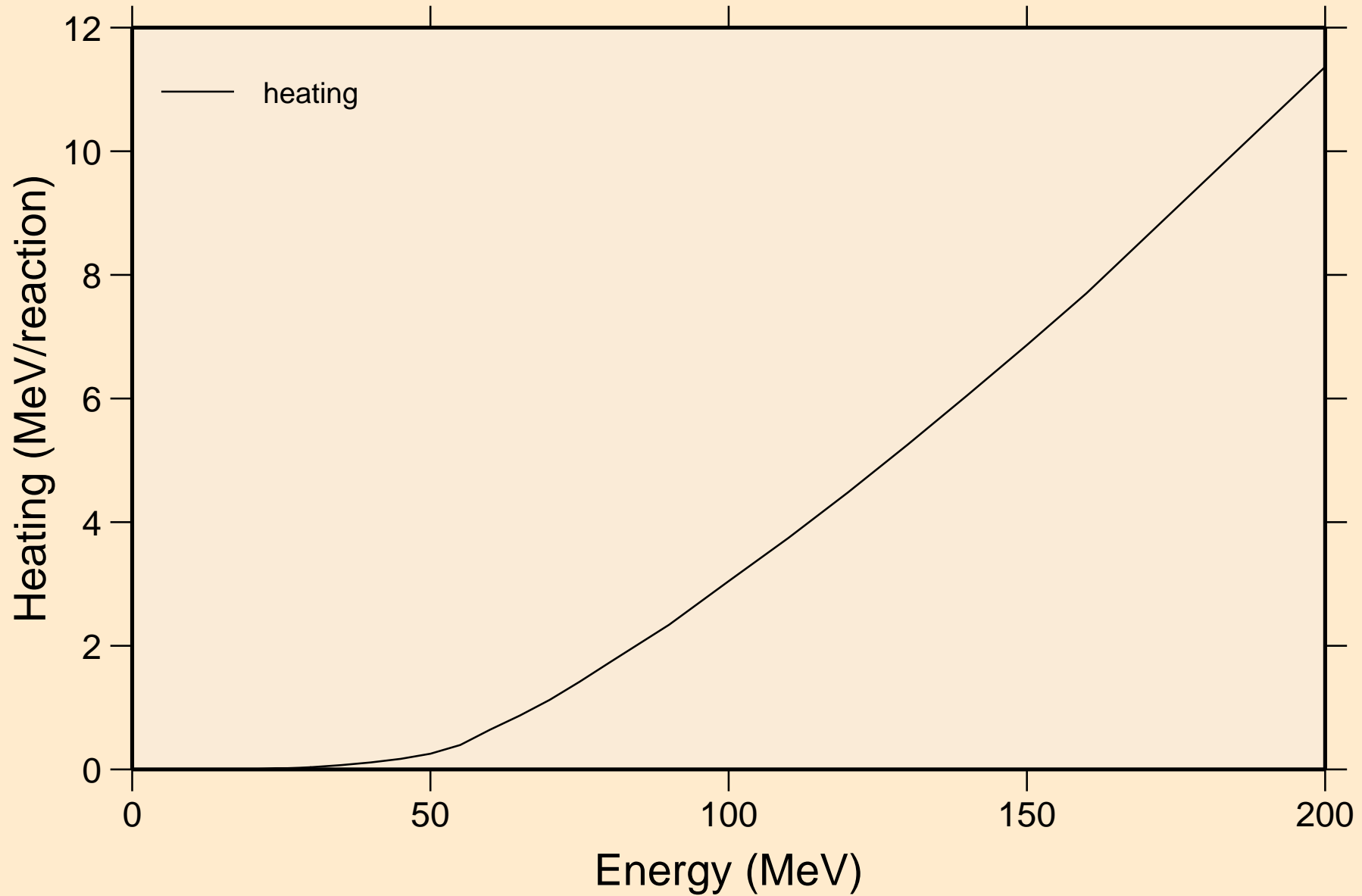

# HF172 PROTON ACER TENDL-2023 LIBRARY; T=0.K

## Threshold reactions

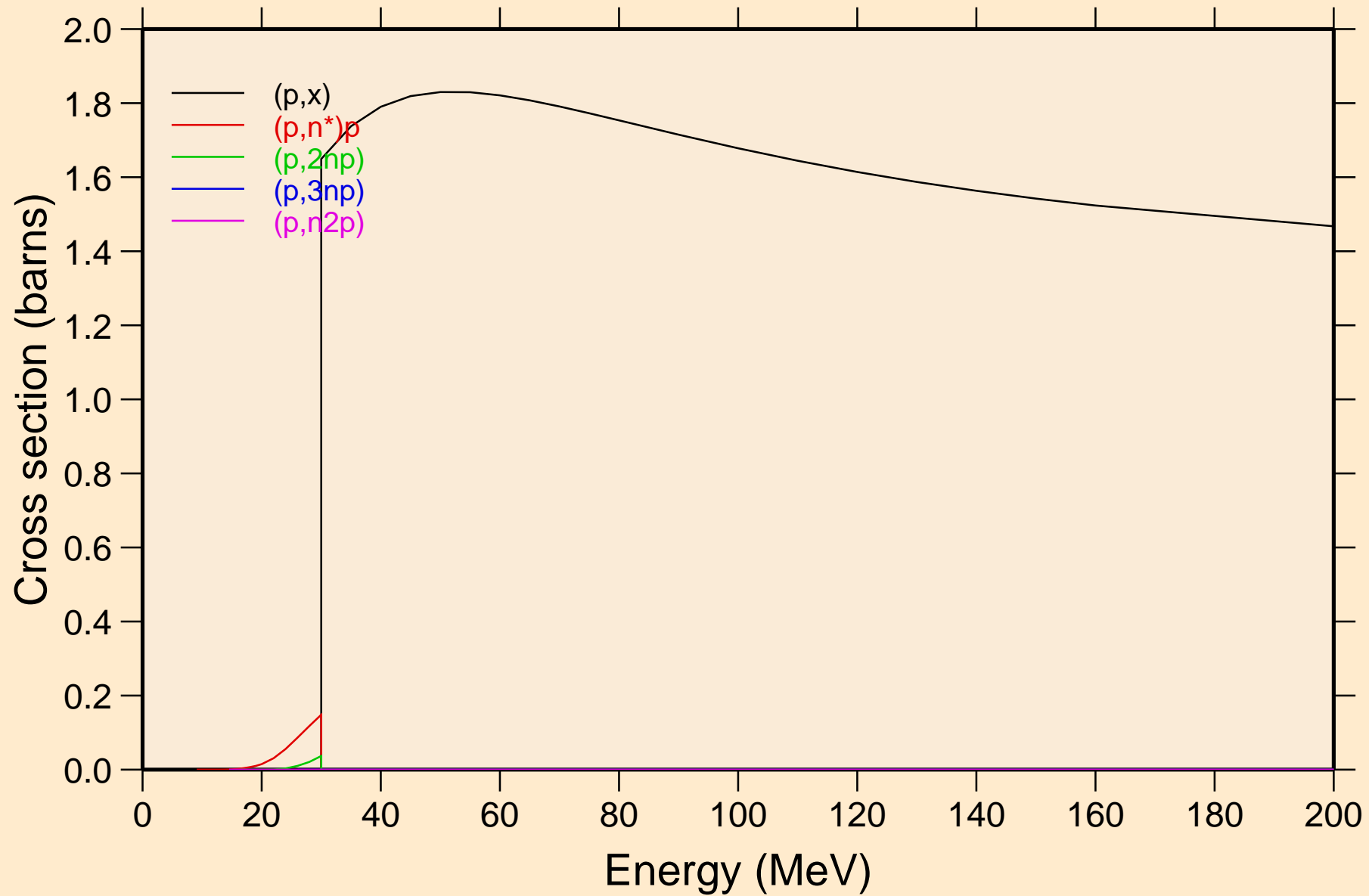

# HF172 PROTON ACER TENDL-2023 LIBRARY; T=0.K

## Threshold reactions

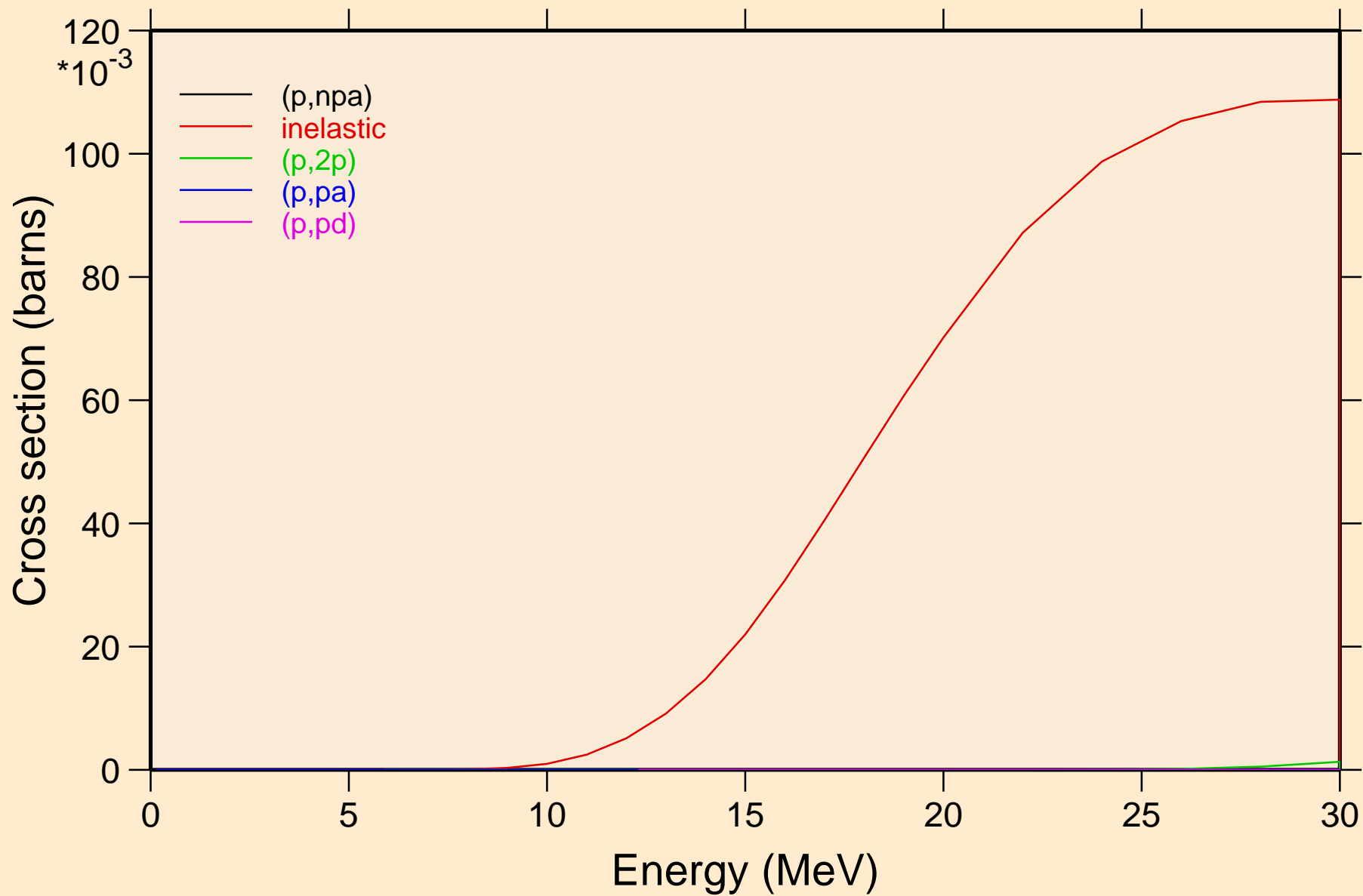

HF172 PROTON ACER TENDL-2023 LIBRARY; T=0.K  
Threshold reactions

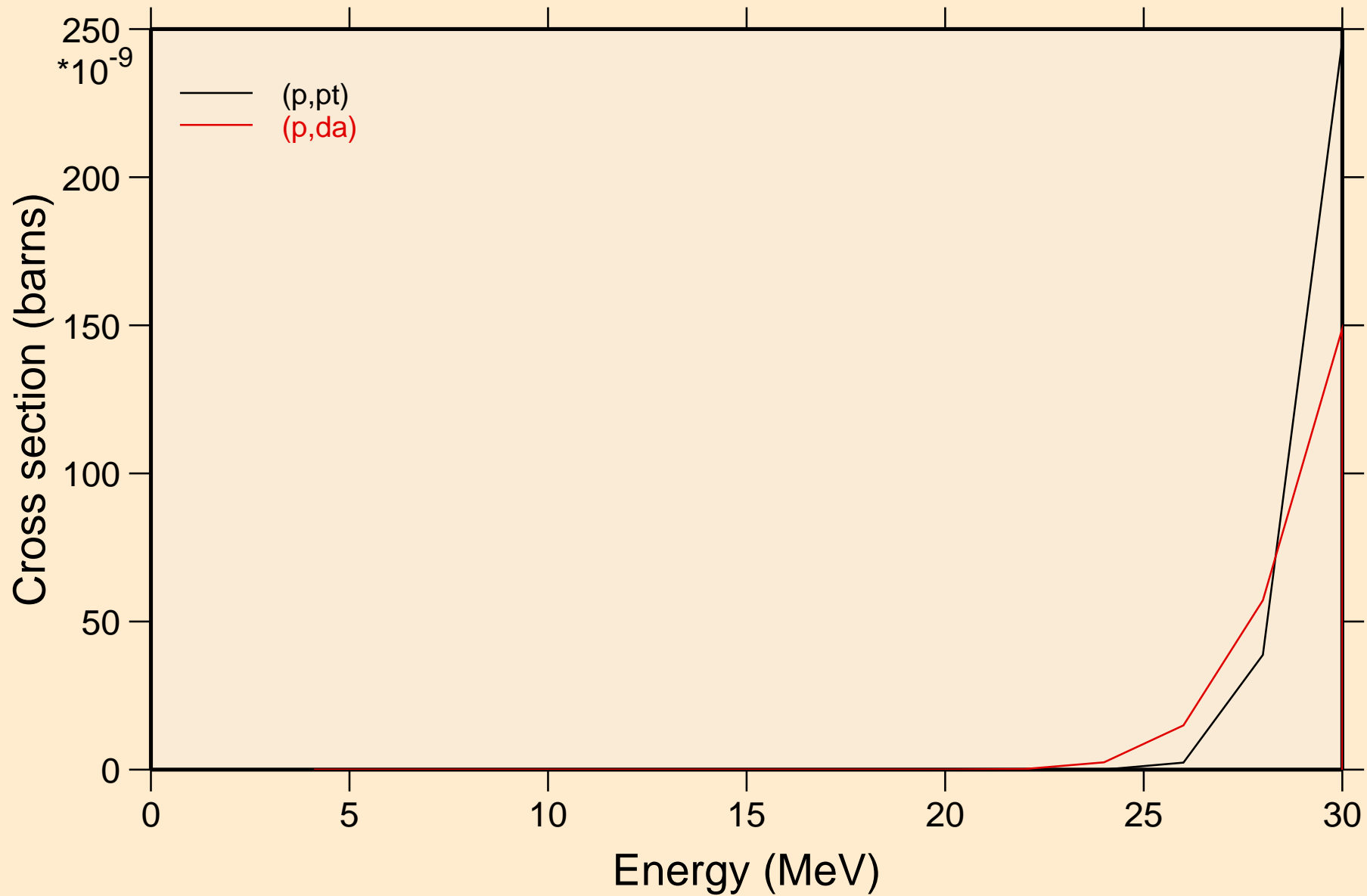

HF172 PROTON ACER TENDL-2023 LIBRARY; T=0.K  
angular distribution for elastic

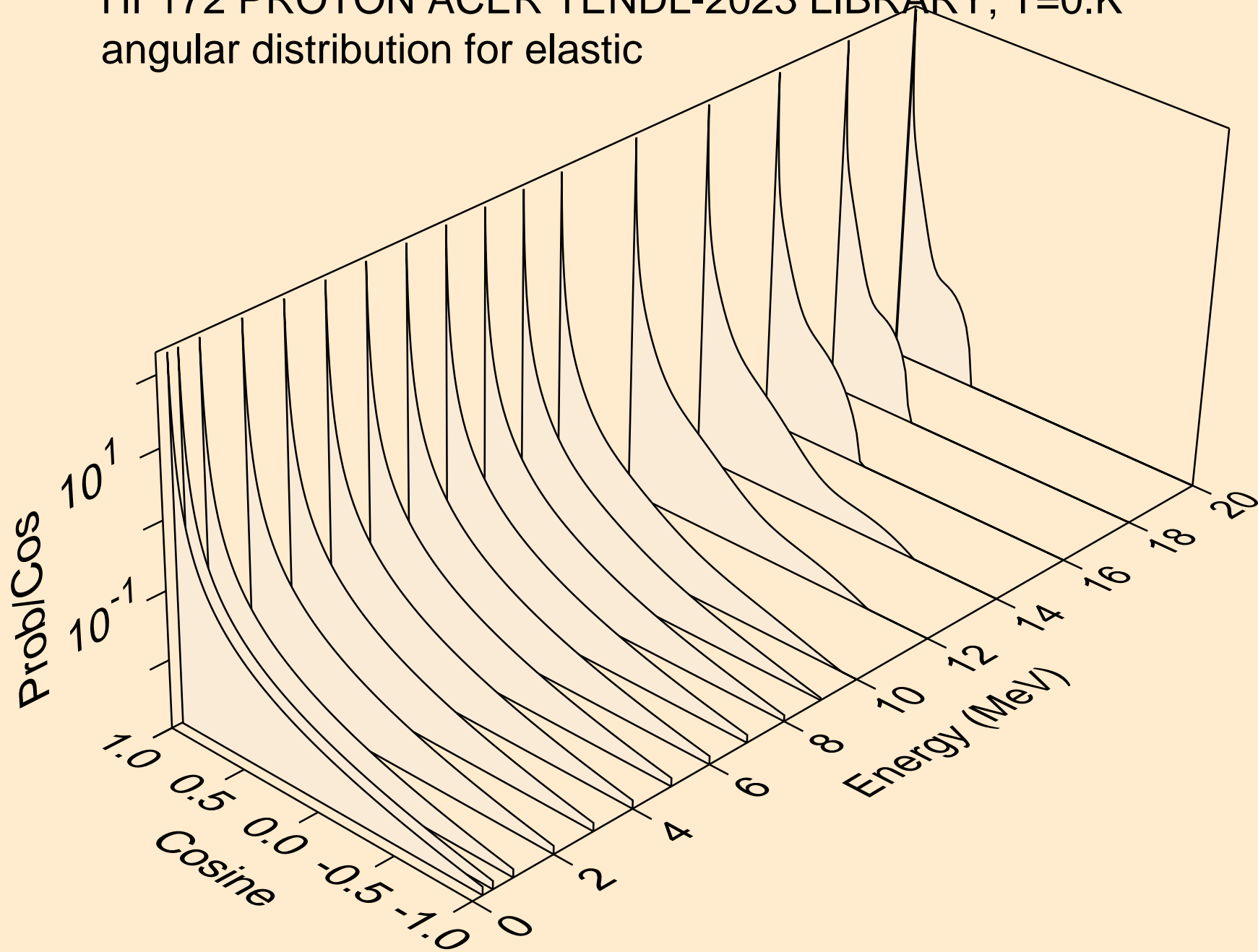



HF172 PROTON ACER TENDL-2023 LIBRARY; T=0.K  
angular distribution for elastic

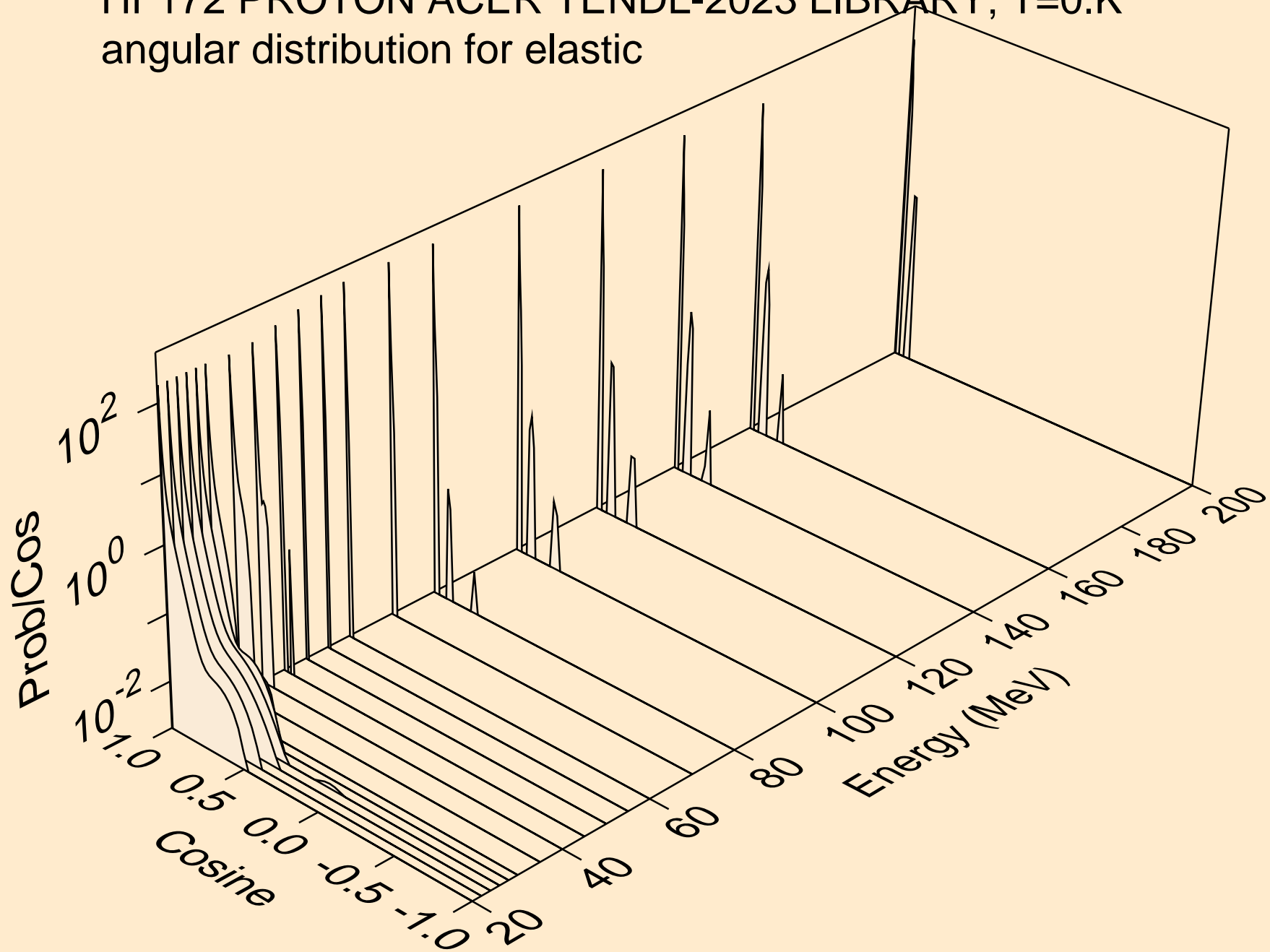

HF172 PROTON ACER TENDL-2023 LIBRARY; T=0.K  
Proton emission for (p,x)

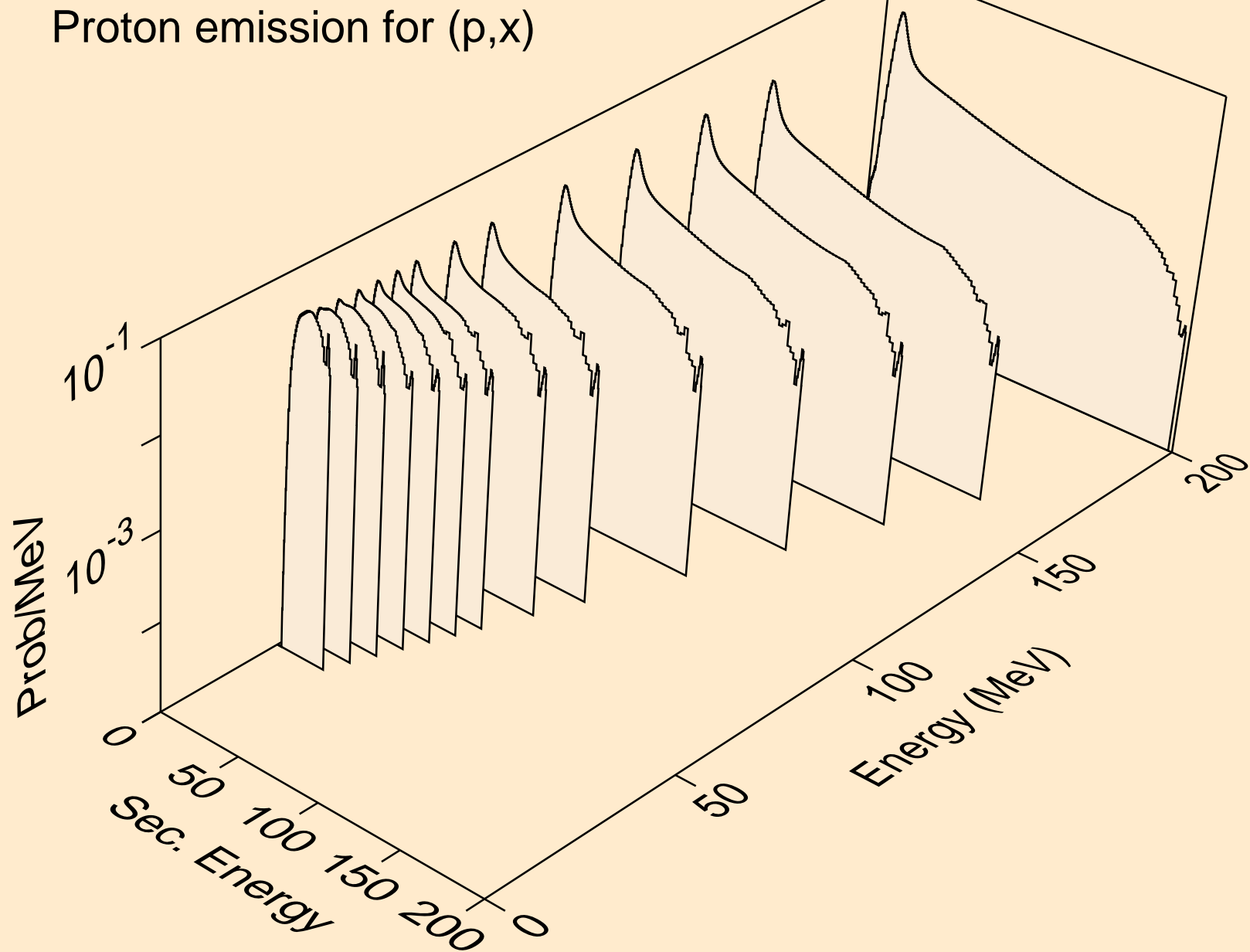

HF172 PROTON ACER TENDL-2023 LIBRARY; T=0.K  
Proton emission for (p,n\*)p

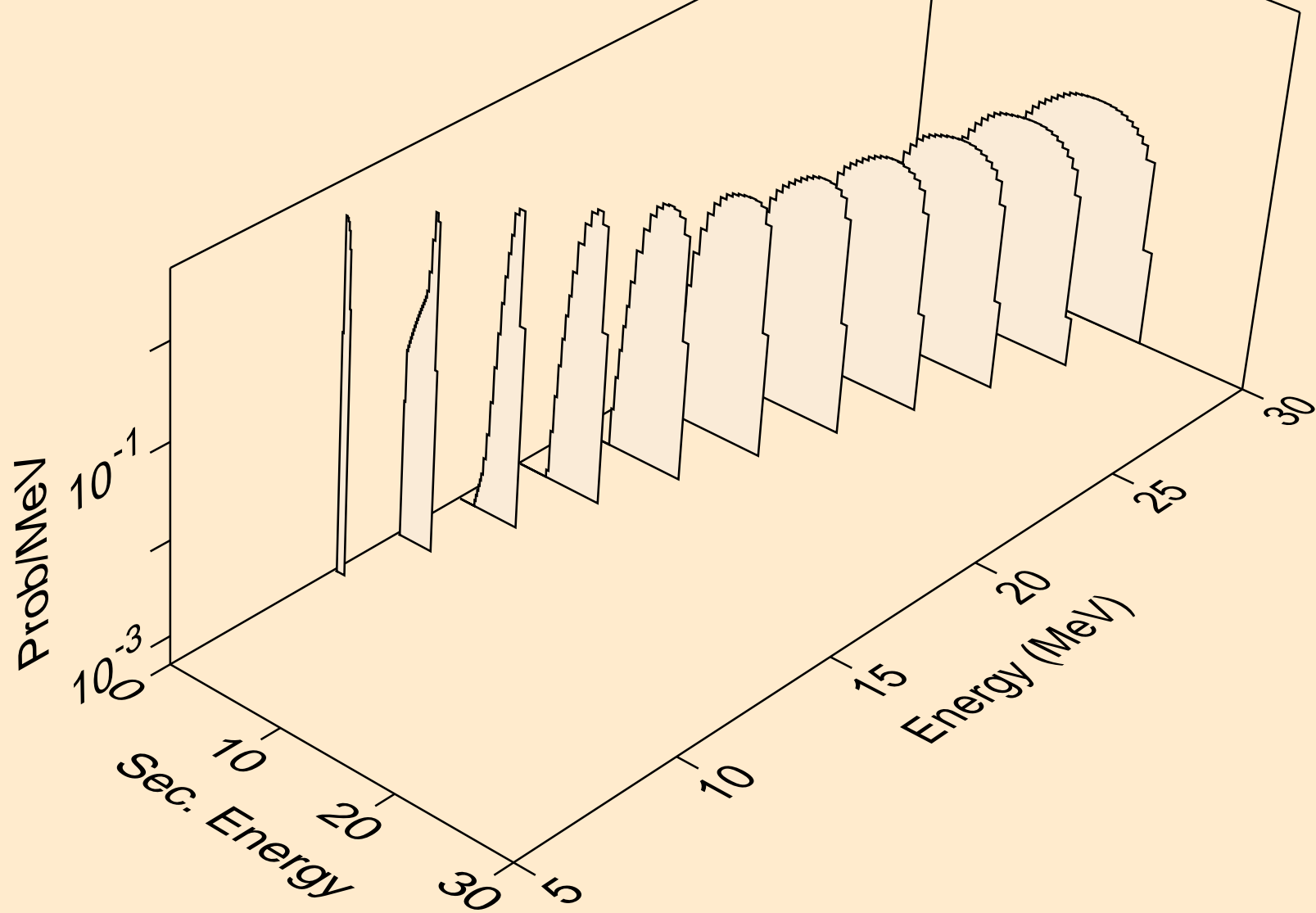

HF172 PROTON ACER TENDL-2023 LIBRARY; T=0.K  
Proton emission for (p,2np)

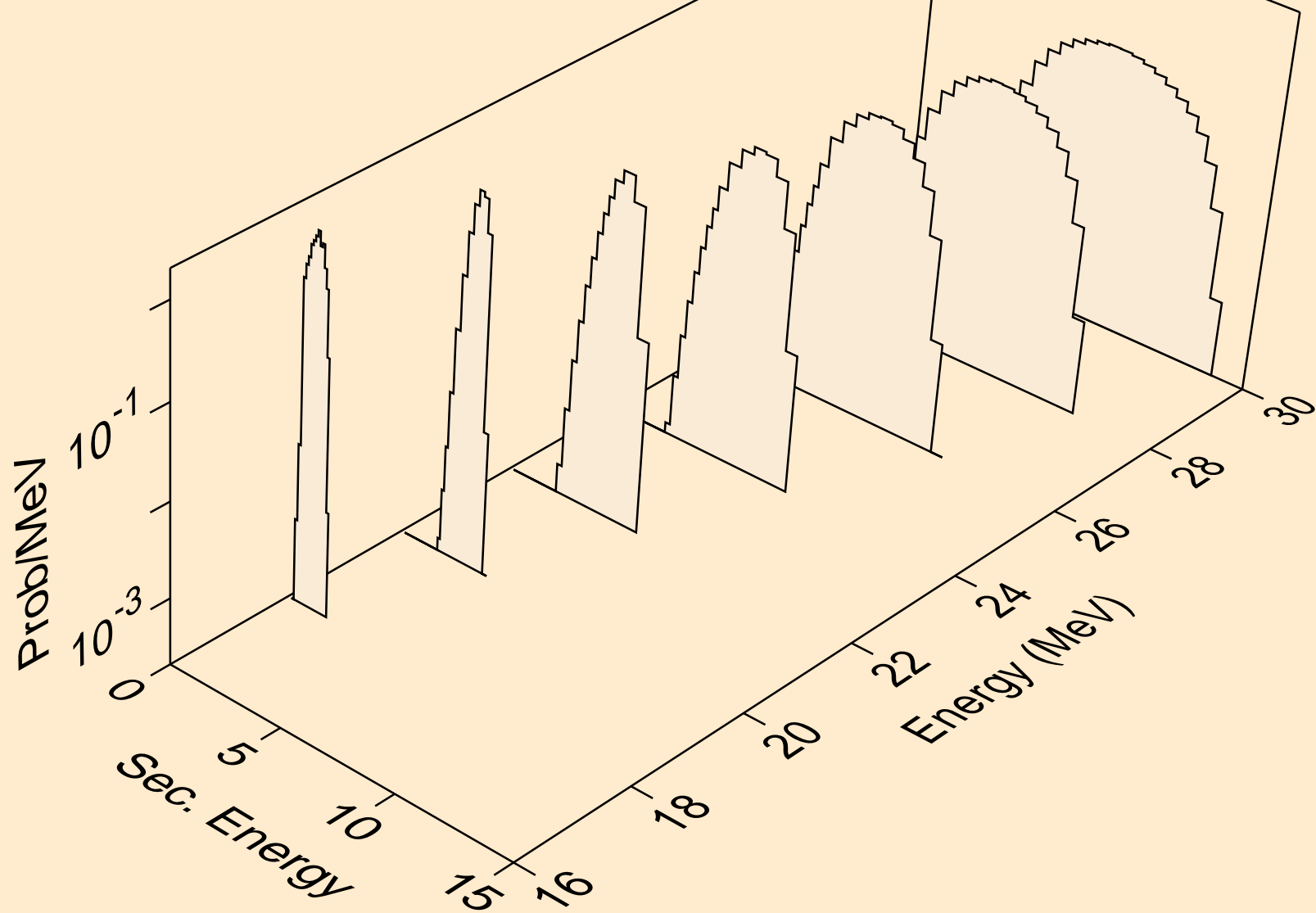

HF172 PROTON ACER TENDL-2023 LIBRARY; T=0.K  
Proton emission for (p,3np)

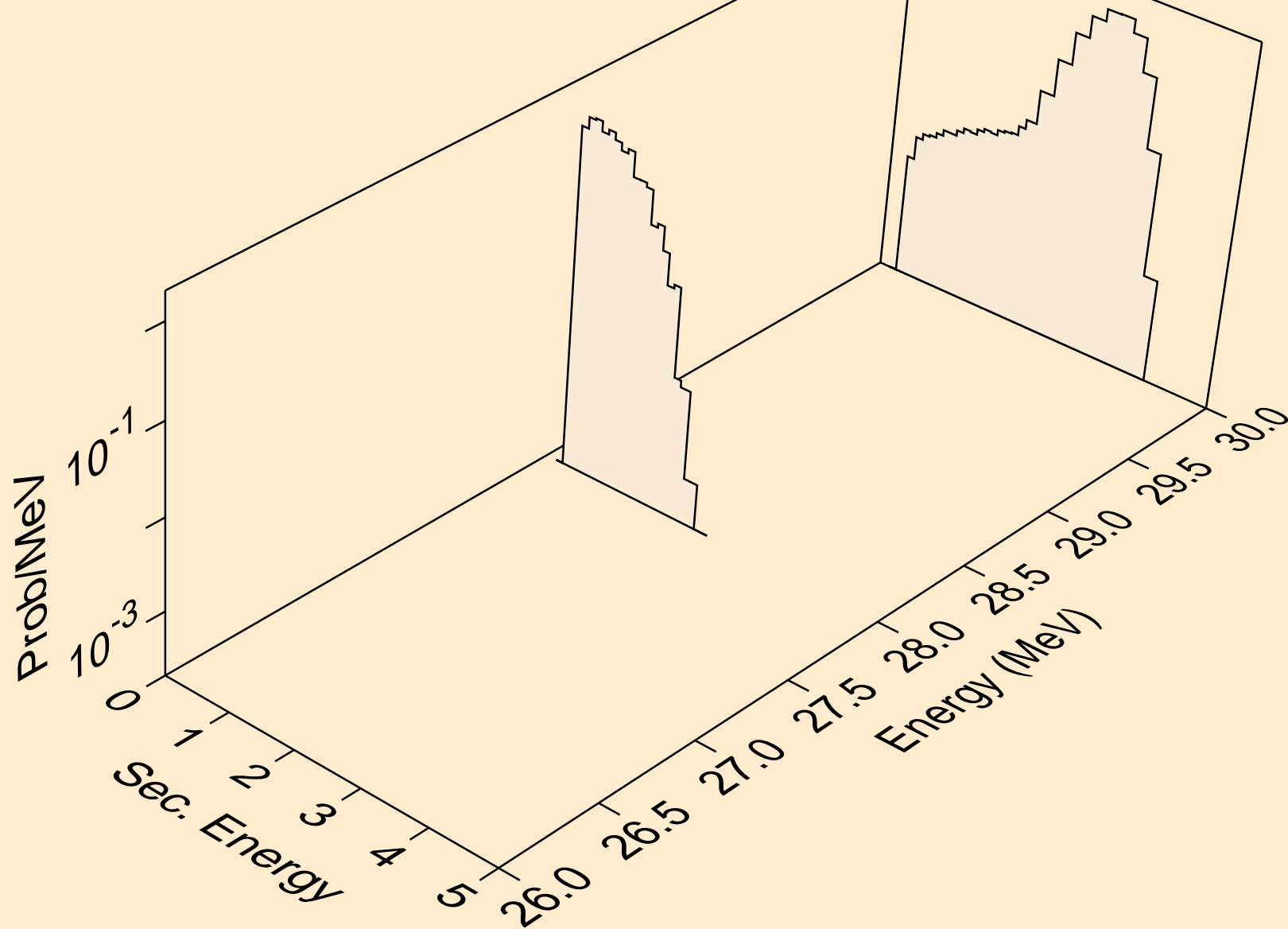

HF172 PROTON ACER TENDL-2023 LIBRARY; T=0.K  
Proton emission for (p,n2p)

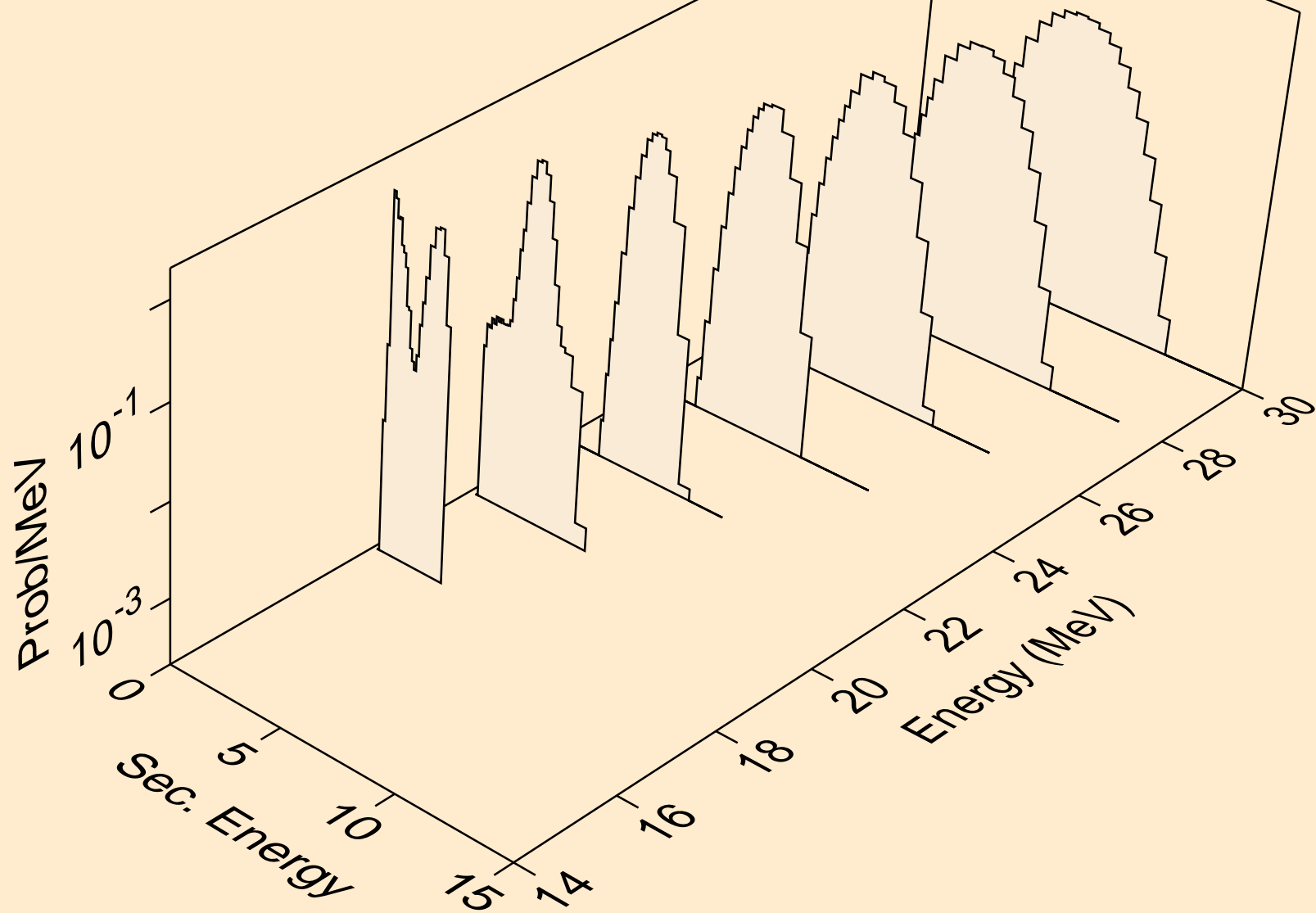

HF172 PROTON ACER TENDL-2023 LIBRARY; T=0.K  
Proton emission for (p,npa)

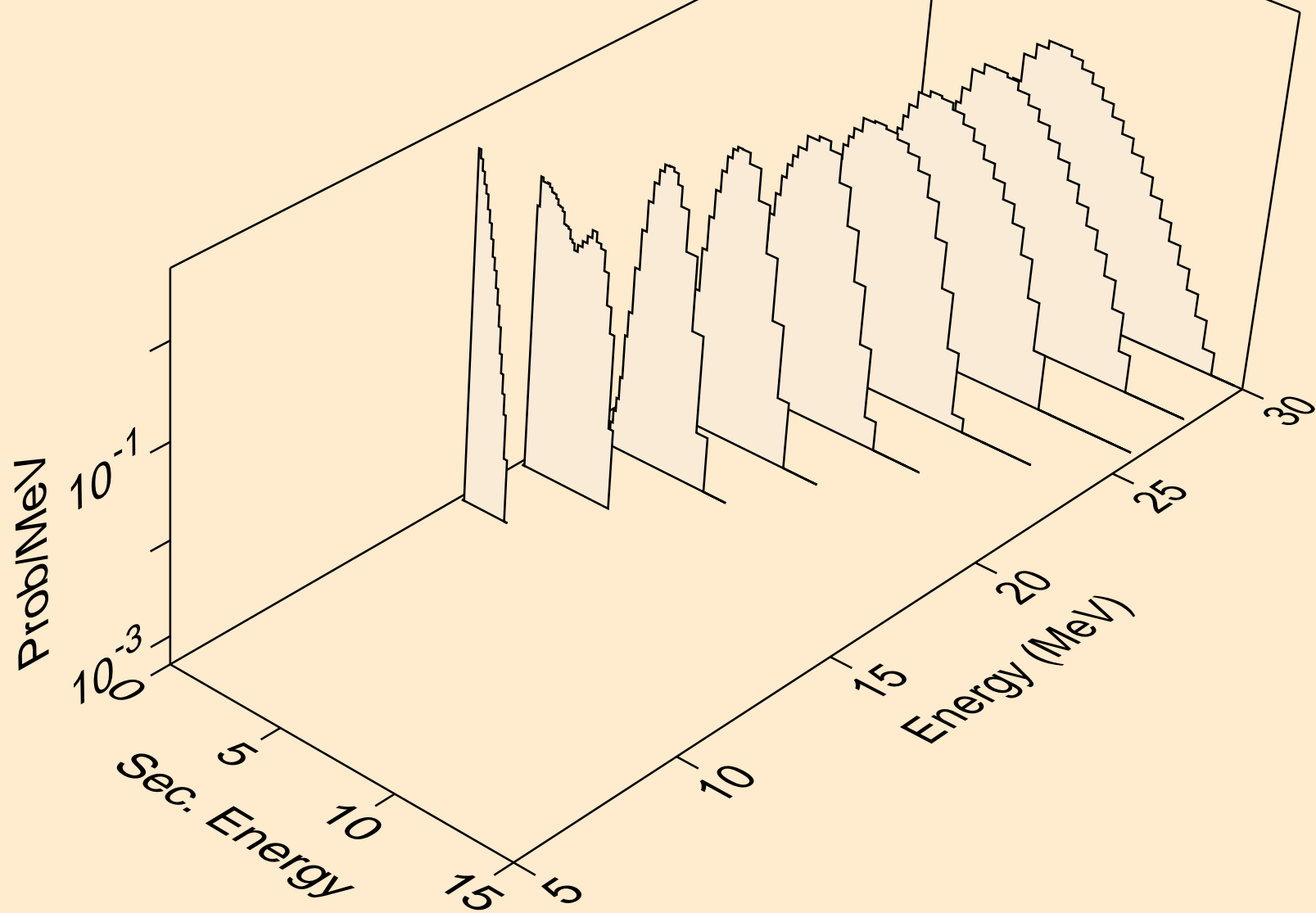

HF172 PROTON ACER TENDL-2023 LIBRARY; T=0.K  
Proton emission for inelastic

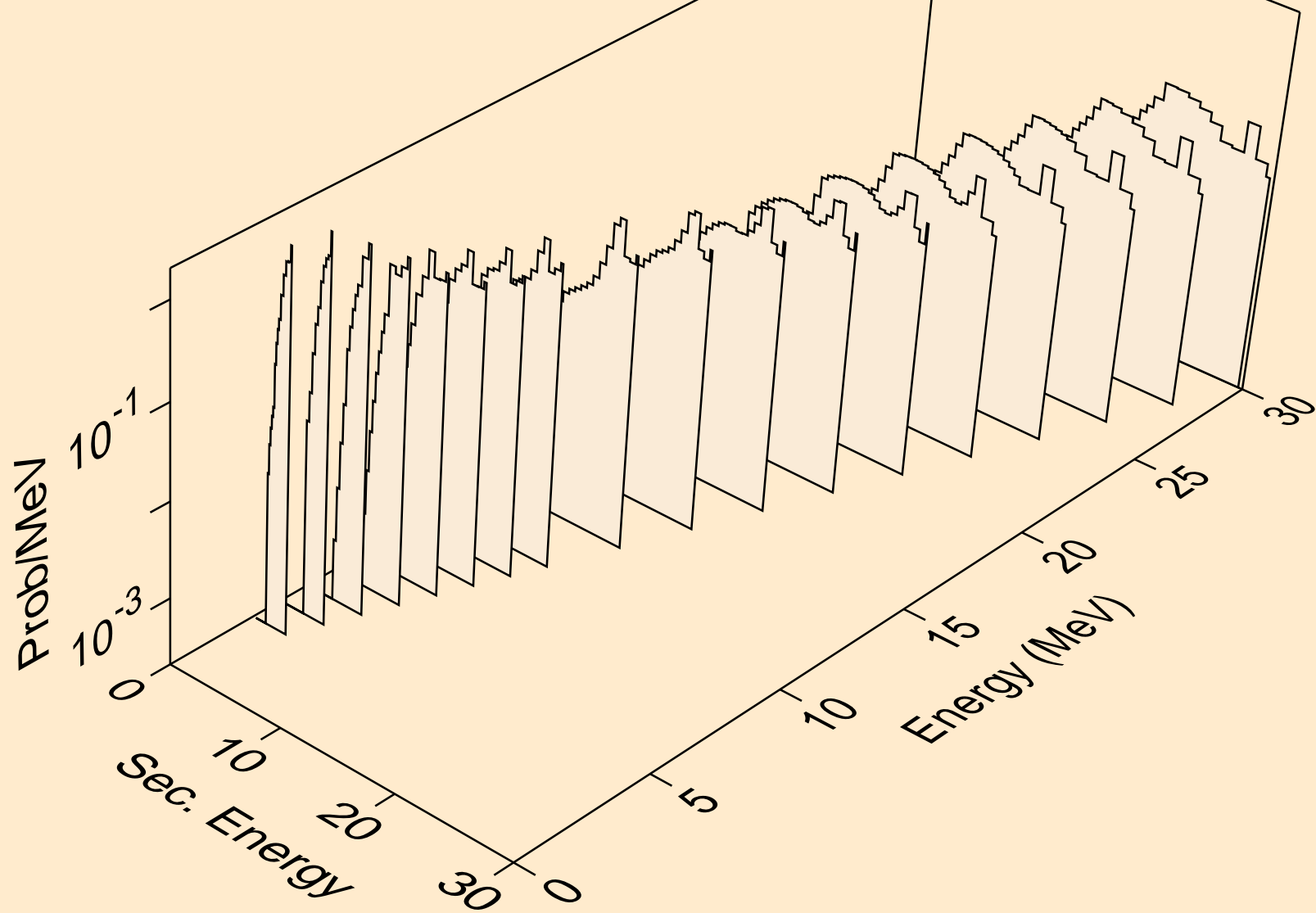



HF172 PROTON ACER TENDL-2023 LIBRARY; T=0.K  
Proton emission for (p,2p)

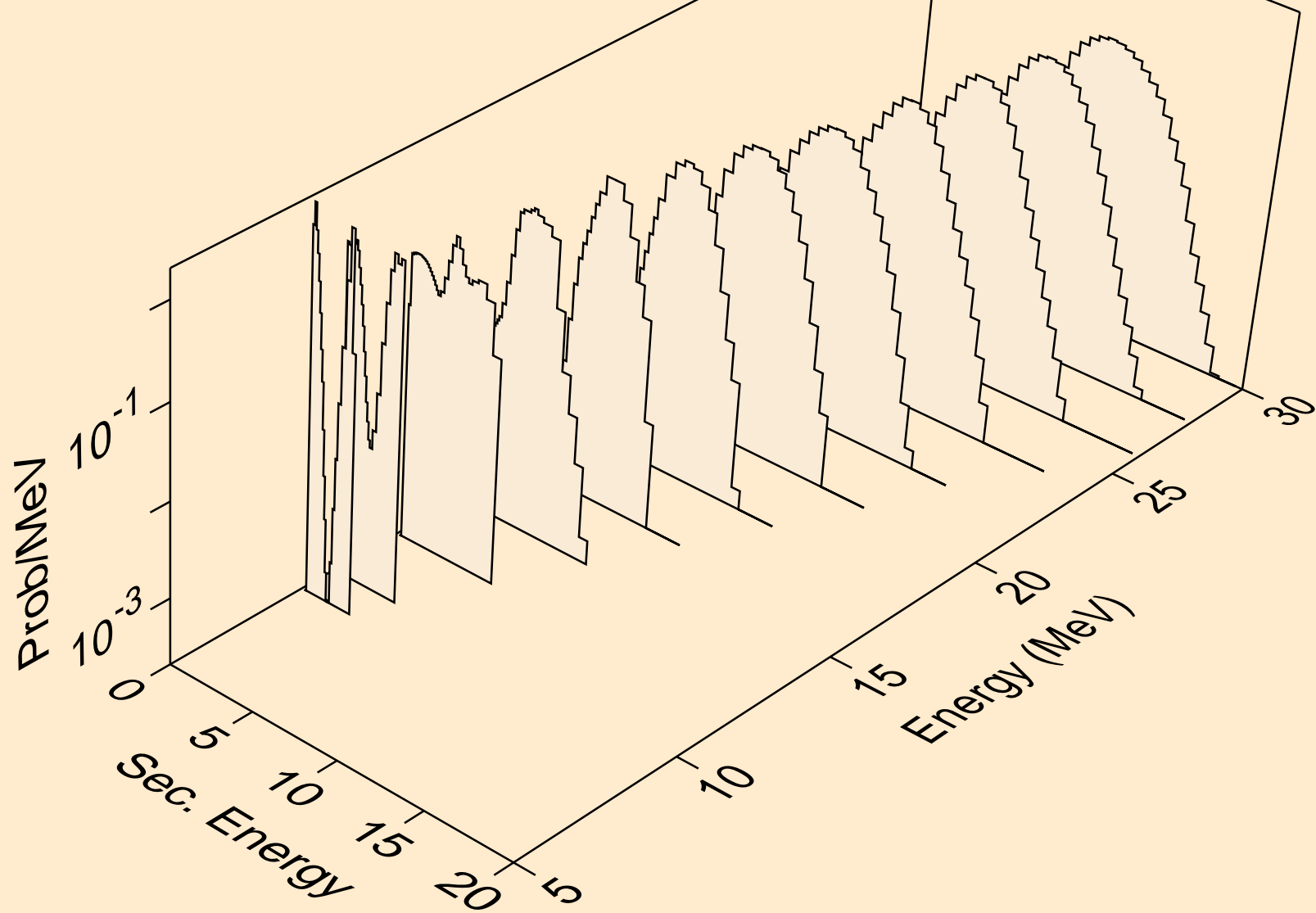

HF172 PROTON ACER TENDL-2023 LIBRARY; T=0.K  
Proton emission for (p,pa)

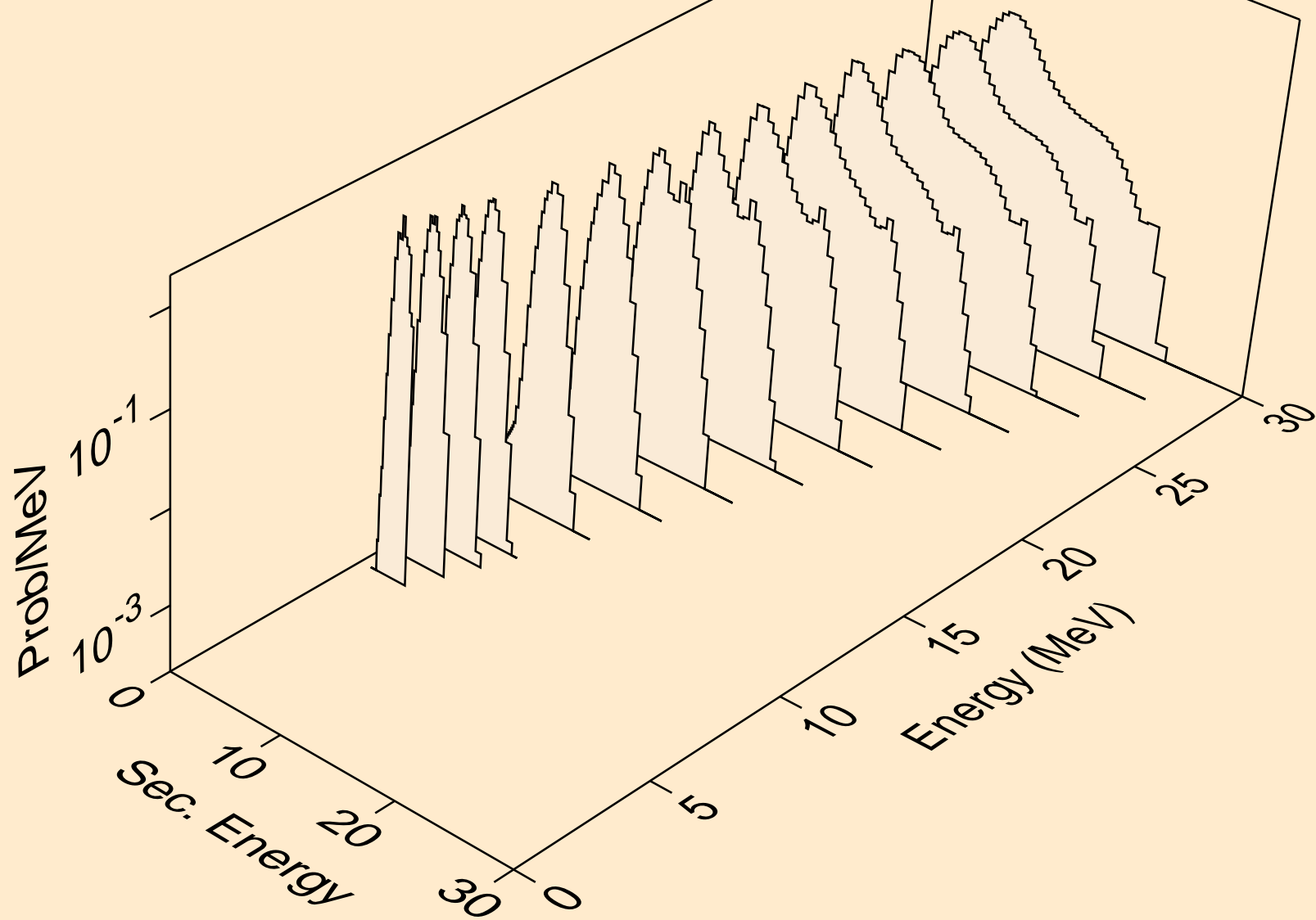

HF172 PROTON ACER TENDL-2023 LIBRARY; T=0.K  
Proton emission for (p,pd)

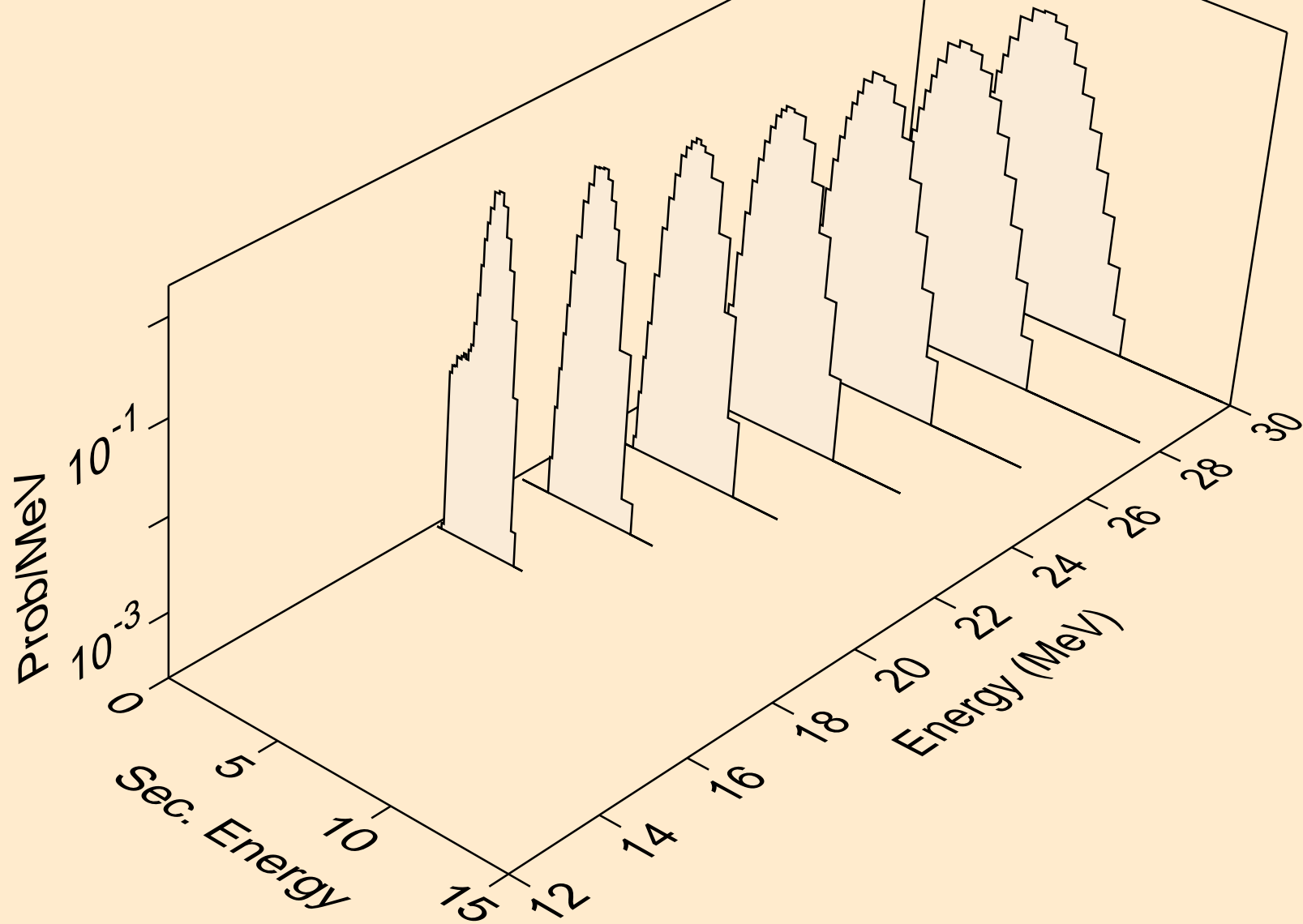

HF172 PROTON ACER TENDL-2023 LIBRARY; T=0.K  
Proton emission for (p,pt)

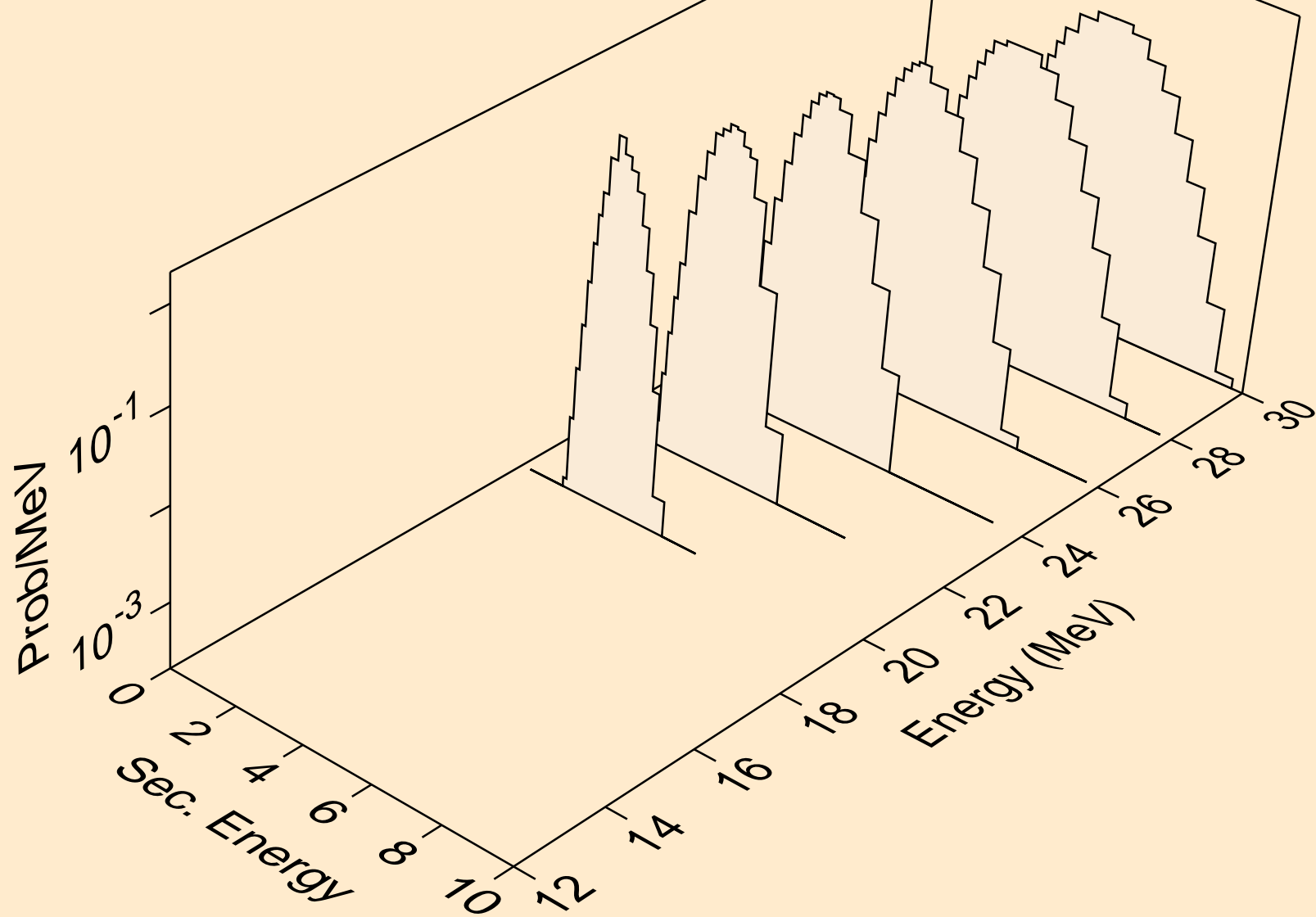

HF172 PROTON ACER TENDL-2023 LIBRARY; T=0.K  
Photon emission for (z,n)

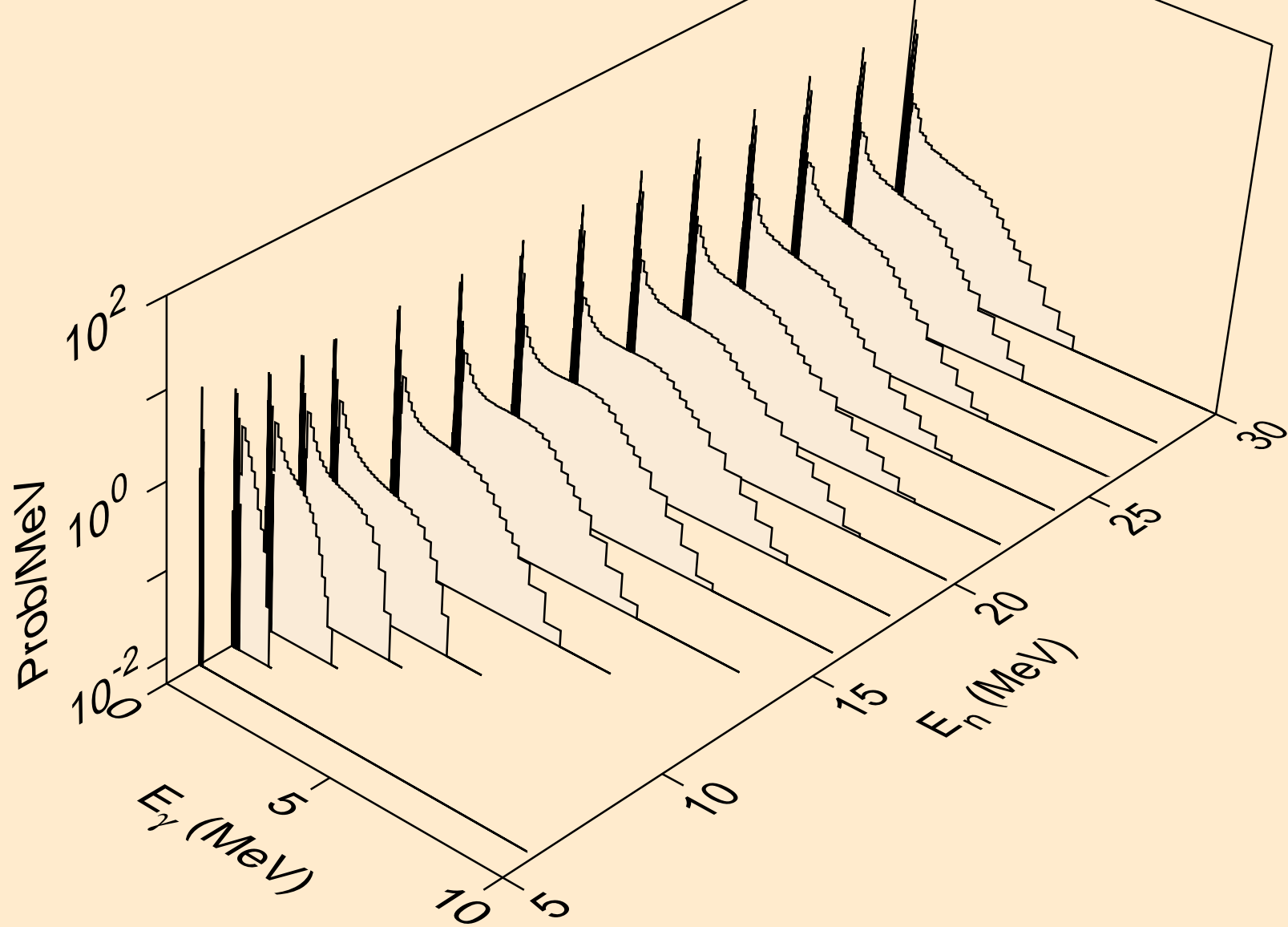

HF172 PROTON ACER TENDL-2023 LIBRARY; T=0.K  
Photon emission for (z,x)

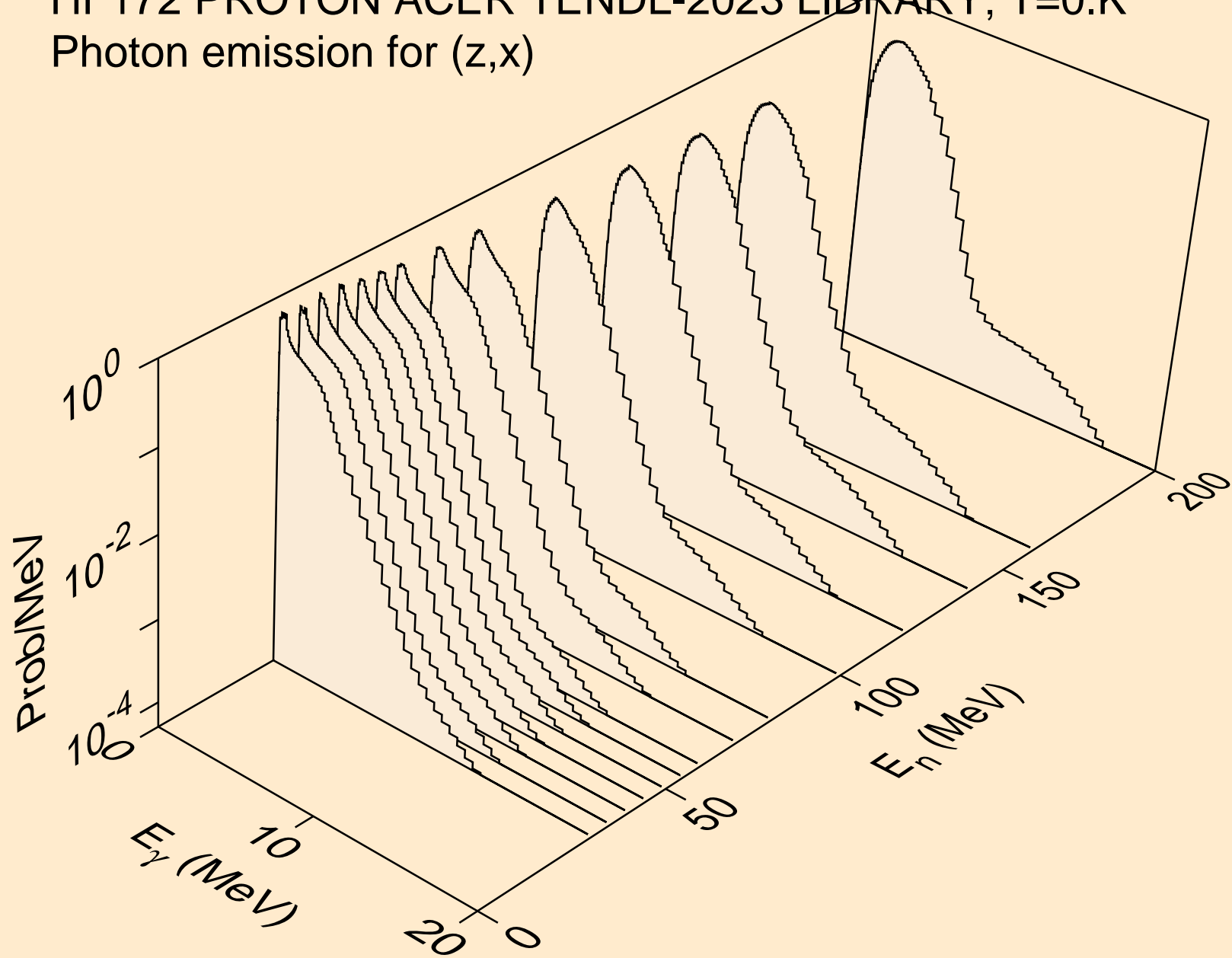

HF172 PROTON ACER TENDL-2023 LIBRARY; T=0.K  
Photon emission for (n,2nd)

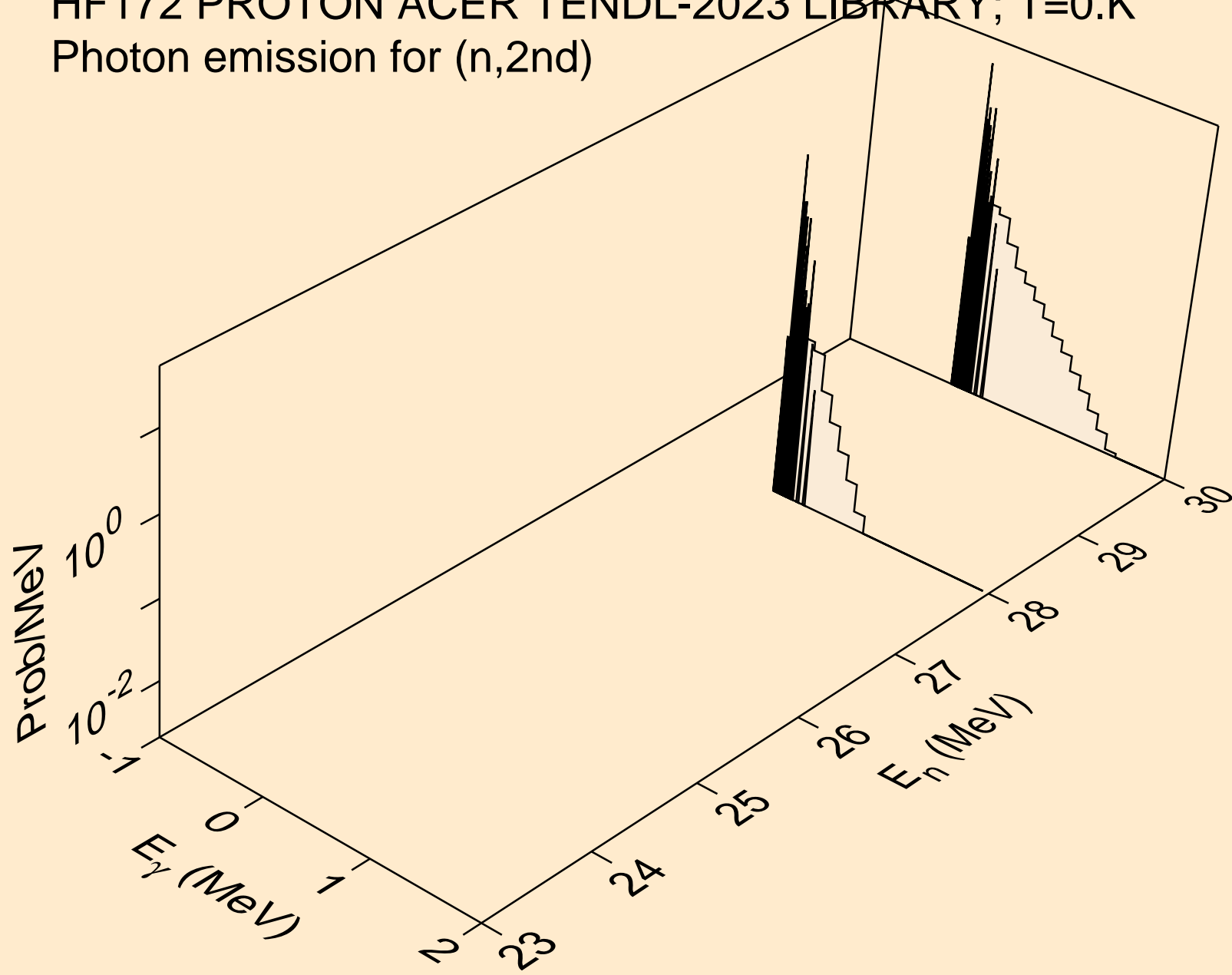

HF172 PROTON ACER TENDL-2023 LIBRARY; T=0.K  
Photon emission for (n,2n)

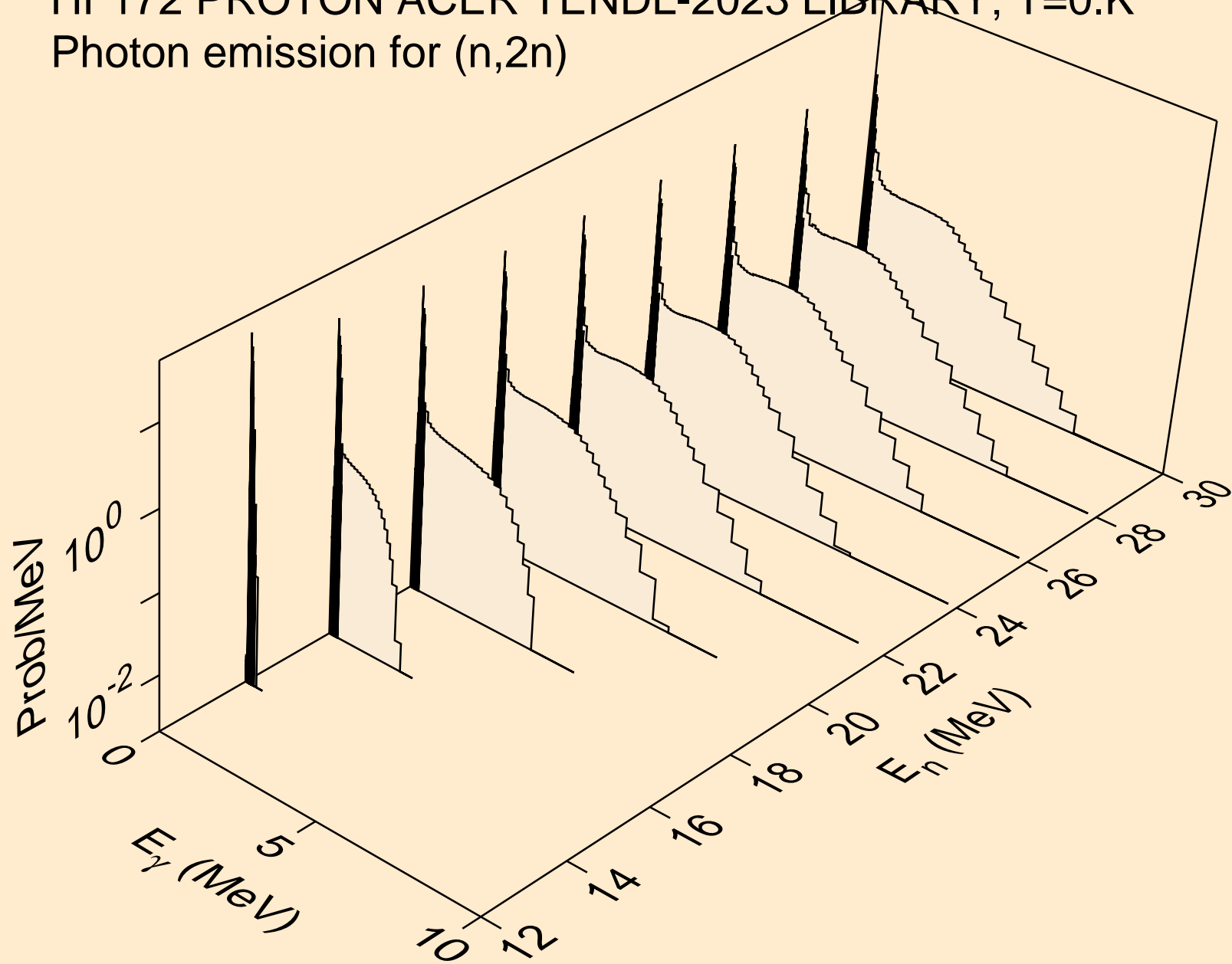



HF172 PROTON ACER TENDL-2023 LIBRARY; T=0.K  
Photon emission for (n,3n)

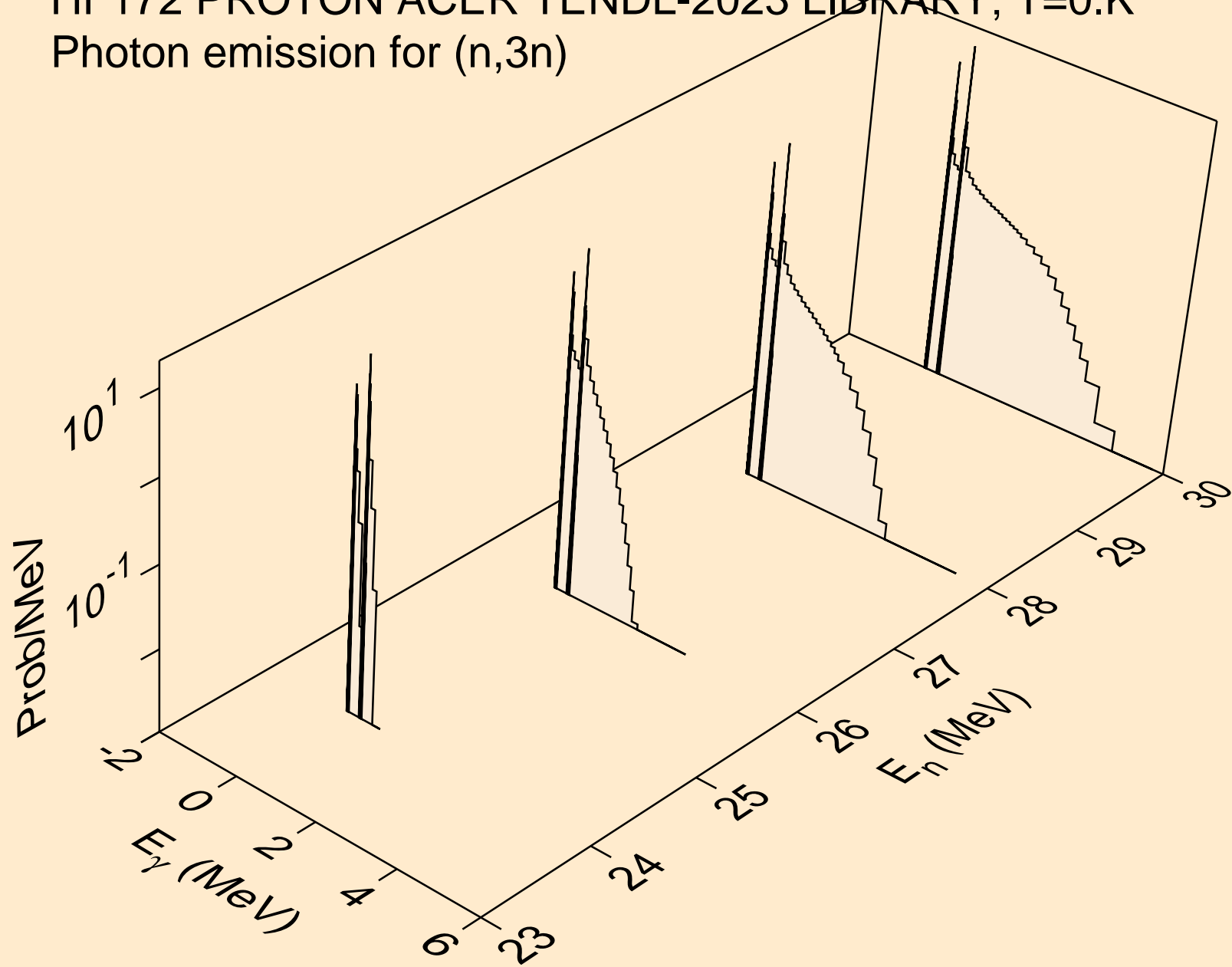

HF172 PROTON ACER TENDL-2023 LIBRARY; T=0.K  
Photon emission for (n,n\*)a

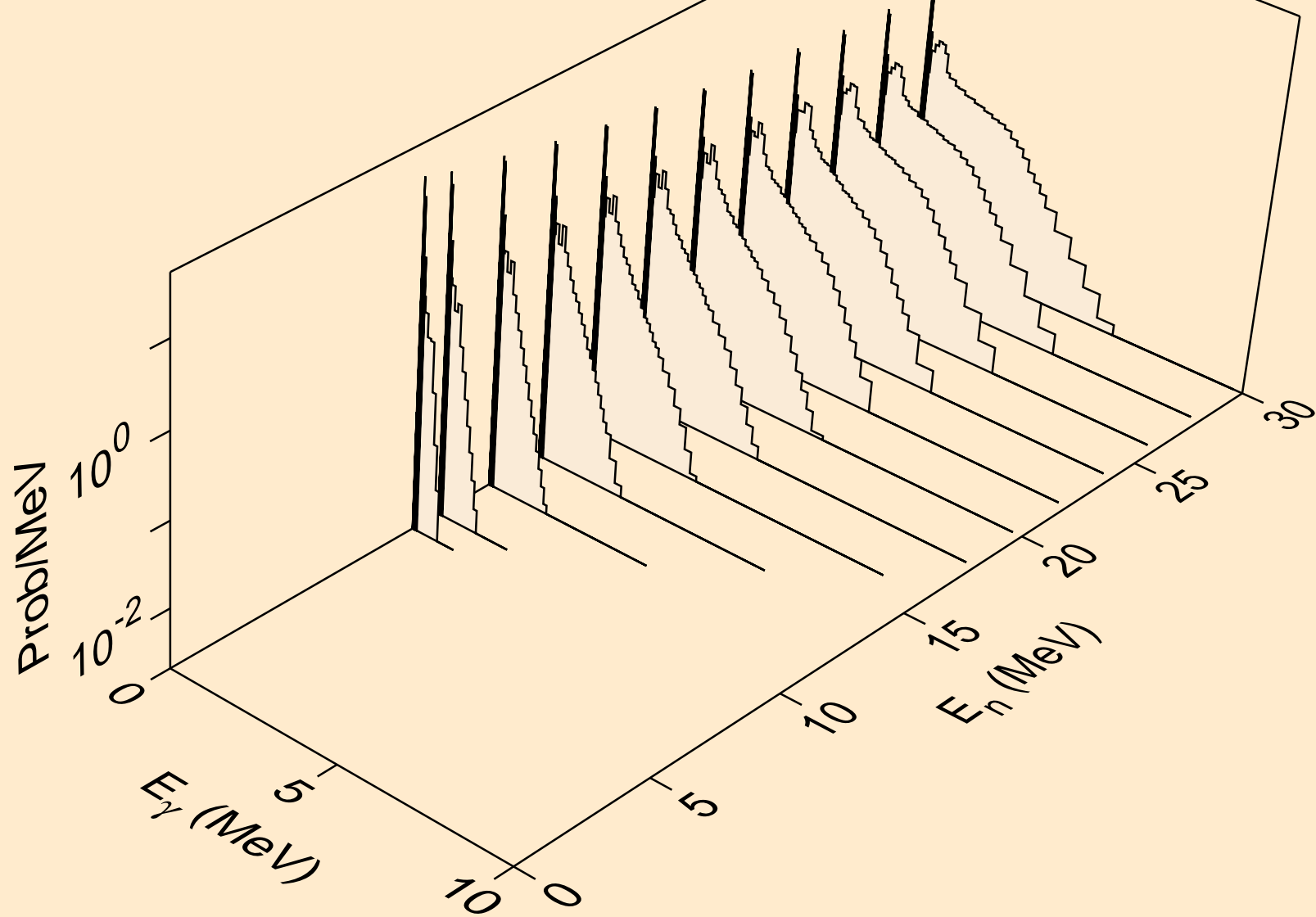

HF172 PROTON ACER TENDL-2023 LIBRARY; T=0.K  
Photon emission for (n,2n)a

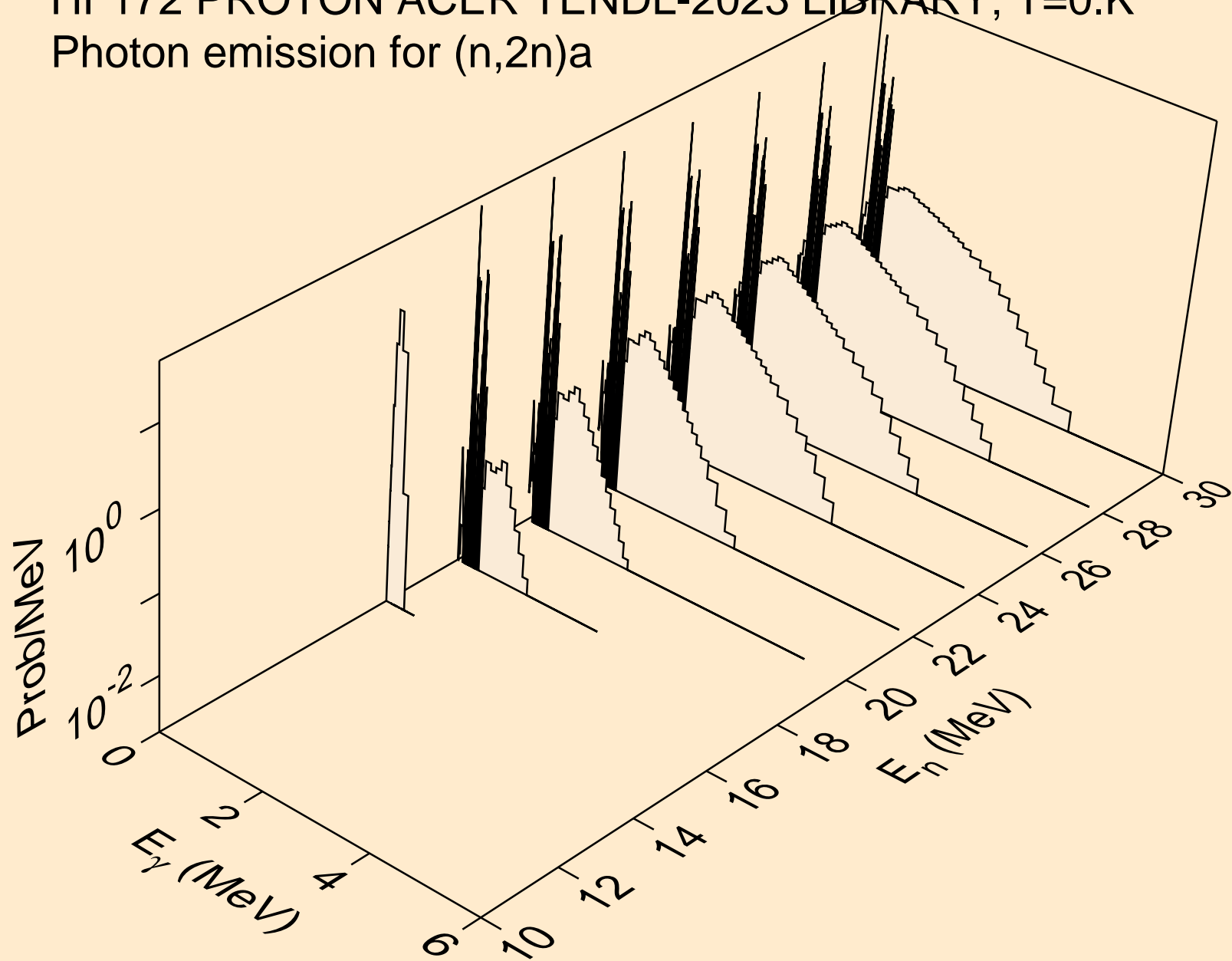

HF172 PROTON ACER TENDL-2023 LIBRARY; T=0.K  
Photon emission for (n,3n)a

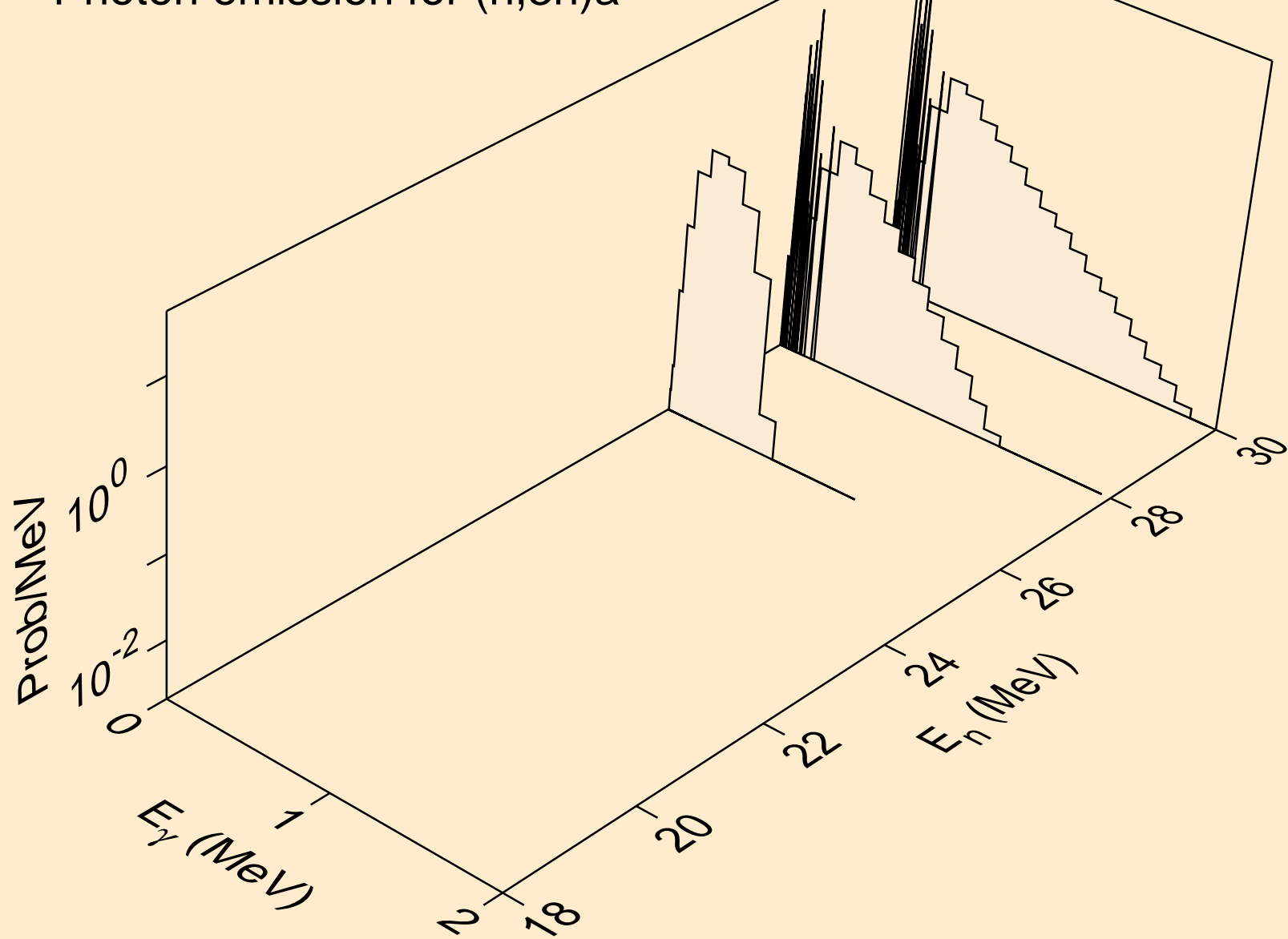

HF172 PROTON ACER TENDL-2023 LIBRARY; T=0.K  
Photon emission for (n,n\*)p

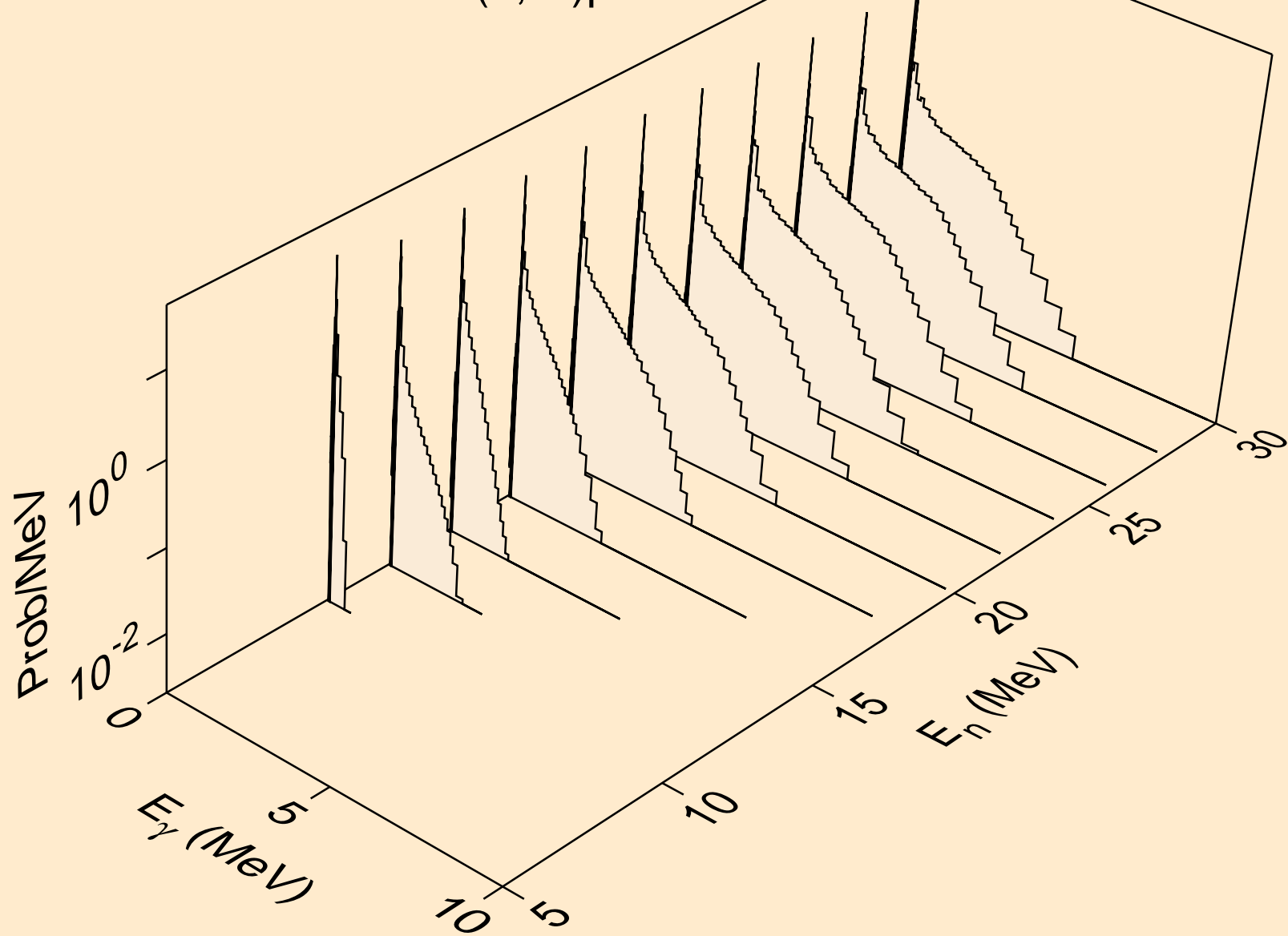

HF172 PROTON ACER TENDL-2023 LIBRARY; T=0.K  
Photon emission for (n,n\*)2a

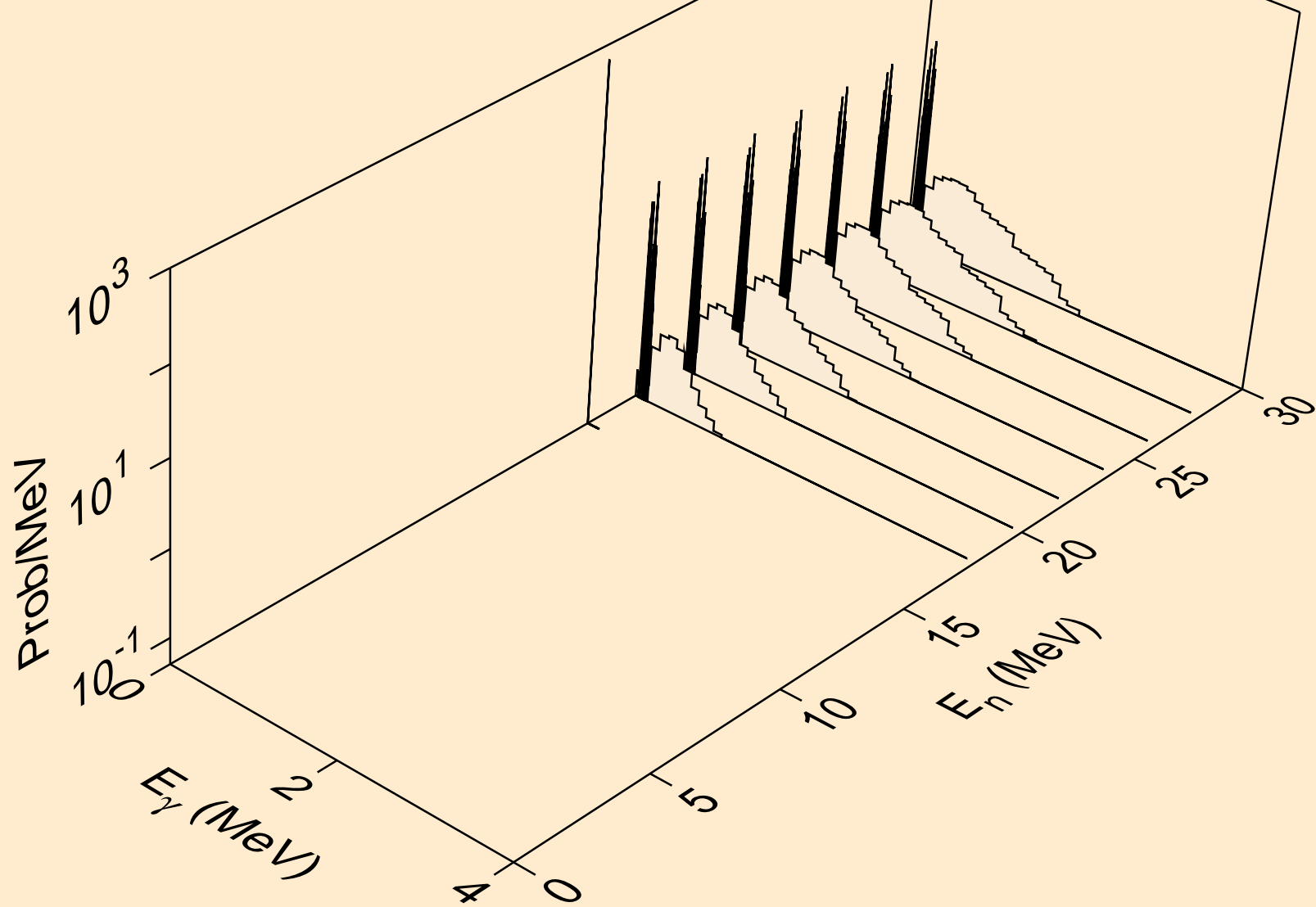

HF172 PROTON ACER TENDL-2023 LIBRARY; T=0.K  
Photon emission for (n,n\*)d

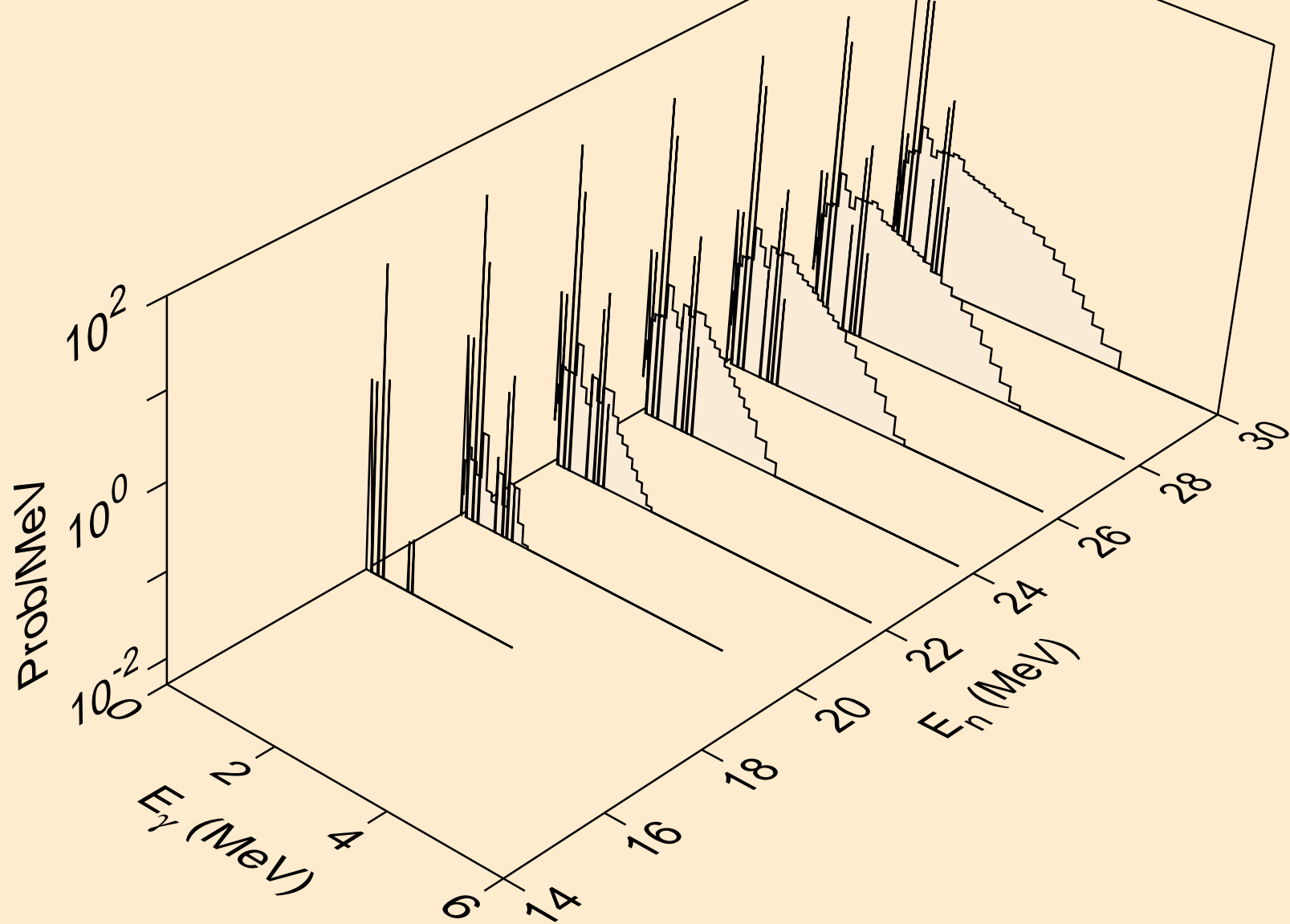

HF172 PROTON ACER TENDL-2023 LIBRARY; T=0.K  
Photon emission for (n,n\*)t

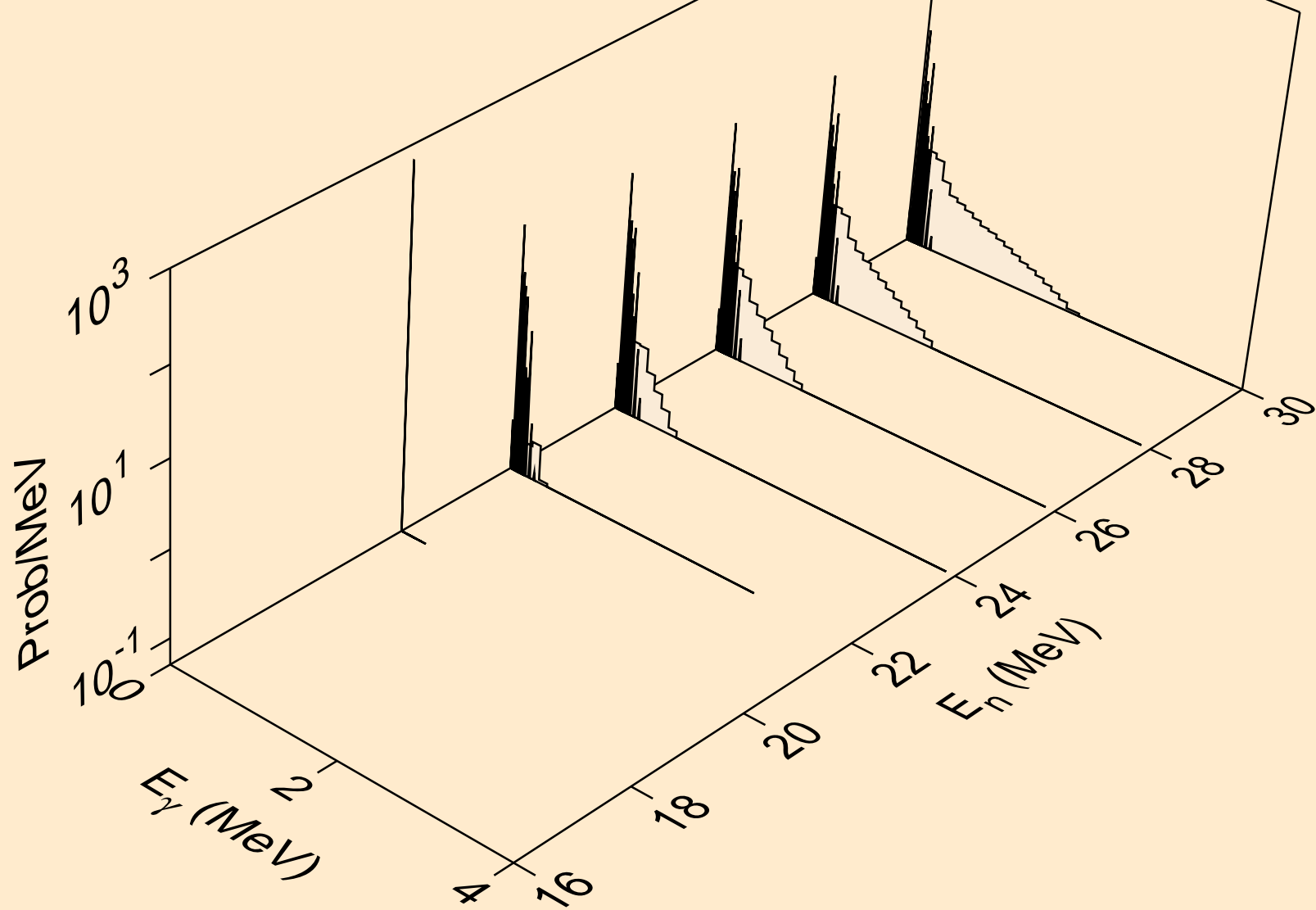



HF172 PROTON ACER TENDL-2023 LIBRARY; T=0.K  
Photon emission for (n,n\*)he3

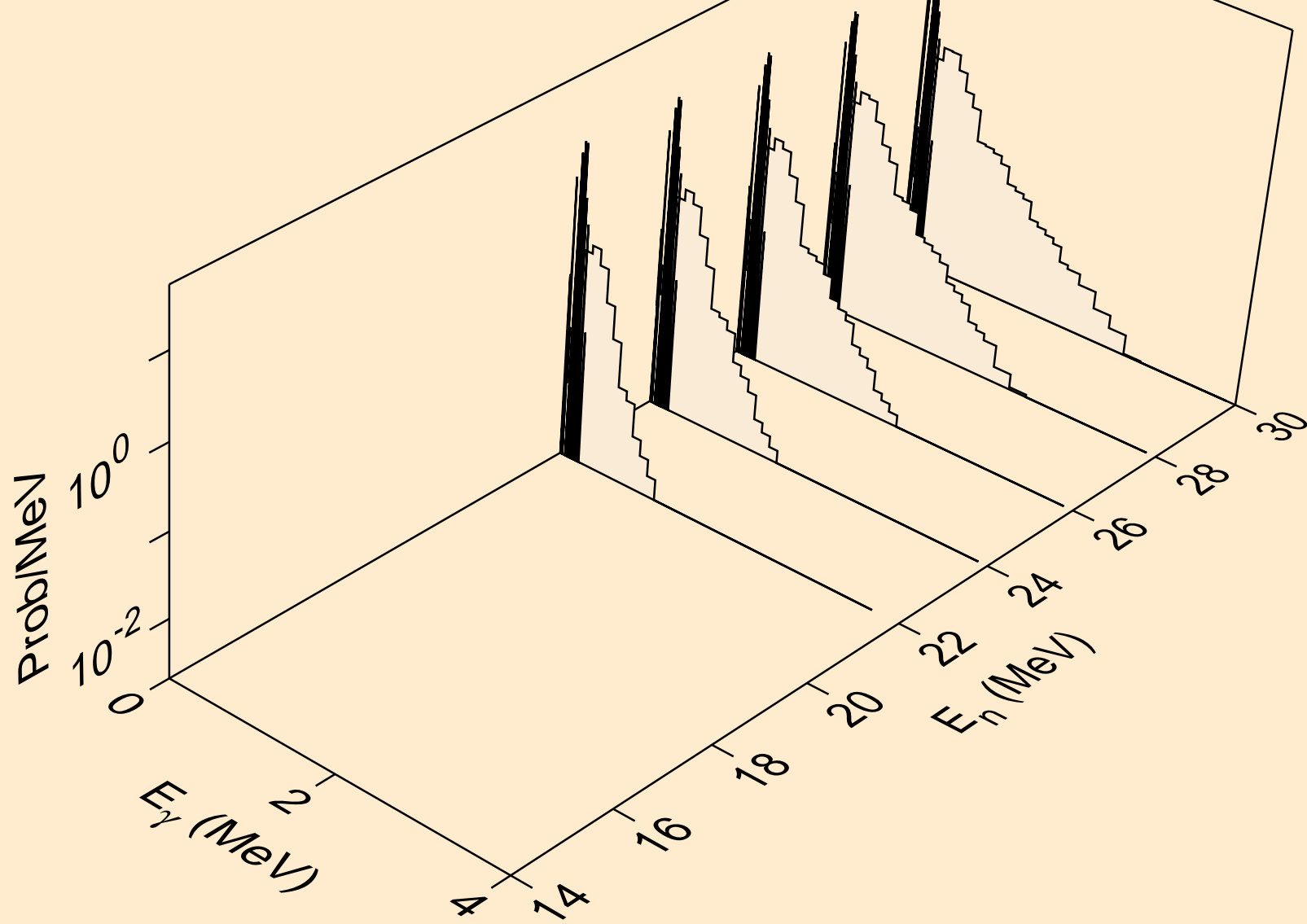

HF172 PROTON ACER TENDL-2023 LIBRARY; T=0.K  
Photon emission for (n,2np)

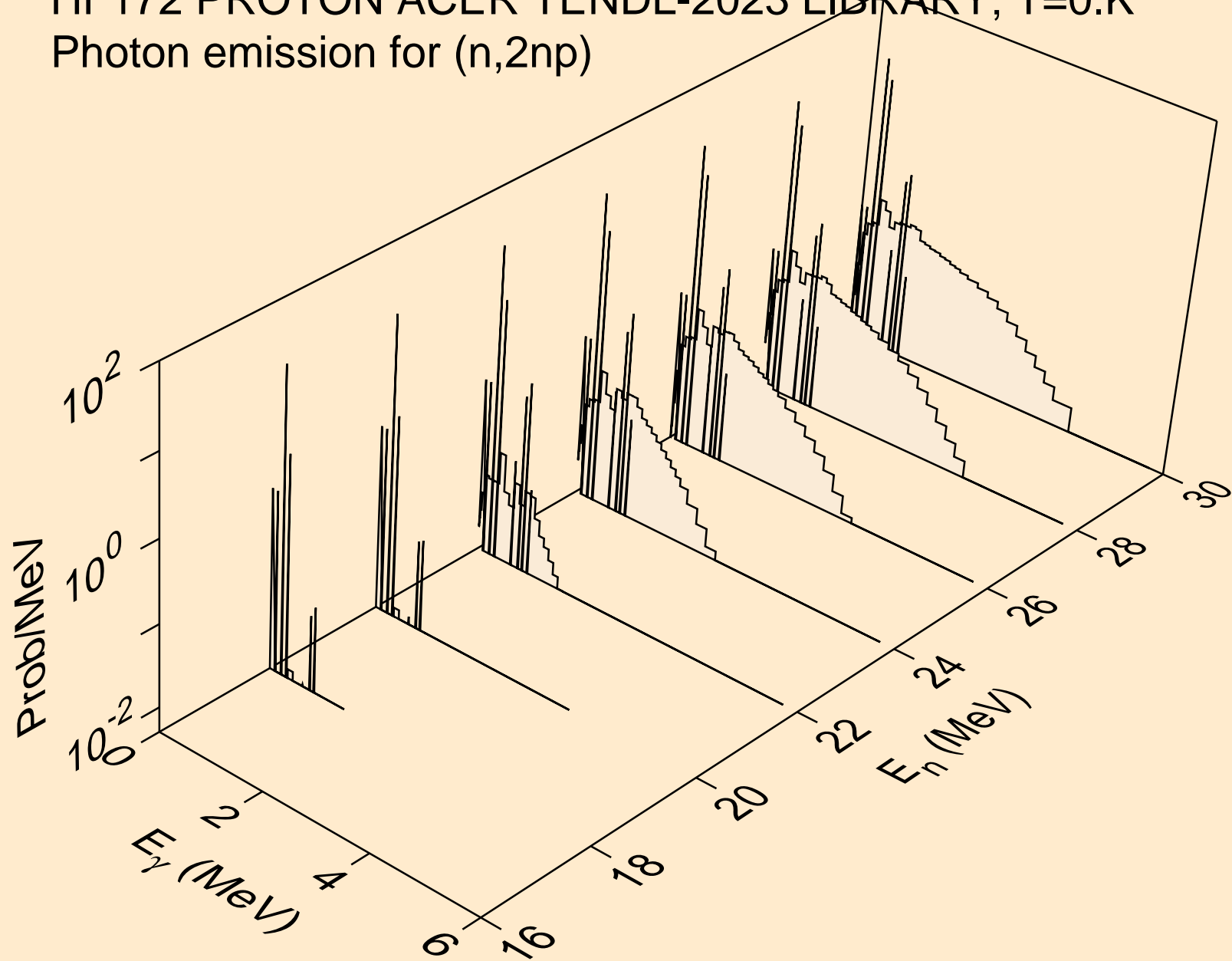

HF172 PROTON ACER TENDL-2023 LIBRARY; T=0.K  
Photon emission for (n,3np)

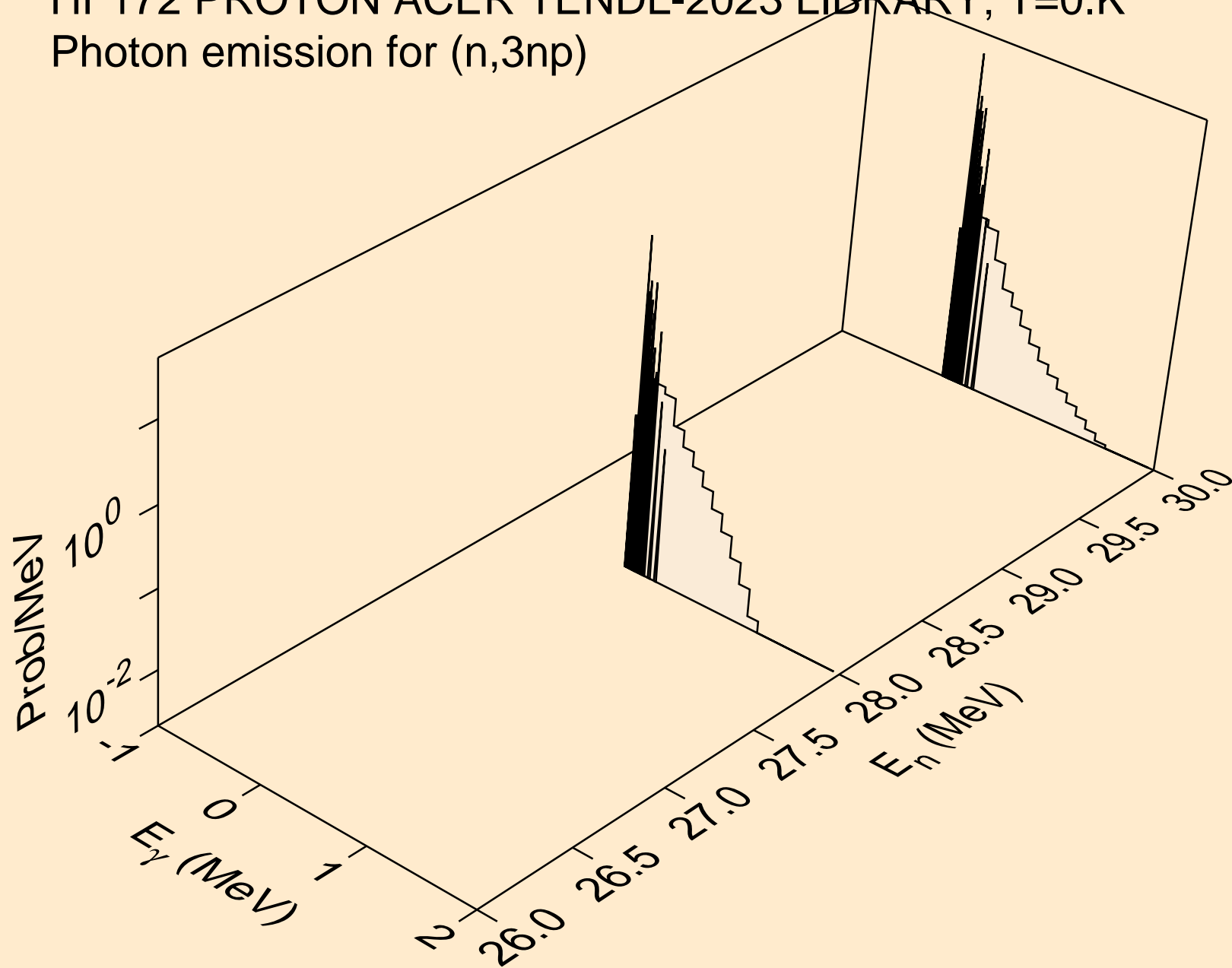

HF172 PROTON ACER TENDL-2023 LIBRARY; T=0.K  
Photon emission for (n,n2p)

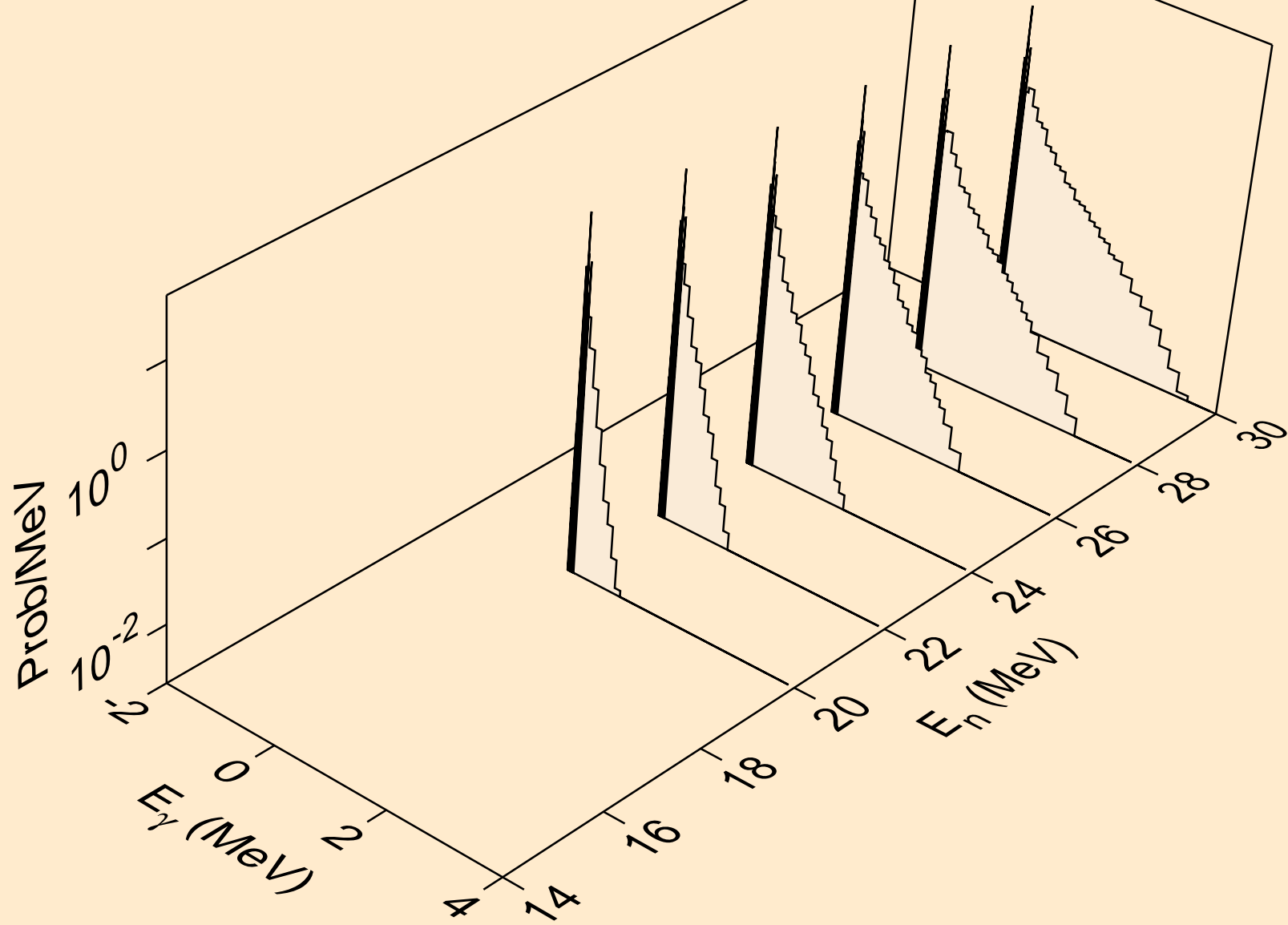

HF172 PROTON ACER TENDL-2023 LIBRARY; T=0.K  
Photon emission for (n,npa)

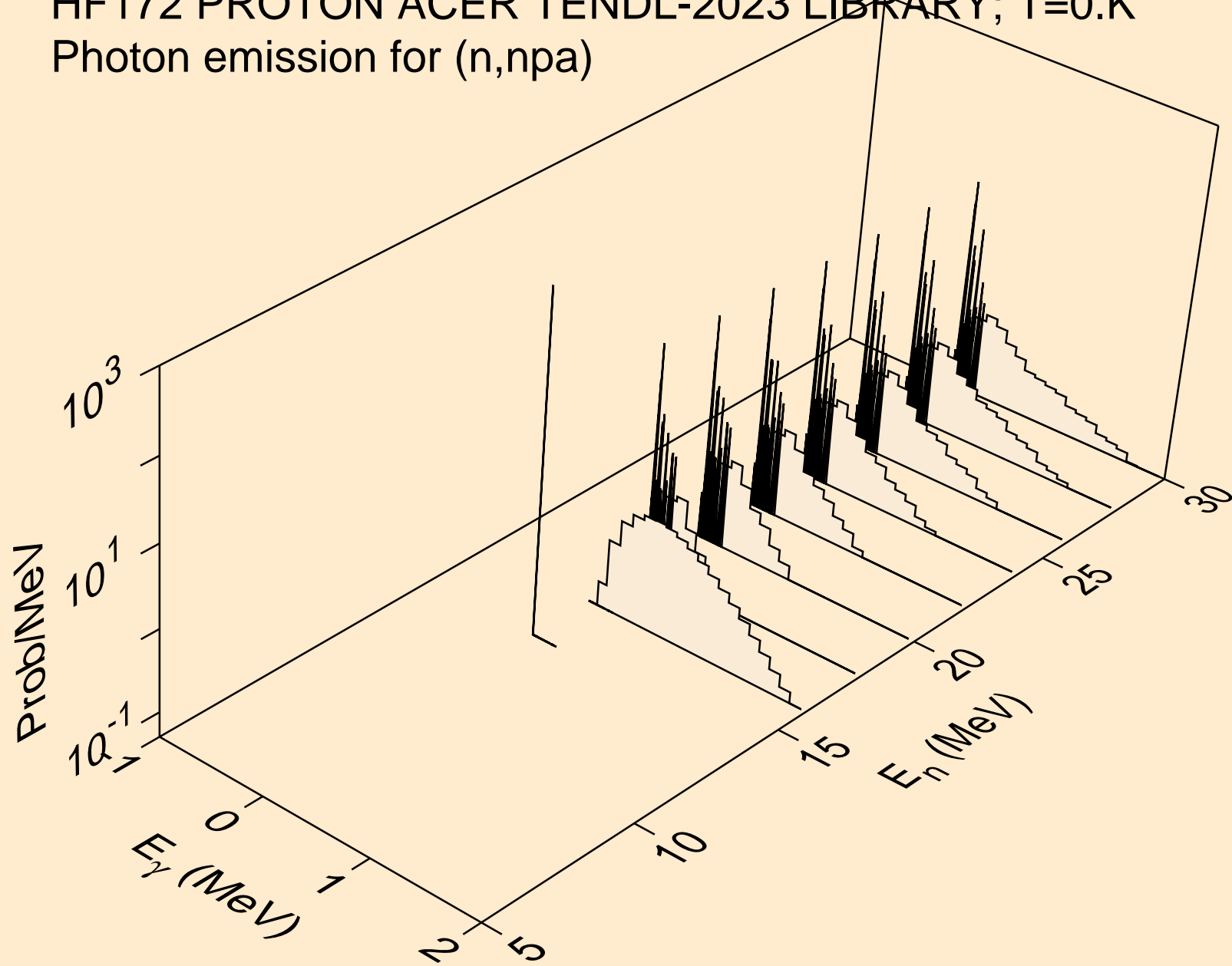

HF172 PROTON ACER TENDL-2023 LIBRARY; T=0.K  
Photon emission for (n,gma)

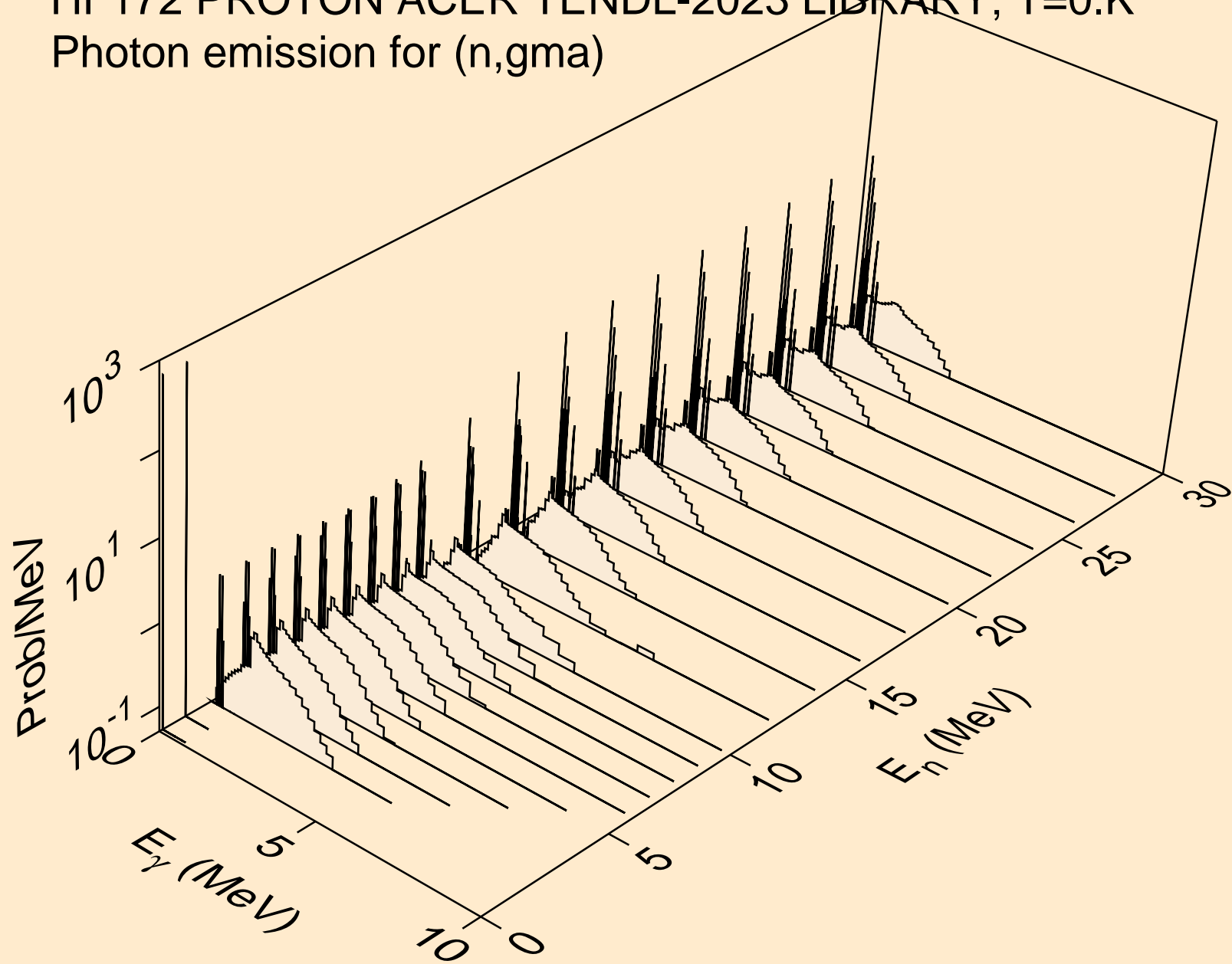

HF172 PROTON ACER TENDL-2023 LIBRARY; T=0.K  
Photon emission for inelastic

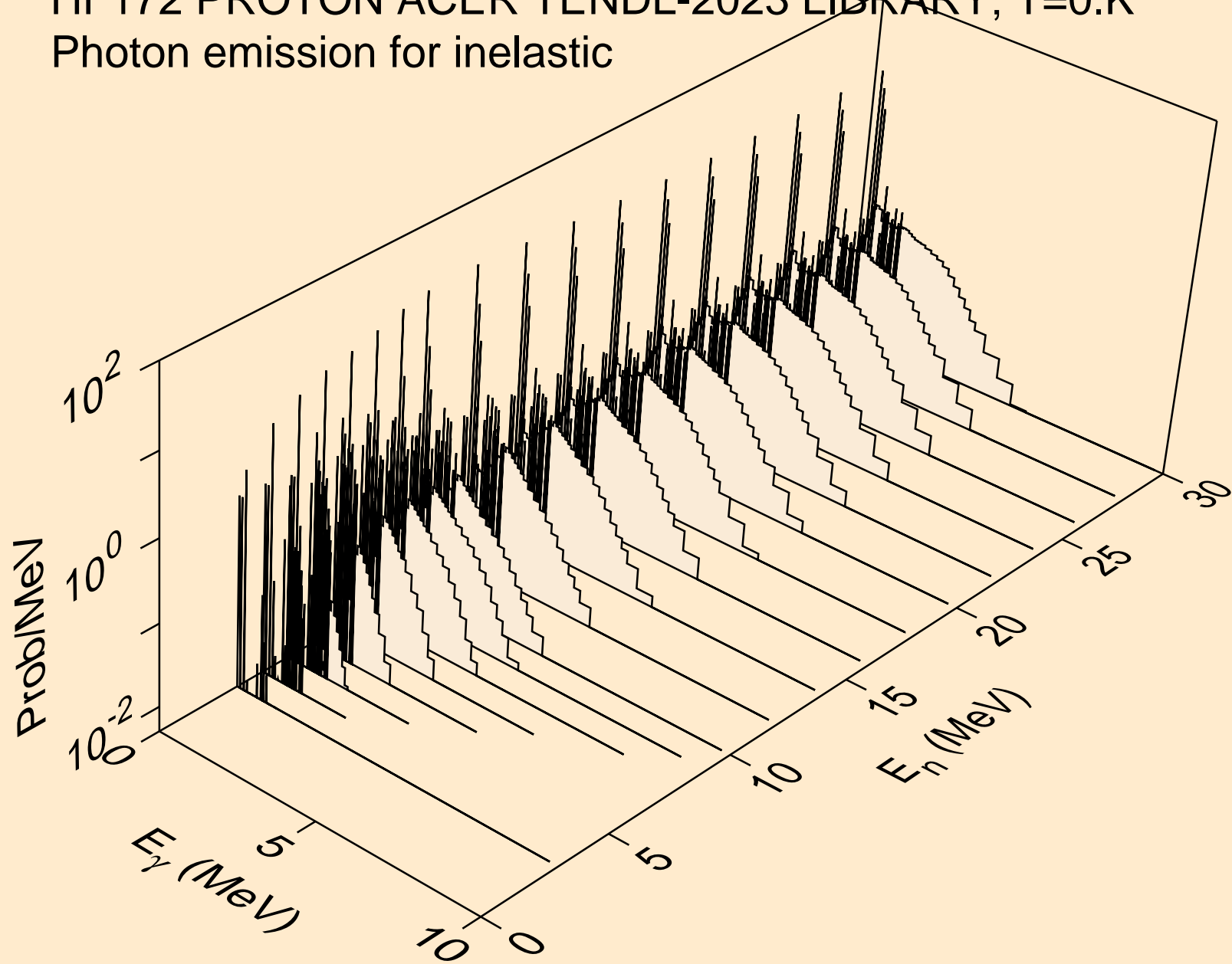

HF172 PROTON ACER TENDL-2023 LIBRARY; T=0.K  
Photon emission for (n,d)

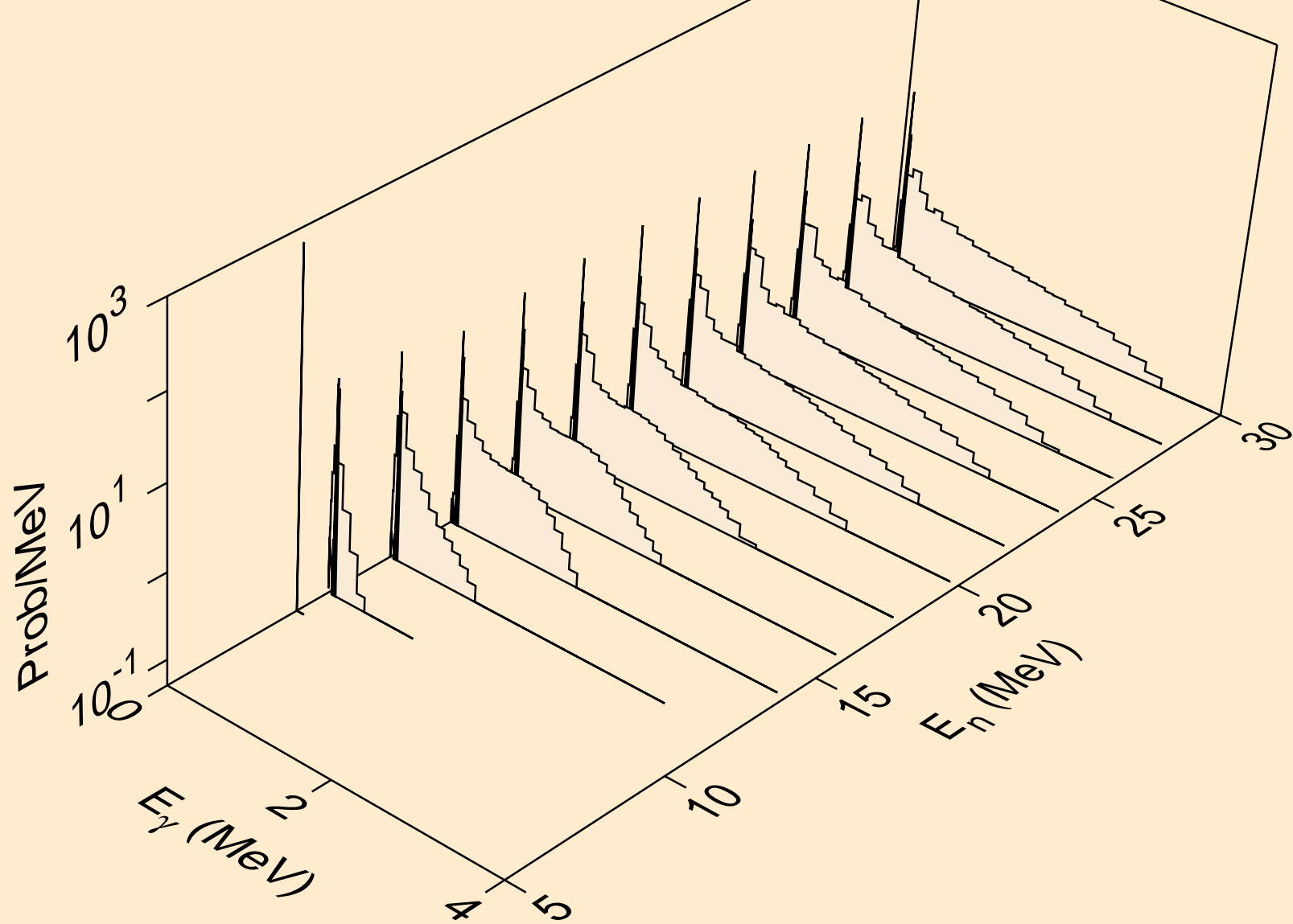



HF172 PROTON ACER TENDL-2023 LIBRARY; T=0.K  
Photon emission for (n,t)

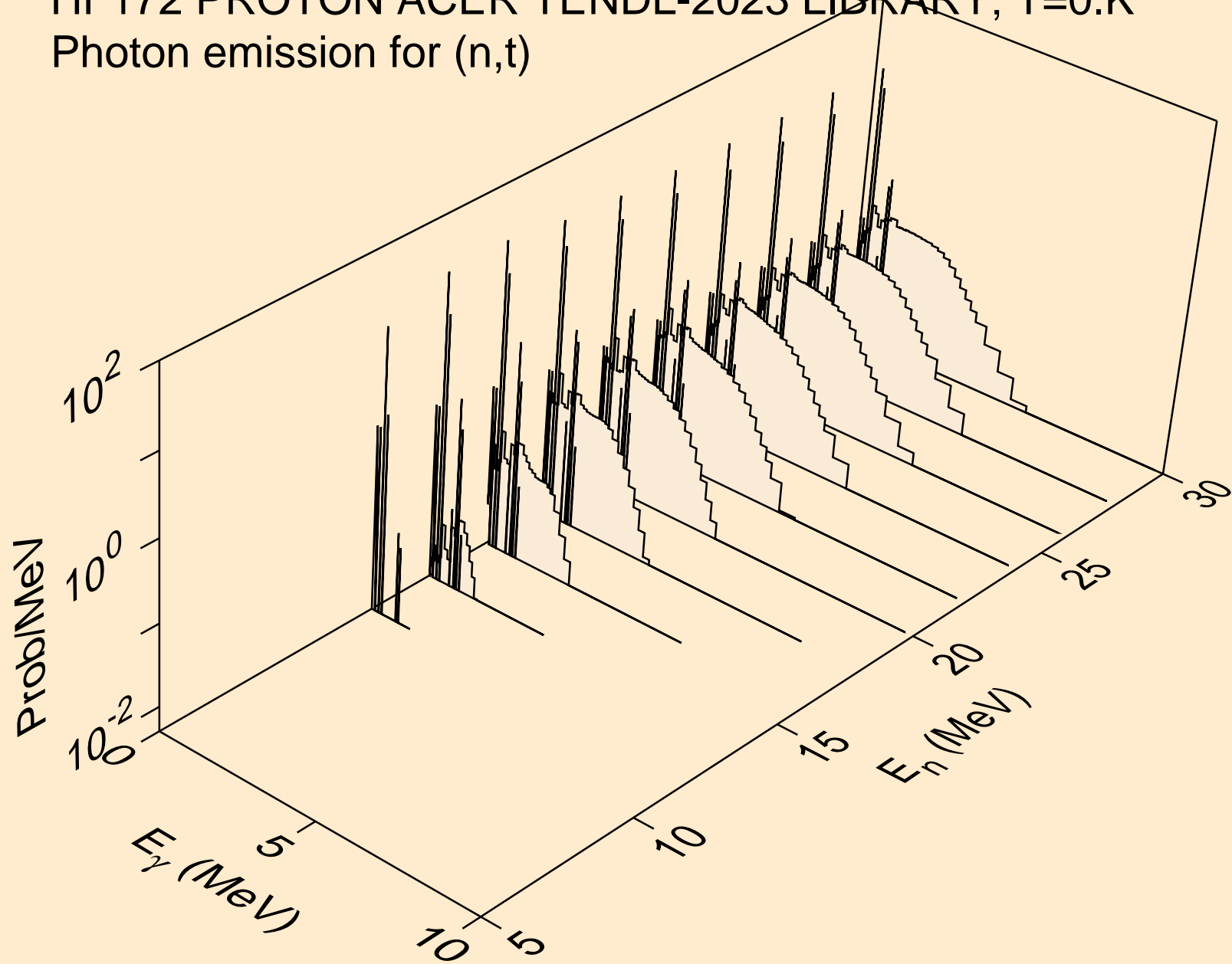

HF172 PROTON ACER TENDL-2023 LIBRARY; T=0.K  
Photon emission for (n,he3)

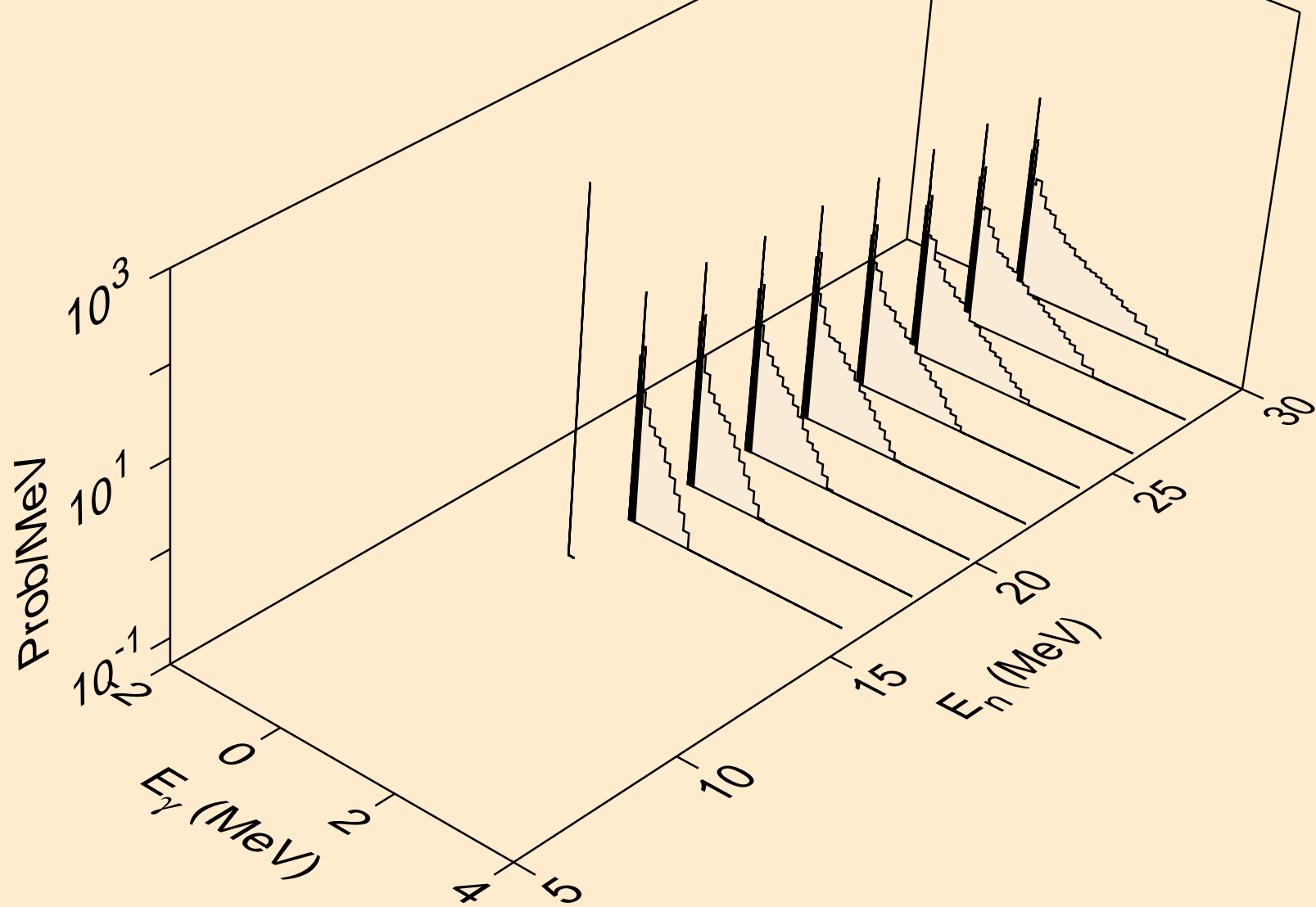

HF172 PROTON ACER TENDL-2023 LIBRARY; T=0.K  
Photon emission for (n,a)

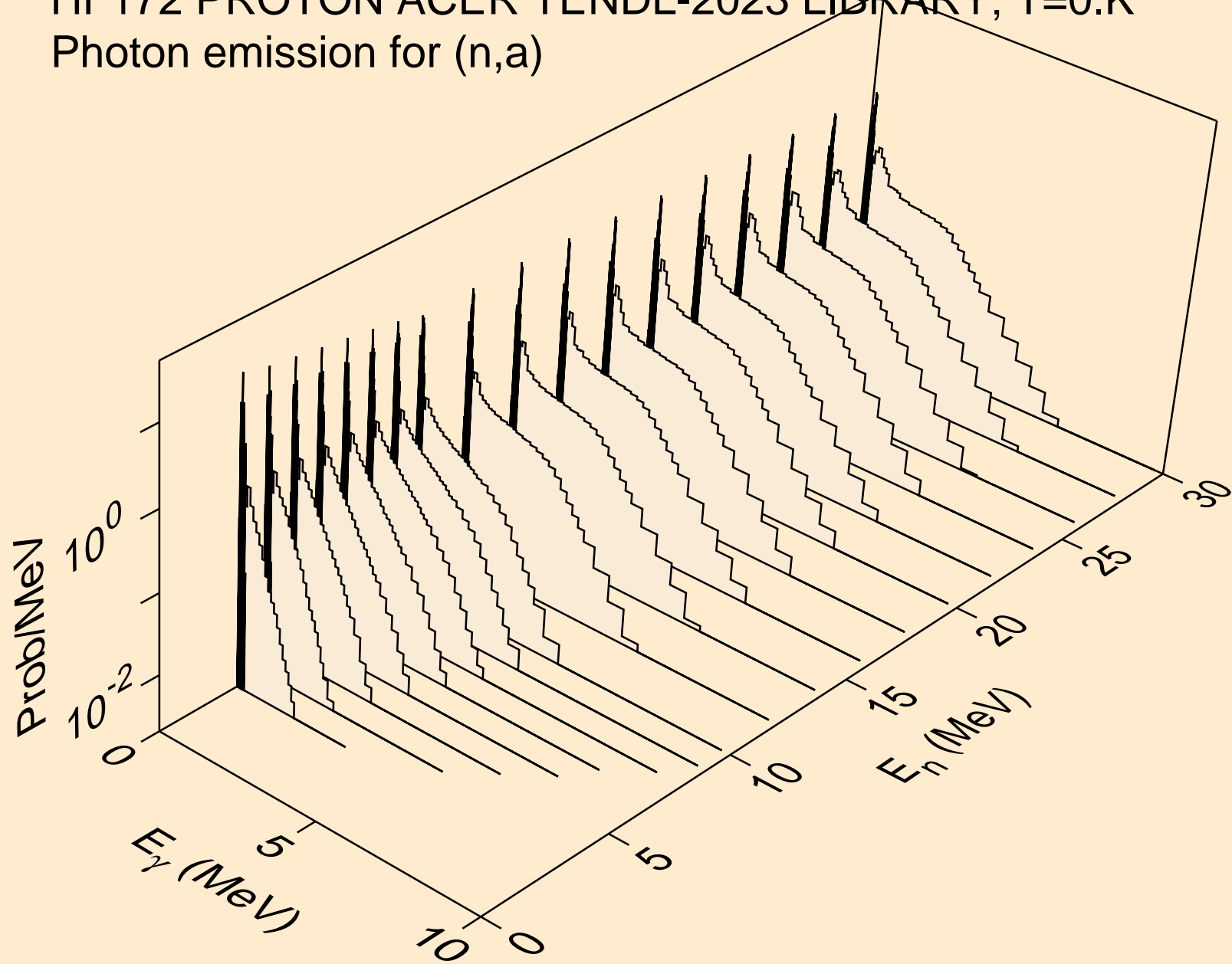

HF172 PROTON ACER TENDL-2023 LIBRARY; T=0.K  
Photon emission for (n,2a)

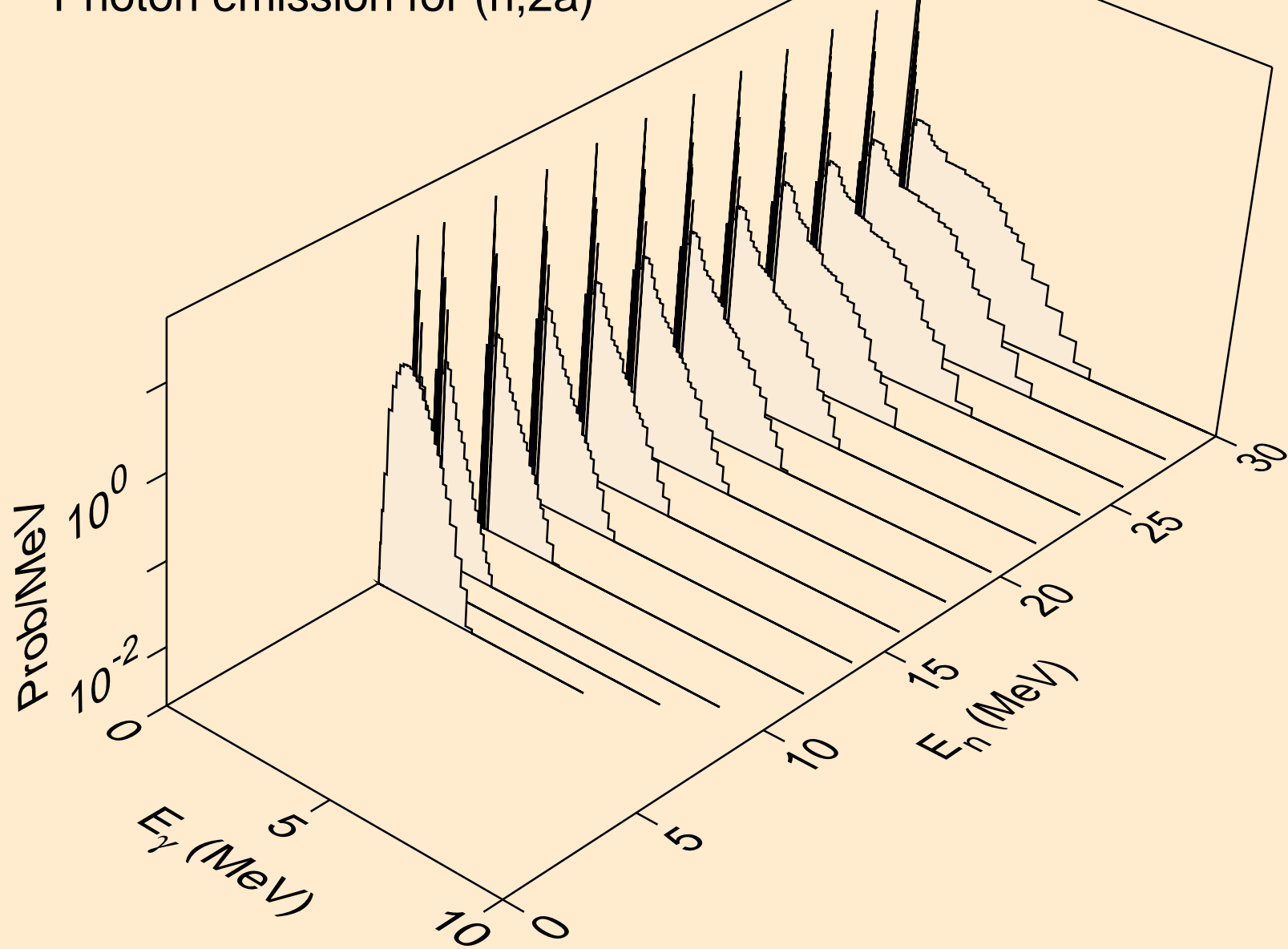

HF172 PROTON ACER TENDL-2023 LIBRARY; T=0.K  
Photon emission for (n,2p)

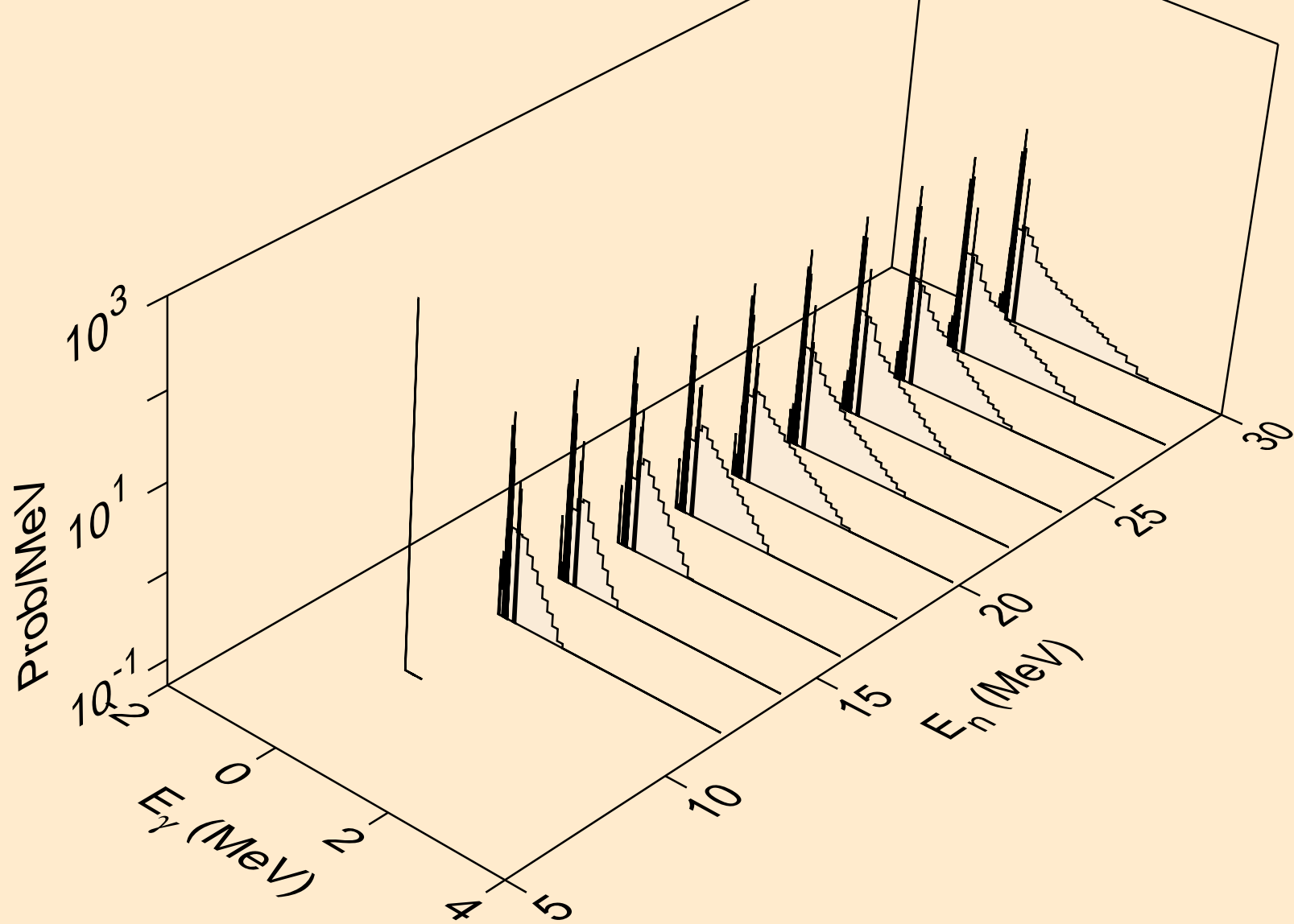

HF172 PROTON ACER TENDL-2023 LIBRARY; T=0.K  
Photon emission for (n,pa)

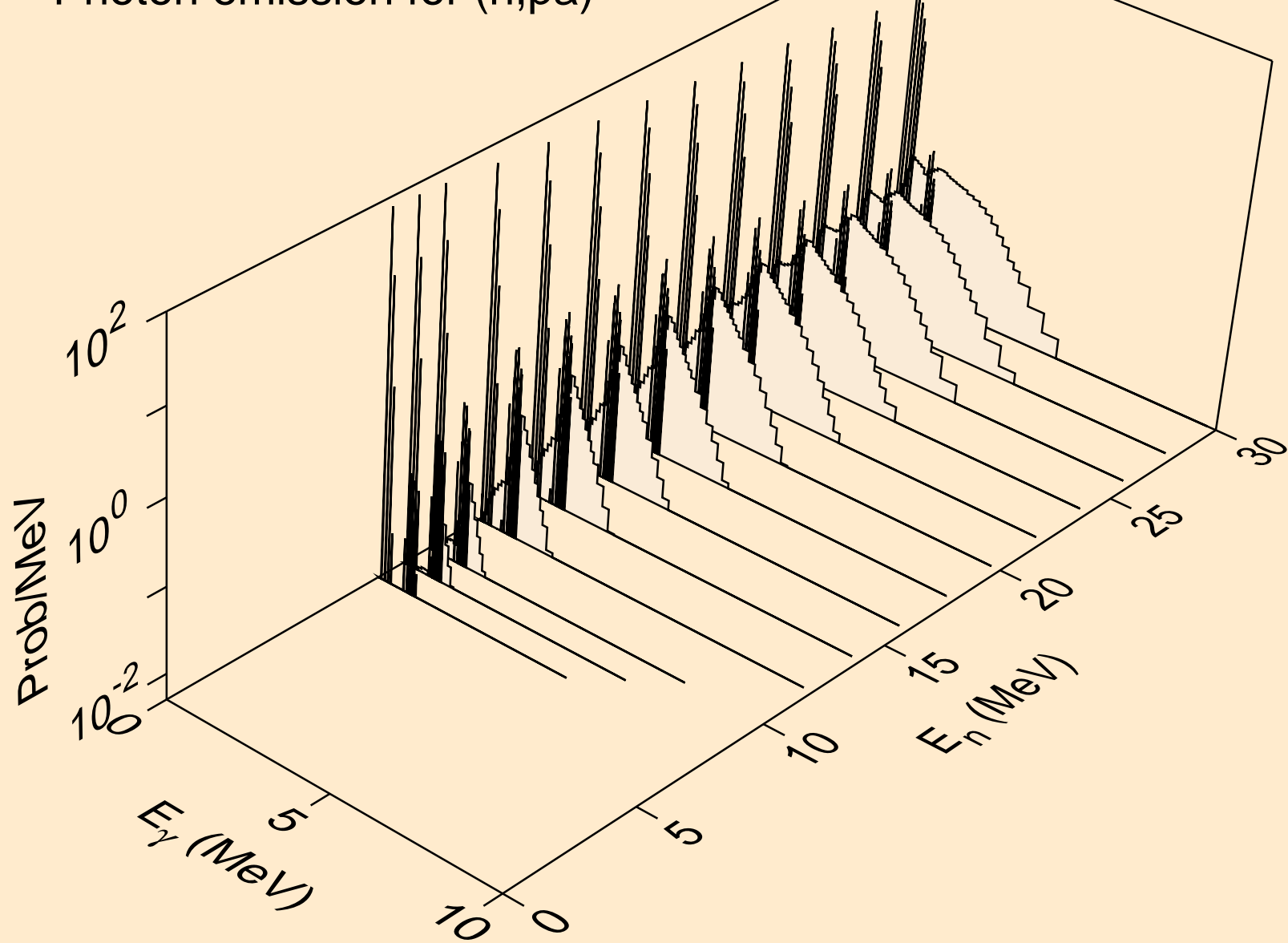

HF172 PROTON ACER TENDL-2023 LIBRARY; T=0.K  
Photon emission for (n,pd)

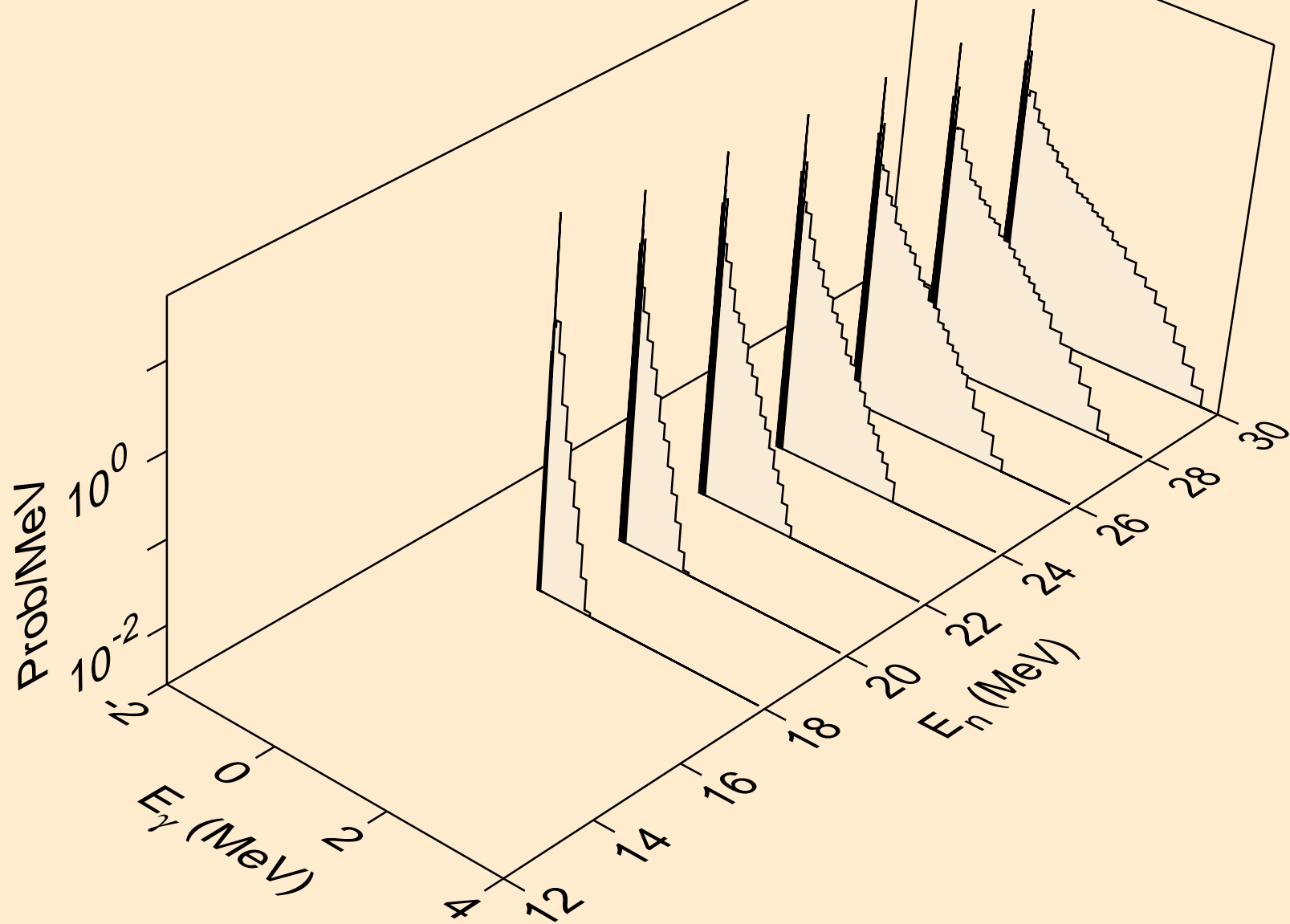

HF172 PROTON ACER TENDL-2023 LIBRARY; T=0.K  
Photon emission for (n,pt)

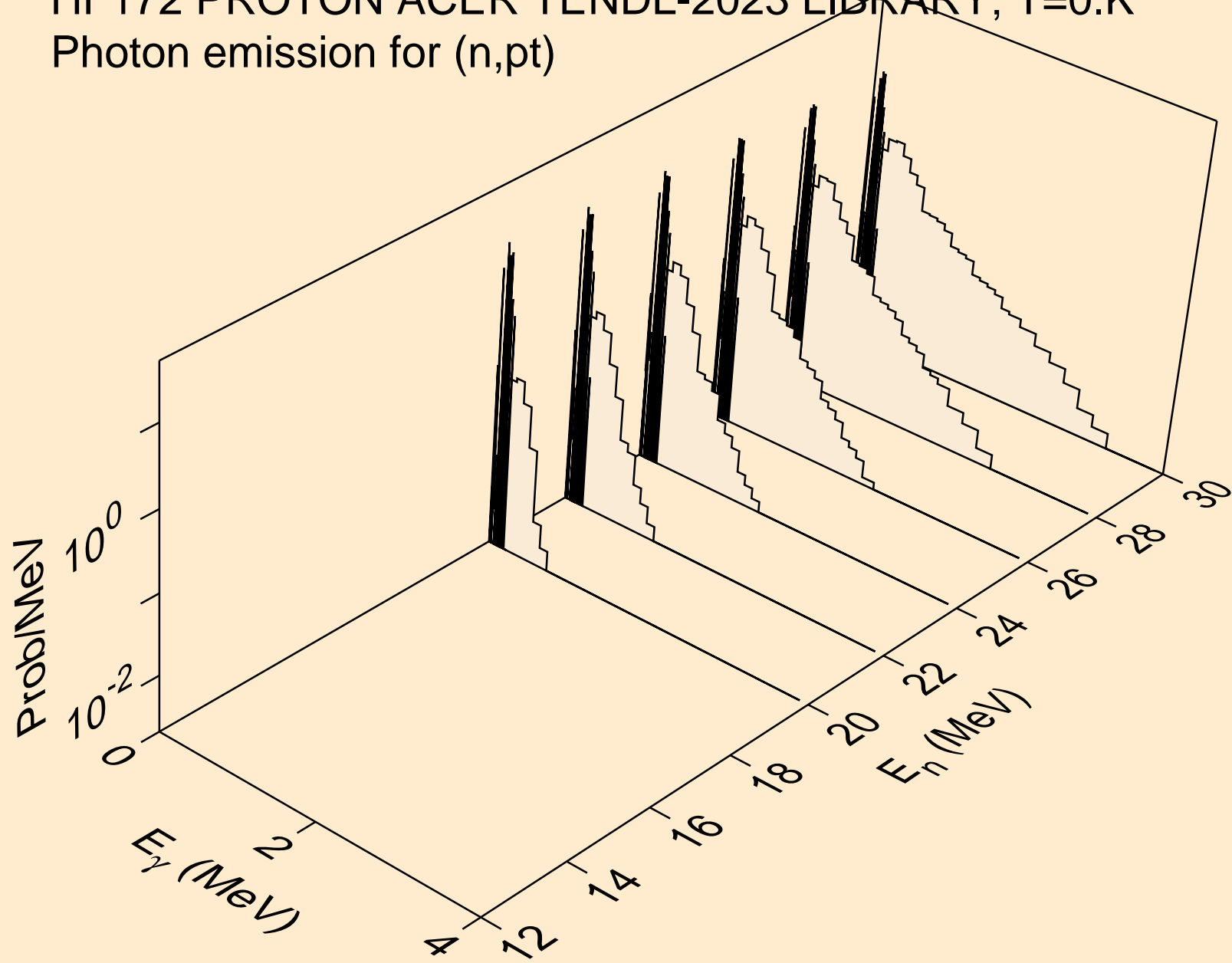



HF172 PROTON ACER TENDL-2023 LIBRARY; T=0.K  
Photon emission for (n,da)

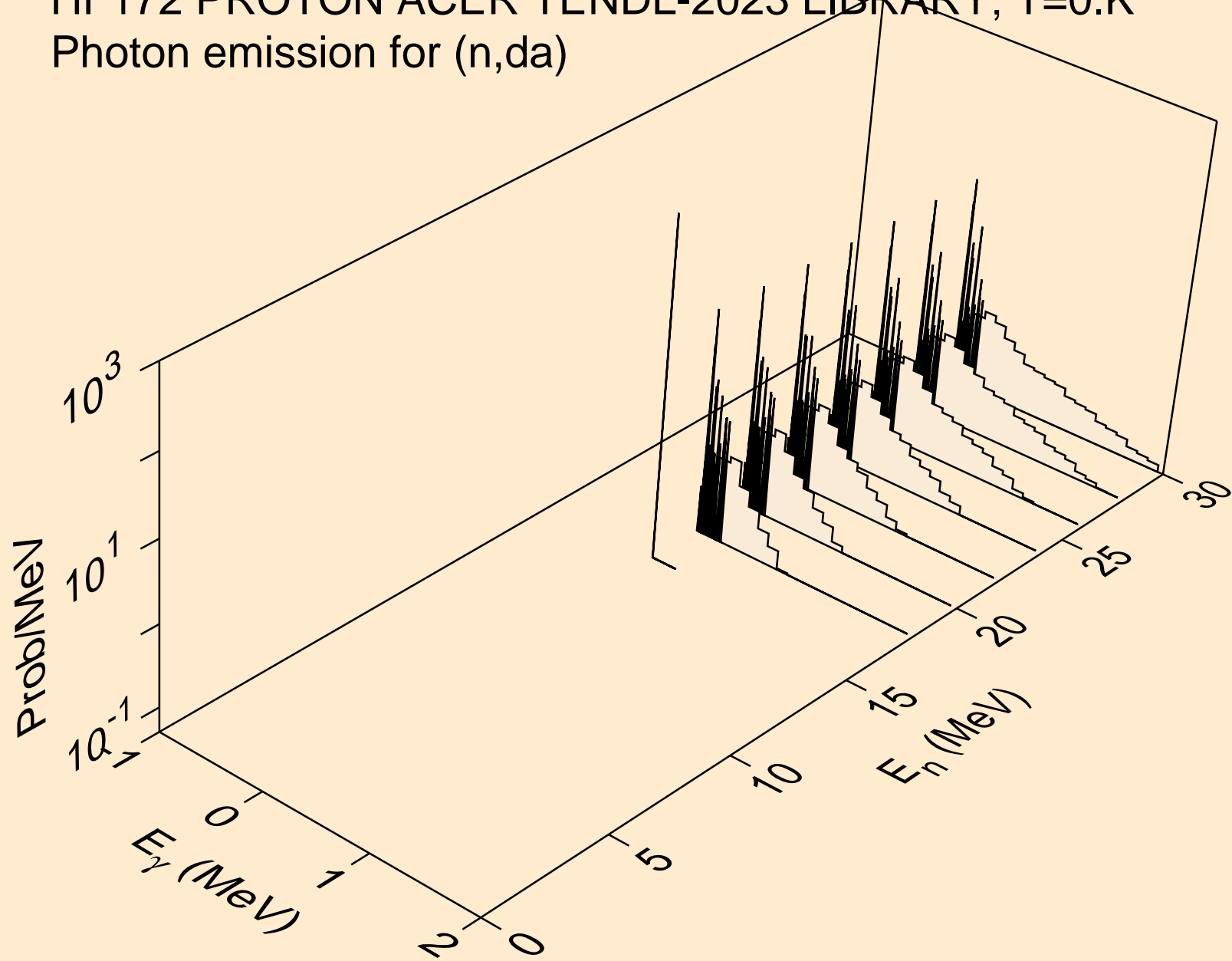

# HF172 PROTON ACER TENDL-2023 LIBRARY; T=0.K

## Particle heating contributions

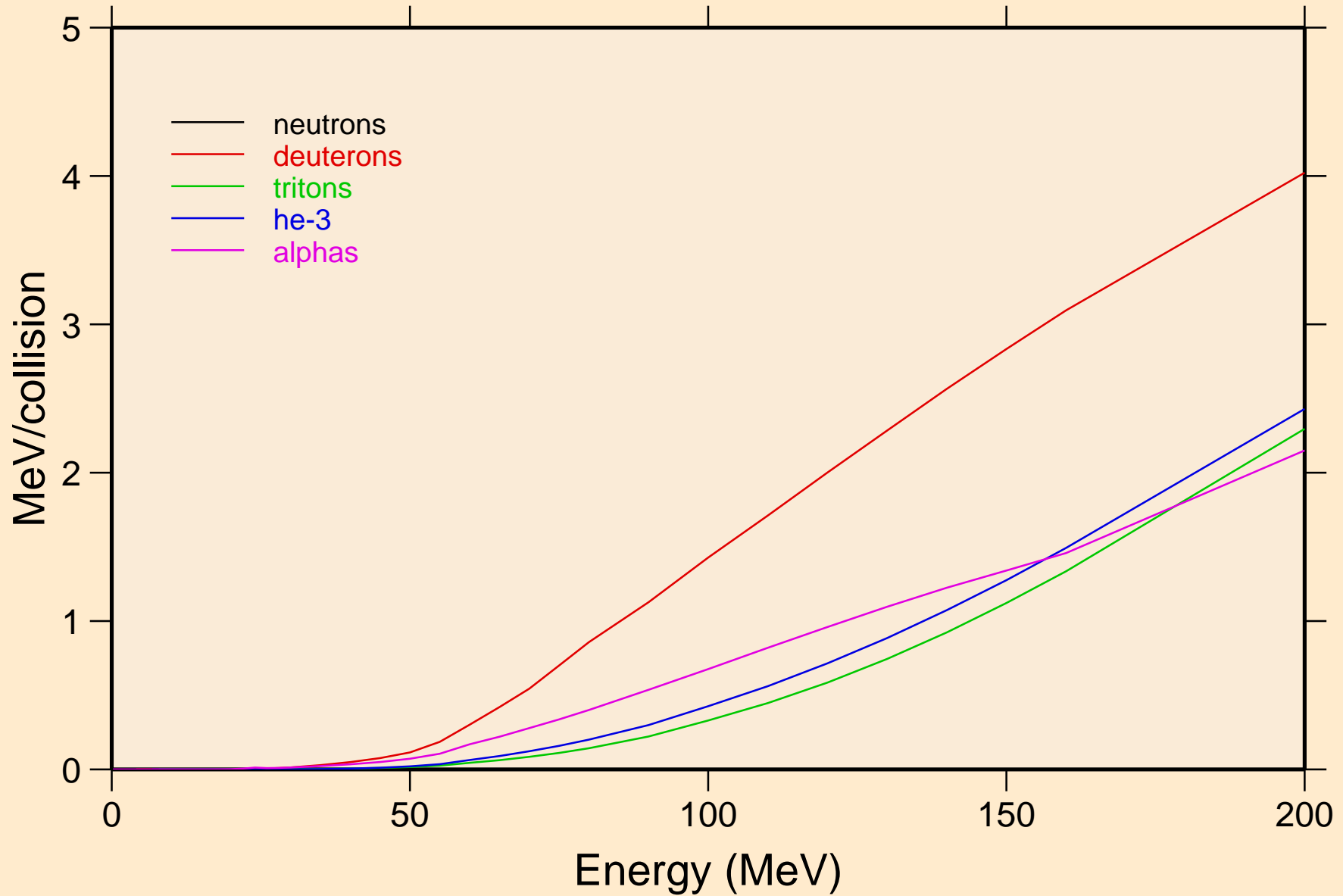

HF172 PROTON ACER TENDL-2023 LIBRARY; T=0.K  
Recoil Heating

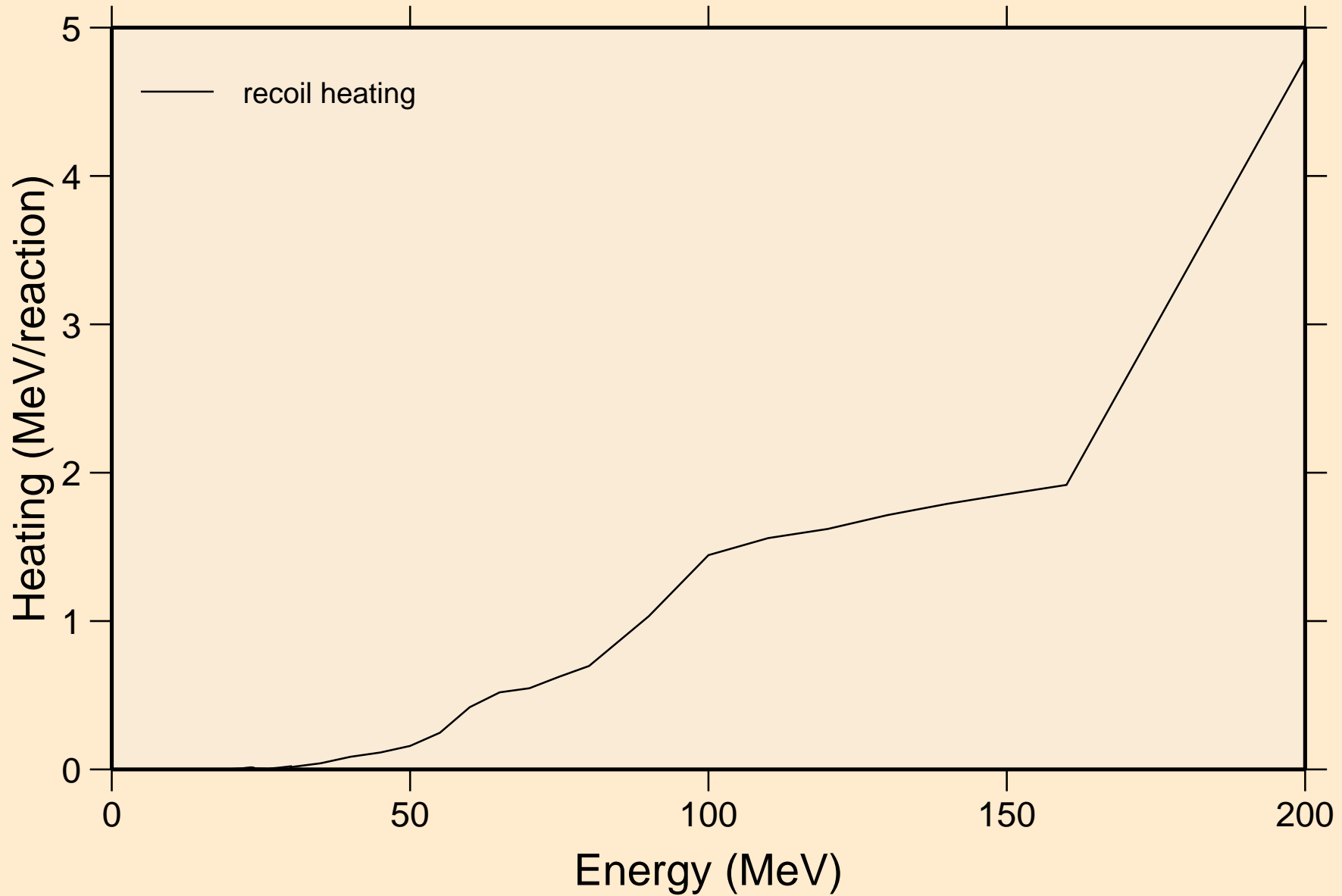

HF172 PROTON ACER TENDL-2023 LIBRARY; T=0.K  
Particle production cross sections

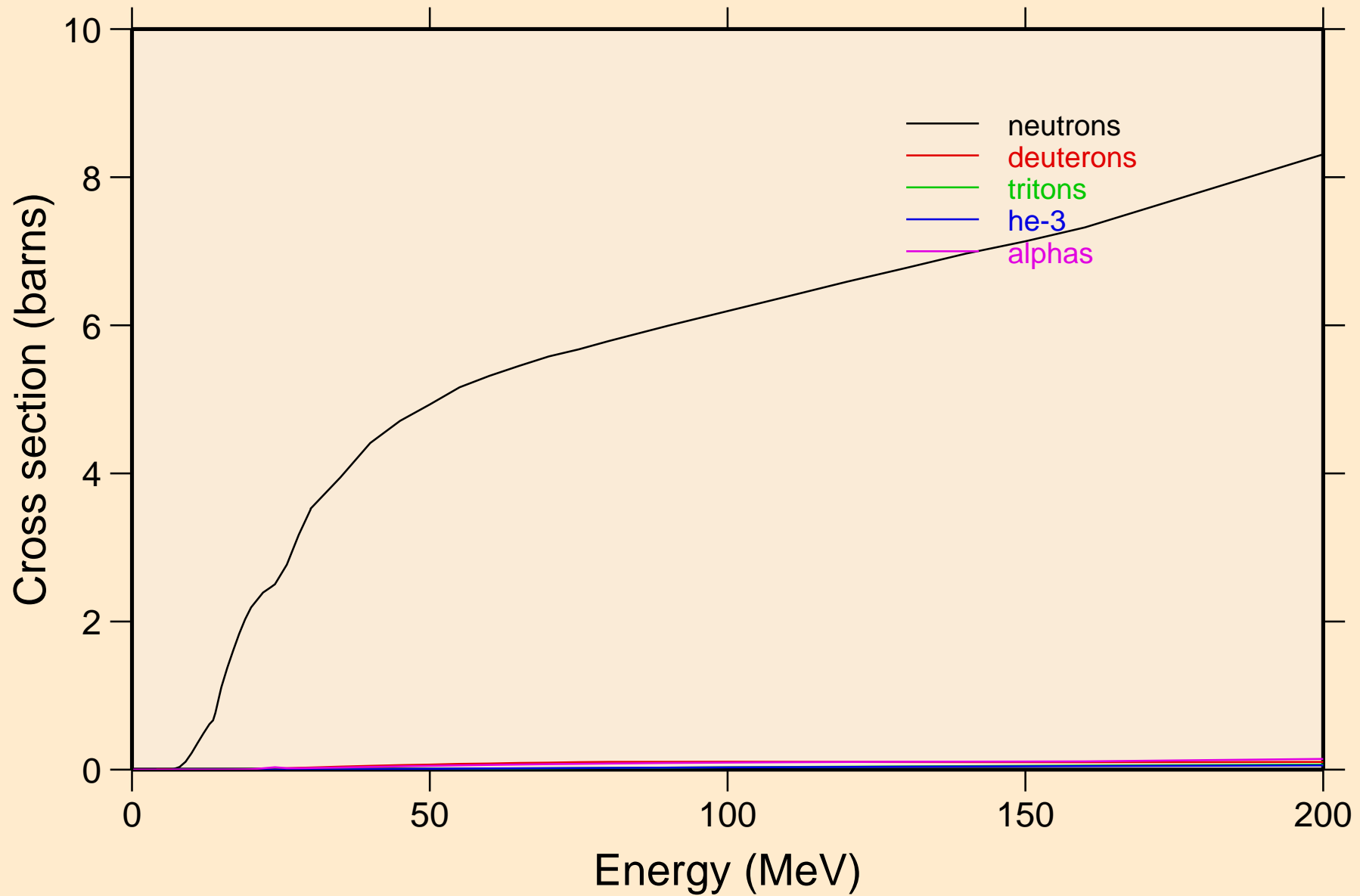

HF172 PROTON ACER TENDL-2023 LIBRARY; T=0.K  
neutrons from (p,n)

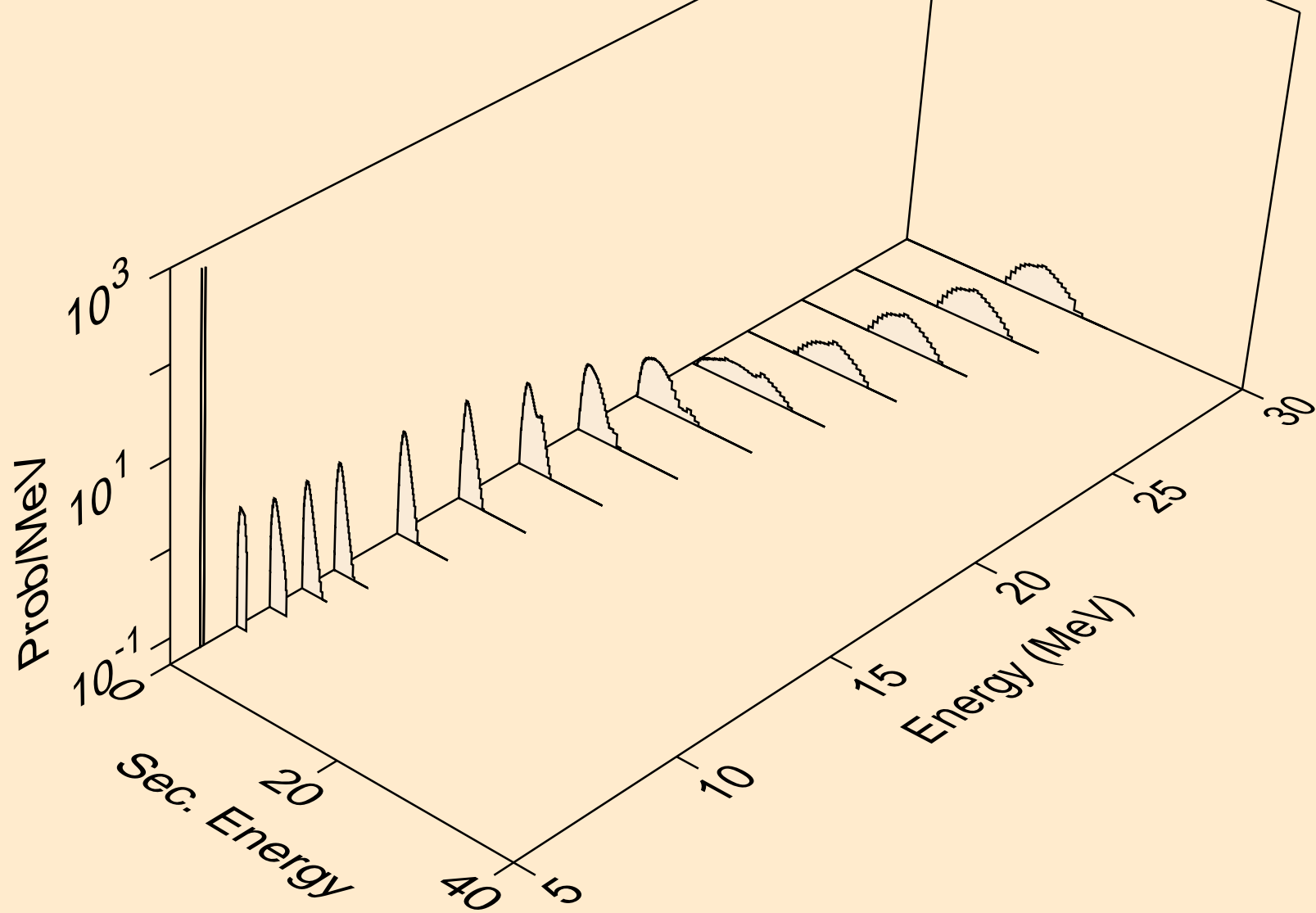

HF172 PROTON ACER TENDL-2023 LIBRARY; T=0.K  
neutrons from (p,x)

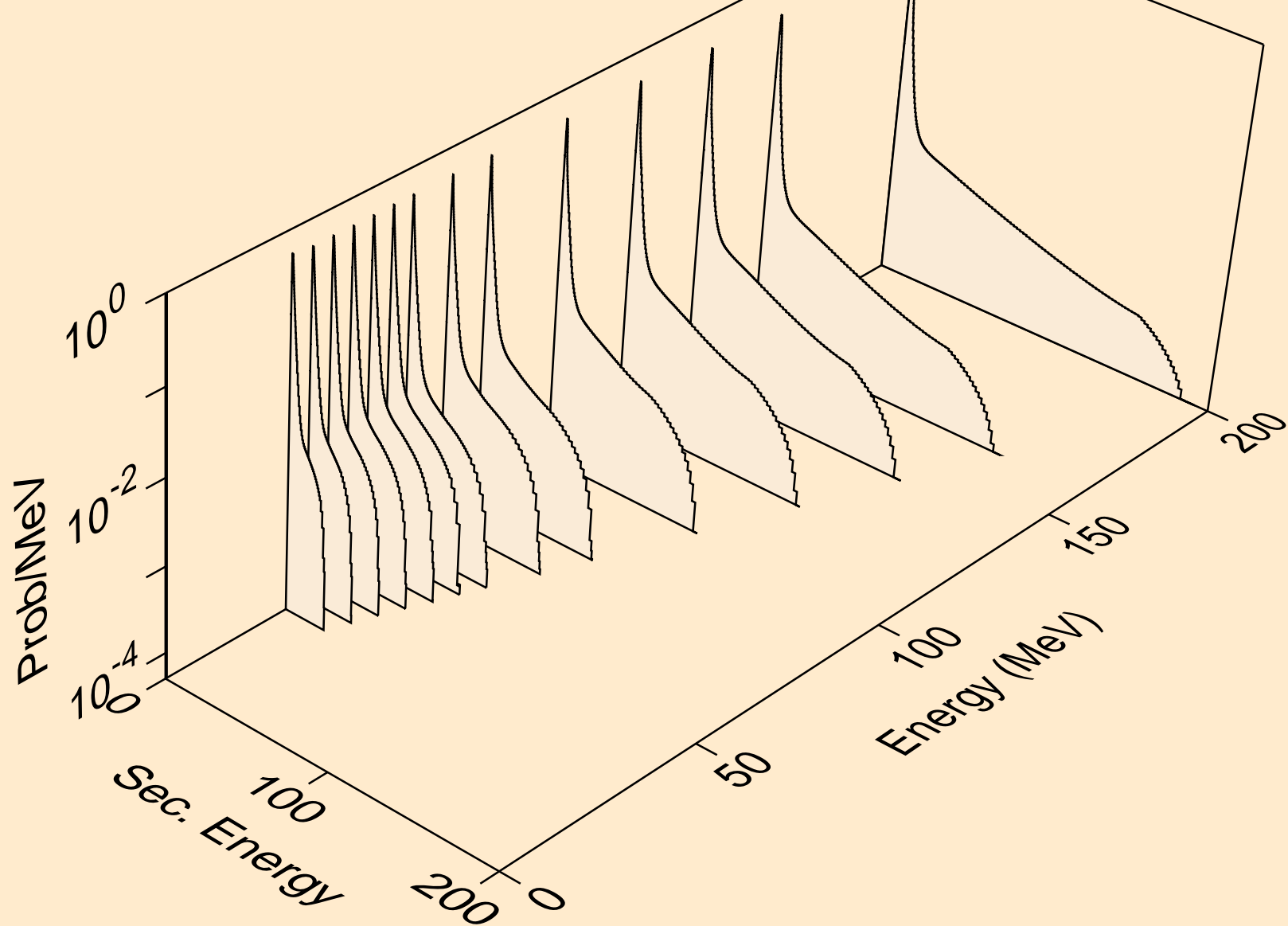

HF172 PROTON ACER TENDL-2023 LIBRARY; T=0.K  
neutrons from (p,2nd)

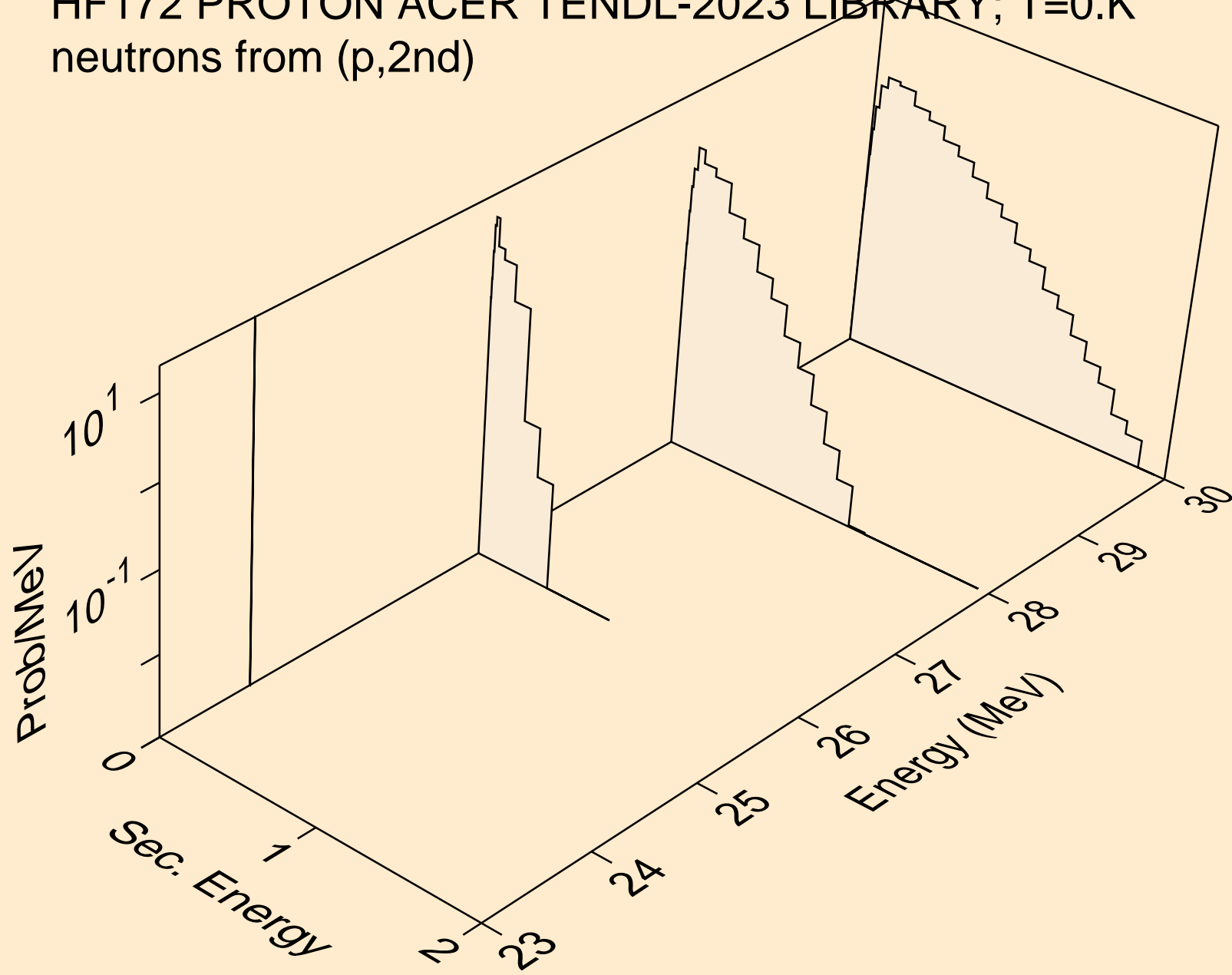

HF172 PROTON ACER TENDL-2023 LIBRARY; T=0.K  
neutrons from (p,2n)

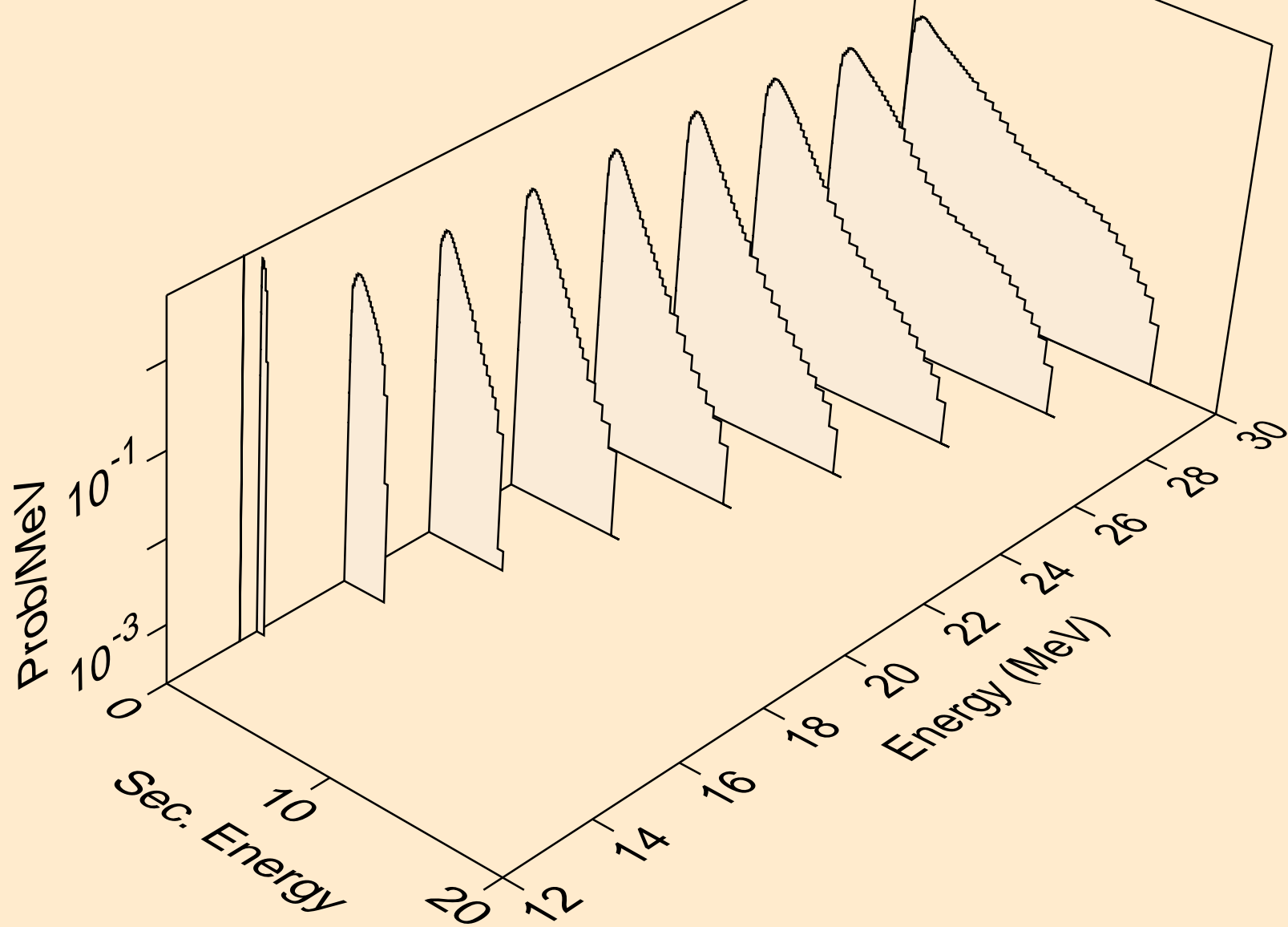



HF172 PROTON ACER TENDL-2023 LIBRARY; T=0.K  
neutrons from (p,3n)

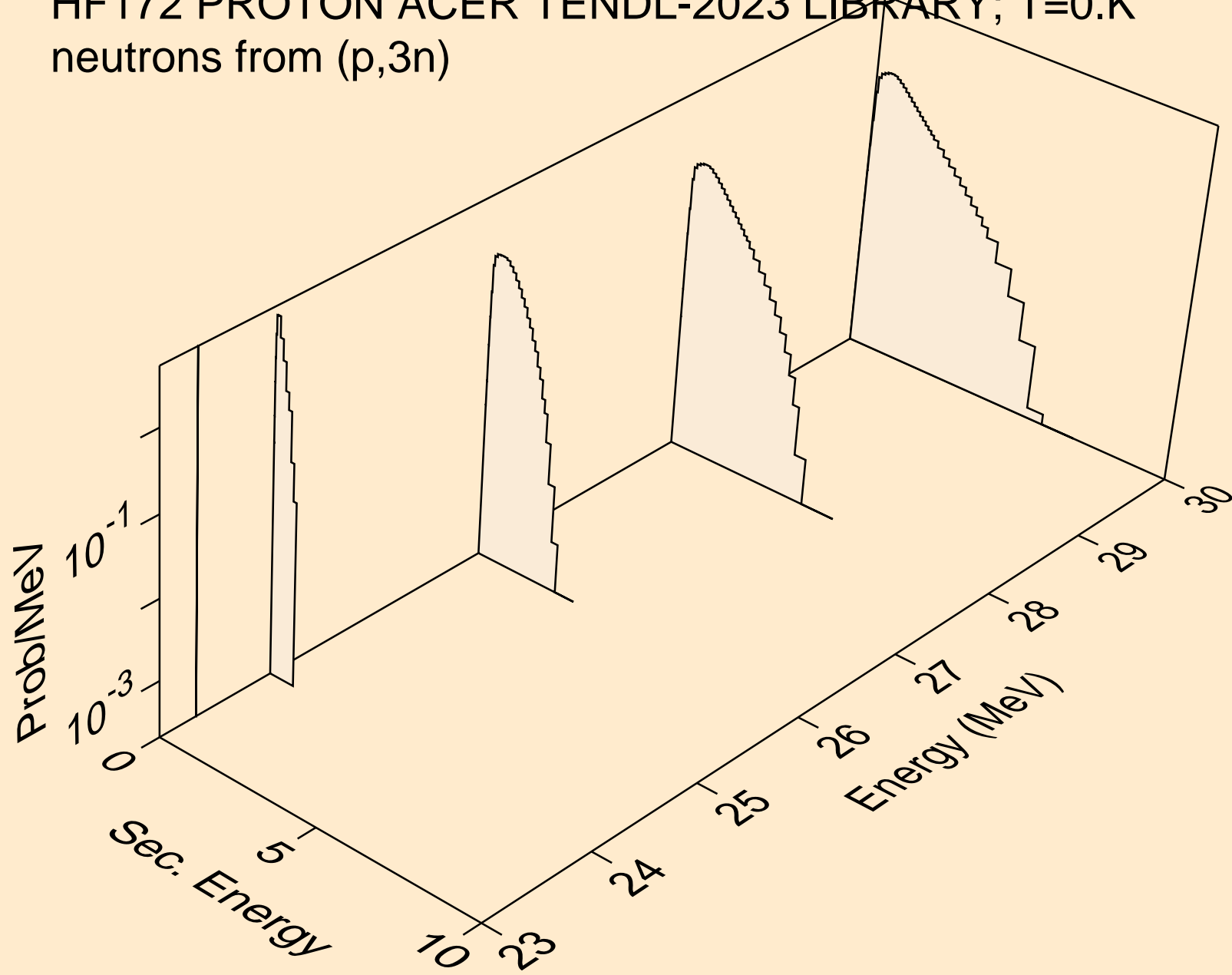

HF172 PROTON ACER TENDL-2023 LIBRARY; T=0.K  
neutrons from (p,n\*)a

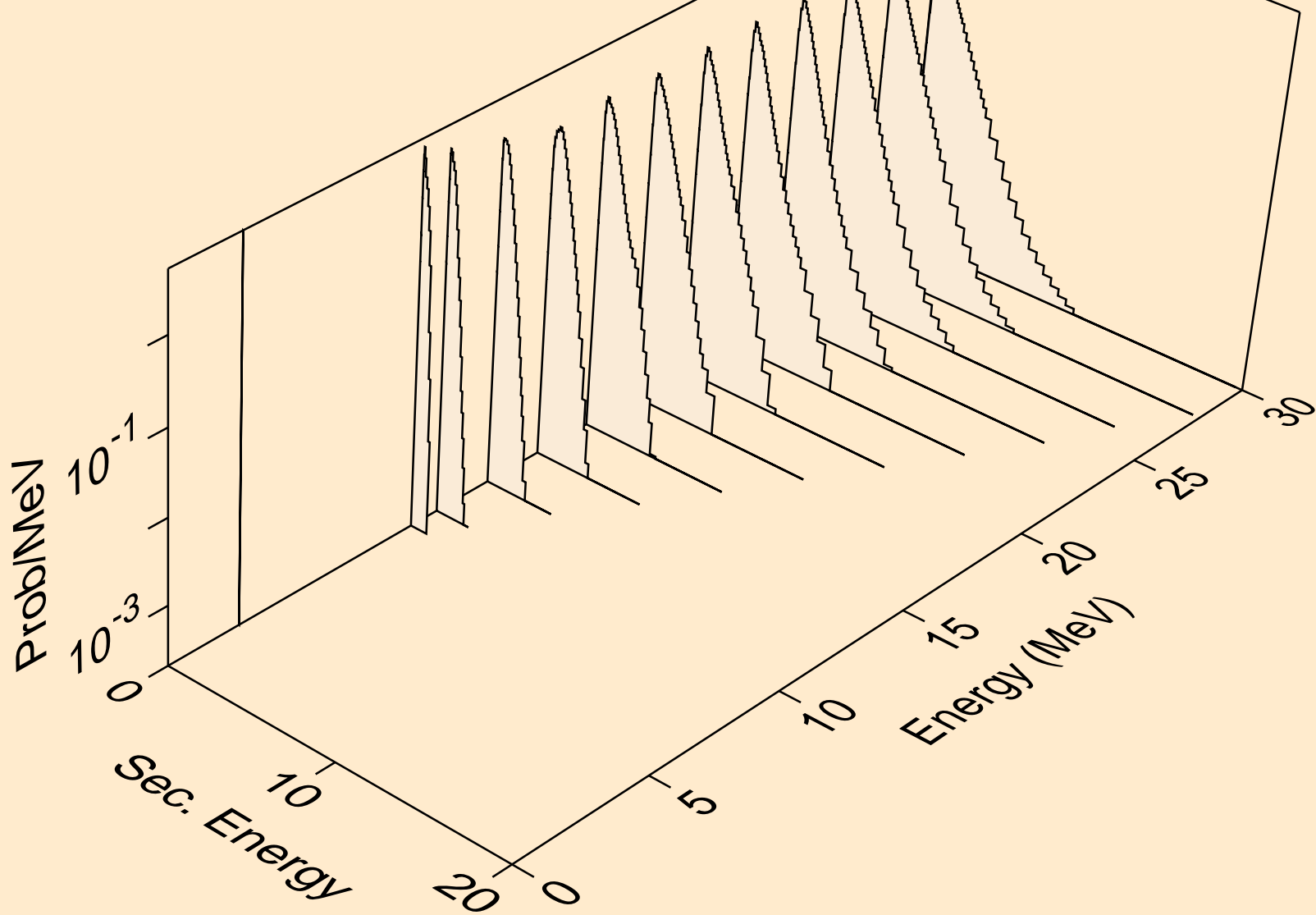

HF172 PROTON ACER TENDL-2023 LIBRARY; T=0.K  
neutrons from (p,2n)a

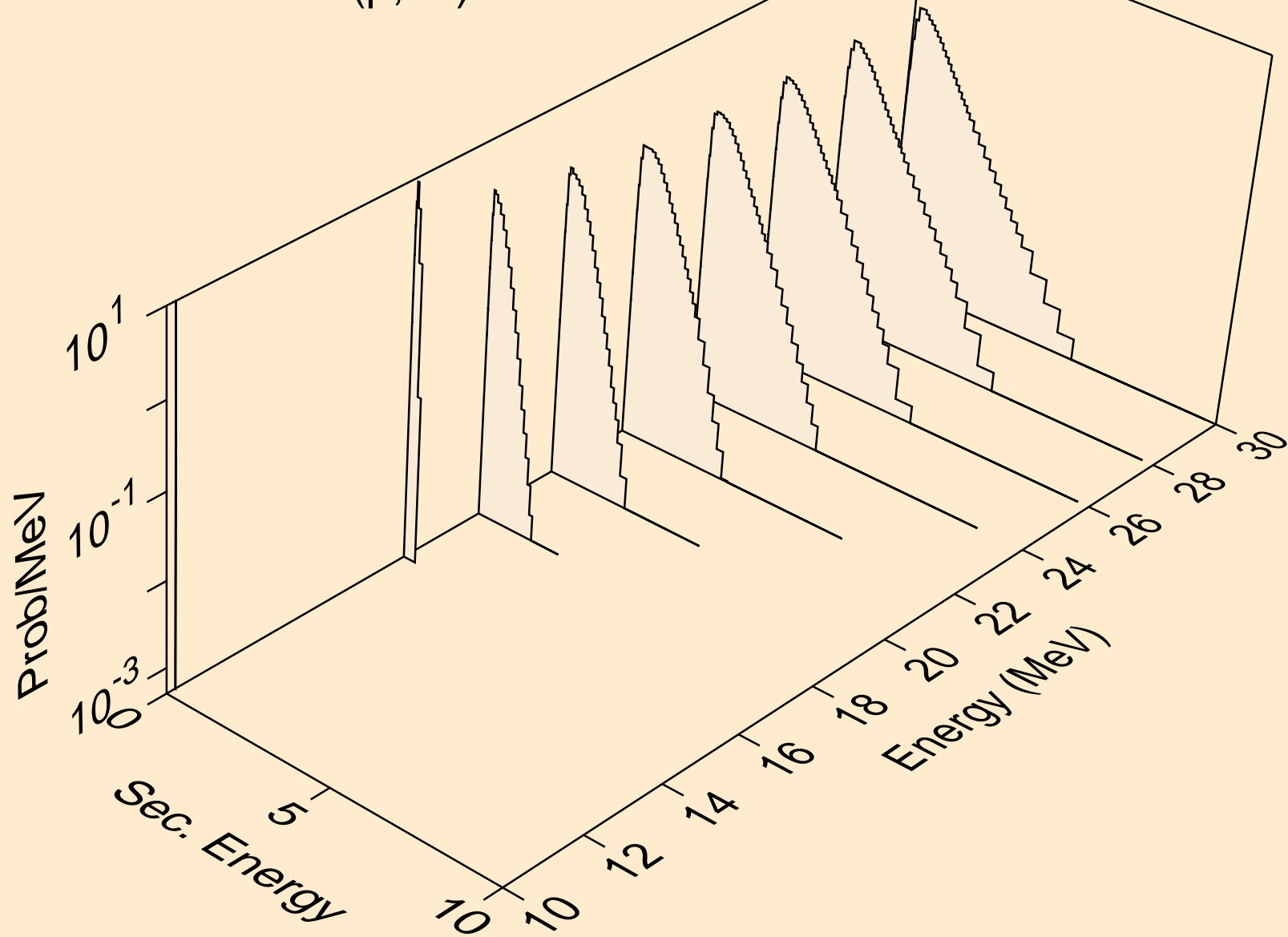

HF172 PROTON ACER TENDL-2023 LIBRARY; T=0.K  
neutrons from (p,3n)a

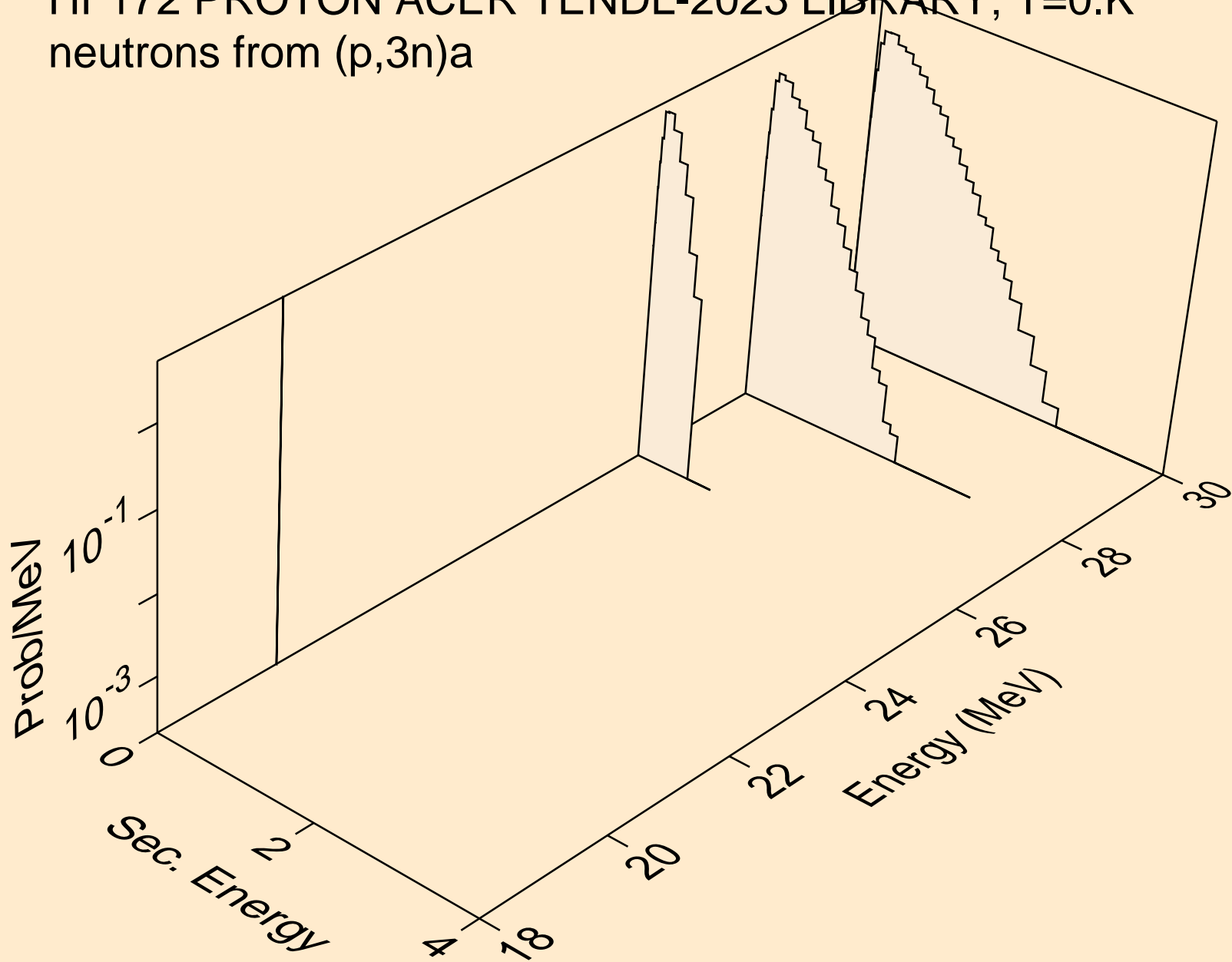

HF172 PROTON ACER TENDL-2023 LIBRARY; T=0.K  
neutrons from (p,n\*)p

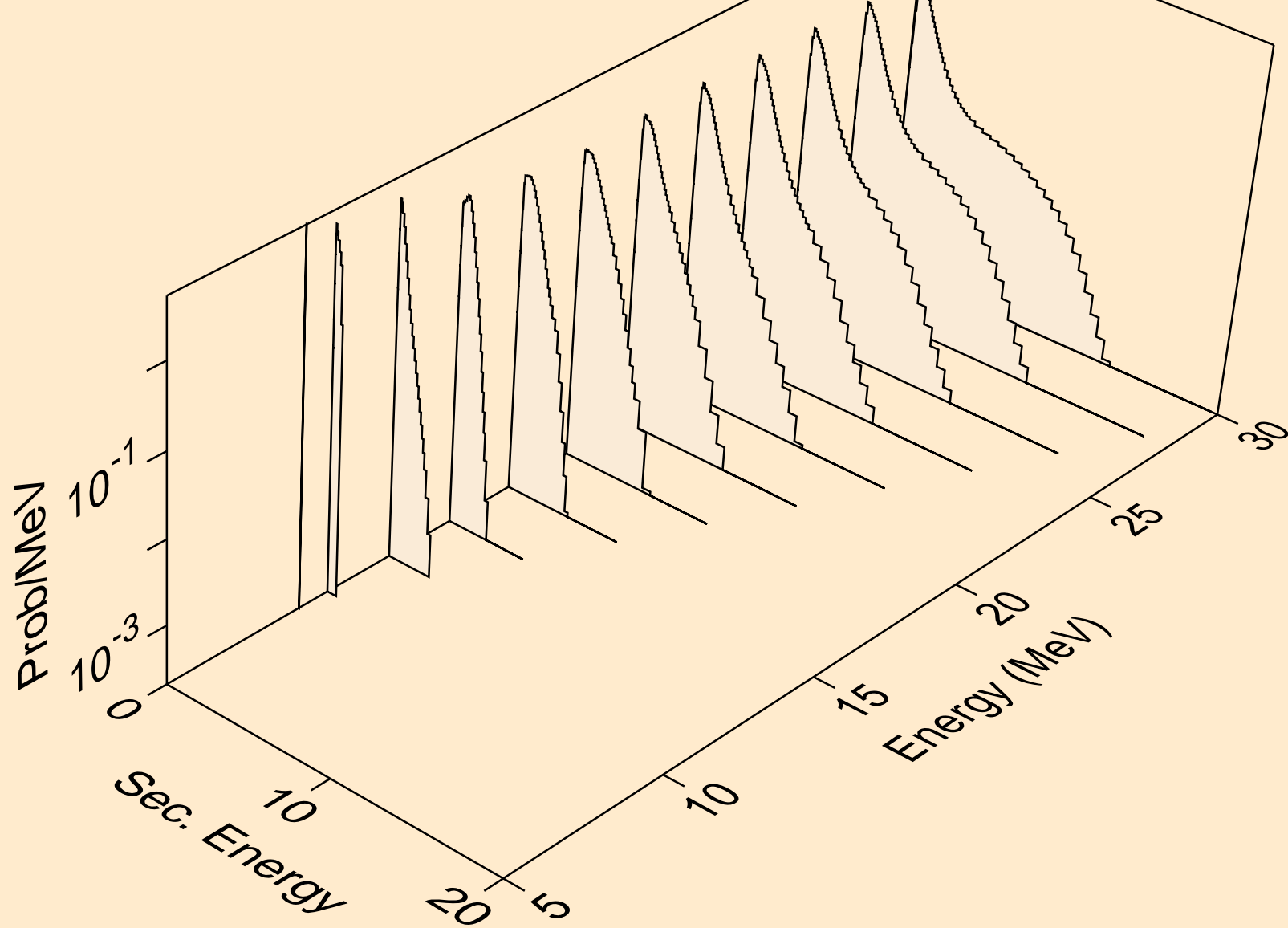

HF172 PROTON ACER TENDL-2023 LIBRARY; T=0.K  
neutrons from (p,n\*)2a

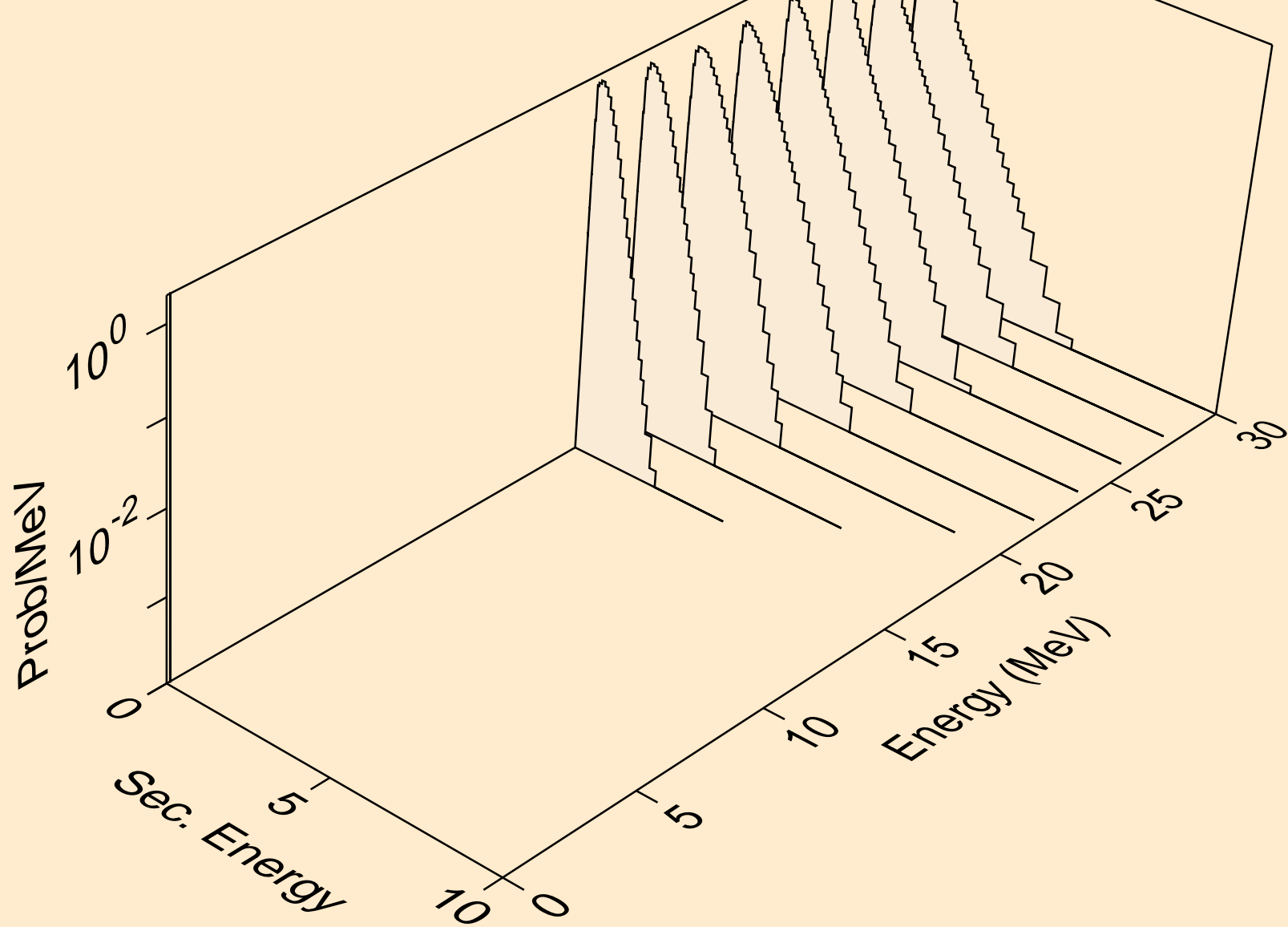

HF172 PROTON ACER TENDL-2023 LIBRARY; T=0.K  
neutrons from (p,n\*)d

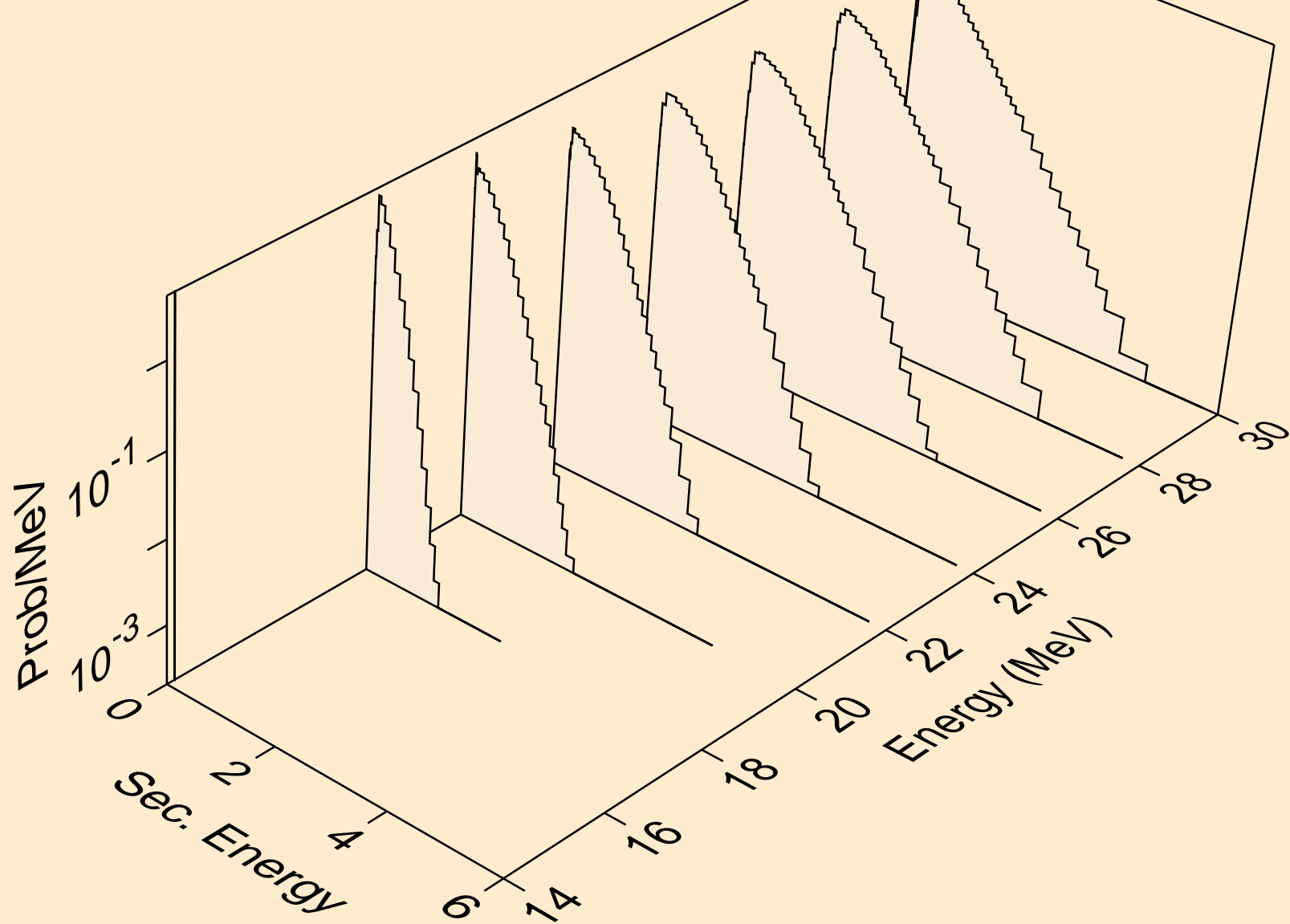

HF172 PROTON ACER TENDL-2023 LIBRARY; T=0.K  
neutrons from (p,n\*)t

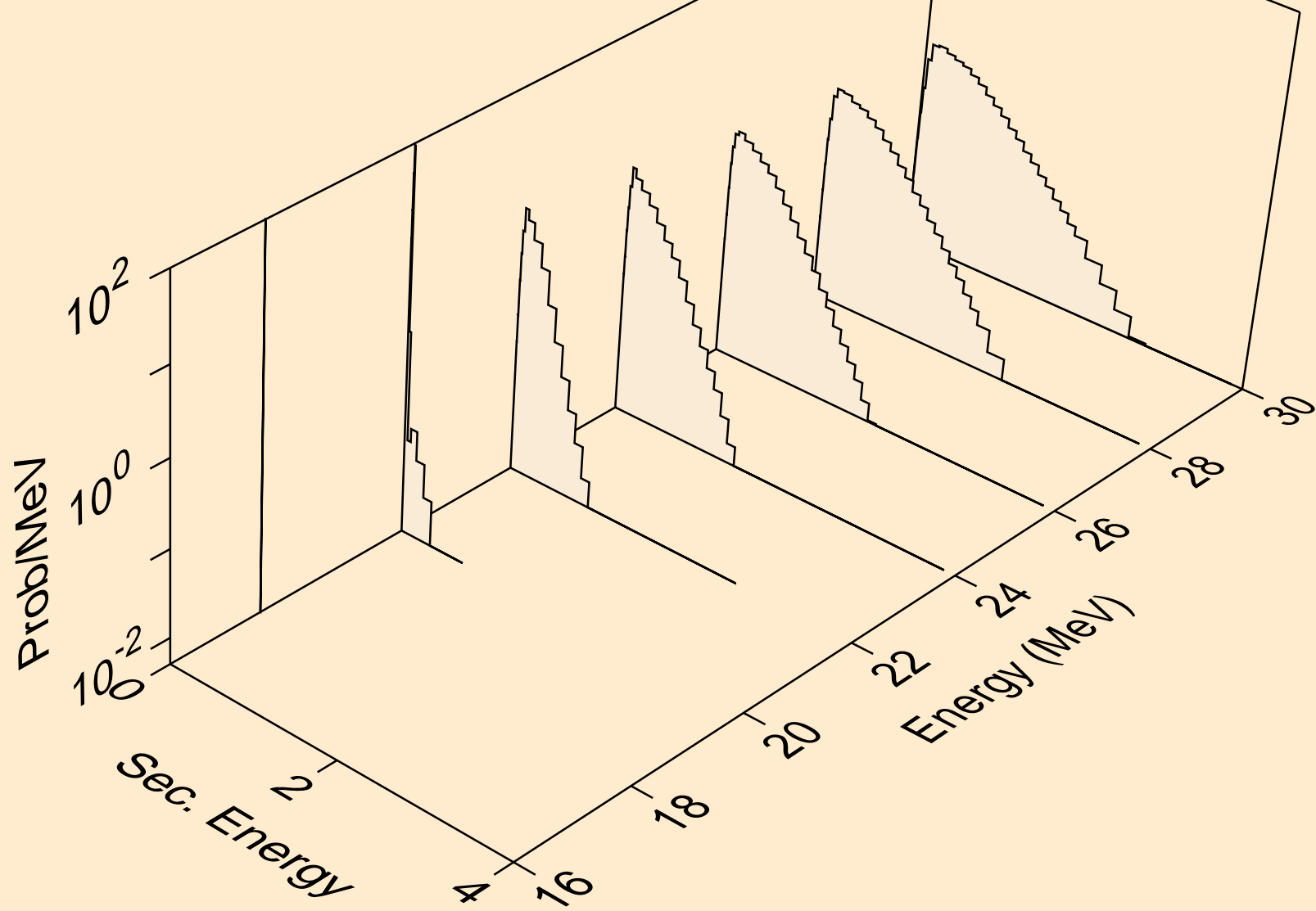



HF172 PROTON ACER TENDL-2023 LIBRARY; T=0.K  
neutrons from (p,n\*)he3

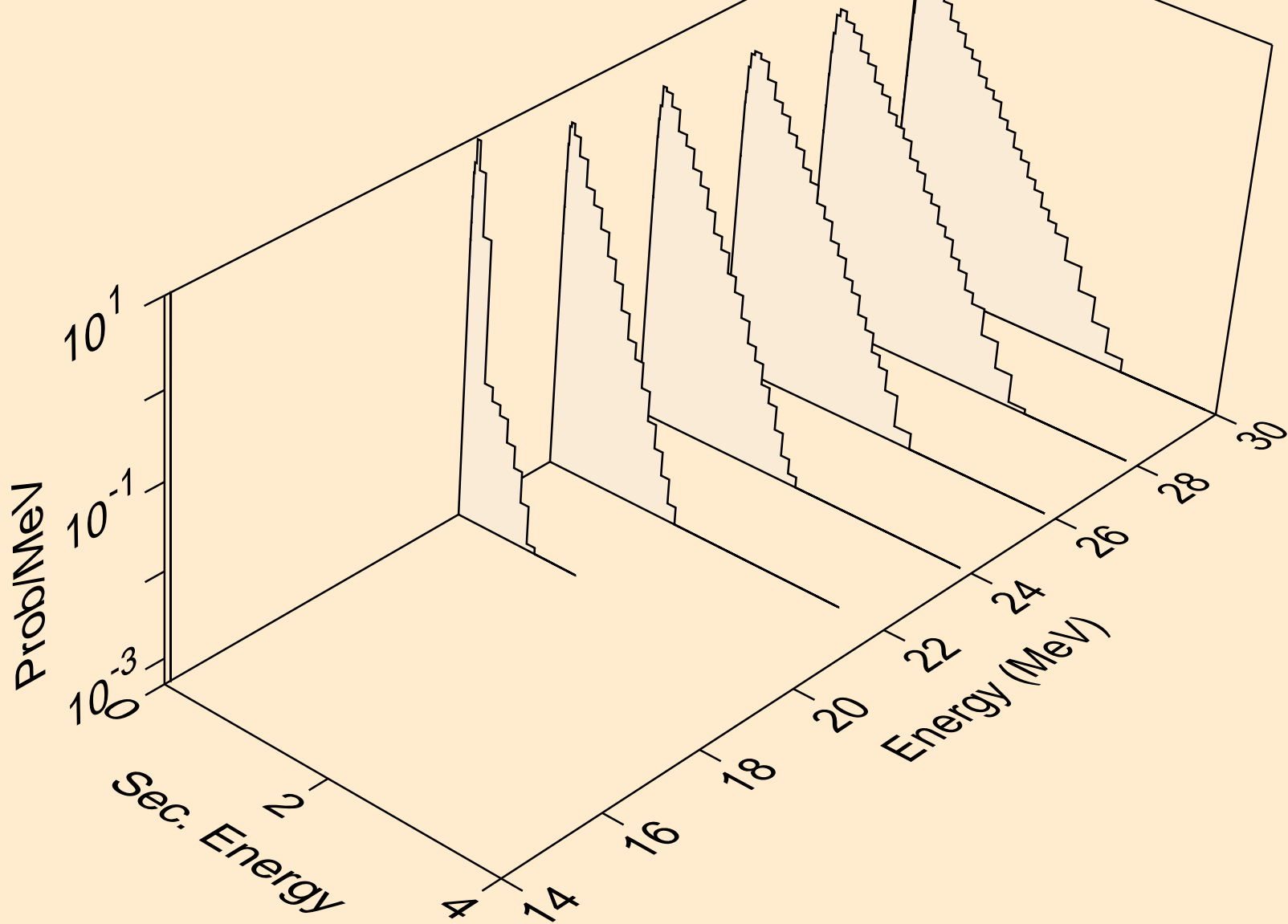

HF172 PROTON ACER TENDL-2023 LIBRARY; T=0.K  
neutrons from (p,2np)

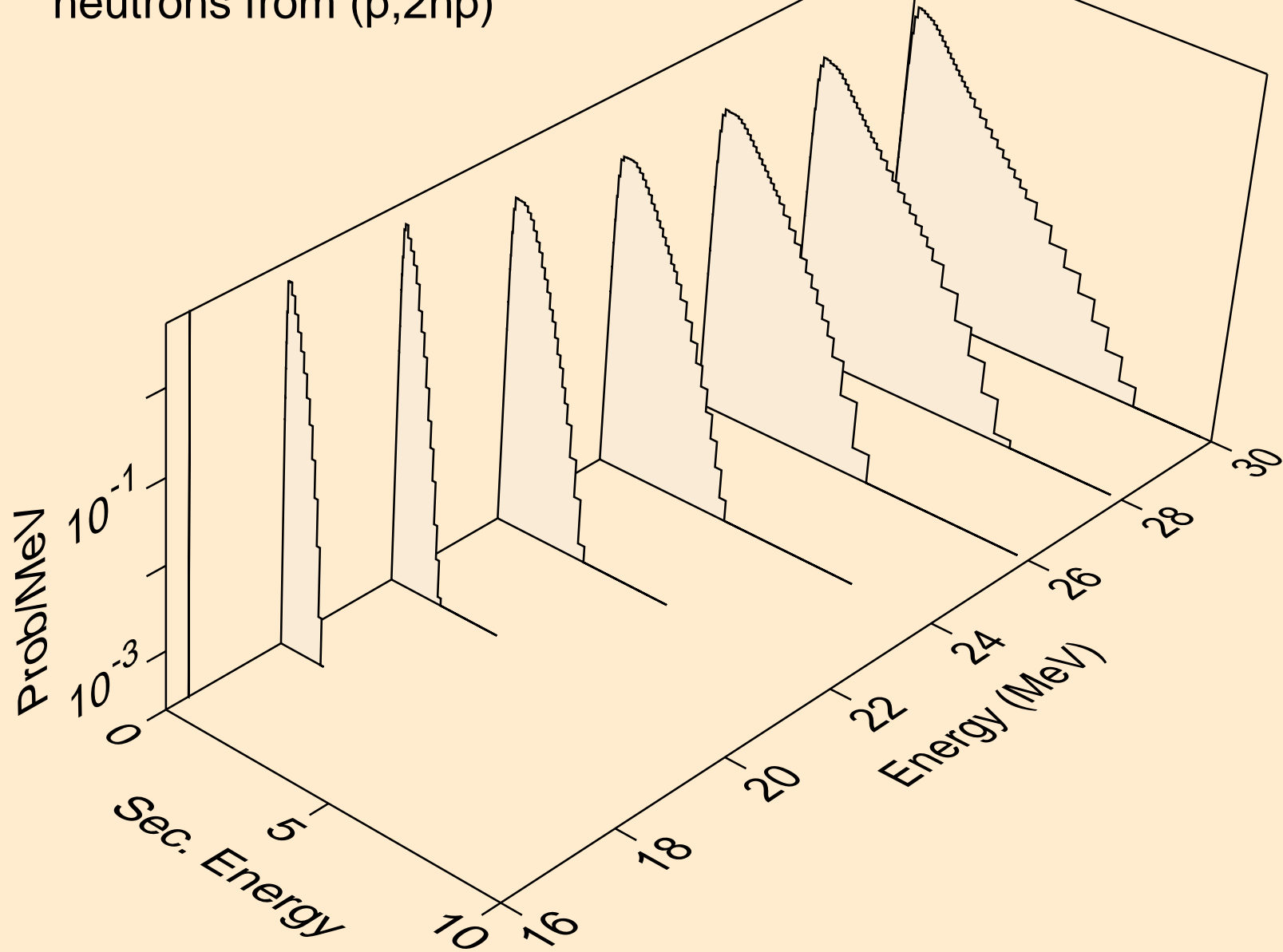

HF172 PROTON ACER TENDL-2023 LIBRARY; T=0.K  
neutrons from (p,3np)

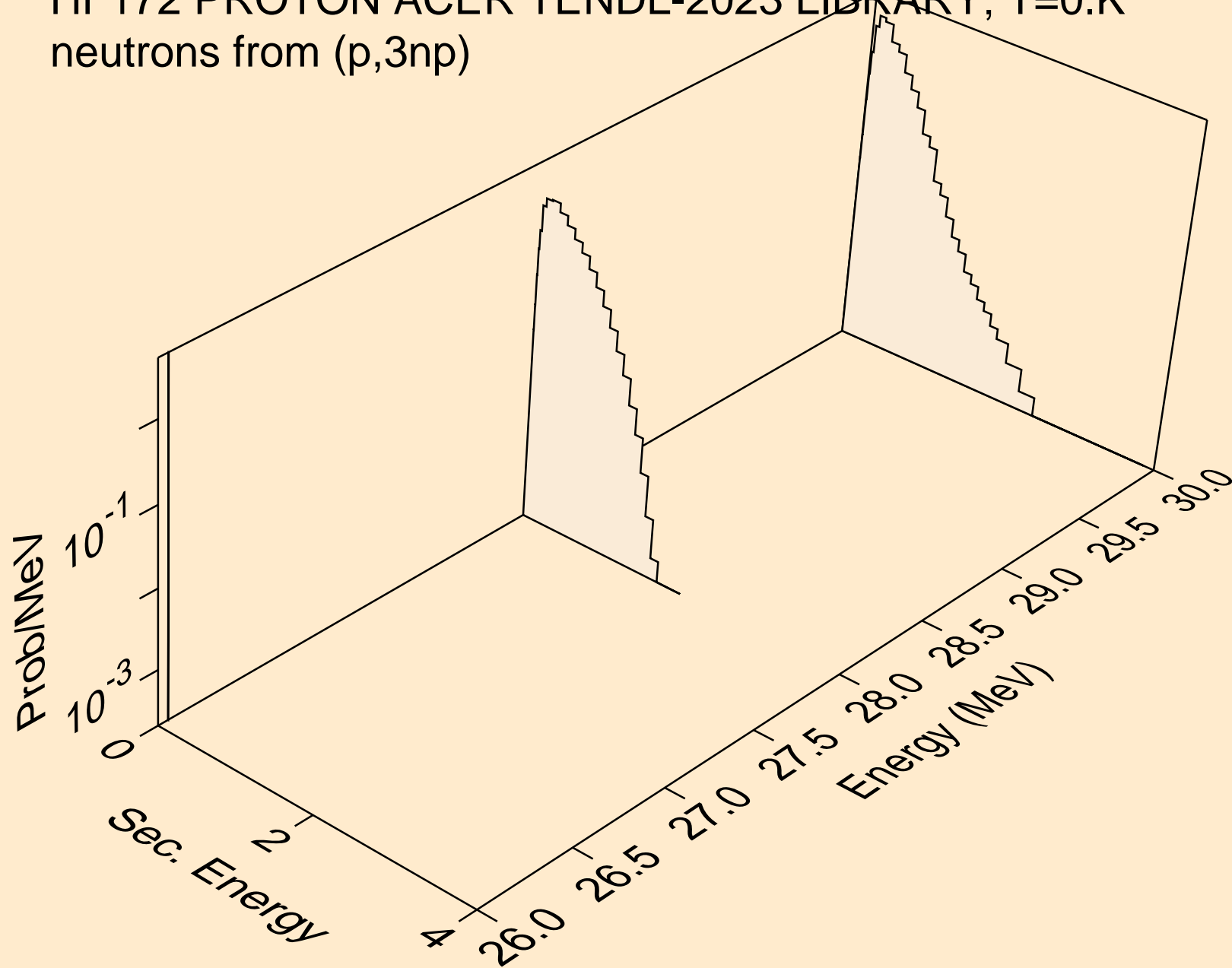

HF172 PROTON ACER TENDL-2023 LIBRARY; T=0.K  
neutrons from (p,n2p)

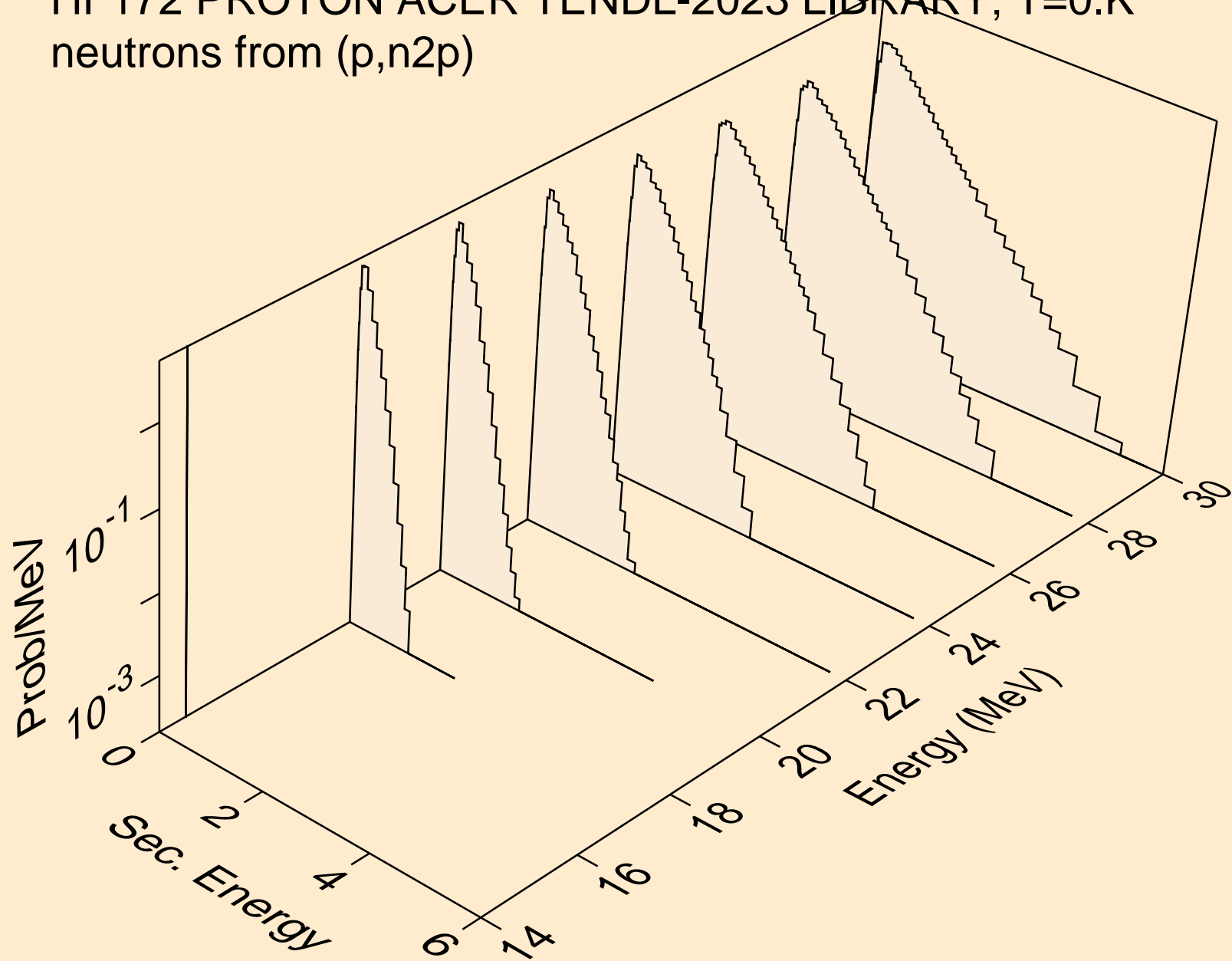

HF172 PROTON ACER TENDL-2023 LIBRARY; T=0.K  
neutrons from (p,npa)

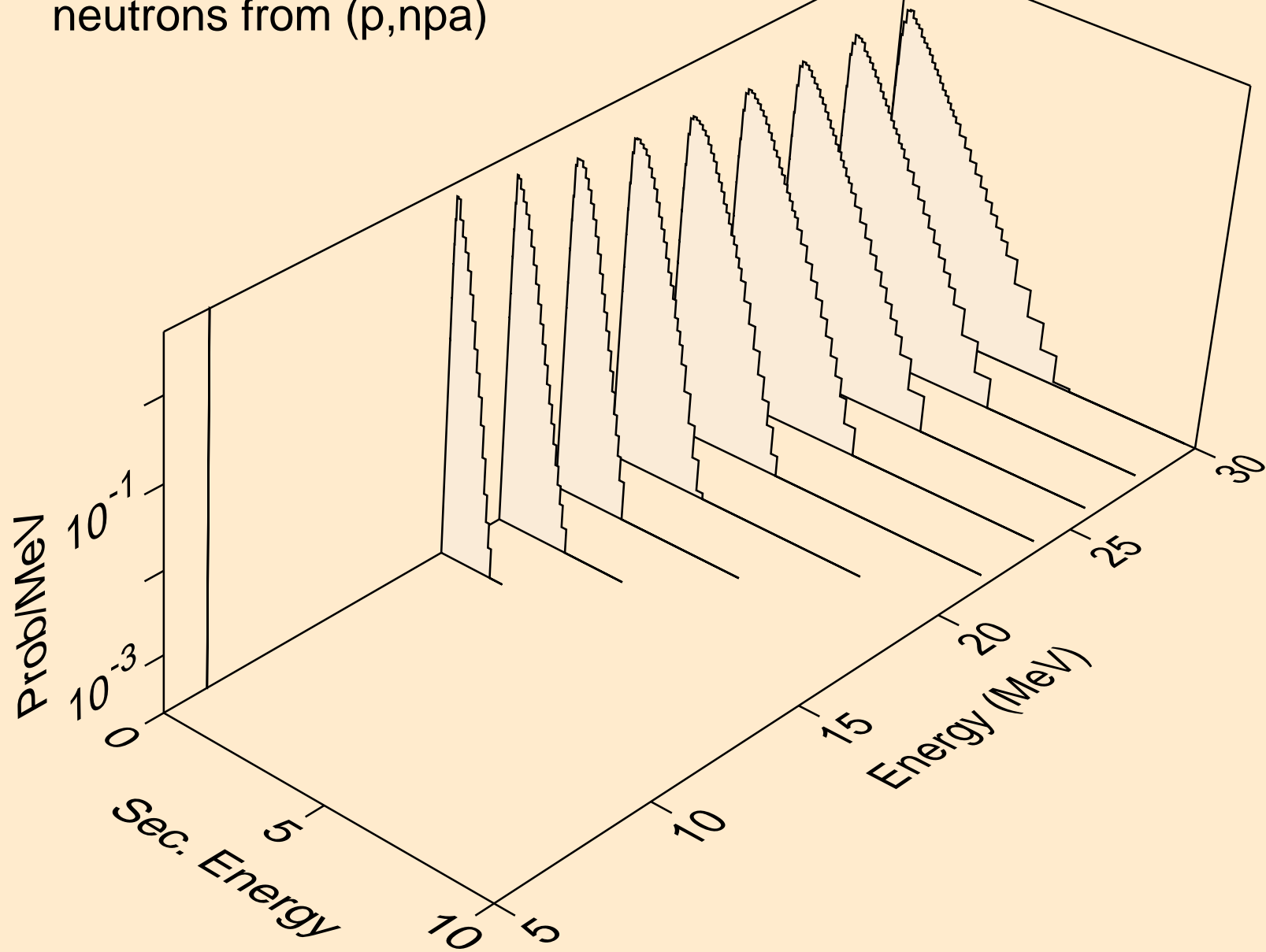

HF172 PROTON ACER TENDL-2023 LIBRARY; T=0.K  
deuterons from (p,x)

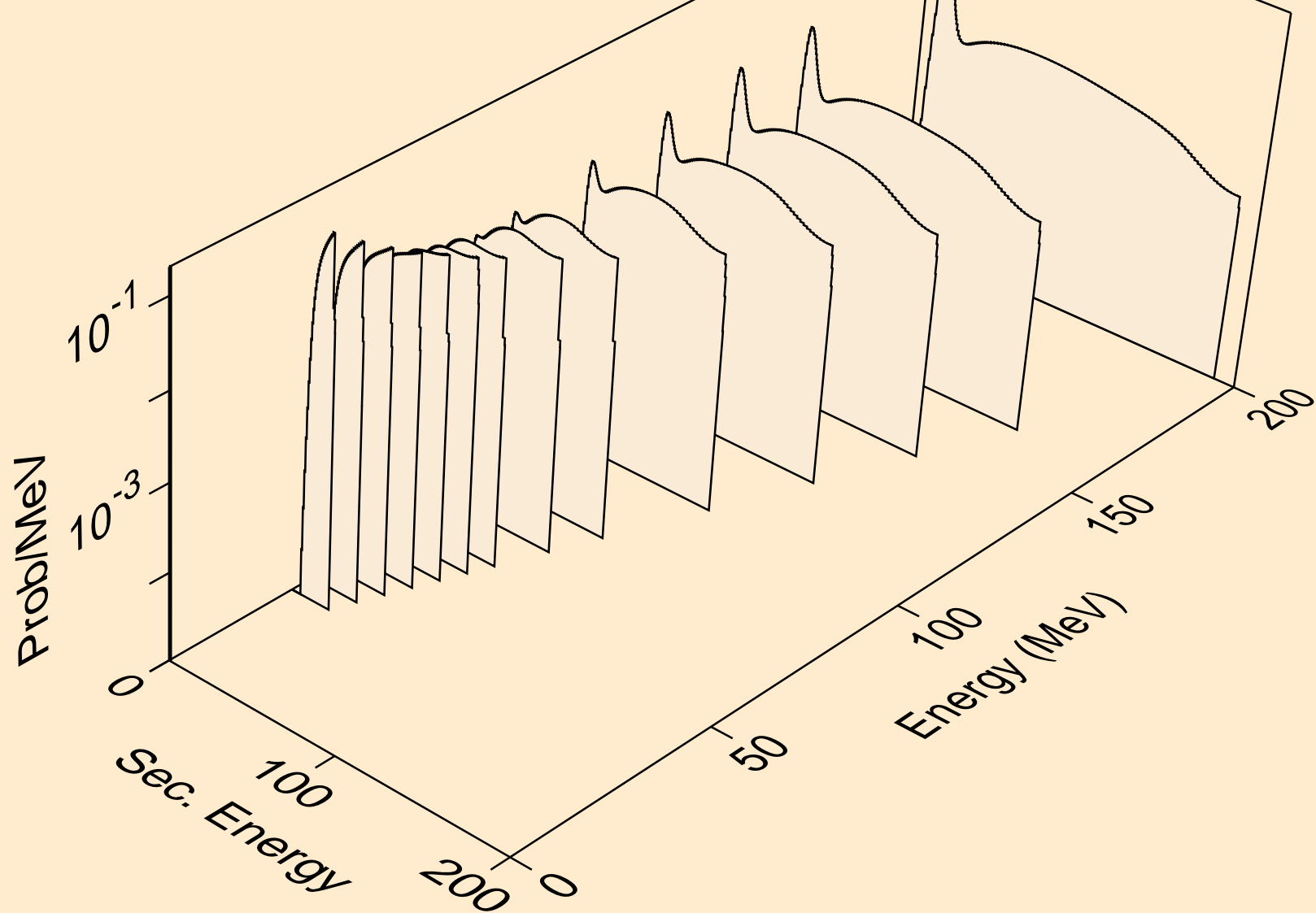

HF172 PROTON ACER TENDL-2023 LIBRARY; T=0.K  
deuterons from (p,2nd)

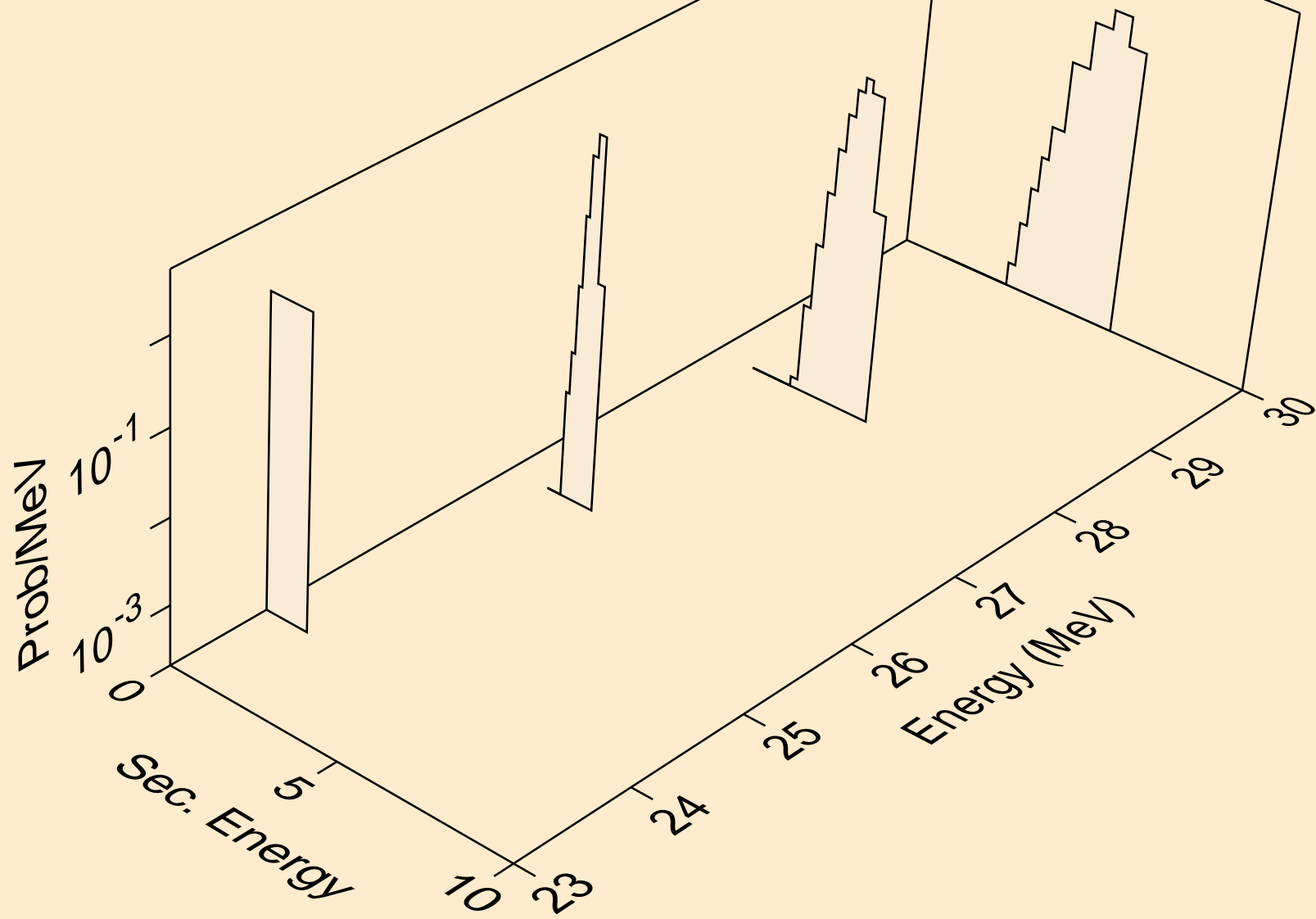

HF172 PROTON ACER TENDL-2023 LIBRARY; T=0.K  
deuterons from (p,n\*)d

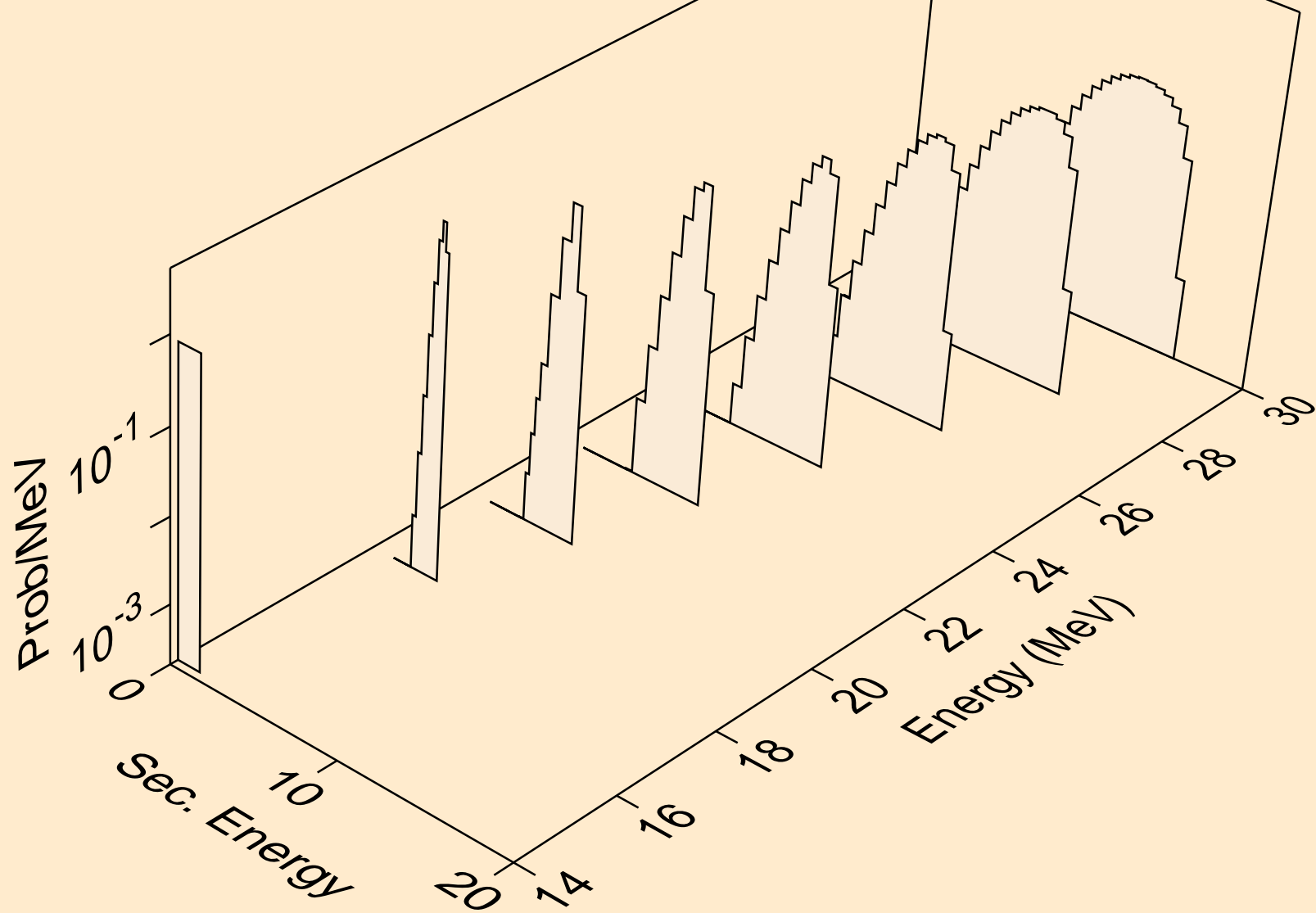



HF172 PROTON ACER TENDL-2023 LIBRARY; T=0.K  
deuterons from (p,d)

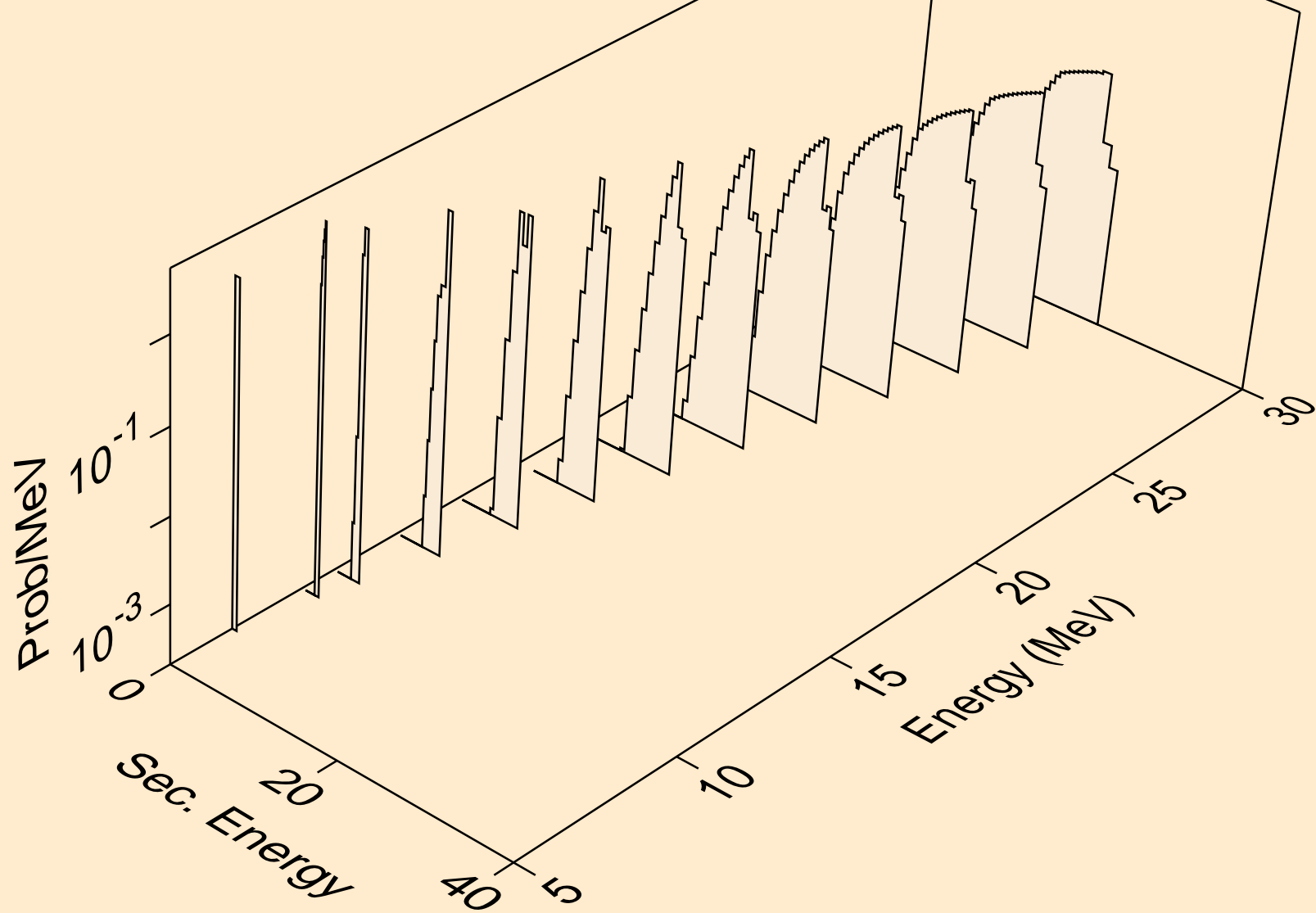

HF172 PROTON ACER TENDL-2023 LIBRARY; T=0.K  
deuterons from (p,pd)

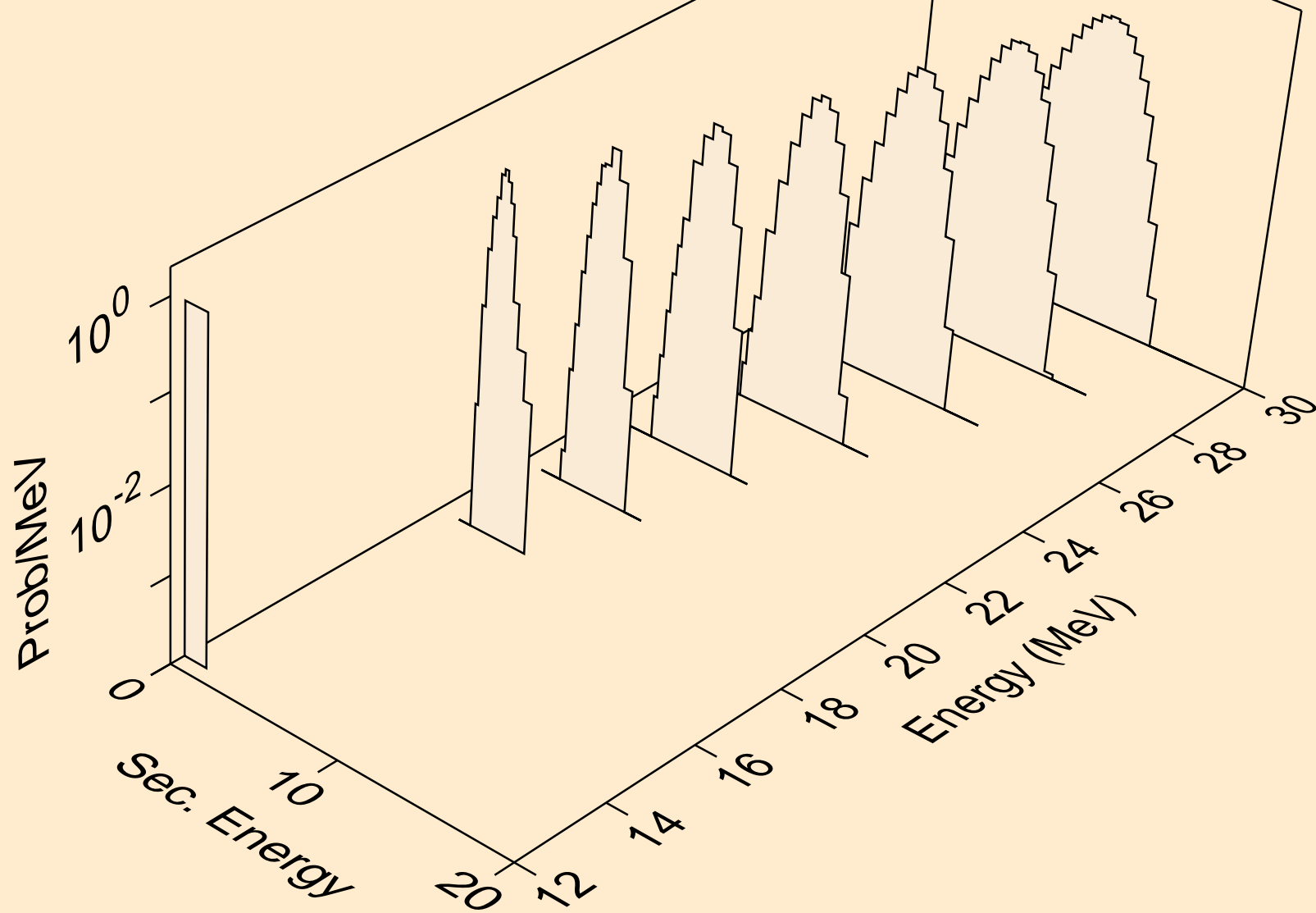

HF172 PROTON ACER TENDL-2023 LIBRARY; T=0.K  
deuterons from (p,da)

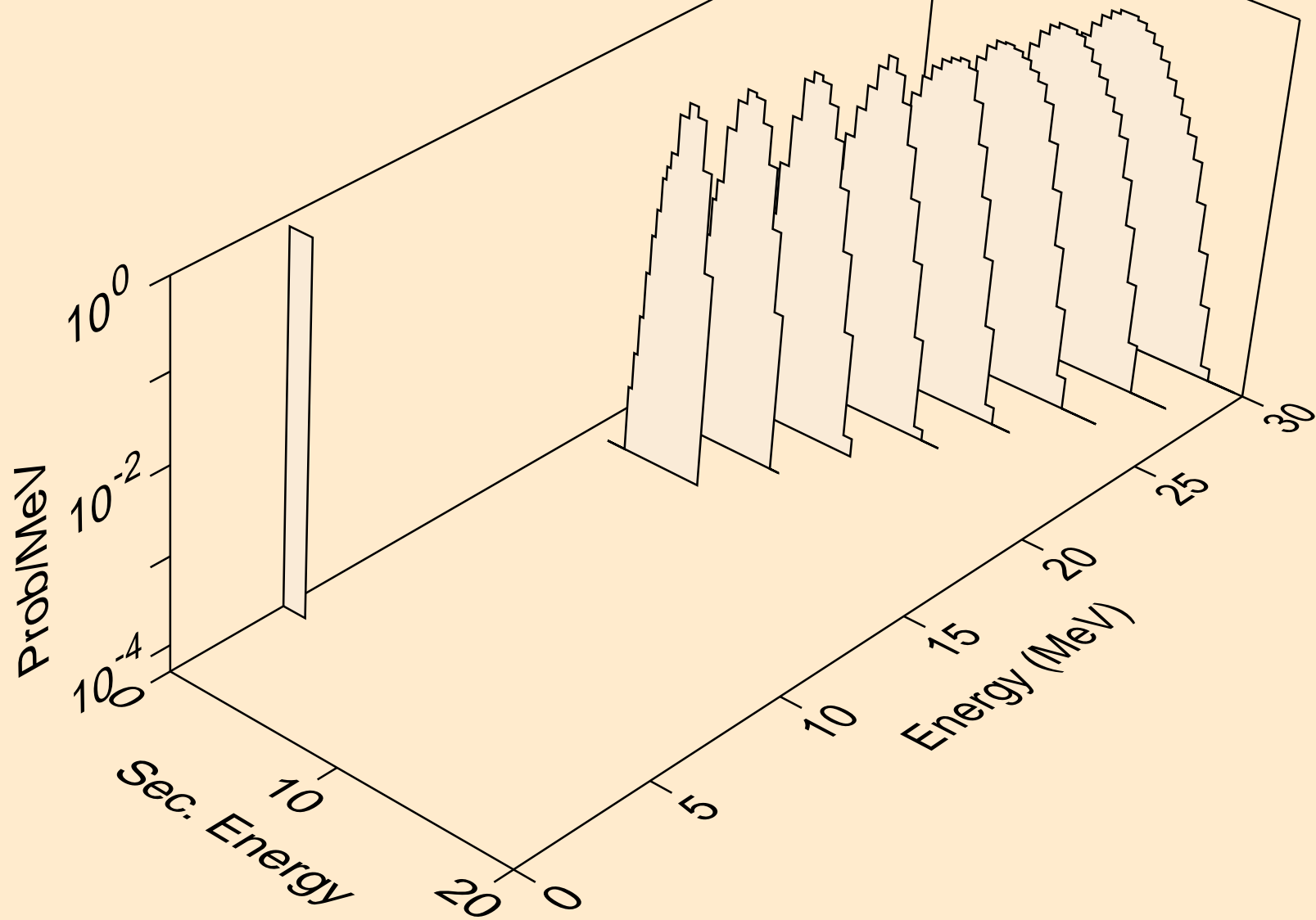

HF172 PROTON ACER TENDL-2023 LIBRARY; T=0.K  
tritons from (p,x)

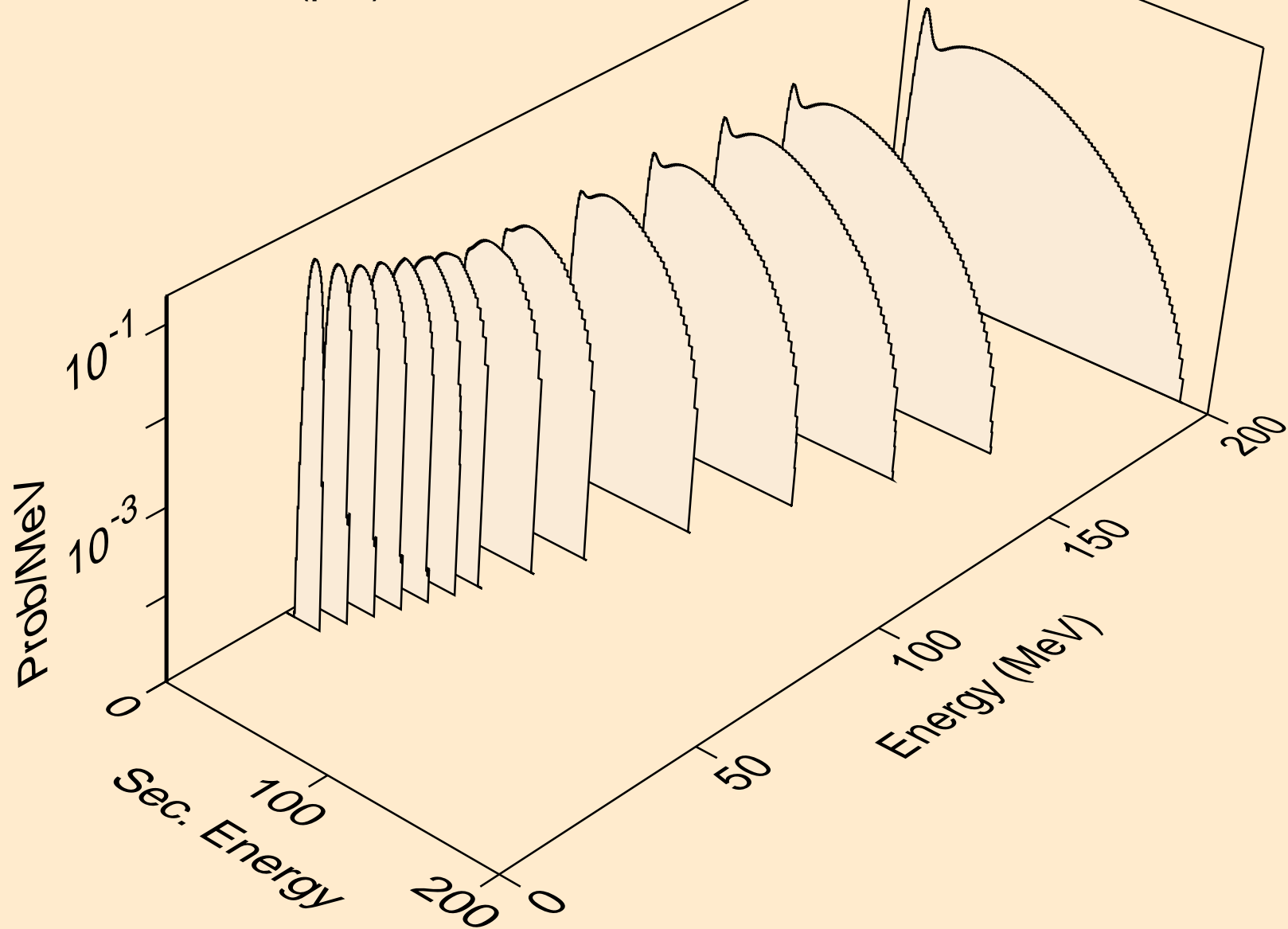

HF172 PROTON ACER TENDL-2023 LIBRARY; T=0.K  
tritons from (p,n\*)t

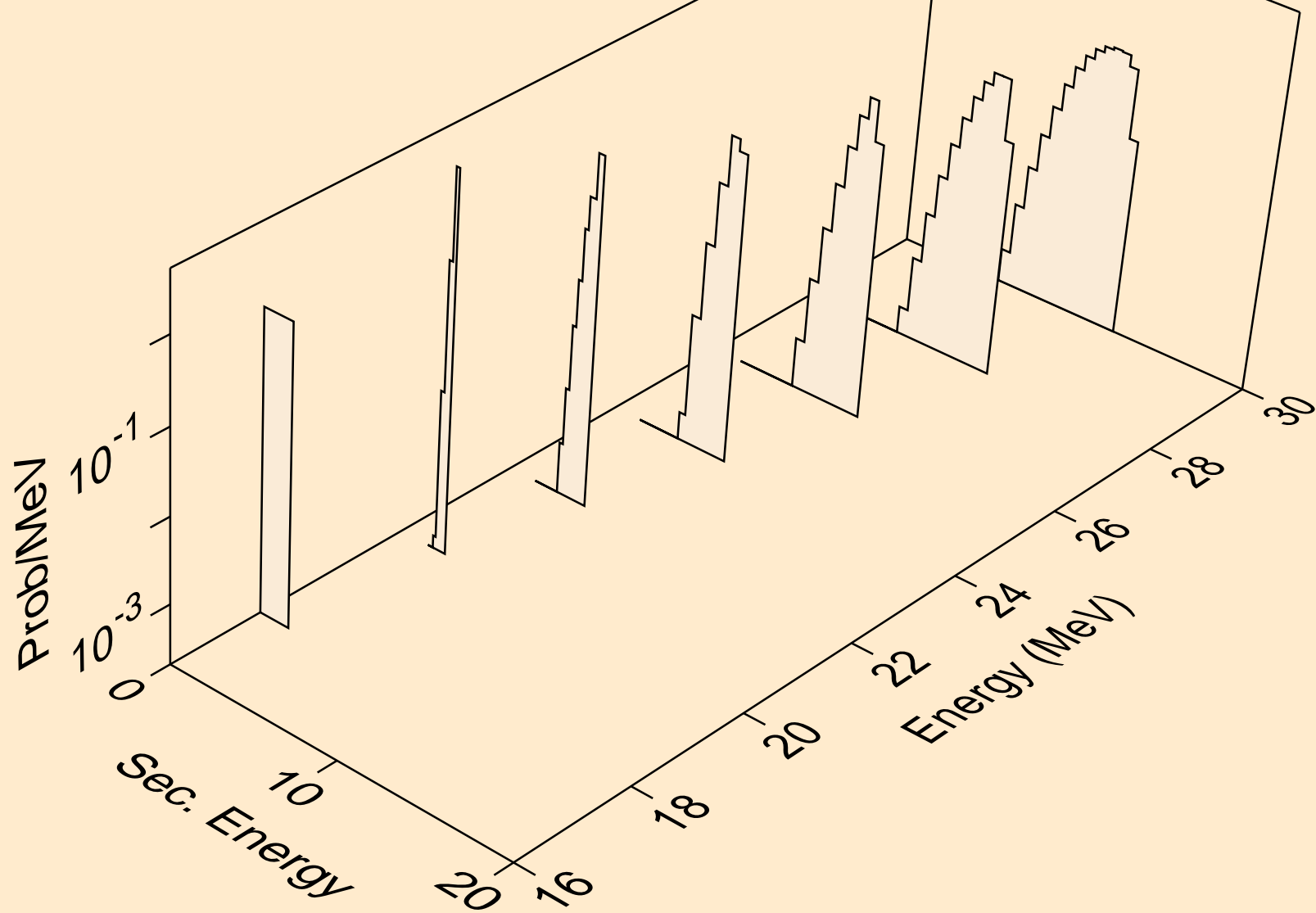

HF172 PROTON ACER TENDL-2023 LIBRARY; T=0.K  
tritons from (p,t)

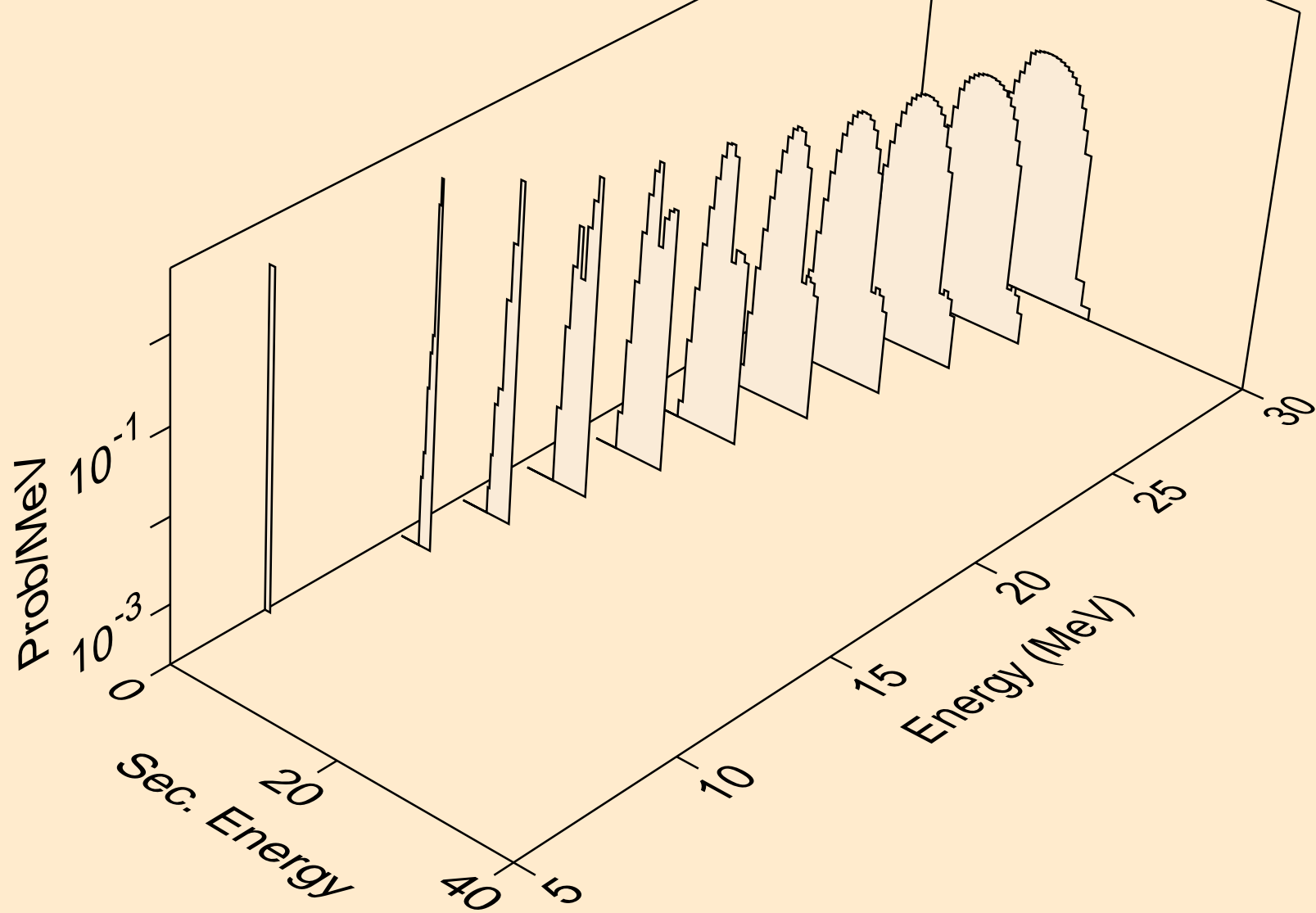

HF172 PROTON ACER TENDL-2023 LIBRARY; T=0.K  
tritons from (p,pt)

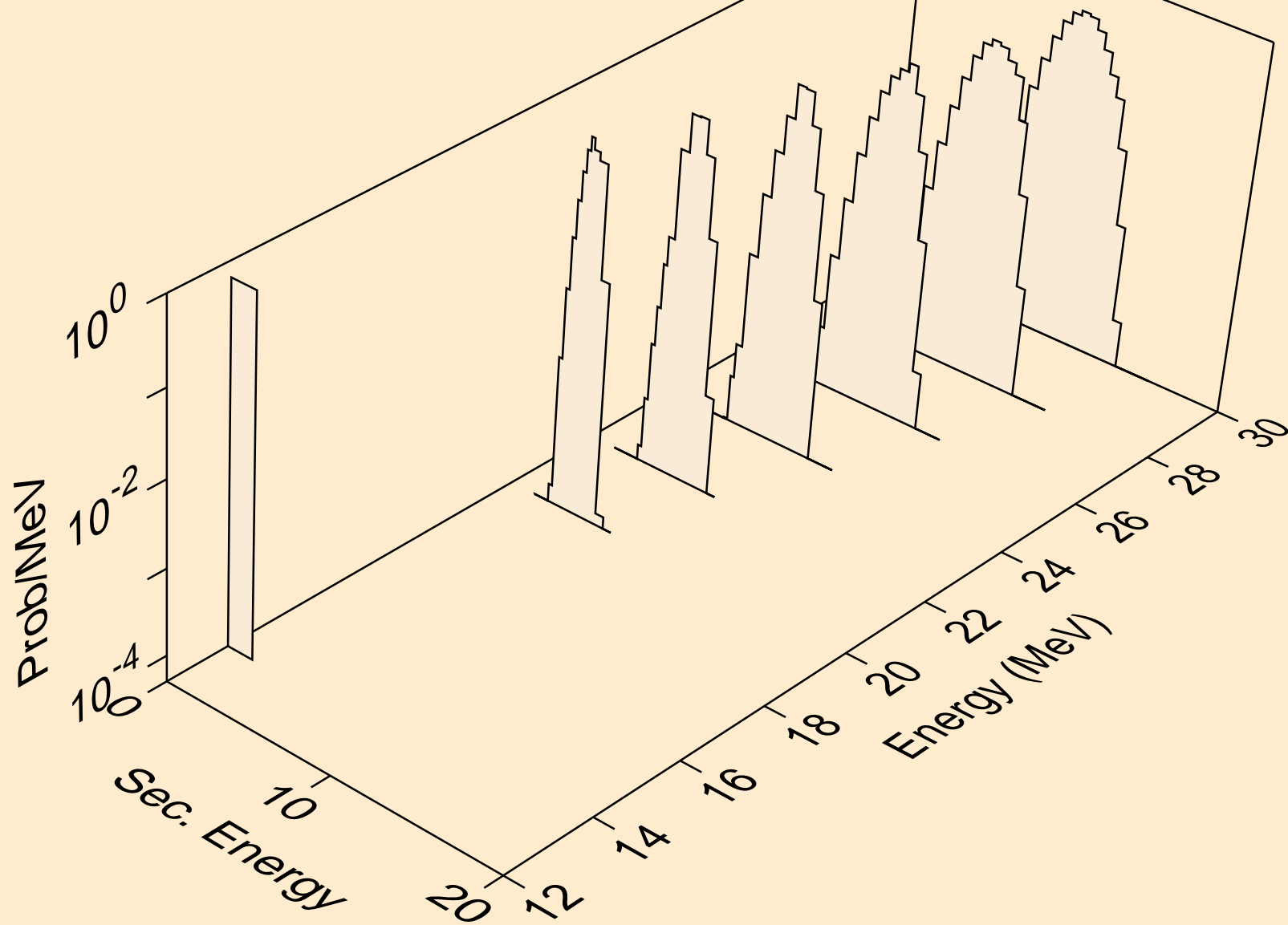

HF172 PROTON ACER TENDL-2023 LIBRARY; T=0.K  
he3s from (p,x)

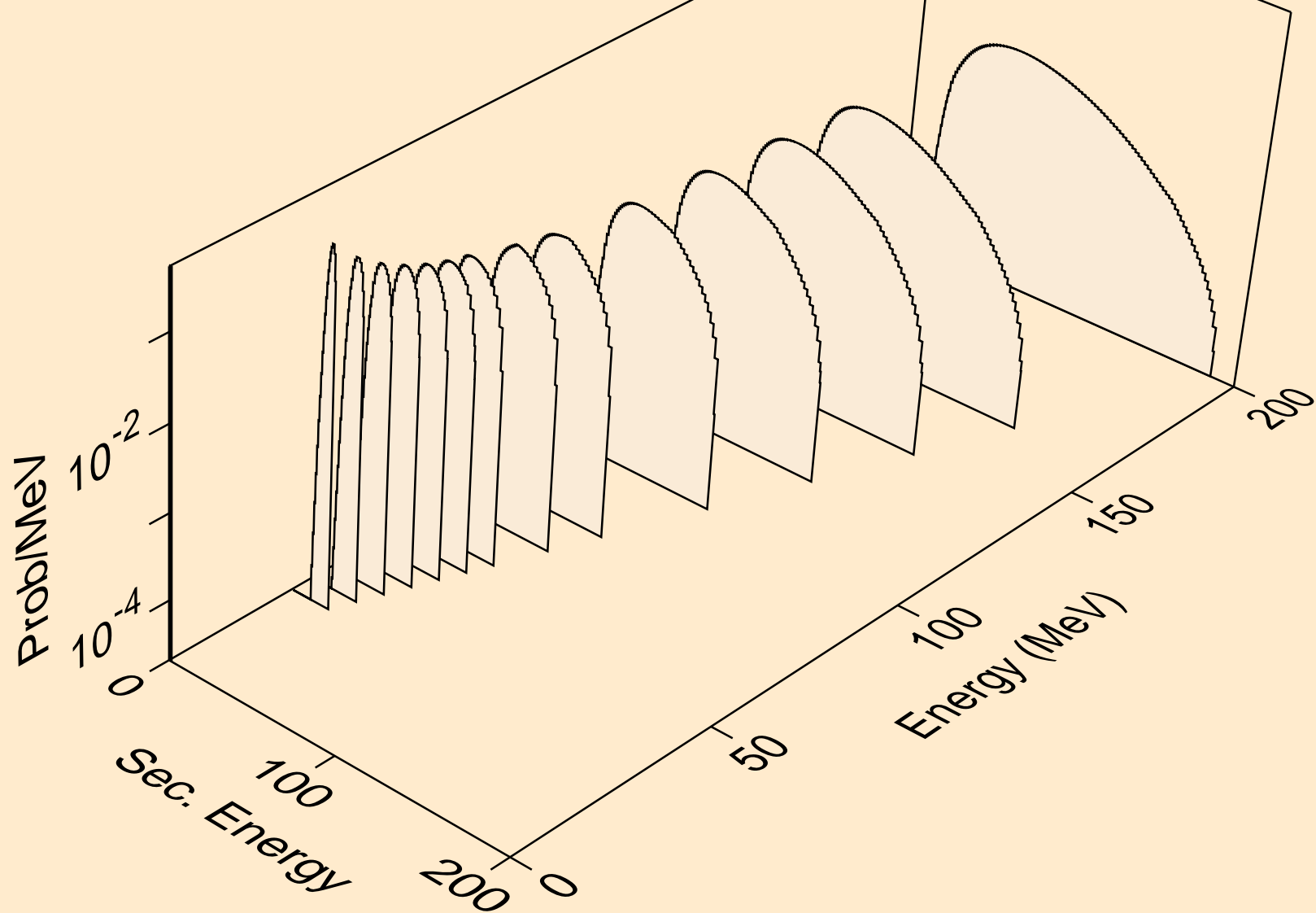



HF172 PROTON ACER TENDL-2023 LIBRARY; T=0.K  
he3s from (p,n\*)he3

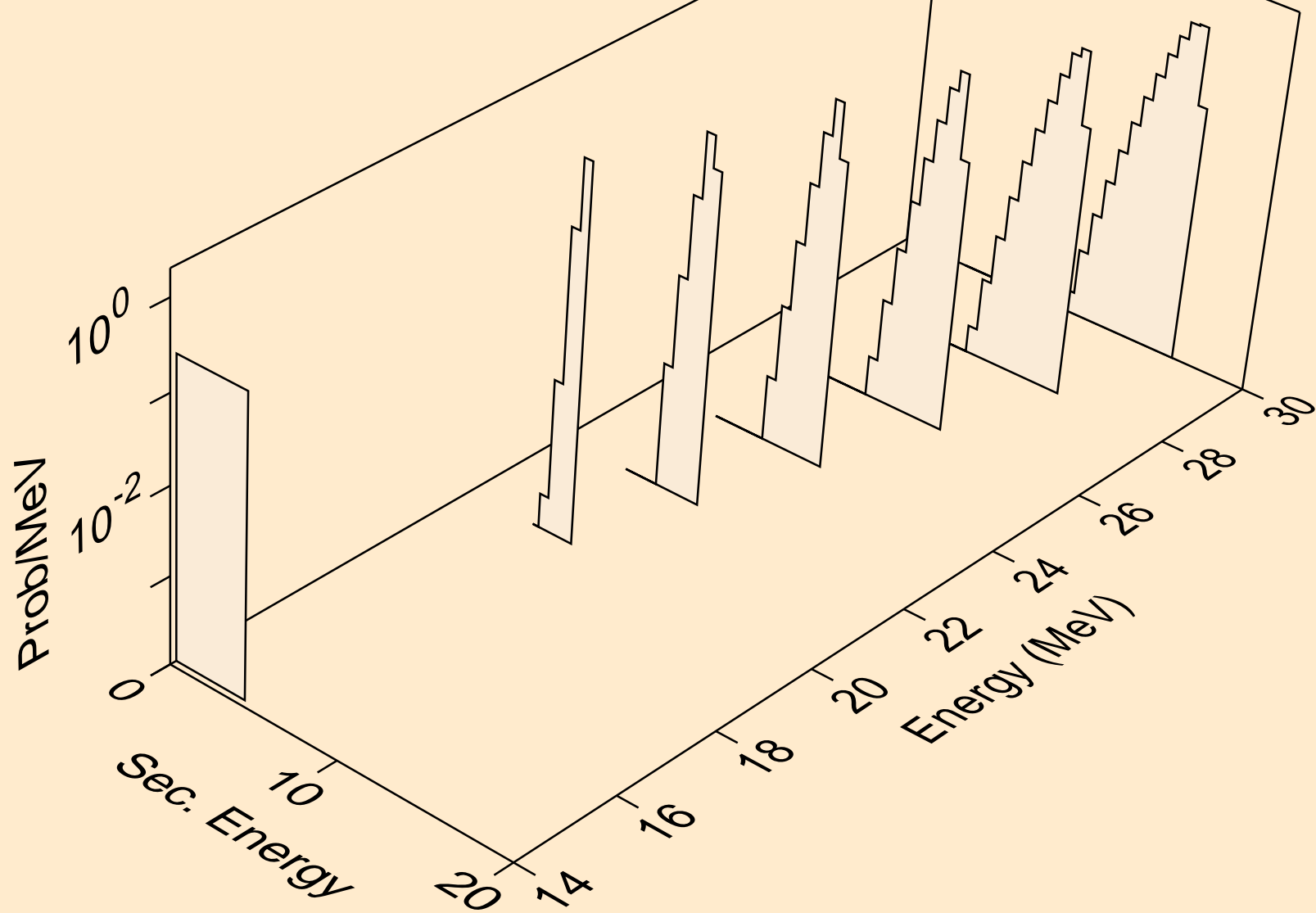

HF172 PROTON ACER TENDL-2023 LIBRARY; T=0.K  
he3s from (p,he3)

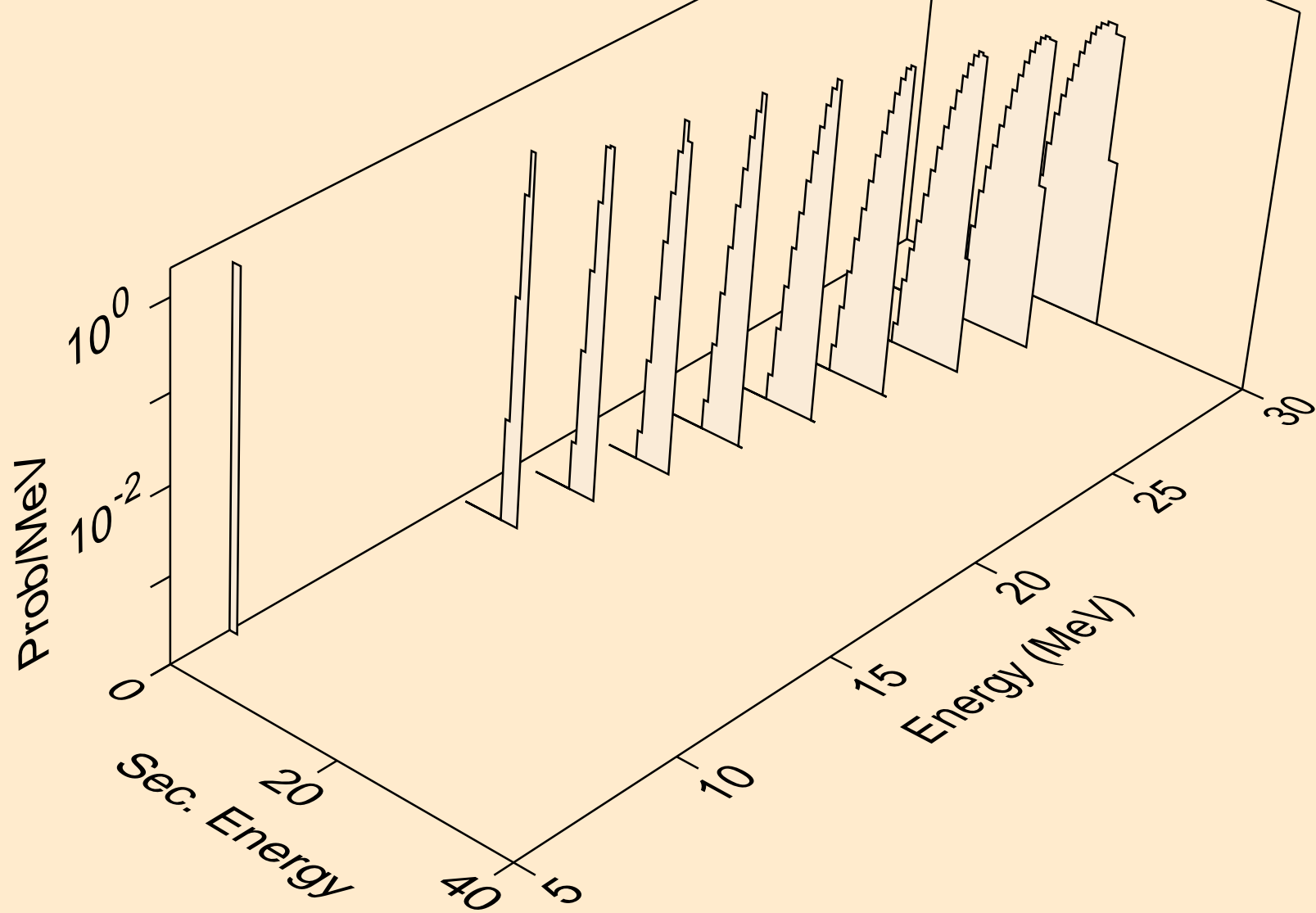

HF172 PROTON ACER TENDL-2023 LIBRARY; T=0.K  
alphas from (p,x)

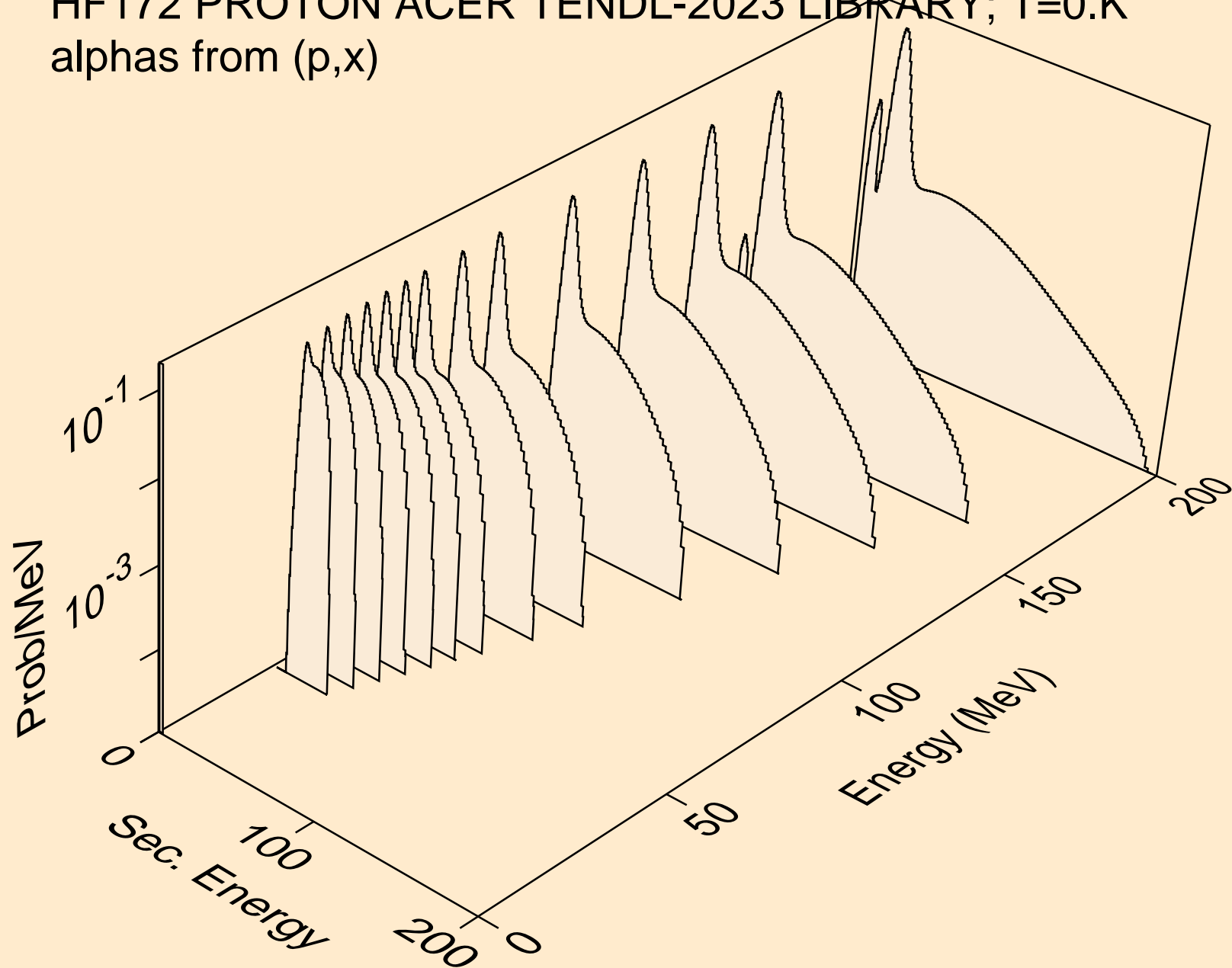

HF172 PROTON ACER TENDL-2023 LIBRARY; T=0.K  
alphas from (p,n\*)a

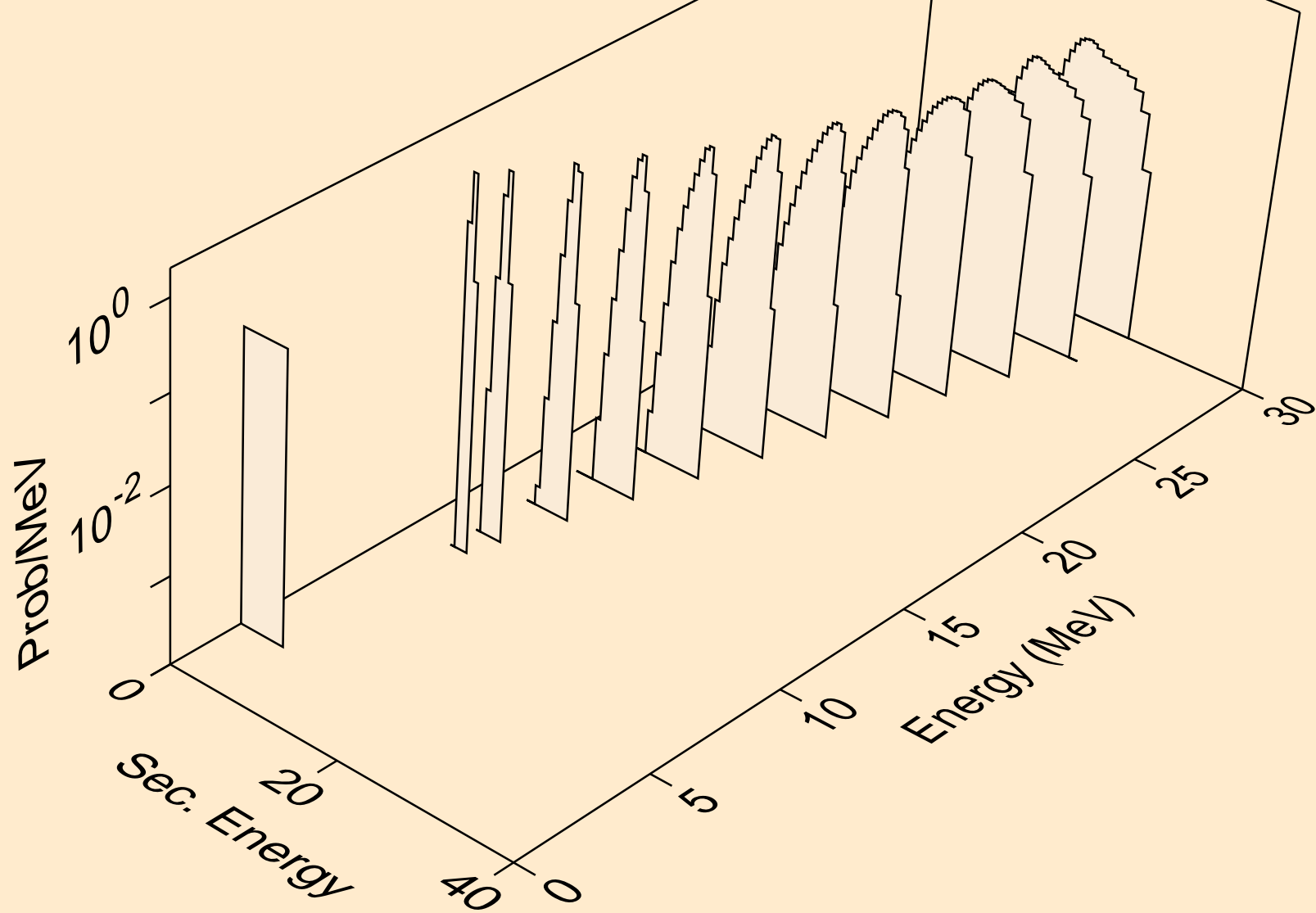

HF172 PROTON ACER TENDL-2023 LIBRARY; T=0.K  
alphas from (p,2n)a

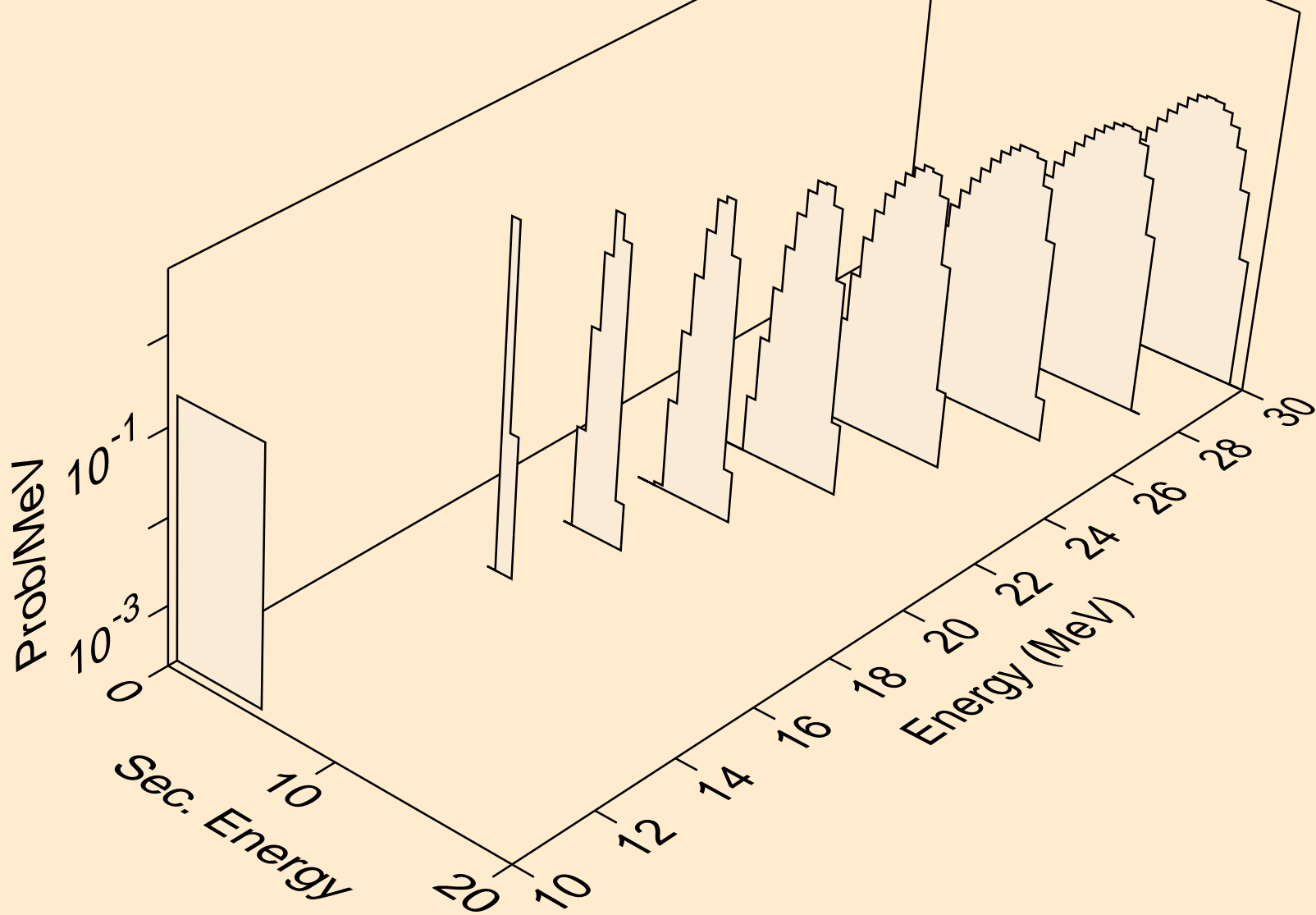

HF172 PROTON ACER TENDL-2023 LIBRARY; T=0.K  
alphas from (p,3n)a

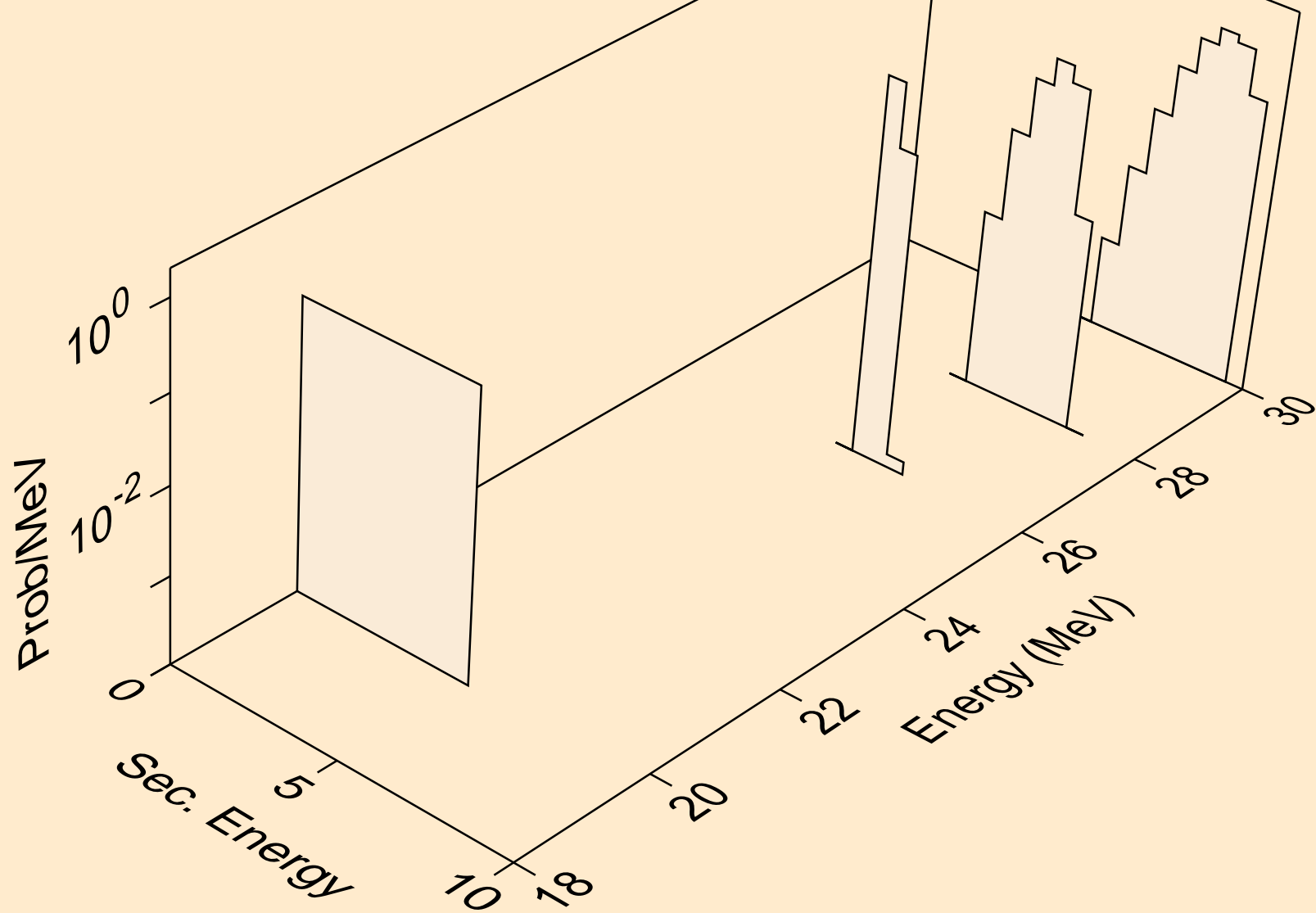

HF172 PROTON ACER TENDL-2023 LIBRARY; T=0.K  
alphas from (p,n\*)2a

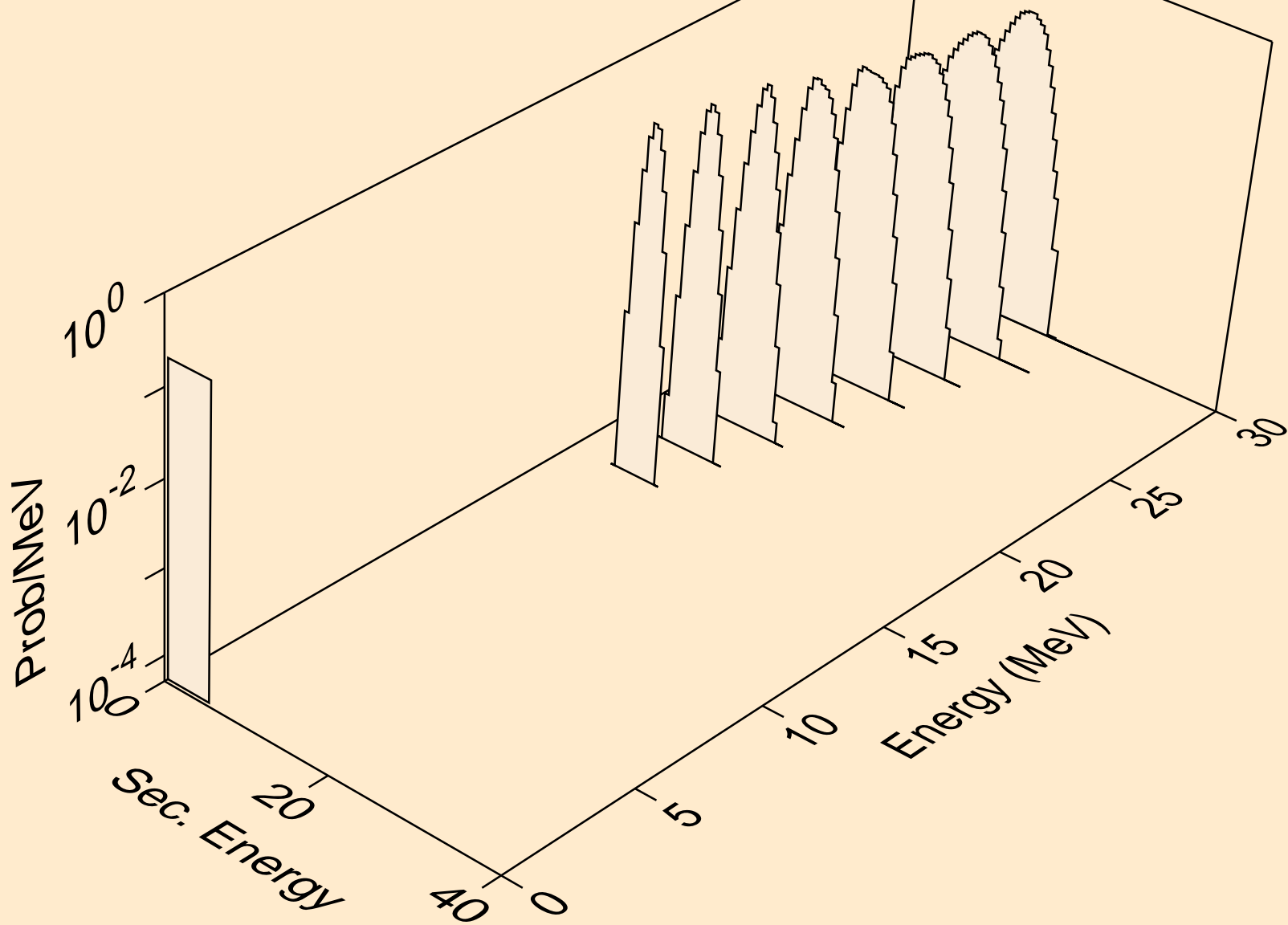

HF172 PROTON ACER TENDL-2023 LIBRARY; T=0.K  
alphas from (p,npa)

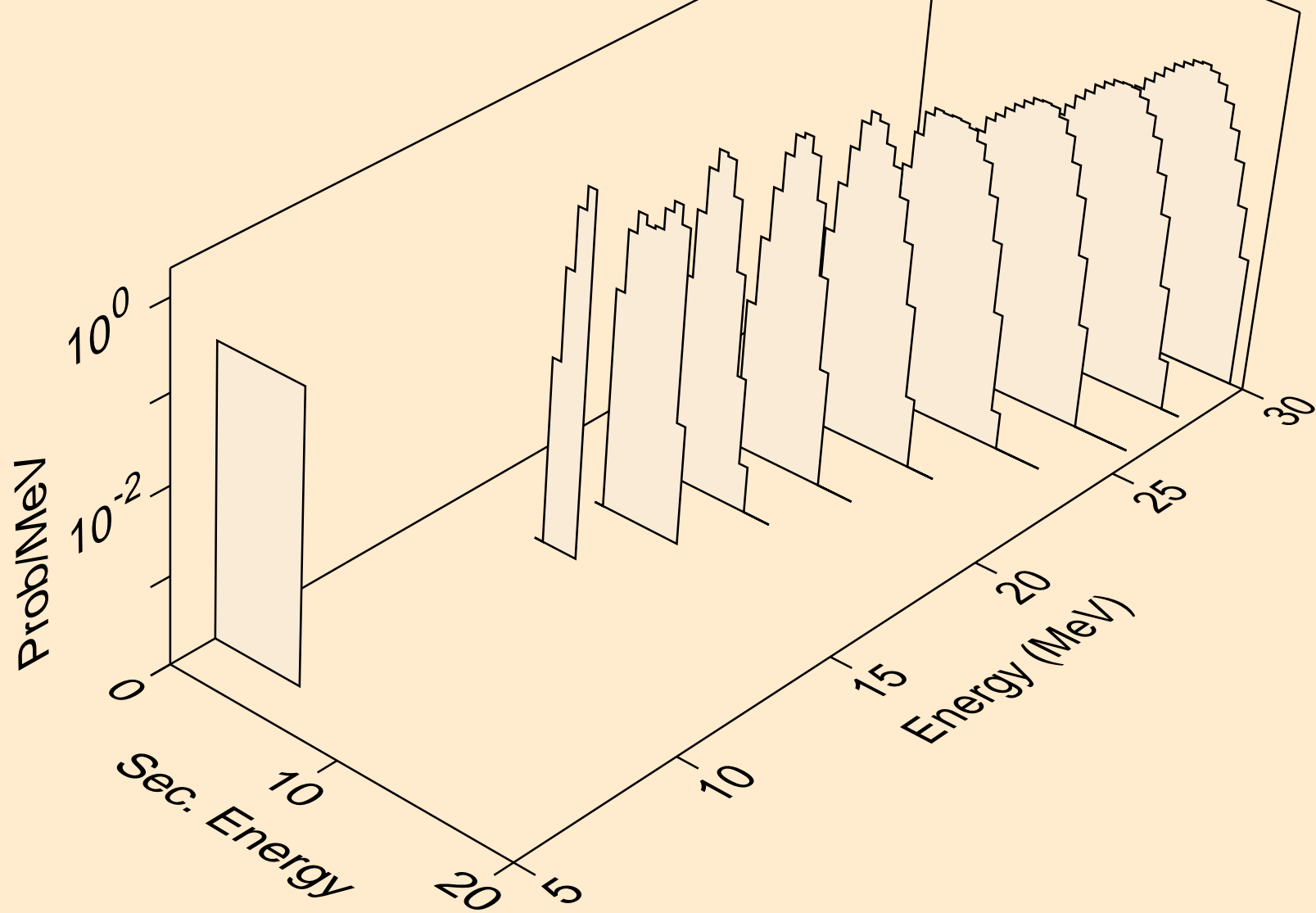



HF172 PROTON ACER TENDL-2023 LIBRARY; T=0.K  
alphas from (p,a)

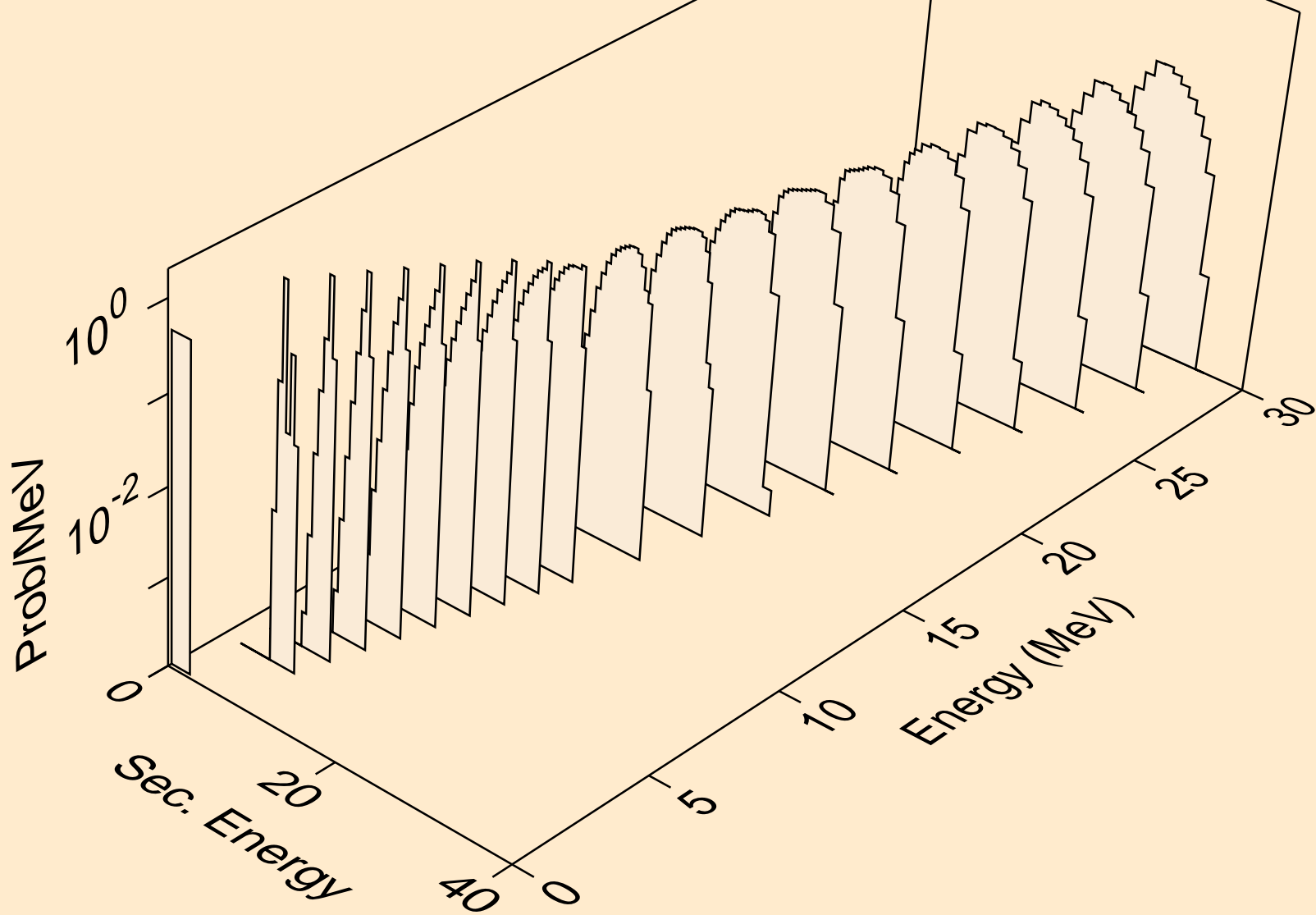

HF172 PROTON ACER TENDL-2023 LIBRARY; T=0.K  
alphas from (p,2a)

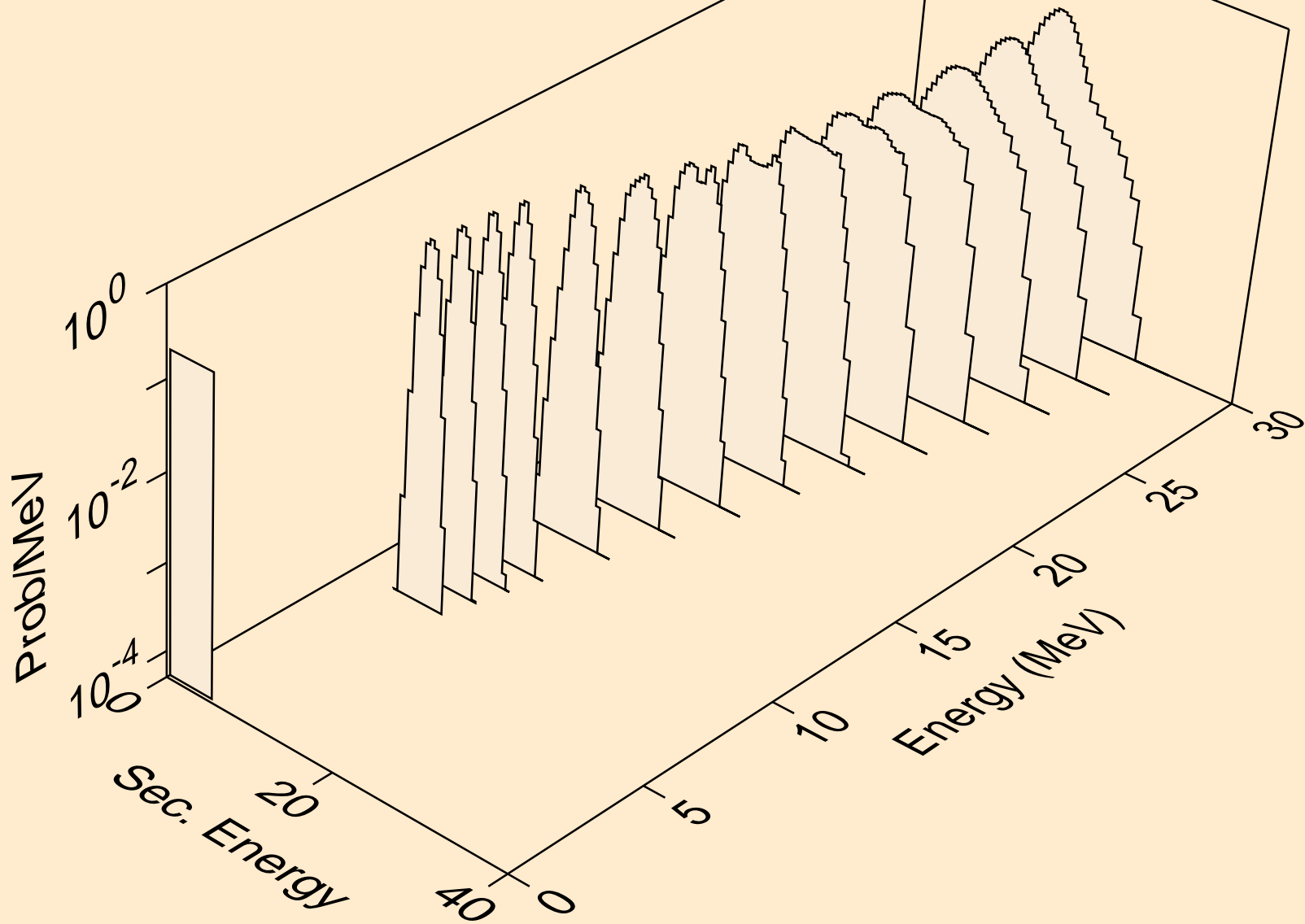

HF172 PROTON ACER TENDL-2023 LIBRARY; T=0.K  
alphas from (p,pa)

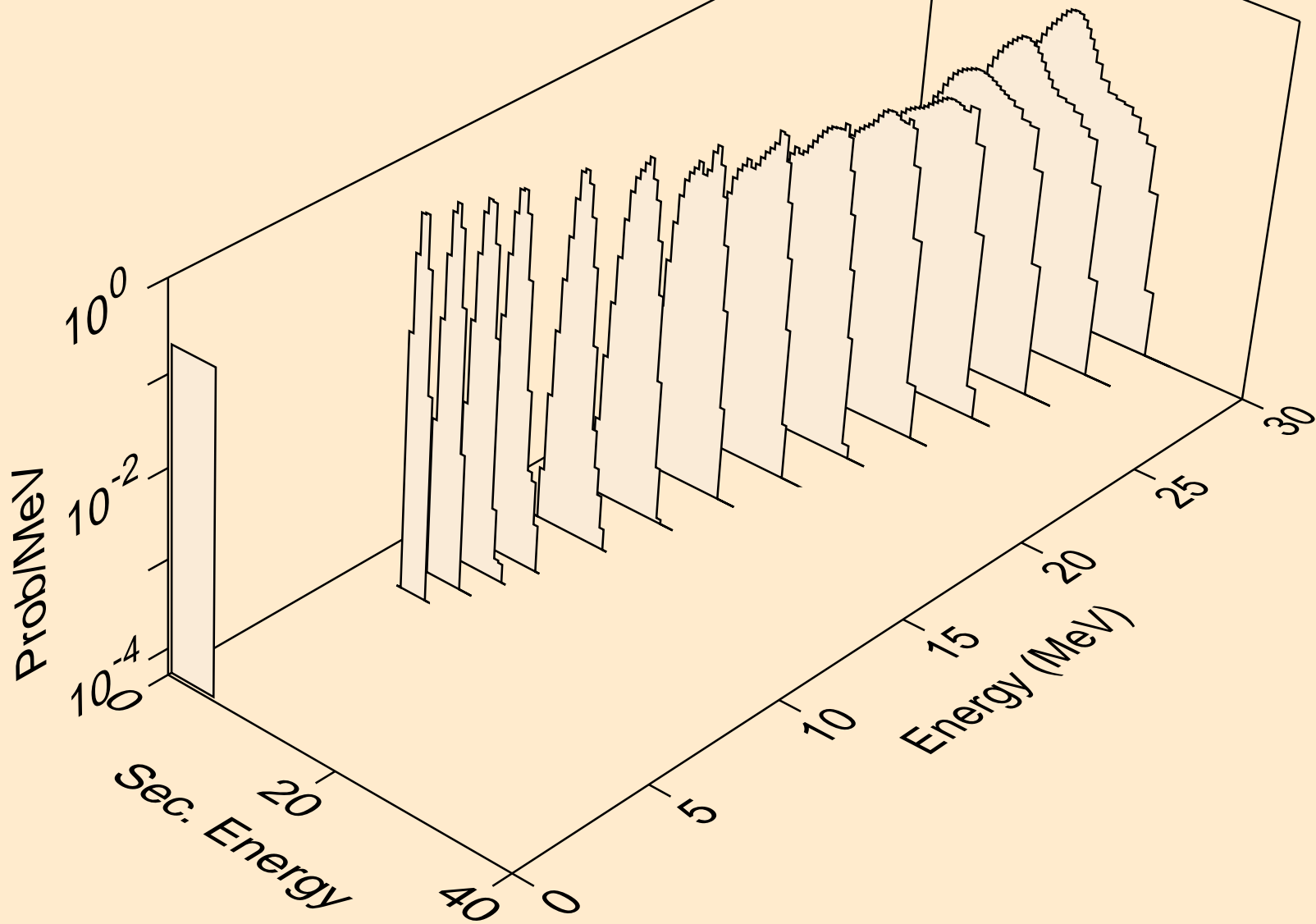

HF172 PROTON ACER TENDL-2023 LIBRARY; T=0.K  
alphas from (p,da)

