

# HO173 PROTON ACER TENDL-2023 LIBRARY; T=0.K

## Principal cross sections

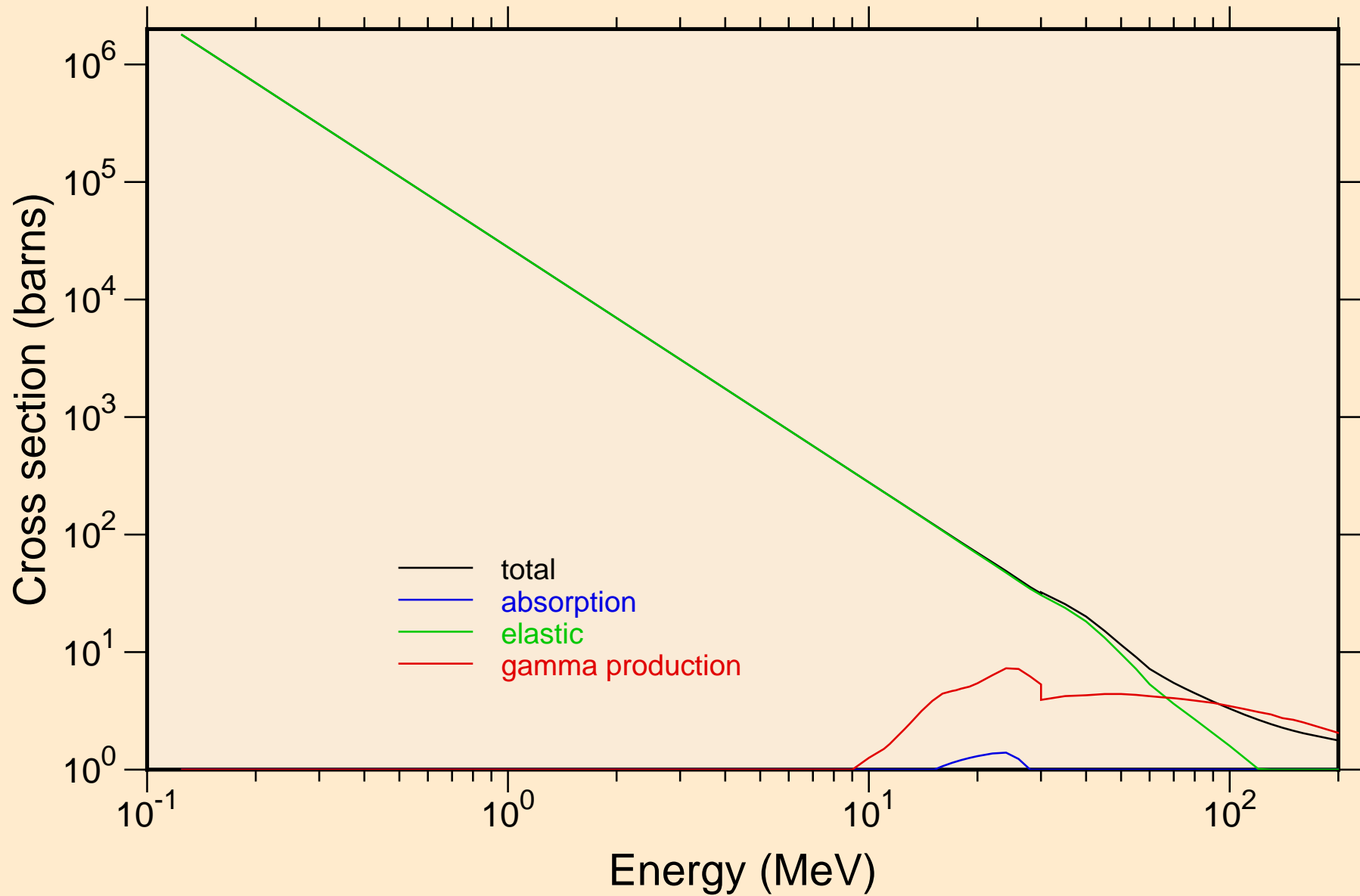

# HO173 PROTON ACER TENDL-2023 LIBRARY; T=0.K

## Heating

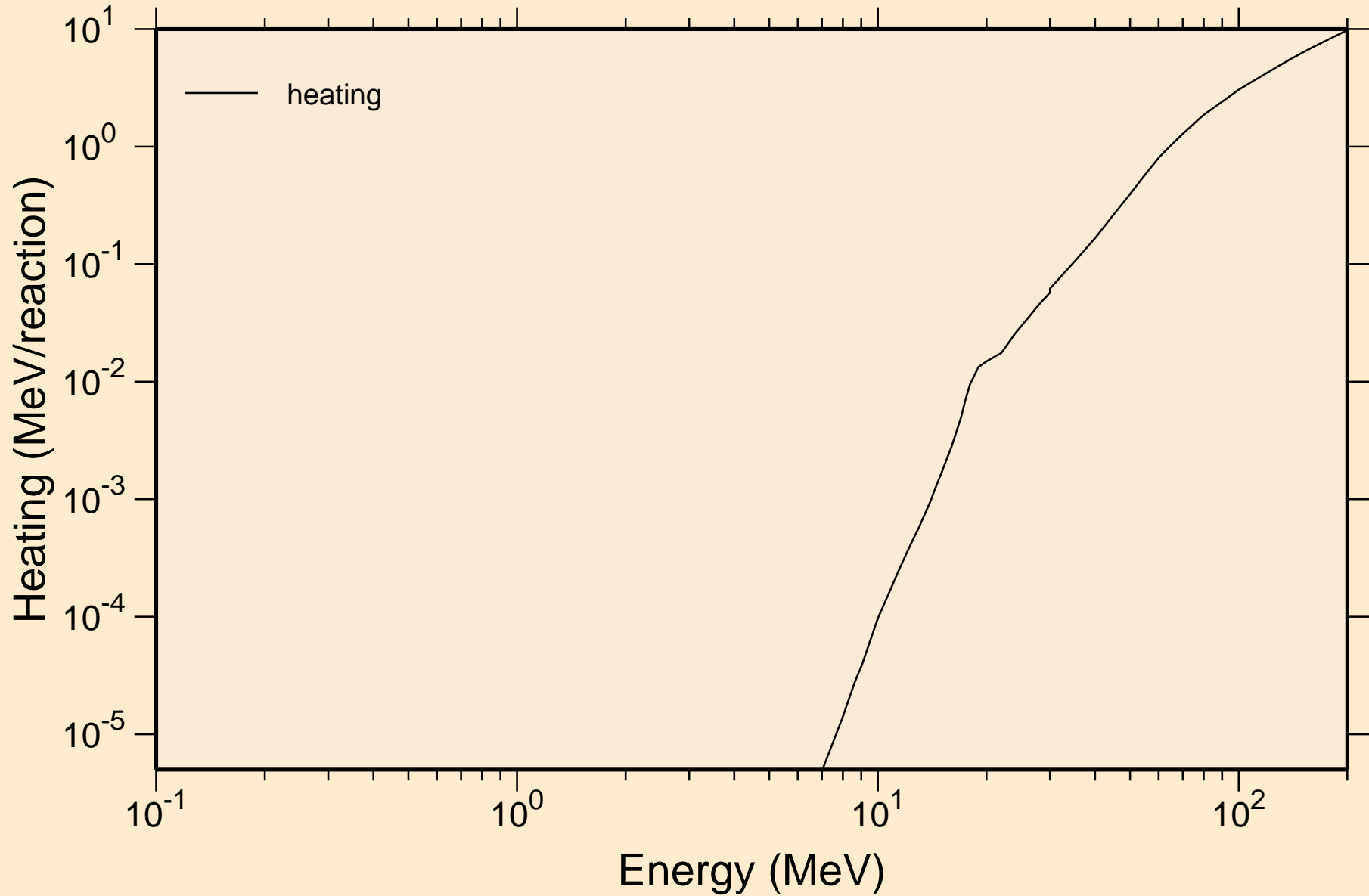

# HO173 PROTON ACER TENDL-2023 LIBRARY; T=0.K

## Principal cross sections

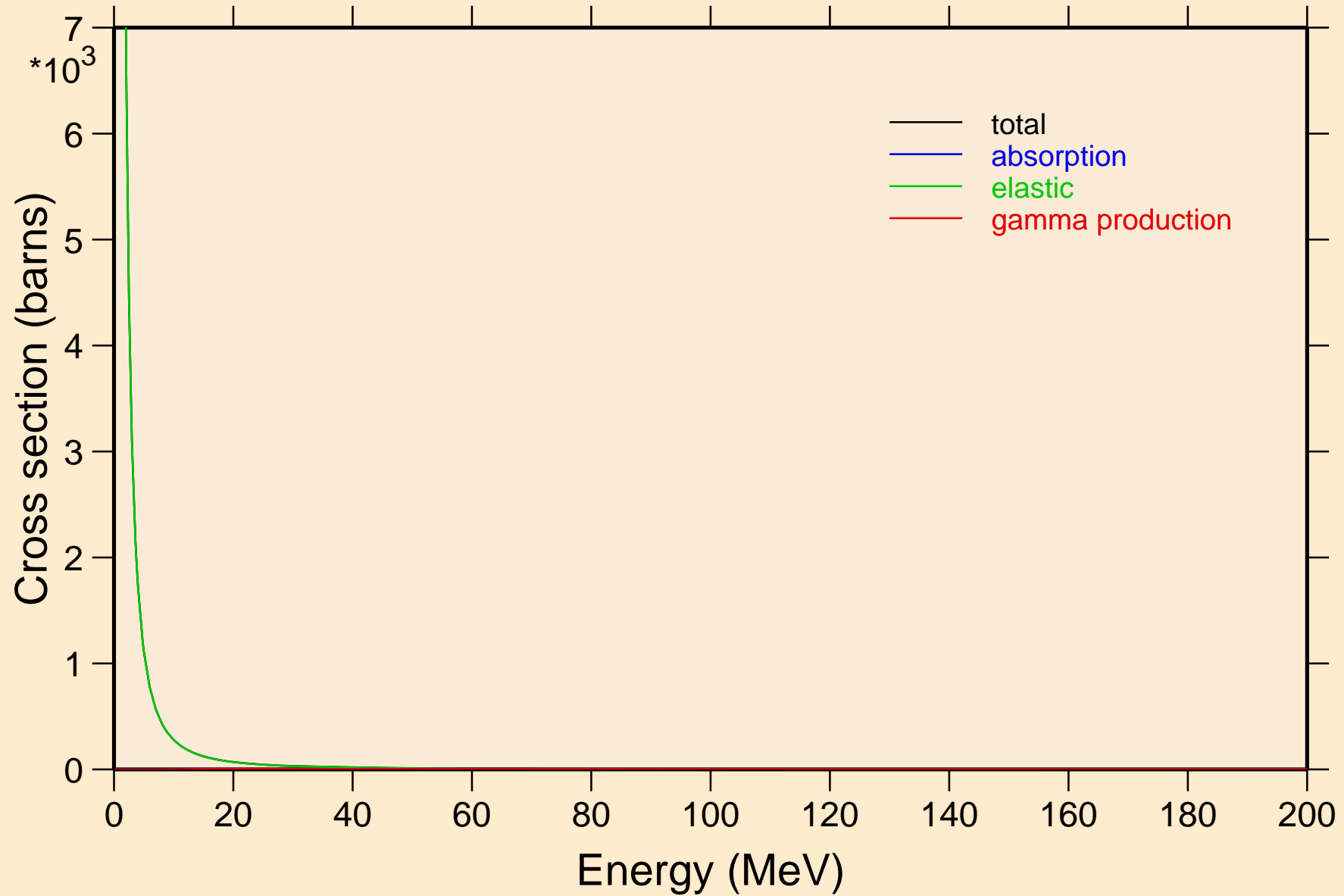

# HO173 PROTON ACER TENDL-2023 LIBRARY; T=0.K

## Heating

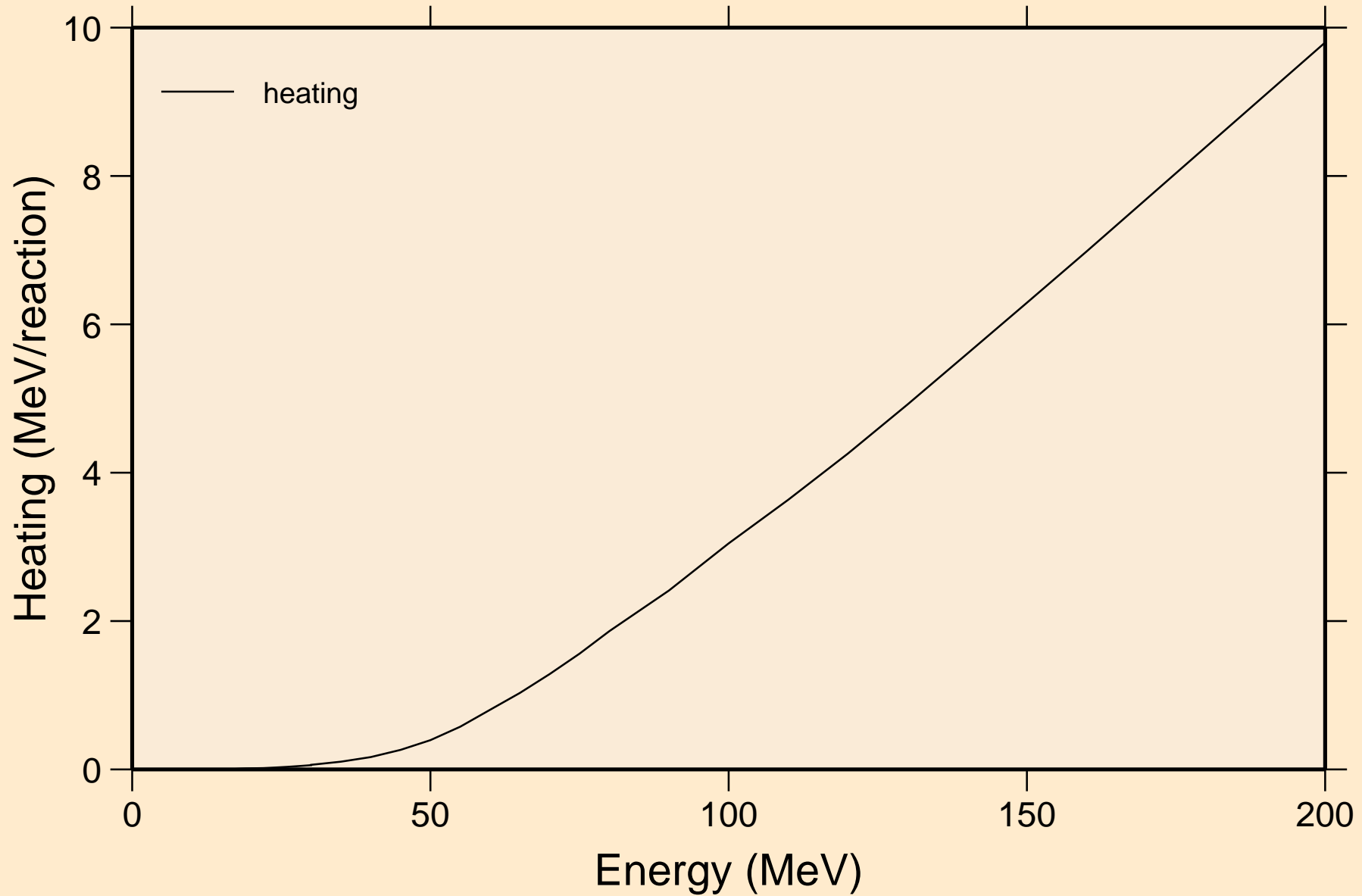

# HO173 PROTON ACER TENDL-2023 LIBRARY; T=0.K

## Threshold reactions

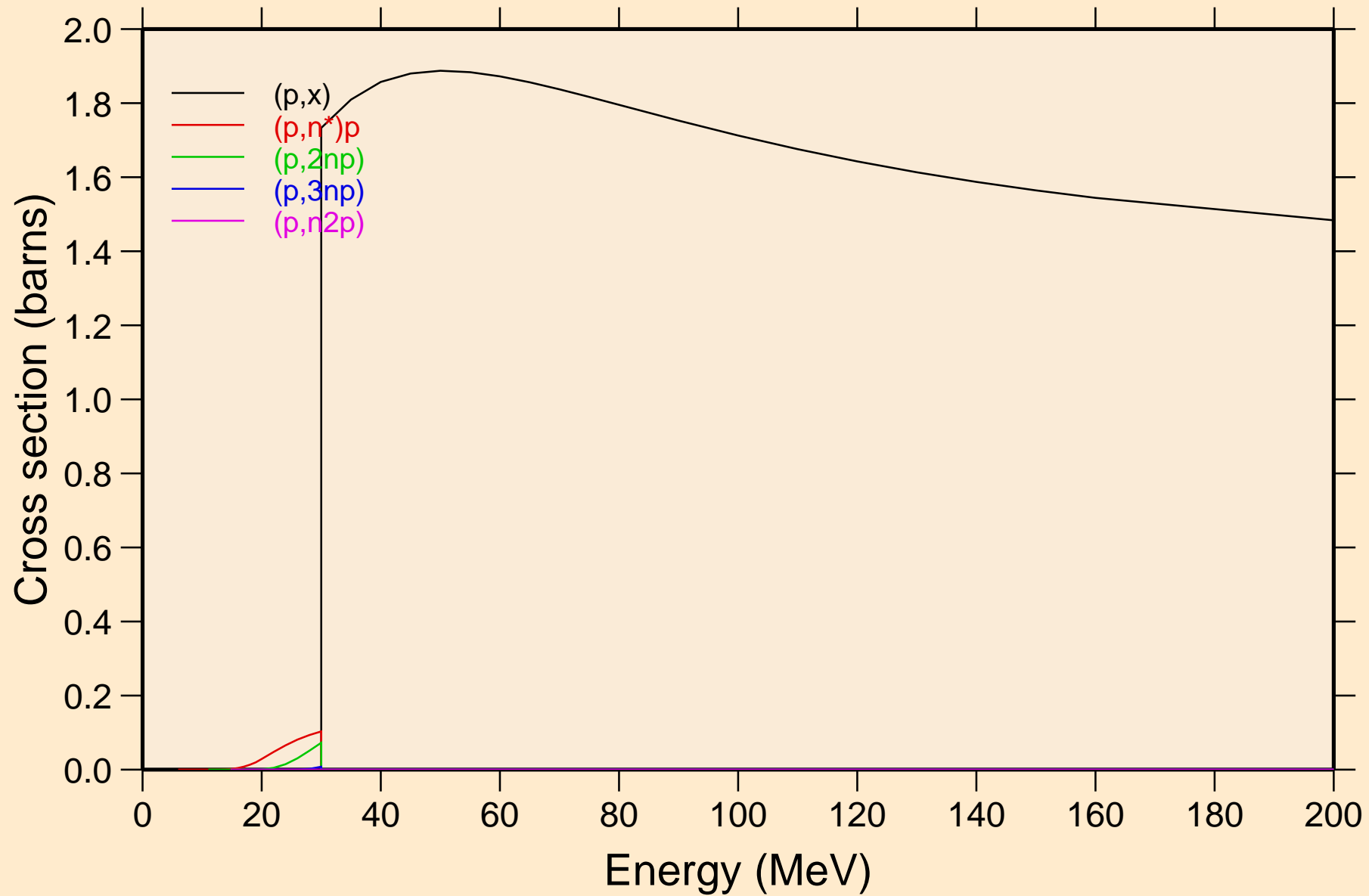

# HO173 PROTON ACER TENDL-2023 LIBRARY; T=0.K

## Threshold reactions

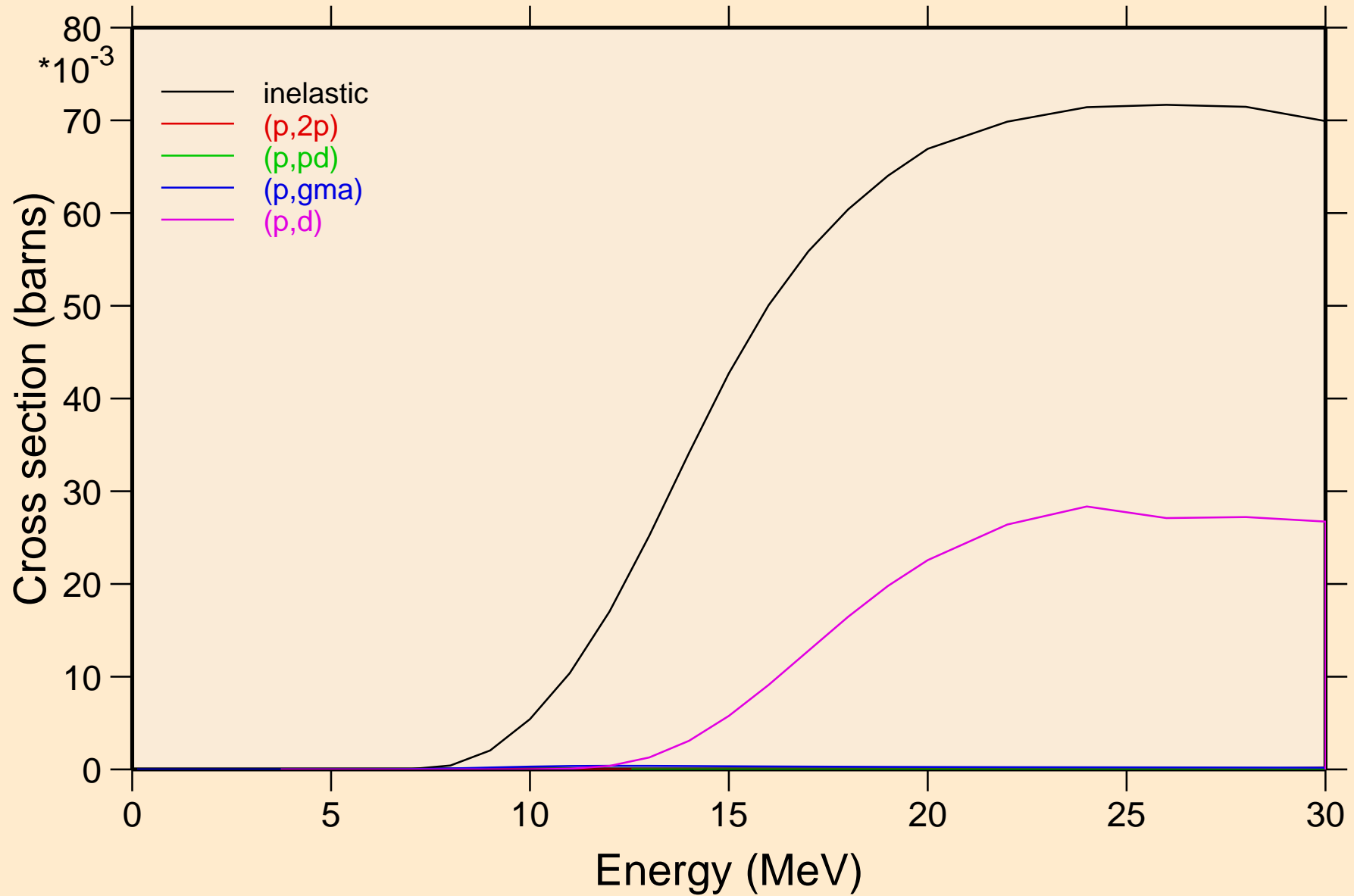

# HO173 PROTON ACER TENDL-2023 LIBRARY; T=0.K

## Threshold reactions

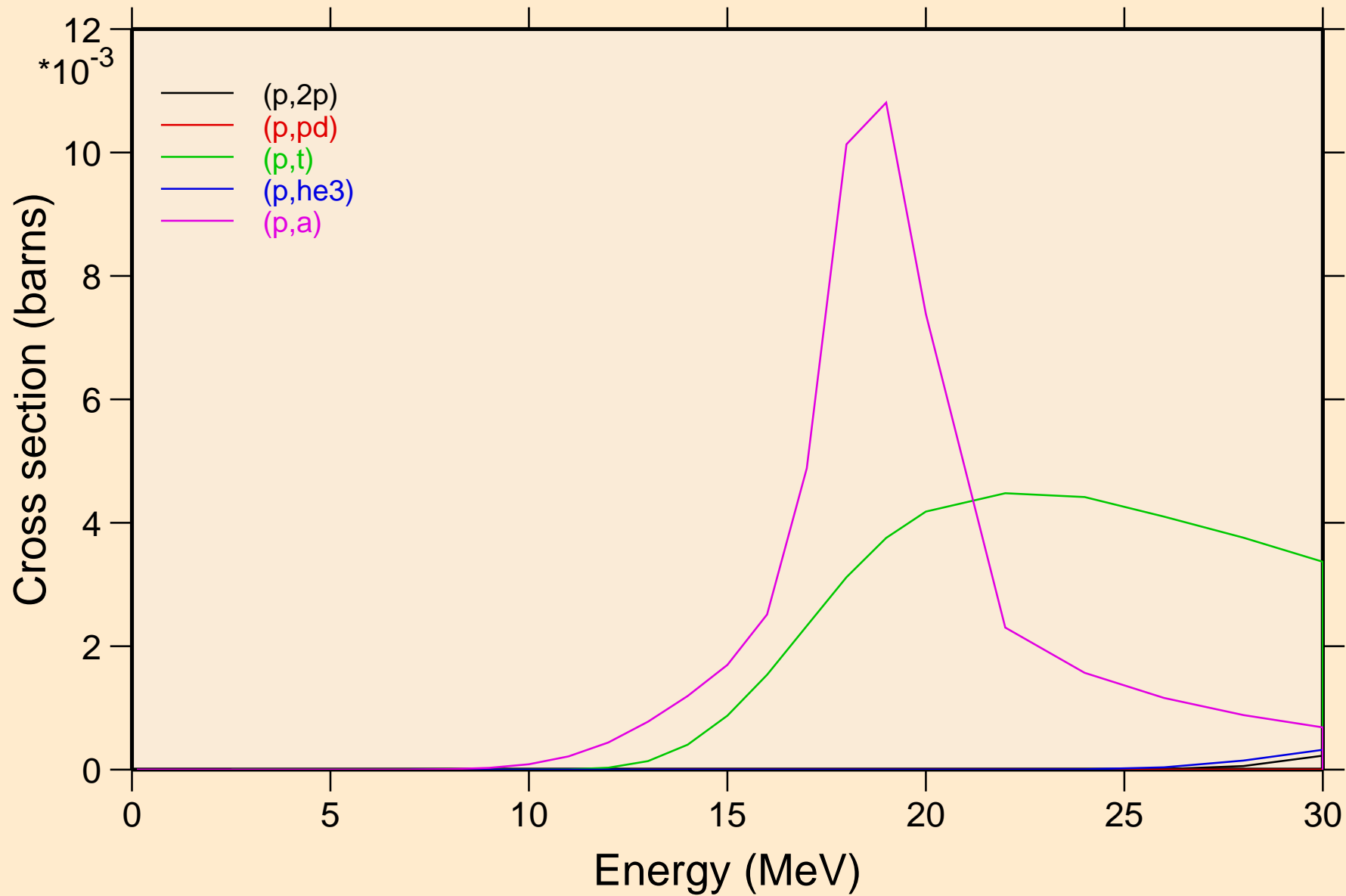

HO173 PROTON ACER TENDL-2023 LIBRARY; T=0.K  
Threshold reactions

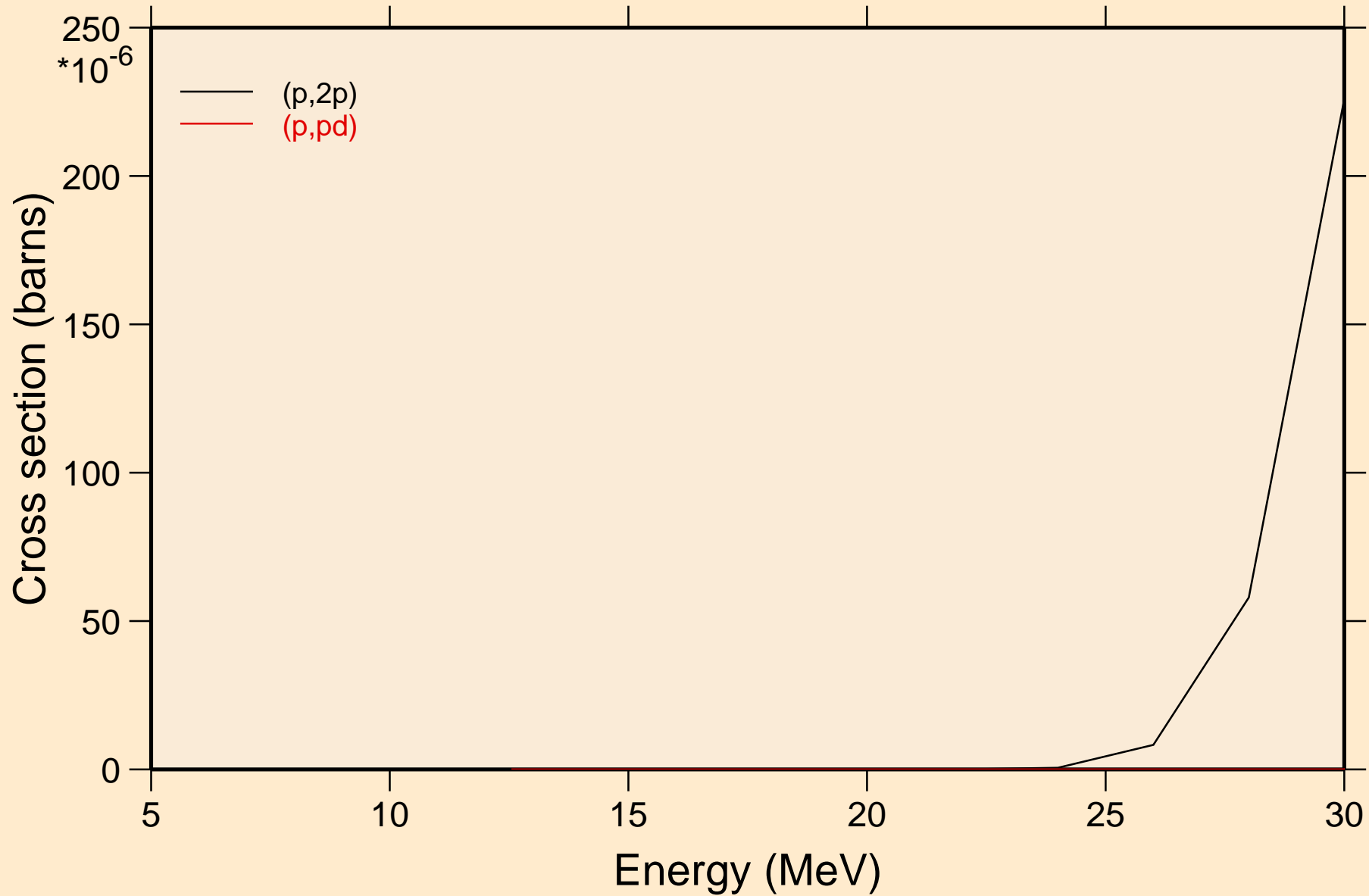



HO173 PROTON ACER TENDL-2023 LIBRARY; T=0.K  
angular distribution for elastic

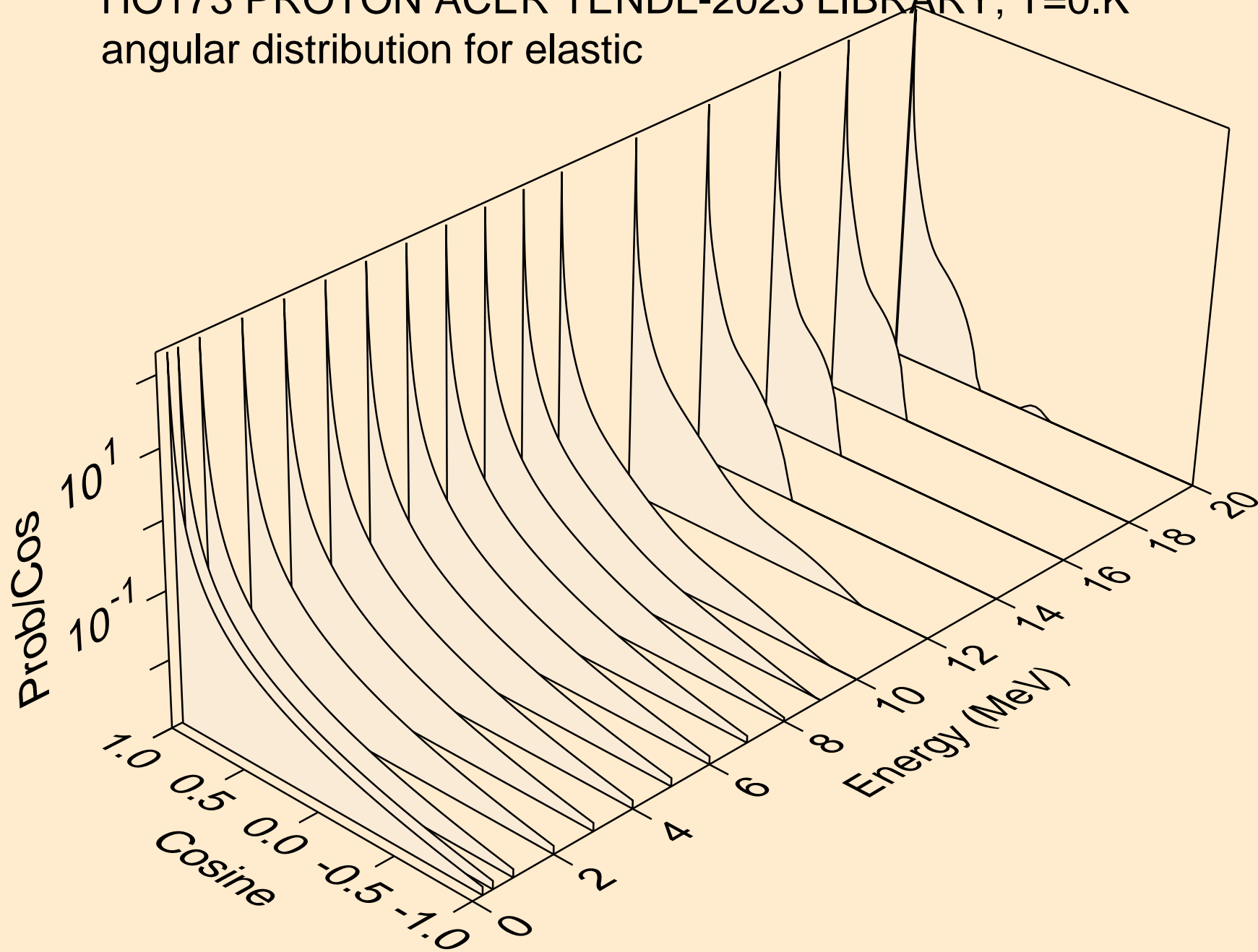

HO173 PROTON ACER TENDL-2023 LIBRARY; T=0.K  
angular distribution for elastic

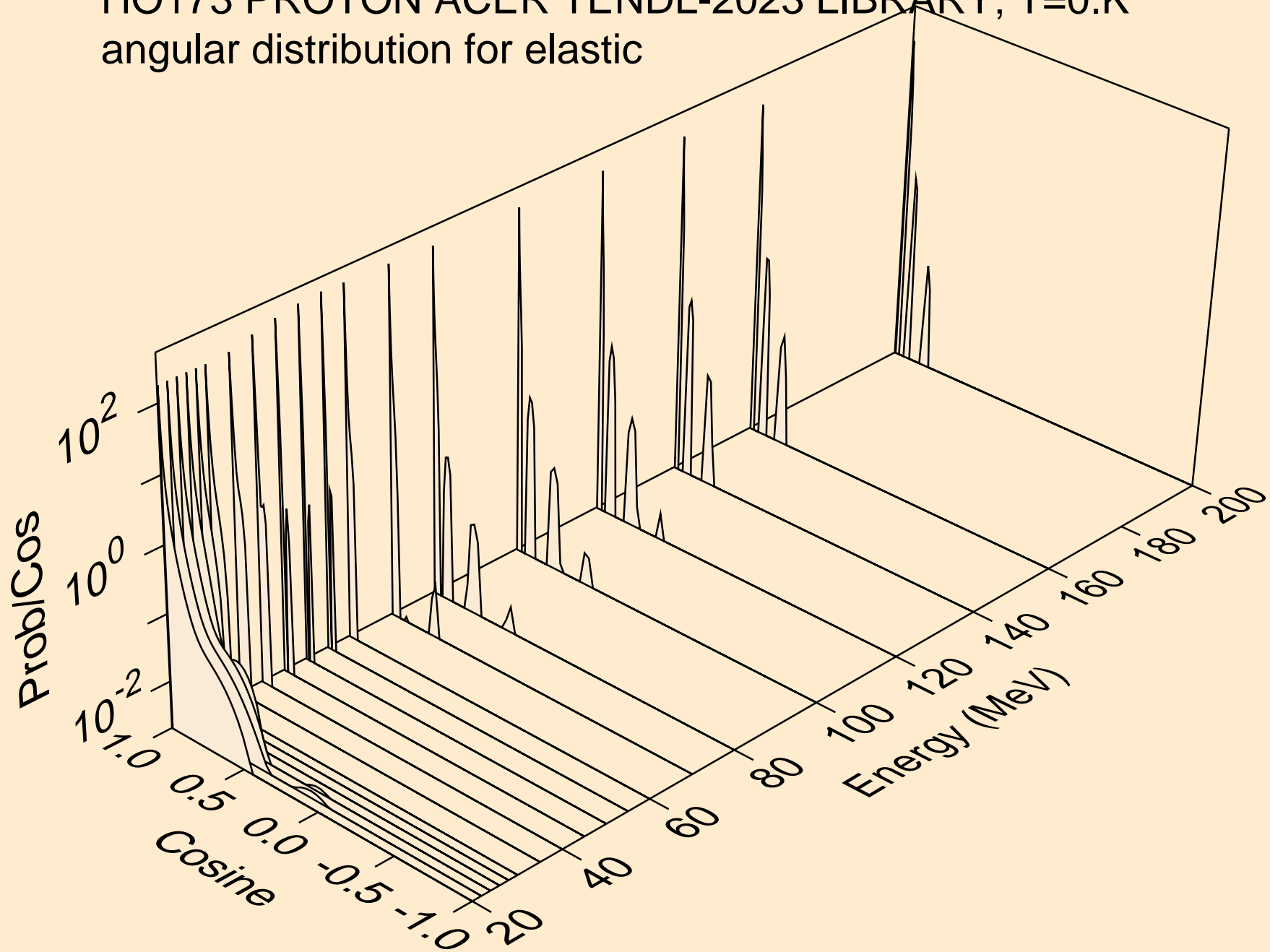

HO173 PROTON ACER TENDL-2023 LIBRARY; T=0.K  
Proton emission for (p,x)

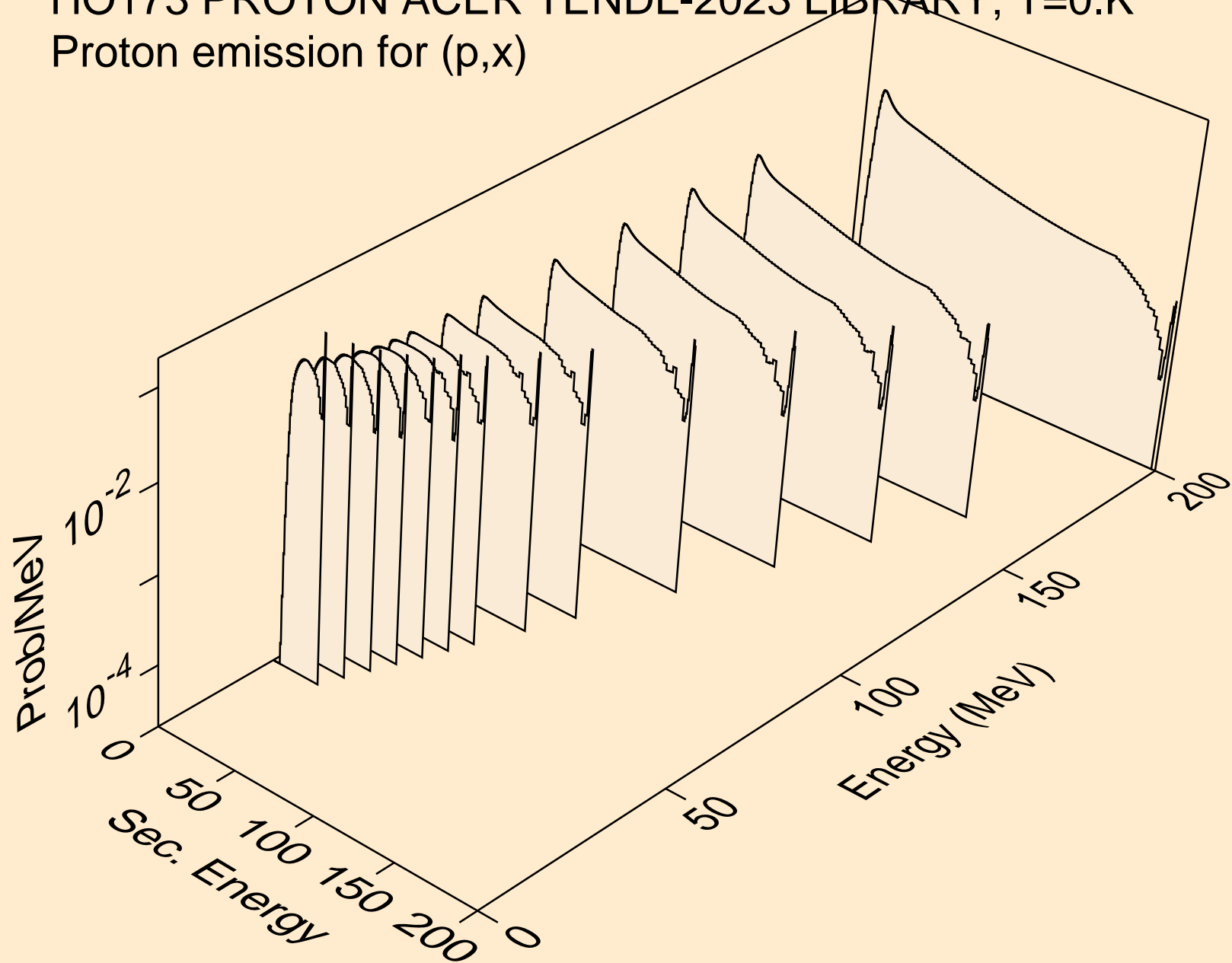

HO173 PROTON ACER TENDL-2023 LIBRARY; T=0.K  
Proton emission for (p,n\*)p

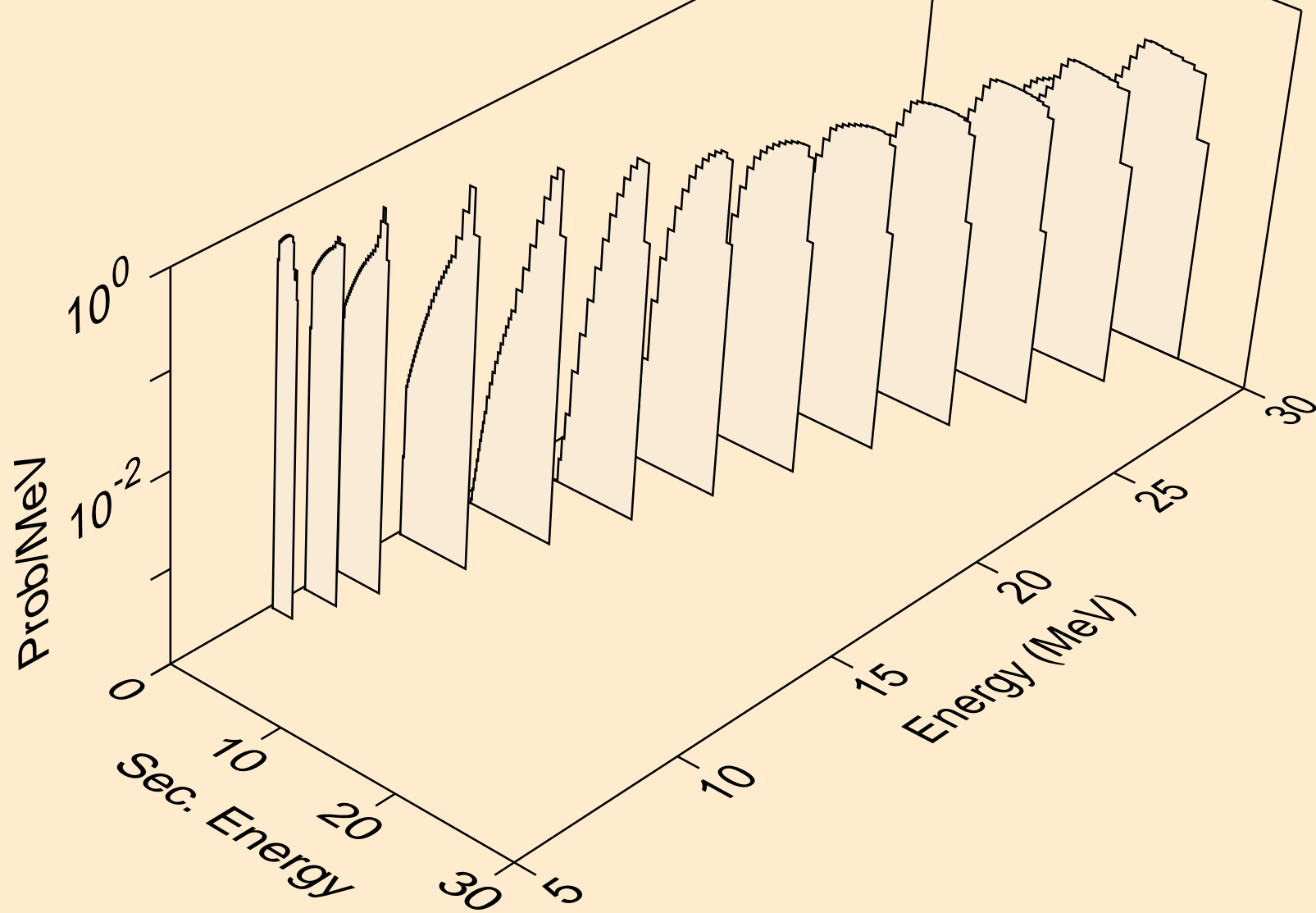

HO173 PROTON ACER TENDL-2023 LIBRARY; T=0.K  
Proton emission for (p,2np)

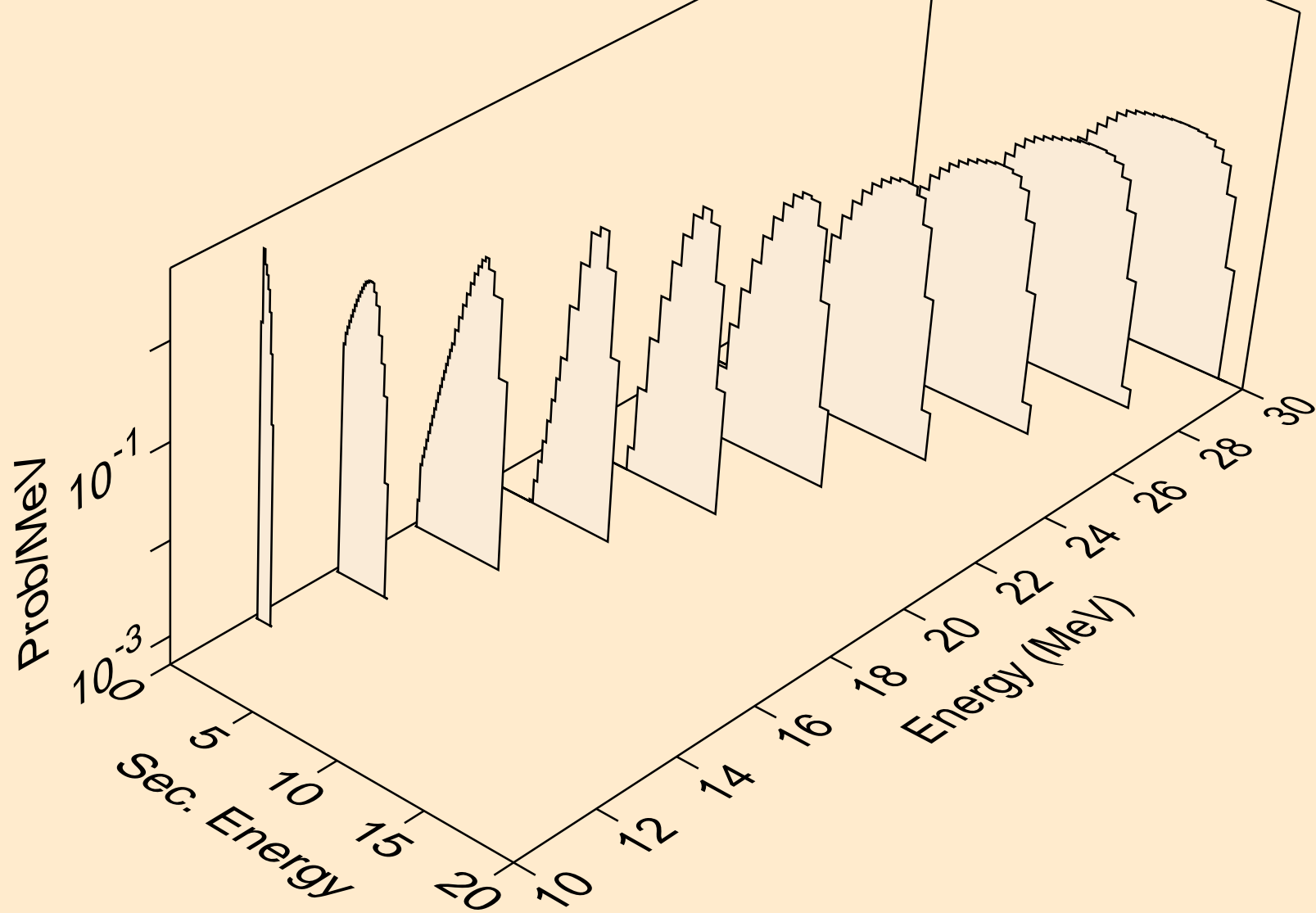

HO173 PROTON ACER TENDL-2023 LIBRARY; T=0.K  
Proton emission for (p,3np)

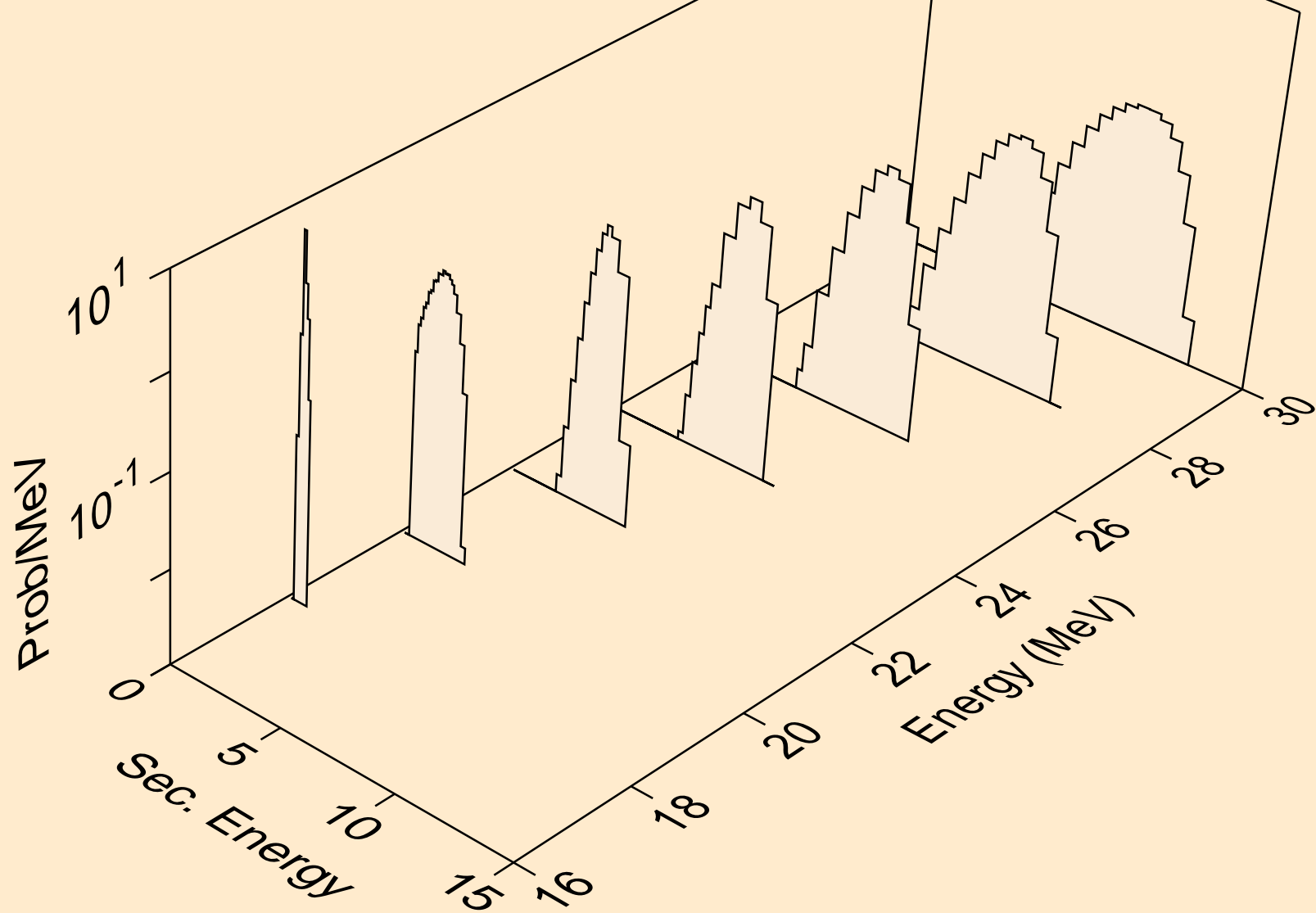

HO173 PROTON ACER TENDL-2023 LIBRARY; T=0.K  
Proton emission for (p,n2p)

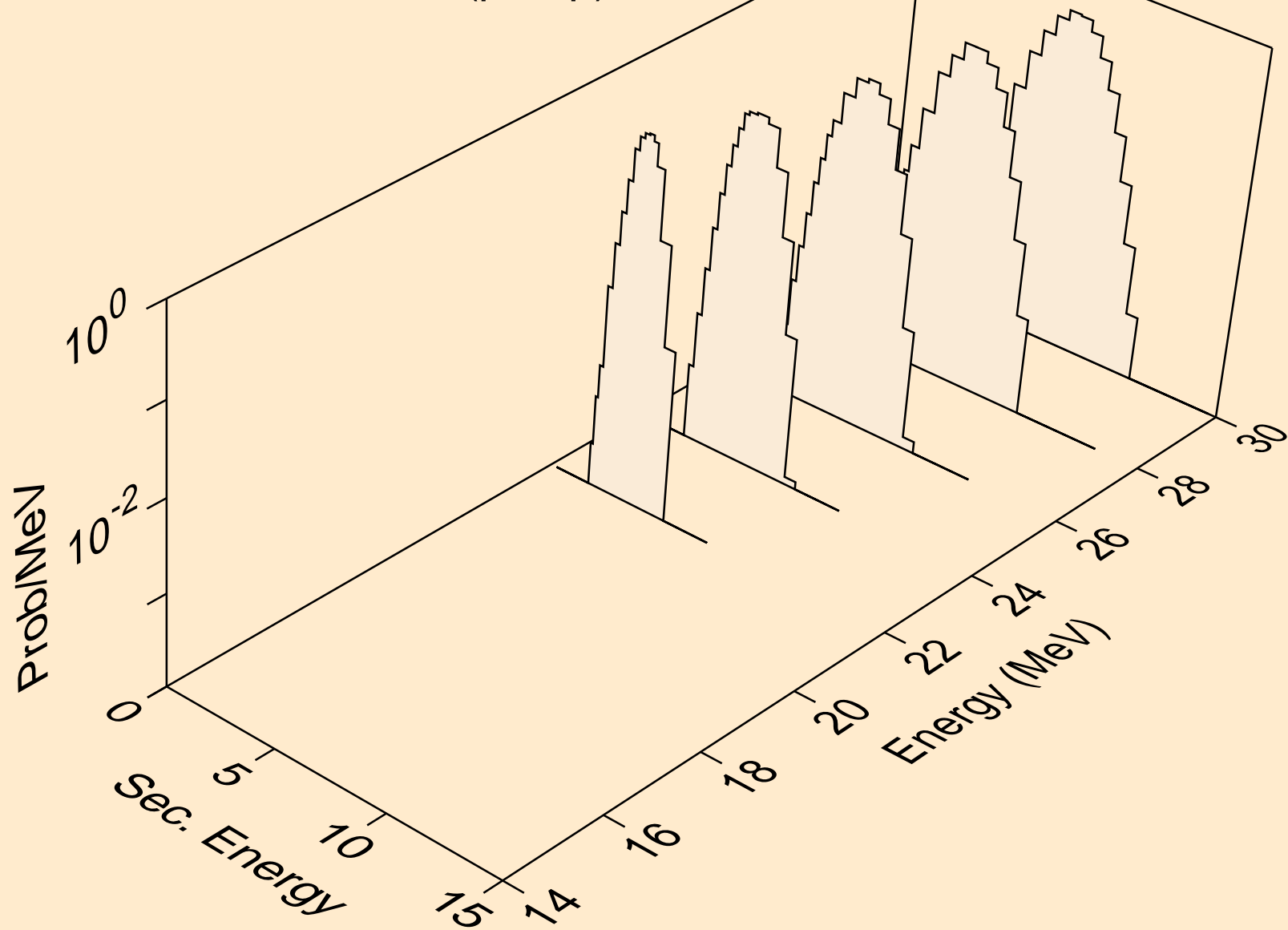

HO173 PROTON ACER TENDL-2023 LIBRARY; T=0.K  
Proton emission for inelastic

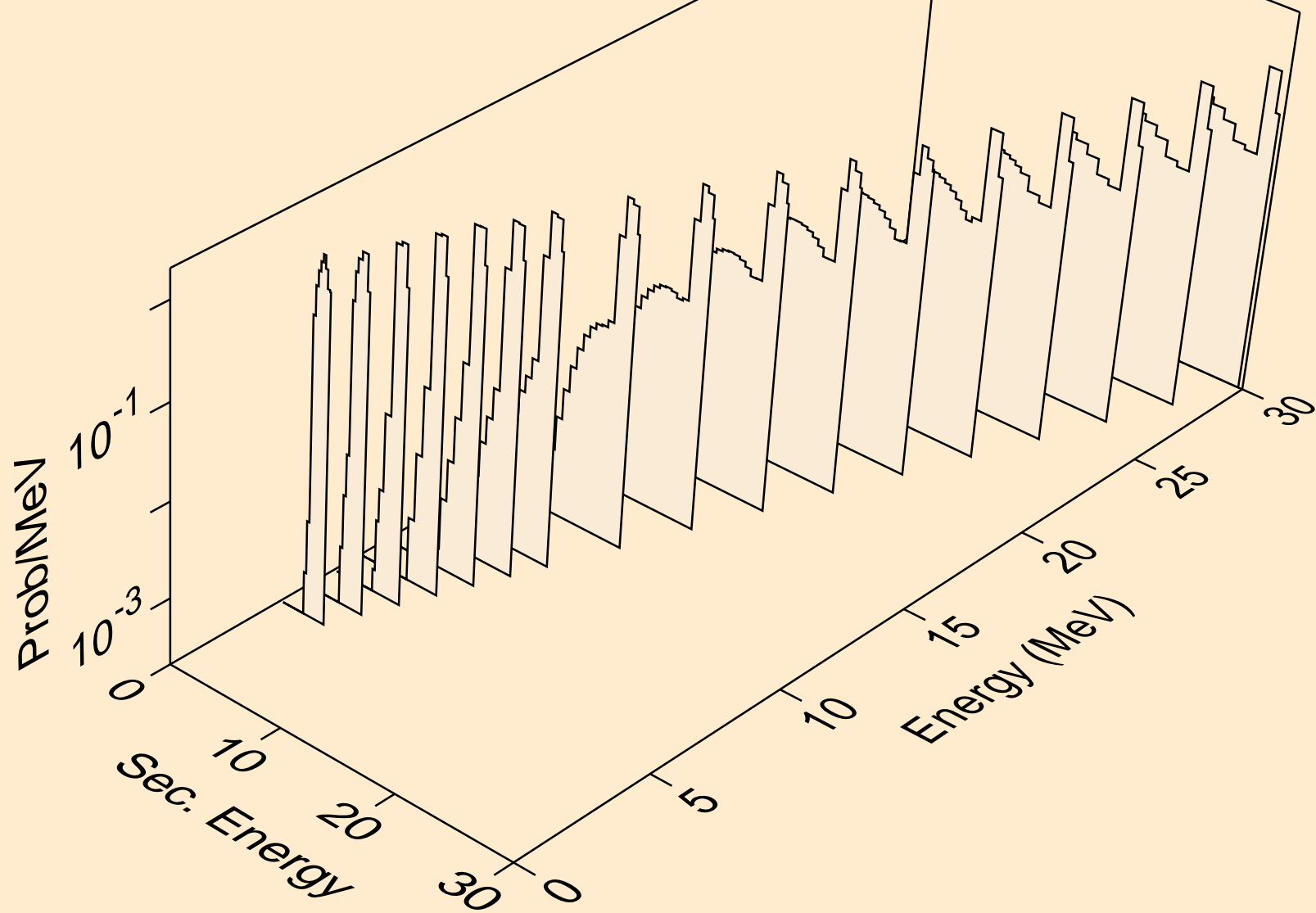



HO173 PROTON ACER TENDL-2023 LIBRARY; T=0.K  
Proton emission for (p,2p)

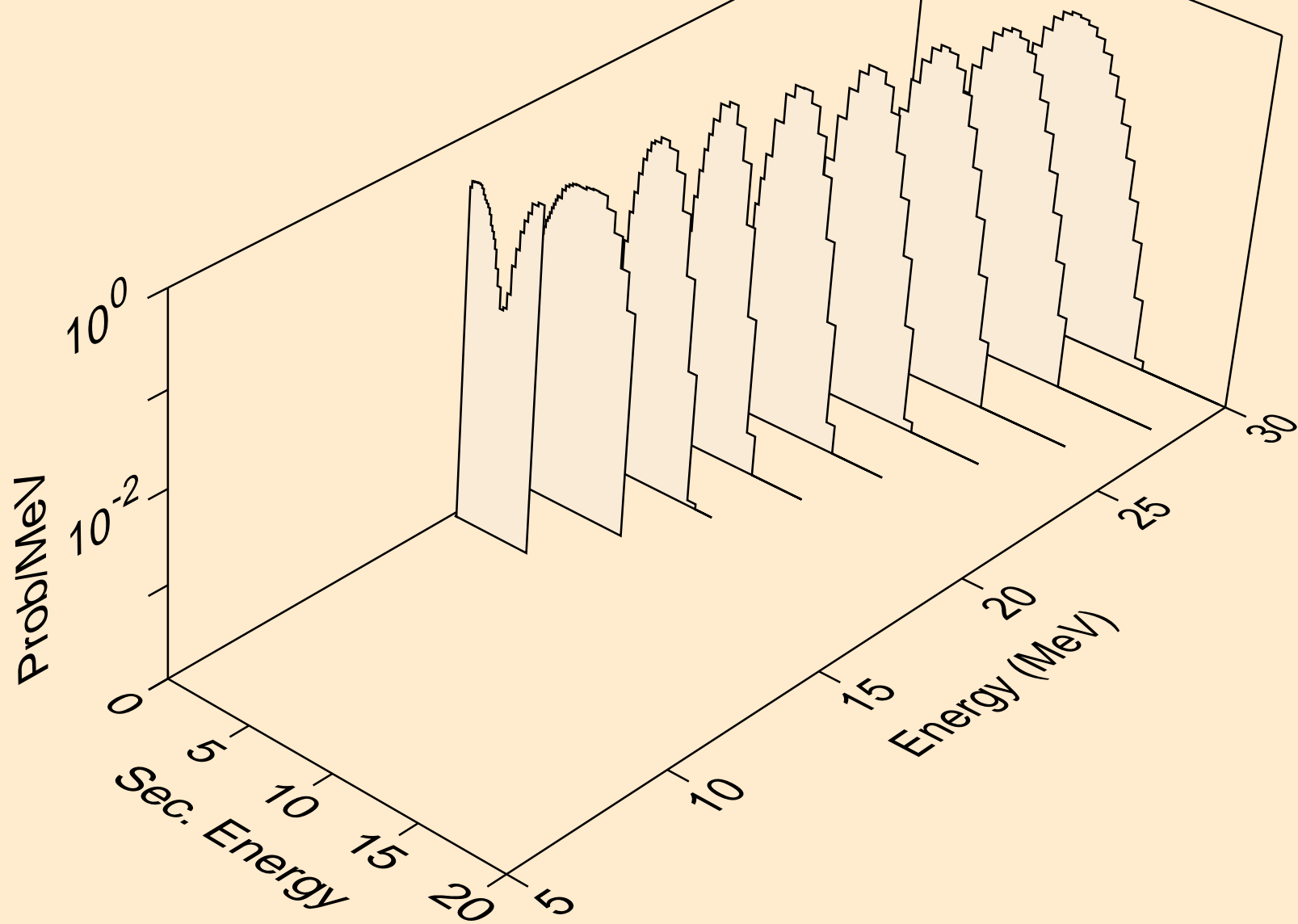

HO173 PROTON ACER TENDL-2023 LIBRARY; T=0.K  
Proton emission for (p,pd)

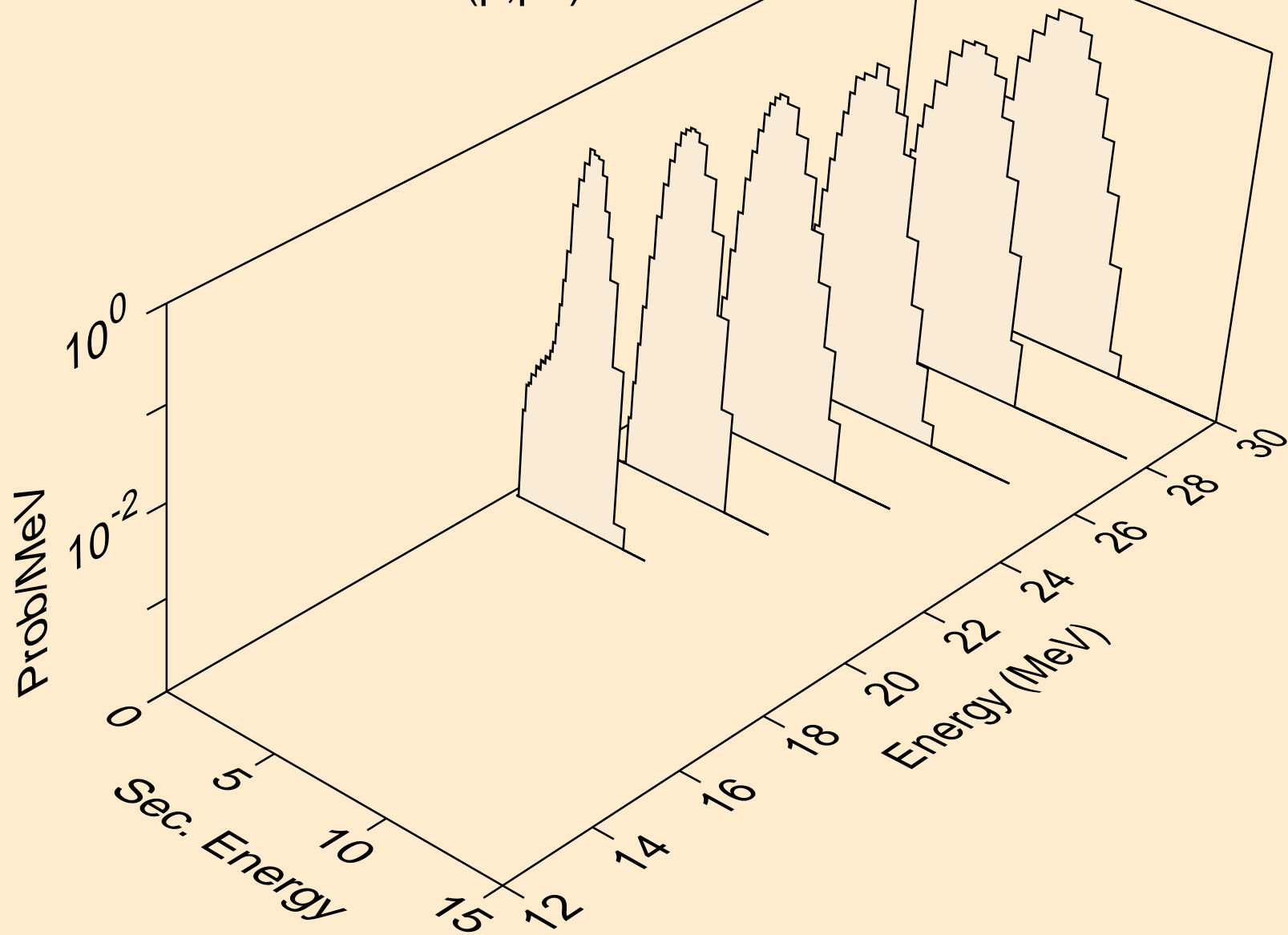

HO173 PROTON ACER TENDL-2023 LIBRARY; T=0.K  
Photon emission for (z,n)

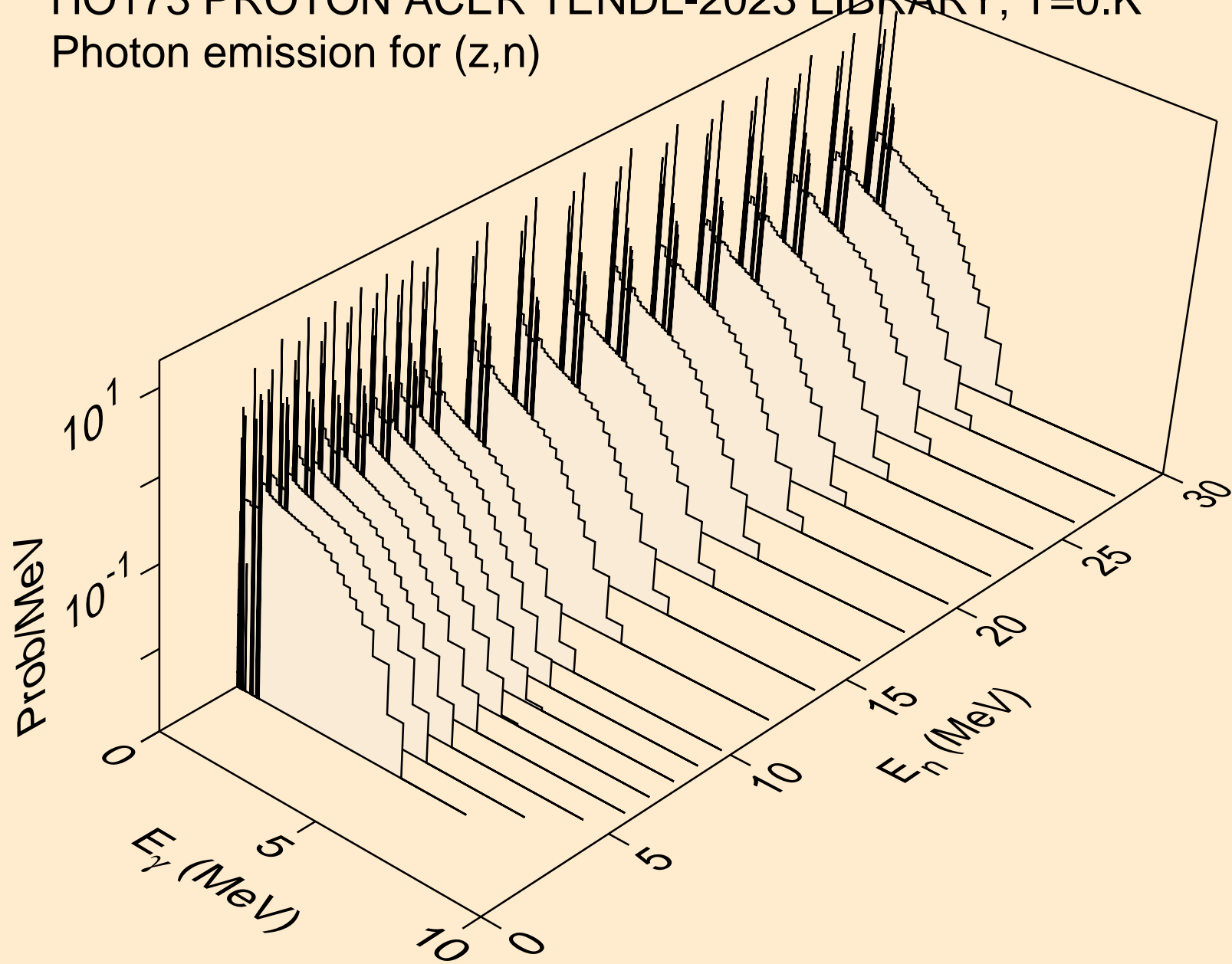

HO173 PROTON ACER TENDL-2023 LIBRARY; T=0.K  
Photon emission for (z,x)

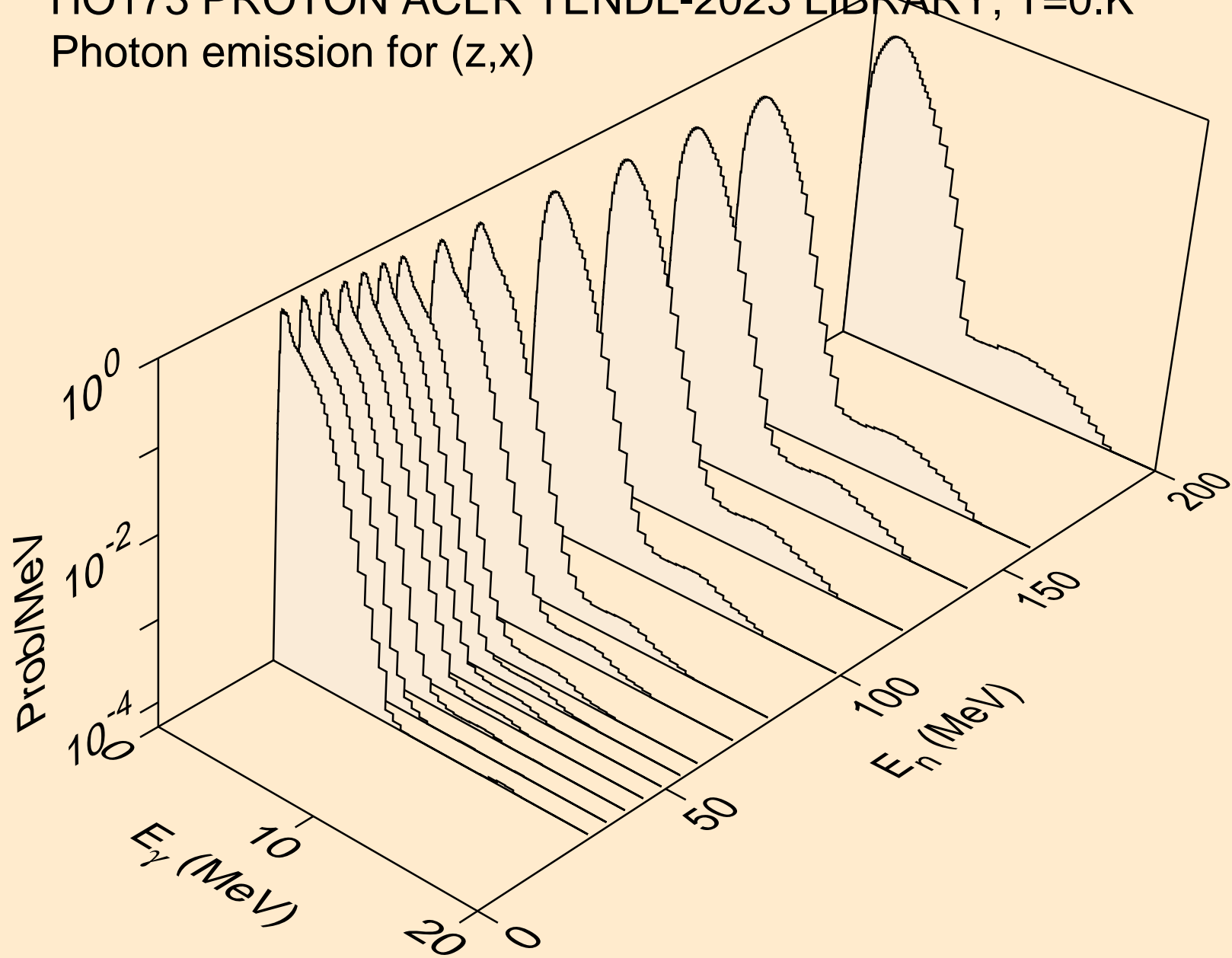

HO173 PROTON ACER TENDL-2023 LIBRARY; T=0.K  
Photon emission for (n,2nd)

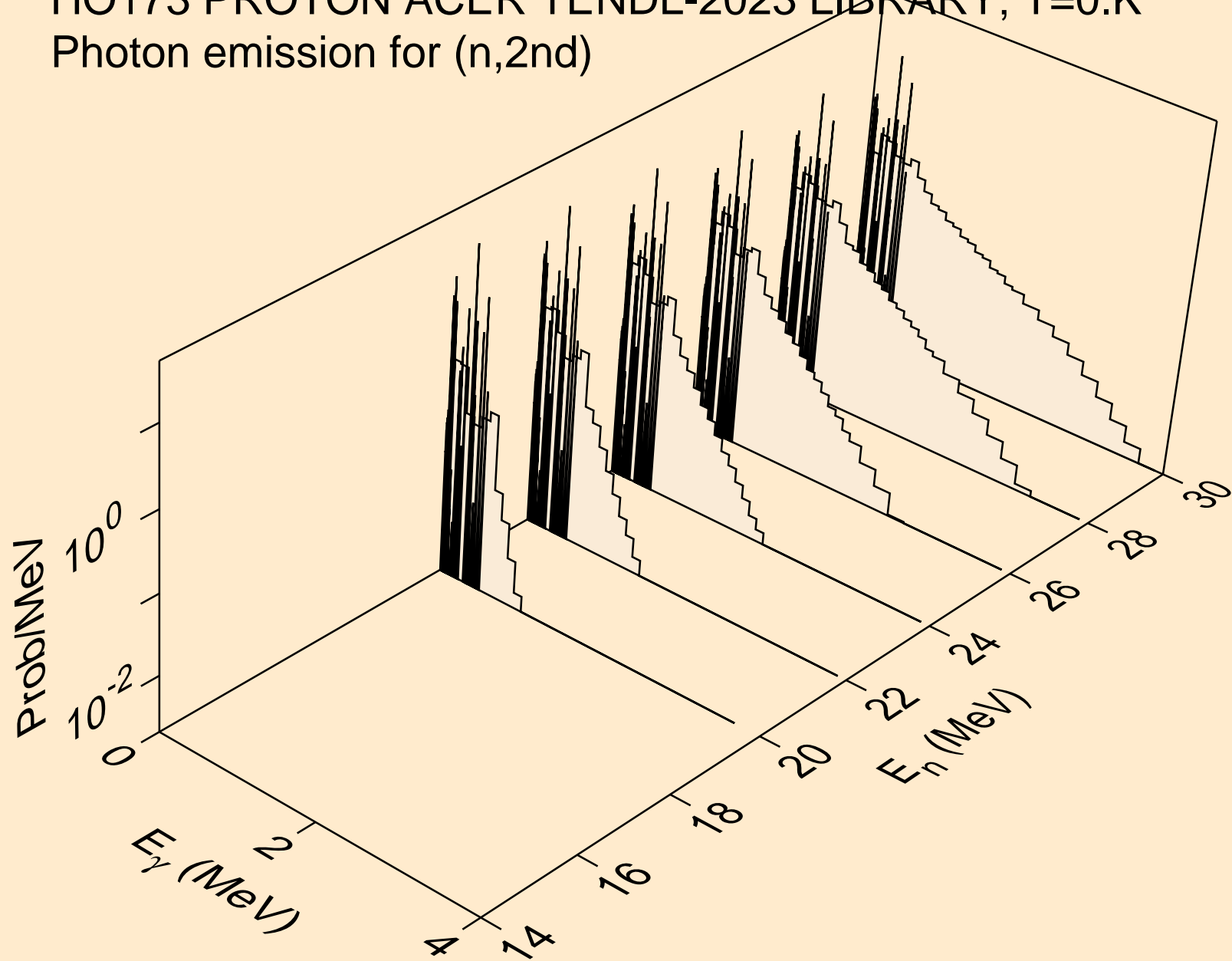

HO173 PROTON ACER TENDL-2023 LIBRARY; T=0.K  
Photon emission for (n,2n)

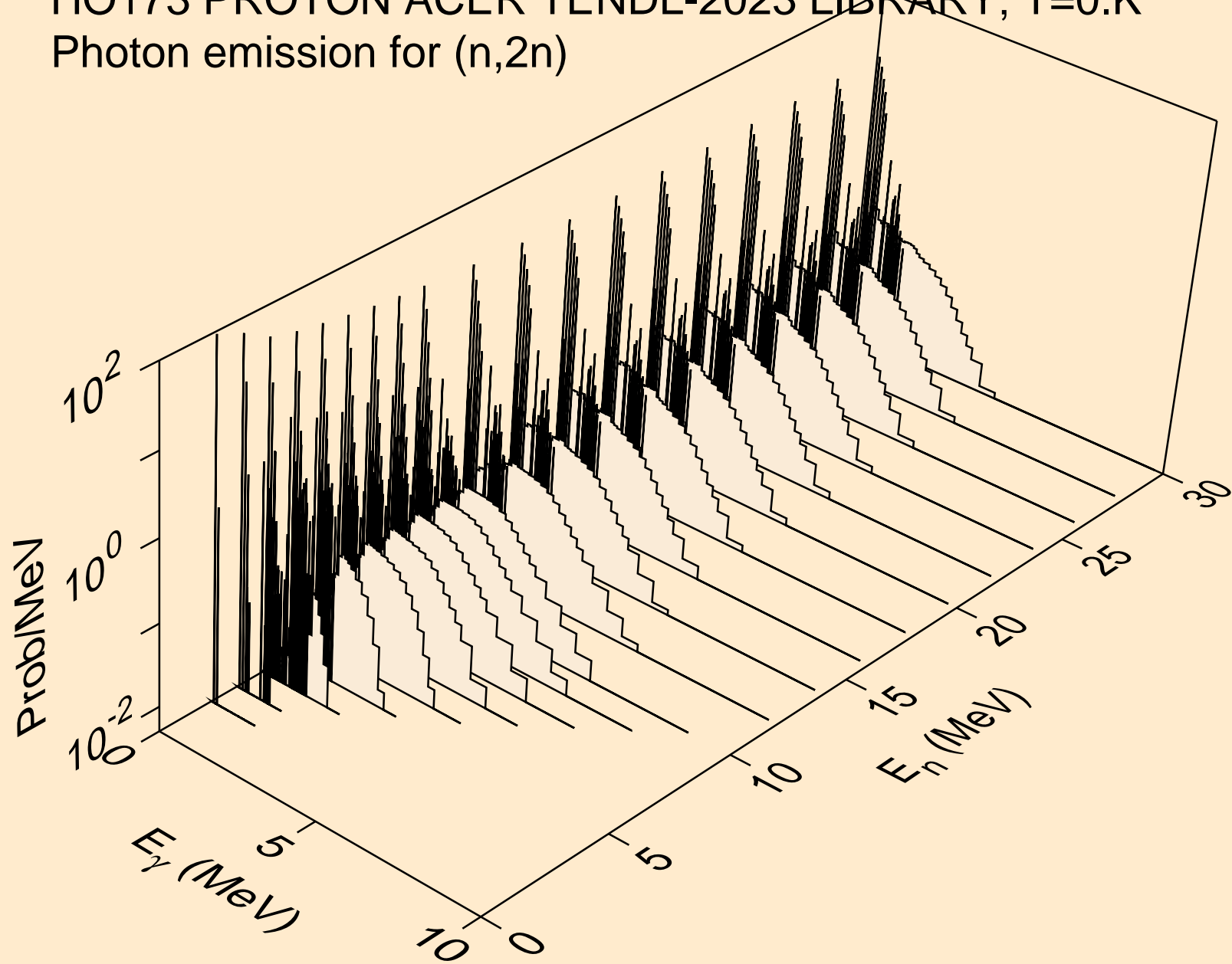

HO173 PROTON ACER TENDL-2023 LIBRARY; T=0.K  
Photon emission for (n,3n)

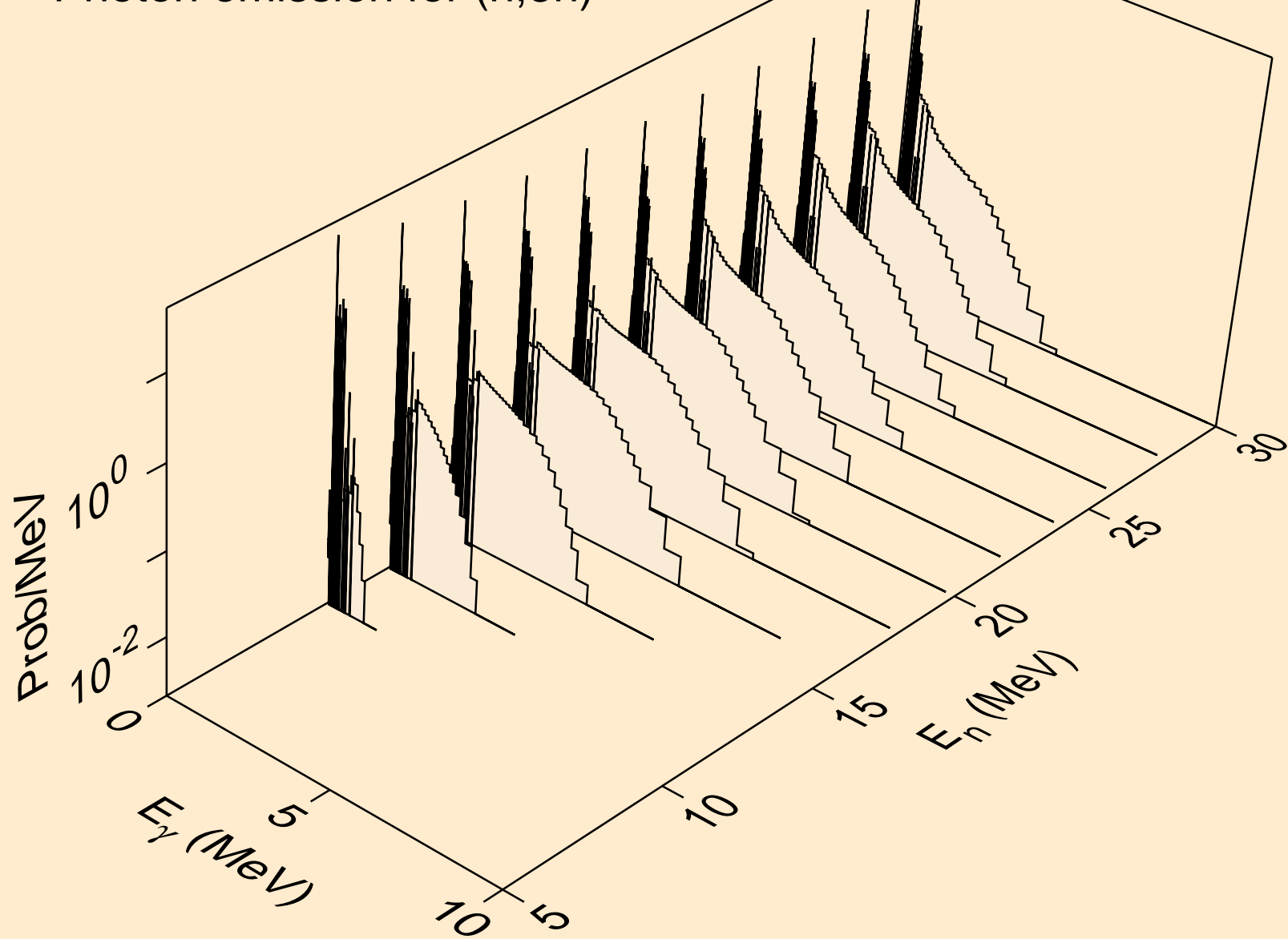

HO173 PROTON ACER TENDL-2023 LIBRARY; T=0.K  
Photon emission for (n,n\*)a

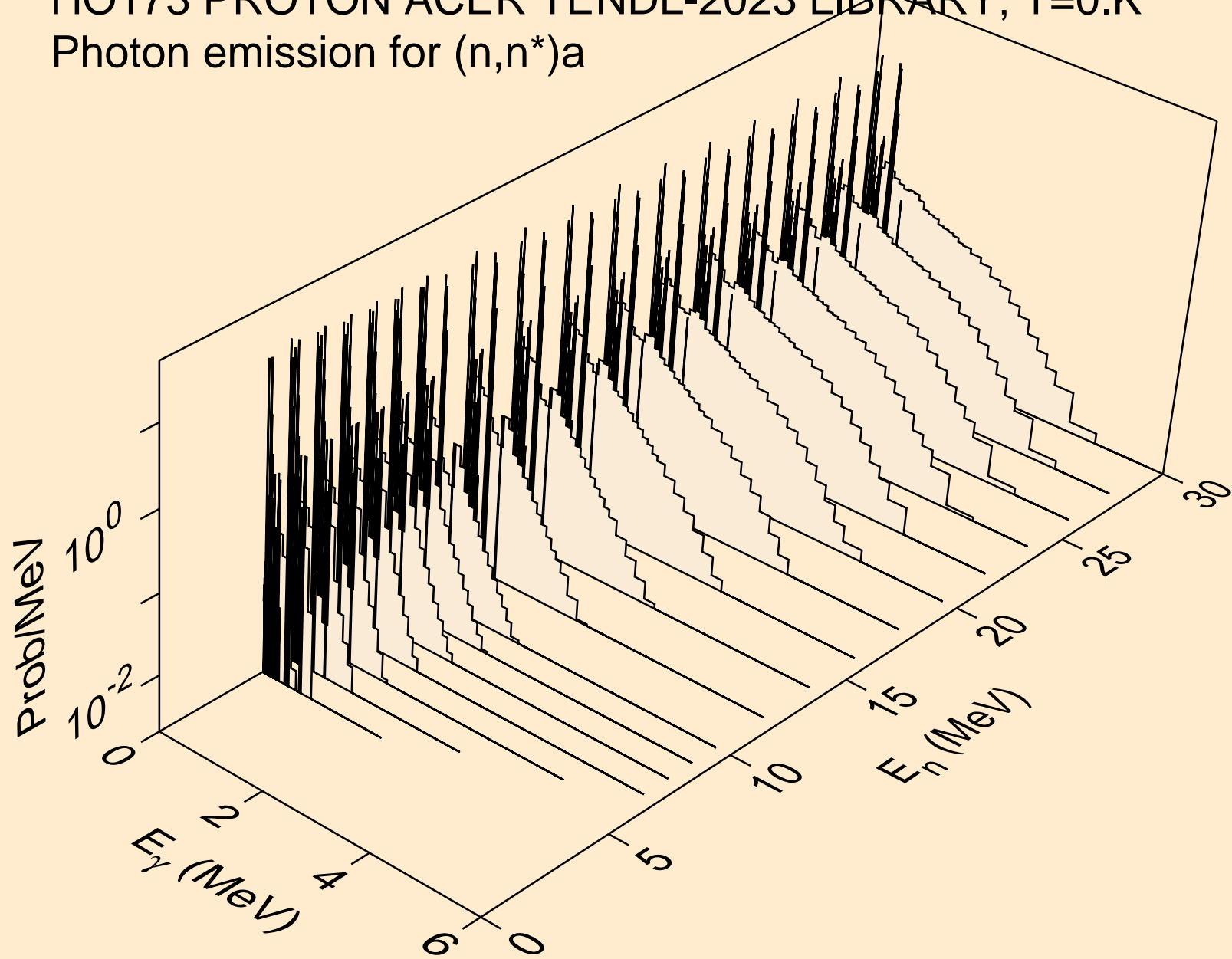



HO173 PROTON ACER TENDL-2023 LIBRARY; T=0.K  
Photon emission for (n,2n)a

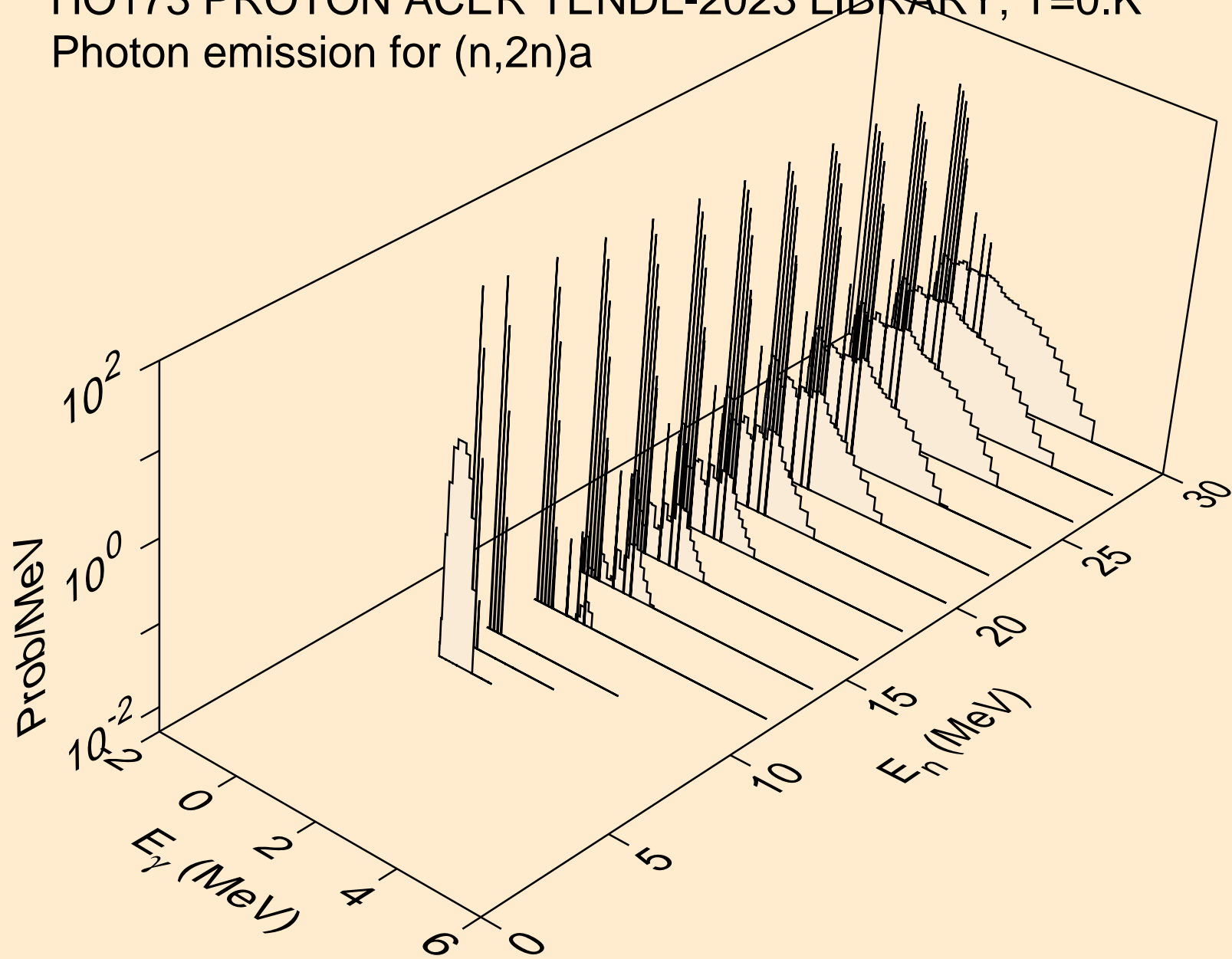

HO173 PROTON ACER TENDL-2023 LIBRARY; T=0.K  
Photon emission for (n,3n)a

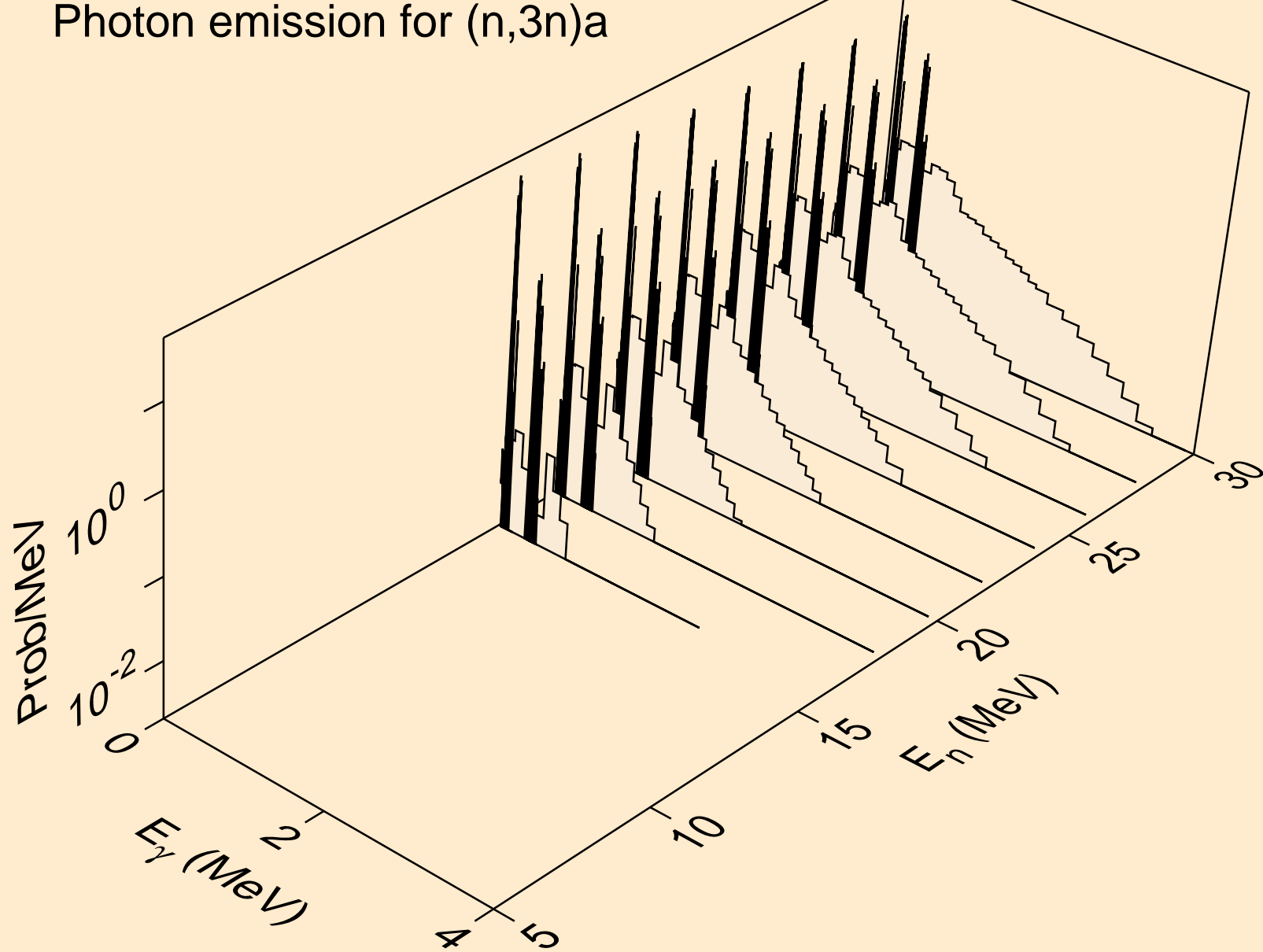

HO173 PROTON ACER TENDL-2023 LIBRARY; T=0.K  
Photon emission for (n,n\*)p

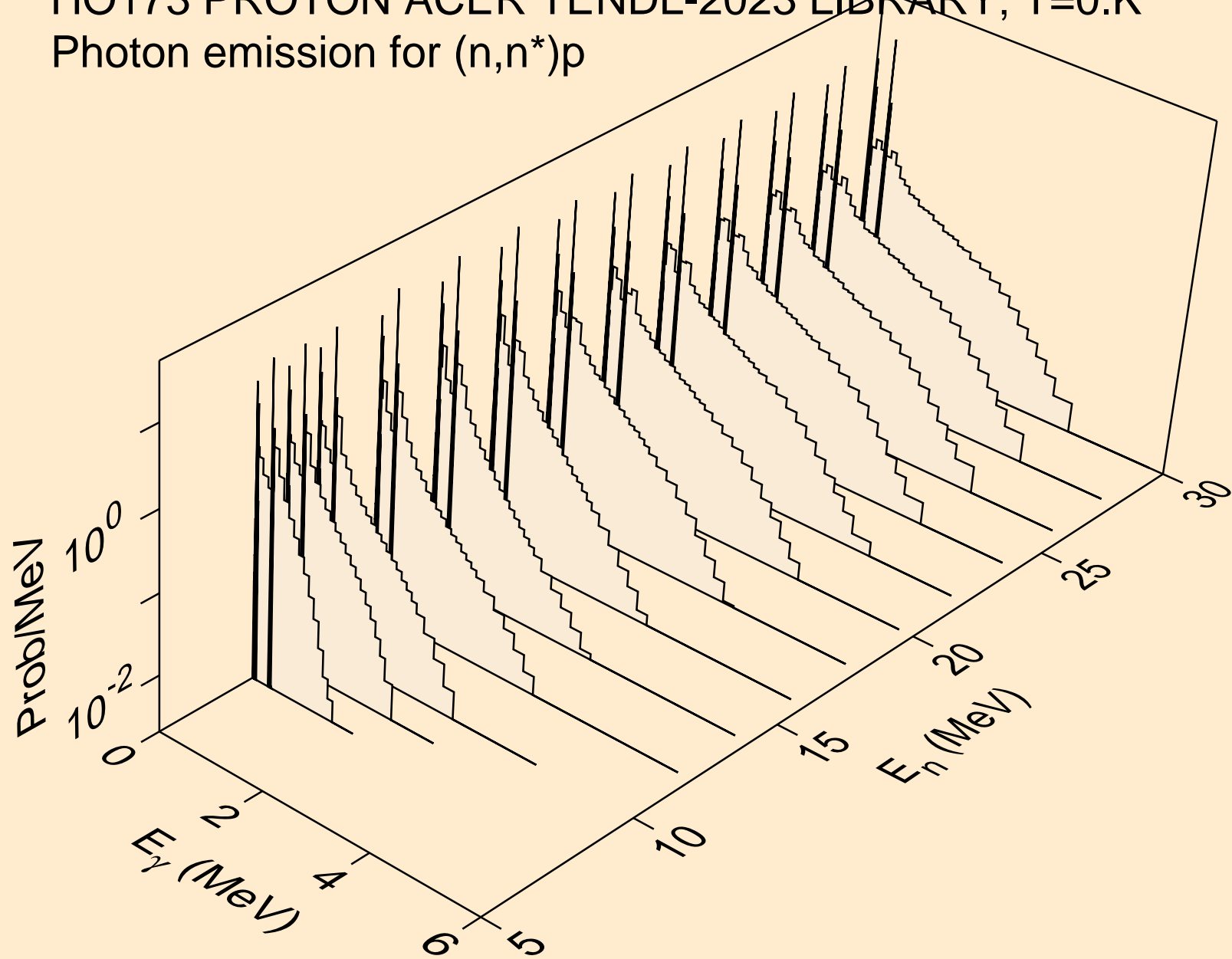

HO173 PROTON ACER TENDL-2023 LIBRARY; T=0.K  
Photon emission for (n,n\*)d

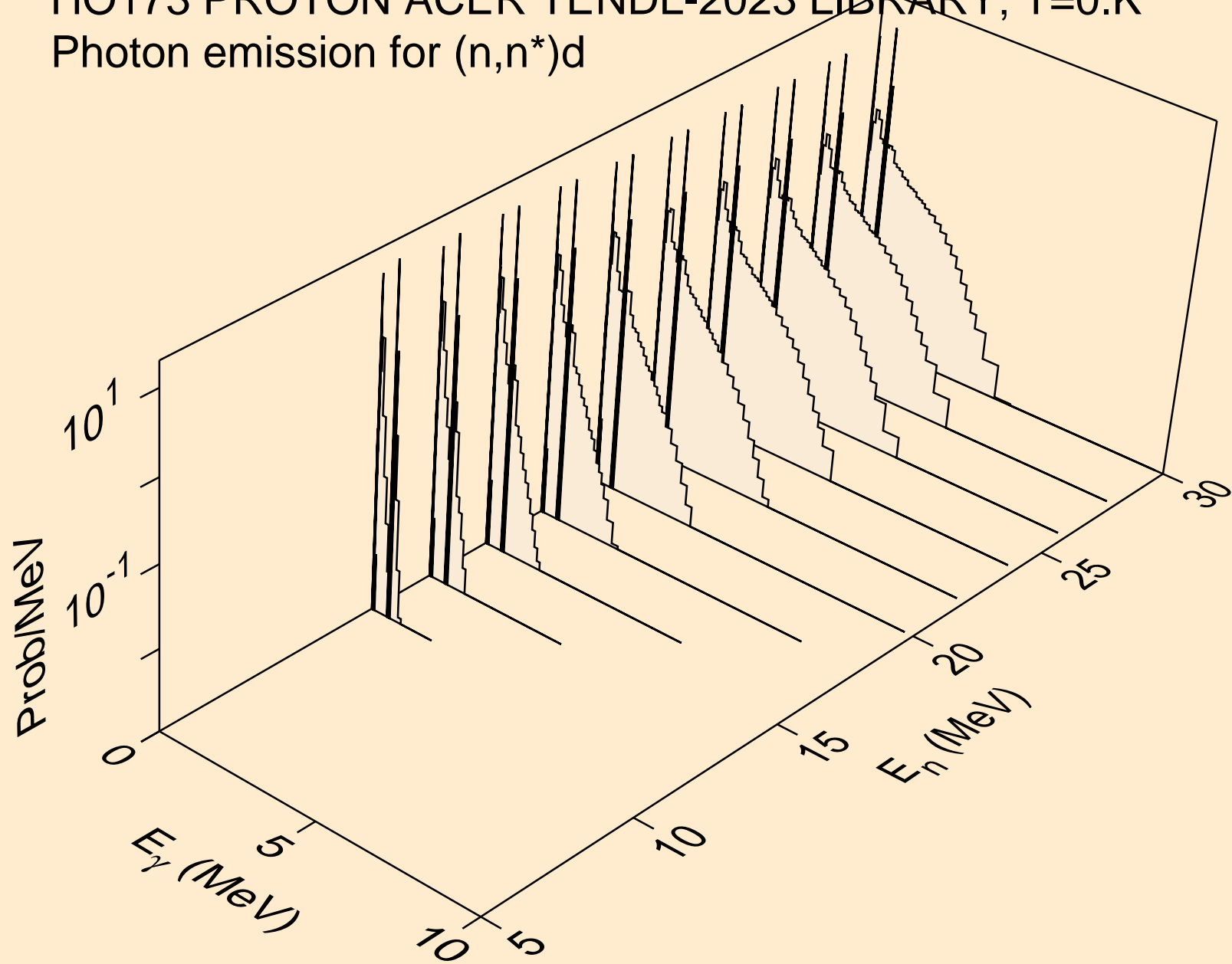

HO173 PROTON ACER TENDL-2023 LIBRARY; T=0.K  
Photon emission for (n,n\*)t

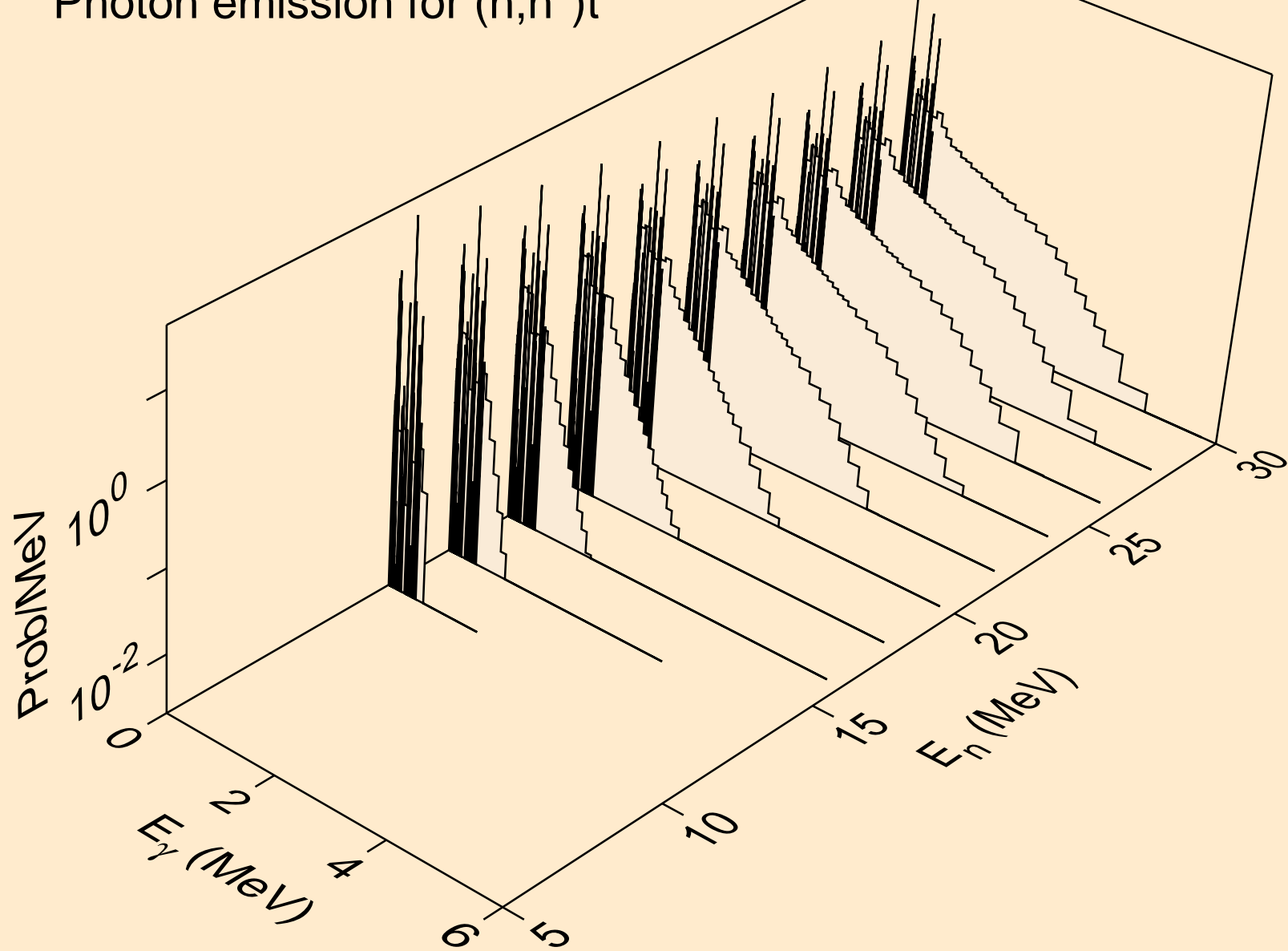

HO173 PROTON ACER TENDL-2023 LIBRARY; T=0.K  
Photon emission for (n,n\*)he3

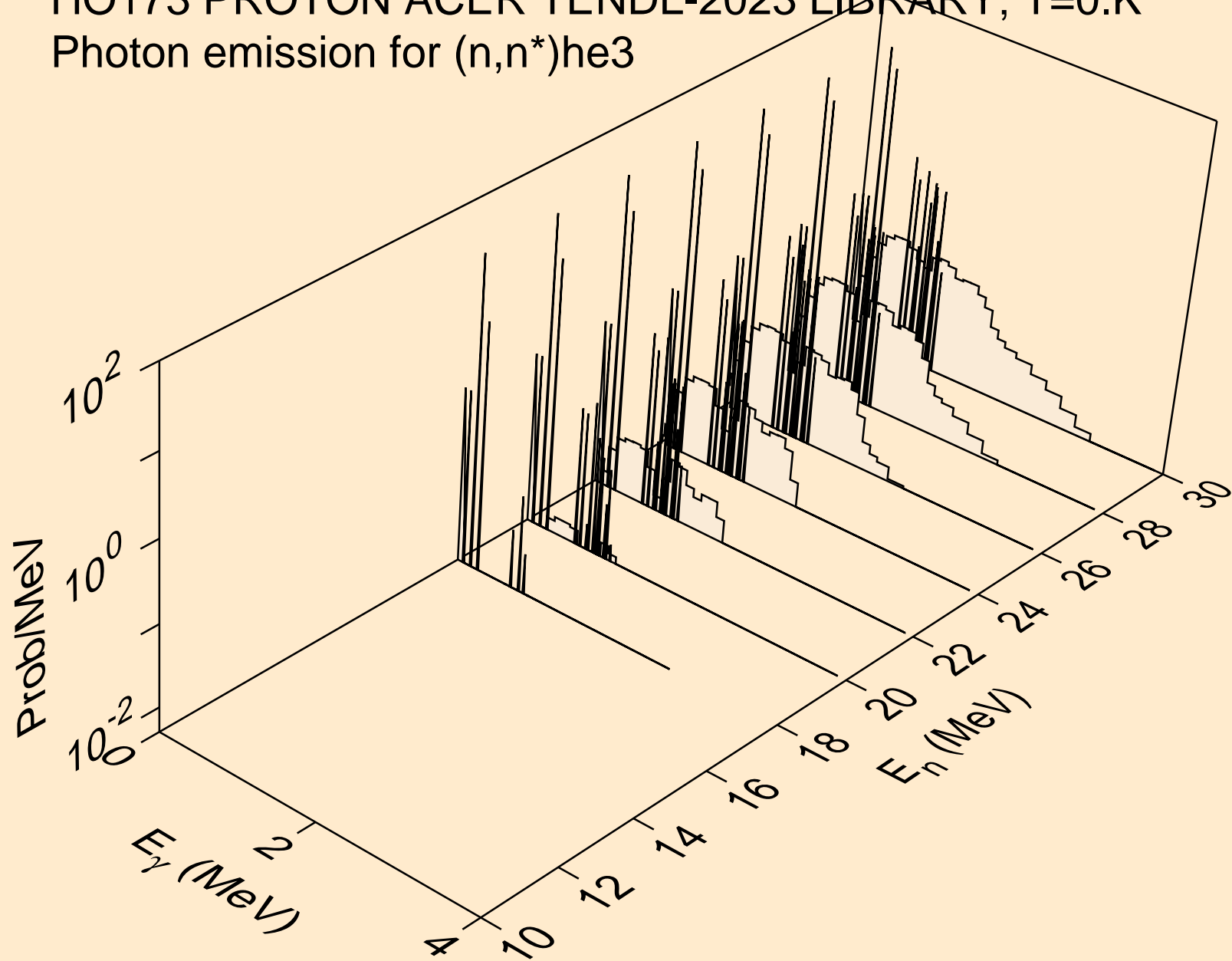

HO173 PROTON ACER TENDL-2023 LIBRARY; T=0.K  
Photon emission for (n,4n)

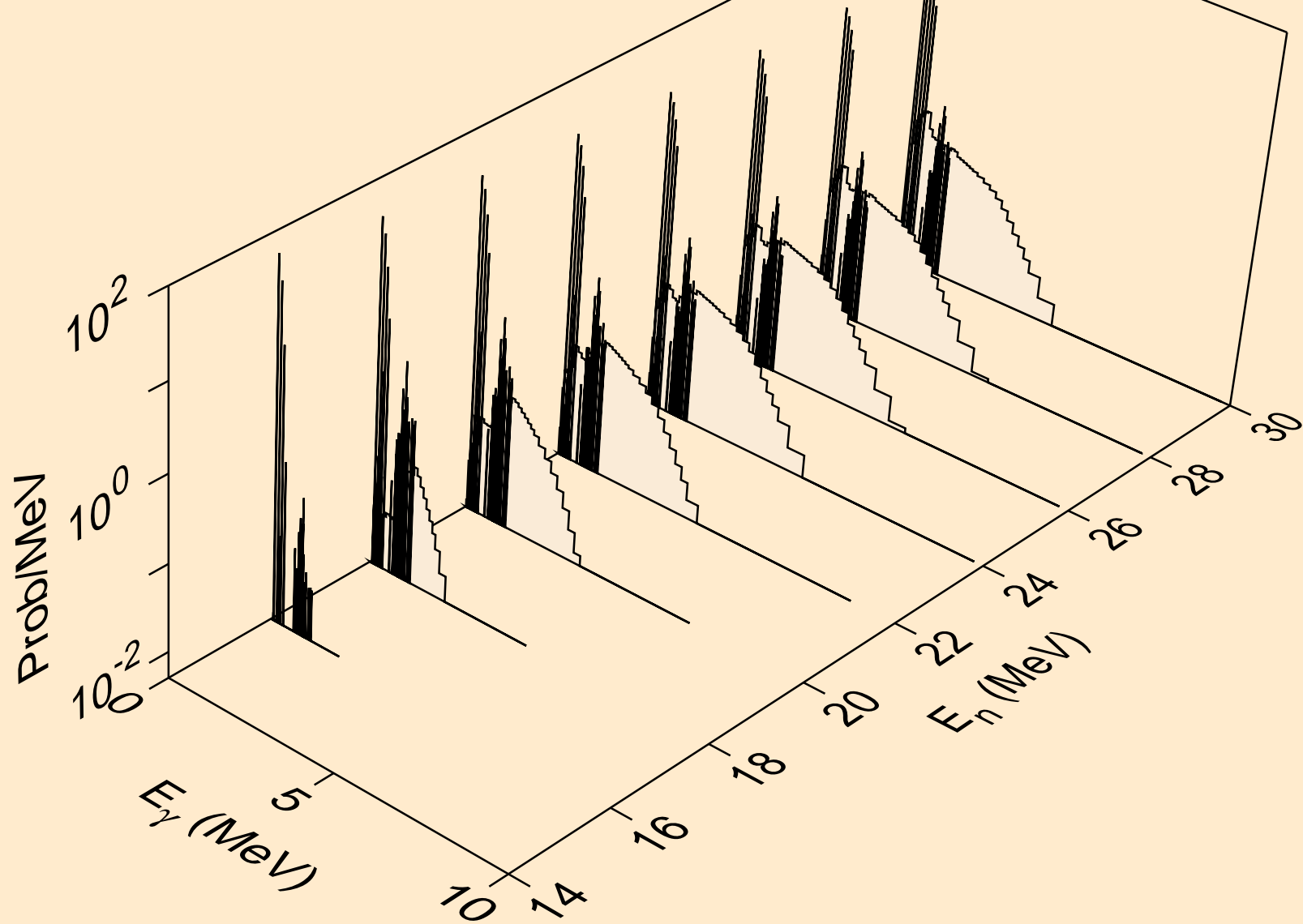

HO173 PROTON ACER TENDL-2023 LIBRARY; T=0.K  
Photon emission for (n,2np)

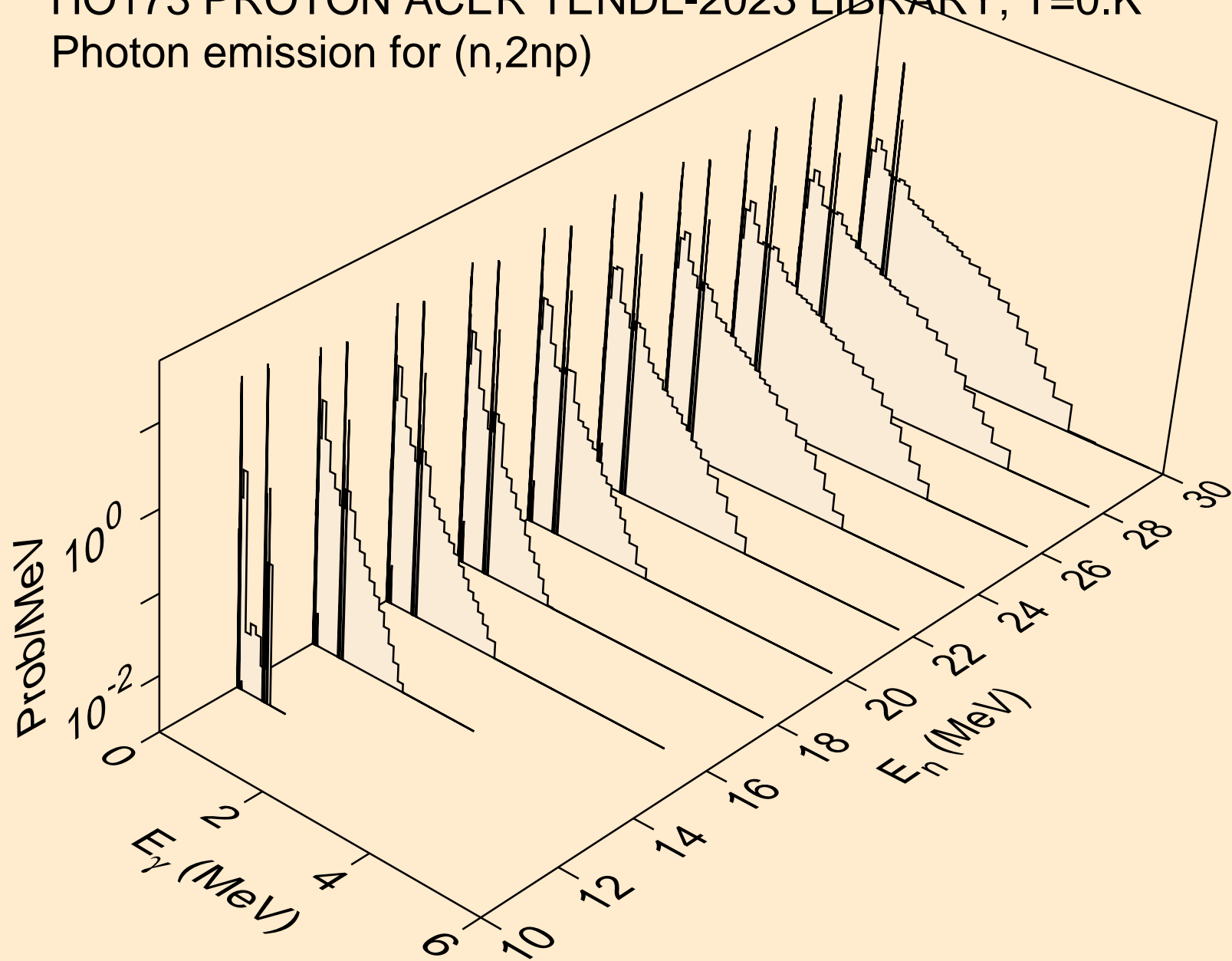



HO173 PROTON ACER TENDL-2023 LIBRARY; T=0.K  
Photon emission for (n,3np)

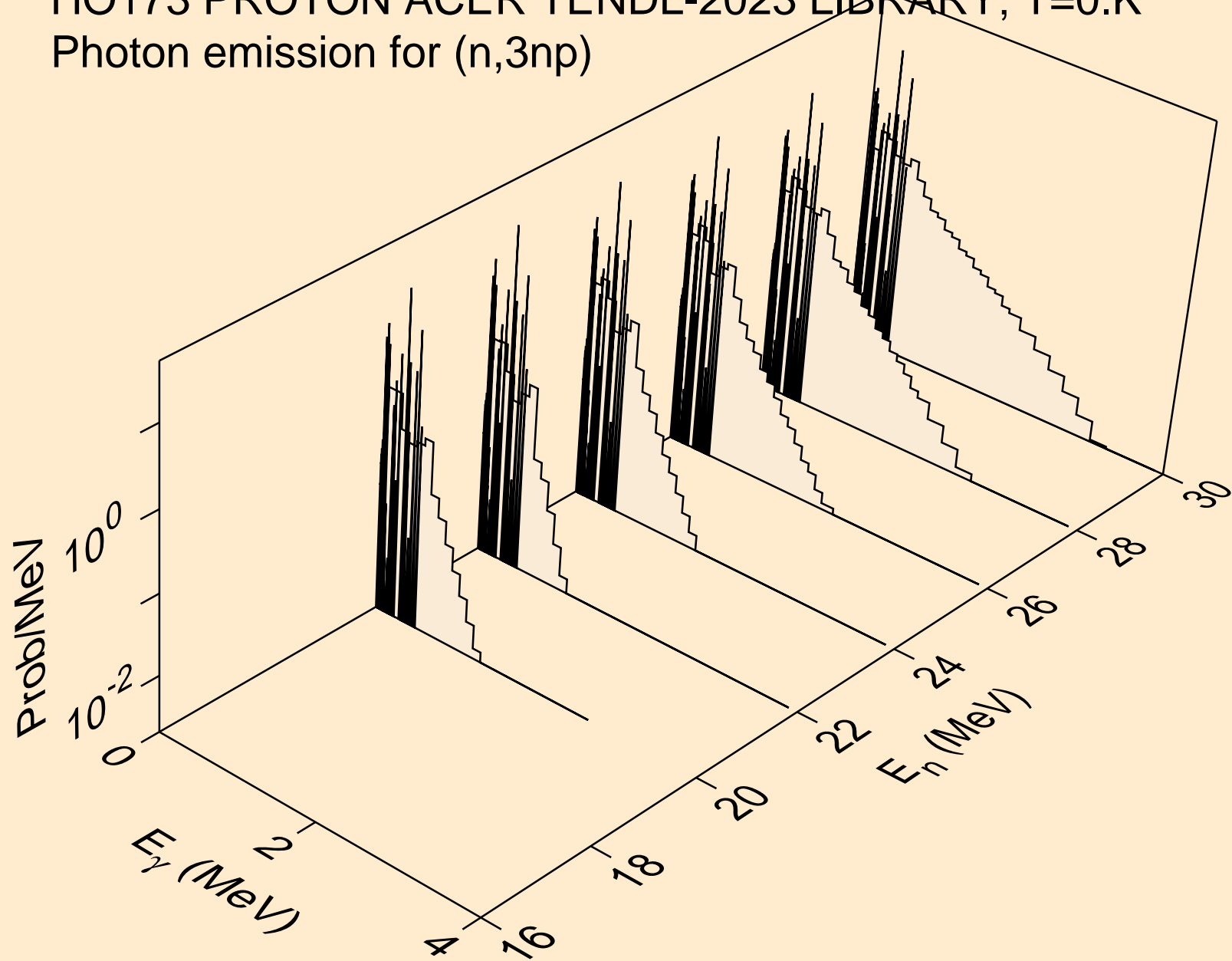

HO173 PROTON ACER TENDL-2023 LIBRARY; T=0.K  
Photon emission for (n,n2p)

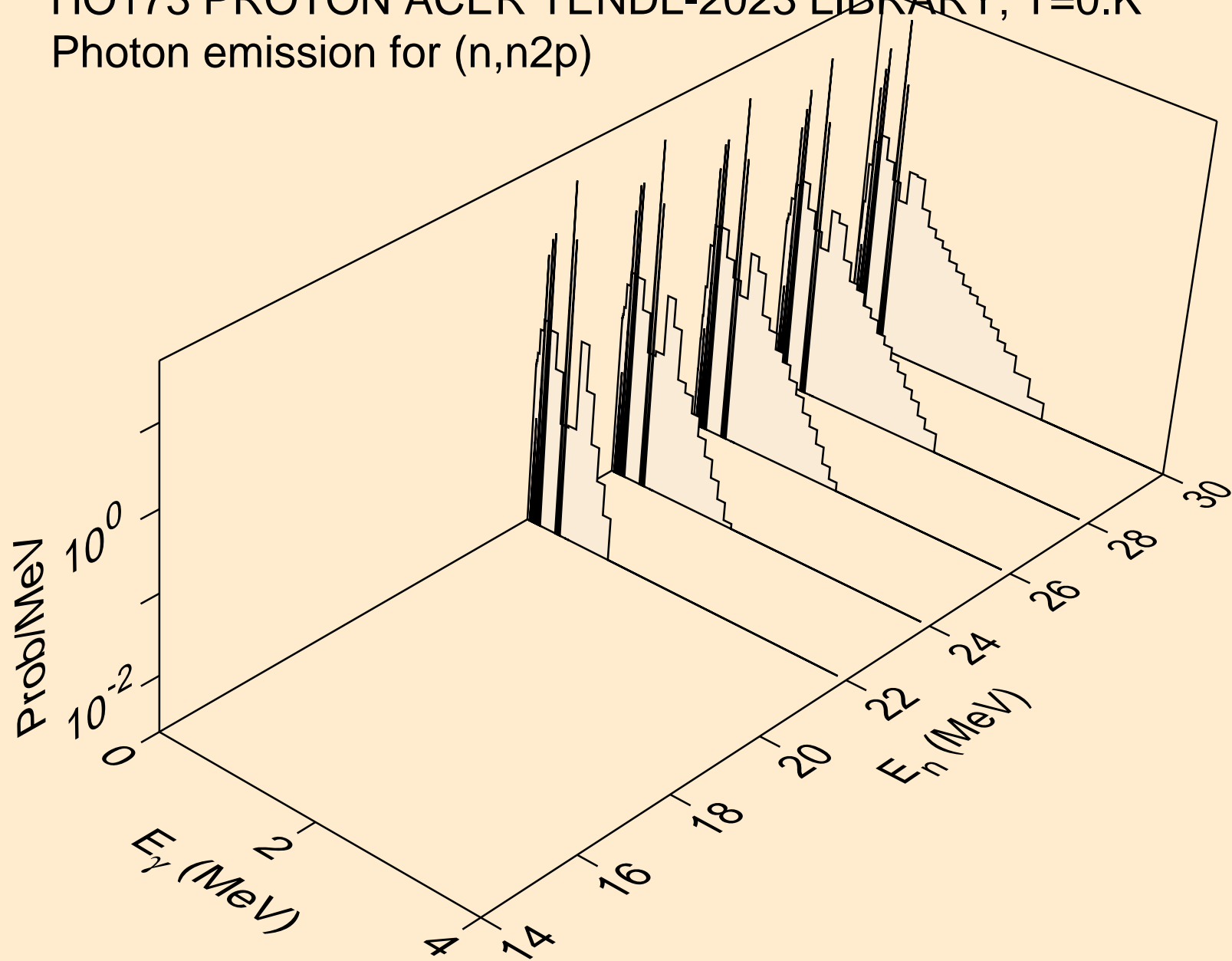

HO173 PROTON ACER TENDL-2023 LIBRARY; T=0.K  
Photon emission for (n,gma)

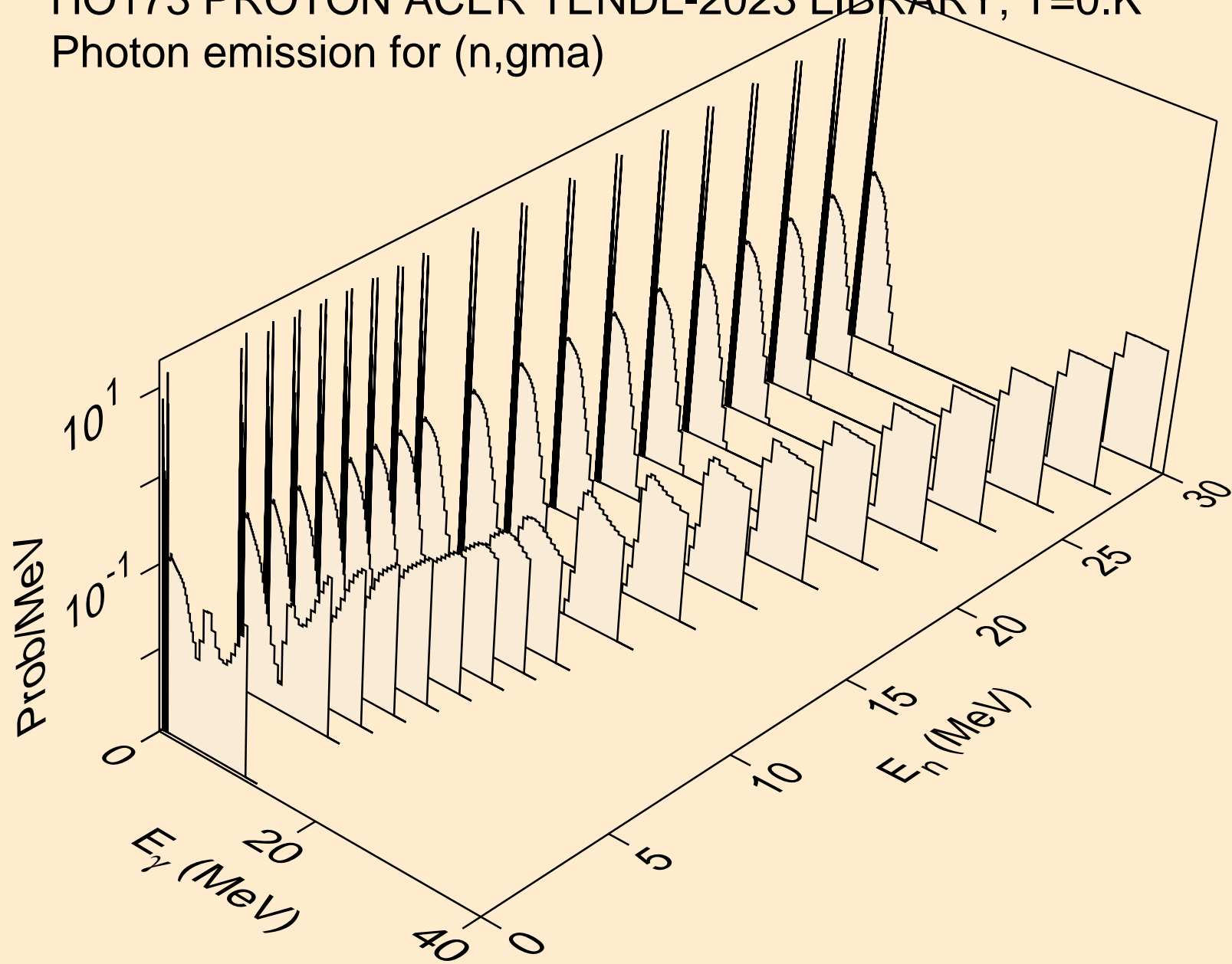

HO173 PROTON ACER TENDL-2023 LIBRARY; T=0.K  
Photon emission for inelastic

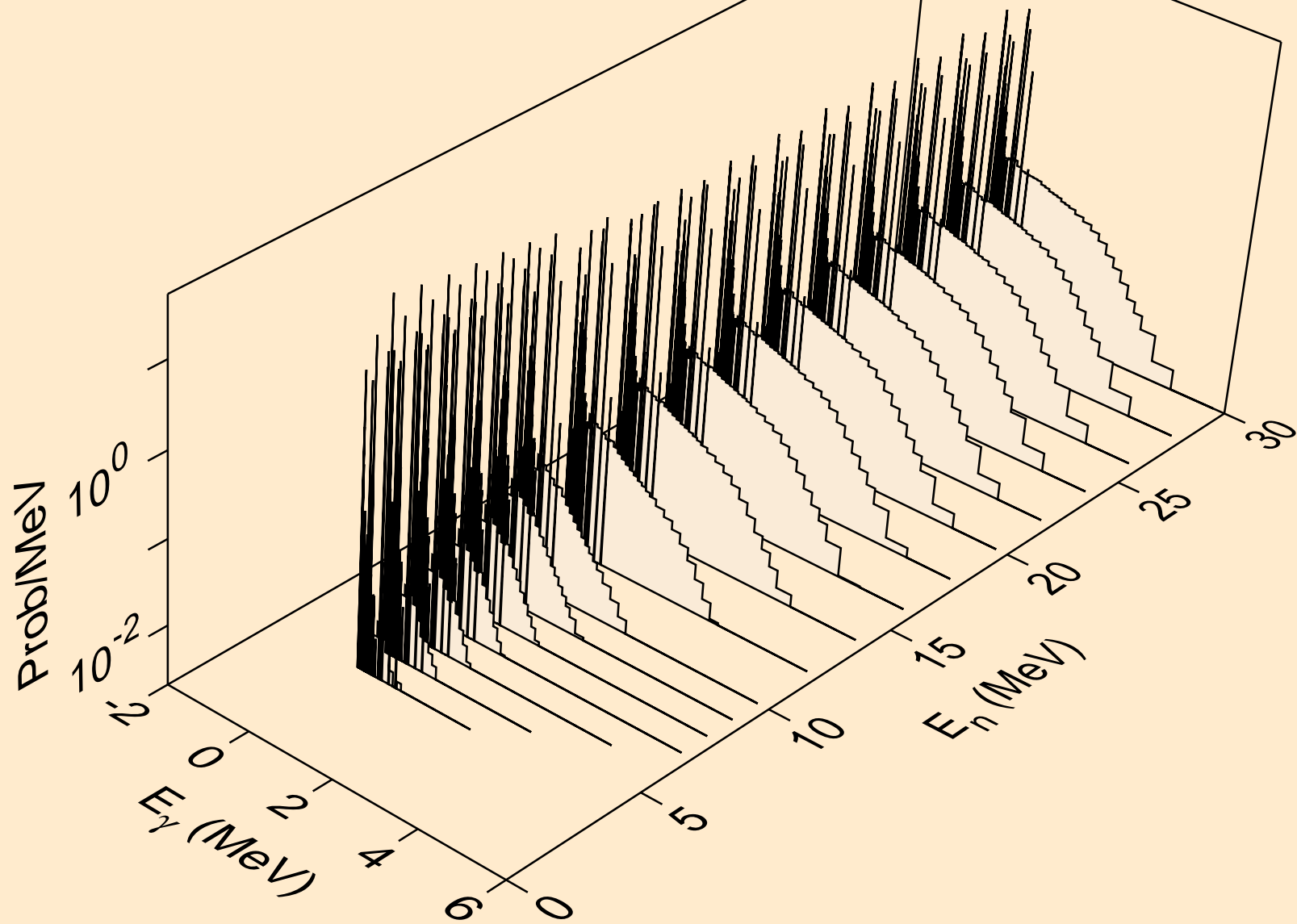

HO173 PROTON ACER TENDL-2023 LIBRARY; T=0.K  
Photon emission for (n,d)

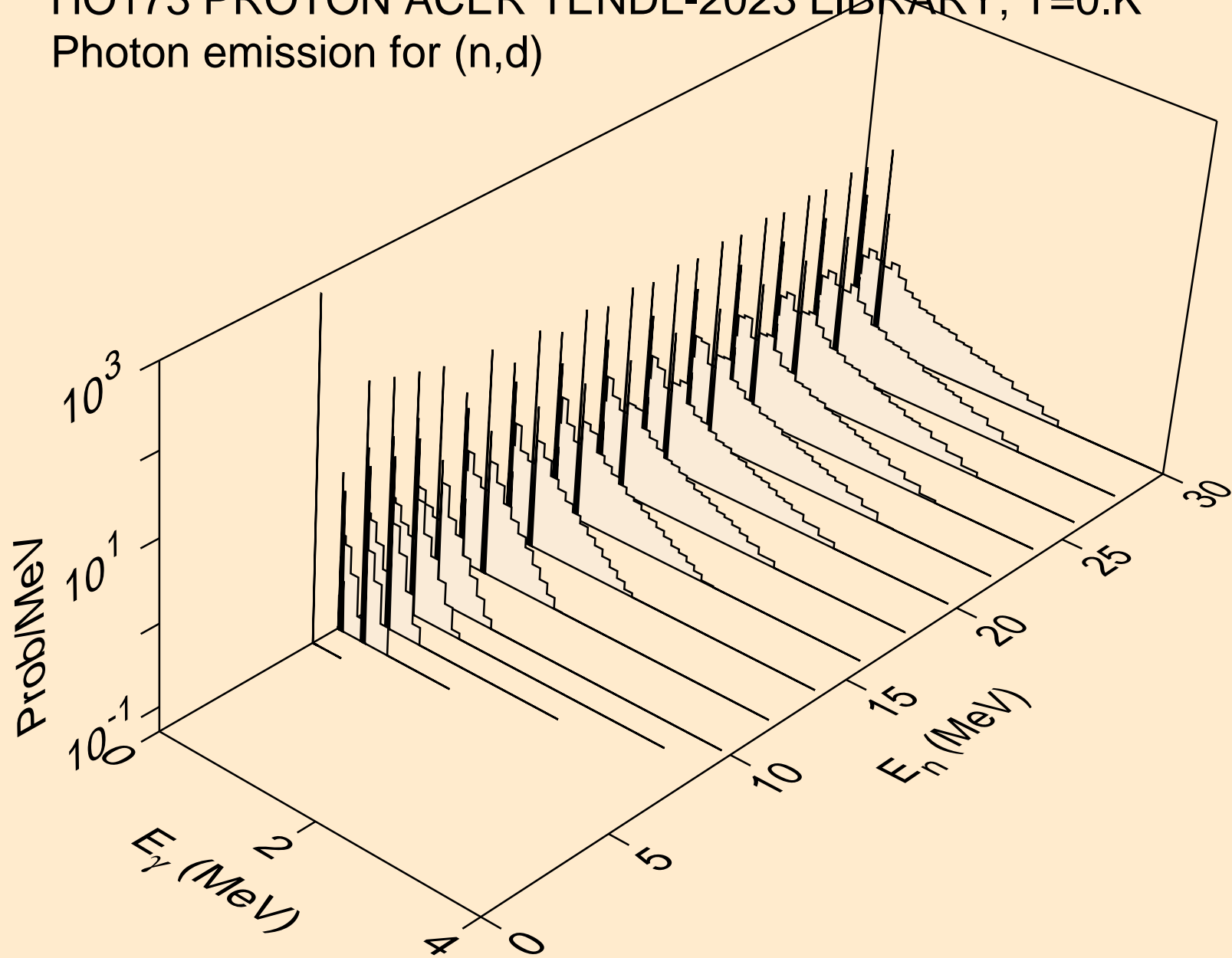

HO173 PROTON ACER TENDL-2023 LIBRARY; T=0.K  
Photon emission for (n,t)

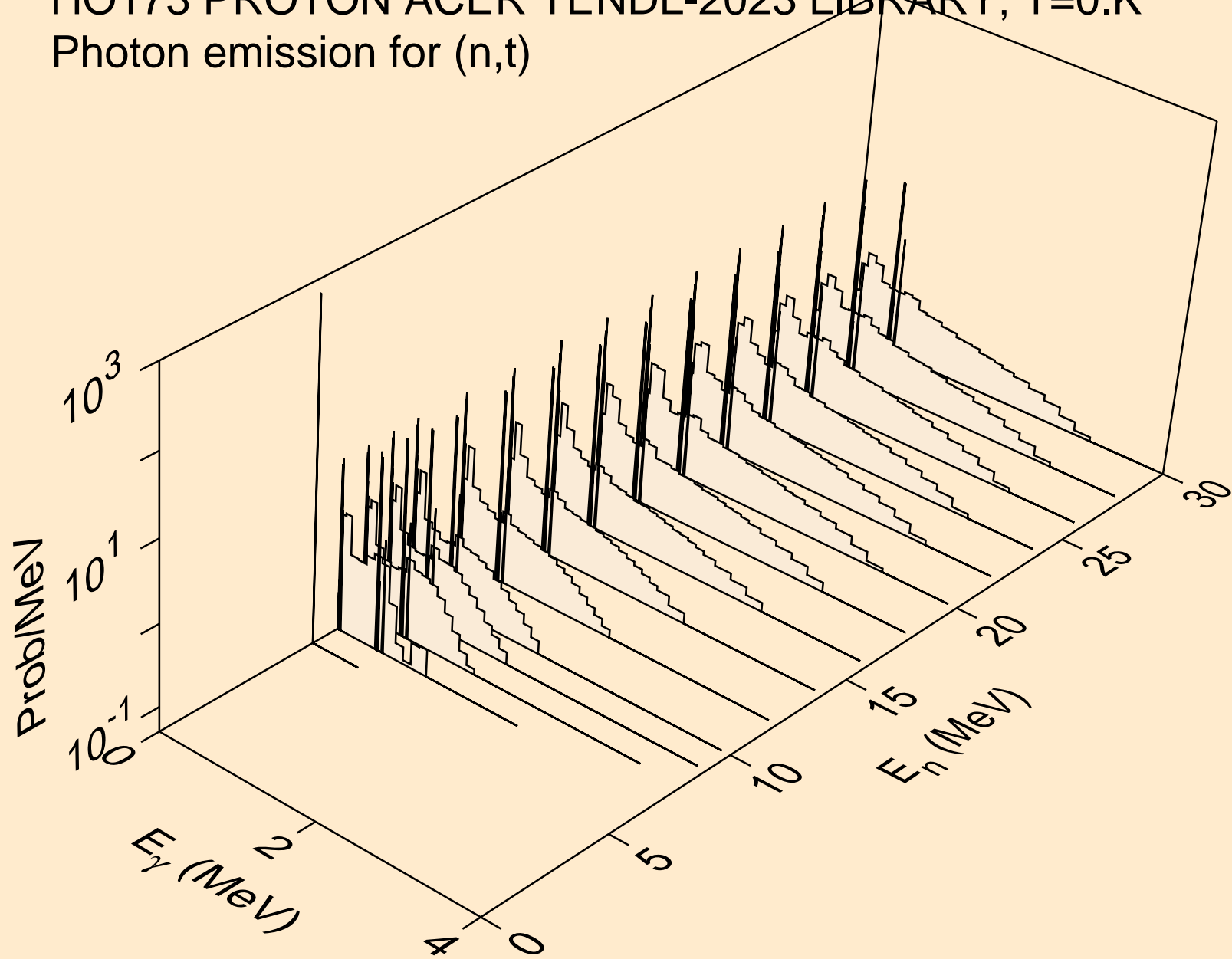

HO173 PROTON ACER TENDL-2023 LIBRARY; T=0.K  
Photon emission for (n,he3)

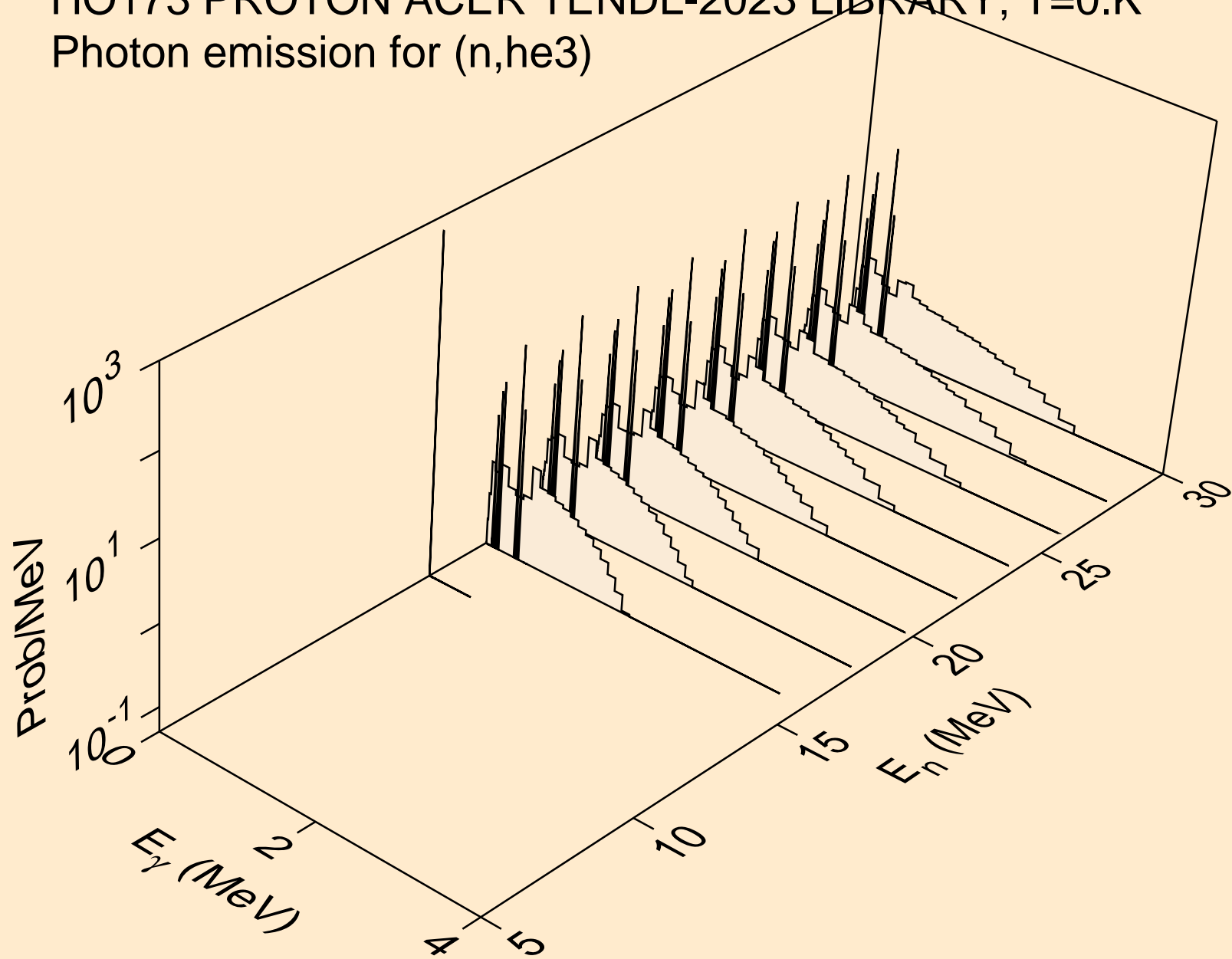

HO173 PROTON ACER TENDL-2023 LIBRARY; T=0.K  
Photon emission for (n,a)

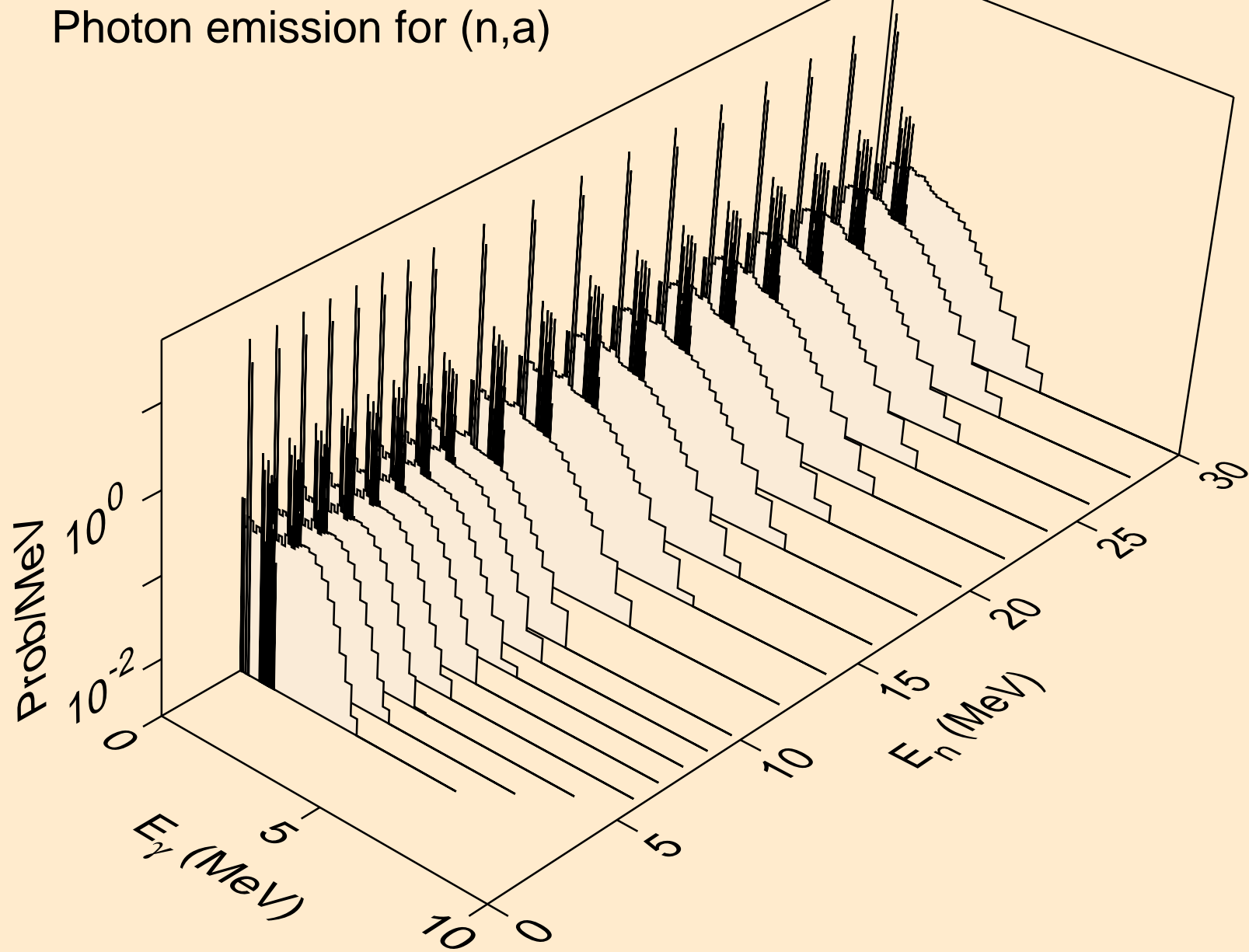



HO173 PROTON ACER TENDL-2023 LIBRARY; T=0.K  
Photon emission for (n,2p)

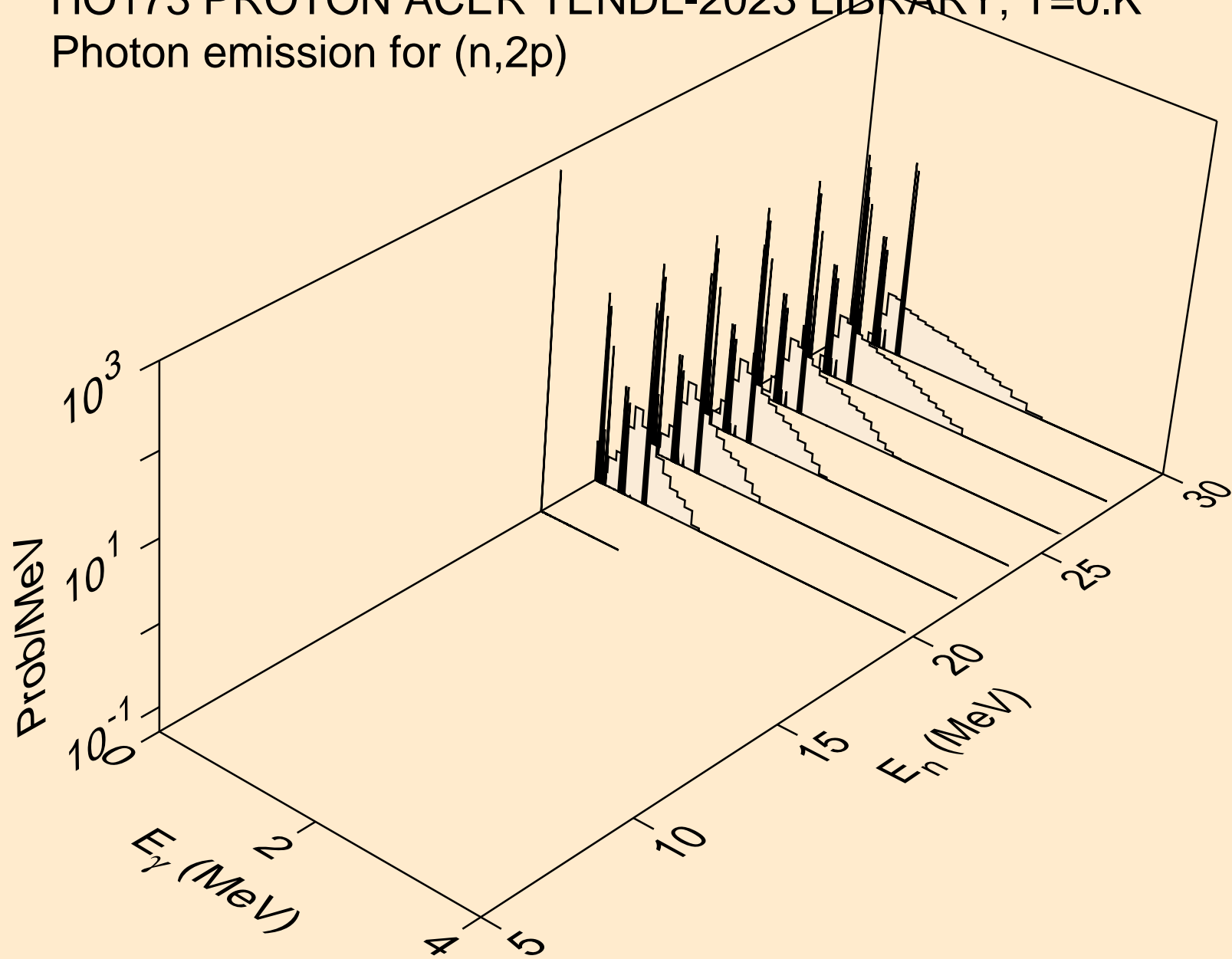

HO173 PROTON ACER TENDL-2023 LIBRARY; T=0.K  
Photon emission for (n,pd)

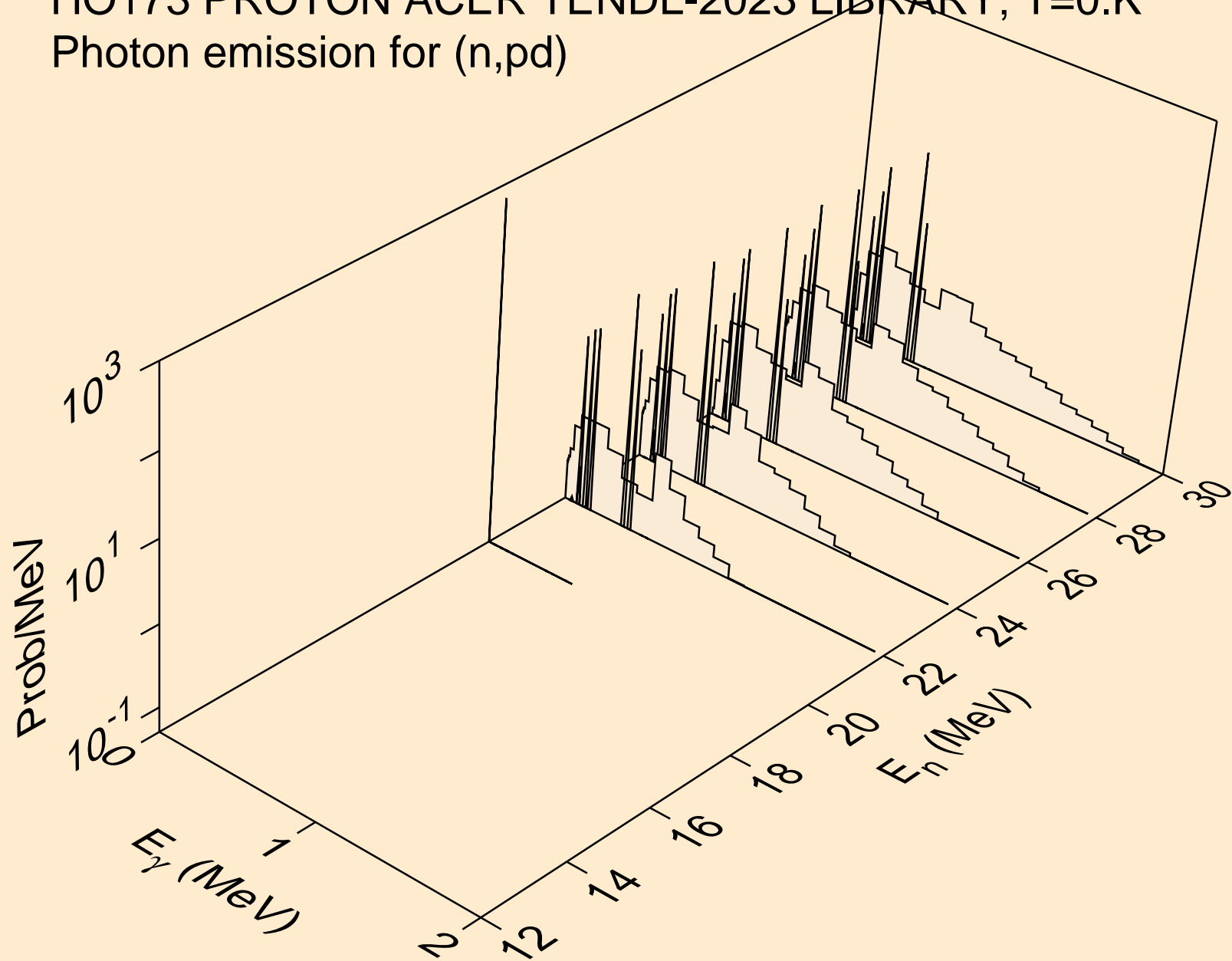

# HO173 PROTON ACER TENDL-2023 LIBRARY; T=0.K

## Particle heating contributions

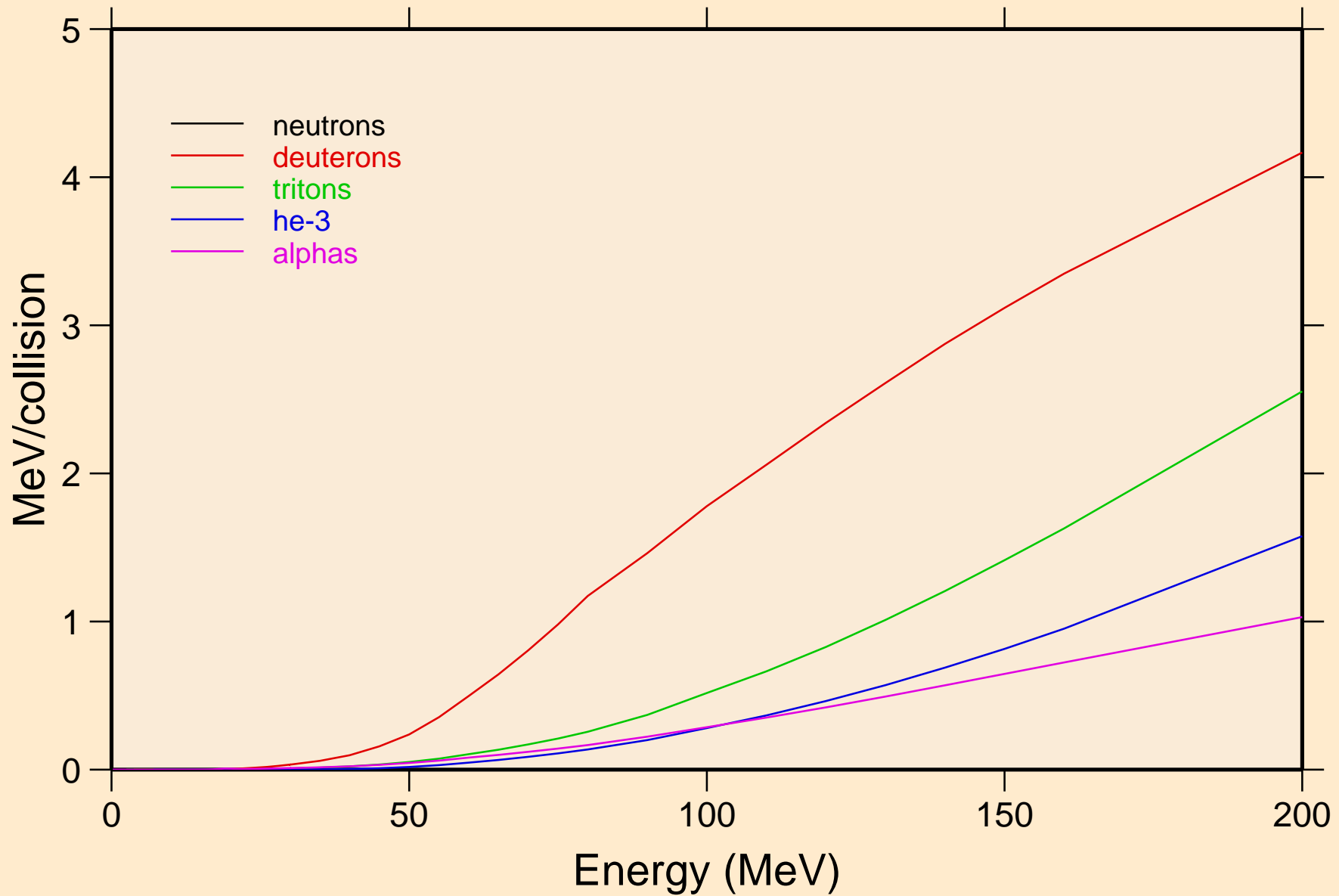

HO173 PROTON ACER TENDL-2023 LIBRARY; T=0.K  
Recoil Heating

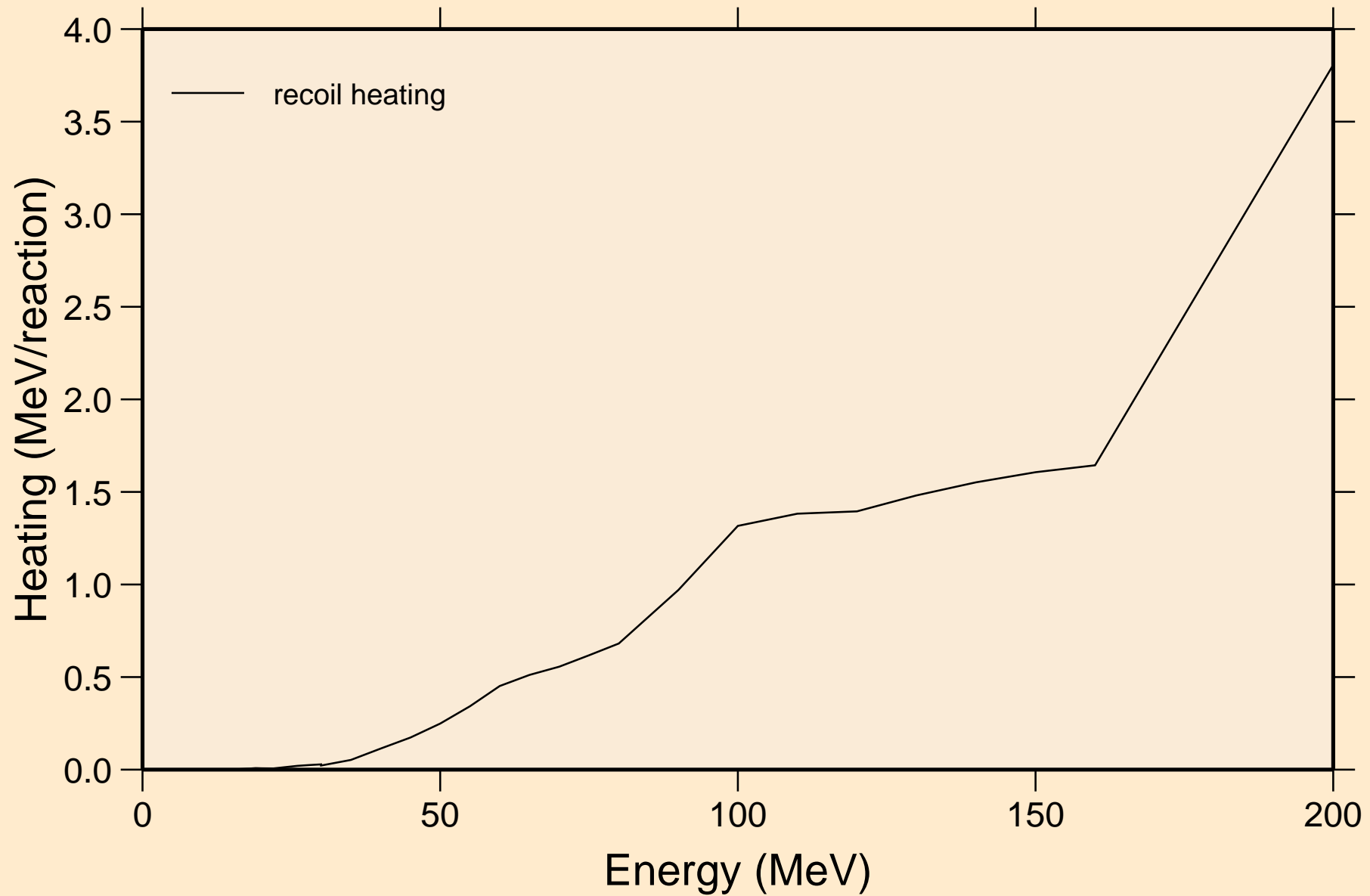

HO173 PROTON ACER TENDL-2023 LIBRARY; T=0.K  
Particle production cross sections

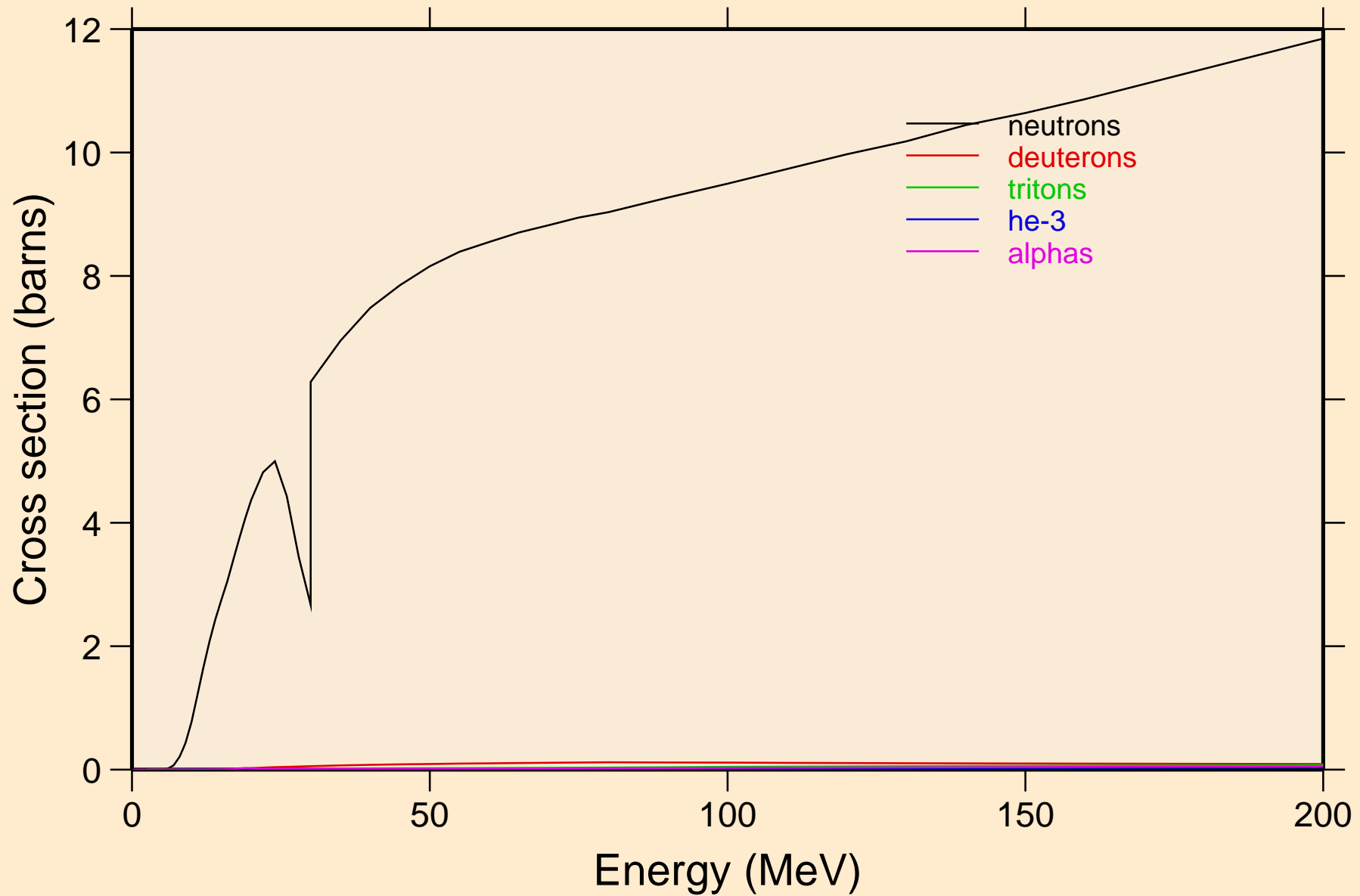

HO173 PROTON ACER TENDL-2023 LIBRARY; T=0.K  
neutrons from (p,n)

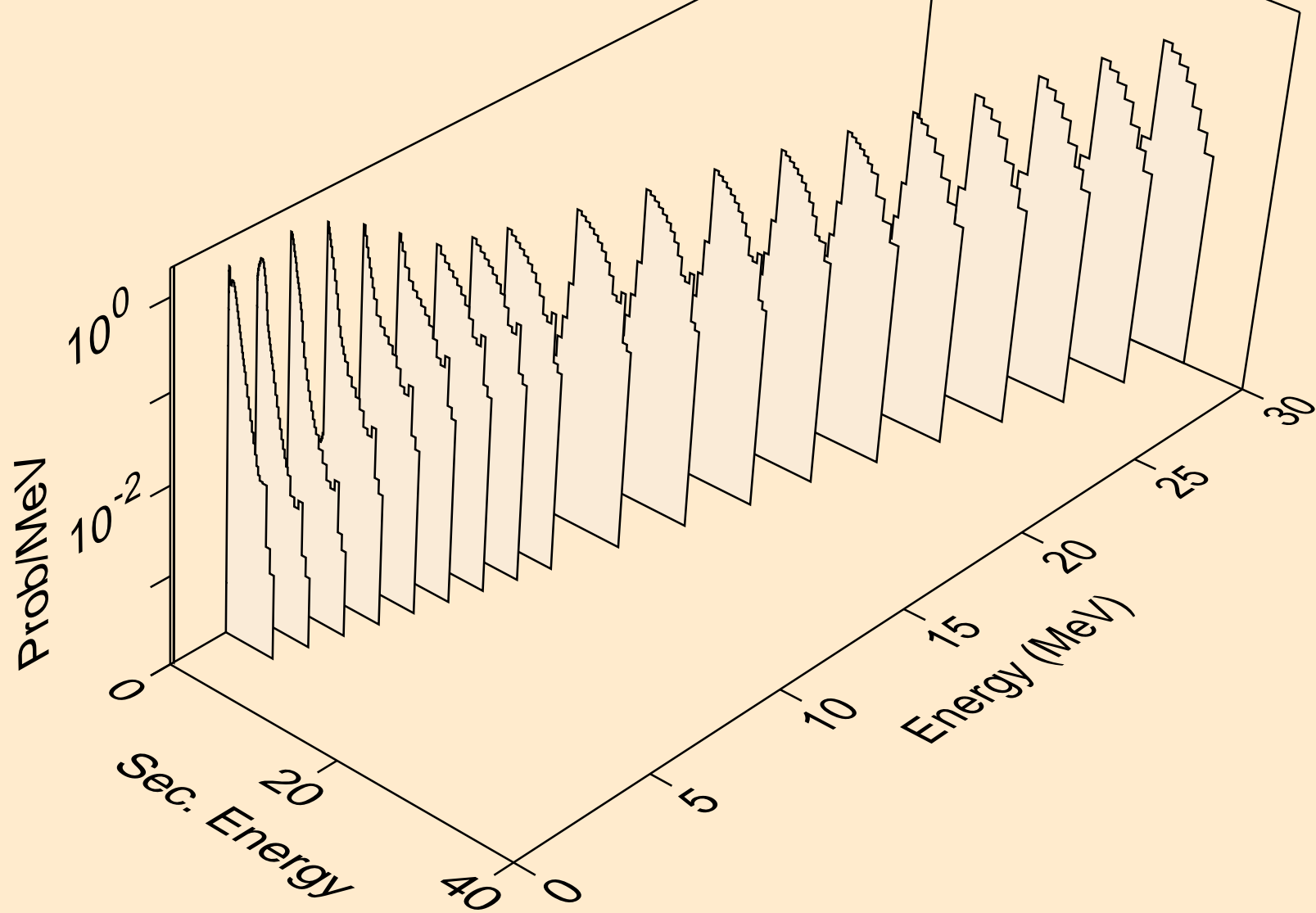

HO173 PROTON ACER TENDL-2023 LIBRARY; T=0.K  
neutrons from (p,x)

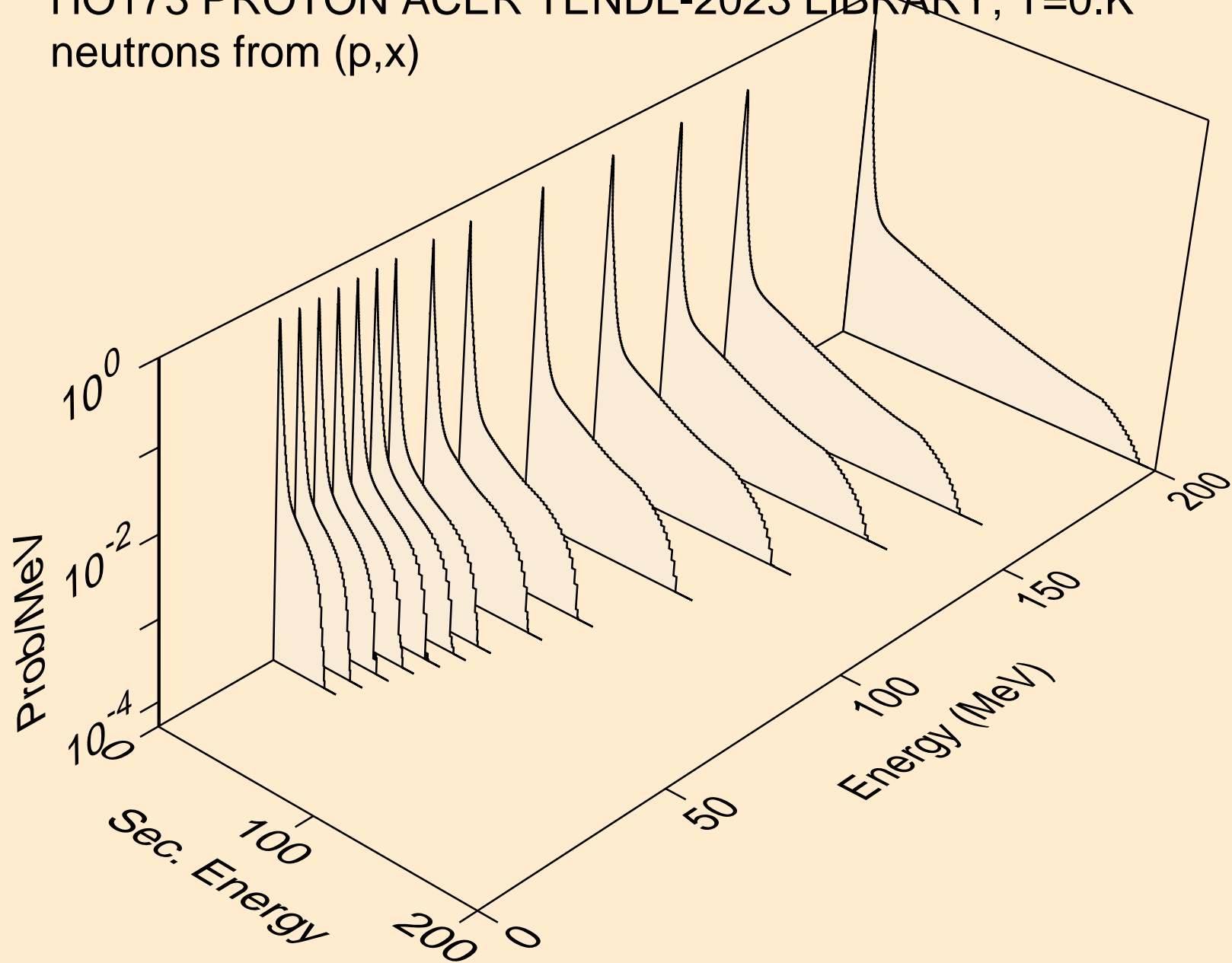

HO173 PROTON ACER TENDL-2023 LIBRARY; T=0.K  
neutrons from (p,2nd)

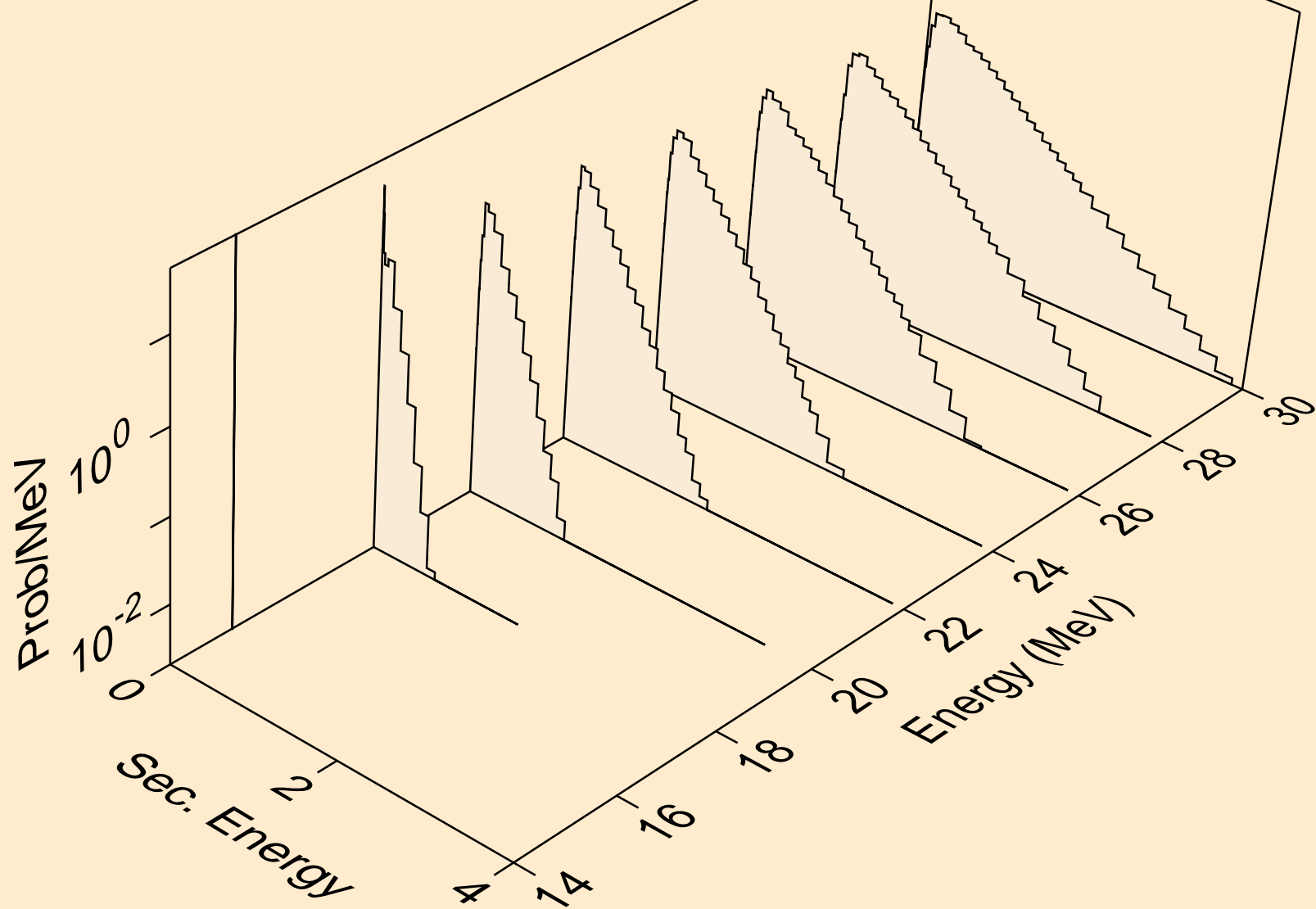



HO173 PROTON ACER TENDL-2023 LIBRARY; T=0.K  
neutrons from (p,2n)

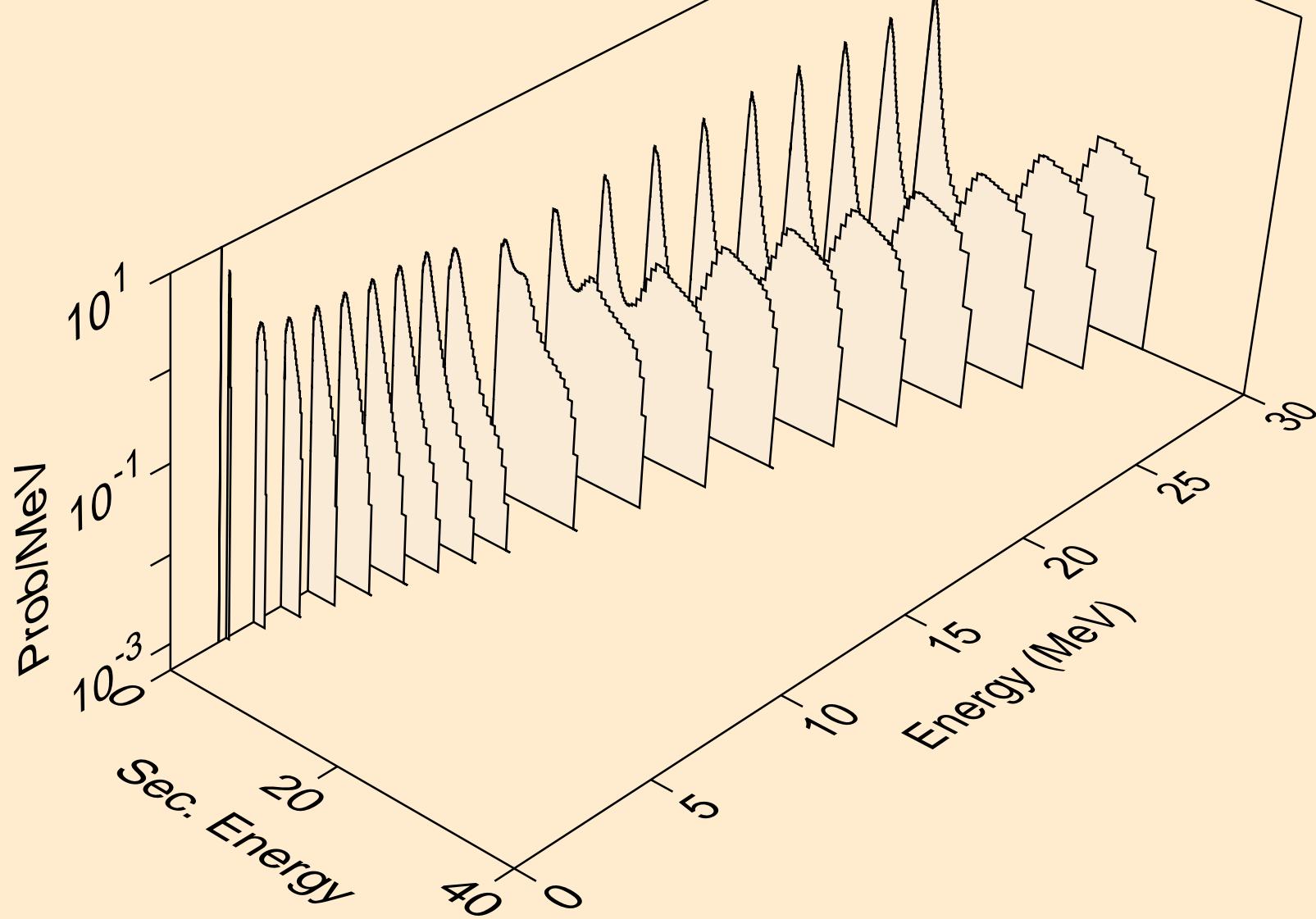

HO173 PROTON ACER TENDL-2023 LIBRARY; T=0.K  
neutrons from (p,3n)

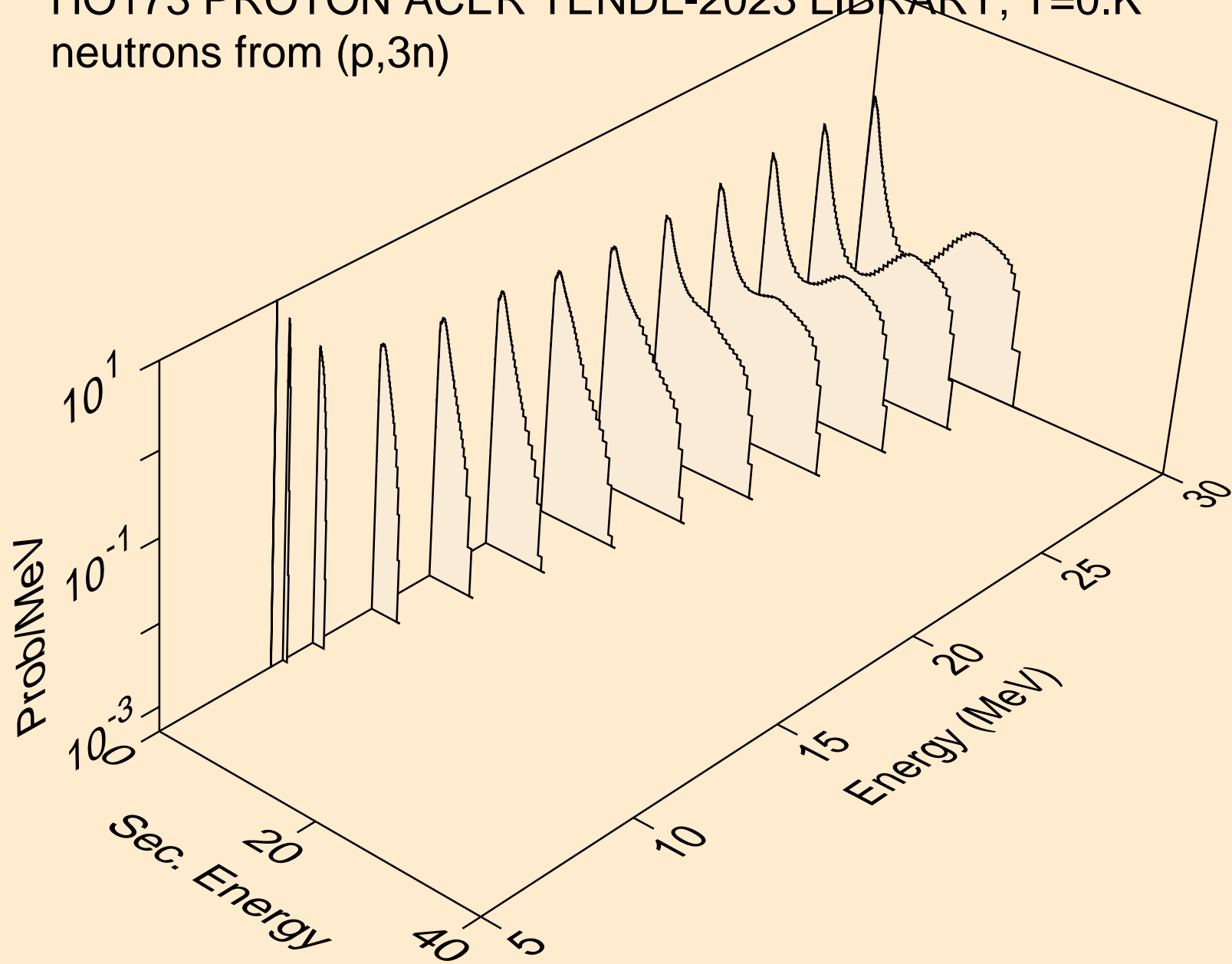

HO173 PROTON ACER TENDL-2023 LIBRARY; T=0.K  
neutrons from (p,n\*)a

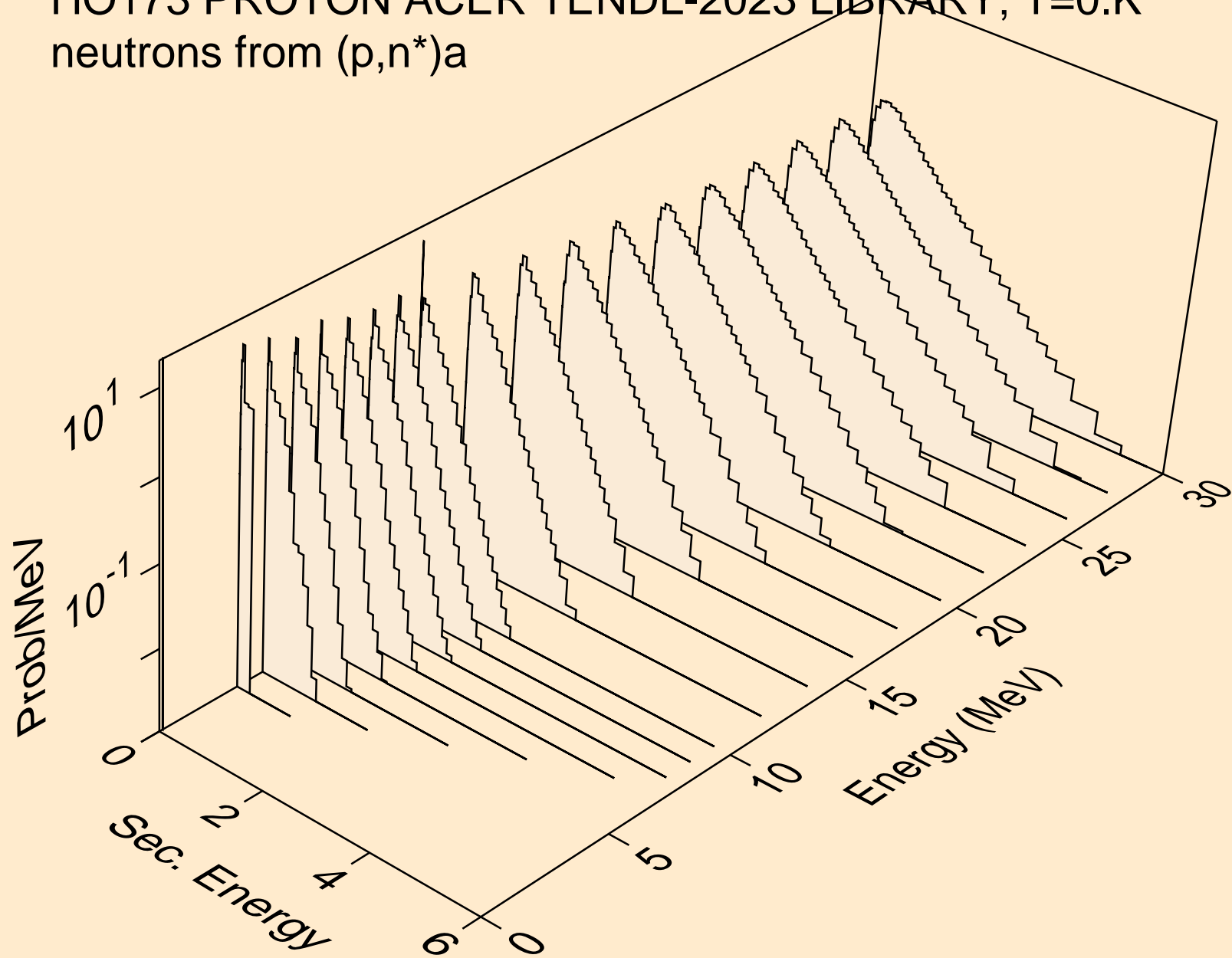

HO173 PROTON ACER TENDL-2023 LIBRARY; T=0.K  
neutrons from (p,2n)a

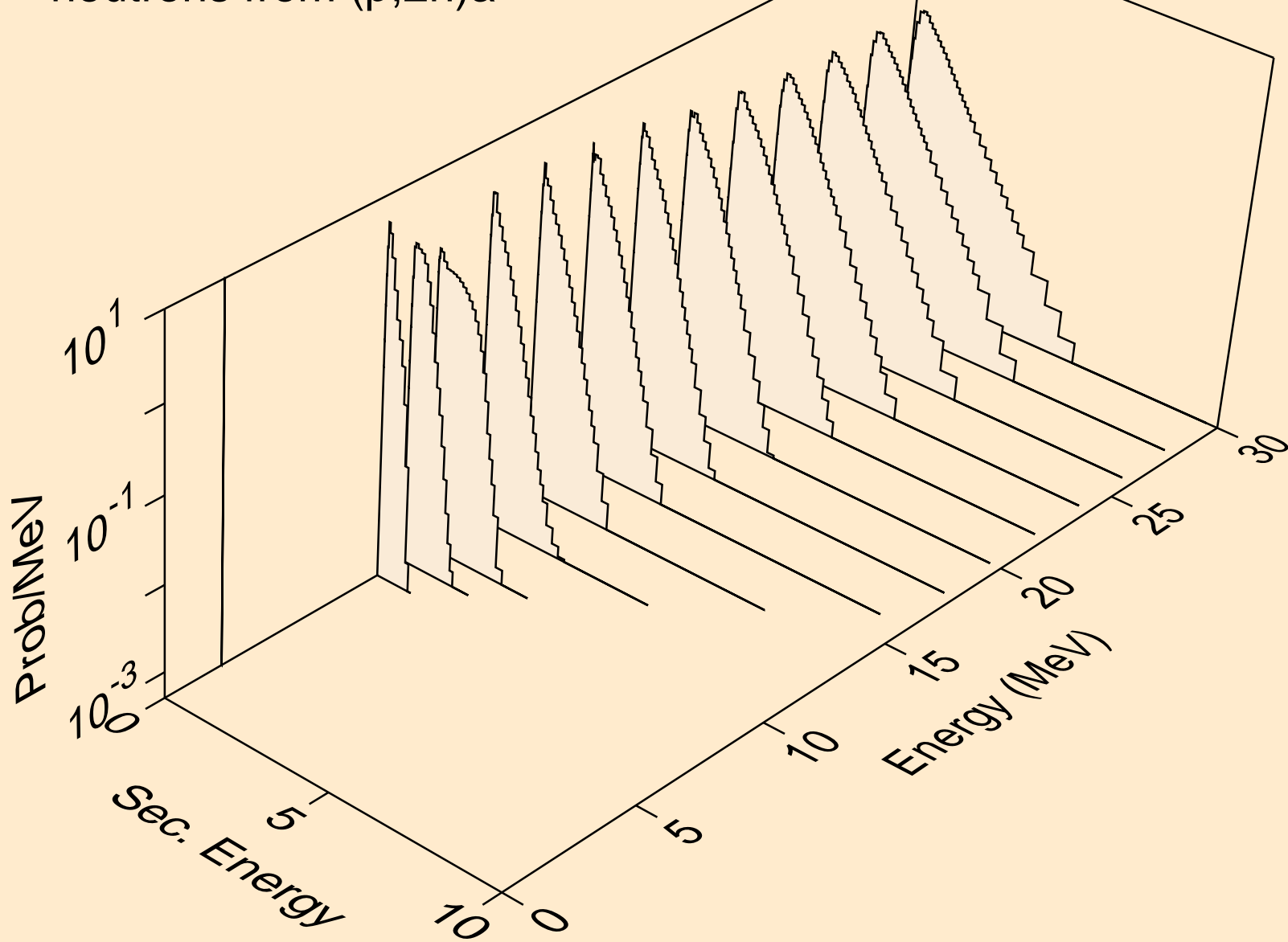

HO173 PROTON ACER TENDL-2023 LIBRARY; T=0.K  
neutrons from (p,3n)a

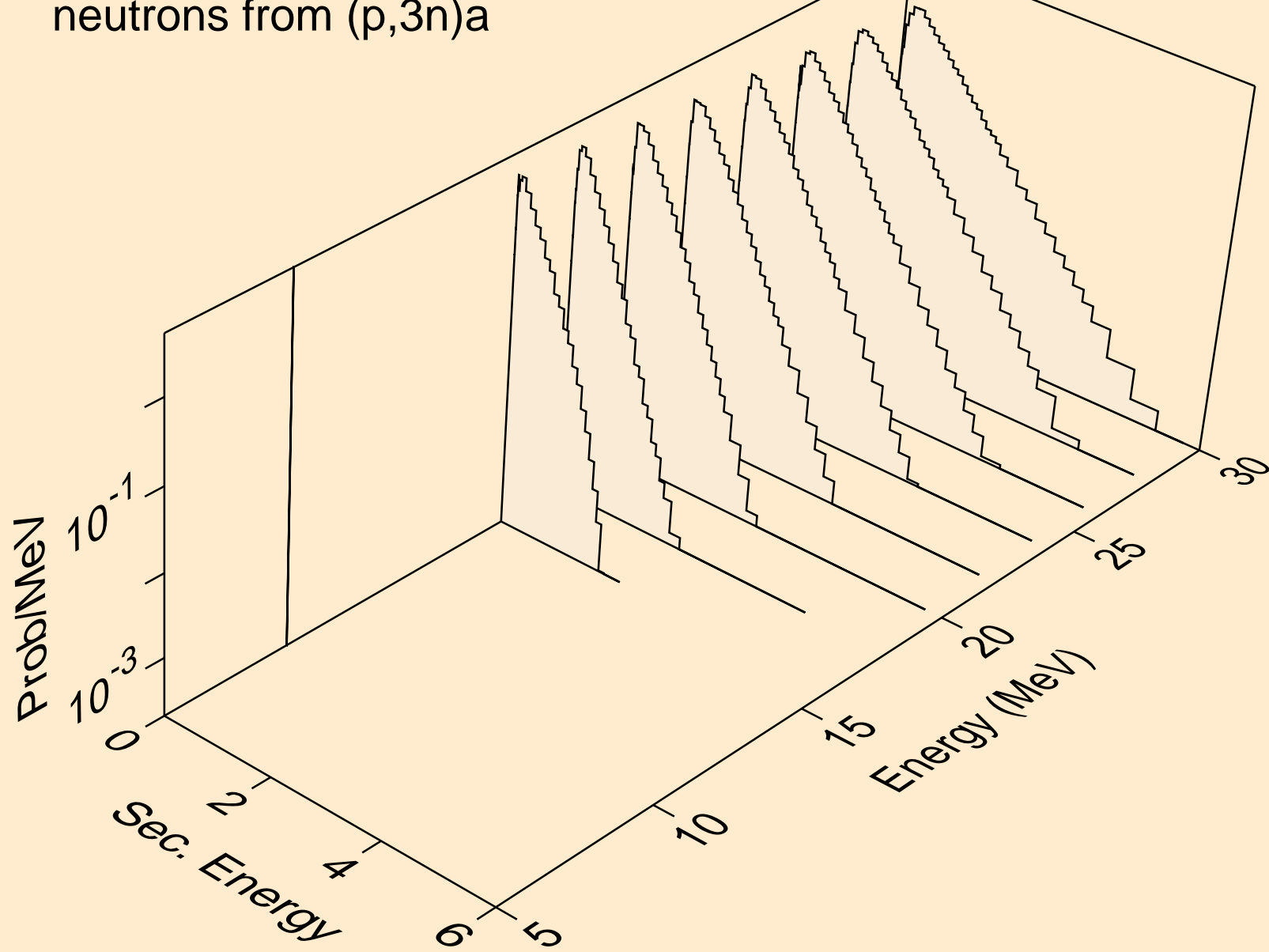

HO173 PROTON ACER TENDL-2023 LIBRARY; T=0.K  
neutrons from (p,n\*)p

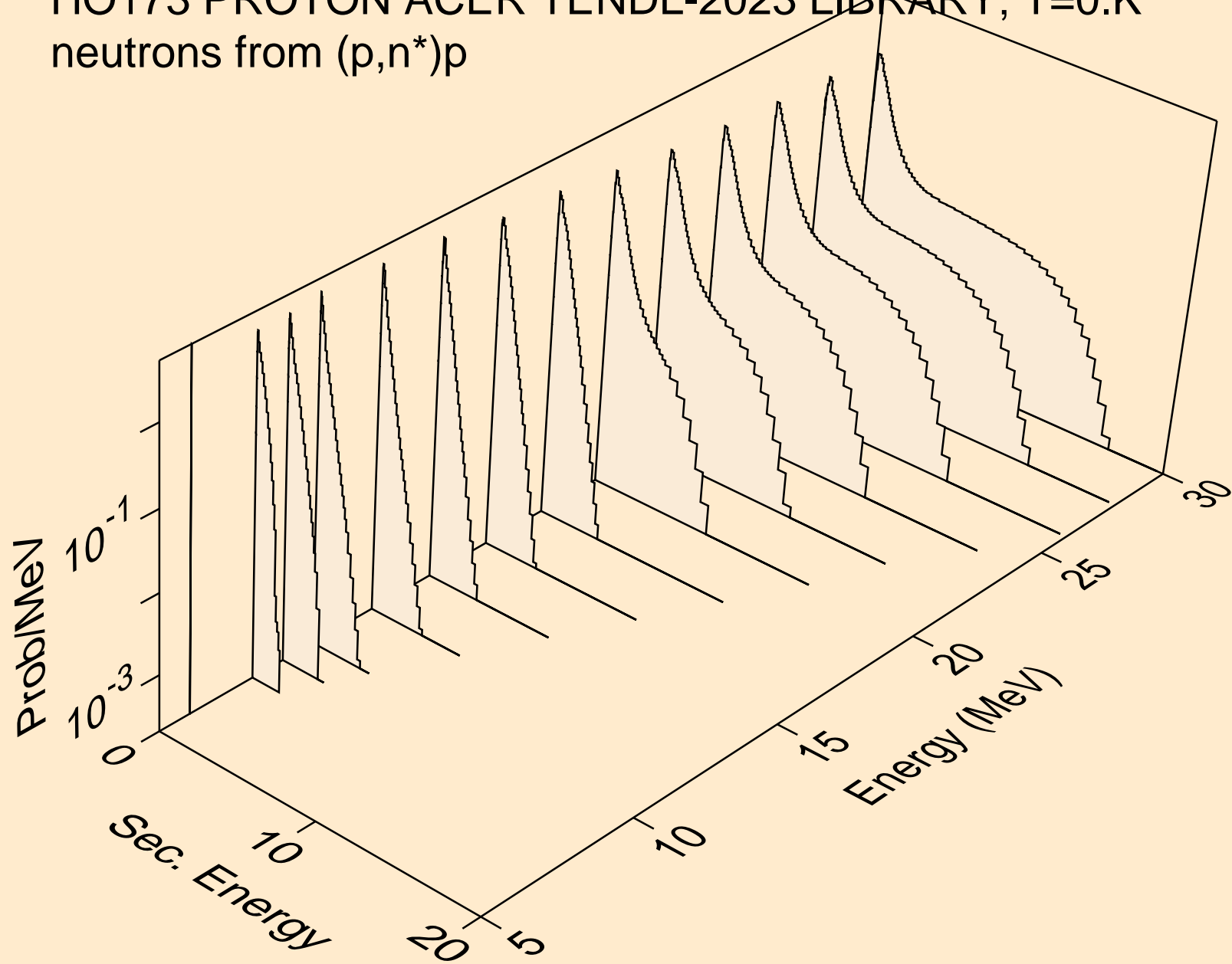

HO173 PROTON ACER TENDL-2023 LIBRARY; T=0.K  
neutrons from (p,n\*)d

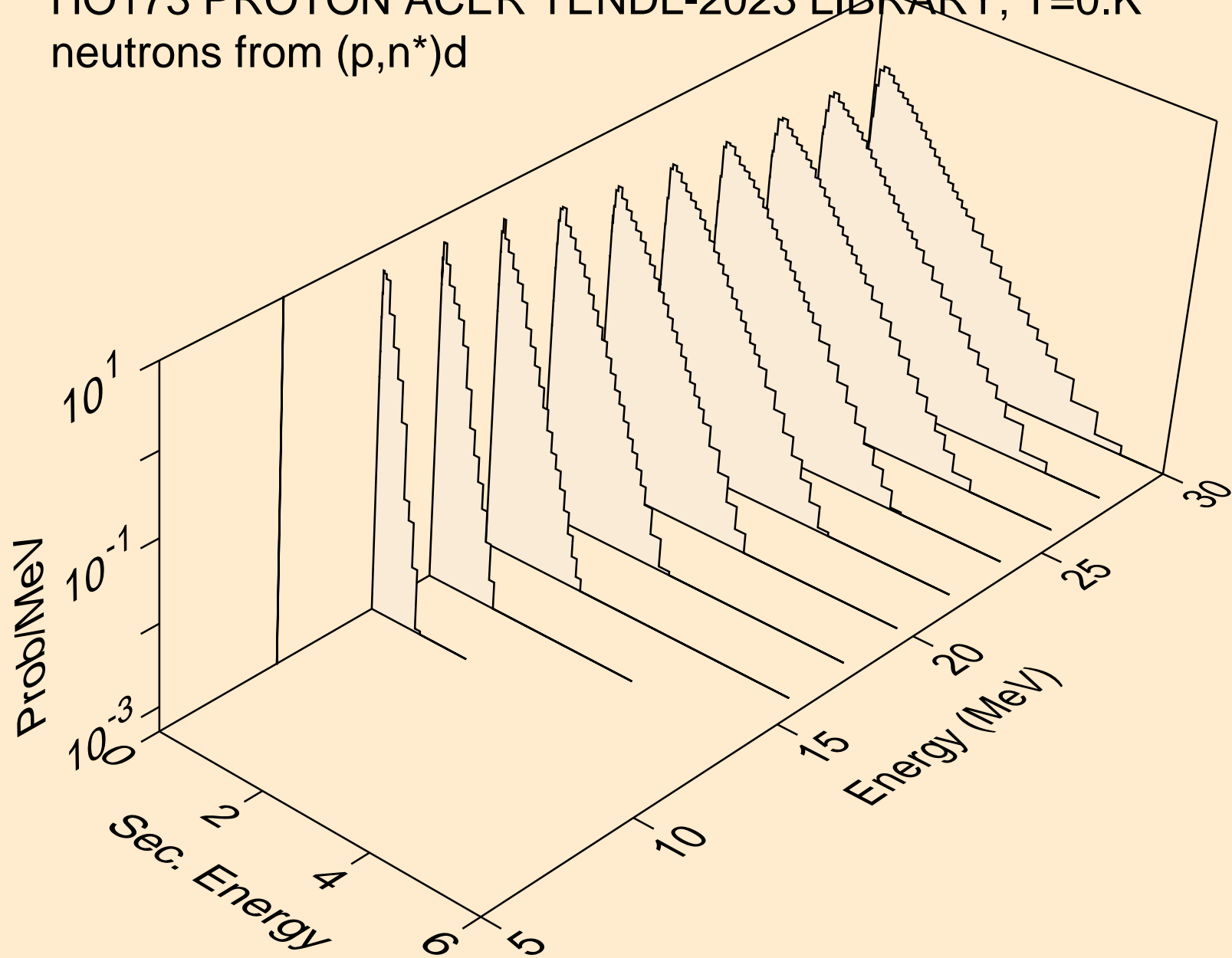

HO173 PROTON ACER TENDL-2023 LIBRARY; T=0.K  
neutrons from (p,n\*)t

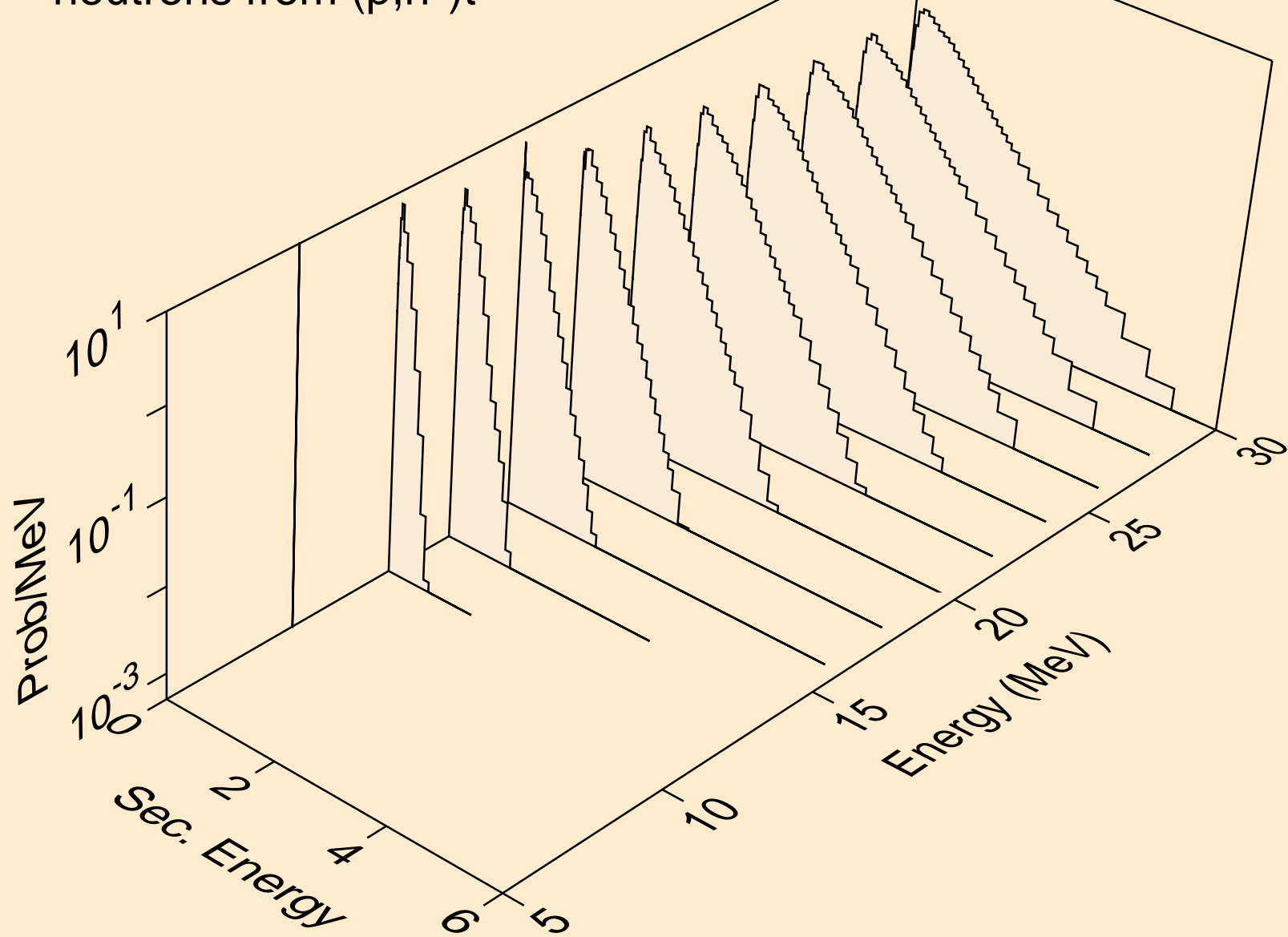



HO173 PROTON ACER TENDL-2023 LIBRARY; T=0.K  
neutrons from (p,n\*)he3

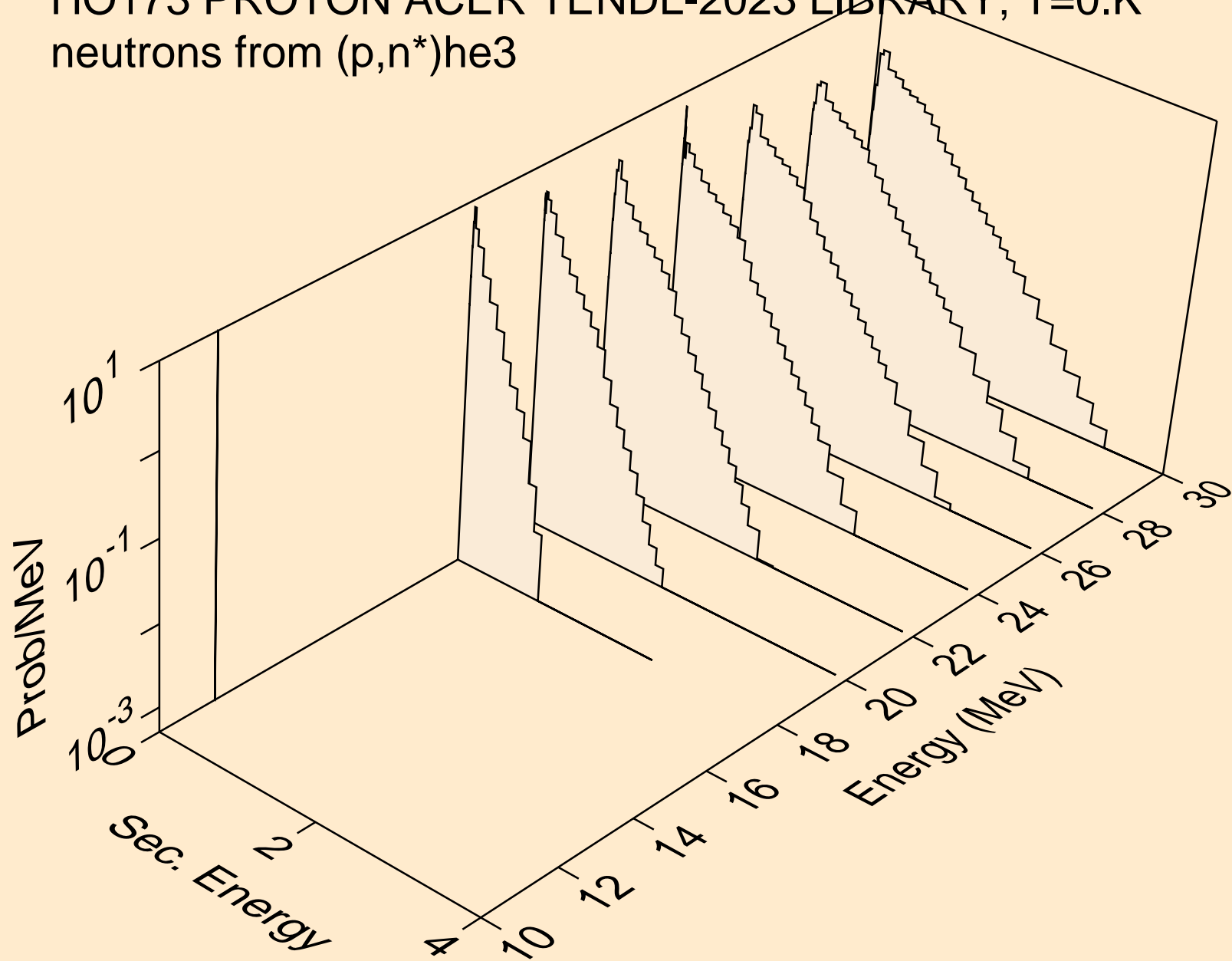

HO173 PROTON ACER TENDL-2023 LIBRARY; T=0.K  
neutrons from (p,4n)

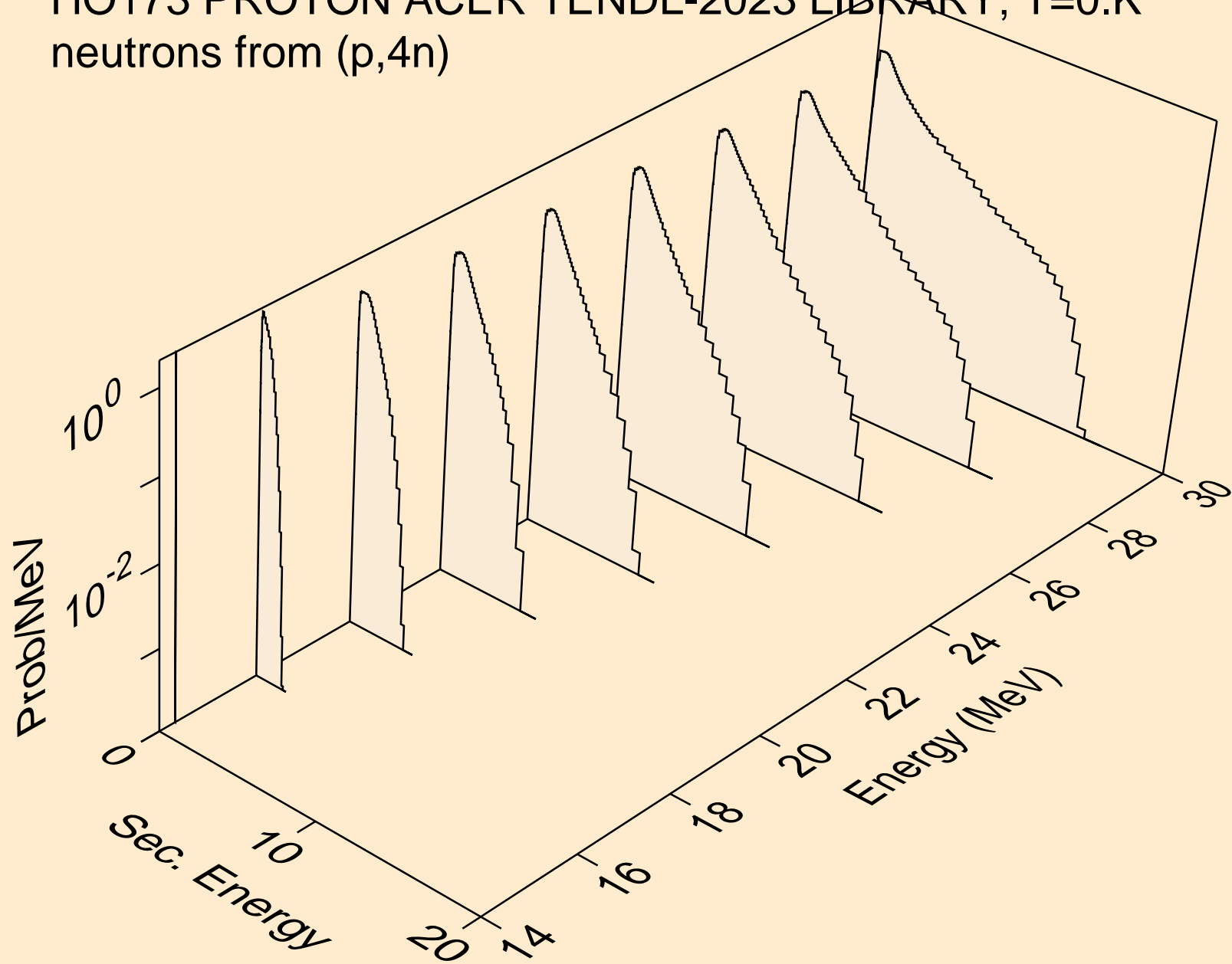

HO173 PROTON ACER TENDL-2023 LIBRARY; T=0.K  
neutrons from (p,2np)

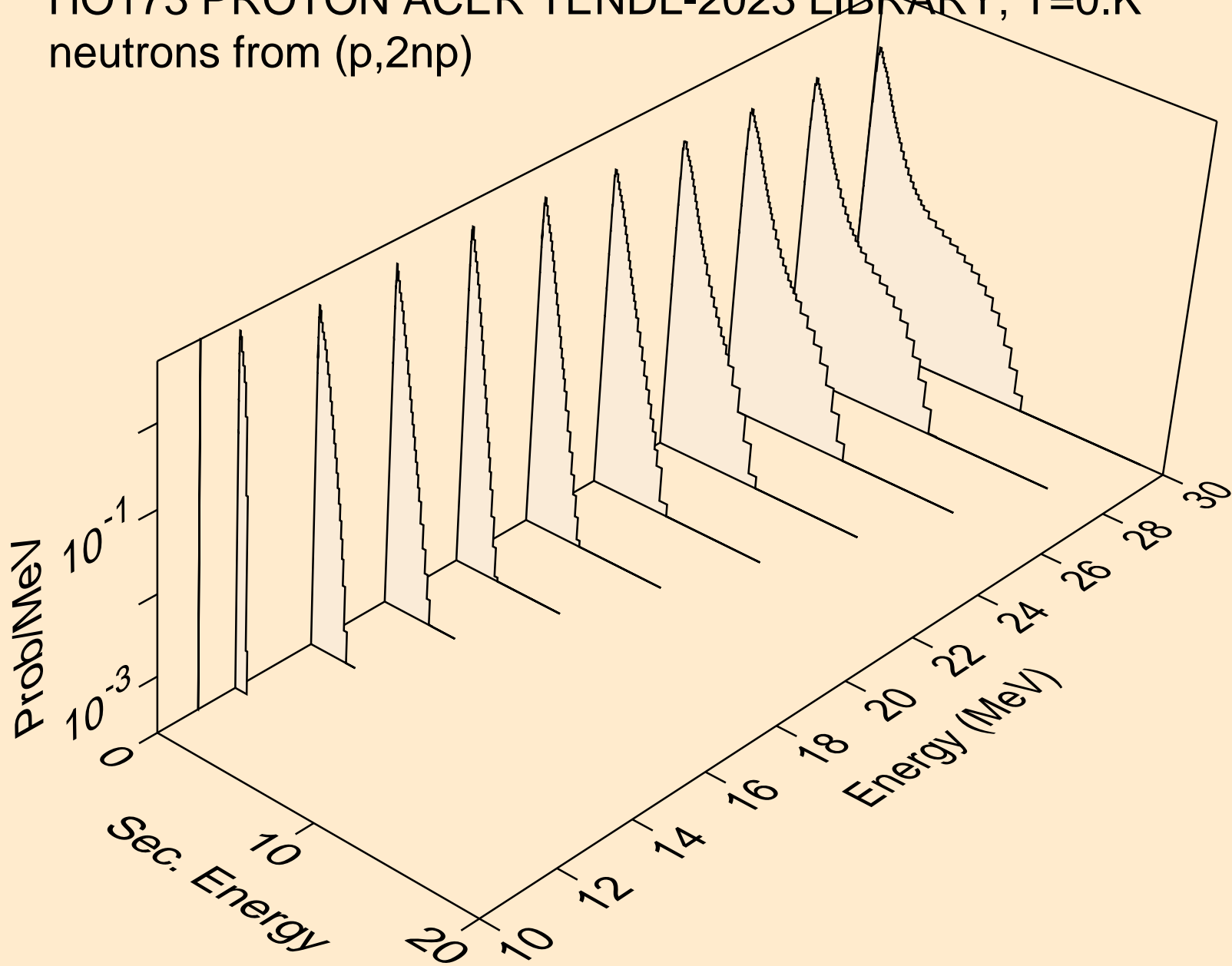

HO173 PROTON ACER TENDL-2023 LIBRARY; T=0.K  
neutrons from (p,3np)

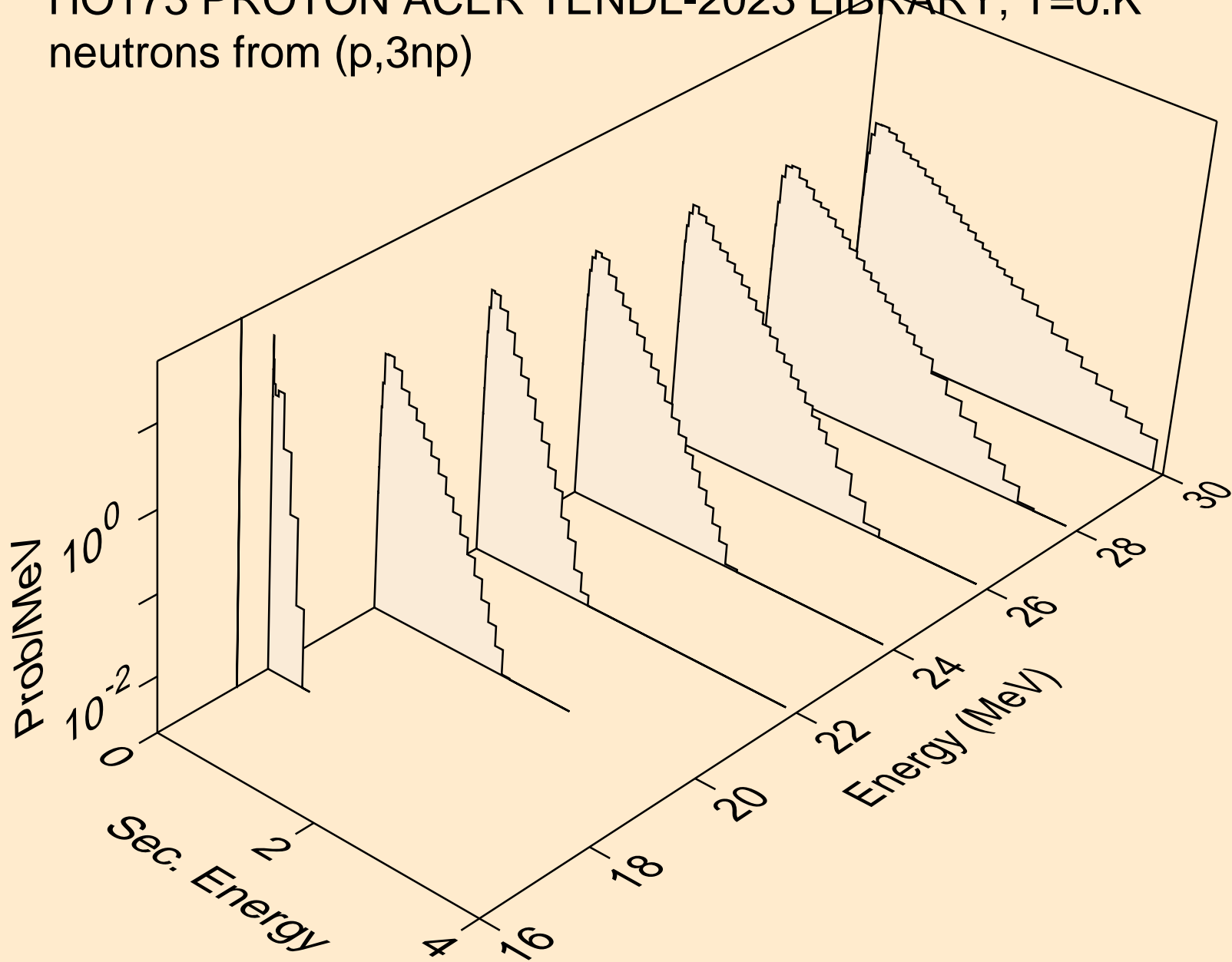

HO173 PROTON ACER TENDL-2023 LIBRARY; T=0.K  
neutrons from (p,n2p)

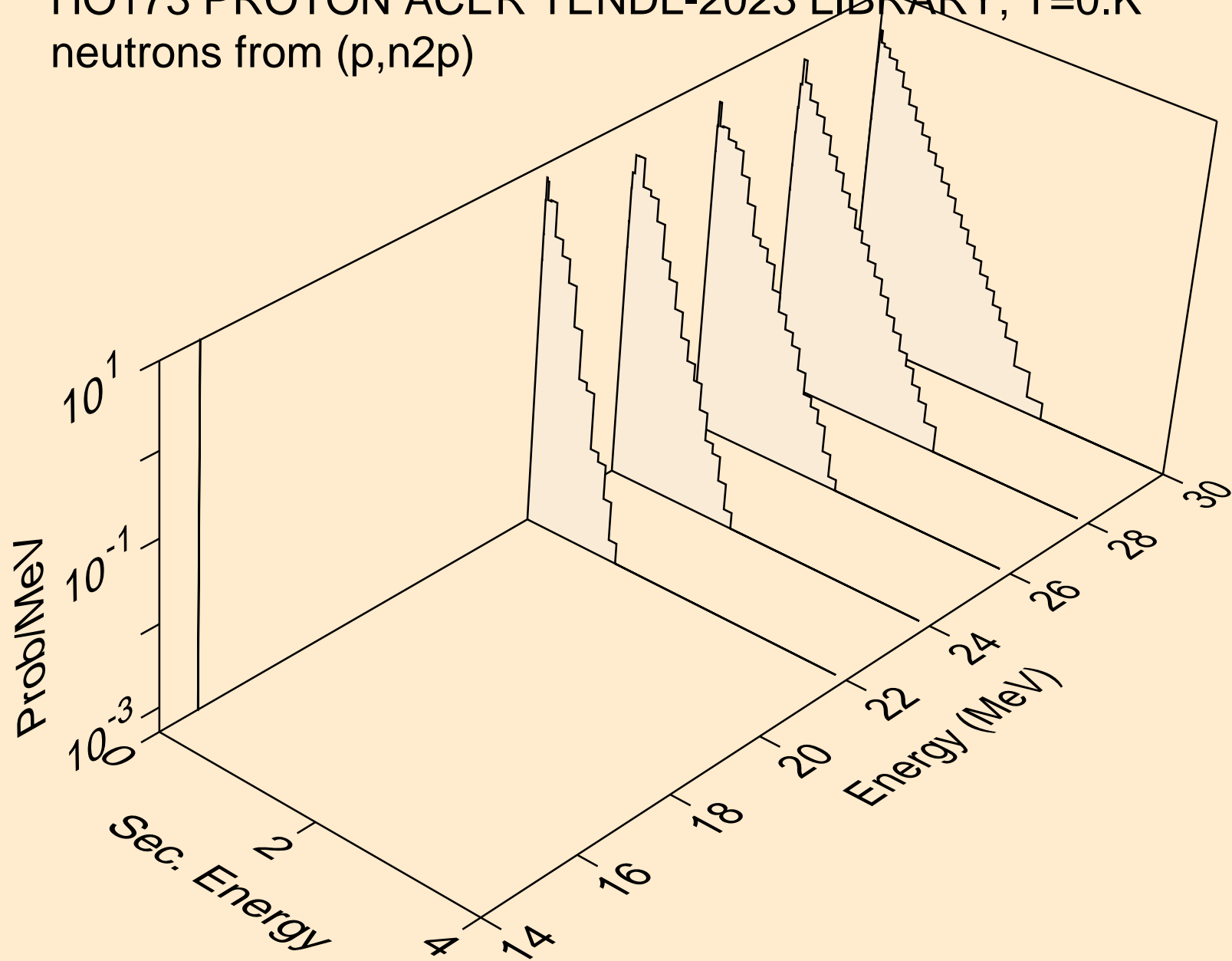

HO173 PROTON ACER TENDL-2023 LIBRARY; T=0.K  
deuterons from (p,x)

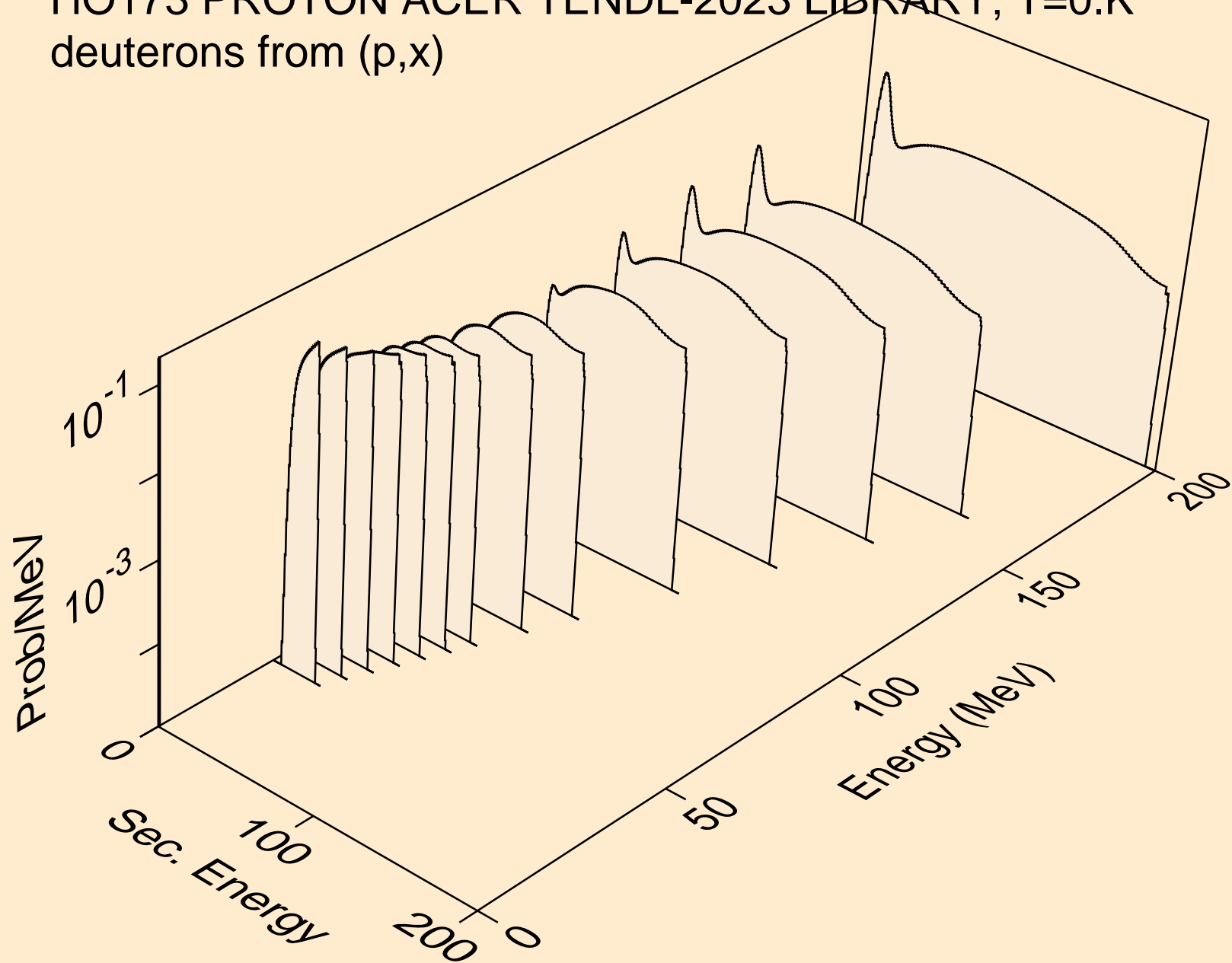

HO173 PROTON ACER TENDL-2023 LIBRARY; T=0.K  
deuterons from (p,2nd)

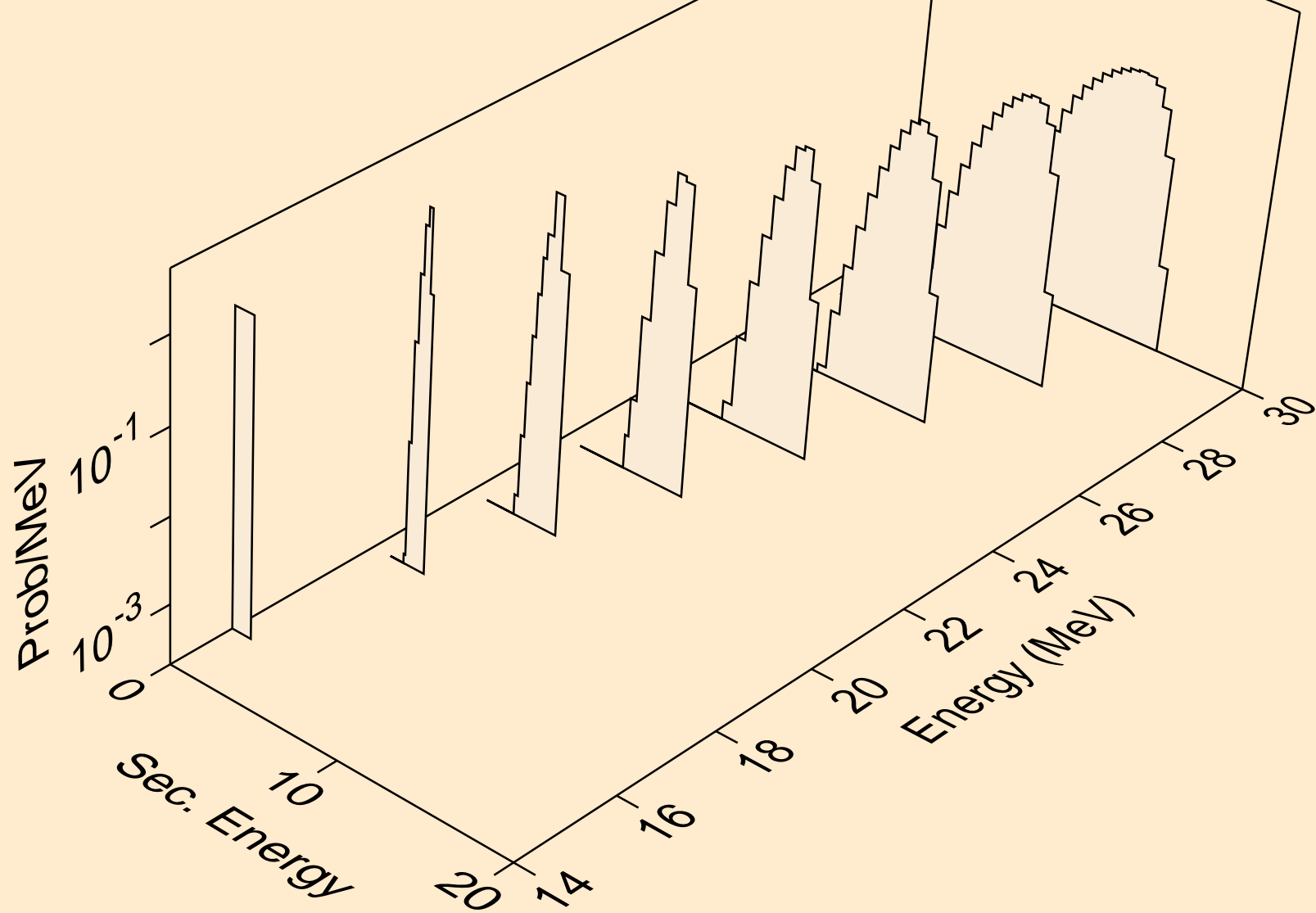

HO173 PROTON ACER TENDL-2023 LIBRARY; T=0.K  
deuterons from (p,n\*)d

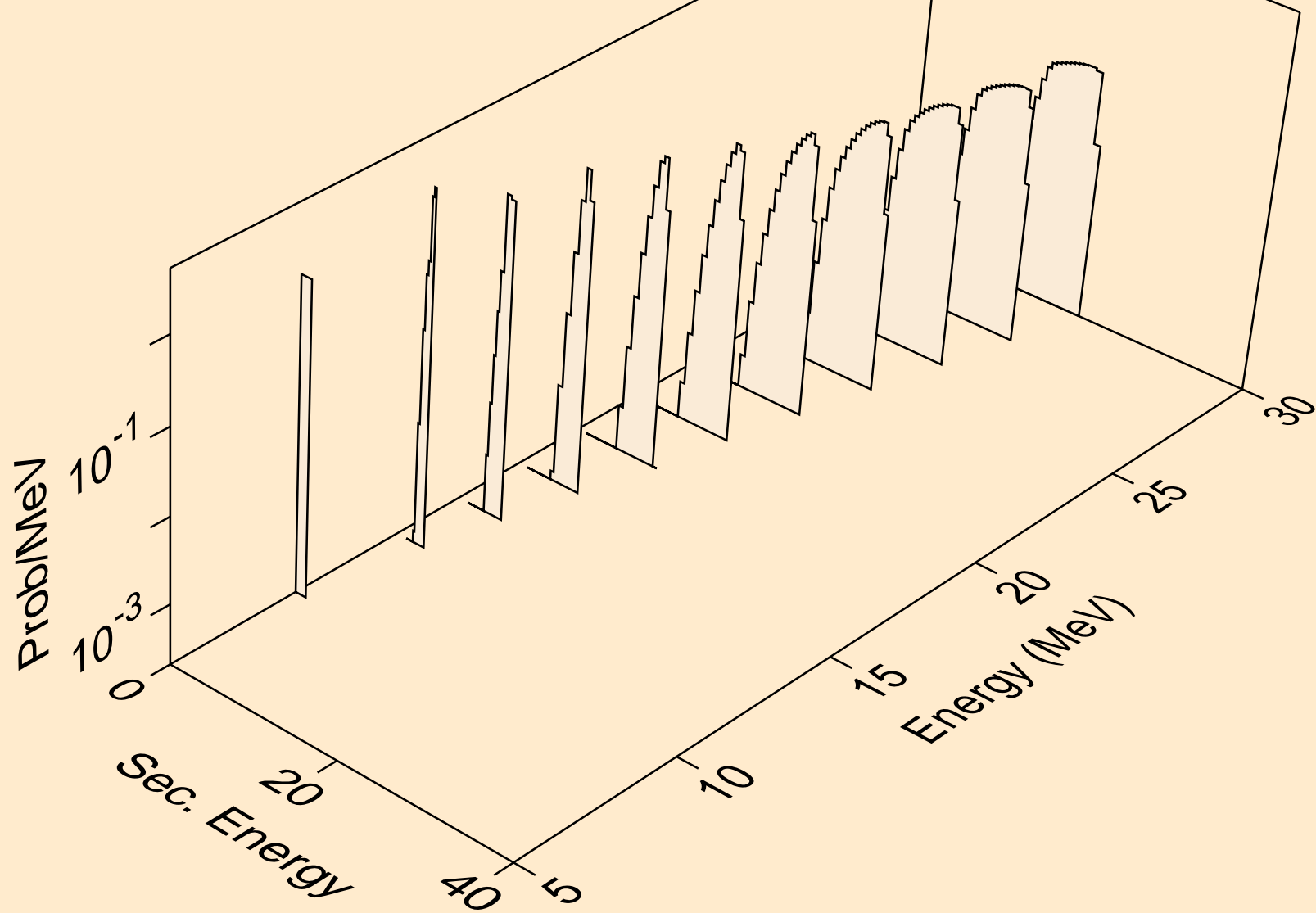



HO173 PROTON ACER TENDL-2023 LIBRARY; T=0.K  
deuterons from (p,d)

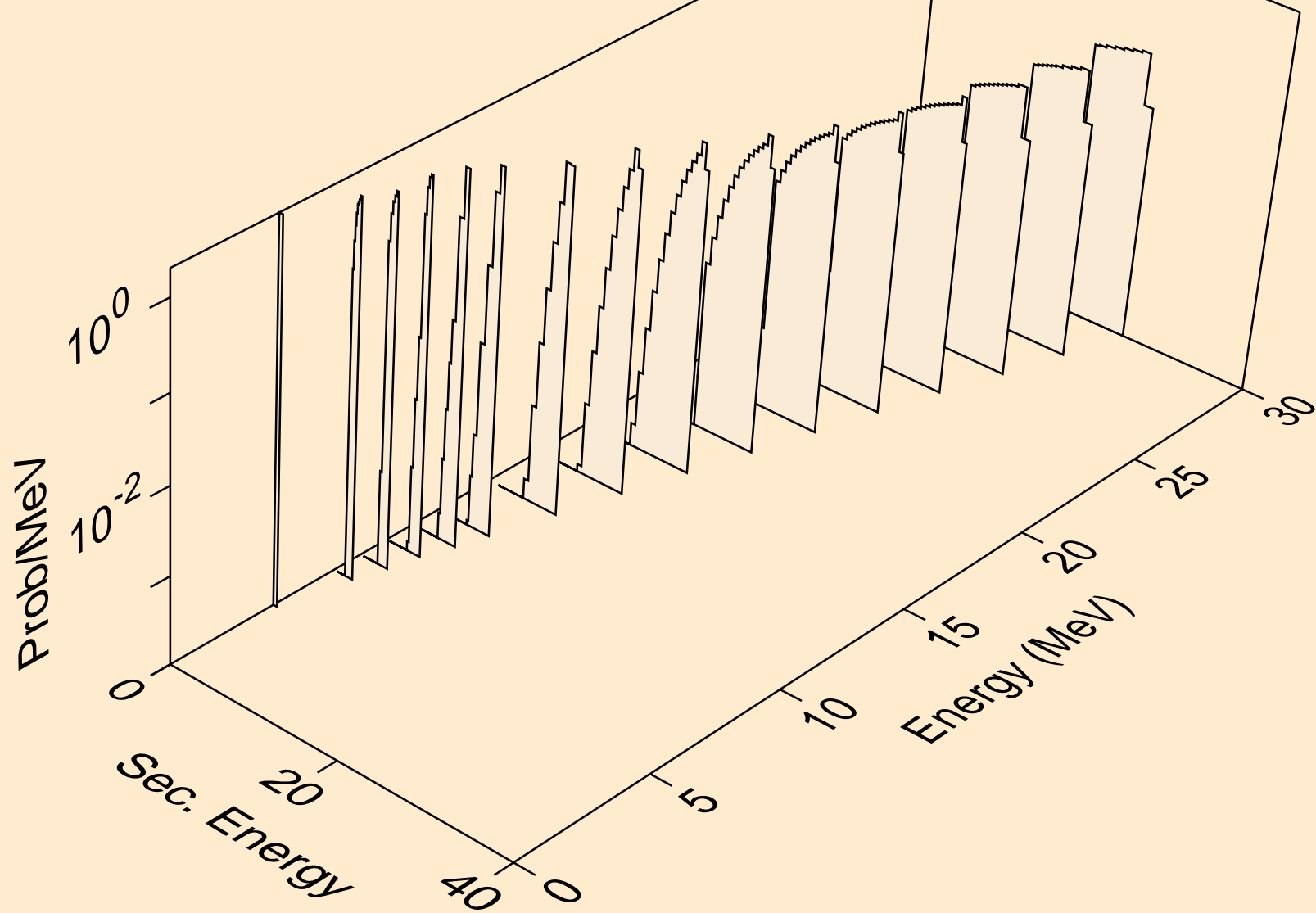

HO173 PROTON ACER TENDL-2023 LIBRARY; T=0.K  
deuterons from (p,pd)

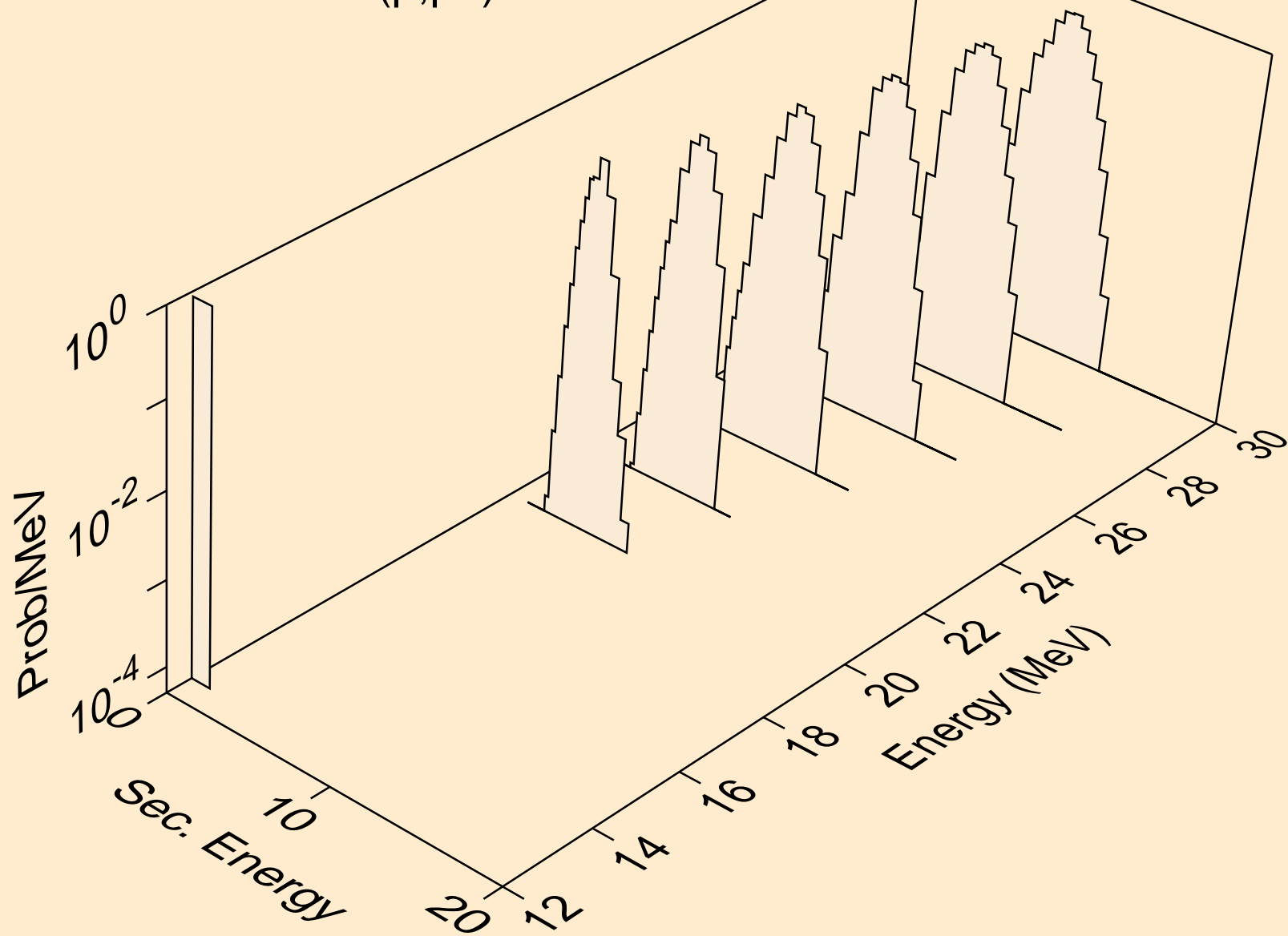

HO173 PROTON ACER TENDL-2023 LIBRARY; T=0.K  
tritons from (p,x)

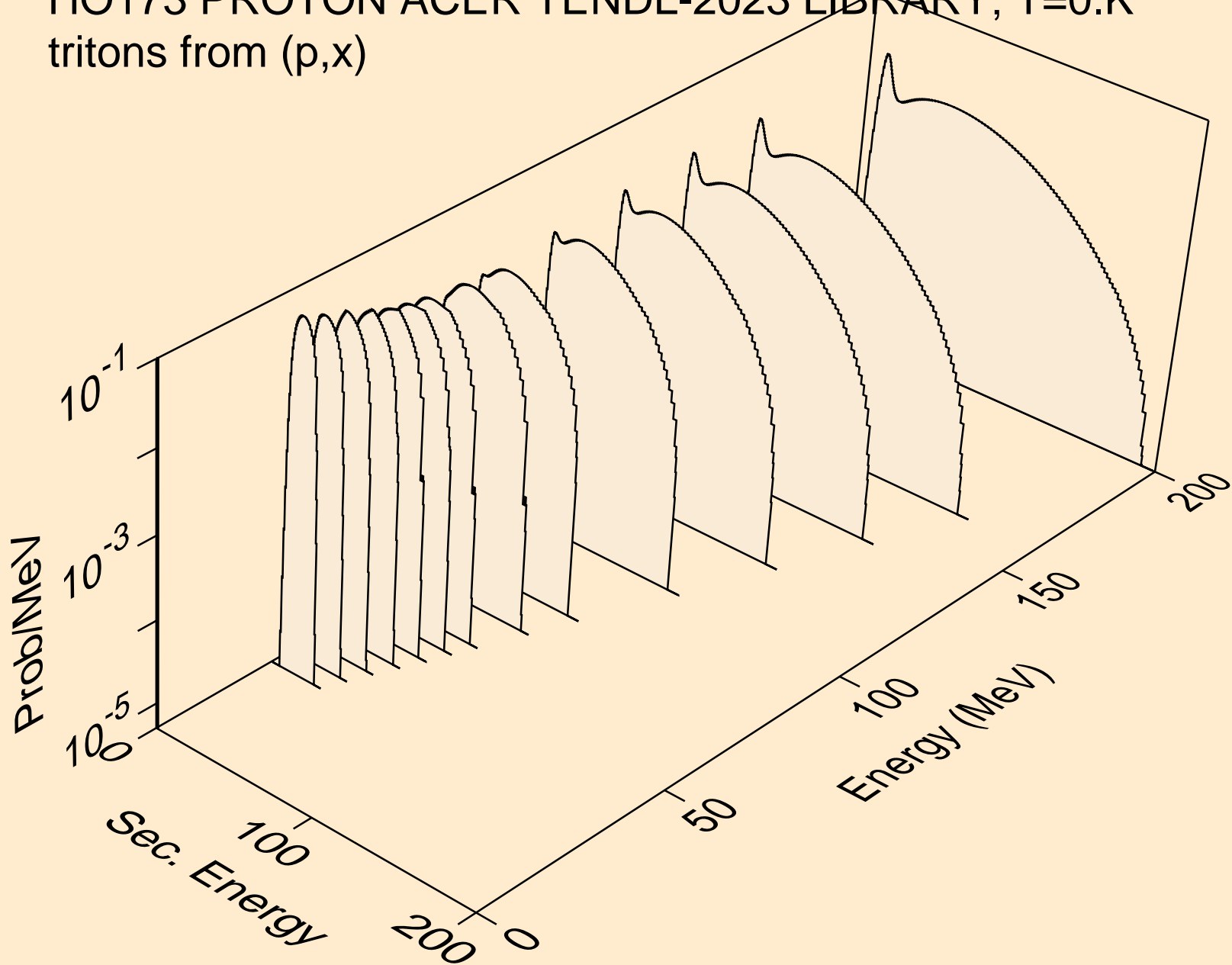

HO173 PROTON ACER TENDL-2023 LIBRARY; T=0.K  
tritons from (p,n\*)t

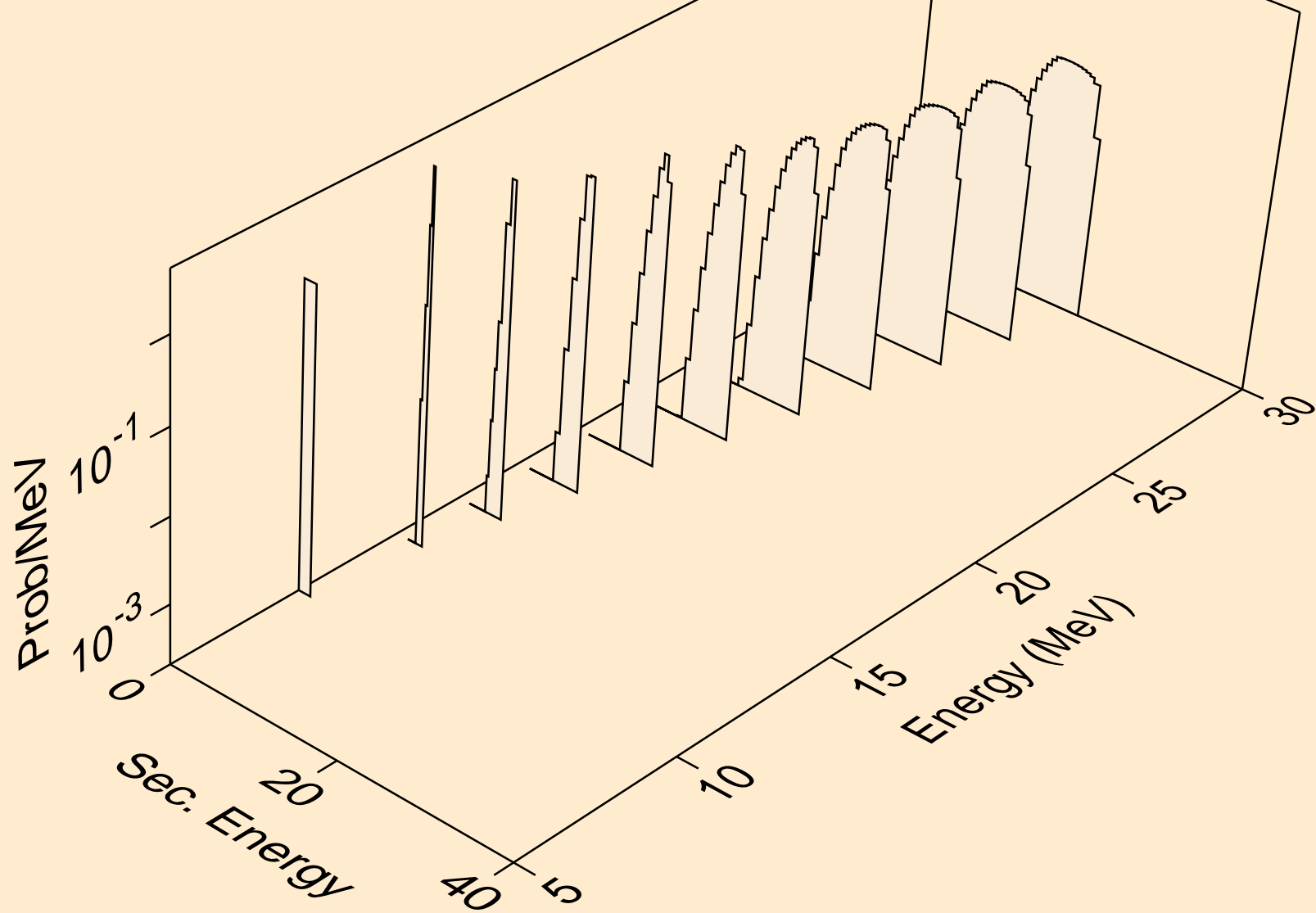

HO173 PROTON ACER TENDL-2023 LIBRARY; T=0.K  
tritons from (p,t)

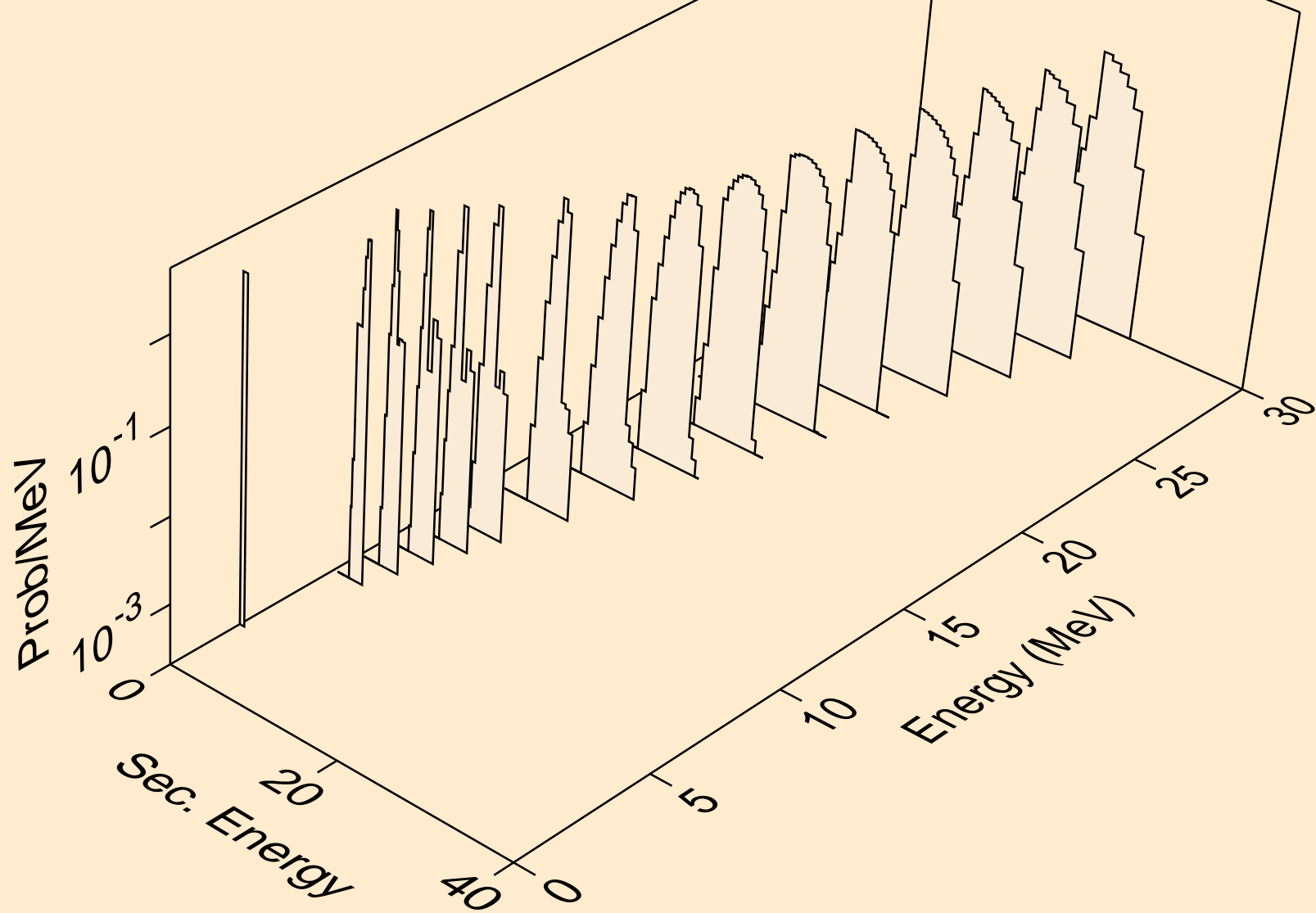

HO173 PROTON ACER TENDL-2023 LIBRARY; T=0.K  
he3s from (p,x)

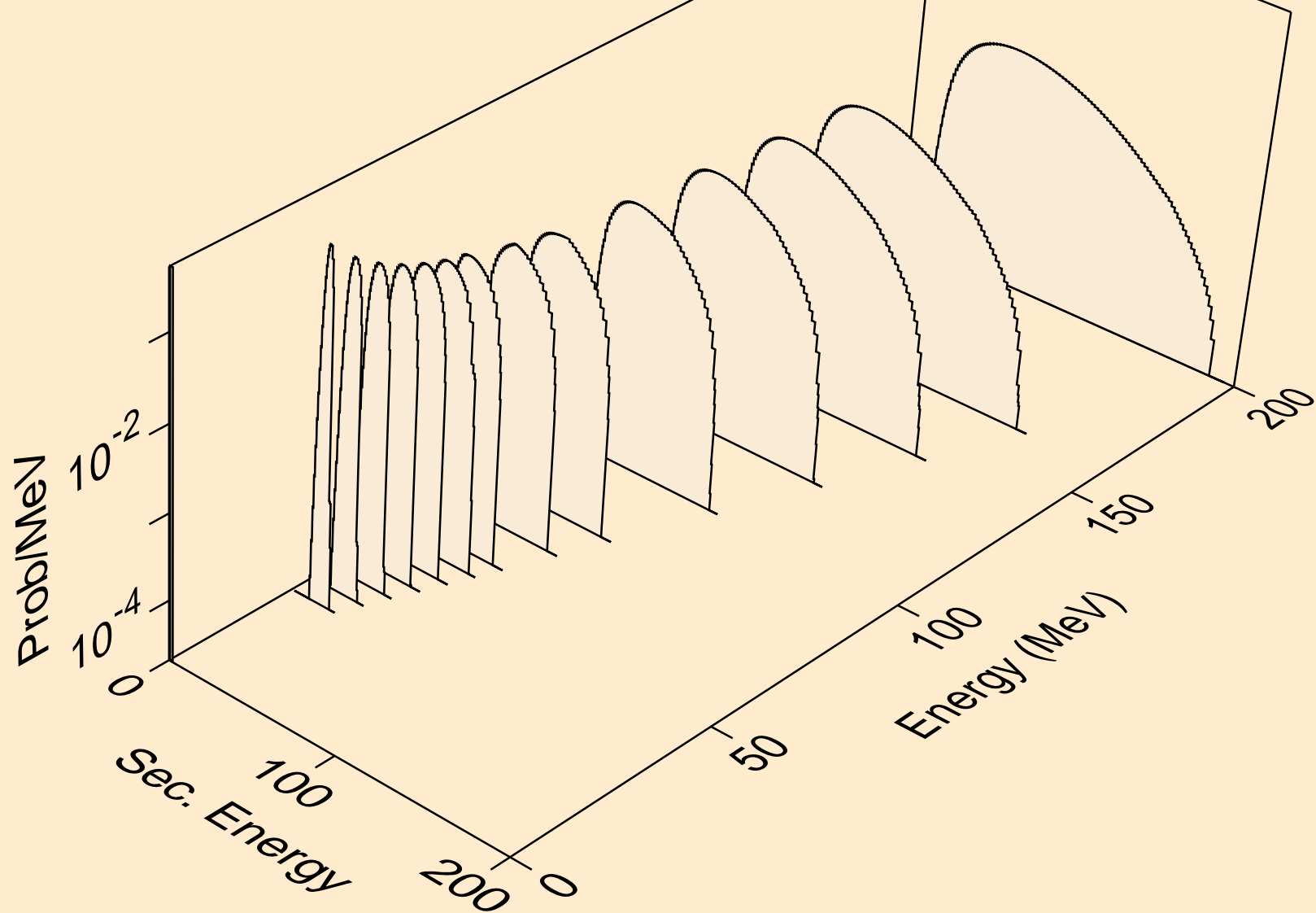

HO173 PROTON ACER TENDL-2023 LIBRARY; T=0.K  
he3s from (p,n\*)he3

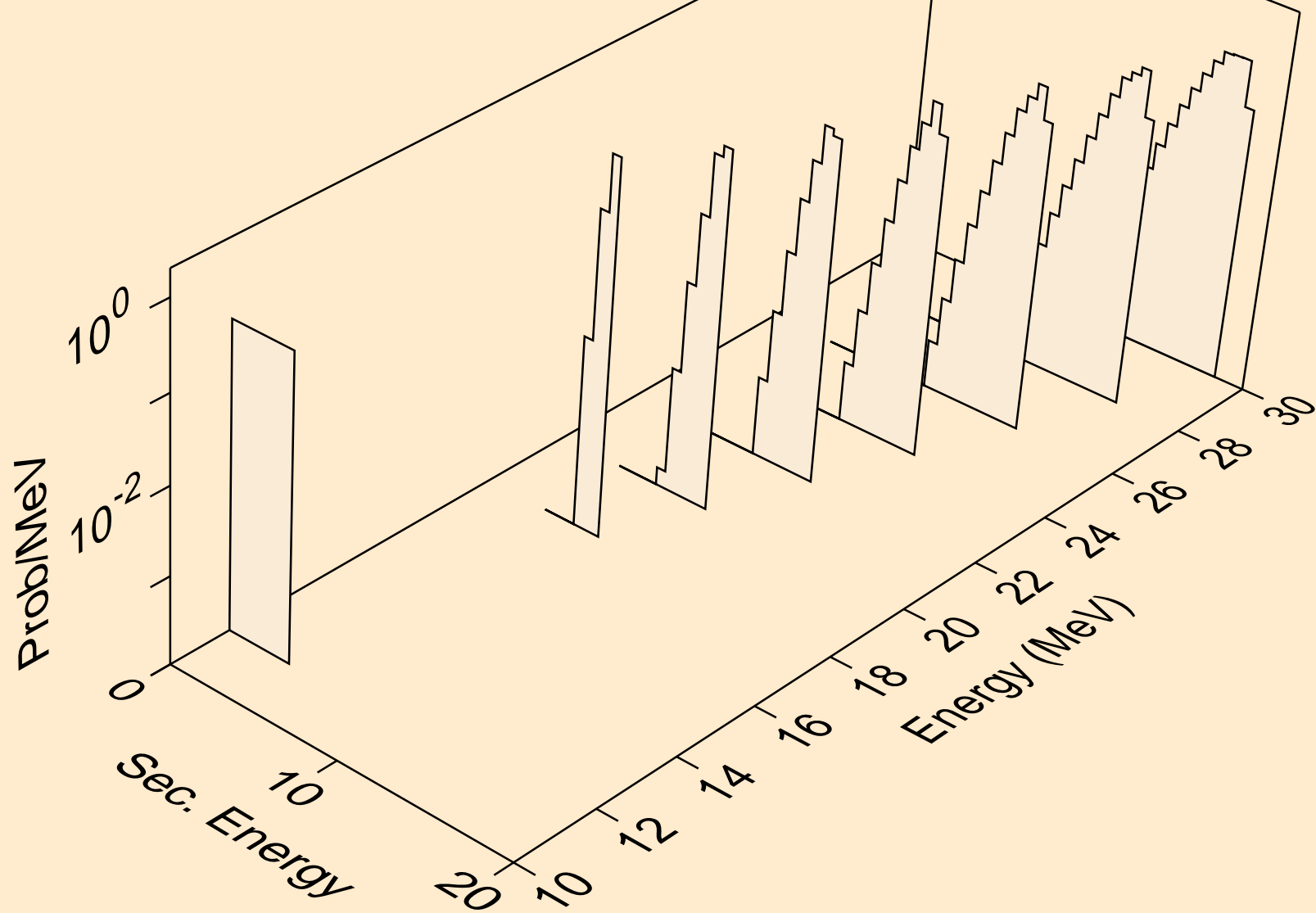

HO173 PROTON ACER TENDL-2023 LIBRARY; T=0.K  
he3s from (p,he3)

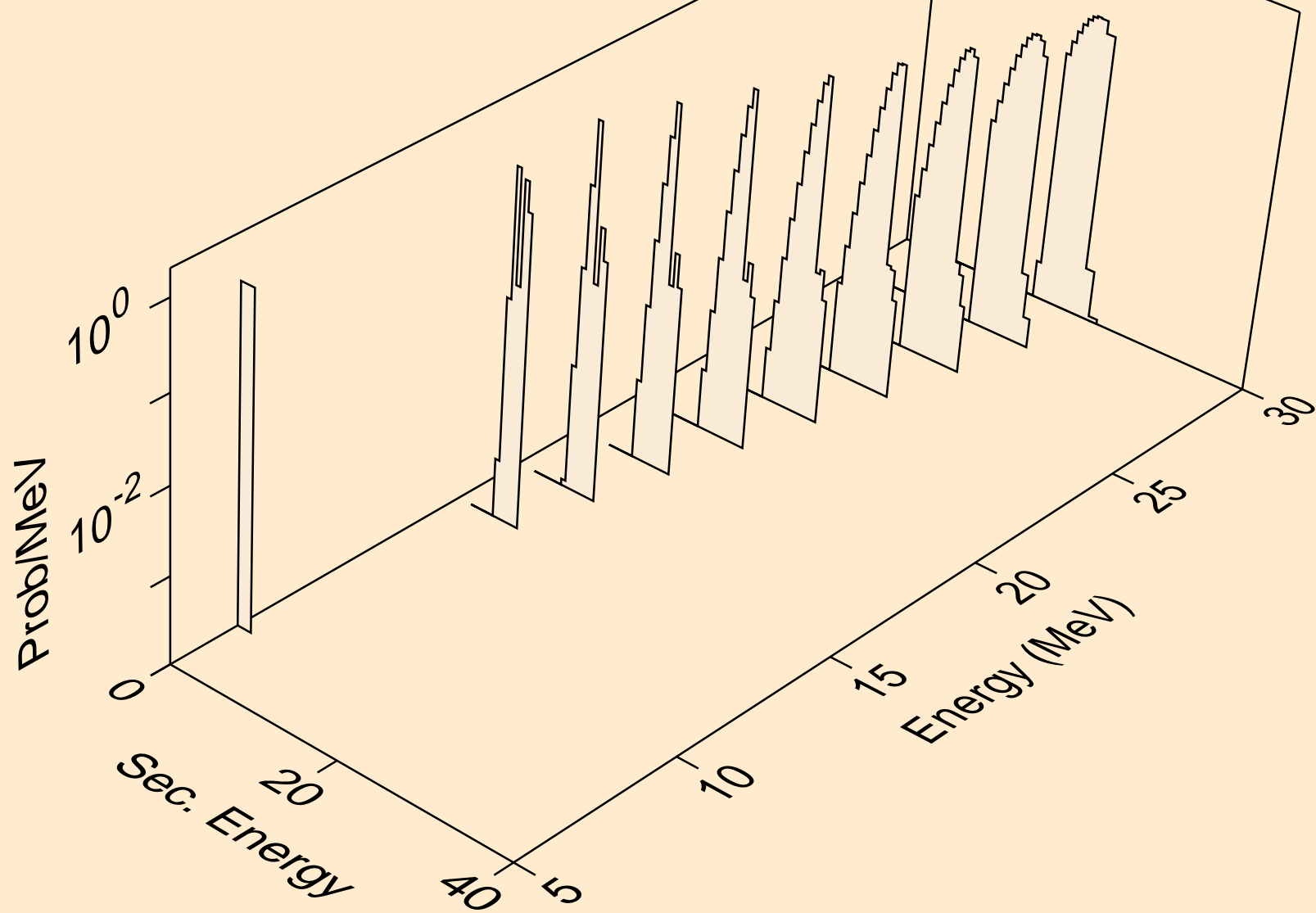



HO173 PROTON ACER TENDL-2023 LIBRARY; T=0.K  
alphas from (p,x)

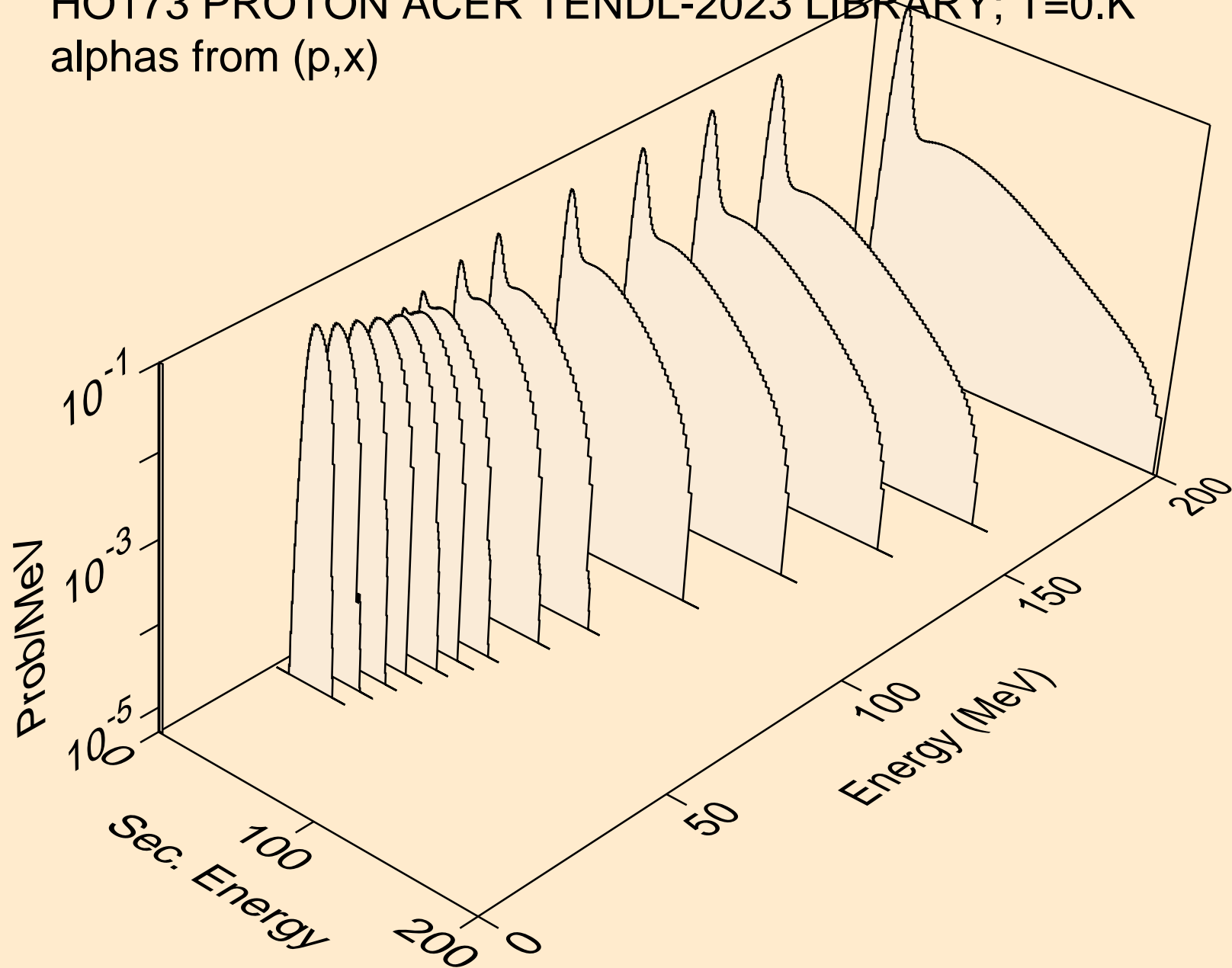

HO173 PROTON ACER TENDL-2023 LIBRARY; T=0.K  
alphas from (p,n\*)a

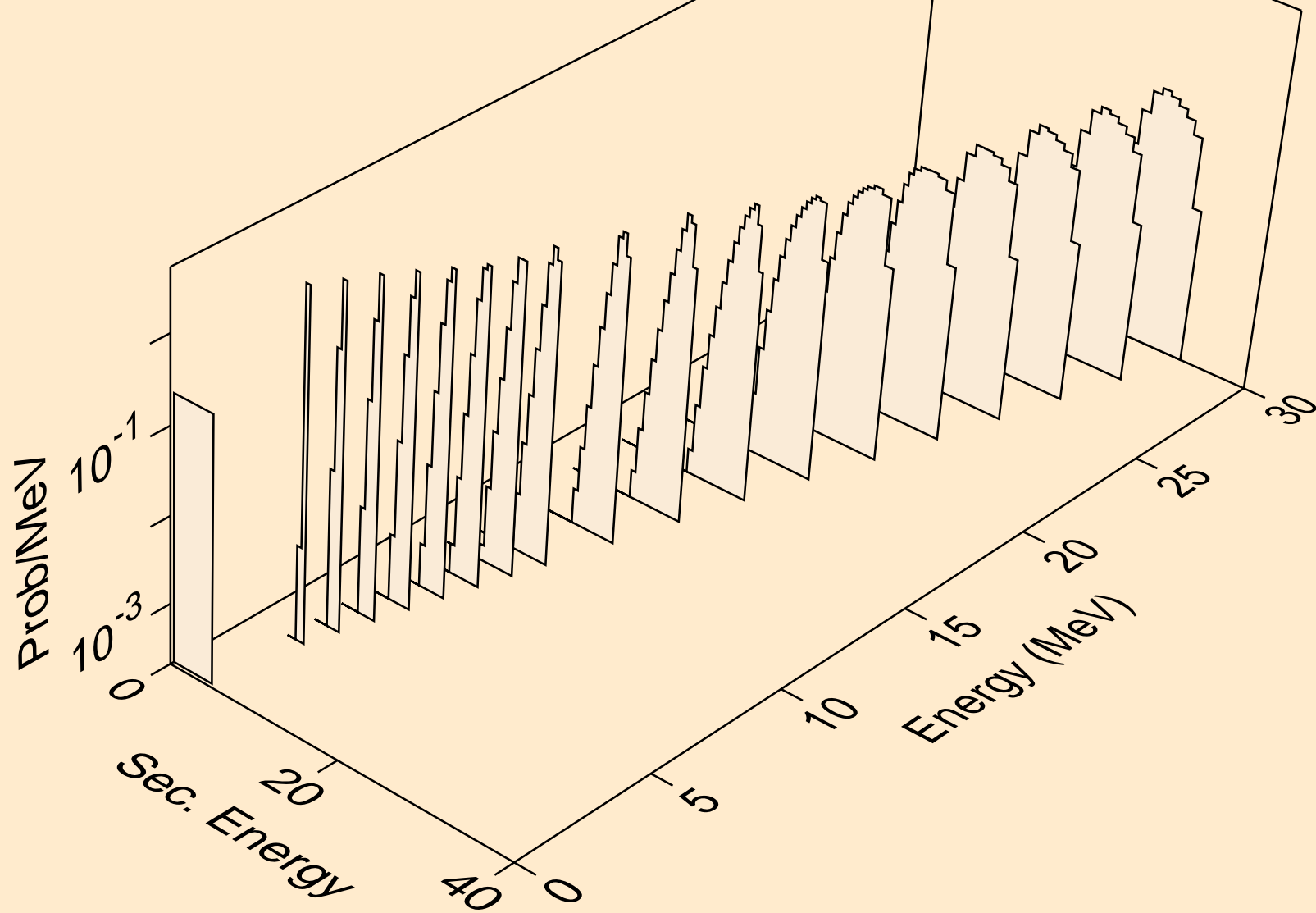

HO173 PROTON ACER TENDL-2023 LIBRARY; T=0.K  
alphas from (p,2n)a

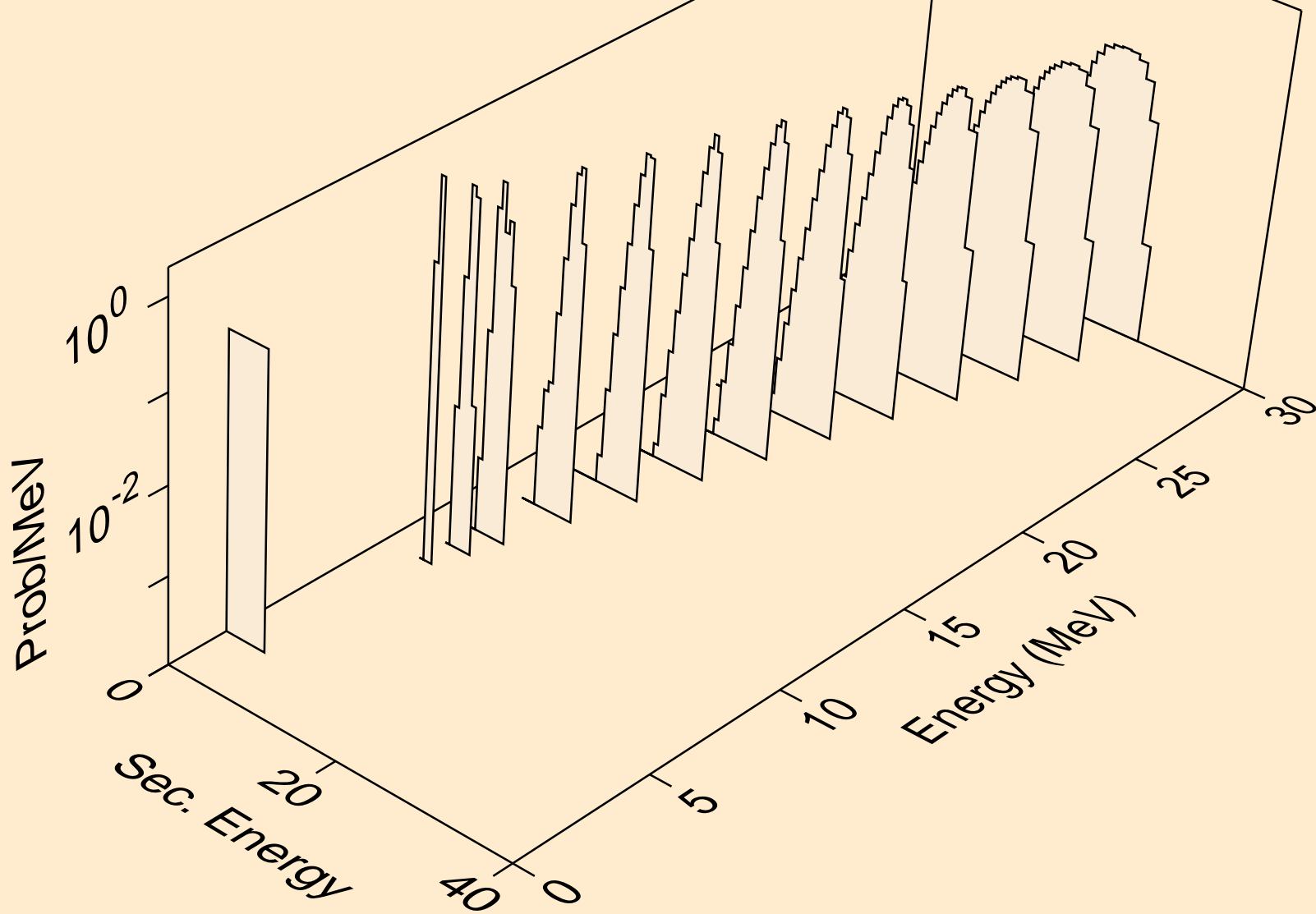

HO173 PROTON ACER TENDL-2023 LIBRARY; T=0.K  
alphas from (p,3n)a

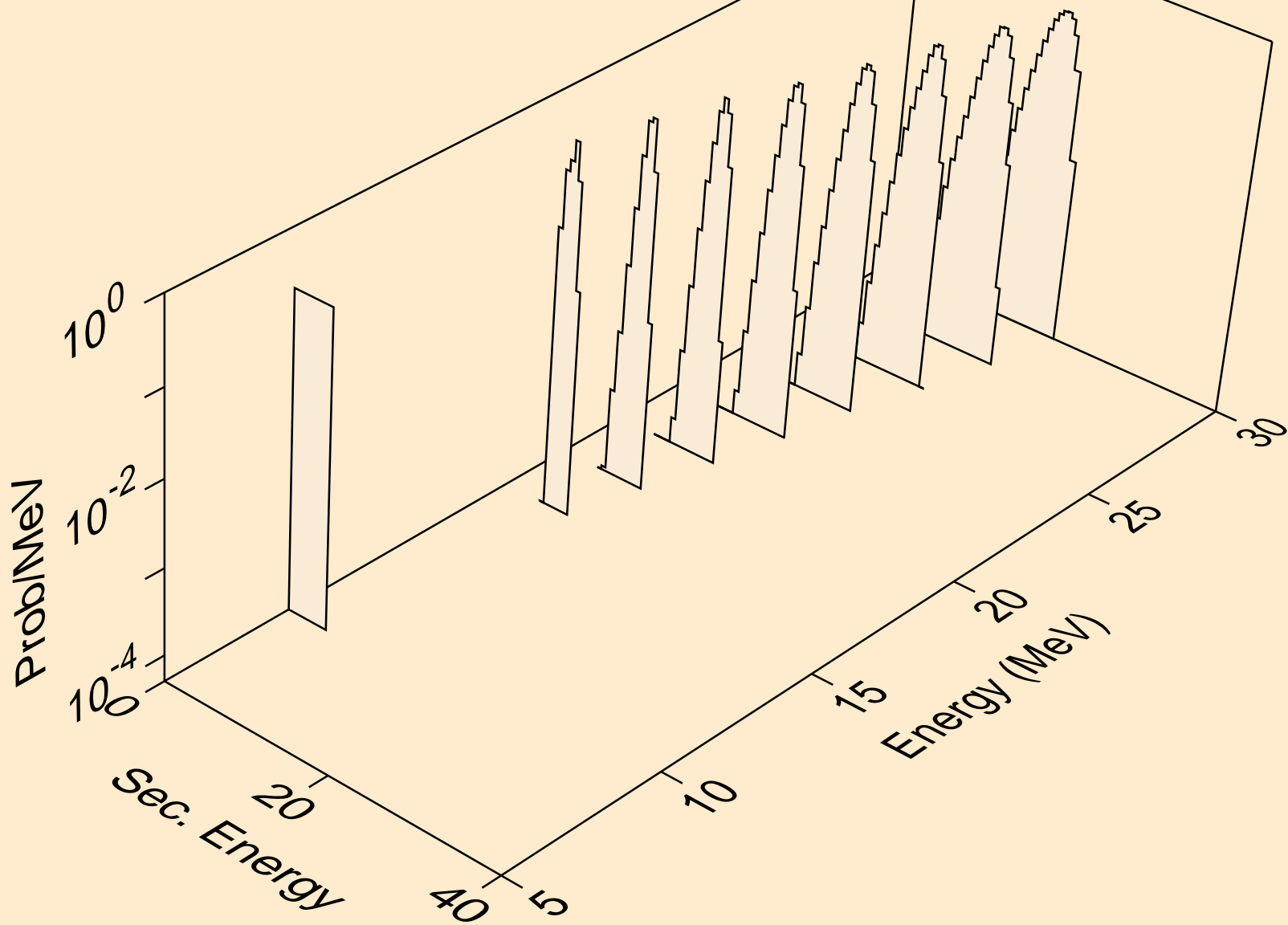

HO173 PROTON ACER TENDL-2023 LIBRARY; T=0.K  
alphas from (p,a)

