

# I135 PROTON ACER TENDL-2023 LIBRARY; T=0.K

## Principal cross sections

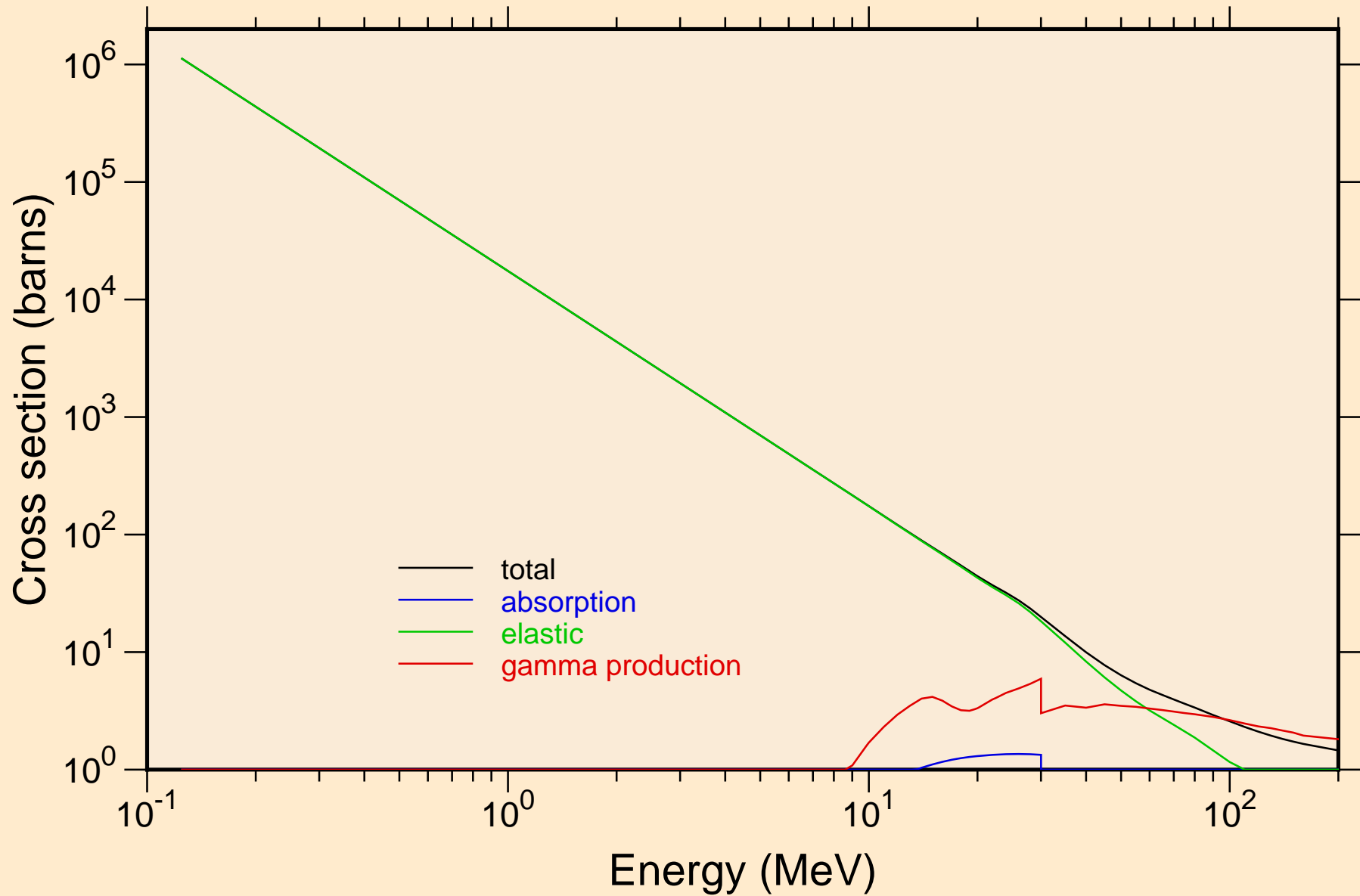

I135 PROTON ACER TENDL-2023 LIBRARY; T=0.K  
Heating

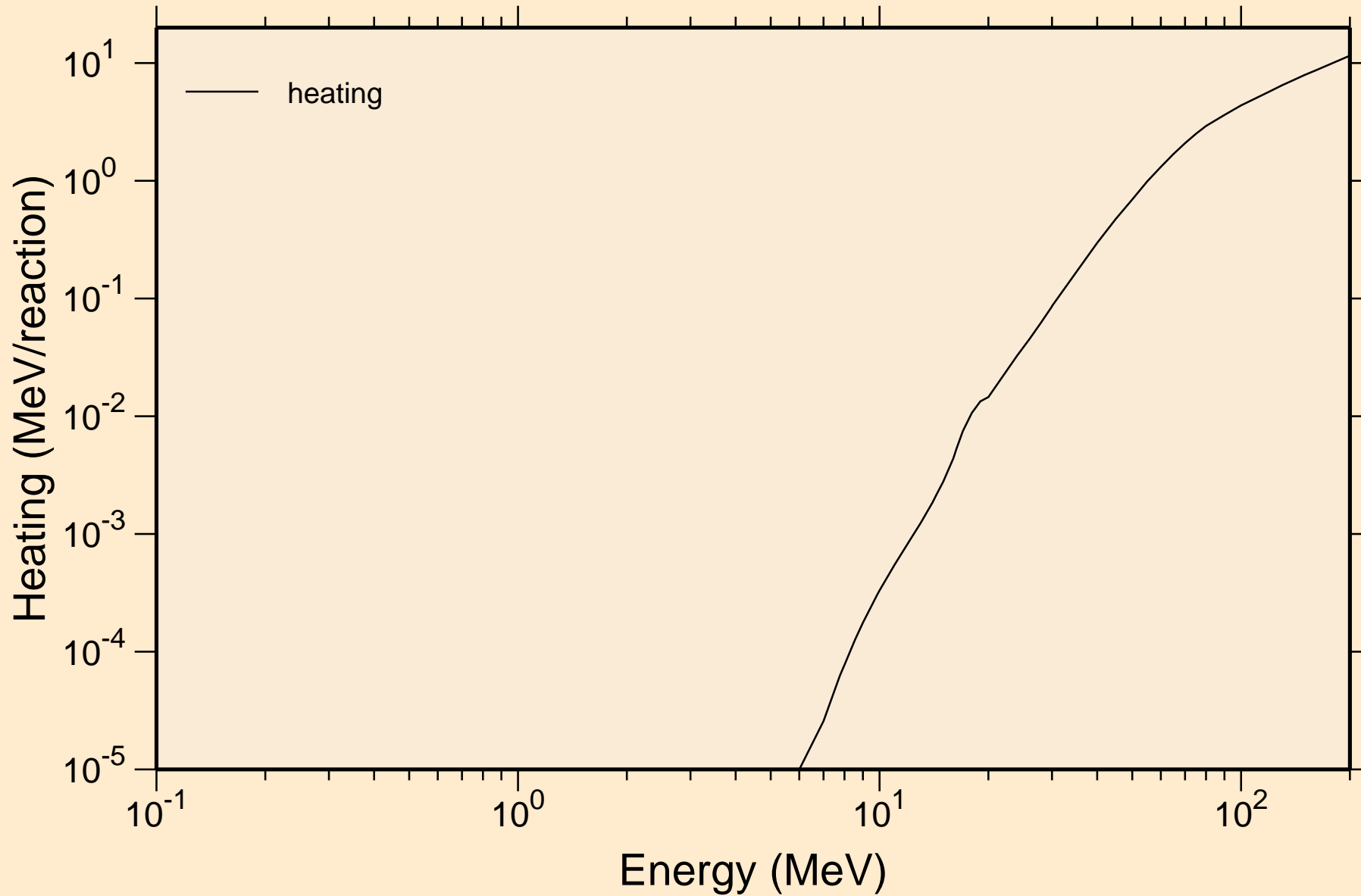

I135 PROTON ACER TENDL-2023 LIBRARY; T=0.K  
Principal cross sections

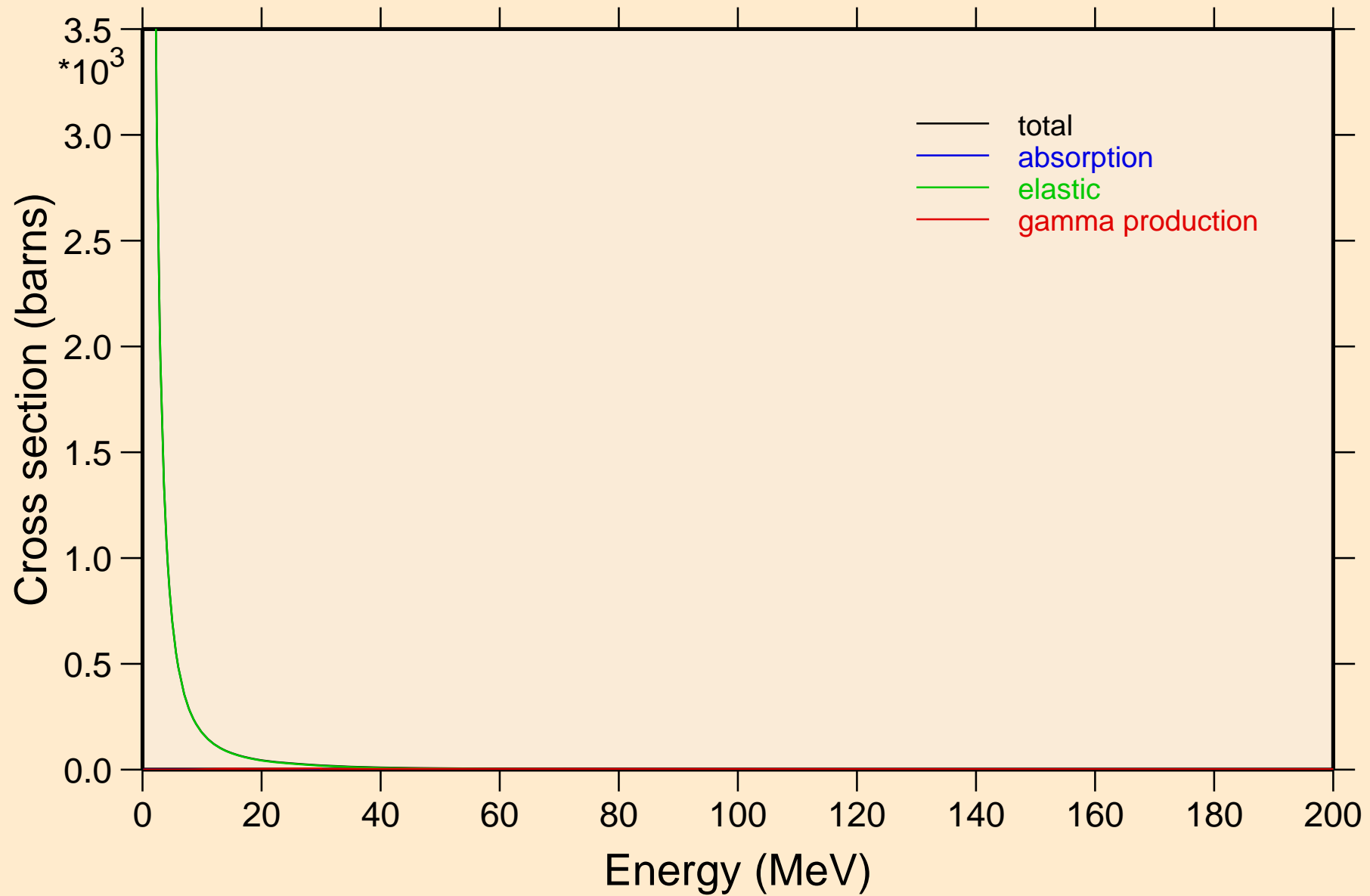

# I135 PROTON ACER TENDL-2023 LIBRARY; T=0.K

## Heating

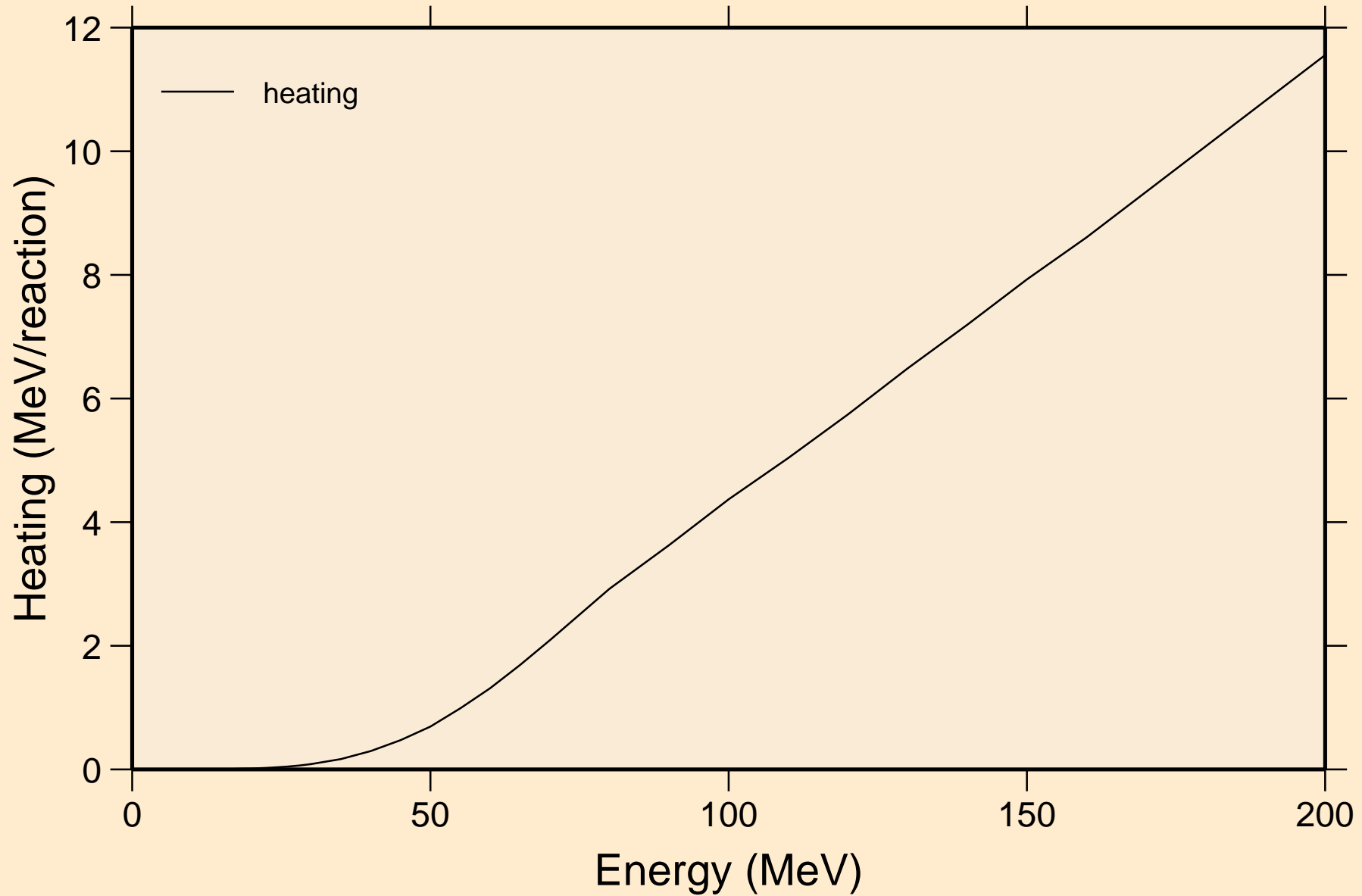

I135 PROTON ACER TENDL-2023 LIBRARY; T=0.K  
Threshold reactions

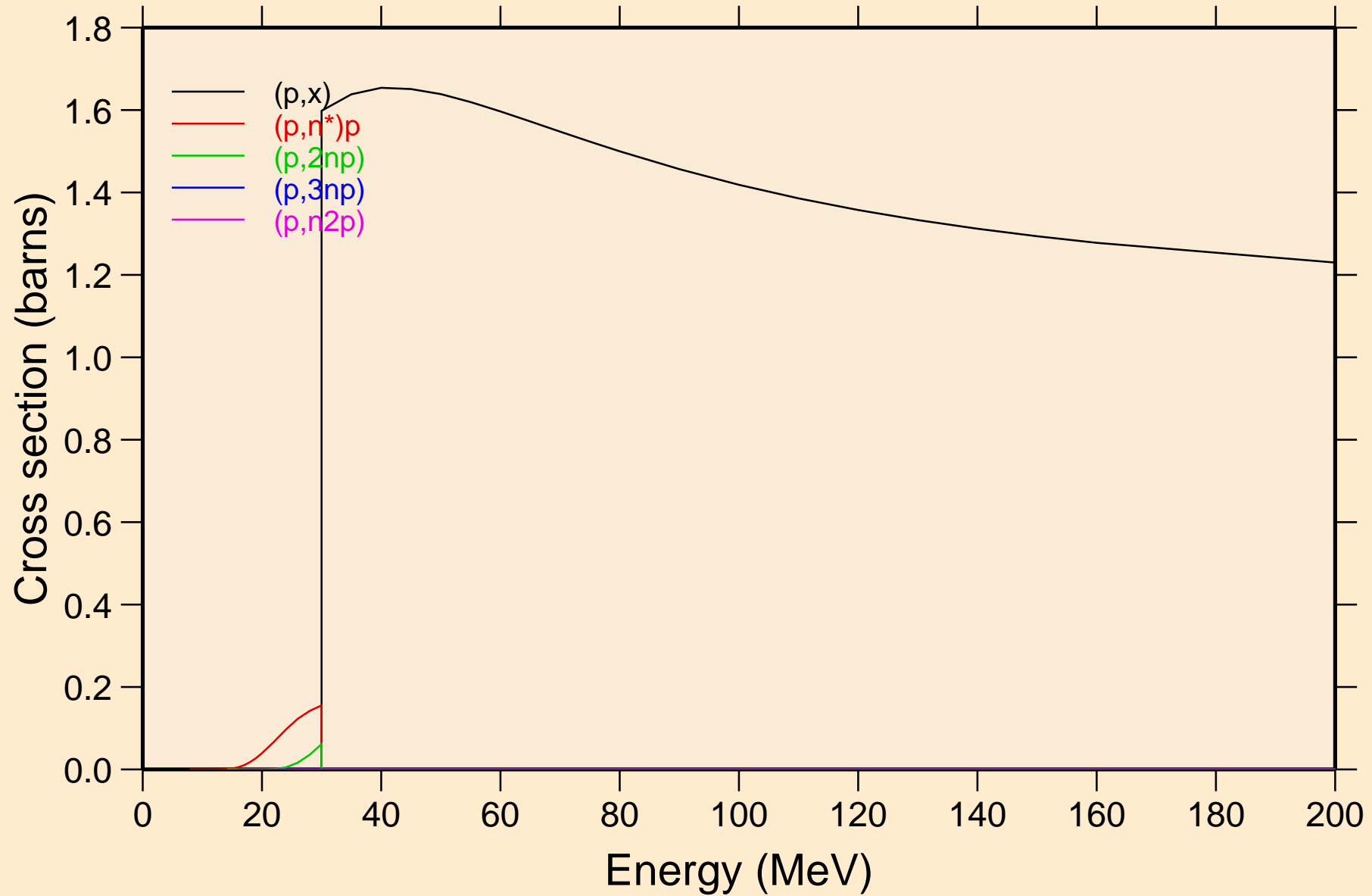

# I135 PROTON ACER TENDL-2023 LIBRARY; T=0.K

## Threshold reactions

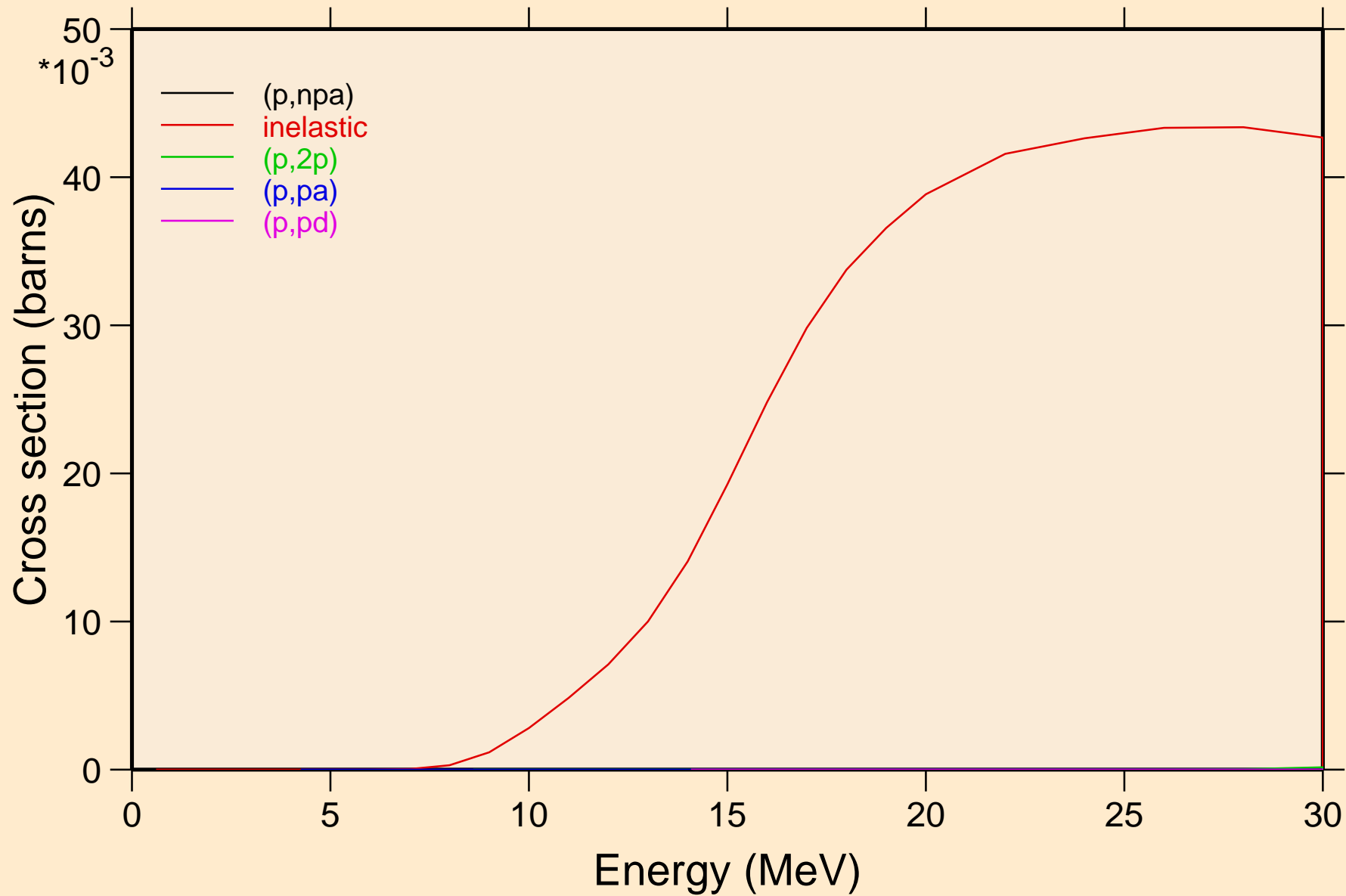

I135 PROTON ACER TENDL-2023 LIBRARY; T=0.K  
Threshold reactions

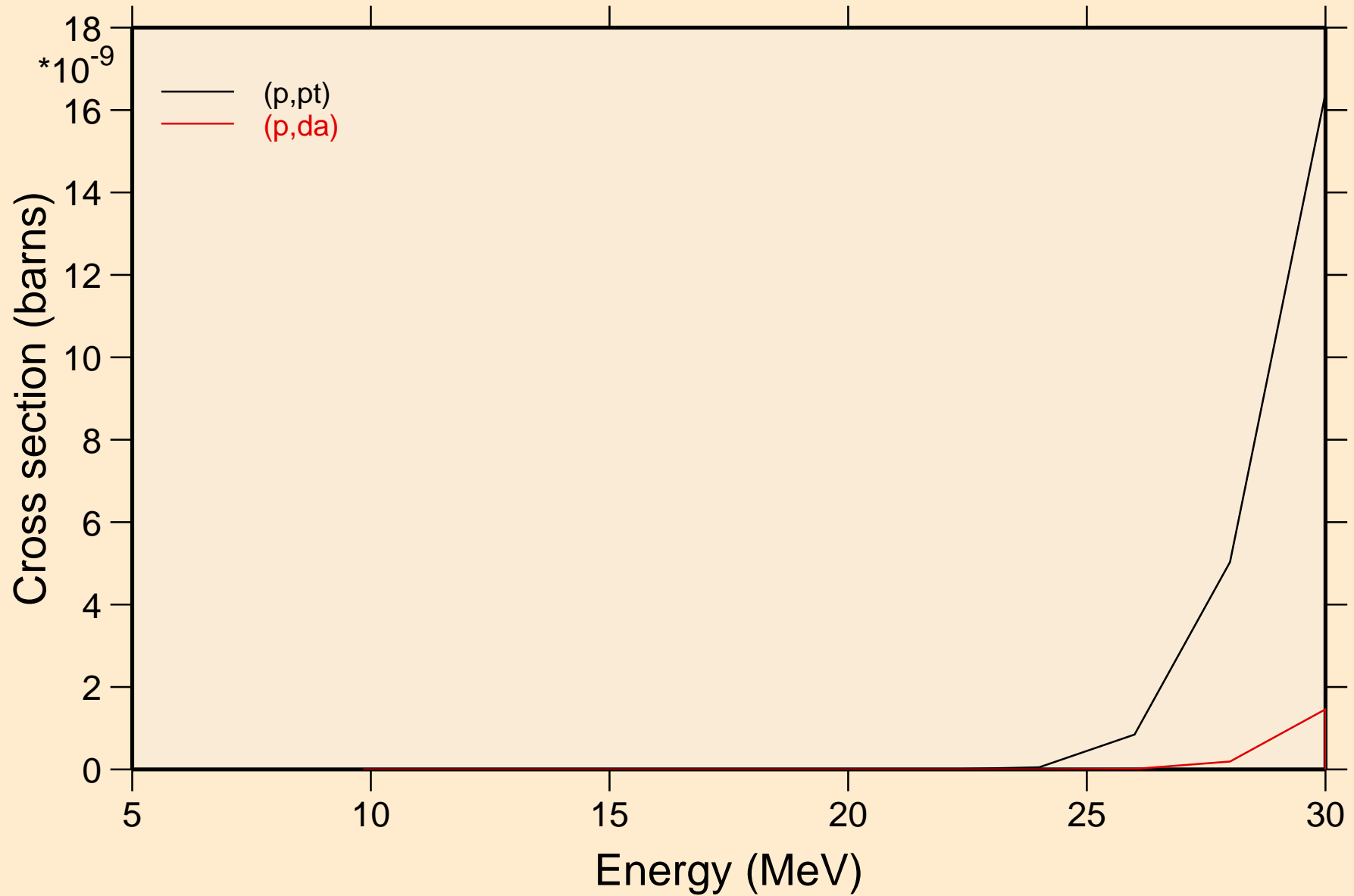

I135 PROTON ACER TENDL-2023 LIBRARY; T=0.K  
angular distribution for elastic

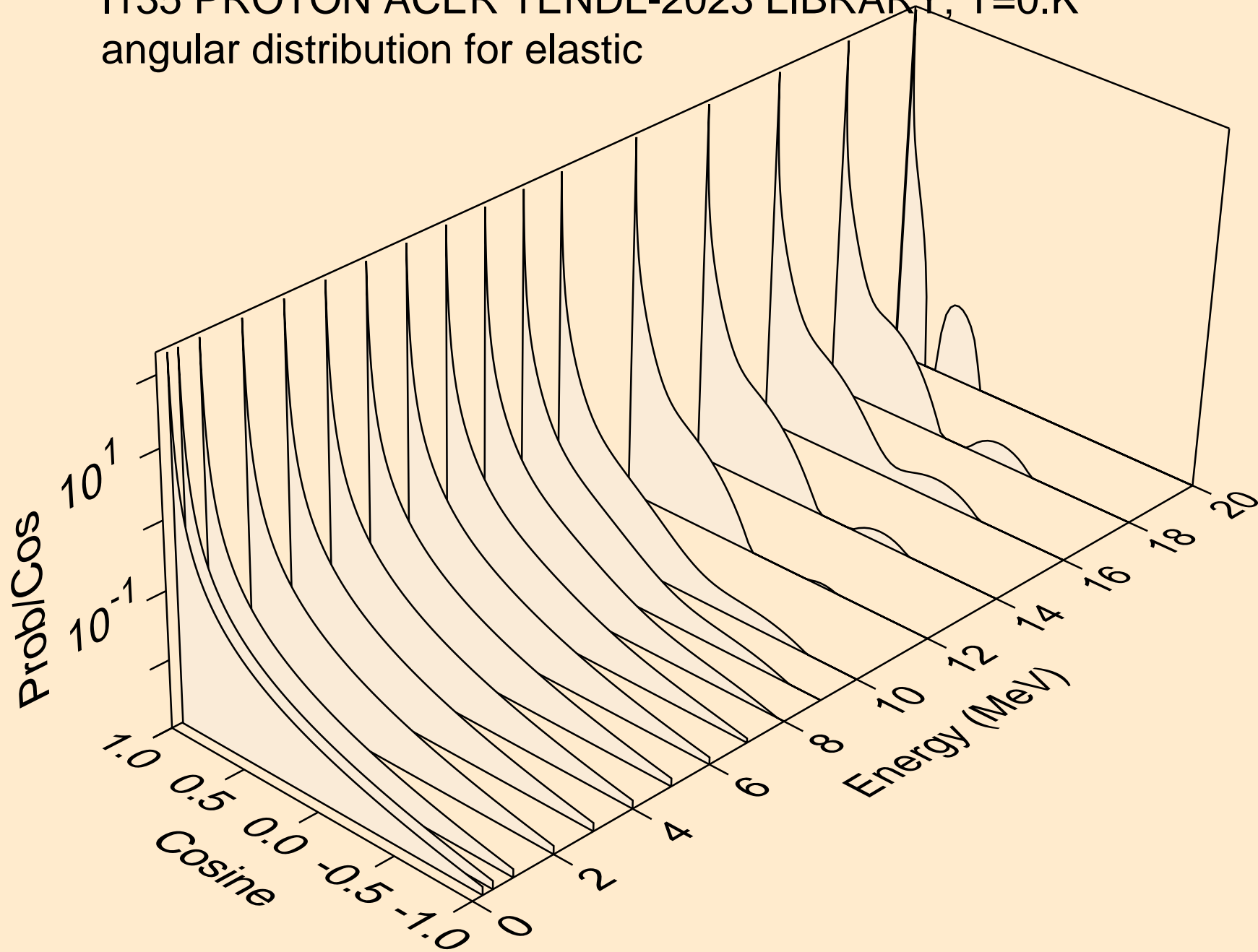



I135 PROTON ACER TENDL-2023 LIBRARY; T=0.K  
angular distribution for elastic

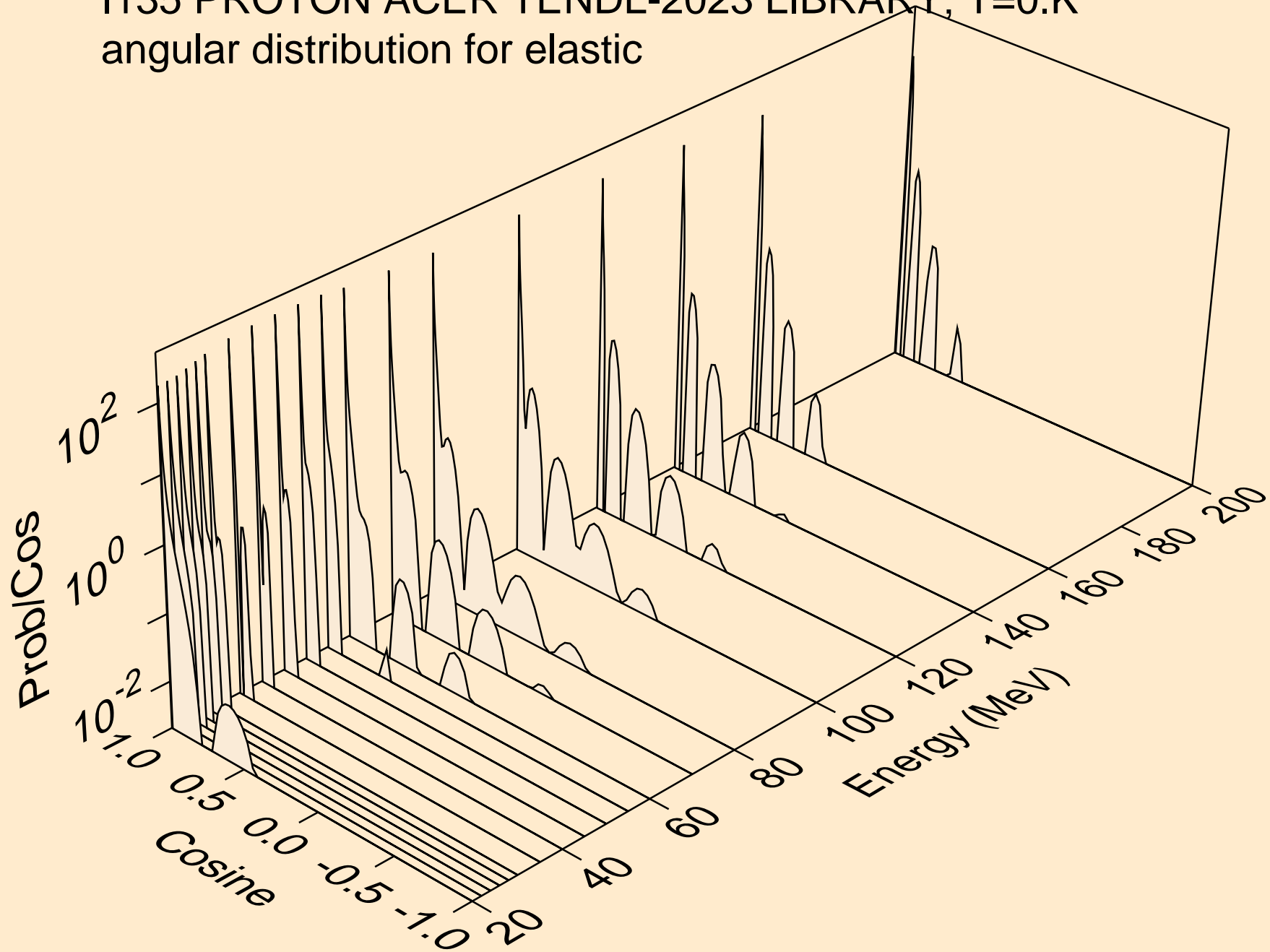

I135 PROTON ACER TENDL-2023 LIBRARY; T=0.K  
Proton emission for (p,x)

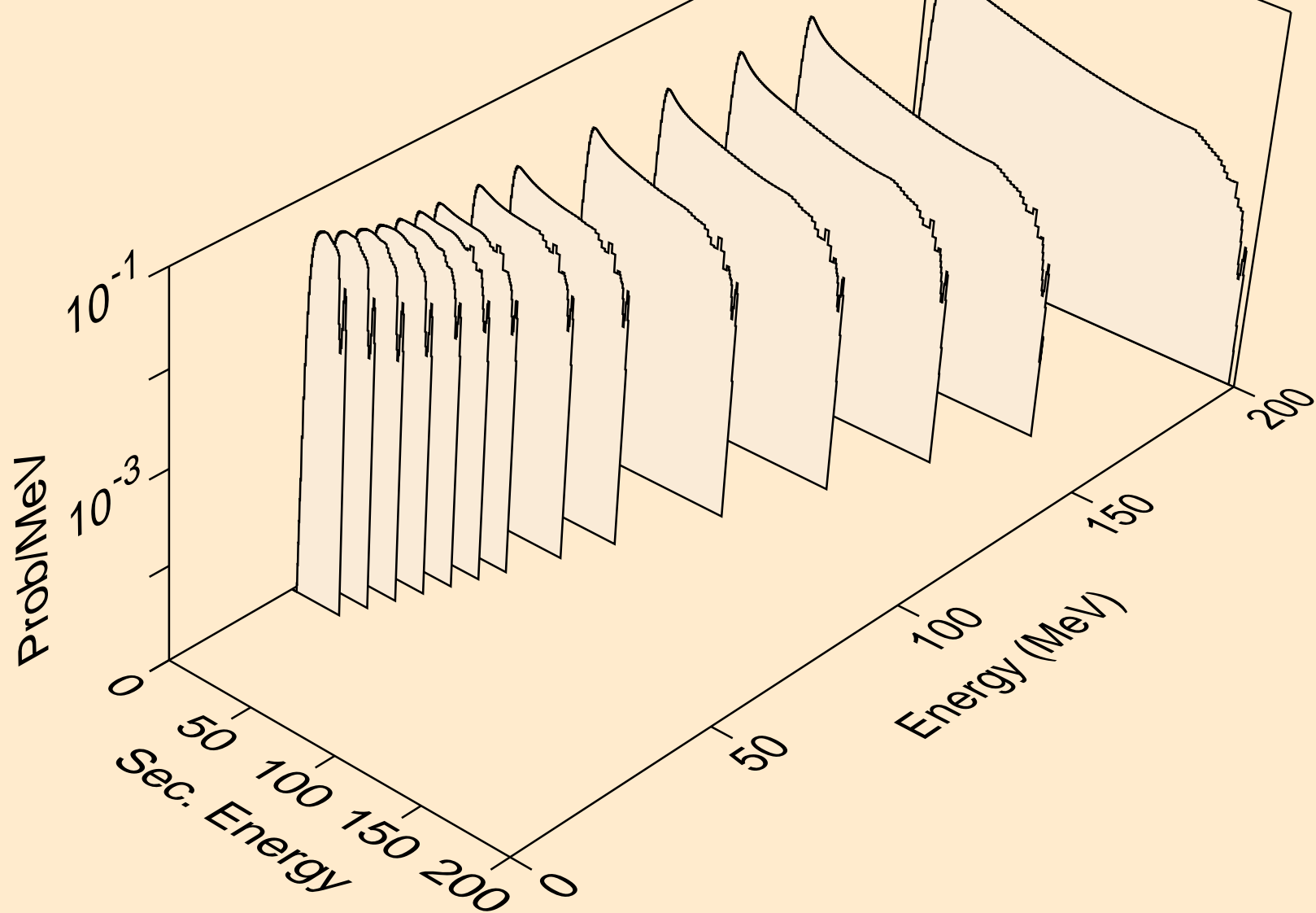

I135 PROTON ACER TENDL-2023 LIBRARY; T=0.K  
Proton emission for (p,n\*)p

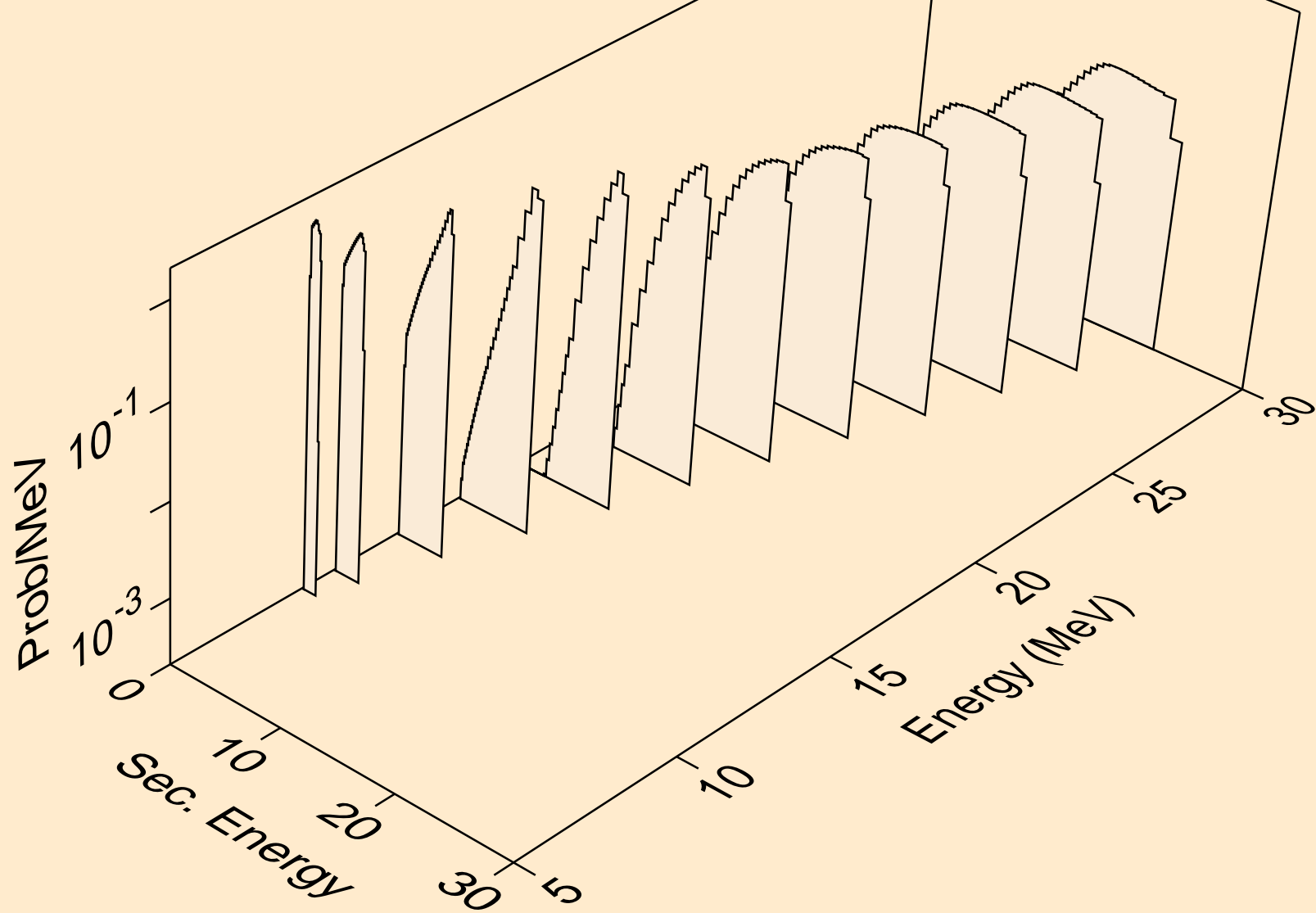

I135 PROTON ACER TENDL-2023 LIBRARY; T=0.K  
Proton emission for (p,2np)

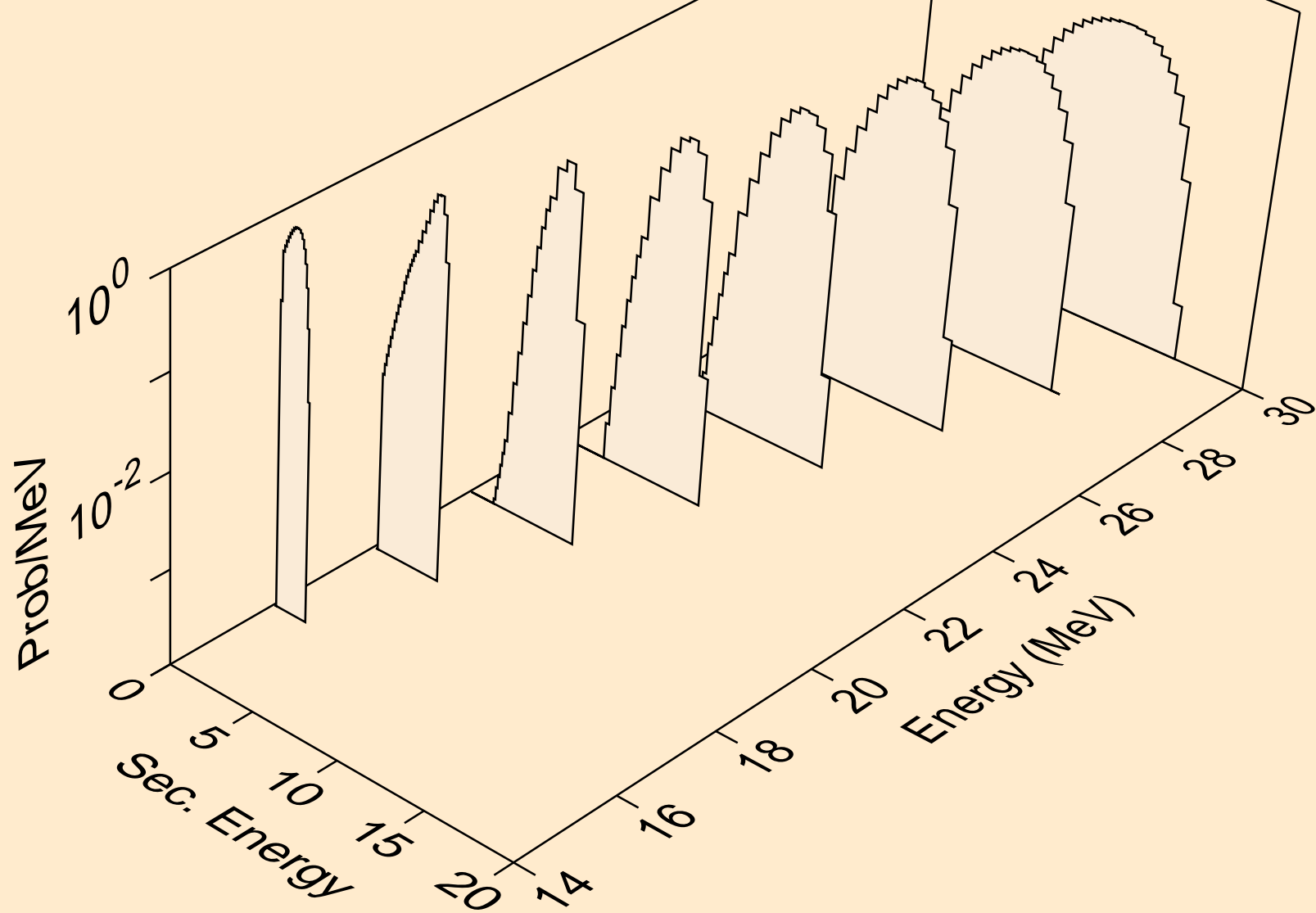

I135 PROTON ACER TENDL-2023 LIBRARY; T=0.K  
Proton emission for (p,3np)

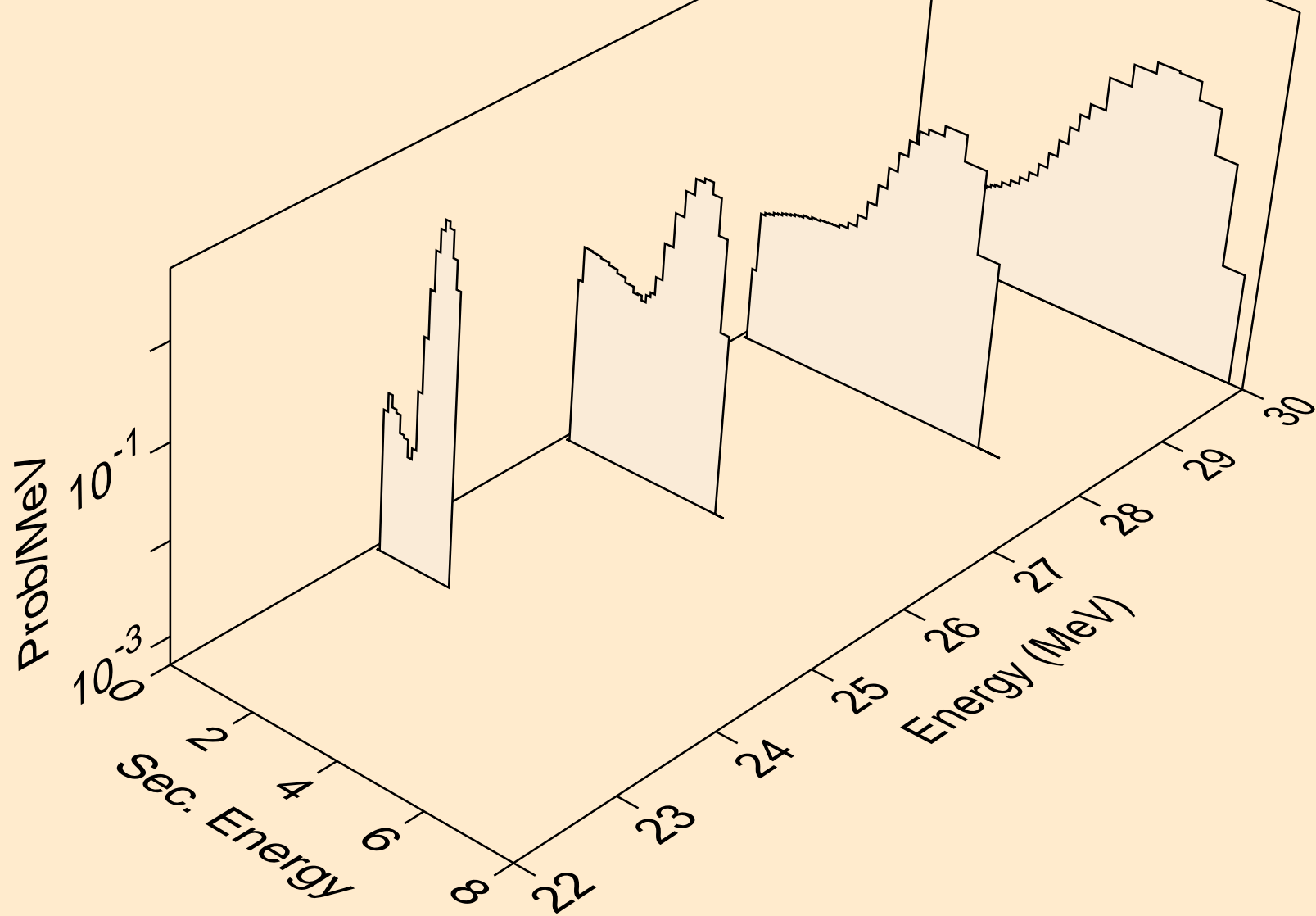

I135 PROTON ACER TENDL-2023 LIBRARY; T=0.K  
Proton emission for (p,n2p)

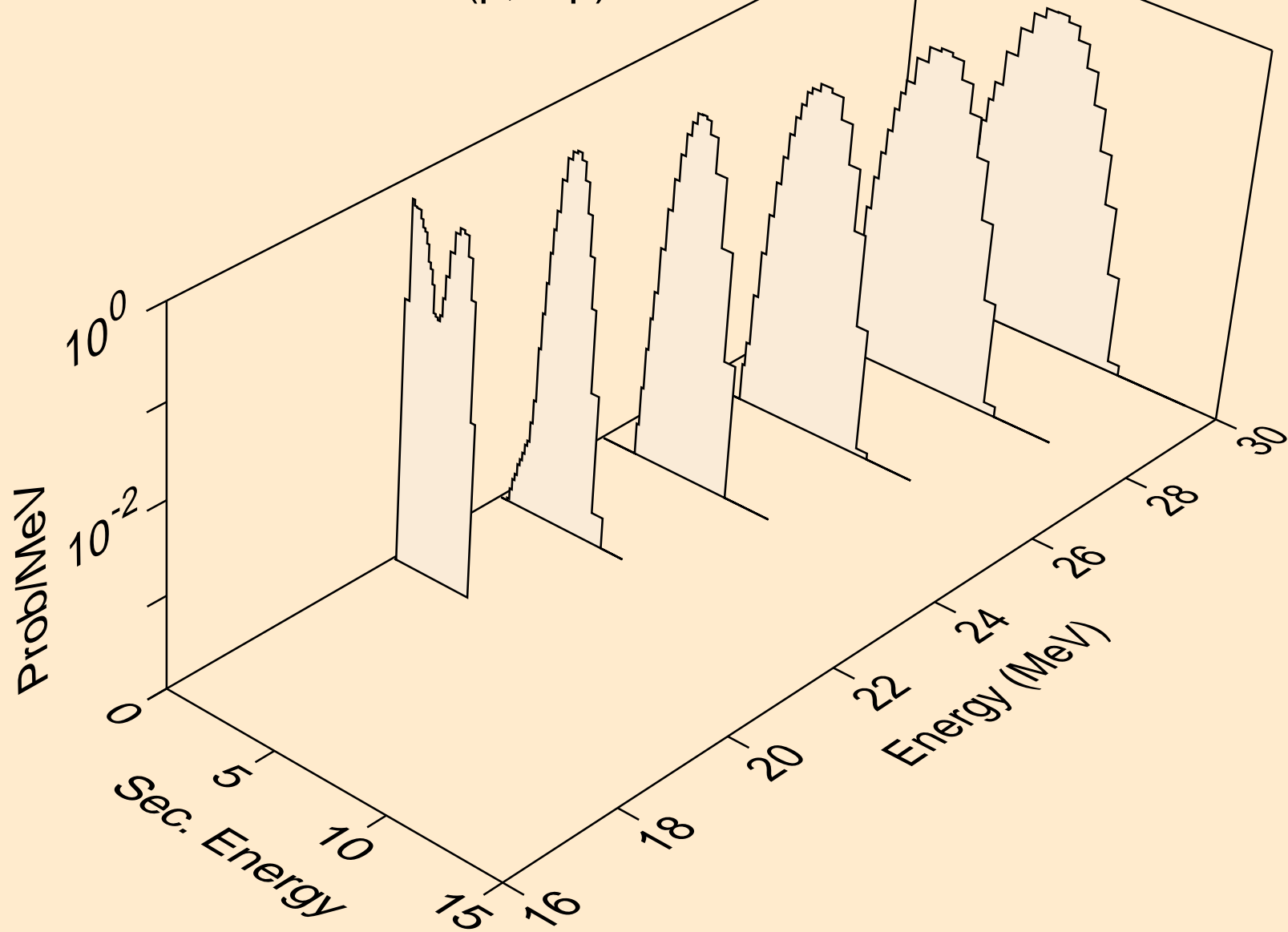

I135 PROTON ACER TENDL-2023 LIBRARY; T=0.K  
Proton emission for (p,npa)

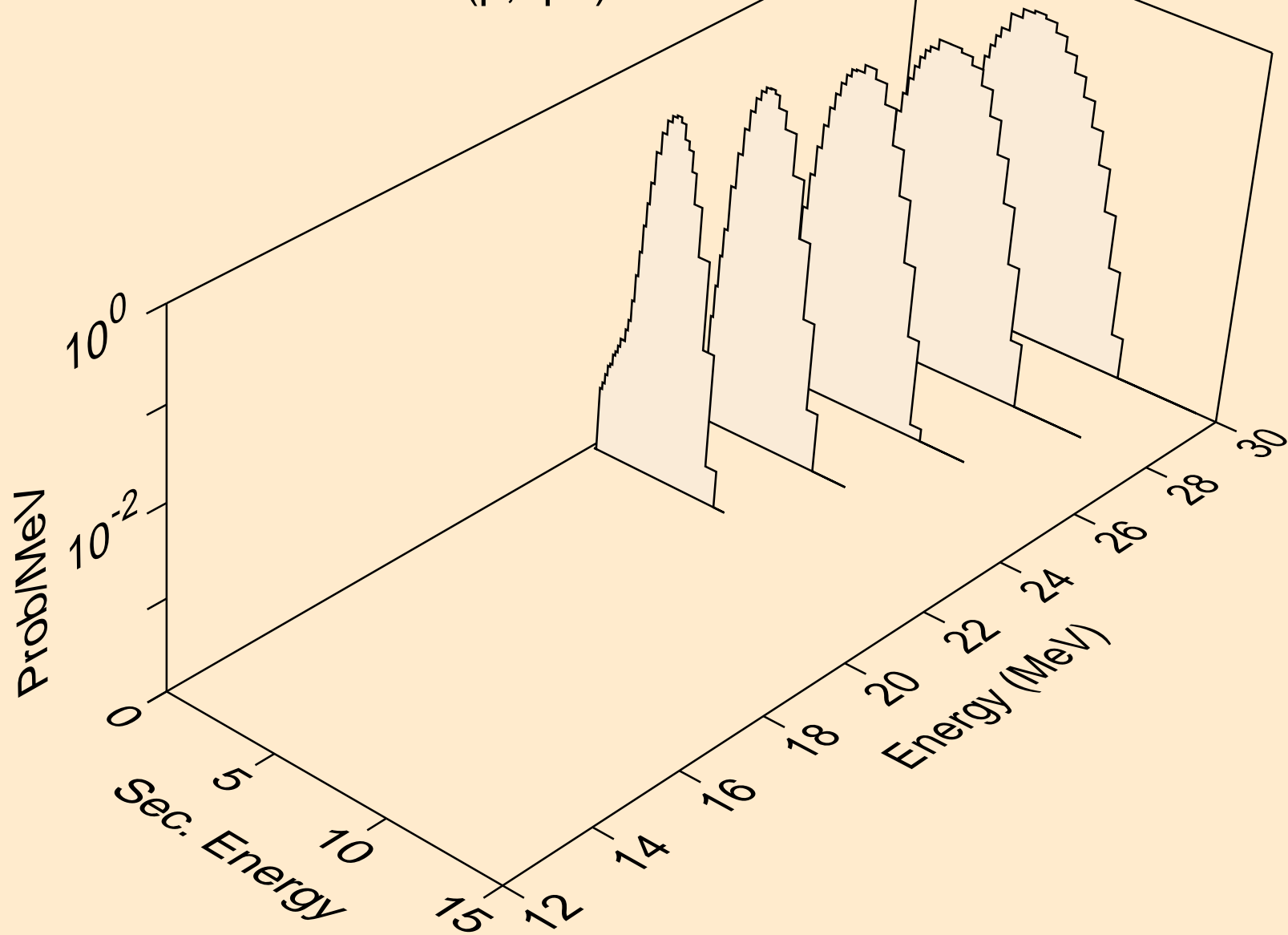

I135 PROTON ACER TENDL-2023 LIBRARY; T=0.K  
Proton emission for inelastic

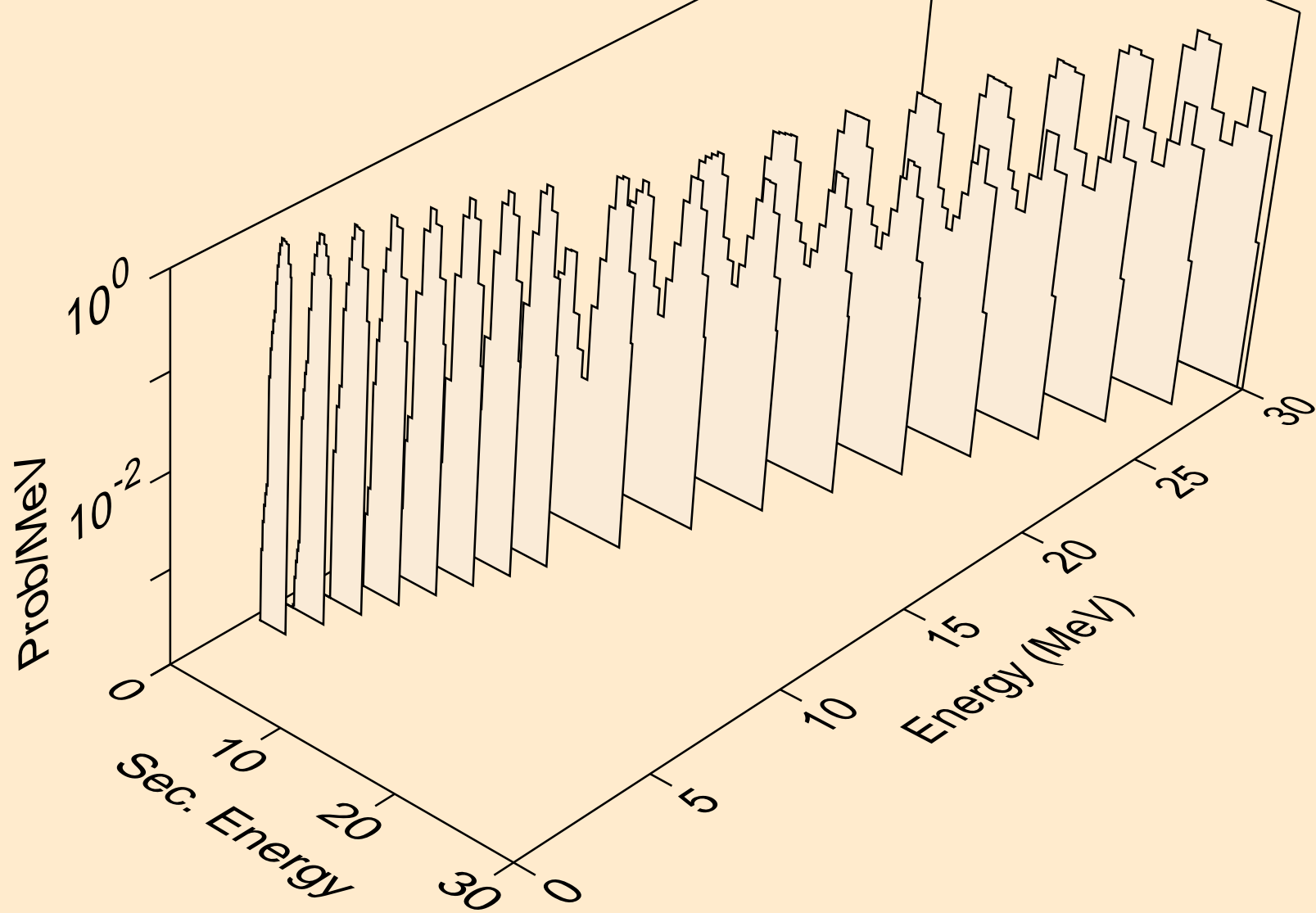



I135 PROTON ACER TENDL-2023 LIBRARY; T=0.K  
Proton emission for (p,2p)

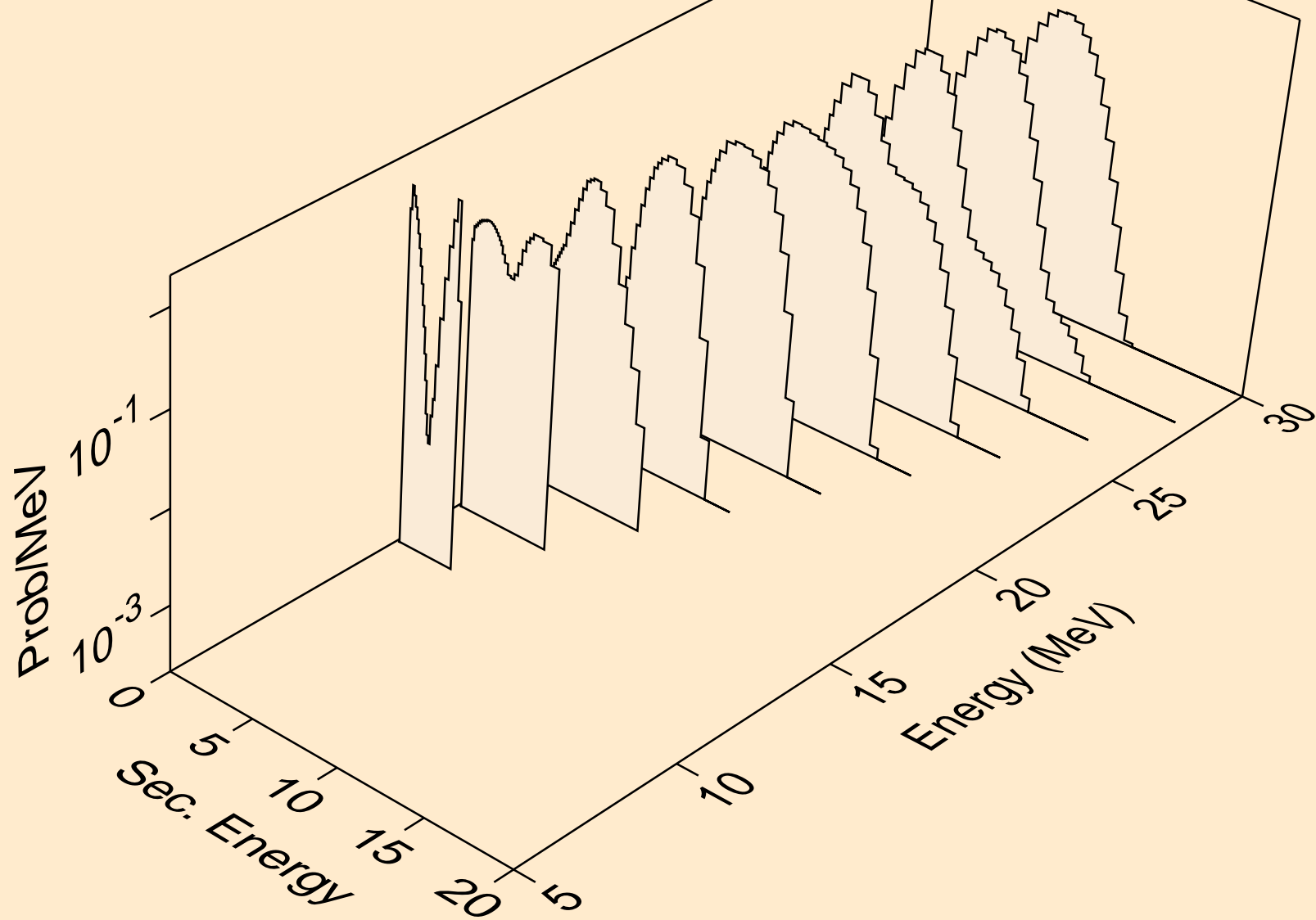

I135 PROTON ACER TENDL-2023 LIBRARY; T=0.K  
Proton emission for (p,pa)

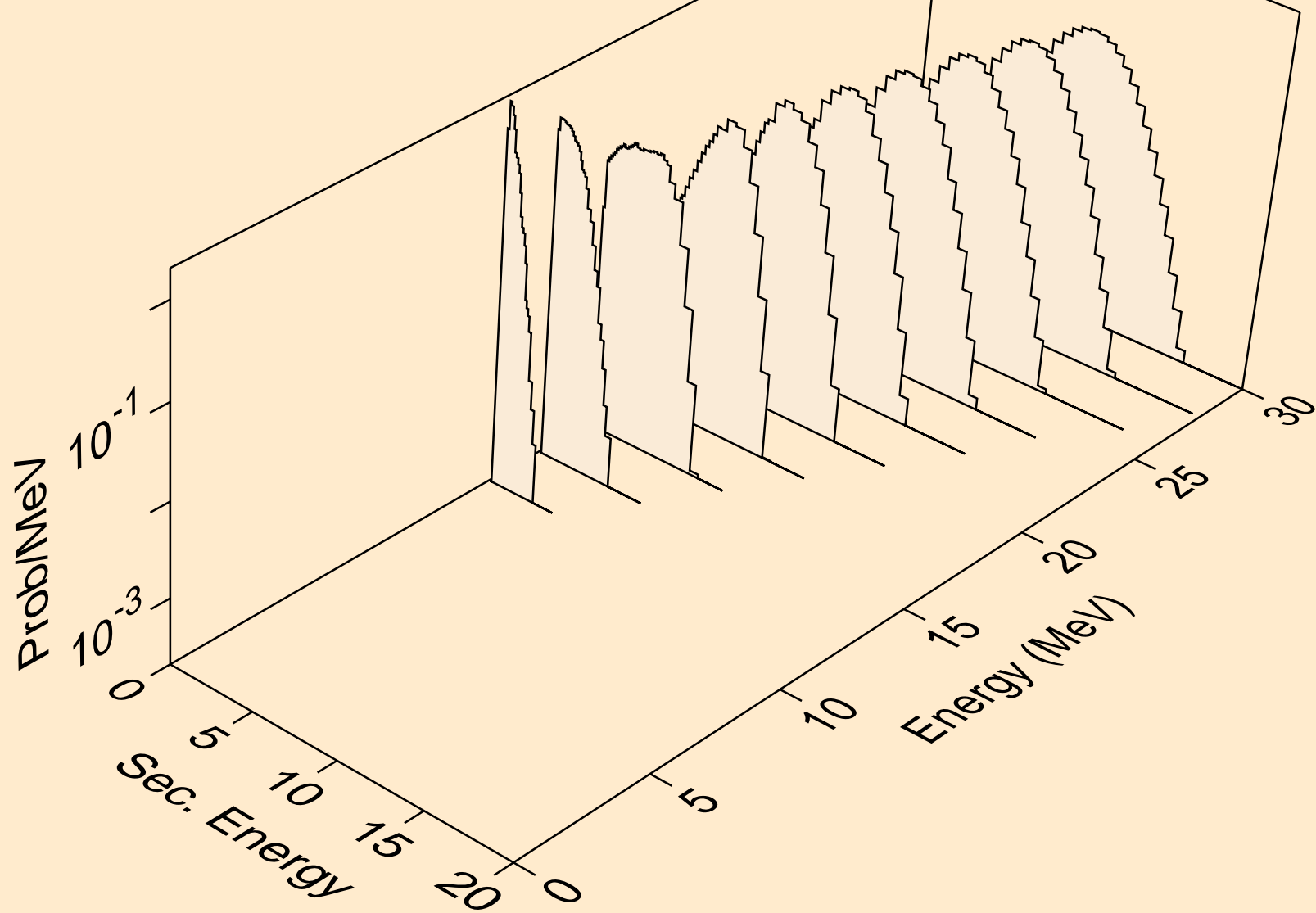

I135 PROTON ACER TENDL-2023 LIBRARY; T=0.K  
Proton emission for (p,pd)

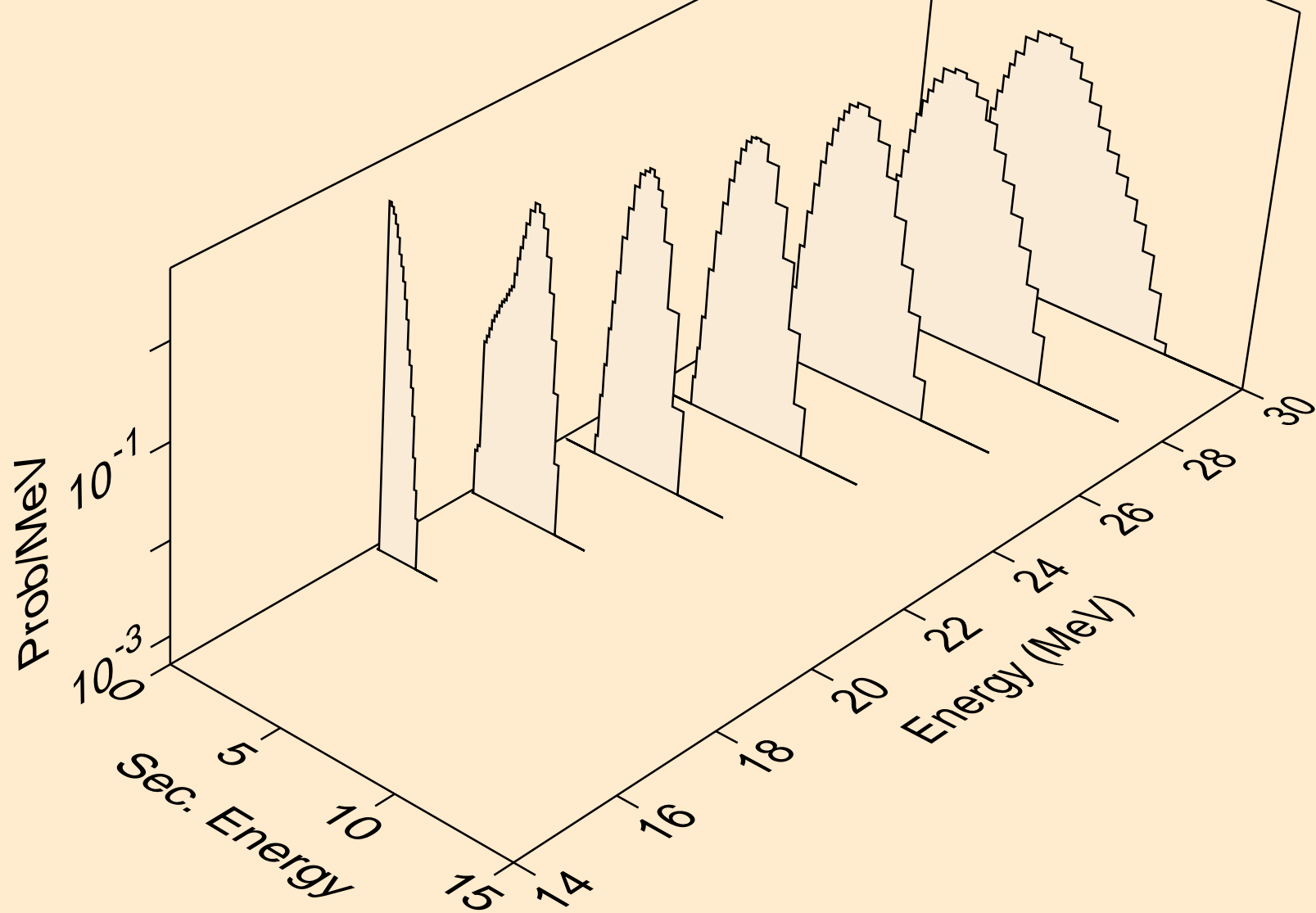

I135 PROTON ACER TENDL-2023 LIBRARY; T=0.K  
Proton emission for (p,pt)

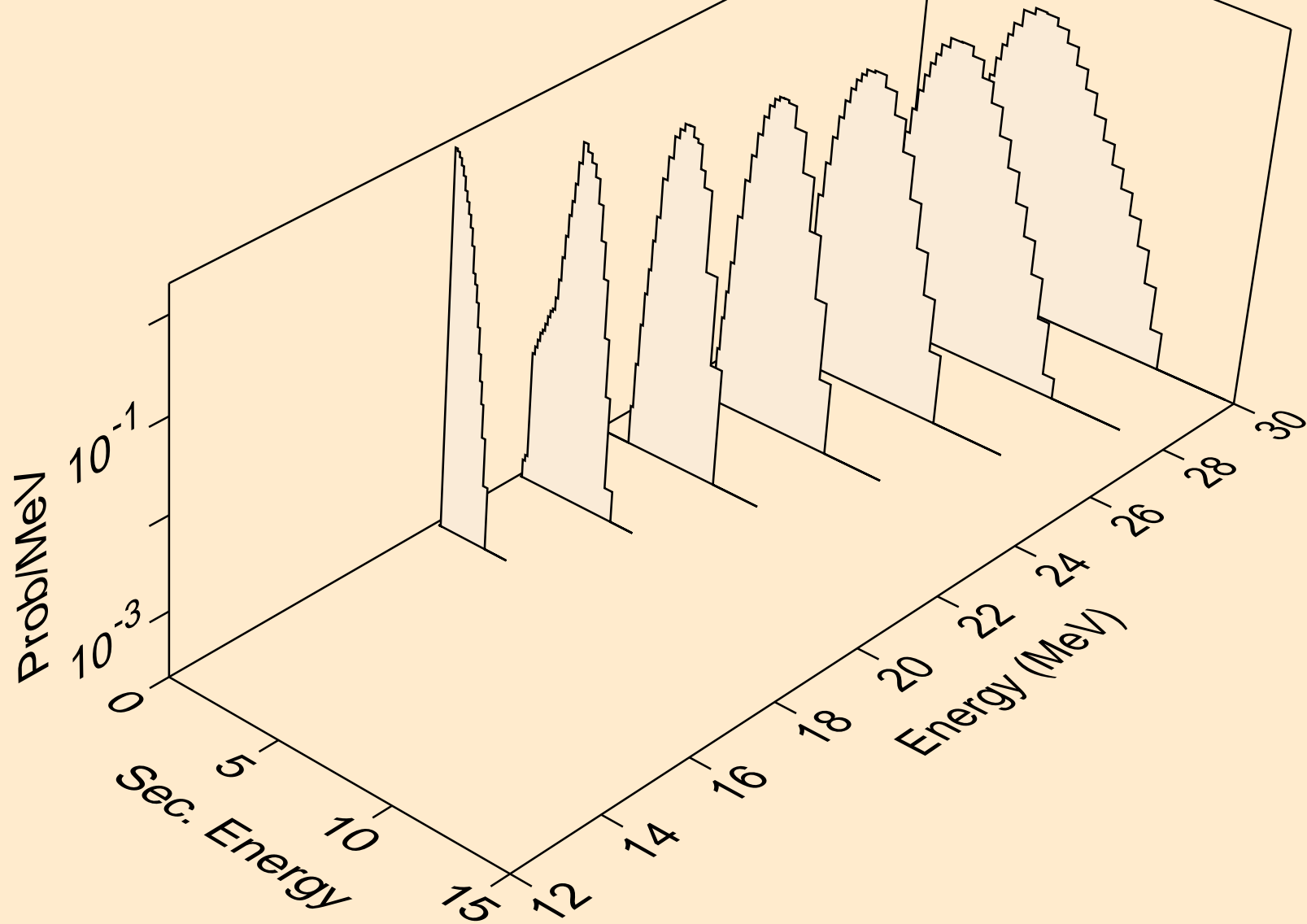

I135 PROTON ACER TENDL-2023 LIBRARY; T=0.K  
Photon emission for (z,n)

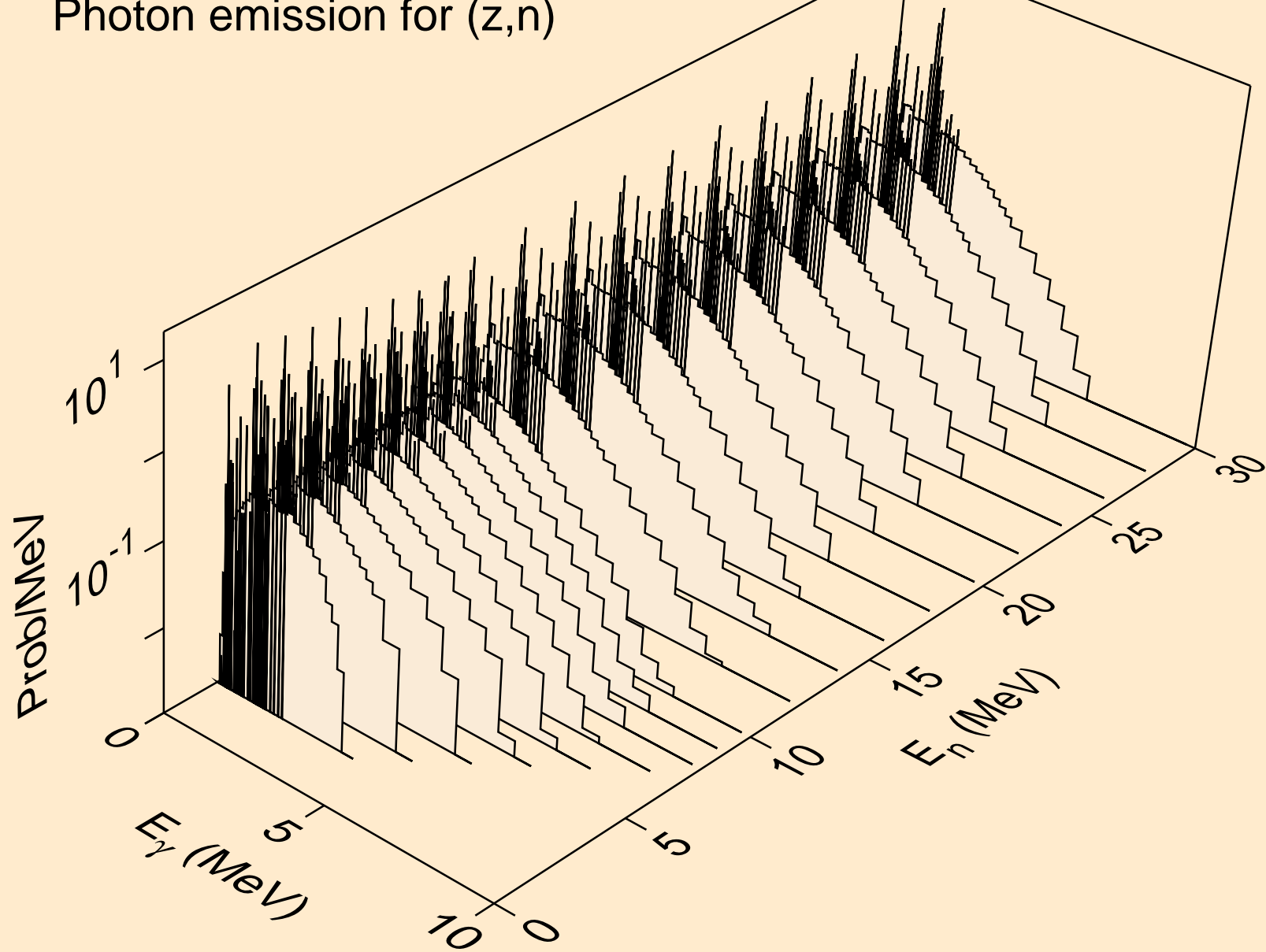

I135 PROTON ACER TENDL-2023 LIBRARY; T=0.K  
Photon emission for (z,x)

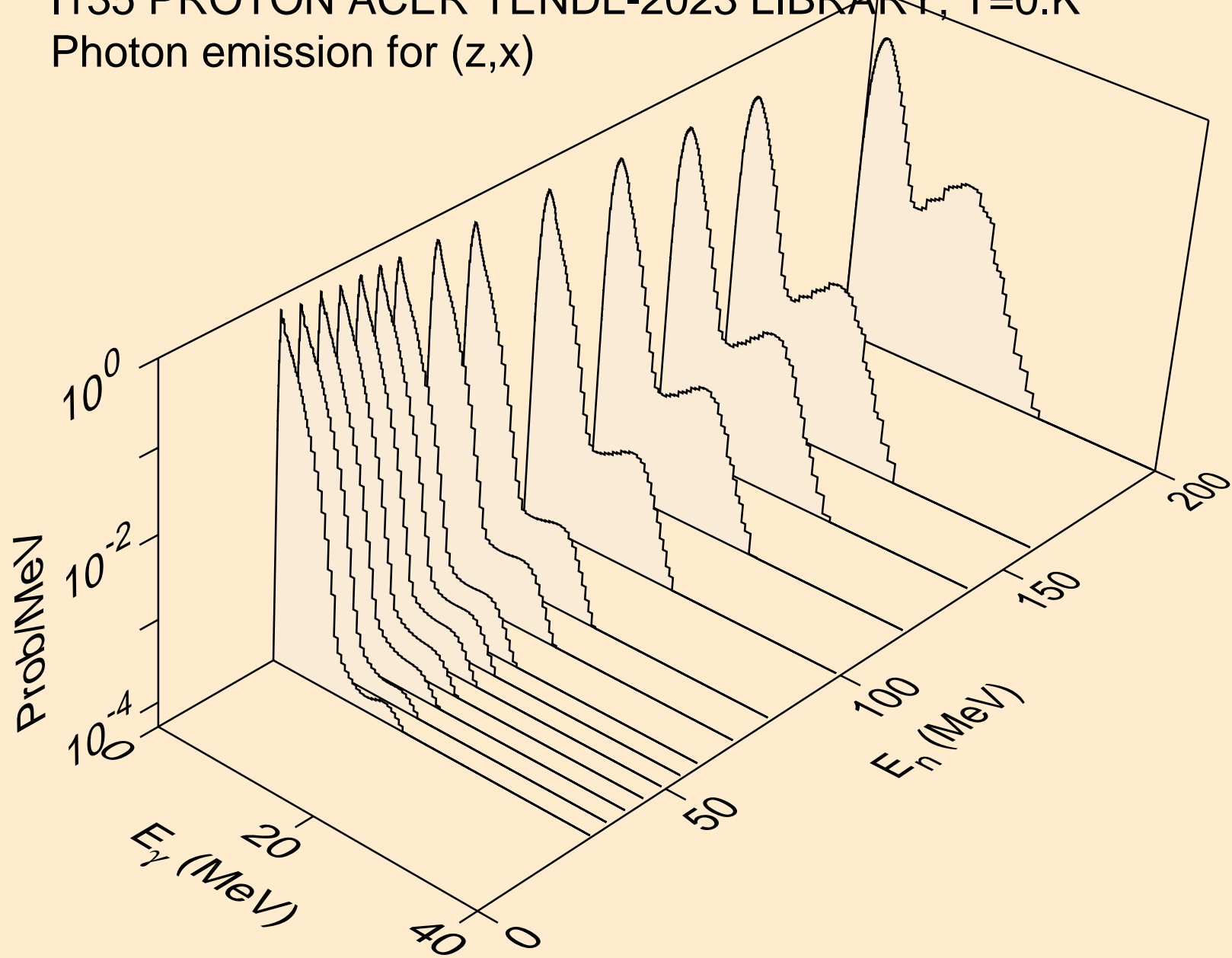

I135 PROTON ACER TENDL-2023 LIBRARY; T=0.K  
Photon emission for (n,2nd)

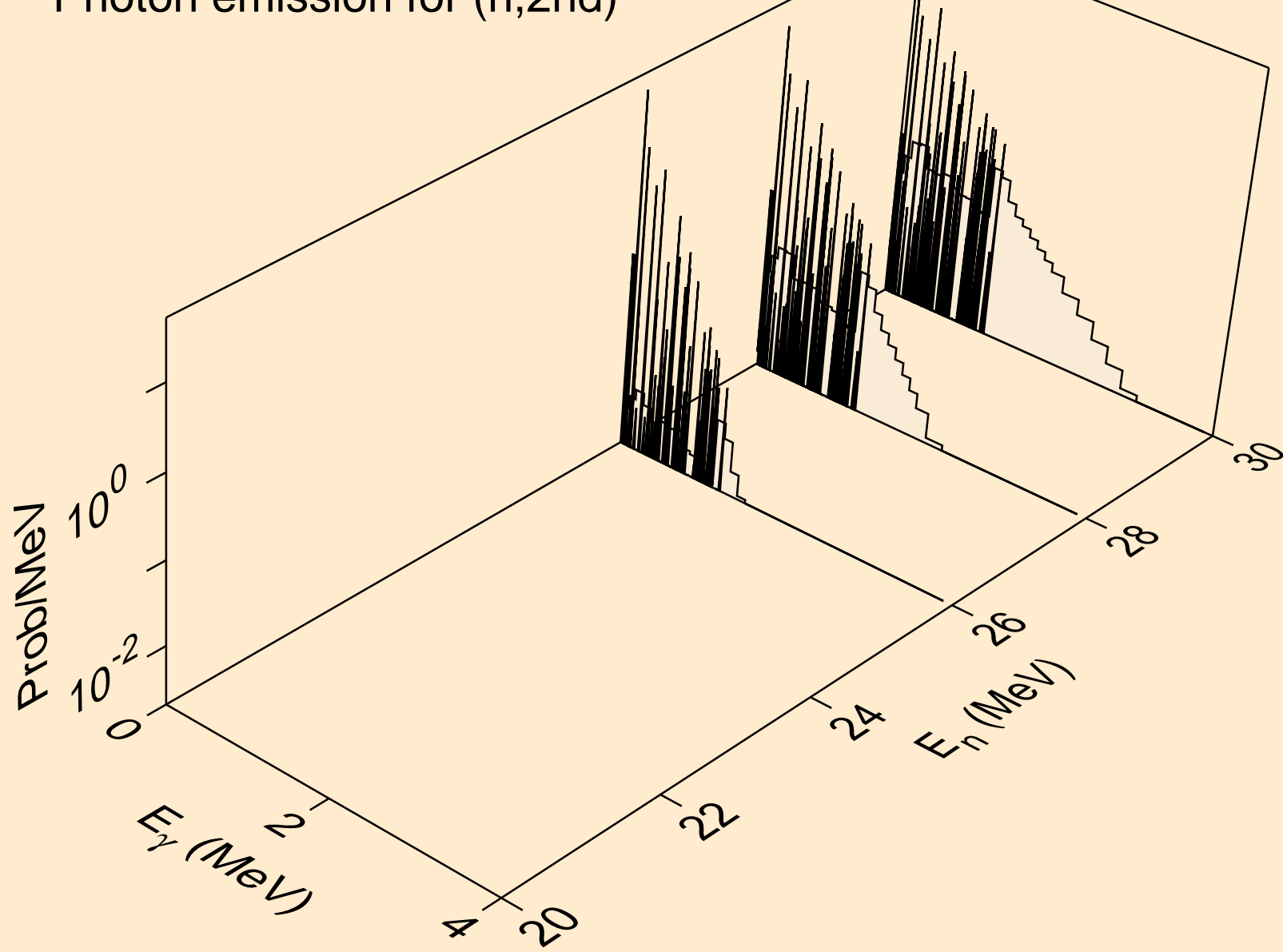

I135 PROTON ACER TENDL-2023 LIBRARY; T=0.K  
Photon emission for (n,2n)

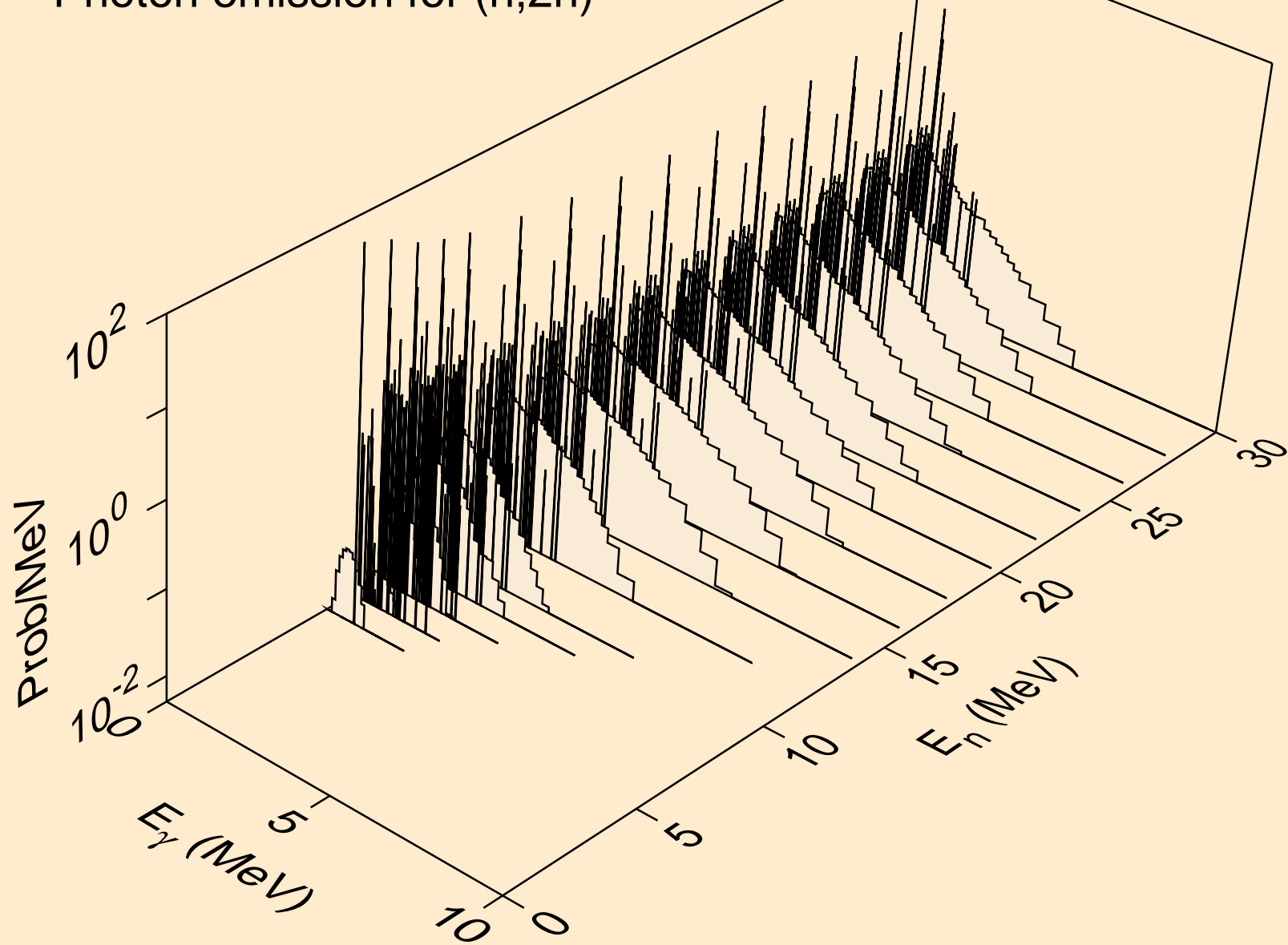



I135 PROTON ACER TENDL-2023 LIBRARY; T=0.K  
Photon emission for (n,3n)

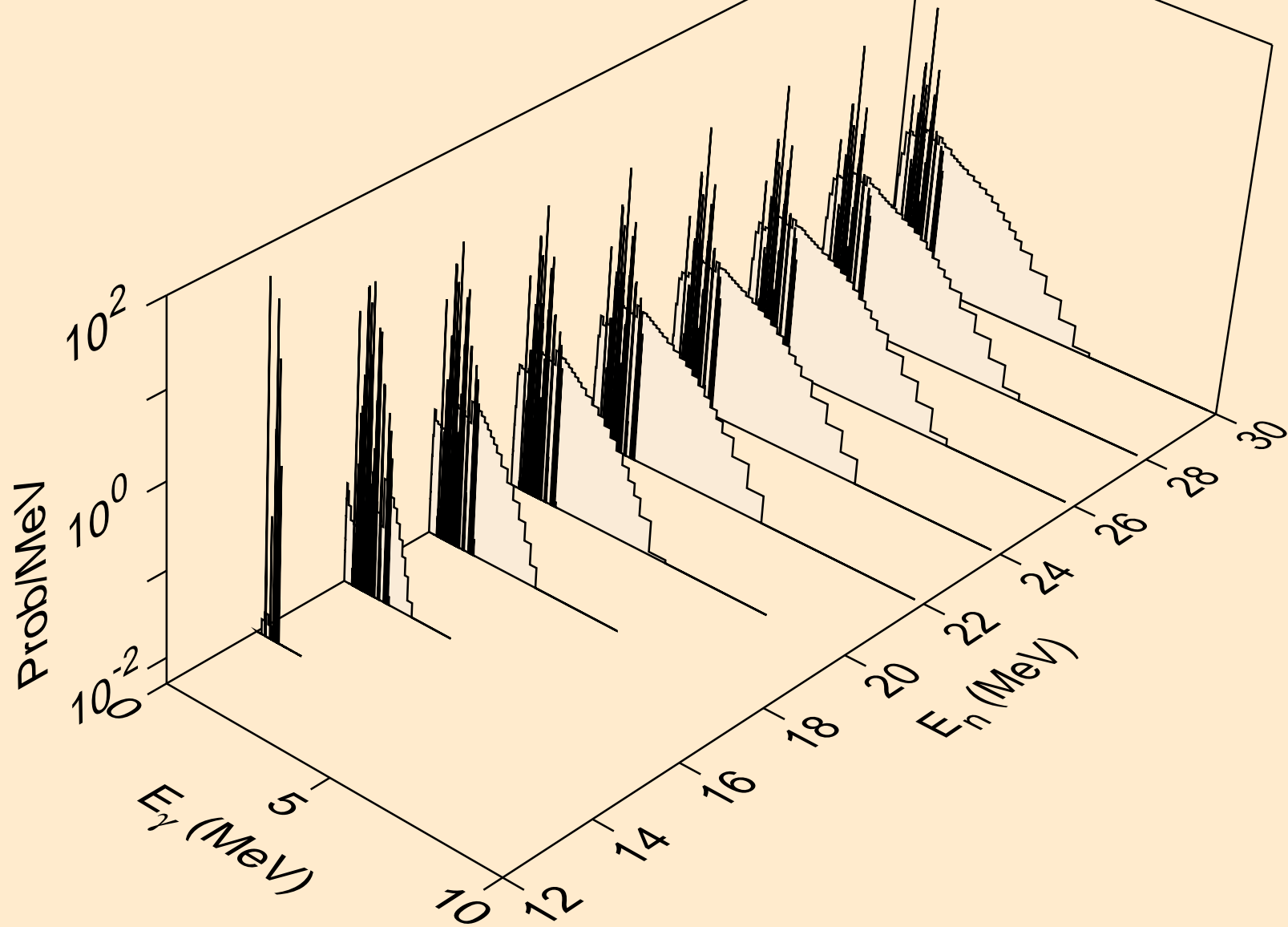

I135 PROTON ACER TENDL-2023 LIBRARY; T=0.K  
Photon emission for (n,n\*)a

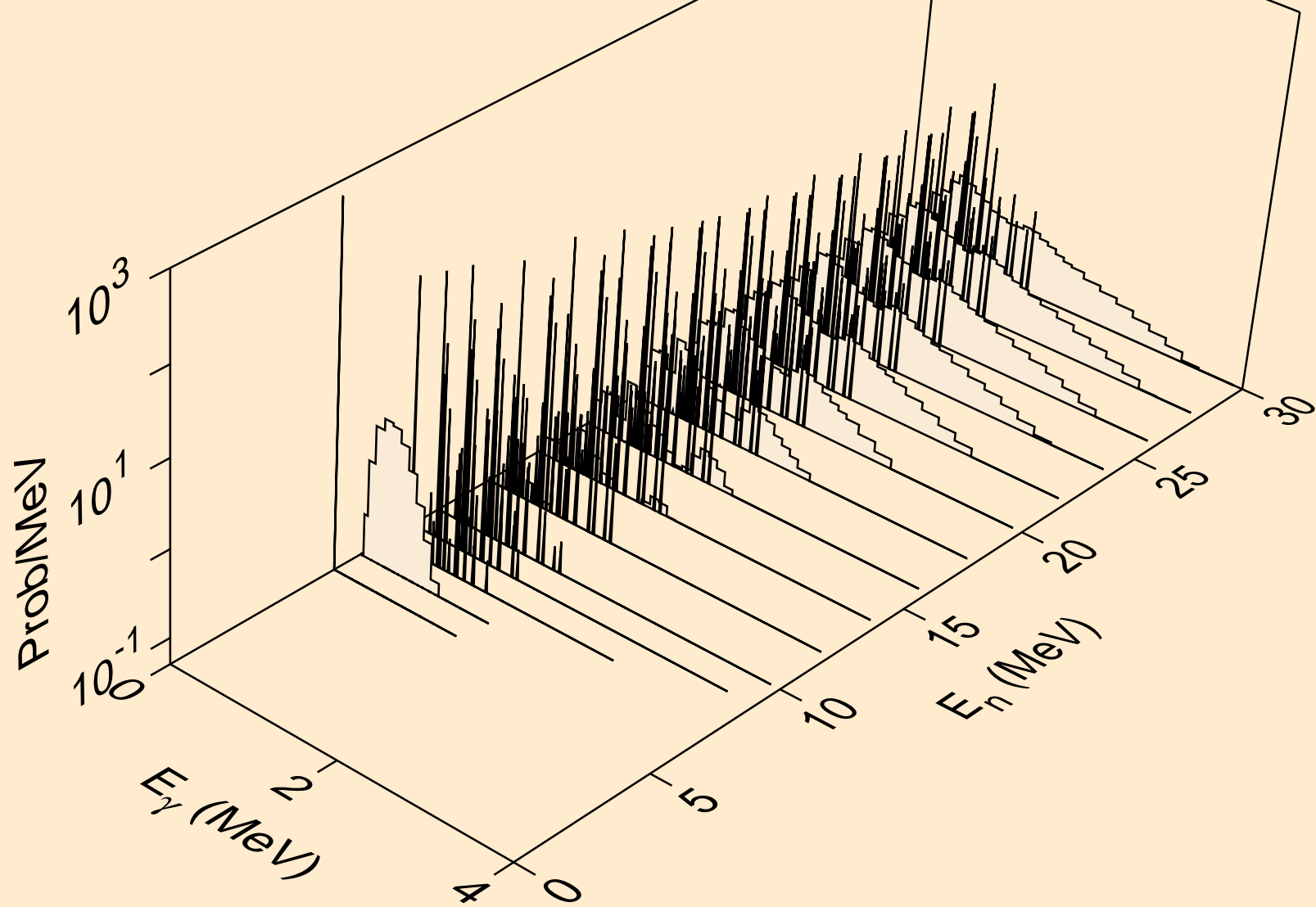

I135 PROTON ACER TENDL-2023 LIBRARY; T=0.K  
Photon emission for (n,2n)a

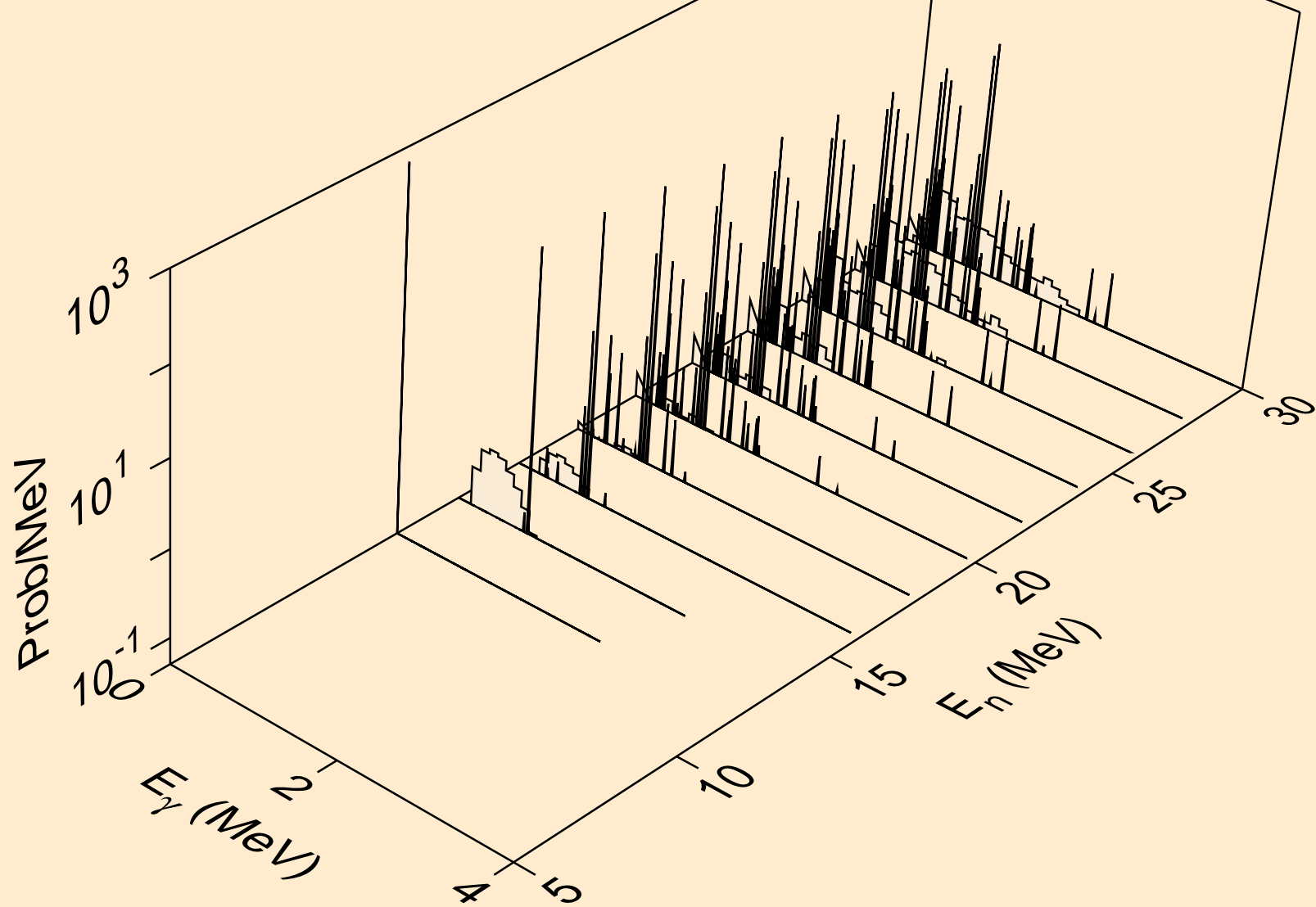

I135 PROTON ACER TENDL-2023 LIBRARY; T=0.K  
Photon emission for (n,3n)a

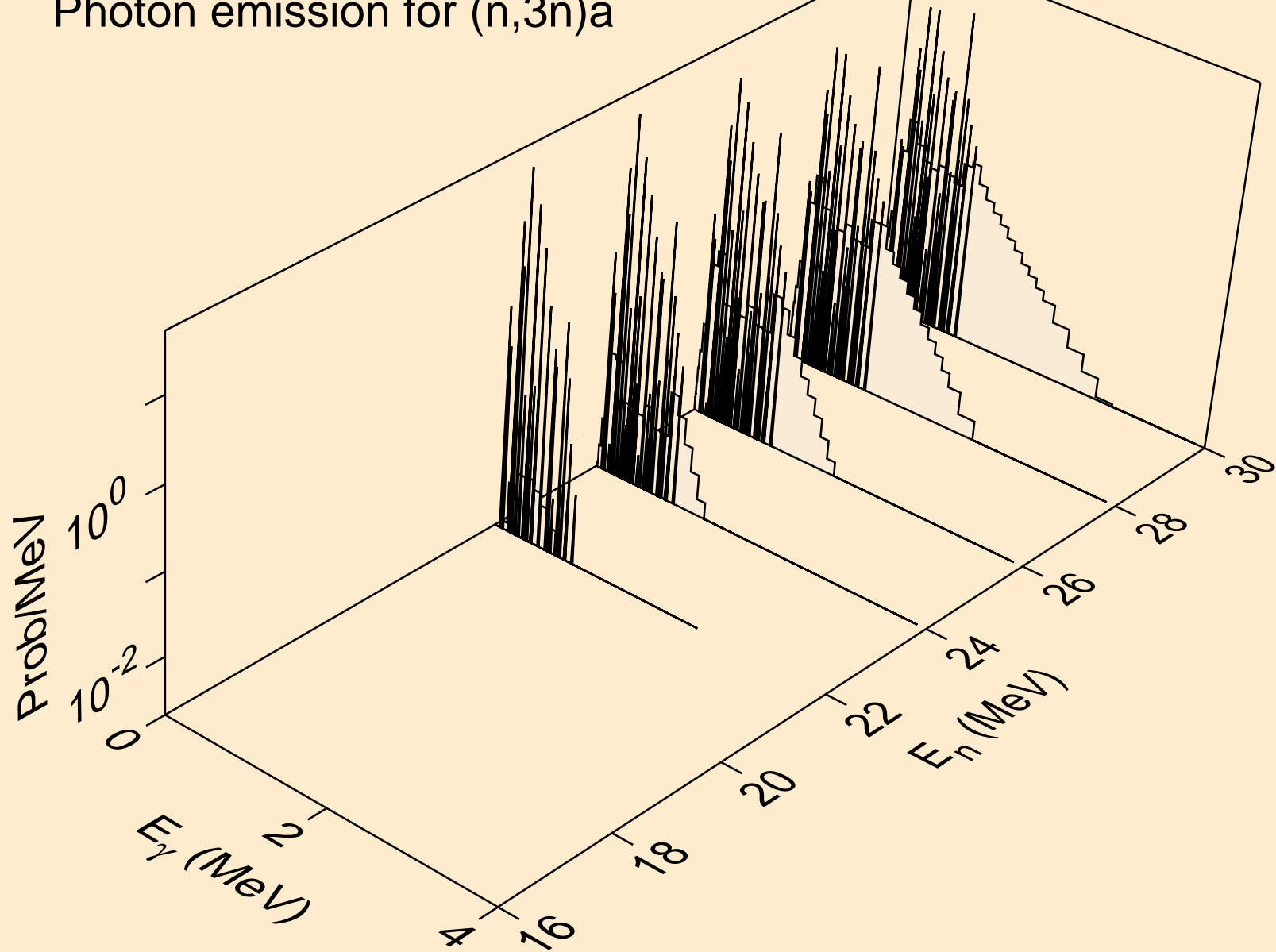

I135 PROTON ACER TENDL-2023 LIBRARY; T=0.K  
Photon emission for (n,n\*)p

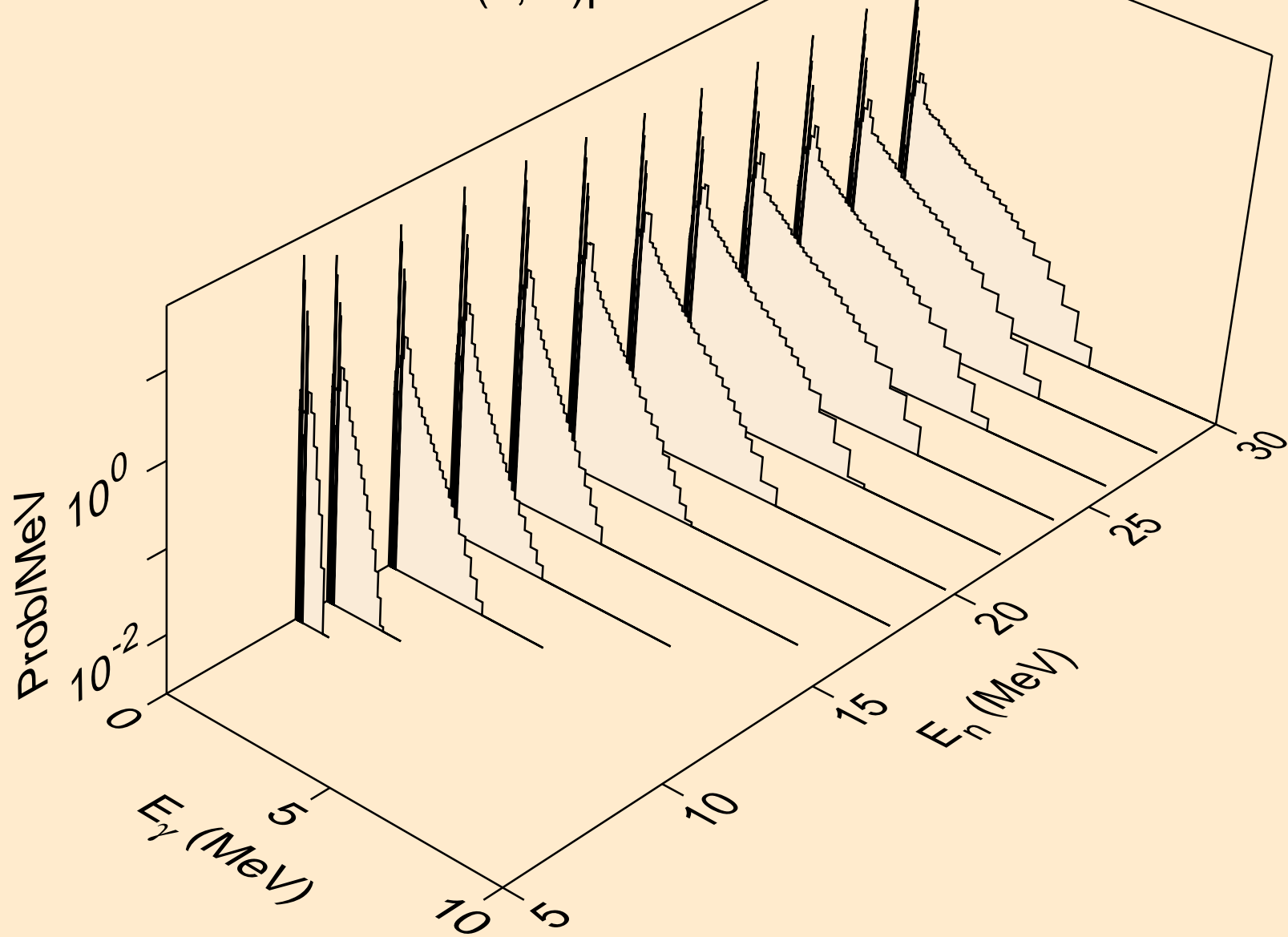

I135 PROTON ACER TENDL-2023 LIBRARY; T=0.K  
Photon emission for (n,n\*)d

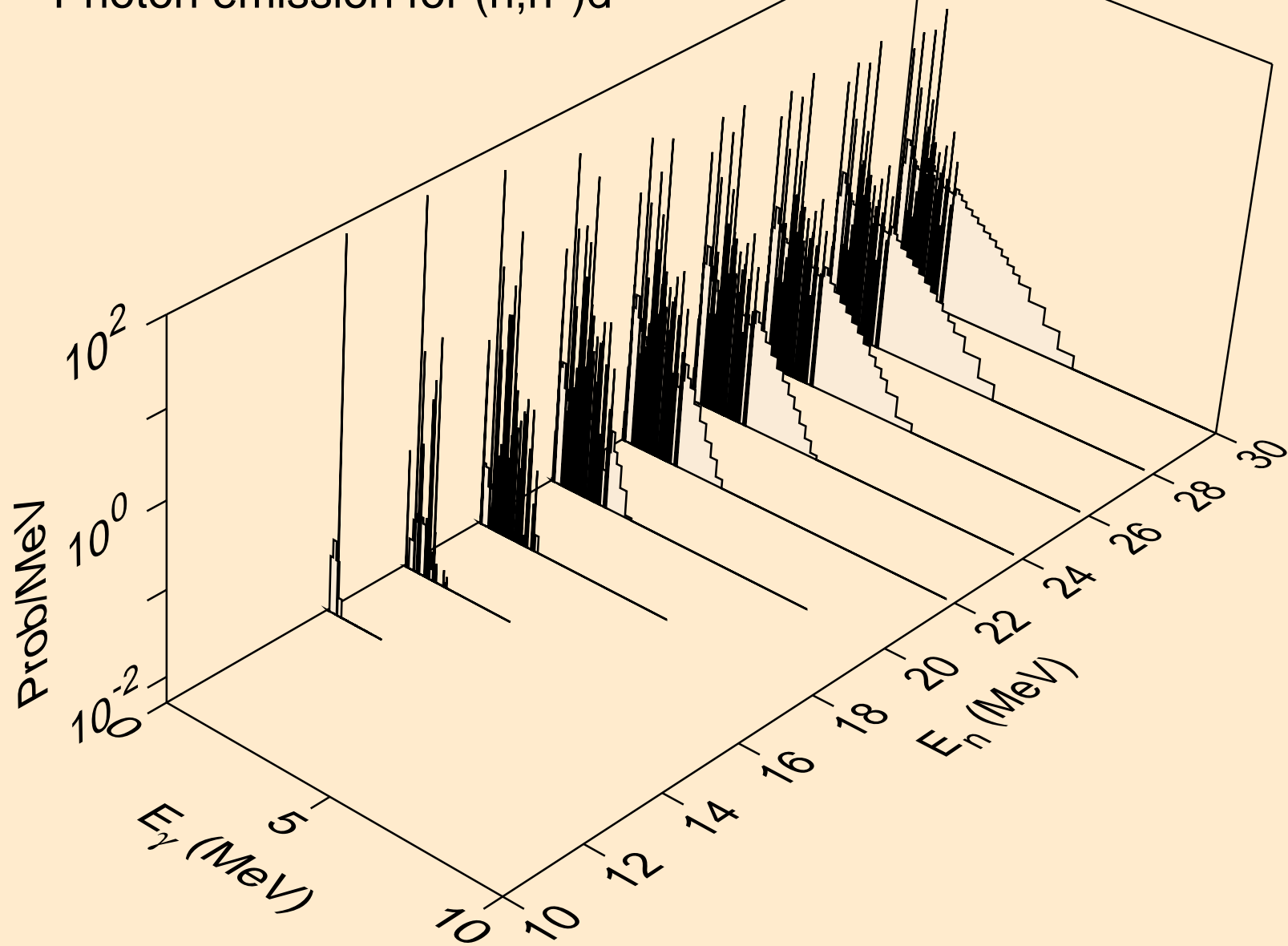

I135 PROTON ACER TENDL-2023 LIBRARY; T=0.K  
Photon emission for (n,n\*)t

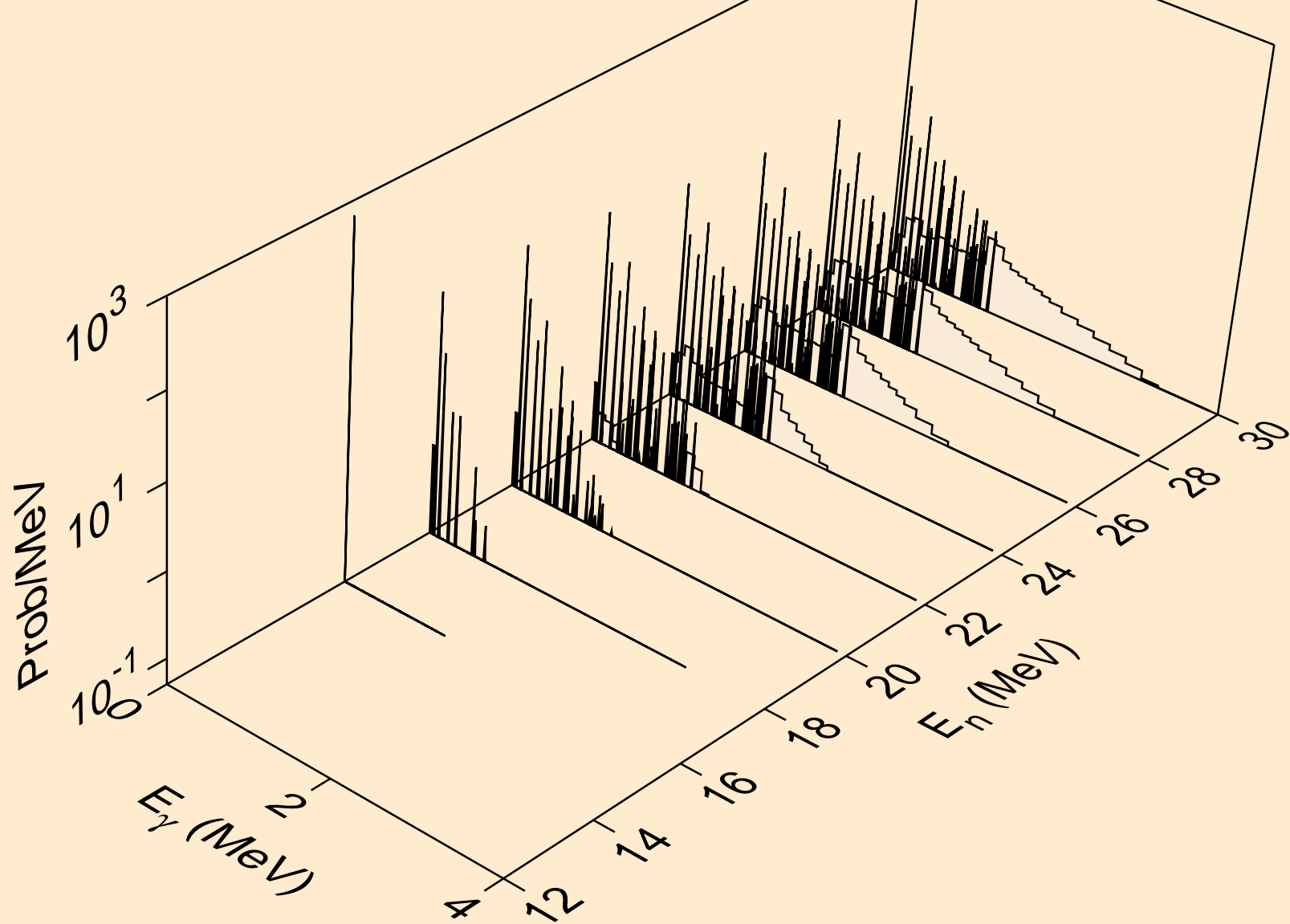

I135 PROTON ACER TENDL-2023 LIBRARY; T=0.K  
Photon emission for (n,n\*)he3

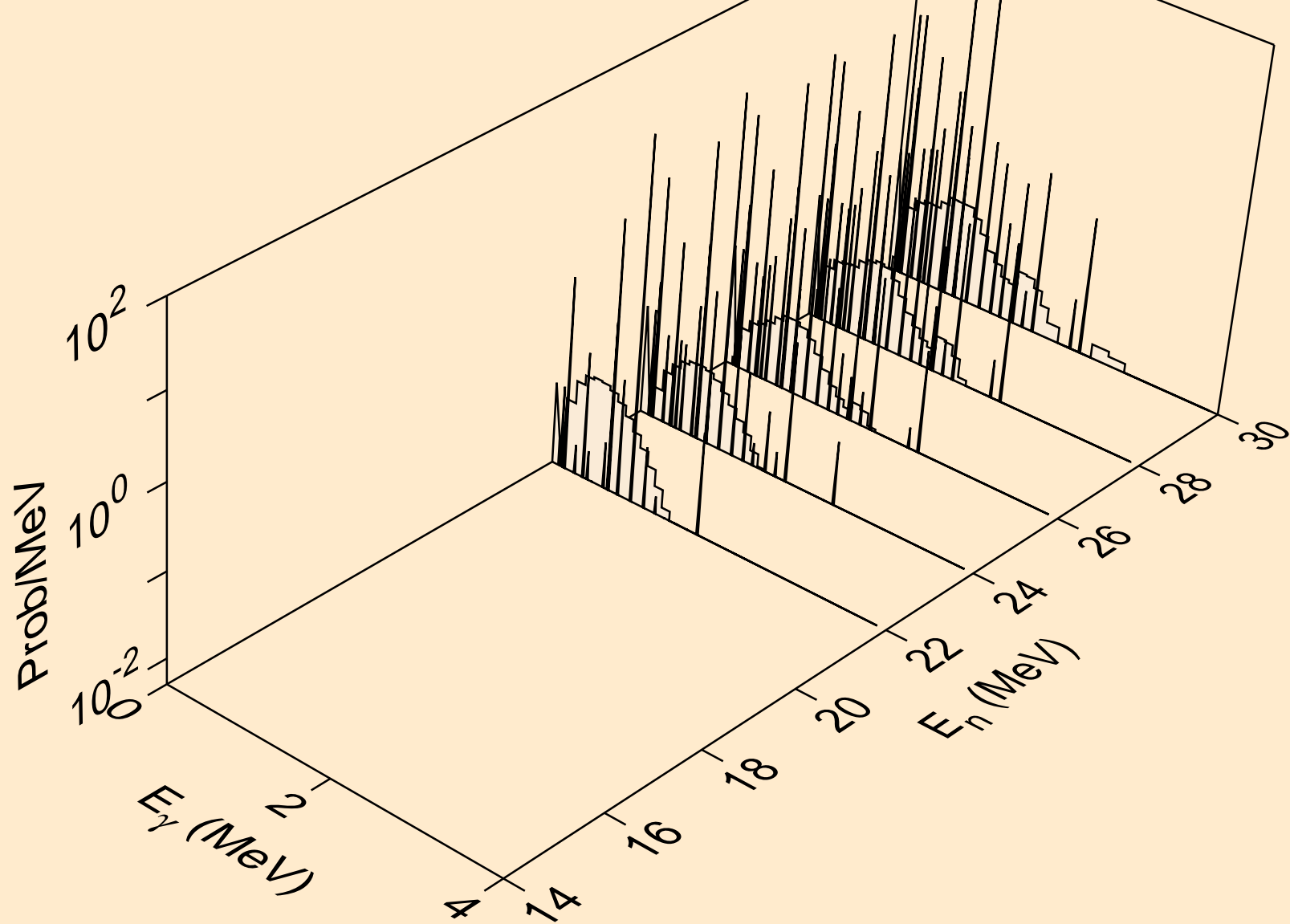



I135 PROTON ACER TENDL-2023 LIBRARY; T=0.K  
Photon emission for (n,4n)

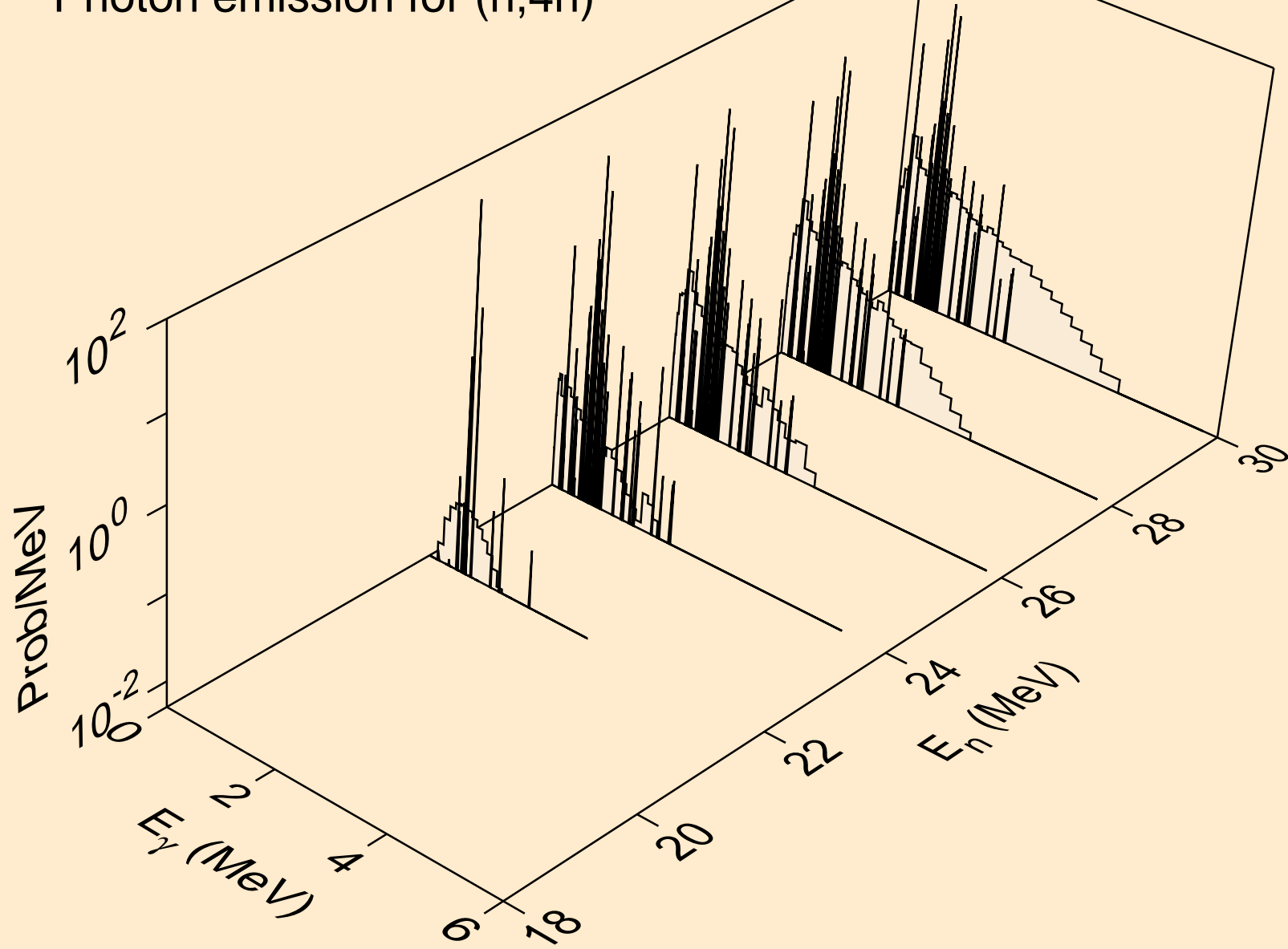

I135 PROTON ACER TENDL-2023 LIBRARY; T=0.K  
Photon emission for (n,2np)

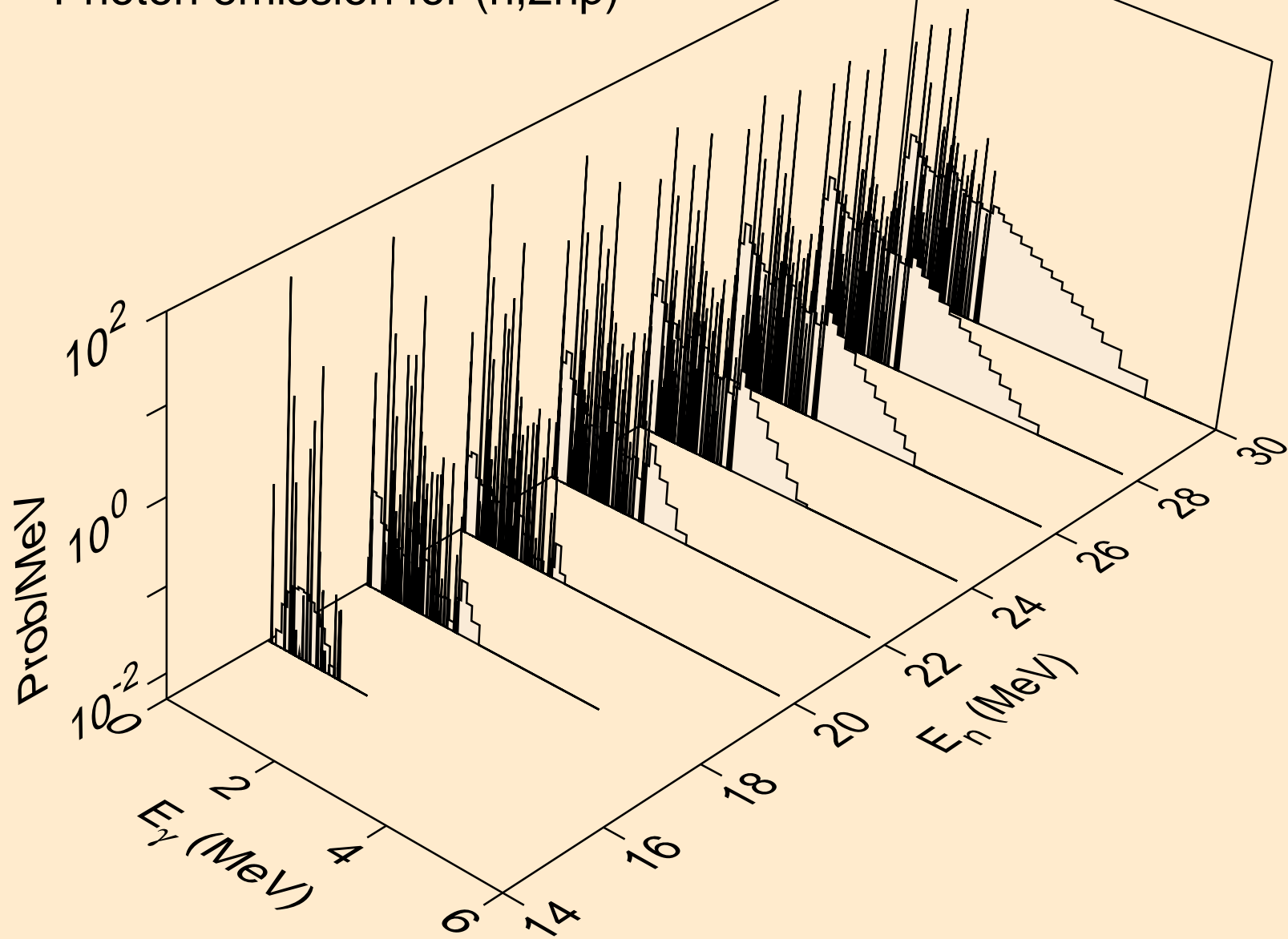

I135 PROTON ACER TENDL-2023 LIBRARY; T=0.K  
Photon emission for (n,3np)

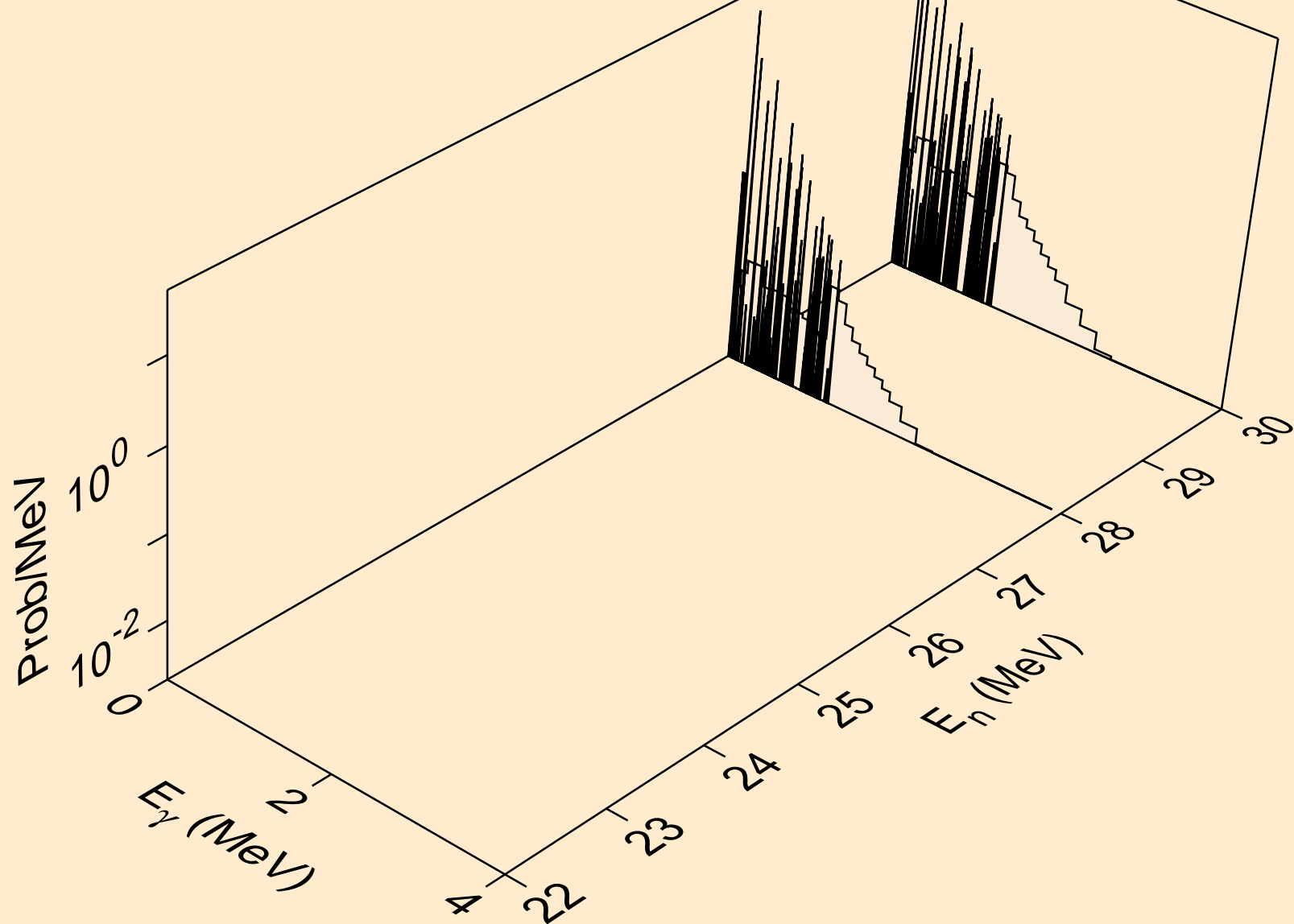

I135 PROTON ACER TENDL-2023 LIBRARY; T=0.K  
Photon emission for (n,n2p)

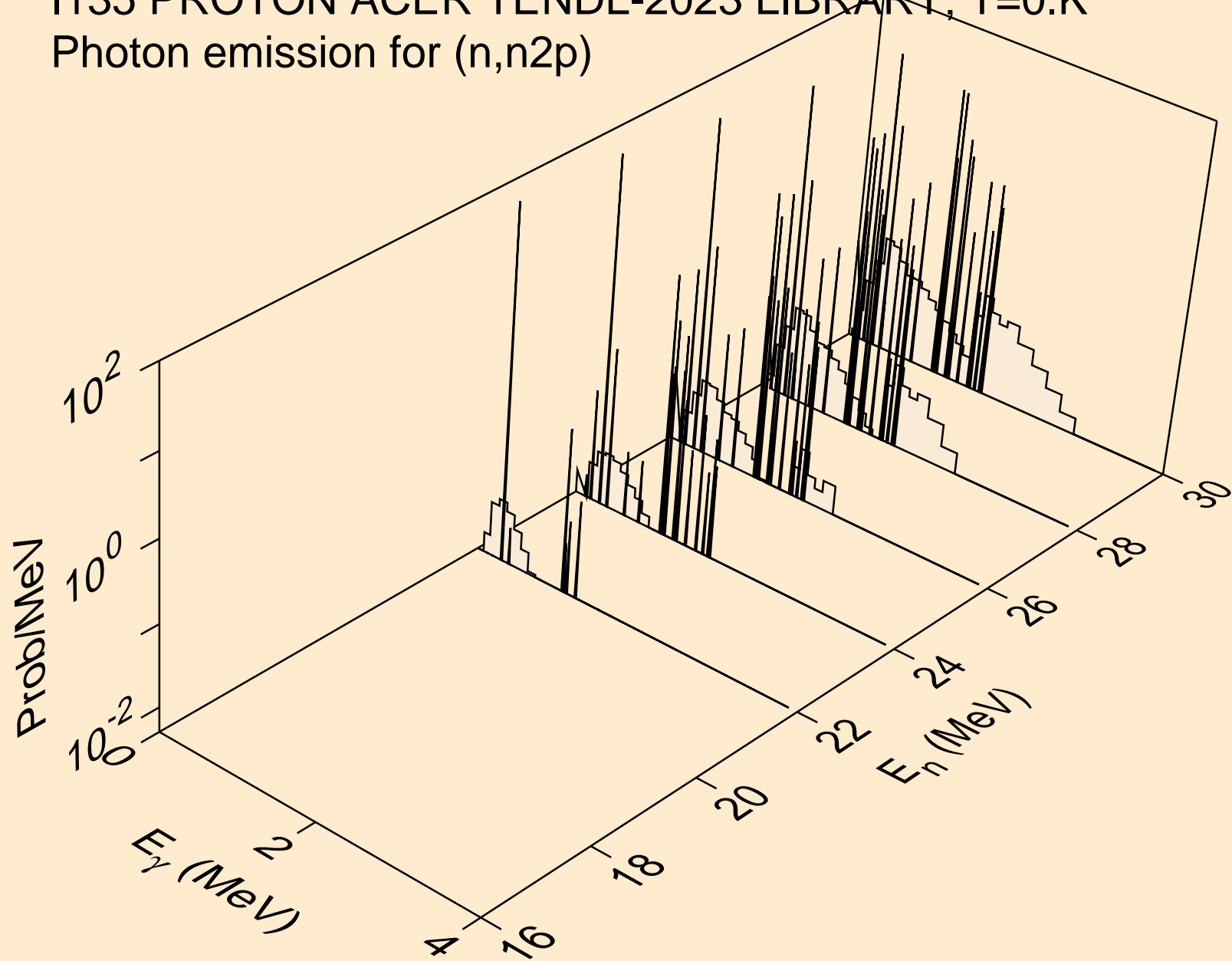

I135 PROTON ACER TENDL-2023 LIBRARY; T=0.K  
Photon emission for (n,npa)

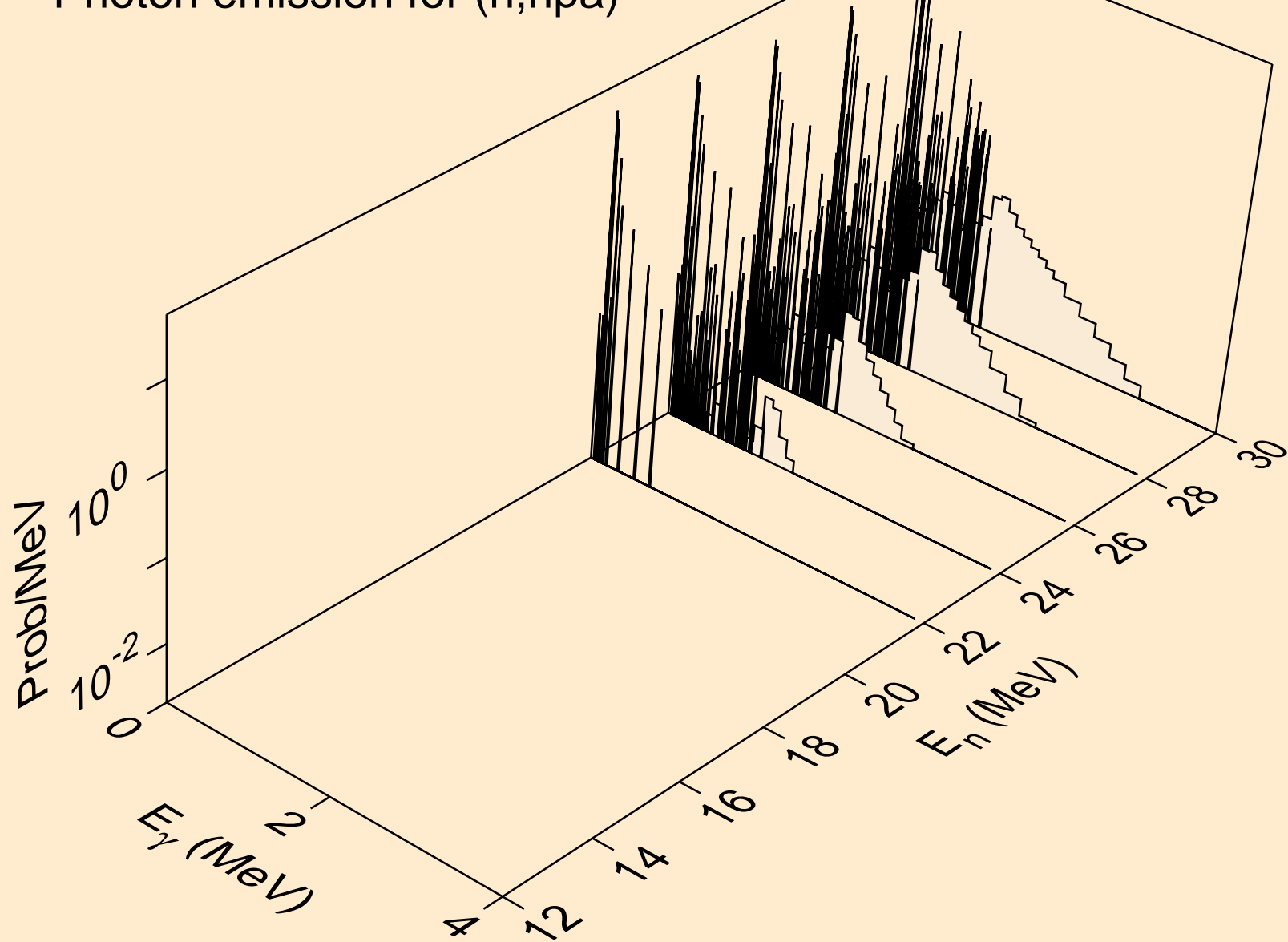

I135 PROTON ACER TENDL-2023 LIBRARY; T=0.K  
Photon emission for (n,gma)

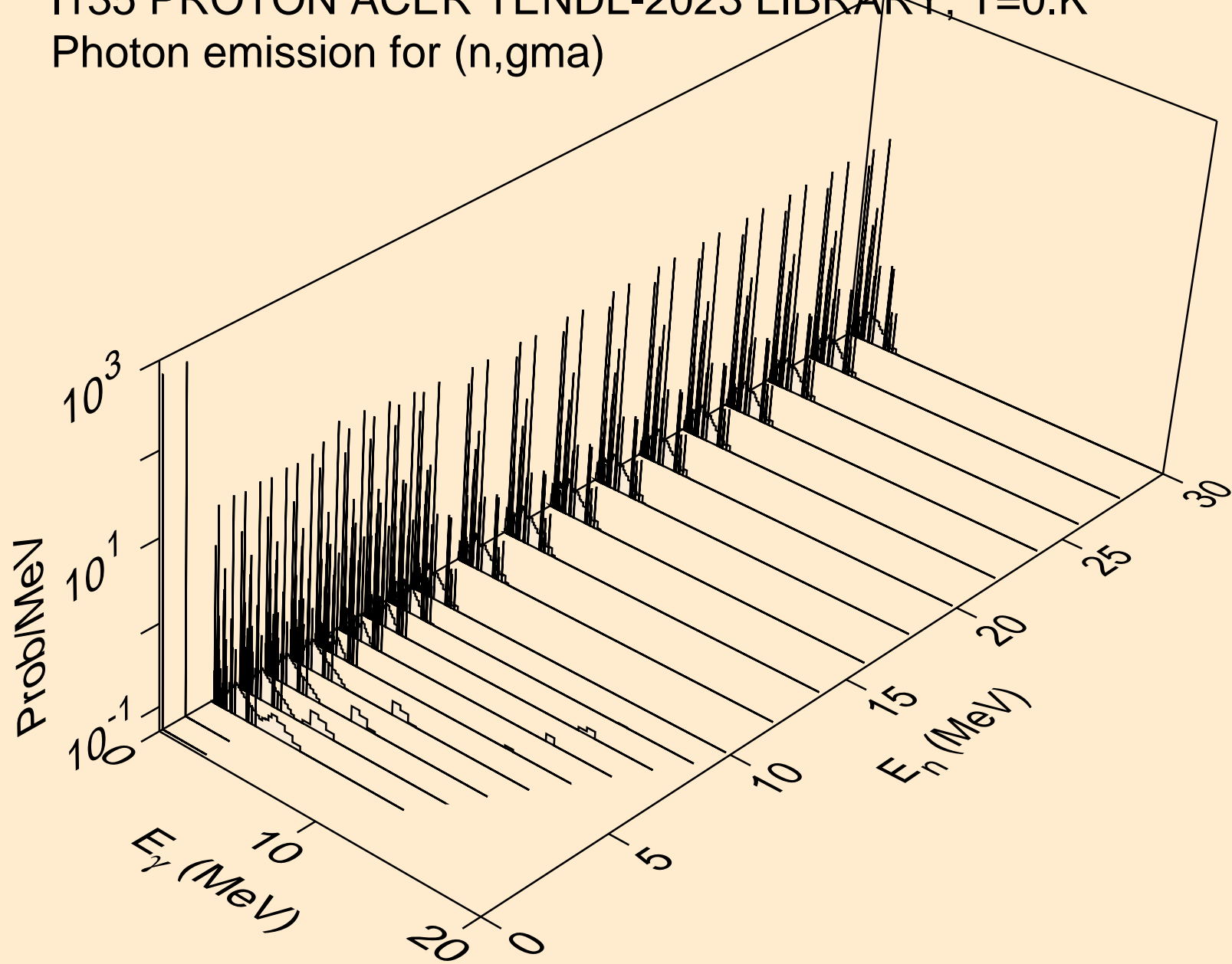

I135 PROTON ACER TENDL-2023 LIBRARY; T=0.K  
Photon emission for inelastic

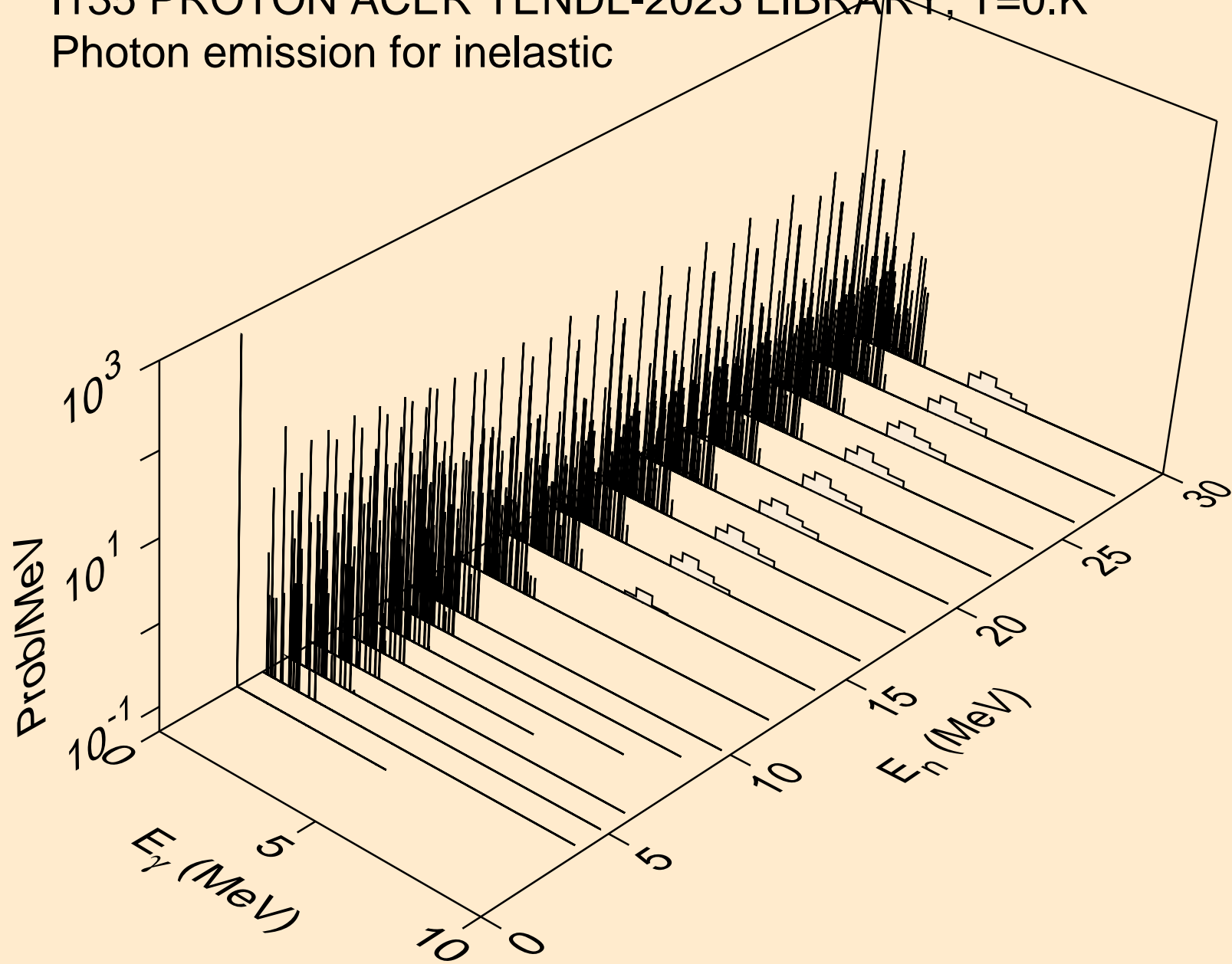

I135 PROTON ACER TENDL-2023 LIBRARY; T=0.K  
Photon emission for (n,d)

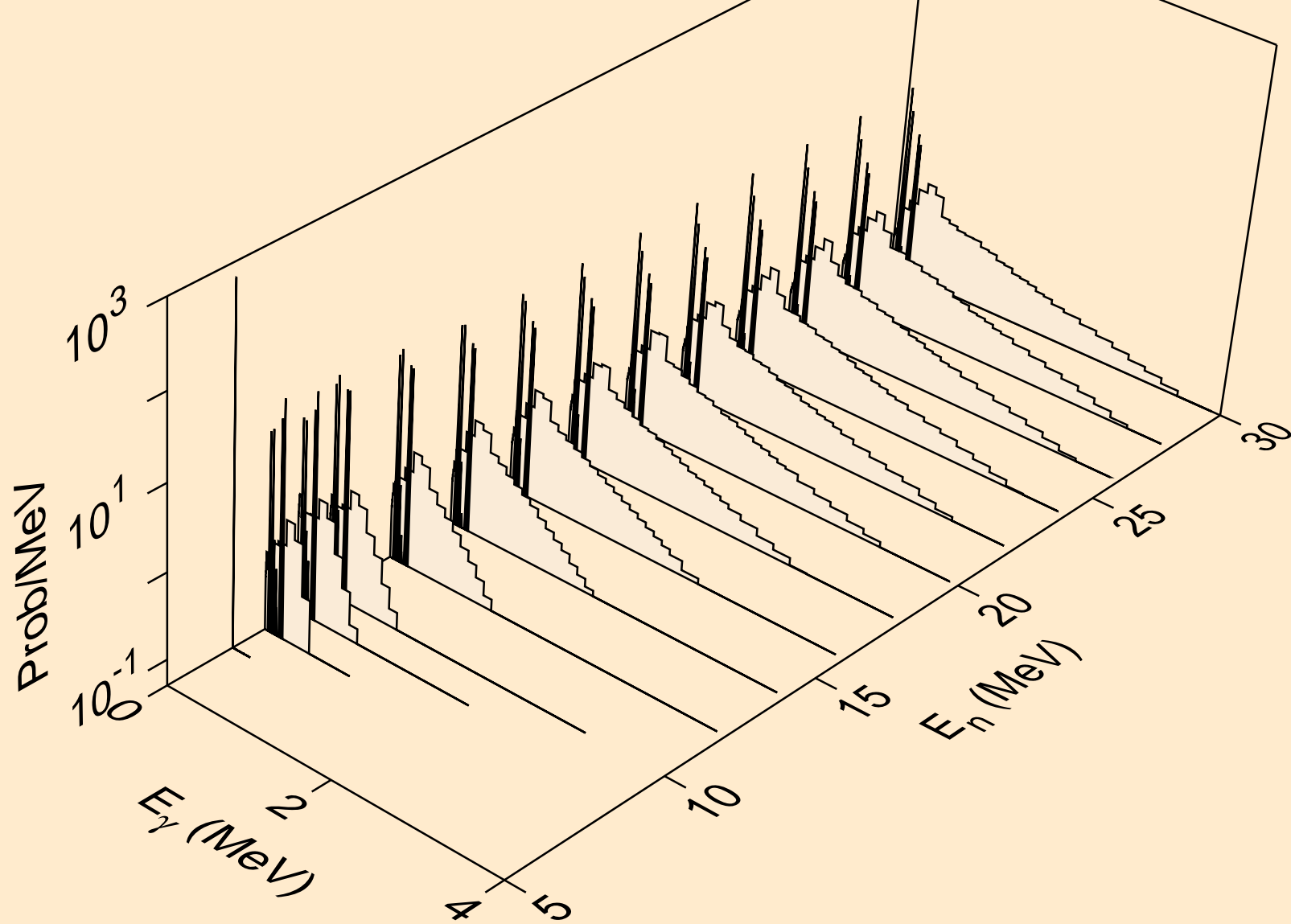



I135 PROTON ACER TENDL-2023 LIBRARY; T=0.K  
Photon emission for (n,t)

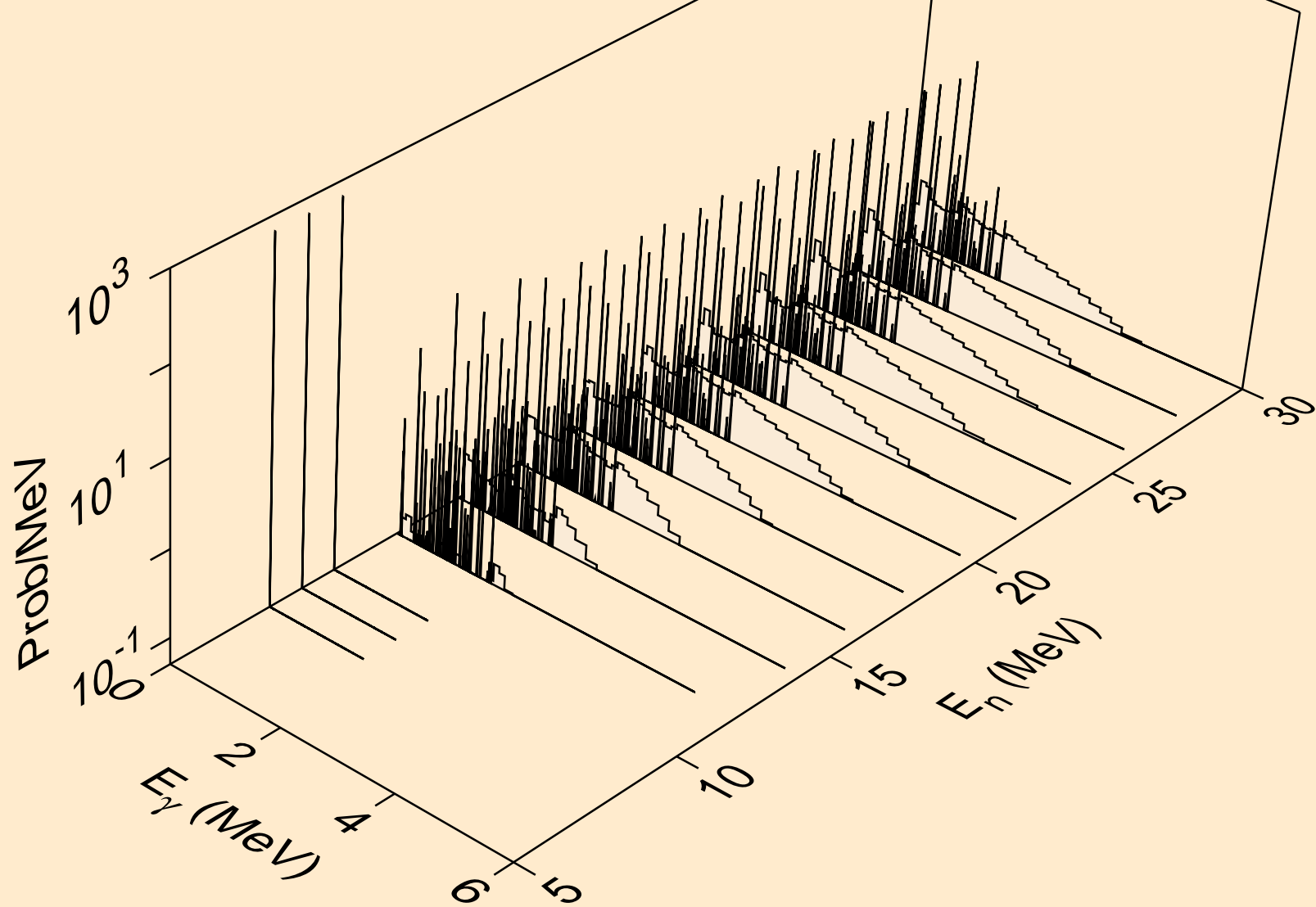

I135 PROTON ACER TENDL-2023 LIBRARY; T=0.K  
Photon emission for (n,he3)

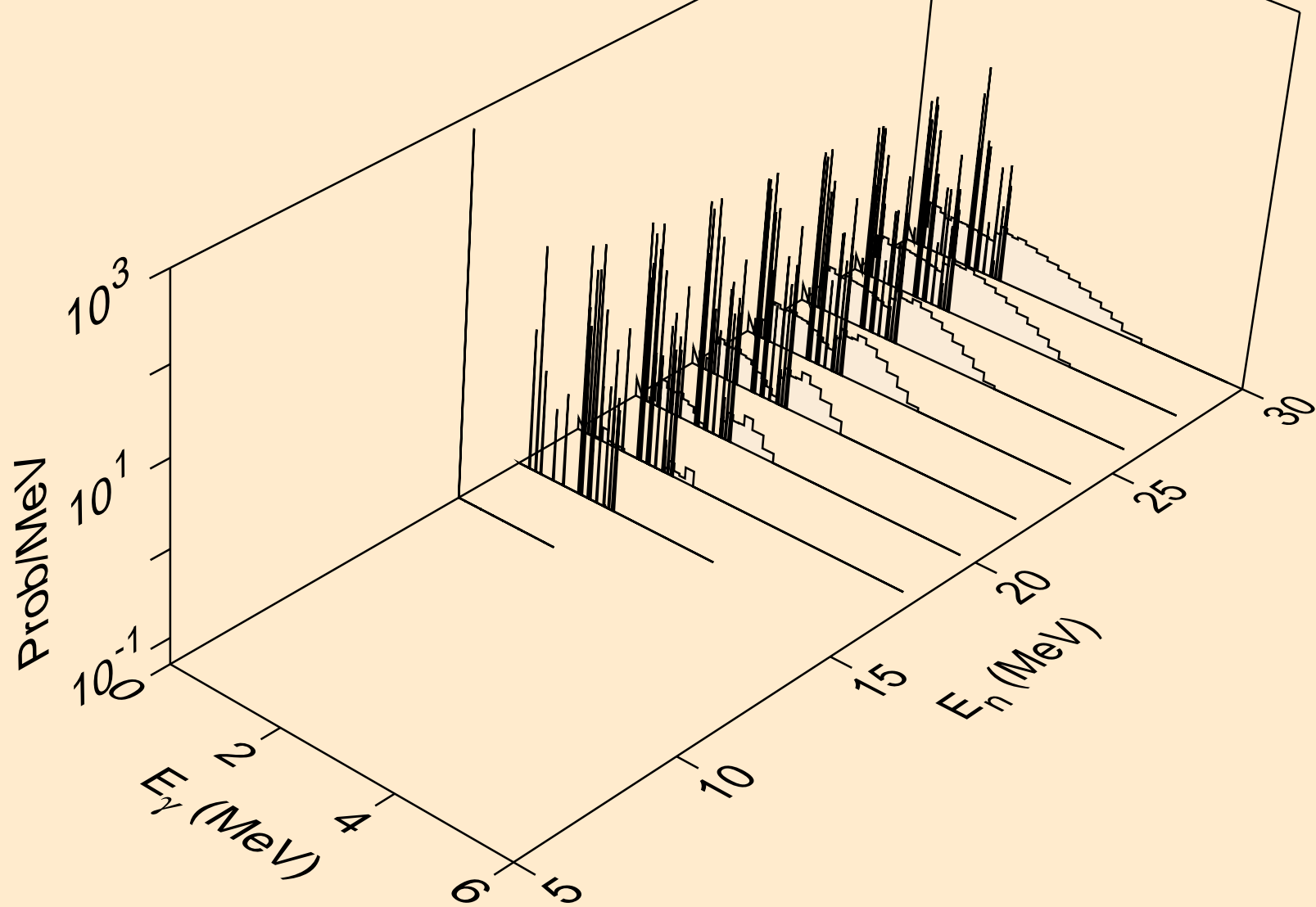

I135 PROTON ACER TENDL-2023 LIBRARY; T=0.K  
Photon emission for (n,a)

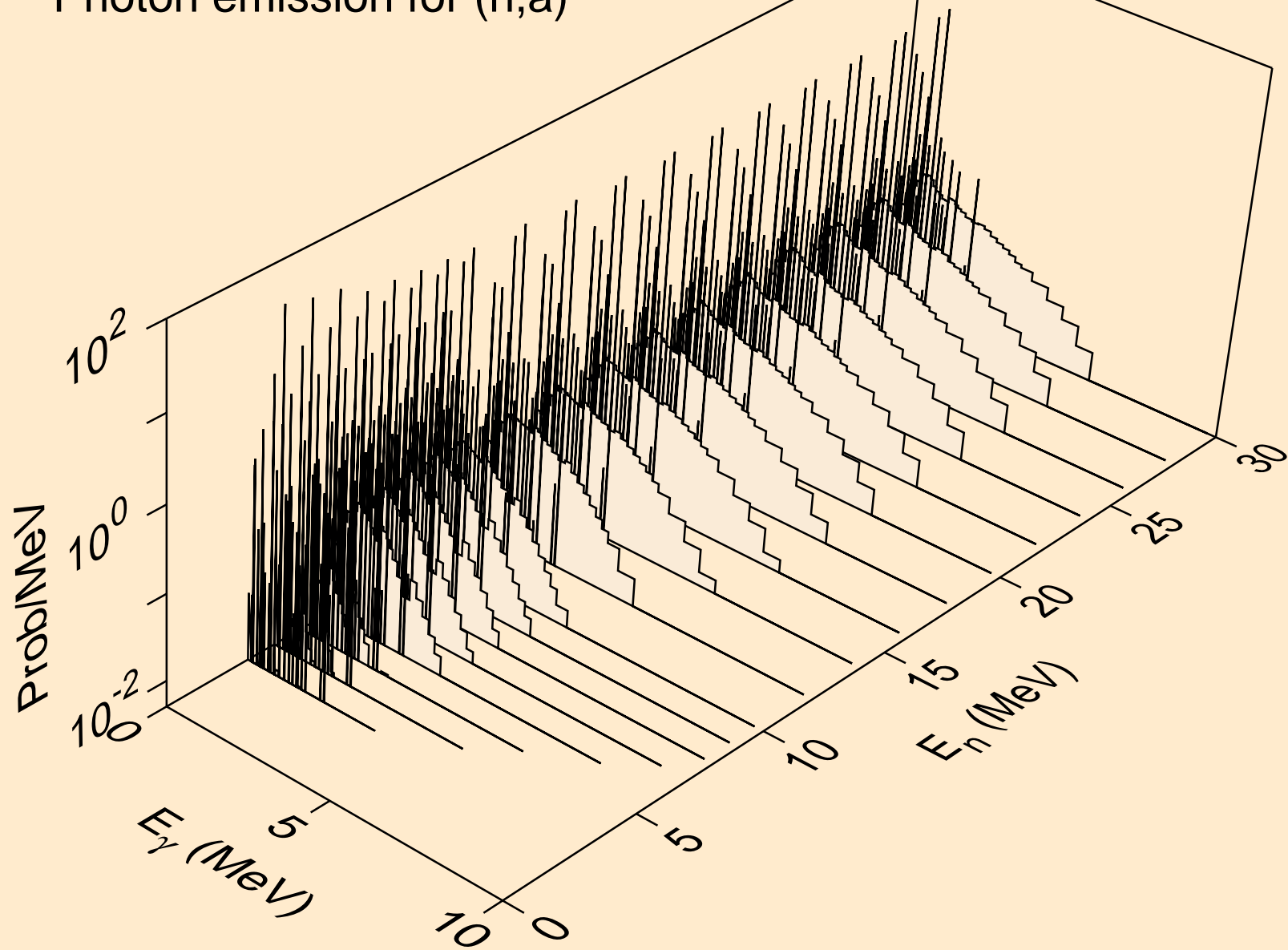

I135 PROTON ACER TENDL-2023 LIBRARY; T=0.K  
Photon emission for (n,2p)

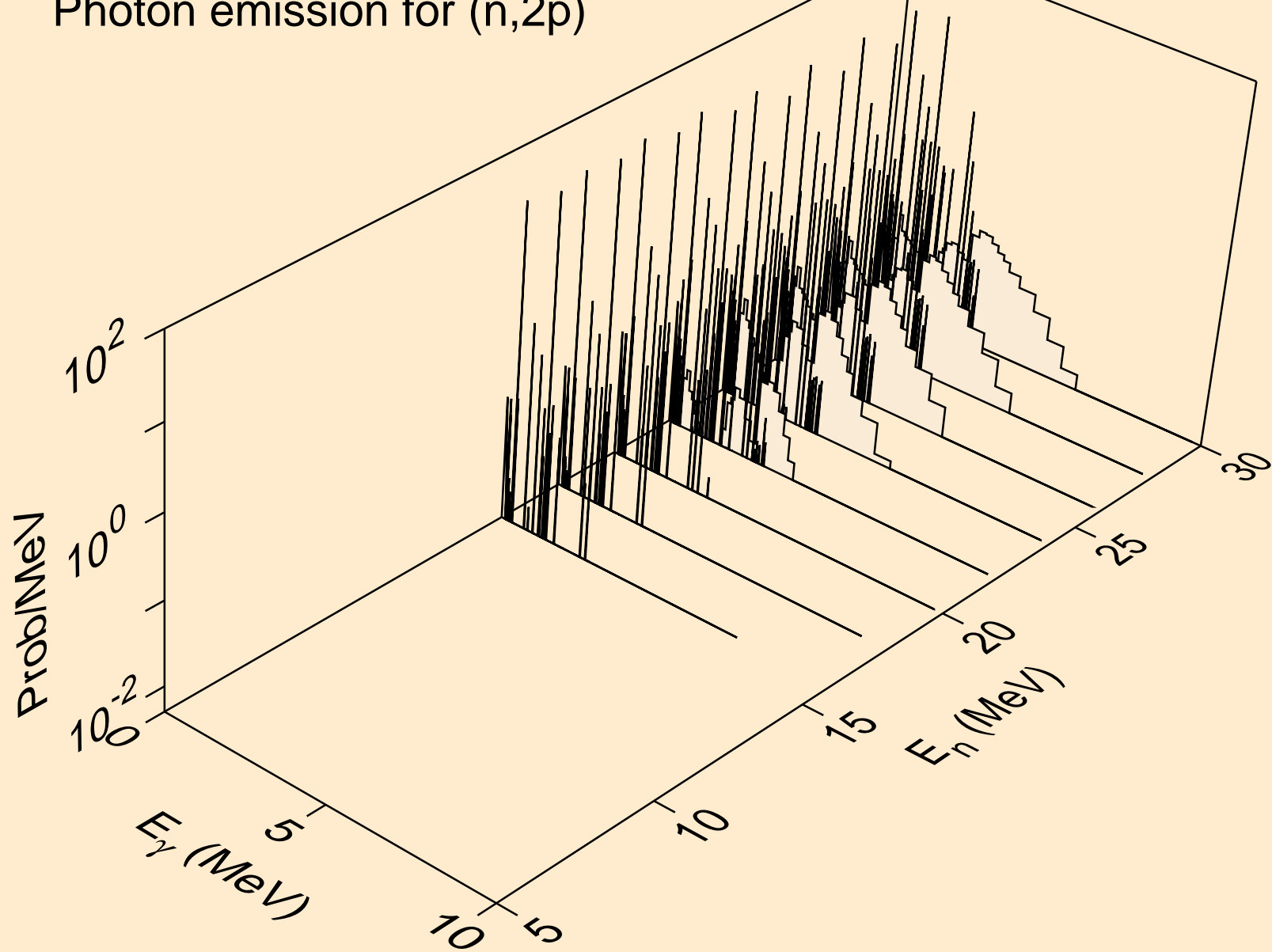

I135 PROTON ACER TENDL-2023 LIBRARY; T=0.K  
Photon emission for (n,pa)

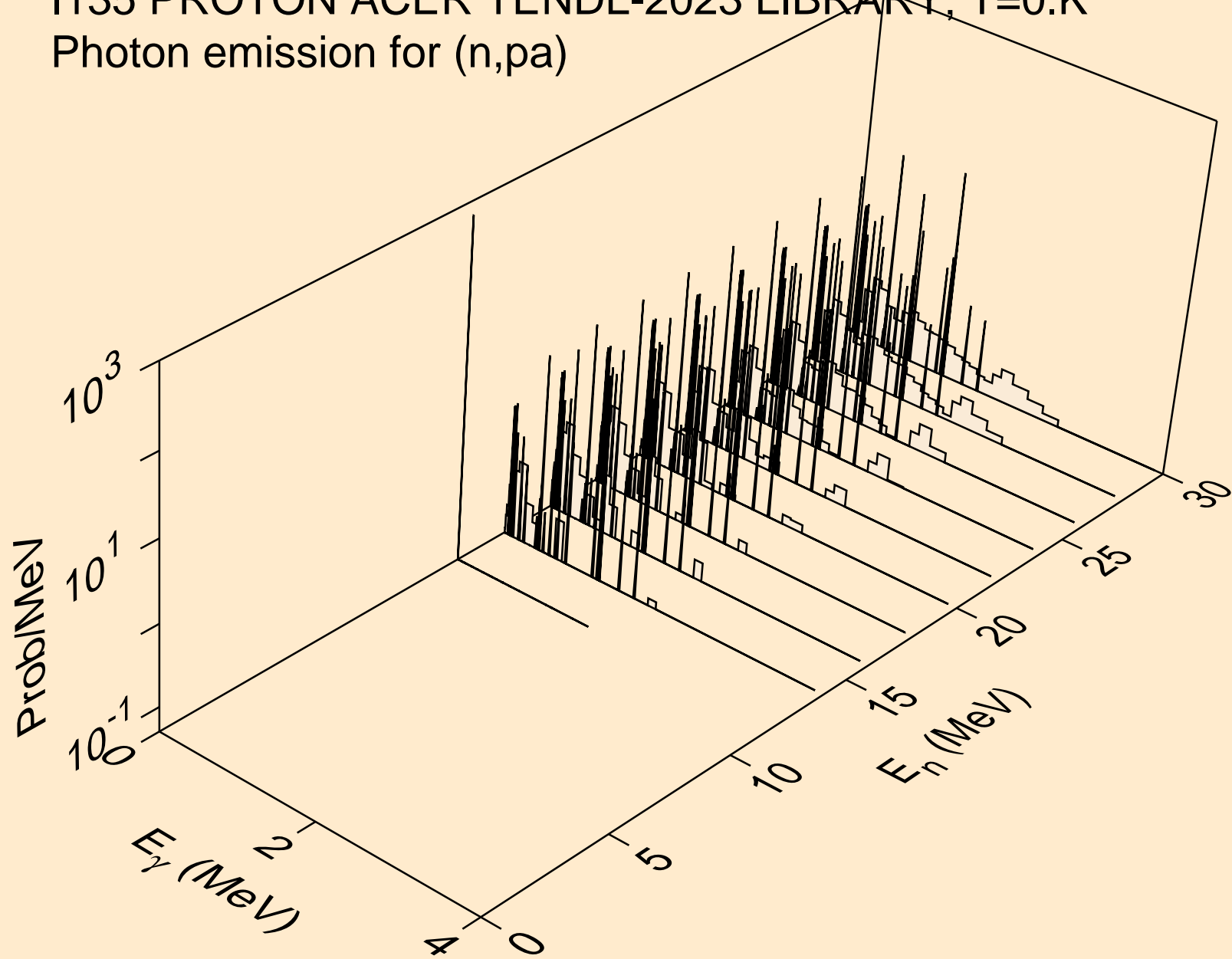

I135 PROTON ACER TENDL-2023 LIBRARY; T=0.K  
Photon emission for (n,pd)

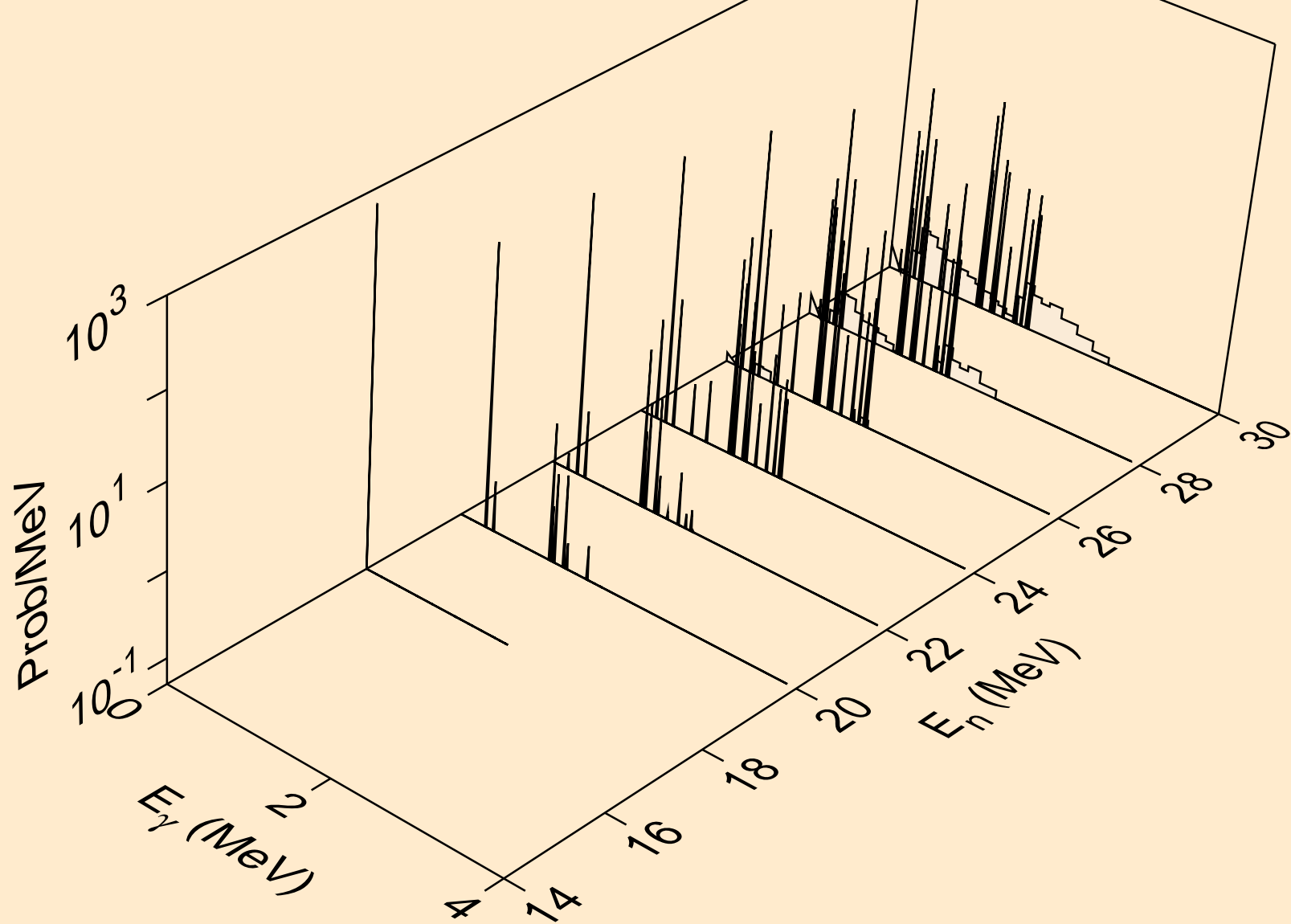

I135 PROTON ACER TENDL-2023 LIBRARY; T=0.K  
Photon emission for (n,pt)

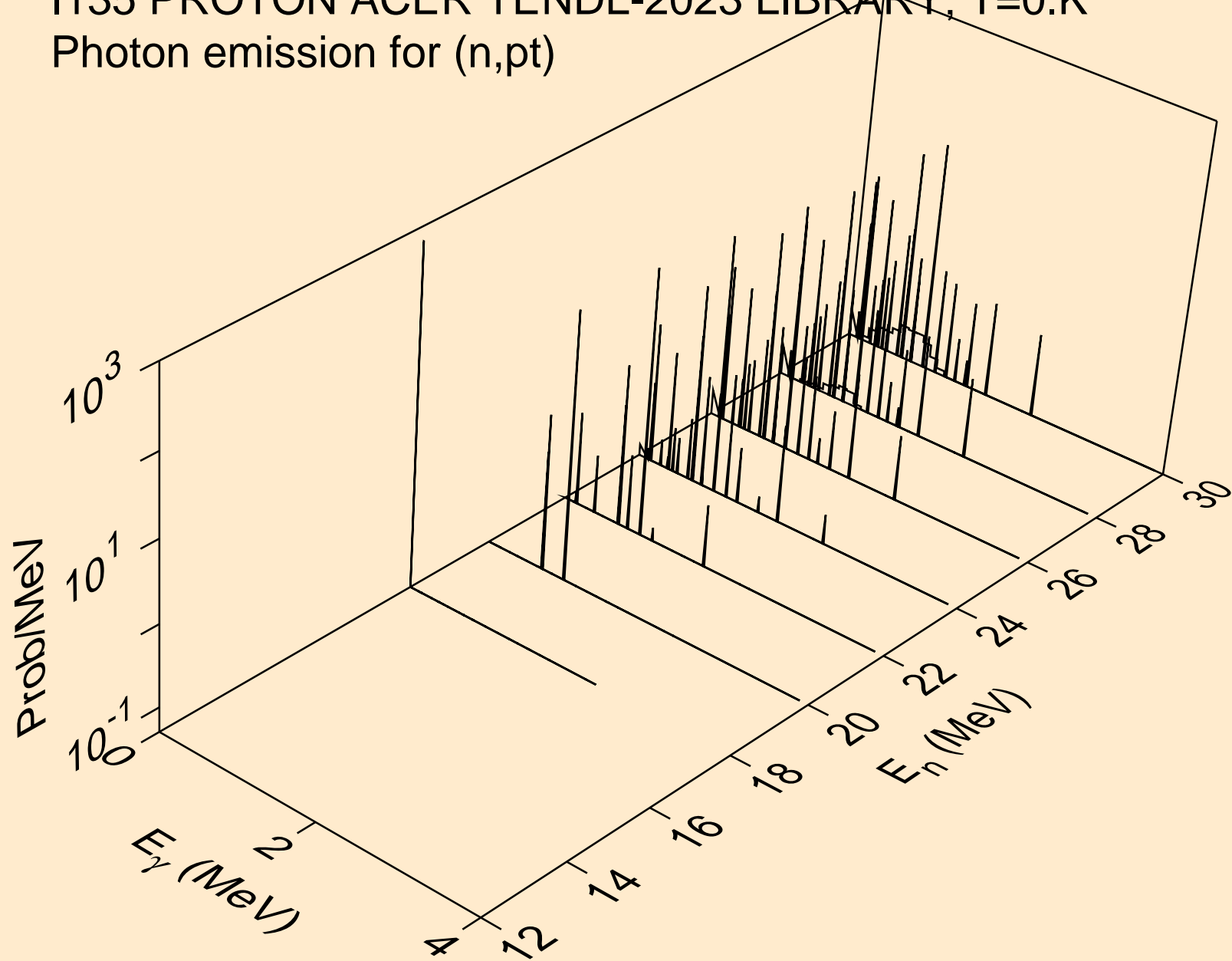

I135 PROTON ACER TENDL-2023 LIBRARY; T=0.K  
Photon emission for (n,da)

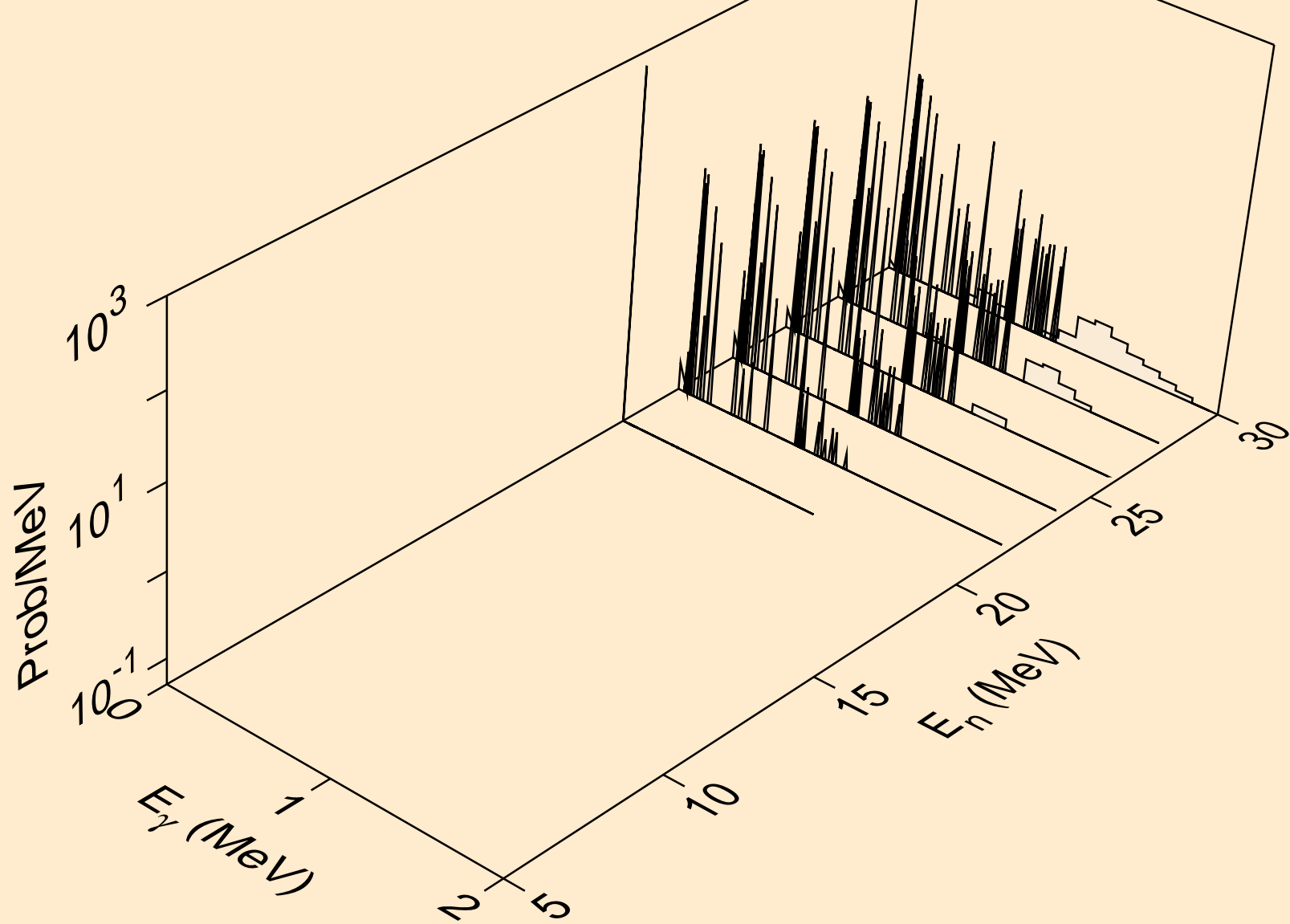



I135 PROTON ACER TENDL-2023 LIBRARY; T=0.K  
Particle heating contributions

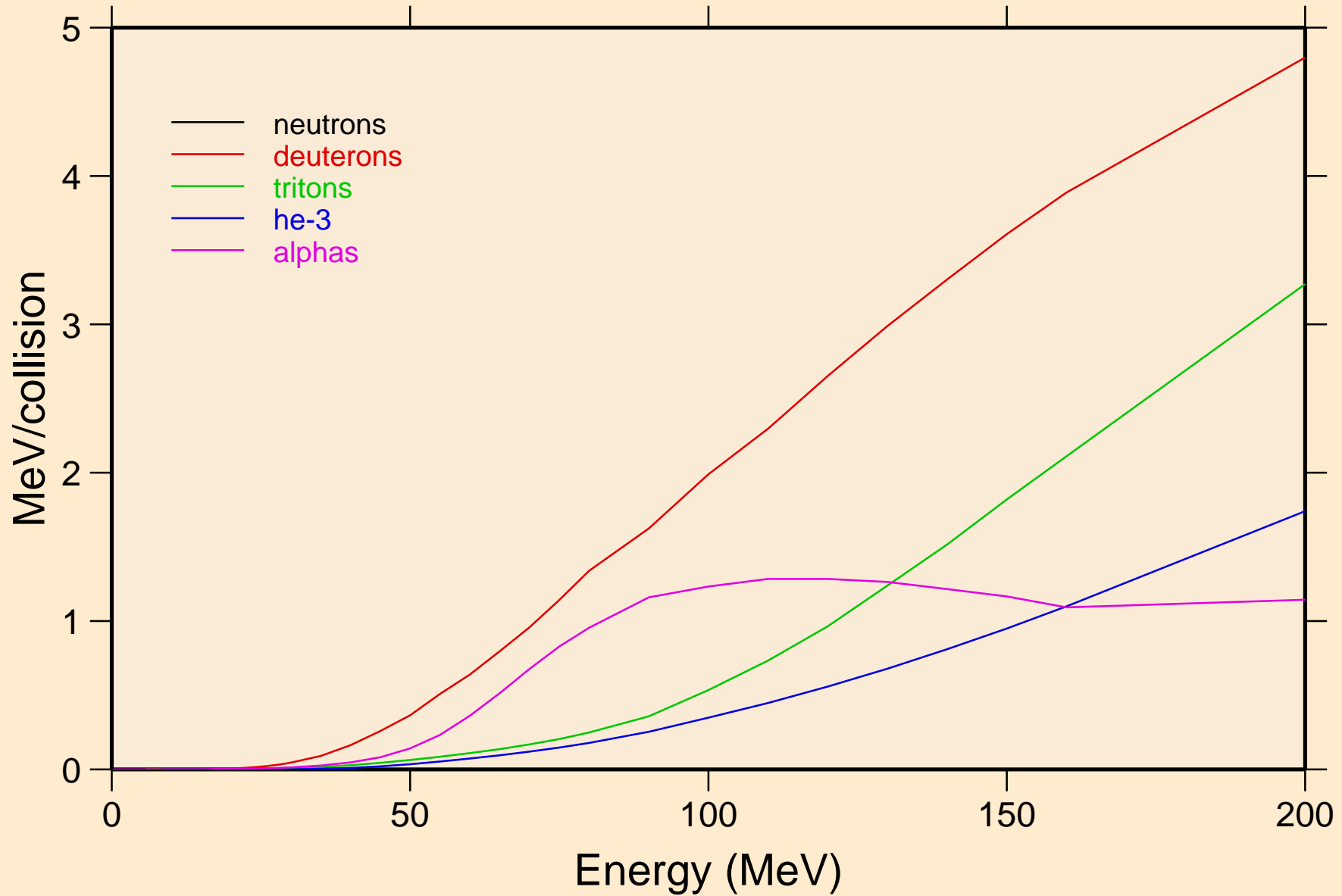

I135 PROTON ACER TENDL-2023 LIBRARY; T=0.K  
Recoil Heating

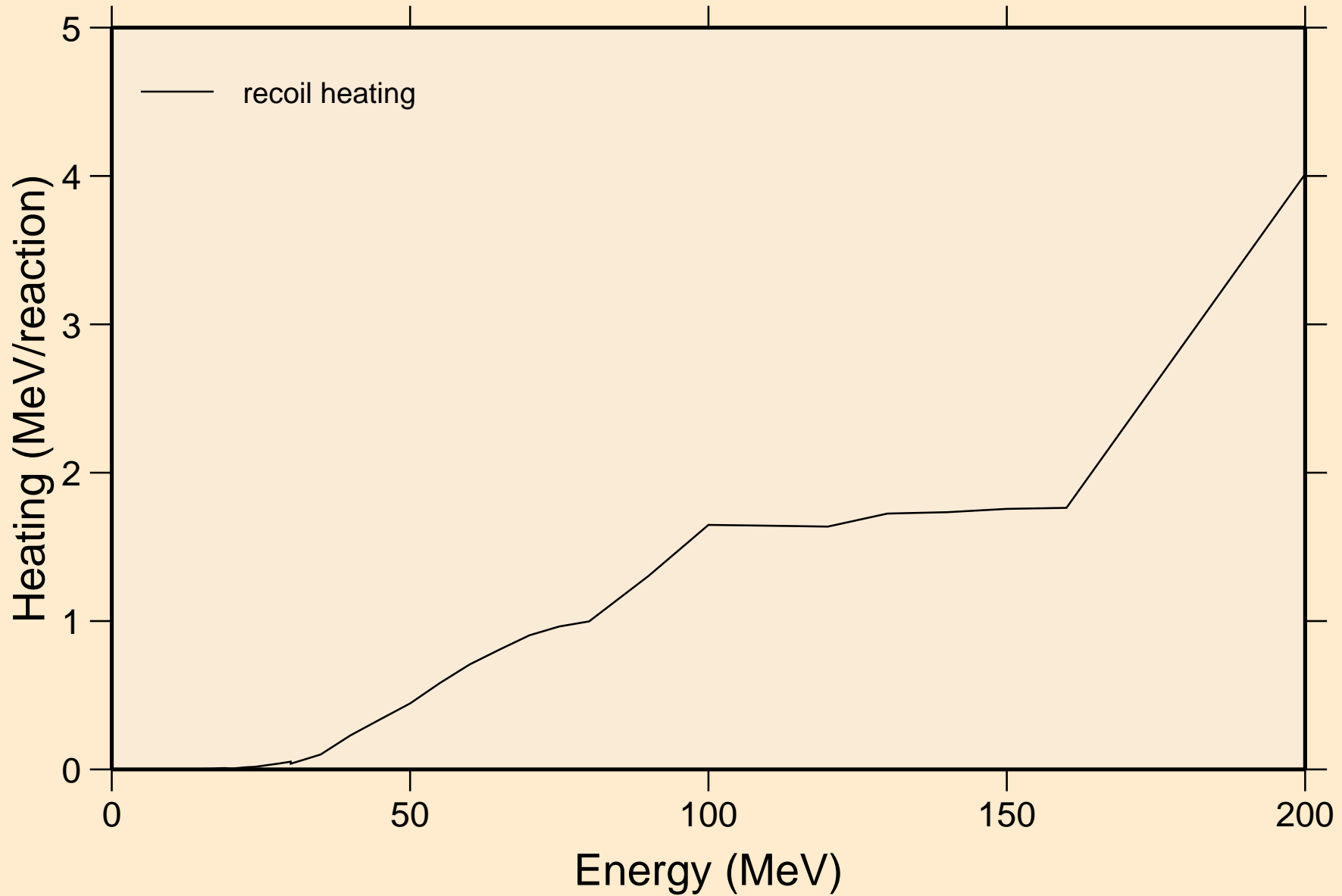

# I135 PROTON ACER TENDL-2023 LIBRARY; T=0.K

## Particle production cross sections

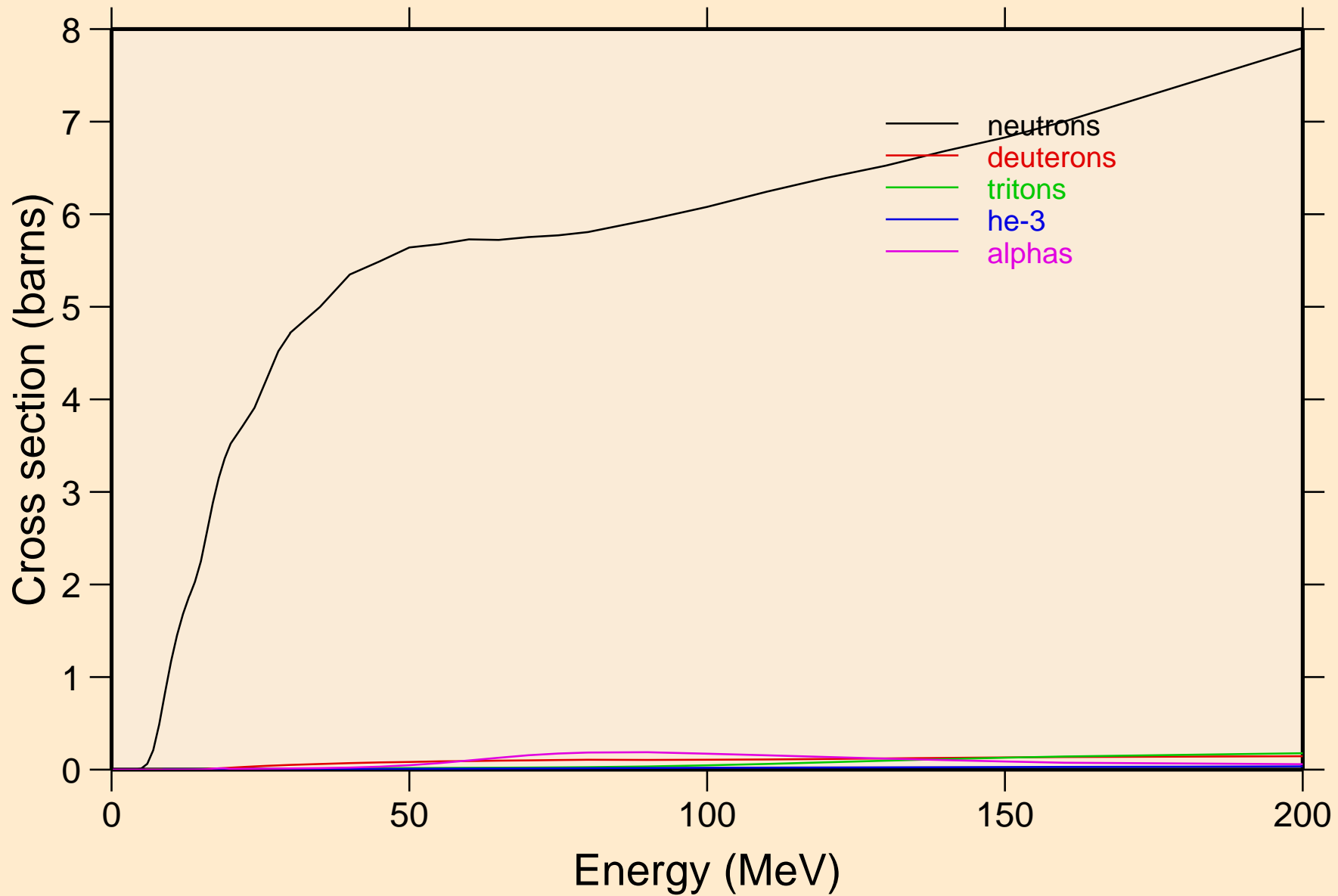

I135 PROTON ACER TENDL-2023 LIBRARY; T=0.K  
neutrons from (p,n)

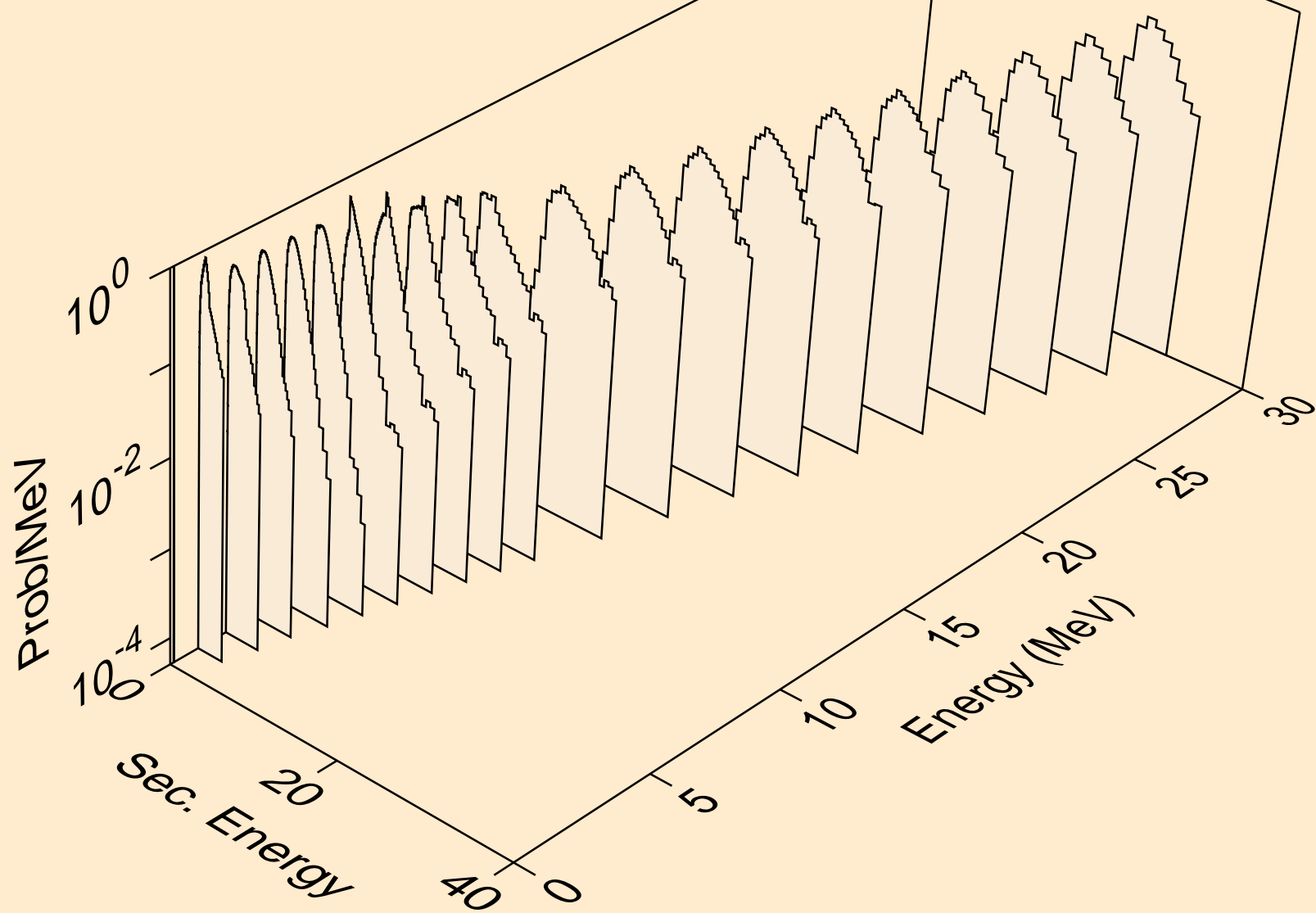

I135 PROTON ACER TENDL-2023 LIBRARY; T=0.K  
neutrons from (p,x)

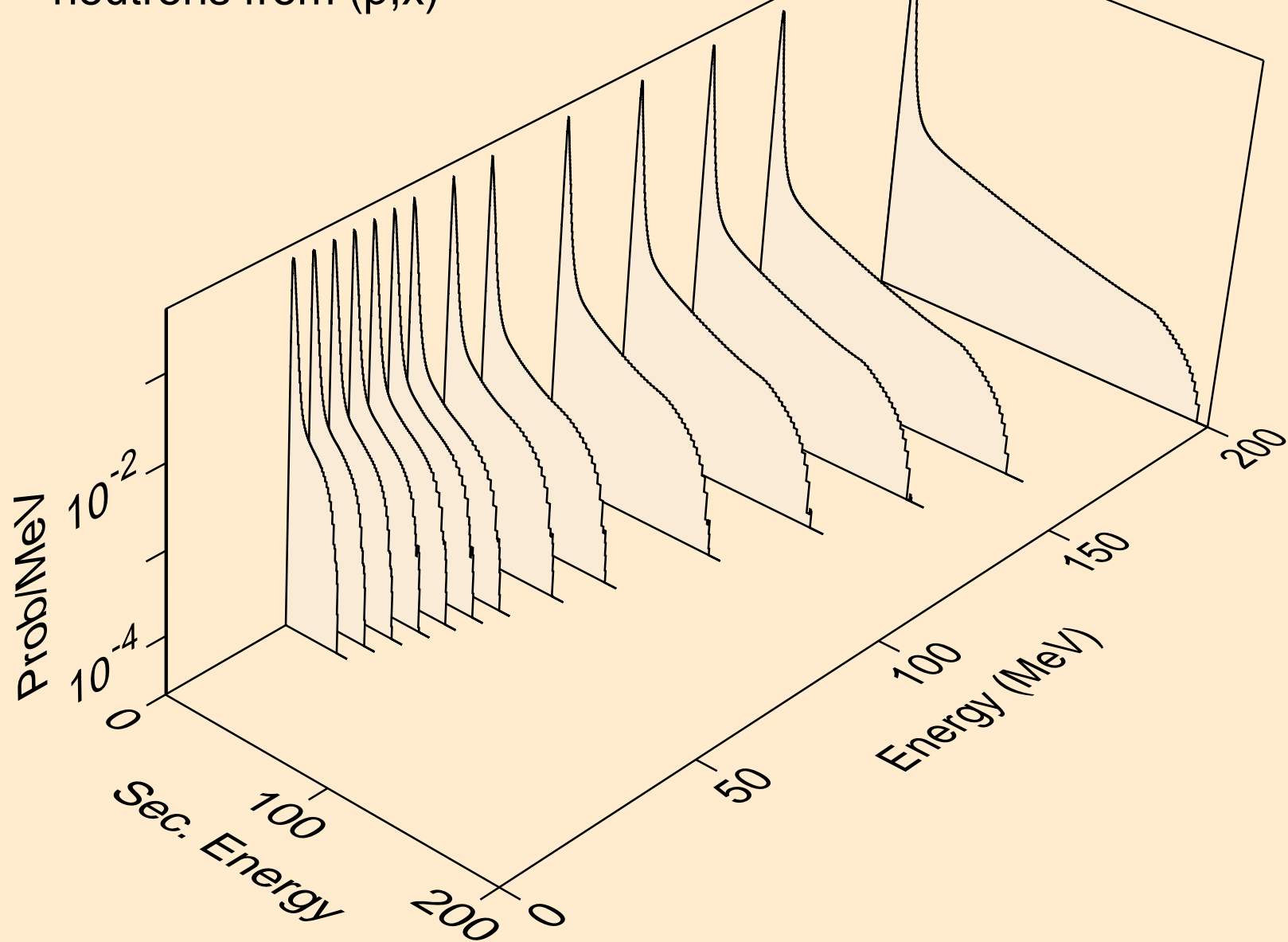

I135 PROTON ACER TENDL-2023 LIBRARY; T=0.K  
neutrons from (p,2nd)

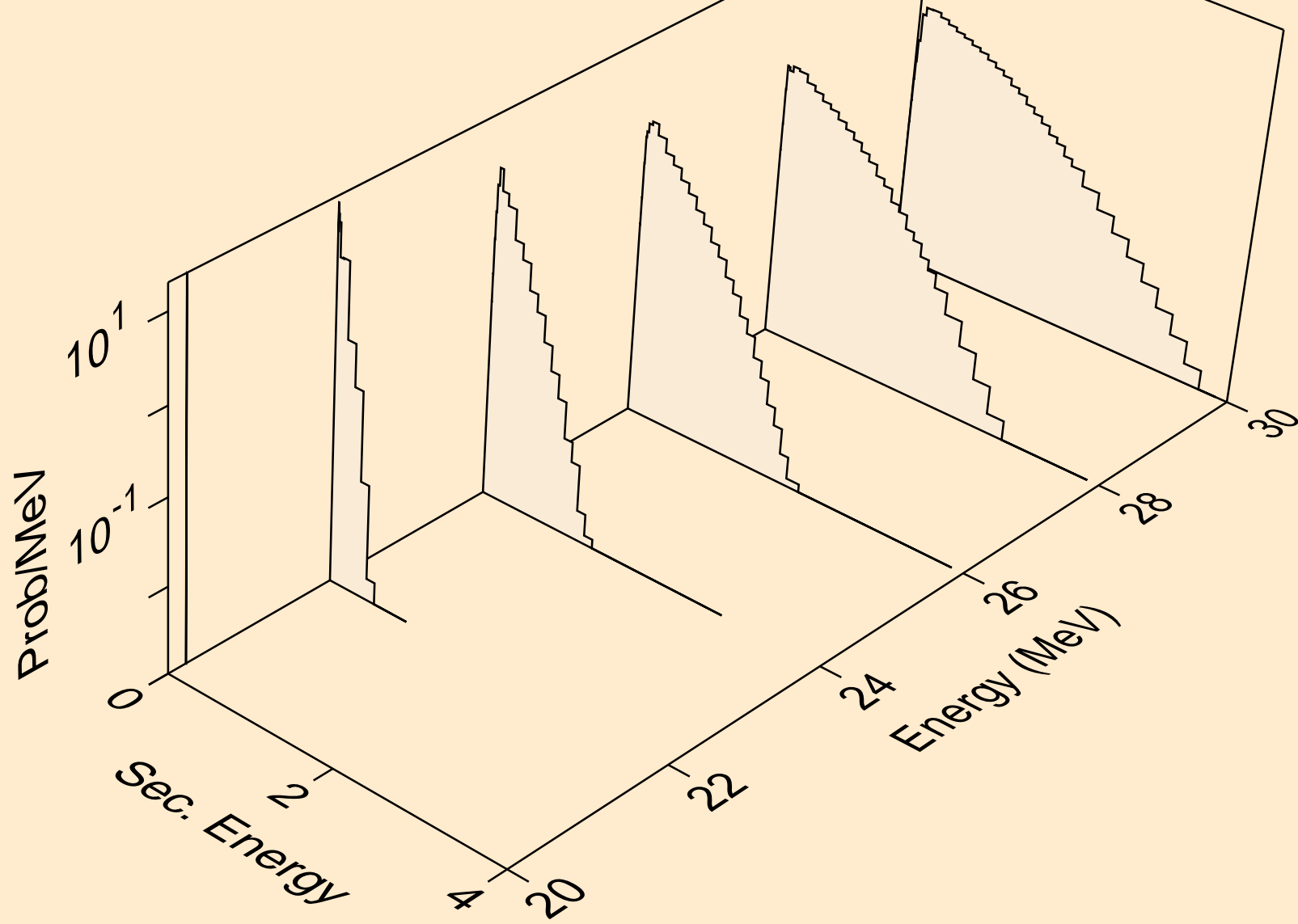

I135 PROTON ACER TENDL-2023 LIBRARY; T=0.K  
neutrons from (p,2n)

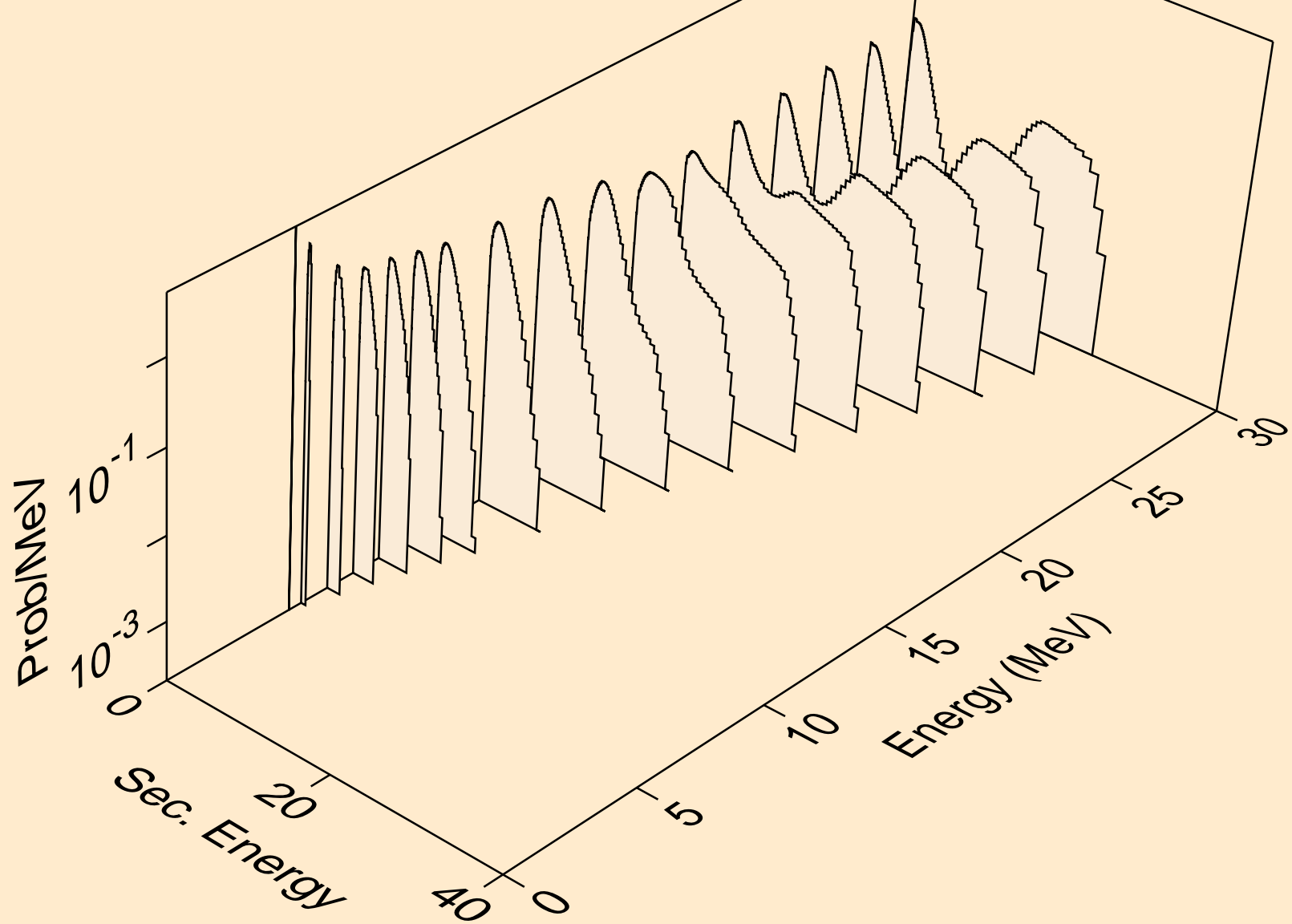

I135 PROTON ACER TENDL-2023 LIBRARY; T=0.K  
neutrons from (p,3n)

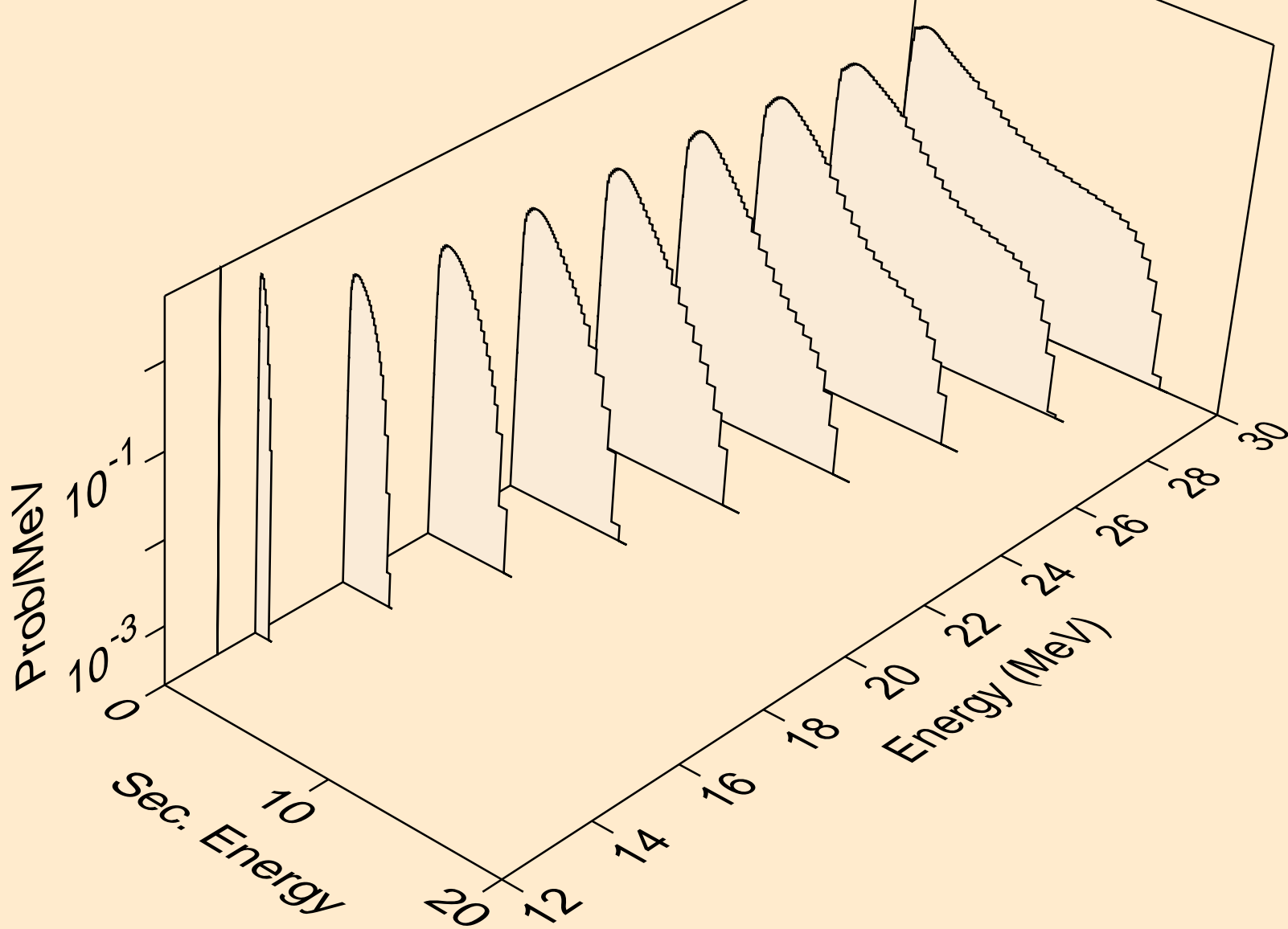



I135 PROTON ACER TENDL-2023 LIBRARY; T=0.K  
neutrons from (p,n\*)a

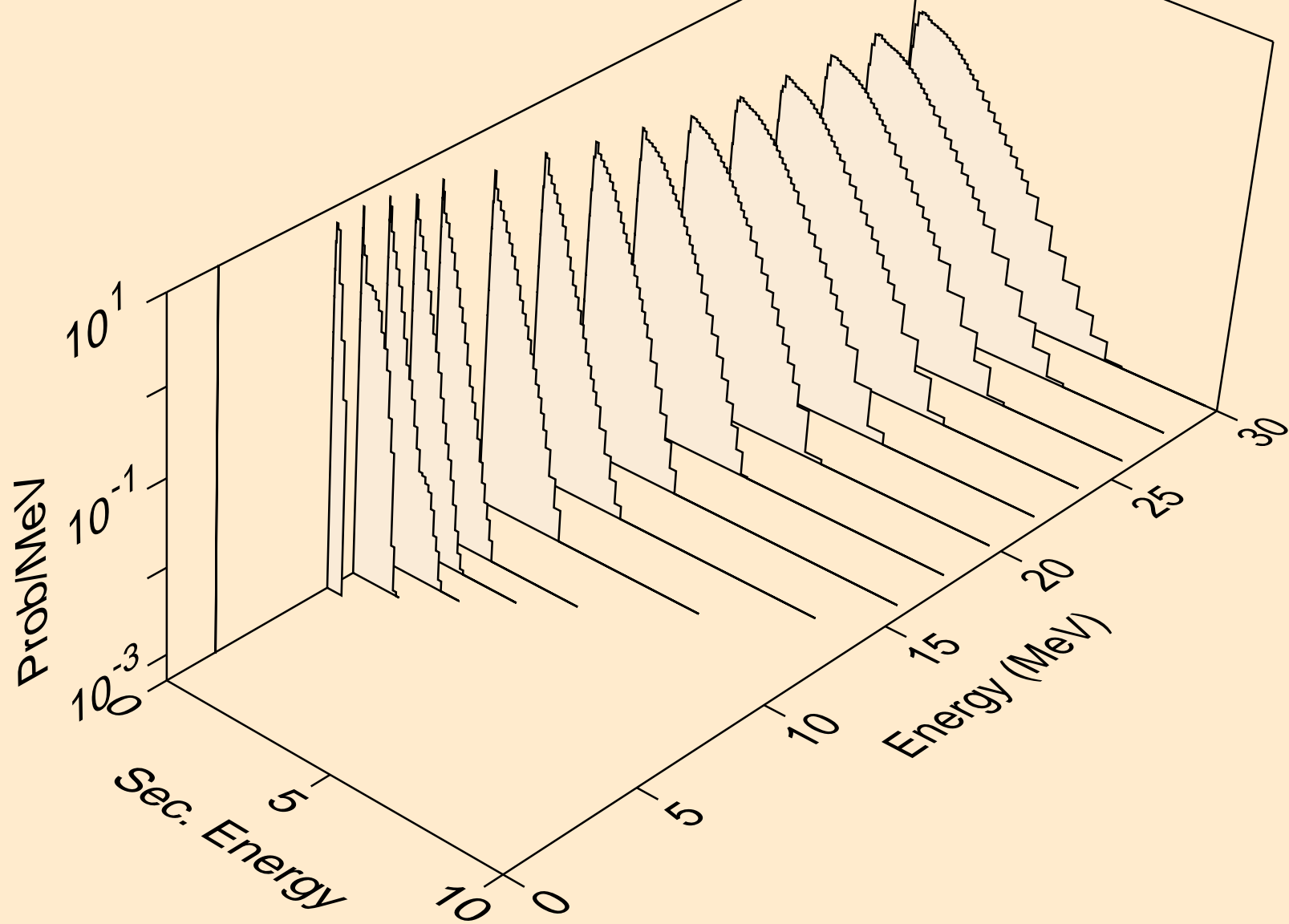

I135 PROTON ACER TENDL-2023 LIBRARY; T=0.K  
neutrons from (p,2n)a

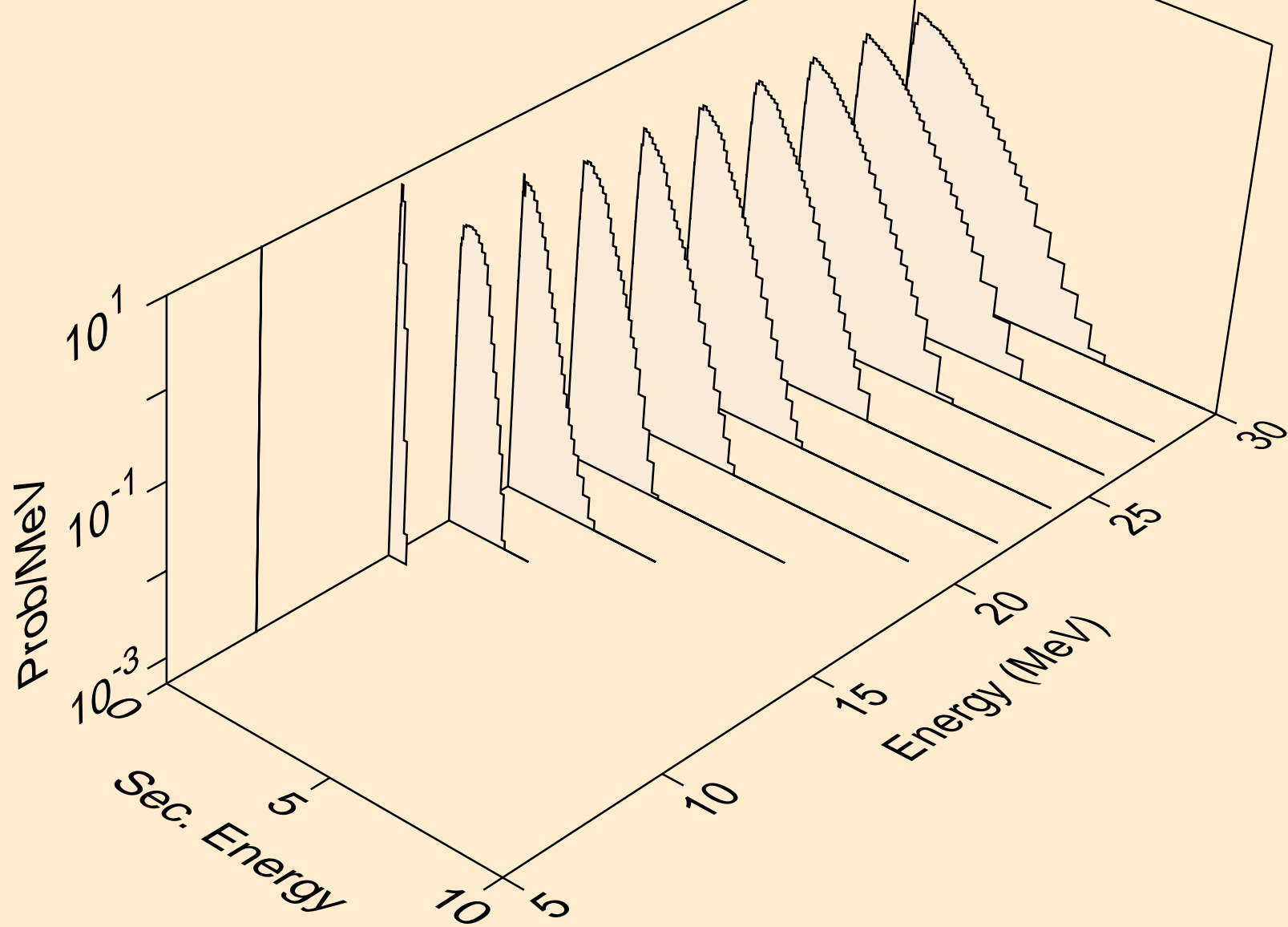

I135 PROTON ACER TENDL-2023 LIBRARY; T=0.K  
neutrons from (p,3n)a

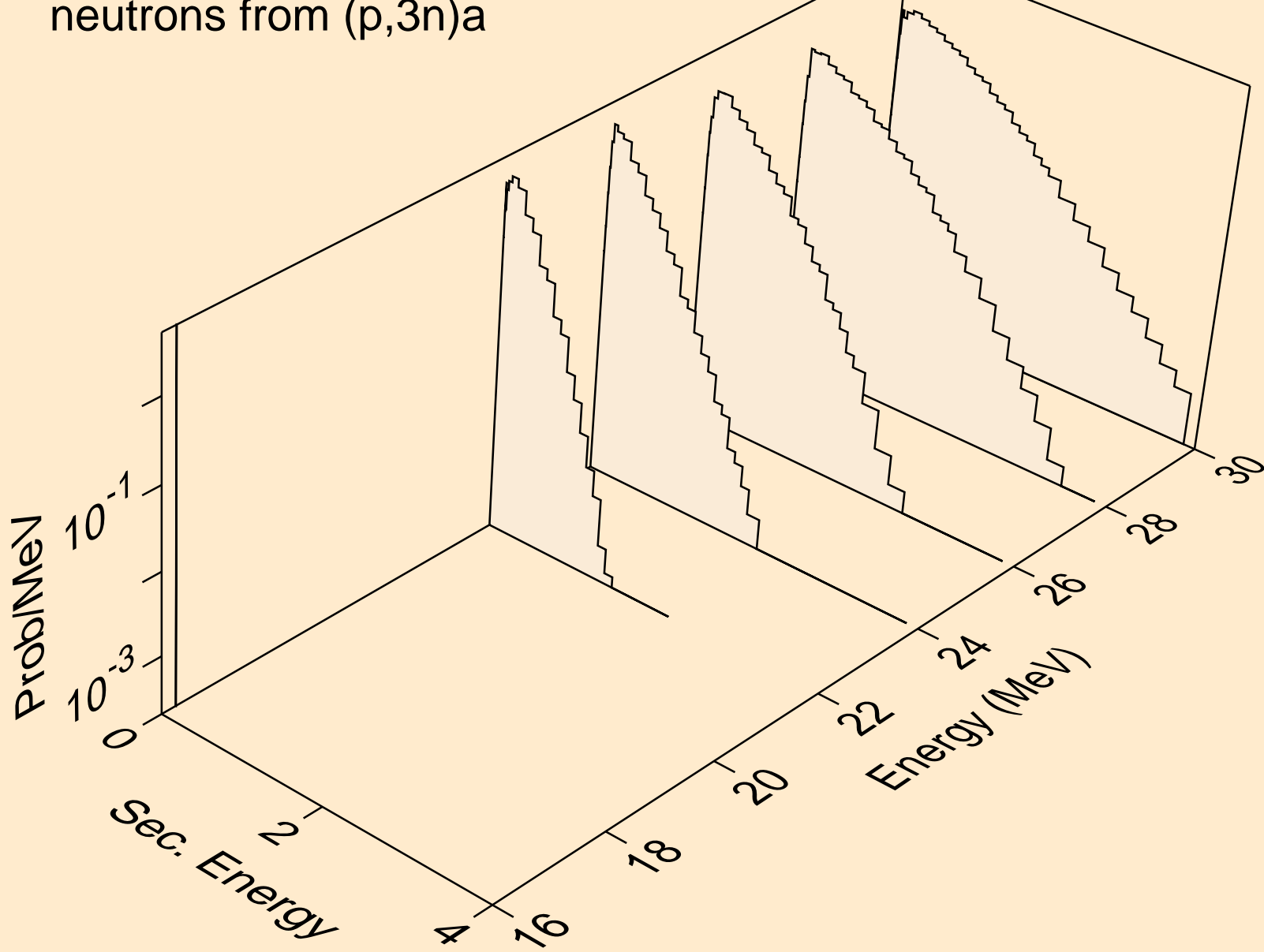

I135 PROTON ACER TENDL-2023 LIBRARY; T=0.K  
neutrons from (p,n\*)p

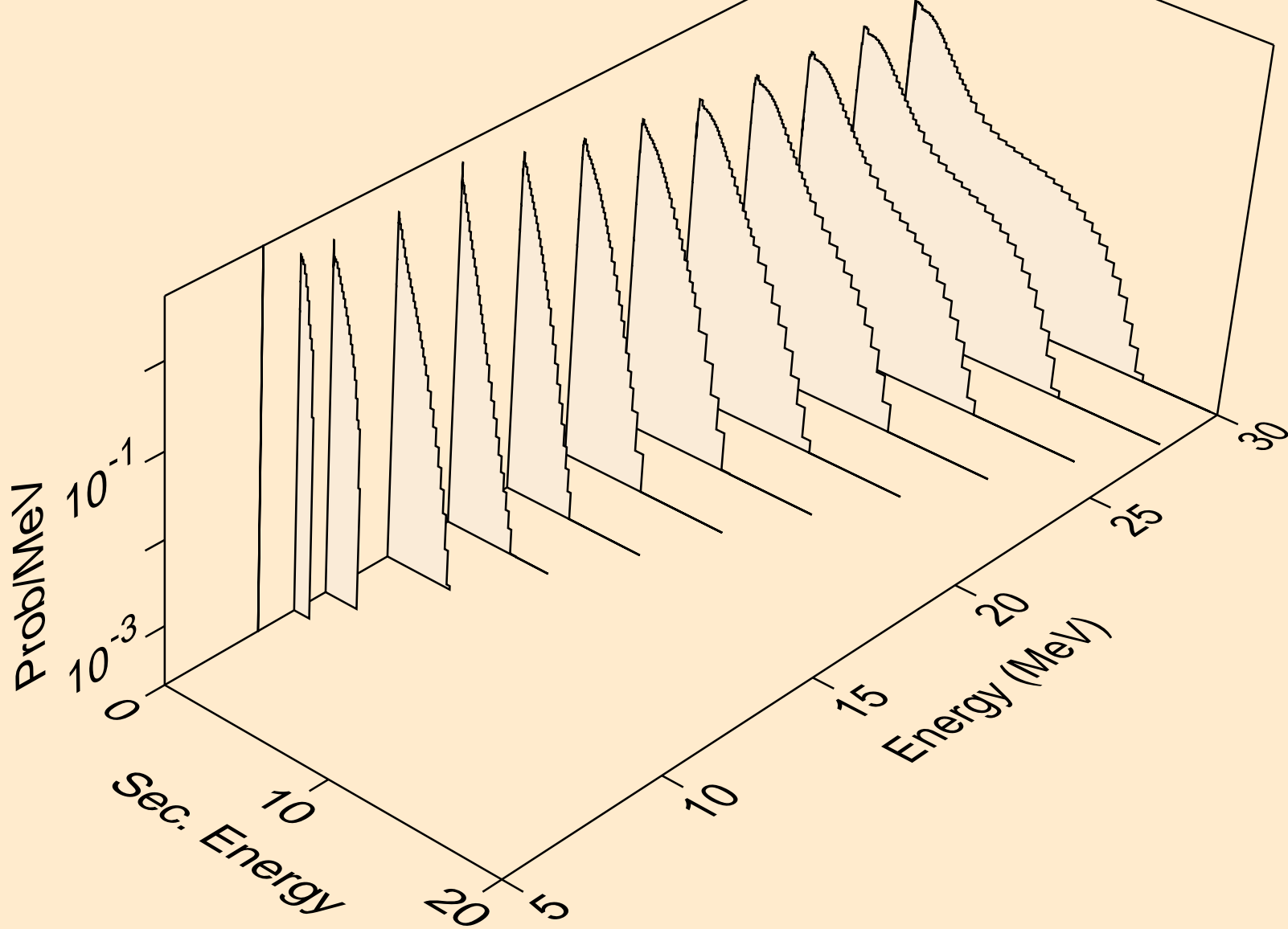

I135 PROTON ACER TENDL-2023 LIBRARY; T=0.K  
neutrons from (p,n\*)d

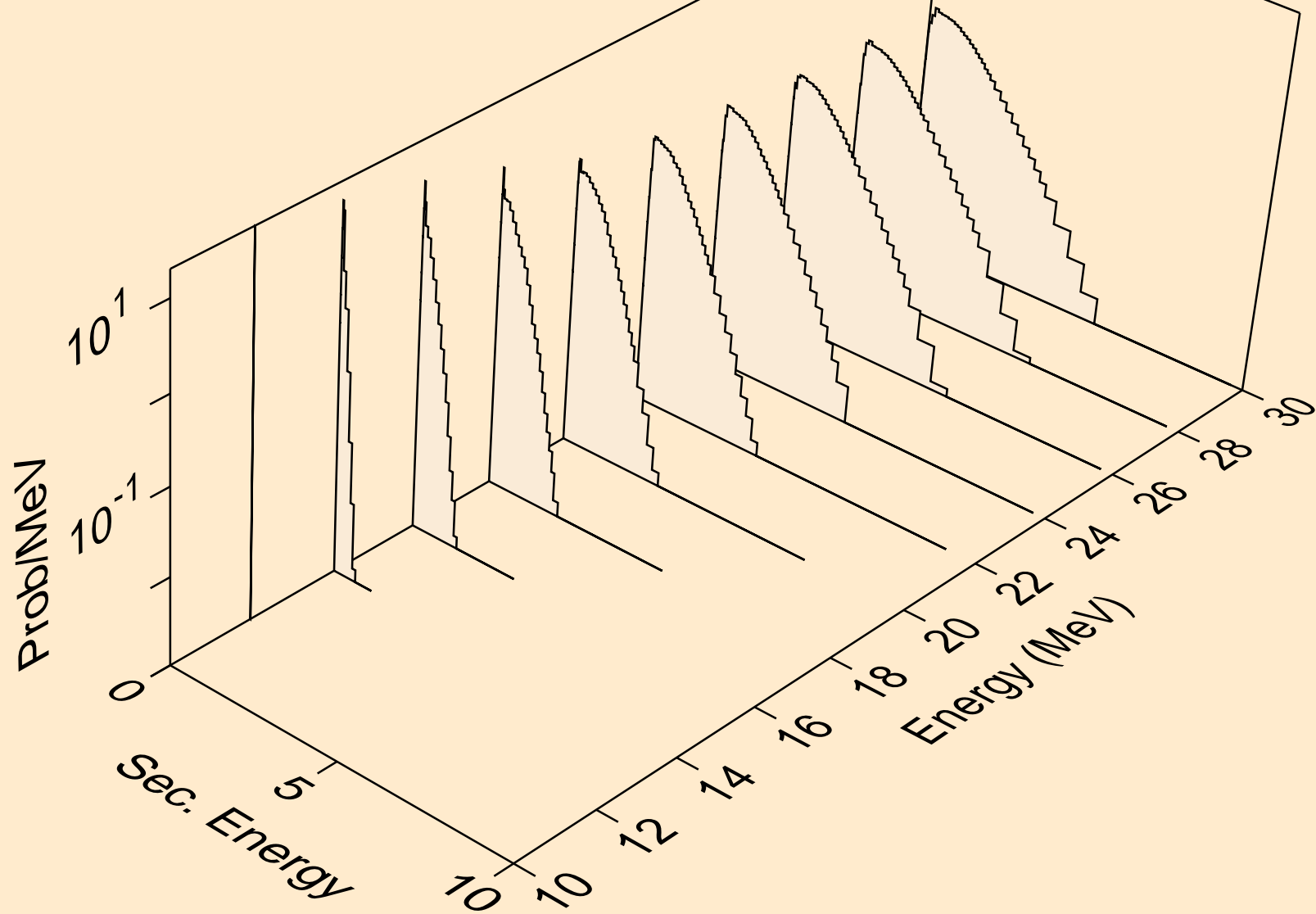

I135 PROTON ACER TENDL-2023 LIBRARY; T=0.K  
neutrons from (p,n\*)t

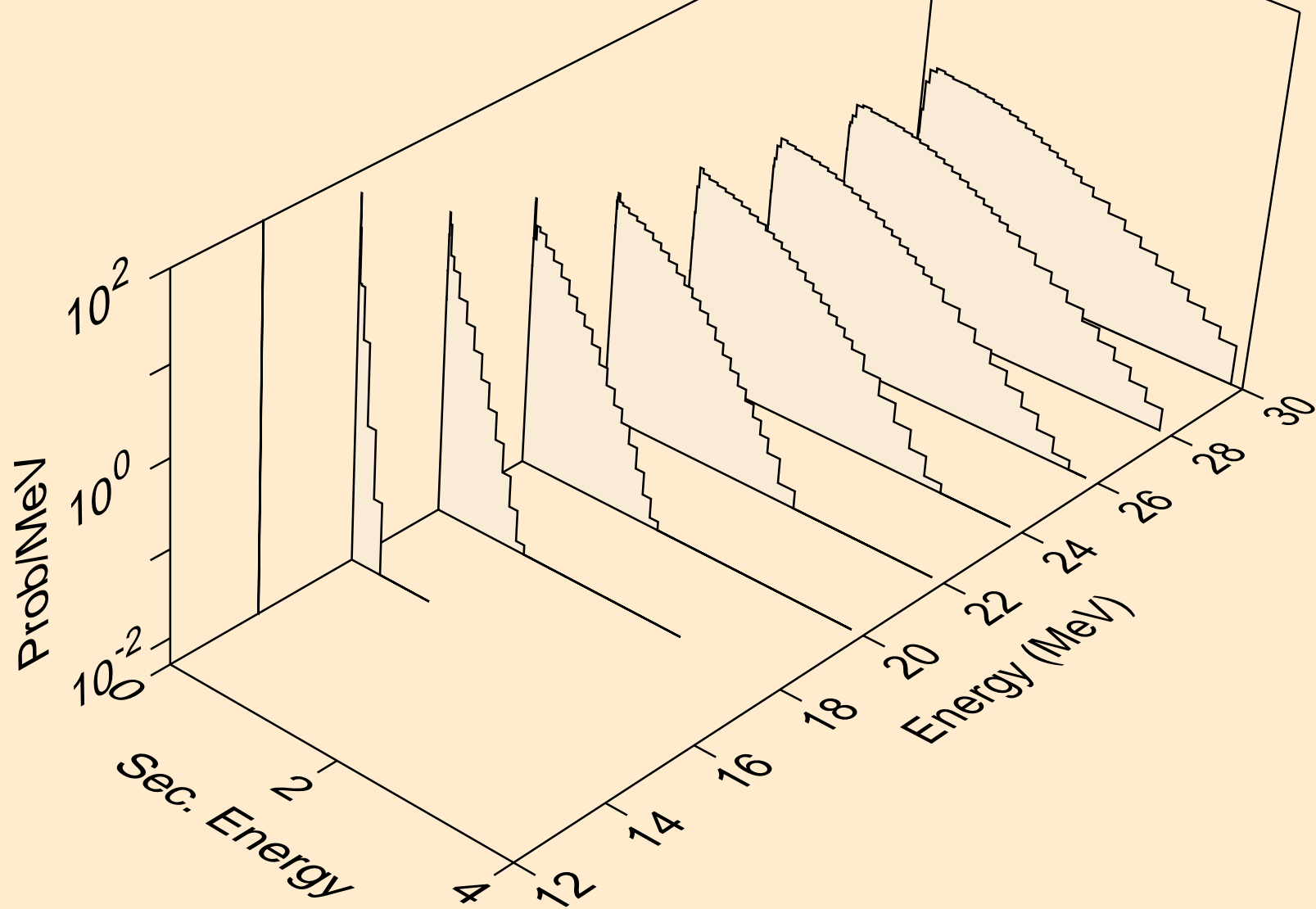

I135 PROTON ACER TENDL-2023 LIBRARY; T=0.K  
neutrons from (p,n\*)he3

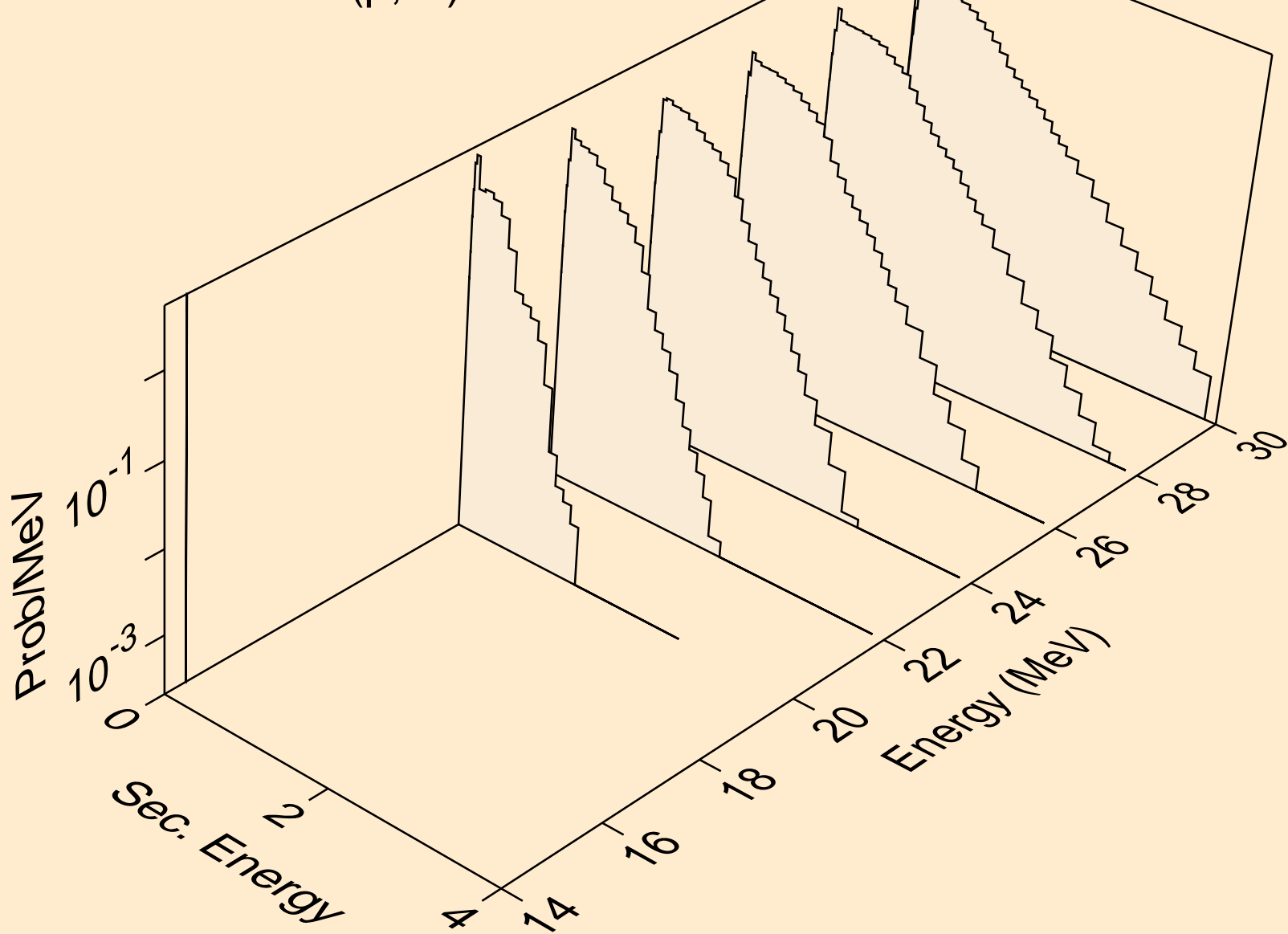

I135 PROTON ACER TENDL-2023 LIBRARY; T=0.K  
neutrons from (p,4n)

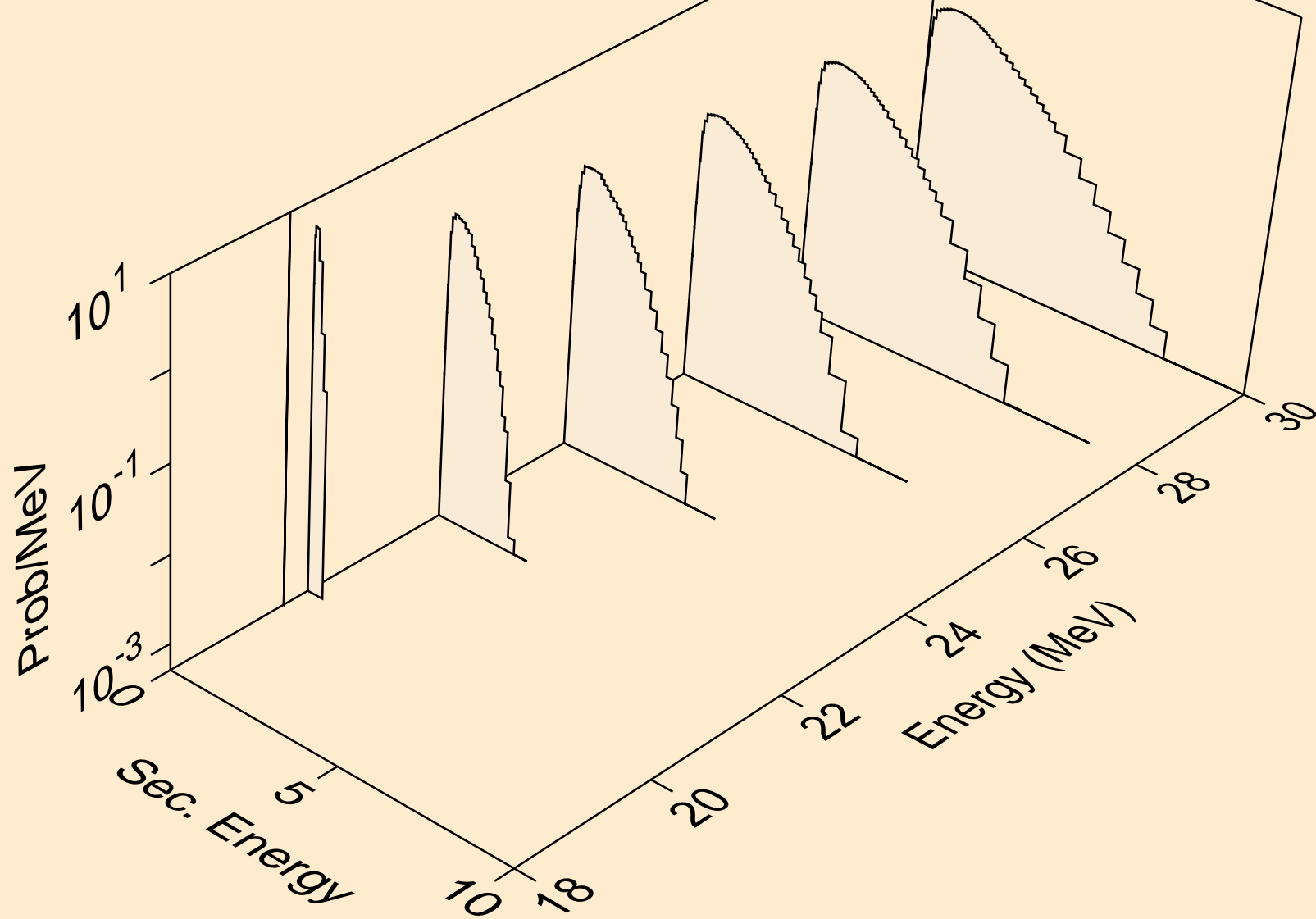



I135 PROTON ACER TENDL-2023 LIBRARY; T=0.K  
neutrons from (p,2np)

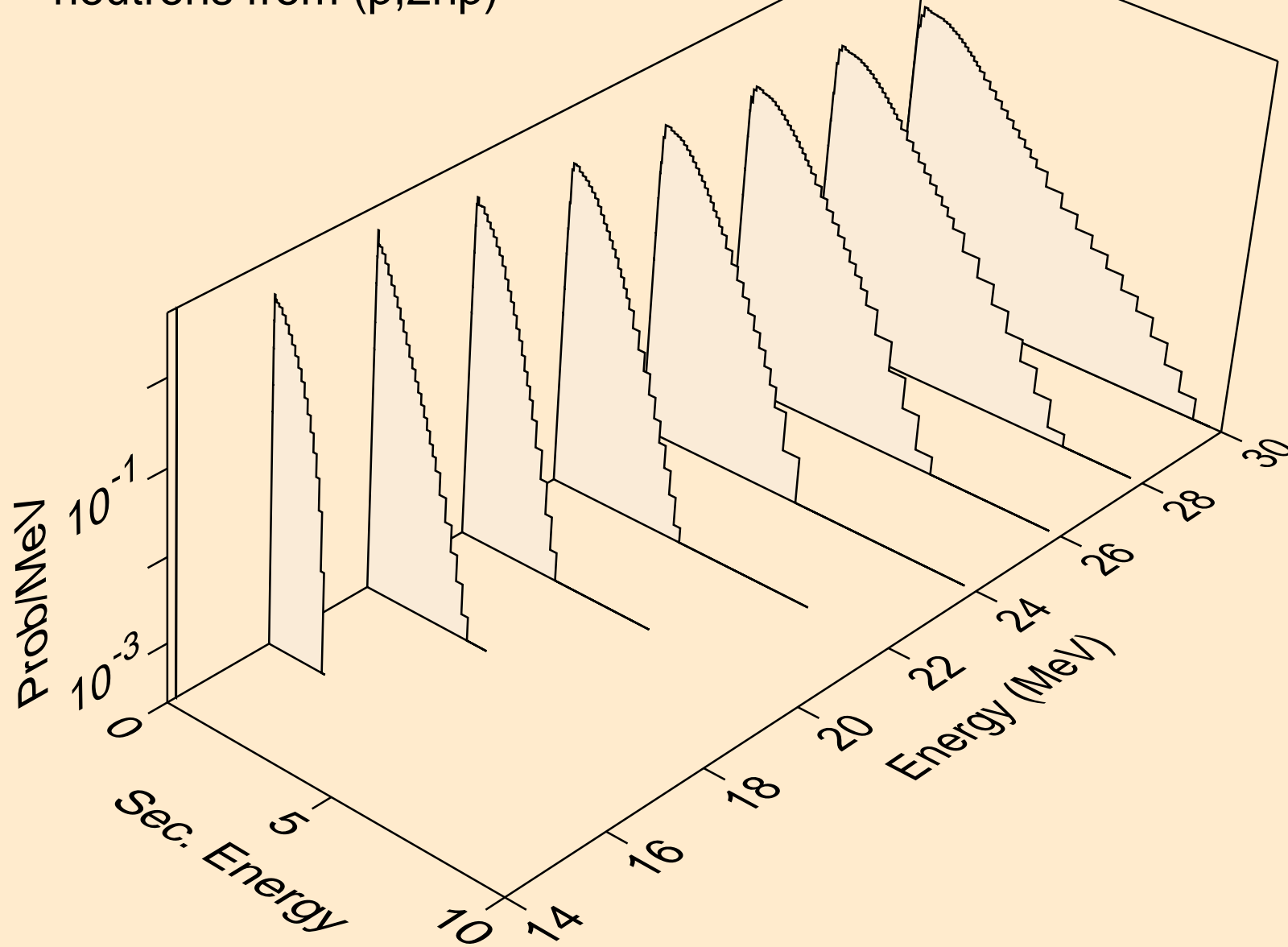

I135 PROTON ACER TENDL-2023 LIBRARY; T=0.K  
neutrons from (p,3np)

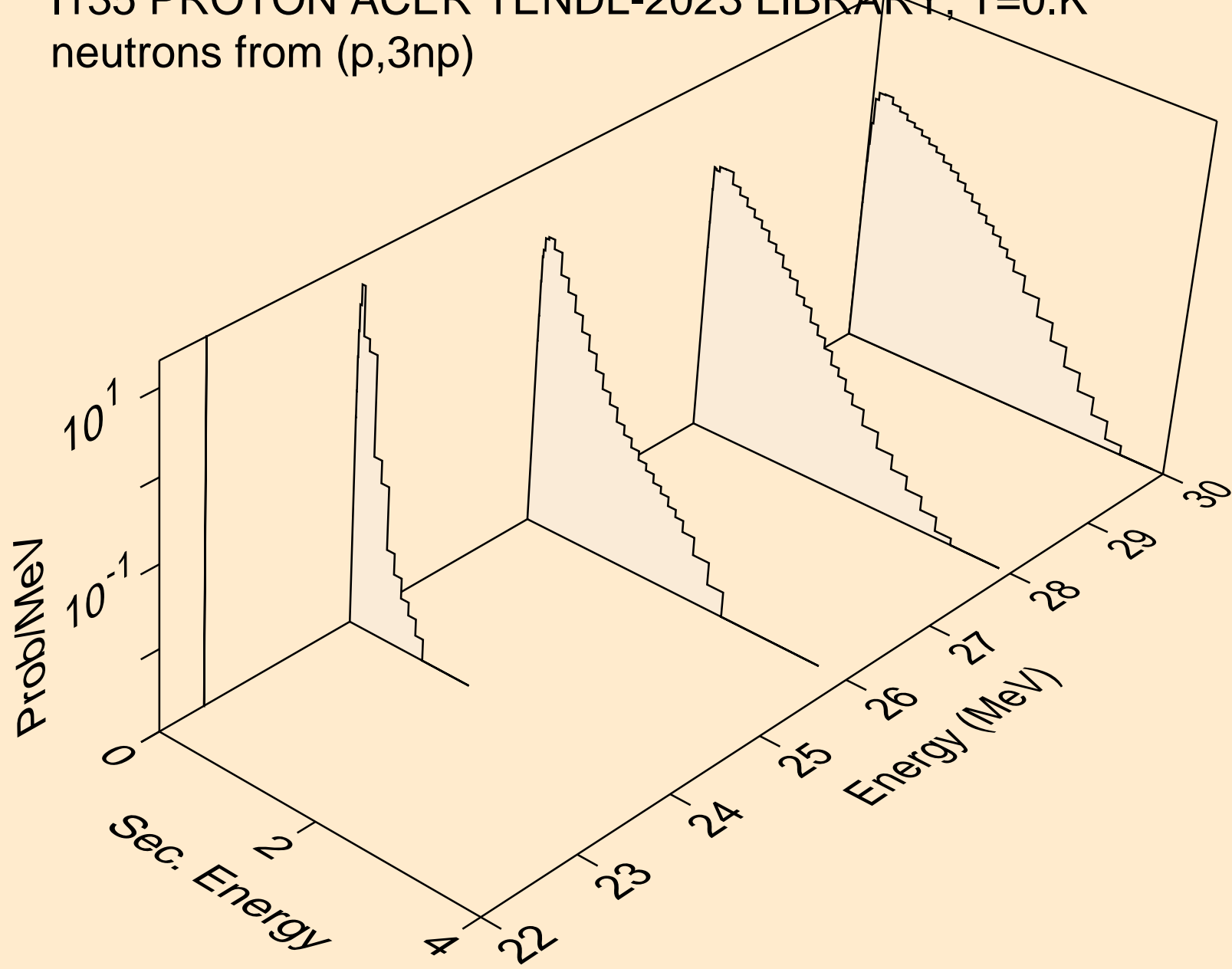

I135 PROTON ACER TENDL-2023 LIBRARY; T=0.K  
neutrons from (p,n2p)

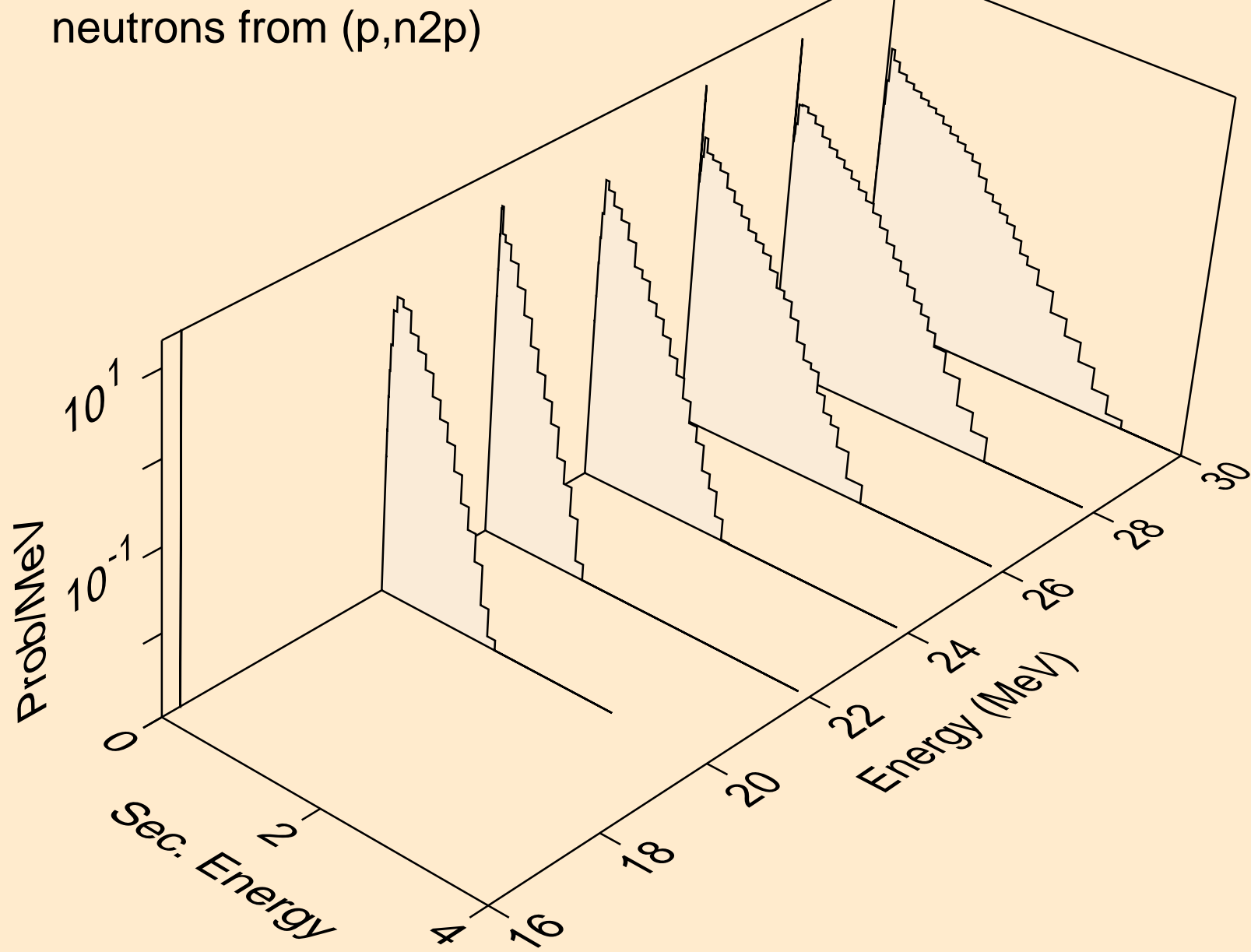

I135 PROTON ACER TENDL-2023 LIBRARY; T=0.K  
neutrons from (p,npa)

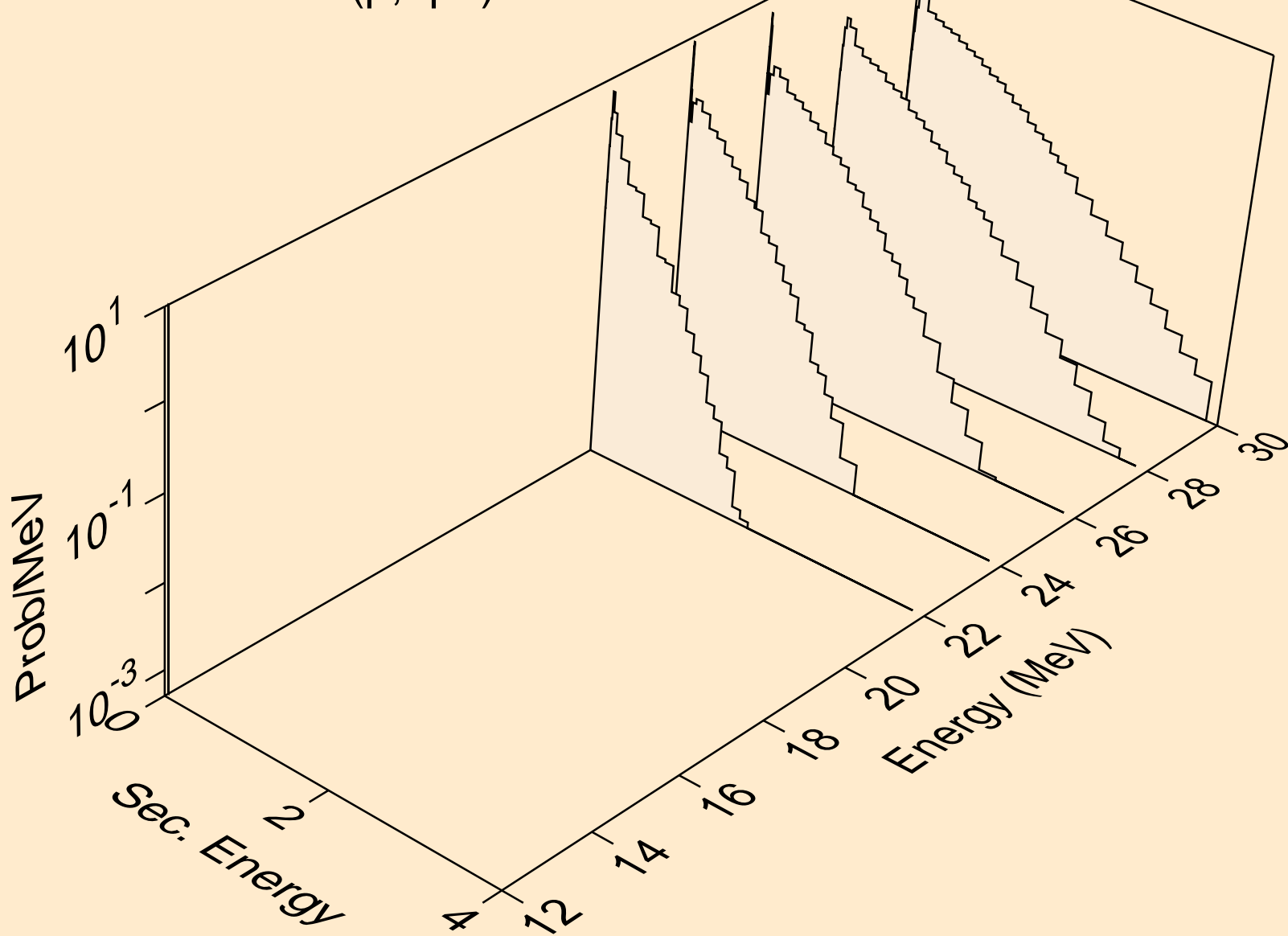

I135 PROTON ACER TENDL-2023 LIBRARY; T=0.K  
deuterons from (p,x)

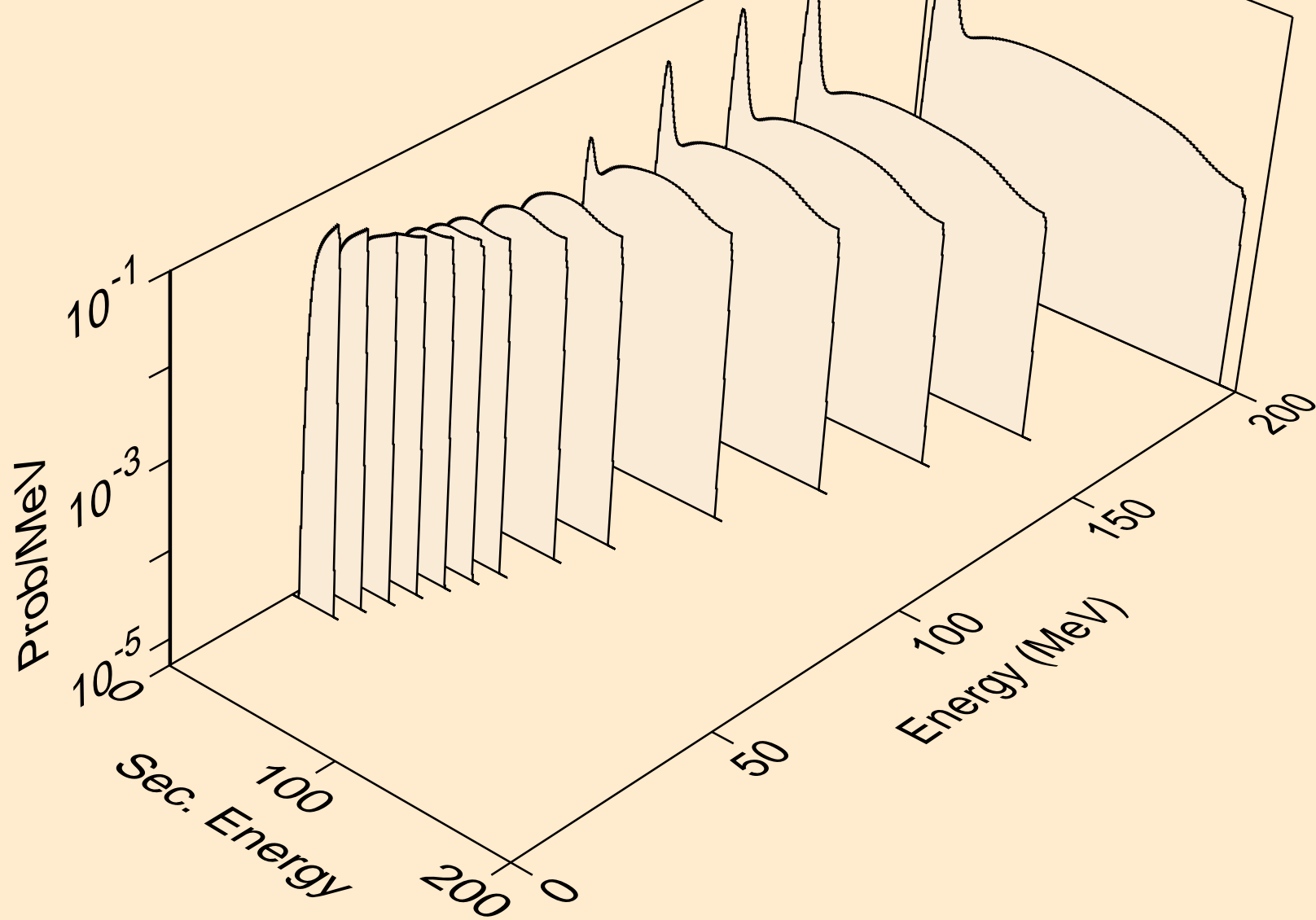

I135 PROTON ACER TENDL-2023 LIBRARY; T=0.K  
deuterons from (p,2nd)

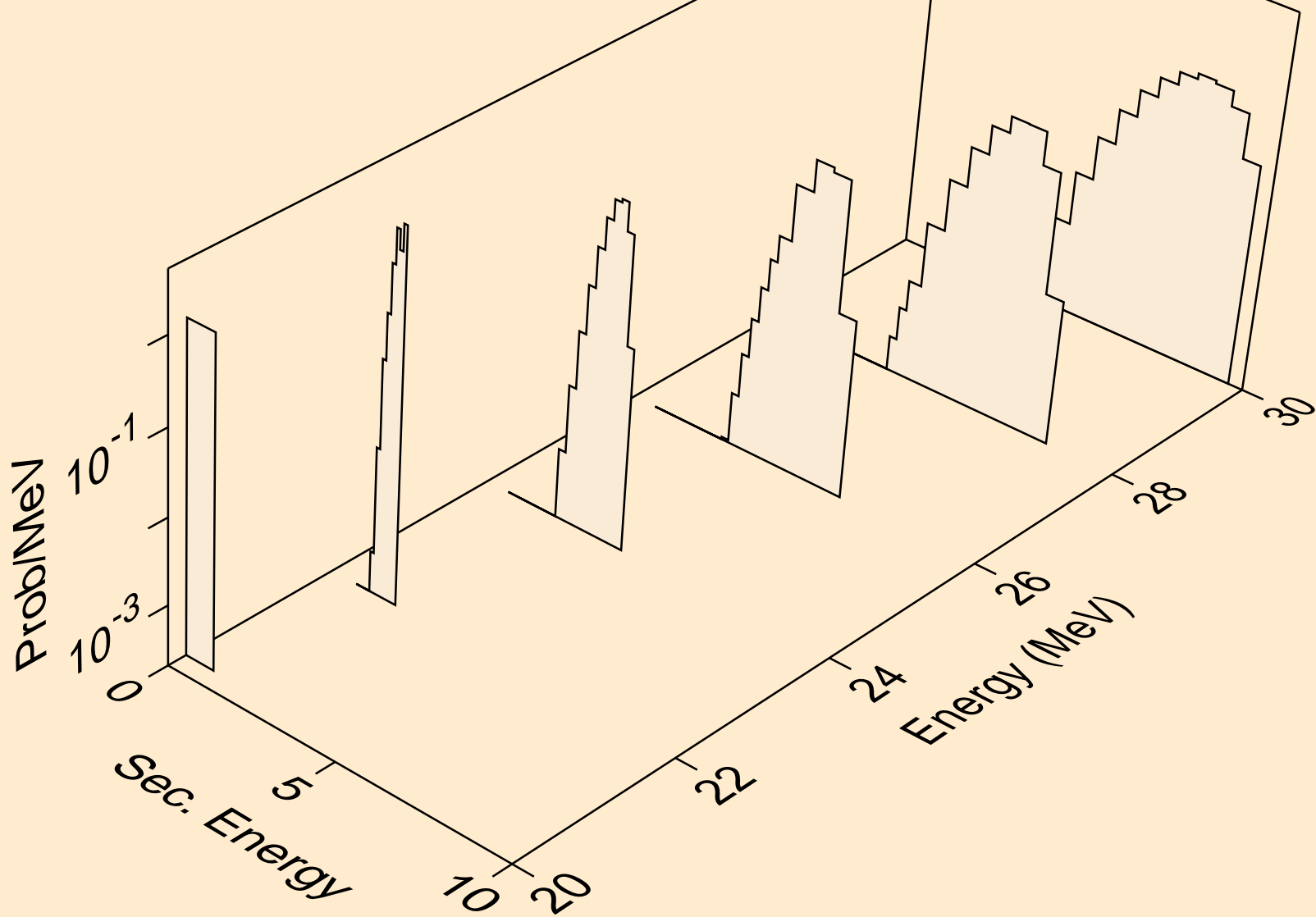

I135 PROTON ACER TENDL-2023 LIBRARY; T=0.K  
deuterons from (p,n\*)d

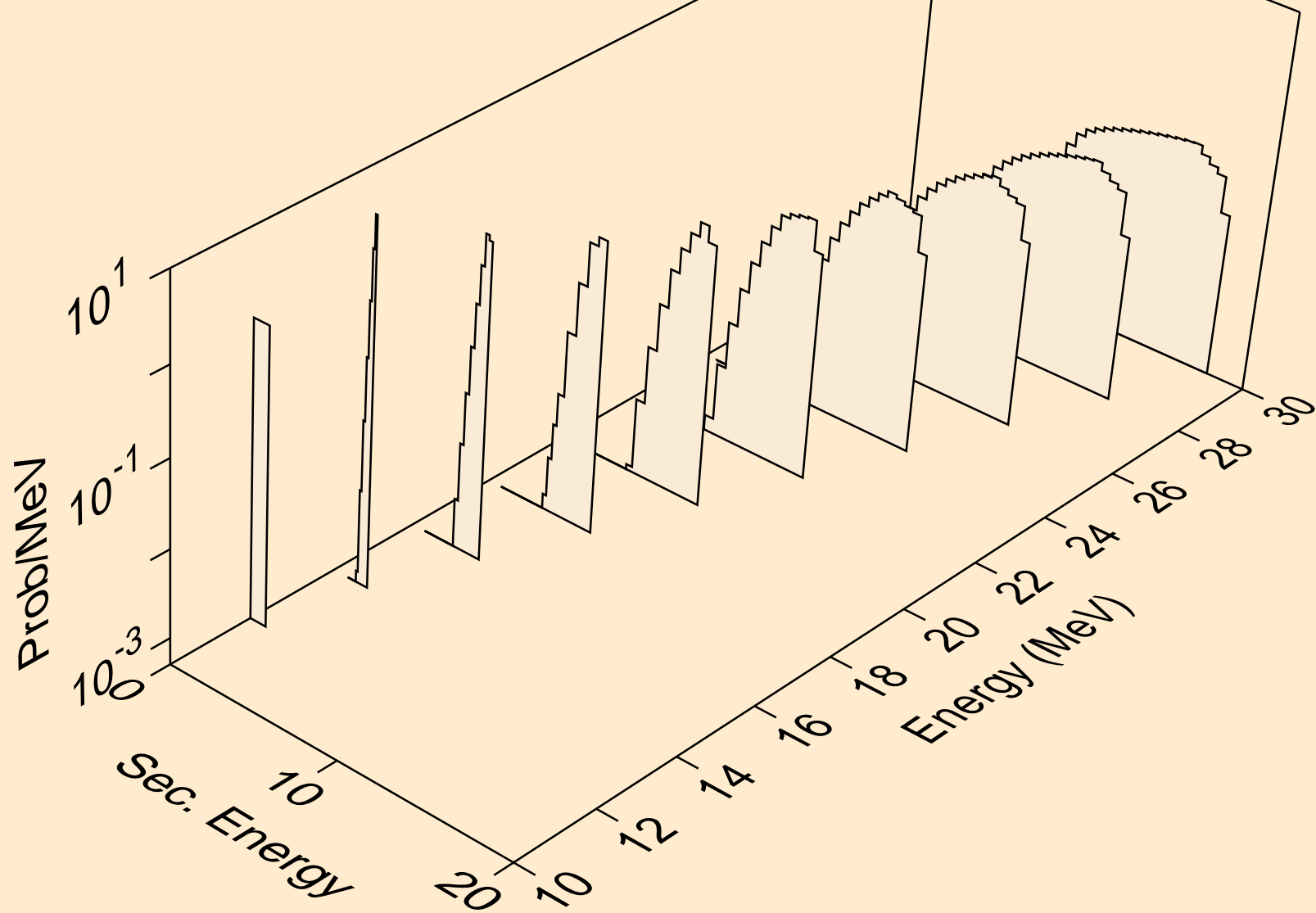

I135 PROTON ACER TENDL-2023 LIBRARY; T=0.K  
deuterons from (p,d)

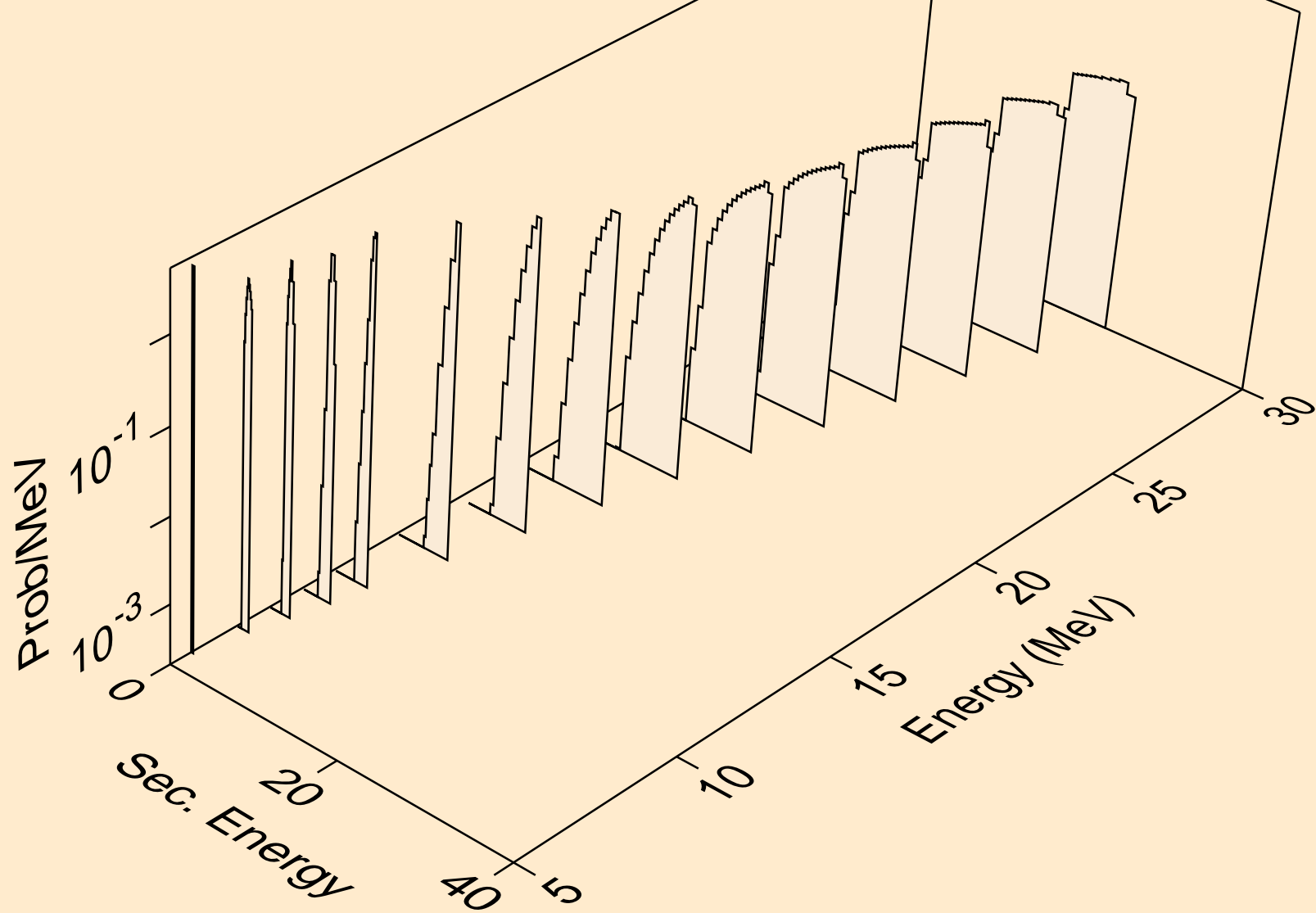



I135 PROTON ACER TENDL-2023 LIBRARY; T=0.K  
deuterons from (p,pd)

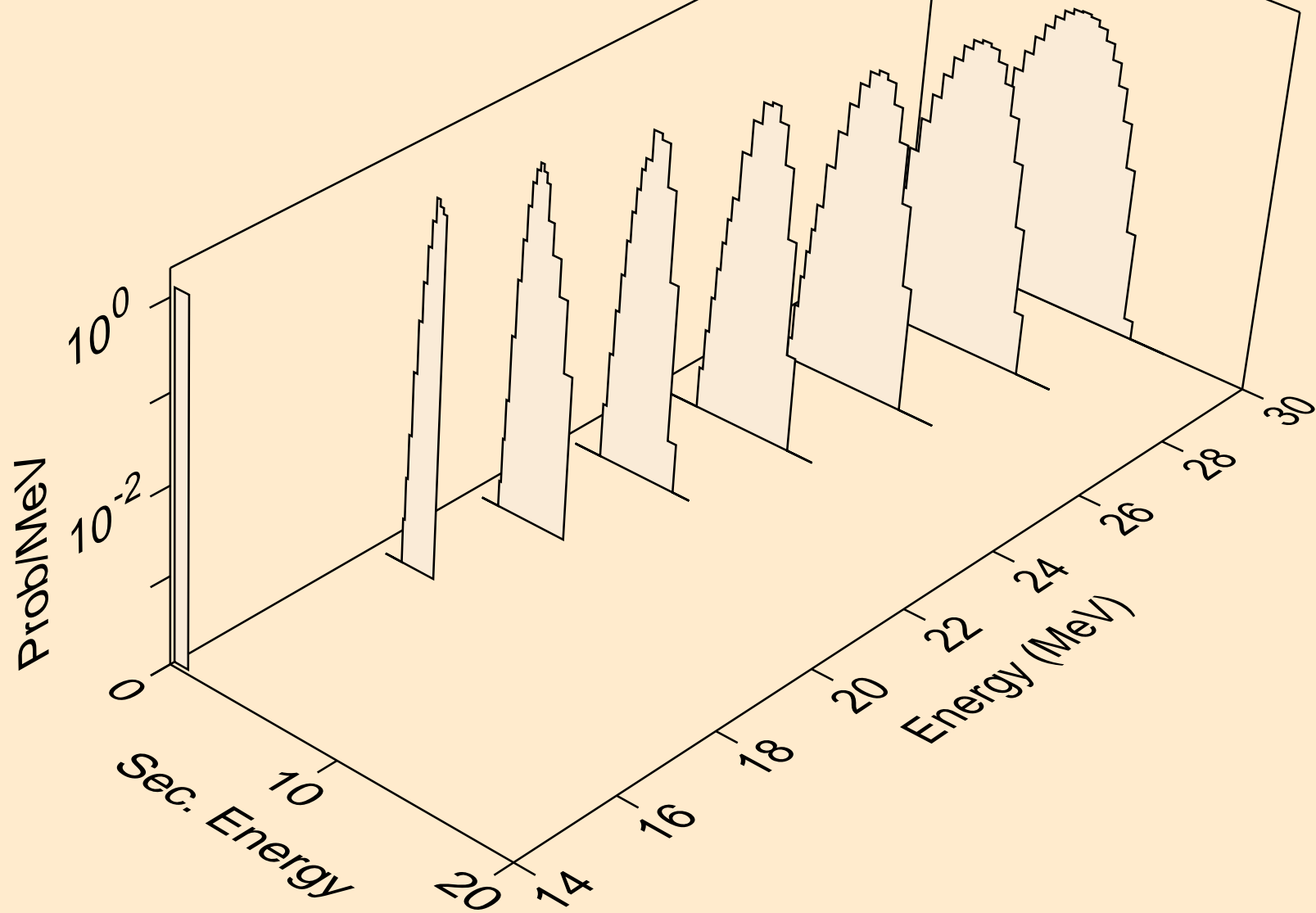

I135 PROTON ACER TENDL-2023 LIBRARY; T=0.K  
deuterons from (p,da)

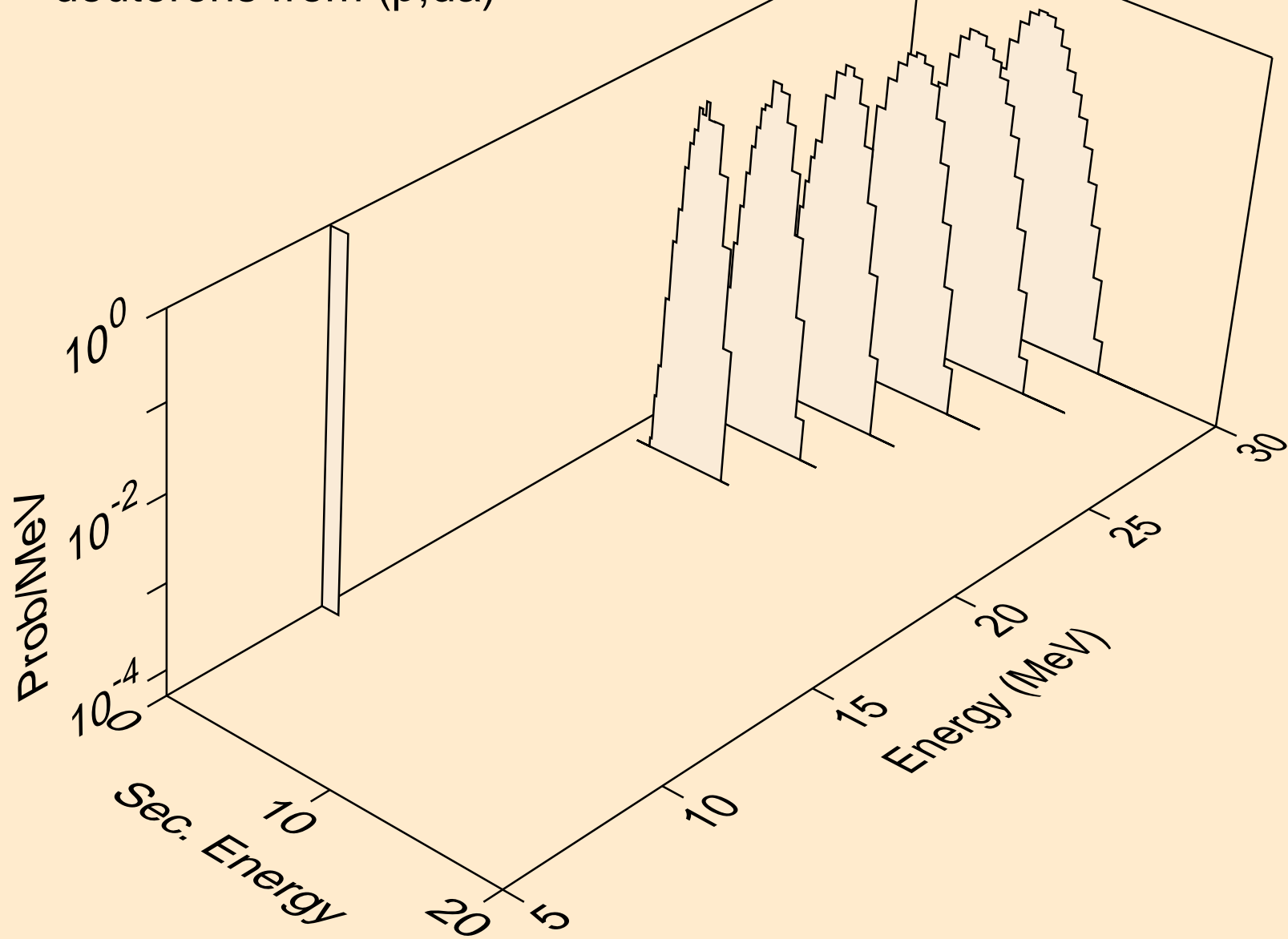

I135 PROTON ACER TENDL-2023 LIBRARY; T=0.K  
tritons from (p,x)

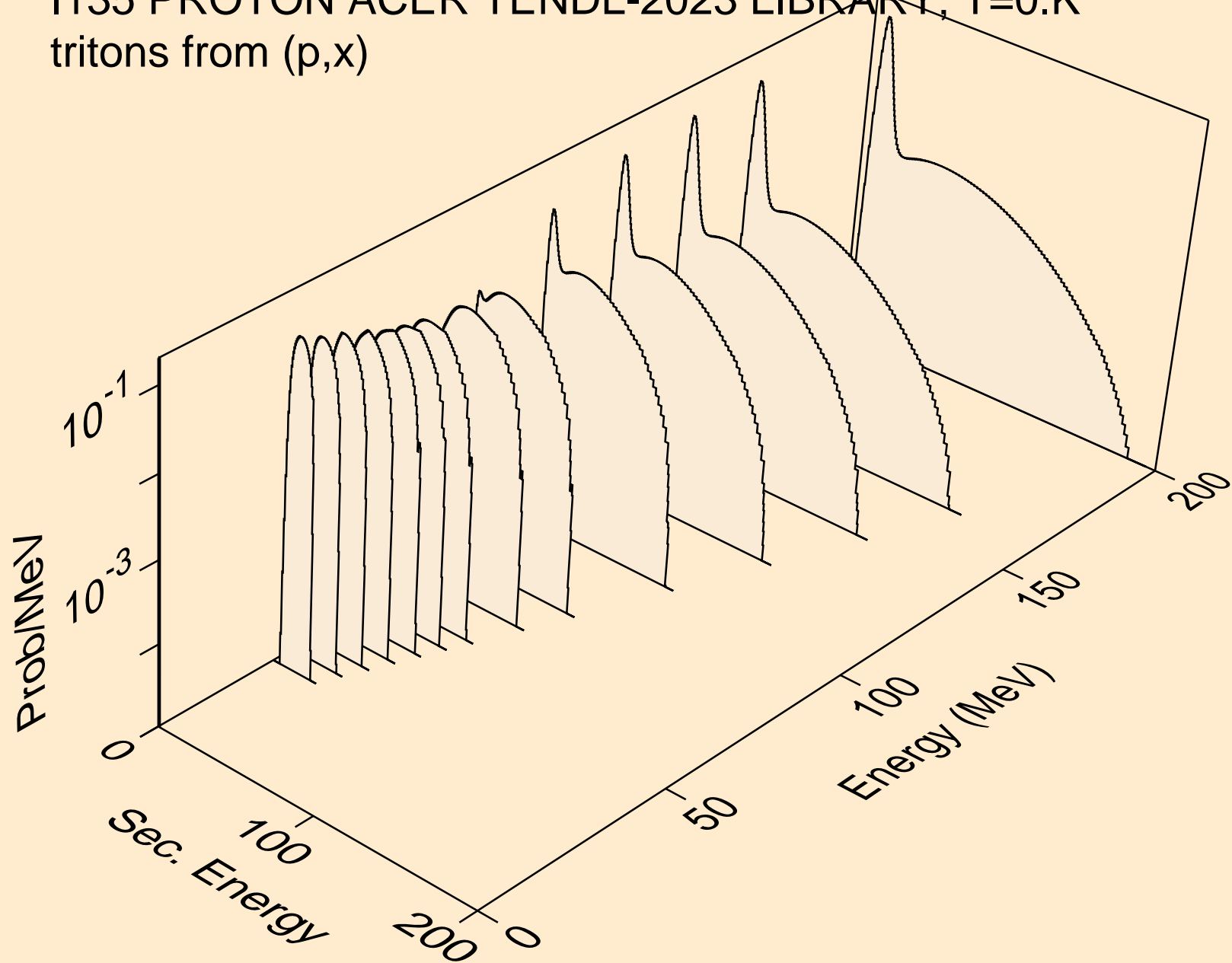

I135 PROTON ACER TENDL-2023 LIBRARY; T=0.K  
tritons from (p,n\*)t

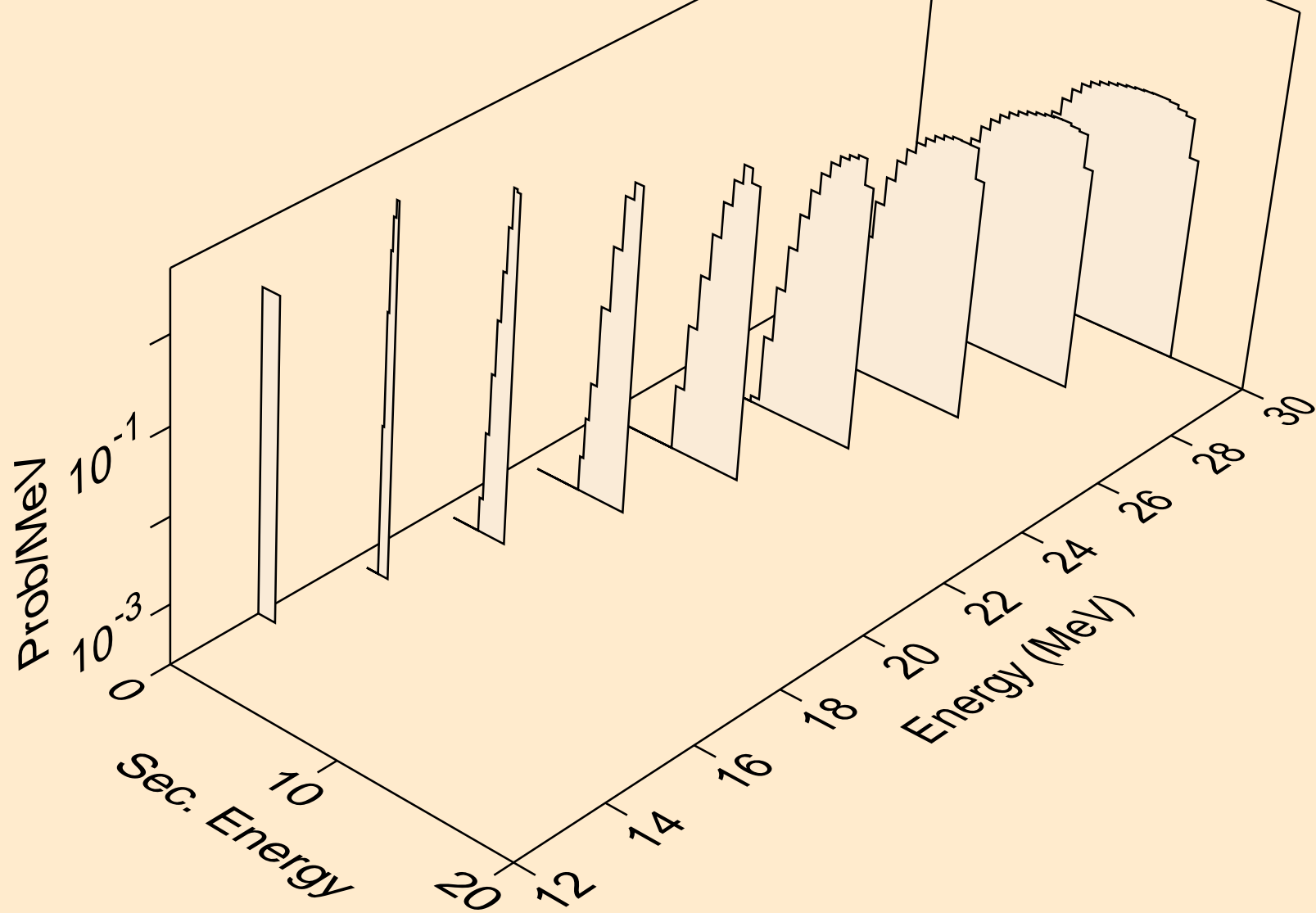

I135 PROTON ACER TENDL-2023 LIBRARY; T=0.K  
tritons from (p,t)

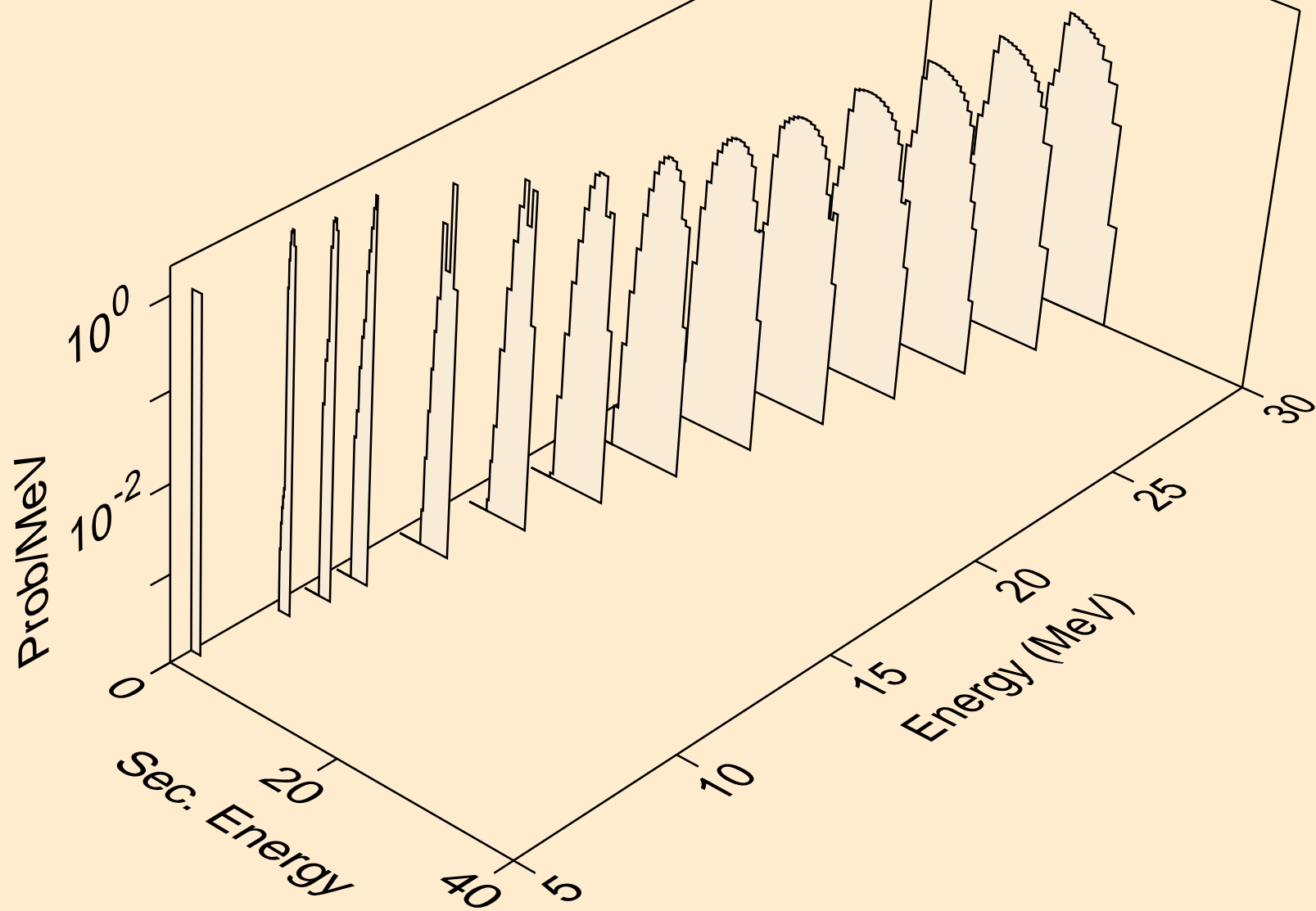

I135 PROTON ACER TENDL-2023 LIBRARY; T=0.K  
tritons from (p,pt)

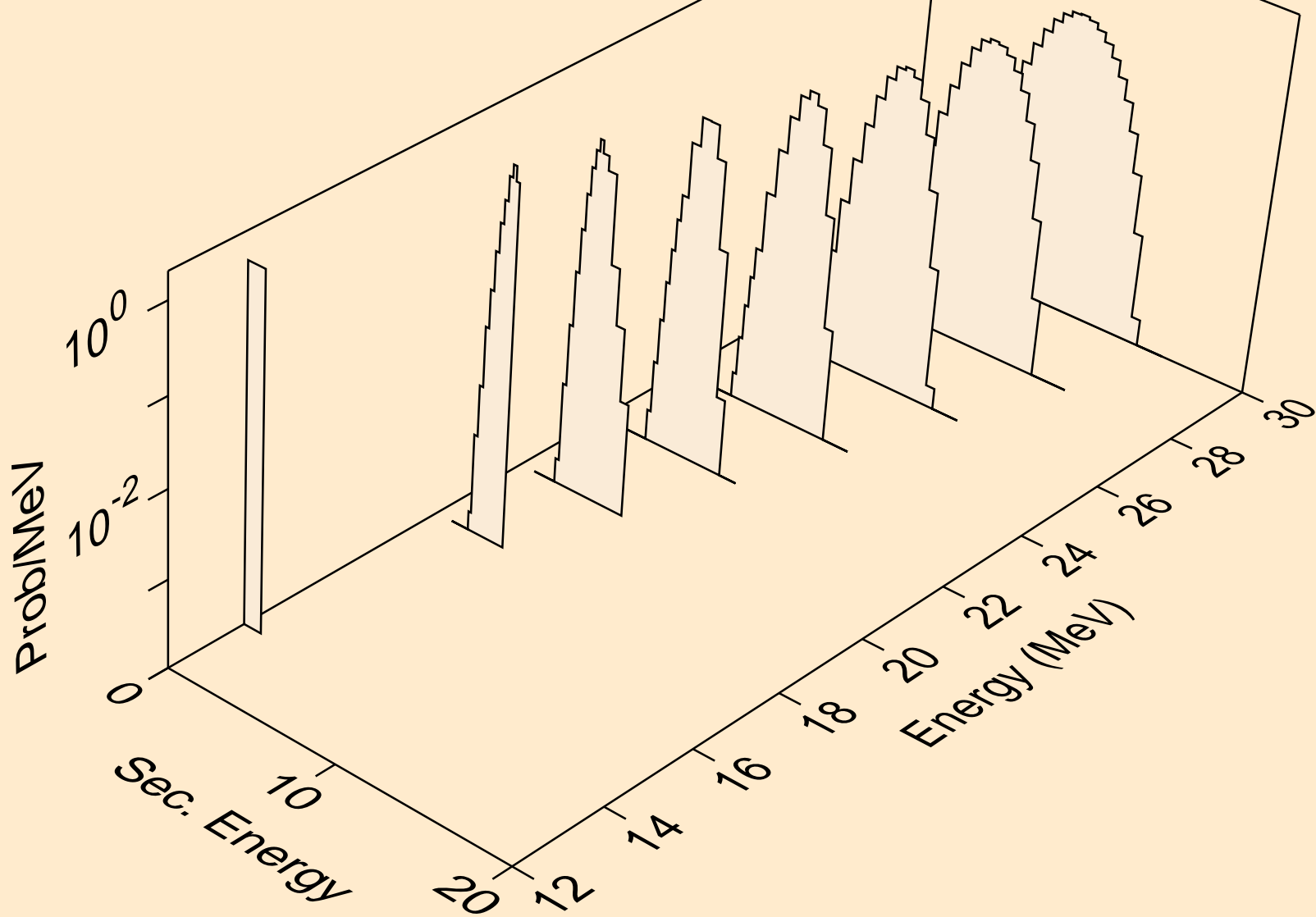

I135 PROTON ACER TENDL-2023 LIBRARY; T=0.K  
he3s from (p,x)

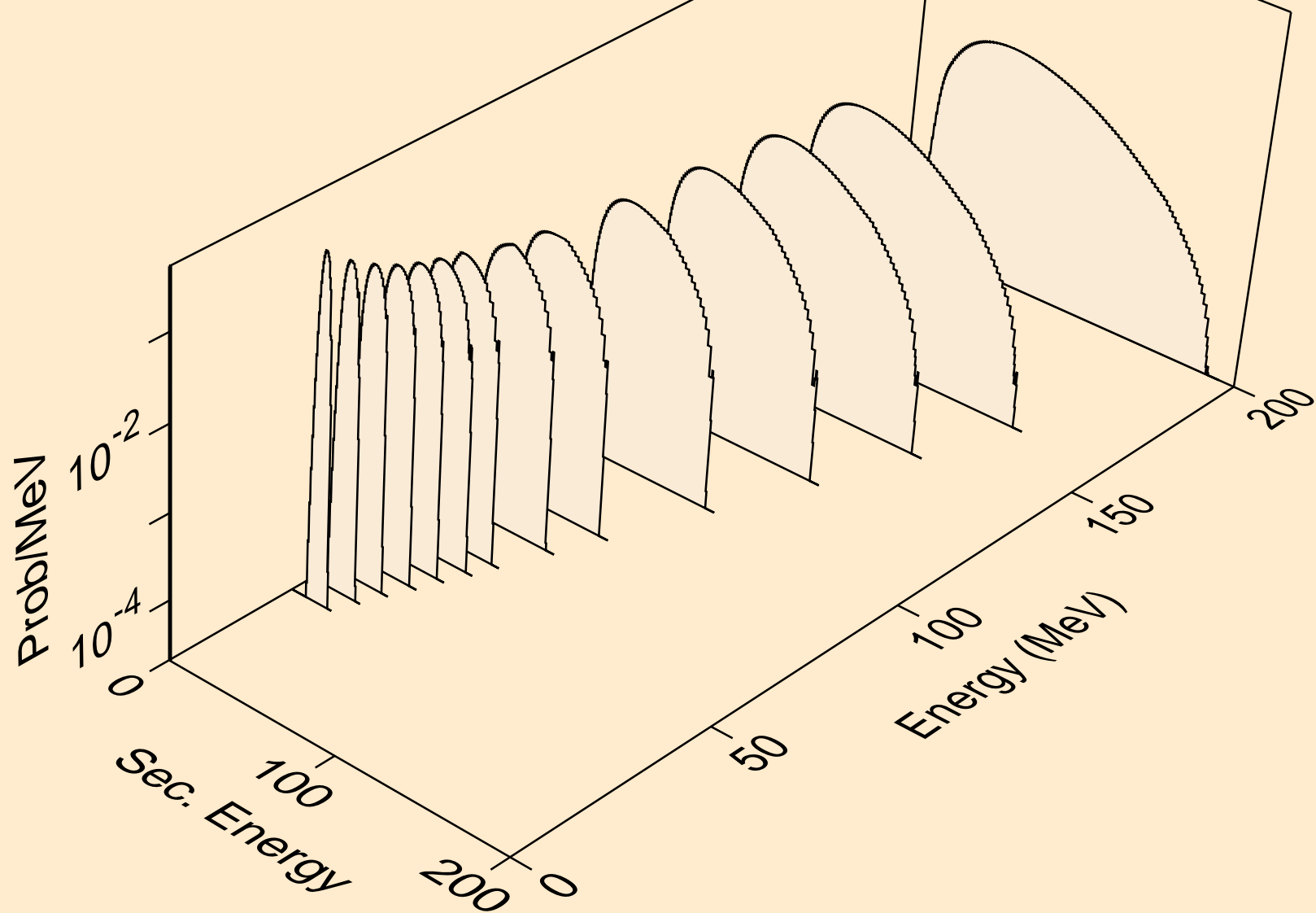

I135 PROTON ACER TENDL-2023 LIBRARY; T=0.K  
he3s from (p,n\*)he3

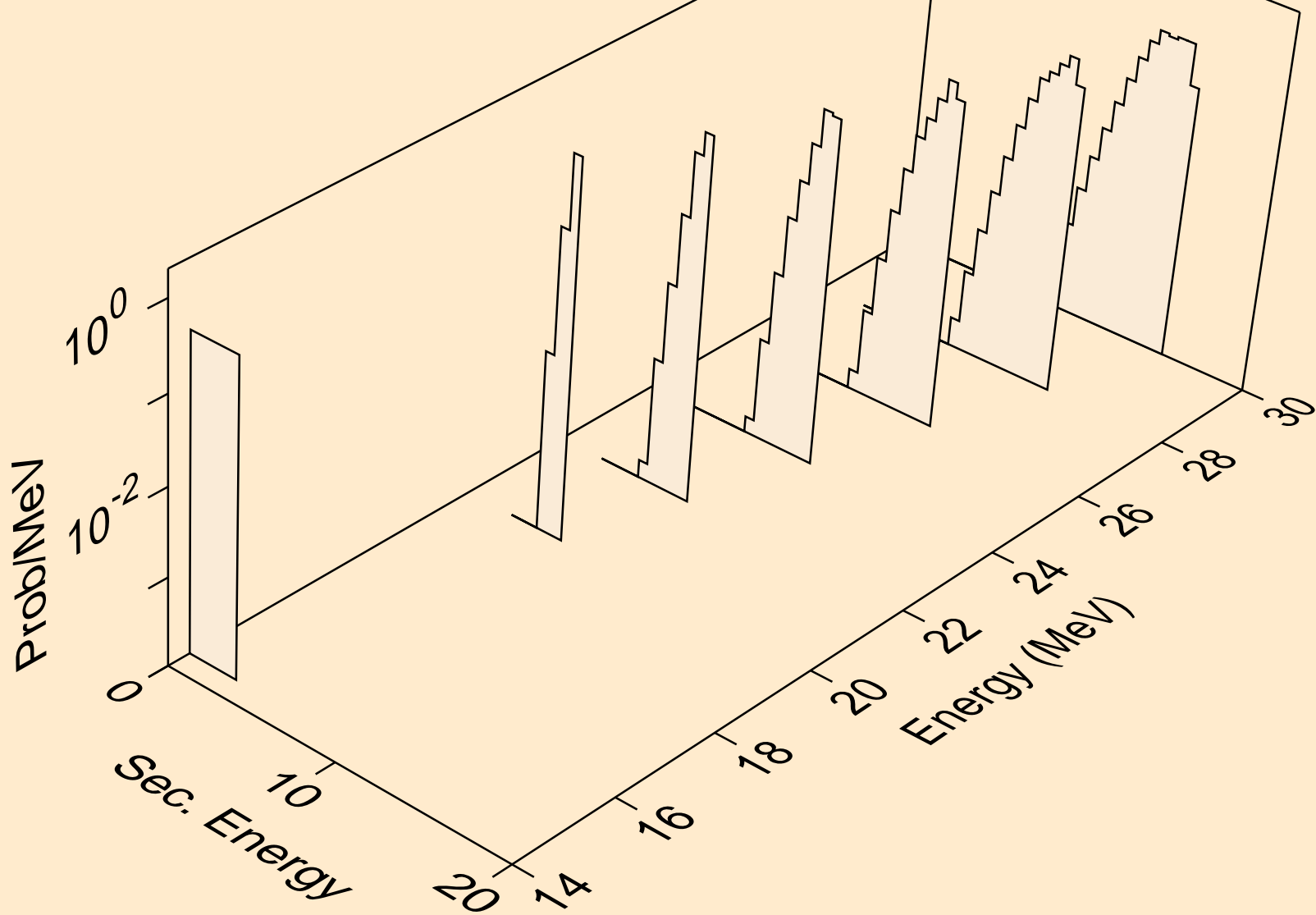



I135 PROTON ACER TENDL-2023 LIBRARY; T=0.K  
he3s from (p,he3)

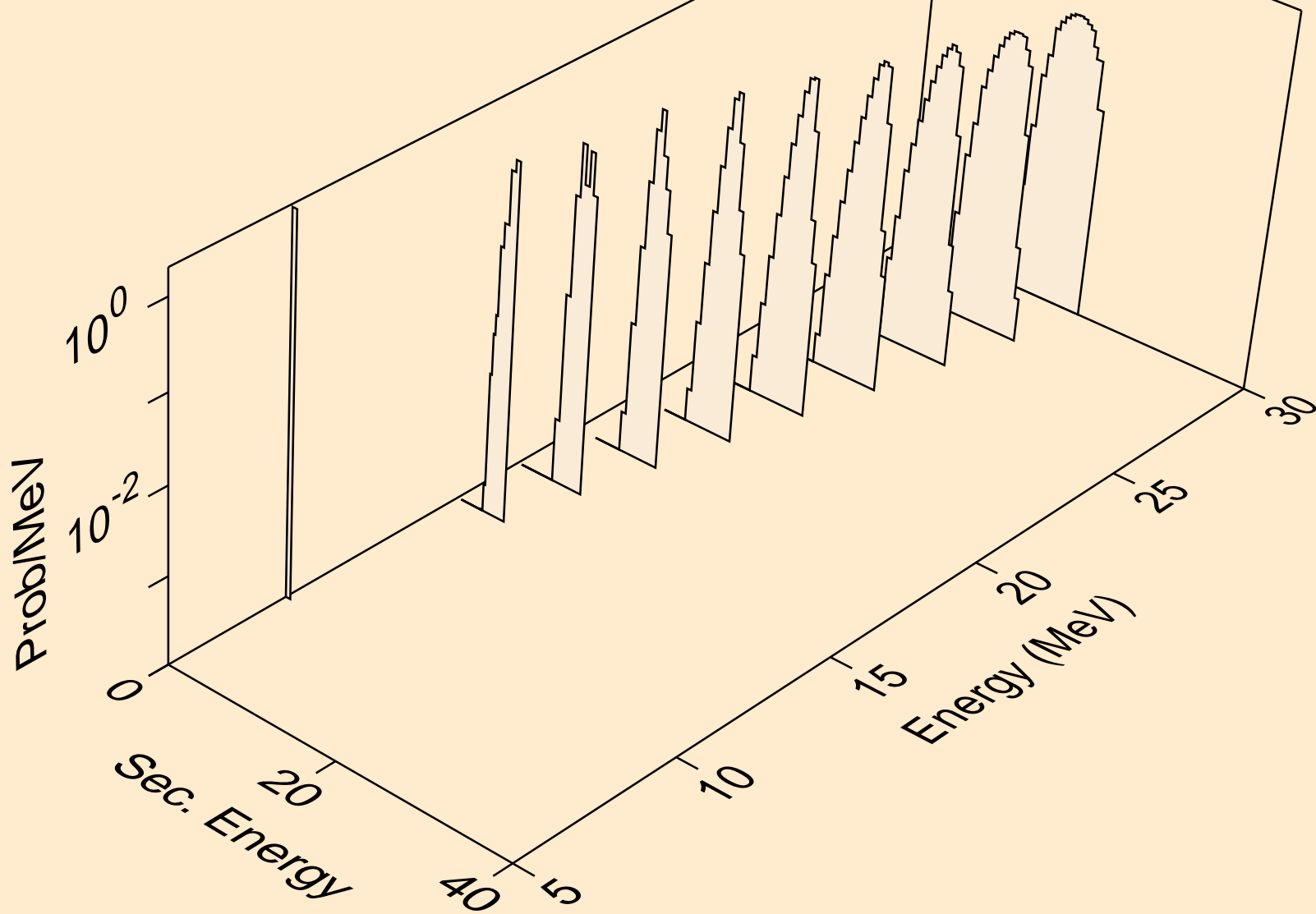

I135 PROTON ACER TENDL-2023 LIBRARY; T=0.K  
alphas from (p,x)

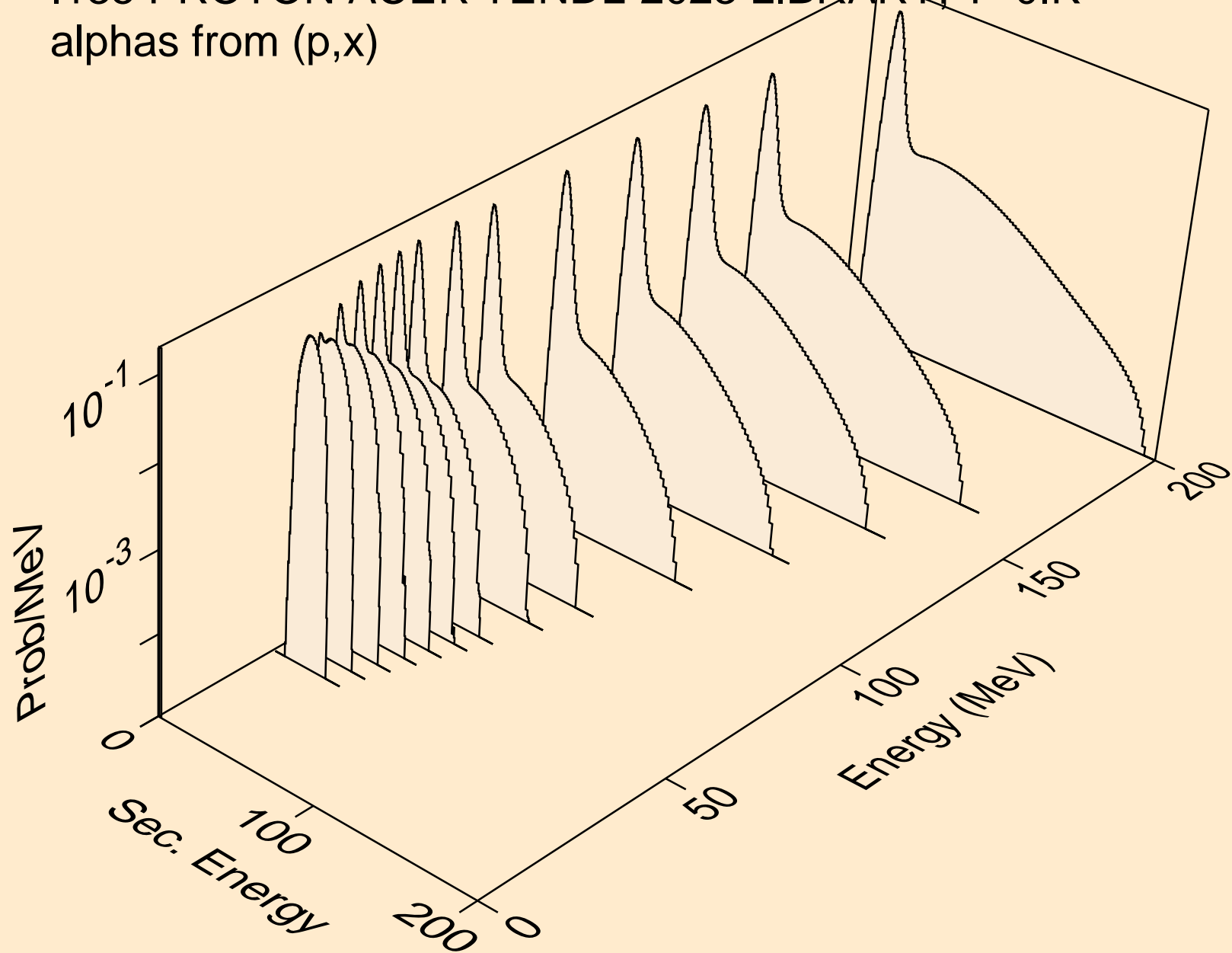

I135 PROTON ACER TENDL-2023 LIBRARY; T=0.K  
alphas from (p,n\*)a

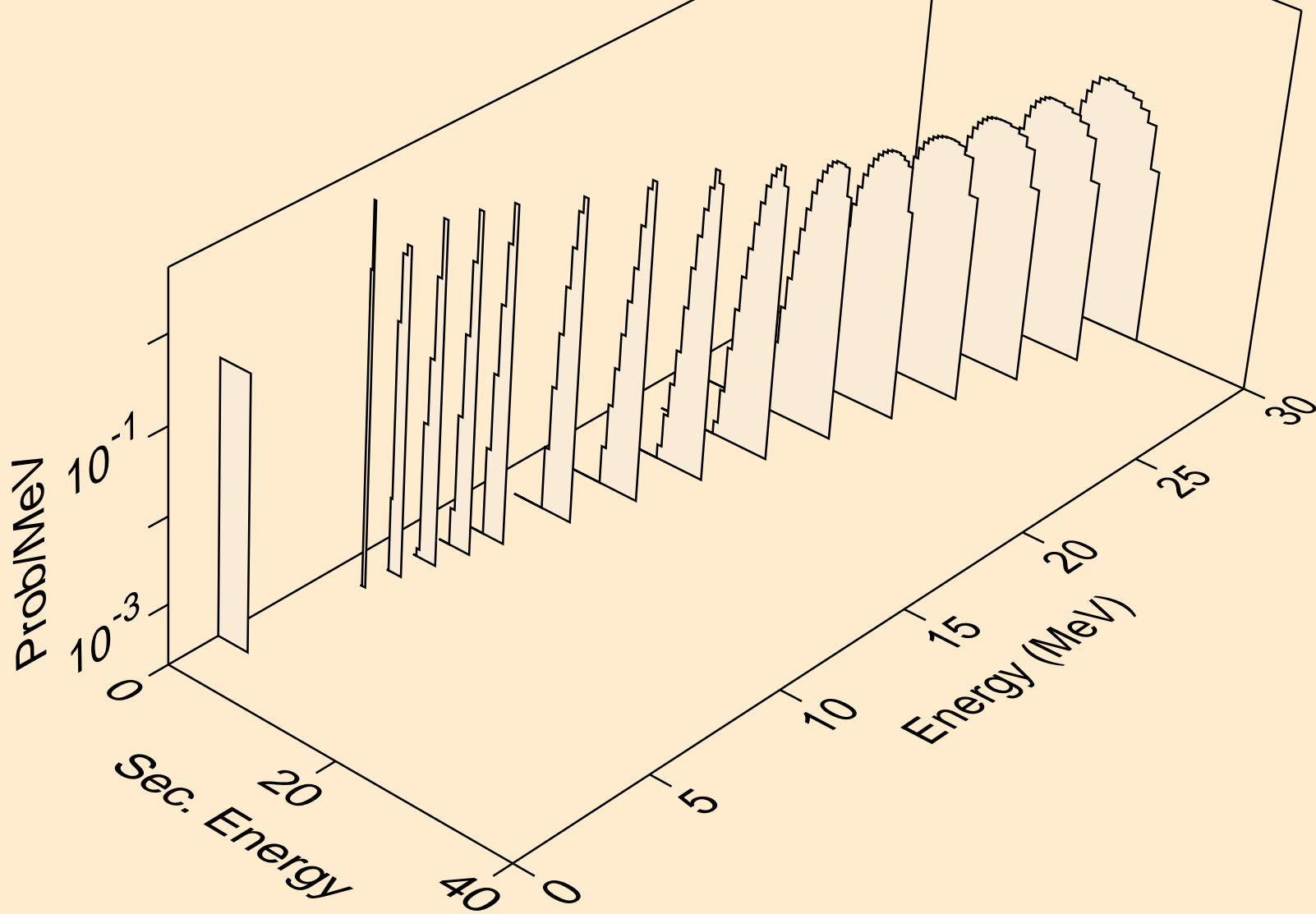

I135 PROTON ACER TENDL-2023 LIBRARY; T=0.K  
alphas from (p,2n)a

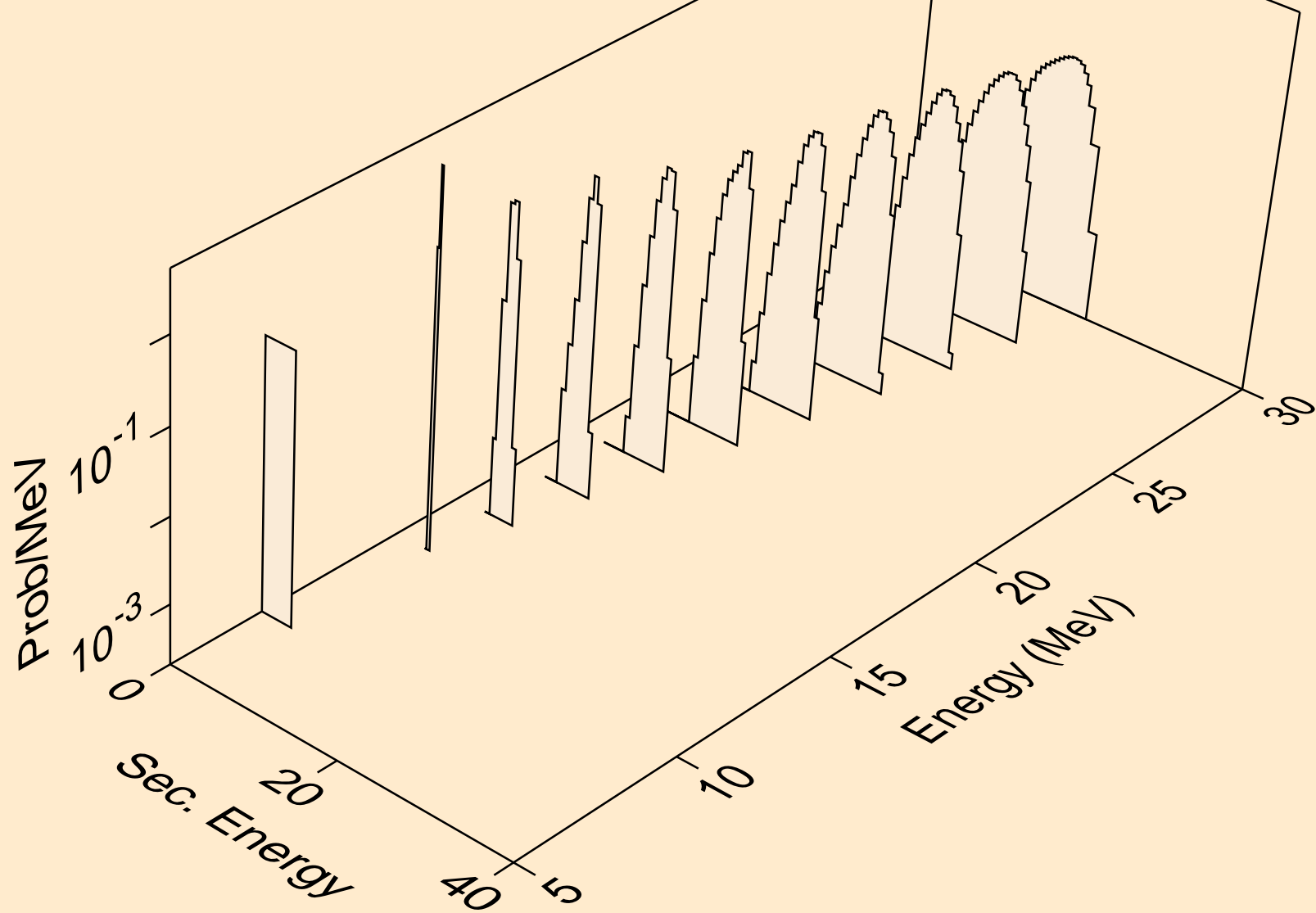

I135 PROTON ACER TENDL-2023 LIBRARY; T=0.K  
alphas from (p,3n)a

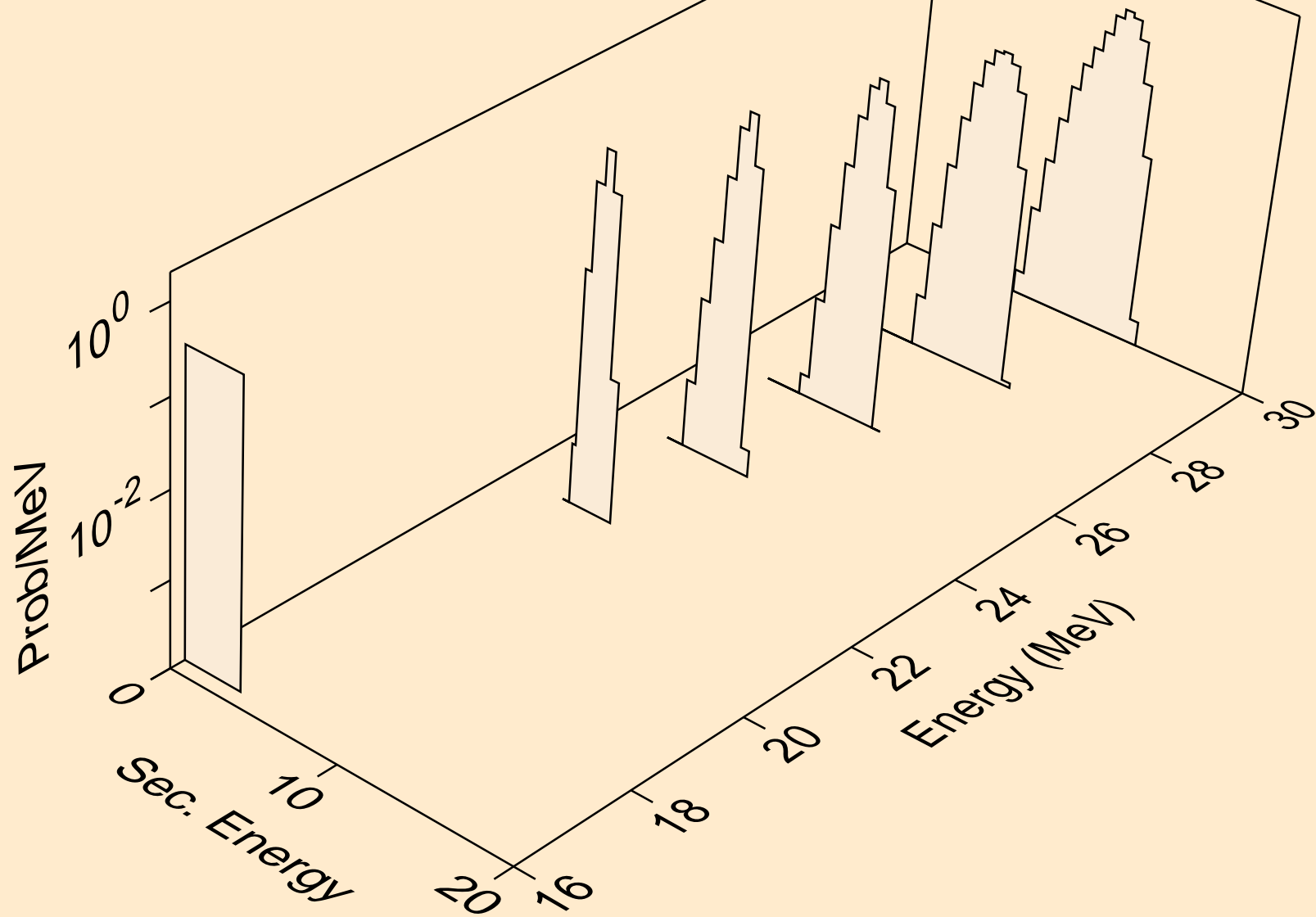

I135 PROTON ACER TENDL-2023 LIBRARY; T=0.K  
alphas from (p,npa)

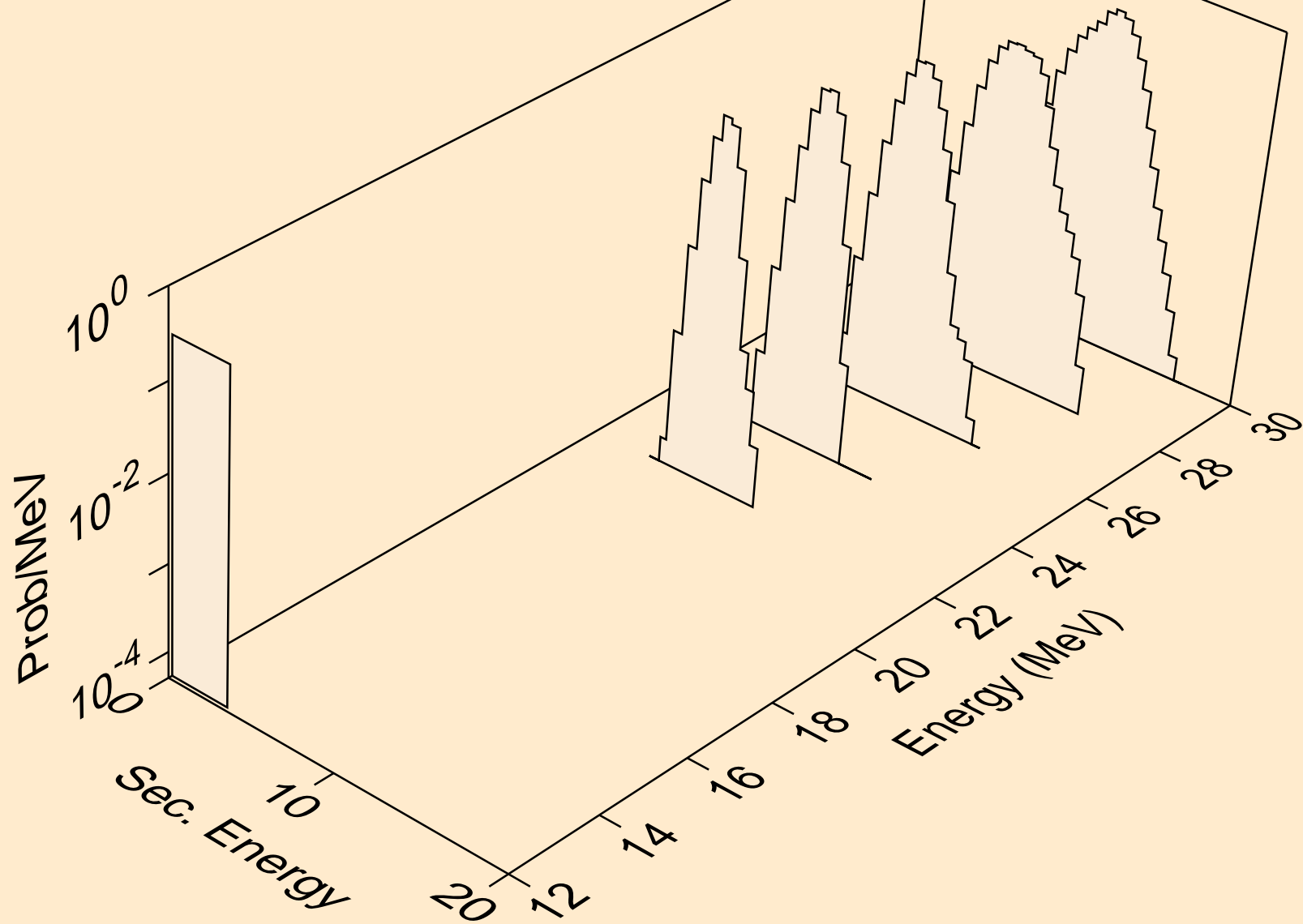

I135 PROTON ACER TENDL-2023 LIBRARY; T=0.K  
alphas from (p,a)

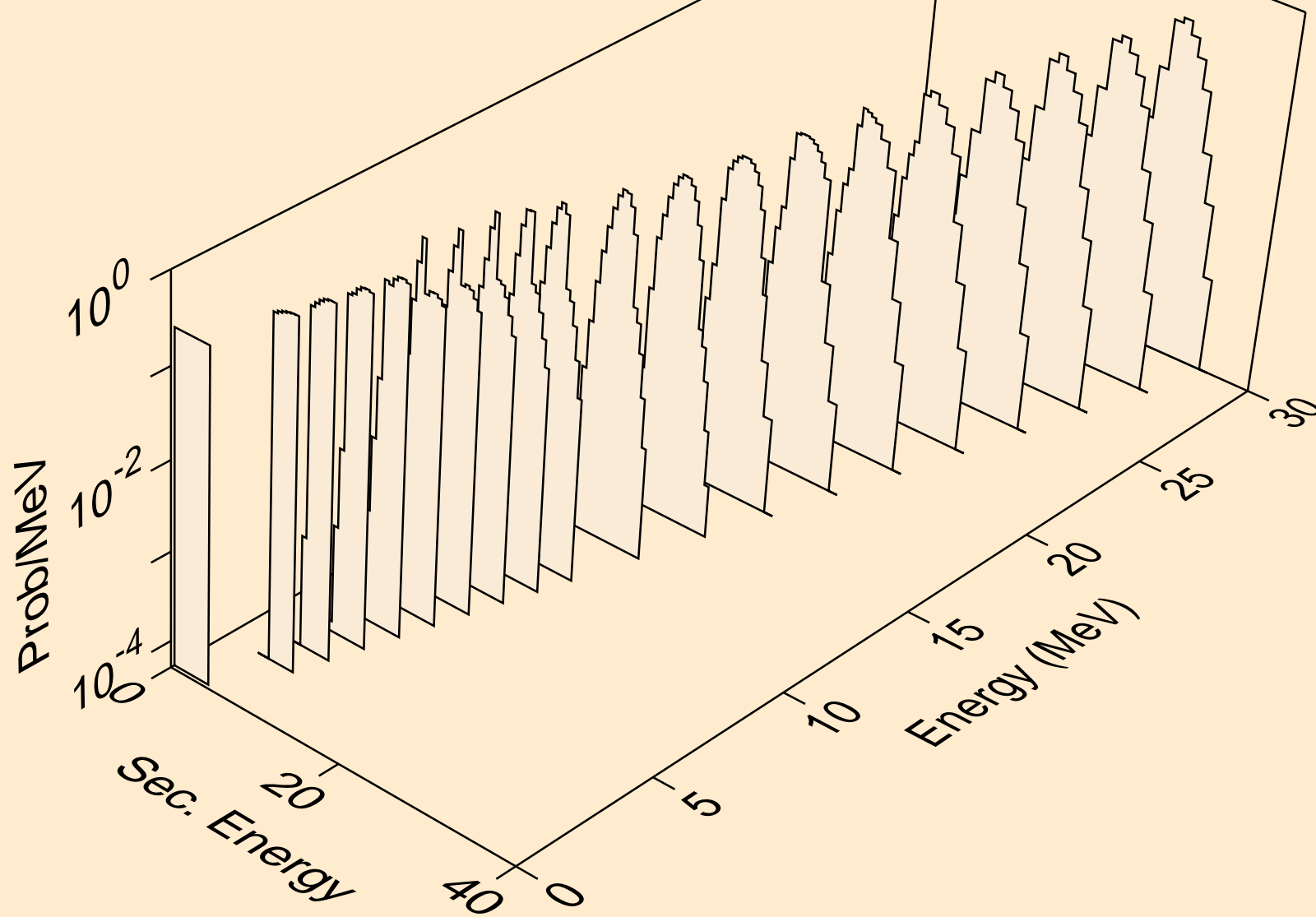

I135 PROTON ACER TENDL-2023 LIBRARY; T=0.K  
alphas from (p,pa)

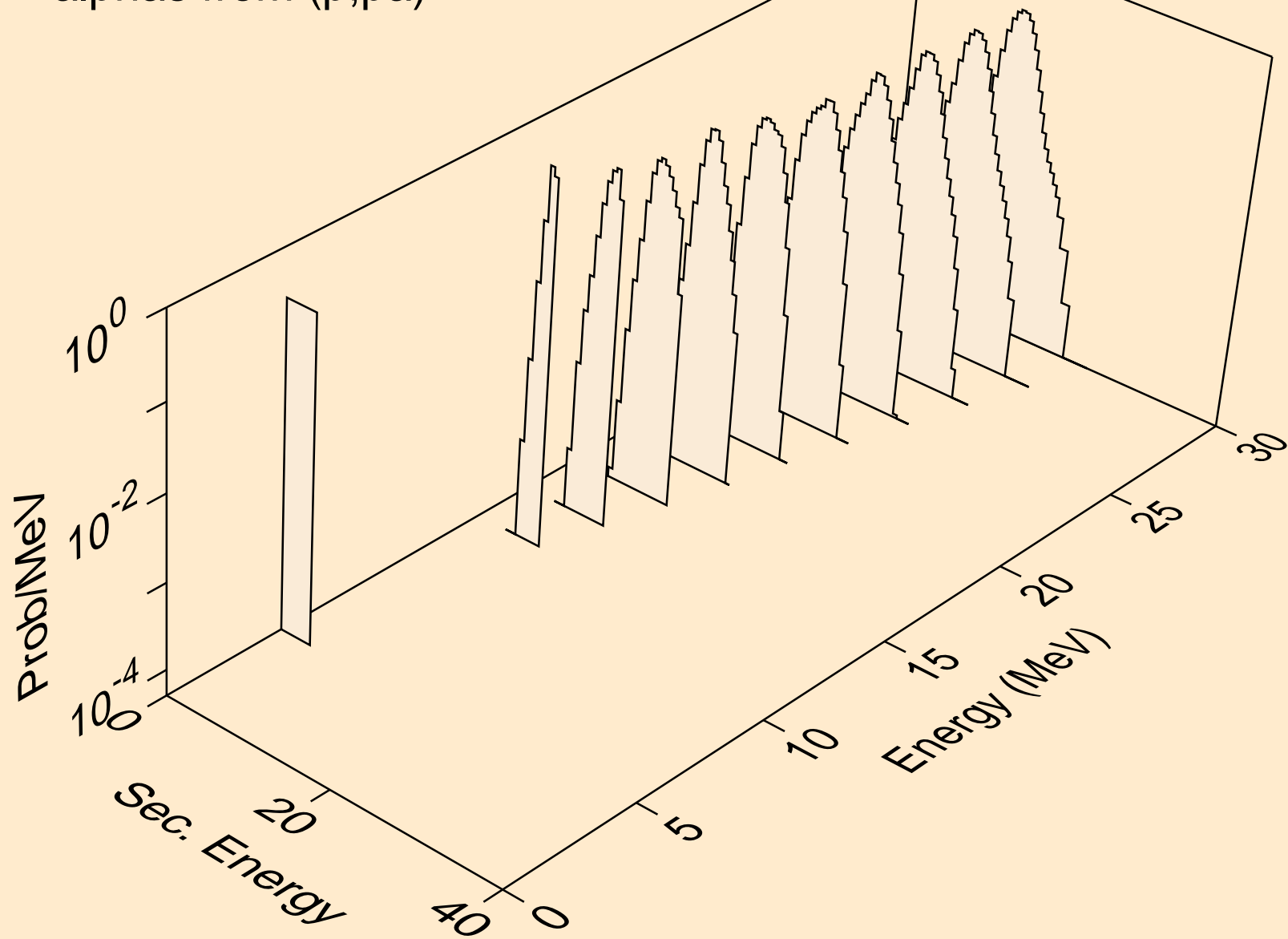



I135 PROTON ACER TENDL-2023 LIBRARY; T=0.K  
alphas from (p,da)

