

IR191M PROTON ACER TENDL-2023 LIBRARY; T=0.K  
Principal cross sections

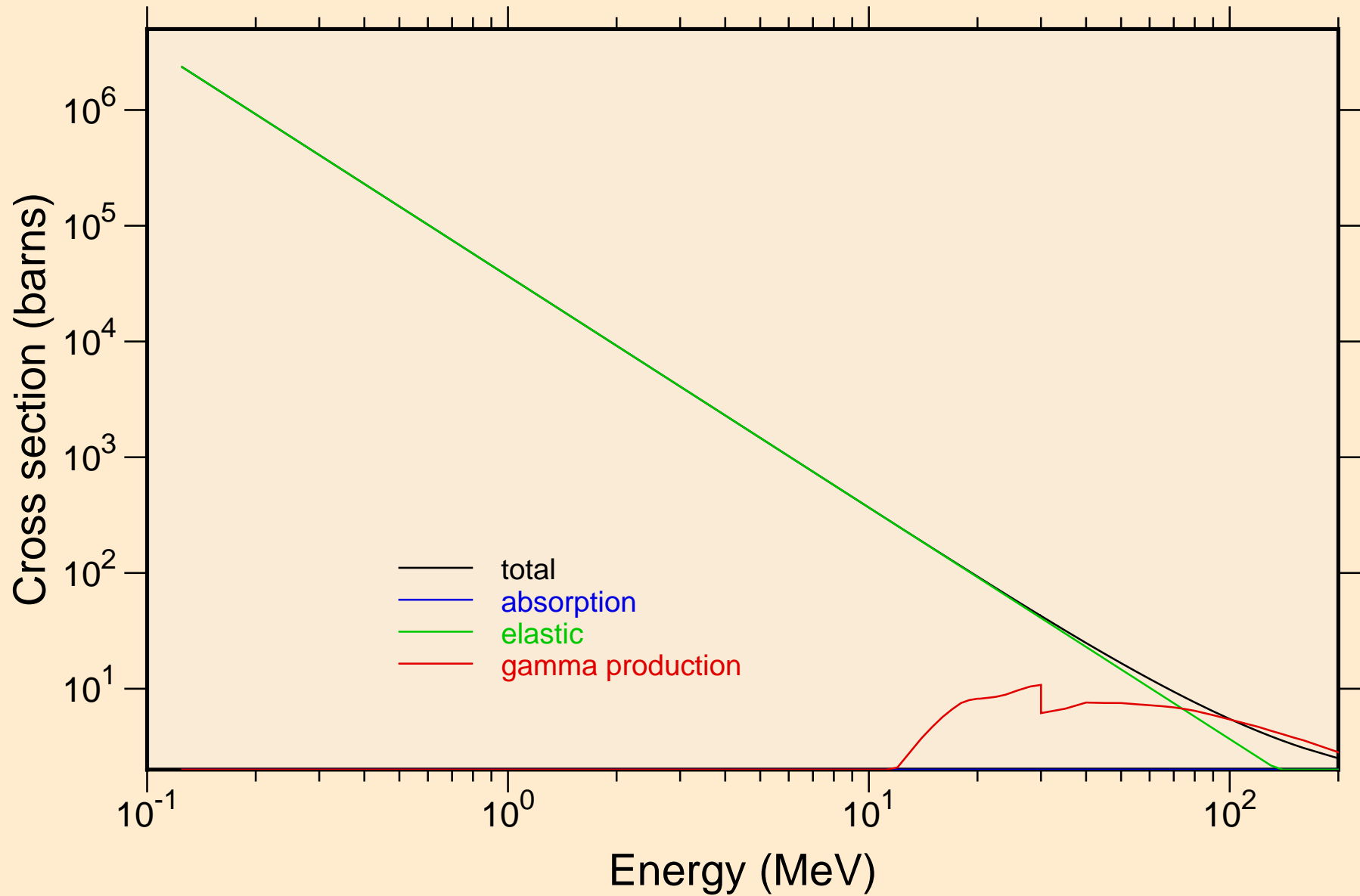

# IR191M PROTON ACER TENDL-2023 LIBRARY; T=0.K

## Heating

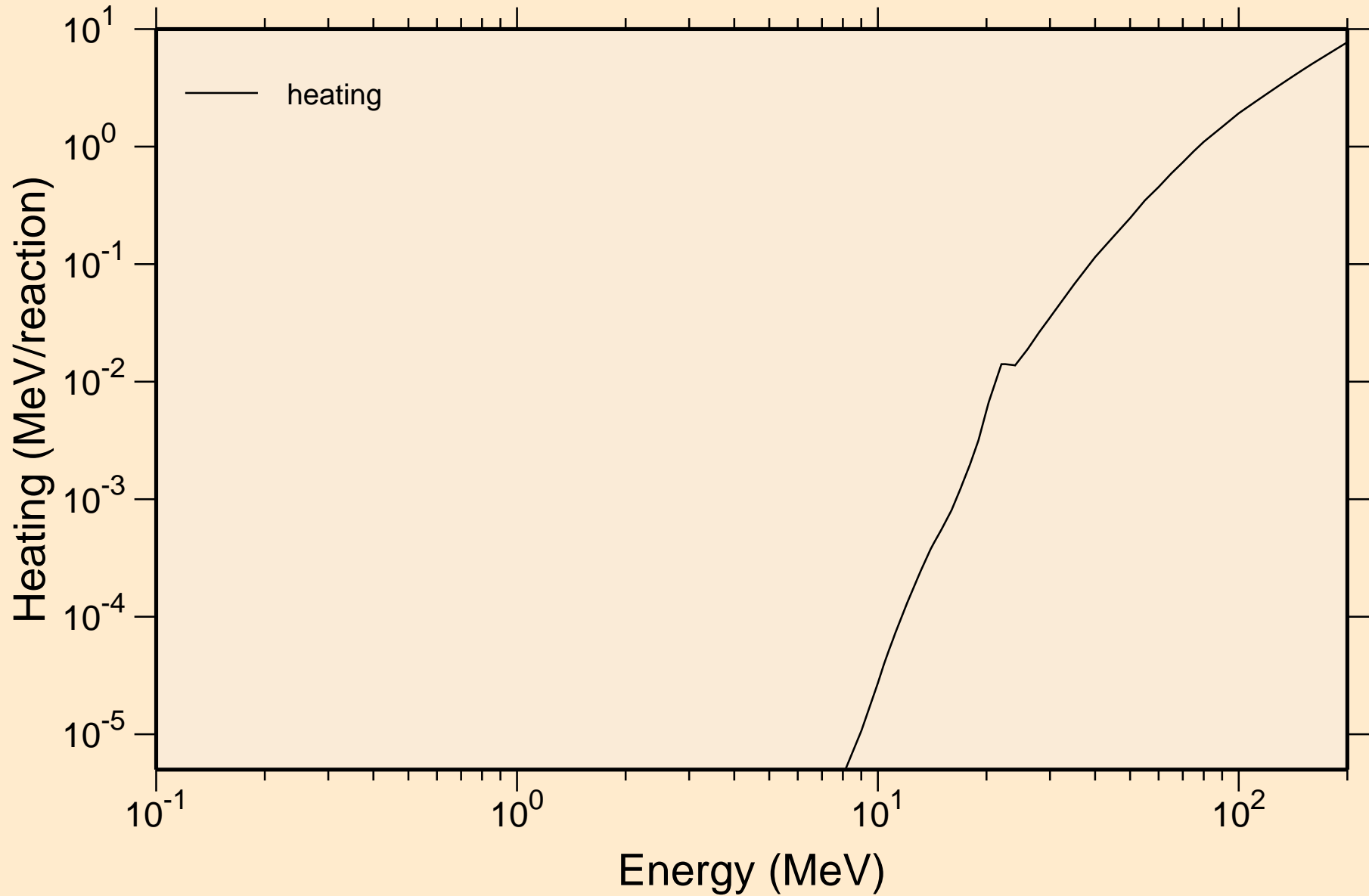

IR191M PROTON ACER TENDL-2023 LIBRARY; T=0.K  
Principal cross sections

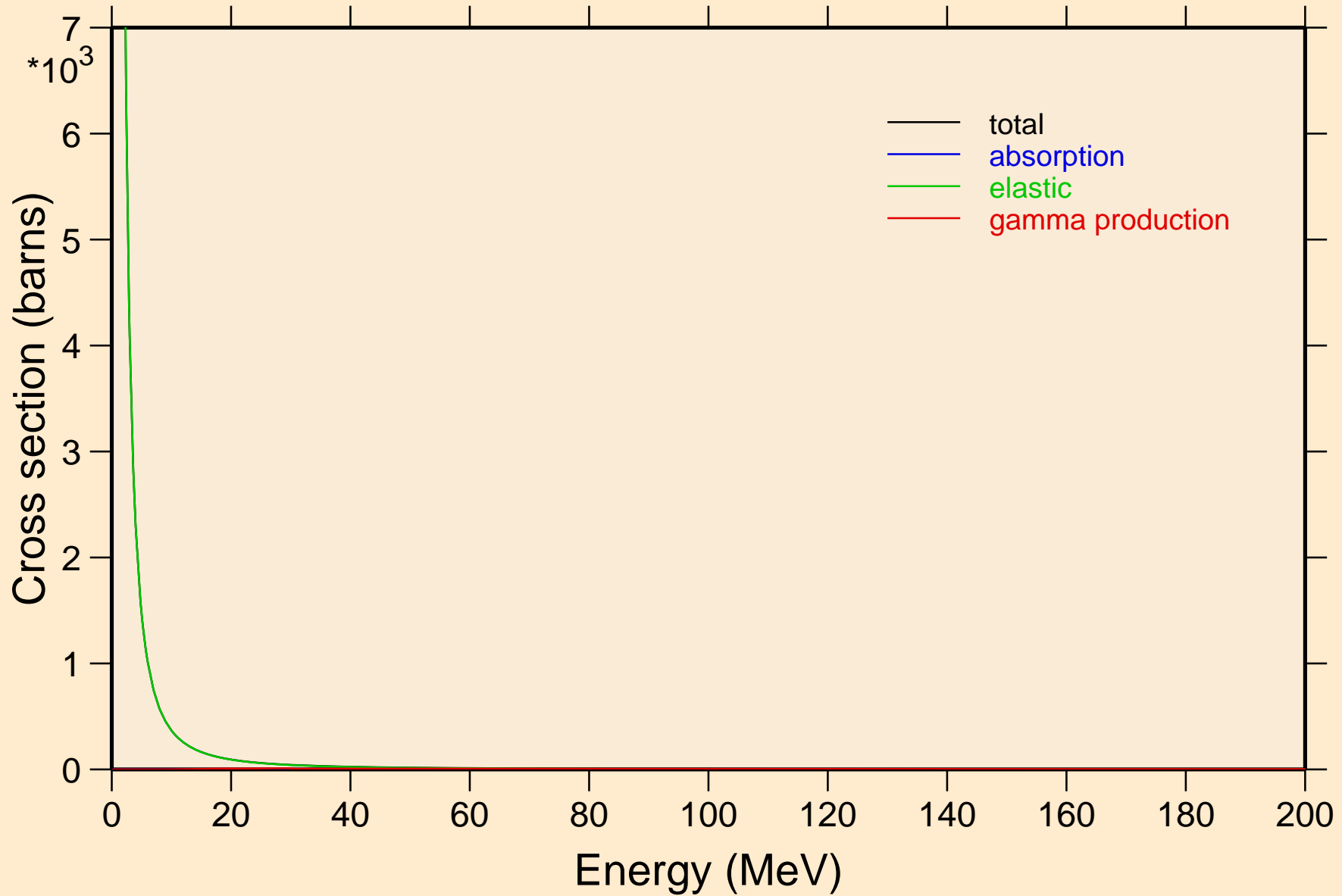

# IR191M PROTON ACER TENDL-2023 LIBRARY; T=0.K

## Heating

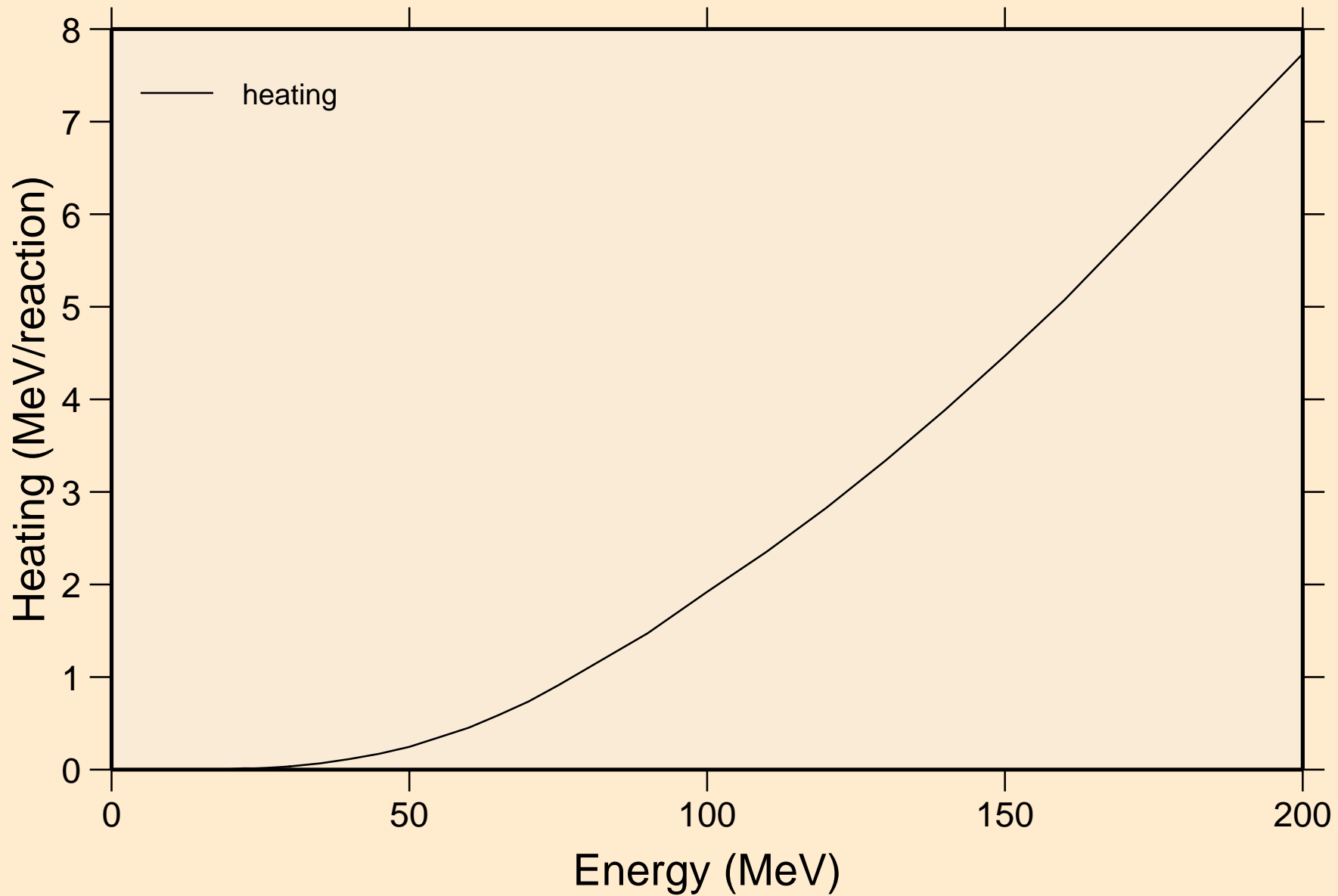

IR191M PROTON ACER TENDL-2023 LIBRARY; T=0.K  
Threshold reactions

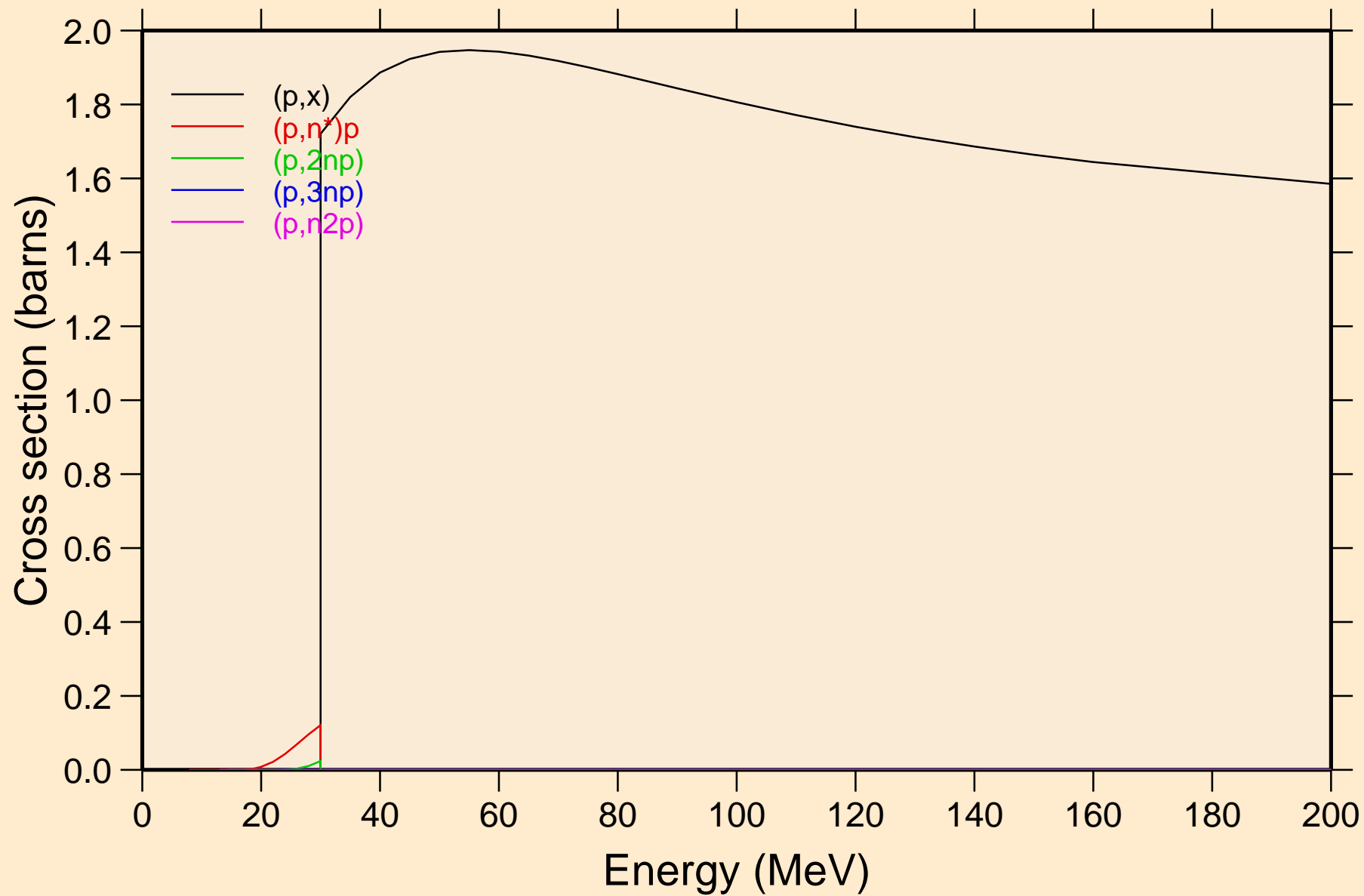

IR191M PROTON ACER TENDL-2023 LIBRARY; T=0.K  
Threshold reactions

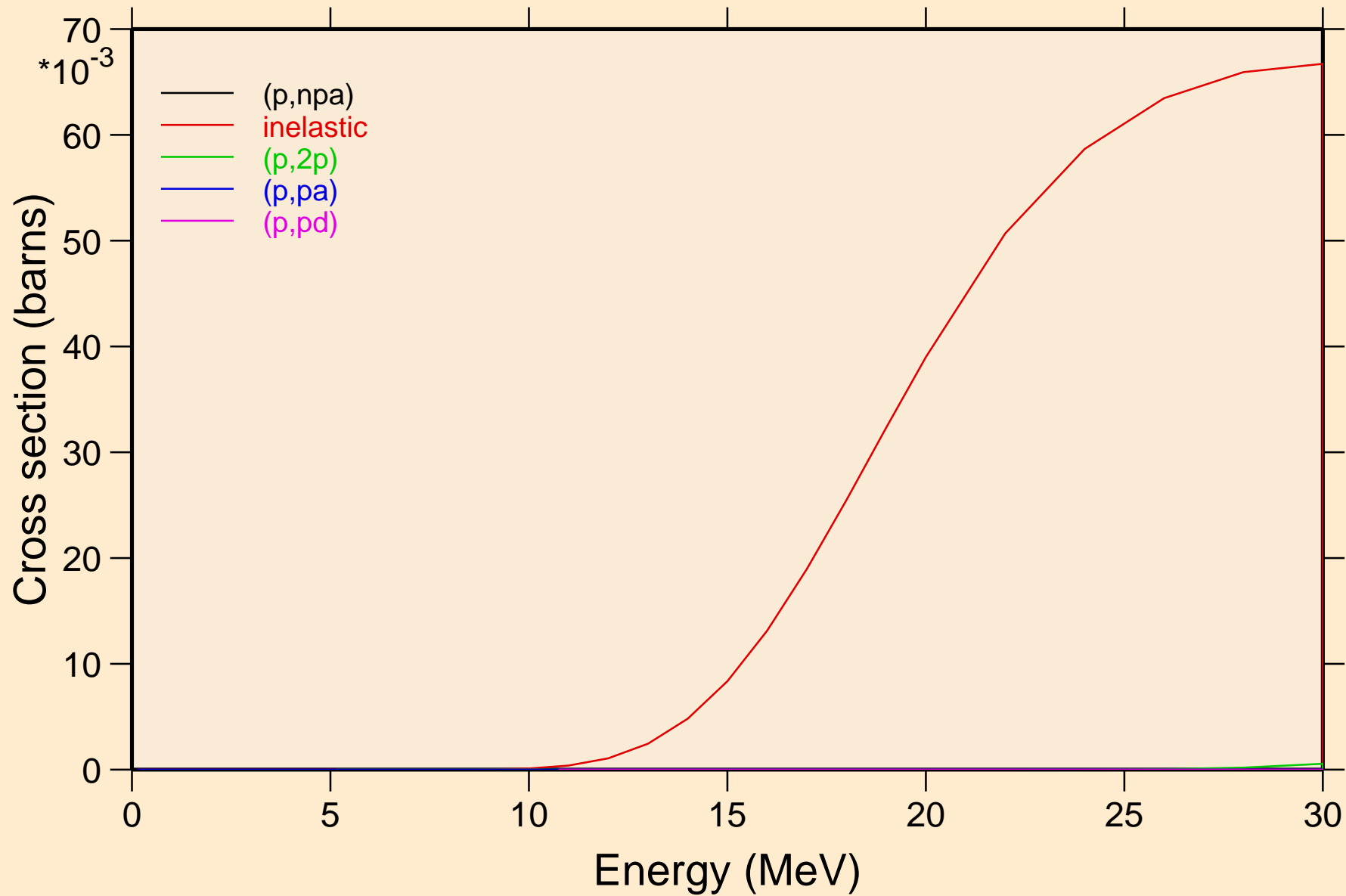

IR191M PROTON ACER TENDL-2023 LIBRARY; T=0.K  
Threshold reactions

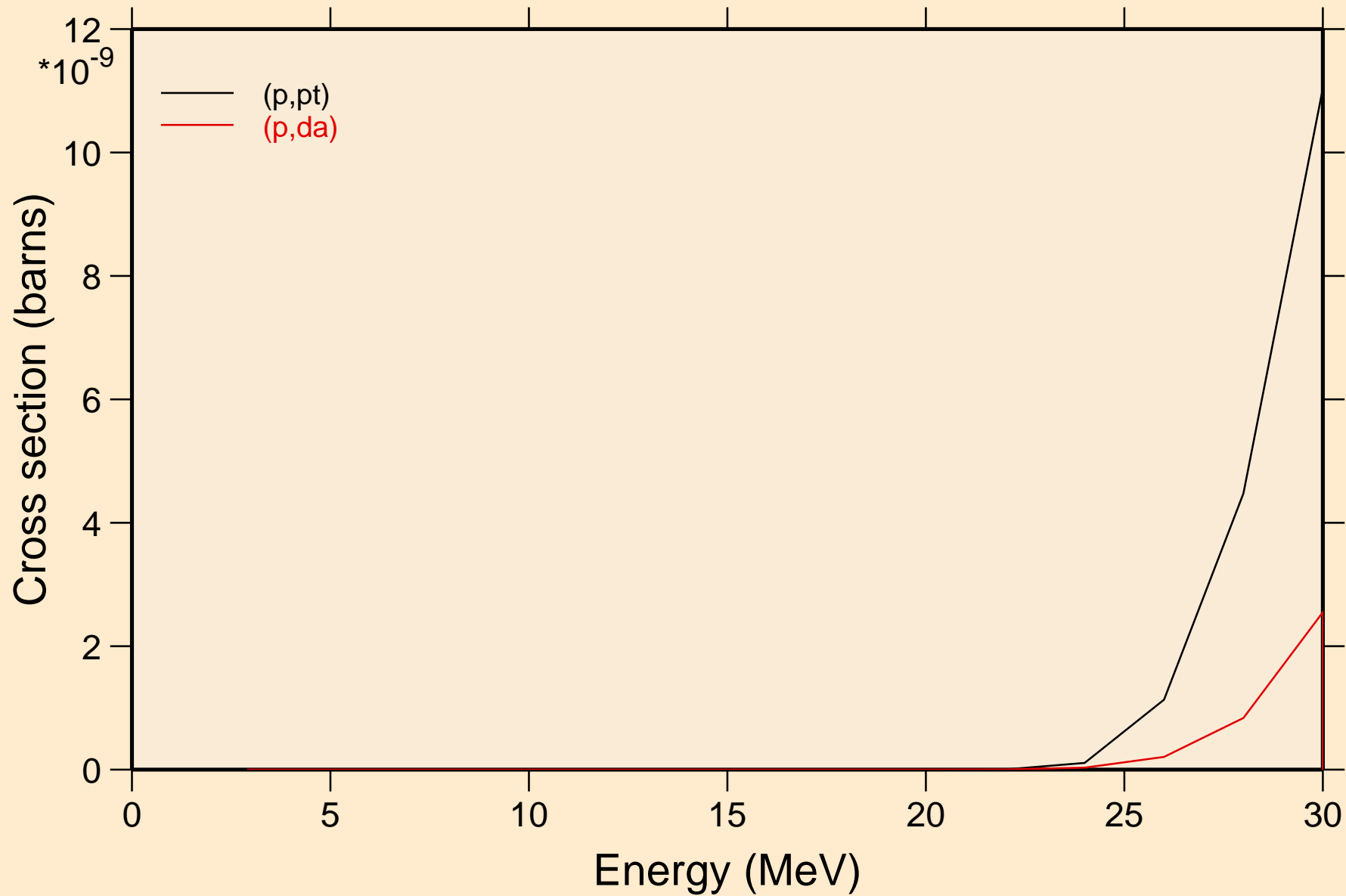

IR191M PROTON ACER TENDL-2023 LIBRARY; T=0.K  
angular distribution for elastic

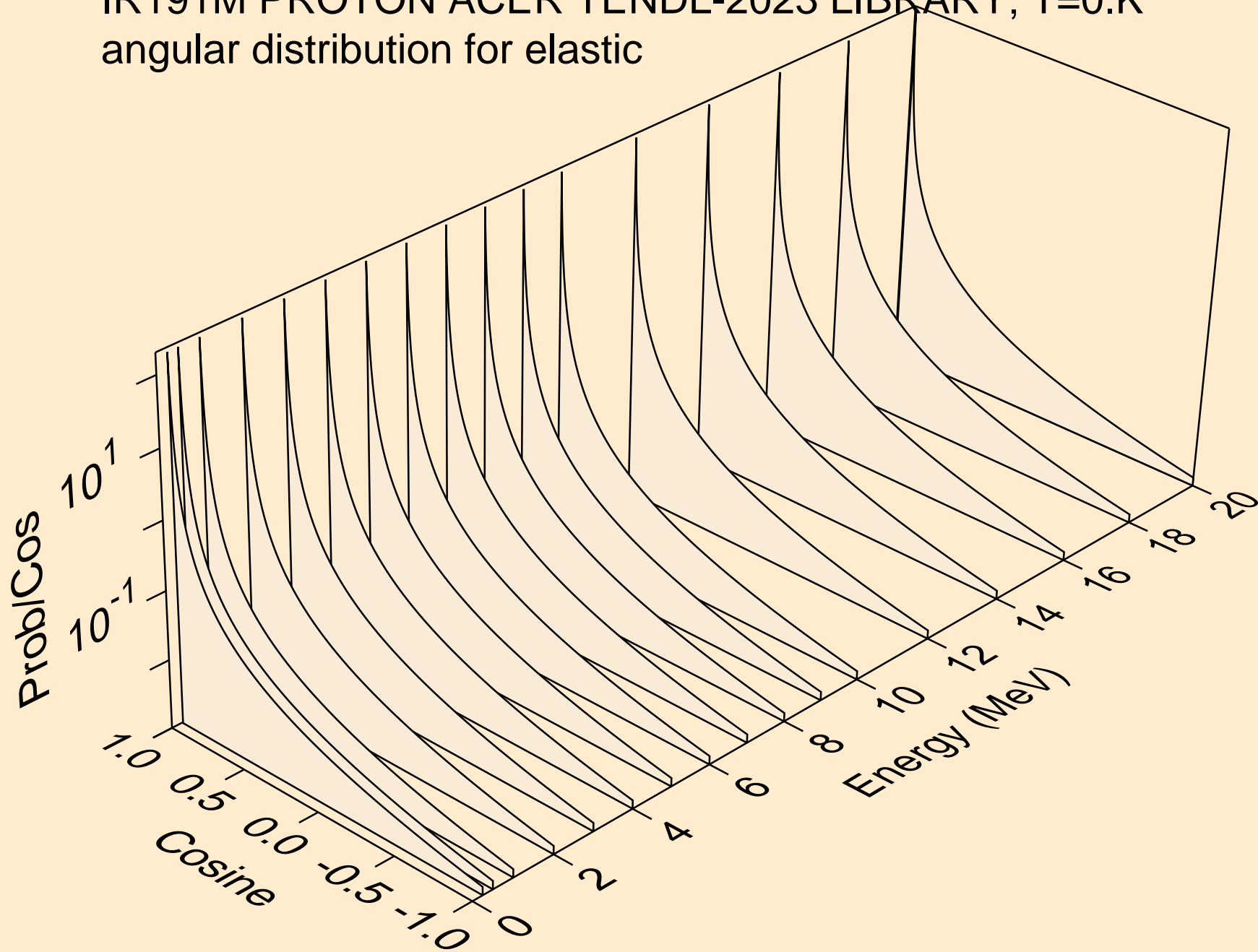



IR191M PROTON ACER TENDL-2023 LIBRARY; T=0.K  
angular distribution for elastic

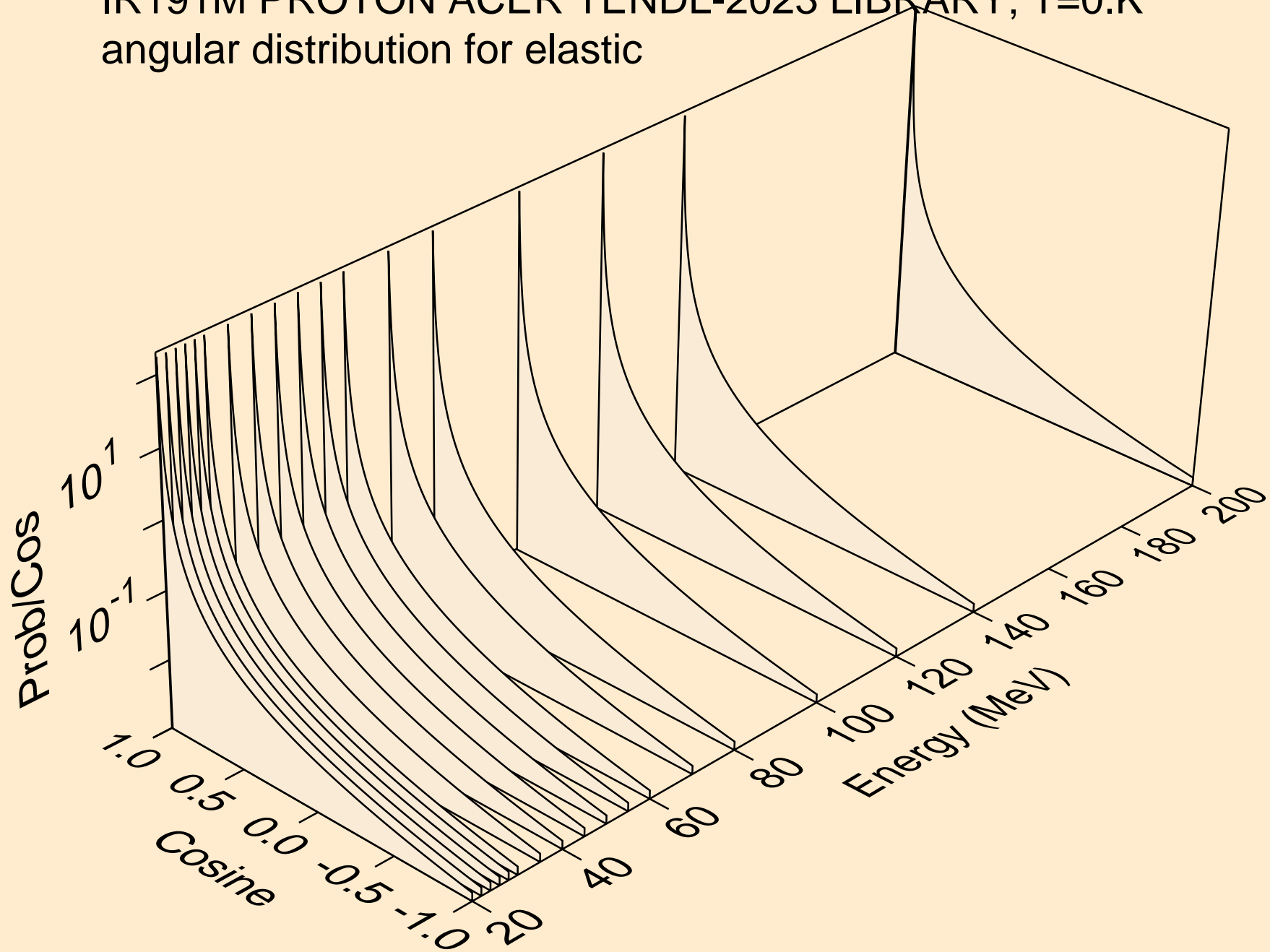

IR191M PROTON ACER TENDL-2023 LIBRARY; T=0.K  
Proton emission for (p,x)

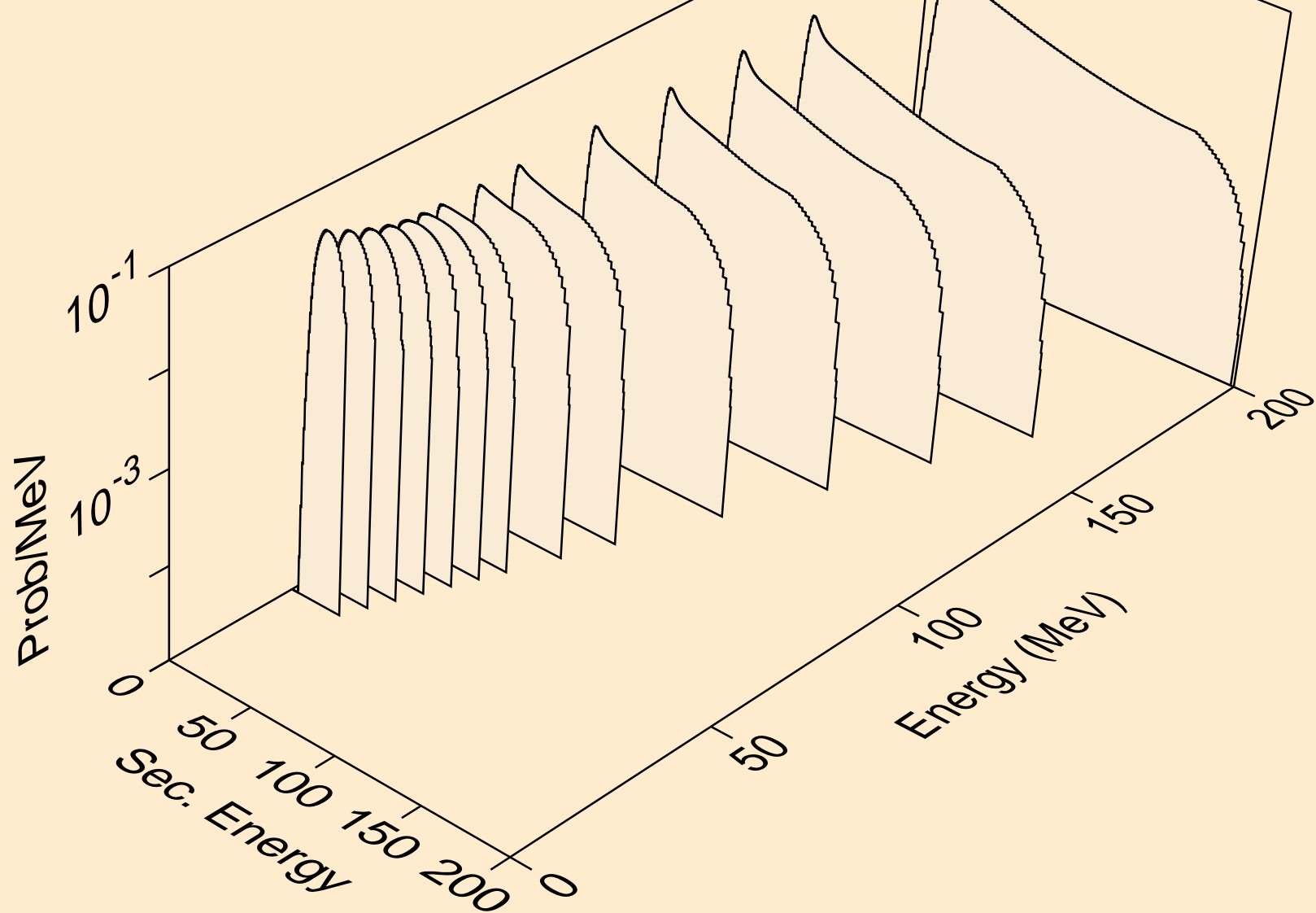

IR191M PROTON ACER TENDL-2023 LIBRARY; T=0.K  
Proton emission for (p,n\*)p

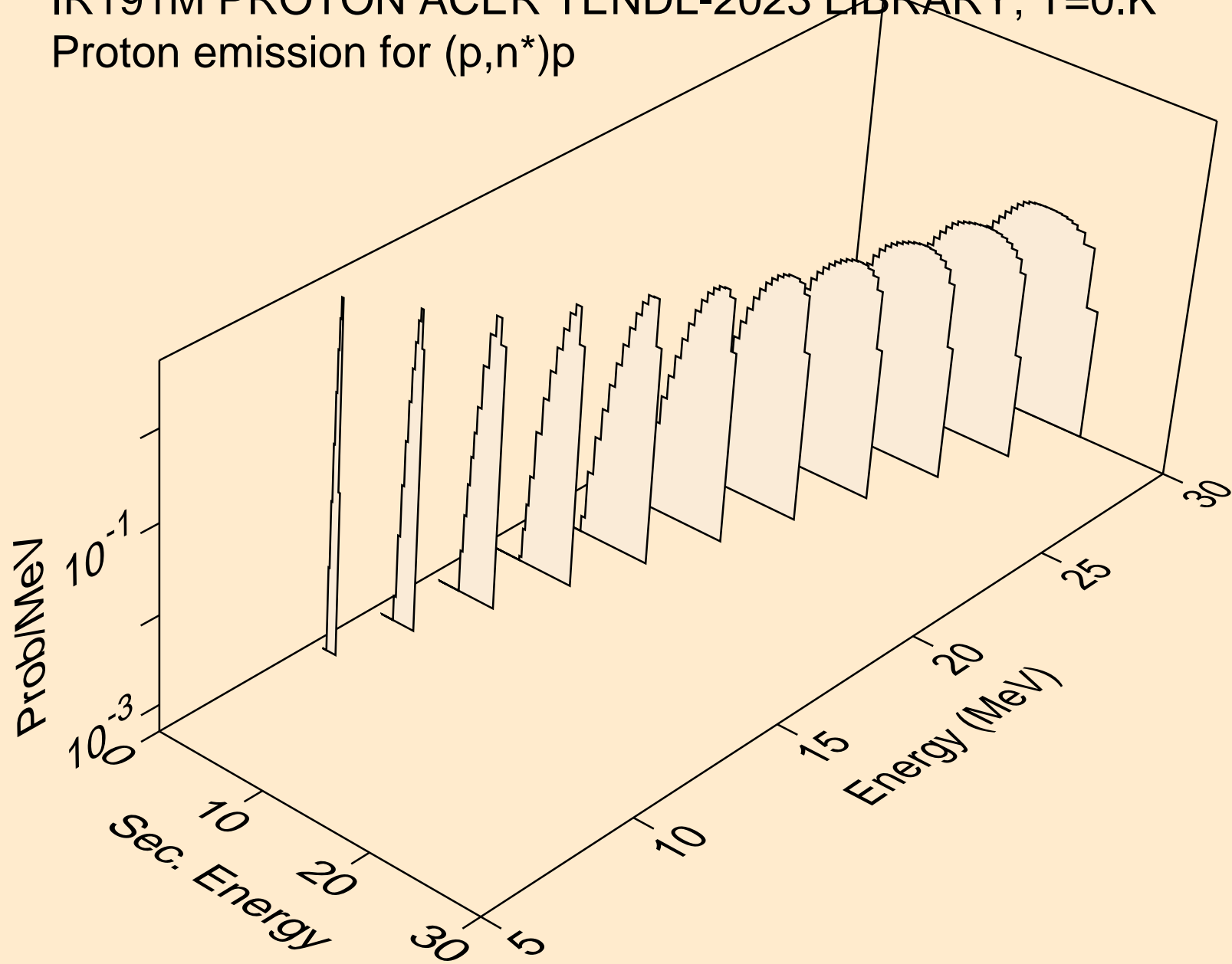

IR191M PROTON ACER TENDL-2023 LIBRARY; T=0.K  
Proton emission for (p,2np)

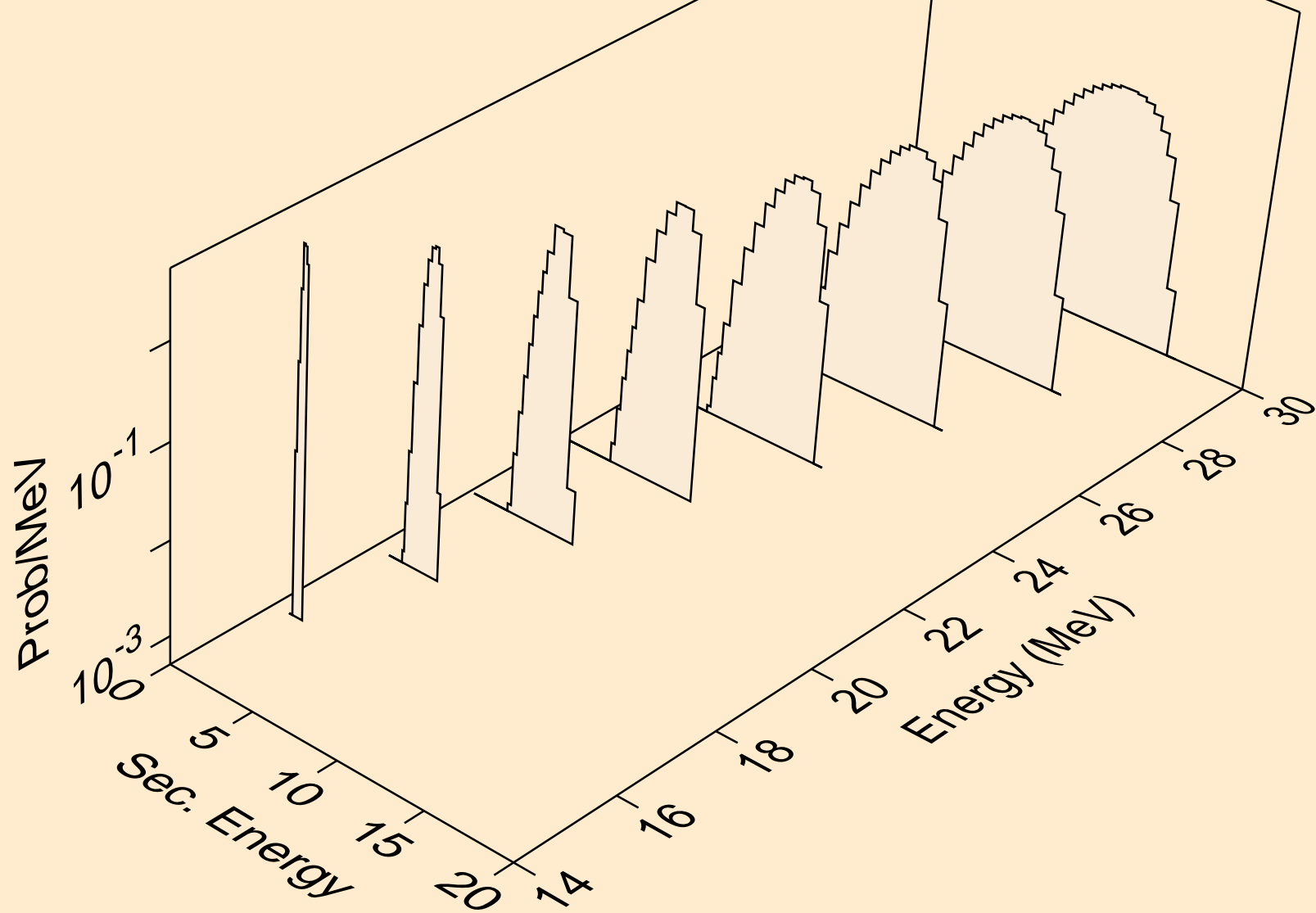

IR191M PROTON ACER TENDL-2023 LIBRARY; T=0.K  
Proton emission for (p,3np)

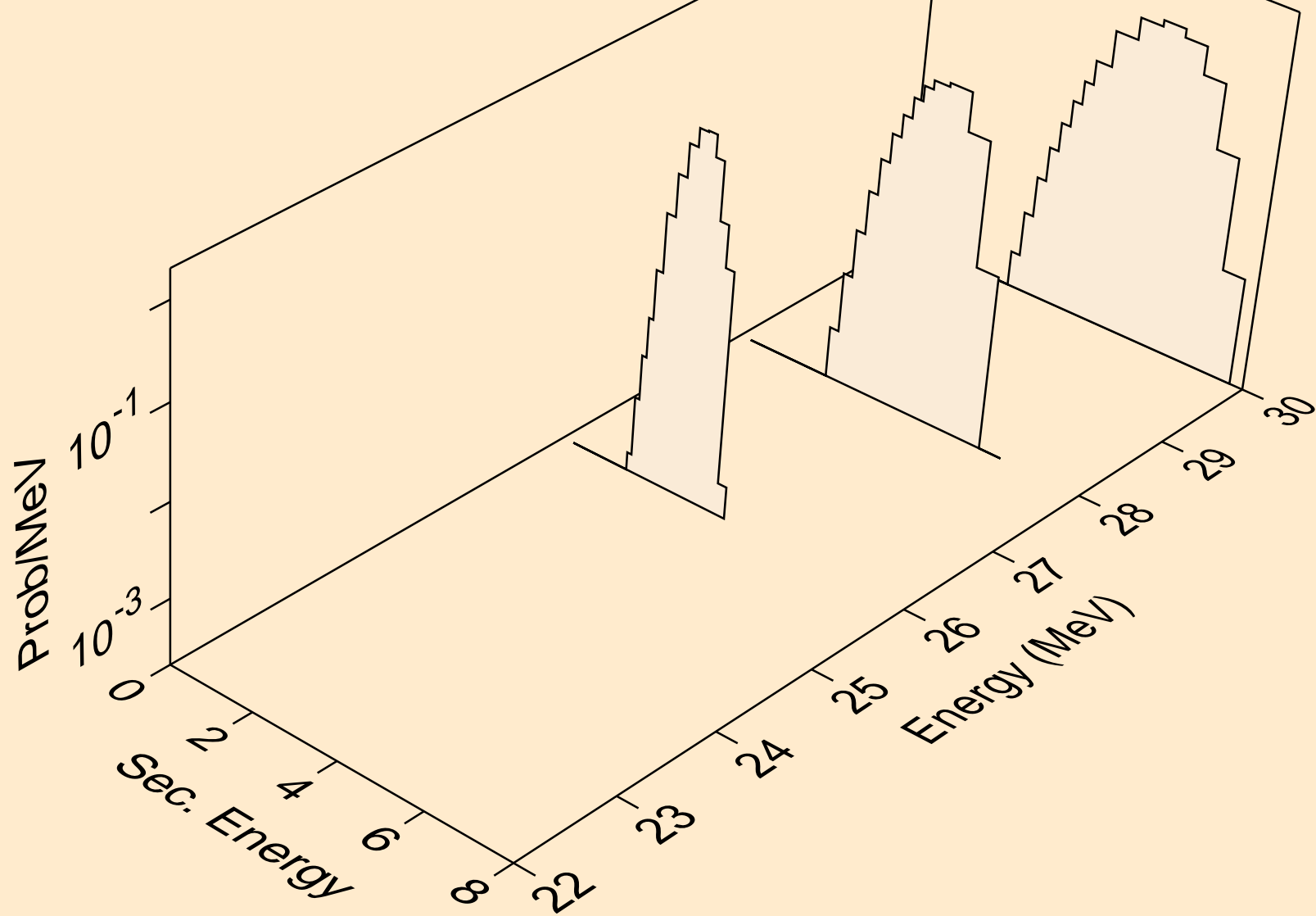

IR191M PROTON ACER TENDL-2023 LIBRARY; T=0.K  
Proton emission for (p,n2p)

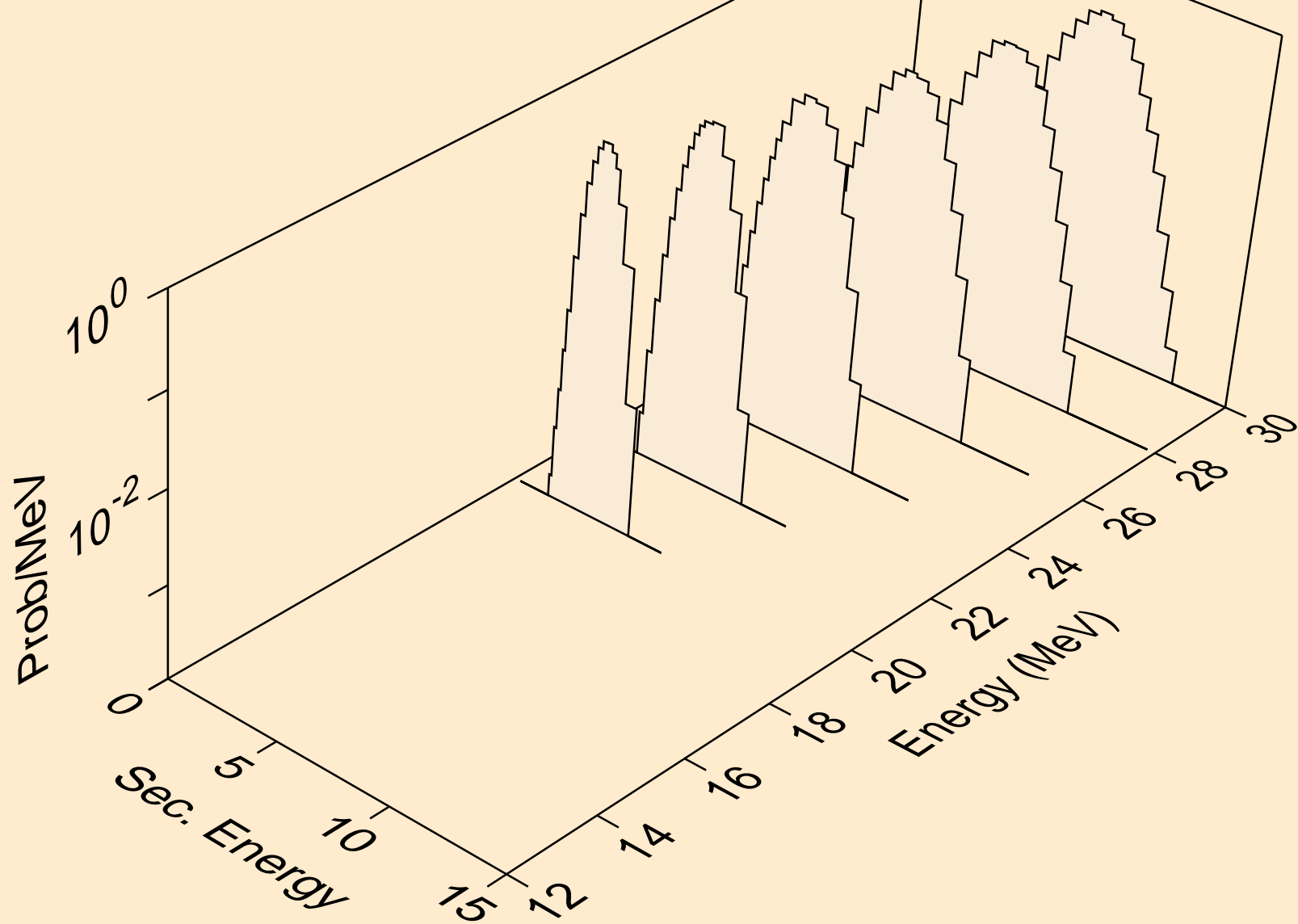

IR191M PROTON ACER TENDL-2023 LIBRARY; T=0.K  
Proton emission for (p,npa)

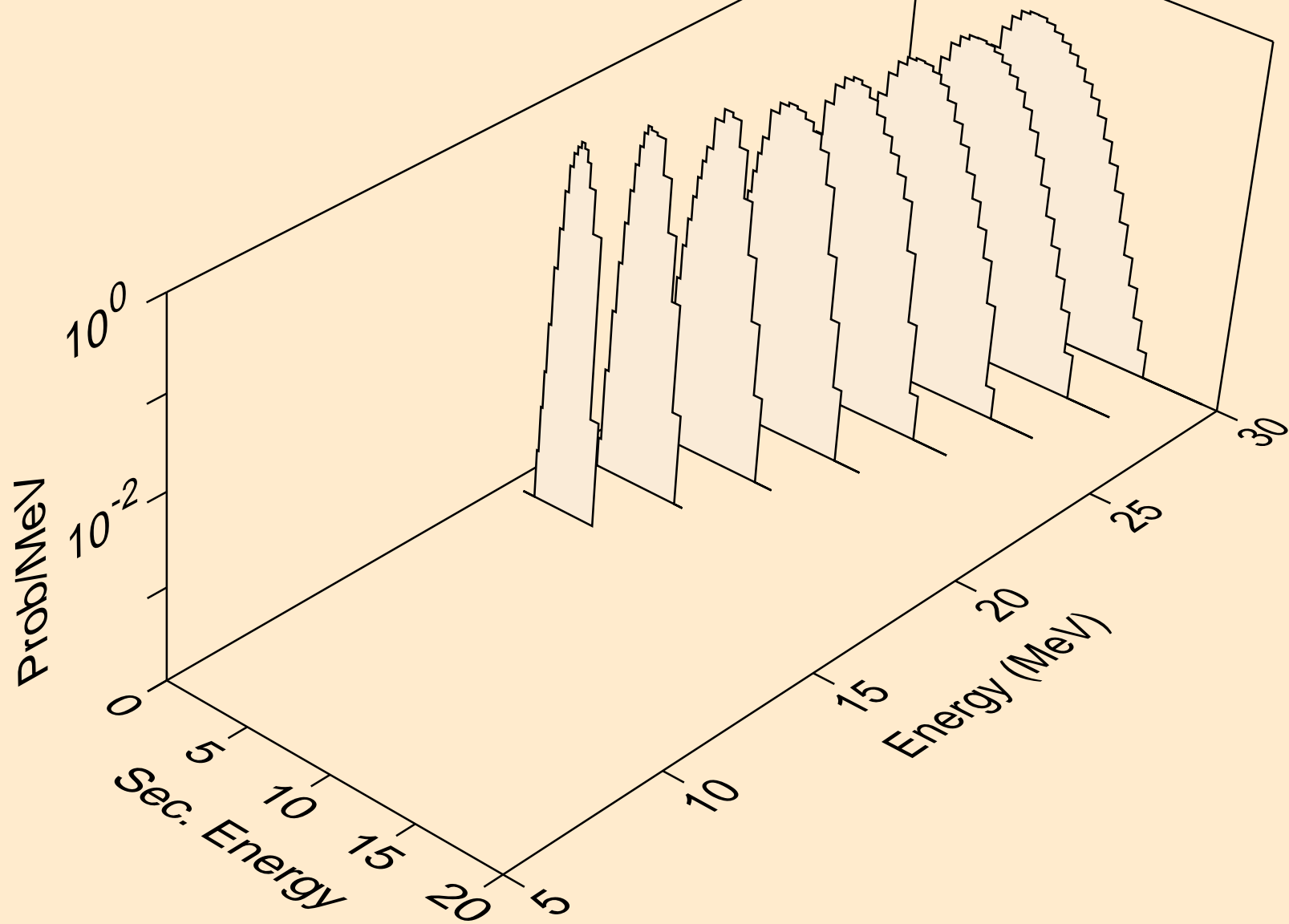

IR191M PROTON ACER TENDL-2023 LIBRARY; T=0.K  
Proton emission for inelastic

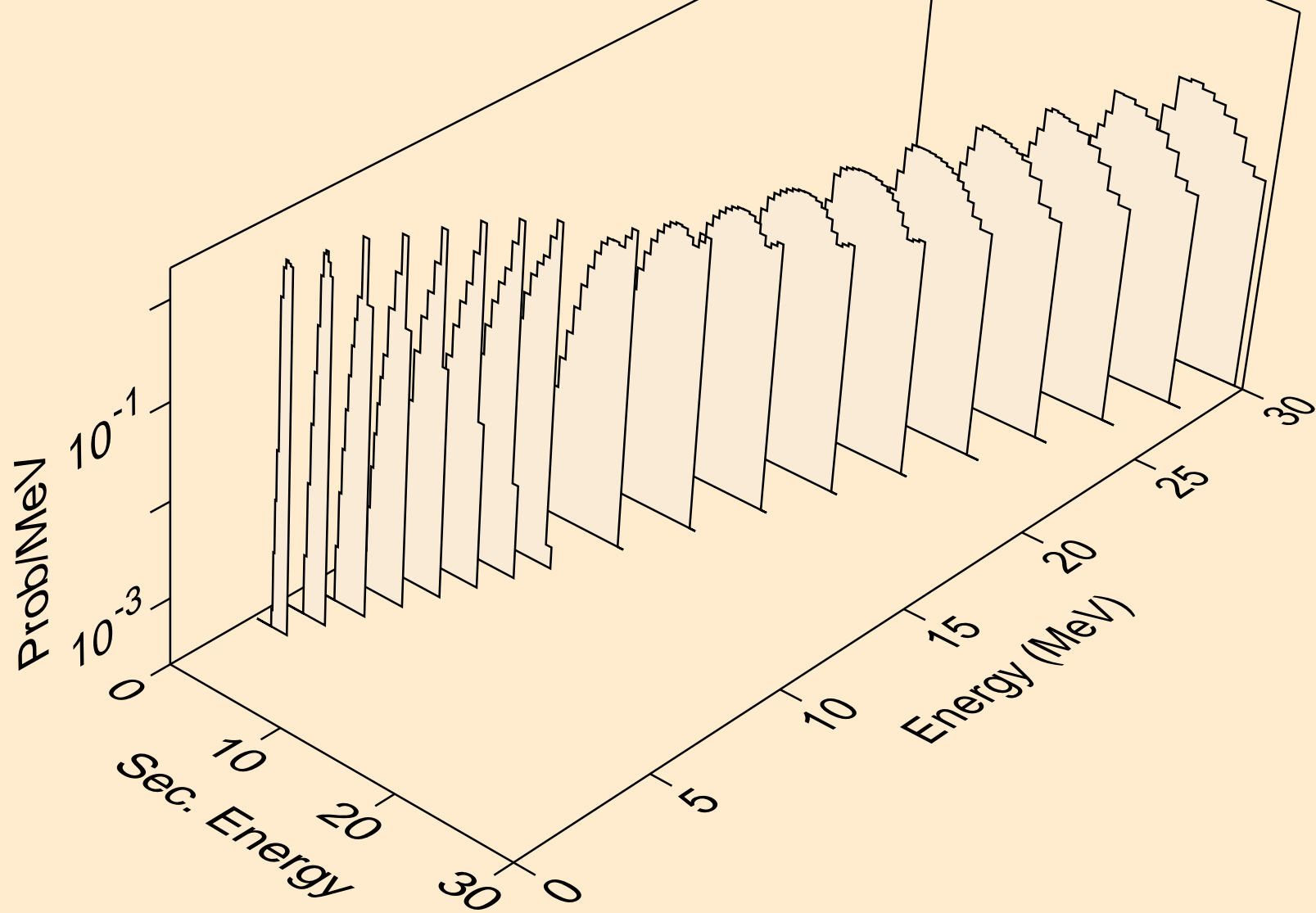



IR191M PROTON ACER TENDL-2023 LIBRARY; T=0.K  
Proton emission for (p,2p)

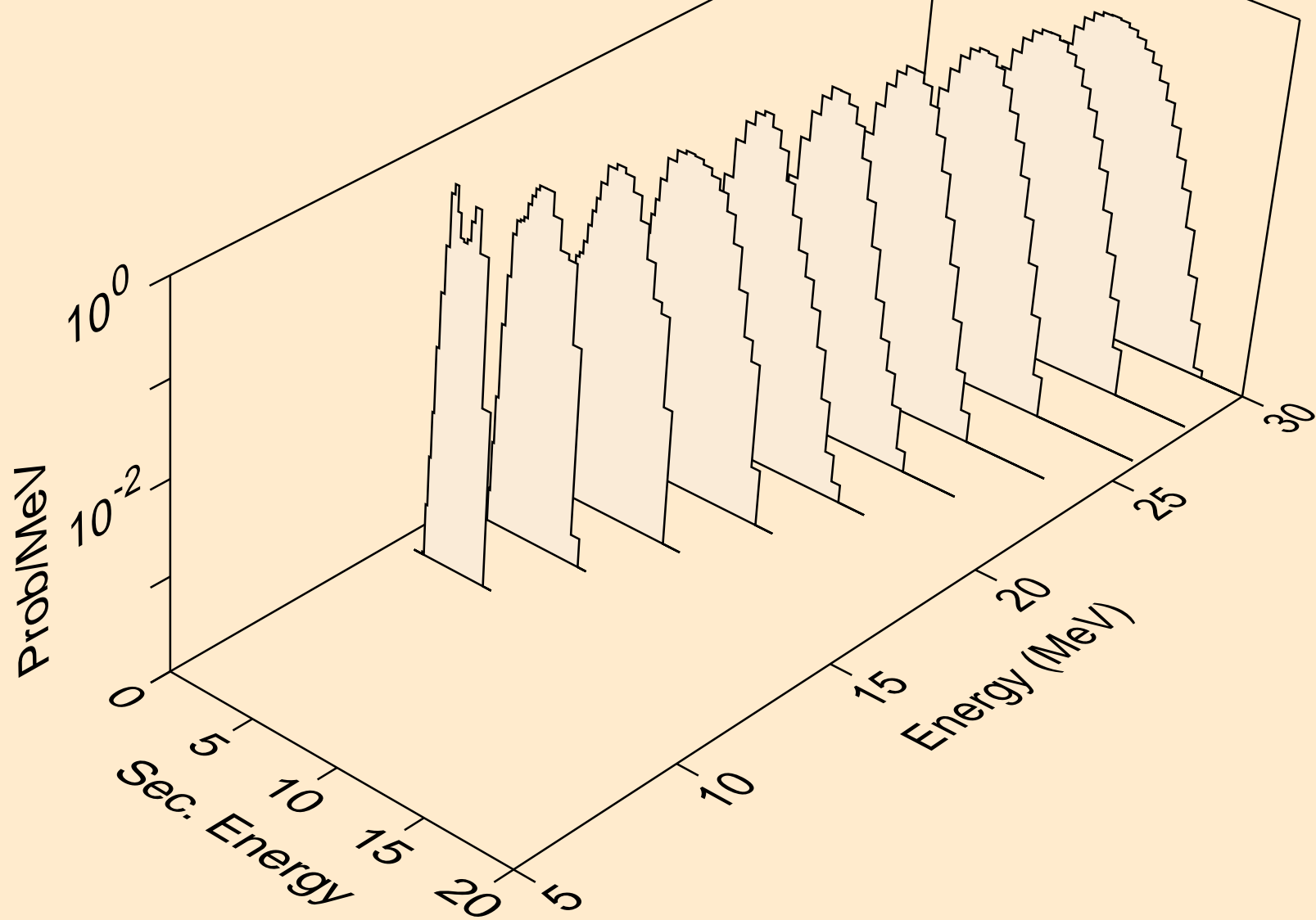

IR191M PROTON ACER TENDL-2023 LIBRARY; T=0.K  
Proton emission for (p,pa)

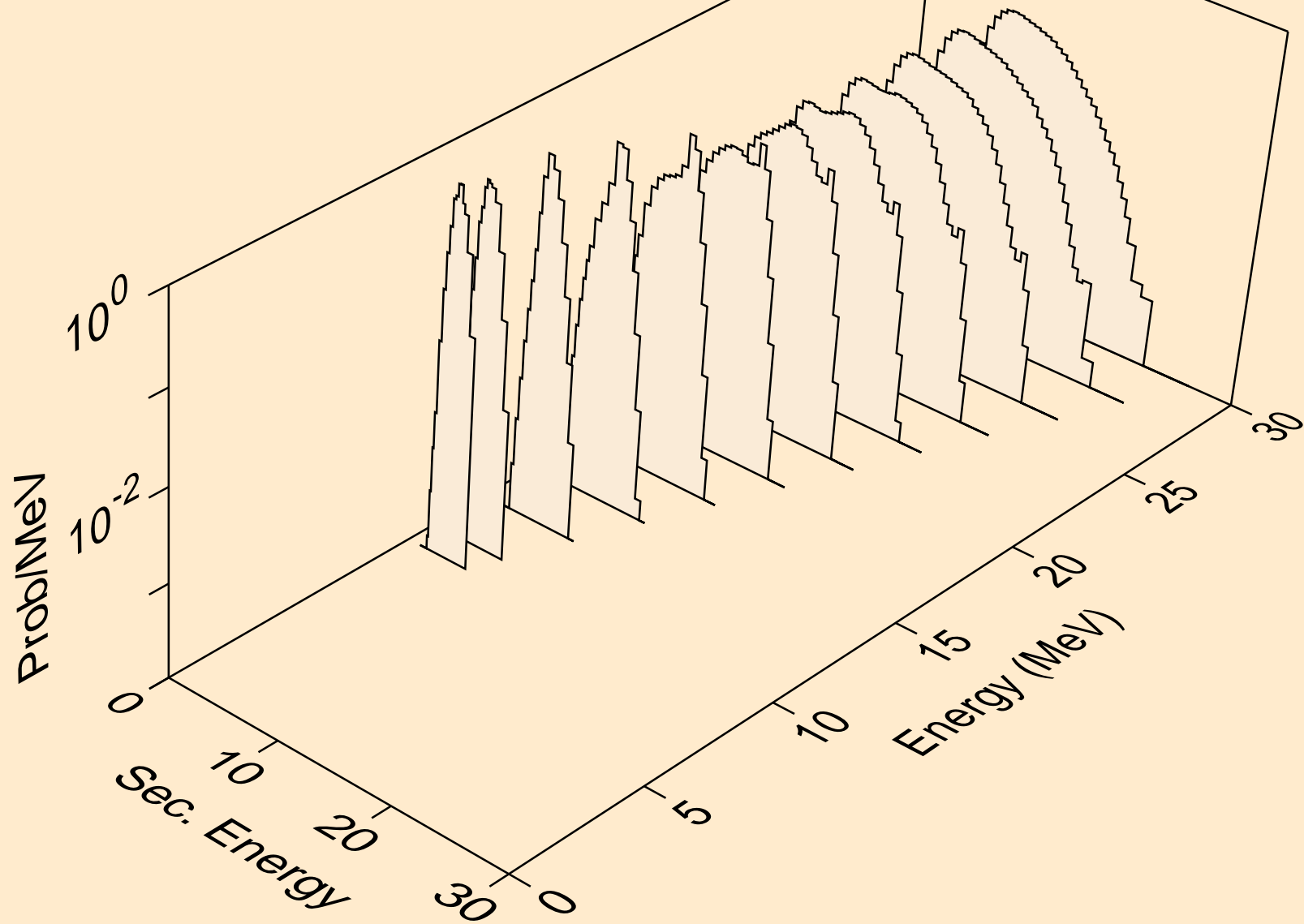

IR191M PROTON ACER TENDL-2023 LIBRARY; T=0.K  
Proton emission for (p,pd)

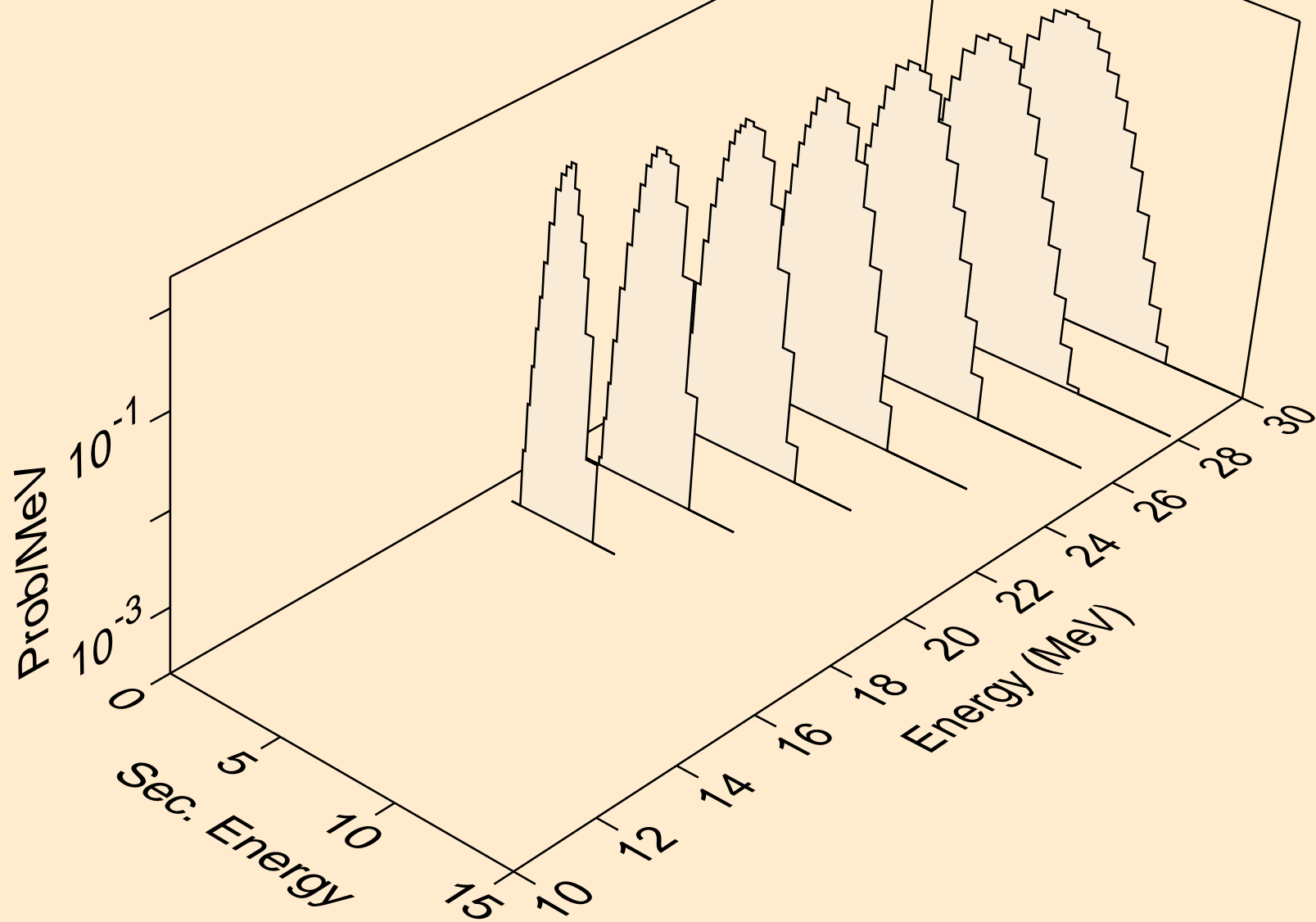

IR191M PROTON ACER TENDL-2023 LIBRARY; T=0.K  
Proton emission for (p,pt)

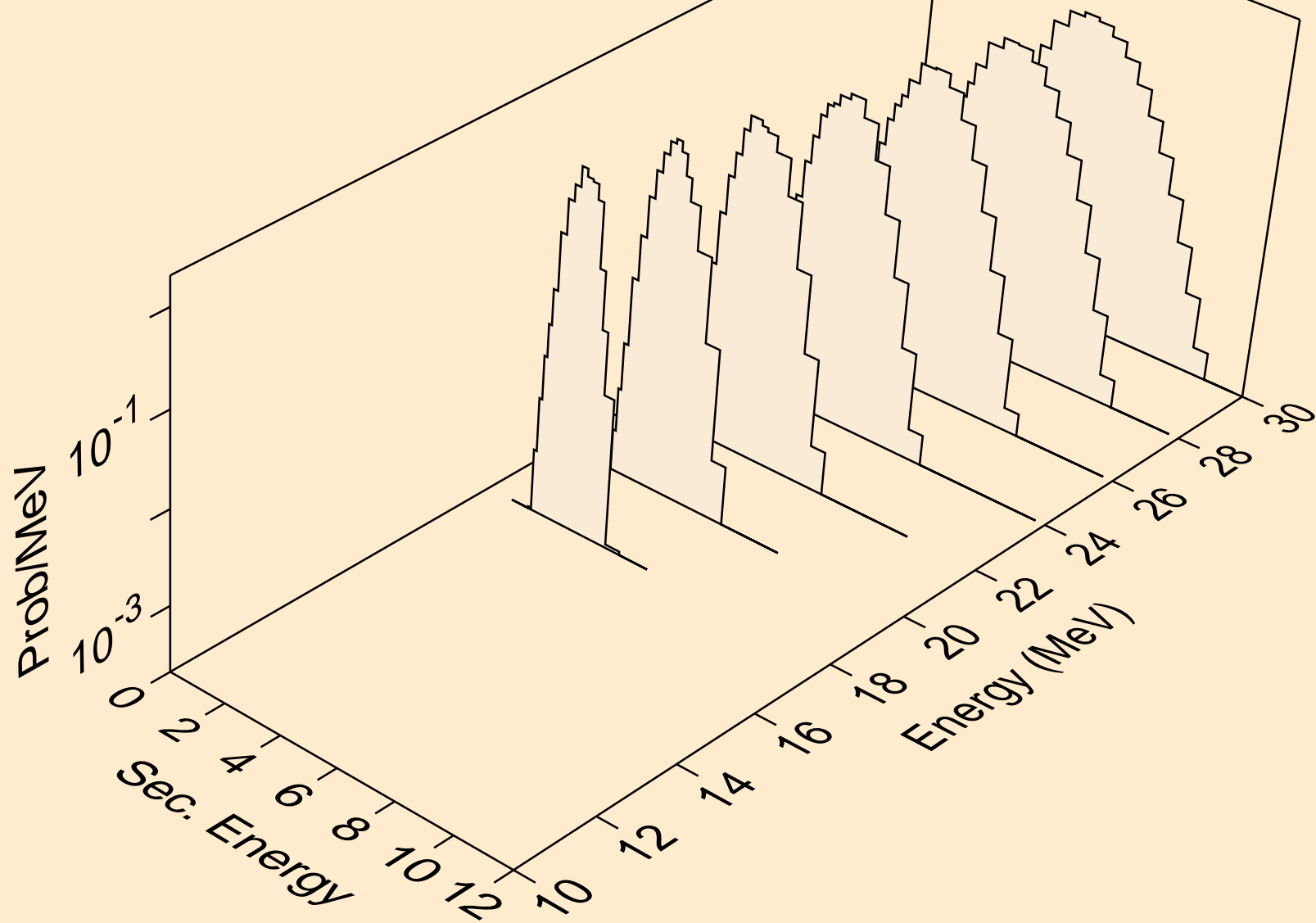

IR191M PROTON ACER TENDL-2023 LIBRARY; T=0.K  
Photon emission for (z,n)

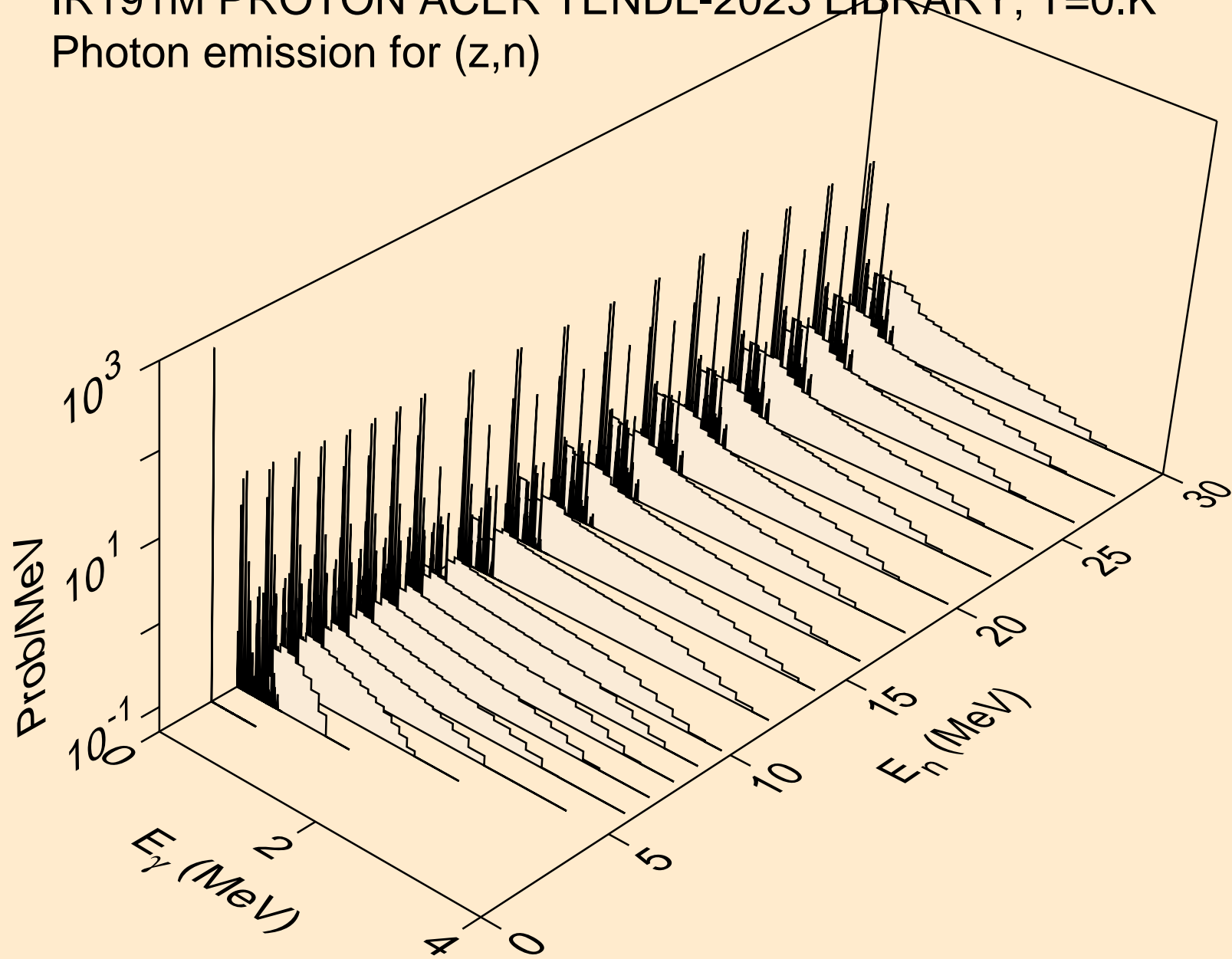

IR191M PROTON ACER TENDL-2023 LIBRARY; T=0.K  
Photon emission for (z,x)

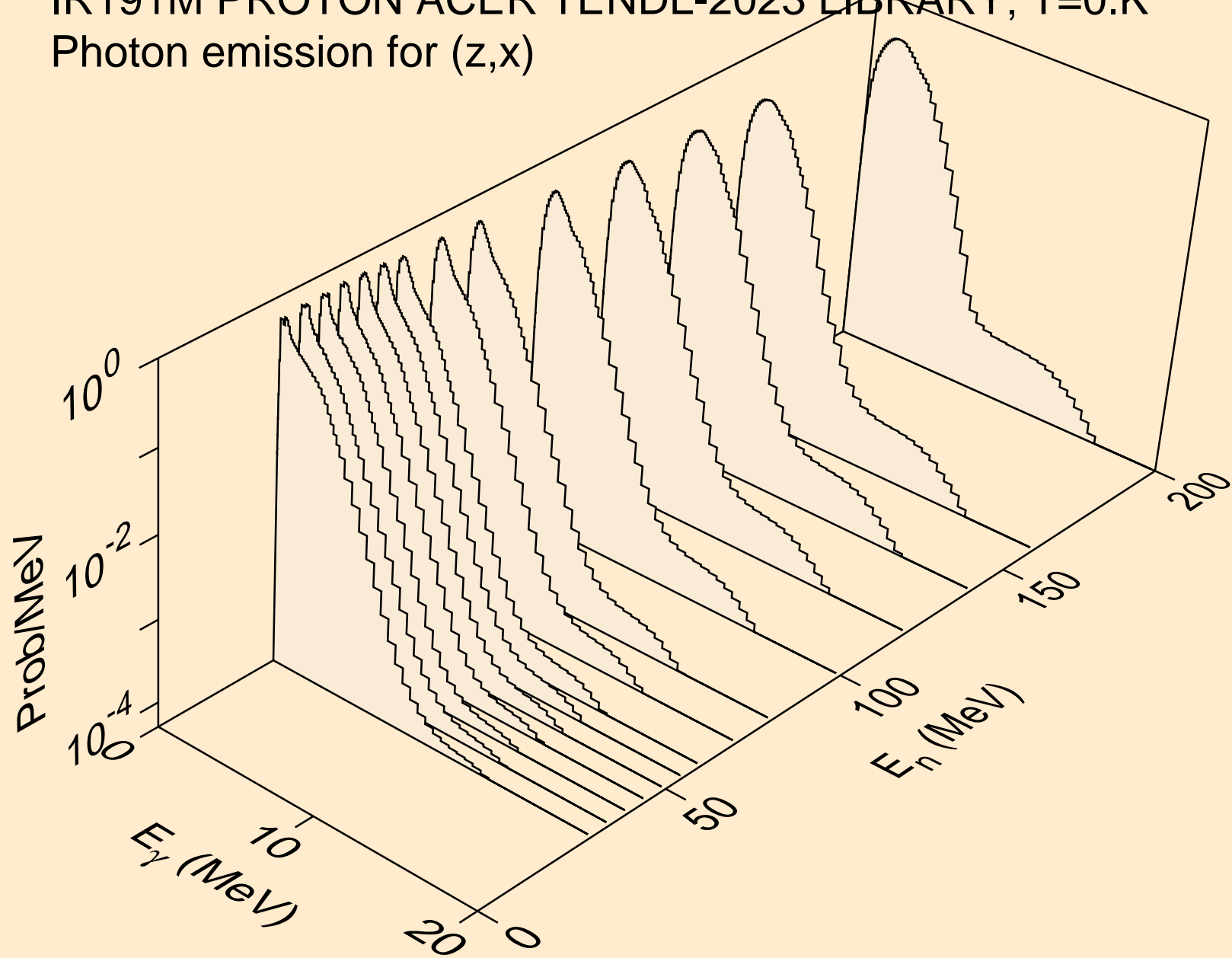

IR191M PROTON ACER TENDL-2023 LIBRARY; T=0.K  
Photon emission for (n,2nd)

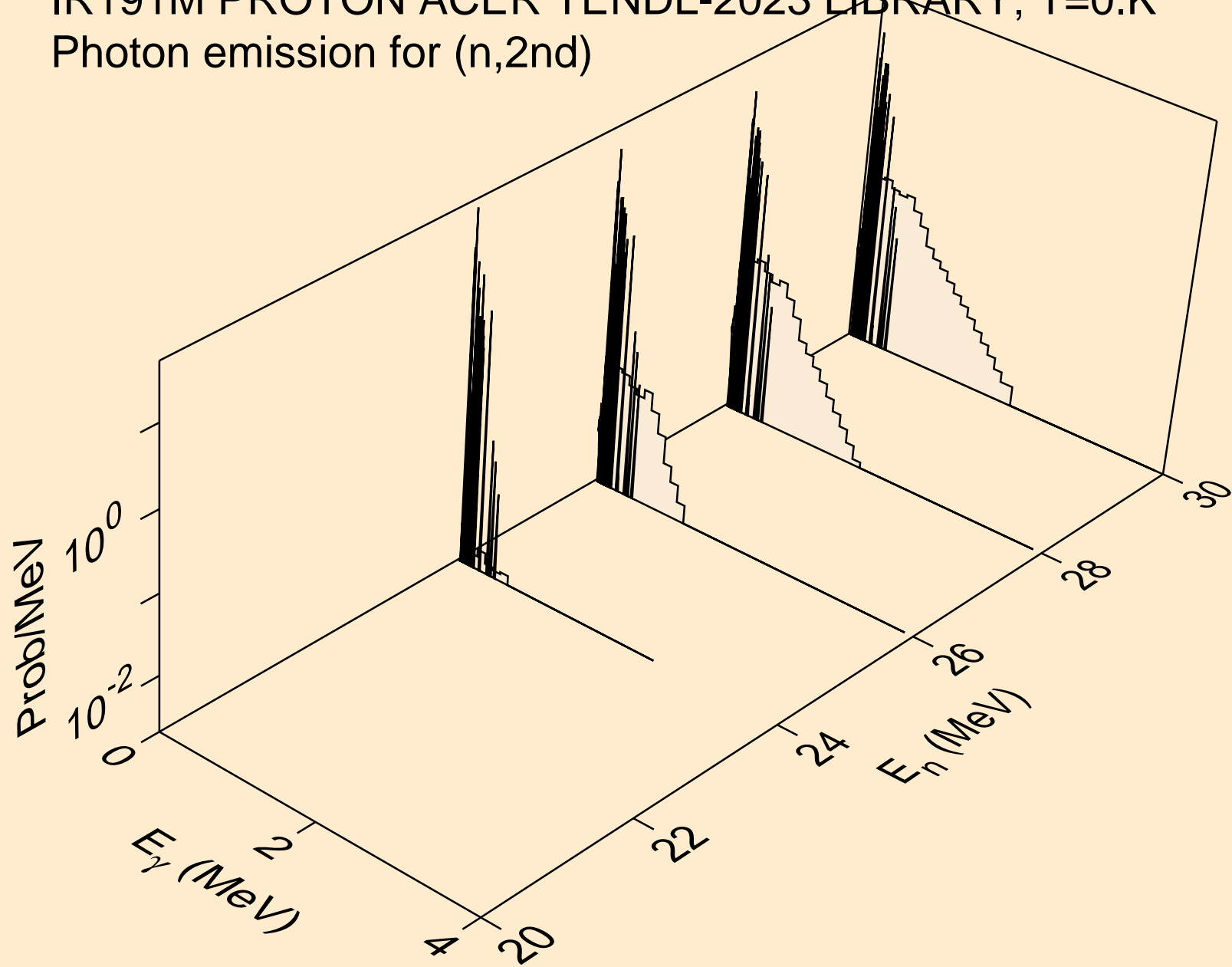

IR191M PROTON ACER TENDL-2023 LIBRARY; T=0.K  
Photon emission for (n,2n)

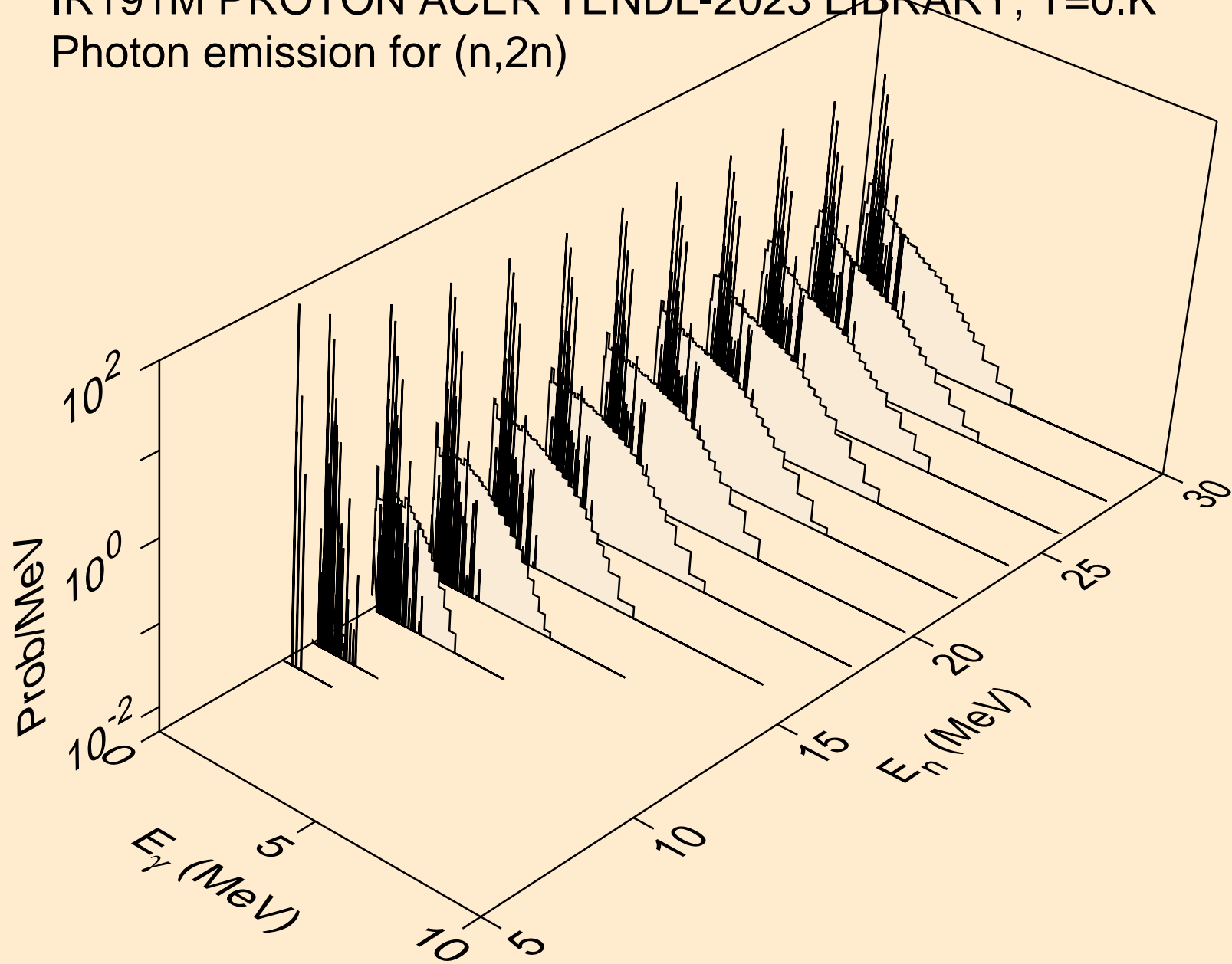



IR191M PROTON ACER TENDL-2023 LIBRARY; T=0.K  
Photon emission for (n,3n)

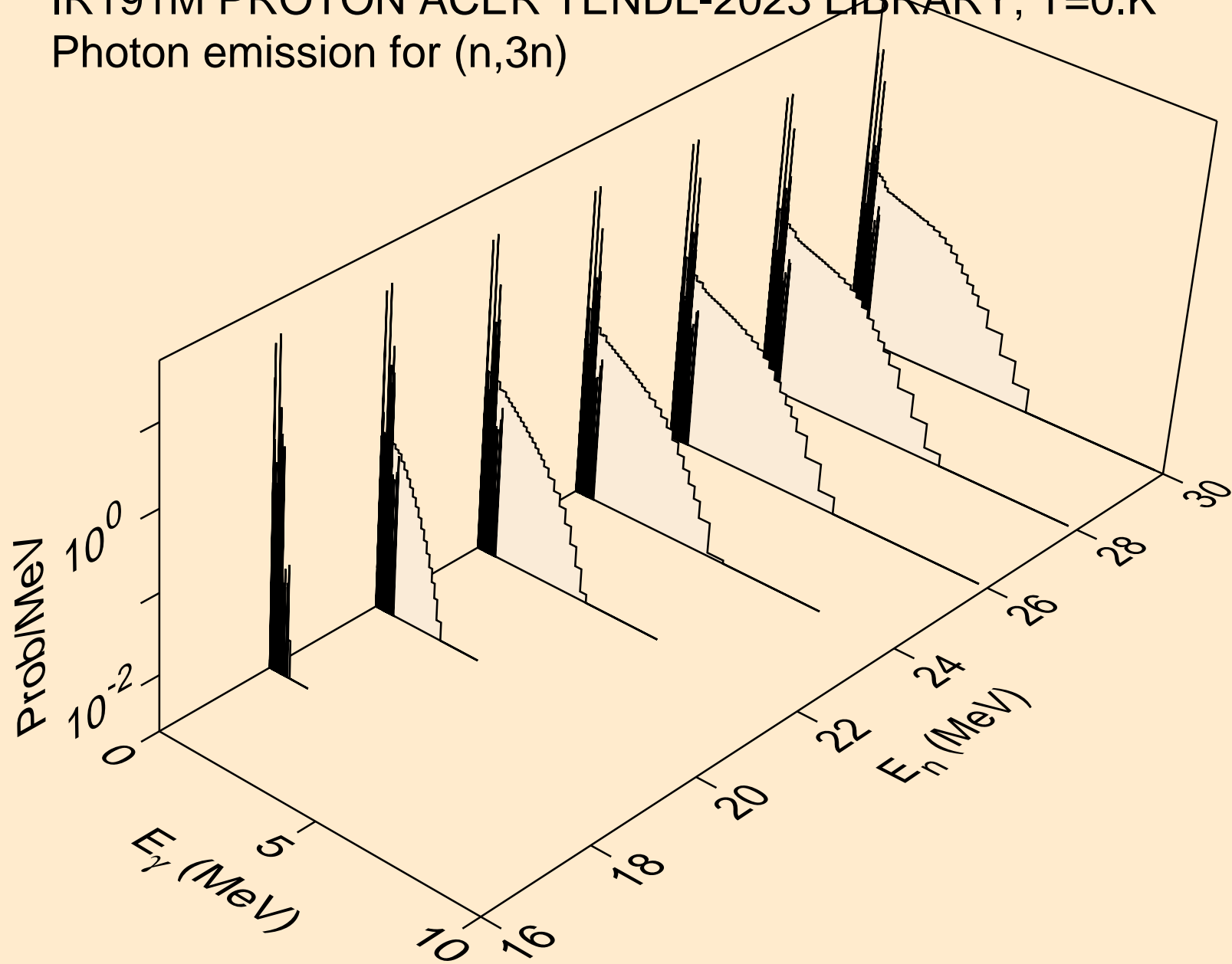

IR191M PROTON ACER TENDL-2023 LIBRARY; T=0.K  
Photon emission for (n,n\*)a

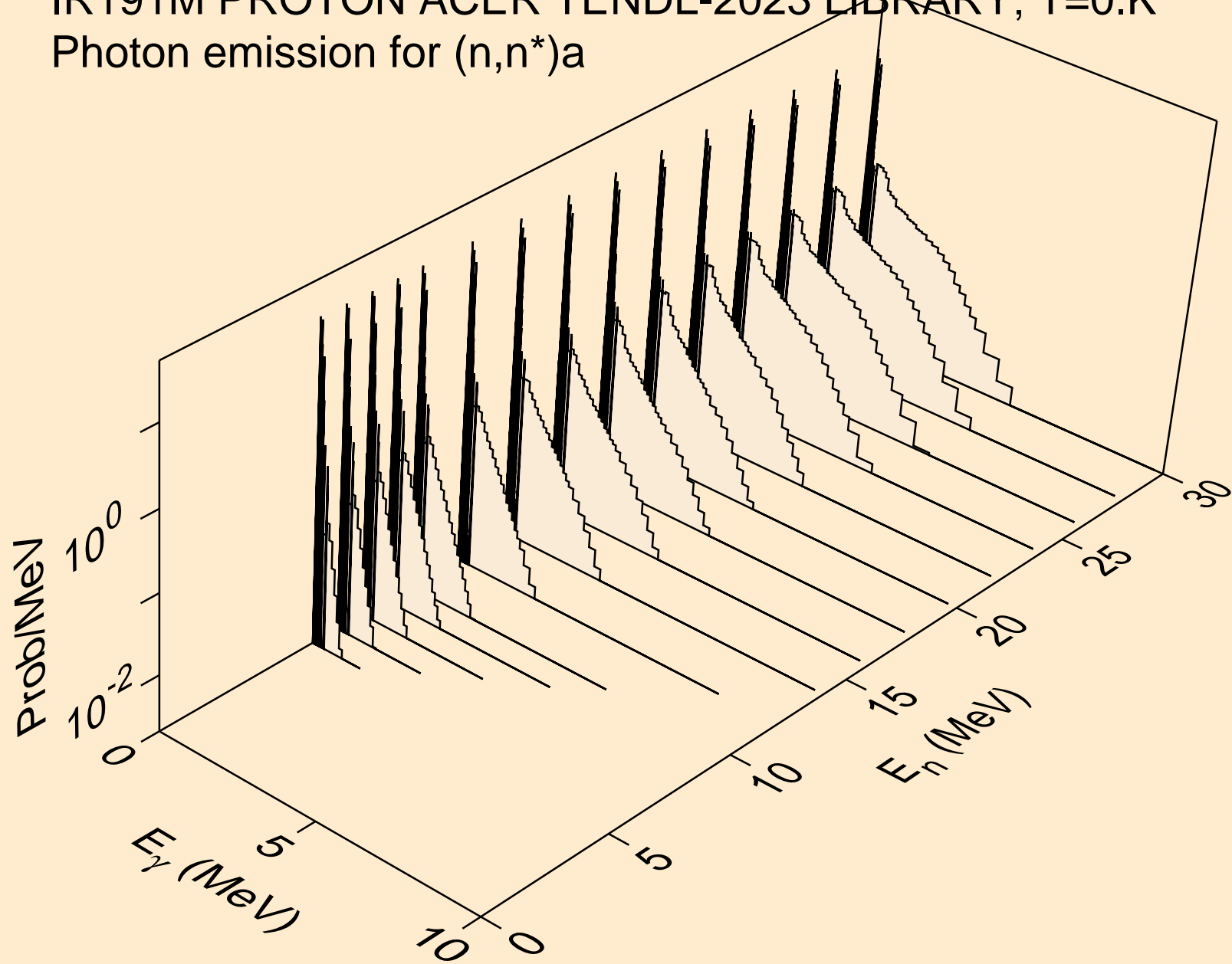

IR191M PROTON ACER TENDL-2023 LIBRARY; T=0.K  
Photon emission for (n,2n) $\alpha$

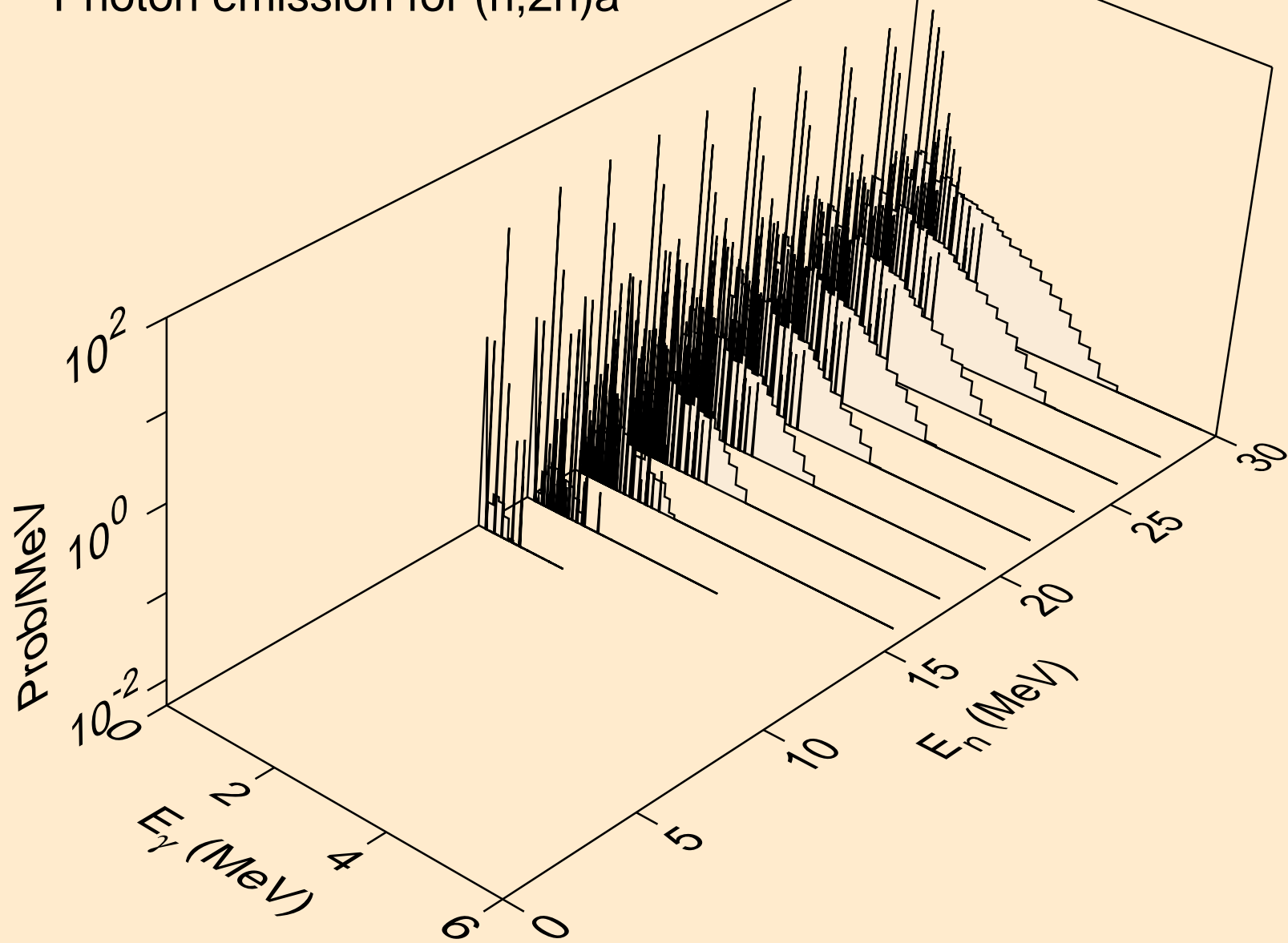

IR191M PROTON ACER TENDL-2023 LIBRARY; T=0.K  
Photon emission for (n,3n)a

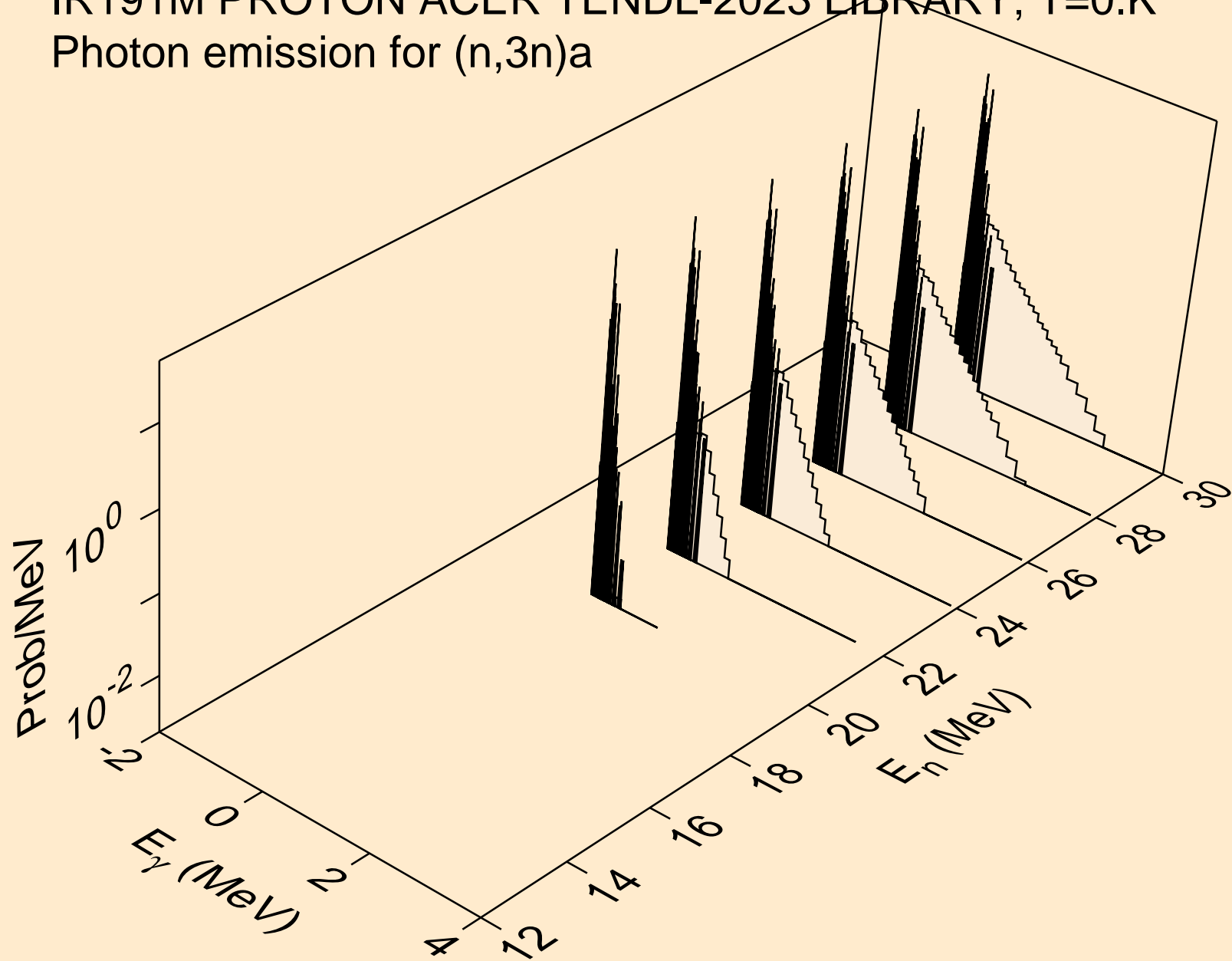

IR191M PROTON ACER TENDL-2023 LIBRARY; T=0.K  
Photon emission for (n,n\*)p

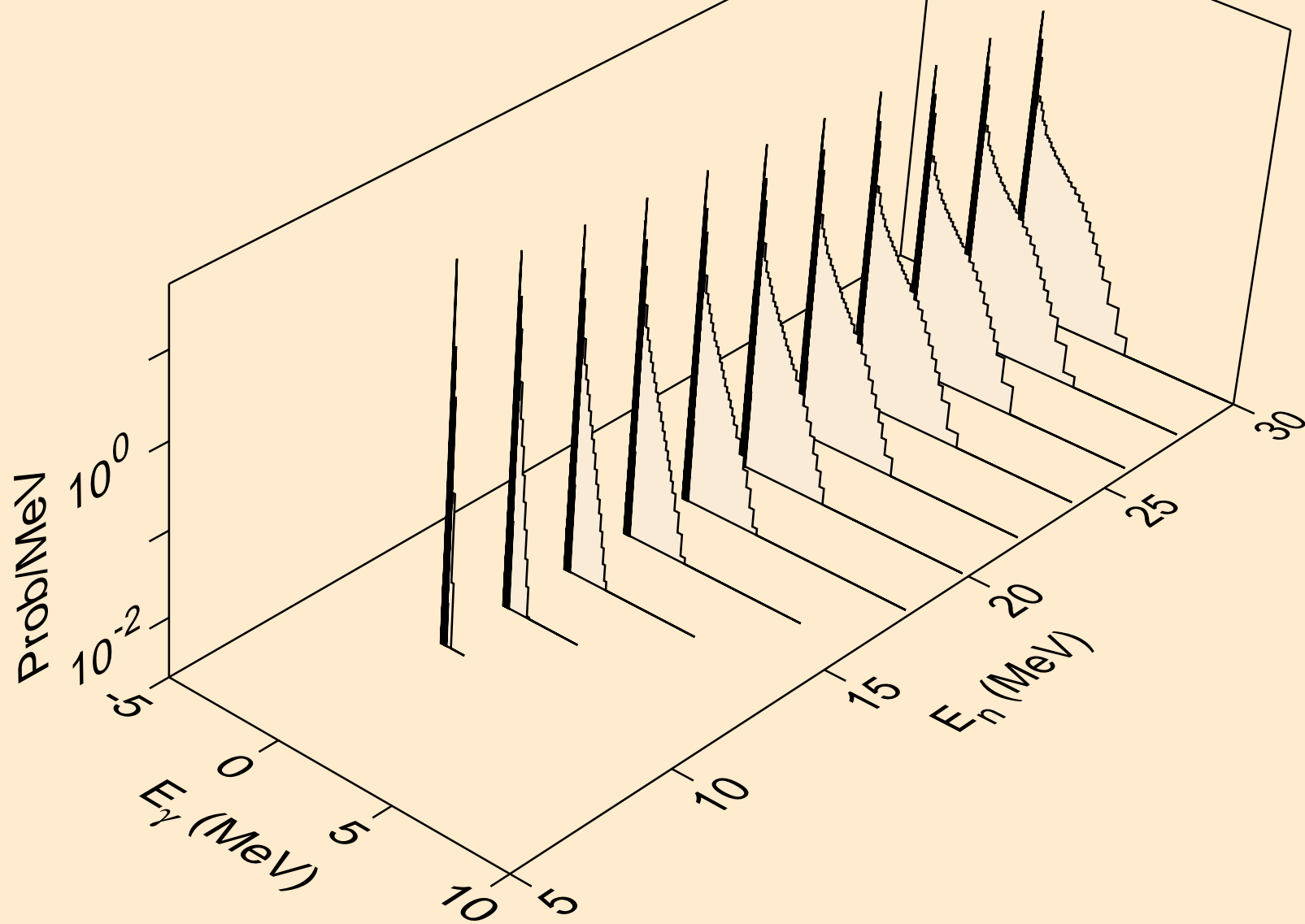

IR191M PROTON ACER TENDL-2023 LIBRARY; T=0.K  
Photon emission for (n,n\*)2a

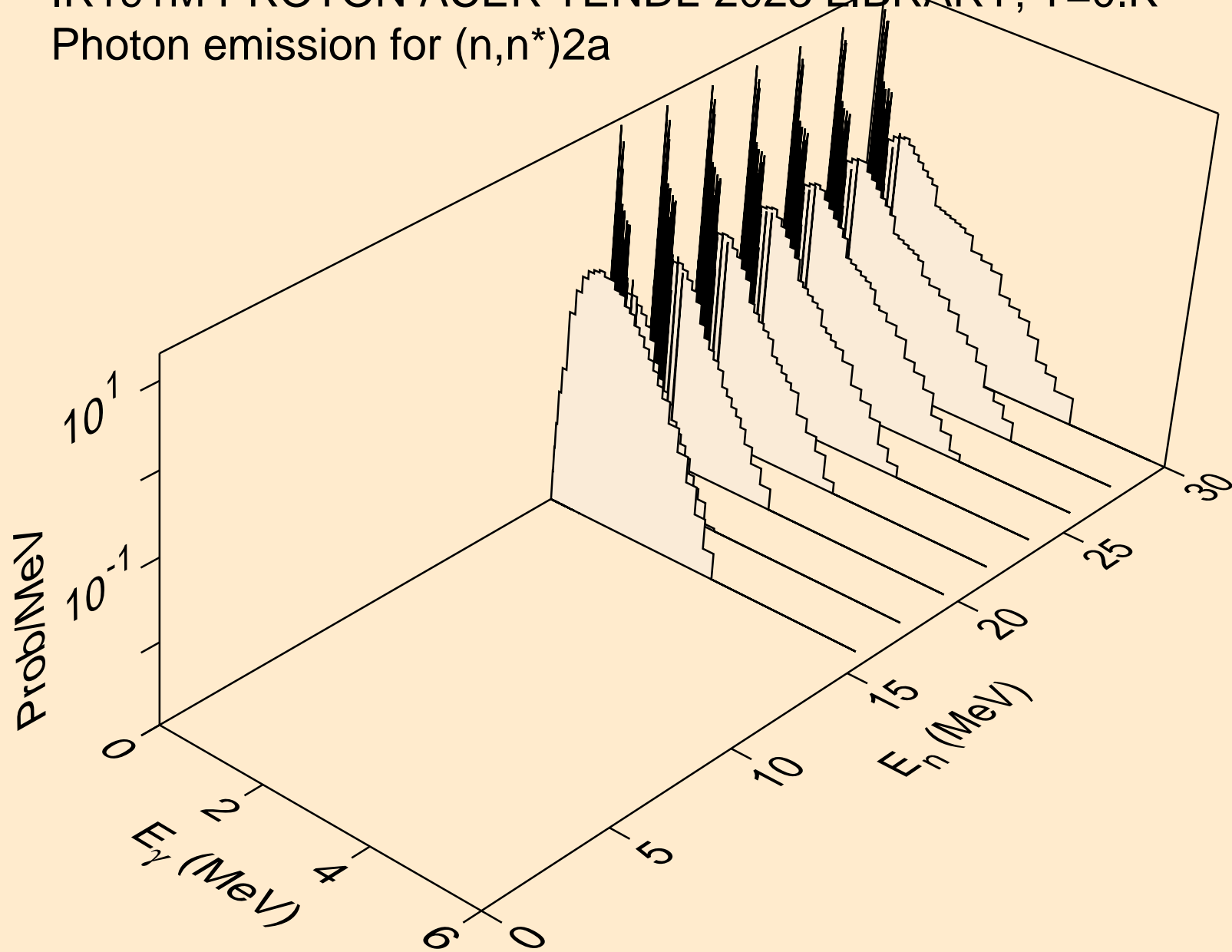

IR191M PROTON ACER TENDL-2023 LIBRARY; T=0.K  
Photon emission for (n,n\*)d

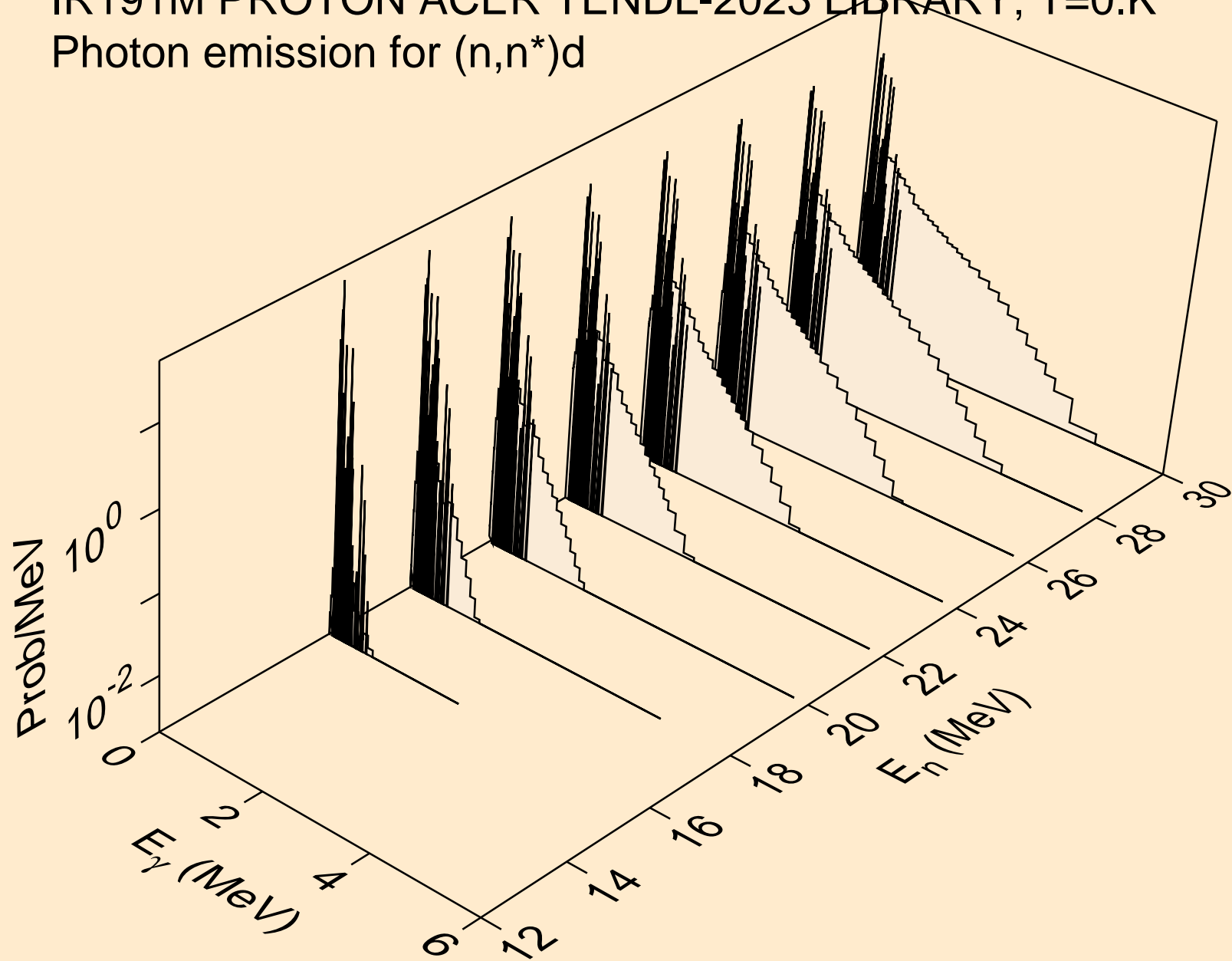

IR191M PROTON ACER TENDL-2023 LIBRARY; T=0.K  
Photon emission for (n,n\*)t

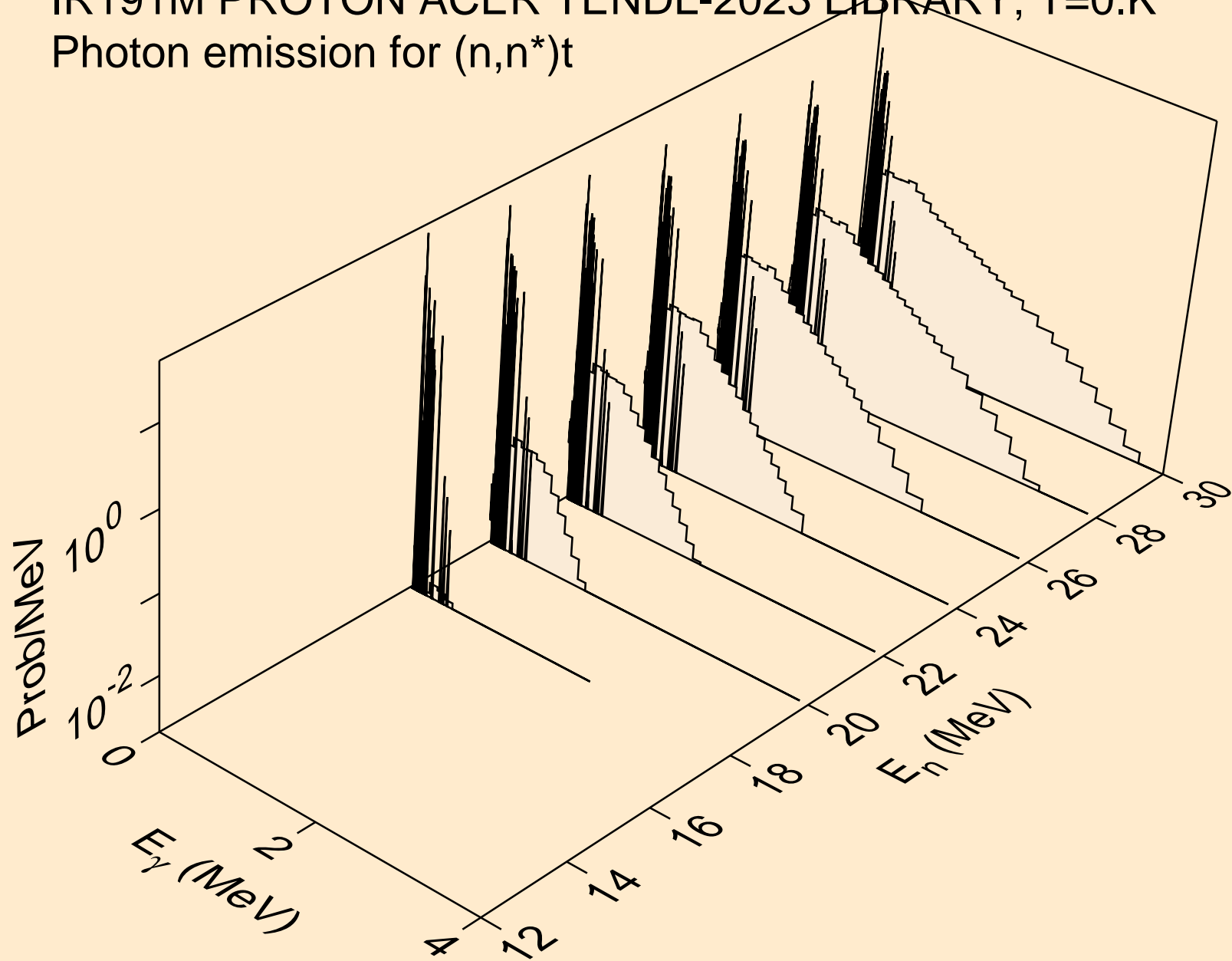



IR191M PROTON ACER TENDL-2023 LIBRARY; T=0.K  
Photon emission for (n,n\*)he3

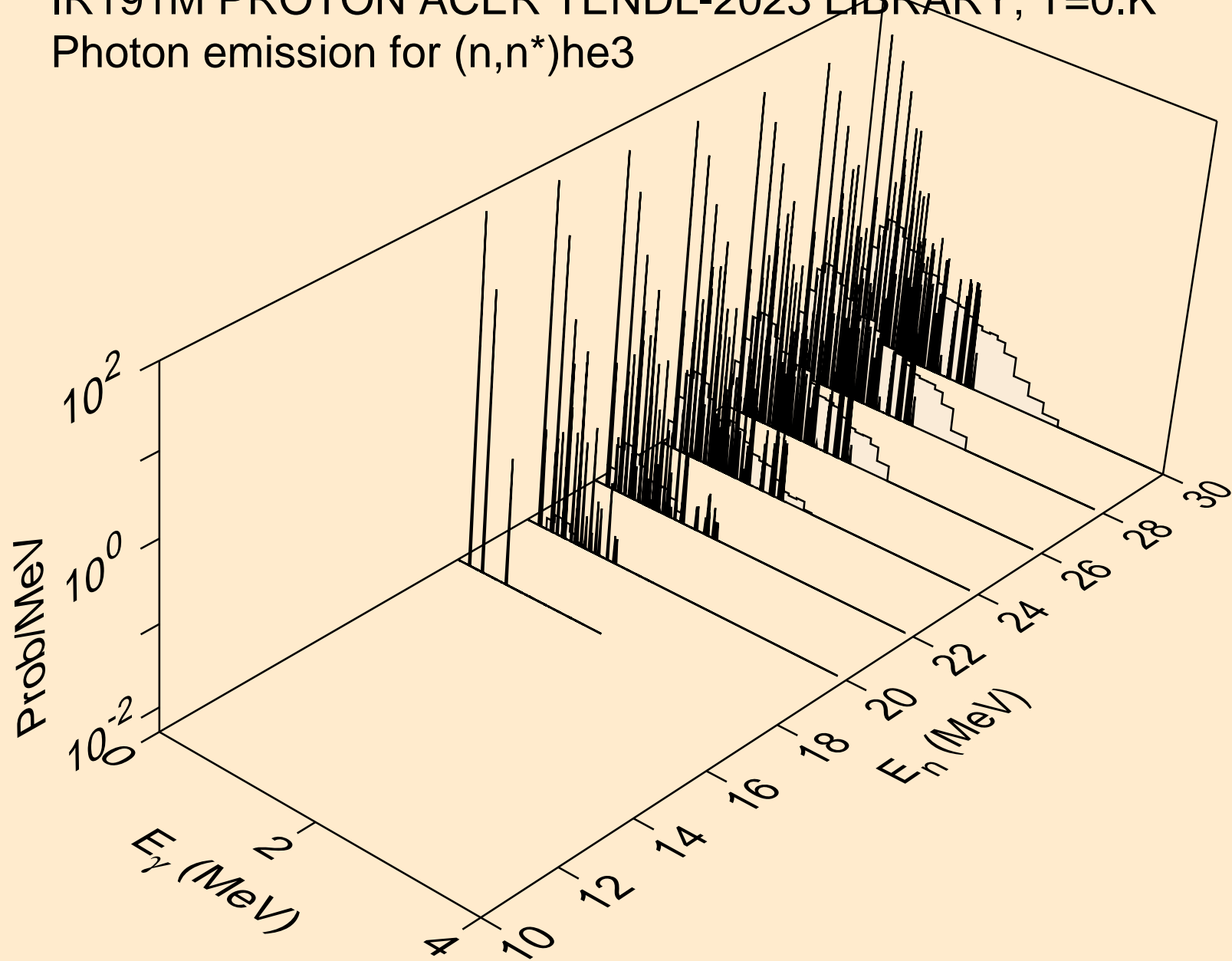

IR191M PROTON ACER TENDL-2023 LIBRARY; T=0.K  
Photon emission for (n,4n)

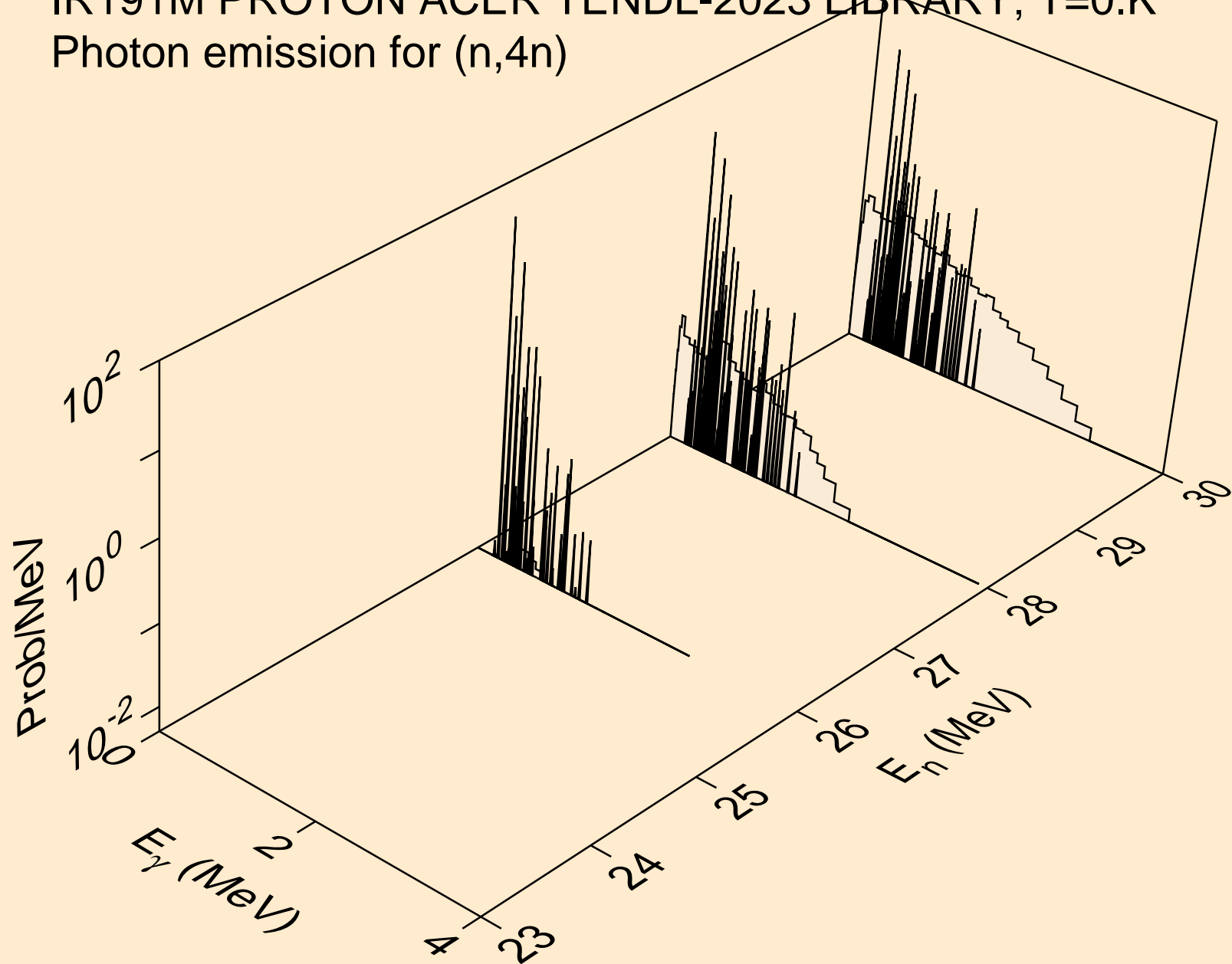

IR191M PROTON ACER TENDL-2023 LIBRARY; T=0.K  
Photon emission for (n,2np)

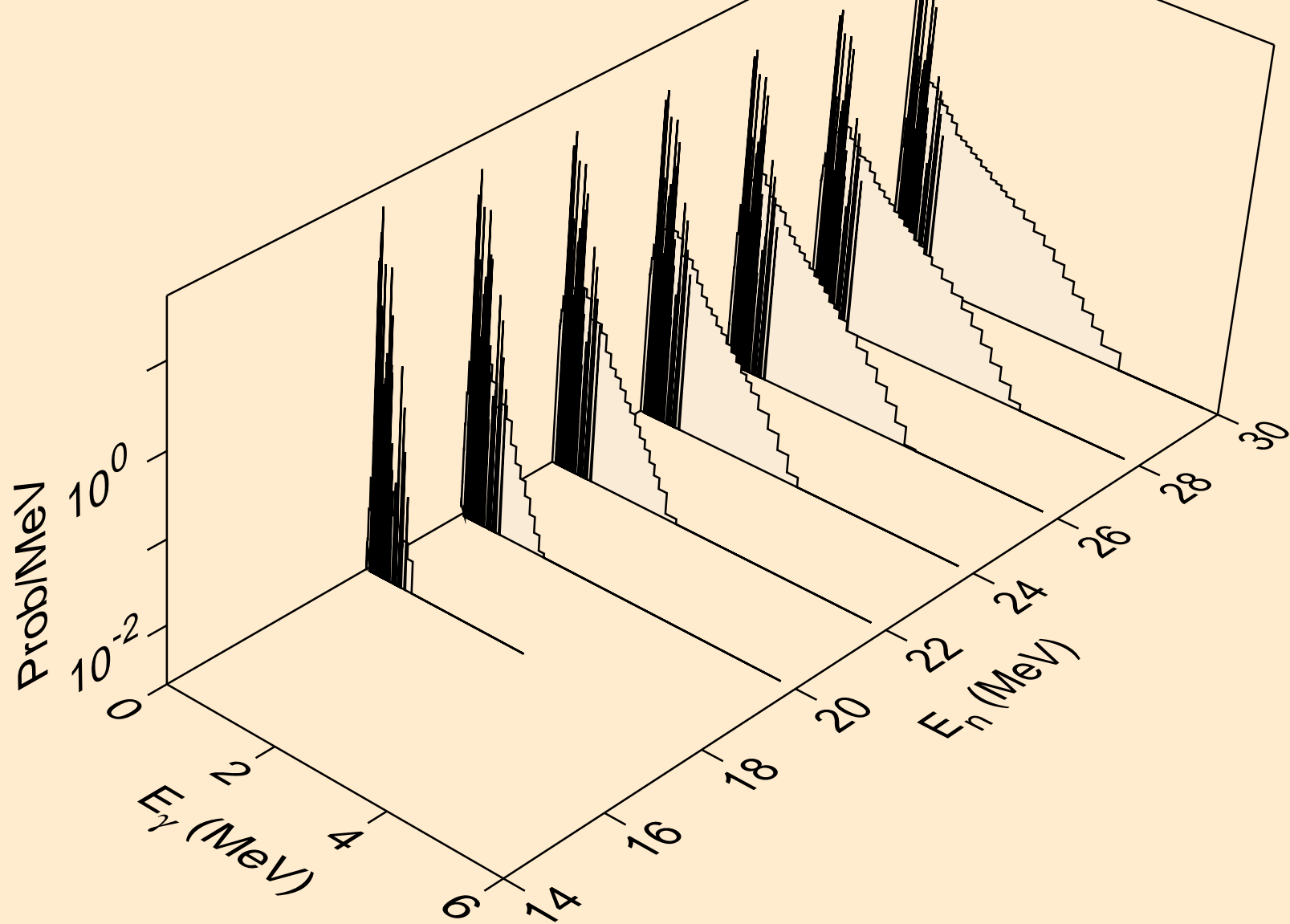

IR191M PROTON ACER TENDL-2023 LIBRARY; T=0.K  
Photon emission for (n,3np)

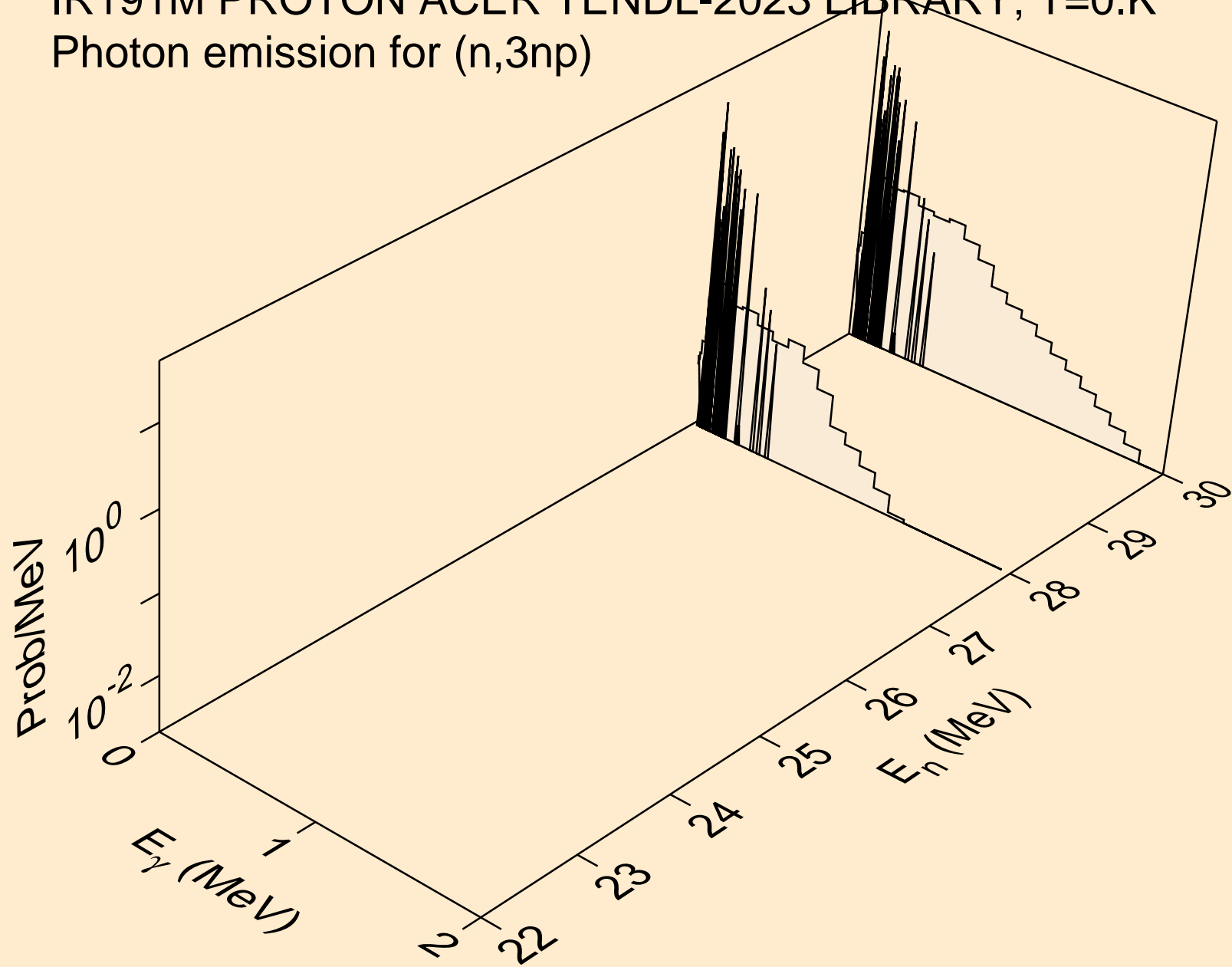

IR191M PROTON ACER TENDL-2023 LIBRARY; T=0.K  
Photon emission for (n,n2p)

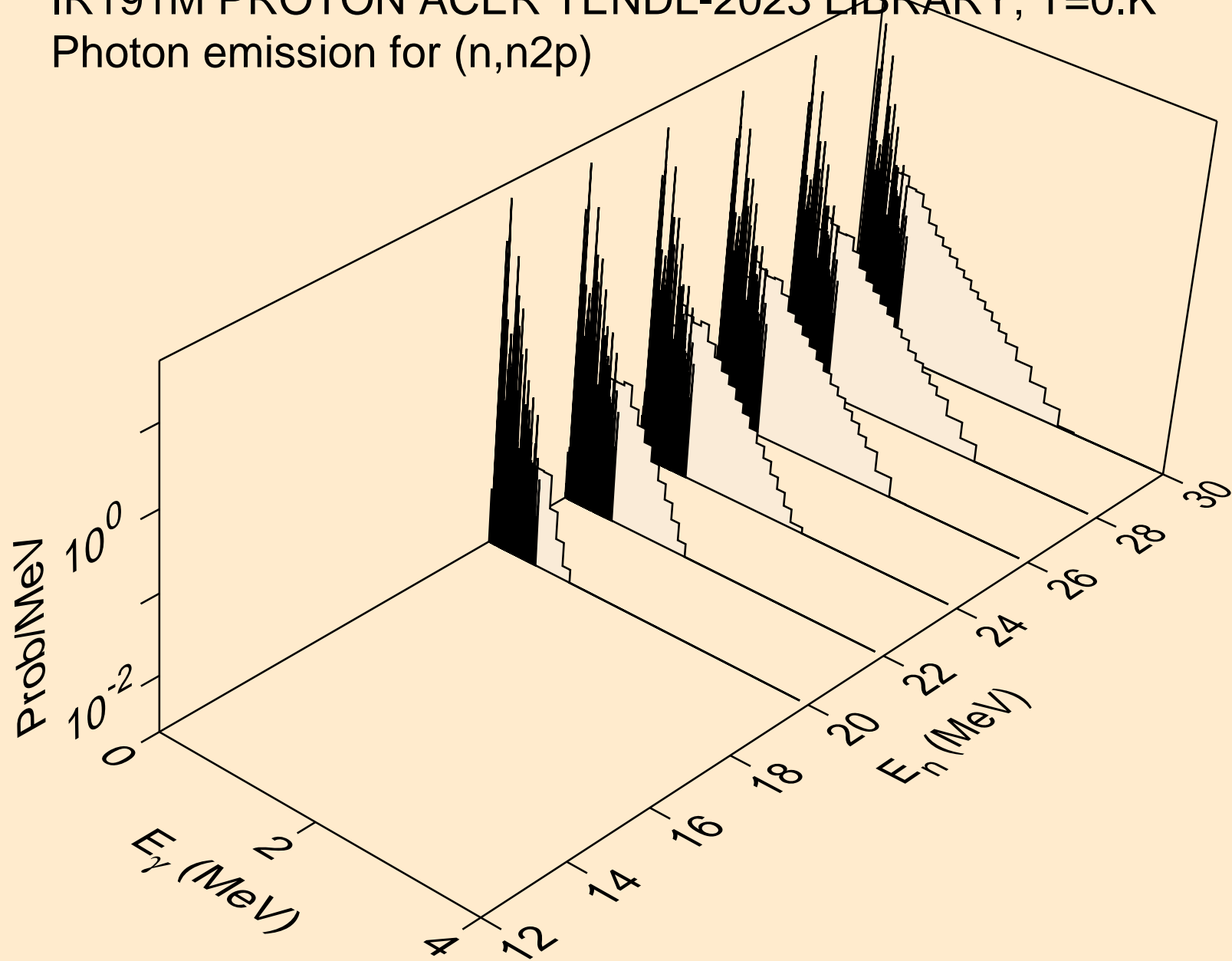

IR191M PROTON ACER TENDL-2023 LIBRARY; T=0.K  
Photon emission for (n,npa)

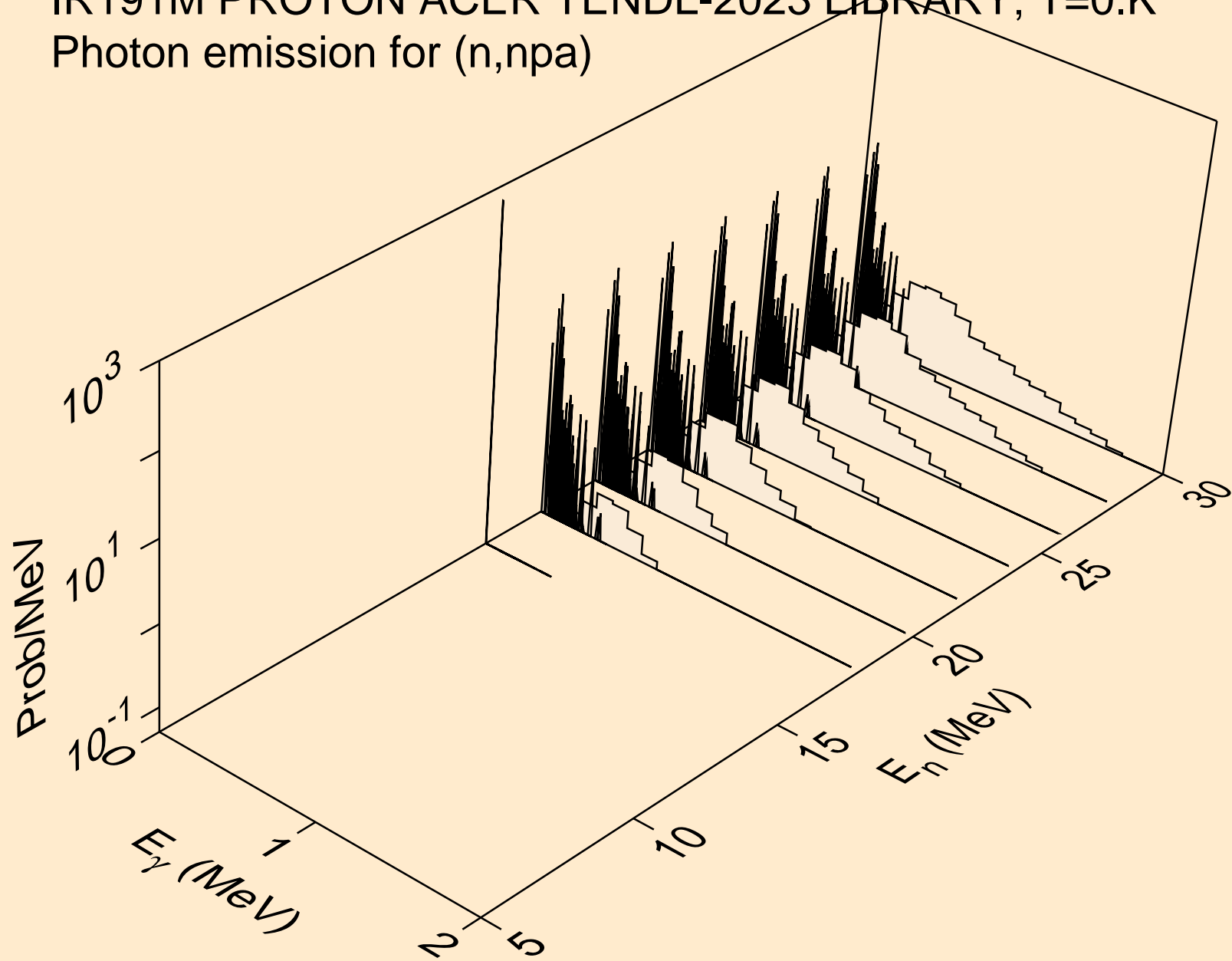

IR191M PROTON ACER TENDL-2023 LIBRARY; T=0.K  
Photon emission for (n,gma)

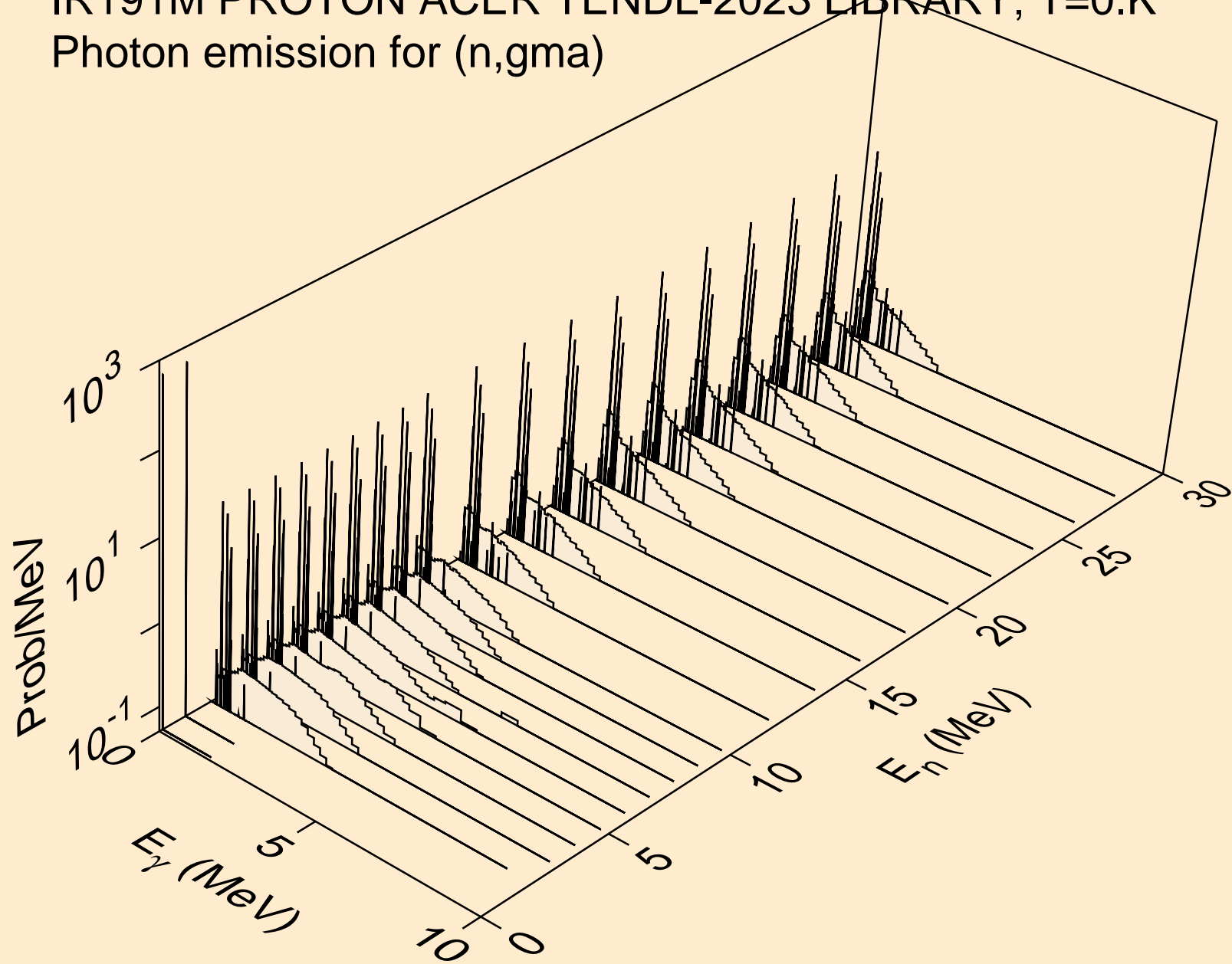

IR191M PROTON ACER TENDL-2023 LIBRARY; T=0.K  
Photon emission for inelastic

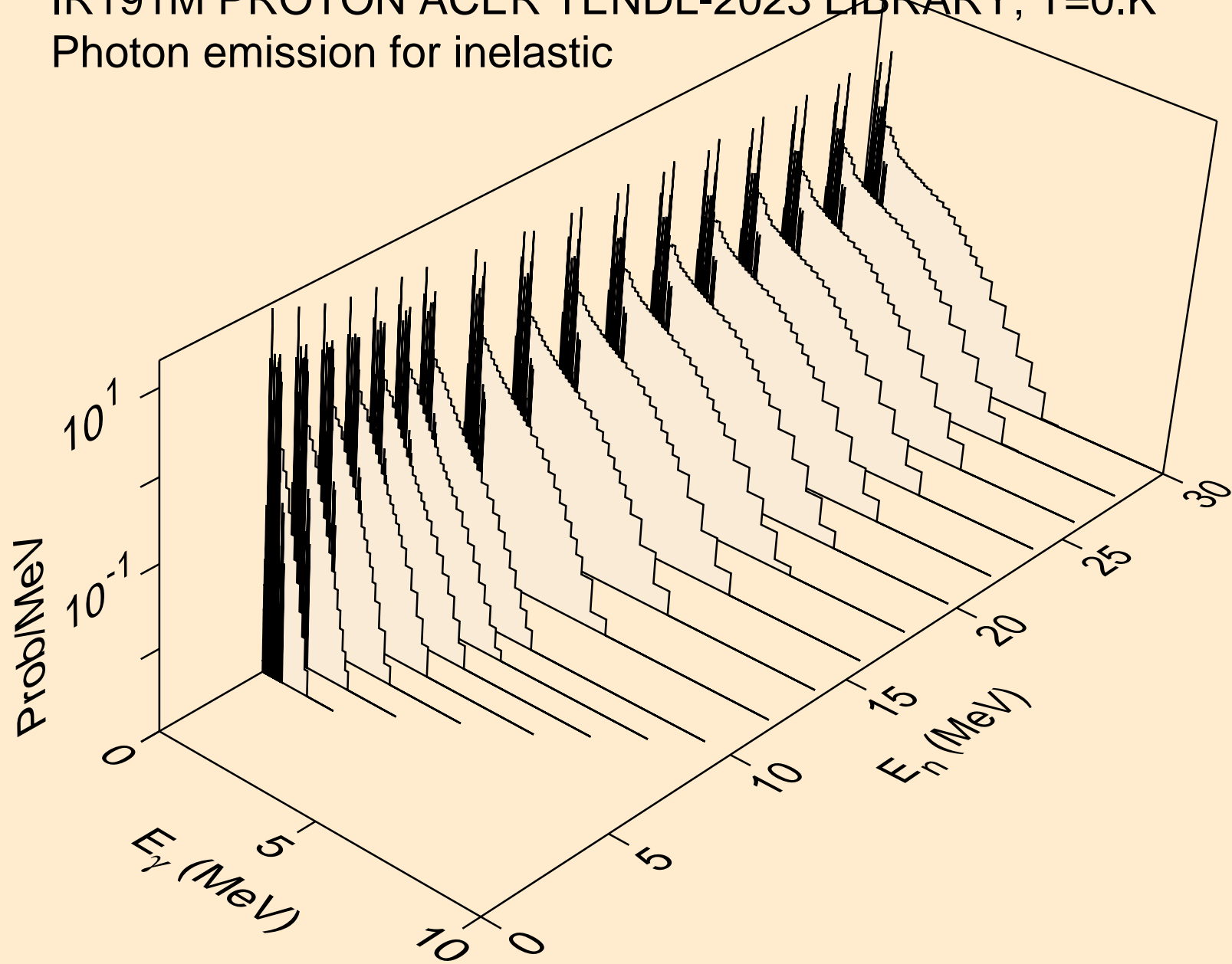



IR191M PROTON ACER TENDL-2023 LIBRARY; T=0.K  
Photon emission for (n,d)

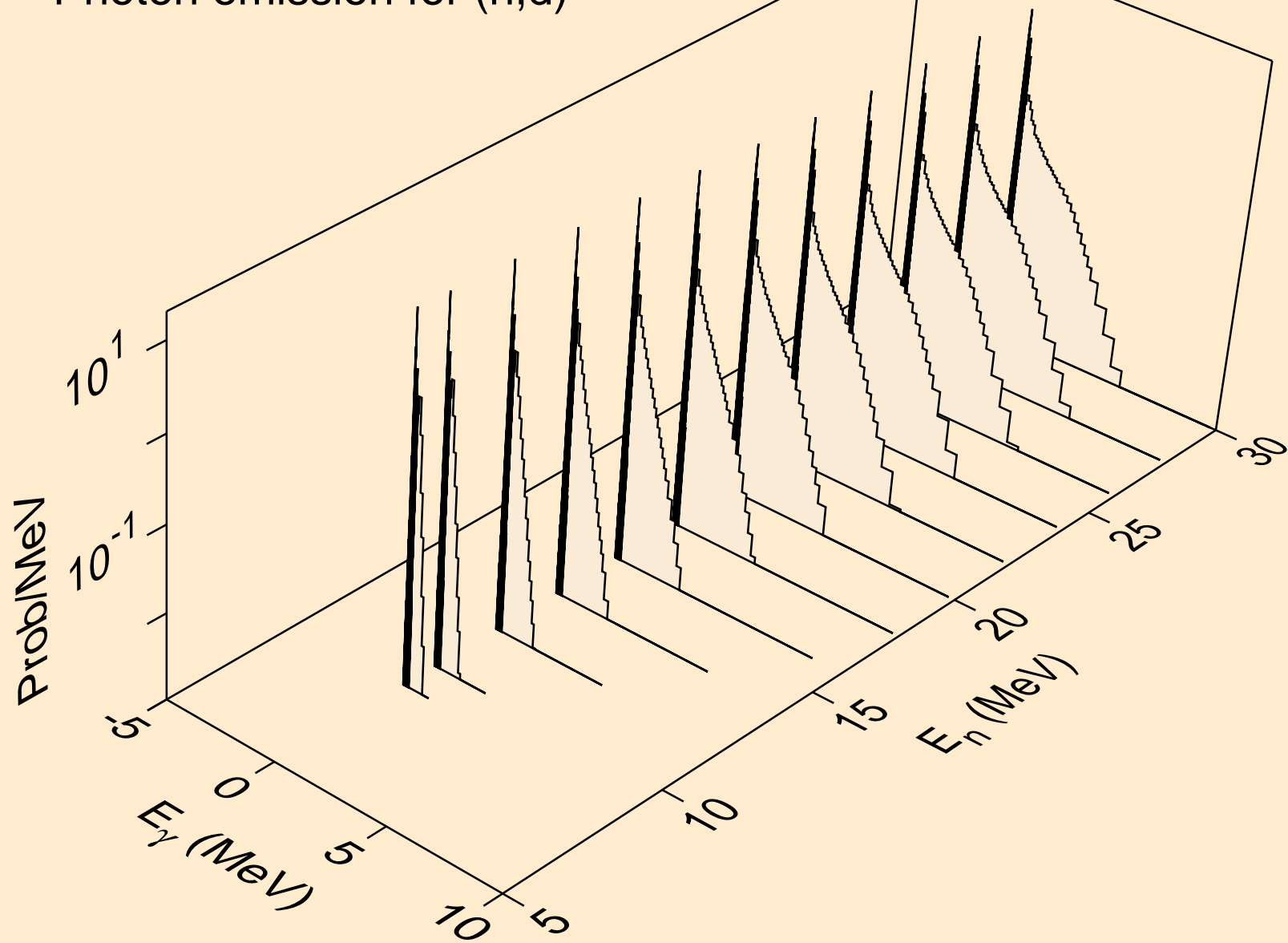

IR191M PROTON ACER TENDL-2023 LIBRARY; T=0.K  
Photon emission for (n,t)

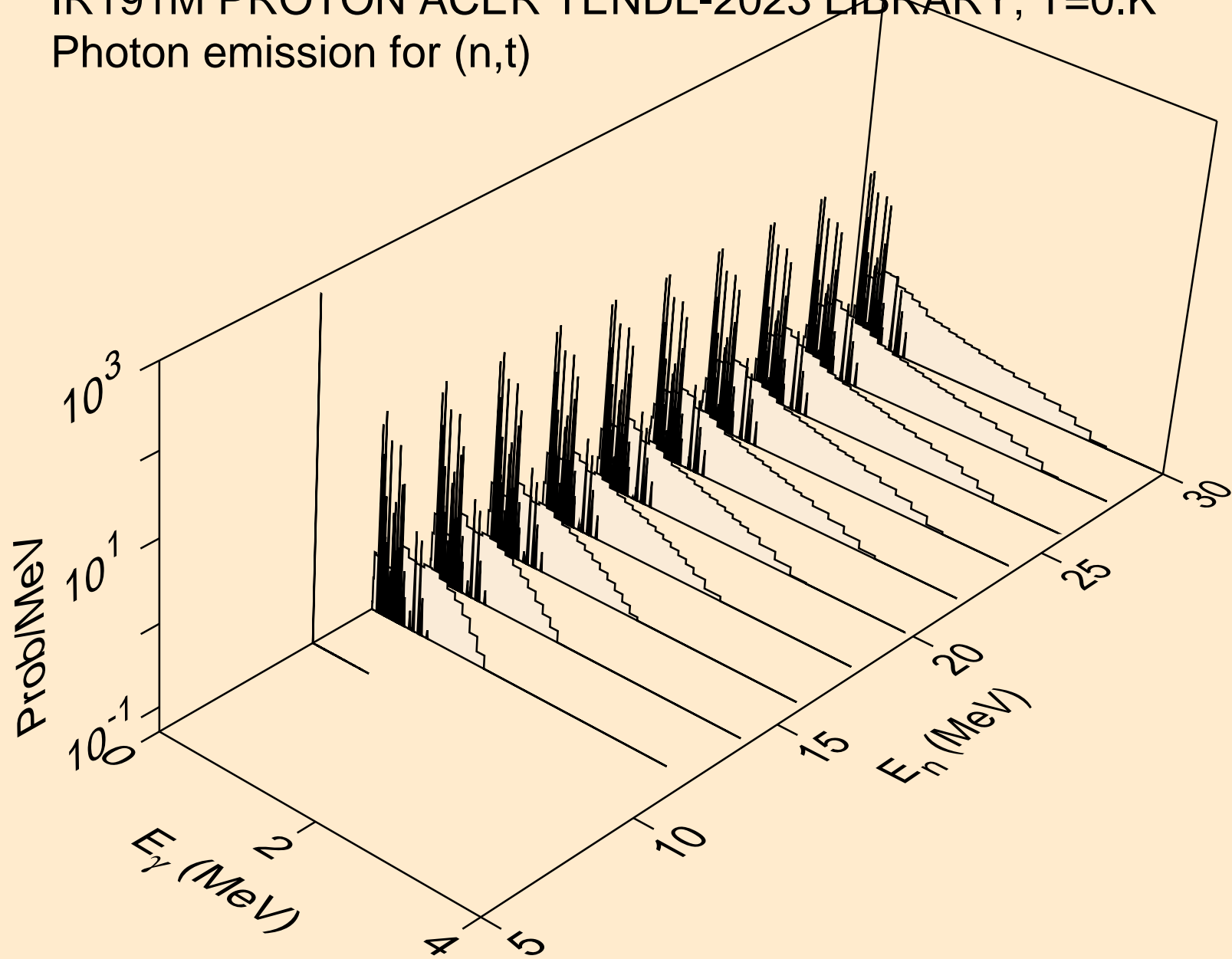

IR191M PROTON ACER TENDL-2023 LIBRARY; T=0.K  
Photon emission for (n,he3)

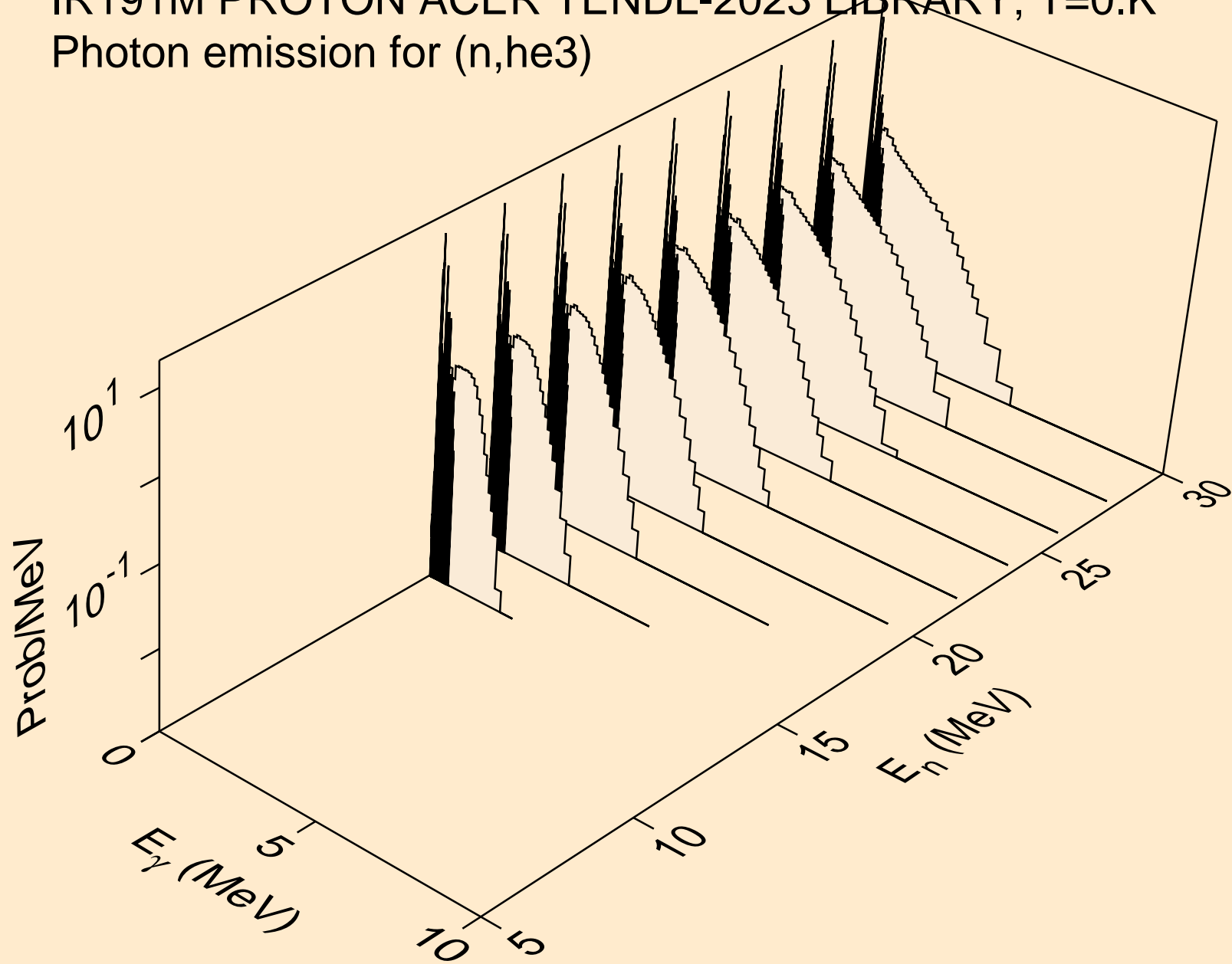

IR191M PROTON ACER TENDL-2023 LIBRARY; T=0.K  
Photon emission for (n,a)

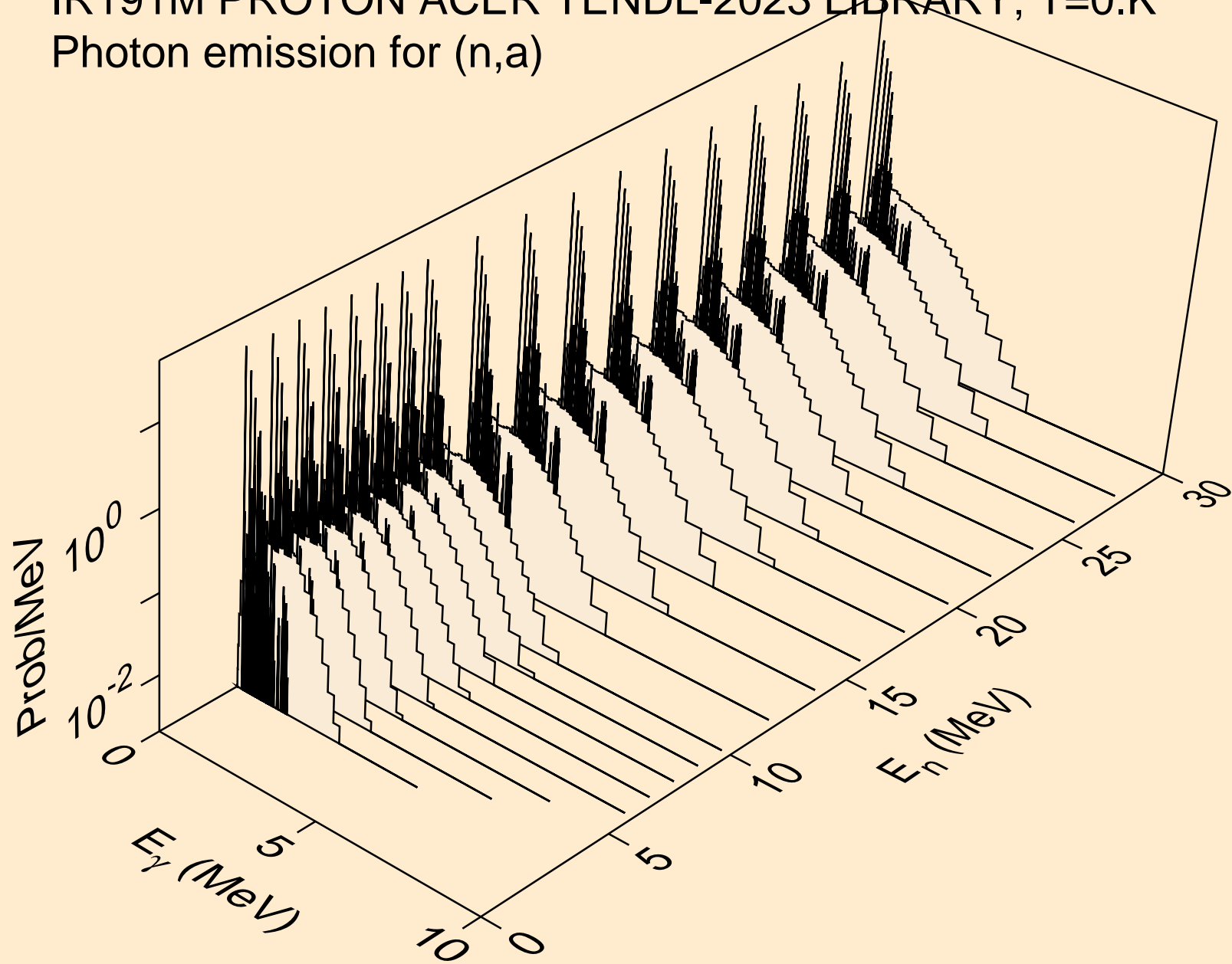

IR191M PROTON ACER TENDL-2023 LIBRARY; T=0.K  
Photon emission for (n,2a)

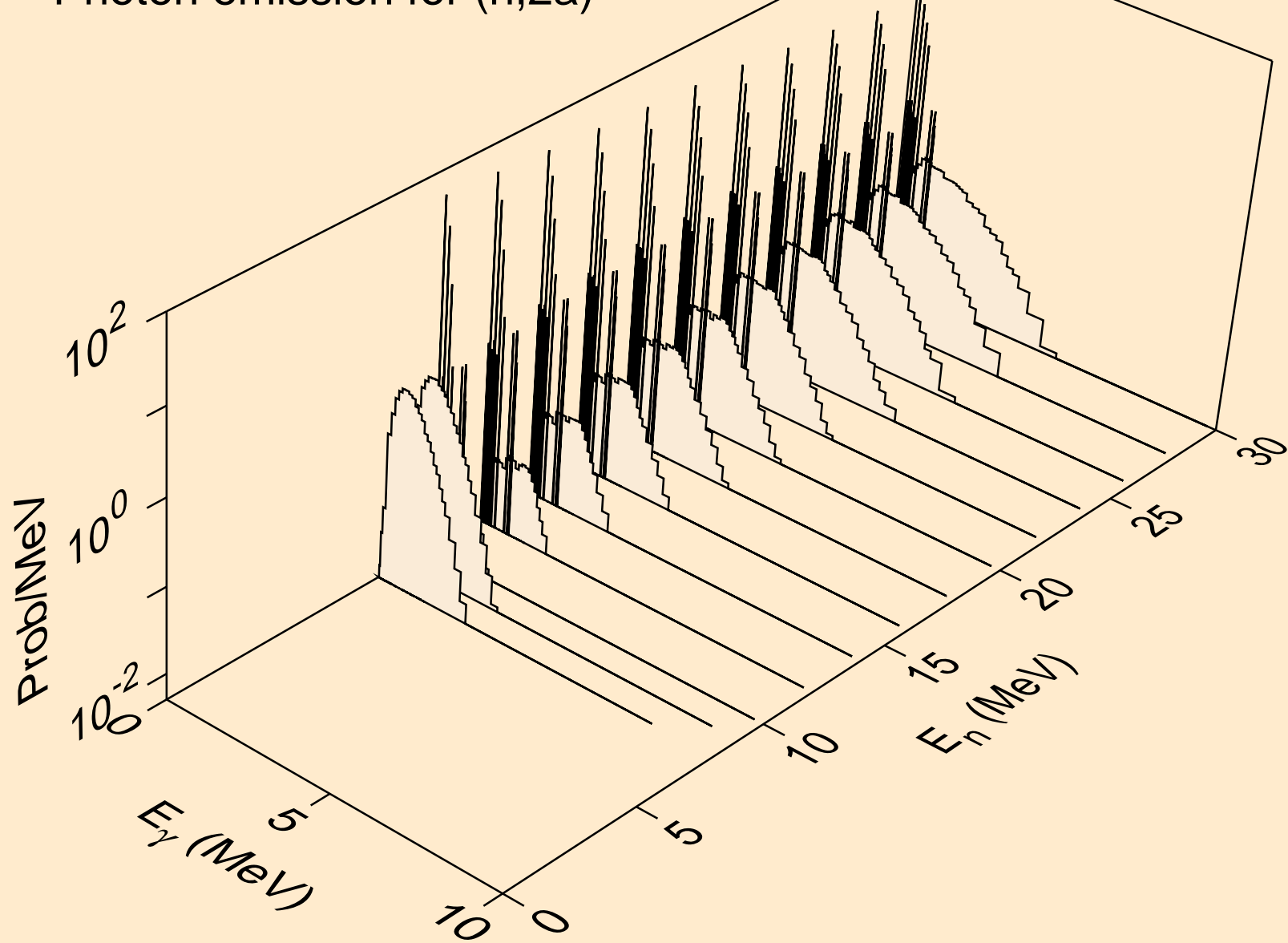

IR191M PROTON ACER TENDL-2023 LIBRARY; T=0.K  
Photon emission for (n,2p)

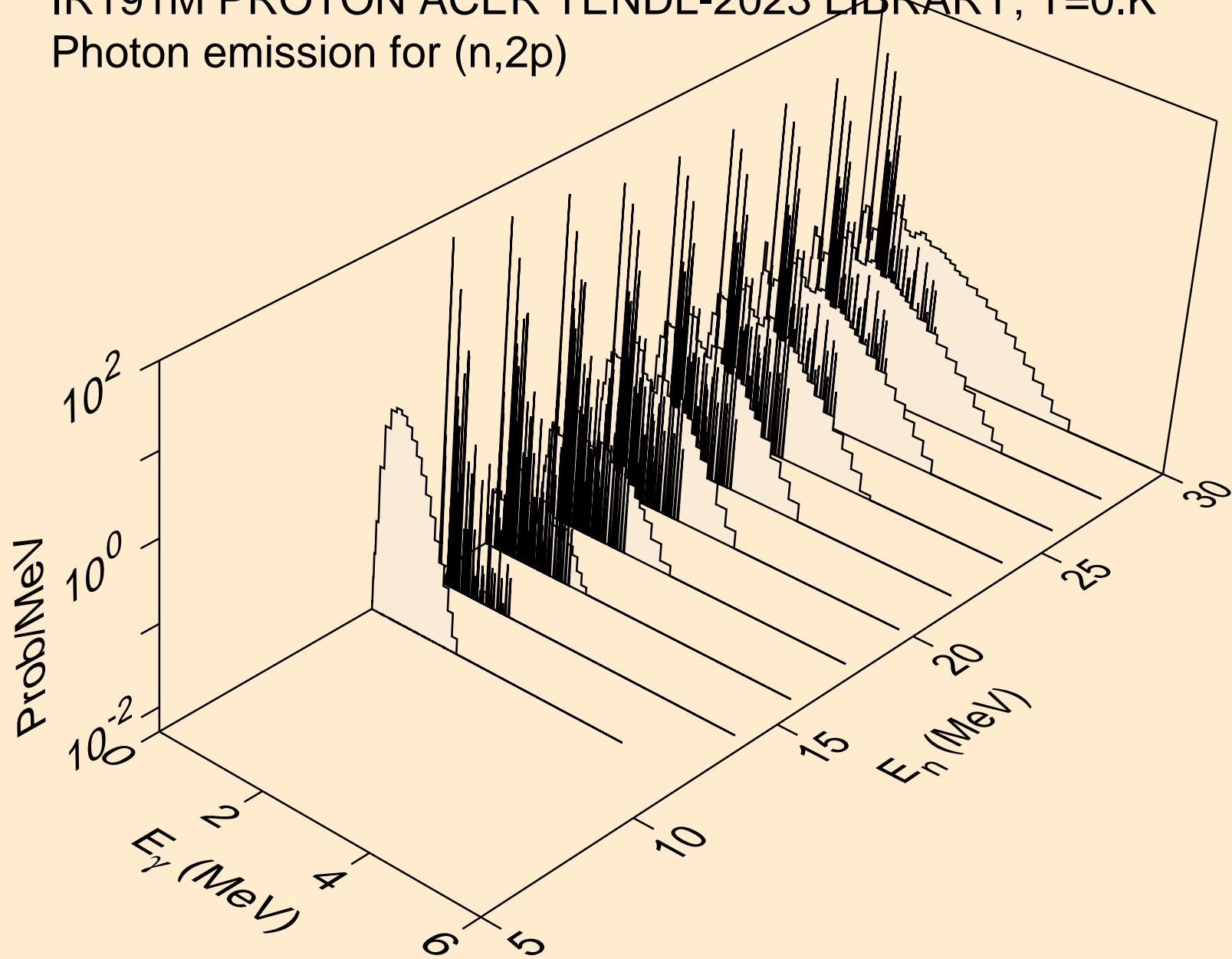

IR191M PROTON ACER TENDL-2023 LIBRARY; T=0.K  
Photon emission for (n,pa)

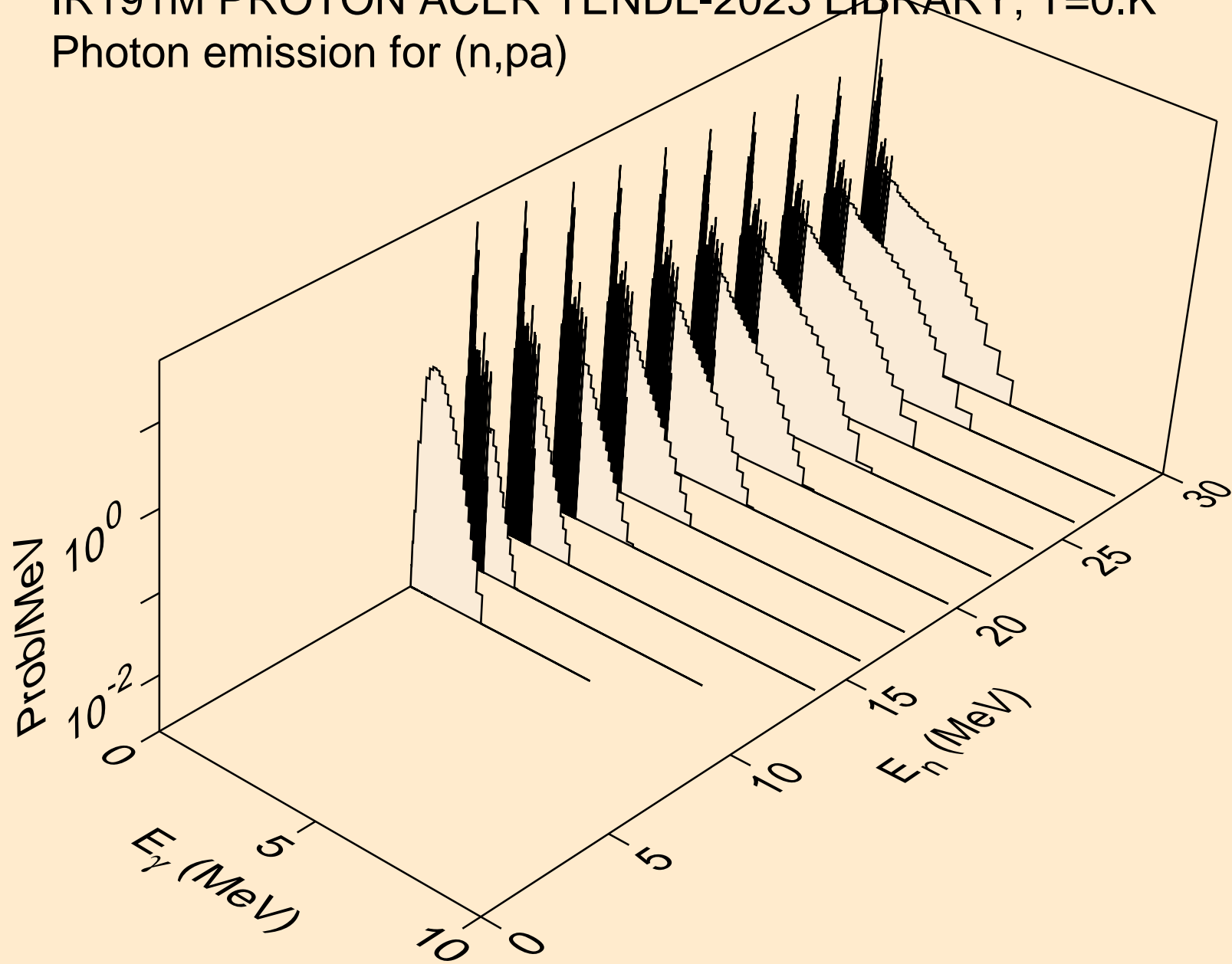

IR191M PROTON ACER TENDL-2023 LIBRARY; T=0.K  
Photon emission for (n,pd)

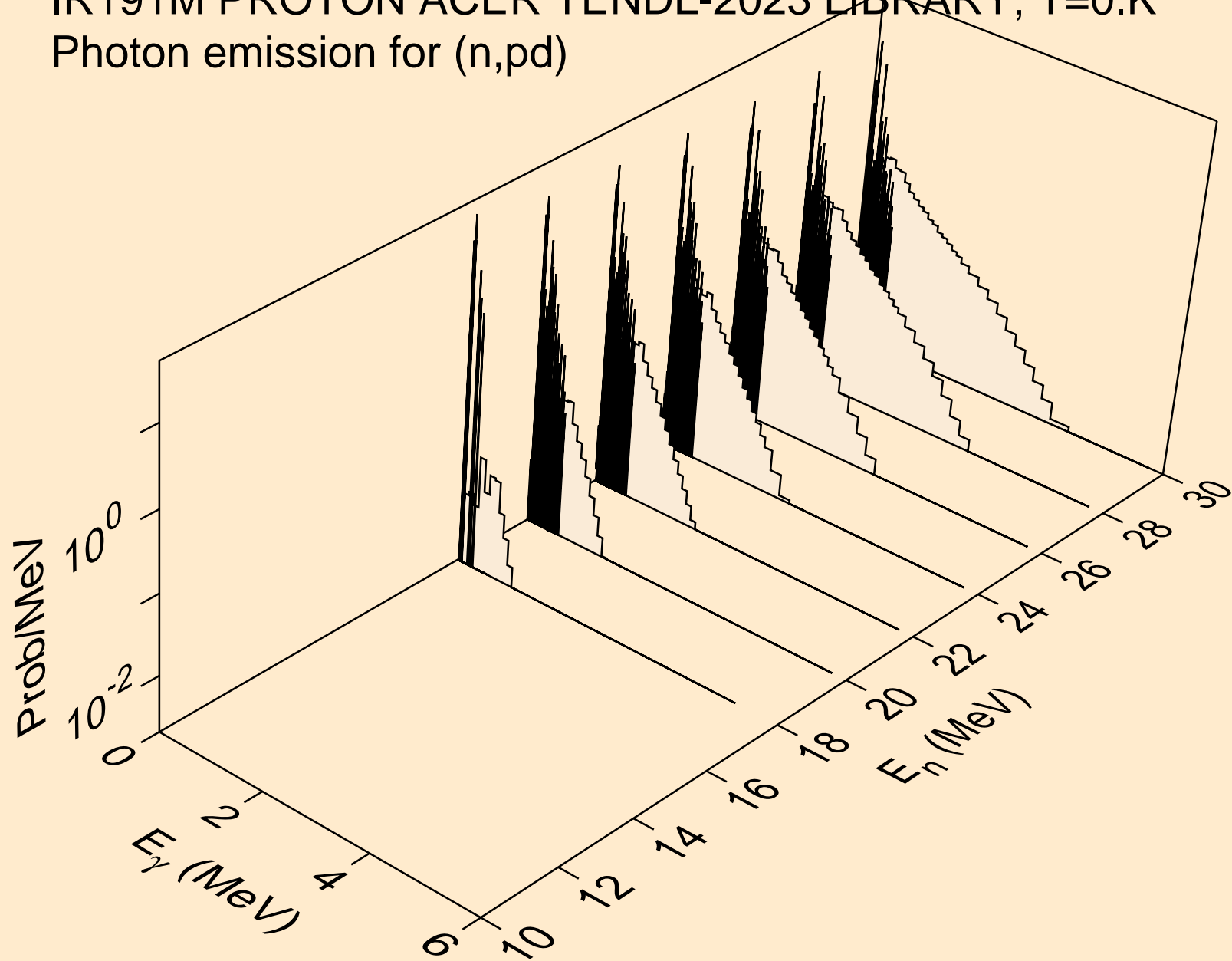



IR191M PROTON ACER TENDL-2023 LIBRARY; T=0.K  
Photon emission for (n,pt)

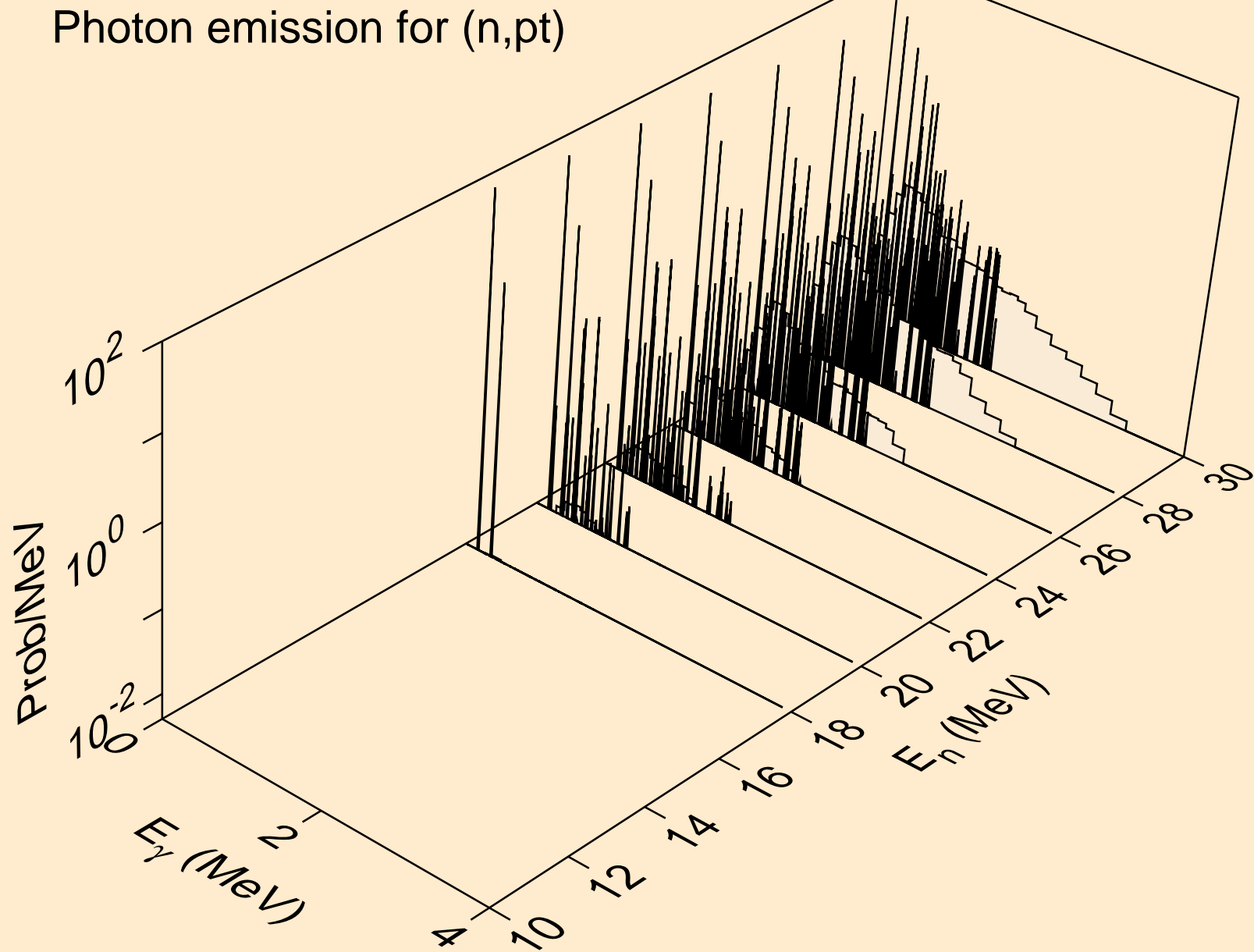

IR191M PROTON ACER TENDL-2023 LIBRARY; T=0.K  
Photon emission for (n,da)

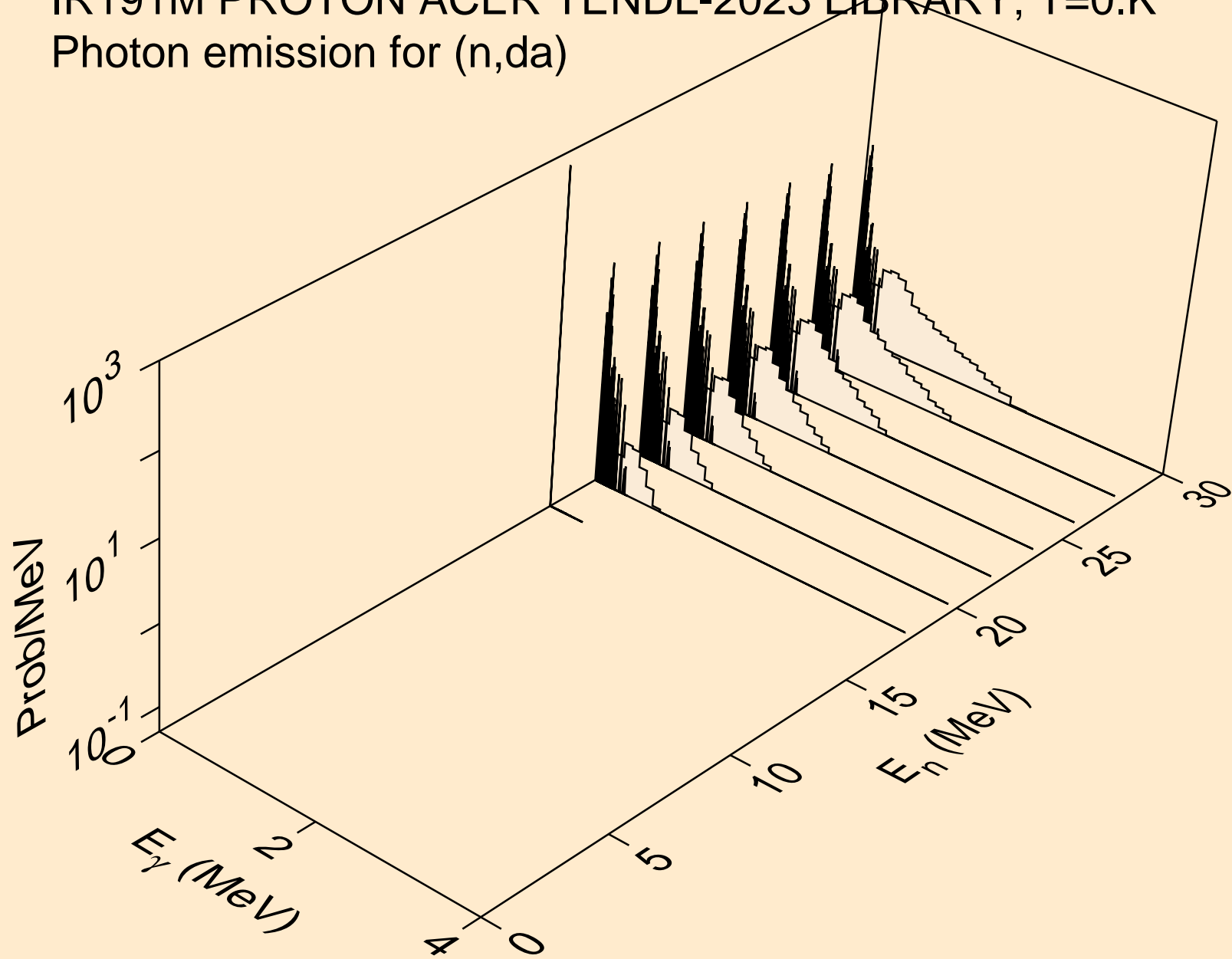

# IR191M PROTON ACER TENDL-2023 LIBRARY; T=0.K

## Particle heating contributions

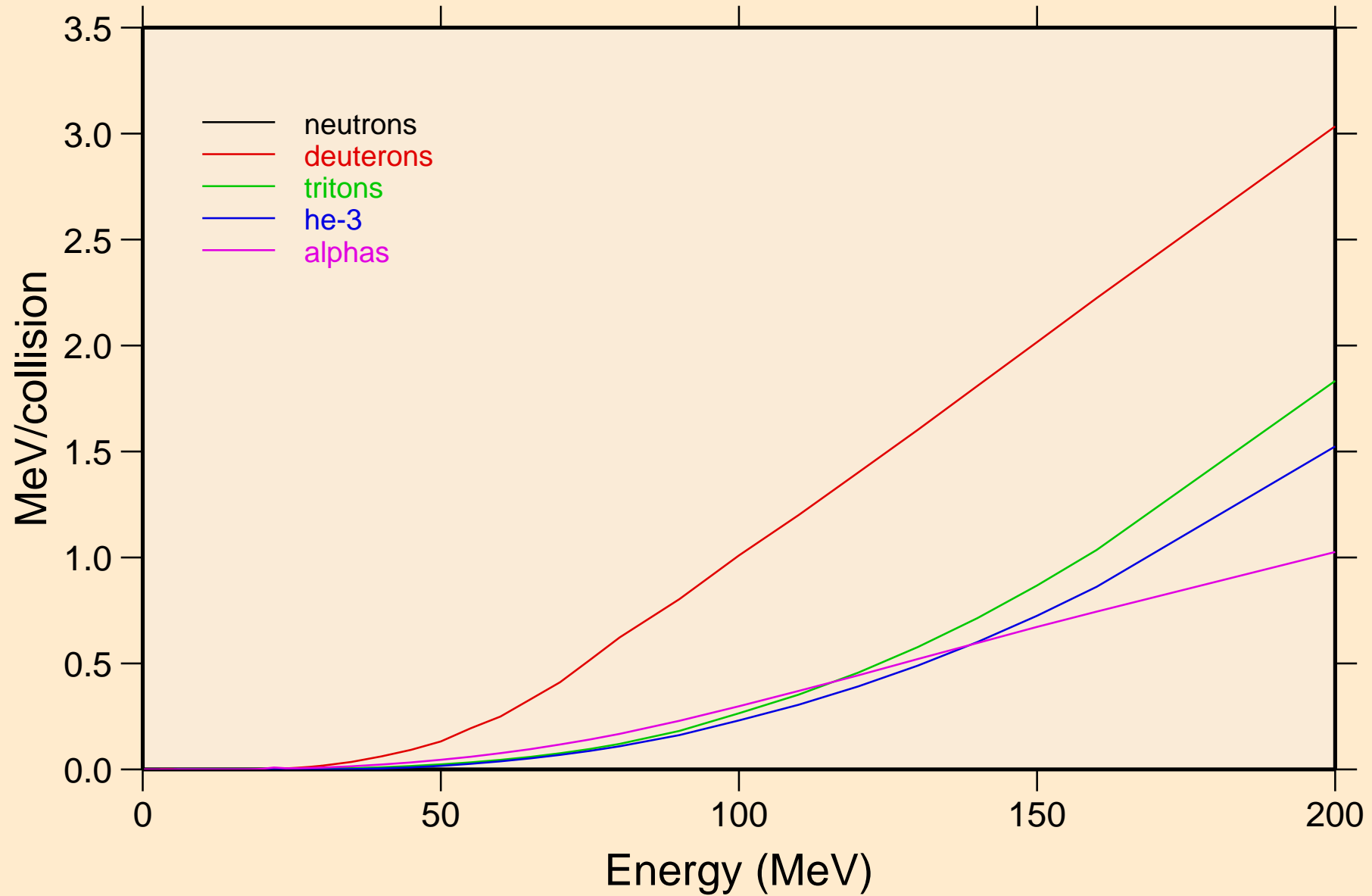

IR191M PROTON ACER TENDL-2023 LIBRARY; T=0.K  
Recoil Heating

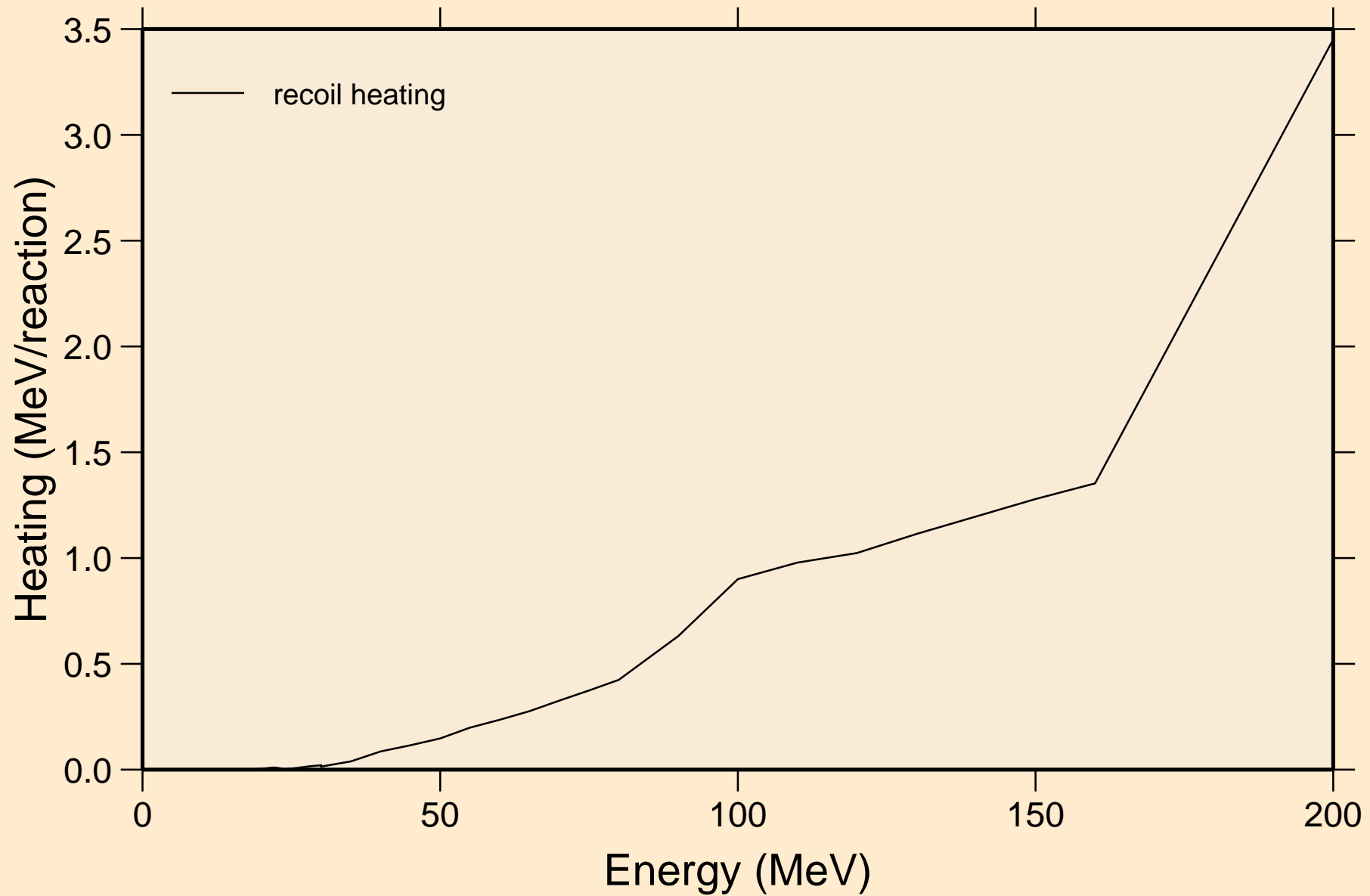

IR191M PROTON ACER TENDL-2023 LIBRARY; T=0.K  
Particle production cross sections

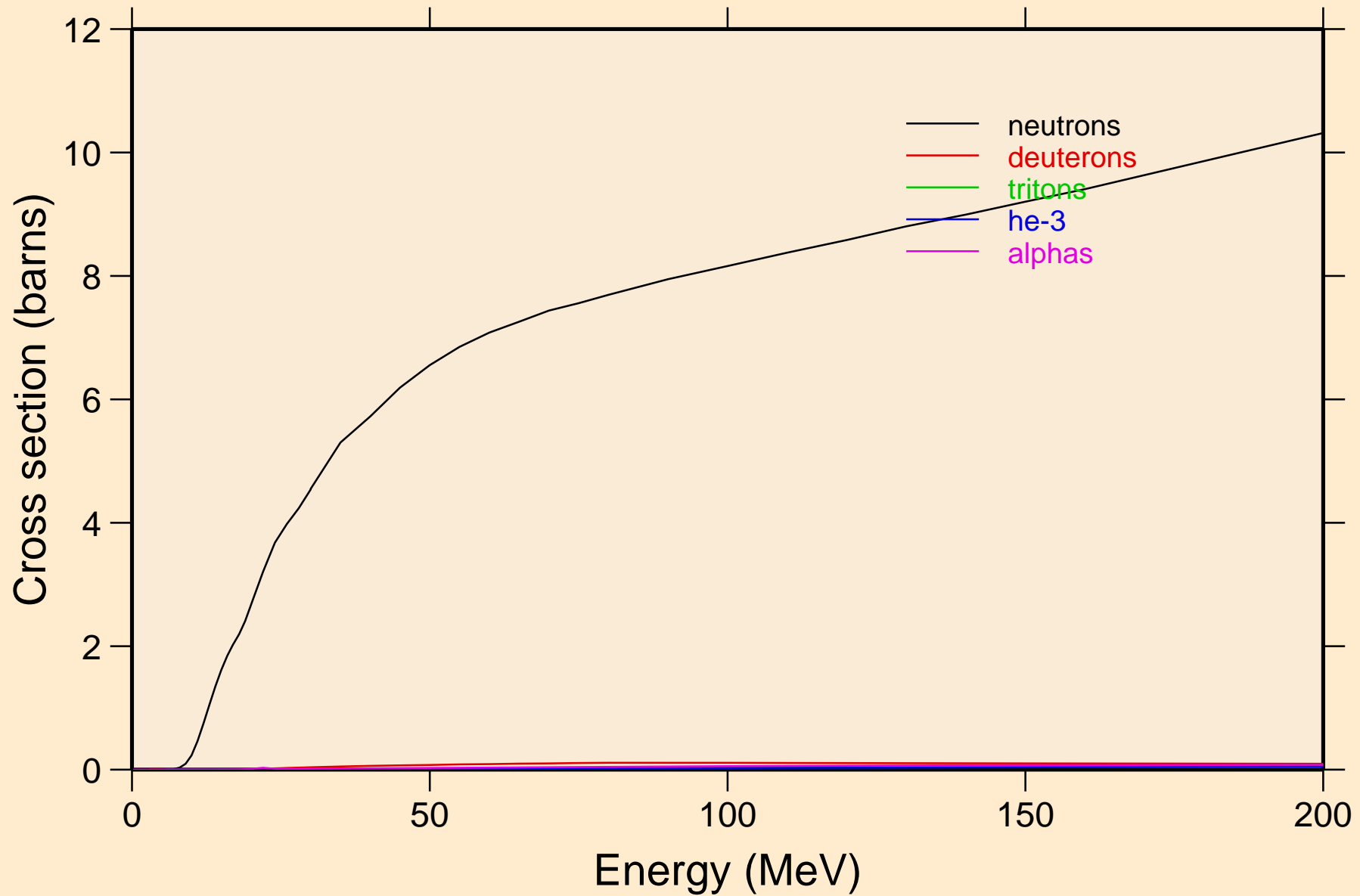

IR191M PROTON ACER TENDL-2023 LIBRARY; T=0.K  
neutrons from (p,n)

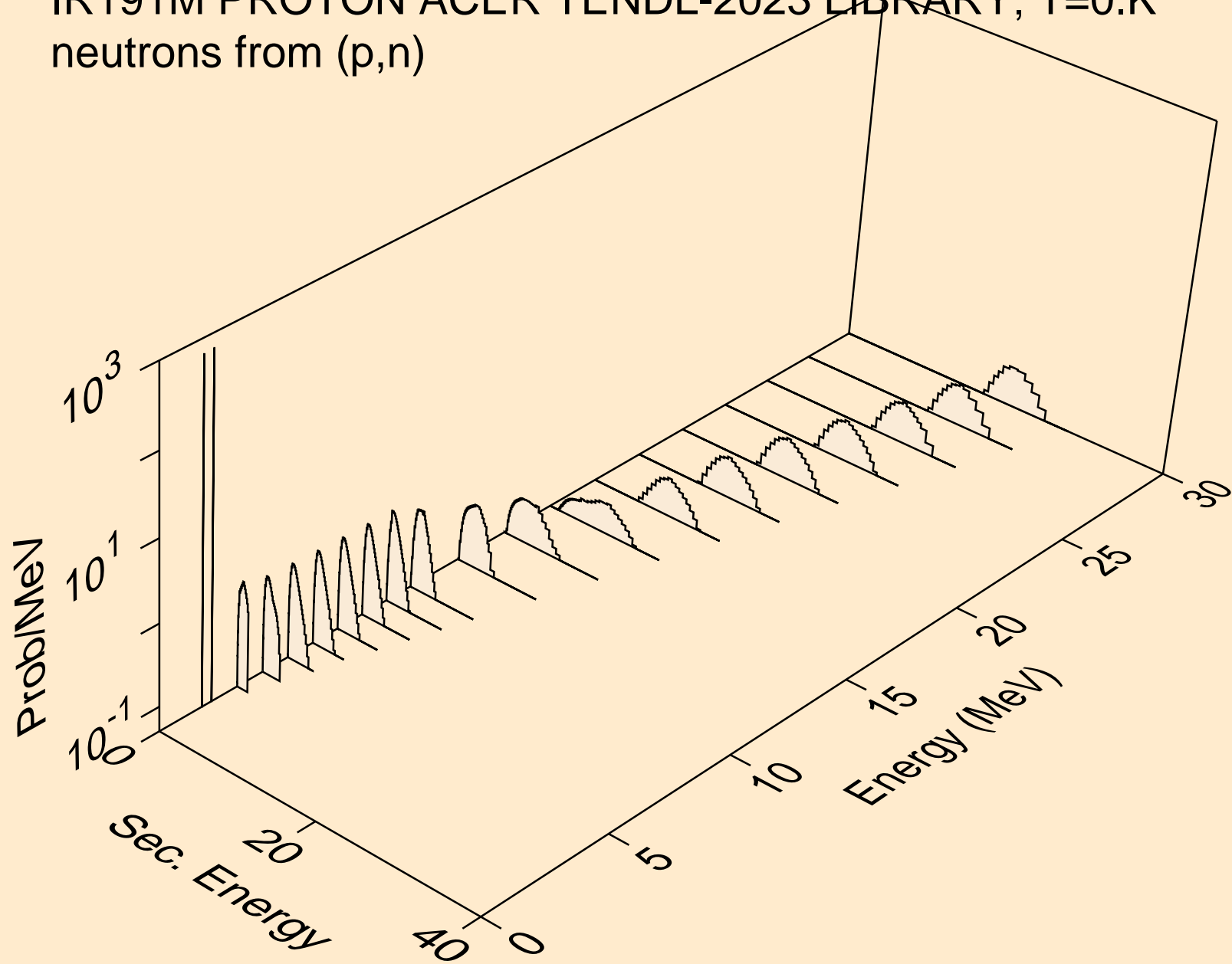

IR191M PROTON ACER TENDL-2023 LIBRARY; T=0.K  
neutrons from (p,x)

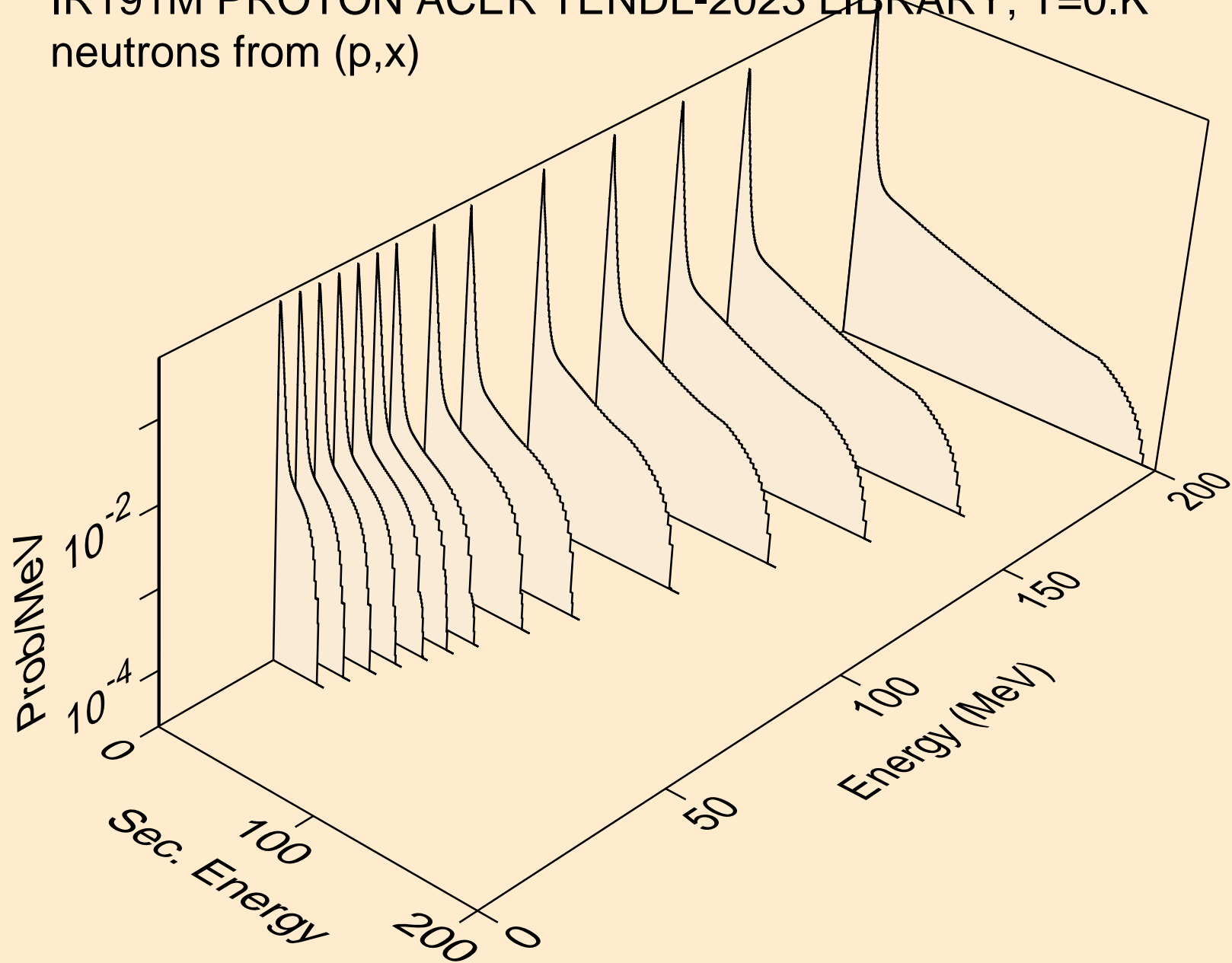

IR191M PROTON ACER TENDL-2023 LIBRARY; T=0.K  
neutrons from (p,2nd)

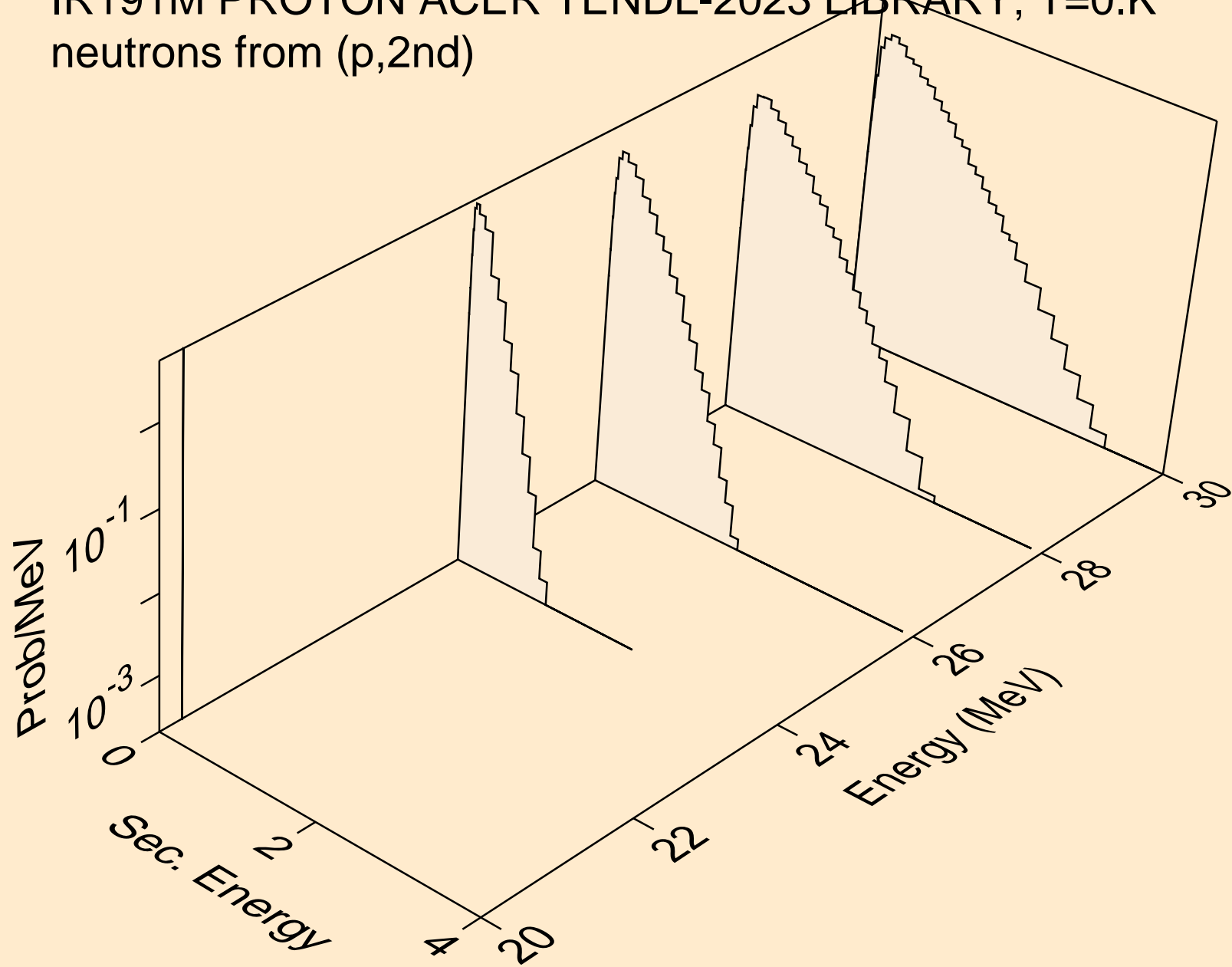



IR191M PROTON ACER TENDL-2023 LIBRARY; T=0.K  
neutrons from (p,2n)

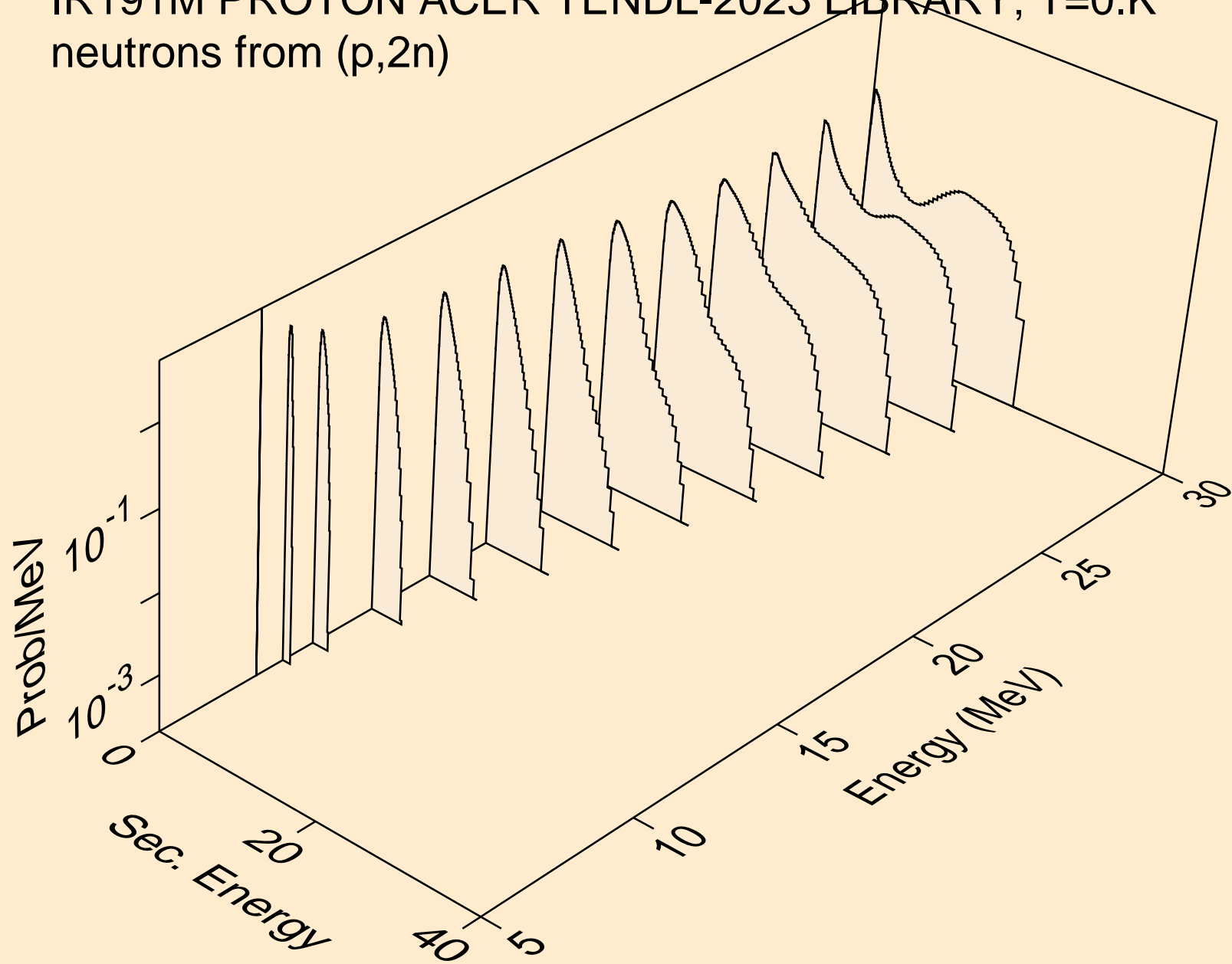

IR191M PROTON ACER TENDL-2023 LIBRARY; T=0.K  
neutrons from (p,3n)

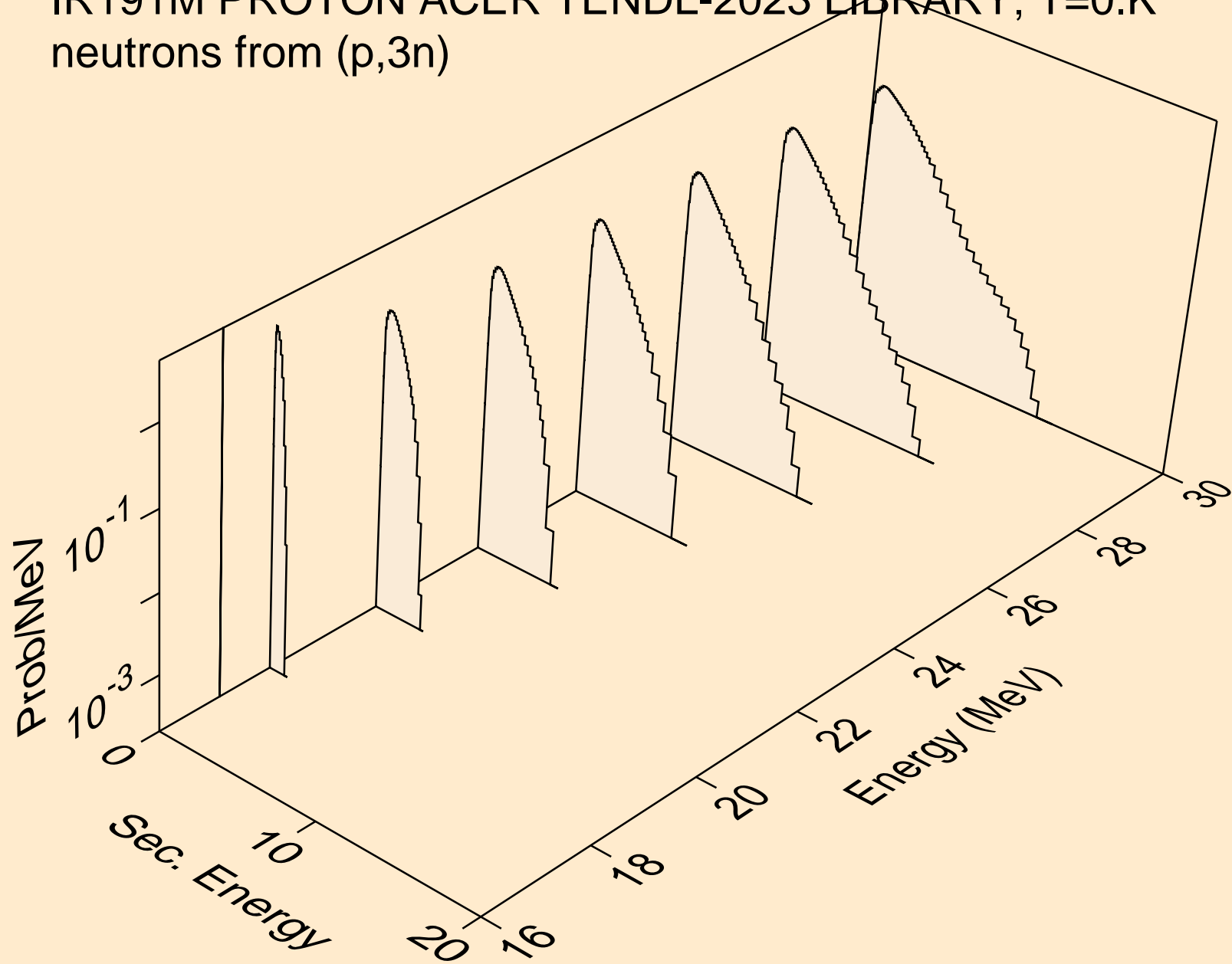

IR191M PROTON ACER TENDL-2023 LIBRARY; T=0.K  
neutrons from (p,n\*)a

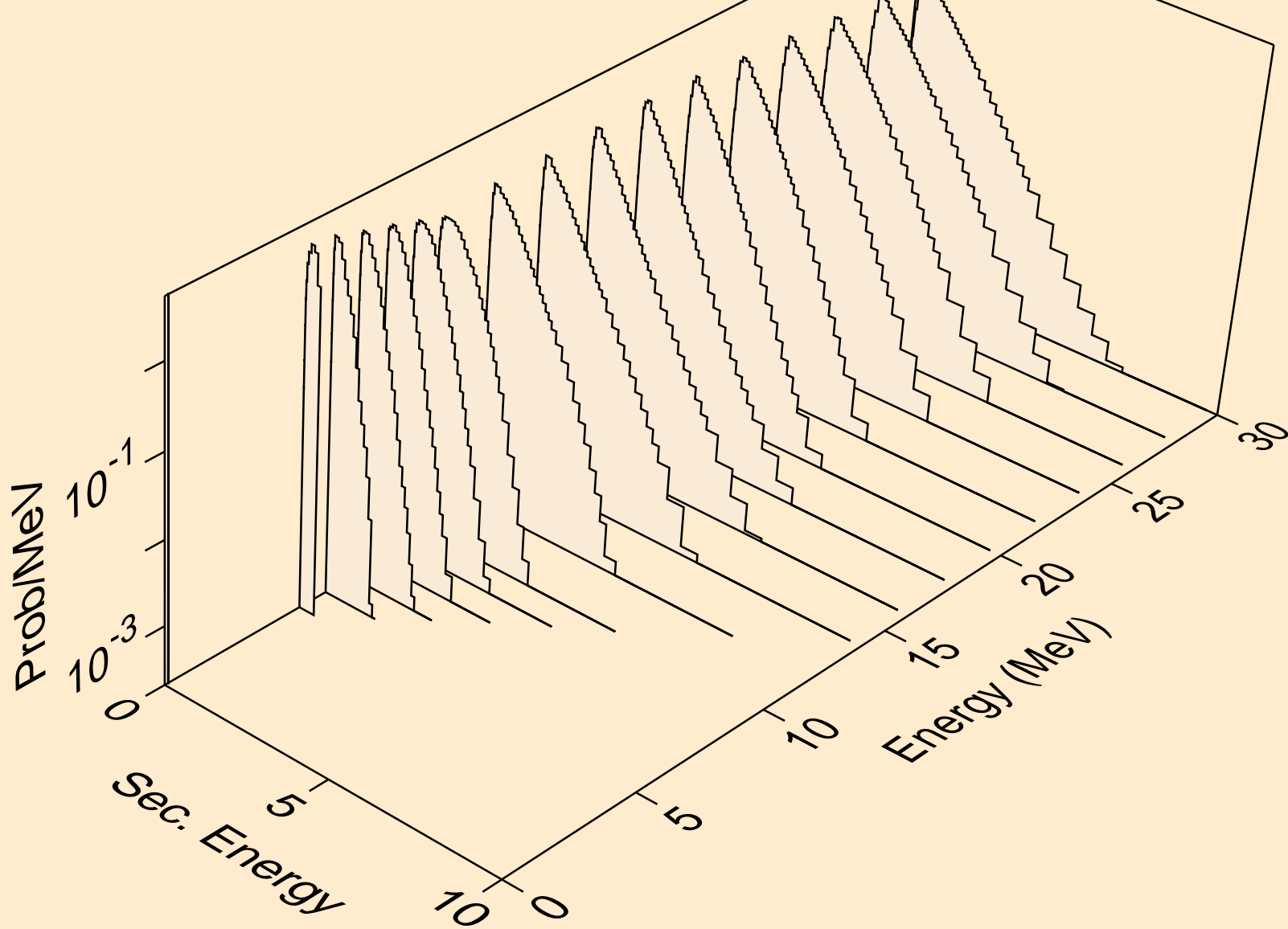

IR191M PROTON ACER TENDL-2023 LIBRARY; T=0.K  
neutrons from (p,2n)a

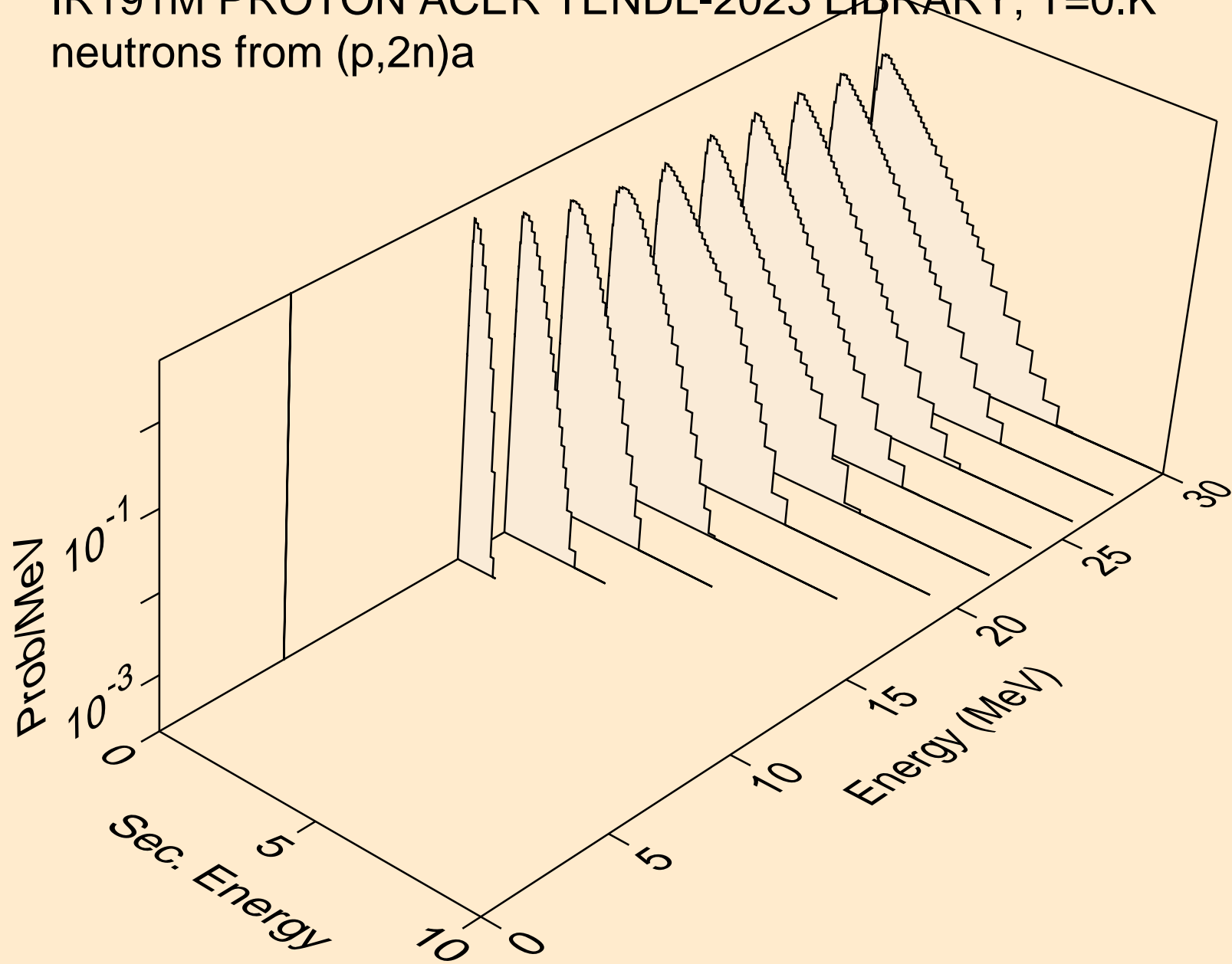

IR191M PROTON ACER TENDL-2023 LIBRARY; T=0.K  
neutrons from (p,3n)a

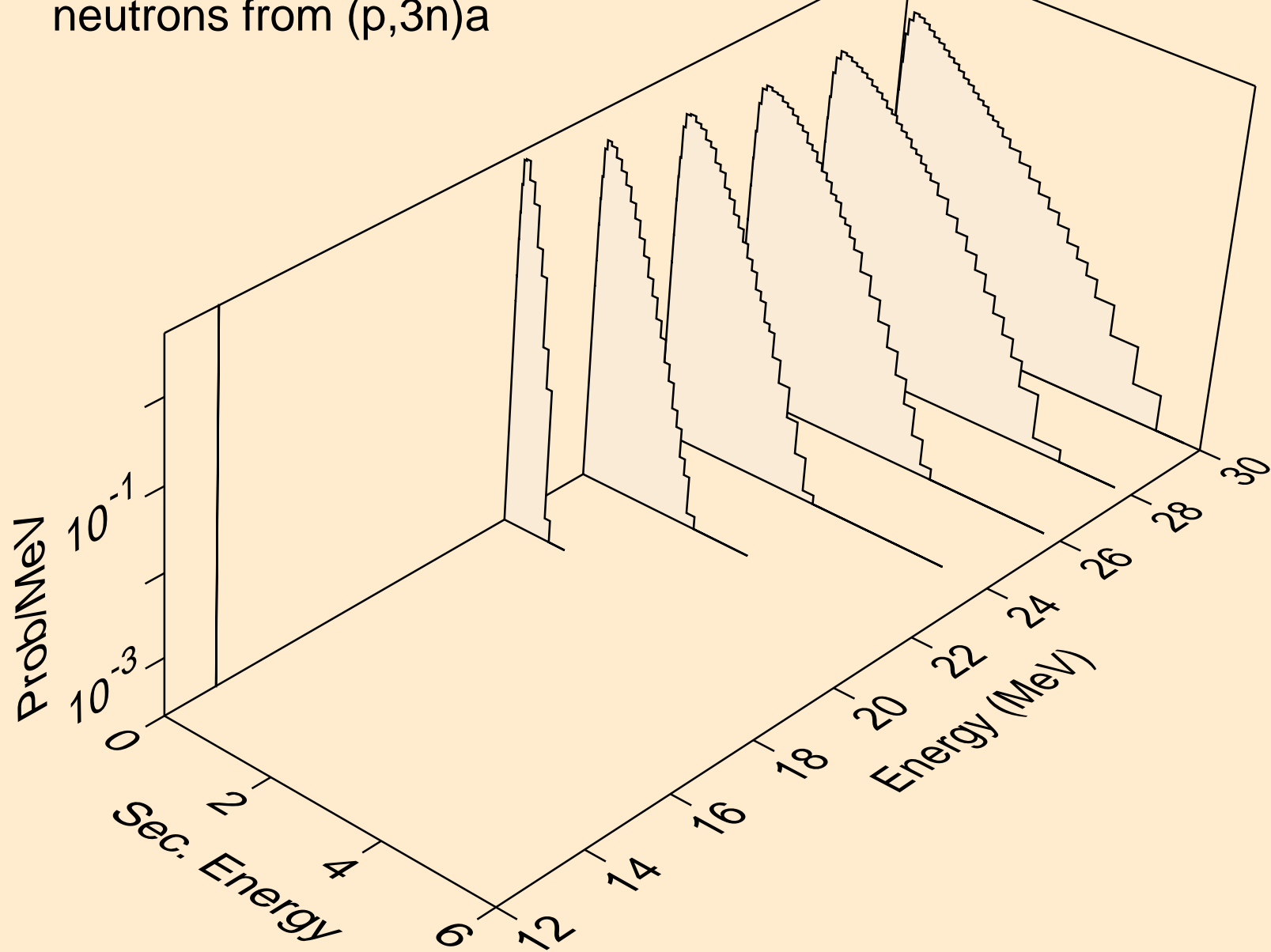

IR191M PROTON ACER TENDL-2023 LIBRARY; T=0.K  
neutrons from (p,n\*)p

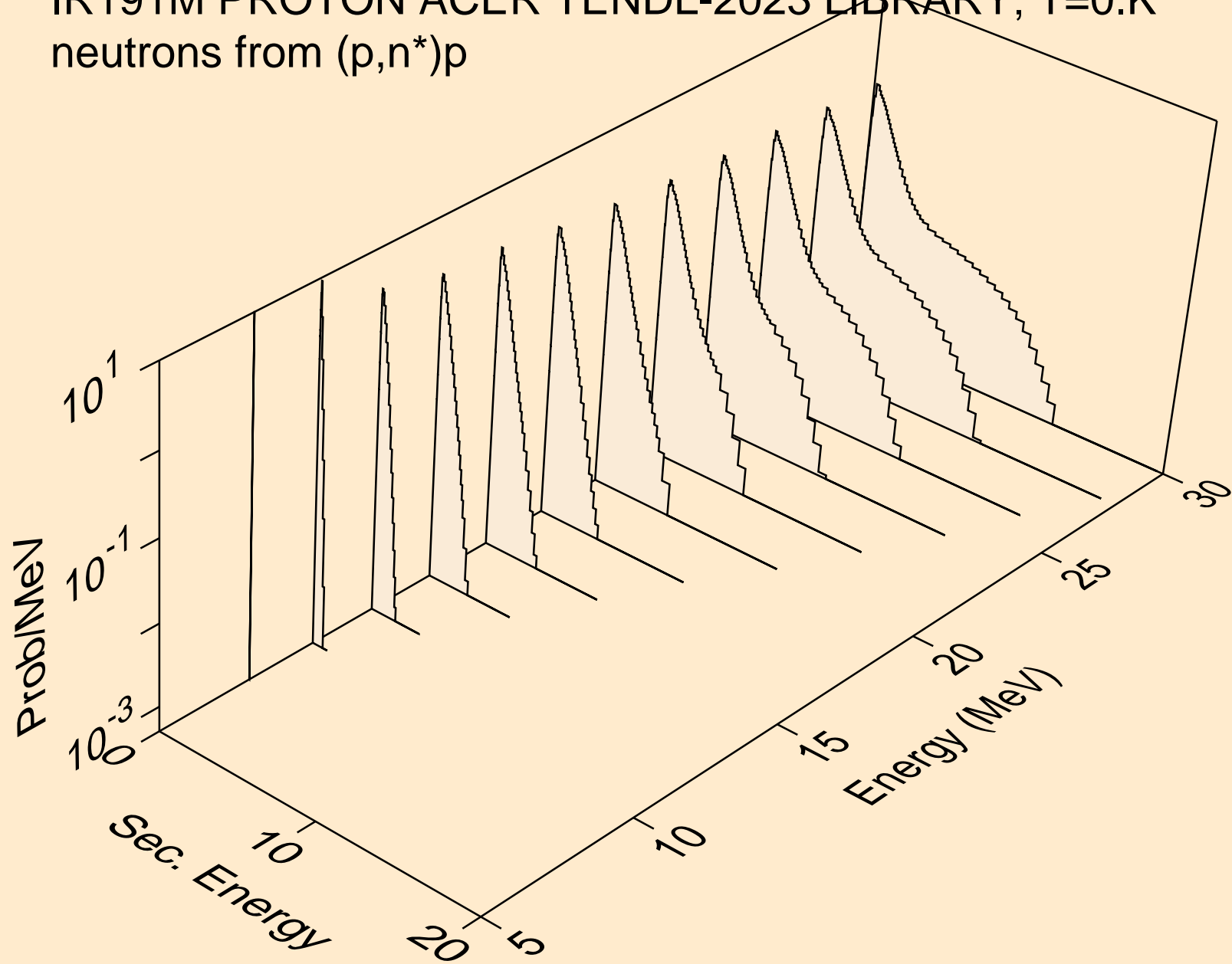

IR191M PROTON ACER TENDL-2023 LIBRARY; T=0.K  
neutrons from (p,n\*)2a

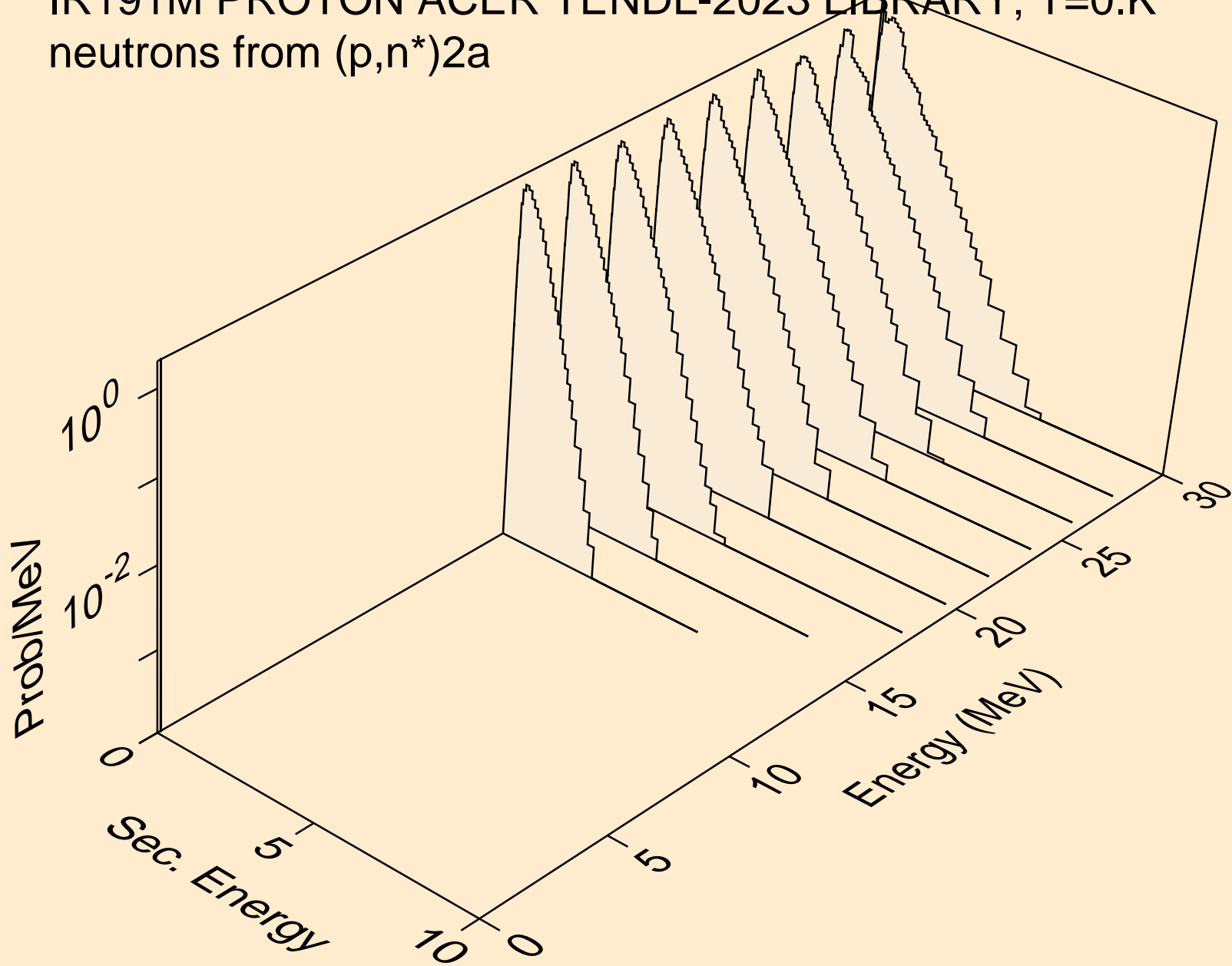

IR191M PROTON ACER TENDL-2023 LIBRARY; T=0.K  
neutrons from (p,n\*)d

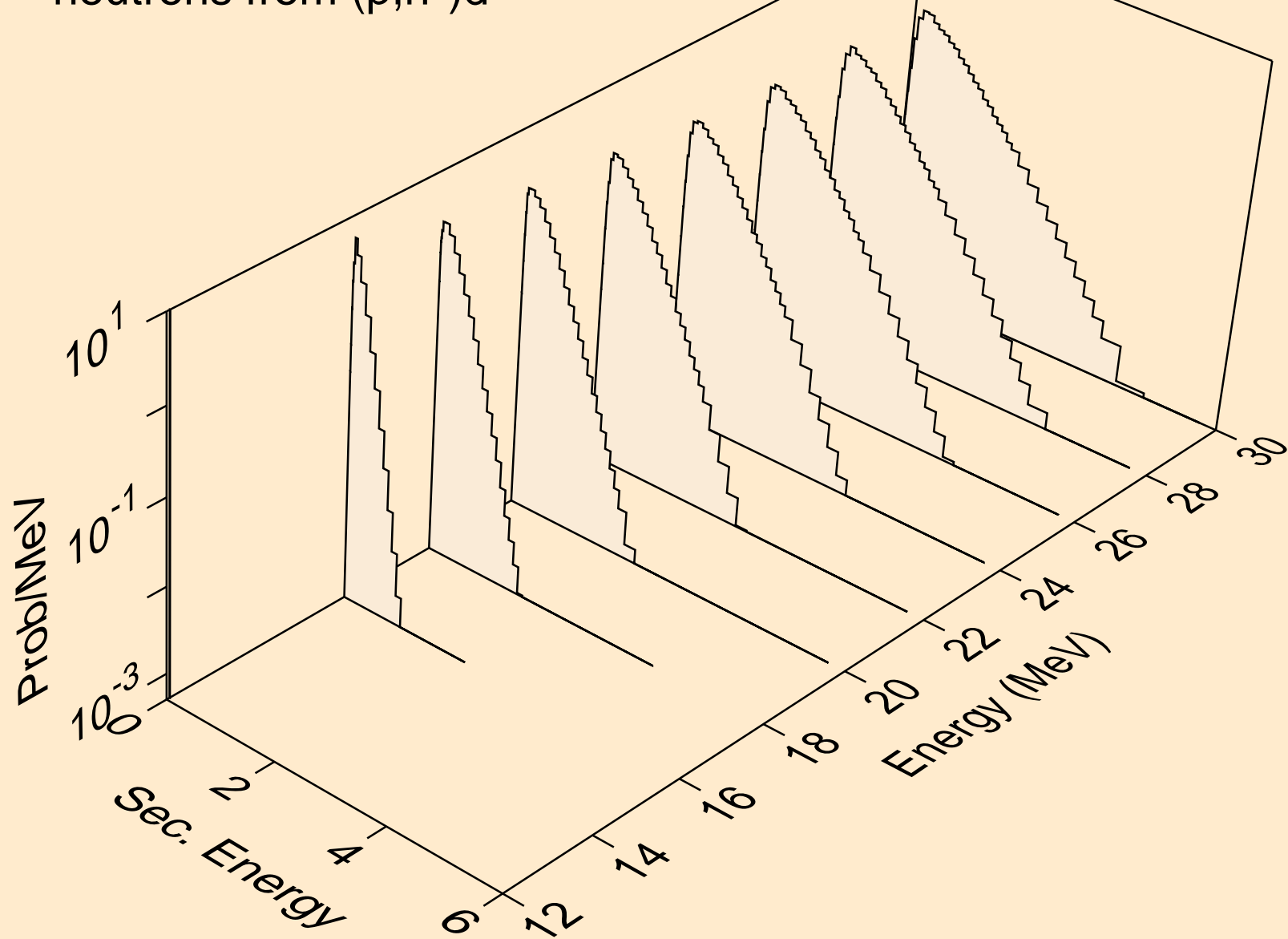



IR191M PROTON ACER TENDL-2023 LIBRARY; T=0.K  
neutrons from (p,n\*)t

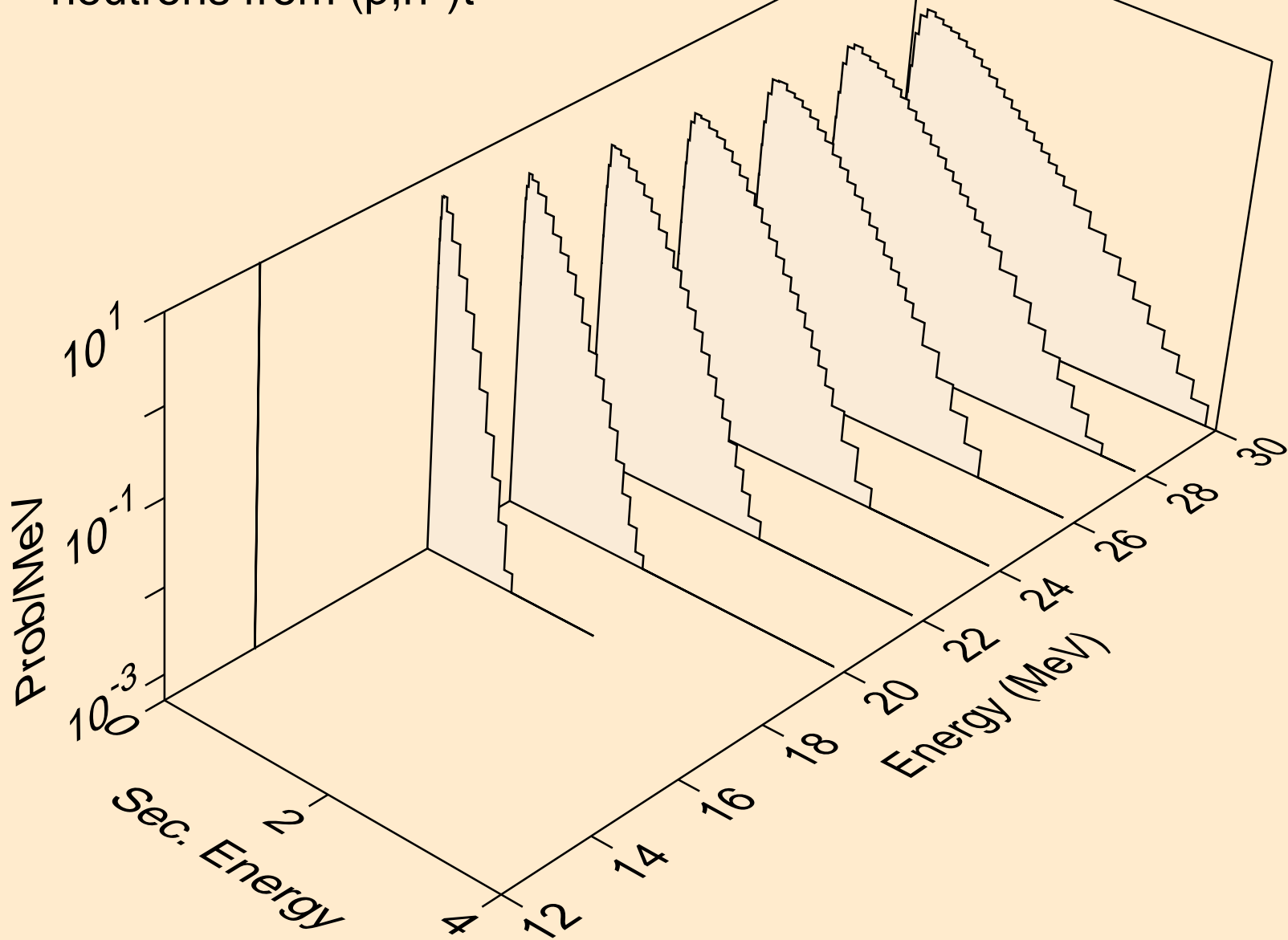

IR191M PROTON ACER TENDL-2023 LIBRARY; T=0.K  
neutrons from (p,n\*)he3

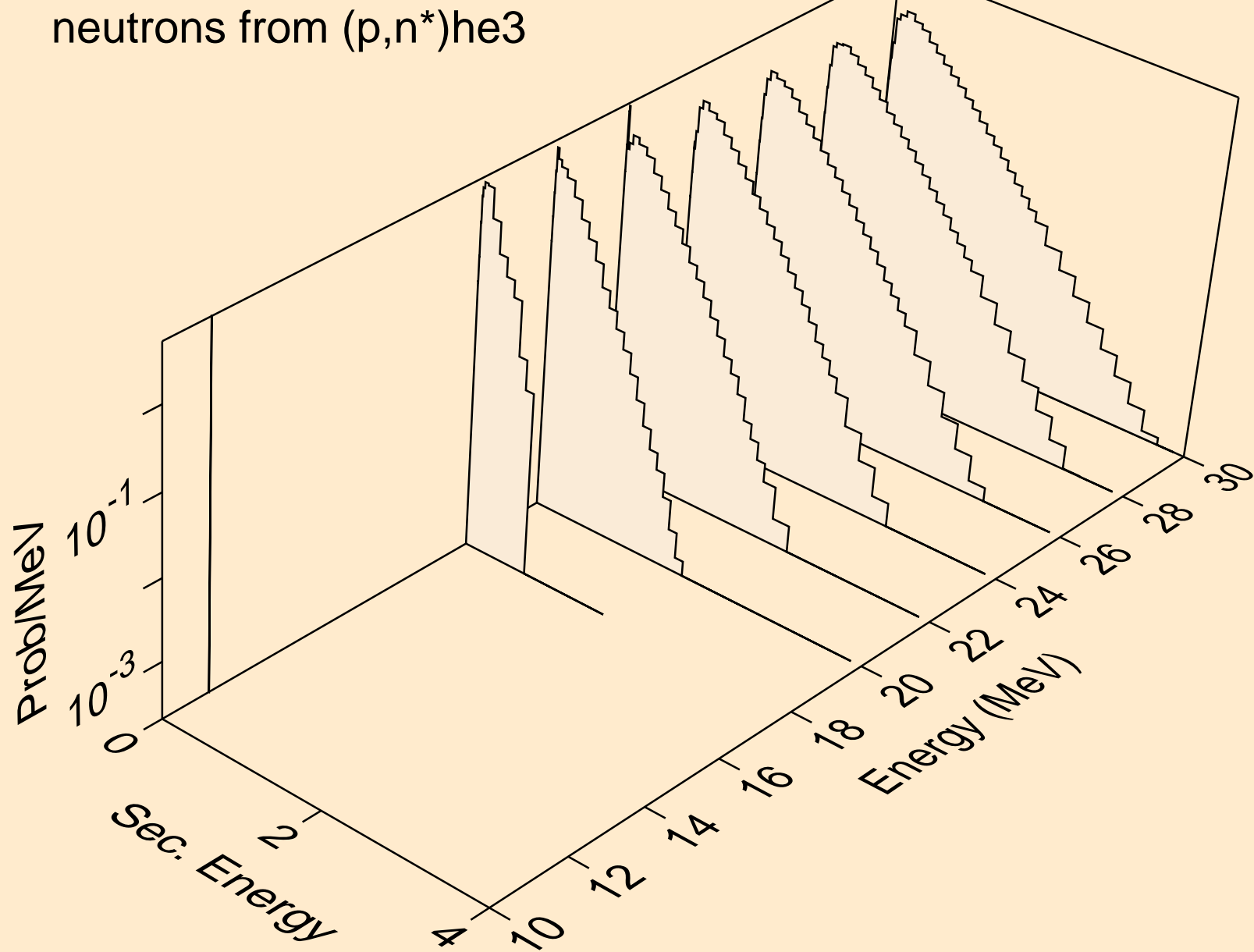

IR191M PROTON ACER TENDL-2023 LIBRARY; T=0.K  
neutrons from (p,4n)

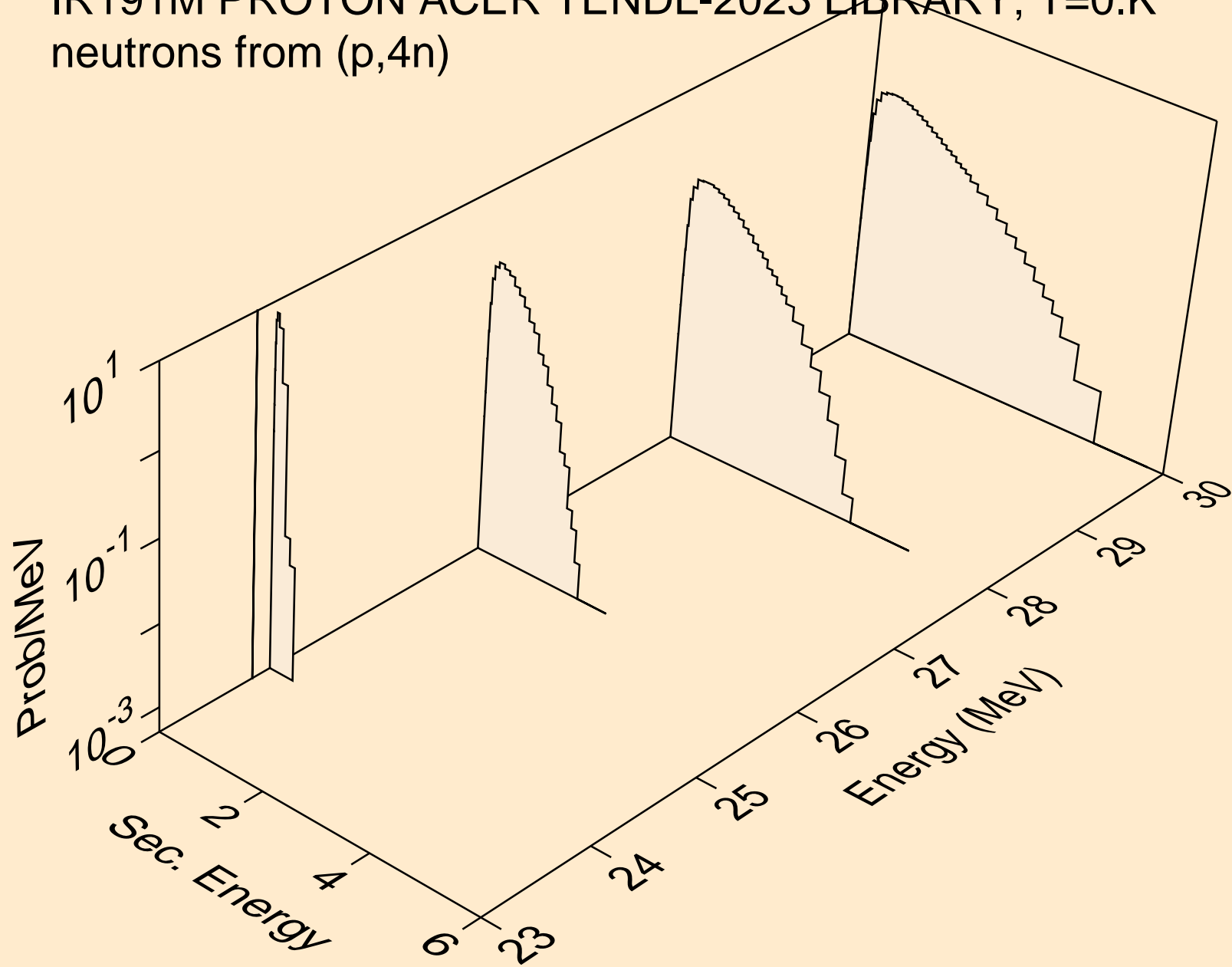

IR191M PROTON ACER TENDL-2023 LIBRARY; T=0.K  
neutrons from (p,2np)

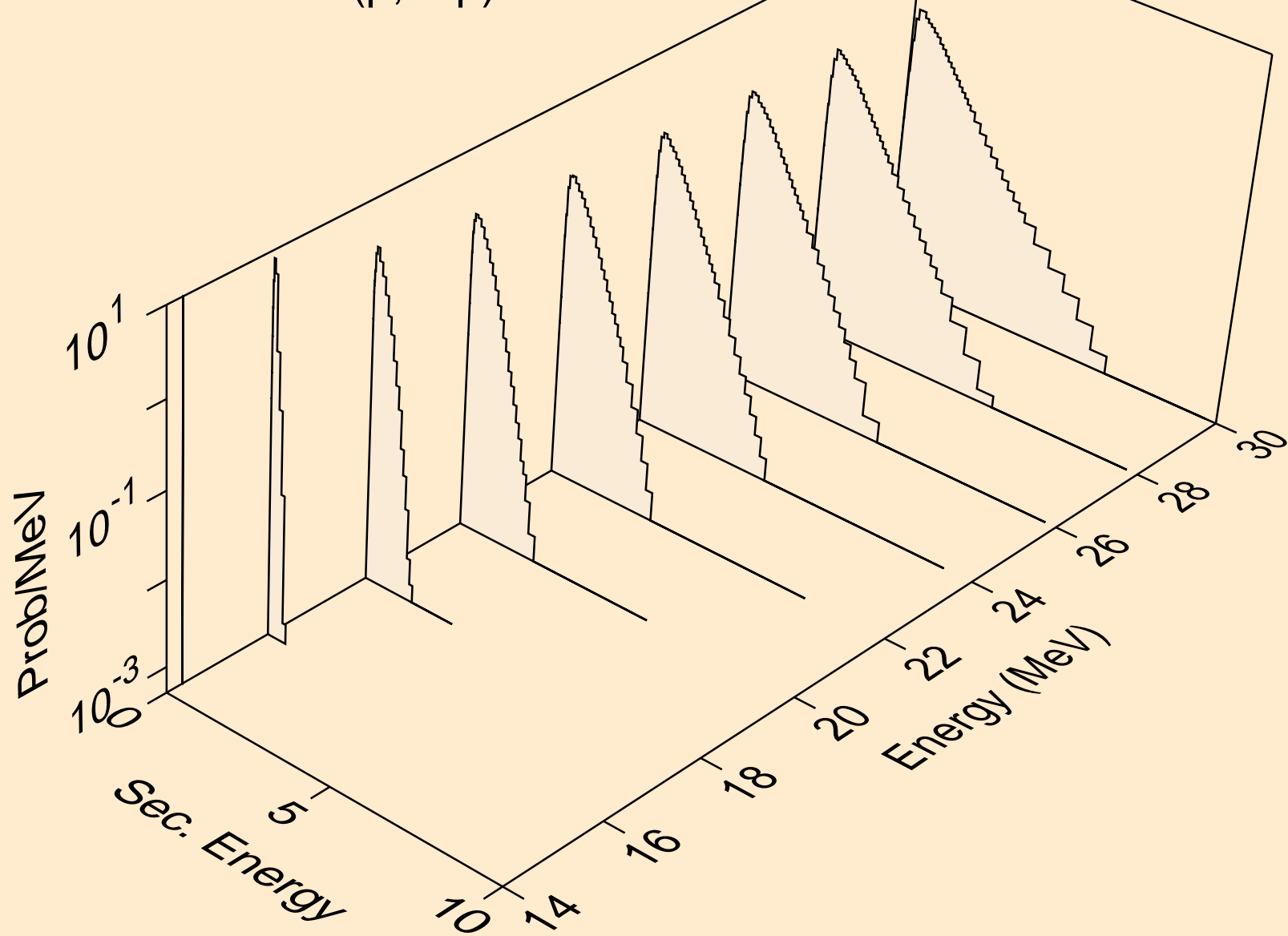

IR191M PROTON ACER TENDL-2023 LIBRARY; T=0.K  
neutrons from (p,3np)

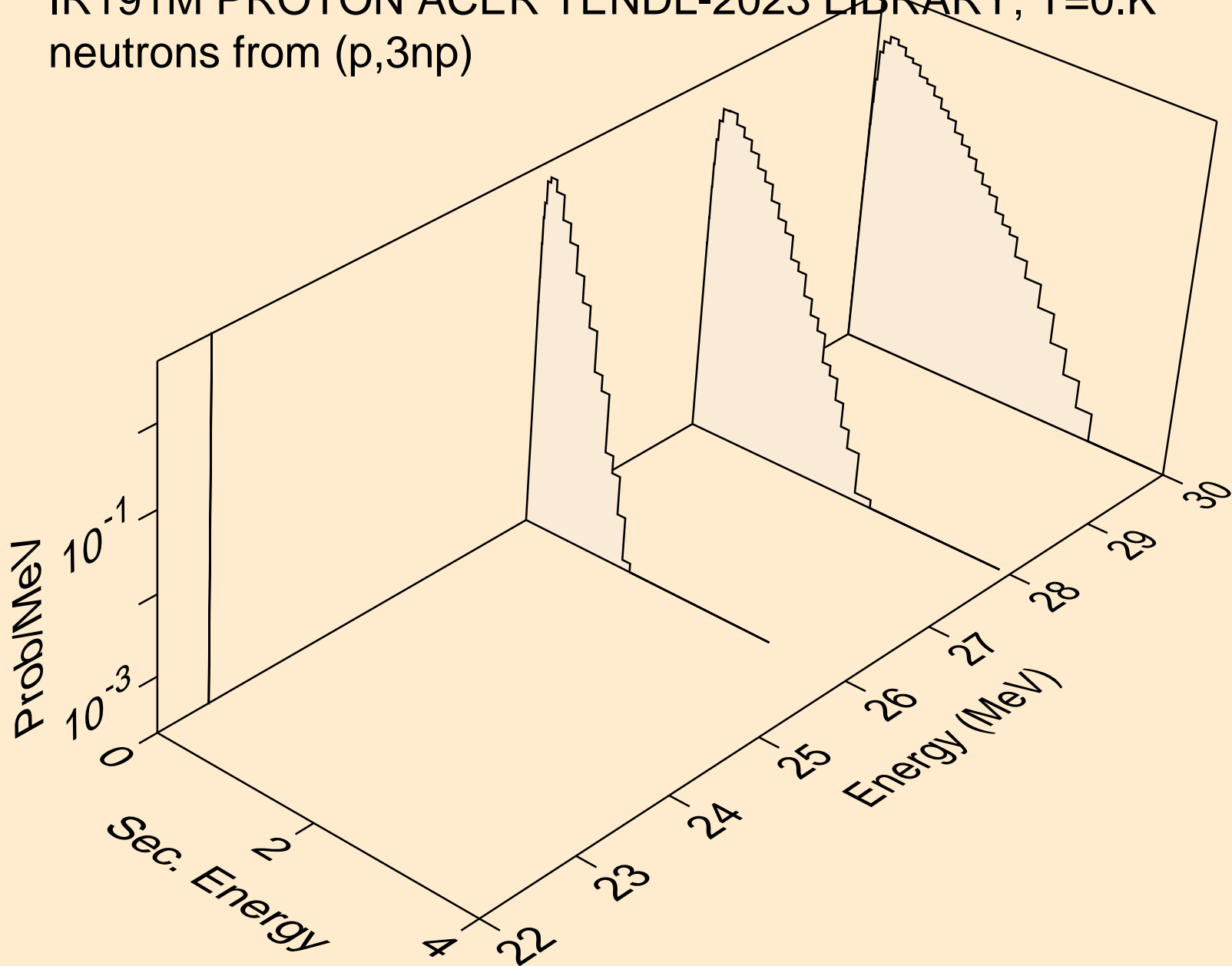

IR191M PROTON ACER TENDL-2023 LIBRARY; T=0.K  
neutrons from (p,n2p)

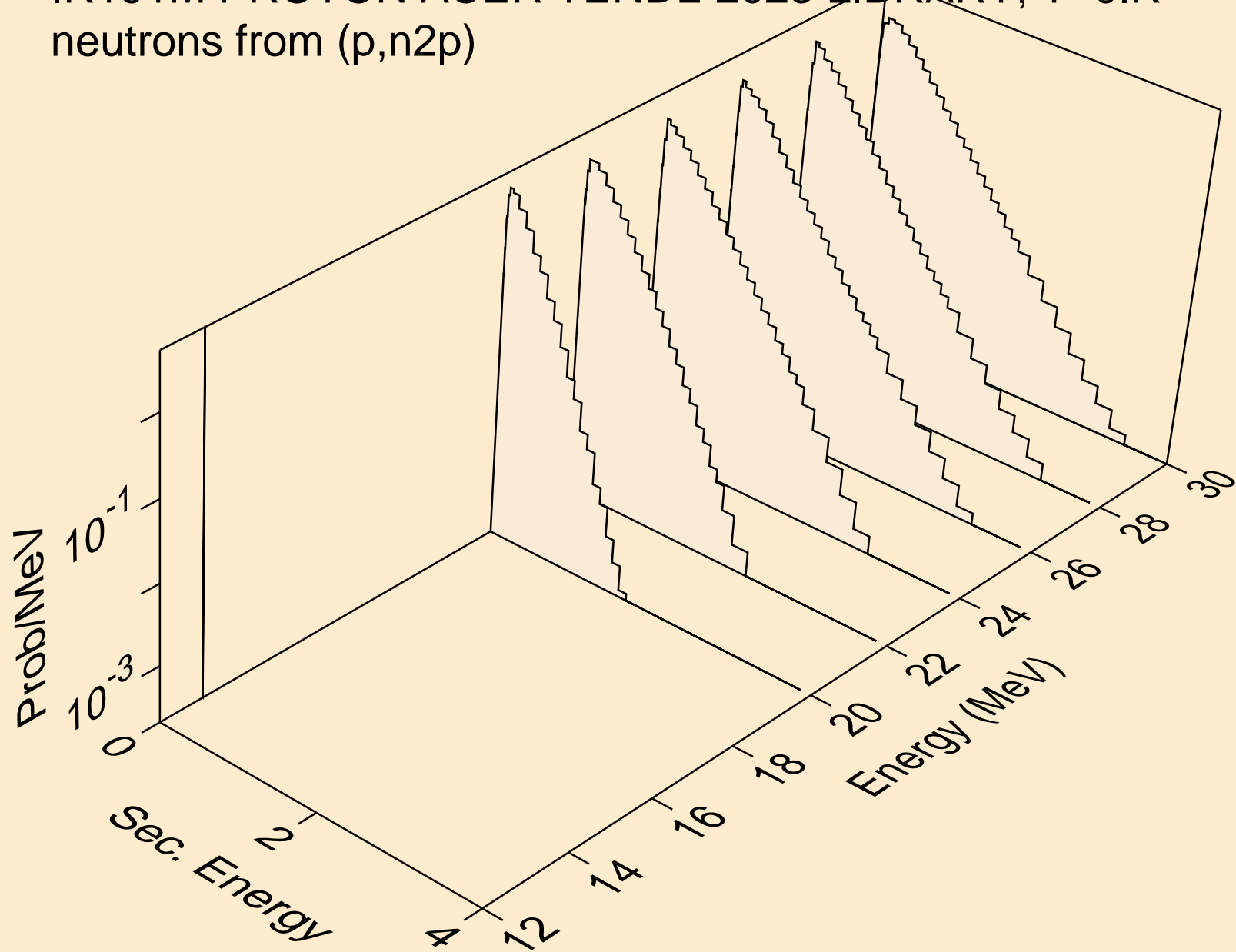

IR191M PROTON ACER TENDL-2023 LIBRARY; T=0.K  
neutrons from (p,npa)

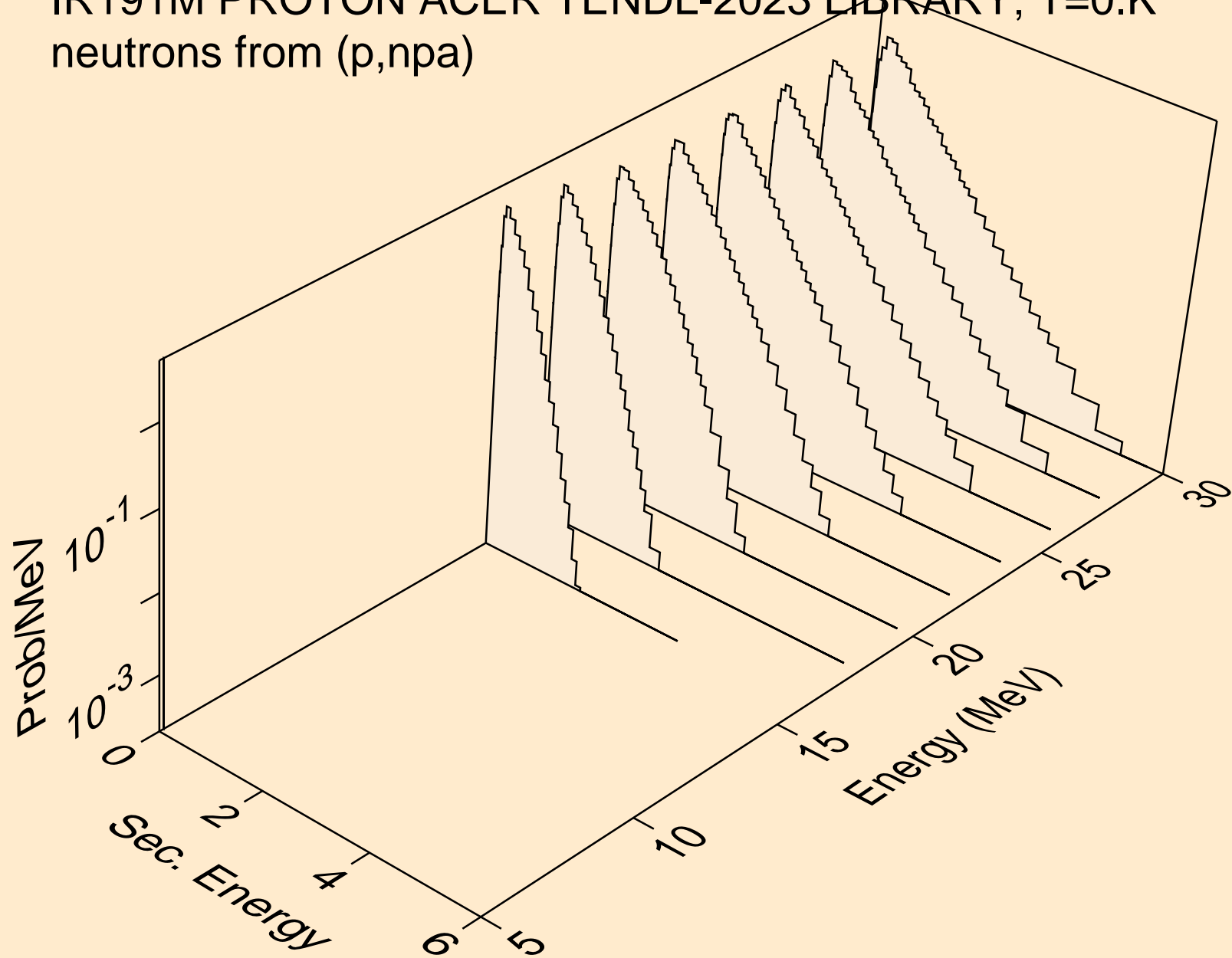

IR191M PROTON ACER TENDL-2023 LIBRARY; T=0.K  
deuterons from (p,x)

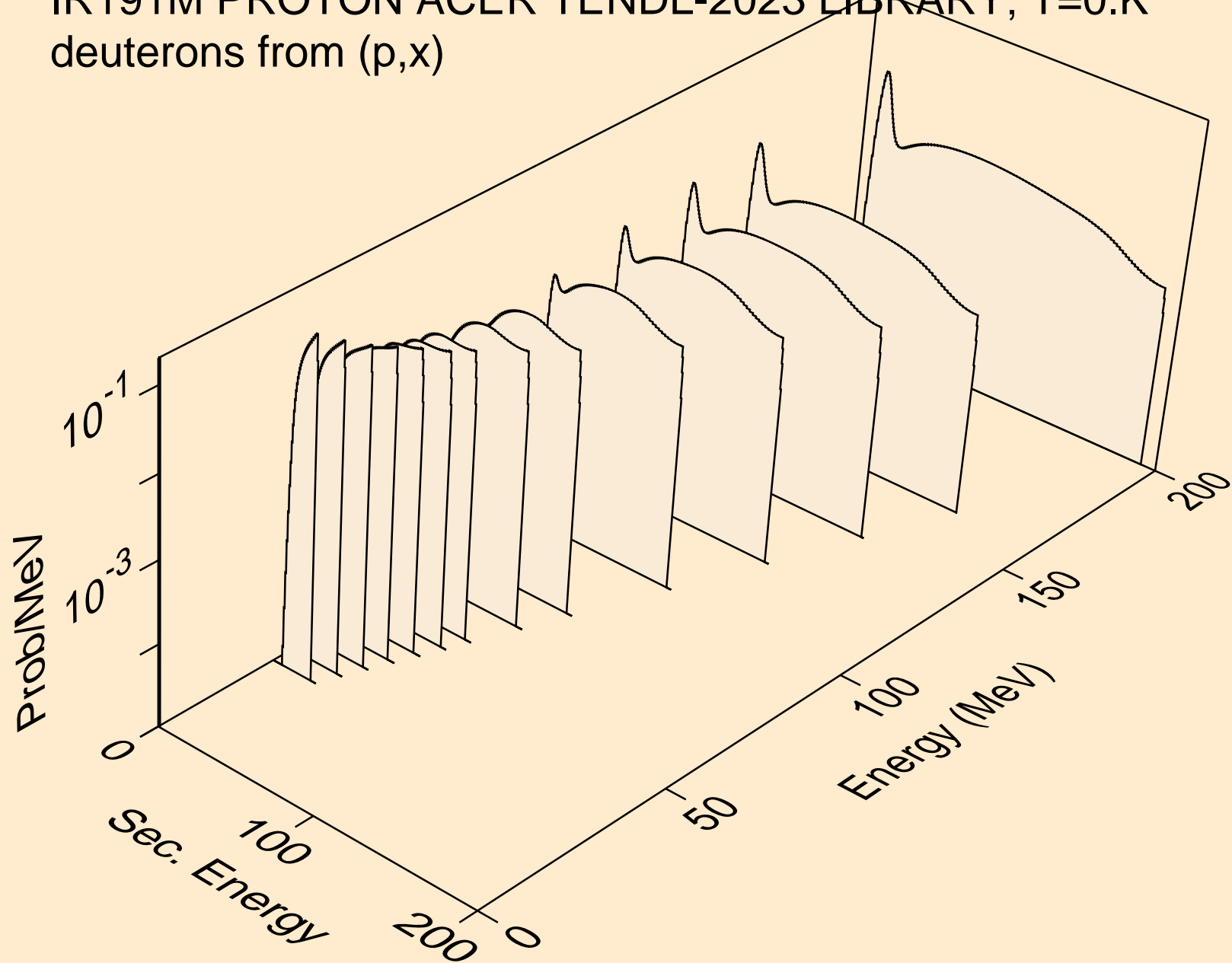



IR191M PROTON ACER TENDL-2023 LIBRARY; T=0.K  
deuterons from (p,2nd)

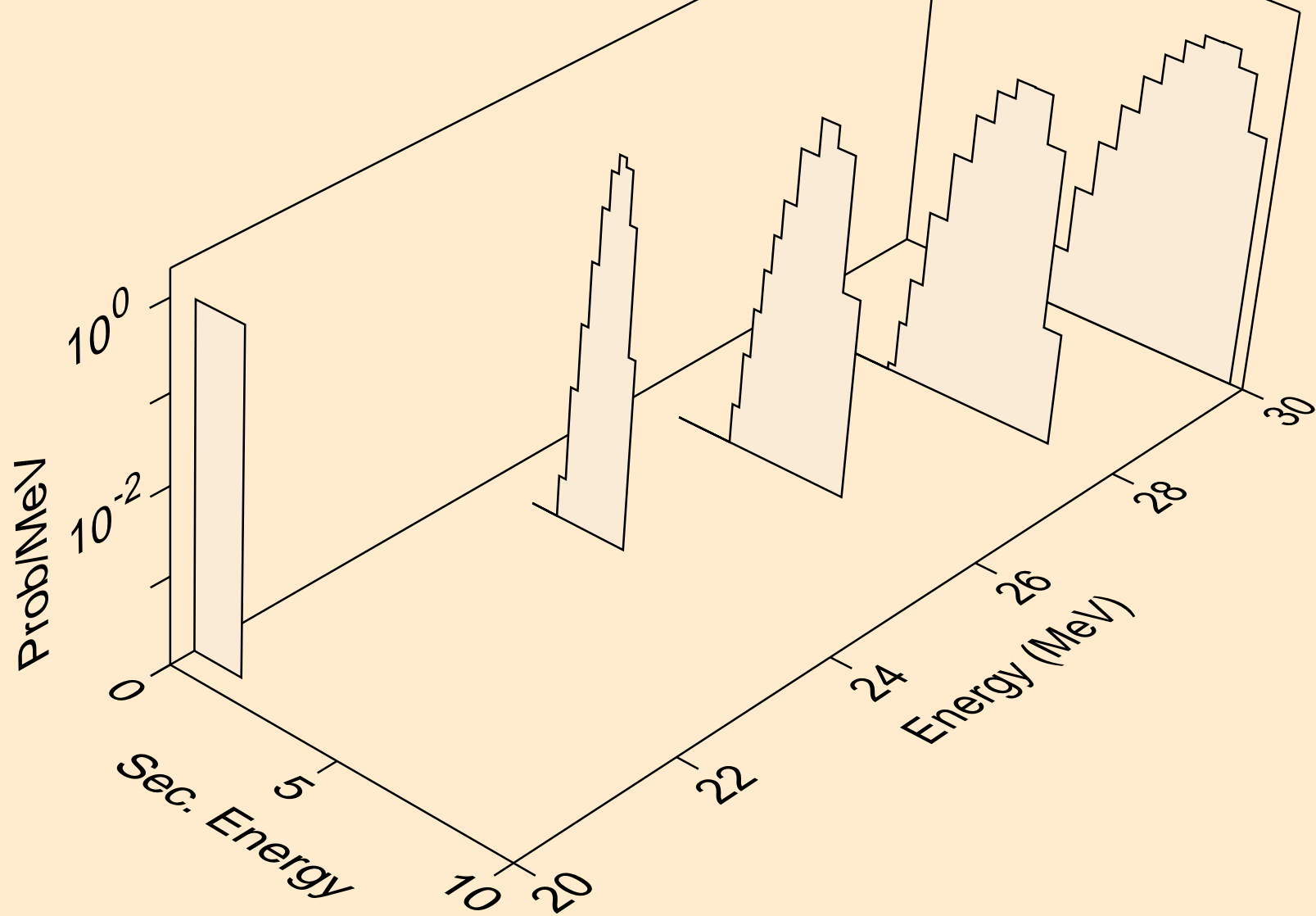

IR191M PROTON ACER TENDL-2023 LIBRARY; T=0.K  
deuterons from (p,n\*)d

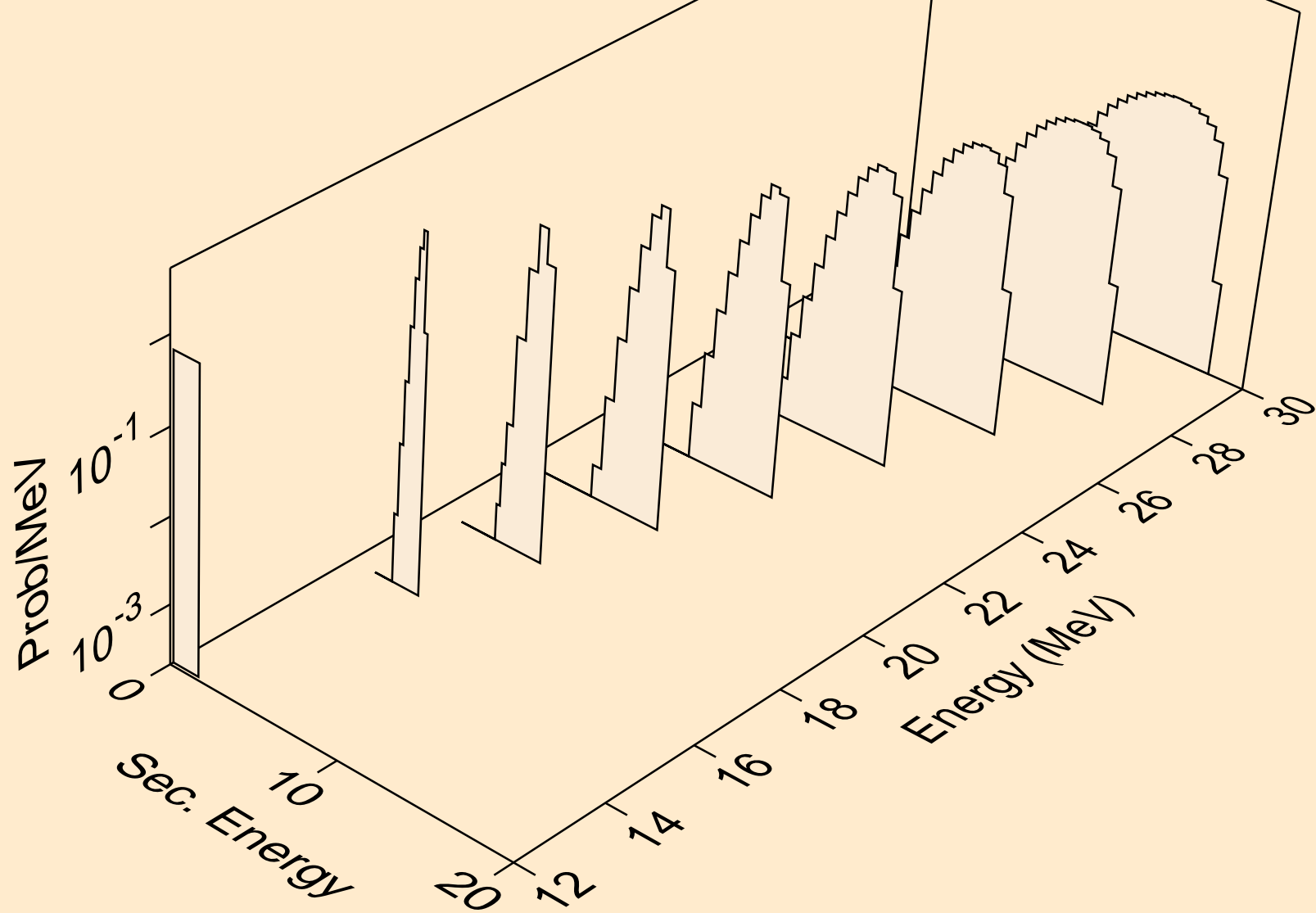

IR191M PROTON ACER TENDL-2023 LIBRARY; T=0.K  
deuterons from (p,d)

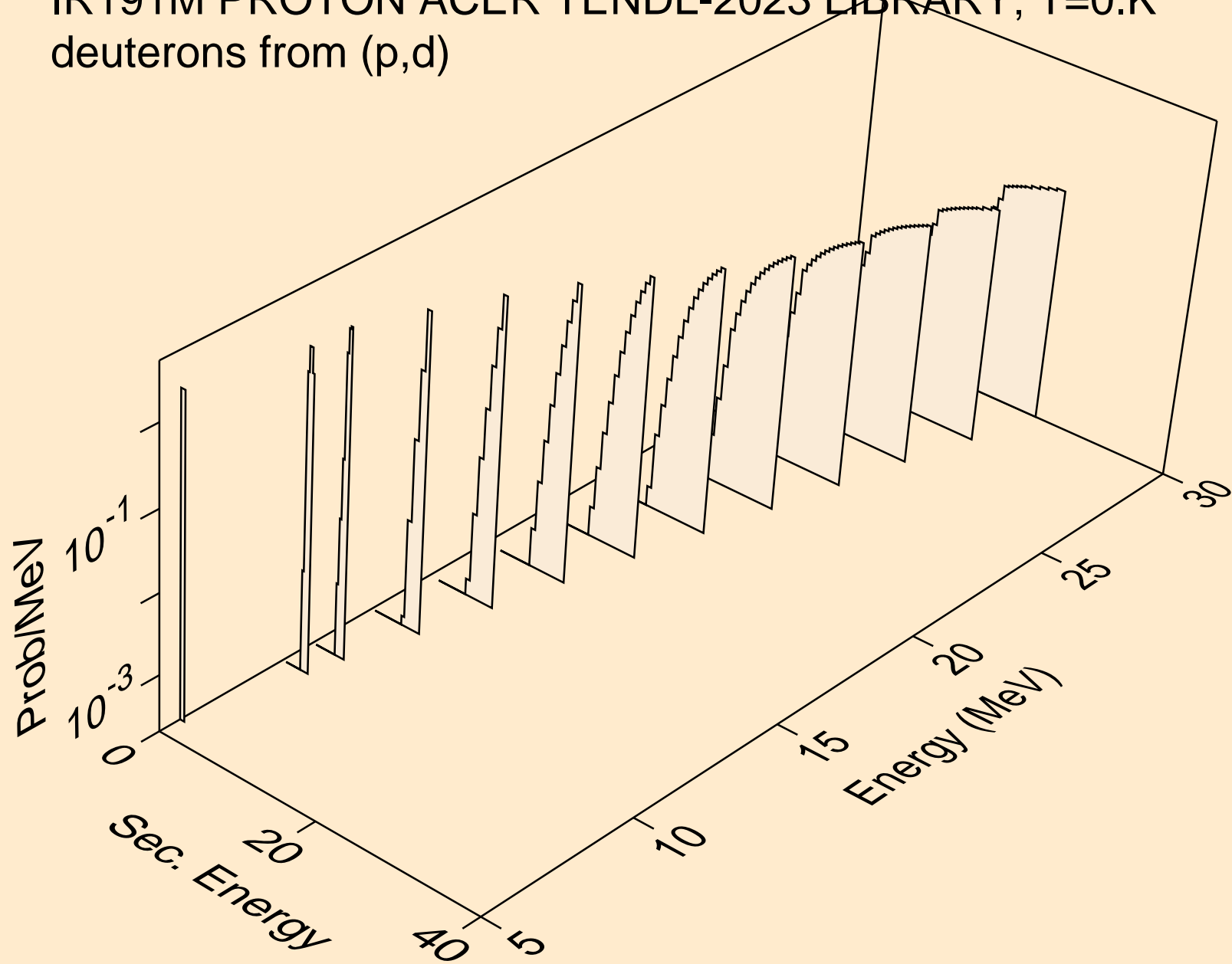

IR191M PROTON ACER TENDL-2023 LIBRARY; T=0.K  
deuterons from (p,pd)

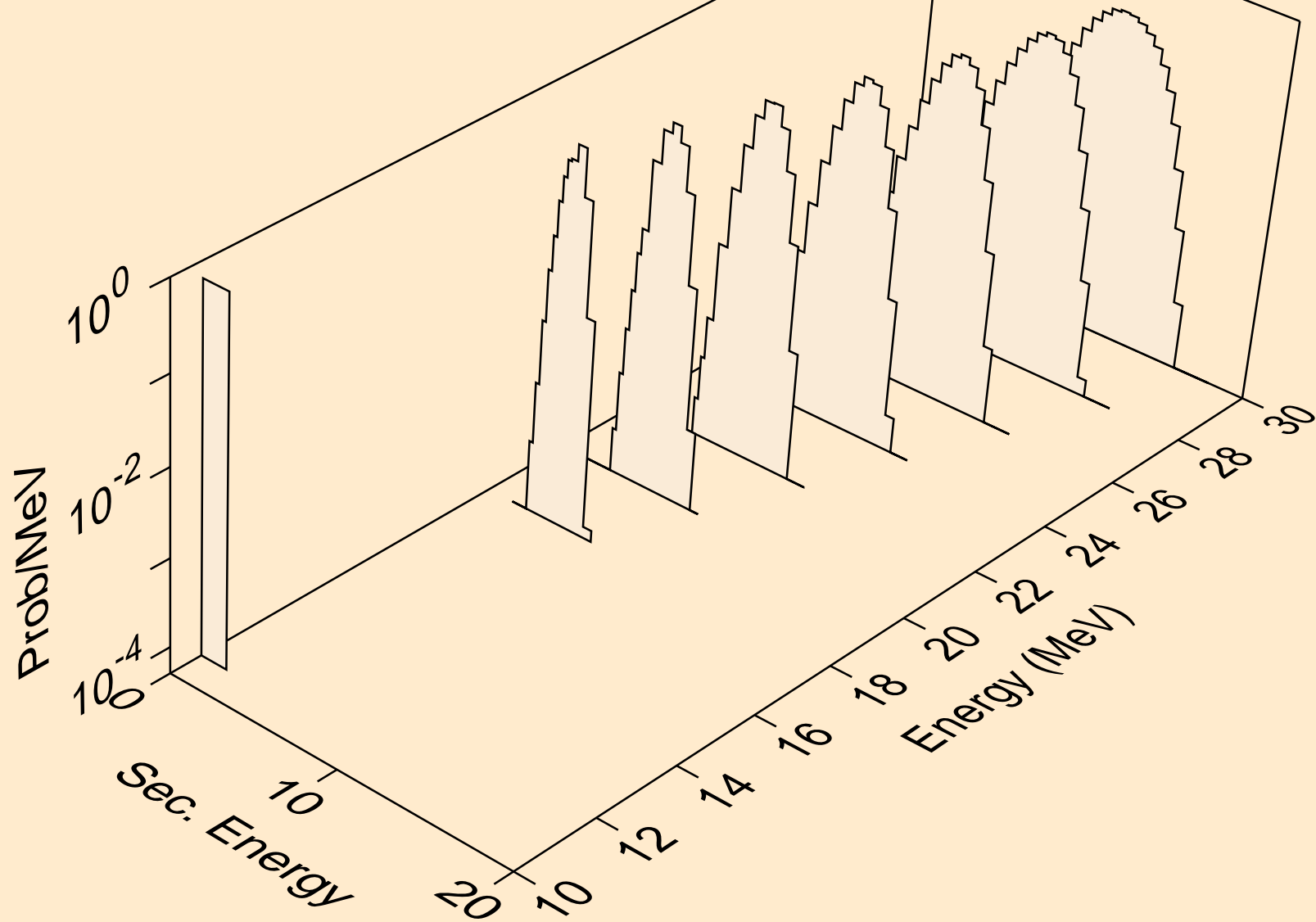

IR191M PROTON ACER TENDL-2023 LIBRARY; T=0.K  
deuterons from (p,da)

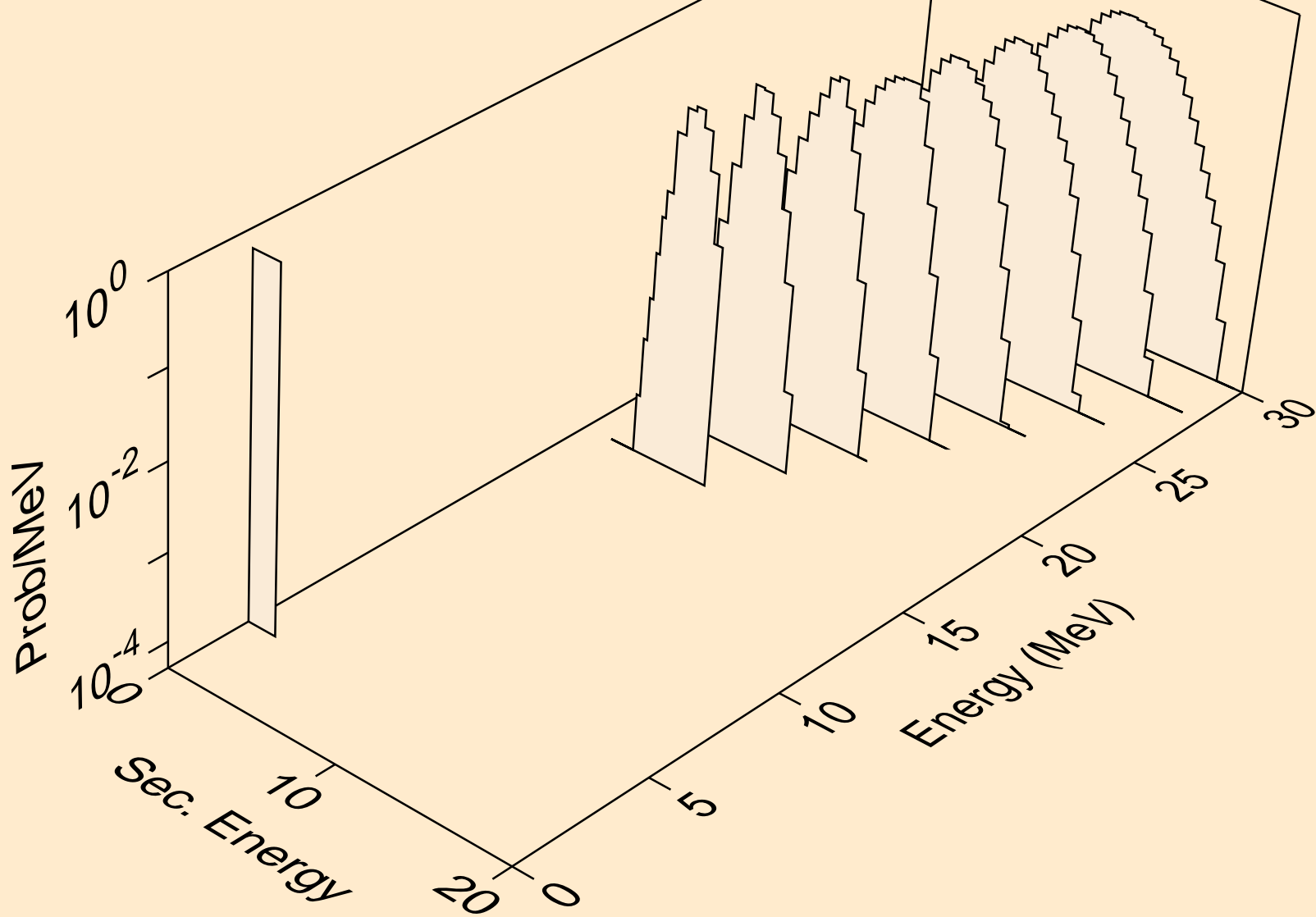

IR191M PROTON ACER TENDL-2023 LIBRARY; T=0.K  
tritons from (p,x)

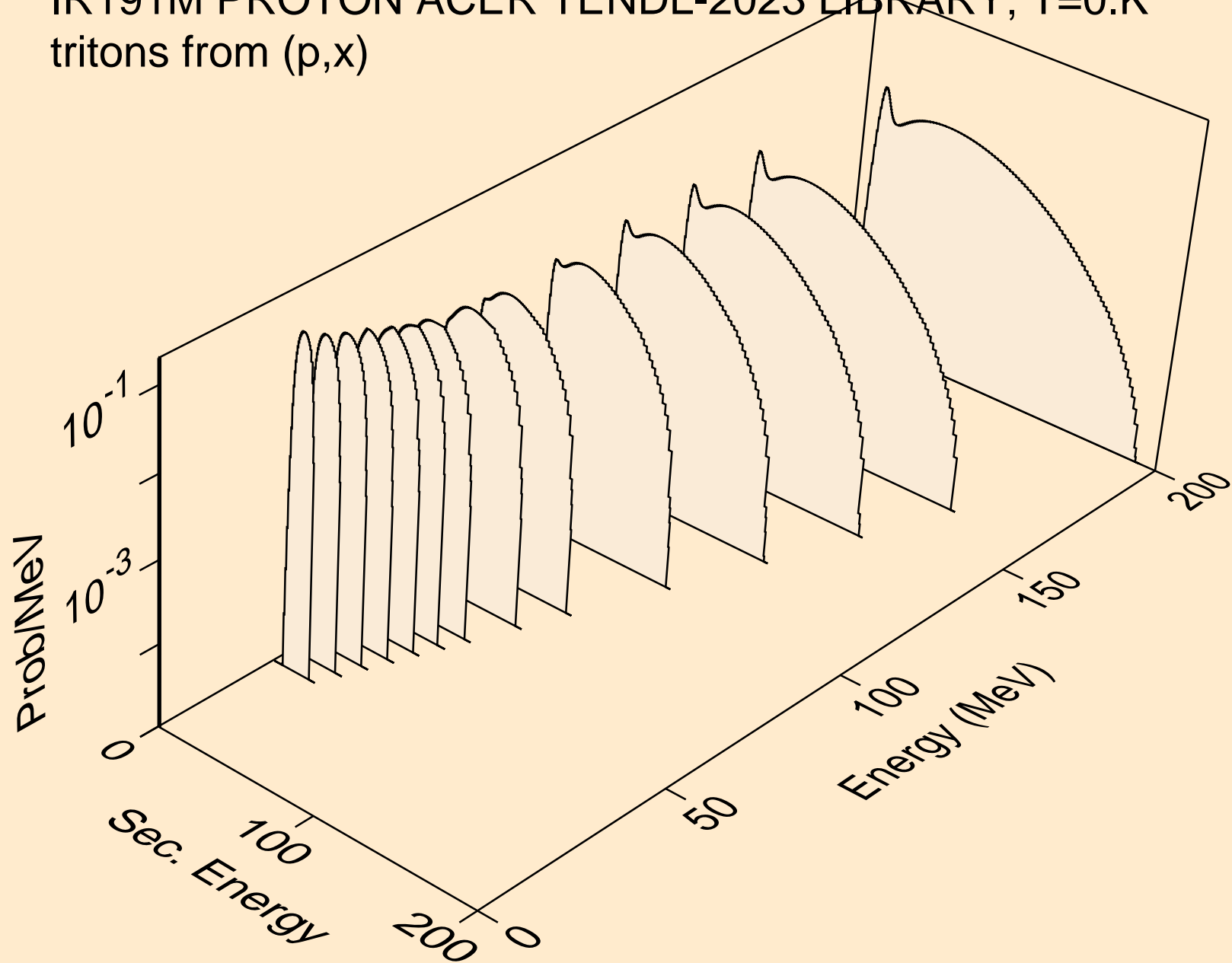

IR191M PROTON ACER TENDL-2023 LIBRARY; T=0.K  
tritons from (p,n\*)t

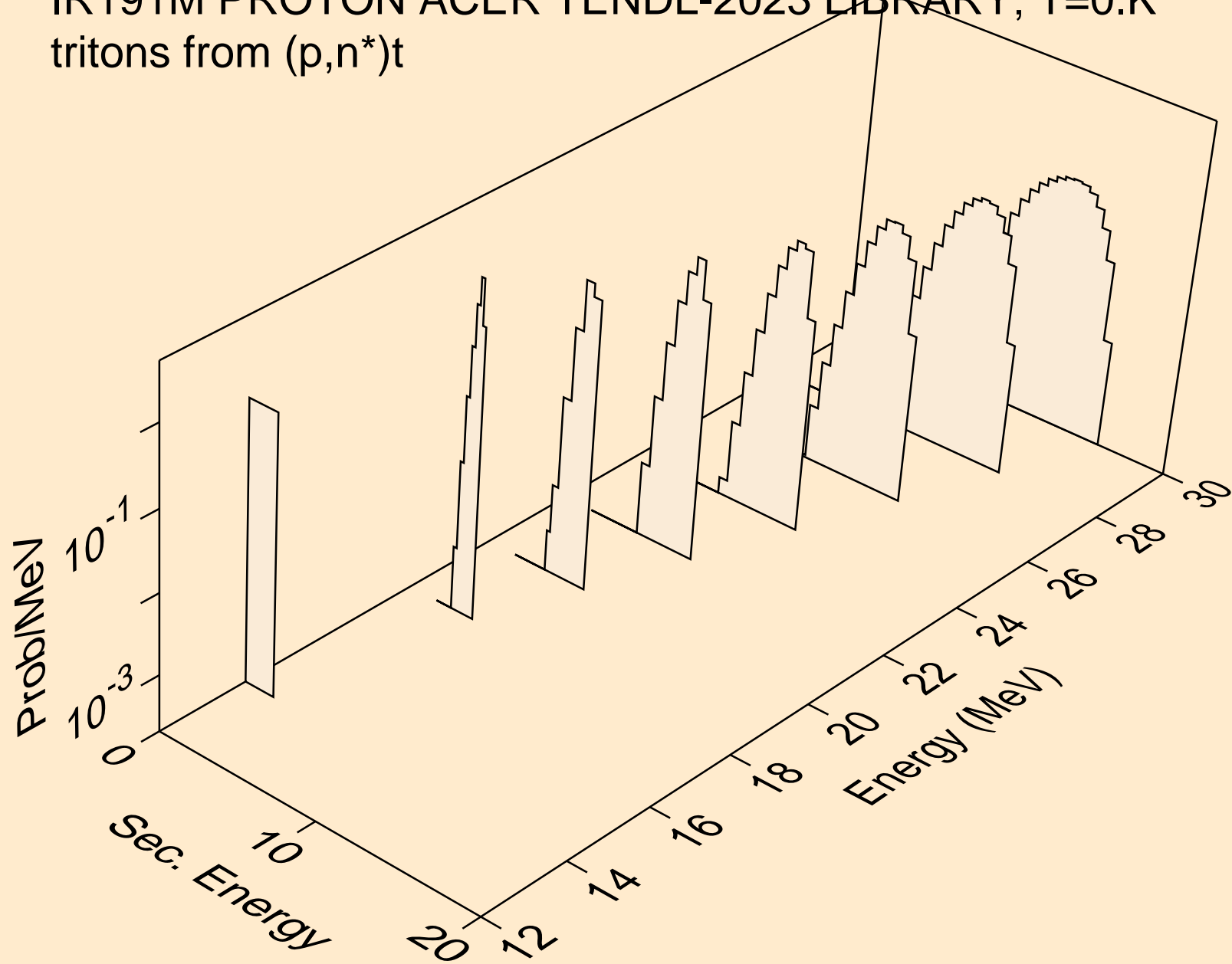

IR191M PROTON ACER TENDL-2023 LIBRARY; T=0.K  
tritons from (p,t)

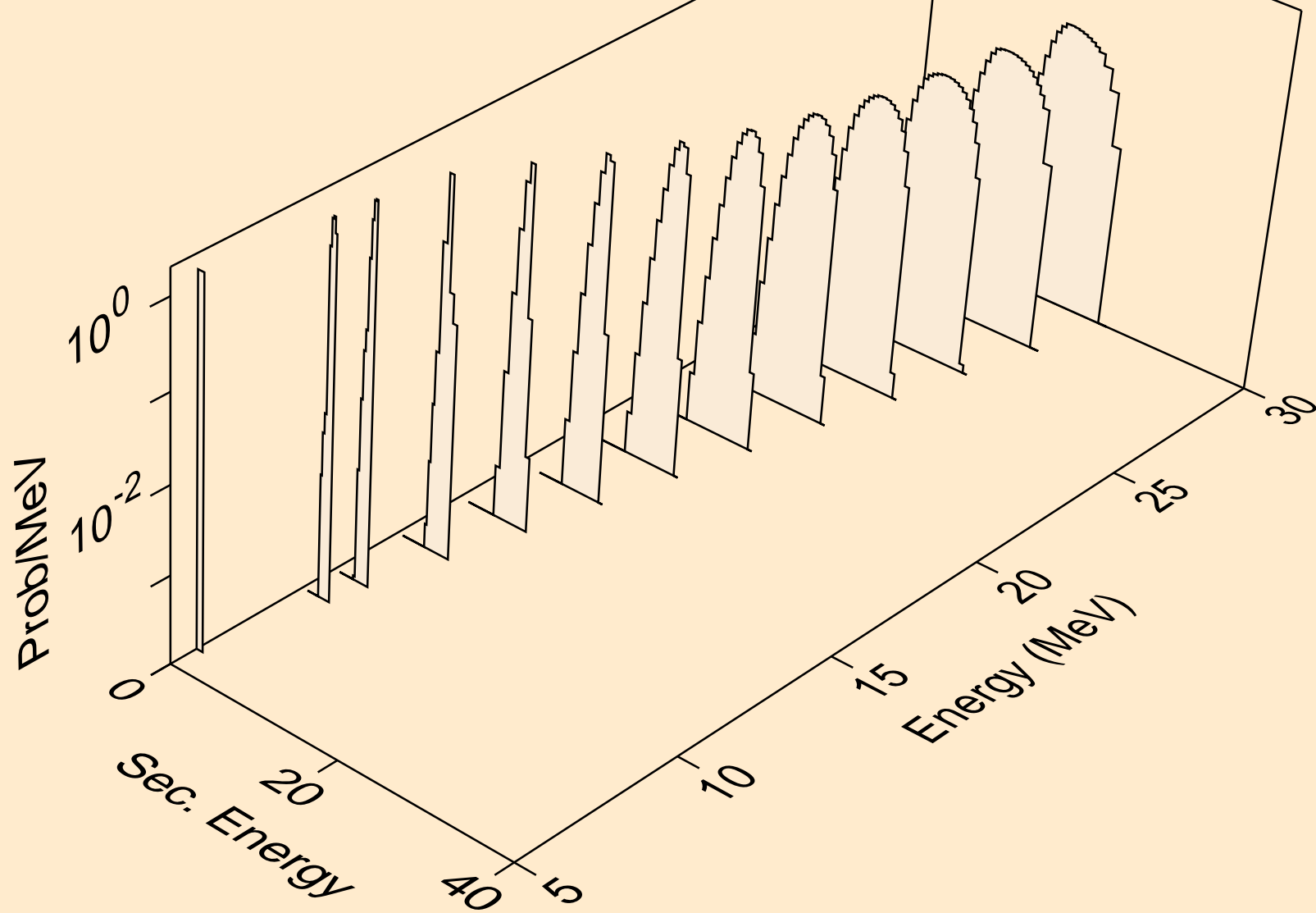



IR191M PROTON ACER TENDL-2023 LIBRARY; T=0.K  
tritons from (p,pt)

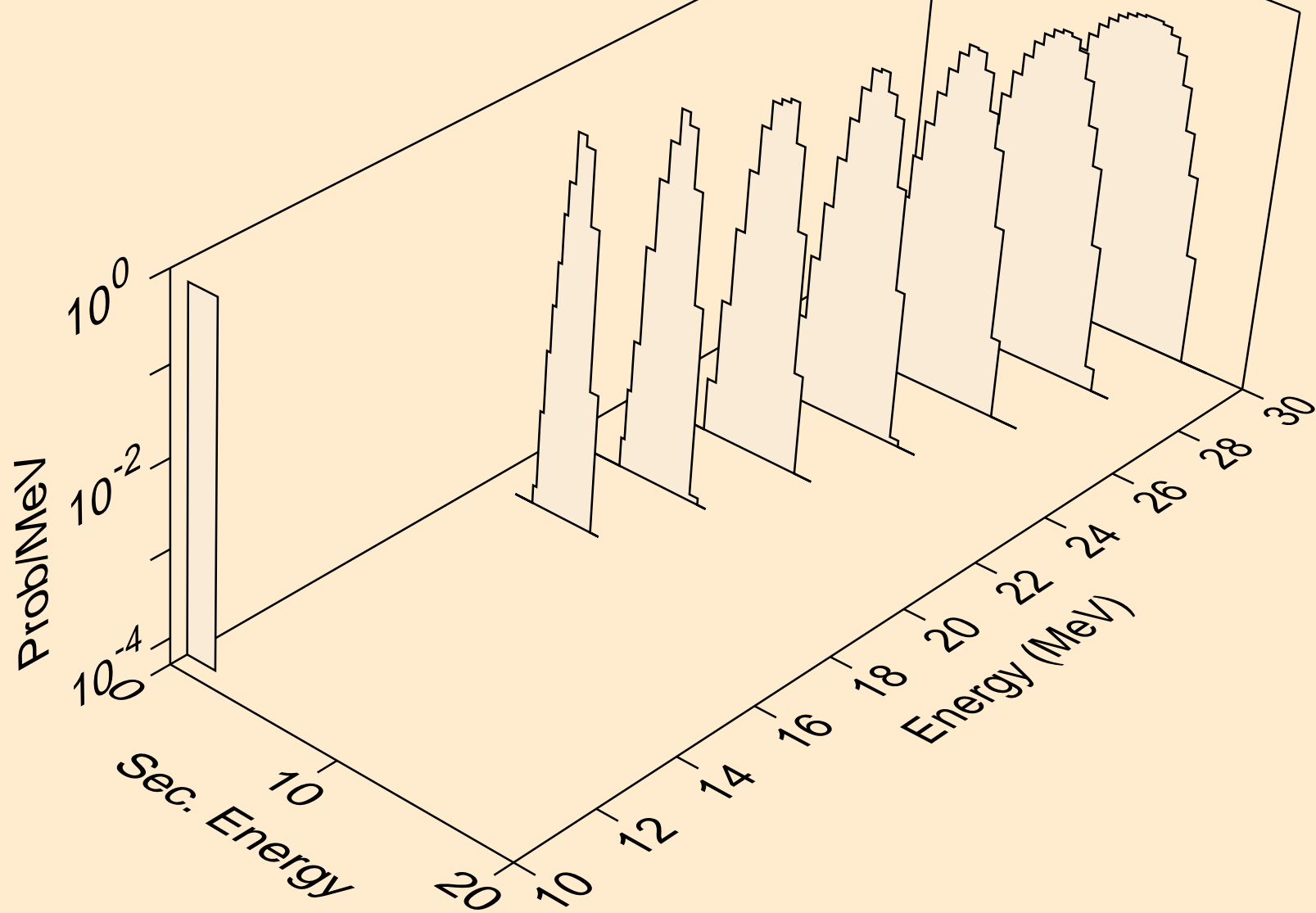

IR191M PROTON ACER TENDL-2023 LIBRARY; T=0.K  
he3s from (p,x)

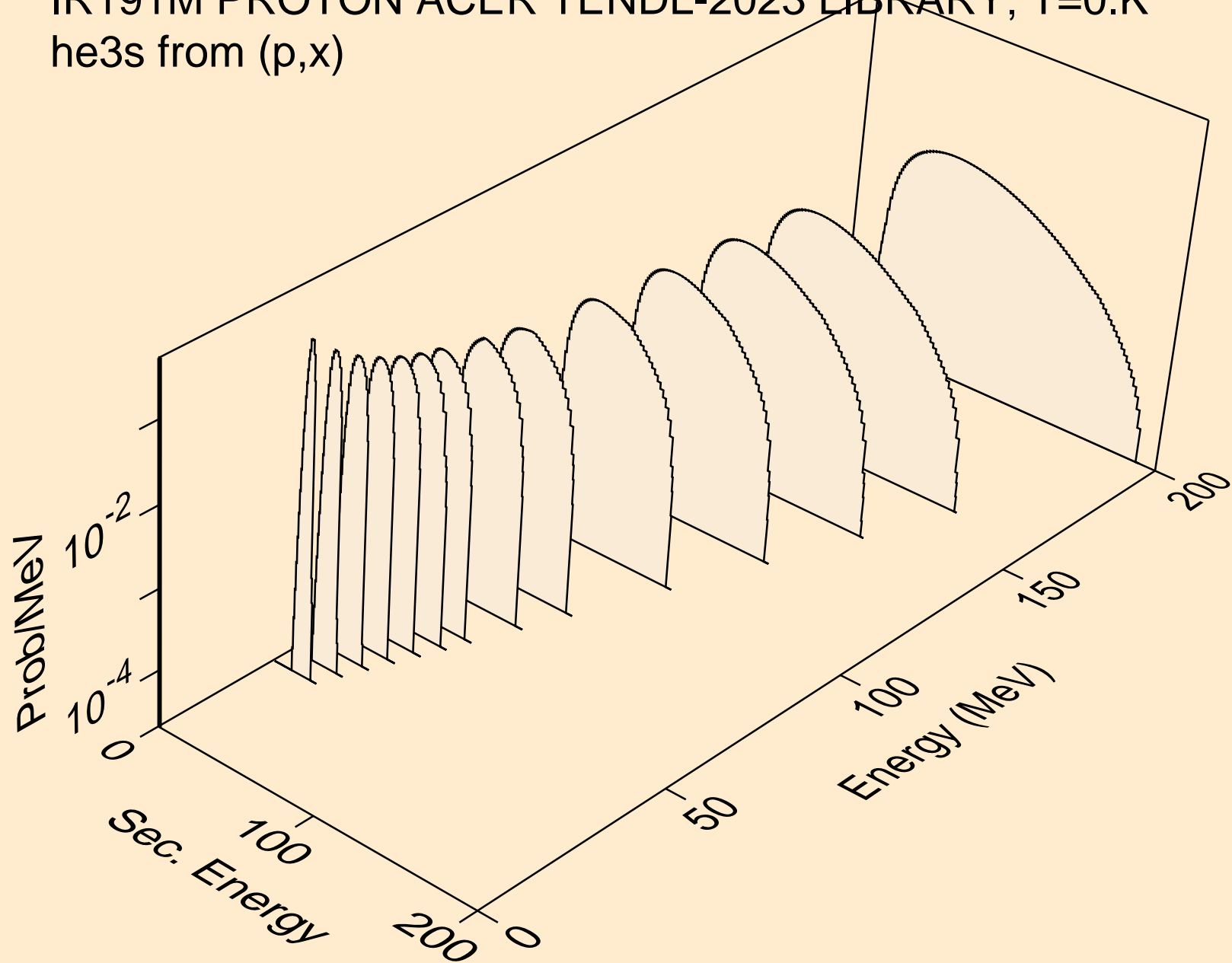

IR191M PROTON ACER TENDL-2023 LIBRARY; T=0.K  
he3s from (p,n\*)he3

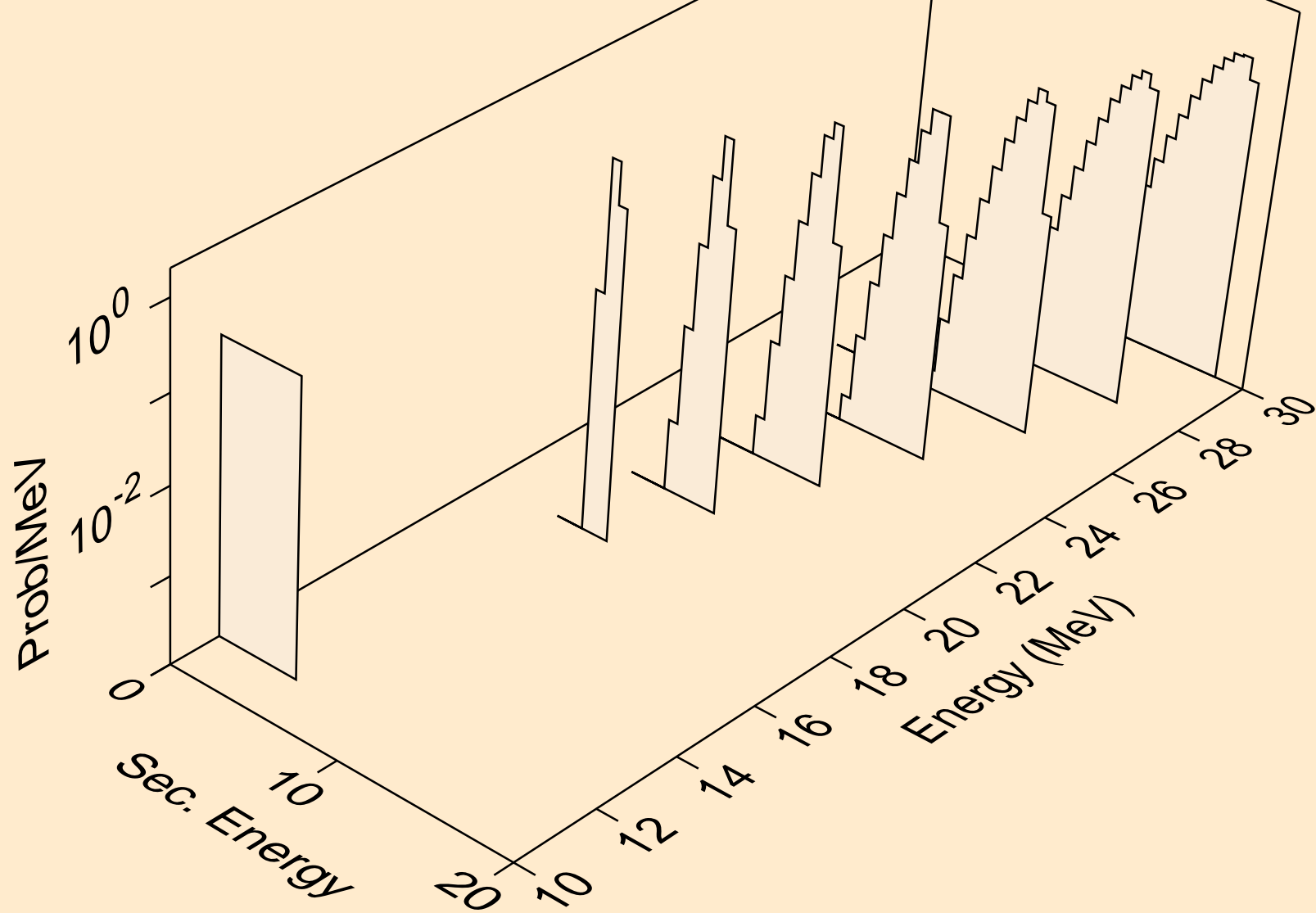

IR191M PROTON ACER TENDL-2023 LIBRARY; T=0.K  
he3s from (p,he3)

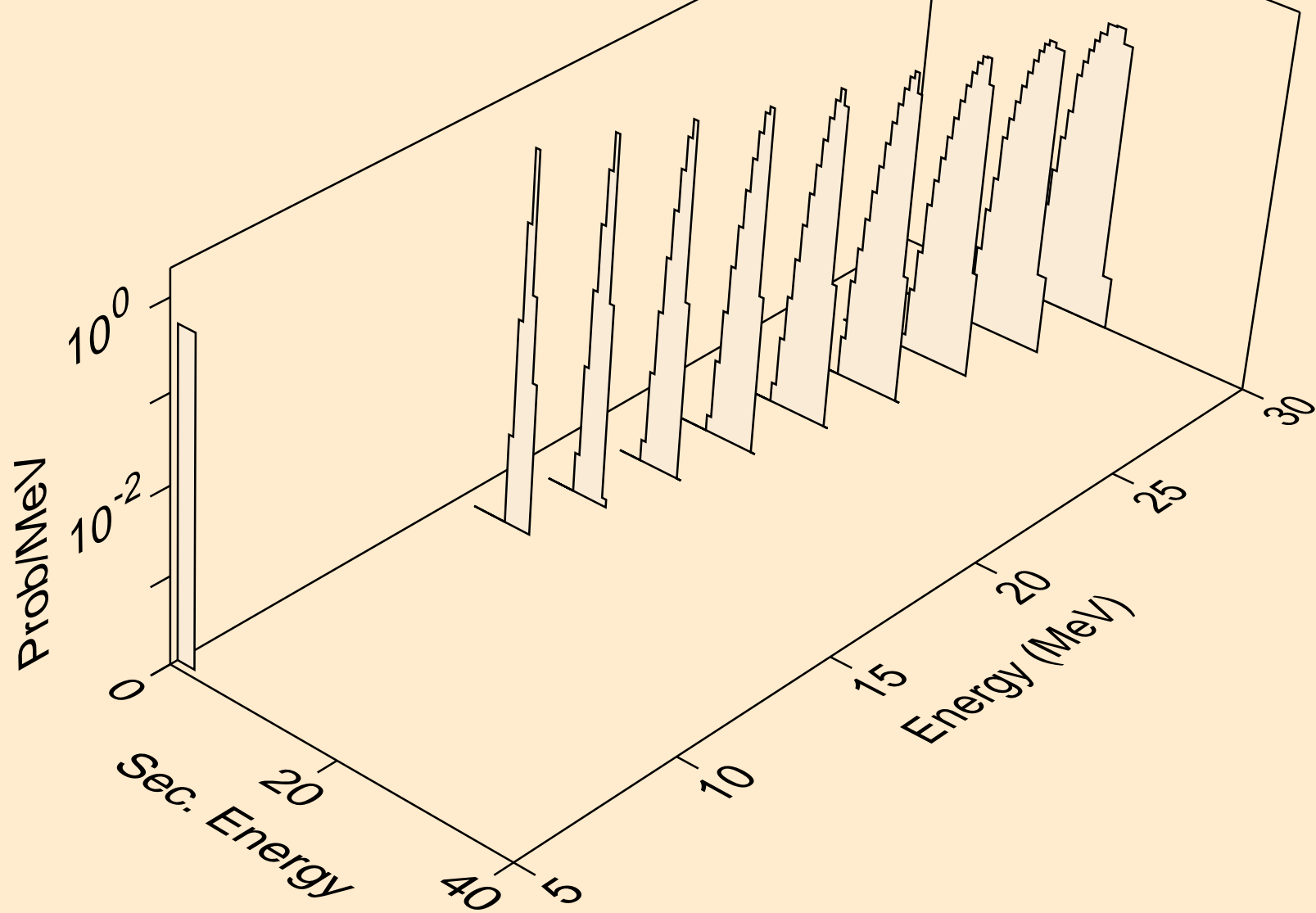

IR191M PROTON ACER TENDL-2023 LIBRARY; T=0.K  
alphas from (p,x)

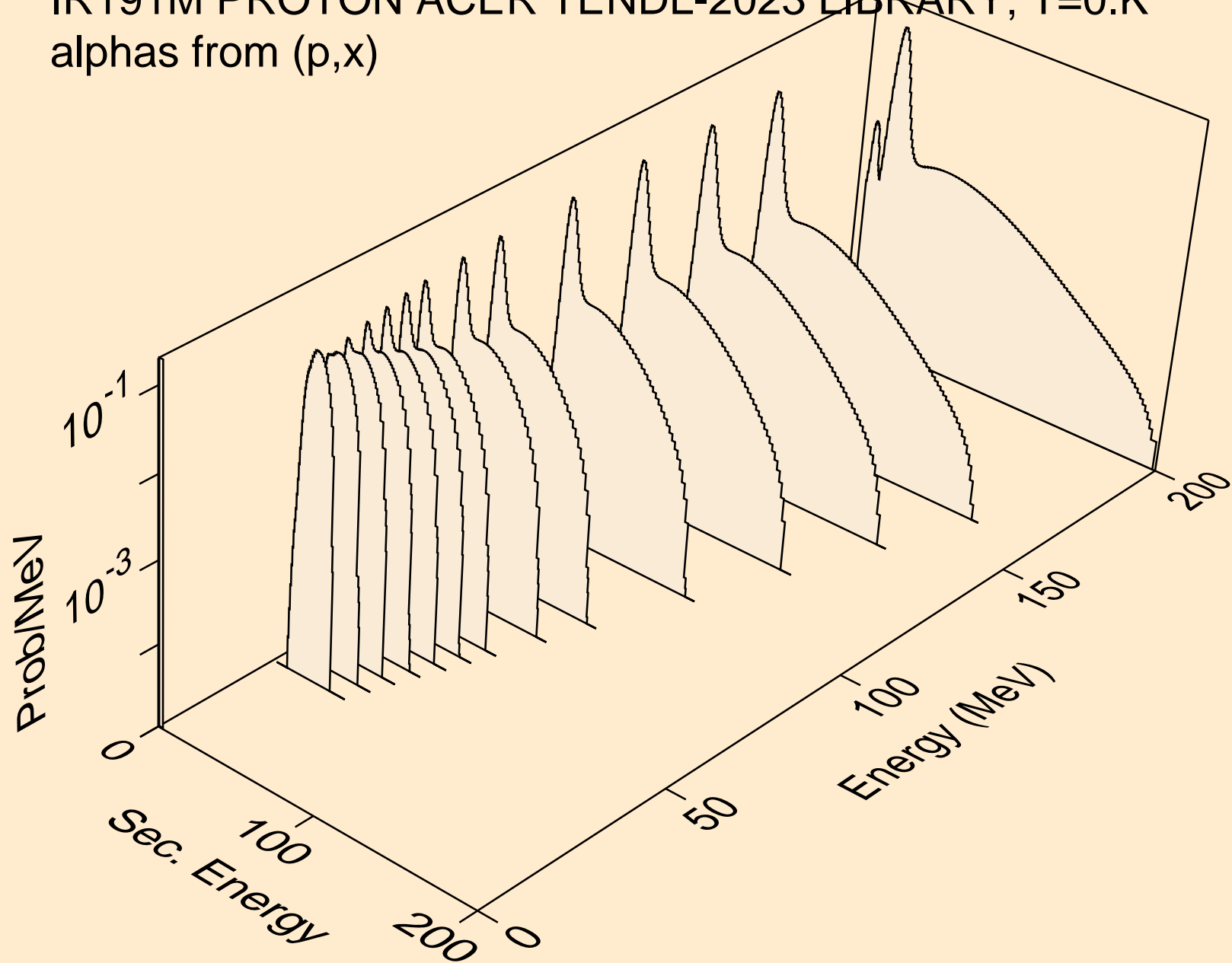

IR191M PROTON ACER TENDL-2023 LIBRARY; T=0.K  
alphas from (p,n\*)a

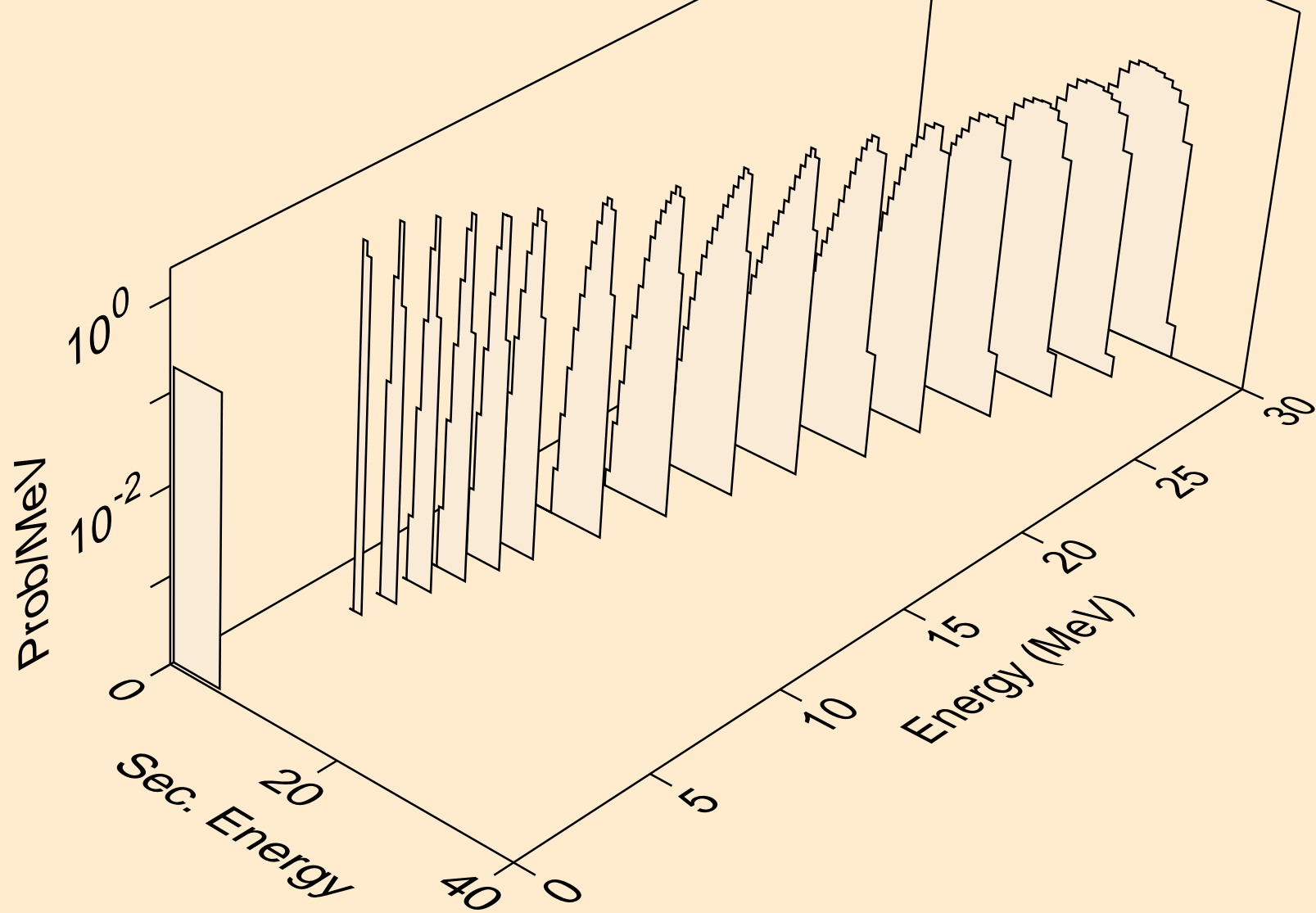

IR191M PROTON ACER TENDL-2023 LIBRARY; T=0.K  
alphas from (p,2n)a

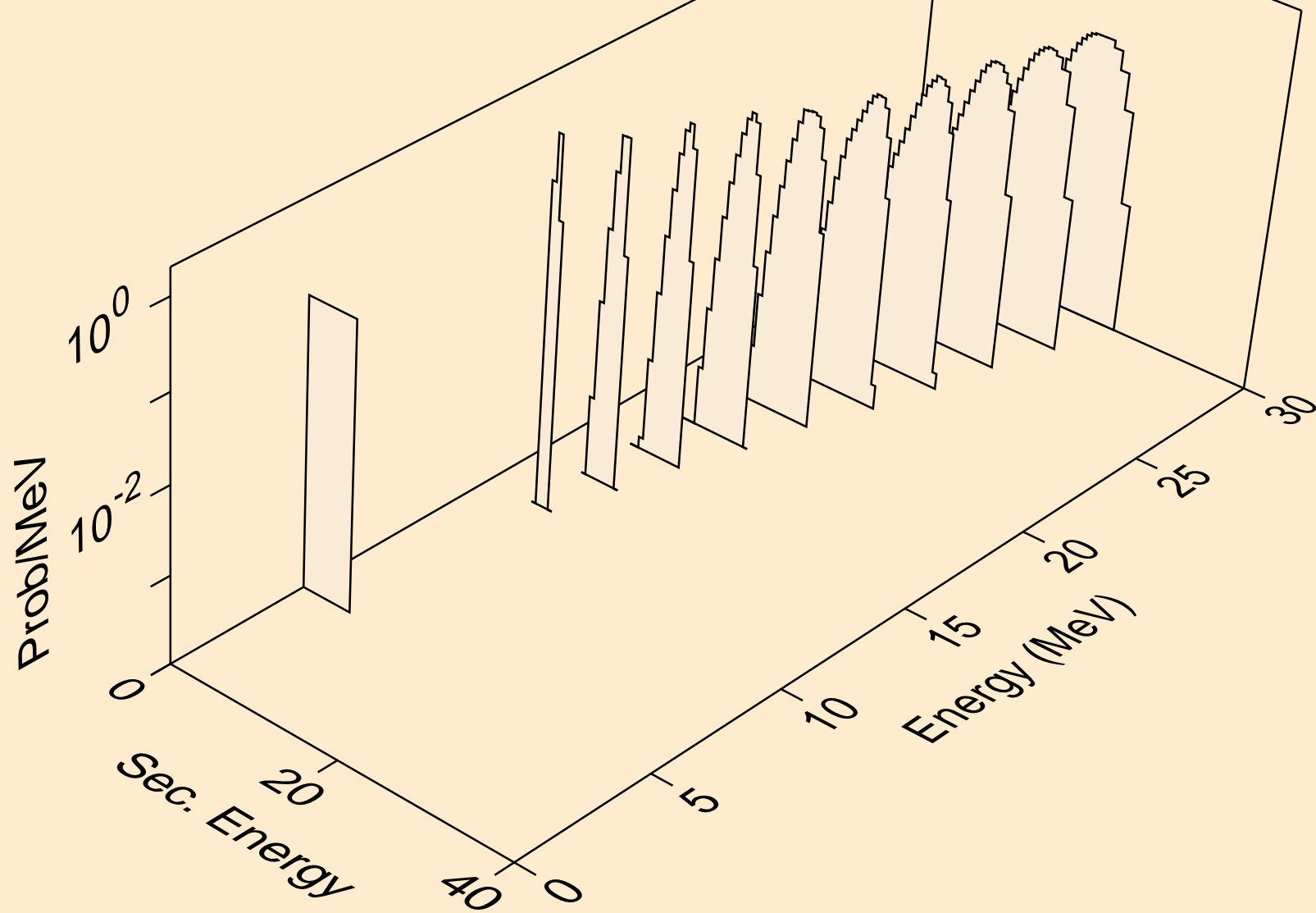

IR191M PROTON ACER TENDL-2023 LIBRARY; T=0.K  
alphas from (p,3n)a

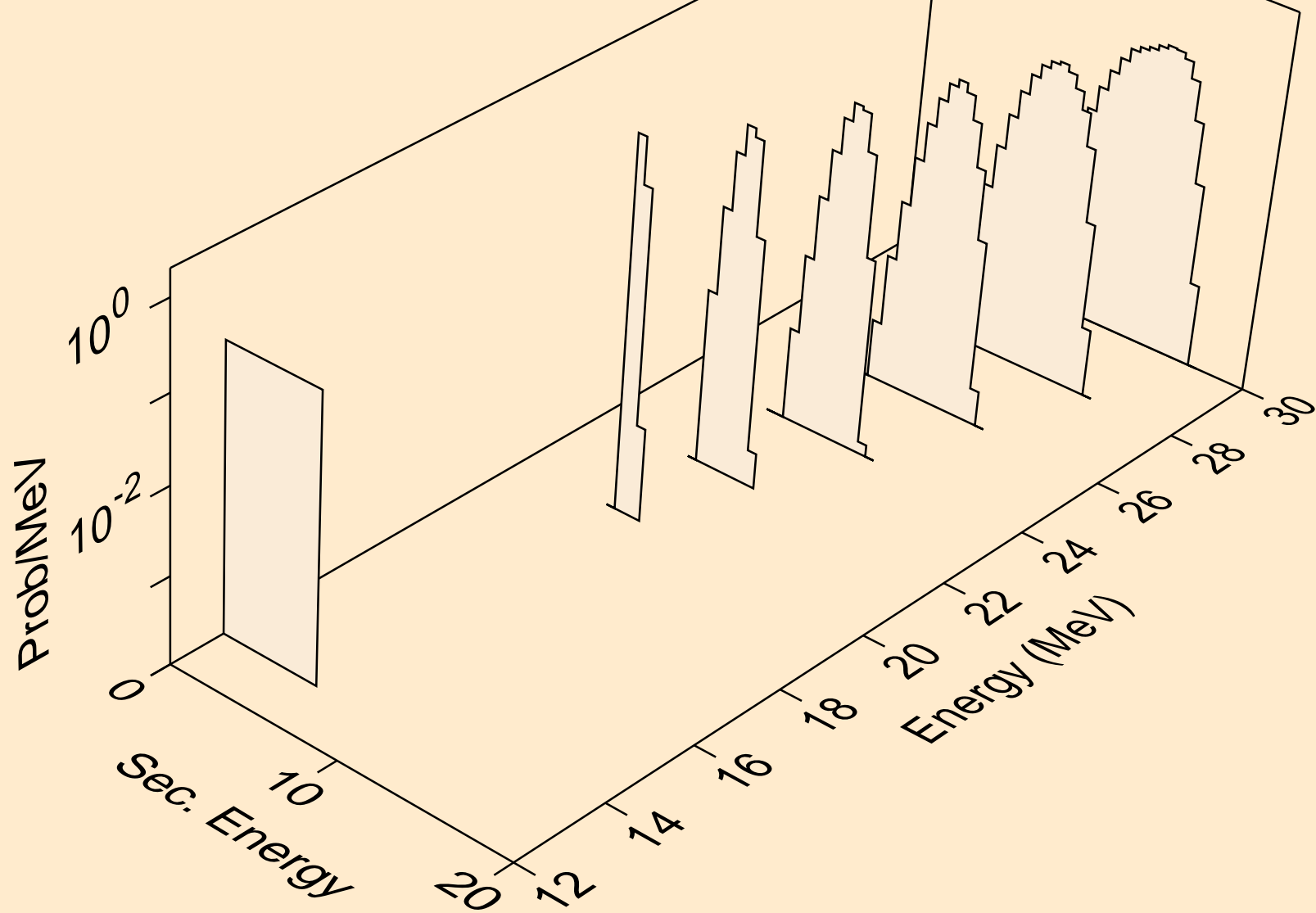



IR191M PROTON ACER TENDL-2023 LIBRARY; T=0.K  
alphas from (p,n\*)2a

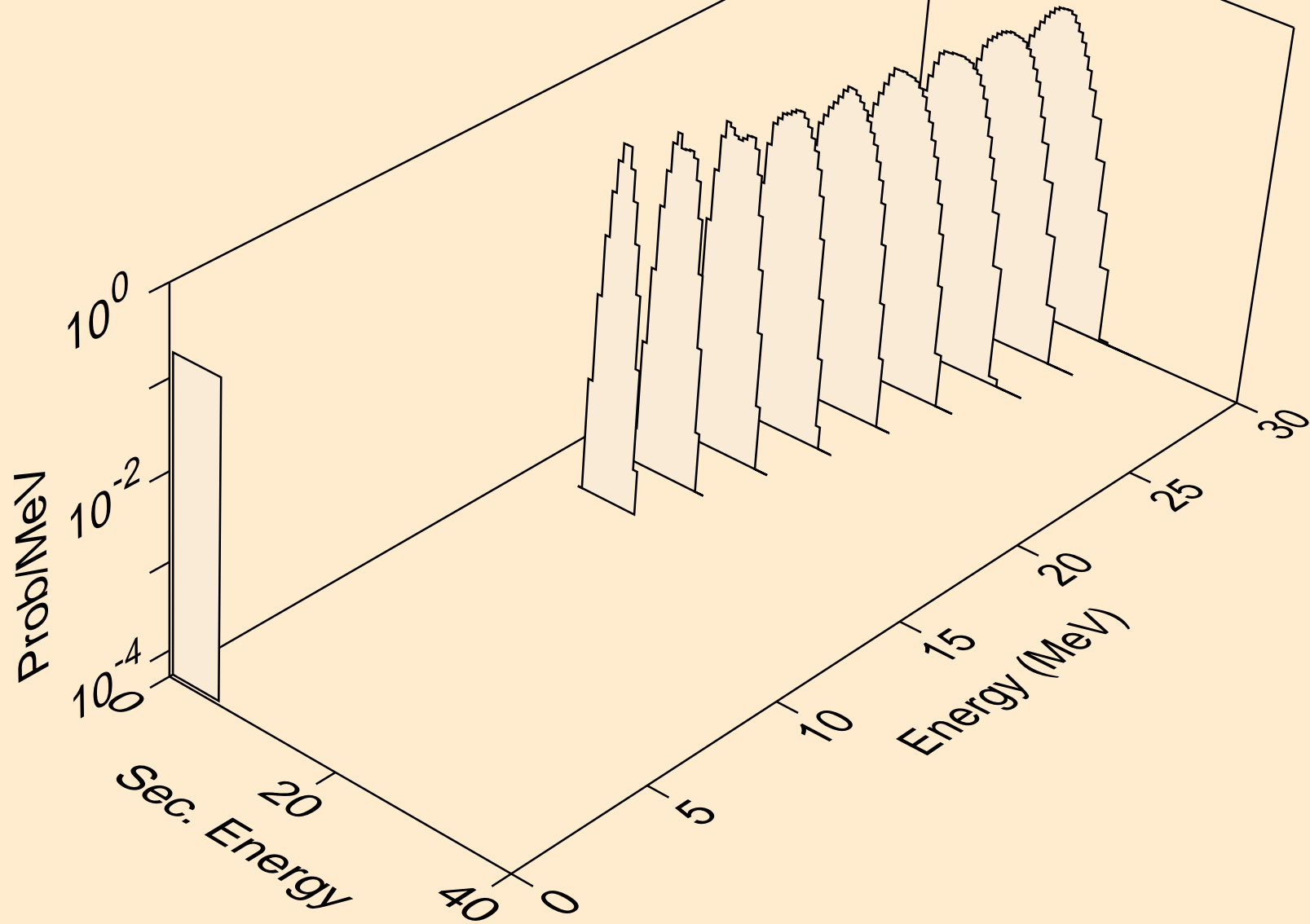

IR191M PROTON ACER TENDL-2023 LIBRARY; T=0.K  
alphas from (p,npa)

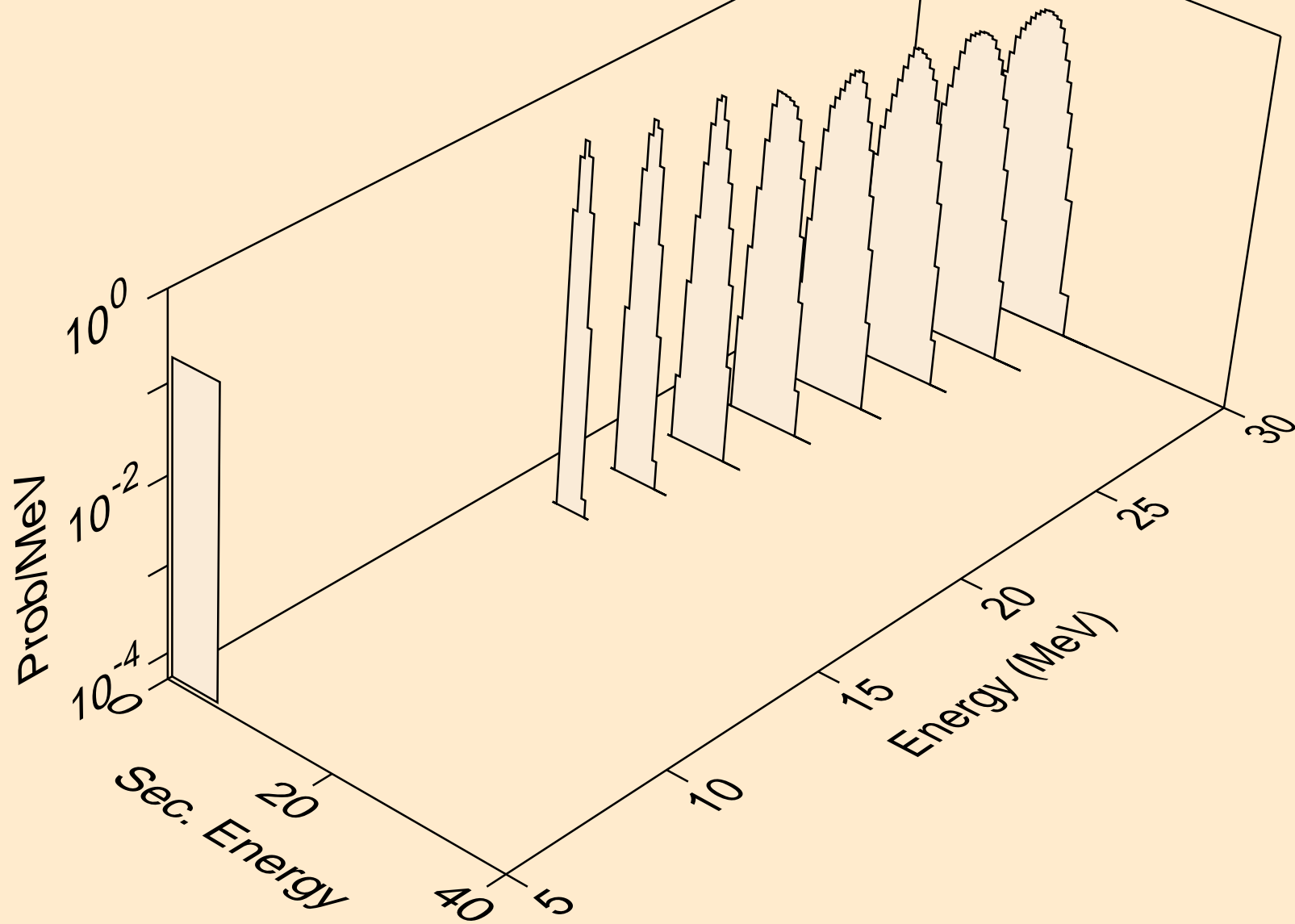

IR191M PROTON ACER TENDL-2023 LIBRARY; T=0.K  
alphas from (p,a)

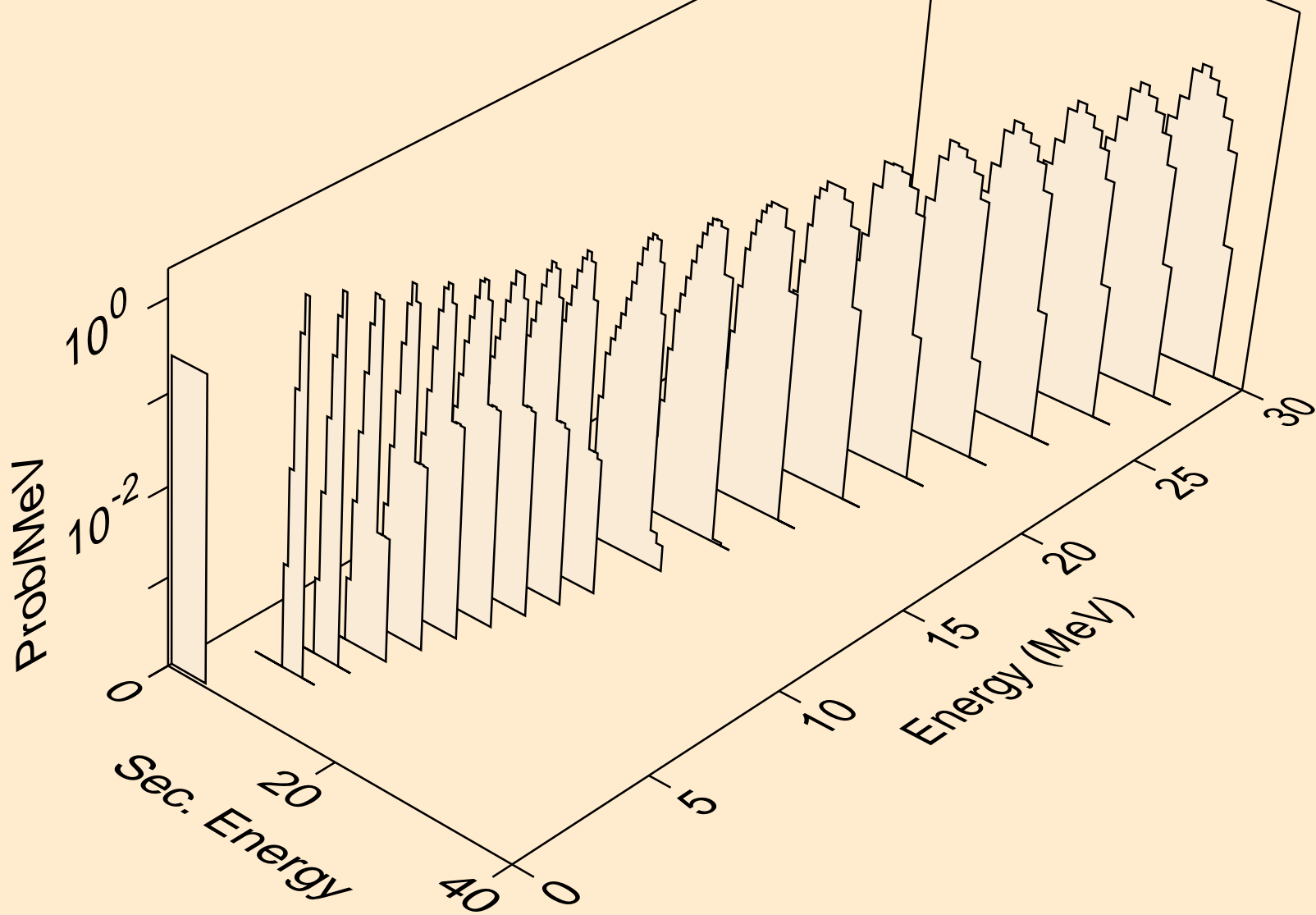

IR191M PROTON ACER TENDL-2023 LIBRARY; T=0.K  
alphas from (p,2a)

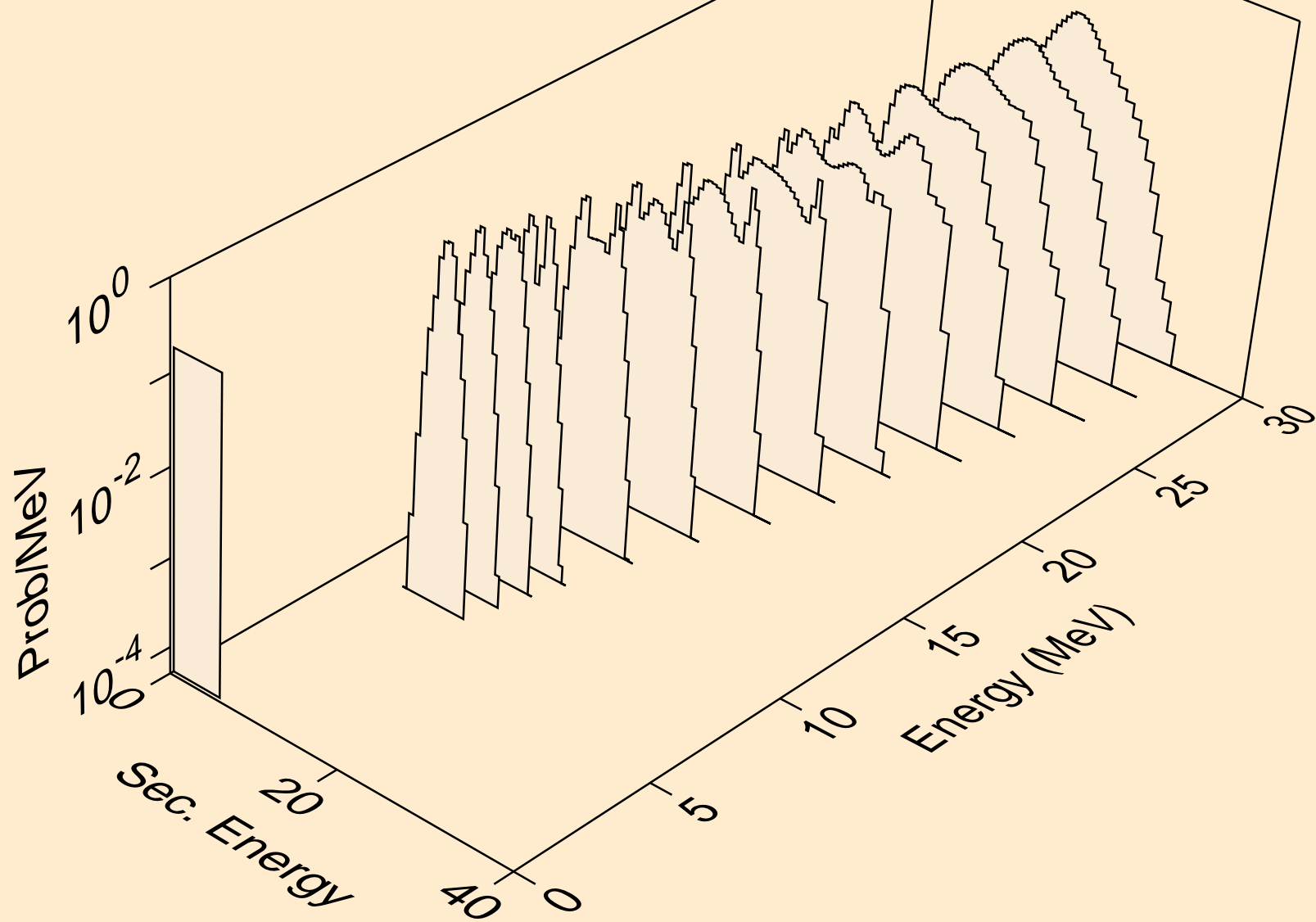

IR191M PROTON ACER TENDL-2023 LIBRARY; T=0.K  
alphas from (p,pa)

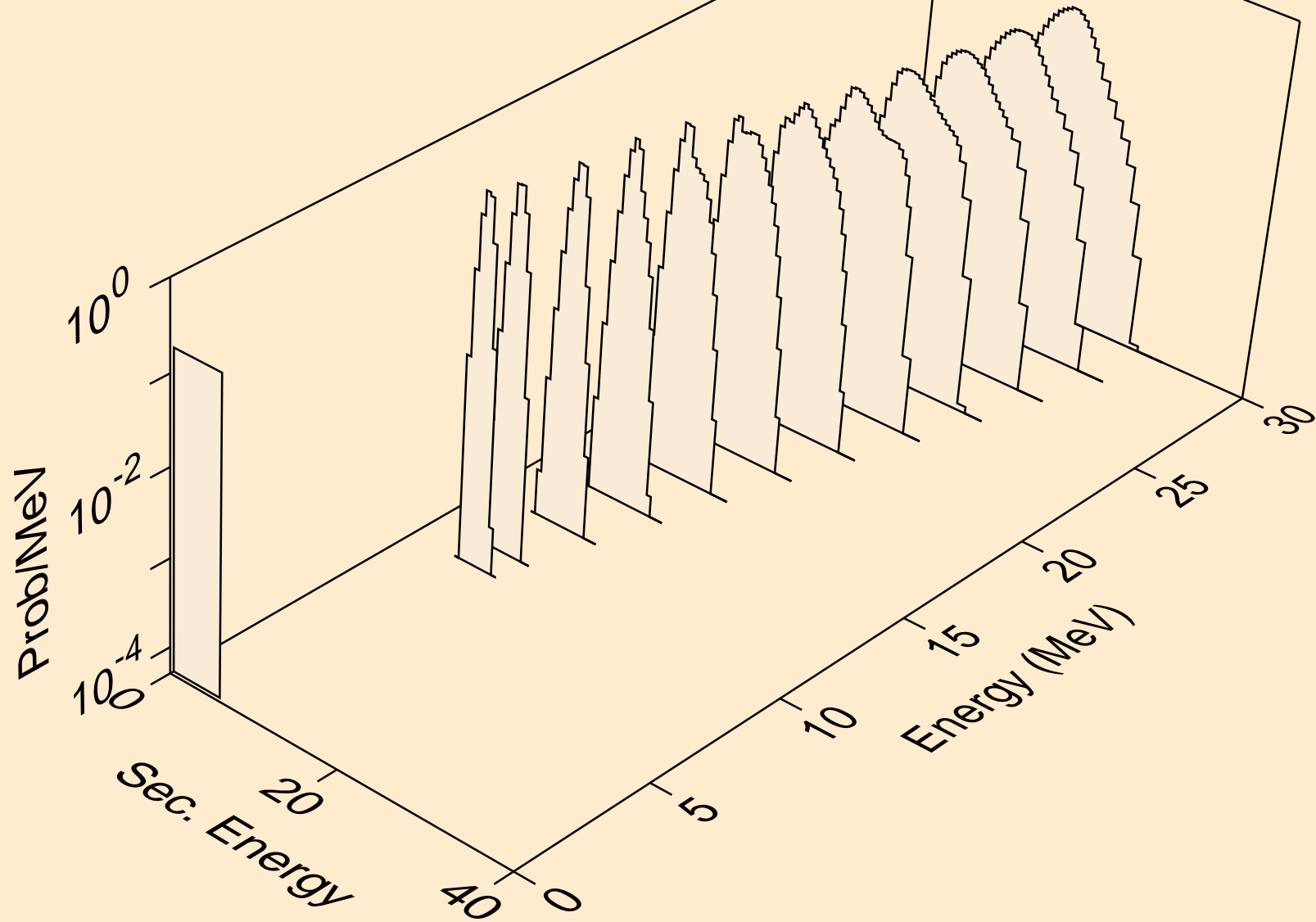

IR191M PROTON ACER TENDL-2023 LIBRARY; T=0.K  
alphas from (p,da)

