

# LU172 PROTON ACER TENDL-2023 LIBRARY; T=0.K

## Principal cross sections

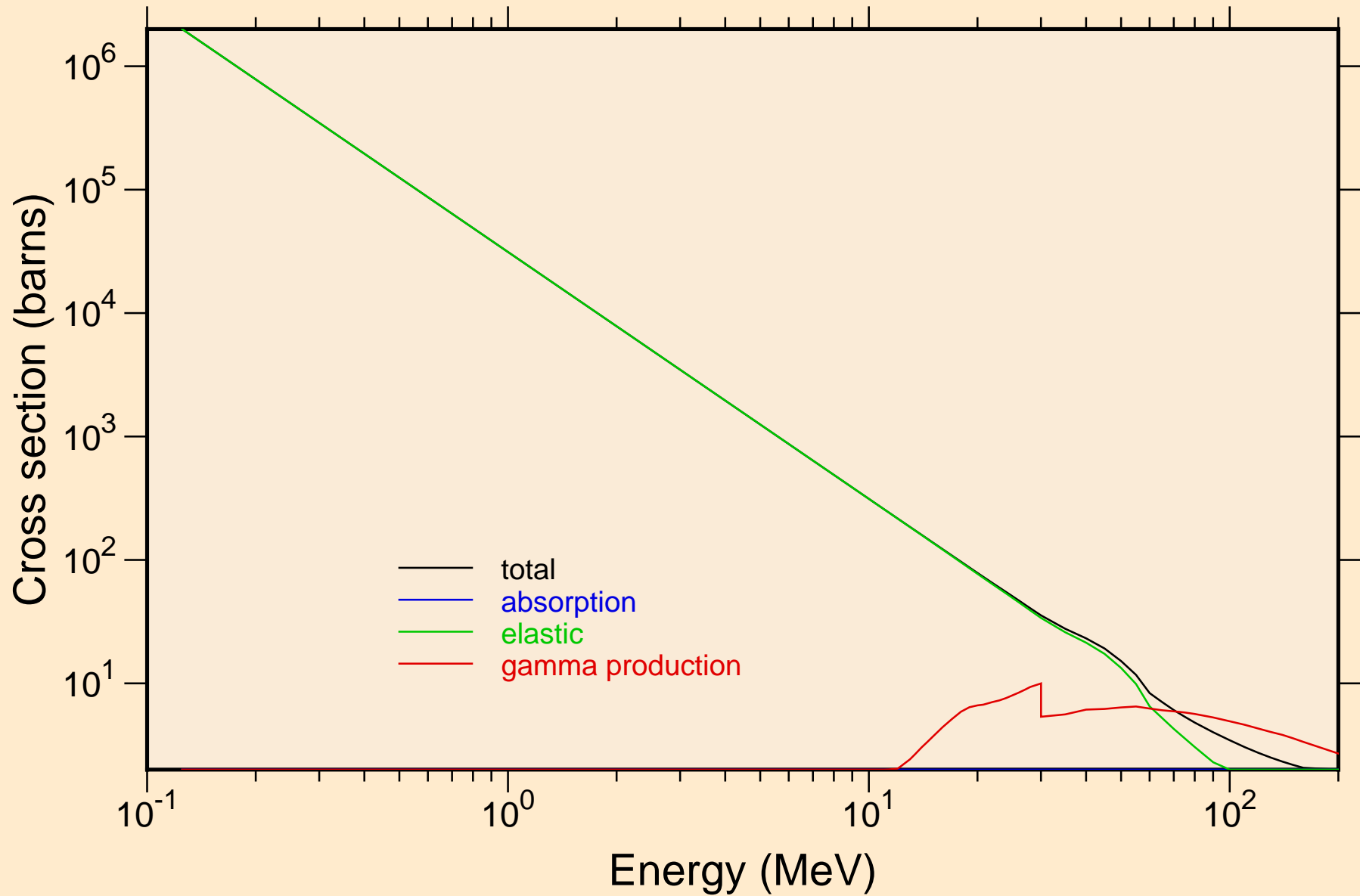

# LU172 PROTON ACER TENDL-2023 LIBRARY; T=0.K

## Heating

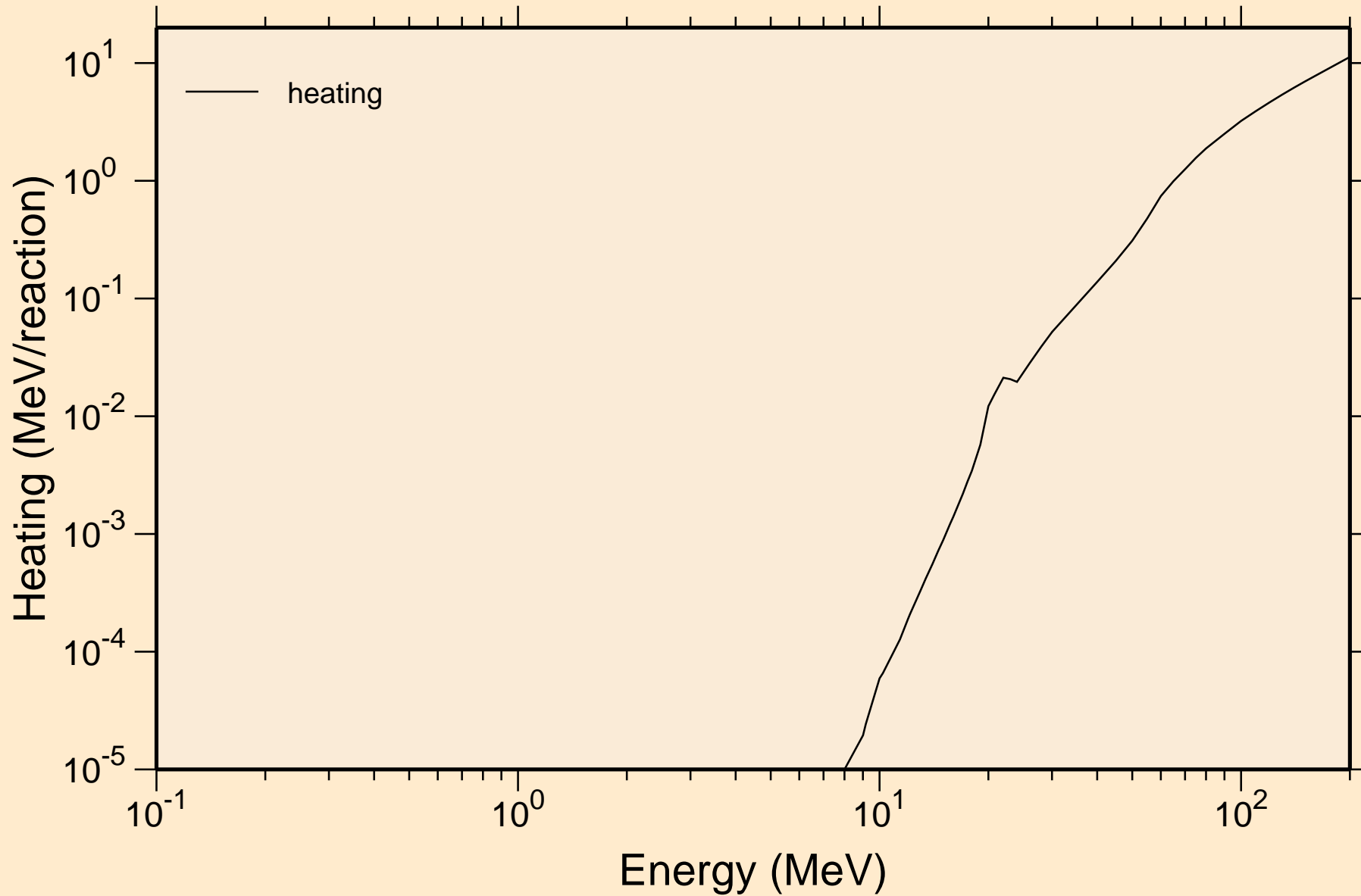

# LU172 PROTON ACER TENDL-2023 LIBRARY; T=0.K

## Principal cross sections

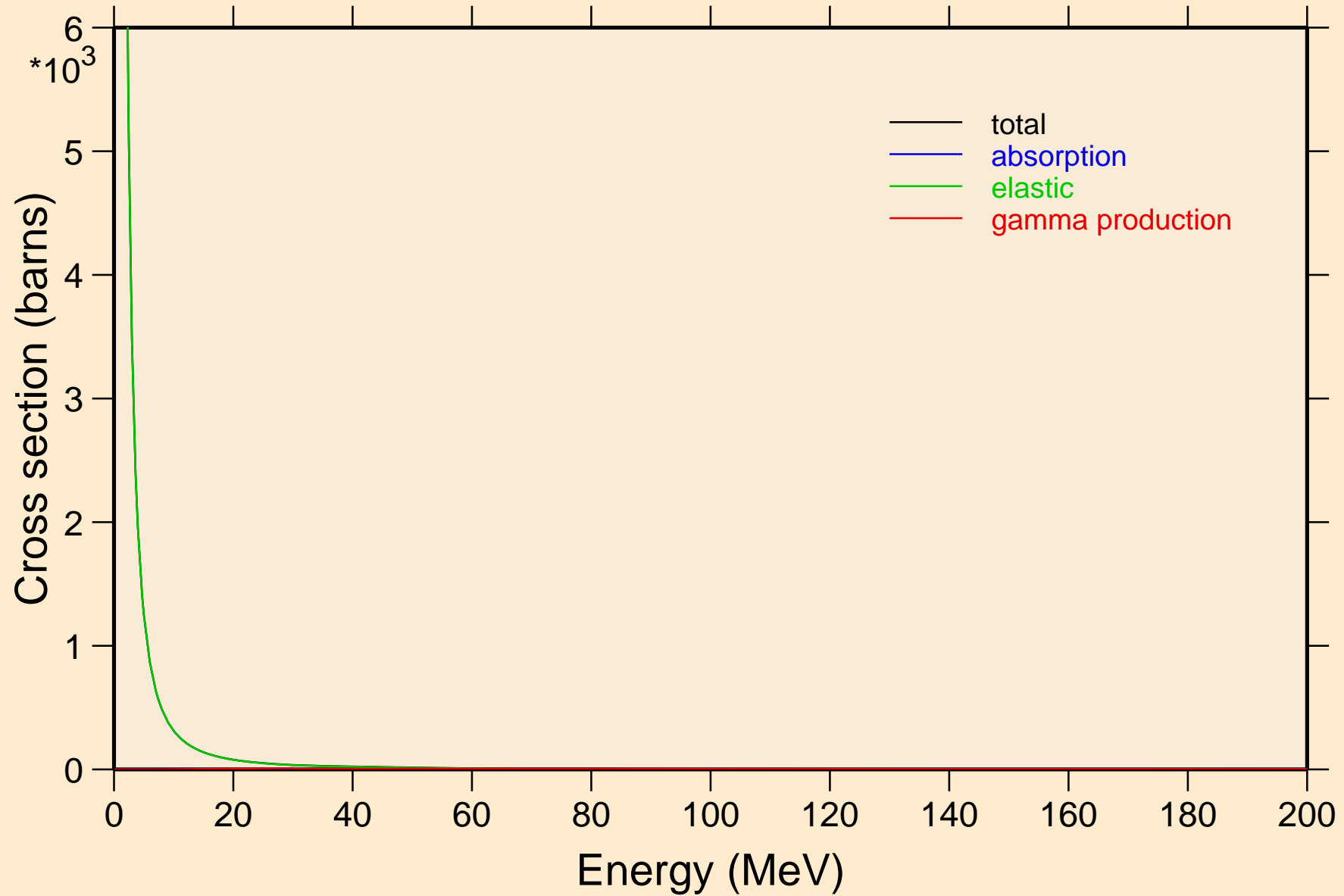

# LU172 PROTON ACER TENDL-2023 LIBRARY; T=0.K

## Heating

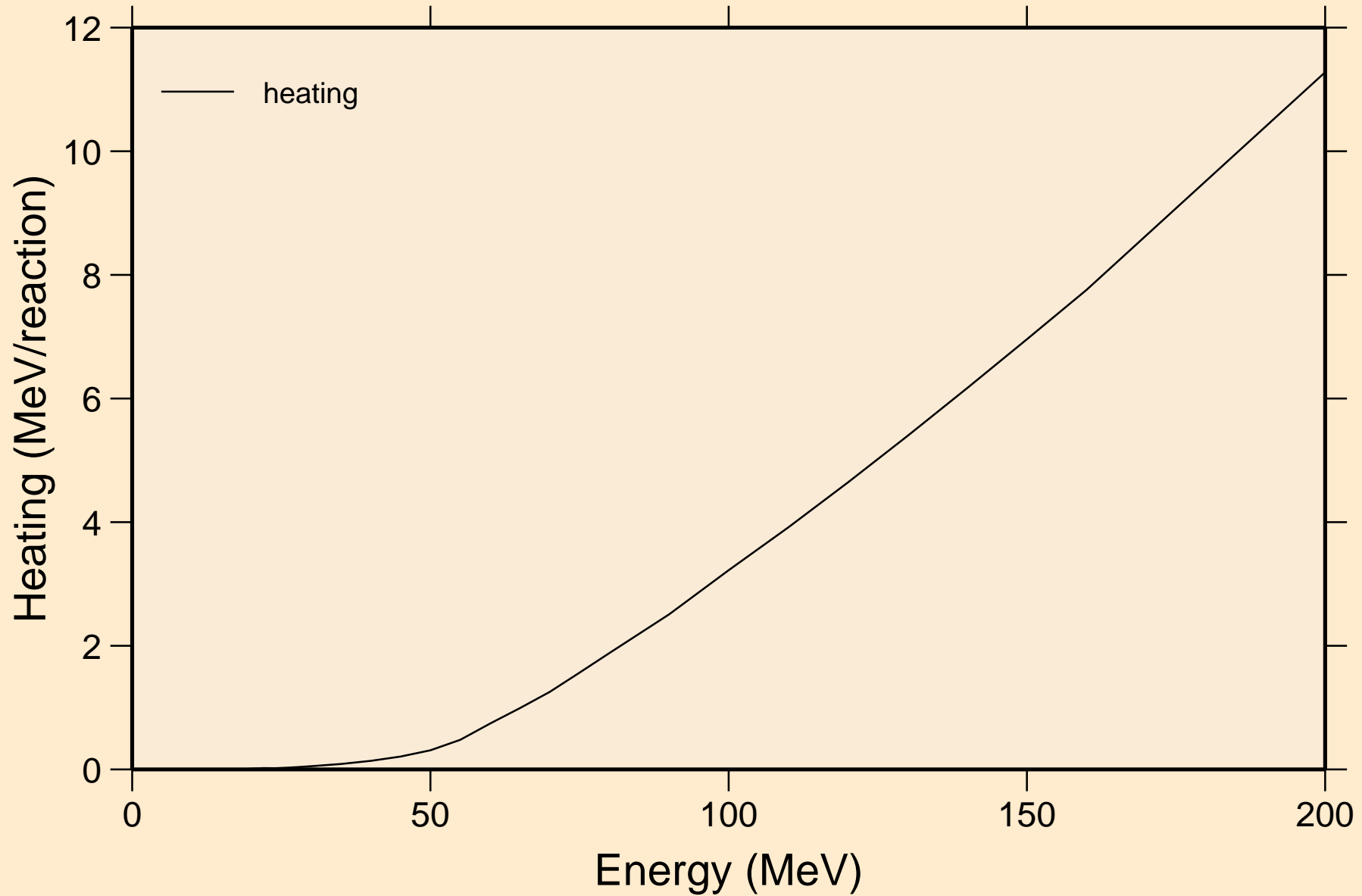

# LU172 PROTON ACER TENDL-2023 LIBRARY; T=0.K

## Threshold reactions

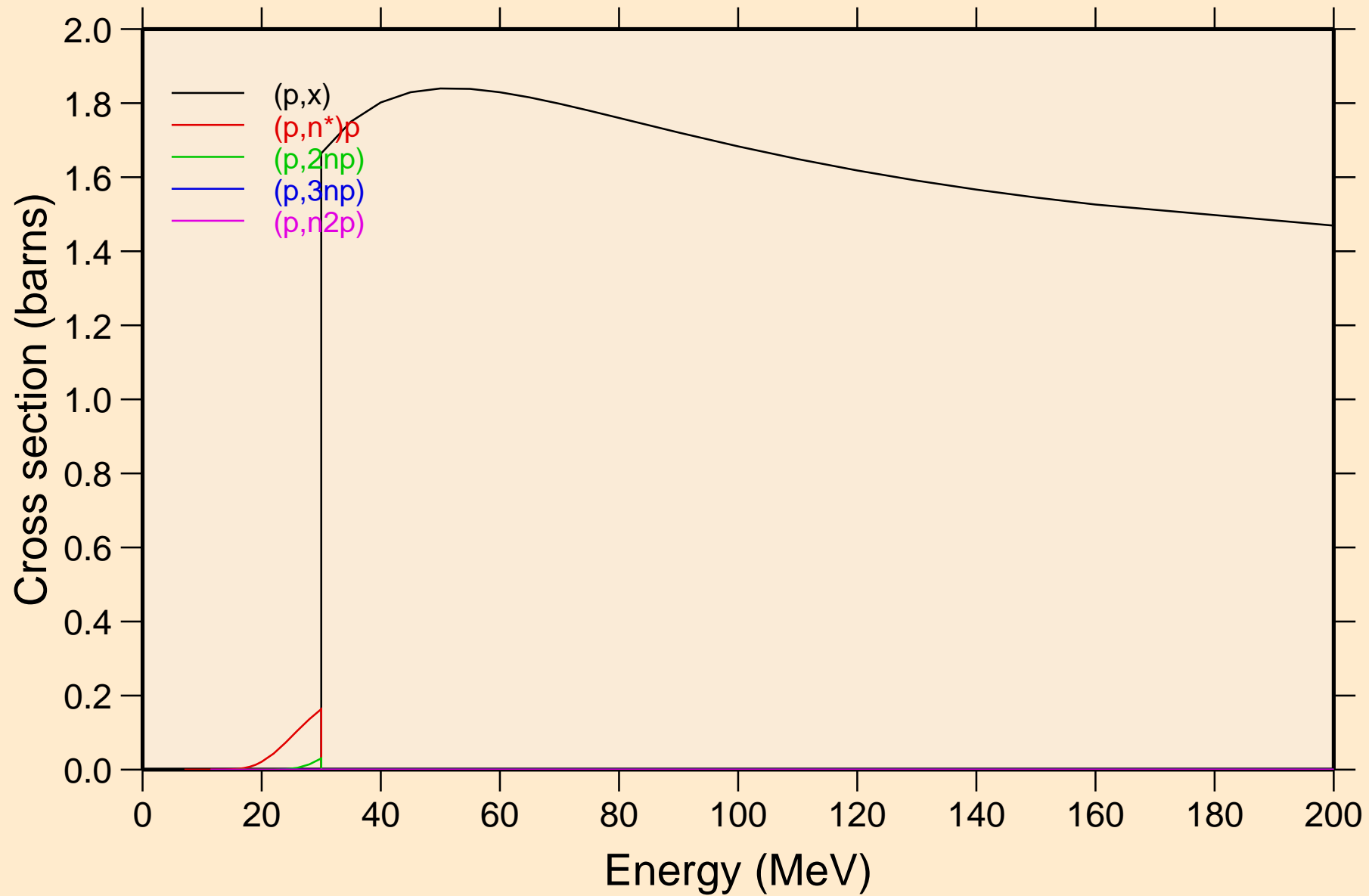

LU172 PROTON ACER TENDL-2023 LIBRARY; T=0.K  
Threshold reactions

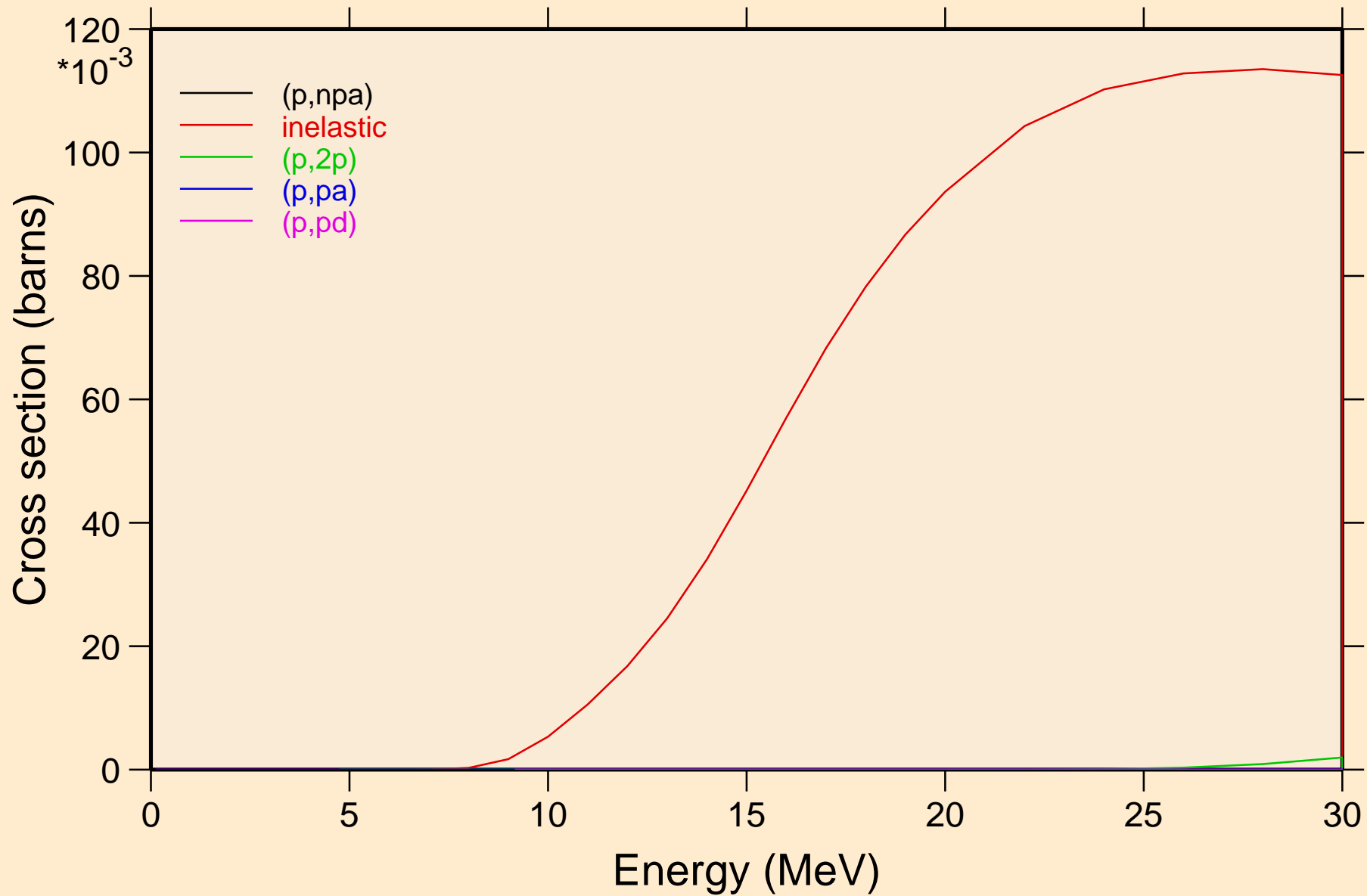

LU172 PROTON ACER TENDL-2023 LIBRARY; T=0.K  
Threshold reactions

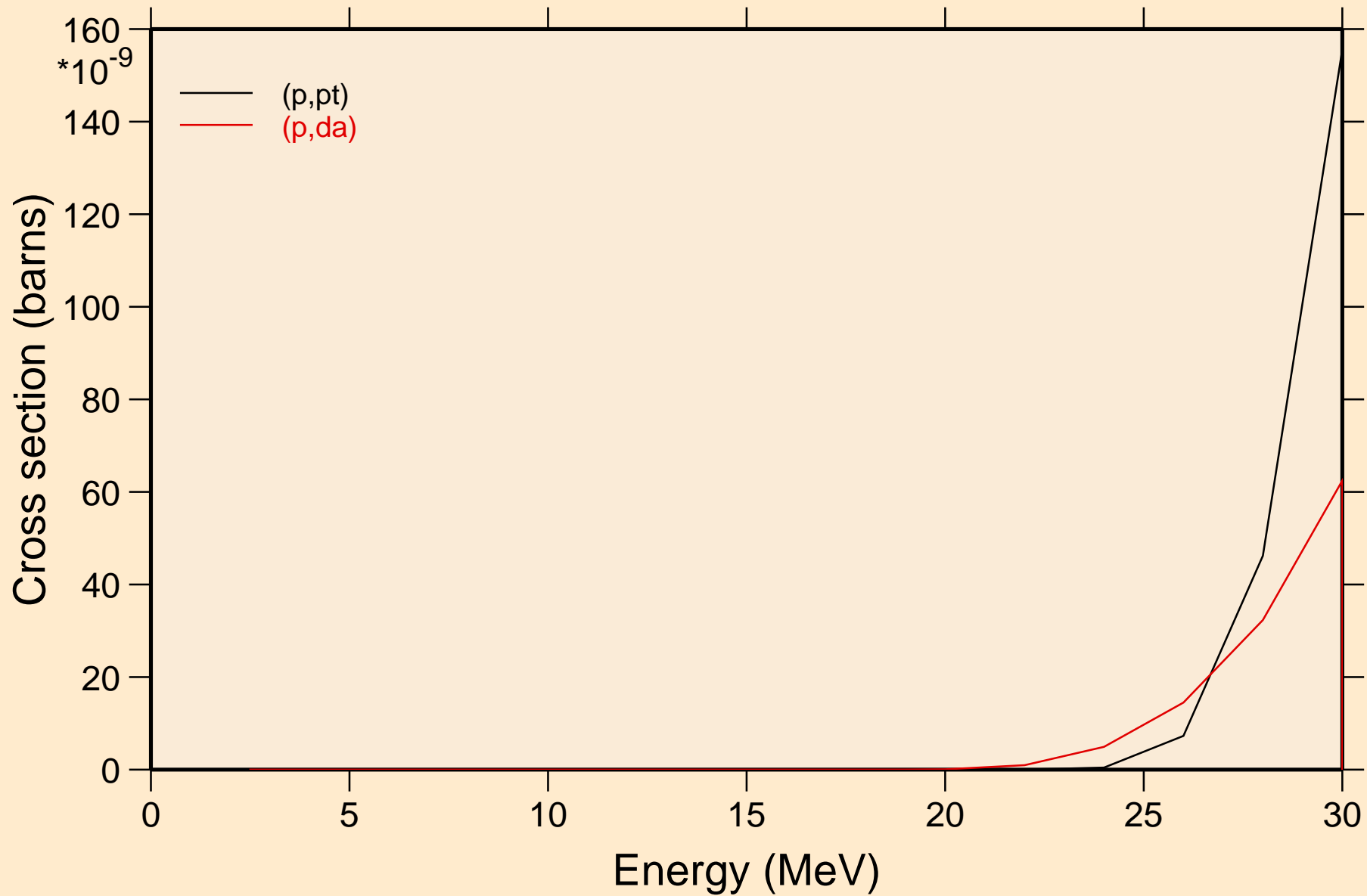

LU172 PROTON ACER TENDL-2023 LIBRARY; T=0.K  
angular distribution for elastic

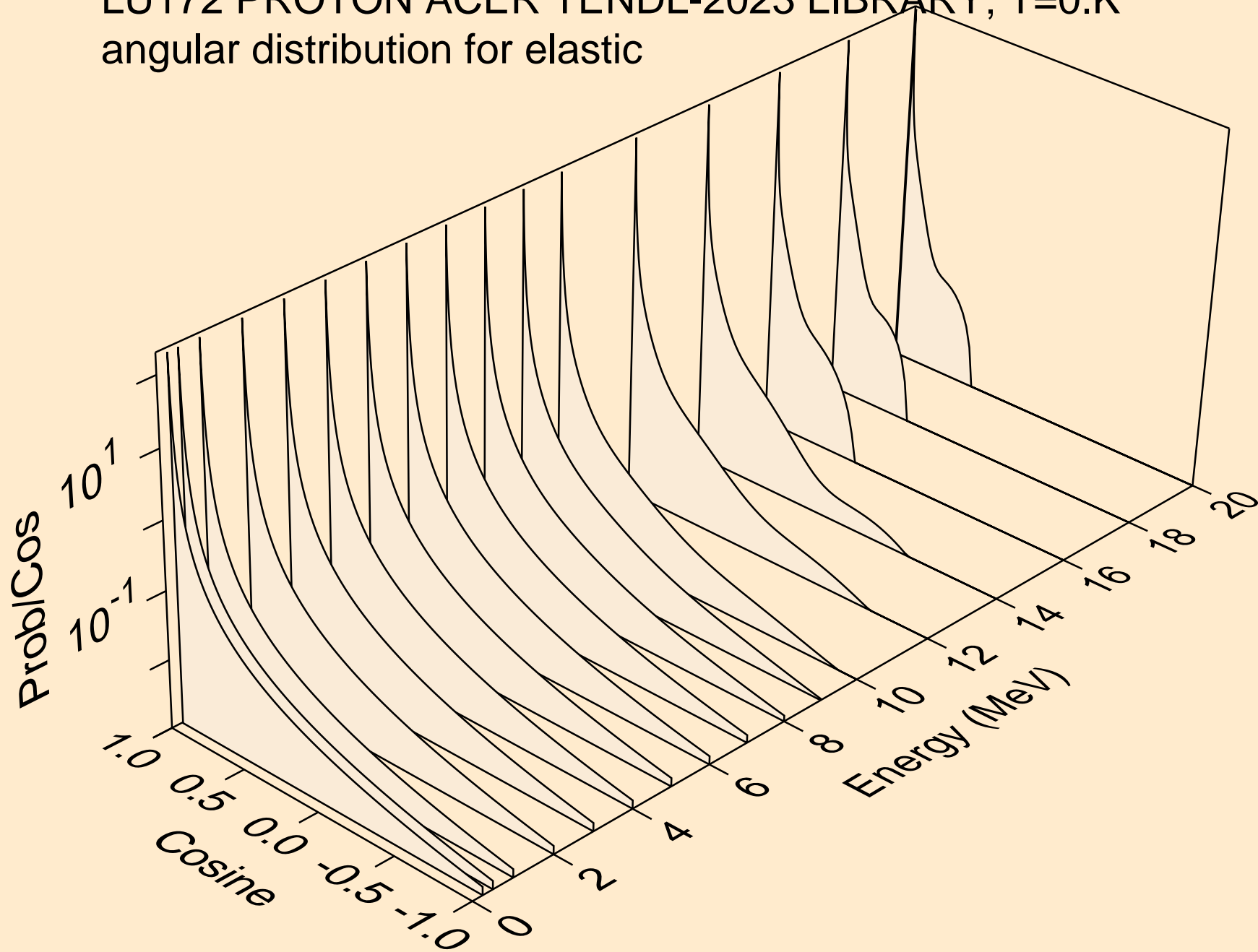



LU172 PROTON ACER TENDL-2023 LIBRARY; T=0.K  
angular distribution for elastic

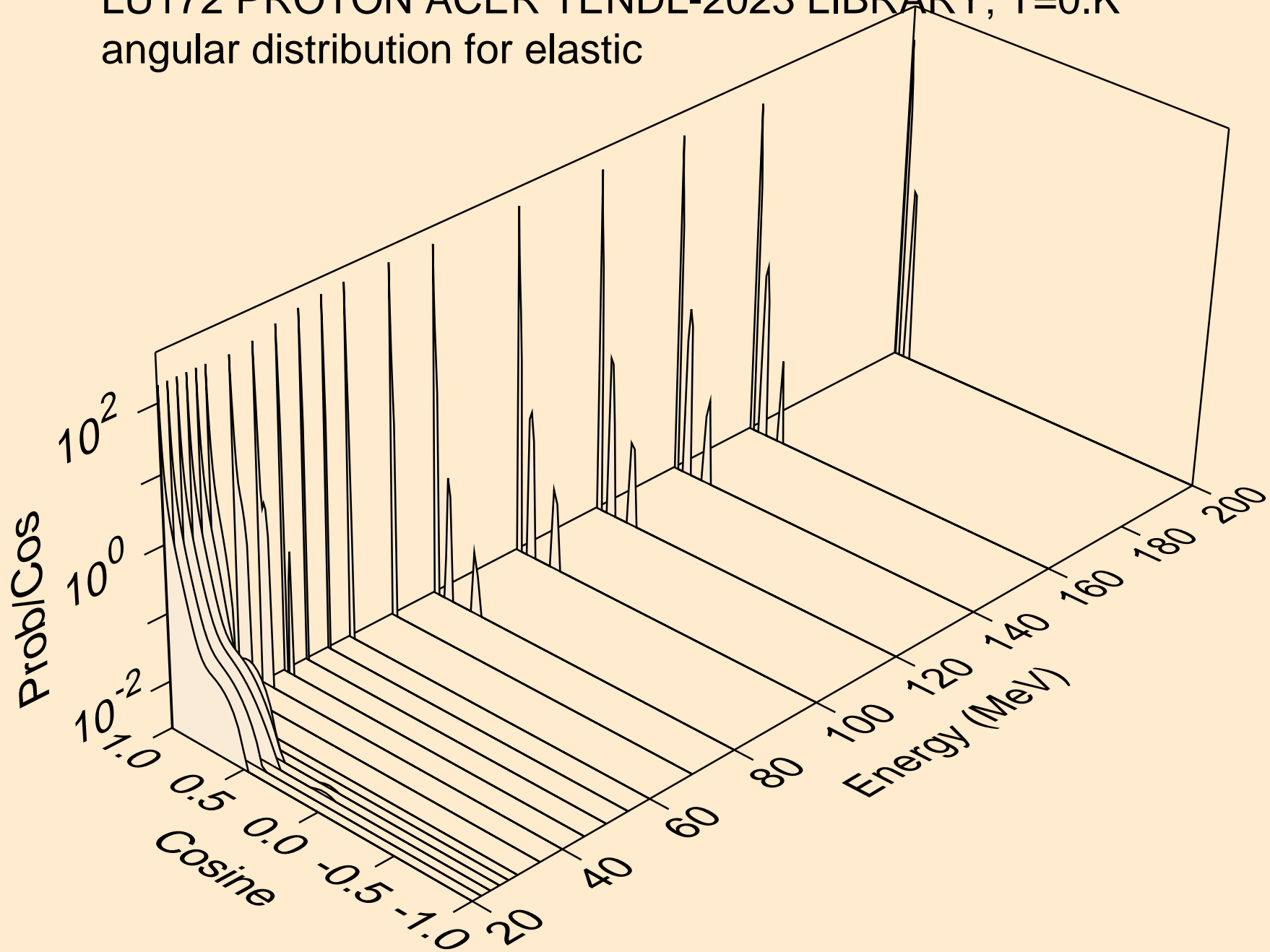

LU172 PROTON ACER TENDL-2023 LIBRARY; T=0.K  
Proton emission for (p,x)

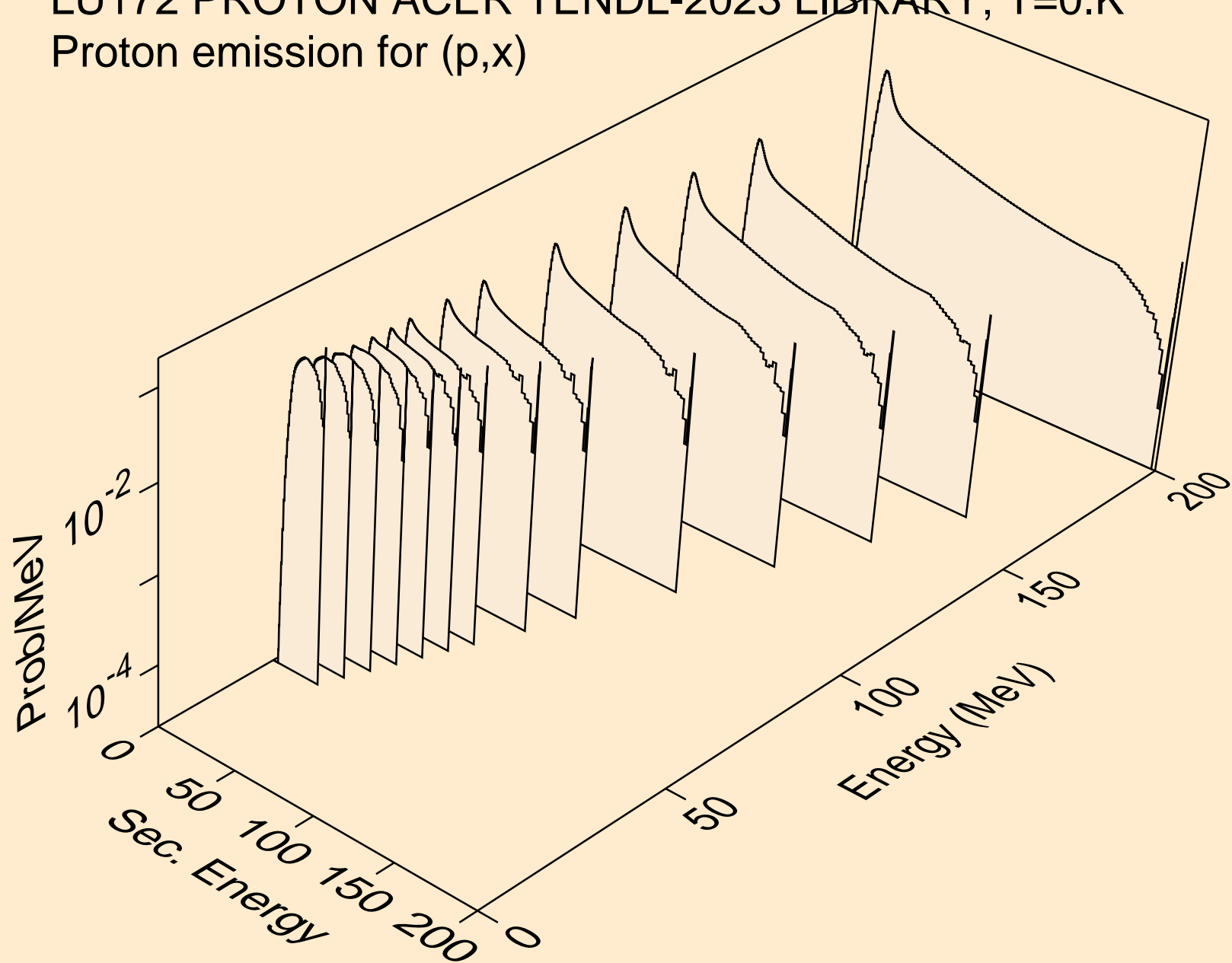

LU172 PROTON ACER TENDL-2023 LIBRARY; T=0.K  
Proton emission for (p,n\*)p

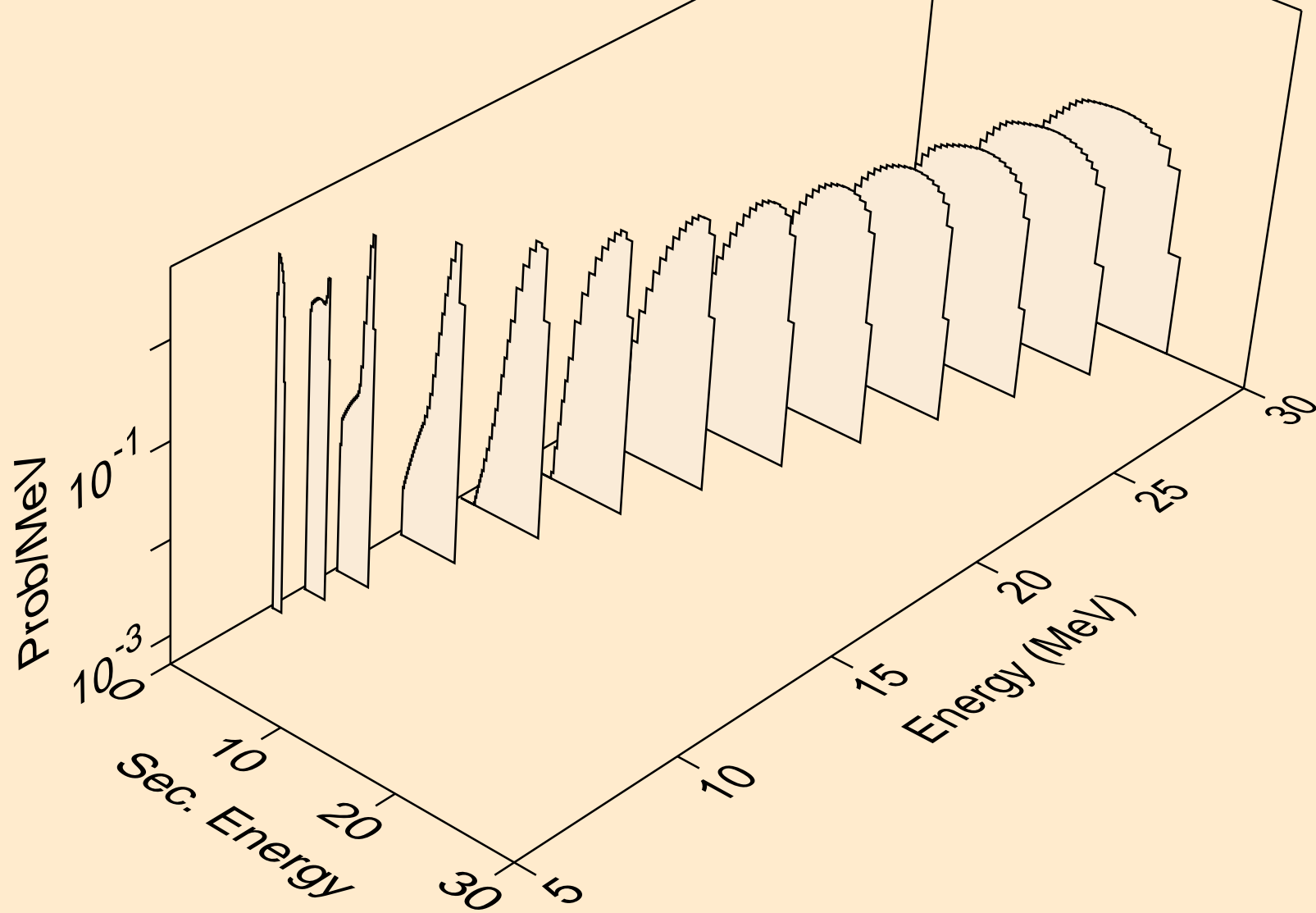

LU172 PROTON ACER TENDL-2023 LIBRARY; T=0.K  
Proton emission for (p,2np)

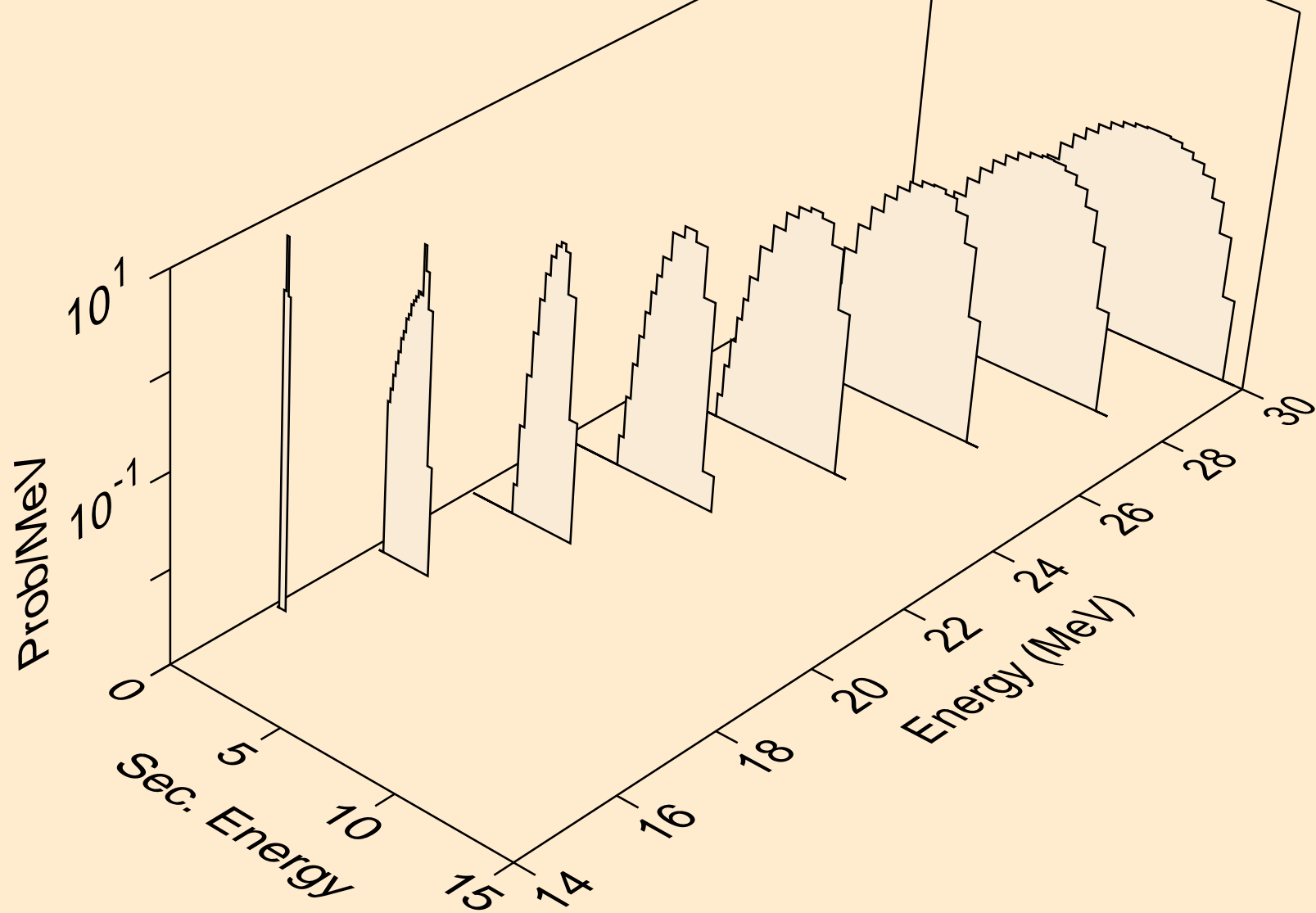

LU172 PROTON ACER TENDL-2023 LIBRARY; T=0.K  
Proton emission for (p,3np)

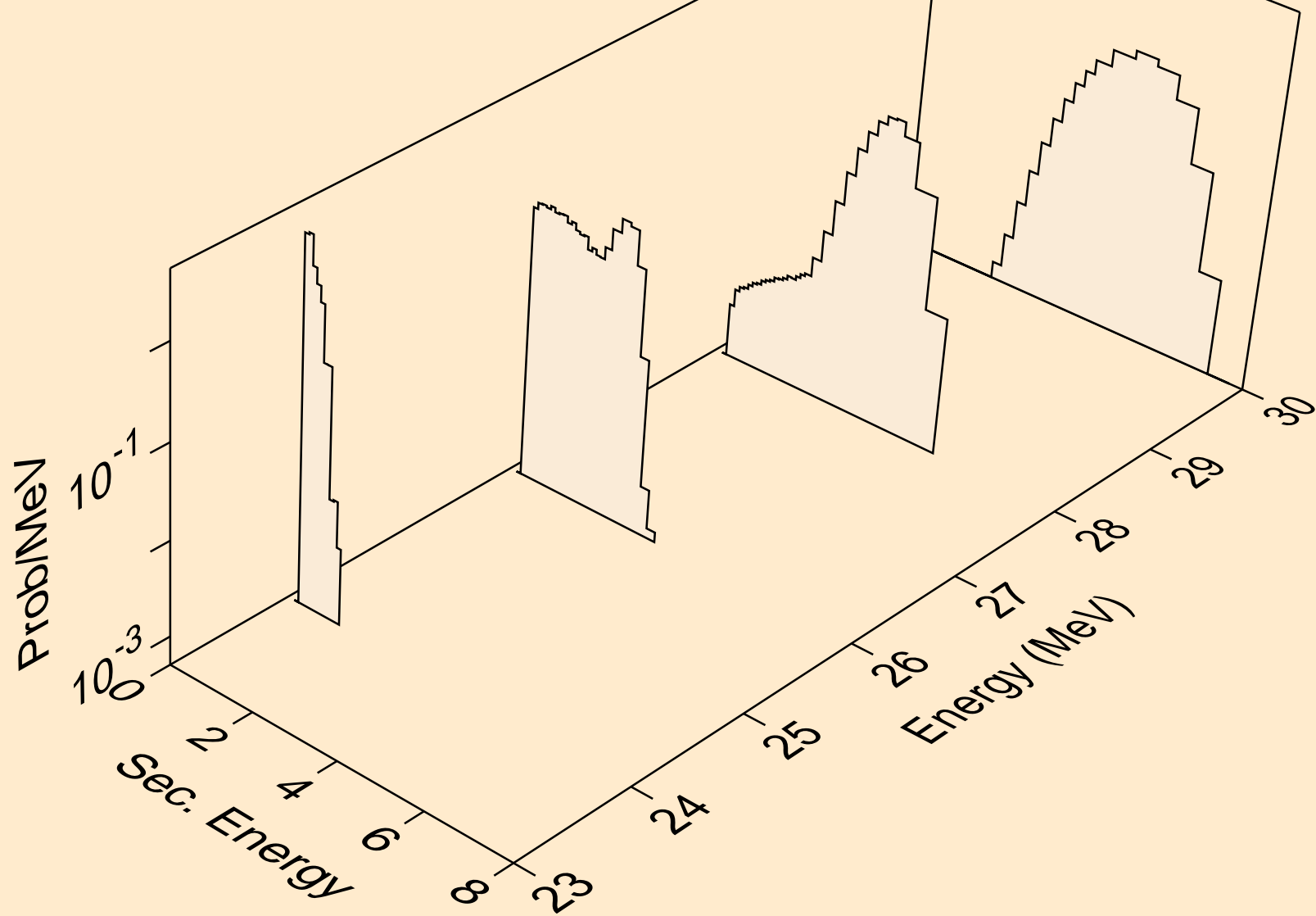

LU172 PROTON ACER TENDL-2023 LIBRARY; T=0.K  
Proton emission for (p,n2p)

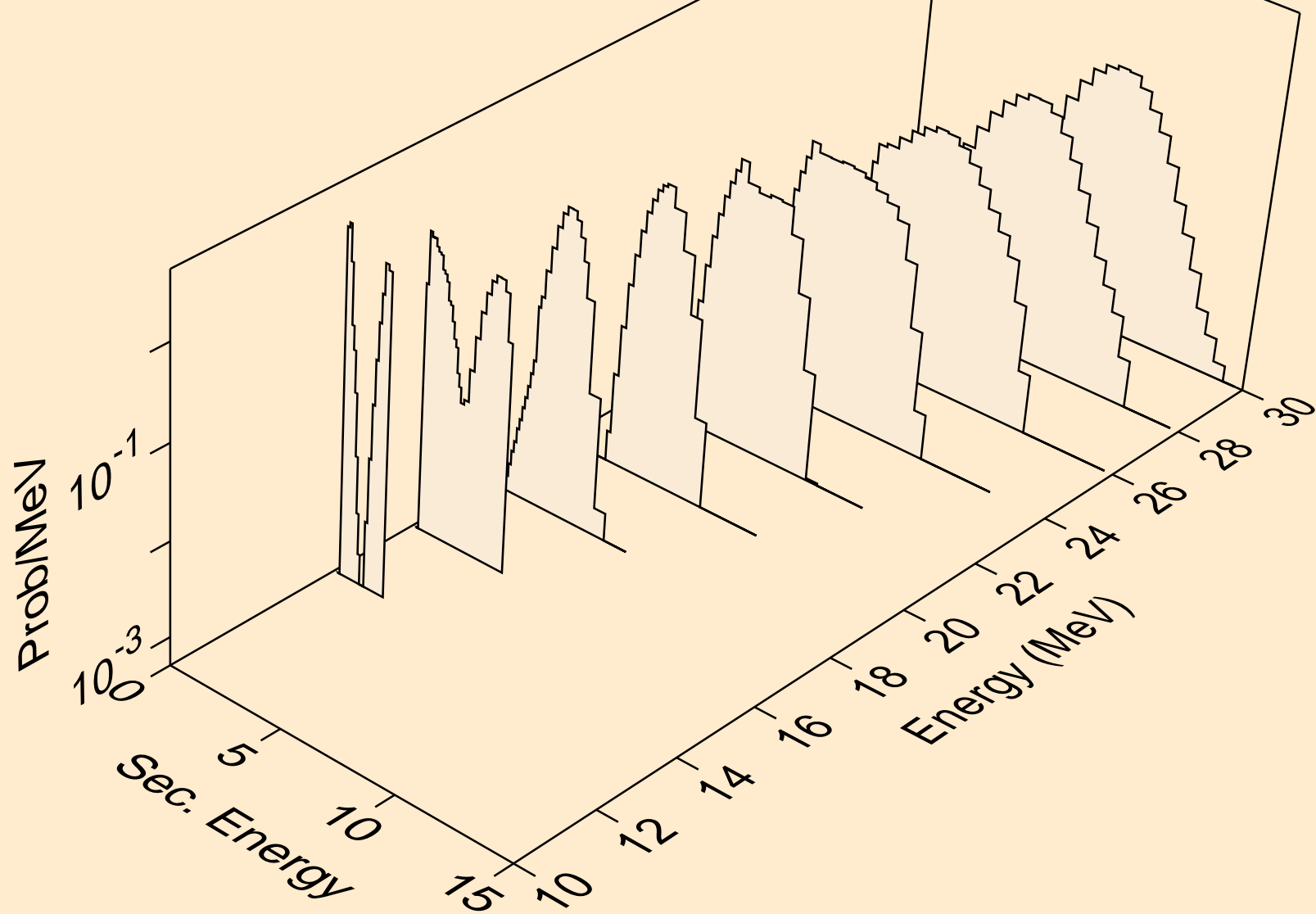

LU172 PROTON ACER TENDL-2023 LIBRARY; T=0.K  
Proton emission for (p,npa)

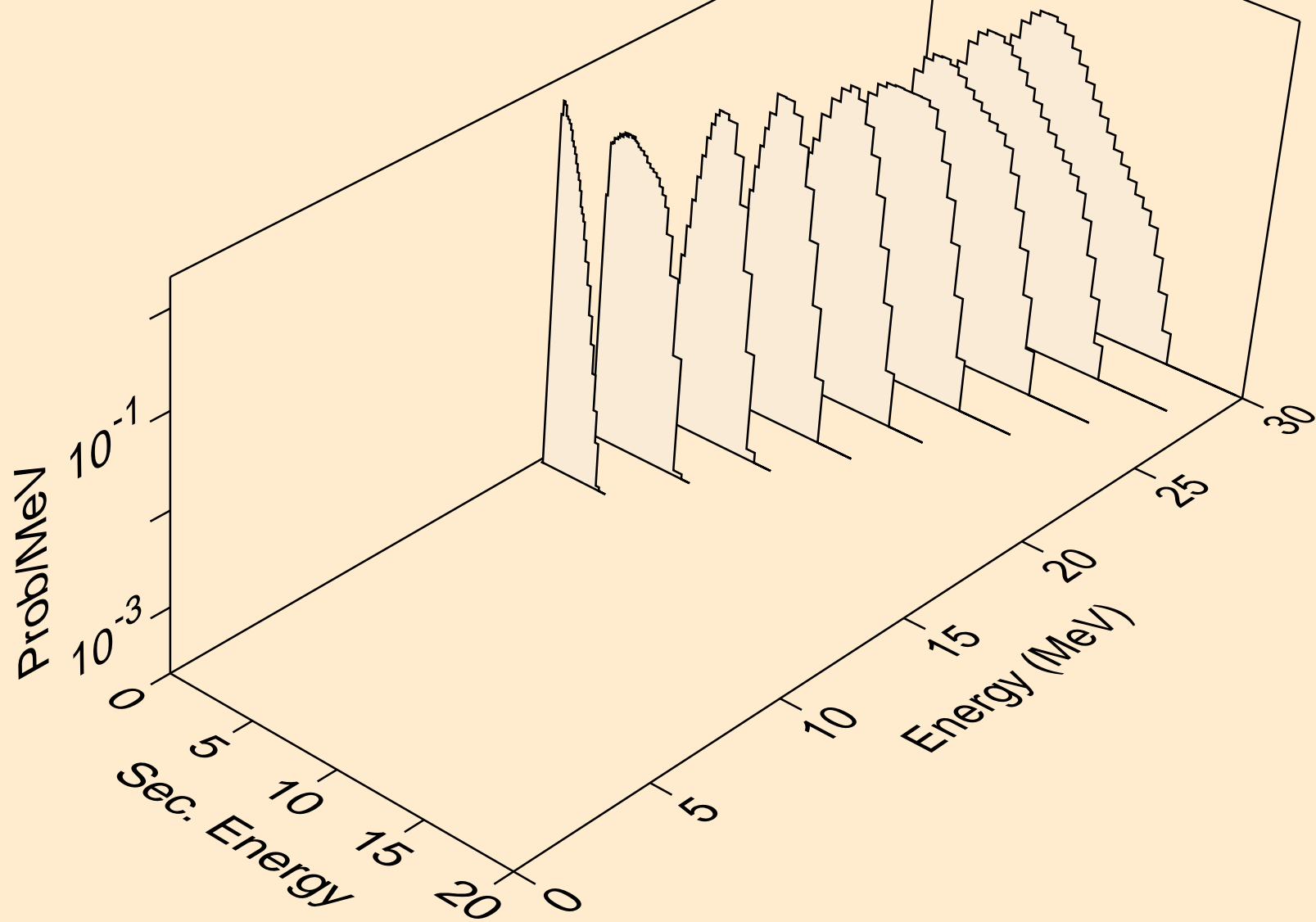

LU172 PROTON ACER TENDL-2023 LIBRARY; T=0.K  
Proton emission for inelastic

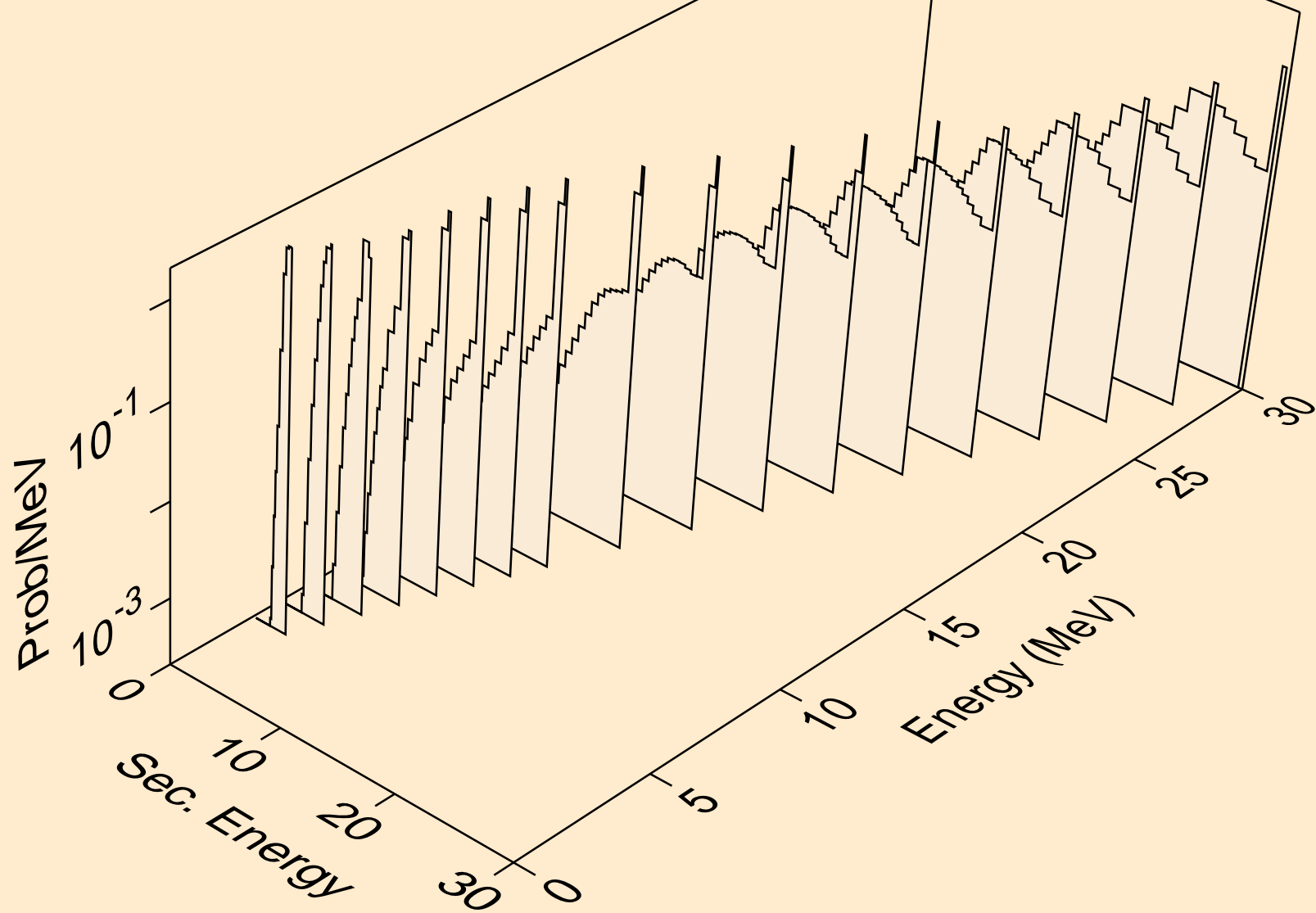



LU172 PROTON ACER TENDL-2023 LIBRARY; T=0.K  
Proton emission for (p,2p)

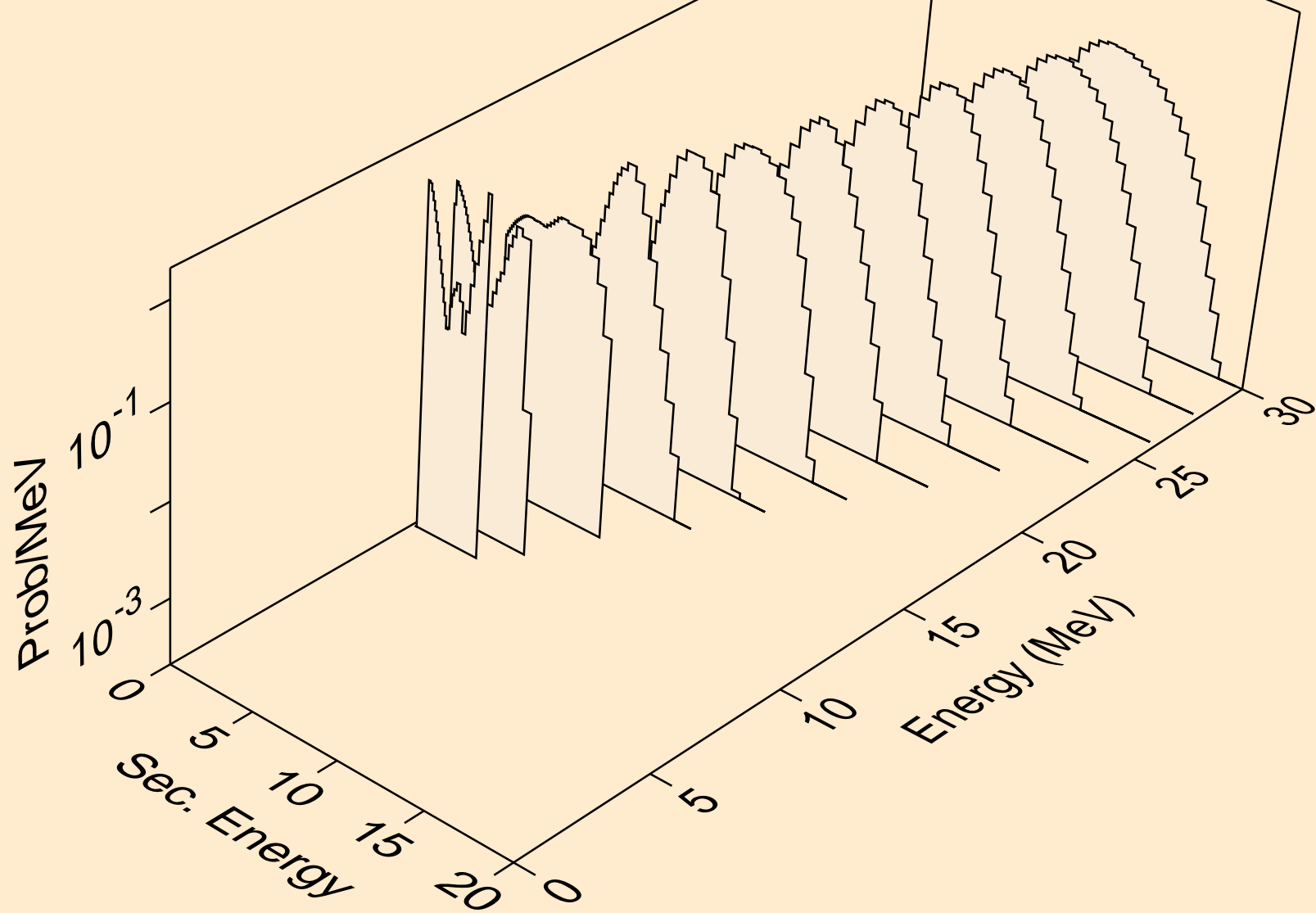

LU172 PROTON ACER TENDL-2023 LIBRARY; T=0.K  
Proton emission for (p,pa)

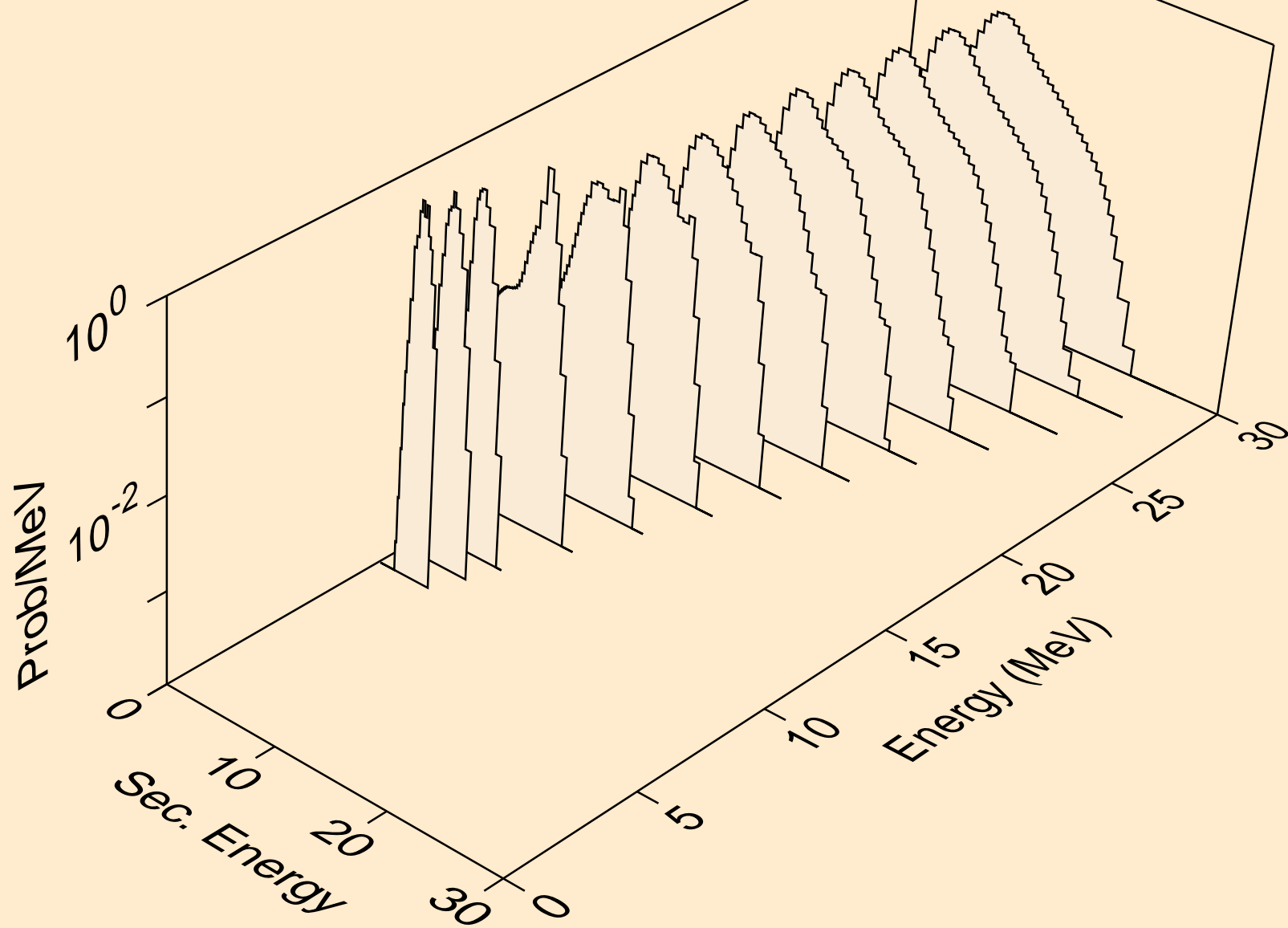

LU172 PROTON ACER TENDL-2023 LIBRARY; T=0.K  
Proton emission for (p,pd)

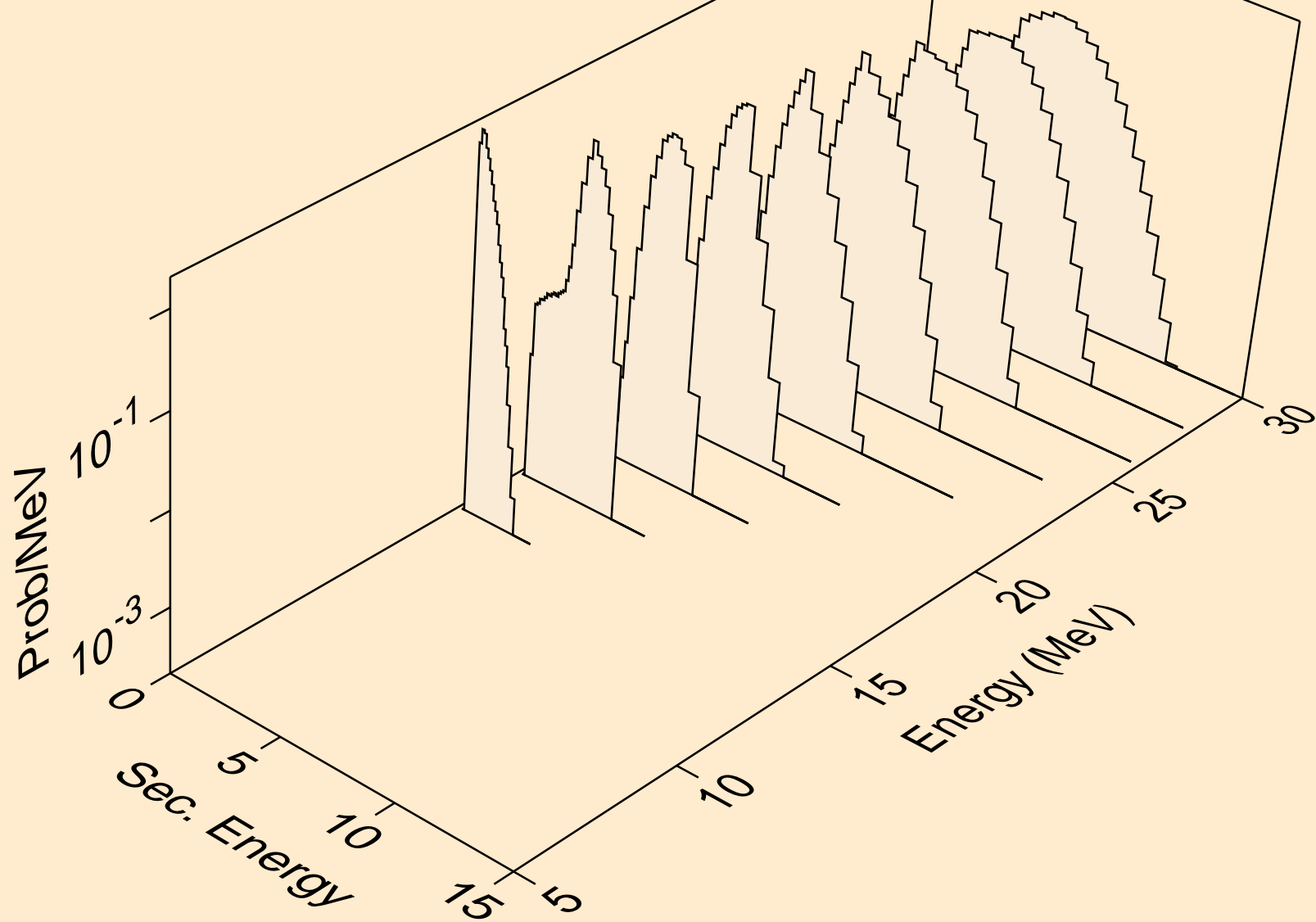

LU172 PROTON ACER TENDL-2023 LIBRARY; T=0.K  
Proton emission for (p,pt)

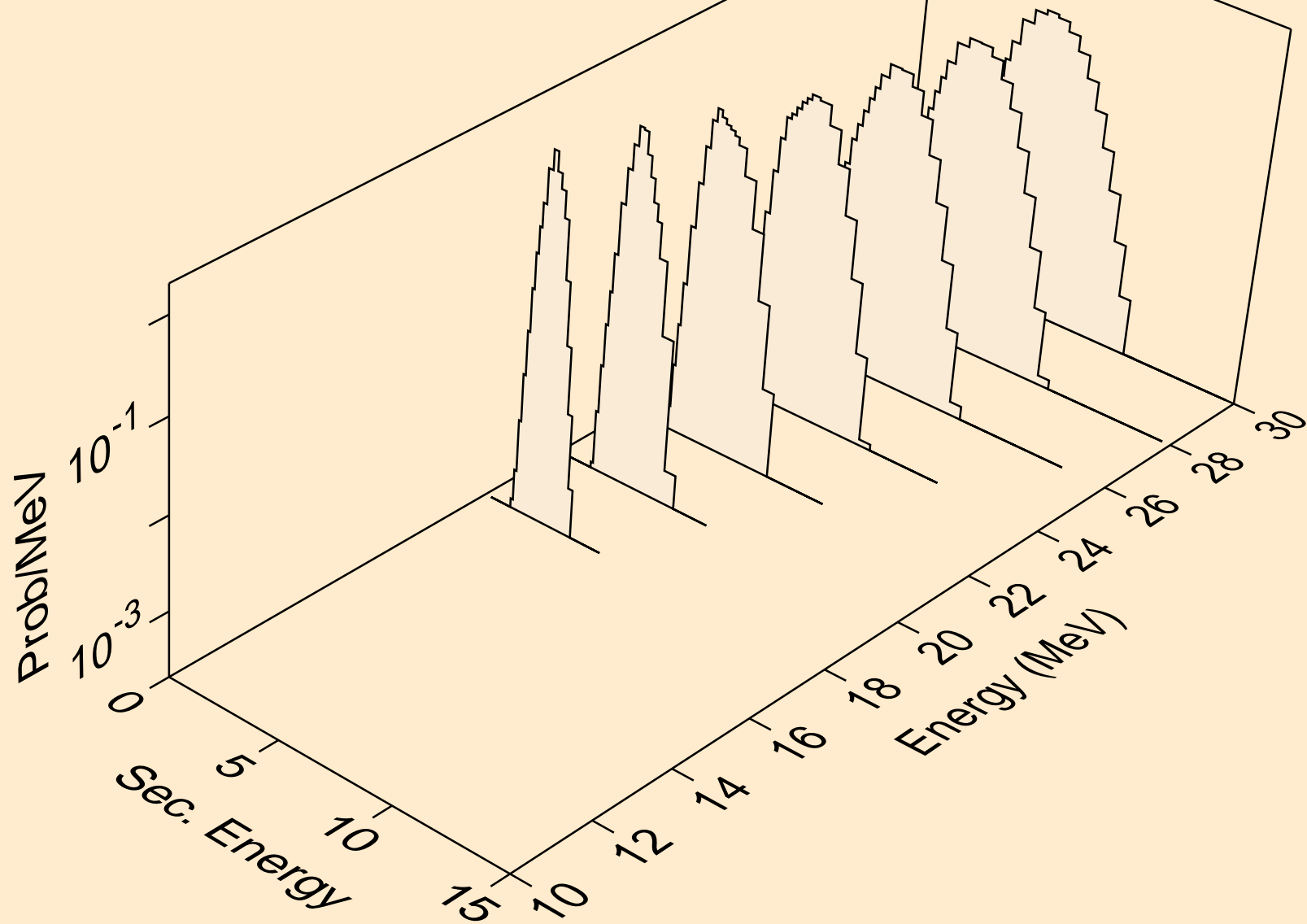

LU172 PROTON ACER TENDL-2023 LIBRARY; T=0.K  
Photon emission for (z,n)

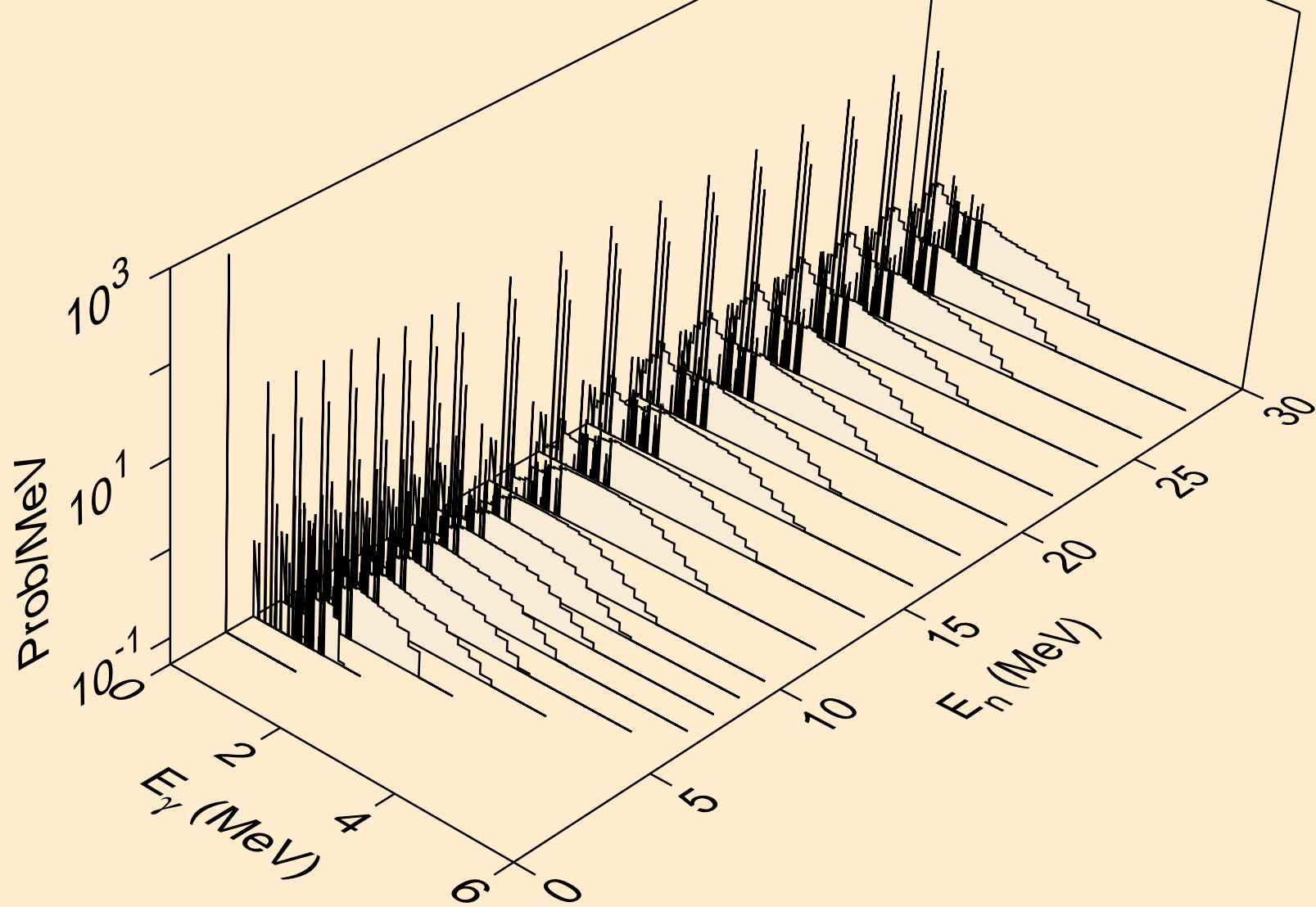

LU172 PROTON ACER TENDL-2023 LIBRARY; T=0.K  
Photon emission for (z,x)

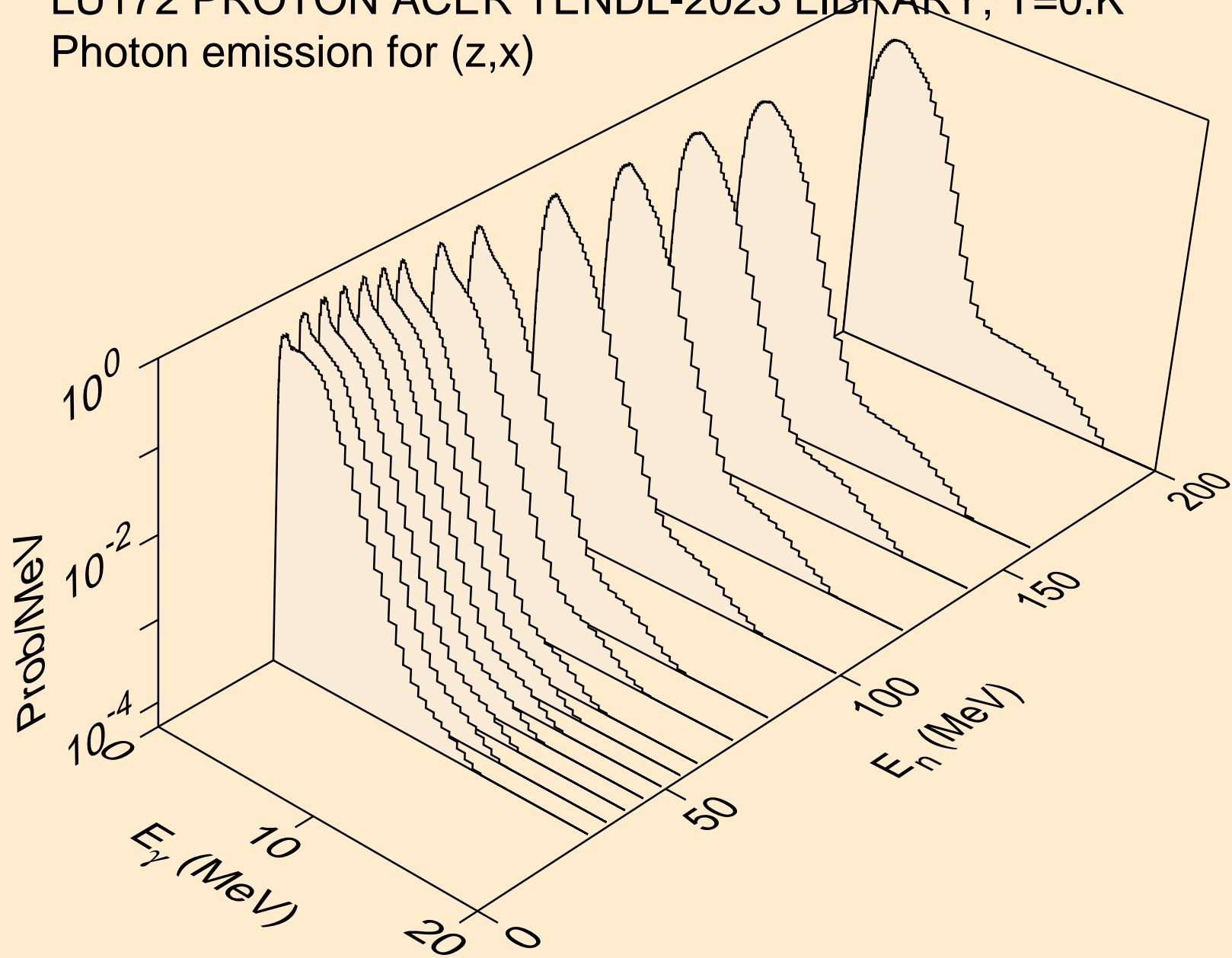

LU172 PROTON ACER TENDL-2023 LIBRARY; T=0.K  
Photon emission for (n,2nd)

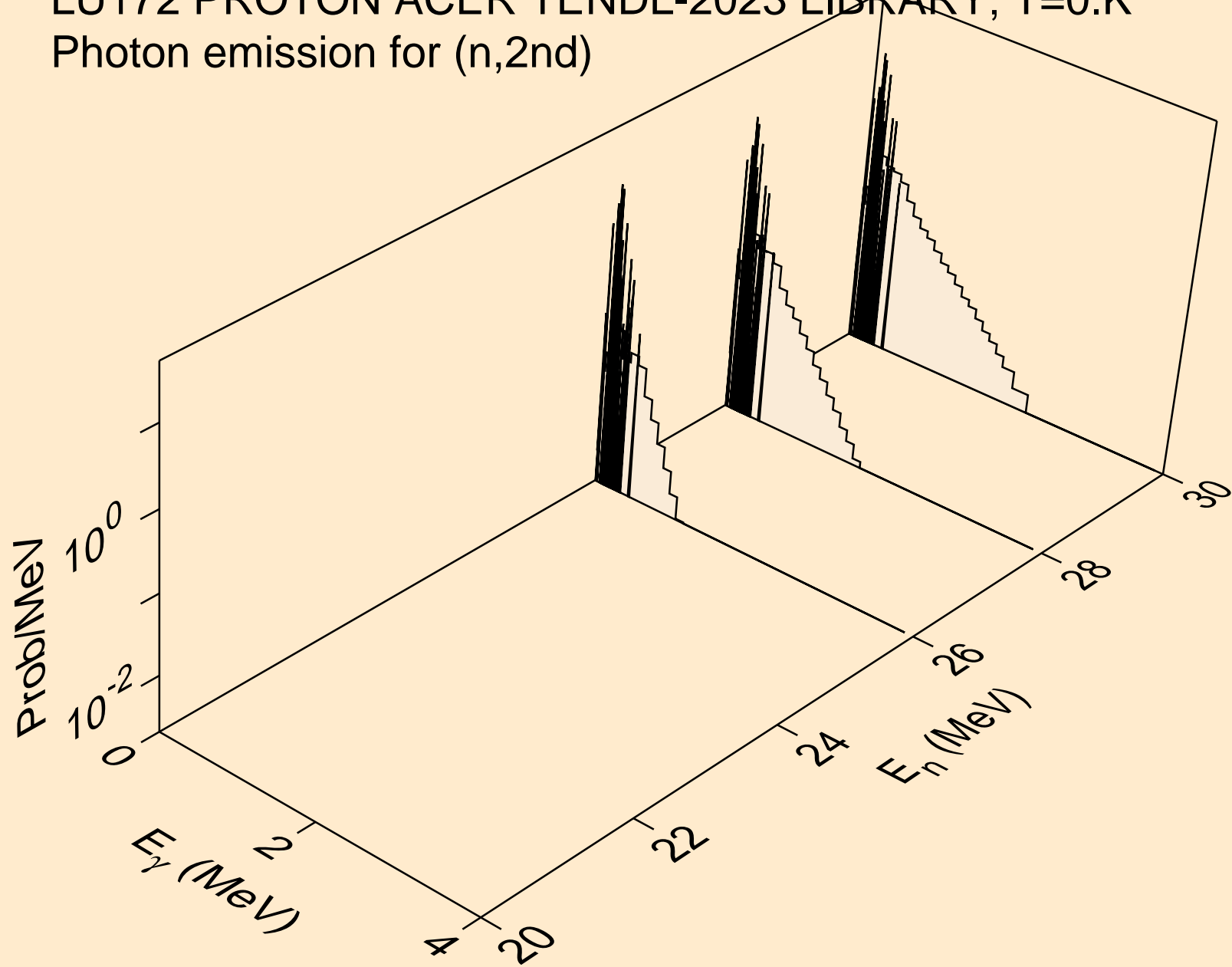

LU172 PROTON ACER TENDL-2023 LIBRARY; T=0.K  
Photon emission for (n,2n)

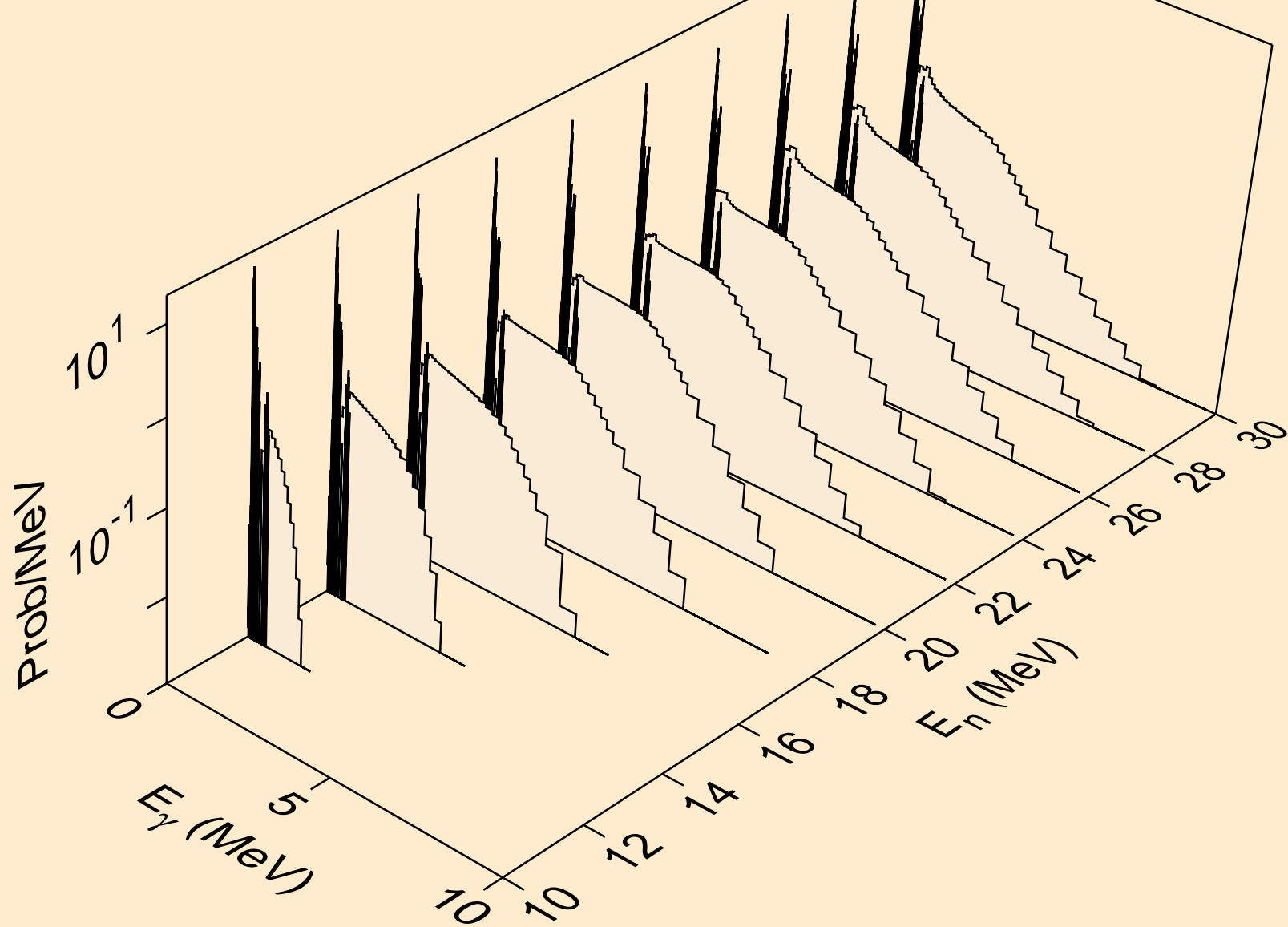



LU172 PROTON ACER TENDL-2023 LIBRARY; T=0.K  
Photon emission for (n,3n)

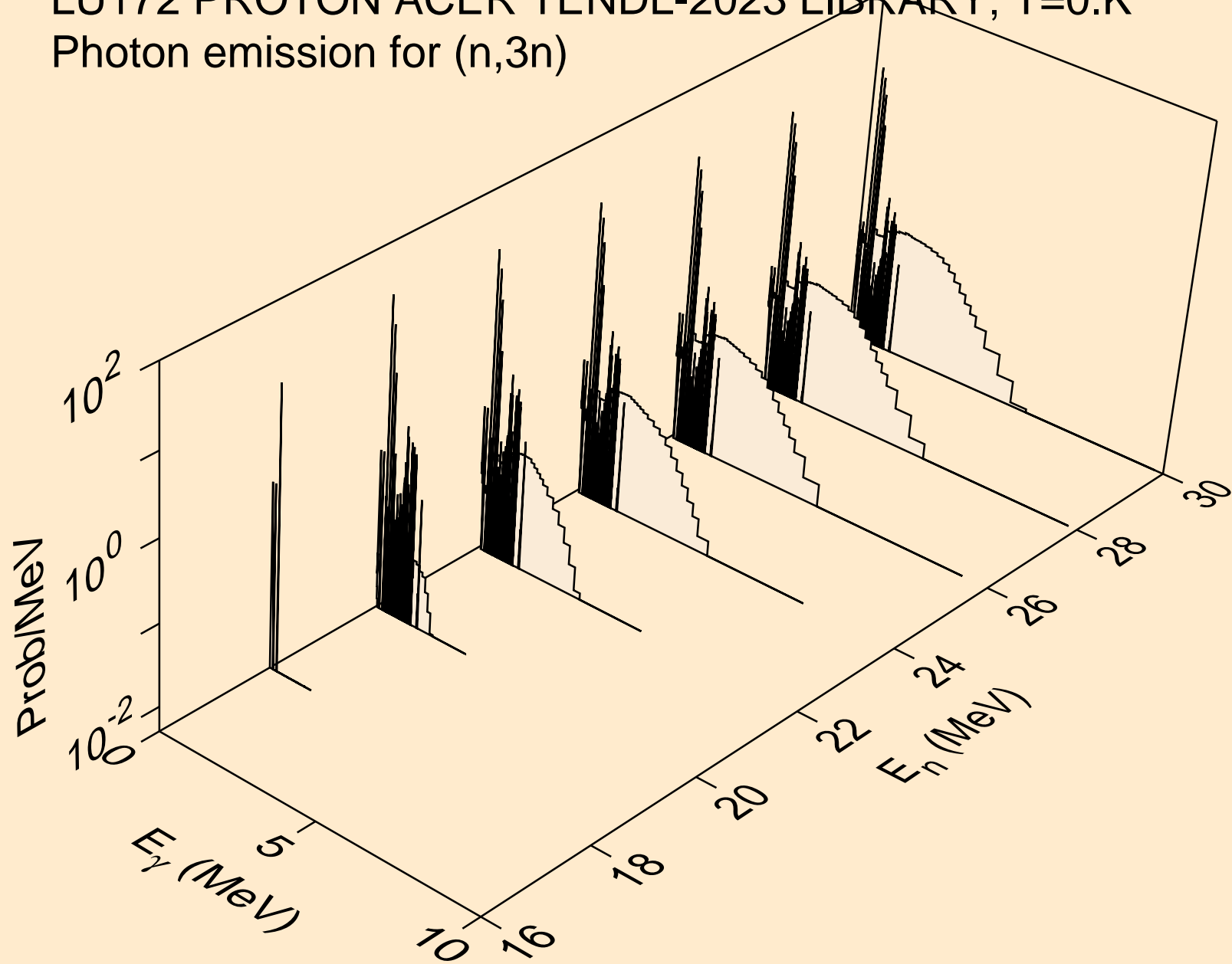

LU172 PROTON ACER TENDL-2023 LIBRARY; T=0.K  
Photon emission for (n,n\*)a

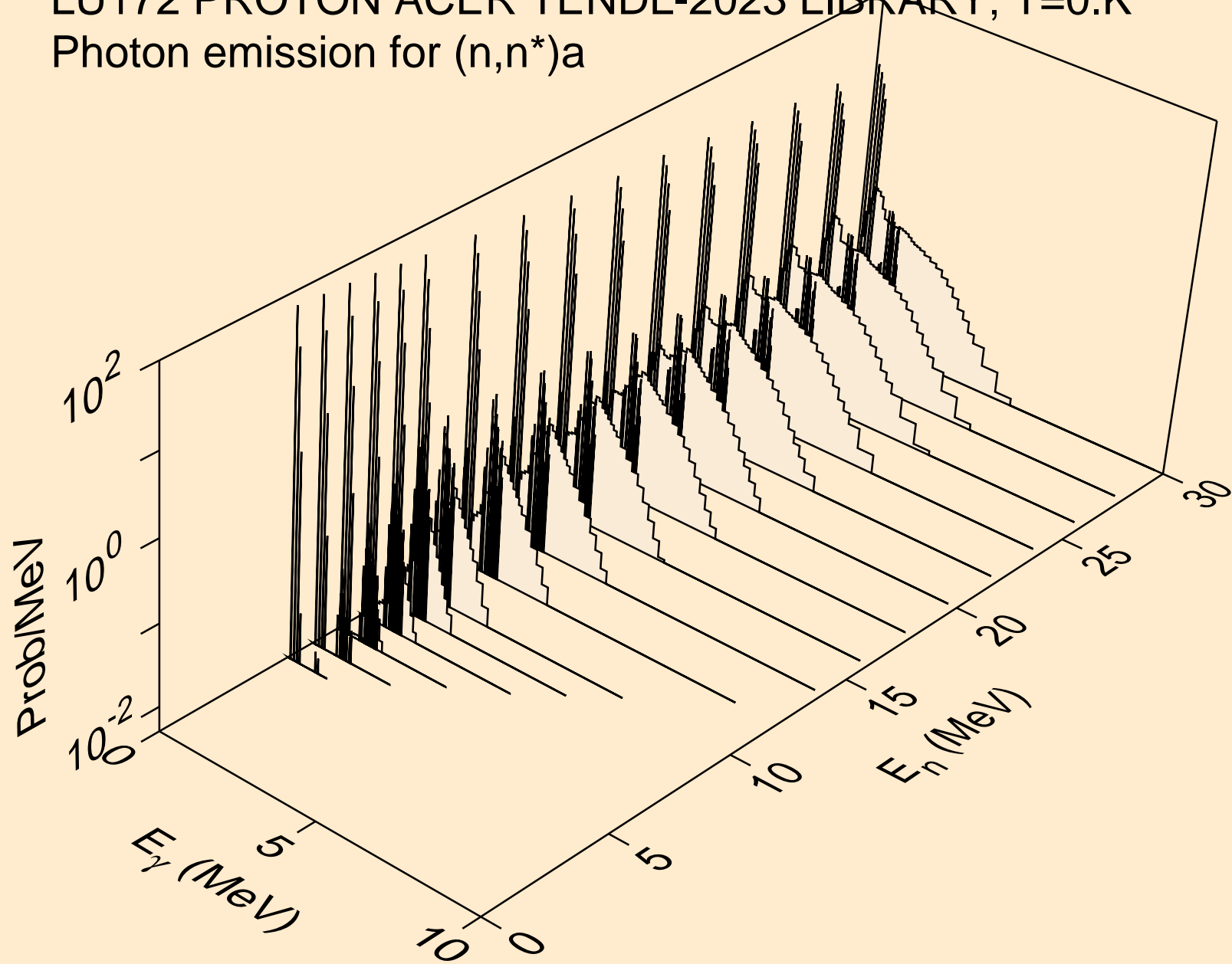

LU172 PROTON ACER TENDL-2023 LIBRARY; T=0.K  
Photon emission for (n,2n)a

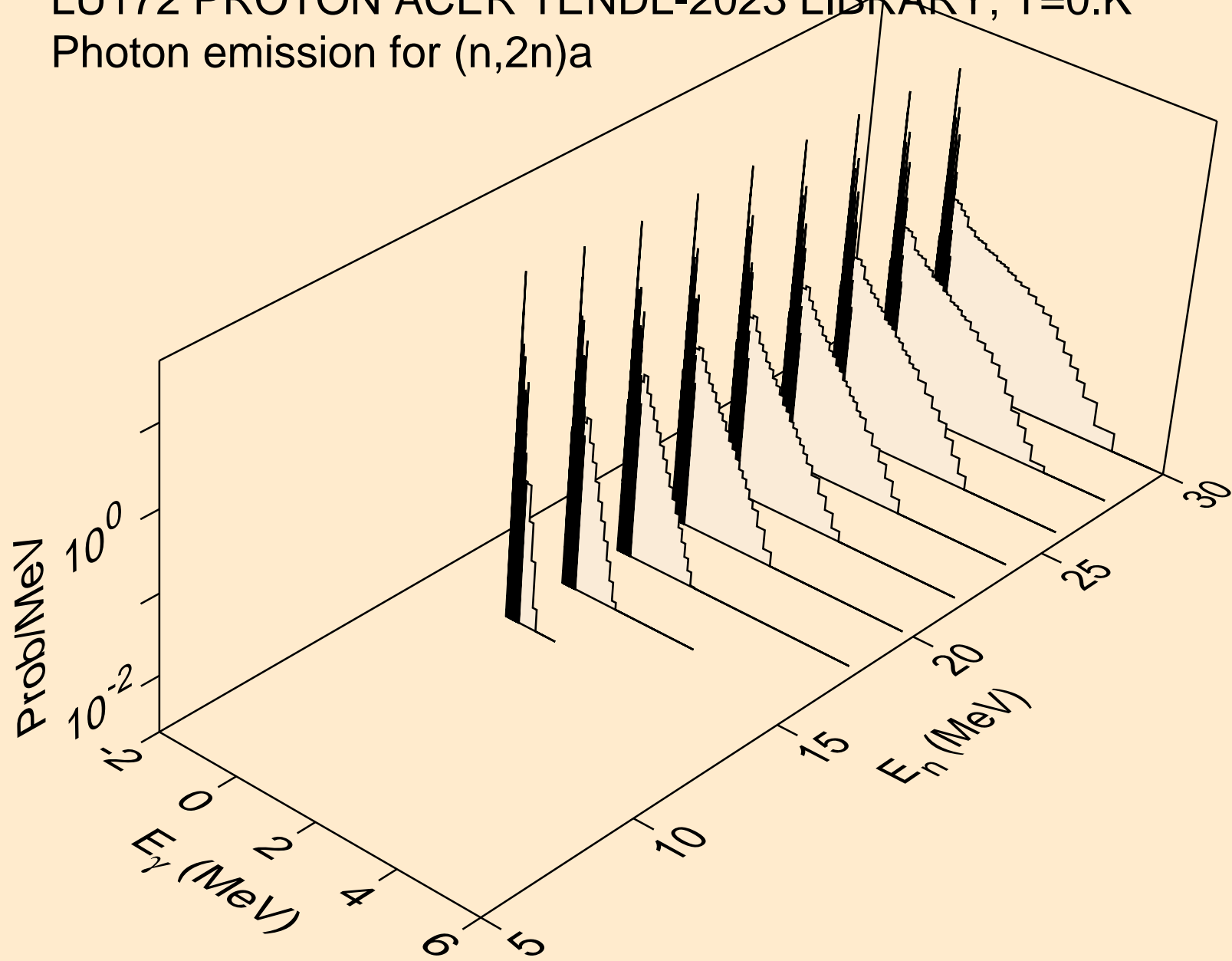

LU172 PROTON ACER TENDL-2023 LIBRARY; T=0.K  
Photon emission for (n,3n)a

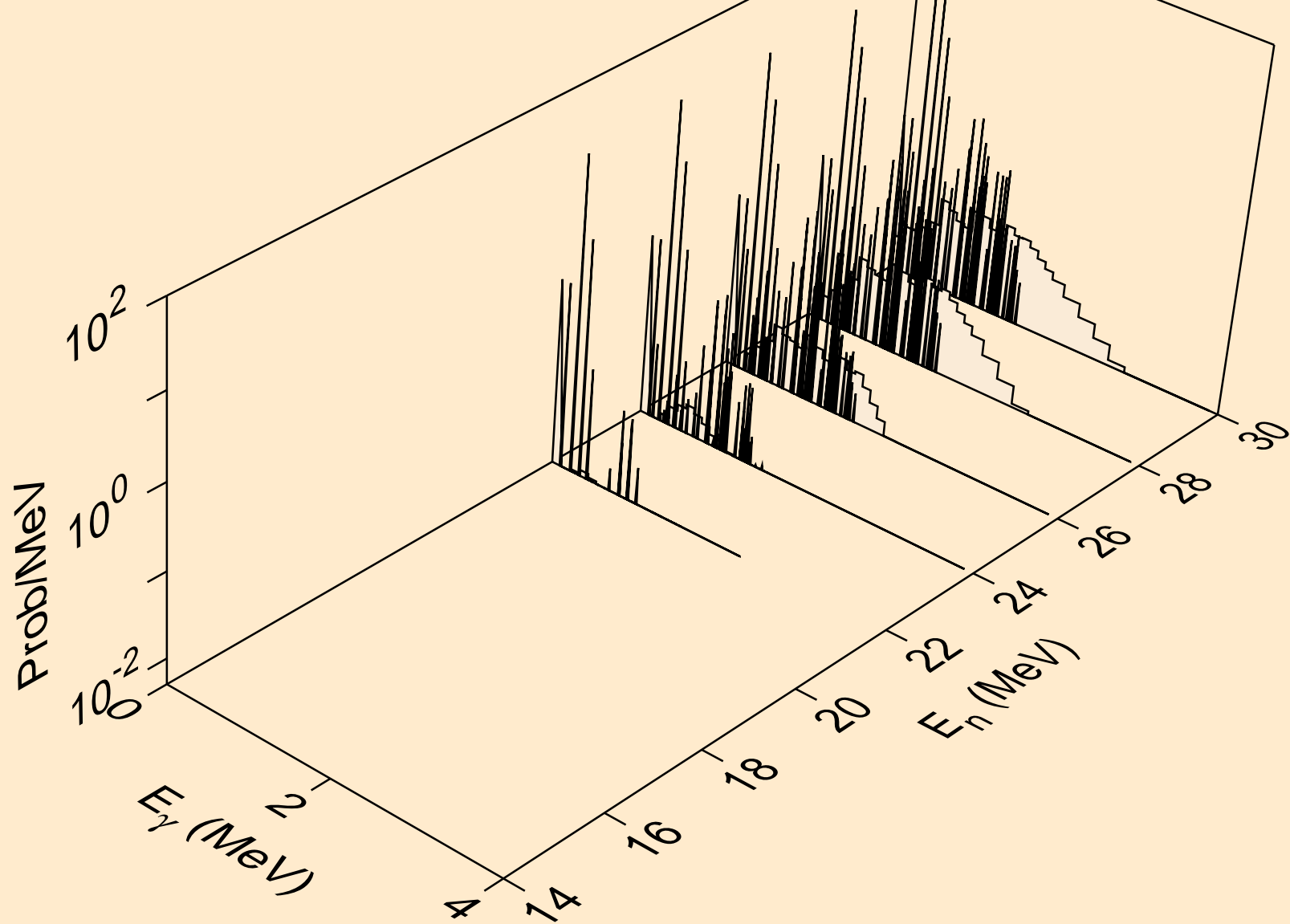

LU172 PROTON ACER TENDL-2023 LIBRARY; T=0.K  
Photon emission for (n,n\*)p

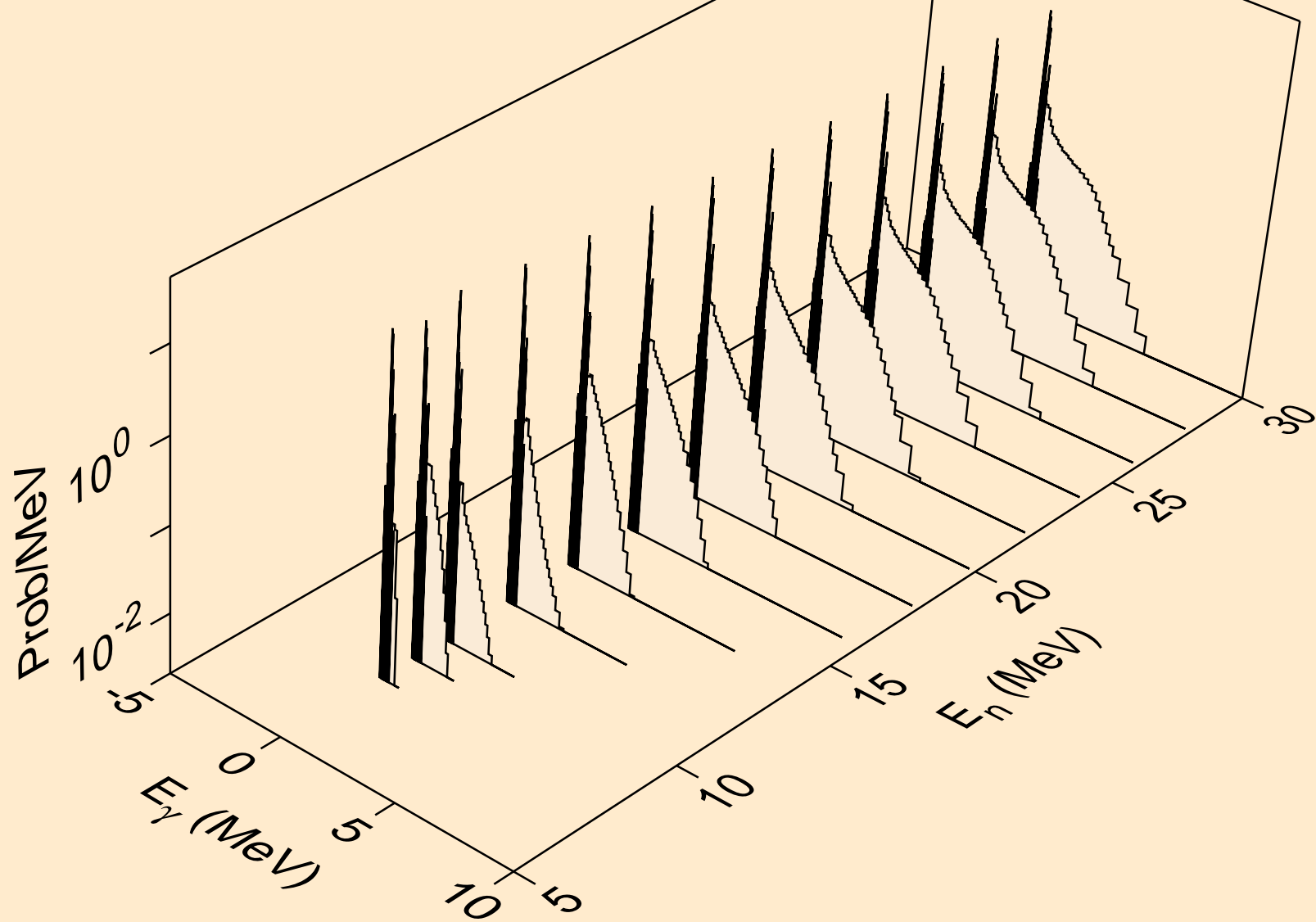

LU172 PROTON ACER TENDL-2023 LIBRARY; T=0.K  
Photon emission for (n,n\*)2a

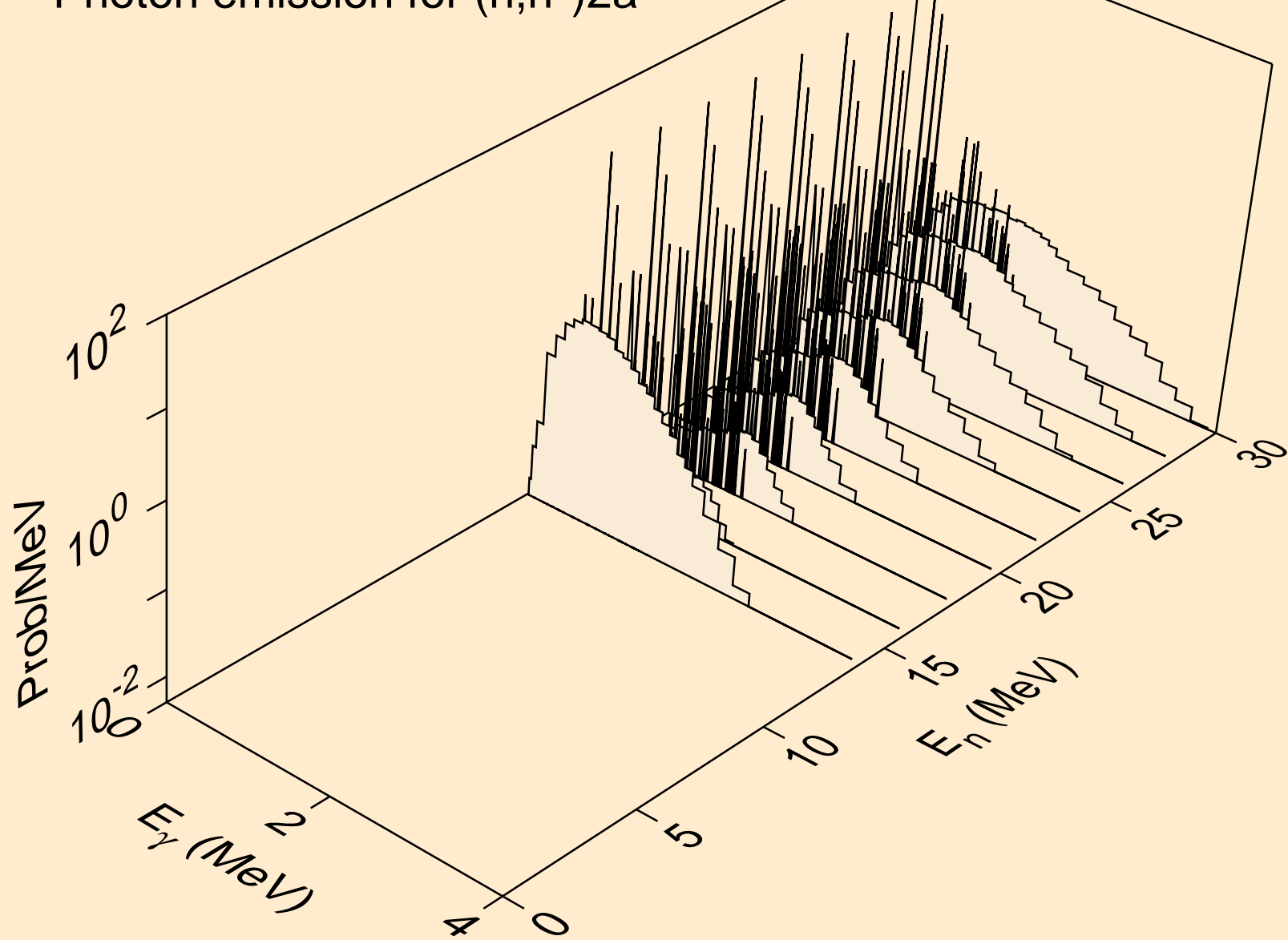

LU172 PROTON ACER TENDL-2023 LIBRARY; T=0.K  
Photon emission for (n,n\*)d

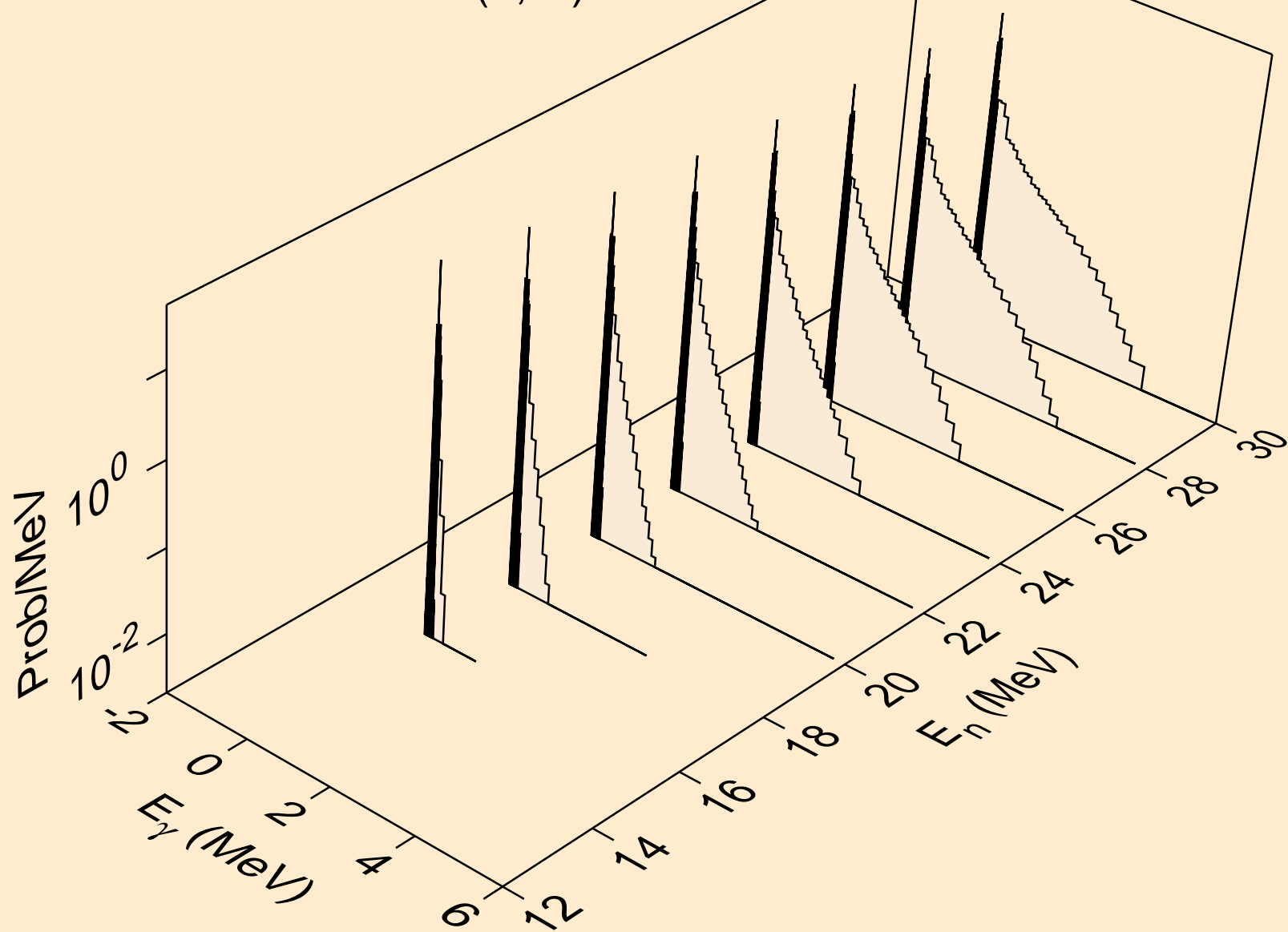

LU172 PROTON ACER TENDL-2023 LIBRARY; T=0.K  
Photon emission for (n,n\*)t

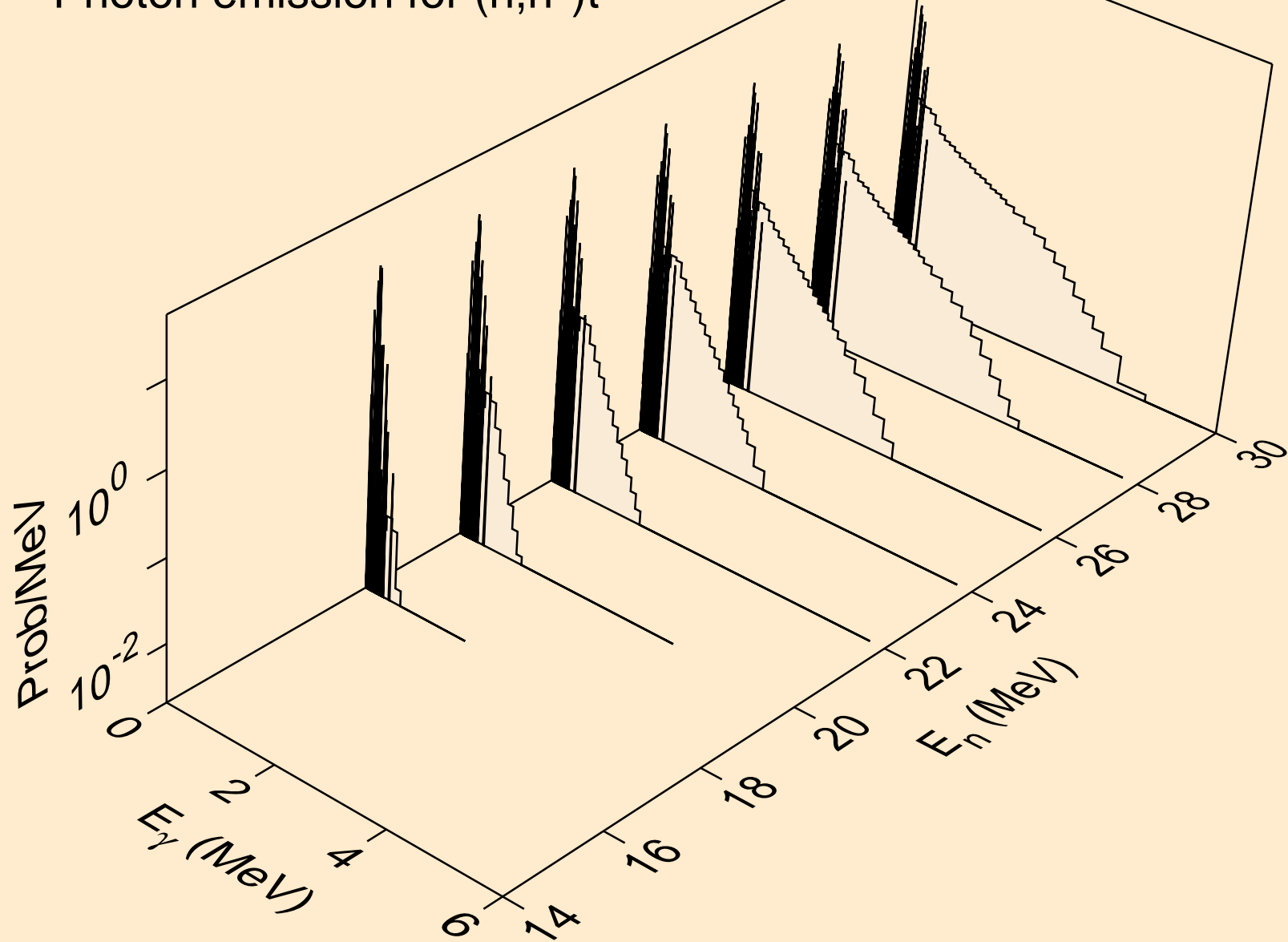



LU172 PROTON ACER TENDL-2023 LIBRARY; T=0.K  
Photon emission for (n,n\*)he3

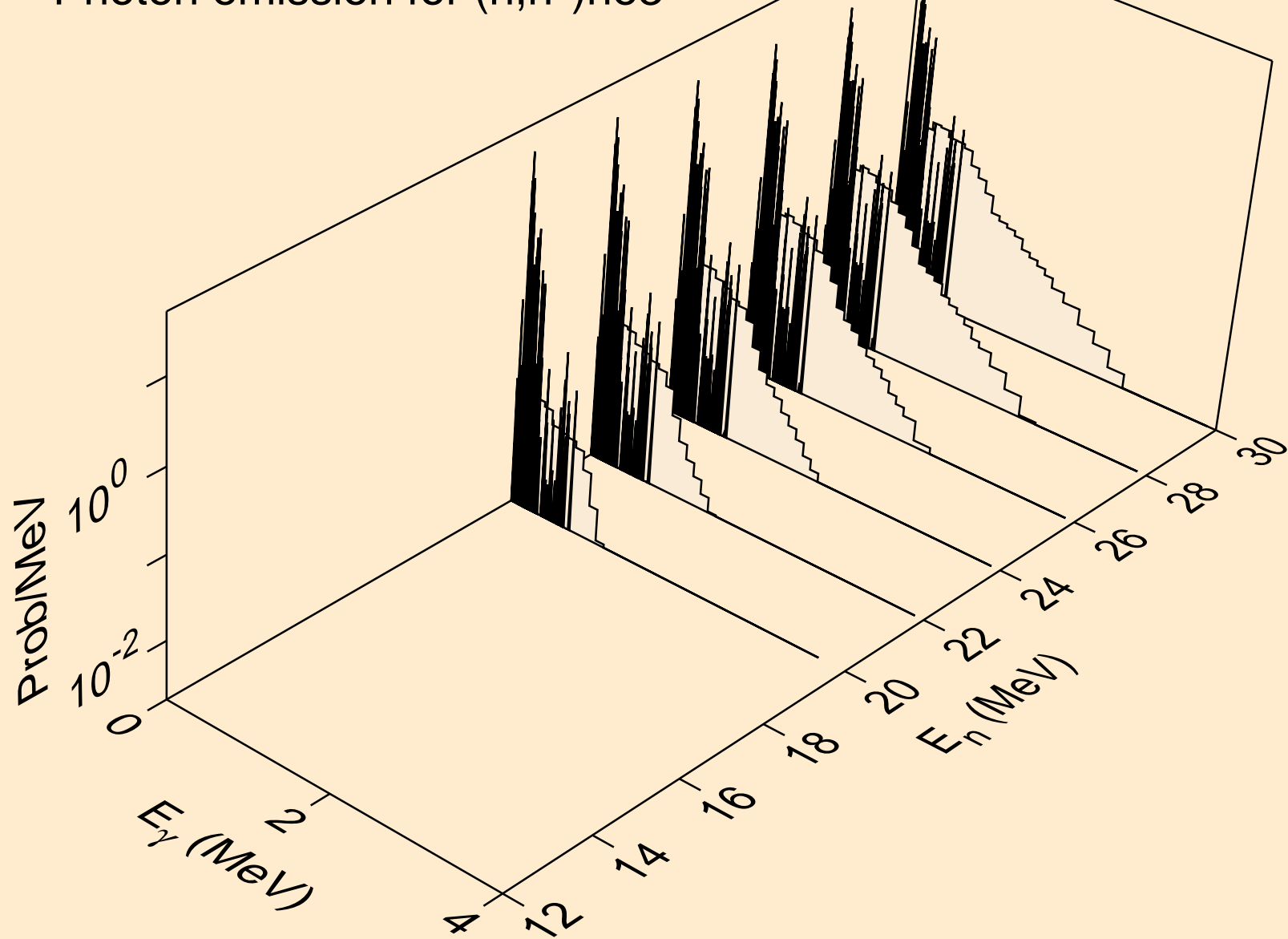

LU172 PROTON ACER TENDL-2023 LIBRARY; T=0.K  
Photon emission for (n,4n)

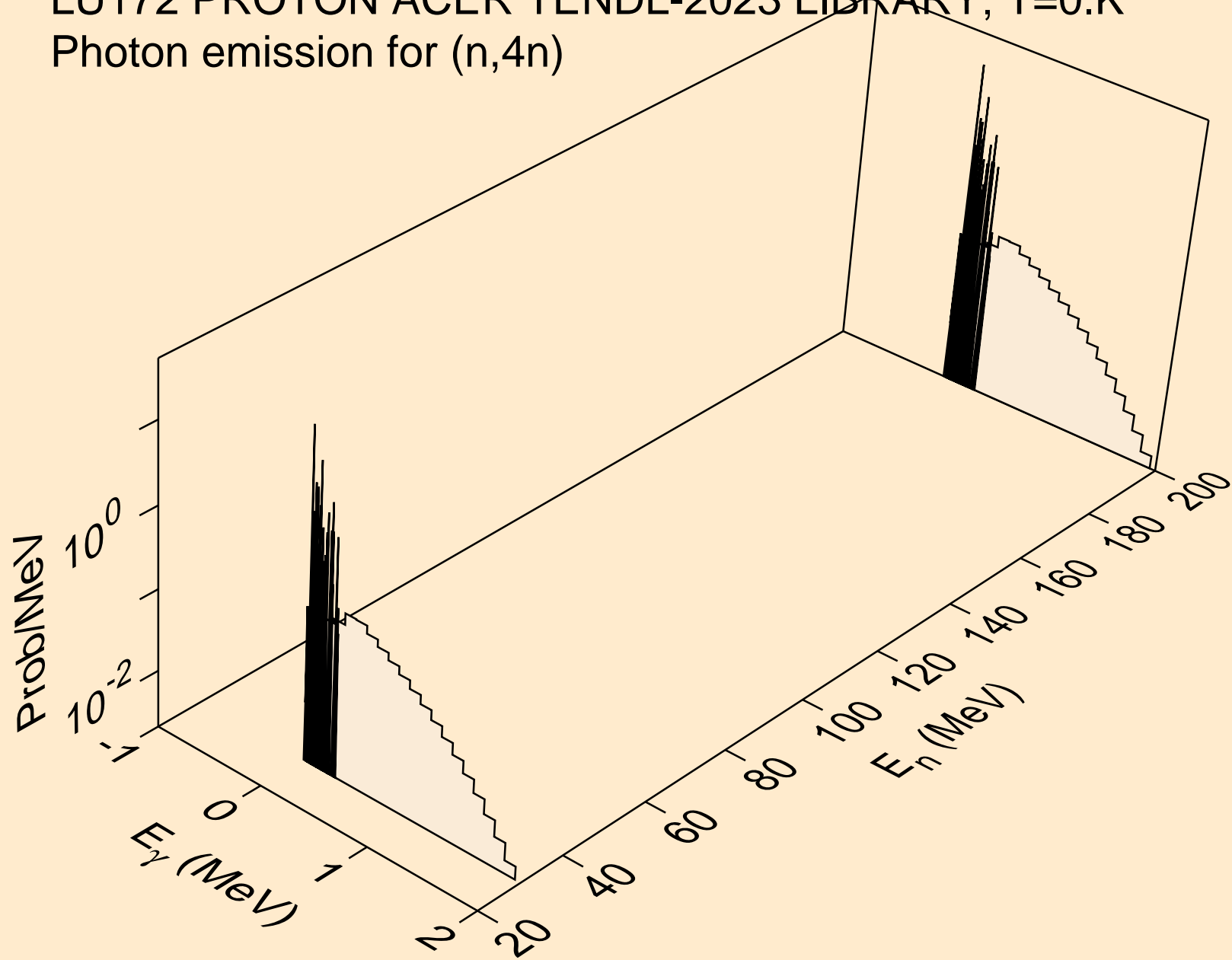

LU172 PROTON ACER TENDL-2023 LIBRARY; T=0.K  
Photon emission for (n,2np)

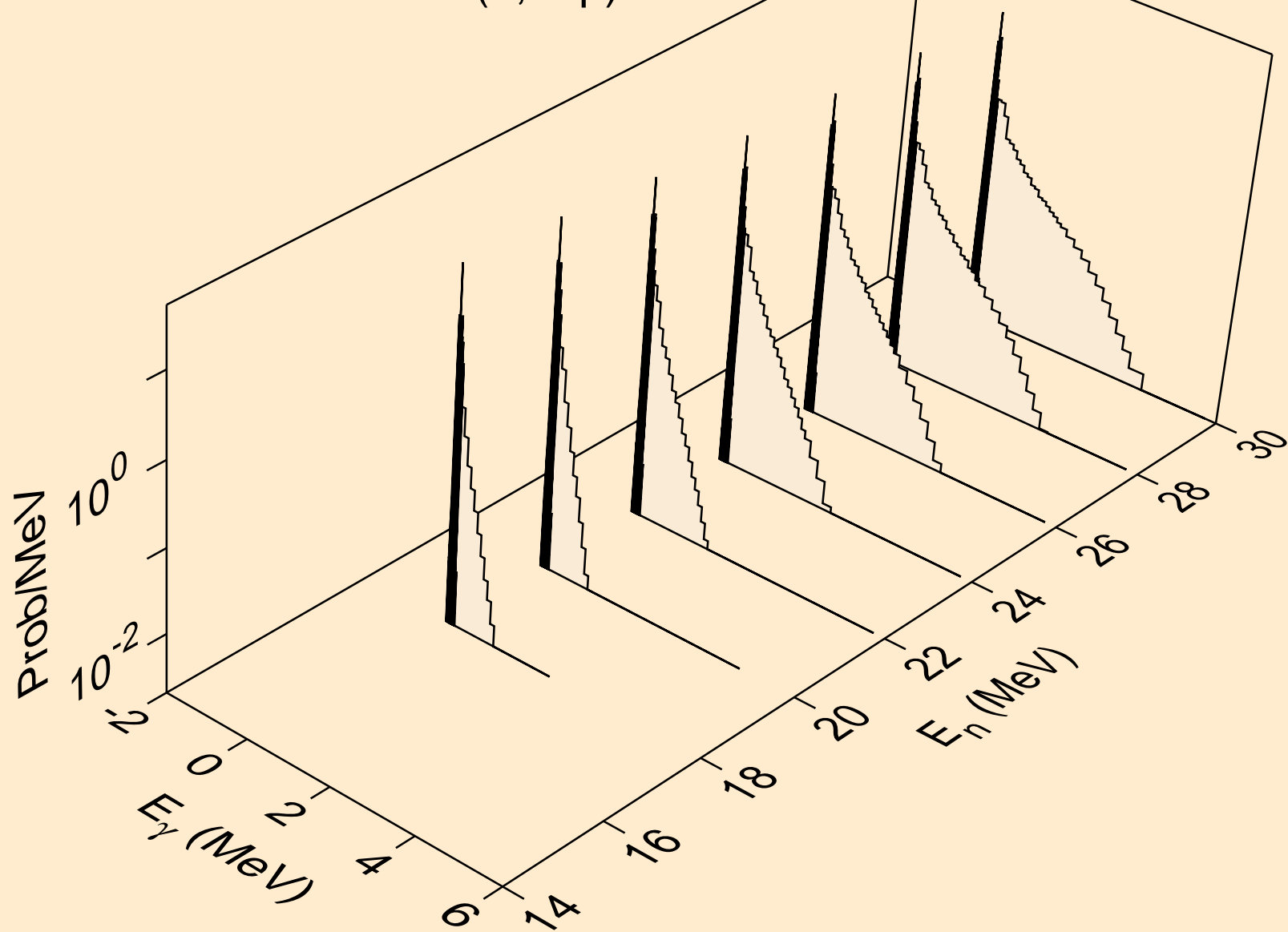

LU172 PROTON ACER TENDL-2023 LIBRARY; T=0.K  
Photon emission for (n,3np)

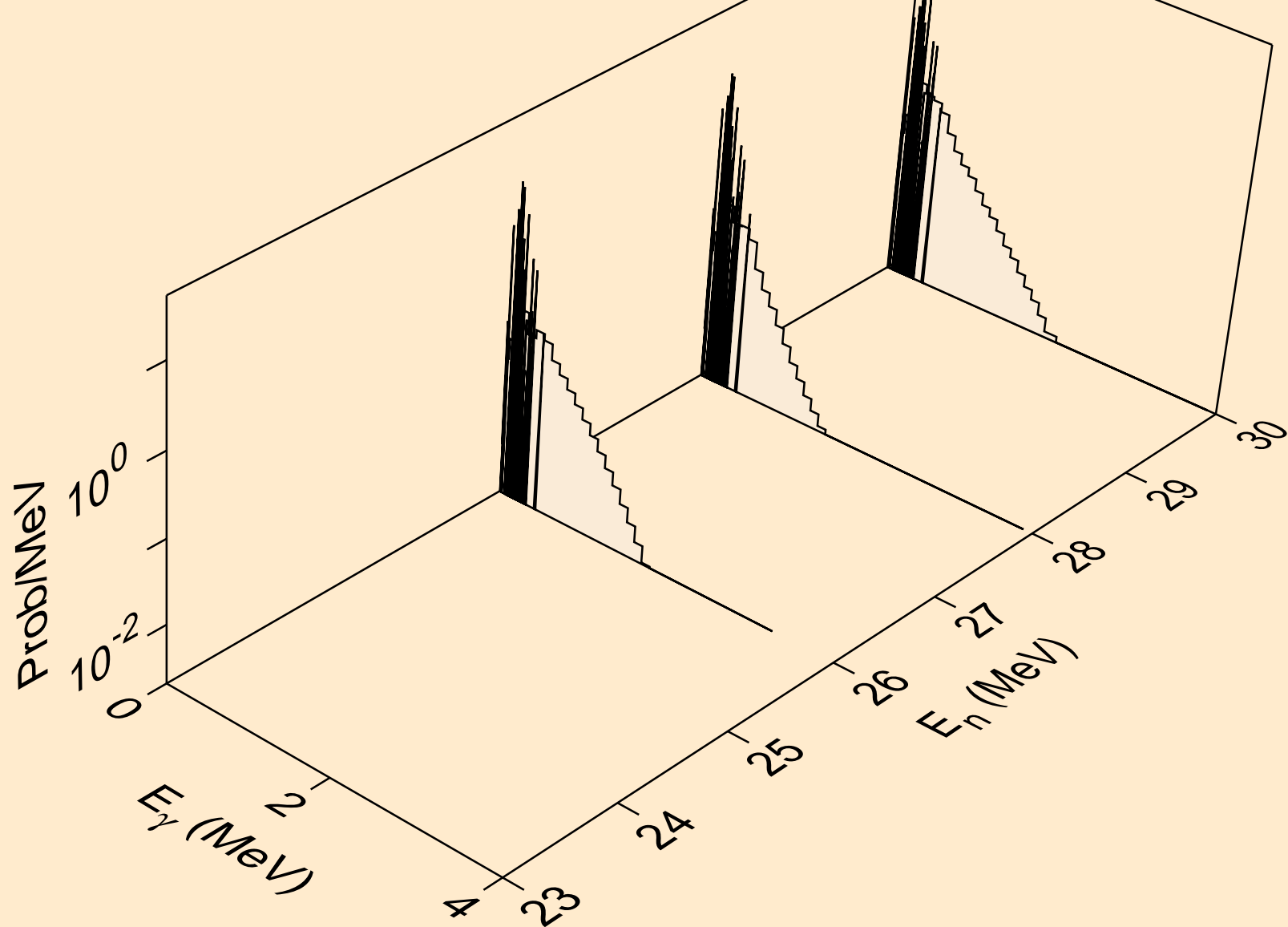

LU172 PROTON ACER TENDL-2023 LIBRARY; T=0.K  
Photon emission for (n,n2p)

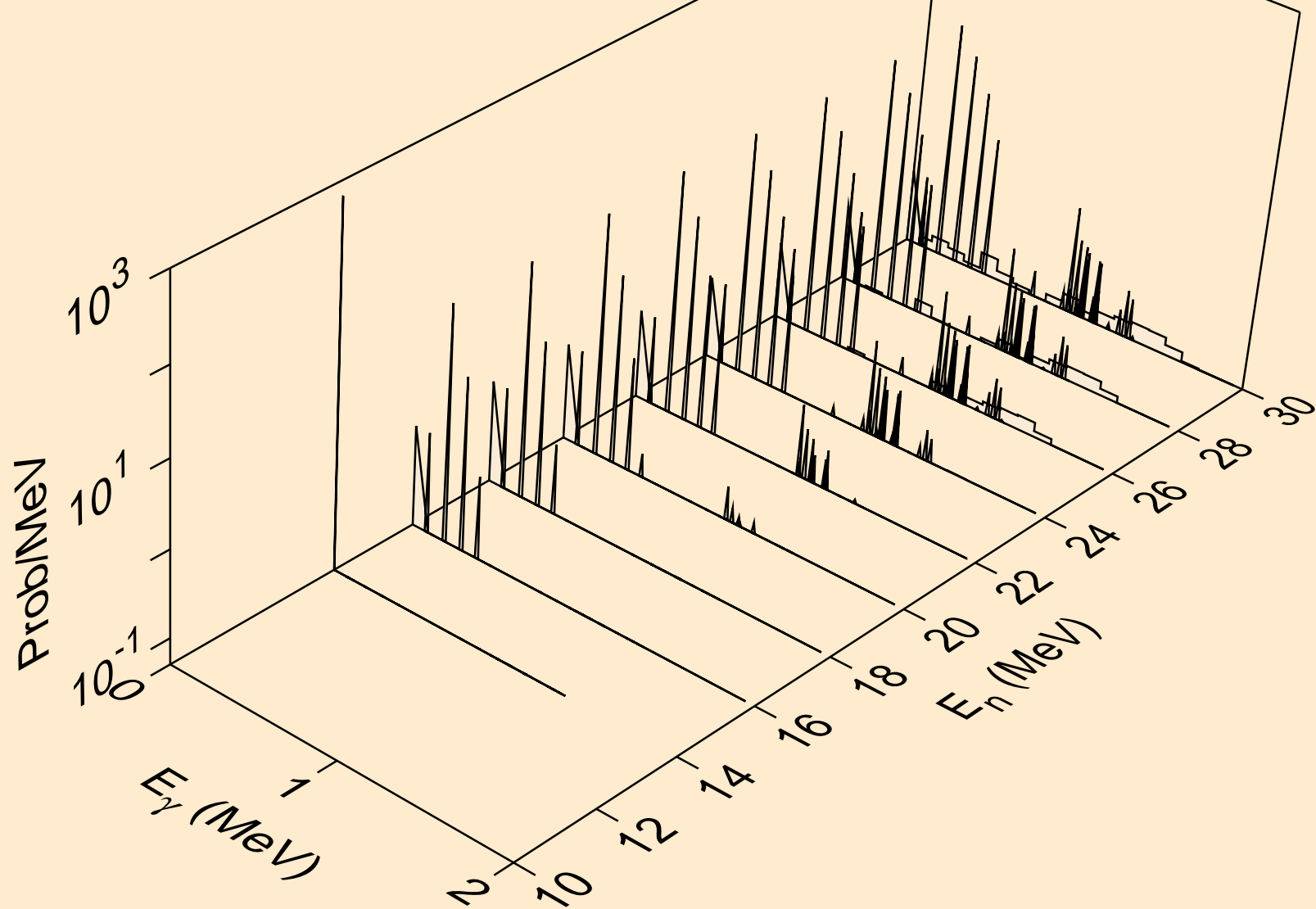

LU172 PROTON ACER TENDL-2023 LIBRARY; T=0.K  
Photon emission for (n,npa)

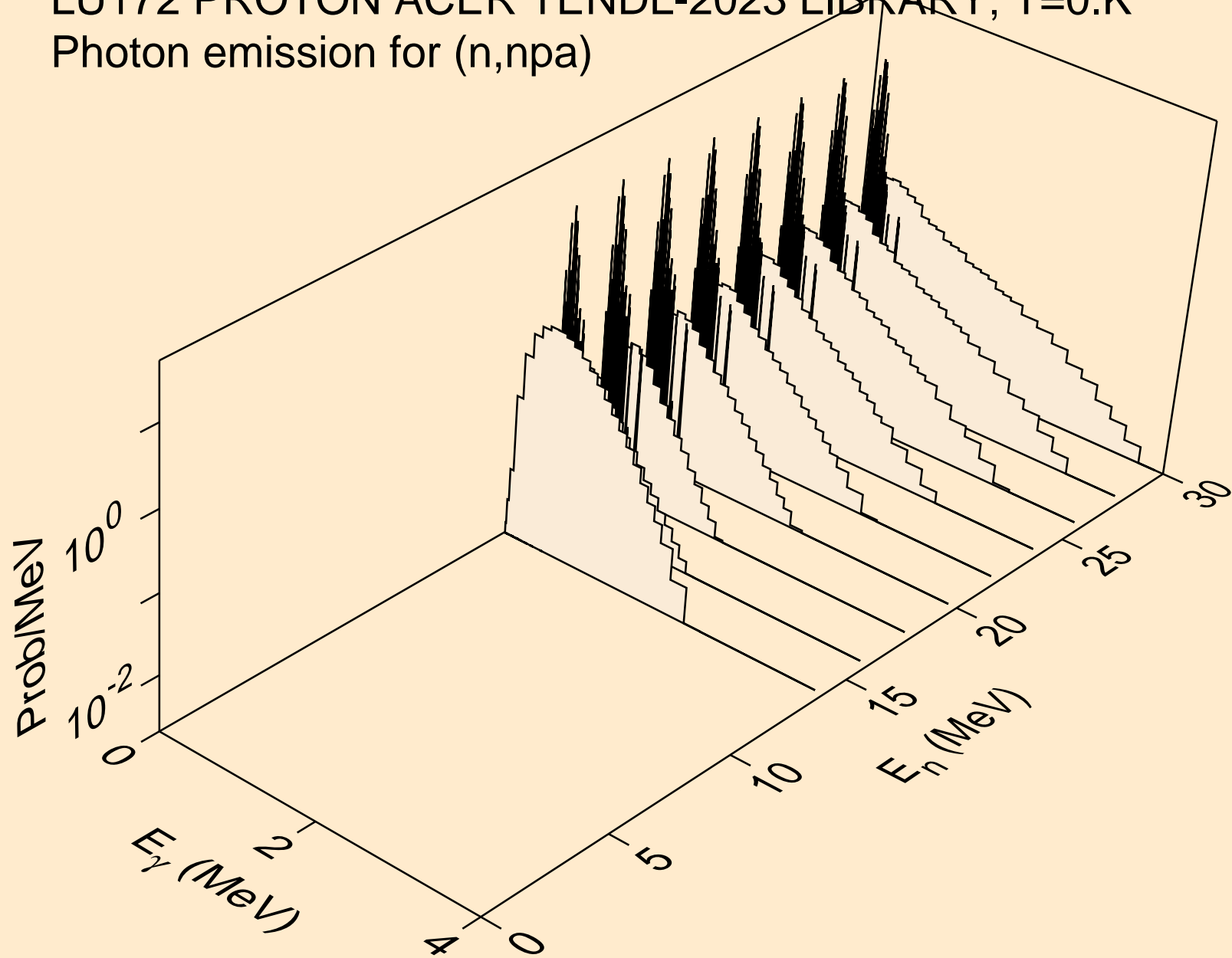

LU172 PROTON ACER TENDL-2023 LIBRARY; T=0.K  
Photon emission for (n,gma)

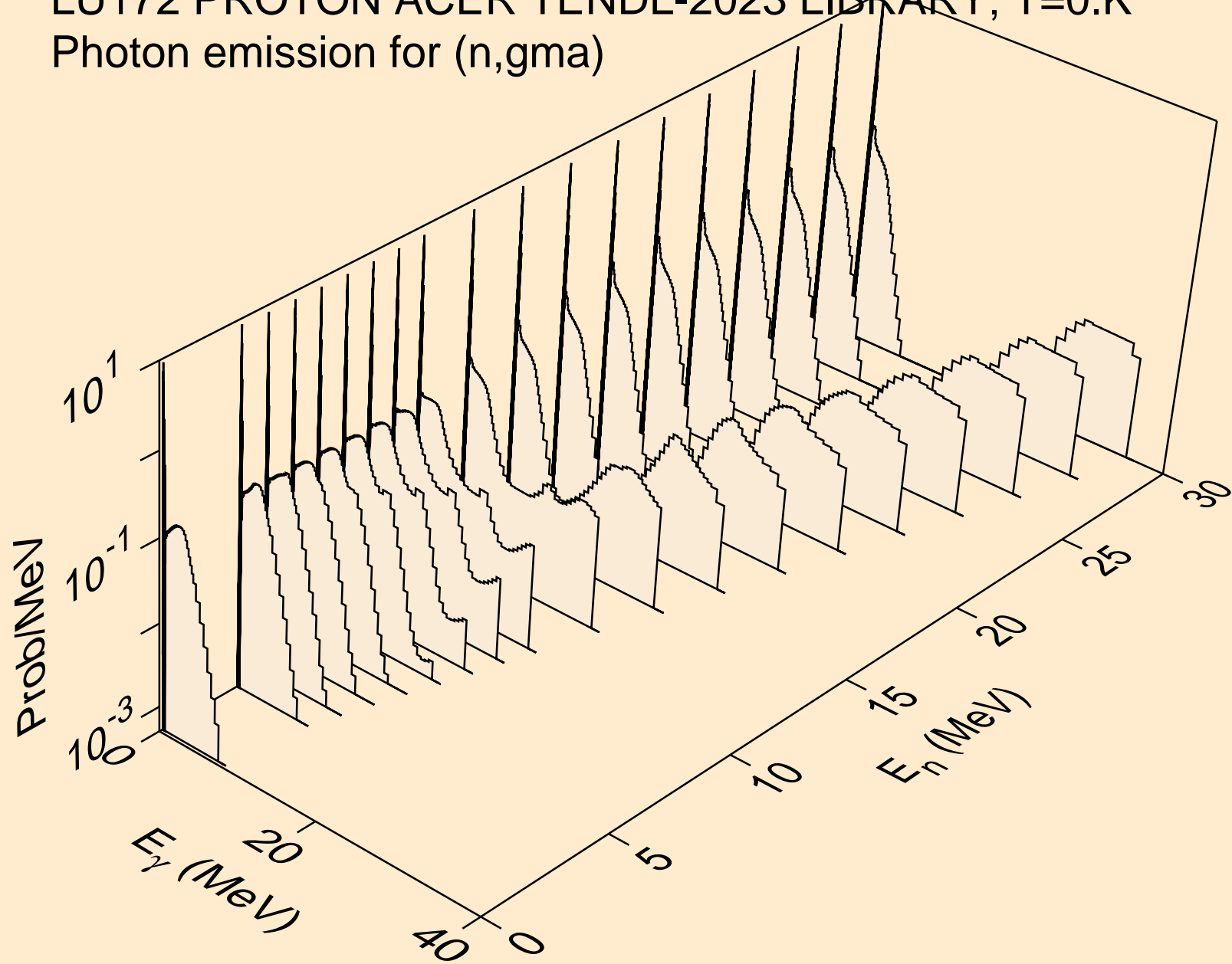

LU172 PROTON ACER TENDL-2023 LIBRARY; T=0.K  
Photon emission for inelastic

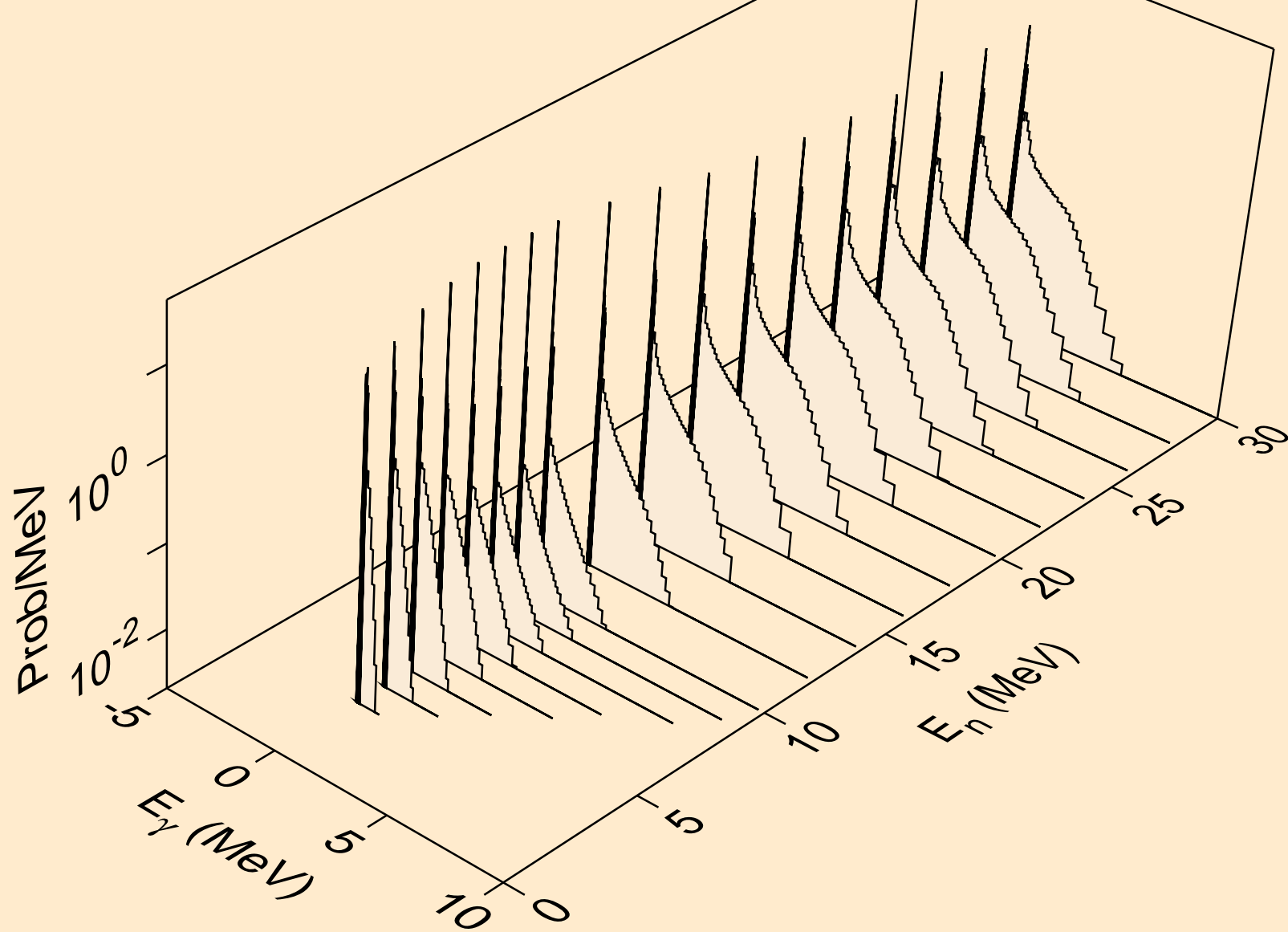



LU172 PROTON ACER TENDL-2023 LIBRARY; T=0.K  
Photon emission for (n,d)

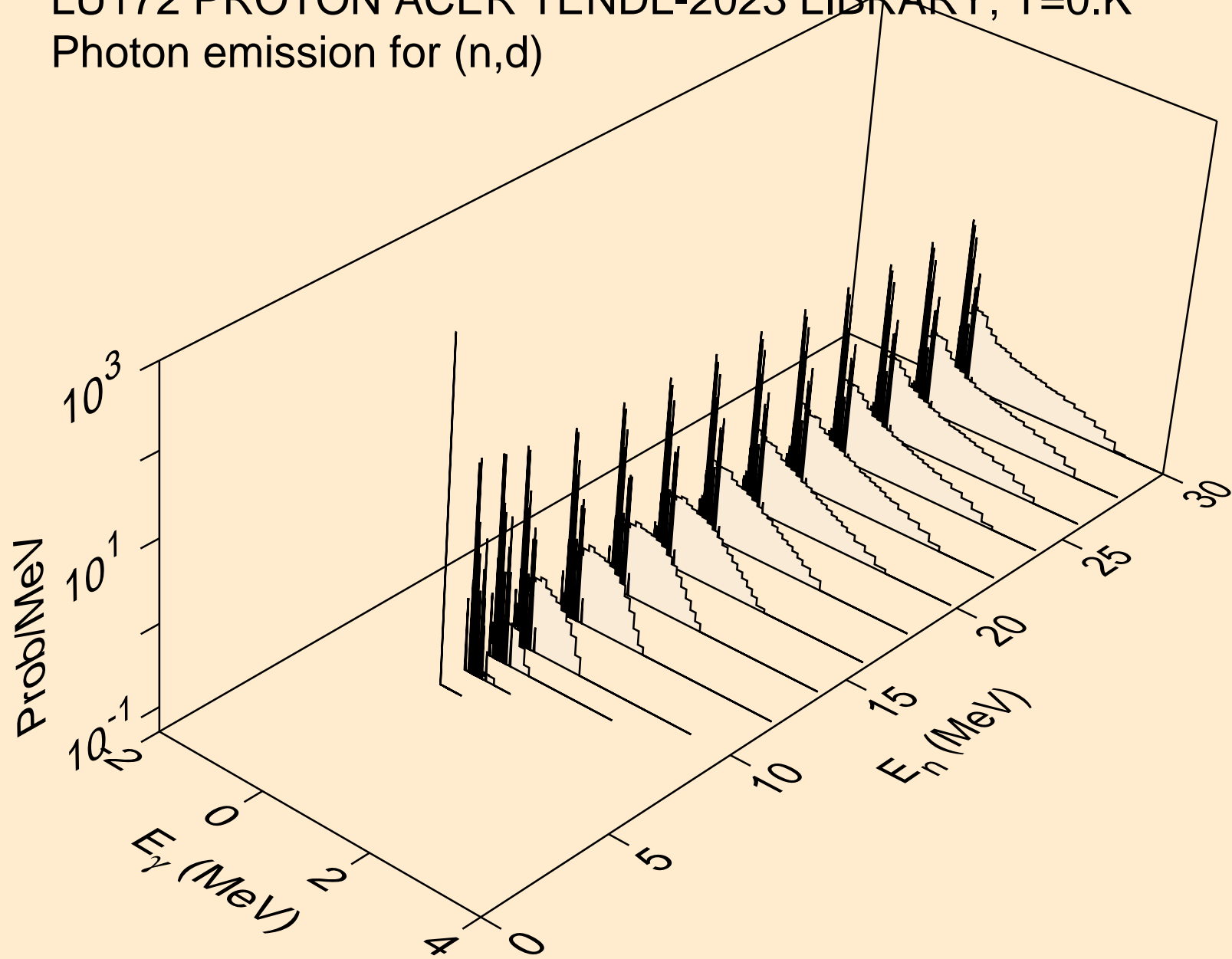

LU172 PROTON ACER TENDL-2023 LIBRARY; T=0.K  
Photon emission for (n,t)

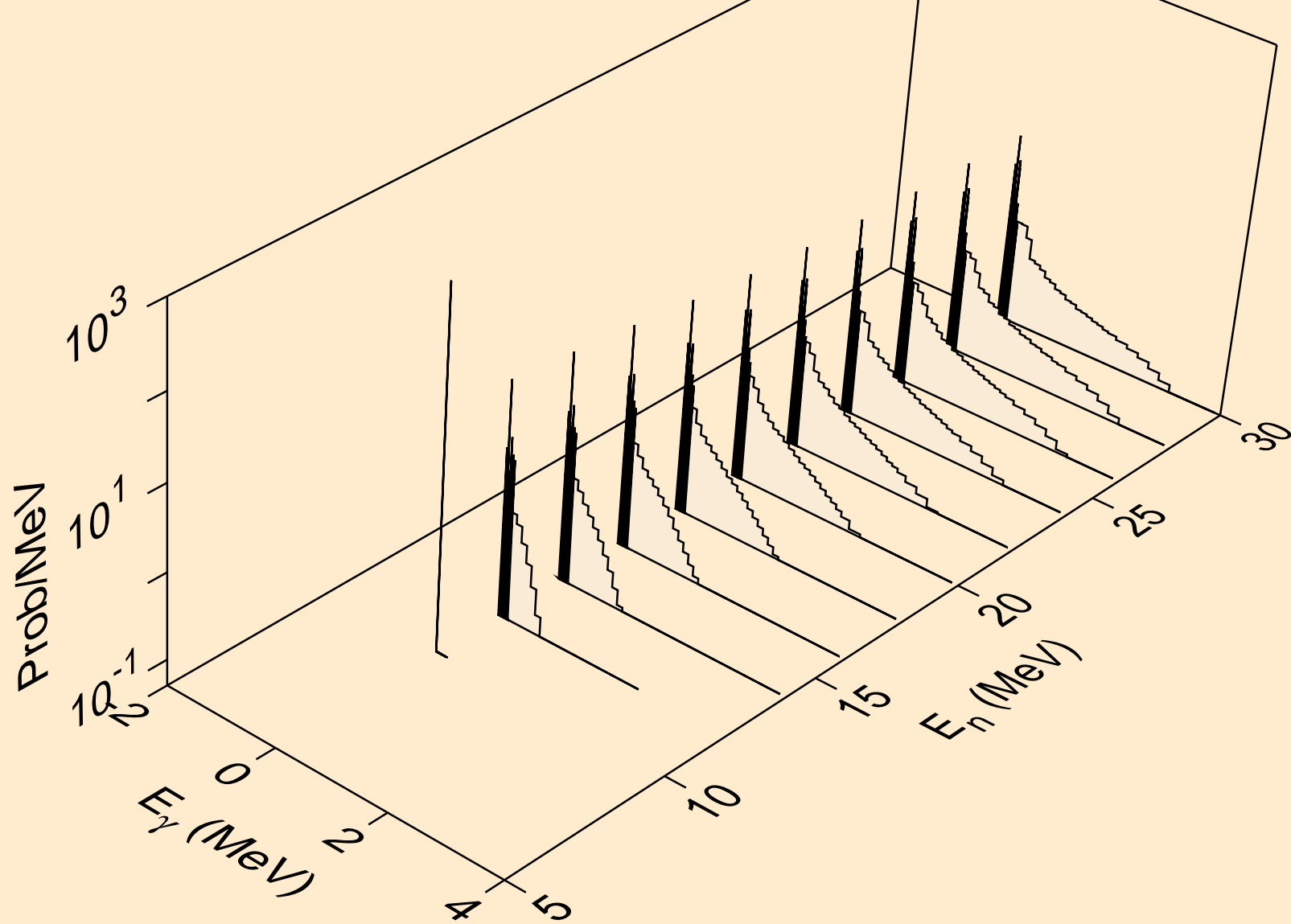

LU172 PROTON ACER TENDL-2023 LIBRARY; T=0.K  
Photon emission for (n,he3)

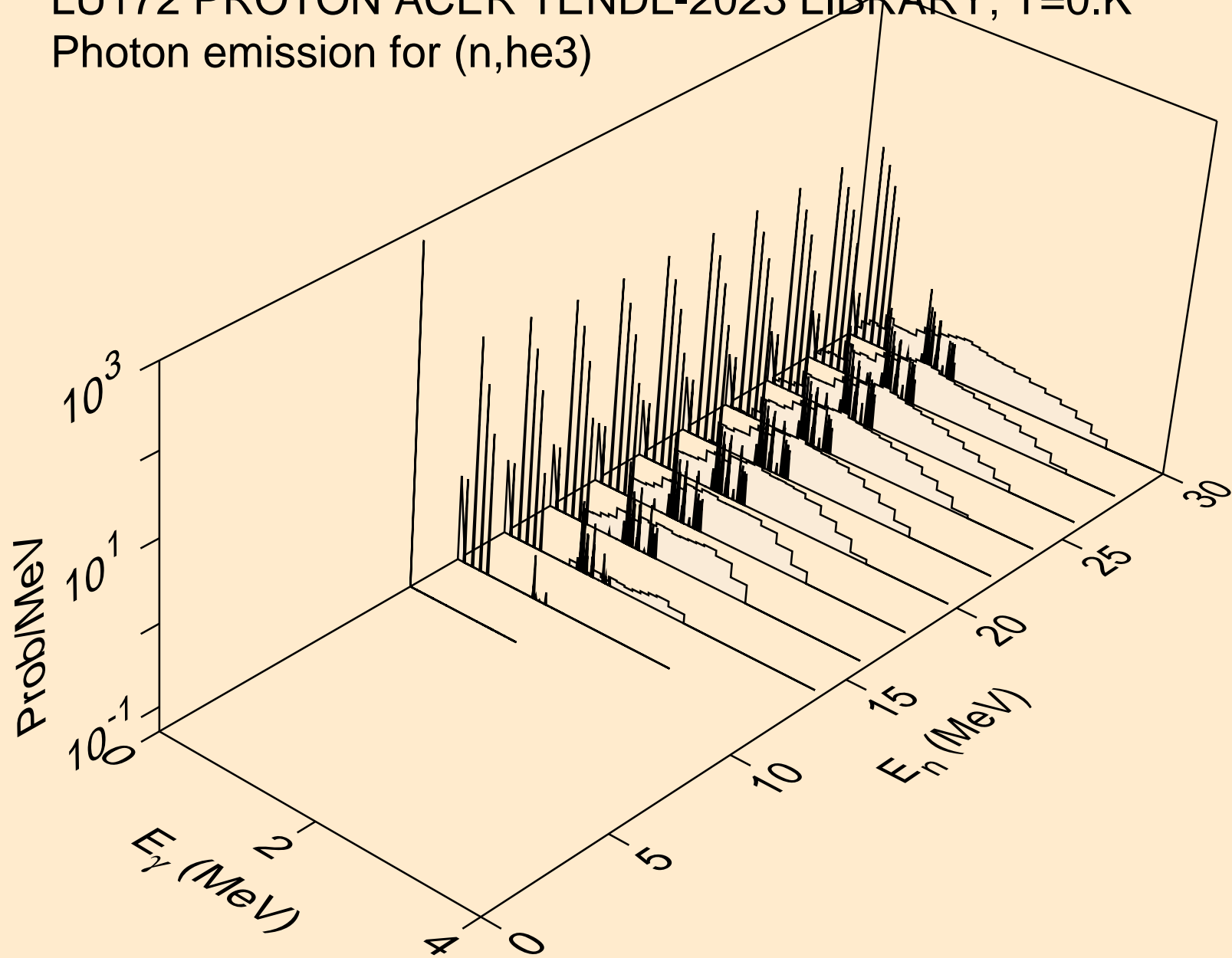

LU172 PROTON ACER TENDL-2023 LIBRARY; T=0.K  
Photon emission for (n,a)

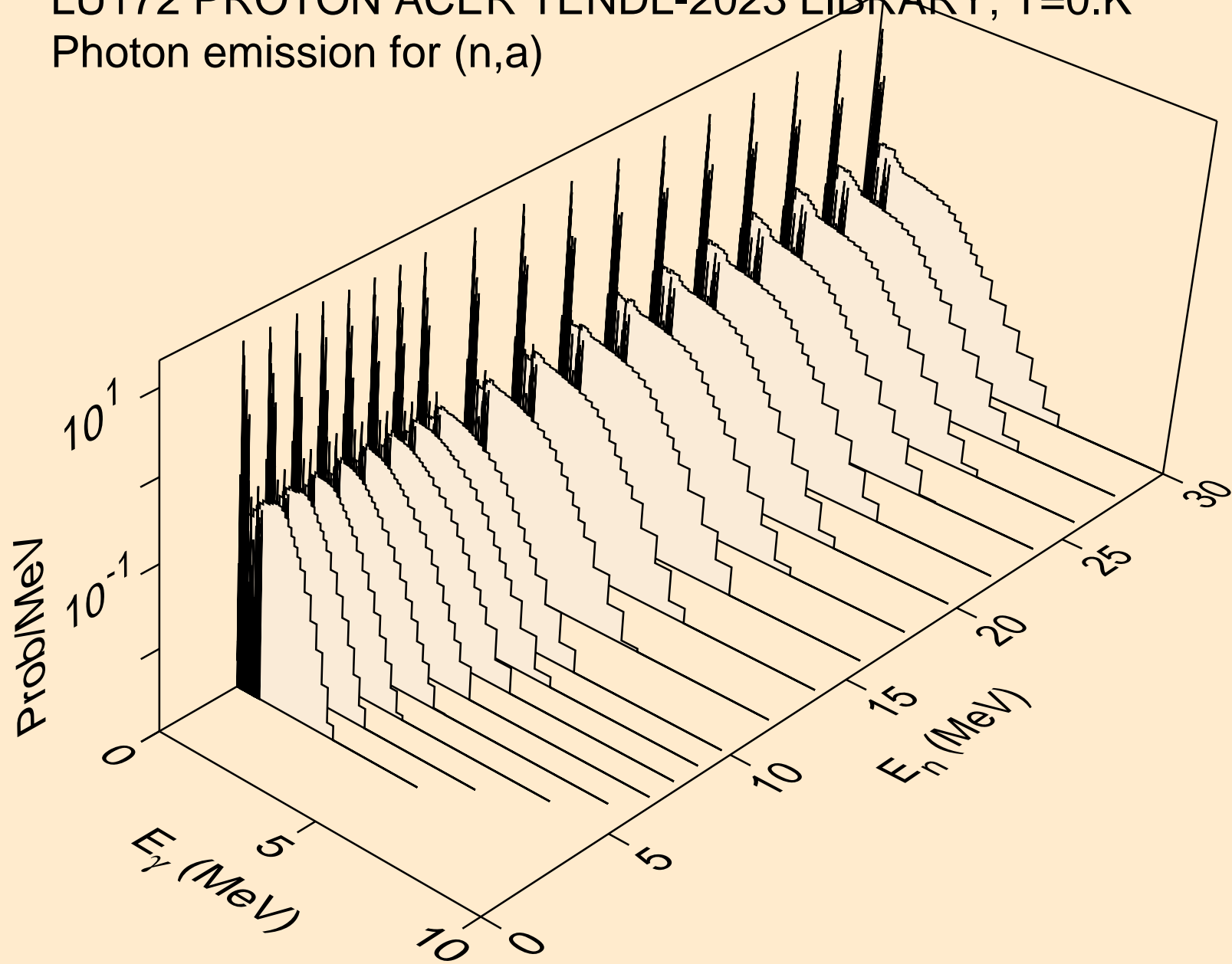

LU172 PROTON ACER TENDL-2023 LIBRARY; T=0.K  
Photon emission for (n,2a)

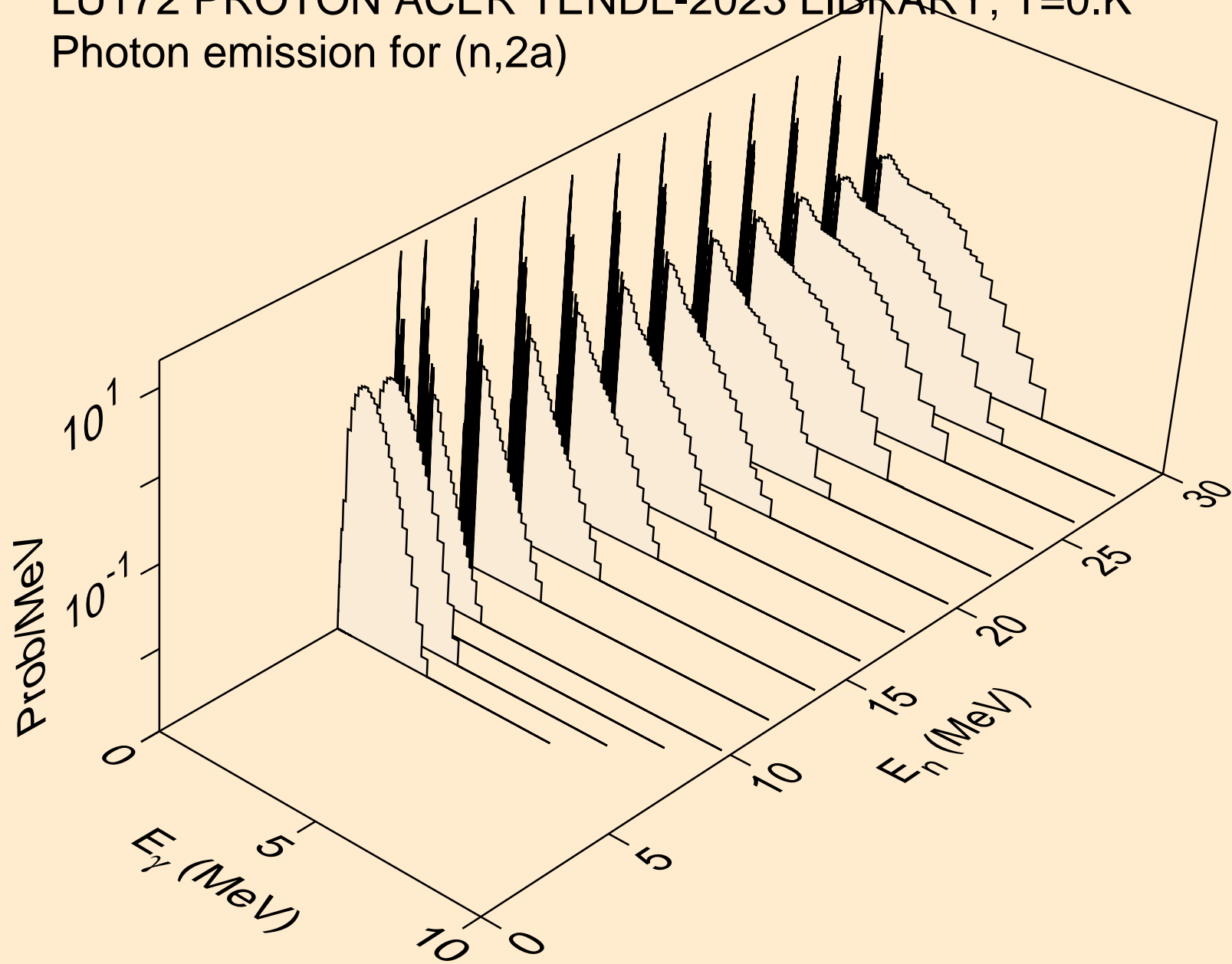

LU172 PROTON ACER TENDL-2023 LIBRARY; T=0.K  
Photon emission for (n,2p)

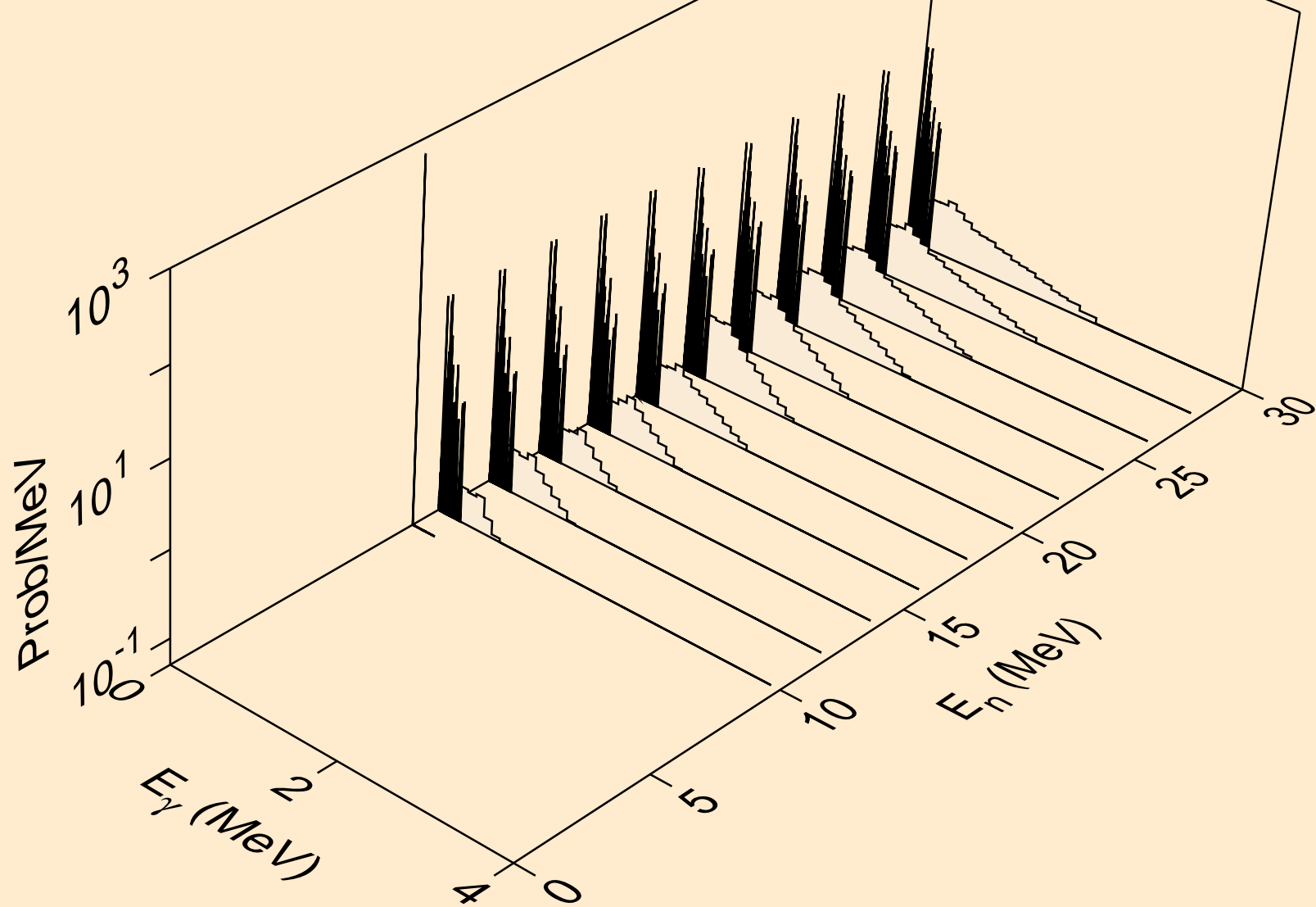

LU172 PROTON ACER TENDL-2023 LIBRARY; T=0.K  
Photon emission for (n,pa)

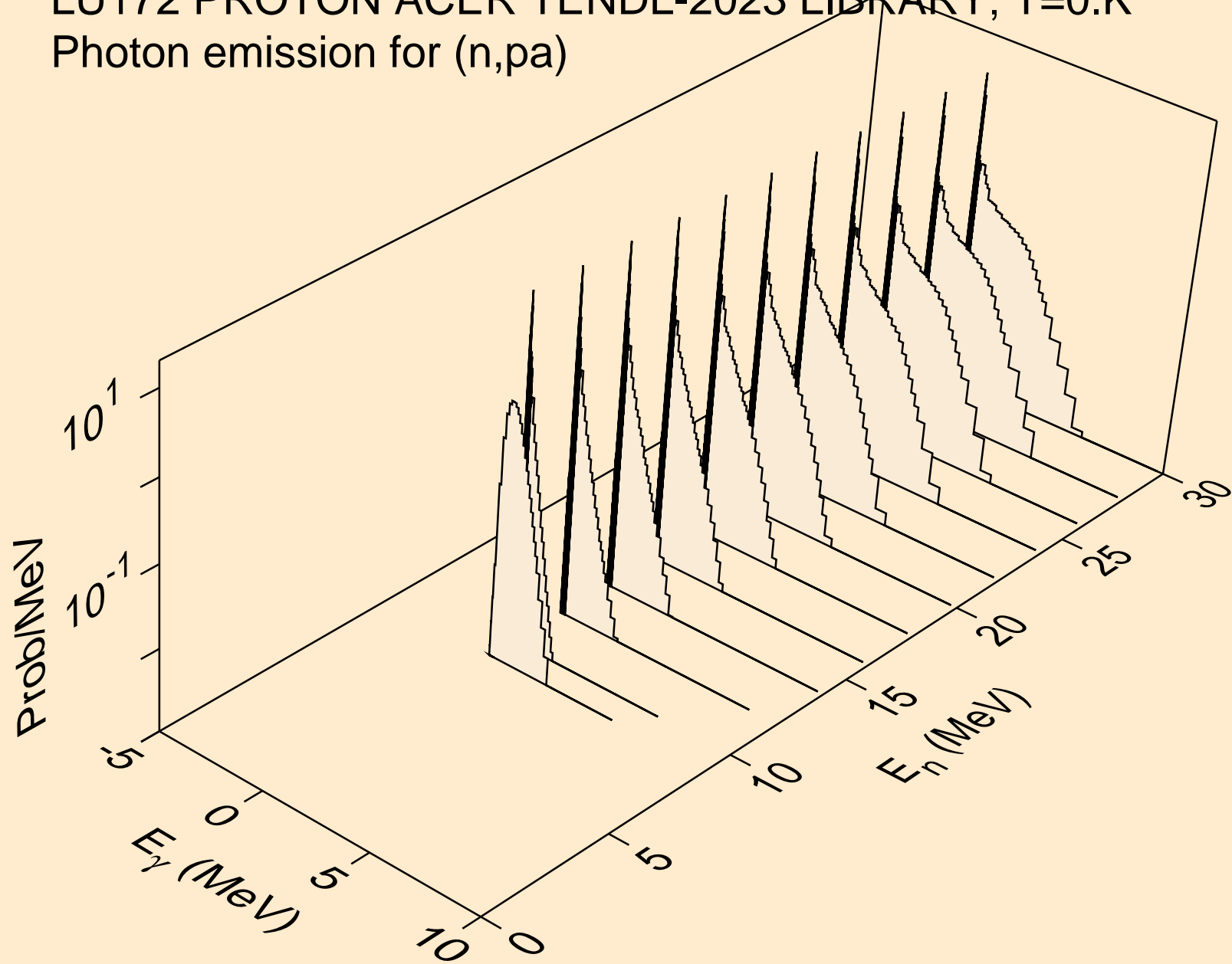

LU172 PROTON ACER TENDL-2023 LIBRARY; T=0.K  
Photon emission for (n,pd)

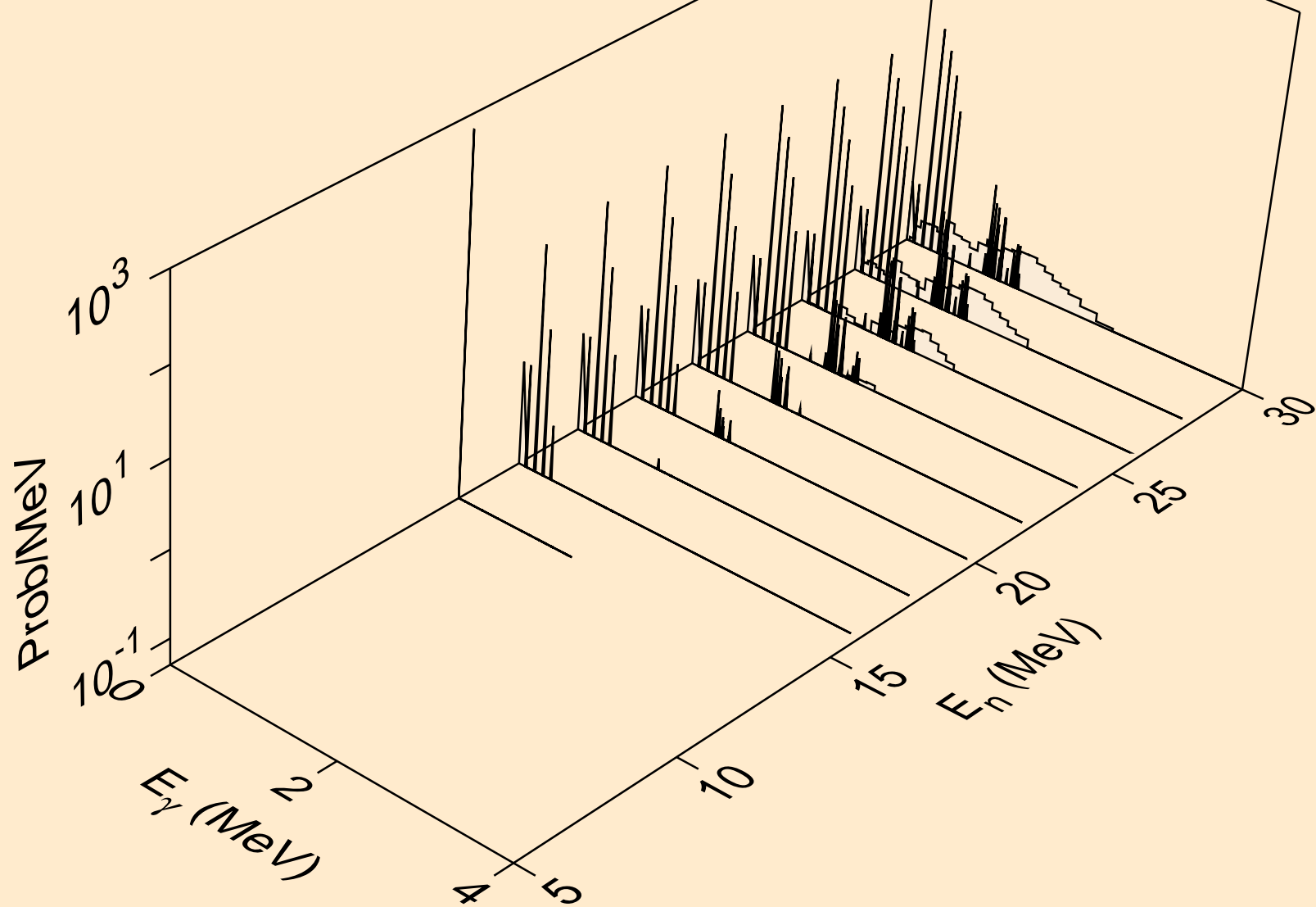



LU172 PROTON ACER TENDL-2023 LIBRARY; T=0.K

Photon emission for (n,pt)

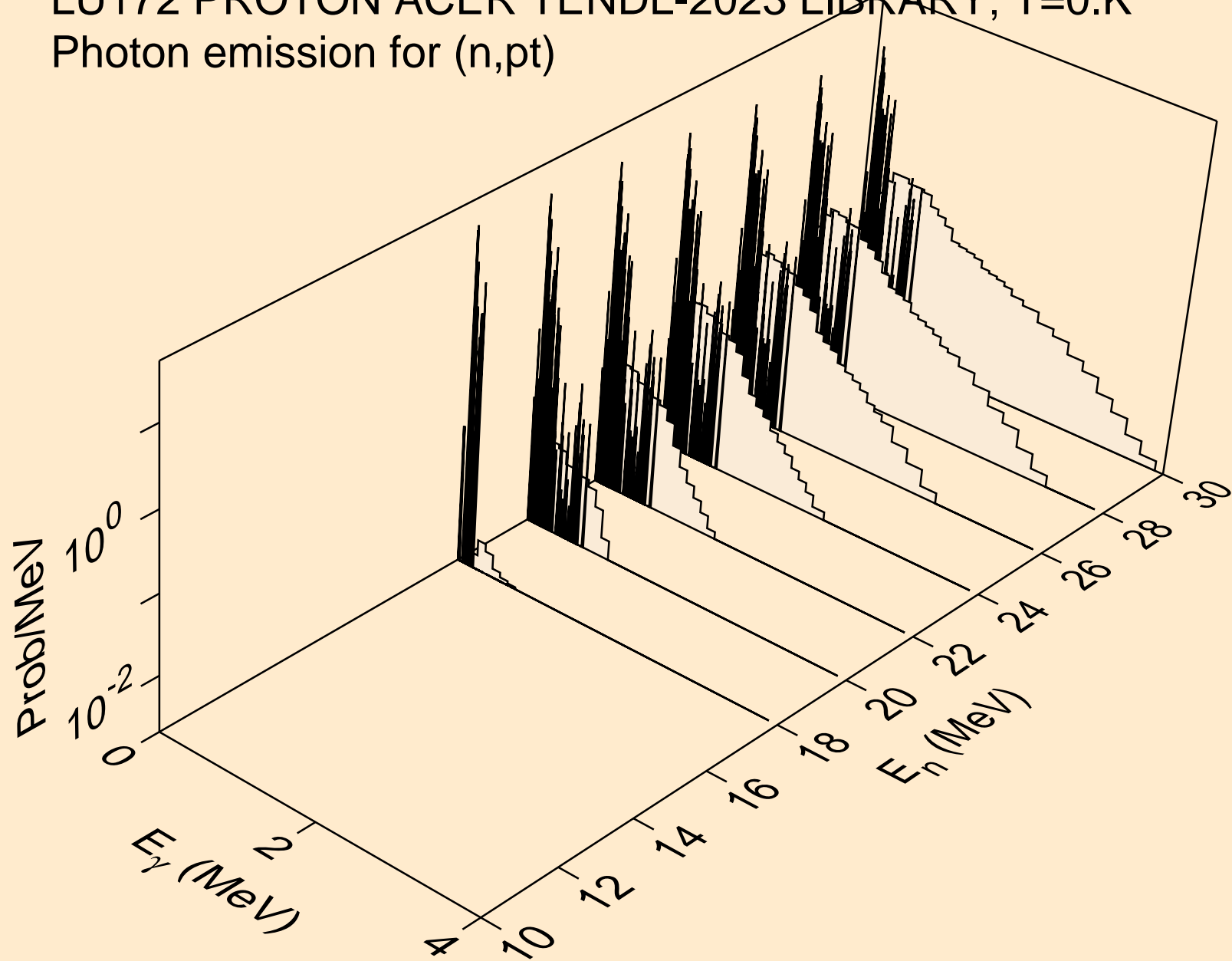

LU172 PROTON ACER TENDL-2023 LIBRARY; T=0.K  
Photon emission for (n,da)

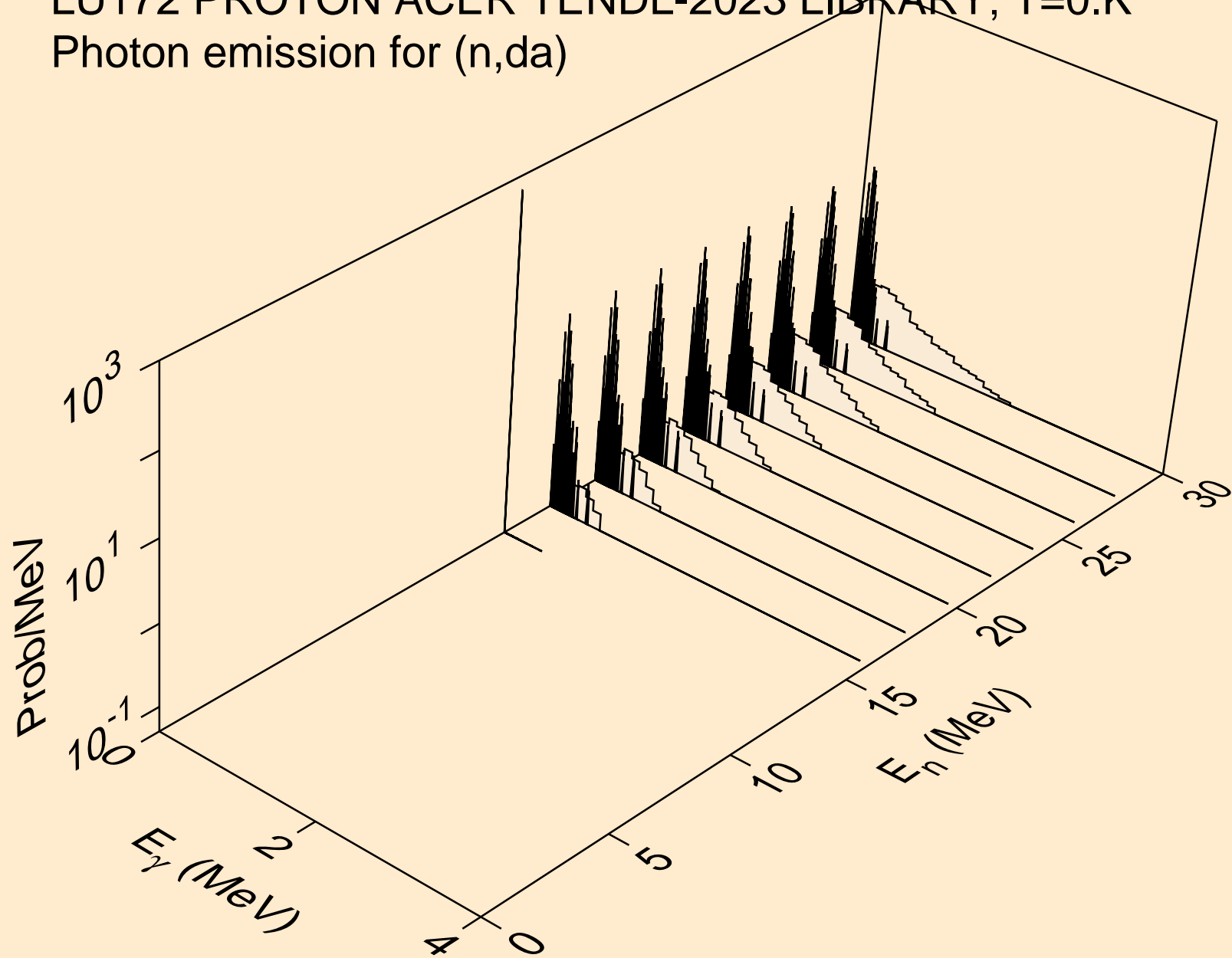

LU172 PROTON ACER TENDL-2023 LIBRARY; T=0.K  
Particle heating contributions

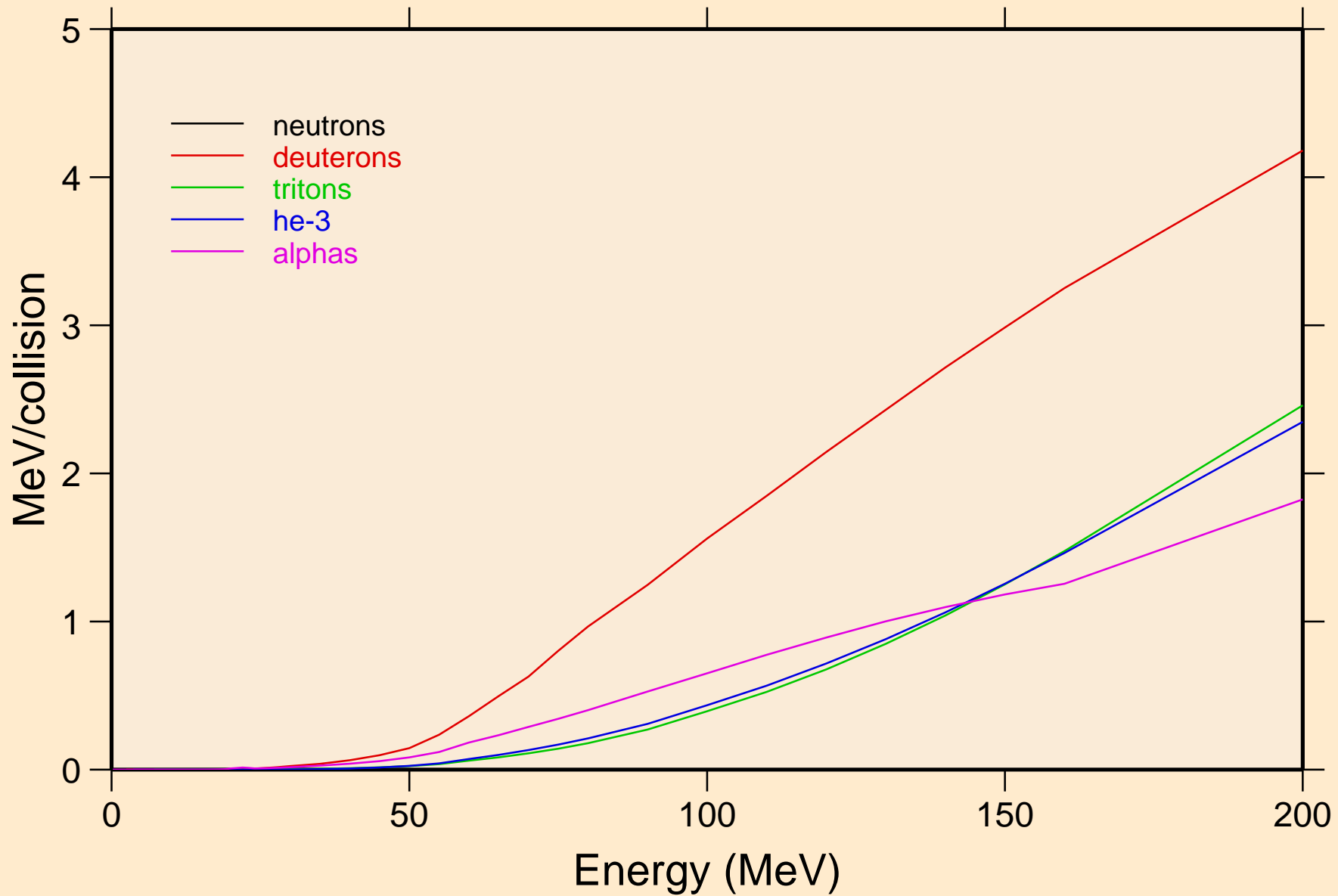

# LU172 PROTON ACER TENDL-2023 LIBRARY; T=0.K

## Recoil Heating

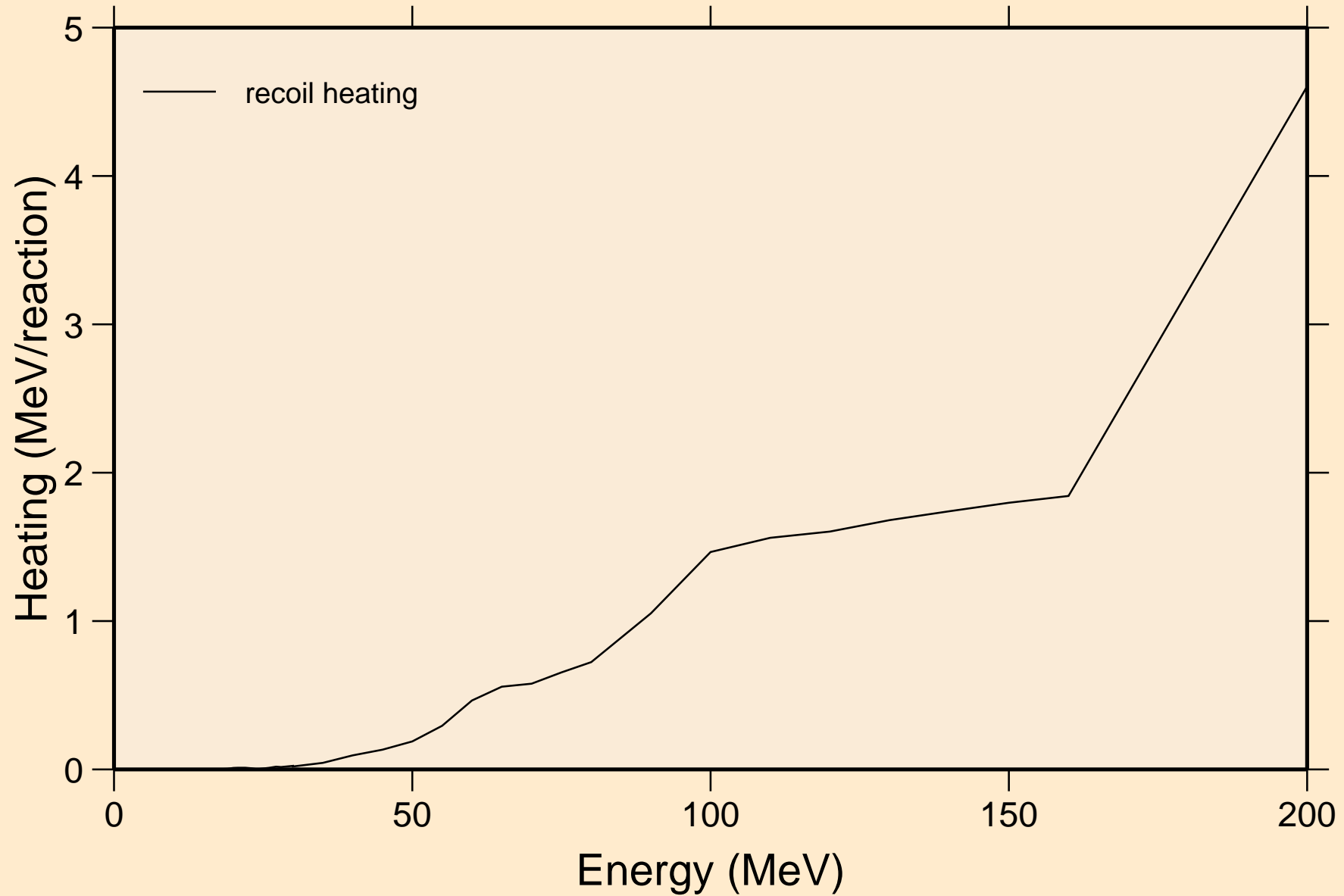

LU172 PROTON ACER TENDL-2023 LIBRARY; T=0.K  
Particle production cross sections

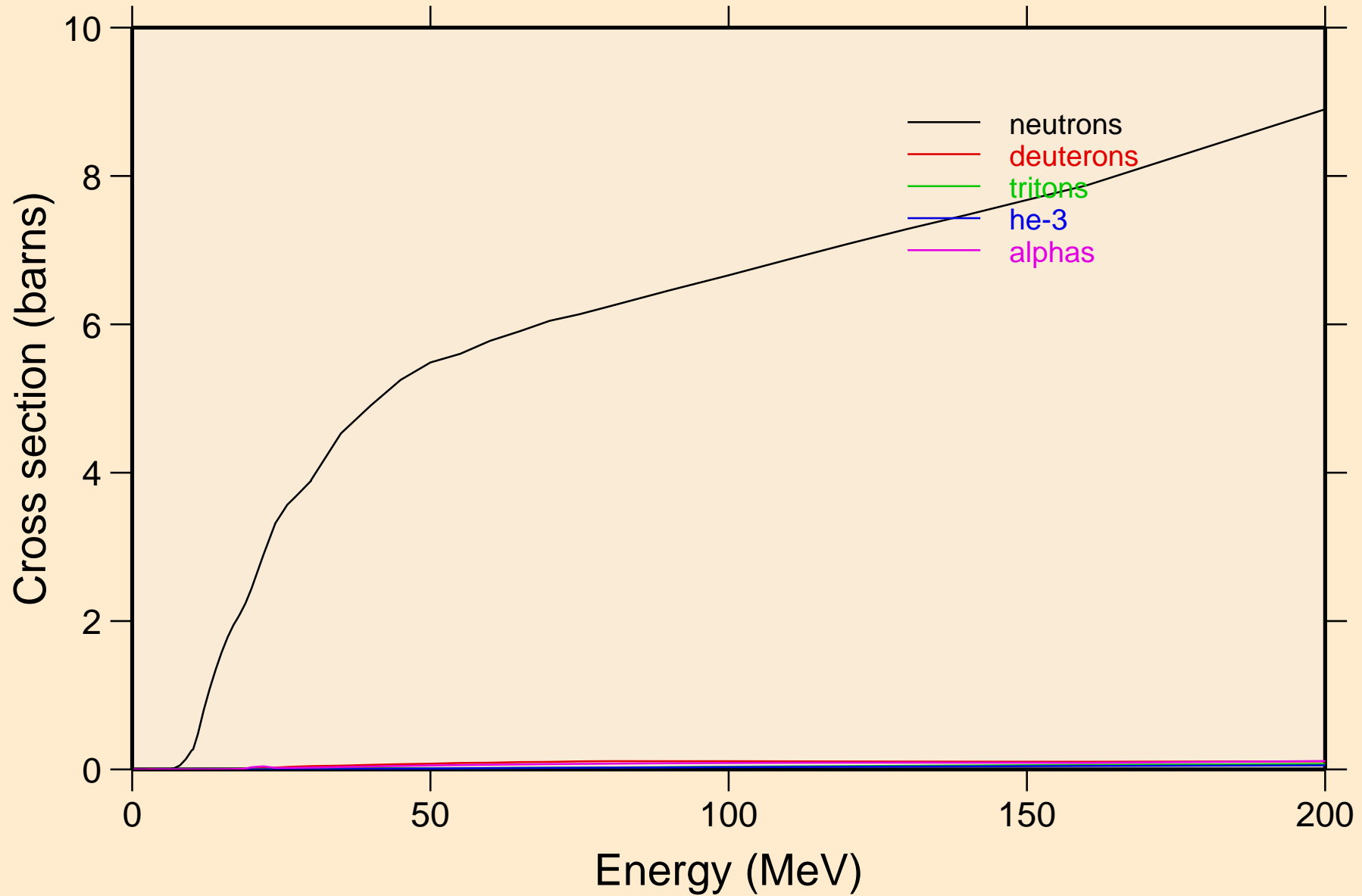

LU172 PROTON ACER TENDL-2023 LIBRARY; T=0.K  
neutrons from (p,n)

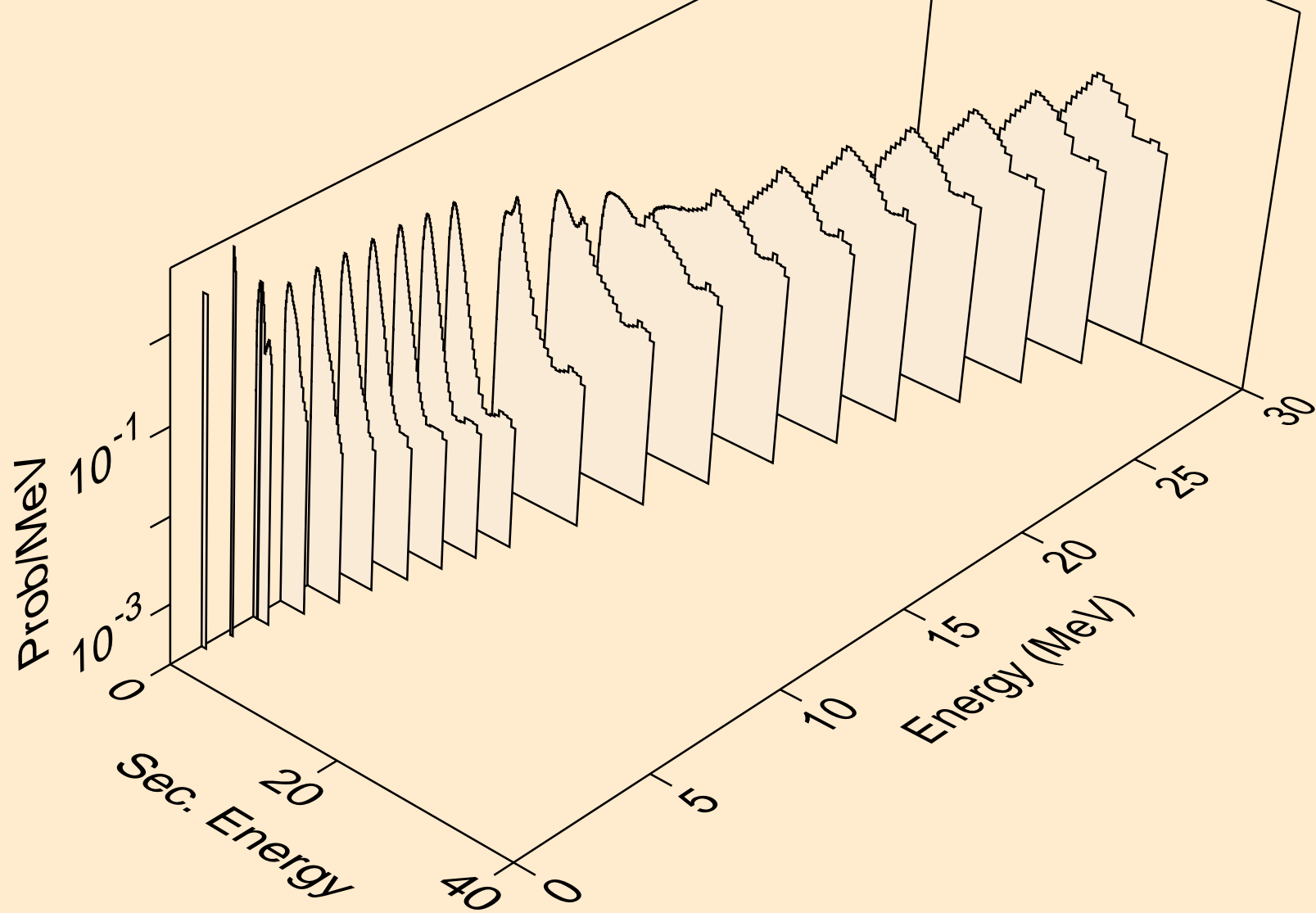

LU172 PROTON ACER TENDL-2023 LIBRARY; T=0.K  
neutrons from (p,x)

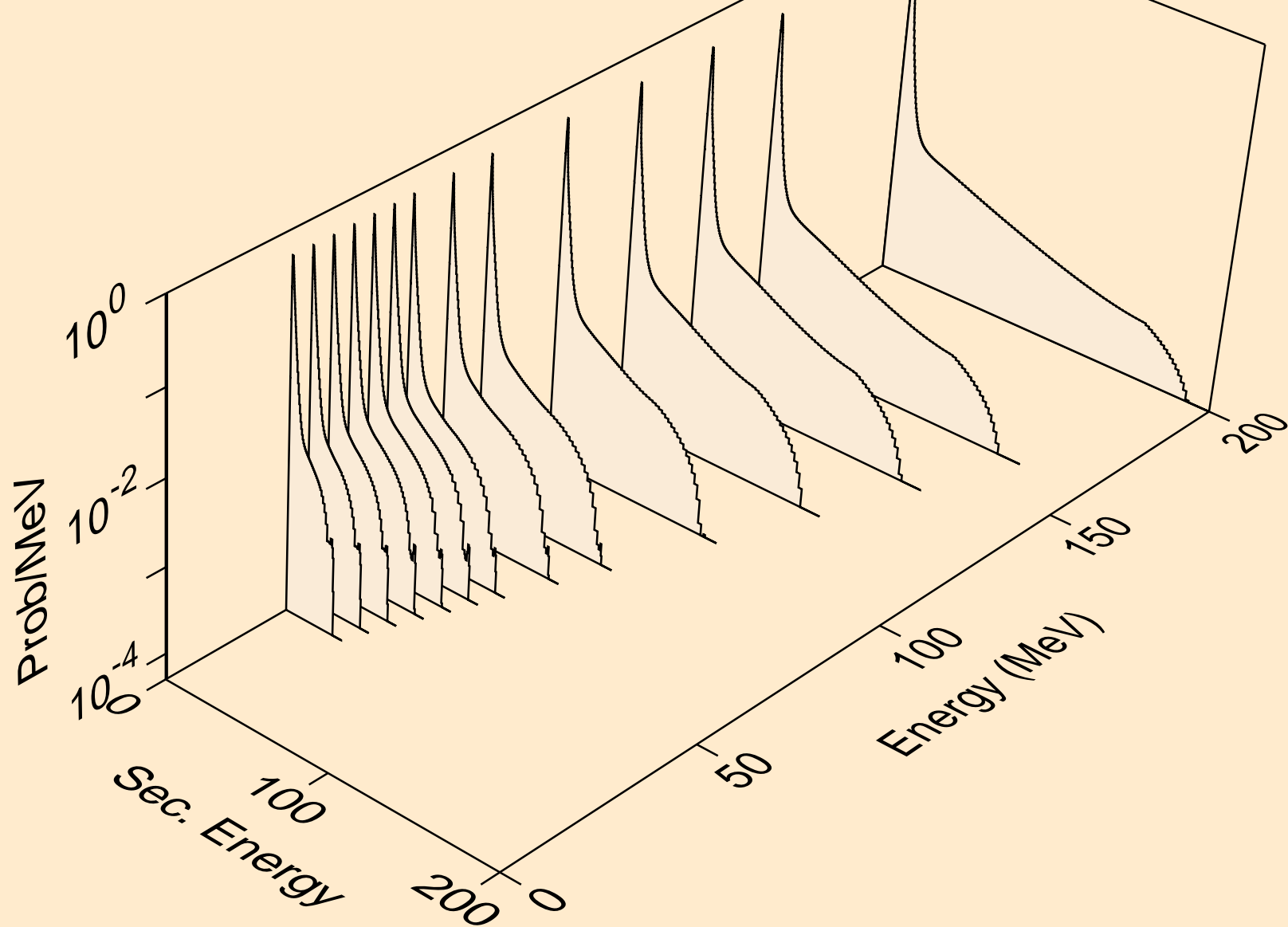

LU172 PROTON ACER TENDL-2023 LIBRARY; T=0.K  
neutrons from (p,2nd)

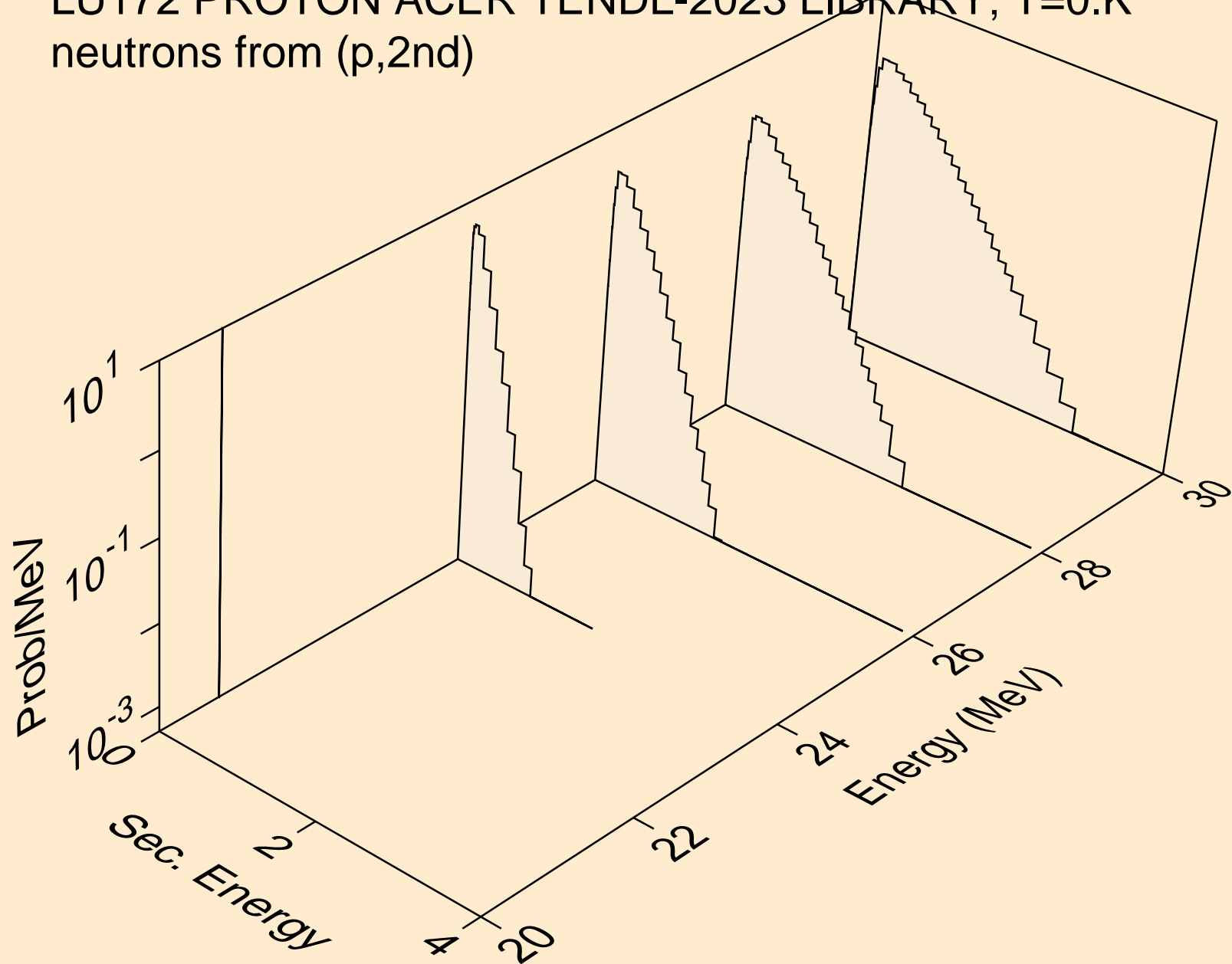



LU172 PROTON ACER TENDL-2023 LIBRARY; T=0.K  
neutrons from (p,2n)

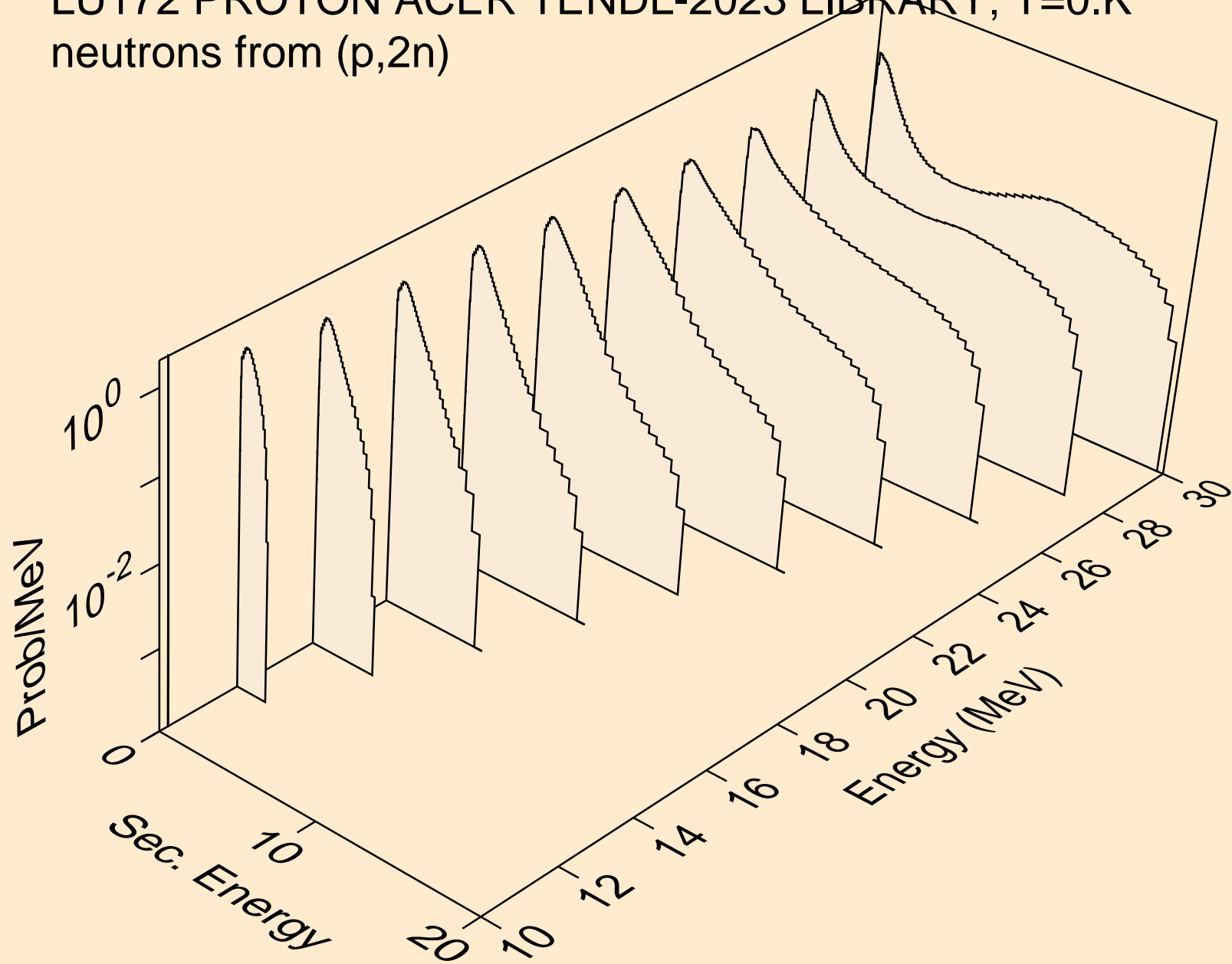

LU172 PROTON ACER TENDL-2023 LIBRARY; T=0.K  
neutrons from (p,3n)

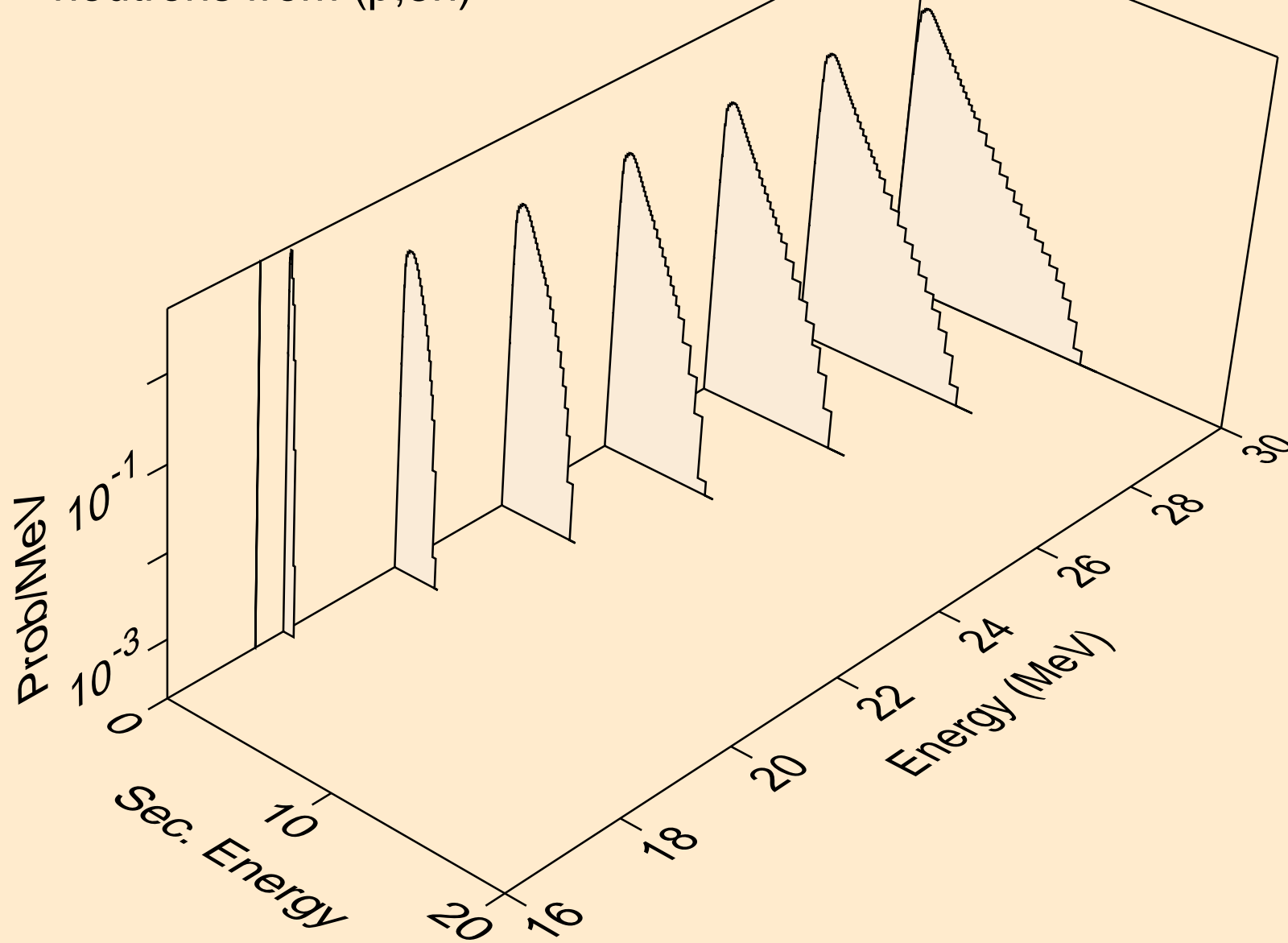

LU172 PROTON ACER TENDL-2023 LIBRARY; T=0.K  
neutrons from (p,n\*)a

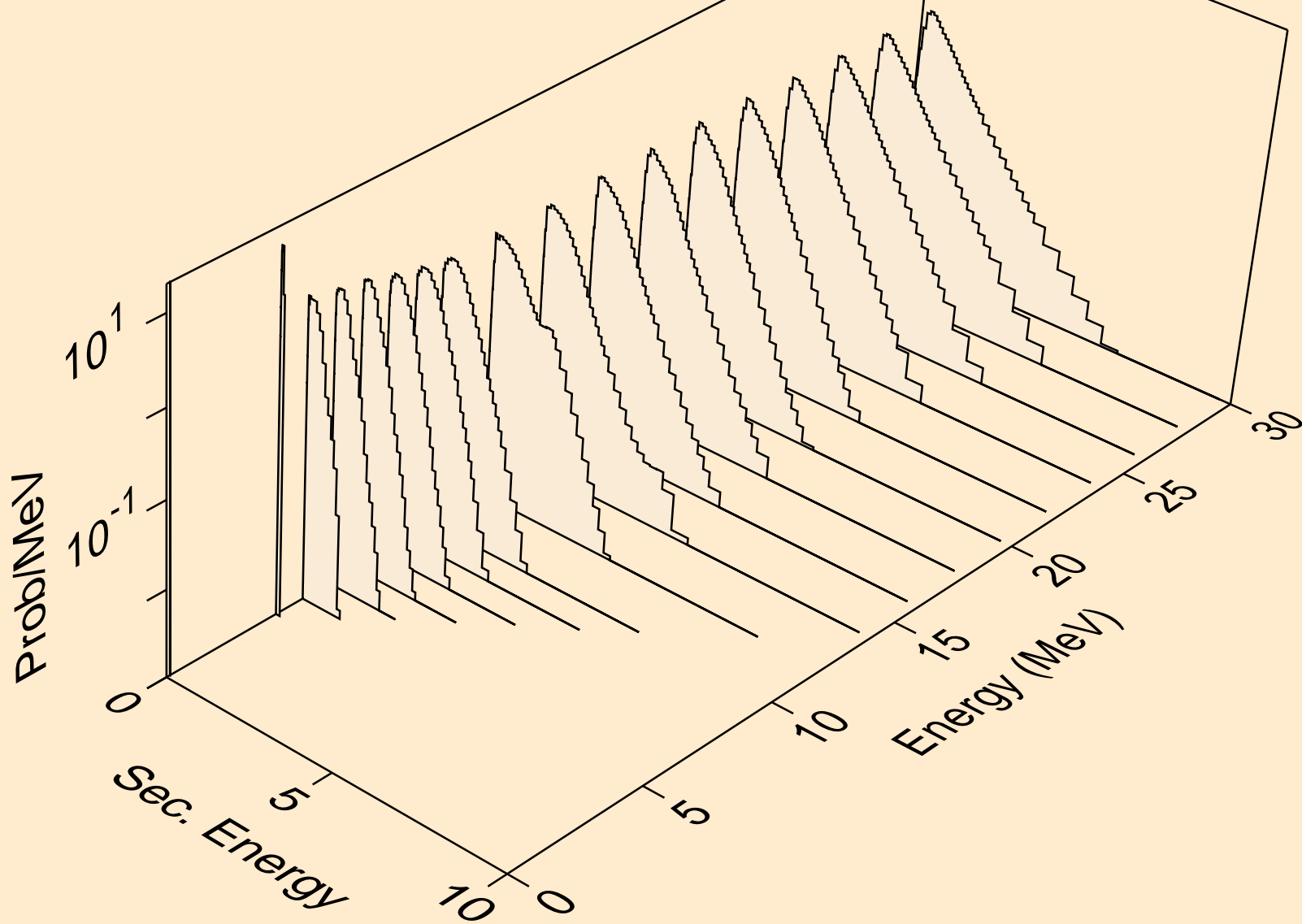

LU172 PROTON ACER TENDL-2023 LIBRARY; T=0.K  
neutrons from (p,2n)a

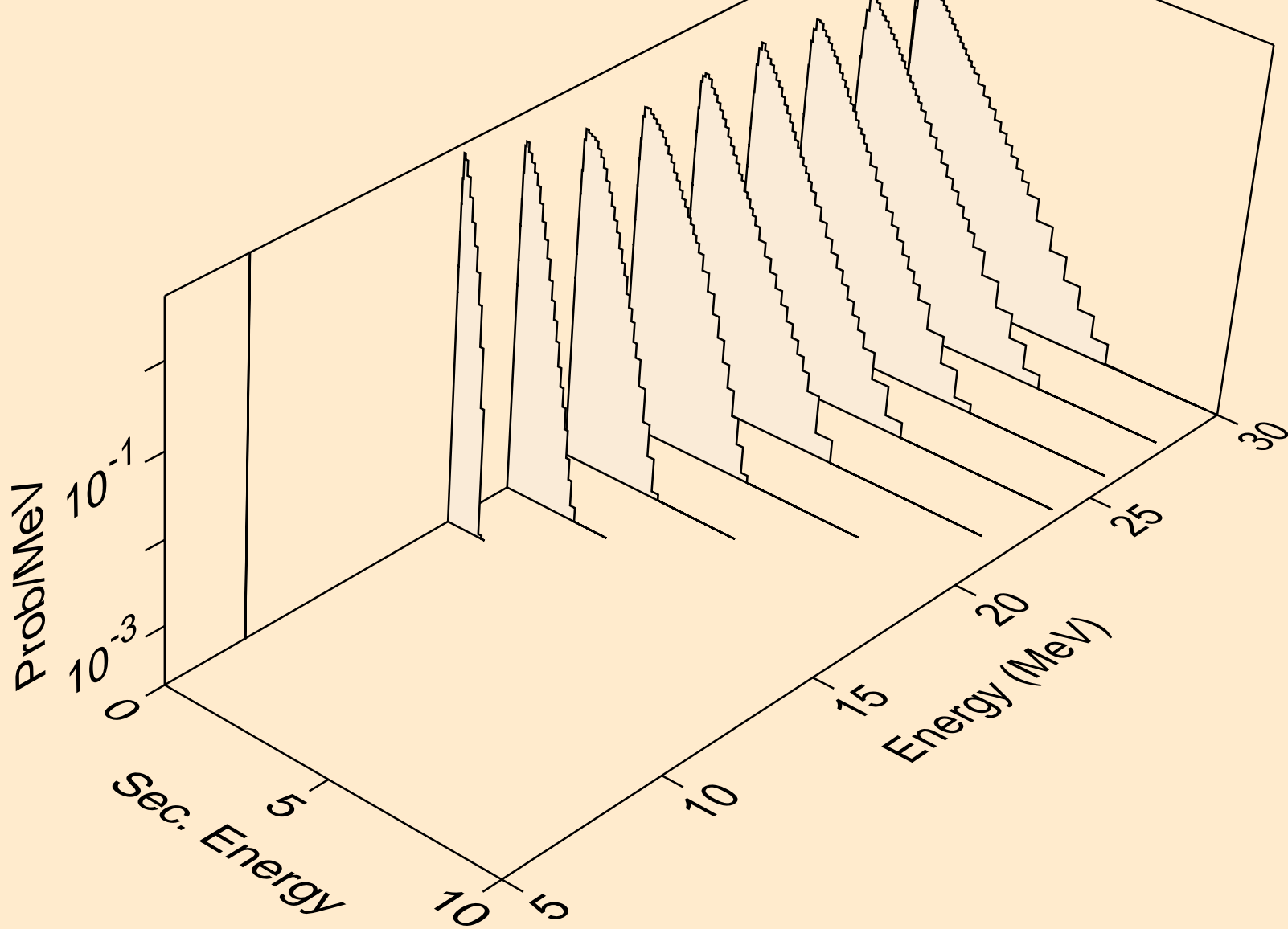

LU172 PROTON ACER TENDL-2023 LIBRARY; T=0.K  
neutrons from (p,3n)a

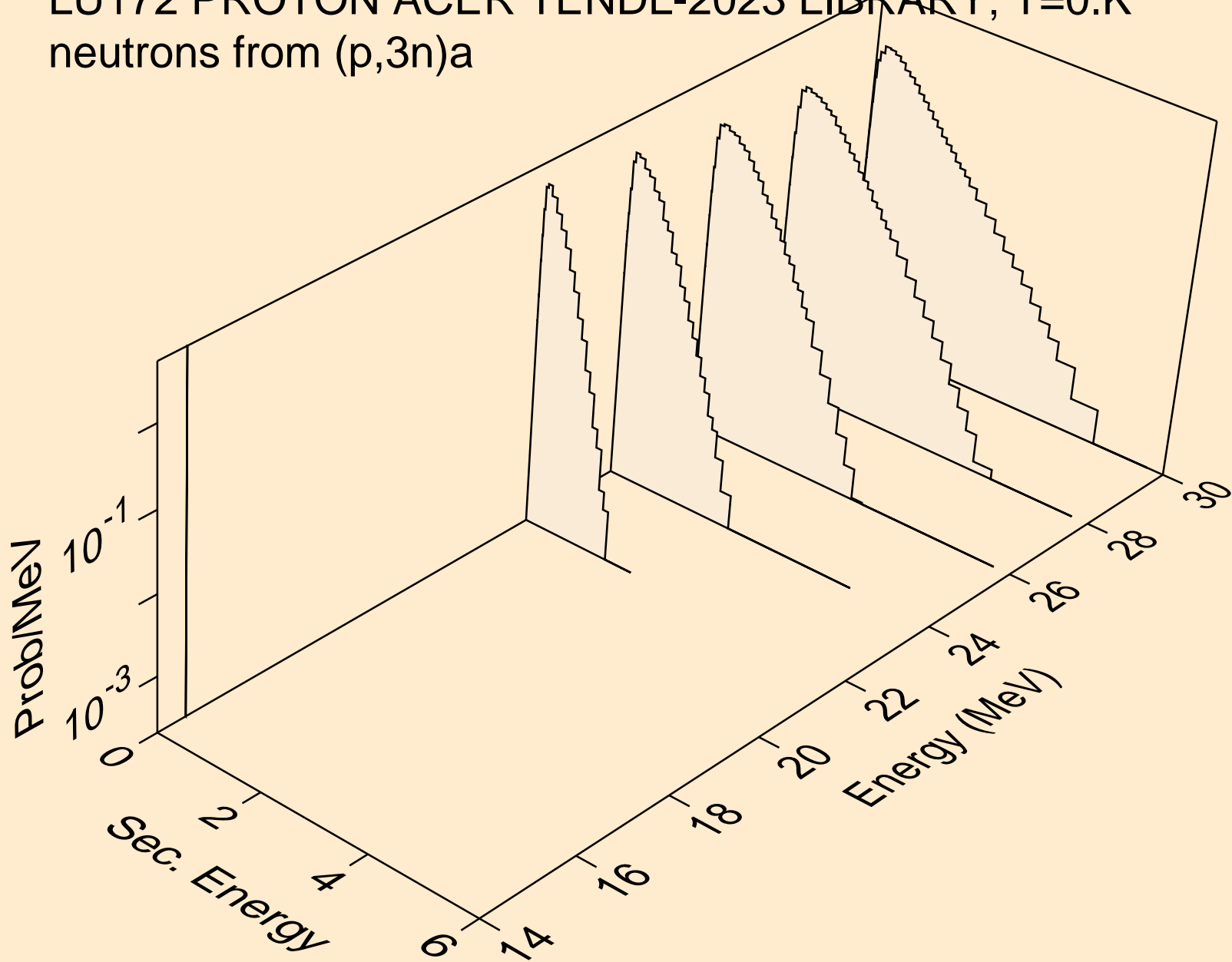

LU172 PROTON ACER TENDL-2023 LIBRARY; T=0.K  
neutrons from (p,n\*)p

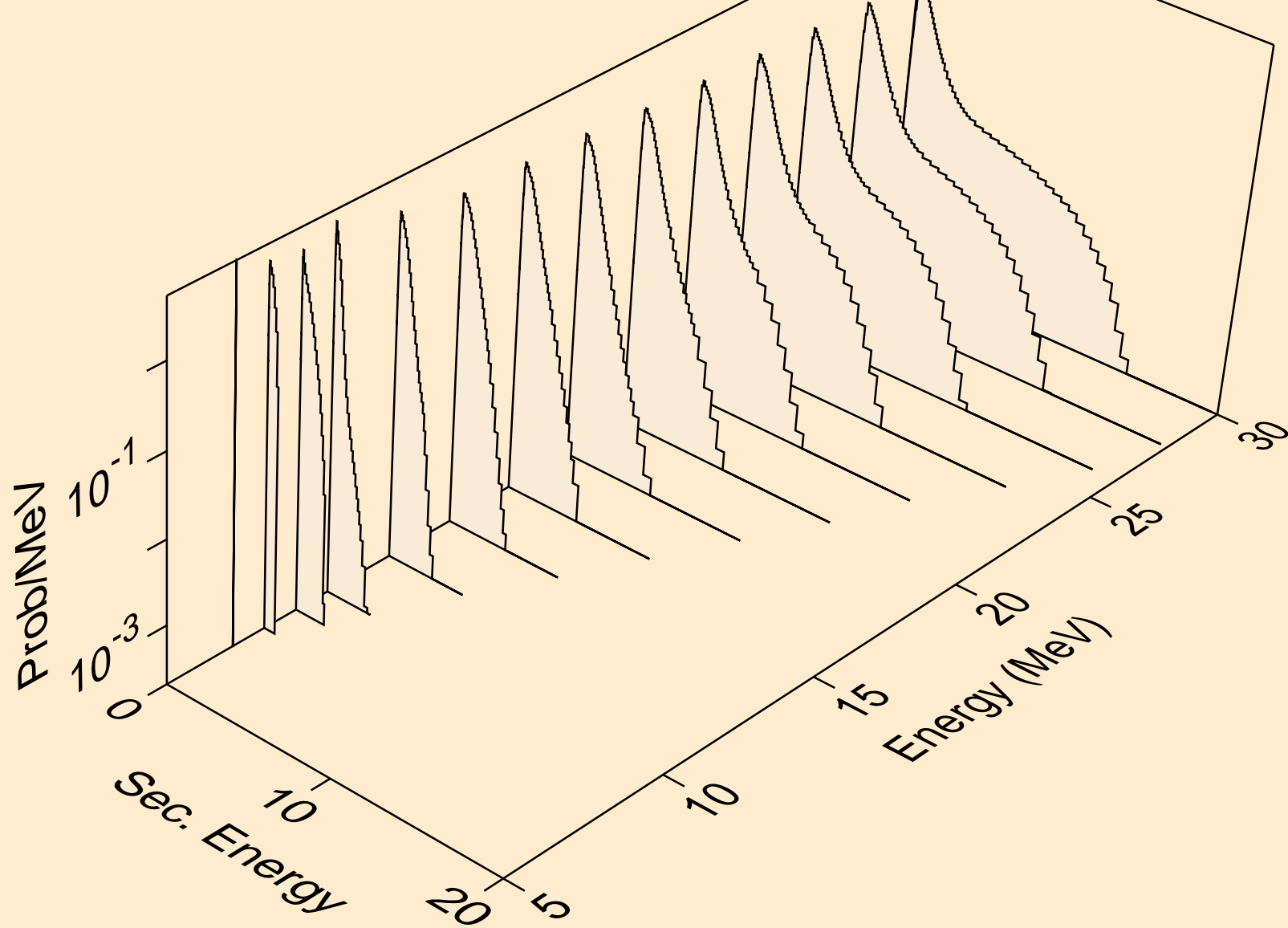

LU172 PROTON ACER TENDL-2023 LIBRARY; T=0.K  
neutrons from (p,n\*)2a

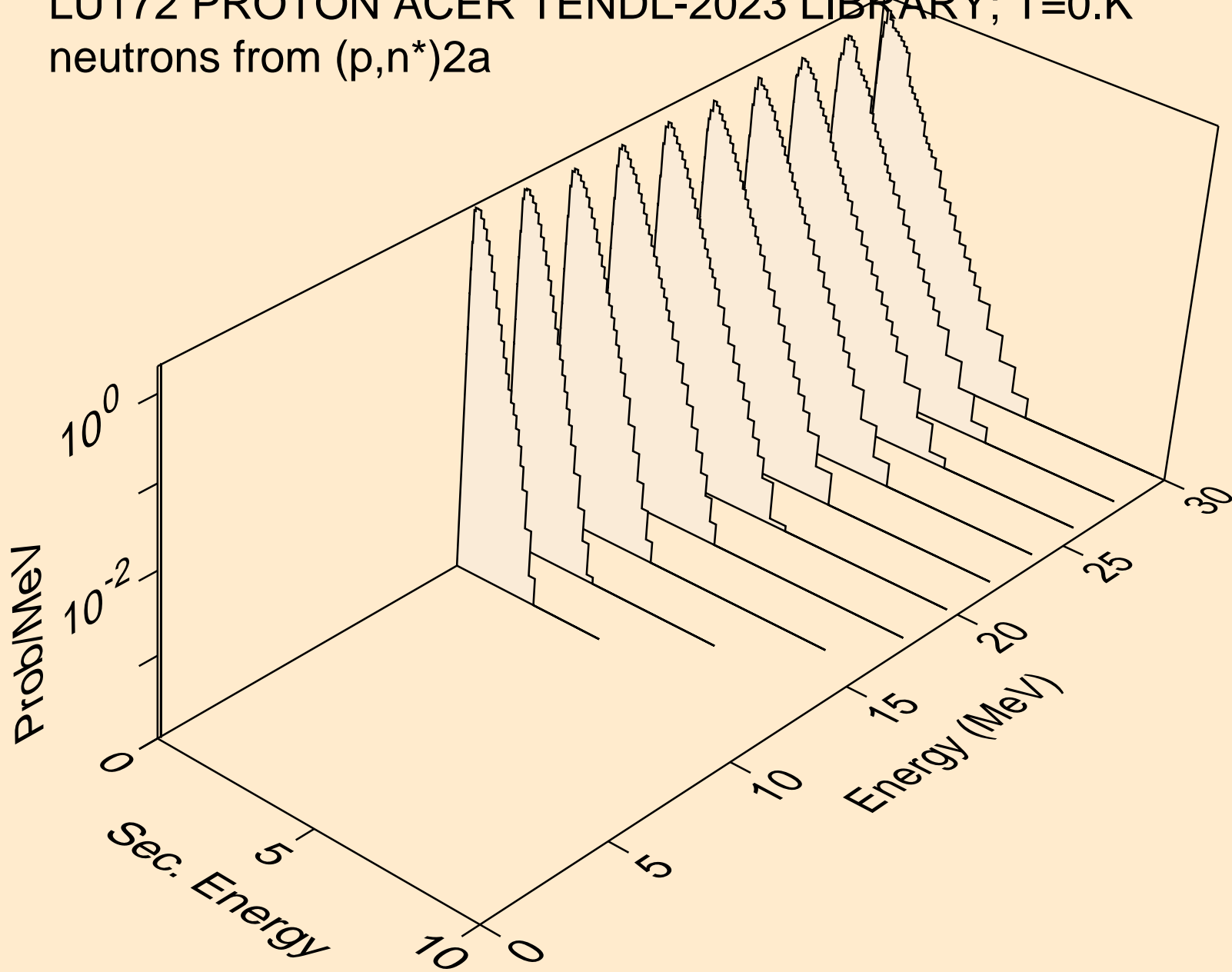

LU172 PROTON ACER TENDL-2023 LIBRARY; T=0.K  
neutrons from (p,n\*)d

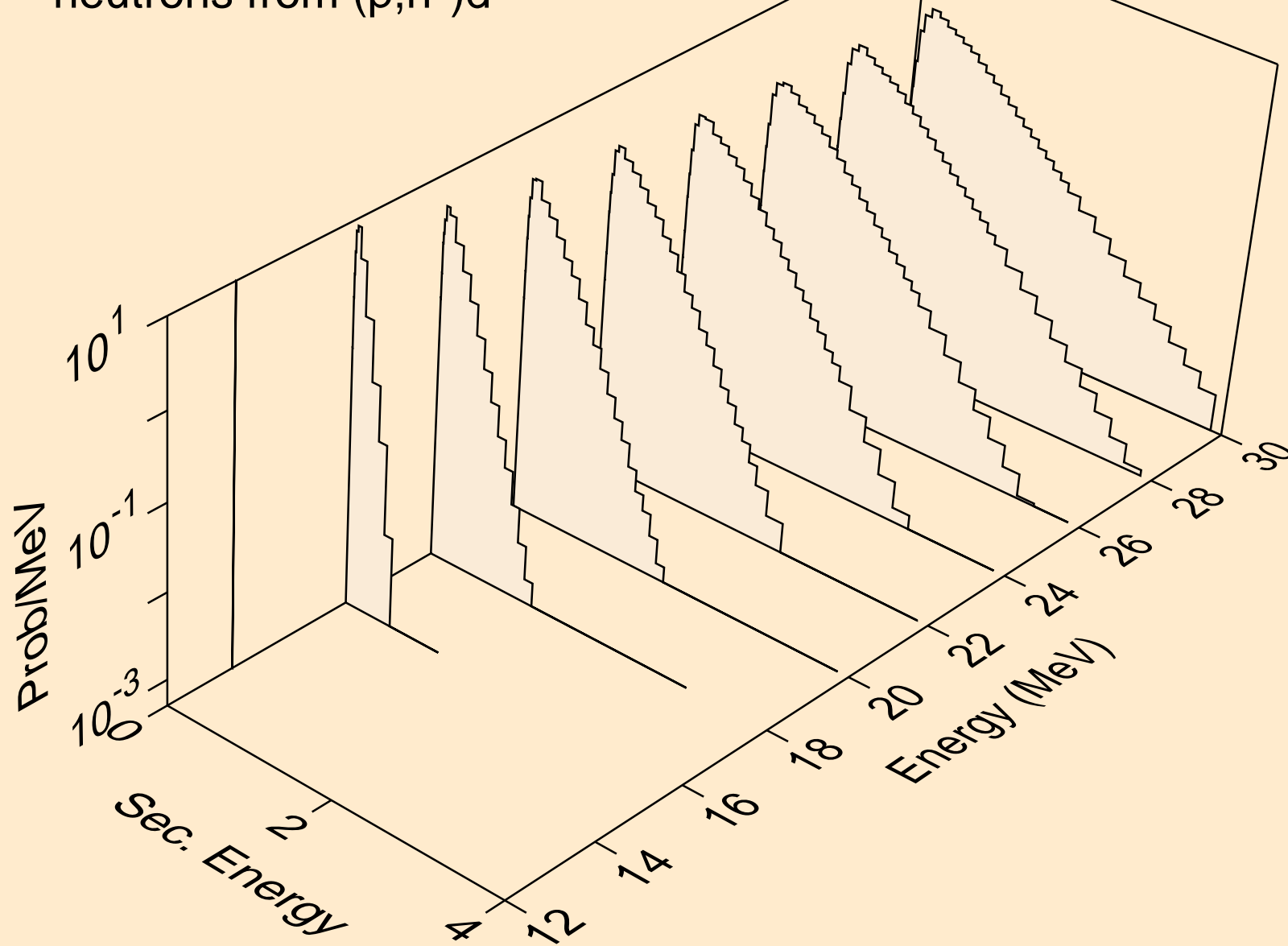



LU172 PROTON ACER TENDL-2023 LIBRARY; T=0.K  
neutrons from (p,n\*)t

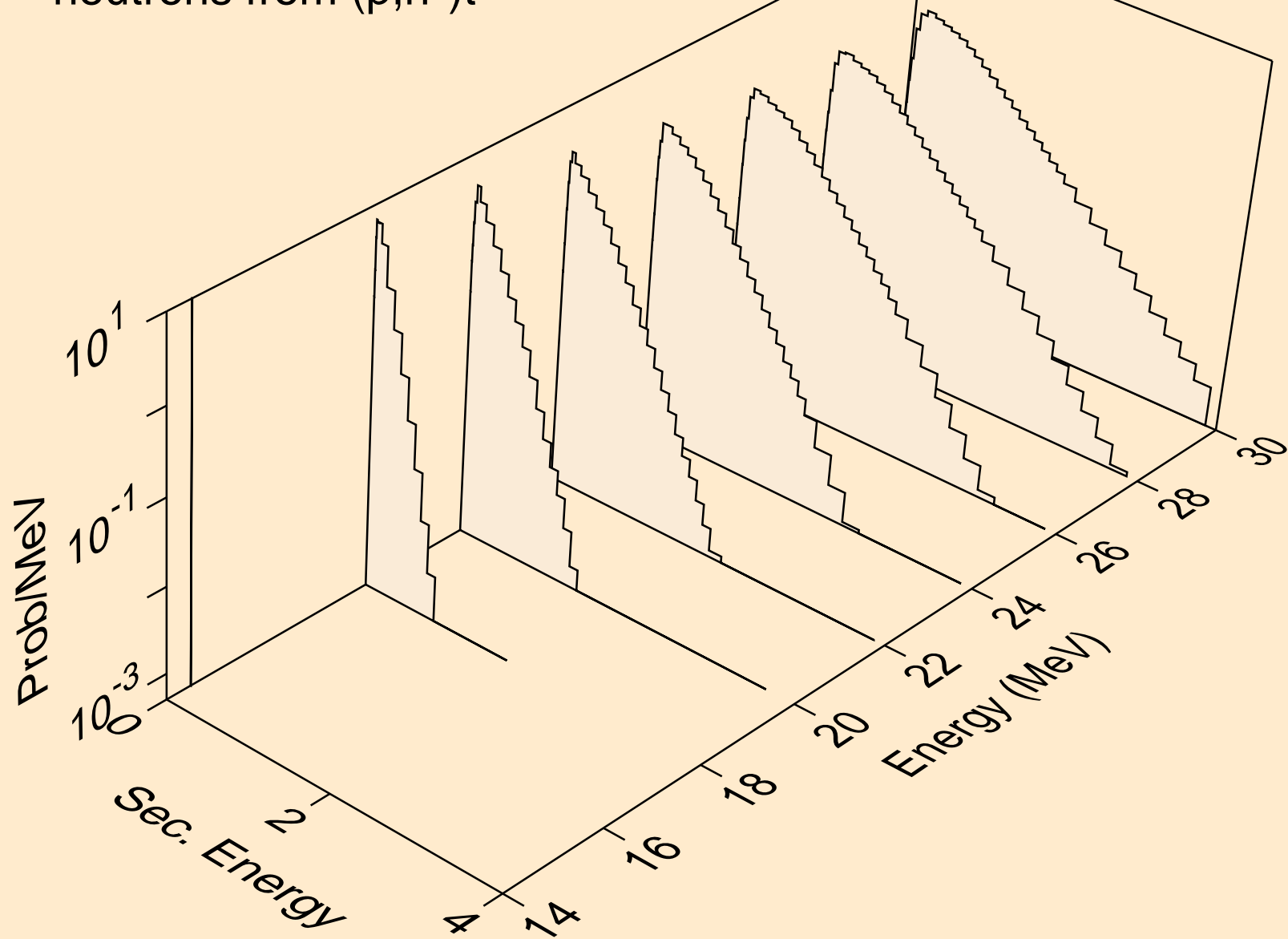

LU172 PROTON ACER TENDL-2023 LIBRARY; T=0.K  
neutrons from (p,n\*)he3

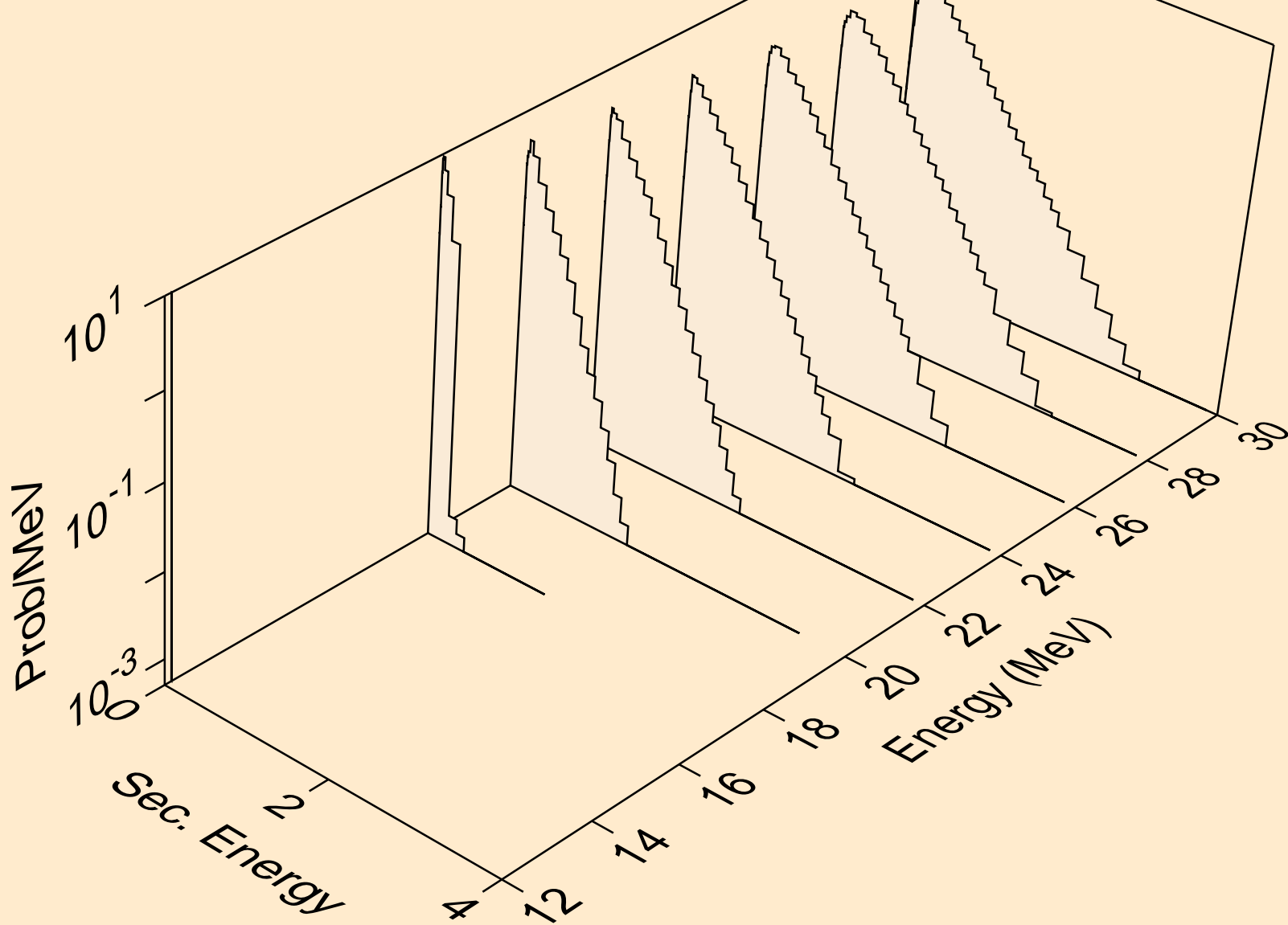

LU172 PROTON ACER TENDL-2023 LIBRARY; T=0.K  
neutrons from (p,4n)

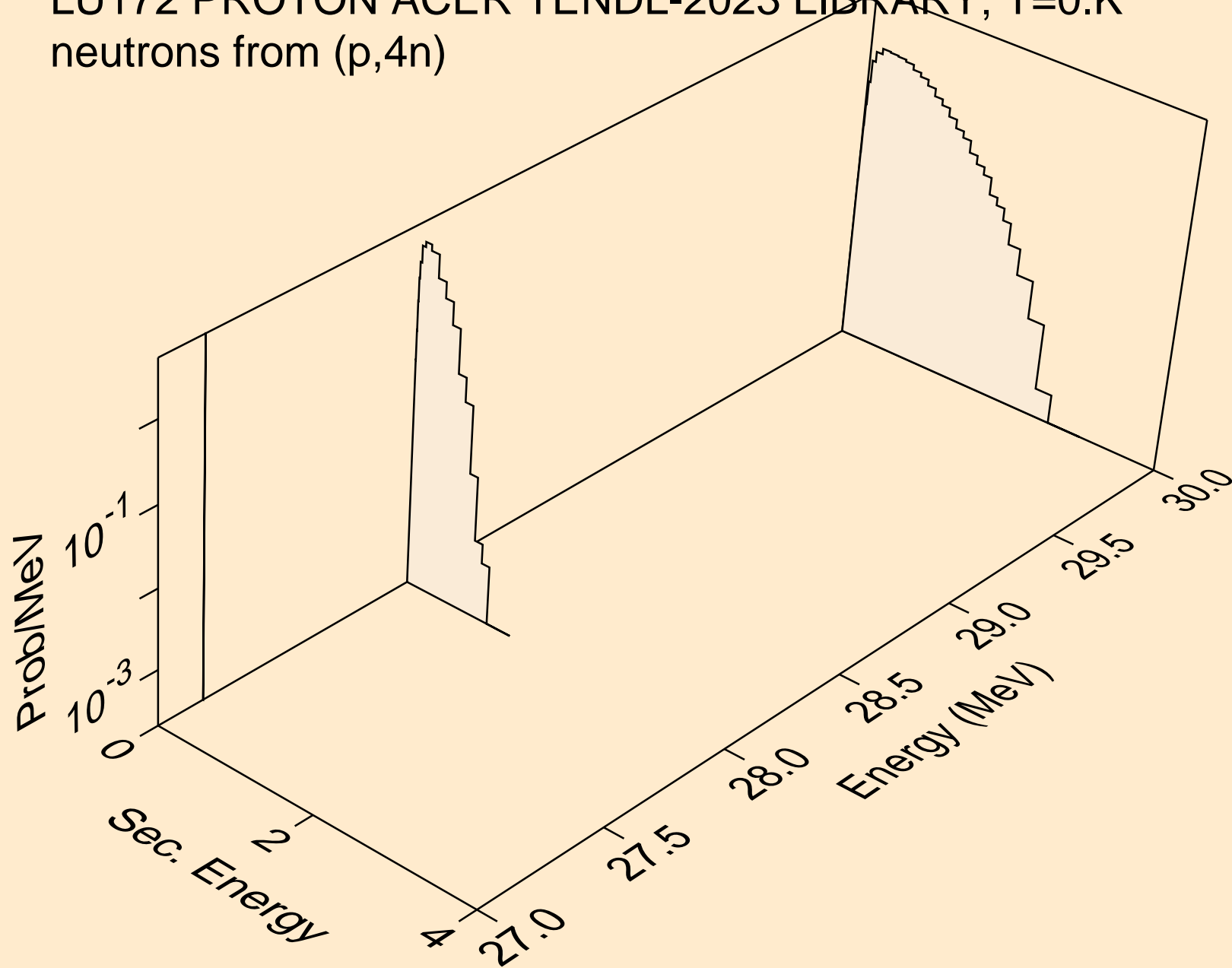

LU172 PROTON ACER TENDL-2023 LIBRARY; T=0.K  
neutrons from (p,2np)

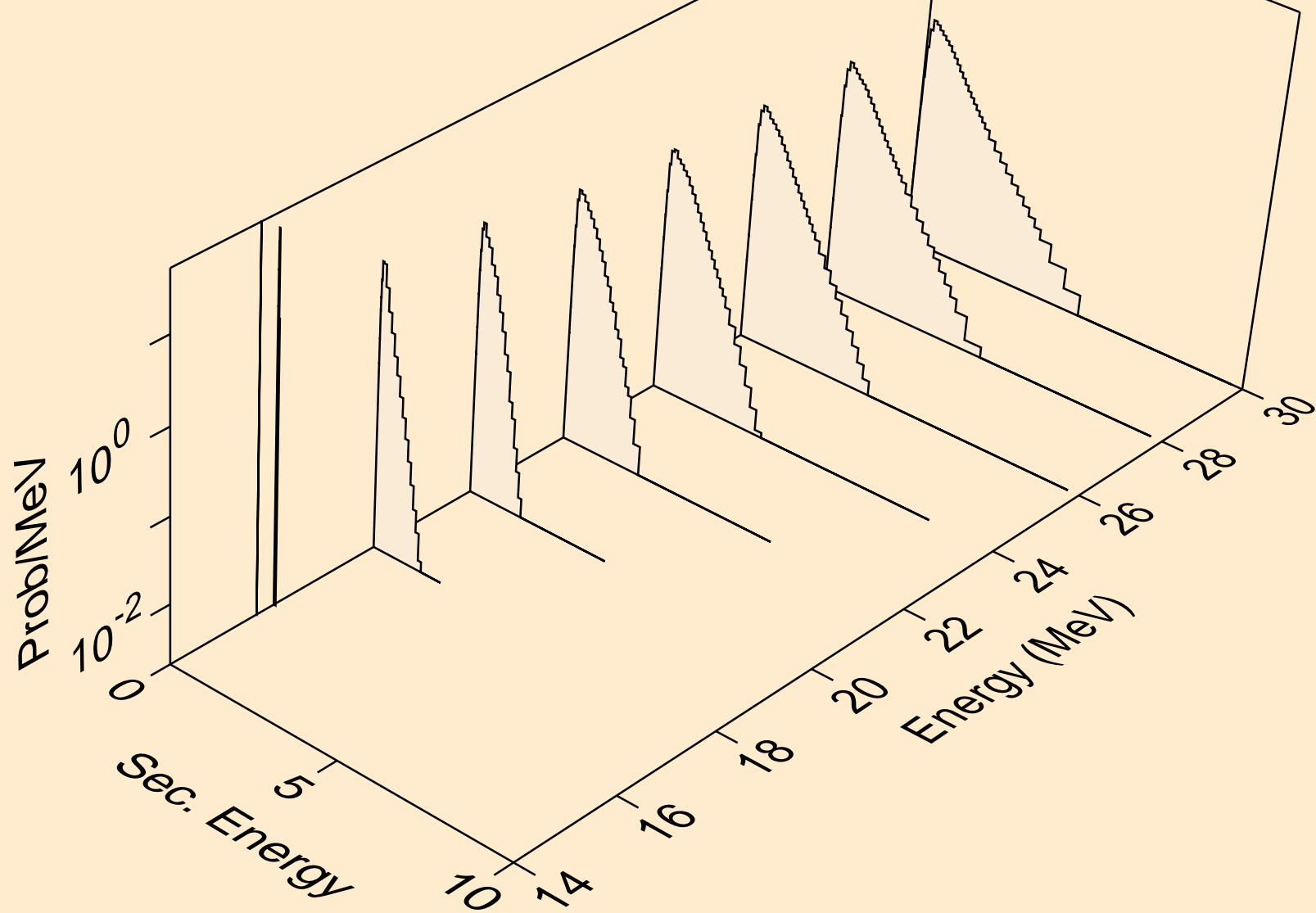

LU172 PROTON ACER TENDL-2023 LIBRARY; T=0.K  
neutrons from (p,3np)

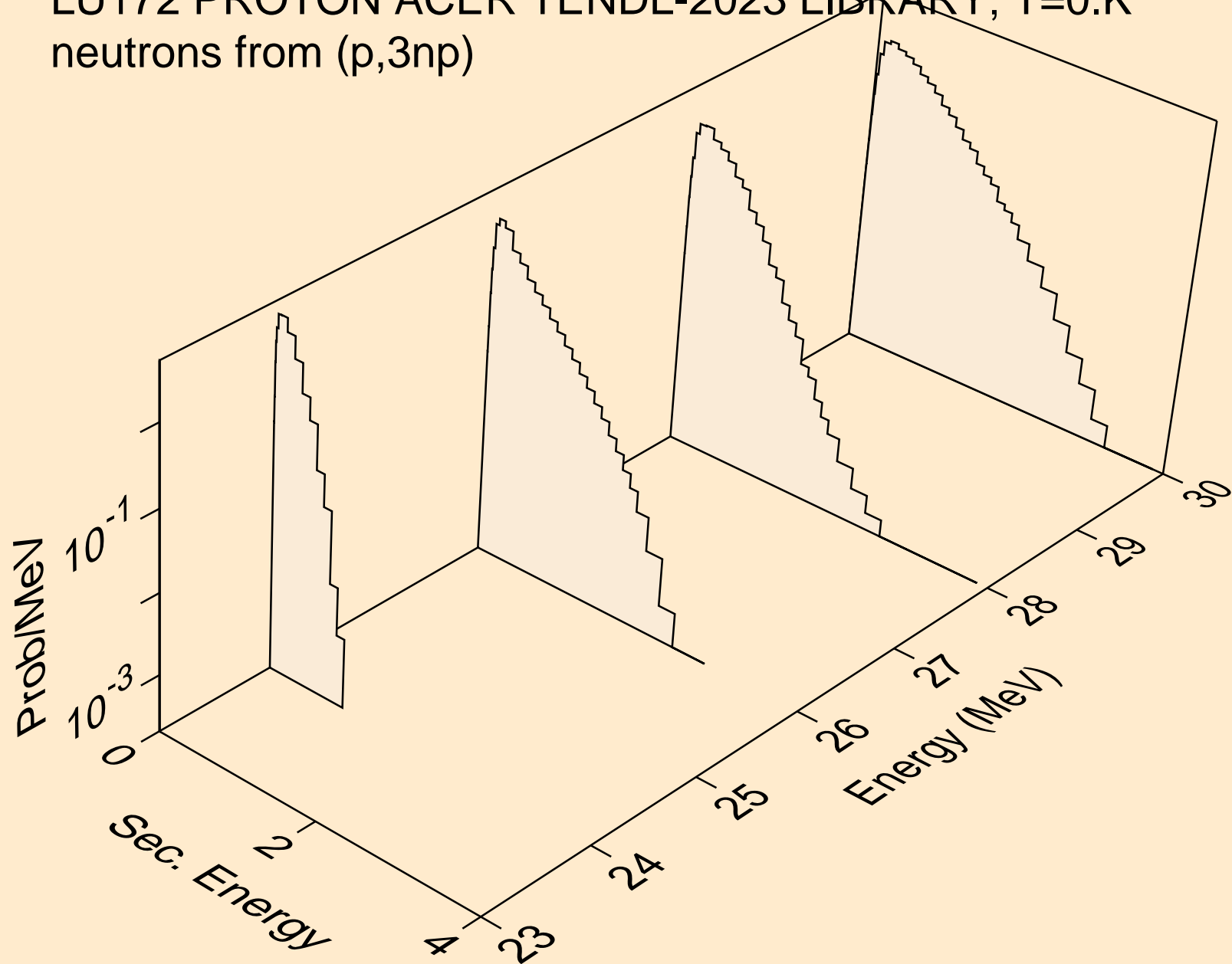

LU172 PROTON ACER TENDL-2023 LIBRARY; T=0.K  
neutrons from (p,n2p)

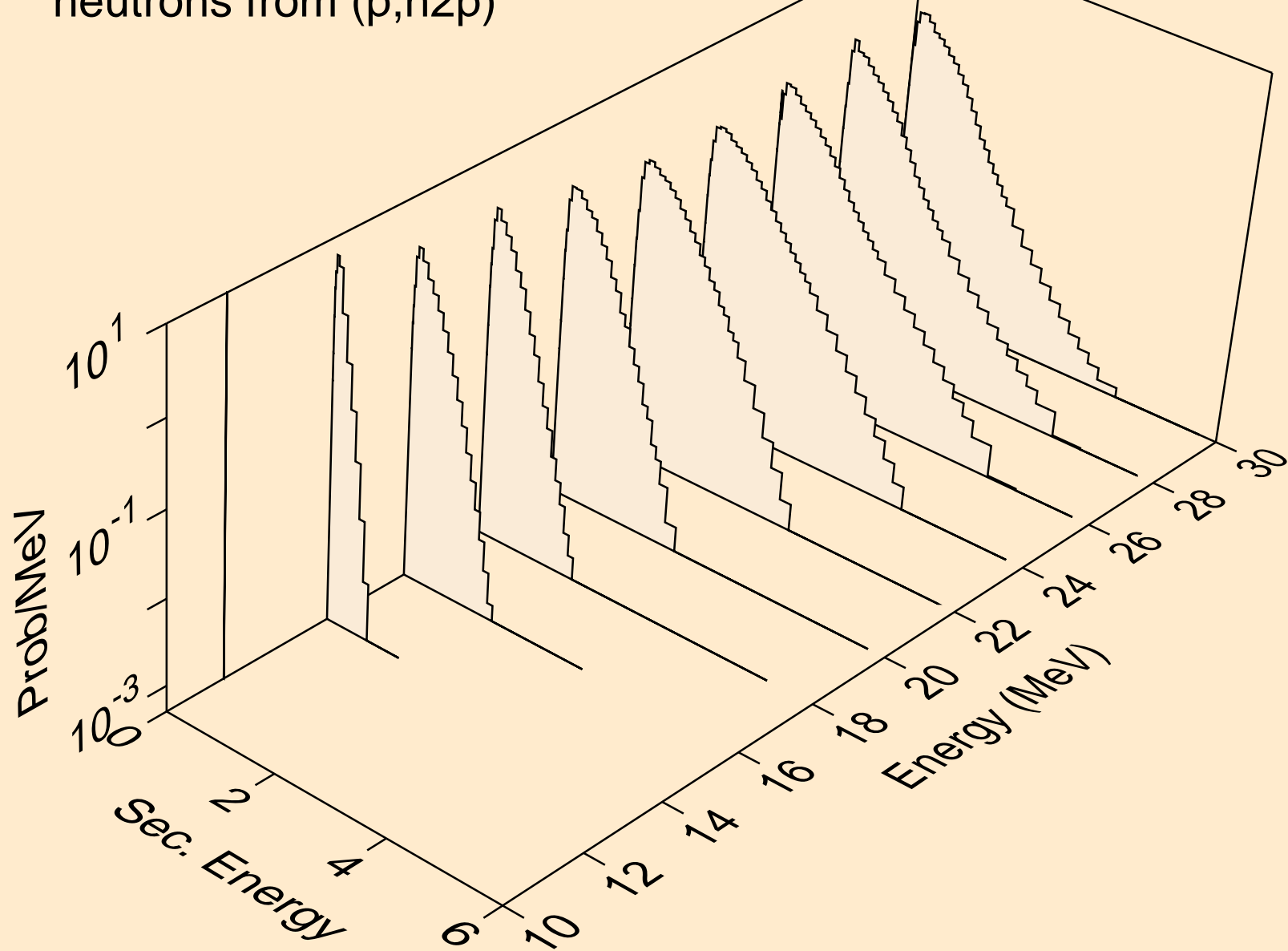

LU172 PROTON ACER TENDL-2023 LIBRARY; T=0.K  
neutrons from (p,npa)

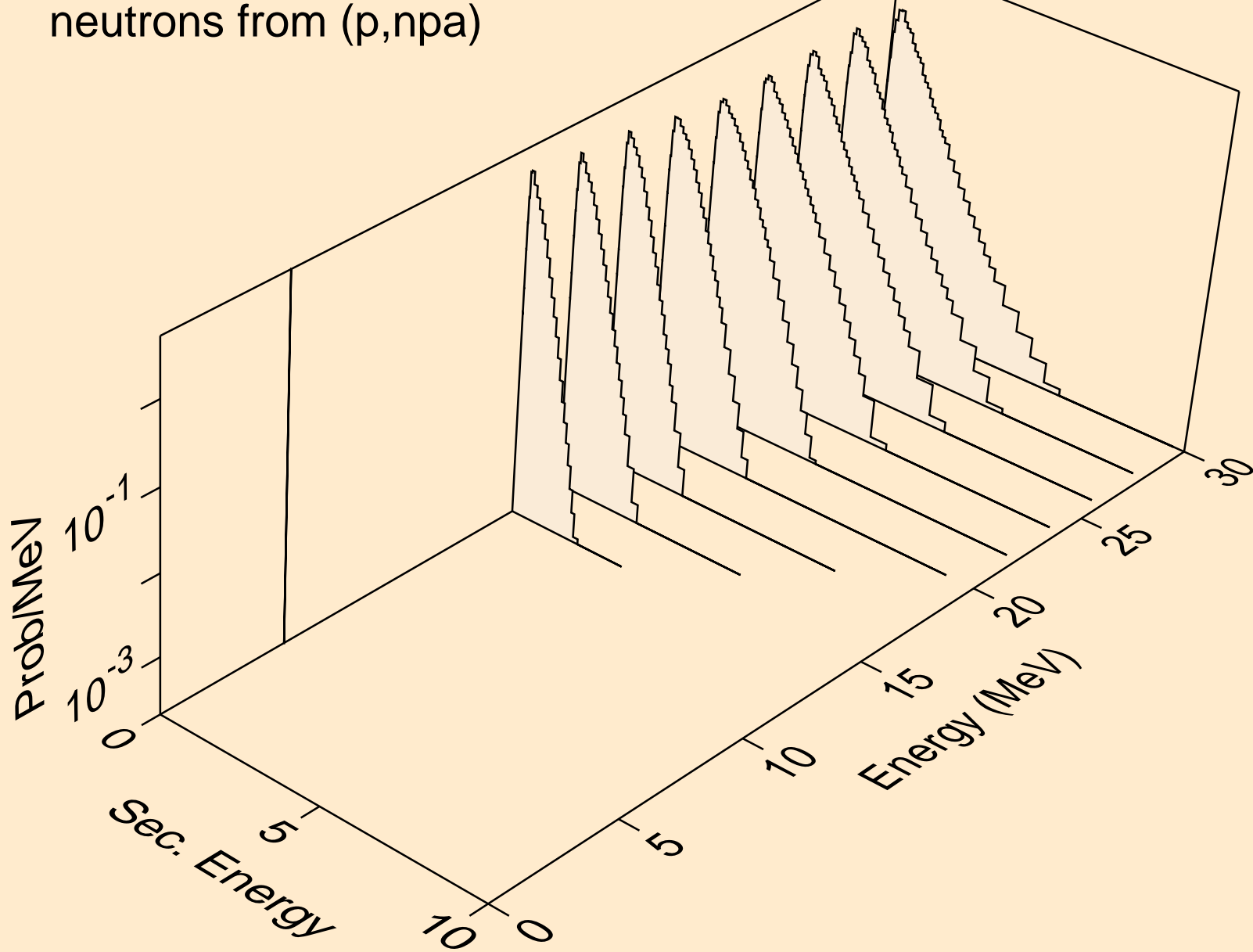

LU172 PROTON ACER TENDL-2023 LIBRARY; T=0.K  
deuterons from (p,x)

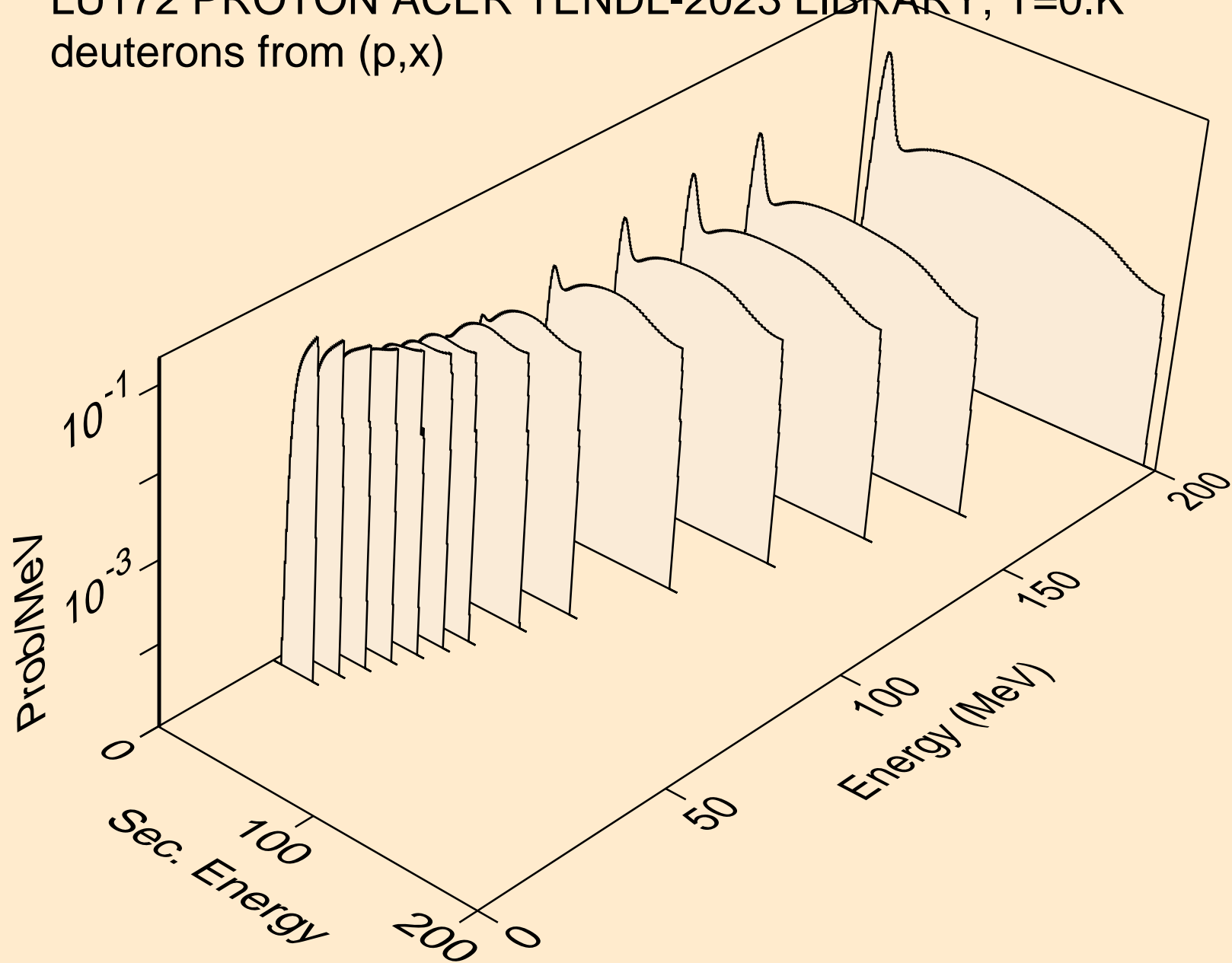



LU172 PROTON ACER TENDL-2023 LIBRARY; T=0.K  
deuterons from (p,2nd)

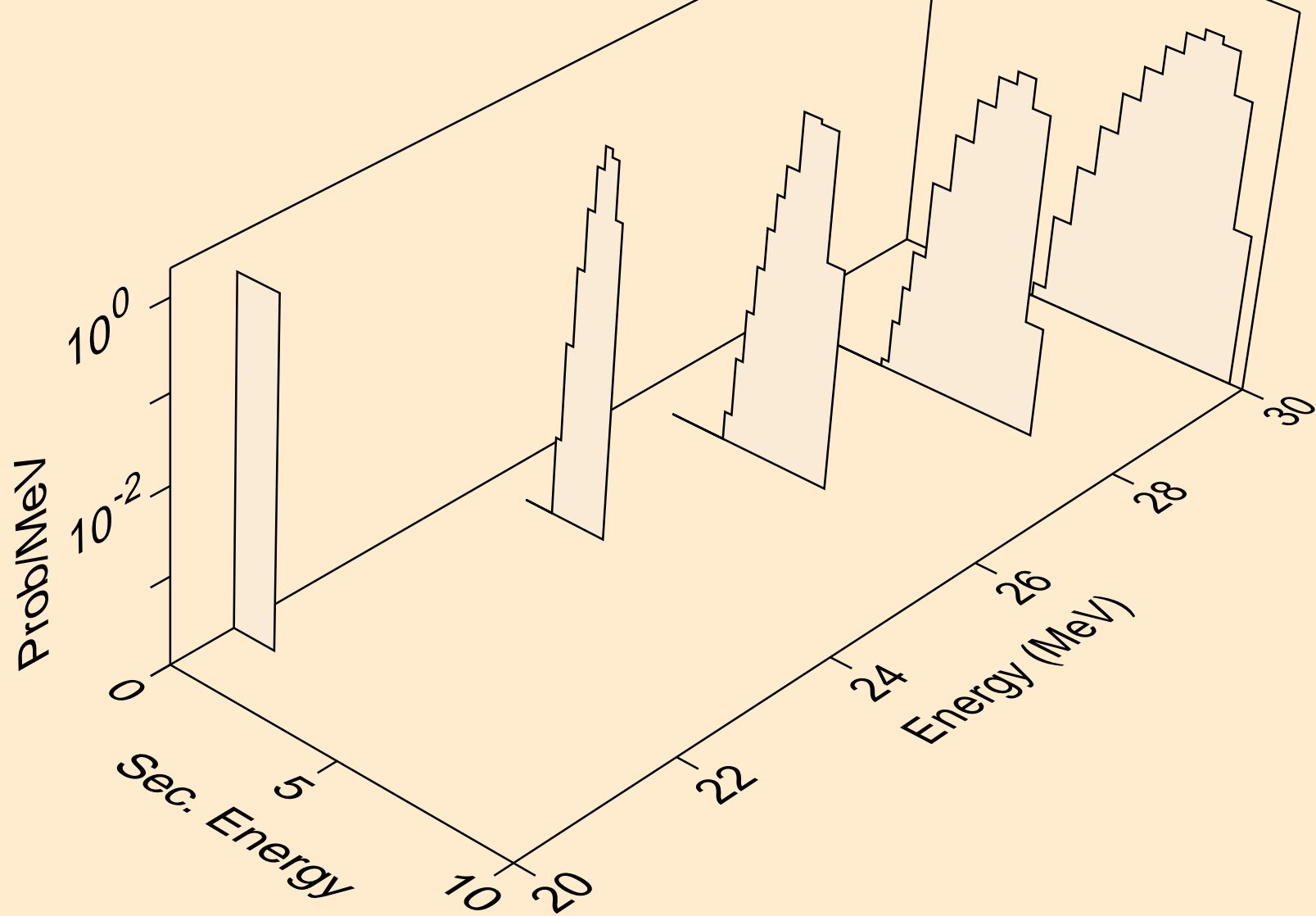

LU172 PROTON ACER TENDL-2023 LIBRARY; T=0.K  
deuterons from (p,n\*)d

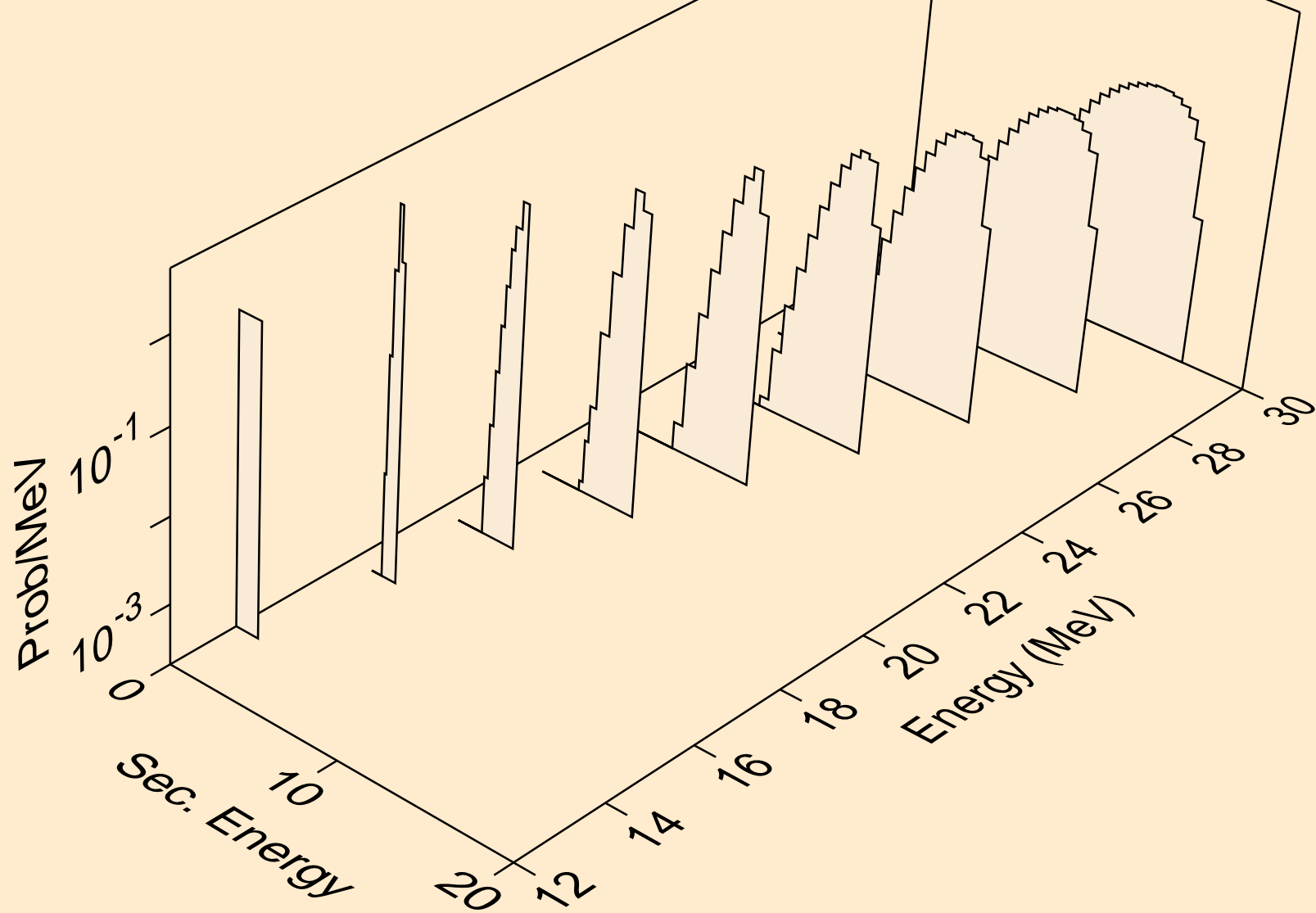

LU172 PROTON ACER TENDL-2023 LIBRARY; T=0.K  
deuterons from (p,d)

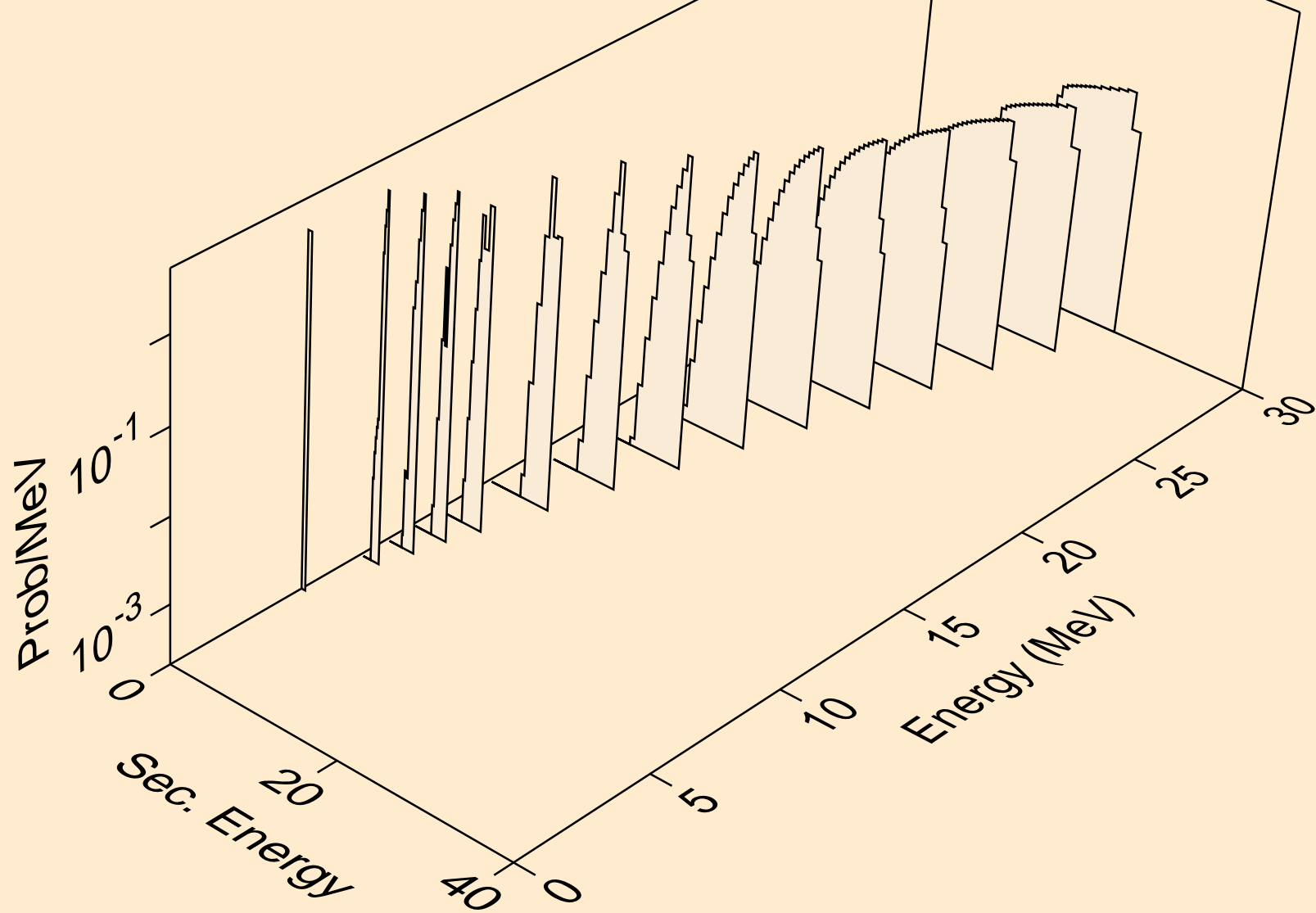

LU172 PROTON ACER TENDL-2023 LIBRARY; T=0.K  
deuterons from (p,pd)

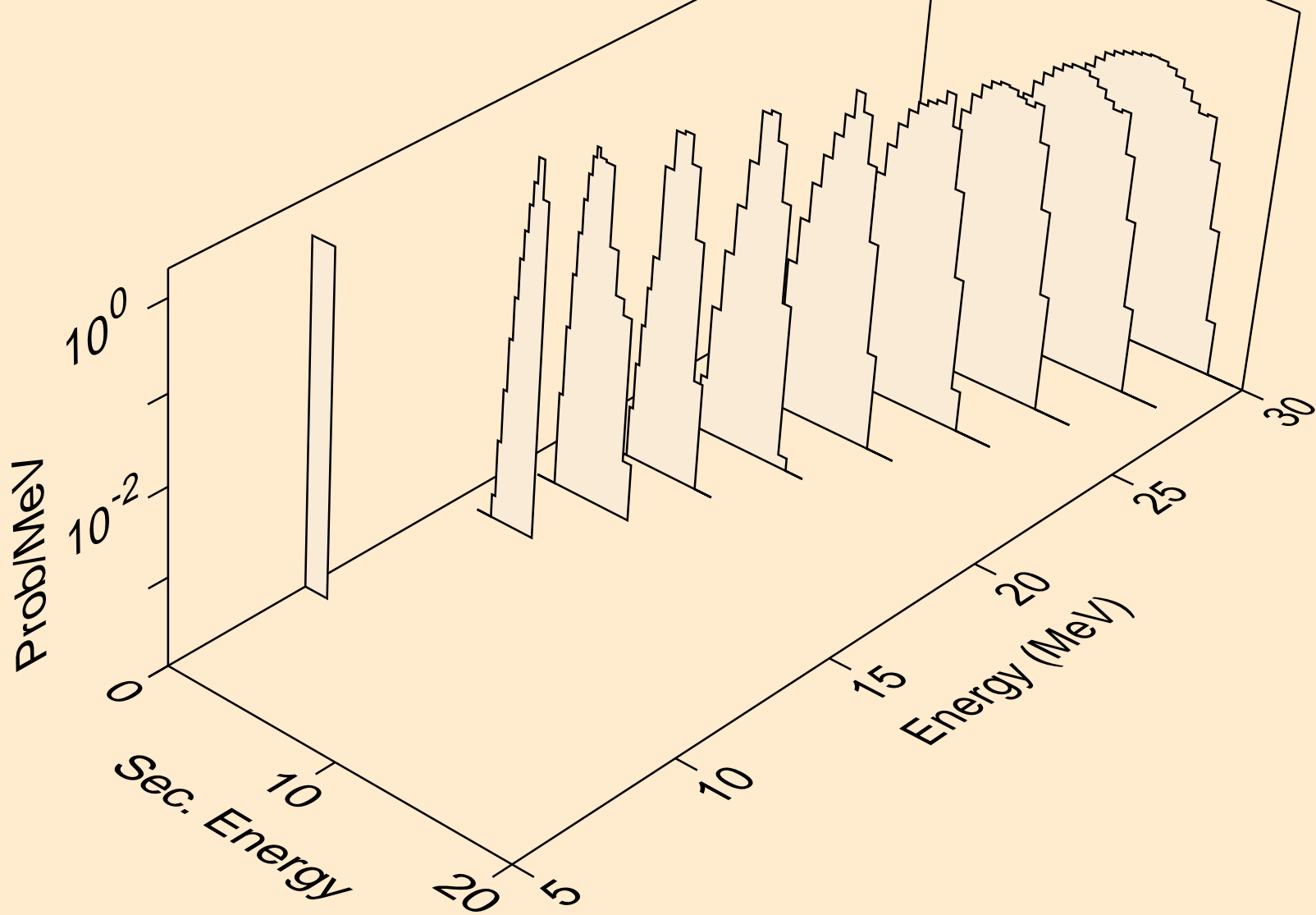

LU172 PROTON ACER TENDL-2023 LIBRARY; T=0.K  
deuterons from (p,da)

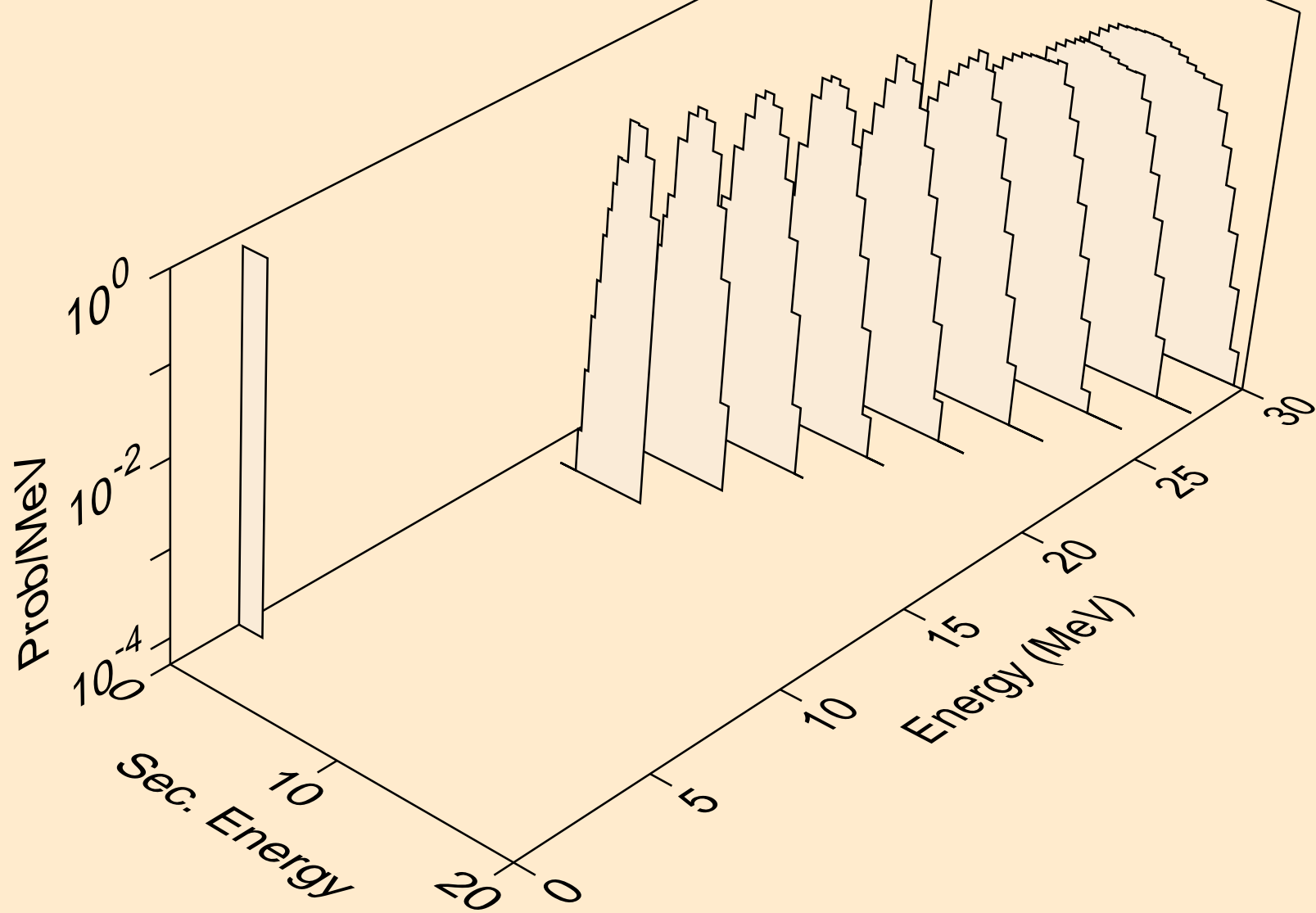

LU172 PROTON ACER TENDL-2023 LIBRARY; T=0.K  
tritons from (p,x)

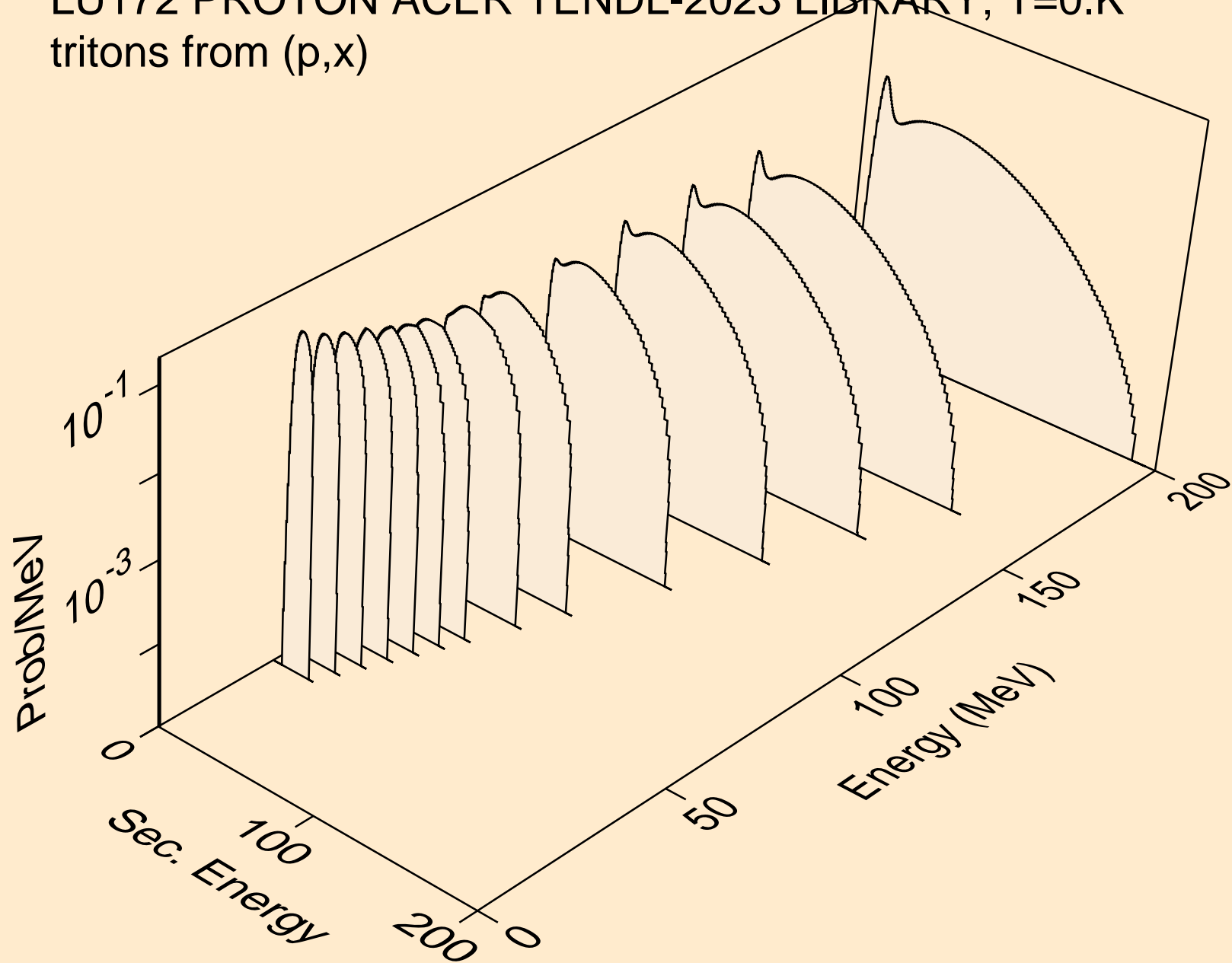

LU172 PROTON ACER TENDL-2023 LIBRARY; T=0.K  
tritons from (p,n\*)t

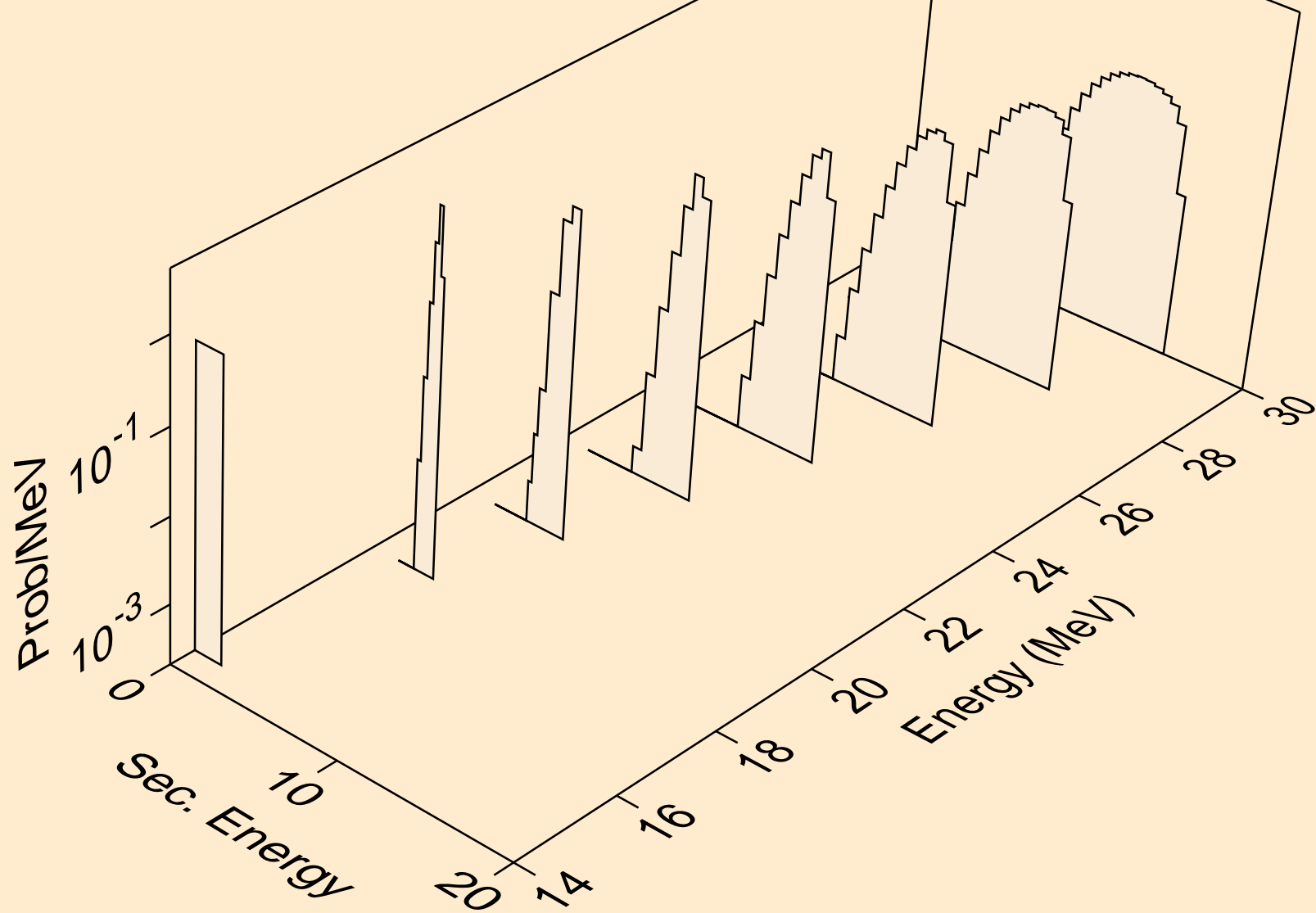

LU172 PROTON ACER TENDL-2023 LIBRARY; T=0.K  
tritons from (p,t)

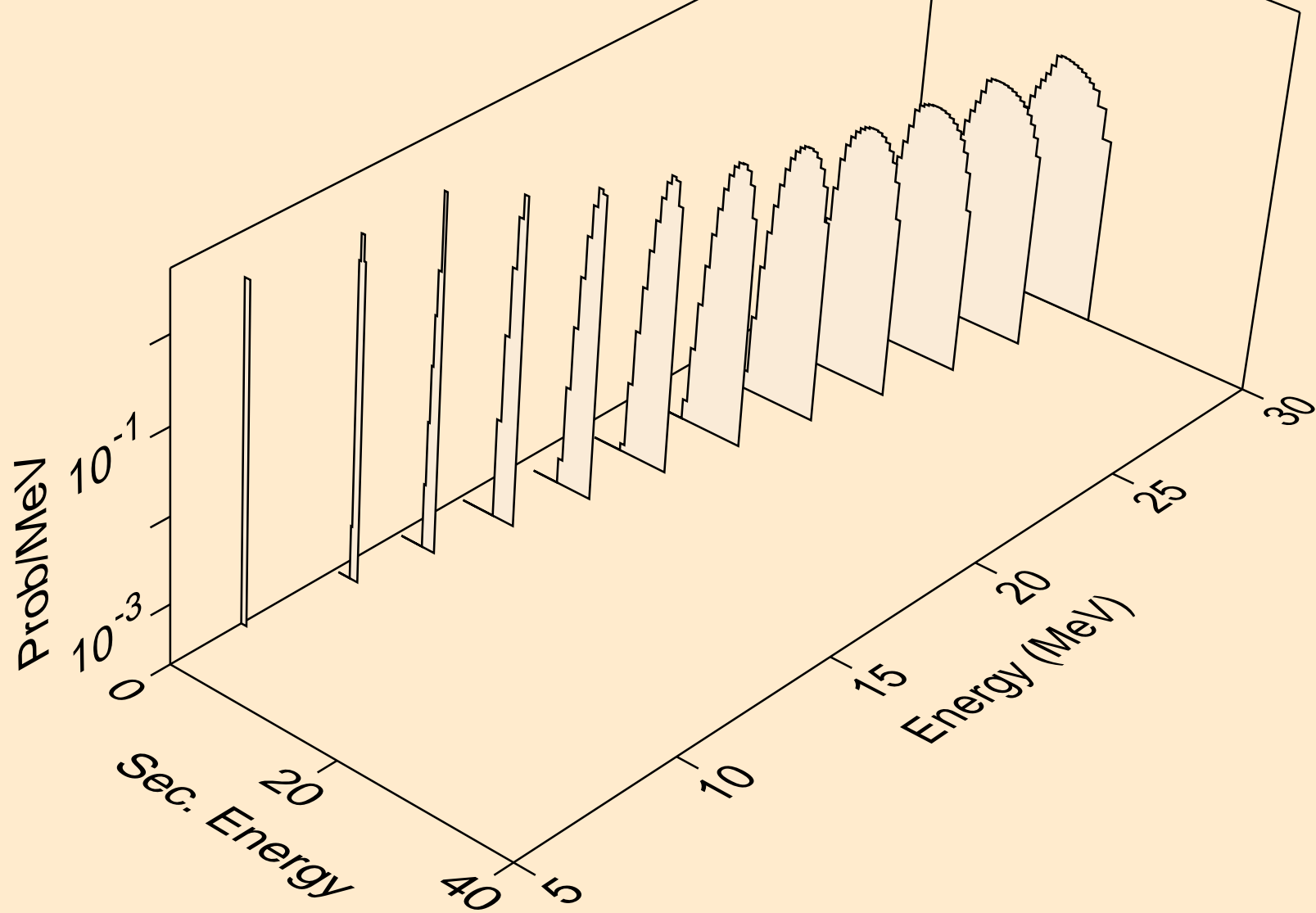



LU172 PROTON ACER TENDL-2023 LIBRARY; T=0.K  
tritons from (p,pt)

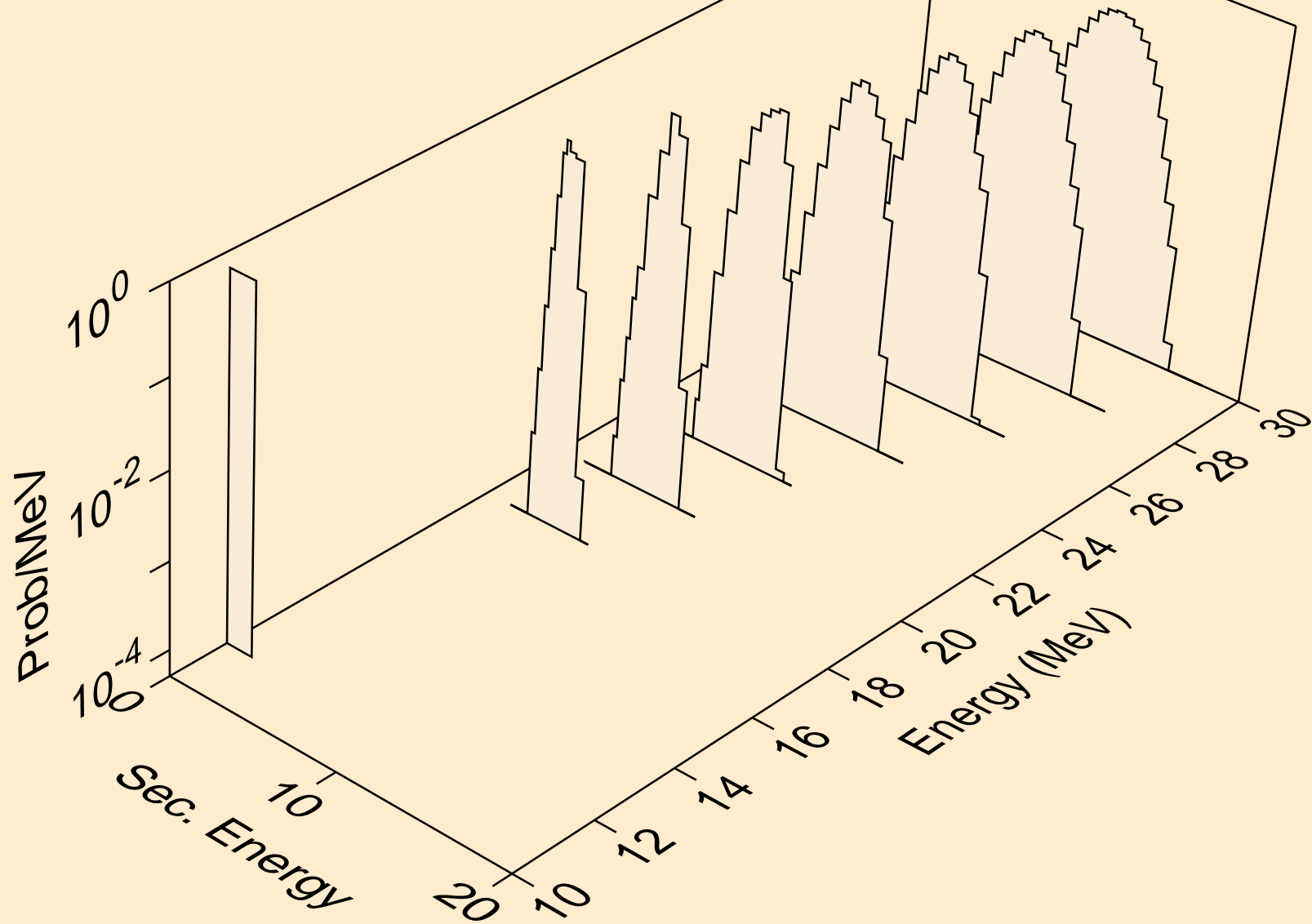

LU172 PROTON ACER TENDL-2023 LIBRARY; T=0.K  
he3s from (p,x)

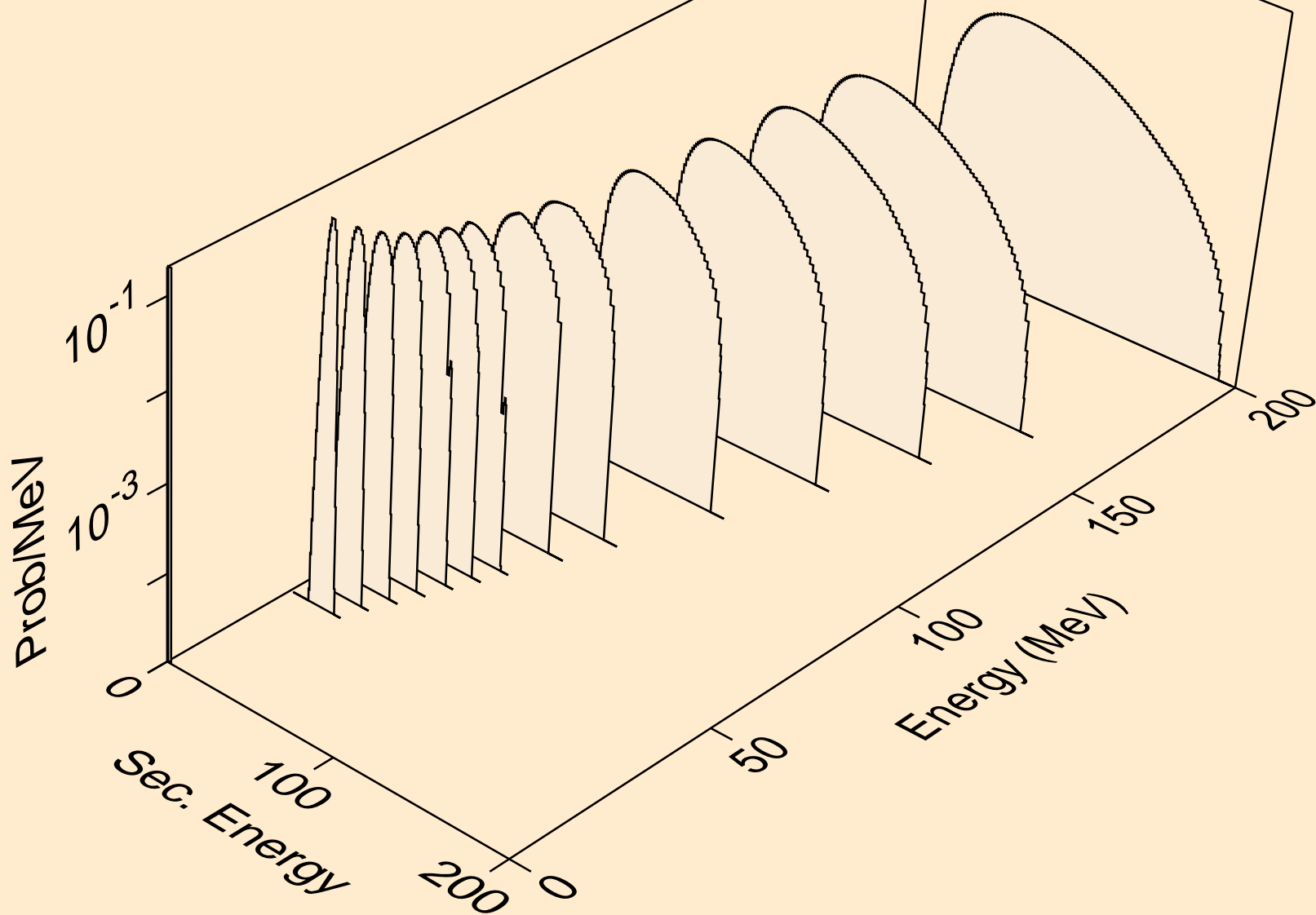

LU172 PROTON ACER TENDL-2023 LIBRARY; T=0.K  
he3s from (p,n\*)he3

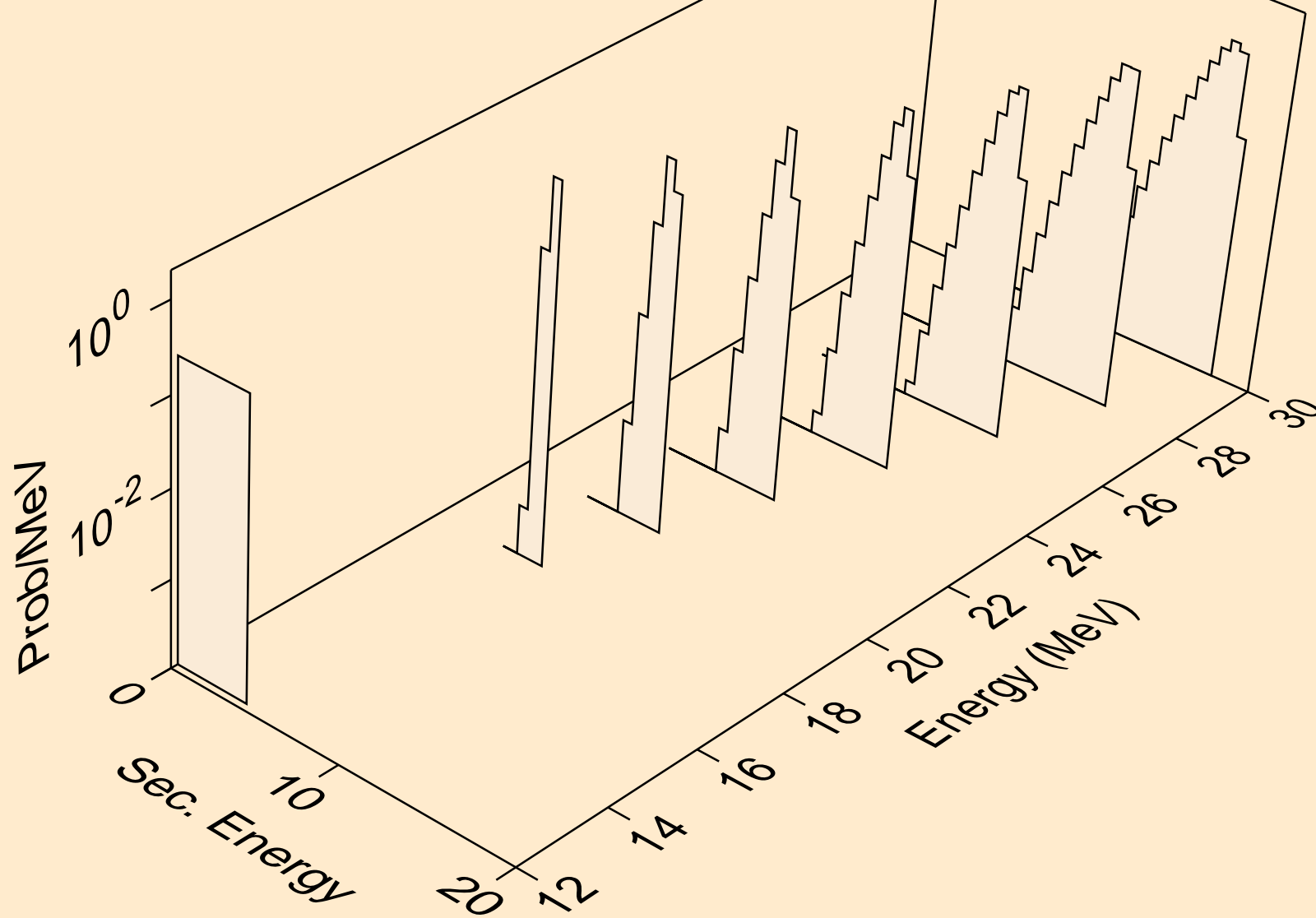

LU172 PROTON ACER TENDL-2023 LIBRARY; T=0.K  
he3s from (p,he3)

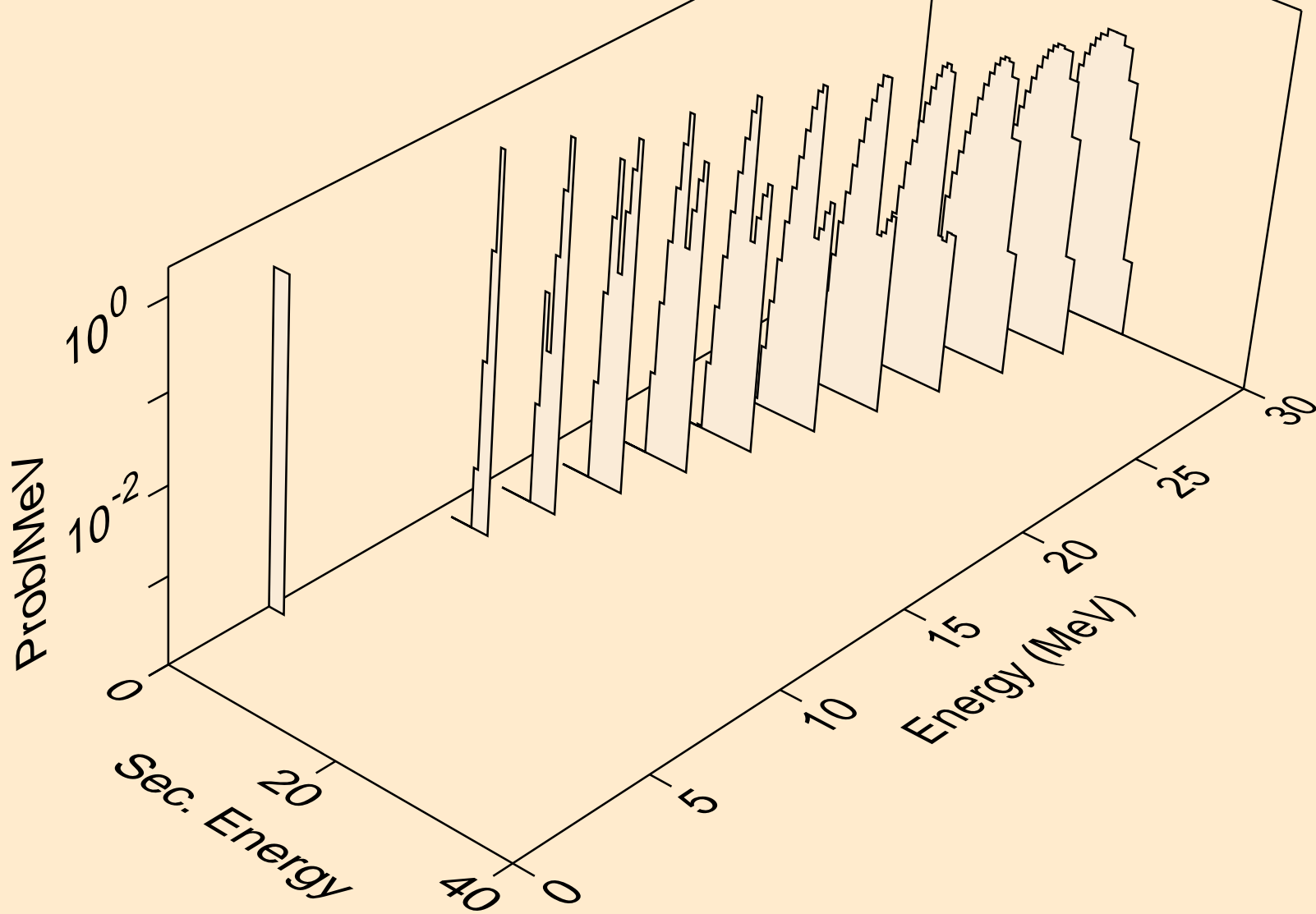

LU172 PROTON ACER TENDL-2023 LIBRARY; T=0.K  
alphas from (p,x)

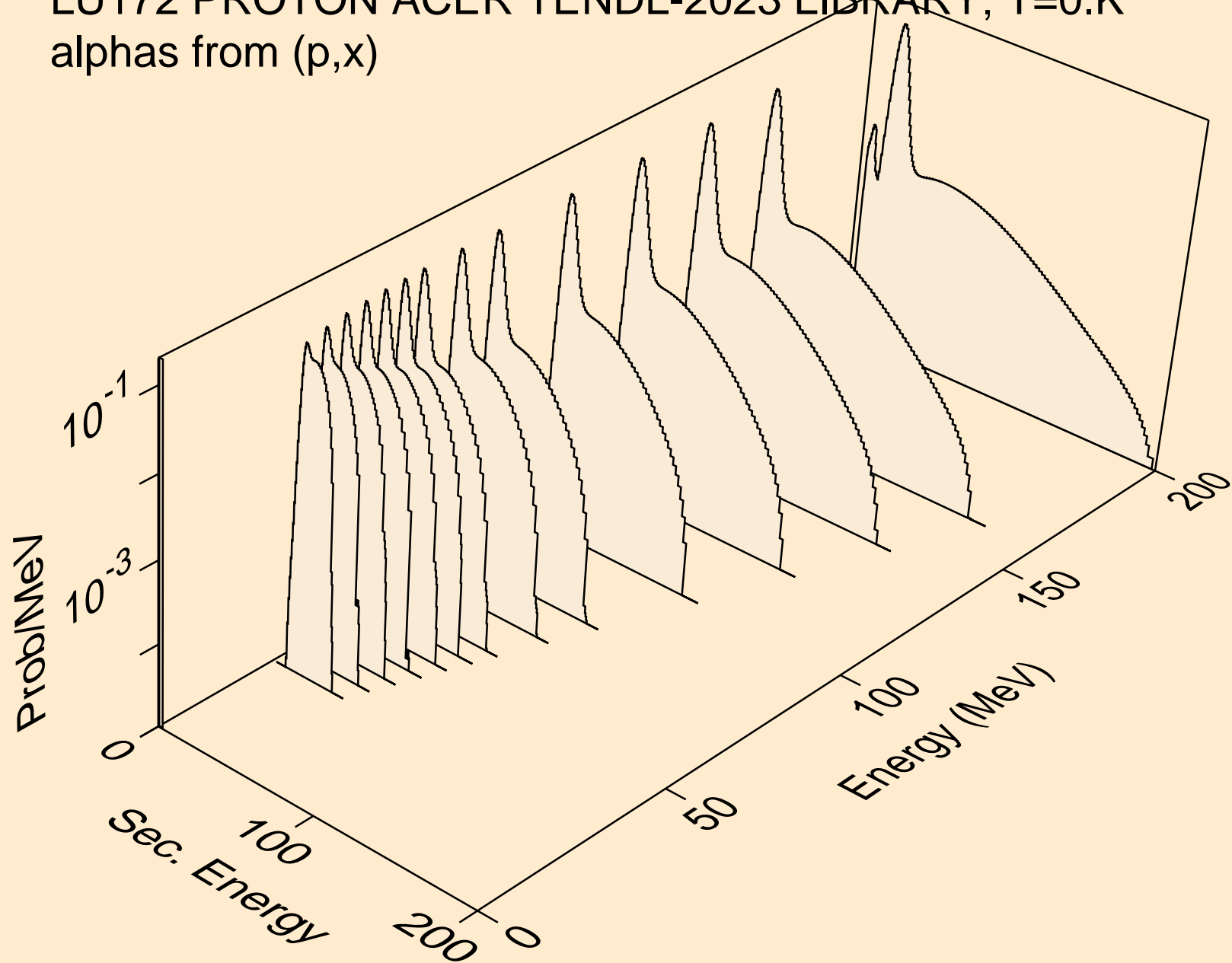

LU172 PROTON ACER TENDL-2023 LIBRARY; T=0.K  
alphas from (p,n\*)a

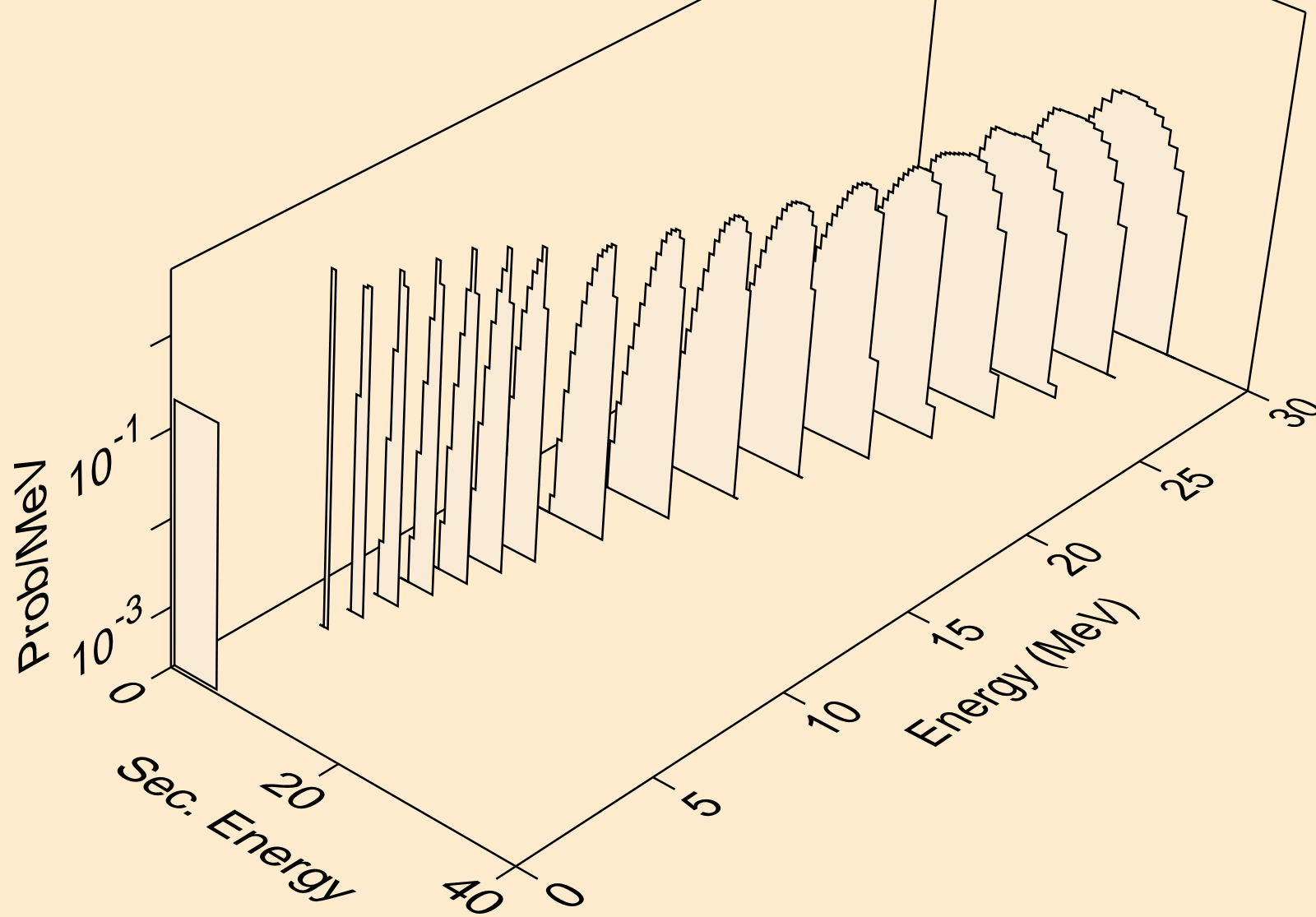

LU172 PROTON ACER TENDL-2023 LIBRARY; T=0.K  
alphas from (p,2n)a

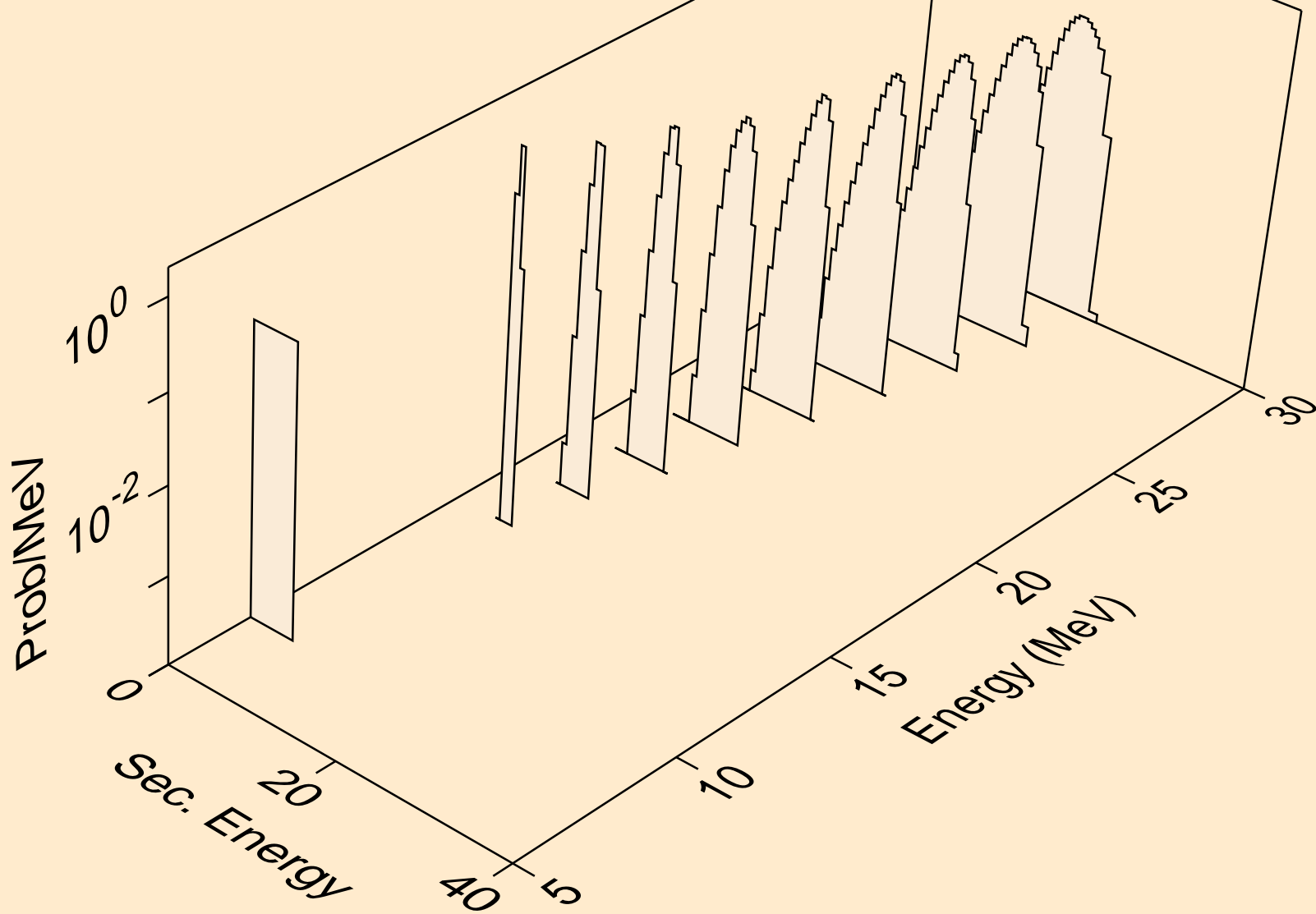

LU172 PROTON ACER TENDL-2023 LIBRARY; T=0.K  
alphas from (p,3n)a

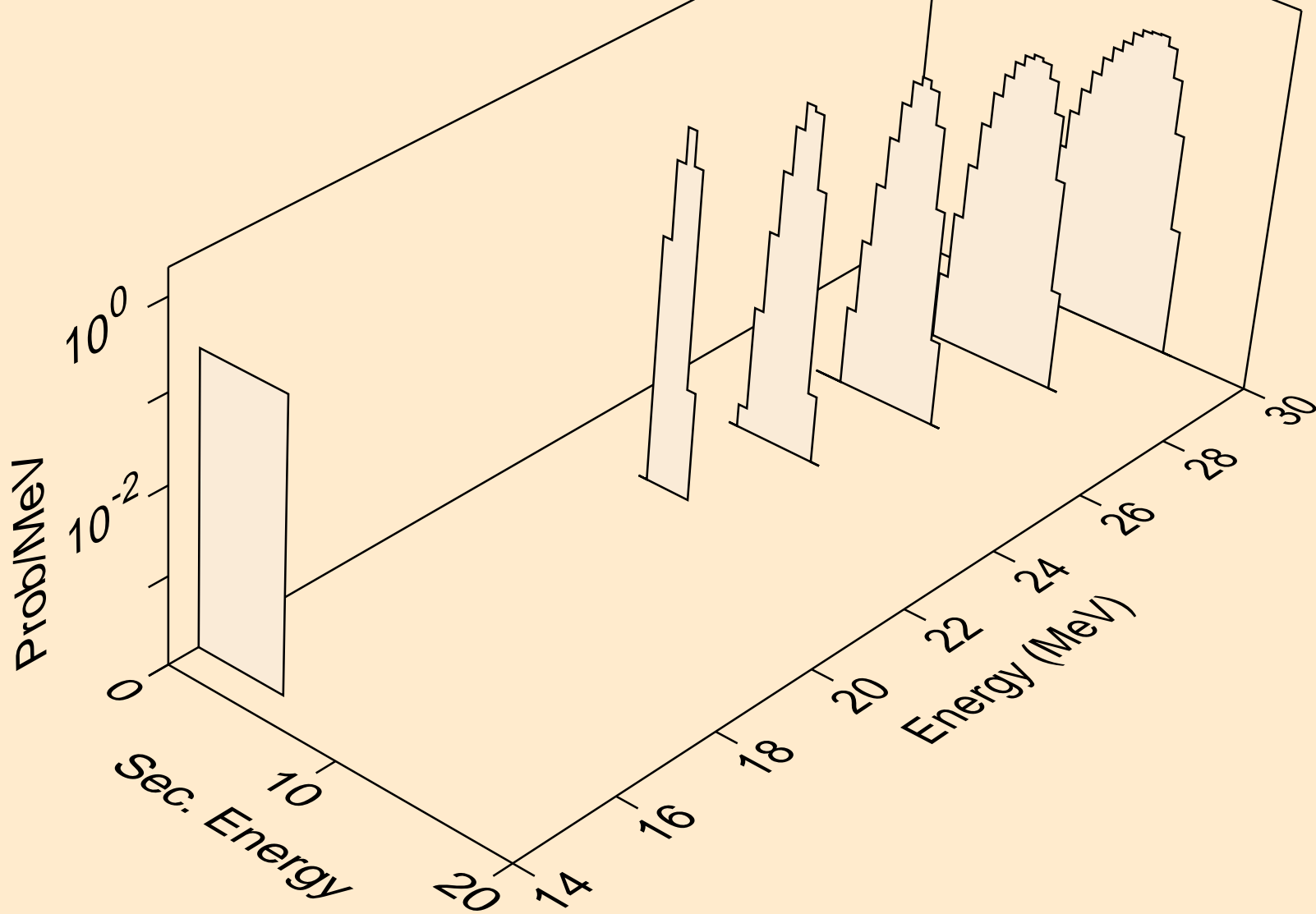



LU172 PROTON ACER TENDL-2023 LIBRARY; T=0.K  
alphas from (p,n\*)2a

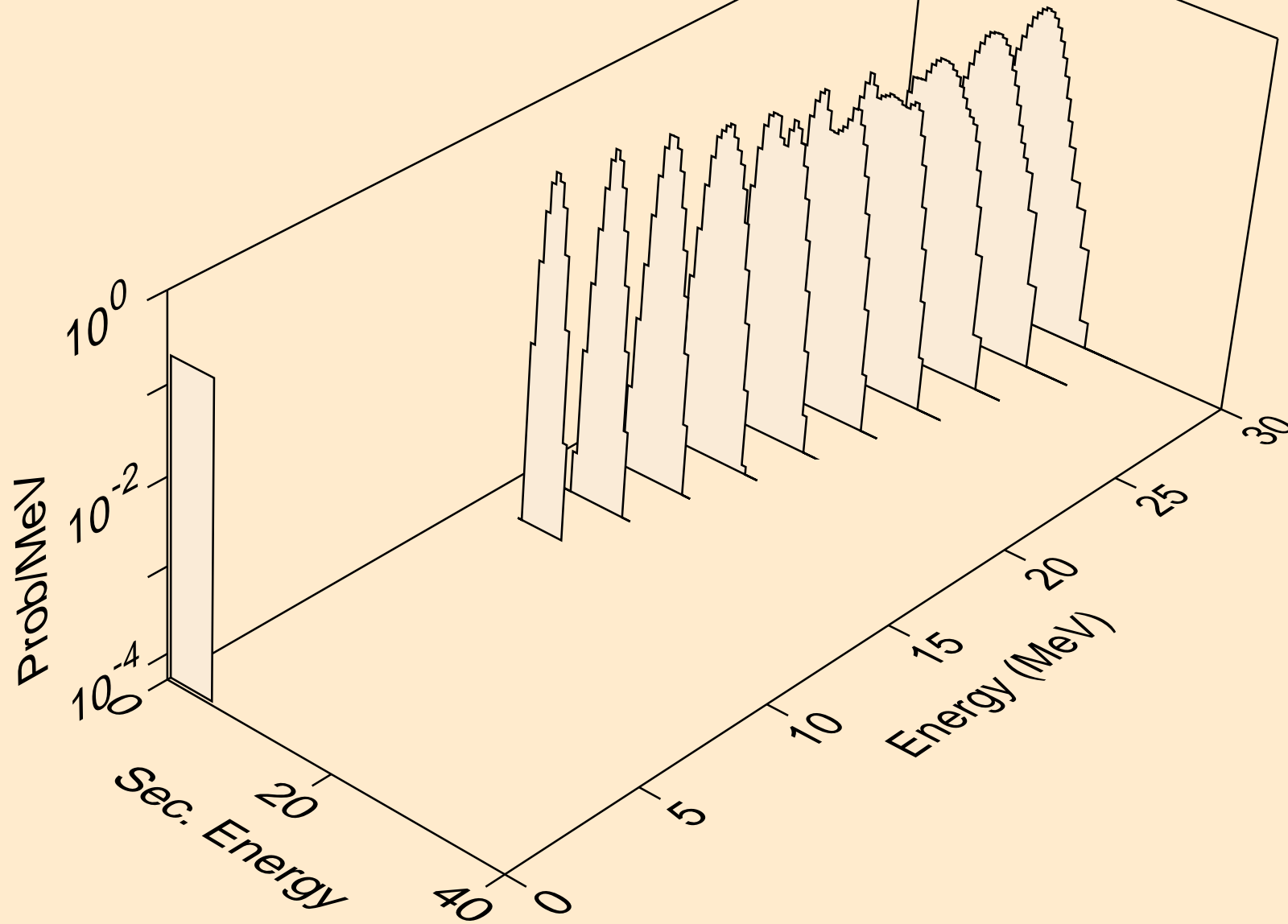

LU172 PROTON ACER TENDL-2023 LIBRARY; T=0.K  
alphas from (p,npa)

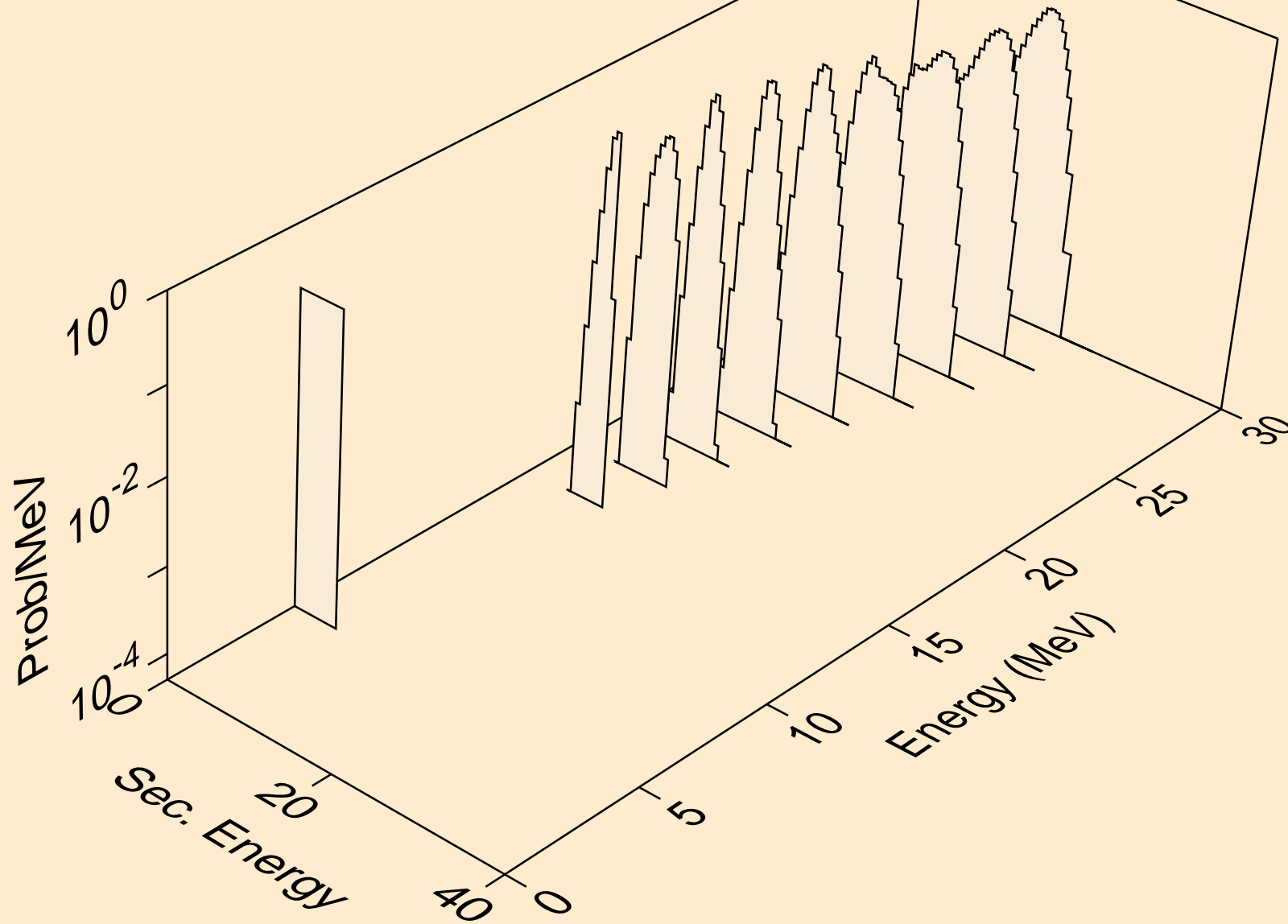

LU172 PROTON ACER TENDL-2023 LIBRARY; T=0.K  
alphas from (p,a)

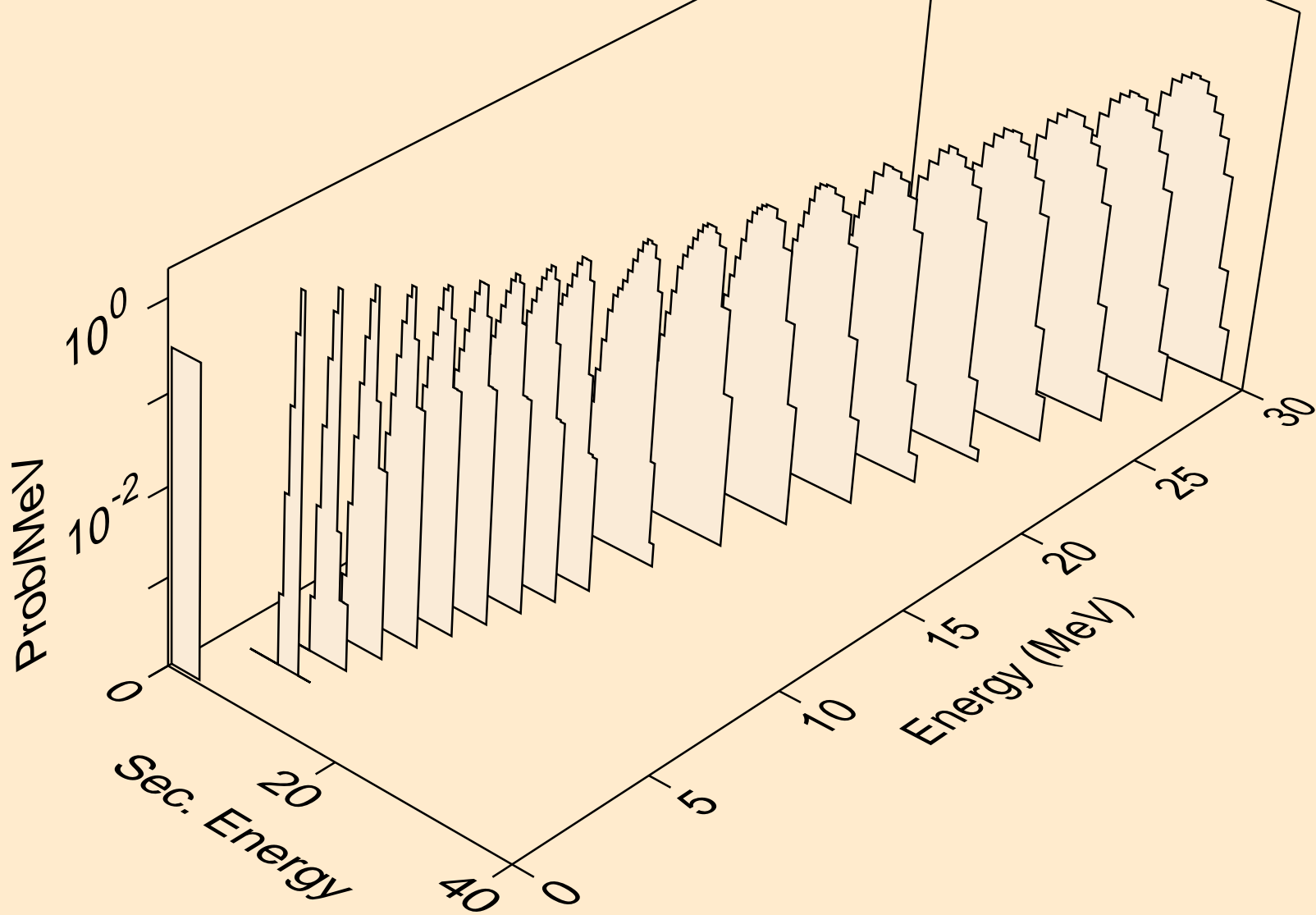

LU172 PROTON ACER TENDL-2023 LIBRARY; T=0.K  
alphas from (p,2a)

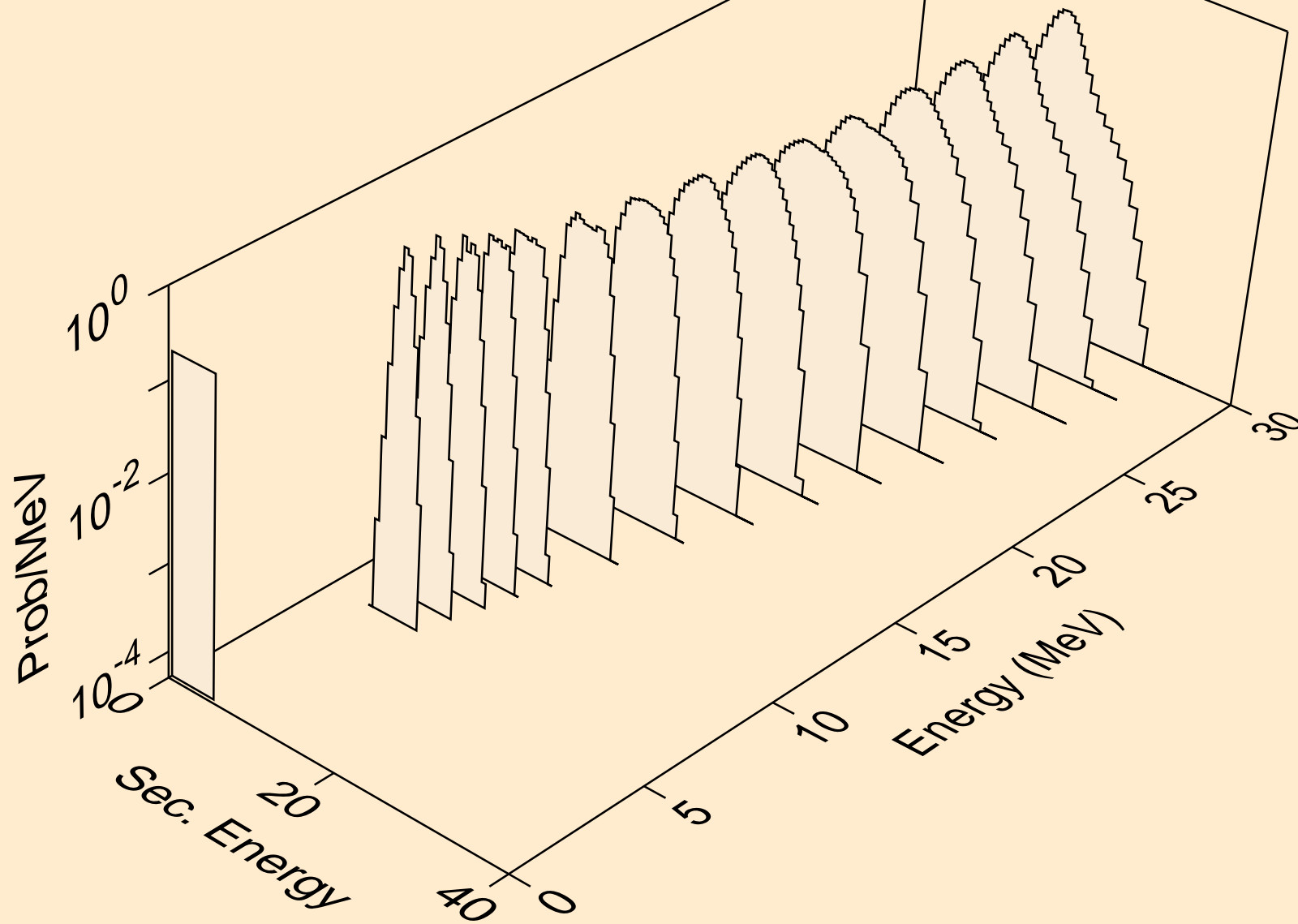

LU172 PROTON ACER TENDL-2023 LIBRARY; T=0.K  
alphas from (p,pa)

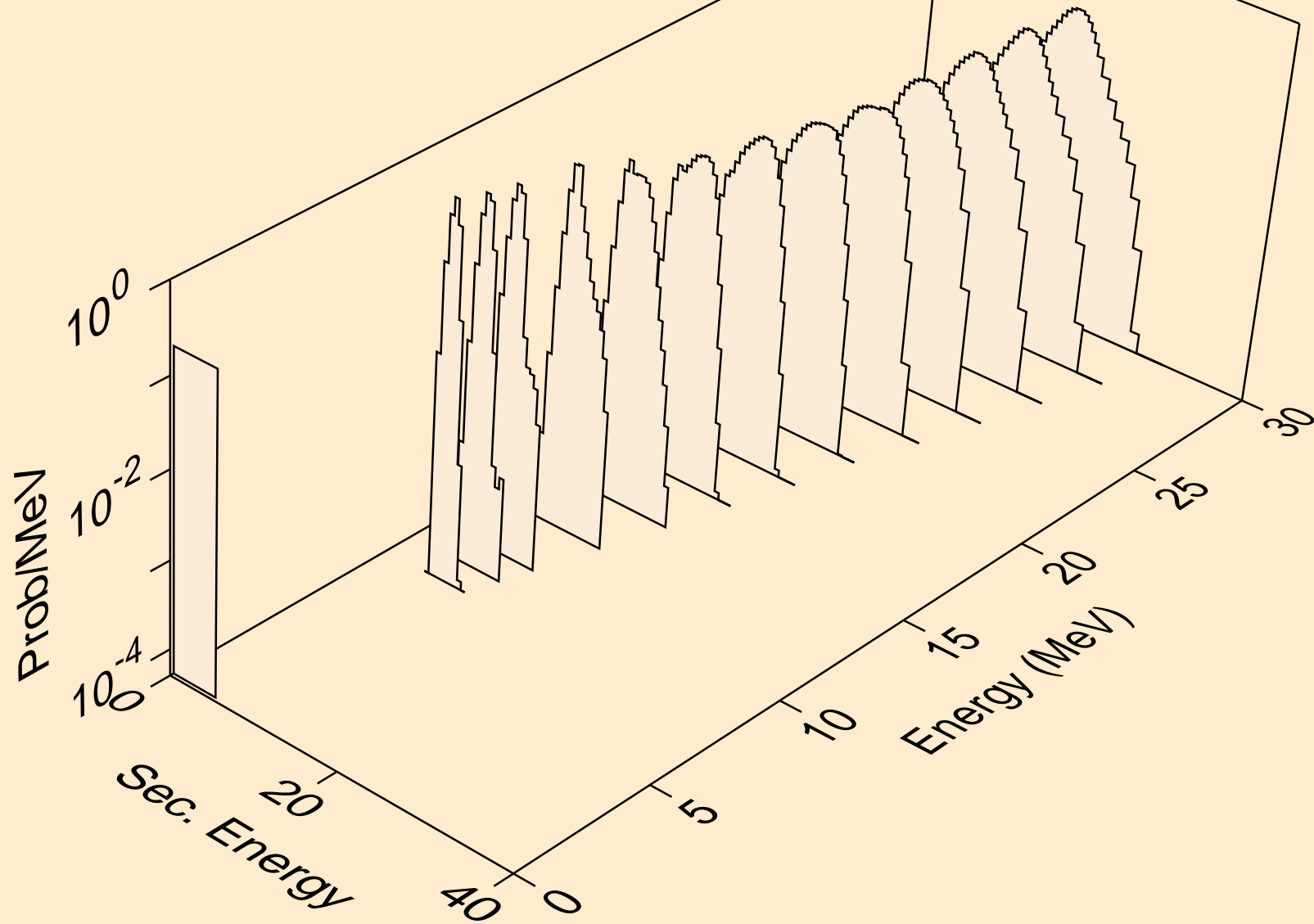

LU172 PROTON ACER TENDL-2023 LIBRARY; T=0.K  
alphas from (p,da)

