

MD246M PROTON ACER TENDL-2023 LIBRARY; T=0.K
Principal cross sections

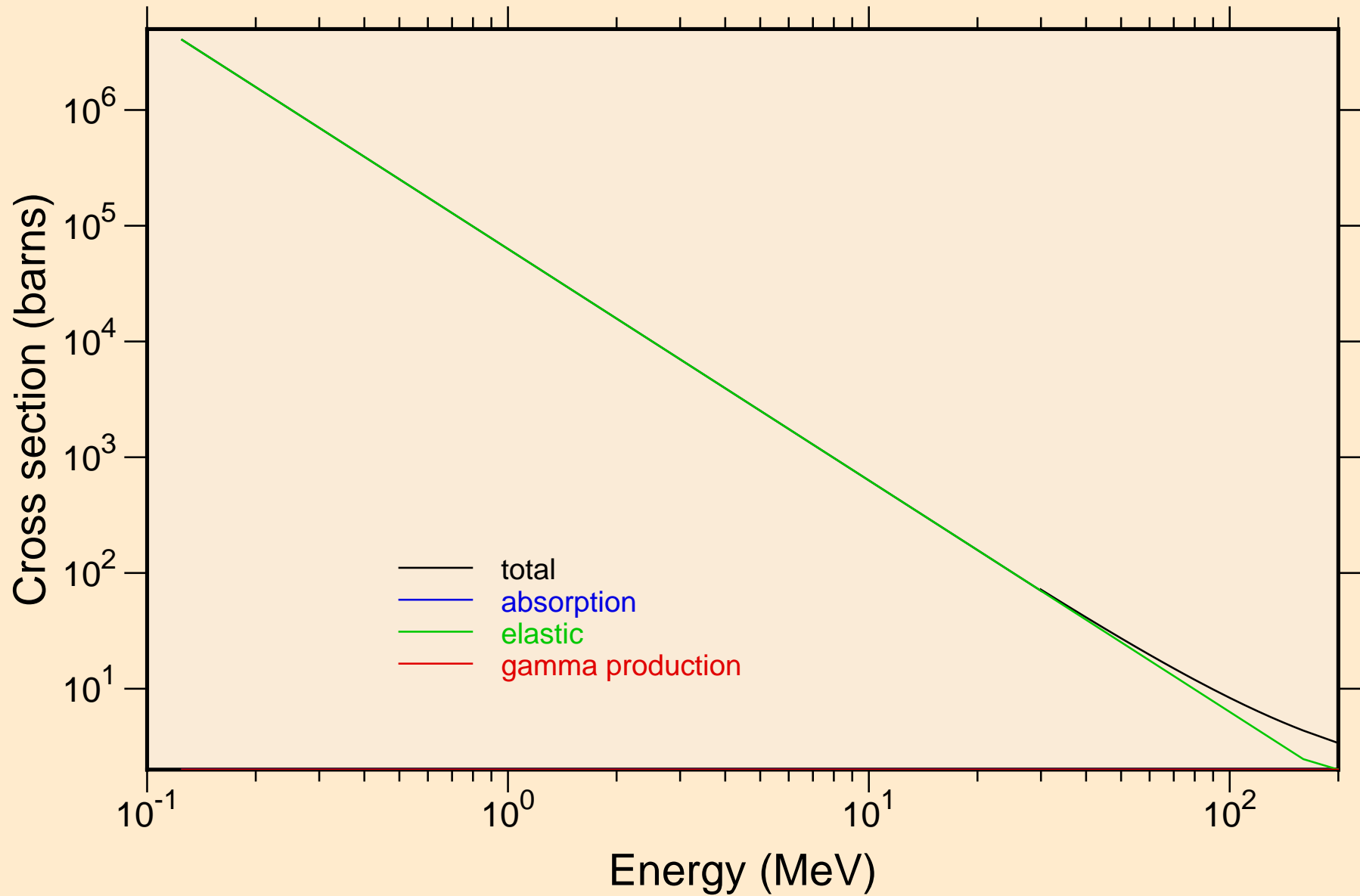

MD246M PROTON ACER TENDL-2023 LIBRARY; T=0.K

Heating

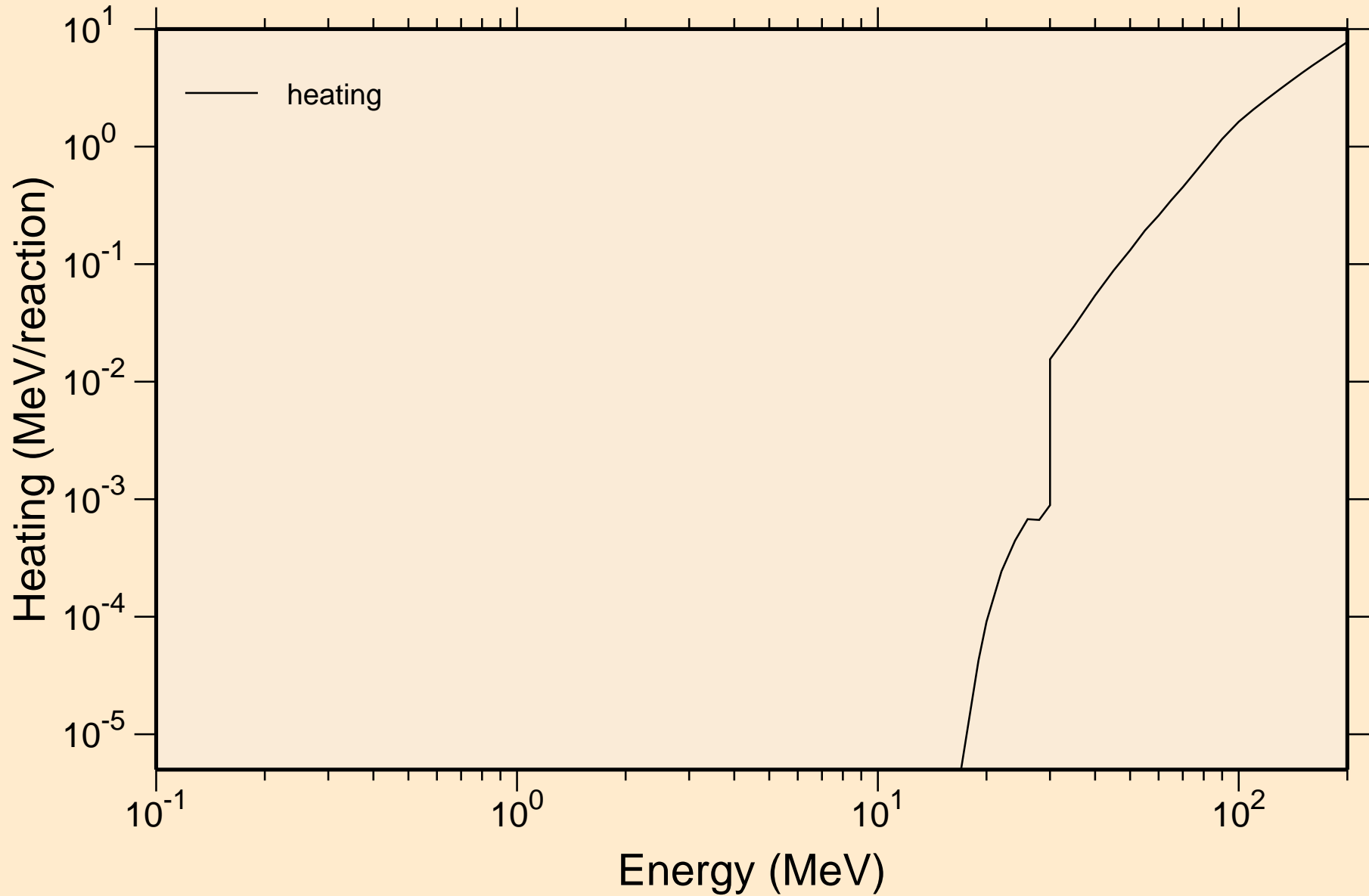

MD246M PROTON ACER TENDL-2023 LIBRARY; T=0.K
Principal cross sections

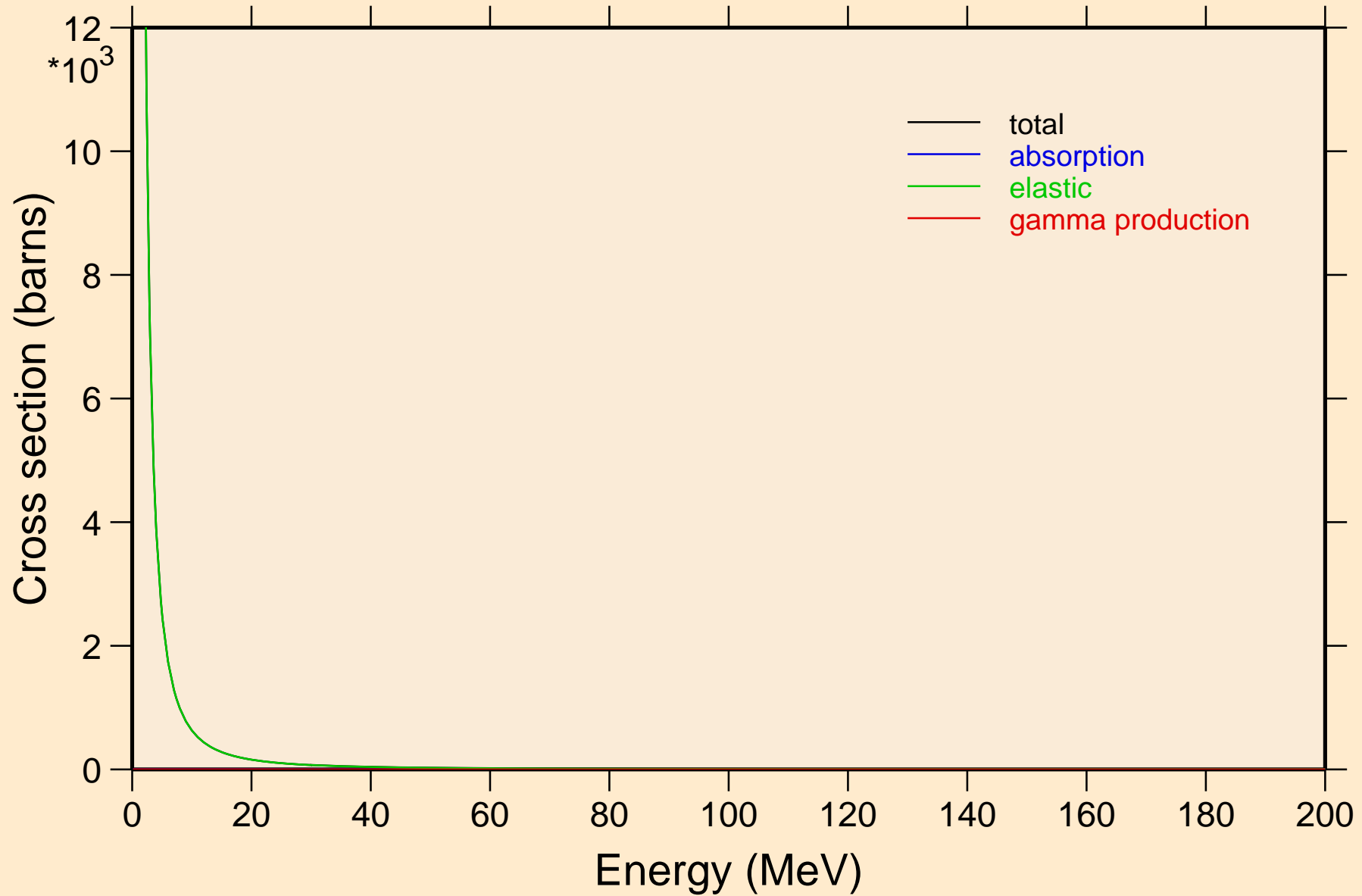

MD246M PROTON ACER TENDL-2023 LIBRARY; T=0.K

Heating

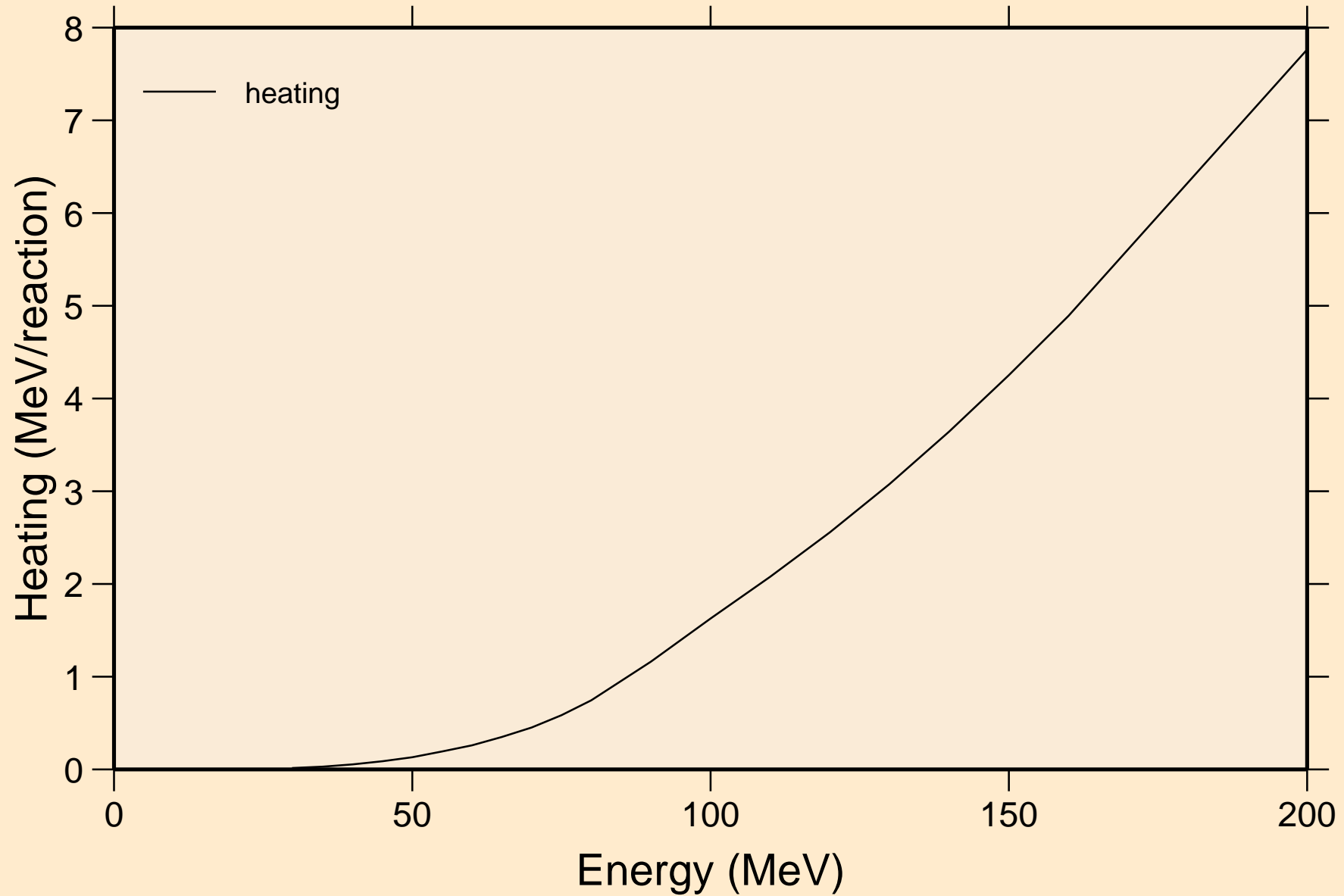

MD246M PROTON ACER TENDL-2023 LIBRARY; T=0.K
Threshold reactions

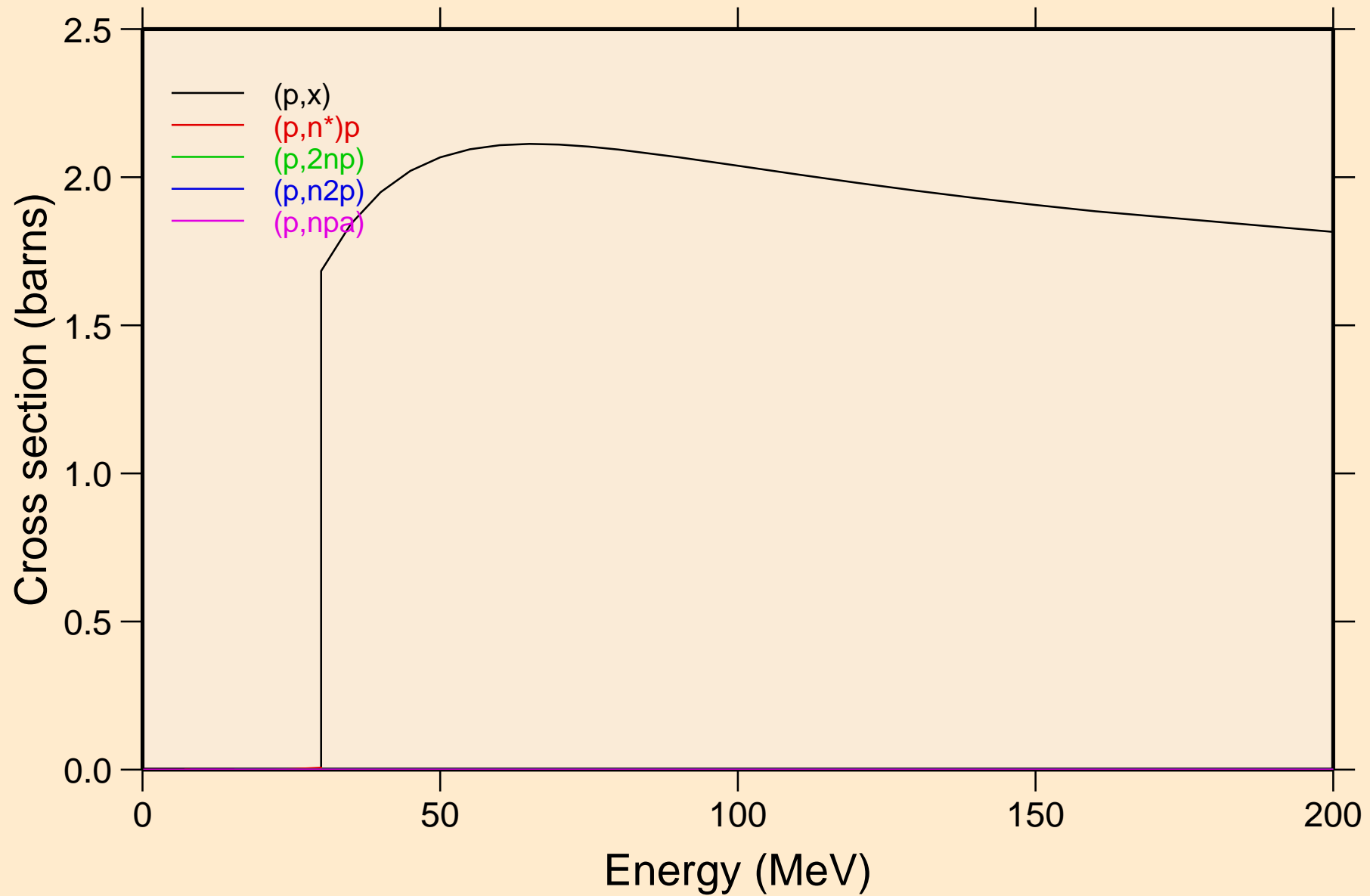

MD246M PROTON ACER TENDL-2023 LIBRARY; T=0.K
Threshold reactions

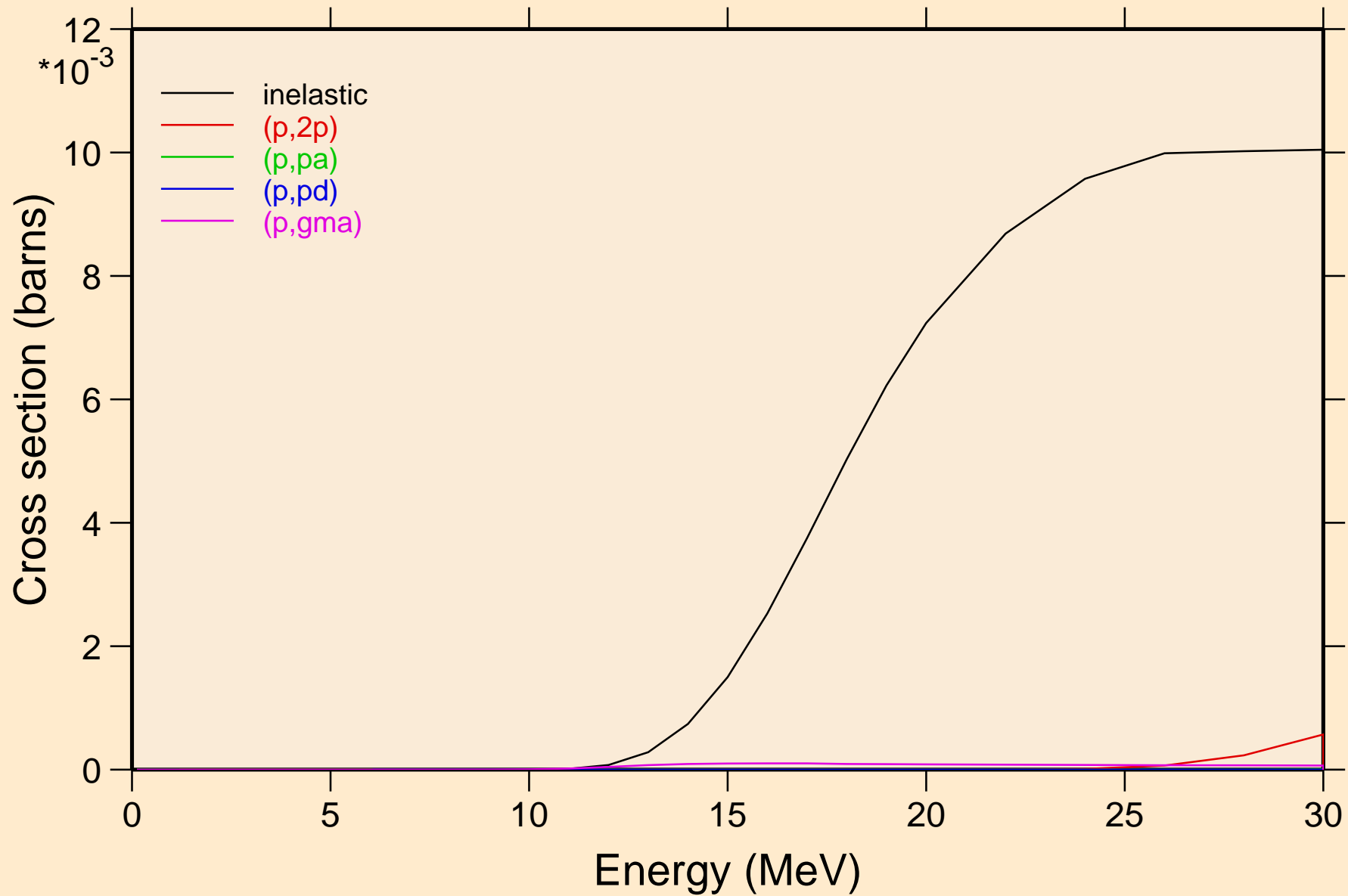

MD246M PROTON ACER TENDL-2023 LIBRARY; T=0.K
Threshold reactions

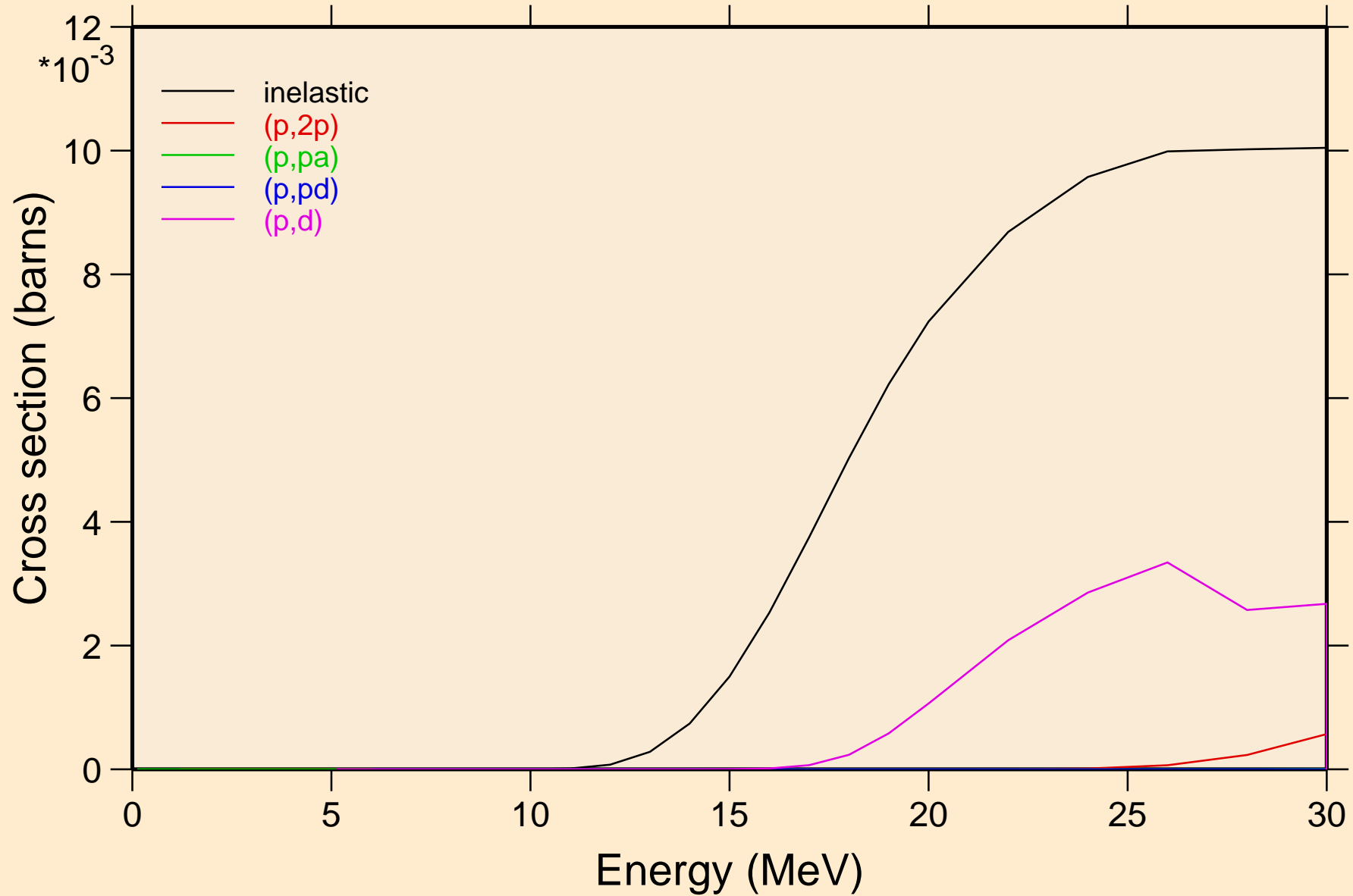

MD246M PROTON ACER TENDL-2023 LIBRARY; T=0.K

Threshold reactions

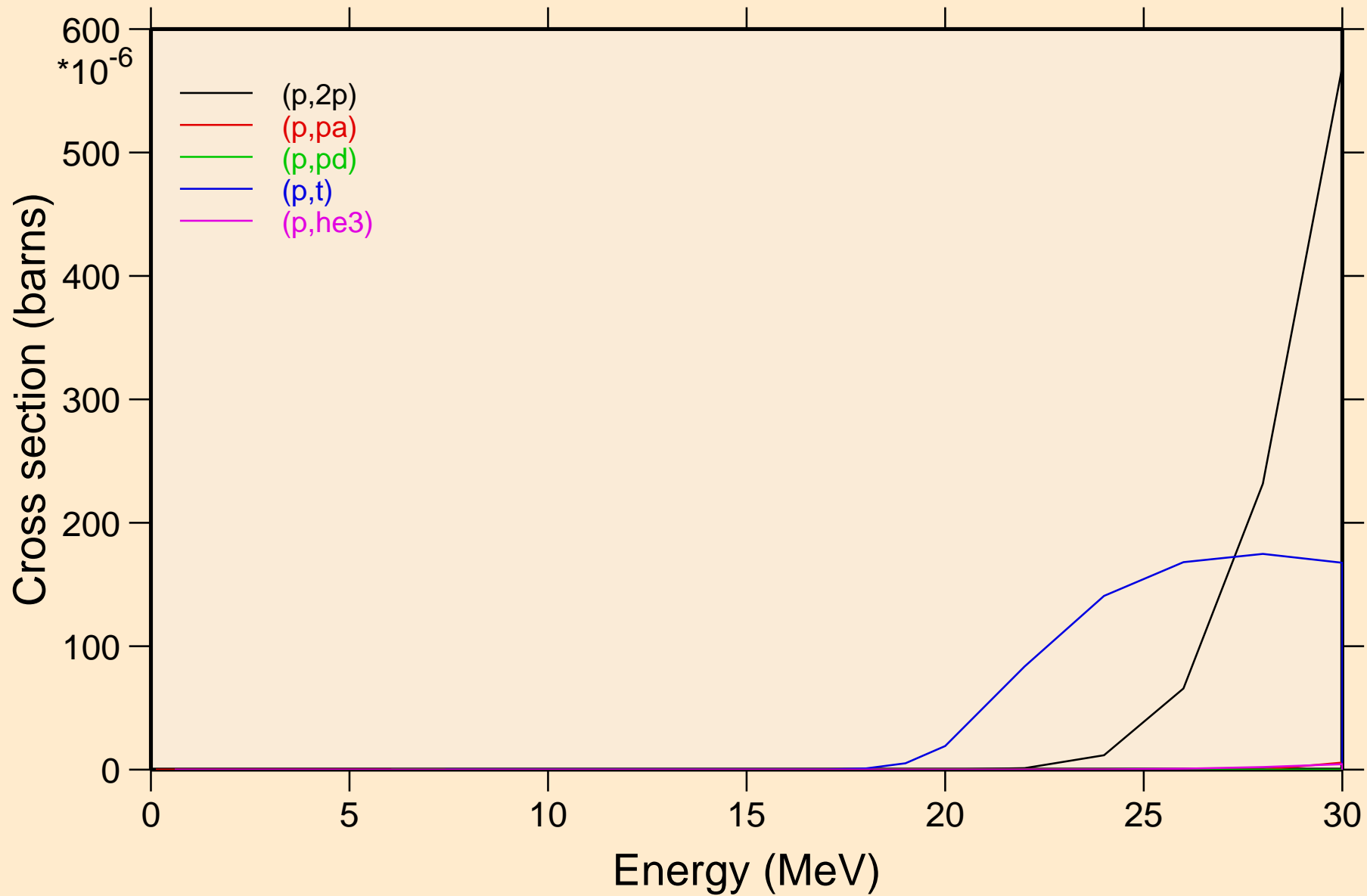

MD246M PROTON ACER TENDL-2023 LIBRARY; T=0.K
Threshold reactions

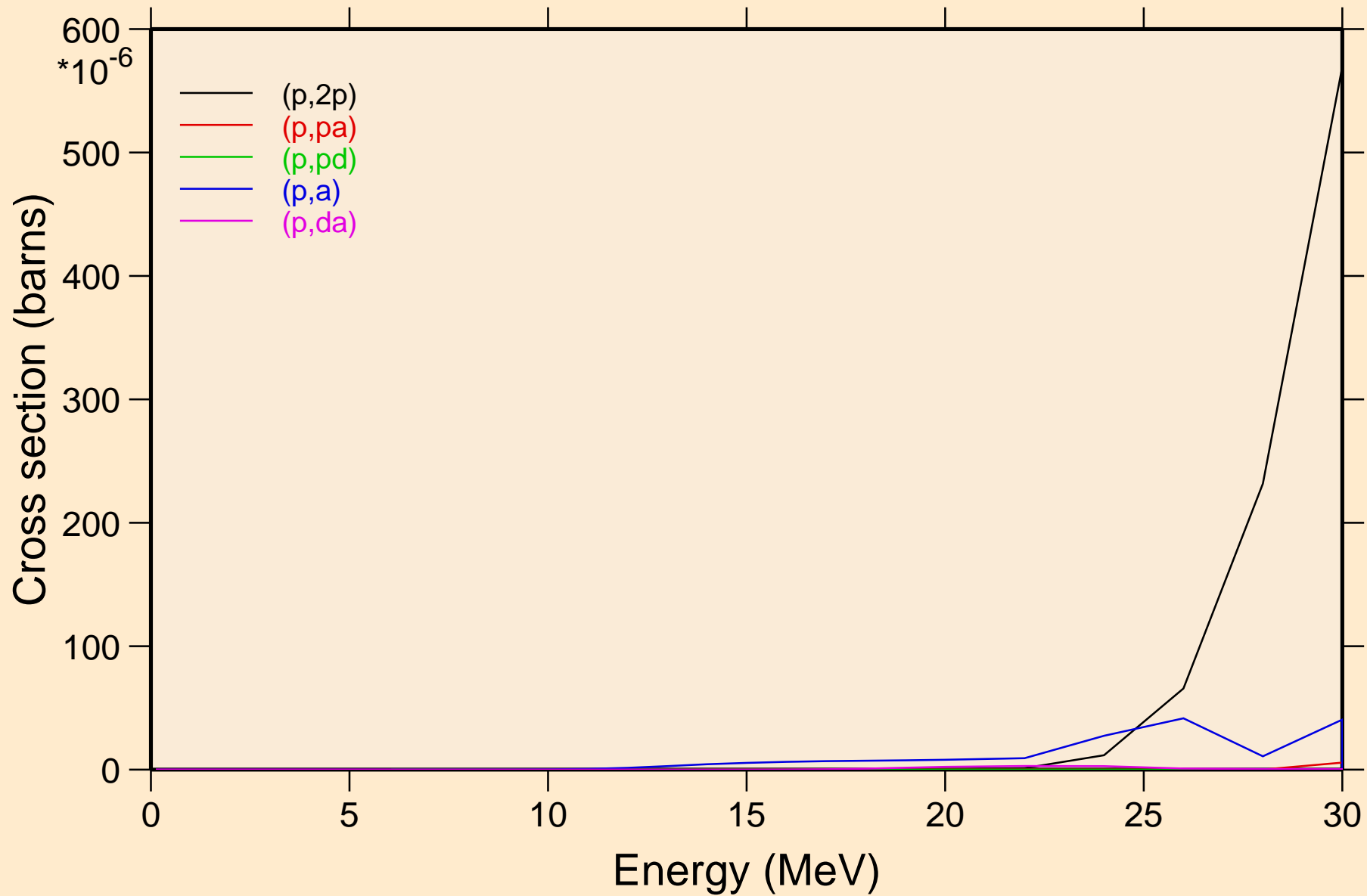

MD246M PROTON ACER TENDL-2023 LIBRARY; T=0.K
angular distribution for elastic

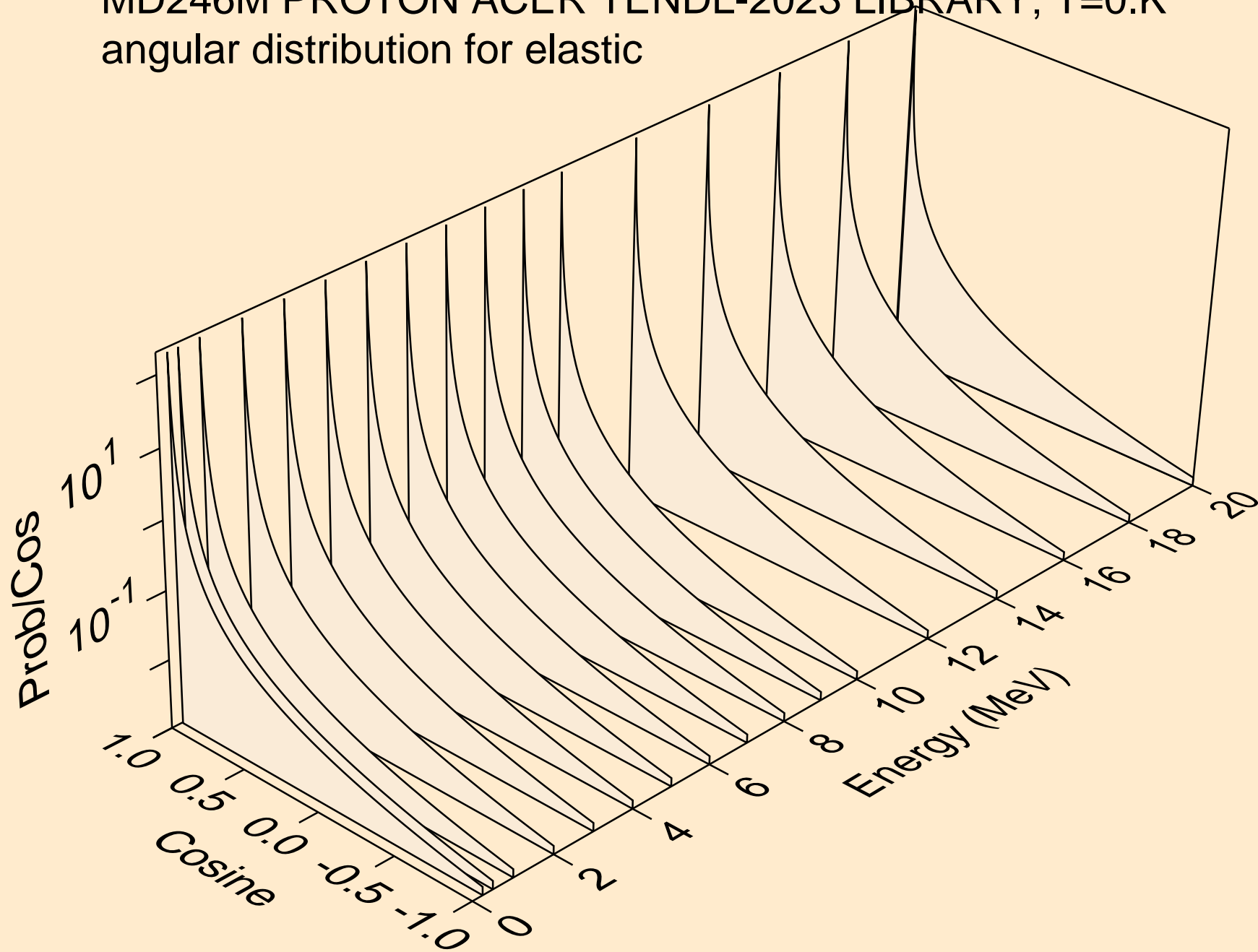

MD246M PROTON ACER TENDL-2023 LIBRARY; T=0.K
angular distribution for elastic

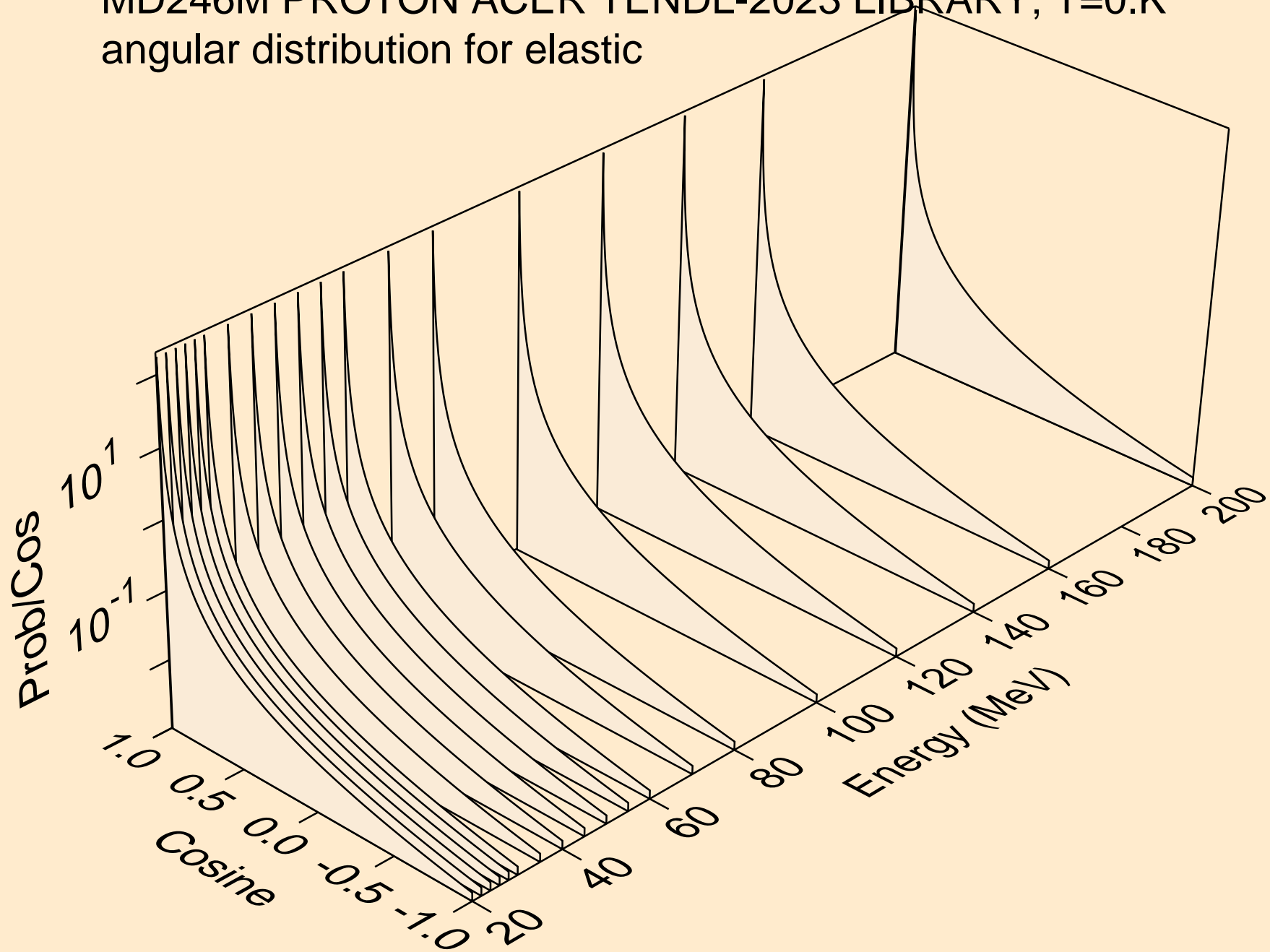

MD246M PROTON ACER TENDL-2023 LIBRARY; T=0.K
Proton emission for (p,x)

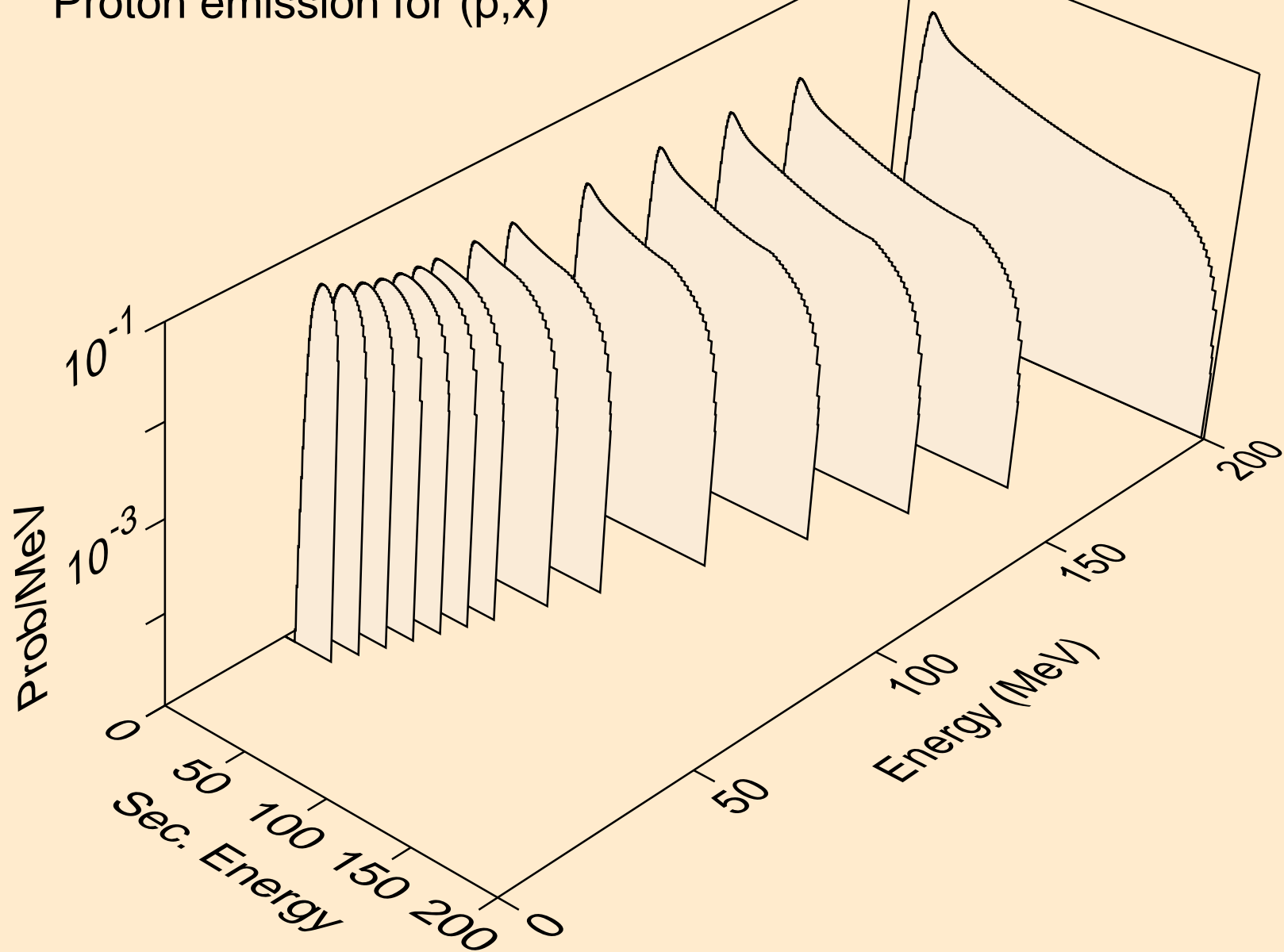

MD246M PROTON ACER TENDL-2023 LIBRARY; T=0.K
Proton emission for (p,n*)p

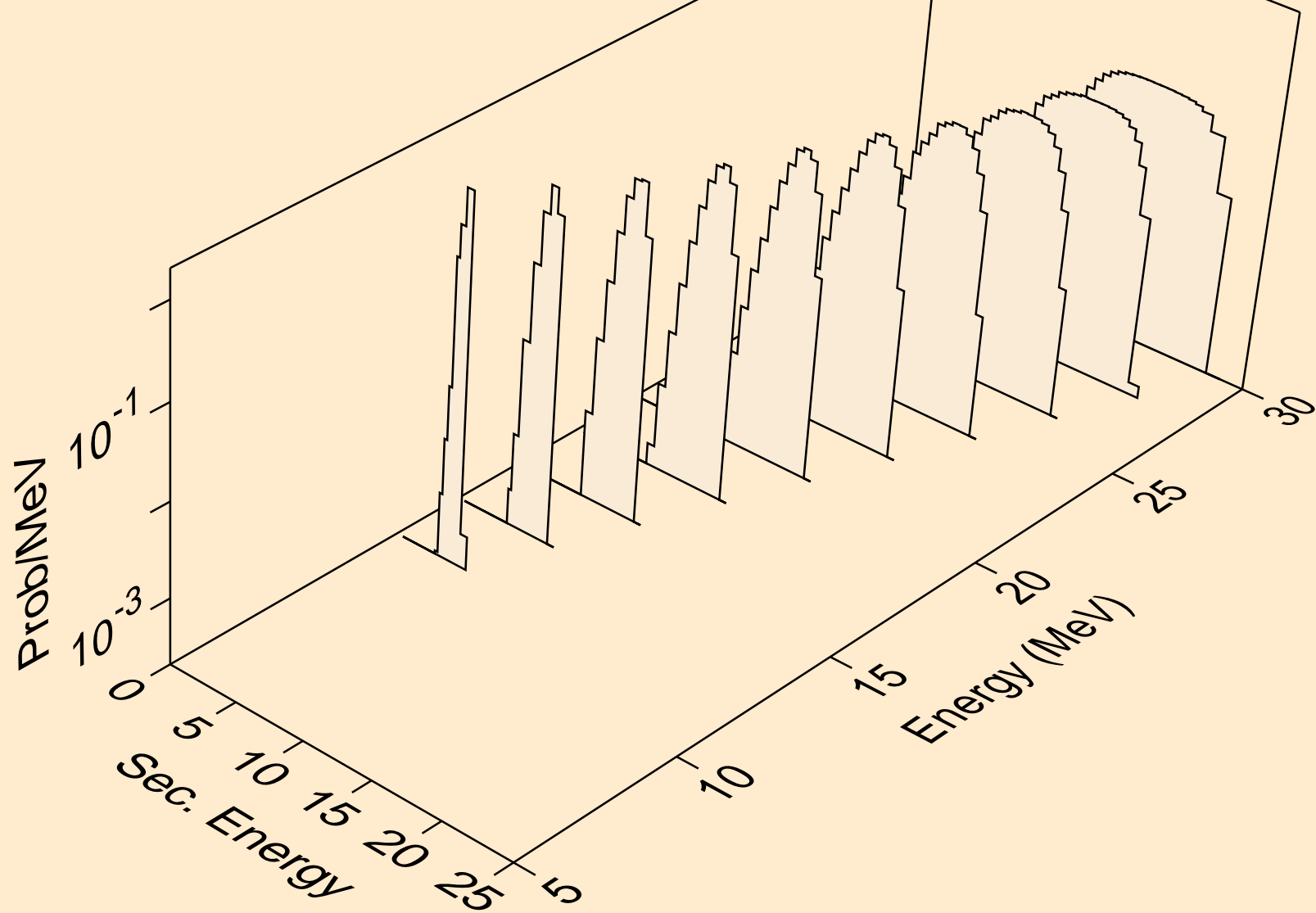

MD246M PROTON ACER TENDL-2023 LIBRARY; T=0.K
Proton emission for (p,2np)

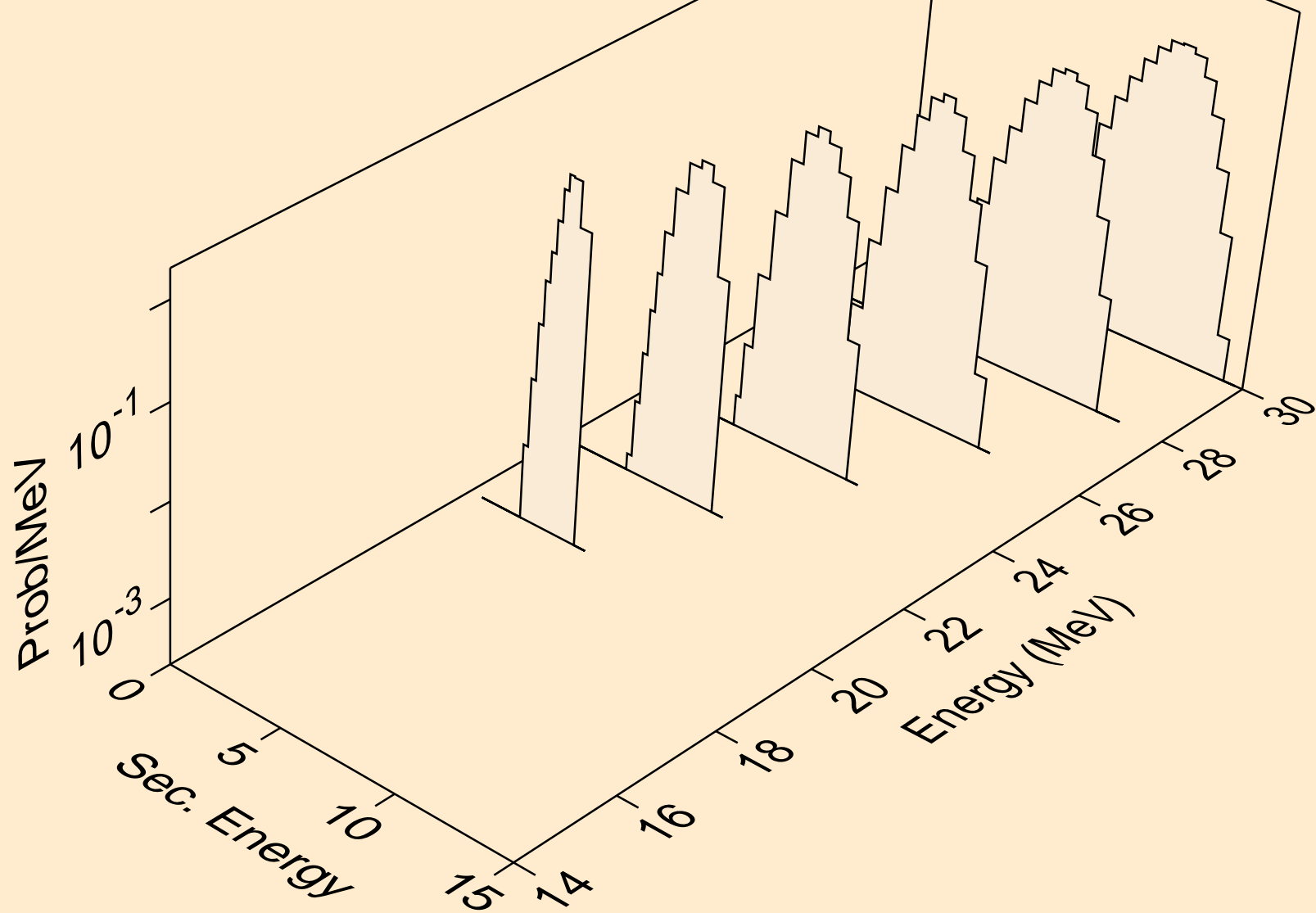

MD246M PROTON ACER TENDL-2023 LIBRARY; T=0.K
Proton emission for (p,n2p)

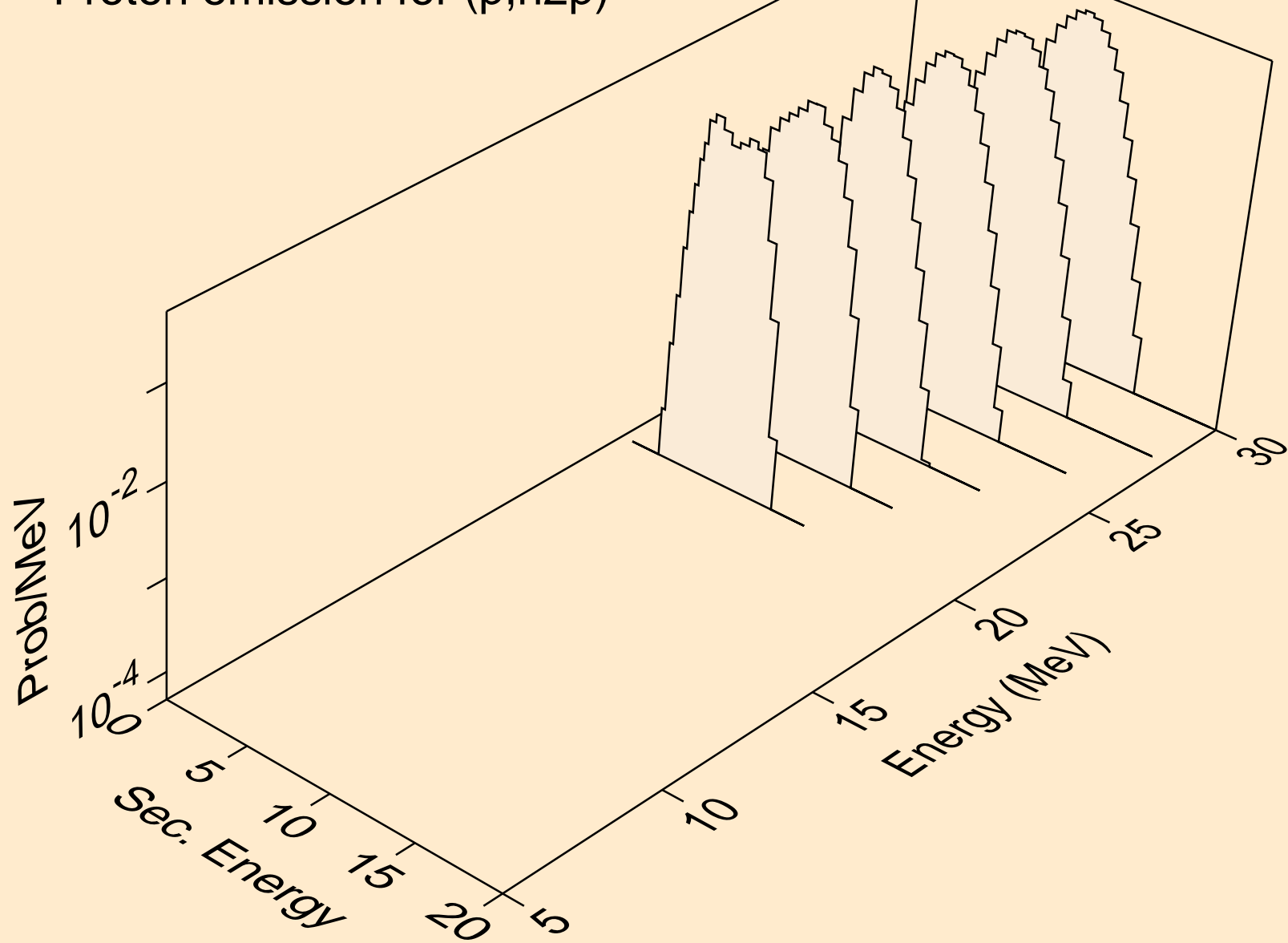

MD246M PROTON ACER TENDL-2023 LIBRARY; T=0.K
Proton emission for (p,npa)

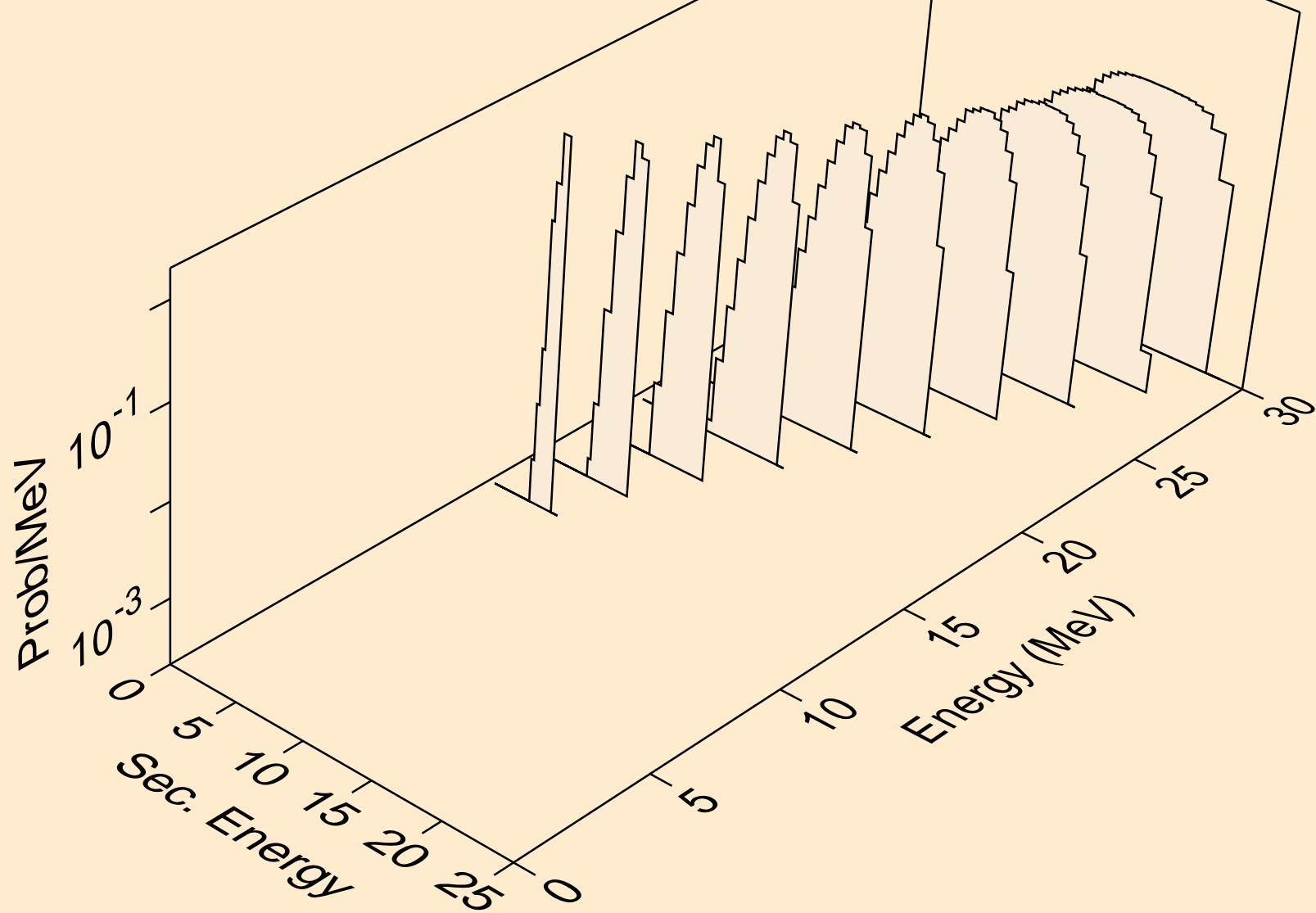

MD246M PROTON ACER TENDL-2023 LIBRARY; T=0.K
Proton emission for inelastic

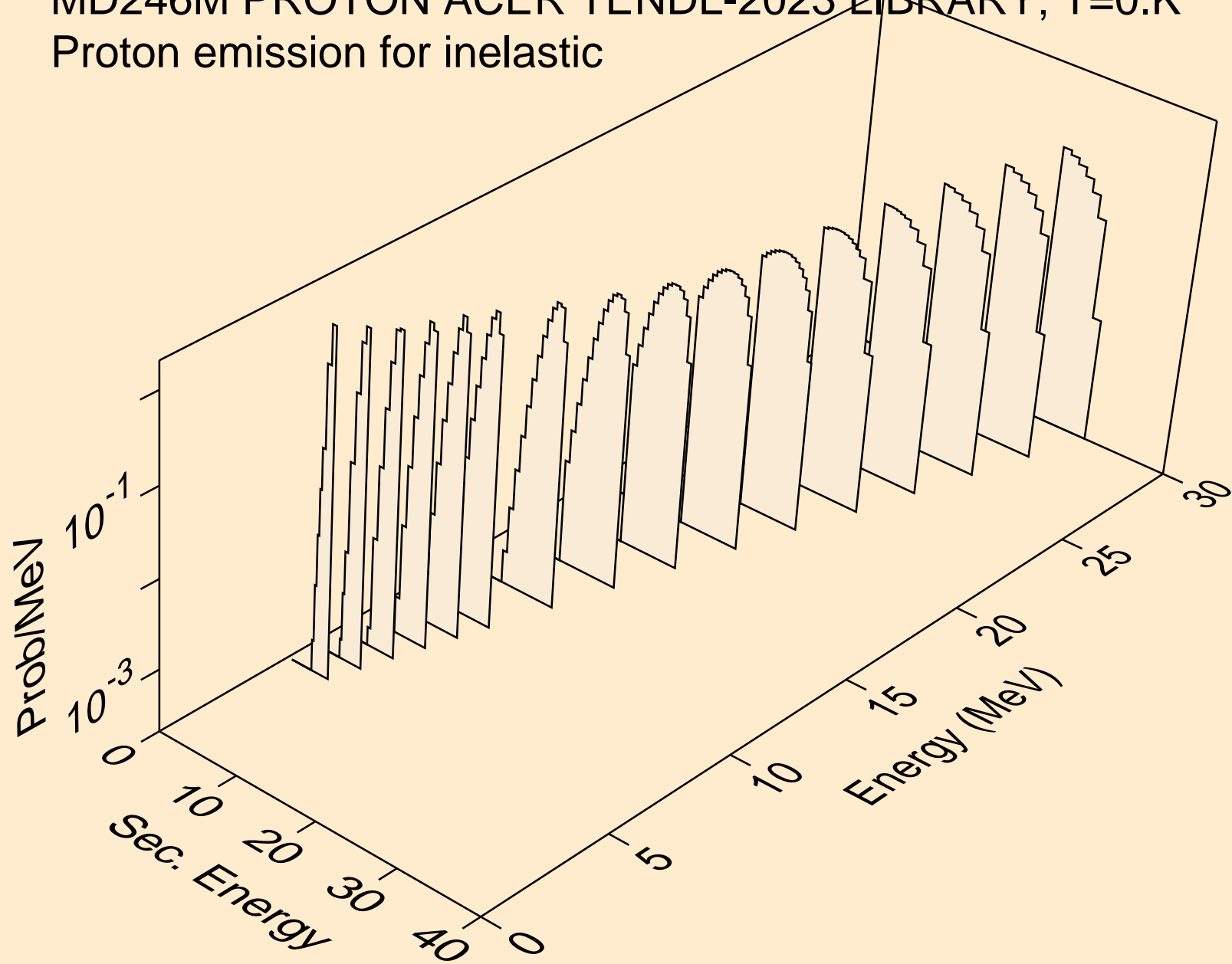

MD246M PROTON ACER TENDL-2023 LIBRARY; T=0.K
Proton emission for (p,2p)

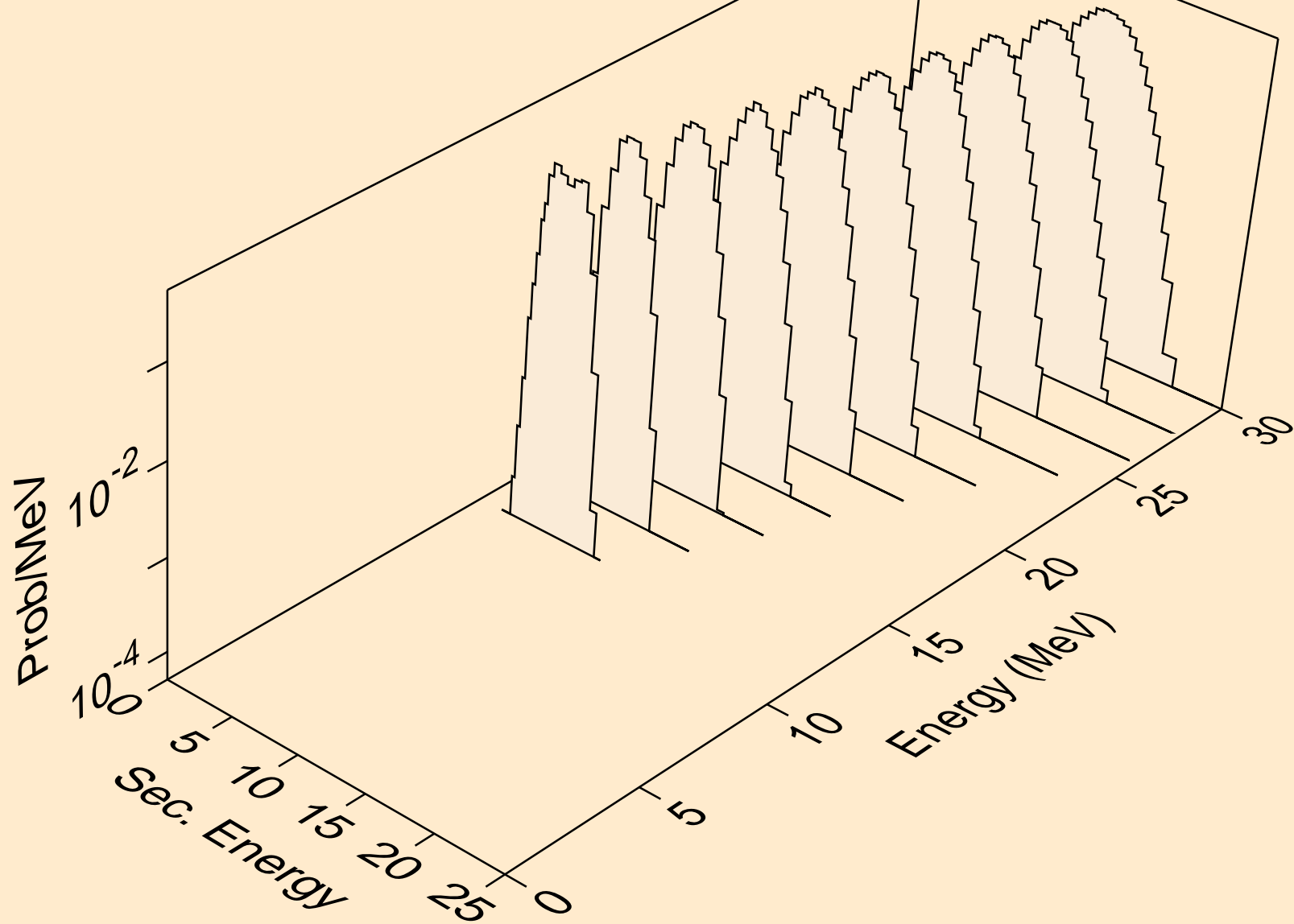

MD246M PROTON ACER TENDL-2023 LIBRARY; T=0.K
Proton emission for (p,pa)

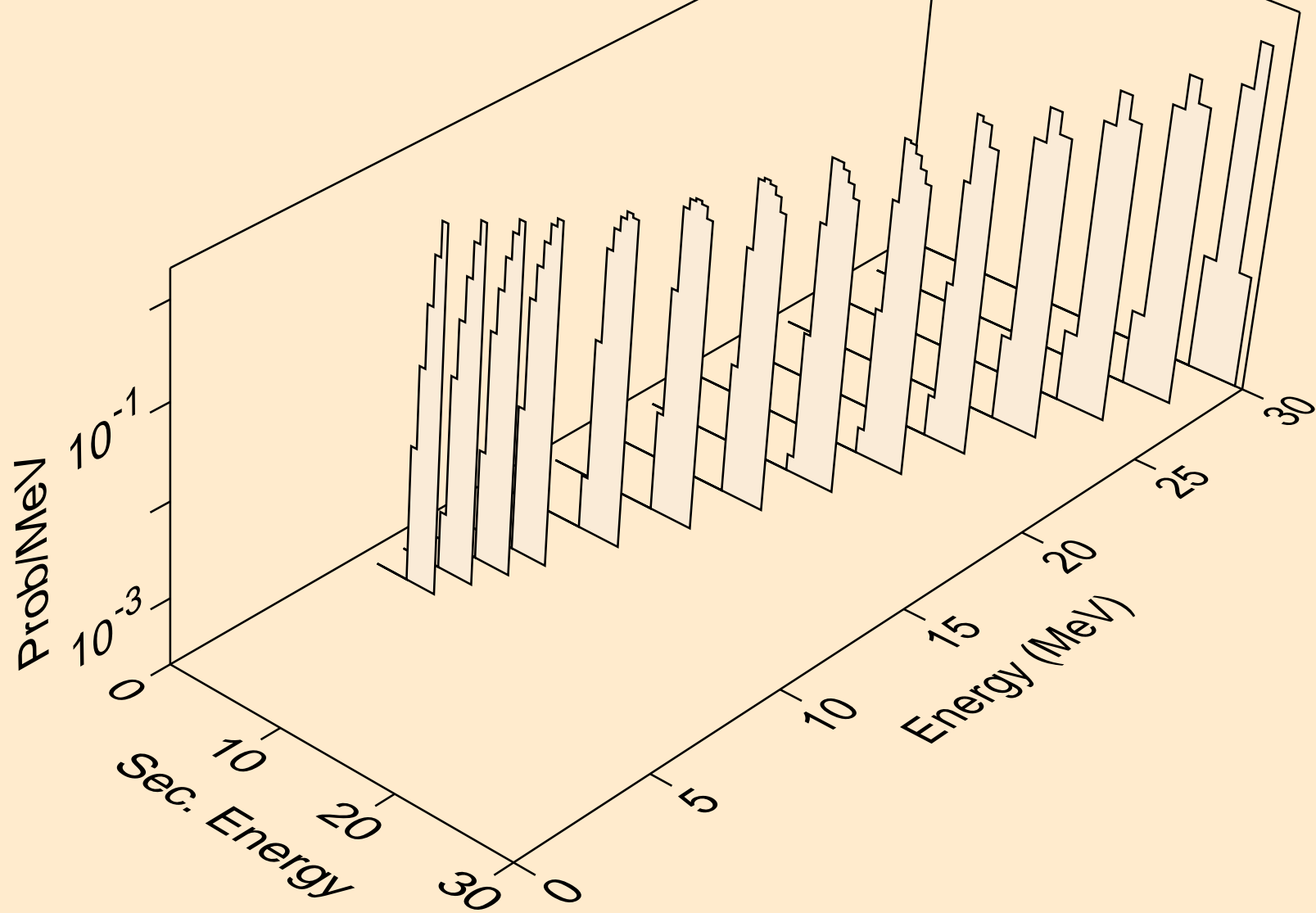

MD246M PROTON ACER TENDL-2023 LIBRARY; T=0.K
Proton emission for (p,pd)

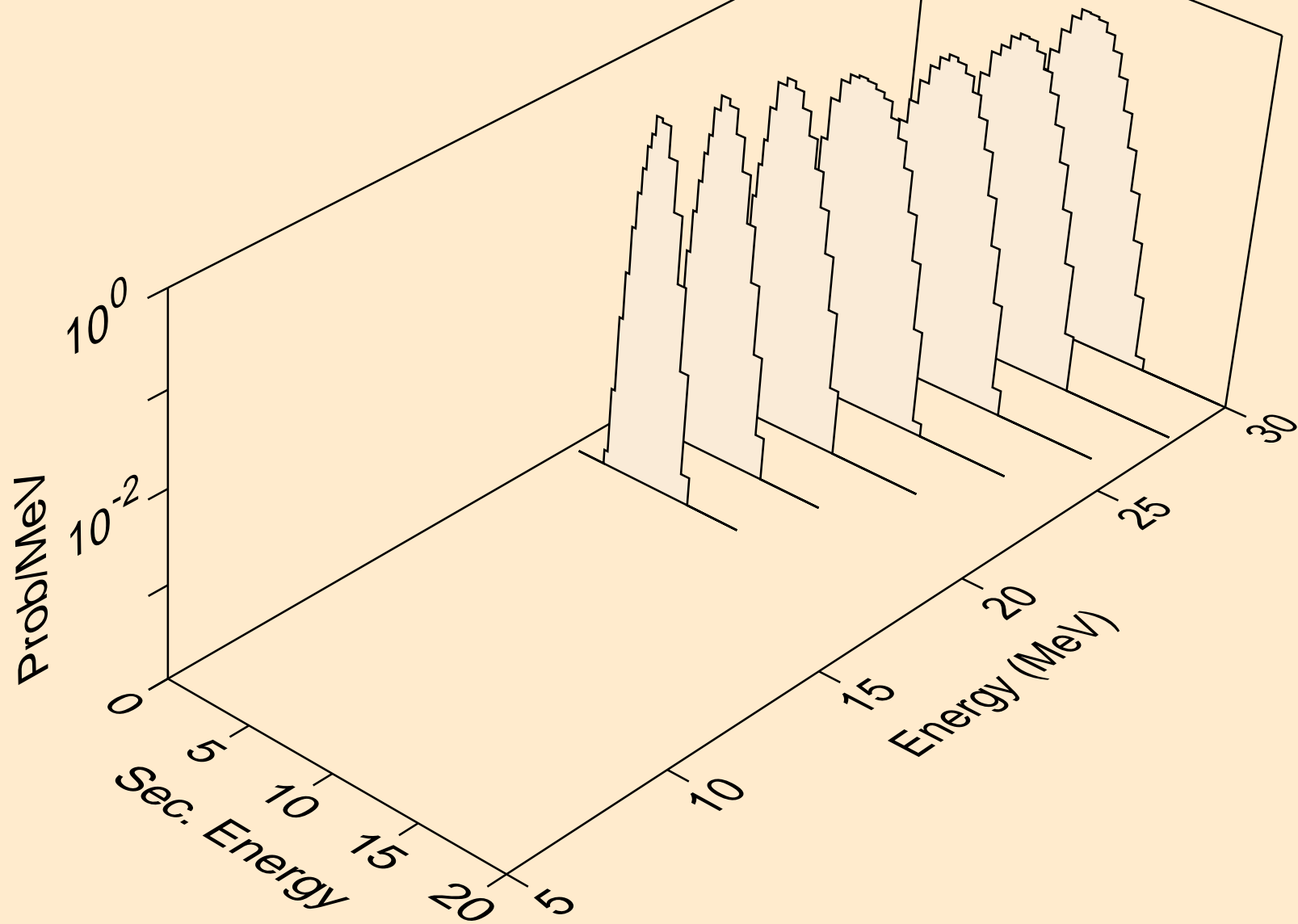

MD246M PROTON ACER TENDL-2023 LIBRARY; T=0.K
Photon emission for (z,n)

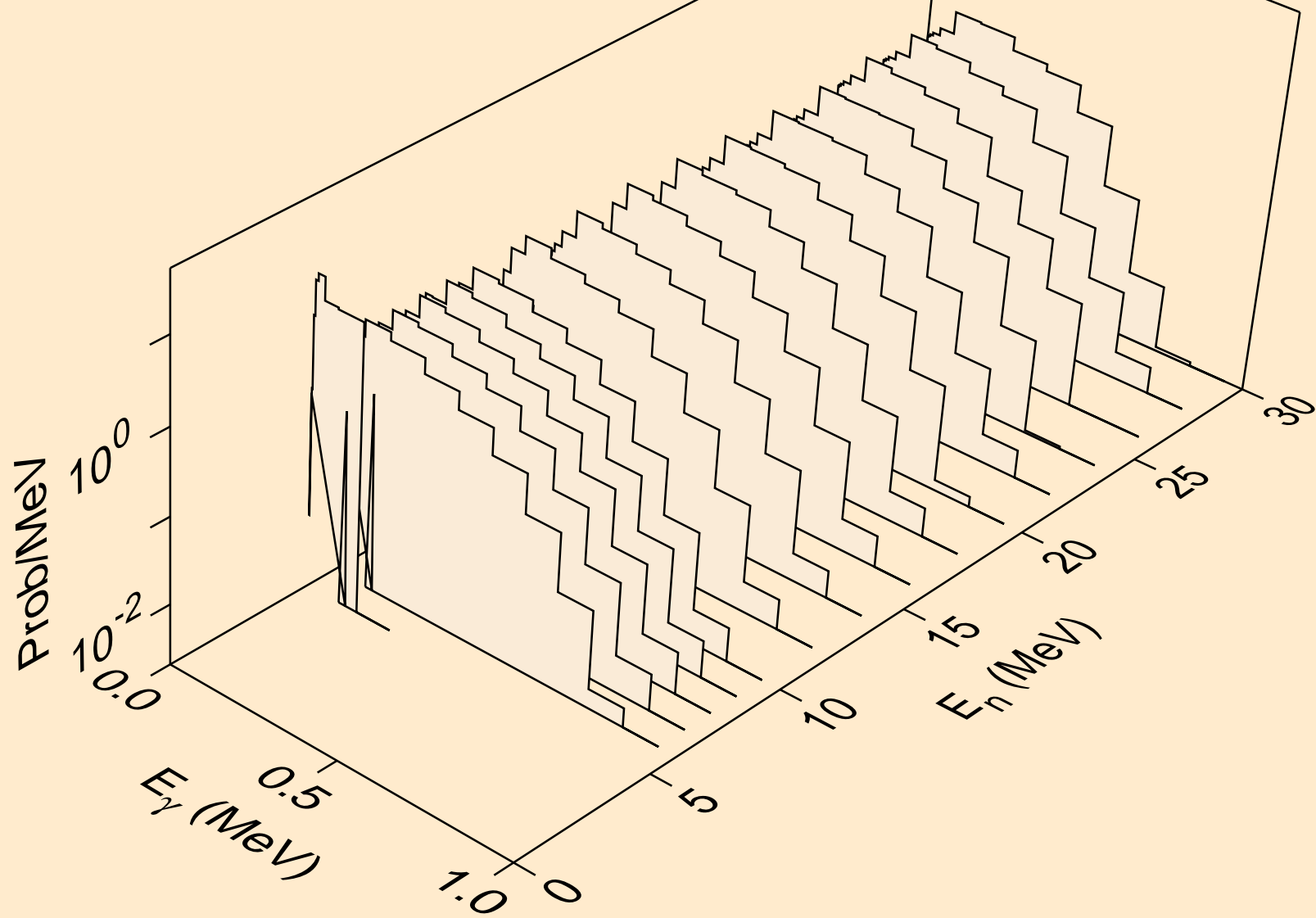

MD246M PROTON ACER TENDL-2023 LIBRARY; T=0.K
Photon emission for (z,x)

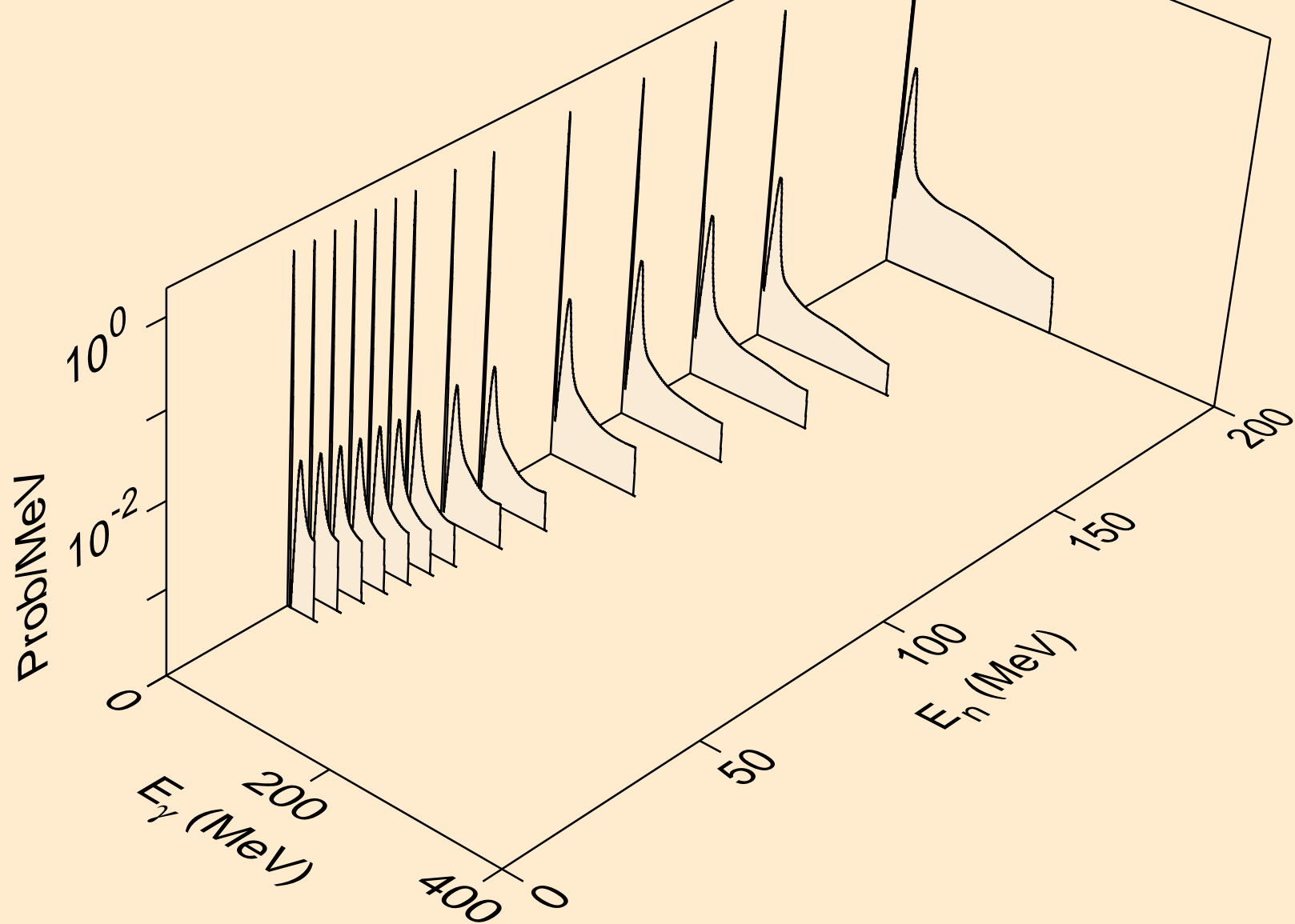

MD246M PROTON ACER TENDL-2023 LIBRARY; T=0.K
Photon emission for (n,2n)

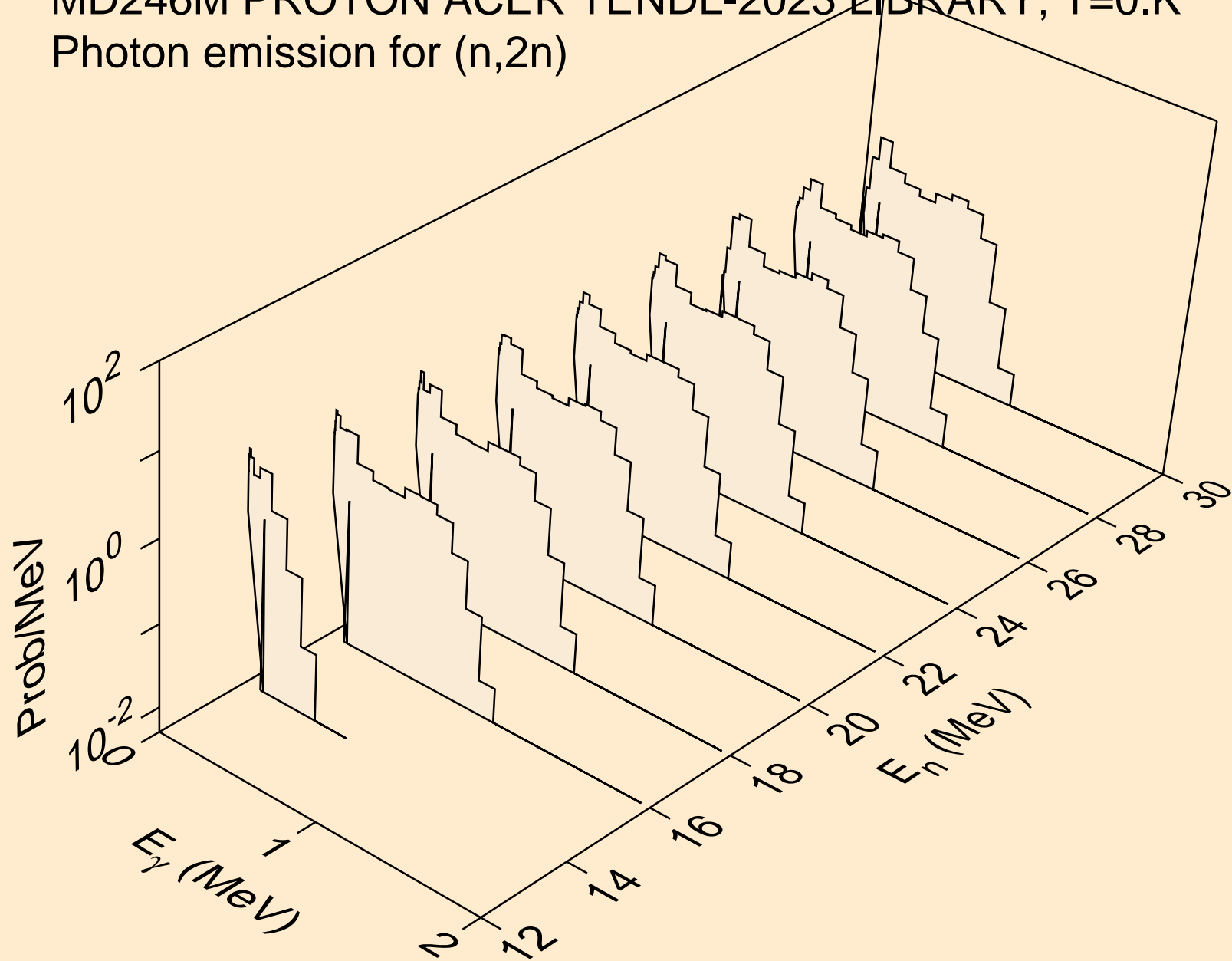

MD246M PROTON ACER TENDL-2023 LIBRARY; T=0.K
Photon emission for (n,n*)a

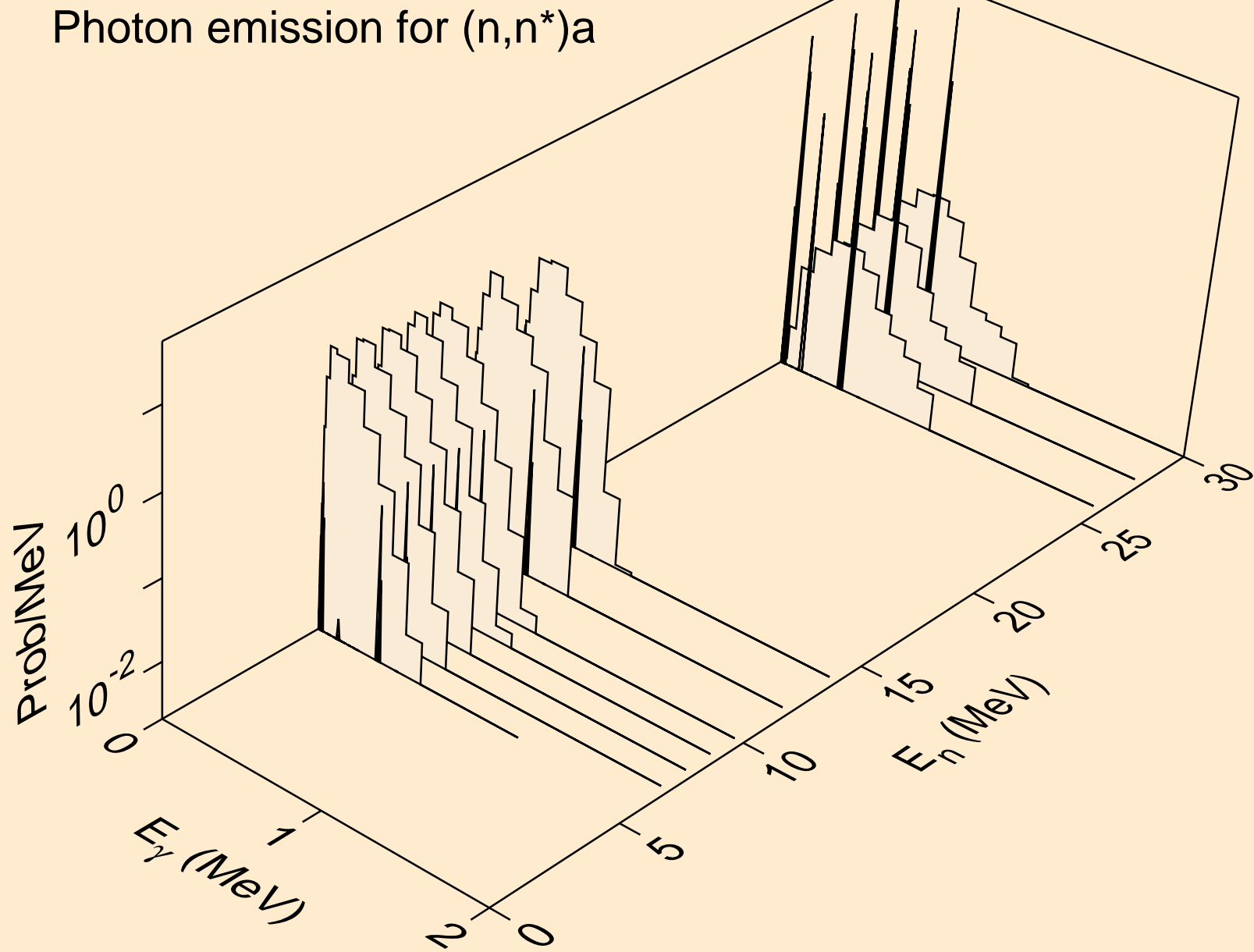

MD246M PROTON ACER TENDL-2023 LIBRARY; T=0.K
Photon emission for (n,2n)a

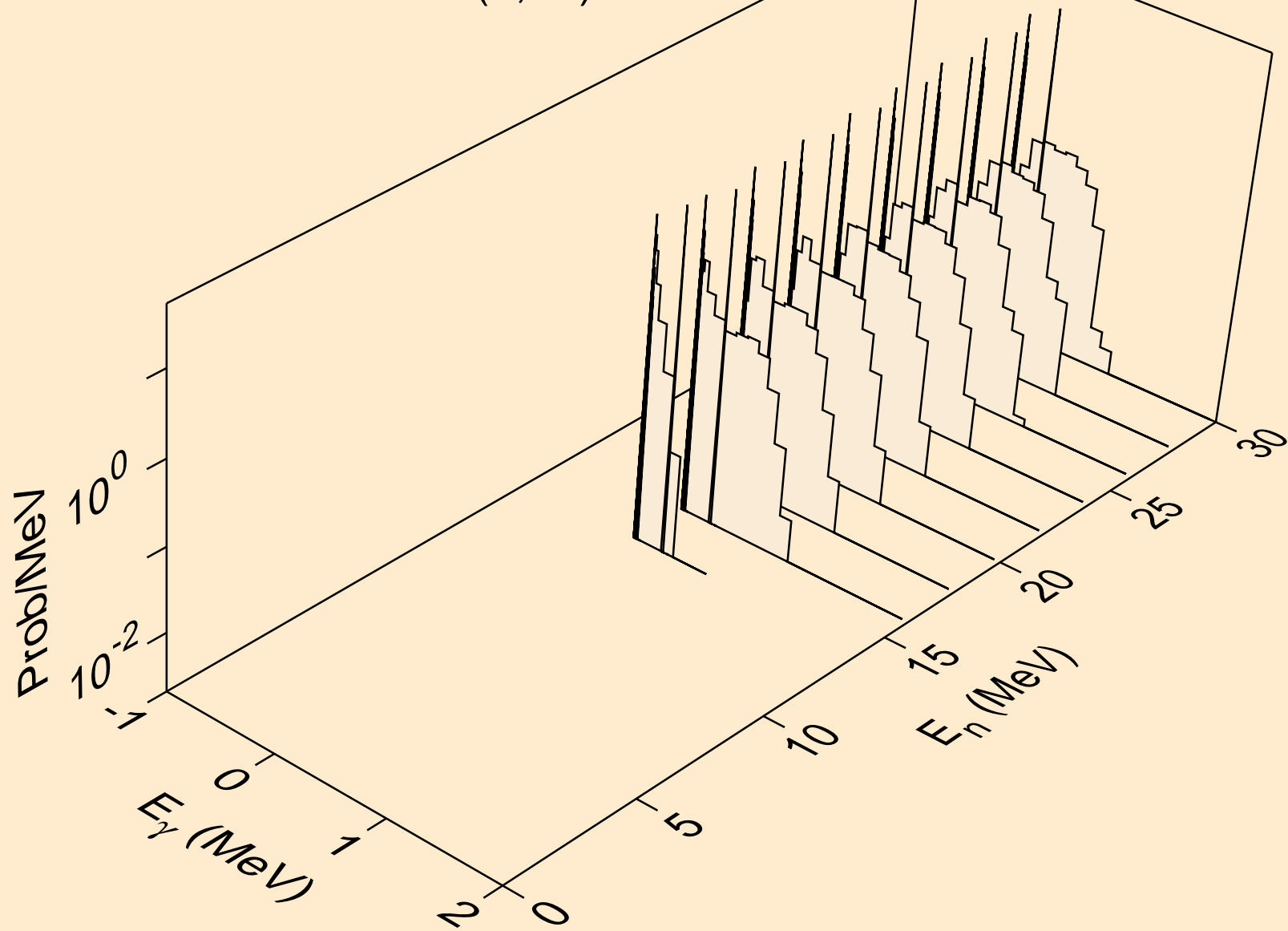

MD246M PROTON ACER TENDL-2023 LIBRARY; T=0.K
Photon emission for (n,n*)p

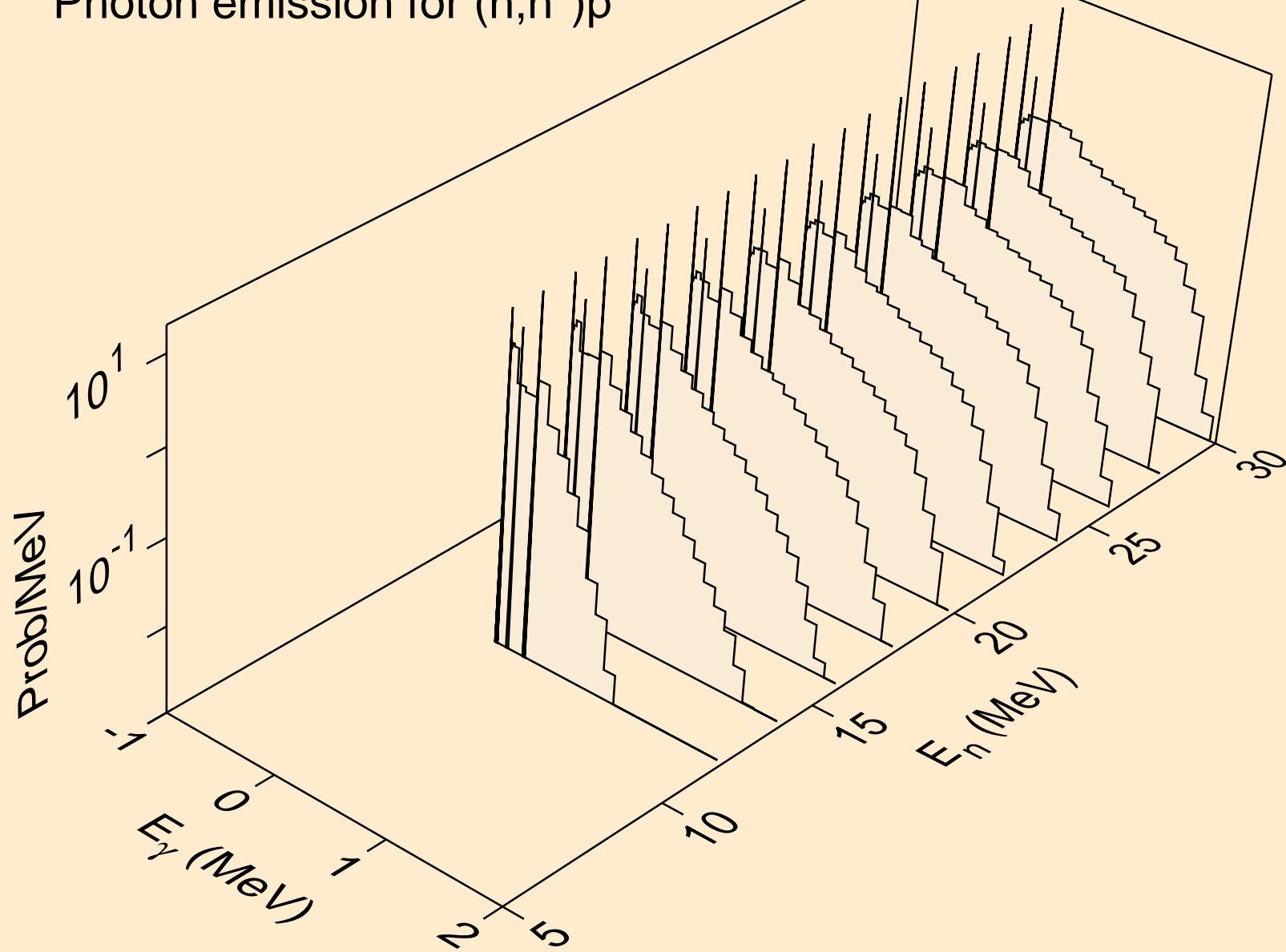

MD246M PROTON ACER TENDL-2023 LIBRARY; T=0.K
Photon emission for (n,n*)d

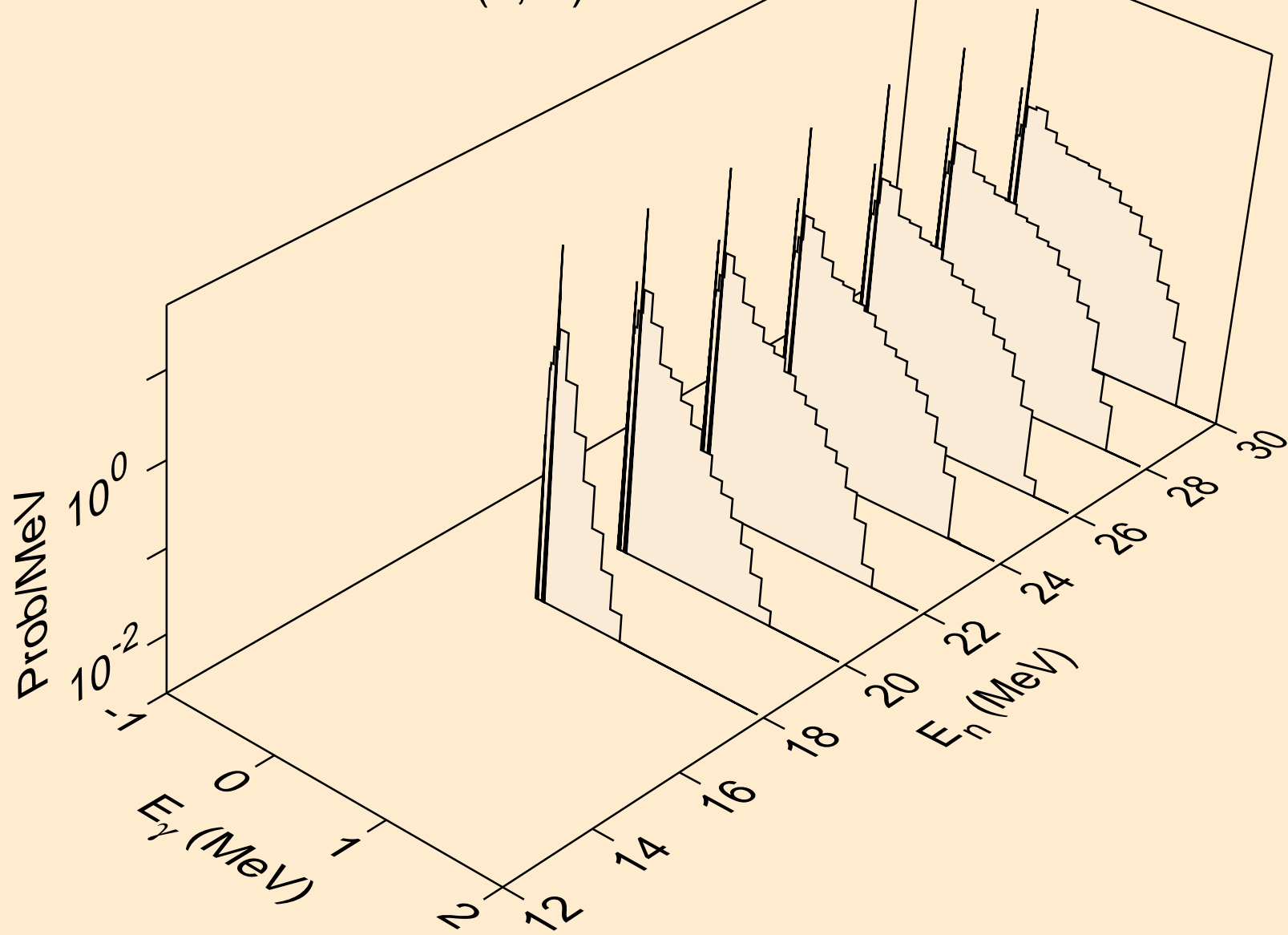

MD246M PROTON ACER TENDL-2023 LIBRARY; T=0.K
Photon emission for (n,2np)

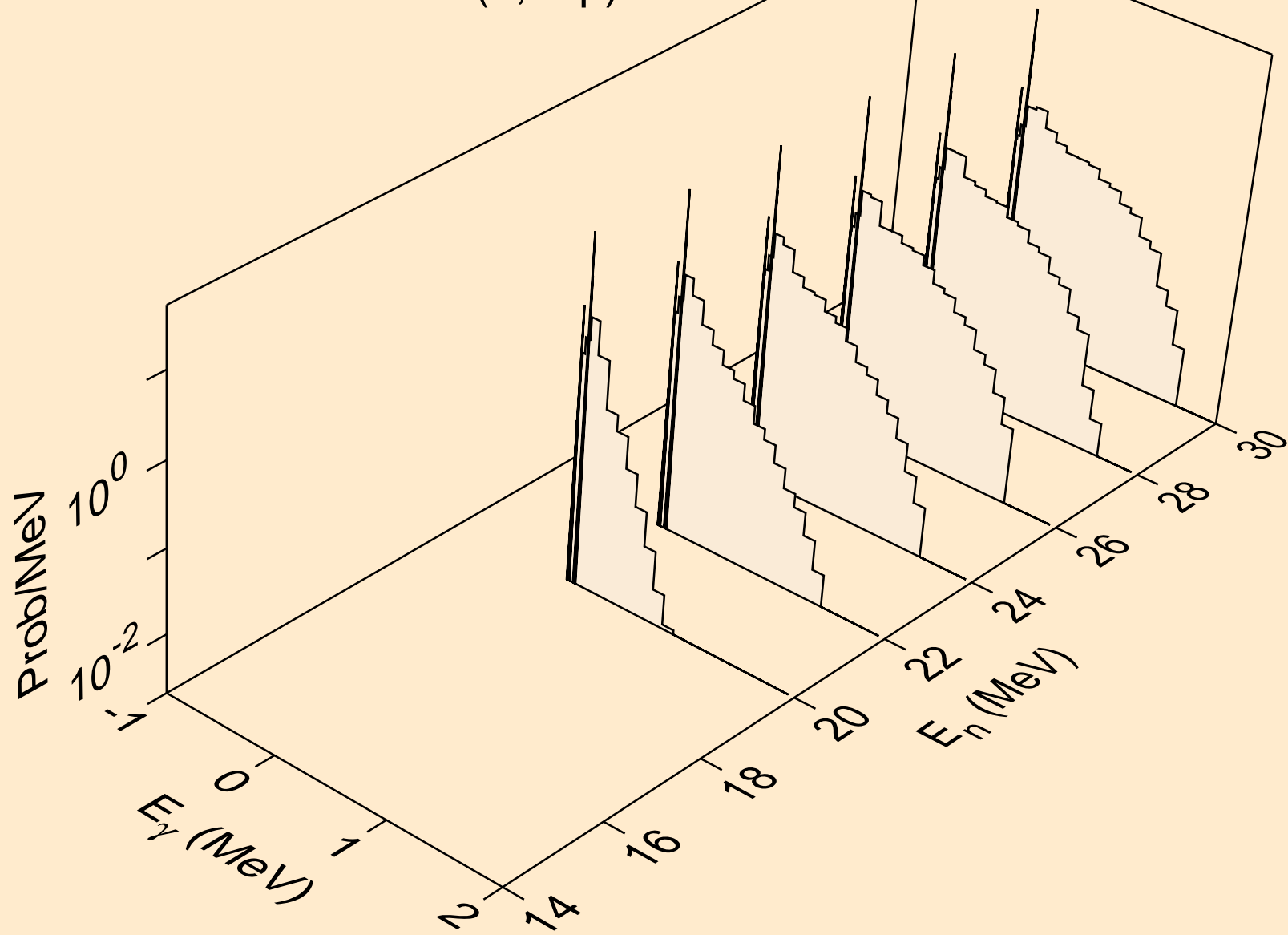

MD246M PROTON ACER TENDL-2023 LIBRARY; T=0.K
Photon emission for (n,n2p)

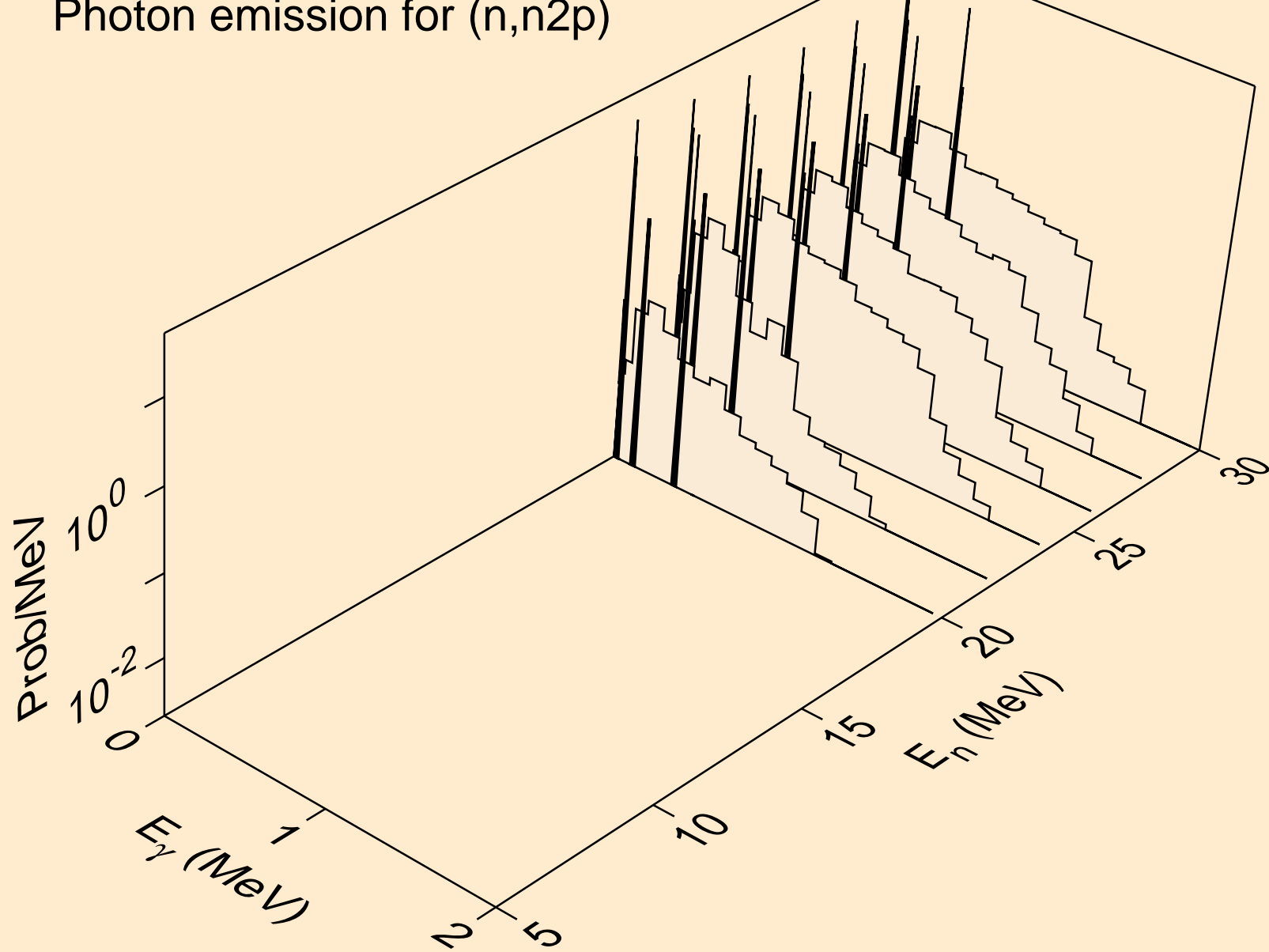

MD246M PROTON ACER TENDL-2023 LIBRARY; T=0.K
Photon emission for (n,npa)

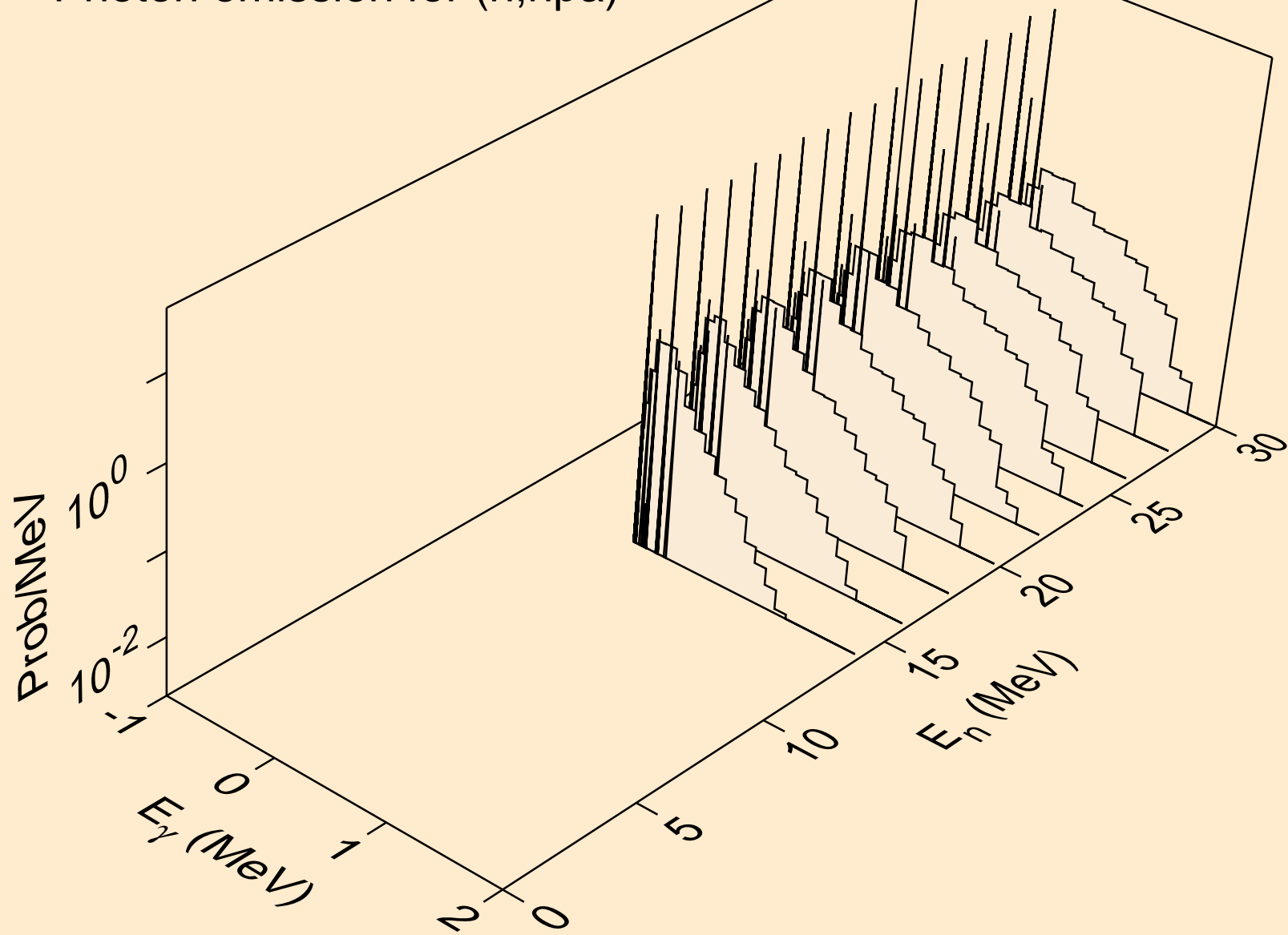

MD246M PROTON ACER TENDL-2023 LIBRARY; T=0.K
Photon emission for (n,gma)

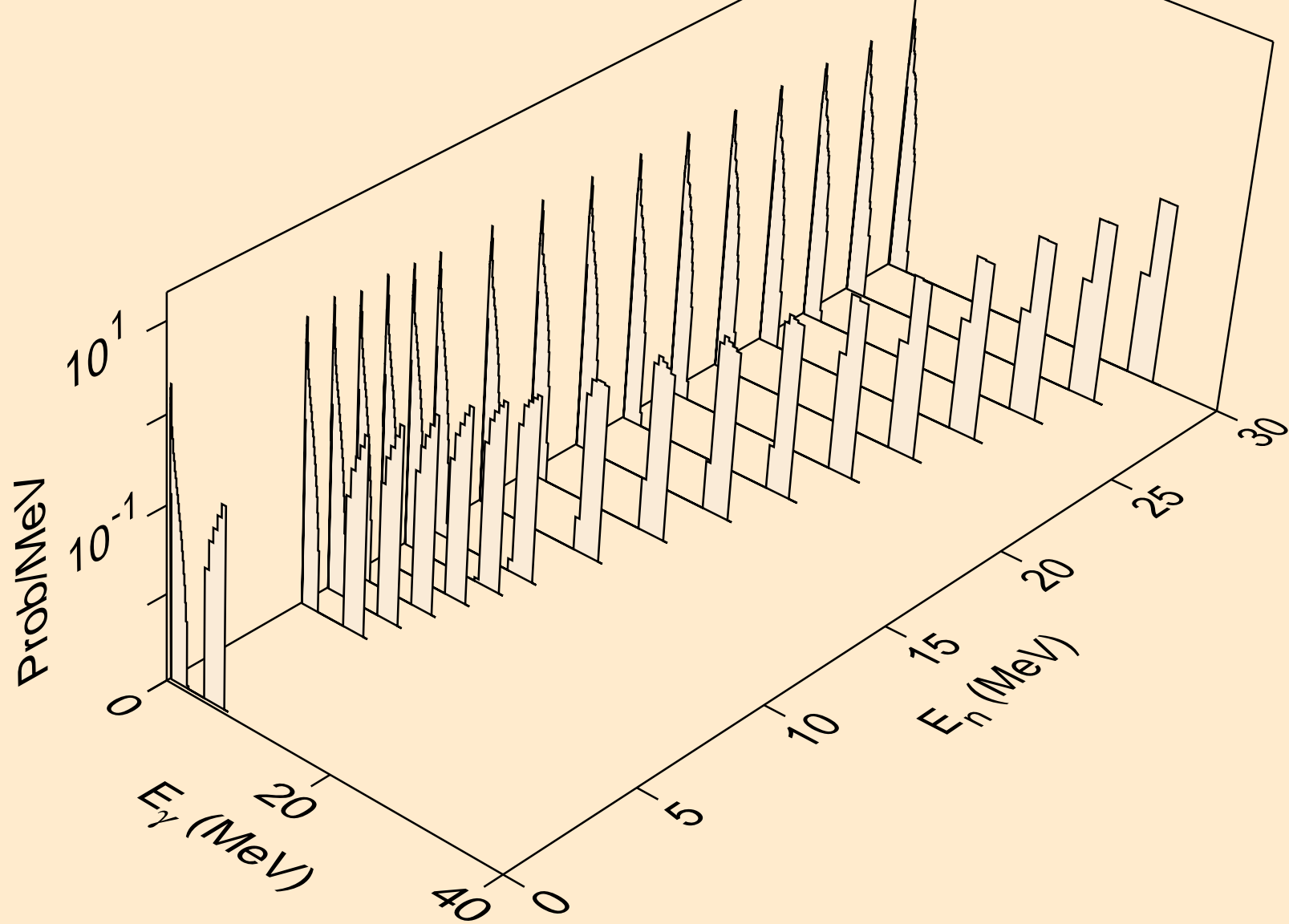

MD246M PROTON ACER TENDL-2023 LIBRARY; T=0.K
Photon emission for inelastic

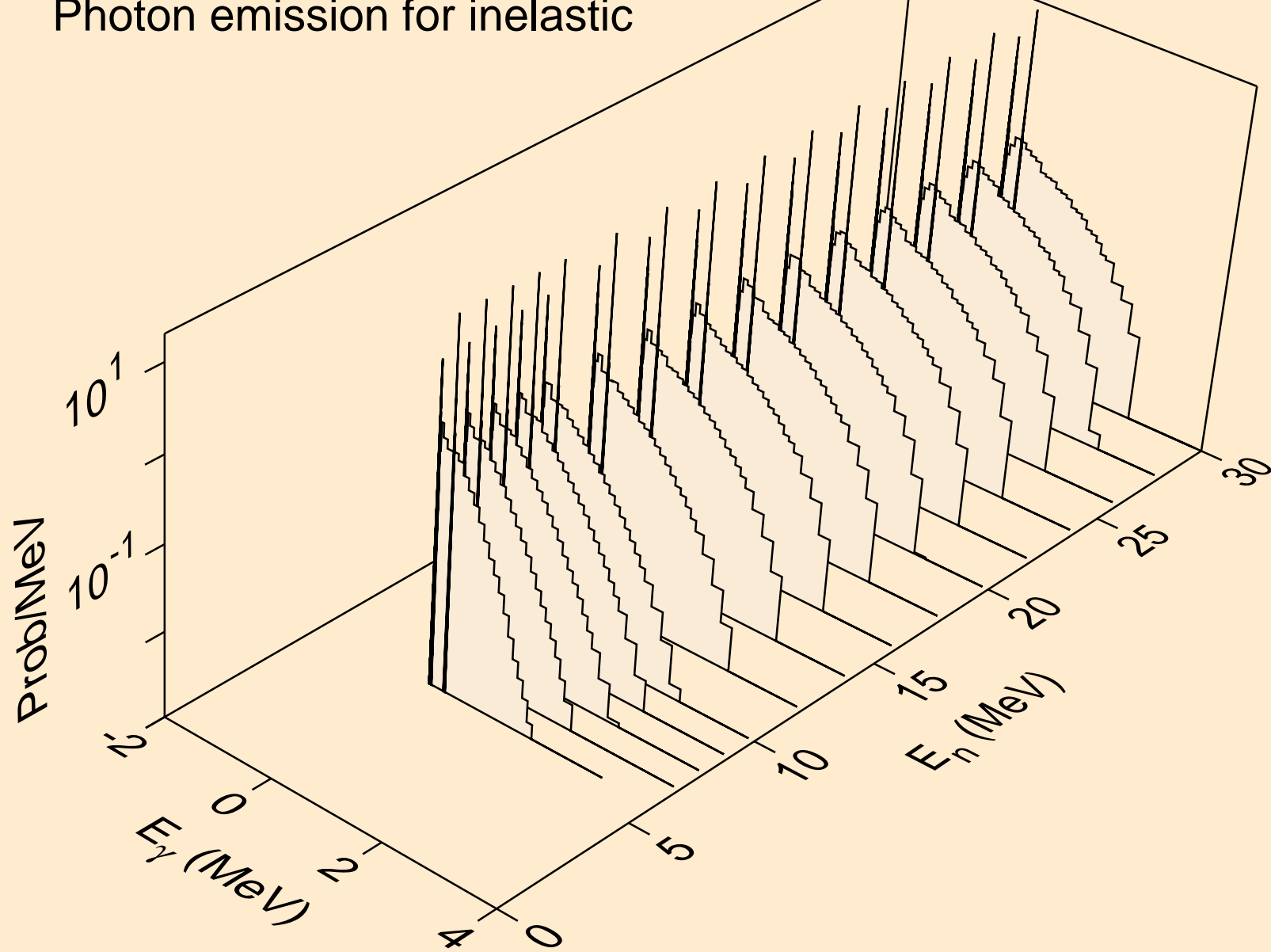

MD246M PROTON ACER TENDL-2023 LIBRARY; T=0.K
Photon emission for (n,d)

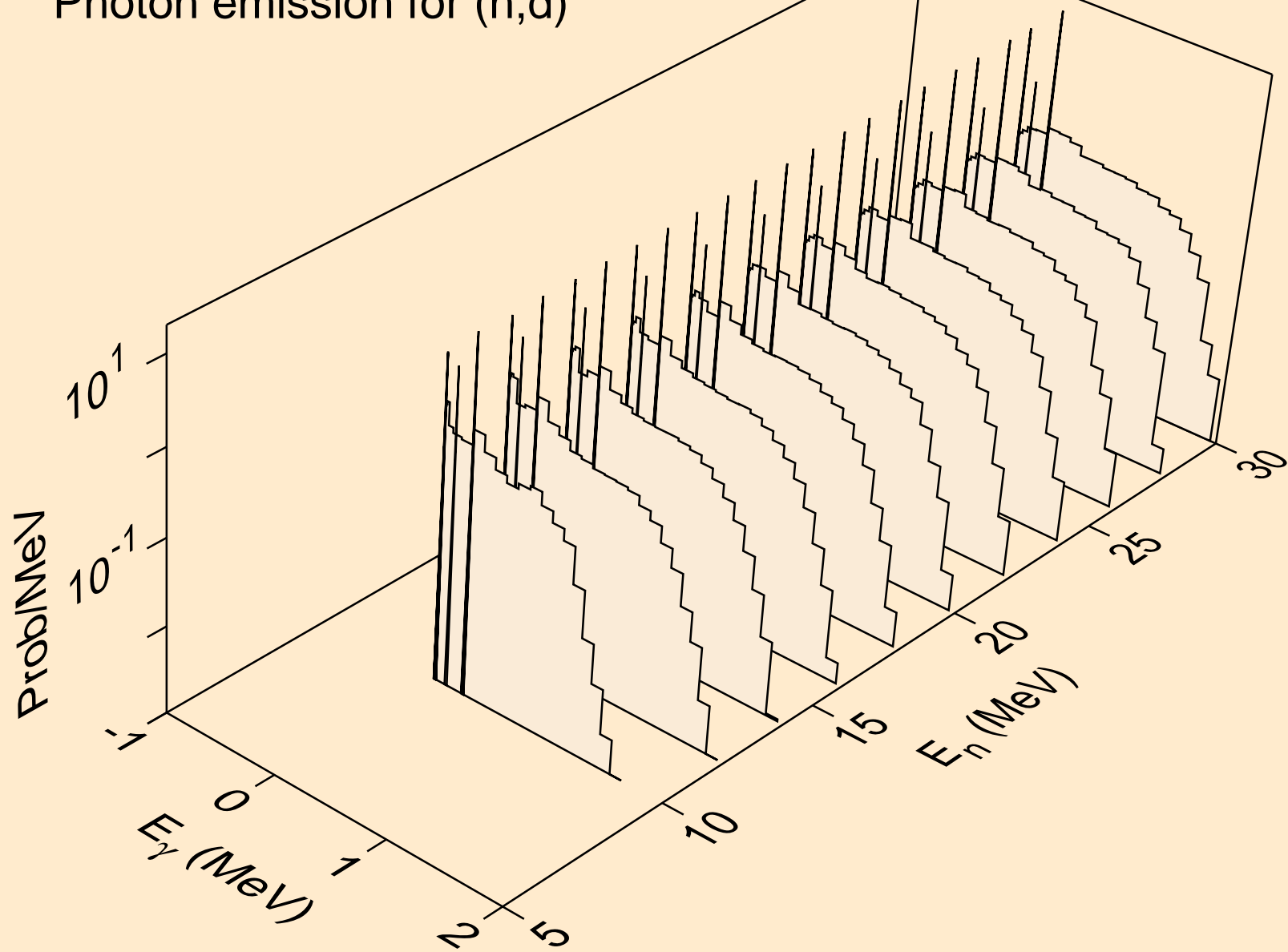

MD246M PROTON ACER TENDL-2023 LIBRARY; T=0.K
Photon emission for (n,t)

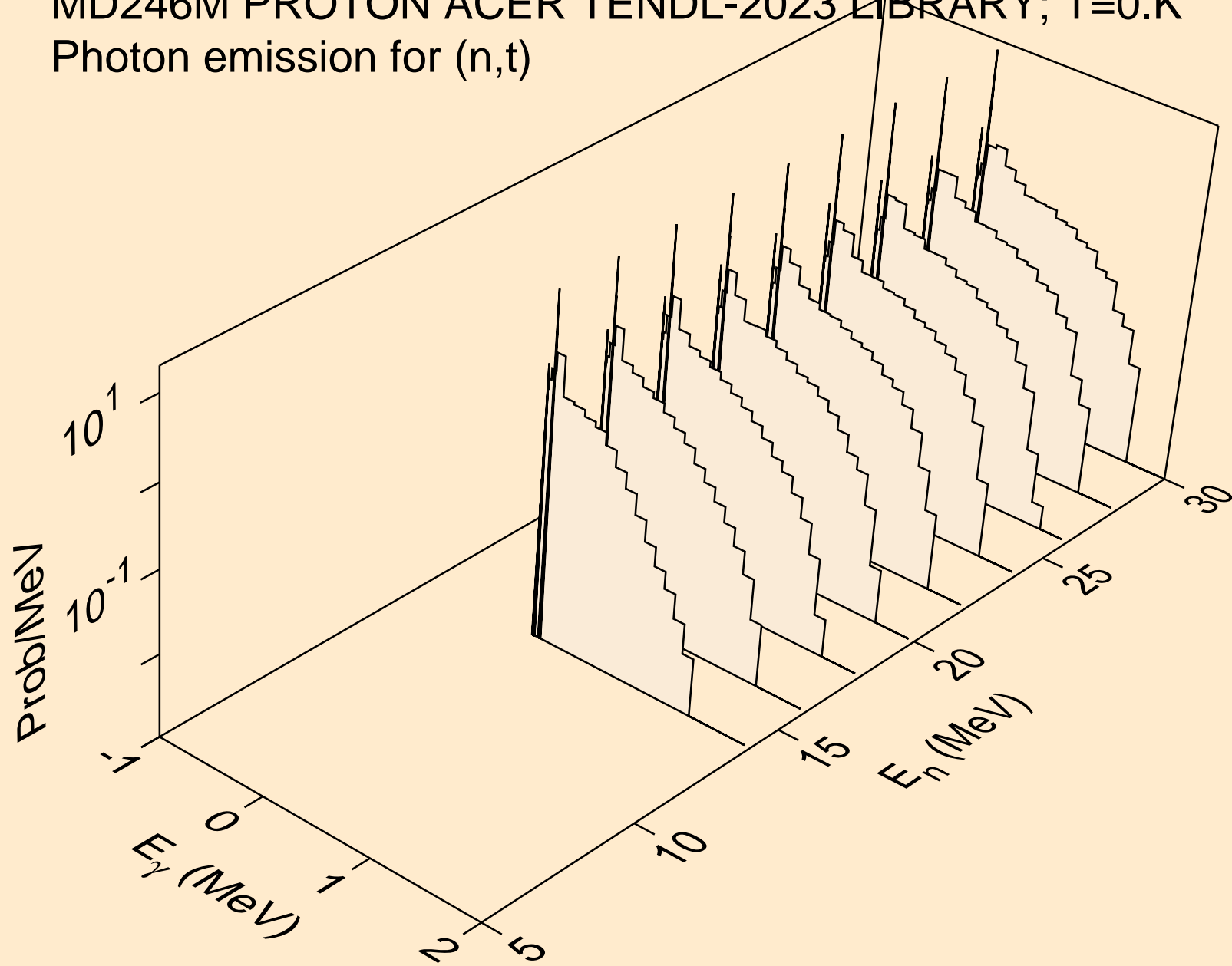

MD246M PROTON ACER TENDL-2023 LIBRARY; T=0.K
Photon emission for (n,he3)

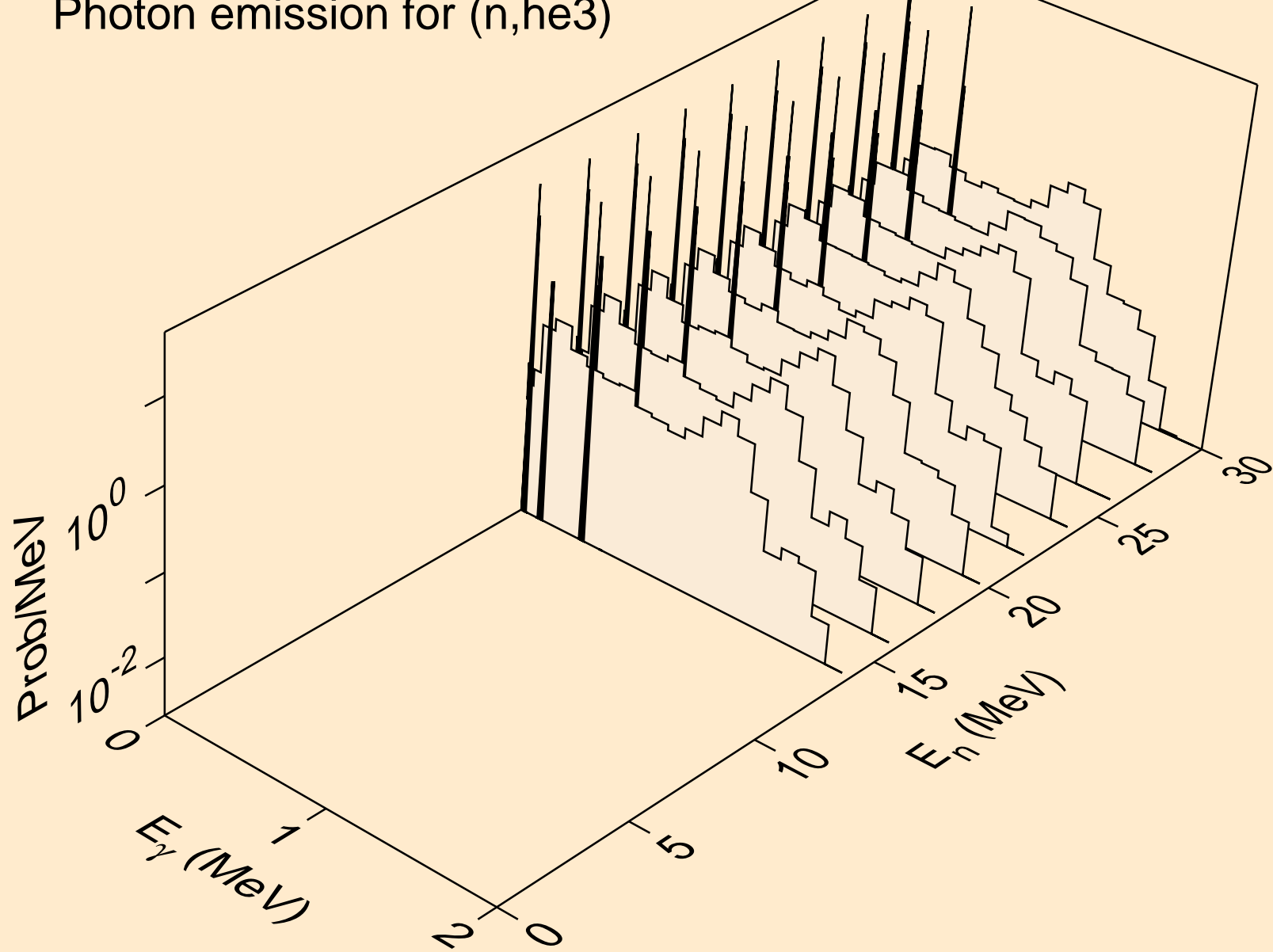

MD246M PROTON ACER TENDL-2023 LIBRARY; T=0.K
Photon emission for (n,a)

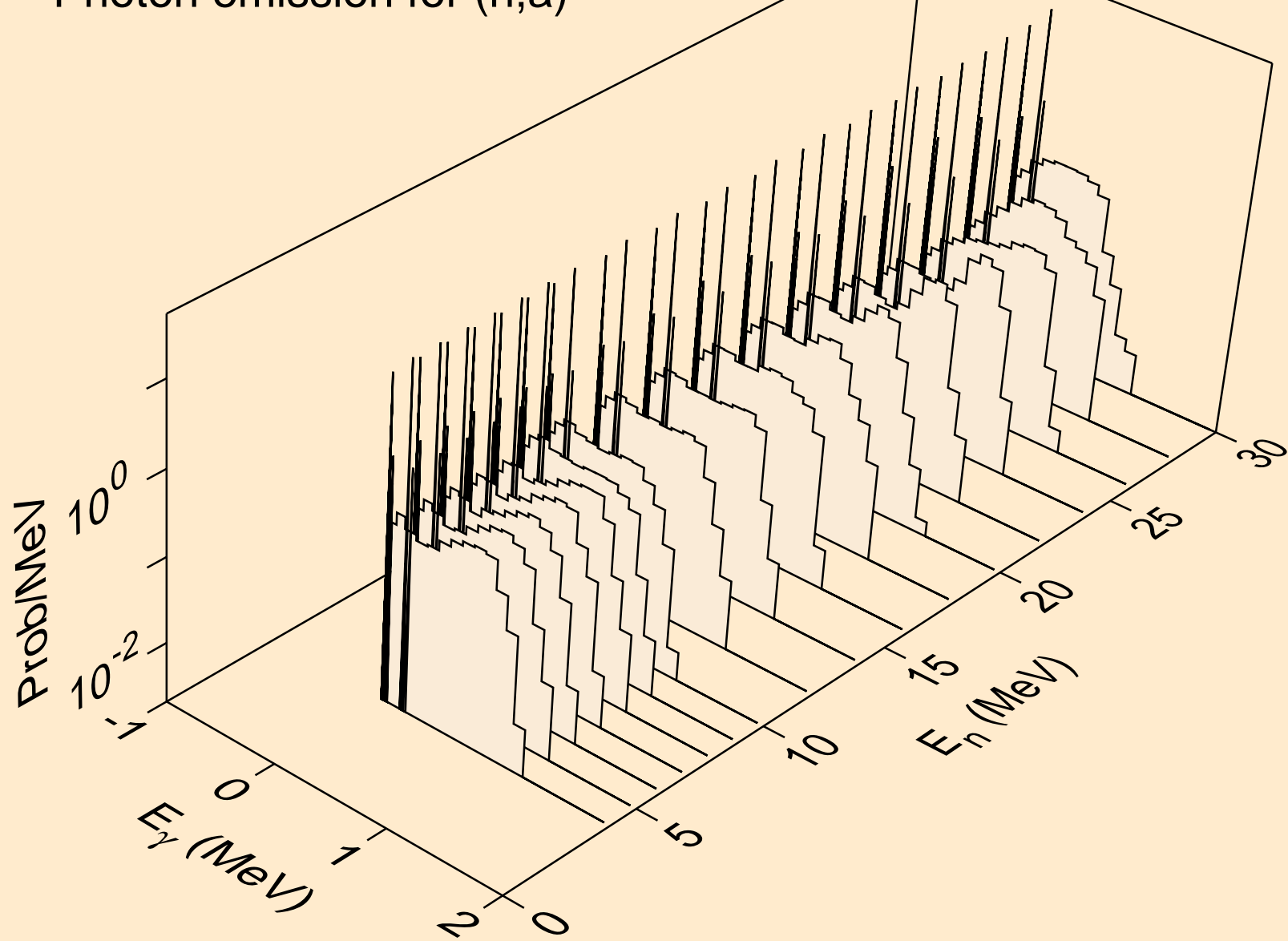

MD246M PROTON ACER TENDL-2023 LIBRARY; T=0.K
Photon emission for (n,2p)

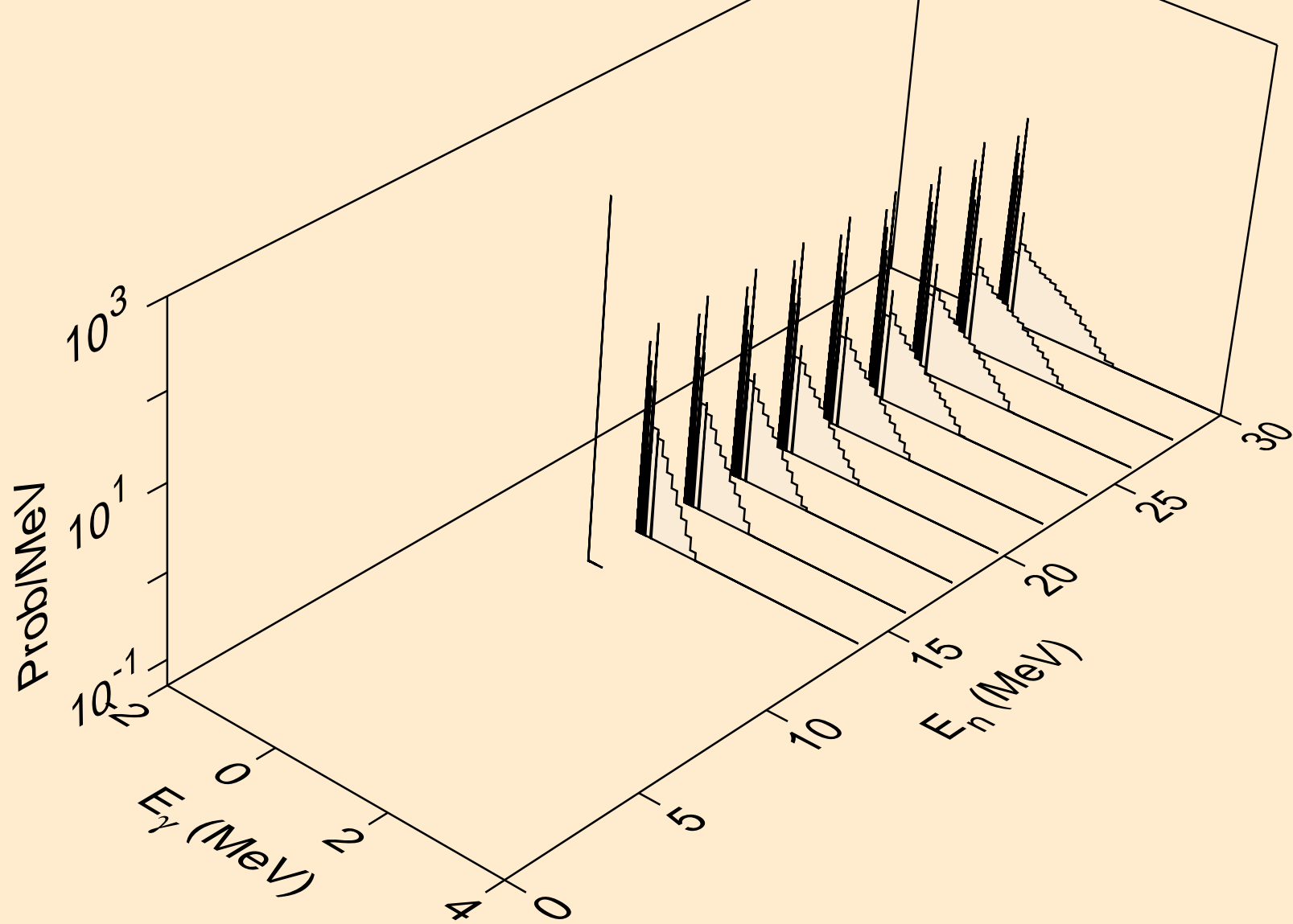

MD246M PROTON ACER TENDL-2023 LIBRARY; T=0.K
Photon emission for (n,pa)

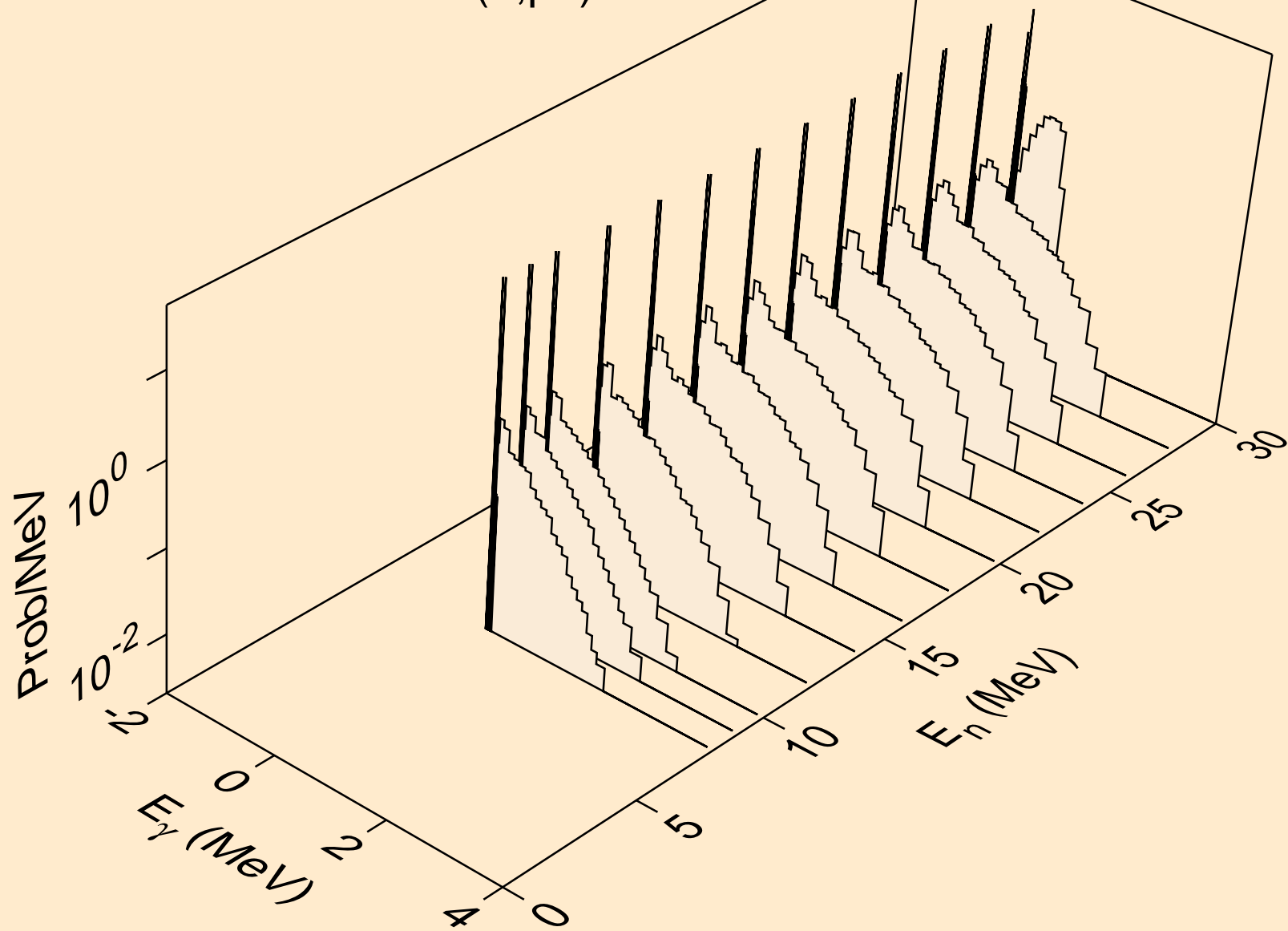

MD246M PROTON ACER TENDL-2023 LIBRARY; T=0.K
Photon emission for (n,pd)

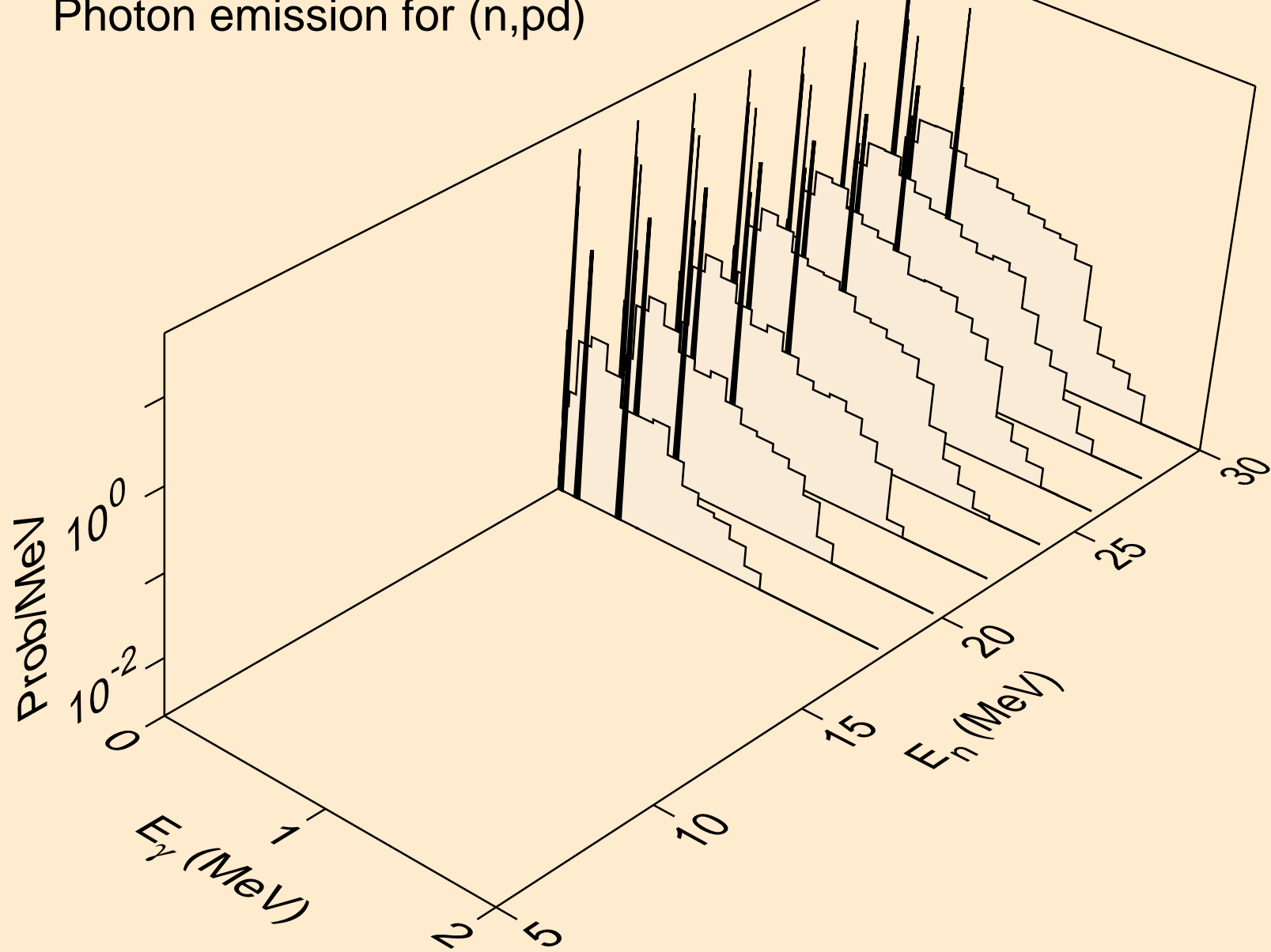

MD246M PROTON ACER TENDL-2023 LIBRARY; T=0.K
Photon emission for (n,da)

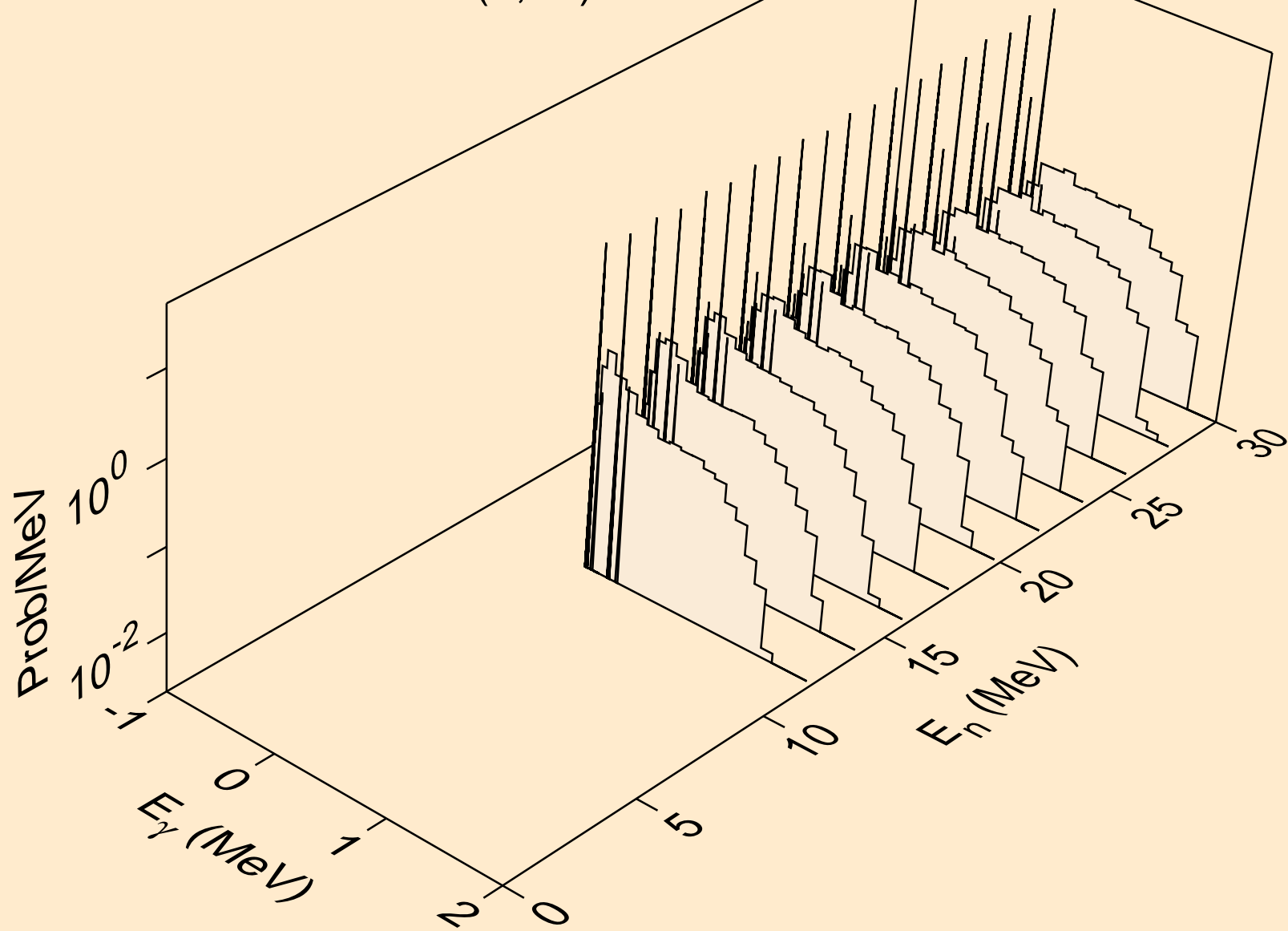

MD246M PROTON ACER TENDL-2023 LIBRARY; T=0.K

Particle heating contributions

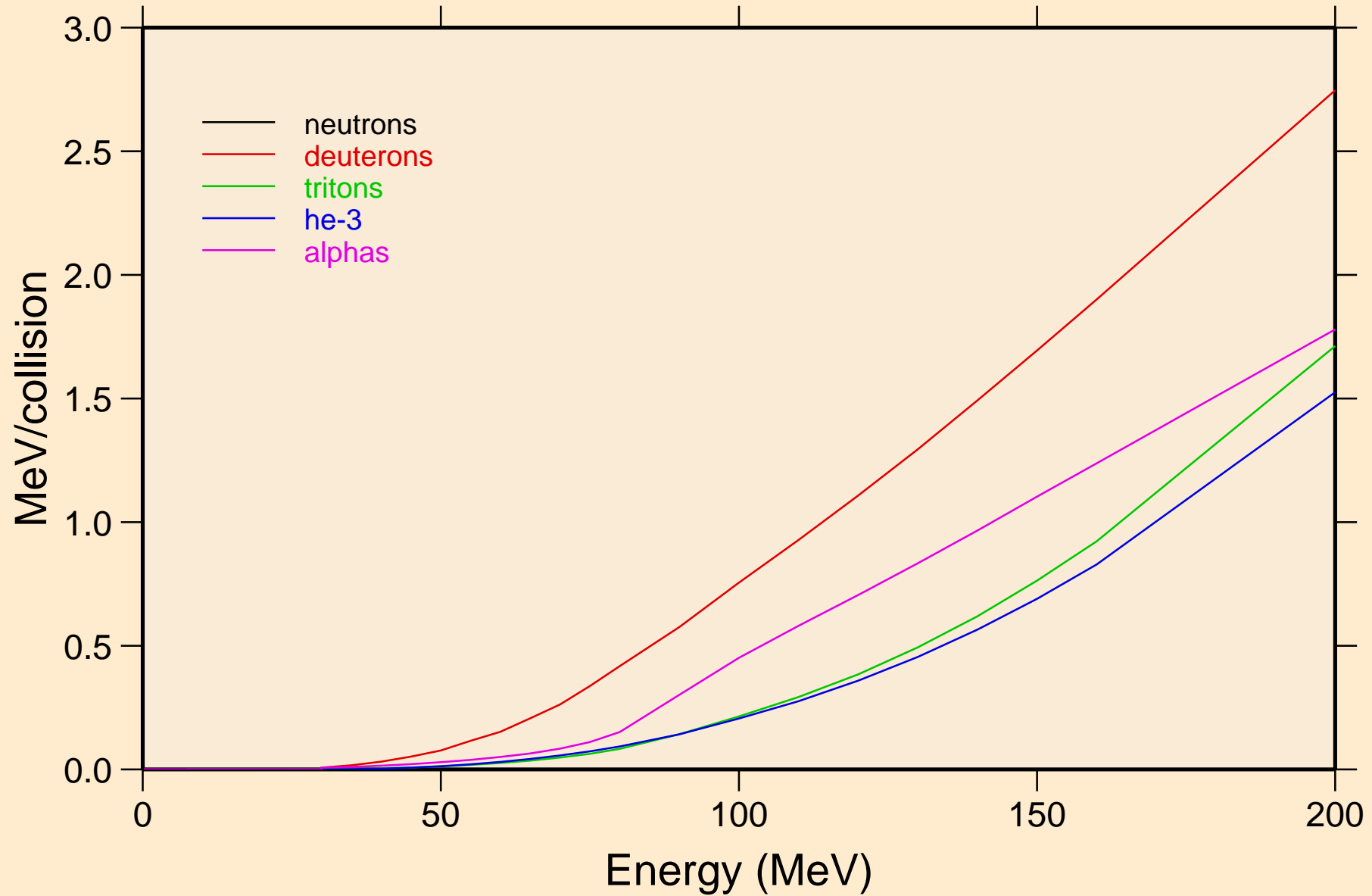

MD246M PROTON ACER TENDL-2023 LIBRARY; T=0.K
Recoil Heating

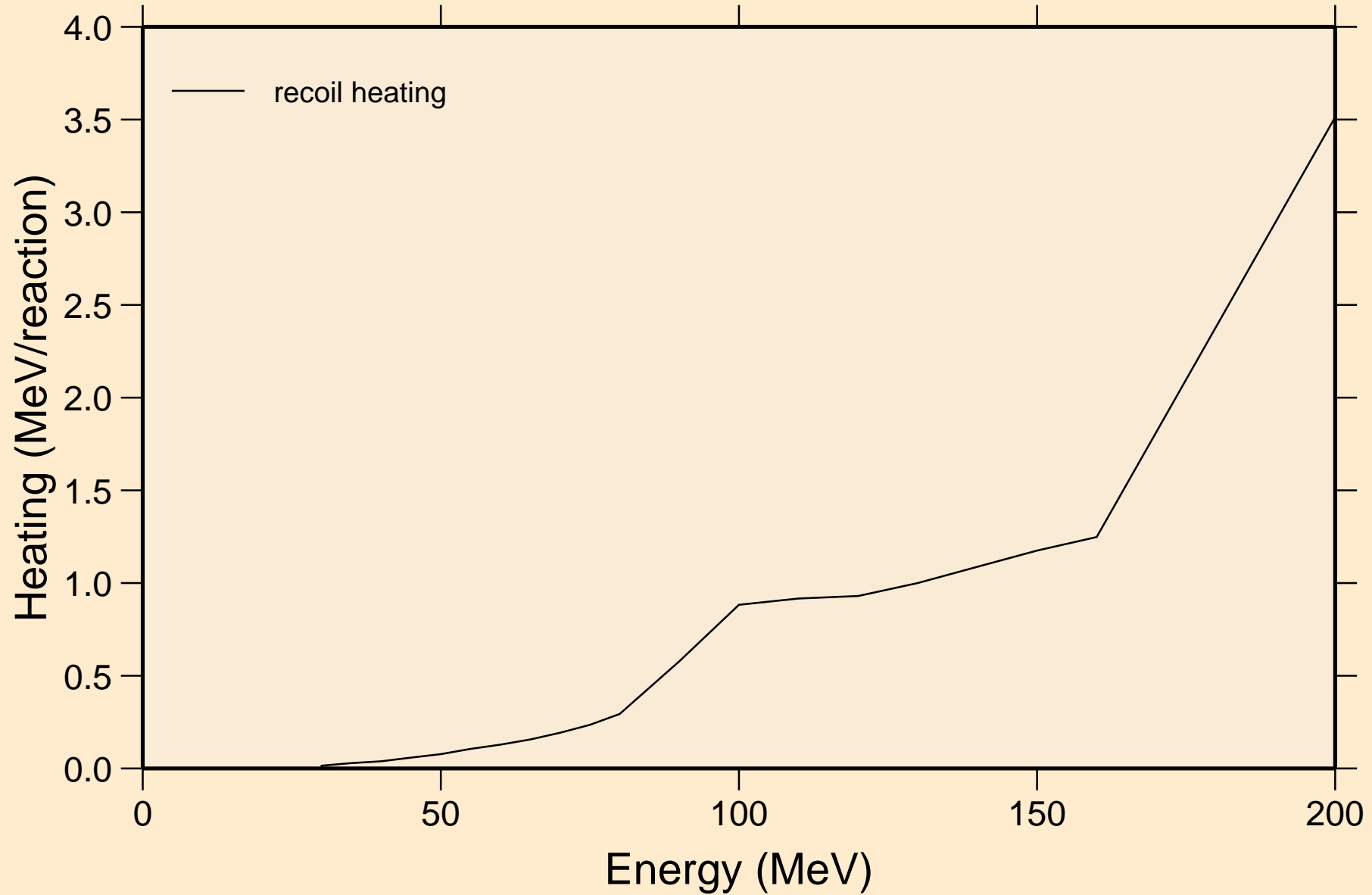

MD246M PROTON ACER TENDL-2023 LIBRARY; T=0.K
Particle production cross sections

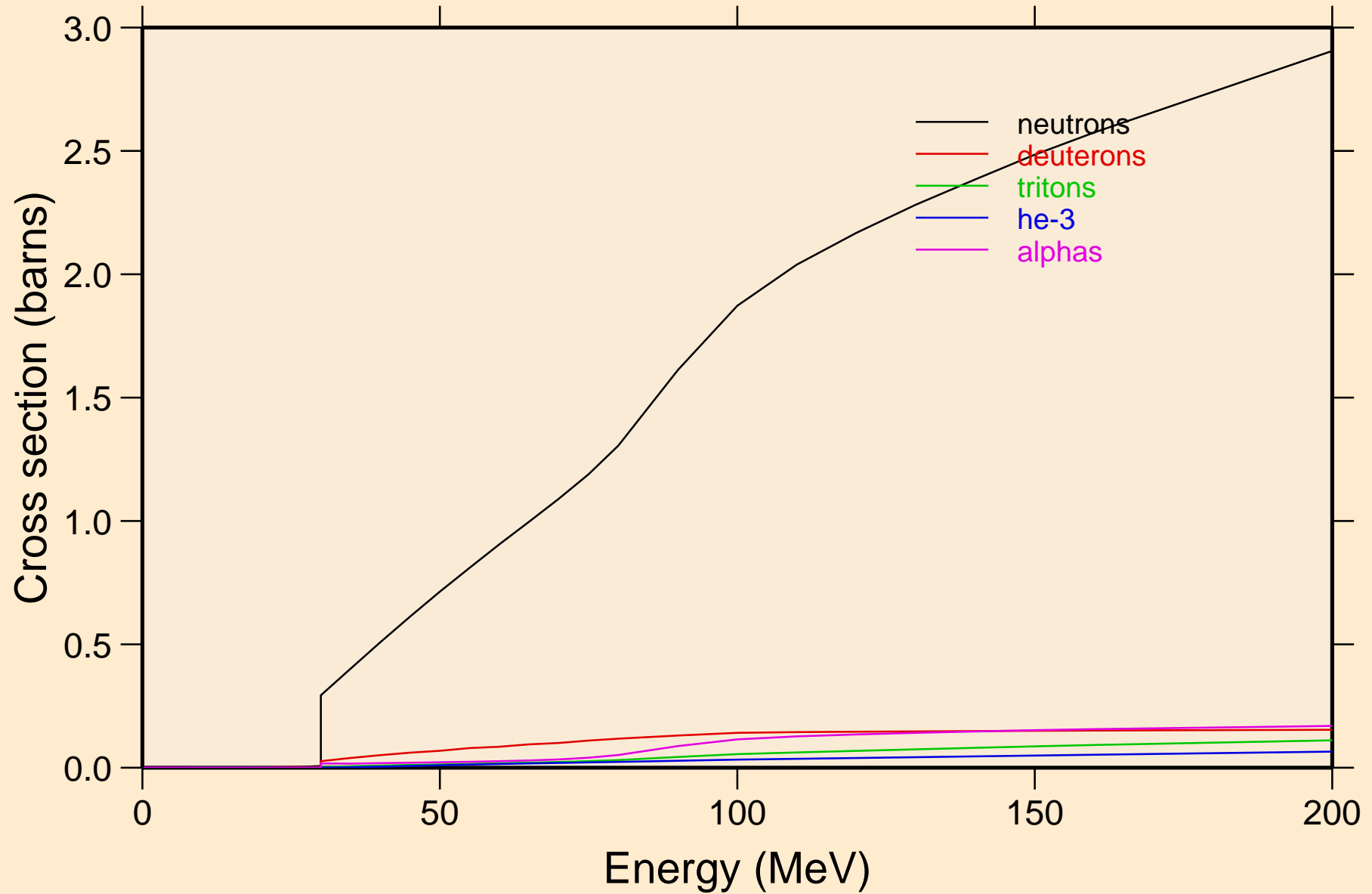

MD246M PROTON ACER TENDL-2023 LIBRARY; T=0.K
neutrons from (p,n)

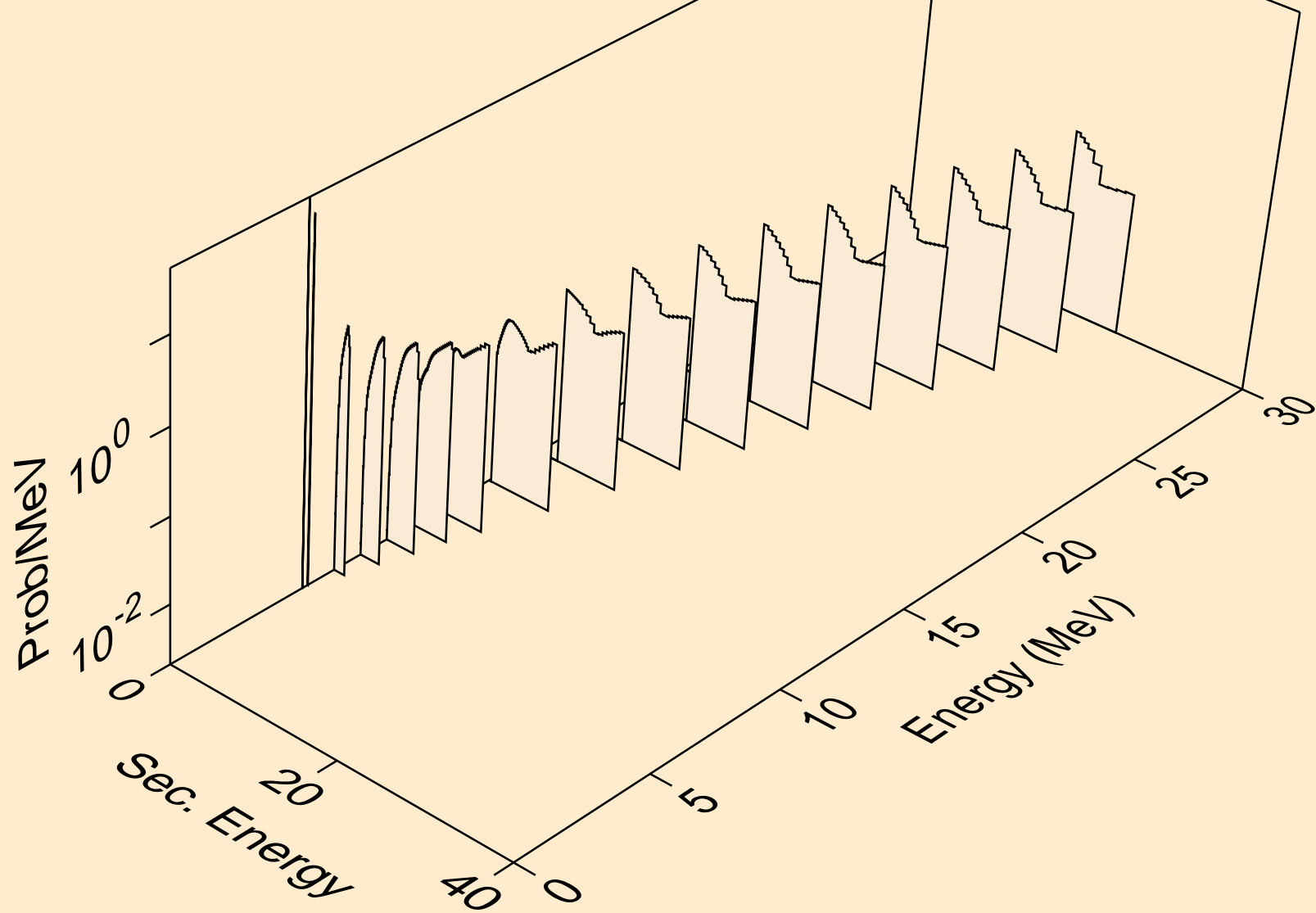

MD246M PROTON ACER TENDL-2023 LIBRARY; T=0.K
neutrons from (p,x)

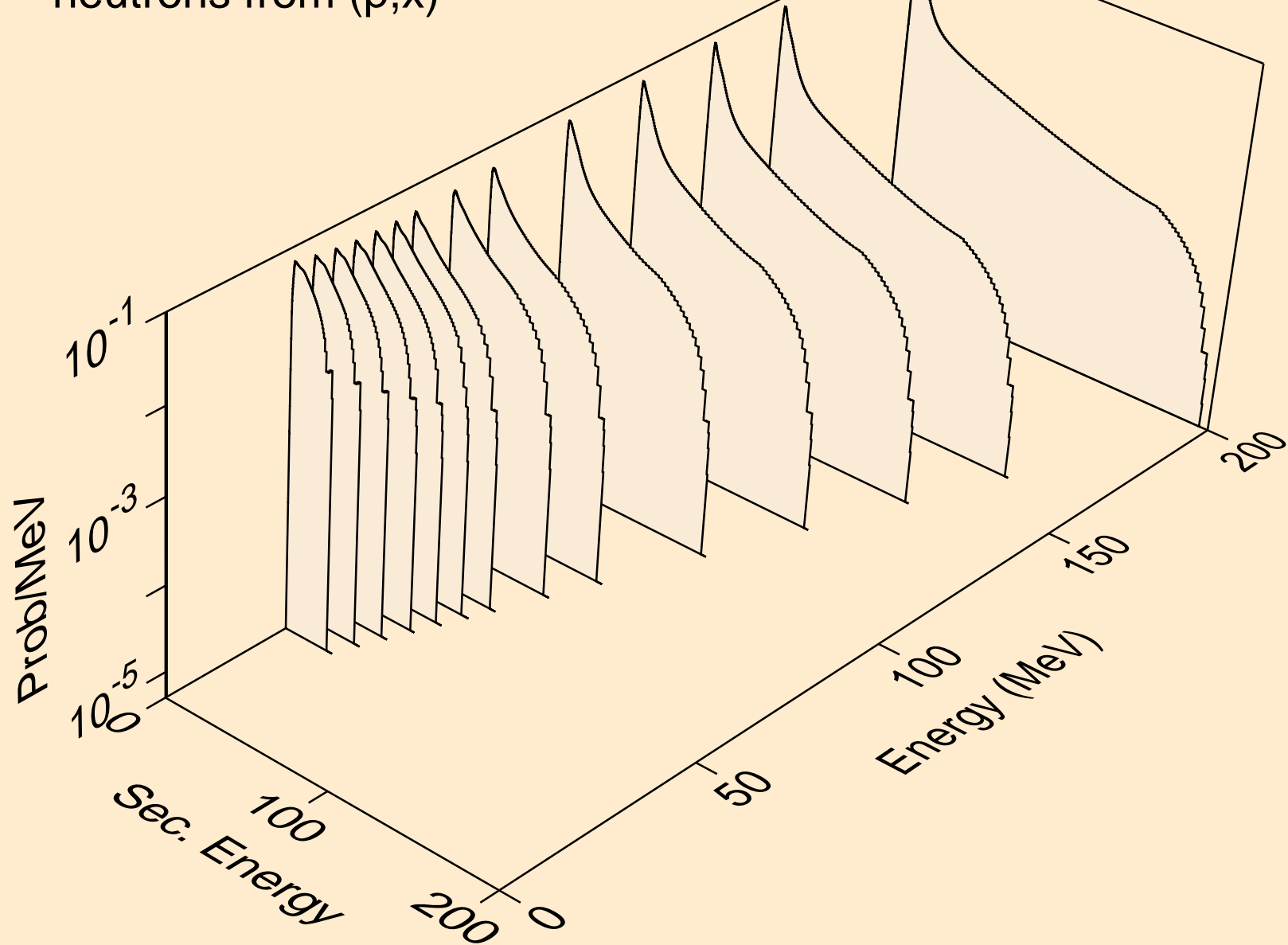

MD246M PROTON ACER TENDL-2023 LIBRARY; T=0.K
neutrons from (p,2n)

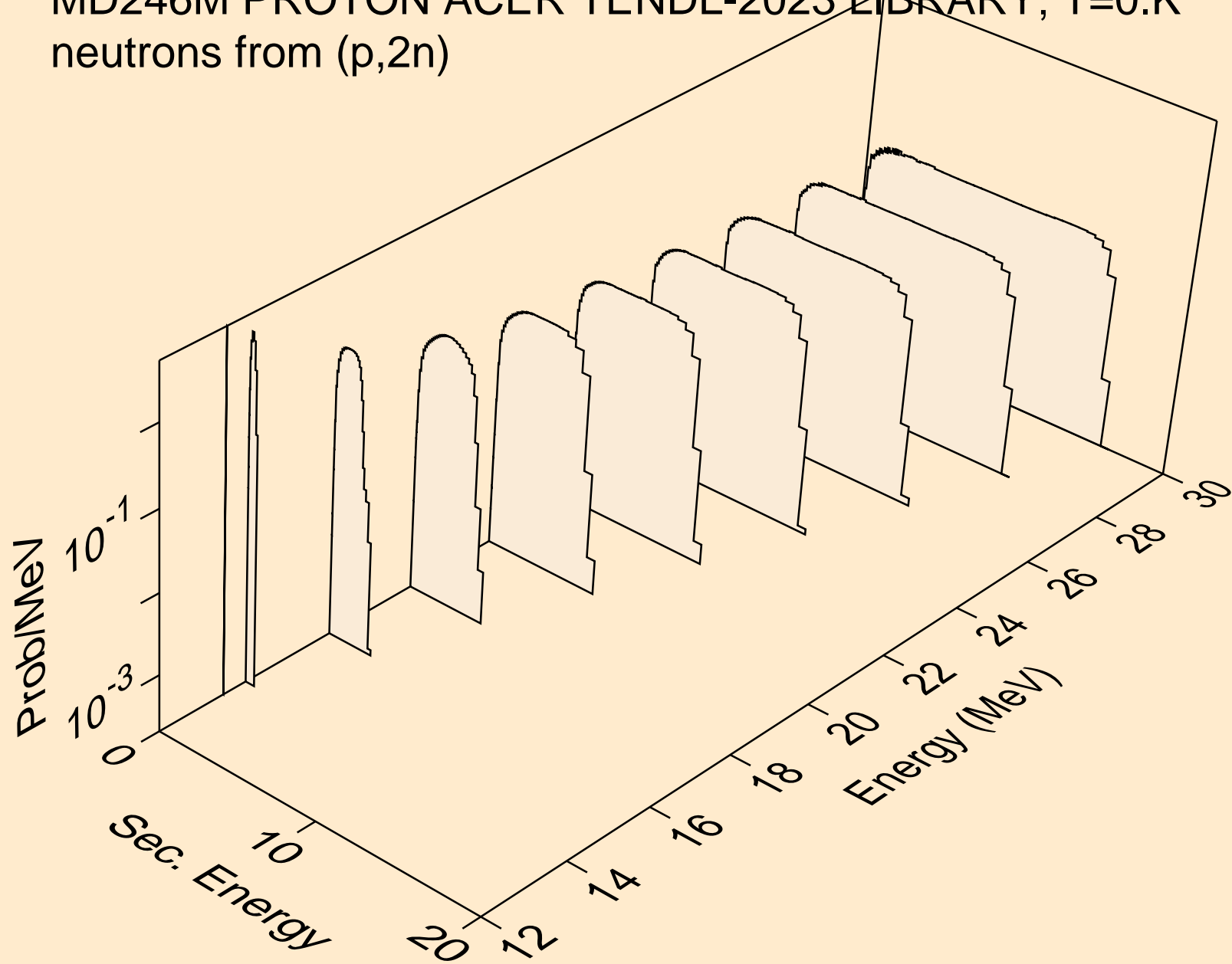

MD246M PROTON ACER TENDL-2023 LIBRARY; T=0.K
neutrons from (p,n*)a

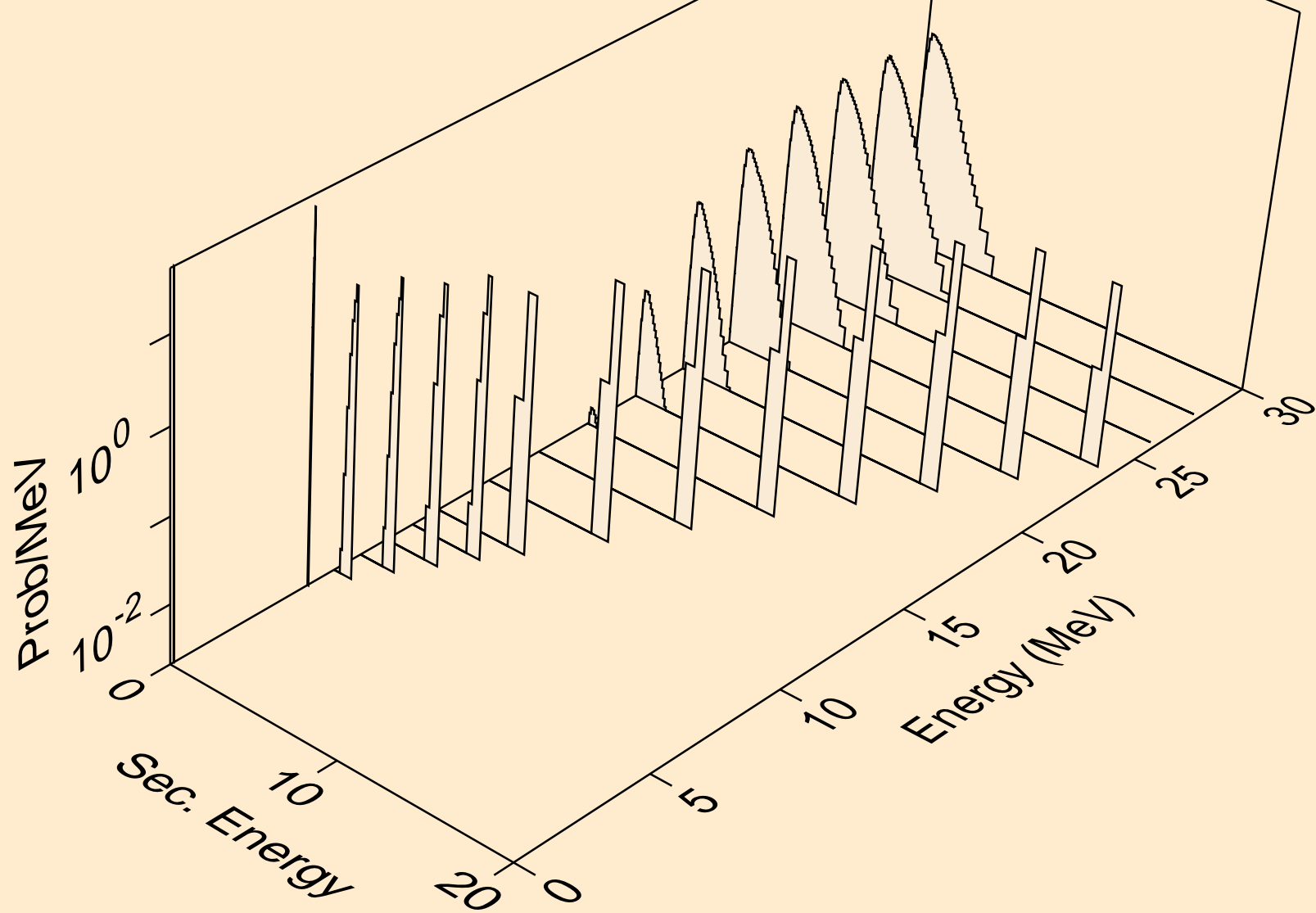

MD246M PROTON ACER TENDL-2023 LIBRARY; T=0.K
neutrons from (p,2n)a

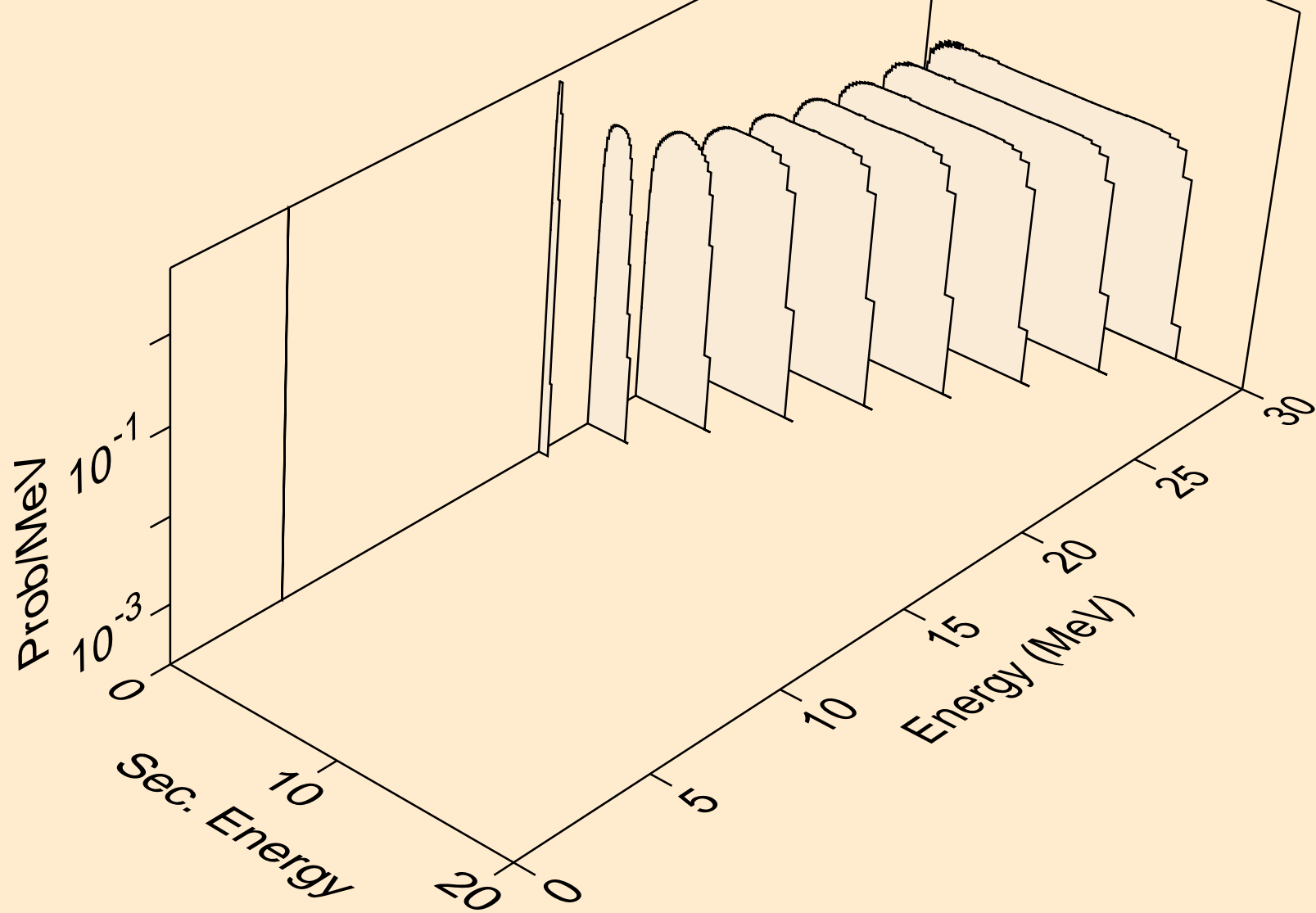

MD246M PROTON ACER TENDL-2023 LIBRARY; T=0.K
neutrons from (p,n*)p

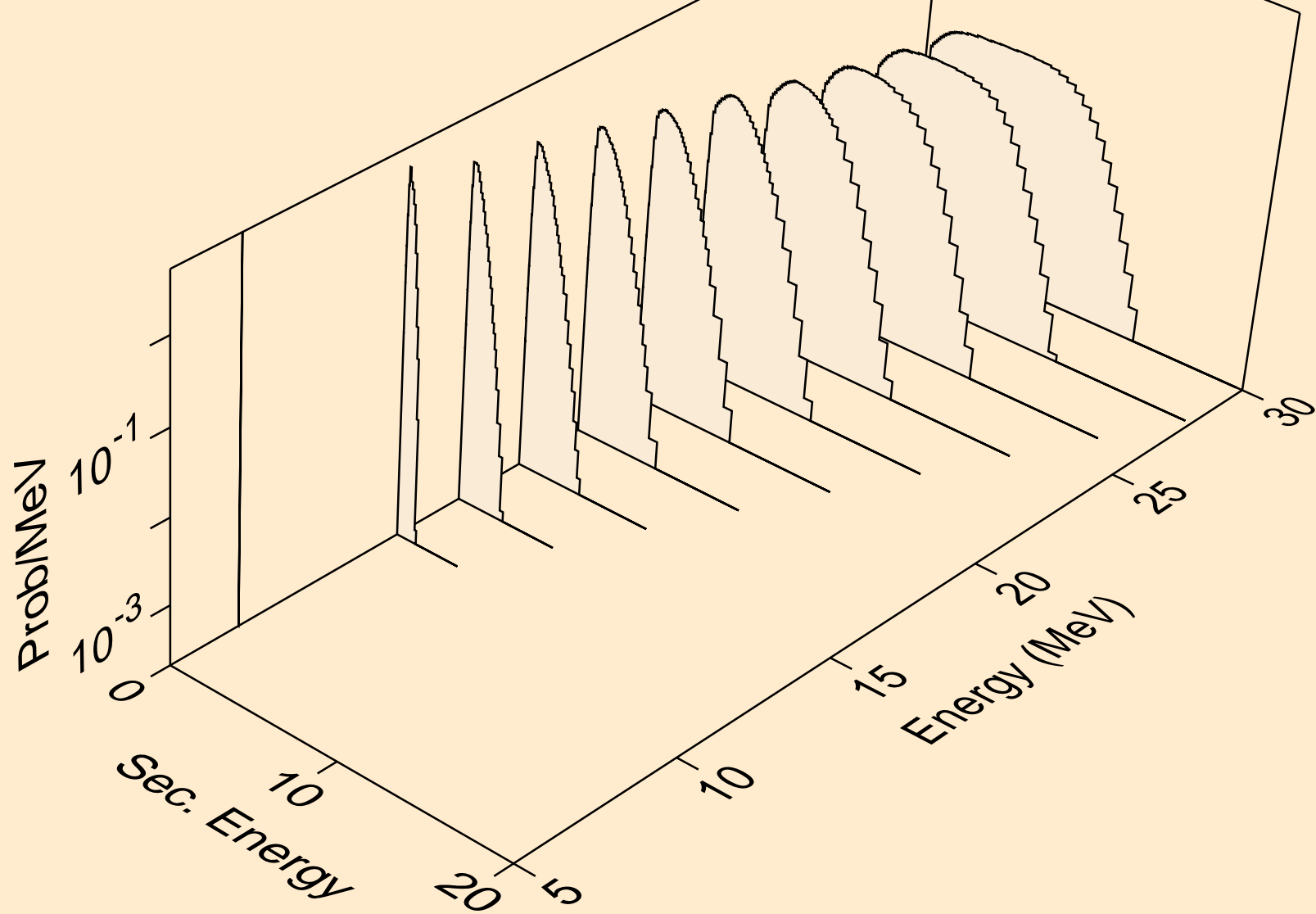

MD246M PROTON ACER TENDL-2023 LIBRARY; T=0.K
neutrons from (p,n*)d

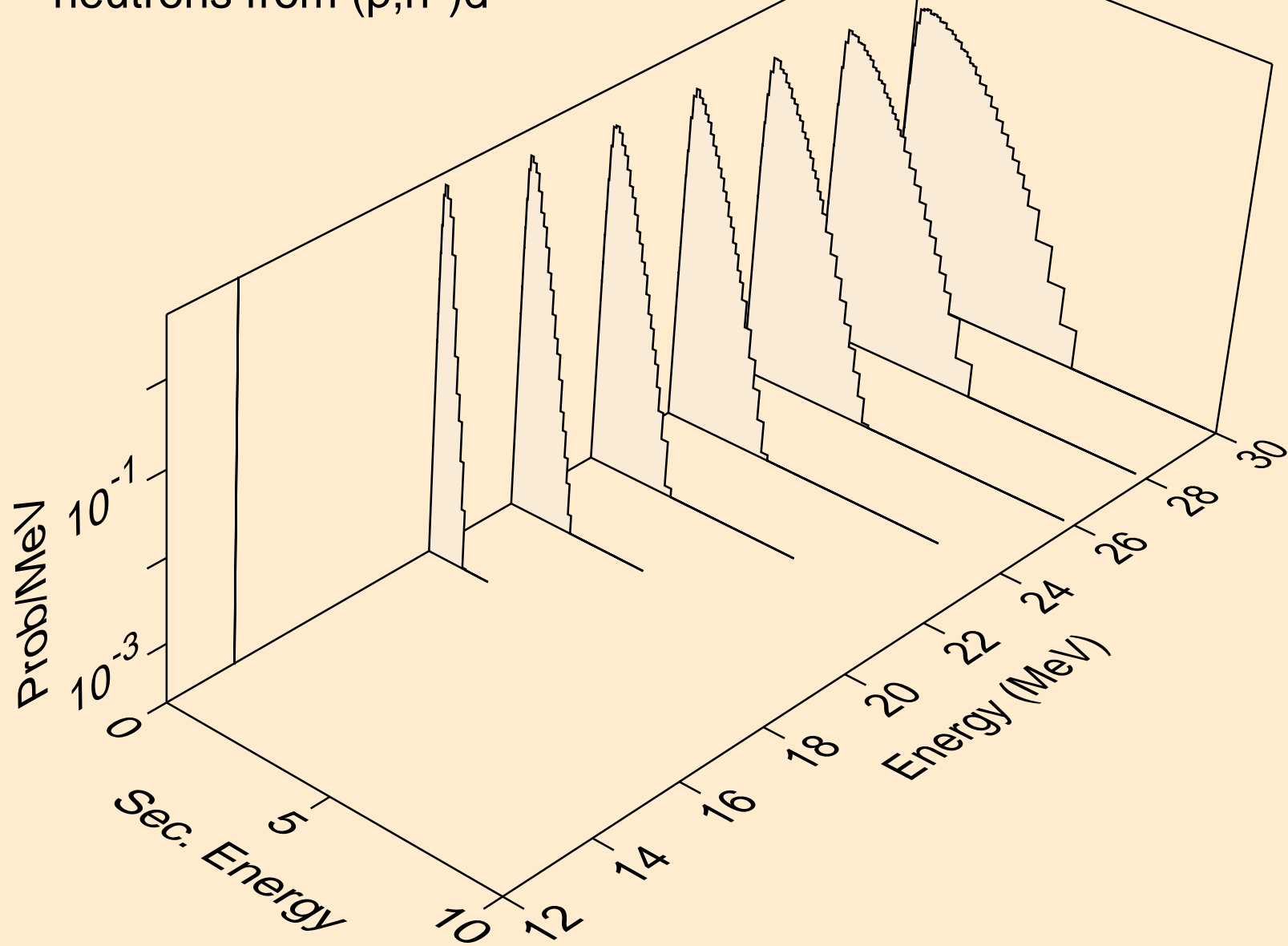

MD246M PROTON ACER TENDL-2023 LIBRARY; T=0.K
neutrons from (p,2np)

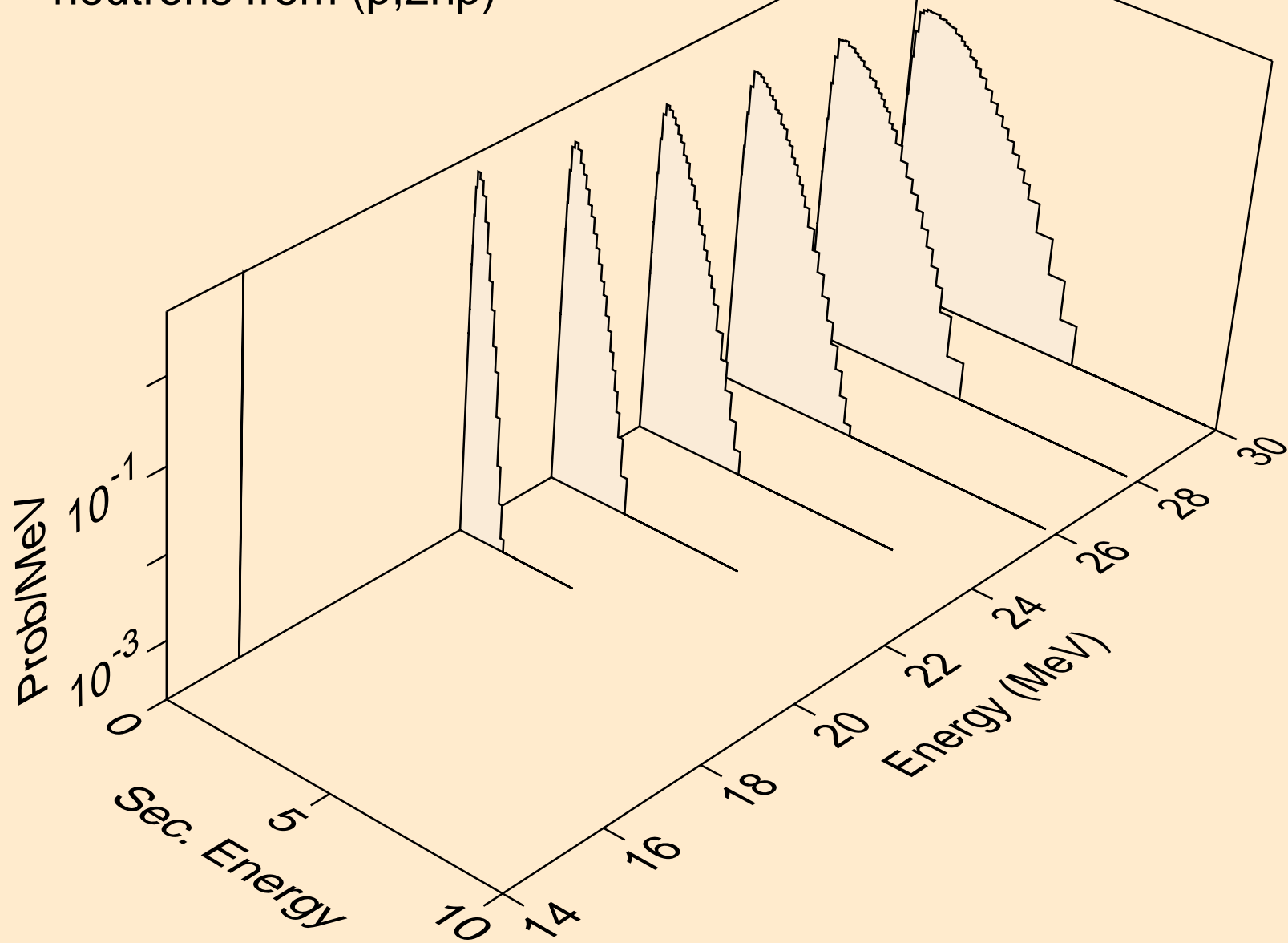

MD246M PROTON ACER TENDL-2023 LIBRARY; T=0.K
neutrons from (p,n2p)

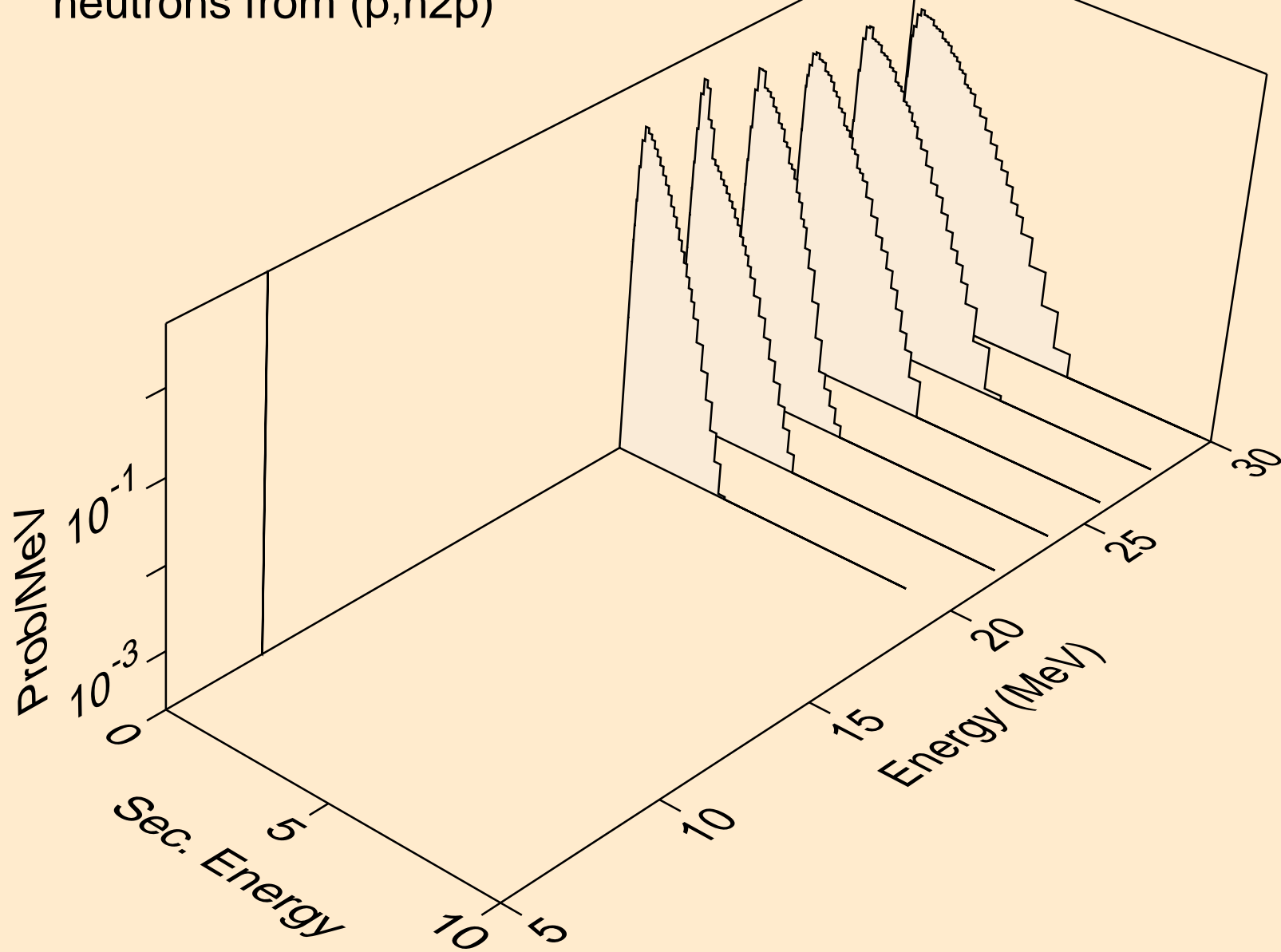

MD246M PROTON ACER TENDL-2023 LIBRARY; T=0.K
neutrons from (p,npa)

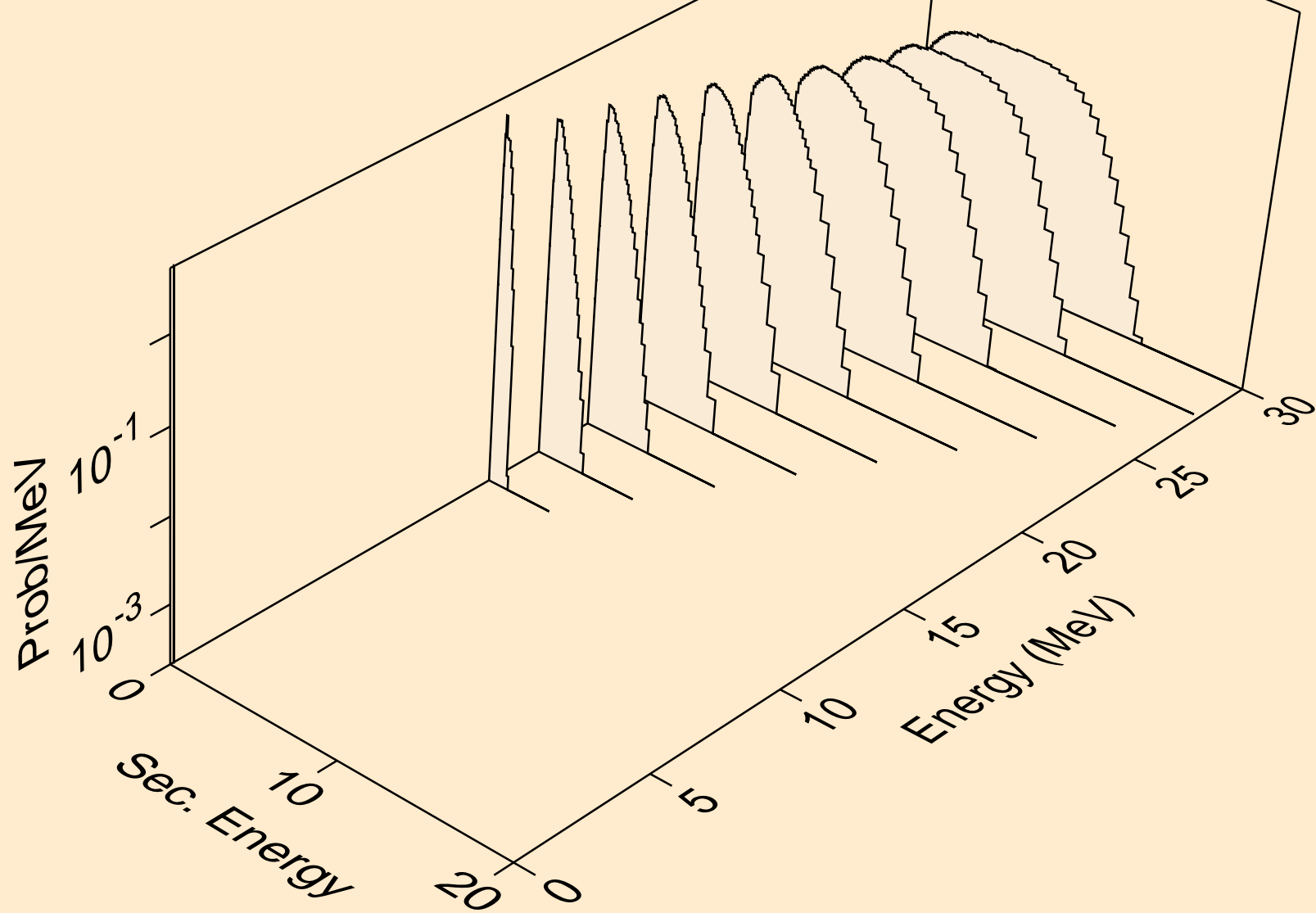

MD246M PROTON ACER TENDL-2023 LIBRARY; T=0.K
deuterons from (p,x)

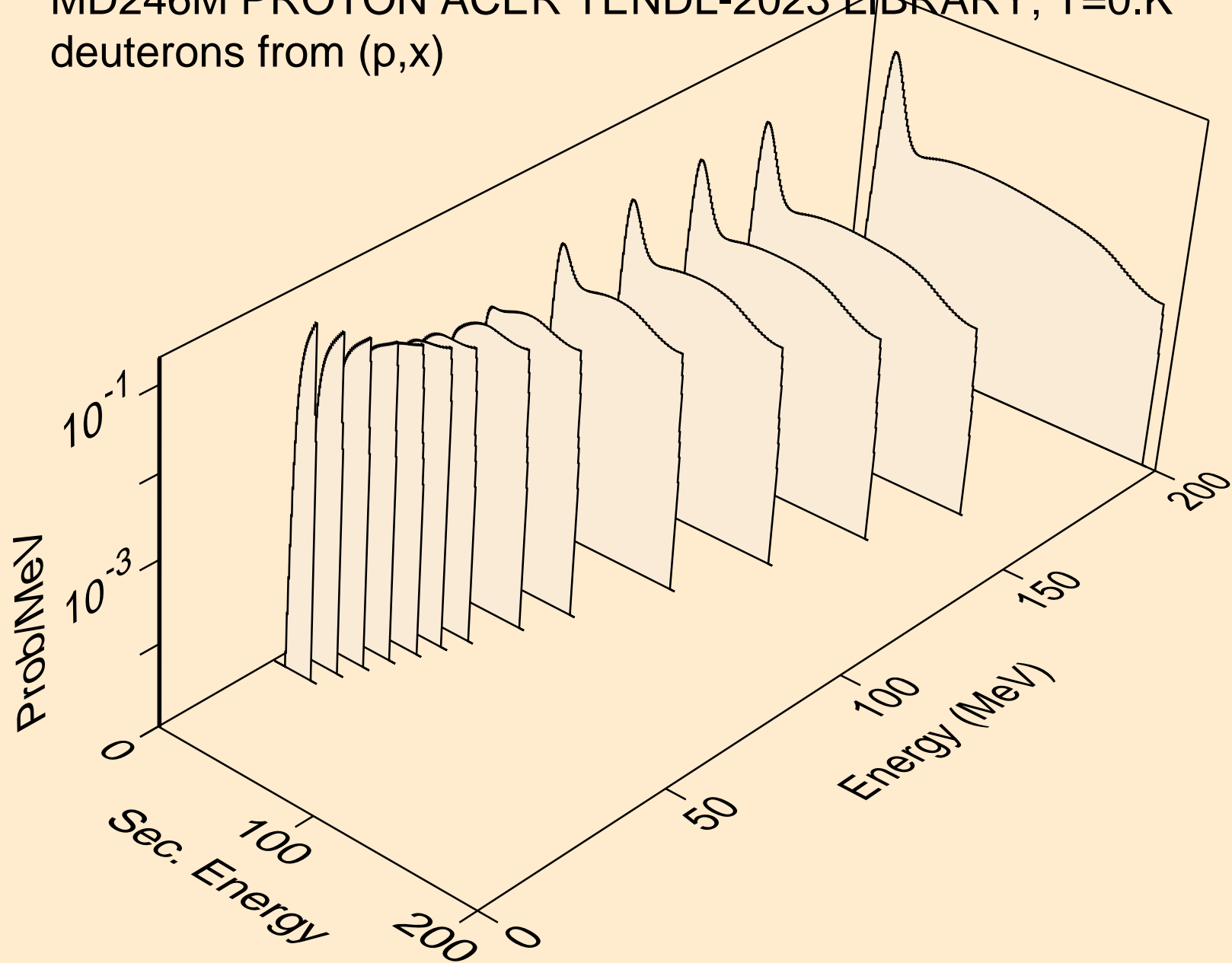

MD246M PROTON ACER TENDL-2023 LIBRARY; T=0.K
deuterons from (p,n*)d

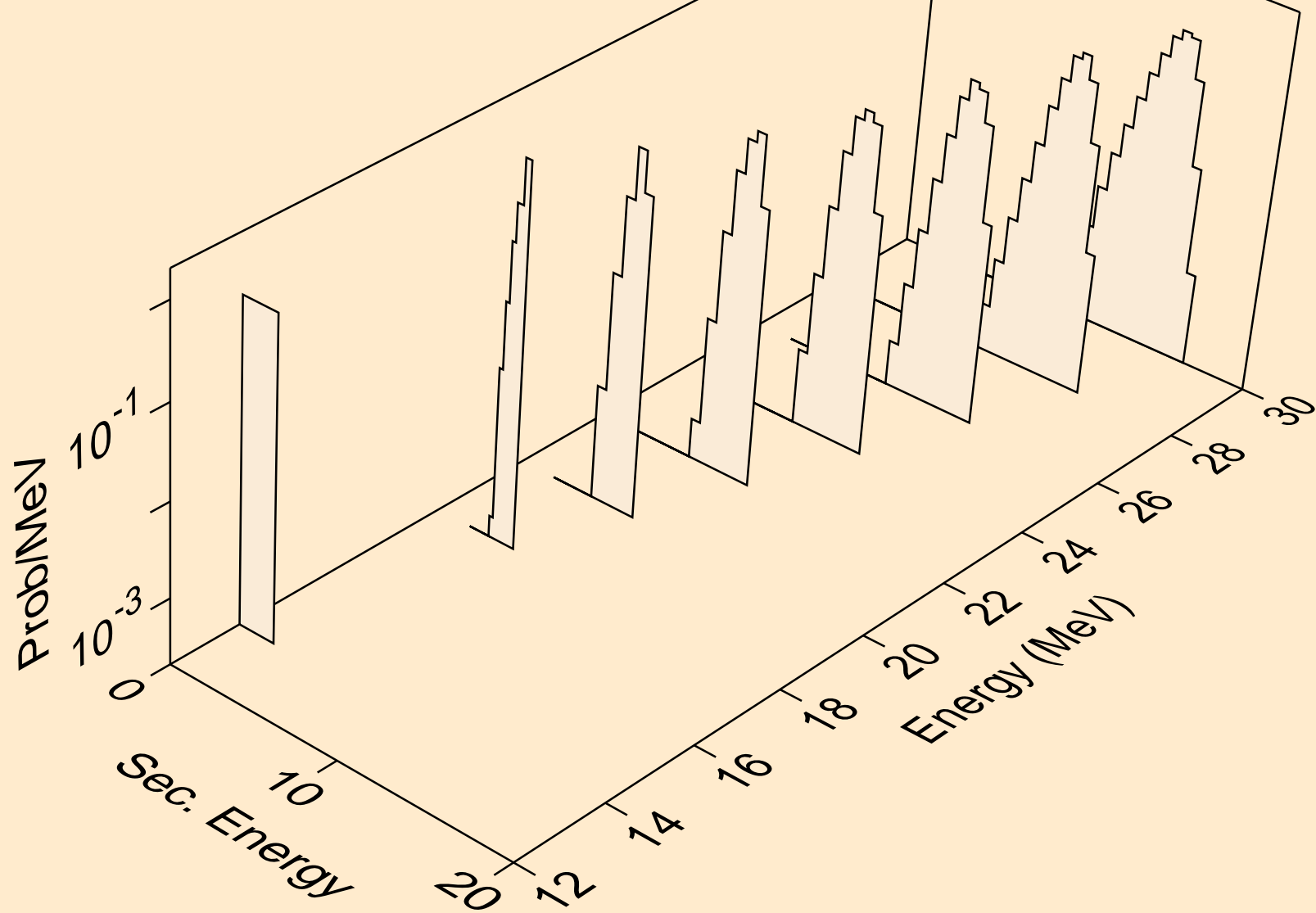

MD246M PROTON ACER TENDL-2023 LIBRARY; T=0.K
deuterons from (p,d)

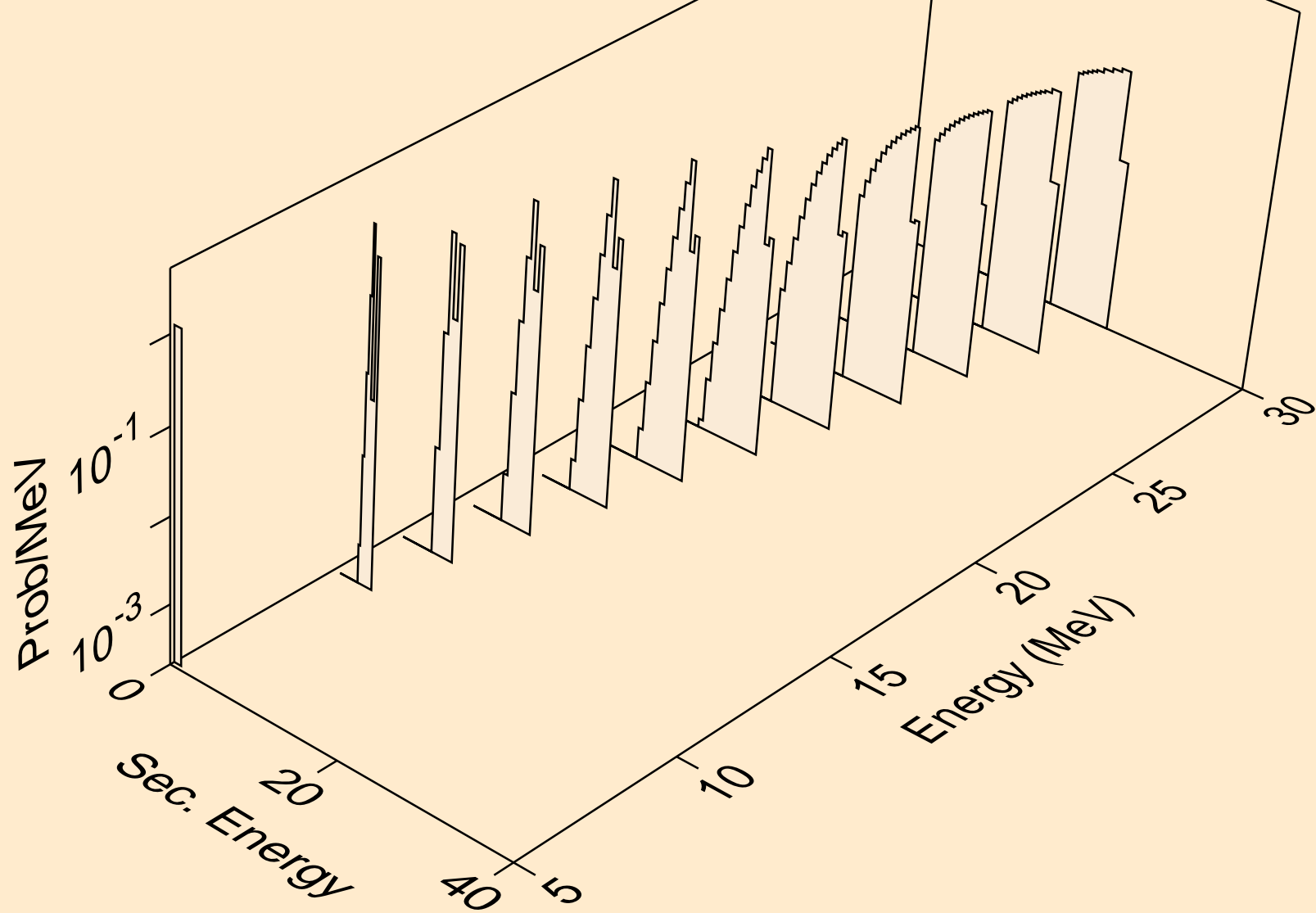

MD246M PROTON ACER TENDL-2023 LIBRARY; T=0.K
deuterons from (p,pd)

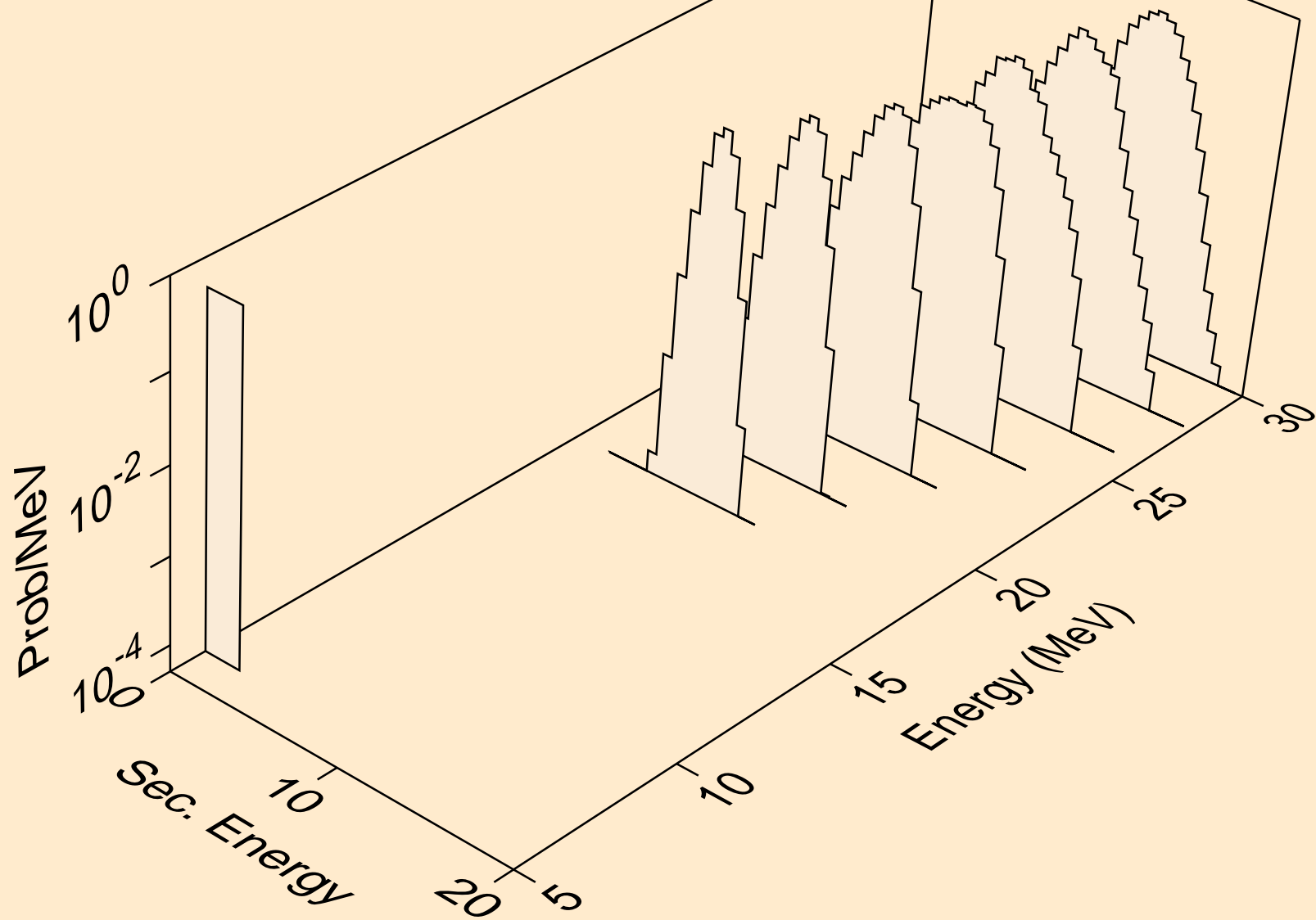

MD246M PROTON ACER TENDL-2023 LIBRARY; T=0.K
deuterons from (p,da)

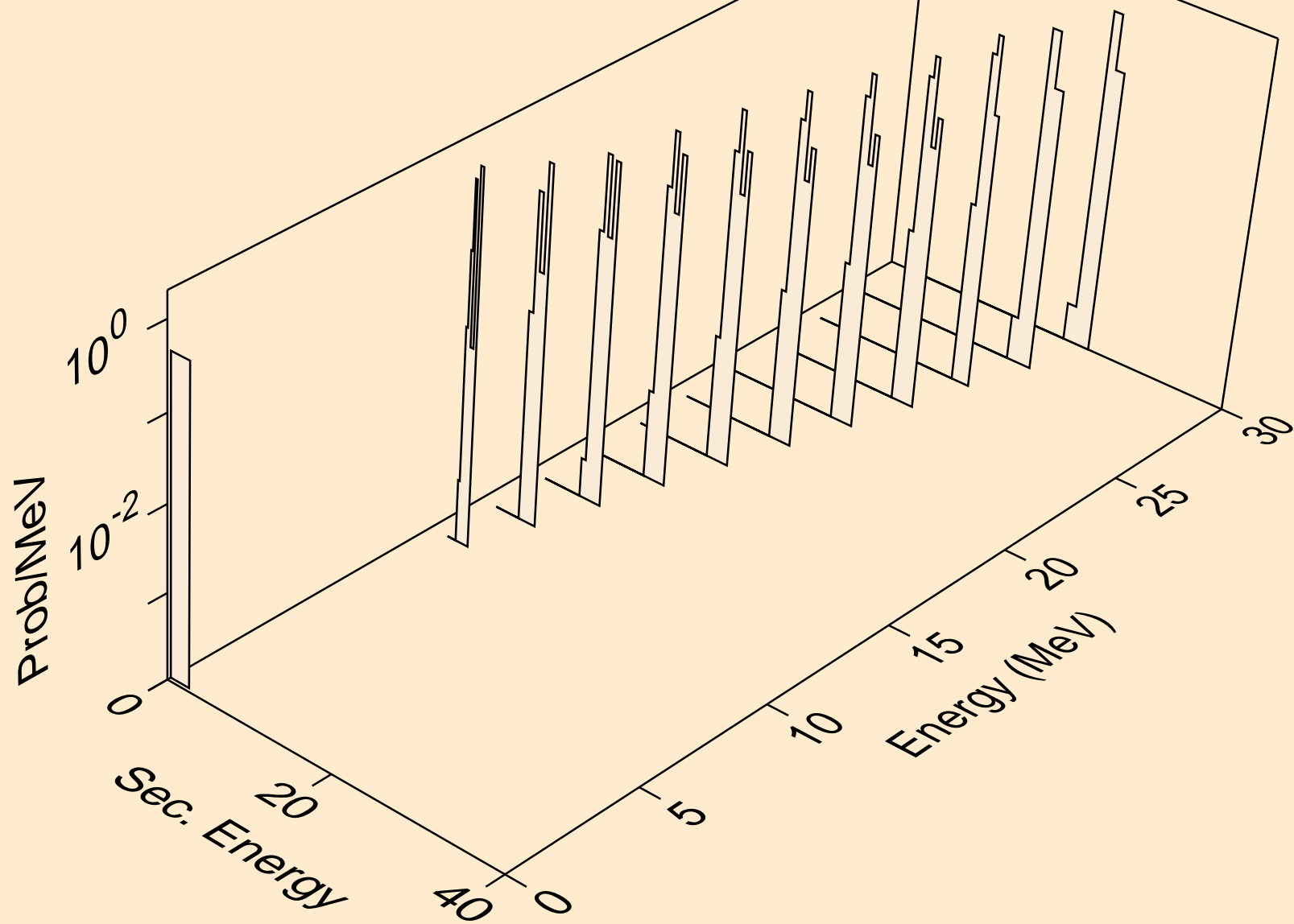

MD246M PROTON ACER TENDL-2023 LIBRARY; T=0.K
tritons from (p,x)

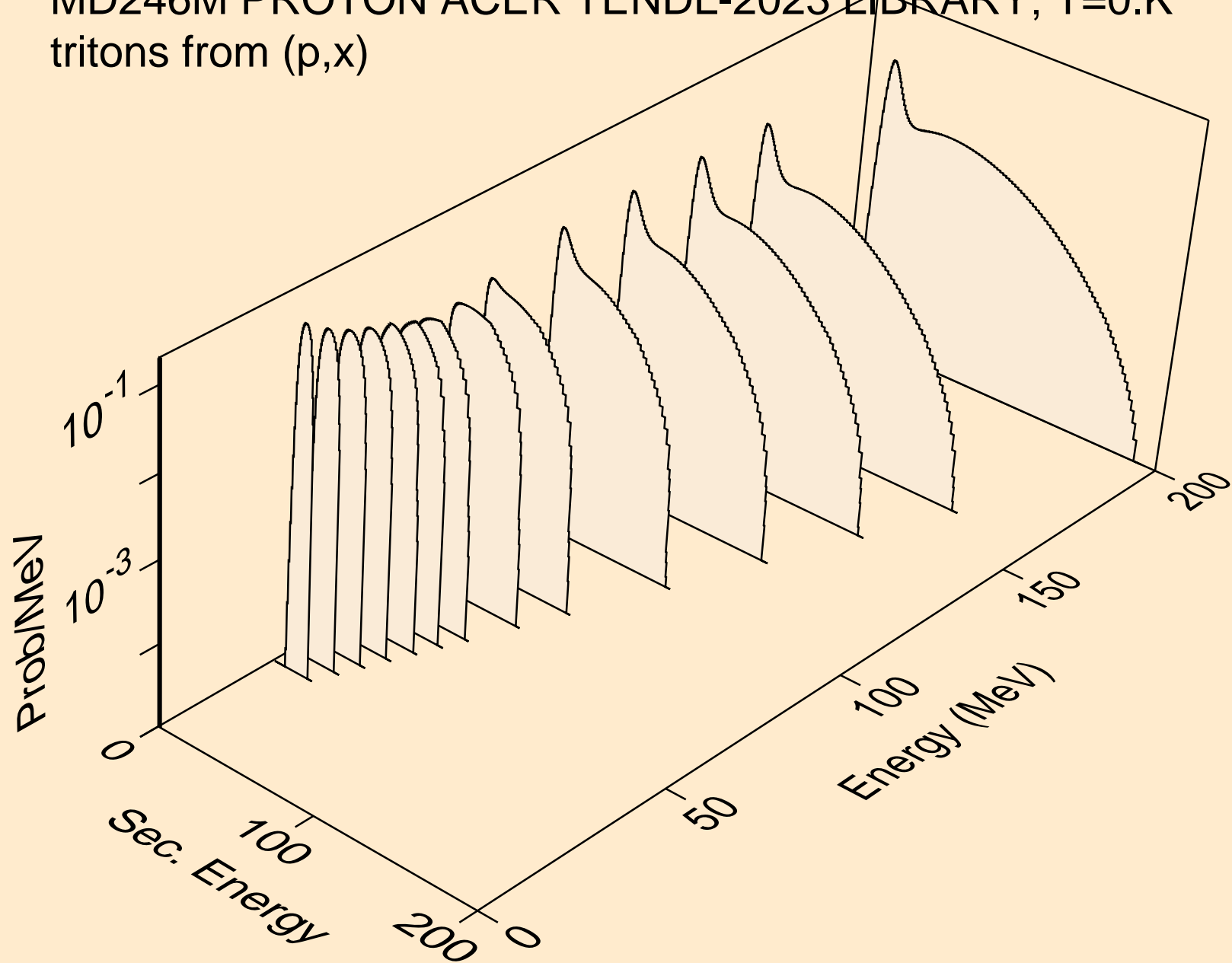

MD246M PROTON ACER TENDL-2023 LIBRARY; T=0.K
tritons from (p,t)

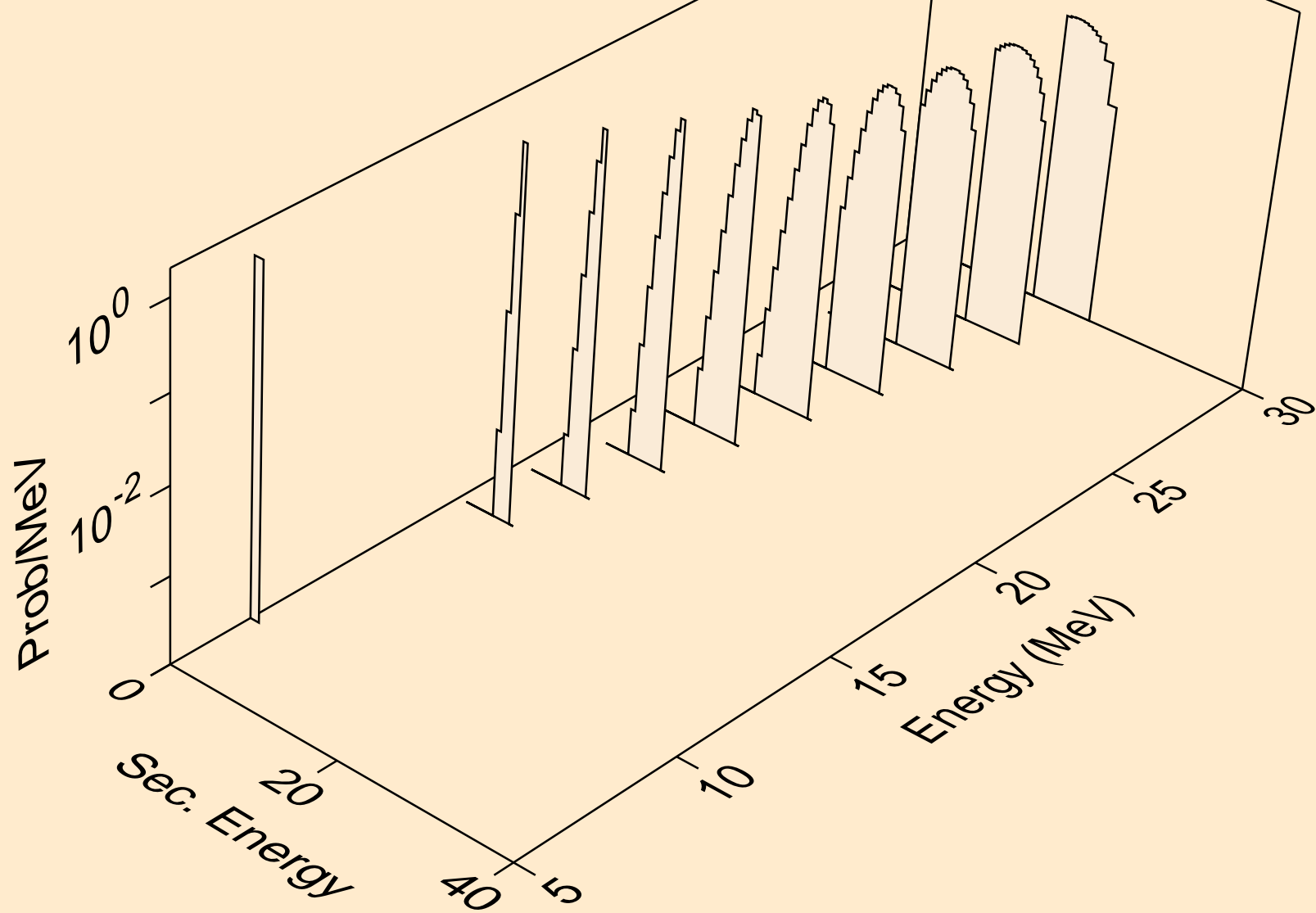

MD246M PROTON ACER TENDL-2023 LIBRARY; T=0.K
he3s from (p,x)

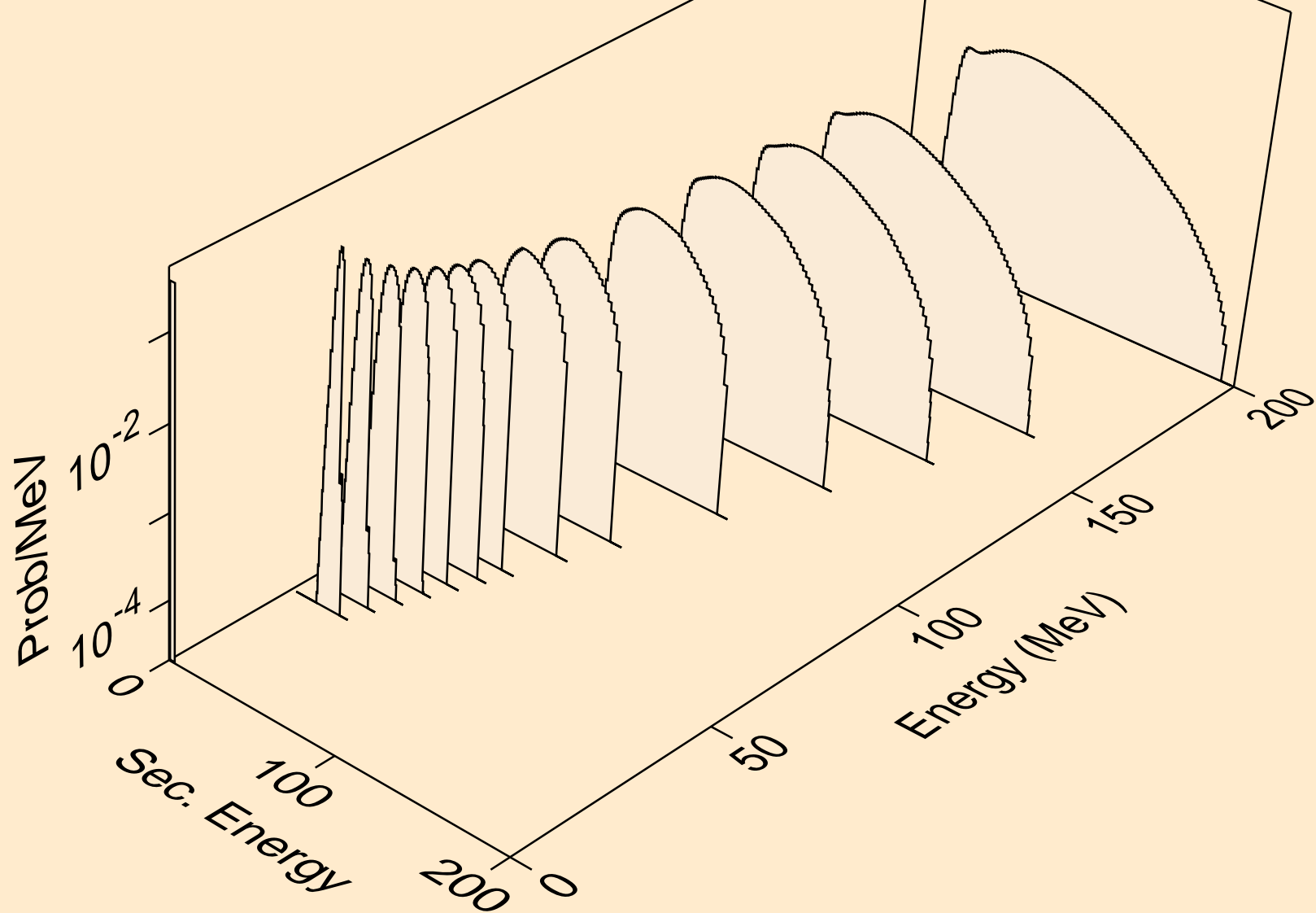

MD246M PROTON ACER TENDL-2023 LIBRARY; T=0.K
he3s from (p,he3)

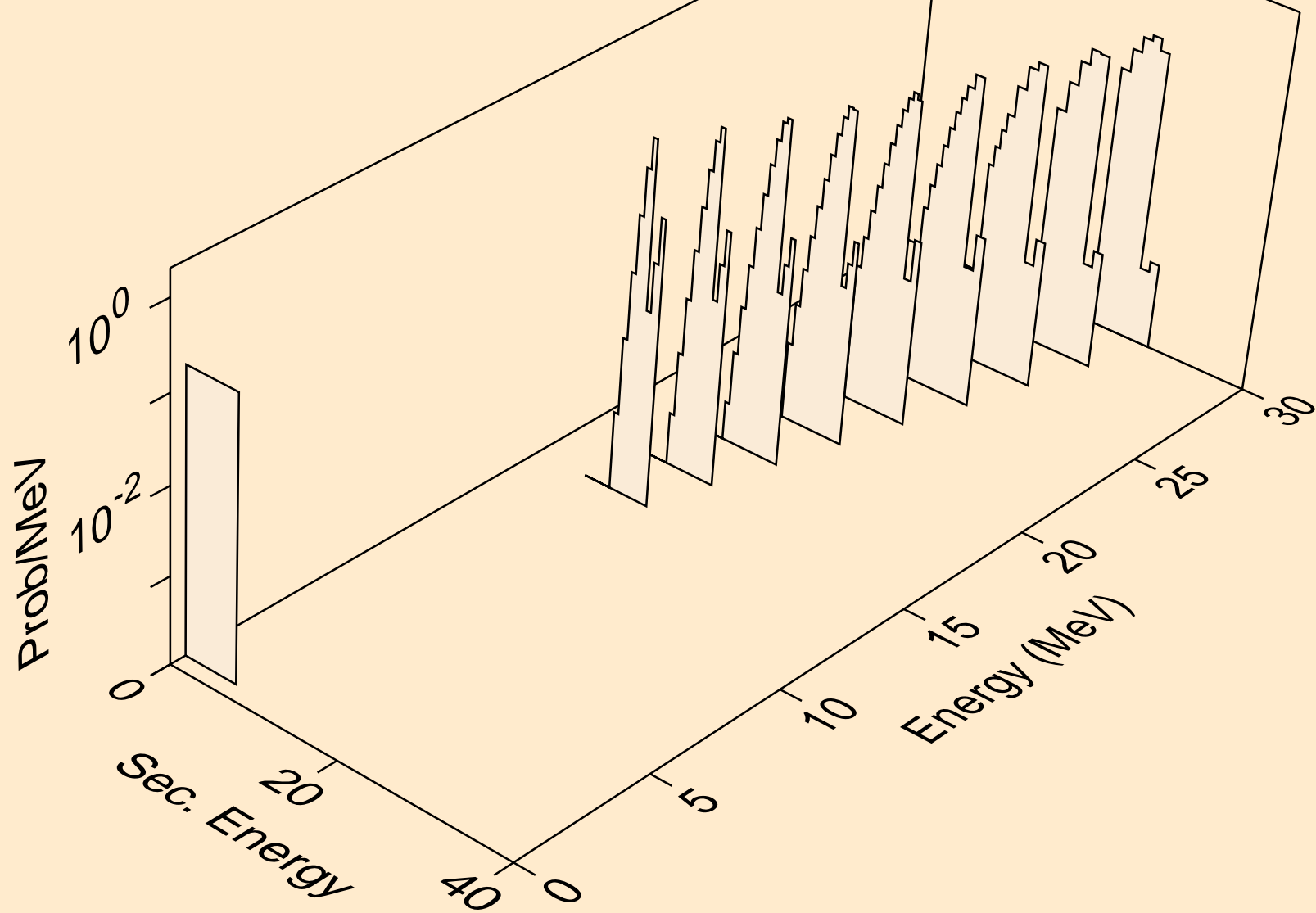

MD246M PROTON ACER TENDL-2023 LIBRARY; T=0.K
alphas from (p,x)

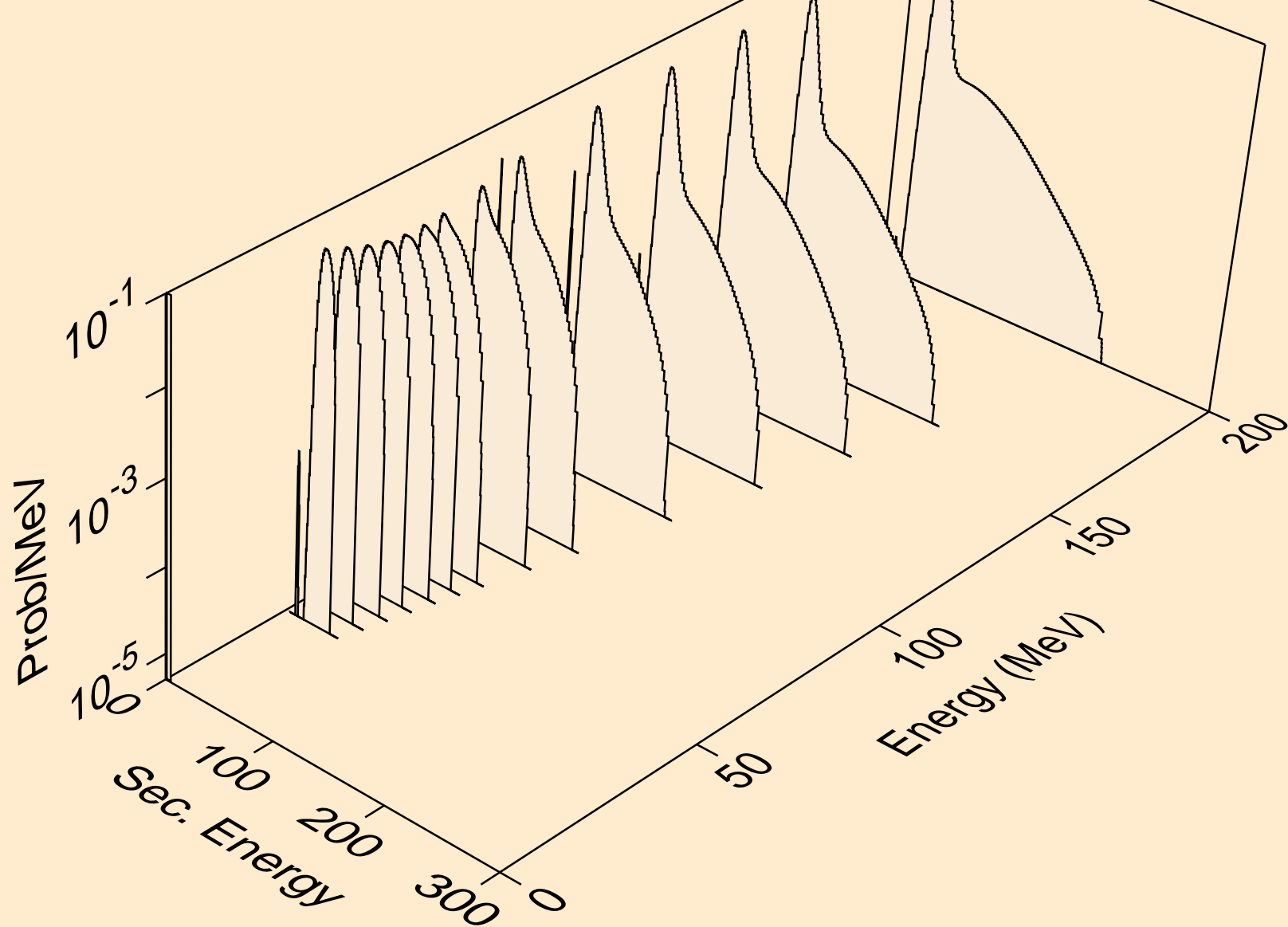

MD246M PROTON ACER TENDL-2023 LIBRARY; T=0.K
alphas from (p,n*)a

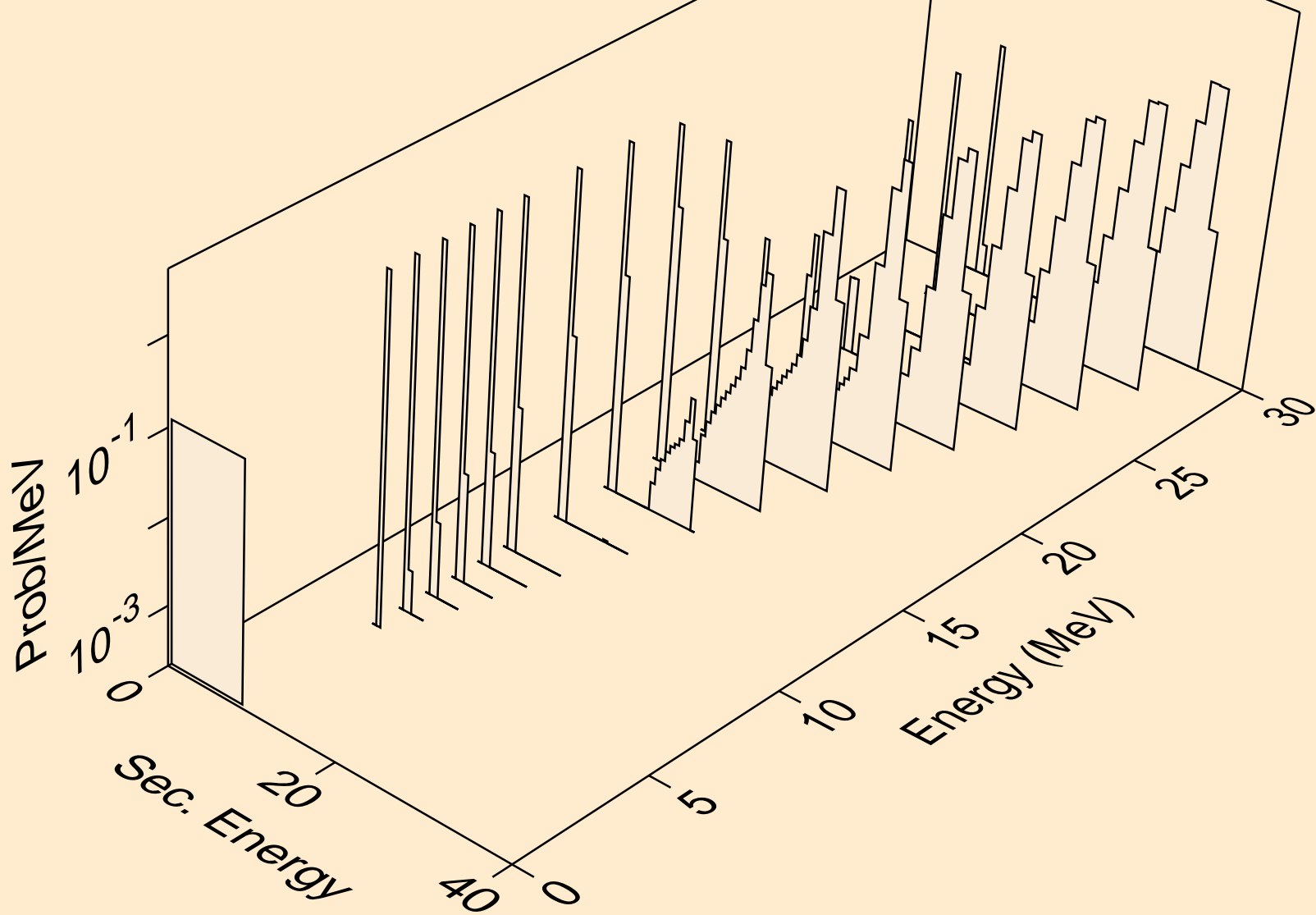

MD246M PROTON ACER TENDL-2023 LIBRARY; T=0.K
alphas from (p,2n)a

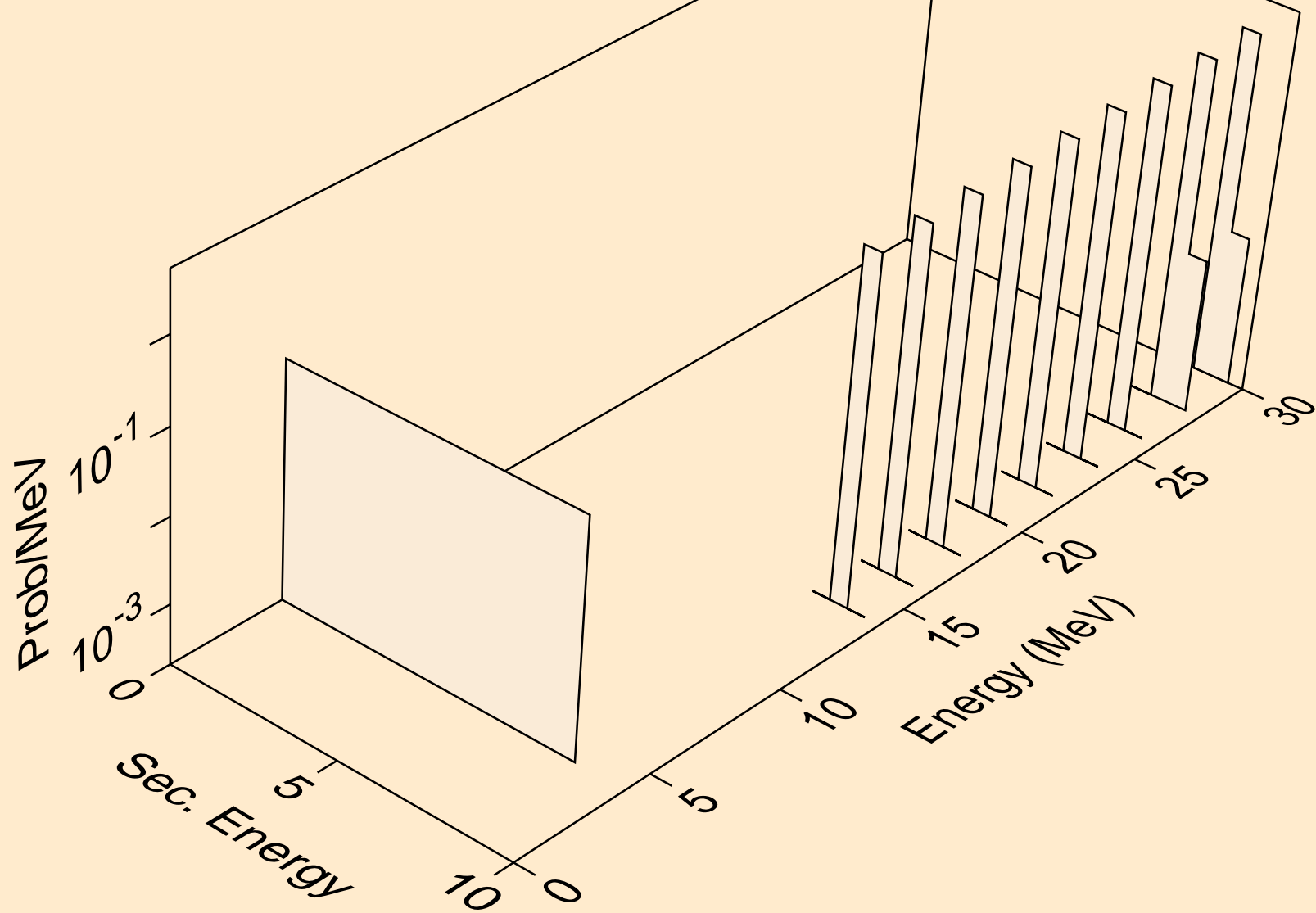

MD246M PROTON ACER TENDL-2023 LIBRARY; T=0.K
alphas from (p,npa)

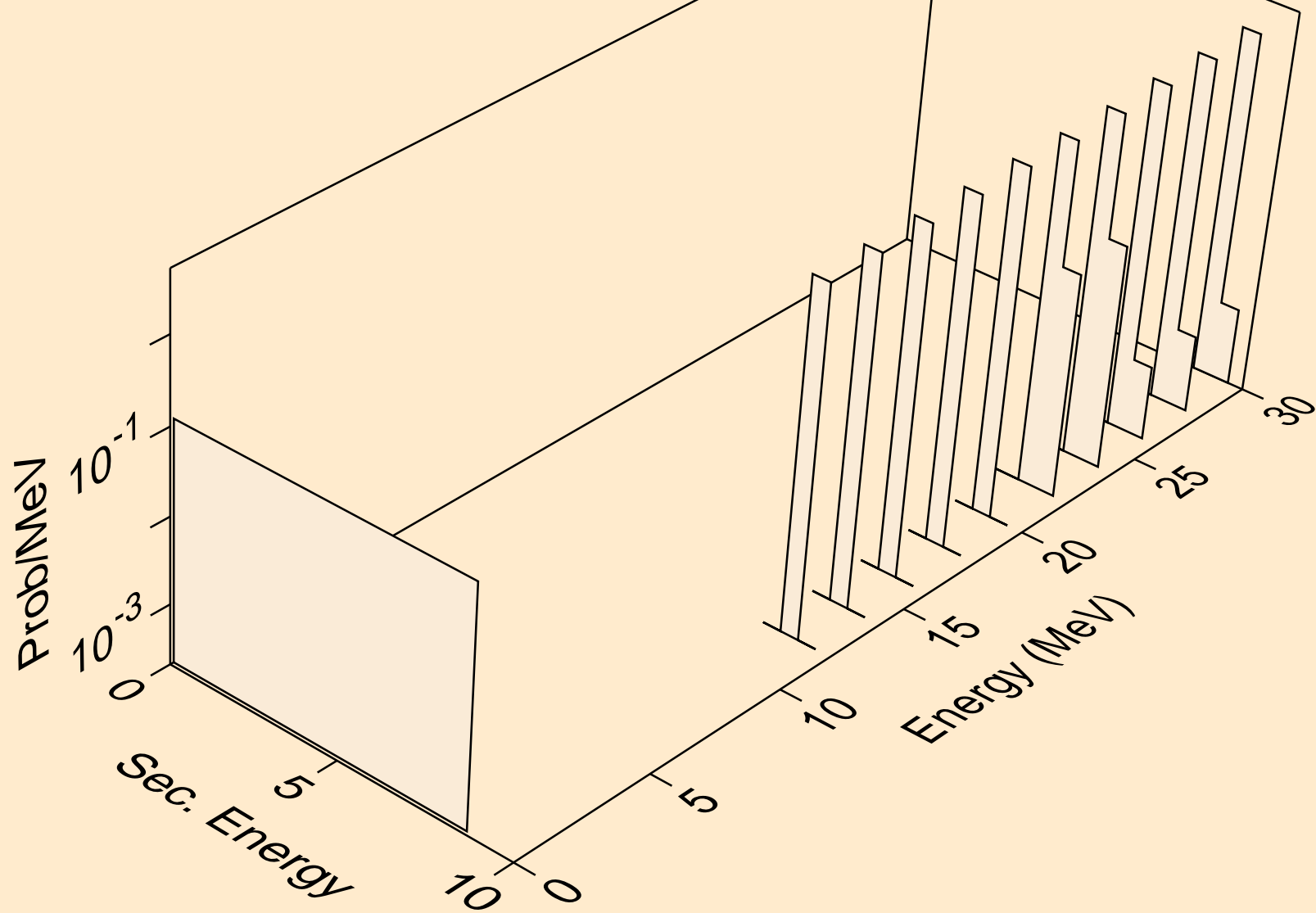

MD246M PROTON ACER TENDL-2023 LIBRARY; T=0.K
alphas from (p,a)

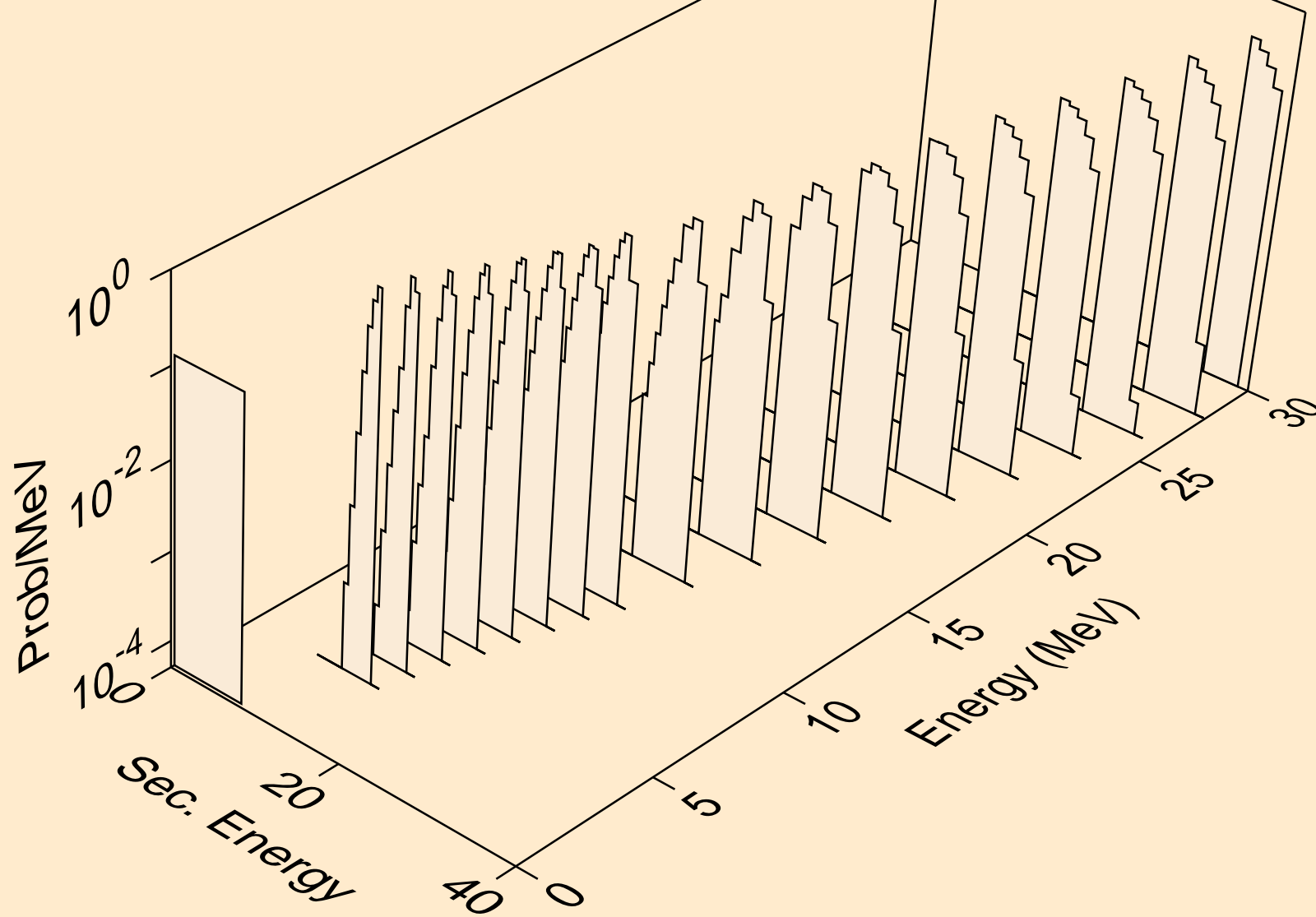

MD246M PROTON ACER TENDL-2023 LIBRARY; T=0.K
alphas from (p,pa)

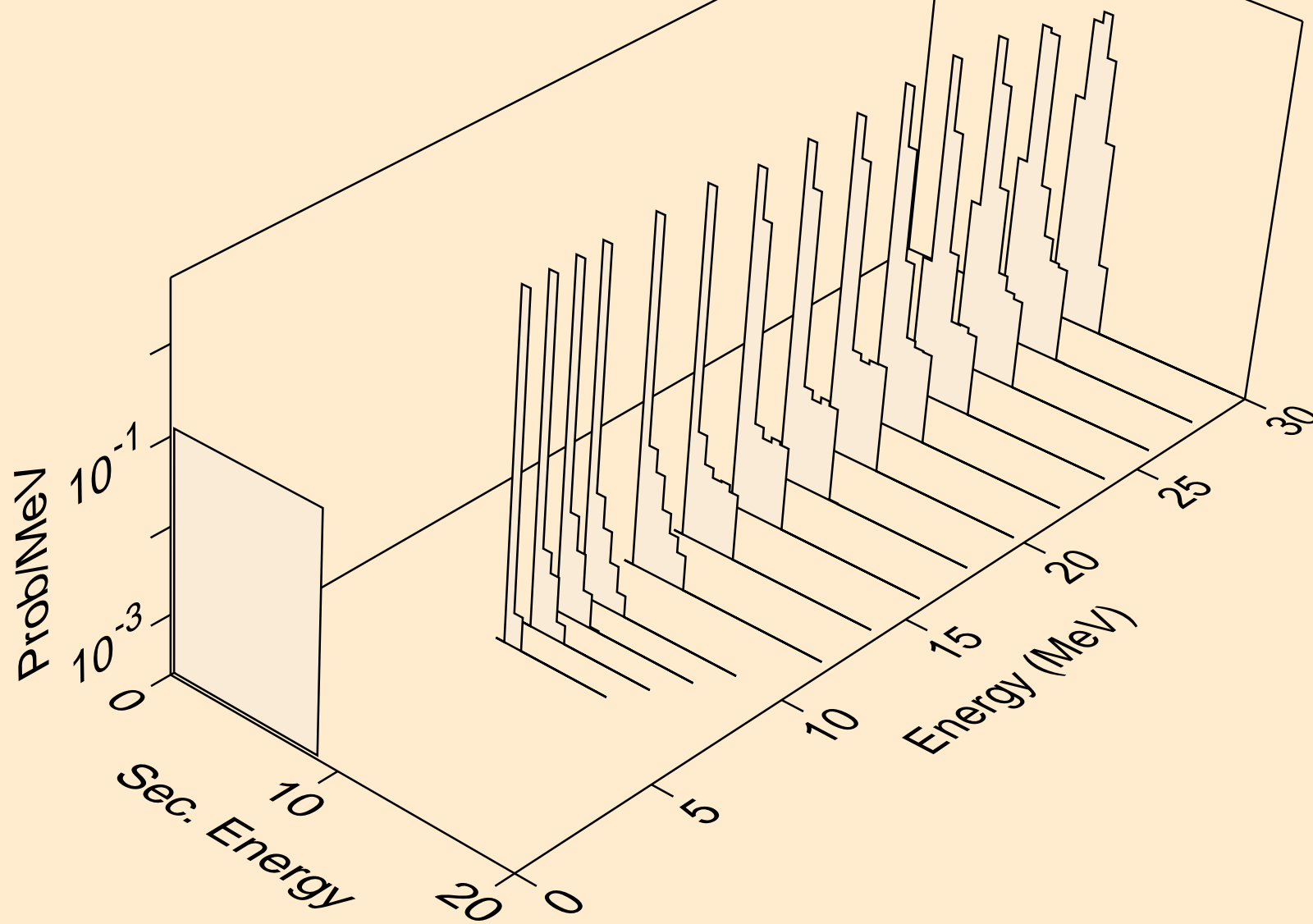

MD246M PROTON ACER TENDL-2023 LIBRARY; T=0.K
alphas from (p,da)

