

MD255 PROTON ACER TENDL-2023 LIBRARY; T=0.K
Principal cross sections

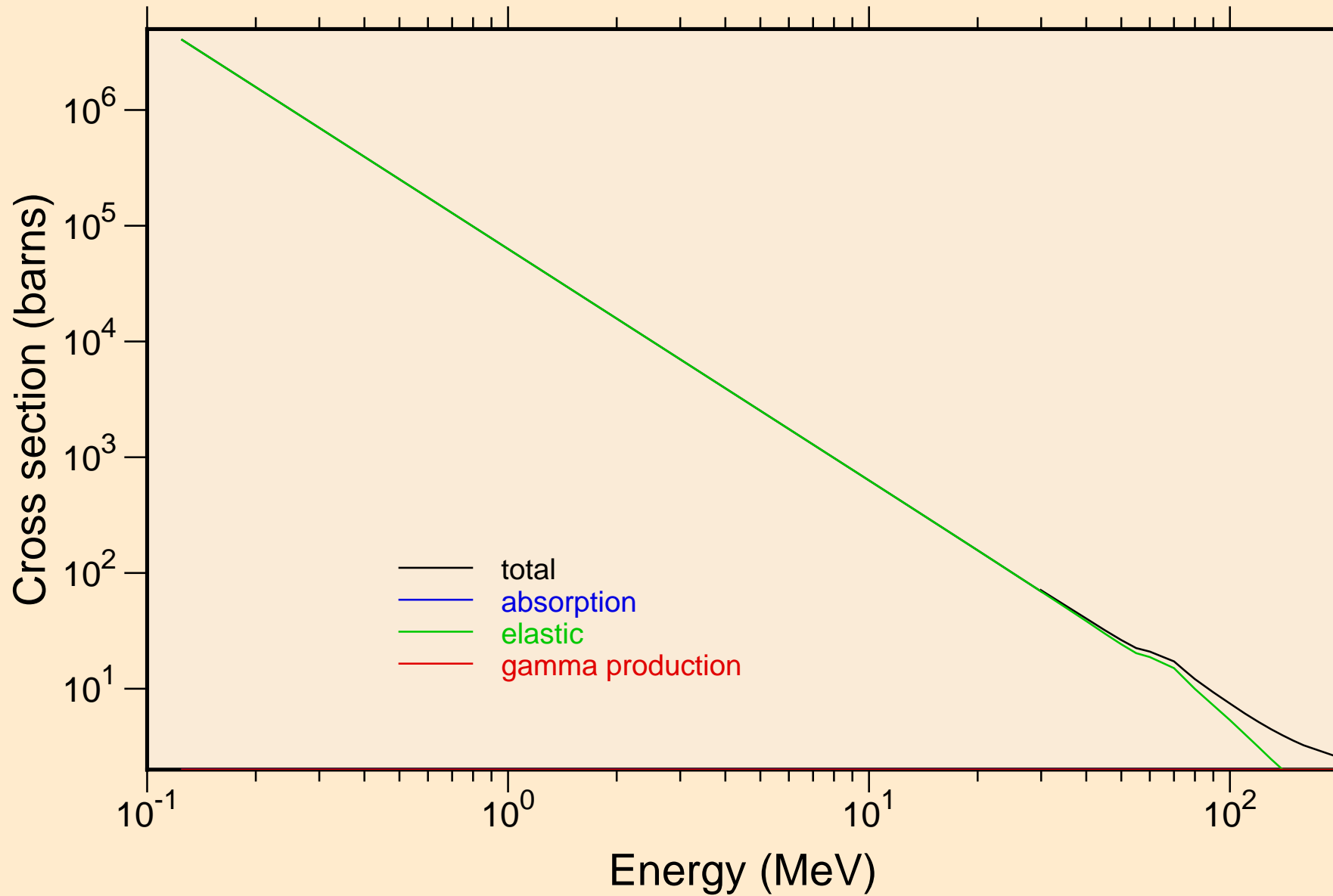

MD255 PROTON ACER TENDL-2023 LIBRARY; T=0.K

Heating

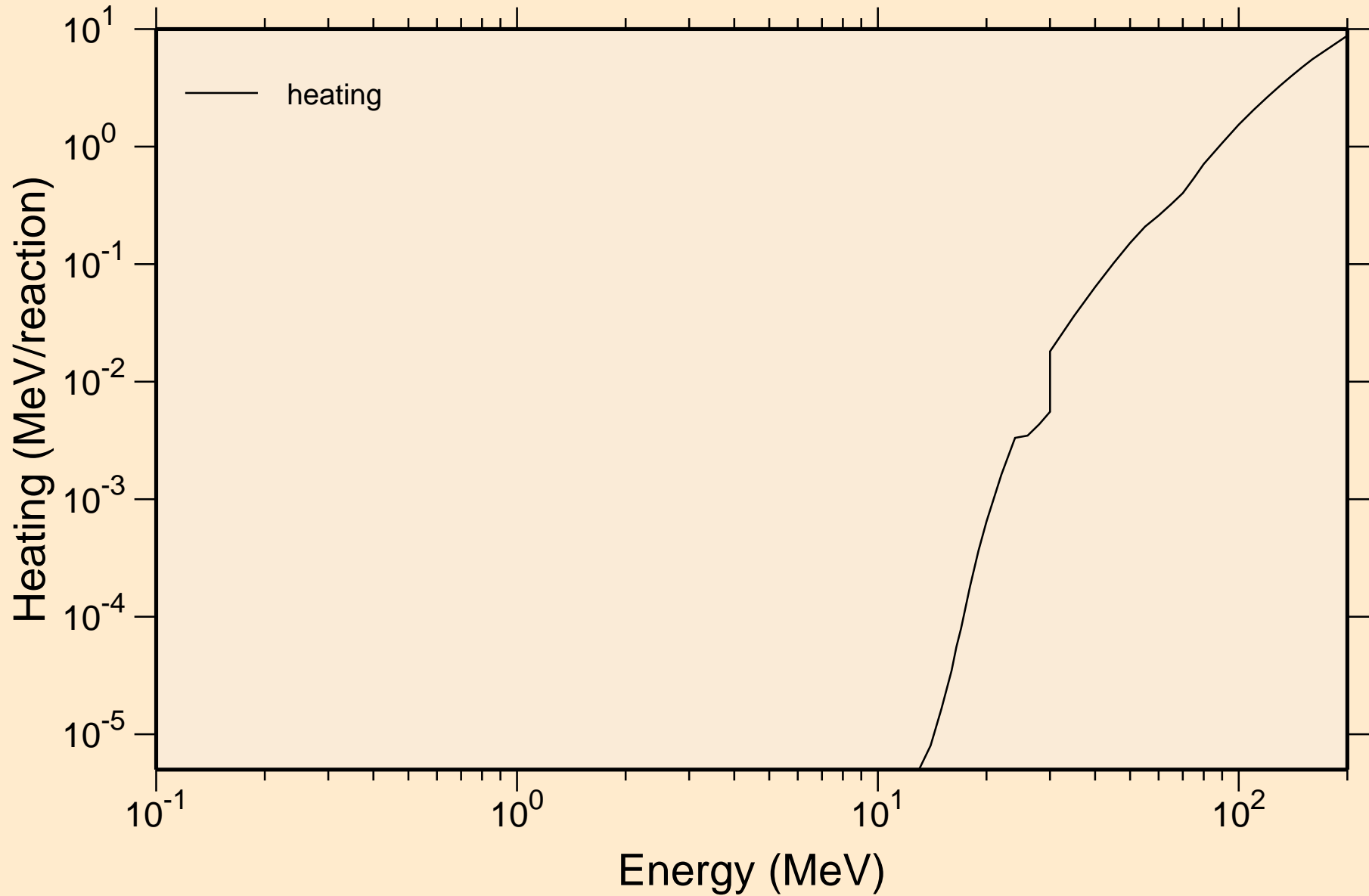

MD255 PROTON ACER TENDL-2023 LIBRARY; T=0.K

Principal cross sections

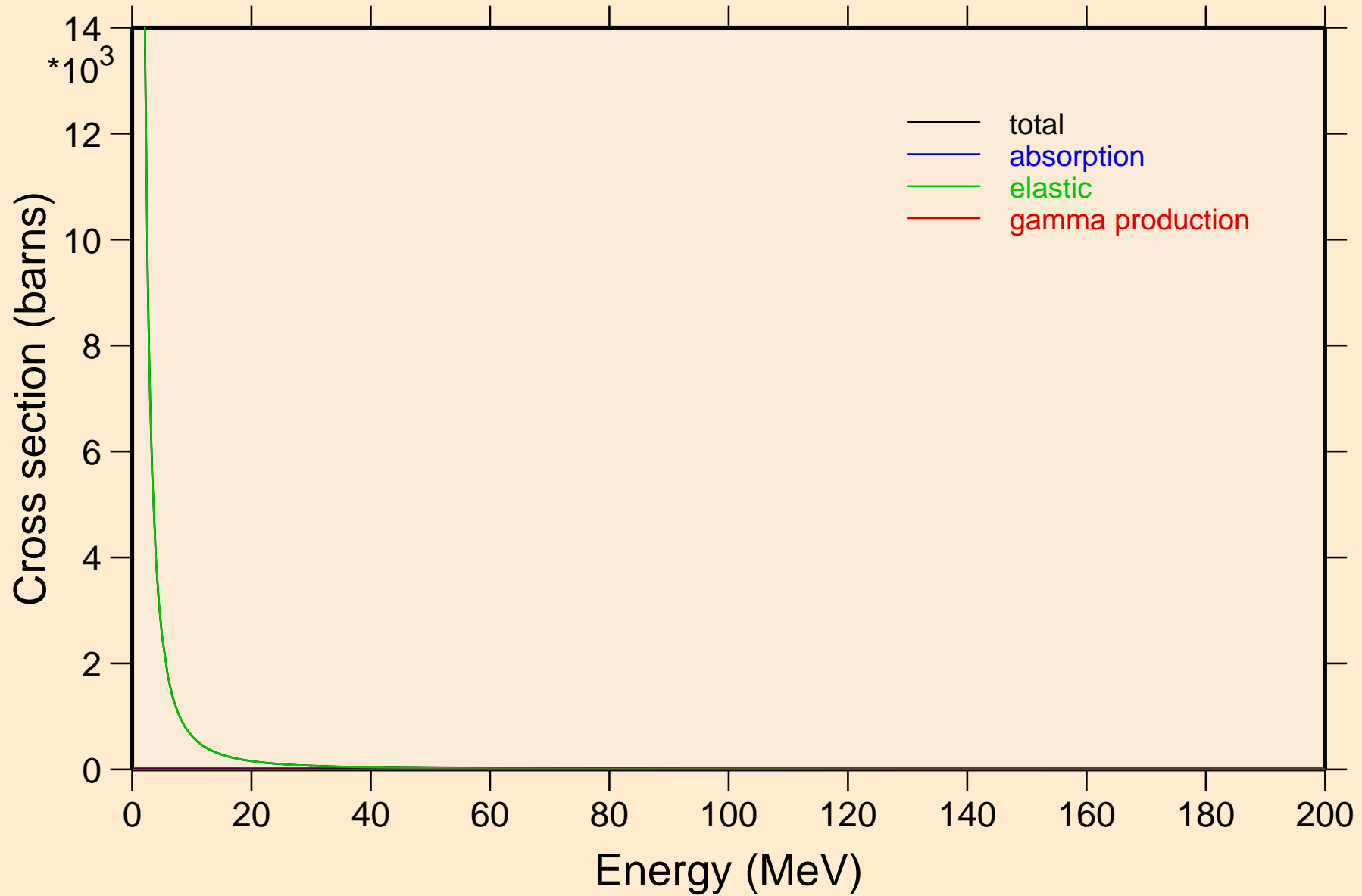

MD255 PROTON ACER TENDL-2023 LIBRARY; T=0.K

Heating

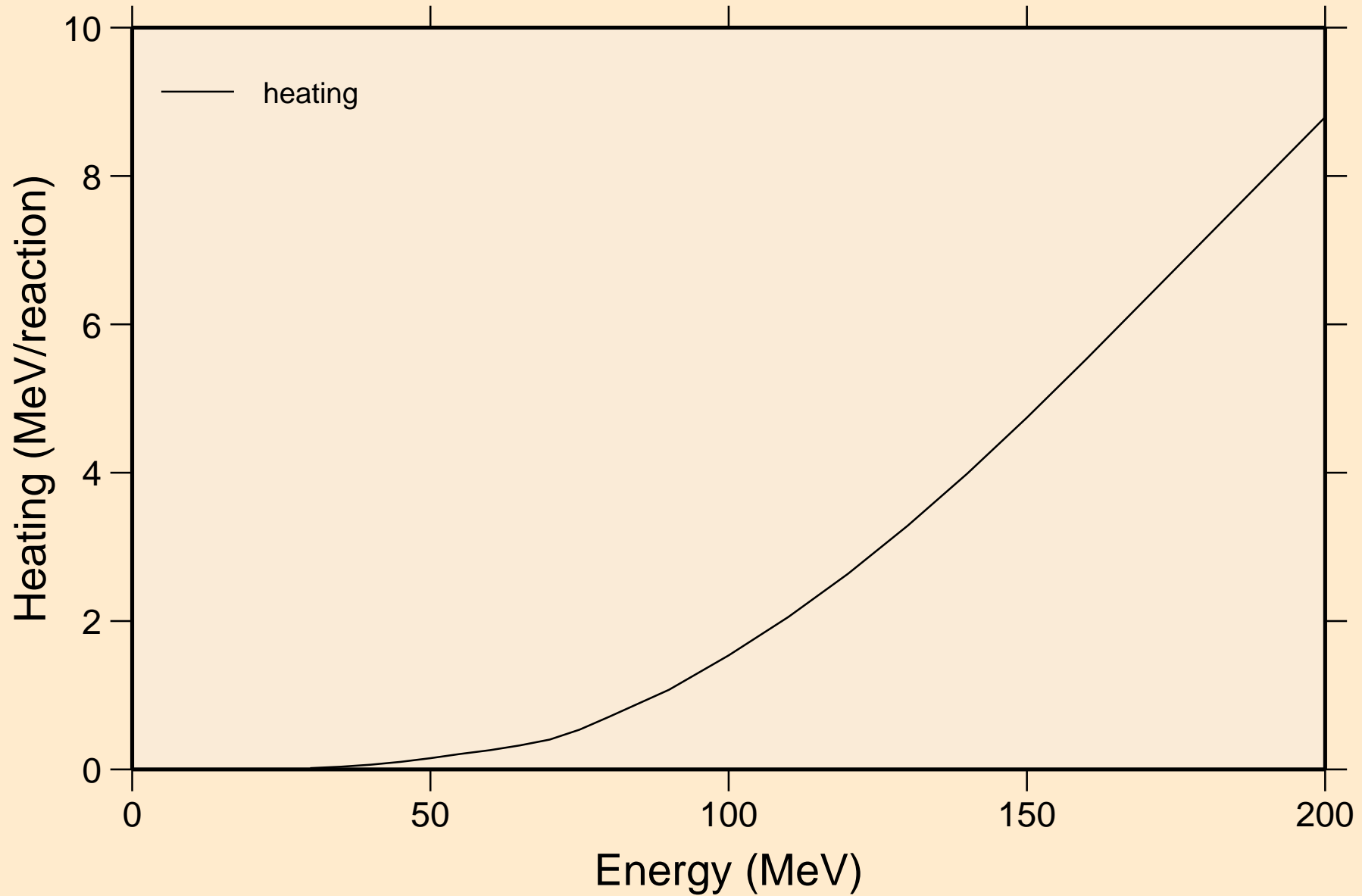

MD255 PROTON ACER TENDL-2023 LIBRARY; T=0.K

Threshold reactions

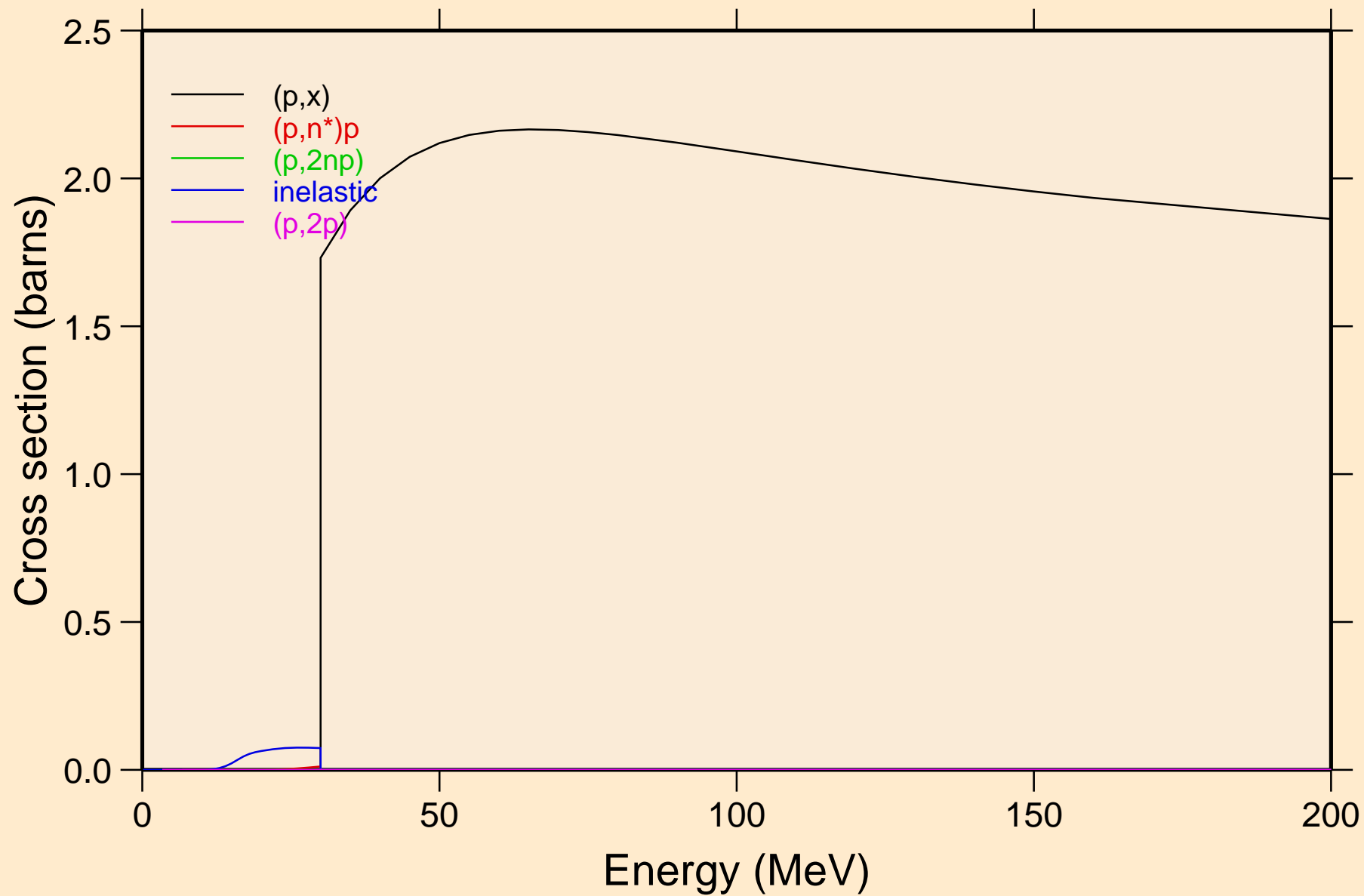

MD255 PROTON ACER TENDL-2023 LIBRARY; T=0.K
angular distribution for elastic

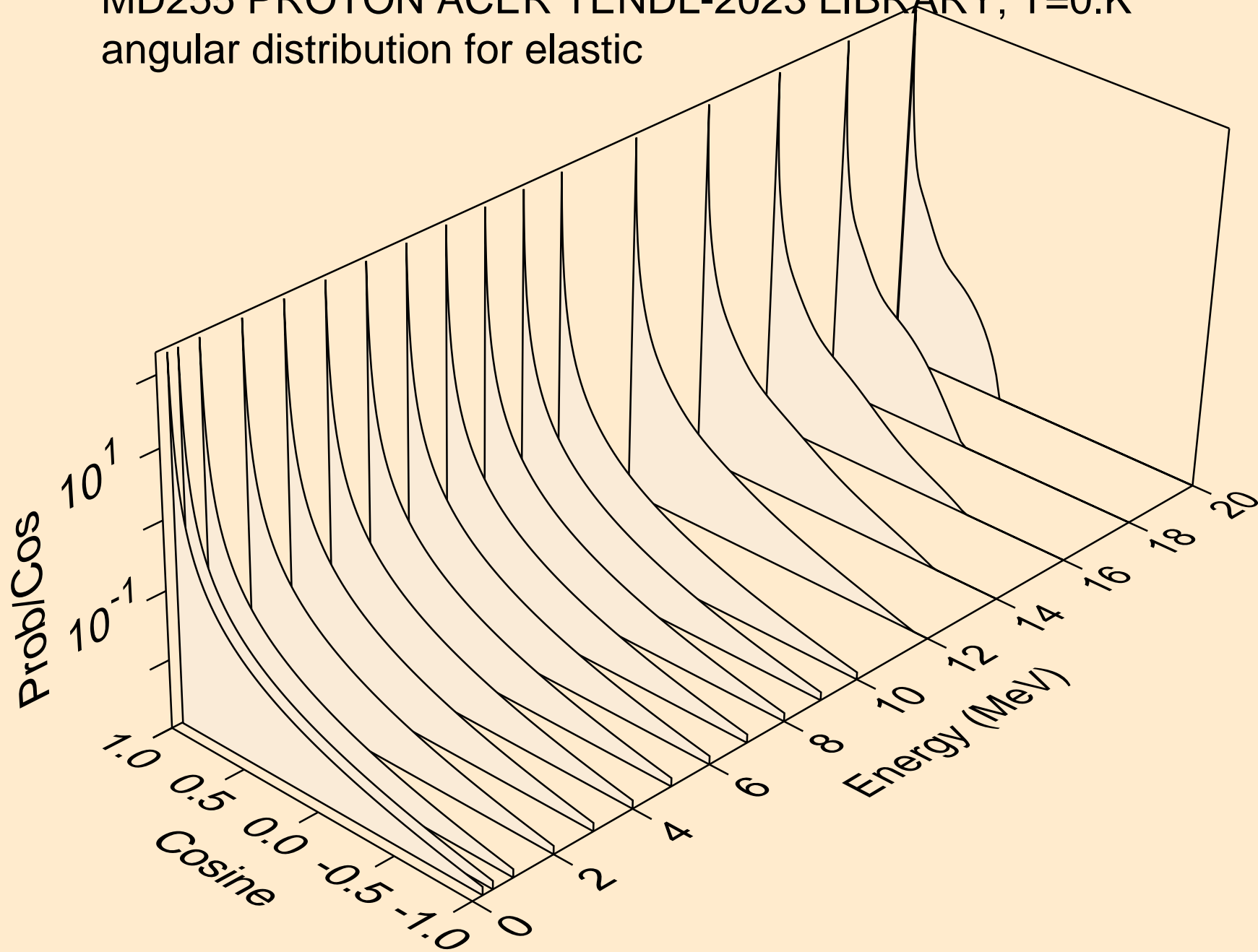

MD255 PROTON ACER TENDL-2023 LIBRARY; T=0.K
angular distribution for elastic

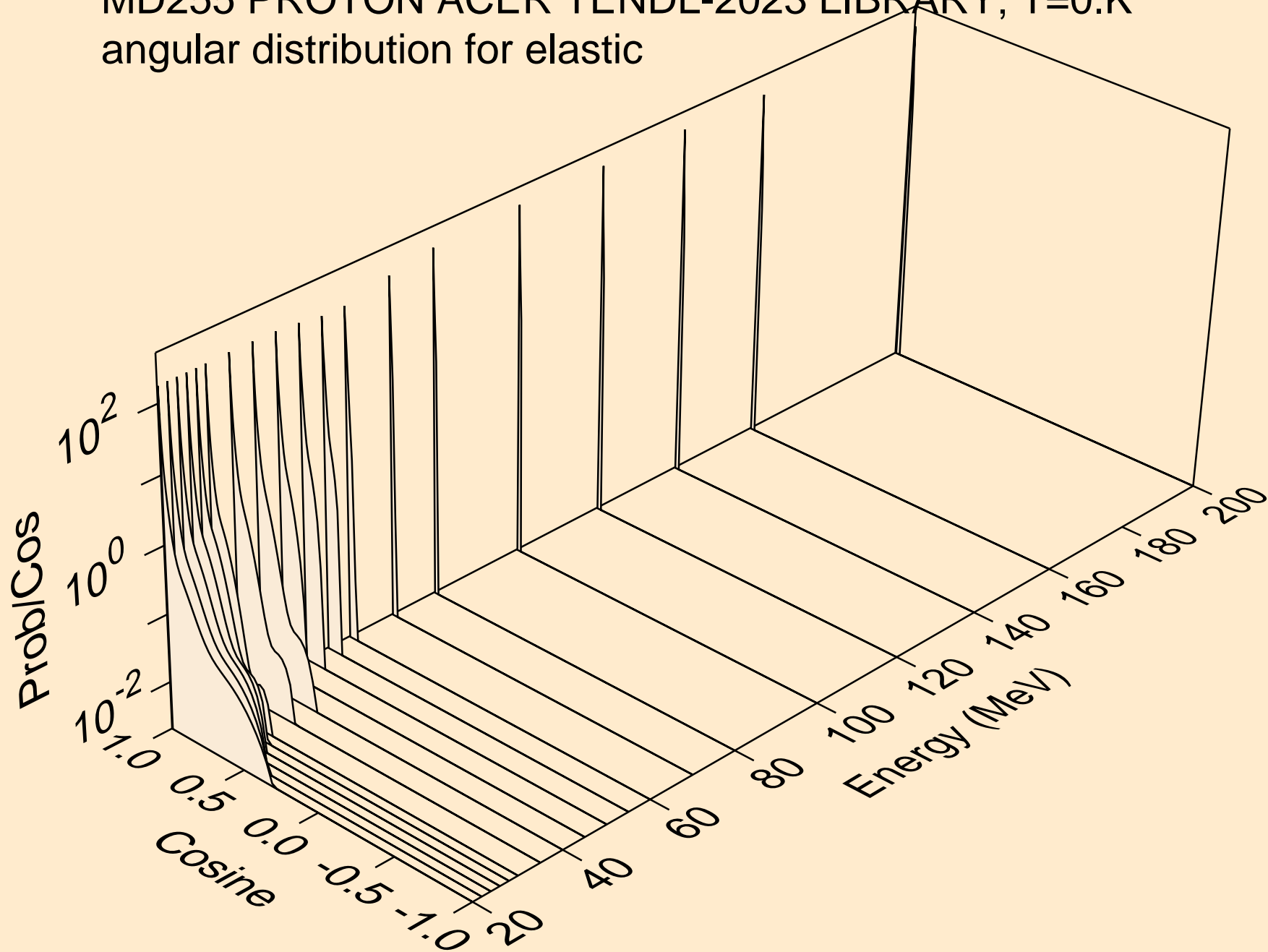

MD255 PROTON ACER TENDL-2023 LIBRARY; T=0.K
Proton emission for (p,x)

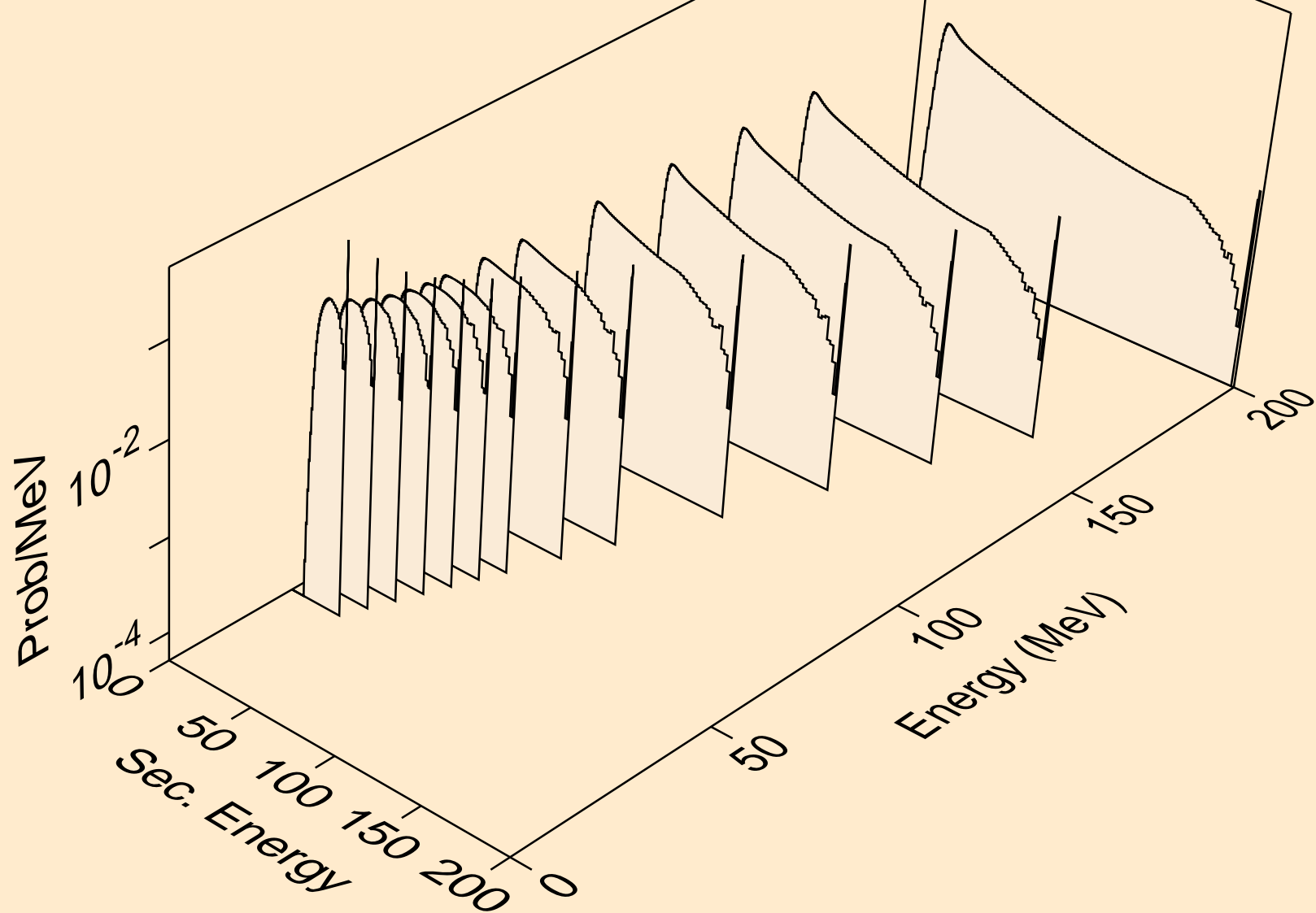

MD255 PROTON ACER TENDL-2023 LIBRARY; T=0.K
Proton emission for (p,n*)p

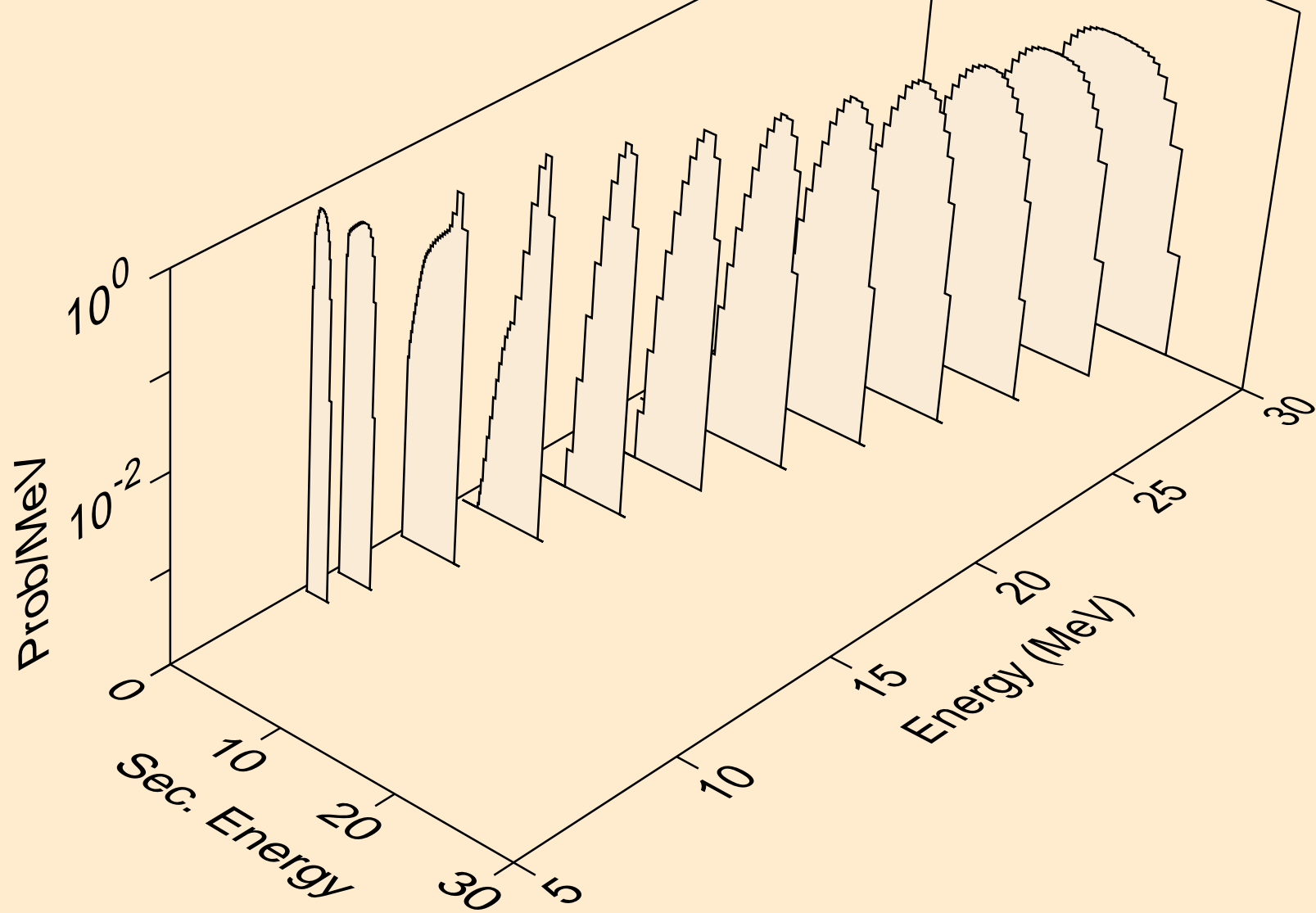

MD255 PROTON ACER TENDL-2023 LIBRARY; T=0.K
Proton emission for (p,2np)

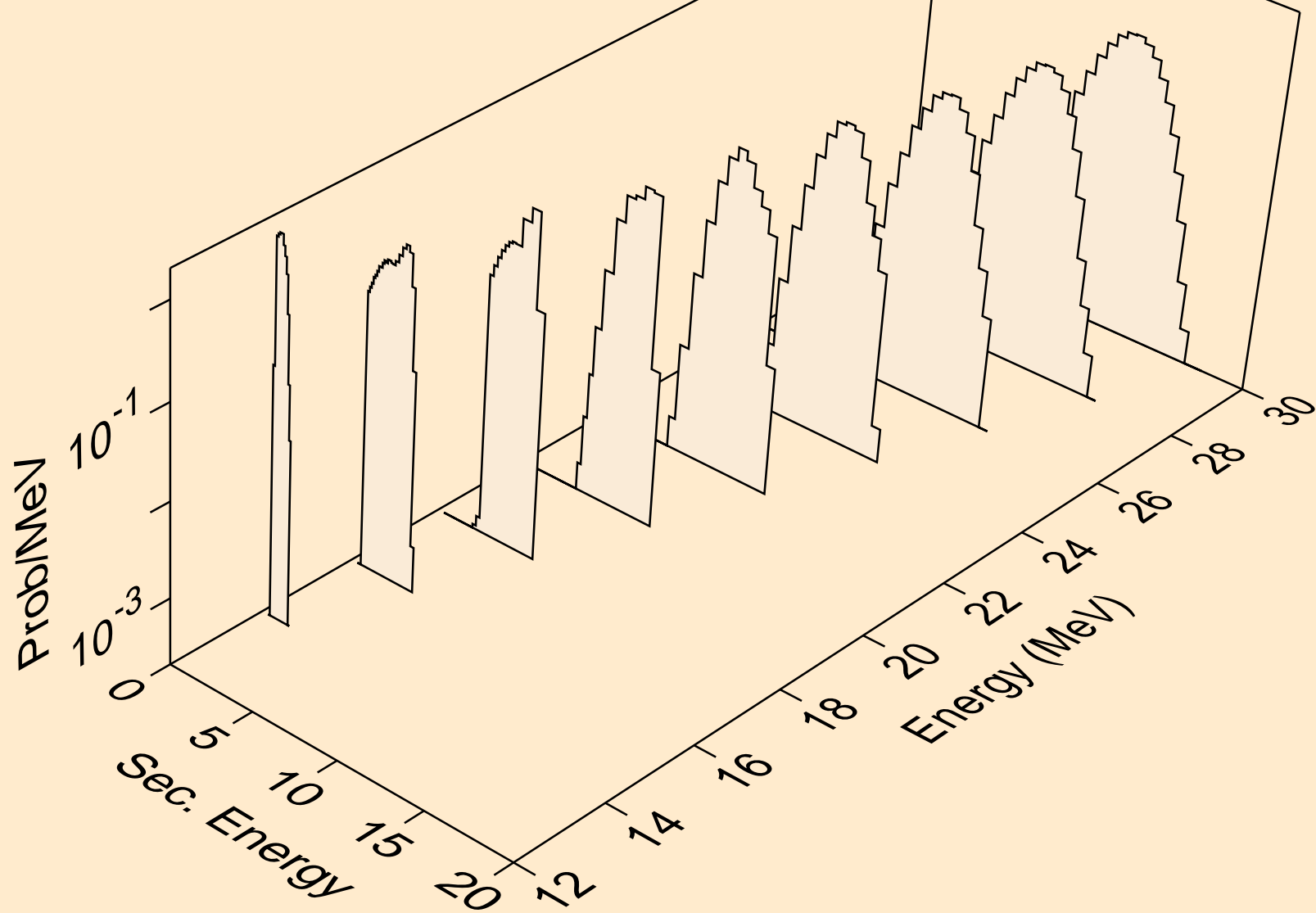

MD255 PROTON ACER TENDL-2023 LIBRARY; T=0.K
Proton emission for inelastic

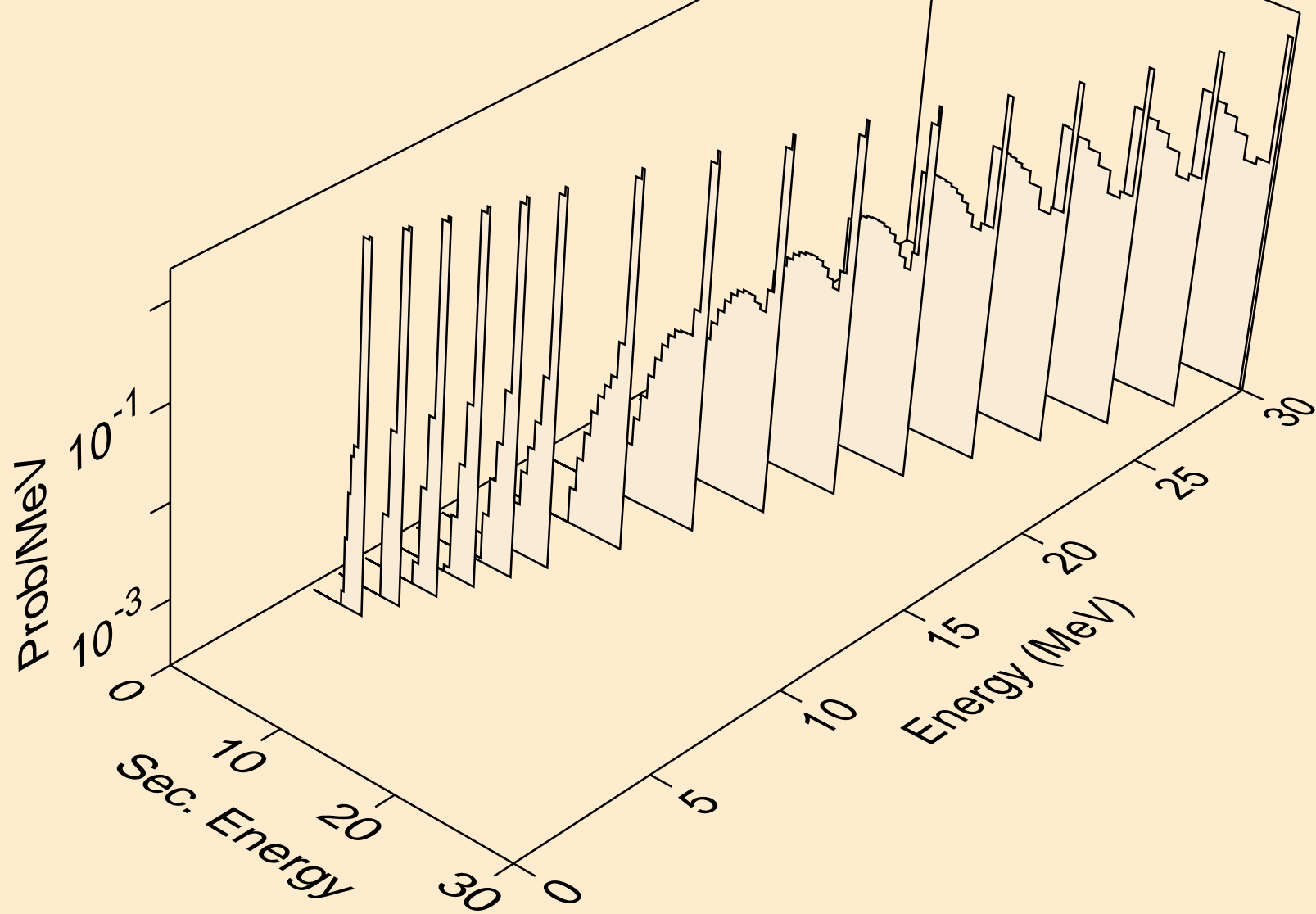

MD255 PROTON ACER TENDL-2023 LIBRARY; T=0.K
Proton emission for (p,2p)

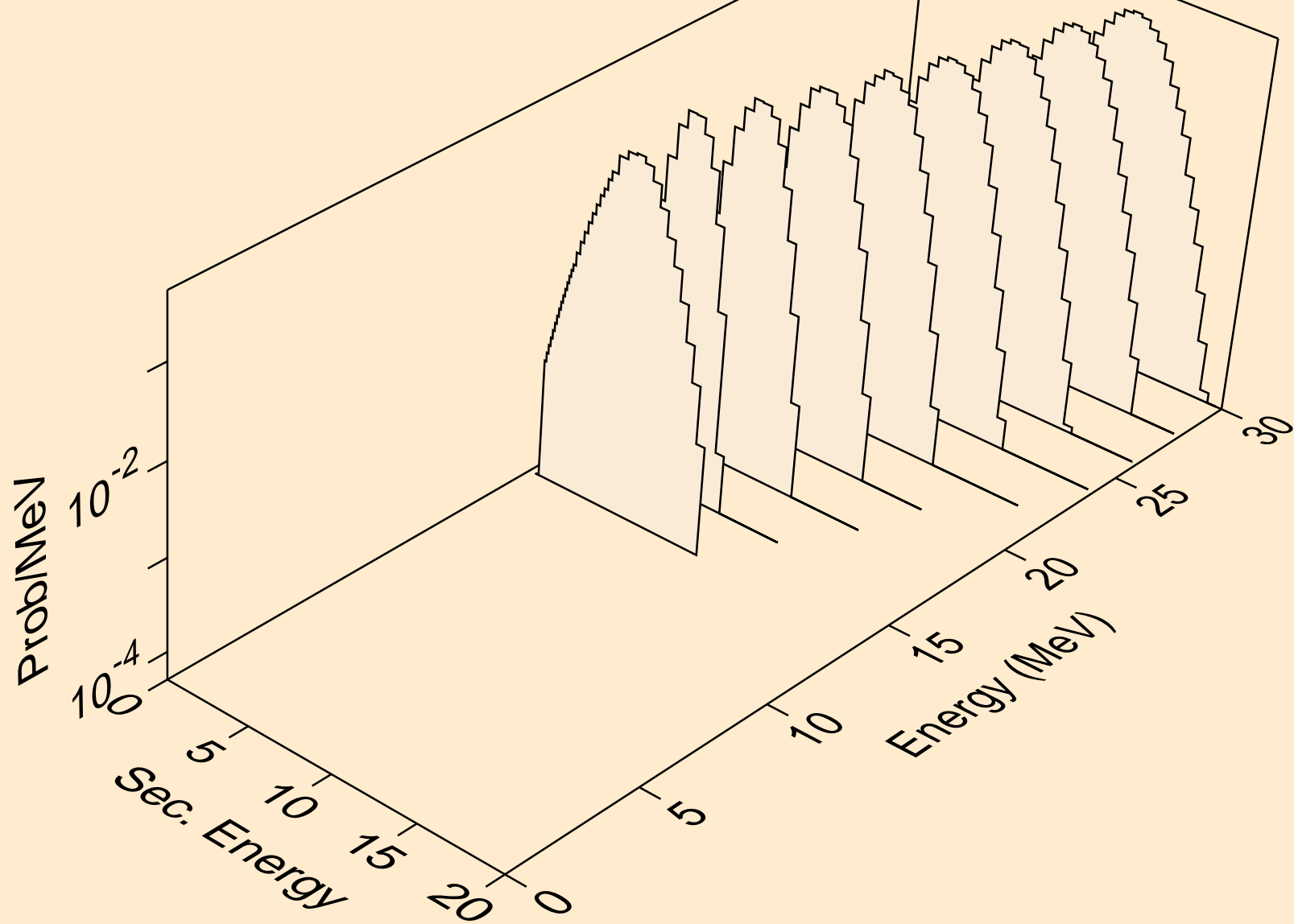

MD255 PROTON ACER TENDL-2023 LIBRARY; T=0.K
Photon emission for (z,n)

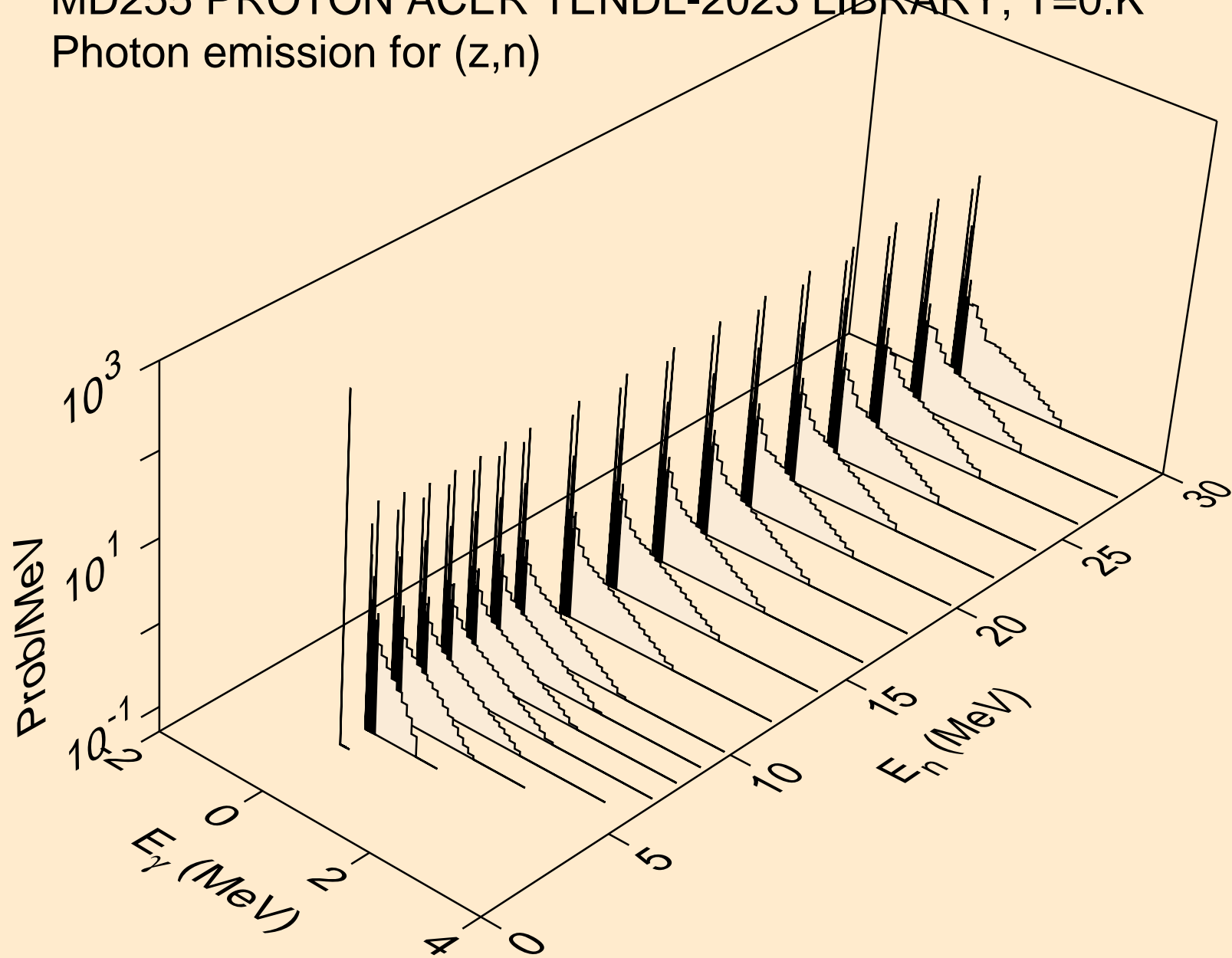

MD255 PROTON ACER TENDL-2023 LIBRARY; T=0.K
Photon emission for (z,x)

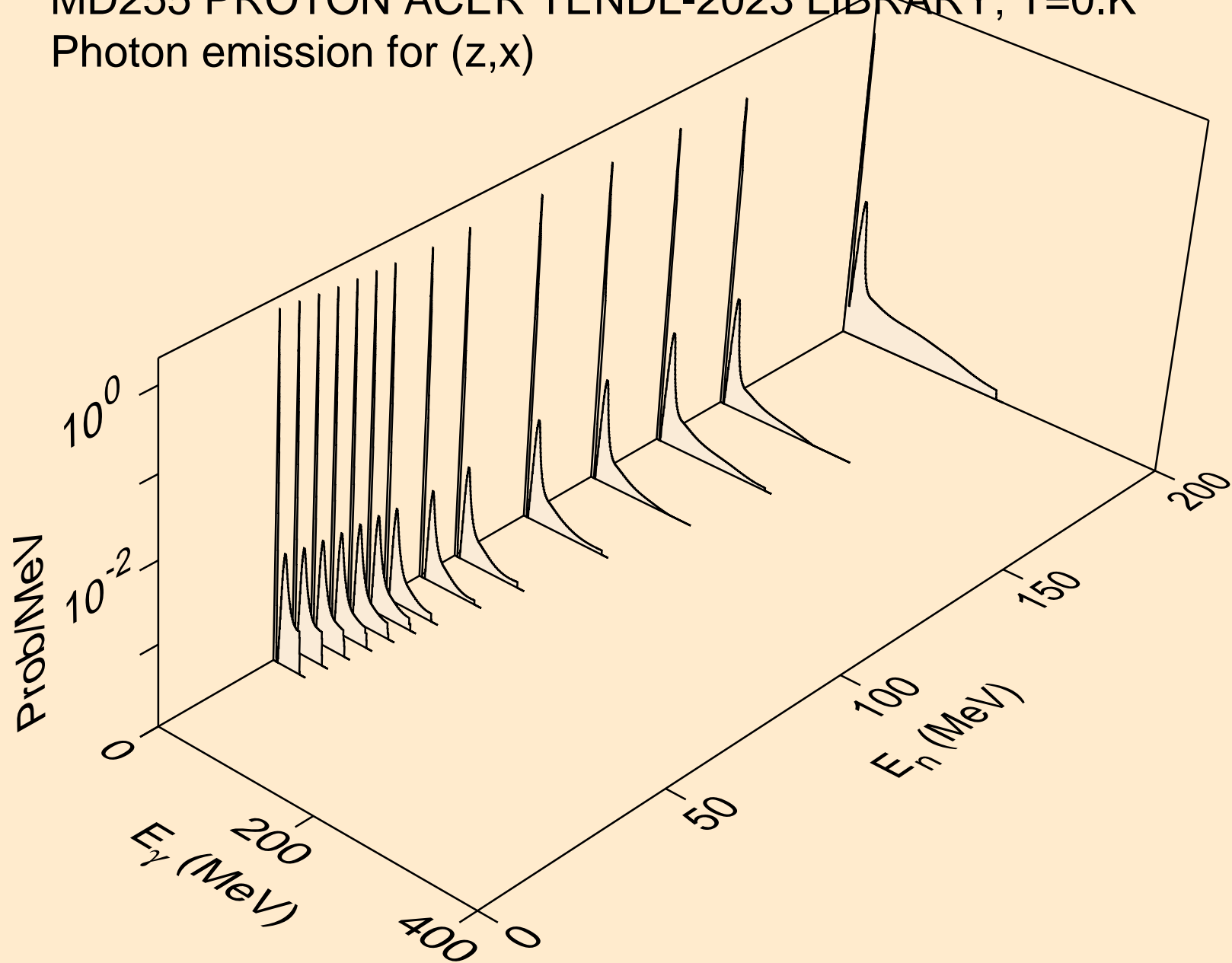

MD255 PROTON ACER TENDL-2023 LIBRARY; T=0.K
Photon emission for (n,2n)

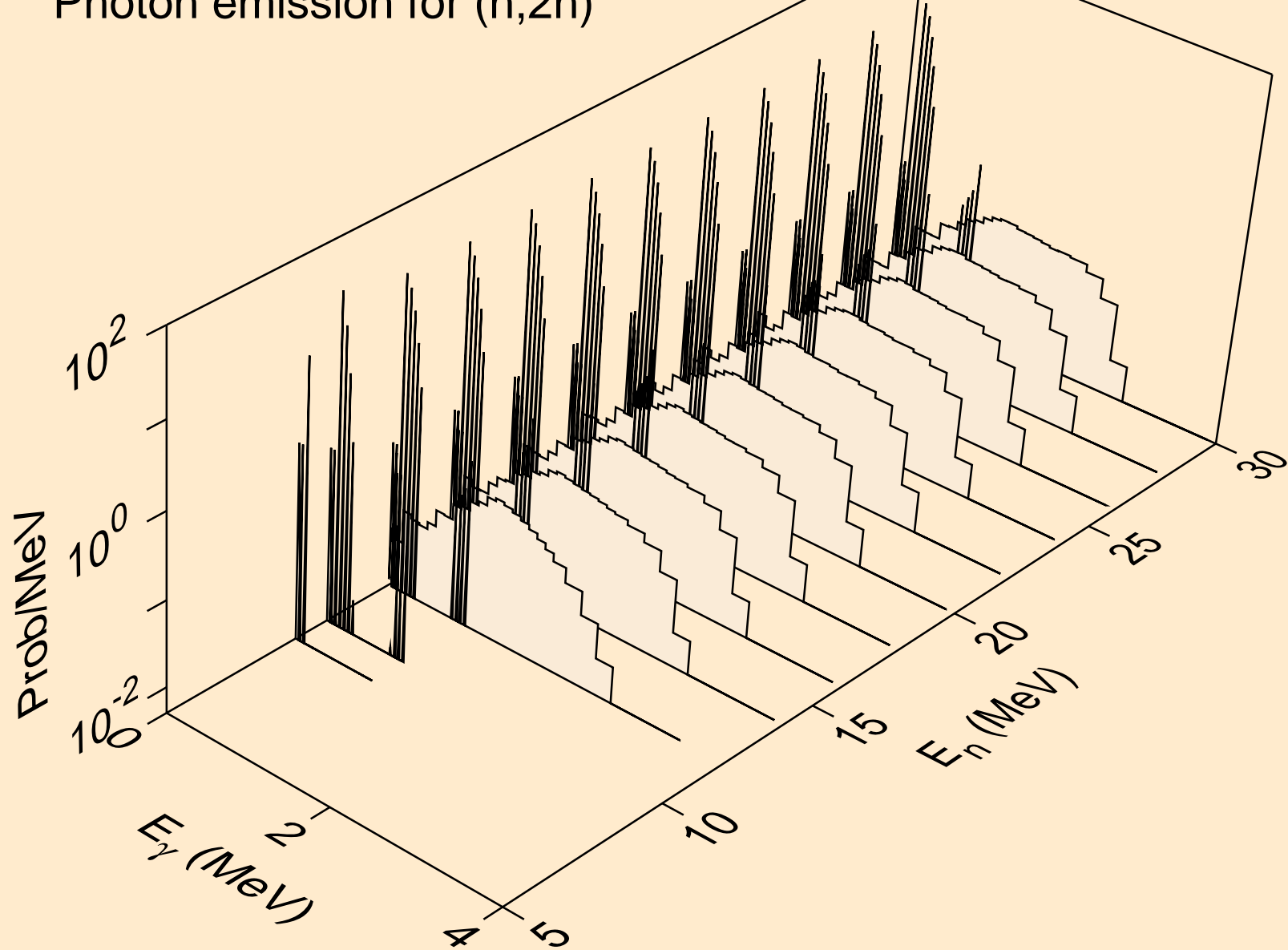

MD255 PROTON ACER TENDL-2023 LIBRARY; T=0.K
Photon emission for (n,3n)

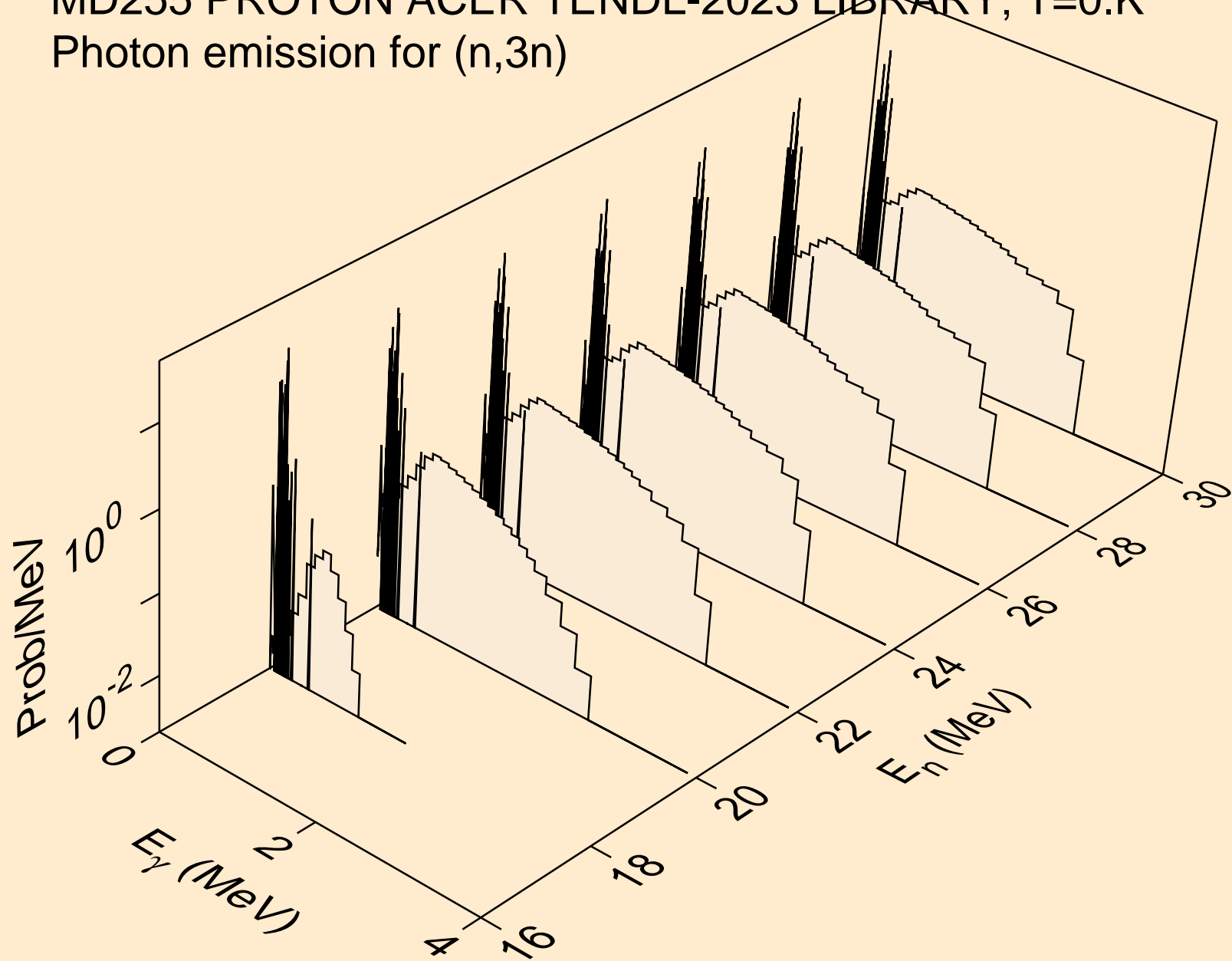

MD255 PROTON ACER TENDL-2023 LIBRARY; T=0.K
Photon emission for (n,n*)a

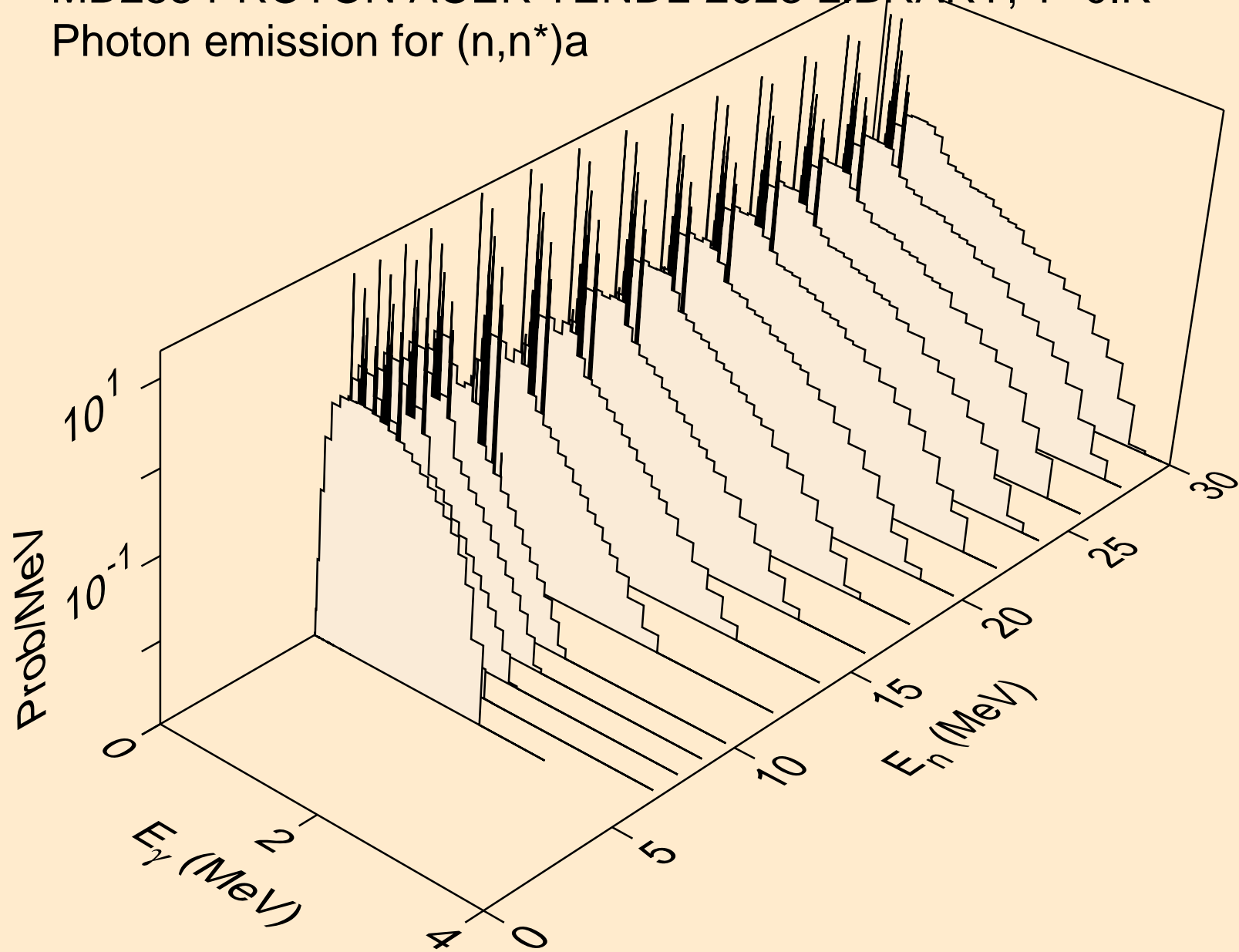

MD255 PROTON ACER TENDL-2023 LIBRARY; T=0.K
Photon emission for (n,2n)a

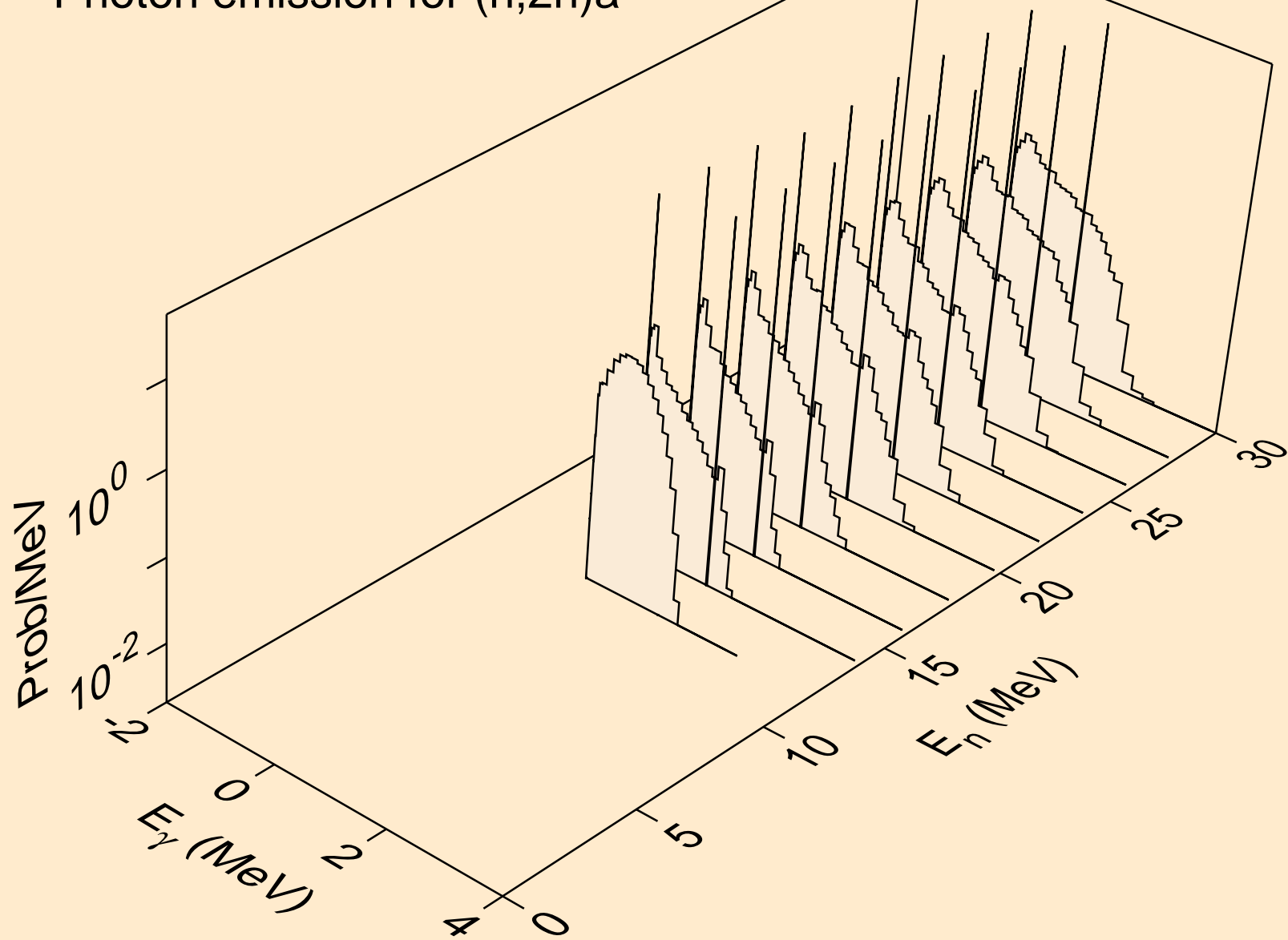

MD255 PROTON ACER TENDL-2023 LIBRARY; T=0.K
Photon emission for (n,n*)p

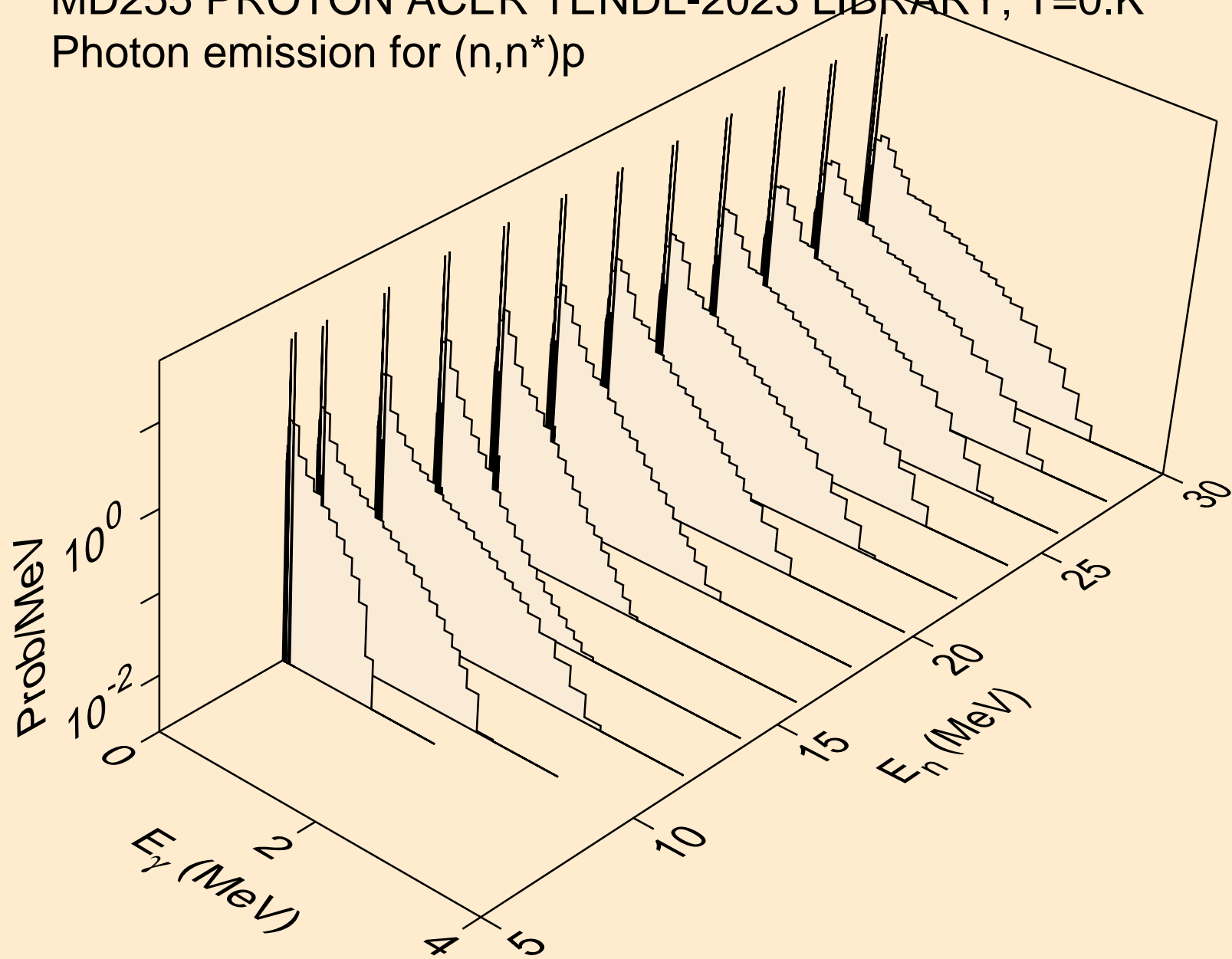

MD255 PROTON ACER TENDL-2023 LIBRARY; T=0.K
Photon emission for (n,n*)d

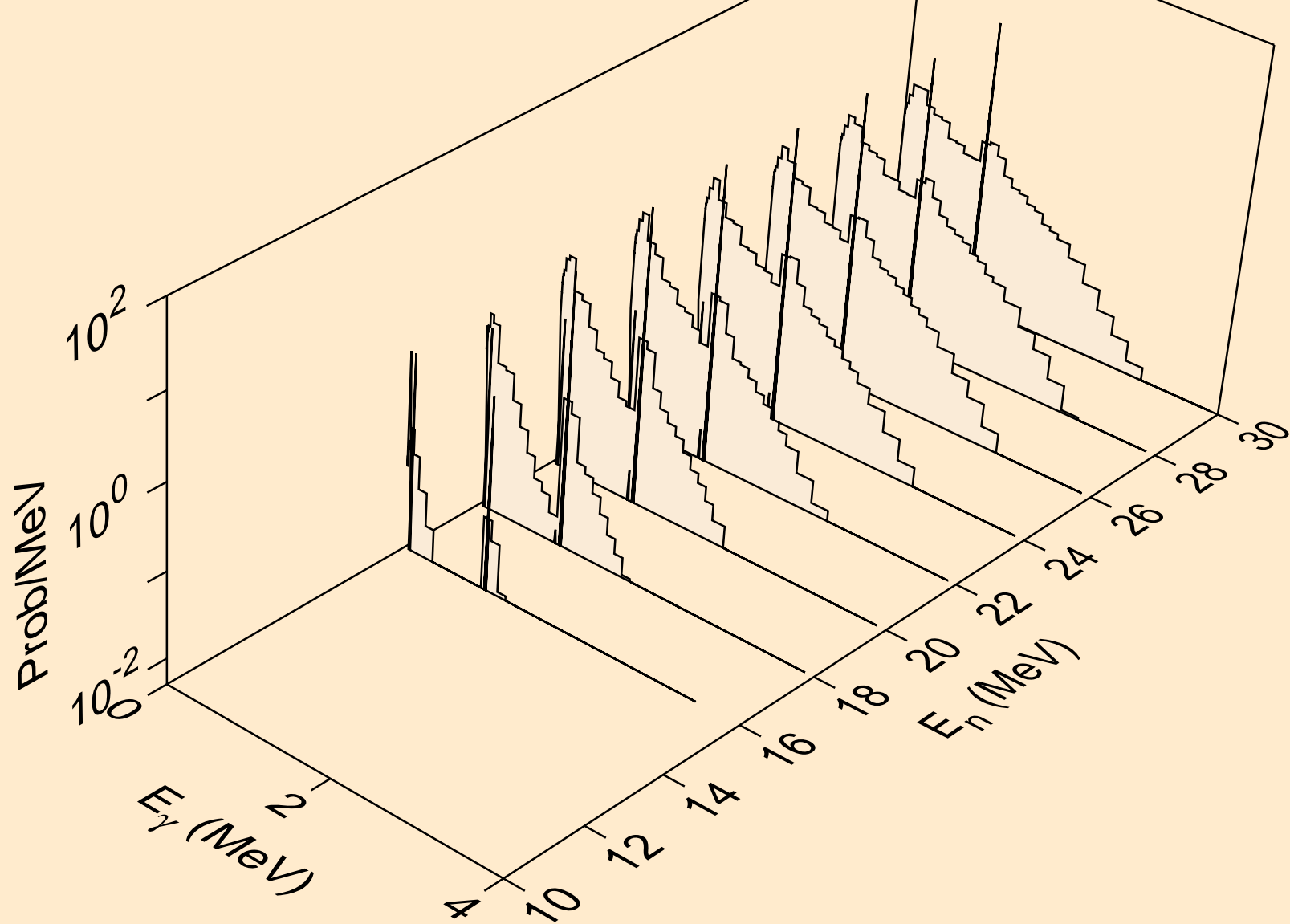

MD255 PROTON ACER TENDL-2023 LIBRARY; T=0.K
Photon emission for (n,n*)t

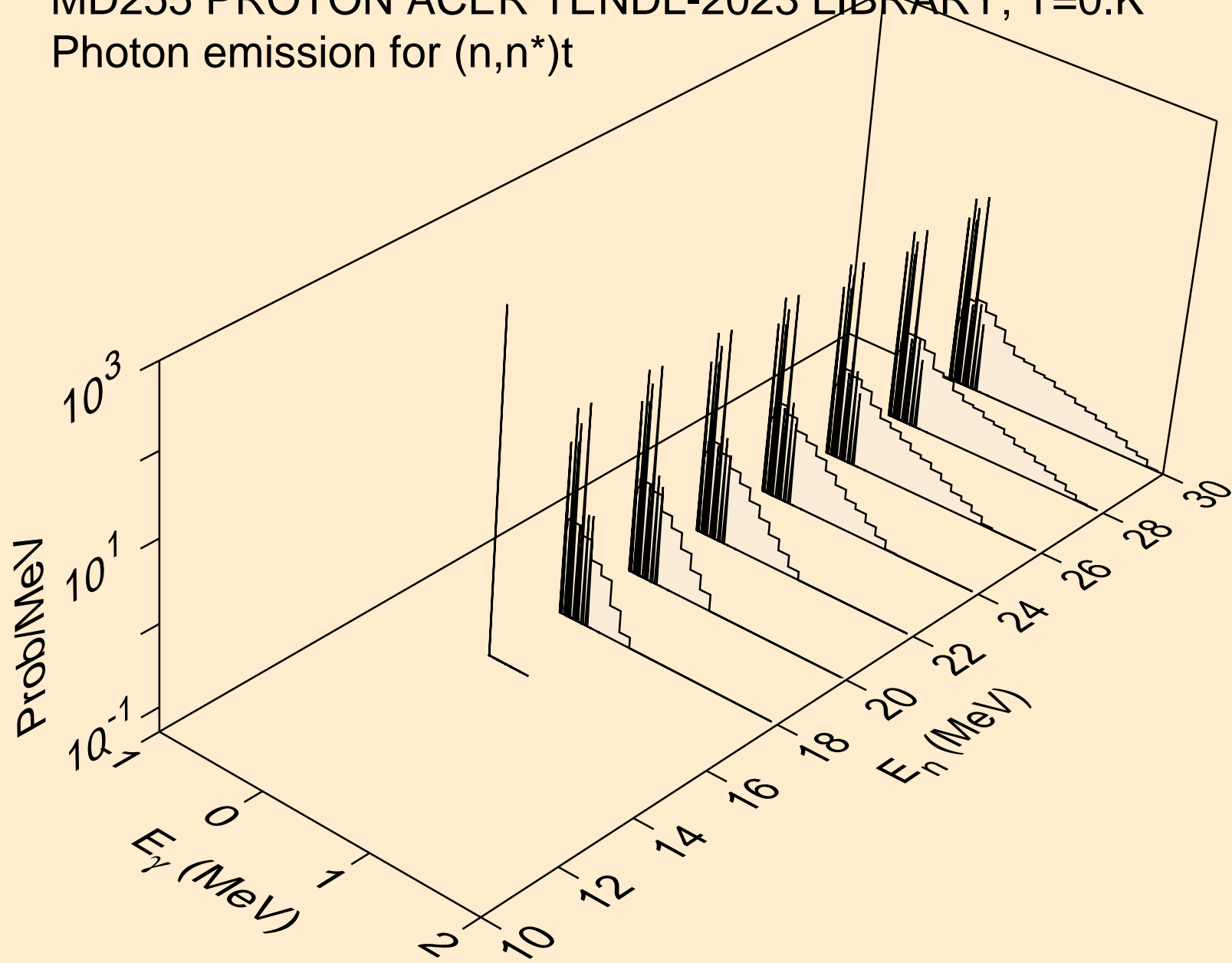

MD255 PROTON ACER TENDL-2023 LIBRARY; T=0.K
Photon emission for (n,n*)he3

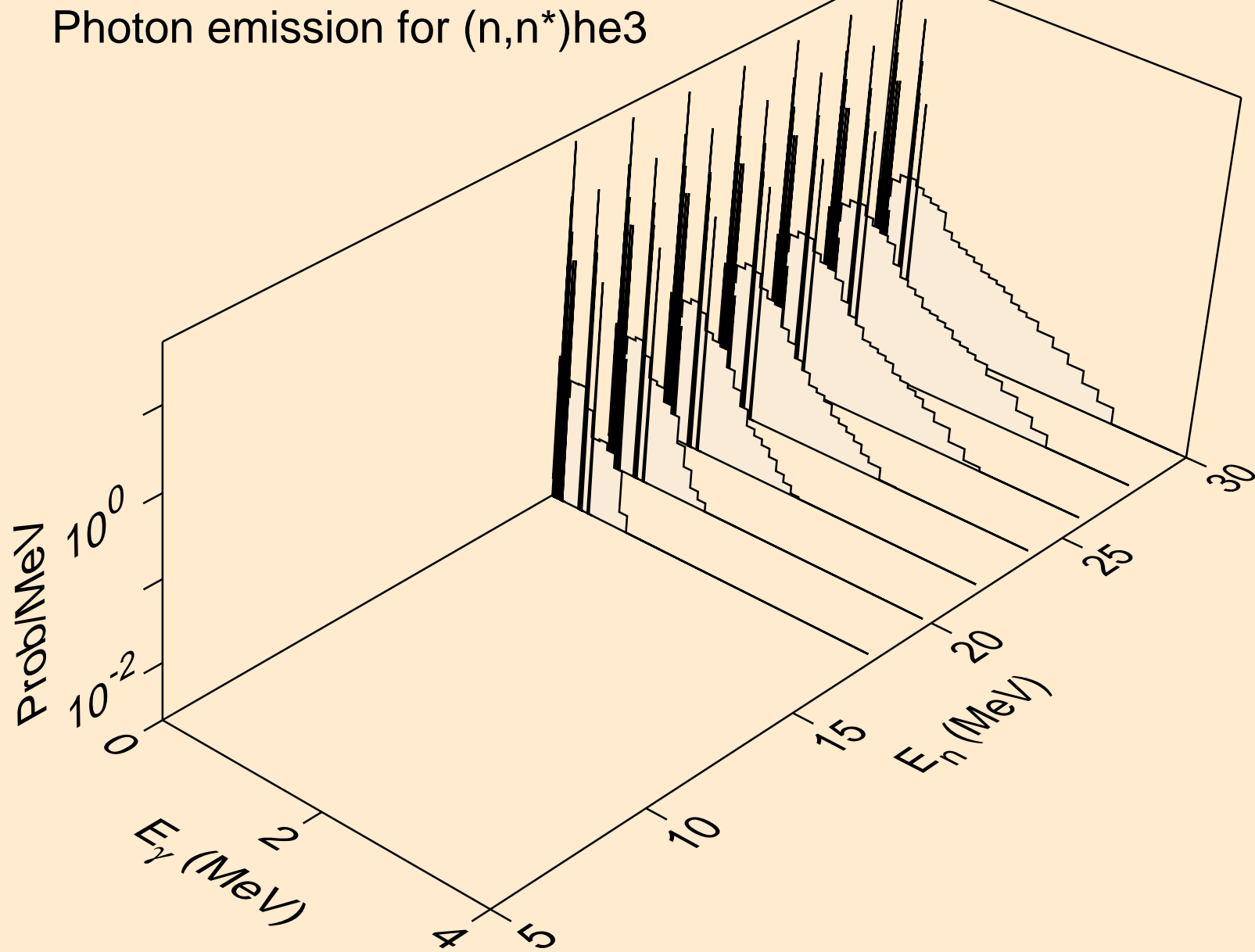

MD255 PROTON ACER TENDL-2023 LIBRARY; T=0.K
Photon emission for (n,2np)

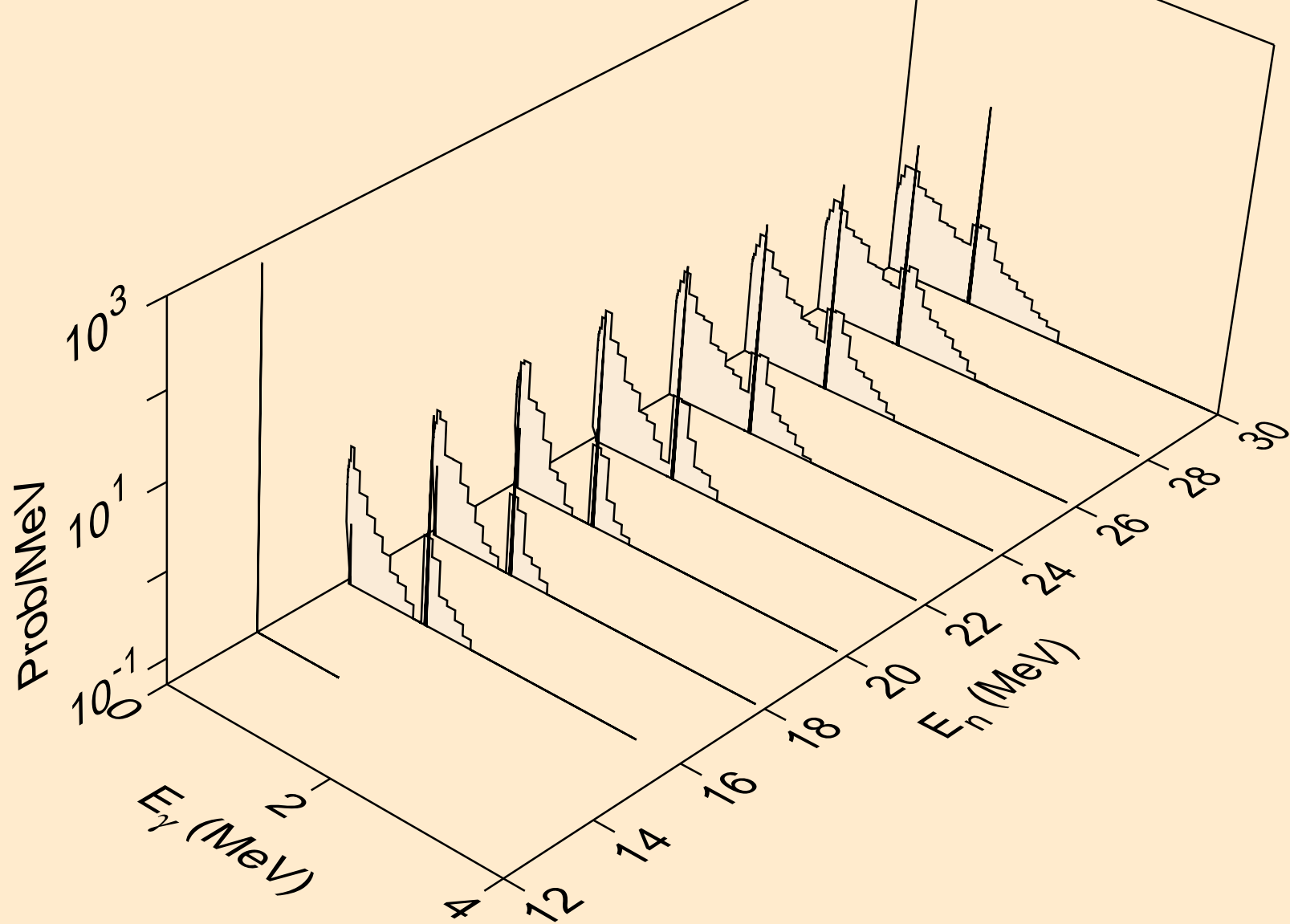

MD255 PROTON ACER TENDL-2023 LIBRARY; T=0.K
Photon emission for (n,gma)

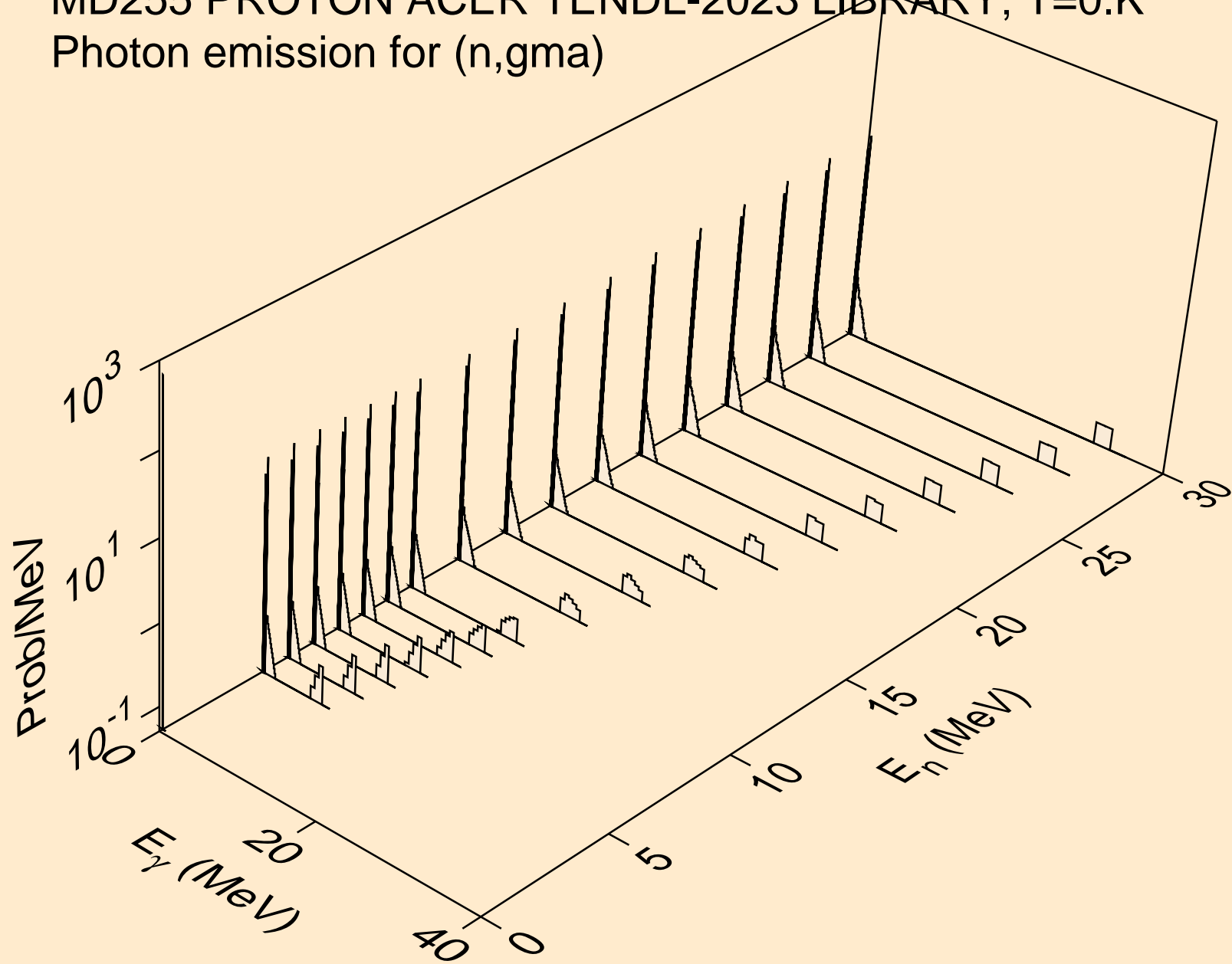

MD255 PROTON ACER TENDL-2023 LIBRARY; T=0.K
Photon emission for inelastic

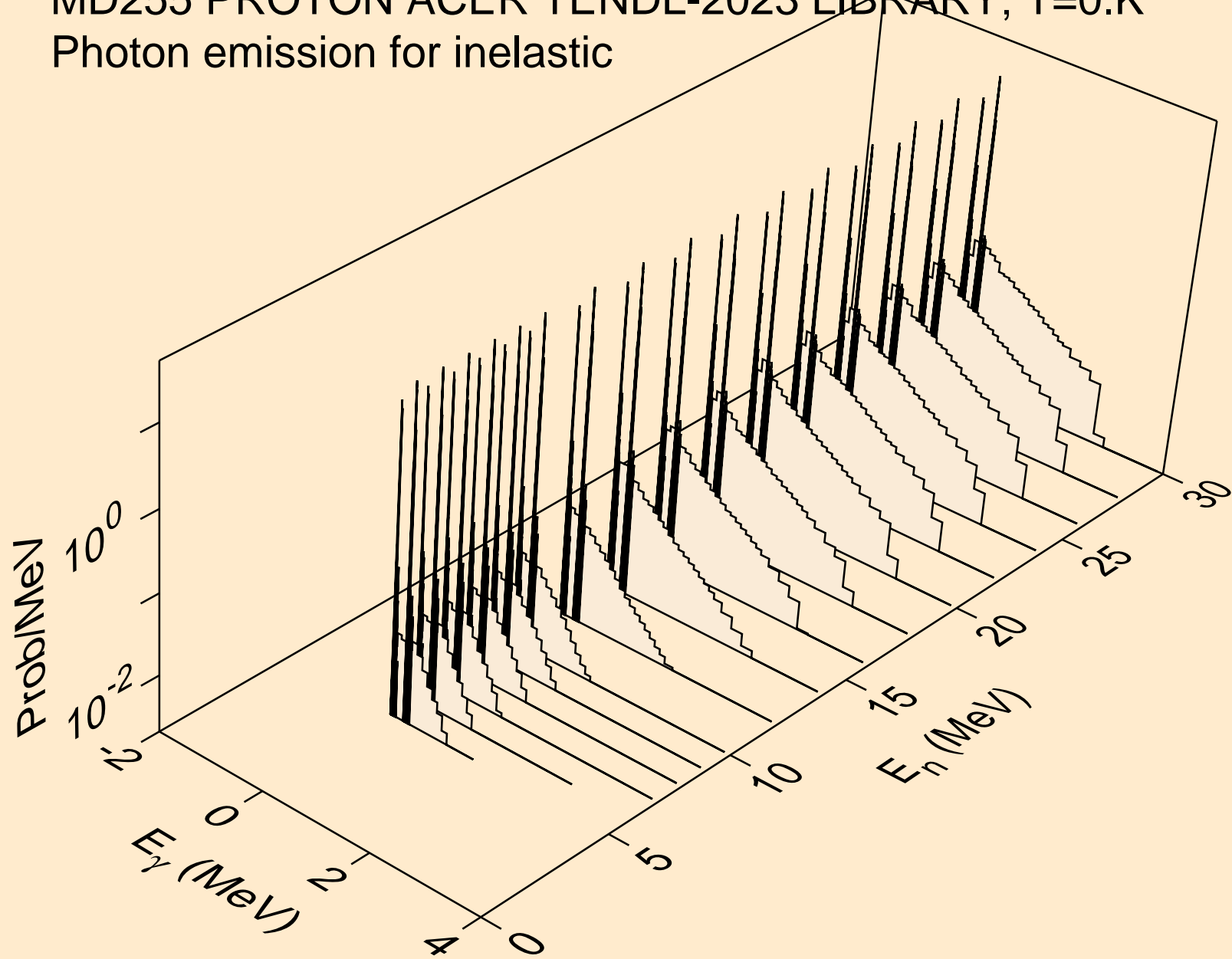

MD255 PROTON ACER TENDL-2023 LIBRARY; T=0.K
Photon emission for (n,d)

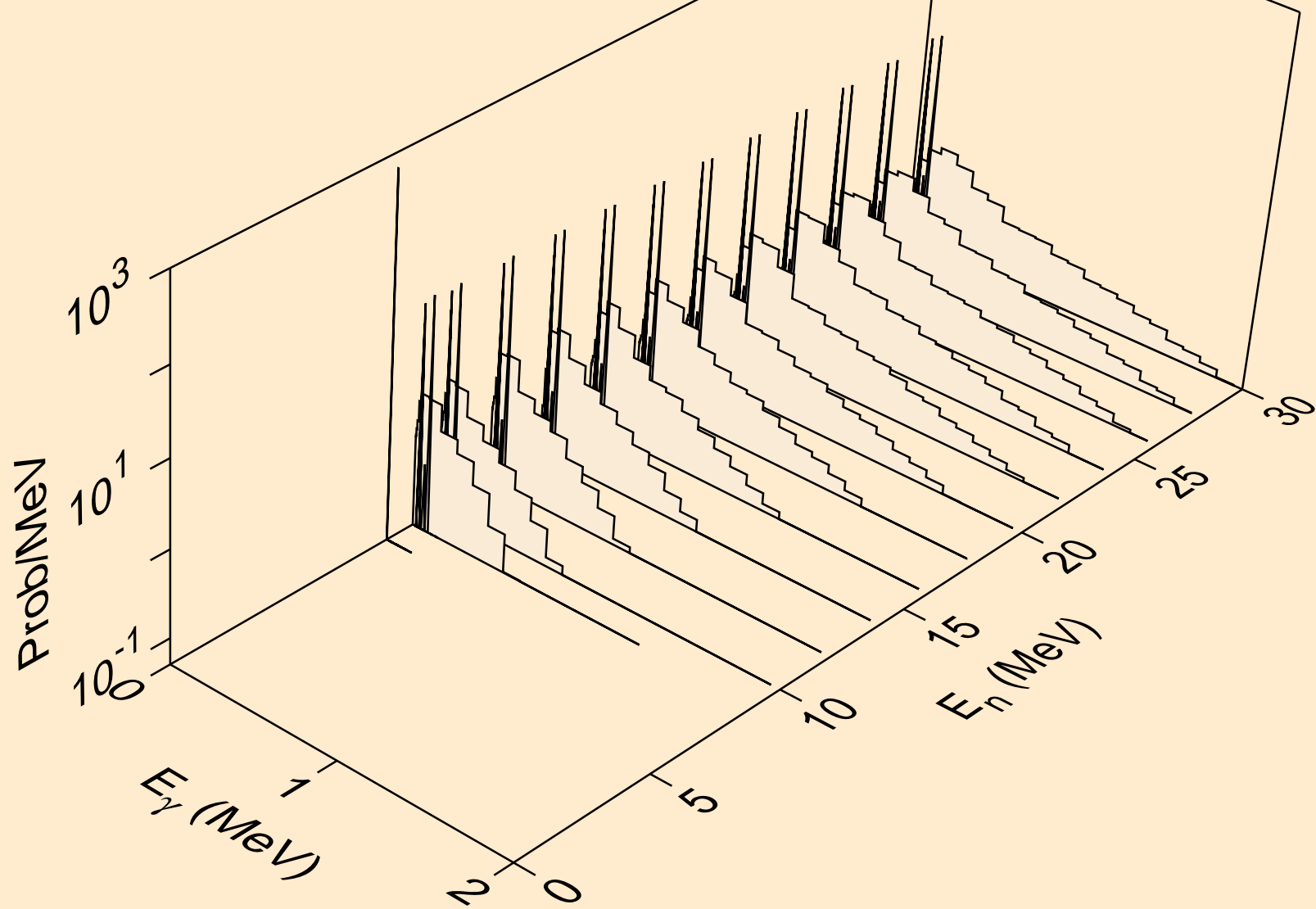

MD255 PROTON ACER TENDL-2023 LIBRARY; T=0.K
Photon emission for (n,t)

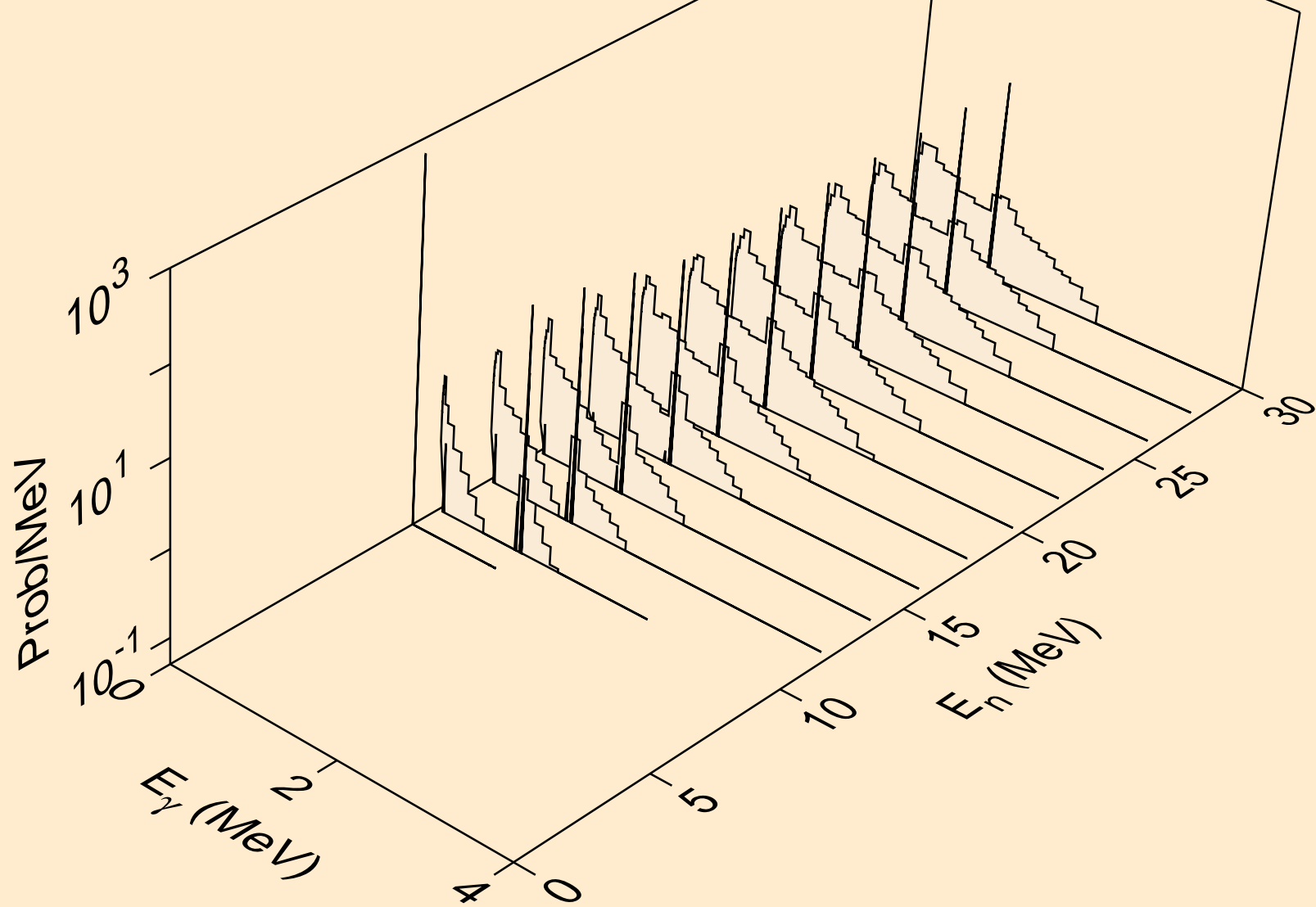

MD255 PROTON ACER TENDL-2023 LIBRARY; T=0.K
Photon emission for (n,he3)

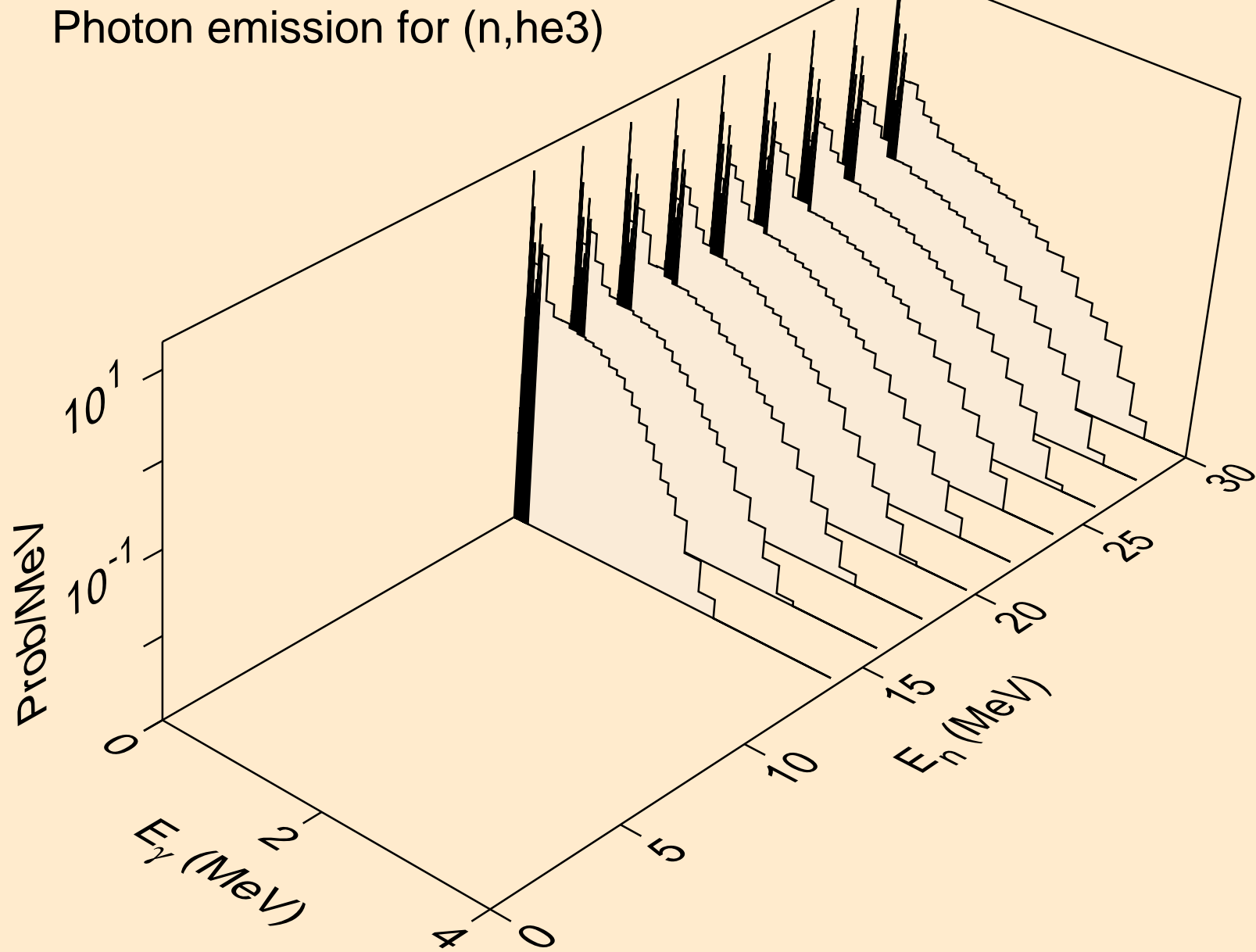

MD255 PROTON ACER TENDL-2023 LIBRARY; T=0.K
Photon emission for (n,a)

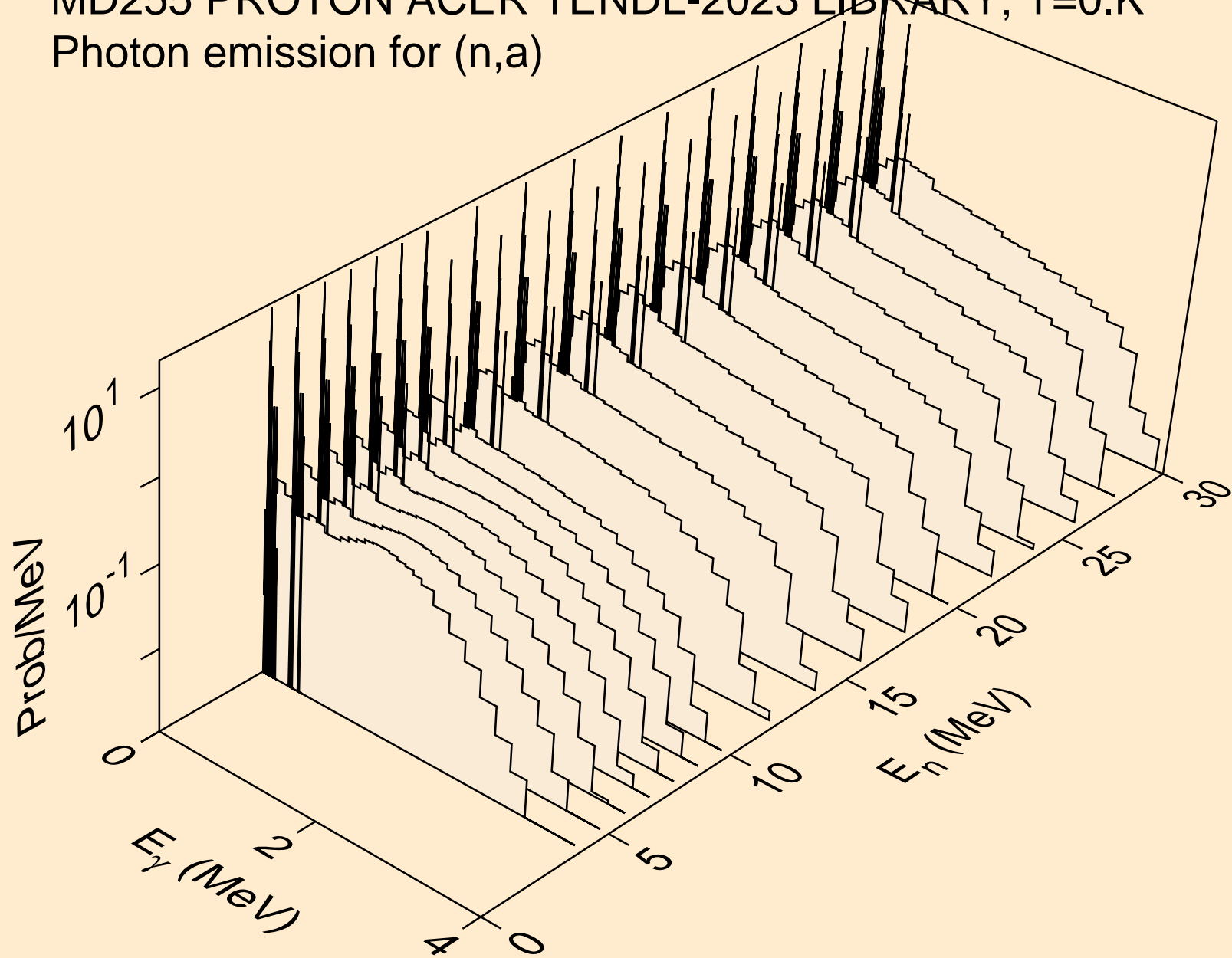

MD255 PROTON ACER TENDL-2023 LIBRARY; T=0.K
Photon emission for (n,2p)

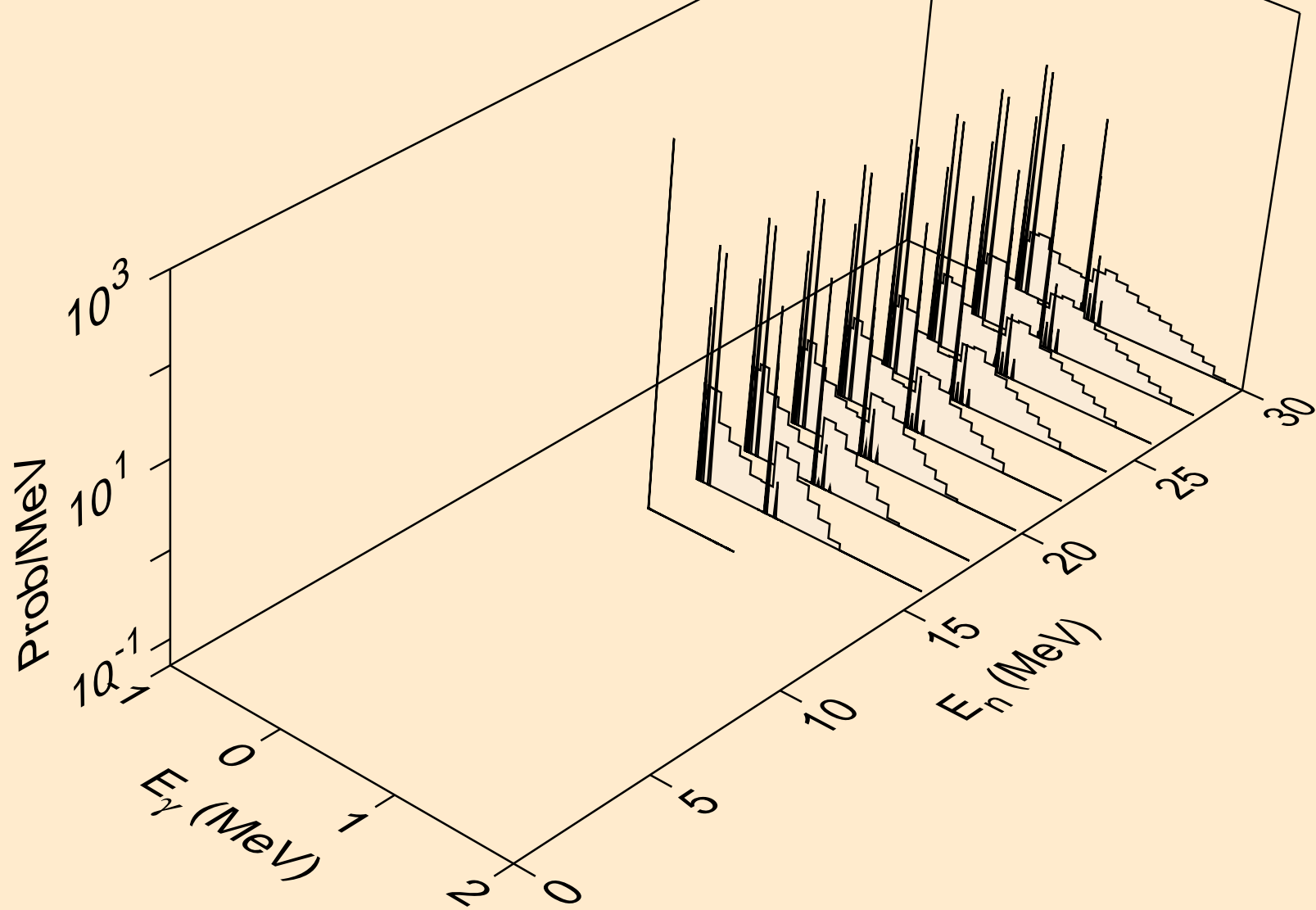

MD255 PROTON ACER TENDL-2023 LIBRARY; T=0.K
Particle heating contributions

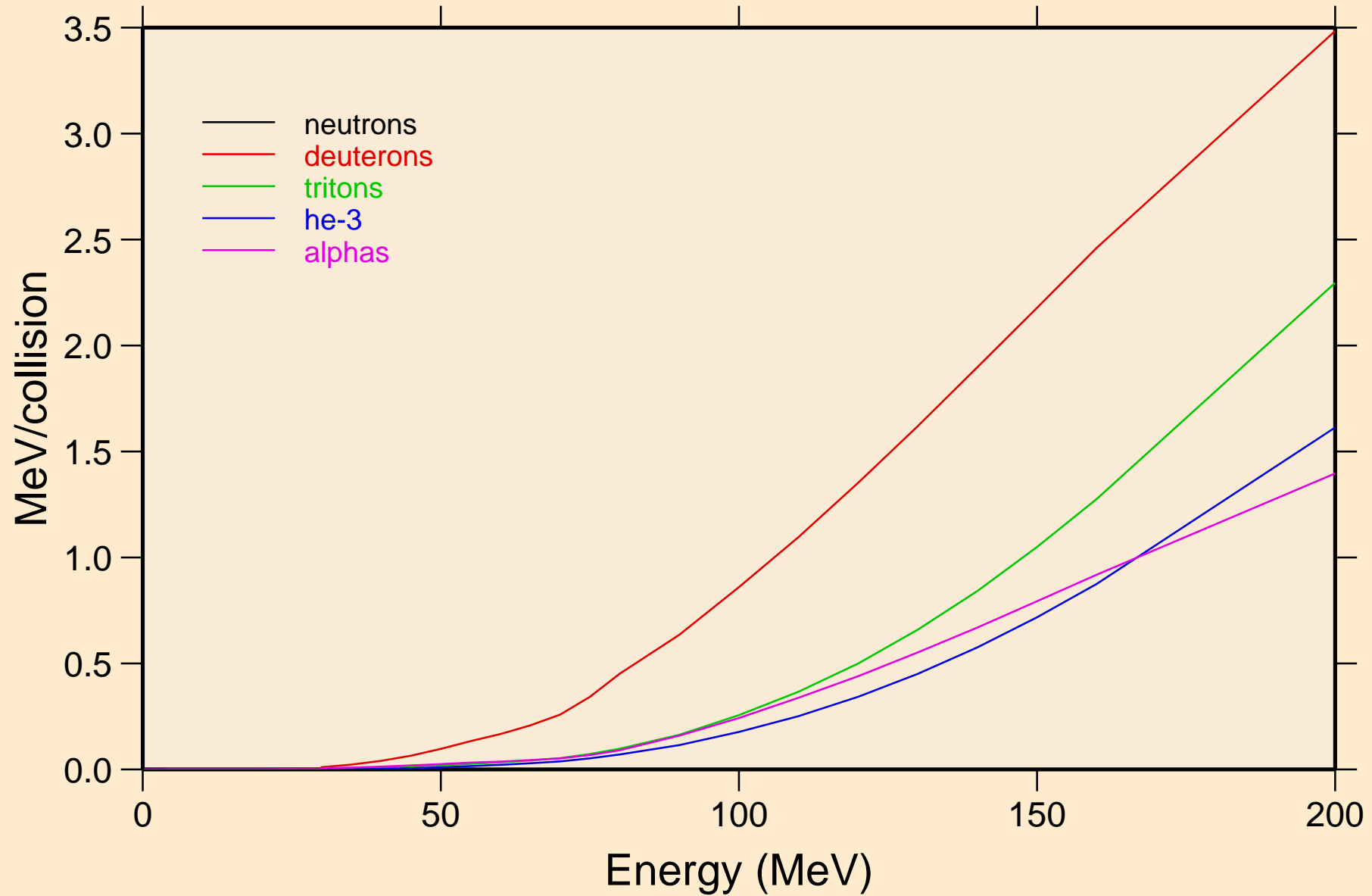

MD255 PROTON ACER TENDL-2023 LIBRARY; T=0.K
Recoil Heating

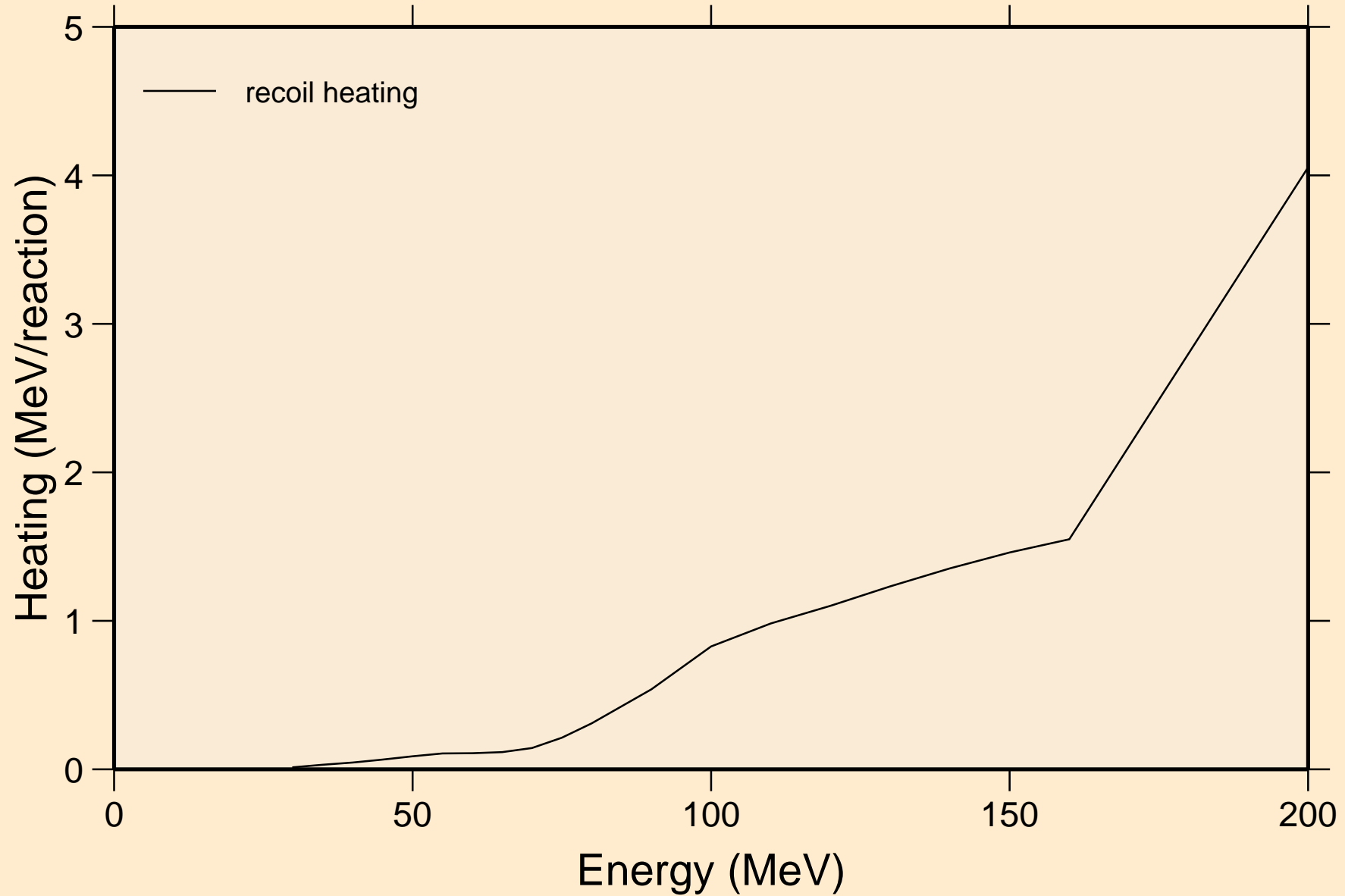

MD255 PROTON ACER TENDL-2023 LIBRARY; T=0.K

Particle production cross sections

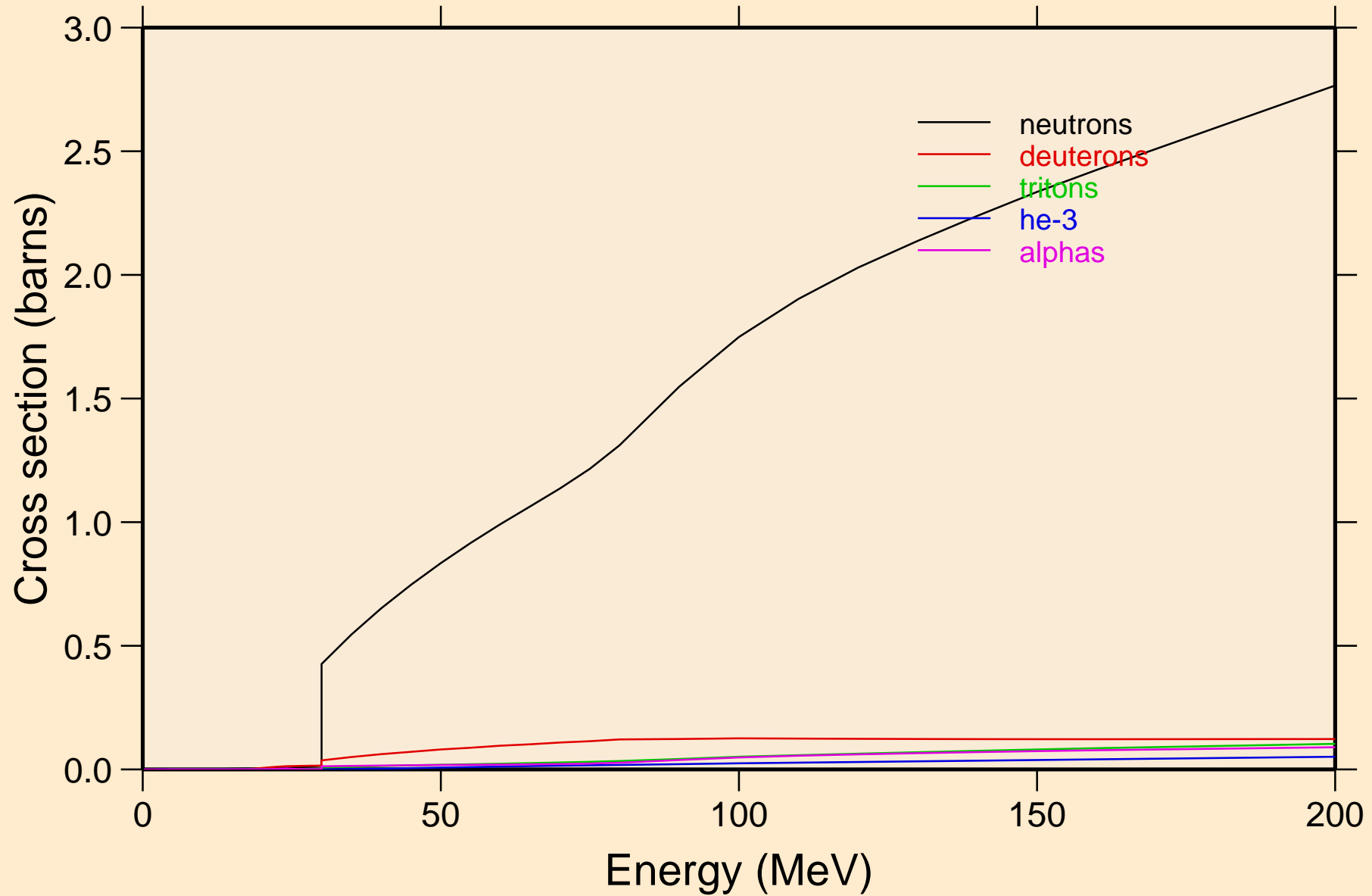

MD255 PROTON ACER TENDL-2023 LIBRARY; T=0.K
neutrons from (p,n)

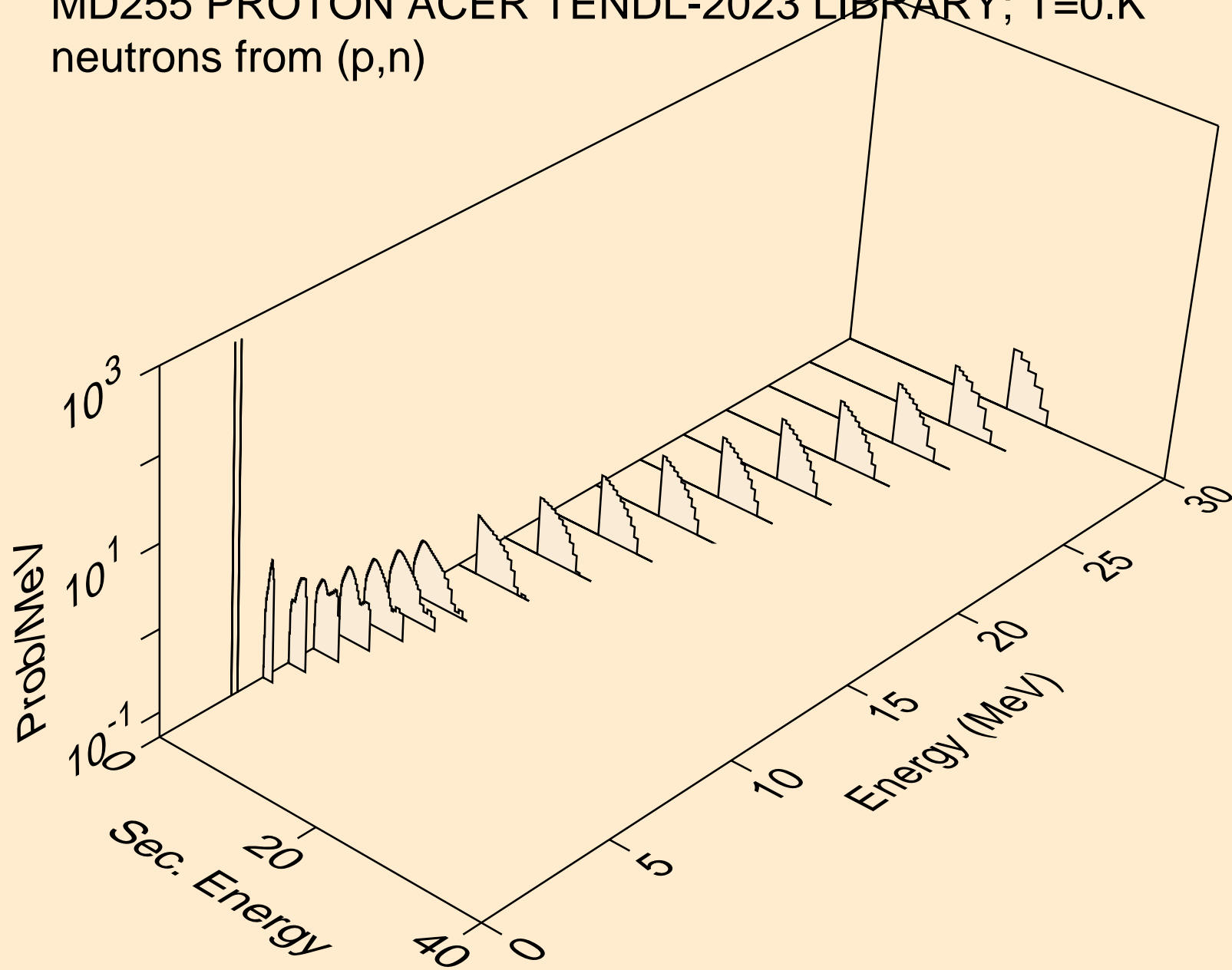

MD255 PROTON ACER TENDL-2023 LIBRARY; T=0.K
neutrons from (p,x)

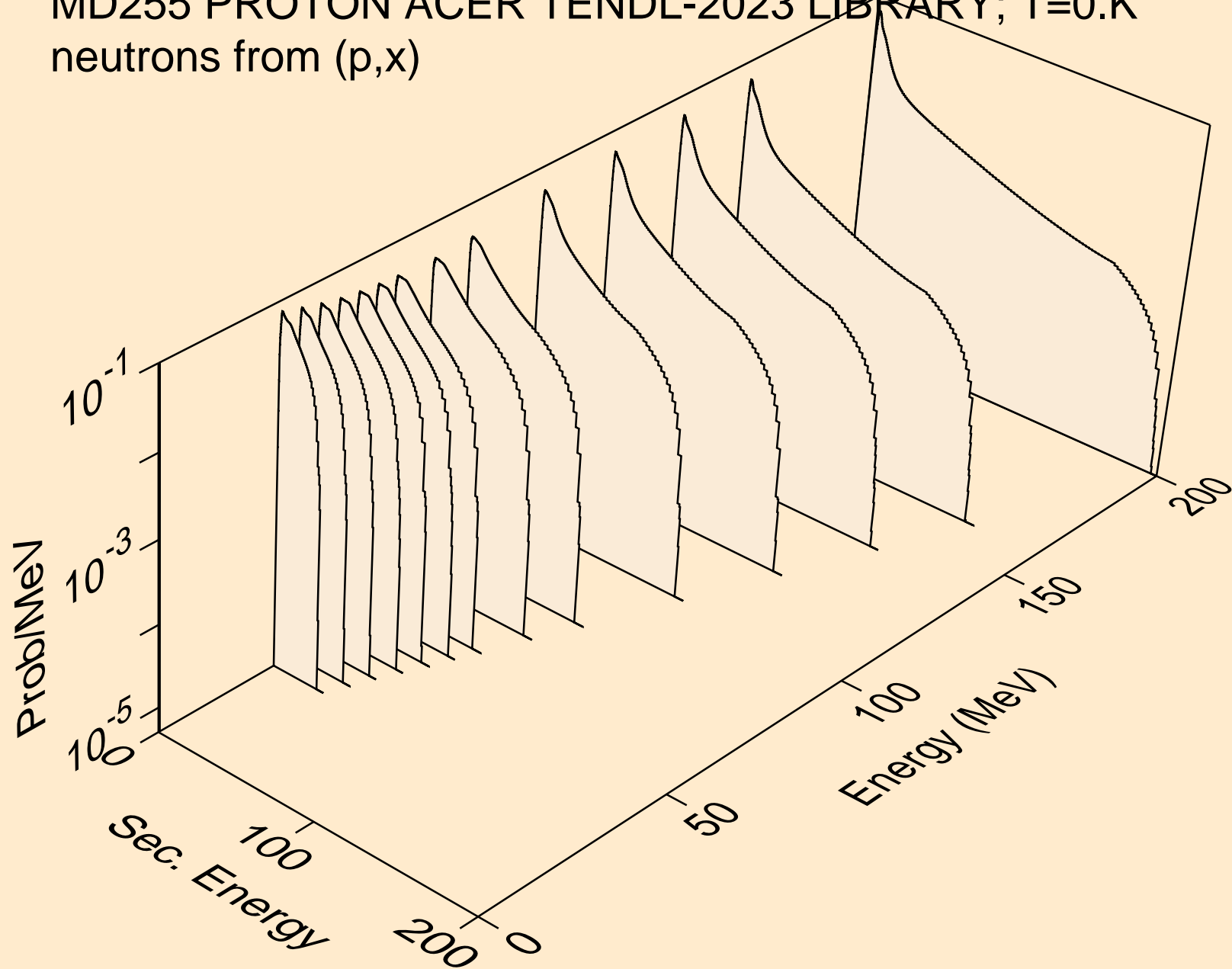

MD255 PROTON ACER TENDL-2023 LIBRARY; T=0.K
neutrons from (p,2n)

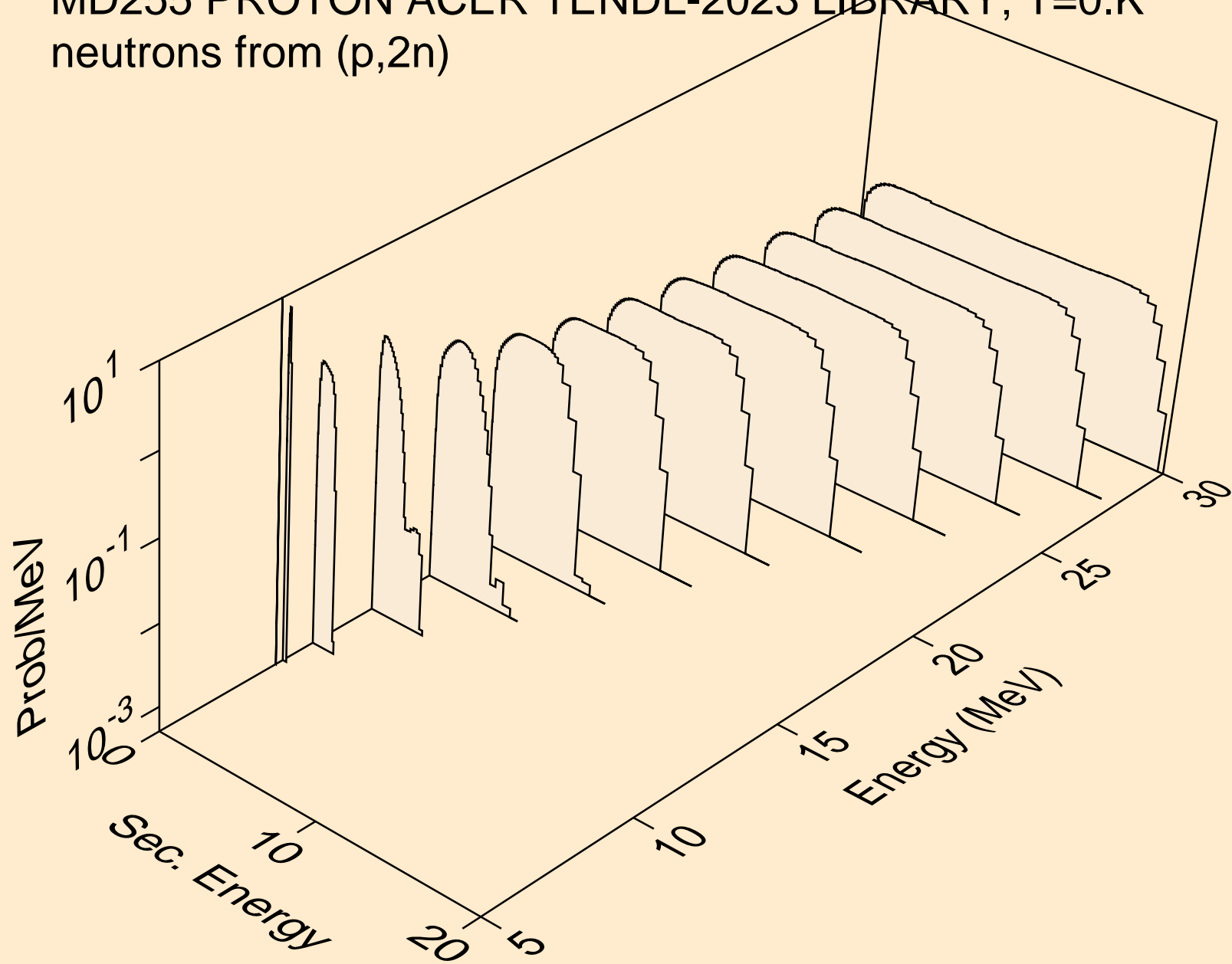

MD255 PROTON ACER TENDL-2023 LIBRARY; T=0.K
neutrons from (p,3n)

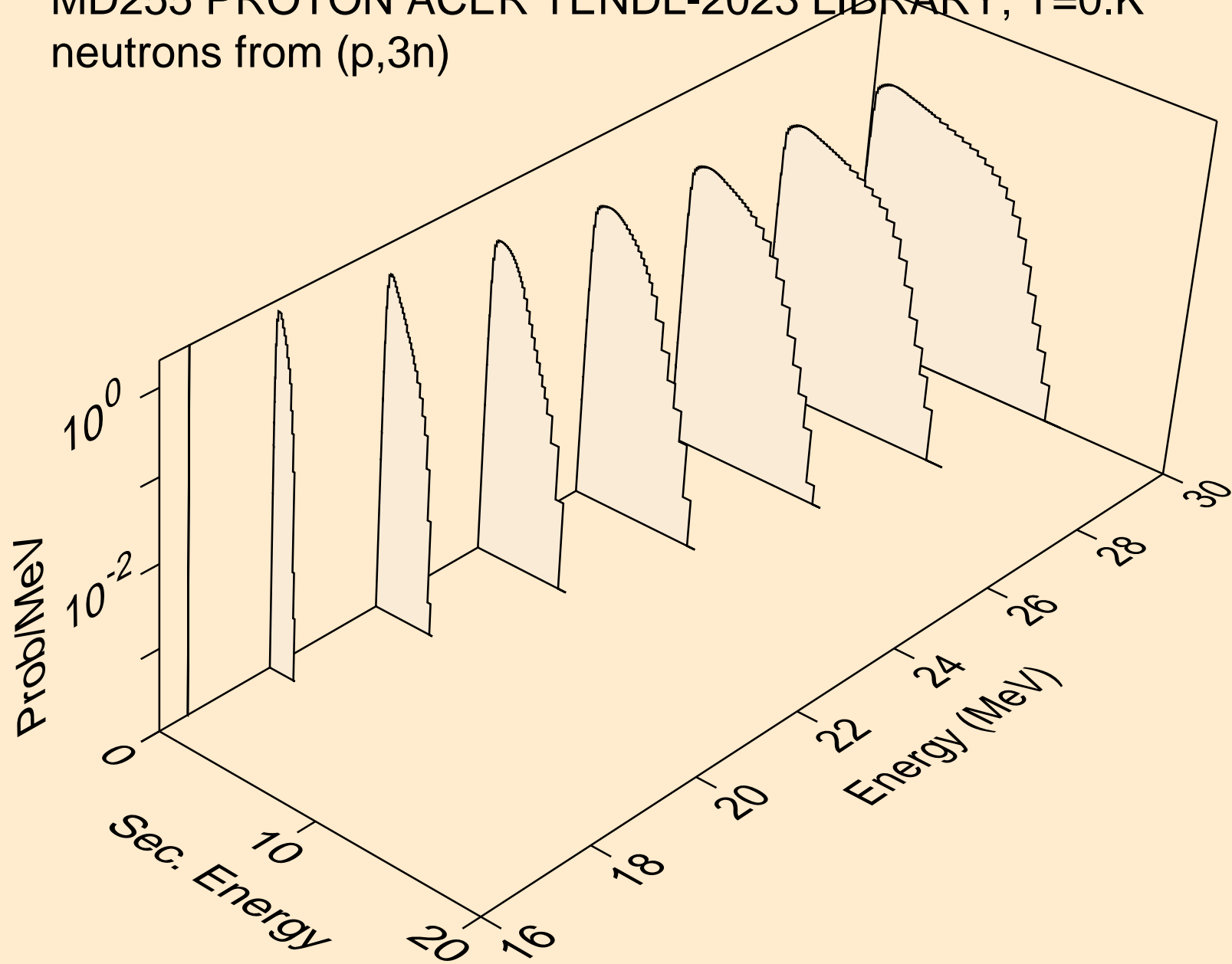

MD255 PROTON ACER TENDL-2023 LIBRARY; T=0.K
neutrons from (p,n*)a

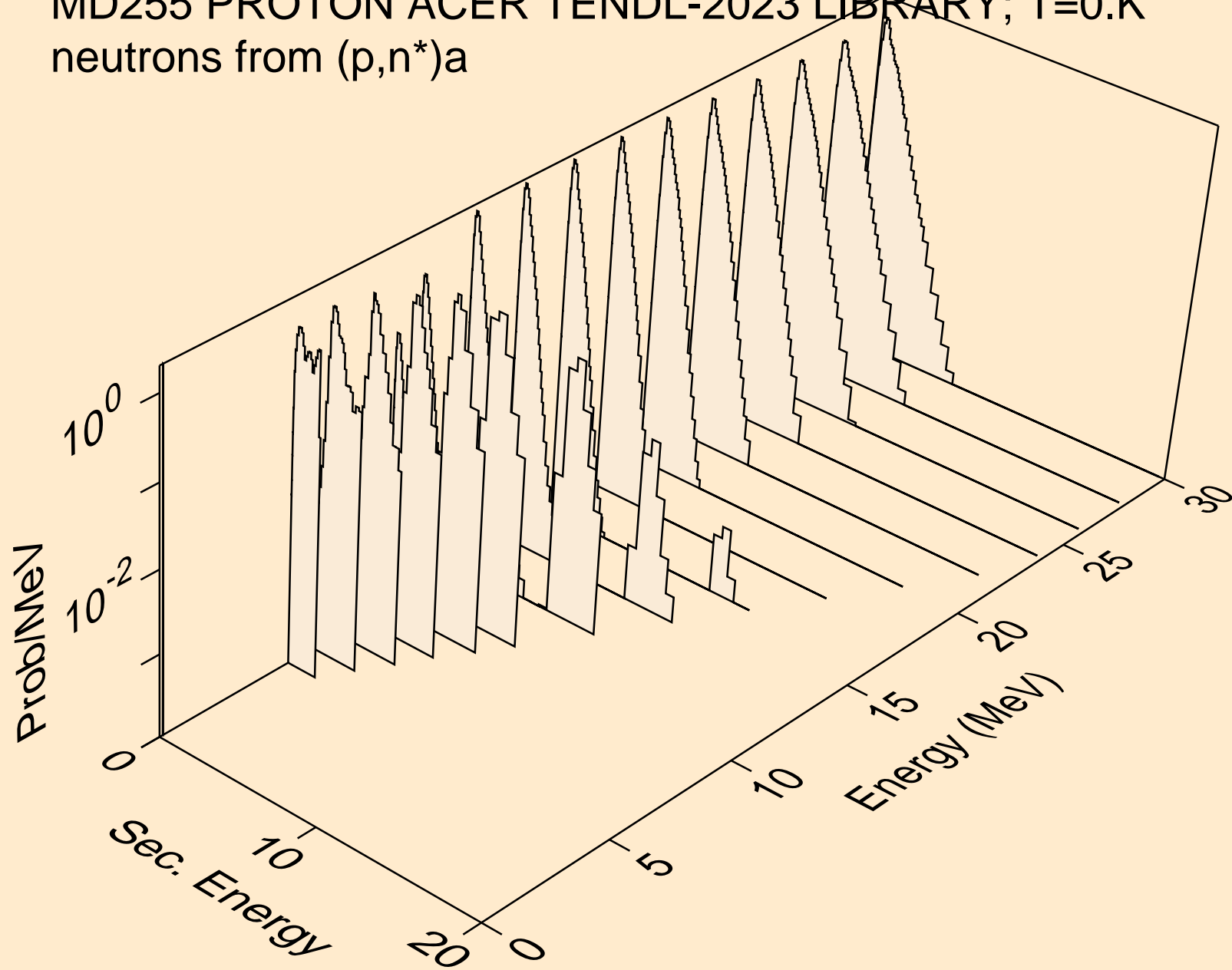

MD255 PROTON ACER TENDL-2023 LIBRARY; T=0.K
neutrons from (p,2n)a

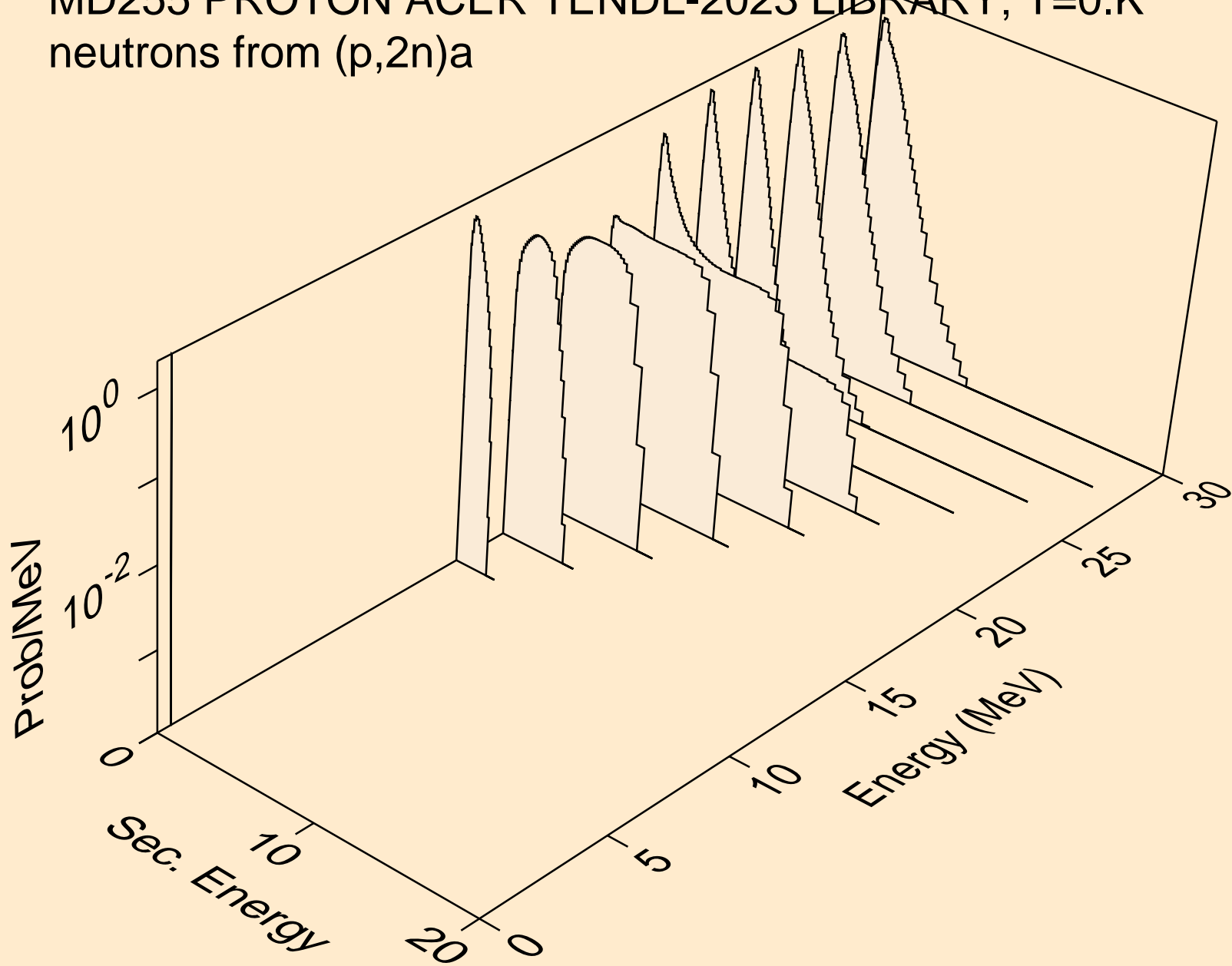

MD255 PROTON ACER TENDL-2023 LIBRARY; T=0.K
neutrons from (p,n*)p

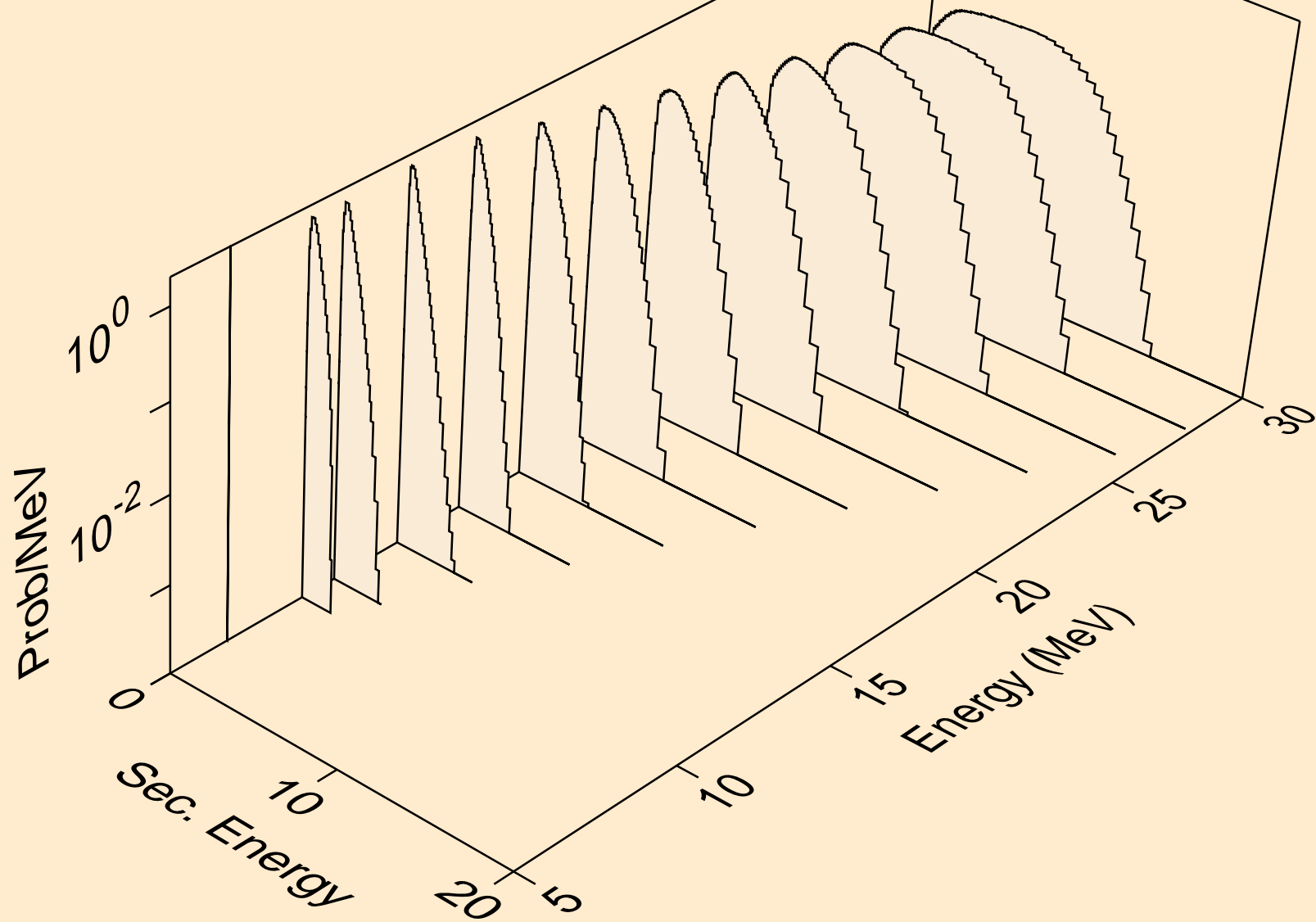

MD255 PROTON ACER TENDL-2023 LIBRARY; T=0.K
neutrons from (p,n*)d

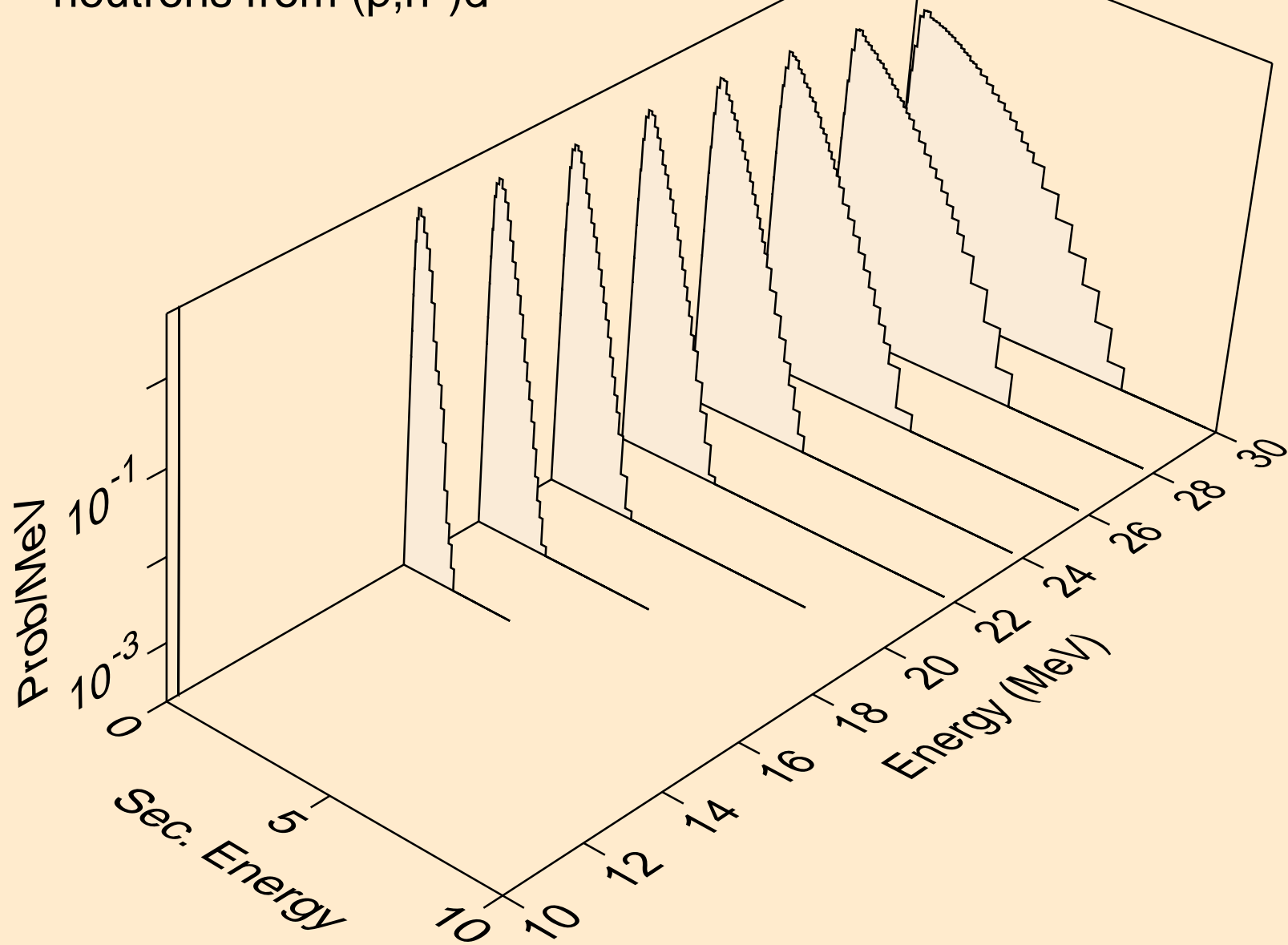

MD255 PROTON ACER TENDL-2023 LIBRARY; T=0.K
neutrons from (p,n*)t

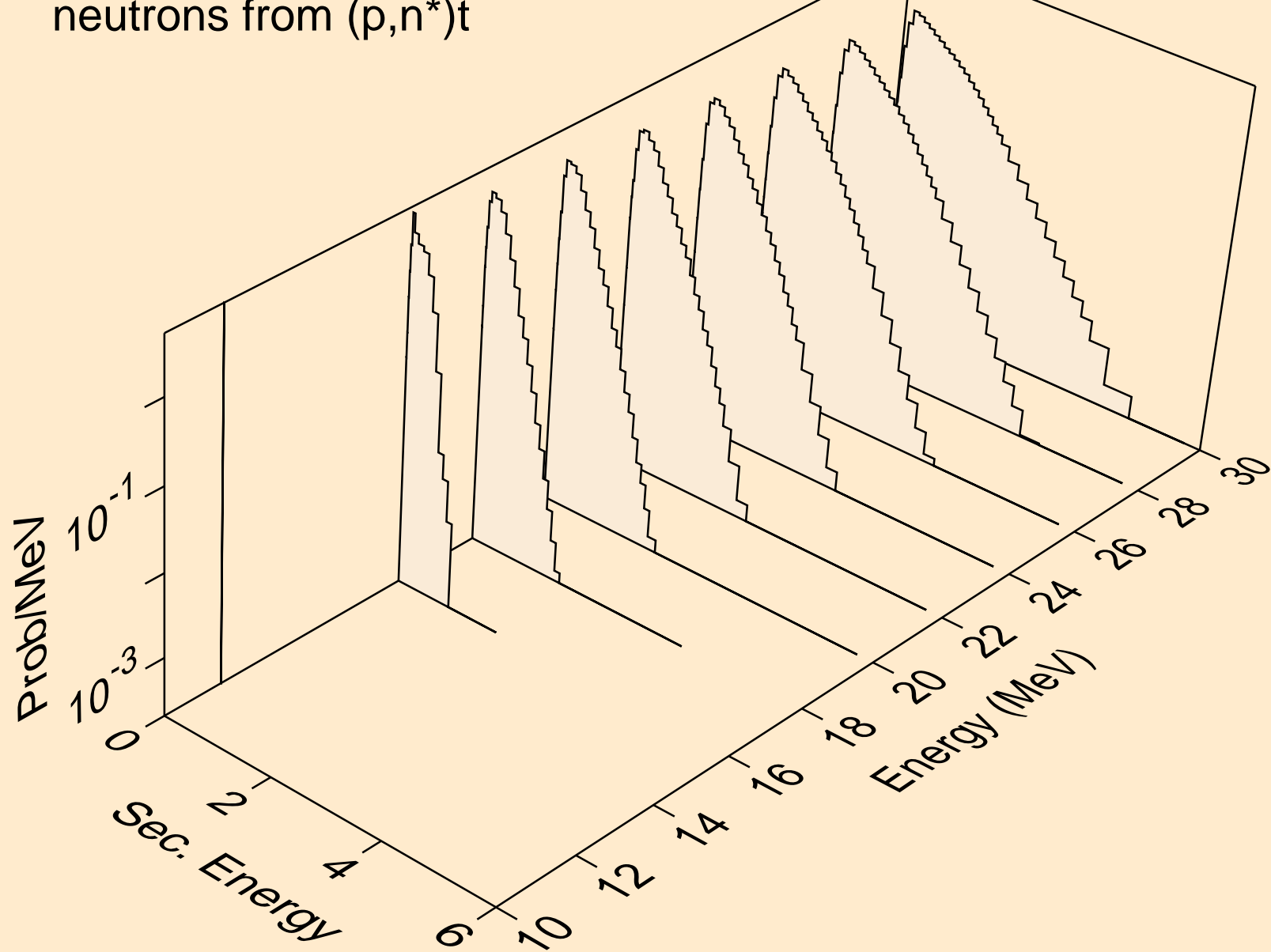

MD255 PROTON ACER TENDL-2023 LIBRARY; T=0.K
neutrons from (p,n*)he3

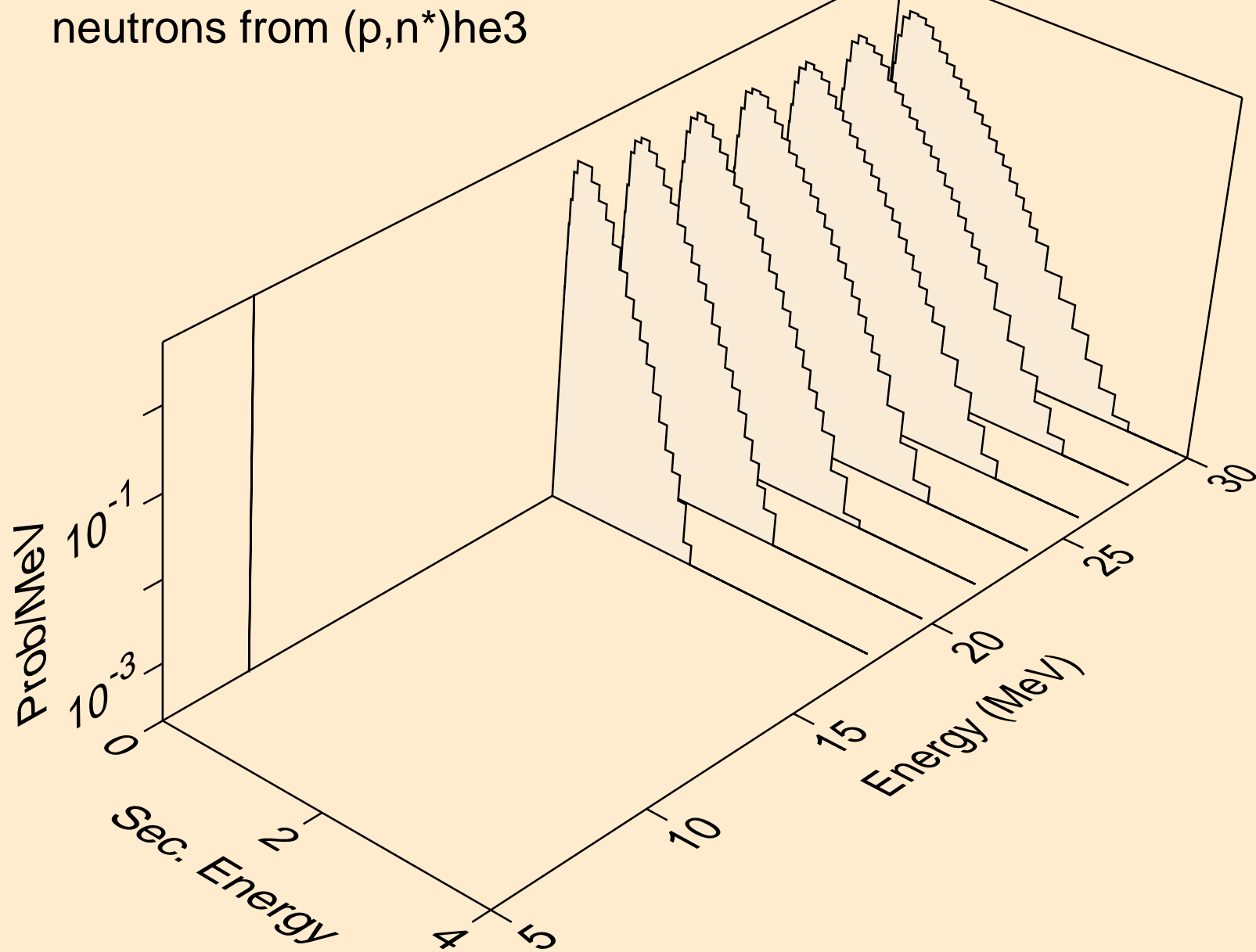

MD255 PROTON ACER TENDL-2023 LIBRARY; T=0.K
neutrons from (p,2np)

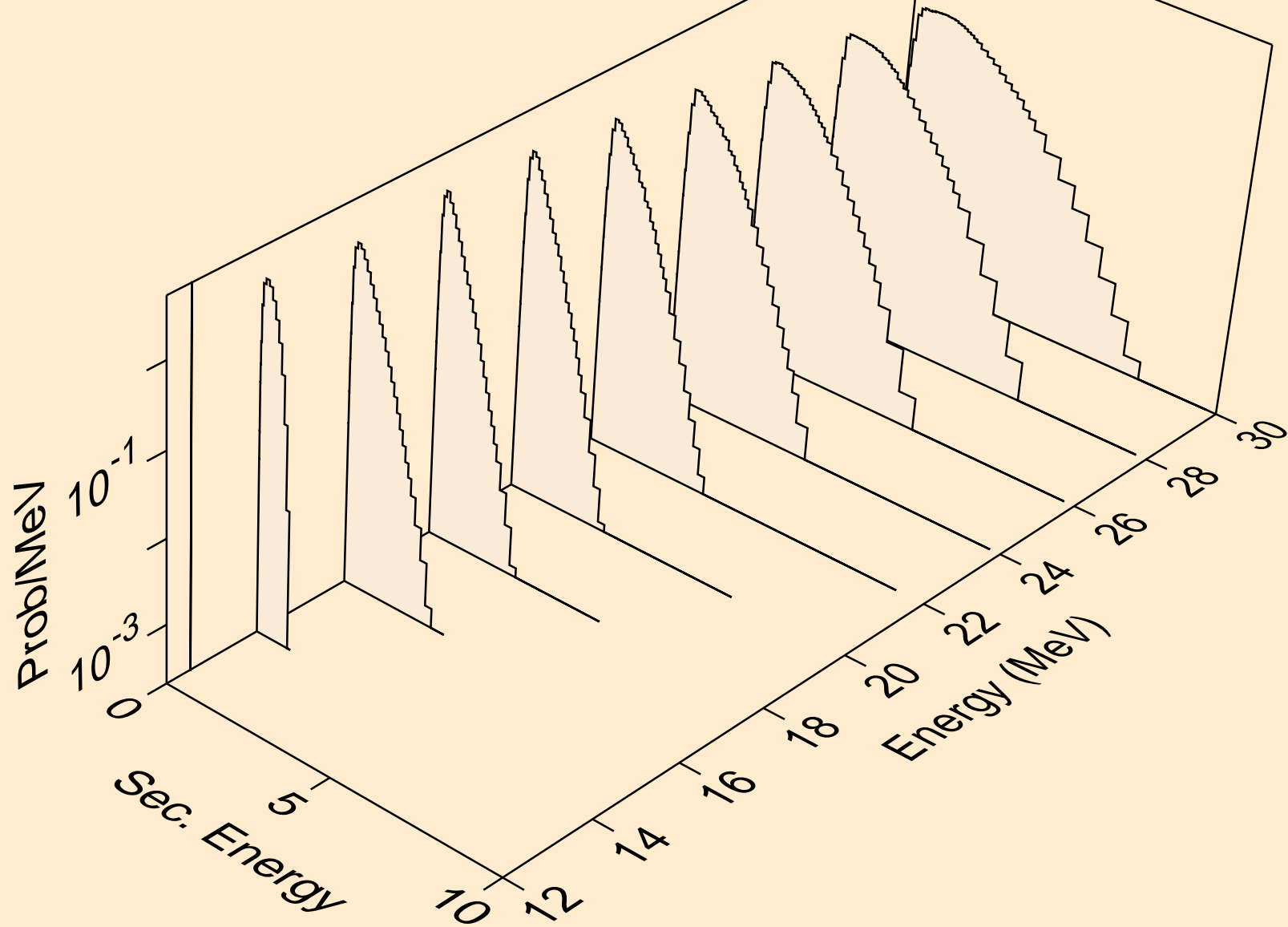

MD255 PROTON ACER TENDL-2023 LIBRARY; T=0.K
deuterons from (p,x)

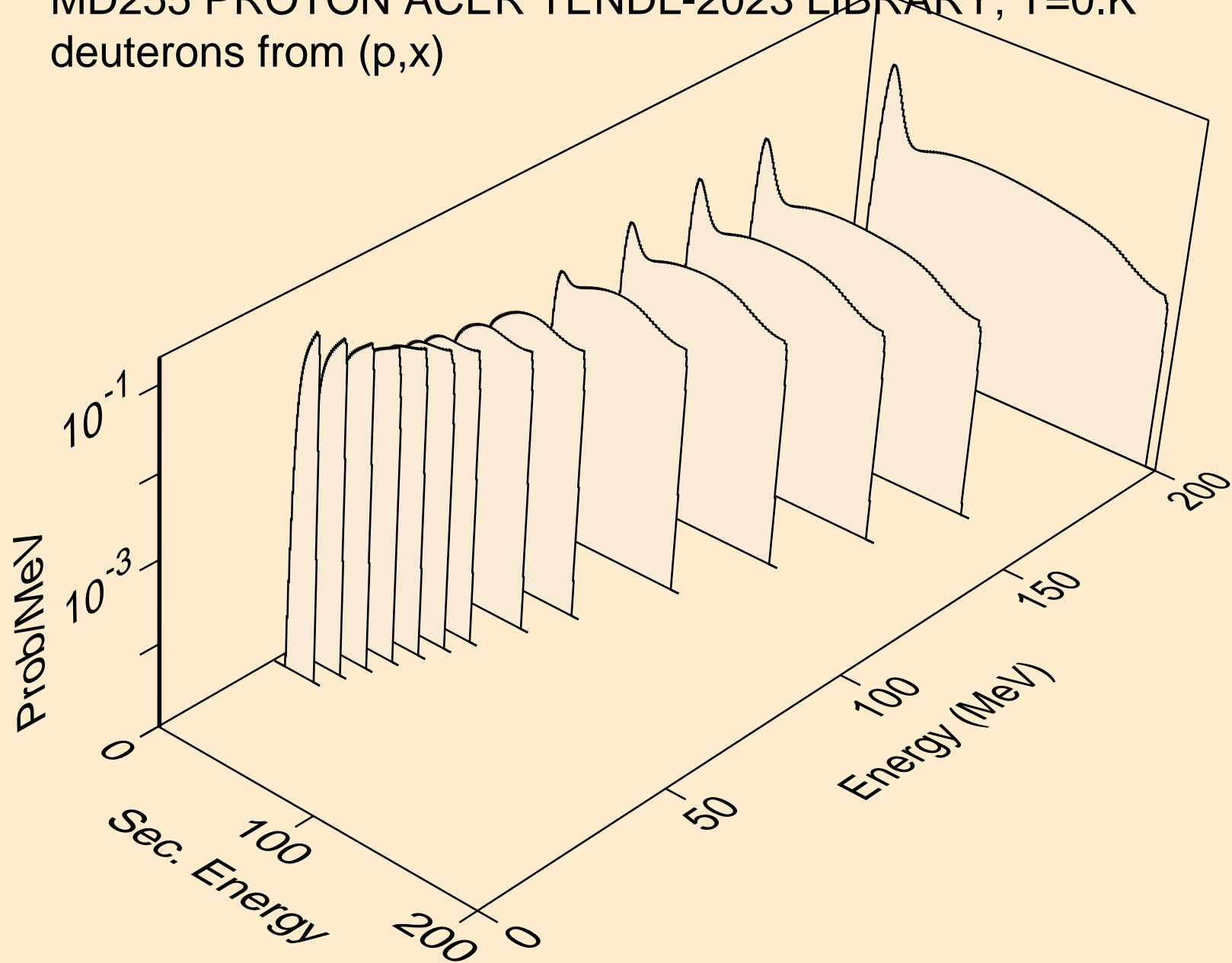

MD255 PROTON ACER TENDL-2023 LIBRARY; T=0.K
deuterons from (p,n*)d

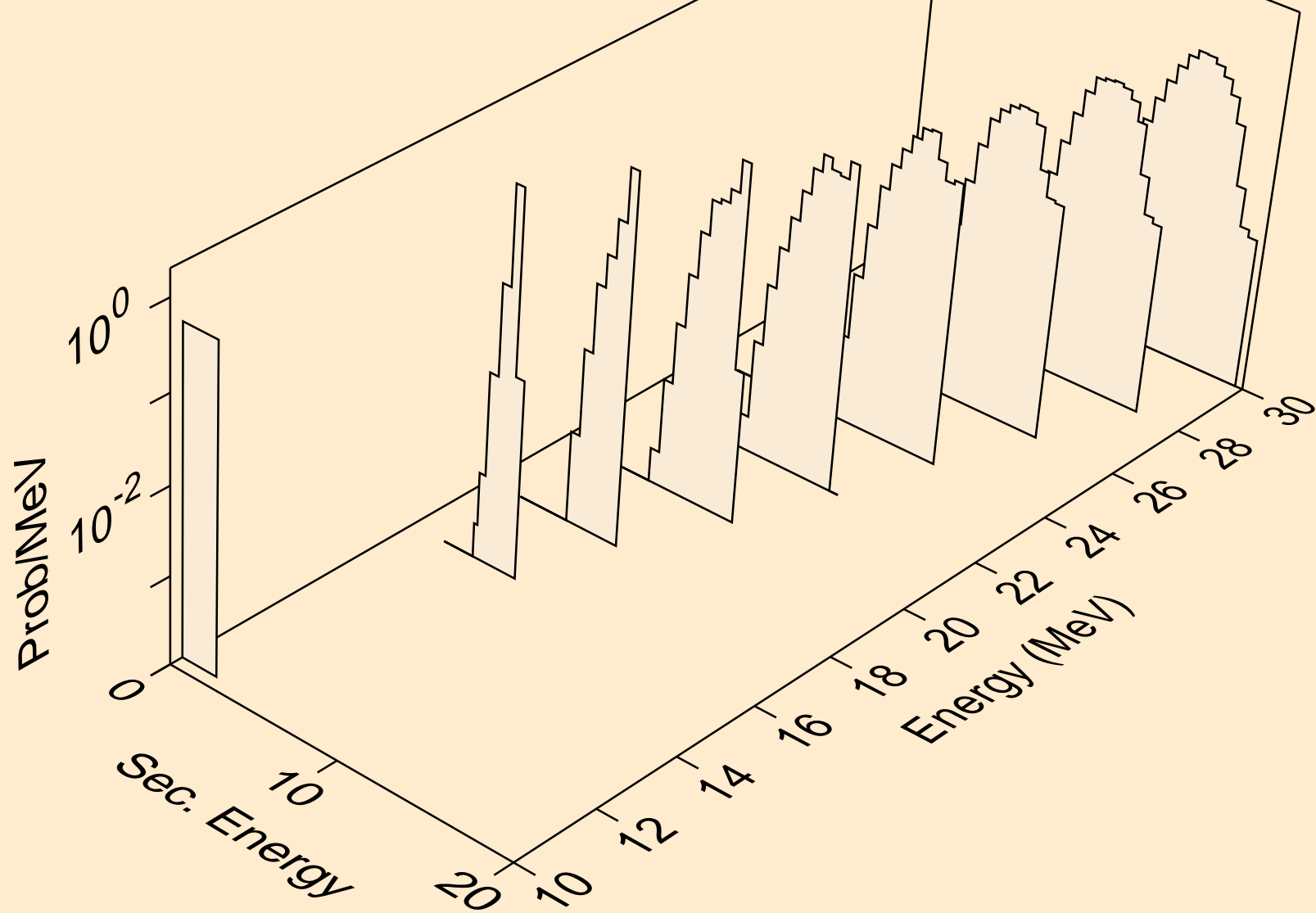

MD255 PROTON ACER TENDL-2023 LIBRARY; T=0.K
deuterons from (p,d)

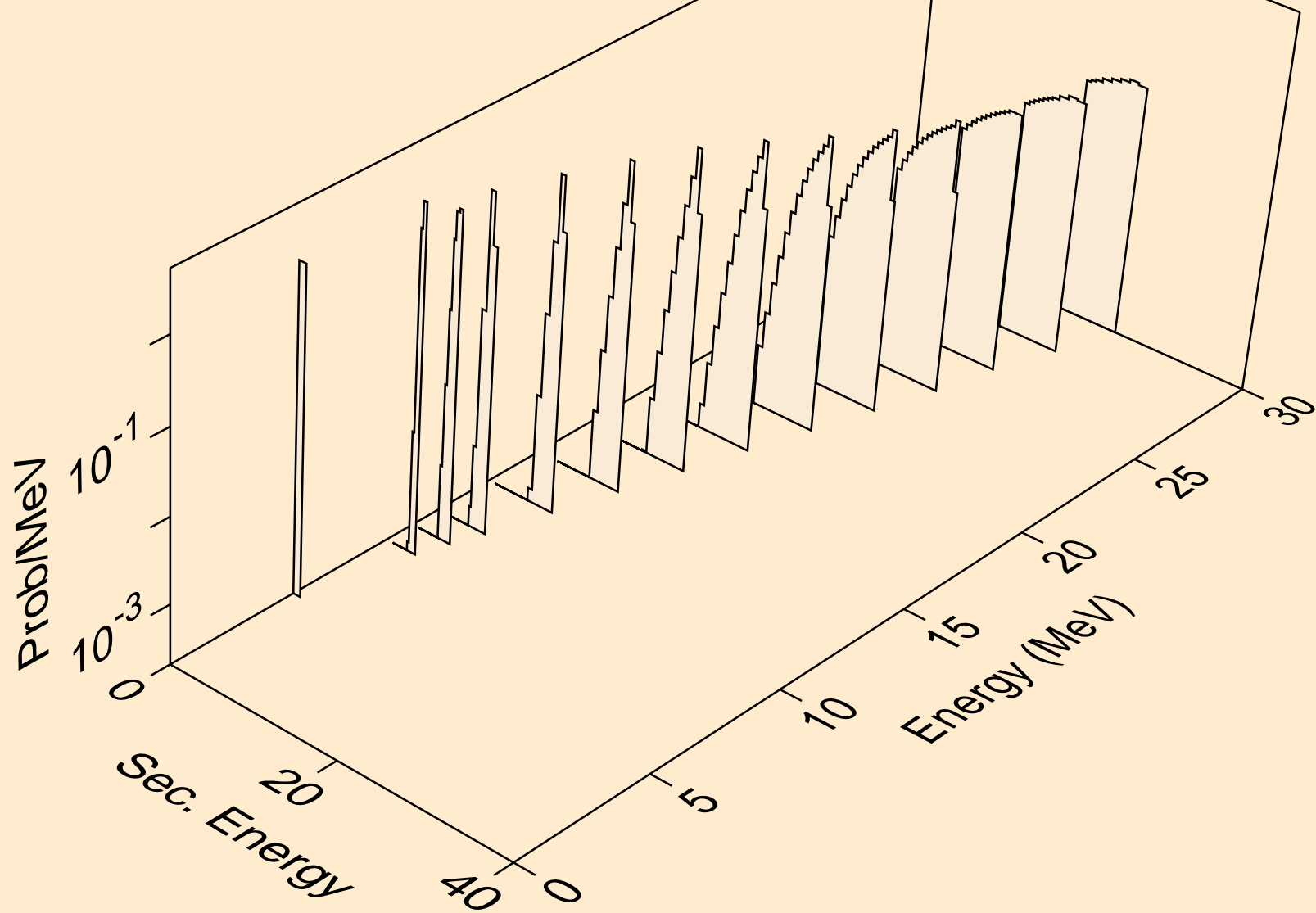

MD255 PROTON ACER TENDL-2023 LIBRARY; T=0.K
tritons from (p,x)

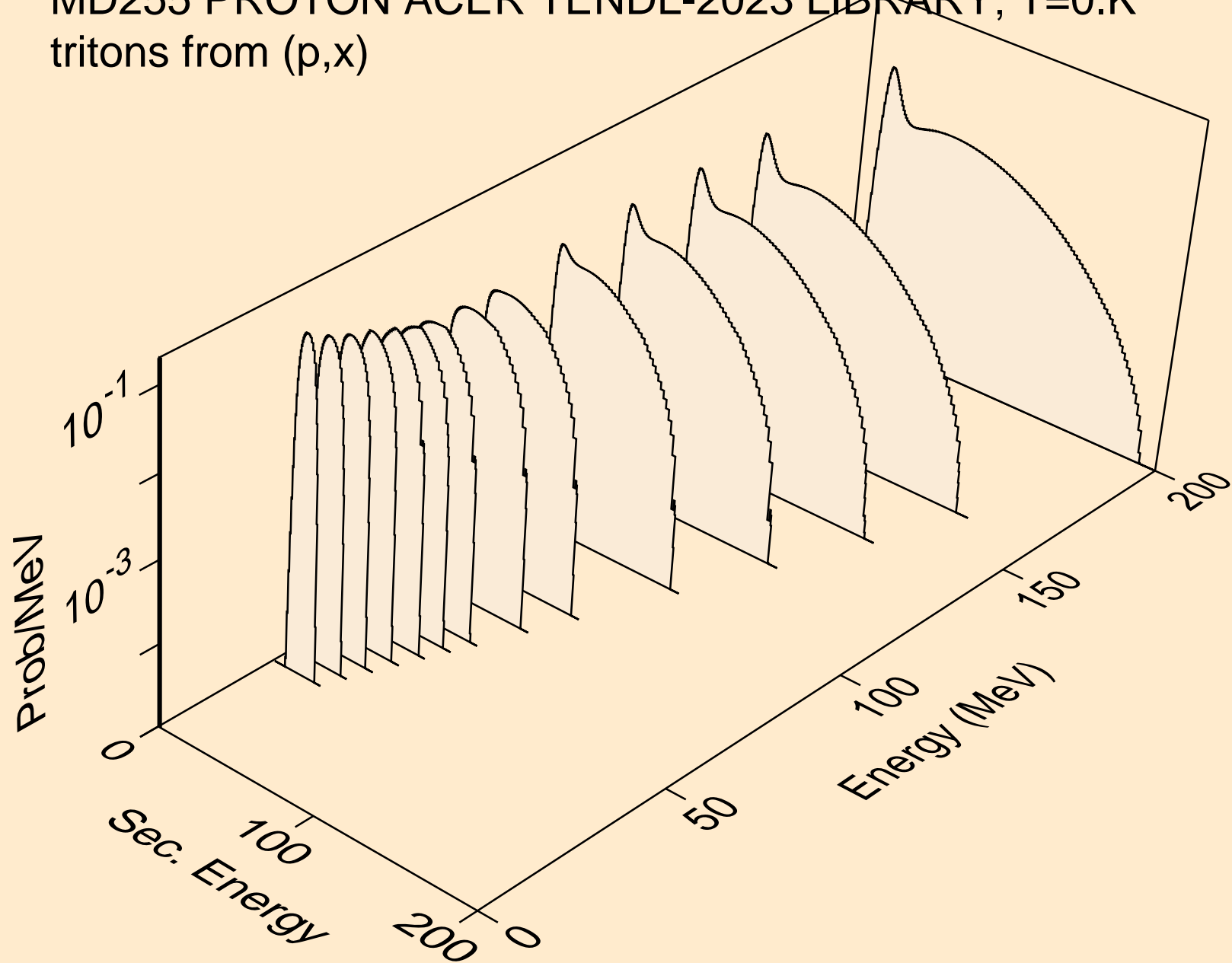

MD255 PROTON ACER TENDL-2023 LIBRARY; T=0.K
tritons from (p,n*)t

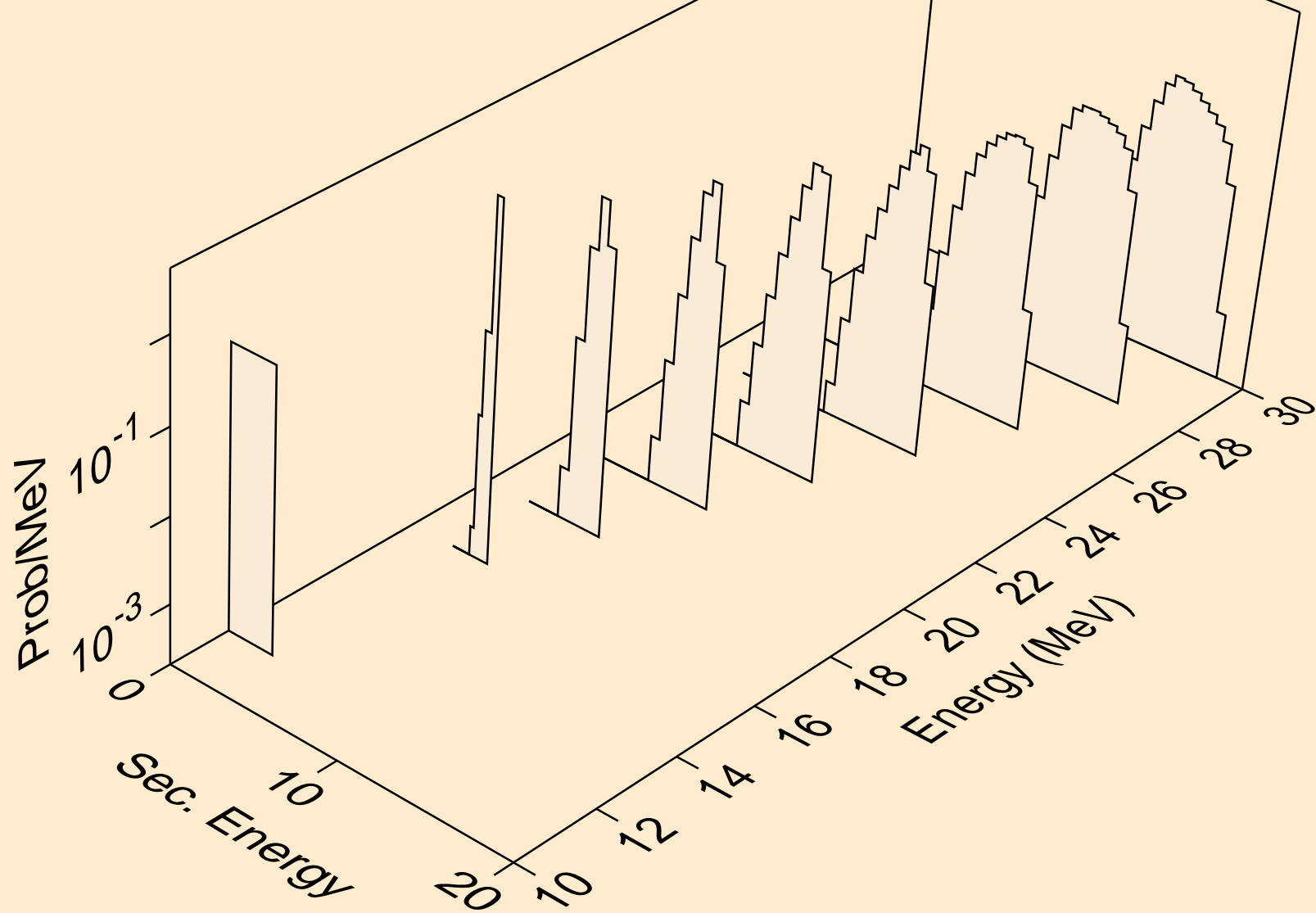

MD255 PROTON ACER TENDL-2023 LIBRARY; T=0.K
tritons from (p,t)

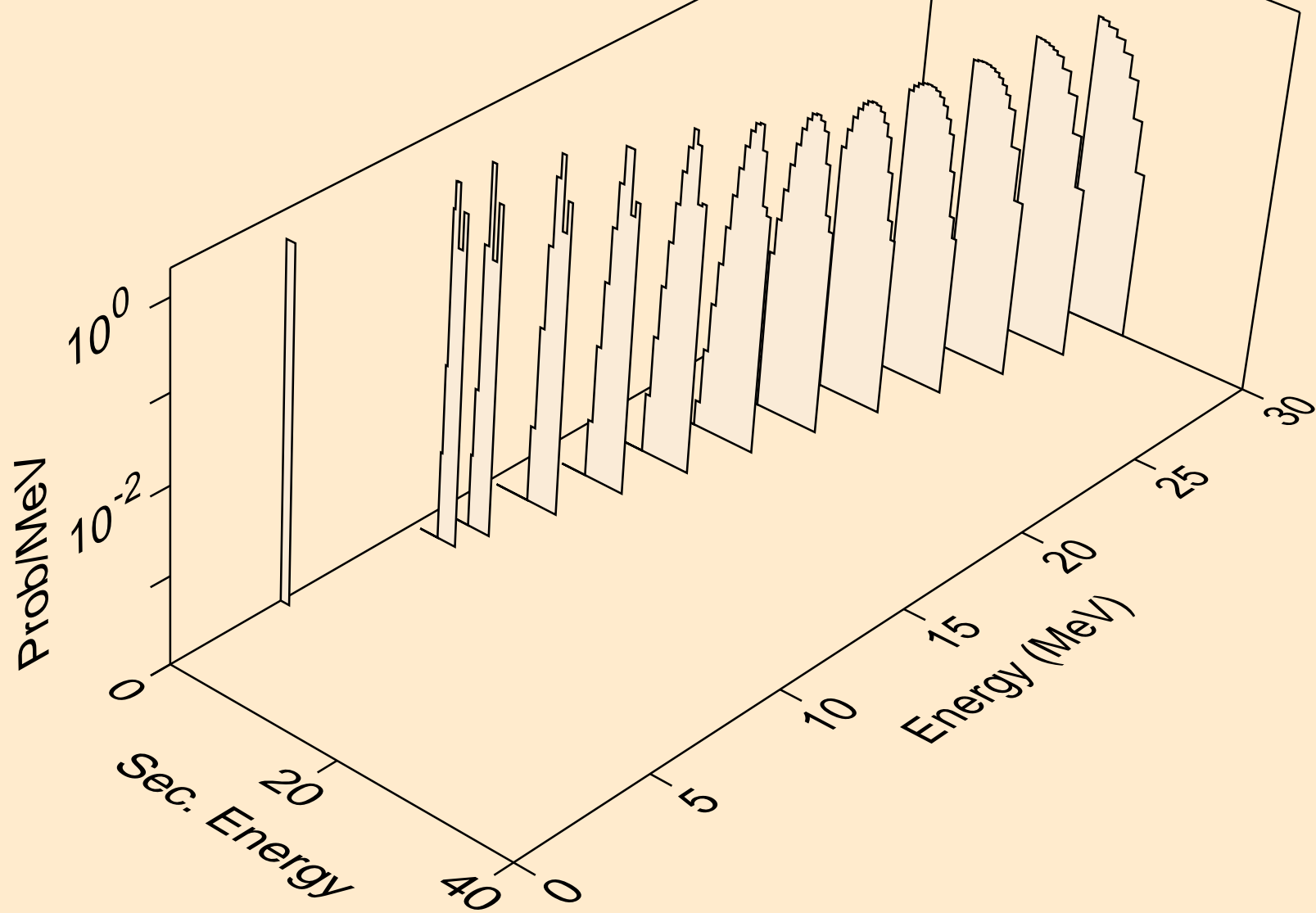

MD255 PROTON ACER TENDL-2023 LIBRARY; T=0.K
he3s from (p,x)

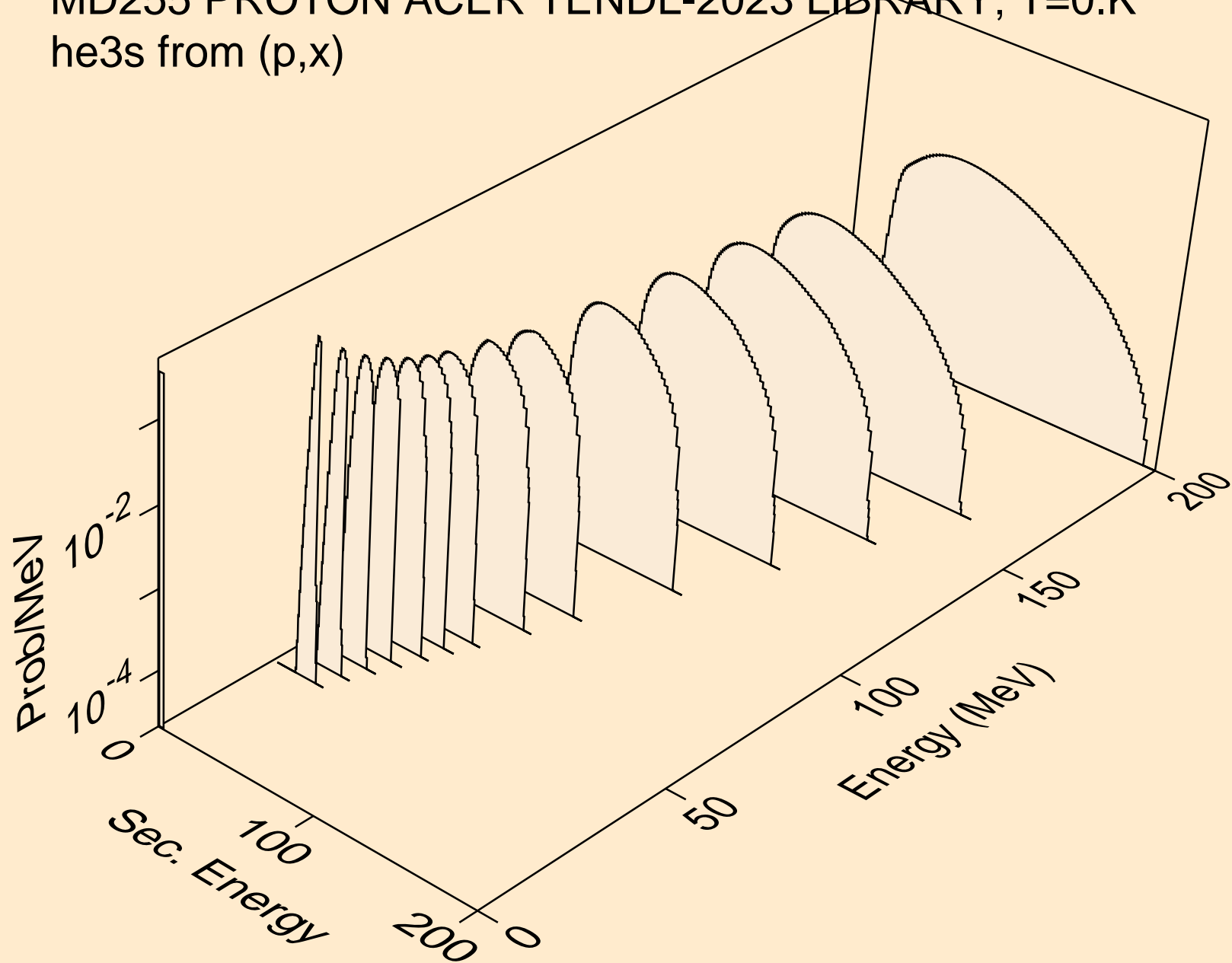

MD255 PROTON ACER TENDL-2023 LIBRARY; T=0.K
he3s from (p,n*)he3

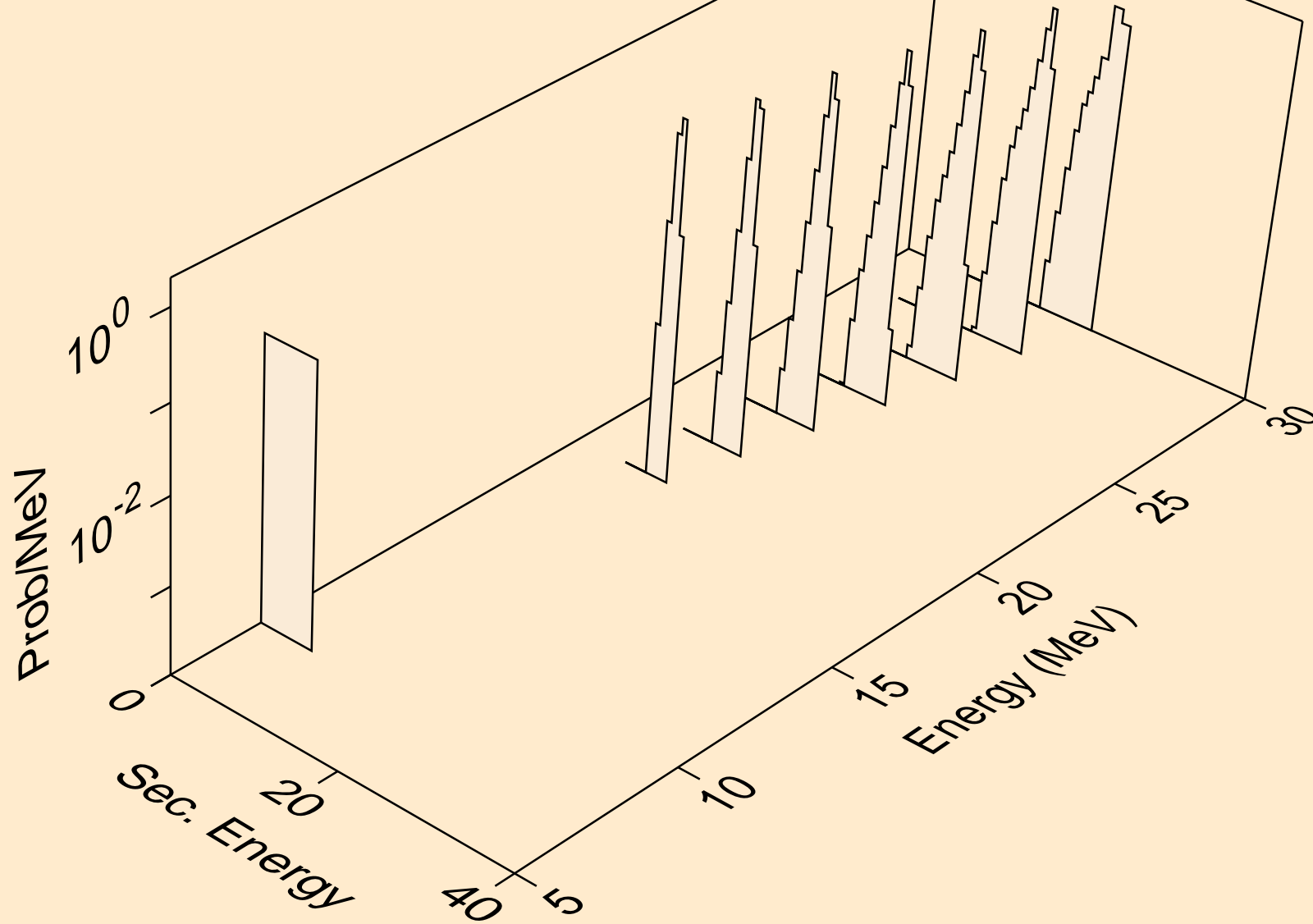

MD255 PROTON ACER TENDL-2023 LIBRARY; T=0.K
he3s from (p,he3)

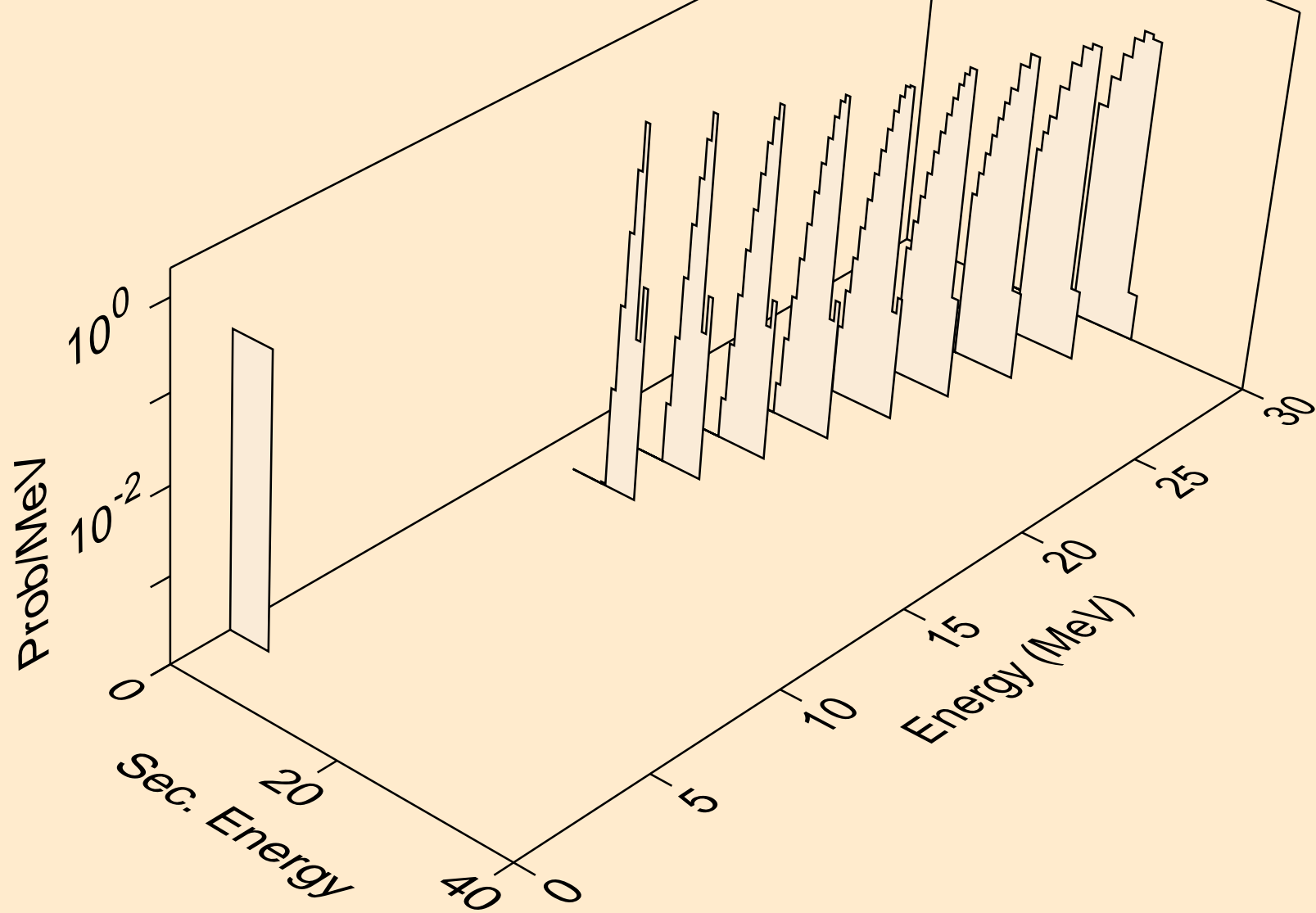

MD255 PROTON ACER TENDL-2023 LIBRARY; T=0.K
alphas from (p,x)

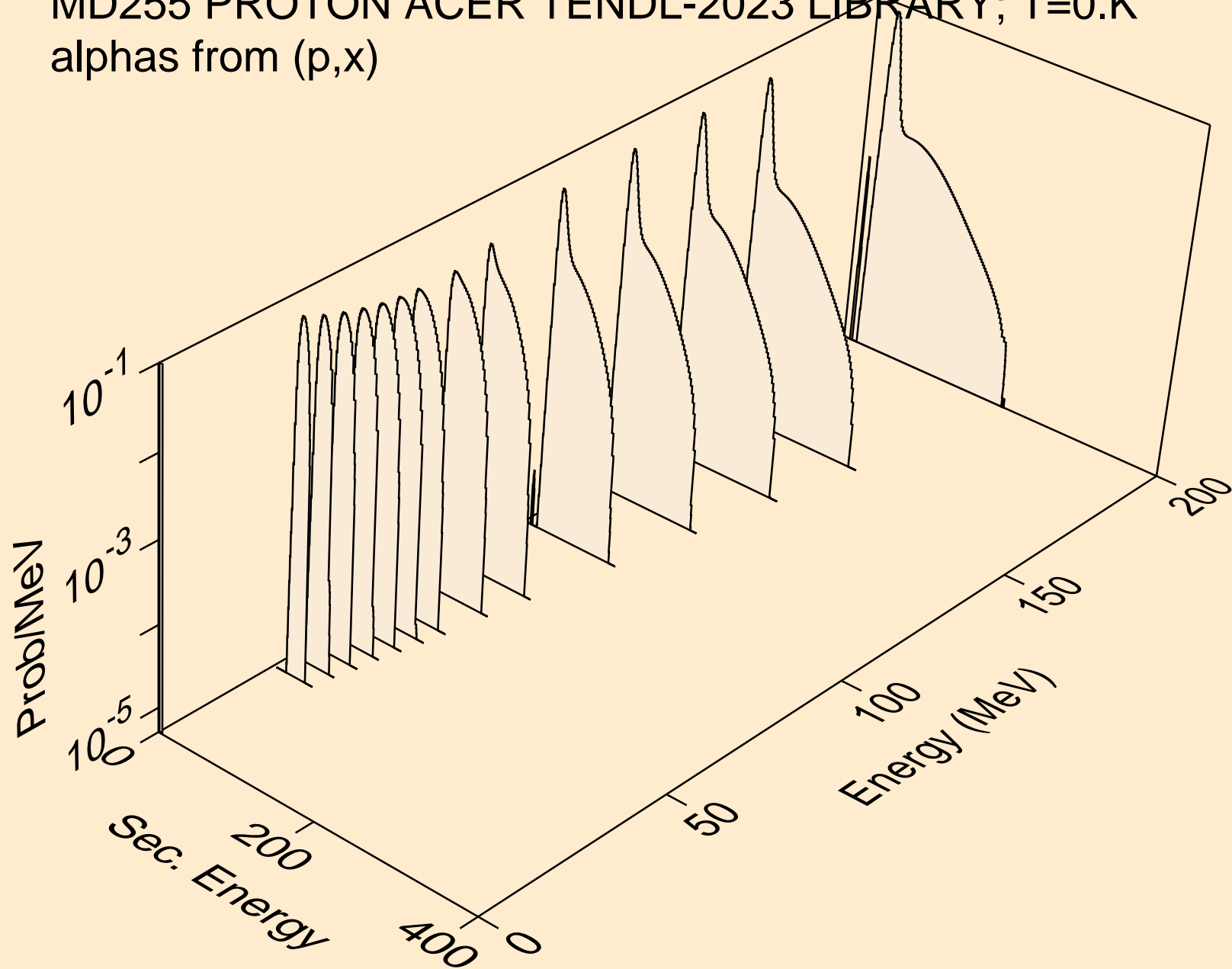

MD255 PROTON ACER TENDL-2023 LIBRARY; T=0.K
alphas from (p,n*)a

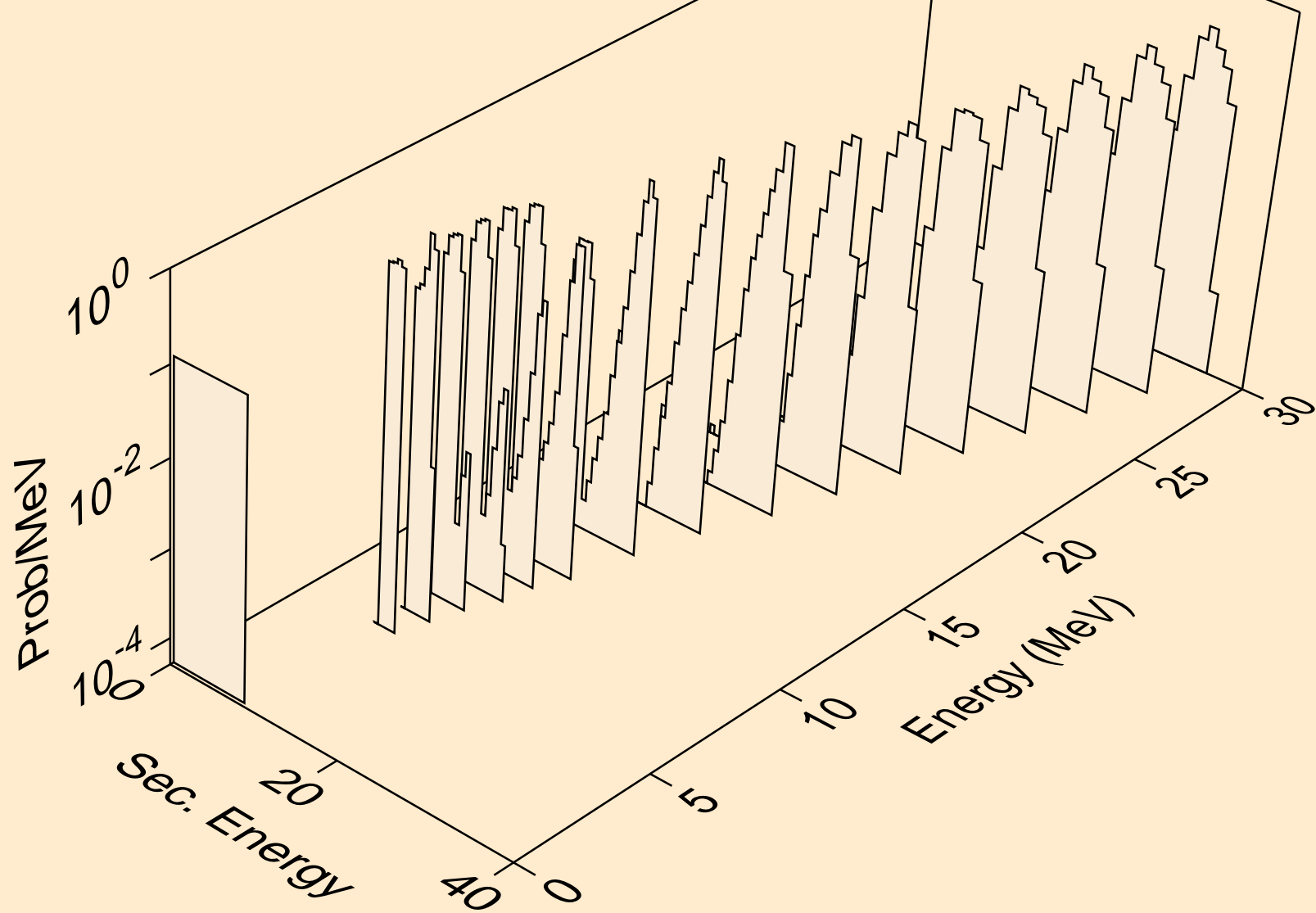

MD255 PROTON ACER TENDL-2023 LIBRARY; T=0.K
alphas from (p,2n)a

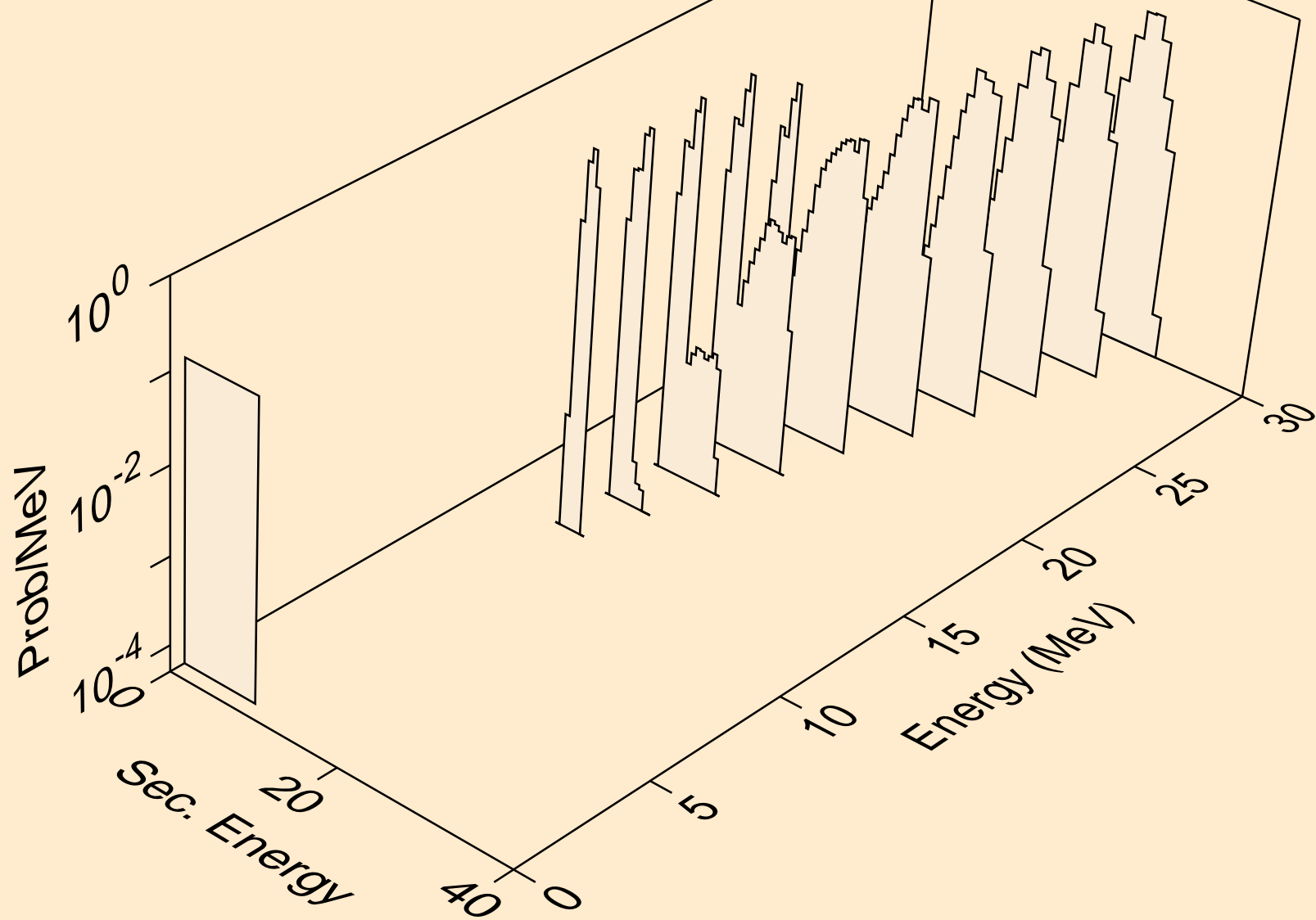

MD255 PROTON ACER TENDL-2023 LIBRARY; T=0.K
alphas from (p,a)

