

MO095 PROTON ACER TENDL-2023 LIBRARY; T=0.K  
Principal cross sections

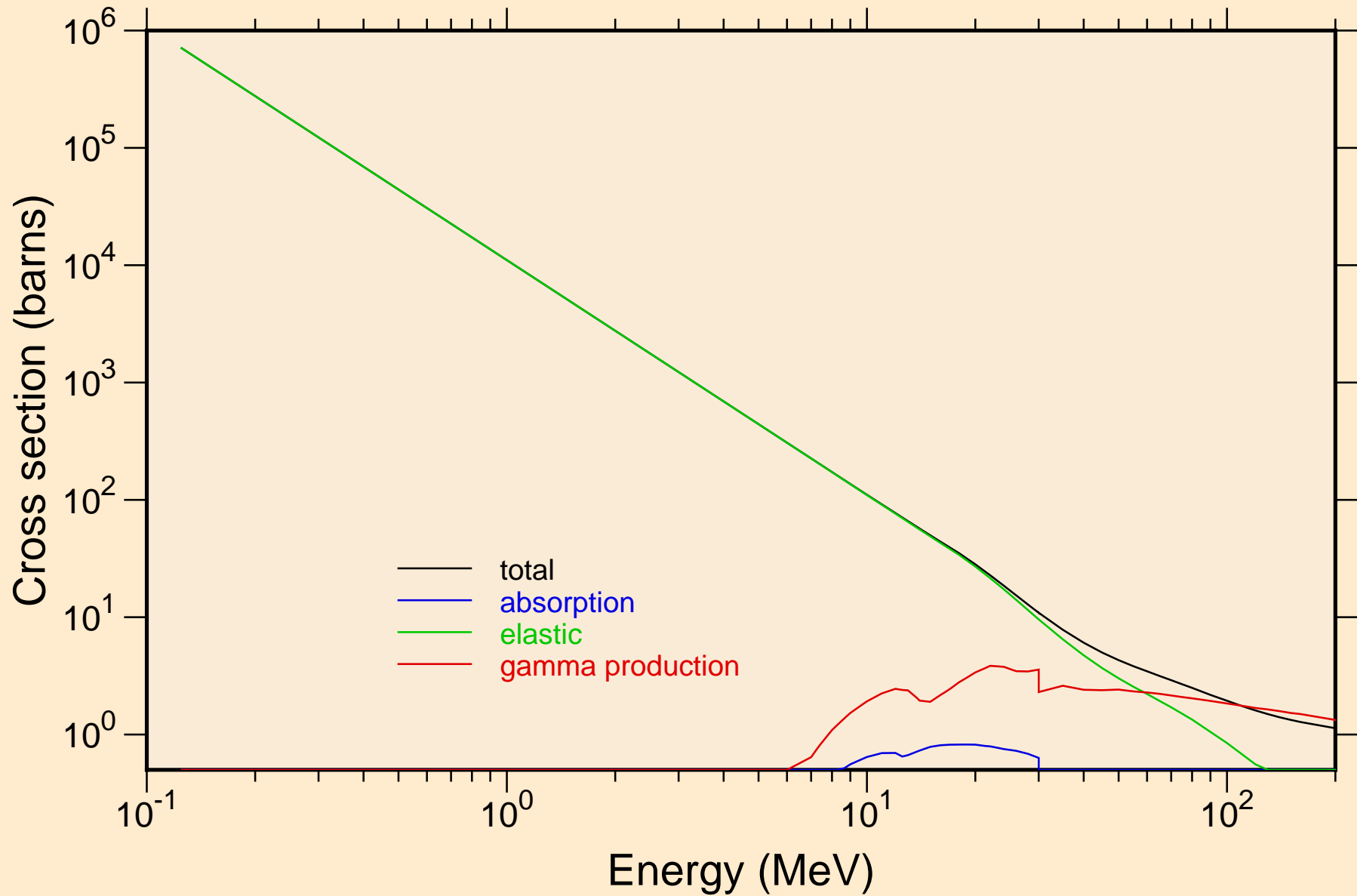

MO095 PROTON ACER TENDL-2023 LIBRARY; T=0.K  
Heating

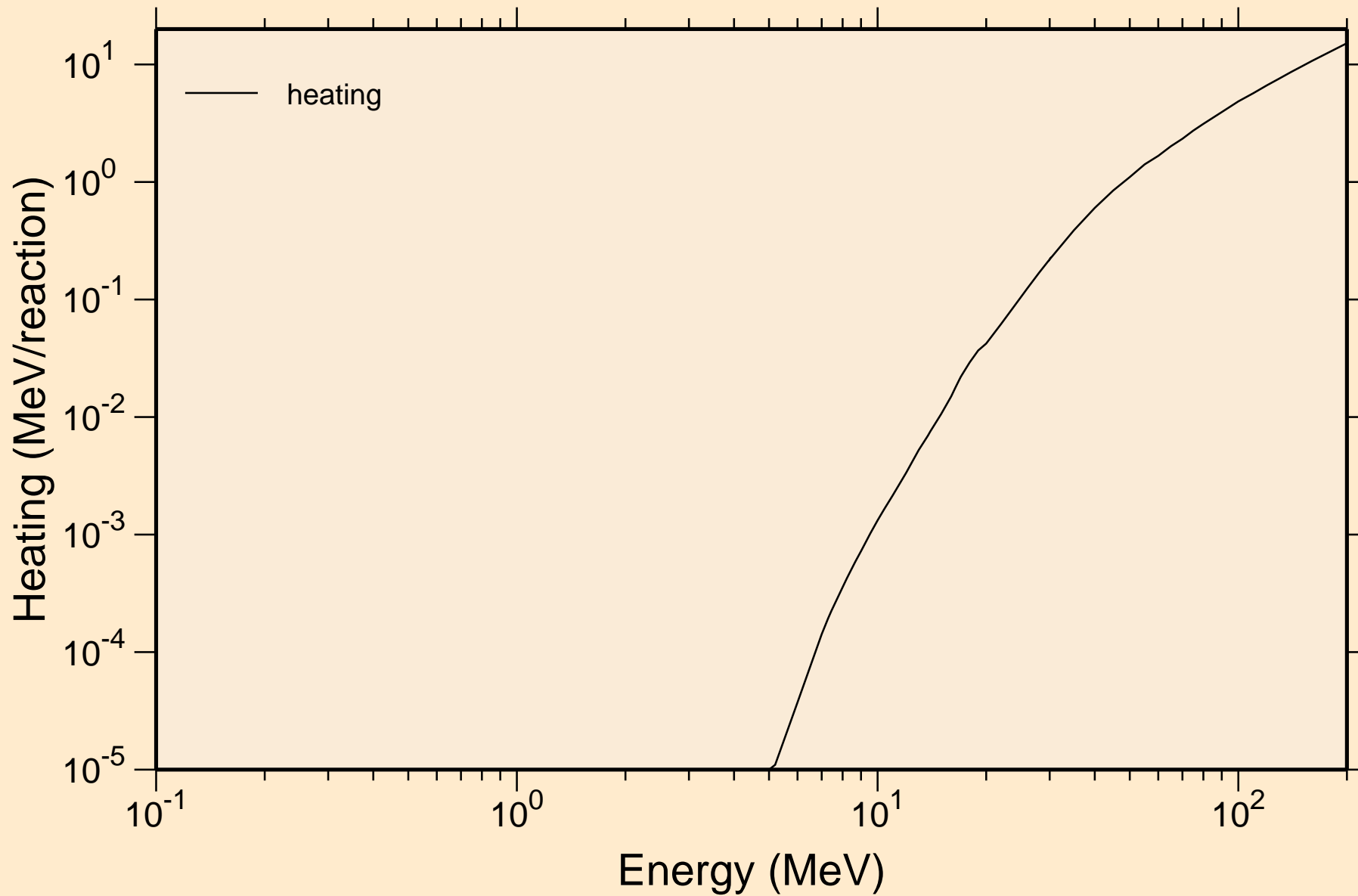

# MO095 PROTON ACER TENDL-2023 LIBRARY; T=0.K

## Principal cross sections

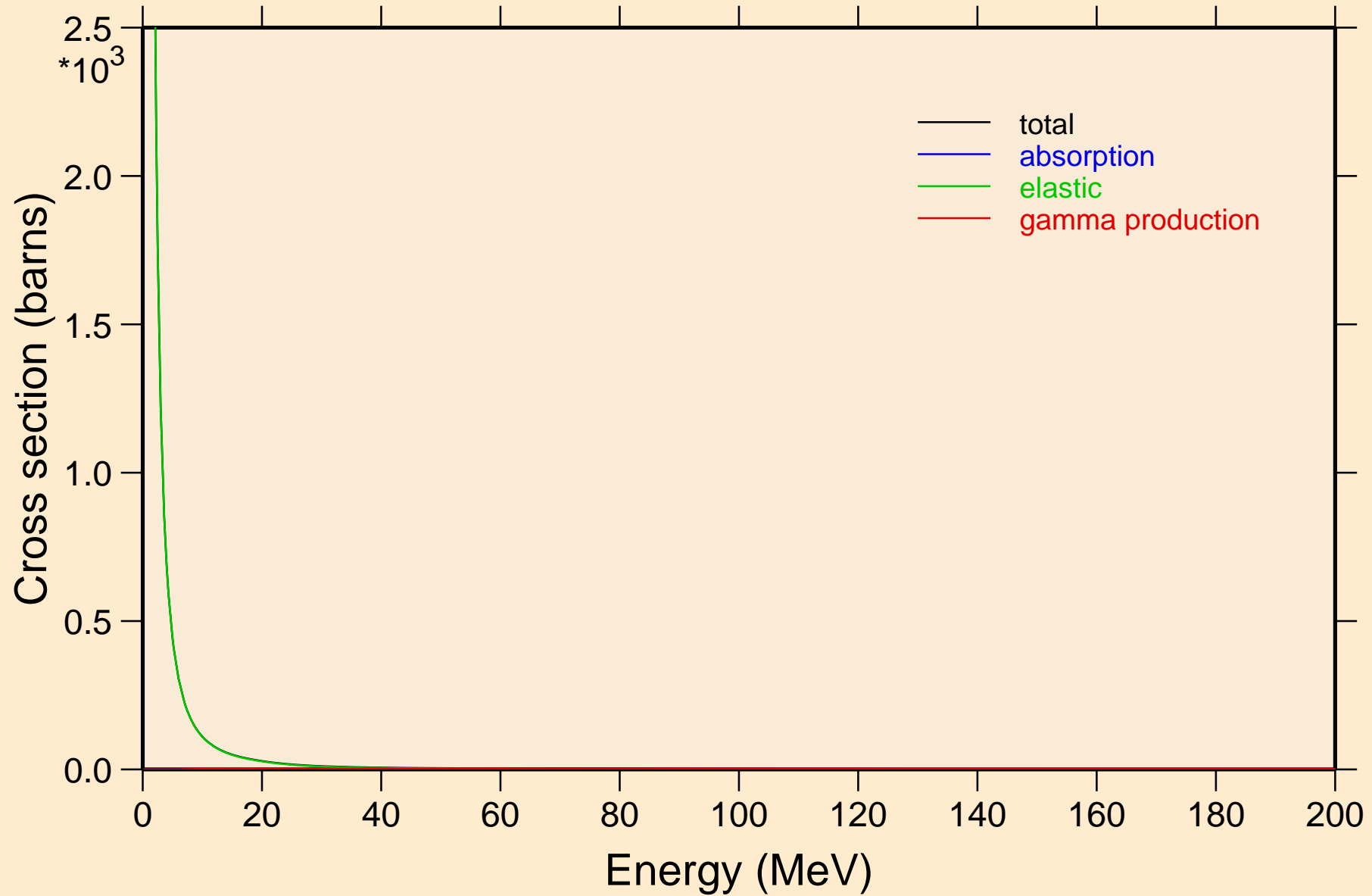

# MO095 PROTON ACER TENDL-2023 LIBRARY; T=0.K

## Heating

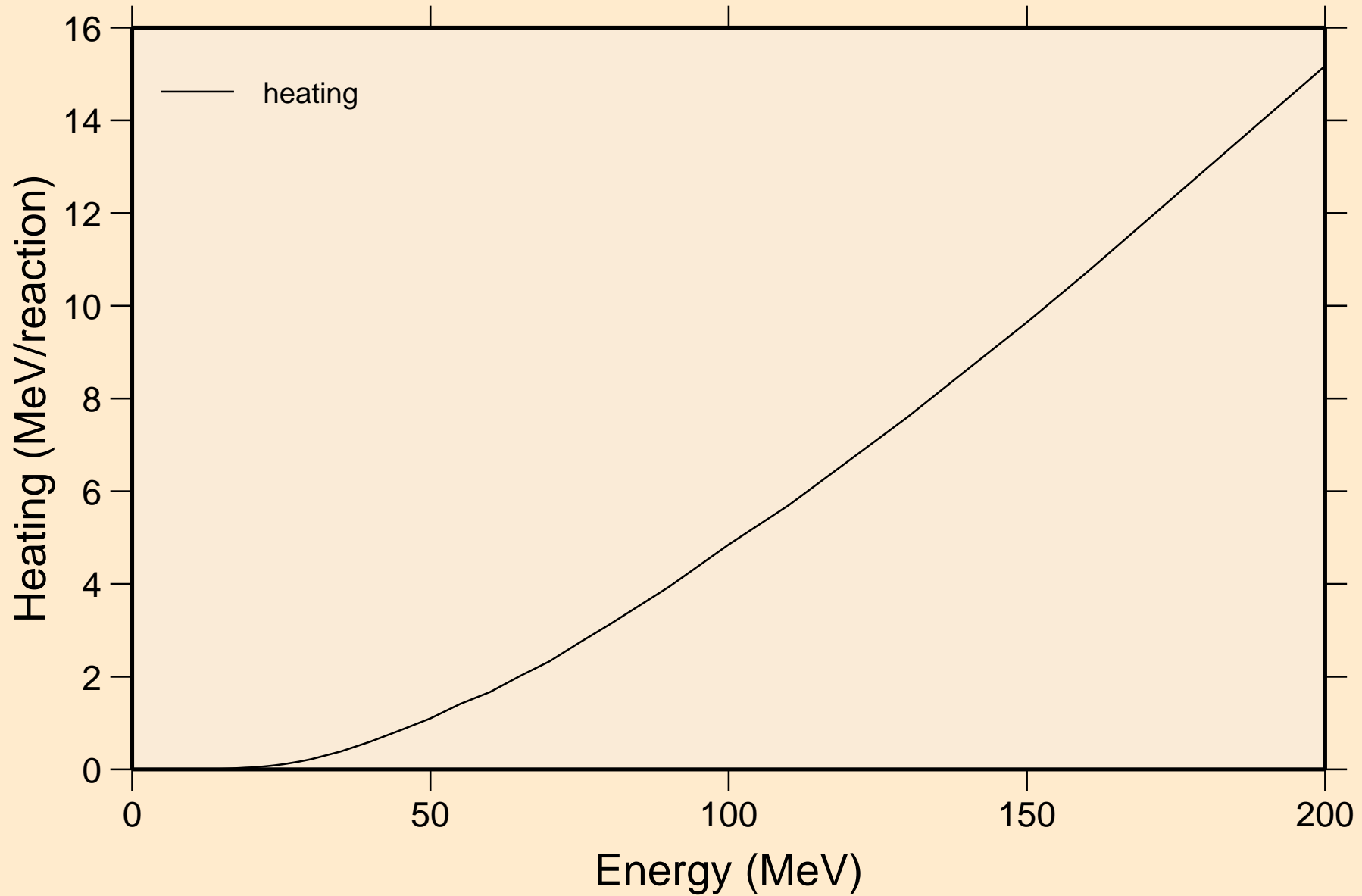

MO095 PROTON ACER TENDL-2023 LIBRARY; T=0.K  
Threshold reactions

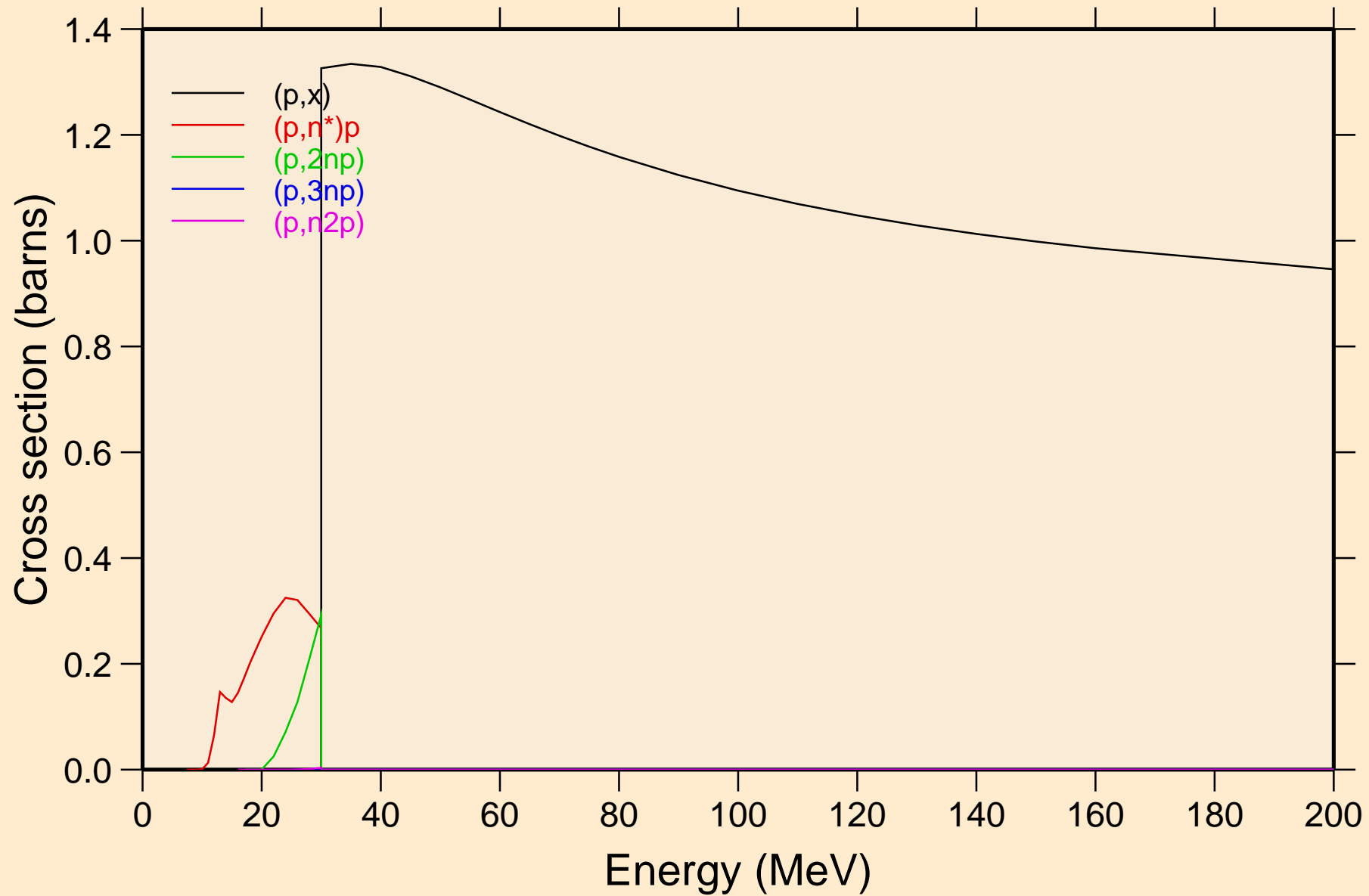

MO095 PROTON ACER TENDL-2023 LIBRARY; T=0.K  
Threshold reactions

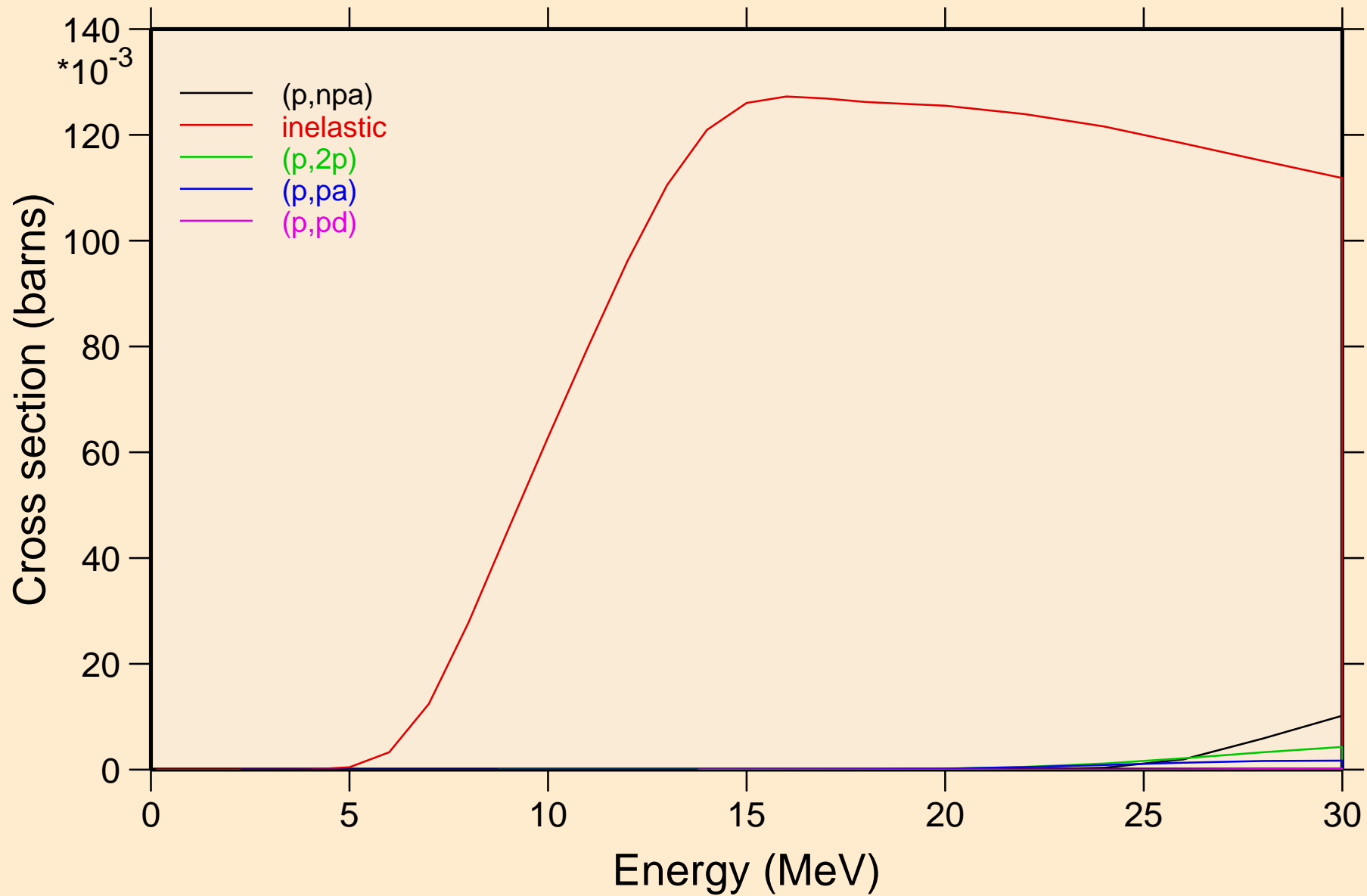

MO095 PROTON ACER TENDL-2023 LIBRARY; T=0.K  
Threshold reactions

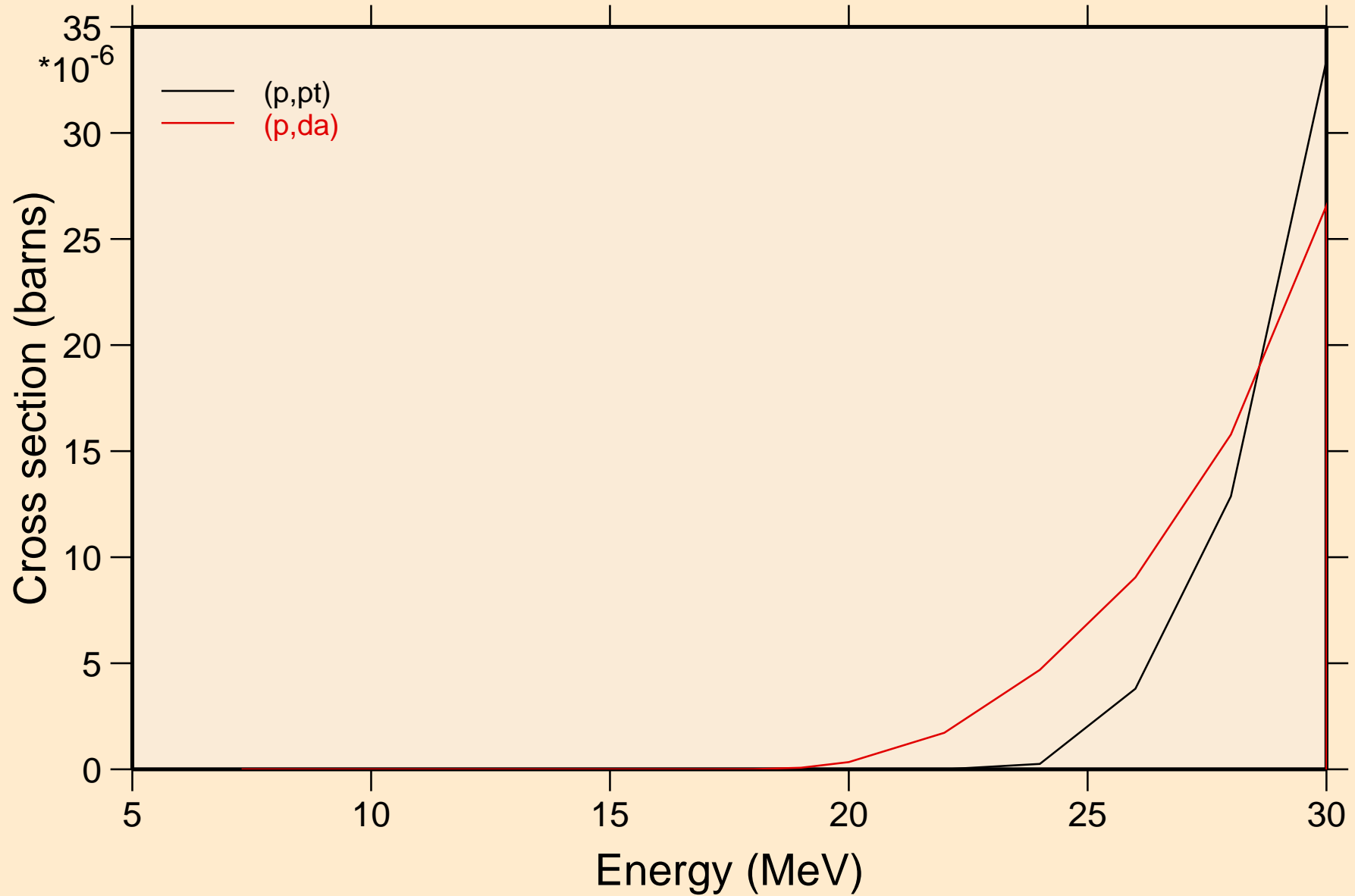

MO095 PROTON ACER TENDL-2023 LIBRARY; T=0.K  
angular distribution for elastic

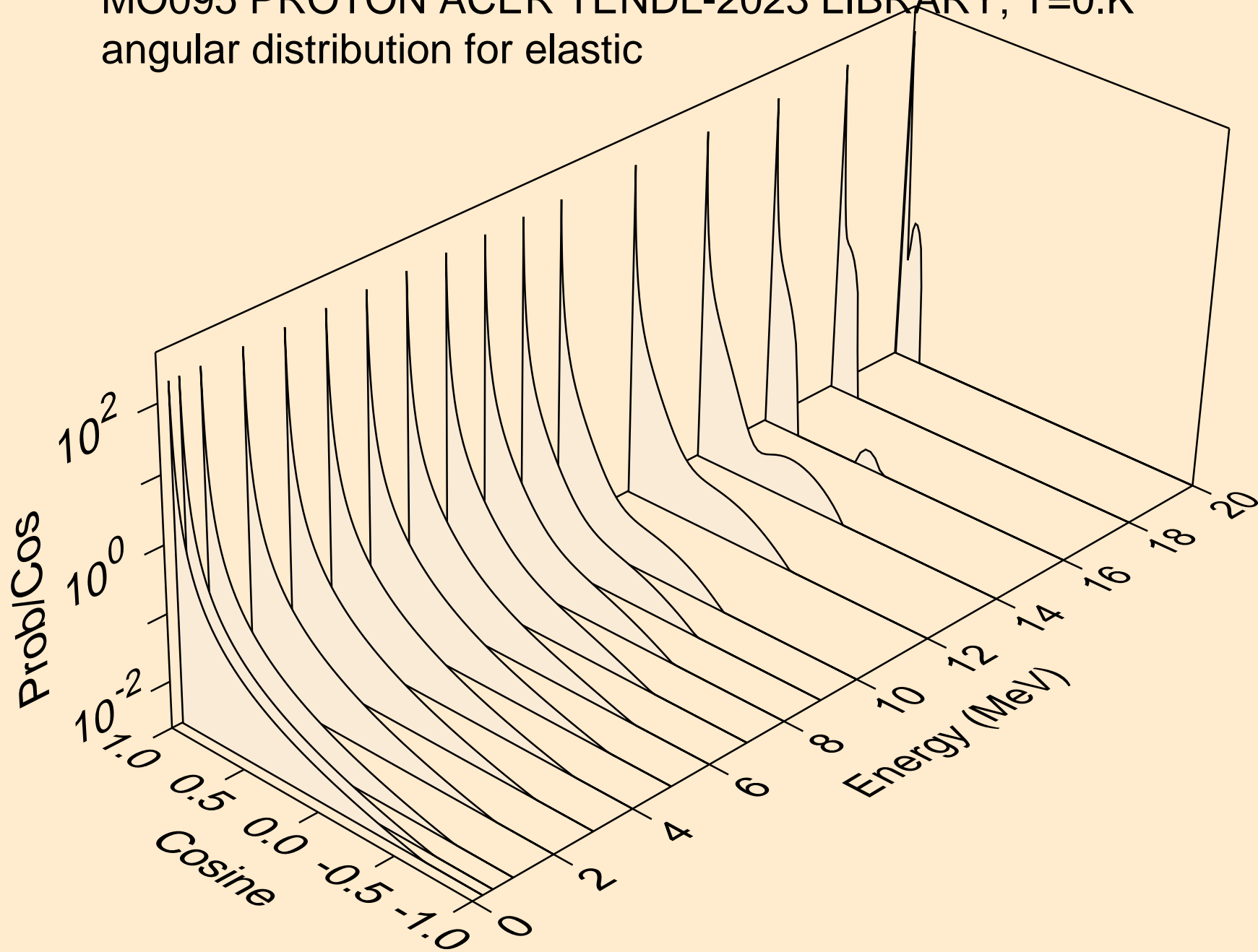



MO095 PROTON ACER TENDL-2023 LIBRARY; T=0.K  
angular distribution for elastic

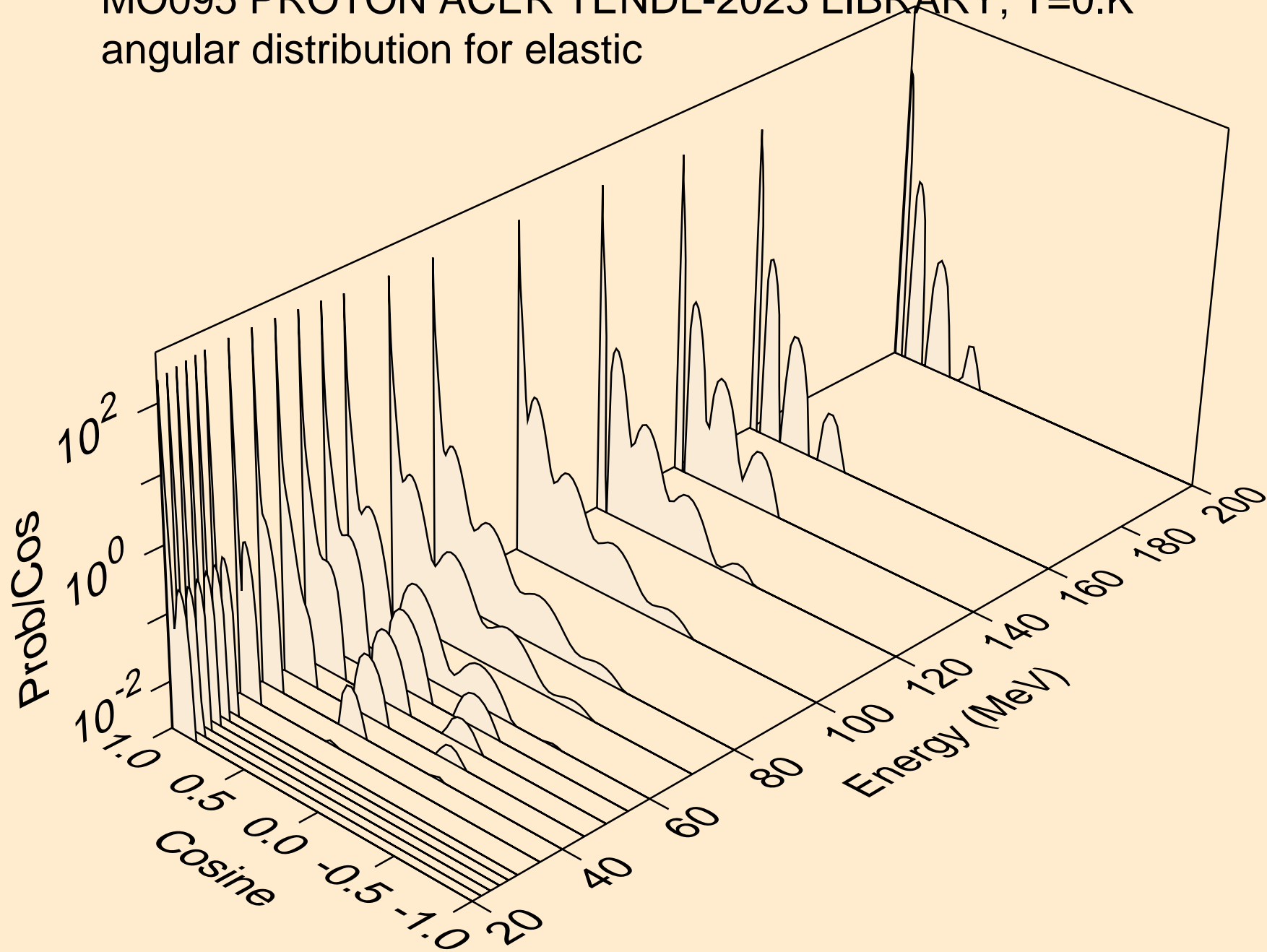

MO095 PROTON ACER TENDL-2023 LIBRARY; T=0.K  
Proton emission for (p,x)

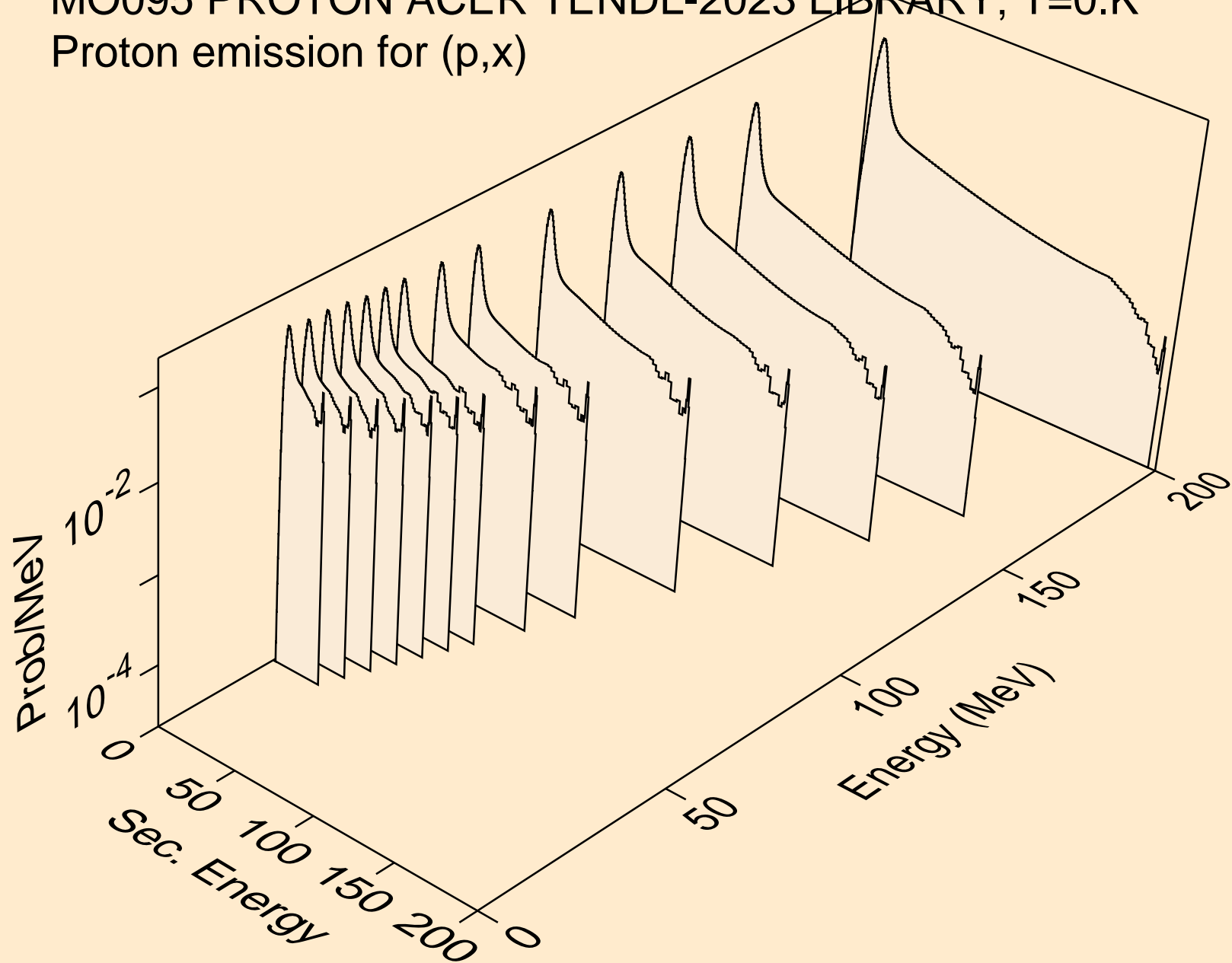

MO095 PROTON ACER TENDL-2023 LIBRARY; T=0.K  
Proton emission for (p,n\*)p

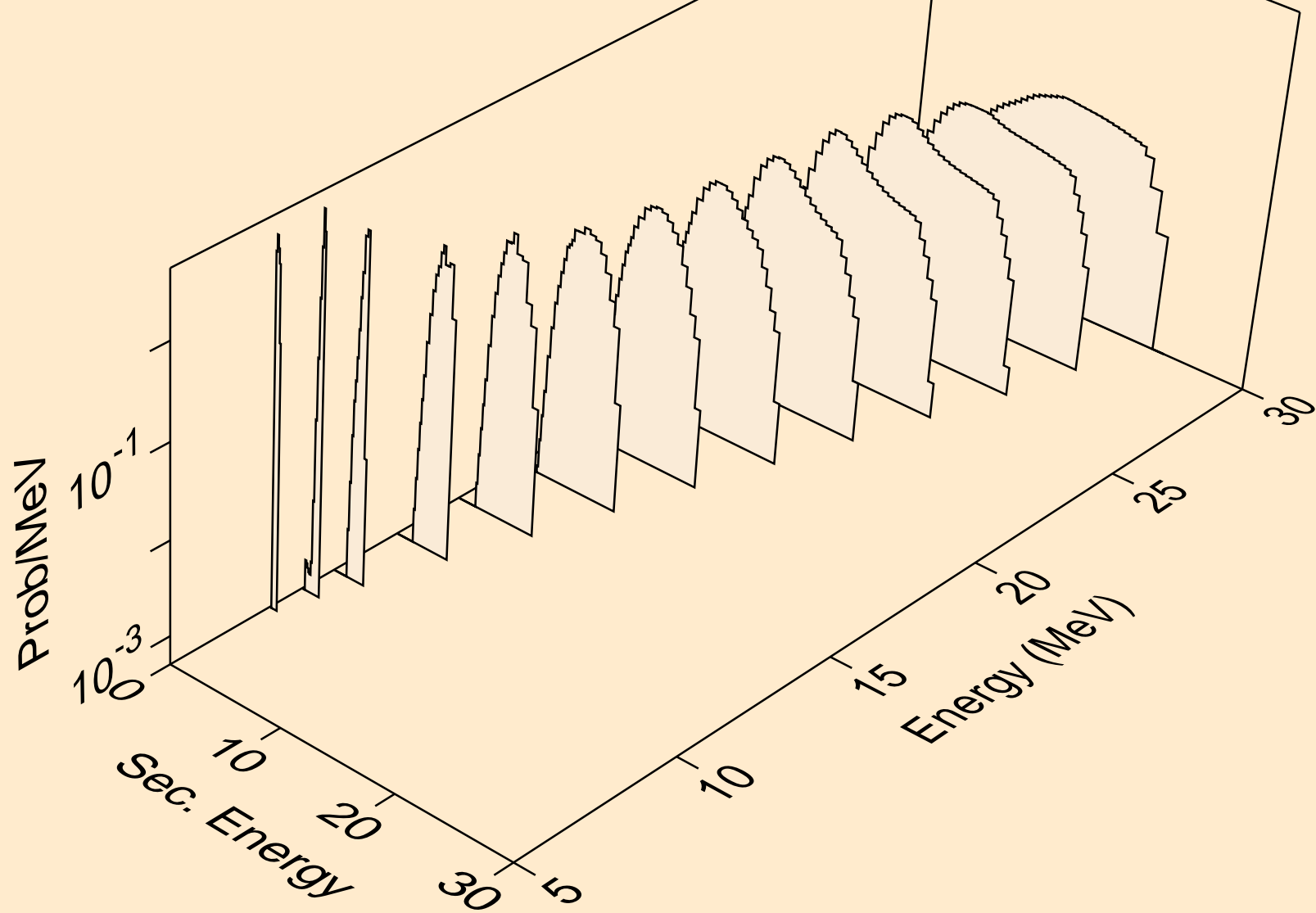

MO095 PROTON ACER TENDL-2023 LIBRARY; T=0.K  
Proton emission for (p,2np)

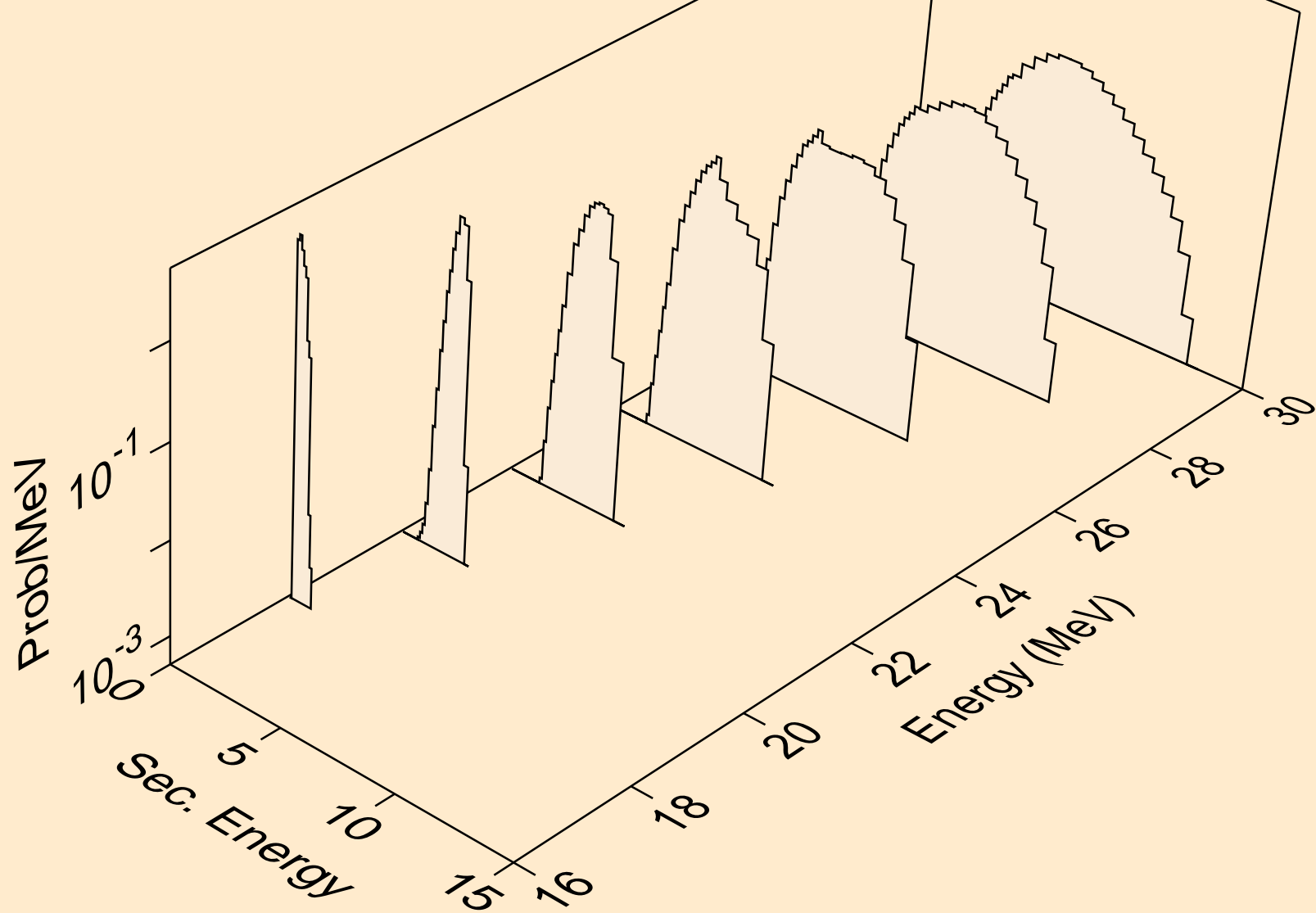

MO095 PROTON ACER TENDL-2023 LIBRARY; T=0.K  
Proton emission for (p,3np)

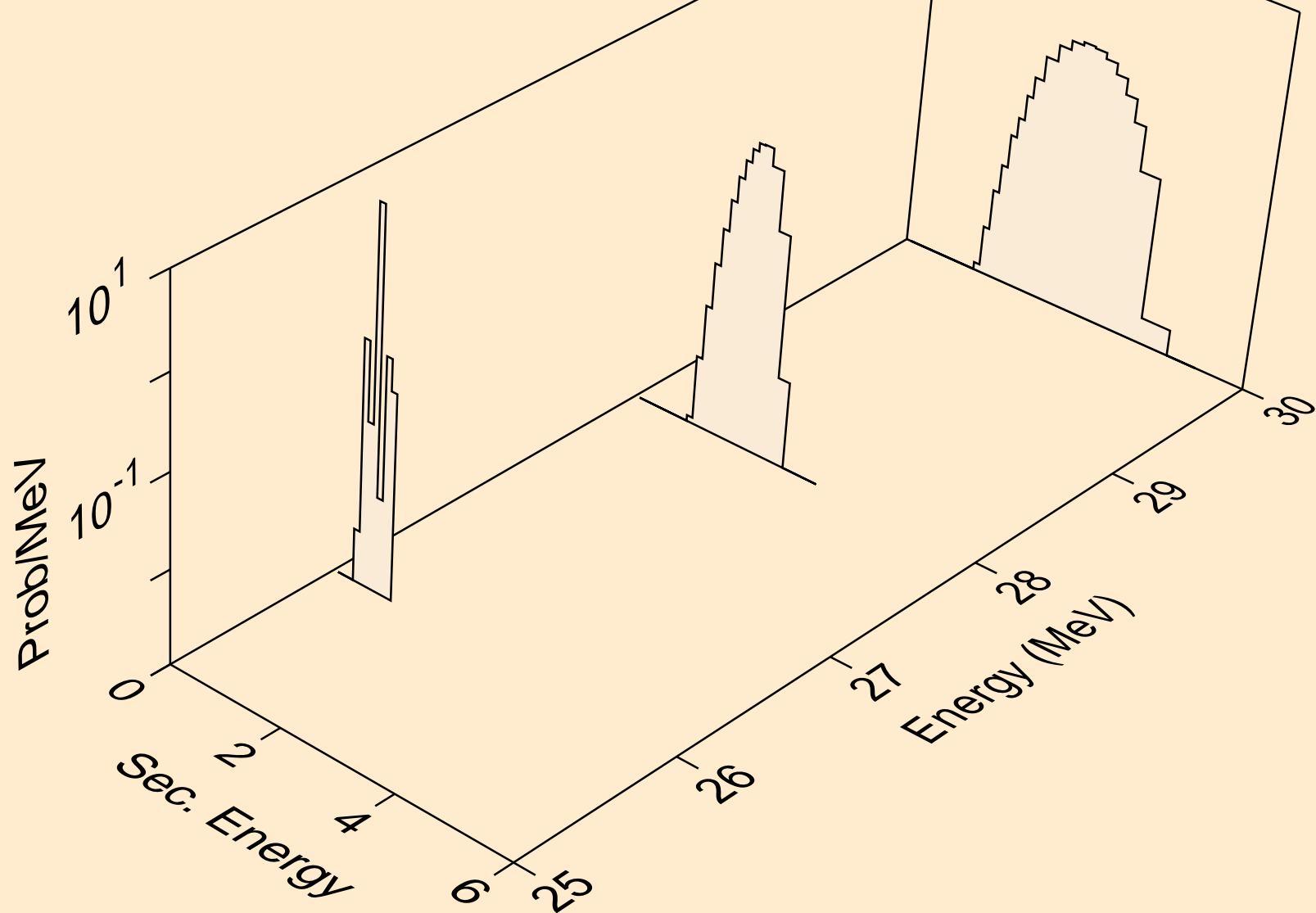

MO095 PROTON ACER TENDL-2023 LIBRARY; T=0.K  
Proton emission for (p,n2p)

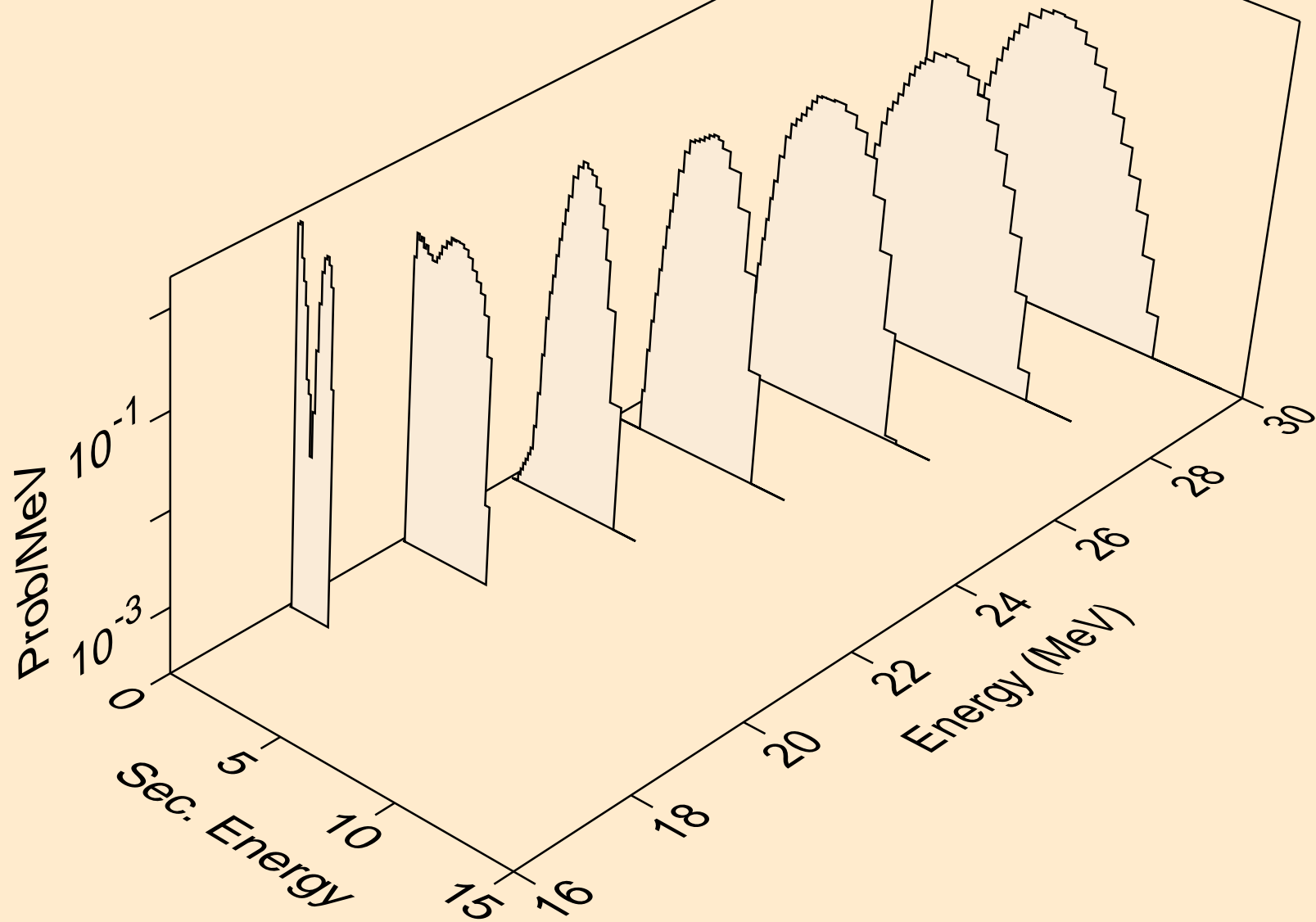

MO095 PROTON ACER TENDL-2023 LIBRARY; T=0.K  
Proton emission for (p,npa)

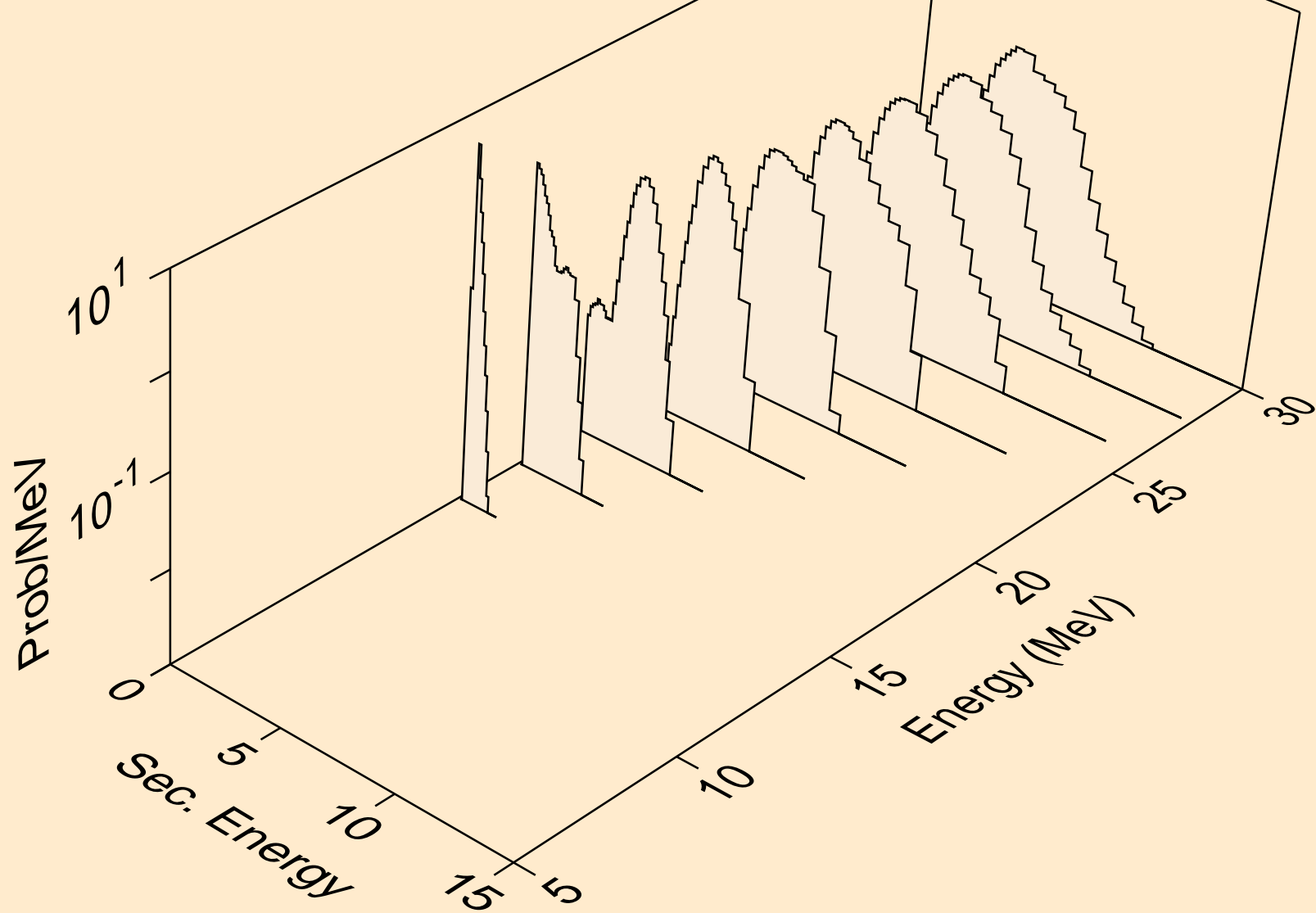

MO095 PROTON ACER TENDL-2023 LIBRARY; T=0.K  
Proton emission for inelastic

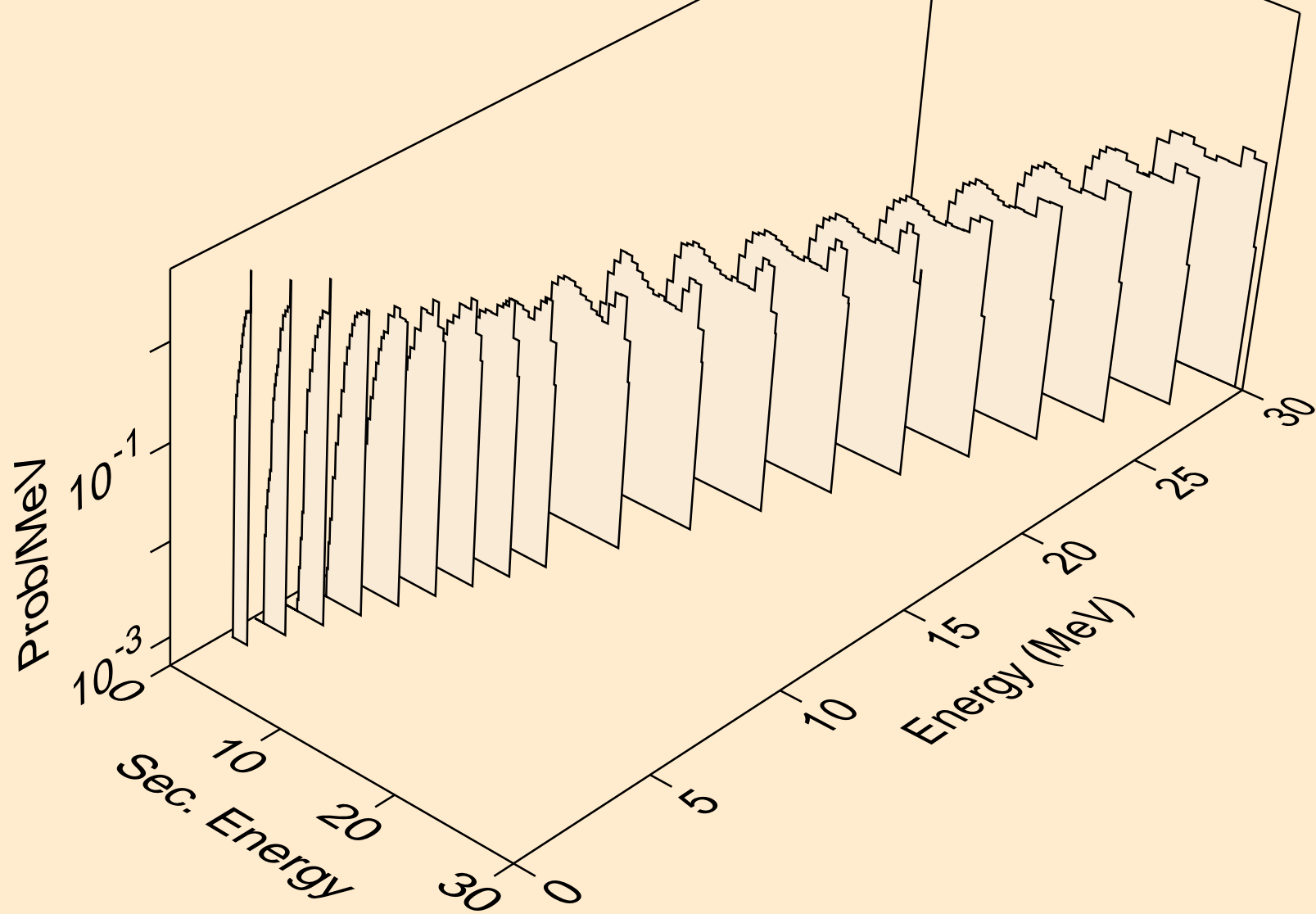



MO095 PROTON ACER TENDL-2023 LIBRARY; T=0.K  
Proton emission for (p,2p)

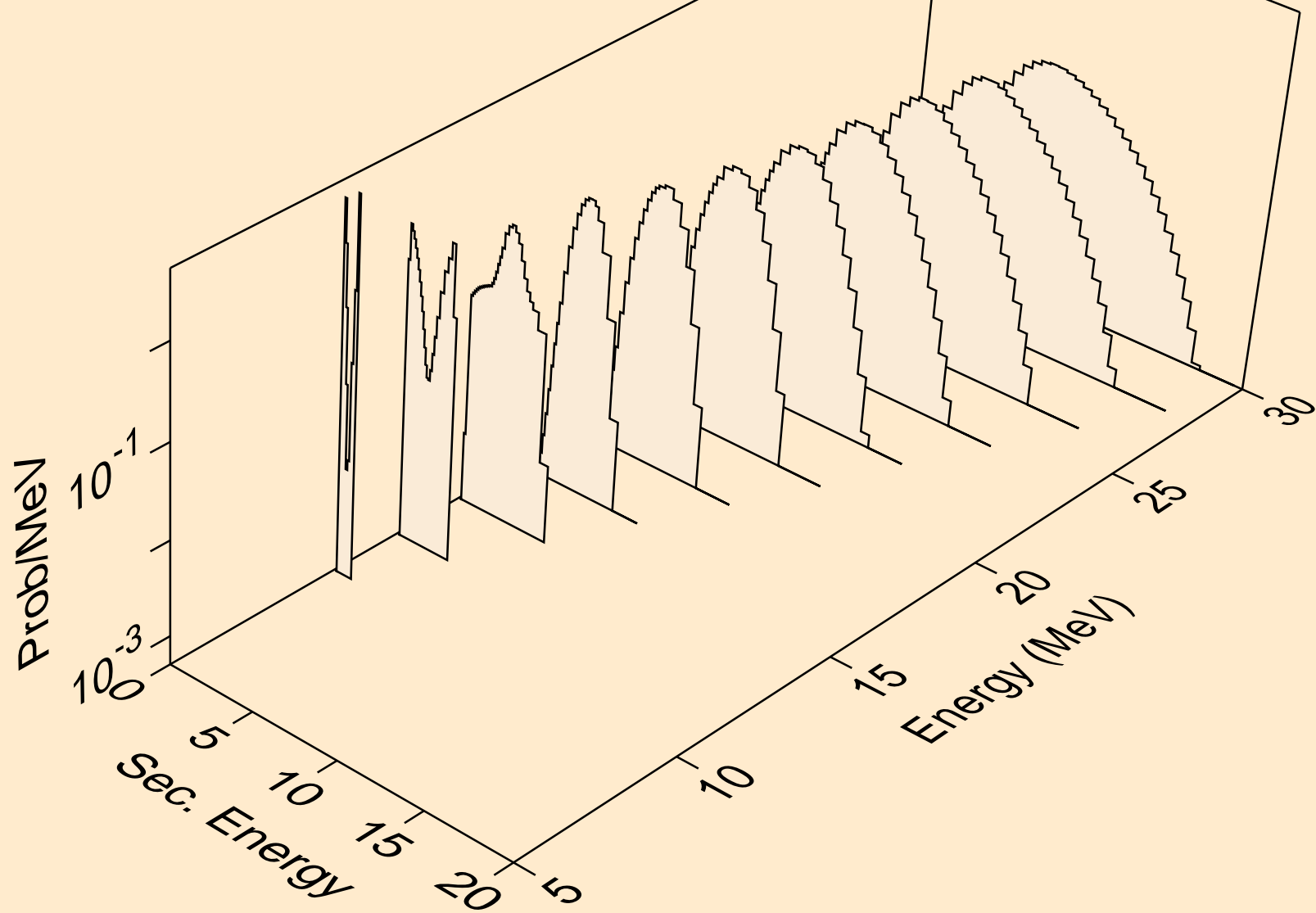

MO095 PROTON ACER TENDL-2023 LIBRARY; T=0.K  
Proton emission for (p,pa)

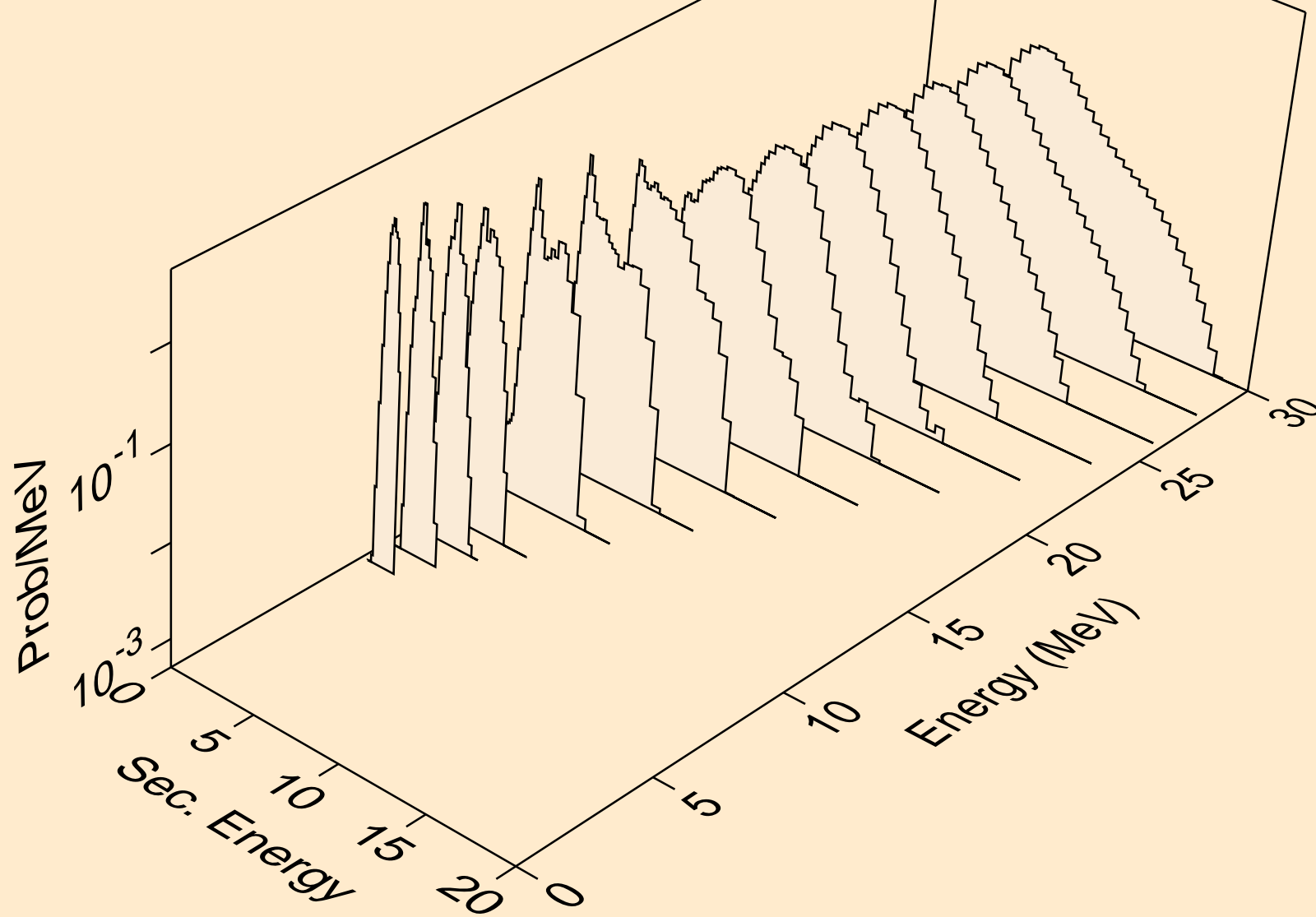

MO095 PROTON ACER TENDL-2023 LIBRARY; T=0.K  
Proton emission for (p,pd)

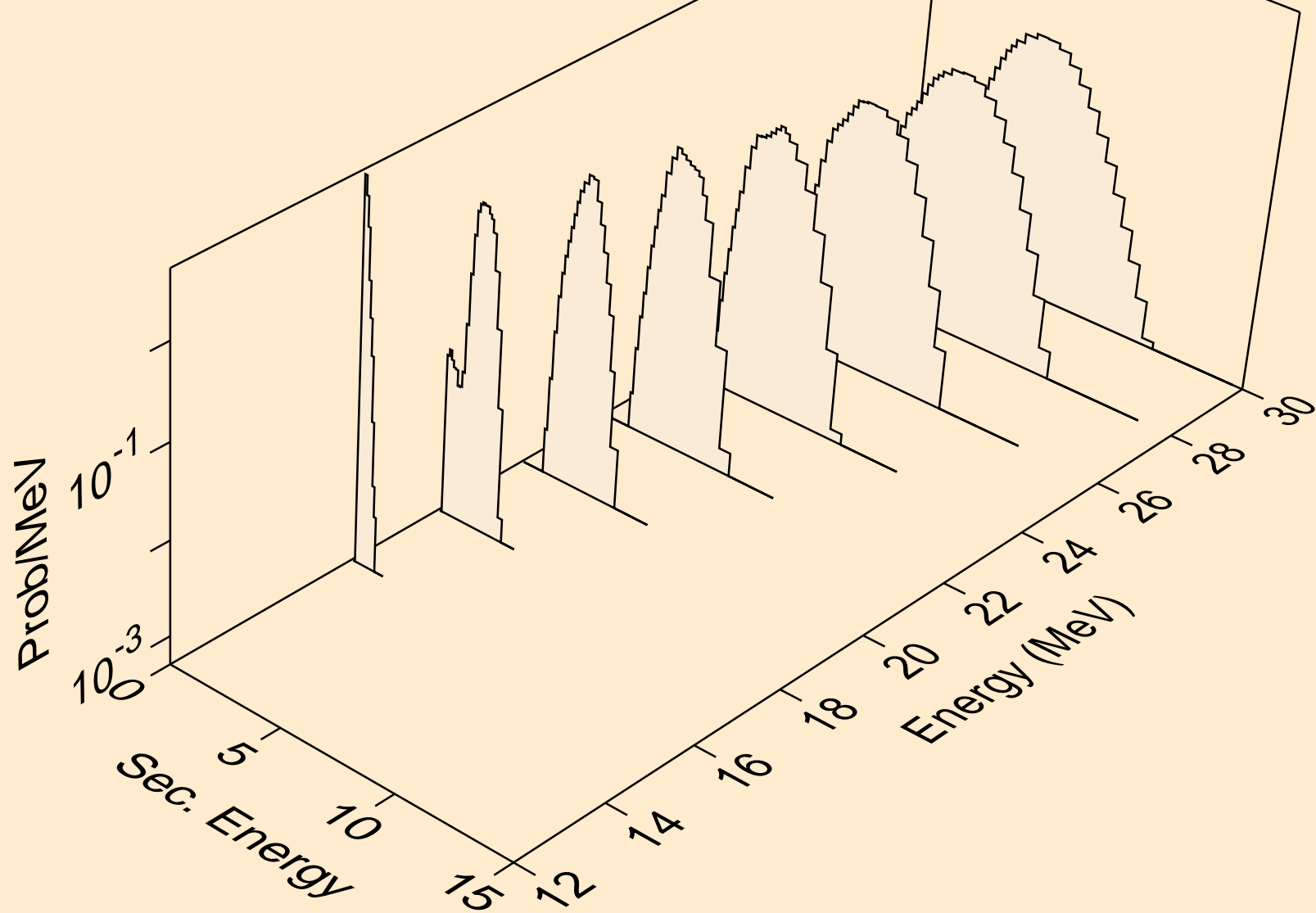

MO095 PROTON ACER TENDL-2023 LIBRARY; T=0.K  
Proton emission for (p,pt)

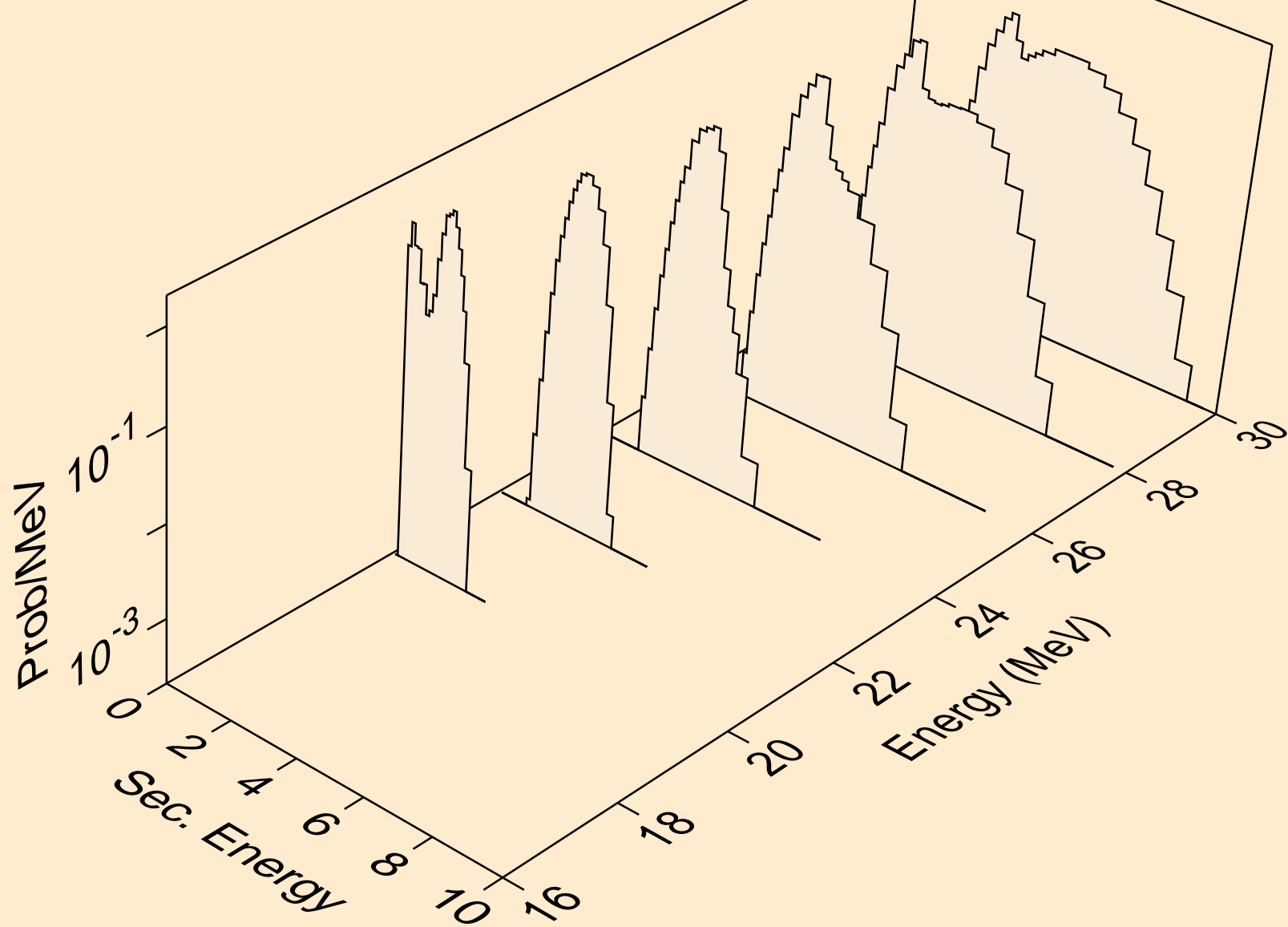

MO095 PROTON ACER TENDL-2023 LIBRARY; T=0.K  
Photon emission for (z,n)

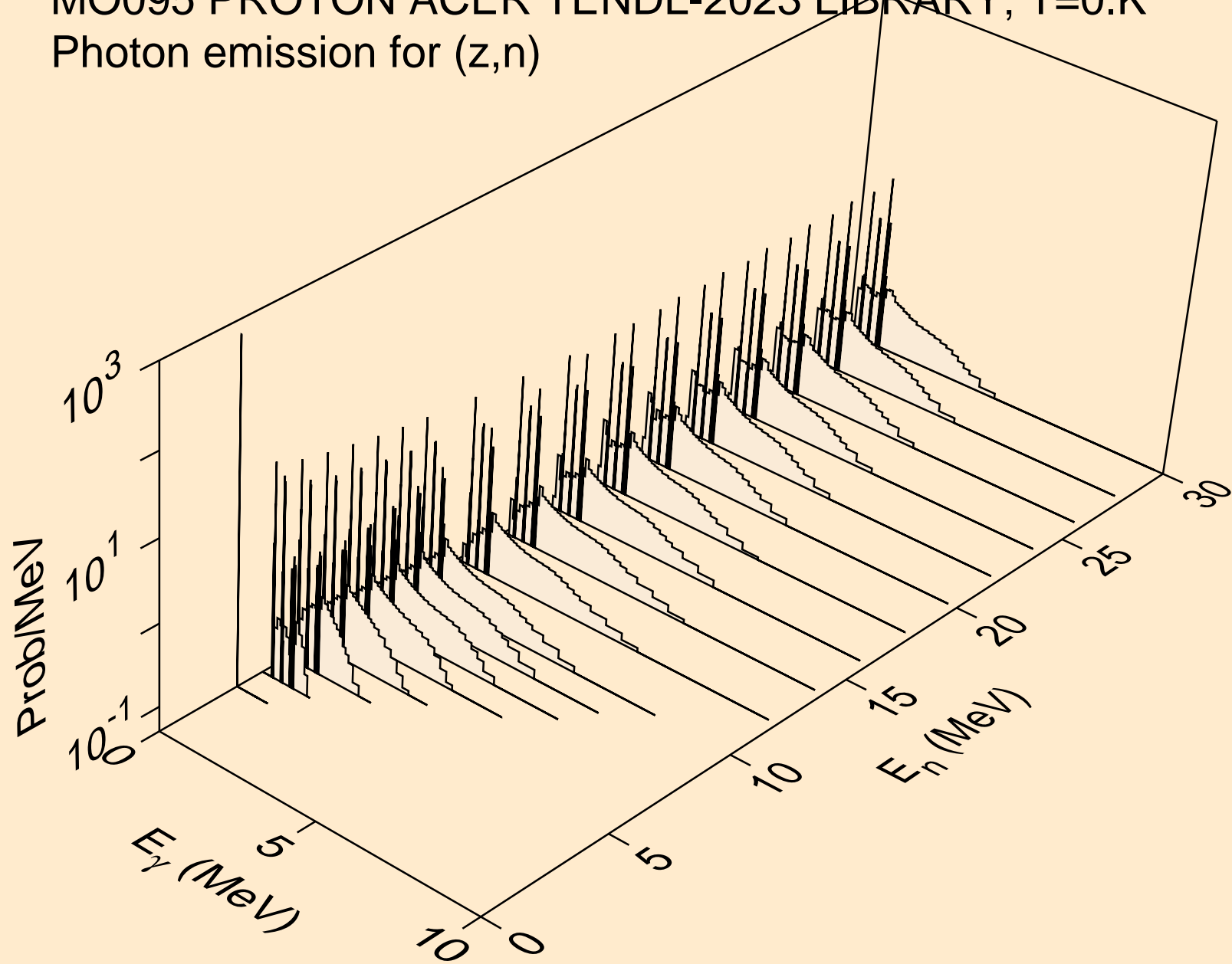

MO095 PROTON ACER TENDL-2023 LIBRARY; T=0.K  
Photon emission for (z,x)

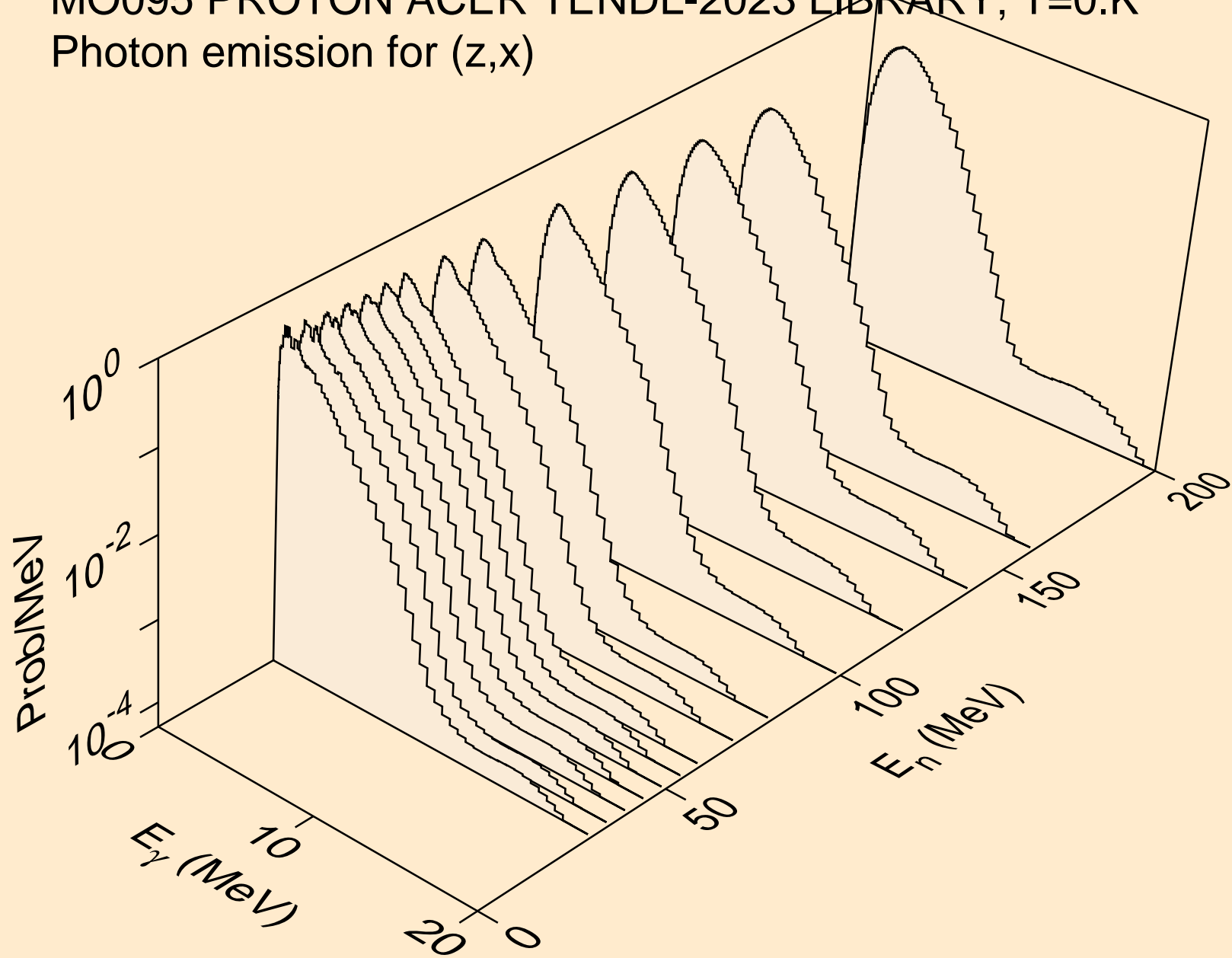

MO095 PROTON ACER TENDL-2023 LIBRARY; T=0.K  
Photon emission for (n,2nd)

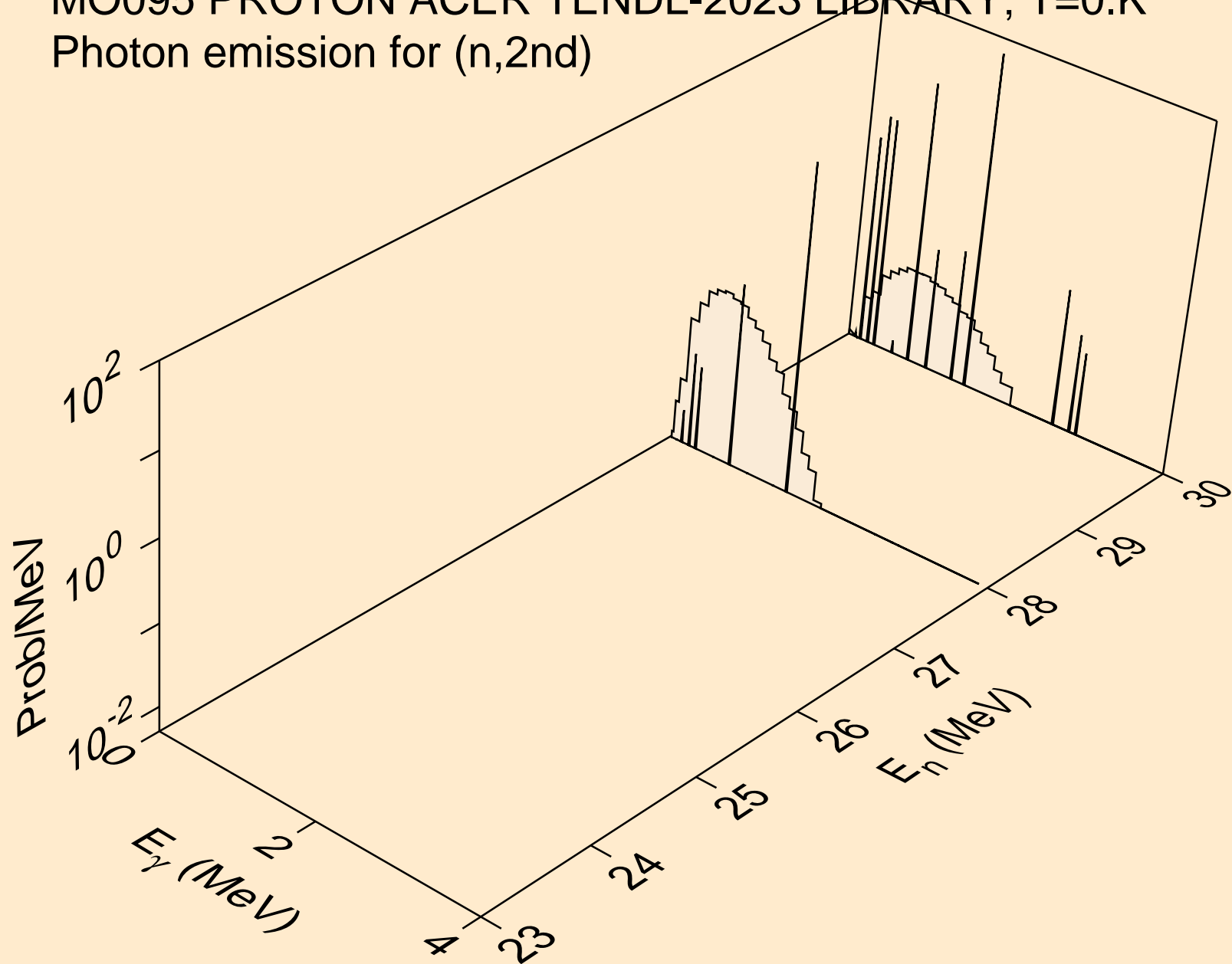

MO095 PROTON ACER TENDL-2023 LIBRARY; T=0.K  
Photon emission for (n,2n)

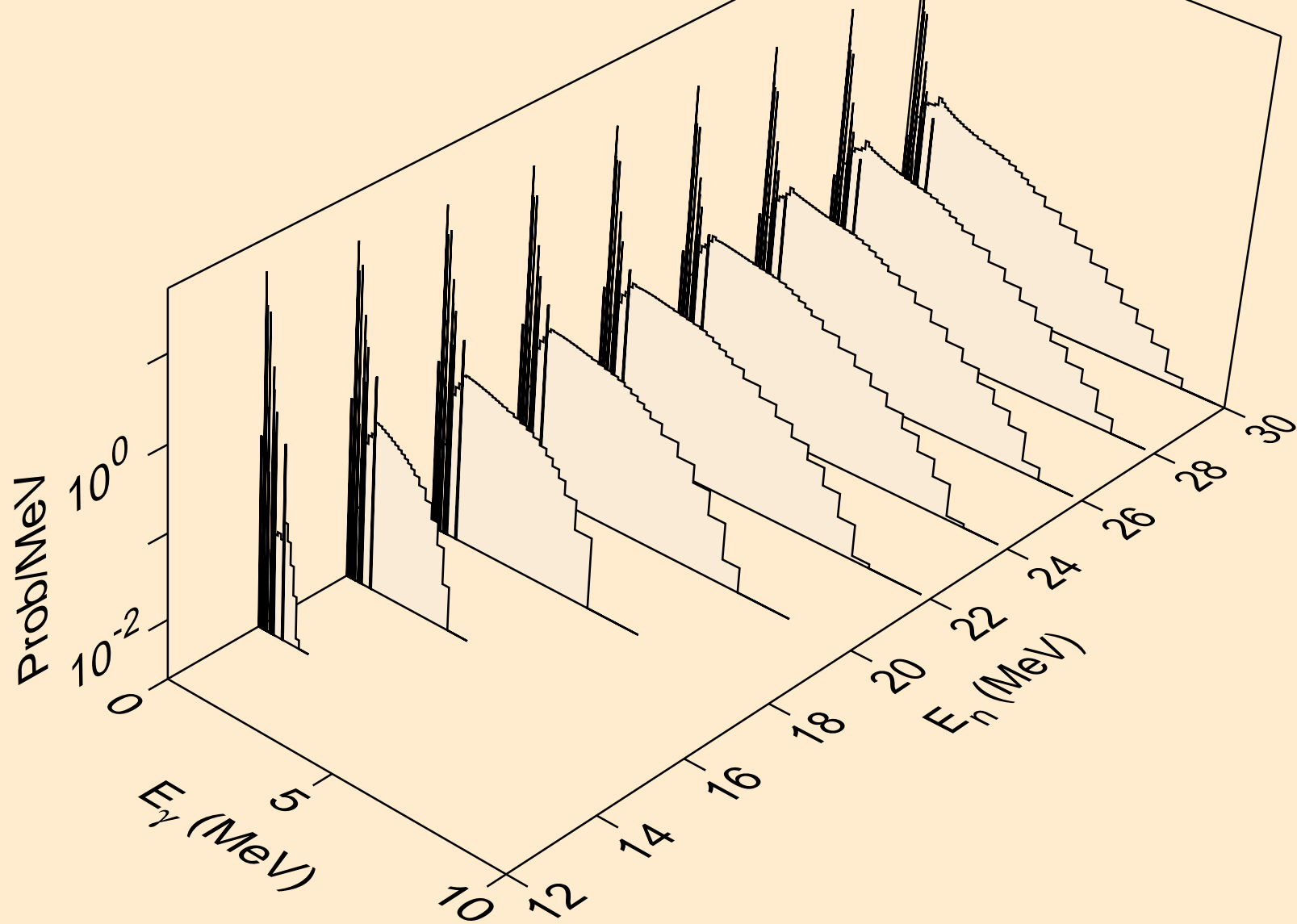



MO095 PROTON ACER TENDL-2023 LIBRARY; T=0.K  
Photon emission for (n,3n)

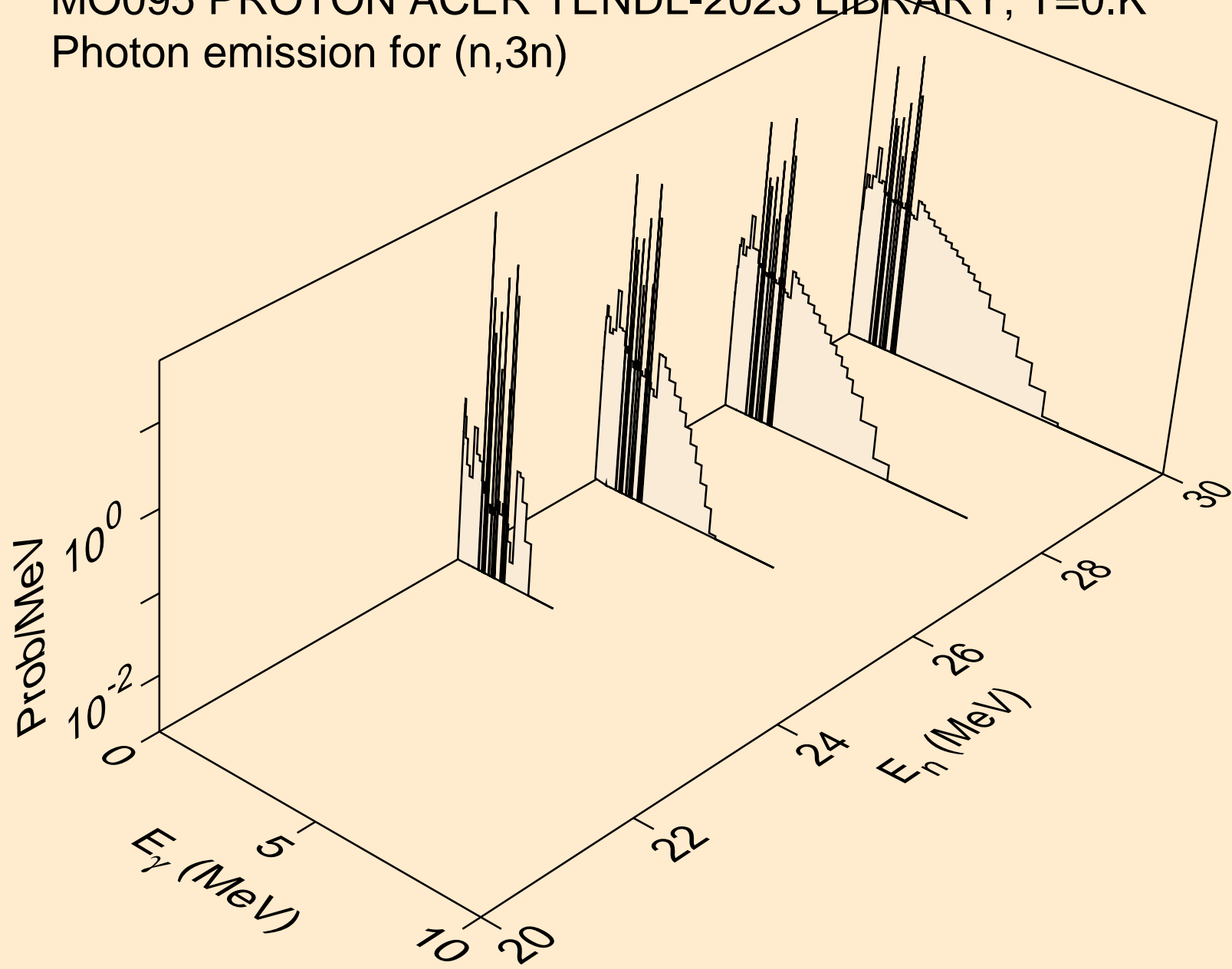

MO095 PROTON ACER TENDL-2023 LIBRARY; T=0.K  
Photon emission for (n,n\*)a

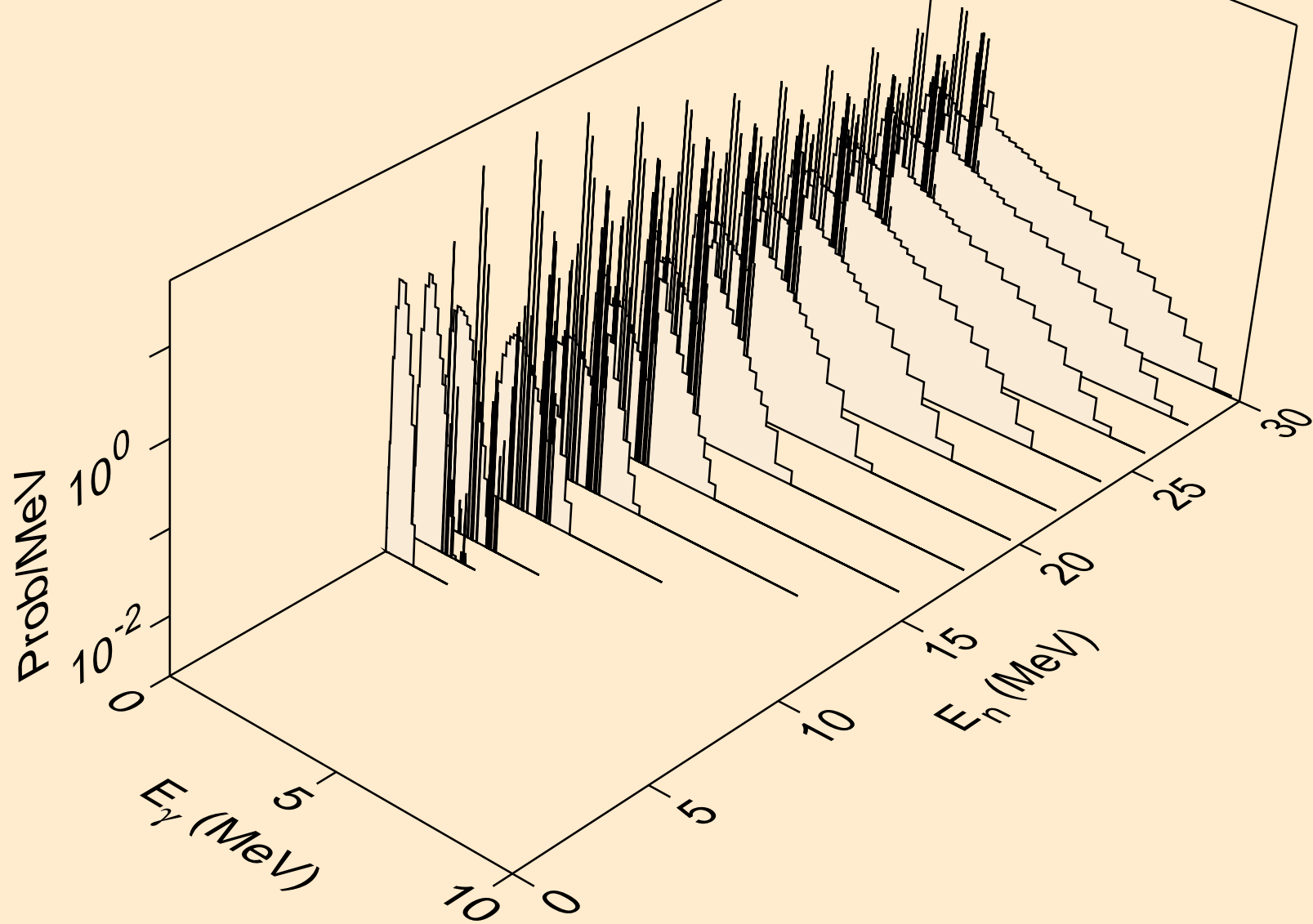

MO095 PROTON ACER TENDL-2023 LIBRARY; T=0.K  
Photon emission for (n,2n) $\alpha$

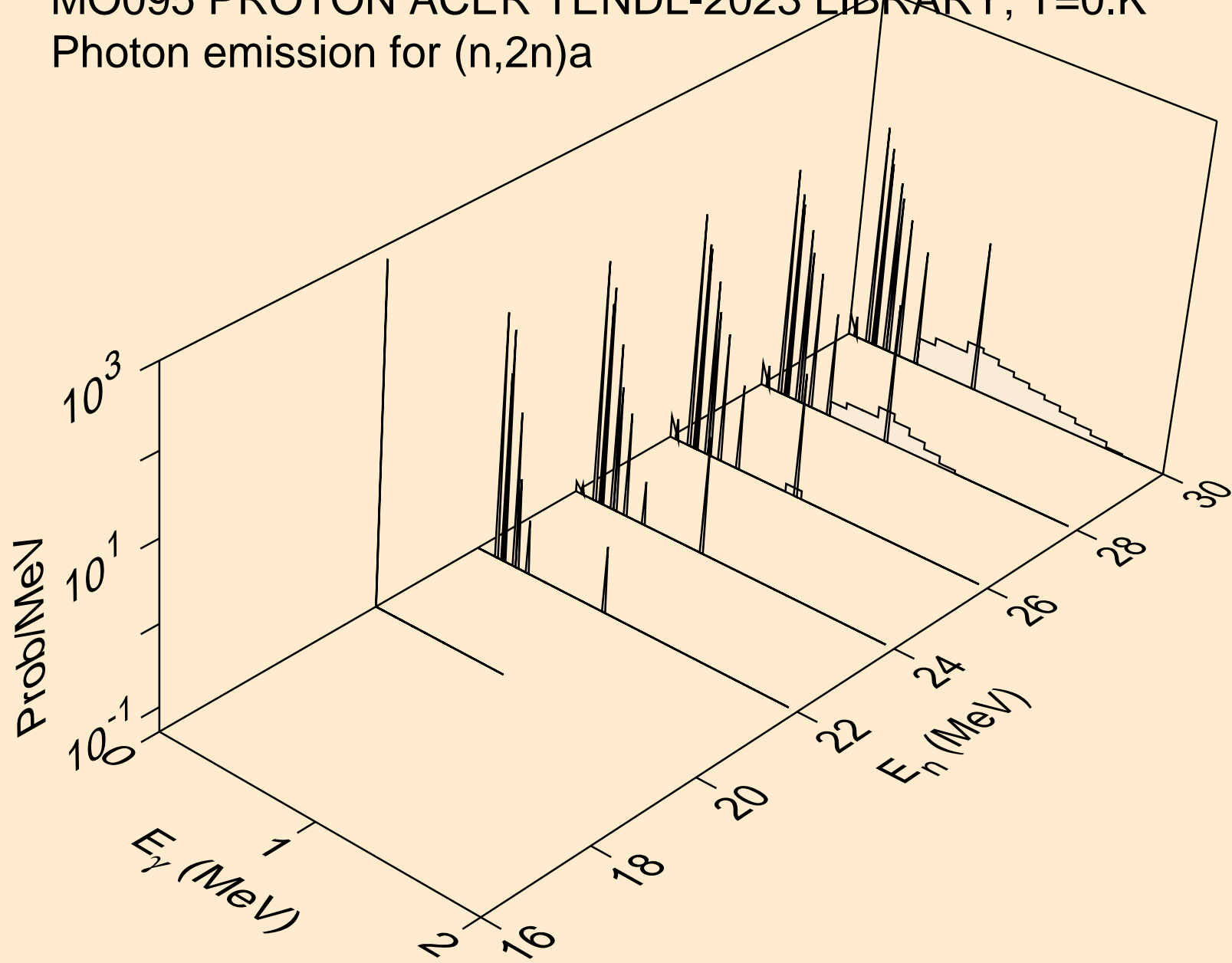

MO095 PROTON ACER TENDL-2023 LIBRARY; T=0.K  
Photon emission for (n,n\*)p

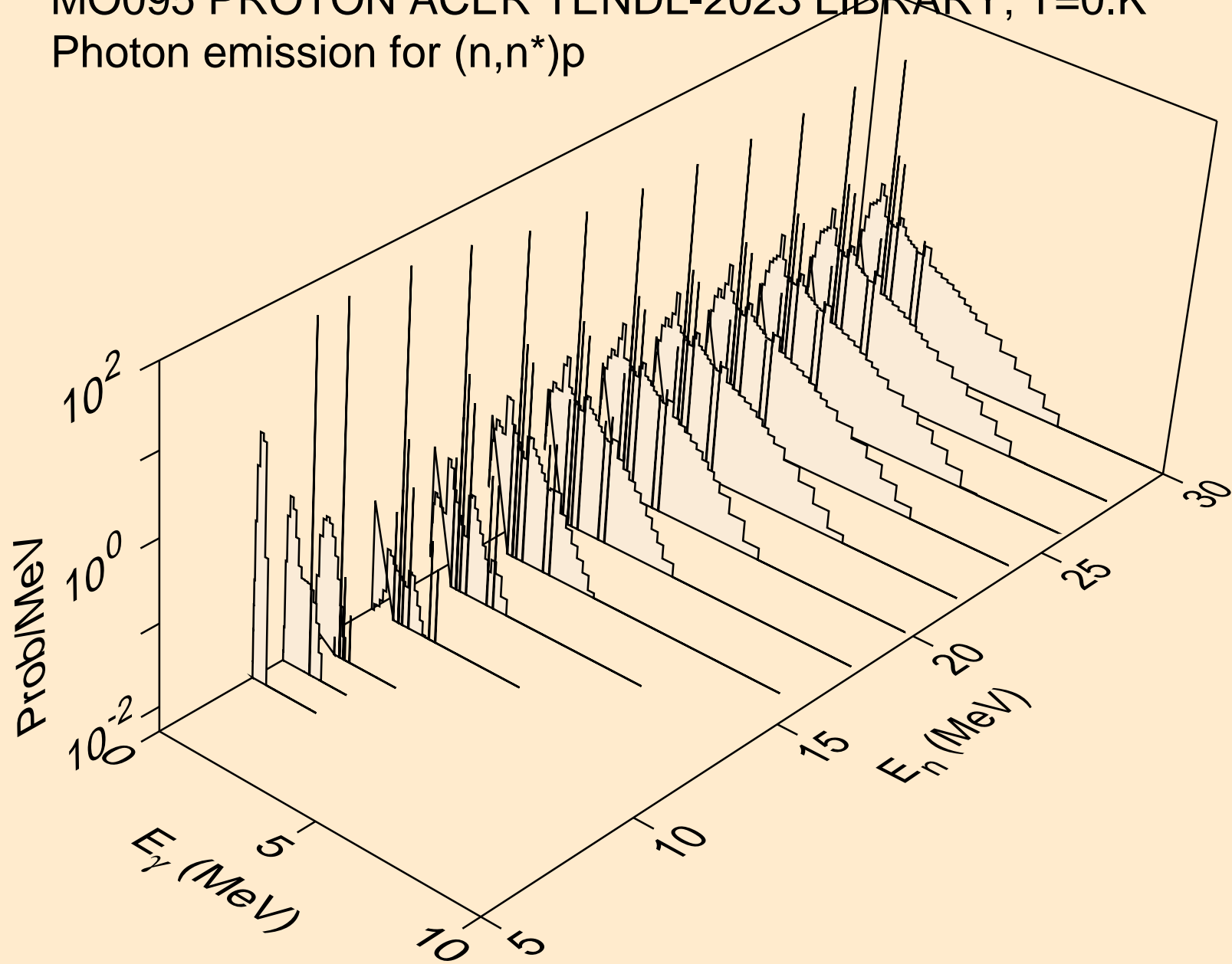

MO095 PROTON ACER TENDL-2023 LIBRARY; T=0.K  
Photon emission for (n,n\*)2a

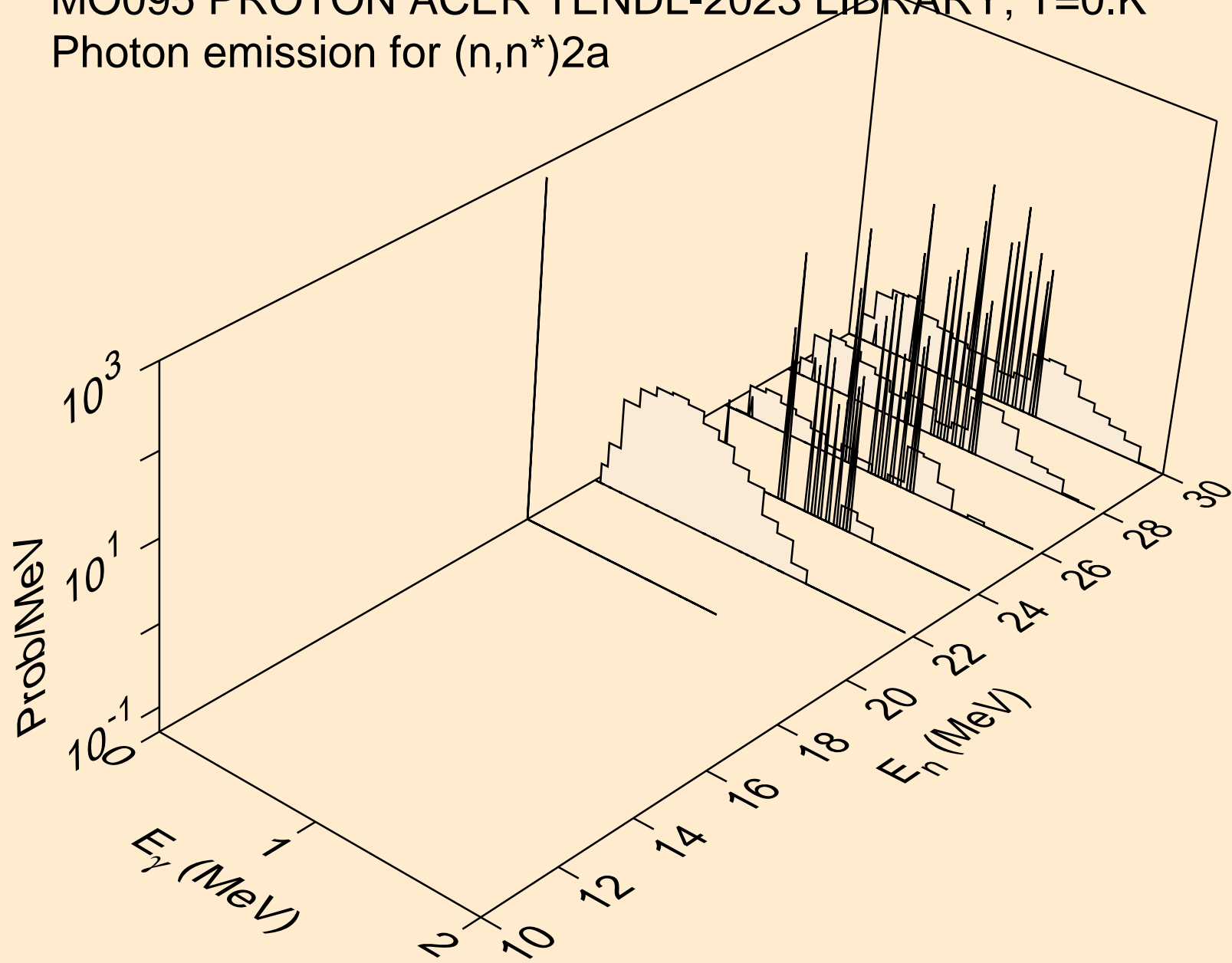

MO095 PROTON ACER TENDL-2023 LIBRARY; T=0.K  
Photon emission for (n,n\*)d

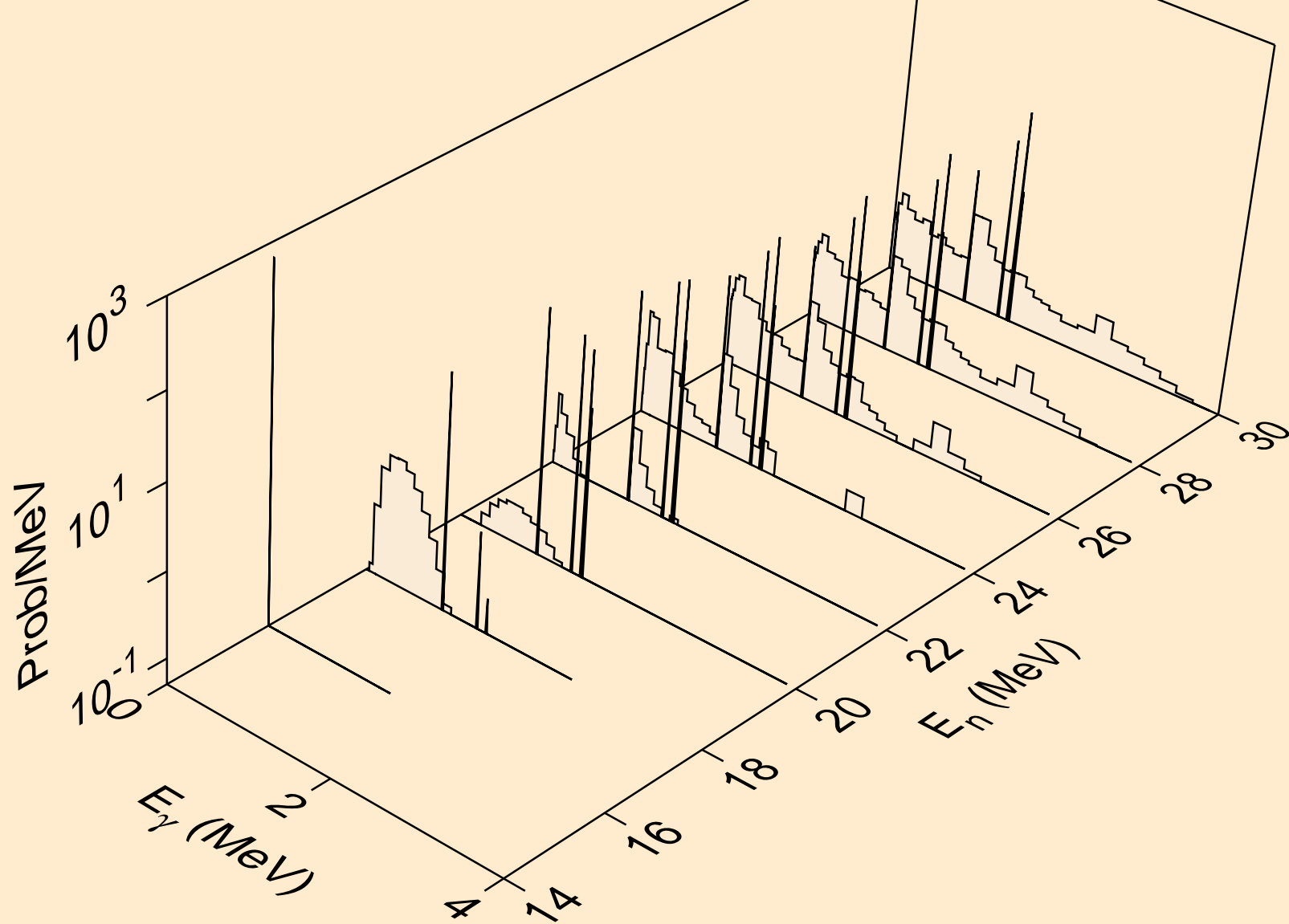

MO095 PROTON ACER TENDL-2023 LIBRARY; T=0.K  
Photon emission for (n,n\*)t

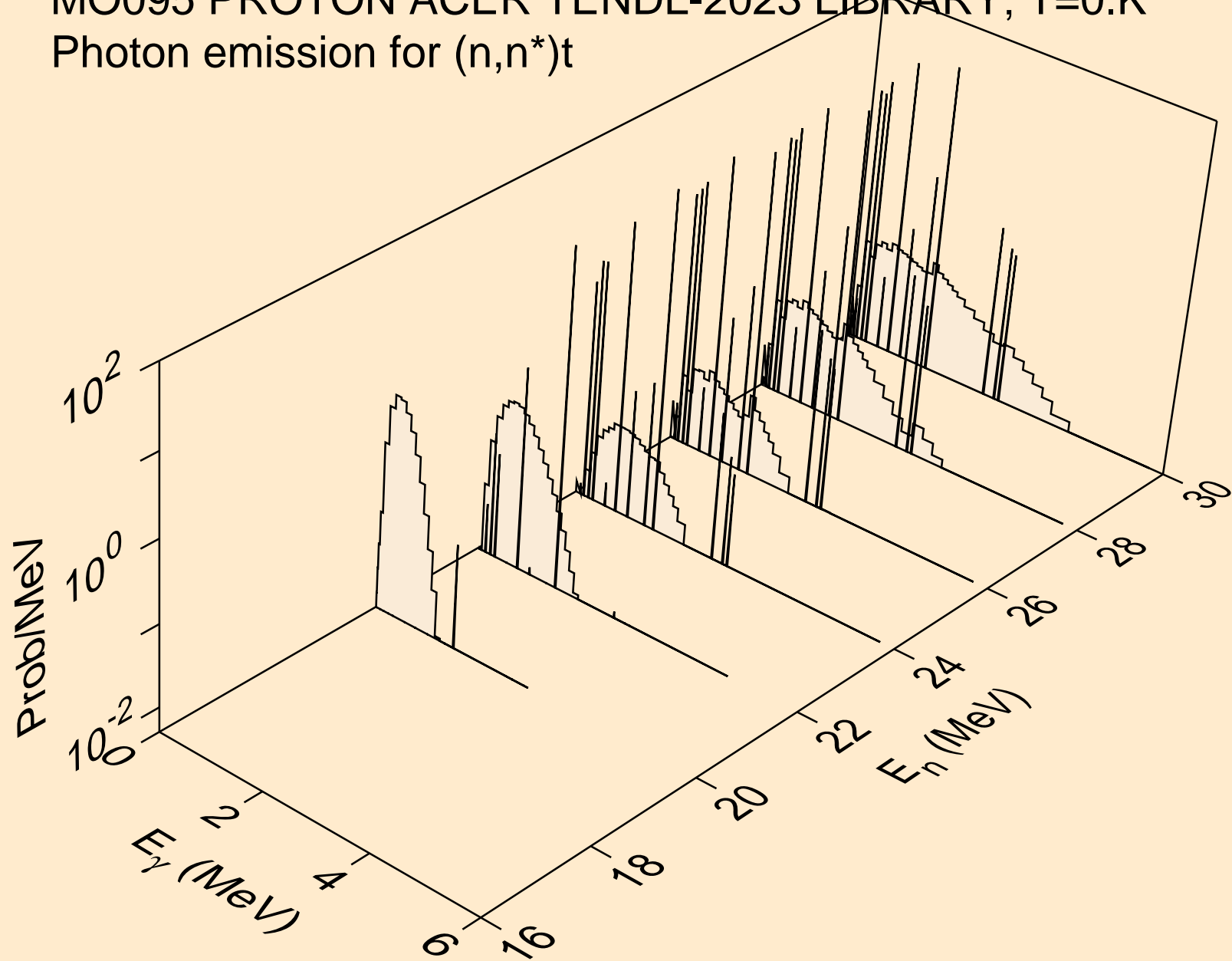

MO095 PROTON ACER TENDL-2023 LIBRARY; T=0.K  
Photon emission for (n,n\*)he3

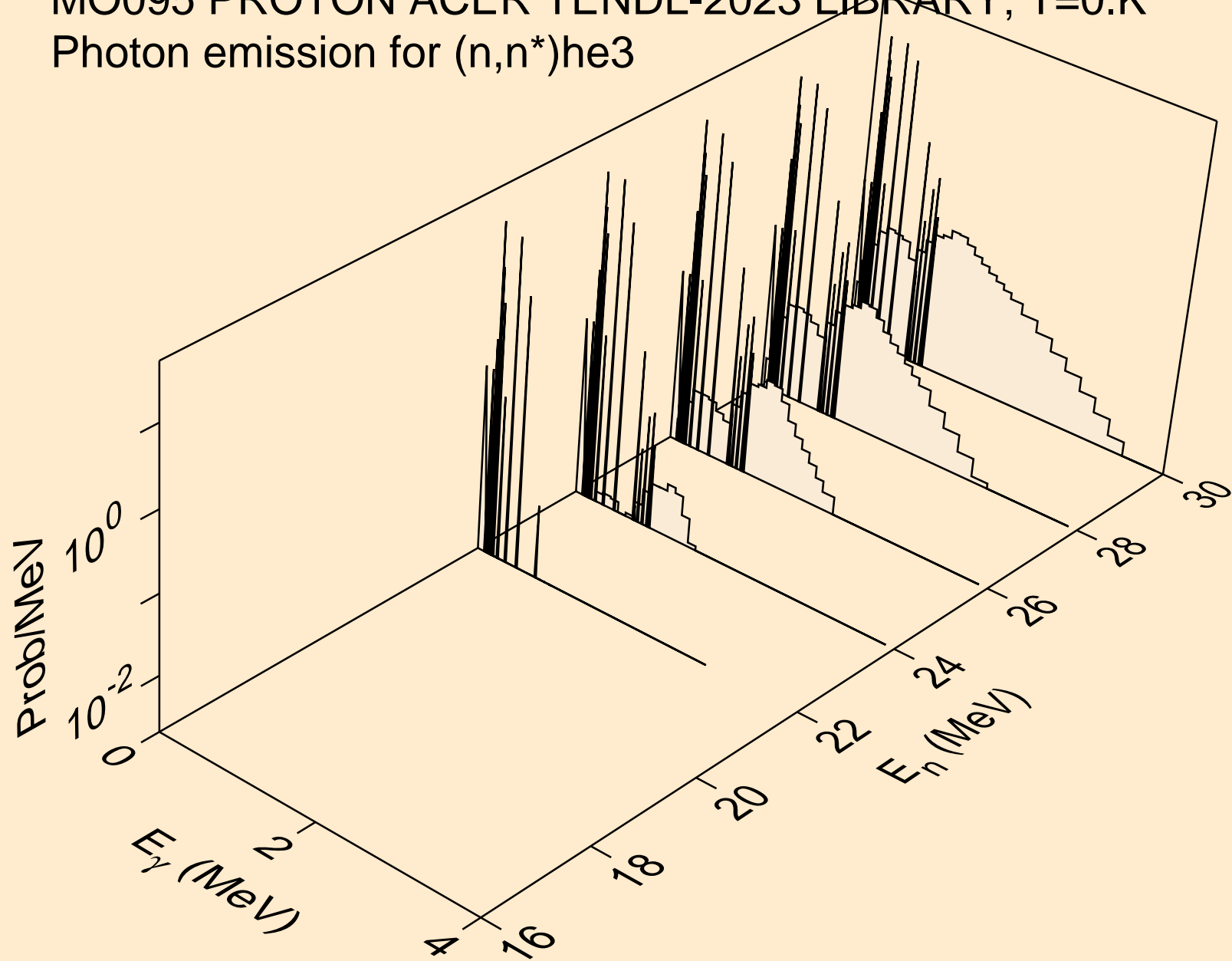



MO095 PROTON ACER TENDL-2023 LIBRARY; T=0.K  
Photon emission for (n,2np)

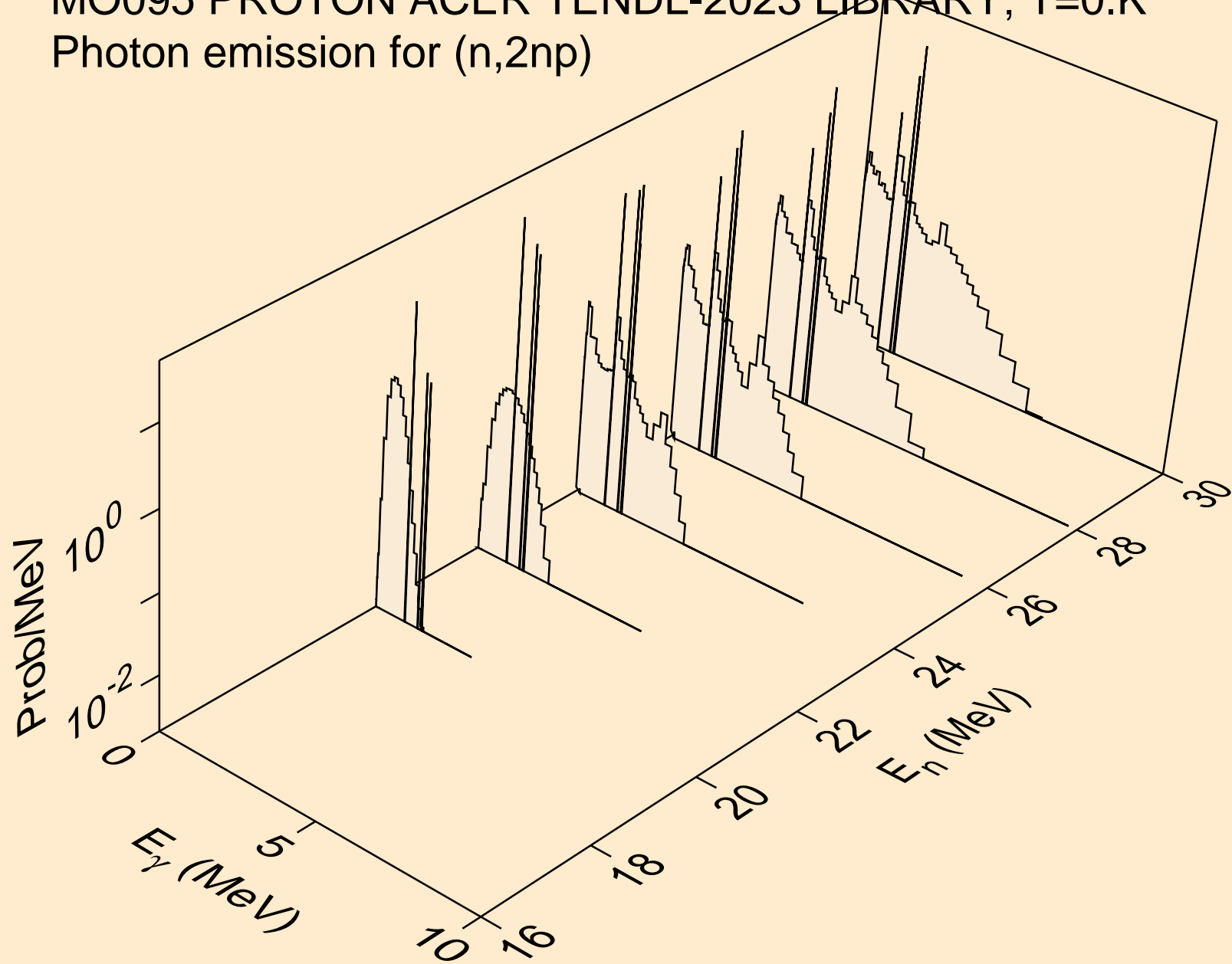

MO095 PROTON ACER TENDL-2023 LIBRARY; T=0.K  
Photon emission for (n,3np)

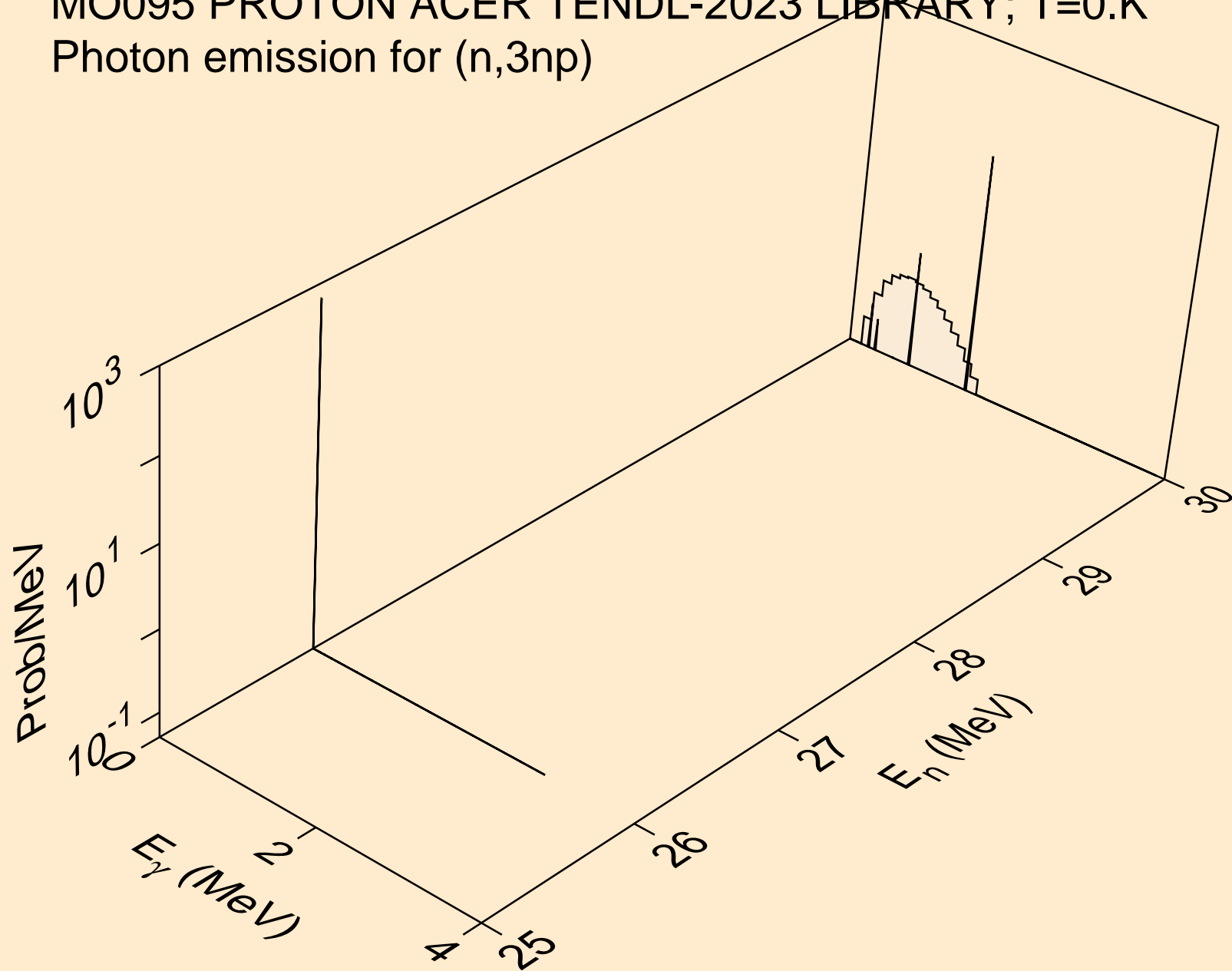

MO095 PROTON ACER TENDL-2023 LIBRARY; T=0.K  
Photon emission for (n,n2p)

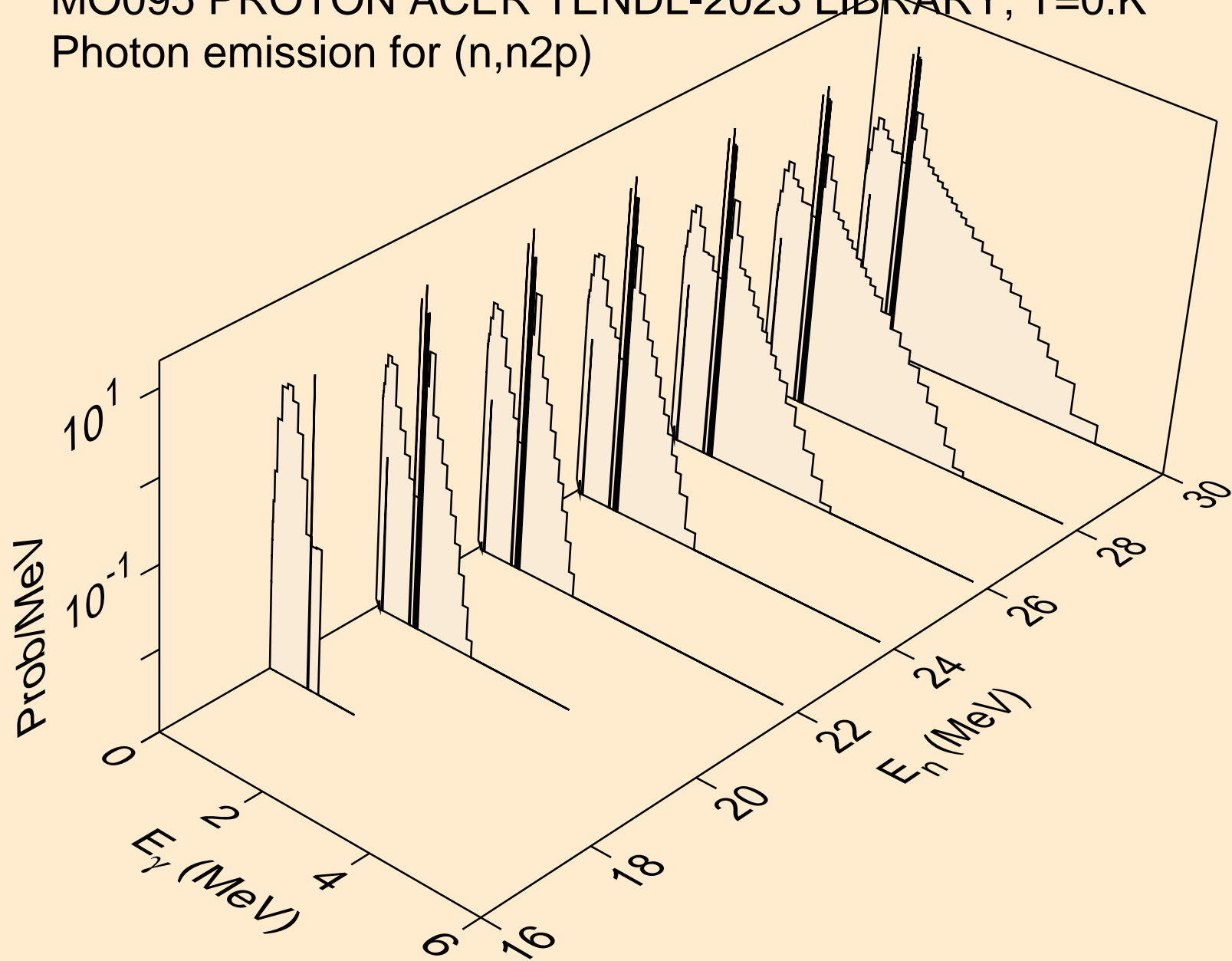

MO095 PROTON ACER TENDL-2023 LIBRARY; T=0.K  
Photon emission for (n,npa)

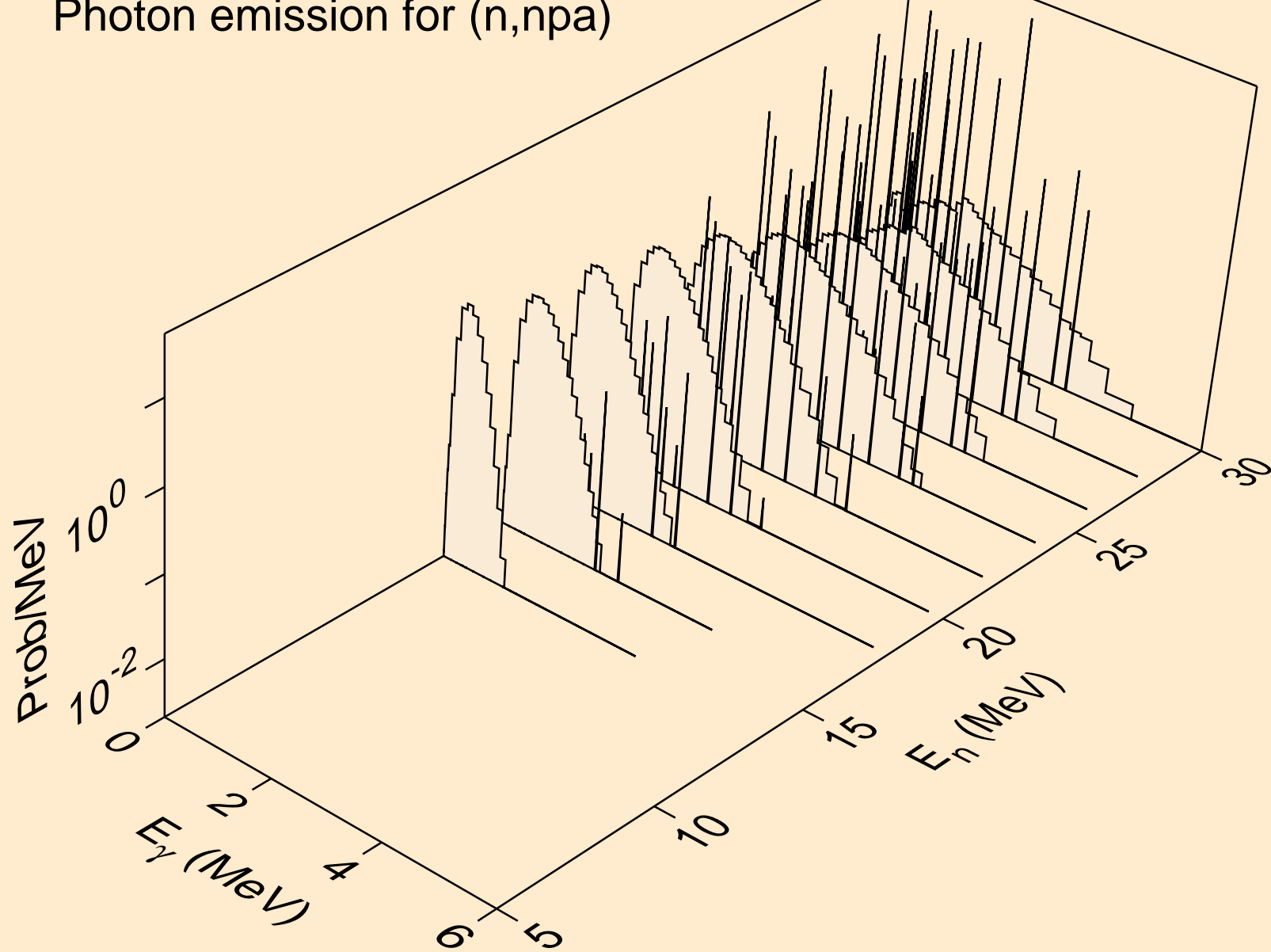

MO095 PROTON ACER TENDL-2023 LIBRARY; T=0.K  
Photon emission for (n,gma)

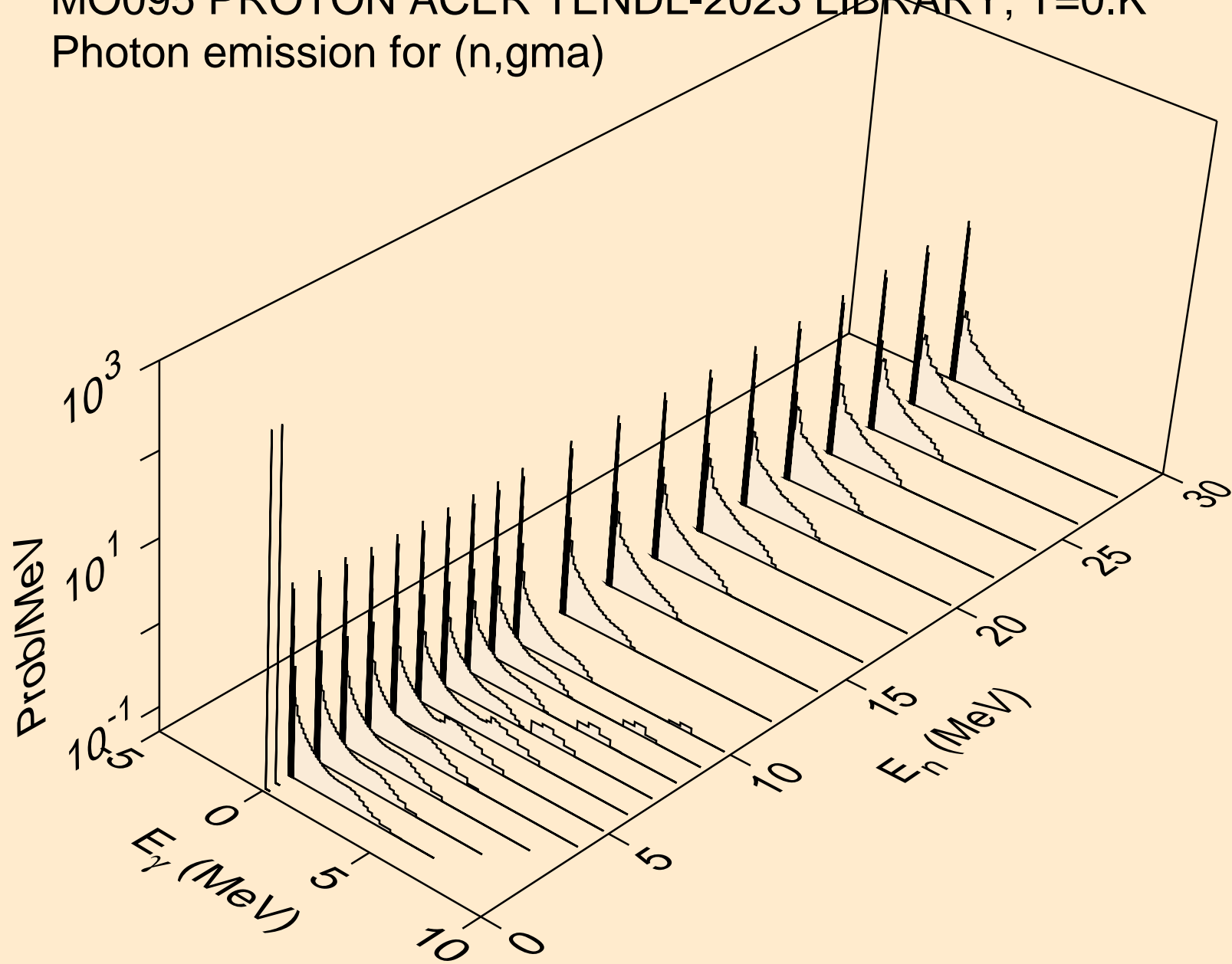

MO095 PROTON ACER TENDL-2023 LIBRARY; T=0.K  
Photon emission for inelastic

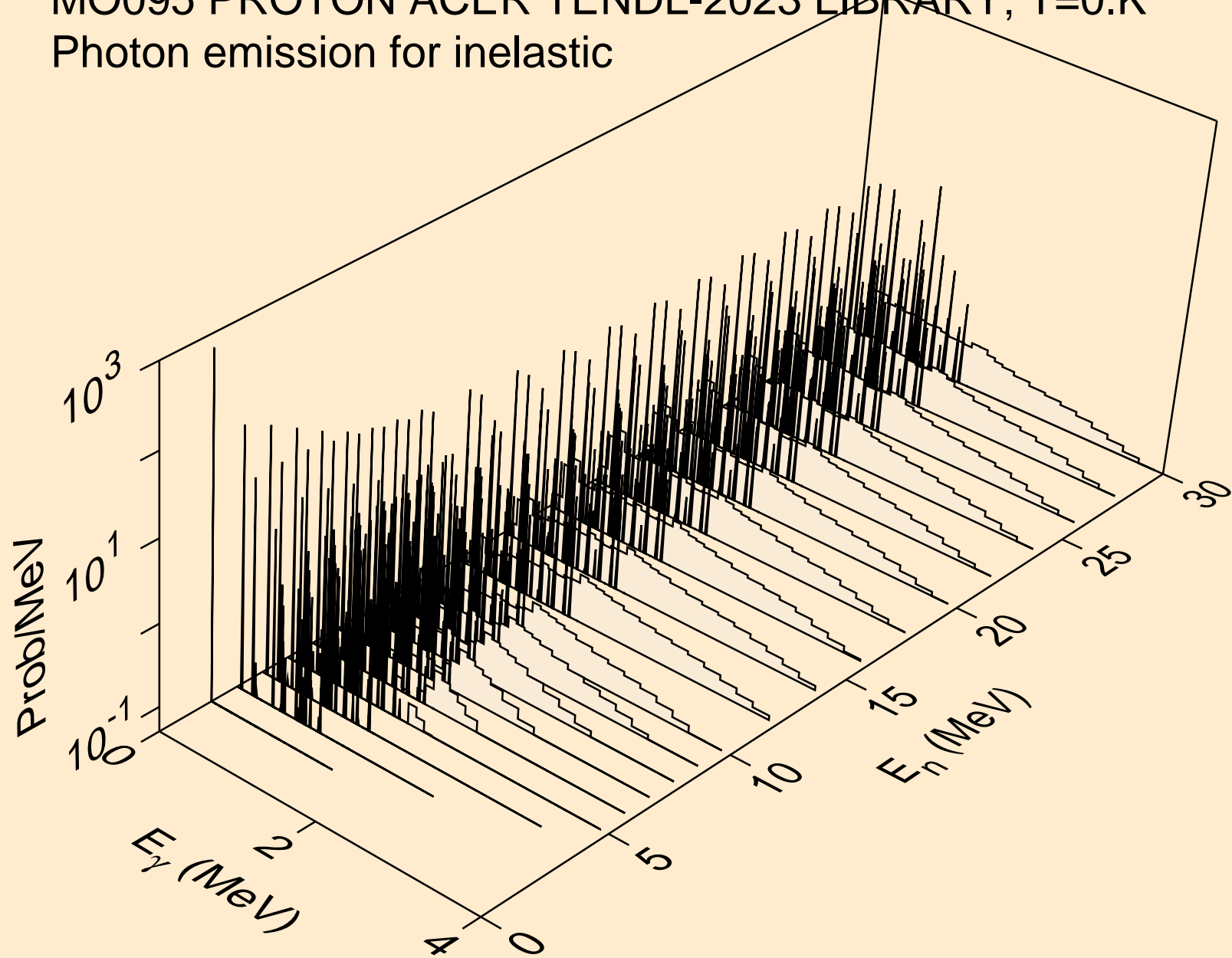

MO095 PROTON ACER TENDL-2023 LIBRARY; T=0.K  
Photon emission for (n,d)

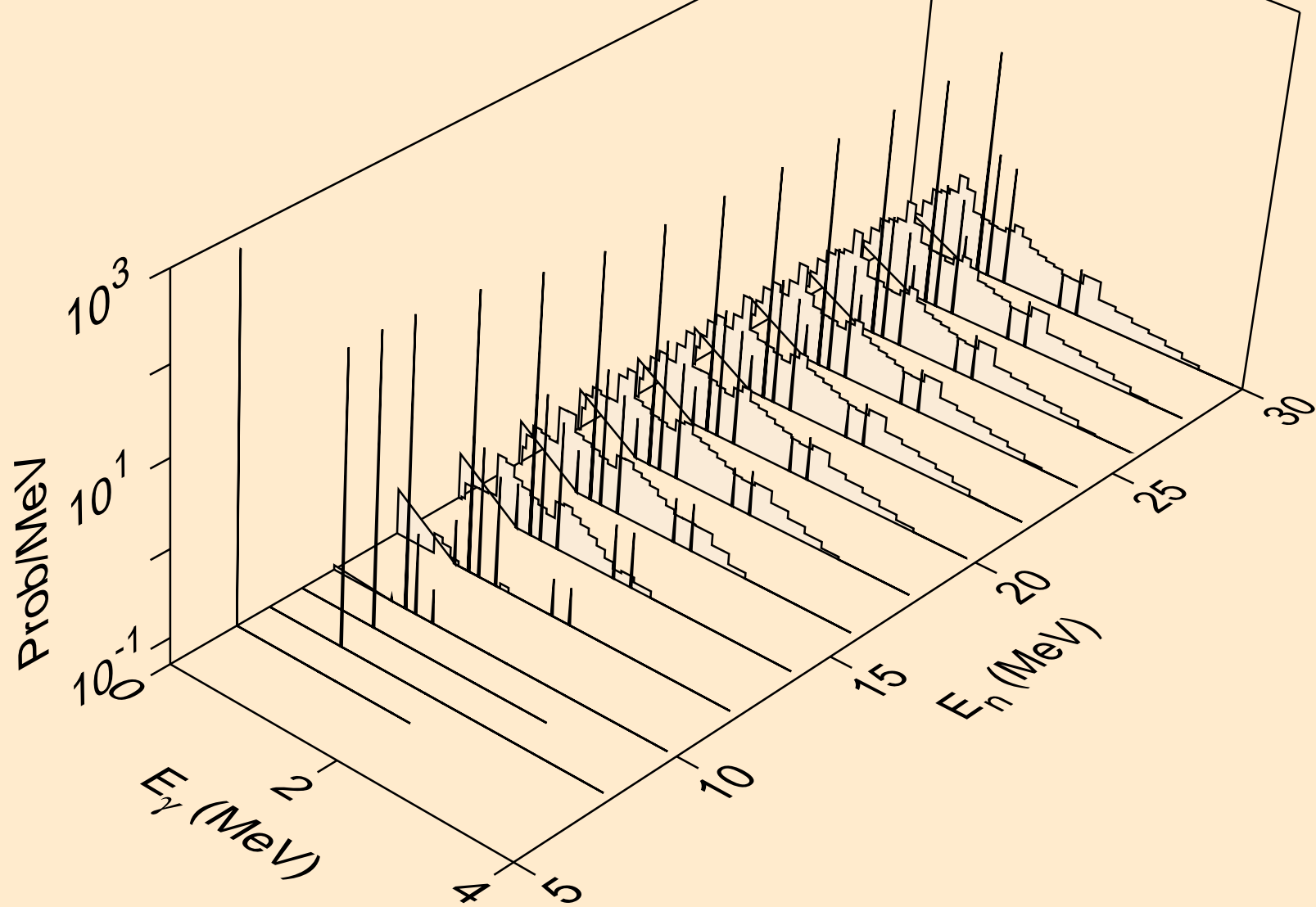

MO095 PROTON ACER TENDL-2023 LIBRARY; T=0.K  
Photon emission for (n,t)

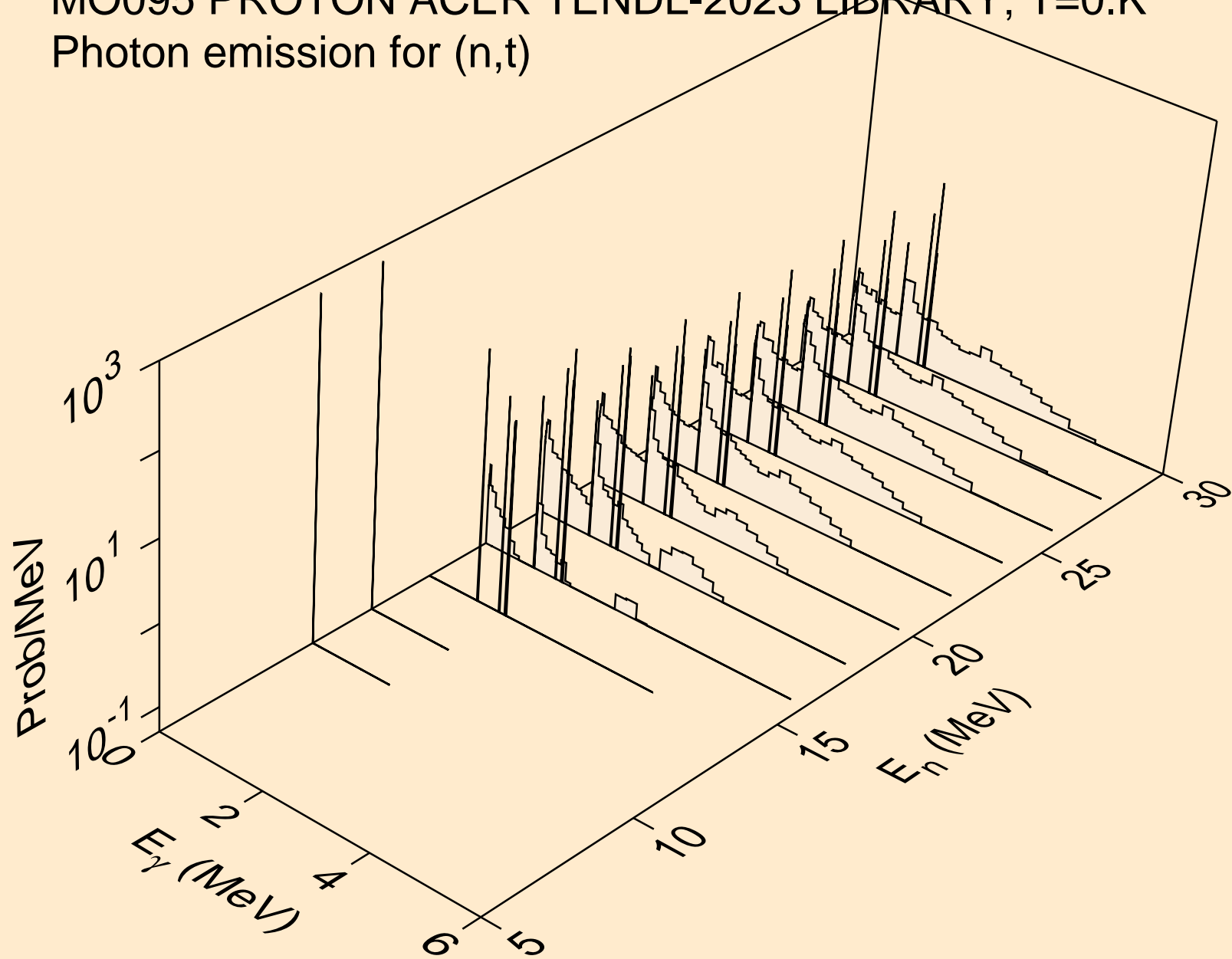



MO095 PROTON ACER TENDL-2023 LIBRARY; T=0.K  
Photon emission for (n,he3)

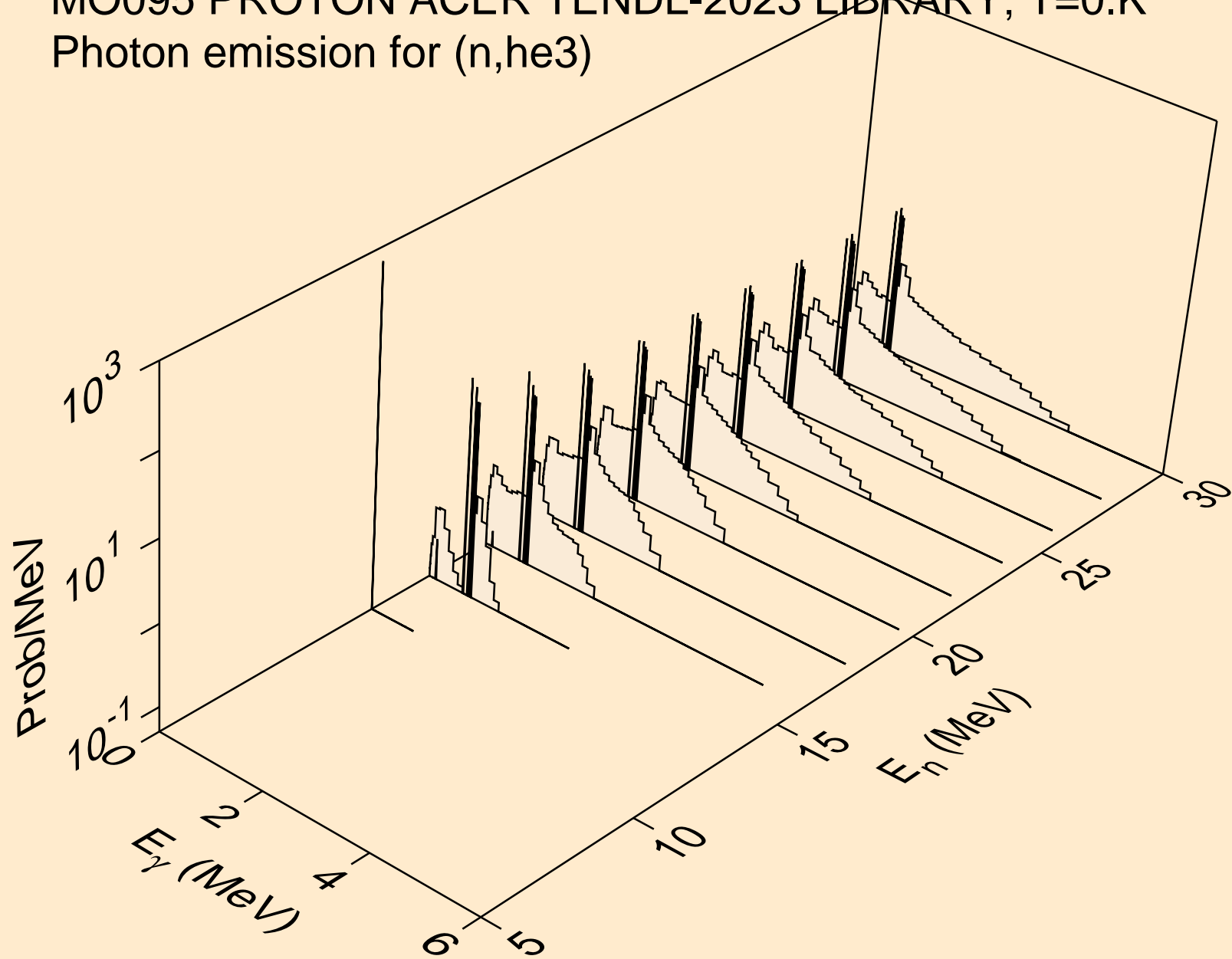

MO095 PROTON ACER TENDL-2023 LIBRARY; T=0.K  
Photon emission for (n,a)

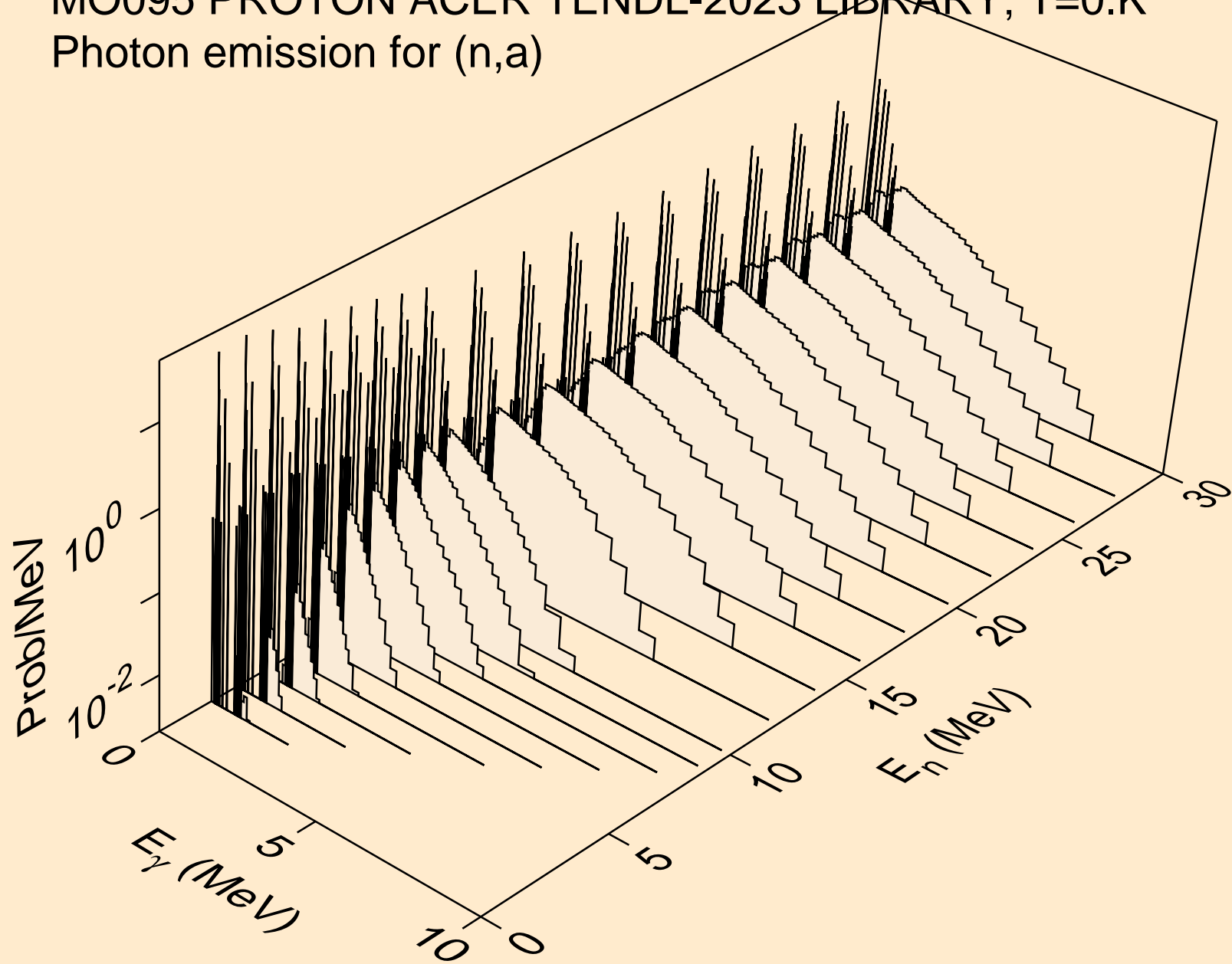

MO095 PROTON ACER TENDL-2023 LIBRARY; T=0.K  
Photon emission for (n,2a)

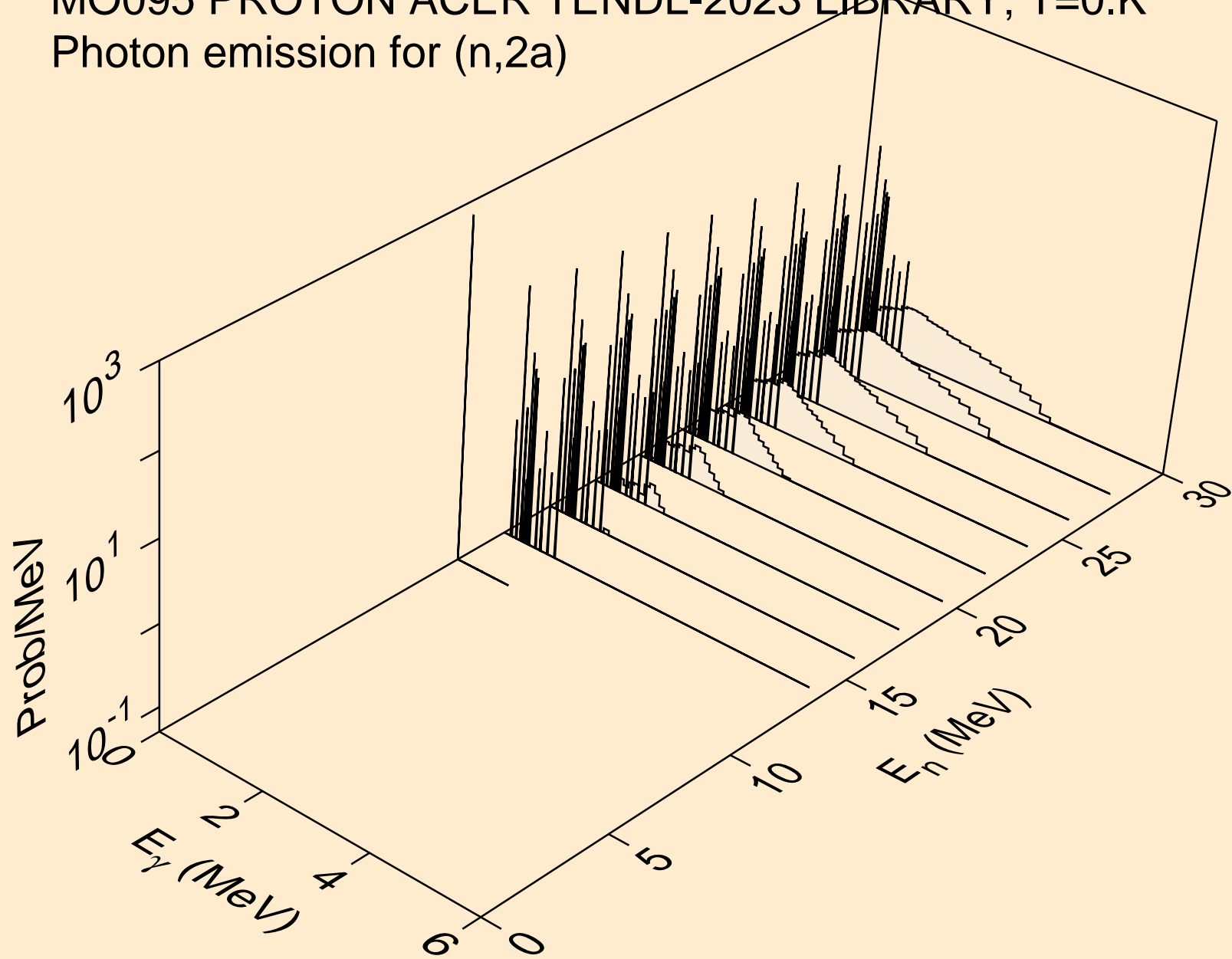

MO095 PROTON ACER TENDL-2023 LIBRARY; T=0.K  
Photon emission for (n,2p)

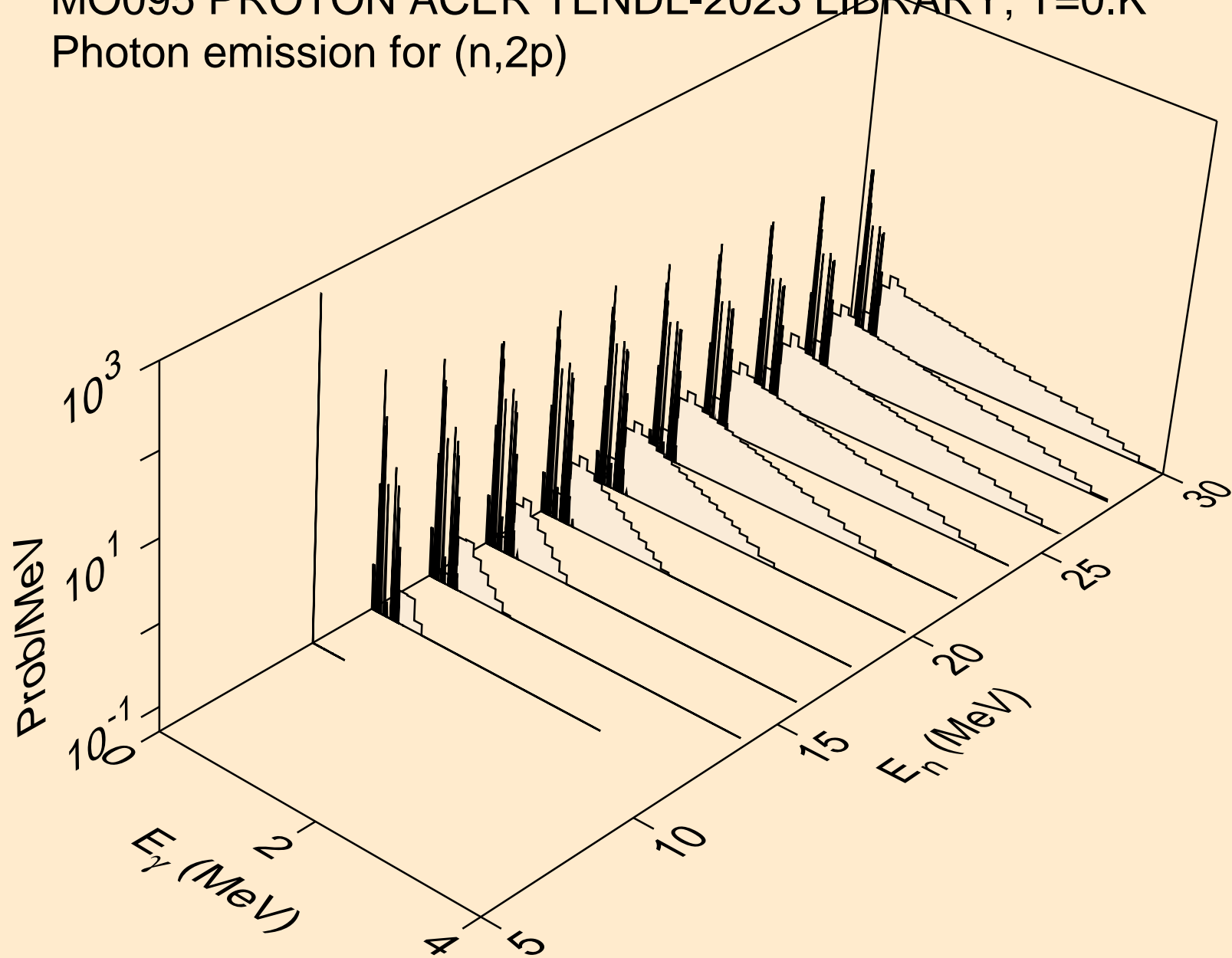

MO095 PROTON ACER TENDL-2023 LIBRARY; T=0.K  
Photon emission for (n,pa)

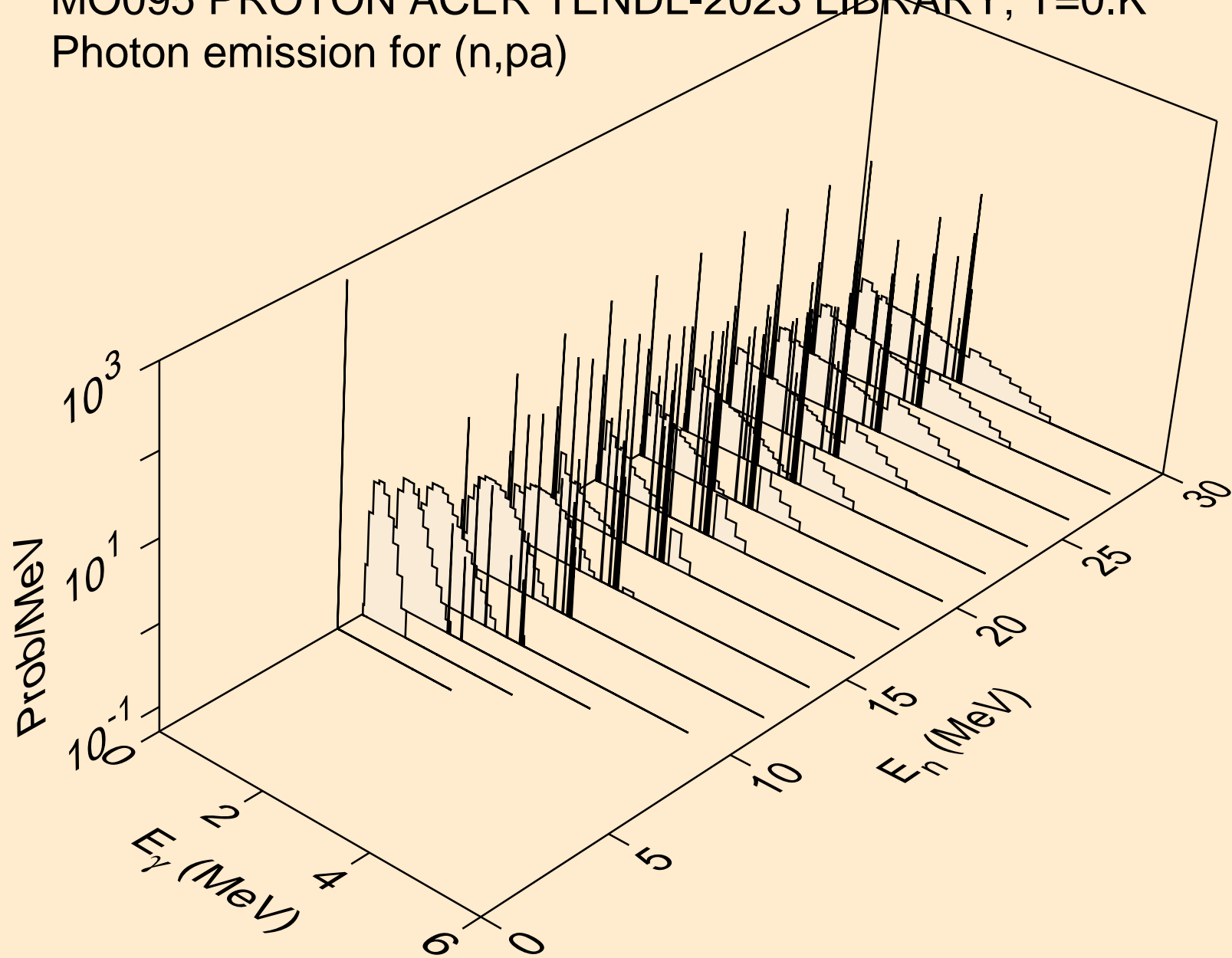

MO095 PROTON ACER TENDL-2023 LIBRARY; T=0.K  
Photon emission for (n,pd)

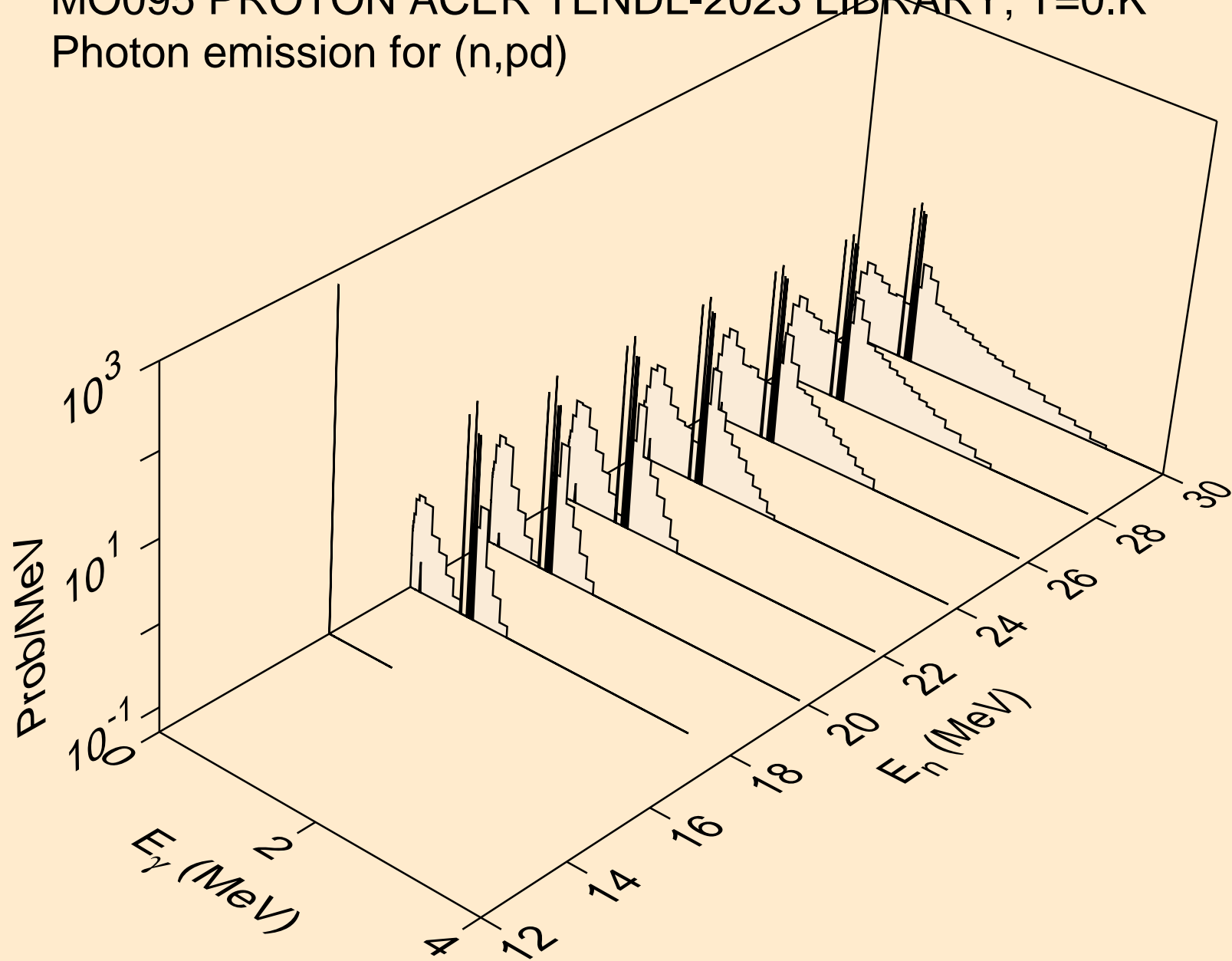

MO095 PROTON ACER TENDL-2023 LIBRARY; T=0.K  
Photon emission for (n,pt)

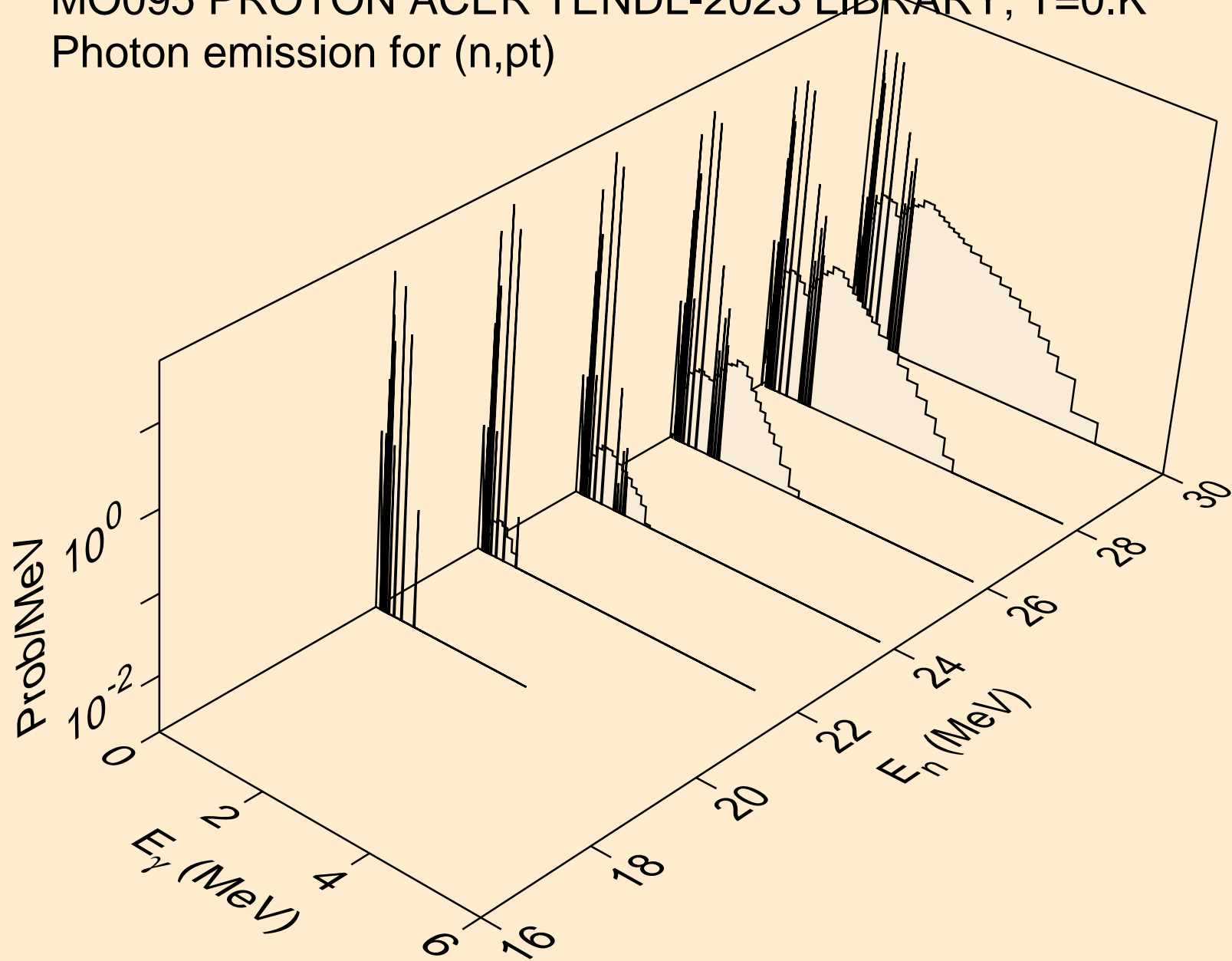

MO095 PROTON ACER TENDL-2023 LIBRARY; T=0.K  
Photon emission for (n,da)

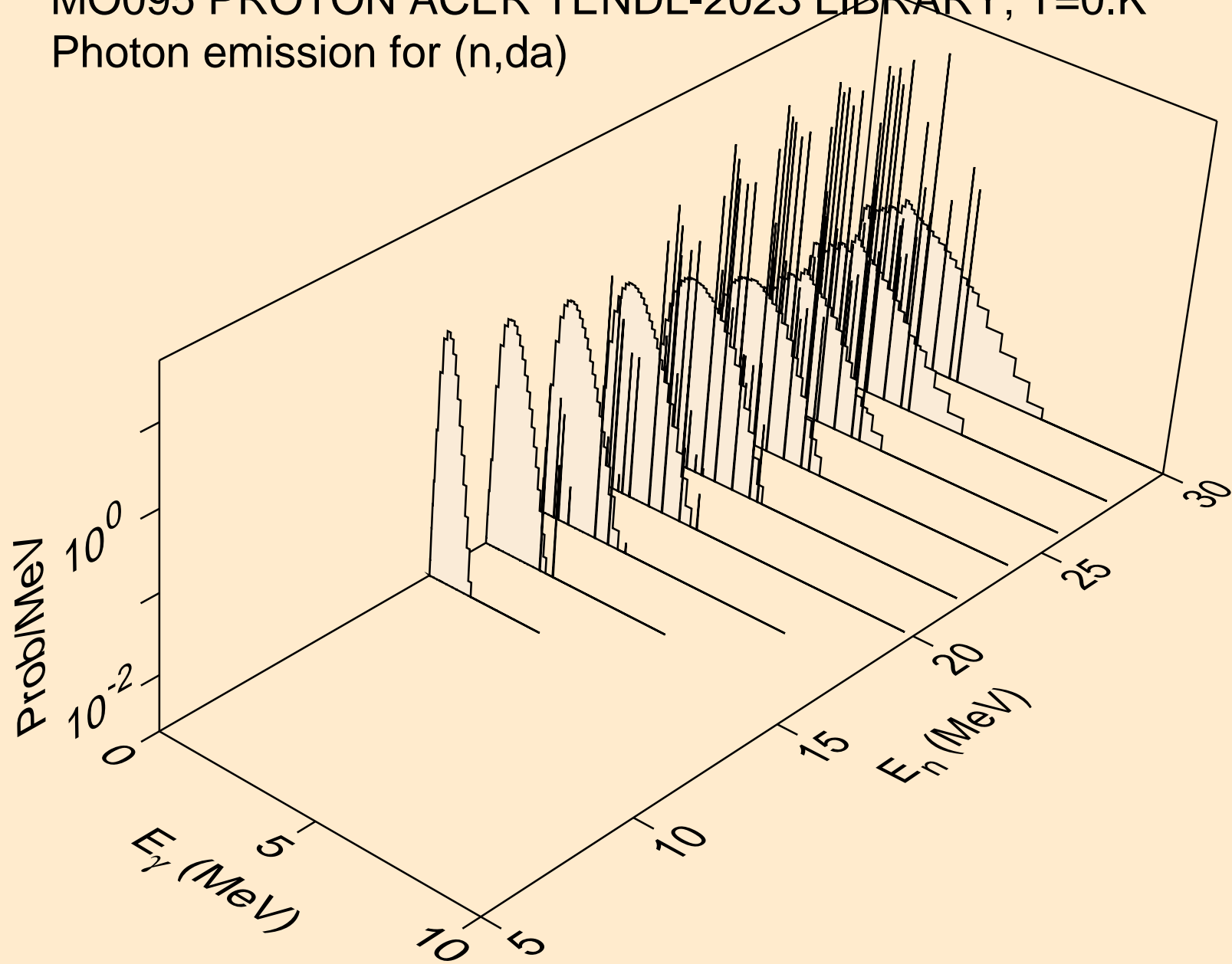



MO095 PROTON ACER TENDL-2023 LIBRARY; T=0.K  
Particle heating contributions

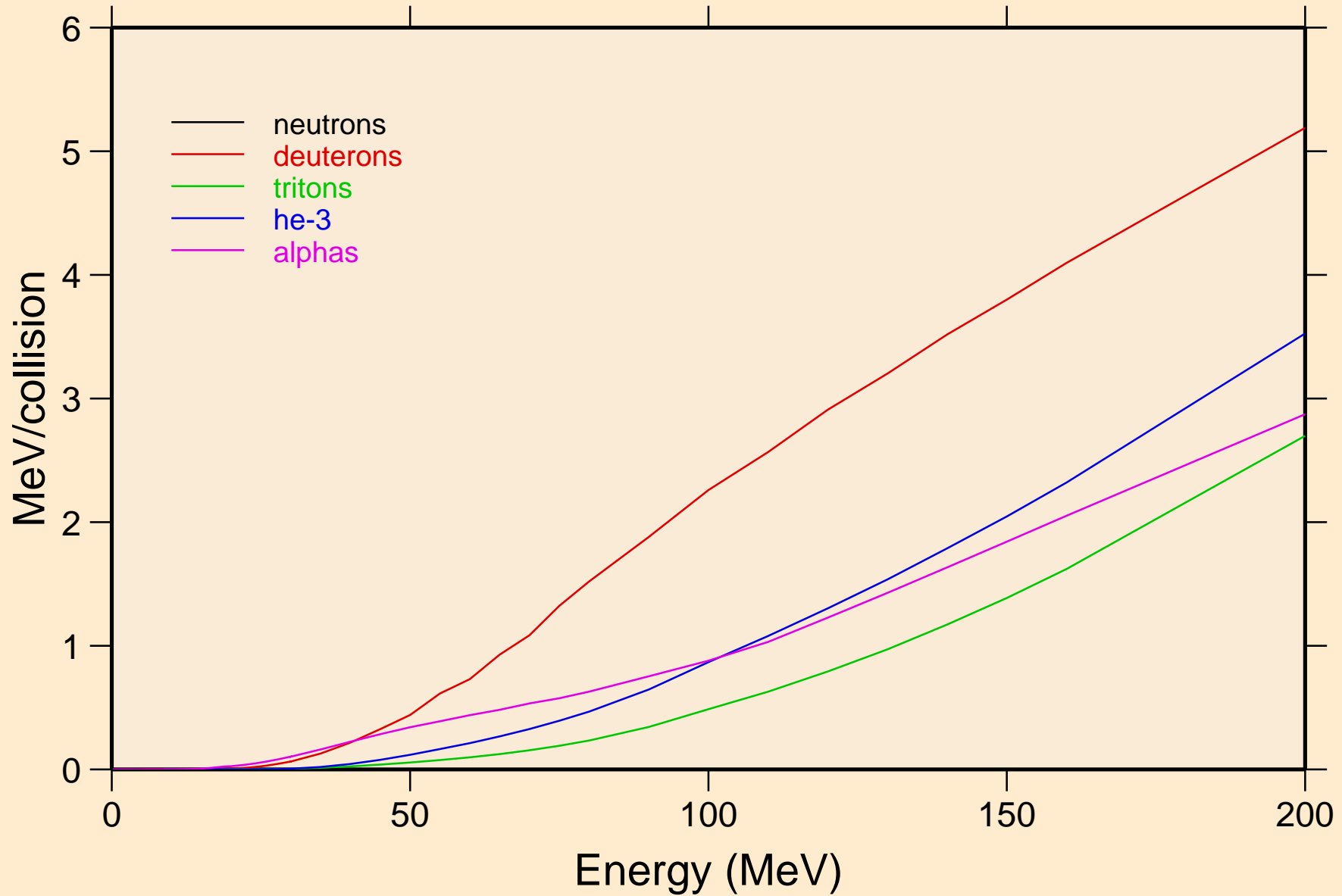

# MO095 PROTON ACER TENDL-2023 LIBRARY; T=0.K

## Recoil Heating

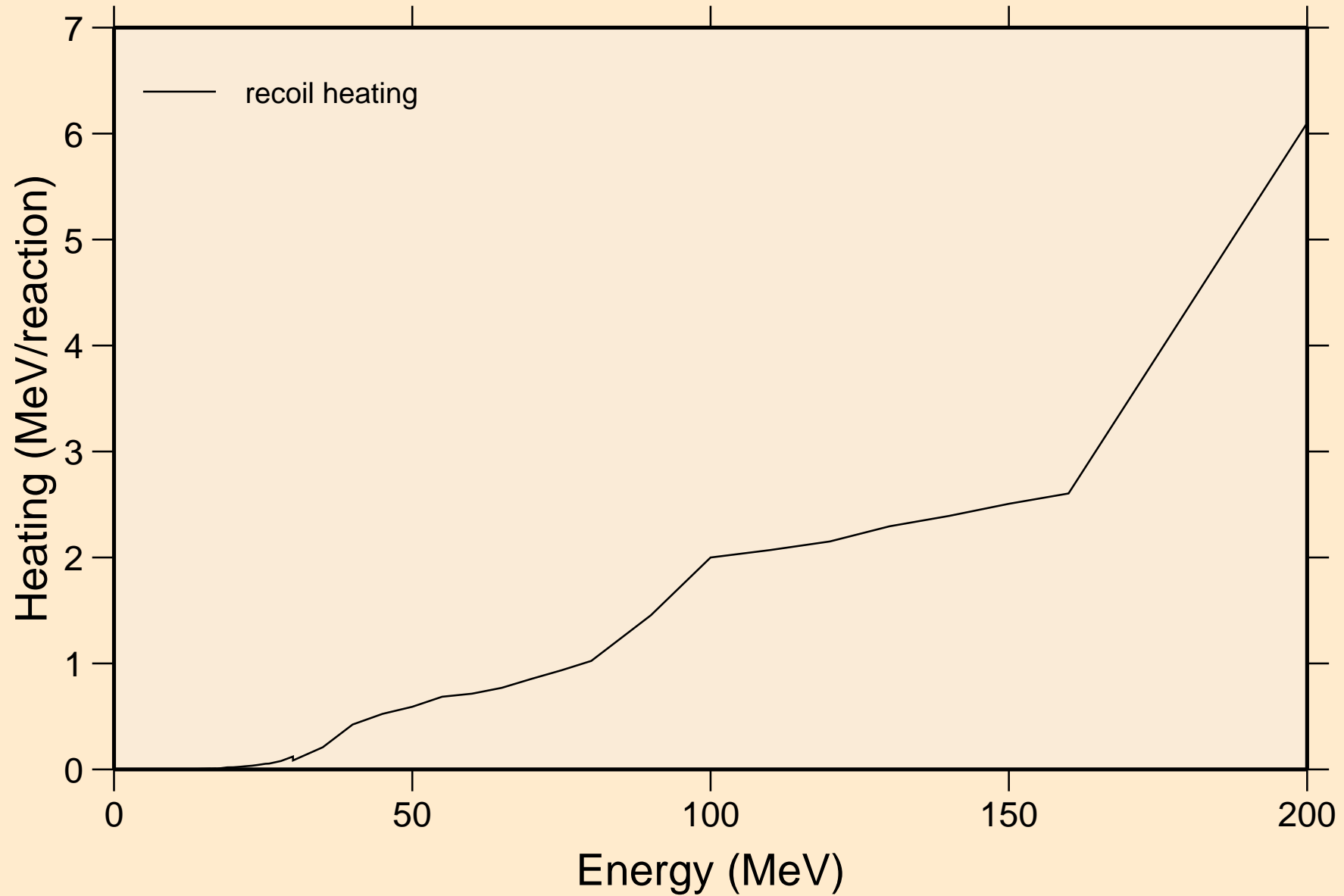

MO095 PROTON ACER TENDL-2023 LIBRARY; T=0.K  
Particle production cross sections

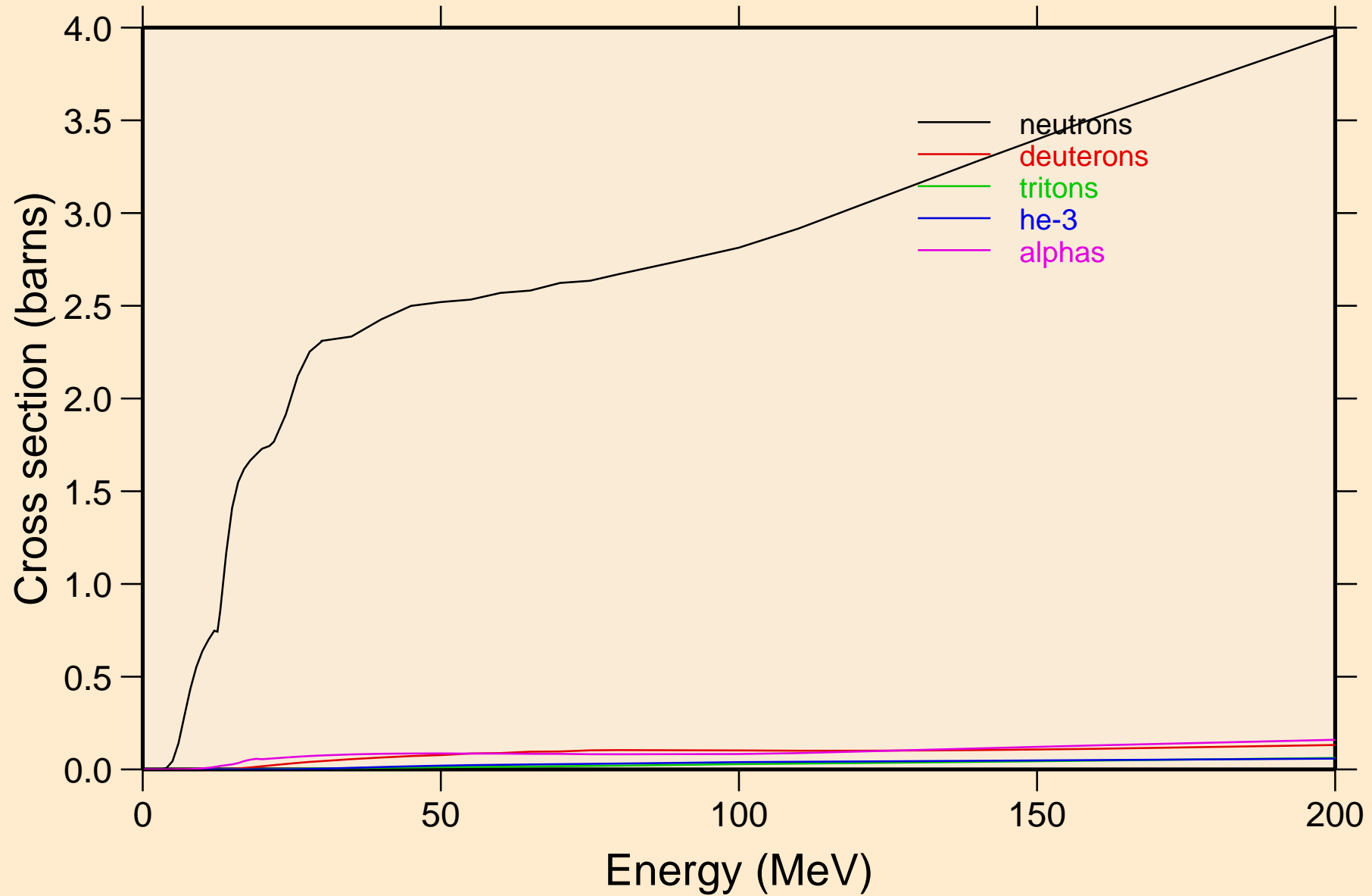

MO095 PROTON ACER TENDL-2023 LIBRARY; T=0.K  
neutrons from (p,n)

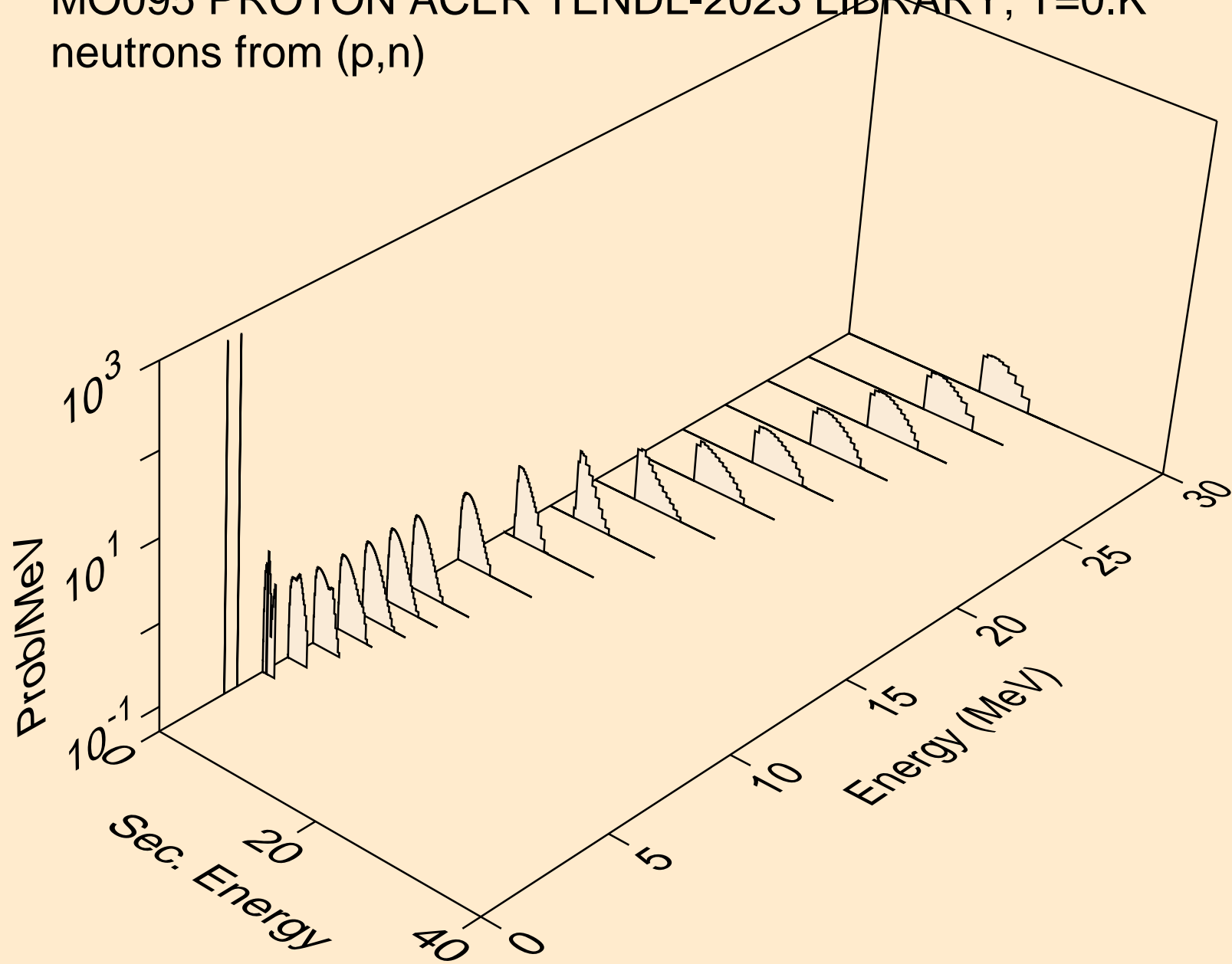

MO095 PROTON ACER TENDL-2023 LIBRARY; T=0.K  
neutrons from (p,x)

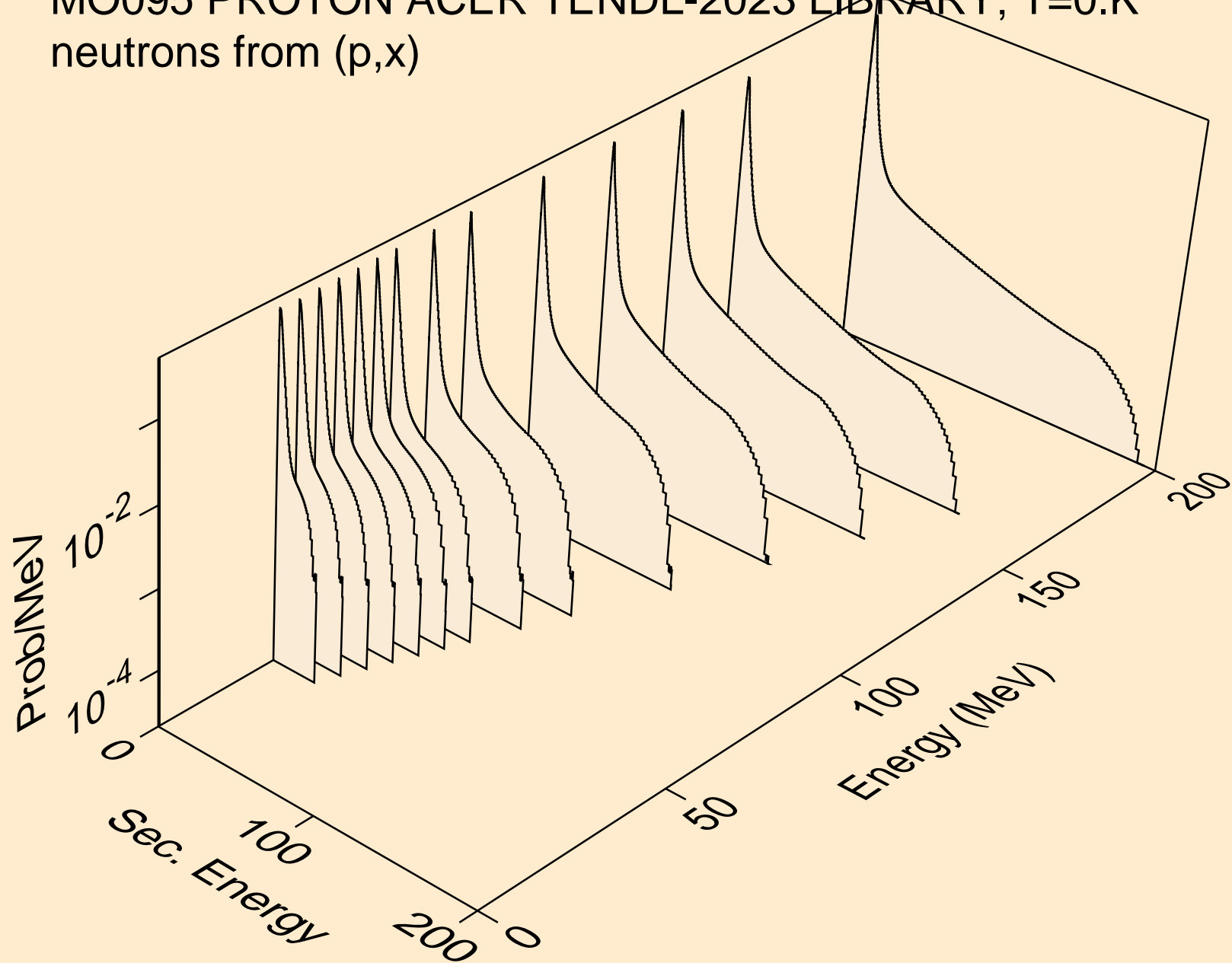

MO095 PROTON ACER TENDL-2023 LIBRARY; T=0.K  
neutrons from (p,2nd)

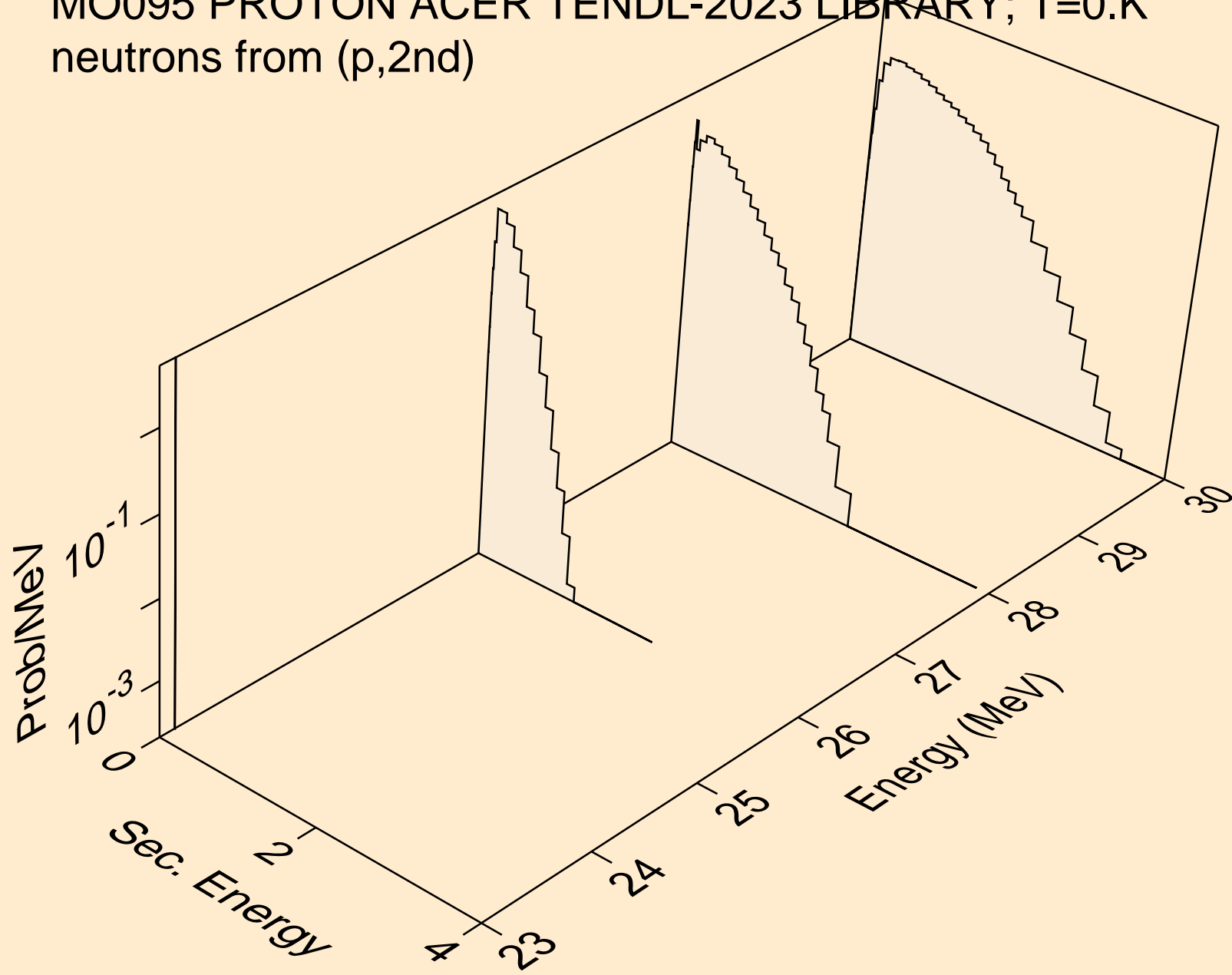

MO095 PROTON ACER TENDL-2023 LIBRARY; T=0.K  
neutrons from (p,2n)

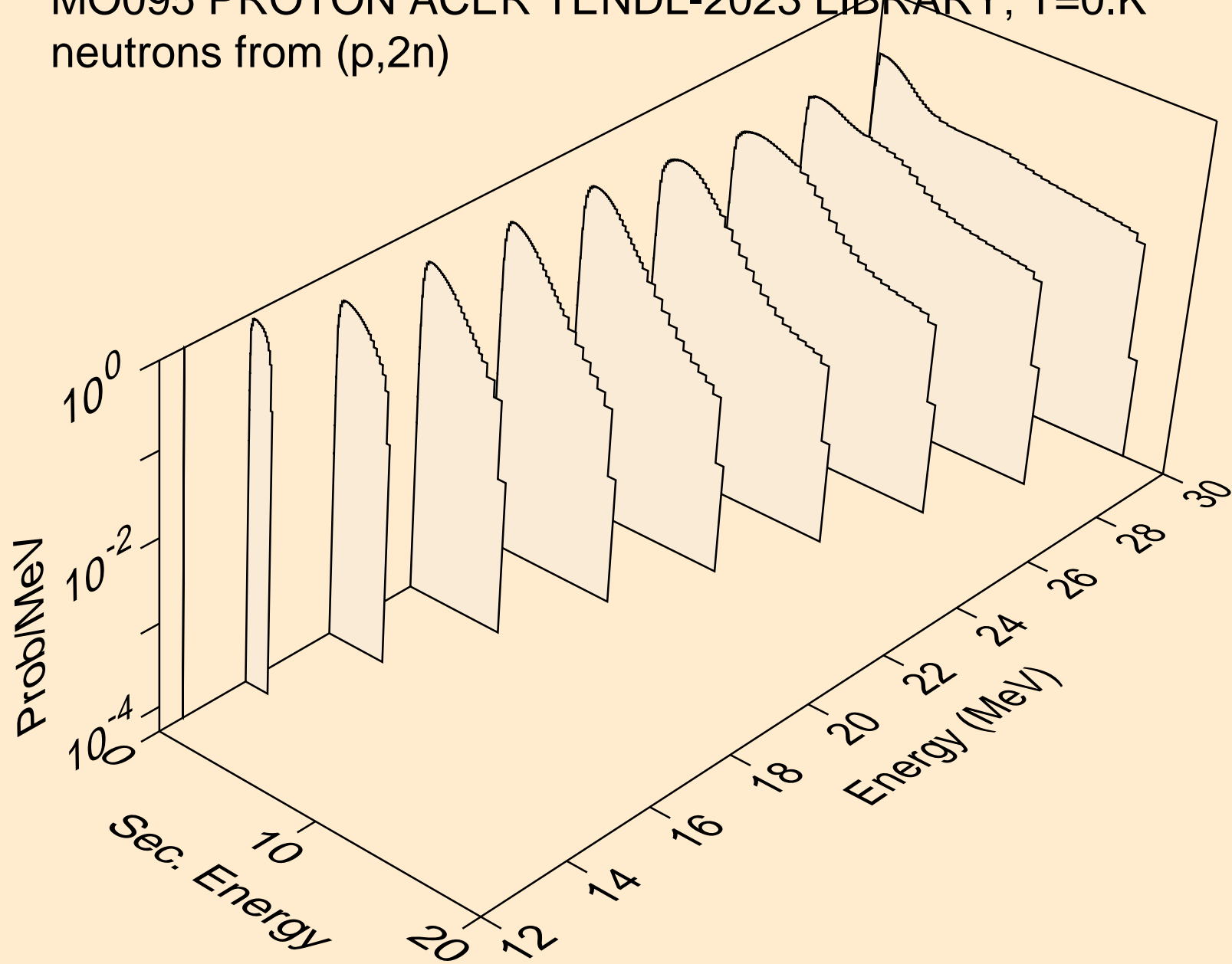

MO095 PROTON ACER TENDL-2023 LIBRARY; T=0.K  
neutrons from (p,3n)

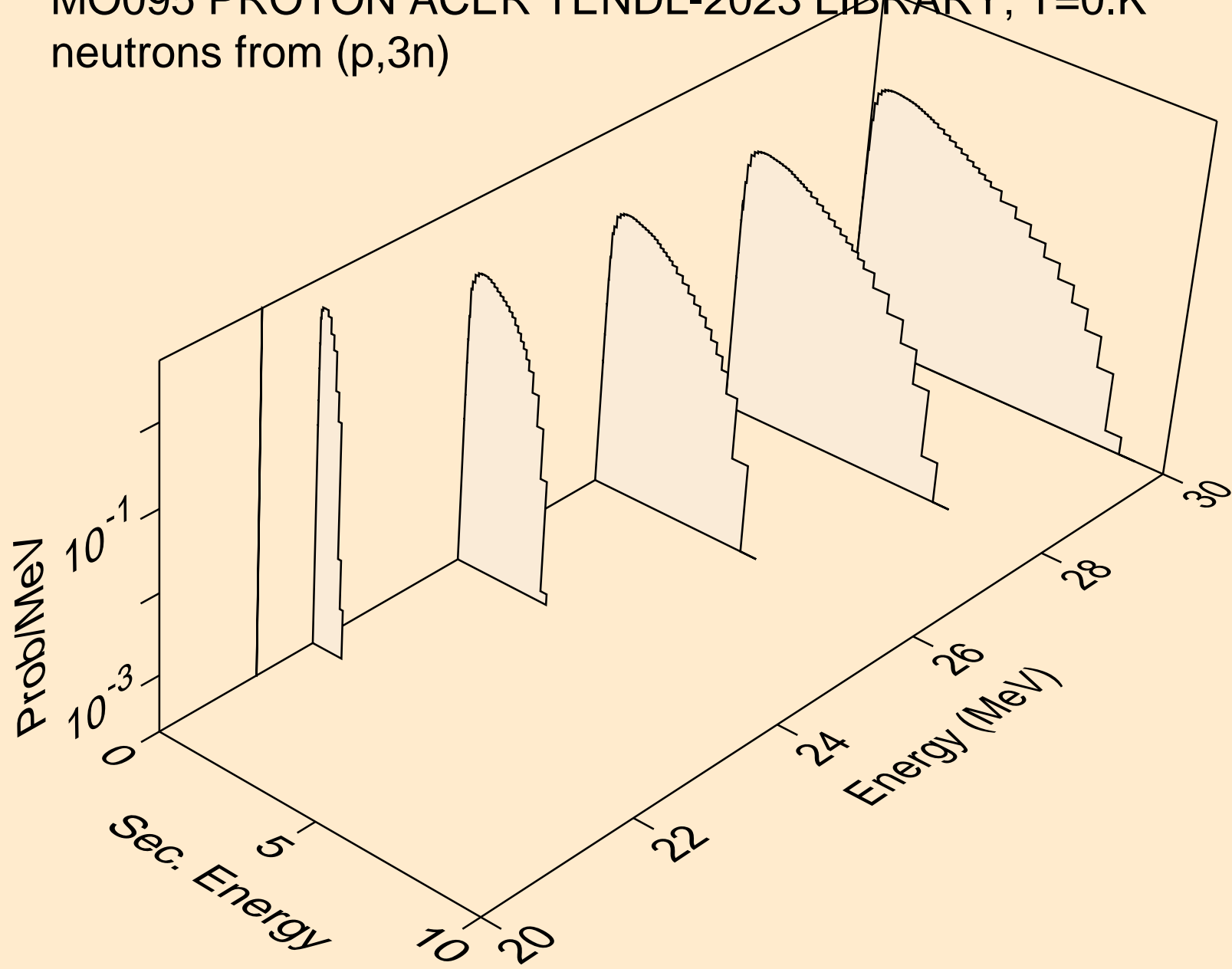



MO095 PROTON ACER TENDL-2023 LIBRARY; T=0.K  
neutrons from (p,n\*)a

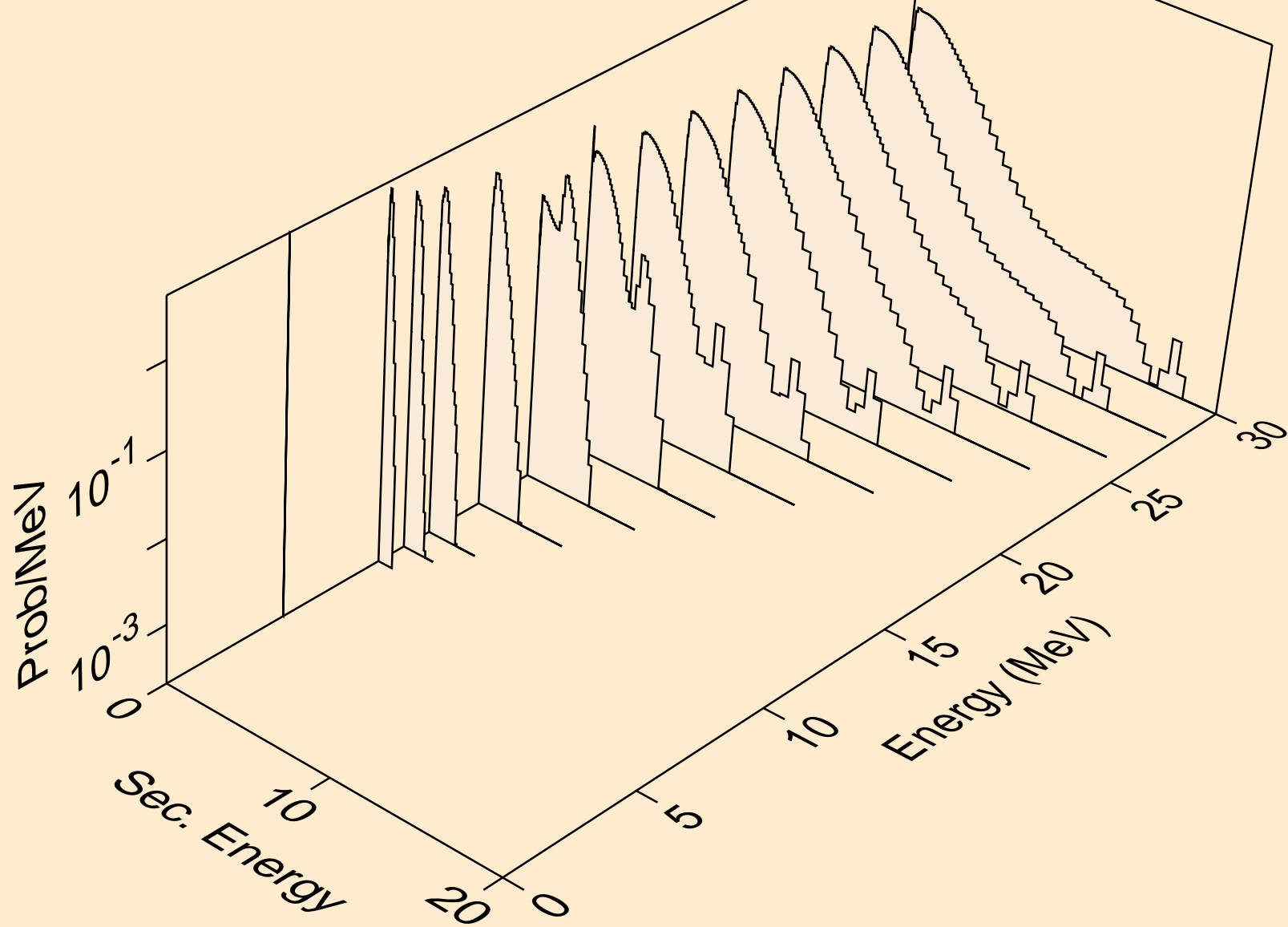

MO095 PROTON ACER TENDL-2023 LIBRARY; T=0.K  
neutrons from (p,2n)a

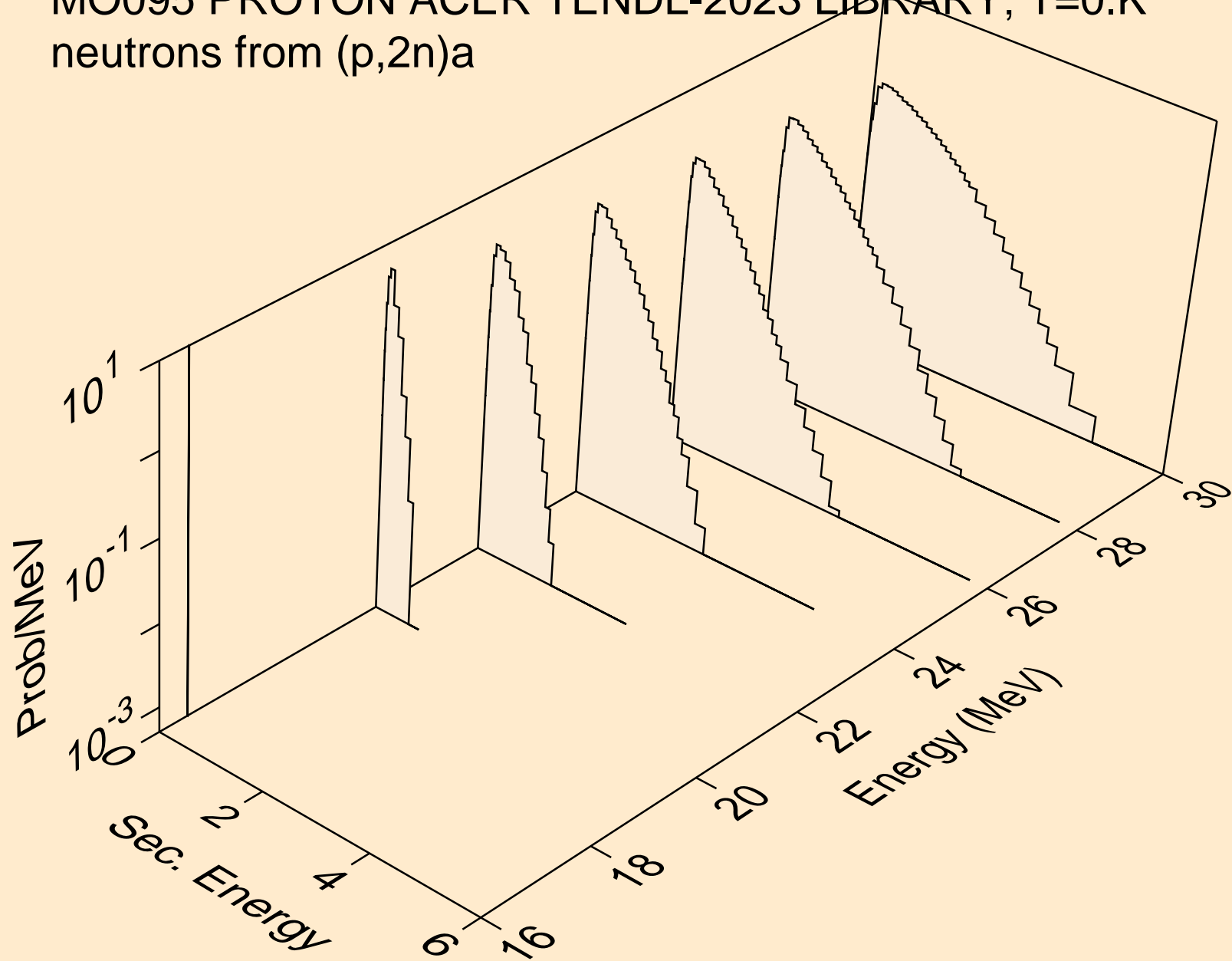

MO095 PROTON ACER TENDL-2023 LIBRARY; T=0.K  
neutrons from (p,n\*)p

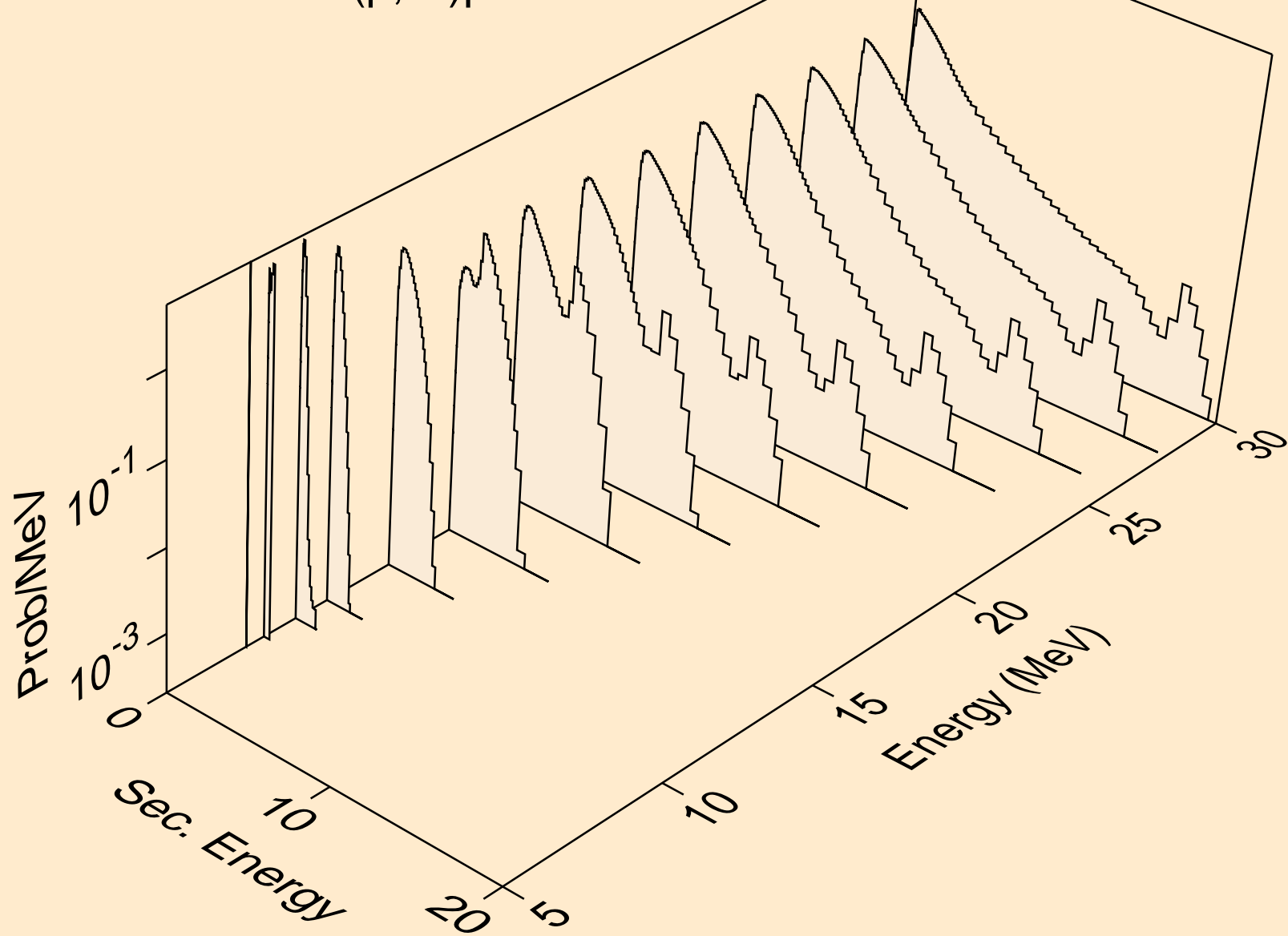

MO095 PROTON ACER TENDL-2023 LIBRARY; T=0.K  
neutrons from (p,n\*)2a

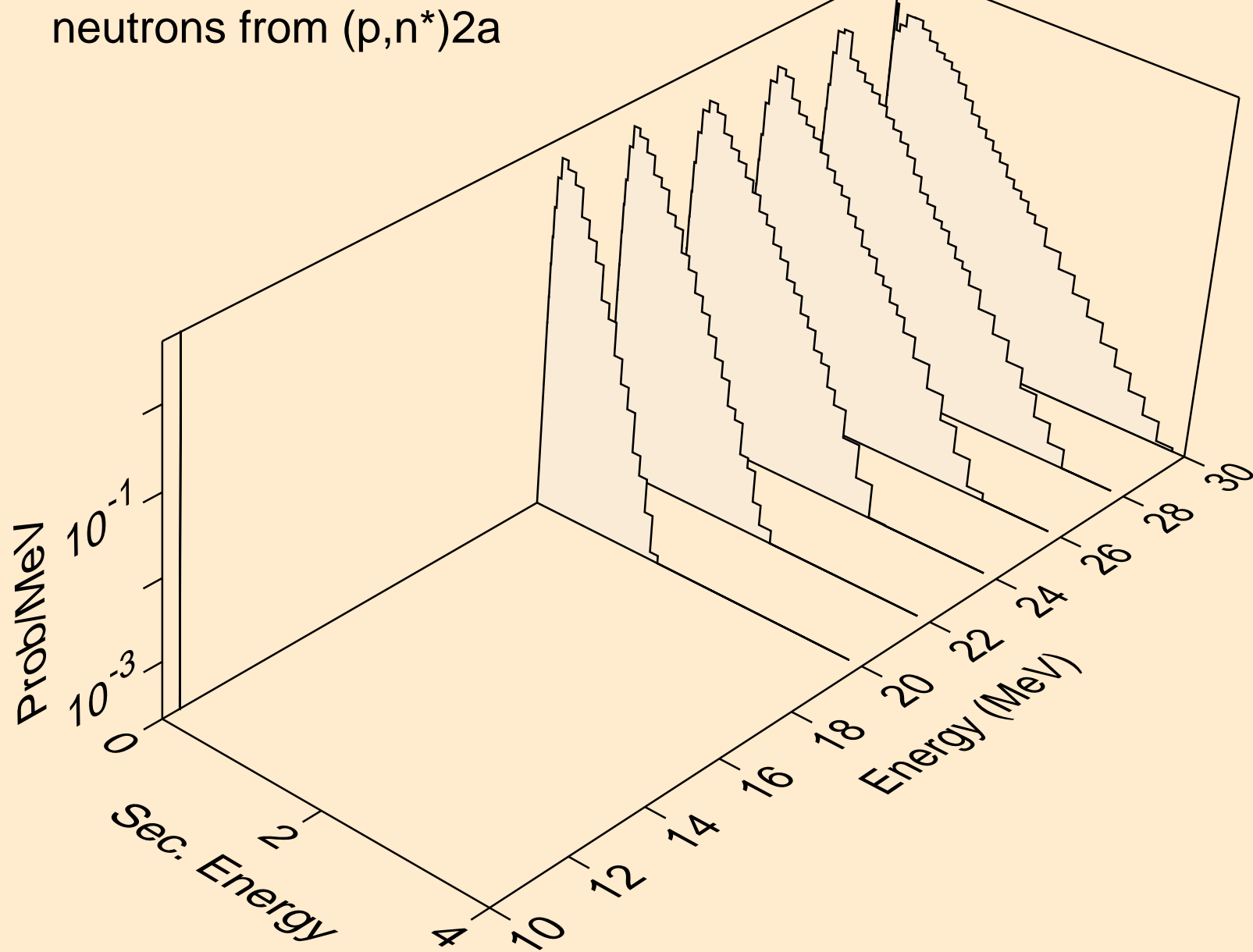

MO095 PROTON ACER TENDL-2023 LIBRARY; T=0.K  
neutrons from (p,n\*)d

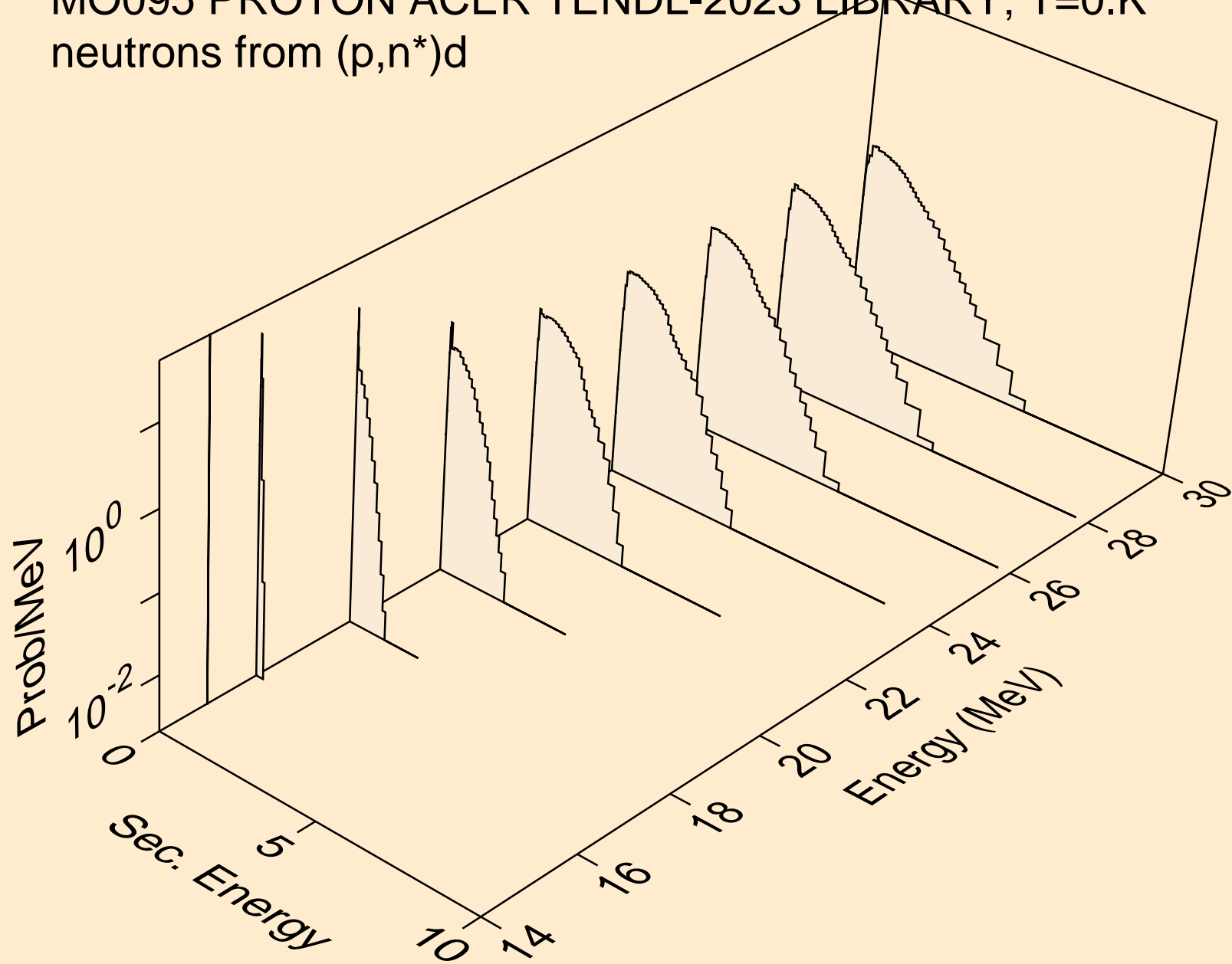

MO095 PROTON ACER TENDL-2023 LIBRARY; T=0.K  
neutrons from (p,n\*)t

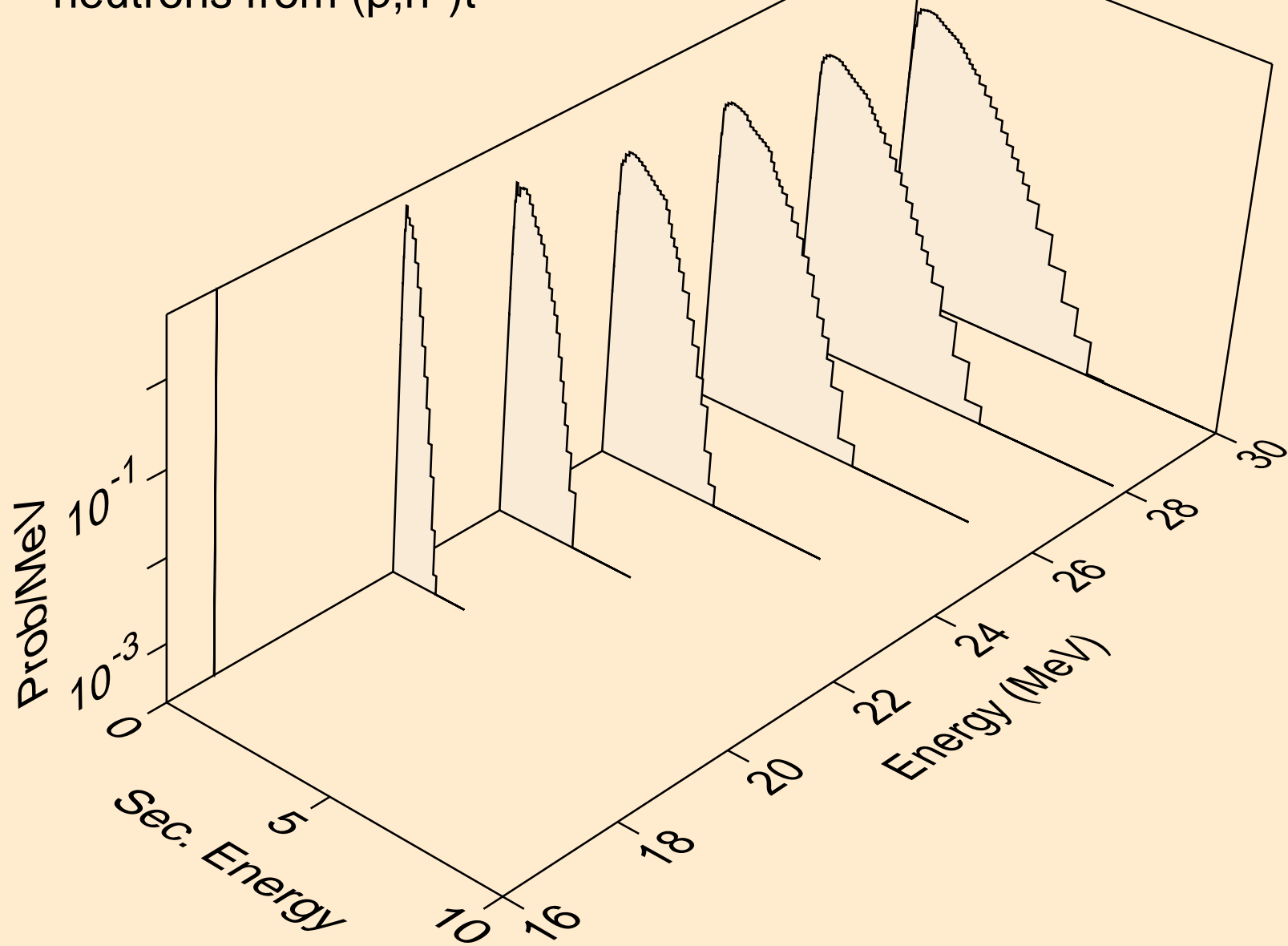

MO095 PROTON ACER TENDL-2023 LIBRARY; T=0.K  
neutrons from (p,n\*)he3

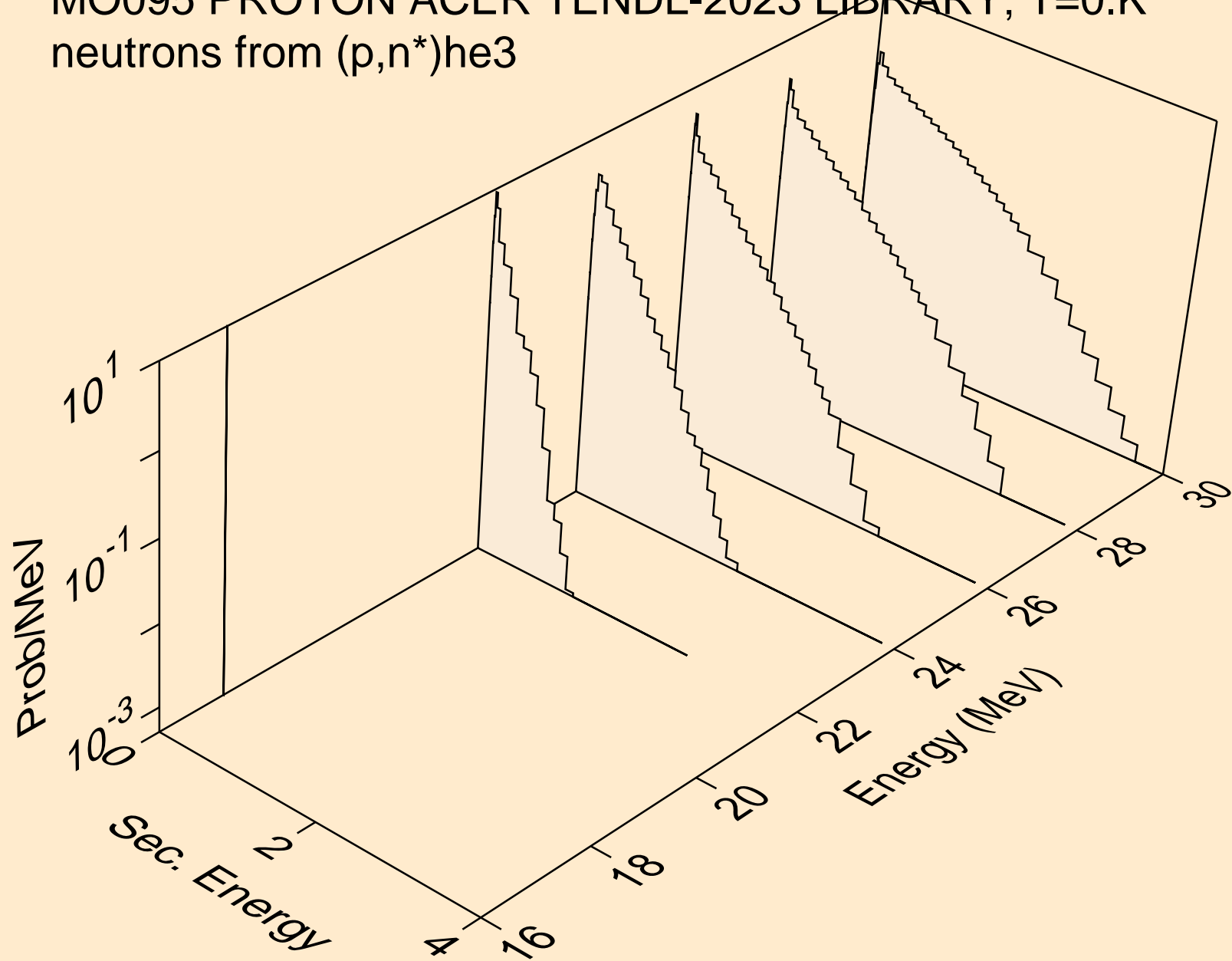

MO095 PROTON ACER TENDL-2023 LIBRARY; T=0.K  
neutrons from (p,2np)

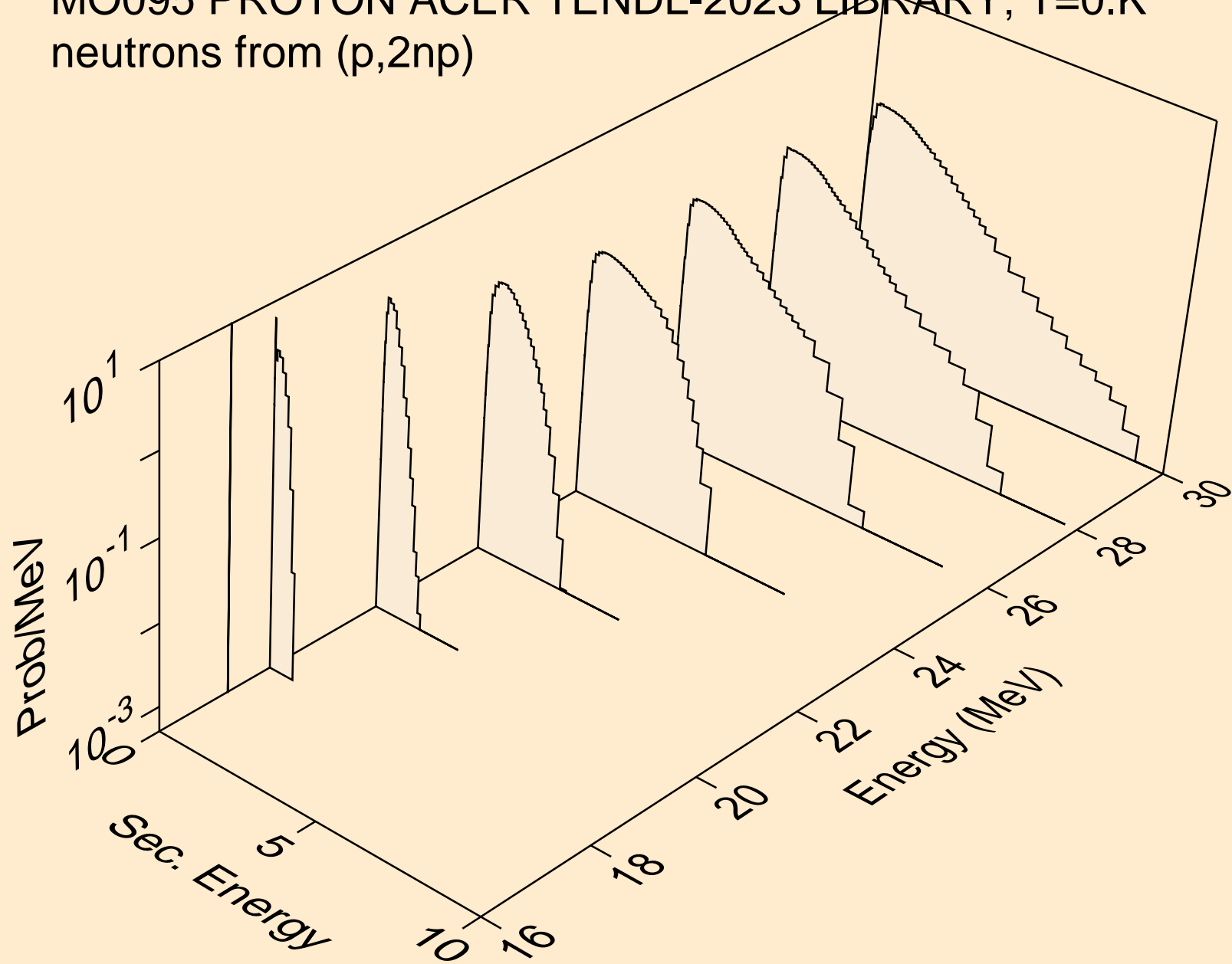



MO095 PROTON ACER TENDL-2023 LIBRARY; T=0.K  
neutrons from (p,3np)

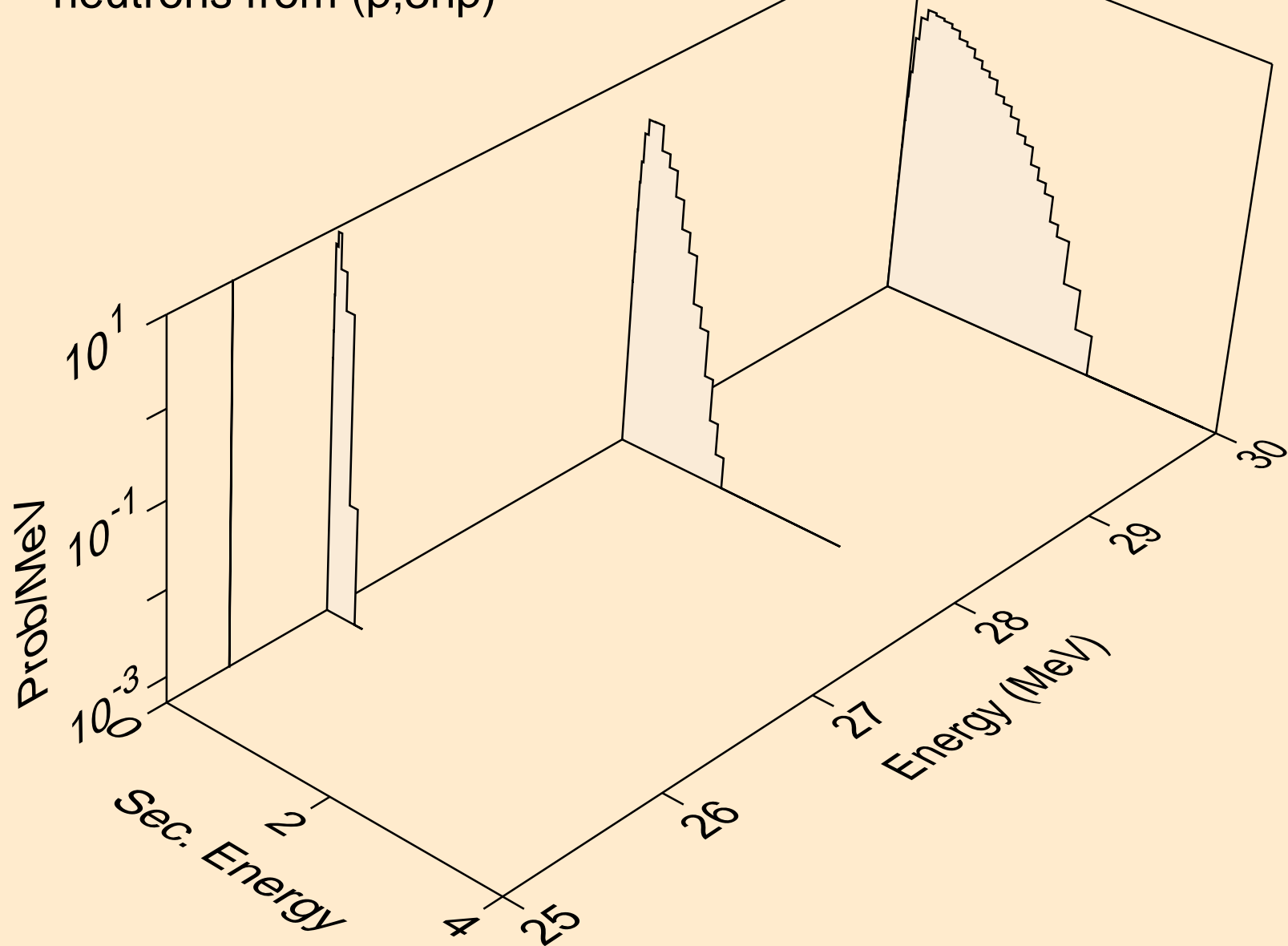

MO095 PROTON ACER TENDL-2023 LIBRARY; T=0.K  
neutrons from (p,n2p)

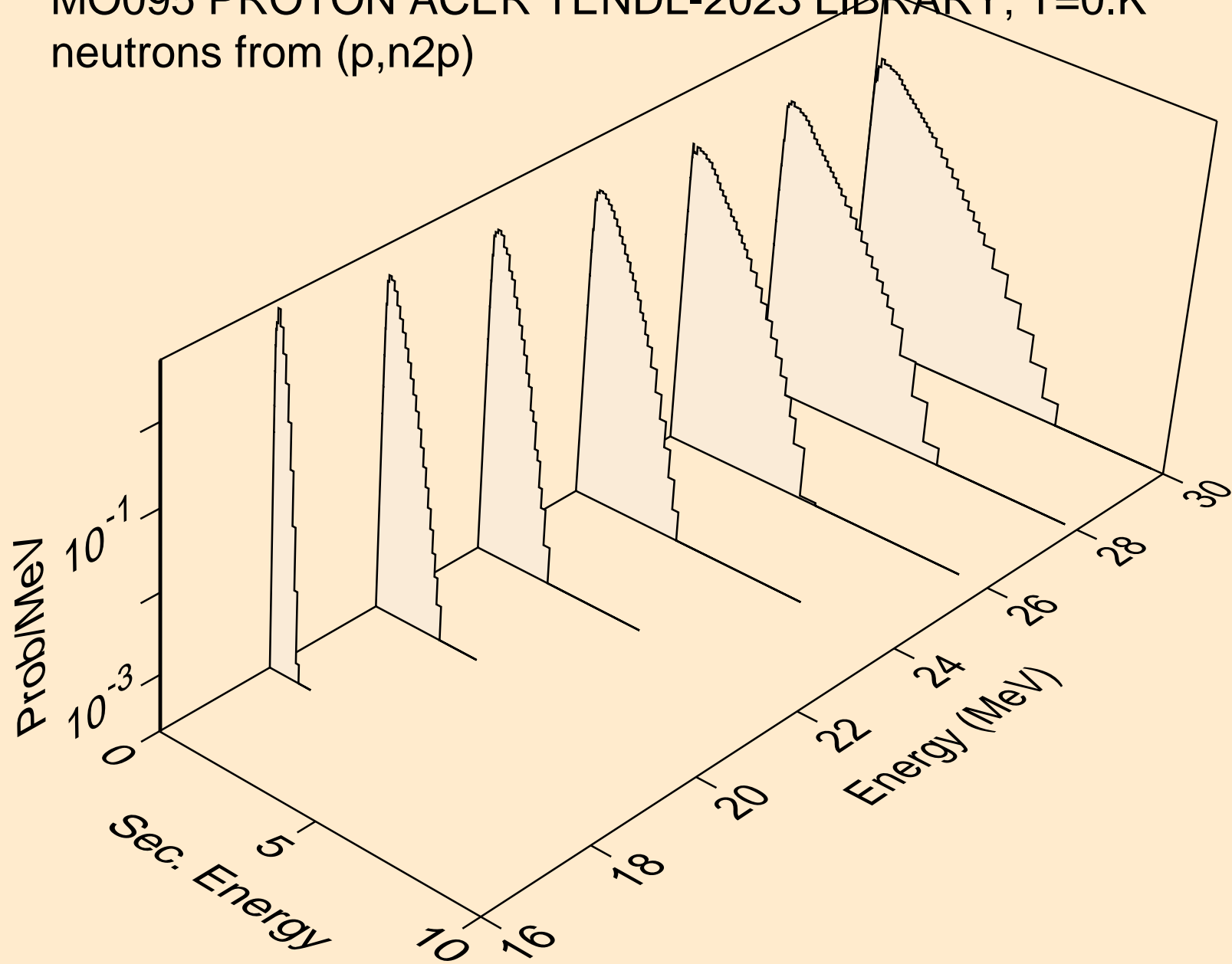

MO095 PROTON ACER TENDL-2023 LIBRARY; T=0.K  
neutrons from (p,npa)

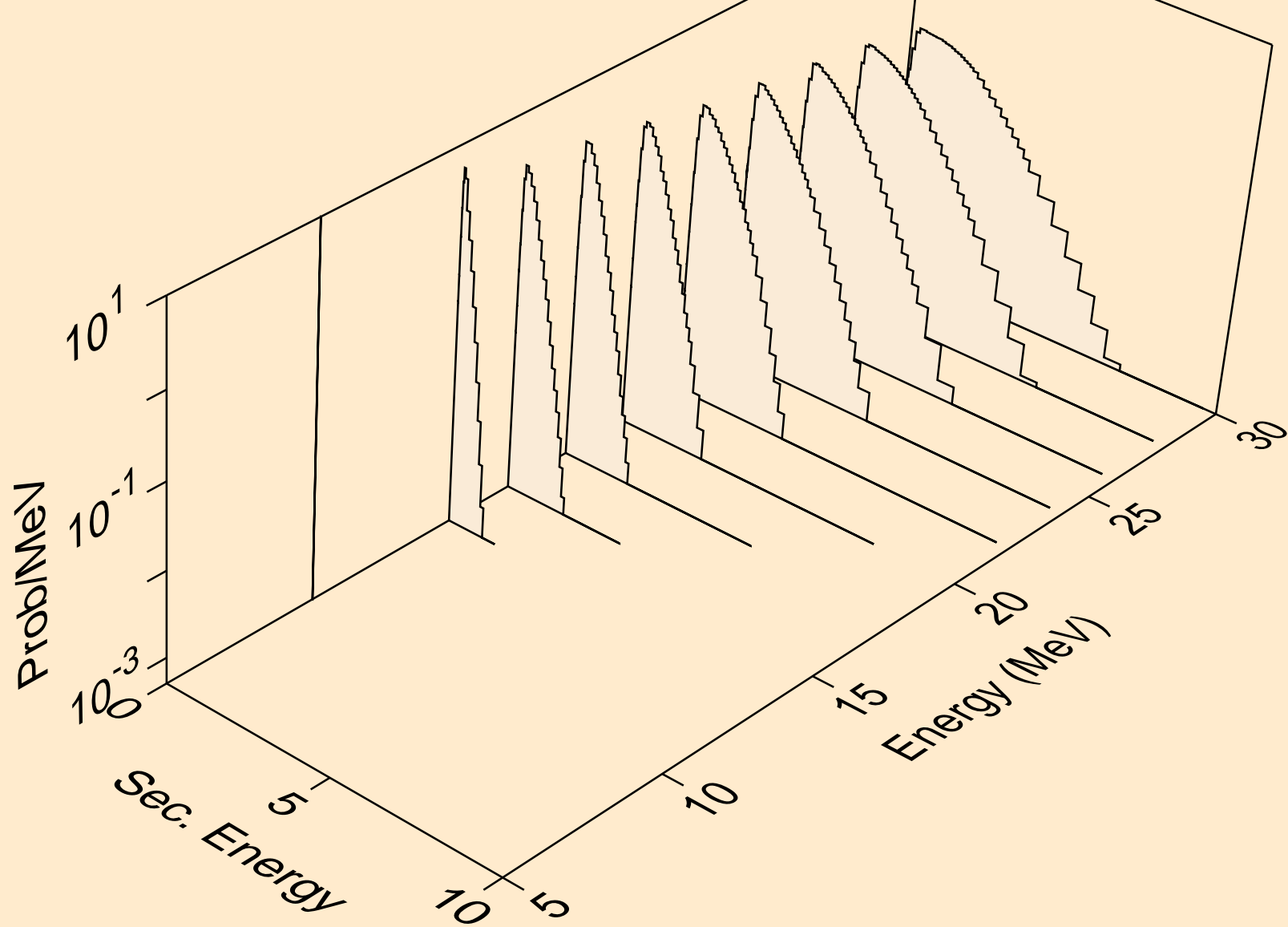

MO095 PROTON ACER TENDL-2023 LIBRARY; T=0.K  
deuterons from (p,x)

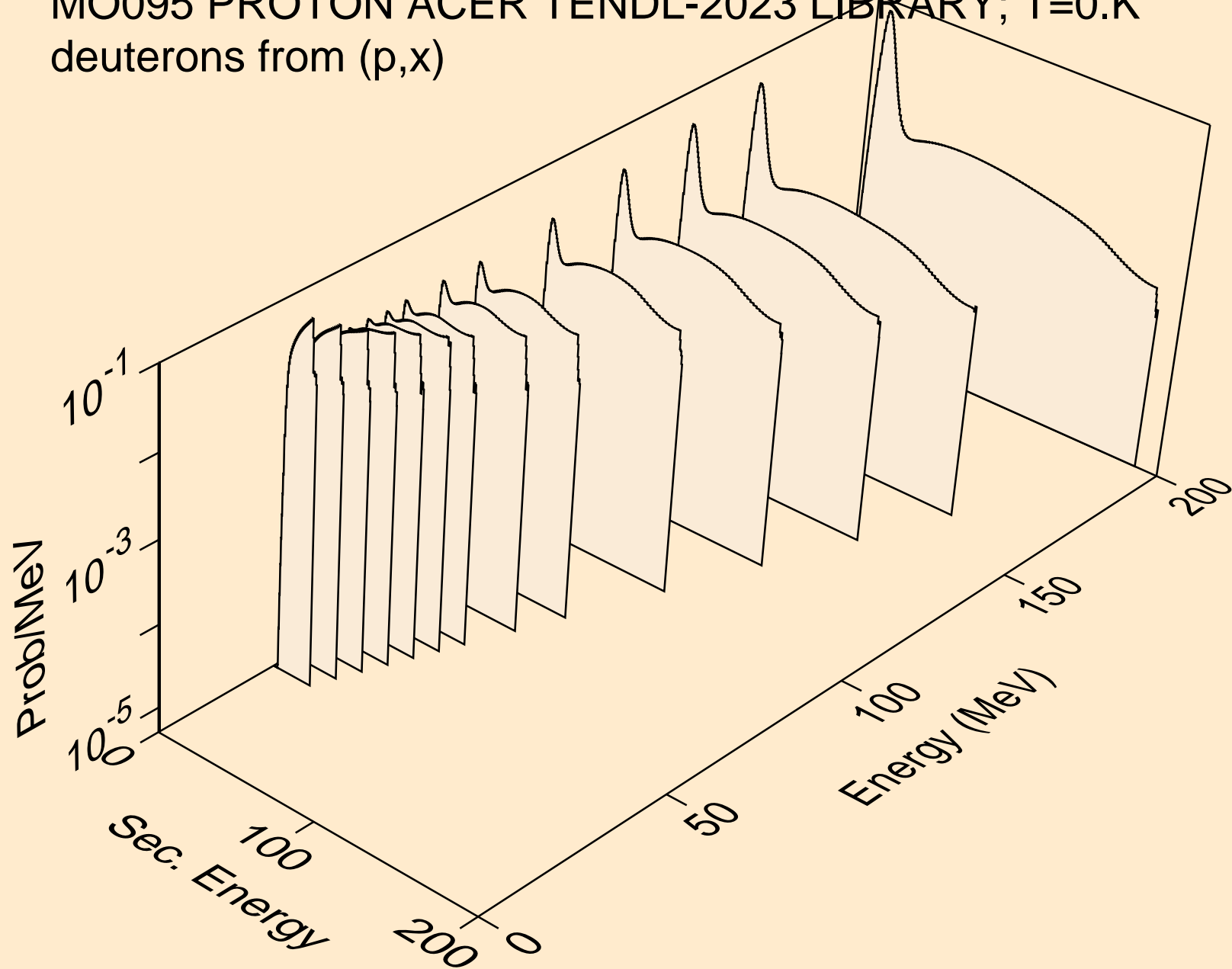

MO095 PROTON ACER TENDL-2023 LIBRARY; T=0.K  
deuterons from (p,2nd)

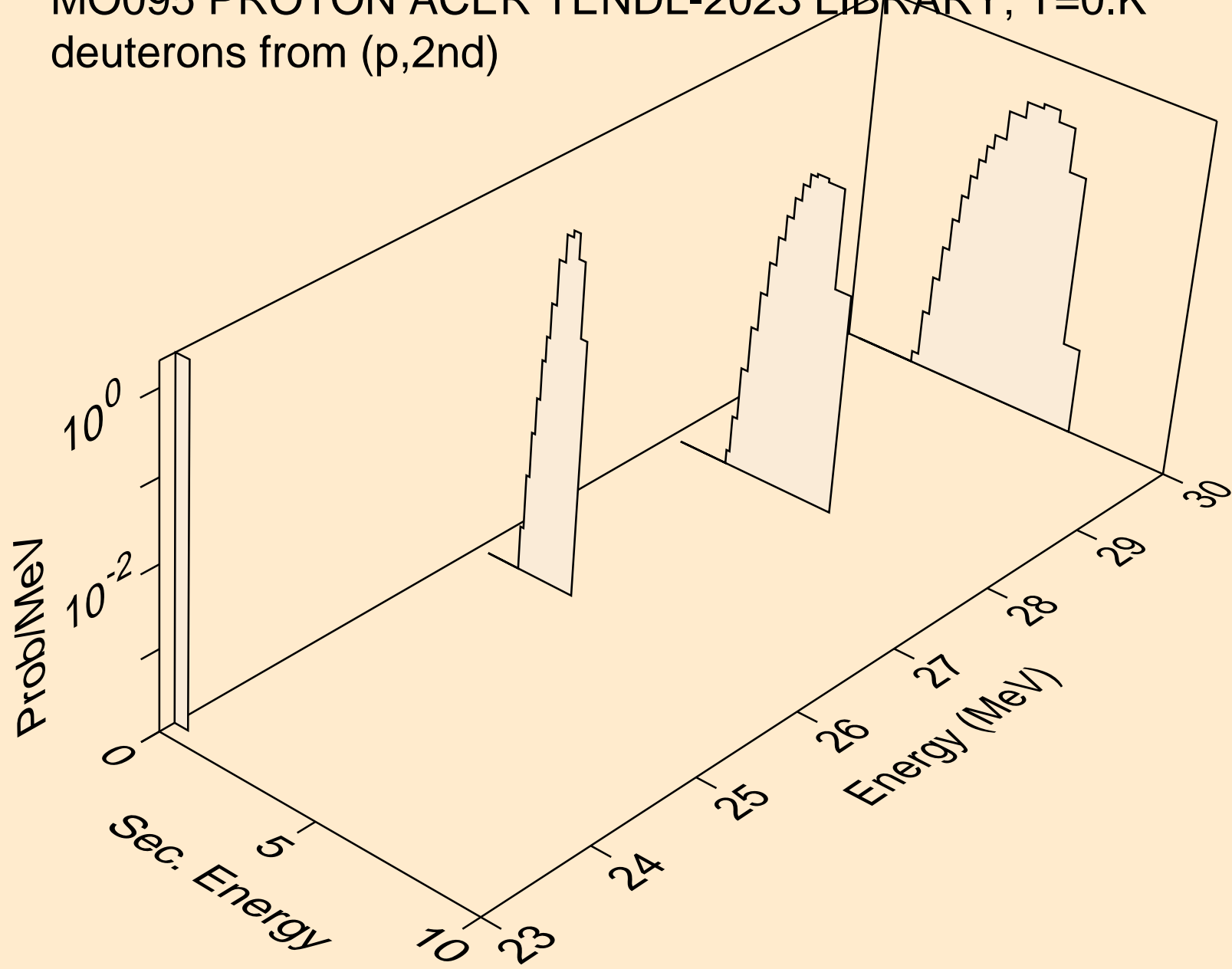

MO095 PROTON ACER TENDL-2023 LIBRARY; T=0.K  
deuterons from (p,n\*)d

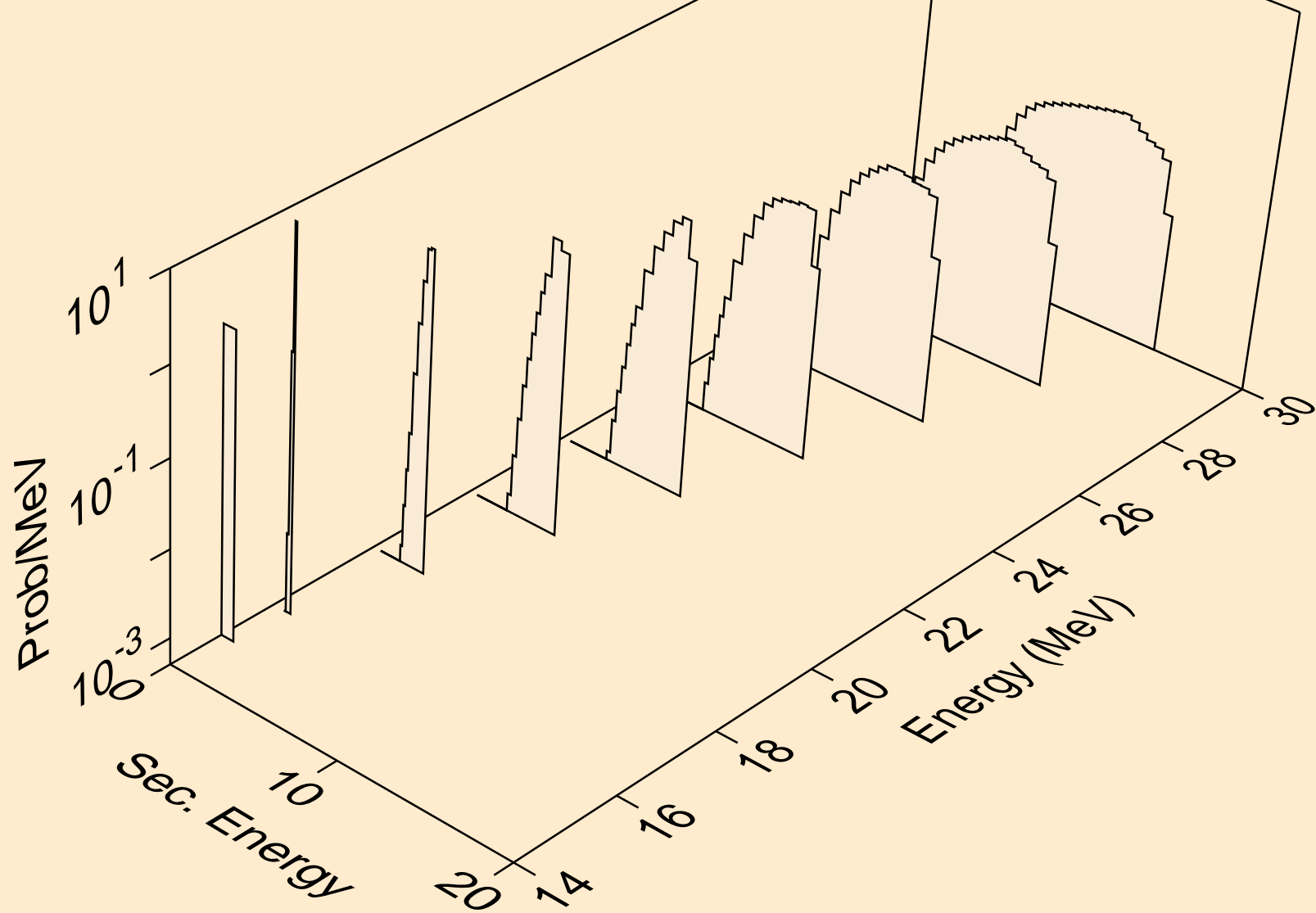

MO095 PROTON ACER TENDL-2023 LIBRARY; T=0.K  
deuterons from (p,d)

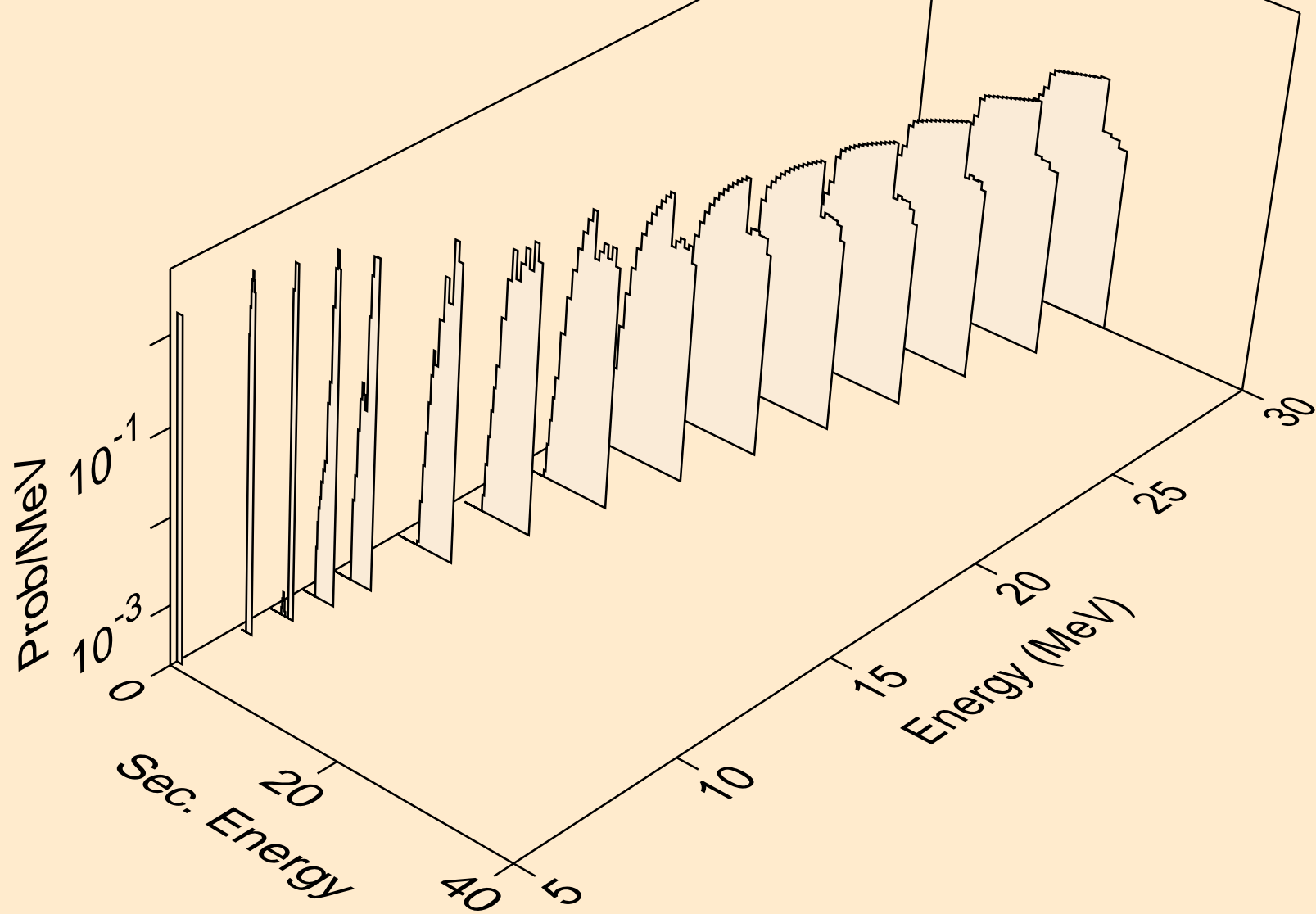

MO095 PROTON ACER TENDL-2023 LIBRARY; T=0.K  
deuterons from (p,pd)

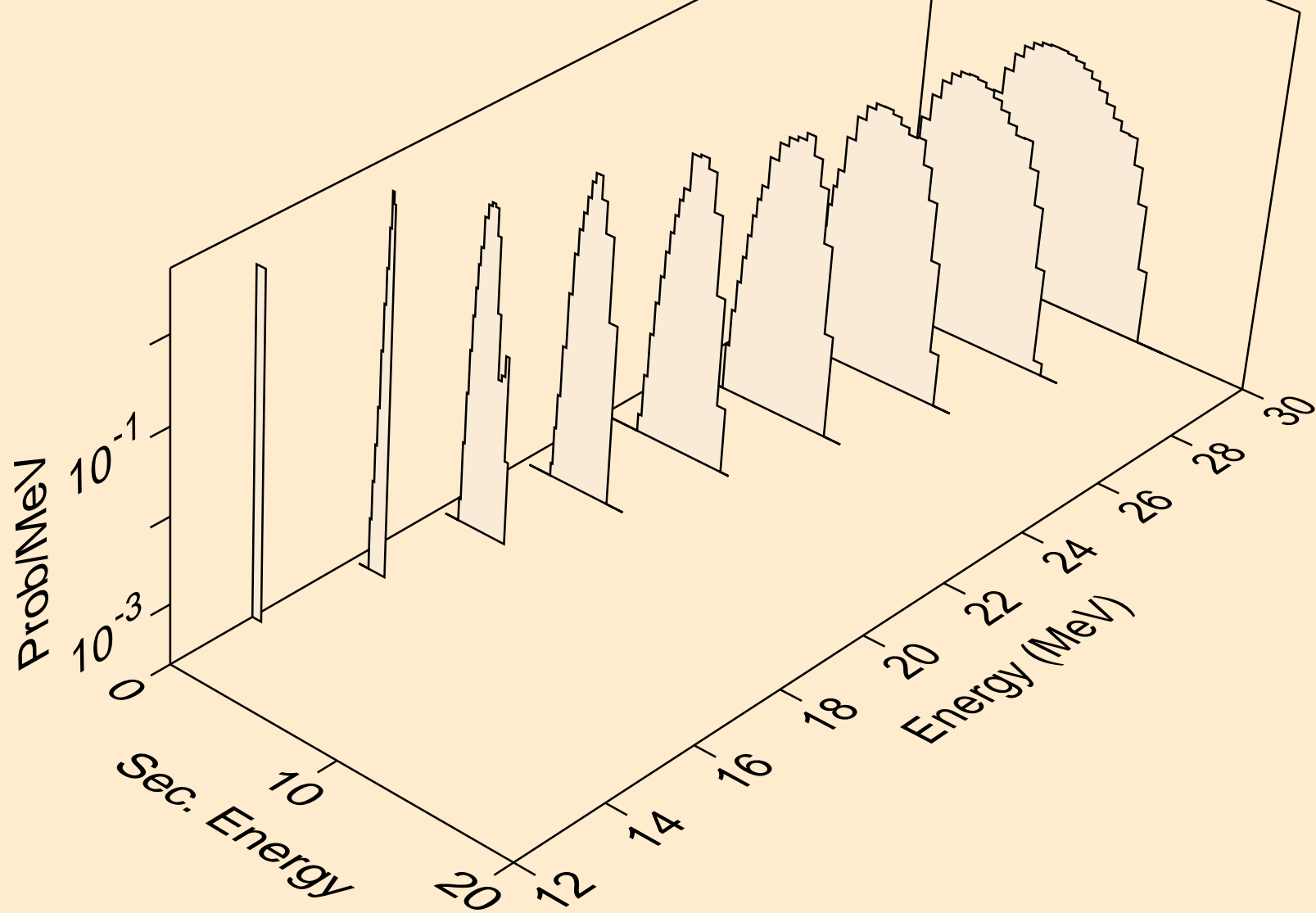



MO095 PROTON ACER TENDL-2023 LIBRARY; T=0.K  
deuterons from (p,da)

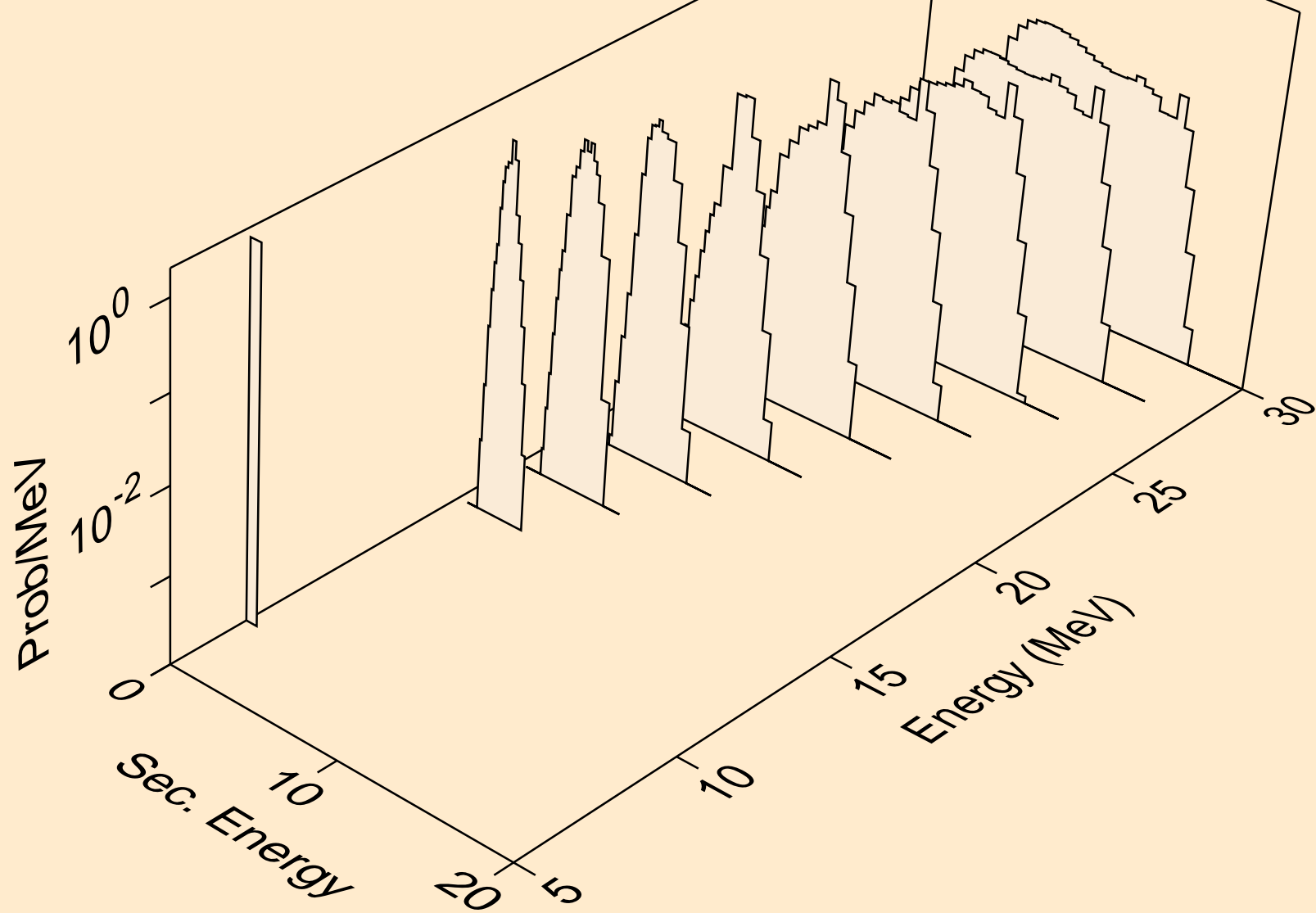

MO095 PROTON ACER TENDL-2023 LIBRARY; T=0.K  
tritons from (p,x)

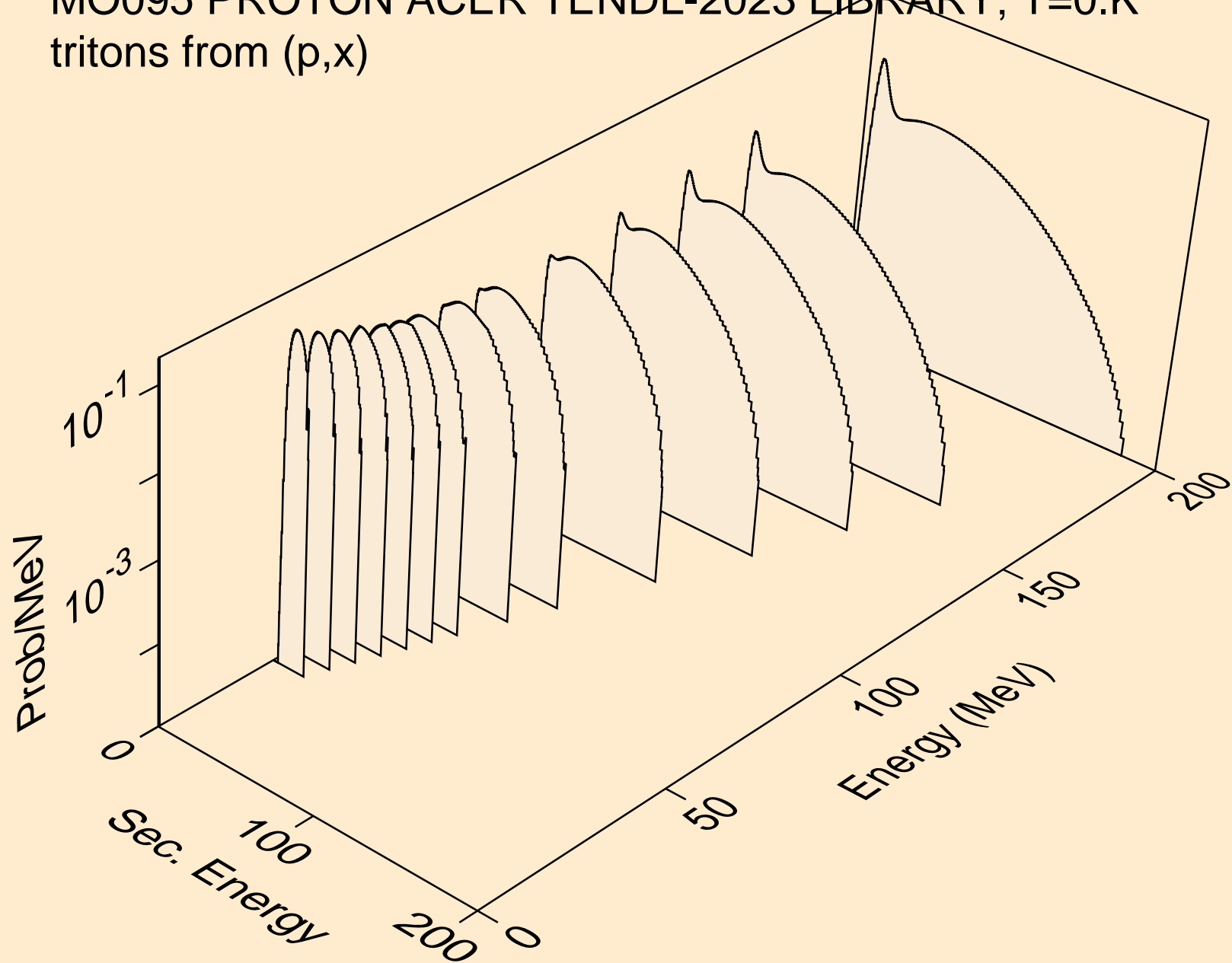

MO095 PROTON ACER TENDL-2023 LIBRARY; T=0.K  
tritons from (p,n\*)t

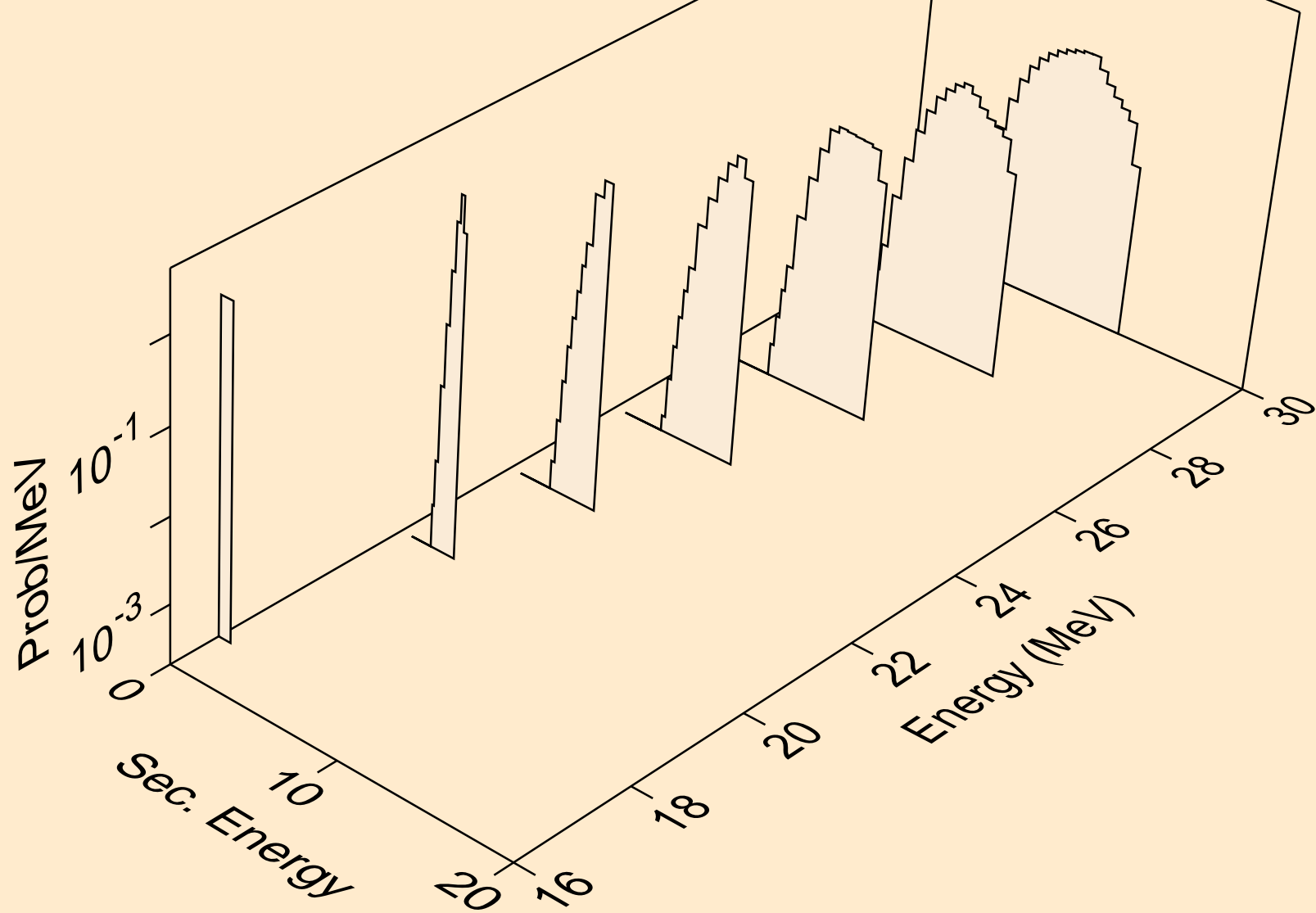

MO095 PROTON ACER TENDL-2023 LIBRARY; T=0.K  
tritons from (p,t)

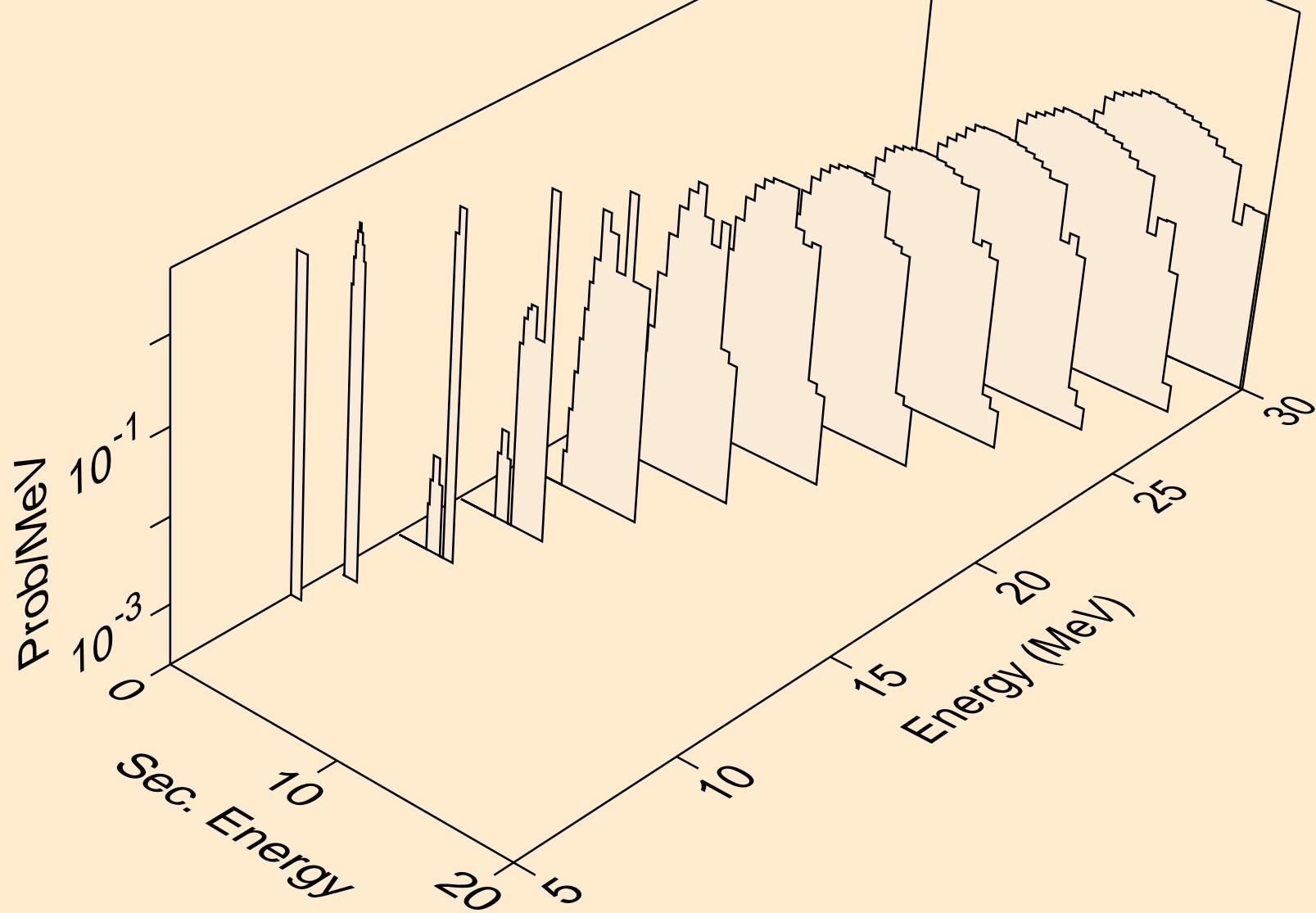

MO095 PROTON ACER TENDL-2023 LIBRARY; T=0.K  
tritons from (p,pt)

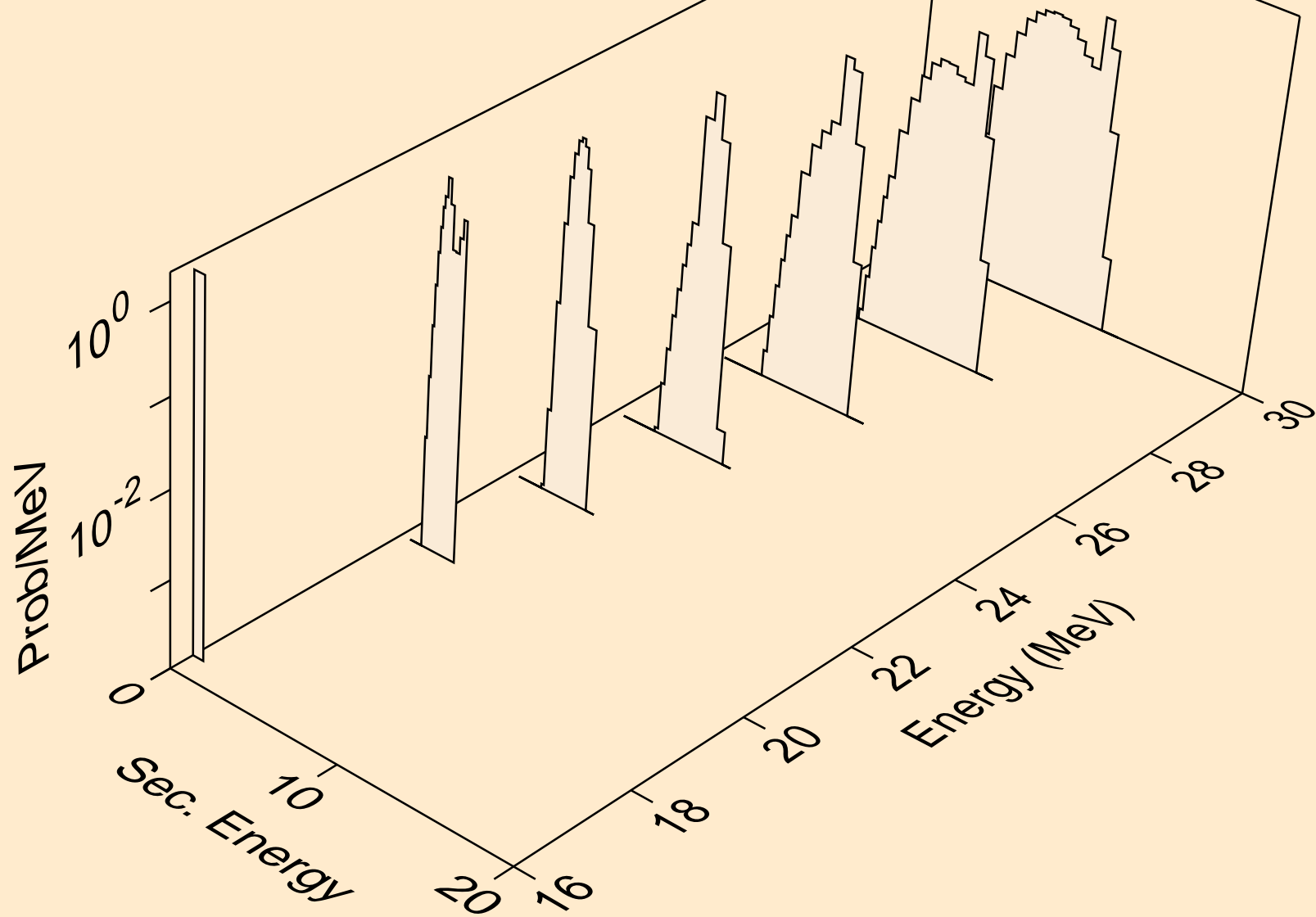

MO095 PROTON ACER TENDL-2023 LIBRARY; T=0.K  
he3s from (p,x)

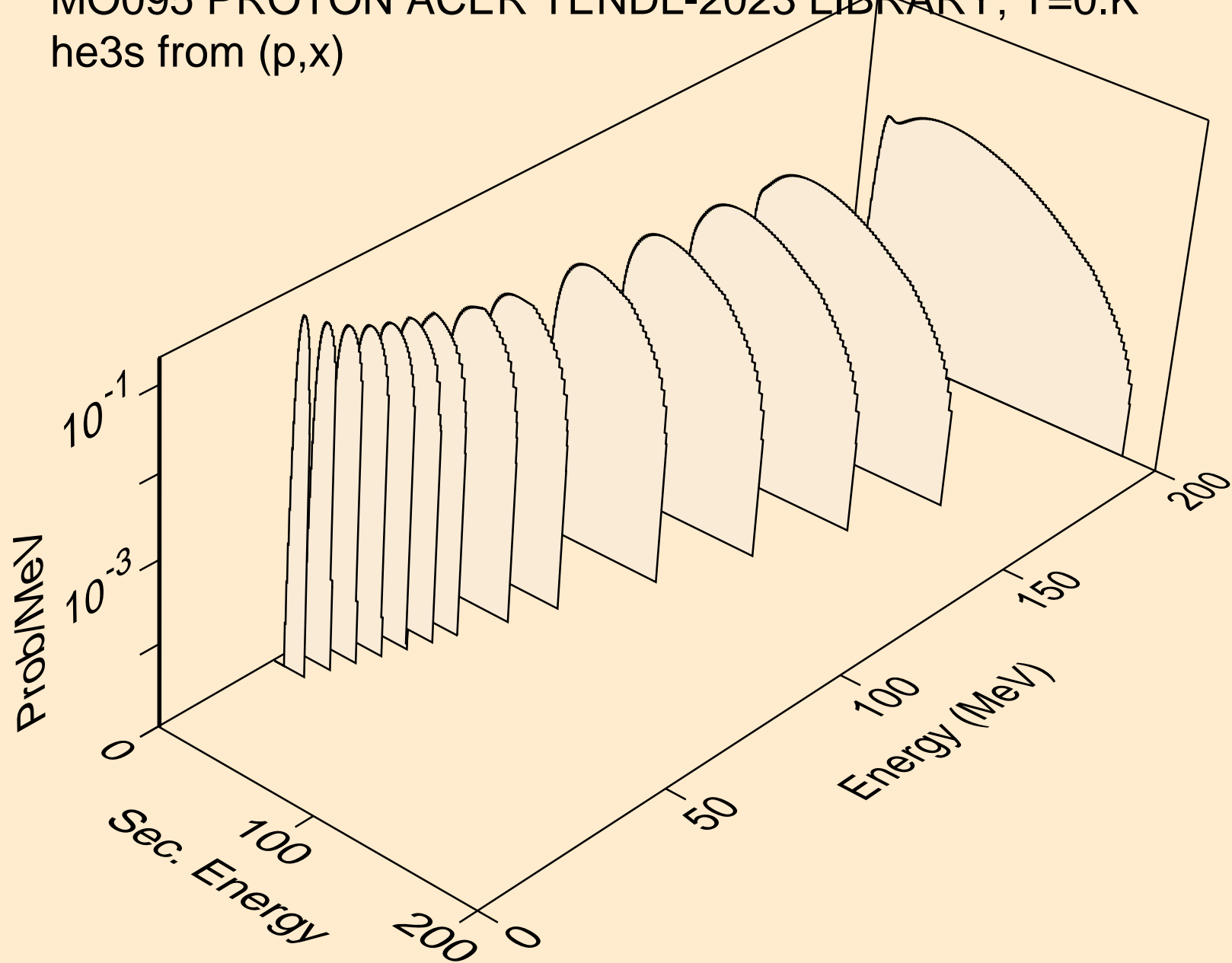

MO095 PROTON ACER TENDL-2023 LIBRARY; T=0.K  
he3s from (p,n\*)he3

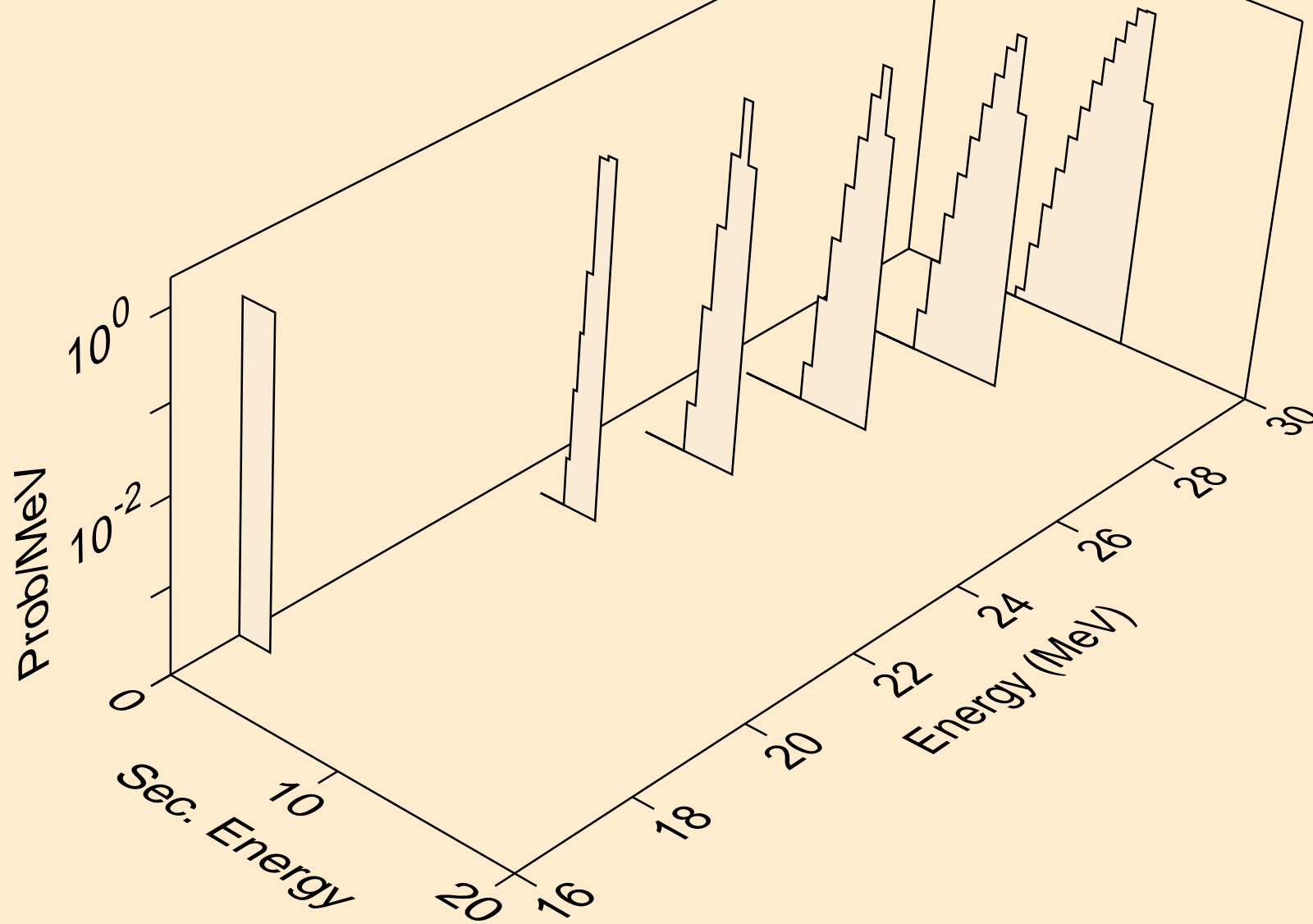

MO095 PROTON ACER TENDL-2023 LIBRARY; T=0.K  
he3s from (p,he3)

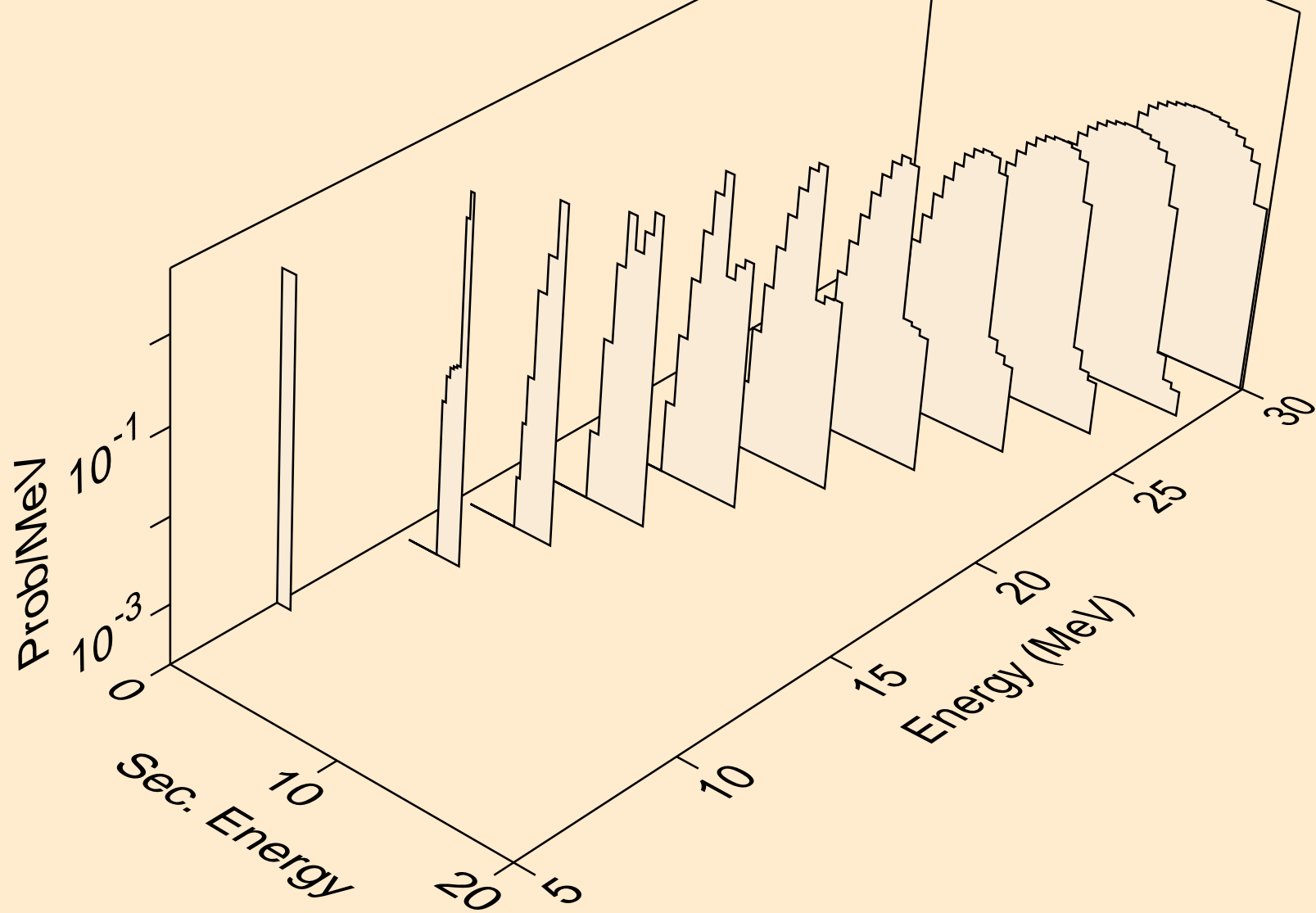



MO095 PROTON ACER TENDL-2023 LIBRARY; T=0.K  
alphas from (p,x)

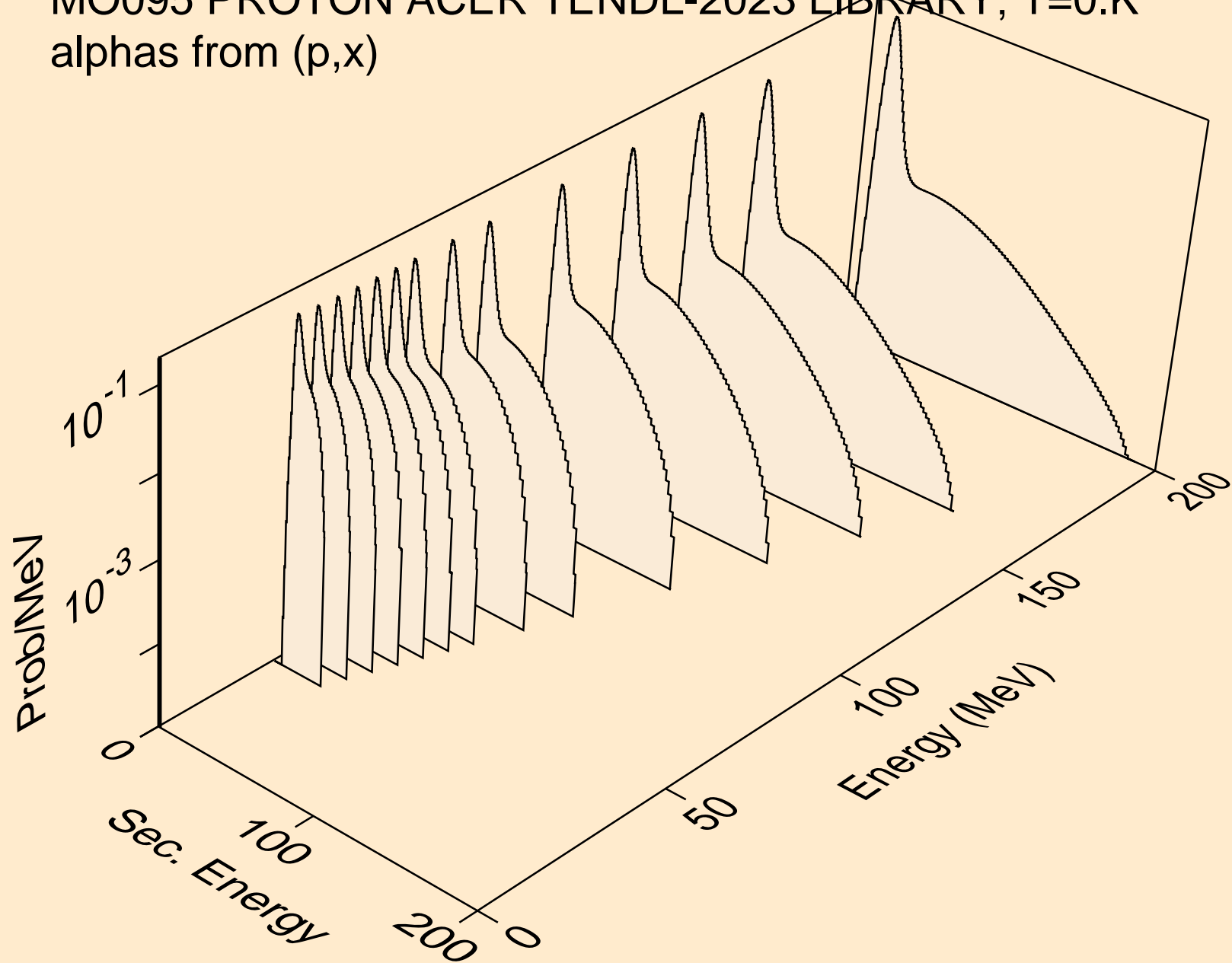

MO095 PROTON ACER TENDL-2023 LIBRARY; T=0.K  
alphas from (p,n\*)a

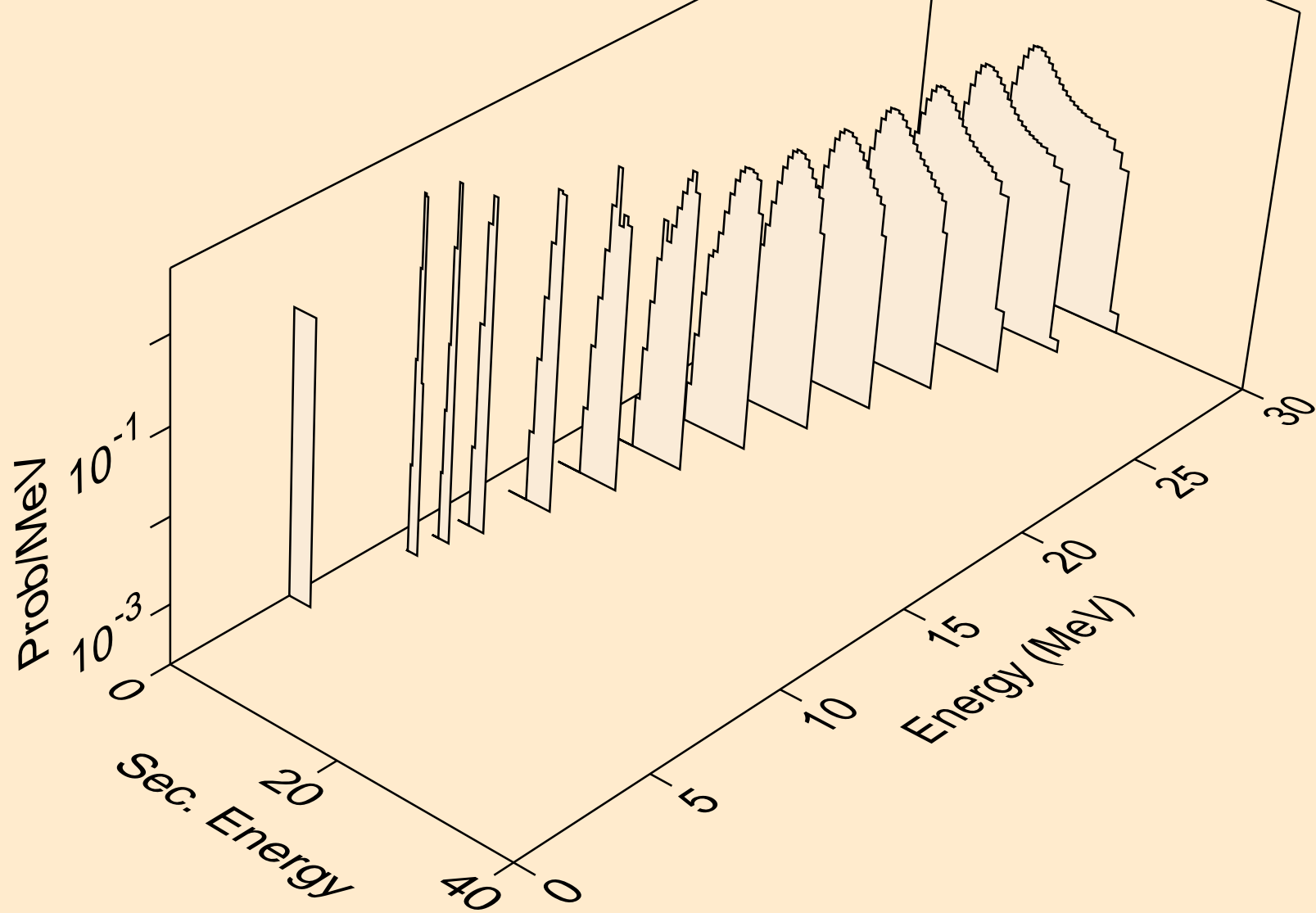

MO095 PROTON ACER TENDL-2023 LIBRARY; T=0.K  
alphas from (p,2n)a

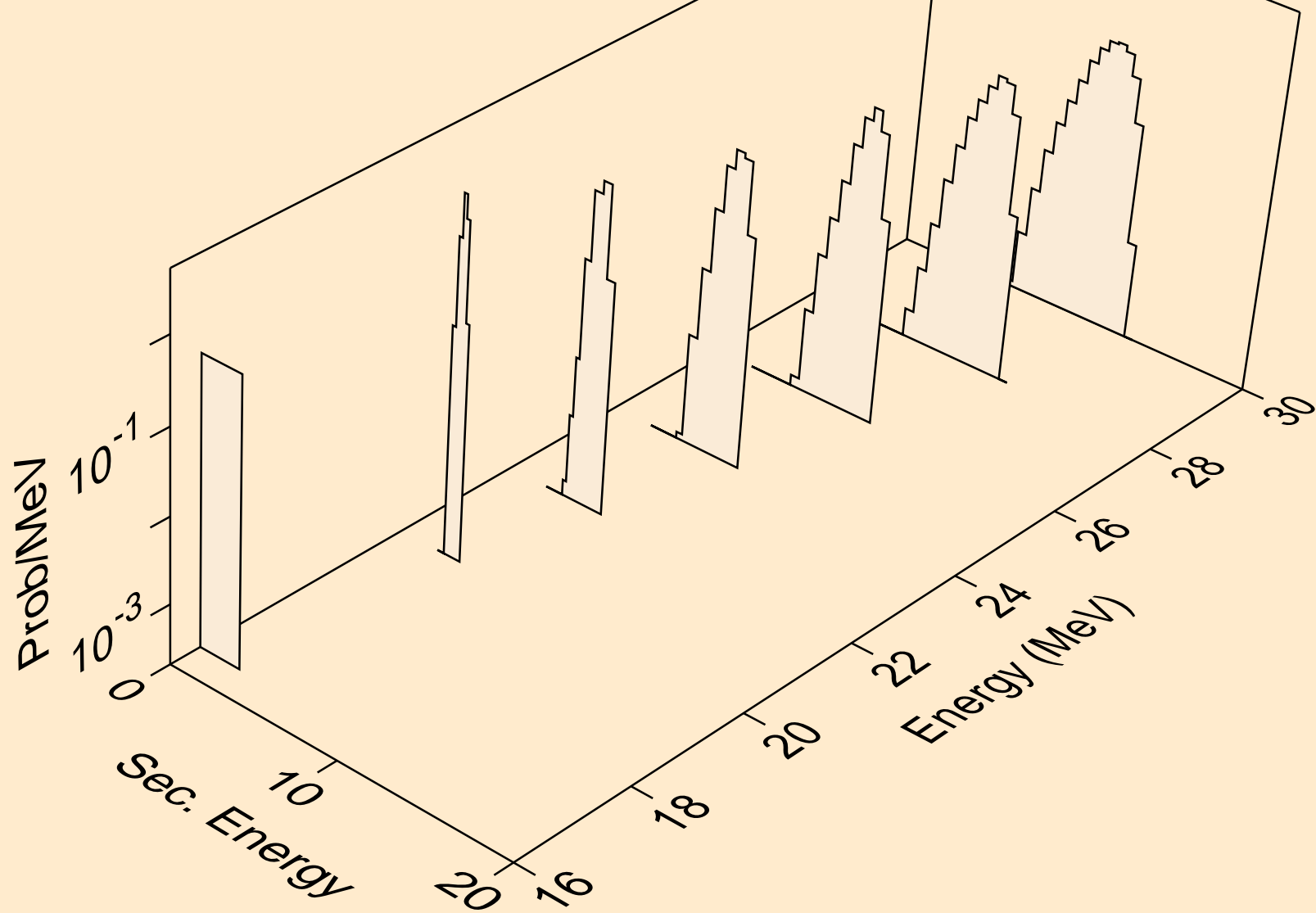

MO095 PROTON ACER TENDL-2023 LIBRARY; T=0.K  
alphas from (p,n\*)2a

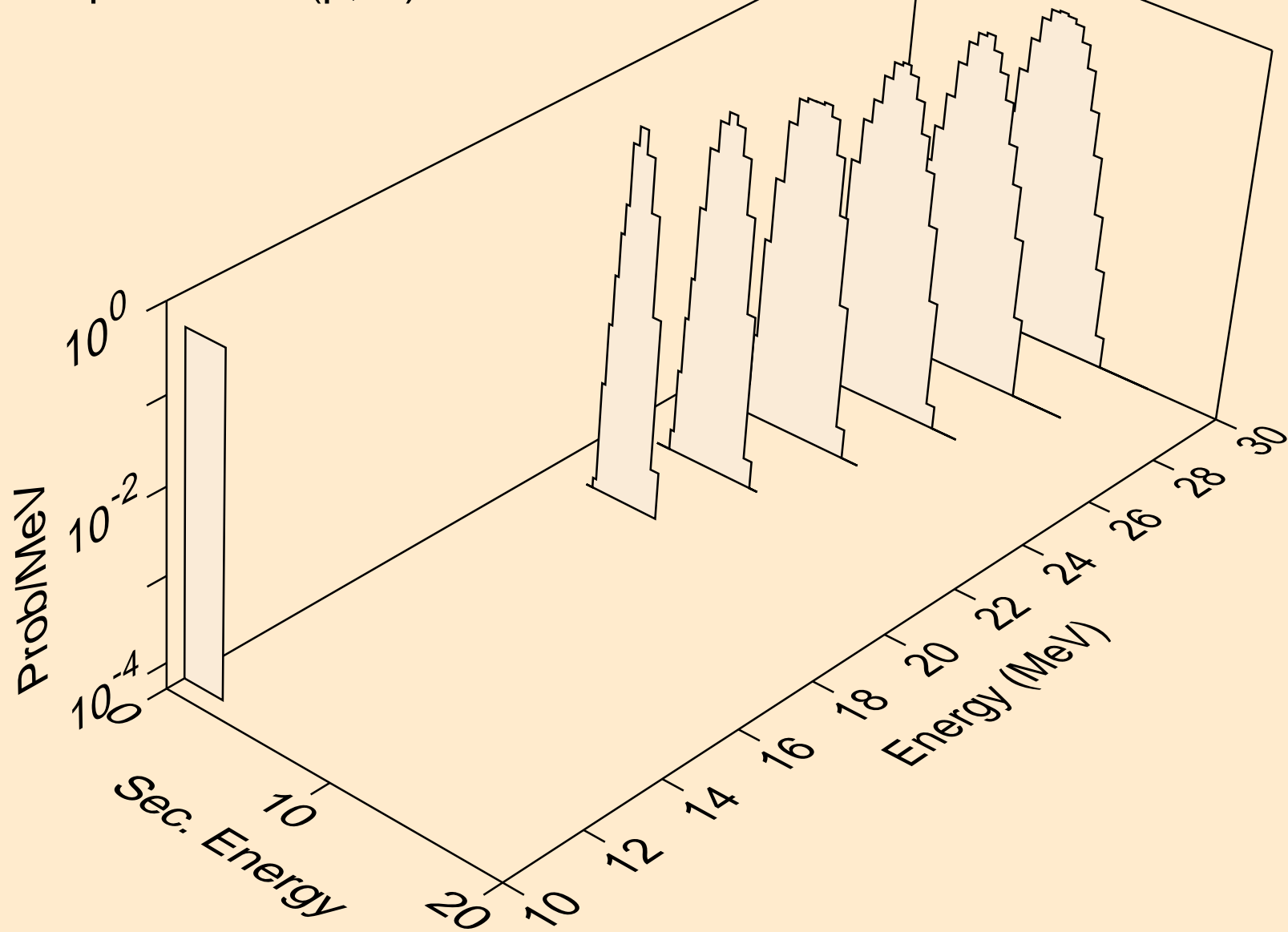

MO095 PROTON ACER TENDL-2023 LIBRARY; T=0.K  
alphas from (p,npa)

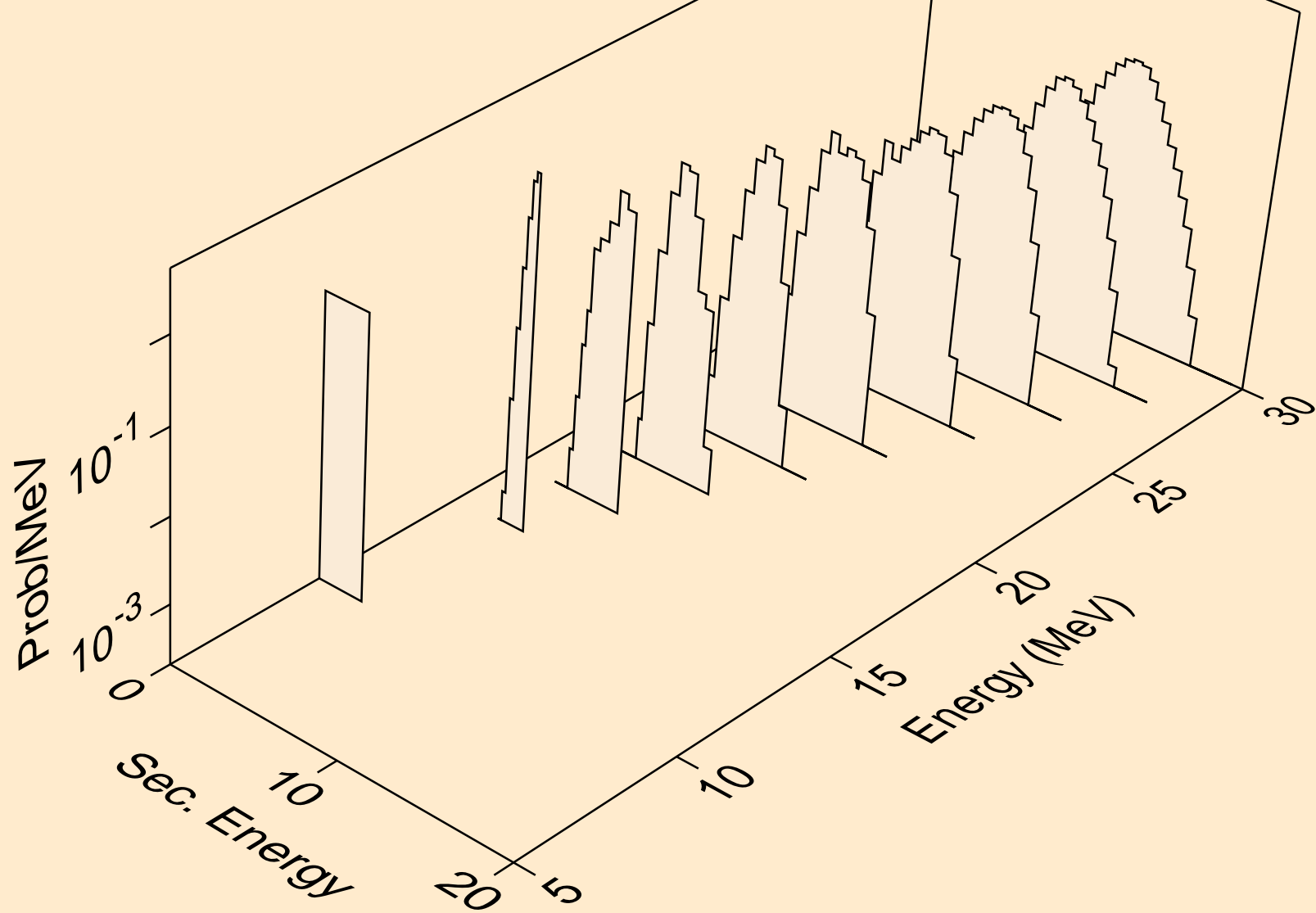

MO095 PROTON ACER TENDL-2023 LIBRARY; T=0.K  
alphas from (p,a)

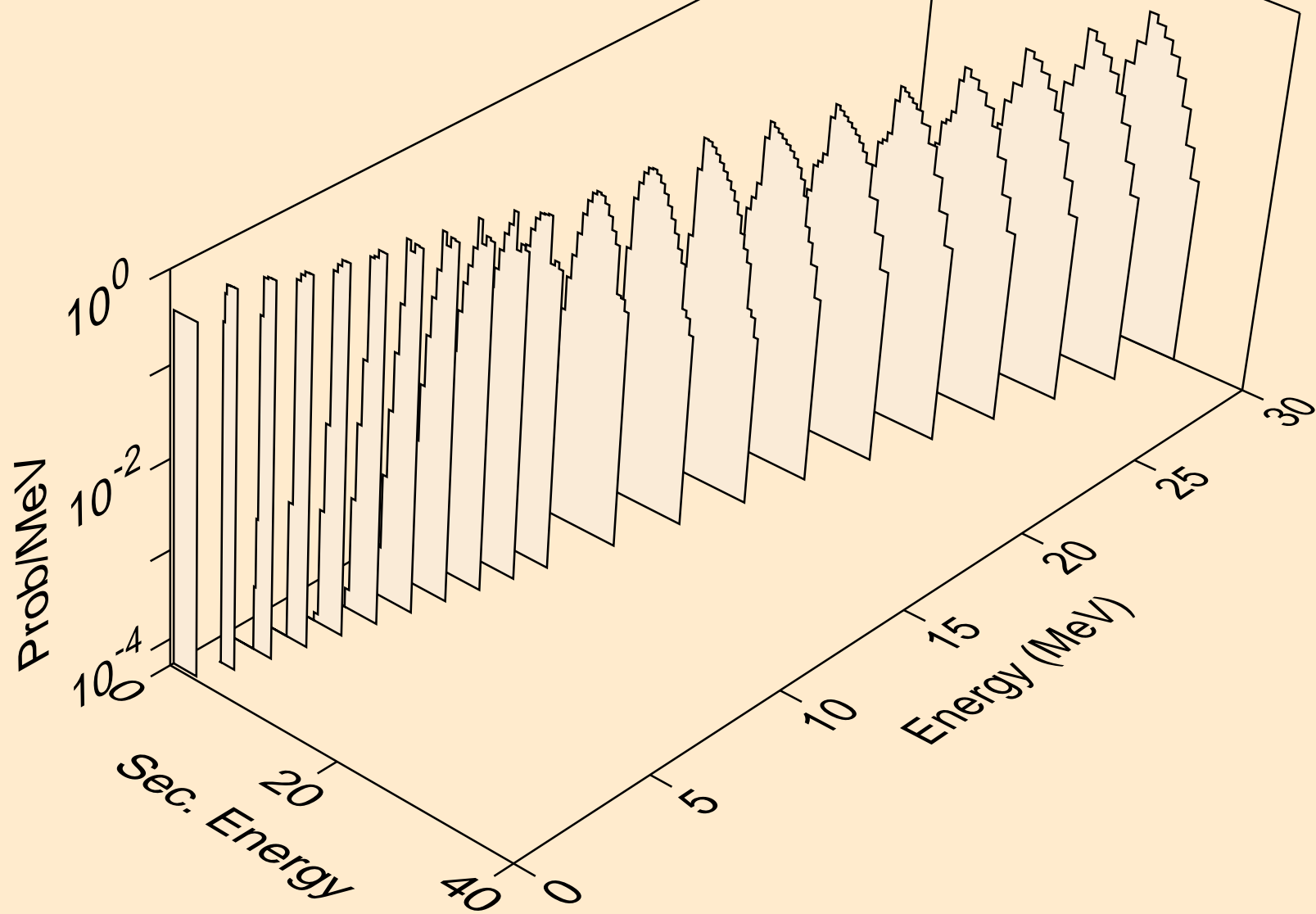

MO095 PROTON ACER TENDL-2023 LIBRARY; T=0.K  
alphas from (p,2a)

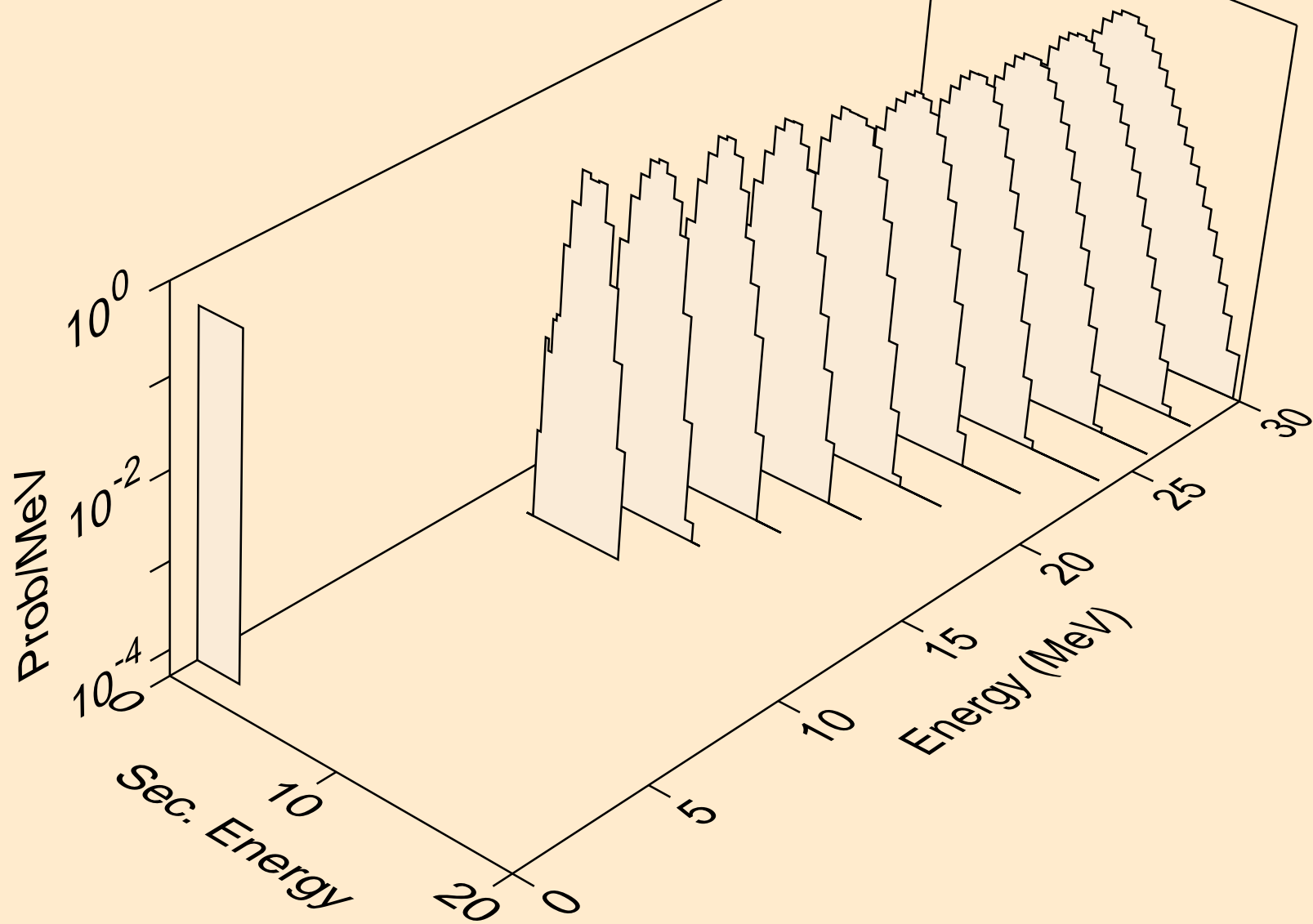

MO095 PROTON ACER TENDL-2023 LIBRARY; T=0.K  
alphas from (p,pa)

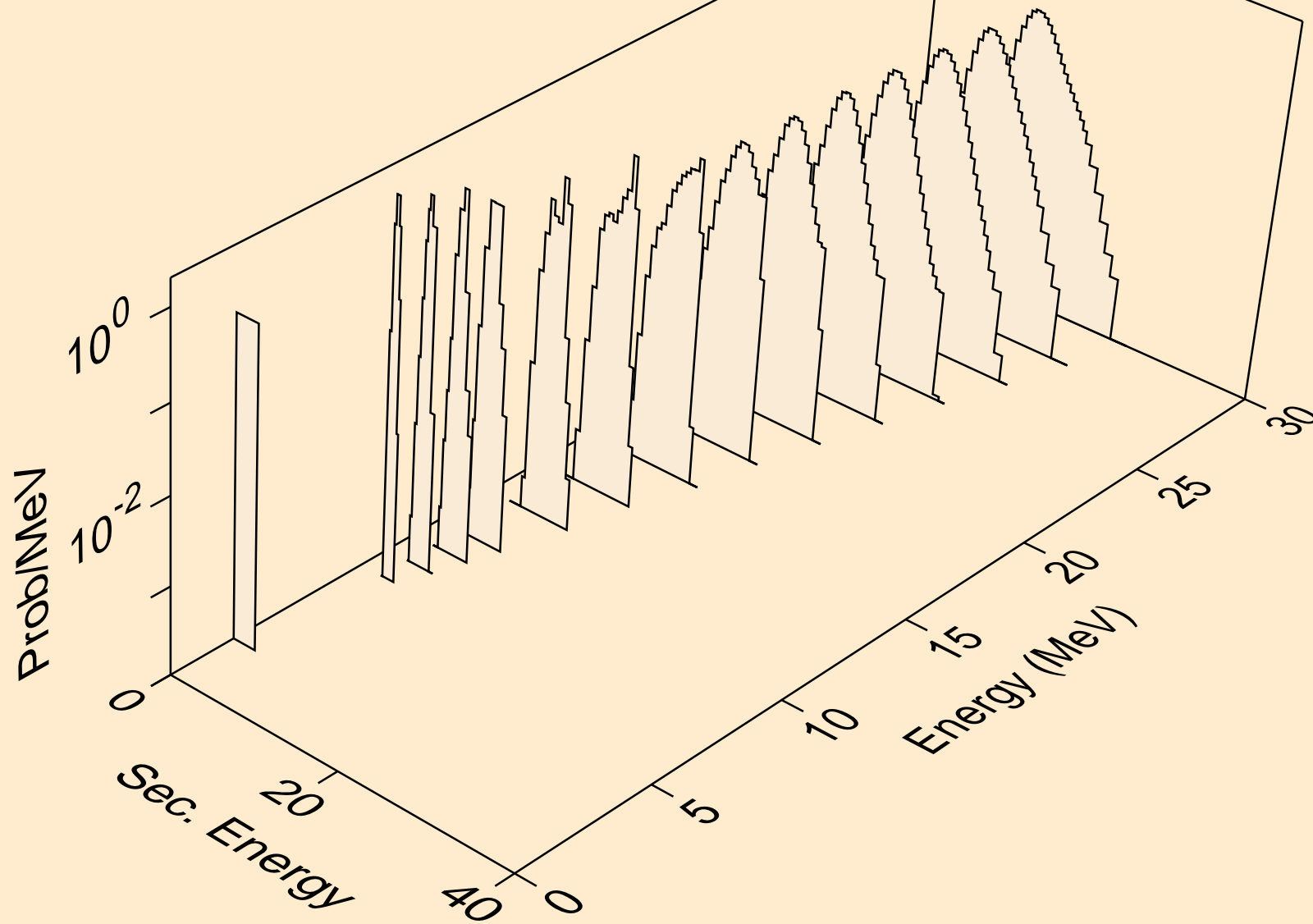



MO095 PROTON ACER TENDL-2023 LIBRARY; T=0.K  
alphas from (p,da)

