

N016 PROTON ACER TENDL-2023 LIBRARY; T=0.K

Principal cross sections

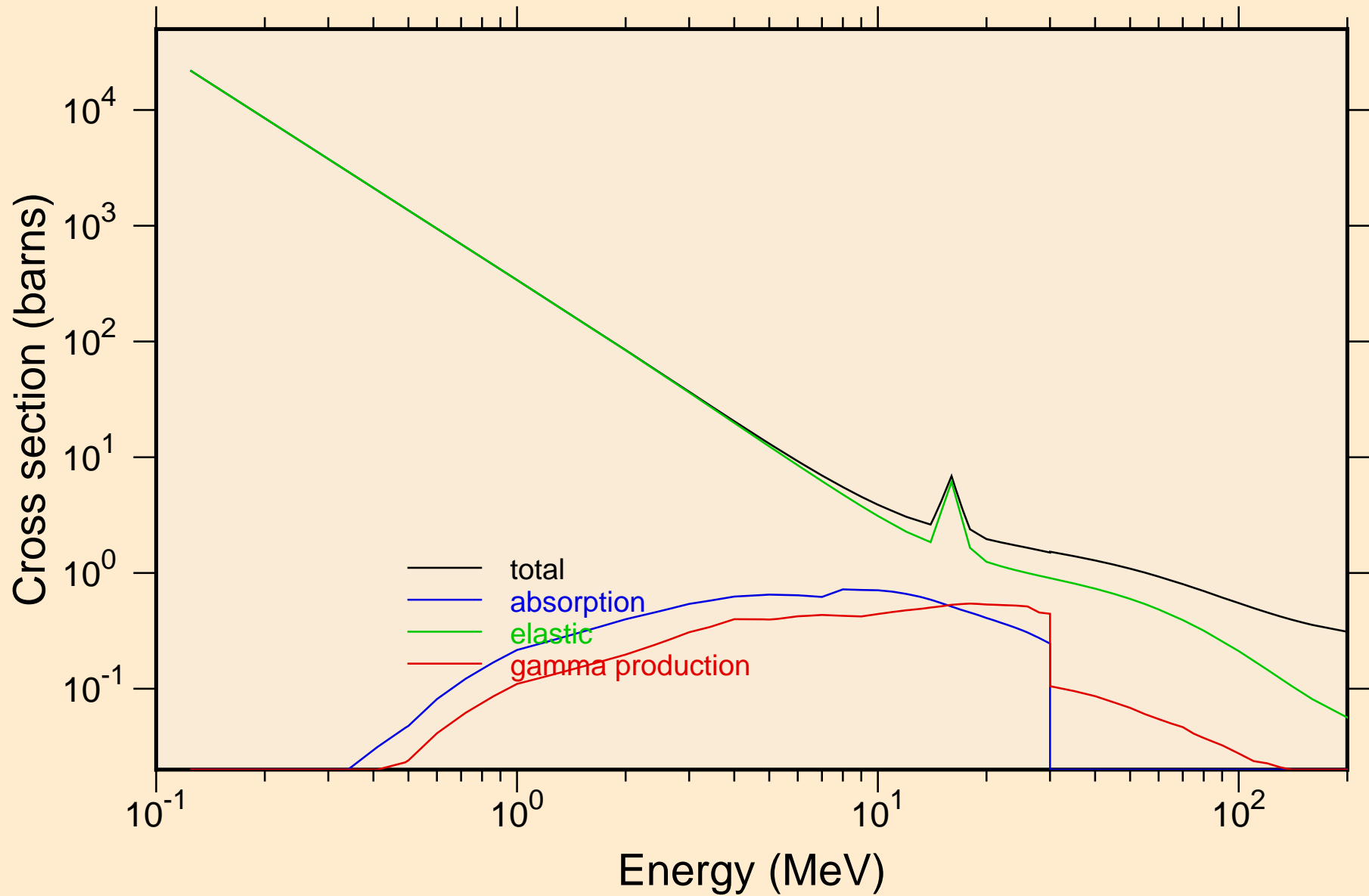

N016 PROTON ACER TENDL-2023 LIBRARY; T=0.K
Heating

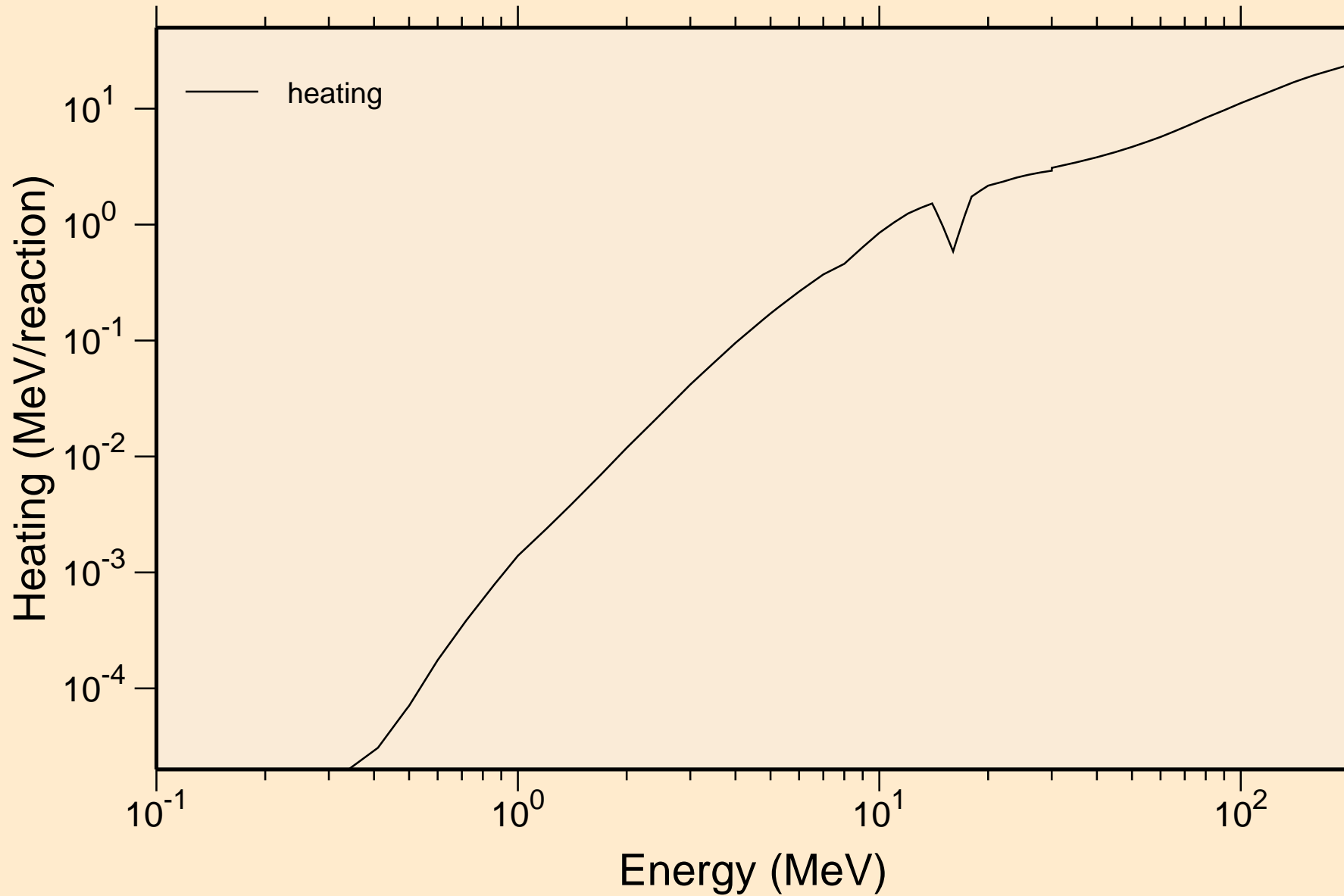

N016 PROTON ACER TENDL-2023 LIBRARY; T=0.K
Principal cross sections

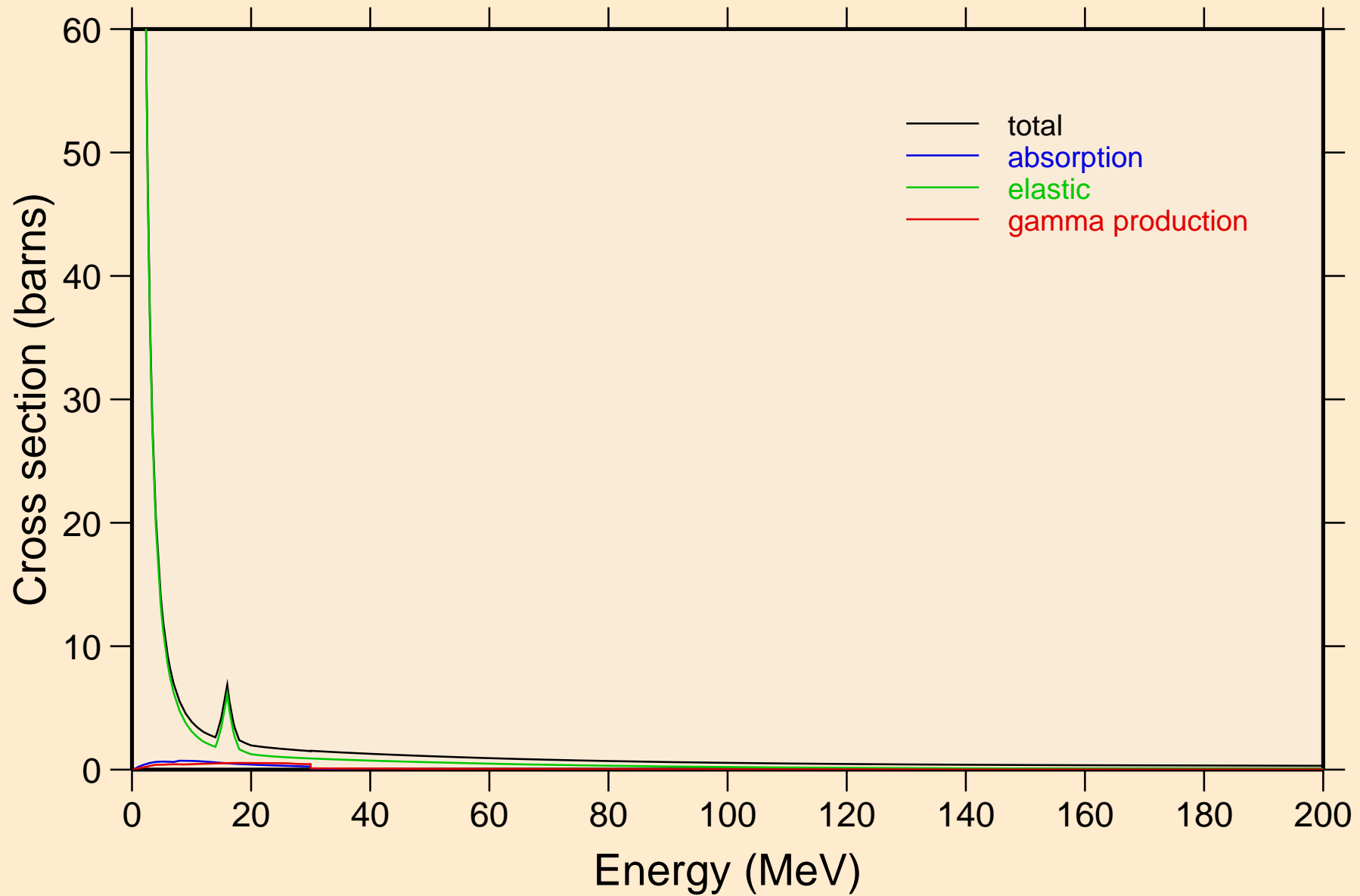

N016 PROTON ACER TENDL-2023 LIBRARY; T=0.K

Heating

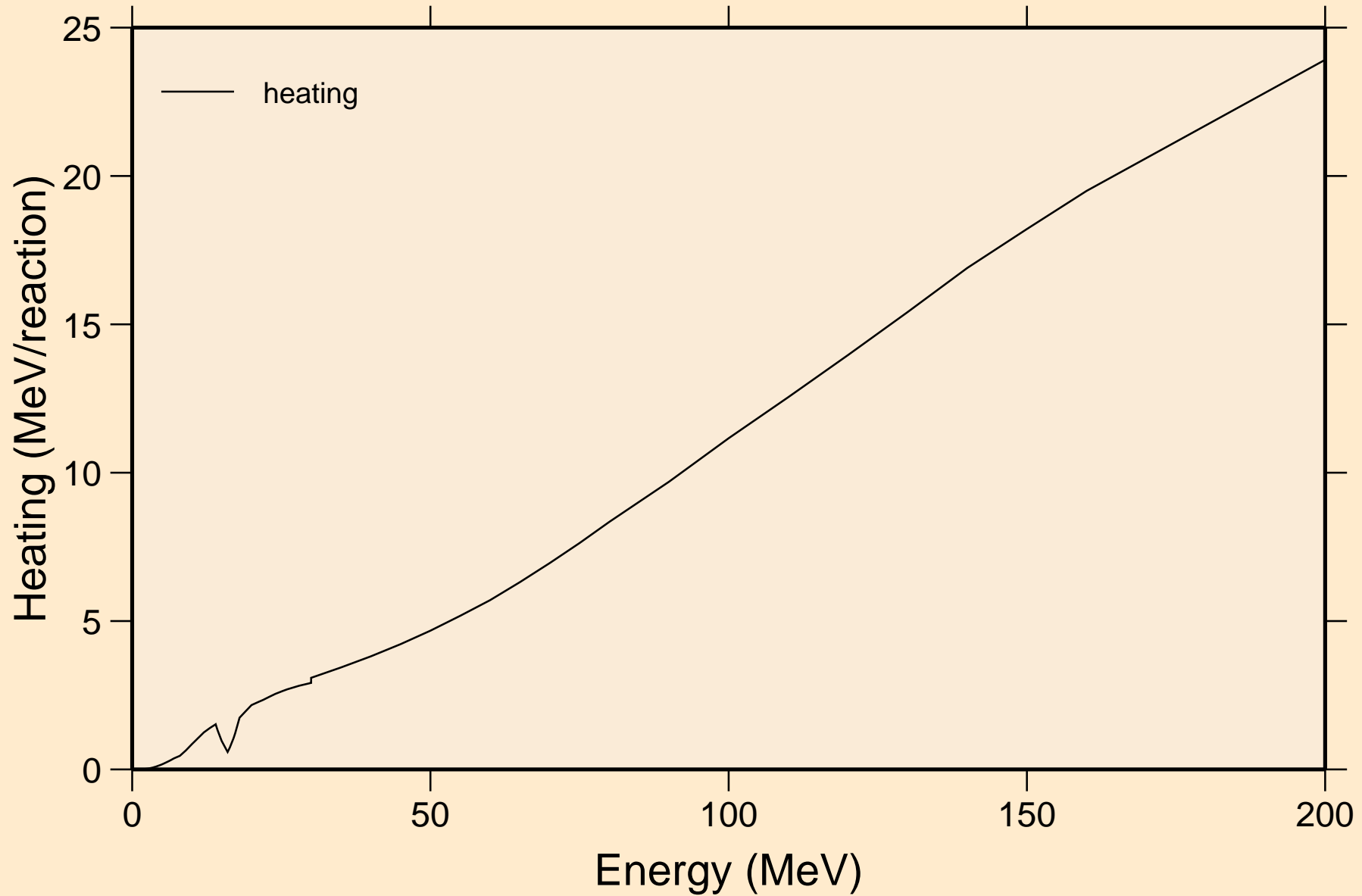

N016 PROTON ACER TENDL-2023 LIBRARY; T=0.K

Threshold reactions

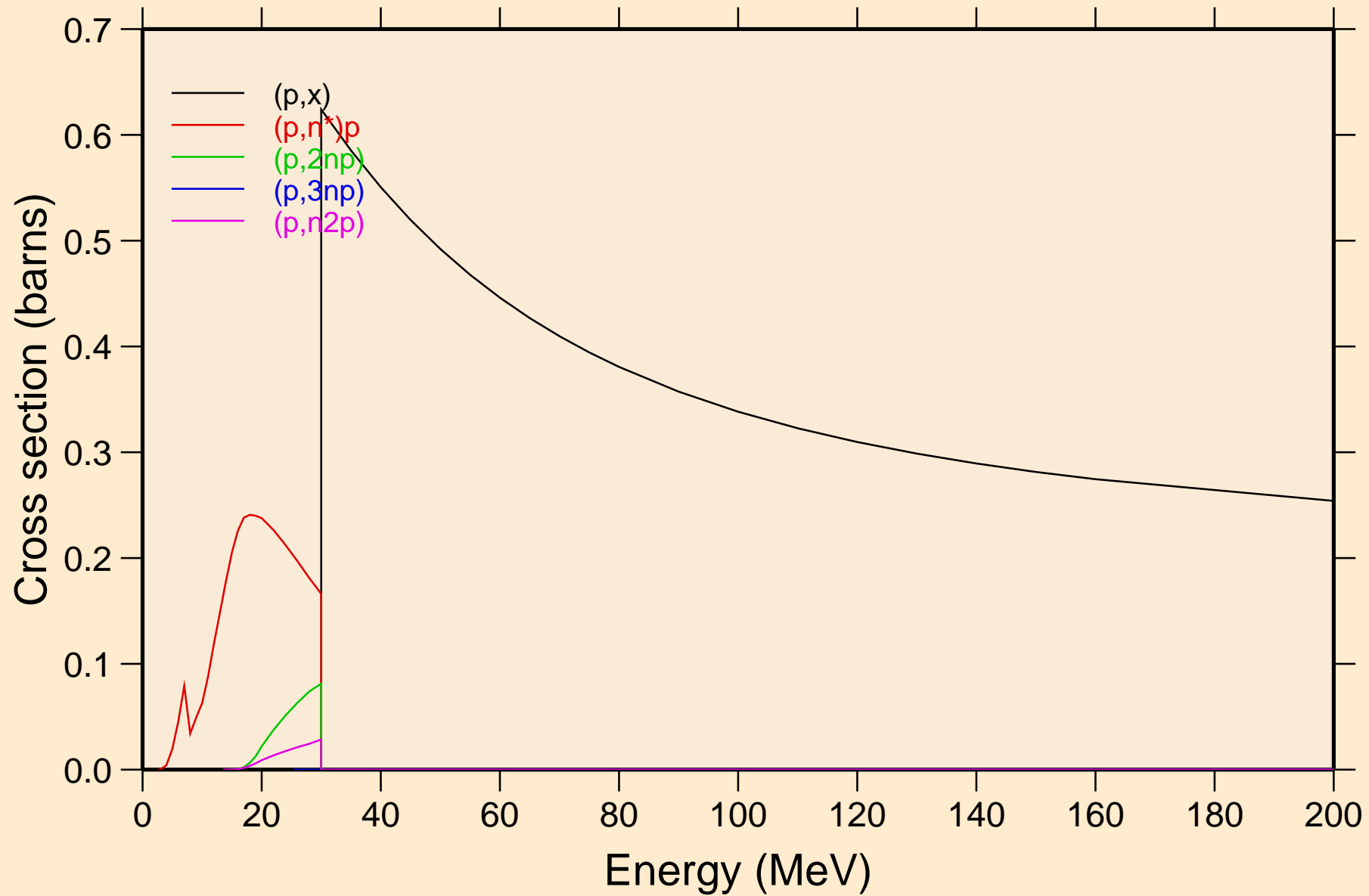

N016 PROTON ACER TENDL-2023 LIBRARY; T=0.K

Threshold reactions

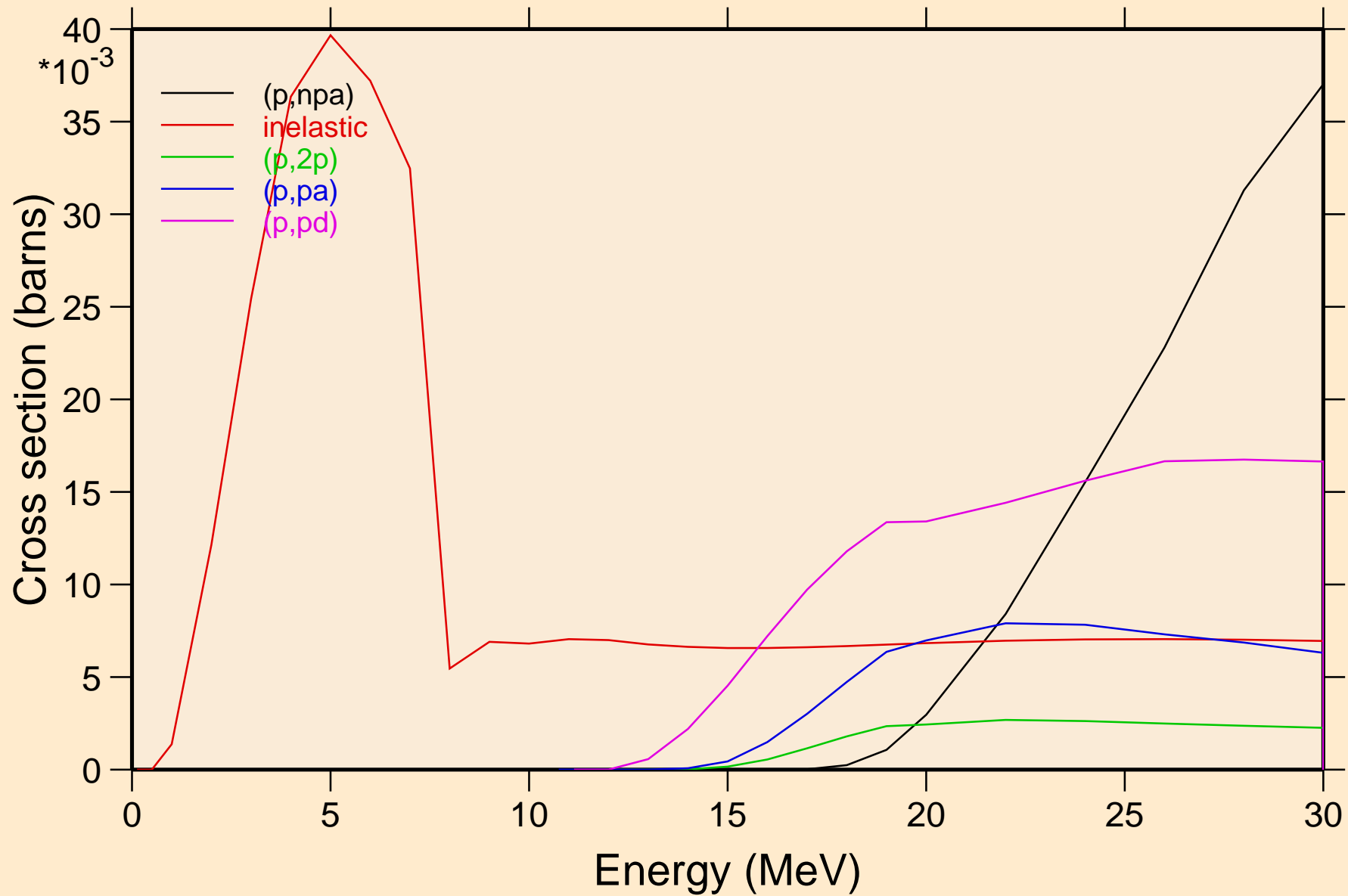

N016 PROTON ACER TENDL-2023 LIBRARY; T=0.K
Threshold reactions

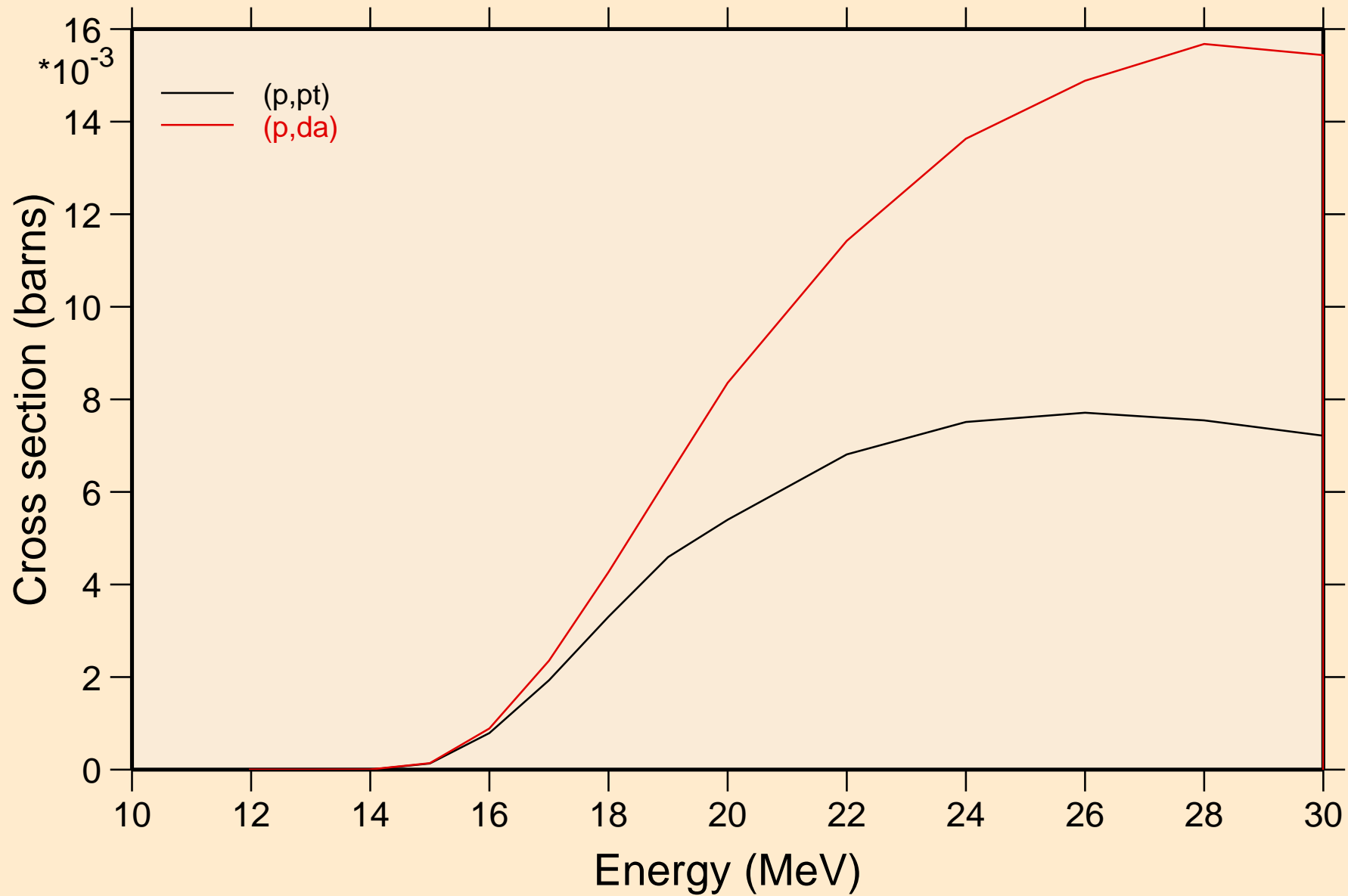

N016 PROTON ACER TENDL-2023 LIBRARY; T=0.K
angular distribution for elastic

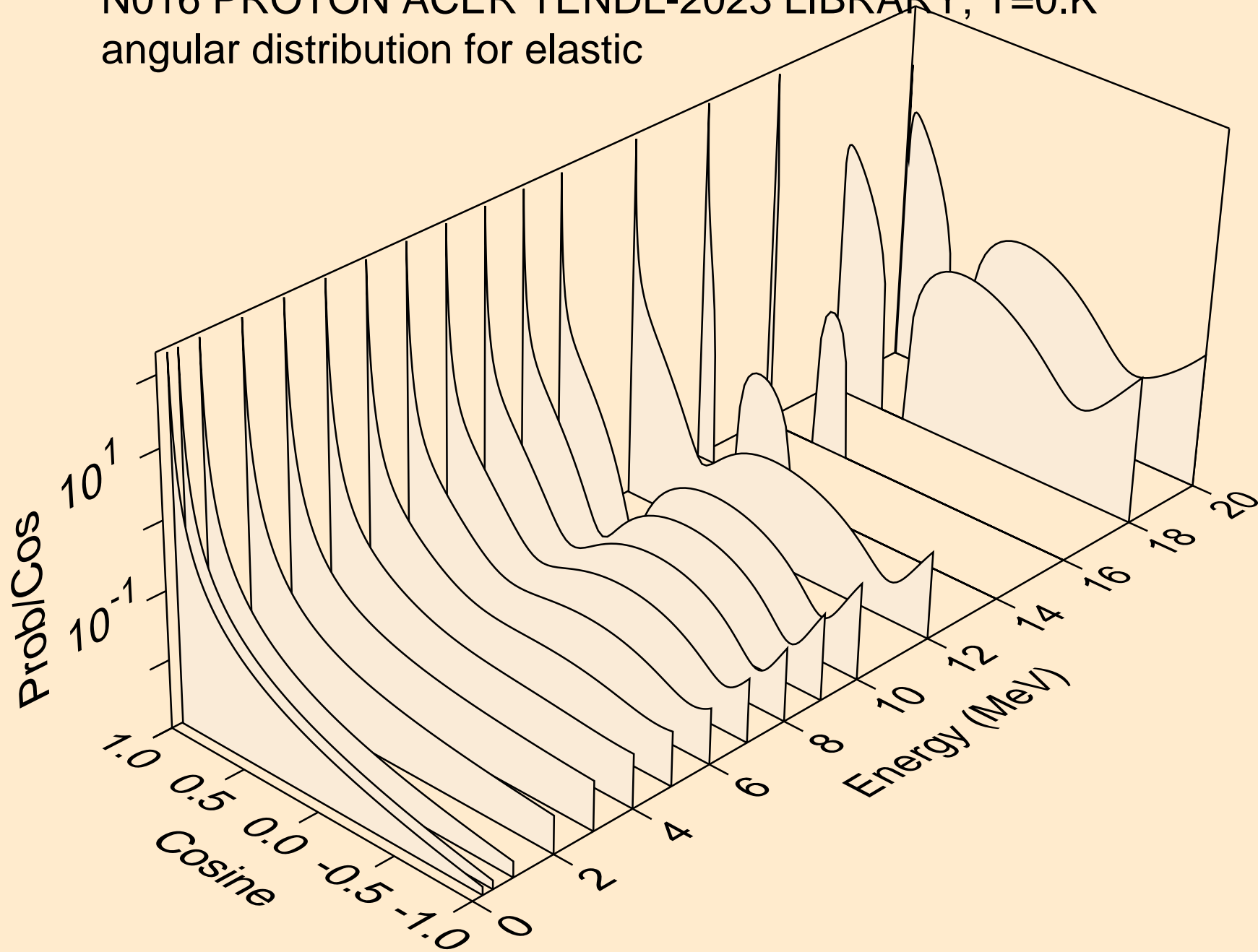

N016 PROTON ACER TENDL-2023 LIBRARY; T=0.K
angular distribution for elastic

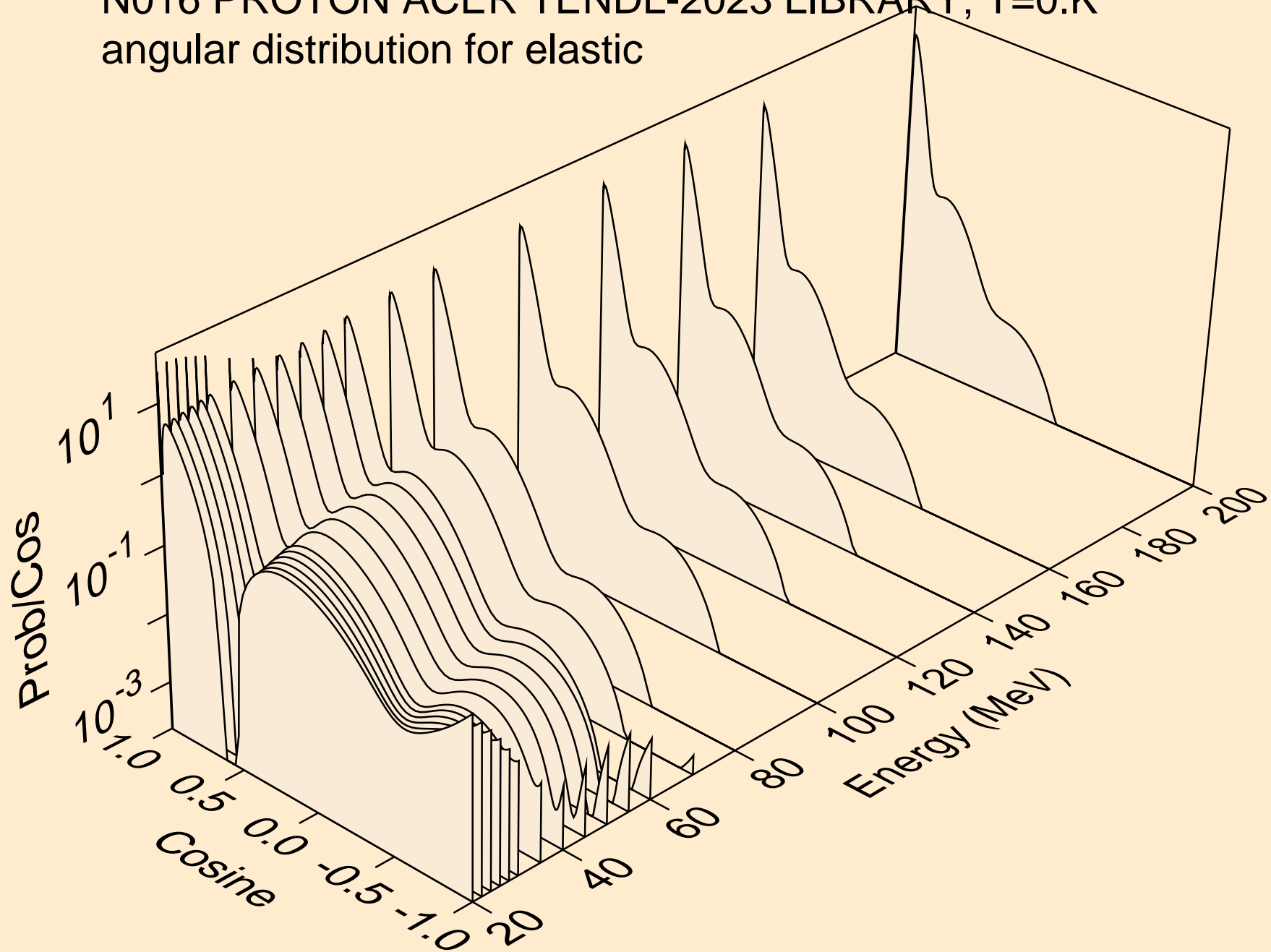

N016 PROTON ACER TENDL-2023 LIBRARY; T=0.K
Proton emission for (p,x)

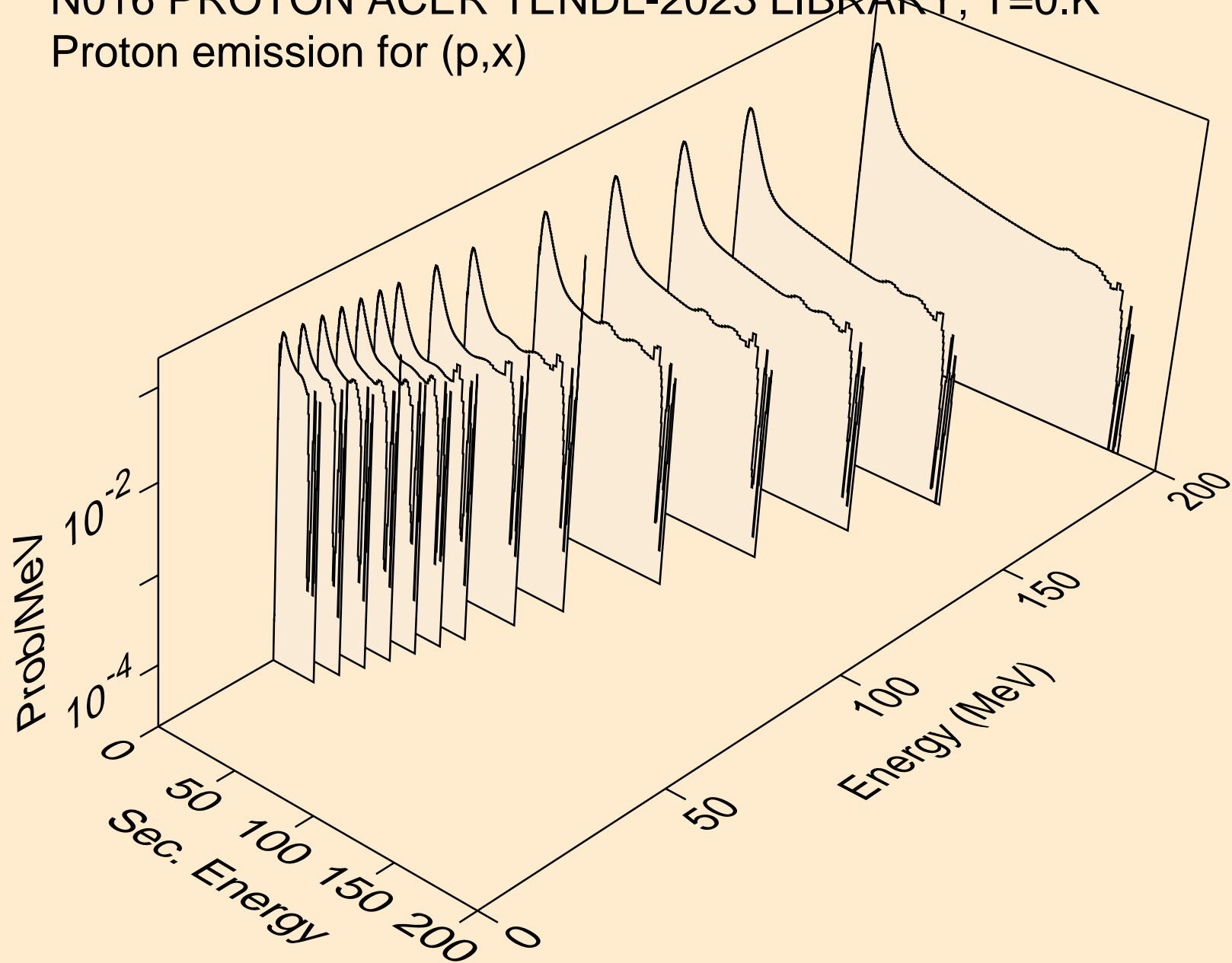

N016 PROTON ACER TENDL-2023 LIBRARY; T=0.K
Proton emission for (p,n*)p

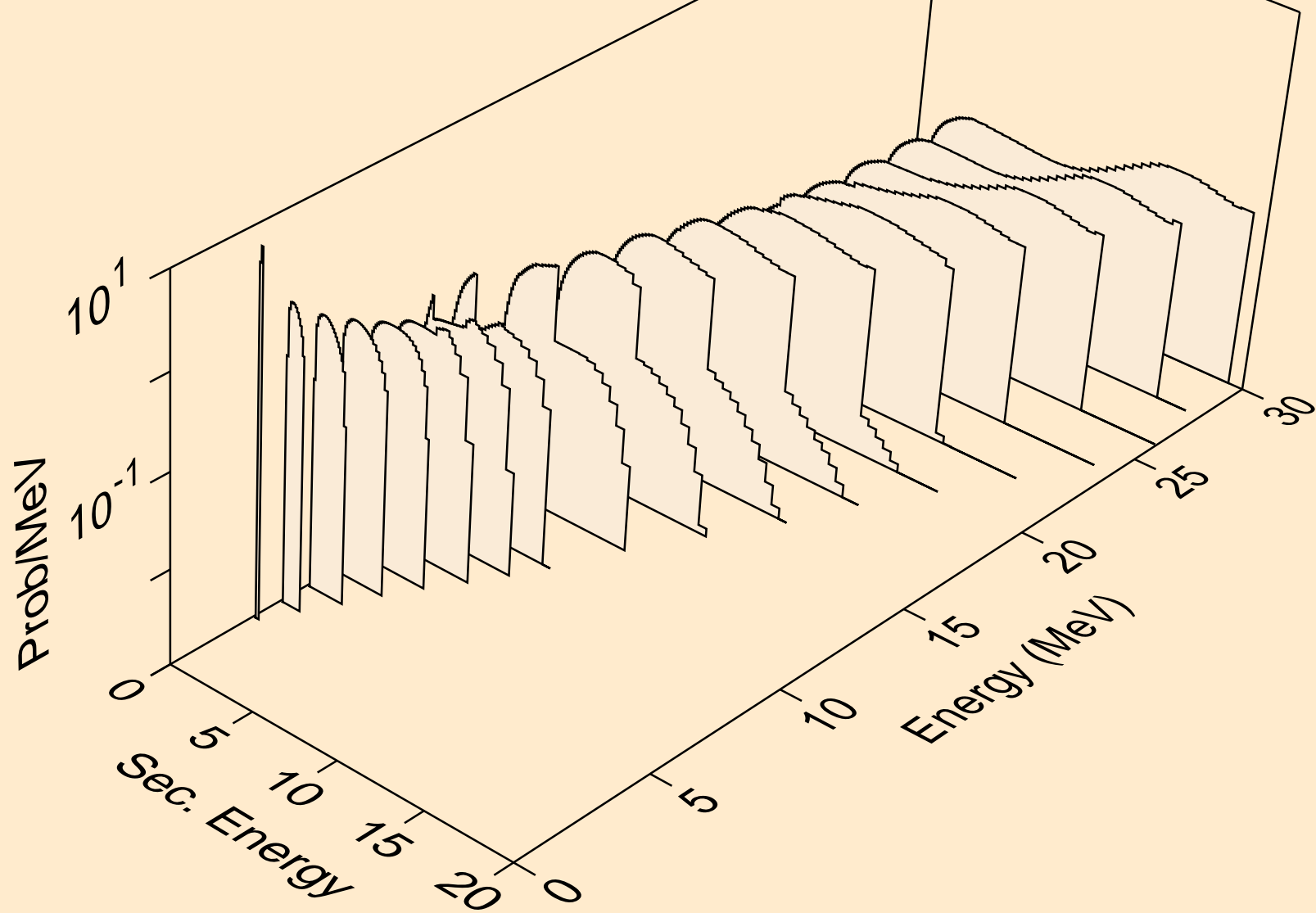

N016 PROTON ACER TENDL-2023 LIBRARY; T=0.K
Proton emission for (p,2np)

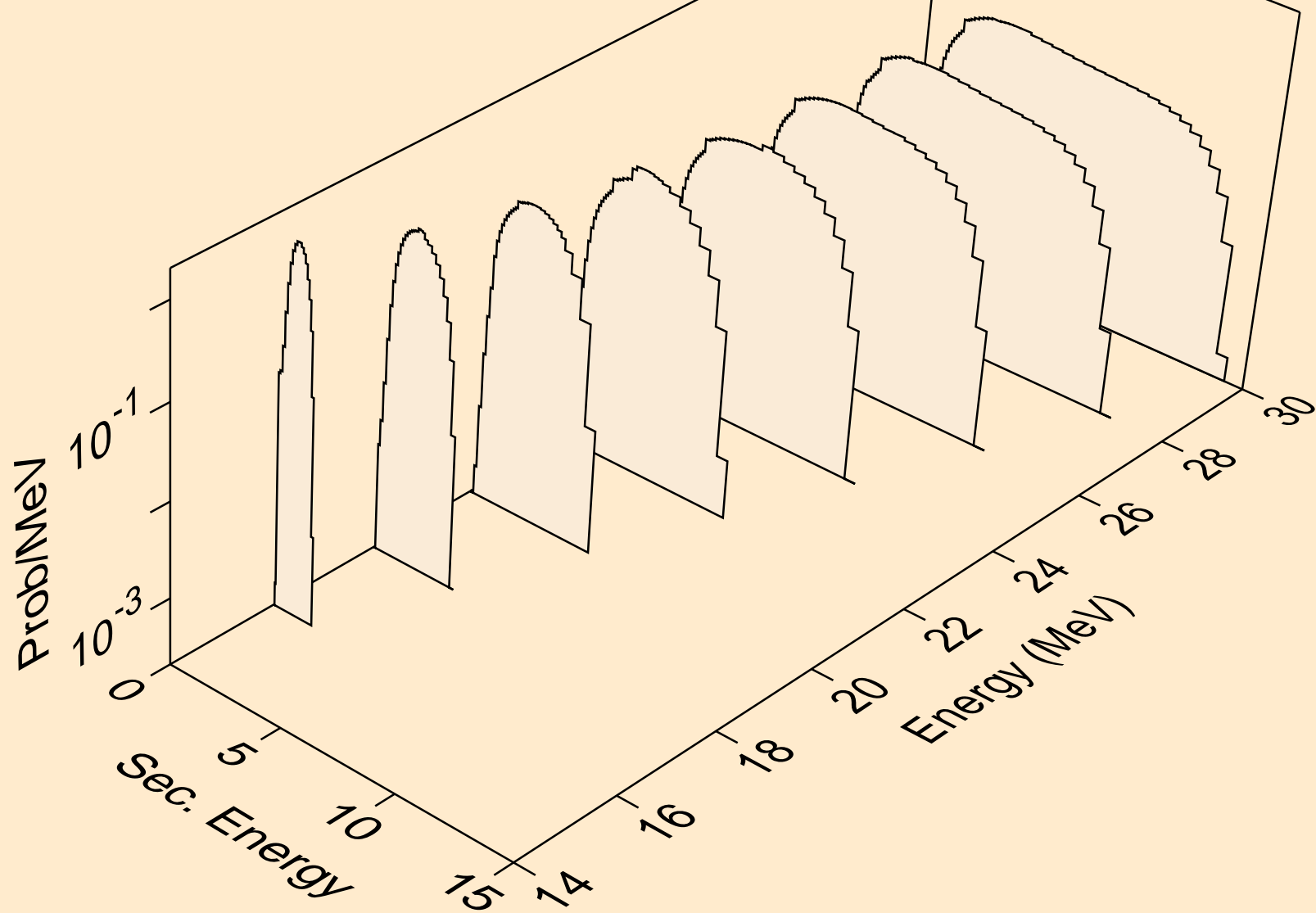

N016 PROTON ACER TENDL-2023 LIBRARY; T=0.K
Proton emission for (p,3np)

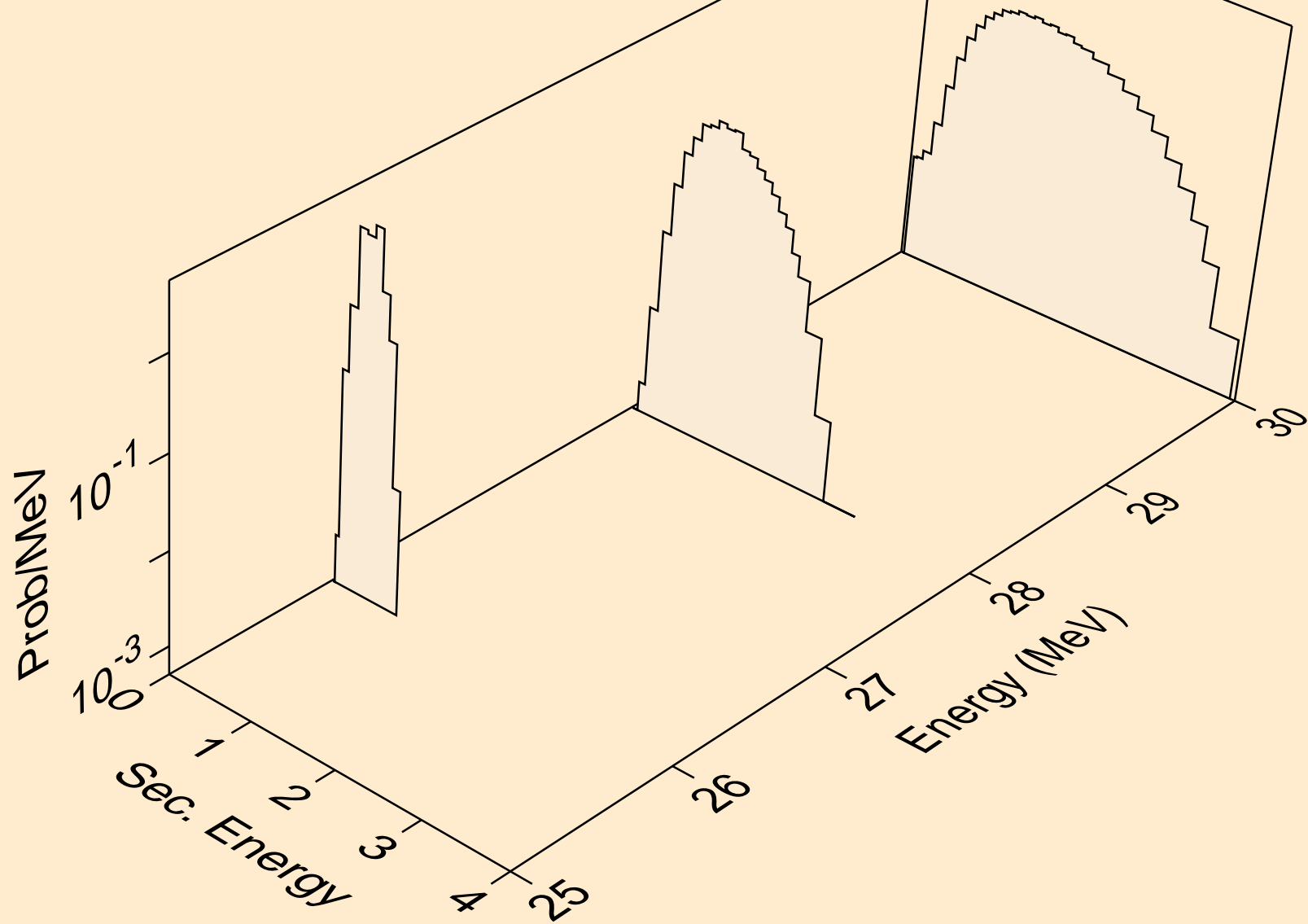

N016 PROTON ACER TENDL-2023 LIBRARY; T=0.K
Proton emission for (p,n2p)

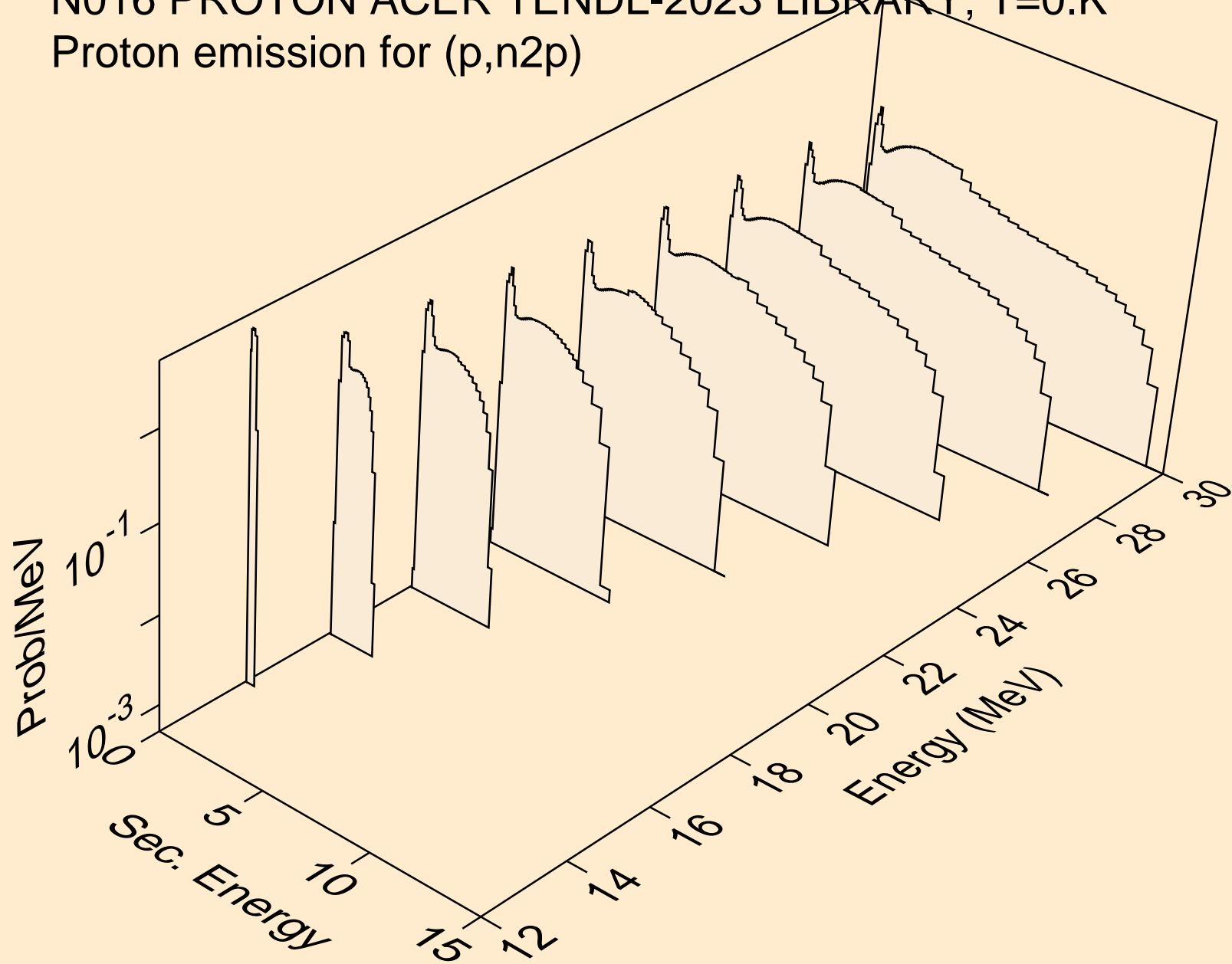

N016 PROTON ACER TENDL-2023 LIBRARY; T=0.K
Proton emission for (p,npa)

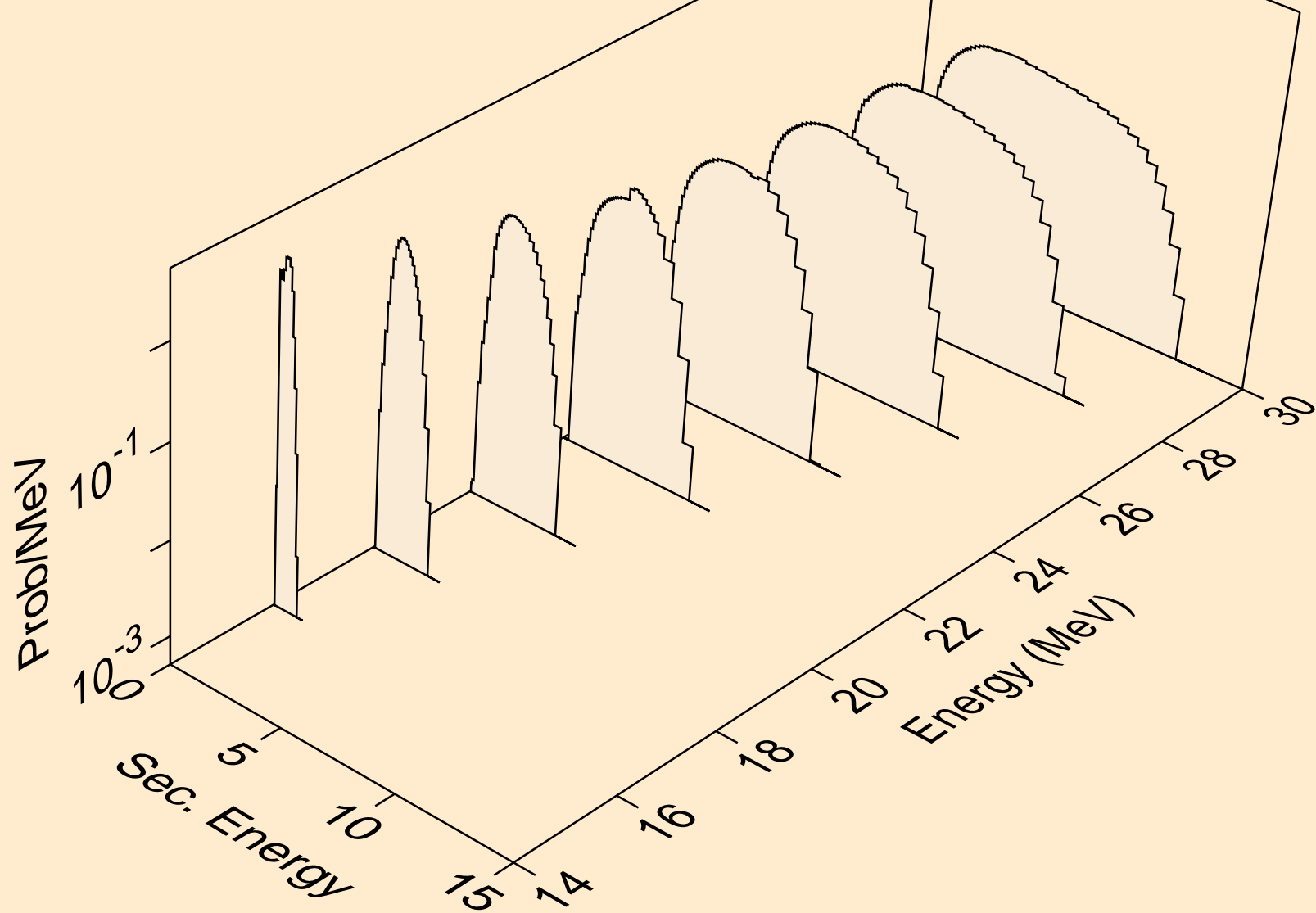

N016 PROTON ACER TENDL-2023 LIBRARY; T=0.K
Proton emission for inelastic

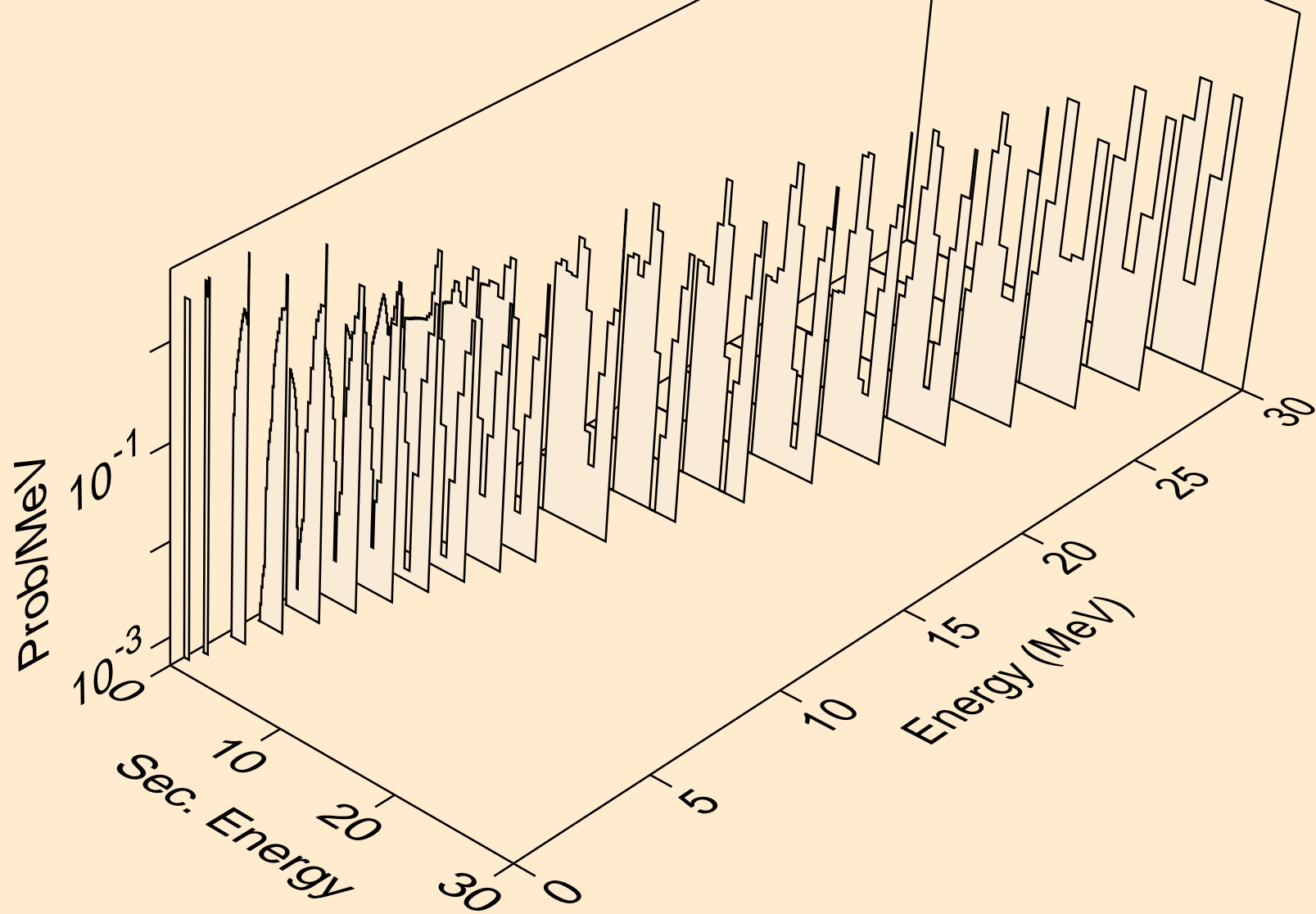

N016 PROTON ACER TENDL-2023 LIBRARY; T=0.K
Proton emission for (p,2p)

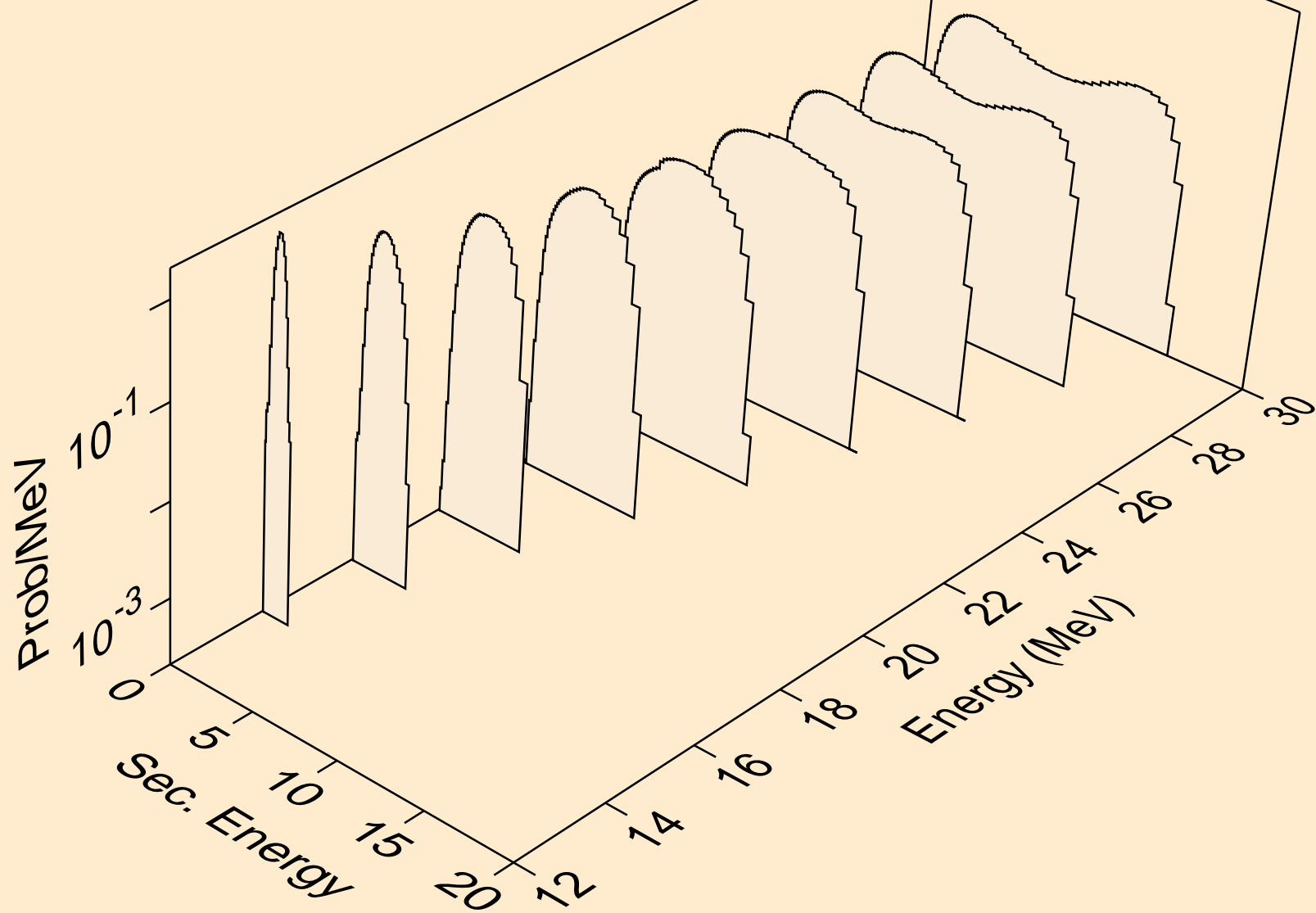

N016 PROTON ACER TENDL-2023 LIBRARY; T=0.K
Proton emission for (p,pa)

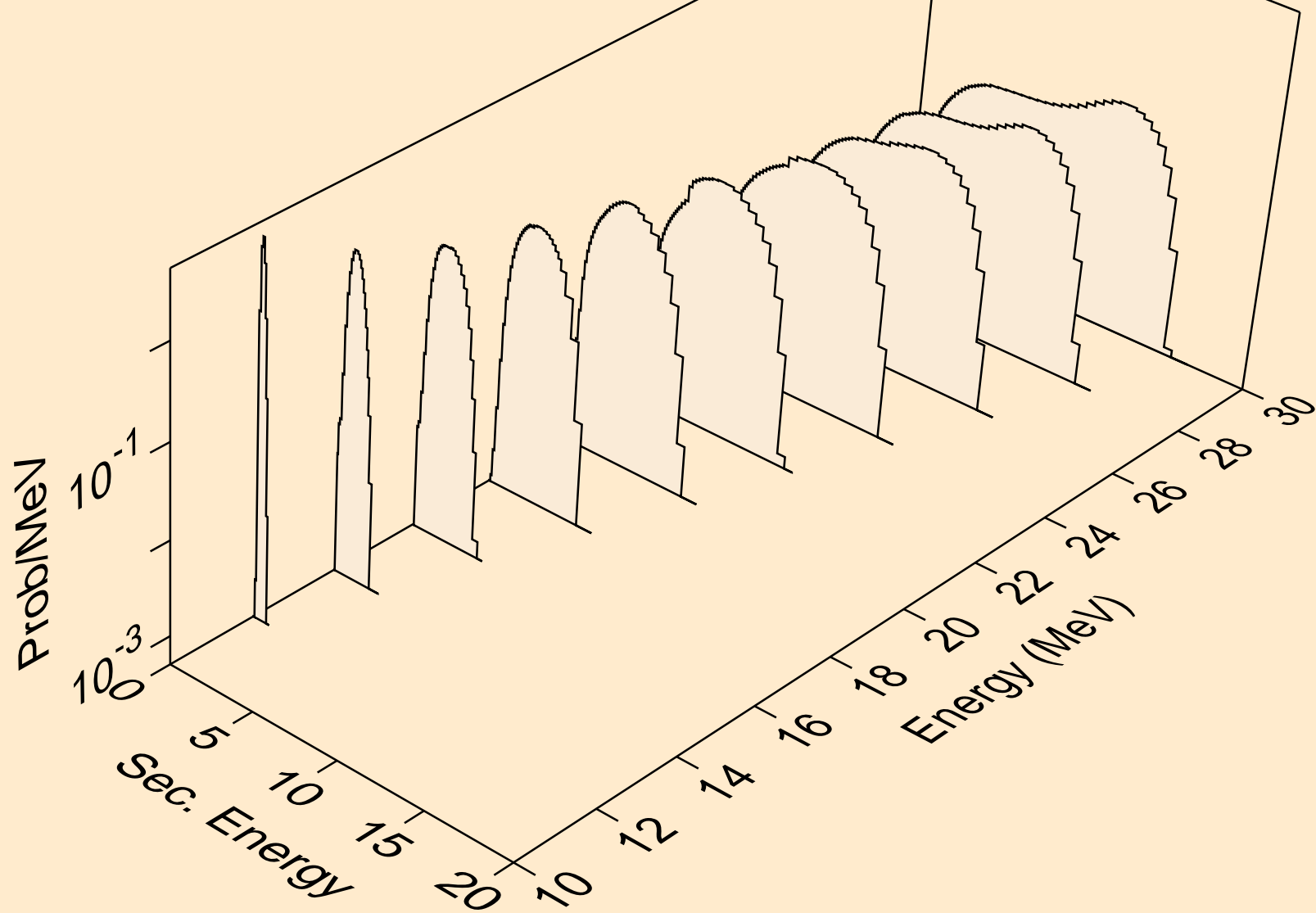

N016 PROTON ACER TENDL-2023 LIBRARY; T=0.K
Proton emission for (p,pd)

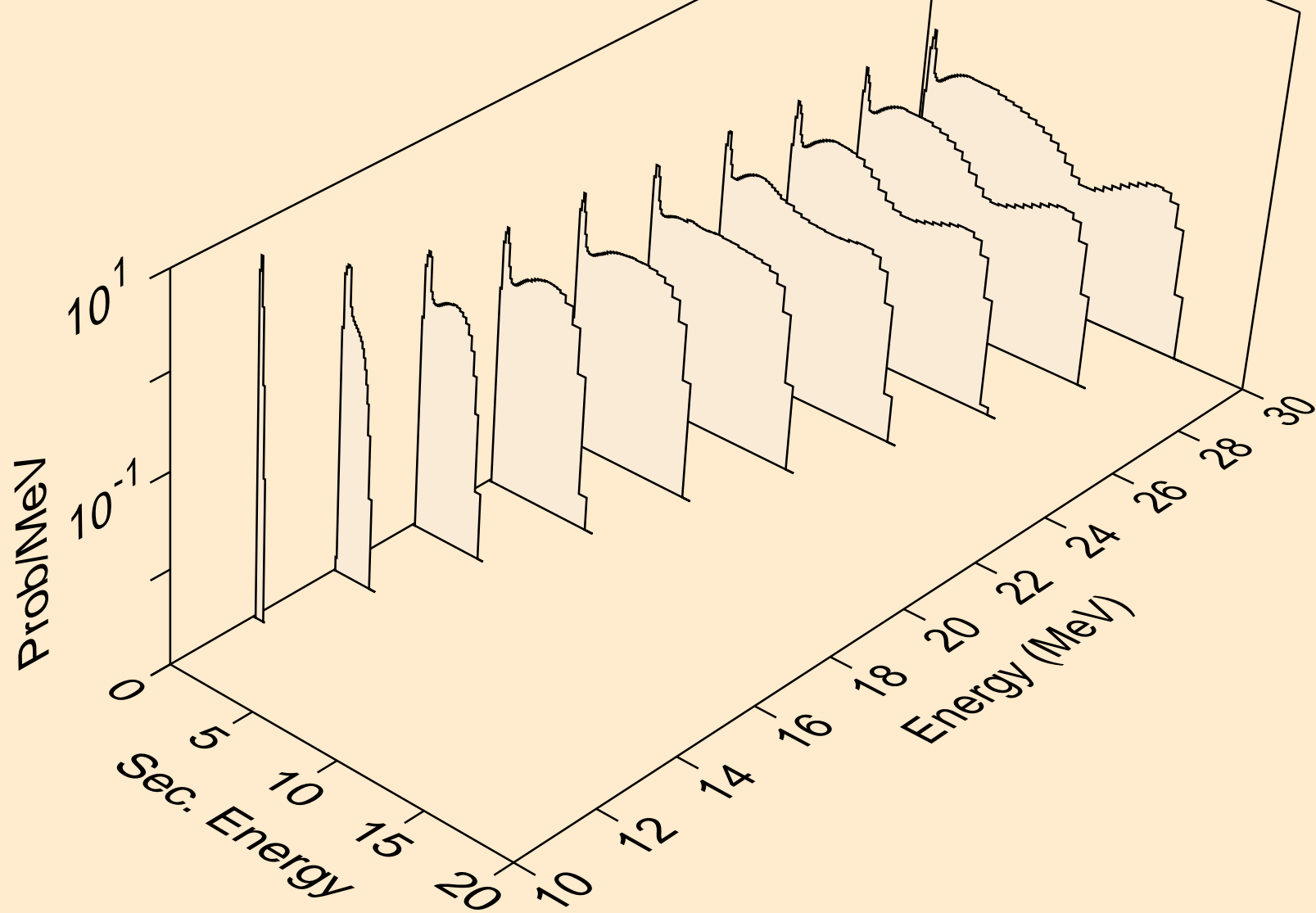

N016 PROTON ACER TENDL-2023 LIBRARY; T=0.K
Proton emission for (p,pt)

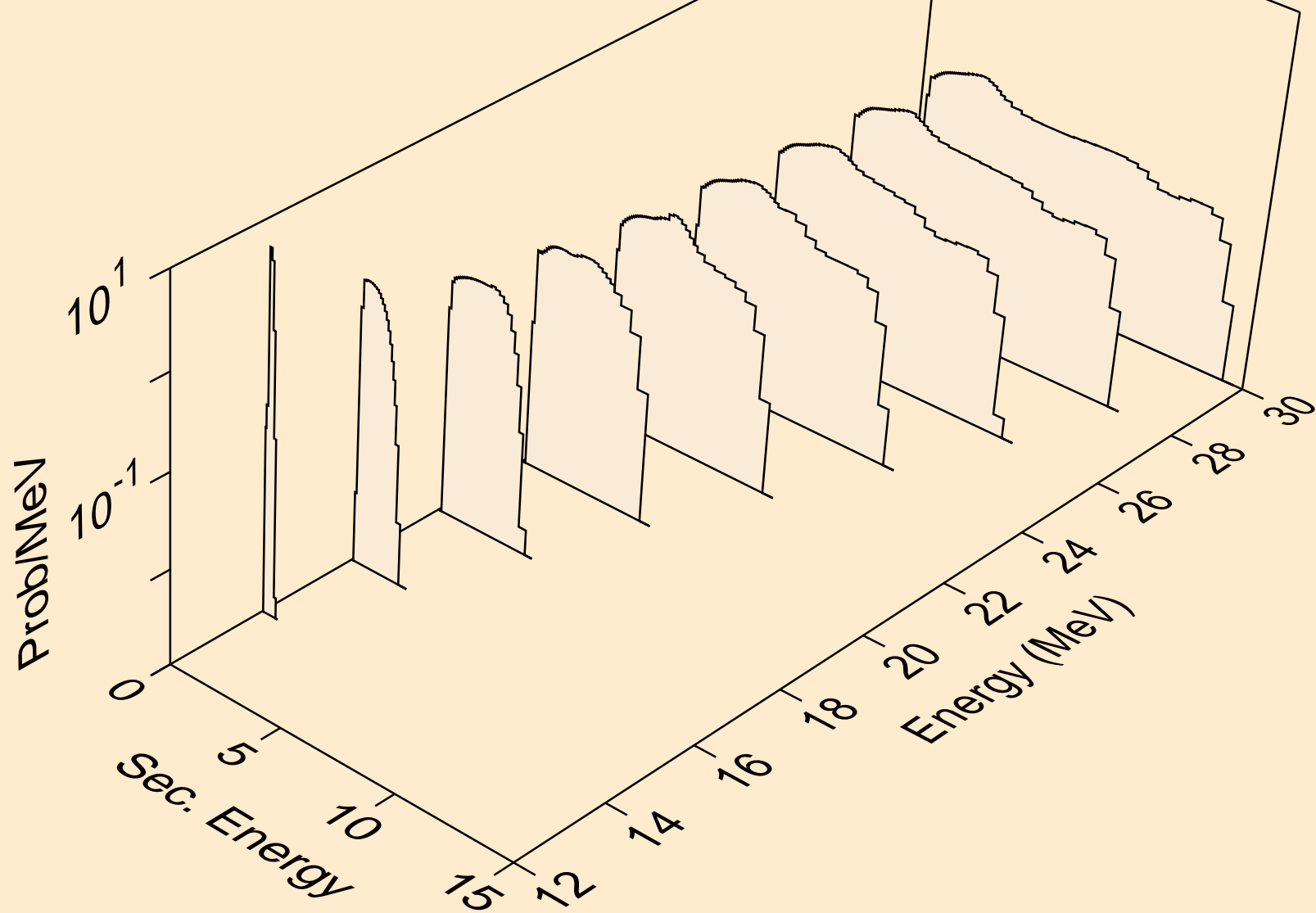

N016 PROTON ACER TENDL-2023 LIBRARY; T=0.K
Photon emission for (z,n)

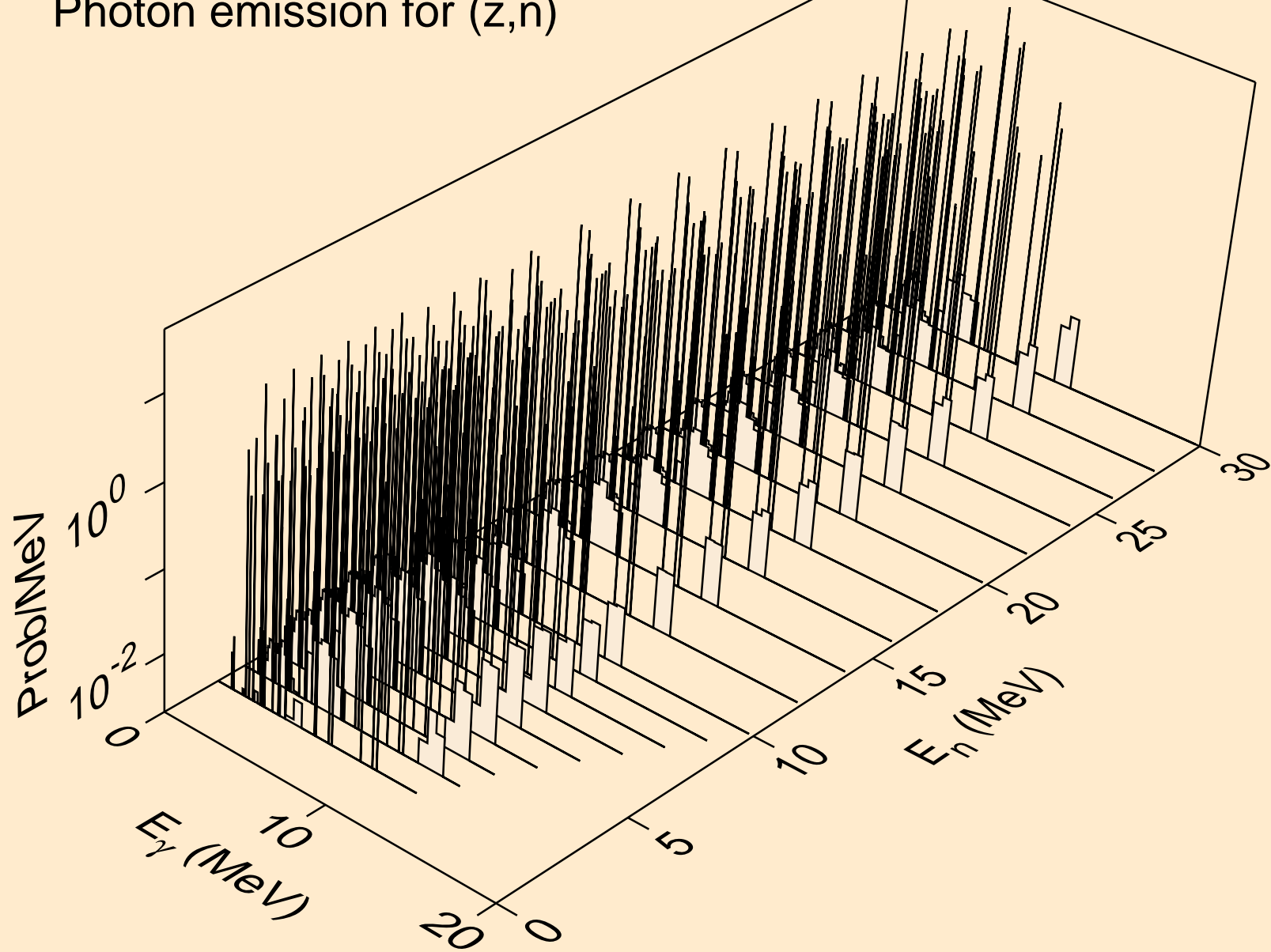

N016 PROTON ACER TENDL-2023 LIBRARY; T=0.K
Photon emission for (z,x)

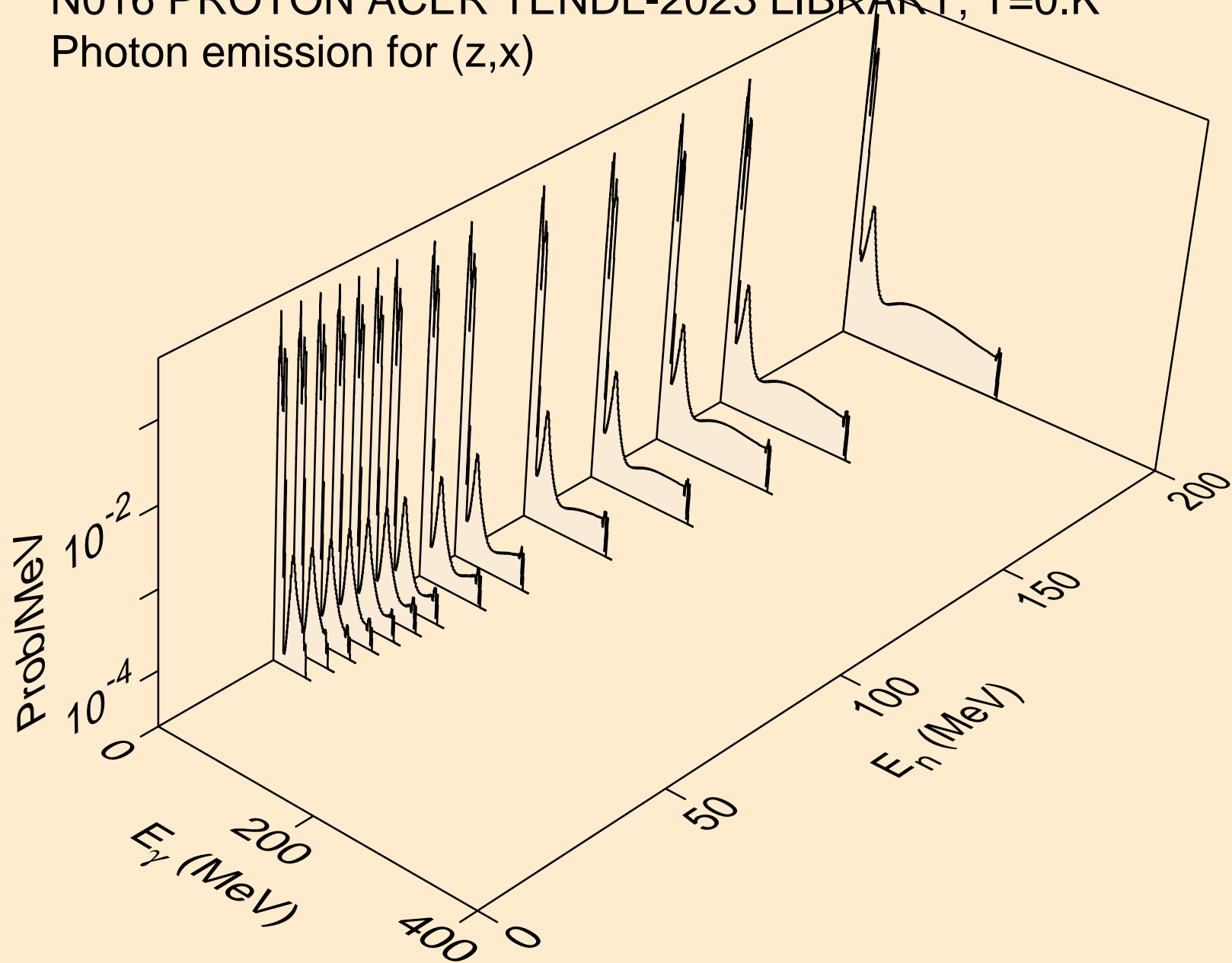

N016 PROTON ACER TENDL-2023 LIBRARY; T=0.K
Photon emission for (n,2nd)

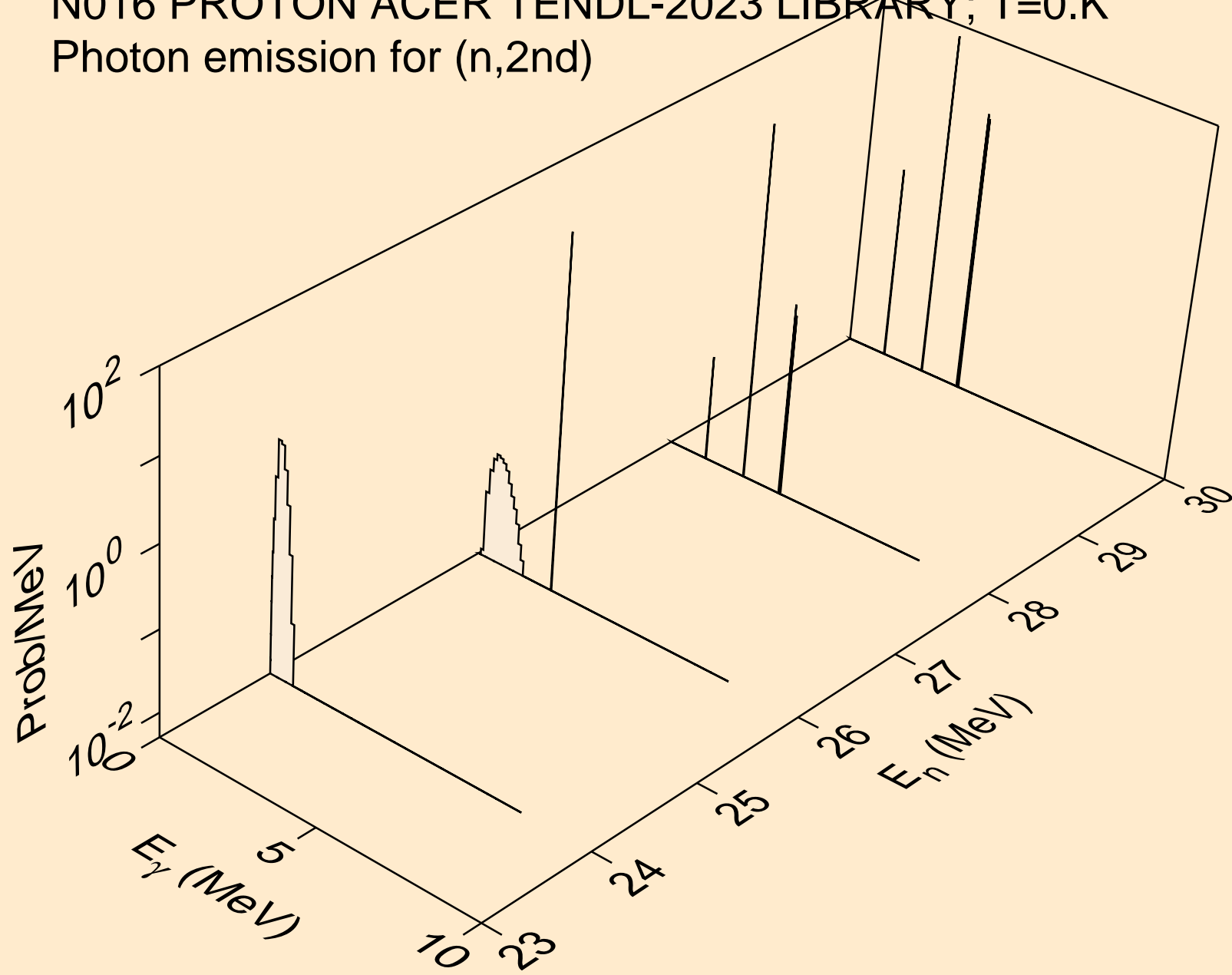

N016 PROTON ACER TENDL-2023 LIBRARY; T=0.K
Photon emission for (n,2n)

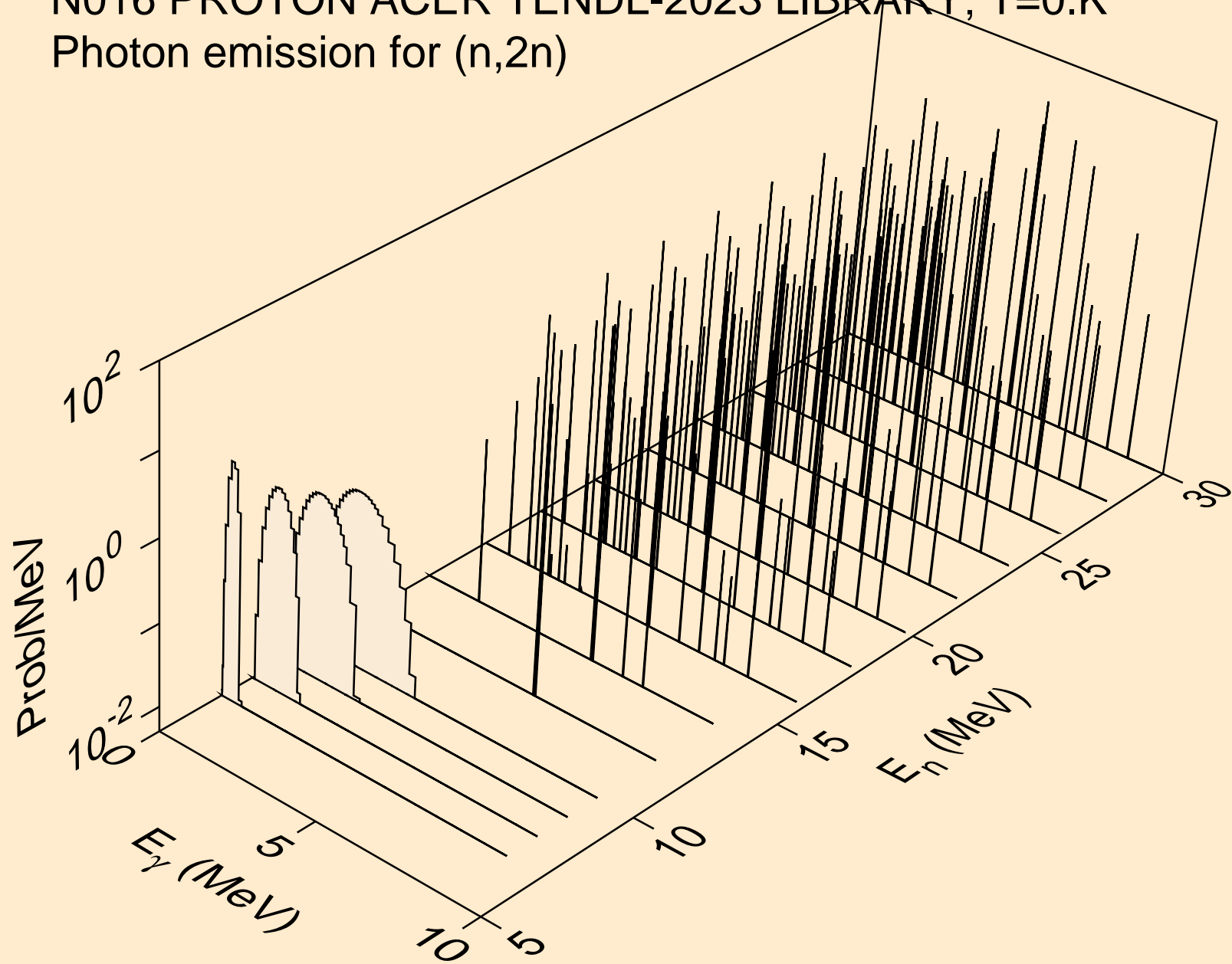

N016 PROTON ACER TENDL-2023 LIBRARY; T=0.K
Photon emission for (n,3n)

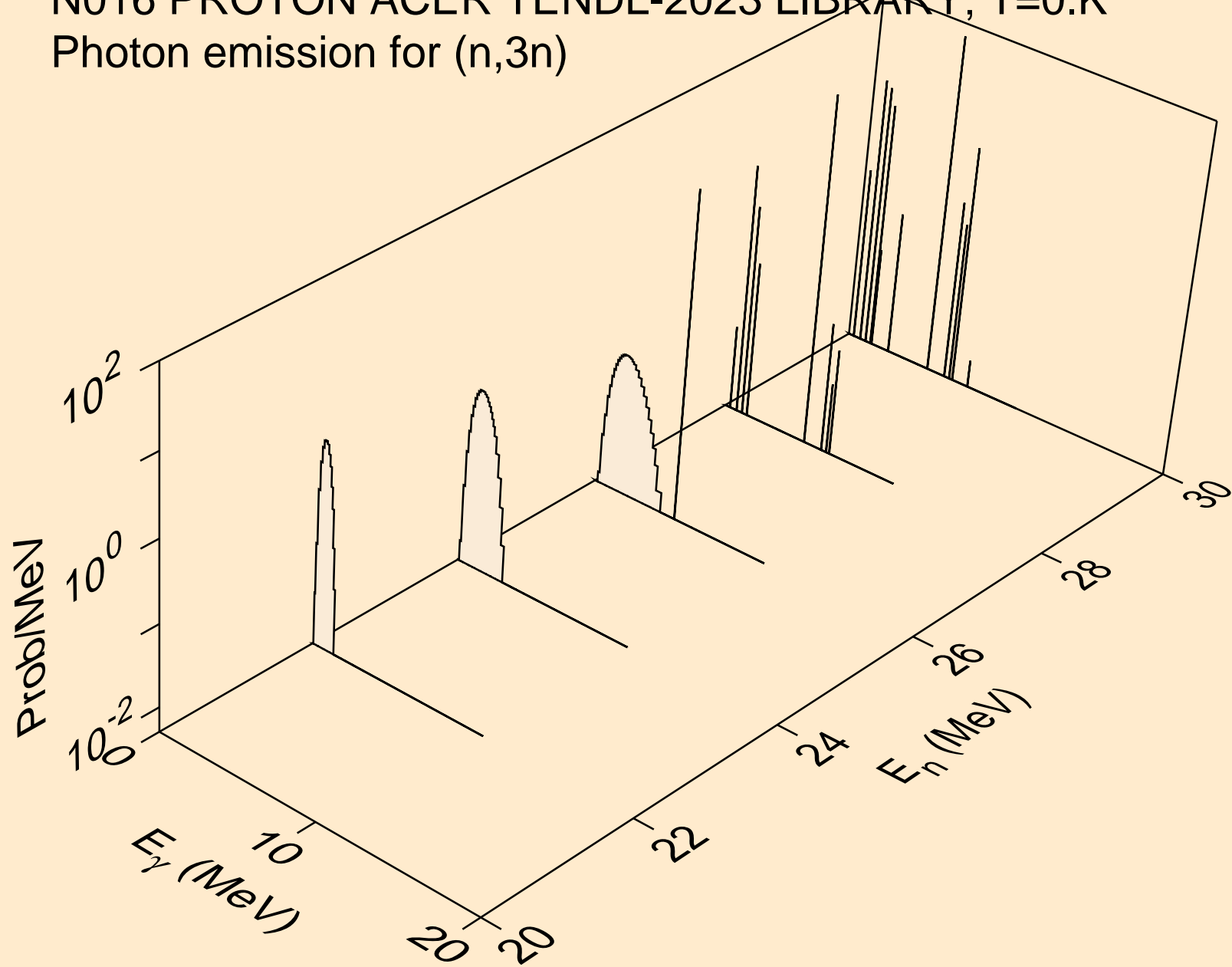

N016 PROTON ACER TENDL-2023 LIBRARY; T=0.K
Photon emission for (n,n*)a

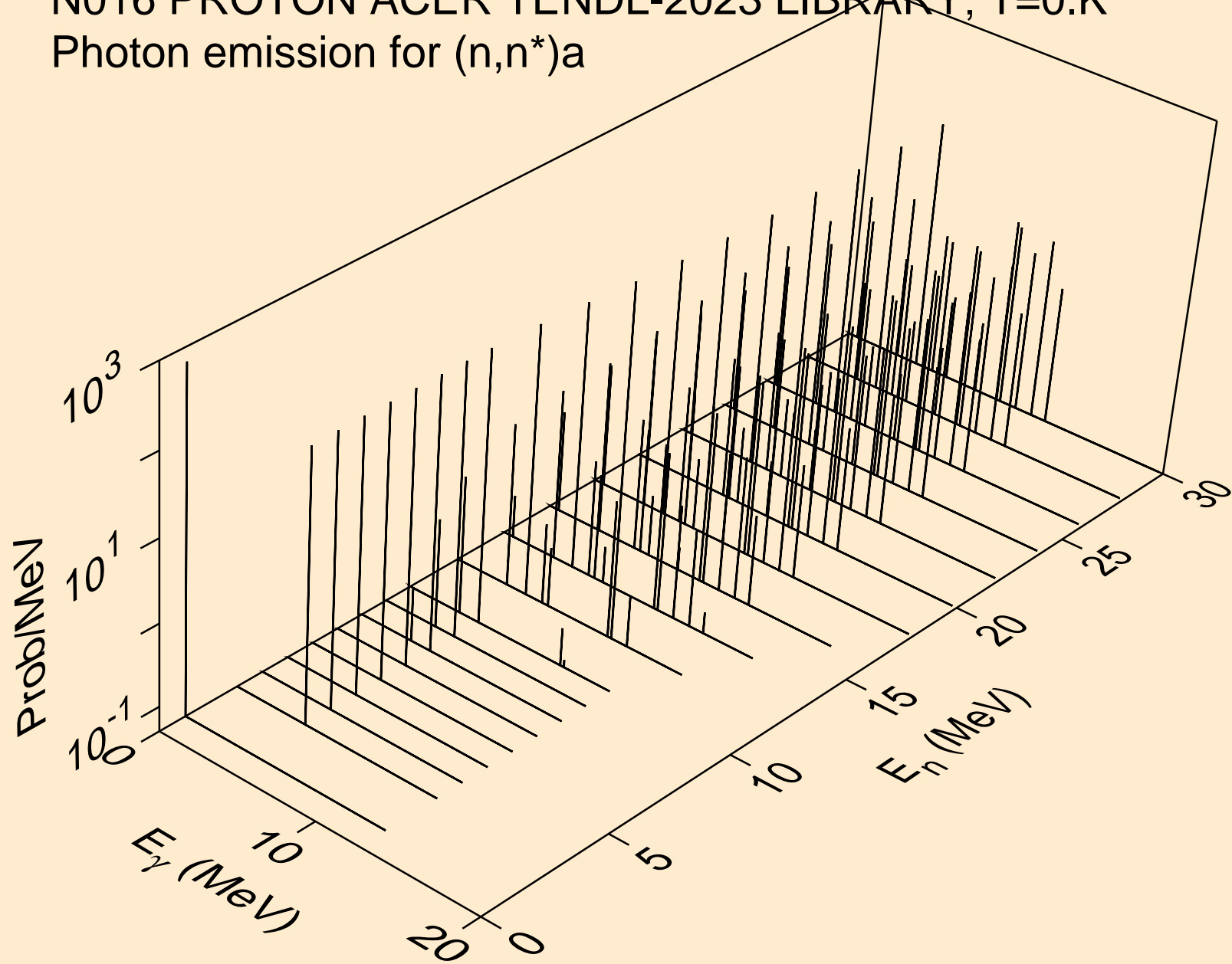

N016 PROTON ACER TENDL-2023 LIBRARY; T=0.K
Photon emission for (n,2n)a

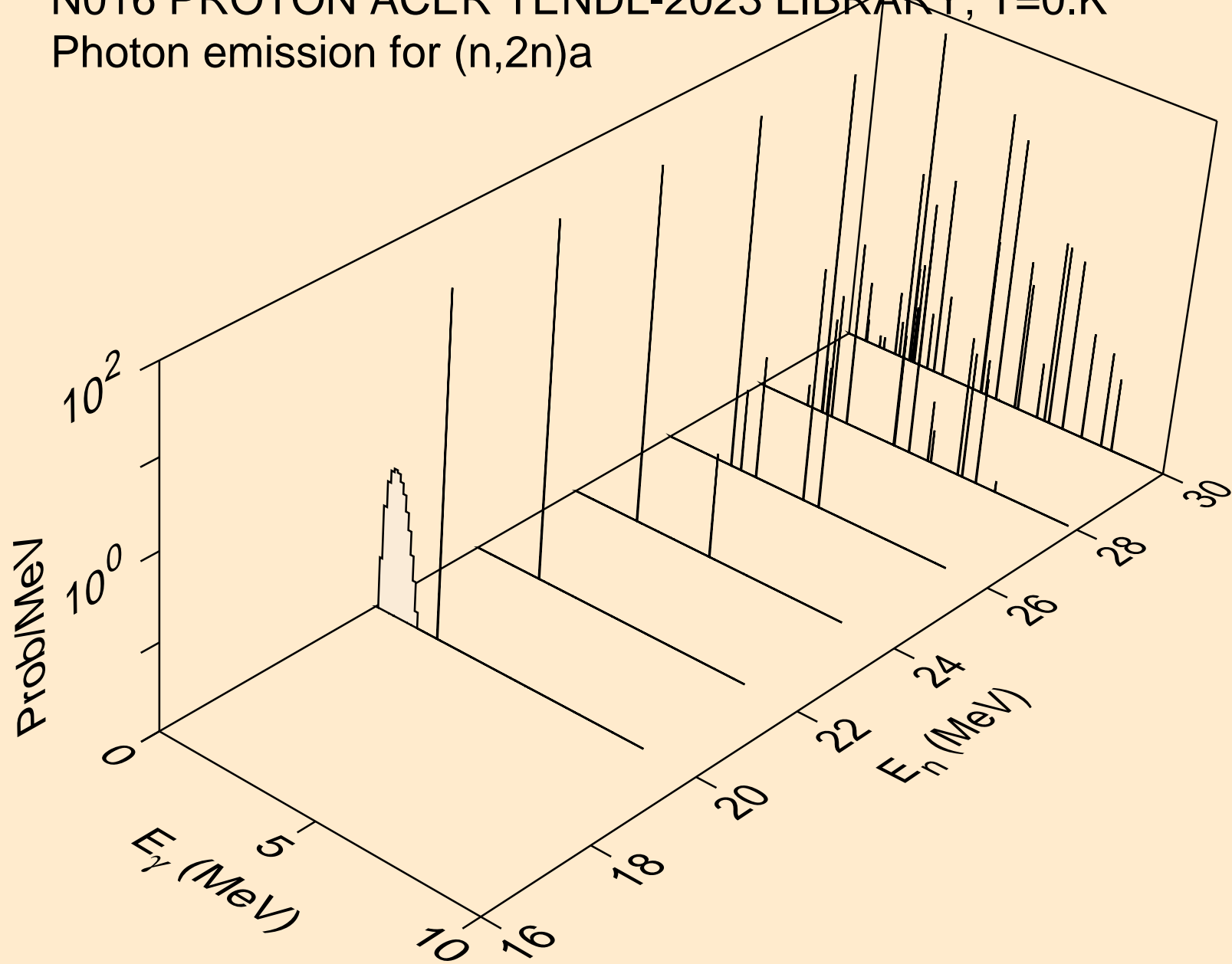

N016 PROTON ACER TENDL-2023 LIBRARY; T=0.K
Photon emission for (n,n*)p

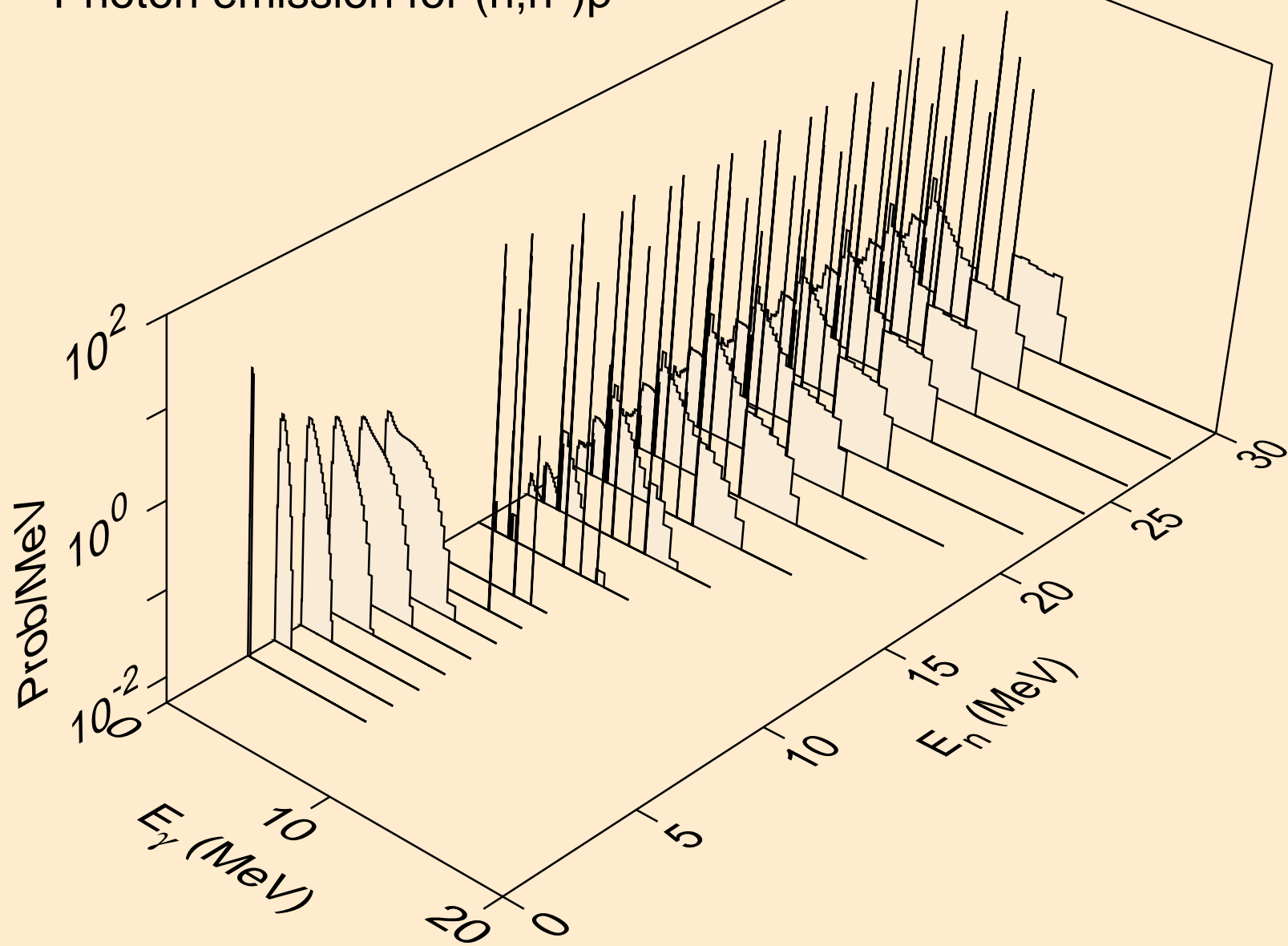

N016 PROTON ACER TENDL-2023 LIBRARY; T=0.K
Photon emission for (n,n*)2a

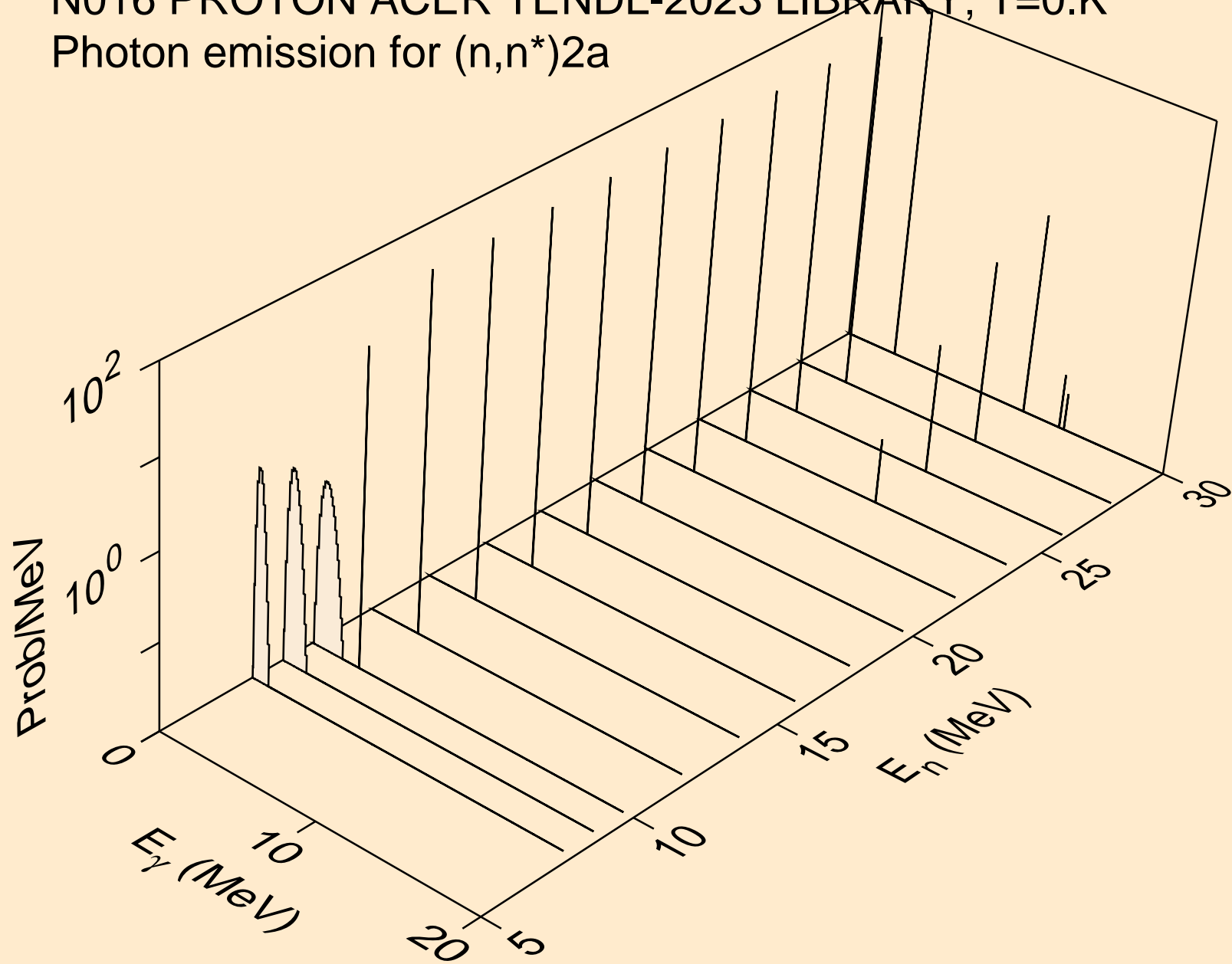

N016 PROTON ACER TENDL-2023 LIBRARY; T=0.K
Photon emission for (n,2n)2a

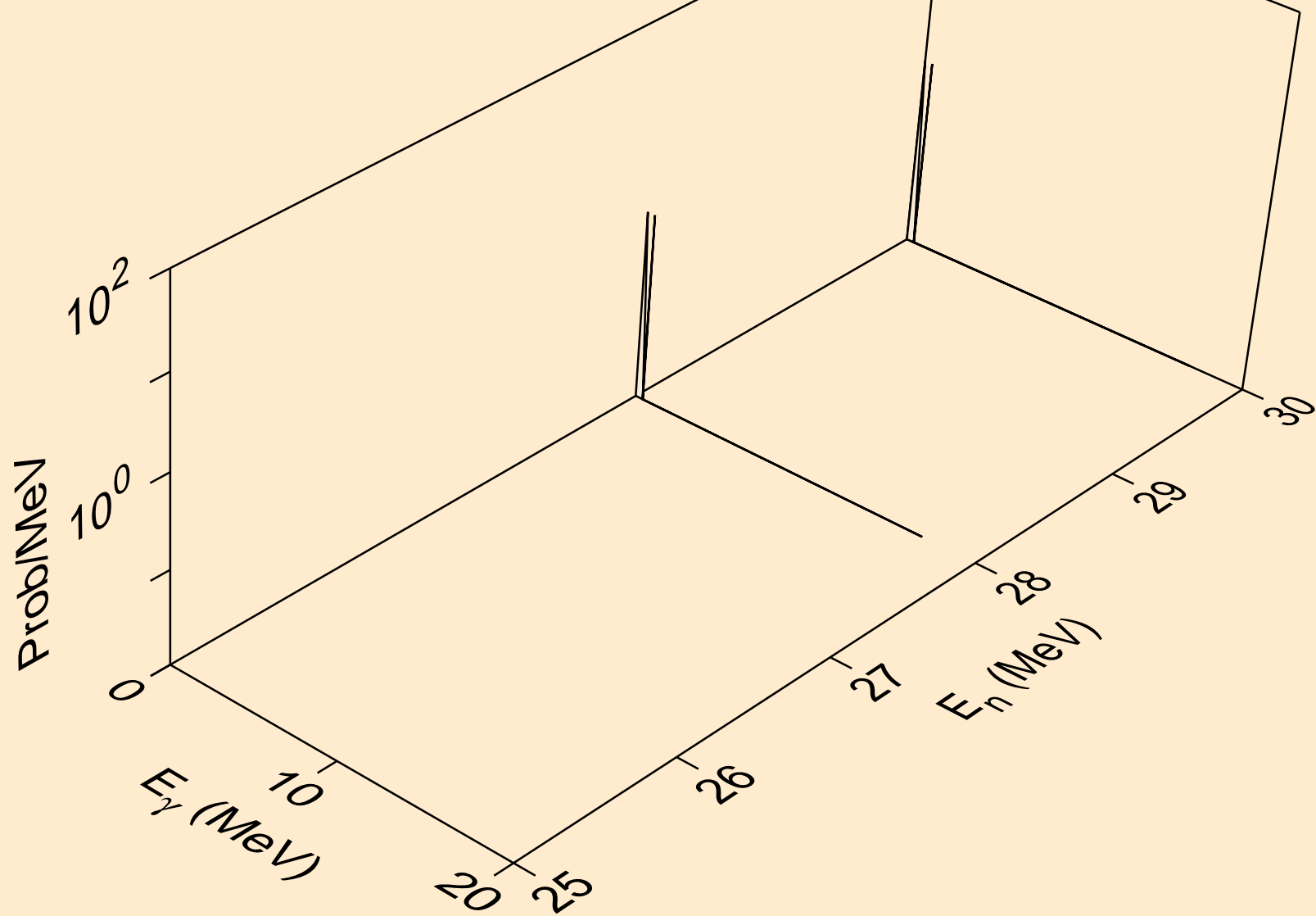

N016 PROTON ACER TENDL-2023 LIBRARY; T=0.K
Photon emission for (n,n*)d

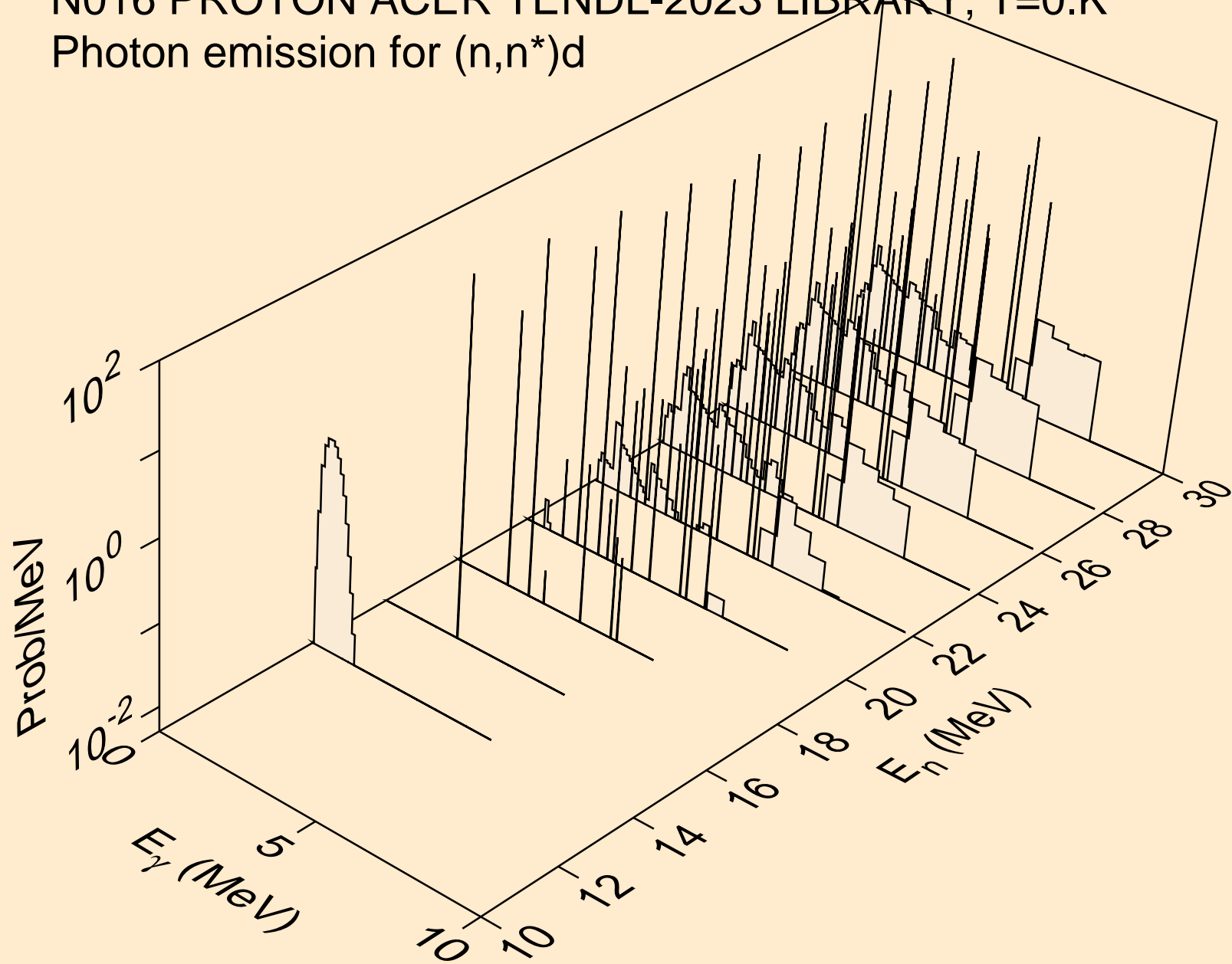

N016 PROTON ACER TENDL-2023 LIBRARY; T=0.K
Photon emission for (n,n*)t

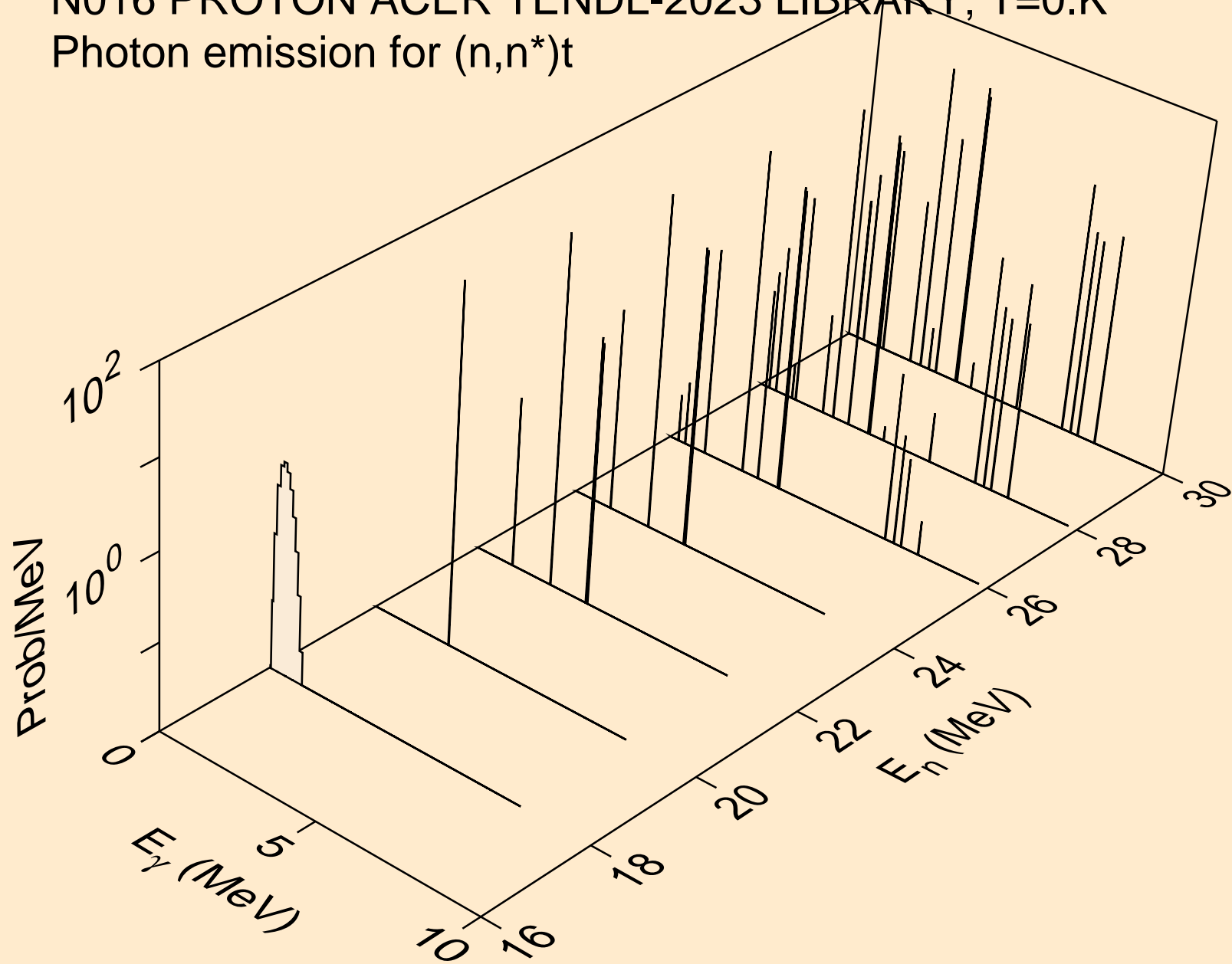

N016 PROTON ACER TENDL-2023 LIBRARY; T=0.K
Photon emission for (n,n*)he3

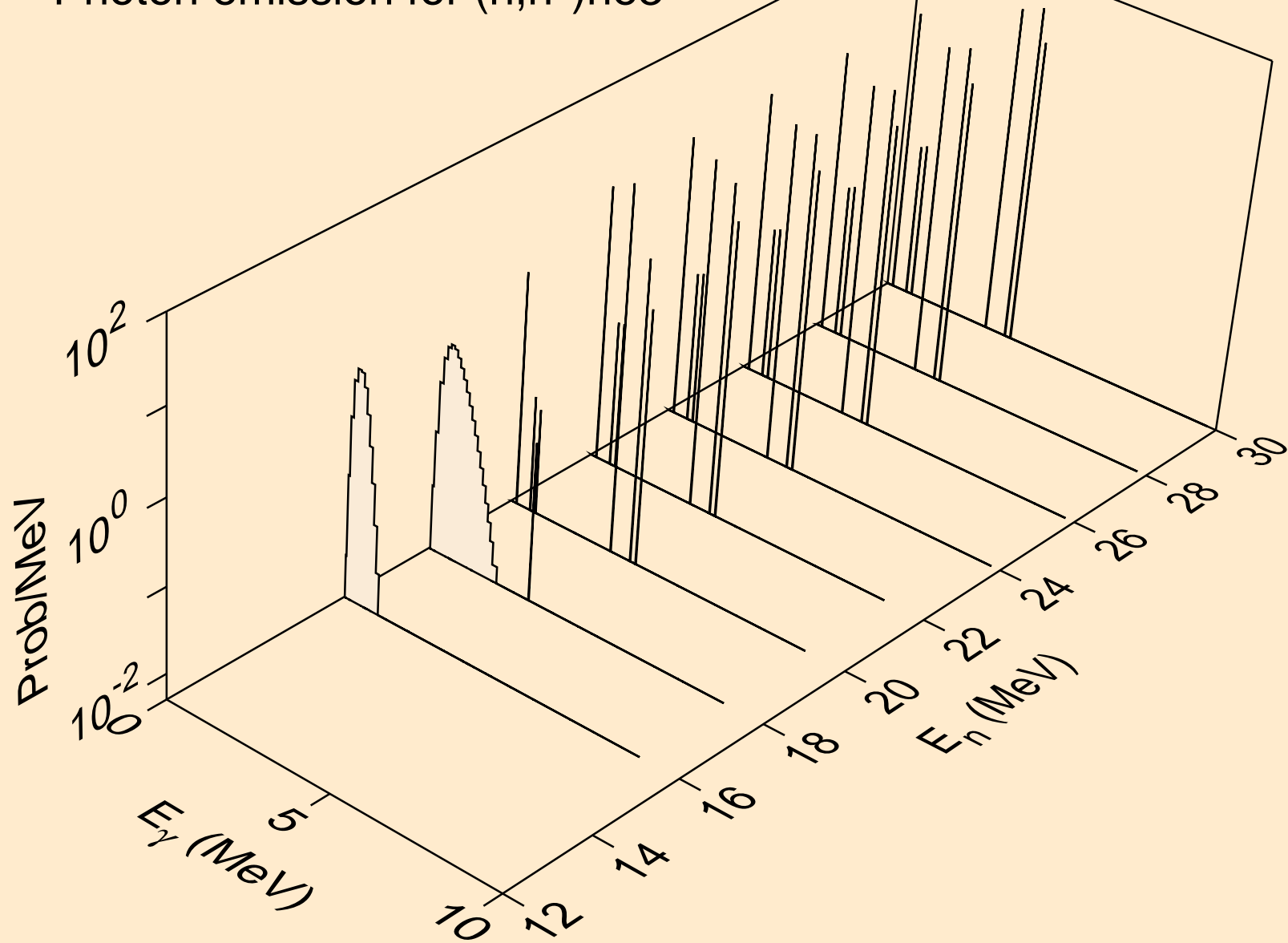

N016 PROTON ACER TENDL-2023 LIBRARY; T=0.K
Photon emission for (n,2np)

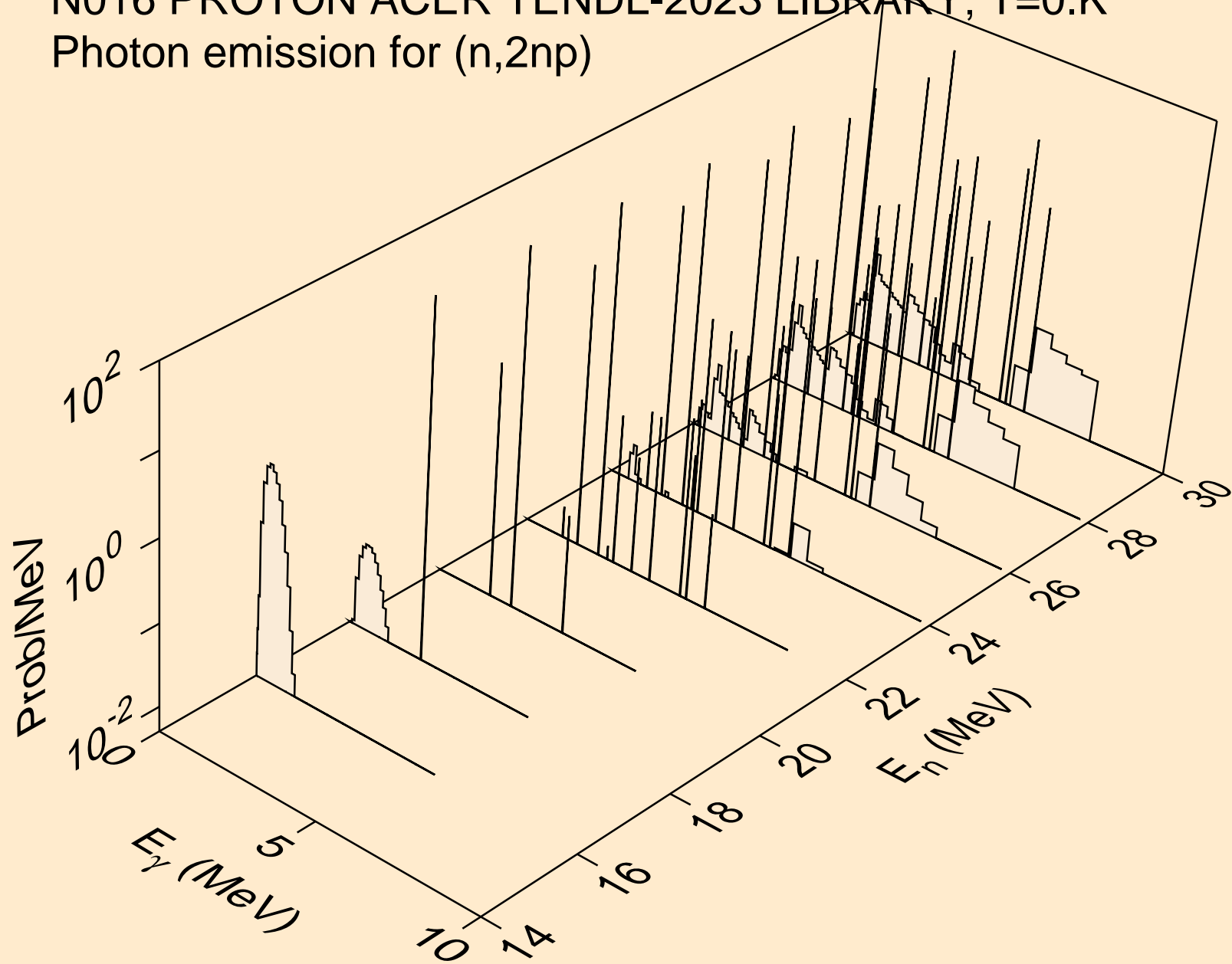

N016 PROTON ACER TENDL-2023 LIBRARY; T=0.K
Photon emission for (n,3np)

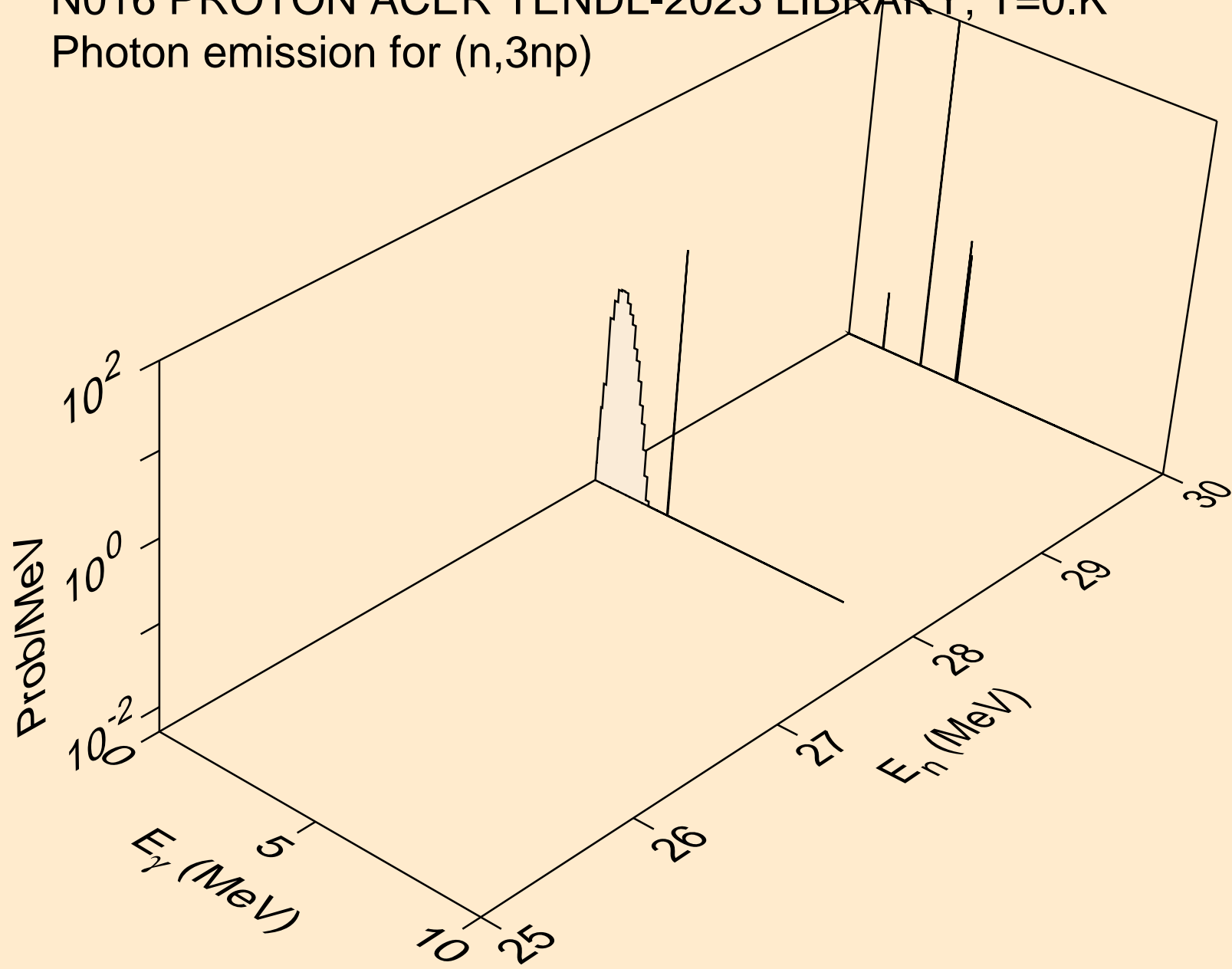

N016 PROTON ACER TENDL-2023 LIBRARY; T=0.K
Photon emission for (n,n2p)

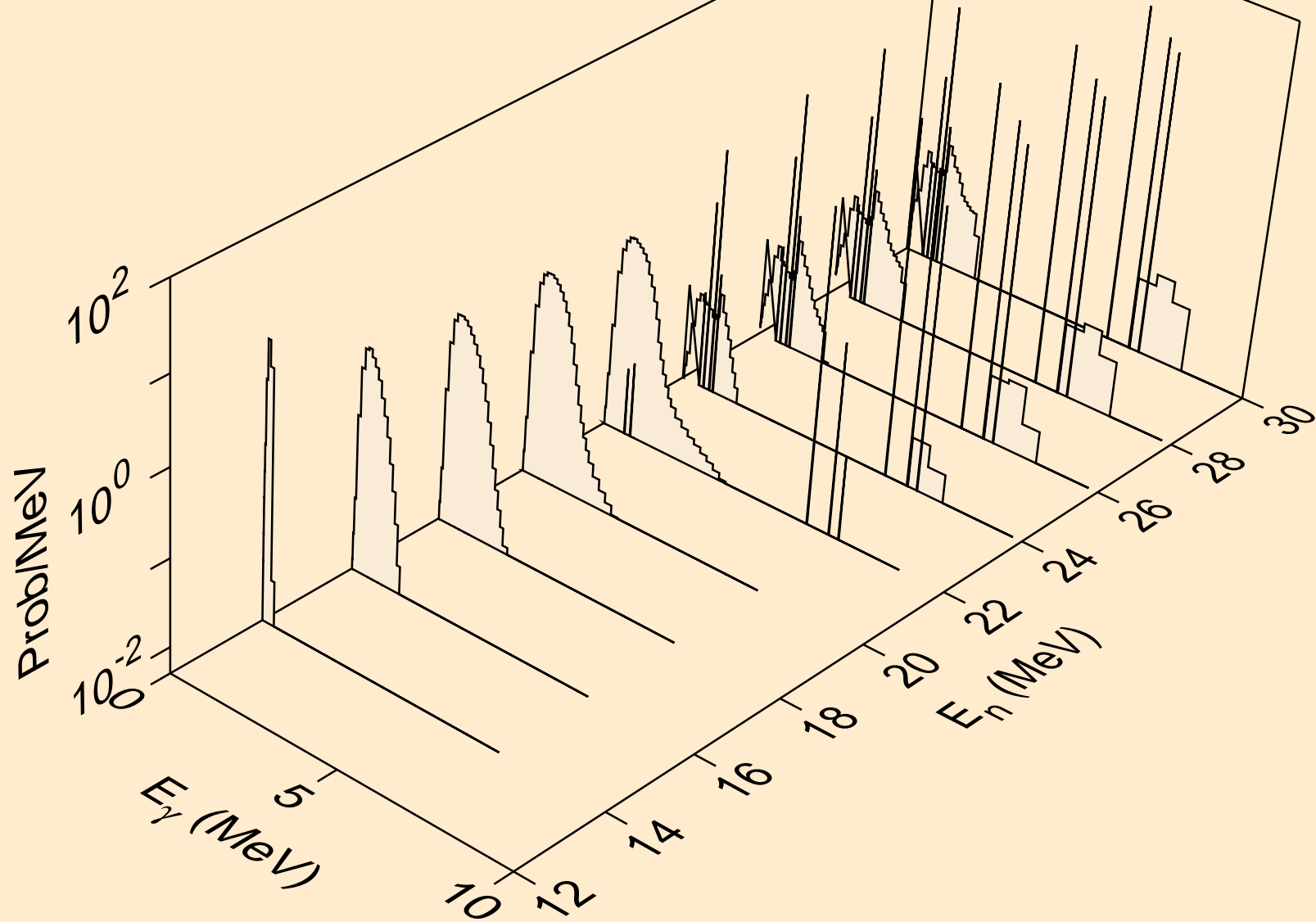

N016 PROTON ACER TENDL-2023 LIBRARY; T=0.K
Photon emission for (n,npa)

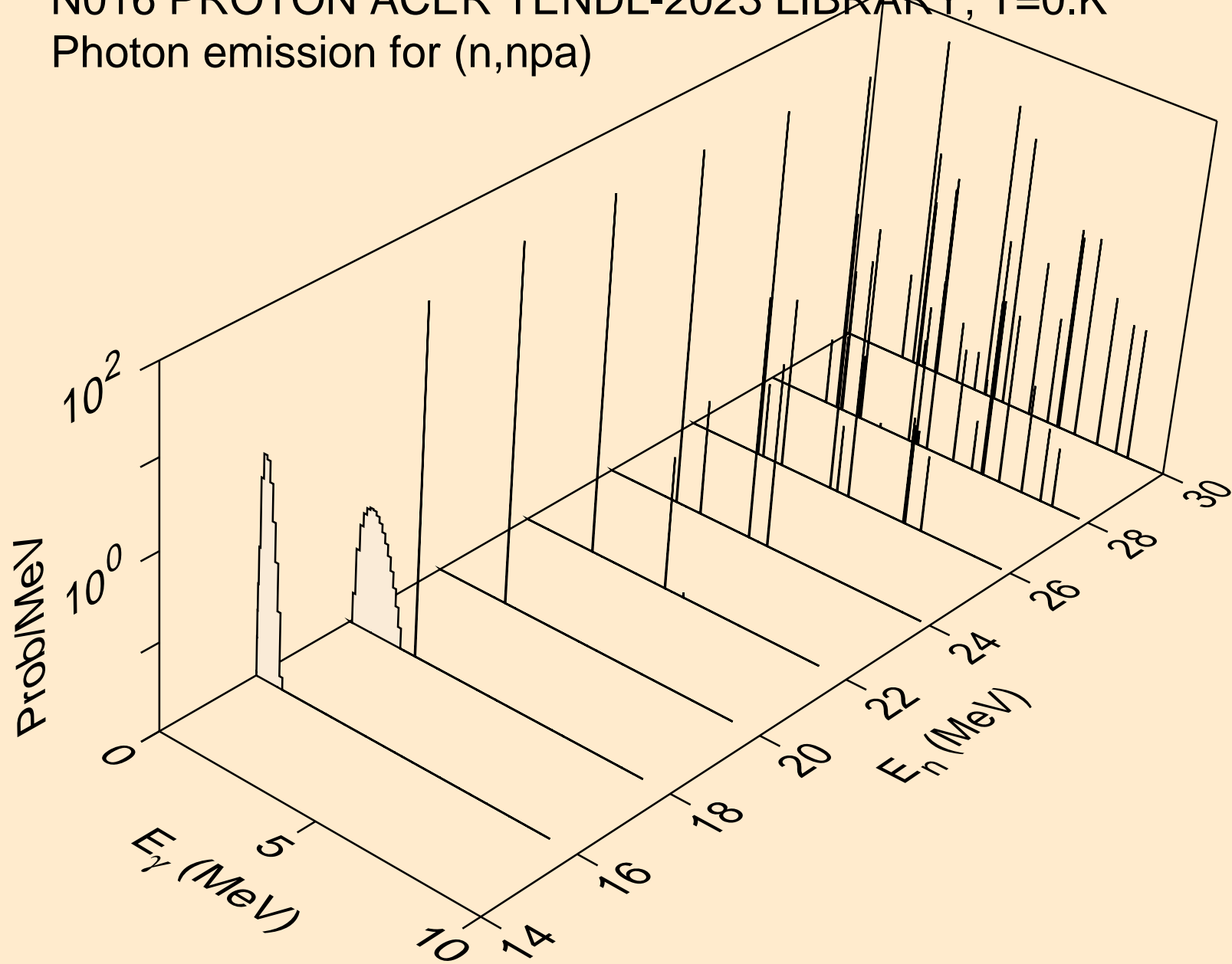

N016 PROTON ACER TENDL-2023 LIBRARY; T=0.K
Photon emission for (n,gma)

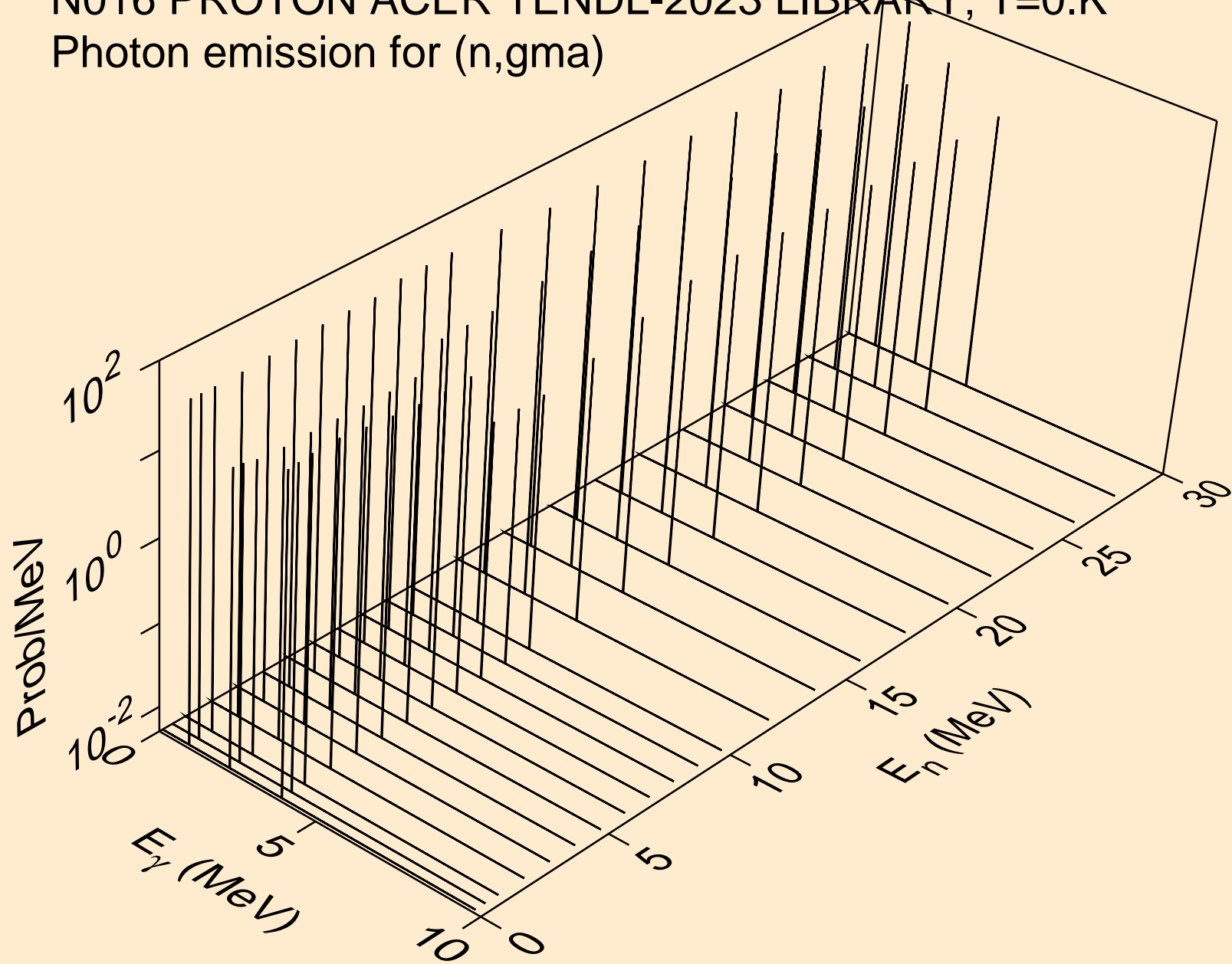

N016 PROTON ACER TENDL-2023 LIBRARY; T=0.K
Photon emission for inelastic

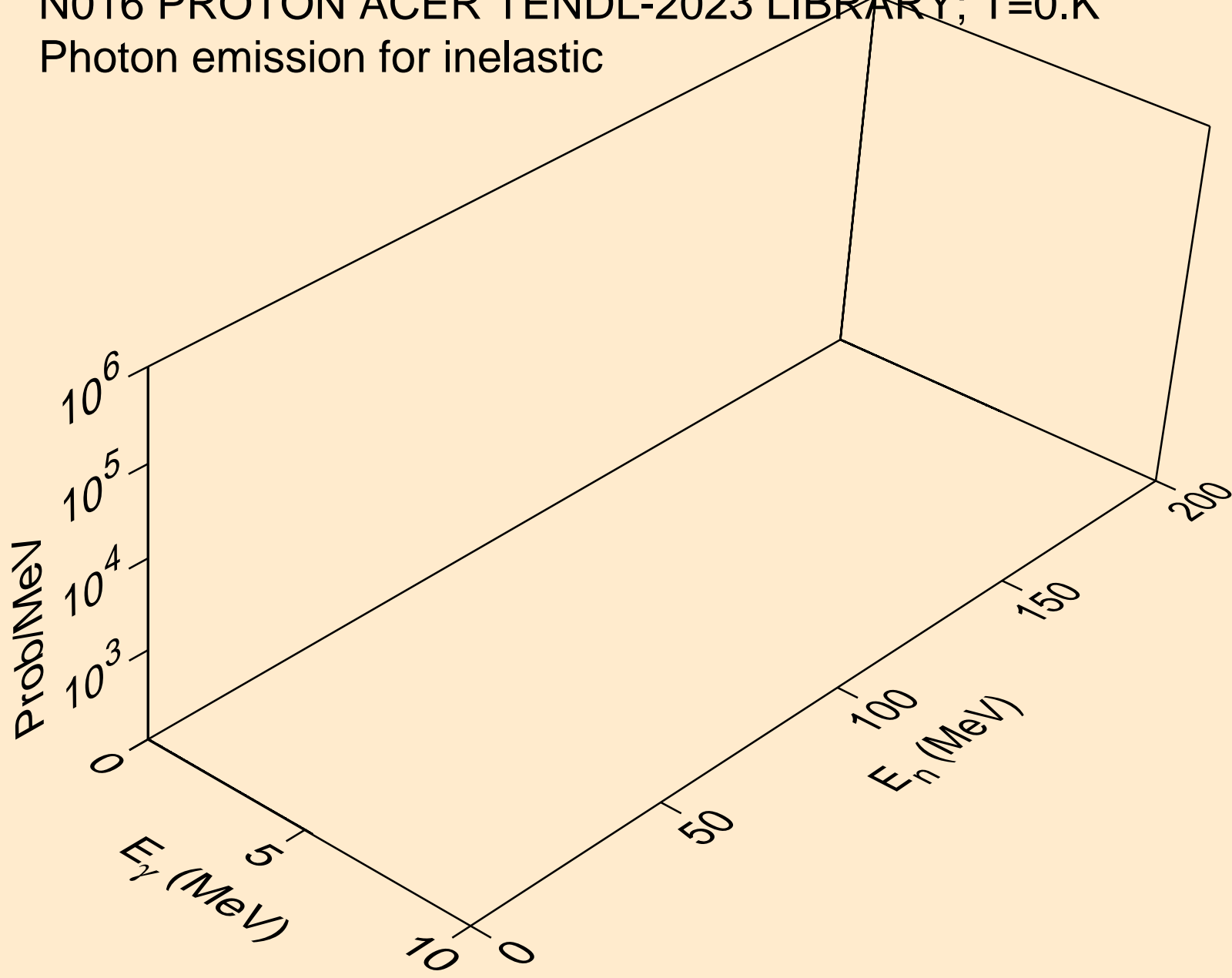

N016 PROTON ACER TENDL-2023 LIBRARY; T=0.K
Photon emission for (n,d)

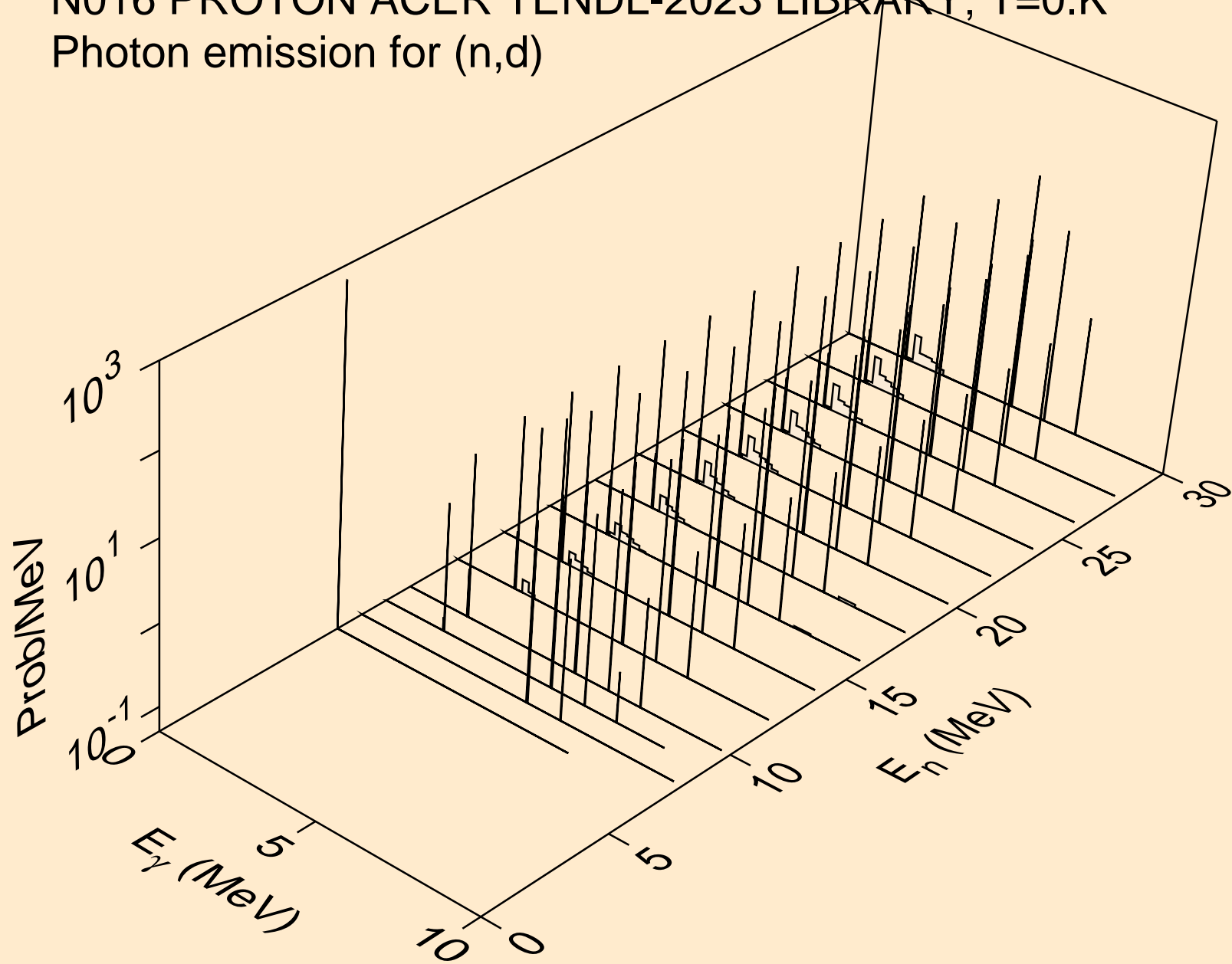

N016 PROTON ACER TENDL-2023 LIBRARY; T=0.K
Photon emission for (n,t)

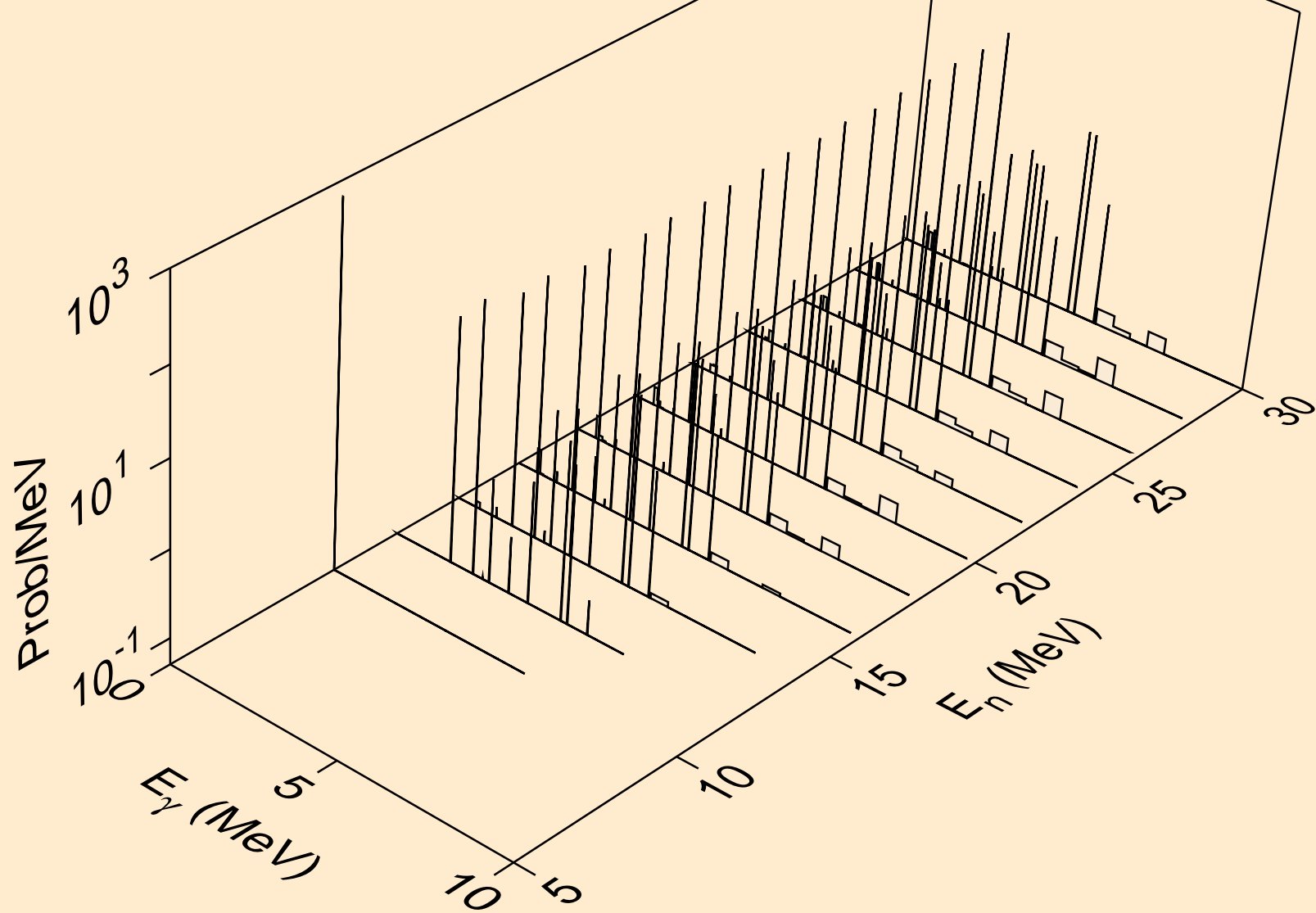

N016 PROTON ACER TENDL-2023 LIBRARY; T=0.K
Photon emission for (n,he3)

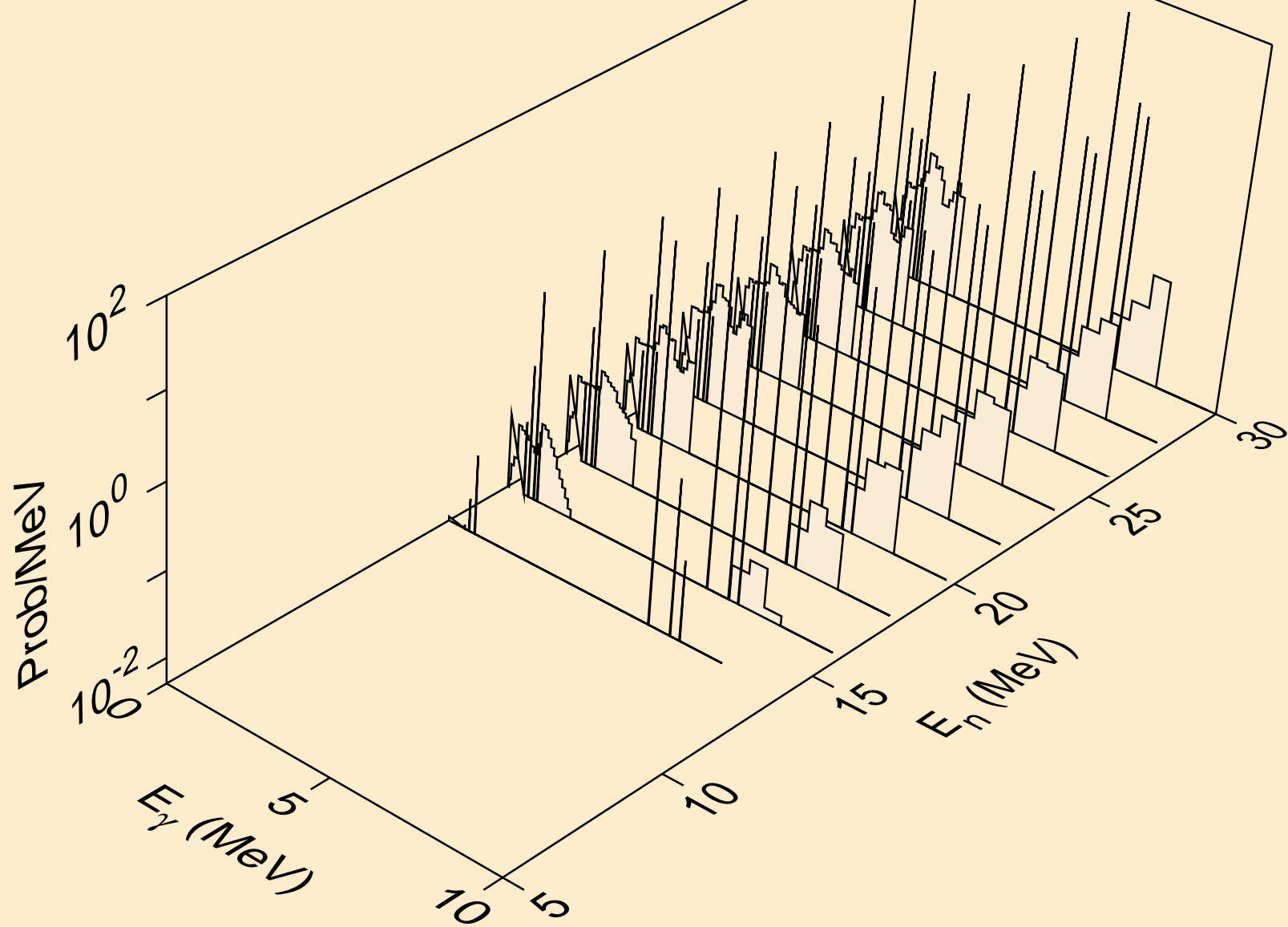

N016 PROTON ACER TENDL-2023 LIBRARY; T=0.K
Photon emission for (n,a)

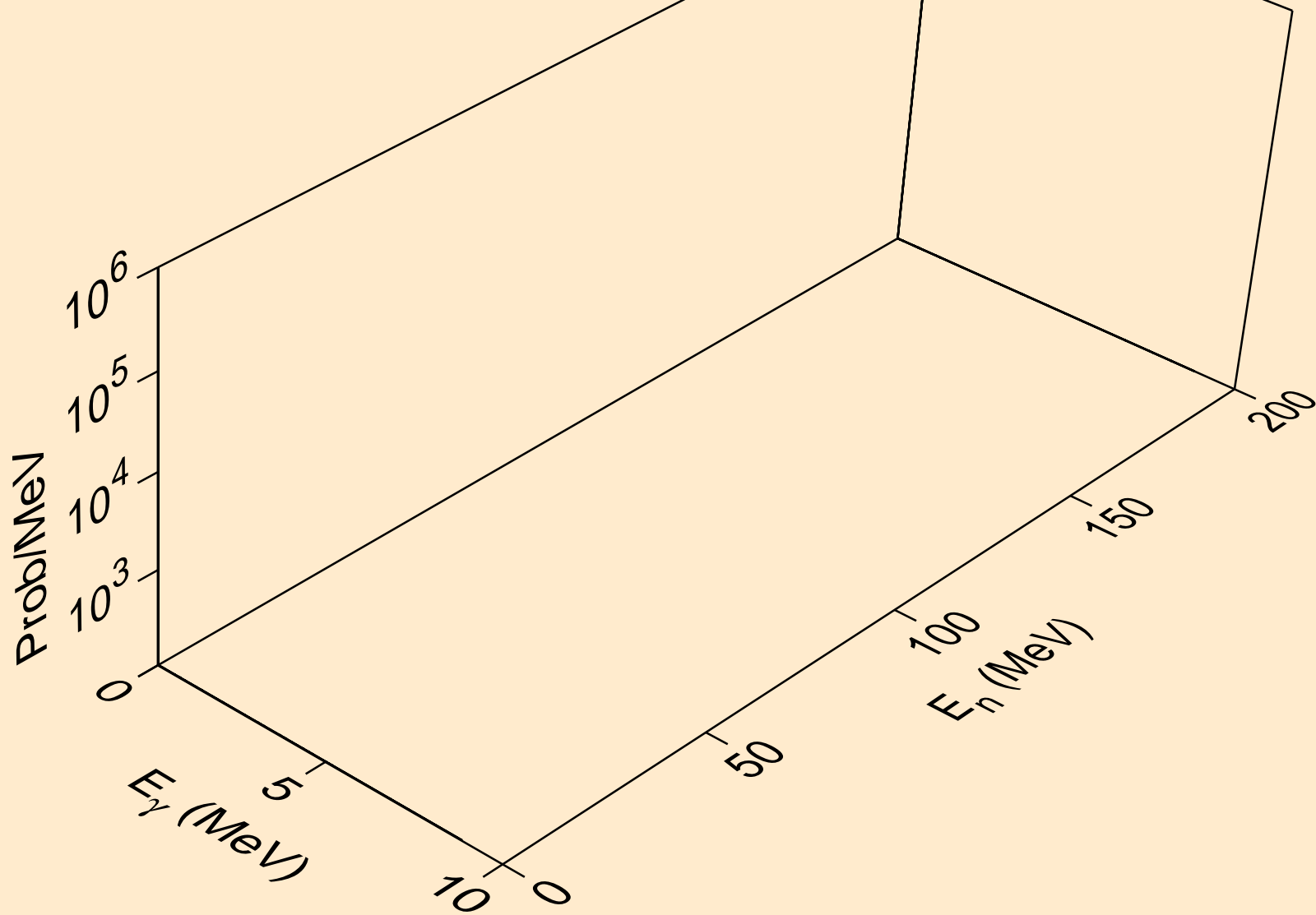

N016 PROTON ACER TENDL-2023 LIBRARY; T=0.K
Photon emission for (n,2a)

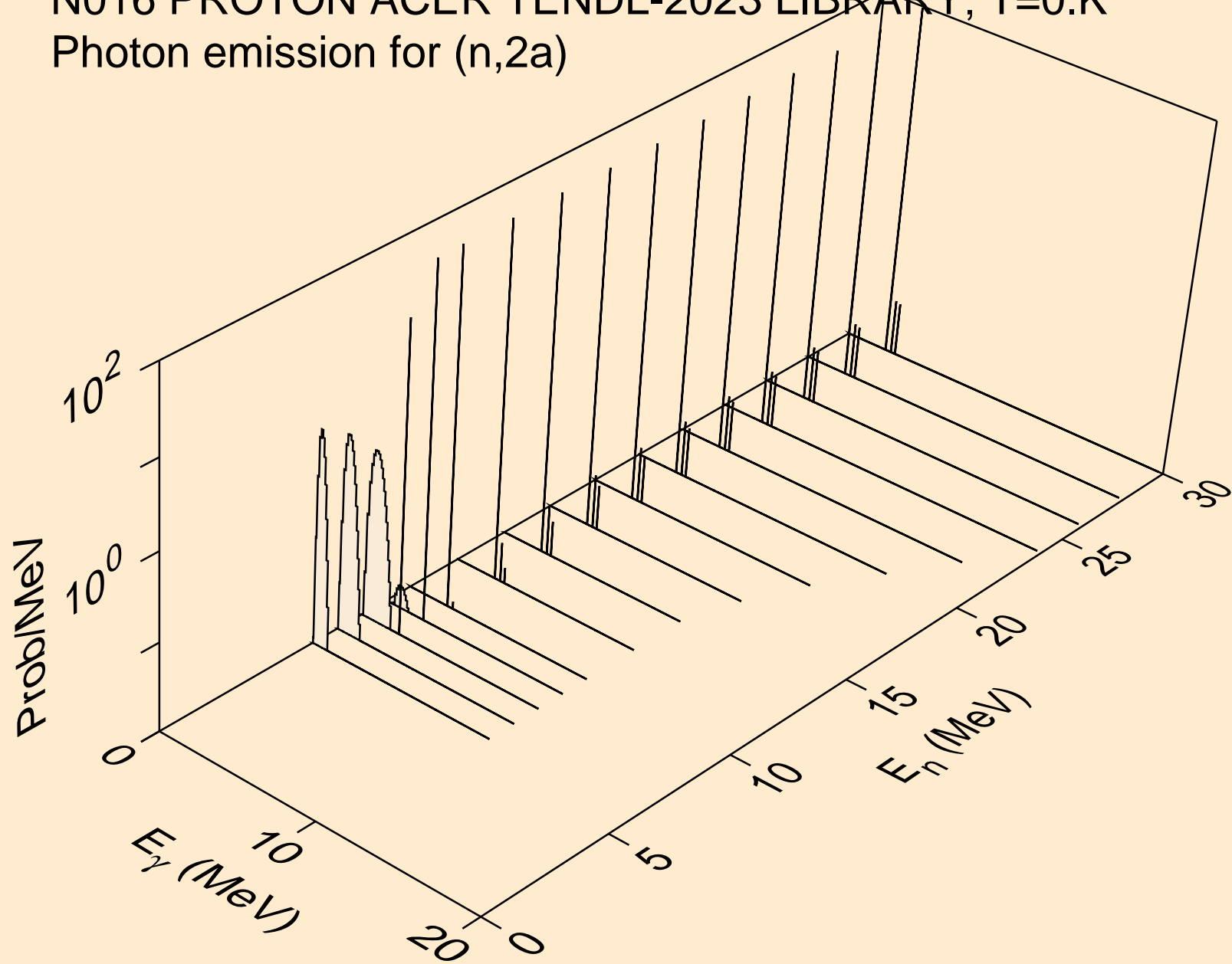

N016 PROTON ACER TENDL-2023 LIBRARY; T=0.K
Photon emission for (n,2p)

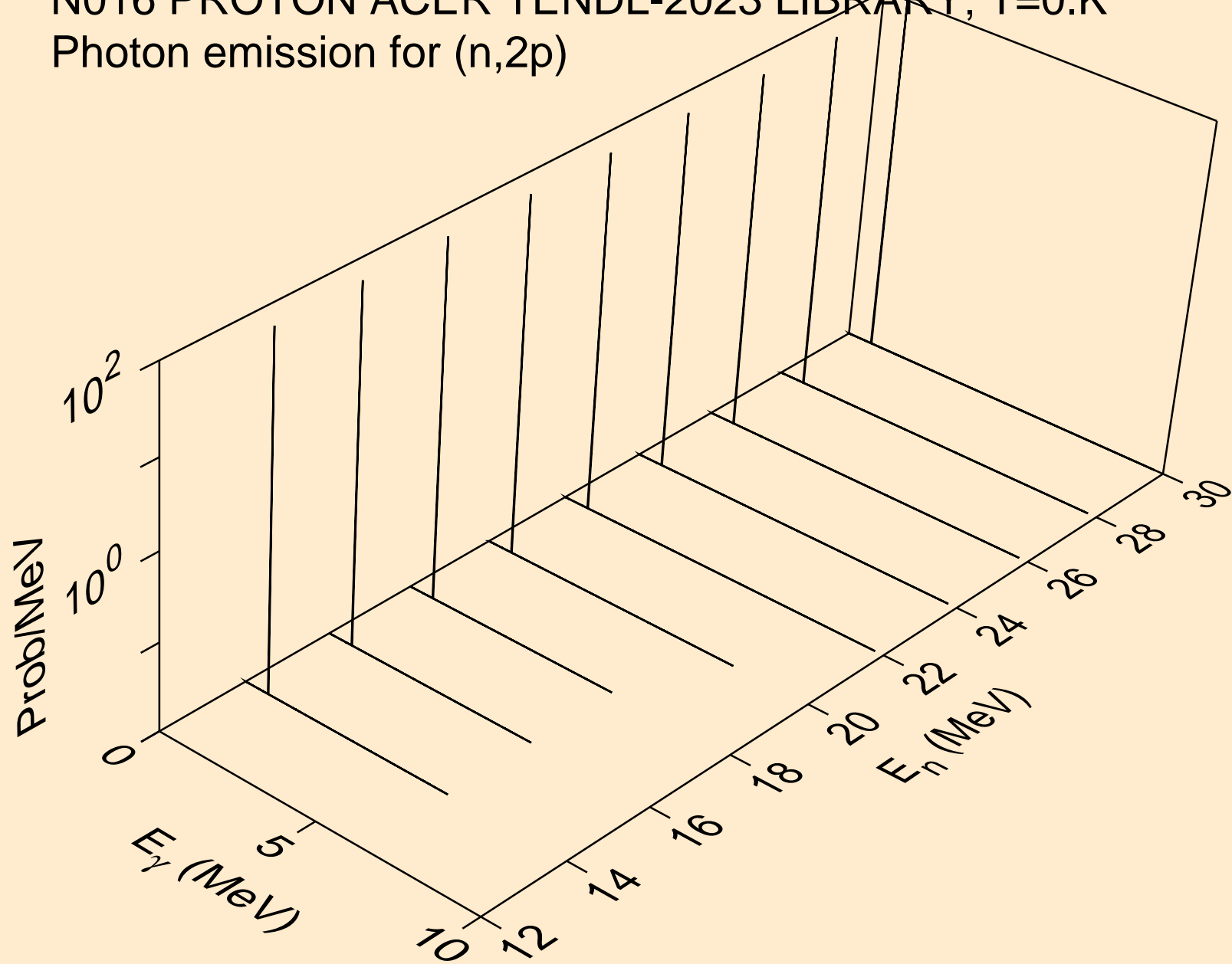

N016 PROTON ACER TENDL-2023 LIBRARY; T=0.K
Photon emission for (n,pa)

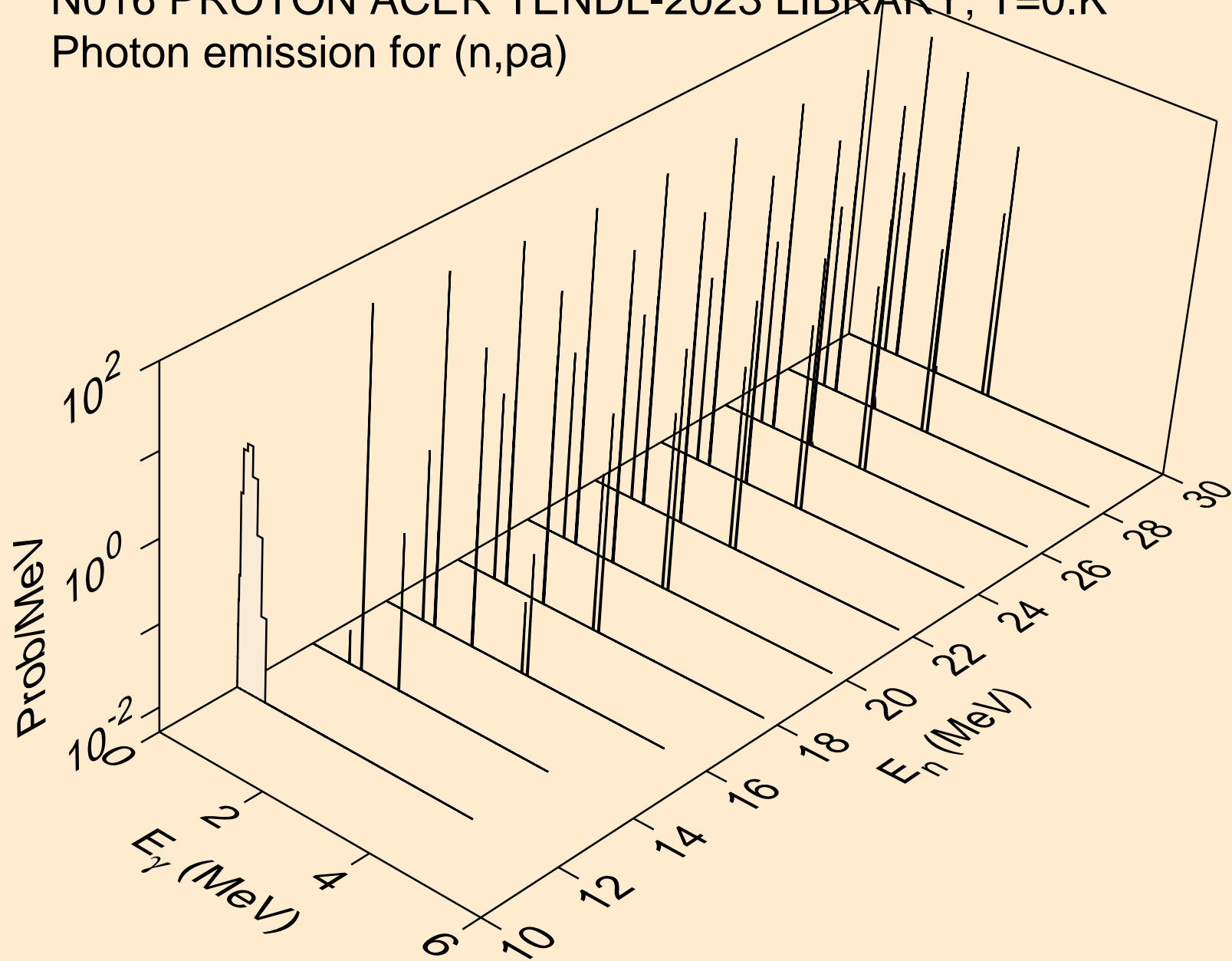

N016 PROTON ACER TENDL-2023 LIBRARY; T=0.K
Photon emission for (n,t2a)

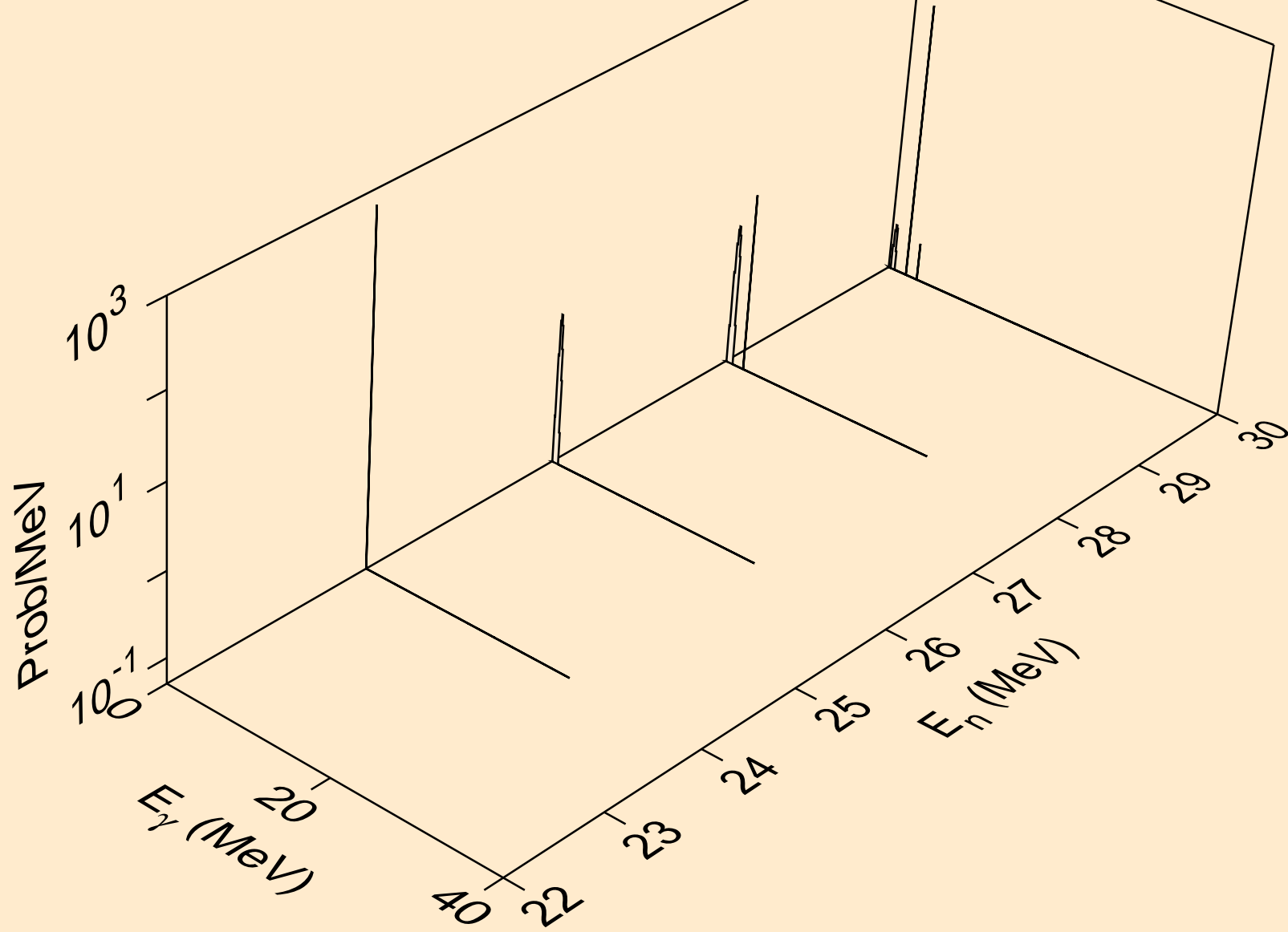

N016 PROTON ACER TENDL-2023 LIBRARY; T=0.K
Photon emission for (n,d2a)

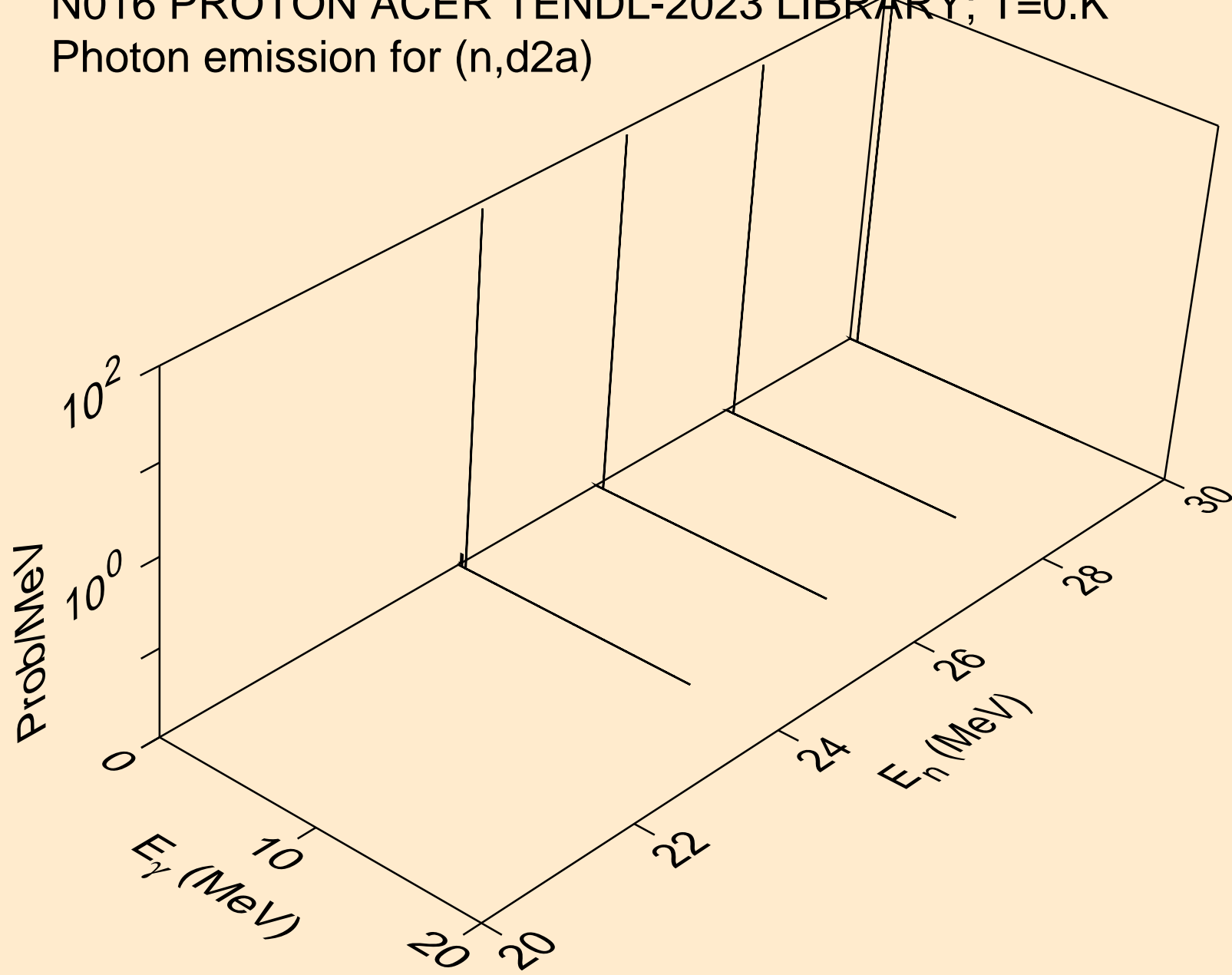

N016 PROTON ACER TENDL-2023 LIBRARY; T=0.K
Photon emission for (n,pd)

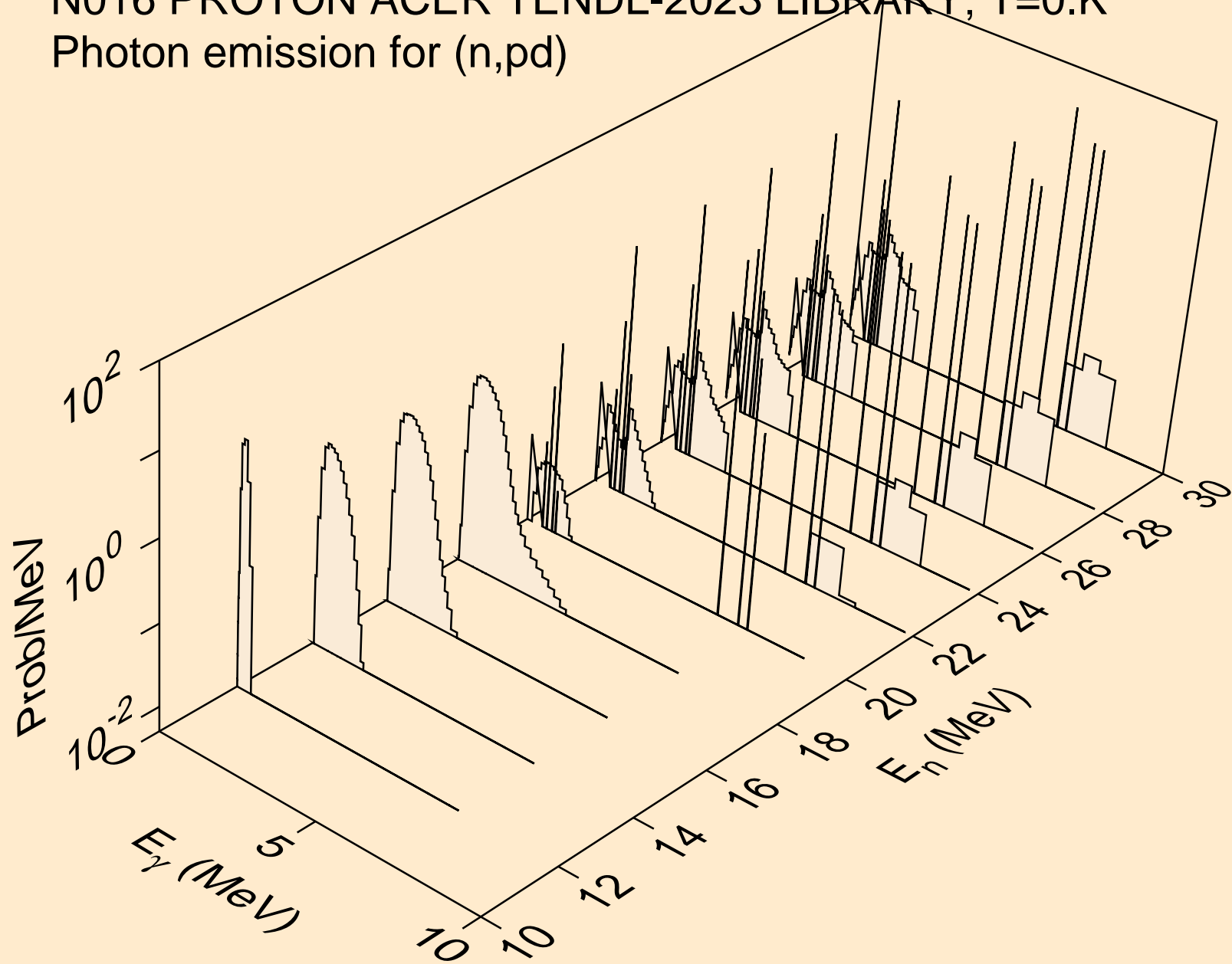

N016 PROTON ACER TENDL-2023 LIBRARY; T=0.K
Photon emission for (n,pt)

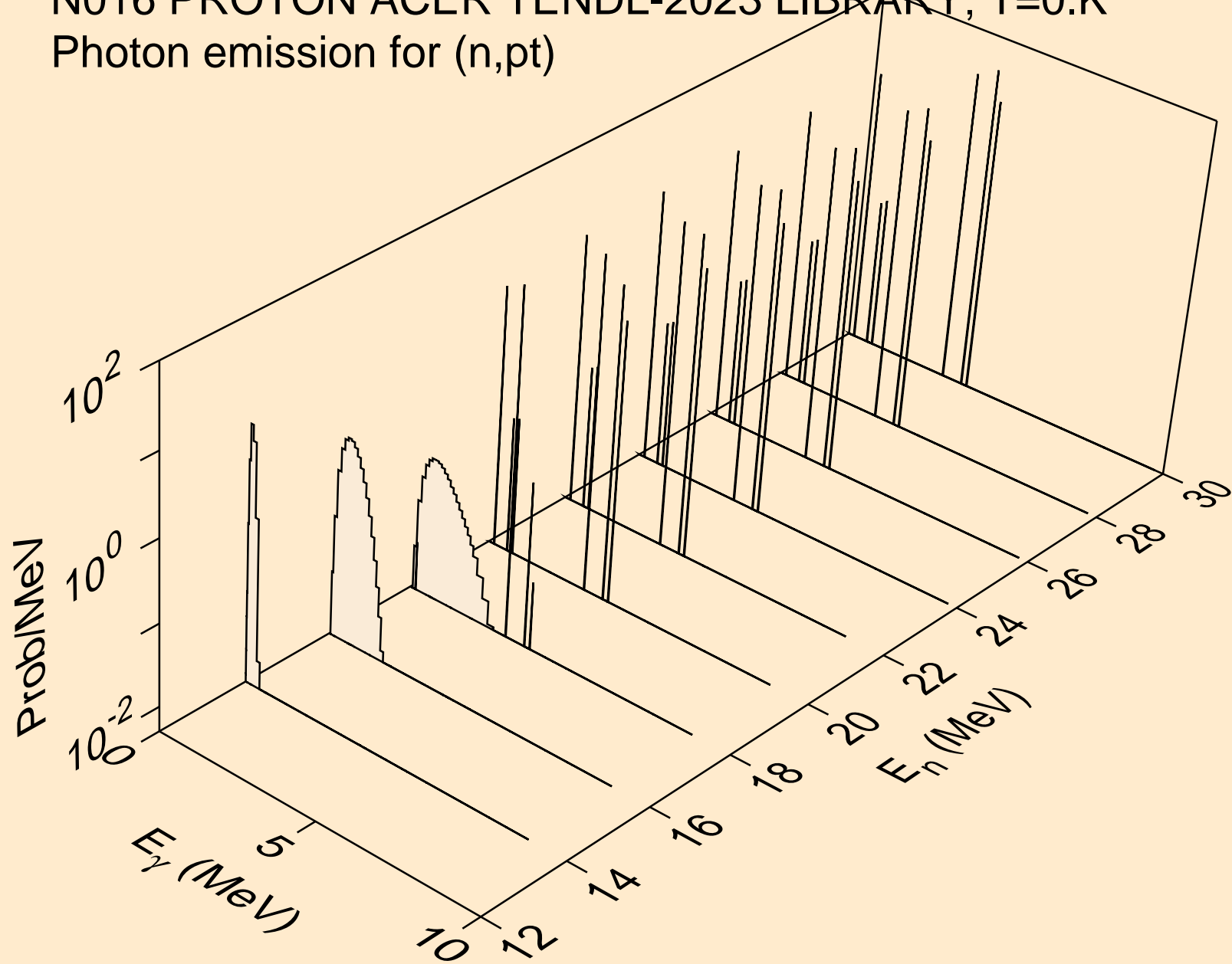

N016 PROTON ACER TENDL-2023 LIBRARY; T=0.K
Photon emission for (n,da)

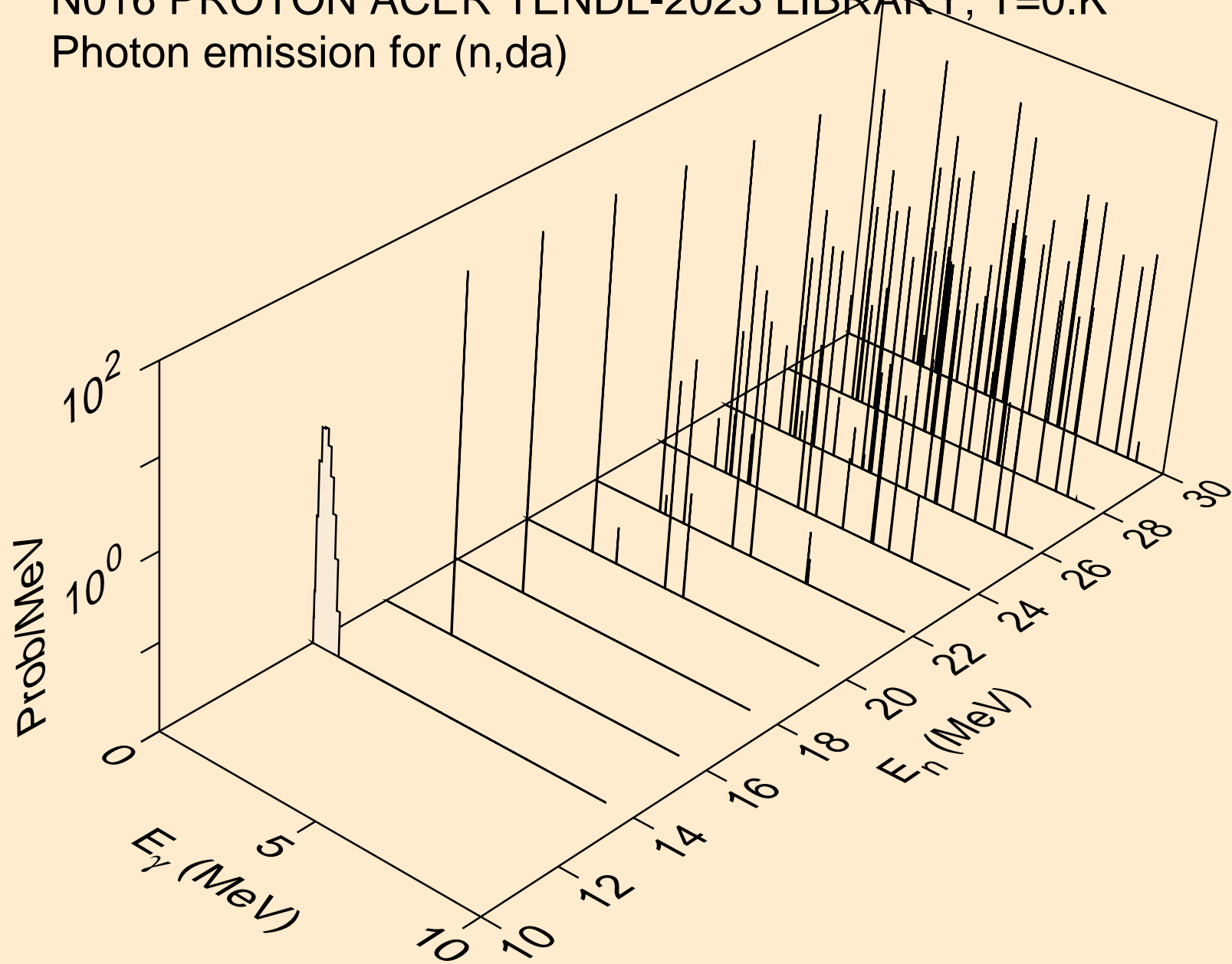

N016 PROTON ACER TENDL-2023 LIBRARY; T=0.K

Particle heating contributions

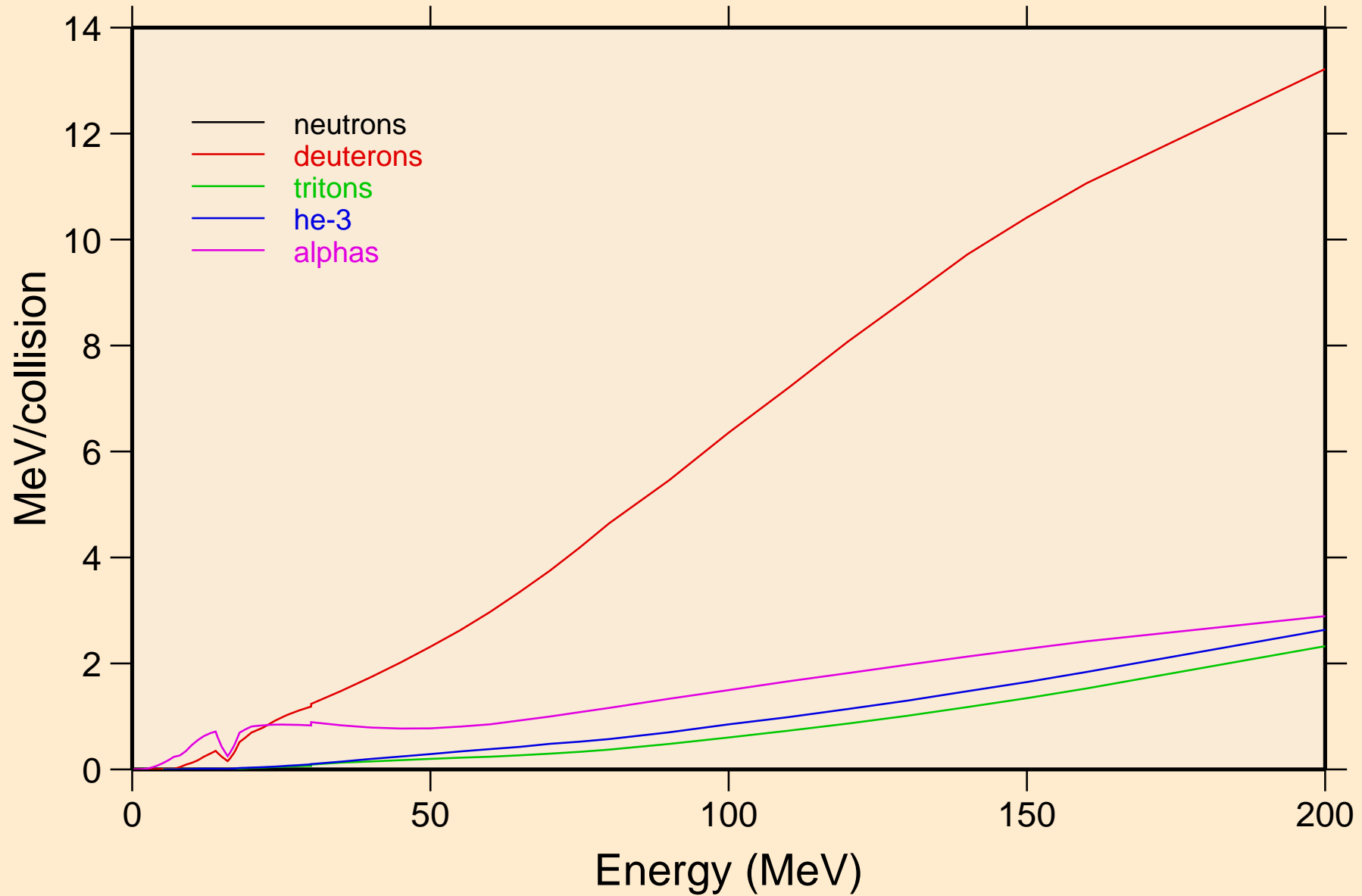

N016 PROTON ACER TENDL-2023 LIBRARY; T=0.K
Recoil Heating

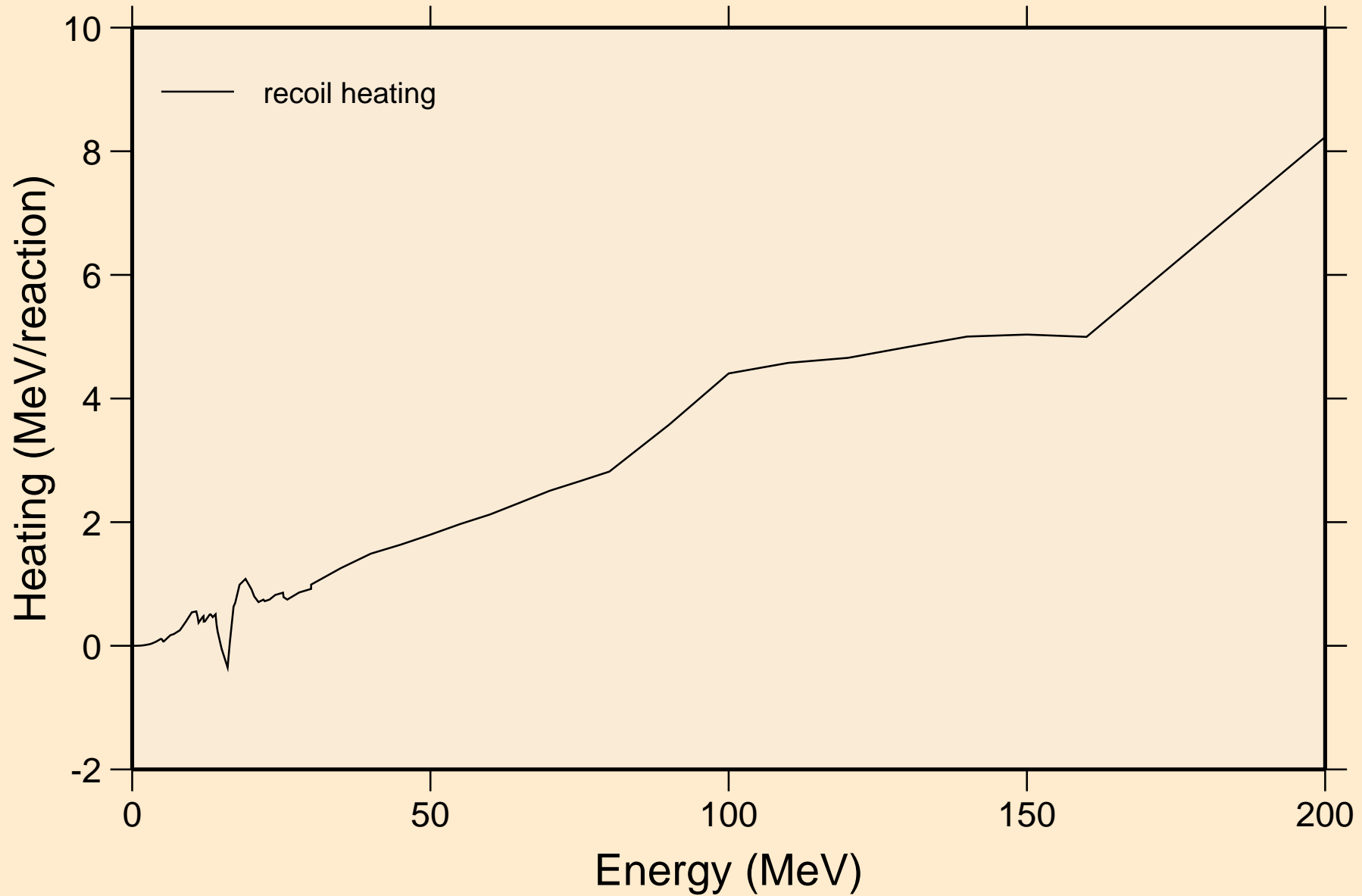

N016 PROTON ACER TENDL-2023 LIBRARY; T=0.K

Particle production cross sections

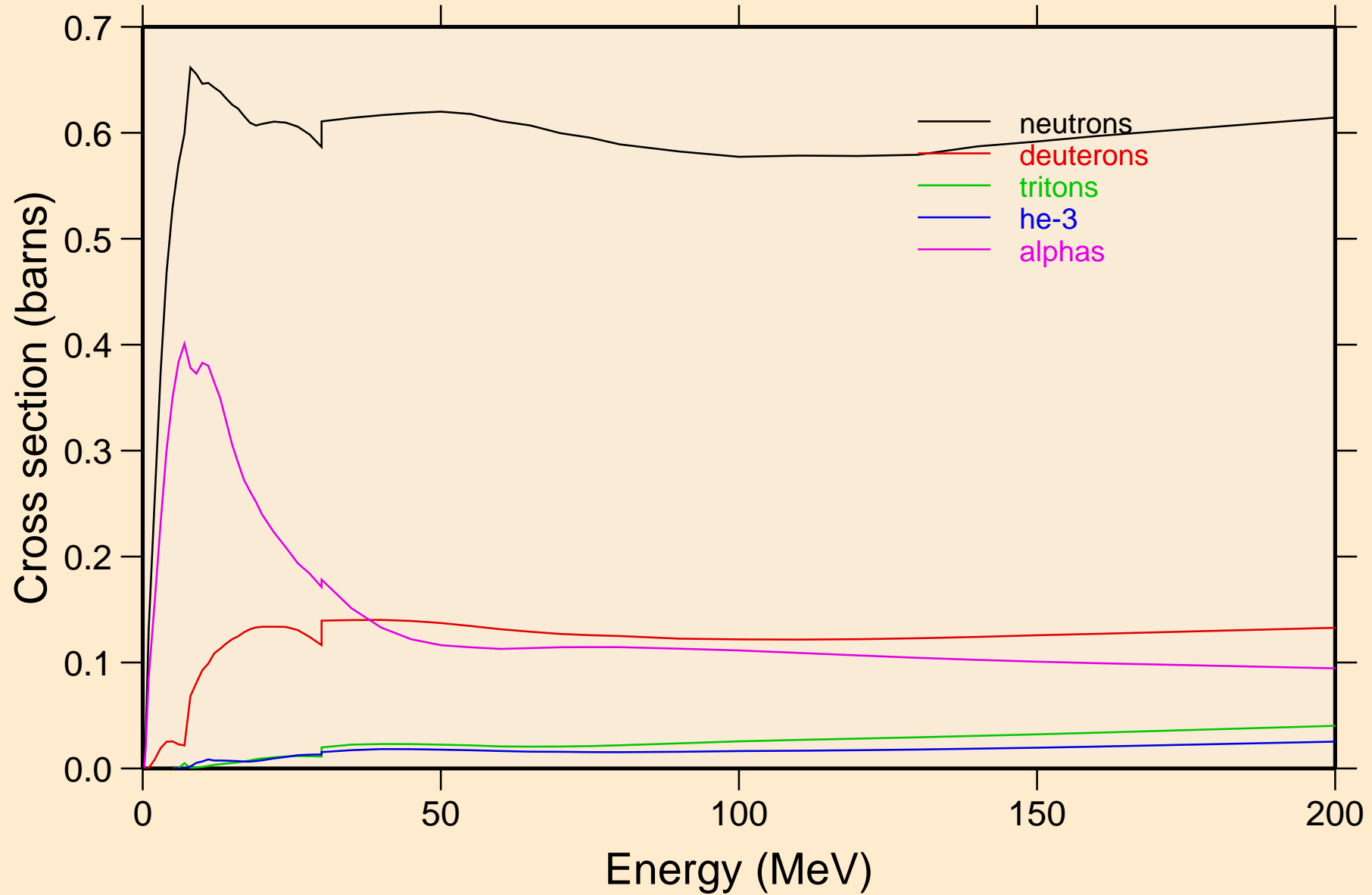

N016 PROTON ACER TENDL-2023 LIBRARY; T=0.K
neutrons from (p,n)

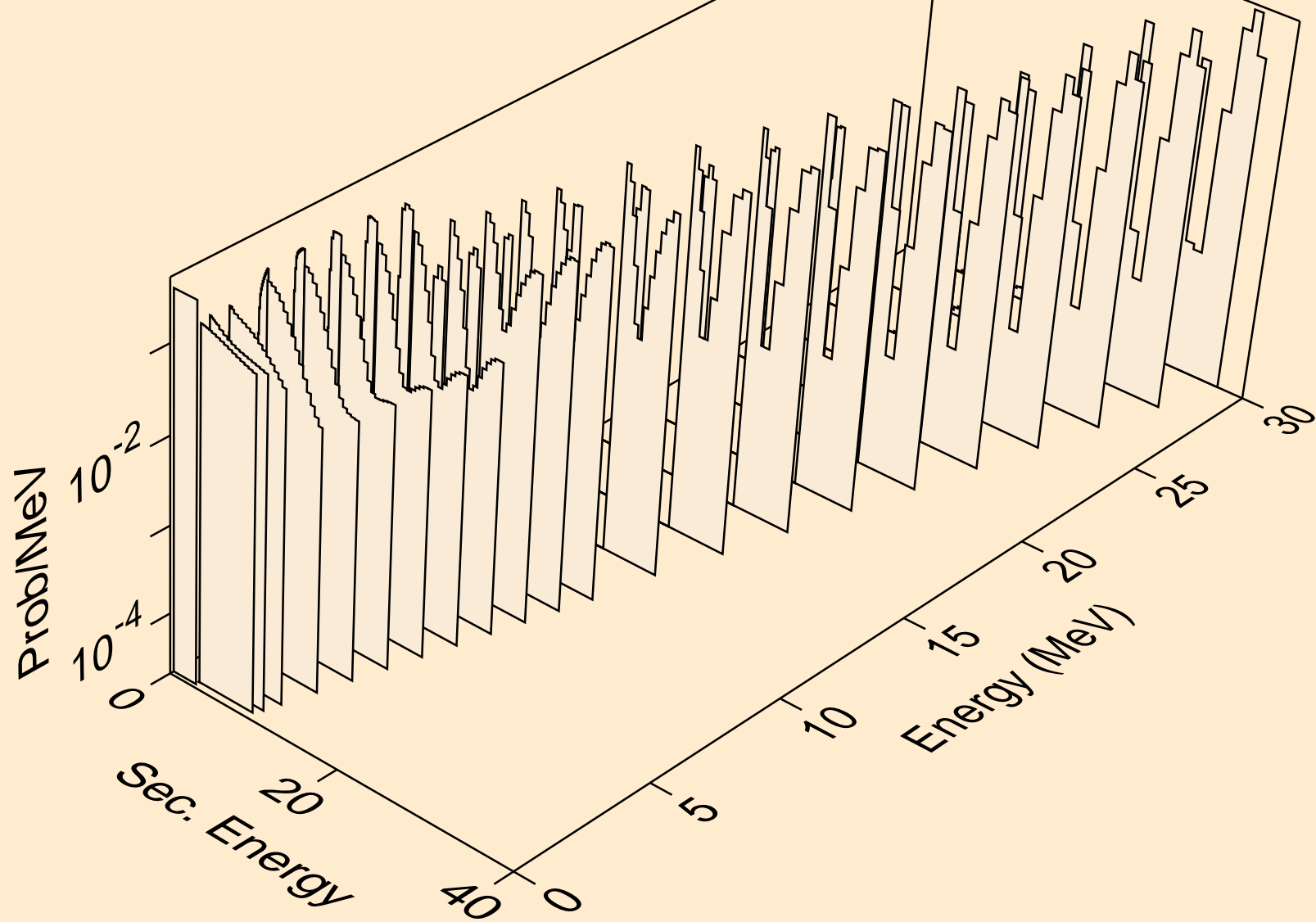

N016 PROTON ACER TENDL-2023 LIBRARY; T=0.K
neutrons from (p,x)

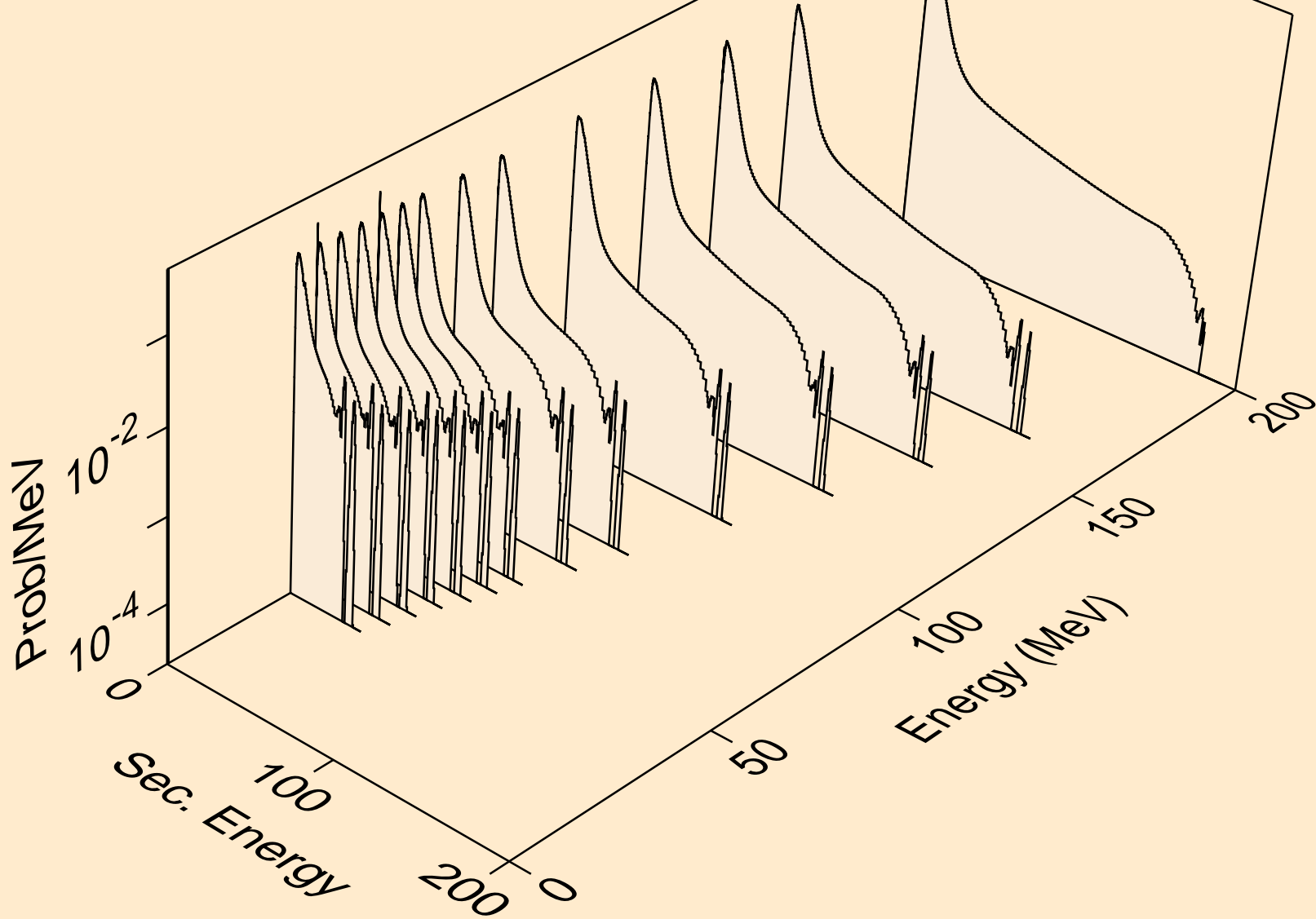

N016 PROTON ACER TENDL-2023 LIBRARY; T=0.K
neutrons from (p,2nd)

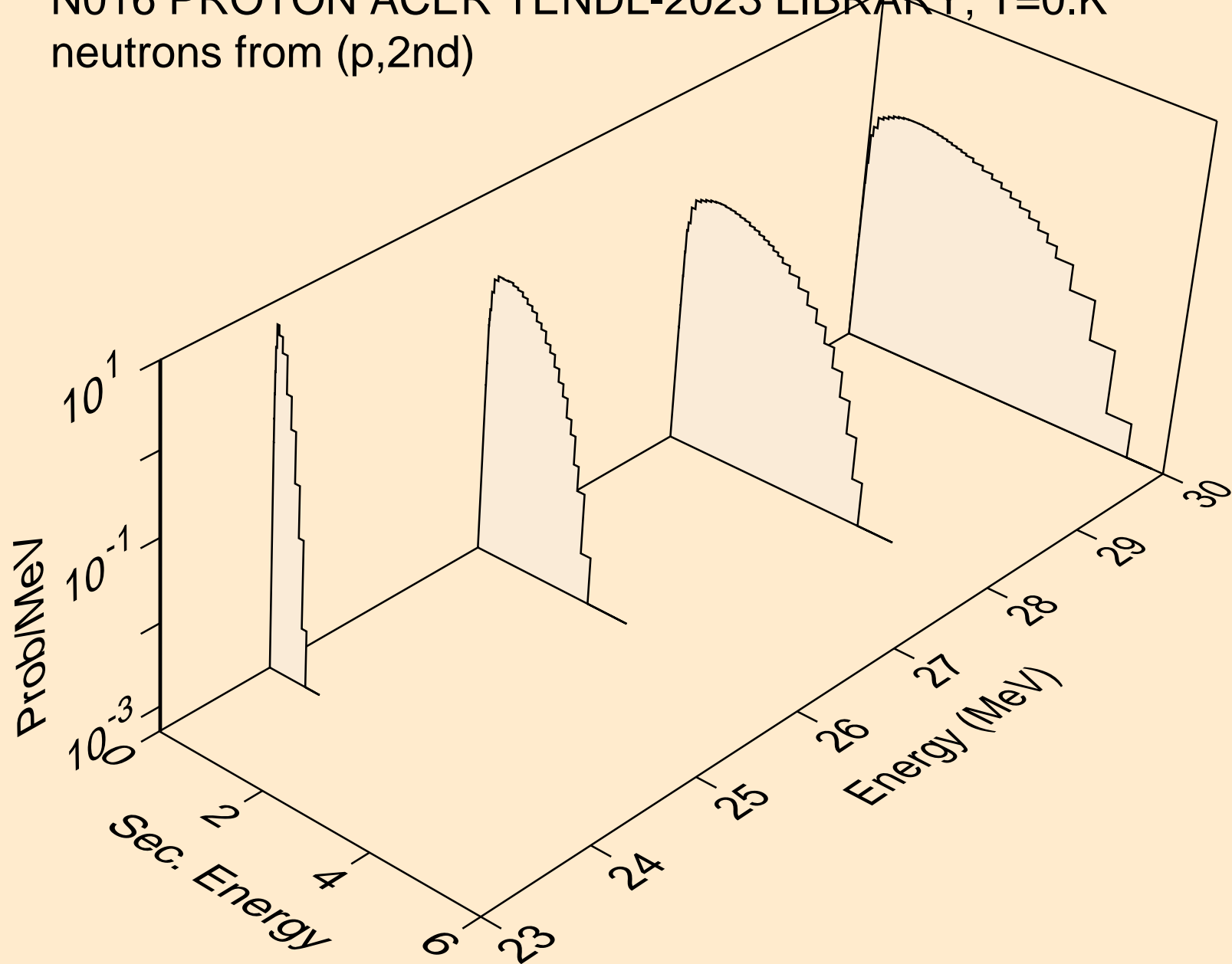

N016 PROTON ACER TENDL-2023 LIBRARY; T=0.K
neutrons from (p,2n)

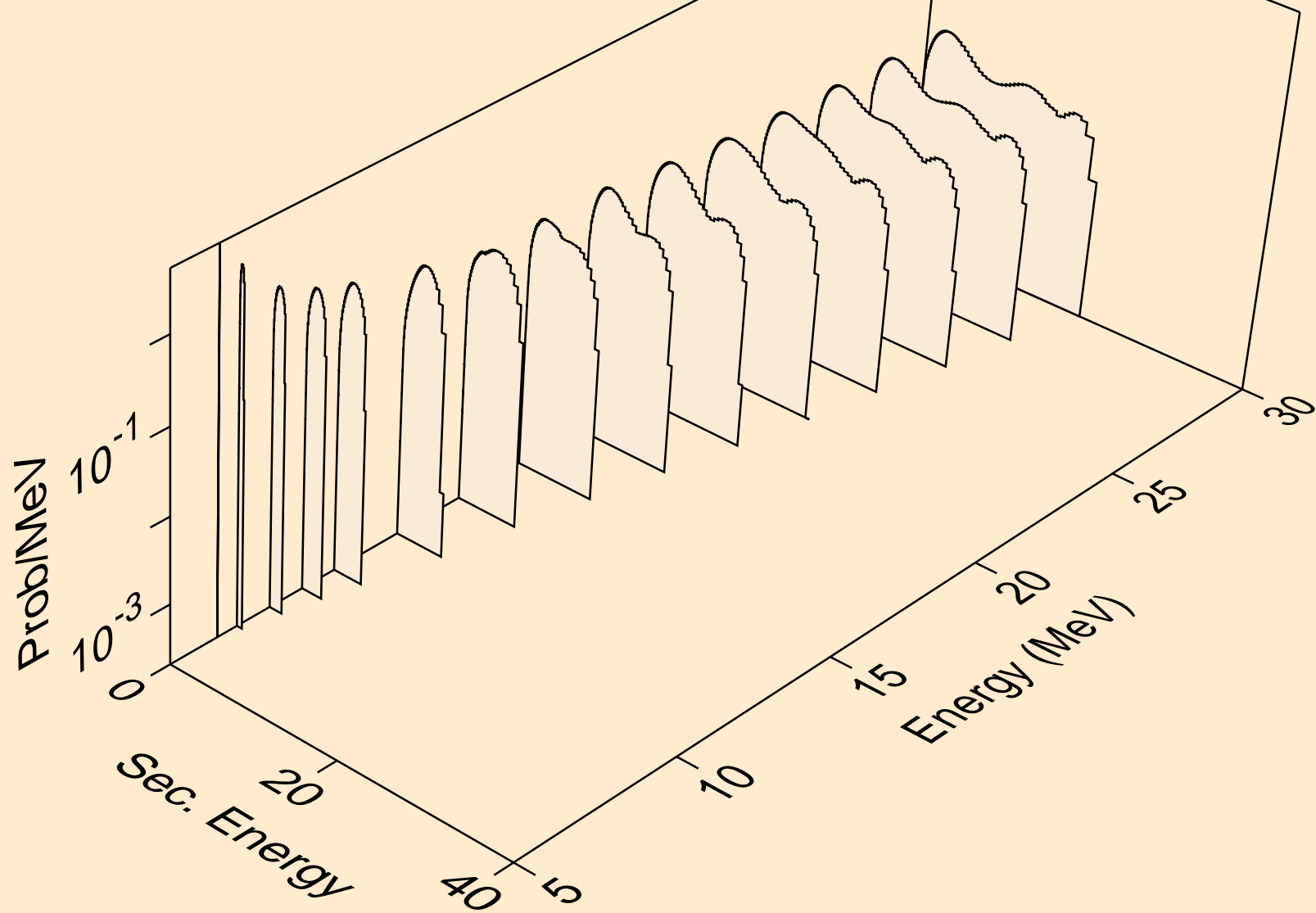

N016 PROTON ACER TENDL-2023 LIBRARY; T=0.K
neutrons from (p,3n)

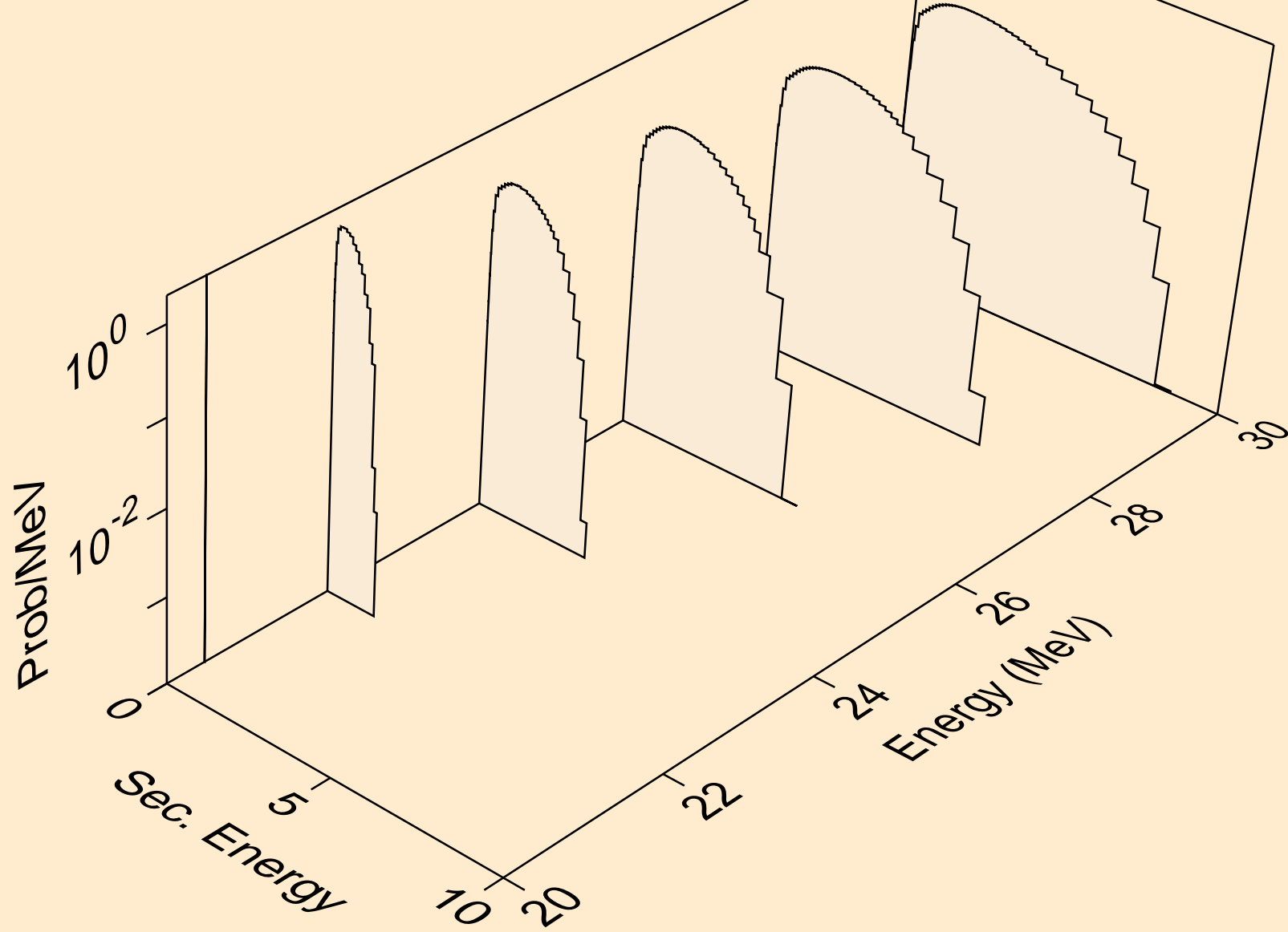

N016 PROTON ACER TENDL-2023 LIBRARY; T=0.K
neutrons from (p,n*)a

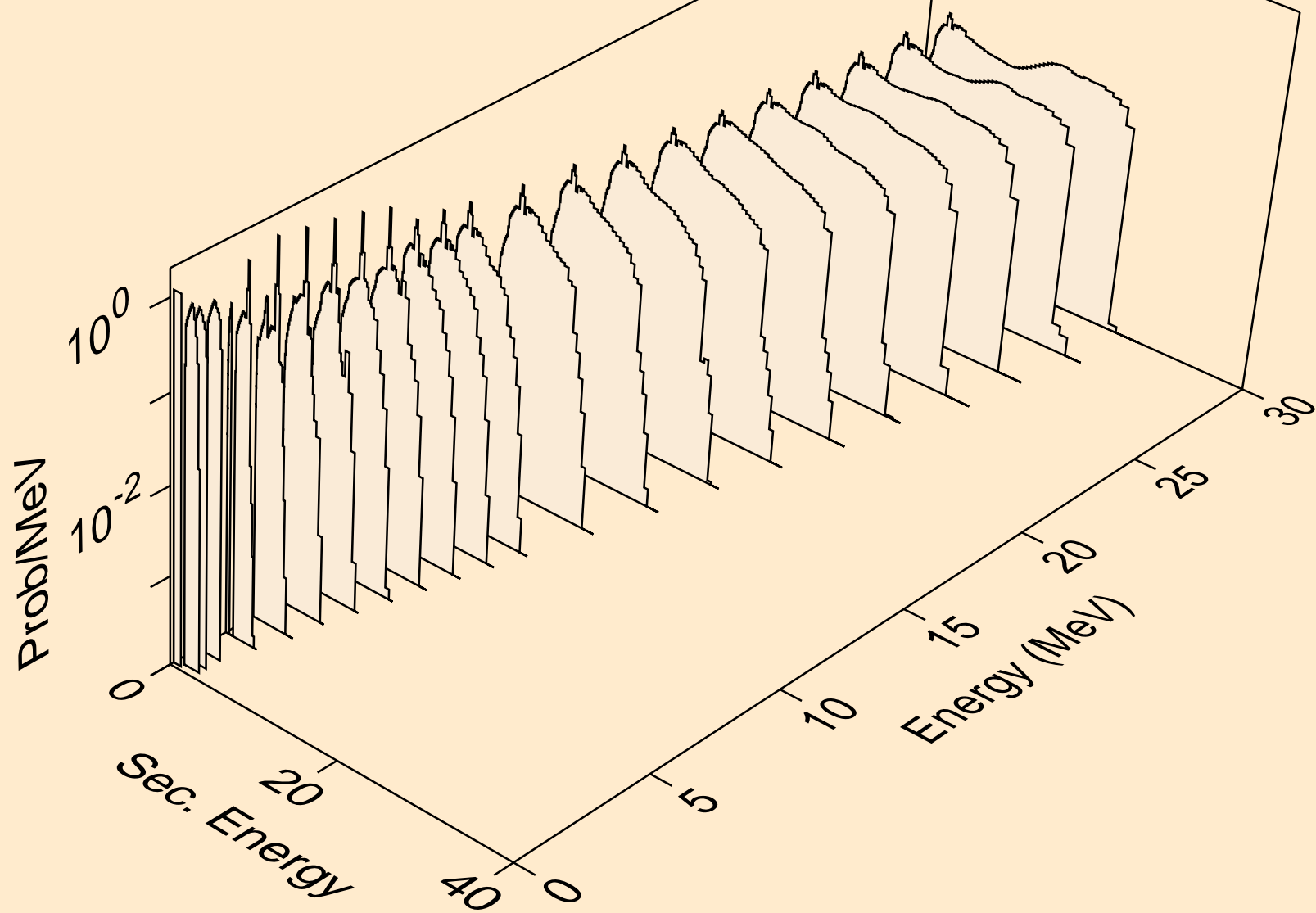

N016 PROTON ACER TENDL-2023 LIBRARY; T=0.K
neutrons from (p,2n)a

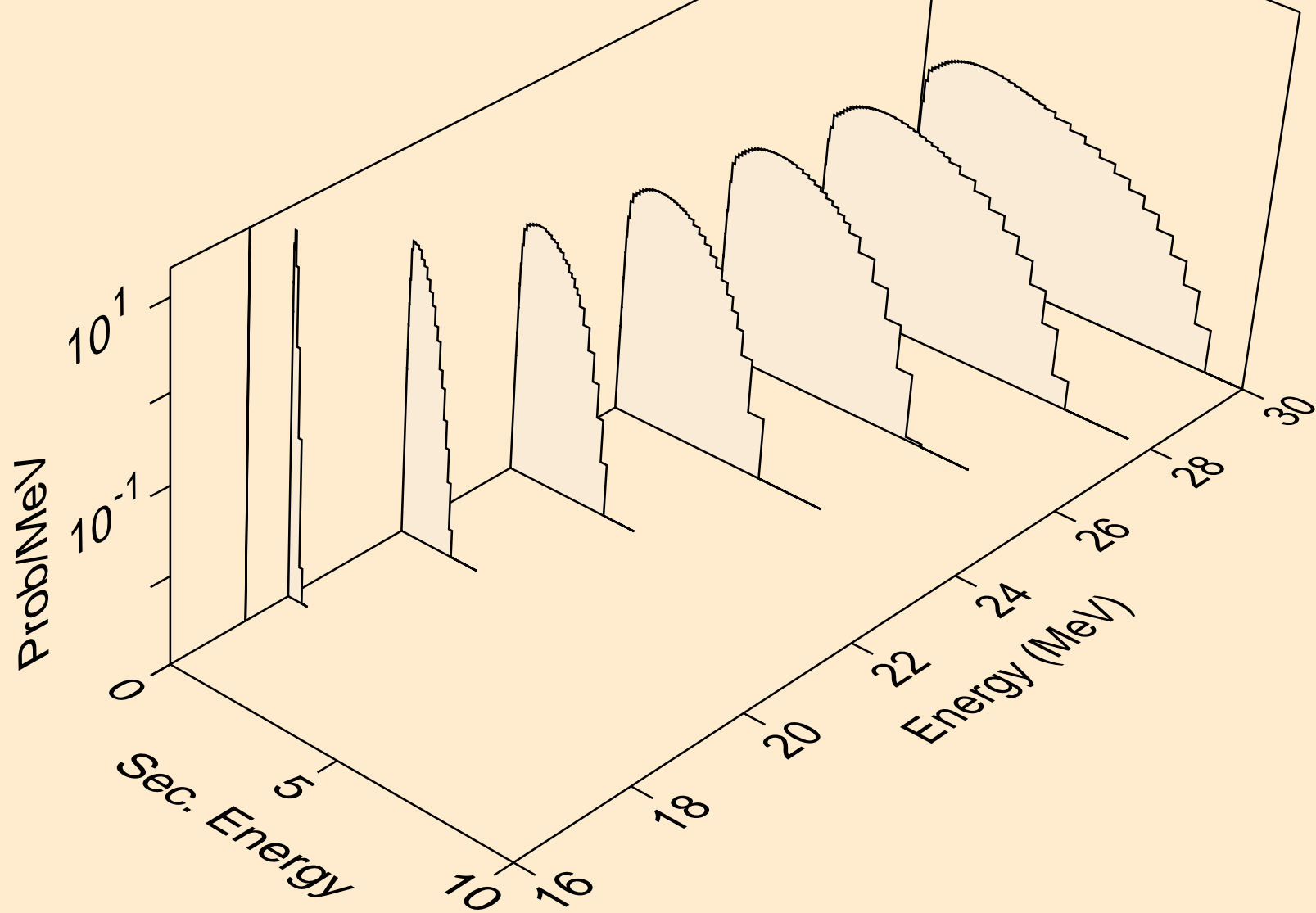

N016 PROTON ACER TENDL-2023 LIBRARY; T=0.K
neutrons from (p,n*)p

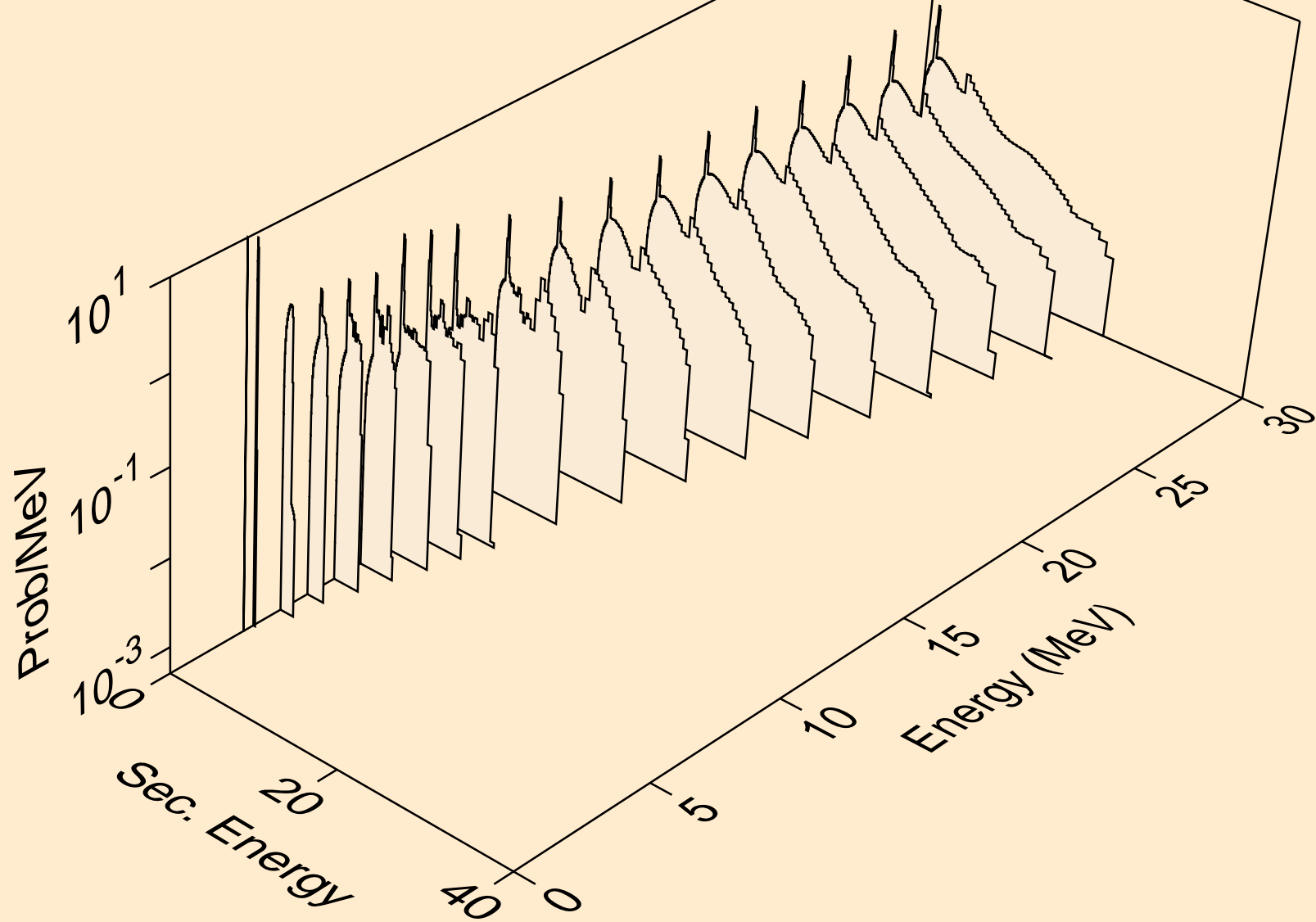

N016 PROTON ACER TENDL-2023 LIBRARY; T=0.K
neutrons from (p,n*)2a

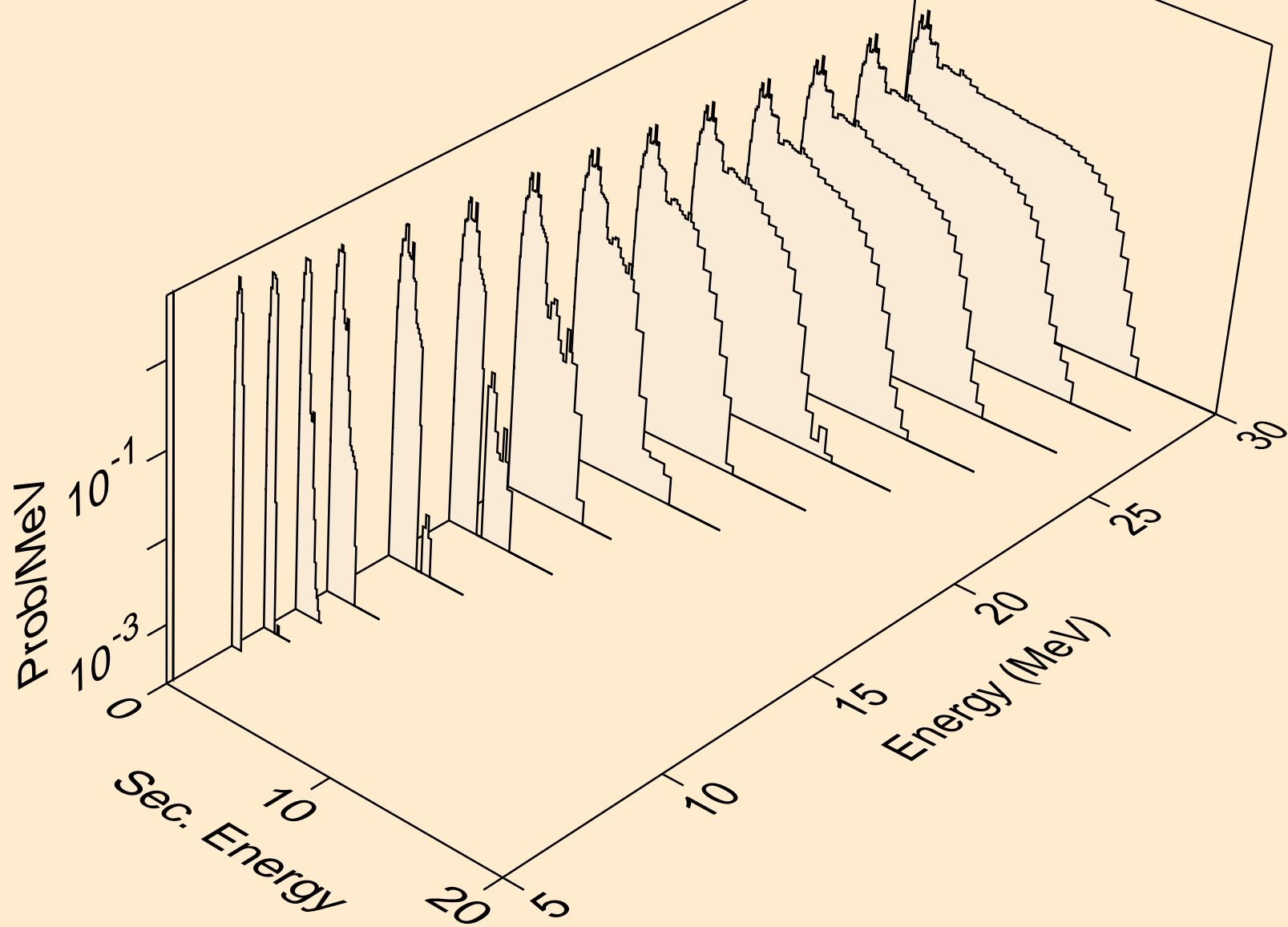

N016 PROTON ACER TENDL-2023 LIBRARY; T=0.K
neutrons from (p,2n)2a

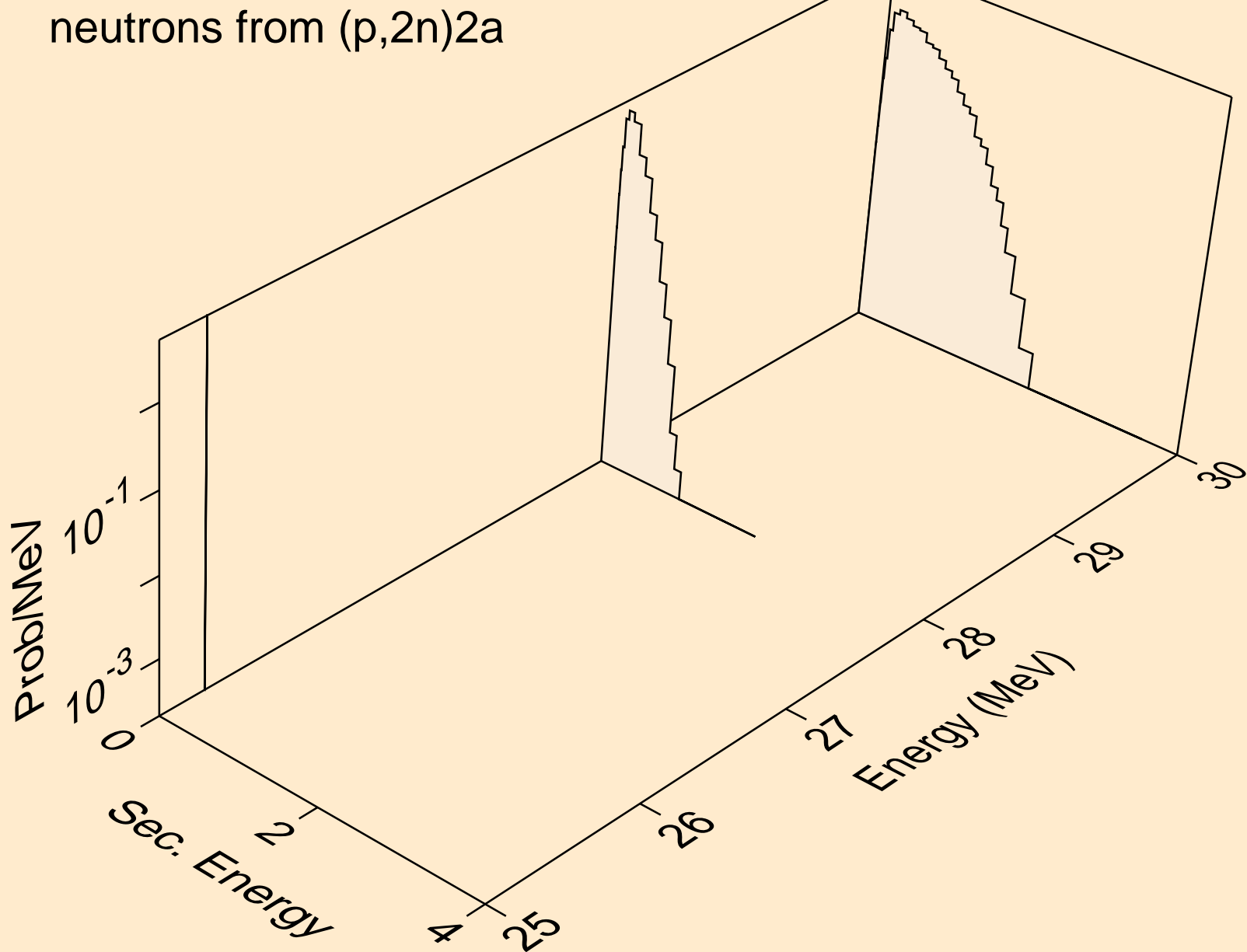

N016 PROTON ACER TENDL-2023 LIBRARY; T=0.K
neutrons from (p,n*)d

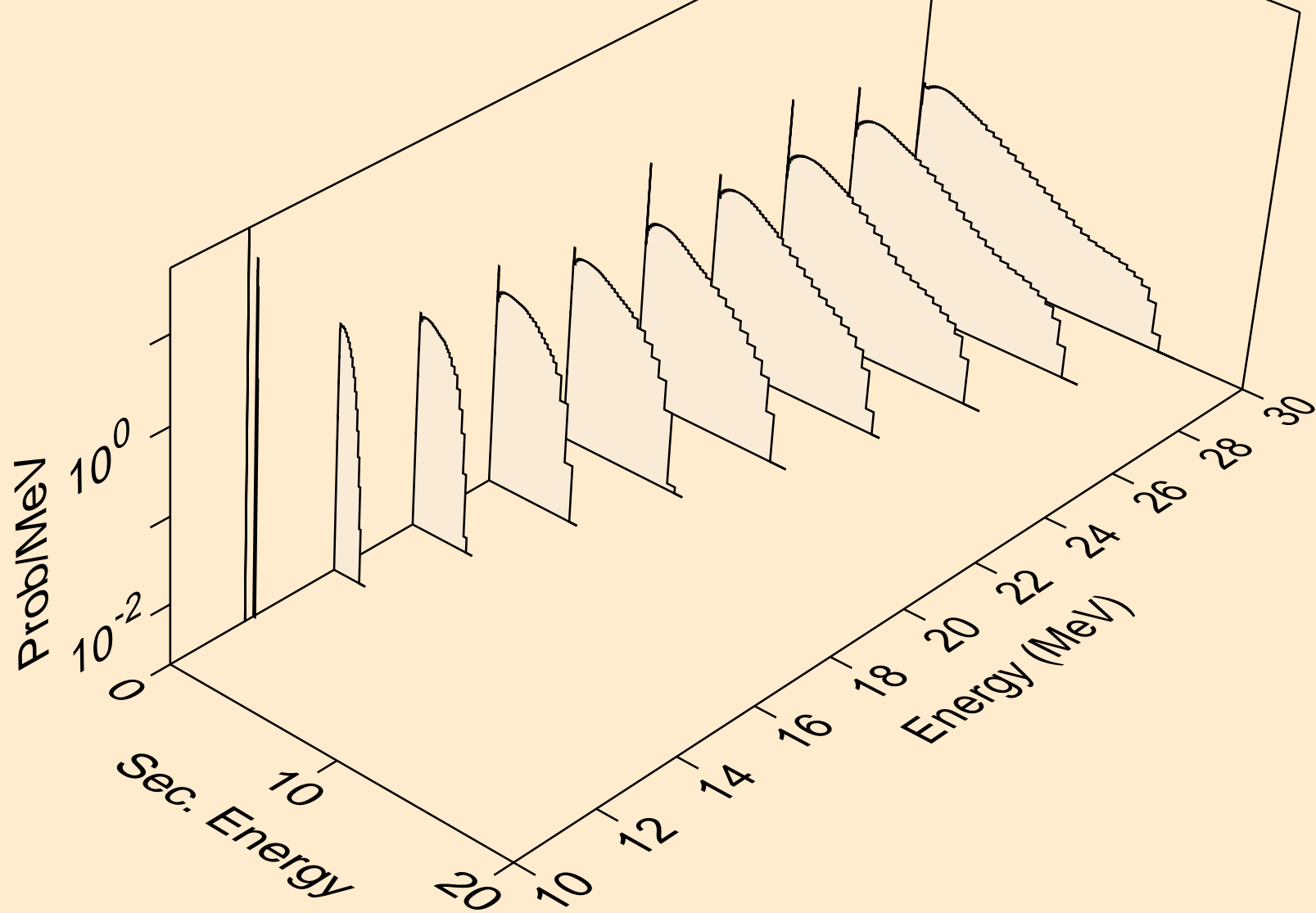

N016 PROTON ACER TENDL-2023 LIBRARY; T=0.K
neutrons from (p,n*)t

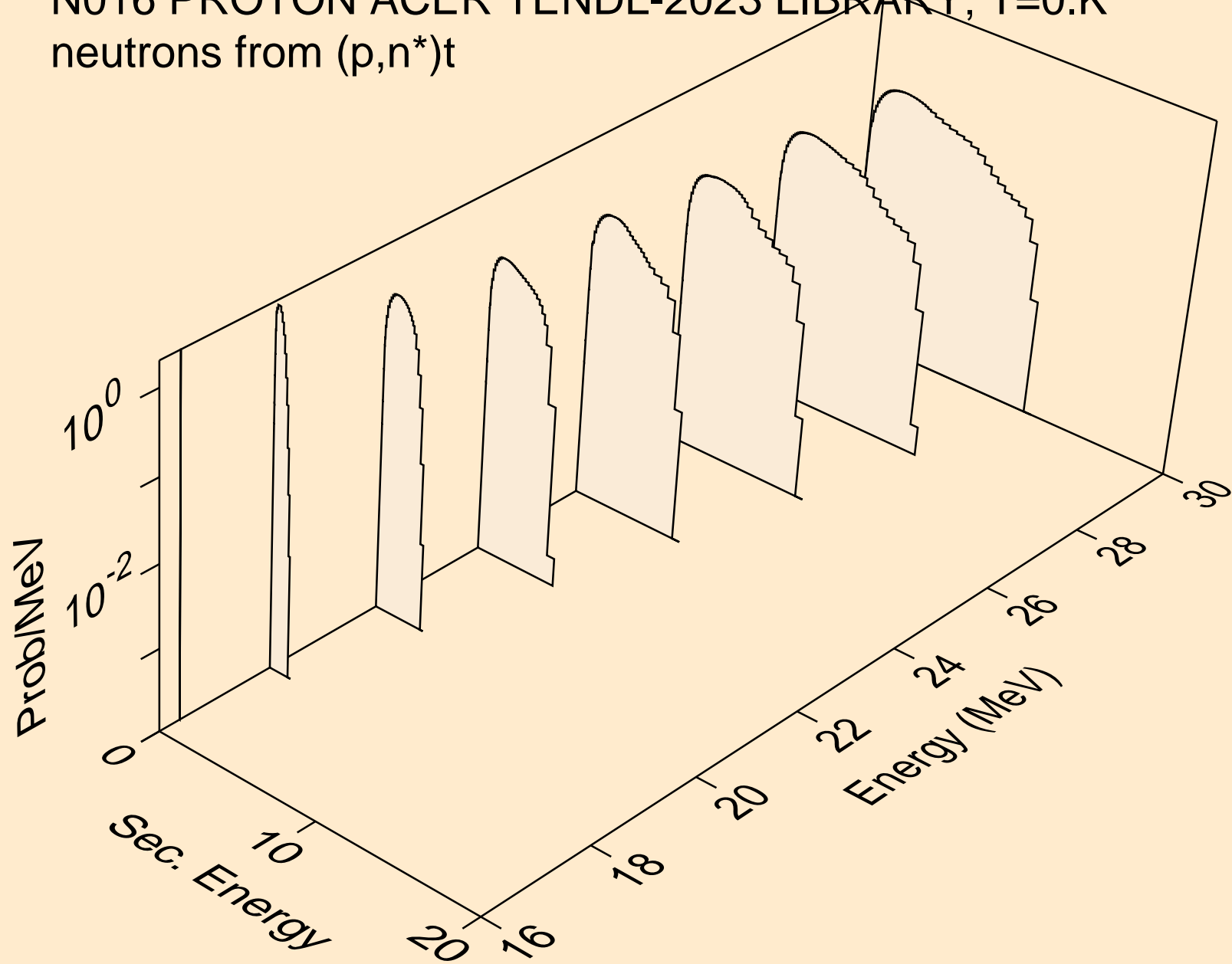

N016 PROTON ACER TENDL-2023 LIBRARY; T=0.K
neutrons from (p,n*)he3

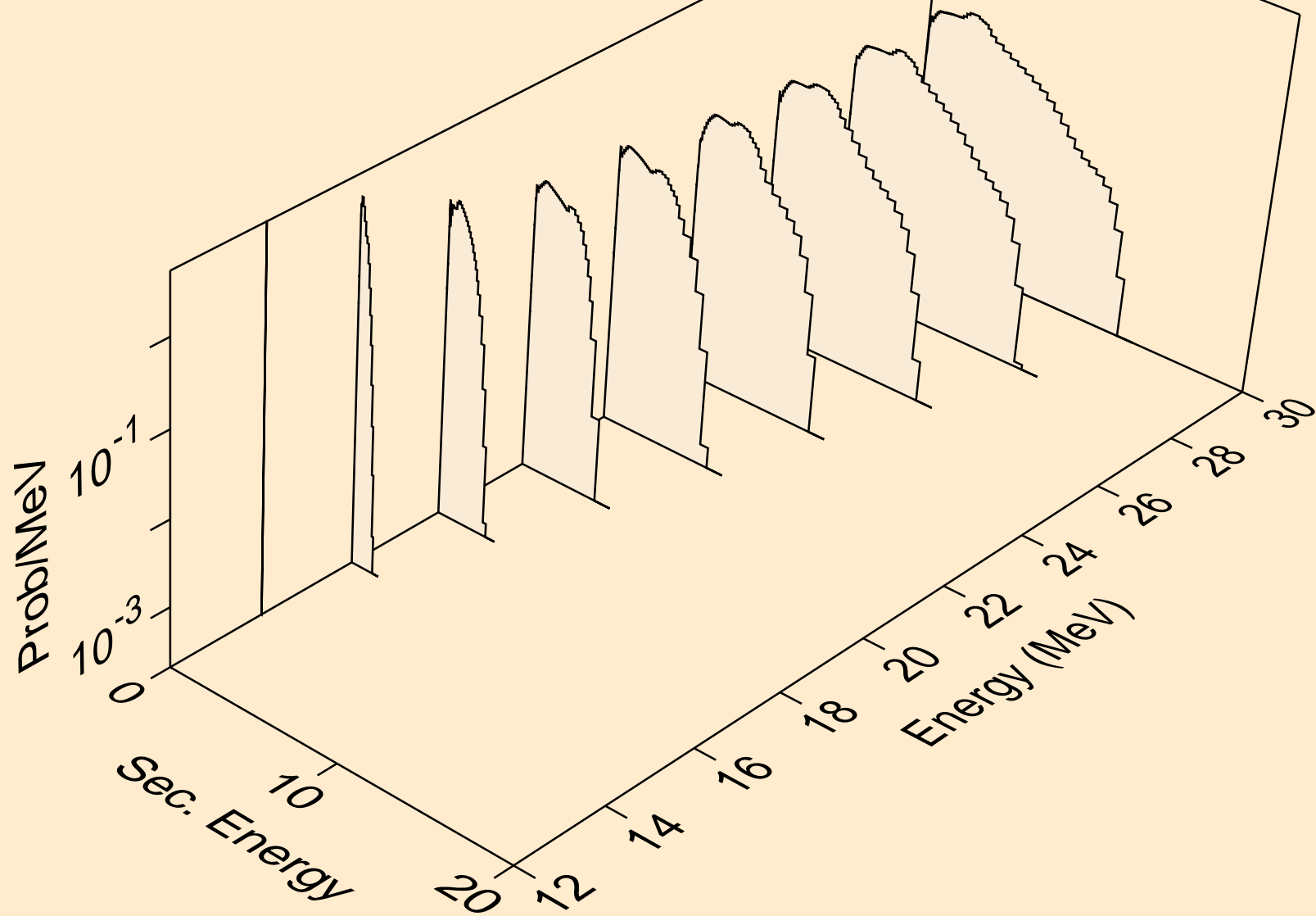

N016 PROTON ACER TENDL-2023 LIBRARY; T=0.K
neutrons from (p,2np)

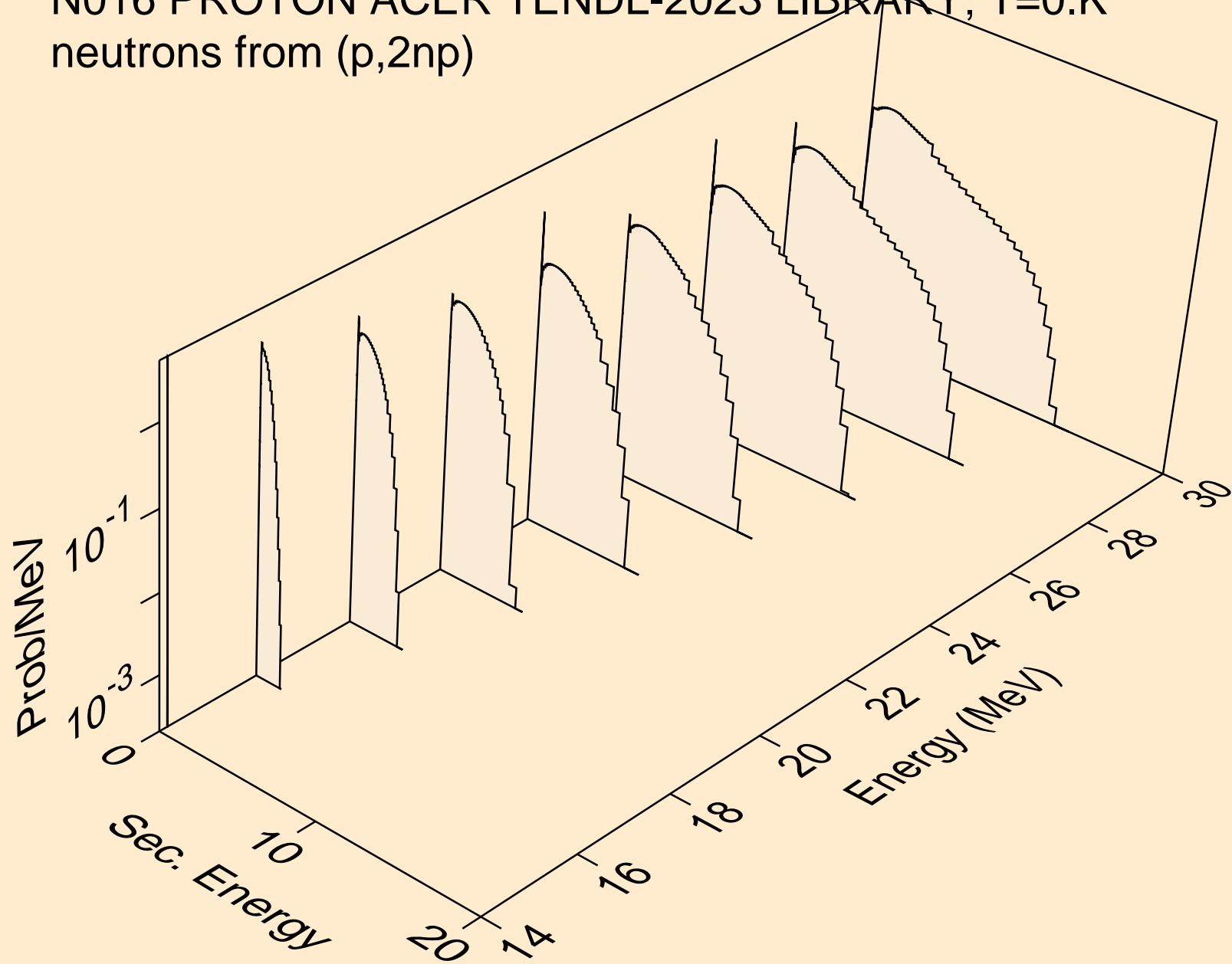

N016 PROTON ACER TENDL-2023 LIBRARY; T=0.K
neutrons from (p,3np)

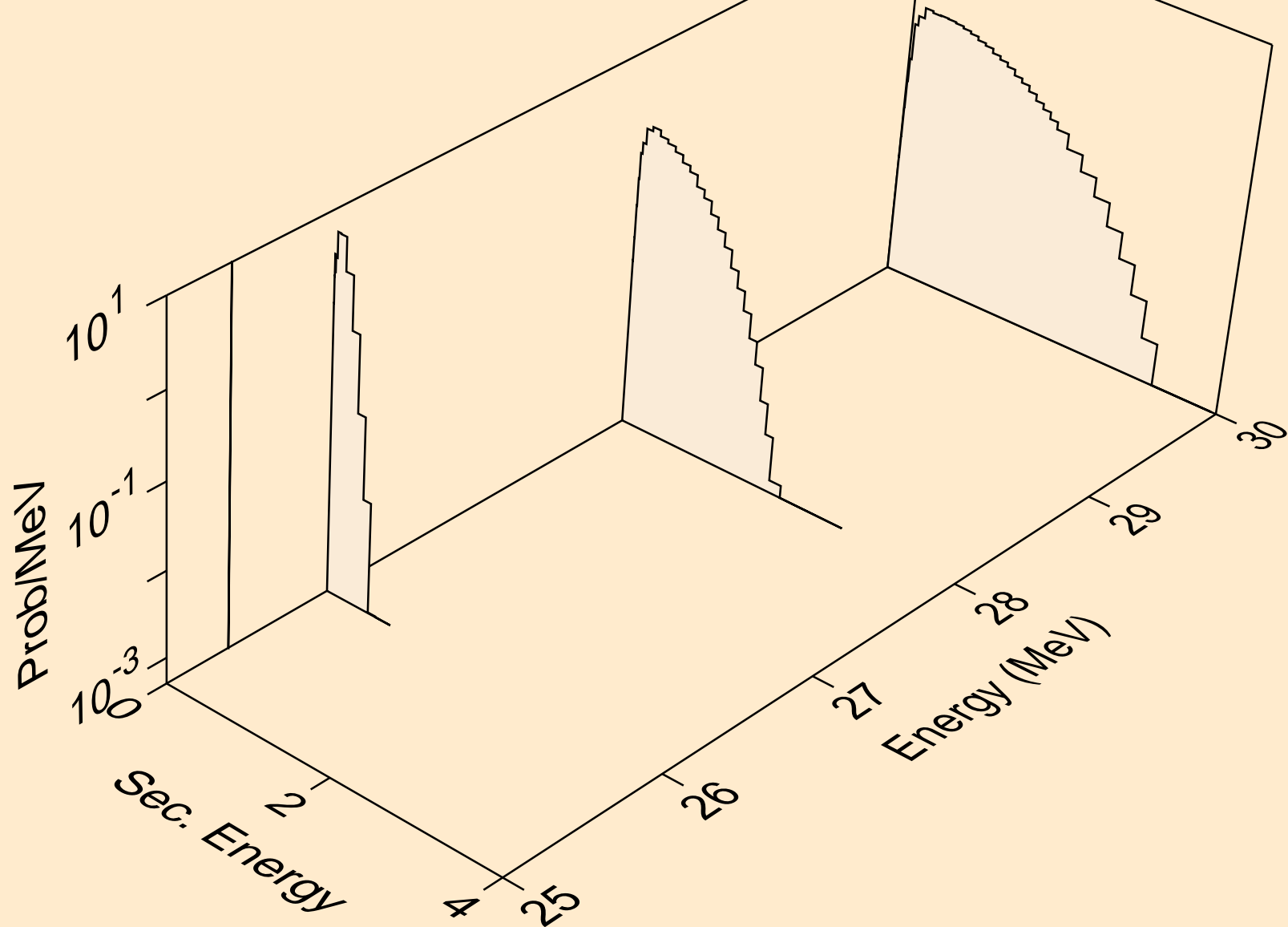

N016 PROTON ACER TENDL-2023 LIBRARY; T=0.K
neutrons from (p,n2p)

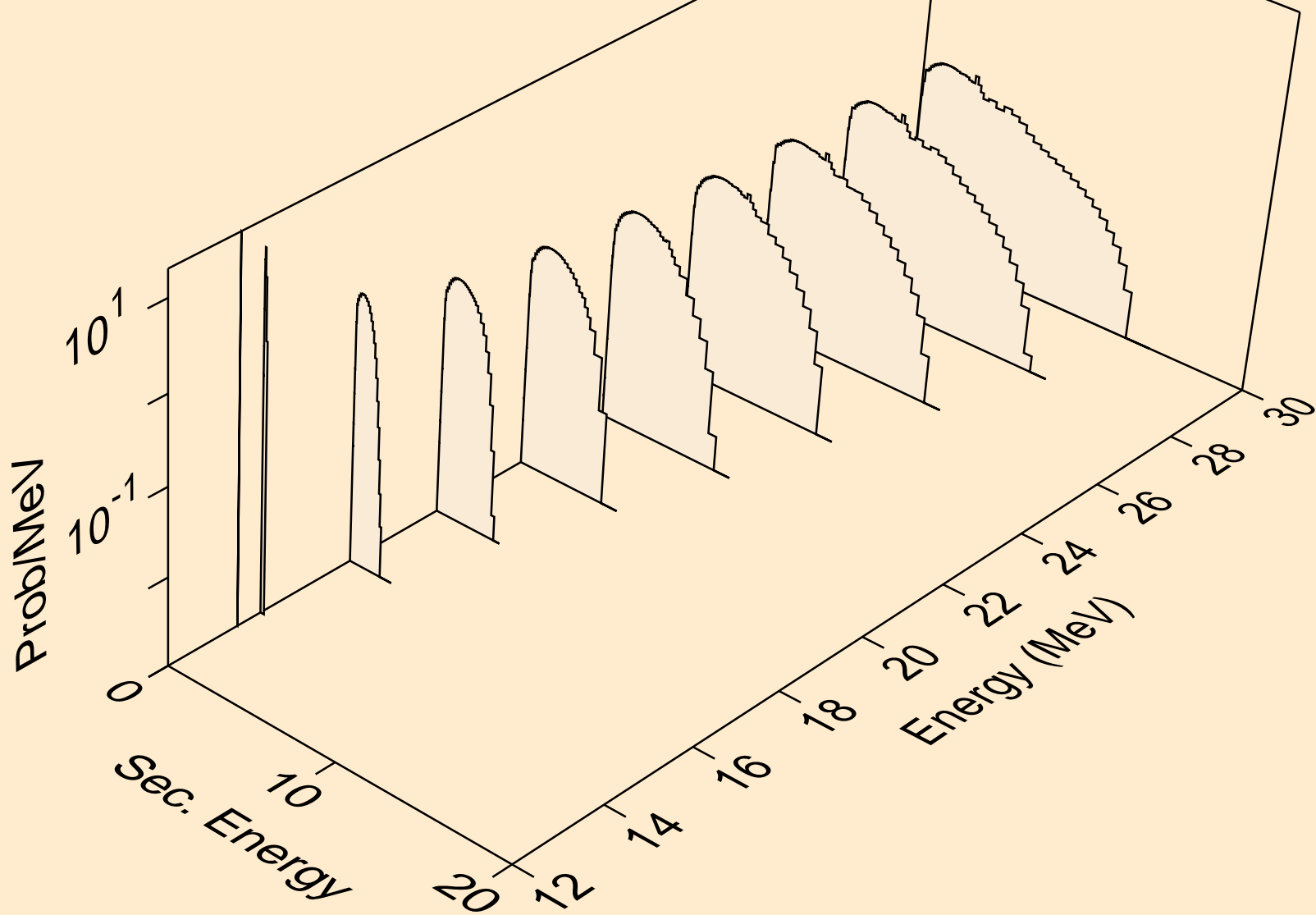

N016 PROTON ACER TENDL-2023 LIBRARY; T=0.K
neutrons from (p,npa)

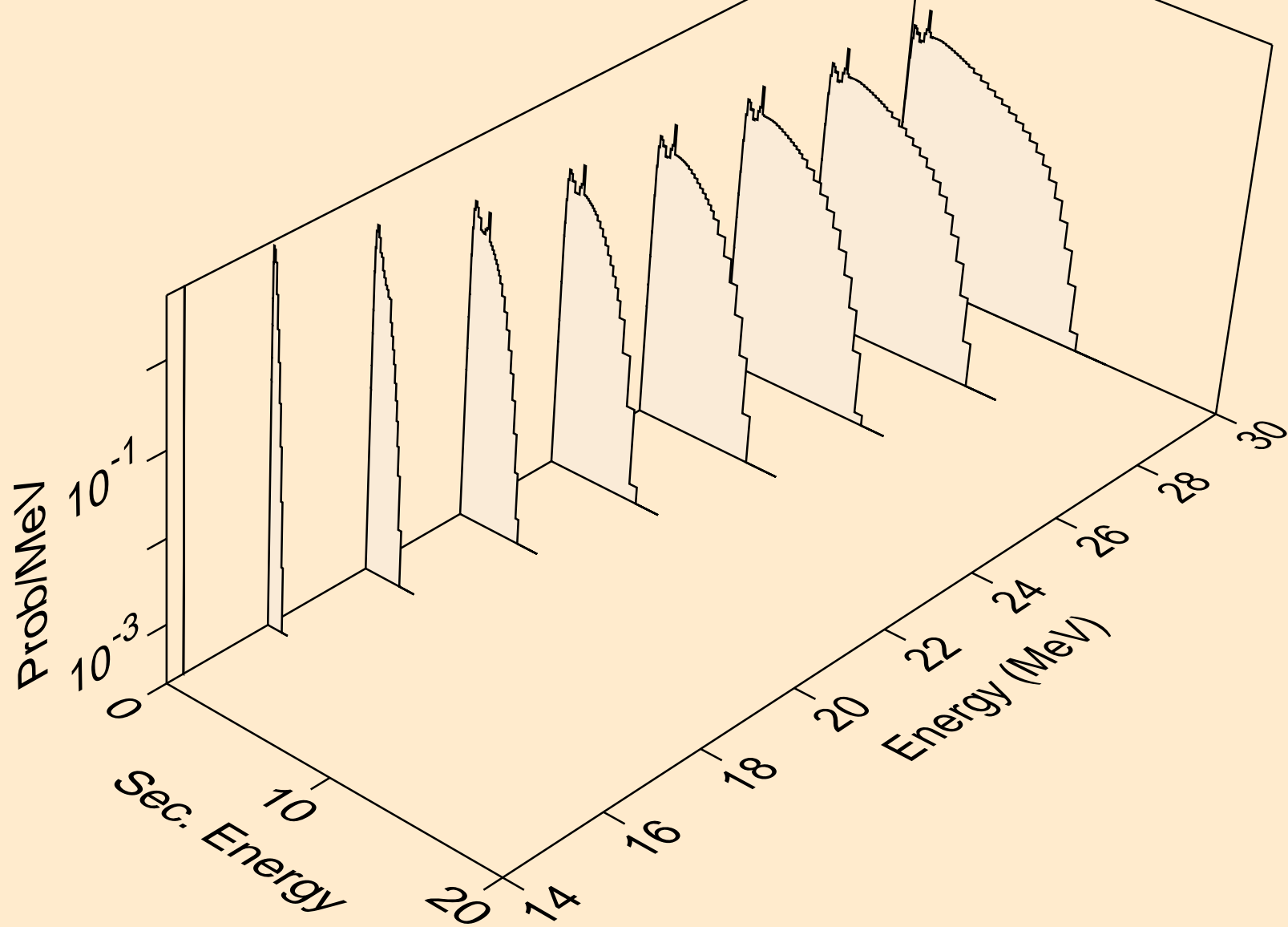

N016 PROTON ACER TENDL-2023 LIBRARY; T=0.K
deuterons from (p,x)

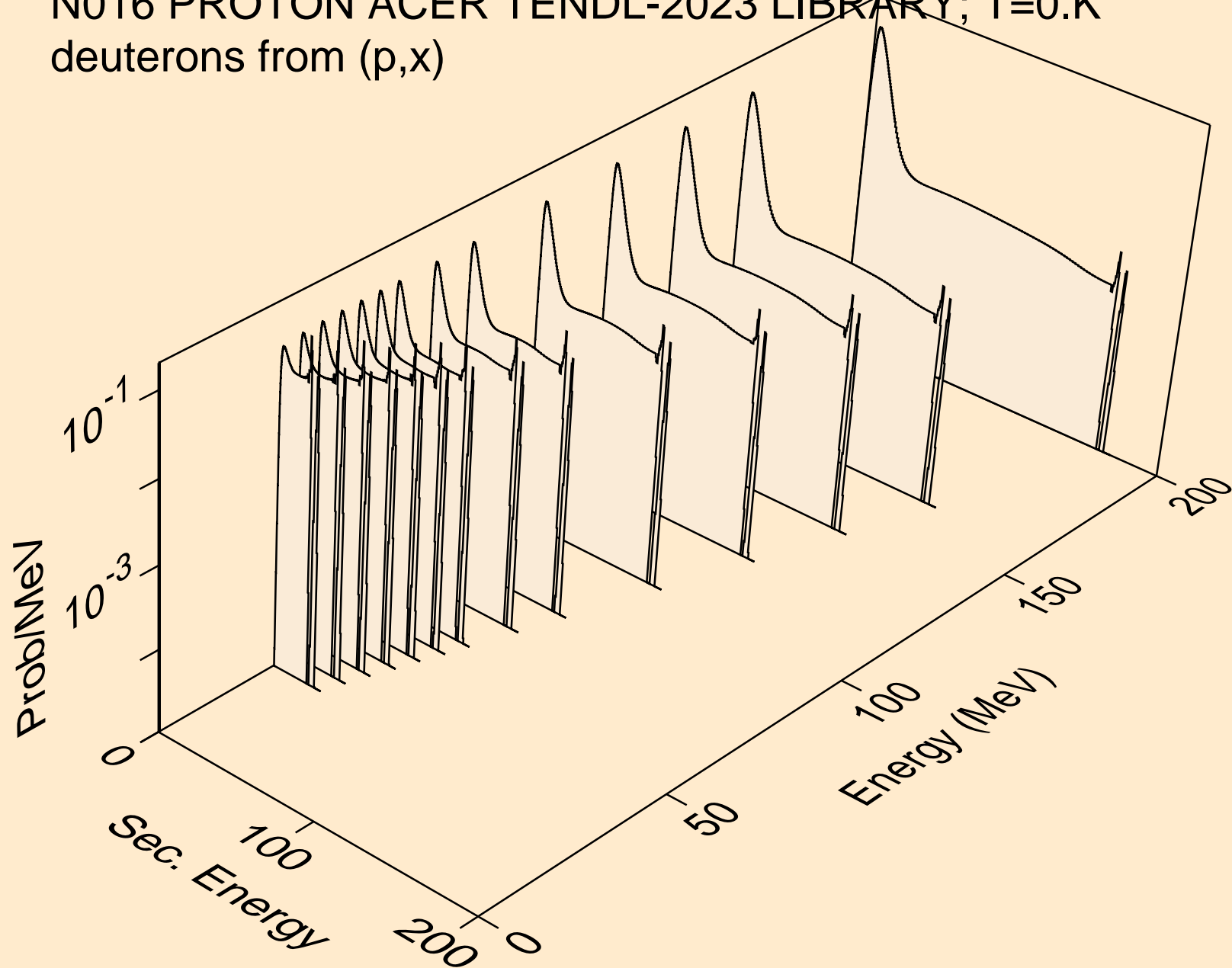

N016 PROTON ACER TENDL-2023 LIBRARY; T=0.K
deuterons from (p,2nd)

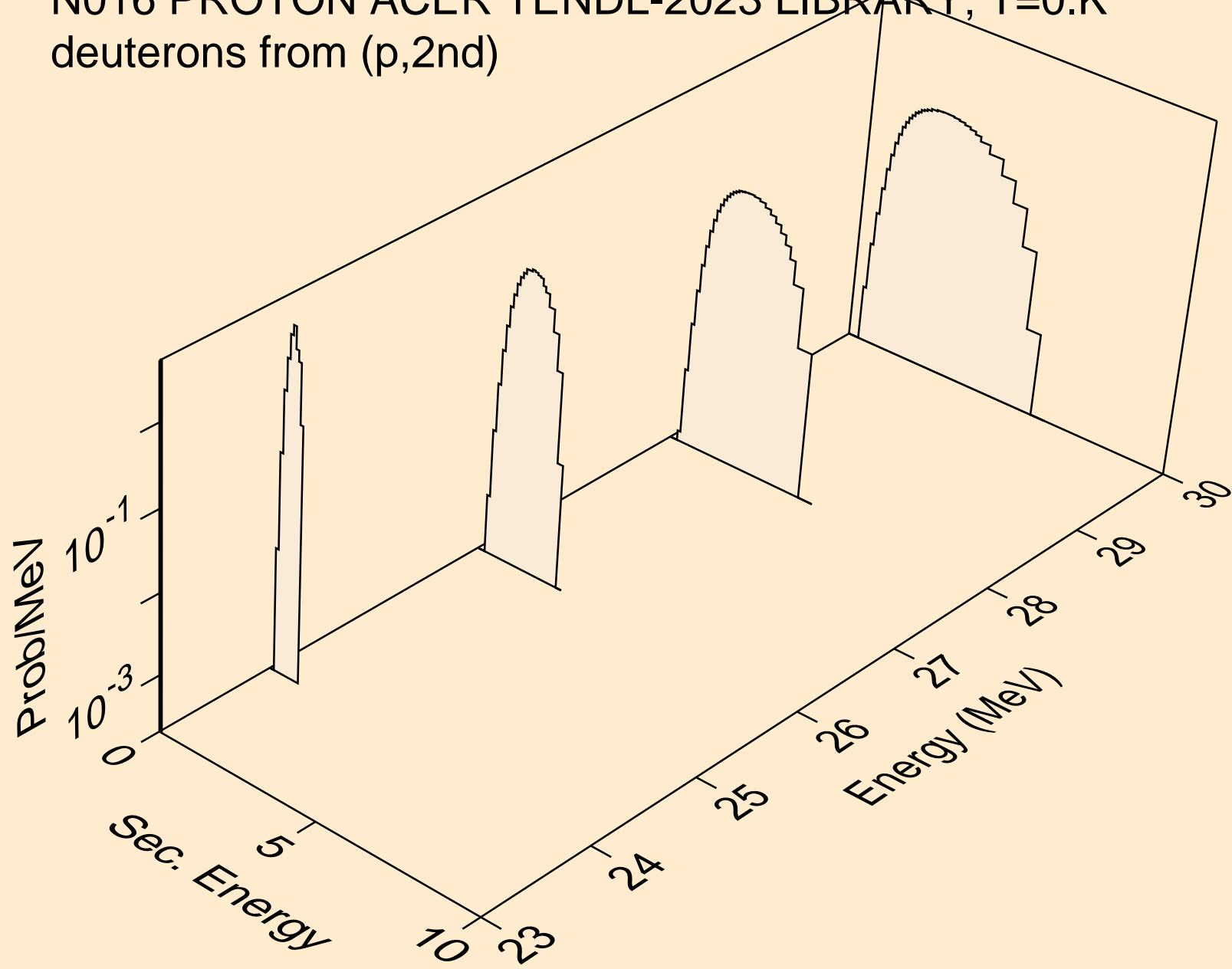

N016 PROTON ACER TENDL-2023 LIBRARY; T=0.K
deuterons from (p,n*)d

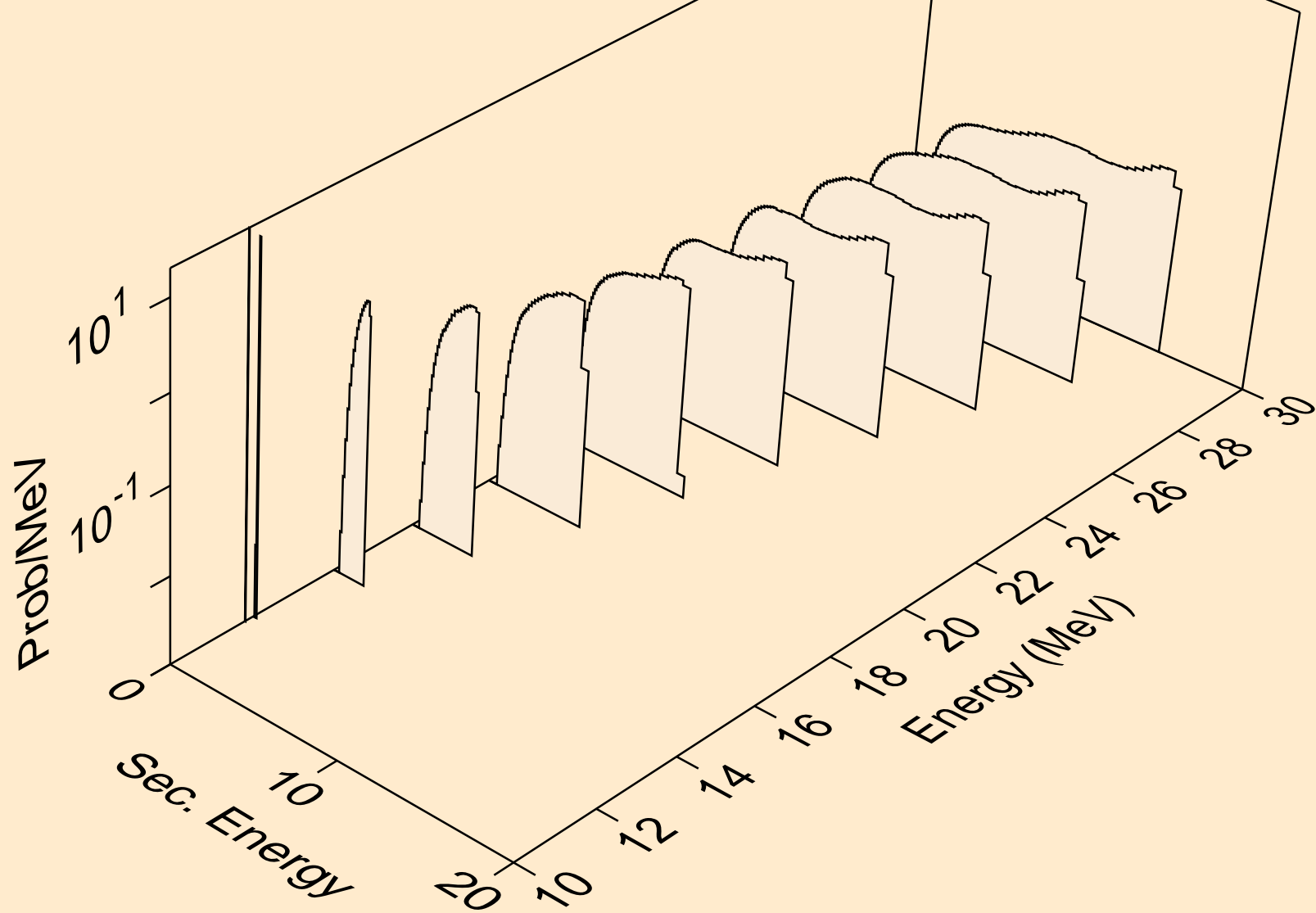

N016 PROTON ACER TENDL-2023 LIBRARY; T=0.K
deuterons from (p,d)

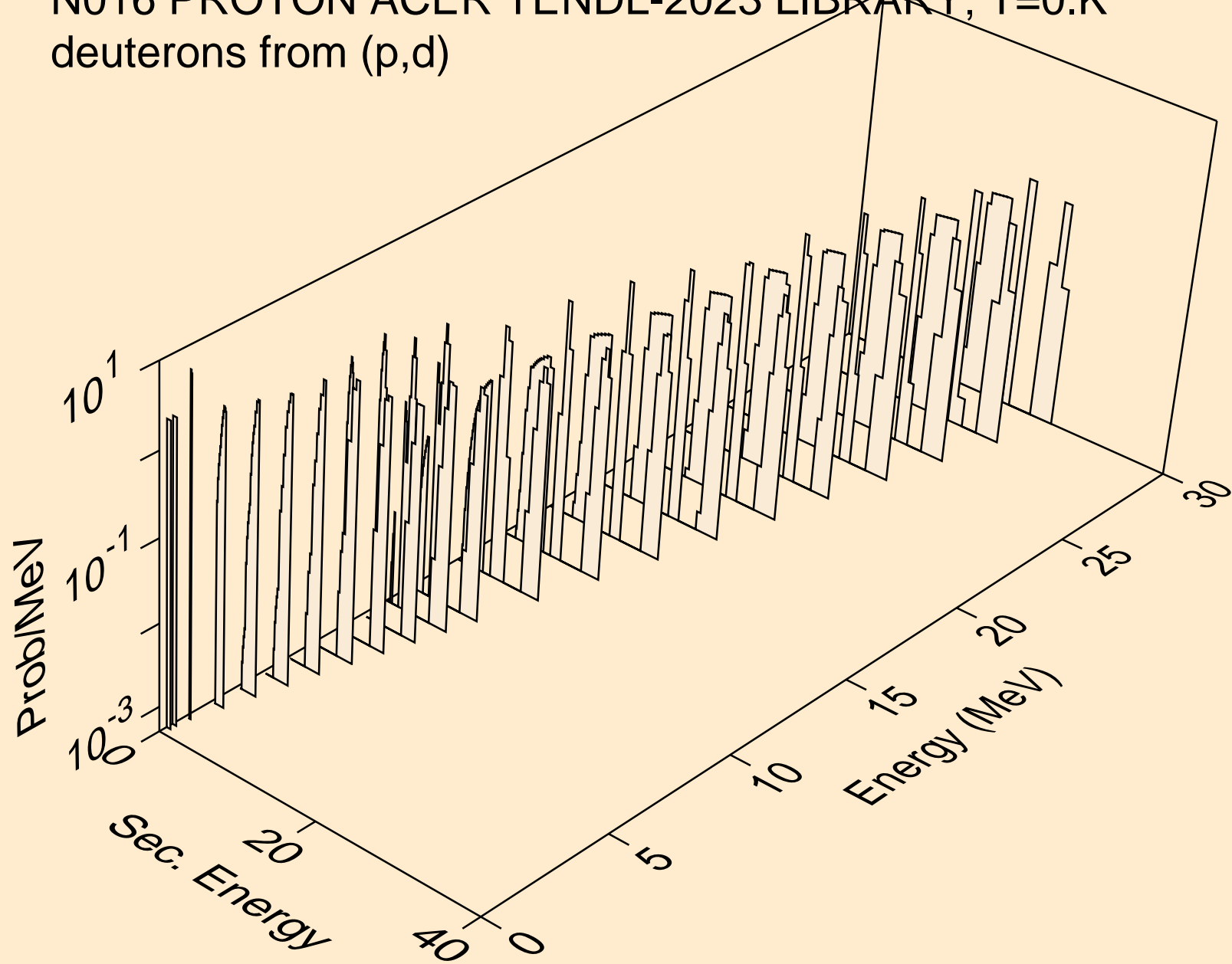

N016 PROTON ACER TENDL-2023 LIBRARY; T=0.K
deuterons from (p,d2a)

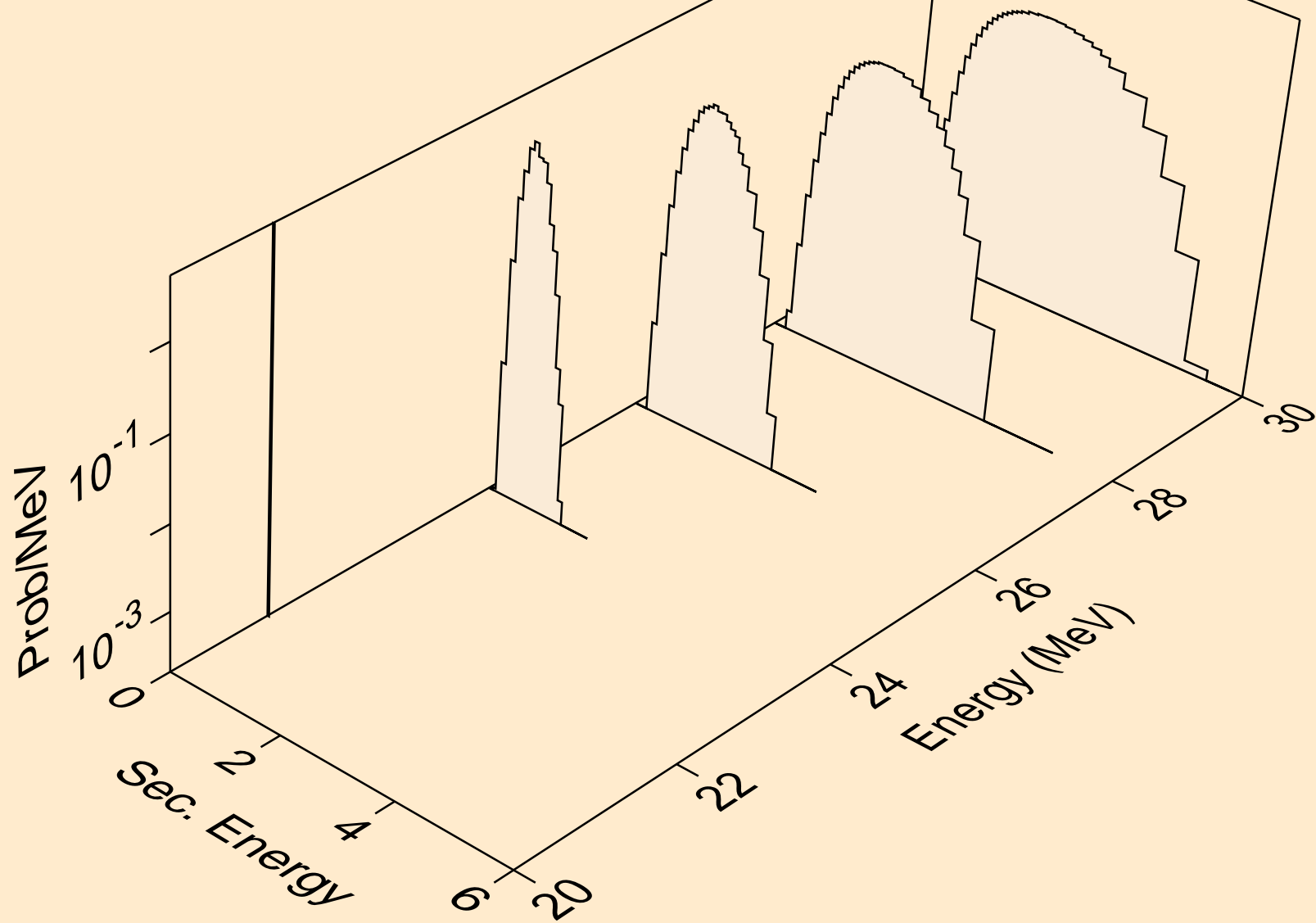

N016 PROTON ACER TENDL-2023 LIBRARY; T=0.K
deuterons from (p,pd)

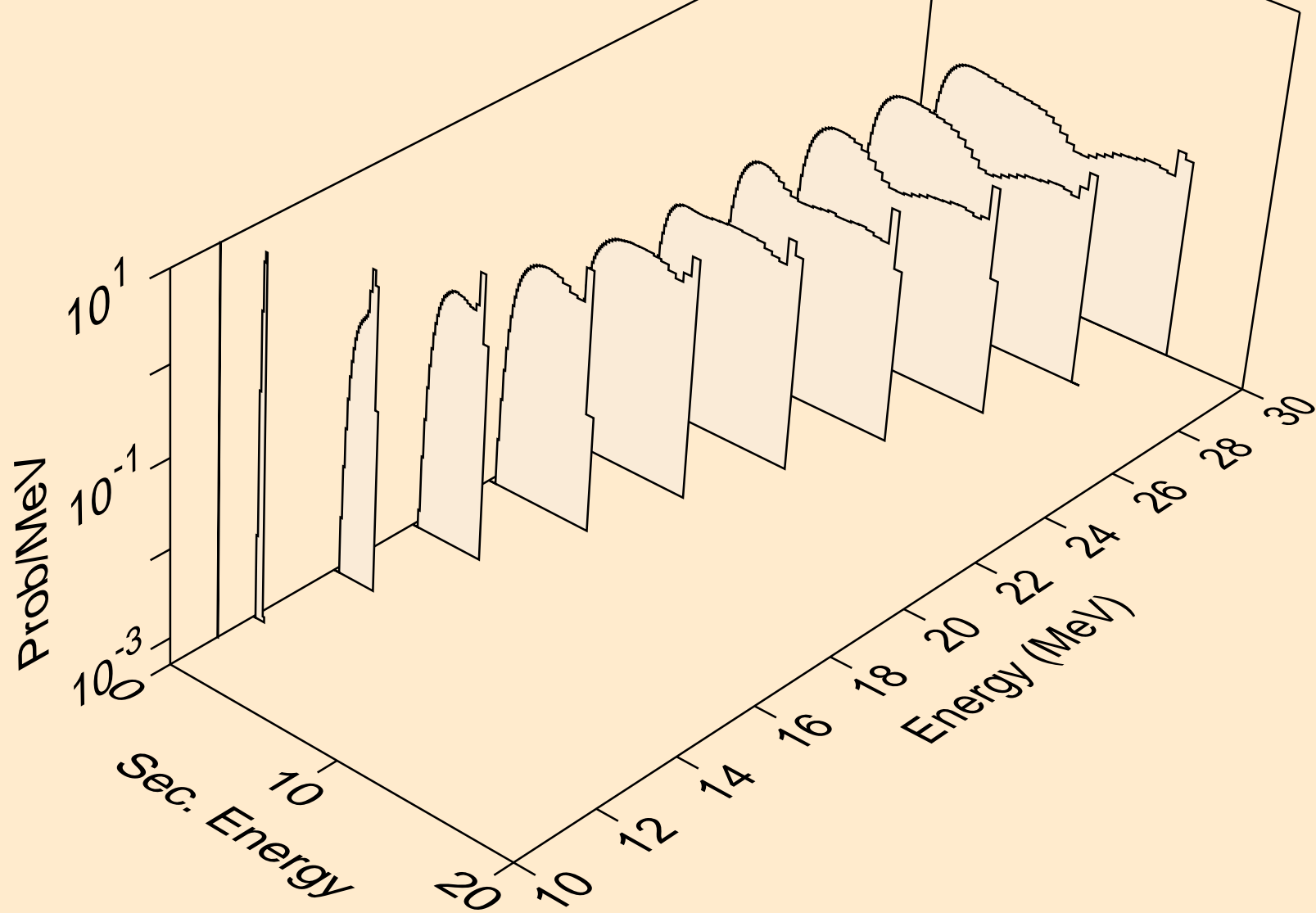

N016 PROTON ACER TENDL-2023 LIBRARY; T=0.K
deuterons from (p,da)

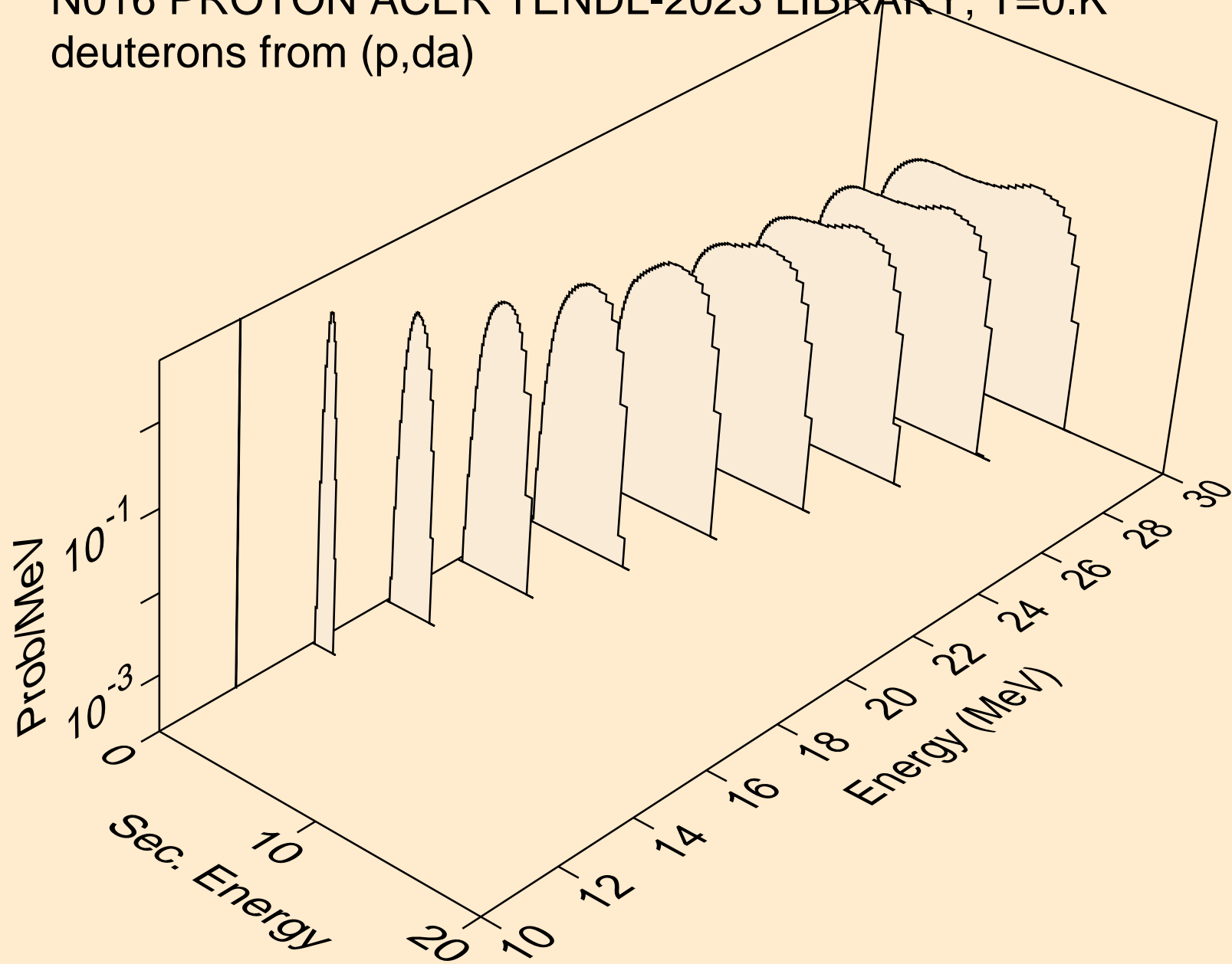

N016 PROTON ACER TENDL-2023 LIBRARY; T=0.K
tritons from (p,x)

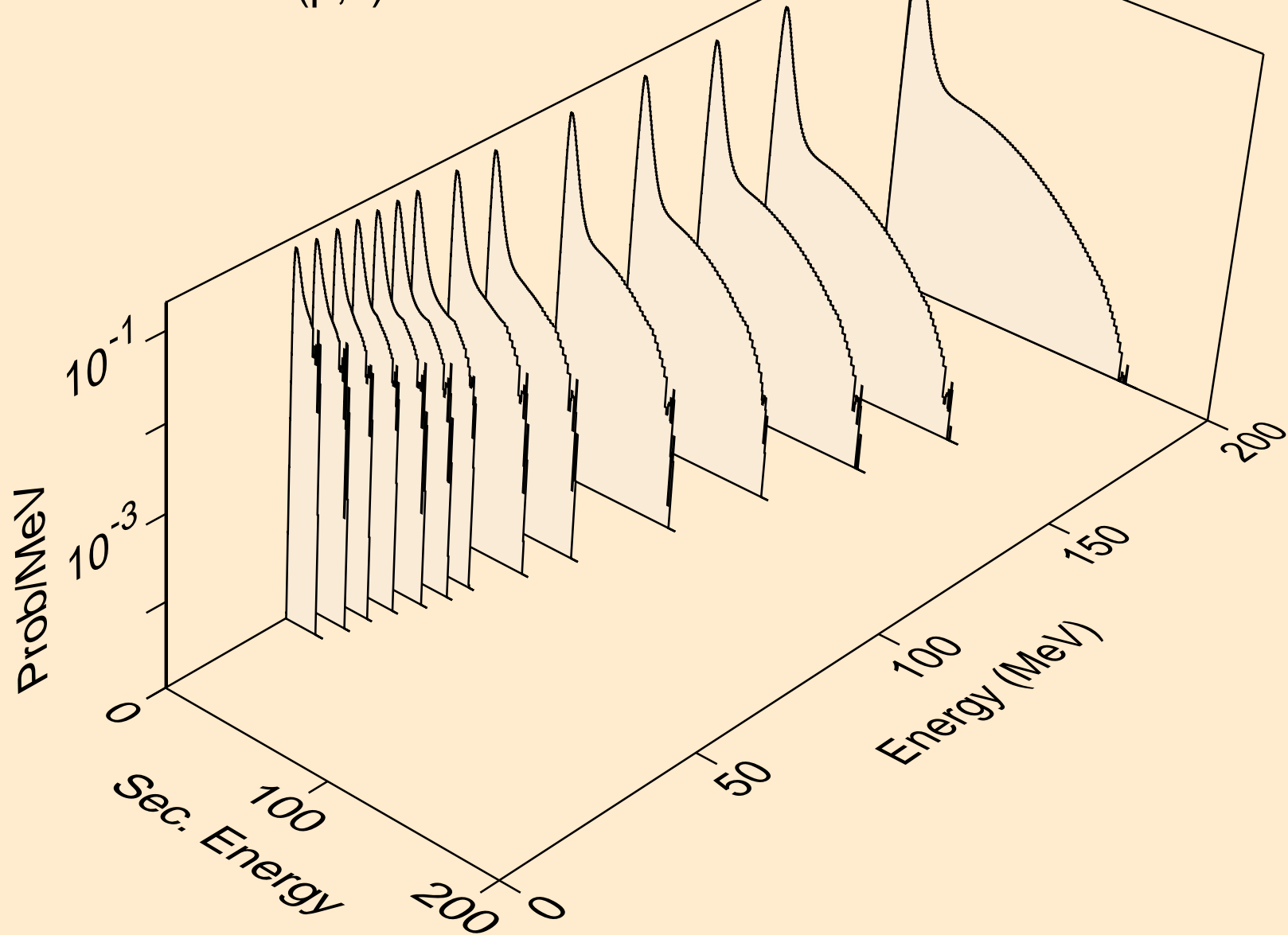

N016 PROTON ACER TENDL-2023 LIBRARY; T=0.K
tritons from (p,n*)t

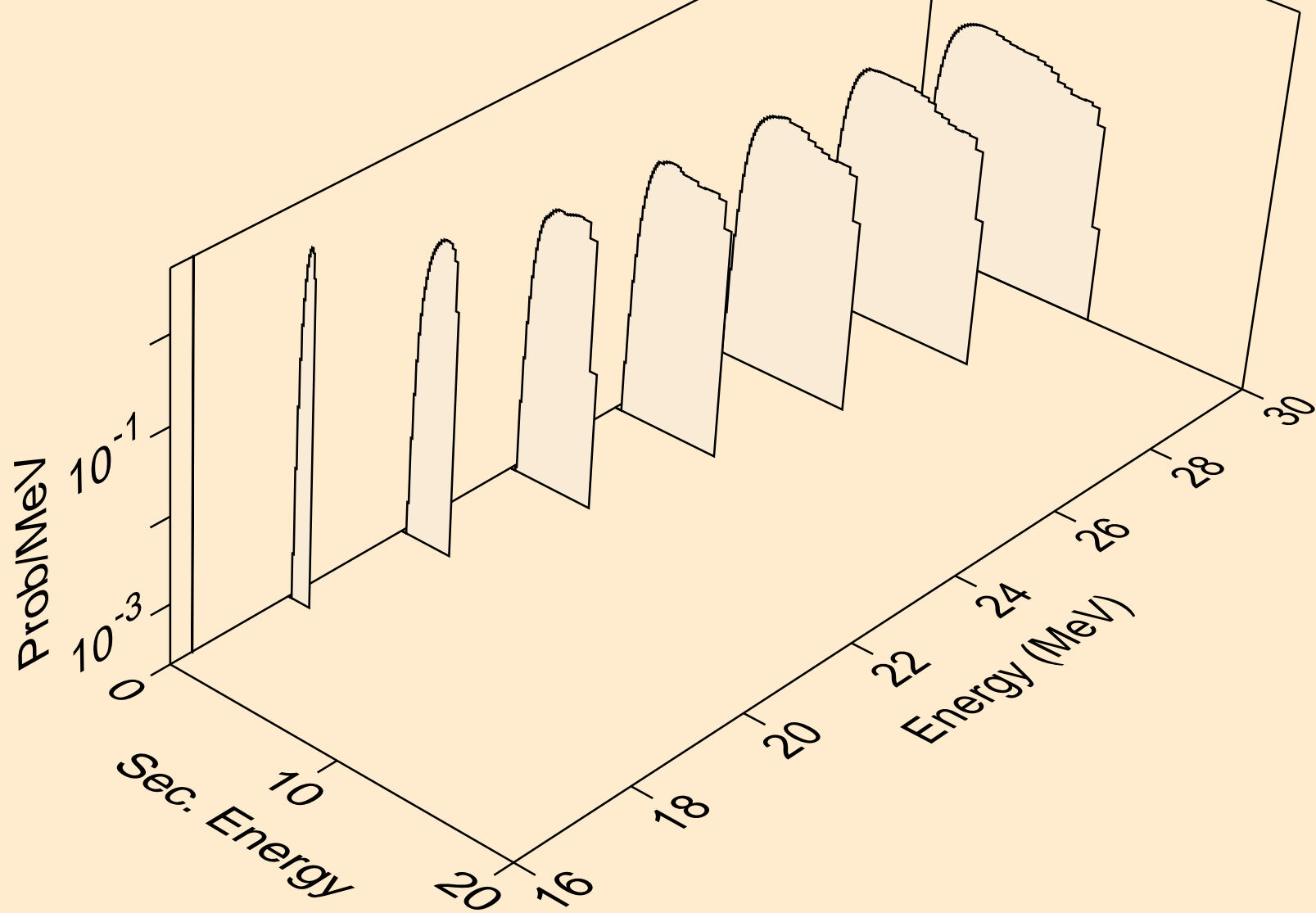

N016 PROTON ACER TENDL-2023 LIBRARY; T=0.K
tritons from (p,t)

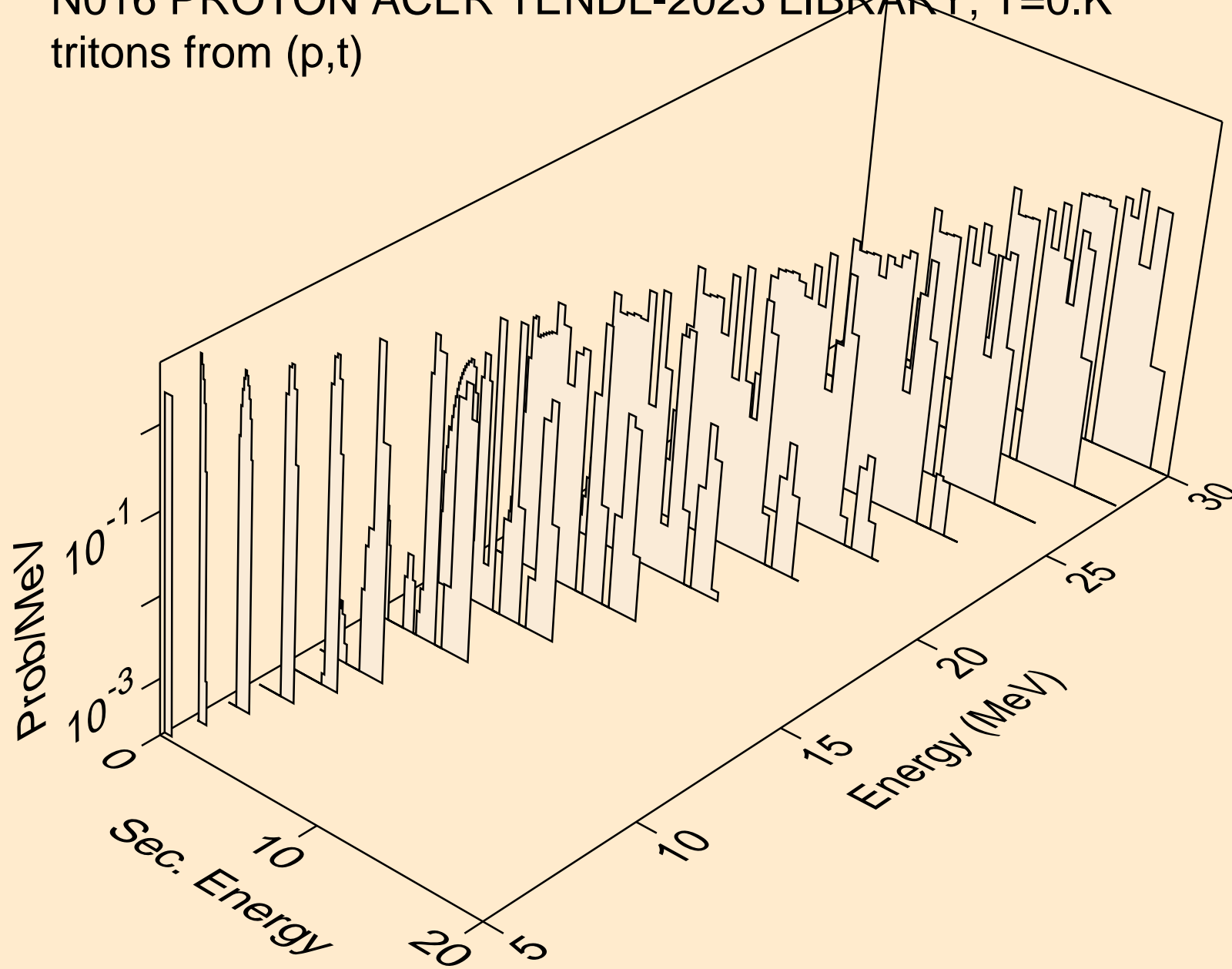

N016 PROTON ACER TENDL-2023 LIBRARY; T=0.K
tritons from (p,t2a)

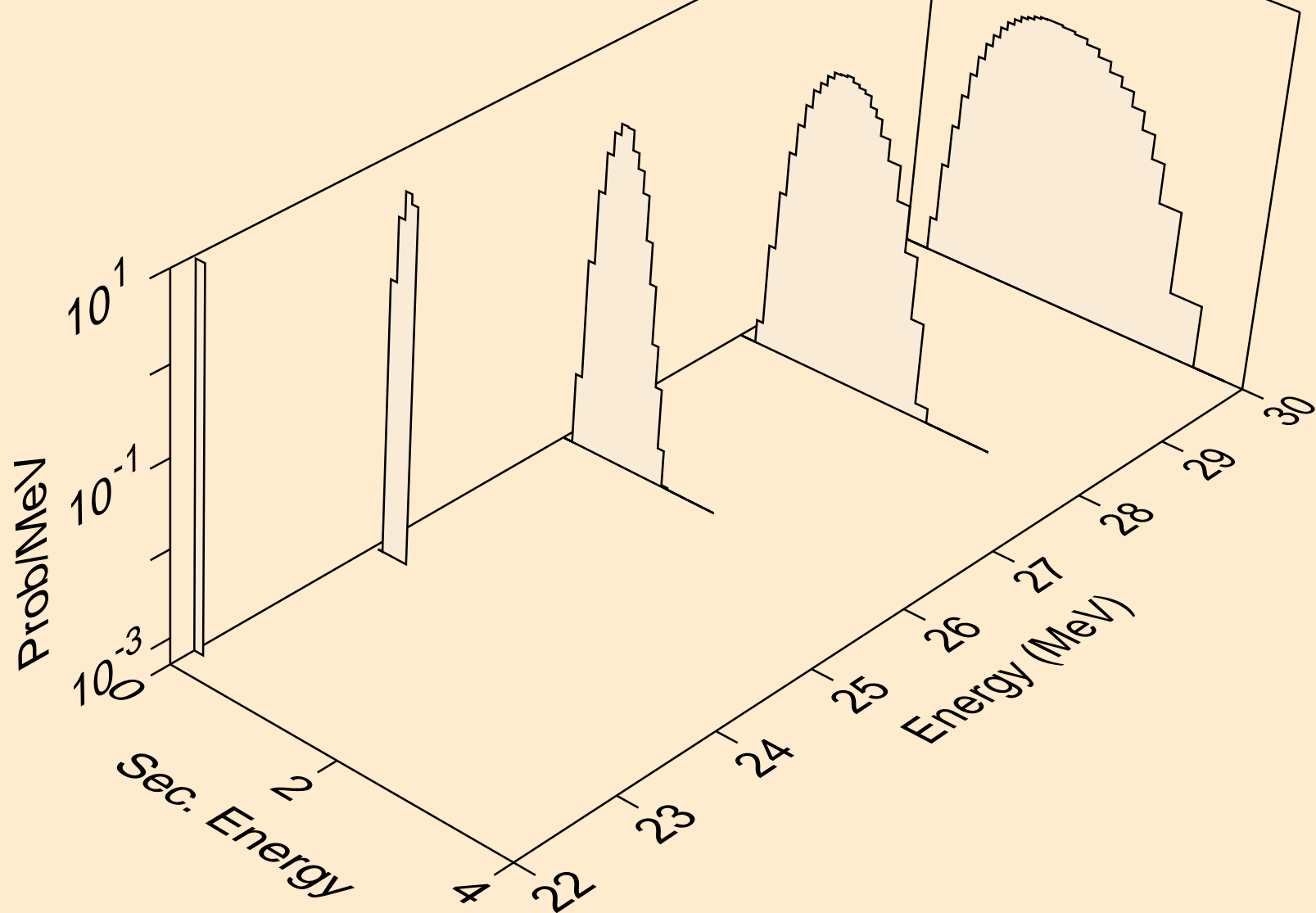

N016 PROTON ACER TENDL-2023 LIBRARY; T=0.K
tritons from (p,pt)

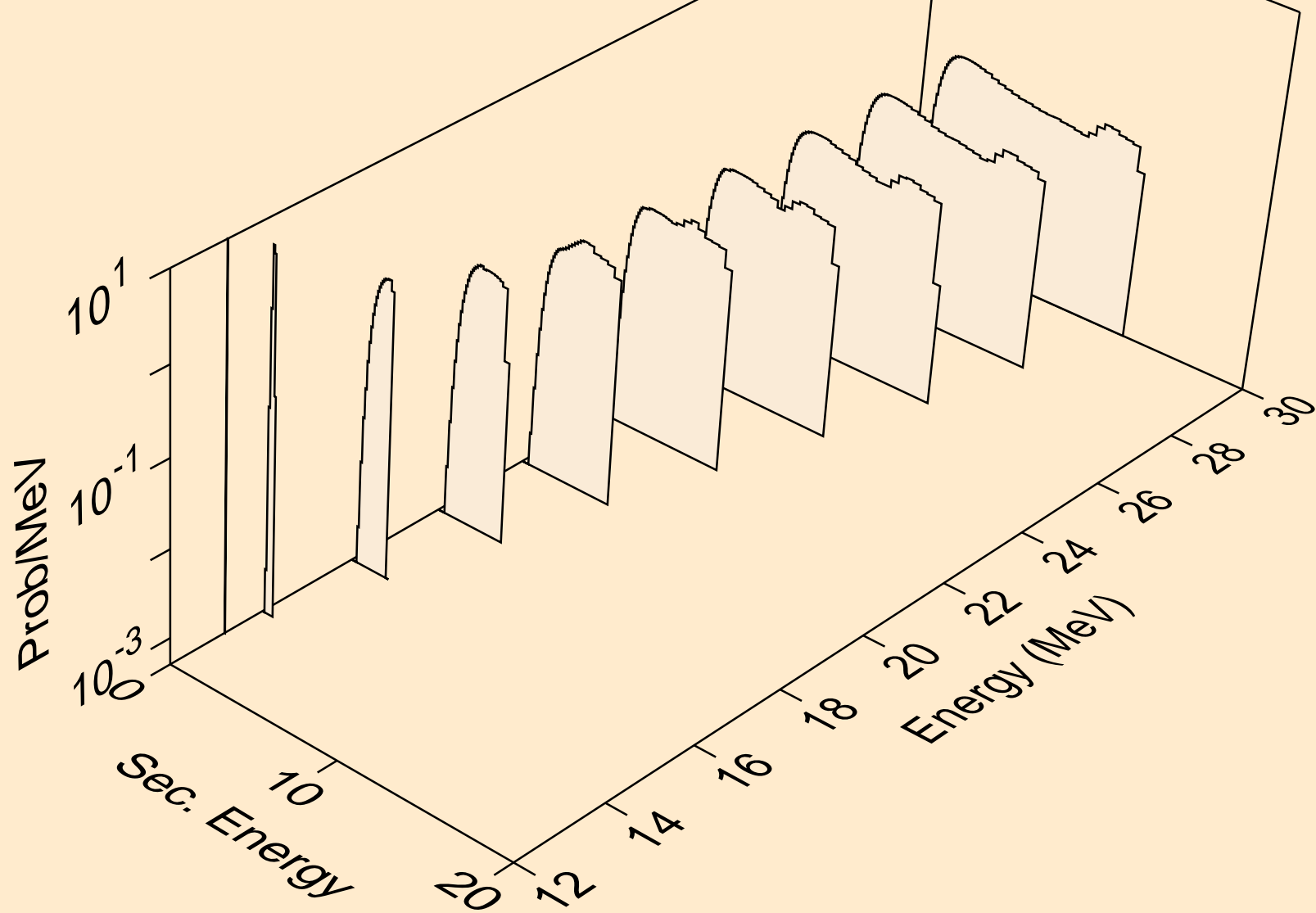

N016 PROTON ACER TENDL-2023 LIBRARY; T=0.K
he3s from (p,x)

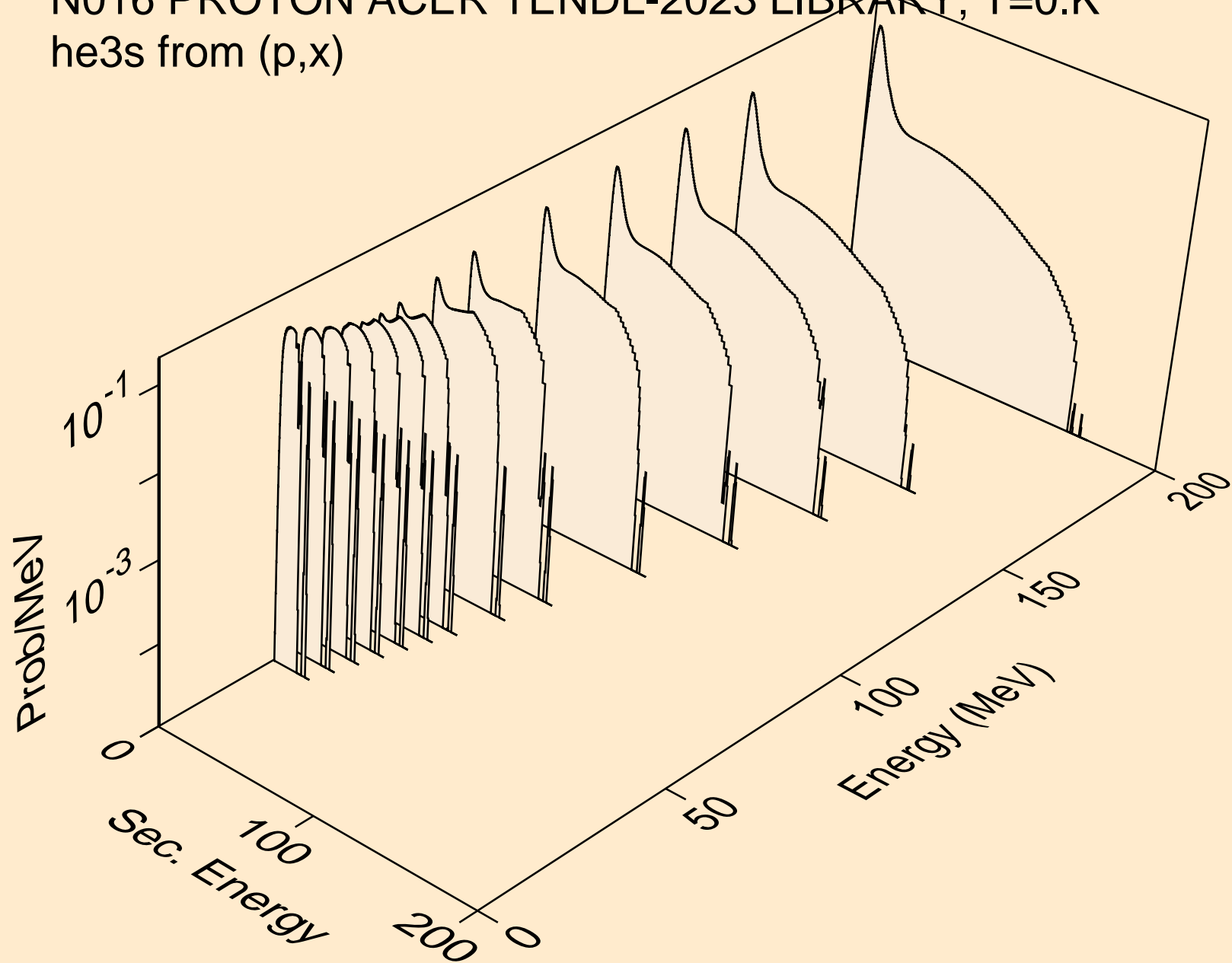

N016 PROTON ACER TENDL-2023 LIBRARY; T=0.K
he3s from (p,n*)he3

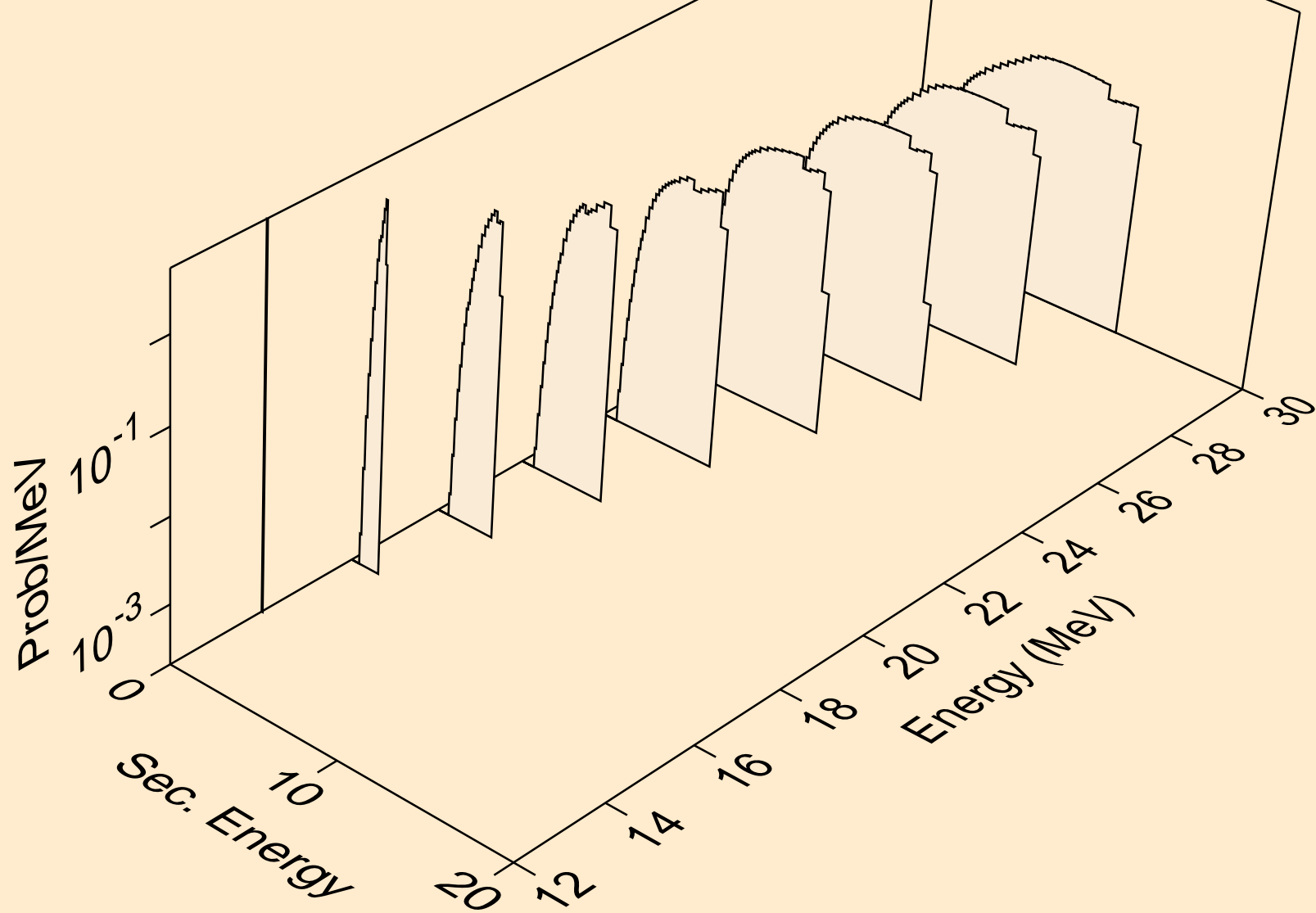

N016 PROTON ACER TENDL-2023 LIBRARY; T=0.K
he3s from (p,he3)

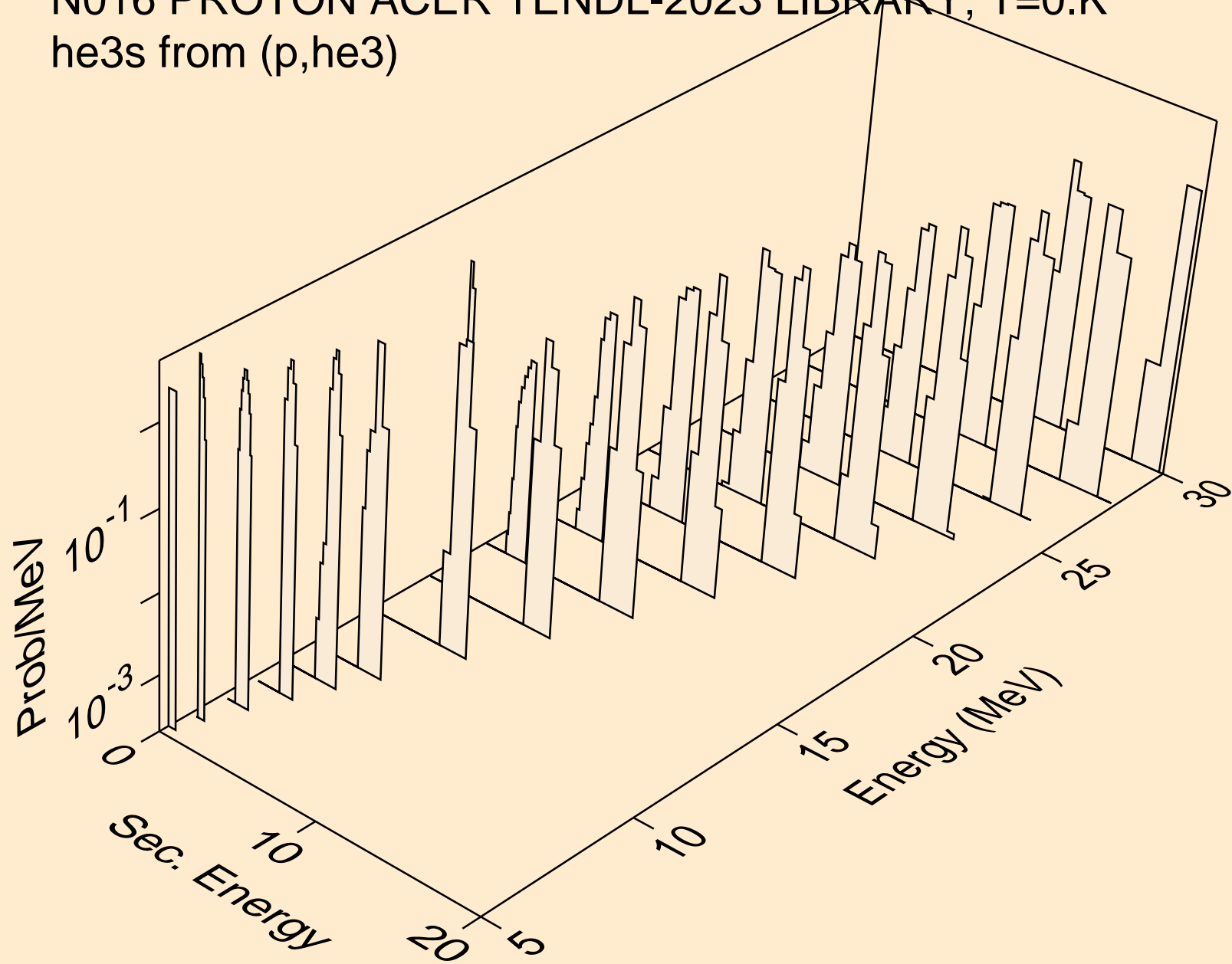

N016 PROTON ACER TENDL-2023 LIBRARY; T=0.K
alphas from (p,x)

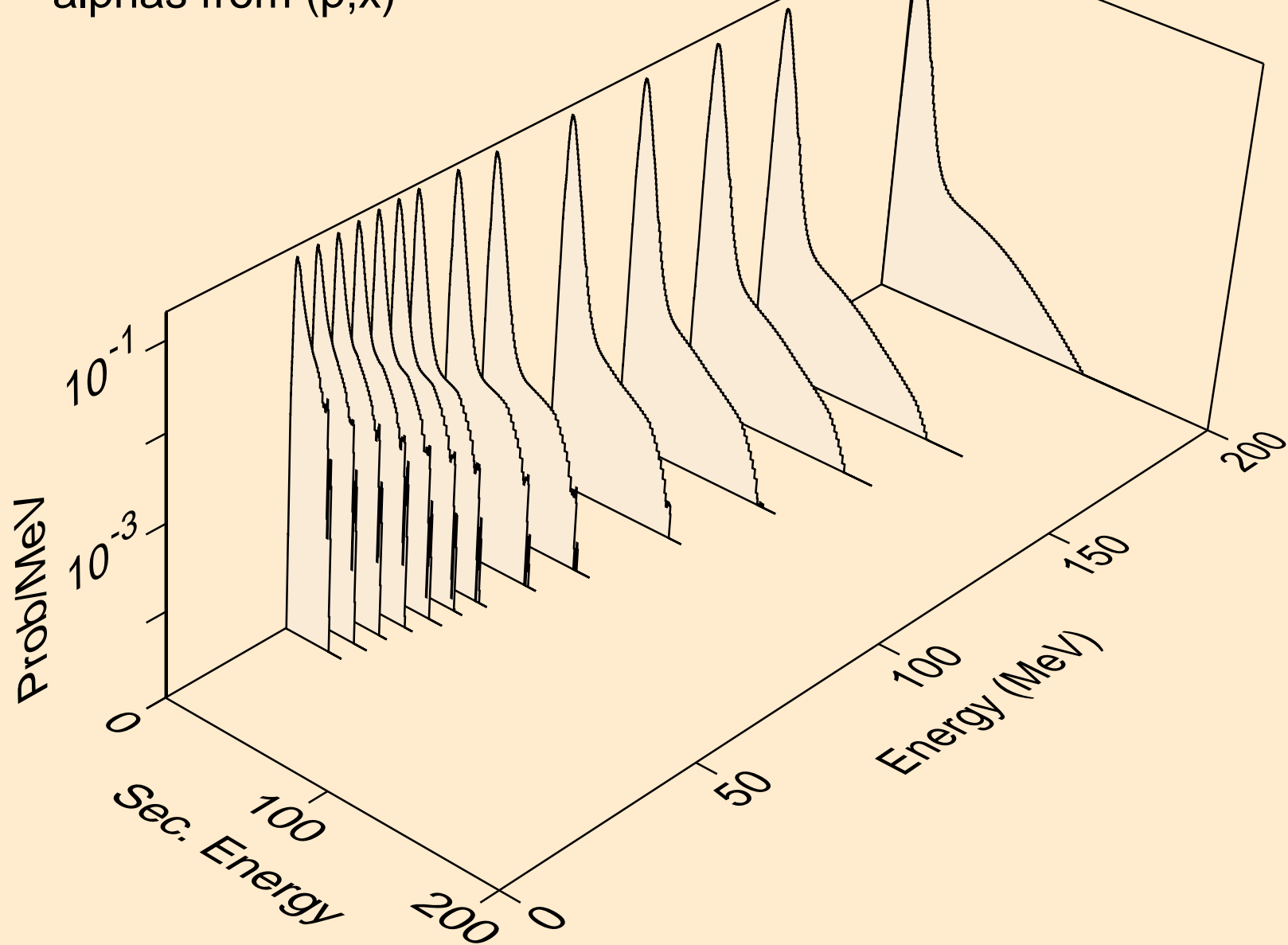

N016 PROTON ACER TENDL-2023 LIBRARY; T=0.K
alphas from (p,n*)a

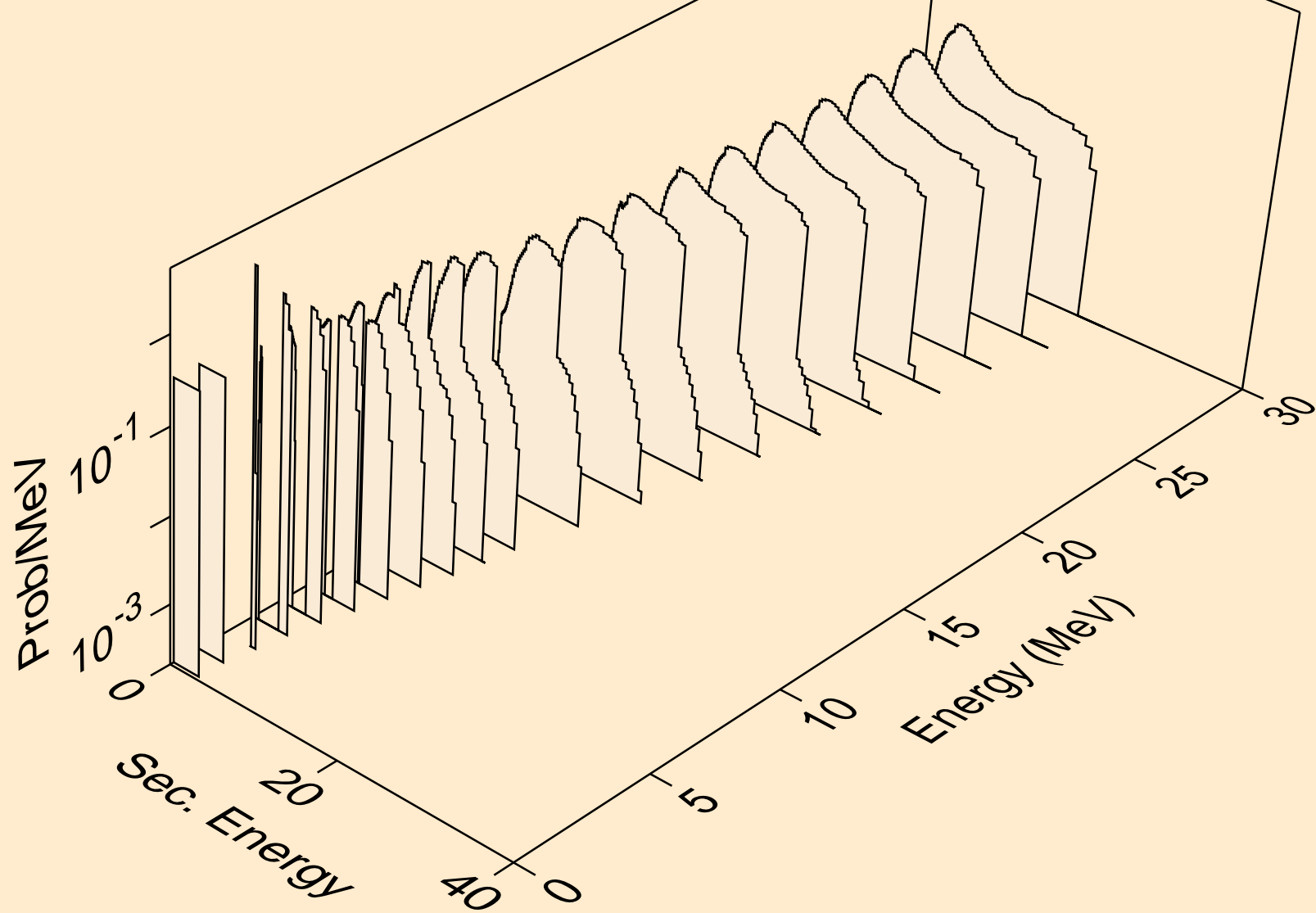

N016 PROTON ACER TENDL-2023 LIBRARY; T=0.K
alphas from (p,2n)a

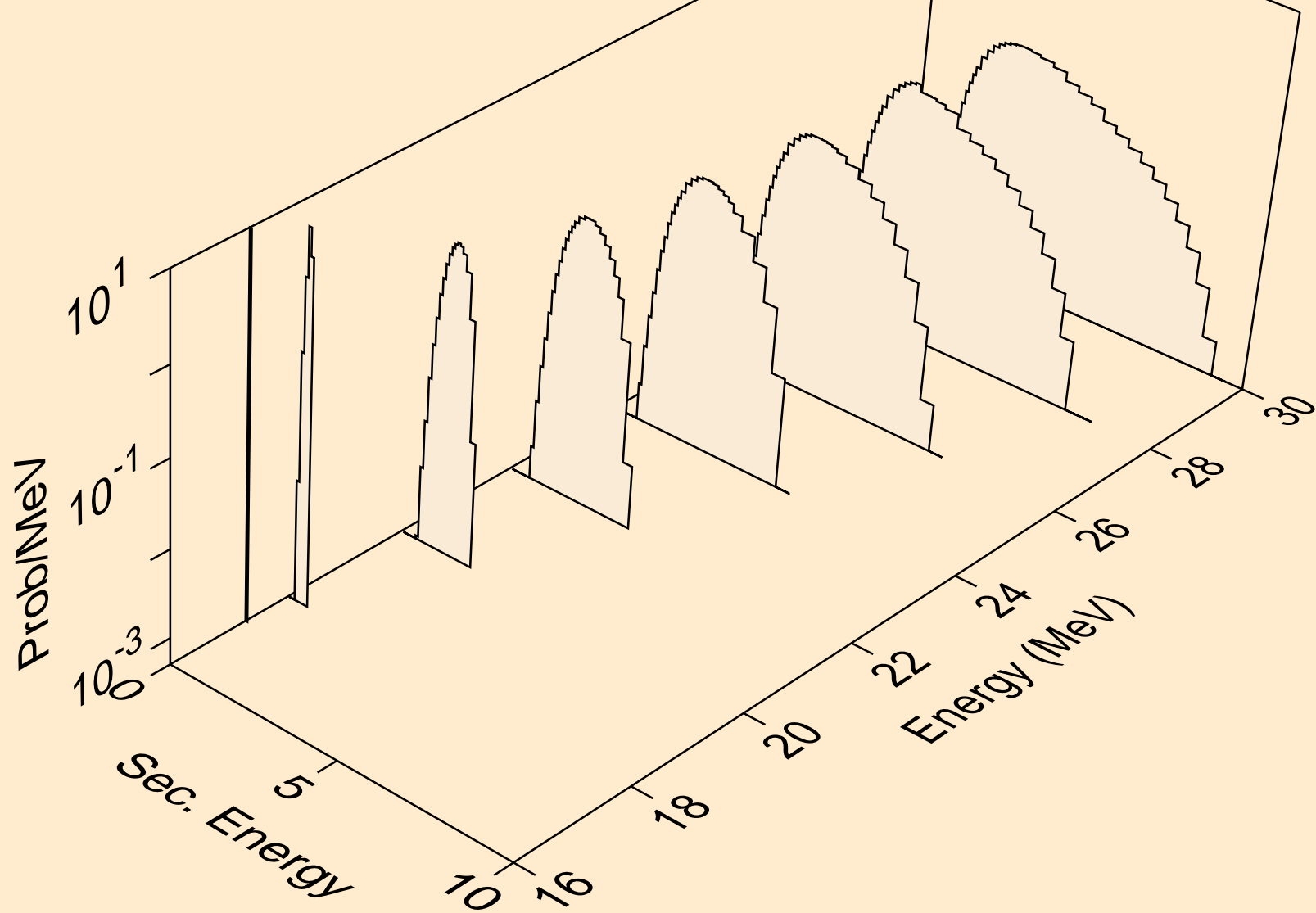

N016 PROTON ACER TENDL-2023 LIBRARY; T=0.K
alphas from (p,n*)2a

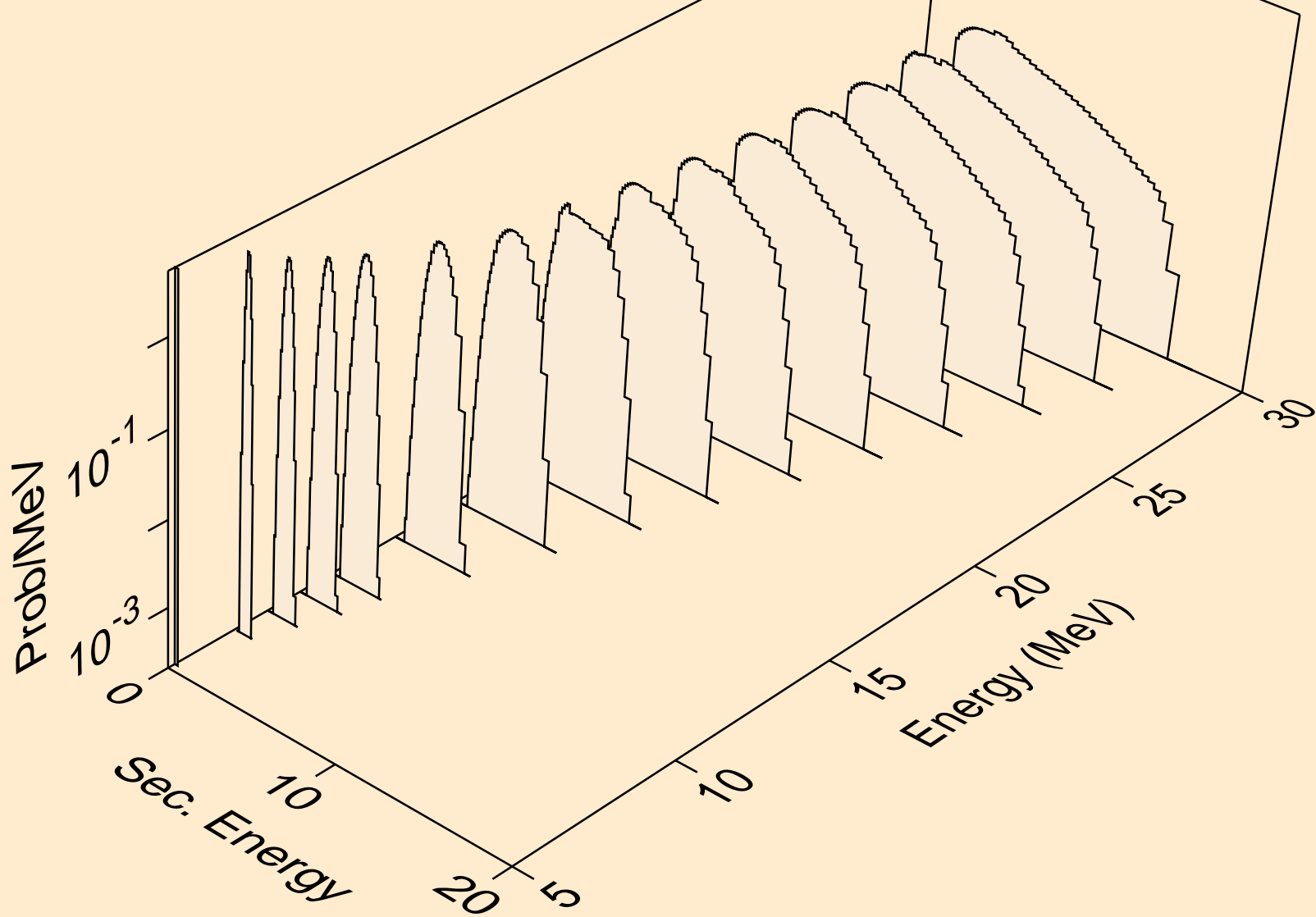

N016 PROTON ACER TENDL-2023 LIBRARY; T=0.K
alphas from (p,2n)2a

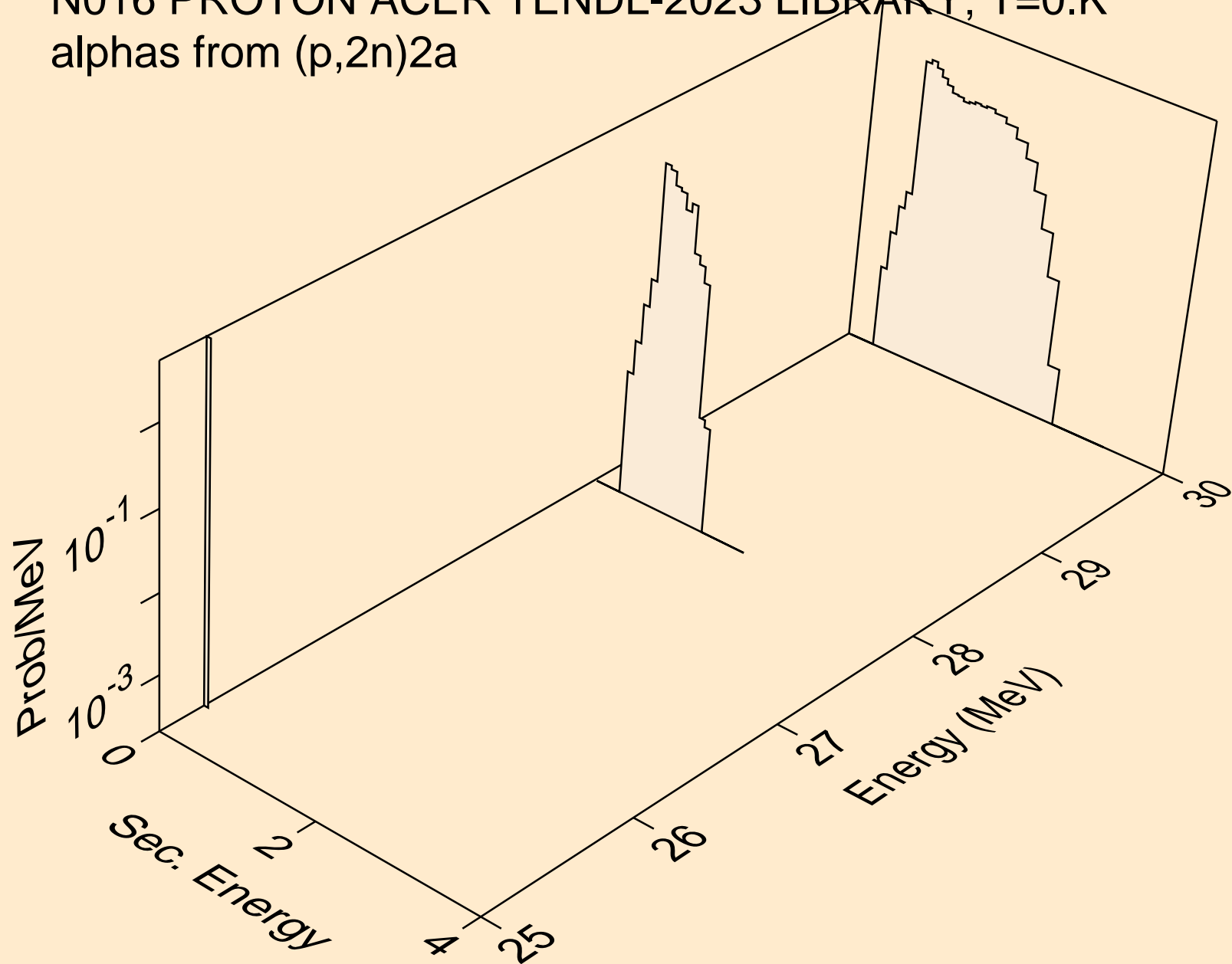

N016 PROTON ACER TENDL-2023 LIBRARY; T=0.K
alphas from (p,npa)

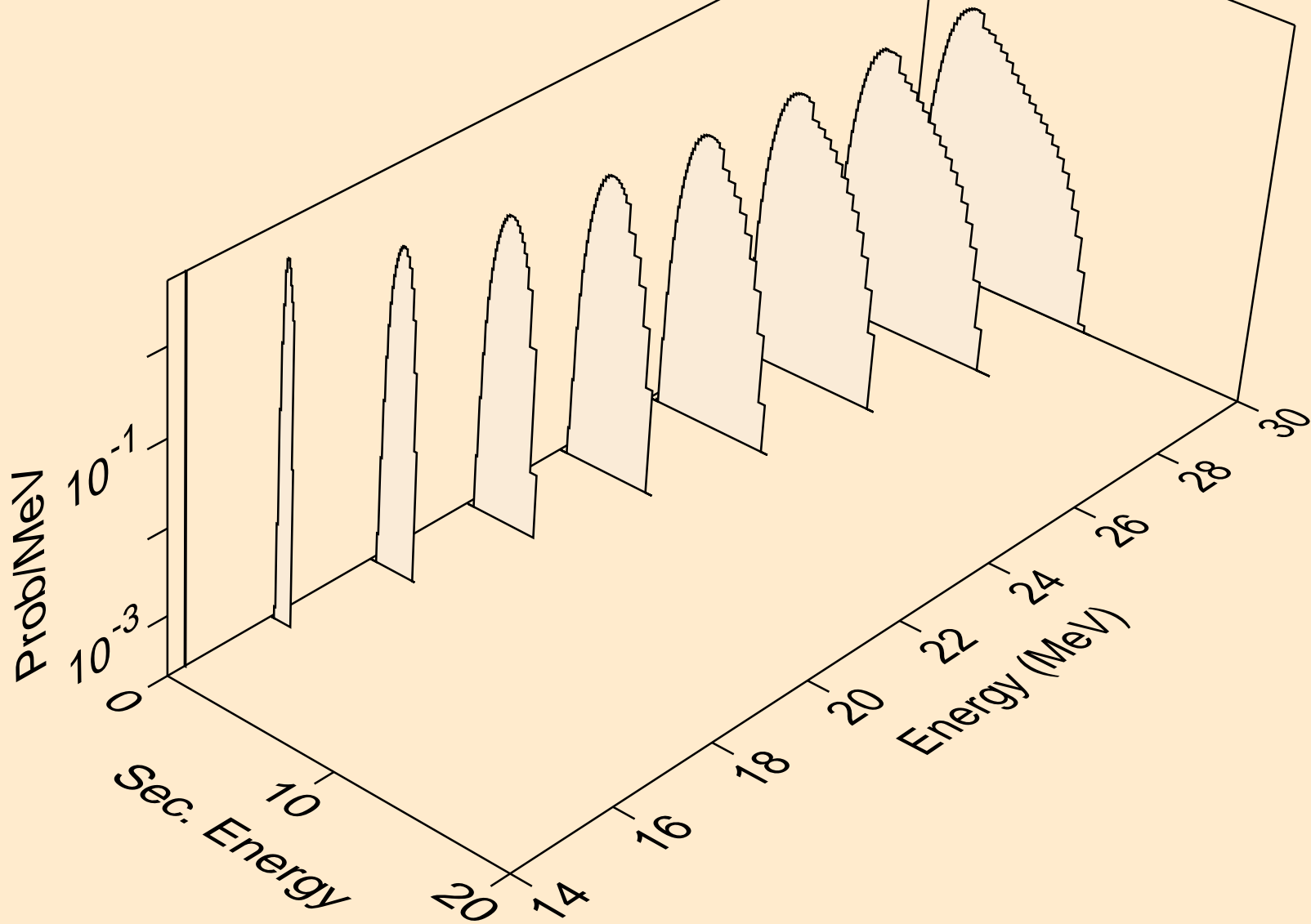

N016 PROTON ACER TENDL-2023 LIBRARY; T=0.K
alphas from (p,a)

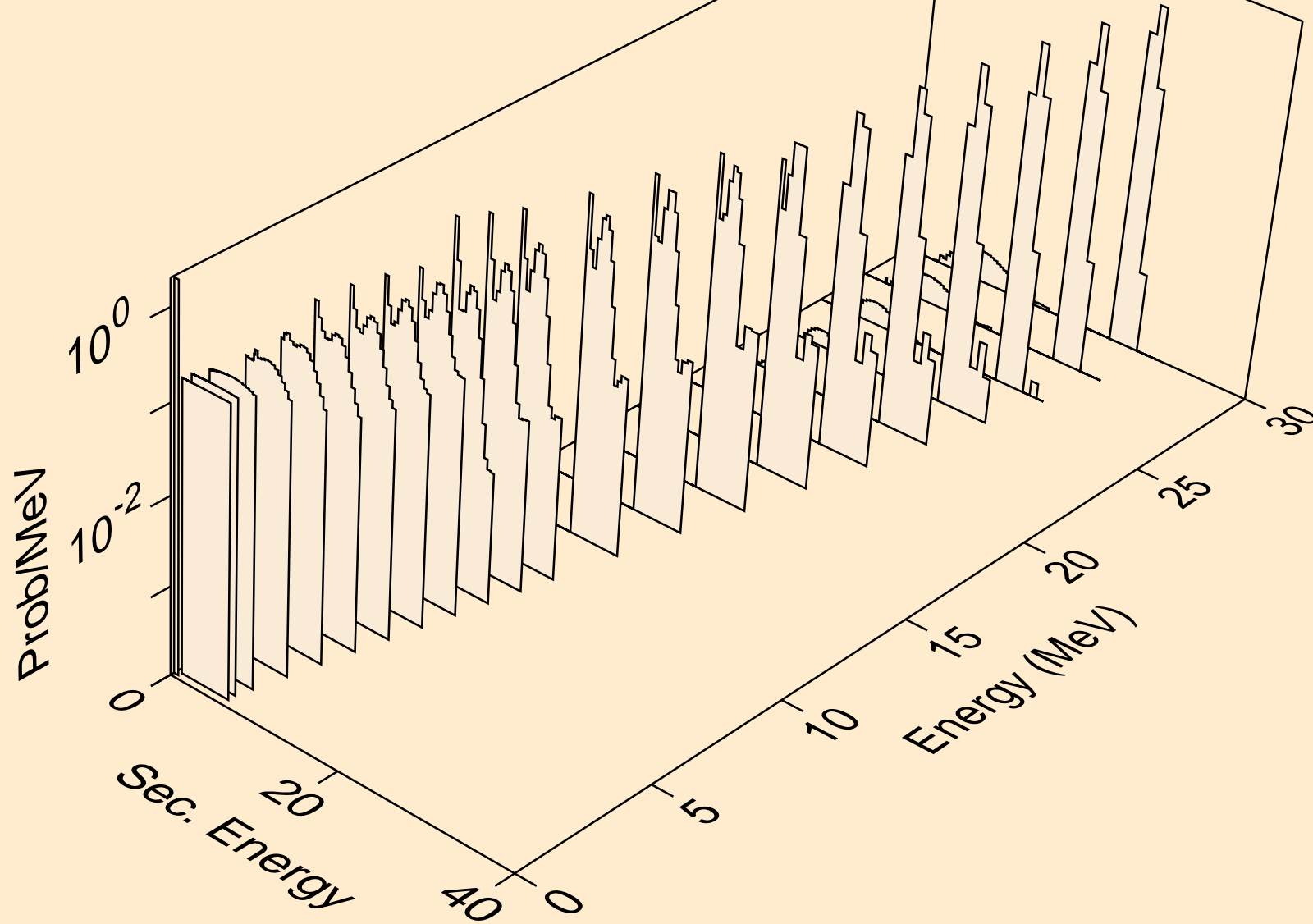

N016 PROTON ACER TENDL-2023 LIBRARY; T=0.K
alphas from (p,2a)

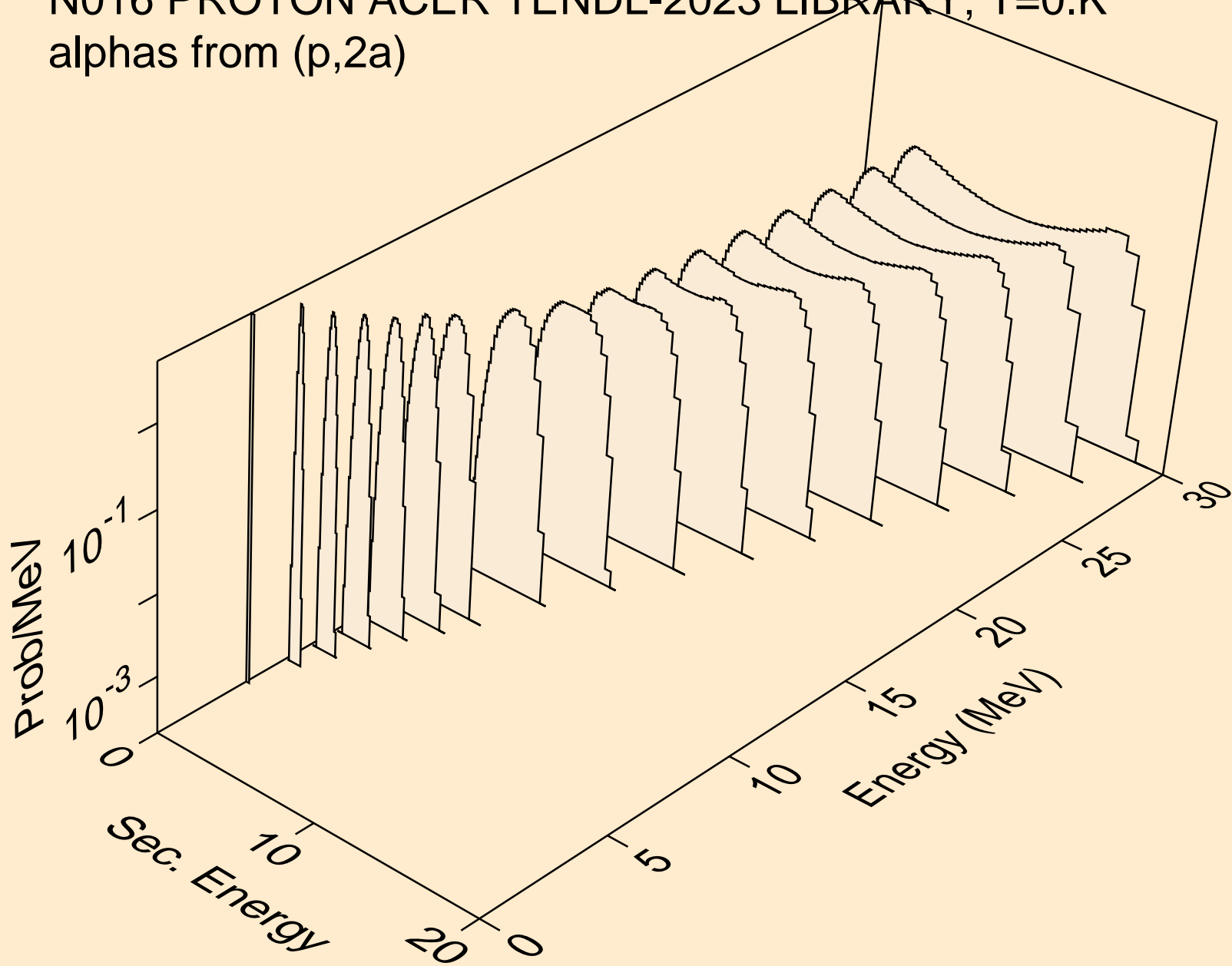

N016 PROTON ACER TENDL-2023 LIBRARY; T=0.K
alphas from (p,pa)

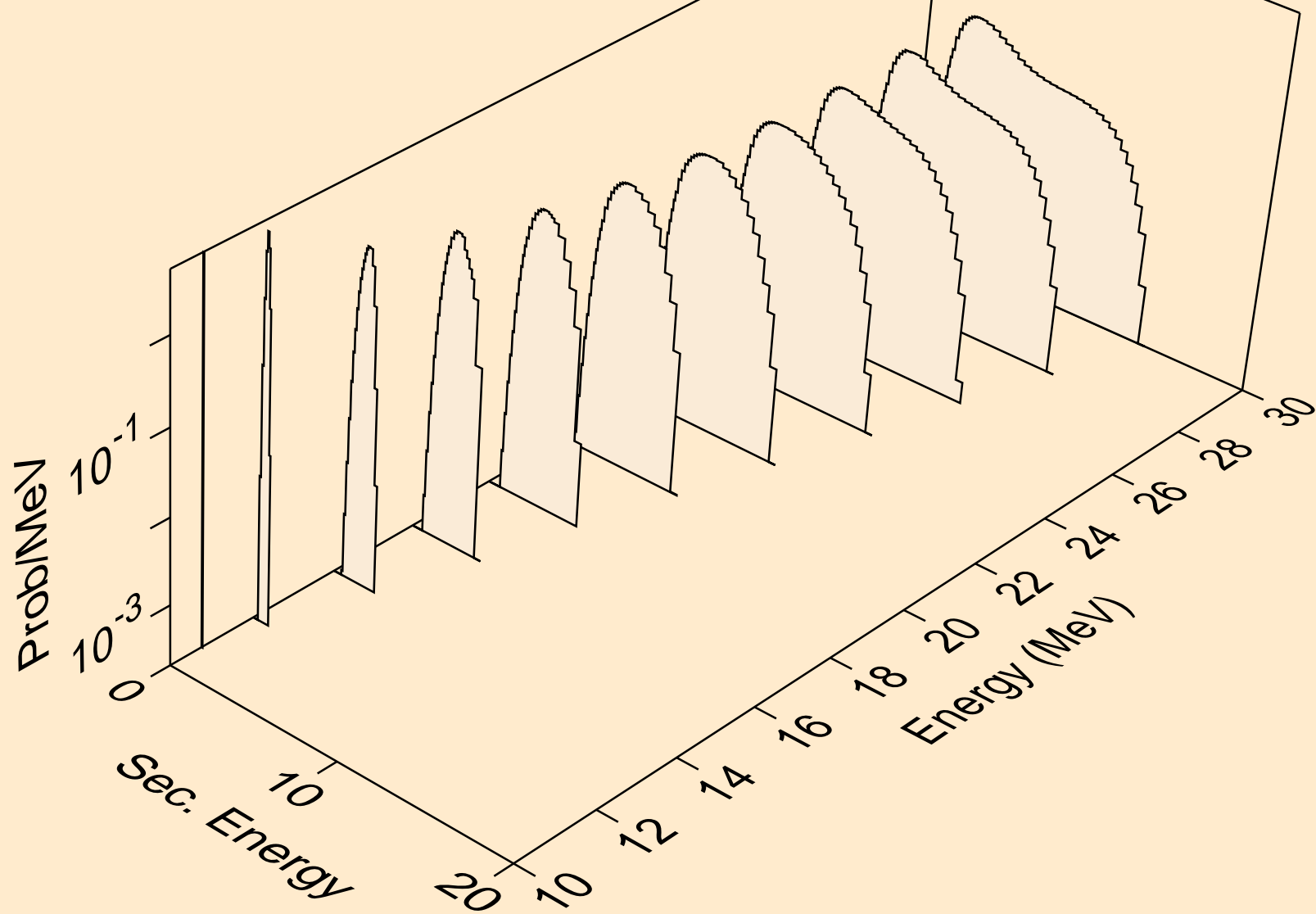

N016 PROTON ACER TENDL-2023 LIBRARY; T=0.K
alphas from (p,t2a)

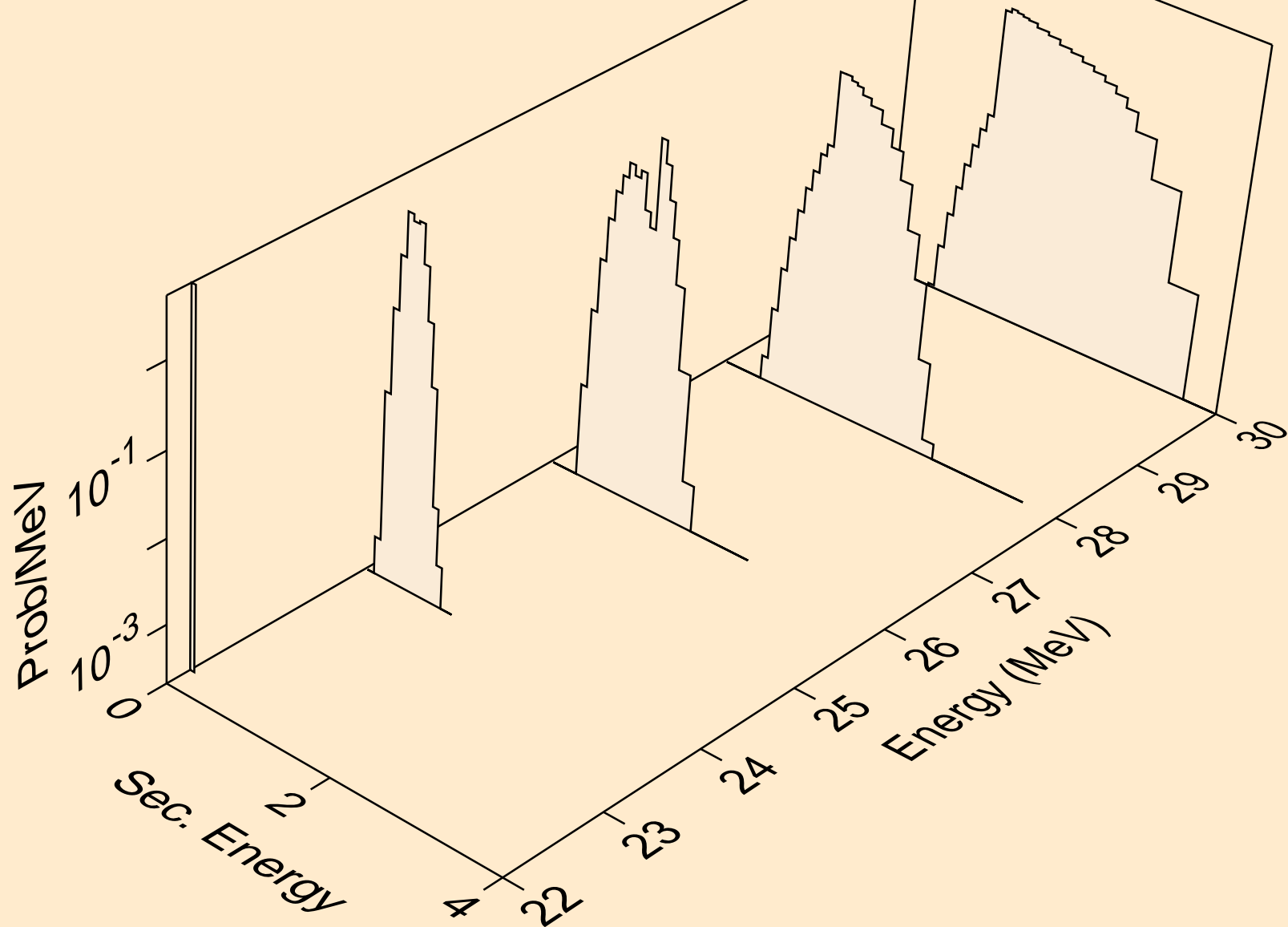

N016 PROTON ACER TENDL-2023 LIBRARY; T=0.K
alphas from (p,d2a)

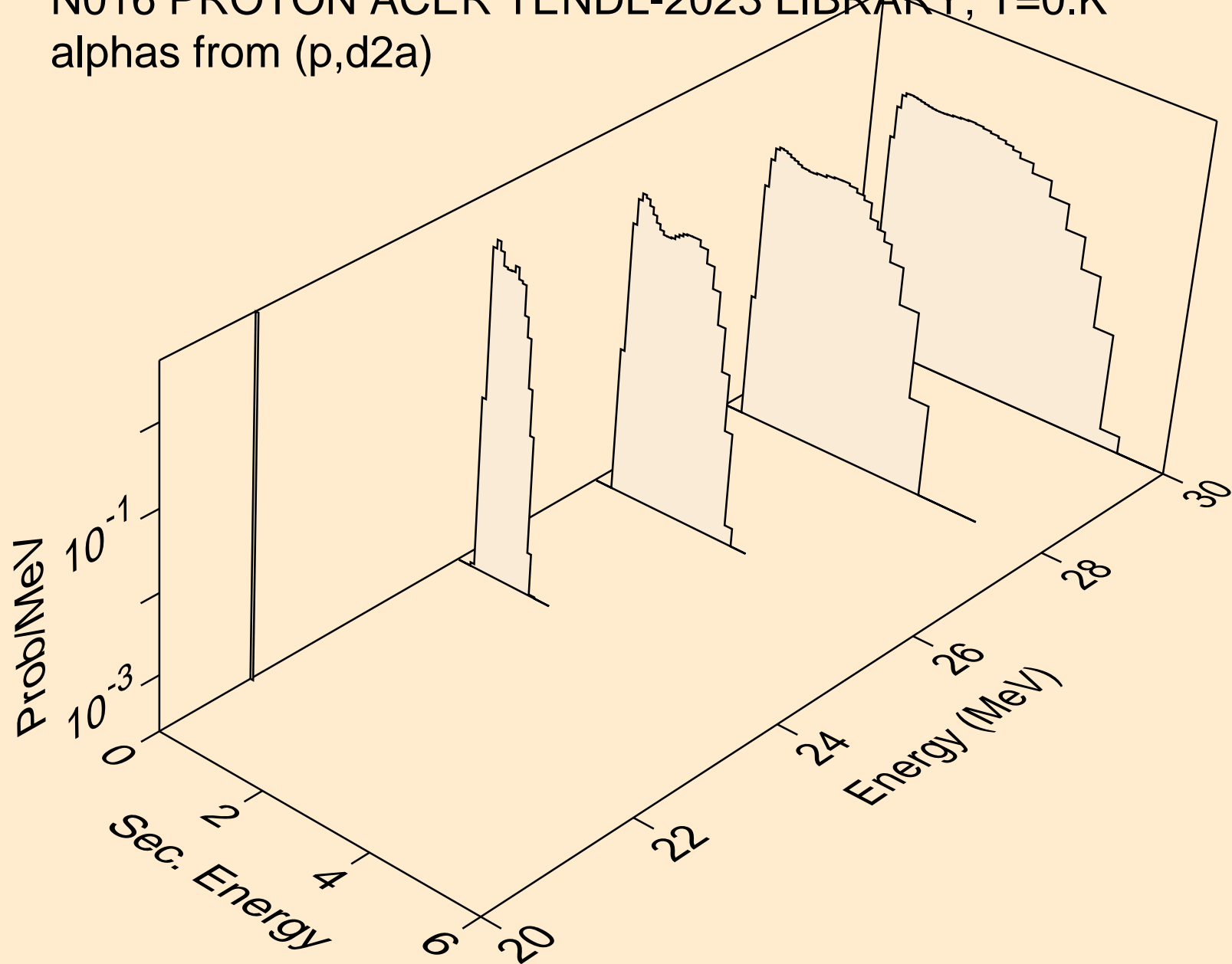

N016 PROTON ACER TENDL-2023 LIBRARY; T=0.K
alphas from (p,da)

