

PB191M PROTON ACER TENDL-2023 LIBRARY; T=0.K
Principal cross sections

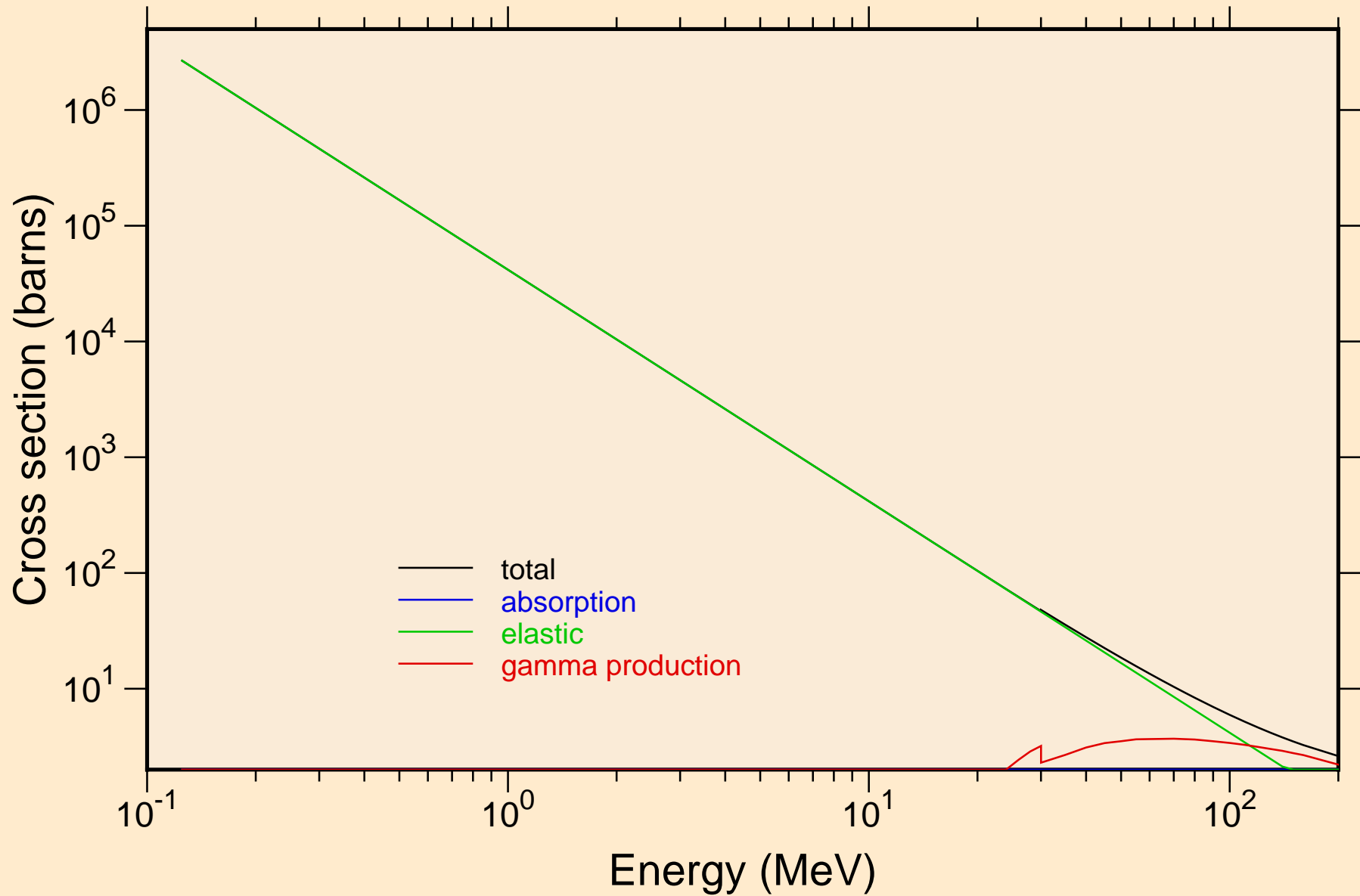

PB191M PROTON ACER TENDL-2023 LIBRARY; T=0.K

Heating

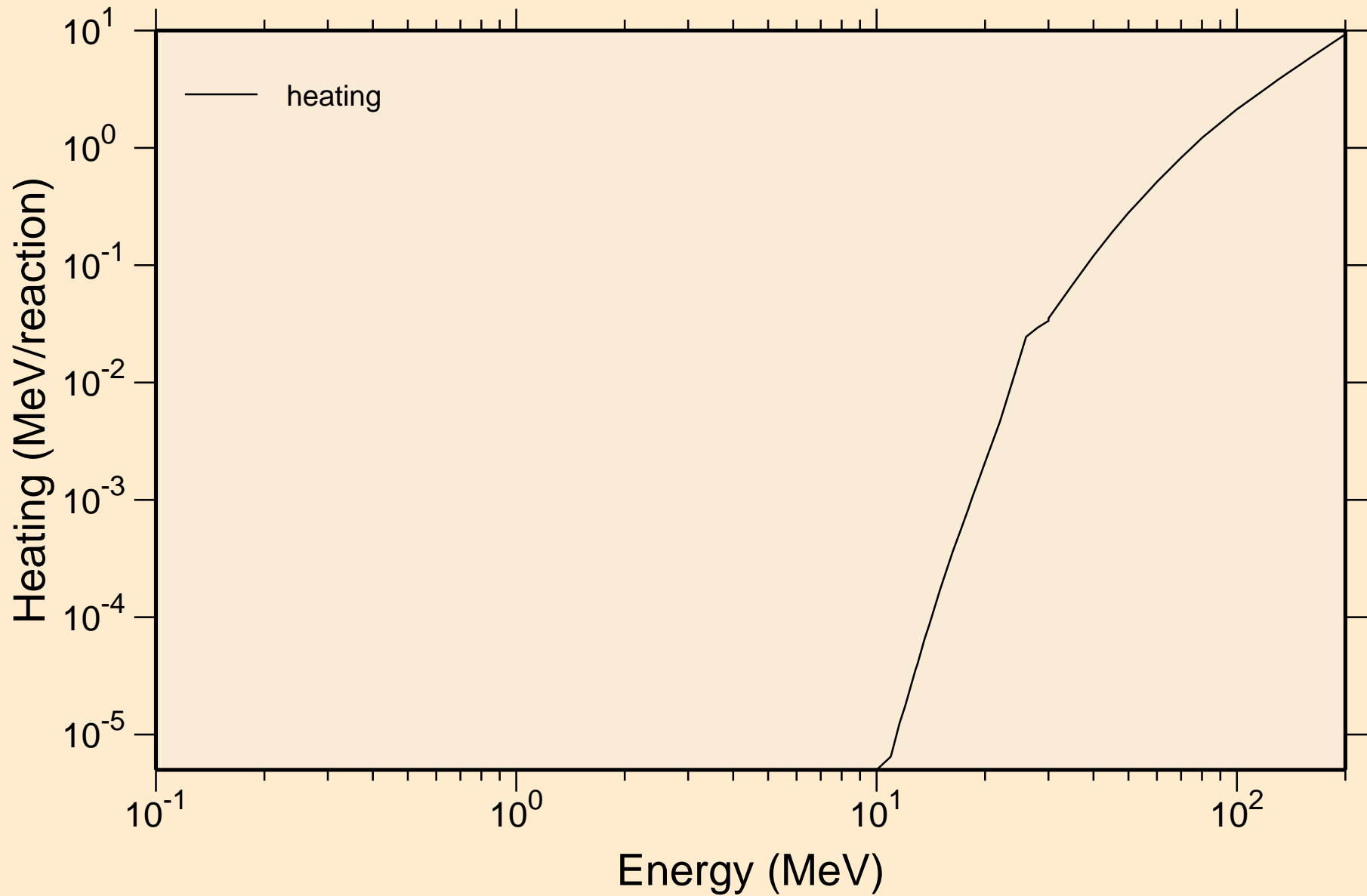

PB191M PROTON ACER TENDL-2023 LIBRARY; T=0.K

Principal cross sections

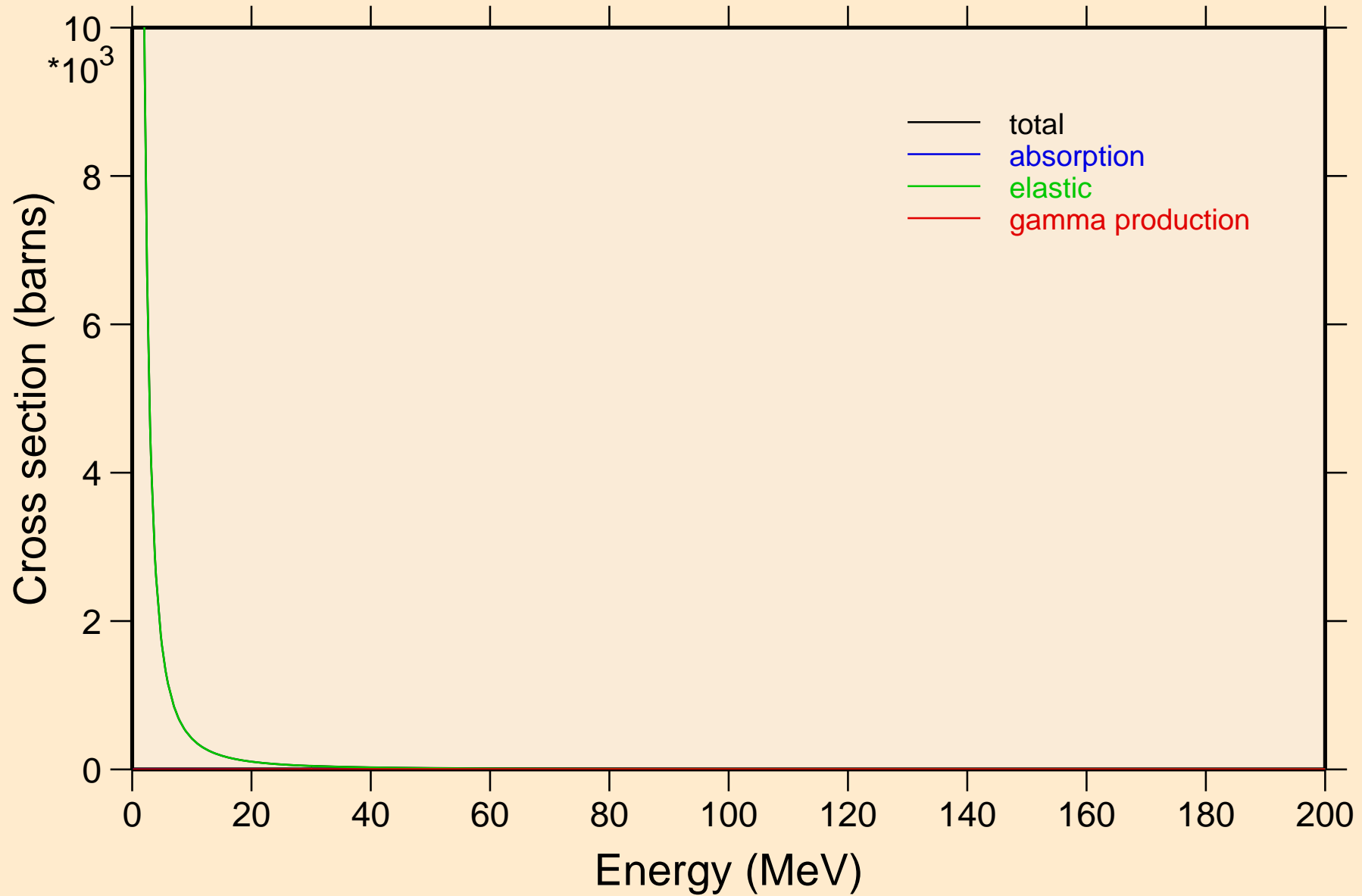

PB191M PROTON ACER TENDL-2023 LIBRARY; T=0.K

Heating

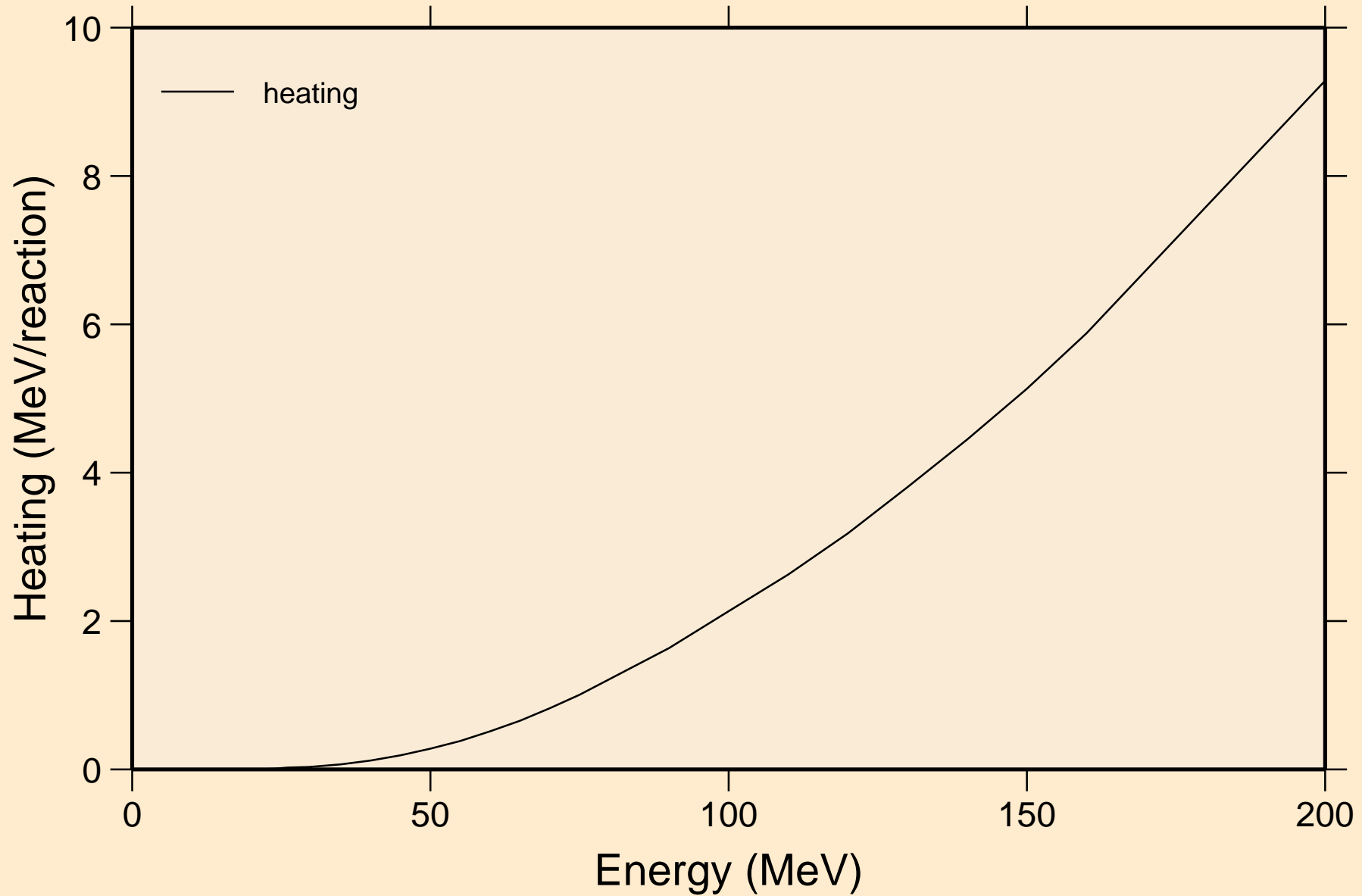

PB191M PROTON ACER TENDL-2023 LIBRARY; T=0.K
Threshold reactions

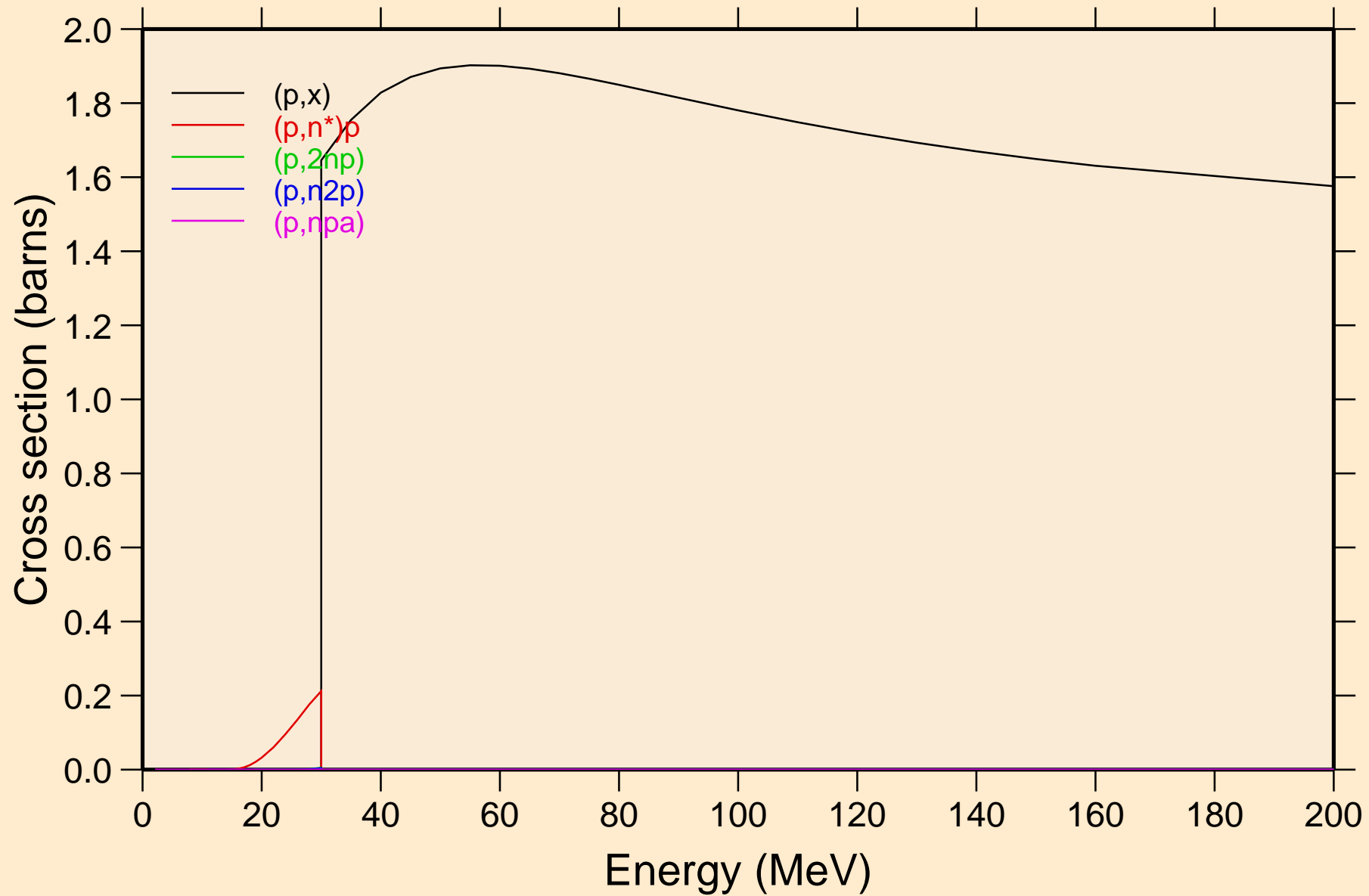

PB191M PROTON ACER TENDL-2023 LIBRARY; T=0.K
Threshold reactions

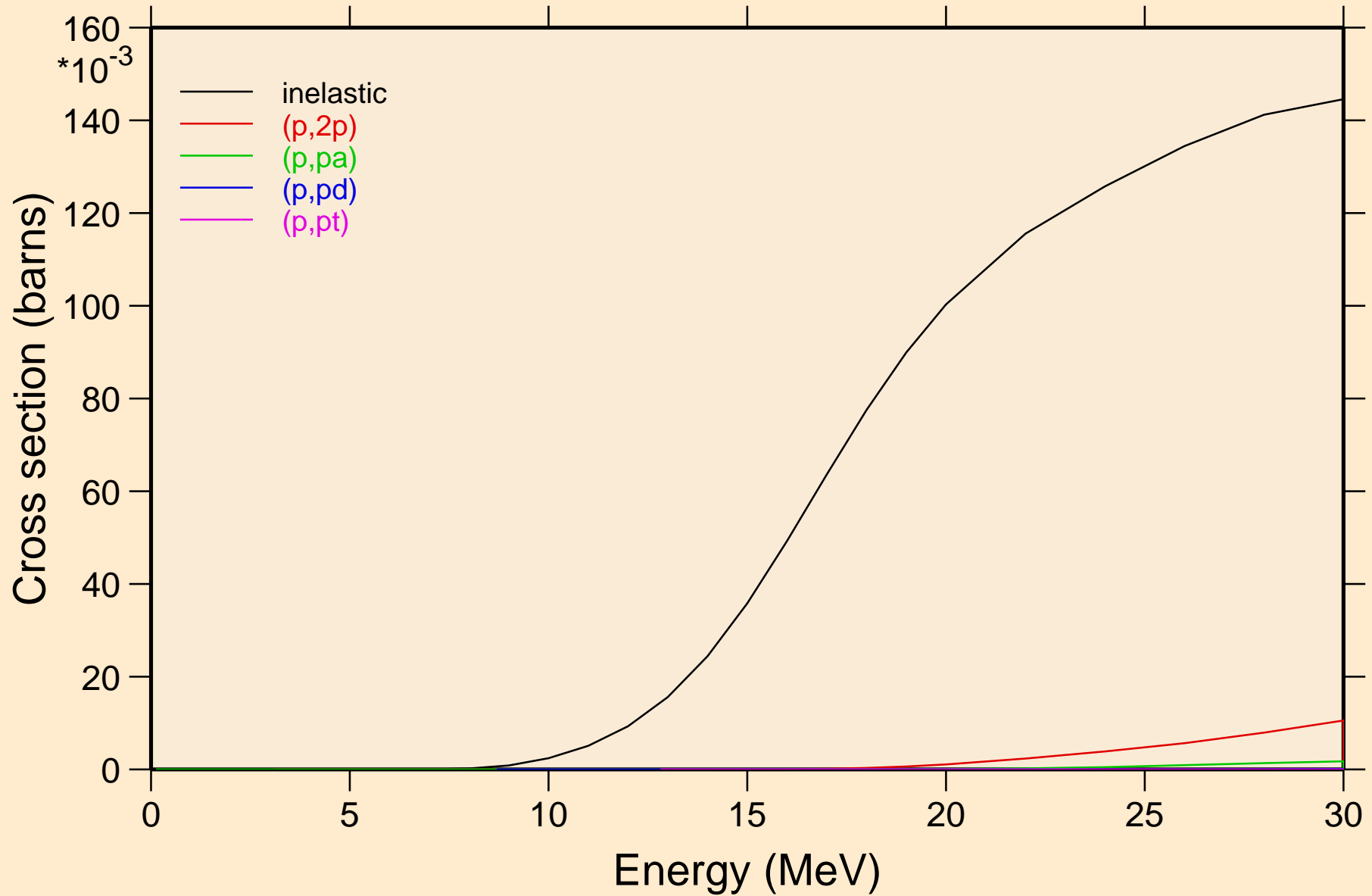

PB191M PROTON ACER TENDL-2023 LIBRARY; T=0.K
Threshold reactions

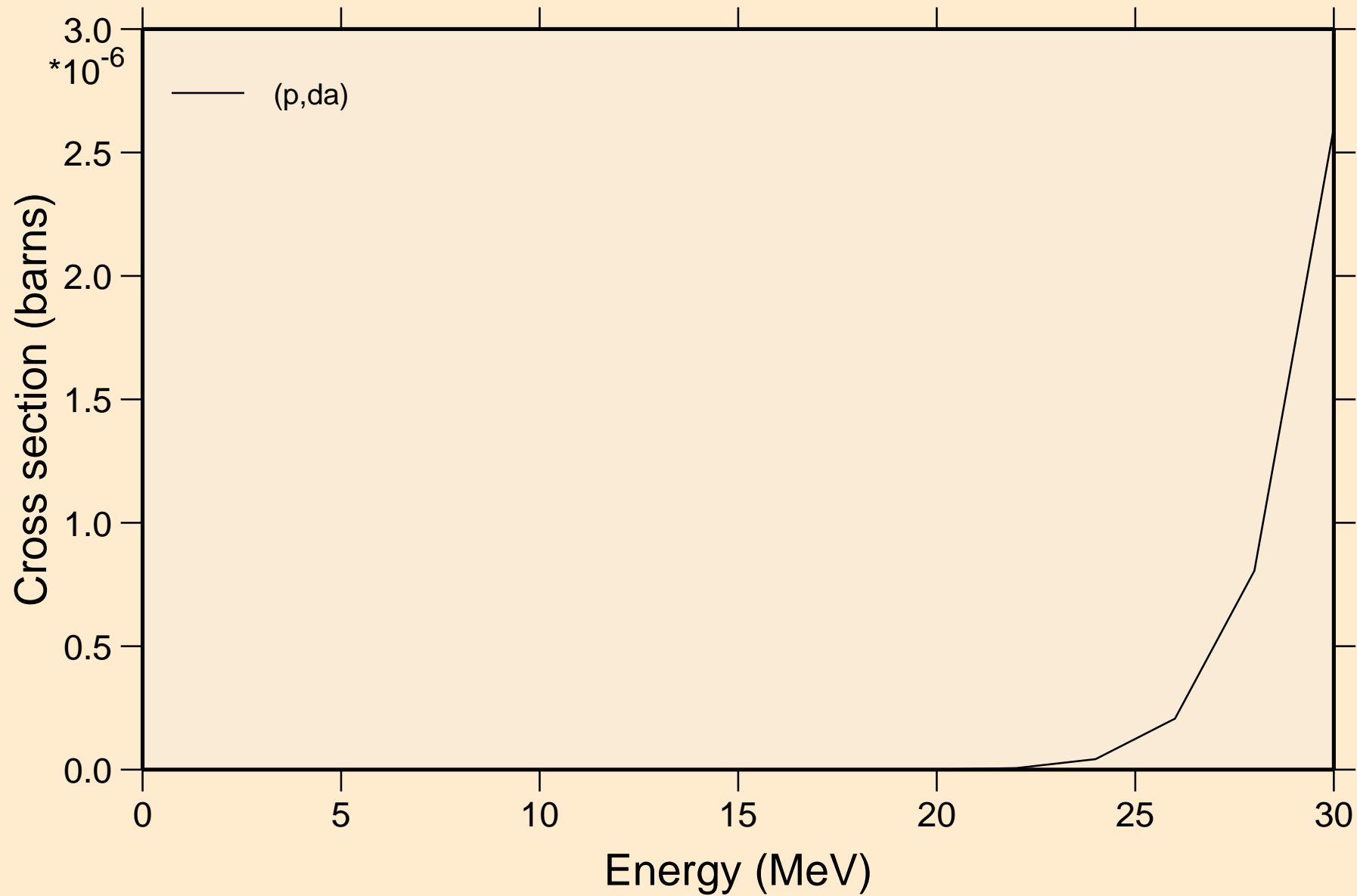

PB191M PROTON ACER TENDL-2023 LIBRARY; T=0.K
angular distribution for elastic

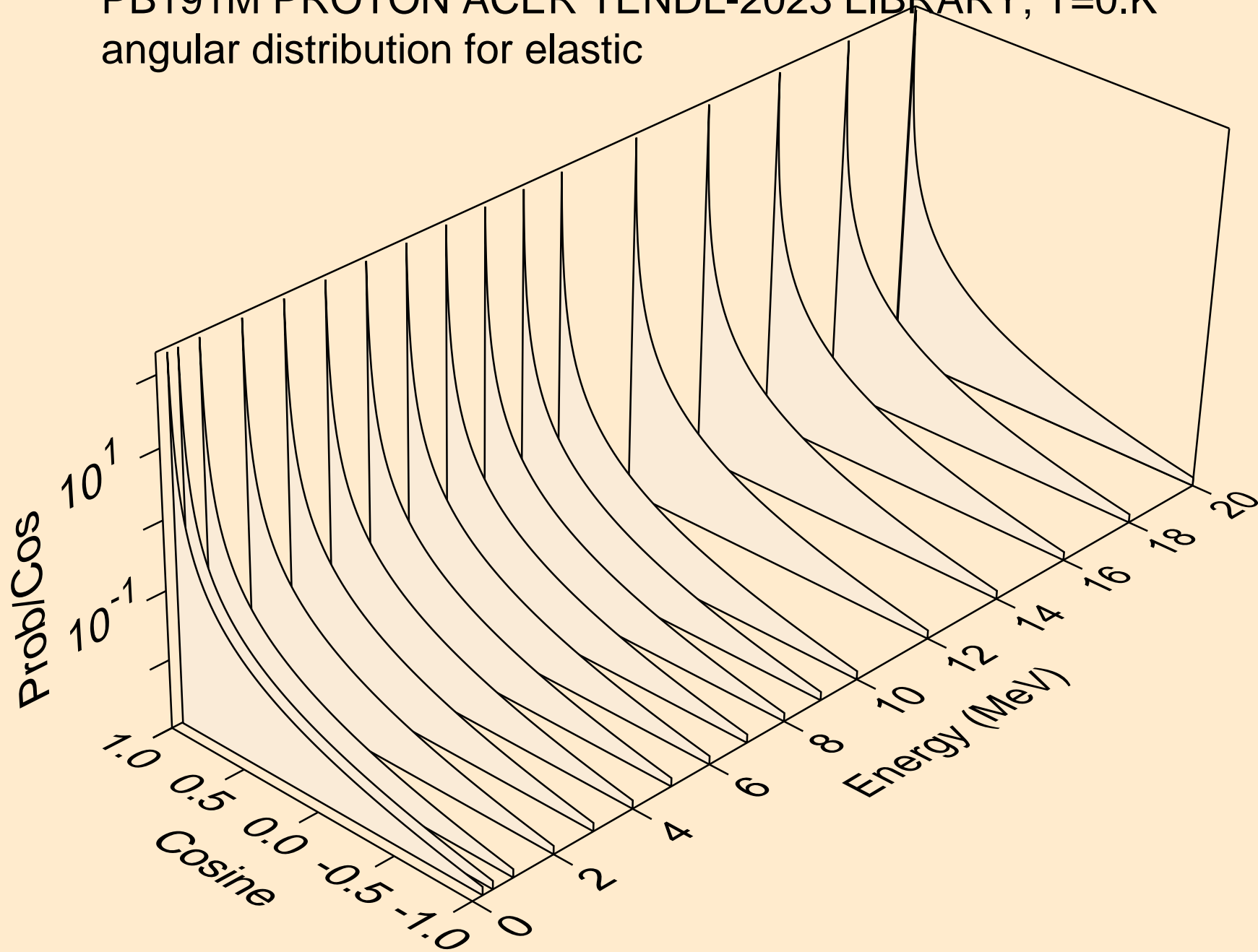

PB191M PROTON ACER TENDL-2023 LIBRARY; T=0.K
angular distribution for elastic

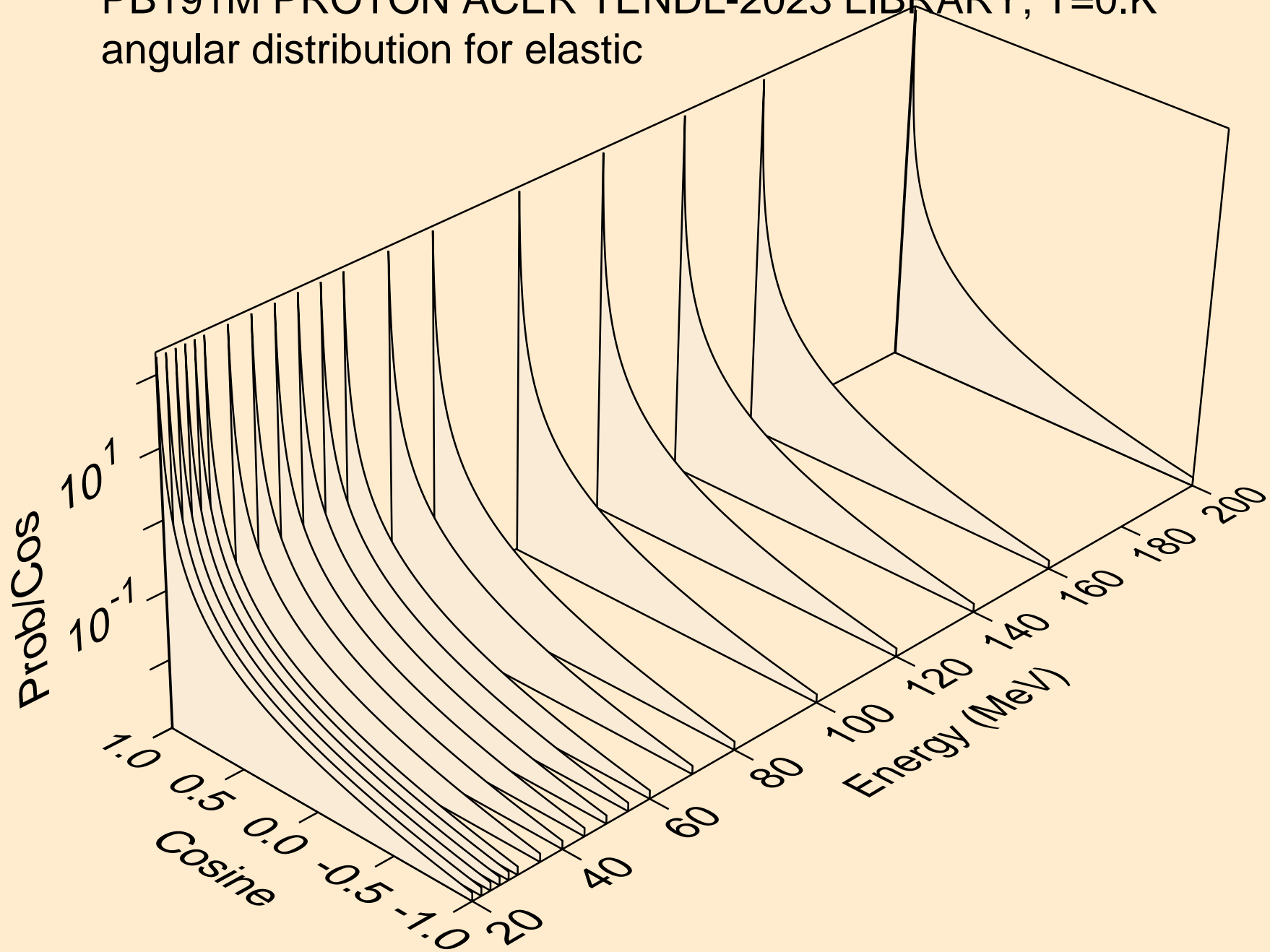

PB191M PROTON ACER TENDL-2023 LIBRARY; T=0.K
Proton emission for (p,x)

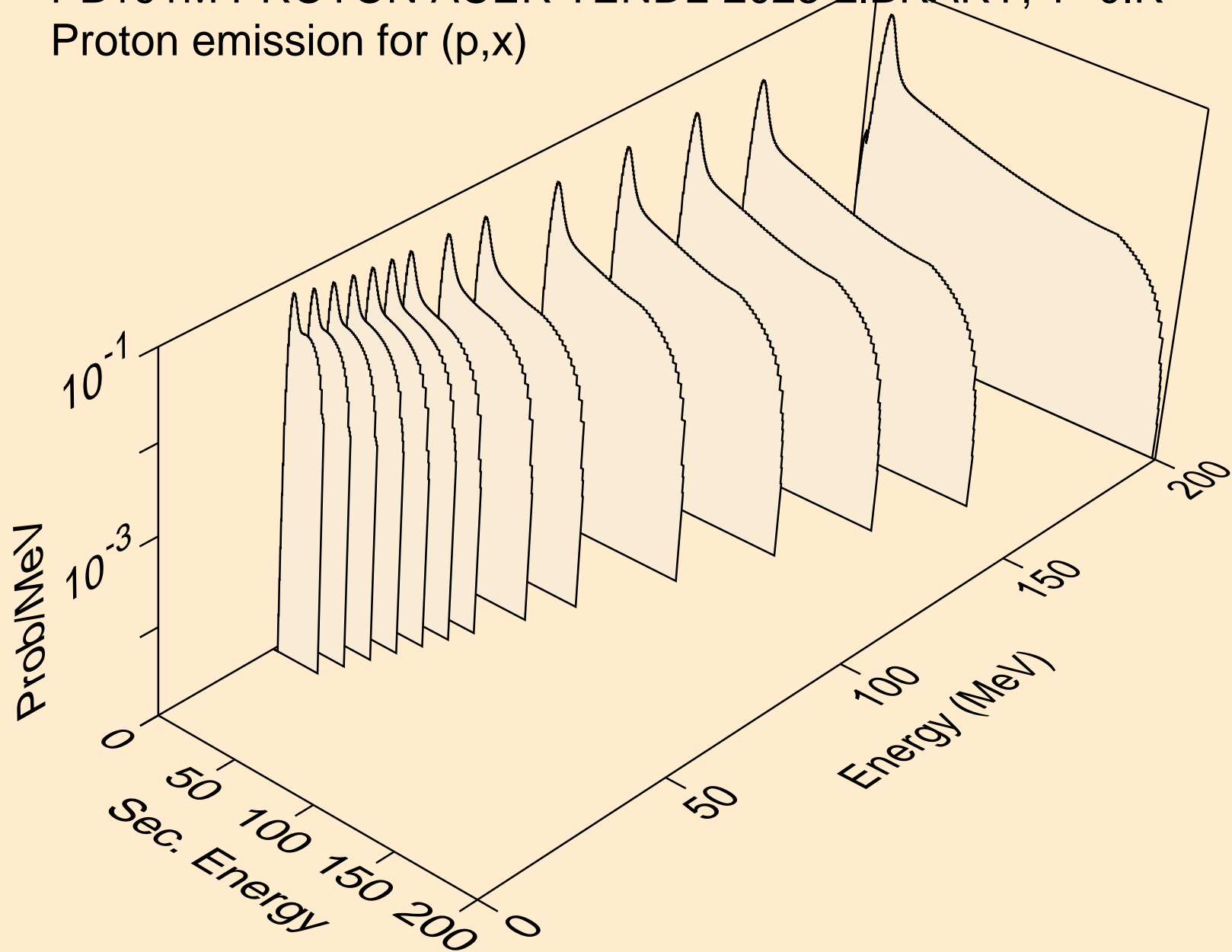

PB191M PROTON ACER TENDL-2023 LIBRARY; T=0.K
Proton emission for (p,n*)p

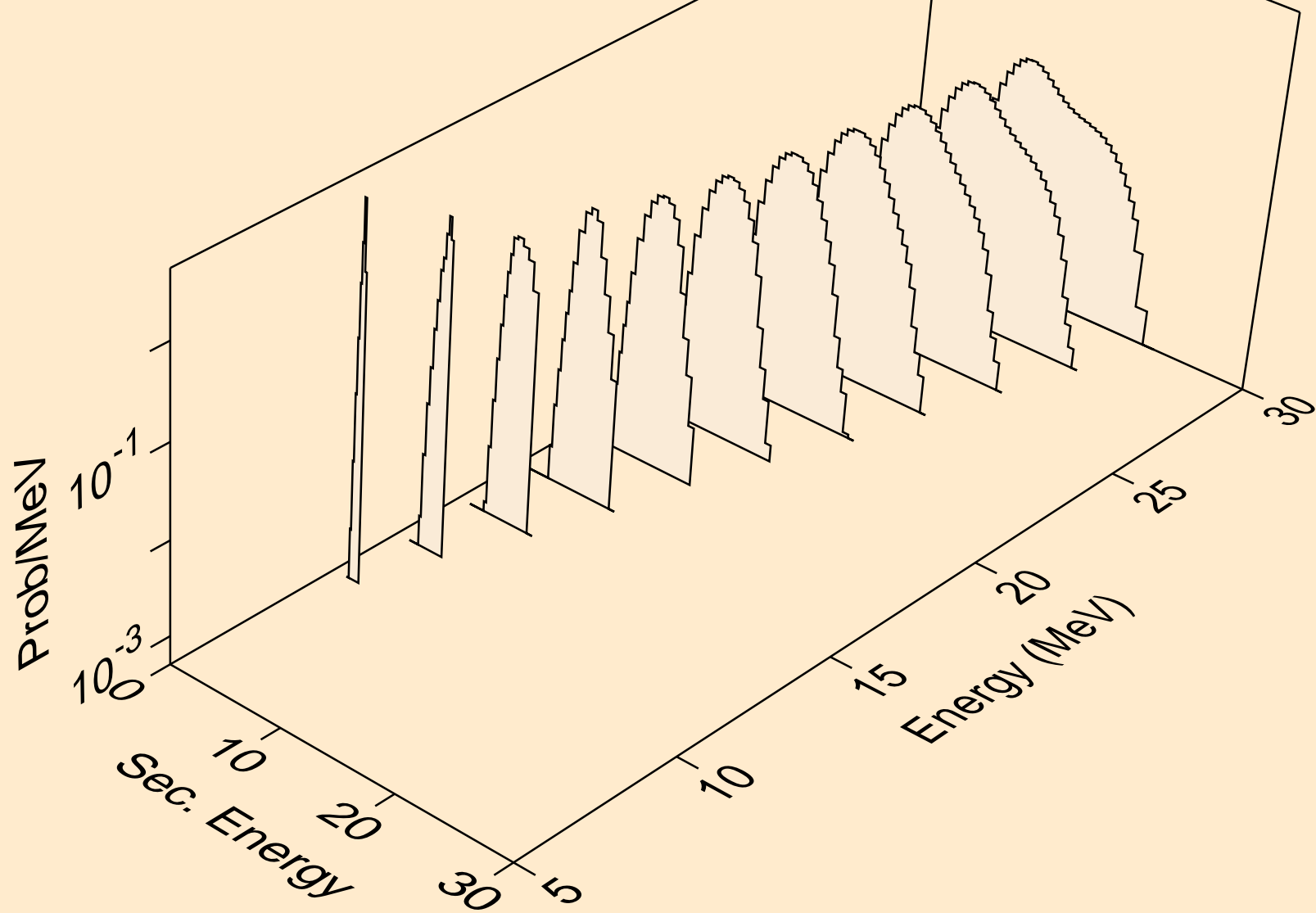

PB191M PROTON ACER TENDL-2023 LIBRARY; T=0.K
Proton emission for (p,2np)

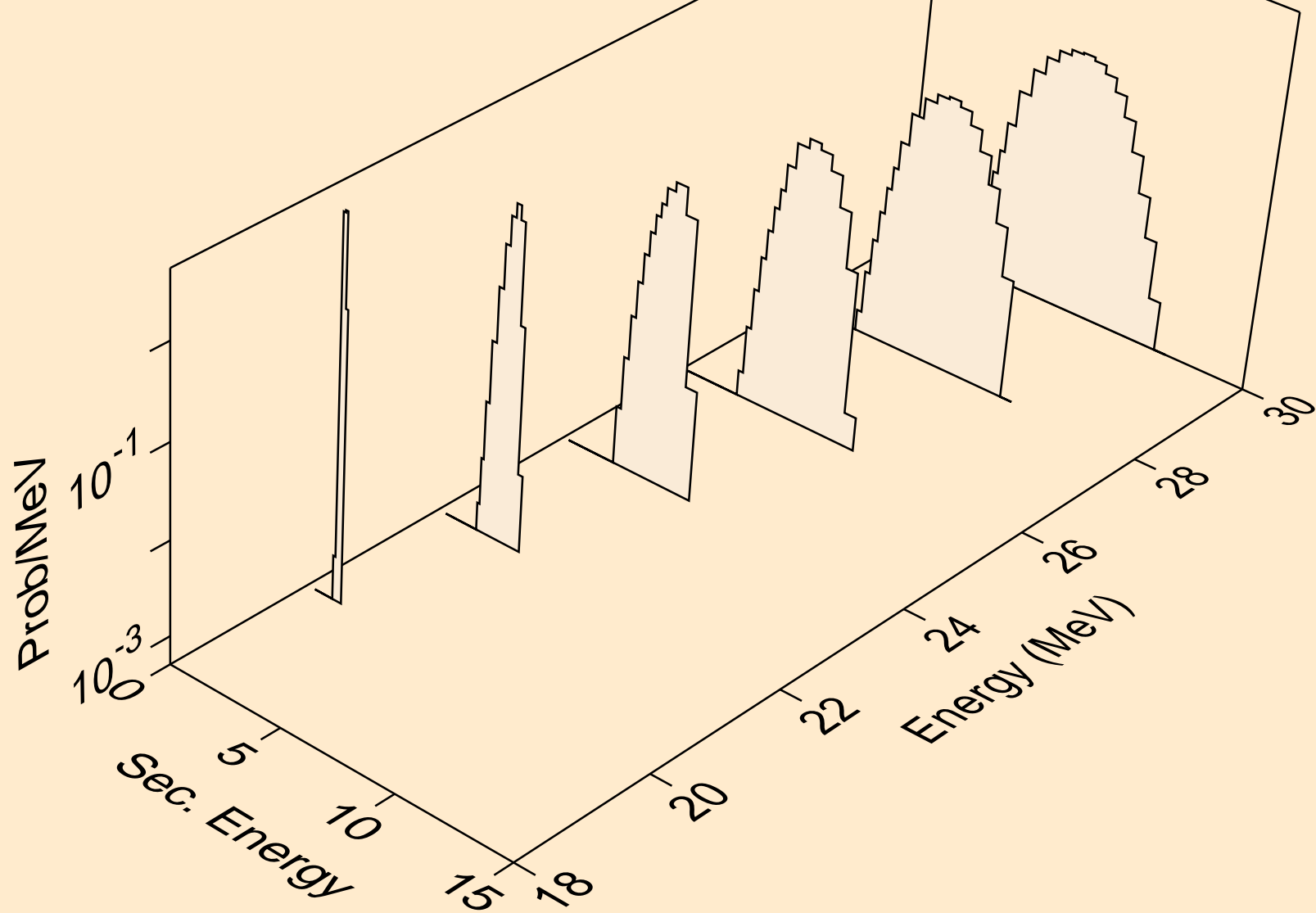

PB191M PROTON ACER TENDL-2023 LIBRARY; T=0.K
Proton emission for (p,n2p)

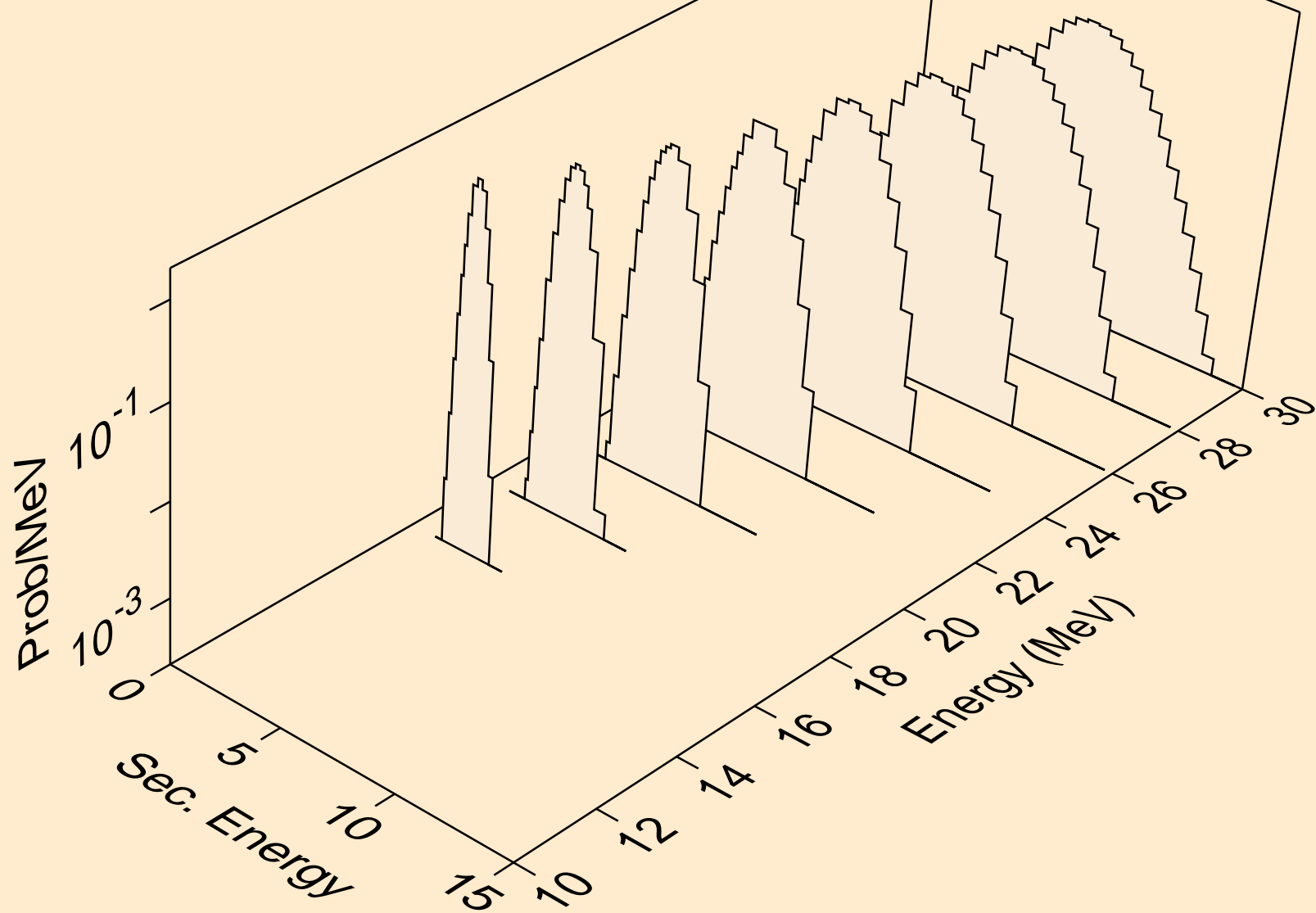

PB191M PROTON ACER TENDL-2023 LIBRARY; T=0.K
Proton emission for (p,npa)

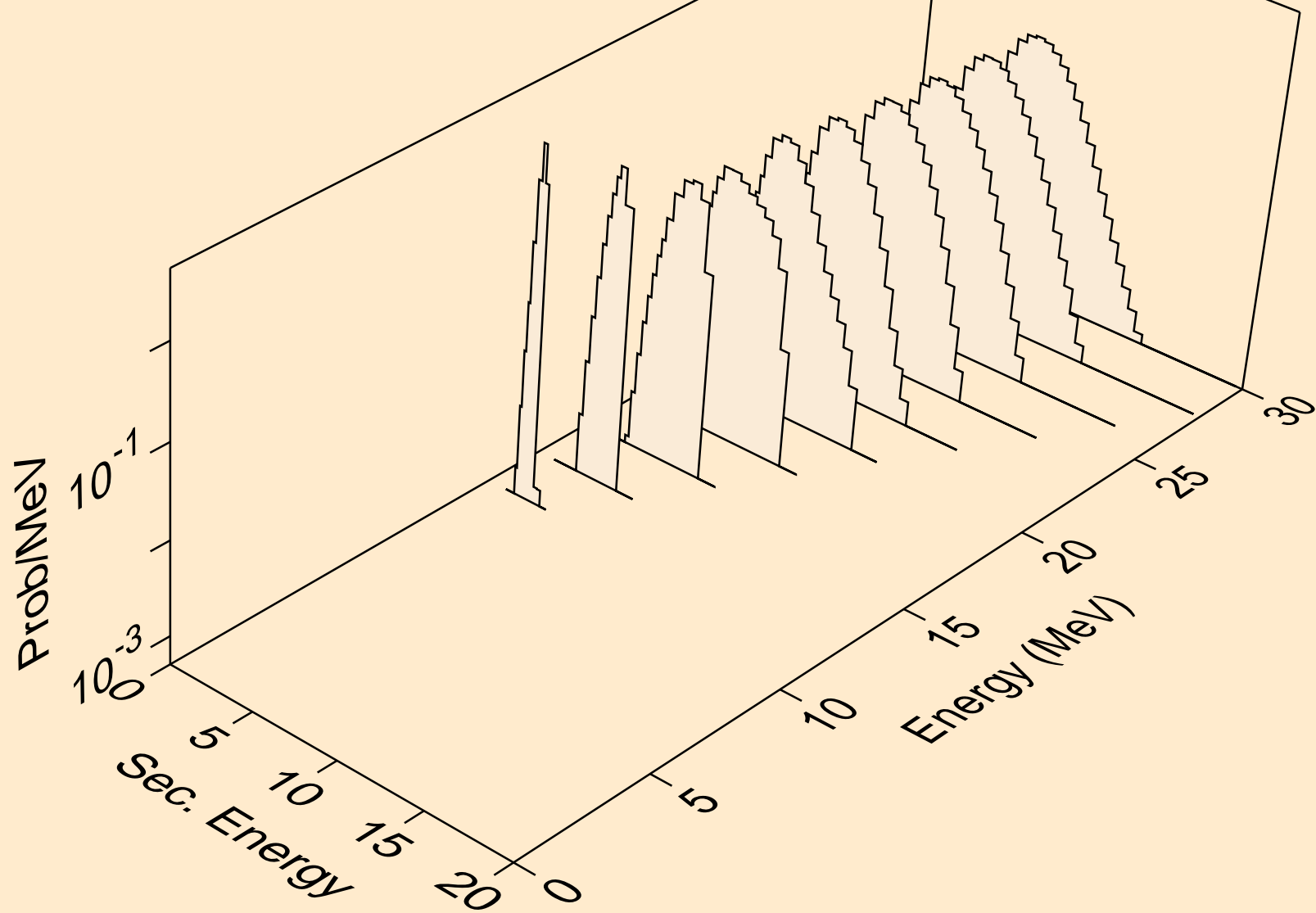

PB191M PROTON ACER TENDL-2023 LIBRARY; T=0.K
Proton emission for inelastic

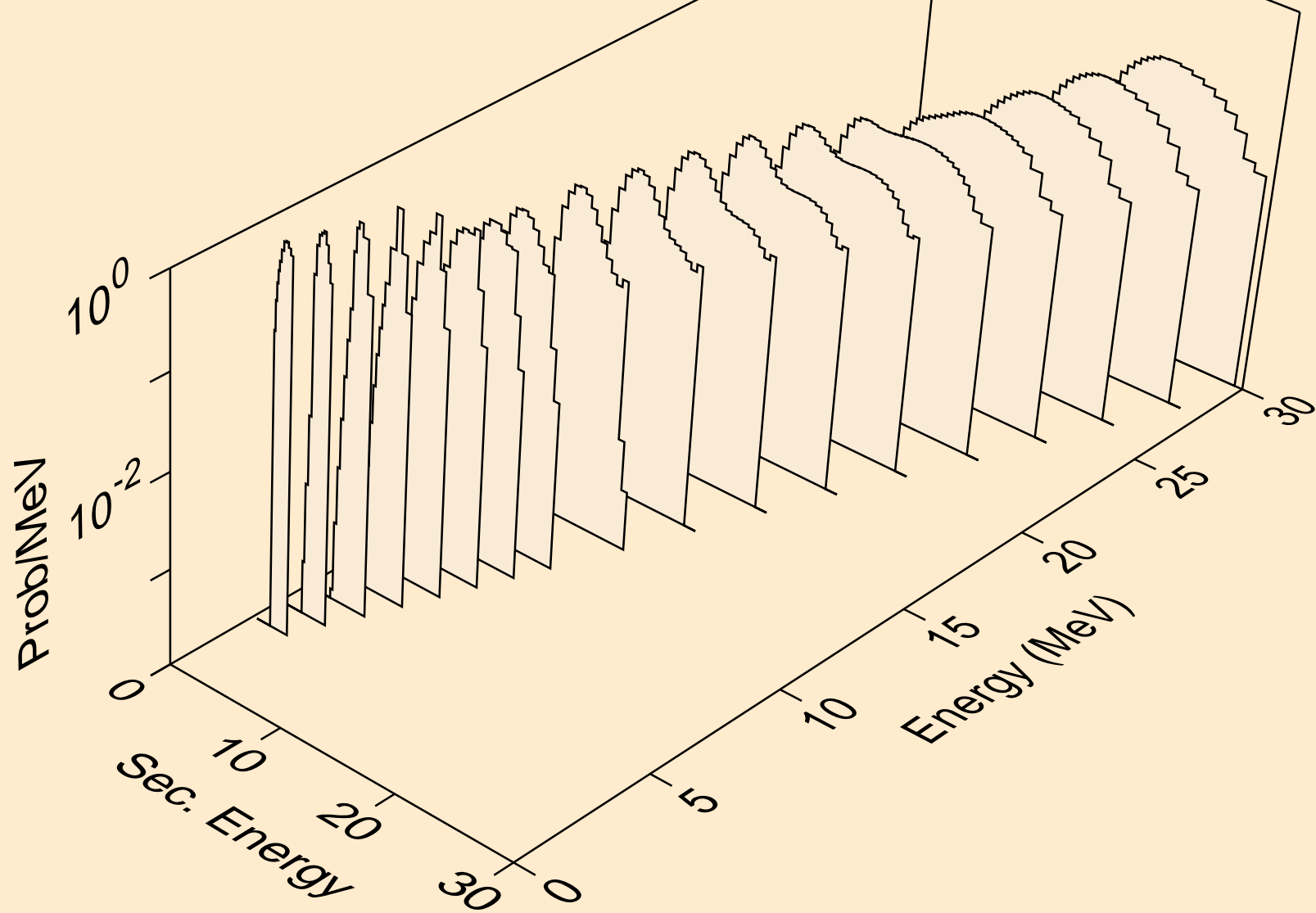

PB191M PROTON ACER TENDL-2023 LIBRARY; T=0.K
Proton emission for (p,2p)

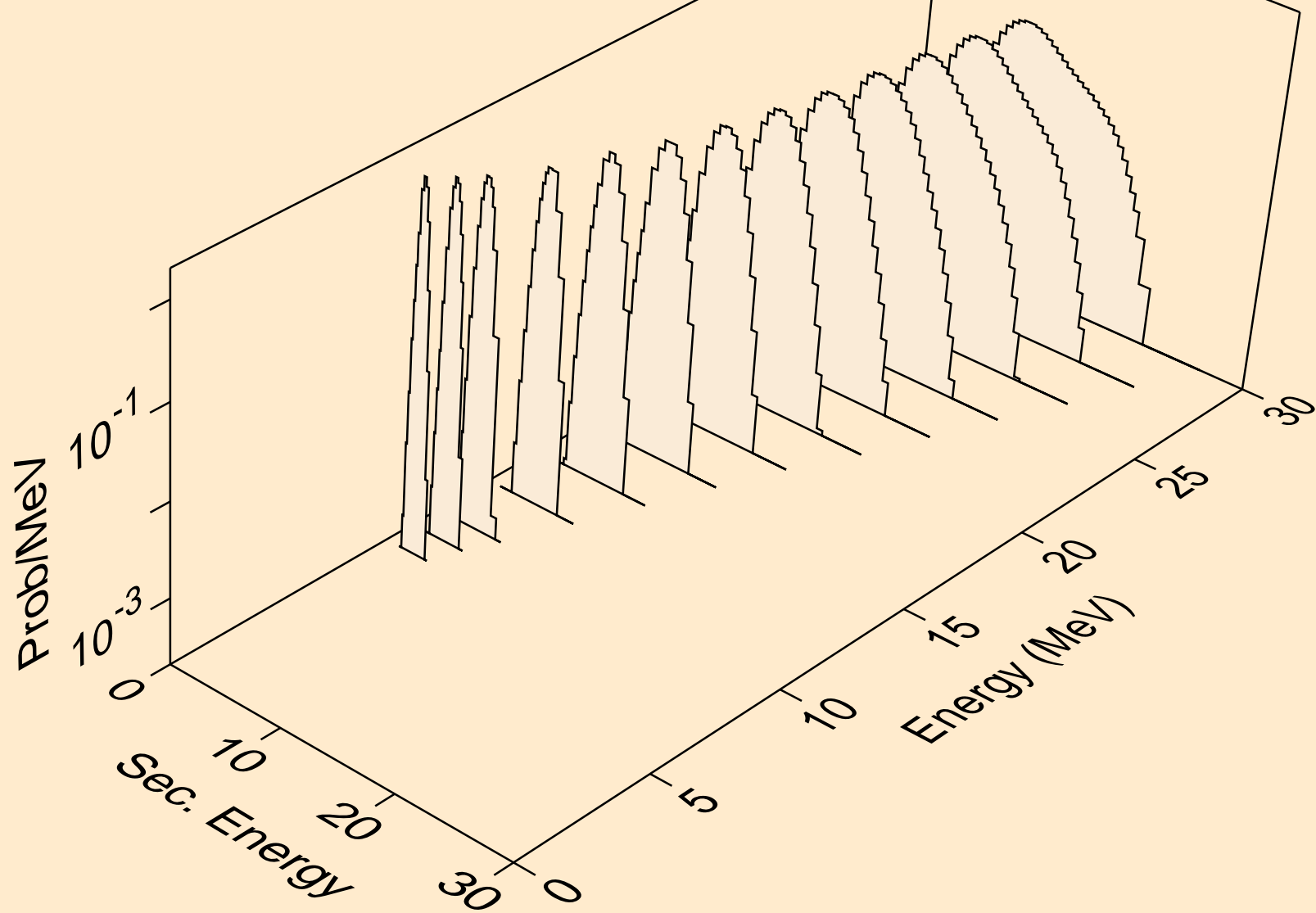

PB191M PROTON ACER TENDL-2023 LIBRARY; T=0.K
Proton emission for (p,pa)

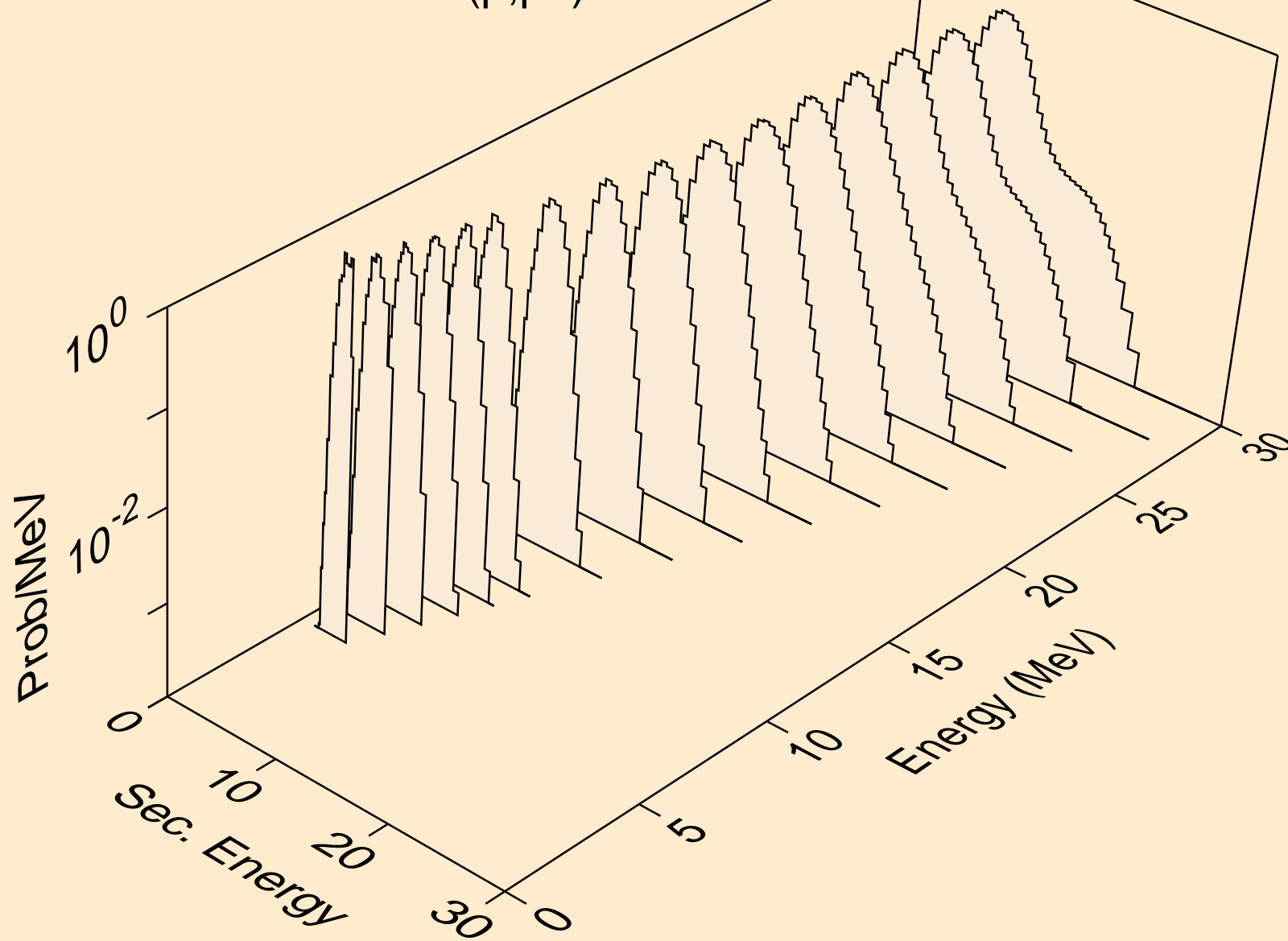

PB191M PROTON ACER TENDL-2023 LIBRARY; T=0.K
Proton emission for (p,pd)

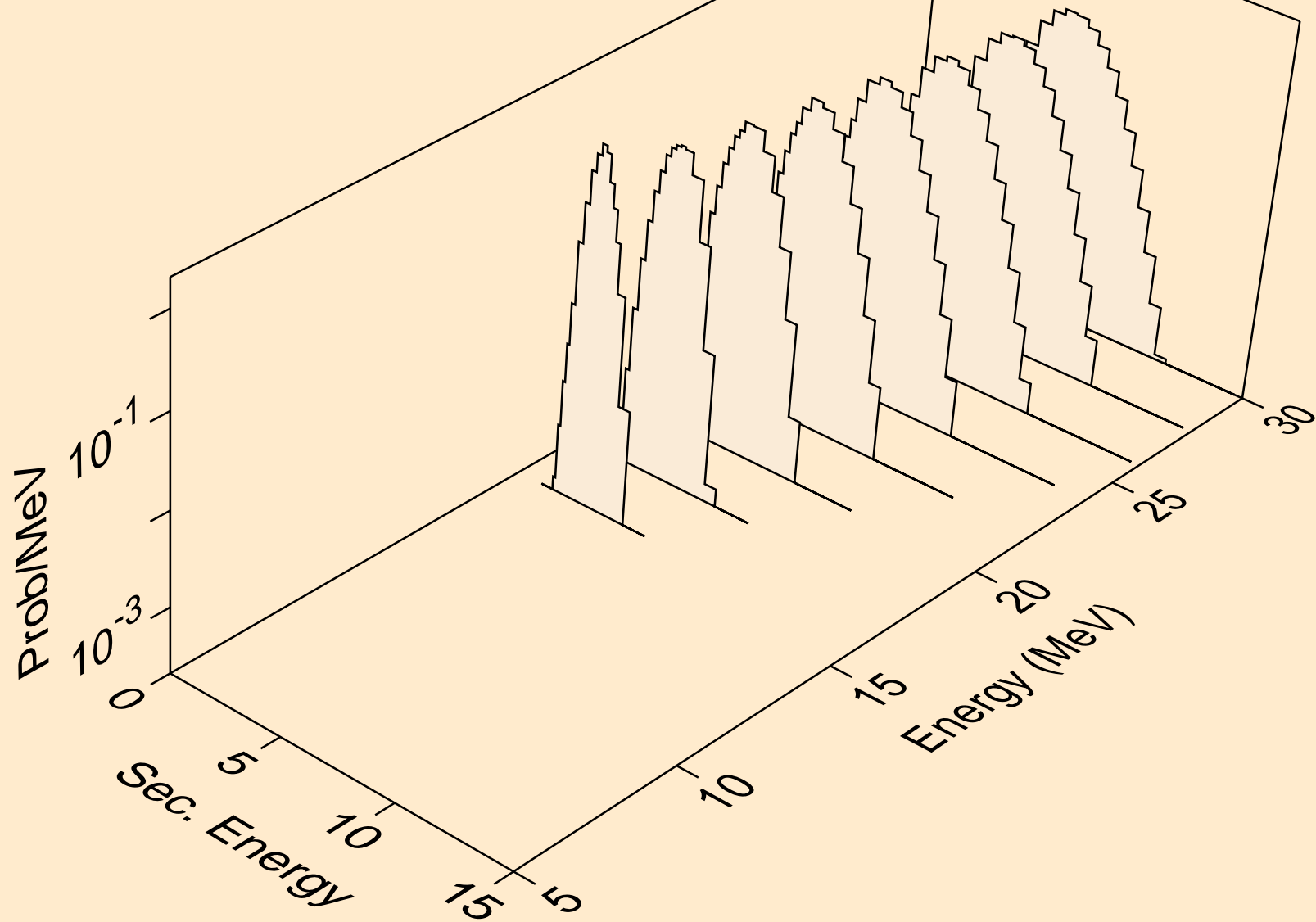

PB191M PROTON ACER TENDL-2023 LIBRARY; T=0.K
Proton emission for (p,pt)

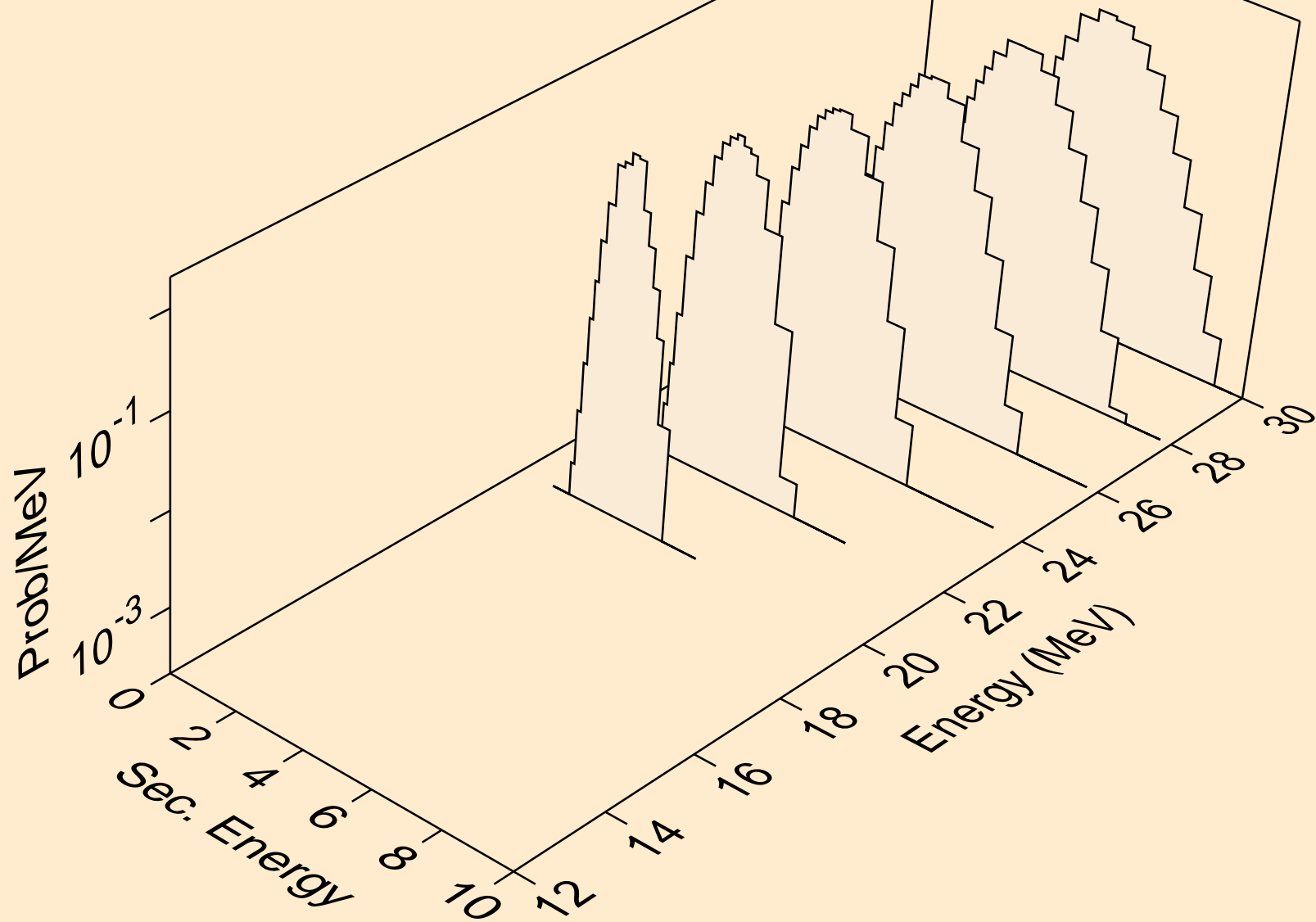

PB191M PROTON ACER TENDL-2023 LIBRARY; T=0.K
Photon emission for (z,n)

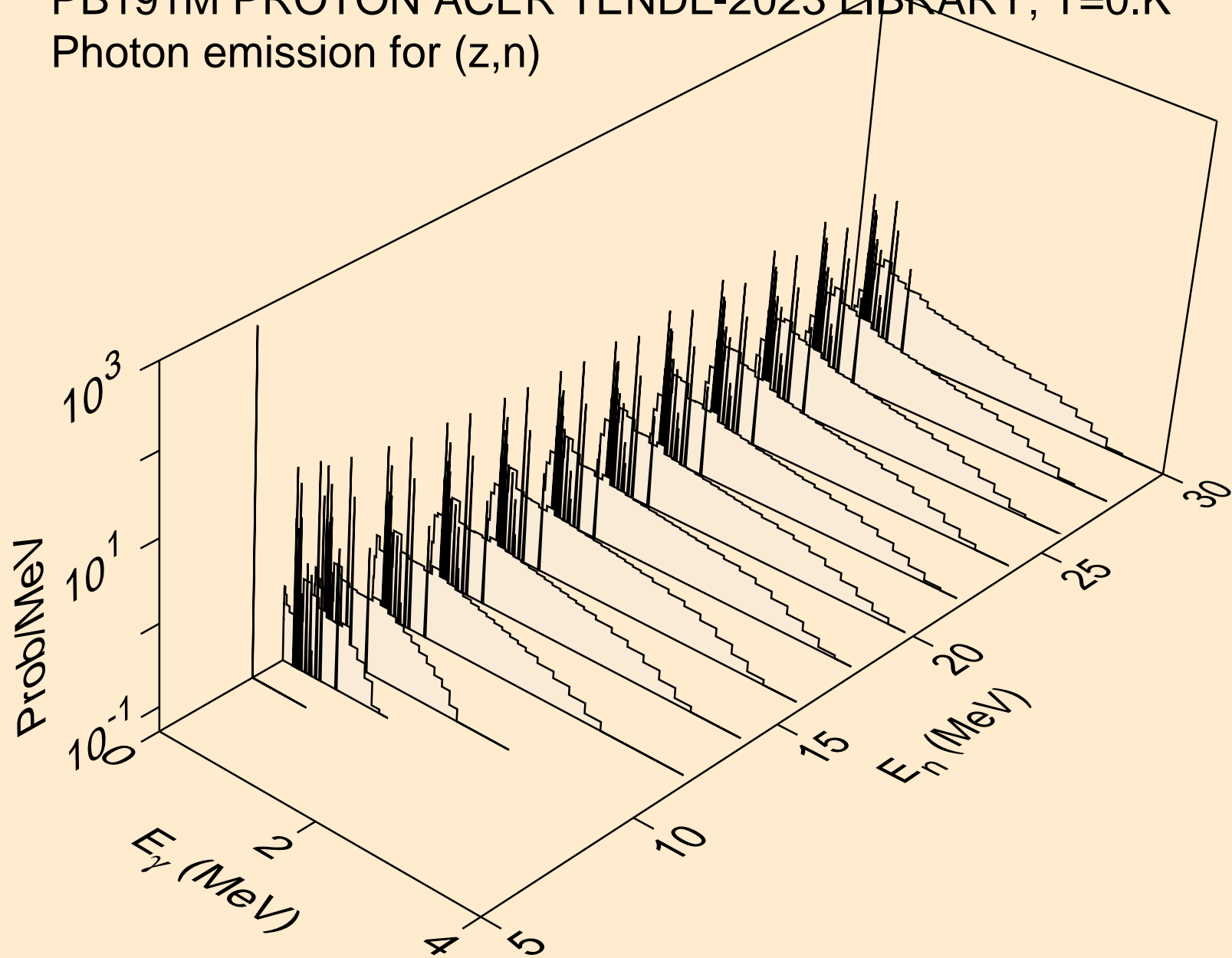

PB191M PROTON ACER TENDL-2023 LIBRARY; T=0.K
Photon emission for (z,x)

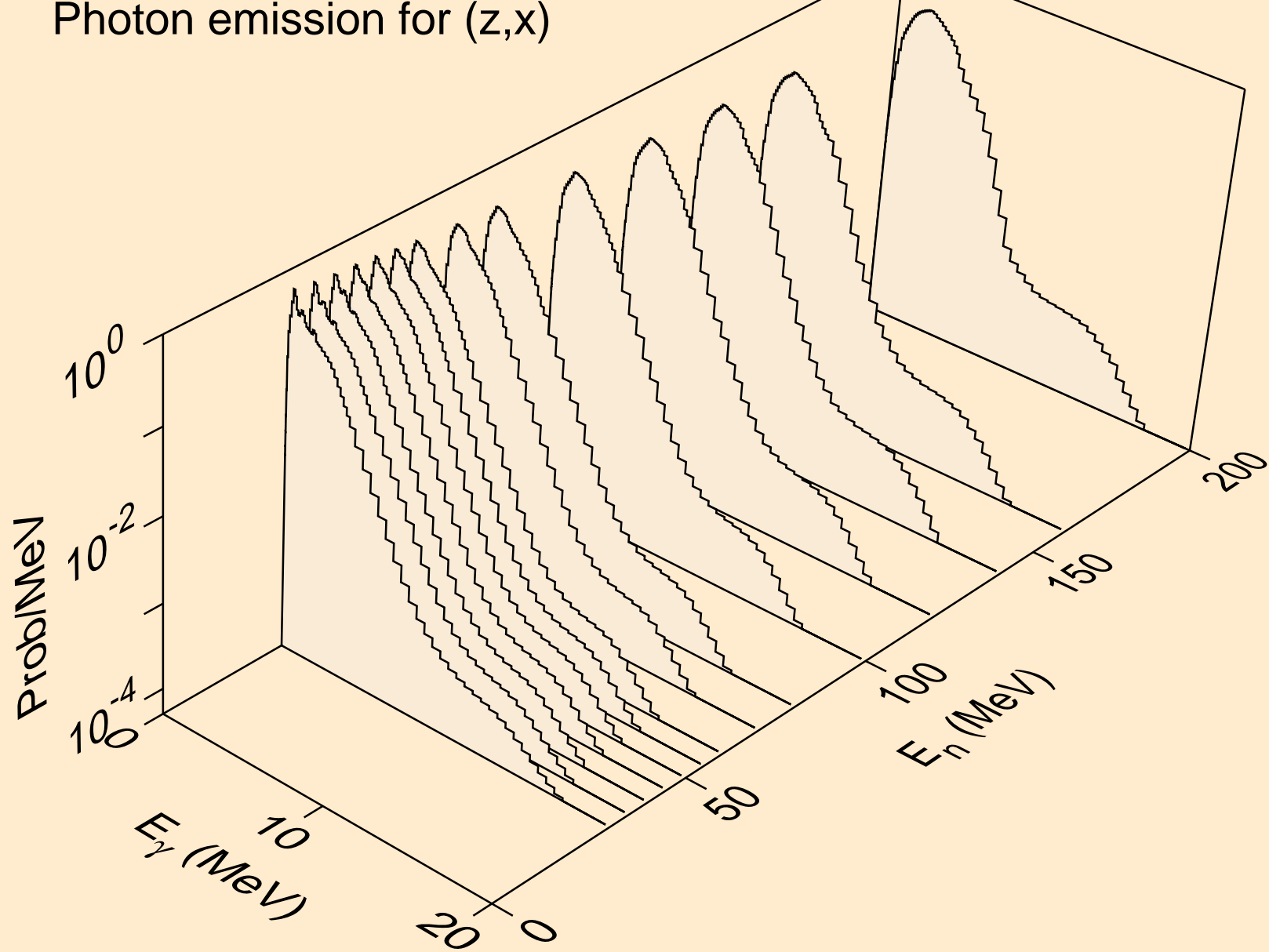

PB191M PROTON ACER TENDL-2023 LIBRARY; T=0.K
Photon emission for (n,2n)

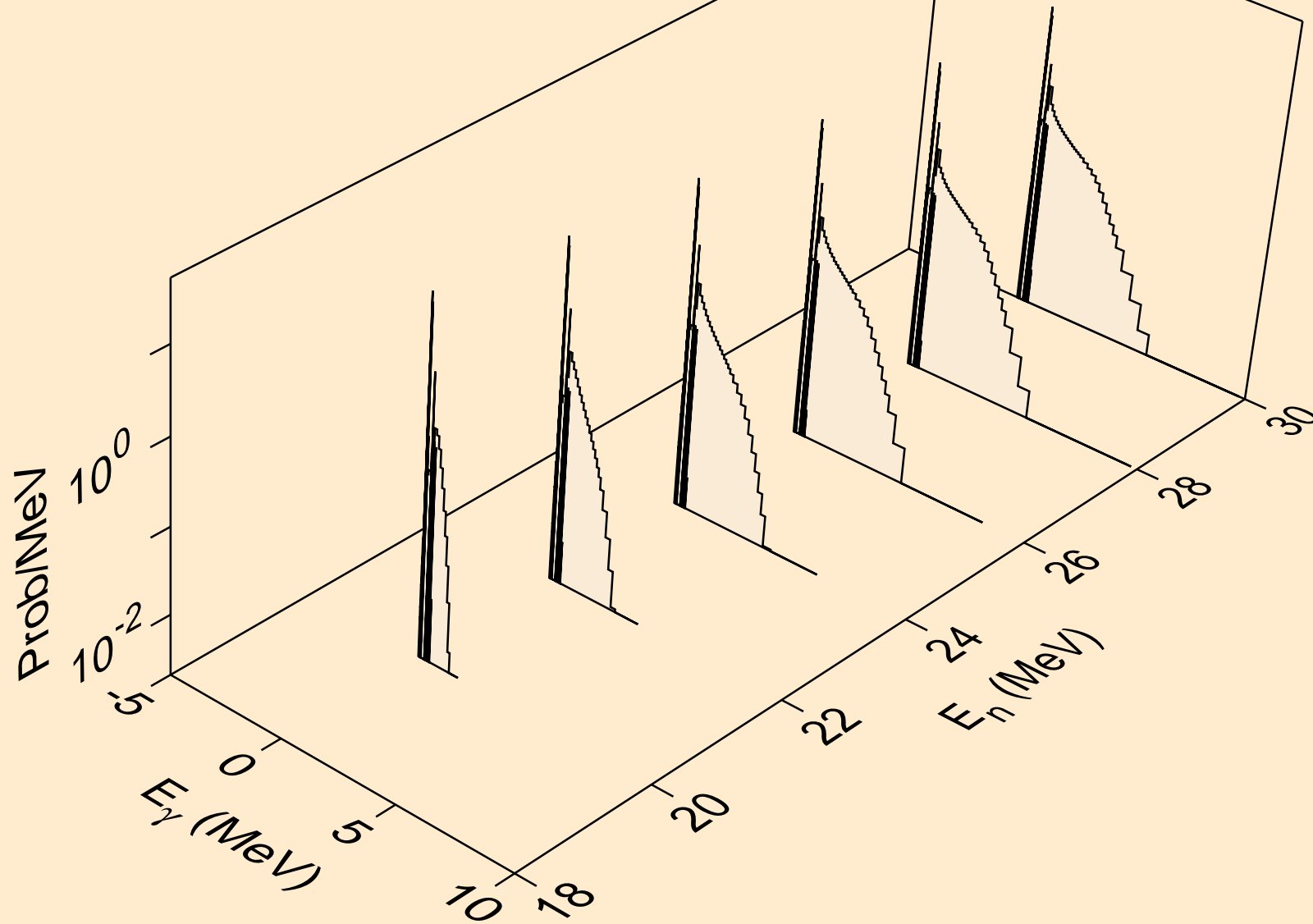

PB191M PROTON ACER TENDL-2023 LIBRARY; T=0.K
Photon emission for (n,3n)

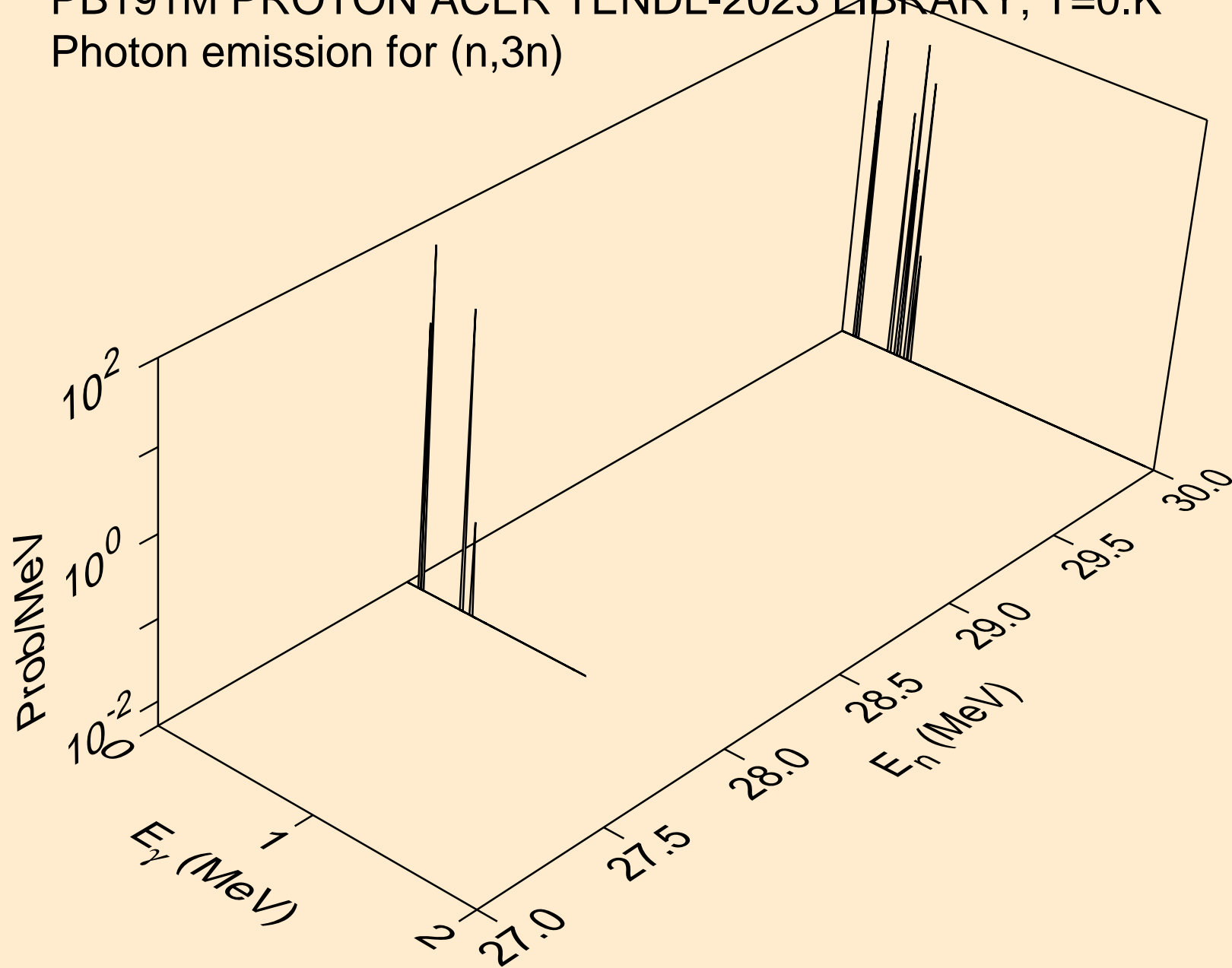

PB191M PROTON ACER TENDL-2023 LIBRARY; T=0.K
Photon emission for (n,n*)a

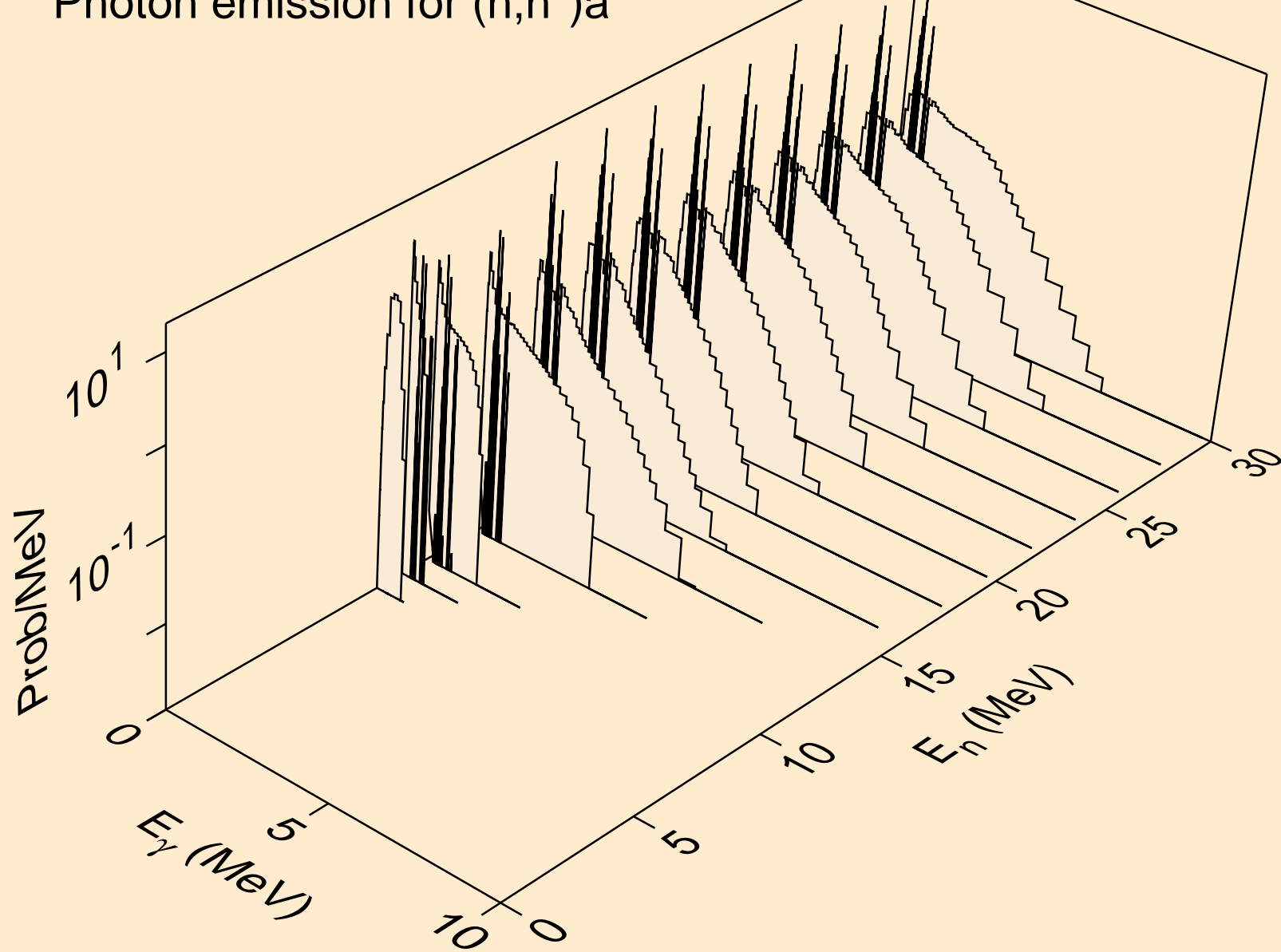

PB191M PROTON ACER TENDL-2023 LIBRARY; T=0.K
Photon emission for (n,2n)a

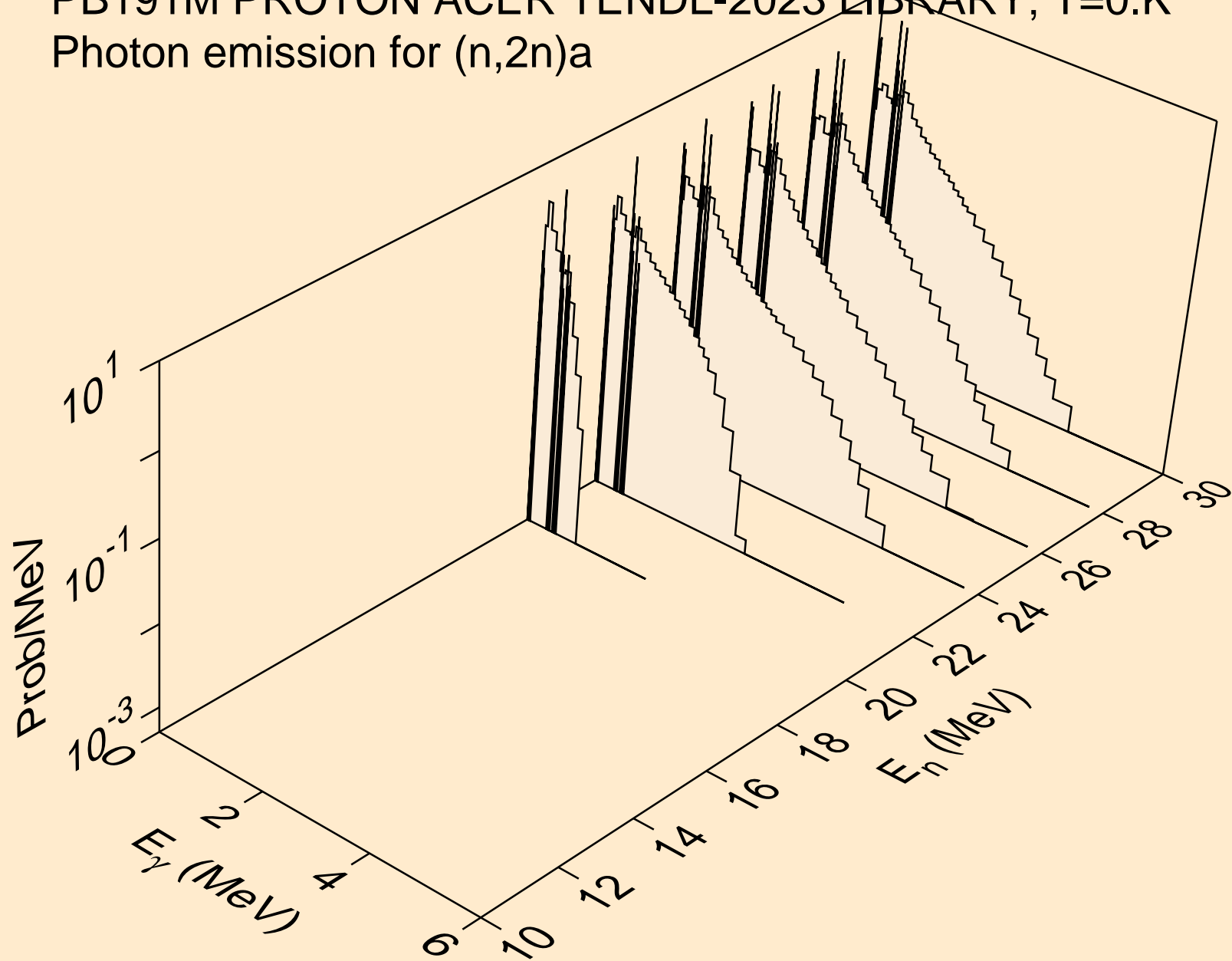

PB191M PROTON ACER TENDL-2023 LIBRARY; T=0.K
Photon emission for (n,n*)p

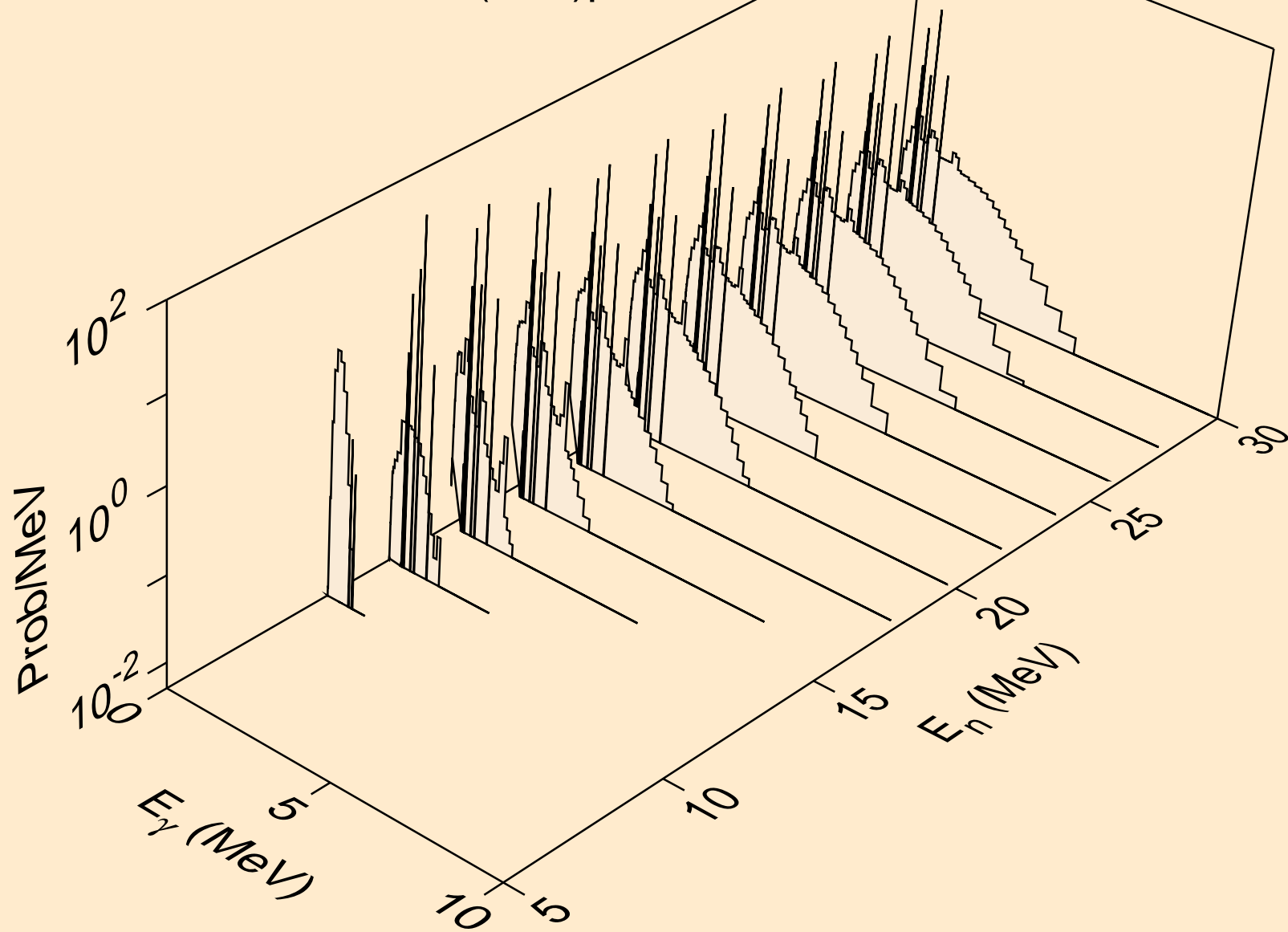

PB191M PROTON ACER TENDL-2023 LIBRARY; T=0.K
Photon emission for (n,n*)2a

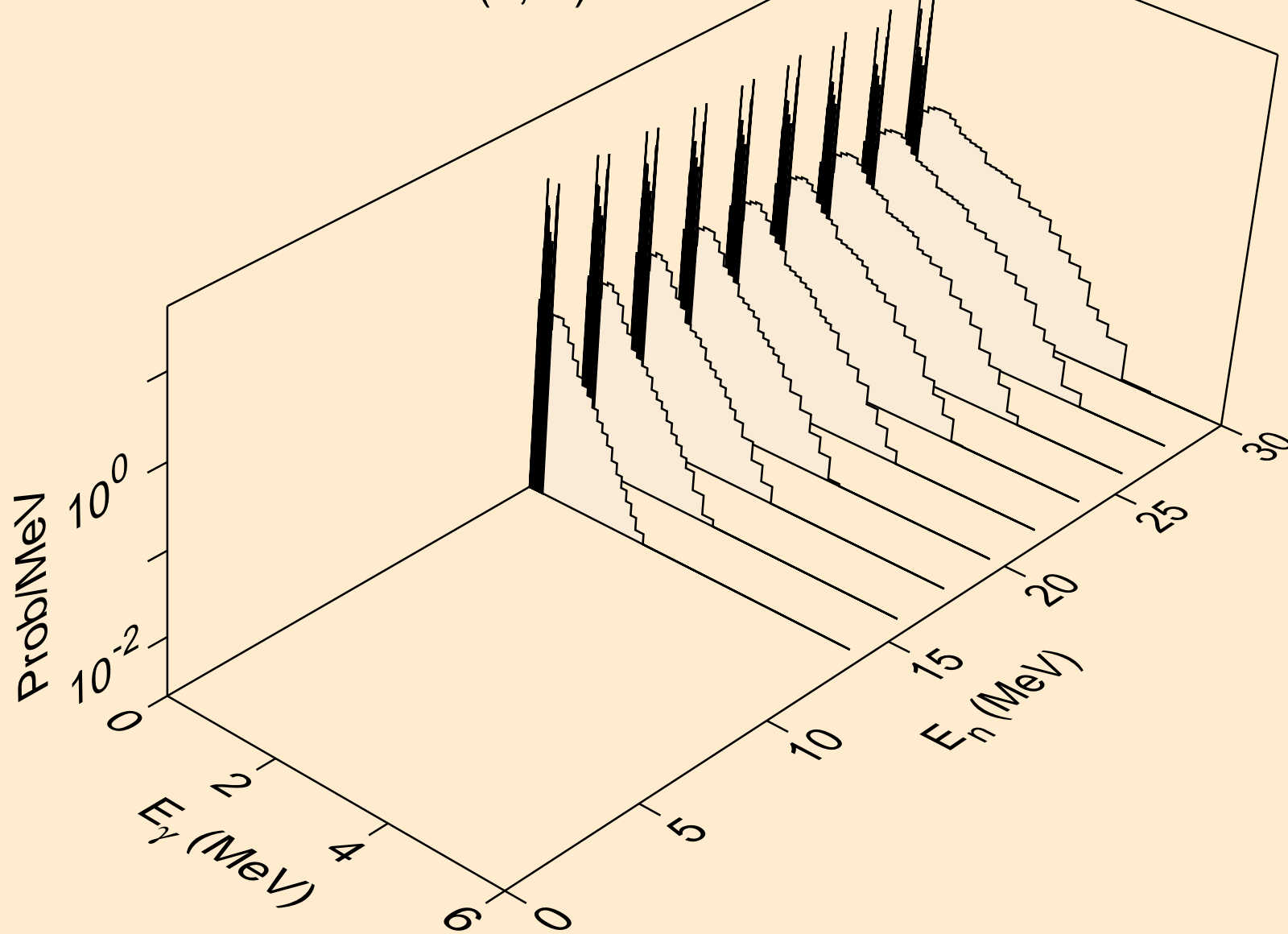

PB191M PROTON ACER TENDL-2023 LIBRARY; T=0.K
Photon emission for (n,n*)d

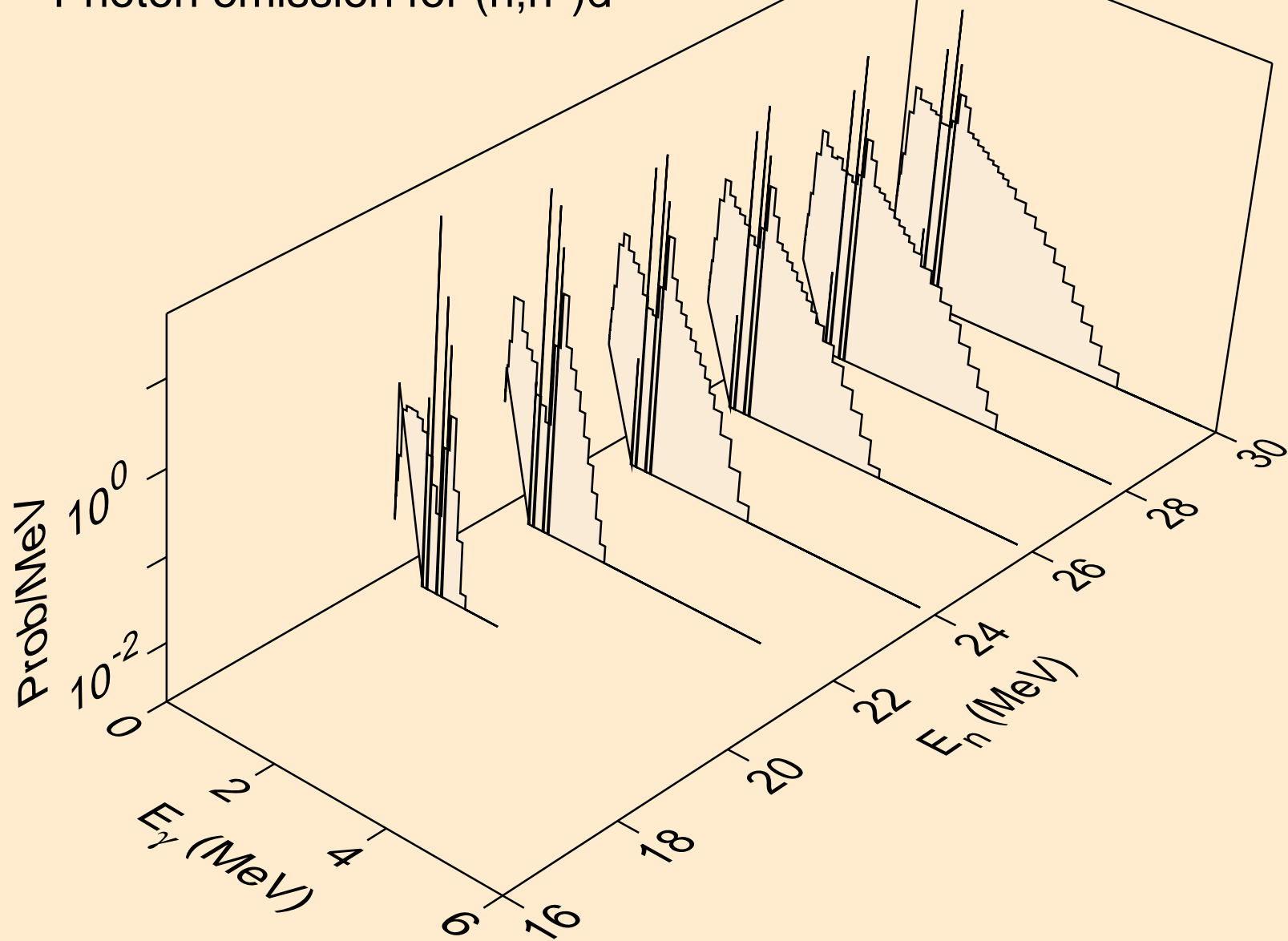

PB191M PROTON ACER TENDL-2023 LIBRARY; T=0.K
Photon emission for (n,n*)t

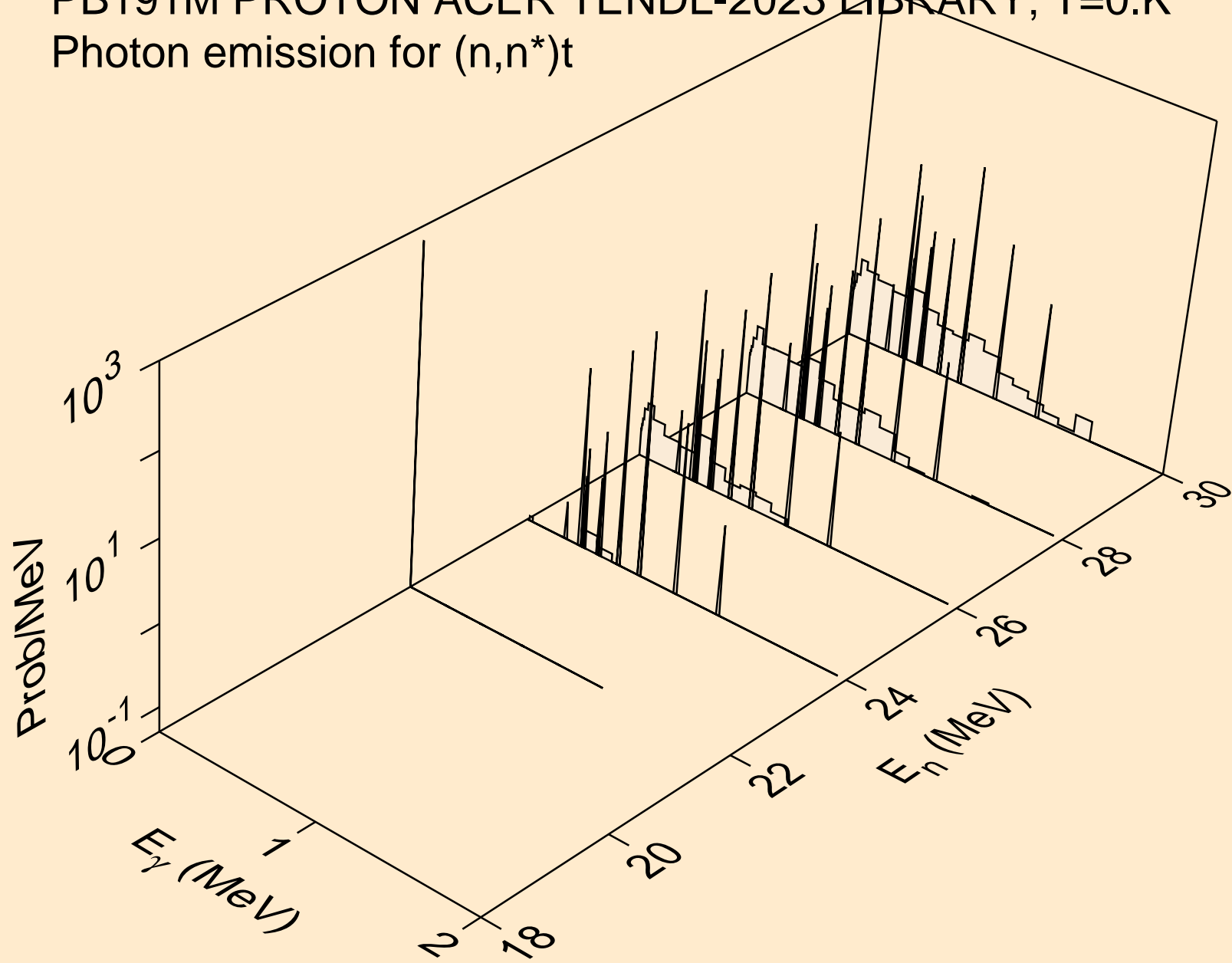

PB191M PROTON ACER TENDL-2023 LIBRARY; T=0.K
Photon emission for (n,n*)he3

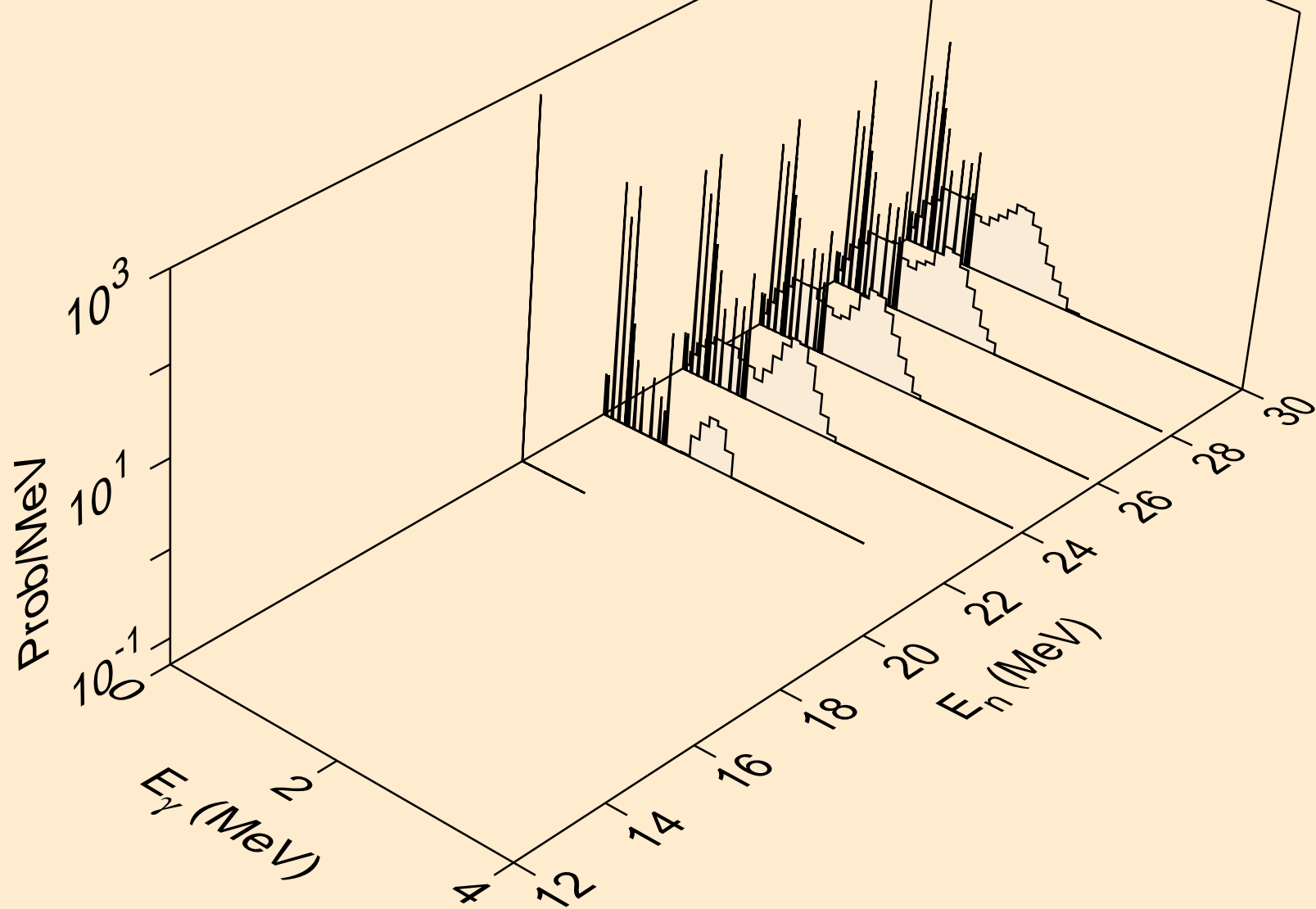

PB191M PROTON ACER TENDL-2023 LIBRARY; T=0.K
Photon emission for (n,2np)

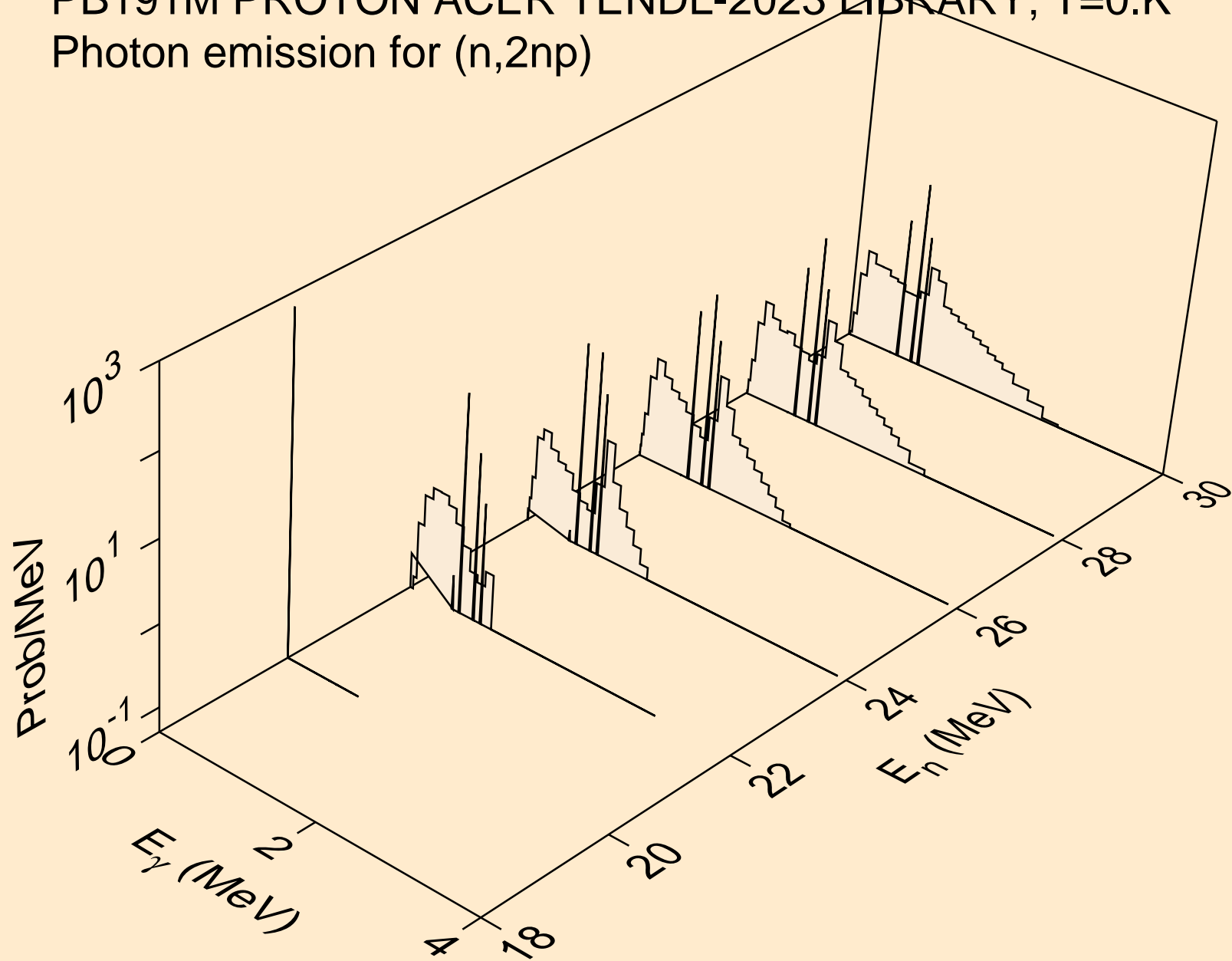

PB191M PROTON ACER TENDL-2023 LIBRARY; T=0.K
Photon emission for (n,n2p)

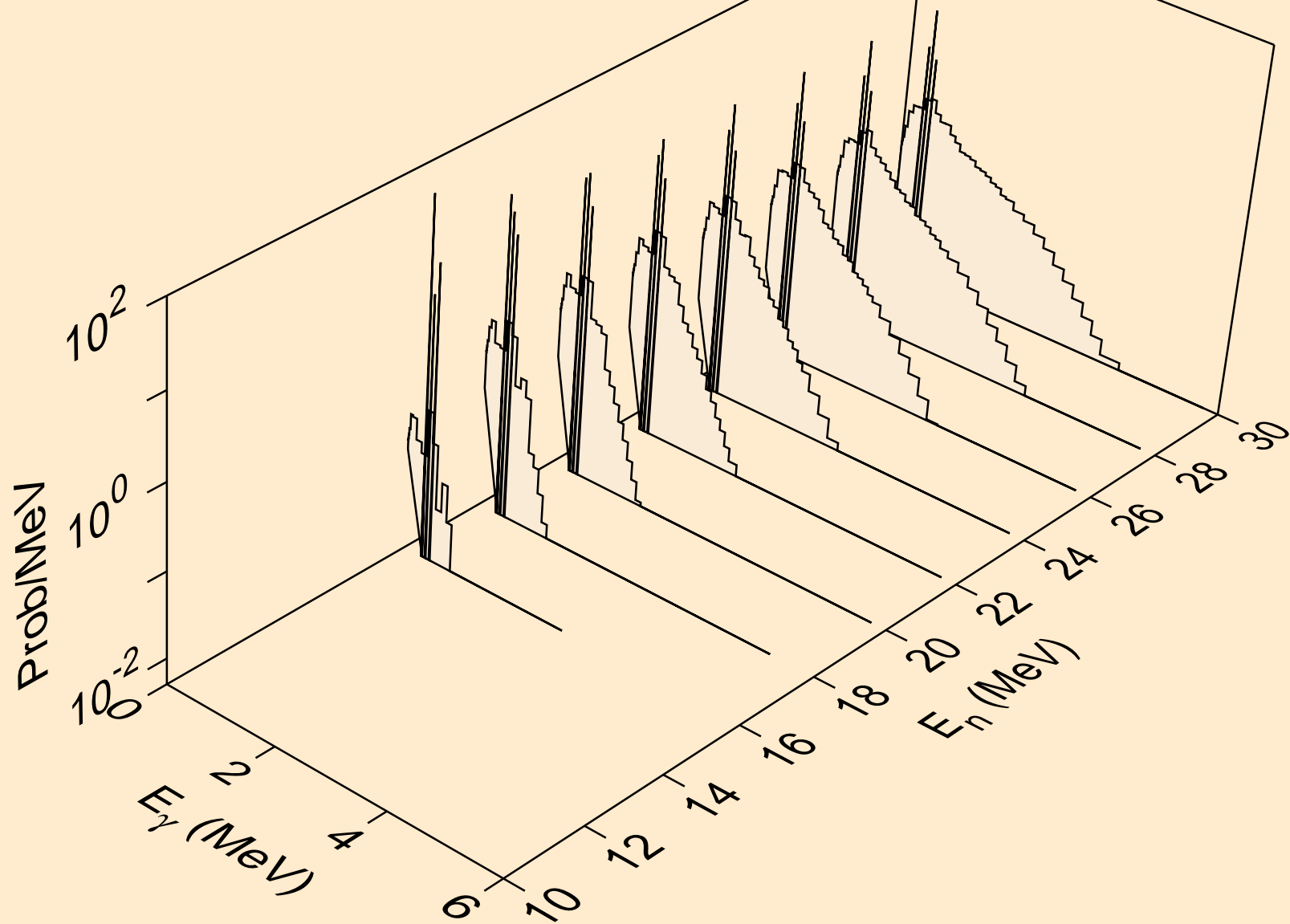

PB191M PROTON ACER TENDL-2023 LIBRARY; T=0.K
Photon emission for (n,npa)

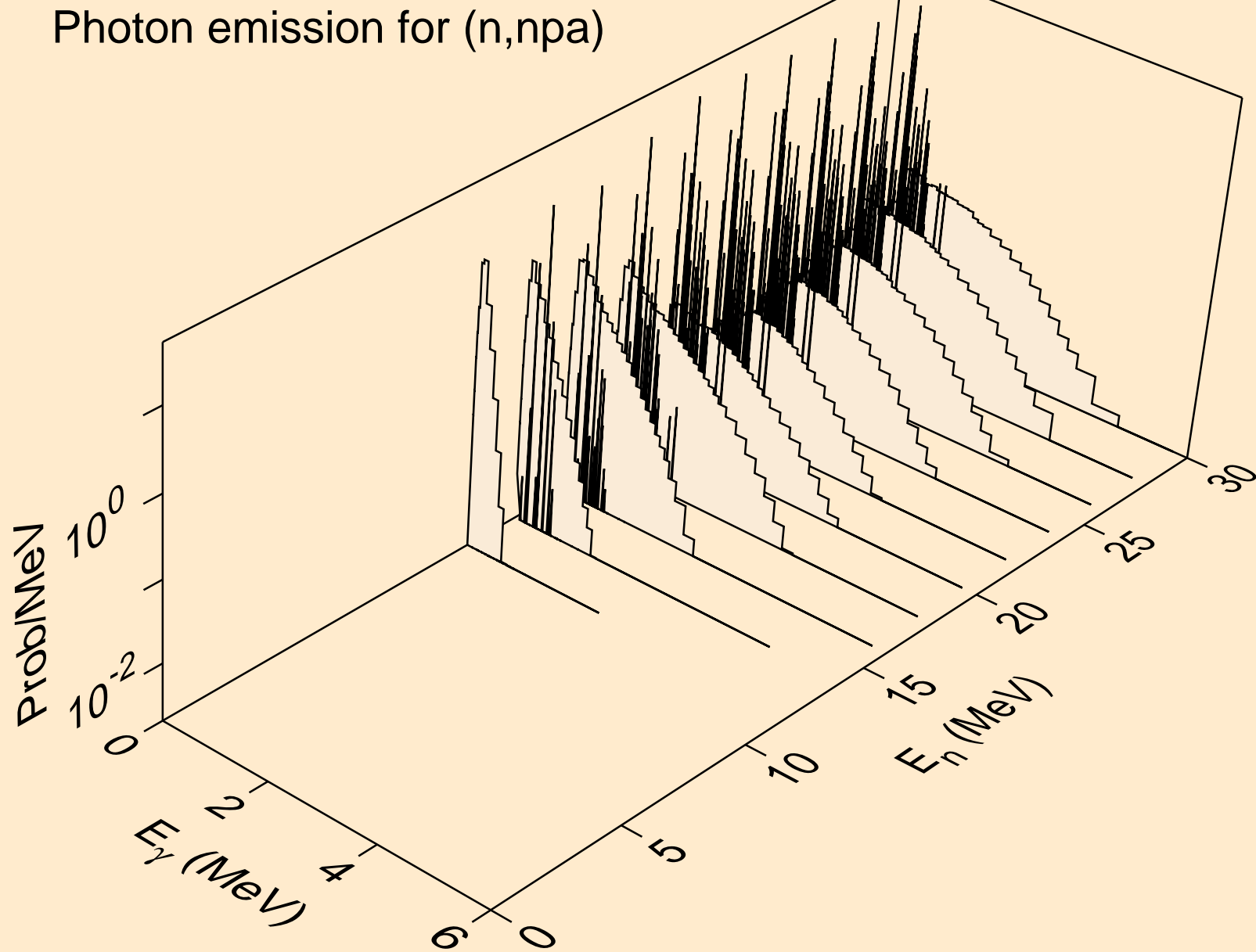

PB191M PROTON ACER TENDL-2023 LIBRARY; T=0.K
Photon emission for (n,gma)

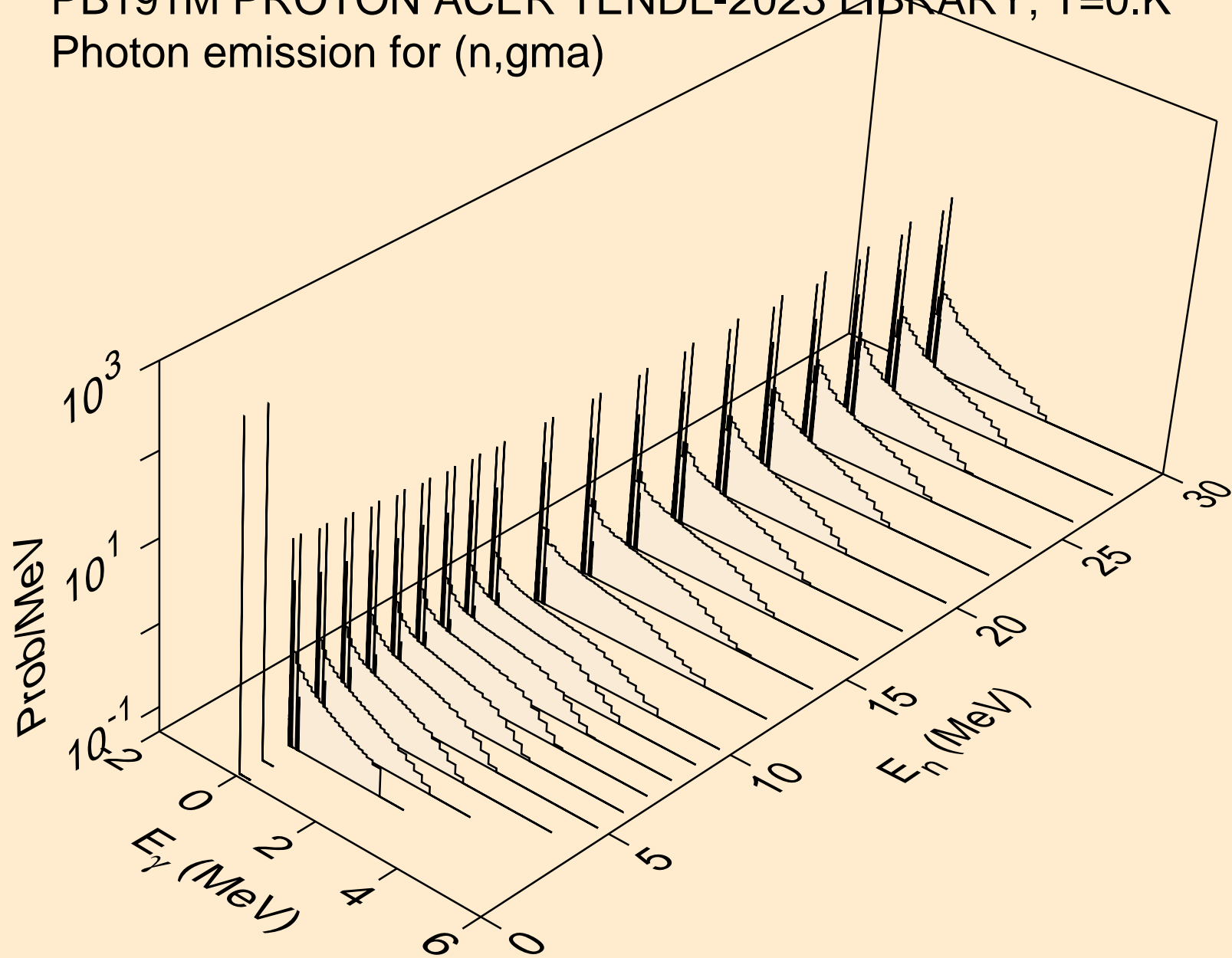

PB191M PROTON ACER TENDL-2023 LIBRARY; T=0.K
Photon emission for inelastic

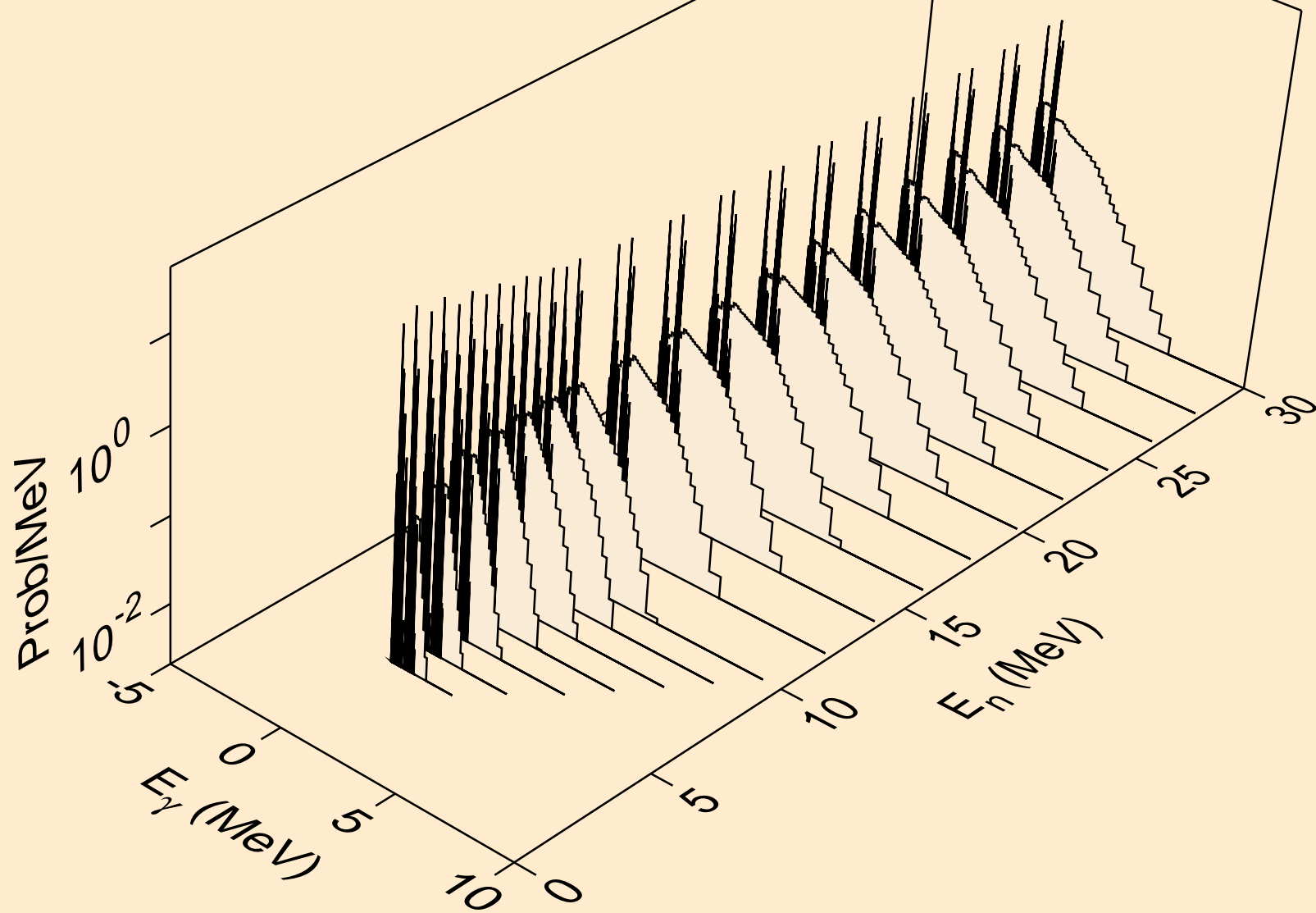

PB191M PROTON ACER TENDL-2023 LIBRARY; T=0.K
Photon emission for (n,d)

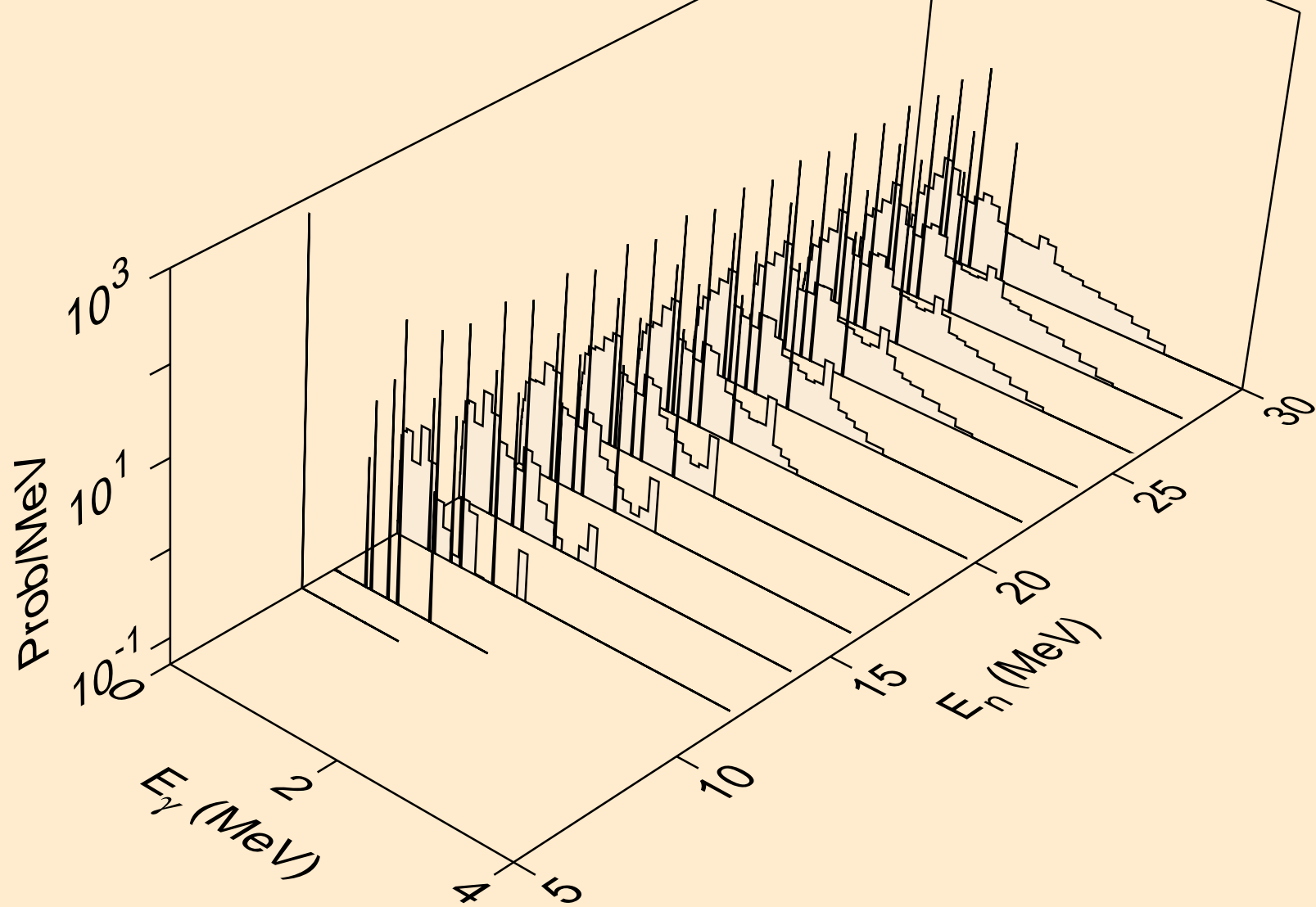

PB191M PROTON ACER TENDL-2023 LIBRARY; T=0.K
Photon emission for (n,t)

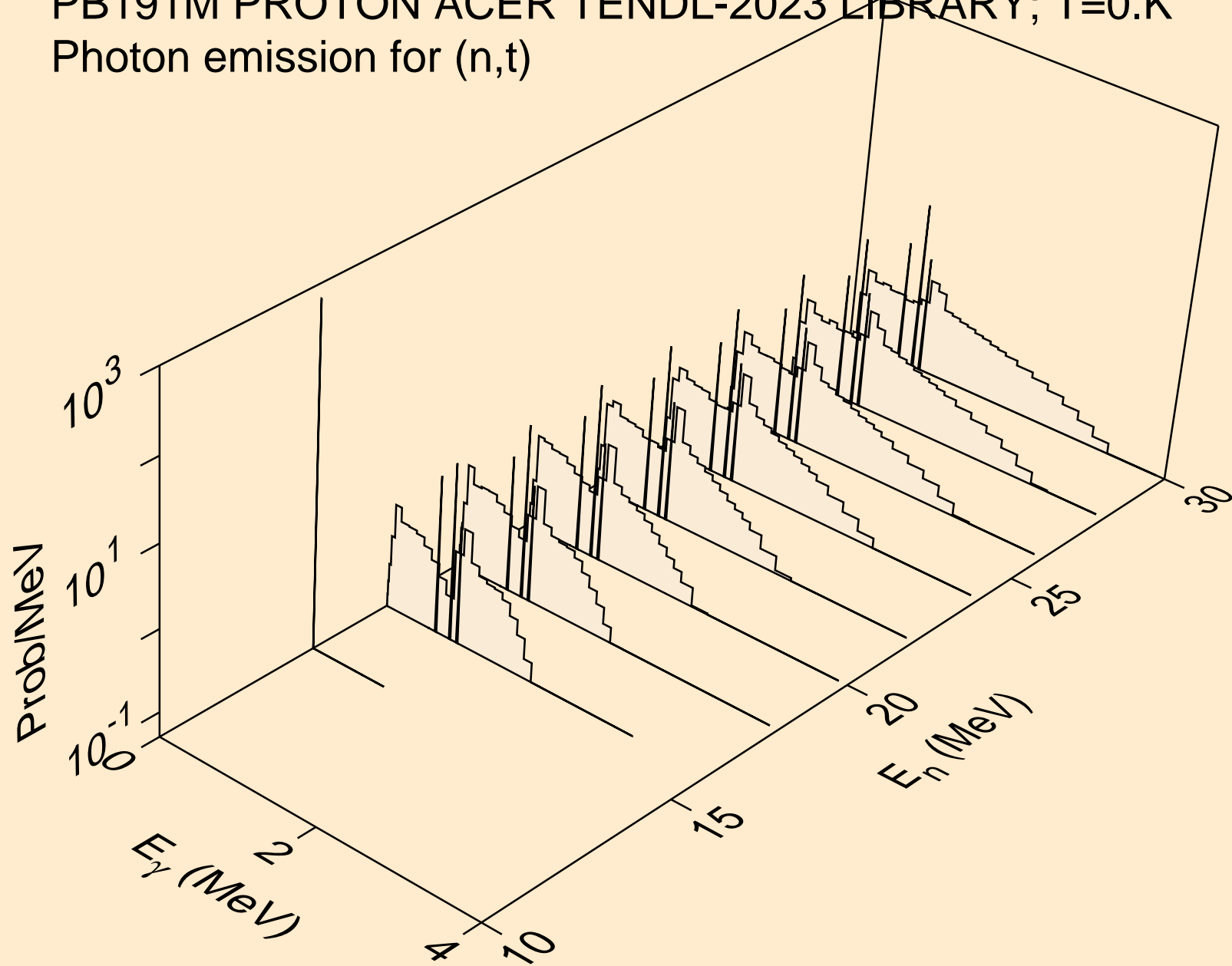

PB191M PROTON ACER TENDL-2023 LIBRARY; T=0.K
Photon emission for (n,he3)

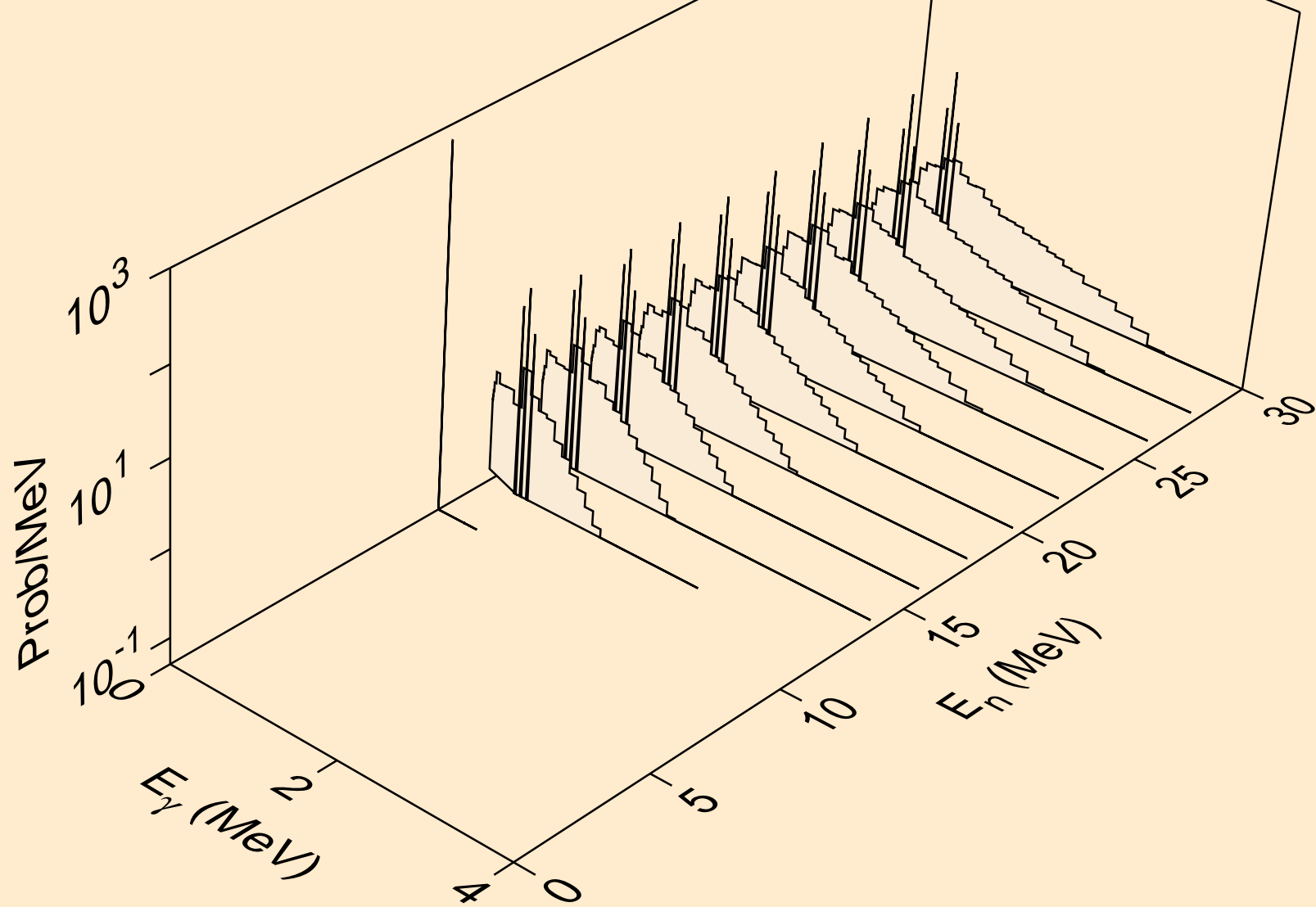

PB191M PROTON ACER TENDL-2023 LIBRARY; T=0.K
Photon emission for (n,a)

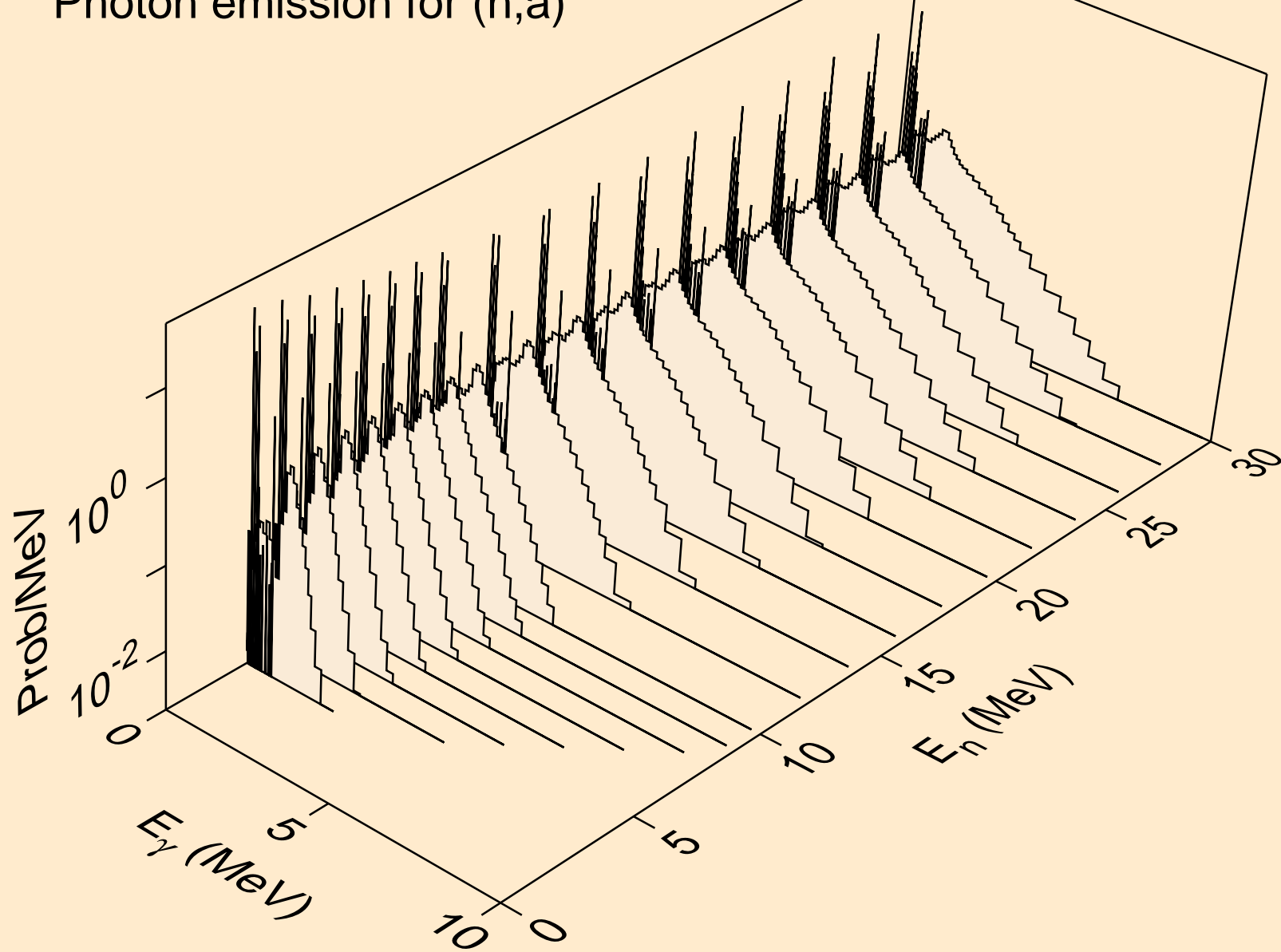

PB191M PROTON ACER TENDL-2023 LIBRARY; T=0.K
Photon emission for (n,2a)

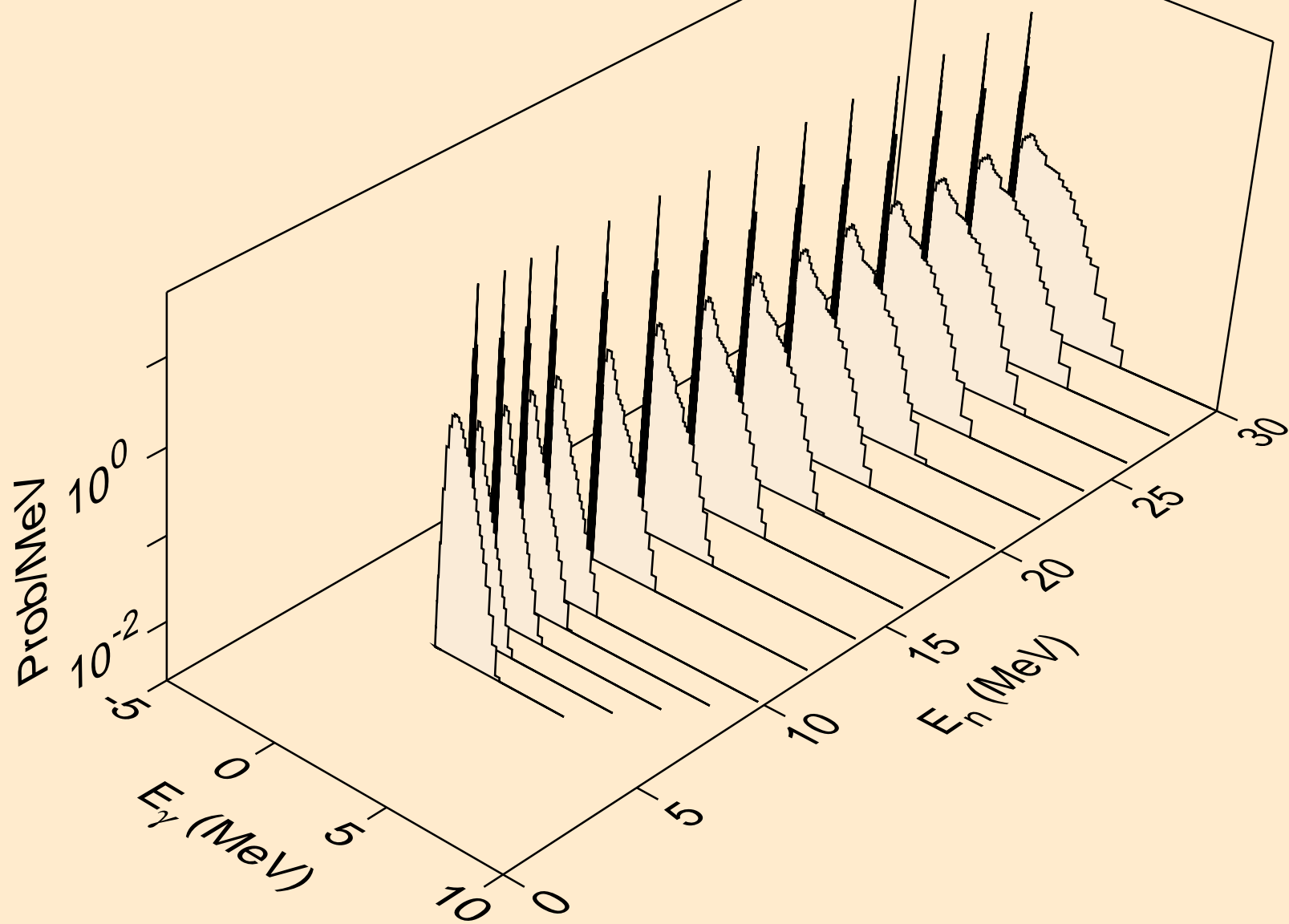

PB191M PROTON ACER TENDL-2023 LIBRARY; T=0.K
Photon emission for (n,3a)

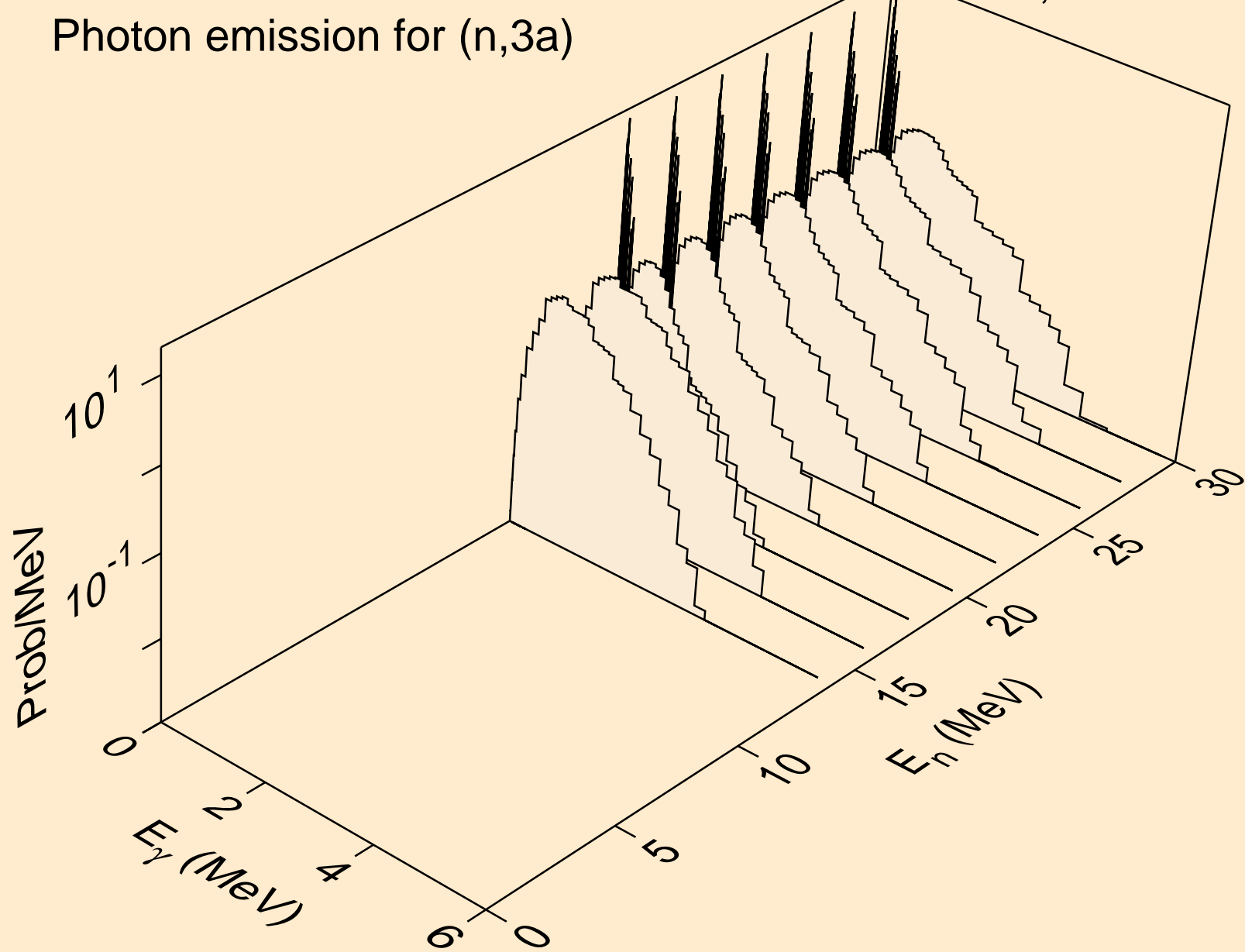

PB191M PROTON ACER TENDL-2023 LIBRARY; T=0.K
Photon emission for (n,2p)

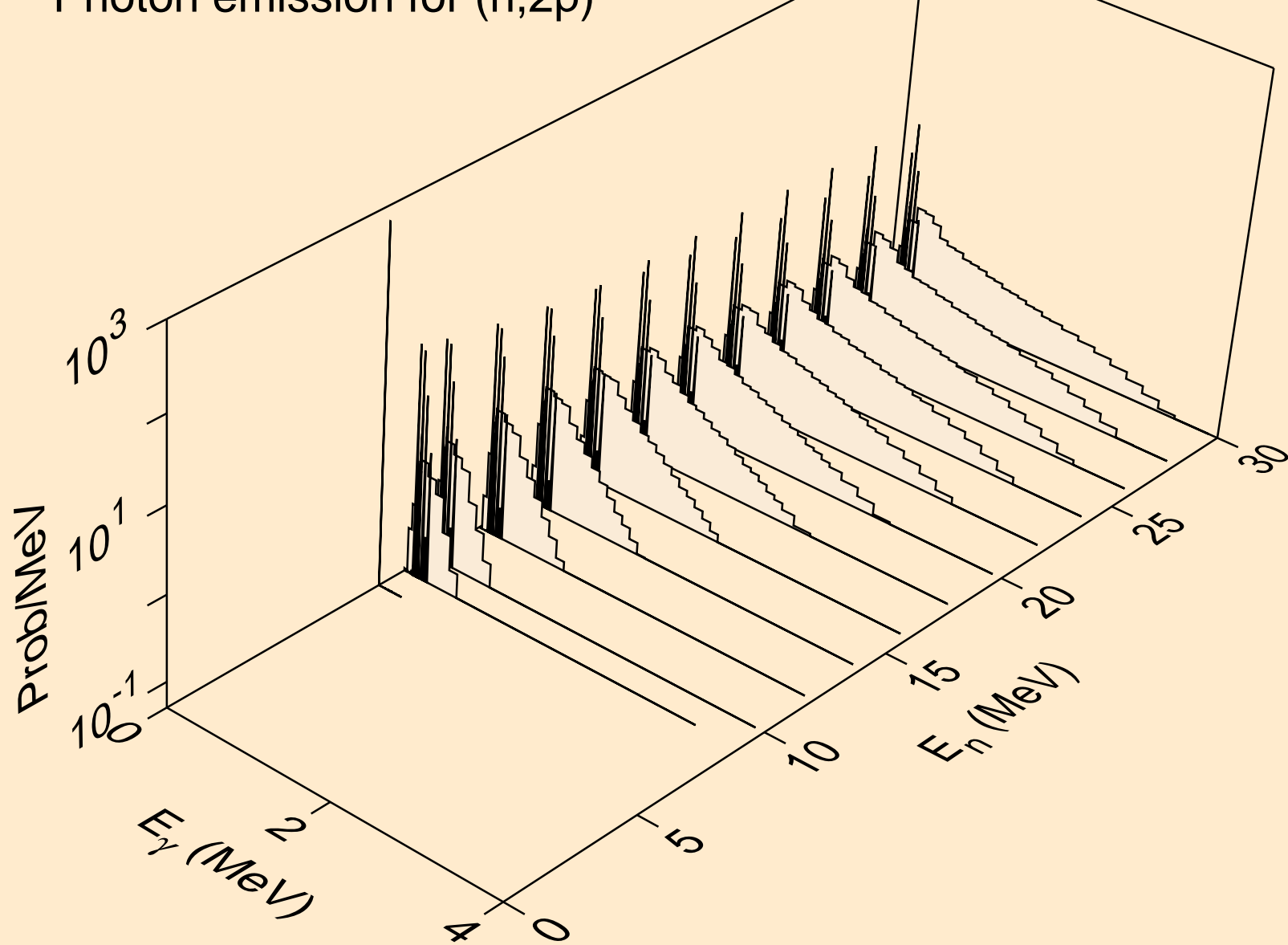

PB191M PROTON ACER TENDL-2023 LIBRARY; T=0.K
Photon emission for (n,pa)

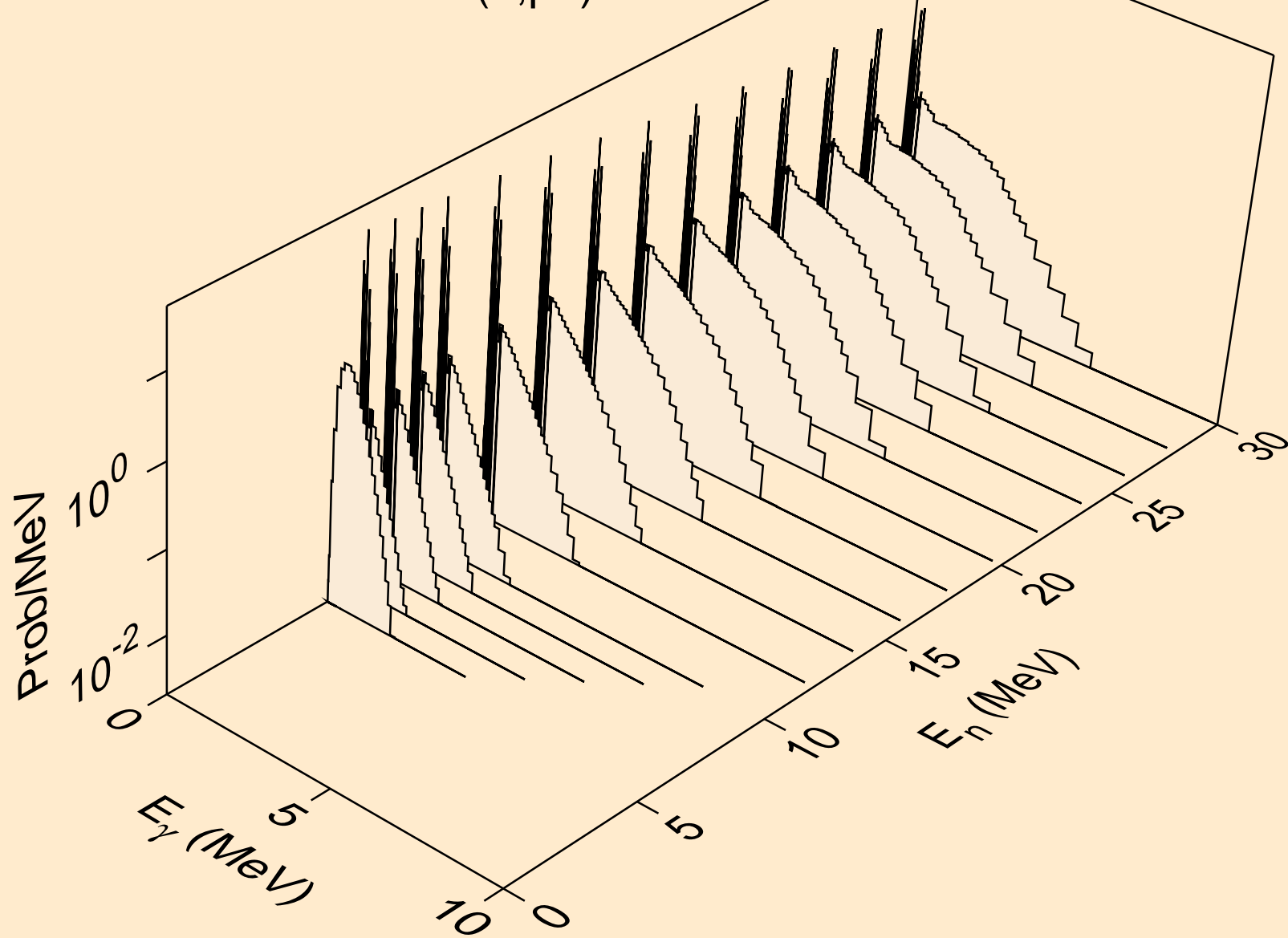

PB191M PROTON ACER TENDL-2023 LIBRARY; T=0.K
Photon emission for (n,pd)

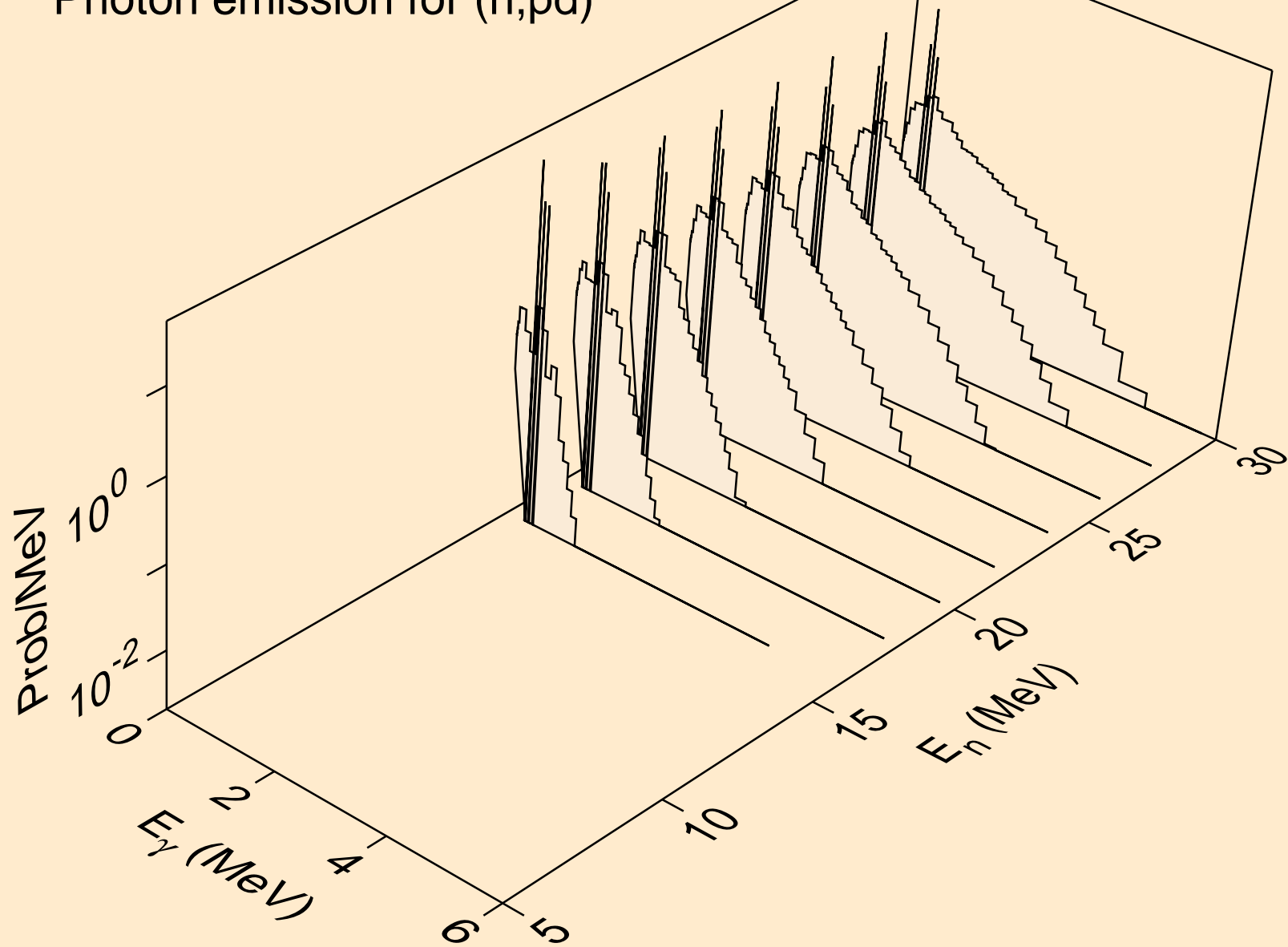

PB191M PROTON ACER TENDL-2023 LIBRARY; T=0.K
Photon emission for (n,pt)

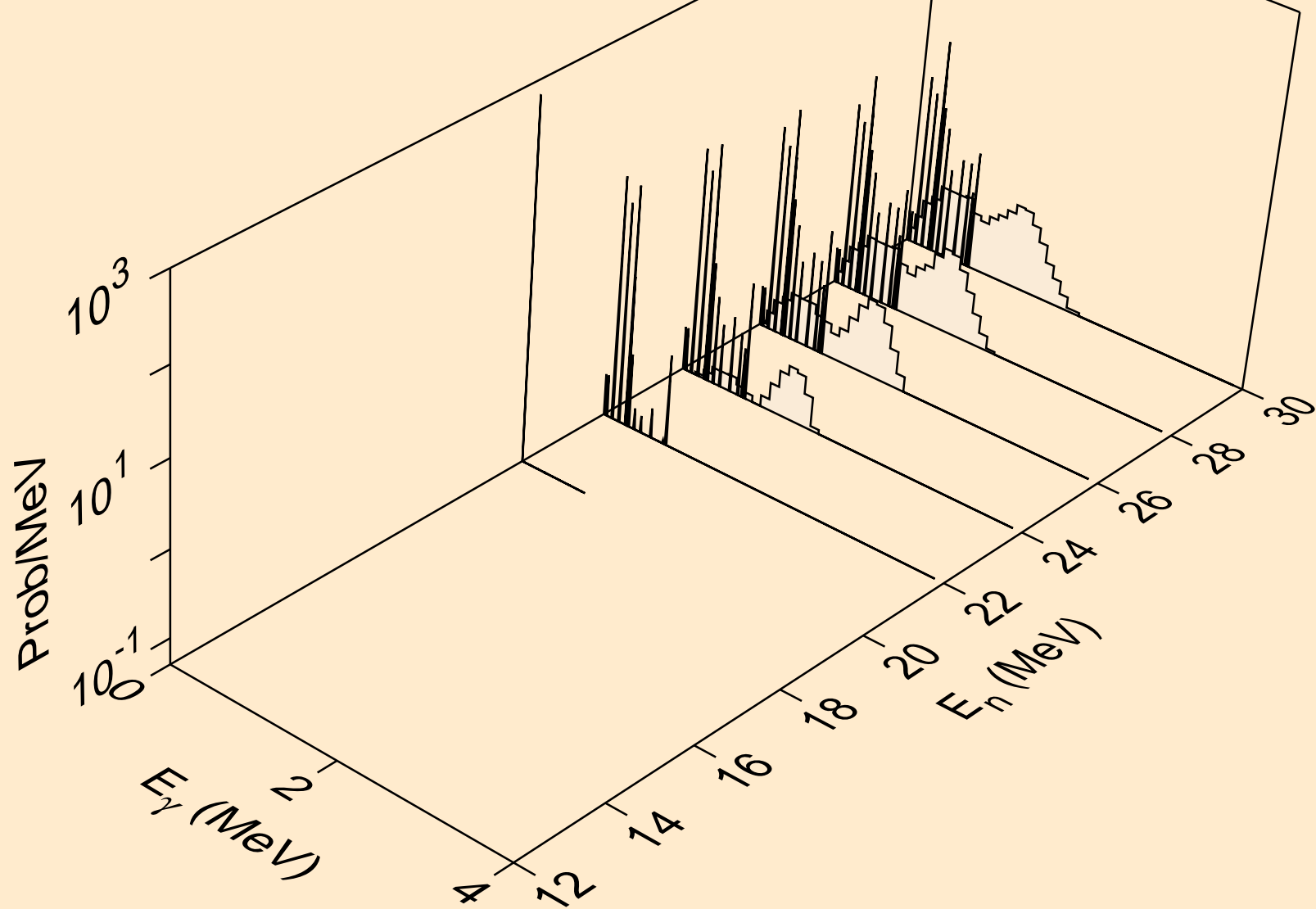

PB191M PROTON ACER TENDL-2023 LIBRARY; T=0.K
Photon emission for (n,da)

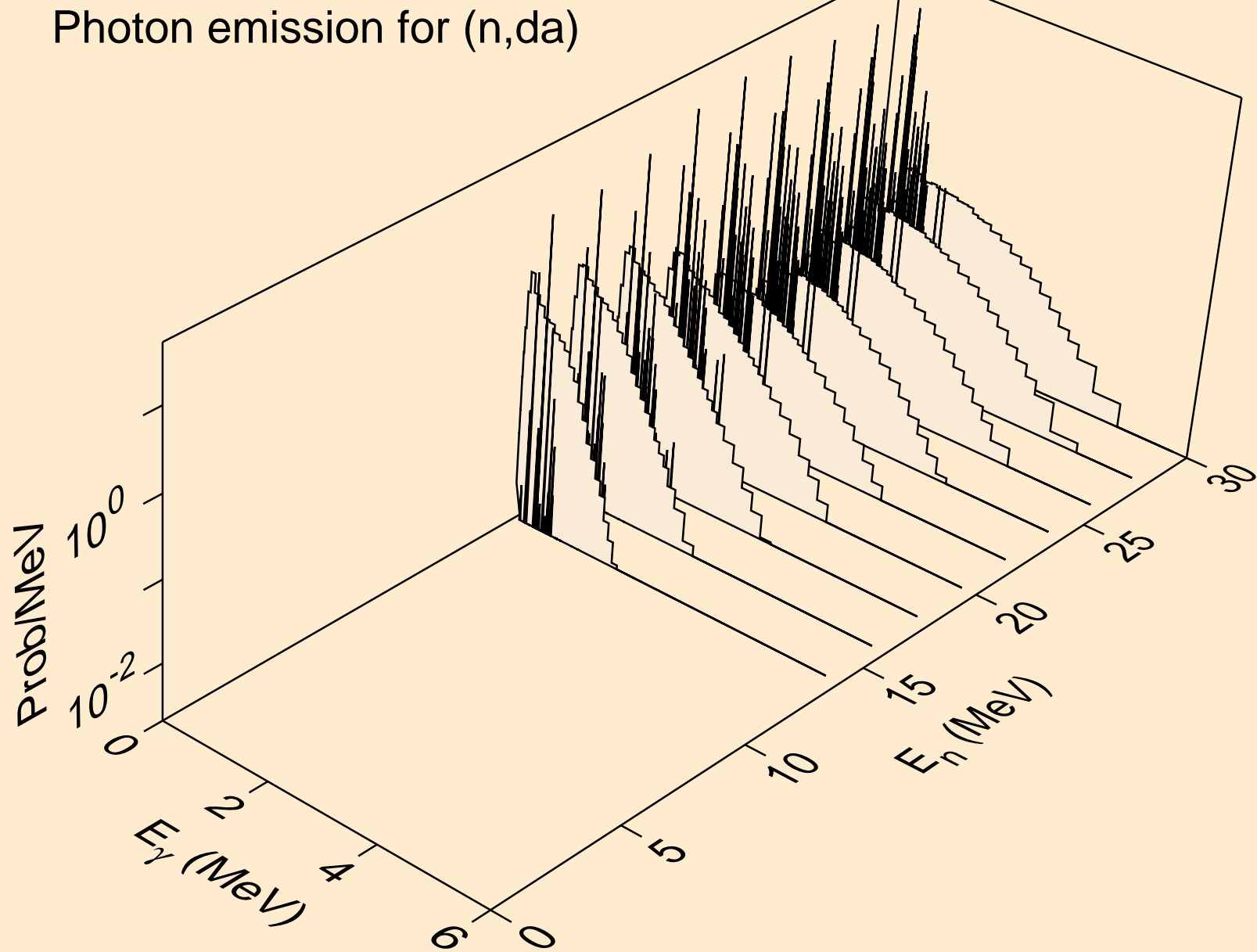

PB191M PROTON ACER TENDL-2023 LIBRARY; T=0.K
Particle heating contributions

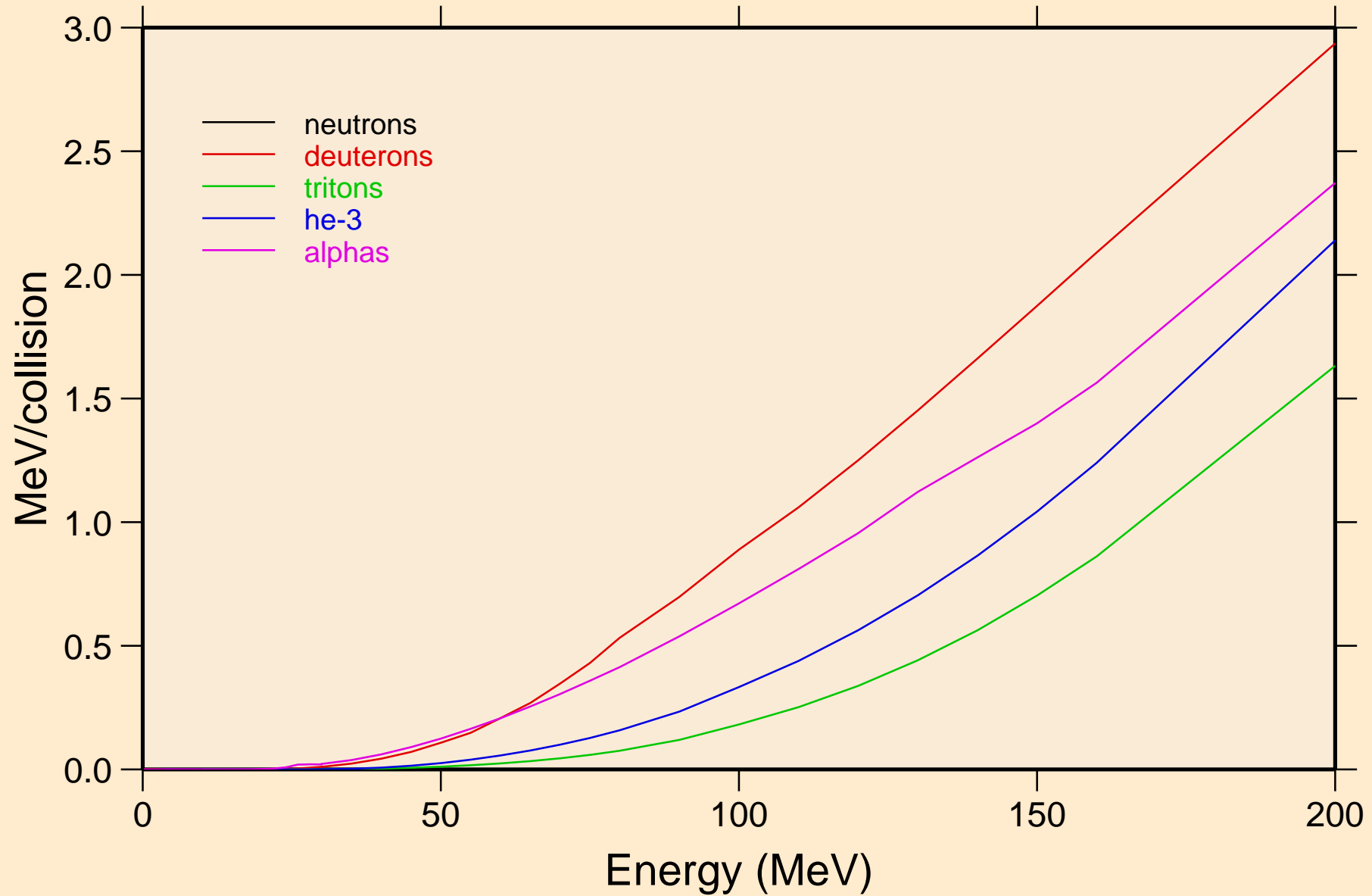

PB191M PROTON ACER TENDL-2023 LIBRARY; T=0.K

Recoil Heating

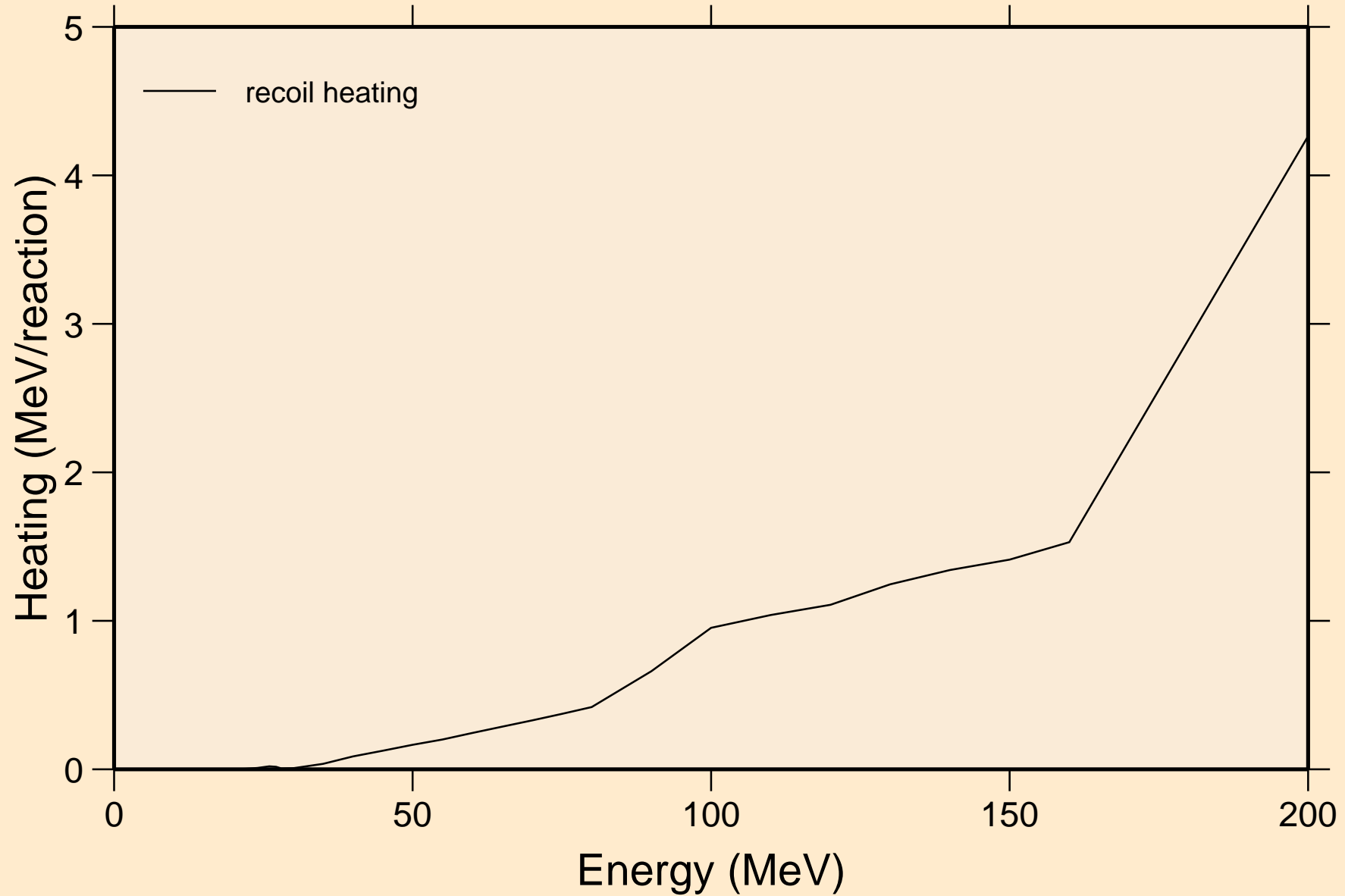

PB191M PROTON ACER TENDL-2023 LIBRARY; T=0.K
Particle production cross sections

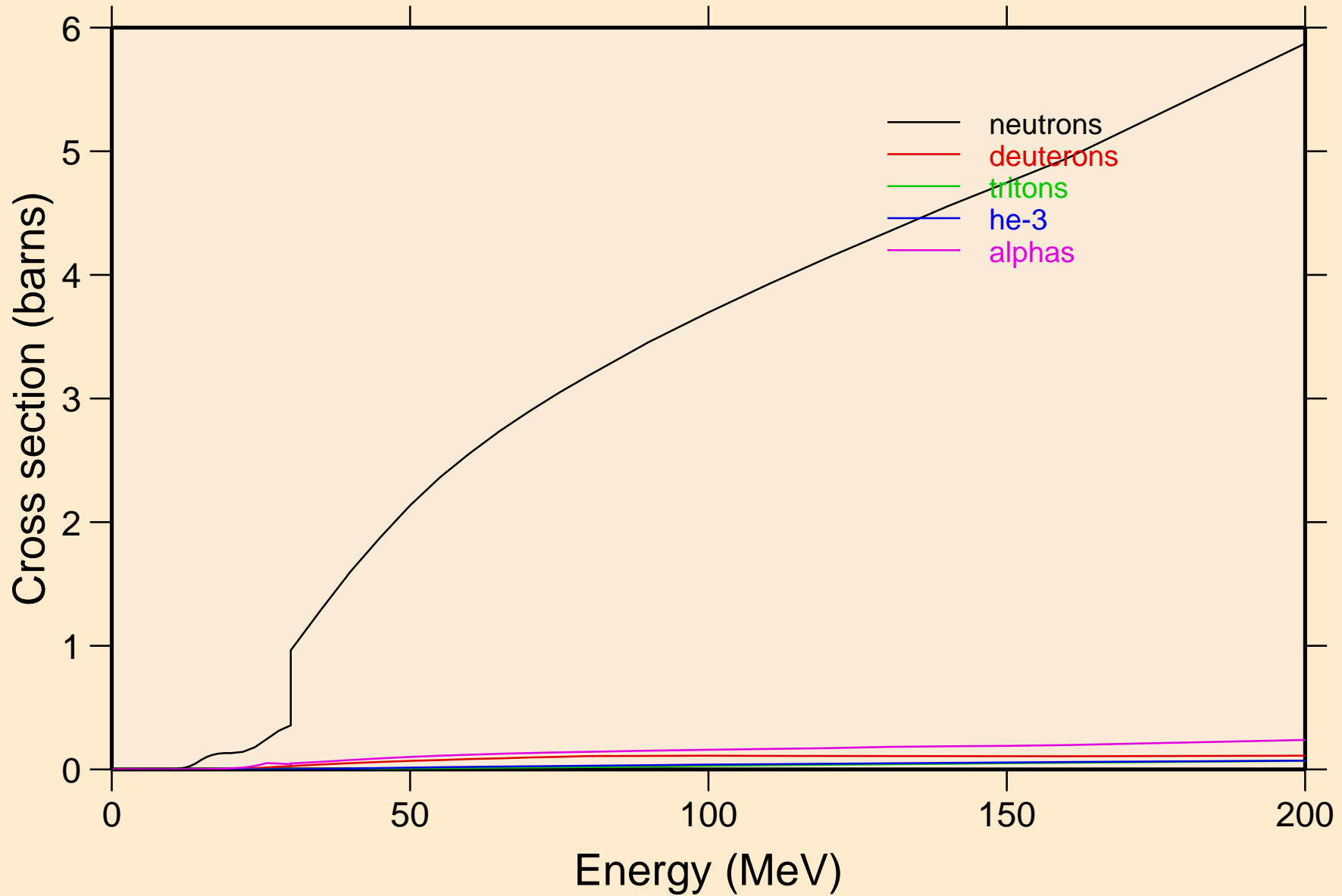

PB191M PROTON ACER TENDL-2023 LIBRARY; T=0.K
neutrons from (p,n)

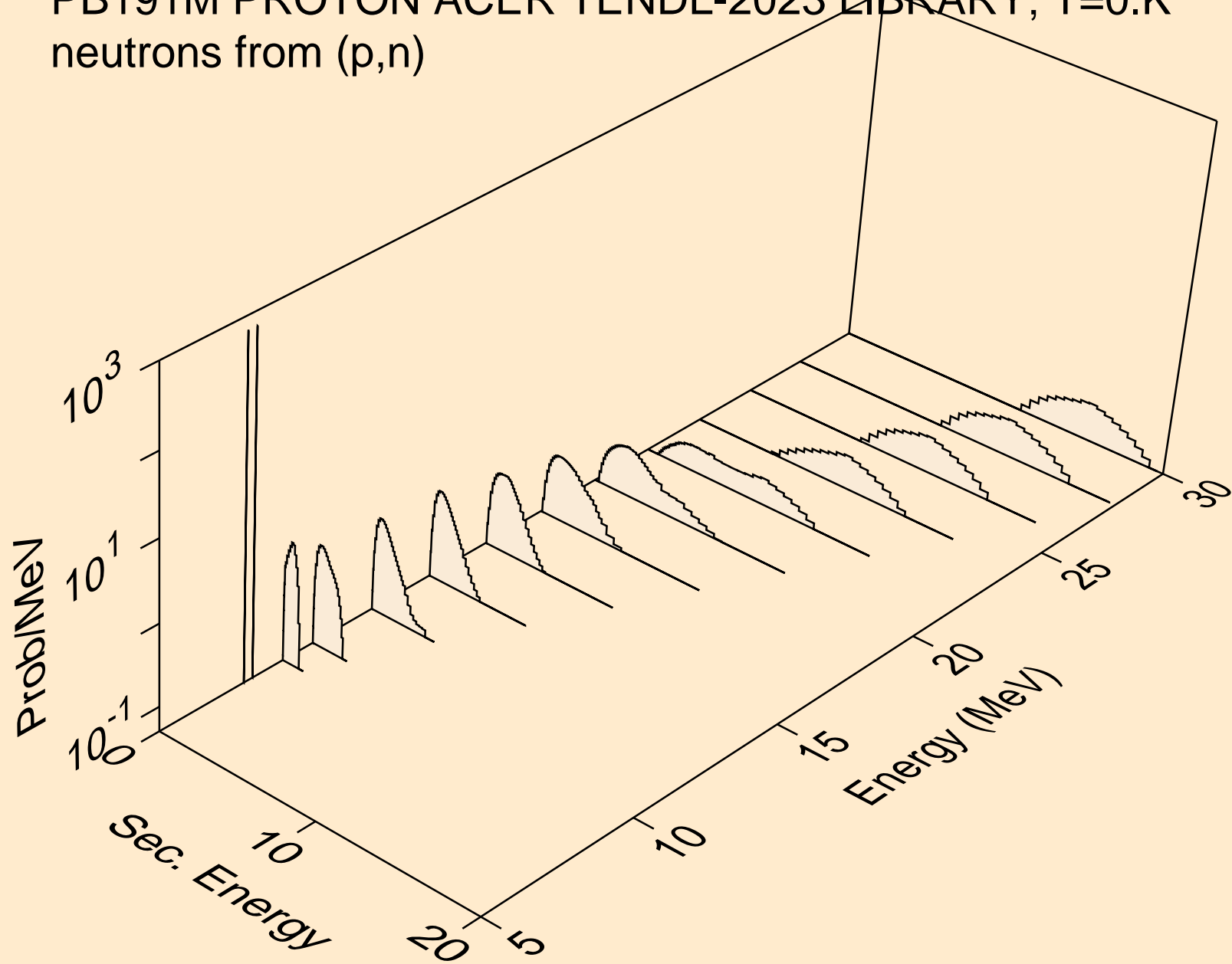

PB191M PROTON ACER TENDL-2023 LIBRARY; T=0.K
neutrons from (p,x)

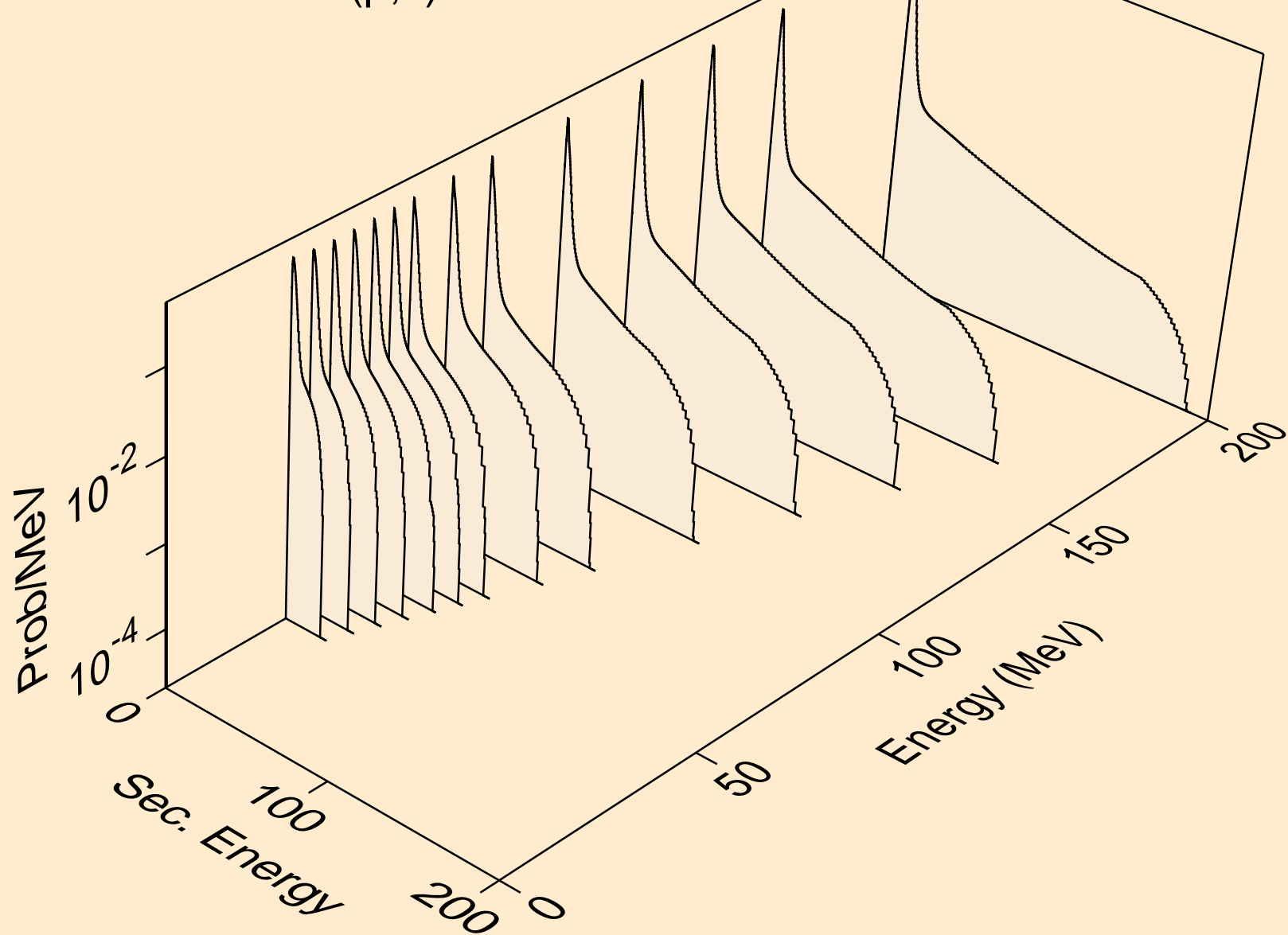

PB191M PROTON ACER TENDL-2023 LIBRARY; T=0.K
neutrons from (p,2n)

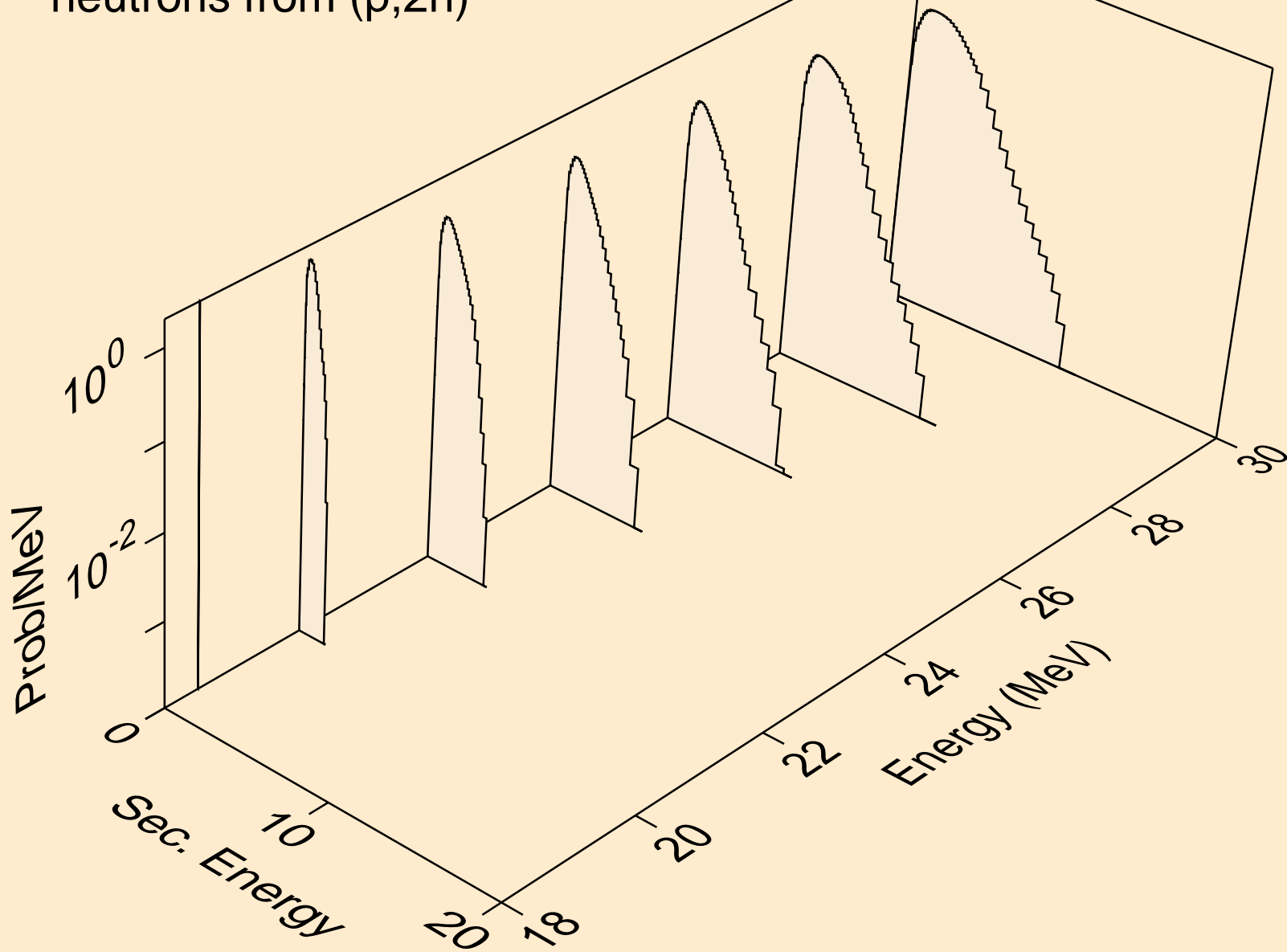

PB191M PROTON ACER TENDL-2023 LIBRARY; T=0.K
neutrons from (p,3n)

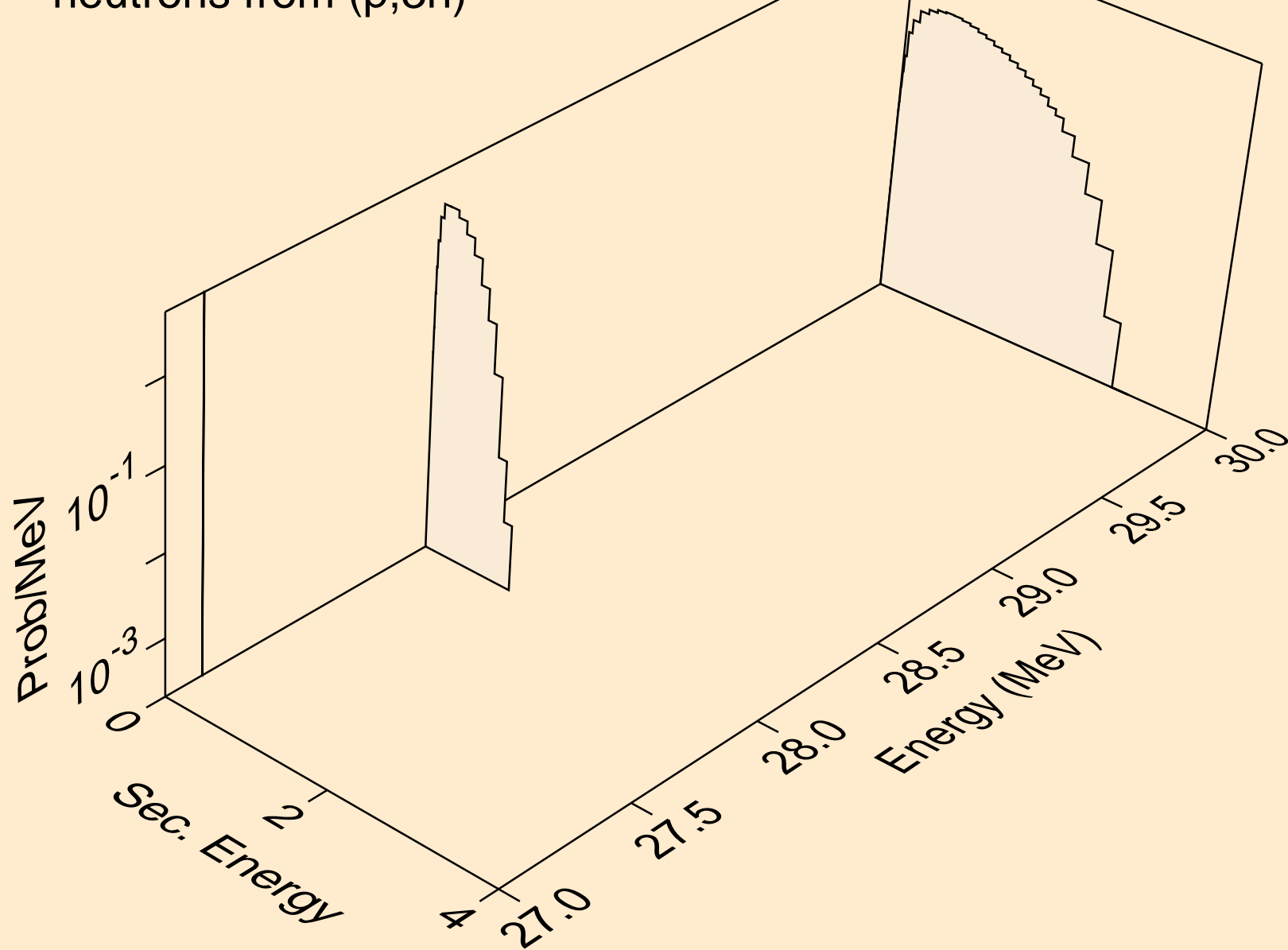

PB191M PROTON ACER TENDL-2023 LIBRARY; T=0.K
neutrons from (p,n*)a

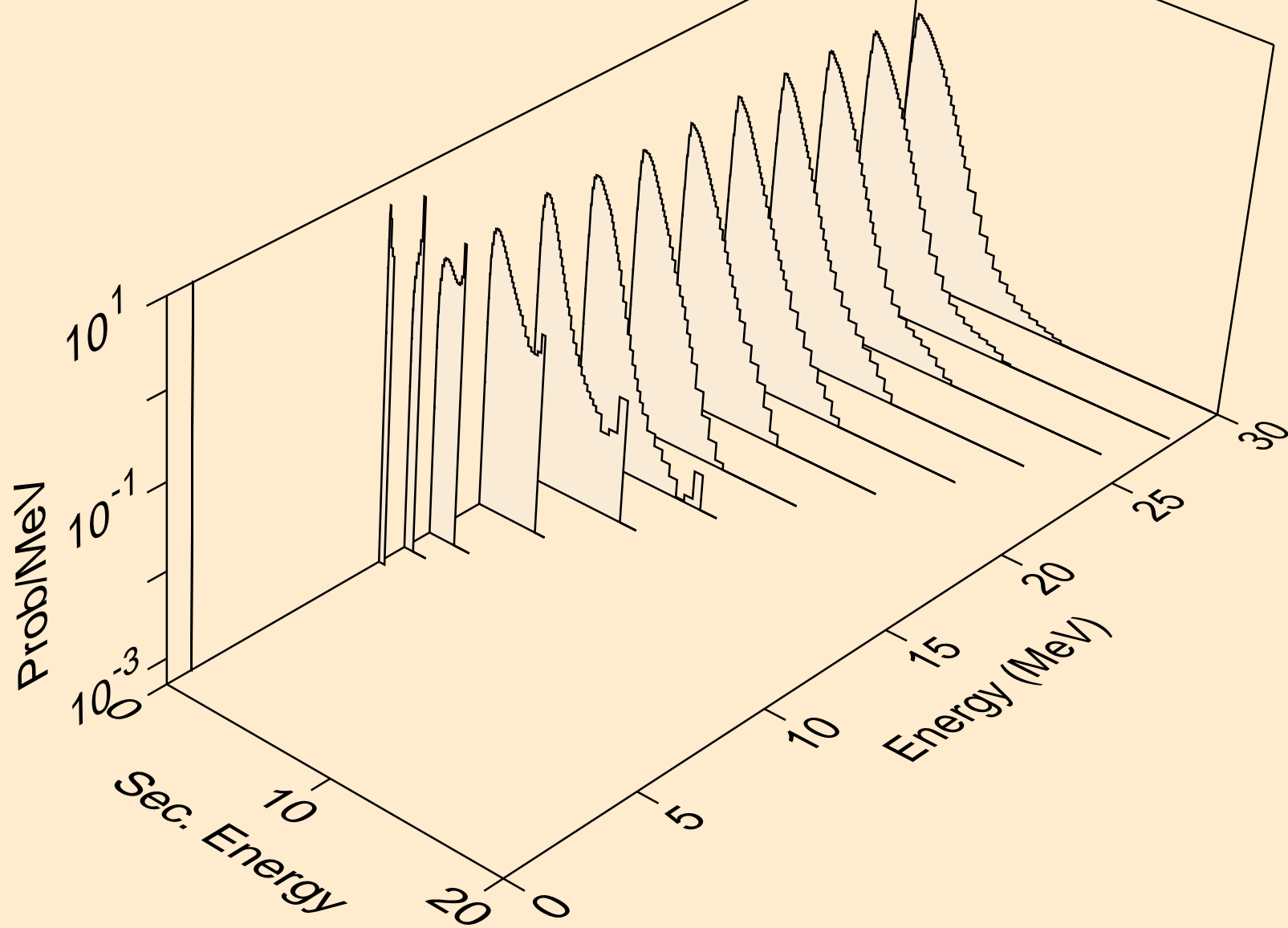

PB191M PROTON ACER TENDL-2023 LIBRARY; T=0.K
neutrons from (p,2n)a

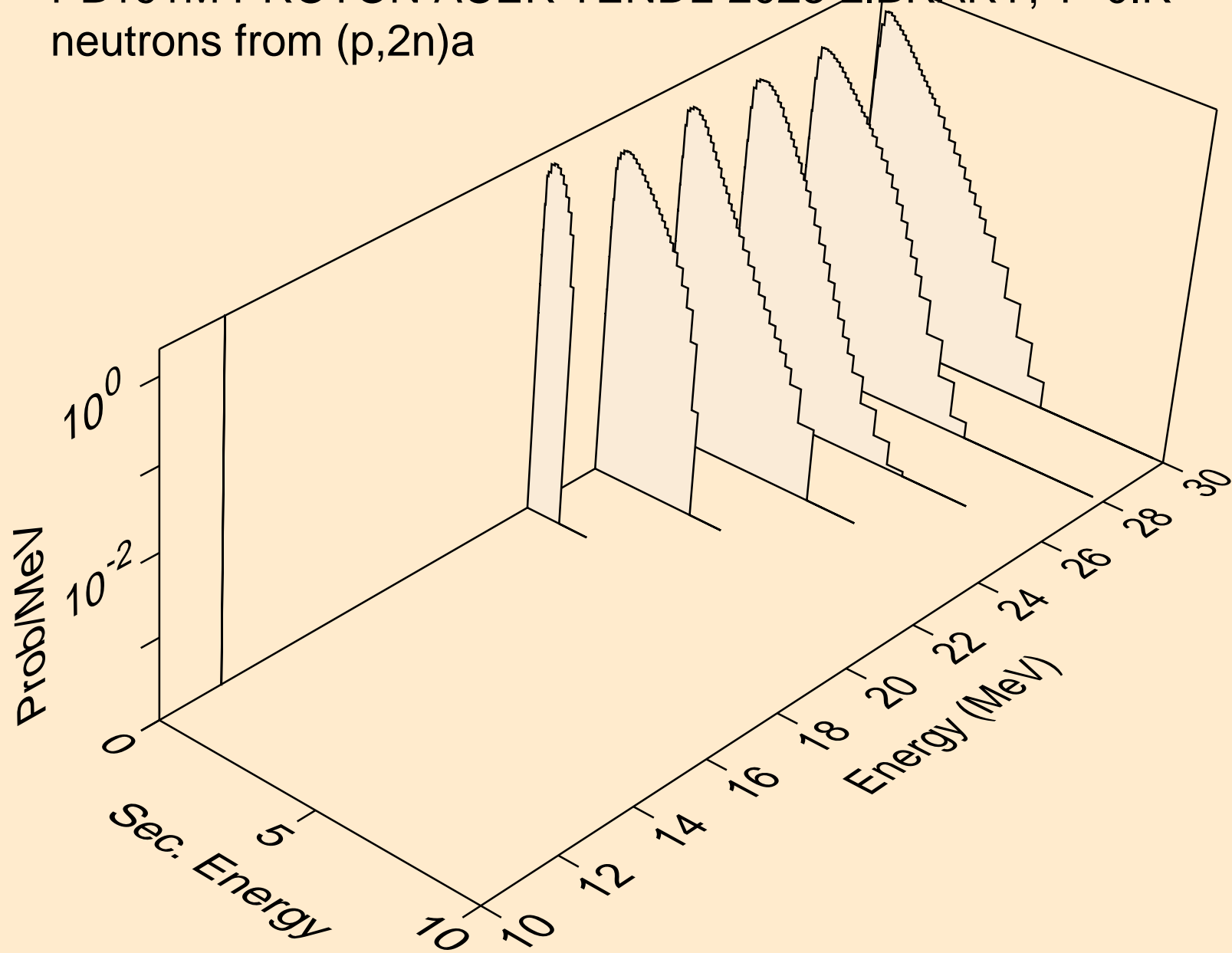

PB191M PROTON ACER TENDL-2023 LIBRARY; T=0.K
neutrons from (p,n*)p

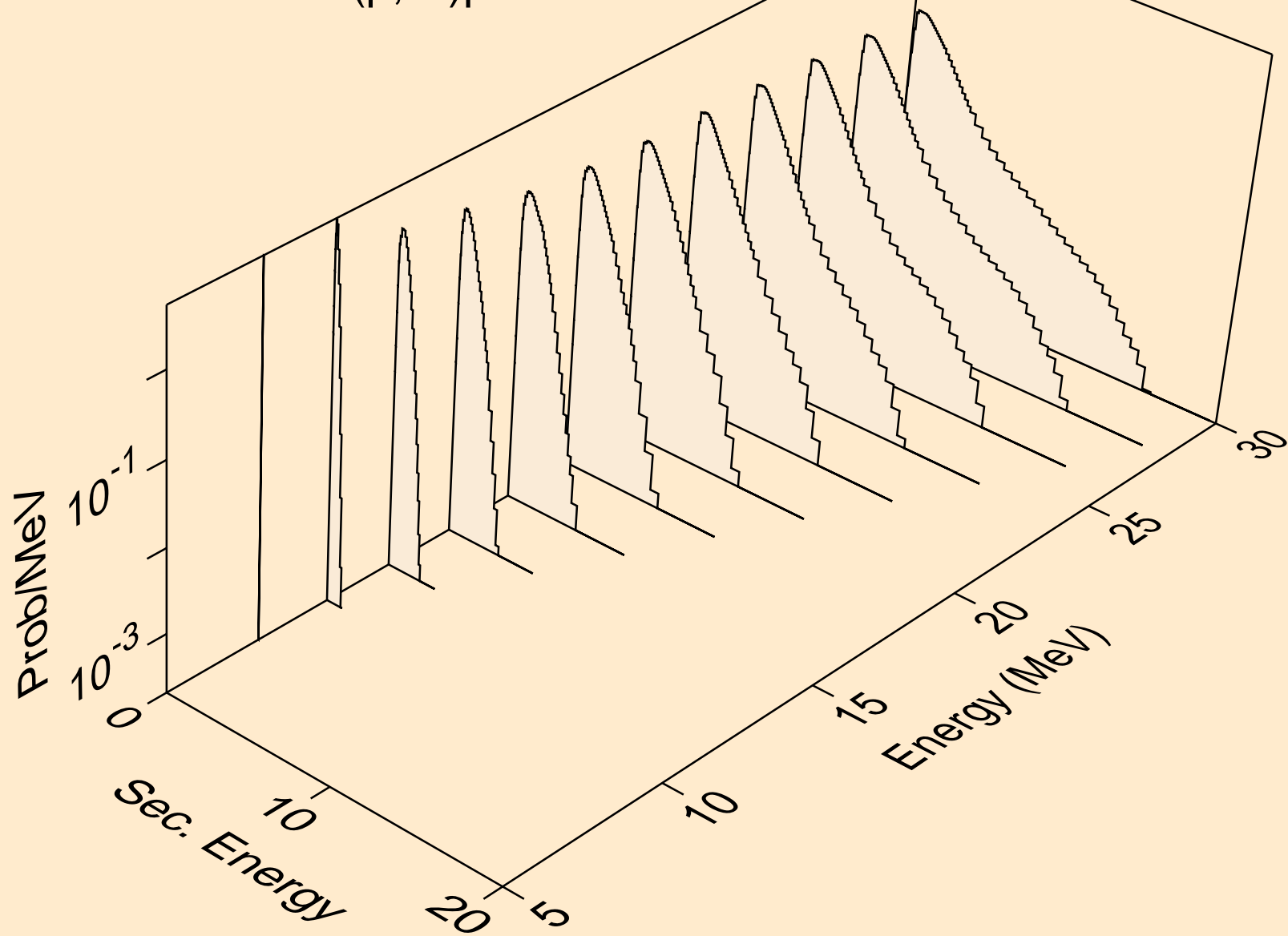

PB191M PROTON ACER TENDL-2023 LIBRARY; T=0.K
neutrons from (p,n*)2a

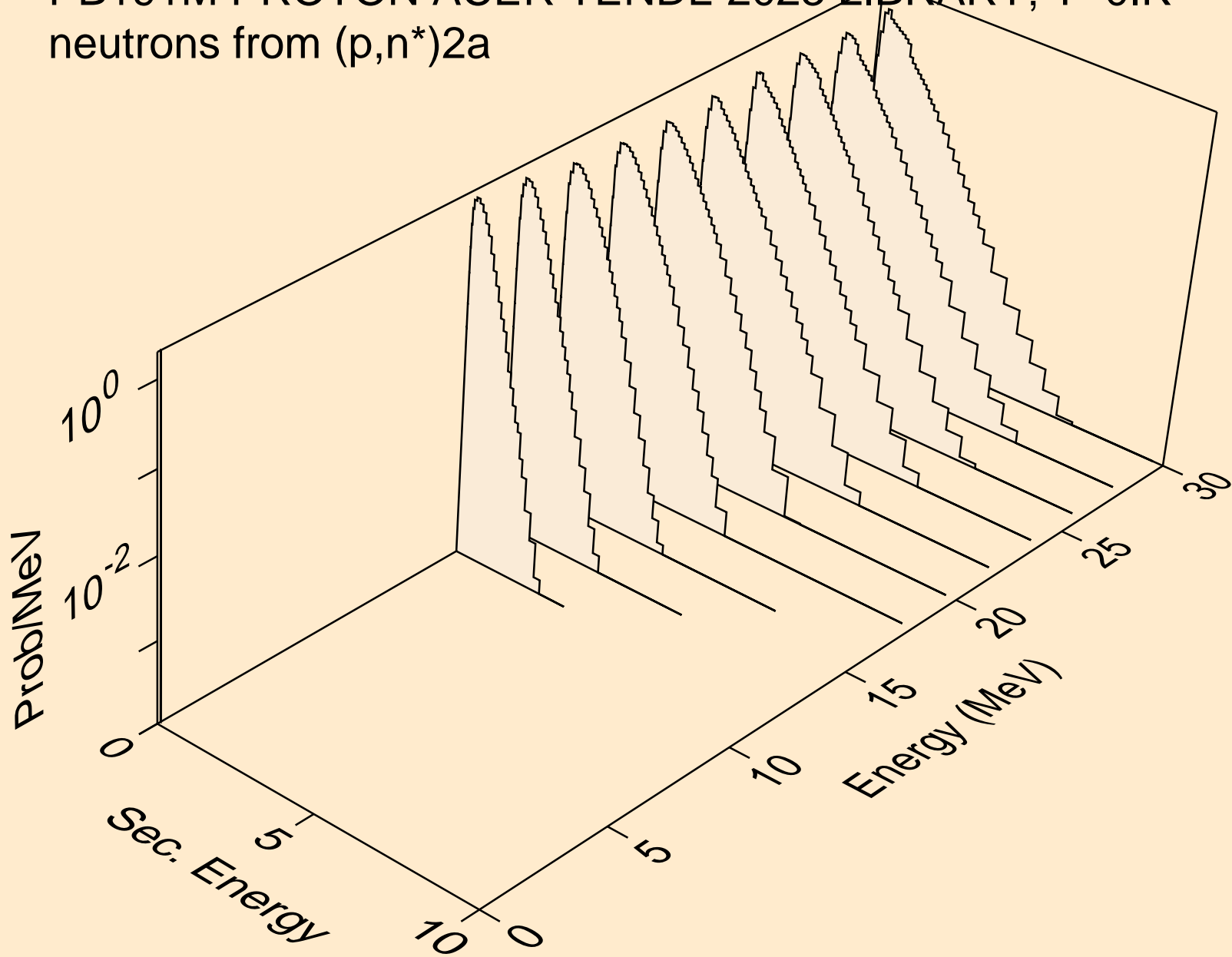

PB191M PROTON ACER TENDL-2023 LIBRARY; T=0.K
neutrons from (p,n*)d

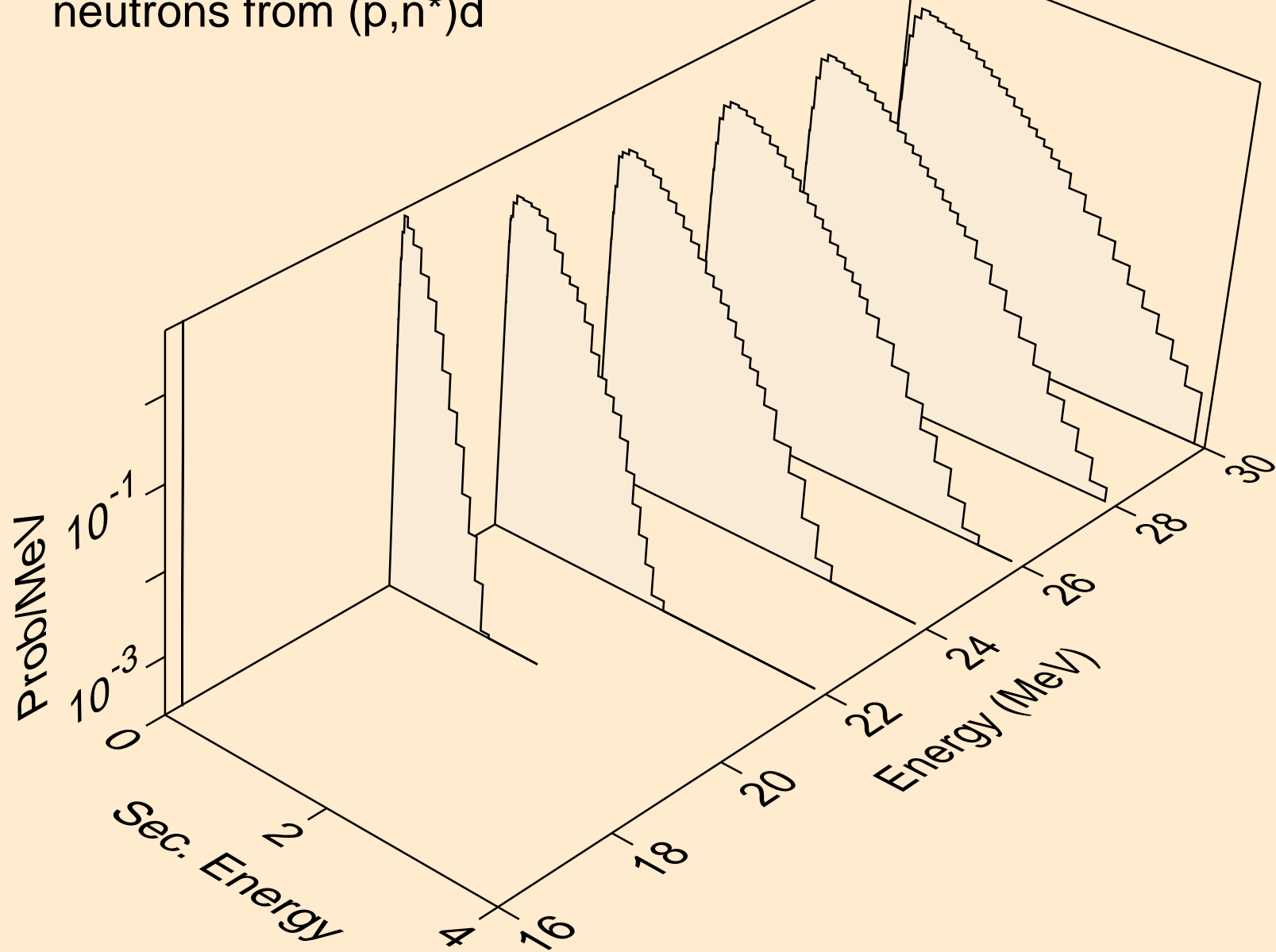

PB191M PROTON ACER TENDL-2023 LIBRARY; T=0.K
neutrons from (p,n*)t

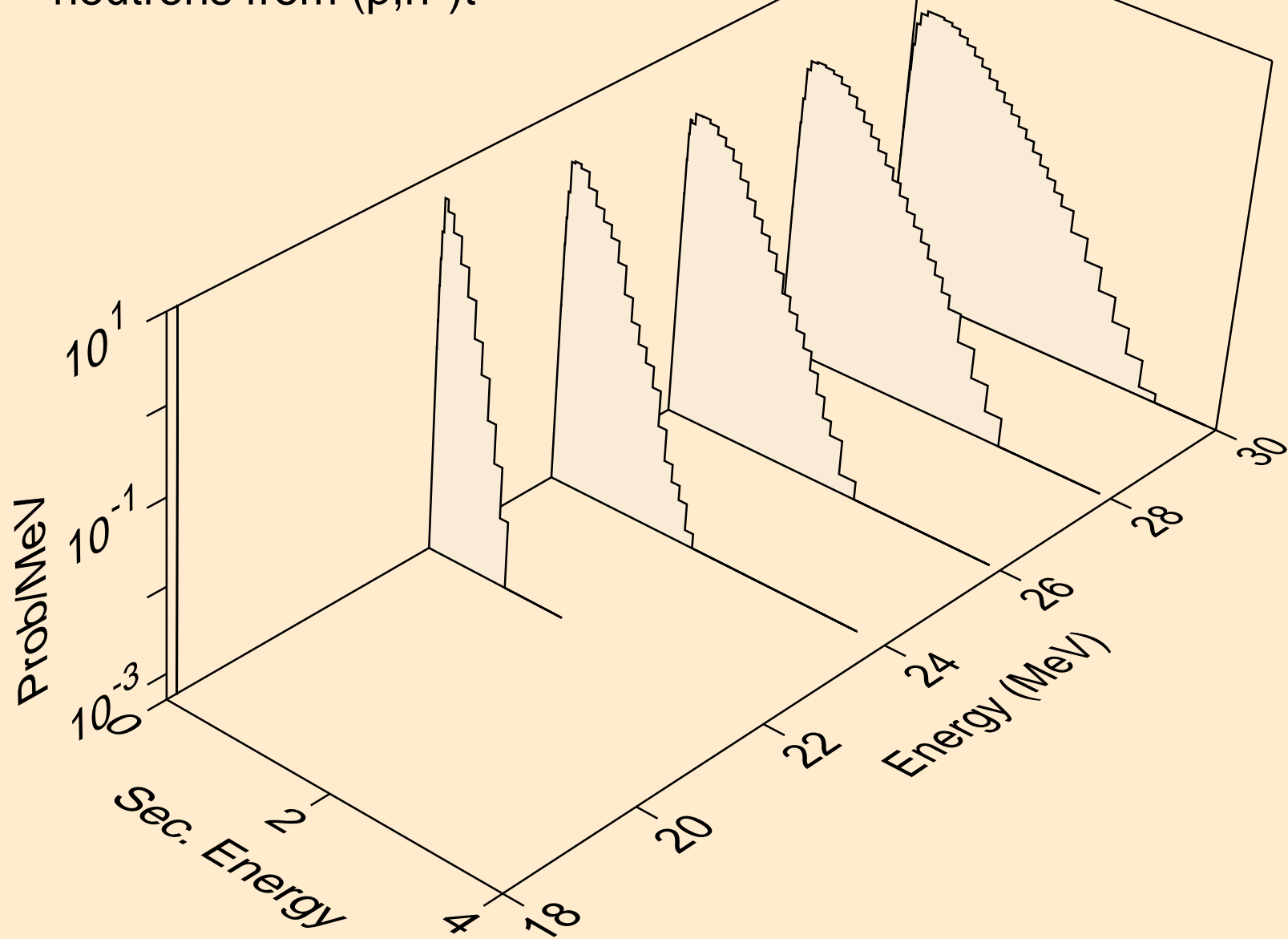

PB191M PROTON ACER TENDL-2023 LIBRARY; T=0.K
neutrons from (p,n*)he3

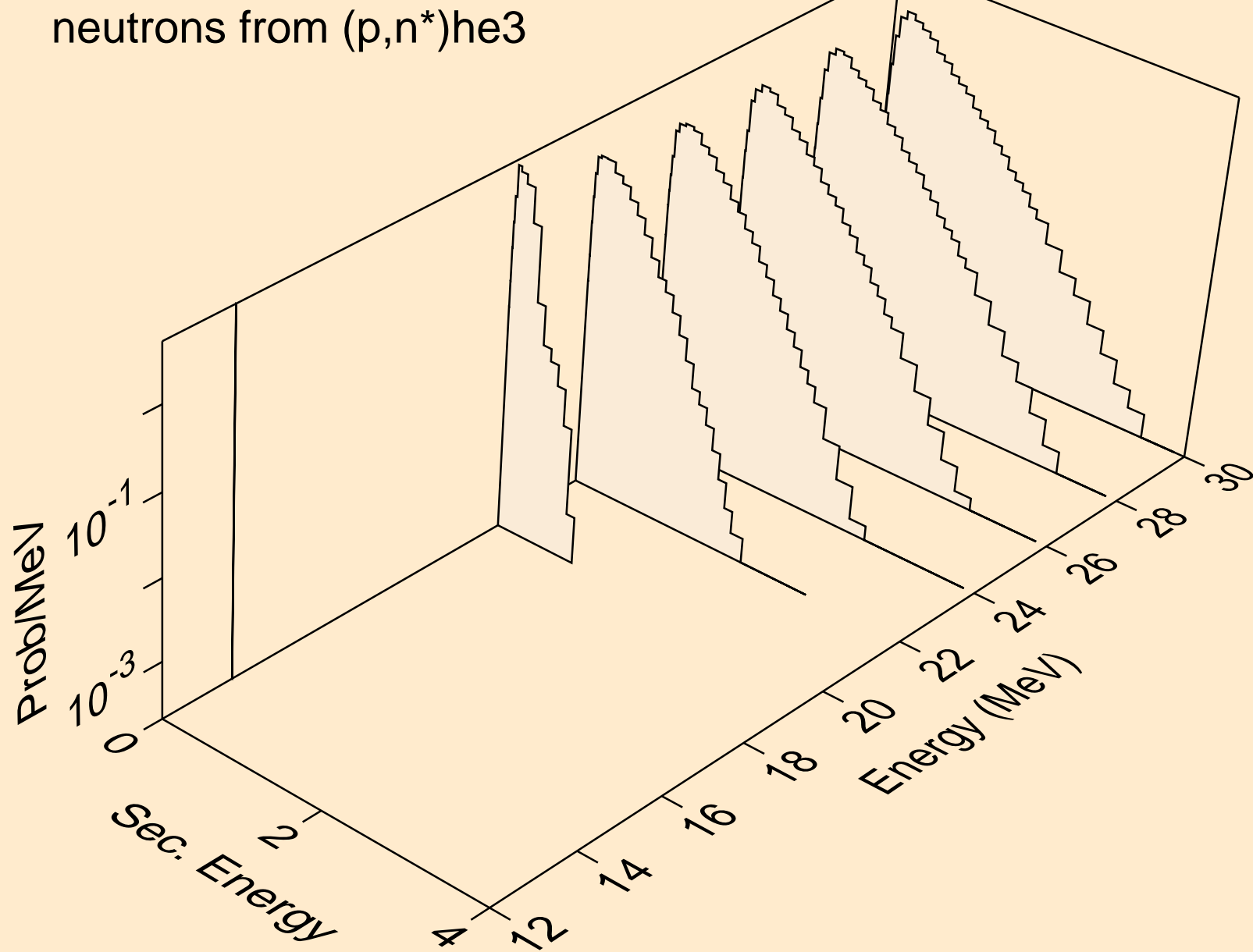

PB191M PROTON ACER TENDL-2023 LIBRARY; T=0.K
neutrons from (p,2np)

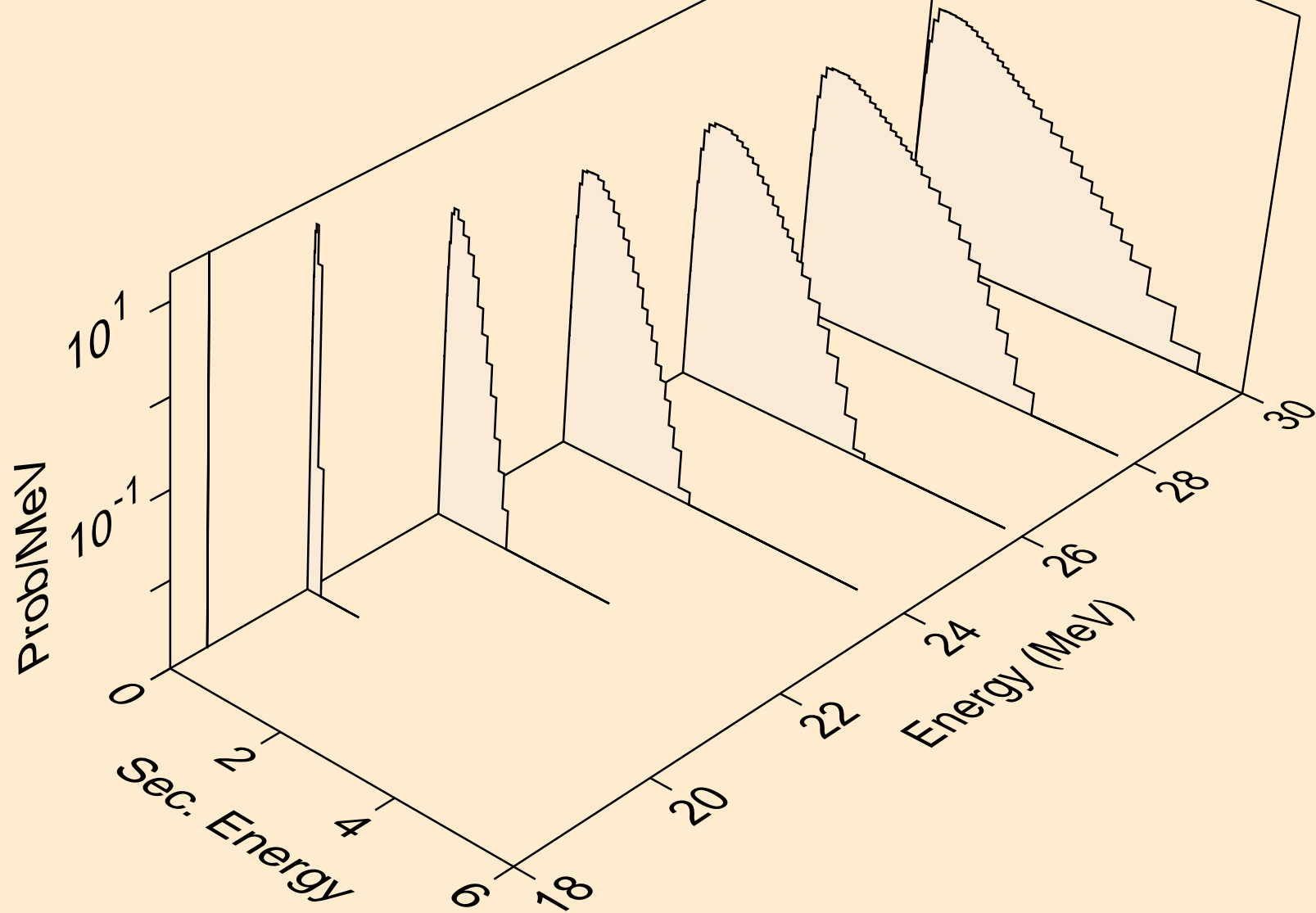

PB191M PROTON ACER TENDL-2023 LIBRARY; T=0.K
neutrons from (p,n2p)

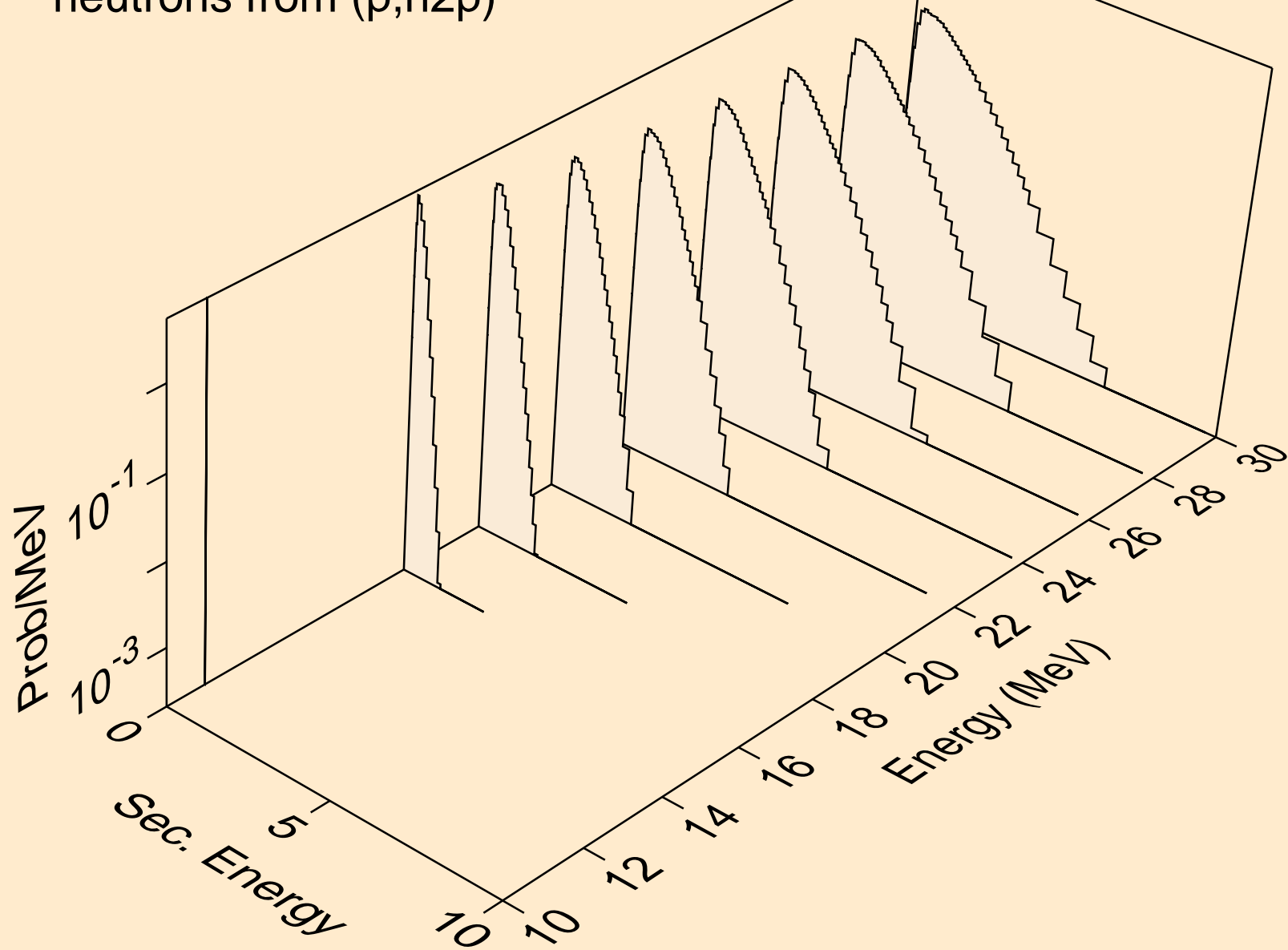

PB191M PROTON ACER TENDL-2023 LIBRARY; T=0.K
neutrons from (p,npa)

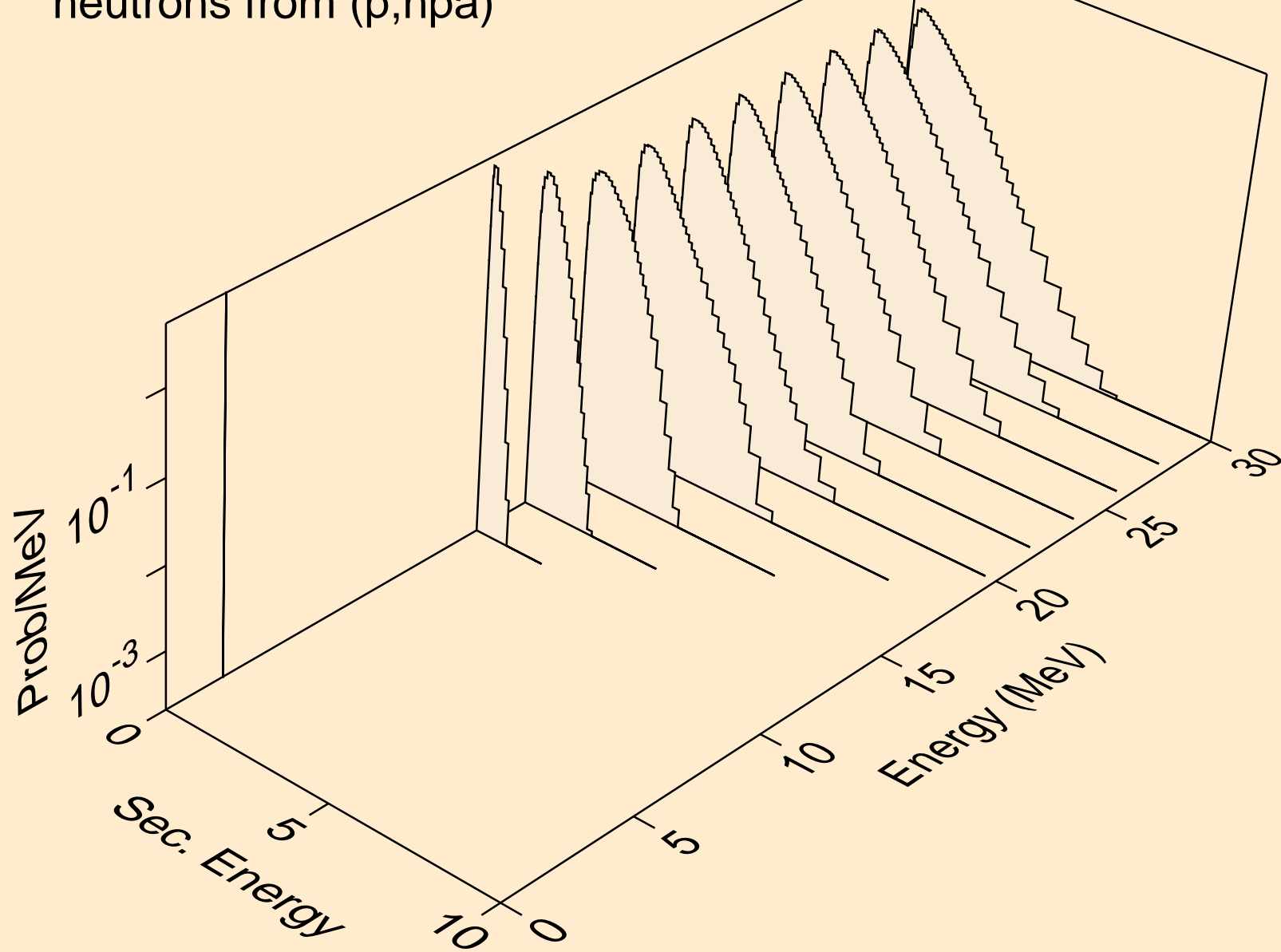

PB191M PROTON ACER TENDL-2023 LIBRARY; T=0.K
deuterons from (p,x)

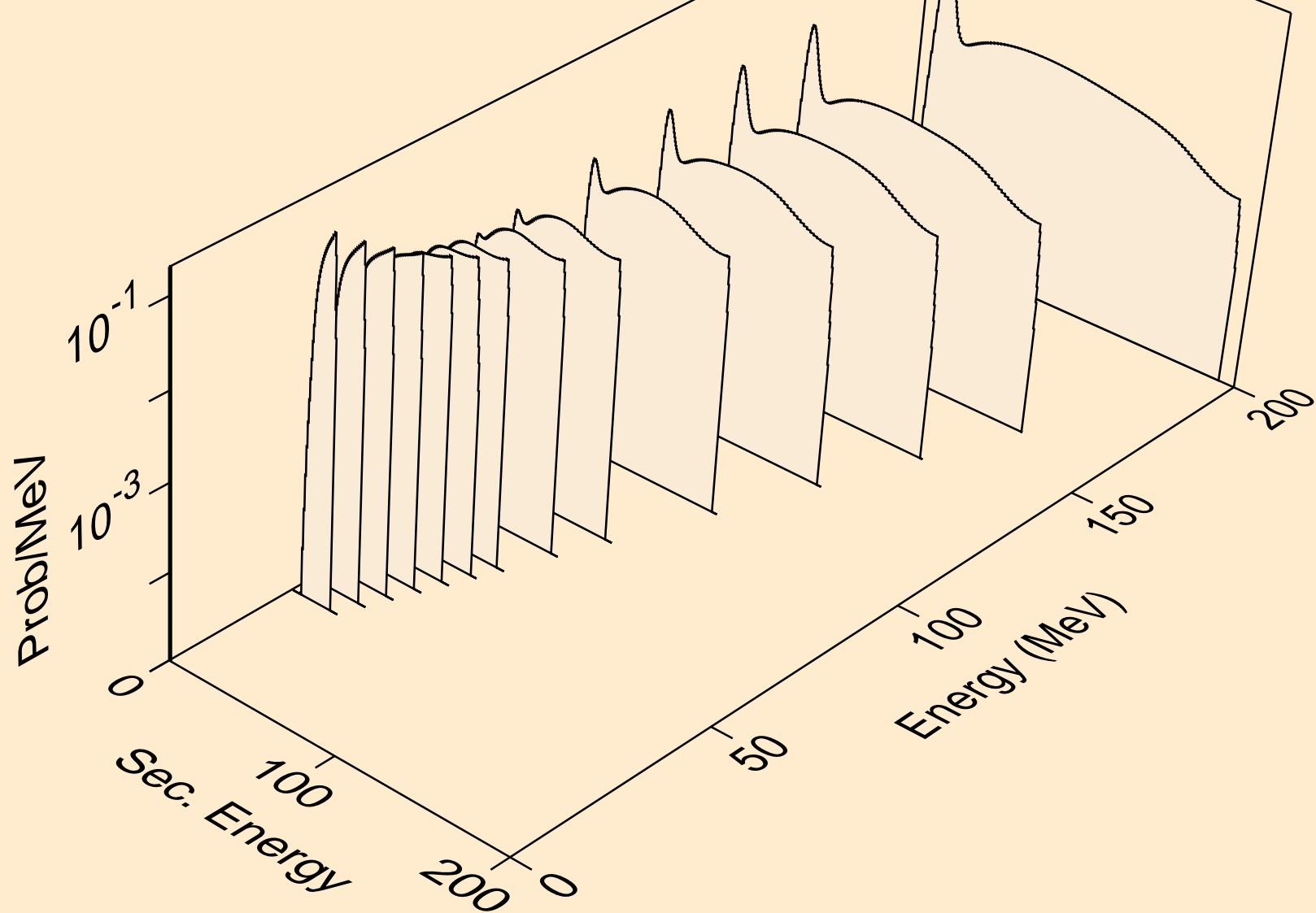

PB191M PROTON ACER TENDL-2023 LIBRARY; T=0.K
deuterons from (p,n*)d

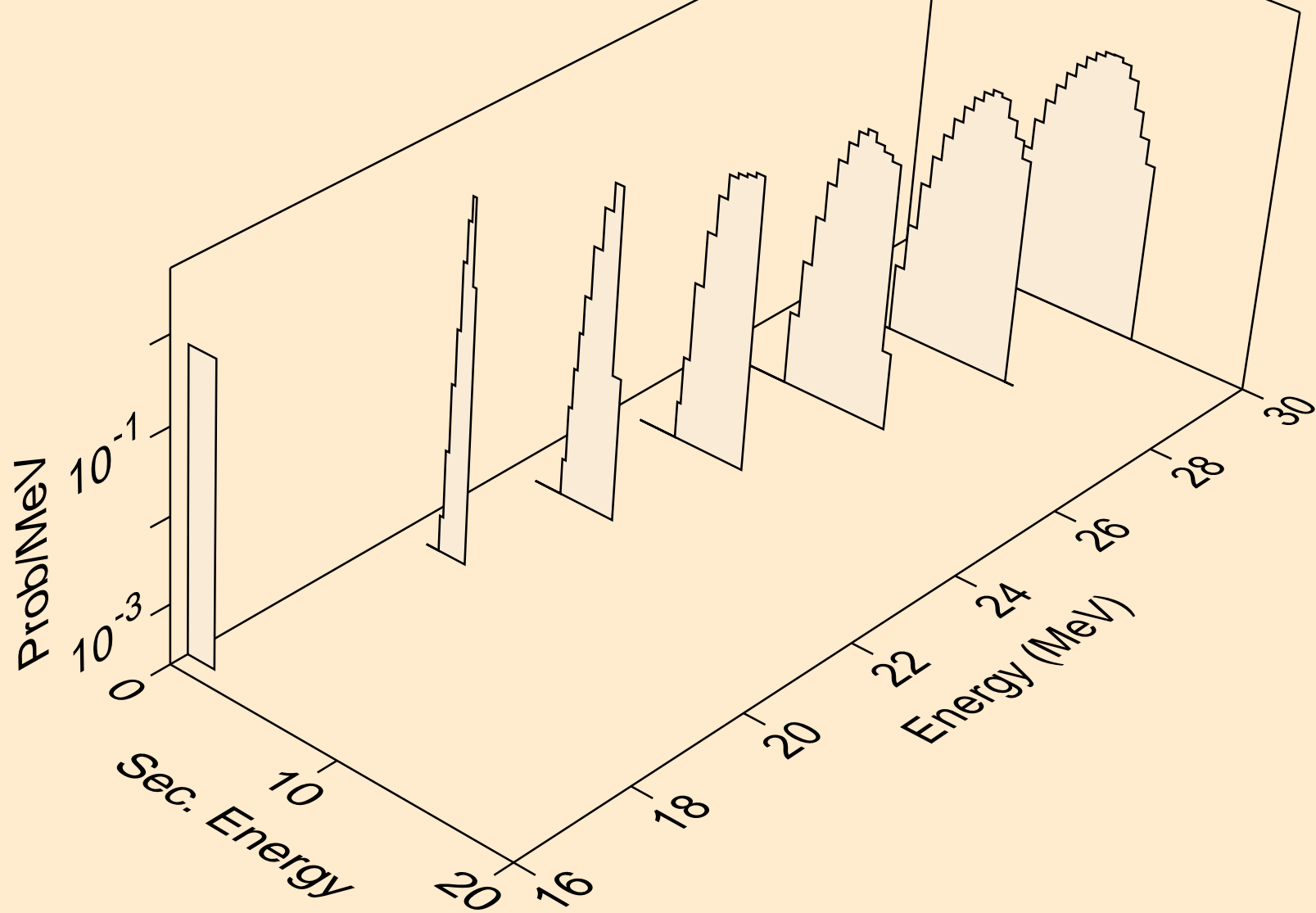

PB191M PROTON ACER TENDL-2023 LIBRARY; T=0.K
deuterons from (p,d)

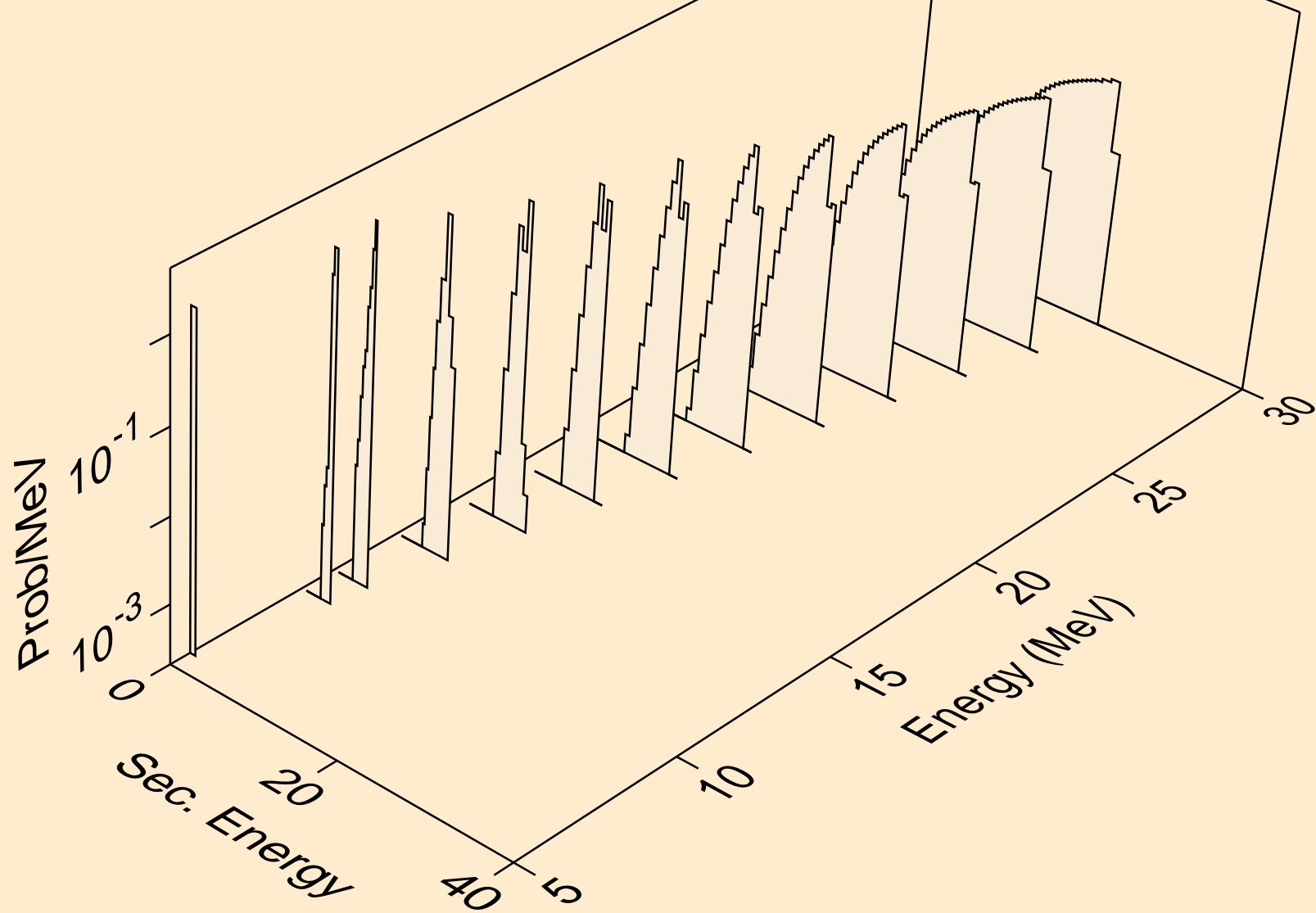

PB191M PROTON ACER TENDL-2023 LIBRARY; T=0.K
deuterons from (p,pd)

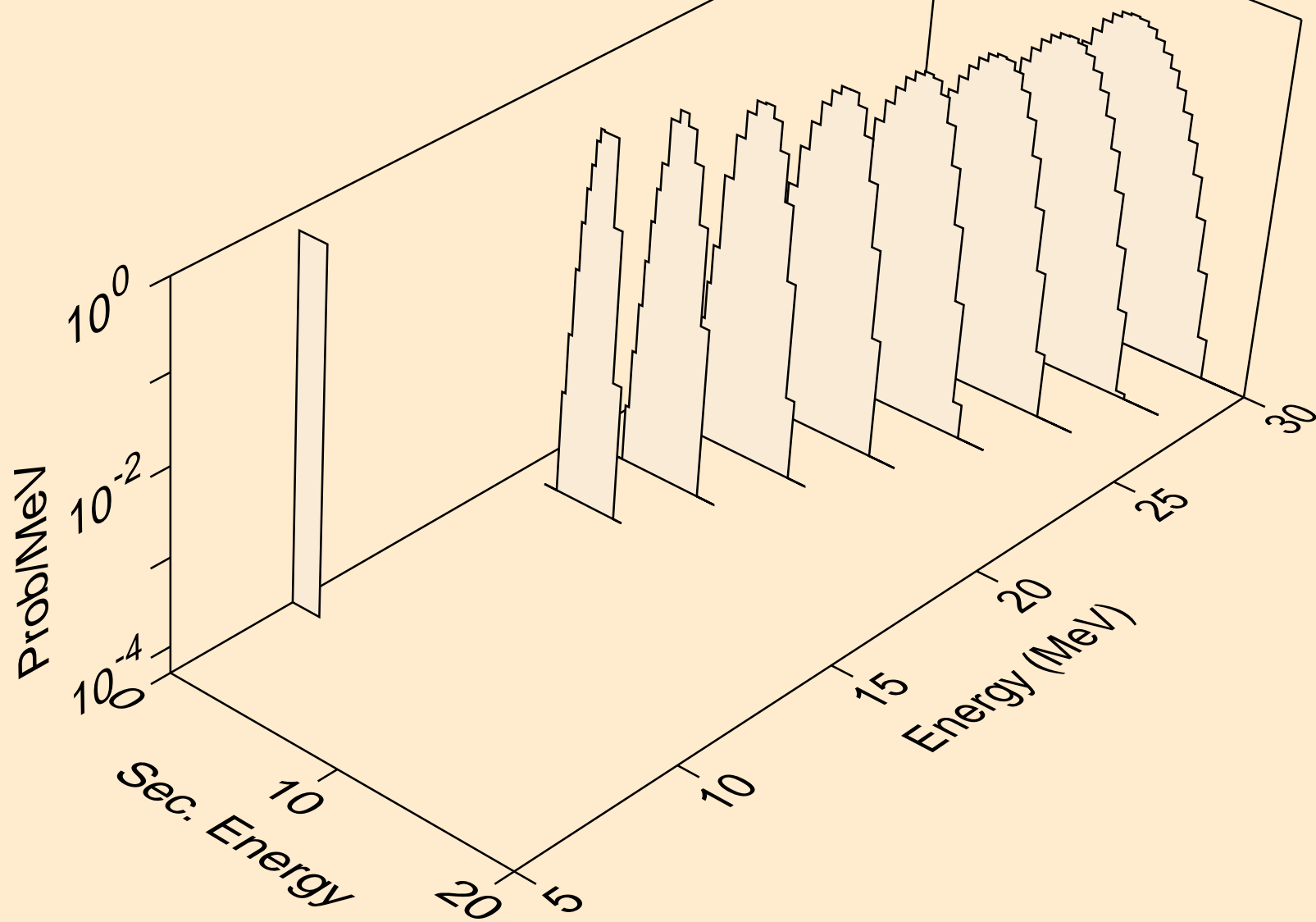

PB191M PROTON ACER TENDL-2023 LIBRARY; T=0.K
deuterons from (p,da)

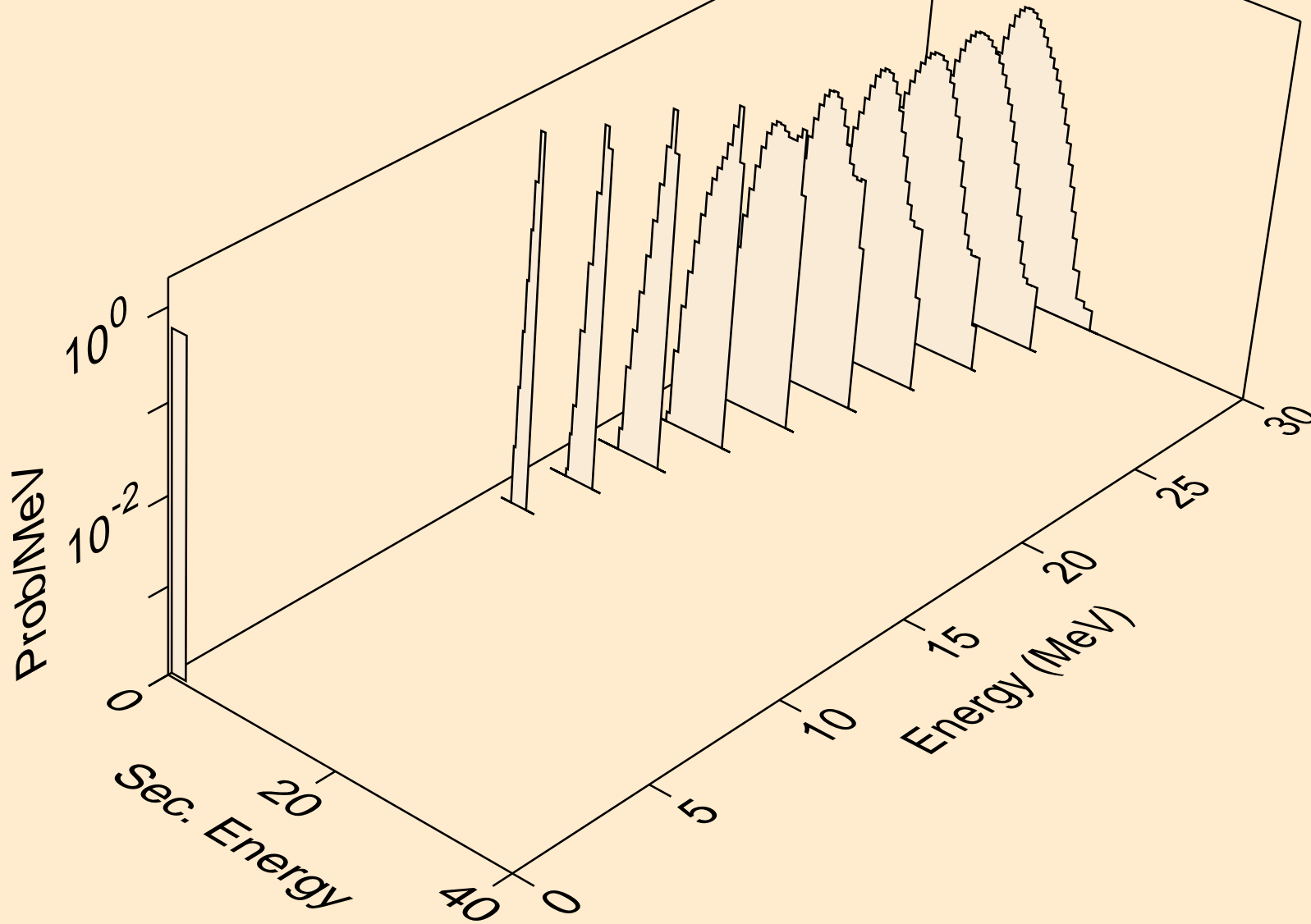

PB191M PROTON ACER TENDL-2023 LIBRARY; T=0.K
tritons from (p,x)

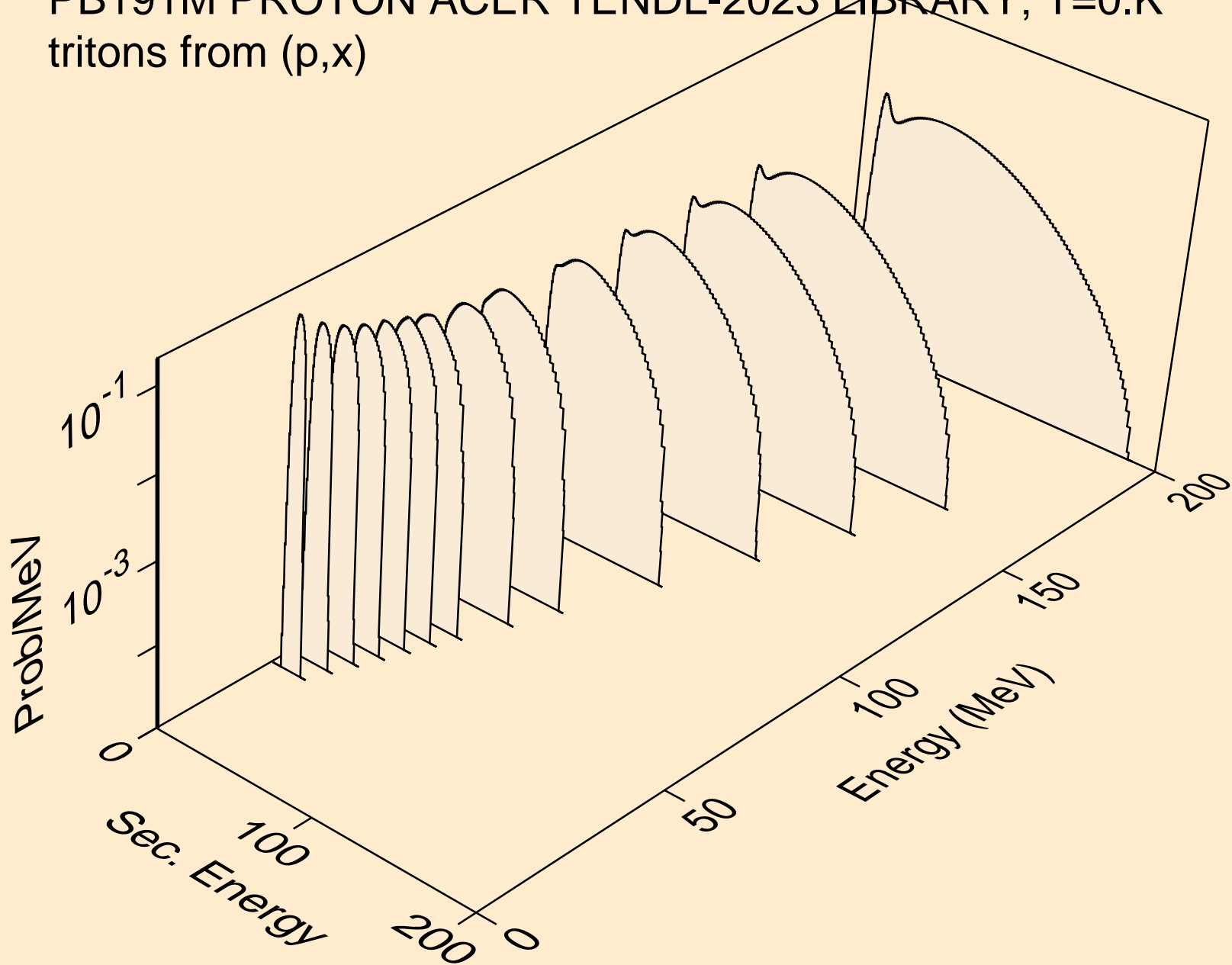

PB191M PROTON ACER TENDL-2023 LIBRARY; T=0.K
tritons from (p,n*)t

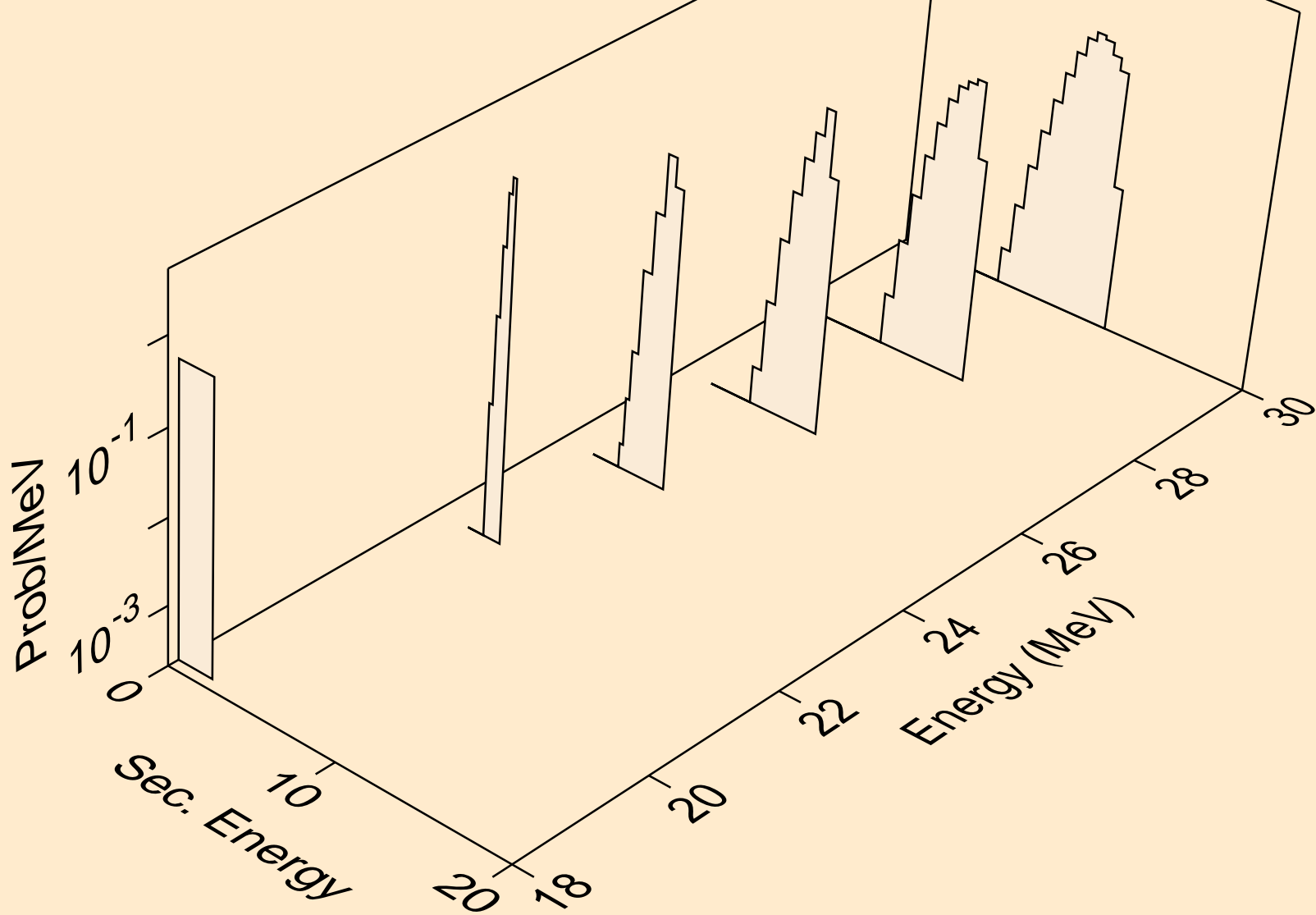

PB191M PROTON ACER TENDL-2023 LIBRARY; T=0.K
tritons from (p,t)

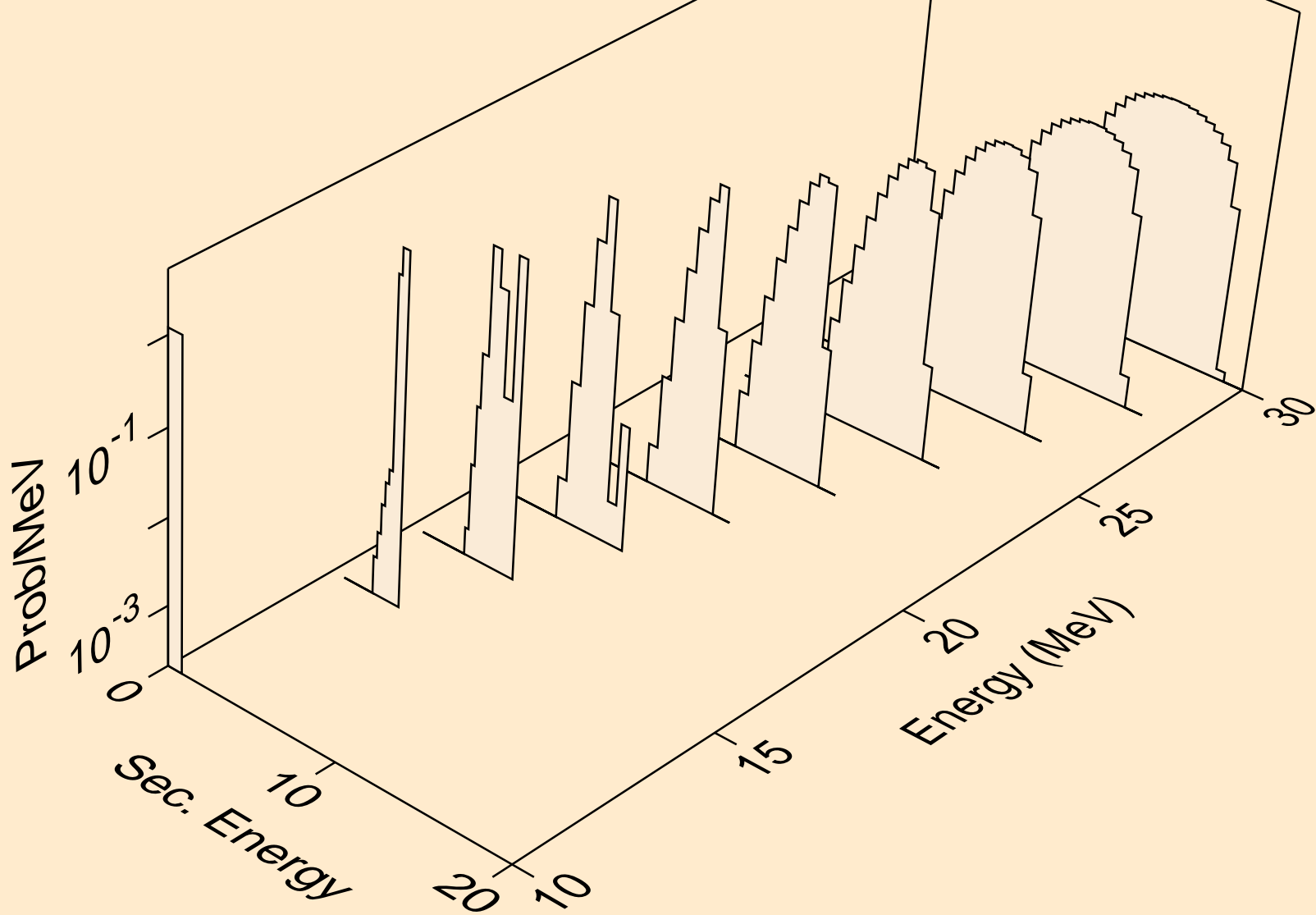

PB191M PROTON ACER TENDL-2023 LIBRARY; T=0.K
tritons from (p,pt)

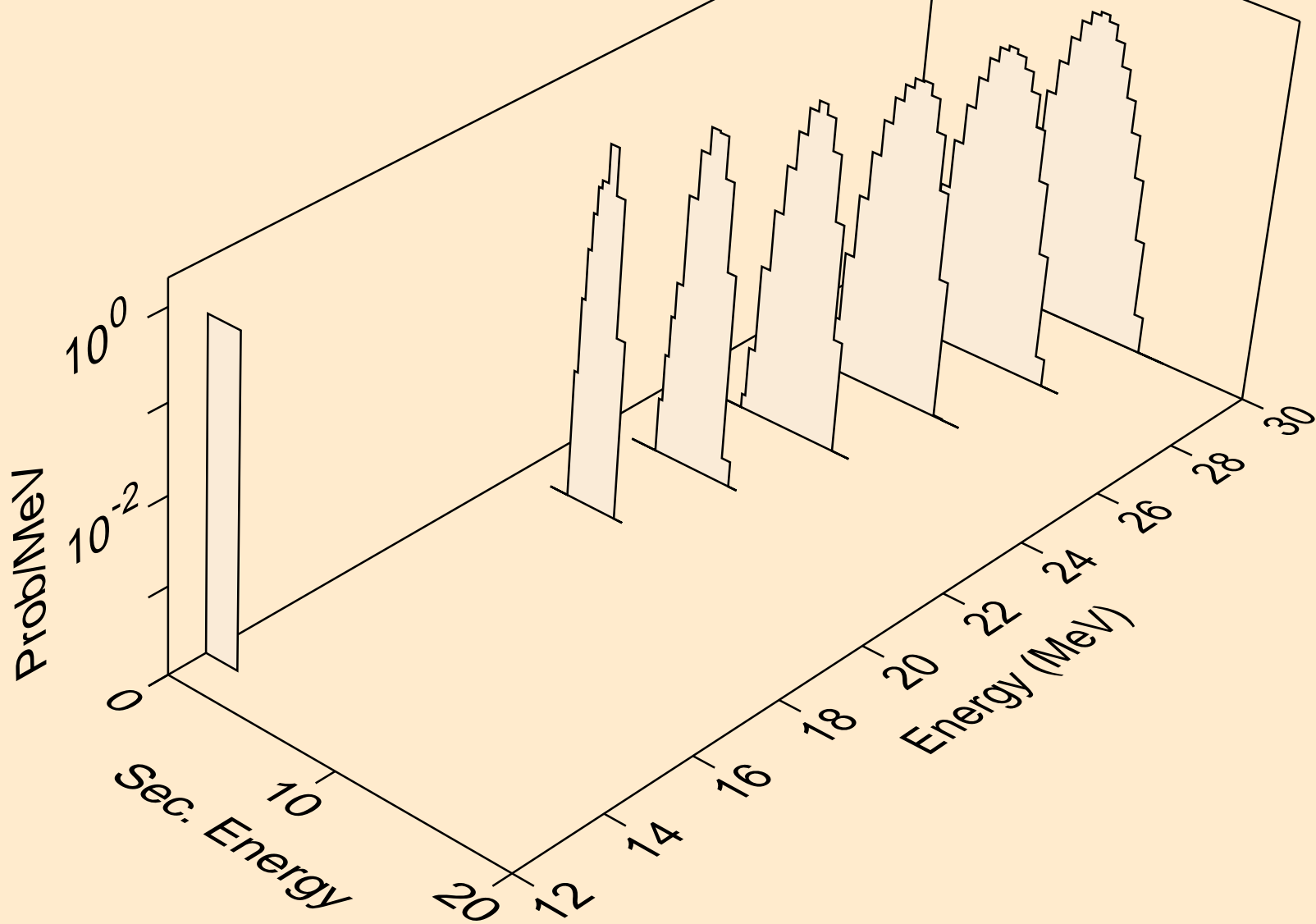

PB191M PROTON ACER TENDL-2023 LIBRARY; T=0.K
he3s from (p,x)

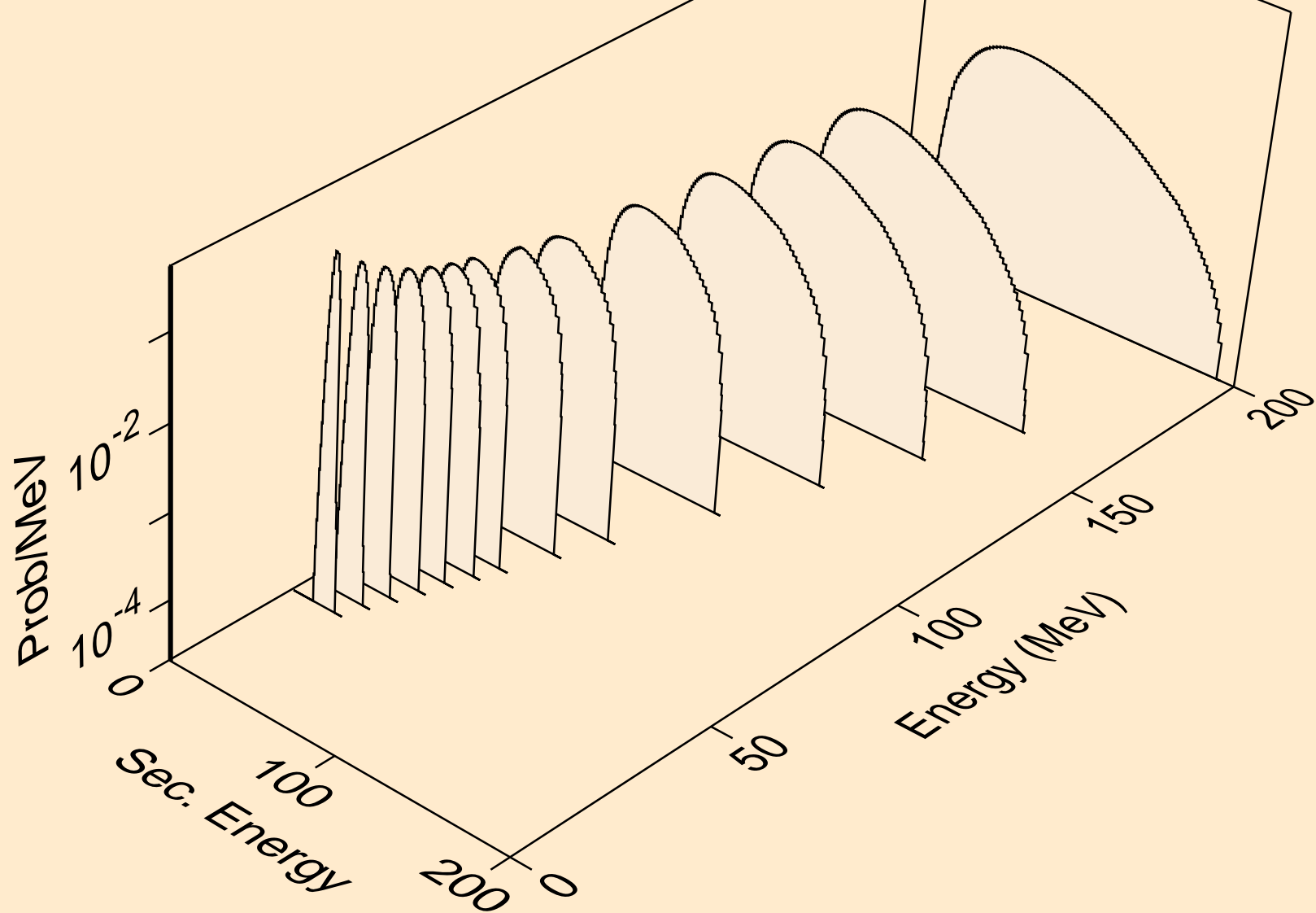

PB191M PROTON ACER TENDL-2023 LIBRARY; T=0.K
he3s from (p,n*)he3

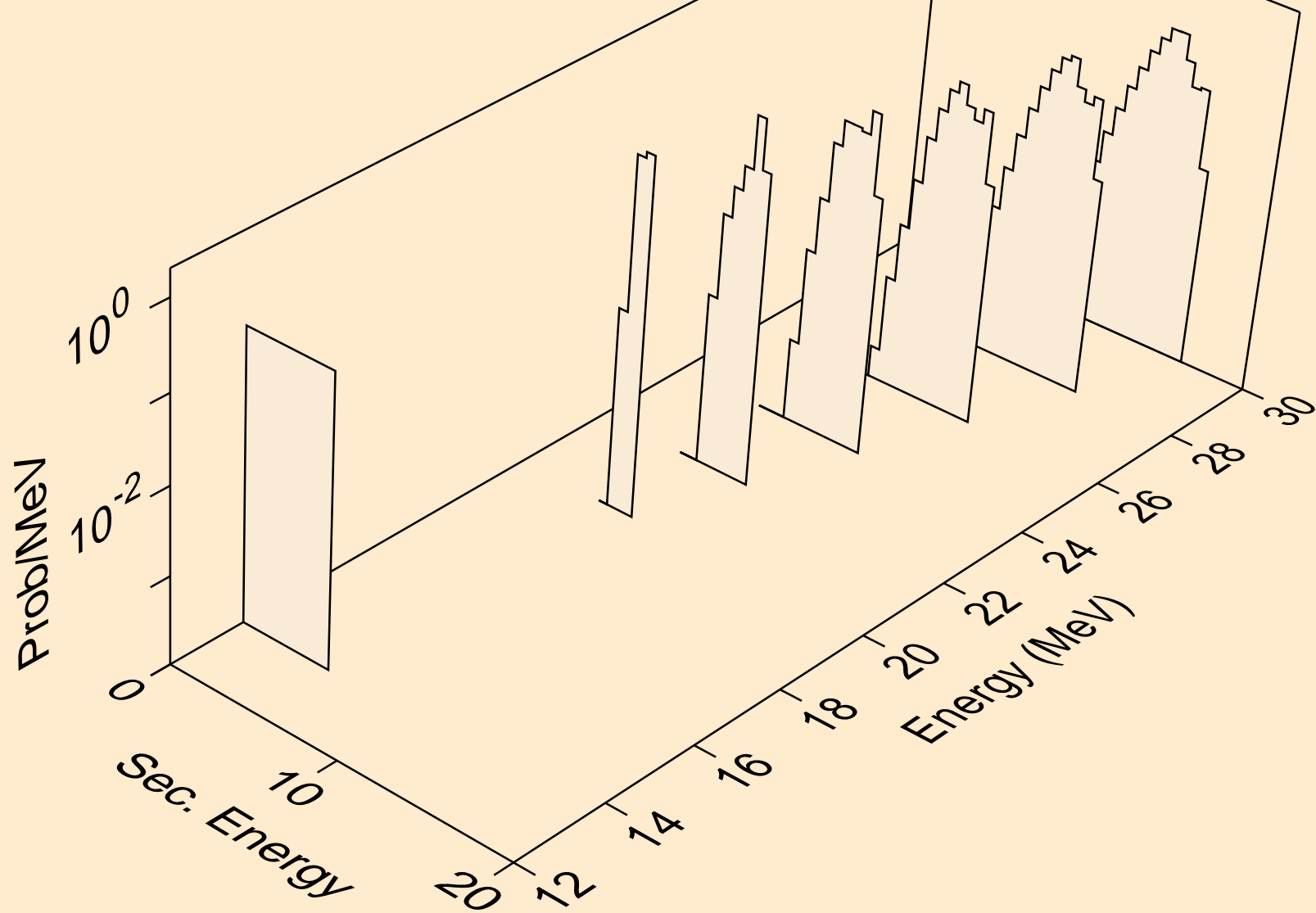

PB191M PROTON ACER TENDL-2023 LIBRARY; T=0.K
he3s from (p,he3)

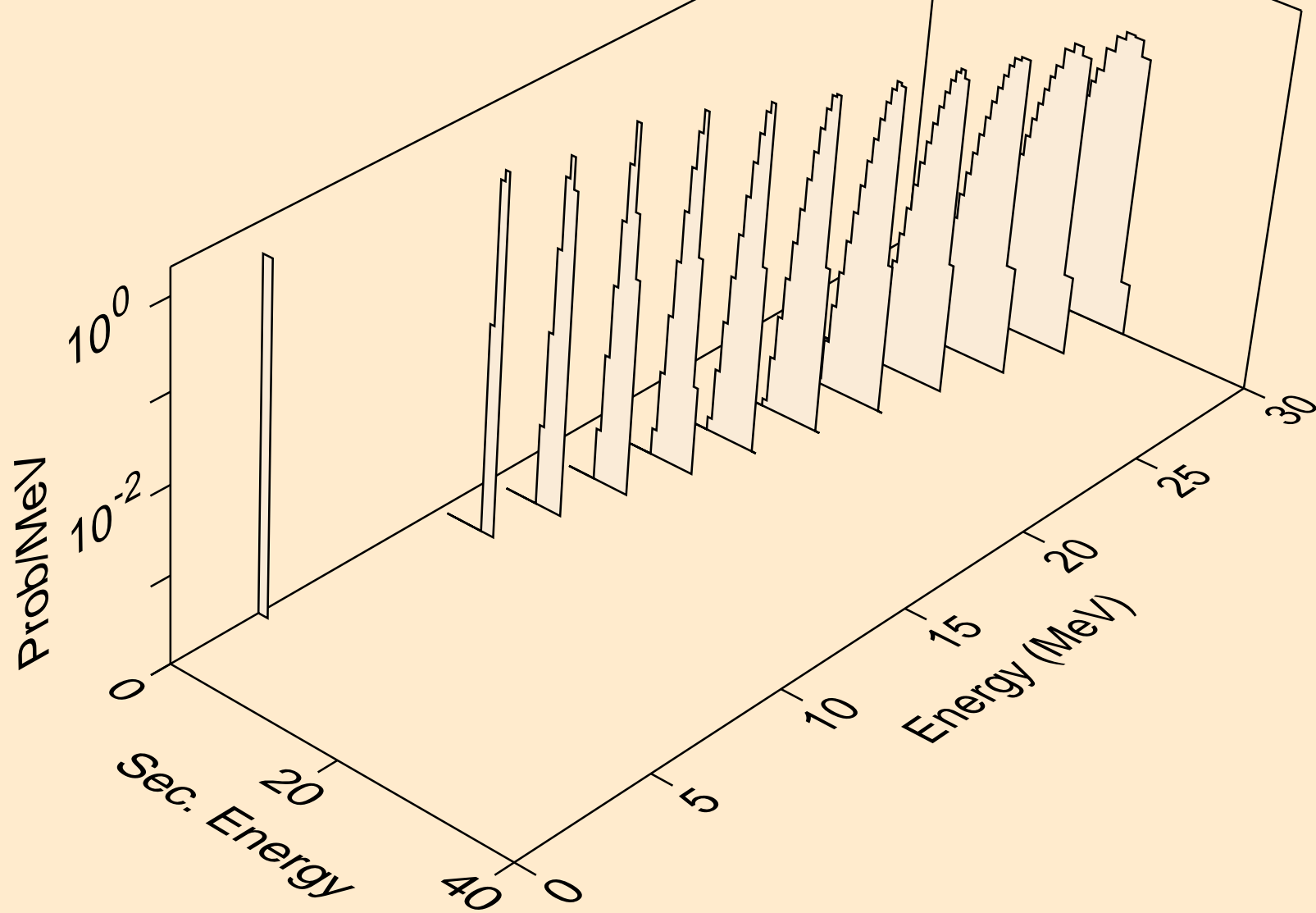

PB191M PROTON ACER TENDL-2023 LIBRARY; T=0.K
alphas from (p,x)

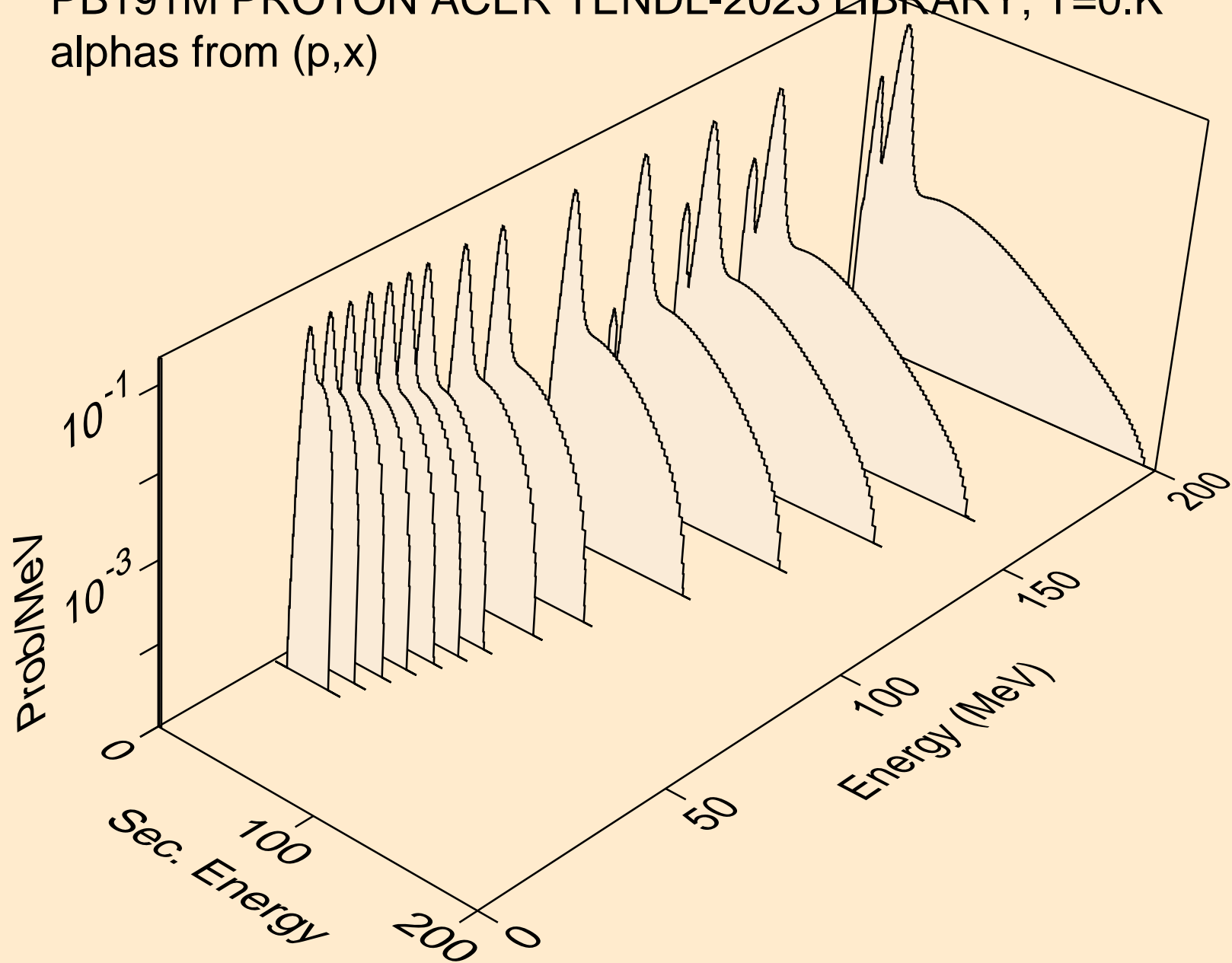

PB191M PROTON ACER TENDL-2023 LIBRARY; T=0.K
alphas from (p,n*)a

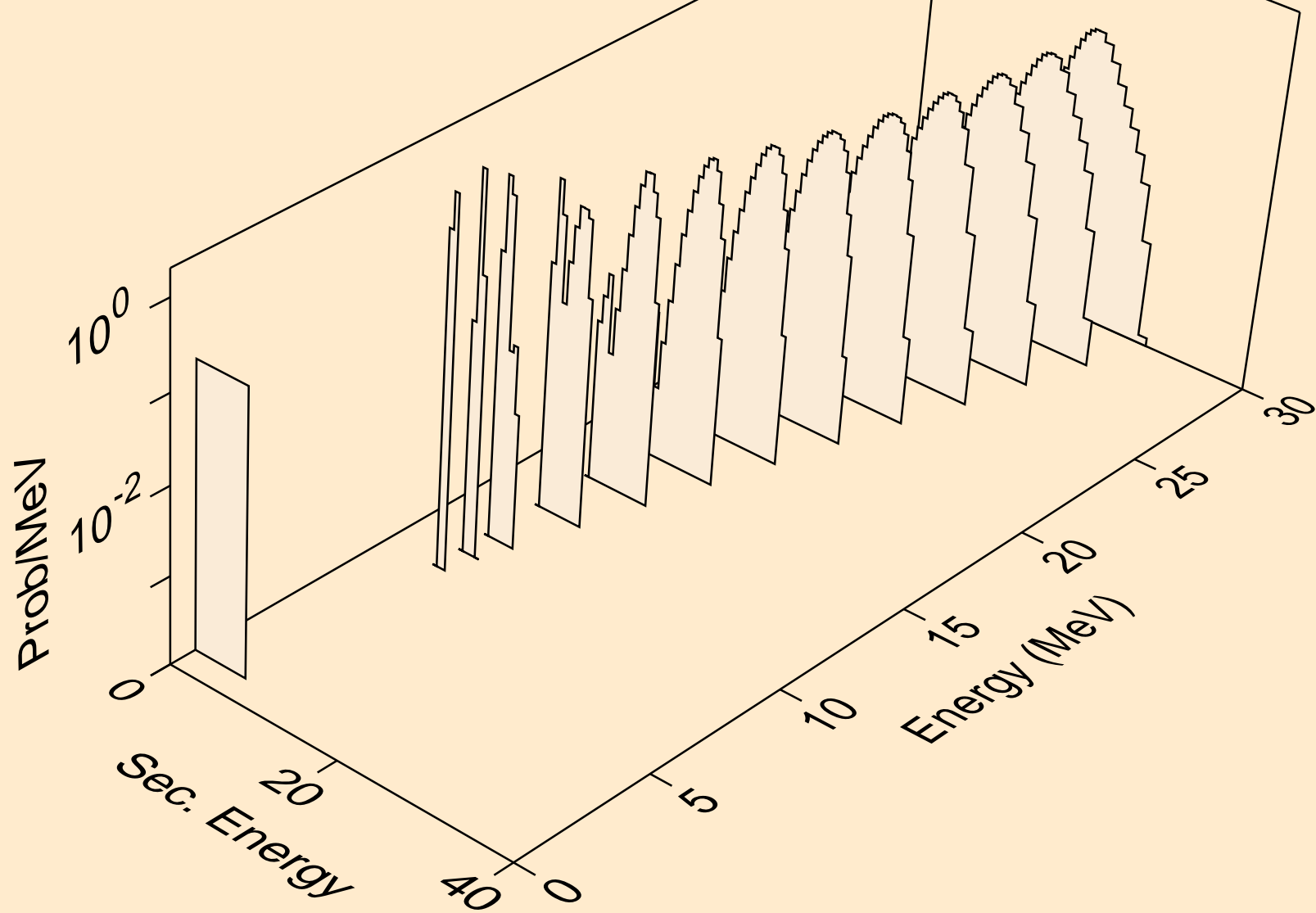

PB191M PROTON ACER TENDL-2023 LIBRARY; T=0.K
alphas from (p,2n)a

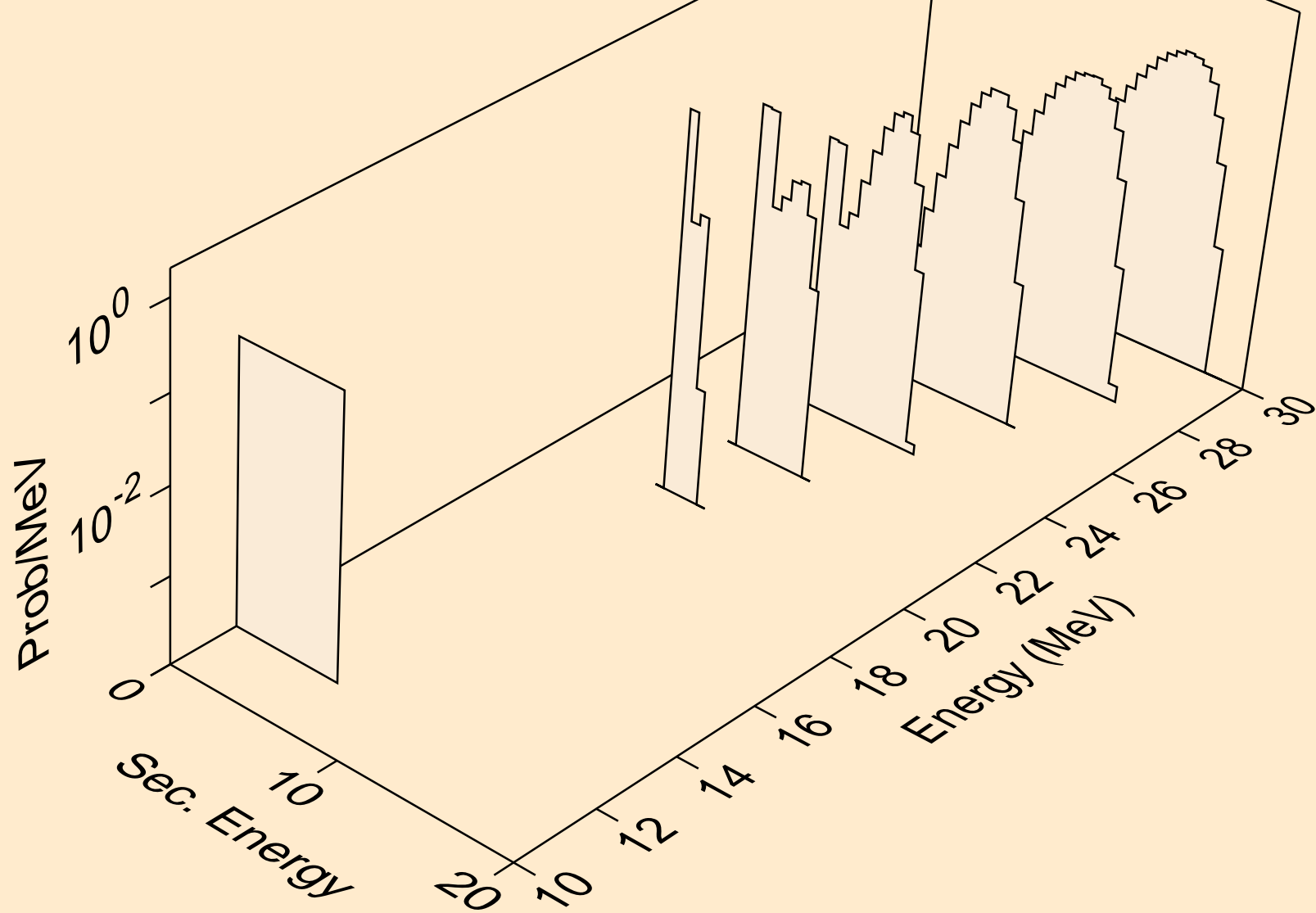

PB191M PROTON ACER TENDL-2023 LIBRARY; T=0.K
alphas from (p,n*)2a

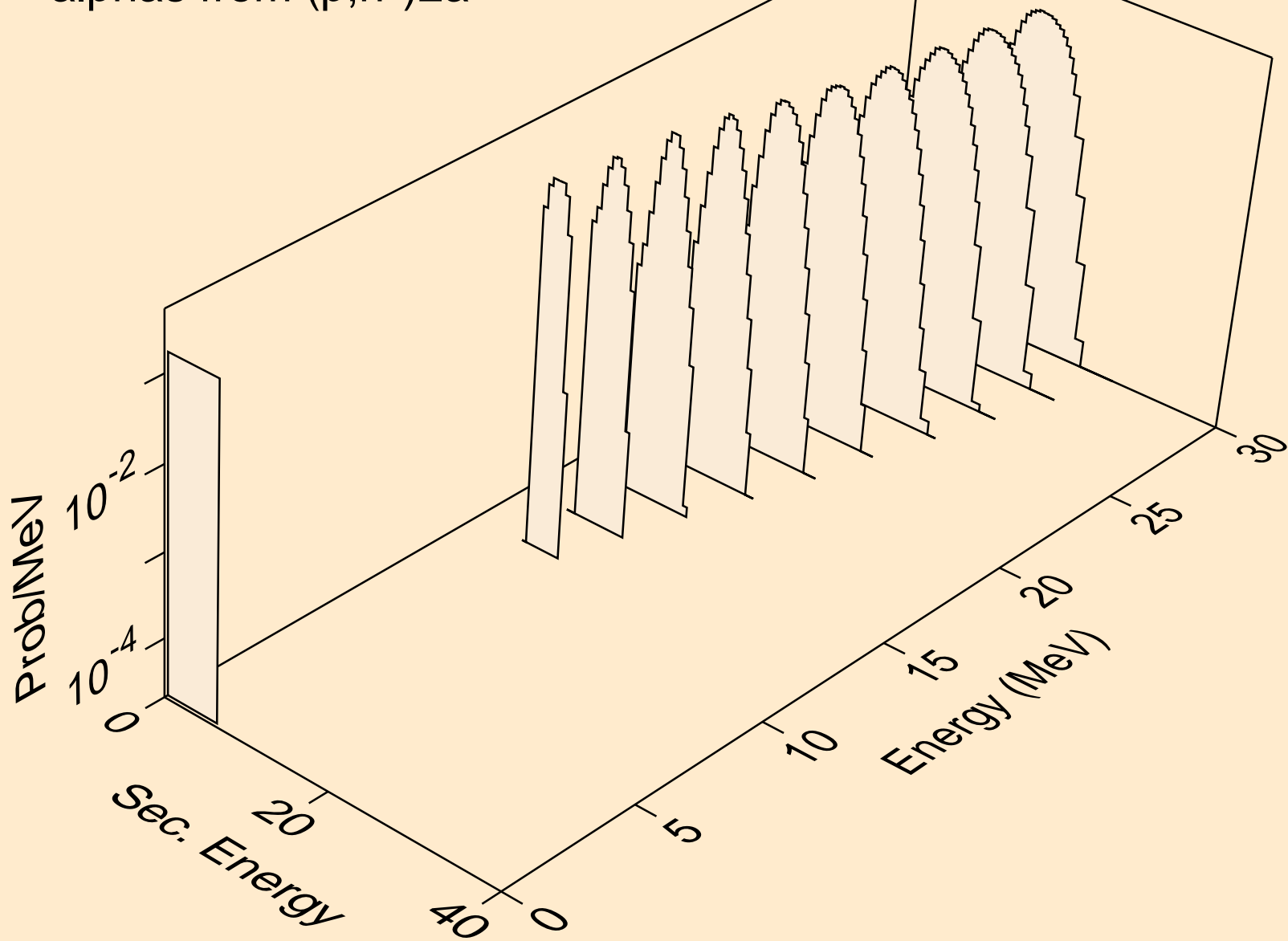

PB191M PROTON ACER TENDL-2023 LIBRARY; T=0.K
alphas from (p,npa)

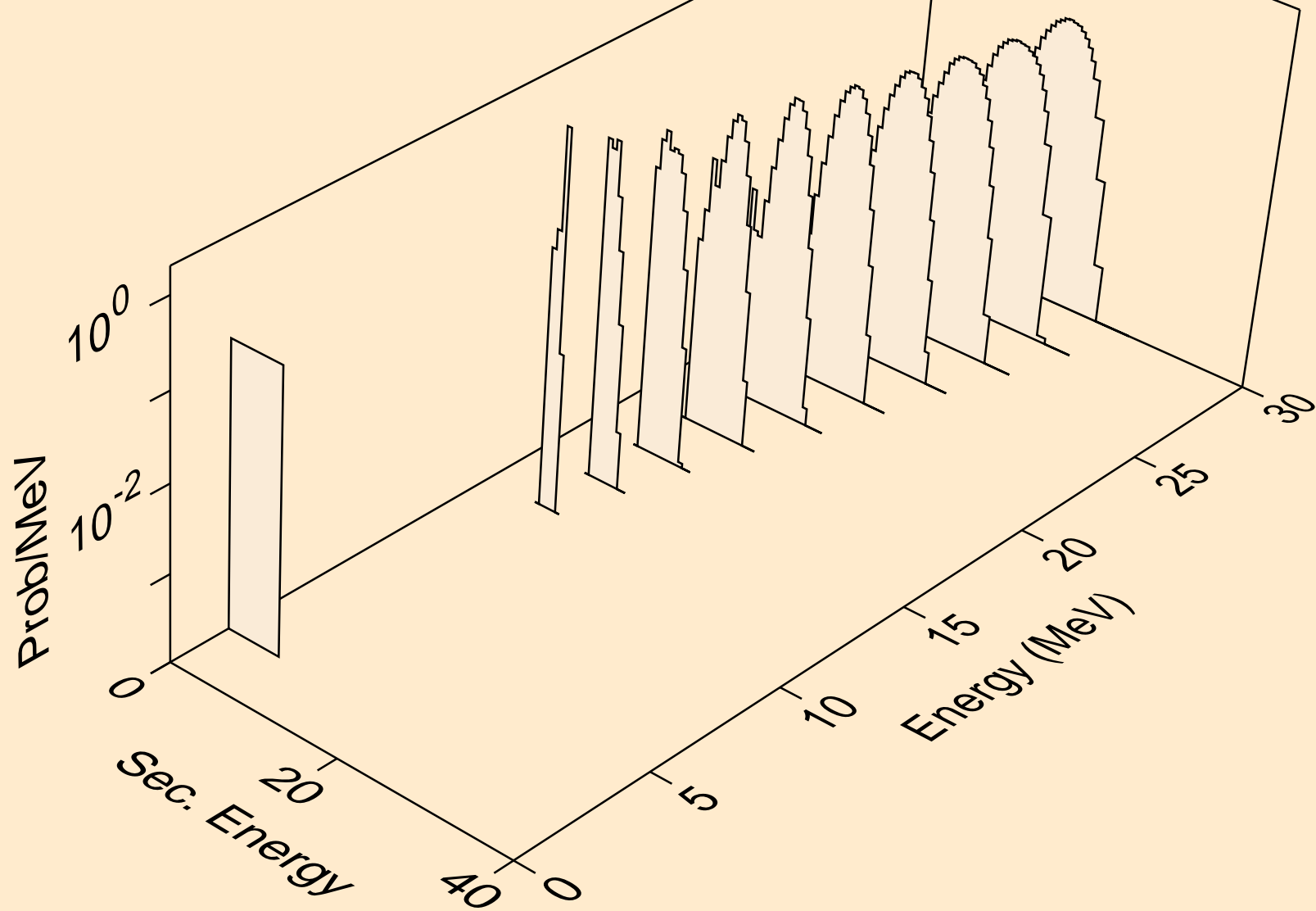

PB191M PROTON ACER TENDL-2023 LIBRARY; T=0.K
alphas from (p,a)

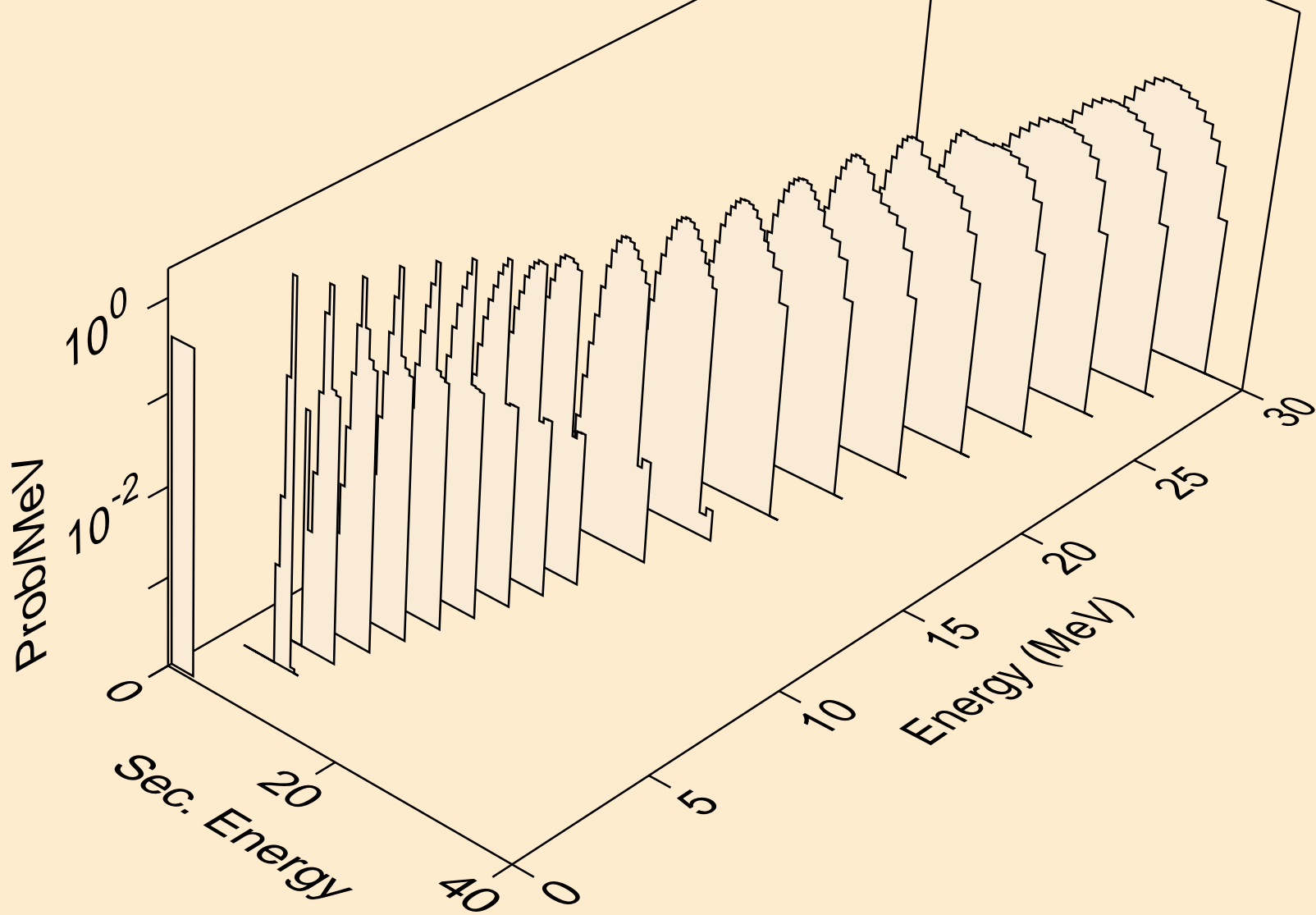

PB191M PROTON ACER TENDL-2023 LIBRARY; T=0.K
alphas from (p,2a)

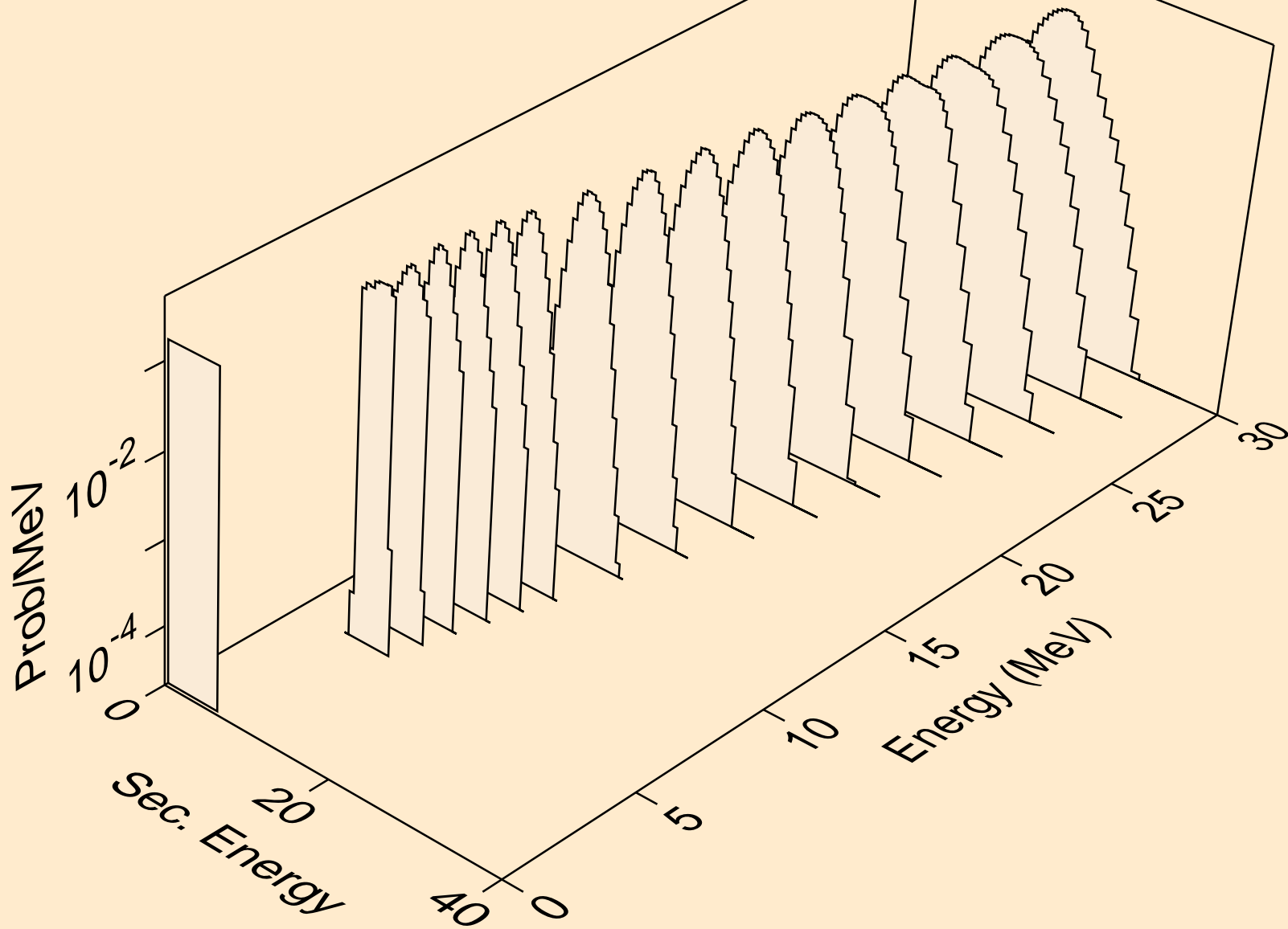

PB191M PROTON ACER TENDL-2023 LIBRARY; T=0.K
alphas from (p,3a)

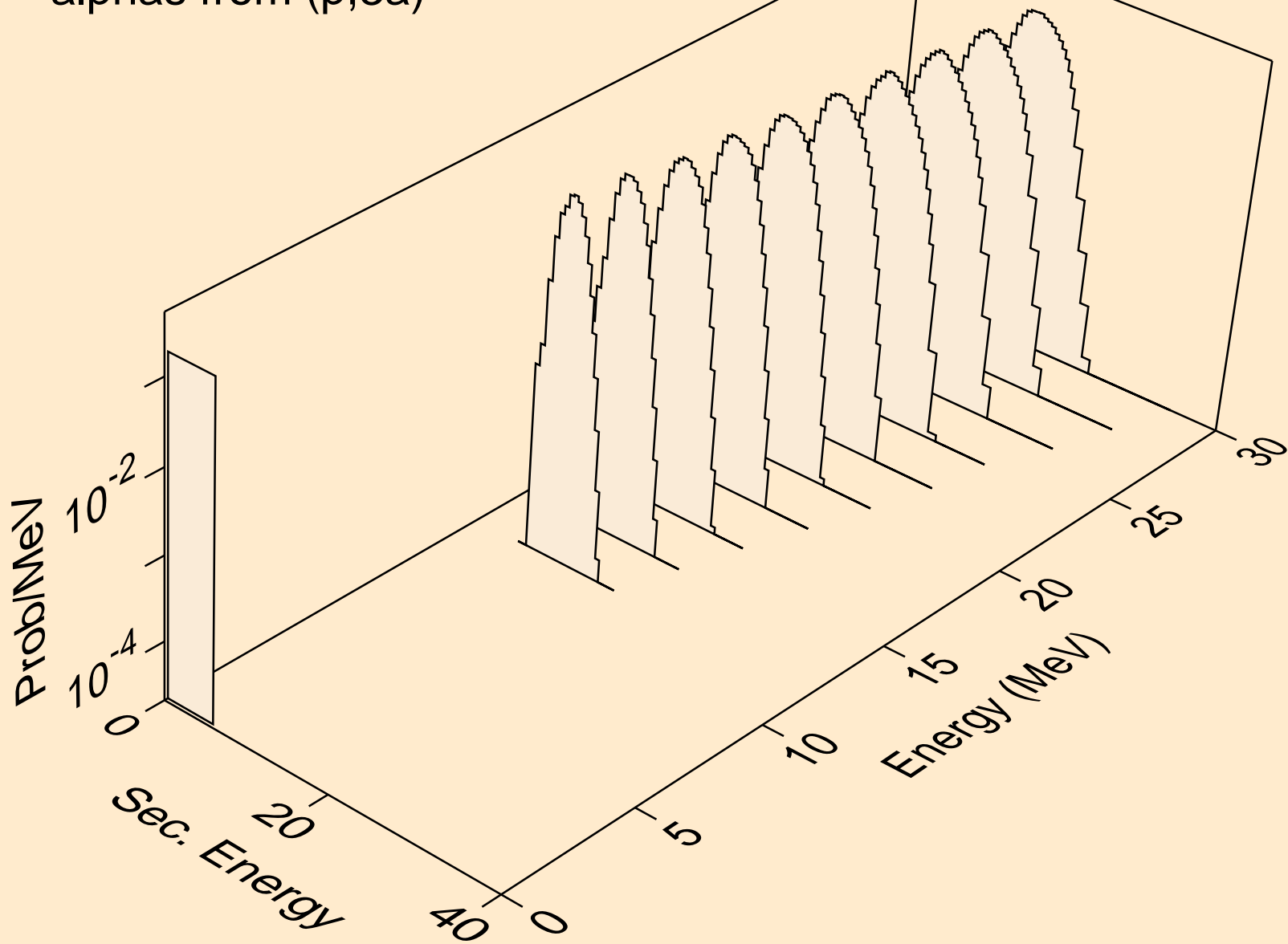

PB191M PROTON ACER TENDL-2023 LIBRARY; T=0.K
alphas from (p,pa)

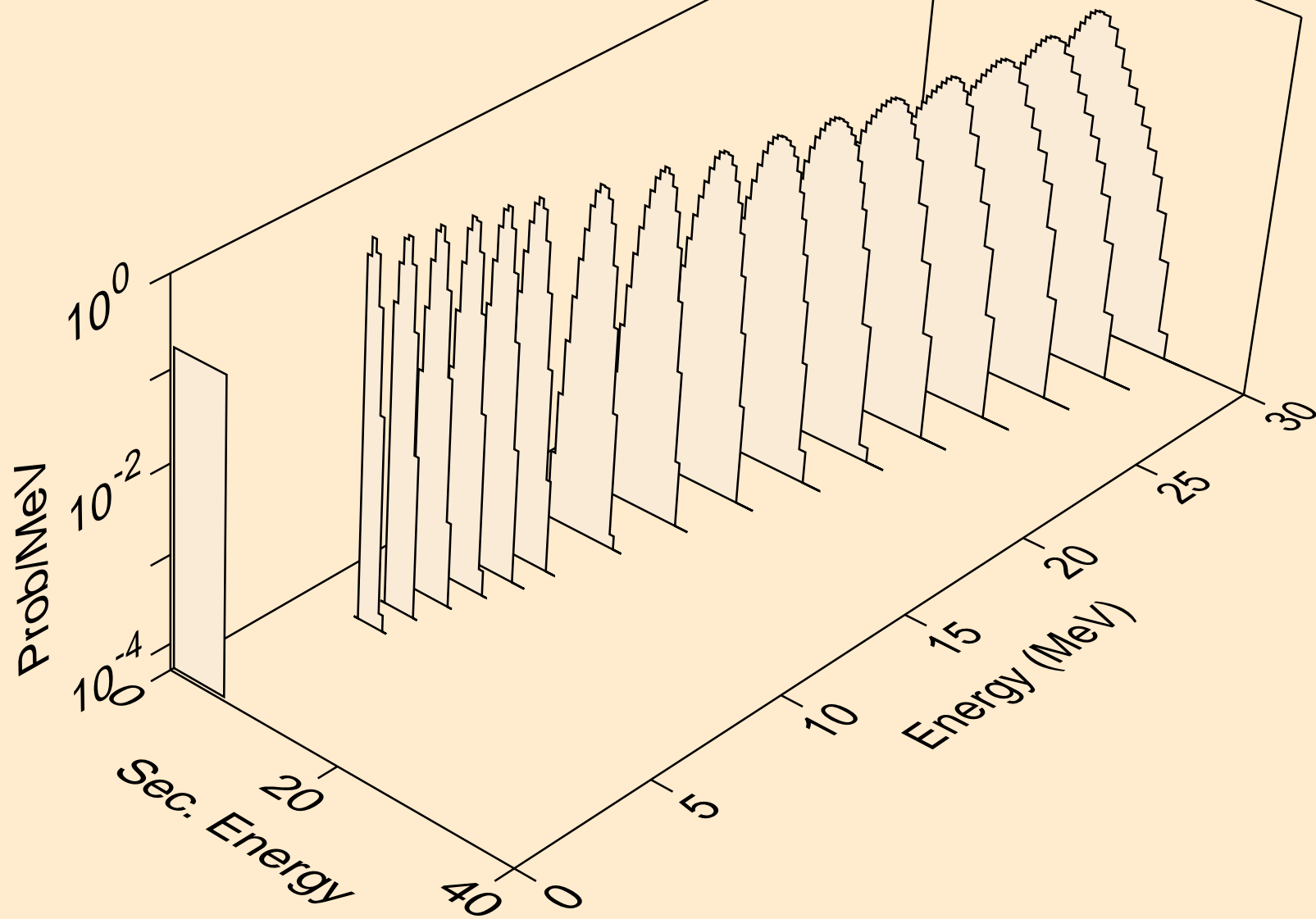

PB191M PROTON ACER TENDL-2023 LIBRARY; T=0.K
alphas from (p,da)

